



This is a digital copy of a book that was preserved for generations on library shelves before it was carefully scanned by Google as part of a project to make the world's books discoverable online.

It has survived long enough for the copyright to expire and the book to enter the public domain. A public domain book is one that was never subject to copyright or whose legal copyright term has expired. Whether a book is in the public domain may vary country to country. Public domain books are our gateways to the past, representing a wealth of history, culture and knowledge that's often difficult to discover.

Marks, notations and other marginalia present in the original volume will appear in this file - a reminder of this book's long journey from the publisher to a library and finally to you.

### **Usage guidelines**

Google is proud to partner with libraries to digitize public domain materials and make them widely accessible. Public domain books belong to the public and we are merely their custodians. Nevertheless, this work is expensive, so in order to keep providing this resource, we have taken steps to prevent abuse by commercial parties, including placing technical restrictions on automated querying.

We also ask that you:

- + *Make non-commercial use of the files* We designed Google Book Search for use by individuals, and we request that you use these files for personal, non-commercial purposes.
- + *Refrain from automated querying* Do not send automated queries of any sort to Google's system: If you are conducting research on machine translation, optical character recognition or other areas where access to a large amount of text is helpful, please contact us. We encourage the use of public domain materials for these purposes and may be able to help.
- + *Maintain attribution* The Google "watermark" you see on each file is essential for informing people about this project and helping them find additional materials through Google Book Search. Please do not remove it.
- + *Keep it legal* Whatever your use, remember that you are responsible for ensuring that what you are doing is legal. Do not assume that just because we believe a book is in the public domain for users in the United States, that the work is also in the public domain for users in other countries. Whether a book is still in copyright varies from country to country, and we can't offer guidance on whether any specific use of any specific book is allowed. Please do not assume that a book's appearance in Google Book Search means it can be used in any manner anywhere in the world. Copyright infringement liability can be quite severe.

### **About Google Book Search**

Google's mission is to organize the world's information and to make it universally accessible and useful. Google Book Search helps readers discover the world's books while helping authors and publishers reach new audiences. You can search through the full text of this book on the web at <http://books.google.com/>



6  
abn

ep

425  
701

GIFT OF  
Thomas H. Means



AGRIC. DEPT. Main library



Thos. W. Meares,

Nov. 20, 1901



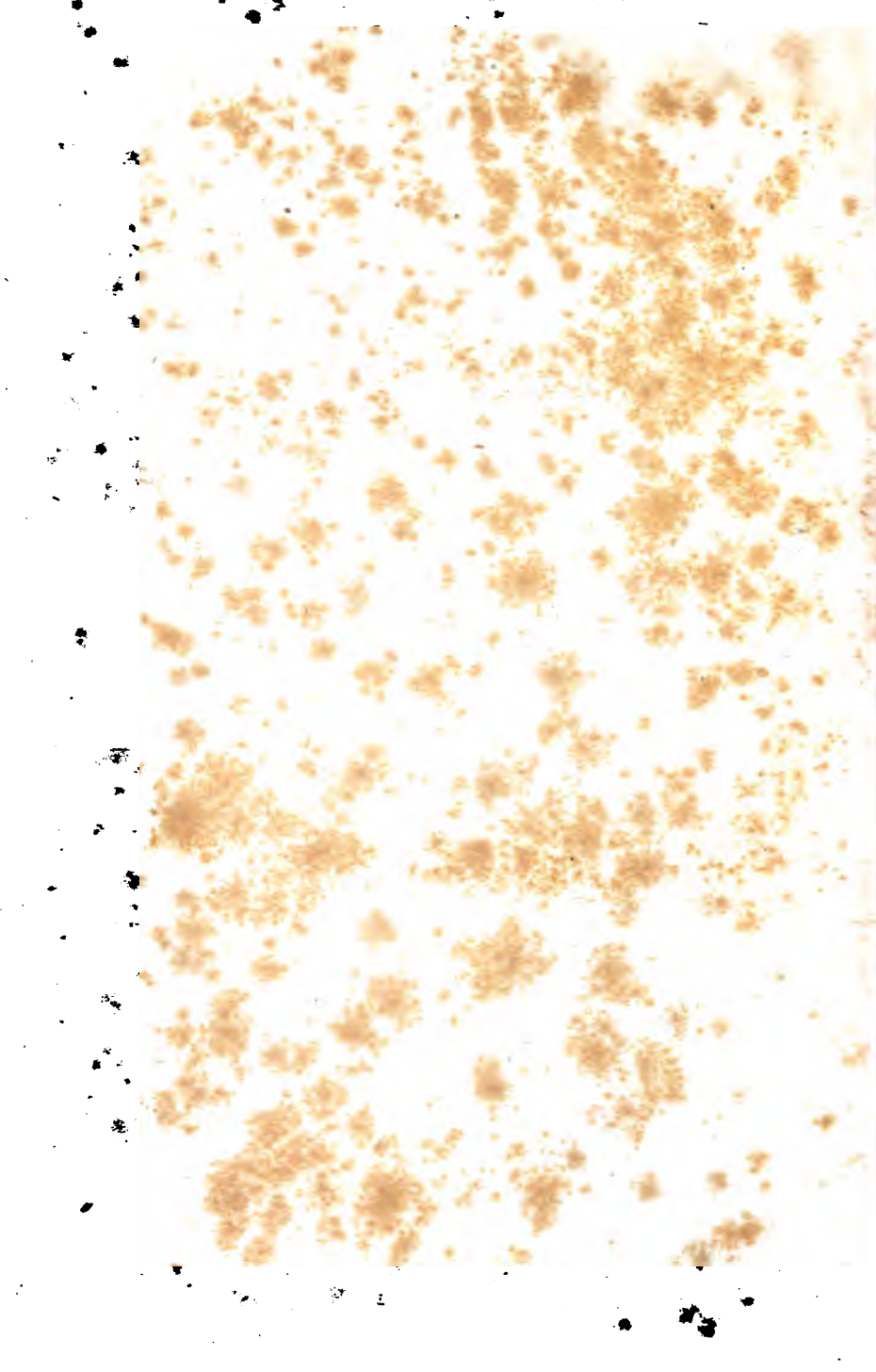

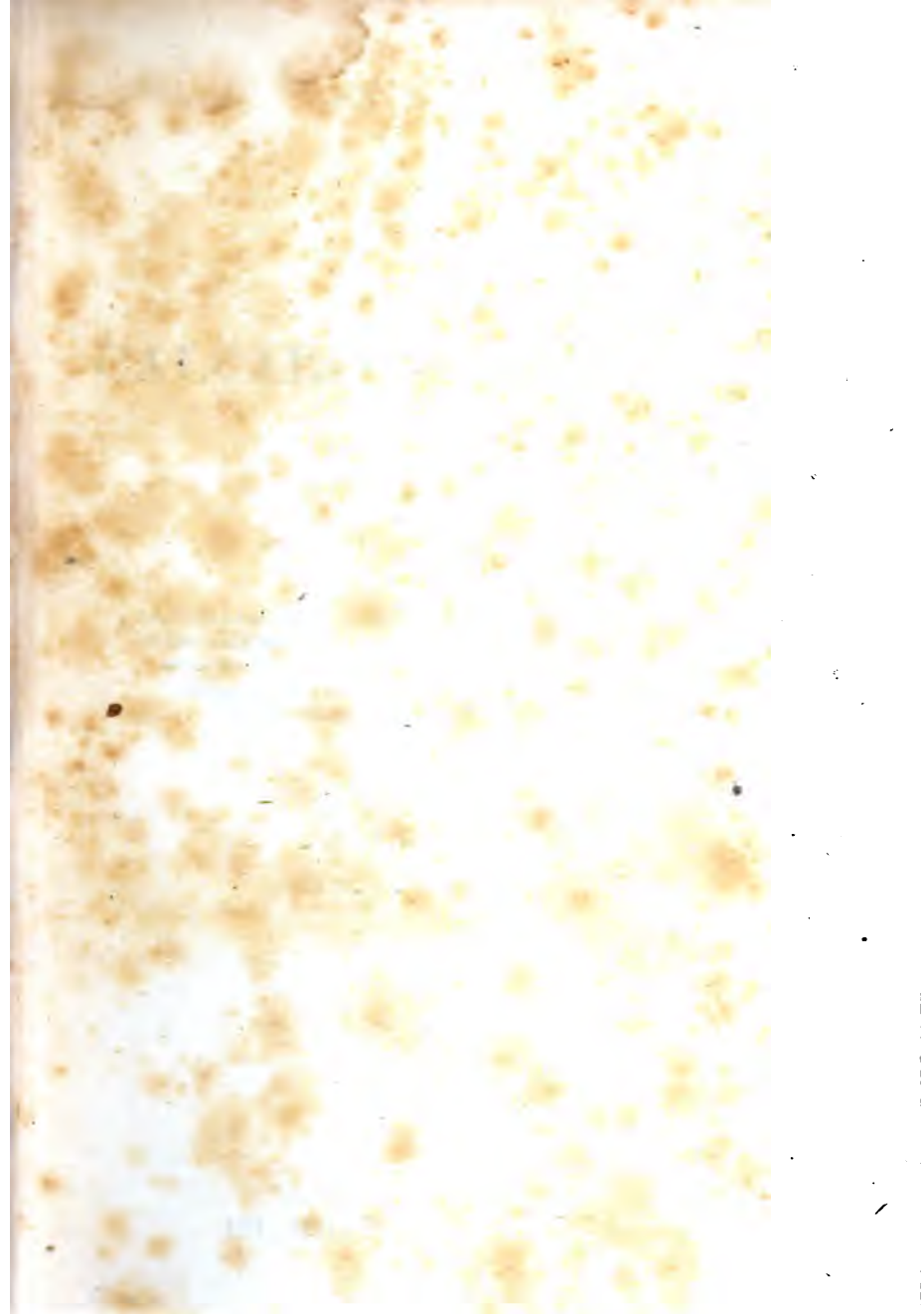



AN ESSAY

UNIV. OF  
CALIFORNIA

ON

# CALCAREOUS MANURES;

BY

EDMUND RUFFIN,

A PRACTICAL FARMER OF VIRGINIA FROM 1812; FOUNDER AND SOLE EDITOR  
OF THE FARMERS' REGISTER; MEMBER AND SECRETARY OF THE FORMER  
STATE BOARD OF AGRICULTURE; FORMERLY AGRICULTURAL SUR-  
VEYOR OF THE STATE OF SOUTH CAROLINA; AND PRESIDENT  
OF THE VIRGINIA STATE AGRICULTURAL SOCIETY.

FIFTH EDITION:

AMENDED AND ENLARGED.

---

J. W. RANDOLPH,  
121, MAIN STREET, RICHMOND, VA.  
1852.

TO THE  
LIBRARY OF

S643  
R8  
1852

*Gift of Thos. H. Means*  
*Main Library - ag dept*

Entered according to Act of Congress in the year 1852,

BY J. W. RANDOLPH.

In the Clerk's Office of the District Court in and for the Eastern Dist. of Virginia.

---

PRINTED BY C. H. WYNNE, RICHMOND.

---



## PREFACE TO THE FIFTH EDITION.

---

THE publication of another edition of this Essay was not designed to be made during the life of the author, until recent circumstances served to induce a change of purpose. When closing my publication of the "Farmers' Register"—to which service I had devoted and (in reference to my own interest) sacrificed the ten best years of my life—I had withdrawn from all connexion with the public, and had no thought of again leaving the quiet seclusion which I had sought and found. But though not expecting again to appear in print during my life, it was nevertheless my practice to make corrections of this Essay, and to prepare materials for future emendations and additions, as new lights were afforded by extended observation and investigation, or by my still extending practical experience. This labour was due to my own reputation. Further, I trusted that, when the results should finally be offered to my countrymen, this and also other previous services might be the more justly appreciated, because the author would then be beyond the reach of applause or recompense. Thus, at different and irregular times, separated by long intervals of cessation of this particular labour, this edition was prepared for posthumous publication. And though the publication is now advanced in time, the before-designed form and manner are not changed, except in the making of still later additions and corrections.

Under all the existing circumstances, I trust it will not be deemed improper, or offensively egotistical, for me, at this time and in plain words, to assert my just claim to the most important of the truths which were first announced in the earliest and also in every subsequent edition of this Essay; and which truths, though having formerly no other support than my obscure name, are now so generally accepted and recognised, that they may seem to have been long established and undisputed. Among these opinions, or facts, which I was the first to distinctly assert, and to maintain at length by proof and argument, were the following:—

1. The capacity of impoverished soils for receiving improvement from putrescent manures, being in proportion to their original or natural measures of fertility; and that soils naturally poor (especially in this country) could not be enriched by these manures, durably or profitably, above their natural degree of productiveness.

2. The almost universal and total absence of *carbonate of lime* in the soils of the Atlantic slope of Virginia, and (by inference) of most others of the United States—and even in most lime-stone

soils—while, from all existing testimony of preceding writers on agriculture, the very general, if not universal prevalence of carbonate of lime would have been inferred by every reader.

3. The general presence of some vegetable acid in all our naturally poor soils, and this acid acting as a cause of sterility.

4. The application of carbonate of lime to soils deficient in that necessary element, serving to neutralize the acid—and, by that and other stated and important operations or effects, serving to fit the before poor and unimprovable soils for speedy and profitable improvement.

These positions were assumed and maintained in all the different editions of this essay, from 1821 to 1842.\* For my own practice they served, as soon as impressed on my mind, to direct and enjoin, as indispensable for any important and remunerating improvement of poor soils, the application of calcareous manures; and especially of the cheapest and most abundant resources in this region, the beds of fossil-shells (or marl), then scarcely noticed, and not used in any known practice.

My just claim to the actual introduction in this country of this now wide-spread and most beneficial means for fertilization, and my making generally known the value, and inducing the later numerous and extensive applications by many other farmers, has not been openly disputed. Detractors in wish and intention have indeed thought that they had plucked from me some borrowed plumes, when stating that numerous older writers (in Europe) had recommended marling—that thousands of farmers in Europe had thus improved land—and that, even in this country, some few persons had tried disintegrated fossil shells as manure, and, in still fewer cases, with success. Such facts, as to European opinions and practice, have been long and well known to all reading farmers; and it would have been impossible, if I had desired it, to shut out this information. The trials in America were so limited, and so little known (and of which but one case had then appeared in print, and that later than my earliest practice, in 1818), that not one of them had reached me until after my opinions had been formed and uttered, and my practice, founded thereupon, had been commenced and was in progress. And when these cases were subsequently heard of, I industriously sought to gather the facts; and have published them all, at length, in the former editions of this work. But, in truth, none of these prior practices, or opinions

---

\* The principal and more important of these opinions had been asserted as early as 1818, in a communication to the Prince George Agricultural Society. But as that communication (which was the first concise sketch, since enlarged to this Essay) was not then printed, perhaps I may have no right to cite it as showing so early a date for my claims of discovery. An extract from that communication will be embraced in one of the pieces in the Appendix.

connected therewith, had any bearing on my claim—which is of showing why, and under what circumstances, calcareous manures are especially and generally necessary in this country, and of inducing the extensive use of the particular material above named, of which the existence had before attracted the notice of but few persons, and of which any value was suspected by still fewer—and the few earlier trials of which had been altogether empirical, and made without any knowledge of the mode of operation—and which therefore had generally ended in supposed failure and certain disappointment, and speedy abandonment of all further effort.

As to the opinions above enumerated, which served to direct my practice from the beginning of 1818, they had either no support from previous authority, or, if asserted by any, had been denied by higher authority and by general understanding. This latter case, of feeble assertion and stronger denial, covers only the doctrine of acid in soils. The other important positions had not been asserted by any known authority, previous to my declaration. Yet all these doctrines are now received either generally or universally, and so appear in recent publications on scientific agriculture. And in regard to the existence of acid in soil, the actual discovery was truly made in Europe, later, indeed, than my first announcement of the doctrine, by men of high scientific attainments, who most probably had never even heard of the opinions of so remote and obscure a writer as myself.

Under these circumstances, when these now generally received opinions are seen stated in any of my former editions (and still more if in a subsequent edition), such appearance would not necessarily imply the originality of such opinions. For it might well be inferred by the (otherwise well-informed) reader, that these doctrines had been introduced in the later editions, after they had been discovered and published by other authorities. For it is the general and proper usage of authors of scientific and didactic works, to add to each successive edition any new lights on the subject, up to the latest time of publication. Hence, when dates and authorities are omitted (in regard to doctrines long established and received), it is left doubtful which of the positions of an author's latest edition had also been maintained in his earliest; and also, whether such doctrines were original with the author then stating them, or belonged to some other discoverer not then cited. It is especially designed, in this last edition, to avoid every such source of error. For this purpose, the Chapters (from II. to VIII. inclusive) which will set forth all these theoretical doctrines, will exhibit an exact reprint of the edition of 1832. No alterations of the original text will be made, other than merely verbal and immaterial corrections. Any new matter, or extension of remark or illustration, will be designated in every case; and,

however since amplified in expression or varied in form, these same positions, more concisely worded, were all embraced in the earlier edition of 1821 (in the "American Farmer"), and, as was before stated, the main points of these opinions were also set forth in the earlier communication of 1818.

E. R.

MARLBORNE, HANOVER, VA., August, 1852.

---

## PREFACE TO THE EDITION OF 1832.

THE object of this Essay is to investigate the peculiar features and qualities of the soils of our tide-water district, to show the causes of their general unproductiveness, and to point out means, as yet but little used, for their effectual and profitable improvement. My observations are particularly addressed to the cultivators of that part of Virginia which lies between the sea coast and the falls of the rivers, and are generally intended to be applied only within those limits. By thus confining the application of the opinions which will be maintained, it is not intended to deny the propriety of their being farther extended. On the contrary, I do not doubt that they may correctly apply to all similar soils, under similar circumstances; for the operations of Nature are directed by uniform laws, and like causes must everywhere produce like effects. But as I shall rely for proofs on such facts as are either sufficiently well known already, or may easily be tested by any inquirer, I do not choose to extend my ground so far as to be opposed by the assertion of other facts, the truth of which can neither be established nor overthrown by any available or sufficient testimony.

The peculiar qualities of our soils have been little noticed, and the causes of those peculiarities have never been sought; and though new and valuable truths may await the first explorers of this opening for agricultural research, yet they can scarcely avoid mistakes sufficiently numerous to moderate the triumph of success. I am not blind to the difficulties of the investigation, nor to my own unfitness to overcome them; nor should I have hazarded the attempt, but for the belief that such an investigation is all-important for the improvement of our soil and agriculture, and that it was in vain to hope that it would be undertaken by those who were better qualified to do justice to the subject. I ask a deliberate hearing, and a strict scrutiny of my opinions, from those most interested in their truth. If a change, in most of our lands, from hopeless sterility to a high state of productiveness, is a vain fancy, it will be easy to discover and expose the fallacy of my views; but if these views are well founded, none deserve better the attention of farmers, and nothing can more seriously affect the future agricultural prosperity of our country. No where ought such improvements to be more highly valued, or more eagerly sought, than among us, where so many causes have concurred to reduce our products, and the prices of our lands, to the lowest state, and are yearly extending want, and its consequence, ignorance, among the cultivators and proprietors.

In pursuing this inquiry, it will be necessary to show the truth of various facts and opinions which as yet are unsupported by authority, and most of which have scarcely been noticed by agricultural writers, unless to be denied. The number of proofs that will be required, and the discursive course through which they must be reached, may probably render more

obscure the reasoning of an unpractised writer. Treatises on agriculture ought to be so written as to be clearly understood, though it should be at the expense of some other requisites of good writing; and, in this respect, I shall be satisfied if I succeed in making my opinions intelligible to every reader, though many might well dispense with such particular explanations. Agricultural works are seldom considered as requiring very close attention; and therefore, to be made useful, they should be put in a shape suited to cursory and irregular reading. A truth may be clearly established—but if its important consequences cannot be regularly deduced for many pages afterwards, the premises will then probably have been forgotten, so that a very particular reference to them may be required. These considerations must serve as my apology for some repetitions—and for minute explanations and details, which some readers may deem unnecessary.

The theoretical opinions supported in this Essay, together with my earliest experiments with calcareous manures, were published in the "American Farmer" (vol. iii. page 313), in 1821. No reason has since induced me to retract any of the important positions then assumed. But the many imperfections in that publication, which grew out of my want of experience, made it my duty, at some future time, to correct its errors, and supply the deficiencies of proof, from the fruits of subsequent practice and observation. With these views, this Essay was commenced and finished in 1826. But the work had so grown on my hands, that instead of being of a size suitable for insertion in an agricultural journal, it would have filled a volume. The unwillingness to assume so conspicuous a position as the publication in that form would have required, and the fear that my work would be more likely to meet with neglect or censure than applause, induced me to lay it aside, and to give up all intention of publication. Since that time, the use of fossil shells as manure has greatly increased, in my own neighbourhood and elsewhere, and has been attended generally with all the improvement and profit that was expected. But from paying no regard to the theory of the operation of this manure, and from not taking warning from the errors and losses of myself as well as others, most persons have operated injudiciously, and have damaged more or less of their lands. So many disasters of this kind seemed likely to restrain the use of this valuable manure, and even to destroy its reputation, just as it was beginning rapidly to be extended. This additional consideration has at last induced me to risk the publication of this Essay. The experience of five more years, since it was written, has not contradicted any of the opinions then advanced—and no change has been made in the work, except in form, and by continuing the reports of experiments to the present time.

It should be remembered that my attempt to convey instruction is confined to a single means of improving our lands, and increasing our profits; and though many other operations are, from necessity, incidentally noticed, my opinions or practices on such subjects are not referred to as furnishing rules for good husbandry. In using calcareous manure for the improvement of poor soils, my labours have been highly successful; but that success is not necessarily accompanied by general good management and economy. To those who know me intimately, it would be unnecessary to confess the small pretensions that I have to the character of a good farmer; but to others it may be required, for the purpose of explaining why other improvements and practices of good husbandry have not more aided, and kept pace with, the effects of my use of calcareous manures. E. B.

*Prince George county, Virginia, January 20th, 1832.*



EXTRACTS FROM THE  
PREFACE TO THE EDITION OF 1835.

WHEN the preceding edition of this Essay was published, it met with a reception far more favourable, and a demand from purchasers much greater, than the author's anticipations had reached; and it is merely in accordance with the concurrent testimony of the many agriculturists who have since expressed and published opinions on the subject, to say that the publication has already had great and valuable effects in directing attention, and inducing successful efforts, to the improvement of land by calcareous manures. Experimental knowledge on this head has probably been more than doubled within the last two years; and the narrow limits of the region within which marling had previously been confined, have been enlarged to perhaps ten-fold their former extent. Still, the circumstances now existing, however changed for the better, present a mere beginning of the immense and valuable improvements of soil, and increase of profits, that must hereafter grow out of the use of calcareous manures, *if their operation is properly understood by those who apply them.* But if used without that knowledge, their great value will certainly not be found; and indeed, they will often cause more loss than profit. It is therefore not so important to the farmers of our country at large to be convinced of the general and great value of calcareous manures—and to those in the great Atlantic tide-water region to know the newly established truth, that their beds of fossil shells furnish the best and cheapest of manures—as it is, that all should know in what manner, and by what general laws, these manures operate—how they produce benefit, and when they may be either worthless or injurious. And this more important end, the author regrets to believe has as yet scarcely been even partially attained, by the dissemination and proper understanding of correct views of the subject. Of course it is not to be supposed that this Essay has been read (if even heard of) by one in ten of the many who have been prompted by verbal information to attempt the practice it recommends; and of those who have read, and who have even expressed warm approbation of the work, it has seldom been found that their praise was discriminating, or founded upon a thorough examination of its reasoning and theoretical views, on which principally rests whatever value it may possess. For all persons who are so easily convinced, it may truly be said, that the volume embraced nothing more, and was worth no more, than would be stated in these few words—“the application of calcareous manures will be found highly improving and profitable.” It is not therefore at all strange that the attentive reading of a volume, to obtain this truth, was generally deemed unnecessary.

Though the previous edition of this work has been nearly exhausted, the circulation has as yet been almost confined to that small portion of the state of Virginia alone in which the mode of improvement recommended had previously been successfully commenced, or had at least attracted much attention. But this district is not better fitted to be thus improved than the remainder of the great tide-water region stretching from Long Island to Mobile—and to a great part of which calcareous manures may be cheaply applied. It is only in parts of Maryland and Virginia that many extensive and highly profitable applications of fossil shells, or marl, have been yet made. In North Carolina the value of the manure has been but lately tried; in South Carolina and Georgia, no notice of it has yet been taken, or at least has yet been made known; and in Florida and Alabama (parts of which are peculiarly suited to receive these benefits), it is most erroneously thought that such improvements are only profitable for long settled and impoverished countries. \* \* \* \* \*

But though the circulation of this work will be most useful through the great tide-water region, which is so generally supplied with underlying beds of fossil shells, and so much of the soil of which especially needs such manure, still the assertion may be ventured that there is no part of the country where the views presented, *if true*, are not important to be known; and, if known, would not be highly useful to aid the improvement of soils. It is to the general theory of the constitution of fertile and barren soils, that the attention and severe scrutiny of both scientific and practical agriculturists are invited; and to the several minor points there presented, which are either altogether new, or not established by authority—such as the doctrine of acidity in soils—of the incapacity of poor and acid soils to be enriched—and of the entire absence of carbonate of lime in most of the soils of this country.

April, 1835.

---

### EXTRACTS FROM THE PREFACE TO THE EDITION OF 1842.

In the few years which have passed since the issue of the preceding edition, it is believed that the use of marl and lime, in lower Virginia, has been extended over thrice as much land as had been previously thus improved; and the previous clear income of the farmers thus fertilizing their lands has probably been already thereby increased in amount by several hundreds of thousands of dollars, and the intrinsic value of the lands raised by as many millions. These great augmentations of annual profits and of the true value of landed capital, from this single source, if they could be accurately estimated, would be seen to have produced an important item of additional revenue to the treasury of the commonwealth. And these additions of wealth to individuals and to the state, would be obvious as well as real, but for the existence of other circumstances which have operated to counteract or to disguise the proper results. The most important of such influences will be merely referred to here in the cursory manner only that the occasion permits.

In the first place—besides the deservedly very low appreciation of all lands in Virginia, founded on the smallness of their products, the market prices were formerly still more reduced by the almost universal urgent desire of proprietors to sell, that they might be enabled then to emigrate to the new and rich lands of the west. The impossibility of selling, even at the lowest valuation price, was the only thing which prevented the actual flood of emigration being so much more swelled as to leave half our lands unoccupied and waste. If purchasers had but presented themselves, fully half the farms in Prince George county (and it is presumed of many other counties) might have been bought up at a considerable deduction from the lowest estimated value; and all the sellers would have removed, with all their capital, to the western wilderness. To the then actual and regular flow of emigration from the now marling district, an effectual barrier has been opposed by the introduction of that mode of improvement. All emigration has ceased wherever by trial of this means the cultivators of the land found their labours to be richly repaid. Thus, in estimating the gains of individuals and of the state, on this score, the comparison should be made, not with the value of property and population which remained twenty years ago, but with what would have remained now, if the then existing inducements to emigration had continued to go on and to increase, as they would have done, with time.

Next—the actual increase of intrinsic value of marled lands is far from being even yet fully appreciated, because of the generally prevailing and

very erroneous mode of estimating the values of the increase of permanent net income from land, (as will be made manifest in a part of this Essay—) and but few even of those persons who have obtained such values by marling their lands, would estimate them at one-fourth of their true amount. The source of any *permanent net increase* of only \$6 of annual income from land, adds \$100 to the intrinsic value of the land. And this proposition is not the less true, and to the full extent asserted, even though the estimate of private purchasers and sellers, and of public assessors of lands, may all count for the market price but a small proportion of the increased real value.

Next—even whatever of new appreciation the foregoing influences might have permitted to be exhibited in the increased market price of lands, and still more their new real value, have been disguised, or altogether concealed, by the great and frequent fluctuations of all market prices of property, and by the general misdirections of capital and industry, all caused by the universal individual and national gambling (whether voluntary or compulsory), at the maddening and ruinous game of paper-money banking—to which system of delusion and fraud this otherwise most blessed country and fortunate people are indebted for so much of disaster, loss, and, still worse, of wide-spread corruption of habits and morals. The enormous apparent and illusory profits promised by this system, and by the stockjobbers who alone have fattened upon the facilities it offered for fraud and plunder, served powerfully to depress the market price of lands, and to discourage agricultural investments and pursuits. For, whatever actual profits the improvement and cultivation of the soil might offer to reward the care and labour of the proprietor, the stocks of various corporations, falsely appreciated by means of a bloated paper currency, and by the arts of stockjobbers, *promised* much higher profits, without requiring either care, labour, or risk. Thus, the higher that fictitious dividends of profits or the false values of stocks rose, and the stronger became the inducements to make stock investments, the more the prices of lands sank (comparatively) below their true value, because of the general disposition to convert landed capital to stock capital. But the real and solid increase of income and of wealth to individuals and to the commonwealth, caused by the permanent improvement of the soil, is not the less certain, or the less profitable, because fictitious appreciations of values, caused by the fraudulent banking system, and the consequent speculations and madness of its votaries and victims, have been both so much higher and lower, at different times, as to make the amount of actual improved values appear small in comparison, even if they were not thereby entirely concealed. But these delusive and ruinous causes of fluctuating prices and values are now fast showing their emptiness, and vanishing from view; and whenever the fraudulent paper system shall be completely exposed and entirely exploded, then both lands and the paper-money system will be estimated at their true value. May the consummation be speedy, complete, and final!

But even though, if properly and accurately estimated, the true value of the lands already marled and limed in Virginia has been increased to the amount of millions of dollars, the gain is very small compared to that which yet remains ready to be obtained. Marling has not yet been extended over the hundredth part of the surface to which it may be profitably applied; and liming, not to the ten-thousandth part of the lands of the state to which lime may be brought. And elsewhere, with the exception of a small part of Maryland, the beginnings of marling only have as yet been made. Nevertheless, these beginnings are the widely-scattered seeds which will spring up and spread, and hereafter yield abundant harvests.

*December, 1842.*

# CONTENTS.

<i>Preface to fifth edition</i> . . . . .	iii
<i>Preface to earlier editions</i> . . . . .	vi
<b>CHAPTER I.—Introductory. General description of agricultural earths and soils. Physical and chemical constituents of soils.</b>	
Difficulties of defining earths and soils, 17, 18. Chemists' definitions unsuitable for agriculture, 18. Agricultural earths, 19. Siliceous earth, 19. Aluminous, 20. Calcareous, 20; different definitions thereof by authors, 22. Chalk, 23. Magnesian earth, 24. Humus, 25. Soils and sub-soils, 25. Constituents of soils, 26, and of sub-soils, 27. Physical and chemical constituents, 28, 29, 30. Nomenclature and definitions of soils, 31, 32, 33.	
<b>CHAP. II.—On the soils and state of agriculture of the Tide-water District of Virginia.</b>	
General features of the district and its soils, 34, 36. Ridges, 35. Slopes, 35, 36. River margins and alluvial lands, 36. Exhausting tillage and small products, 36. Decreasing population, 38. Hopeless of improvement under existing circumstances, 39.	
<b>CHAP. III.—The different capacities of soils for improvement.</b>	
Five principal propositions stated for discussion, 39. Natural fertility defined, 40. Permanency of either fertile or sterile character of different countries and soils, 41. Land naturally poor not capable of being enriched by putrescent manures, 41, 42. Opposing opinions and authorities, 43, 45. Facts in support, 44. The degree of original fertility the limit of profitable improvement by putrescent manures, 46, 47.	
<b>CHAP. IV.—Effects of the presence of calcareous earth.</b>	
Calcareous earth not found in our poor soils, 48. Its presence indicating great fertility, 48. Natural growths on shelly and on poor soils, 49. All authority supports the general presence of carbonate of lime in soils, 50 to 53. Soils rarely calcareous in Virginia, 54. Recent confirming testimony (note), 54, 55.	
<b>CHAP. V.—Results of chemical examinations of various soils.</b>	
Methods for testing the presence or absence of carbonate of lime in soils, 56 to 59. Various soils tested—calcareous, 59 to 61. All known calcareous soils rich, and no poor soil calcareous, 61.	
<b>CHAP. VI.—Chemical examination of rich soils containing no calcareous earth.</b>	
Rich river lands, 62—and also mountain lime-stone soils, 63 to 65. Prairie soils of Alabama generally highly calcareous, or super-calcareous, 66, 67.	
<b>CHAP. VII.—Proofs of the existence of acid and neutral soils.</b>	
Lime in some form present in every soil, 68. Acid not considered an ingredient of soil by any writers of authority, and denied by others, 69, 70. Proofs of acidity in soil, 70. Growth of acid plants, 71. Nourished best by dead acid plants, 71, 72. By other putrescent manures, 72. Acid poisonous to cultivated plants, 73. Disappearance of carbonate of lime in cultivated soils, 75 to 80. Wood ashes contain lime, 81, 82. Scientific confirmation of acid in soil, 82 to 88. Discovery of humic acid, 83; its properties, 86. Successive natural changes of chemical character in soils, 88, 89, 90. Testimony of Loudon of originality of doctrine (note), 91.	
<b>CHAP. VIII.—The mode of operation by which calcareous earth increases the fertility and productiveness of soils.</b>	
Siliceous and aluminous earths have no chemical power to retain putrescent manure, 92, 93, 94. Calcareous earth has such power, and how, 94, 95. Examples of combining operations, 95. Power of fixing fertilizing matters in soils, 96. Power of neutralizing injurious acids, 97, 98. Power of altering and improving texture of both sandy and clayey soils, 98,	

99, and of lessening evils of too much dryness and moisture, 99. Lime a necessary food for plants, but only within narrow limitation, 100, 101. Proportions of lime in ashes of various plants, 102.

CHAP. IX.—*Action of caustic lime as manure.*

Davy's theory of liming stated, 103. Applied to practice, 104. Action of caustic lime generally to be avoided, 104. Lime acts generally as carbonate, 105. Form of classification of manures, 106.

CHAP. X.—*Introductory and general observations on marl and lime.*

Fossil shells, improperly called marl, 107. Incorrect use of terms in England, 108-9. Different and general misapplications of the name of "marl" (note), 109, and of "marling" (note), 110. "Liming," in practice, equivalent to marling, 110 to 113. Preliminary remarks on experiments, 114. Oldest applications of marl in Virginia, 114.

CHAP. XI.—*Experiments with, and effects of, calcareous manures on acid sandy soils, newly cleared.*

Experiments stated, and earliest and later results on light and acid loam, recently brought under cultivation, 116 to 122. Errors in the mode of experimenting stated, 122-4.

CHAP. XII.—*Effects of calcareous manures on acid clay (or stiff) soils recently cleared.*

Description of the peculiar soil operated on, 124. Experiments and results stated, 125 to 129. Remarkable effects on clover and grain crops, 127 to 129.

CHAP. XIII.—*The effects of calcareous manures on acid soils reduced by cultivation.*

Marling always effective on such soils, 130. Experiments stated, and early good results, 130 to 136. Diseased crops of grain caused by excessive marling, 133. Effects of marl with putrescent manure, 137, 138.

CHAP. XIV.—*Effects of calcareous manures on "free light land."*

Character of such soil, 139. Experiments, 139, 140.

CHAP. XV.—*Effects of calcareous manures on exhausted acid soils, under their second growth of trees.*

Experiments of this kind, 141, 142.

CHAP. XVI.—*Effects of calcareous manures alone, or with gypsum, on calcareous and neutral soils.*

Inefficiency of marl on such soils, 143. Gypseous marl, 144. Experiments, 145 to 147.

CHAP. XVII.—*Digression to the theory of the action of gypsum as manure. Supposed cause of its want of power and value on acid soils.*

General inefficiency of gypsum on Atlantic coast, and mistaken views as to the cause, 147. Exceptions on neutral soils, 148. And the true cause of usual inefficiency, 149. Theory of this inefficiency, and its removal, 151 to 154.

CHAP. XVIII.—*The damage caused by too heavy dressings of calcareous manure, and the remedy.*

Earliest effects observed, and symptoms described, 155. Means for preventing or of curing the injury, 156-7. The disease found only on soils naturally acid, 157; and not caused merely by excess of calcareous earth, 158, and probably by humate of lime, 159.

CHAP. XIX.—*Recapitulation and more full statements of the effects of calcareous manures.*

The results of marling have conformed to previous theoretical views, 159. Exceptions above the granite range, and causes, 161. Hazel loam, 161. Effects of calcareous manure proportioned to the organic matter in soil, 162. Marl on "galls," 163. Prevents the washing effects by rains, and the moving of sandy soils by winds, 164. Quantities of marl to be applied, 164. Effects in preserving vegetable matter from waste, 167. "Free light land," and its speedy exhaustion, 168. Marling deepens soils, 169. Gives peculiar value to sandy sub-soils, 170. Hastens maturing of crops—cotton—wheat, 170. Strengthens straw of wheat, 171. Peculiar benefits to leguminous plants, and especially to clover, 172, and to some bad weeds, 173. Failures of clover on marled lands, 173. Effect of calking in eradicating acid plants, 174-5.



CHAP. XX.—*Directions for the use of marl in connexion with other farming operations.*

Usual difficulties of beginners without reason, 175. The labours to be regular and continuous, 176. Necessity for intermixing marl regularly with the soil, 176-7. Manner of dropping and spreading heaps, 177. Organic manure an essential accompaniment, 177, 178; supplied by vegetable growth of the fields, 178. Ordinary farm-made manures, 179; other materials, 180.

CHAP. XXI.—*Actual improvements and results of marling. Peculiar value of sandy soils.*

Causes of defective results of earliest marling labours, 181-2. Actual results on Coggin's Point farm, to 1842, 183. Crops from 1813 to 1851, 184. Remarks and notes on same, 185-6. Culture and crops on Marlbourne, 187-8. Causes of neglect of marling, and small effects, 189. Value of sandy soils, 190. Poor soils of lower Virginia also very shallow, 191. Rates of increase of products from marling, on different lands, 192.

CHAP. XXII.—*The extent of duration of the effects of calcareous manures.*

Duration of effects known by experience, 192-4. Re-marlings, why required, 195. Question of duration of calxing, 196. Practice and opinions in Britain, 197, 198. Alleged reasons for waste of lime in soils, and answers thereto, 199 to 211. Sinking of lime in soil, 211, 212. Effect of organic (or putrescent) manures made permanent by combination with calcareous, 214 to 216. Apparent exceptions, 217. Actual duration of effects, 218. Anticipated progress of improvement, and fixing of organic matter by calxing, 219—and of sterility caused, under reverse circumstances, 220.

CHAP. XXIII.—*General observations on the valuations of lands and their improvements, and the expenses and profits of marling.*

Usual estimates altogether erroneous, 221. True mode of estimating values, 222 to 225. Supply and demand regulate selling prices of lands, 227. Injudicious marling labours, 228. General profits, 229.

CHAP. XXIV.—*Other fertilizing powers and effects of calcareous earth.*

Soils of ancient alluvial formation (or latter drift), 230. Effects of calxing thereon, 231 to 233. Action of calx by solvent power, 234. Sterility, when caused by calxing, and how, 235 to 237. Benefit of lenient cropping, 237, and supplying vegetable matter, 238. Erroneous practices in South Carolina, 239 to 241. Organic matter in plants, 242; how constituted, 243. Proportions of carbon, hydrogen, oxygen, and azote in plants, 244. Whence derived, 246 to 248. Supply of carbon from the atmosphere increased on calcareous soil, 248 to 250. Dr. Wight's experiments thereupon, 250 to 252. Other proofs, 253. Azote supplied from the atmosphere through leguminous plants, 253 to 257. Their peculiar manuring effects thus caused, 258. Residue of roots of clover, &c., 259. Value of the southern field pea (or bean), 261. Recapitulation, 262. Effect of lime in soils and compost heaps to produce nitrates, 263. This explains some practical results before not understood, 265, 267. Effect of lime in promoting the healthy constitution and vigorous growth of plants, 267, 268, and the better quality of products, 268.

CHAP. XXV.—*The use of calcareous earth recommended to preserve putrescent manures, and to promote cleanliness and health.*

Effects of calcareous earth in preventing waste of products of animal matter, 269, 270. Cases for use of this power, 271 to 274. Unfitness of quick-lime for this purpose, 274. Benefit in preventing disease, 275, 276. How the burning of towns benefits health, 277. Benefits to health of calcareous soil in Alabama, 278—in Virginia, 279 to 281—in France, 281, 283—in England, 283.

CHAP. XXVI.—*The excavation of marl-pits, and carrying out and applying marl.*

Dry and high-lying marl, 284. Wet marl in hilly lands, 285. Method of opening and working pits of such marl, 286 to 289. Draining the excavation, 289, 290. Deep pitting, 290. Machines for raising marl, 291 to 295. Making roads, 295. Implements and carts for marling, 297. Spreading, 298. Marling tables and estimates, 299 to 302. Importance of marling labours being continuous, 303.

CHAP. XXVII.—*Directions for the searching for and testing of marl.*

Searching for marl, 304. Use of the auger, 305. Exposures of marl, 306-7. Extended labours anticipated, 307. Usual appearances of marl, 308-9. Position and character of the strata, 309-10. Directions for analyzing, 310 to 313. Distant transportation of marl, 313 to 317.

**CHAP. XXVIII.—Estimates of the cost of labour applied to marling.**

The proper grounds for estimates, 318. Cost of the labour of a negro man, 319—of boy, woman, and girl, 320; of working horse and mule, 320; costs of carts and implements, 321. These estimates applied to particular operations of marling, 322 to 326.

**CHAP. XXIX.—Details of actual and extensive marling labours.**

Actual labours on low-lying and wet marl, 327. Marl and accompanying beds described, 328-9. Excavation in small perpendicular pits, 329. Horizontal plan of diggings, 330-31. Beginning and progress of labour, 329, 333. Work of a single mule, 334 to 339. Estimated cost of the work, and remarks, 336 to 341. Excavating marl in large graduated pits, 342 to 350. Savings of expense before incurred, 351-52. Expenses at various distances, and rule for estimating, 353. Hazard of large excavations, 354. Quantity of marl removed, 355.

**CHAP. XXX.—The progress of marling in Virginia.**

Usual obstacles to the progress of all new improvements in agriculture, 356. The beginning and progress of marling in Virginia, and general condition (in 1842), 357 to 360. Lining, 360. General effects of the use of calcareous manures in Virginia (to 1850), on values of lands and products of taxation, general wealth, and population, 360 to 363.

## APPENDIX.

*Introductory remarks* . . . . . 363

**NOTE I.—Additional proof, offered in the production and existence of black waters, of the action of lime in combining vegetable matters with soil.**

Black waters of certain streams and ponds, and absence of colouring matter in others, 363 to 365. Causes, 365. Proofs and illustrations, 366. Clearness of lime-stone water, 367. Facts and causes of black waters, 368 to 371.

**NOTE II.—The statements of British authors on “marl,” and their applications of the name generally incorrect, and often contradictory.**

Subject stated, 371-2. Correct definitions of marl, 373. Clay and shell marl, 374. “Marls” not calcareous, 375-6. Old authors. Marls not known to be calcareous by their describers, 377 to 380. American opinions deduced from English books, 380. Other manures not valued for their known calcareous parts, 381. Errors of modern writers, 382; Arthur Young, 382 to 385; Lord Kames and Sir John Sinclair, 386. Cases of English marling not serving to make soil calcareous, 387-8. Sir John Sinclair confounding the operations of carbonate, phosphate, and sulphate of lime, 389. Marling of Norfolk, 390. Clays of New York calcareous, 391. Marshall’s notices of marl and marling, 391 to 394. Errors of Farmers’ Journal, 395. Fossil sea-shell beds (or marl of Virginia) in Europe, 395. *Faluns* and *falsunage* of France, 397-8. Oldest and English views of the marl (now so called) of Virginia, 399. Deductions, 399, 400. Marl and marling of the ancients—notices by Varro and Pliny, 401-2.

**NOTE III.—The earliest known successful applications of fossil shells as manure.**

Oldest applications unsuccessful, 403-4. First successful use in Virginia, 405, and in Maryland, 405. John Taylor’s slighting opinion, 406. Marling of John Singleton, 406 to 408.

**NOTE IV.—First views which led to marling in Prince George county.**

The author’s early lessons and opinions, and errors in farming, 410-11. Former condition of his land, and sources of opinions, 412. Taylor’s and Davy’s doctrines, 413. Acid in soils supposed, 414-15. First effort in marling, 416, and first results, 417. Earliest opinions of constitution of soils, 418 to 420. English views and writings opposing the use of our marl, 421. “Ruffin’s Folly” and first operation of example, 422-3. Succeeding labours, 423-4. Damage caused by marling, 424 to 426.

**NOTE V.—Description and account of the different kinds of marl, and of the gypseous earth of the tide-water region of Virginia.**

Need for the information to be offered, 427. Character, constitution, and formation of true marl, 428 to 430. Classification of marls, 431. Chalk and rotten lime-stone, 432. Travertin,

433. Argillo-calcareous, or true marl, 433. Shell-sand, 434. Shell marl, as understood in Britain, 434-5. Tertiary fossil shell marl (in Virginia), 435-6. Miocene marl, 437 to 440. Varieties, 441 to 448. Crystallisation in marl, 443-4. Loss of calcareous parts of marl, 448. Comparative values, 449. Eocene marl, 450; of Coggins Point, 450-1. Extent of same kind, 452. Qualities, 453. Other eocene marls, 454. Gypseous earth, 454. Gypseous earth of James river, 455 to 475. Green-sand, 458. Use of gypseous earth as manure, 459. Sulphuret of iron (and gypsum) contained, 460. The various strata at Evergreen, 462 to 464. At Coggins Point, 465 to 467. Harrison's Bar of gypseous earth, 467. Green-sand of New Jersey, 468. Analyses of green-sands of Europe and America, 469-70. Analyses of gypseous earth of Coggins Point, 471 to 473. Gypsum the main operating ingredient, 474. Eocene green-sand (or gypseous) marl of Pamunkey, 475 to 482. Different layers described, 476 to 479. Olive earth, 479-80. Gypseous earth of Pamunkey, 481-2. All appreciable effects due, not to green-sand, but to gypsum, 482. Position and order of succession of the different layers of the Pamunkey eocene, 483 to 485. Sulphuret of iron in gypseous earth and some marls, 486-7. Alleged existence of green-sand, in quantity, in ordinary miocene marls, 487-8. The assertion disproved, 489 to 491. Peculiar miocene, of Hampstead bed only, known to contain green-sand in considerable proportion, 491 to 493.



# AN ESSAY

ON

## CALCAREOUS MANURES.

---

### CHAPTER I.—INTRODUCTORY.

#### GENERAL DESCRIPTION OF AGRICULTURAL EARTHS AND SOILS.— PHYSICAL AND CHEMICAL CONSTITUENTS OF SOILS.

IN discussions or instructions upon the fertilization of land, it is an important requisite that we should correctly distinguish between *earths* and *soils*, and the many varieties of the latter compound bodies. Yet the terms used for this purpose, are generally misapplied; and even among writers of high reputation and authority, no two agree in their definitions of soils, or modes of classification. That such differences of definition, and contradiction of terms, should exist, will appear the less strange, and the resulting errors the more excusable, to those readers who have most carefully studied this branch of agricultural science, and who, therefore, can best appreciate the difficulties of the required classification. Each writer on soils is compelled to use terms in senses different from the greater number of his many predecessors; because but few of them have concurred in even the most important definitions. Where such great differences exist, and where no one known plan of nomenclature is so free from material imperfections as to be referred to as a standard of authority, it becomes necessary for every one who treats on soils to define for himself; though perhaps he may thereby add still more to the general mass of confusion previously existing. This necessity must serve to excuse the writer for whatever is new, unauthorized, or confessedly defective in the definitions and terms which will be here adopted, and used as required hereafter through this treatise. It would be inferred by most readers, from the general heading alone, that this introductory chapter must consist mainly of definitions and explanations already established by scientific authority, and generally received by and known to well-informed agriculturists. This inference would be correct to a considerable extent; nevertheless, there will be many



of the views which are either new and unsupported, or entirely opposed to all existing authority; and which will require to be understood and borne in mind by all who desire to study with proper advantage the theory of fertilization which will be presented and maintained in this essay.

Previous to the recent attention of chemists directed to agriculture, which may be said to have begun with the publication of Davy's admirable and very valuable (though necessarily very imperfect) work on the "Elements of Agricultural Chemistry," agricultural writers had defined and described soils by their qualities obvious to the senses, and without much, if any, regard to their chemical, or even their physical constitution. Of course they were often in error; as the sensible qualities, or textures of soils, do not always quadrate with, or conform to the proportions or kinds of their materials. For example: an open and light soil, is most generally made so by an excess of silicious sand; but occasionally soils owe their possessing this texture to an excess of humus or vegetable matter, or of chalk; and which soils may be greatly deficient in sand, and would be rendered even more compact by an addition of this earth. Again: the closeness and intractability of a soil is generally owing to the excess of clay; but a soil superabounding in clay, with large intermixture of vegetable and calcareous earths, may be much more friable and light than another with much less clay, and much more of silicious sand in a very finely divided state.

More recently, when many men of science took their present ground as co-labourers in agricultural investigation, they brought to bear, on this branch of the science, terms and definitions exact and precise enough indeed, they being those recognised in chemistry; but altogether inapplicable to agriculture, because referring to conditions of purity, and simplicity of composition, having no existence in nature, nor even subject to the observation and senses of the agriculturist. Hence, when chemists, using their scientific nomenclature, attempt to instruct farmers of the composition of soils, and refer to their contents of the chemical earths proper, alumina, lime, magnesia, &c., they are speaking of things which have no existence in nature, nor even in agricultural art; and they might as well go farther back in search of scientific strictness, and treat of the elementary parts of these several earths—that is, oxygen, with the metals aluminum, calcium, and magnesium, respectively; which elements are rarely produced or preserved separate, and never except in the chemist's laboratory. The substances known in chemistry as *earths*, are, indeed, defined with precision, and their distinguishing properties are well understood by those who are even slightly acquainted with that science. But of the nine earths known to chemists, one only, *silica*, exists naturally in

a state of purity, or uncombined; and in this state of purity (as rock-crystal, or pure quartz-rock), it can have no action whatever as an agricultural earth. Two other chemical earths, *alumina* and *lime*, are only found combined with other bodies; and, as thus combined, exhibiting very different properties from the pure earths, which can be produced only by chemical decomposition. A fourth earth, *magnesia*, likewise is never found uncombined, and rarely in other than very minute proportions, and always intermixed with other earths, so as to be imperceptible by the senses. The other chemical earths (barytes, strontian, zircon, &c.) are so rarely found, and still more rarely in soil, and most of them only in such minute quantities that, as to any influence on agriculture, they may be deemed as non-existent.\*

These few preliminary remarks will serve to expose something of the difficulty of distinguishing and clearly defining the earths of agriculture. That the attempt which will here be made will but imperfectly reach the desired object, will not be more evident to other persons than to the writer.

The *agricultural earths* will here be understood as bodies naturally existing, and, when separate, as pure as ever presented by nature; and of which, each one, except *humus*, is composed principally of some one chemical earth. They are five in number—silicious, aluminous, calcareous, magnesian, and vegetable or humus. These agricultural earths, variously intermixed, serve to compose the superficial layer of the globe. This layer, more or less productive of vegetable growth, is *soil*; and however varying in different places, all soils, for almost their entire bulk, are composed of one or more of the three principal agricultural earths—the silicious, aluminous, and calcareous, with more or less of humus, or vegetable mould. It is convenient, though still a farther departure from scientific strictness of definition, to include humus among the earths of agriculture.

1. *Silicious earth* is presented in the cleanest, most crystalline,

---

\* The chemical earths are combinations of different metals (which are known only in these combinations) with oxygen. Before Davy's splendid discovery of these metals, and their combinations with oxygen, the earths were supposed to be simple bodies, or incapable of being decomposed. A single combination of one of these very rare chemical earths, the sulphate of barytes, has been recently found to be a very effective manure, acting on clover with the remarkable power of sulphate of lime (gypsum). Professor Armstrong, of Washington College, has fully tested it by the practical use of the earth as manure. He also informed me that the sulphate of barytes was found in some parts of that mountain region in sufficient quantity to be used for manuring, in the small proportions required for its effects. These interesting facts do not contradict the remarks in the text above, which referred to barytes and the other scarcer earths only as constituents of soils.

whitest, and purest sand, as washed and deposited by rapid streams, or other water in motion. This, the very abundant agricultural or natural earth, often approaches nearly in purity to the chemical earth *silica*. Silicious earth generally appears as *sand*; that is, in separate and loose grains of small size, which are rugged and irregular in shape, usually with sharp angles, rough to the touch, and hard enough to scratch glass. This earth is not soluble in any acid except the fluoric, and cannot be made coherent by any mixture with water. The solidity of the particles of sand renders each one impenetrable by water; and their loose and open arrangement permits water to pass easily through the mass. The same conditions of impenetrable grains and loose and open texture cause silicious earth to be incapable of absorbing moisture from the air, or of retaining, with any force, either moisture or any aerial or gaseous fluid with which it may have been in any manner supplied. Silicious earth is also quickly and strongly heated by the sun, which increases the rapidity with which it loses moisture.

2. *Aluminous earth, or argil, or purest clay*, as it may also be called for convenience, is composed, for a large part, of the chemical earth *alumina*, from which this and all other less pure clays derive their peculiar and well-known qualities. Still, this purest of clays, naturally existing (or "pipe clay," as termed by some agricultural chemists), contains no more than 36 to 40 per cent. of alumina, chemically combined with 52 to 60 per cent. of silica, and 3 or 4 per cent. of oxide of iron.\* Thus even the purest natural clay, or aluminous earth, does not approach the purity of the chemical earth alumina within some 60 to 64 per cent. And all ordinary and less pure clays, of course, have much more of silicious sand, the additional quantity being in the state of mechanical mixture. Aluminous earth and all clays, in proportion to their purity, when dry, absorb water abundantly; and when wet, form tough and ductile paste, smooth and soapy to the touch. By burning, the mass becomes brick, hard like stone, and is no longer capable of being softened by water. When drying from a previous wet and softened condition, aluminous earth and all clays shrink greatly, and, separating by numerous cracks and fissures, the mass is broken into hard lumps.

3. *Calcareous earth, carbonate of lime,† or calx*, is the next

---

\* Prof. J. F. W. Johnston's "Lectures on the Applications of Chemistry and Geology to Agriculture," p. 230, *et seq.* First Am. edition of Wiley and Putnam, New York, 1844.

† *Carbonate of lime* is the chemical name for the substance formed by the combination of *carbonic acid* with *lime*. The names of all the thousands of different substances (*neutral salts*) which are formed by the combination of each of the many acids with each of the various earths, alkalies, and metals, are formed by one uniform rule, which is as simple and easy to be

most abundant agricultural earth. It is a combination of the chemical earth *lime* with carbonic acid, in the constant proportions (in whole numbers) of 56 parts lime to 44 of carbonic acid. It is converted to pure or quick-lime by red heat, which drives off the carbonic acid; and quick-lime, by exposure, and attracting carbonic acid from the atmosphere, soon reverts to its original condition of carbonate, or calcareous earth. It forms marble, limestone, chalk, and shells, with very small admixtures of other materials. Thus the term *calcareous earth* will not be used here to include either *lime* in its pure state, or any of the numerous combinations which lime forms with the various acids, except the one combination (carbonate of lime) which is beyond comparison the most abundant throughout the world, and most important as an ingredient of soils. Pure lime attracts all acids so powerfully, that it is never presented by nature except in combination with some one of them, and generally with the carbonic acid. When this compound is thrown into any stronger acid, as the muriatic, nitric, or even common vinegar, the lime, being more powerfully attracted, unites with and is dissolved by the stronger acid, and lets go the carbonic, which escapes with effervescence in the form of air. In this manner, the carbonate of lime, or calcareous earth, may not only be easily distinguished from silicious and aluminous earth, but also from all other combinations of lime.

The foregoing definition of calcareous earth, which confines that term to the *carbonate* of lime, is certainly liable to objections, but less so than any other designation. It may at first seem improper and even absurd to consider as one of the principal earths which compose soils, *one* only of the many combinations of lime, rather than either *pure lime* alone, or lime in *all its combinations*. One or the other of these significations is adopted by the highest authorities, when the calcareous ingredients of soils are described; and in either sense, the use of this term is more conformable with scientific arrangement than mine. Yet much inconvenience is caused by thus applying the term calcareous earth. If applied to

---

understood and remembered as it is useful. To avoid repeated explanations in the course of this essay, the rule will now be stated by which these compounds are named. The termination of the name of the acid is changed to the syllable *ate*, and then prefixed to the particular earth, alkali, or metal with which the acid is united. With this explanation, any reader can at once understand what is meant by each of some thousands of terms, none of which might have been heard of before, and which (without this manner of being named) would be too numerous to be fixed in the most retentive memory. Thus, it will be readily understood that the *carbonate of magnesia* is a compound of the carbonic acid and magnesia—the *sulphate of lime* a compound of sulphuric acid and lime—the *sulphate of iron* a compound of sulphuric acid and iron—and in like manner for all other terms so formed.

*lime*, it is to a substance which is never found existing naturally, and which will always be considered by most persons as the artificial product of the process of calcination, and as having no more part in the composition of natural soils than the manures obtained from oil-cake or pounded bones. It is equally improper to include under the same general term all the combinations of lime with the fifty or sixty various acids. Two of these compounds, the sulphate and the phosphate of lime, are known as valuable manures; but they exist naturally in soils in such minute quantities, as not to deserve to be considered as important physical ingredients. Many other salts of lime are known to chemists; but their several qualities, as affecting soils, are entirely unknown—and their quantities are too small, and their presence too rare, to require consideration. If all the numerous different combinations of lime, having perhaps as many various and unknown properties, had not been excluded by my definition of calcareous earth, continual exceptions would have been necessary to avoid stating what was not meant. The *carbonate of lime*, to which I have confined that term, though only one of many existing combinations, yet in quantity and in importance, as an ingredient of soils, as well as a part of the known portion of the globe, very far surpasses all the others.

But even if calcareous earth, as thus defined and limited, is admitted to be the substance which it is proper to consider as one of the important earths of agriculture, still there are objections to its name which I would gladly avoid. However strictly defined, many readers will attach to terms such meanings as they had previously understood: and the word *calcareous* has been so loosely and so differently applied in common language, and in agriculture, that much confusion may attend its use. Anything “partaking of the nature of lime” is “calcareous,” according to Walker’s Dictionary; Lord Kames limits the term to *pure lime*;\* Davy† and Sinclair‡ include under it pure lime and all its combinations; and Kirwan,§ Rozier,¶ and Young,§ whose example I have followed, confine the name calcareous earth to the carbonate of lime. Nor can any other term be substituted without producing other difficulties. *Carbonate of lime* would be precise; but there are insuperable objections to the frequent use of chemical names in a work addressed to ordinary readers, and this one would be especially awkward and inconvenient for such use. Chalk, or shells, or mild lime (or what had been quick-lime, but which, from exposure to the air, had again

---

\* Gentleman Farmer, page 264 (2d Edin. ed.)

† Agr. Chem., page 223 (Phil. ed. of 1821.)

‡ Code of Agriculture, page 134 (Hartford ed. 1848.)

§ Kirwan on Manures, chap. 1.

¶ “*Terres*”—Cours Complet d’Agriculture Pratique.

§ Young’s Essay on Manures, chap. 3.

become carbonated), all these are the same chemical substance; but none of these names would serve, because each would be supposed to refer to such certain form or appearance of calcareous earth as they usually express. If I could hope to revive an obsolete term, and, with some modification, establish its use for this purpose, I would call this earth *calx*—and from it derive *calxing*, to signify the application of calcareous earth, in any form, as manure. A general and definite term for this operation is much wanting. Liming, marling, applying drawn ashes, or the rubbish of old buildings, chalk, or limestone gravel, all these operations are in part, and some of them entirely, that manuring which I would thus call *calxing*. But because their names are different, so are their effects generally considered—not only in those respects where differences really exist, but in those where they are precisely alike.

Calcareous earth, in the agricultural sense here assumed (*calx*, or carbonate of lime), has almost no existence as an ingredient of soil throughout all the great Atlantic slope of the United States north of Florida. Nor has it any existence, separate from soil, unless as lime-stone rock and travertine in the mountain region, and subterranean beds of fossil shells in the tide-water lands. In England, France, and some other parts of Europe, this earth occurs as chalk, in beds of great thickness and vast extent of surface. The whiteness of chalk repels the rays of the sun, and its open texture permits water to sink through almost as easily as through sand. Thus calcareous earth alone, or when constituting the bulk of a soil, is remarkable for possessing some of the worst qualities of both sand and clay.

But though the true chalk, which is so widely spread in Europe, does not exist in North America, there are very extensive regions of this continent of which the soils are composed in part, and their subsoils mainly, of calcareous earth, and which may be considered as chalk soils and subsoils in an agricultural, though not a geological sense. Such are most of the "prairie" lands of Alabama, Mississippi, and Arkansas; and (as I infer from analogy) of Texas, and of the vast prairie region west of the Mississippi River. The "everglades" of Florida, as I infer, and the nearest sea islands also, are of like constitution. The subsoil and inferior layers, known in many cases to be several hundred feet thick, are like an impure chalk, composed principally of carbonate of lime (of which there is a proportion from 70 to more than 80 per cent.), intermixed intimately, or combined, with fine clay, which constitutes the small remaining part. This great formation of impure calcareous earth may be considered as either a very rich marl, or a poor chalk; and similar to true chalk in every relation to agriculture, except (in consequence of its argillaceous admixture) in being, in most cases, as much impervious to water as true chalk is the reverse.

4. It seems doubtful whether magnesia, in any form or condition, should be counted among the earths of agriculture, or physical constituents of soils. Though very generally diffused through soils, it is usually in extremely small proportions. In this country, so far as my personal observation or other information has extended, no soil is known to contain magnesia, in any form, as a physical or considerable constituent; and even as a chemical or manuring agent, the quantities present in soil have been so small, and, moreover, so associated with larger proportions of the kindred earth lime, that the effects of the magnesia alone could not be appreciated. Nor are the chemical effects of magnesia much better known in Europe, where they are more obvious to observation, and have been more or less remarked upon by all agricultural chemists. They have been considered by most writers as injurious to the fertility and productiveness of soils. But, though without any evidence of facts, I would infer the reverse operation of magnesia in small proportions. The grounds of this inference are presented in the general similarity of chemical character of magnesia to lime—and also the very general diffusion of magnesia, in some form of combination (though not often as carbonate), in soils, and especially the richest soils.\*

In other parts of the world, however, magnesia is much more abundant. It is present in large and (as there supposed) injurious quantity in the Gatinais (between the rivers Seine and Yonne), in France,† and also in Cornwall, in England.‡

Magnesia very much resembles lime in most of their known qualities, and especially in their respective chemical affinities to other bodies. The resemblance is perfect in this important respect, that the pure chemical earth magnesia has no natural existence, because of its strong attraction for acids. If made pure by art, it is then the "calcined magnesia" of druggists. In that artificial state, and in which only the pure chemical earth ever exists at all, if exposed to the atmosphere, it soon attracts carbonic acid, and so

---

\* In a specimen of the celebrated rich alluvial soil of Red River, Louisiana, I found from 1 to 2 per cent. of carbonate of magnesia; and something less in the equally rich deposit of the Mississippi River, on the Arkansas shore. The rich mud of the Nile contains 4 per cent. of this earth. (Regnault, quoted by Boussingault), Rural Economy, &c., p. 338, (1st Am. ed., 1845.)

† These peculiar soils were described at length in the "*Annales d'Agriculture Française*," by M. Puvion, whose article was translated for and published in the *Farmer's Register*, vol. iv., p. 212, accompanied by my reasons for doubting the conclusions of the author as to the magnesia being the cause of sterility.

‡ The Lizard Downs. (Davy.) This soil is formed in part by the disintegration of the underlying serpentine, a magnesian rock. (J. F. W. Johnston.)

becomes the carbonate of magnesia, which is the ordinary mild substance used as medicine. This is a combination of 48 parts of magnesia with 52 of carbonic acid. It is to this compound only, the *carbonate of magnesia*, I affix the term of *magnesian earth*, and not to any other form of combination with other earths or with acids, nor to the pure chemical earth magnesia, which has no existence in nature, and, of course, can have no natural influence on soils or on agriculture.

5. *Humus* is the partially decomposed remains of dead vegetable growth, reduced by time to nearly an earthy texture, pulverulent when dry, and soft and slimy, and almost semi-fluid when full of water. This vegetable earth, as peat, and in its purest state, is very abundant in Great Britain and other cool and moist countries. But in Eastern Virginia, it has scarcely any existence, separate or alone, except in the Great Dismal Swamp, and in marshes covered by the tides. In these places, and also in the still larger swamps of North Carolina, the continual wetness and dense shade serve to prevent the complete decomposition of vegetable matter, as is done in Europe by the prevalence of cloudy and damp air, and low average temperature; and under such conditions only, in our hotter and dryer climates, does humus occur alone, or even as forming the principal material of any soil. The peat soil of Europe is composed of pure vegetable matter, for 60 per cent. or more of its dry weight. (Johnston.) The peat used for fuel is probably still more of vegetable constitution. Of four specimens of soil of the Dismal Swamp, selected and examined by myself, the vegetable parts were, respectively, 75, 90, and, in the other two, 96 per cent. of the *bulk* of the soil. Different specimens of soils, from both salt and fresh-water tide marshes, bordering on Powhatan (or James) River, lost full 50 per cent. of their dry weight by being burnt thoroughly; showing that half their weight, and probably five-sixths of their bulk, is pure vegetable matter. These soils are, perhaps, as near to pure humus as any in our climate.

As a small, or chemical ingredient of soil, intermixed or combined with other earths and far more abundant materials, humus is present universally, serving as aliment to be drawn up by the roots of growing plants, and without which no healthy or luxuriant growth could be produced. Humus gives colour and value to the black rich mould of old garden ground, and to the richest forest or alluvial soils, before they are reduced in fertility by tillage.

#### *Soils and Sub-soils in General.*

All the agricultural earths, including humus as one, when separated pure, or as nearly pure as ever presented by nature, are nearly or entirely barren. This might be inferred from the mere



description of their respective qualities. Further—the too large proportion of any one earth, in the mixture of several, is injurious to fertility in proportion to such excess. But the quantity which would thus be hurtful by excess would be very different in the different earths, and also as to each one, as modified by attendant circumstances. Thus, as a supposition, or, at best, a mere approximation to truth, we may suppose the following named proportions to be as large as can be present, respectively, in different soils, and under ordinary circumstances, without being injurious to production:—

Silicious earth (as pure sand), in a particular soil, will be injurious by its excess, if more in proportion to the soil than	85 per cent.
Or aluminous earth (argil, or purest clay), in another soil,	25 “
Or calcareous earth (carbonate of lime, or calx), in another,	5? “
Or magnesian earth (carbonate of magnesia), in another,	2? “
Or humus (nearly pure vegetable matter), in another,	12? “

In such large proportion as indicated by the above quantities, the greater part of each earth could act only *physically* or *mechanically*. If considered merely as chemical or manuring constituents, and embraced in one soil, perhaps one per cent. of calx, a mere trace of magnesian earth, and five per cent. of humus, would be enough; while nearly all the remainder of the hundred parts would be of silicious earth mainly, and aluminous earth, serving merely as physical constituents, for nearly their whole quantities.

But whatever may be the most suitable proportions, and however much the action and power of each one may be in some cases modified by other ingredients, or by attendant circumstances, still the admixture, in due proportions, of the different earths will serve to correct the defects of all, and thus to form *soils* of every character and variety. And various as are the soils naturally formed by mixtures of some or all of the different earths, and greatly defective as most of them are, there are but few which do not more or less fulfil their purpose of serving to sustain the growth of useful plants; in which they may extend their roots freely, yet be firmly sustained in their erect position; and obtain the necessary supplies of air, moisture, warmth, and food, without being too much oppressed by the excess of either. Such are the soils, though of various proportions and values, on all the surface of the globe wherever fit for culture. And though the qualities and values of soils are as various as the proportions of their ingredients are innumerable, yet they are mostly so constituted that no one earthy ingredient is

so abundant but that the texture\* of the soil is mechanically suited to some one valuable crop; as some plants require a degree of closeness, and others of openness in the soil, which would cause other plants to decline or perish.

The depth of soil seldom extends more than a few inches below the surface, as on the surface only are received those natural supplies of vegetable and animal matters, which are necessary to constitute soil. Valleys subject to inundation have washings of soils brought from higher lands and deposited by the water, and therefore are of much greater depth.

Below the soil is the *sub-soil*, of uncertain depth, and which need not be considered as extending deeper than its texture or condition may affect the production of the soil above, whether beneficially or injuriously. It is, however, most common that the sub-soil is apparently nearly of the same constitution with the subjacent mass for several or many feet deeper. The sub-soil is usually a mixture of two or more earths, and the same as may predominate in the soil above. But the sub-soil is much more deficient in calcareous earth (except under chalky soils), and lime in every state, and also in humus; and, indeed, nearly all sub-soils in lower Virginia are totally deficient in all those ingredients essential to vegetable production. Even where such absolute deficiency may not exist, the usual great excess of either sand or clay in sub-soils would alone serve to render them nearly barren; and, consequently, their mixture with the better soil lying above would be injurious rather than beneficial to its improvement.

The qualities and value of soils depend on the proportions of their ingredients. We can easily comprehend in what manner silicious and aluminous earths, by their mixture, serve to cure the defects of each other; the open, loose, thirsty, and hot nature of sand being corrected by, and correcting in turn, the close, adhesive, and water-holding qualities of aluminous earth. This curative operation is merely mechanical; and in that manner it seems likely that calcareous earth, when in large proportions, and serving as a mechanical constituent, also acts, and aids the corrective powers of both the other earths. This, however, is only supposition, as I have met with scarcely any such natural soil.

But besides the mechanical effects of calcareous earth (which are weaker than those of the other two), that earth has chemical powers far more effectual in altering the texture of soils, and for which a comparatively small quantity is amply sufficient. The chemical action of calcareous earth, as an ingredient of soils, will be fully treated of hereafter; it is only mentioned in this place to

---

\* The *texture* of a soil means the disposition of its parts, which produces such sensible qualities as being close, adhesive, open, friable, &c.

avoid the apparent contradiction which might be inferred, if, in a general description of calcareous earth, I had omitted all allusion to qualities that will afterwards be brought forward as all-important.

*Physical (or Mechanical) and Chemical Constituents of Soils.*

In the discussion of this general subject, we should always bear in mind the different actions of the earths as the *physical*, or *mechanical*, and the *chemical* ingredients of soils. These different actions have already been incidentally referred to; but they require more particular notice.

Any of the earths which may serve as large materials in the composition of a soil, must act, for much their greater proportion, merely mechanically in the relation of the soil to the growth of plants. Thus, the various mixtures of silicious and aluminous earths existing in all ordinary soils—and these more rarely with large proportions of either calcareous or magnesian earth, or humus—serve, for much the larger proportions of each and all, to furnish merely that mechanical position and support for growing plants which is necessary for them to draw freely the available supplies of water, air, and food. The conditions necessary for this purpose are, that the soil shall have enough sand to be sufficiently permeable by moisture, and for the extension of the rootlets; that there shall be enough clay to give firm support to the plant in its upright position, and sufficiently to close the too great openness of the sand. These necessary physical conditions of the soil, in relation to its texture and powers of receiving, retaining, and transmitting moisture, are further improved, and opposite evils either modified or prevented, by additional admixtures of calcareous (and perhaps magnesian) earth, and humus. But so far the action of each and all these materials, in large quantities, (and for much the larger proportion being always understood), act only by their physical qualities, and exert such powers in proportion to quantities. Any one of these materials, for much its greater part, might be substituted by some other, if offering like physical qualities, though totally different in chemical character and constitution. Thus, when chalk greatly predominates in soil disposed to dampness, from position or climate, its physical qualities serve to increase the evil, as would clay; and the soil is both colder and wetter than if there were no physical action of the calcareous earth. On the other hand, in a soil disposed to suffer by dryness, the like chalky constitution would increase that evil, as would sand, by its open texture permitting the too rapid escape of moisture. Humus, in large proportion, acting mechanically like clay, serves to close the too open pores of sandy soils; and, by its remarkable absorbent power, to make them more retentive of moisture wherever excess

of moisture exists. Yet in a soil largely composed of clay, and as much deficient in sand, a very large natural supply of humus will prevent the tenacity and intractability which the clay otherwise would have induced; and cause the soil, when dry, to be friable, loose, and permeable. In wet seasons, however, the same soil will be again too close and adhesive.

Further—if we can conceive that other materials could be substituted, having entirely different chemical characters, they might serve as well for physical constituents of soils, as the earths of which they took the place. Thus the purest clay, or even pure alumina, if calcined to the state of brick, and then reduced to fine grains, would serve the same physical purposes in soil as silicious sand. And if an artificial soil were thus composed, it might have all the physical qualities of the most sandy soil, while its chemical composition would be more aluminous than ever exists in nature.

The physical or mechanical action of earths has been kept generally in view through the foregoing pages, inasmuch as the earths have been considered as forming large ingredients of soils. But besides this more obvious action of the agricultural earths, all of them, as well as many other different bodies, act also by chemical power. For the fullest exercise of this power by each, comparatively very small proportions of each ingredient are required. In a soil composed of any proportion whatever of silicious, aluminous, calcareous, magnesian, and vegetable earths, perhaps the quantity of each acting chemically, might not exceed the hundredth, if the thousandth, part of the whole mass of soil—all the remainders of each earth, whether great or small, having, for the time, no other than mechanical action.

But the magnitude and importance, and value to the farmer, of the mechanical and chemical ingredients of soils are not at all in proportion to the quantities required to exert the different powers. The chemical action is much the more valuable in effect and benefit produced; and also because the producing agents, from the small quantities required, are more or less under the control of man; while the great quantity alone of any material required for physical effect, would generally place it entirely beyond control.

All *chemical* ingredients of soils, whether of the agricultural earths which also make the universal mechanical materials, or of any other bodies so far as they operate in soils by chemical action, are *manures*, which serve directly or indirectly, immediately or remotely, to give food to and promote the growth and production of plants.

Thus, according to my views, and in the sense in which I use the terms, the *physical* or *mechanical* constituents of soils, and the *agricultural earths*, when serving as *earths*, are the same; and also, that so much of these earths as act *chemically*, or as *chemical*

*constituents* of soils, are *manures*. The same substance (whether silicious sand, clay, chalk, or humus) which, when in quantity, and for the much larger proportion of such quantity, is a mere earth, or mere physical material, also, for a very small proportion, in the same or other soil, acts chemically and as a manure. And these different operations of the same substance may even oppose each other; and then it will depend on other circumstances whether the manuring action of a minute proportion of the substance will do more good than is produced of injury by the excess of the same substance as an agricultural earth and physical material of the soil.

If I have succeeded in clearly showing the distinction of mechanical and chemical action in soils of even the same substances, it will serve to remove much of the obscurity and mystery which have attended the general subject. When the application of calcareous matter as manure is new, or but beginning in any country (as in Virginia thirty years ago), it has been deemed (by many partially informed persons) a sufficient objection to the promised benefit of a small application, that much larger natural proportions elsewhere did not always make rich lands. It seemed incredible that a proportion of calcareous earth less than 1 per cent. of the soil could much promote its fertilization and productiveness, when other soils had 5, 10, or 50 per cent. of that material, and were not always rich, and in some cases were extremely barren. But, in such cases, 1 per cent. (or less), perhaps, was as large a proportion of carbonate of lime as could act chemically and as a manure. All beyond that proportion would be mere physical material; and if in excess even for its mechanical operation, would be injurious in proportion to its excess. Thus (as will be shown hereafter) a very small proportion of this earth serves to lessen the evil effects to soils of both too much wetness and too much dryness, and the opposite evils of too much heat and also of low temperature. But in a chalky soil, where this ingredient is in great quantity, the mechanical action predominates and overpowers the chemical; and such constitution of soil serves to aggravate all the opposite evils of dryness and moisture, heat and cold, which the chemical action, if alone, would greatly mitigate.

The perplexity and erroneous deductions which have prevailed have been much increased by some writers of scientific celebrity. From analyzing specimens of remarkably fertile soils, and finding in most cases very large proportions of carbonate of lime, they have absurdly inferred that these were the most proper proportions. Hence, different chemists have indicated as the most suitable for the highest fertility of soil, proportions of this earth varying from 2 to 30 per cent. of the whole mass of soil. They who advocated the larger quantities were ignorant that perhaps nine-tenths of the

lime was either inert earth, or positively hurtful by its peculiar mechanical action; and that such soils, when highly fertile (as the mud of the Nile, with its 25 per cent.), were so by aid of their other useful ingredients, which enabled the soil to withstand the evil operation of the greater portion of its lime.

It is scarcely necessary to state that neither of the agricultural earths applied to soil can serve as a manure (i. e., have any *chemical* action), when there is already enough of the same earth present to have any mechanical action. And however useful each of the earths may be if applied where its chemical action is deficient, it would be as absurd in reasoning as useless in practice, to apply sand to sandy, and clay to clayey soils, or lime to the chalky, or vegetable matters to peaty soils.

The foregoing definitions and explanations offer some materials, or ground-work, for the classification of soils. But, greatly as that is needed, it is not designed here to attempt the construction of a proper general classification or nomenclature—which would serve to add another failure to those of all preceding writers on soils. But as it is impossible to discuss the subjects to be presented for consideration in this essay without the use and aid of some definite terms, I will adopt, for present and provisional use, the following general terms for soils, deduced from their respective predominant or most operative *physical* ingredients, and which will have relation only to mechanical constitution, and such qualities and characters of soils as are generally indicated by their texture, and are evident to the senses.

In reference, then, to physical predominating ingredients only, each of the agricultural earths above described, by its quantity, serves to make a different general character of soil—which, according to the predominant physical constituent earth, belongs to some one of the following five classes or general divisions of soils:—

1. A *silicious* or *sandy soil* contains so large a proportion of silicious earth, in the state of sand, as by its excess to give more or less of the peculiar texture and mechanical qualities of that earth to the soil. Thus, a silicious or sandy soil will show most strongly such qualities as openness, looseness, want of adhesiveness when wet, permeability, rapidity in drying, &c., such as are still more strongly shown by pure silicious sand.

2. An *aluminous, argillaceous, or clayey soil* contains such excess of aluminous earth, or purest clay, as will give to the soil the qualities of adhesiveness and plasticity when wet, more or less of obstruction to the passage or sinking of rain-water, great tendency to shrink in drying, and to hardness when dry, &c.

3. A *chalky, or super-calcareous soil*, whether made so by true chalk, or by any other form of calx or carbonate of lime, from any other source, contains an excess of that agricultural earth large

enough to be injurious, in any of the modes indicated to the physical properties above stated of that earth. No such soil exists in all Virginia, nor in any other of the Atlantic States north of Florida.

As these general divisions of soils are determined according to their predominating or most operative physical ingredient only, the term *calcareous soil* (of which such frequent use will be made in this essay) has been designedly omitted above. But to prevent misapprehension, it will be merely mentioned, in anticipation, that calcareous soil will be hereafter used as a still more comprehensive term, embracing not only all the super-calcareous soils, but all others that contain even the smallest appreciable proportion of carbonate of lime. Generally, however, the term calcareous will be that applied to soils in reference to their contents of small and harmless proportions of carbonate of lime (acting as a chemical constituent only or mainly); while those having larger and hurtful proportions will always be contra-distinguished as the chalky or super-calcareous.\*

4. A *magnesian soil* would be one in which magnesian earth is in sufficient excess to make its physical qualities predominate over the other earths serving as ingredients. Such soils are of doubtful existence; certainly of extremely rare occurrence.

5. A *humic, peaty, or vegetable soil*, has so large a proportion of humus that it is either injurious to production, or otherwise serves to counteract and overbalance the opposite injurious qualities of some other ingredient. Thus, a soil which by its aluminous constitution alone would have been very clayey, or another which would otherwise have been chalky, might have either of such defects of texture, &c., counteracted, and partially remedied, by a greater predominance of humus; and thereby be made a humic instead of either a clayey or chalky soil.

For an earth to be *predominant* and *excessive* in a soil, as understood above, and so to convey its qualities and its name, it is not necessary that it shall be the ingredient greatest in quantity—

---

\* The previous difficulties of definition and of understanding on this head, would be greatly increased by admitting the strange nomenclature of the latest writer, Professor J. P. W. Johnston, whose authority stands so high, and is so generally worthy of respect. He confines the term "calcareous soil" (by express definition) to such as contain *more than 20 per cent.* of carbonate of lime! Those containing from 5 to 10 per cent. he terms "marly soils;" and all containing less than 5 per cent. are left without any distinguishing term or character in regard to their calcareous constitution. (Johnston's Lectures, p. 238.) According to these designations, there would not be an acre of natural "calcareous soil," or even of "marly soil," in all Virginia; nor will there be, after all that shall be judiciously done by the industry of man in, supplying calcareous manure to the soils deficient in that ingredient.

which only is always the case as to silicious earth. Of this, in its pure and uncombined state, as sand (capable of being separated by washing in water), it requires a very large proportion, say not less than 80 per cent. of the whole mass, to constitute a sandy soil. But, in other soils, though consisting for much more than half their mass of uncombined silicious sand, a much smaller proportion of either one of the other earths would serve to make the latter the predominant ingredient, and properly to give character and name to the soil. Thus, from 35 to 40 per cent. of "purest clay" (which itself contains about 60 per cent. of silica), or 30 per cent. of calx, or 25 per cent. of humus, or perhaps less of each, under ordinary conditions, would serve to constitute, respectively, either a clayey, a chalky, or a humic soil; though, in each case, the other and much larger ingredients would be other earthy materials than the one so predominating.

But even in soils having some one physical ingredient sufficiently predominant and distinguished to indicate their general character and name, there also are usually apparent the manifest though weaker indications of the presence of some other influential ingredient. For such compound qualities, terms may be compounded of the foregoing, which will sufficiently express the characters referred to. For this purpose, there will be found a convenience in using also the term *loam* for all soils approaching to a medium texture and composition of the two usually most abundant ingredients, silicious sand and clay—or soils in which the opposite qualities of silicious and aluminous earths serve in great measure to correct each other, leaving no great or injurious excess of either. Such a medium texture, or soil approaching nearly to such, would be simply a *loam*. If still more sandy, it might be termed a *sandy loam*; or a *clayey* or *chalky*, or *peaty loam*, under other conditions of physical constitution. Besides all these and other such compounded terms, others may be used for other physical and accidental qualities of soils, as stony, gravelly, ferruginous, &c., any of which may apply to any soil of different predominant character, and different general designation.\*

---

\* The convenient and very common term *loam* is defined above (it is presumed) with enough precision and correctness; and also in accordance with common understanding. Yet this term offers (next, perhaps, to "marl") one of the strongest examples of the conflict of definitions and confusion which prevail among agricultural writers. This term is so common that it is used by every one who writes of soils—and which, in some one or other sense, each writer probably considered as forming a very large, if not the greatest proportion of the cultivated soils of his country, and of the world. Some of various and contradictory and erroneous definitions will be here quoted:—

Kirwan says—"Loam denotes any soil moderately cohesive, and more so



## CHAPTER II.\*

### ON THE SOILS AND STATE OF AGRICULTURE OF THE TIDE-WATER DISTRICT OF VIRGINIA.

—“DURING several days of our journey, no spot was seen that was not covered with a luxuriant growth of large and beautiful forest trees, except where they had been destroyed by the natives for the purpose of cultivation. The least fertile of their fields, when left untilled and without seeding, are soon covered with grass several feet in height; and unless prevented by subsequent cultivation, a second growth of trees rapidly springs up, which, without care or attention, attain their giant size in half the time that would be expected on the best lands in England.”

---

than loose chalk. By the author of the ‘Body of Agriculture,’ it is said to be a clay mixed with sand.” (Essay on Manures, ch. 1.)

“Loam, or that species of *artificial soil* into which the others are generally brought by the course of long cultivation.”—“Where a soil is moderately cohesive, less tenacious than clay, and more so than sand, it is known by the name of loam. From its frequency, there is reason to suppose that in some cases it might be called an ‘*original soil*.’” [Sinclair’s Code of Agriculture—chap. 1.]

“The word loam should be limited to soils containing at least one-third of impalpable earthy matter, *copiously effervescing with acids*.” [Davy’s Agricultural Chemistry—Lecture 4.] According to this definition by the most scientific writer and highest authority in chemical agriculture, if we except the small portion of shelly land, there is certainly not an acre of *natural loam* between the sea-coast of Virginia and the Blue Ridge Mountains—and very few even in the limestone region.

“By loam is meant any of the earths combined with decayed animal or vegetable matter.” [Appendix to Agr. Chem. by George Sinclair.]

“Loam—fat unctuous earth—marl.” [Johnson’s Dictionary, 8vo. ed., and also Walker’s.]

“Loam may be considered a clay of loose or friable consistency, mixed with mica or isinglass, and iron ochre.” [Editor of American Farmer, (old series) vol. iii., page 320.]

[\* In this and the next following seven chapters (II. to IX. inclusive), in which are set forth my peculiar views of the qualities of our soils, the general absence and want of calcareous earth, the mode of action of calcareous manures, and, in general, the theory of fertilization, the entire matter of the edition of 1832 has been scrupulously retained, without alteration, other than in a few transpositions of matter and merely verbal corrections, which have not at all altered the purport. Whatever else has been added, in later editions and the present, whether to the text or as notes, will be designated by being enclosed in brackets, and will also, in most cases, be marked with the date of the edition, or the writing, in which such additional passages first appeared.—1852.]

If the foregoing description was met with in a 'Journey through Cabul,' or some equally unknown region, no European reader would doubt that such lands were fertile in the highest degree—and many even of ourselves would receive the same impression. Yet it is no exaggerated account of the poorest natural soils in our own generally poor country, which are as remarkable for their producing luxuriant growths of pines, and broom-grass, as for their unproductiveness in every cultivated or valuable crop. We are so accustomed to these facts, that we scarcely think of their strangeness; or of the impropriety of calling any land barren, which will produce a rapid or heavy growth of any one plant. Indeed, by the rapidity of that growth (or the fitness of the soil for its production), we have in some measure formed a standard of the poverty of the soil.

With some exceptions to every general character, the tide-water district of Virginia may be described as generally level, sandy, poor, and free from any fixed rock, or any other than stones rounded apparently by the attrition of water. On much the greater part of the lands, no stone of any kind is to be found of larger size than gravel. Pines of different kinds form the greater part of a heavy cover to the silicious soils in their virgin state, and mix considerably with oaks and other growth of clay land. Both these kinds of soil, after being exhausted of their little fertility by cultivation, and "turned out" to recruit, are soon covered by young pines which grow with vigour and luxuriance. This general description applies more particularly to the *ridges* which separate the *slopes* on different streams. The ridge lands are always level, and very poor—sometimes clayey, more generally sandy, but stiffer than would be inferred from the proportion of silicious earth they contain, which is caused by the fineness of its particles. Whortleberry bushes, as well as pines, are abundant on ridge lands—and numerous shallow basins are found, which are ponds of rain water in winter, but dry in summer. None of this large proportion of our lands has paid the expense of clearing and cultivation, and much the greater part still remains under its native growth. Enough, however, has been cleared and cultivated in every neighbourhood to prove its utter worthlessness under common management. The soils of ridge lands vary between sandy loam and clayey loam. It is difficult to estimate their general product under cultivation; but judging from my own experience of such soils, the product may be from five bushels of corn, or as much of wheat, to the acre on the most clayey soils, to twelve bushels of corn, and less than three of wheat, on the most sandy—if wheat were there attempted to be made.

The *slopes* extend from the ridges to the streams, or to the alluvial bottoms, and include the whole interval between neighbouring branches of the same stream. This class of soils forms another

great body of lands, of a higher grade of fertility, though still far from valuable. It is generally more sandy than the poorer ridge land, and when long cultivated, is more or less deprived of its soil, by the washing of rains, on every slight declivity. The washing away of three or four inches in depth exposes a sterile subsoil (or forms a "gall"), which continues thenceforth bare of all vegetation. A greater declivity of the surface serves to form gullies several feet in depth, the earth carried from which covers and injures the adjacent lower land. Most of this kind of land has been cleared and greatly exhausted. Its virgin growth is often more of oak, hickory, and dogwood, than pine; but when turned out of cultivation, an unmixed growth of pine follows. Land of this kind in general has very little durability. Its best usual product of corn may be, for a few crops, eighteen or twenty bushels—and even as much as twenty-five bushels, from the highest grade. Wheat is seldom a productive or profitable crop on the slopes, the soil being generally too sandy. When such soils as these are called rich or valuable (as most persons would describe them), those terms must be considered as only comparative; and such an application of them proves that truly fertile and valuable soils are very scarce in lower Virginia.

Almost the only very rich and durable soils below the falls of our rivers are narrow strips of high-land along their banks, and the low-lands formed by the alluvion of the numerous smaller streams which water our country. These alluvial bottoms, though highly productive, are lessened in value by being generally too sandy, and by the damage they suffer from being often inundated by floods of rain. The best high-land soils seldom extend more than half a mile from the river's edge—sometimes not fifty yards. These irregular margins are composed of loams of various qualities, but all highly valuable; and the best soils are scarcely to be surpassed in their original fertility, and durability under severe tillage. Their nature and peculiarities will be again adverted to, and more fully described hereafter.

The simple statement of the general course of tillage to which this part of the country has been subjected, is sufficient to prove that great impoverishment of the soil has been the inevitable consequence. The small portion of rich river margin was soon all cleared, and was tilled without cessation for many years. The clearing of the slopes was next commenced, and is not yet entirely completed. On these soils, the succession of crops was less rapid, or, from necessity, tillage was sooner suspended. If not rich enough for tobacco when first cleared (or as soon as it ceased to be so), land of this kind was planted in corn two or three years in succession, and afterwards every second year. The intermediate year between the crops of corn, the field was "rested" under a

crop of wheat, if it would produce four or five bushels to the acre. If the sandiness, or exhausted condition of the soil, denied even this small product of wheat, that crop was probably not attempted; and, instead of it, or oats, the field was exposed to close grazing, from the time of gathering one crop of corn to that of preparing to plant another. No manure was applied, except on the tobacco lots; and this succession of a grain crop every year, and afterwards every second year, was kept up as long as the field would produce five bushels of corn to the acre. When reduced below that product, and to still more below the necessary expense of cultivation, the land was turned out to recover under a new growth of pines. After twenty or thirty years, according to the convenience of the owner, the same land would be again cleared, and put under similar scourging tillage, which, however, would then much sooner end, as before, in exhaustion. Such a general system is not yet everywhere abandoned; and many years have not passed since such was the usual course on almost every farm.

How much our country has been impoverished during the last fifty years, cannot be determined by any satisfactory testimony. But, however we may differ on this head, there are but few who will not concur in the opinion, that [up to 1831] our system of cultivation has been every year lessening the productive power of our lands in general—and that no one county, no neighbourhood, and but few particular farms, have been at all enriched since their first settlement and cultivation. Yet many of our farming operations have been much improved and made more productive. Driven by necessity, proprietors direct more personal attention to their farms—better implements of husbandry are used—every process is more perfectly performed—and, whether well or ill directed, a spirit of inquiry and enterprise has been awakened, which before had no existence.

Throughout the country below the falls of the rivers, and perhaps thirty miles above, if the best land be excluded, say one-tenth, the remaining nine-tenths will not yield an average product of ten bushels of corn to the acre; though that grain is best suited to our soils in general, and far exceeds in quantity all other kinds raised. Of course, the product of a large proportion of the land would fall below this average. Such crops, in very many cases, cannot remunerate the cultivator. If our remaining wood-land could be at once brought into cultivation, the *gross* product of the country would be greatly increased; but the *nett* product very probably diminished; as the general poverty of these lands would cause more expense than profit to accompany their cultivation under the usual system. Yet every year we are using all our exertions to clear wood-land, and in fact seldom increase either nett or gross products—because nearly as much old exhausted land is turned out of cul-

tivation as is substituted by the newly cleared. Sound calculations of profit and loss would induce us even greatly to reduce the extent of our present cultivation, in lower Virginia, by turning out and leaving waste (if not to be improved), every acre that yields less than the total cost of its tillage.\*

No political truth is better established than that the population of every country will increase, or diminish, according to its regular supply of food. We know from the census of 1830, compared with those of 1820 and 1810, that our population is nearly stationary, and, in some counties, is actually lessening; and therefore it is certain that [to 1830] our agriculture in general is not increasing the amount of food, or the means of purchasing food—with all the assistance of the new land annually brought under culture. In these circumstances, a surplus population, with all its deplorable consequences, is only prevented by the great current of emigration which is continually flowing westward. No matter who emigrates, or with what motive—the enterprising or wealthy citizen who leaves us to seek richer lands and greater profits, and the slave sold and carried away on account of his owner's poverty—all concur in producing the same result, though with very different degrees of benefit to those who remain. If this great and continued drain from our population was stopped, and our agriculture was not improved, want and misery would work to produce the same results. Births would diminish, and deaths would increase; and hunger and disease, operating here as in other countries, would keep down population to that number that the average products of our agricultural and other productive labour can feed, and supply with the other necessary means for living.

A stranger to our situation and habits might well oppose to my statements the very reasonable objection, that no man would, or could, long pursue a system of cultivation of which the returns fell short of his expenses, including rent of land, hire of labour, interest on the necessary capital, &c. Very true; if he had to pay those expenses out of his profits, he would soon be driven from his farm to a jail. But we own our land, our labourers, and stock; and though the calculation of nett profit, or of loss, is precisely the same, yet we are not ruined by making only two per cent. on our capital,

---

[\* The foregoing description was written in 1826, and first published in 1831, and particular exceptions to the general correctness of the application had been even then recently exhibited; and, with the passage of every year since, these exceptions have been becoming more numerous and more important, and in a rapidly increasing ratio. These recent facts of improved lands and increased production, as well as their peculiar causes, will be treated of subsequently. The observations and deductions presented in the remainder of this chapter were also of the same date as the foregoing statements, on which they are founded. (1842.) ]

provided we can manage to live on that income. If we live on still less, we are actually growing richer (by laying up a part of our two per cent.), notwithstanding the most clearly-proved regular loss on our farming.

Our condition has been so gradually growing worse, that we are either not aware of the extent of the evil, or are in a great measure reconciled by custom to profitless labour. No hope for a better state of things can be entertained, until we shake off this apathy—this excess of contentment, which makes no effort to avoid existing evils. I have endeavoured to expose what is worst in our situation as farmers; if it should have the effect of arousing any of my countrymen to a sense of the absolute necessity of some improvement, to avoid ultimate ruin, I hope also to point out to some of their number, if not to all, that the means for certain and highly profitable improvements are completely within their reach.

---

### CHAPTER III.

#### THE DIFFERENT CAPACITIES OF SOILS FOR RECEIVING IMPROVEMENT.

As far as the nature of the subjects permitted, the foregoing chapters have been merely explanatory and descriptive. The same subjects will be resumed and more fully treated in the course of the following general argument, the premises of which are the facts and circumstances that have been detailed. The object of this essay will now be entered upon; and what is desired to be proved will be stated in a series of propositions, which will now be presented at one view, and afterwards separately discussed in their proper order.

*Proposition 1.* Soils naturally poor, and rich soils reduced to poverty by cultivation, are essentially different in their powers of retaining putrescent (or alimentary) manures; and, under like circumstances, the fitness of any soil to be enriched by these manures is in proportion to the degree of its natural fertility.

2d. The natural sterility of the soils of lower Virginia is caused by such soils being destitute of calcareous earth, and their being injured by the presence and effects of vegetable acid.

3d. The fertilizing effects of calcareous earth are chiefly produced by its power of neutralizing acids, and of combining putres-

cent manures with soils, between which there would otherwise be but little if any chemical attraction.\*

4th. Poor and acid soils cannot be improved durably, or profitably, by putrescent manures, without previously making such soils calcareous, and thereby correcting the natural defect in their constitution.

5th. Calcareous manures will give to our worst soils a power of retaining putrescent manures, equal to that of the best—and will cause more productiveness, and yield more profit, than any other improvement practicable in lower Virginia.

Dismissing from consideration, for the present, all the others, I shall proceed to maintain the

**FIRST PROPOSITION.**—*Soils naturally poor, and rich soils reduced to poverty by cultivation, are essentially different in their powers of retaining putrescent (or alimentary) manures; and, under like circumstances, the fitness of any soil to be enriched by these manures is in proportion to the degree of its natural fertility.*

The natural fertility of a soil is not intended to be estimated by the amount of its earliest product, when first brought under cultivation, because several temporary causes then operate either to keep down or to augment the product. If land be cultivated immediately after the trees are cut down, the crop is greatly lessened by the numerous living roots, and consequent bad tillage—by the excess of unrotted vegetable matter—and the coldness of the soil, from which the rays of the sun had been so long excluded. On the other hand, if cultivation is delayed one or two years, the leaves and other vegetable matters are rotted, and in the best state to supply food to plants, and are so abundant, that a far better crop will be raised than could have been obtained before, or perhaps can be again, without manure. For these reasons, the degree of natural fertility of any soil should be measured by its products after these

---

\* When any substance is mentioned as *combining* with one or more other substances, as different manures with each other, or with soil, I mean that a union is formed by chemical attraction, and not by simple mixture. *Mixtures* are made by mechanical means, and may be separated in like manner; but *combinations* are chemical, and require some stronger chemical attraction, to take away either of the bodies so united.

When two substances combine, they both lose their previous peculiar qualities, or *neutralize* them for each other, and form a third substance different from both. Thus, if certain known proportions of *muratic acid* and pure or caustic *soda* be brought together, their strong attraction will cause them to combine immediately. The strong corrosive acid quality of the one, and the equally peculiar alkaline taste and powers of the other, will *neutralize* or entirely destroy each other—and the compound formed is *common table salt*, the qualities of which are as strongly marked, but totally different from those of either of its constituent parts.

temporary causes have ceased to act, which will generally take place before the third or fourth crop is obtained. According, then, to this definition, a certain degree of *permanency* in its early productiveness is necessary to entitle a soil to be termed *naturally fertile*. It is in this sense that I deny to any poor lands, except such as were naturally fertile, the capacity of being made rich by putrescent manures only.

The foregoing proposition would by many persons be so readily admitted as true, that attempting to prove it would be deemed entirely superfluous. But many others will as strongly deny its truth, and can support their opposition by high agricultural authorities.

General readers, who may have no connexion with farming, must have gathered from the incidental notices in various literary and descriptive works, that some countries or districts that were noted for their uncommon fertility or barrenness as far back as any accounts of them have been recorded, still retain the same general character, through every change of culture, government, and even of races of inhabitants. They know that, for some centuries at least, there has been no change in the strong contrast between the barrenness of Norway, Brandenburg, and the Highlands of Scotland, and the fertility of Flanders, Lombardy, and Valencia. Sicily, notwithstanding its government is calculated to discourage industry, and production of every profitable kind, still exhibits that fertility for which it was celebrated two thousand years ago. It seems a necessary inference from the many statements of which these are examples, that the labours of man have been but of little avail in altering, generally or permanently, or in any marked degree, the characters and qualities given to soils by nature.

Most of our experienced practical cultivators, through a different course, have arrived at the same conclusion. Their practice has taught them the truth of this proposition; and the opinions thus formed have profitably directed their most important operations. They are accustomed to estimate the worth of land by its natural degree of fertility; and by the same rule they are directed on what soils to bestow their scanty stock of manure, and where to expect exhausted fields to recover by rest, and their own unassisted powers. But, content with knowing the fact, this useful class of farmers have never inquired for its cause; and even their opinions on this, as on most other subjects, have not been communicated so as to benefit other cultivators.

But if all literary men, who are not farmers, and all practical cultivators, who seldom read, admitted the truth of my proposition, it would avail but little for improving our agricultural operations; and the only prospect of its being usefully disseminated is through that class of farmers who have received their first opinions of im-



proving soils from books, and whose subsequent plans and practices have grown out of those opinions. If poor natural soils cannot be durably or profitably improved by putrescent manures, this truth should not only be known, but be kept constantly in view, by every farmer who can hope to improve with success. Yet it is a remarkable fact, that the difference in the capacities of soils for receiving improvement has not attracted the attention of scientific farmers; and the doctrine has no direct and positive support from the author of any treatise on agriculture, European or American, that I have been able to consult. On the contrary, it seems to be considered by all of them, that to collect and apply as much vegetable and animal manure as possible, is sufficient to insure profit to every farmer, and fertility to every soil. They do not tell us that numerous exceptions to that rule will be found, and that many soils of apparently good texture, if not incapable of being enriched from the barn-yard, would at least cause more loss than clear profit, by being improved from that source.

When it is assumed that the silence of every distinguished author as to certain soils being incapable of being profitably enriched, amounts to ignorance of the fact, or a tacit denial of its truth—it may be objected that the exception was not omitted from either of these causes, but because it was established and undoubted. This is barely possible; but even if such were the case, their silence has had all the ill consequences that could have grown out of a positive denial of any exceptions to the propriety of manuring poor soils. Every zealous young farmer, who draws most of his knowledge and opinions from books, adopts precisely the same idea of their directions—and if he owns barren soils he probably throws away his labour and manure for their improvement, for years, before experience compels him to abandon his hopes, and acknowledge that his guides have led him only to failure and loss. Such farmers as I allude to, by their enthusiasm and spirit of enterprise, are capable of rendering the most important benefits to agriculture. Whatever may be their impelling motives, the public derives nearly all the benefit of their successful plans; and their far more numerous mis-directed labours, and consequent disappointments, are productive of national, still more than individual loss. The occurrence of only a few such mistakes, made by reading farmers, will serve to acquit me of combating a shadow—and there are few of us who cannot recollect some such examples.

But if the foregoing objection has any weight in justifying European authors in not naming this exception, it can have none for those of our own country. If it be admitted that soils naturally poor are incapable of being enriched with profit, that admission must cover three-fourths of all the high land in the tide-water district. Surely no one will contend that so sweeping an exception

was silently understood by the author of '*Arator*,' as qualifying his exhortations to improve our lands; and if no such exception were intended to be made, then will his directions for enriching soils and his promises of reward be found equally fallacious, for the greater portion of the country which his work was especially intended to benefit. The omission of any such exception, by the writers of the United States, is the more remarkable, as the land has been so recently brought under cultivation, that the original degree of fertility of almost every farm may be known to its owner, and compared with the after progress of exhaustion or improvement.

Many authorities might be adduced to prove that I have correctly stated what is the fair and only inference to be drawn from agricultural books, respecting the capacity of poor soils to receive improvement. But a few of the most strongly marked passages in '*Arator*' will be fully sufficient for this purpose. The venerated author of that work was too well acquainted with the writings of European agriculturists, to have mistaken their doctrines in this important particular. A large portion of his useful life was devoted to the successful improvement of exhausted, but originally fertile lands. His instructions for producing similar improvements are expressly addressed to the cultivators of the eastern parts of Virginia and North Carolina, and are given as applicable to all our soils, without exception. Considering all these circumstances, the conclusions which are evidently and unavoidably deduced from his work, may be fairly considered, not only as supported by his own experience, but as concurring with the general doctrine of improving poor soils, maintained by previous writers.

At page 54, third edition of '*Arator*,' "*enclosing*" (i. e. leaving fields to receive their own vegetable cover, for their improvement, during the years of rest) is said to be "the most powerful means of fertilizing the earth"—and the process is declared to be rapid, the returns near, and the gain great.

At page 61 are the following passages: "If these few means of fertilizing the country (corn-stalks, straw, and animal dung) were skilfully used, they would of themselves suffice to change its state from sterility to fruitfulness."—"By the litter of Indian corn, and of small grain, and of penning cattle, managed with only an inferior degree of skill, in union with enclosing, I will venture to affirm that a farm may in ten years be made to double its produce, and in twenty to quadruple it."

No opinions could be more strongly or unconditionally expressed than these. No reservation or exception is made. I may safely appeal to each of the many hundreds who have attempted to obey these instructions, to declare whether any one considered his own naturally poor soils excluded from the benefit of these promises—or

whether a tithe of the promised benefit was realized upon trial on any farm having generally such soils.

In a field of mine that has been secured from grazing since 1814, and cultivated on the mild four-shift rotation, the produce of a marked spot has been measured every fourth year (when in corn) since 1820. The difference of product has been such as the differences of season might have caused—and the last crop (in 1828) was worse than those of either of the two preceding courses. There is no reason to believe that even the smallest increase of productive power had taken place in all the preceding fourteen years. [Nor has there been, to 1841, in the apparent products of this ground, any manifestation that there has been any more of subsequent than of previous improvement, from the vegetable manurings furnished by its growth. 1842.]

[A still more striking proof, because of the much larger scale, as well as long continuance of the experiment, has been very recently (in 1842), as well as in former times, mentioned to me, as confirmation of my views in this respect. Col. George Blow, of Sussex, a highly respectable gentleman and intelligent and observant farmer, had adhered for nearly thirty years to Taylor's "enclosing system," and with a very mild rotation, on a farm of 600 arable acres, of sandy soil, and originally poor; and had taken but one crop (corn) in every three years. A few spots only of better quality (the sites of old buildings, &c.) were put in wheat or oats after the corn; the great body of the land having had regularly two years in three to rest, and to manure itself by its volunteer growth of weeds and grass. Very little grazing, and that but rarely, was permitted. There could have been no material mistake as to the general products and results; and the proprietor is confident that the land has not improved in production in all this long time. Yet, on soil differently constituted, Col. Blow has improved and increased the products, rapidly and profitably. These two facts, though observed more particularly and for longer time than any others known, agree with, and are but confirmatory of others presented to some extent on almost every farm in the tide-water region of Virginia. 1842.]

It is far from my intention, by these remarks, and statements of facts, to deny the propriety, or to question the highly beneficial results, of applying the system of improvement recommended by 'Arator,' to soils originally fertile. On the contrary, it is as much my object to maintain the facility of restoring to worn lands their natural degree of fertility, by vegetable applications, as it is to deny the power of exceeding that degree, however low it may have been.

One more quotation will be offered, because its recent date and the source whence it is derived furnish the best proof that it is still

the received opinion, among agricultural writers, that all soils may be profitably improved by putrescent manures. An article in the '*American Farmer*,' of October 14th, 1831, on "manuring large farms," by the editor (G. B. Smith), contains the following expressions. "By proper exertions, every farm in the United States can be manured with less expense than the surplus profits arising from the manure would come to. This we sincerely believe, and we have arrived at this conclusion from long and attentive observation. We never yet saw a farm that we could not point to means of manuring, and bring into a state of high and profitable cultivation at an expense altogether inconsiderable when contrasted with the advantages to be derived from it." The remainder of the article shows that putrescent manures are principally relied on to produce these effects; marsh and swamp mud are the only kinds referred to that are not entirely putrescent in their action; and mud certainly cannot be used to manure every farm. Mr. Smith having been long the conductor of a valuable agricultural journal, as a matter of course, is extensively acquainted with the works and opinions of the best writers on agriculture; and therefore, his advancing the foregoing opinions, as certain and undoubted, is as much a proof of the general concurrence therein of preceding writers, as if the same had been given as a digest of their precepts.\*

Some persons will readily admit the great difference in the capacities of soils for improvement, but consider a deficiency of clay only to cause the want of power to retain manures. The general excess of sand in our poor lands might warrant this belief in a superficial and limited observer. But though clay soils are more rarely met with, they present, in proportion to their extent, full as much poor land. The most barren and worthless soils in the county of Prince George are also the stiffest. A poor clay soil will retain manure longer than a poor sandy soil—but it will not the less certainly lose its acquired fertility at a somewhat later period. When it is considered that a much greater quantity of manure is required by clay soils, it may well be doubted whether the tem-

---

[\* Though not then known to me, and probably to few if any others in America, there was then in print the expression of the opinion which I have announced and maintained above. This exception I subsequently met with, and republished the article in the *Farmer's Register* (Vol. iv. p. 335.) It was a communication from the excellent practical farmer, William Dawson, of Scotland, to the *Farmer's Magazine*, published in Edinburgh. In this communication, the writer, and, so far as I know, he only, before myself, asserts opinions which approach very nearly to the doctrine above maintained, of the incapacity of naturally poor soils for being profitably or durably improved by putrescent manures alone—and also their newly acquired fitness for being enriched after having been limed.]

porary improvement of the sandy soils would not be attended with more profit—or, more properly speaking, with less actual loss.

It is true that the capacity of a soil for improvement is greatly affected by its texture, shape of the surface, and its supply of moisture. Dry, level, or clay soils, will retain manure longer than the sandy, hilly, or wet. But however important these circumstances may be, neither the presence nor absence of any of them can cause the essential differences of capacity for improvement. There are some rich and valuable soils with either one or more of all these faults—and there are other soils the least capable of receiving improvement, free from objections as to their texture, degree of moisture, or inclination of their surface. Indeed the great body of our poor ridge lands are more free from faults of this kind, than soils of far greater productiveness usually are. Unless then some other and far more powerful obstacle to improvement exists, why should not all our wood-land be highly enriched, by the thousands of crops of leaves which have successively fallen and rotted there? Notwithstanding this vegetable manuring, which infinitely exceeds all that the industry and patience of man can possibly equal, most of our wood-land remains poor; and this one fact (which at least is indisputable) ought to satisfy all of the impossibility of enriching such soils by putrescent manures only. Some few acres may be highly improved, by receiving all the manure derived from the offal of the whole farm—and entire farms, in the neighbourhood of towns, may be kept rich by continually applying large quantities of purchased manures. But no where can a farm be found, which has been improved beyond its original fertility, by means of the vegetable resources of its own arable fields. If this opinion is erroneous, nothing is easier than to prove my mistake, by adducing undoubted examples of such improvements having been made.

But a few remarks will suffice on the capacity for improvement of worn lands, which were originally fertile. With regard to these soils, I have only to concur in the received opinion of their fitness for durable and profitable improvement by putrescent manures. After being exhausted by cultivation, they will recover their productive power, by merely being left to rest for a sufficient time, and receiving the manure made by nature, of the weeds and other plants that grow and die upon the land. Even if robbed of the greater part of that supply, by the grazing of animals, a still longer time will serve to obtain the same result. The better a soil was at first, the sooner it will recover by these means, or by artificial manuring. On soils of this kind, the labours of the improving farmer meet with certain success and full reward; and whenever we hear of remarkable improvements of poor lands by putrescent

manures, further inquiry will show us that these poor lands had once been rich.

The continued fertility of certain countries, for hundreds or even thousands of years, does not prove that the land could not be, or had not been, exhausted by cultivation; but only that it was slow to exhaust and rapid in recovering; so that whatever repeated changes may have occurred in each particular tract, the whole country taken together always retained a high degree of productiveness. Still the same rule will apply to the richest and the poorest soils—to wit, that each exerts strongly a force to retain as much fertility as nature gave to it—and that when worn and reduced, each kind may easily be restored to its original state, but cannot be raised higher, with either durability or profit, by putrescent manures, whether applied by the bounty of nature, or the industry of man.



## CHAPTER IV.

### EFFECTS OF THE PRESENCE OF CALCAREOUS EARTH IN SOILS.

**PROPOSITION 2.**—*The natural sterility of the soils of lower Virginia is caused by such soils being destitute of calcareous earth, and their being injured by the presence and effects of vegetable acid.*

The means which would appear the most likely to lead to the causes of the different capacities of soils for improvement is to inquire whether any known ingredient or quality is always to be found belonging to improvable soils, and never to the unimprovable—or which always accompanies the latter, and never the former kind. If either of these results can be obtained, we will have good ground for supposing that we have discovered the general cause of fertility, in the one case, or of barrenness, in the other; and it will follow that, if we can supply to barren soils the deficient beneficial ingredient—or can destroy that which is injurious to them—their incapacity for receiving improvement will be removed. All the common ingredients of soils, as sand, clay, or gravel—and such qualities as moisture or dryness—a level, or a hilly surface—however they may affect the value of soils, are each sometimes found exhibited, in a remarkable degree, in both the fertile and the sterile. The abundance of putrescent vegetable matter might well be considered the cause of fertility, by one who judged only from lands long under cultivation. But though vegetable matter in sufficient quantity is essential to the existence of fertility, yet will

this substance also be found inadequate for the cause. Vegetable matter abounds in all rich land, it is admitted; but it has also been furnished by nature, in quantities exceeding all computation, to the most barren soils known.

But there is one ingredient of which not the smallest proportion can be found in any of our poor soils, and which, wherever found, (and not in great excess), indicates a soil remarkable for natural and durable fertility. This is *calcareous earth*, or carbonate of lime. These facts alone, if sustained, will go far to prove that this earth is the cause of fertility, and the cure for barrenness.

On some part of most farms touching tide-water, either mussel or oyster shells are found mixed with the soil. Oyster shells are confined to the lands on salt water, where they are very abundant, and sometimes extend through large fields. Higher up the rivers, mussel shells only are to be seen thus deposited by nature, or by the aboriginal inhabitants, and they decrease as we approach the falls of the rivers. The proportion of shelly land in the counties highest on tide-water is very small; but the small extent of these spots does not prevent, but rather aids, the exhibition of the peculiar qualities of such soils. Spots of shelly land, not exceeding a few acres in extent, could not well have been cultivated differently from the balance of the fields of which they formed parts—and therefore they can be better compared with the worse soils under like treatment. Every acre of shelly land is, or has been, remarkable for its richness, and still more for its durability. There are few farmers among us who have not heard described tracts of shelly soil on Nansemond and York rivers, which are celebrated for their long resistance of the most exhausting course of tillage, and which still remain fertile, notwithstanding all the injury which they must have sustained from their severe treatment. We are told that on some of these lands, corn has been raised every successive year, without any help from manure, for a longer time than the owners could remember, or could be informed of correctly. But without relying on any such remarkable cases, there can be no doubt that every acre of our shelly land has been at least as much tilled, and as little manured, as any in the country; and that it is still the richest and most valuable of all our old cleared lands.

The fertile but narrow strips, along the banks of our rivers (which form the small portion of our high-land of first-rate quality), seldom extend far without exhibiting spots in which shells are visible, so that the eye alone is sufficient to prove the soil of such places to be calcareous. The similarity of natural growth, and of all other marks of character, are such, that the observer might very naturally infer that the former presence of shells had given the same valuable qualities to all these soils—but that they had so generally rotted, and been incorporated with the other earths, that

they remained visible only in a few places, where they had been most abundant. The accuracy of this inference will hereafter be examined.

The natural growth of the shelly soils (and of those adjacent of similar value) is entirely different from that of the great body of our lands. Whatever tree thrives well on the one, is seldom found on the other class of soils—or, if found, it shows plainly, by its imperfect and stunted condition, on how unfriendly a soil it is placed. To the rich river margins are almost entirely confined the black or wild locust, hackberry or sugar-nut tree, and papaw. The locust is with great difficulty eradicated, or the newer growth of it kept under on cultivated lands; and from the remarkable rapidity with which it springs up and increases in size, it forms a serious obstacle to the cultivation of land on the river banks. Yet on the wood-land only a mile or two from the river, not a locust is to be seen. On shelly soils, pines and broom-grass [*Andropogon scoparius*] cannot thrive, and are rarely able to maintain even the most sickly growth.

Some may say that these striking differences of growth do not so much show a difference in the constitution of the soils, as in their state of fertility; or that one class of the plants above named delights in rich, and the other in poor land. No plant prefers poor to rich soil—or can thrive better on a scarcity of food, than with an abundant supply. Pine, broom-grass, and sheep-sorrel, delight in a class of soils that are generally unproductive—but not on account of their poverty; for all these plants show, by the greater or less vigour of their growth, the abundance or scarcity of vegetable matter in the soil. But on this class of soils, no quantity of vegetable manure could make locusts flourish, though they will grow rapidly on a calcareous hill-side, from which all the soil capable of supporting other ordinary plants has been washed away.

In thus describing and distinguishing soils by their growth, let me not be understood as extending these rules, without exception, to other soils and climates than our own. It is well established that changes of kind in successive growths of timber have occurred in other places, without any known cause; and a difference of climate may elsewhere produce effects, which here would indicate a change of soil.

Some rare apparent exceptions to the general fertility of shelly lands are found where the proportion of calcareous earth is in great excess. Too much of this ingredient causes even a greater degree of sterility than its total absence. This cause of barrenness is very common in France and England (on chalk soils), and very extensive tracts are not worth the expense of cultivation, or improvement. The few small spots that are rendered barren here are seldom (if ever) so affected by the excess of oyster or mussel shells



in the soil. These effects generally are caused by beds of fossil sea-shells, which in some places reach the surface, and are thus exposed to the plough. These spots (which are the only super-calcareous or chalky soils of this region) are not often more than thirty feet across, and their nature is generally evident to the eye; and if not, is so easily determined by chemical tests, as to leave no reason for confounding the injurious and beneficial effects of calcareous earth. This exception to the general fertilizing effect of this ingredient of our soils would scarcely require naming, but to mark what might be deemed an apparent contradiction. But this exception, and its cause, must be kept in mind, and considered as always understood and admitted throughout all my remarks, and which therefore it is not necessary to name specially, when the general qualities of calcareous earth are spoken of. [After all, this exception is only in appearance, as it is found only in *super-calcareous* soils, and never in any soil in which calcareous earth is not so abundant as to form a physical material.—1849.]

In the beginning of this chapter, I advanced the important fact that none of our poor soils contain naturally the least particle of calcareous earth. So far, this is supported merely by my assertion—and all those who have studied agriculture in books will require strong proof before they can give credit to the existence of a fact, which is either unsupported, or indirectly denied, by all written authority. Others, who have not attended to such descriptions of soils in general, may be too ready to admit the truth of my assertion—because, not knowing the opinions on this subject heretofore received and undoubted, they would not be aware of the importance of their admission.

It is true that no author has said expressly that every soil contains calcareous earth. Neither perhaps has any one stated that every soil contains some silicious or aluminous earth. But the manner in which each one has treated of soils and their constituent parts, would cause their readers to infer that neither of these three earths is ever entirely wanting—or at least that the entire absence of the calcareous is as rare as the absence of silicious or aluminous earth. Nor are we left to gather this opinion solely from indirect testimony, as the following examples, from the highest authorities, will prove. Davy says, “four earths generally abound in soils, the aluminous, the silicious, the calcareous, and the magnesian;”\* and the soils of which he states the constituent parts, obtained by chemical analysis, as well as those reported by Kirwan, and by Young, all contain some proportion (and generally a large proportion) of calcareous earth.† Kirwan states the component parts of

\* Davy's Agr. Chem., Lecture 1.

† Agr. Chem., Lect. 4.—Kirwan on Manures,—and Young's Prize Essay on Manures.

a soil which contained thirty-one per cent. of calcareous earth, and he supposes that proportion neither too little nor too much.\* Young mentions soils of extraordinary fertility containing seventeen and twenty per cent., besides others with smaller proportions of calcareous earth—and says that Bergman found thirty per cent. in the best soil he examined.† Rozier speaks still more strongly for the general diffusion and large proportions of this ingredient of soils. In his general description of earths and soils, he gives examples of the supposed composition of the three grades of soils which he designates by the terms *rich*, *good*, and *middling soils*; to the first class he assigns a proportion of one-tenth, to the second, one-fourth, and to the last, one-half of its amount of calcareous earth. The fair interpretation of the passage is that the author considered these large proportions as general, in France—and he gives no intimation of any soil entirely without calcareous earth.‡

The position assumed above, of the general or universal concurrence of former European authors in the supposed general presence of calcareous earth in soils, could be placed beyond dispute by extracts from their publications. But this would require many and long extracts, too bulky to include here, and which cannot be fairly abridged, or exhibited by a few examples. No author says directly, indeed, that calcareous earth is present in all soils; but its being always named as one of the ingredients of soils in general, and no cases of its absolute deficiency in tilled lands being directly stated, amount to the declaration that calcareous earth is very rarely, if ever, entirely wanting in any soil. We may find enough directions to apply calcareous manures to soils that are deficient in that ingredient; but that deficiency seems to be not spoken of as *absolute*, but *relative* to other soils more abundantly supplied. In the same manner, writers on agriculture direct clay, or sand, to be used as manure for soils very deficient in one or the other of those earths; but without meaning that any soil under cultivation can be found entirely destitute of sand or of clay. My proofs from general treatises would therefore be generally indirect; and the quotations

\* Kirwan on Manures, article "Clayey Loam."

† Young's Essay on Manures.

‡ "Composition of soils. Examples of the various composition of soils: *Rich soil*; silicious earth, 2 parts; aluminous, 6; calcareous, 1; vegetable earth, [*humus*] 1; in all, 10 parts. *Good soil*—silicious, 3 parts; aluminous, 4; calcareous, 2½; vegetable earth, ½ of 1 part; in all, 10 parts. *Middling soil* [*sol mediocre*]; silicious, 4 parts; aluminous, 1; calcareous, 5 parts, less by some atoms of vegetable earth; in all, 10 parts. We see that it is the largest proportion of aluminous earth that constitutes the greatest excellence of soils; and we know that independently of their harmony of composition, they require a sufficiency of depth."—Translated from the article "*Terres*," in the "*Cours Complet d'Agriculture Pratique*," etc. par l'Abbe Rozier," 1815.

necessary to exhibit them would show what had *not* been said, rather than what *had*—and that they did *not* assert the absence of calcareous earth, instead of directly asserting its universal presence. Extracts for this purpose, however satisfactory, would necessarily be too voluminous, and it is well that they can be dispensed with. Better proof, because it is direct, and more concise, will be furnished by quoting the opinions of a few agriculturists of our own country, who were extensively acquainted with European authors, and have evidently drawn their opinions from those sources. These quotations will not only show conclusively that their authors consider the received European doctrine to be that all soils are more or less calcareous—but also, that they apply the same general character to the soils of the United States, without expressing a doubt or naming an exception. These writers, as all who have heretofore written of soils in this country, have uttered but the echoes of preceding English general descriptions of soils. They seem not to have suspected that any very important difference existed in this respect between the soils of England and of this country; and certainly not one had made the slightest investigation by any attempt at chemical analysis, to sustain the false character thus given to our soils.

1. From a "Treatise on Agriculture" (ascribed to General Armstrong), published in the *American Farmer*. [Vol. i. page 153.]

"Of six or eight substances, which chemists have denominated earths, four are *widely and abundantly diffused*, and form the crust of our globe. These are silica, alumina, lime, and magnesia."—"In a pure or isolated state, these earths are wholly unproductive; but when decomposed and mixed, and to this mixture is added the residuum of dead animal or vegetable matter, they become fertile, and take the general name of soils; and are again denominated after the earth that most abounds in their composition respectively."

2. Address of R. H. Rose to the Agricultural Society of Susquehanna. [*Am. Far. Vol. ii. p. 101.*]

"Geologists suppose our earth to have been masses of rock of various kinds, but principally silicious, aluminous, calcareous, and magnesian—from the gradual attrition, decay, and *mixture* of which, together with an addition of vegetable and animal matter, is formed the soil; and this is called sandy, clayey, calcareous, or magnesian, according as the particular primitive material preponderates in its formation."

3. Address of Robert Smith to the Maryland Agricultural Society. [*Am. Far. Vol. iii. p. 228.*]

"—The soils of our country are in general clay, sand, gravel, clayey loam, sandy loam, and gravelly loam. Clay, sand, and gravel, need no description, &c."—"Clayey loam is a compound soil, consisting of clay and sand or gravel, with a mixture of *calcareous matter*, and in which clay is predominant. *Sandy or gravelly loam* is a compound soil, consisting of sand or gravel and clay with a mixture of *calcareous matter*, and in which sand or gravel is predominant."

The first two extracts merely state the geological theory of the formation of soils, which is received as correct by the most eminent agriculturists of Europe. How far it may be supported or opposed by the actual constitution and number of ingredients of European soils, is not for me to decide, nor is the consideration necessary to my subject. But the adoption of this general theory by American writers, without excepting American soils, is an indirect, but complete application to them of the same character and composition. The writer last quoted states positively, that the various loams (which comprise at least nineteen twentieths of *our* soils, and I presume also of the soils of Maryland) contain calcareous matter. The expression of this opinion by Mr. Smith is sufficient to prove that such was the fair and plain deduction from his general reading on agriculture, from which source only could his opinions have been derived. If the soils of Maryland are not very unlike those of Virginia, I will venture to assert, that not one in a thousand of all the clayey, sandy, and gravelly loams, contains the smallest proportion of *carbonate of lime*—and that not a single specimen of calcareous soil can be found, between the falls of the rivers and the most eastern body of limestone.

But though the direct testimony of European authors, as cited in a foregoing page, concurs with the indirect proofs referred to since, to induce the belief that soils are very rarely destitute of calcareous earth, yet statements may be found of some particular soils being considered of that character. These statements, even if presented by the authors of general treatises, would only seem to present exceptions to their general rule of the almost universal diffusion of calcareous earth in soils. But, so far as I know, no such exceptions are named in the descriptions of soils in any general treatise, and therefore have not the slightest influence in contradicting or modifying their testimony on this subject. It is in the description of soils of particular farms, or districts, that some such statements are made; and even if no such examples had been mentioned, they would not have been needed to prove the existence, in Europe, of some soils, like most of ours, destitute of calcareous earth. These facts do not oppose my argument. I have not asserted (nor believed, since endeavouring to investigate this subject), that there were not soils in Europe, and perhaps many extensive districts, containing no calcareous earth. My argument merely maintains, that these facts would not be inferred; but the contrary, by any general and cursory reader of the agricultural treatises of Europe with which we are best acquainted. It has not been my purpose to inquire as to the existence, or extent, of soils of this kind in Europe. But judging from the indirect testimony furnished by accounts of the mineral and vegetable productions, in general descriptions of different countries, I would infer that soils having

no calcareous earth were often found in Scotland and the northern part of Germany, and that they were comparatively rare in England and France.

With my early impressions of the nature and composition of soils, derived in like manner from the general descriptions given in books, it was with surprise, and some distrust, that, when first attempting to analyze soils, in 1817, I found most of the specimens entirely destitute of calcareous earth. The trials were repeated with care and accuracy, on soils from various places, until I felt authorized to assert, without fear of contradiction, that no naturally poor soil, below the falls of the rivers, contains the smallest proportion of calcareous earth. Nor do I believe that any exception to this peculiarity of constitution can be found in any poor soil above the falls; but though these soils are far more extensive and important in other respects, they are beyond the district within the limits of which I propose to confine my investigation.

These results are highly important, whether considered merely as serving to establish my proposition, or as showing a radical difference between most of our soils, and those of the best cultivated parts of Europe. Putting aside my argument to establish a particular theory of improvement, the ascertained fact of the universal absence of calcareous earth in our poor soils leads to this conclusion, that profitable as calcareous manures have been found to be in countries where the soils are generally calcareous in some degree, they must be far more so on our soils that are quite destitute of that necessary earth.\*

---

[\* Since the first and even the last edition (1842) containing the above deductions, the later agricultural chemists have removed much of the obscurity before resting upon the calcareous character of European soils. Two recent European works have been republished in the United States, which, on soils and calcareous manures especially, are more full and satisfactory than any which had previously reached me. One is Boussingault's "Rural Economy, in its relations with Chemistry, &c., &c." This volume was first published in this country in 1845 (by Appleton, & Co., N. Y.), from the English translation and first edition. There is no date given to show the time of publication of the original work in French, nor of the English translation. But both were manifestly very recent; and probably neither had been introduced or was accessible in this country before the American edition appeared. As there is contained a reference to analyses of all the crops made in 1841. on the author's farm, in which "long and tedious labour" he "spent nearly a whole year," the original work could not have been printed before the close of 1842, even if so early. The author, besides being one of the most profound and able of modern chemists; and who has directed much research to agricultural chemistry, was also a practical farmer, on a scale of operations sufficient to inform him how to properly direct his scientific investigations. Therefore, many of his subjects and reported results are full of instruction, and doubtless are to be relied on as among the latest and most certain lights and truths yet derived from applying chemistry to agriculture. The other work referred to above is

## CHAPTER V.

### RESULTS OF THE CHEMICAL EXAMINATIONS OF VARIOUS SOILS.

#### PROPOSITION 2 — *continued.*

The certainty of any results of chemical analysis would be doubted by most persons who have paid no attention to the means employed for such operations; and their incredulity will be the more excusable, when such results are reported by one knowing very little of the science of chemistry, and whose limited knowledge was gained without aid or instruction, and was sought solely with the view of pursuing this investigation. Appearing under such disadvantages, it is therefore the more incumbent on me to show my claim to accuracy, or to so explain my method as to ena-

---

Johnston's "Lectures on the Applications of Chemistry and Geology to Agriculture," which was first published, complete in four parts, in London in 1844. But as the earlier parts had been published in succession, I had been able to see the first three at the close of 1843. The third part contains the author's views and compilation of facts, chemical and agricultural, of lime, as a constituent of soils and as manure. On these subjects, he is more full of information than any or all preceding authors, because able to draw from, compare, and decide upon the views of all his predecessors, with the aid of the latest information as to European scientific research and agricultural practices and results—and which advantages seem to have been used generally with ability and discretion.

It appears from both Boussingault's and Johnston's works, that the new and still very defective science of agricultural chemistry no longer labours under some of the grossest defects and errors which were indirectly and justly charged in my remarks above; or is liable to the formerly just censure there indicated, as will appear in the course of this essay. It is not now left to be inferred, as before, that all or nearly all soils of England and France contain carbonate of lime; and the errors of the process of analyzing soils, used by Davy, and all other chemists, previous to a very recent time, are pointed out, which errors led to the erroneous conclusion that carbonate of lime is almost universally present in soils. These two authors state many particular soils, as well as classes of soils by inference, which contain not a trace of lime in the state of *carbonate*, as I had before declared, in opposition to all the then existing authority, to be the case with nearly all the soils of our Atlantic states. But still, after removing this obscurity, it appears manifest from the many reported contents of soils given by Boussingault, Johnston, and Liebig, that soils containing carbonate of lime, and usually in large proportions, are very general in Europe, so far as investigation has gone; in this respect confirming my own previous inferences, as stated above.

Some of the statements of these latest and ablest authorities, which now offer confirmatory testimony for my formerly unsupported and novel opinions, will be quoted in notes, or otherwise, on proper occasions.—1849.]

ble others to detect its errors, if any exist. To analyze a specimen of soil completely, requires an amount of scientific acquirement and practical skill to which I make no pretension. But merely to ascertain the absence of calcareous earth (or carbonate of lime), or, if present, to find its quantity, requires but little skill, and less science.

The methods recommended by different agricultural chemists for ascertaining the proportion of calcareous earth in all soils, agree in all material points. Their process will be described, and made as plain as possible. A specimen of soil of convenient size is dried, pounded, and weighed, and then thrown into muriatic acid diluted with three or four times its quantity of water. The acid combines with, and dissolves the *lime* of the calcareous earth, and its other ingredient, the *carbonic acid*, being disengaged, rises through the liquid in the form of *gas*, or air, and escapes with effervescence. After the mixture has been well stirred, and has stood until all effervescence is over (the fluid still being somewhat acid to the taste, to prove that enough acid had been used, by some excess being left), the whole is poured into a piece of blotting paper, folded so as to fit within a glass funnel. The fluid containing the dissolved lime passes through the paper, leaving behind the clay and silicious sand, and any other solid matter; over which, pure water is poured and passed off several times, so as to wash off all remains of the dissolved lime. These filtered washings are added to the solution, to all of which is then poured a solution of *carbonate of potash*. The two dissolved salts thus thrown together (*muriate of lime*, composed of muriatic acid and lime, and *carbonate of potash*, composed of carbonic acid and potash), immediately decompose each other, and form two new combinations. The muriatic acid leaves the lime, and combines with the potash, for which it has a stronger attraction—and the muriate of potash thus formed, being a soluble salt, remains dissolved and invisible in the water. The lime and carbonic acid being in contact, when let loose by their former partners, instantly unite, and form *carbonate of lime*, or calcareous earth, which, being insoluble, falls to the bottom. This precipitate is then separated by filtering paper, is washed, dried and weighed, and thus shows the proportion of carbonate of lime contained in the soil.\*

In this process, the carbonic acid which first composed part of the calcareous earth, escapes into the air, and another supply is afterwards furnished from the decomposition of the carbonate of potash. But this change of one of its ingredients does not alter the quantity of the calcareous earth, which is always composed of

---

\* More full directions for the analysis of soils may be found in Kirwan's Essay on Manures, Rozier's Cours Complet, &c., and Davy's Agricultural Chemistry.

certain invariable proportions of its two component parts; and when all the lime has been precipitated as above directed, it will necessarily be combined with precisely its first quantity of carbonic acid.

This operation is so simple, and the means for conducting it so easy to obtain, that it will generally be the most convenient mode for finding the proportion of calcareous earth in those manures that are known to contain it abundantly, and where an error of a few grains cannot be very material. But if a very accurate result is necessary, this method will not serve, on account of several causes of error which always occur. Should no calcareous earth be present in a soil thus analyzed, the muriatic acid will take up a small quantity of aluminous earth, which will be precipitated by the carbonate of potash, and without further investigation, would be considered as so much calcareous earth. And if any compounds of lime and vegetable acids are present (which, for reasons hereafter to be stated, I believe to be not uncommon in soils), some portion of these may be dissolved, and appear in the result as *carbonate* of lime, though not an atom of that substance was in the soil. Thus, every soil examined by this method of solution and precipitation will yield some small result of what would appear as carbonate of lime, though actually destitute of that ingredient. The inaccuracies of this method were no doubt known (though passed over without notice) by Davy, and other men of science who have recommended its use; but as they considered calcareous earth merely as one of the earthy ingredients of soil, operating mechanically (as do sand and clay), on the texture of the soil, they would scarcely suppose that a difference of a grain or two could materially affect the practical value of an analysis, or the character of the soil under examination.\*

The pneumatic apparatus proposed by Davy, as another means for showing the proportion of calcareous earth in soils, is liable to none of these objections; and when some other causes of error, peculiar to this method, are known and guarded against, its accuracy is almost perfect, in ascertaining the quantity of calcareous earth—to which substance alone its use is limited.

---

\* "Chalks, calcareous marls, or powdered limestone, act merely by forming a useful earthy ingredient in the soil, and their efficacy is proportioned to the deficiency of calcareous matter, which in larger or smaller quantities seems to be an essential ingredient of all fertile soils; necessary perhaps to their proper texture, and as an ingredient in the organs of plants." [Davy's Agr. Chem. page 21—and further on he says] "Chalk and marl or carbonate of lime only improve the texture of a soil, or its relation to absorption; it acts merely as one of its earthy ingredients." [It is evident, from these expressions, that Davy considered calcareous earth important only as a physical constituent of soils; and it does not appear that he had any conception of its far more important and useful service, in very minute proportions, as a chemical agent, essential to fertilization.]



The following representation and description will make the operation quite clear :

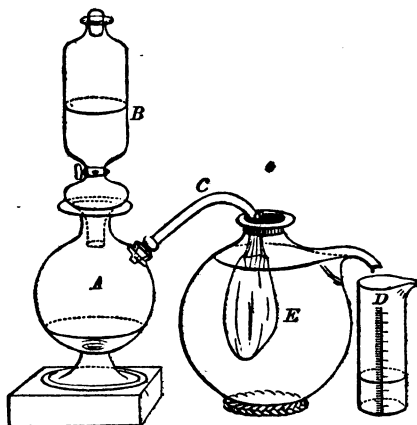

"A, B, C, D, E, represent the different parts of this apparatus. A represents the bottle for receiving the soil. B the bottle containing the acid, furnished with a stop-cock. C the tube connected with a flaccid bladder. D the graduated measure. E the bottle for containing the bladder. When this instrument is used, a given quantity of soil is introduced into A. B is filled with muriatic acid diluted with an equal quantity of water; and the stop-cock being closed, is connected with the upper orifice of A, which is ground to receive it. The tube C is introduced into the lower orifice of A, and the bladder connected with it placed in its flaccid state into E, which is filled with water. The graduated measure is placed under the tube of E. When the stop-cock of B is turned, the acid flows into A, and acts upon the soil; the elastic fluid generated passes through C, into the bladder, and displaces a quantity of water in E equal to it in bulk, and this water flows through the tube into the graduated measure; and gives by its volume the indication of the proportion of carbonic acid disengaged from the soil; for every ounce measure of which two grains of carbonate of lime may be estimated."—*Davy's Agr. Chem.*

The correctness of this mode of analysis depends on two well-established facts in chemistry: 1st, That the component parts of calcareous earth always bear the same proportion to each other, and these proportions are as 43.7 parts (by weight) of carbonic acid, to 56.3 of lime; and, 2d, That the carbonic acid gas which two grains of calcareous earth will yield, is equal in bulk to one ounce of fresh water. The process, with the aid of this apparatus, disengages, confines, and measures the gas evolved; and for every measure equal to the bulk of an ounce of water, the operator has but to allow two grains of calcareous earth in the soil acted on. It is evident that the result can indicate the presence of lime in no other combination except that which forms calcareous earth; nor of any

other earth, except carbonate of magnesia, which, if present, might be mistaken for calcareous earth, but which is too rare, and occurs in proportions too small, to cause any material error in ordinary cases, and in soils of this region.

But if it be only desired to know whether calcareous earth is entirely wanting in any soil—or to test the truth of my assertion that so great a proportion of our soils are destitute of that earth—it may be done with far more ease than by either of the foregoing methods, and without apparatus of any kind. Let a handful of the soil (without drying or weighing) be thrown into a large drinking-glass, containing enough of pure water to cover the soil about two inches. Stir it until all the lumps have disappeared, and the water has certainly taken the place of all the atmospheric air which the soil had enclosed. Remove any vegetable fibres, or froth, from the surface of the liquid, so as to have it clear. Then pour in gently about a table spoonful of undiluted muriatic acid, which by its greater weight will sink, and penetrate the soil, without any agitation being necessary for that purpose. If any calcareous earth is present, it will quickly begin to combine with the acid, throwing off its carbonic acid in *gas*, which cannot fail to be observed as it escapes, as the gas that eight grains only of calcareous earth would throw out, would be equal in bulk to a gill measure. Indeed, the product of a single grain only of calcareous earth would be abundantly plain to the eye of the careful operator, though it might be the whole amount of gas from two thousand grains of soil. If no effervescence is seen even after adding more acid and gently stirring the mixture, then it is absolutely certain that the soil contained not the smallest portion of carbonate of lime; nor of carbonate of magnesia, the only other substance which could possibly be mistaken for it.

The examinations of all the soils that will be here mentioned were made in this pneumatic apparatus, except some of those which evidently evolved no gas, and when no other result was required. As calcareous earth is plainly visible to the eye in all shelly soils, they only need examination to ascertain its proportion. A few examples will show what proportions we may find, and how greatly they vary, even in soils apparently of equal value.

1. Soil, a black clayey loam, from the top of the high knoll at the end of Coggins Point [then my own farm], on James River, containing fragments of mussel shells throughout. Never manured, and supposed to have been under scourging cultivation and close grazing from the first settlement of the country; then (1818) capable of producing twenty-five or thirty bushels of corn—and the soil well suited to wheat. One thousand grains, cleared by a fine sieve of all coarse shelly matter (as none can act on the soil until minutely divided), yielded sixteen ounce measures of carbonic acid

gas, which showed the finely divided calcareous earth to be thirty-two grains.

2. One thousand grains of similar soil from another part of the same field, treated in the same manner, gave twenty-four grains of finely divided calcareous earth.

3. From the east end of a small island, at the end of Coggins Point, surrounded by the river and tide marsh. Soil, dark brown loam, much lighter than the preceding specimens, though not sandy—under like exhausting cultivation—then capable of bringing thirty to thirty-five bushels of corn—not a good wheat soil, ten or twelve bushels being probably a full crop. One thousand grains yielded eight grains of coarse shelly matter, and eighty-two of finely divided calcareous earth.

4. From a small spot of sandy soil, almost bare of vegetation, and incapable of producing any grain, though in the midst of very rich land, and cleared but a few years. Some small fragments of fossil sea-shells being visible, proved this barren spot to be calcareous, which induced its examination. Four hundred grains yielded eighty-seven of calcareous earth—nearly twenty-two per cent. This super-calcareous soil was afterwards dug and carried out as manure. [It is, in fact, the upper layer of a bed of fossil-shell earth, the shells there being entirely disintegrated and invisible.]

5. Black friable loam, from Indian Fields, on York River. The soil was a specimen of a field of considerable extent, mixed throughout with oyster shells. Though light and mellow, the soil did not appear to be sandy. Rich, durable, and long under exhausting cultivation.

1260 grains of soil yielded

168 — of coarse shelly matter, separated mechanically,

8 — finely divided calcareous earth.

The remaining solid matter, carefully separated (by agitation and settling in water), consisted of

130 grains of fine clay, black with putrescent matter, and which lost more than one-fourth of its weight by being exposed to a red heat,

875 — white sand, moderately fine,

20 — very fine sand,

30 — lost in the process.

---

1061

6. Oyster shell soil, of the best quality, from the farm of Wills Cowper, Esq., on Nansemond River—never manured, and supposed to have been cultivated in corn as often as three years in four, since the first settlement of the country—now yields (by actual measurement) thirty bushels of corn to the acre—but is very unproduc-

tive in wheat. A specimen taken from the surface, to the depth of six inches, weighed altogether 242 dwt., which consisted of

126	—	of shells and their fragments, separated by the sieve,
116	—	remaining finely divided soil.
Of the finely divided part, 500 grains consisted of		
18		grains of carbonate of lime,
330	—	silicious sand—none very coarse,
94	—	impalpable aluminous and silicious earth,
35	—	putrescent vegetable matter—none coarse or unrotted,
23	—	loss.

500

It is unnecessary to cite any particular trials of our poor soils, as it has been stated, in the preceding chapter, that all are entirely destitute of calcareous earth—excluding the rare, but well marked exceptions of its great excess, of which an example has been given in the soil marked 4, in the foregoing examinations.

Unless then I am mistaken in supposing that these facts are universally true, the certain results of chemical analysis, as well as more extended general observation, completely establish these general rules—viz. :

1st. *That all calcareous soils are naturally fertile and durable in a very high degree—and,*

2d. *That all soils naturally poor are entirely destitute of calcareous earth.*

It then can scarcely be denied that calcareous earth must be the cause of the fertility of the one class of soils, and that the want of it produces the poverty of the other. Qualities that always thus accompany each other cannot be otherwise than *cause and effect*. If further proof is wanting, it can be safely promised to be furnished when the practical application of calcareous manures to poor soils will be treated of, and the effects stated.

These deductions are then established as to all calcareous soils, and all poor soils—which two classes comprise nine-tenths of all. This alone would open a wide field for the practical exercise of the truths we have reached. But still there remain strong objections and stubborn facts opposed to the complete proof and universal application of the proposition now under consideration, and consequently to the theory which that proposition is intended to support. The whole difficulty will be apparent at once when I now proceed to state that nearly all of our best soils, such as are very little if at all inferior in value to the small portion of shelly lands, are as *destitute of calcareous earth (carbonate of lime) as the poorest*. So far as I have examined, this deficiency is no less general in the

richest alluvial lands of the upper country—and, what will be deemed by some as incredible, by far the greater part of the rich limestone soils between the Blue Ridge and Alleghany Mountains are equally destitute of calcareous earth. These facts were not named before, to avoid embarrassing the discussion of other points—nor can they now be explained, and reconciled with my proposition, except through a circuitous and apparently digressive course of reasoning. They have not been kept out of view, nor slurred over, to weaken their force, and are now presented in all their strength. These difficulties will be considered, and removed, in the following chapters.

---

## CHAPTER VI.

### CHEMICAL EXAMINATION OF RICH SOILS CONTAINING NO CALCAREOUS EARTH.

#### PROPOSITION 2—*continued.*

Under common circumstances, when any disputant admits facts that seem to contradict his own reasoning, such admission is deemed abundant evidence of their existence. But though now placed exactly in this situation, the facts admitted by me are so opposed to all that scientific agriculturists have taught us to expect, that it is necessary for me to show the grounds on which my admission rests. Few would have believed in the absence of calcareous earth in all our poor soils, forming as they do the much larger part of all this region—and far more strange is it that the same deficiency should extend to such rich soils as some that will be here cited.

The following specimens, taken from well known and very fertile soils, were found to contain no calcareous earth. Many trials of other rich soils have yielded like results—and, indeed, I have never found calcareous earth in any soil below the falls of the rivers, in which, or near which, some particles of shells were not visible.

1. Soil from Eppes' Island, which lies in Powhatan, or James-river, near City Point; light and friable (but not sandy) brown loam, rich and durable. The surface is not many feet above the highest tides, and, like most of the best river lands, this tract seems to have been formed by alluvion many ages ago, but which may be termed recent, when compared to the general formation of the tide-water district.

2. Black silicious loam from the celebrated lands on Back river, near Hampton.

3. Soil from rich land on Pocoson-river, York county.

4. Black clay vegetable soil, from a fresh-water tide marsh on James river—formed by recent alluvion.

5. Alluvial soil of first-rate fertility above the falls of James river—dark brown clay loam, from the valuable and extensive body of bottom land belonging to General J. H. Cocke, of Fluvanna.

The most remarkable facts of the absence of calcareous earth are to be found in the lime-stone soils, between the Blue Ridge and Alleghany Mountains. Of these, I will report all that I have examined; and none contained any calcareous earth, unless when the contrary will be stated.

Before the first of these trials was made, I supposed (as probably most other persons do) that *lime-stone soil* was necessarily *calcareous*, and in a high degree. It is difficult to get rid of this impression entirely—and it may seem a contradiction in terms to say that a *lime-stone soil* is not calcareous. This I cannot avoid. I must take the term *lime-stone soil* as custom has already fixed it. But it should not be extended to any soils except those which are so near to lime-stone rock, as in some measure to be thereby affected in their qualities and value.

1 to 6. Lime-stone soils selected in the neighbourhood of Lexington, Virginia, by Professor Graham; with the view of enabling me to investigate this subject. All the specimens were from first-rate soils, except one, which was from land of inferior value. One of the specimens, Mr. Graham's description stated to be "taken from a piece of land so rocky [with lime-stone] as to be unfit for cultivation, at least with the plough. I could scarcely select a specimen which I would expect to be more strongly impregnated with calcareous earth." This specimen, by two separate trials, yielded only one grain of calcareous earth, from one thousand of soil. The other five soils contained none. The same result was obtained from

7. A specimen of alluvial land on North river, near Lexington.

8. Brown loam from the Sweet Spring valley, remarkable for its extraordinary productiveness and durability. It is of alluvial formation, and before it was drained, must have been often covered and saturated by the Sweet Spring and other mineral waters, which hold lime in solution. [The carbonate of lime dissolved in these waters is so abundant, and so readily parted with, that it is deposited on every twig that is exposed therein, forming rapidly growing incrustations.] The surrounding high land is of lime-stone soil. Of this specimen, taken from about two hundred yards below the Sweet Spring, from land long cultivated every year, three

hundred and sixty grains yielded not a particle of calcareous earth. It contained an unusually large proportion of *oxide of iron*, though my imperfect means enabled me to separate and collect only eight grains, the process evidently wasting several more.

About a mile lower down, drains were then making (in 1826) to reclaim more of this rich valley from the overflowing waters. Another specimen was taken from the bottom of a ditch just opened, eighteen inches below the surface. It was a black loam, and exhibited to the eye some very diminutive fresh-water spiral shells, about one-tenth of an inch in length, and many of their broken fragments. This gave, from two hundred grains, seventy-four of calcareous earth. But this cannot fairly be placed on the same footing with the other soils, as it had obviously been once the bottom of a stream, or lake, and the collection and deposit of so large and unusual a proportion of calcareous matter seemed to be of animal formation. Both these specimens were selected at my request by one of our best farmers, and who also furnished a written description of the soils, and their situation.

9. Wood-land, west of Union, Monroe county. Soil, a black clay loam, lying on, but not intermixed at the surface with lime-stone rock. Sub-soil, yellowish clay. The rock at this place, a foot below the surface. Principal growth, sugar maple, white walnut, and oak. This and the next specimen are from one of the richest tracts of high land that I have seen.

10. Soil similar to the last, and about two hundred yards distant. Here the lime-stone showed above the surface, and the specimen was taken from between two large masses of fixed rock, and about a foot distant from each.

11. Black rich soil, from wood-land between the Hot and Warm Springs, in Bath county. The specimen was part of what was in contact with a mass of lime-stone.

12. Soil from the western foot of the Warm Spring mountain, on a gentle slope between the court-house and the road, and about one hundred and fifty yards from the Warm Bath. Rich brown loam, containing many small pieces of lime-stone, but no finely divided calcareous earth.

13. A specimen taken two or three hundred yards from the last, and also at the foot of the mountain. Soil, a rich black loam, full of small fragments of lime-stone of different sizes, between that of a nutmeg and small shot. The land had never been broken up for cultivation. One thousand grains contained two hundred and forty grains of small stone or gravel, mostly lime-stone, separated mechanically, and sixty-nine grains of finely divided calcareous earth.

14. Black loamy clay, from the excellent wheat soil adjoining the town of Bedford, in Pennsylvania: the specimen taken from

beneath and in contact with lime-stone. One thousand grains yielded less than one grain of calcareous earth.

15. A specimen from within a few yards of the last, but not in contact with lime-stone, contained no calcareous earth; neither did the red clay sub-soil, six inches below the surface.

16. Very similar soil, but much deeper, adjoining the principal street of Bedford—the specimen taken from eighteen inches below the surface, and adjoining a mass of lime-stone. A very small disengagement of gas indicated the presence of calcareous earth—but certainly less than one grain in one thousand, and perhaps not half that quantity.

17. Alluvial soil on the Juniata, adjoining Bedford.

18. Alluvial vegetable soil near the stream flowing from all the Saratoga Mineral Springs, and necessarily often covered and soaked by those waters, and

19. Soil taken from the bed of the same stream—neither contained any portion of carbonate of lime.

Thus it appears that of these nineteen specimens of soils, only four contained calcareous earth, and three of these four in exceedingly small proportions. It should be remarked that all these were selected from situations which, from their proximity to calcareous rock, or exposure to calcareous waters, were supposed most likely to present highly calcareous soils. If five hundred specimens had been taken, without choice, even from what are commonly called lime-stone soils (merely because they are not very distant from lime-stone rock, or springs of lime-stone water), the analysis of that whole number would be less likely to show calcareous earth, than the foregoing short list. I therefore feel justified, from my own few examinations, and unsupported by any other authority, to pronounce that calcareous earth will very rarely be found in any soils between the falls of our rivers and the navigable western waters.\* In a few specimens of some of the best soils from the borders of the Mississippi and its tributary rivers, I have since found calcareous earth present in all—but in very small proportions, and in no case exceeding two per cent.

[When the total deficiency of carbonate of lime, in nearly all the soils of Virginia, was first asserted, as above, in the earliest publication of this essay (1821, in *American Farmer*, vol. iii.), the

---

[\* *Recent Confirmatory Testimony*.—Still more strange cases of the total absence of (carbonate of) lime have been stated recently in Johnston's *Agricultural Chemistry*: "It is a fact which will strike you as not a little remarkable that soils which rest upon chalk, as well as upon other lime-stone rocks, even at the depth of a few inches only, are often, and especially when in a state of nature, so destitute of lime, that not a particle can be detected in them." (p. 377.) The author of course meant the carbonate of lime.—1849.]



proposition was so entirely new, and so opposed to all inferences from authority then existing, that it was indispensably necessary to adduce my facts, as is done above, to sustain the otherwise unsustainable doctrine. And such support, for the same reason, continued to be wanting through the two next editions. Now (in 1842) the case is altogether different. The fact of the absence of carbonate of lime, as generally as I had assumed, through the eastern or seaward slope of the United States, and especially in New England, has been confirmed by all the analyses of soils which have been since made by Professor Hitchcock and other accurate scientific investigators; and the proposition, however untenable or incredible it might have been deemed before, is now universally admitted, and indeed is placed beyond question or doubt, as an important feature in the chemical constitution of soils.—1842.]

[The only soils of considerable extent of surface which, from the specimens that I have examined, appear to be highly calcareous, and to agree in that respect with many European soils, are from the *prairies*, those lands of the south-west which, whether rich or poor, are remarkable for being destitute of trees, and covered with grass, so as to form natural meadows. The examinations were made but recently (in 1834), and are reported because presenting striking exceptions to the general constitution of soils in this country.

20. Prairie soil of the most productive kind in Alabama; a black clay, with very little sand, yet so far from being stiff, that it becomes too light by cultivation. This kind of land is stated by the friend to whom I am indebted for the specimens, to "produce corn and oats most luxuriantly—and also cotton for two or three years; but after that time cotton is subject to the rust, probably from the then open state of the soil, which by cultivation has by that time become as light and as soft as a bank of ashes." One hundred grains of the specimen contained eight of carbonate of lime. All this prairie land in Alabama lies on a substratum of what is there called "rotten lime-stone" (specimens of which contained seventy-two to eighty-two per cent. of lime), and which rises to the surface sometimes, forming the "bald prairies," a sample of the soil of which (21) contained fifty-nine per cent. of carbonate of lime. This was described as "comparatively poor—neither trees nor bushes grow there, and only grass and weeds before cultivation—corn does not grow well—small grain better—and cotton soon becomes subject to the rust." The excessive proportion of calcareous earth is evidently the cause of its barrenness. The substratum called lime-stone is soft enough to be cut easily and smoothly with a knife, and some of it is in appearance and texture more like the chalk of Europe, than any other earth that I have seen in this country.

22. A specimen of the very rich "cane brake" lands in Marengo county, Alabama, contained sixteen per cent. of carbonate of lime. This is a kind of prairie, of a wetter nature, from the winter rains not being able to run off from the level surface, nor to sink through the tenacious clay soil, and the solid stratum of lime-stone below.

23. A specimen from the very extensive "Choctaw Prairie" in Mississippi, of celebrated fertility, yielded thirteen per cent. of carbonate of lime.

Several other specimens of different, but all of very fertile soils from southern Alabama, and all lying over the substratum of soft lime-stone, were found to be *neutral*, containing not a particle of lime in the form of *carbonate*. These specimens were as follows:

24. One from the valley cane land—"very wet through the winter, but always dry in summer—and after being ditched is dry enough to be cultivated in cotton, which will grow from eight to twelve feet high."

25. Another from what is called the best "post-oak land," on which trees of that kind grow to the size of from two to four feet in diameter—having but little underwood, and no cane growth—"thought to be nearly as rich as the best cane land, and will produce 1500 lbs., or more, of seed cotton, or fifty bushels of corn to the acre."

26. Another from what is termed "palmetto land, having on it that plant as well as a heavy cover of large trees growing luxuriantly. It is a cold and wet soil before being brought into good tilth; but afterwards is soft and easy to till, and produces corn and cotton finely. The cane on it is generally small—the soil from four to ten feet deep."

One more prairie soil only will be adduced, from many analyses which have furnished general results like the foregoing (20 to 26); and this one is given because it serves as a fair specimen of a very large class of the prairie lands. It was selected by Dr. R. W. Withers, in 1835, and described by him as follows: (*Farmers' Register*, vol. iii. p. 498.)

27. Soil of Greene county, Alabama, "from our open or *bald* prairie, [*i. e.*, totally without trees,] which has been cultivated for seven or eight years—produces corn very well—nearly fifty bushels to the acre are now standing on the ground; but cotton does not produce so well on it as on poor sandy soil. I feel very confident that this specimen is highly calcareous, as there are many fragments of shells mixed with the soil, and the rock is not two feet from the surface. Of all the specimens hitherto sent, this is the one which will give the nearest approach to the general character of our open prairie land in this part of the country."—This specimen was found to contain 33 per cent. of carbonate of lime.—1835.]

The foregoing details, respecting lime-stone lands, may perhaps

be considered an unnecessary digression, in a treatise on the soils of the tide-water district. But the analysis of lime-stone soils furnishes the strongest evidence of the remarkable and novel fact of the general absence of calcareous earth—and the information thence derived will be used to sustain the following steps of my argument.

All the examinations of soils in this chapter concur in opposing the general application of the proposition that the deficiency of calcareous earth is the cause of the sterility of our soils. And having stated the objection in all its force, I shall now proceed to inquire into its causes, and endeavour to dispel its apparent opposition to my doctrine.

---

## CHAPTER VII.

### PROOFS OF THE EXISTENCE OF ACID AND NEUTRAL SOILS.

#### PROPOSITION 2—*continued.*

Sufficient evidence has been adduced to prove that many of our most fertile and valuable soils are destitute of calcareous earth. But it does not necessarily follow that such has always been their composition; or that they may not now contain enough lime combined with some other acid than the carbonic. That this is really the case, I shall now offer proofs to establish; and not only maintain this position with regard to those valuable soils, but shall contend, that *lime, in some proportion, combined with vegetable acid, is present in every soil capable of supporting vegetation.*

But, while I shall endeavour to maintain these positions, without asking or even admitting any exception, let me not be understood as asserting that the degree of natural fertility of a calcareous soil is in proportion to the amount of calcareous earth contained; or, that the knowledge of the proportion of calcareous earth, or of lime in any form, contained, would serve to measure the capacity of the soil for production or for fertilization. On the contrary, chalky and calcareous soils, not differing materially in agricultural qualities or fertility, sometimes exhibit remarkable differences in their proportions of calcareous earth; so that one soil, having less than one per cent., may seem as well constituted and as valuable as another having ten per cent., or more. [The reason is, that a very small proportion is enough for the full chemical action; and that any surplus, even if not hurtful by its amount, will have no other than the comparatively feeble mechanical action—which may even be injurious, and in opposition to, and counteracted by the chemical action.]

In all naturally poor soils, producing freely pine and whortleberry in their virgin state, and sheep-sorrel after cultivation, I suppose to have been formed some *vegetable acid*, which, after taking up, and combining with whatever small quantity of lime might have been present, still remains in excess in the soil, and nourishes in the highest degree the plants named above, but is a poison to all useful crops; and effectually prevents such *acid* soils from becoming rich, by either natural or artificial applications of putrescent manures.

In a *neutral soil*, I suppose calcareous earth to have been sufficiently abundant at some former time to induce a high degree of fertility—but that it has been decomposed, and the lime taken up, by the gradual formation of vegetable acid, until the lime and the acid neutralize and balance each other, leaving no considerable excess of either; and that such are all our fertile soils which are not now calcareous.

Both these suppositions remain to be proved, in all their parts.

No opinion has been yet advanced that is less supported by good authority, or to which more general opposition may be expected, than that which supposes the existence of acid soils. The term *sour soil* is indeed frequently used by farmers, but in so loose a manner as to deserve no consideration. It has been thus applied to any moist, cold, and ungrateful land, without intending that the term should be literally understood, and perhaps without attaching to its use any precise meaning whatever. Dundonald only, of all those who have applied chemistry to agriculture, has asserted the existence of vegetable acid in soils;\* but he has offered no analysis of soils in proof, nor any other evidence to establish the fact; and his opinion has received no confirmation, nor even the slightest notice, from later and more able investigators of the chemical characters of soils. Kirwan and Davy profess to enumerate all the common ingredients of soils; and it is not intimated by either that vegetable acid is one of them. Even this tacit denial by Davy more strongly opposes the existence of vegetable acid, than it is supported by the opinion of Dundonald, or any early writers on agriculture, if there be any who may have admitted its existence. [For it cannot be supposed that so able and profound an investigator would have omitted all reference to an ingredient of soils so general, and therefore so important, as is here asserted, even if its presence had been even suspected by him, much less if fully known.] Grisenthwaite, a late writer on agricultural chemistry, and who has the advantage of knowing the discoveries, and comparing the opinions, of all his predecessors, expressly denies the possibility of any acid existing in soils. His *New 'Theory of Agriculture'*† con-

\* Dundonald's *Connexion of Chemistry and Agriculture*.

† Republished in *American Farmer*, (old) vol. ii.

tains the following passage: "Chalk has been recommended as a substance calculated to correct the sourness of land. It would surely have been a wise practice to have previously ascertained this existence of acid, and to have determined its nature, in order that it might be effectually removed. The fact really is, that no soil was ever yet found to contain any notable quantity of acid. The acetic and the carbonic are the only two that are likely to be generated by any spontaneous decomposition of animal or vegetable bodies, and neither of them have any fixity when exposed to the air." Thus, then, my doctrine is deprived of even the feeble support it might have had from Dundonald's mere opinion, if that opinion had not been contradicted by later and better authority; and the only support to be looked for, will be in the facts and arguments that I shall be able to adduce.

I am not prepared to question what Grisenthwaite states as a chemical fact, "that no soil was ever yet found to contain any notable quantity of acid." No soil examined by me for this purpose, with such poor means as I could apply, gave any evidence of the presence of uncombined acid. Still, however, the term acid may be applied with propriety to soils in which growing vegetables continually receive acid from the decomposition of others (for which no "fixity" is requisite), or in which acid is present, not free, but combined with some base, by which it is readily yielded, to promote, or retard, the growth of plants in contact with it. It will be sufficient for my purpose to show that certain soils contain some substance, or possess some quality, which promotes almost exclusively the growth of acid plants—that this power is strengthened by adding known vegetable acids to the soil—and is totally removed by the application of calcareous manures, which would necessarily destroy any acid, if it were present. Leaving it to chemists to determine the nature and properties of this substance, I merely contend for its existence and effects; and the cause of these effects, whatever it may be, for the want of a better name, I shall call *acidity*.

The proofs now to be offered in support of the existence of acid and neutral soils, however weak each may be when considered alone, yet, when taken in connexion, will together form a body of evidence not easily to be resisted.

*First proof.*—Pines and common sorrel [*rumex acetocella*] have leaves well known to be acid to the taste; and their growth is favoured by such soils as are here supposed to be acid, to an extent which would be thought remarkable in other plants on the richest soils. Except wild locust on the best of our river land, no growth can compare in rapidity with pines on soils naturally poor, and even when greatly reduced by long cultivation. Pines usually stand so thick, on old exhausted fields, that the increase of size in

each plant is greatly retarded; but if the whole growth of an acre were estimated, it would probably exceed in quantity the different growth of the richest soils, of the same age and on an equal space. Every cultivator of corn on poor light soil knows how rapidly sorrel\* will cover his otherwise naked field, unless kept in check by continual tillage—and that to root it out, so as to prevent the like future labour, cannot be effected by any mode of cultivation whatever. This weed too is considered far more hurtful to growing crops, than any other of equal size. Yet neither of these acid plants can thrive on the best lands. Sorrel cannot even live on a calcareous soil; and if a pine is sometimes found there, it has nothing of its usual elegant form, but seems as stunted and ill-shaped as if it had always suffered for want of nourishment. Innumerable facts, of which these are examples, prove that these acid plants must derive from their favourite soil some kind of food peculiarly suited to their growth, and quite useless, if not hurtful, to cultivated crops.

2d. Dead acid plants are the most effectual in promoting the growth of living ones. When pine leaves are applied to a soil, whatever acid they contain is of course given to that soil, for such time as circumstances permit it to retain its form, or peculiar properties. Such an application is often made on a large scale, by cutting down the second growth of pines, on land once under tillage, and suffering them to lie a year before clearing and cultivating the land. The invariable consequence of this course is a growth of sorrel, for one or two years, so abundant and so injurious to the crops, as to more than balance any benefit derived by the soil from the vegetable matter having been allowed to rot. From the general experience of this effect, most persons put pine land under tillage as soon as cut down, after carefully burning (to destroy) the whole of the heavy cover of leaves, both green and dry. Until within a few years, it was generally supposed that the leaves of pine were worthless, if not hurtful, in all applications to cultivated land—which opinion doubtless was founded on such facts as have been just stated. But if they are used as litter for cattle, and heaped to ferment, the injurious quality of pine leaves is destroyed, and they become a valuable manure. This practice is but of recent origin—but is highly approved, and rapidly extending. [Still later it has been found that when these leaves are applied unrotted, as raked up in woodland, to calcareous land, they produce only and

---

\* Sheep sorrel, or *Rumex acetocella*. The wood sorrel (*Oxalis acetocella*) is of a very different character. The latter prefers rich and even calcareous soils, and I have seen it growing well on spots calcareous to excess. It would seem, therefore, that wood sorrel forms its acid from the atmosphere, and does not draw it from the soil, as I suppose to be the case with common sorrel. [The wood sorrel is a trefoil, and pod-bearing or leguminous plant.]

always beneficial results; and that this is the best as well as cheapest mode of their application.]

On one of the washed and barren declivities (or *galls*) which are so numerous on all our farms, I had the small gullies packed full of green pine bushes, and then covered with the earth drawn from the equally barren intervening ridges, so as nearly to smooth the whole surface. The whole piece had borne nothing previously except a few scattered tufts of poverty grass (*aristida gracilis*) and dwarfish sorrel, all of which did not prevent the spot seeming quite bare at mid-summer, if viewed at some distance. This operation was performed in February or March. The land was not cultivated, nor again observed, until the second summer afterwards. At that time, the piece remained as bare as formerly, except along the filled gullies, which, throughout the whole of their crooked courses, were covered by a thick and uncommonly tall growth of sorrel, remarkably luxuriant for any situation, and which, being bounded exactly by the width of the narrow gullies, had the appearance of some vegetable sown thickly in drills, and kept clean by tillage. So great an effect of this kind has not been produced within my knowledge—though facts of like nature, and leading to the same conclusion, are of frequent occurrence. If small pines standing thinly over a broom-grass old-field are cut down and left to lie, under every top will be found a patch of sorrel, before the leaves have all rotted.

3d. The growth of sorrel is not only peculiarly favoured by the application of vegetables containing acids already formed, but also by such matters as will form acid in the course of their decomposition. Farm-yard manure, and all other putrescent animal and vegetable substances, form *acetic acid* as their decomposition proceeds.\* If heaps of rotting manure are left without being spread, in a field but very slightly subject to produce sorrel, a few weeks of growing weather will bring out that plant close around every heap; and for some time the sorrel will continue to show more benefit from that rank manuring than any other grass. For several years my winter-made manure was spread and ploughed in on land not cultivated until the next autumn, or the spring after. This practice was founded on the mistaken opinion, that it would prevent much of the usual exposure to evaporation and waste of the manure. One of the reasons which alone would have compelled me to abandon this absurd practice was, that a crop of sorrel always followed, (even on *neutral* or good soils that before barely permitted a scanty growth of it to live), which so injured the next grain crop as greatly to lessen the benefit from the manure. Sorrel unnaturally produced by such applications does not infest the land longer than

---

\* Agr. Chem. p. 187. (Phil. ed.)

until we may suppose the recent supply of acid to have been removed by cultivation and other causes.

It may be objected that, even if fully admitted, my authorities prove only the formation of a single vegetable acid in soil, the acetic—that my facts show only the production of a single acid plant, sorrel—and that the acid which sorrel contains is not the acetic, but the oxalic.\* In reply to such objections, it may be said, that from the application of acids to recently ploughed land, no acid plant except sorrel is made to grow, because that one only can spring up speedily enough to arrest the the fleeting nutriment. Poverty grass (*Aristida gracilis* or *A. dichotoma*) grows only on the same kinds of soil, and generally covers them after they have been a year free from a crop, but does not show sooner; and pines require two years before their seeds will produce plants. But when pines begin to spread over the land, they soon put an end to the growth of all other plants, and are abundantly supplied with their acid food, from the dropping of their own leaves. Thus they may be first supplied with the vegetable acid ready formed in the leaves, and afterwards with the acetic acid, formed by their subsequent slow decomposition. It does not weaken my argument, that the product of a plant is a vegetable acid different from the one supposed to have nourished its growth. All vegetable acids (except the prussic), however different in their properties, are composed of the same three elementary bodies, differing only in their proportions†—and consequently are, all convertible into each other. A little more, or a little less of one or the other of these ingredients, may change the acetic to the oxalic acid, and that to any other. We cannot doubt but that such simple changes may be produced by the chemical powers of vegetation, when others are effected far more difficult for us to comprehend. The most tender and feeble organs, and the mildest juices, aided by the power of animal or vegetable life, are able to produce decompositions and combinations which the chemist cannot explain, and which he would in vain attempt to imitate.

4th. This ingredient of soils, which nourishes acid plants, also poisons cultivated crops. Plants have not the power of rejecting noxious fluids, but take up by their roots everything presented in a soluble form.‡ Thus the acid also enters the sap-vessels of cultivated plants, stints their growth, and makes it impossible for them to attain that size and perfection which their proper food would insure, if it were presented to them without its poisonous accompaniment. When the poorest virgin wood-land is cut down, it is

---

\* Agr. Chem. Lecture 8.

† Carbon, oxygen, and hydrogen. Agr. Chem. Lecture 8, p. 78.

‡ Agr. Chem. Lecture 6, page 186.



covered and filled to excess with leaves and other rotted and rotting vegetable matters. Can a heavier vegetable manuring be desired? And as this completely rots during cultivation, must it not offer to the growing plants as abundant a supply of food as they can require? Yet the best product obtained may be from ten to fifteen bushels of corn, or five or six of wheat, soon to come down to half those quantities. If the noxious quality which causes such injury is an acid, it is as certain as any chemical truth whatever, that it will be neutralized, and its powers destroyed, by applying enough of calcareous earth to the soil; and precisely such effects are found wherever that remedy is tried. On land thus relieved of this unceasing annoyance, the young plants of corn no longer appear of a pale and sickly green, approaching to yellow, but take immediately a deep healthy colour; by which they may readily be distinguished from any on adjoining ground, left in its former state, before there is any perceptible difference in the size of the plants. The crop will produce fifty to one hundred per cent. more, the first year, before its supply of food can possibly have been increased; and the soil is soon found not only clear of sorrel, but absolutely incapable of producing it. I have anticipated these effects of calcareous manures, before furnishing the evidence; but they will hereafter be established by facts beyond contradiction.

The truth of the existence of either acid or neutral soils depends on the existence of the other; and to prove either, will necessarily establish both. If acid exists in soils, then whenever it meets with calcareous earth, the two substances must combine with and neutralize each other, so far as their proportions are properly adjusted. On the other hand, if I can show that compounds of lime and vegetable acid are present in most soils, it follows inevitably that nature has provided means by which soils can generally obtain this acid; and if the amount formed can balance the lime, the operation of the same causes can exceed that quantity, and leave an excess of free acid. From these premises will be deduced the following proofs.

5th. It has been stated (page 57) that the process recommended by chemists for finding the calcareous earth in soils was unfit for that purpose, because *some precipitate* was always obtained, even when no calcareous earth or carbonate of lime was present. Frequent trials have shown me that this precipitate is considerably more abundant from good soils than bad. The substance thus obtained from rich soils by solution and precipitation, in every case that I have tried, contains some carbonate of lime, although the soil from which it was derived had none. The alkaline liquor from which the precipitate has been separated, we are told by Davy, will, after boiling, let fall the carbonate of magnesia, if any had been in the soil; but when any notable deposit is thus obtained, it will

often be found to consist more of carbonate of lime, than of magnesia. The following are examples of such products:

One thousand grains of tide-marsh soil (page 63, No. 4), acted on by muriatic acid in the pneumatic apparatus, gave out no carbonic acid gas, and therefore could have contained no carbonate of lime. The precipitate obtained from the same weighed sixteen grains; which being again acted on by sulphuric acid, evolved as much gas as showed that three grains had become carbonate of lime, in the previous part of the process.

Two hundred grains of alluvial soil from Saratoga Springs (page 65, No. 18), containing no carbonate of lime, yielded a precipitate of twelve grains, of which three was carbonate of lime—and a deposit from the alkaline solution weighing six grains, four of which was carbonate of lime.

Seven hundred grains of limestone soil from Bedford, Pennsylvania (part of the specimen marked 14, page 64), contained about two-thirds of a grain of carbonate lime—and its precipitate of twenty-eight grains, only yielded two grains: but the alkaline solution deposited eleven grains of the carbonates of lime and magnesia, of which at least five was of the former, as there remained seven and a half of solid matter, after the action of sulphuric acid.\*

[Eleven hundred and fifty grains of the rich alluvial earth deposited by the Mississippi river, in Arkansas, yielded, in the pneumatic apparatus, 9½ ounce measures of carbonic acid gas, and of course could not have contained more than nineteen grains of carbonate of lime,—or, so far as the carbonate was of magnesia, something less in proportion. But by adding carbonate of potash to the acid solution, fifty-two grains were precipitated, all of which, according to Davy, should have been carbonate of lime; and from the alkaline solution thus made, by standing and boiling, 20½ grains more of solid matter was precipitated, which, according to Davy, should have been carbonate of magnesia; and making of

---

\* The measurement of the carbonic acid gas evolved was relied on to show the whole amount of carbonates present—and sulphuric acid was used to distinguish between lime and magnesia, in the deposit from the alkaline solution. If any alumina or magnesia had made part of the solid matter exposed to diluted sulphuric acid, the combinations formed would have been soluble salts, which would of course have remained dissolved and invisible in the fluid. Lime only, of the four chemical earths, forms with sulphuric acid a substance but slightly soluble, and which therefore can be mostly separated in a solid form. The whole of this substance (sulphate of lime) cannot be obtained in this manner, as a part is always dissolved; but whatever is obtained, proves that at least two-thirds of that quantity of carbonate of lime had been present; as that quantity of lime which will combine with enough carbonic acid to make 100 parts (by weight) of carbonate of lime, will combine with so much more of sulphuric acid, as to form about 150 parts of the sulphate of lime, or gypsum.

both precipitates ( $52 + 20\frac{1}{2} = 72\frac{1}{2}$ ) grains of carbonates of lime and magnesia, for the quantity in the original specimen of soil. Yet the first operation clearly proved there could have been no more than nineteen. Subsequent information and experience showed that Davy's mode for separating the results of lime and magnesia was as little to be relied on, as that for ascertaining the quantity of carbonate of lime alone.]

From these processes, there can be no doubt but that the soils contained a proportion of some *salt of lime* (or lime combined with some kind of acid), which being decomposed by and combined with the muriatic acid, was then precipitated, not in its first form, but in that of carbonate of lime—it being supplied with carbonic acid from the carbonate of potash used to produce the precipitation. The proportions obtained in these cases were small; but it does not follow that the whole quantity of lime contained in the soil was found. However, to the extent of this small proportion of lime, is proved clearly the presence of enough of some acid (and that not the carbonic) to combine with it. Neither could it have been the sulphuric, or the phosphoric acid; for though both the sulphate and phosphate of lime are in some soils, yet neither of these salts can be decomposed by muriatic acid.

6th. The strongest objection to the doctrine of neutral soils is, that, if true, the salt formed by the combination of the lime and acid must often be present in such considerable proportions, that it is scarcely credible that its presence and nature should not have been discovered by any of the able chemists who have analyzed soils.\* This difficulty I cannot remove, but it may be met (or

---

\* This difficulty, founded on my then profound and often misplaced respect for all scientific authorities, would have been less, if my own acquaintance with chemistry and chemists had been greater. Boussingault says that any substance in minute quantity, not appearing among the results of analyses by chemists, is by no means evidence that such substances might not have been present, and even easily detected in the original body analyzed. Thus, he adds, "iodine and bromine for a long time escaped notice in all the analyses of sea-water. Chemists, in fact, only discover readily the bodies which exist in some very appreciable quantities in the compounds they examine. The substances whose presence is not foreseen, those which only enter in extremely small quantity in a mineral, are apt to pass the eyes unperceived, of even the most skilful and conscientious." *Rur. Econ. &c.*, p. 205.

Stephens, in his late "Book of the Farm," in reference to his reports of analyses of soils, says: "I regret that I must refer to foreign works to furnish these analyses; but the truth is, we have not one single published analysis of British soil by a British chemist which is worth reading. Sir Humphry Davy just analyzed soil to determine the amount of the first four substances mentioned [silica, alumina, oxide of iron, and oxide of manganese], and one or two others, and failed to detect five or six of the most important ingredients." (P. 224, of republication in Skinner's Farmer's Library.)

neutralized, to borrow a figure from my subject), by showing that an equal difficulty awaits those who may support the other side of the argument.

The theory of geologists of the formation of soils, from the decomposition or disintegration of rocks, is received as true by all scientific agriculturists. The soils thus supposed to be formed, receive admixtures from each other, by means of different operations of nature, and after being more or less enriched by the decay of their own vegetable products, make the endless variety of existing soils.\* But where a soil, lying on and thus supposed to have been formed from any particular kind of rock, is so situated that it could not have been moved, nor received considerable accessions from torrents or other agents, then, according to this theory, the rock and the soil should be composed of the same materials; and such soils as the specimens, marked 11 and 16 (page 64), would be, like the rock they touched, nearly pure calcareous earth, instead of being (as they were in truth) destitute, or nearly so, of that ingredient. Such are the doctrines received and taught by Davy, or the unavoidable deductions from them. But, without contending for the full extent of this theory of the formation of soils, every one must admit that soils thus situated must have received, in the lapse of ages, some accessions to their bulk, from the effects of frost, rain, sun, and air, on the lime-stone in contact with them. All lime-stone soils, properly so called, exhibit certain marked and peculiar characters of colour, texture, and products, which can only be derived from receiving into their composition more or less of the rock which lies beneath, or rises above their surface. This mixture will not be denied by any one who has observed lime-stone soils, and reasons fairly, whether his investigation begins with the causes, or their effects. If then all this accession of carbonate of lime remains in the soil, why is it that none, or almost none, is discovered by accurate chemical analysis? Or, if it be supposed not present, nor yet changed in its chemical character, in what possible manner could a ponderous and insoluble earth have made its escape from the soil? To remove this obstacle, without admitting the operation of acid in making such soils neutral, will be attended with at least as much difficulty, as any arising from that admission being made.

7th. But we are not left entirely to conjecture that soils were once more calcareous than they now are, if chemical tests can be relied on to furnish proof. Acid soils that have received large quantities of calcareous earth as manure, after some time, will yield very little when analyzed. To a soil of this kind, full of vegetable matter, I applied, in 1818 and 1821, fossil shells at such a known

---

\* Agr. Chem. p. 131. Also Treatise on Agriculture (by General Armstrong), quoted in a preceding page (53) of this essay.

and heavy rate as would have given to the soil (by calculation) at least three per cent. of calcareous earth, for the depth of five inches. Only a small portion of the shelly matter was very finely divided when applied. Since the application of the greater part of this dressing (only one-fourth having been laid on in 1818), no more than six years had passed before the following examinations were made (at end of 1826); and the cultivation of five crops in that time, three of which were horse-hoed, must have well mixed the calcareous earth with the soil. Three careful examinations gave the following results:

No. 1.—100 grains yielded  $7\frac{1}{2}$  of coarse calcareous earth (fragments of shells),

And less than  $\frac{1}{2}$  of finely divided.

8

No. 2.—1000 grains yielded 5 of coarse,  
2 finely divided,

7

No. 3.—1500 grains yielded 15 of coarse,  
 $2\frac{1}{2}$  finely divided.

17 $\frac{1}{2}$

The specimens, No. 1 and No. 2, were obtained by taking handfuls of soil from several places (four in one case, and twelve in the other), mixing them well together, and then taking the samples for trial from the two parcels. On such land, when not recently ploughed, there will always be an over-proportion of the pieces of shells on the surface, as the rains have settled the fine soil, and left exposed the coarser matters. On this account, in making these two selections, the upper half-inch was first thrown aside, and the handful dug from below. No. 3 was taken from a spot showing a full average quantity of small fragments of shells, and included the surface. I considered the three trials made as fairly as possible, to give a general average. Small as is the proportion of finely divided calcareous earth exhibited, it must have been increased by rubbing some particles from the coarser fragments, in the operation of separating them by a fine sieve. Indeed it may be doubted whether any proportion remained very finely divided—or in other words, whether it had not been combined with acid, as fast as it was so reduced. But without the benefit of this supposition, the finely divided calcareous earth in the three specimens averaged only one and one-fourth grains to the thousand, which is one twenty-fourth of the quantity laid on; and the total quantity

obtained, of coarse and fine, is eight grains in one thousand, or about one-fourth of the original proportion. All the remainder had changed its form, or otherwise disappeared, in the few years that had passed since the application.\*

[Another similar trial of this soil from the same ground was repeated in July, 1842, which showed that the finely divided *carbonate* of lime, then remaining, was in quantity so small as to be barely perceptible and appreciable. The land had then remained undisturbed by tillage for nine months; and some scattered fragments of shells were exposed to view on the surface generally. For the obvious reasons stated in the preceding paragraph, there will always appear an over-proportion of such fragments, upon the surface of land not recently ploughed; for this reason, as on two of the three former trials, the upper half-inch of surface soil was thrown aside, and the sample for examination taken immediately below. Of this, 2400 grains yielded two grains only of small fragments of shells, and less than one grain of finely divided carbonate of lime; whereas seventy-two grains had been the original quantity furnished to the soil. This result, with those of the earlier trials, agree precisely with what would be expected from the action of acid in soil, and cannot be satisfactorily explained by any other doctrine.†—1842.]

---

[\* An experiment conducted by Lampadius, and quoted by Johnston in his recent work, is very like the above, and shows like results. "He mingled [the carbonate of] lime with the soil of a piece of ground till it was in the proportion of 1.19 per cent. of the whole, and he determined subsequently by analysis, the quantity of lime it contained in each of the three succeeding years.

1st year	it contained	1.19	per cent.	of carbonate of lime.
2d year	.	0.89	"	"
3d year	.	0.52	"	"
4th year	.	0.24	"	"

But from these premises, so similar to mine, it must be admitted that Prof. Johnston arrives at a very different conclusion. He takes the gradual lessening of the *carbonate* as proving the entire removal from the soil of so much lime; while I considered it as showing merely the change from the carbonate to some other salts of lime.—1849.]

[† Even of this very small amount of fragments of shells found (2 grains), more than half was of the very hard gray shells (oyster and scallop), which seem almost indestructible in soil. They must contain some chemical ingredient which enables them to withstand the acid or other corroding action of soil, to which all the white fossil shells, whether hard or soft, so readily yield in the course of time. I recently observed a most striking proof of this well known general fact of the long durability of these gray shells, and consequently their comparative worthlessness as a manure. On like soil to the subject of the above trials, and near the same spot, I recently (1842) found a small and thin but well-marked oyster-shell (*Ostrea Virginiana*), apparently as perfect and as well preserved as when it was dug up, and which was a good characteristic specimen of the kind, and, as

The very small proportions of finely divided calcareous earth compared to the coarse, in some shelly soils, furnish still stronger evidence of this kind. Of the York river soil (described page 60 No. 5),

1260 grains, yielded of coarse calcareous parts,	-	168 grains.
And of finely divided,	-	8

1044 of the rich Nansemond soil (No. 6),	-	544 coarse:
	-	18 fine.

As many of the shells and their fragments in these soils are in a mouldering state, it is incredible that the whole quantity of finely divided particles derived from them should have amounted to no more than these small proportions. Independent of the action of natural causes, the plough alone, in a few years, must have pulverized at least as much of the shells as was found.

8th. In other cases, where the operations of nature have been applying calcareous earth for ages, none now remains in the soil; and the proof thence derived is more striking than any obtained from artificial applications of only a few years' standing. Valleys, subject to be frequently flooded and saturated by the water of lime-stone streams, must necessarily retain a new supply of calcareous earth from every such soaking and drying. Lime-stone water contains the *super-carbonate of lime*, which is soluble; but this loses its excess of carbonic acid when left dry by evaporation, and becomes the carbonate of lime, which not being soluble, is in no danger of being removed by subsequent floods. Thus, accessions are slowly but continually made, through many centuries. Yet such soils are found containing no calcareous earth—of which a remarkable example is presented in the soil of the cultivated part of the Sweet Spring Valley (No. 8, page 63.)

[The excess of carbonic acid, which unites with lime and renders the compound soluble in water, is lost by exposure of the calcareous water to the air, as well as by evaporation to dryness. [*Accum's Chemistry—Lime.*] The masses of soft calcareous rock which are deposited in the rapids of lime-stone streams are examples of the loss of carbonic acid from exposure to the air; and the stalactites in caves, the deposit of the slow-dropping water holding in solution the super-carbonate of lime, are examples of the same effect produced by evaporation. A similar deposit of insoluble carbonate of lime, from both these causes, is necessarily made on all land subject to be flooded by lime-stone waters.]

such, has been placed in my cabinet. This shell was part of the dressing spread upon the field for the crop of 1821, and had been since exposed to all the vicissitudes of tillage and of weather for nearly twenty-two years.—1842.]

9th. All *wood ashes* contain salts of lime (and most kinds in large proportions), which could have been derived from no other source than the soils on which the trees grew. The lime thus obtained from ashes is principally combined with carbonic acid, and partly with the phosphoric, forming phosphate of lime. The table of Saussure's analyses of the ashes of numerous plants,\* is sufficient to show that these products are general, if not universal. The following examples of some of my own few examinations indicate that ashes yield calcareous earth in proportions suitable to their kind, although the wood grew on soils destitute of that ingredient—as was ascertained with regard to each of these soils.

100 GRAINS OF ASHES FROM	WHAT SOIL TAKEN FROM.	CARBONATE OF LIME.	PHOSPHATE OF LIME.
Whortleberry bushes, the entire plants, except the leaves,	Acid silicious loam,	4 grains.	4 grains.
Equal parts of the bark, heart, and sap-wood of an old locust,	The same,	51 "	18 "
Young locust bushes entire	Rich neutral clay loam,	40 "	30 "
Young pine bushes,	Acid silicious loam,	9 "	6 "
Body of a young pine tree,	Acid clay soil,	14 "	18 "
Body of a white oak sapling,	Stiff whitish clay, acid and poor,	70	of both.

The potash was first carefully taken out of all these samples. The remaining solid matter was silicious sand and charcoal; the proportion of the latter varying according to the degree of heat used in burning the wood, which was not permitted to be very strong, for fear of converting the calcareous earth into quick-lime.†

\* Quoted in Davy's *Agr. Chem.* Lecture 8.

† [In the first sketch and earliest publication of this essay in the "American Farmer," of 1821, the statement of the calcareous contents of ashes, similar to the above, was followed by the following remark: "The results of the few examinations I have made do not confirm the opinion [or results] of De Saussure, that ashes yield quantities of calcareous earth somewhat proportioned to the quantities contained in the soils from which they were taken. But they show, in different plants, quantities suited to the soil which each prefers. Thus, of three kinds of ashes from the same soil, those of pine gave 5½, of whortleberry 4, and of locust 51 per cent. of carbonate of lime, and [somewhat] similar proportions of other salts of lime." (*Am. Far.* iii., p. 316.) In all the succeeding separate editions of the essay, this remark was suppressed, being deemed too presumptuous for me to use. But I may now dare to reassume the position, since Johnston denies the accuracy of De Saussure's and also of Berthier's analyses, which concur in the conclusions referred to, and also the correctness of these



It must be evident and unquestionable that all the carbonate of lime yielded by the ashes had been necessarily furnished in some form by the soil on which the plants grew; and when the soil itself contained no carbonate, as in all these cases, some other compound of lime must have been present, to enable us to account for these certain and invariable results. The presence of a combination of lime with some *vegetable* acid, and none other, would serve to produce such effects. According to established chemical laws, if any such combination had been taken up into the sap-vessels of the tree, it would be decomposed by the heat necessary to convert the wood to ashes; the acid would be reduced to its elementary principles, and the lime would immediately unite with the carbonic acid (which is produced abundantly by the process of combustion), and thus present a product of *carbonate of lime* newly formed from the materials of the other substances decomposed.\*

On the foregoing facts and deductions, I am content to rest the truth of the existence of acid and neutral soils.

---

NOTE.

*Scientific Confirmation of the doctrine of Acid in Soils.*

[1835. I have chosen to leave all the preceding part of this chapter (with the exception of a few merely verbal corrections and alterations) precisely as it appeared in the previous edition of this

---

conclusions. He adds the following words, which, in connexion with his context, show that his opinion concurs with my position, that (supposing enough lime to be present) the proportion in the ashes of plants is according to the nature and demand for lime, of the particular plant; and not to the great abundance or scarcity of lime in the soil producing the plant. He says—"the ash of the same plant, if ripe and healthy, is nearly the same in kind and quality in whatever circumstances (if favourable) of soil or climate it may grow." (p. 244.) That chemists now generally admit De Saussure's conclusions to be erroneous may also be safely inferred from this: the many results of the ashes of plants which have appeared in recent works, are rarely (if ever) accompanied by any report of the contents of the soil whence derived; thus showing that the calcareous or other ingredients are inferred to be according to the kind of plant, and not dependent on the character of the soil.—1849.]

\* The reasoning on the presence of the carbonate of lime found in ashes from acid soils, does not apply to the phosphate of lime which is also always present. The latter salt is not decomposed by any known degree of heat [Art. *Chemistry*, in *Edin. Ency.*], and therefore might possibly have remained unchanged, in passing from the soil to the tree, and thence to the ashes.

essay, (January 1832.)\* - But since that time I have first heard of a discovery, and of consequent investigations by men of science, which seem to furnish direct proof of what I have been contending for, viz. *the existence of a vegetable acid substance in soils and manures, generally diffused, and often in large proportions, and yet which had not been known or suspected by chemists previously.*

The first intimation of this discovery which reached me was in an extract in a newspaper from the "*Alphabet of Scientific Gardening*," by Professor Rennie, published in London in 1833, from which the part relative to this subject will be quoted below. Since, I have seen the French version of the late work of Berzelius, in which his views of humic acid (or, as he names it, the geic acid) are given more at length.† The facts respecting humic acid, as concisely stated in the following quotation from Professor Rennie, furnish strong confirmation of some of the opinions which I have endeavoured to maintain. It will however be left, without farther comment, for the reader to observe the accordance, and to make the application.

"*Humic acid and humin.*—In most chemical books the terms *ulmic acid* and *ulmin* are used, from *ulmus*, elm; but, as its substance occurs in most, if not all plants, the name is bad. I prefer Sprengel's terms, from *humus*, soil.

"This important substance was first discovered by Klaproth, in a sort of gum from an elm; but it has since been found by Berzelius in all barks; by M. Braconnot in saw-dust, starch, and sugar; and, what is still more interesting for our present purpose, it has been found by Sprengel and M. Polydore Boullay to constitute a leading principle in soils and manures. *Humin* appears to be formed of carbon and hydrogen, and the *humic acid* of humin and oxygen. Pure humin is of a deep blackish brown, without taste or smell, and water dissolves it with great difficulty and in small quantities; consequently it cannot, when pure, be available as food for plants.

"Humic acid, however, which, I may remark, is not sour to the taste, readily combines with many of the substances found in soils and manures, and not only renders them, but itself also, easy to be dissolved in water, which in their separate state could not take place. In this way *humic acid* will combine with lime, potass, and ammonia, in the form of *humates*, and the smallest portion of these will render it soluble in water and fit to be taken up by the spongetlets of the root fibres.

"It appears to have been from ignorance of the important action of the humic acid in thus helping to dissolve earthy matters, that the older writers were so puzzled to discover how lime and potass got into plants; and it seems also to be this, chiefly, which is so vaguely treated of in the

---

\* The general positions and views taken as to acid and neutral soils are also, in substance and purport, just as they appeared in my first publication on this subject, in 1821.

† A long extract from Berzelius' "*Traité de Chimie*," embracing these views, was translated for and published in the two preceding editions of this essay, and also in the *Farmer's Register*. It is omitted now as unnecessary.—1849.

older books, under the names of *extractive*, *vegetable extract*, *muclaginous matter*, and the like. Saussure, for instance, filled a vessel with turf, and moistened it thoroughly with pure water, when by putting ten thousand parts of it by weight under a heavy press, and filtering and evaporating the fluid, he obtained twenty-six parts of what he termed *extract*; from ten thousand parts of well dunged and rich kitchen garden mould, he obtained ten parts of *extract*; and from ten thousand parts of good corn field mould, he obtained four parts of *extract*.

"M. Polydore Boullay found that the liquid manure, drained from dunghills, contains a large proportion of humic acid, which accounts for its fertilizing properties so well known in China and on the continent; and he found it also in peat earth, and in varying proportions in all sorts of turf. It appears probable, from Gay-Lussac having found a similar acid (technically *azumic acid*), on decomposing the prussic acid (technically *hydro-cyanic acid*), that the humic acid may be found in animal blood, and if so, it will account for its utility as a manure for vines, &c. Dobereiner found the gallic acid convertible into the humic."

[When the second edition of this essay was published (in 1835), the above annunciation had but just before been made, showing that there was indeed high scientific authority for the very general existence of a vegetable acid in soils. And since that time, the fact has been admitted by almost all scientific writers, and has been treated of at length in sundry chemical works and reports of geological surveys in this country. The doctrine of the existence of an acid of soil, of vegetable origin, which before had scarcely any other authority for its support than mine, humble and obscure as that was, is now of universal acceptance. Still, notwithstanding all that has been written on the subject, very little light has been thrown on it by the chemists who have treated of it. Being myself too little informed to be able to properly digest these different speculations and to balance authorities, and to separate the true and valuable from the erroneous or worthless of what has been lately published, I deem it best still to rely on my own previously published views and proofs only, as presented in the foregoing pages. Therefore, leaving it to chemists to settle their present differences of opinion in regard to the qualities, and even identity, as well as name of the acid of soil, and to clear away the existing confusion and obscurity of their views, I will, for the present, adopt nothing on their authority in this respect. Still, I earnestly hope that their subsequent investigations may be successful in eliciting and determining what is true of this acid—and also in applying the truths ascertained to advance the knowledge of the composition and improvement of soils. For the same reason, I shall also decline adopting any of the various terms which have been successively applied by different, and even the same chemists, to designate the *acid of soil*; as *humic*, *geic*, *crenic*, and *apocrenic acid*, &c.—1842.]

[Long after the publication of the latest of the passages of the foregoing chapter, I first learned the existence of good and sufficient

authority, in a work of deservedly high reputation, for my doctrine of acid soils. This is Thaer's "Principles of Agriculture," of which the English translation was first published in the United States in 1846, (in Skinner's "Farmers' Library,") and which permitted my earliest access to the work. The portion on *humus* testifies positively and fully to the existence of acid soils, and also to such results therefrom as I have maintained. At what time these particular and important views of Thaer were first published, does not appear; though it may be inferred, as almost certain, that it was subsequent to the discovery and early observations of humic acid of Sprengel and Boullay, as stated above in the article quoted from Rennie's publication of 1833. The preface to the translation of Thaer's work states that the original was first published in Germany, in successive numbers, from 1810 to 1812. But a work of this kind, in every succeeding edition, would undoubtedly receive from its author such additions and alterations as would keep pace with the progress of agricultural and chemical science. In presenting the doctrine of acid in soil, Thaer does not claim the important discovery as his own, nor has he ever been quoted as the first discoverer, or even as one among the earlier investigators. Neither does he refer to other names, as authorities (as Rennie has done above), which would naturally have been done if it was then a discovery so recent as to require such authentication. These would be enough reasons for inferring that Thaer's statements on this subject are of date much later than his first edition. There is another strong reason for this position. If he had announced the existence of acid in soils in his earliest edition, it would have been prior to the earliest elaborate and very able works on agricultural chemistry, by Davy and Chaptal. It is incredible that both these distinguished investigators should have passed over such evidence, if in existence, and upon such high agricultural authority as Thaer's, without the slightest notice, and (as before stated) without making any allusion to the existence of humic or any other vegetable acid as a very general ingredient of soils. Indeed there is direct proof that Thaer's work was a later publication than Chaptal's, as the latter is quoted from in the former, in the portion entitled "Theory of Soils." For each and all these reasons, it is impossible that Thaer's notice of humic acid could have been as early as his first edition; and very improbable that it should have been as early as Professor Rennie's statement copied above.

But whatever was their date, the following passages from Thaer offer confirmation of my views of acid soils more full and complete than to be seen in any other author within my observation, and which, therefore, are doubly welcome, as the testimony of so profound and distinguished an investigator.

"Humus" is the term used by this author for the decomposed vegetable and other organic matter which is more or less mixed with all surface soil, and which gives to soil all its fertility, and furnishes all the food of plants. He continues:—

"It is the residue of animal and vegetable putrefaction, and is a black body; when dry it is pulverulent, and when wet has a soft, greasy feel."—

"It is the produce of organic power—a compound of carbon, hydrogen, nitrogen, and oxygen, such as cannot be chemically composed," &c. p. 534.

"When humus remains constantly damp, without, however, being covered with water, it forms a very unpleasant smelling acid, which is more particularly characterized by the property which it possesses of colouring blue litmus paper into red. This circumstance has long been known, and it is the reason that land and meadows which are not properly drained, and which exhibit these phenomena, are called *sour*. We have carefully examined these facts, and have endeavoured to discover the peculiar constitution of this acid. At first, we were inclined to regard it as being of a distinct nature, and having carbon for its base; but we have since become convinced that it is generally composed of acetic acid, and occasionally contains a portion of the phosphoric. This latter always adheres so firmly to the humus that it cannot be separated from it either by boiling or washing. The liquid in which the humus is boiled certainly acquires a slight acid flavour, but the greater part of the acid remains attached to the humus."—"This acid or sour humus is not at all of a fertilizing nature; on the contrary, it is prejudicial to vegetation.\* Where it is very strong and pervades the whole of the humus, the soil only produces reeds, rushes, sedge, and other useless, unpalatable plants; and whenever these abound, it may be inferred that the soil contains a great deal of sour or acid humus."†—"There are various means of getting rid of this baneful property, and rendering the humus fertile."—"It is well known that with the aid of alkalies, ashes, lime, and marl, humus may be deprived of its acidity, and rendered easily soluble."—"Heaths do not thrive where this [acid] humus does not exist, and when they have established themselves in one particular spot, they suffer few other plants to appear. This humus may be changed by a dressing composed of marl, lime, or ammonia; and where this has been mixed with the soil, the heaths, &c., speedily perish." (p. 538-9.)

"In the greater number of cases, peat is very much like acid or sour humus; indeed, it sometimes resembles it so strikingly that it is impossible to distinguish these substances apart." (p. 540.)

"In both the kinds of land we have been considering [i. e., classes of very fertile soil, rich in humus], we have supposed the humus to be mild, or exempt from acidity.‡ Sour or acid humus totally destroys the fertility of a soil; sometimes, however, the soil contains so very small a portion of acidity that its fertility is very slightly diminished, and only with regard to some few plants. Barley crops become more and more scanty in proportion as the acidity is increased; but oats do not appear to be at all affected by it. Rye grown on such land is peculiarly liable to rust, and is easily laid or lodged. The grains of all the cereals become larger, but contain

\* Even to this day, Von Thaer is the only agricultural chemist known, who affirms, with me, this important evil quality of the acid of soil.—E. R.

† These, of course, are like our broom-grass, sorrel, poverty grass, pine, &c., of the general class of what I called acid plants. Heath is another, and the most abundant in Europe, though not existing in America.—E. R.

‡ Which, according to my views and language, would be expressed by the acid of the soil having been neutralized by lime.—E. R.

less farina. Grass which grows on these spots is, both in species and taste, less agreeable, and less suitable for cattle, than any other, although it yields a very considerable produce in hay. In fact, in exact proportion with the increase of acidity, is the decrease of the value of the soil," &c.

[If the foregoing examinations of soils, and the arguments which follow, remain unquestioned, these two remarkable and important facts may be considered as thereby established beyond dispute or doubt:

1st. That calcareous earth, calx, or carbonate of lime, is in general as entirely deficient in the soils of Virginia, as that ingredient had heretofore been supposed, by agricultural writers, to be common in all soils; and,

2d, That, notwithstanding this total absence of the carbonate of lime, lime in some other form of combination, and in greater or less quantity, is an ingredient of every soil capable of producing vegetation.

Nor do these facts come in conflict with each other; nor either of them with the position which has been contended for, that calcareous matter in proper proportions is necessary to cause fertility in soils. Should some other person, who may be aided by sufficient scientific light, undertake the investigation, he may supply all that is wanting for the direct proof of this theory of the cause of fertility, and perhaps show that the productive value of a soil (under equal circumstances) is in proportion to the quantity of the *vegetable salts of lime* present in the soil. The direct and positive proof of this doctrine, I confidently anticipate will hereafter be obtained from more full examinations of the humic acid, and its compounds in various soils, and from correct and minute reports of the quantities and kinds of those ingredients, in connexion with the degree of the natural fertility of each soil. As yet, however interesting the recent discovery of humic acid may be to chemists, it does not seem that they have suspected it to have anything like the important bearing on the fertilization of soil which I had attributed to the supposed acid principle or ingredient of soils. Berzelius seems scarcely to have bestowed a thought on this most important application of his investigation of the properties of geine and geic acid.—1842.] [Other authors deem not only humin but also humic acid as directly fertilizing to soils, and beneficial to plants; which, as to this, or any other uncombined acid, is altogether opposed to my views.\*—1849.]

\* *Confirmatory testimony.*—After treating extensively of different acids of soils (humic, ulmic, crenic, apocrenic, and medusous), Johnston adds: "Besides these acids, it is known that the malic and acetic are occasionally produced in the soil during the slow decay of vegetable matter of different kinds. It is probable that many other analogous compounds are likewise formed—which are more or less soluble in water, and more or less fitted to aid in the nourishment of plants." (p. 280.) The last words of the passage

Supposing the doctrine to be sufficiently established by my own proofs offered above, it may be useful to trace the formation and increase of acidity in different soils, according to the views which have been presented, and to display the promise which that quality holds out for improving those soils which it has heretofore rendered barren and worthless.

Every neutral soil at some former time must have contained calcareous earth in sufficient quantity to produce the uniform effect of that ingredient of storing up and fixing fertility. [It was then a *calcareous* soil, however small might have been the proportion of free carbonate of lime contained.] The decomposition of the successive growths of plants, left to rot on the rich soil, continually formed vegetable acid, which, as fast as formed, united with the lime in the soil. At last these two principles balanced each other, and the soil was no longer calcareous, but neutral. Instead of its former ingredient, *carbonate of lime*, it was now supplied with a *vegetable salt of lime*. This change of soil does not affect the natural growth, which remains the same, and thrives as well as when the soil was calcareous; and when brought into cultivation, the soil is equally productive under all crops suited to calcareous soils. If the supplies of vegetable matter continue, the soil may even become acid in some measure, as may be evidenced by the growth of sorrel—but without losing any of its fertility before acquired. The degree of acidity in any one soil frequently varies; it is increased by the growth of such plants as delight to feed on it, and by the decomposition of all vegetable matters. Hence the longer a poor field remains at rest, and not grazed, the more acid it becomes; and this evil keeping pace with the benefits derived, is the cause why so little improvement, or increased product, is obtained from putting acid soils under that mild treatment. Cultivation not only prevents new supplies, but also diminishes the acidity already present

---

of course I oppose; deeming all acid products of soil, alone, as injurious to fertility and productiveness of the land for useful crops.

Besides the state of carbonate, Johnston says that lime exists in fertile soils as chloride of calcium (muriate of lime), as sulphate, phosphate, silicate, or humate of lime. "In combination with humic acid, lime exists most frequently in soils which abound in vegetable matter—in peaty soils, for example, to which lime or marl have been added. \* \* \* Few investigations have as yet been made in regard to the proportion of lime which exists in the soil in the state of humate. It has generally been taken for granted, either that a soil was *destitute of lime*, if it exhibited no sensible effervescence with dilute muriatic acid, or, when further research was made, and the quantity of lime rigorously determined, *that the whole of this lime must have existed in the state of carbonate*. That this is not necessarily the case, however, appears to be proved by some recent examinations of certain soils in Normandy, which contain as much as 14 to 15 per cent. of lime, and yet exhibit no effervescence, and contain no carbonate. The whole of the lime is said to be in the state of humate. (p. 280-1.—1849.)

in excess, by exposing it to the atmosphere; and therefore the more a soil is exhausted of its fertility, the more will also be lessened its acidity, [in absolute quantity; though not relatively to its degree of fertility, which will be lessened still more.]

We have seen from the proof furnished by the analysis of wood ashes, that even poor acid soils contain a little salt of lime, and therefore must have been slightly calcareous at some former time. But such small proportions of calcareous earth were soon equalled, and then exceeded, by the formation of vegetable acid, before much productiveness was caused. The soil being thus changed, the plants suitable to calcareous soils died off, and gave place to others which produce, as well as feed and thrive on, acidity. Still, however, even these plants furnish abundant supplies of vegetable matter, sufficient to enrich the land in the highest degree; but the antiseptic power of the acid prevents the leaves from rotting for years, and even then the soil has no power to profit by their products. Though continually wasted, the vegetable matter is continually again forming, and always present in abundance; but must remain almost useless to the soil, until the accompanying acidity shall be destroyed.

[It may well be doubted whether any soil destitute of lime in every form would not necessarily be a perfect barren, incapable of producing a spire of grass. No soil thus destitute is known, as the plants of all soils show in their ashes the presence of some lime. But it is probable that our sub-soils, which, when left naked by the washing away of the soil, are so generally and totally barren, are made so by their being entirely destitute of lime in any form. There is a natural process regularly and at all times working to deprive the sub-soil of all lime, unless the soil is abundantly supplied. What constitutes soil, and makes the strong and plain mark of separation and distinction between the more or less fertile soil and the absolutely sterile sub-soil beneath? The most obvious cause for this difference which might be stated, is the dropping of the dead vegetable matter on the surface; but this is not sufficient alone to produce the effects, though it may be so when aided by another cause of more power. When the most barren surface earth was formed or deposited by any of the natural agents to which such effects are attributed by geologists, it seems reasonable to suppose that the surface was no richer than any lower part of the whole upper stratum so deposited. If, then, a very minute proportion of lime had been equally distributed through the body of poor earth to any depth that the roots of trees could penetrate, it would follow that the roots would, in the course of time, take up all the lime, as all of it would be wanting for the support of the trees; and their death and decay would afterwards leave all this former ingredient of the soil, in general, on the surface. This



process must have the effect, in the course of time, of fixing on and near the surface the whole of a scanty supply of lime, and of leaving the subsoil without any. But if there is within the reach of the roots more lime than any one crop or growth of plants needs, then the superfluous lime will be permitted to remain in the sub-soil, which sub-soil will then be improvable by vegetable substances, and readily convertible to productive soil. The manner in which lime thus operates will be explained in the next chapter. —1835.]

Nearly all the woodland now remaining in lower Virginia, and also much of the land which has long been arable, is rendered unproductive by acidity; and successive generations have toiled on such land, almost without remuneration, and without suspecting that their worst virgin land was then richer than their manured lots appeared to be. The cultivator of such soil, who knows not its peculiar disease, has no other prospect than a gradual decrease of his always scanty crops. But if the evil is once understood, and the means of its removal are within his reach, he has reason to rejoice that his soil was so constituted as to be preserved from the effects of the improvidence of his forefathers, who would have worn out any land not almost indestructible. The presence of acid, by restraining the productive powers of the soil, has in a great measure saved it from exhaustion; and after a course of cropping which would have utterly ruined soils much better constituted, the powers of our acid land remain not greatly impaired, though dormant, and ready to be called into action by merely being relieved of its acid quality. A few crops will reduce a new acid field to so low a rate of product, that it scarcely will pay for its cultivation; but no great change is afterwards caused, by continuing scourging tillage and grazing, for fifty years longer. Thus our acid soils have two remarkable and opposite qualities, both proceeding from the same cause: they can neither be enriched by manure, nor impoverished by cultivation, to any great extent. Qualities so remarkable deserve all our powers of investigation; yet their very frequency seems to have caused them to be overlooked; and our writers on agriculture have continued to urge those who seek improvement to apply precepts drawn from English authors, to soils which are totally different from all those for which their instructions were intended.\*

---

[\* *Confirmatory testimony.*—Professor Johnston affirms that lime is indispensable to the fertility of soils, as I have done. But he goes still farther than what is true, at least as to America, in the following passage: “The results of all the analyses hitherto made of soils naturally fertile, show that lime is universally present. The percentage of lime in a soil may be very small, yet it can always be detected when valuable and healthy crops will grow upon it. Thus the fertile soil of the

Marsh lands of Holstein contains 0.2 per cent. of carbonate of lime.

Salt marsh in East Friesland . . . 0.6     "     "

Rich pasture near Durham . . . 1.31     "     "

But though the percentage of lime in these cases appears small, the absolute quantity of lime present in the land is still large. Thus, suppose the first of these soils, which contains the least, to be only six inches deep, and each cubic foot to weigh only 80 lbs.—it would contain about 3500 lbs. of carbonate of lime to every acre.—Though the author at first speaks of "lime" as universally present in very fertile soils, it is clear, from the context, that he meant *carbonate* of lime. In succeeding passages he claims the presence of lime in all producing soils, upon the same grounds that I did, viz.: the presence of lime in all ashes of plants. (*Johnston's Lectures*, pp. 378-9.)

It is interesting to compare this recent admission of Johnston, of even more than I claimed (or would admit), and the now general acceptance of the true doctrine, with the following expressions of the late J. C. Loudon, perhaps then the highest agricultural authority in England, if not in all Europe. Both the passages were editorial, in his "Gardener's Magazine" for 1836. The first is part of a short notice of the first edition of this essay (of 1832), which had been "pirated," garbled, and disguised by the editor of the "British Farmer's Magazine," and so published, as if a communication to that periodical. In this notice Mr. Loudon copies the heads of my five propositions, and says—"These propositions contain the marrow of the Essay, which is closely reasoned, and in several particulars original. Mr. Ruffin has the merit of first pointing out that there can be no such thing as naturally fertile soil without the presence of calcareous earth; but where this earth is present, the soil, however exhausted it may have been by culture, will, when left to itself, after a time regain its original fertility; that soils which contain no calcareous earth are never found naturally fertile, . . . and that all that art can do to them, exclusive of adding calcareous earth, is to force crops by putrescent manures; but that when these manures are withheld, the soil will speedily revert to its original sterility. Mr. Ruffin observes that no agricultural or chemical writer ever denied these facts; but, he asserts, *and we think with truth*, that by not one of them have they ever been distinctly stated. We are not quite certain as to Grisenthwaite, but we are so as to Kirwan, Dundonald, Davy, Chaptal, and other agricultural chemists of the continent. . . . It is due to Mr. Ruffin to state it as our opinion, that he has performed a very important service to the scientific agriculturist in this country, as well as in America."

And again, in a subsequent long editorial article, noticing all the important and valuable discoveries or new improvements in agriculture during the preceding year, Mr. Loudon says—

"In agricultural science, the only point that we can recollect worthy of notice, that has occurred during the past year, is the advancement of the principle by the American agricultural writer, Mr. Ruffin, that no soil whatever will continue fertile for any length of time that does not contain calcareous matter. This we believe was never distinctly stated as a principle by Kirwan, Chaptal, Davy, or any other European chemist or agriculturist."—1849.]

## CHAPTER VIII.

THE MODE OF OPERATION BY WHICH CALCAREOUS EARTH INCREASES THE FERTILITY AND PRODUCTIVENESS OF SOILS.

PROPOSITION 3.—*The fertilizing effects of calcareous earth are chiefly produced by its power of neutralizing acids, and of combining putrescent manures with soils, between which there would otherwise be but little, if any, chemical attraction.*

PROPOSITION 4.—*Poor and acid soils cannot be improved durably, or profitably, by putrescent manures, without previously making them calcareous, and thereby correcting the defect in their constitution.*

It has already been made evident that the presence of calcareous earth [in small proportion, or not in too great excess], in a natural soil, causes great and durable fertility. But it still remains to be determined, to what properties of this earth its peculiar fertilizing effects are to be attributed.

Chemistry has taught that silicious earth, in any state of division, attracts but slightly, if at all, any of the parts of putrescent animal and vegetable matters.\* But even if any slight attraction really exists when this earth is minutely divided for experiment in the laboratory of the chemist, it cannot be exerted by silicious sand in the usual form in which nature gives it to soils; that is, in particles comparatively coarse, loose, and open, and yet each particle impenetrable to any liquid, or gaseous fluid, that might be passing through the vacancies. Hence, silicious earth can have no power, chemical or mechanical, either to attract enriching manures, or to preserve them when actually placed in contact and intermixed with them; and soils in which the qualities of this earth greatly predominate, must give out freely all enriching matters which they may have received, not only to a growing crop, but to the sun, air, and water, so as soon to lose the whole. No portion of putrescent matter can remain longer than the completion of its decomposition; and if not arrested during this process, by the roots of living plants, all will escape in the form of *gas* (the latest products of decomposition), into the air, without leaving a trace of lasting improvement. With a knowledge of these properties, we need not resort to the common opinion that manure is

---

\* Davy's Agr. Chem. page 129.

lost by *sinking* through sandy soils, to account for its usually rapid and total disappearance.\*

Aluminous earth, by its closeness, mechanically excludes those agents of decomposition, heat, air, and moisture, which sand so freely admits; and therefore clay soils, in which this earth predominates, give out manure much more slowly than sand, whether for waste or for use. The practical effect of this is universally understood—that clay soils retain manure much longer than sand, but require much heavier applications to show as much effect early, or at once. But as this means of retaining manure is altogether mechanical, it serves only to delay both its use and its waste.

---

\* Except the very small proportions of earthy, saline, and metallic matters that may be in animal and vegetable manures, the whole remainder of their bulk (and the whole of whatever can feed plants) is composed of different elements which are known only in the forms of *gases*—into which manures must be finally resolved, after going through all the various stages of fermentation and decomposition. So far from sinking in the earth, if in quantity, these final results could not be possibly confined there, but must escape into the atmosphere as soon as they take a gaseous form, unless immediately taken up by the organs of growing plants, [or unless held by the soil's absorbing chemical power.] It is probable, however, that but a small portion of any dressing of manure remains long enough in the soil to make this final change; and that nearly all of it is used by growing plants, during previous changes, or carried off by air and water. [During the progress of the many changes caused by fermentation and decomposition, every portion of the manure fit for use, becomes soluble. When in the soluble state only, it is ready for the use of plants; and if not then so used, is as ready to be wasted, if the soil has not enough of attracting and combining power to hold the soluble products. I infer that it depends mainly, if not entirely, on the presence or absence of such chemical power in a sandy soil, with also a sandy or other pervious sub-soil, whether the soluble *products* of putrescent manures are lost by sinking. If there is not enough such power in the soil—that is, if it contains very little lime in any state)—and there is too much manure in a soluble state for the roots of growing plants to take up immediately, then the remainder will be dissolved in the first rain, and follow the course of the excess of water, whether to flow off the surface, or to sink deep into the sub-soil. Of so much as thus sinks, the further decomposition and final conversion to gases must be retarded by the greater seclusion from heat and air. In the mean time, the substance continues to be soluble, and liable to be again carried deeper, by successive heavier rains, until, with their excess of water, penetrating to the sources of springs, either temporary or permanent, and thus passing into the streams. We know that springs are thus supplied by the rains, and that their waters are in many cases polluted by organic as well as mineral soluble matters. This waste by sinking, even of the fertile parts of natural or unmanured soil, is manifest on tilled land of which the pervious sub-soil needs and has failed to receive drainage. In such cases, the water below is oozing away after every wet spell; and sometimes the soil disappears as if washed away, though having nearly a level surface. The dark-coloured organic and alimentary parts only have been thus removed, leaving that which had been soil as poor as its sub-soil.—1849.]

Aluminous earth also exerts some chemical power in attracting and combining with putrescent manures, but too feebly to enable a clay soil to become rich by natural means. [For though clays are able to exert more force than sands in holding manures, their closeness also acts to deny admittance beneath the surface to the enriching matters furnished by the growth and decay of plants. And therefore, before being brought into cultivation, a poor clay soil would derive scarcely any benefit from its small power of combining chemically with putrescent matters. If then it is considered how small is the power of both silicious and aluminous earths to receive and retain putrescent manures, it will cease to cause surprise that such soils cannot be thus enriched, with profit, if at all. It would indeed be strange and unaccountable, if earths and soils thus constituted *could be* enriched by putrescent manures alone.—1835.]

Davy states that both aluminous and calcareous earth will combine with any vegetable extract, so as to render it less soluble (and consequently not subject to the waste that would otherwise take place), and hence "that the soils which contain most alumina and carbonate of lime, are those which act with the greatest chemical energy in preserving manures." Here is high authority for calcareous earth possessing the power which my argument demands, but not in so great a degree as I think it deserves. Davy apparently places both earths in this respect on the same footing, and allows to aluminous soils retentive powers equal to the calcareous. But though he gives evidence (from chemical experiments) of this power in both earths, he does not seem to have investigated the difference of their forces. Nor could he deem it very important, holding the opinion which he elsewhere expresses, that calcareous earth acts "merely by forming a useful earthy ingredient in the soil," and consequently attributing to it no remarkable chemical effects as a manure. I shall offer some reasons for believing that the powers of attracting and retaining manure, possessed by these two earths, differ greatly in their degrees of force.

The aluminous and calcareous soils of this country, through the whole of their virgin state, have had equal means of receiving vegetable matter; and if their powers for retaining it were nearly equal, so would be their acquired fertility. Instead of this, while the calcareous soils have been raised to the highest condition, many of the tracts of clay soil remain the poorest and most worthless. It is true that the one laboured under acidity from which the other was free. But if we suppose nine-tenths of the vegetable matter to have been rendered useless by that poisonous quality, the remaining tenth, applied for so long a time, would have made fertile any soil that had the power to retain the enriching matter.

[Many kinds of shells are partly composed of gelatinous animal

matter, which, I suppose, must be chemically combined with the calcareous earth, and by that means only is preserved from the putrefaction and waste that would otherwise certainly and speedily take place. Indeed, the large proportion of animal matter which thus helps to constitute some kinds of shells, instead of making them more perishable, serves to increase their firmness and solidity. When long exposure, as in fossil shells, has destroyed all animal matter, the texture of the calcareous substance is greatly weakened. A simple experiment will serve to separate, and make manifest to the eye, the animal matter which is thus combined with and preserved by the calcareous earth. If a fresh-water mussel-shell is kept for some days immersed in a weak mixture of muriatic acid and water, all the calcareous part will be gradually dissolved, leaving the animal matter so entire, as to appear still to be a whole shell—but which, when lifted from the fluid which supports it, will prove to be entirely a flaccid, gelatinous, and putrescent substance, without a particle of calcareous matter being left. Yet this substance, which is so highly putrescent when alone, would have been preserved in combination with calcareous matter, in the shell, for many years, if exposed to the usual changes of air and moisture; and if secured from such changes, would be almost imperishable.—1835.]

Calcareous earth has power to preserve those animal matters which are most liable to waste, and which give to the sense of smell full evidence when they are escaping. Of this, a striking example is furnished by an experiment which was made with care and attention. The carcass of a cow, that was killed by accident in May, was laid on the surface of the earth, and covered with about seventy bushels of finely divided fossil shells and earth (mostly silicious), their proportions being as thirty-six of calcareous, to sixty-four of silicious earth. After the rains had settled the heap, it was only six inches thick over the highest part of the carcass. The process of putrefaction was so slow, that several weeks passed before it was over; nor was it ever so violent as to throw off any effluvia that the calcareous earth did not intercept in its escape, so that no offensive smell was ever perceived. In October, the whole heap was carried out and applied to one-sixth of an acre of wheat—and the effect produced far exceeded that of the like calcareous manure alone, which was applied at the same rate on the surrounding land. No such power as this experiment indicated (and which I have since repeated in various modes, and always with like results), will be obtained, or expected, from using clay as the covering earth.

Quick-lime is used to prevent the escape of offensive effluvia from animal matter; but its operation is entirely different from that of calcareous earth. The former effects its object by "eating"

or decomposing the animal substance (and nearly destroying it as manure), before putrefaction begins. The operation of calcareous earth is to moderate and retard, but not to prevent putrefaction; not to destroy the animal matter, but to preserve it effectually, by forming new combinations with the products of putrefaction. This important operation will be treated of more fully in a subsequent chapter.

The power of calcareous earth to combine with and retain putrescent manure, implies the power of fixing them in any soil to which both are applied. The same power will be equally exerted if the putrescent manure is applied to a soil which had previously been made calcareous, whether by nature, or by art. When a chemical combination is formed between the two kinds of manure, the one is necessarily as much fixed in the soil as the other. Neither air, sun or rain, can then waste the putrescent manure, because neither can take it from the calcareous earth, with which it is chemically combined. Nothing can effect the separation of the parts of this compound manure, except the attractive power of growing plants—which, as all experience shows, will draw their food from this combination as fast as they require it, and as easily as from sand. The means then by which calcareous earth acts as an improving manure are, *completely preserving putrescent manures from waste, and yielding them freely for use.* These particular benefits, however great they may be, cannot be seen very quickly after a soil is made calcareous, but will increase with time, and, with the means for obtaining vegetable matters, until their accumulation is equal to the soil's power of retention. The kind, or the source, of enriching manure, does not alter the process described. The natural growth of the soil, left to die and rot, or other putrescent manures collected and applied, would alike be seized by the calcareous earth, and fixed in the soil.

This, the most important and valuable operation of calcareous earth, then gives nothing to the soil; but only secures other manures, and gives *them* wholly to the soil. In this respect, the action of calcareous earth in fixing manures in soils, is precisely like that of *mordants* in "setting" or fixing colours on cloth. When alum, for example, is used by the dyer for this purpose, it adds not the slightest tint of itself—but it holds to the cloth, and also to the otherwise fleeting dye, and thus fixes them permanently together. Without the mordant, the colour might have been equally vivid, but would be lost by the first wetting of the cloth.

[Thus, reasoning *a priori* from that chemical power possessed by calcareous earth, which is wanting to both sandy and clayey earths, would lead to the conclusion that calcareous earth serves to combine putrescent matters with the soil in general; and the known results of fertility being therein so fixed, might serve for

the like proof, even without the other course of reasoning. There is still another proof of this combination being formed, which is obtained by a chemical process, but which is so simple that no chemical science is requisite to make the trial.

If a specimen of any naturally poor soil, after being dried and reduced to powder, be agitated in a vessel of water (as a common drinking glass), and then allowed to stand still, the coarser silicious sand will subside first, the finer sand next, and last the clay. In this manner, and by pouring off the lighter parts, before their subsidence, it is very easy to separate with sufficient accuracy the sand from the clay. But if a specimen of a good rich *neutral soil* be tried in that manner, it will be found that the finest sand and the clay and putrescent matter hold together so closely that they cannot be separated by mere agitation in water. Then take another sample of the same soil, and pour to it a small quantity of diluted muriatic acid; and though no effervescence is produced (the lime not being in the form of carbonate), the acid will take away the lime, or destroy its combination with the other earths, so that the sand and the clay may then be separated by agitation in water, as perfectly and easily as in the case of the poorest soils. This difference between good and bad soils (whether light or stiff), or those naturally rich and those naturally poor, cannot escape the observation of the young experimenter; and the cause can be no other than what I have supposed. This then serves as the third mode of proof of the important position, that calcareous earth (or lime in some other form) not only combines with vegetable and animal matters, but also serves (as a connecting link) to combine these matters with the sand and clay of the soil.—1842.]

The next most valuable property of calcareous manures for the improvement of soil is their *power of neutralizing acids*, which has already been incidentally brought forward in the preceding chapter. According to the views already presented, even our poorest cultivated soils contain more vegetable matter than they can beneficially use; and when first cleared, they have it in great excess. So antiseptic is the acid quality of poor woodland, that before the crop of leaves of one year can entirely rot, two or three others will have fallen; and there are always enough, at any one time, to greatly enrich the soil, if the leaves could be rotted and fixed in it at once.

[This alleged antiseptic effect of vegetable acid in our soils receives strong support from the facts established with regard to *peat soils*, in which vegetable acids have been discovered by chemical analysis; and though the peat or moss soils of Britain differ entirely from any soils in eastern Virginia (except that of the great Dismal Swamp, the only extensive peat bog known), still some facts relating to the former class may throw light on the properties



of our own soils, different as they may be. Not only does vegetable matter remain without putrefaction in peat soils and bogs, and serve to increase their depth by regular accretions from the successive annual growths, but even the bodies of beasts and men have been found unchanged under peat, many years after they had been covered.\* It is well known that the leaves of trees rot very quickly on the rich lime-stone soils of the Western States (neutral soils), while the successive crops of several years' growth, in the different stages of their slow decomposition, may be always found on the acid woodland of lower Virginia.

The presence of acid in soils, by preventing or retarding putrefaction, keeps the vegetable matter inert, and even hurtful on cultivated land; and the crops are still further injured by taking up this poisonous acid with their nutriment. A sufficient quantity of calcareous earth, mixed with such a soil, will immediately neutralize the acid, and destroy its powers; and the soil, released from this baneful influence, will be rendered capable, for the first time, of using the fertility which it really possessed. The benefit thus produced is almost immediate; but though the soil will show a new vigour in its earliest vegetation, and may even double its first crop, yet no part of that increased product is due to the direct operation of the calcareous manure, but merely to the removal of acidity. The calcareous earth, in such a case, has not made the soil richer in the slightest degree, but has merely permitted it to bring into use the enriching principles it had before, and which were concealed by the acid character of the soil. It will be a dangerous error for the farmer to suppose that calcareous earth can enrich soil by direct means. It destroys the worst foe of productiveness, and uses to the greatest advantage the fertilizing powers of other manures; but of itself it gives no fertility to soils, nor does it furnish the least food to growing plants.†

These two kinds of action are by far the most powerful of the means possessed by calcareous earth for fertilizing soils. It has another however of great importance—or rather two others, which may be best described together as the *power of altering the texture and absorbency of soils.*

At first it may seem impossible that the same manure can produce such opposite effects on soils as to lessen the faults of being either too sandy or too clayey—and the evils occasioned by both the want and the excess of moisture. Contradictory as this may

---

\* See Aiton's Essay on Moss Earth, republished in Farmers' Register, vol. v., p. 462.

[† *Confirmation.*—Lime "neutralizes acid substances, which are naturally formed in the soil, and decomposes or renders harmless other noxious compounds which are not unfrequently within reach of the roots of plants." *Johnston's Agr. Chem.* p. 400.]

appear, it is strictly true as to calcareous earth. In common with clay, calcareous earth possesses the power of making sandy soils more close and firm—and in common with sand, the power of making clay soils lighter, or more open and mellow. When sand and clay thus alter the textures of soils, their operation is altogether mechanical; but calcareous earth must exert chemical action in producing such effects, as its power is very far greater than that of either sand or clay. A very great quantity of clay would be required to stiffen a sandy soil perceptibly, and still more sand would be necessary to make a clay soil much lighter—so that the cost of such improvement would generally exceed the benefit obtained. Far greater effects on the texture of soils are derived from much less quantities of calcareous earth, besides obtaining the more valuable operation of its other powers.\*

Every substance that is open enough for air to enter, and the particles of which are not absolutely impenetrable, must absorb moisture from the atmosphere. Aluminous earth, reduced to an impalpable powder, has strong absorbing powers. But this is not the form in which such soils can act—and a close and solid clay will scarcely admit the passage of air or water, and therefore cannot absorb much moisture except by its surface. Through sandy soils, the air passes freely; but most of its particles are impenetrable by moisture, and therefore these soils are also extremely deficient in absorbent power. Calcareous earth, by rendering clay more open to the entrance of air, and closing partially the too open pores of sandy soils, increases the absorbent powers of both. To increase that power in any soil, is to enable it to draw supplies of moisture from the air, in the driest weather, and to resist more strongly the waste by evaporation of light rains. A calcareous soil will so quickly absorb a hasty shower of rain as to appear to have received less than adjoining land of different character; and yet if observed in summer, when under tillage, some days after a rain, and when other adjacent land appears dry on the surface, the part made calcareous will still show the moisture to be yet remaining, by its darker colour. All the effects from this power of calcareous manures may be observed within a few years after their application—though none of them so strongly marked, as they are on lands made calcareous by nature, and in which time has aided and perfected the operation. These soils present great variety in their proportions of sand and clay; yet the most clayey is friable enough, and the most sandy firm and close enough, to be considered soils of good texture; and they resist the extremes of both wet

---

[\* Professor Johnston confirms this remarkable power of calcareous manures to make clay soils lighter, and light soils more close; but (strangely enough), ascribes these opposite operations to the *physical* or *mechanical* action of lime. (P. 400, Agr. Chem.)—1849.]

and dry seasons, better than any other soils whatever. Time, and the increase of vegetable matter, will bring those qualities to the same perfection in soils made calcareous by artificial means, as they are in soils made calcareous by nature.

The subsequent gradual accumulation of vegetable or other putrescent matter in the soil, by the combining or fixing power of calcareous earth, must have yet another beneficial effect on vegetation. The soil is thereby made darker in colour, and it consequently is made warmer, by more freely absorbing the rays of the sun. [This must cause earlier ripening of all the vegetable growths.]

[There is another power or function of lime in soil, indispensable to the perfection, healthy growth, and perhaps even to the existence of every plant; and which has already been considered as a proof of neutral soils. This is to supply, through the roots, to every growing plant some lime in soluble state which will remain fixed in the plant. This quantity varies with the kind of plant, and its wants in different stages of growth; and however varying in different kinds of plants, even when most abundant, it is always very small in proportion to the other (organic) matters taken up by and retained in the substance of plants. By reducing the plant to ashes only can the lime taken up by the roots be found, and the proportion to the ashes and to the former vegetable substance be known.]

It may be perhaps deemed a contradiction, or drawing a distinction where there is no real difference, to affirm the absolute necessity of every plant receiving through its roots, a certain proportion of lime, however minute, and yet denying that lime serves as food for plants. I admit the difficulty of clearly discriminating by definition between the two functions. Still, there is great difference between the manner and results of the supply of lime to plants, and of the aliment which they draw from putrescent manures, humus, or other soluble organic matter. According to the quantity of soluble putrescent manure supplied to or naturally in a soil (unless so enormous as to be hurtful), so will be the quantity of the earliest vegetable growth thereon. But if a soil has been so moderately supplied with lime, as to be barely rendered neutral, the subsequent addition of any greater quantity of lime will add nothing directly, or speedily, to the production of grain or other ordinary crops—nor to the quantity of lime taken up by the whole of such succeeding growth. If a soil so destitute of organic matter—such as is recognised by all as furnishing food to plants—as to be nearly barren, is supplied properly and profusely with putrescent manures, the next growth of vegetables may be remarkable for luxuriance and heavy product. But if this rich supply of food had been entirely withheld, and lime or calcareous earth given

instead, in any quantity, either a very slight increase of productive power, or none at all, would be shown in the next immediately succeeding attempt to produce a crop thereon. Whether then it be correct to consider lime as food for plants, or not, it is all-important that farmers should act, in applying calcareous manures, as if they thereby furnished no food whatever to plants in the direct manner that is done by dung. And great as is this error of the opposite opinion, it has had extensive influence and very injurious consequences. In the greater number of cases, where ignorant farmers have just arrived at the before unknown truth that calcareous manures are of benefit to crops and land, they proceed immediately to the false conclusion that they will produce benefit in the same manner as putrescent manures; and they apply them by the same rules and to similar soils, in the vain expectation of in like manner supplying food to the crops. Such course can result only in disappointment and loss of means, if not injury to the land.

As has been stated, all known plants, not excepting the acid kinds, contain some lime, and therefore it may safely be assumed that some lime is indispensable to the growth of every plant, and to even the lowest productive power of every soil. But, for the greater number of plants, the quantity of lime required is so exceedingly small, that they readily obtain their needed supplies from soils the least supplied by nature with lime. And many plants (like pines and sorrel) prefer the soils having such scant supply of lime as to permit an excess of acid. Other plants require comparatively large supplies, such as clover, and all other of the leguminous or pea tribe. The ashes of these plants contain comparatively very large proportions of lime. Red clover, lucerne, and still more sainfoin, cannot thrive well, except on soils largely supplied with lime in some state; though, for most of such plants, perhaps a rich neutral soil will offer the requisite supplies of lime as well as if calcareous, or containing carbonate of lime. Among trees, locust, papaw, and hackberry (or sugar nut), are also plants to which lime in considerable quantity in the soil is essential. For all such plants, lime is a *specific manure*; that is, it improves their growth in a peculiar and remarkable degree, though none of them can take up into their bodies more than a very small amount of lime.

The following list, showing the proportions of lime in many cultivated plants, is extracted and abridged from the late publication of Johnston, who copied the analyses of Sprengel. The quantities of pure lime are here understood, without reference to the acid (or its kind) with which the lime was combined. 1000 parts in each case of the dry vegetable matters are supposed to be burnt to ashes, and the weights of ashes, and of the pure lime they contain, are only stated.

1000 lbs. of	Gives total of ashes.	Of which there is lime (pure).
Grain of wheat . . . . .	11.77	0.96
Straw of wheat . . . . .	85.19	2.40
Grain of barley . . . . .	23.49	1.06
Straw of barley . . . . .	52.42	5.54
Grain of oats . . . . .	26.	0.86
Straw of oats . . . . .	57.5	1.52
Grain of rye . . . . .	10.5	1.22
Straw of rye . . . . .	28.	1.78
Field bean seed . . . . .	21.86	1.65
Do. straw . . . . .	31.21	6.24
Field peas (English) . . . . .	24.64	0.58
Do. straw . . . . .	49.71	27.30
Common vetch seed ( <i>vicia sativa</i> ) [our part- ridge pea?] . . . . .	29.9	1.60
Straw of same . . . . .	51.1	19.55
Rye grass . . . . .	52.86	7.34
Red clover . . . . .	74.78	27.80
White clover . . . . .	91.32	23.48
Lucerne . . . . .	95.53	48.31
Sainfoin . . . . .	69.57	21.95

—1849.]

Additional and practical proofs of all these powers of calcareous earth will be furnished, when its use and effects as manure will be stated. I am persuaded, however, that enough has already been said both to establish and account for the different capacities of soils for improvement by putrescent manures. If the power of fixing manures in soils has been correctly ascribed to calcareous earth, that alone is enough to show that soils containing that ingredient, in proper quantities, must become rich; and that aluminous and silicious earths mixed in any proportions, and even with vegetable or other putrescent matter added, can never form other than a sterile soil.\*

[\* The several peculiar or stronger powers for increasing fertility and production ascribed above to calcareous earth in soil, are those which were presented to my mind either in advance of all practical applications of the earth as manure, or otherwise were the results of actual observation within a few years after the commencement. The chemical laws and agencies were of course gathered from books. The confirmatory facts were mostly found in my observation of the characters of natural soils, and in the earliest results of my calcareous manurings. It is not necessary here, and would scarcely be proper, to adduce other powers of calcareous manures, learned from much later practical results, or which have since been presented by later and much more scientific investigators. Sundry other useful and some very important agencies of calcareous earth in soils may be seen in the "Lectures on the Applications of Chemistry and Geology to Agriculture," by J. F. W. Johnston. It is gratifying to me, that this author in most respects sustains my doctrine; though in some points we are entirely opposed. These differences, as well as the most im-

## CHAPTER IX.

### ACTION OF CAUSTIC LIME AS MANURE.

THE object of this essay is to treat only of calcareous earth (as before defined) as a manure, and not of pure caustic lime, nor of manures in general. Still the nature of that which is properly my subject is so intimately connected with some other kinds of manures, and is so liable to be confounded with others which act very differently, that frequent references to both classes have been and will be again necessary. To make such references more plain and useful, some general remarks and opinions will now be submitted, as to the peculiar modes of the operation of various manures, and particularly of lime.

Until now I have been careful to say as little as possible of *pure* or *quick-lime*, for fear of my meaning being mistaken, from the usual practice of confounding it with calcareous earth; or of considering both its first and later operations as belonging to one and the same manure. The connexion between the manures is so intimate, and yet their actions so distinct, that it is necessary to mark the points of resemblance as well as those of difference.

My own use of quick or caustic lime as a manure has not extended beyond a few acres; and I do not pretend to know anything from experience of its first or caustic effects. But Davy's simple and beautiful theory of its operation carries conviction with it, and in accordance with his opinions I shall state the theory, and thence attempt to deduce its proper practical use.

By a sufficient degree of heat, the carbonic acid is driven off from shells, lime-stone, or chalk, and the remainder is pure or caustic lime. In this state it has a powerful decomposing power on all putrescent animal and vegetable matters, which it exerts on every such substance in the soils to which it is applied as manure. If the lime thus meets with solid and inert vegetable matters, it hastens their decomposition, renders them soluble, and brings them into use and action as manure. But such vegetable and animal matters as were already decomposed, and fit to support growing plants, are injured by the addition of lime; as the chemical action

---

portant of other operations and values of calcareous manures which he presents, will be brought in view, and considered, at a later part of this essay. Other passages confirming my opinions previously advanced, have been or will be quoted in notes.—1849.]

which takes place between these bodies forms different compounds, which are always less valuable than the putrid or soluble matters were, before being acted on by the lime.\*

This theory will direct us to expect profit from applying caustic lime to all soils containing much unrotted and inert vegetable matter, as our acid wood-land when first cleared, and perhaps worn fields, covered with broomgrass; and to avoid the application of lime, or (what is the same thing) to destroy previously its caustic quality by exposure to the air, for all good soils containing soluble vegetable or animal matters, and on all poor soils deficient in inert, as well as in active nourishment for plants. The warmth of our climate so much aids the fermentation of all putrescent matters in soils, that it can seldom be required to hasten it by artificial means. To check its rapidity is much more necessary, to avoid the waste of manures in our lands. But in England, and still more in Scotland, the case is very different. There, the coldness and moisture of the climate greatly retard the fermentation of the vegetable matter that falls on the land; so much so that, in certain situations, the most favourable to such results, the vegetable cover is increased by the deposit of every successive year, and forms those vegetable soils which are called *moor*, *peat*, and *bog* lands. Vegetable matter abounds in these soils, and sometimes it even forms the greater bulk for many feet in depth; but it is inert, insoluble, and useless, and the soil is unable to bring any useful crop, though containing vegetable matter in such great excess. Many millions of acres in Britain are of the different grades of peat soils, of which almost none exist in the eastern half of Virginia. Upon this ground of the difference of climate, and its effects on fermentation, I deduce the opinion that *caustic lime* would be serviceable much more generally in Britain than here; and indeed that there are very few cases in which the caustic quality would not do our arable lands more harm than good. This is no contradiction to the great improvements which have been made on many farms by applying lime; for its caustic quality was seldom allowed to act at all. Lime is continually changing to the carbonate of lime; and, in practice, no exact line of separation can be drawn between the transient effects of the one, and the later, but durable improvement from the other. Lime powerfully attracts the carbonic acid of which it was deprived by heat, and that acid is universally diffused through the atmosphere (though in a very small proportion), and is produced by every decomposing putrescent substance. Consequently, caustic lime, when on land, is continually absorbing and combining with this acid; and, with more or less rapidity, according to the manner of its application, is returning to its for-

---

\* Davy's Agr. Chem. Lect. vii.

mer state of mild calcareous earth. If spread as a top-dressing on grass lands—or on ploughed land, and superficially mixed with the soil by harrowing—or used in composts with fermenting vegetable matter—the lime is probably completely carbonated, before its causticity can act on the soil. In no case can lime, applied properly as manure, long remain caustic in the soil. Thus most applications of *lime* are, in effect, and even from the beginning of the manuring action, simply applications of *calcareous earth*; but acting with greater energy and power at first, in proportion to the quantity, because more finely divided, and more equally distributed.

[Whether lime, or carbonate of lime, or calcareous earth, may be the term used in reference to any such manure used, or recommended, the general, most important, and all effects other than some of the earliest and least certain to occur, are the same in practice of all. The operation in every case is that of *calxing*. In presenting the theory, and in reasoning, and instruction, it is important to maintain the precise line of separation and distinction between the artificial product, quick or caustic lime, and the naturally existing calcareous earth, or carbonate of lime. But in practical effects they are the same, excepting those only which may be due to the different early conditions of the different substances. Therefore, (always allowing for those early and transient and minor differences), whatever I may say of the operation of calcareous earth as manure, would as well be produced by the *proper* use of lime; and whatever other writers on lime as manure have *correctly* stated, even though perhaps designed by them to be confined to quick-lime, would, as to all abiding and important effects and operations, apply as well to mild and naturally existing calcareous earth, in any of its various forms.

Further—even when the first chemical characters of both caustic lime and carbonate of lime have been altered in the soil, and they may have become changed to other salts of lime, by combining with different acids of soils, still, judging from all experienced and abiding effects, the general and beneficial operations of the original manures still continue. The only known exception is, and which is abundantly obvious, that the power to neutralize acids has then been fully used, and cannot again be exercised by the same lime on any subsequently produced acids.—1849.]\*

---

[\* *Recent Confirmation*.—Johnston says—“The effects of pure lime upon the land, and upon vegetation, are *ultimately* the same, whether it be laid on in a state of hydrate [or newly slaked], or of carbonate.” . . . . .  
“In general, however, the chemical action of the marls and calcareous sands is precisely the same in kind as that of lime in the burne<sup>d</sup> and slaked state, and so far the effects which we have already seen to be produced by marls, represent also the general effects of lime in any form.”—Lectures, p. 390. And further—“You may safely proceed on the principle that the lime in the marls, &c., will ultimately produce precisely the same effects



upon your land, as the lime from the kiln, provided you lay on an equal quantity, and in an equally minute state of division. The effect will only be a little more slow," &c.—Ib. p. 387.—1849.]

[By adopting the views which have been presented of the action of calcareous earth and of lime as manures, and those which are generally received as to the modes of operation of other manures, the following table has been constructed, which may be found useful, though necessarily imperfect, and in part founded only on conjecture. The various particular kinds of manures are arranged in the supposed order of their power, under the several heads or characters to which they belong; and when one manure possesses several different modes of action, the comparative force of each is represented by the letters annexed—the letter *a* designating its strongest or most valuable agency, *b* the next strongest, and so on as to *c* and *d*.

## PROPOSED CLASSIFICATION OF MANURES.

Substances which act as manures are either	<i>Alimentary, or serving as food for plants—as</i>	Feathers, hair, woollen rags, Pounded bones, ( <i>b</i> ) All putrescent animal and vegetable substances, as dung, Stable and farm-yard manures, ( <i>a</i> ) Straw, ( <i>a</i> ) Green crops ploughed in, and dead grass and weeds left on the surface. ( <i>a</i> )
	<i>Solvent of alimentary manures—as</i>	Quick-lime, ( <i>a</i> ) Potash and soap lie, ( <i>a</i> ) Wood ashes not drawn, ( <i>d</i> ) Paring and burning the surface of the soil. ( <i>a</i> )
	<i>Fixers, or Mordants—serving to combine with or set other manures in soils—as</i>	Calcareous earth, including Lime become mild by exposure, ( <i>a</i> ) Chalk, ( <i>a</i> ) Lime-stone gravel, ( <i>a</i> ) Wood ashes, ( <i>b</i> ) Fossil shells (or shell marl), ( <i>a</i> ) Marl (a calcareous clay), ( <i>a</i> ) Old mortar and lime cements. All calcareous manures, ( <i>b</i> )
	<i>Neutralising acids—as</i>	Quick-lime, ( <i>b</i> ) Potash and soap lie, ( <i>b</i> ) Wood ashes. ( <i>c</i> )
	<i>Mechanical, or improving by altering the texture of soil—as</i>	Clay, Sand, Clay marl, ( <i>b</i> ) Fermenting vegetable manures, ( <i>b</i> ) Green manures, ( <i>b</i> ) Unfermented litter. ( <i>b</i> ) Sulphate of lime, or gypsum (for clover), Gypseous earth (or green-sand earth), for clover,
	<i>Specific, or furnishing ingredients necessary for particular plants—as</i>	Calcareous manures (for clover) Phosphate of lime (for wheat) in Bones, ( <i>a</i> ) and Drawn ashes, ( <i>a</i> ) Salt, for asparagus. ( <i>a</i> ).—1835.]

## CHAPTER X.

### INTRODUCTORY AND GENERAL OBSERVATIONS ON MARL AND LIME.\*

**PROPOSITION 5.**—*Calcareous manures will give to our worst soils a power of retaining putrescent manures, equal to that of the best—and will cause more productiveness, and yield more profit, than any other improvement practicable in lower Virginia.*

The theory of the constitution of fertile and barren soils, has now been regularly discussed. It remains to show its practical application, in the use of calcareous earth as a manure. If the opinions which have been maintained are unsound, the attempt to reduce them to practice will surely expose their futility; and if they pass through that trial, agreeing with and confirmed by facts, their truth and value must stand on impregnable ground. The belief in the most important of these opinions (the incapacity of poor soils for improvement, and its cause) first directed the commencement of my use of calcareous manures; and the manner of my practice has also been directed entirely by the views which have been exhibited. Yet in every respect the results of practice have sustained the theory of the action of calcareous manures; unless indeed there be claimed as exceptions the injuries which have been caused by applying too heavy dressings to poor and acid lands; and also the beneficial effects of proper practice being found to exceed in degree what the theory seemed to promise.

My use of calcareous earth as manure has been almost entirely confined to that form of it which is so abundant in the neighbourhood of our tide-waters—the beds of *fossil shells*; together with the *matrix*, or earth with which they are found mixed. The shells are in various states—in some beds generally whole, and in others

---

[\* My views of the *theory of fertilization* have been presented in the preceding pages, (chapters ii. to ix. inclusive), precisely as they appeared in 1832 (and, in substance, at a still earlier time), the later additions being all distinctly marked as such. This was deemed necessary to the maintenance of my claim of priority or of originality of opinions, some of which, though then novel and unsupported by other authority, have since been recognised as true, and are now generally if not universally received by writers on agricultural chemistry. The like necessity will not apply to the remainder of this work; and therefore the distinguishing of later additions to or alterations of the edition of 1832, will not be regularly marked for distinction. Still it will be done whenever it may be required for more clear exposition, or where the later dates of additions are deemed of any importance to their purport.—1852.]

reduced nearly to a coarse powder. The earth which fills their vacancies, and serves to make the whole a compact mass, in most cases is principally silicious sand, and usually contains no putrescent or valuable matter, other than the calcareous.\* The same effects, in the main, might be expected from calcareous earth in any other form, whether chalk, lime-stone gravel, wood ashes, or lime—though the two last have other qualities besides the calcareous. During the short time that lime can remain *quick* or *caustic*, after being applied as manure, it exerts (as before stated) a solvent power, sometimes beneficial and at others hurtful, which has no connexion with its subsequent and permanent action as calcareous earth.

These natural deposits of fossil shells are commonly, but very improperly, called *marl*. This misapplied term is particularly objectionable, because it induces erroneous views of this manure. Other earthy manures have long been used in Europe under the name of marl, and numerous publications have described their general effects, and recommended their use. When the same name is given here to a different manure, many persons will consider both operations as similar, and perhaps may refer to English authorities for the purpose of testing the truth of my opinions, and the results of my practice. But no two operations called by the same name can well differ more. The process which it is my object to recommend, is *calxing*, or simply *the application of calcareous earth in any form whatever, to soils wanting that ingredient, and generally being quite destitute of it; and the propriety of the application depends entirely on the knowing that the manure contains calcareous earth, and what proportion, and that the soil contains none.* In England, the most scientific agriculturists apply the term *marl* correctly to a *calcareous clay* of peculiar texture. But many authors, as well as the illiterate cultivators, have used that name for any smooth soapy clay, which may or may not have contained, so far as they knew, any proportion whatever of calcareous matter. Indeed, in most cases, they have seemed unconscious of the presence as well as of the importance of that ingredient, by their not alluding to it when attempting most carefully to point out the distinguishing characters by which marl may be known. Still less have they inquired into the deficiency of calcareous earth in soils proposed to be marled—but applied any earth which either science or ignorance may have called *marl*, to any soils within a

---

[\* From later observation I have formed the opinion that the colouring matter of blue marls is vegetable extract, chemically combined with the calcareous matter, of which opinion the grounds will be stated hereafter. But still the amount of this vegetable admixture is too small to have much appreciable effect as food for plants; and, for all practical use, the general position assumed above may yet be considered as altogether true.—1842.]

convenient distance—and relied upon the subsequent effects to direct whether the operation should be continued or abandoned. These remarks more especially apply to the older writers; but even the later authors, of the highest character (as Sinclair and Young, for example), when telling of the practical use and valuable effects of marl, omit giving the strength of the manure, and generally even its nature—and in no instance have I found the ingredients of the soil stated, so that the reader might learn what kind of operation really was described, or be enabled to form a judgment of its propriety. From all this, it follows that though what is called *marling* in England may sometimes be (though very rarely, as I infer) the same chemical operation on the soil that I am recommending, yet it may also be either applying clay to sand, or clay to chalk, or true marl to either of those soils, or to some other soil still more calcareous than the earth applied; and the reader will generally be left to guess, in every separate case, which of all these operations is meant by the term *marling*. For these reasons, the practical knowledge to be gathered from all this mass of written instruction on marling will be far less abundant than the errors and mistakes of the authors, and the consequent inevitable false deductions by their readers. The recommendations of marl by English authors, induced me very early to look to what was here called by the same name, as a means for improvement. But their descriptions of the manure convinced me that our marl was nothing like theirs, and thus actually deterred me from using it, until other and original and more correct views instructed me that its value did not depend on its having “a soapy feel,” or on any admixture of clay whatever.\*

---

[\* The remarks above were written in 1820, and are much less applicable to authors of later date. How well justified my expressions then were, will fully appear in the Appendix, in the testimony furnished by quotations of the language and opinions of many authors.

There is no want of precision and clearness in the *definitions* of marl given by modern scientific writers. Though even with some of them, there are still very remarkable misapplications of the terms; as incorrect, indeed, as could be expected from the most ignorant cultivators. Thus the former geological surveyor of New Jersey habitually applies the name of marl to the “green-sand” of that country; which remarkable earth is a soft incoherent crumbly mass of separate grains, neither clayey nor marly in texture or compactness, nor in the least calcareous in its chemical composition. Still more strange than this, is an example found as late as 1849, in the “Second Visit to the United States” of the distinguished geologist Sir Charles Lyell. This author says, when passing from New York to Philadelphia, “In New Jersey we passed over a gently undulating surface of country, formed of red marl and sand-stone, resembling in appearance, and of about the same geological age as the new red sand-stone (trias) of England.” Vol. i. p. 191. This error was not caused by merely the careless use of an incorrect provincial term; for the “new red

[Nevertheless, much valuable information may be obtained from these same English works, on calcareous manure, or on marl (in the

sand-stone" formation of England is largely composed of a true (calcareous) "red marl." The soil in question was probably a red clay, but, as I should suppose, containing not a particle of calcareous earth—and certainly having no quality in common with any marl, true or false, or agreeing with any of the different understandings of what marl is, in texture or composition.

According to scientific definition, marl is composed of carbonate of lime and fine clay. When taken moist from its bed, such marl is not ductile or plastic, like ordinary clay; and is broken more easily than bent. It is cut by a knife to a smooth surface, having an unctuous or soapy feel. When a lump has been dried, and is then put into water, it speedily crumbles to powder, or into thin laminae. Puvis (in his "*Essai sur la Marne*"), considers the clay and carbonate of lime in marl to be chemically combined—which opinion seems well founded. He also supposes marl to be generally, if not universally, of fresh-water formation—as shown by the shells contained.

The term marl may be considered as understood in four principal significations, and two of these running into numerous provincial varieties. With all the precision and care in defining that can be used, it will not be possible for me to avoid using the term sometimes in the different senses in which it is used by other authorities to whom I may refer, or whose opinions may be quoted. Therefore, it will serve for better understanding and greater clearness, to state, in general terms, all the different meanings applied to the term marl, by different classes.

1. The definition of marl by mineralogists, and men of science, is the most exact and most restricted in application—a calcareous clay of peculiar texture and physical qualities, as described more at full above, and elsewhere in this work.

2. The most extended sense—in which I shall use it in reference to its fertilizing operation, (calxing), to embrace every kind of substance of earthy texture, containing carbonate of lime in useful quantity to serve as manure, and that being the principal manuring ingredient.

3. The sense in which it is understood by modern British agricultural authors—which is the mineralogical marl, but also embraces other earths used for the calcareous contents.

4. All the provincial applications of the term in different regions—as to fine clay (in England)—fossil shells, in lower Virginia—calcareous tufa, or travertine, in our mountain region—and non-calcareous green-sand, in New Jersey, &c.: In short, to any kind of earth that experience has proved, or that ignorance has supposed, to be useful as manure.

The operation called "marling" in England is even less like what is known by the same name here, than are the different substances used under that name. That which I have done, and advise, and call marling (in conformity to our provincial and incorrect name given to the substance used), is, as above stated, the application of calcareous earth of any kind, or from any source, to soils deficient in that ingredient—and also, in quantities no greater than will serve to produce the desired *chemical* change in each particular soil. This required proportion of carbonate of lime is rarely more than will make one per cent. of the soil for its ploughed depth; and generally less than half that quantity is enough for profit and for safety. Hence, according to the strength of the manure and the condition of the soil, the usual applications lie between the extremes of 100 and

sense in which that term is used among us)—but under a different head, viz., *lime*. This manure is generally treated of with as little

500 bushels to the acre—and more generally between 200 and 300. In England, (even where we know that the manure is truly marl, or is calcareous), the quantities applied are enormous, and must act mechanically for much the greater part, even if acting chemically at all. For there can be no chemical action, if the soil was calcareous in the slightest degree before the application. The expense there is great, because of the heavy applications; and liming, though that also is there very much heavier and therefore more expensive than with us, is always deemed cheaper labour, and is substituted for marling whenever water-borne lime can be obtained. The case here is reversed—marling being always much cheaper than the cheapest liming, if the marl is dug on or near to the farm to which it is applied.

I will cite a few facts and authorities to show the enormous quantities in which marl is applied in Britain. Arthur Young (in his *Farmer's Calendar*, 10th London collection, p. 40), describes and commends the labours of Mr. Rodwell, who put 140,000 loads of marl (effervescing with acids), to 120 acres of *leased* land, with great profit. The size of the load not stated. But if 20 bushels, this would be (171 loads of 20 bush.) 3420 bushels to the acre. Sir John Sinclair says the red marl (which is calcareous, certainly, as I learn from the *Agricultural Report of Lancashire*) is the great source of fertilization in Lancashire and Cheshire. "The quantity used is enormous; in many cases 300 middling cart-loads to the acre, and the fields are sometimes so thickly covered as to have the appearance of a red-soiled fallow, fresh ploughed." (*Code of Agriculture*.) Counting these loads at 20 bushels, makes 6000 bushels to the acre. The *Lancashire Report*, made by order of the Board of Agriculture, says that the carts for marling are usually drawn by 3 horses, and carry about 15 cwt. (1680 lbs.) This is a very light load, for short distances and level ground. This Report gives sundry facts concurring with the foregoing. A few only will be here quoted. "The quantity [of marl] laid on is from 2 to 3½ cubic roods of 64 [cubic] yards to the statute acre; the expense of which is, according to the distance carried, if within 60 rods [330 yards] on the average, about £8 [or nearly \$40] the acre."—"A cubic rood of marl, of 64 [cubic] yards to the rood, adds nearly half an inch to the staple of the soil to a statute acre of land."—Consequently, the usual dressing, of 2 to 3½ such "cubic" roods, must give a coat of from nearly 1 inch to nearly 1½ inches to the soil. A particular piece of 9 acres of "a wretched black sandy waste" (which however was bought for £33 6s. 8d. per acre), was afterwards marled "at nearly 12 roods, of 64 cubic yards to the acre of 8 rods." [This is a provincial measure, equal to 2 acres, and 18½ perches, statute measure.] This was equal to 20,730 cubic feet to the [large] acre—and more than as many heaped bushels, if the cubic measure of the marl was made in its bed. The cost of this marling was £27 15s. 6d. per [large] acre—[or about \$135, or not quite half this quantity and price, per statute acre]. In this same report, particular estimates are made of the expenses of marling, at stated rates and distances, which of course we must suppose ordinary cases. 1. A field of 30 rods square (about 6 statute acres), marled from a pit in the centre, at 6 cubic roods, would cost for *cartage* per rood, 18s., or £32 8s. for the 6 acres. 2. If a like square, adjoining the first, be marled from the same pit, the previous average distance of 15 rods will be increased by 30, or to 45 rods ( $\times 5\frac{1}{2}$  yards = 247 yds.), the increased expense will be 12s. the acre, or £54 in

clearness or correctness, as is done with marl; but the reader at least cannot be mistaken in this, that the ultimate effect of every application of lime must be to make the soil more calcareous; and to that cause solely are to be imputed all the long-continued beneficial consequences, and great profits, which have been derived from liming. But excepting this one point, in which we cannot be misled by ignorance or want of precision, the mass of writings on lime, as well as on calcareous manures in general, will need much sifting to yield instruction. The opinions published on the mode of operation of lime are so many, so various, and so contradictory, that it seems as if each author had hazarded a guess, and added it to a compilation of those of all who had preceded him. For a reader of these publications to be able to reject all that is erroneous in reasoning, and in statements of facts—or inapplicable on account of difference of soil, or other circumstances—and thus

all for marling the 6 acres. 3. Another 6 acres, adjoining the last, at 75 rods average distance from the pit, would cost £79 4s. So that at this very small distance of 412 yards only, and on even, firm, and level ground, the cost of ordinary marling is about \$35 the English statute acre. Of course, for one or more miles, the expense would be intolerable.

Neither is this marl (or even the poorer "clay" as there termed) in Lancashire wanting in calcareous matter. Of 4 specimens stated, the calcareous proportions were between 19½ and 22 per cent. I infer, from general notices, that others are much richer. There is no intimation in the report as to whether the soils are or are not calcareous before being marled. But there is other and better authority for supposing that the soils are naturally calcareous. The red marl of Lancashire is of the "new red sand-stone" geological formation, and so I presume is the over-lying soil (Morton on Soils, p. 67). If so, this would remove all chemical action from the very heavy dressings of calcareous marl in Lancashire. At p. 70, the same author speaks of the great improvement made by liming "on the red marl" in Somerset and Devonshire. The deservedly high authority of this writer is enough to establish these facts of improvement which he asserts. But it requires no argument to prove that when lime is found a beneficial application to a "red marl" soil, or any soil before calcareous, that it must be by some other mode than that chemical action which I call *marling* or *calxing*, and which always consists in rendering a soil calcareous, which was not so before. We might safely infer that the farmers of Lancashire do not incur the enormous expense of their marlings merely to put the calcareous ingredient on their lands. But the author of the "Report" leaves no doubt on that point. He says: "Undoubtedly the calcareous matter contained in either marl [the clay or the richer marl] is of the highest importance; but obviating the natural deficiencies of the soil, by adding sand to clay, or clay to sand, is of more consequence than the mere calcareous stimulus, which might be obtained at a much lighter expense"—[i. e. by using lime instead.]

In the appendix there will be presented many more facts in confirmation. But these alone will go far to prove that the *marling* of England is still more different from the "marling" or *calxing* which I have recommended and practised, than is our "marl" from the substances so called in Europe.—1851.]

obtain only what is true, and useful—it would be necessary for him first to understand the subject better than most of those whose opinions he was studying. Indeed it was not possible for them to be correct, when treating (as most writers do) of *lime* as one kind of manure, and every different form of the *carbonate of lime* as so many others. Only one distinction of this kind (as to mode of operation and effects) should be made, and never lost sight of—and that is one of substance, still more than of name. Pure or quick-lime, and carbonate of lime, are manures entirely different in their powers and effects. But it should be remembered that the substance that was *pure lime* when just burned, often becomes *carbonate of lime* before it is used (by absorbing carbonic acid from the atmosphere); still more frequently before a crop is planted; and probably always before the first crop ripens. Thus, it should be borne in mind that the manure spoken of as lime is often at first, and always at a later period, neither more nor less than calcareous earth; that lime, which at different periods is two distinct kinds of manure, is considered in agricultural treatises as only one; and to calcareous earth are given as many different names, all considered to have different values and effects, as there are different forms and mixtures of the substance presented by nature.—1835.]

But, however incorrect and inconvenient the term *marl* may be, custom has too strongly fixed its application for any proposed change to be adopted. Therefore, I must submit to use the word *marl* to mean beds of *fossil shells*, notwithstanding my protest against the property of its being so applied.\*

---

[\* The geological character of this tide-water region renders impossible the existence of true marl beds, which can only be sought for with hope, if anywhere in Virginia, in the valleys of our mountain lime-stone region—where it would be as much in vain to seek for the fossil shells, so abundant elsewhere. The latter deposit is the product of the ancient ocean (during the tertiary formations), of which the bottom, with its beds of shells, has been subsequently “up-heaved” to the position of dry land. True marl, when found in considerable quantity, is usually, if not always, a fresh-water formation; being produced from the earth torn up and borne along by rapid rivers and mountain streams, flowing over a chalky or other highly calcareous country. By such suspension and intermingling, the heavier sand is first dropped, and the still floating calcareous and aluminous earths mix and then combine chemically in suitable proportions; and when the suspending water becomes nearly still, by reaching a lake or estuary, the lightest earthy matter is deposited and forms marl. This natural process continues until the receptacle is filled, and the deposit is raised above the water. However much it may appear like fine clay in some respects, true marl is very different in others. It is not in the least plastic. If laid in water after drying, it speedily crumbles to small fragments, showing a laminated structure, the result of the manner of its deposition. Some clays, however, destitute of lime, exhibit this mechanical



The following experiments are reported, either on account of having been accurately made and carefully observed, or as presenting such results as have been generally obtained on similar soils, from applications of fossil shells to nearly six hundred acres of Coggins Point farm (made before 1830). It had been my habit to make written memoranda of such things; and the material circumstances of these experiments were put in writing at the time they occurred, or not long after. Some of the experiments were, from their commencement, designed to be permanent, and their results to be measured as long as circumstances might permit. These were made with the utmost care. But generally, when precise amounts are not stated, the experiments were less carefully made, and their results reported by guess. Every measurement stated, of land or of crop, was made in my presence. The average strength of the different marls used was ascertained by a sufficient number of analyses; and the quantity applied was known by measuring some of the loads, and having them dropped at regular distances. At the risk of being tedious, I shall state every circumstance supposed to affect the results of the experiments; and the manner of description, and of reference, necessary to use, will require a degree of attention that few readers may be disposed to give, to enable them to derive the full benefit of these details. But, however disagreeable it may be to give to them the necessary attention, I will presume to say that these experiments deserve it. They will present practical proofs of what otherwise would be but uncertain theory—and give to this essay its principal claim to be considered truly instructive and useful.

When these operations were commenced, I had heard of no other experiments having been made with fossil shells, except two, which had been tried long before, and were considered as proving the manure to be too worthless to be resorted to again.

The earliest of these old experiments was made at Spring Garden, in Surry, about 1775, by Mr. Wm. Short, proprietor of that estate. The extent marled was eight or ten acres, on poor sandy land. Nothing is now known of the effects for the first twenty-five or thirty years, except that they were too inconsiderable to induce a repetition of the experiment. The system of cultivation was doubtless as exhausting as usual at that time. Since 1812, the farm has been under mild and improving management generally. No care has been taken to observe the progress either of improvement or exhaustion on the marled piece; but there is no doubt that the product has continued for the last fifteen years

---

structure and character in as marked manner as any true marl. Such clays, in former times, were not distinguished by farmers, or even agricultural writers, from marl.—1849.]

better than that of the adjacent land. Mr. Francis Ruffin, the present owner of the farm, believed that the product was not much increased in favourable seasons; but when the other land suffered either from too much wet or dry weather, the crop on the marled land was comparatively but slightly injured. The loose reports that have been obtained respecting this experiment are at least conclusive in showing the long duration of the effects produced.

The other old experiment referred to was made at Aberdeen, Prince George county, in 1803, by Mr. Thomas Cocke. Three small spots (neither exceeding thirty yards square) of poor land, kept before and since generally under exhausting culture, were covered with this manure. He found a very inconsiderable early improvement, which he thought altogether an inadequate reward for the labour of applying the marl. The experiment, being deemed of no value, was but little noticed until after the commencement of my use of the same manure. On examination, the improvement appeared to have increased greatly on two of the pieces, but the third was evidently the worse for the application. For a number of years after making this experiment, Mr. Cocke had considered it as giving full proof of the worthlessness of the manure. But more correct views of its mode of operation, caused by my experiments and reasoning, induced him to recommence its use; and no one has met with more success, or produced more valuable early improvement.

Inexperience, and the total want of any practical guide, caused my applications, for the first few years, to be frequently injudicious, particularly as to the quantities laid on. For this reason, these experiments will show what was actually done, and the effects thence derived, and not what better information would have directed as the most profitable course.

The measurements of corn that will be reported were all made at the time and place of gathering. The measure used for all except very small quantities was a barrel, holding five bushels when filled level, and which being filled twice with ears of corn, well shaken to settle them, and heaped, was estimated to make five bushels of grain; and the products will be reported in *grain*, according to this estimate. This mode of measurement will best serve for comparing results; but in most cases it is far from giving correctly the actual quantity of dry and sound grain, for the following reasons. The common large soft-grained white corn was the kind cultivated, which was always cut down for sowing wheat before the best matured was dry enough to grind, or even to be stored in the ear for keeping; and when the ears from the poorest land were in a state to lose considerably more by shrinking. Yet, for fear of some mistake, or mixture of the different quantities, occurring if measurements were delayed until the crop was gathered,

these experiments were measured when the land was ploughed for wheat in October. The subsequent loss from shrinking would of course be greatest on the corn from the poorest and most backward land, as the most defective and unripe ears would always be there found. Besides, every ear, however imperfect or rotten, was included in the measurement. For these several reasons, the actual increase of product on the marled land was always greater than will appear from the comparison of quantities measured; and from the statements of all such early measurements, there ought to be allowed a deduction, varying from 10 or 15 per cent. on the best and most forward corn, to 30 or 35 per cent. on the latest and most defective. Having stated the grounds of this estimate, practical men can draw such conclusions as their experience may direct, from the dates and amounts of the actual measurements that will be reported. Some careful trials of the amount of shrinkage in particular experiments will be hereafter stated.

No grazing had been permitted on any land from which experiments will be reported, since 1814 (or since being cleared, if in forest at that time), unless the contrary shall be specially stated. The cropping had also been mild, during that time, though previously it was the usual exhausting three-shift and grazing course.

---

## CHAPTER XI.

### EXPERIMENTS WITH AND EFFECTS OF CALCAREOUS MANURES ON ACID SANDY SOILS, NEWLY CLEARED.

#### PROPOSITION 5—*continued.*

As most of the experiments on new land were made on a single piece of twenty-six acres, a general description or plan of the whole will enable me to be better understood, as well as to be more concise, by references being made to the annexed figure. It forms part of the ridge or high table land lying between James River and the nearest stream running into Powell's creek. The surface is nearly level, but slightly undulating. The soil in its natural state very similar throughout, but the part next to the line B C somewhat more sandy, and more productive in corn, than the part next to A D; and, in like manner, it is lighter along A c, than nearer to D f. The whole soil, a gray sandy acid loam, not more than two inches deep at first, resting on a yellowish sandy subsoil, from one to two feet deep, when it changes to clay. Natural

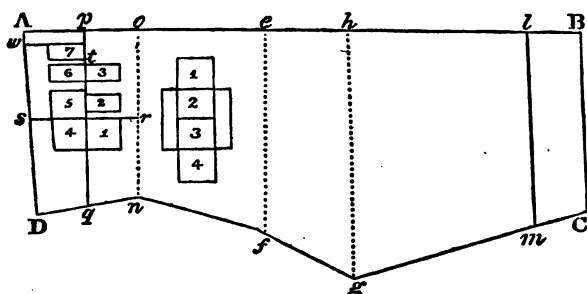

growth mostly pine—next in quantity, oaks of different kinds—a little of dogwood and chinquapin—whortleberry bushes throughout in plenty. The quality of the soil better than the average of ridge lands in general, but yet quite poor. Judging from experience of adjoining grounds and similar soil, this land would have produced as its early and best crop, and under the best treatment, about 12 bushels of corn to the acre, well ripened and fully shrunk. And if thereafter kept under ordinary culture and management, the products would have gradually and speedily sunk to 5 bushels to the acre. Being still less suitable to wheat, that crop would have been scarcely worth being sown on the land in its best natural state (when the product might be 6 bushels), and certainly not at all after a few years of the usual downward progress. The effects of putrescent manures were very transient, as on all such poor lands.

#### *Experiment 1.*

The part B C g h, about 11 acres, grubbed and the trees cut down in the winter of 1814–15—suffered to lie three years with most of the wood and brush on it. February, 1818, my earliest application of marl was made on the smaller part B C m l, about 2½ acres. Marl, containing 33 per cent. of pure calcareous earth, and the balance silicious sand, except a very small proportion of clay; the shelly matter finely divided. Quantity of marl to the acre, one hundred and twenty-five to two hundred heaped bushels. The whole space B C g h coultured, and planted in its first crop of corn in 1818. This was my earliest experiment of calcareous manures.

*Results.* 1818. The corn on the marled land evidently much better—supposed difference, forty per cent.

1819. In wheat. The difference as great, perhaps more so—particularly to be remarked from the commencement to the end of the winter, by the marled part preserving a green colour, while

the remainder was seldom visible from a short distance, and in the spring stood much thinner, from the greater number of plants killed during the winter. The line of separation very perceptible throughout both crops.

1820. At rest. During the summer marled B C *g h*, at the rate of five hundred bushels, without excepting the space before covered, and a small part of that made as heavy as one thousand bushels, counting both dressings. The shells now generally coarse—average strength of the marl, 37 per cent. of calcareous earth. In the winter after, ploughed three inches deep only, as nearly as could be; which however, shallow as it was, made the whole new surface yellow, by bringing the barren sub-soil of yellow sand to the top. One of my neighbours, an intelligent and experienced farmer, who saw the land when in this state, pronounced that I “had ruined the land for ever, by ploughing and turning the soil too deep.”

*Results continued*, 1821. In corn. The whole a remarkable growth for such a soil. The oldest (and heaviest) marled piece better than the other, but not enough so to show the dividing line. The average product of the whole supposed to have been fully twenty-five bushels of ripe and good corn to the acre.

1822. In wheat—and red clover sowed on all the old marling, and one or two acres adjoining. A severe drought in June killed the greater part of the clover, but left it much the thickest on the oldest marled piece, so as again to show the dividing line, and to yield, in 1823, two middling crops to the scythe—the first that I had known obtained from any acid soil, without high improvement from putrescent manures.

1823. At rest—nothing taken off, except the clover on B C *m l*.

1824. In corn—product seemed as before, and its rate may be inferred from the actual measurements on other parts, which will be stated in the next experiment, the whole twenty-six acres being now cleared, and brought under like cultivation.

#### *Experiment 2.*

The part *e f n o*, cleared and cultivated in corn at the same times as the preceding—but treated differently in some other respects. This had been deprived of nearly all its wood, and the brush burnt, at the time of cutting down—and its first crop of corn (1818) being very inferior, was not followed by wheat in 1819, because promising too little product to pay for the cost of the crop. This gave two years of rest before the crop of 1821—and five years rest out of six, since the piece had been cut down. As before stated, the soil rather lighter on the side next to *o e*, than *n f*.

March, 1821. A measured acre near the middle, covered with six hundred bushels of calcareous sand, containing 20 per cent.

of calcareous earth, the upper layer of another body of fossil shells.

*Results.* 1821. In corn. October—the four adjoining quarter acres, marked 1, 2, 3, 4, extending nearly across the piece, two of them within, and two without the marled part, measured as follows :

Not marled, No. 1,	6½	} average to the acre 22½ bushels of grain.
Do. No. 4,	5½	
Marled, No. 2,	8½	} average 33½ bushels.
Do. No. 3,	8½	

The remainder of this piece was marled before sowing wheat in 1821.

1823. At rest.

1824. In corn—distance 5½ by 3½ feet, making 2436 stalks to the acre. October 11th, measured two quarter acres very nearly, if not precisely, coinciding with Nos. 2 and 3 in the last measurement. The products now were as follows :

No. 2 brought 7 bushels 3¼ pecks,		} average 31.2½.
or per acre,	31.1	
No. 3 brought 8 bushels,	32	
Average in 1821,		33.1

#### *Experiment 3.*

The part *e f g h* was cut down in January, 1821, and the land planted in corn the same year. The coultering and after-tillage very badly executed, on account of the number of whortleberry and other roots. As much as was convenient was marled at six hundred bushels, 37 per cent. and the dressing limited by a straight line. Distance of corn 5½ by 3½ feet—2262 stalks to the acre.

*Results.* 1821. October—on each side of the dividing line, a piece of twenty-eight by twenty-one corn hills measured as follows :

No. 1, 588 stalks, not marled, 2 bushels, equal to 7 bushels 3 pecks the acre.

No. 2, 588 stalks, marled, 4½ bushels, equal to 16 bushels 2½ pecks the acre.

1822. In wheat, the remainder having been previously marled.

1823. At rest. During the following winter it was covered with a second dressing of marl at 250 bushels, 45 per cent., making 850 bushels to the acre altogether.

1824. In corn. Two quarter acres, chosen as nearly as possible on the same spaces that were measured in 1821, produced as follows :

No. 1 made 8 bushels, 2 pecks, or to the acre, 34 bushels.

The same in 1821, before marling, . . . 7.3½

Increase, . . . . . 26.0½

No. 2 made 7 bushels, 2½ pecks, or to the acre,	30.2
The same in 1821, after marling,	16.2½

Increase average,	13.3½
-------------------	-------

The second dressing of marl, or the larger quantity, had but little effect in making the increase of crops greater than in 1821. The difference was caused mainly by the greater length of time since the clearing of the land.

1825. The whole twenty-six acres, including the subjects of all these experiments and observations, were in wheat. The first marled piece, in Exp. 1, was decidedly the best—and a gradual decline was to be seen to the latest. I have never measured the product of wheat from any experiment, on account of the great trouble and difficulty that would be encountered. Even if the wheat from small measured spaces could be reaped and secured separately, during the urgent labours of harvest, it would be scarcely possible afterwards to carry the different parcels through all the operations necessary to show exactly the clean grain derived from each. But without any separate measurement, all my observations convince me that the increase of wheat, from marling, was at least equal to that of corn, during the first two years, and certainly greater afterwards, in comparison to the product before using marl.

It was from the heaviest marled part of Exp. 1, that soil was analyzed to find how much calcareous earth remained in 1826 (page 78.) Before that time the marl and soil had been well mixed by ploughing to the depth of five inches. One of the specimens of this soil then examined consisted of the following parts—half an inch of the surface, and consequently the undecomposed weeds upon it, being excluded.

1000 grains of soil yielded	
769 grains of silicious sand moderately fine,	
15 finer sand,	
<hr/>	
784	
8	calcareous earth, from the manure applied,
108	finely divided gray clay, vegetable matter, &c.
28	lost in the process.
<hr/>	
1000	

This part, it has been already stated, was originally somewhat lighter than the general texture of the remainder of the land.

#### *Experiment 4.*

The four acres marked A D n o were cleared in the winter of

1823-4. The lines *p q* and *r s* divide the piece nearly into quarters. The end nearest *A p o* is lighter, and best for corn, and was still better for the first crop, owing to nearly all that half having been accidentally burnt over. After twice coultering, marl and putrescent manures were applied as follows; and the products measured, October 11th, the same year.

*s q* not marled nor manured—produced on a quarter acre (No. 4), of soft and badly filled corn,

	Bush. P.
3 bushels, . . . . . or per acre	12.
<i>q r</i> and <i>r p</i> , marled 800 bushels (45 per cent.) by three measurements of different pieces—	
Quarter acre (No. 1) 5 bushels, very nearly, or per acre	19.3½
Eighth (No. 2) 2.3½ { average }	22.2
Eighth (No. 3) 3.1½ { 24.1½ }	27.
<i>s t</i> manured at 900 to 1100 bushels to the acre, of which,	
Quarter acre (No. 5) with rotted corn stalks, from a winter cow-pen, gave 5.2½ . . . . .	22.2
Eighth (No. 6) with stable manure, 4.1½ . . . . .	35.2
Eighth (No. 7) covered with the same heavy dressings of stable manure, and of marl also, gave 4.2 . . . . .	36.
<i>p w</i> , marled at 450 bushels, brought not so good a crop as the adjoining <i>r p</i> at 800.	

The distance was 5½ by 3½ feet. Two of the quarter acres were measured by a surveyor's chain (as were four other of the experiments of 1824), and found to vary so little from the distance counted by corn rows, that the difference was not worth notice.

1825. In wheat, the different marked pieces seemed to yield in comparison to each other, proportions not perceptibly different from those of the preceding crop—but the best not equal to any of the land marled before 1822, as stated in the 1st, 2d, and 3d experiments.

1827. Wheat on a very rough and imperfect summer fallow. This was too exhausting a course, (being three grain crops in the four-shift rotation), but was considered necessary to check the growth of bushes that had sprung from the roots still living. The crop was small, as might have been expected from its bad preparation.

1828. Corn—in rows five feet apart, and about three feet of distance along the rows, the seed being dropped by the step. Owing to unfavourable weather, and to insects and other vermin, not more than half of the first planting of this field lived; and so much replanting of course caused its product to be much less-matured than usual, on the weaker land. All the part not marled (and more particularly that manured) was so covered by sorrel, as to require ten times as much labour in weeding as the marled parts,



which, as in every other such case, bore no sorrel. October 15th, gathered and measured the corn from the several spaces, which were laid off (by the chain) as nearly as could be, on the same land as in 1824. The products so obtained, together with those of the previous and subsequent courses of tillage, will be presented below in a tabular form, for the purpose of being more readily compared.

[On the wheat succeeding this crop, clover seed was sown, but very thinly, and irregularly. On the parts not marled, only a few yards width received seed, which the next year showed the expected result of scarcely any living clover, and that very mean. On the marled portions, the growth of clover was of middling quality. Was not mowed or grazed, but seed gathered by hand both in 1830 and 1831.]

1832. Again in corn. It was soon evident that much injury was caused to the marled half *q p o n*, by the too great quantity applied. A considerable proportion of the stalks, during their growth, showed strongly the marks of disease from that cause, and some were rendered entirely barren. A few stalks only had appeared hurt by the quantity of marl in 1828. On the lightly marled piece, *w p*, and also on *w t*, where the heaviest marling was accompanied by stable manure, there appeared no sign of injury. The products of the [three] successive crops were as follows:

MARKS.	DESCRIPTION.	PRODUCTS OF GRAIN PER ACRE.					
		1st course.		2d course.		3d course.	
		1824.		1828.		1832.	
		October 11.		October 15.		October 26.	
		Bush.	pecks.	Bush.	pecks.	Bush.	pecks.
<i>s q</i>	Not marled or manured,	12		21	1	17	3½
<i>q r</i> 1	Marled at 800 bushels,	19	3½	28	1½	28	
<i>r p</i> 2	The same,	22	2	31	0¼	27	3
<i>r p</i> 3	The same,	27					
<i>s t</i> 5	Cow-pen manure only, 900 to 1100 bushels,	22	2	25	2	more than <i>s q</i>	
<i>s t</i> 6	Stable manure only, 900 to 1100 bushels,	35	2	29		28	1
<i>w t</i> 7	Marl and stable manure, both as above,	36		33	2	37	3¼
<i>w p</i>	Marled at 450 bushels,	Less than <i>r</i> <i>p</i> (800) }		Equal to <i>r p</i>		31	3

An accidental omission prevented the measurement of *s t* 5, in 1832.]

[This experiment has been made with much trouble, and every care bestowed to insure accuracy. Still several causes have operated to affect the correctness of the results, and to prevent the comparative products showing the true rate of improvement,

either from the marl or the putrescent manure. These causes will be briefly stated.

1st. The quantity of marl (800 bushels) in *q r* and *r p* is nearly double the amount that ought to have been used; and this error has not only increased the expense uselessly but has served to prevent the increase of product that would otherwise have taken place. This loss is proved by the gradual increase, and at last the greater product of *w p*, marled at only 450 bushels.

2d. The comparative superiority of all the marled ground to *s q*, not marled, is lessened by this circumstance: most of the large logs, as well as all the small branches, were burnt upon the land, when it was cleared in 1824, before the experiment was commenced; and the ashes have durably improved a spot where each of these large fires was made on *s q*, but have done no good, and perhaps have been injurious, to the marled pieces that were made sufficiently calcareous without the addition of ashes. At least, the good effect of ashes, on spots, is very evident in *s q*, and has helped somewhat to increase all its measured products, and no such benefit has been visible on the marled parts.

3d. The quantity of putrescent manure applied to *s t* (900 to 1100 bushels) was much too great both for fair experiment and profit; and the excess of quantity, together with the imperfectly rotted state of the stable manure, has given more durability to the effect, than is to be expected from a more judicious and economical rate of manuring on such land when not marled. For these several seasons, it is evident that far more satisfactory results than even these would have been obtained, especially in the amounts of *nett* products, if only half as much of either marl or manure had been applied.

There are other circumstances to be considered, which, if not attended to, will cause the comparative increase or decrease of product in this experiment to be misunderstood. It is well known that poor land put under tillage immediately after being cleared, as this was in 1824, will not yield near as much as on the next succeeding course of crops. This increase, which depends merely on the effects of time, operates independently of all other means for improvement that the land may possess; and its rate, in this experiment, may be fairly estimated by the increase on the piece *s q* from 1824 to 1828. The increase here, where time only acted, was from 12 to 21½ bushels. But as the corn gathered here was always much the most imperfectly ripened, and would therefore lose the most by shinking, I will suppose eight bushels to be the rate of increase from time, and that so much of the product of all the pieces should be attributed to that cause. Then, to estimate alone the increased or diminished effects of marl or manure on the

other pieces, eight bushels should be deducted from all the different applications, and the estimate will stand thus:

	1824.	1828.	Deduct for time.	Increase.	Decrease.	
<i>qr</i> 1	B. P. 19 3½	B. P. 28 1½	B. 8	B. P. 0 2	B. P. —	From 800 bushels of marl.
<i>rp</i> 2	22 2	} 24 1½	8	—	1 1½	800 " of marl.
<i>rp</i> 3	27		8	—	5 2	1000 " cow-pen manure.
<i>st</i> 5	22 2	25	8	—	14 2	1000 " stable manure.
<i>st</i> 6	35 2	29	8	—		

Even the piece covered with both marl and stable manure (*w t*) shows according to this estimate a diminished effect equal to 10½ bushels; which was owing to the marl not being able to combine with, and fix, so great a quantity of manure, in addition to the vegetable matter left by its natural growth of wood. The piece *w p*, marled at 450 bushels alone, has shown a steady increase of product at each return of tillage, and thereby has given evidence of its being the only improvement made in such manner as both judgment and economy would have directed.

[After the crop and measurement of 1832, it was inferred that the separate products of such small spaces could no longer be relied on, owing to the mixture of the surfaces of adjacent parts, necessarily caused by tillage. Therefore the previously omitted parts were marled before the next course of crops came round.—1842.]

## CHAPTER XII.

### EFFECTS OF CALCAREOUS MANURE ON ACID CLAY (OR STIFF) SOILS, RECENTLY CLEARED.

#### PROPOSITION 5—*continued.*

THE two next experiments were made on another field of thirty acres of very uniform quality, marled and cleared in 1826 and the succeeding years. The soil is very stiff, close, and intractable under cultivation—seems to contain scarcely any sand—but, in fact, about one half of it is composed of silicious sand, which is so fine, when separated, as to feel like the finest flour. Only a small proportion of the sand is coarser than this state of impalpable powder. Clayey earth of a dirty pale yellow colour forms nearly all of its remaining ingredients. Before being cleared of the forest growth, and ploughed, the soil is not an inch deep; and all below,

for many feet, is apparently composed of the like parts of clay and fine sand. This is decidedly the most worthless kind of soil, in its natural state, that our district furnishes. It is better for wheat than for corn, though its product is contemptible in everything. It is difficult to be made wet, or dry—and therefore suffers more than other soils from both dry and wet seasons, but especially from the former. It is almost always either too wet or too dry for ploughing; and sometimes it will pass through both states in two or three clear and warm days. If broken up early in winter, the soil, instead of being pulverized by frost, like most clay lands, runs together again by freezing and thawing; and by March, will have a sleek (though not a very even) crust upon the surface, quite too hard to plant on without a second ploughing. The natural growth is principally white and red oaks, a smaller proportion of pine, and an under-growth of whortleberry bushes throughout.

*Experiment 5.*

On one side of this field a marked spot of thirty-five yards square was left out, when the adjoining land was marled at the rate of five hundred to six hundred bushels (37 per cent.) to the acre. Paths for the carts were opened through the trees, and the marl dropped and spread in January, 1826, and the land cleared the following winter. Most of the wood was carried off for fuel; the remaining logs and brush burnt on the ground, as usual, at such irregular distances as were convenient to the labourers. This part was perhaps the poorer, because wood had previously been cut here for fuel; though only a few trees had been taken, here and there, each winter, for a long time past.

*Results, 1827.* Planted in corn the whole recent clearing of fifteen acres—all marled, except the spot left out for experiment: broken up late and badly, and worse tilled, as the land was generally too hard, until the season was too far advanced to save the crop. The whole crop so small, that it was useless to attempt to measure the products. The difference would have been only between a few imperfect ears on the marled ground, and still less—indeed almost nothing—on that not marled.

1828. Again in corn—as well broken and cultivated as usual for such land. October 8th—cut down four rows of corn running through the land not marled, and eight others, alongside on the marled—all fifty feet in length. The rows had been laid off for five and a half feet—but were found to vary a few inches—for which the proper allowance was made, by calculation. The spaces taken for measurement were caused to be thus small by a part of the corn having been inadvertently cut down and shocked, just before. The ears were shelled when gathered; and the products,

measured in a vessel which held (by trial) 1-80th of a bushel, were as follows:

On land not marled,

4 rows, average 5 feet, and 50 in length (500 square feet) 13½ measures, or to the acre 7½ bushels.

On adjoining marled land,

4 rows, average 5 feet 1½ inches by 50 feet = 512 square feet, 25½ measures, or to the acre 13½ bushels.

4 next rows, 5 feet 4½ inches by 50 = 537 square feet, 27½ measures, or to the acre 14 bushels.

1829. In wheat.

1880. At rest—the weeds, a scanty cover.

1831. In corn. October 20th—measured by the chain equal spaces, and gathered and measured their products. The corn not marled was so imperfectly filled, that it was necessary to shell it, for fairly measuring the quantity. The marled parcels, being of good ears generally, were measured as usual, by allowing two heaped measures of ears, for one of grain.

On land not marled,

363 square yards made . . . . . 3 gallons,  
or to the acre, . . . . . 5 bushels.

On marled land, close adjoining on one side,

363 square yards made rather more than 6 gallons—to the acre, 10 bushels. 363 square yards on another side, made not quite 8 gallons, or to the acre, 12 bushels.

The piece not marled coincided with that measured in 1828, as nearly as their difference of size and shape permitted—as did the last named marled piece, with the two of 1828. The last crop was greatly injured by the wettest summer that I have ever known, which has caused the decrease of product exhibited in this experiment—which will be best seen in this form:

		Product of grain to the acre.	
		1828—October 18.	1831—October 20.
Not marled,		7 bushels 1 peck.	5 bushels.
Marled (average),		13 “ 3 “	11 “

*Experiment 6.*

	e	
		D
West.	C	E
		B
	f	

The remainder of the thirty acres was grubbed during the winter of 1826-27; marled the next summer at five hundred to six hundred bushels the acre—marl 40 per cent. A rectangle (A) 11 by 13 poles, was laid off by the chain and compass, and left without marl. All the surrounding land supposed to be equal in quality with A—and all level, except on the sides E and B, which were partly sloping, but not otherwise different. The soil suited to the general description given before; no material difference known or suspected between the land on which 5th experiment was made and this, except that the latter had not been robbed of any wood for fuel, before clearing. The large trees (or all more than ten inches through) were belted, and the smaller cut down in the beginning of 1828, and all the land west of the line *ef*, was planted in corn. As usual, the tillage bad, and the crop very small. The remainder lying east of *ef*, was coultured once; but, as mere labour could not be spared, nothing more was done with it until the latter part of the winter, 1829, when it was broken by two-horse ploughs, oats sown and covered by trowel ploughs; then clover sown, and a wooden-tooth harrow passed over to cover the seed, and to smooth down, in some measure, the masses of roots and clods.

*Results, 1829.* The oats produced badly; but yielded more for the labour required than corn would have done. The young clover on the marled land was remarkably good, and covered the surface completely. In the unmarled part, A, only two casts through had been sown, for comparison, as I knew it would be a waste of seed. This looked as badly as had been expected.

1830. The crop of clover would have been considered excellent even on good land, and was most remarkable for so poor a soil as this. The strips sown through A, had but little left alive, and that scarcely of a size to be observed, except one or two small tufts, where I supposed some marl had been deposited by the cleaning of a plough, or that ashes had been left, from burning the brush. The growth of clover was left undisturbed until after midsummer, when it was grazed by my small stock of cattle, but not closely.

1831. Corn on the whole field. October 20th, measured carefully half an acre (10 by 8 poles) in A, the same in D, and half as much (10 by 4) in E. No more space could be taken on this side, for fear of getting within the injurious influence of the contiguous woods. No measurement was made on the side B, because a large oak, which the belting had not killed, affected its product considerably. Another accidental circumstance prevented my being able to know the product of the side C, which however was evidently and greatly inferior to all the marled land on which oats and clover had been raised. This side had been in corn, followed by wheat, and next (1830) under its spontaneous growth of weeds.

The corn on each of the measured spaces was cut down, and put in separate shocks—and on Nov. 25th, when well dried, the parcels were shucked and measured, before being moved. We had then been gathering and storing the crop for more than fifteen days; and therefore these measurements may be considered as showing the amount of dry and firm grain, without any unusual deduction being required for shrinkage.

	Bush.	Pks.
A (half acre) made 7½ bush. of ears, or of grain to the acre,	7	1
D (half acre)	16½	3
E (quarter acre)	11	22

The sloping surface of the side E, prevented water from lying on it, and therefore it suffered less, perhaps not at all, from the extreme wetness of the summer, which evidently injured the growth on A and D, as well as of all the other level parts of the field.

[1832. The field in wheat.

1833. In clover, which was grazed, though not closely, after it had reached its full growth.

1834. Corn, a year earlier than would have been permitted by the four-shift rotation. The tillage was insufficient, and made still worse by the commencement of severe drought before the last ploughing was completed, which was thereby rendered very laborious, and imperfect withal. The drought continued through all August, and greatly injured the whole crop of corn.

*Results continued.* October 22d. Marked off by a chain half an acre within the space A (8 by 10 poles) as much in D, and a quarter acre (10 by 4 poles) in each of the other three sides C, B, and E, having each of the last four spaces as near as could be to the outlines of the space A. The products carefully measured (in the ears) yielded as follows:

A, not marled, yielded	6 bush.	0½ peck	of grain,	to the acre.
D, marled,	19	3½	“	“
E, do.	20	1	“	“
C, do.	20	2	“	“
B, do.	20	1½	“	“

In comparing these products with those of the same land in 1831, stated above, it should be remembered that the corn formerly measured was dry, while that of the last measurement had yet to lose greatly by shrinking. As, after early gathering, the corn from the poorest land of course will lose most by drying, and as the ears on A were generally very defective and badly filled, if the measurement had been made in the sound and well dried grain of each parcel, the product of A could not have exceeded one-fourth of that of the surrounding marled land, and probably was less.

But though these differences of product present the improvement caused by marling in a striking point of view, this close and stub-

born soil at best is very unfit for the corn crop; and its highest value is found under clover, and in wheat on clover, of which some proofs will be found in the next experiment. The first crop of clover, however, after marling, has not since been equalled.—1835.]

[My subsequent distant residence prevented my observing this field when under any matured crop, until in 1842, when in wheat. The then growth on the unmarled space was certainly not more than one-fourth as much as that of the surrounding ground.—1842.]

#### *Experiment 7.*

Another piece of land of twenty-five acres, of soil and qualities similar to the last described (Exp. 5 and 6), was cleared in 1818, and about 6 acres-marled in 1819, at about three hundred and fifty bushels. The course of cultivation was as follows :

1820. Corn—benefit from marl very unequal—supposed to vary between twenty-five and eighty per cent.

1821. Wheat—the benefit derived greater.

1822. At rest.

1823. Ploughed early for corn, but not planted. The whole marled at the rate of six hundred bushels (40 per cent.), again ploughed in August, and sown in wheat in October. The old marled space more lightly covered, so as to make the whole nearly equal.

1824. The wheat much improved.

1825 and 1826, at rest.

1827. Corn.

1828. In wheat, and sown in clover.

1829. The crop of clover was heavier than any I had ever seen in this part of the country, except in some very rare cases of rich natural soil, where gypsum was used and acted well. The growth was thick, but unequal in height (owing probably to unequal spreading of the marl), standing from fifteen to twenty-four inches high. The first growth was mowed for hay, and the second left to manure the land.

1830. The clover not mowed. Fallowed in August, and sowed wheat in October, after a second ploughing.

1831. The wheat was excellent, almost heavy enough to be in danger of lodging. I supposed the product to be certainly twenty bushels, perhaps twenty-five, to the acre.

As it had not been designed to make any experiment on this land, the progress of improvement was not observed with much care. But whatever were the intermediate steps, it is certain that the land, at first, was as poor as that forming the subjects of the two preceding experiments in the unimproved state (the measured products of which have been given), and that its last crop was at least four times as great as could have been obtained, if marl had not



been applied. The peculiar fitness of this kind of soil for clover after marling, and the supposed cause of the remarkable heavy *first* crop of clover, will require further remarks, and will be again referred to hereafter.

---

## CHAPTER XIII.

### THE EFFECTS OF CALCAREOUS MANURES ON ACID SOILS REDUCED BY CULTIVATION.

#### PROPOSITION 5—*continued.*

My use of marl has been more extensive on impoverished acid soils than on all other kinds, and has never failed there to produce striking improvement. Yet it has unfortunately happened that the two experiments made on such land with most care, and on which I relied mainly for evidence of the durable and increasing benefit from this manure, have had their beneficial effects almost destroyed by the applications having been made too heavy. These experiments, like the 4th and 6th, already reported, were designed to remain without any subsequent alteration, so that the measurement of their products, once in every succeeding course of crops, might exhibit the progress of improvement under all the different circumstances. As no danger was then feared from such a course, marl was applied heavily, that no future addition might be required; and for this reason, I have to report my greatest disappointments exactly in those cases where the most evident success and increasing benefits had been expected. However, these failures will be stated fairly, and as fully as the most successful results; and they may at least serve to warn from the danger of error, though not to show, as was designed, the greatest profits of judicious marling.

[It should be observed that the general rotation of crops pursued on the farm, on all land not recently cleared, was that of four shifts (corn, wheat, and then the land two years at rest and not grazed), though some exceptions to this course may be remarked in some of the experiments to be stated.]

#### *Experiment 8.*

Of a poor sandy acid loam, seven acres were marled at the rate of only ninety bushels (87 per cent.) to the acre; laid on and spread early in 1819.

*Results, 1819.* In corn—the benefit too small to be generally perceptible, but could be plainly distinguished along part of the outline, by comparing with the part not marled.

1820. Wheat—the effect something better; and continued to be visible on the weeds following, until the whole was more heavily marled in 1823.

*Experiment 9.*

In the same field, on soil as poor and more sandy than the last described, four acres were marled at one hundred and eighty bushels (37 per cent.), March 1818. A part of the same was also covered heavily with rotted barn-yard manure, which also extended through similar land not marled. This furnished for observation, land marled only—manured only—marled and manured—and some without either. The whole space, and more adjoining, had been heavily manured five or six years before by summer cowpens, and stable litter—of which no appearance remained after two years.

*Results, 1819.* In corn. The improvement from marl very evident; but not to be distinguished on the part covered also by manure, the effect of the latter so far exceeding that of the marl as to conceal it.

1820. In wheat. In 1821 and 1822, at rest.

1823. In corn— $5\frac{1}{2}$  by  $3\frac{1}{2}$  feet. The following measurements were made on adjoining spaces on October 10th. The shape of the ground did not admit of larger pieces, equal in all respects, being measured, as no comparison of products had been contemplated at first, otherwise than by the eye.

		Bush.	Quarts.
From the part not marled, 414 corn-hills made	75 quarts—		
or per acre,		13	26
Marled only, 414	. . . . . 100	18	12
Manured only, 490	. . . . . 105	15	5
Marled and manured, 490	. . . . . 130	20	20

The growth on the part both marled and manured was evidently inferior to that of 1819. This was to be expected, as the small quantity of calcareous earth was not enough to fix half so much putrescent manure; and, of course, the excess was as liable to waste as if no marl had been used.

*Experiment 10.*

Twenty acres of sandy loam, on a sandy sub-soil, covered in 1819 with marl of about 30 per cent. average proportion of calcareous earth, and the remainder silicious sand—at 800 bushels to the acre. This land had been long cleared, and much exhausted by cultivation; since 1814 not grazed, and had been in corn only once in four years; and, as it was not worth sowing in wheat, had three years in each rotation to rest and improve by receiving all its scanty growth of weeds. The same course has been continued from 1819 to 1832, except that wheat has regularly followed the crops of

corn, leaving two years of rest in four. This soil was lighter than the subject of any preceding experiment, except the 9th. On a high level part, surrounded by land apparently equal, a square of about an acre (A) was staked off, and left without marl—which that year's work brought to two sides of the square (C, D, and E).

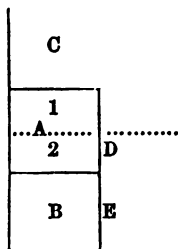

*Results, 1820.* In corn. October 18th, three half acres of marled land were measured, and as many on that not marled, and close adjoining, and produced as follows :

<i>Not marled.</i>		<i>Marled.</i>	
Bush.	Pecks.	Bush.	Pecks.
Half acre in A,	7 1	adjoining in C,	12 3
The same in A,	7 1	“ D,	13 3½
Half acre in B,	7 2½	“ E,	15 0½

The average increase being 12½ bushels of grain to the acre, nearly 100 per cent. as measured, and more than 100 if the defective filling, and less matured state of the corn not marled, be considered. The whole would have lost more by shrinkage than is usual from equal products.

1821. The whole in wheat; much hurt by the wetness of the season. The marled part more than twice as good as that left out.

1822 and 1823. At rest. A good cover of carrot weeds and other kinds had succeeded the former growth of poverty grass and sorrel, and every appearance promised additional increase to the next cultivated crop. November, 1823, when the next ploughing was commenced, the soil was found to be evidently deeper, of a darker colour, and firmer, yet more friable. The two-horse ploughs with difficulty (increased by the cover of weeds) could cut the required depth of five inches, and the slice crumbled as it fell from the mould-board. But as the furrows passed into the part not marled, an immediate change was seen, and even felt by the ploughman, as the cutting was so much more easy; that care was necessary to prevent the plough running too deep; and the slices turned over in flakes, smooth and sleek from the mould-board, like land too wet for ploughing, which however was not the case. The marling of the field was completed at the same rate (800 bushels);

which closed a third side (B) of the marked square. The fourth side was my neighbour's field.

1824. In corn. The newly marled (on B) showed as early and as great benefit as was found in 1820 on C and D; but yet was very inferior to the old, until the latter was 10 or 12 inches high, when it began to give the first known evidence of the very injurious effects of using this manure too heavily. The disease thus produced became worse and worse, until many of the plants had been killed, and still more were so stunted as to leave no hope of their being otherwise than barren. The effects will be known from the measurements which were made as nearly as could be on the same ground as the corresponding marks in 1820, and will be exhibited in the table, together with the products of the succeeding rotations. Besides the general injury suffered here in 1824, there were one hundred and three corn-hills in one of the measured quarter acres (in C), or more than one-sixth, entirely barren, and eighty-nine corn-hills in another quarter acre (D). In counting these, none of the missing hills were included, as these plants might have perished from other causes. [This unlooked for disaster diminished the previous increase gained by marling, by nearly one-half; and the damage has since been still greater, at each successive return of cultivation until some years after 1832.

Just before planting the crops of 1832, straw and chaff very imperfectly rotted by exposure, and which contained no admixture of animal manure, were applied at the rate of 800 bushels the acre to half the square without marl (A, 1), and to the adjacent parts of the marled land. The vegetable manure showed but slight benefit, until after all the worst effects of excessive marling had been produced; and the later operation of the manure served barely to prevent a still farther diminution being exhibited by the land injured by marl.

MARK	DESCRIPTION.	PRODUCT IN SHELLED CORN PER ACRE.							
		1st course		2d course		3d course		4th course	
		1820.		1824.		1828.		1832.	
		October 13.	October 16.	October 13.	October 19.				
		Bush.	pk.	Bush.	pk.	Bush.	pk.	Bush.	pk.
A	Not marled,	14	2	16	1	11	8½	9	3
A 1	After manuring,							16	8
B	Not marled until 1823,	15	1	28		19	2	not measured.	
C	Marled in 1819—manured with chaff, &c., in 1832,	25		19	2	15		18	
D		27	8½	20		19		19 ½	
E		30	1	not measured.		not measured.		not measured.	

The crops of wheat were throughout less injured by the excess of marl than the corn.

For the crop of 1828, ploughed with three mules to each plough, from six to seven inches deep—seldom turning up any sub-soil (which was formerly within three inches of the surface), and the soil appearing still darker and richer than when preparing for the crops of 1824. The ploughing of the square not marled (A) nowhere exceeded six inches; yet that depth must have injured the land, as I can impute to no other cause the remarkable diminution of product, through four courses of the mild four-shift rotation. It was evident that a still greater depth of furrow was not hurtful to the marled land. A strip across the field, in another place, was in 1828 ploughed eight inches deep for experiment, by the side of another of four inches, and the corn on the deepest ploughing was the best. Another strip was trench-ploughed twelve inches deep, without showing any perceptible difference, either of product or in the effects of damage from the excess of marl.

This square left without marl was the land previously referred to (page 44) as showing a diminished product through three successive courses of the rotation recommended by the author of 'Arator' as enriching. Since, another crop has been made and measured, and found to be still smaller than any previous. To whatever cause this continued falling of, for 16 years, may be attributed, it is at least a remarkable contradiction to the doctrine of vegetable matter serving alone to make poor land rich.

Much trouble has been encountered in attending to this experiment, and much loss of product submitted to, since its commencement, for the purpose of knowing the progress and extent of the evil caused by the excess of marl. But another portion of the field, marled as heavily in 1824, and where equal damage was expected to ensue, has been entirely relieved by intermitting the corn crop of 1828, sowing clover, which (by manuring with gypseous earth, or green-sand earth, at 20 bushels to the acre) produced well, and which was left to fall and rot on the land. The next growth of corn on this part of the field (1832) was free from disease, and though irregular, seemed to the eye to amount to full twenty-five bushels to the acre.—1835.]

[After 1836, the rotation and management of this field ceased to be regular or uniform, as previously; and also, by cross ploughing, &c., during so many years, marl had necessarily become slightly diffused over the space designed to remain without marl. Therefore no more measurements were made, as they could no longer be relied on for accurate comparison. The unmarled part, even with its slight accidental gain of marl from the surrounding ground, and half the piece having also been dressed with putrescent manure in 1832 (as stated above), is but very little improved

since 1820. This and other spots, at first omitted for comparison, when no longer fit for that purpose, were subsequently marled.—1849.]

### Experiment 11.

The ground on which this experiment was made was in the midst of nineteen or twenty acres of soil apparently similar in all respects—level, gray sandy loam, cleared about thirty years before, and reduced as low by cultivation as such soil could well be. The land that was marled and measured was about two hundred yards distant from experiment 2, and both places are supposed to have been originally similar in all respects. This land had not been cultivated since 1815, when it was in corn—but had been once ploughed since, November 1817, which had prevented broom-grass from taking possession. The ploughing then was four inches deep, and in five and a half feet beds, as recommended in 'Arator.' The growth in the year 1820 presented little except poverty grass (*Aristida gracilis*), running blackberry briars, and sorrel—and the land seemed very little if at all improved by its five successive years of rest. A small part of this land was covered with calcareous sand (20 per cent.), quantity not observed particularly, but probably about 600 bushels.

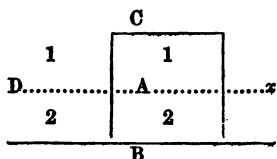

*Results.* 1821. Ploughed level, and planted in corn—distance  $5\frac{1}{2}$  by  $3\frac{1}{2}$  feet. The measurement of spaces nearly adjoining, made in October, was as follows:

23 by 25 corn-hills, not marled (in A) made $2\frac{1}{2}$ bushels,	}	very
or per acre, . . . . . $8\frac{1}{4}$		
23 by 25 corn-hills, marled (on the side B) $5\frac{1}{2}$ . . . . . $22\frac{1}{2}$	}	nearly.

1822. At rest. Marled the whole, except a marked square of fifty yards, containing the space measured the preceding year. Marl 45 per cent. and finely divided—350 bushels to the acre—from the same bed as that used for experiment 4. In August, ploughed the land, and sowed wheat early in October.

1823. Much injury sustained by the wheat from Hessian fly, and the growth was not only mean, but very irregular; but it was supposed that the first marled place (on the side B) was from 50 to 100 per cent. better than the last marled, and the last superior to the included square not marled (A), in as great a proportion.

• 1824. Again in corn. The effects of disease from marling were

as injurious here, both on the new and old part, as those described in experiment 10. No measurement of products made, owing to my being from home when the corn was cut down for sowing wheat.

1825. The injury from disease less on the wheat than on the corn of the last year on the latest marling, and none perceptible on the oldest application. This scourging rotation of three grain crops in four years was particularly improper on marled land, and the more so on account of its poverty.

1826. White clover had been sown thickly over forty-five acres, including this part, on the wheat, in January, 1825. In the spring of 1826, it formed a beautiful green though low cover on even the poorest of the marled land. Marked spots, which were so diseased by over-marling as not to produce a grain of corn or wheat, produced clover at least as good as other places not injured by that cause. The square, which had been sown in the same manner, and on which the plants came up well, had no clover remaining by April, 1826, except on a few small spots, all of which together would not have made three feet square. The piece not marled, white with poverty grass, might be seen, and its outlines traced, at some distance, by its strong contrast with the surrounding dark weeds in winter, or the verdant turf of white clover the spring before.

1827. Still at rest. No grazing allowed on the white clover.

1828. In corn—the land broken in January, five inches deep. October 14th, made the following measurements:

In the square not marled (A), 105 by 104½ feet (thirty-six square yards more than a quarter of an acre), made one barrel of ears—

	Bushels.	Pecks.
Or of grain to the acre . . . . .	9	1½
The same in 1821 . . . . .	8	1½
	<hr/>	
Gain,	1	0½

Old marling (in B)—105 by 104½ feet—2½ barrels,	22	2
The same in 1821 . . . . .	22	0½
	<hr/>	
Gain,		1½

New marling, 105 by 104½ feet, on the side that seemed to be the most diseased (D), 1½ barrels—or nearly 12 bushels to the acre.

[1832. Again in corn. Since 1826, the mild four-shift rotation had been regularly adhered to. Ploughed early in winter five inches deep, and again with two-horse ploughs just before planting, and after manuring the land above the dotted line D x. The manure was from the stable yard, the vegetable part of it composed of straw, corn-stalks, corn-cobs, and leaves raked from wood-land, had been heaped in a wet state a short time before, and was still

hot from its fermentation when carrying to the field. It was then about half rotted. The rate at which it was applied was about 807 heaped bushels to the acre, which was too heavy for the best nett profit. The corn on the oldest marling (B) showed scarcely a trace of remaining damage, while that on D 2 (not manured) was again much injured. On the manured part, D 1, and C, the symptoms of disease began also to show early; but were so soon checked by the operation of the putrescent manure, that very little (if any) loss could have been sustained from that cause. The following table exhibits all the measured products for comparison:

MARKS.	DESCRIPTION.	PRODUCT IN GRAIN, PER ACRE.							
		1st course 1821. October —		2d course 1824.		3d course 1828. October 14.		4th course 1832. October 20.	
		Bush.	pk.			Bush.	pk.	Bush.	pk.
A	{ Not marled, Not marled & ma- nured in 1832, }	8	1½	None measur- ed, but the product of B much reduced by excess of marl, and D and C equally injured from the same cause.	the same	9	1½	9	2½
A 1								23	3
C	Marled in 1822, and manured in 1832,							31	1½
B	Marled in 1821 (lightly)	22	0½			22	2	25	
D	Marled in 1822 (more heavily)					12		17	8
D 1		The same—and manur- ed in 1832,					the same		34

The products of the spaces A and B, in 1828, were not only estimated as usual from the measurement of the corn in ears (which estimated quantities are those in the table), but they were also shelled on the day when gathered, and the grain then measured, and again some months after, when it had become thoroughly dry. Care was taken that there should be no waste of the corn, or other cause of inaccuracy. The result showed nearly double the loss from shrinking in the corn not marled, and of course a proportional greater comparative increase of product in that marled, besides the increase which appears from the early measurement exhibited in the table. The grain of A, not marled, when first shelled, measured a very little more than the quantity fixed by estimate—made as usual by measurement of the ears, and lost by shrinking 30 per cent. The marled grain, from B, measured at first above 4 per cent. more than the estimate, and after shrinking, fell below it so much as to show the loss to be 16 per cent. The loss from shrinking in this case was greater than usual in both, from the poverty and consequent backwardness of the part not marled, and the uncommonly large proportion of replanted and of course late corn on the whole.



The two last experiments, as well as the 4th, were especially designed to test the amount of increased product to be obtained from marling, and to show the regular addition to the first increase, which the theory promised at each renewal of tillage. As to the main objects, all the three experiments have proved failures—and from the same error, that of marling too heavily. Although, for this reason, the results have shown so much of the injurious effects, still, taken altogether, the experiments prove, clearly, not only the great immediate benefit of applying marl, but also its continued and increasing good effects when applied in proper quantities. —1835.]

*Experiment 12.*

On 9 acres of sandy loam, marled in 1819 at 400 bushels (25 per cent.), nearly an acre was manured during the same summer, by penning cattle. With the expectation of preserving the manure, double the quantity of marl, or 800 bushels in all, was laid on that part. The field in corn in 1820; in wheat, 1821; and at rest 1822 and 1823.

*Results, 1824.* In corn, the second rotation after marling. The effects of the dung have not much diminished, and that part shows no damage from the quantity of marl, though the surrounding corn, marled only half as thickly, gave signs of general, though very slight injury from that cause.

*Experiment 13.*

Nearly two acres of loamy sand were covered with barn-yard manure, and marl (45 per cent.), at the same time, in the spring of 1822, and the field put in corn the same year, followed by wheat. The quantity of marl not remembered—but it must have been heavy (say not less than six hundred bushels to the acre), as it was put on to fix and retain the manure, and I had then no fear of damage from heavy dressings.

*Result, 1825.* Again in corn; and except on a small spot of sand almost pure (nearly a "blowing sand," or liable to be drifted by high winds in dry weather), no signs of disease from over-marling were seen, then or afterwards.

## CHAPTER XIV.

### EFFECTS OF CALCAREOUS MANURES ON "FREE LIGHT LAND."

#### PROPOSITION 5—*continued.*

The soil known in this part of the country by the name of "free light land" has so peculiar a character that it deserves a particular notice. It belongs to the slopes and undulating lands, between the highest ridges and the water-courses, but has nothing of the durability which slopes of medium fertility sometimes possess. In its wood-land state it would be called rich, and may remain productive for a few crops after being cleared; but it is rapidly exhausted, and, when poor, seems as unimprovable by vegetable manures as the poorest ridge lands. In its virgin state, this soil might be supposed to deserve the name of neutral; but its productive power is so fleeting, and acid growths and qualities so surely follow its exhaustion, that it must be inferred that it is truly an acid soil.

#### *Experiment 14.*

The subject of this experiment presents soil of this kind with its peculiar characters unusually well marked. It is a loamy sandy soil (the sand coarse), on a similar sub-soil of considerable depth. The surface waving, almost hilly in some parts. The original growth principally red-oak, hickory, and dogwood, not many pines, and very little whortleberry. Cut down in 1816, and put in corn the next year. The crop was supposed to be twenty-five bushels to the acre. Wheat succeeded, and was still a better crop for so sandy a soil; making twelve to fifteen bushels, as it appeared standing. After 18 months of rest, and not grazed, the next corn crop, of 1820, was evidently and considerably inferior to the first; and the wheat of 1821 (which however was a very bad crop, from too wet a season) could not have been more than five bushels to the acre. In January, 1820, a piece of  $1\frac{1}{2}$  acres was limed, at 100 bushels the acre. The lime, being caught by rain before it was spread, formed small lumps of mortar on the land, and produced no benefit on the corn of that year, but could be seen slightly in the wheat of 1821. The land again at rest in 1822 and '23, when it was marled, at 600 bushels (37 per cent.), without omitting the limed piece; and all sowed in wheat that fall. In 1824, the wheat was found to be improved by the marl, but neither that, nor the next crop of 1828, was equal to its earliest product of wheat. The limed part showed injury in 1824, from the quantity of manure, but none since. The field was now under the regular four-shift

rotation, and continued to recover; but did not surpass its first crop until 1831, when it brought rather more than thirty bushels of corn to the acre (estimated by the eye)—being five or six bushels more than its supposed first crop.

*Experiment 15.*

Adjoining this piece, six acres of similar soil were grubbed and the trees belted in August, 1826—marl at 600 to 700 bushels (37 per cent.), spread just before. But few of the trees died until the summer of 1827. In 1828, planted in corn; the crop did not appear heavier than would have been expected if no marl had been applied; but no part had been left without, for comparison. 1829, wheat. 1830, at rest. 1831, in corn, and the product supposed to be near or quite thirty-five bushels, or an increase of thirty-five or forty per cent. on the first crop. No measurement was made; but the product was estimated by comparison with an adjacent piece, which measured thirty-one bushels, and which seemed to be inferior to this piece.

The operation of marl on this kind of soil seems to add to the previous product very slowly, compared with other soils; but it is not the less effectual and profitable in fixing and retaining the vegetable matter accumulated by nature, which otherwise would be quickly dissipated by cultivation, and lost for ever.

The remarkable sandy and open texture of the soil on which the last two experiments were tried, will be evident from the following statement of the quantity and coarseness of the silicious sand contained.

1000 grains of this soil, taken in 1826 from the part that had been both limed and marled, was found to consist of

811 of silicious sand moderately coarse, mixed with a few grains of coarse shelly matter (the remains of the marl).

158 finely divided earthy matter, part fine sand, as well as clay and organic matter.

31 loss.

---

1000

At the same time, from the edge of the adjoining wood-land which formed the next described experiment, 15, and which had not then been marled, a specimen of soil was taken from between the depths of one and three inches—and found to consist of the following proportions. This spot was believed to be rather lighter than the other in its natural state.

865 grains of silicious sand, principally coarse,  
 107 finely divided earthy matter (partly fine sand), &c.  
 28 loss.

---

1000

## CHAPTER XV.

### EFFECTS OF CALCAREOUS MANURES ON EXHAUSTED ACID SOILS, UNDER THEIR SECOND GROWTH OF TREES.

#### PROPOSITION 5—*continued.*

Not having owned much land under a second growth of pines, I can only refer to two experiments of this kind. The improvement in both these cases has been so remarkable, as to induce the belief that the "old fields" to be found on every farm, which have been exhausted and turned out of cultivation thirty or forty years, offer the most profitable subjects for the application of calcareous manures.

#### *Experiment 16.*

May 1826. Marled about eight acres of land under its second growth, by opening paths for the carts ten yards apart. Marl 40 per cent.; put 500 to 600 bushels to the acre—and spread in the course of the summer. In August, belted slightly all the pines that were as much as eight inches through, and cut down or grubbed the smaller growth, of which there was very little. The pines (which were the only trees) stood thick, and were mostly from eight to twelve inches in diameter—eighteen inches where standing thin. The land joined experiment 15 on one side; but this is level, and on the other side joins ridge wood-land, which soon becomes like soil of experiment 1. This piece, in its virgin state, was probably of a nature between those two soils; but less like the ridge soil than the "free light land." No information has been obtained as to the state of this land when its cultivation was formerly abandoned. The soil (that is, the depth which has since been turned by the plough) a whitish loamy sand, on a sub-soil of the same; in fact, *all was sub-soil* before the ploughing, except half an inch or three quarters, on the top, which was principally composed of rotted pine leaves. Above this thin layer were the later dropped and unrotted leaves, lying loosely several inches thick.

The pines showed no symptoms of being killed, until the autumn of 1827, when their leaves began to have a tinge of yellow. To suit the cultivation with the surrounding land, this piece was laid down in wheat for its first crop, in October, 1827. For this purpose, the few logs, the boughs, and grubbed bushes were heaped, but not burnt; the seed then sowed on the coat of pine leaves, and ploughed in by two-horse ploughs, in as slovenly a manner as may be supposed from the condition of the land; and a wooden-tooth

harrow then passed over, to pull down the heaps of leaves, and roughest furrows.

*Results.* The wheat was thin, but otherwise looked well while young. The surface was very soon again covered by the leaves dropping from the then dying trees. On April 2d, 1828, most of the trees were nearly dead, though but few of them entirely. The wheat was then taller than any in my crop, and, when ripe, was a surprising growth for such land, and such imperfect tillage.

1829 and 1830. At rest. Late in the spring of 1830 an accidental fire passed over the land; but the then growing vegetation prevented all of the older cover being burnt, though some was destroyed everywhere.

1831. In corn. The growth excited the admiration of all who saw it, and no one estimated the product so low as it actually proved to be. A square of four (two-pole) chains, or four-tenths of an acre, measured on November 25th, yielded at the rate of thirty-one and three-eighths bushels of grain to the acre.

#### *Experiment 17.*

In a field of acid sandy loam, long under the usual cultivation, a piece of five or six acres was covered by a second growth of pines thirty-nine years old, as supposed from that number of rings being counted on some of the stumps. The largest trees were eighteen or twenty inches through. This ground was altogether on the side of a slope, steep enough to lose soil by washing, and more than one old shallow gully remained to confirm the belief of the injury that had been formerly sustained from that cause. These circumstances, added to all the surrounding land having been continued under cultivation, made it evident that this piece had been turned out of cultivation because greatly injured by tillage. It was again cut down in the winter of 1824-5. Many of the trees furnished fence-rails and fuel, and the remaining bodies were heaped and burnt some months after, as well as the large brush. In August it was marled, supposed at 600 bushels (37 per cent.), twice coulered in August and September, and sowed in wheat—the seed covered by trowel ploughs. The leaves and much of the smaller brush, left on the ground, made the ploughing troublesome and imperfect. The crop (1826) was remarkably good; and still better were the crops of corn and wheat in the ensuing rotation, after two years of rest. On the last crop of wheat (1830) clover was sown—and mowed for hay in 1831. The growth stood about eighteen inches high, and never have I seen so heavy a crop on sandy and acid soil, even from the heaviest dunging, the utmost care, and the most favourable season. The clover grew well in the bottoms of the old gullies, which were still plainly to be seen, and which no means had been used to improve, except such as all the

land had received. Within two feet of the surface the sub-soil of this land is of red clay, which probably helped its growth of clover.

---

## CHAPTER XVI.

### EFFECTS OF CALCAREOUS MANURES ALONE, OR WITH GYPSUM, ON CALCAREOUS AND NEUTRAL SOILS.

#### PROPOSITION 5—*continued.*

Reason had taught that applications of calcareous earth alone to calcareous soils were so manifestly useless, that no more than two experiments of that kind have been made by me, of which, as expected, neither had any improving effect that could be noticed, in the twelve ensuing years during which the experiments were observed.

When calcareous manures have been applied to neutral soils, whether new or worn, no perceptible and manifest benefit has been obtained on the first crop. The subsequent improvement has gradually increased, as would be expected from the power of fixing manures ascribed to calcareous earth. But however satisfactory these general results were to myself, they are not such as could be reported in detail, with any advantage to other persons. It is sufficiently difficult to make fair and accurate experiments where early and remarkable results are expected. But no cultivator of a farm can bestow enough care, and patient observation, to obtain true results from experiments that scarcely will show their first feeble effects in several years after the commencement. On a mere experimental farm, such things may be possible; but not where the main object of the farmer is to reap profit from his general and varied operations. The effects of changes of season, of crops, of the mode of tillage—the auxiliary effects of other manures, and many other circumstances—would serve to defeat any observations of the progress of a slow improvement, though the ultimate result of the general practice might be abundantly evident.

Another cause for being unable to state with any precision the practical benefit of marling neutral soils, arises from the circumstance that nearly all the calcareous manure thus applied by me has been accompanied by a natural admixture of gypsum; and though I feel confident in ascribing some effects to one, and some to the other of these two kinds of manure, yet this division of operation must rest merely on opinion, and cannot be received as certain by any other than him who makes and carefully observes

the experiments. Some of these applications will be described, that other persons may draw their own conclusions from them.

The cause of these manures being applied in conjunction was this. A singular bed of marl lying under Coggins Point, and the only one within a convenient distance to most of the neutral soil of that farm, contains a very small proportion (perhaps about one per cent.) of gypsum, scattered irregularly through the mass, seldom visible, though sometimes and very rarely to be met with in small crystals. The calcareous ingredient, on a general average carefully made, was found to be 62 per cent. If this manure had been used before its *gypseous* quality was discovered, all its effects would have been ascribed to calcareous earth alone, and the most erroneous opinions might thence have been formed of its mode of operation.

What led me to suspect the presence of gypsum, in this bed of fossil shells, was the circumstance that throughout its whole extent, of near a mile along the river bank, this bed lies on another earth, of peculiar character and appearance, and which, in many places, exhibits gypsum in crystals of various sizes. This earth has evidently once been a bed of fossil shells, like that which still remains above; but nothing now is left of the shells, except numerous impressions of their forms. Not the smallest proportion of calcareous earth can be found, and the gypsum into which it must have been changed (by meeting with sulphuric acid, or sulphuret of iron) has also disappeared in most places; and in others, it remains only in small quantities—say from the smallest perceptible proportion, to fifteen or twenty per cent. of the mixed mass. In some rare cases, this gypseous earth is sufficiently abundant to be used profitably as manure, as has been done, by Mr. Thomas Cocke, of Tarbay, as well as myself. It is found in the greatest quantity, and also the richest in gypsum, at Evergreen, two miles below City Point. There the gypsum frequently forms large crystals of varied and beautiful forms. The distance that this bed of gypseous earth extends is about seven miles, interrupted only by some bodies of lower land, apparently of a more recent formation by alluvion.

In the bed of gypseous marl above described, there are regular layers of a calcareous rock, which was too hard to use profitably for manure, and which caused the greatest impediment to obtaining the softer part. This rock contains between eighty-five and ninety per cent. of pure calcareous earth, besides a little gypsum and iron. It makes excellent lime for cement, mixed with twice its bulk of sand, and has been used for part of the brick-work, and all the plastering of my present dwelling-house (at Shellbanks), and for several of my neighbours' houses. The whole body of marl also contains a minute proportion of some soluble salts, which pos-

sibly may have some influence on the operation of the substance, as manure or cement.

Thus, from the examination of a single body of marl, there have been obtained not only a rich calcareous manure, but also gypsum, and a valuable cement. Similar formations may perhaps be abundant elsewhere, and their value unsuspected, and likely to remain useless. This particular body of marl has no outward appearance of possessing even its calcareous character. It would be considered, on slight inspection, as a mass of gritty clay, of no worth whatever.

[The last preceding paragraphs present, as in the previous editions, my earliest views of this particular bed of marl. Further information has taught that it is of the *eocene*, or more ancient formation; and that the underlying stratum (which is usually not at all calcareous), which I formerly named and treated of as "gypseous earth," is what geologists call "green-sand," a term still less descriptive, and not at all more accurate. A full account of both of these bodies will be given in the Appendix.—1842.]

This gypseous marl has been used only on sixty acres, most of which was neutral soil, and generally, if not universally, with early as well as permanent benefits. The following experiments show results more striking than have been usually obtained; but all agree in their general character.

#### *Experiment 18.*

1819. Across the shelly island numbered 3 in the examinations of soils (page 60), but where the land was less calcareous, a strip of three-quarters of an acre was covered with mussel-shell marl, a deposit on parts of the river banks supposed to have been made by the aboriginal inhabitants. Adjoining this, through its whole length, another strip was covered with gypseous marl, 53 per cent., at the rate of 250 bushels.

*Results.* 1819. In corn: No perceptible effect from the mussel-shells. The gypseous marling considerably better than on either side of it.

1820. Wheat—less difference.

1821. Grazed. Natural growth of white clover thickly set on the gypseous marling, much thinner on the mussel-shells, and still less of it where no marl had been applied.

The whole field afterwards was put in wheat on summer fallow every second year, and grazed closely the intervening year: a course very unfavourable for observing, or permitting to take place, any effects of gypsum. Nothing more was noted of this experiment until 1825, when cattle were not turned in until the clover reached its full size. The strip covered with gypseous marl showed a remarkable superiority over the other marled piece, as



well as over the land which was still more calcareous by nature, and which had produced better in 1820. In several places, the white clover stood thickly a foot in height.

*Experiment 19.*

A strip of a quarter acre passing through rich black neutral loam, covered with gypseous marl at 250 bushels.

*Results.* 1818. In corn. By July, the marled part seemed the best by 50 per cent., but afterwards the other land gained on it, and little or no difference was apparent when the crop was matured.

1819. Wheat—no difference seen.

1820 and 1821. At rest. In the last summer the marled strip could again be easily traced, by the entire absence of sorrel (which had been gradually increasing on this land since it had been secured from grazing), and still more by its very luxuriant growth of bird-foot clover, which was thrice as good as that on the adjoining ground.

*Experiment 20.*

1822. On a body of neutral soil which had been reduced quite low, but was well manured in 1819 when last cultivated, gypseous marl was spread on nine acres, at the rate of 300 bushels. This terminated on one side at a strip of mussel-shell marl ten yards wide—its rate not remembered, but it was certainly thicker, in proportion to the calcareous earth contained, than the other, which I always avoided laying on heavily, from a mistaken fear of causing injury by too much gypsum. The line of division between the two marls was through a clay loam. The sub-soil was a retentive clay, which caused the rain water to keep the land very wet through the winter, and early part of spring.

*Results.* 1822. In corn, followed by wheat in 1823—not particularly noticed, but the benefits must have been very inconsiderable. All the mussel-shell marling, and four acres of the gypseous, sowed in red clover, which stood well, but was severely checked, and much of it killed, by a drought in June, when the sheltering wheat was reaped. During the next winter (by neglect) my horses had frequent access to this piece, and by their trampling in its wet state must have injured both land and clover. From these disasters the clover recovered surprisingly; and in 1824, two mowings were obtained, which, though not very heavy, were better than from any of my previous attempts to raise this grass. In 1825, the growth was still better, and yielded more to the scythe. This was the first time that I had seen clover worth mowing on the third year after sowing; and had never heard of its being comparable to the second year's growth anywhere in the lower country. The growth on the mussel-shell marling was very inferior to the

other, and was not mowed at all the last year, being thin and low, and almost eaten out by wire-grass (*Cynodon dactylon*).

1826. In corn—and it was remarkable that the difference shown the last year was reversed, the mussel-shell marling now having much the best crop.

In these and other applications to neutral soils, I ascribe the earliest effects entirely to gypsum, as well as the peculiar benefit shown to clover, throughout. The later effects, and especially on grain, are due to the calcareous earth in the manure.

---

## CHAPTER XVII.

DIGRESSION TO THE THEORY OF THE ACTION OF GYPSUM AS MANURE. SUPPOSED CAUSE OF ITS WANT OF POWER AND VALUE ON ACID SOILS.

### PROPOSITION 5—*continued.*

ANOTHER opinion was formed from the effects of gypseous marl, as stated in the foregoing chapter, which may lead to profits much more important than any to be derived from the limited use of this, or any similar mineral compound—viz. : *that gypsum may be profitably used after calcareous manures, on soils on which it was totally inefficient before.* I do not present this as a fact fully established, or, even if established, of universal application; for the results of some of my own experiments are directly in opposition. But, however it may be opposed by some facts, the greater weight of evidence, furnished by my experiments and observations, decidedly supports this opinion. If correct, its importance to our low country is inferior only to the value of calcareous manures alone—which value may be almost doubled, if the land is thereby fitted to receive the wonderful benefits of gypsum on clover.

It is well known that gypsum has failed entirely as a manure on nearly all the land on which it has been tried in our tide-water district; and we may learn from various publications, that as little general success has been met with along the Atlantic coast, as far north as Long Island. To account for this general failure of a manure so efficacious elsewhere, some one offered a reason, which was received without examination, and which is still considered by many as sufficient, viz. : *that the influence of salt vapours destroyed the power of gypsum on and near the sea-coast.* But the same general worthlessness of that manure extends one hundred miles higher than the salt water of the rivers, and the lands where it is

profitably used are much more exposed to sea air. Such are the rich neutral soils of Curl's Neck, Shirley, Berkley, Westover, Brandon, and Sandy Point, on James river, on all which gypsum on clover has been extensively and profitably used, in advance of marling or liming. On acid soils, I have never heard of enough benefit being obtained from gypsum to induce the cultivator to extend its use further than making a few small experiments. When any effect has been produced on an acid soil (so far as known from my own experience, or the information of others), it has been caused by applying to small spaces comparatively large quantities; and even then, the effects were neither considerable, durable, nor profitable. Such have been the results of many small experiments made on my own acid soils—and very rarely was the least perceptible effect produced. Yet on some of the same soils, after marling, the most evident benefits have been obtained from gypsum on clover. The soils on which the 1st and 10th experiments were made (at some distance from these experiments) had both been tried with gypsum, and at different rates of thickness, before marling, without the least effect. Several years after both had been marled, gypseous earth (from the bed referred to, page 144) was spread at twenty bushels the acre (which gave four bushels of pure gypsum\*) on clover, and produced in some parts a growth I have never seen surpassed. It is proper to state that such results have been produced only by heavy dressings. Mr. Thomas Cocke, of Tarbay, in the spring of 1831 sowed nearly four tons of Nova Scotia gypsum on clover on marled land, the field being a continuation of the same ridge that my 1st, 2d, 3d, and 4th experiments were made on, and very similar soil. His dressing, at a bushel to the acre, before the summer had passed, produced evident benefit, where it is absolutely certain, from abundant previous experience, that none could have been obtained before marling.

On soils naturally calcareous, I have in some experiments greatly promoted the growth of corn by gypsum, and have doubled the growth of clover on my best land of that kind. When the marl containing gypsum was applied, benefit from that ingredient was almost certain to be obtained.

All these facts, if presented alone, would seem to prove clearly the correctness of the opinion, that the acidity of most of our soils caused the inefficacy of gypsum, and that the application of calcareous earth, which will remove the acid, will also serve to bring gypsum into useful operation. But this most desirable conclusion is opposed by the results of other experiments, which, though fewer in number, are as strong as any of the facts which favour that

---

\* There was very little of the gypseous earth so rich as this limited layer—which was soon all removed for use.

conclusion. If the subject were properly investigated, these facts, apparently in opposition, might be explained so as no longer to contradict this opinion, or perhaps might help to confirm it. Good reasons, deduced from established chemical truths, may be offered to explain why the acidity of our soils should prevent the operation of gypsum; though it may be deemed premature to attempt the explanation of any supposed fact, before every doubt of the existence of the fact itself has been first removed.

One of the circumstances will be mentioned, which appears at first glance most strongly opposed to the opinion which has been advanced. On the poor acid clay soil, of such peculiar and base qualities, which forms the subject of the 5th, 6th, and 7th experiments, gypsum has been sufficiently tried, and has not produced the least benefit, either before marling, or afterwards. Yet the first growth of clover on this land after marling is fully equal to what might be expected from the best operation of gypsum. Now if it could be ascertained that a very small proportion of either *sulphuric acid*, or of the *sulphate of iron*, exists in this soil, it would completely explain away this opposing fact, and even make it the strongest support of my position. The sulphate of iron has sometimes been found in arable soil,\* and sulphuric acid has been detected in certain clays.† I have seen, on the same farm, a bed of clay of very similar appearance to this soil, which certainly had once contained one of these substances, as was proved by the formation of crystallized sulphate of lime, where the clay came in contact with a bed of marl. The sulphate of lime was found in the small fissures of the clay, extending sometimes one or two feet in perpendicular height from the calcareous earth below. Precisely the same chemical change would take place in a soil containing sulphuric acid, or sulphate of iron, as soon as marl is applied. The sulphuric acid (whether free or combined with iron) would immediately unite with the lime presented, and form gypsum (sulphate of lime). Proportions of these substances, too small perhaps to be detected by analysis, would be sufficient to form three or four bushels of gypsum to the acre—more than enough to produce the greatest known effect on clover—and to prevent any benefit being derived from a subsequent application of gypsum; because there being already in the soil more gypsum than could act, no additional quantity could be of the slightest benefit.‡

---

\* Davy's Agr. Chem. p. 141.

† Kirwan on Manures.

[‡ *Confirmatory testimony*.—Johnston has since fully sustained this reasoning, by chemical facts. Besides the sulphate of iron, he names the sulphates of alumina and magnesia as occasionally present in soils, and liable to be hurtful to plants. He adds: "When soils which contain any of the three salts I have named, have once been limed or marled, it is in vain to

[Since the publication of the foregoing part of this chapter, in the edition of 1832, my use of gypsum, on land formerly acid, has been more extended, and the results have been such as to give additional confidence in the practice, and, indeed, an assurance of good profit, on the average of such applications. But still, as before, disappointments, either total or nearly so, in the effect of such applications, have sometimes occurred, and without there being any known or apparent cause to which to attribute such disappointment in the results.

In 1832, nine acres of the same body of ridge land above referred to, adjoining the piece on which the 1st, 2d, 3d, and 4th experiments were made, and more lately cleared, were sown in clover in the early part of 1831, on wheat. The next spring, French gypsum was sown at the rate of a bushel to the acre, except on four marked adjoining squares, each about one-third of an acre, one of which was left without gypsum, and the others received it at the several rates of 2, 3, and 4 bushels to the acre. The whole brought a middling crop, and was mowed for hay, except the square left without gypsum, which did not produce more than half as much as the adjoining land where gypsum was applied at one bushel the acre. The products of the other pieces were slightly increased by each addition to the gypsum, but by no means in proportion to the increased quantity used; nor was the effect of the four bushels near equal to that formerly obtained, in several cases, from 20 bushels of gypseous earth taken from the river bank. Hence it seems that it was not merely the unusual quantity of gypsum applied in this earth, which produced such remarkable benefit; and we must infer that it contains some other quality or ingredient capable of giving additional improvement to clover. —1835.]

[Since the first publication of the foregoing passage (in 1835), and in accordance with the views there presented, more than 10 tons of good French gypsum has been used, in different years and with less effect, in general, than formerly, in the first few years after the marling. This general diminution, and more frequent total failures, may be owing to the longer time that the land has been marled, and, by the increase of its vegetable supplies serving as putrescent manure, the land being thereby changed from calcareous to neutral, and perhaps in some cases even approaching again to being acid. If this supposition be well founded, then a repetition of the marling would not only be profitable in other respects, but

---

apply gypsum for favouring the clover crop, since the lime, in decomposing the sulphates, has already formed an abundant supply of this compound for all the purposes of vegetation." Lectures on Agr. Chem.—p. 414.]

would increase or restore the capacity of the soil to receive benefit from gypsum.—1842.]

1832.—The following are my views of the general causes of the inertness and worthlessness of gypsum as manure, on all acid soils, and for the different and valuable results from gypsum, after the soils have been made calcareous.

I do not pretend to explain the mode of operation by which gypsum produces its almost magical benefits; it would be equally hopeless and ridiculous for one having so little knowledge of the successful practice to attempt an explanation, in which so many good chemists and agriculturists, both scientific and practical, have completely failed. There is no operation of nature heretofore less understood, or of which the cause, or agent, seems so totally disproportioned to the effect, as the enormous increase of vegetable growth from a very small quantity of gypsum, in circumstances favourable to its action. All other known manures, whatever may be the nature of their action, require to be applied in quantities very far exceeding any bulk of crop expected from their use. But one bushel of gypsum spread over an acre of land fit for its action, may add more than twenty times its own weight to a single crop of clover hay.

But without pretending to account for the wonderful action of gypsum as manure, and without entertaining any confidence in any of the numerous theories heretofore presented, [not excepting the latest set forth, by Professor Liebig], I concur in the general opinion expressed by Davy. This accurate investigator, who took nothing upon trust which could be subjected to the test of rigid experiment, pursued that mode to obtain light on this obscure subject. He found by chemical analysis, that gypsum was always present in the ashes of red clover, and in quantity, in a good crop, amounting to three or four bushels to the acre. He inferred that gypsum, thus always forming a portion of the clover plant, was essential to its healthy existence; and that it is necessary to the structure of the woody fibre of clover and other grasses. But it is enough if Davy was correct in the main opinion, that a certain though very small proportion of gypsum is an essential component part of certain plants, of which the clover tribe furnishes the most noted examples. If this be so, no matter what may be the office or function of the gypsum, the small amount necessary for the demands of the plants *must be present in the soil*, or otherwise the plants needing it *cannot live, or maintain a healthy growth*. It will follow, further, that on soils well adapted for clover in other respects, but almost totally deficient in gypsum, the application of so small a dressing as one bushel of that substance to the acre may enable a full crop of clover to grow, and twice or thrice as much as the land could have brought without this small application.

Such I suppose to be the circumstances of those lands of this country on which gypsum exerts the greatest power. But in England, though clover culture is universally extended, gypsum has shown scarcely any benefit as manure, and though extensively experimented with, has not been found sufficiently operative to be brought into ordinary practice on any one farm in the kingdom. This may be accounted for by supposing the soils generally to be supplied by nature abundantly with gypsum, so that no more is required. Davy found gypsum in the soil itself of four farms, examined with this view, and in one of them the very large proportion of nearly one per cent. (*Agricultural Chemistry, Lecture vii.*) But there is another and numerous class of cases in which gypsum cannot be supposed to be present, and yet when applied shows no benefit. These are the poor acid soils of lower Virginia (and elsewhere), and the cause of which it seems to me not difficult to explain.

However wonderful and inscrutable the fertilizing power of this manure may be, and admitting its cause as yet to be hidden, and entirely beyond our reach, still it is possible to show reasons why gypsum cannot act in many situations, where all experience has proved it to be worthless. If this only can be satisfactorily explained, it will remove much of the uncertainty as to the effects to be expected; and the farmer may thence learn on which soils he may hope for benefit for this manure, on which it will certainly be thrown away, and by what means the circumstances adverse to its action may be removed, and its efficacy thereby secured. This is the explanation that I shall attempt.

If the vegetable acid, which I suppose to exist in what I have called acid soils, is not in part the oxalic (which is the particular acid in sorrel), at least, every vegetable acid, being composed of different proportions of the same three elements, may easily change to any other, and all to the oxalic acid. This, of all bodies known by chemists, has the strongest attraction for lime, and will take it from any other acid which was before combined with it; and for that purpose, the oxalic acid will let go any other earth or metal, which it had before held in combination. Let us then observe what would be the effect of the known chemical action of these substances, on their meeting in soils. If oxalic acid were produced in any soil, its immediate effect would be to unite with its proper proportion of lime, if enough were in the soil in any combination whatever. If the lime were in such small quantity as to leave an excess of oxalic acid, that excess would seize on the other substances in the soil, in the order of their mutual attractive forces; and one or more of such substances are always present, as magnesia, or, more certainly, iron and alumina. The soil then would not only contain some proportion of the *oxalate of lime*, but also the oxalate of either

one or more of the other substances named. Let us now suppose gypsum to be applied to this soil. The substance (sulphate of lime) is composed of sulphuric acid and lime. It is applied in a finely pulverized state, and in quantities from half a bushel to two bushels the acre—generally not more than one bushel. As soon as the earth is made wet enough for any chemical decomposition to take place, the oxalic acid must let go its *base* of iron or alumina, and seize upon and combine with the lime that formed an ingredient of the gypsum. The sulphuric acid left free, will combine with the iron, or the alumina of the soil, forming copperas in the one case, and alum in the other. *The gypsum no longer exists*—and surely no more satisfactory reason can be given why no effect from gypsum should follow. The decomposition of the gypsum has served to form two or perhaps three other substances. One of them, oxalate of lime, like all salts of lime, is probable valuable as manure; but the very small quantity that could be formed out of one or even two bushels of gypsum, might have no more visible effect on a whole acre, than that small quantity of calcareous earth, or farm-yard manure. The other substance certainly formed, copperas, is known to be a poison to soil and to plants—and alum, of which the formation would be doubtful, I believe is also hurtful. In such small quantities, however, the poison would be as little perceptible as the manure; and no apparent effect whatever could follow such an application of gypsum to an acid soil. So small a proportion of oxalic acid, or any oxalate other than of lime, would suffice to decompose and destroy the gypsum, that it would not amount to one part in twenty thousand of the soil.

Why gypsum sometimes acts as a manure on acid soils when applied in large quantities for the space, is equally well explained by the same theory. If a handful, or even a spoonful of gypsum is put on a space of six inches square, it would so much exceed in proportion all the oxalic or other vegetable acid that could speedily come in contact with it, that all would not be decomposed, and the part that continued to be gypsum would show its peculiar powers perhaps long enough to improve one crop. But as tillage served to scatter these little collections more equally over the whole space—or even as repeated soaking rains allowed the extension of the attractive powers—applications like these would also be destroyed, after a very short-lived, limited, and rarely profitable action.

Soils that are naturally calcareous, or even neutral, cannot contain oxalic acid combined with any other base than lime. Hence, gypsum applied there *continues to be gypsum*, and exerts its great fertilizing power, as in the counties of Loudoun and Frederick. But even on these most suitable soils, this manure is said not to be certain and uniform in its effects; and, of course, more certain results are not to be looked for with us. I have not undertaken



to explain its occasional failures any more than its general success, on the lands where it is profitably used in general—but only why it cannot act at all, on lands of a different kind.

The same chemical action being supposed, explains why the power of profiting by gypsum should be immediately awakened on acid soils after making them calcareous; and why that manure should seldom fail, when applied mixed with much larger quantities of calcareous earth.

[When the foregoing attempt to explain the cause of the non-action of gypsum on acid soils was written, and first published in 1832 (as it here appears distinguished from the later additions), the discovery of *humic acid* by European chemists was not known to me, and its very general existence in soils, now universally recognised, was scarcely known to any. Without pretending to identify the acid of soil whose existence I maintained, as early as 1818, to be almost universally present and injurious in this country, it is now clear and unquestioned that the humic acid is thus plentifully and generally diffused. The effects ascribed above to the supposed oxalic acid, of decomposing and destroying sulphate of lime when applied as manure, may be as much produced by the actually present humic acid. For, not only is the latter convertible to the former, as above argued of all vegetable acids, but, without the need of such conversion, the humic acid is now understood to have the like power of decomposing sulphate of lime. This is stated fully and distinctly in a very recent publication (Browne's American Muck Book, 1852), as follows: "Gypsum is decomposed by carbonate and muriate of barytes, the carbonates of strontia, potash, soda, and ammonia, as well as by *oxalic and humic acids*, and where any of the four last named occur naturally in the soil, or are applied by artificial means, new combinations take place, which are attended in some cases with beneficial results. . . . If, however, it [the soil] contains too much free humic acid, *it will decompose the gypsum*, so that humate of lime will be formed, and the sulphuric acid set free, which may then act as a corrosive on the roots of plants" (p. 71.) Nothing is wanting to the fullest and clearest establishment of my doctrine as stated above, except that the humic acid, like the oxalic, has stronger affinity for lime than the sulphuric, and therefore will decompose sulphate of lime (gypsum), and form instead humate of lime, of which the effect as manure is altogether different. And that humic acid (or whatever may be the acid of soil) really has this stronger affinity for lime, is sustained by enough agricultural facts within my personal observation, even if the proposition had no support whatever from chemical science.—1852.]

## CHAPTER XVIII.

### THE DAMAGE CAUSED BY TOO HEAVY DRESSINGS OF CALCAREOUS MANURE, AND THE REMEDY.

#### PROPOSITION 5—*continued.*

The injury or disease in grain crops produced by marling has so lately been presented to our notice, that the collection and comparison of many additional facts will be required before its cause can be satisfactorily explained. But the facts already ascertained will at least show how to avoid the danger of such injury in future, and to find remedies for the evils already inflicted by the injudicious use of calcareous manures.

The earliest effect of this kind observed was in May, 1824, on the field containing experiment 10. The corn on the land marled four years before sprang up and grew with all the vigour and luxuriance that was expected from the appearance of increased fertility exhibited by the soil, as before described (page 133.) About the 20th of May the change commenced, and the worst symptoms of the disease were seen by the 11th of June. From having as deep a colour as young corn shows on the richest and best soils, it became of a pale sickly green. The leaves, when closely examined, seemed almost transparent, afterwards were marked through their whole length by streaks of rusty red, separated very regularly by other streaks of what was then more of yellow than green; and next they began to shrivel and die downwards from their extremities. The growth of many of the plants was nearly stopped. Still some few showed no sign of injury, and maintained the vigorous growth which they began with, so as by contrast more strongly to mark the general loss sustained. The appearance of the field was such, that a stranger would have supposed that he saw the crop on a rich soil exposed to the worst ravages of some destructive kind of insects; but neither on the roots or stalks of the corn could any thing be found to support that opinion. Before the first of August this gloomy prospect had somewhat improved. Most of the plants seemed to have been relieved of the infliction, and to grow again with renewed vigour. But before that time many were dead, and it was impossible that the others could so fully recover as to produce anything approaching a full crop for the land. It has been shown in the report of the products of Exp. 10, what diminution of crop was then sustained, and that the evil was not abated in the three succeeding courses of cultivation.

Still, neither of the diseased measured pieces has fallen quite as low as its product before marling; nor do I think that such has been the result on any one acre together on my farm, though many smaller spots have been rendered incapable of yielding even so much as a grain of corn or wheat.

The injury caused to wheat by marling is not so easy to describe, though abundantly evident to the observer. Its earliest growth, like that of corn, is not affected. About the time for heading, the plants most diseased appear as if they were scorched, and when ripe will be found very deficient in grain. On very poor spots, from which nearly all the soil has been washed, sometimes fifty heads of wheat, taken together, would not furnish as many grains of wheat. This crop, however, suffers less than corn on the same land; perhaps because its growth is nearly completed by the time that the warm season begins, to which the ill effects of calcareous manures seem confined. The injury to corn is also greater in a wet than a drier summer.

When these unpleasant discoveries were first made, two hundred and fifty acres had already been marled so heavily that the same evil was to be expected to visit the whole. My labours, thus bestowed for years, had been greatly and unnecessarily increased; and the excess, worse than being thrown away, had served to take away that increase of crop which lighter marling would have insured. But though much and general injury was afterwards sustained from the previous work, yet it was lessened in extent and degree, and sometimes entirely avoided, by the remedial measures which were adopted. My observation and comparison of all the facts presented, led to the following conclusions, and pointed out the course by which to avoid the recurrence of the evil, and the means to lessen or remove it, where it had already been inflicted.

1st. No injury has been sustained on any soil of my farm by marling not more heavily than two hundred and fifty heaped bushels to the acre, with marl of strength not exceeding 40 per cent. of calcareous earth.

2d. Dressings twice as heavy seldom produce damage to the first crop on any soil; and never even on the after crops on any calcareous, or good neutral soil; nor on any acid soil supplied plentifully with vegetable matter.

3d. On acid soils marled too heavily, the injury is in proportion to the extent of one or all these circumstances of the soil—poverty, sandiness, and severe cropping and grazing, whether inflicted previously or subsequently.

4th. Clover, both red and white, will live and flourish on the spots most injured for grain crops by marling too heavily. Thus, in the case before cited of land adjacent to the pieces measured in experiment 10, and equally over-marled, very heavy red clover was

raised in 1830, by adding gypseous earth, and which was succeeded by a good growth of corn, free from every mark of disease, in 1832.

5th. A good dressing of putrescent manure removes the disease completely (see Exp. 11, 12, 13). All kinds of marl (or fossil shells) have sometimes been injurious; but such effects have been more generally experienced from the dry yellow marl, than from the blue and wet.

The inferences to be drawn from these facts are obvious. They direct us to avoid injury by applying marl lightly at first, and to be still more cautious according to the existence of the circumstances stated as increasing the tendency of marl to do harm. Next, if the over-dose has already been given, we should forbid grazing entirely, and furnish putrescent manure as far as possible; or omit one or two grain crops, so as to allow more vegetable matter to be fixed in the land—apply putrescent manures—and sow clover as soon as circumstances permit. One or more of these remedies have been used on most of my too heavily marled land; and with considerable, though not always with entire success, because the means for the cure could not always be furnished at once in sufficient abundance. Other persons, who permitted close grazing, and adopted a more scourging rotation of crops, have suffered more damage, from much lighter dressings of marl than those of mine which were injurious.

But though the unlooked-for damage sustained from this cause produced much loss and disappointment, and has greatly retarded the progress of my improvements, it did not suspend my marling, nor abate my estimate of the value of the manure. If a cover of 500 or 600 bushels was so strong as to injure land of certain qualities, it seemed to be a fair deduction, that the benefit expected from so heavy a dressing, might have been obtained from half the quantity; if not on the first crop, at least on every one afterwards. *That* surely is nothing to be lamented. It also afforded some consolation for the evil of the too heavy marlings already applied, that the soil was thereby fitted to seize upon and retain a greater quantity of vegetable matter, and would thereby ultimately reach a higher grade of fertility.

The cause of this disease is less apparent than its remedies. It is certain that it is not produced merely by the quantity of calcareous earth in the soil. If it were so, similar effects, shown in diseased crops, would always be found on soils containing far greater proportions of that earth. These injurious effects have not been known, to any extent, except on soils formerly acid, and made calcareous artificially; and not on neither neutral or calcareous soils, even by the addition of a great excess of marl. The small spots of land that nature has made excessively calcareous, by marl beds cropping out at the surface of cultivated fields (as the speci-

men 4, page 60), produce indeed a pale feeble growth of corn, such as might be expected from poor gravelly soils; but whether the plants yield grain, or are barren, they show none of those peculiar and strongly marked symptoms of disease which have been described. Some such places on my farm, from which great quantities of poor sandy marl had been removed for manure, and where the remainder still was of unknown depth, have been afterwards cultivated with the surrounding land; and with no more aid than the portion of the adjacent soil carried thereto necessarily by the plough, these places have gradually improved to a product equal to 12 or 15 bushels of corn per acre, and have never exhibited any mark of the marl disease.

By calculation, it appears that the heaviest dressing causing injurious consequences, if mixed to the depth of five inches, has not given to the soil a proportion of calcareous earth equal to two per cent. This proportion is greatly exceeded in our best shelly land, and no such disease is found there, even when the rich mould is nearly all washed away, and the shells mostly left. [Soils of remarkable fertility from the prairies of Alabama and Mississippi have been shown (page 66) to contain from 8 to 16 per cent. of calcareous earth, all of which proportions were in the state of most minute division, and therefore most ready to produce this disease, if it could have been produced by the quantity of this ingredient. A specimen of soil remarkable for its great fertility, and maintaining it under 40 years of successive corn culture, in Scioto valley, Ohio, was sent me by Dr. Thomas Massie. It contained 10 per cent. of carbonate of lime and magnesia. The soil of the borders of the Nile, celebrated for its exuberant fertility through thousands of successive crops, contains about 25 per cent. of carbonate of lime. (*Lyell's Geology*.)] Very fertile soils in France and England sometimes contain 20 or 30 per cent. Among the soils of remarkable good qualities analyzed by Davy, one is stated to contain about 28 per cent., and another, which was eight-ninths of silicious sand, contained nearly 10 per cent. of calcareous earth. Nor does he intimate that such proportions are very rare. Similar results have been stated, from analyses reported by Kirwan, Young, Bergman, and Rozier (page 51); and from all the same deduction is inevitable, that much larger natural proportions of calcareous earth, than our diseased lands have received, are very common in France and England, without any such effect being produced.

From the numerous facts of which these are examples, it is certain that calcareous earth acting alone, or directly, has not caused this injury; and it seems most probable that the cause is some new combination of lime formed in acid soils only; and that this new combination is hurtful to grain under certain circumstances, which

we may avoid, and is highly beneficial to every kind of clover. Perhaps it is the [humate, or some other vegetable] *salt of lime*, formed by the calcareous manure combining with the acid of the soil, which, not meeting with enough vegetable matter to combine with and fix in the soil, causes, by its excess, all these injurious effects.

---

## CHAPTER XIX.

### RECAPITULATION AND MORE FULL STATEMENTS OF THE EFFECTS OF CALCAREOUS MANURES.

#### PROPOSITION 5—*continued.*

From the foregoing experiments may be gathered most of the effects, both injurious and beneficial, to be expected from calcareous manures, on the several kinds of soils there described. Information obtained from statements in detail of agricultural experiments is far more satisfactory, to the attentive and laborious inquirer, than a mere report of the general opinions of the experimenter, derived from the results. But however conclusive may be this mode of reporting facts, it is necessarily deficient in method, clearness, and conciseness. It may therefore be useful to bring together the general results of these experiments in a somewhat digested form, to serve as rules for practice. Other effects of calcareous manures will also be stated, which are likewise established by experience, but which did not belong to any one accurately observed experiment.

The results that have been reported confirm in almost every particular the chemical powers before attributed to calcareous manures, by the theory of their action. It is admitted that causes and effects were not always proportioned, and that sometimes trivial apparent contradictions were presented. But this is inevitable, even with regard to the best established doctrines, and the most perfect processes in agriculture. There are many practices universally admitted to be beneficial; yet there are none of these which are not found sometimes useless, or hurtful, on account of some other attendant circumstance, which was not expected, and perhaps not discovered. Every application of calcareous earth to a deficient soil is a chemical operation on a great scale. Decompositions and new combinations are produced, and in a manner generally conforming to the operator's expectations. But other and unknown agents may sometimes have a share in the process, and thus cause unlooked-for results. Such differences between practice and theory have sometimes occurred in my use of calcareous ma-

nures (as may be observed in some of the reported experiments), but they have neither been frequent, uniform, nor important.

[But in nearly all such cases of disproportion between causes and effects in the use of marl, the manner of variation has been in the effects surpassing the anticipated power of the causes (as previously inferred from reasoning and in advance of any practice), and in very few, if indeed any cases, of the contrary operation, of the results falling short of what might have been inferred from the theory of the action of calcareous manures. For such variation as this, it may be that no reader will require either excuse or explanation; nevertheless it is as much due to truth that it should be stated, as if the opposite kind of difference existed.

Before my earliest trials, or practical knowledge, of the effects of marl, I was well assured, by my theoretical reasoning, that this manure would correct the acidity of poor soil, and enable it to be enriched by putrescent manures. But I was still totally at a loss to know, or to guess, how much calcareous earth would be required for that result, or how much time might be required for the sufficient quantity to produce its full effect; and there were grounds to fear that the quantity of the manure and time for its operation, and consequently the cost compared to profit, would be much greater than after-experience has shown. If 1000 bushels of ordinary marl had been required for an acre, and 10 years' time for that application to raise the product to double its previous rate, the theory of the action of calcareous manures would have been sustained. But in fact, as great effect as this has been usually produced (in judicious and proper practice), by measures of marl and of time less by three-fourths than those just stated. And thus, while effects have almost universally exceeded in measure the supposed power of their causes, I may safely assert that in not a single case, in the tide-water region, of a judicious application of marl or lime, has it been known that the effect fell short of what would be indicated by my theory of the action of calcareous earth as manure.

But there is still another exception to admit, if it be one, or of apparent want of accordance between theory and practice; and unluckily, this case is of the effects falling short of the supposed power of causes. There has as yet been made but little use of lime in the region immediately above the granite ridge which forms the lower falls of our eastern rivers. But almost all the failures of lime to act that have been heard of, or of effects falling much short of what were expected and are usual, are among the few experiments which have been made within fifty miles above the granite ridge. While truth requires that the fact of these failures should be stated, I pretend not to account for them. It may be the case, and probably is, that there is a general difference of

chemical constitution between lands even of like apparent texture and qualities, above and below the falls, as there certainly was a great difference of geological formation.\*

Of the poor lands above the falls, my knowledge is but slight, and founded only on general and slight personal observation, or the report and better information of resident cultivators. But judging from such uncertain lights, I would infer that the lands above the falls were much less acid than those below, even when as poor. The growth of pine and of sorrel is more scarce on lands above the falls; and gypsum often acts there on natural soils, and lime (in some known trials) has produced but slight benefit. On the contrary, gypsum is scarcely ever operative on any natural soil below the falls (that is, on any of the great body of acid soil), and lime never fails to act well on these same lands.

The most important observation to be made on the disproportion of causes and effects, in the tide-water region, is in regard to good neutral soils, and especially as to that best class known by the common name of "chocolate" or "mulatto land," or "hazel loam," as designated more properly in England. On such soils, which constitute the chief value of the best farms of James river, the applications of lime have been the most extensive, and always highly effective.

---

\* The falls of the rivers of eastern Virginia mark the eastern and lower outline of the *primitive* region. The soils of that region have been formed more immediately or recently from the disintegration of rocks; and this natural process is still going on, in the gradual continued disintegration of the still remaining rocks, and even of gravel and sand. For, however much the materials of the soils have been intermixed by natural causes, and the soils thereby made more of uniform character, still each remaining stone, and even each grain of sand, is a fragment and sample of the original compound rock from which it crumbled down. Most of the different rocks contain, chemically combined, several, if not all the important chemical earths; though, as in poor soils, silica and alumina are usually most abundant, and lime and magnesia are in very minute proportions. Still, in the intermixture of fragments of all the ordinary rocks of that region, and by their continued gradual disintegration, there are still furnished to every soil so formed new supplies of all the necessary earths, and of potash also. Small as may be the amount of lime and potash, there is some of each furnished every year to every such soil, by the disintegration of its remaining fragments of rocks.

On the other hand, the soils and sub-soils of the region below the falls are composed of a much earlier disintegration of rocks. Except some rarely found hard pebbles, and gravel (mostly of quartz), all rounded by being water-rolled, everything in these soils has been reduced to the minutest particles. Even if these soils had been originally produced from the same kinds of rocks, as those above the falls, still there must be a great difference between the soils in which the process of disintegration and decomposition is yet in continual progress, and those in which it has been completed and has ceased for countless ages.



The fact that the effects of calcareous manures so generally exceed in measure the supposed power and operation of the causes, and more especially in regard to neutral soils, seemed to indicate that calcareous manures possessed other fertilizing powers, besides those set forth in Chapter VIII. This, which formerly was stated as a probability, may now be considered as certain. Evidence of such effects, and of the supposed auxiliary and lately known causes, will hereafter be presented. Dismissing them from consideration for the present, I will return to stating the results of applying marl as they have occurred almost without exception in my own earlier practice, and which are confirmed by the concurrence of all known and certain testimony in regard to practical operations in the marl region of Virginia.]

Under like circumstances in other respects, the benefit derived from marling will be in proportion to the quantity of vegetable or other putrescent matter given to the soil. It is essential that the cultivation should be mild, and that little or no grazing be permitted on poor lands under regular tillage, and which have no supply of putrescent manure, except the grass and weeds growing on them while at rest. Wherever farm-yard manure is used, the land should be marled heavily; and if the marl is applied first, so much the better. The marl cannot act by fixing the other manure, except so far as they are in contact, and when both are well mixed with the soil.

[When I first asserted the agency and force of calcareous manures in fixing alimentary manures in soils, and maintained the great and indispensable necessity of that operation, the proposition was founded almost exclusively on reasoning, and on observation of natural soils, and not at all on practical effects then experienced from applications of marl or lime. From the very nature of the case, such effects as these, however important and valuable, could not be seen at first, nor fully even in a very few years after beginning to marl, nor their extent be understood and appreciated. Moreover, my earlier experience had shown so fully the incapacity of my acid or naturally poor soils to retain alimentary manures, and my labours and expenditures to apply them had been so very unprofitable, that I was not myself prepared for the full extent of the contrary operation, after marl had been applied. And though the views and estimation of such new operation have been yearly enlarging, from the experience of practical results, still my estimate of the *fixing* value of marl fell short of what is now confidently believed, and which is every season manifest, of the greater effect and permanency, and far greater profit of alimentary manures, caused solely by the presence of calcareous earth in the same soils. Notwithstanding that the theory of the action of calcareous manures, as set forth in this essay, and published as early

as 1821, made this fixing operation the first of the two most important agencies, and though that theoretical view guided my practice from the beginning, still it was not until after a long time, that gradually and slowly I fully and truly estimated the full value and profit of this operation. My early and zealous efforts (before beginning to marl) to improve naturally poor lands by the vegetable and animal manures of the farm, had been so much disappointed, and the effects had been so inconsiderable as well as so fleeting, that it was long before I arrived at the conviction of the full extent of the opposite and new condition of the soil. But during latter years, the certain and profitable operation, and durable operation, of every kind of vegetable or alimentary manure, no matter how or when applied, has been made obvious; and now my estimate of value would be, that if marling had no other operation whatever than this one of making other manures much more active and durable, the profit from this one source alone would amply reward all the usual labours and expenses of the operation.\*]

On "galled" spots, from which all the soil has been washed, and where no plant can live, the application of marl *alone* is utterly useless; at least, until time and accident shall furnish some addition of vegetable matter also. Putrescent manures alone would there have but little effect, unless in great quantity, and would soon be all lost. But marl and putrescent matter together serve to form a new soil, and thus both are brought into useful action; the marl is made active, and the putrescent manure permanent. The only perfect cures that I have been able to make, at one operation, of galls produced upon a barren sub-soil, were by applying heavy dressings of both calcareous and putrescent manures together; and this method may be relied on as certainly effectual. But though a fertile soil may thus be created, and fixed durably on galls otherwise irreclaimable, the cost will generally exceed the value of the land recovered, from the great quantity of putrescent matter required. Much of our acid hilly land has been deprived, by washing, of a considerable portion of its natural soil, though not yet made entirely barren. The foregoing remarks equally apply to this kind of land, to the extent that its soil has been carried off. It will be profitable to apply marl to such land; but its effect will be diminished, in proportion to the previous removal of the soil. Calcareous soils, from the difference of texture, are much less apt to wash than other kinds. Within a few years after marling a hilly

---

[\* *Confirmatory testimony.*—Liming "increases the effect of a given application of [putrescent] manure; calls into action that which, having been previously added, appears to lie dormant; and though manure must be plentifully laid upon the land after it has been well limed, yet the same degree of productiveness can still be maintained at a less cost of manure than where no lime has been applied." Johnston's Lectures, p. 391.]

field that has been injured by washing, many of the old gulleys will begin to produce vegetation, and show that a soil is gradually forming from the dead vegetables brought there by winds and rains, although no means had been used to aid this operation.

[This newly acquired ability to resist the washing power of rains, is one of the most beneficial effects of marling on hilly lands. And this effect is no less certain, than it is conformable to the theory of the action of marl and to reason. On soils containing very little lime (or almost none, as in naked sub-soils), whether they be sandy or clayey, there is nothing to combine the vegetable matter with the soil, nor the different ingredients of the soil with each other. Consequently they have no cohesion, and whenever made very soft, or semi-fluid by rains, and there is any declivity, there is nothing to prevent the soil, or upper surface, being washed off by excessive rain, though falling gently. Of course, torrents of rain produce the same injurious effects much more rapidly and effectually. But when such soils have been made calcareous, a chemical combination and bond of union and coherence is formed between the lime and the putrescent or organic matter, and of both with the silicious and argillaceous parts of the soil; which combination is able to resist any but an unusual force of the washing action of rains.\* Moreover, by the increase of productive power thus given, grass grows more kindly and rapidly, and by its decay the vegetable mould is continually augmented, and thereby the power of resisting washing is still more increased as the fertility of the soil is increased. This is but another aspect and operation of the power of calcareous manure in soils to fix and retain manures.

The tendency of some very sandy soils to be moved, and in part blown away, by high winds, is also produced by the want of cohesion of the particles. The wind operates on the soil in its dry state in the same way, and for the same defect of its constitution, as does water in rain torrents. The same remedy, calcareous manure, is even more effectual to prevent the wasting operations of wind than of water. The absorbent power given to the before loose and more rapidly drying particles of sandy soils serves to preserve more moisture at the surface. This alone would tend much to prevent the moving effect of the wind, which can take place only on earth nearly or quite dry and pulverulent. Further, both directly and indirectly (by combining the organic with the earthy parts), the calcareous manure, when thoroughly diffused, interposes some cohesive particles between the particles of sand.

\* *Confirmation.*—Johnston speaks of organic (or putrescent) matter being presented to the action of lime “in the state of chemical combination with earthy substances—with the alumina, for example, and with lime and magnesia—already existing in the soil.” p. 402.

The effect in practice is most striking. Fields and farms, which before were noted for the dense and enormous clouds of dust passing away from them in every high and drying wind, become free from such loss in a short time after being marled or well limed.\*]

The effect of marling will be much lessened by the soil being kept under exhausting cultivation. Such were the circumstances under which we may suppose that marl was tried and abandoned many years ago, in the case referred to in page 114. Proceeding upon the false supposition that marl was to enrich by direct action, like dung, it is most probable that it was applied to some of the poorest and most exhausted land, for the purpose of giving the manure what is called a "fair trial." The disappointment of such ill-founded expectations was a sufficient reason for the experiment not being repeated, or being scarcely ever referred to again, unless as evidence of the worthlessness of marl. Yet with proper views of the action of this manure, this experiment might at first have as well proved the early efficacy and value of marl, as it now does its durability.†

When acid lands are equally poor, the increase of the first crop from marling will be greater on sandy, than on clay soils; though the latter, by heavier dressings and longer time, may ultimately

---

\* I have heard (but do not know from my own personal observation), that the well-known and valuable farm of Lower Wyanoke, the property of the late Fielding Lewis, presented a remarkable example of the frequent loss of soil by winds, before the liming, and of the cessation afterwards.

On March 1st, 1850, a few days before the writing of these lines, I saw from the eminence on which my present dwelling stands, a very remarkable exhibition of this conservative power of marl. The night before, there had fallen a heavy shower; and also some drizzle after day-break, succeeded by bright sunshine and a furious wind. Though the rain-water had stood in puddles in the ruts and low spots of hard roads in the morning, by 11 o'clock, A. M., dense clouds of dust, rising as high as the tops of the forest trees on the higher lands, were seen driven off from the light fields of three different and detached neighbouring farms, and which had not been marled. A much broader space of surface, intermediate or adjoining, was also in view, much of which was equally sandy, and fully as much exposed to the wind. All this land (except one small field, which was both stiff, and low-lying, and of course not then dry) had been well marled; and from none of it was any dust seen to rise. Of the several thousand acres of arable land in sight, and mostly of sandy soil, all the farms and fields not marled (and not of clay or wet soil) might have been designated by the clouds of dust then rising and passing off from them.

† *Confirmation.*—"One thing, however, must be borne in mind by those who, in adopting the best system of [successive] liming, do not wish both to injure their land and to meet with ultimate disappointment. Organic matter—in the form of farm-yard manure, or green crops ploughed under, &c. &c., must be abundantly and systematically added, if at the end of 20 or 40 years the land in which the full supply of lime is kept up is to retain its original fertility. . . . Otherwise present fertility and gain will be followed by future barrenness and loss." Johnston's Lectures, p. 386.

become the best land, at least for wheat and for grass.\* The more acid the growth of any soil is, or would be, if suffered to remain, the more increase of crop may be expected from marl; which is directly the reverse of the effects of putrescent manures. The increase of the first crop on my worn acid land, I have never known under fifty per cent., and more often it is as much as one hundred; and the improvement continues to increase, under mild tillage, to three or four times the original product of the land. (See Exp. 11, page 185, and Exp. 4 and 6.) In this, and other general statements of effects, I suppose the land to bear not more than two grain crops in four years, and not to be subjected to grazing during the other two; and that a sufficient cover of marl has been laid on for use, and not enough to cause disease. It is true, that it is difficult, if not impossible, to fix that proper medium, varying as it may on every change of soil, of cropping, and of the kind of marl. But whatever error may be made in the proportion of marl applied, let it be on the side of light dressing (except where putrescent manures are also laid on, or designed to be laid on before the next course of crops begins); and if less increase of crop is gained to the acre, the cost and labour of marling will be lessened in a still greater proportion. If, when tillage has served to mix the marl well with the soil, sorrel should still show to any extent, it will sufficiently indicate that not enough marl had been applied, and that it may be added to, safely and profitably. If the nature of the soil, its condition and treatment, and the strength of the marl, all were known, it would be easy to direct the amount of a suitable dressing; but without knowing these circumstances, it will be safest to give not more than 200 or 250 bushels of marl, of say 40 per cent. to the acre of worn acid soils. Twice or thrice as much might be given, safely and profitably, to newly cleared wood-land, or well manured land. Or, I would advise that the first dressing should not exceed the quantity which would furnish one per cent. of carbonate of lime to the soil, for its ploughed depth. If only 3 inches deep, 218 bushels of marl, of 40 per cent., would furnish 1 per cent. to the soil. Besides avoiding danger, it is more profitable to marl lightly at first on weak lands. If a farmer can carry out only ten thousand bushels of marl in a year, he will derive more product, and confer a greater amount of improvement, by spreading it over forty acres of the land intended for his next crop, than on twenty; though the increase to the acre would probably be greatest in the latter case. By the lighter dressing, the land of the whole farm will be marled, and be storing up vegetable matter for its progressive improvement, in half the time that it could be marled at double the rate.

---

\* *Confirmation.*—"On clay lands more lime is necessary than on light and sandy soils." Johnston's Lectures, p. 382.

The greater part of the calcareous earth applied at one time cannot begin to act as manure before several years have passed, owing to the coarse state of many of the shells, and the want of thoroughly mixing them with the soil. Therefore, if enough marl is applied to obtain its full effect on the first course of crops, there will certainly be too much afterwards.

Perhaps the greatest profit to be derived from marling, though not the most apparent in the first few years, is on such soils as are full of wasting vegetable matter. Here the effect is mostly preservative, and the benefit and profit may be great, even though the increase of crop may be very inconsiderable. Putrescent manure laid on any acid soil, or the natural vegetable cover of those newly cleared, without marl, would soon be lost, and the crops reduced to one-half or less. But when marl is previously applied, this waste of fertility is prevented; and the estimate of benefit should not only include the actual increase of crop caused by marling, but as much more as the amount of the diminution which would otherwise have followed. Every intended clearing of wood-land, and especially of those under a second growth of pines, ought to be marled before cutting down; and it will be still better if it can be done several years before. If the application is delayed until the new land is brought under cultivation, though much putrescent matter will be saved, still more must be wasted. By using marl some years before obtaining a crop from it, as many more successive growths of leaves will be converted to useful manure, and fixed in the soil; and the increased fertility will more than compensate for the delay. By such an operation, the farmer makes a loan to the soil, at a distant time for payment, but on ample security, and at a high rate of compound interest.

Some experienced (though certainly not land-improving) cultivators have believed that the most profitable way to manage pine old fields, when cleared of their second growth, was to cultivate them every year, until worn out—because, as they said, such land would not last much longer, no matter how mildly treated. This opinion, which would seem at first so absurd, and in opposition to all the received rules for good husbandry, is considerably supported by the properties which are here ascribed to such soils. When these lands are first cut down, an immense quantity of vegetable matter is accumulated on the surface, which, notwithstanding its accompanying acid quality, is capable of making two or three crops nearly as good as the land was ever before able to bring. But as the soil has no power to retain this vegetable matter, it will begin rapidly to decompose and waste, as soon as exposed to the sun; and will be lost, except so much as is caught, while escaping, by the roots of growing crops. The previous application of marl,

however, would make it profitable in these, as well as other cases, to adopt a mild and meliorating course of tillage.

Less improvement will be obtained by marling worn soils of the kind called "free light land," than other acid soils which originally produced much more sparingly. The early productiveness of this kind of soil, and its rapid exhaustion by cultivation, at first view seem to contradict the opinion that durability and the ease of improving by putrescent manures are proportioned to the natural fertility of the soil. But a full consideration of the circumstances will show that no such contradiction exists.

In defining the term *natural fertility*, it was stated that it should not be measured by the earliest products of new land, which might be either much reduced, or increased, by temporary causes. The early fertility of free light land is so rapidly destroyed, as to take away all ground for considering it as fixed in, and belonging to the soil. It is like the effect of dung on the same land afterwards, which throws out all its benefit in the course of one or at most two years, and leaves the land as poor as before. But still it needs explanation why so much productiveness can at first be exerted by any acid soil, as in those described in the 14th experiment. The causes may be found in the following statement. These soils, and also their sub-soils, are principally composed of coarse sand, which makes them of more open texture than best suits pine, and (when rich enough) more favourable to other trees, the leaves of which have no natural acid, and therefore decompose more readily. As fast as the fallen leaves rot, they are of course exposed to waste; but the rains convey much of their finer parts down into the open soil, where the less degree of heat retards their final decomposition. Still this enriching matter is liable to be further decomposed, and to final waste; but though continually wasting, it is also continually added to by the rotting leaves above. The shelter of the upper coat of unrotted leaves, and the shade of the trees, cause the first as well as the last stages of decomposition to proceed slowly, and to favour the mechanical process of the products being mixed with the soil. But there is no chemical union of the vegetable matter with the soil. When the land is cleared, and opened by the plough, the decomposition of all the accumulated vegetable matter is hastened by the increased action of sun and air, and in a short time everything is converted to food for plants. This abundant supply suffices to produce two or three fine crops. But now, the most fruitful source of vegetable matter has been cut off; and the soil is kept so heated (by its open texture) as to be unable to hold enriching matters, even if they were furnished. The land soon becomes poor, and must remain so, as long as these causes operate, even though cultivated under the mildest rotation. When the transient fertility of such a soil is gone, its acid qualities

(which were before concealed in some measure by so much enriching matter) become evident. Sorrel and broom-grass cover the land, and if allowed to stand, pines will then take complete possession, because the poverty of the soil leaves them no rival to contend with.

Marling deepens cultivated sandy soils, even lower than the plough may have penetrated. This was an unexpected result, and when first observed seemed scarcely credible. But this effect also is a consequence of the power of calcareous earth to fix manures. As stated in the foregoing paragraph, the soluble and finely divided particles of rotted vegetable matters are carried by the rains below the soil; but as there is no calcareous earth there to fix them, they must again rise in a gaseous form, after their last decomposition, unless previously taken up by growing plants; [or descending still lower in the sub-soil, dissolved in rain-water, may go off into the sources of springs, and so be lost to the land.] But after the soil is marled, calcareous as well as putrescent matter is carried down by the rains as far as the soil is open enough for it to pass. This will always be as deep as the ploughing has been, and somewhat deeper in loose earth; and the chemical union formed between these different substances serves to fix both, and thus increases the depth of the soil. This effect is very different from the deepening of a soil by letting the plough run into the barren sub-soil. If, by this mechanical process, a soil of only three inches is increased to six, as much as it gains in depth, it loses in richness. But when a marled soil is deepened gradually, its dark colour and apparent richness are increased, as well as its depth. Formerly, single-horse ploughs were used to break all my acid soils, and even these would often turn up sub-soil. The average depth of soil on old land did not exceed three inches, nor two on the newly cleared. Even before marling was commenced, my ploughing had generally sunk into the sub-soil—and since 1825, most of this originally thin soil has required three mules, or two good horses to a plough, to break the necessary depth. The soil is now from six to eight inches deep generally, from the joint operation of marling and deepening the ploughing a little in the beginning of every course of crops; [and to that depth, or very nearly, the land is now ploughed whenever preparing for corn, or for wheat on clover. The summer ploughing of clover land requires four mules to a plough.

Since marling was begun, the deepening of the soil has much more generally preceded than followed the deepening of the ploughing. How destructive to the power of soil this present depth of ploughing would have been, without marling, may be inferred from the continued decrease of the crop, through four successive courses of a very mild rotation, on the spot kept without marl in experiment 10. Yet the depth of ploughing there did not exceed six



inches, and depths of nine and even twelve inches were tried, without injury, on parts of the adjacent marled land.—1835.]

[This remarkable and valuable effect of marling, in deepening the soil, is increased in action by the sub-soil being *sandy*, which is commonly deemed the worst kind of sub-soil. Land having a clay sub-soil, which is known in common parlance as land with “a good foundation,” is almost universally prized; and that impervious sub-soil is supposed necessary to prevent the manure and the rains from sinking, and being lost. And such, indeed, may be among the disadvantages, before marling, of poor land having a sandy sub-soil. But not so after marling. While the open texture of such a sub-soil permits so much of the water as is superfluous and injurious to sink and disappear, and the combined manures to sink enough to deepen the soil (by converting barren sub-soil to productive soil), the attractive force of the calcareous earth, for both putrescent matter and moisture, will much more effectually prevent either from being lost to the soil, than would the mechanical obstruction of a clay sub-soil. Great as are the objections entertained by most farmers to sandy sub-soils, or to what they call “land without any foundation,” I would decidedly prefer such to lands having an impervious clay sub-soil—supposing both to be equally barren. The subjects of all my experiments stated as made on acid sandy loams, had also sub-soils of yellow and barren sand; and on such lands have been made my greatest and most profitable improvements by marling. However, a sub-soil (and also a soil) more of medium texture, would no doubt have been as much better than the very sandy, as the latter was better than the very stiff and impervious clay sub-soils.—1842.]

[Besides the general benefit which marling causes equally to all crops, by making the soils they grow on richer and more productive, there are other particular benefits which affect some plants more than others. For example, marling serves to make soils warmer, and thereby hastens the ripening of every crop, more than would take place on the like soils, if made equally productive by other than calcareous manures.\* This quality of marled land is highly important to cotton, as our summers are not long enough to mature the later pods.

Wheat also derives especial benefit from the warmth thus added to the soil. It is enabled better to withstand the severe cold of winter; and even the short time by which its ripening is forwarded by marling, serves very much to lessen the danger of that crop

---

\* *Confirmation.*—“*Liming hastens the maturity of the crop.*—It is true of all our cultivated crops, but especially those of corn [wheat] that their growth is attained more speedily when the land is limed, and that they are ready for the harvest from 10 to 14 days earlier.” Johnston’s Lectures, p. 392.

from rust, the most frequent and destructive of all its diseases. This, much more than any other grain crop, seems to be especially favoured by calcareous earth in the soil. The product is not only always much increased, but other accessory effects are produced, for want of which on the lands most highly manured, but still deficient in lime, the wheat crop is made feeble, and in danger of great loss or destruction from different disasters. Thus, if a heavy growth of wheat is produced by putrescent manures only, the straw is weak, and the crop is almost sure to be laid by its own weight before ripening, even without stormy weather, and is very much reduced in value. On limed or calcareous land, the crop is far safer; and is seldom laid, even when very heavy, unless by violent storms, which is owing to the greater strength of the straw.\* The opening of the texture of close clay soils by the operation of calcareous manures, by permitting the better percolation of surplus water, serves in some measure as drainage, and especially enables wheat better to withstand the always redundant wet of winter on such soils, which is much more the cause of "winter-killed" wheat, than the severity of cold, or alterations of temperature. Wheat also profits by the absorbent power of marled land (by which sands acquire, to some extent, the best qualities of clays), though less so than clover and other grasses that flourish best in a moist climate.

Indian corn does not need more time for maturing than our summers afford (except on the poorest land), and can sustain much drought without injury, and therefore is less aided by these qualities of marled land. Most (if not all) the different plants of the leguminous or pod-bearing tribe, including all the varieties of clover, peas, and beans, derived such peculiar benefit from marling, that it indicated some peculiar operation on these plants. What this is, has recently been made clear by the researches of chemists. The analyses of the ashes of leguminous plants show that they contain very large proportions of lime, and far exceeding those of any other cultivated plants. Of course, they need a larger and ready supply of lime in the soil; and they profit in proportion to their wants, by such supply being furnished.—1845.]

On acid soils, without heavy manuring, it is scarcely possible to raise red clover; and even with every aid from putrescent manure, the crop will be both uncertain and unprofitable. The recommendation of this grass, as part of a general system of cultivation and improvement, by the author of '*Arator*,' is sufficient to prove that his improvements were made on soils far better than such as are common. Almost every zealous cultivator and improver (in prospect) of acid soil has been induced to attempt clover culture, either by

---

\* This effect is also affirmed by Johnston, p. 392.

the recommendations of writers on this grass, or by the success witnessed on better constituted soils elsewhere. The utmost that has been gained, by any of these numerous efforts, has been sometimes to obtain one, or at most two mowings, of middling clover, on some very rich lot, which had been prepared in the most perfect manner by the previous cultivation of tobacco. Even in such situations, this degree of success could only be obtained by the concurrence of the most favourable seasons. Severe cold, and sudden alternations of temperature in winter and spring, and the spells of hot and dry weather which we usually have in summer, were alike fatal to the growth of clover, on so unfriendly a soil. The few examples of partial success never served to pay for the more frequent failures and losses; and a few years' trial would convince the most ardent, or the most obstinate advocate for the clover husbandry, that its introduction on the ordinary poor soils of lower Virginia was absolutely impossible; and scarcely practicable, even partially, on such lands when very highly manured. Still the general failure was, by common consent, attributed to anything but the true cause. There was always some reason offered for each particular failure, sufficient to cause it, and but for which (it was supposed) a crop might have been raised. Either the young plants were killed by freezing soon after first springing from the seed—or a drought occurred when the crop was most exposed to the sun, by reaping the sheltering crop of wheat—or native and hardy weeds, aided by very favourable weather, overran the crop; and all such disasters were supposed to be increased in force, and rendered generally fatal, by our sandy soil, and hot and dry summers. But after the true evil, *the acid nature of the soil*, is removed by marling, clover ceases to be a feeble exotic. If withstanding the early dangers of frost on the newly sprouted plants, and of drought soon after, clover is then naturalized on our soil, and is able to contend with rival plants, and to undergo every severity and change of season, as safely as our crops of corn and wheat—and offers to our acceptance the fruition of those hopes of profit and improvement from this grass, with which previously we had only been deluded.

After much waste of seed and labour, and years of disappointed efforts, I had abandoned clover as utterly hopeless. But after marling the fields on which the raising of clover had been vainly attempted, there arose from its scattered and feeble remains, a growth which served to prove that its cultivation would then be safe and profitable. It has since been gradually extended over all the fields. It will stand well, and maintain a healthy growth on the poorest marled land; but the crop is too scanty for mowing, or perhaps for profit of any kind, on most poor sandy soils, unless aided by gypsum. Newly cleared lands yield better clover than

the old, though the latter may produce as heavy grain crops. The remarkable crops of clover raised on some very poor clay soils, after marling, have been already described. This grass, even without gypsum, and still more if aided by that manure, will add greatly to the improving power of marl; but it may do as much harm as service, if we greedily take from the soil all of the supply of putrescent matter which it affords.\*

Some other plants, less welcome than clover, are equally favoured by marling. Unless both the tillage and the rotation of crops be good, greensward (*poa pratensis*), blue grass (*poa compressa*), wire-grass (*cynodon dactylon*), and the vetch, or partridge pea (*vicia sativa*), will soon increase so as to be not less impediments to tillage, or to the grain crops, than manifest evidences of an entire change in the character and power of the soil.

[The power of calcareous manures is still more strongly shown in the eradication of certain plants, as has been before incidentally

---

[\* There is great difficulty, and frequent failure of securing a "stand" of the young clover plants, even when the subsequent growth of those which escape early destruction is ever so vigorous. This is not owing to any defect of soil (after calxing), but to our climate. It is necessary to sow clover seed before the close of winter, to avoid, by its early growth, the greater evils of the following summer's drought, which most affects the youngest plants. The time of sowing is usually not later than February. It almost always happens that a succeeding warm spell causes most of the seeds to sprout, and then a severe frost kills them, while in their most tender state. Sometimes, the whole young growth is thus killed by late frosts. The danger from drought, and the hot sun, after reaping the shading cover of wheat, is scarcely less than from frosts at the earlier period. One or both of these disasters have occurred for four of the first five seasons for my sowing clover on Marlbourne; so that but one good "stand" of plants, and of course but one sufficiently thick crop was obtained. The loss was the greater, because no clover had previously been on the land, and, of course, there was no volunteer growth, which otherwise and usually furnishes as many plants as the new seed. Indeed, after a field has once been well covered with clover, and the ripe seeds ploughed under, there is not half the danger at any time afterwards of failing to secure a stand of plants.

But a greater evil has been found than this, since the publication (in 1842) of the passages above reporting so favourably of the growth and hardness of clover. On the Coggins farm, and elsewhere, on the *formerly acid soils* marled more than twenty years ago, the clover crops have recently been much more apt to fail, as above, and are much inferior in product, even when not failing to stand, than previously; and this where the land certainly has not lost anything of its richness, and where other crops than clover show no diminution. It is not certain whether this change is owing to the land being "clover-sick," (a common result in England, but not known here, before), or that the acid of the soil (or sub-soil) is increasing and overbalancing the quantity and effects of the calcareous earth. Some facts sustain this latter supposition. Remarlings, at lighter than the earlier rate, have been found, in some cases, to restore the before reduced power of the land to produce clover.—1849.]

mentioned. Sorrel (*rumex acetocella*) is the most plentiful and injurious weed on the cultivated acid soils of lower Virginia; an unmixed growth of poverty grass (*aristida gracilis*) is spread over all such lands, a year after being left at rest; at a somewhat later time broom-grass (*andropogon*) of different kinds covers them completely; and if suffered to remain unbroken a few years longer, a thick growth of young pines will succeed. But as soon as such land is sufficiently and properly marled, there remains no longer the peculiar disposition or even power of the soil to produce these plants. Sorrel is totally removed, and poverty grass no more is to be found, where both in their turn before had entire possession. The appearance of a single tuft of either of these plants is enough to prove that the acid quality of the soil on that spot still remains, and that either more marl, or more complete intermixture, is still wanting. Thus, the presence of either of these plants is the most unerring as well as most convenient and ready indication of a soil wanting calcareous manure. The most laborious analyses, by the most able chemists, directed to ascertain the different characters of soils in this respect, are not to be compared for accuracy to the tests furnished by either the appearance or total absence of sorrel or poverty grass. In regard to broom-grass and pines, the change is not so sudden, or complete; but still the soil will have been made manifestly unfriendly to both. Some striking apparent exceptions to these rules have caused some persons to doubt of their correctness, when full examination of the circumstances would have confirmed my positions. I have known a mere top-dressing of marl, left for some years on a worn-out old field, to eradicate the before general growth of broom-grass, and substitute a cover of annual weeds. Yet on other tillage land, after marling and one crop of wheat on fallow, I have seen the growth of broom-grass return, and seemingly with greater than its former vigour. But this return and vigour were but temporary, and the land is now comparatively free from this injurious weed. When soil, already filled with its seeds, is very imperfectly mixed with marl by ploughing, there is nothing to prevent the broom-grass springing from all the spots not touched by the marl, whether these spots be above or below or between unmixed masses of marl. And the growth being thin and scattered, and not covering the surface completely as formerly, will cause the separate tufts of broom-grass to be much more luxuriant, and greater impediments to tillage, than previously. But the next course of tillage will serve to mix the marl and soil completely, and remove all this appearance of marl being favourable, instead of destructive to broom-grass. Sorrel may often be seen growing out of the heaps of pure marl, dropped from the carts on acid land, and the heaps left thus, unspread, through a summer. But this apparent and very striking exception

may be fully explained. The heaps of marl, thus left, had not as yet by any intermixture affected the original composition of the soil below; and the seeds or roots of sorrel therein were therefore free to spring and grow; and the great hardness and remarkable vital power of that plant enabled it to rise through the (to it) dead matter and great obstruction of several inches thickness of pure marl above. On examining the roots of sorrel thus growing out of marl, it will be seen clearly, and invariably, that they drew all their support from the still acid soil below, and merely passed through the marl, without drawing anything therefrom.\*]

---

## CHAPTER XX.

### DIRECTIONS FOR THE USE OF MARL IN CONNEXION WITH OTHER FARMING OPERATIONS.

#### PROPOSITION 5—*continued.*

From the foregoing reasoning and statements, the general course most proper to pursue in using calcareous manures, and for cultivation in connexion with them, may be well enough deduced. But as I have found that, notwithstanding all such aids, many persons still require and apply for more special directions to guide their operations, the following suggestions and remarks will be offered, at the risk of their being deemed superfluous. These directions, like all the foregoing reasoning, may apply generally, if not entirely, to the use of all kinds of calcareous manures, and to soils of every region. But to avoid too wide a range, I shall consider them as applying more especially to the lands of the tide-water region; and as addressed to farmers who have just begun the improvement of such lands, by means of the fossil shells or marl of the same region.

Many persons, at first, attach much importance to some of the conditions of marling which I deem scarcely worth consideration. Numerous inquiries have been addressed to me for the purpose of

---

\* In England the effect of lime in preventing the growth of sour plants is stated by Johnston, though most of the plants are different from ours of that character. Elsewhere he speaks doubtfully, and upon report only, of calcareous manure eradicating sorrel. He says, liming "kills heath, moss, and sour and benty (*agrostis*) grasses, and brings up a sweet herbage, mixed with red and white clovers." "All fodder, whether natural or artificial, is said to be sounder and more nourishing when grown upon land to which lime has been applied abundantly. On benty grass the richest animal manure often produces little improvement, until a dressing of lime has been laid on." p. 391.

learning, in the case of each particular applicant for directions, at what time and in what manner to apply marl, and which of different kinds of marl to prefer for different soils. There would be but small danger of misleading any one, if to all such inquiries this one general answer were given: "Put on the most accessible marl, over as much land as possible, and speedily, without regard to any attendant circumstances whatever." If the soil requires marling (and there are scarcely any exceptions in lower Virginia), and the available bed is truly and sufficiently calcareous, there can be no important error made in applying it, except by too heavy dressings, or by very unequal spreading. If merely avoiding these two errors, I should deem that procedure the best by which the new beginner can put on his fields the greatest quantity of calcareous earth in the shortest time.

But though comparatively of little importance, still there are advantages and disadvantages to be found in the circumstances to which so much undue importance has been attached. These I will proceed to remark upon.

To marl extensively or economically, it is essential (as has been before stated) to devote to this business a certain labouring force, either for the whole year, or for such certain parts of the year as may be deemed more proper; and for the time this force shall be so directed, the proprietor must not allow the labour to be diverted to any other object. If he draws upon the marling force whenever he or his overseer thinks the labour is needed to forward other farm operations, it will soon be found that the marling will be generally suspended; and yet, in all probability, the other labours be not the better performed because of this always ready resource for extra aid.

Then supposing that the marling is going on throughout the year, or through different designated portions of the year, it is obvious that the marl cannot be always applied to any one condition of the land. In the beginning, the new marler should aim to cover as much land as possible for his next corn or other tillage crop. After that crop shall have been planted, the marling can proceed no farther on that field; and the operation will be then commenced on the field for corn tillage the following year. It is much better that marling should be followed first by some tilled crop; so that the different ploughings and harrowings shall well mix the marl and soil throughout, to the depth of the ploughing. This mixing is best and most certainly effected, when the marl has been spread over the ploughed surface. The subsequent shallow tillage, by small ploughs, cultivators, harrows, and hand-hoes, at every movement continually stirs and mixes the marl with the soil.

But if the subsequent tillage processes should be such as to effect the object of mixing the marl and soil intimately, I would

prefer spreading the marl before ploughing, on the vegetable cover of the land. When thus placed in contact with the putrescent matter, it has seemed to me that the marl acted more speedily and better. But, if marl be thus applied on the grass and ploughed under, the first ploughing should not be deeper than will be at least one thorough ploughing for the subsequent tillage of the first crop. Otherwise, the marl will not be mixed with the soil above, and will remain unchanged and inert in the masses, whether soft and loose, or lumpy, as turned under by the plough. In such cases, the marl can have but little effect, until brought up again by as deep a ploughing, perhaps some years after.

Each of these modes of applying marl then has different advantages; and may have also disadvantages, if they be not guarded against. But in either mode, by proper care, the important condition of sufficient mixture of the marl and soil may be secured. When marl must be ploughed under (for a corn crop), it is important that the first ploughing should be as shallow as consistent with good culture, and that the tillage, in part, shall be fully as deep. If it be preferred to spread marl on the ploughed surface, that may be done, for the greater part of the land, even after dropping the marl, throughout the previous summer, on the grassy surface. For this purpose, the marl heaps must be dropped accurately along the middles of beds, if the land was then in beds designed to be reversed; or along parallel lines, marked by the plough, if not in beds. The spreading must be postponed until after the intervals of land between the rows of marl shall have been ploughed for the next crop, leaving merely the narrow strips on which the heaps lie. In this manner, from two-thirds to three-fourths of the whole surface is ploughed before the spreading of the marl. This is next done, over the whole surface, after which the before omitted strips are ploughed.

After the first year, generally, the farmer may be able to marl fast enough to keep ahead of his cultivation; and even should he (to effect that end) reduce the extent of his previous tillage one-half, it will be best for him not to put an acre under crop which has not been first marled. Fifty acres can, in most cases, be both marled and tilled at least as cheaply as one hundred can be tilled without marling; and the fifty with marl will usually (if on soil before acid), produce as much in the first course of crops as the hundred without, and much more afterwards.

The most important auxiliary to marl, is to supply vegetable matter (or any putrescent matter) to the land. The cheapest and most efficient means, and especially for poor lands having no foreign sources of supply, will be found in the non-grazing system, by which the land, when not under cultivation, manures itself, by the growth, and death, and decay of its own weeds and grass. Poor



and scanty as may be such products and such manuring of poor lands, they very much exceed any substituted supplies; and more-over cost nothing.\*

That rotation of crops which gives most vegetable matter to the soil, is best to aid the effects of marl recently applied. The four-shift rotation is convenient in this respect, because two or three years of rest may be given in each course of the rotation at first, upon the poorest land; and the number of exhausting crops may be increased, first to two, then to three in the rotation, as the soil advances to higher states of productiveness. But it is only while land is poor that I would advise the four-shift rotation, with as much as two years rest in the course; or the entire exclusion of grazing under any rotation. Both tend to make the fields foul with both weeds and insects; and when the land has been under such treatment for some 8 or 10 years, and has been made richer as well as fouler thereby, it will be expedient to graze moderately and judiciously, and to adopt a different and better rotation.

After marling, clover should be sown, and gypsum on the clover. On poor, though marled land, of course only a poor growth of clover can be expected; but wherever other manures are given, and especially if gypsum is found to act well, the crop of clover becomes a most important aid to the improvement by marling.

---

\* If there is one of the requisitions or accompaniments of marling more insisted on than all others—and both by my theoretical views and practical instructions—in all my writing on this subject—it is the necessity for providing organic (or putrescent) manure for all land in full proportion to the calcareous earth supplied. Without this being done, not only will the early effects of the calxing be small, but, in the end, the land will be more completely exhausted of its actual organic ingredient, and consequently and ultimately of its fertility, than if it had not been calxed. It is not necessary, however, that all the required organic manure shall be furnished from the stable and stock-pens—or shall even be what is ordinarily termed manure. As much of this as may be available should be obtained from these sources. But a much larger supply, and far more cheaply, will be furnished by the fields themselves, in their vegetable cover, whether of clover or weeds, suffered to grow and to die and rot on or under the soil. This is the natural and the greatest source of supply of organic manure to the calxing farmer—and which he can increase to any desired extent, by merely giving more time for the land to rest from tillage, and to produce more of alimentary or manuring growths.

But as often and as strongly as I have urged the indispensable necessity for this course, scarcely any of my disciples have obeyed the injunction fully and properly. Nine out of ten of all the farmers who have used marl, and to great profit, still have drawn too heavily from their land, and are lessening, instead of continuing to increase, the fund of productive power in the soil, which calxing had made active. But with this important truth they cannot be impressed. They cannot be persuaded that they are operating to exhaust their fields, while they still continue to derive from them crops three-fold greater than formerly could be grown.

Without clover, and without returning the greater part of the early product to the soil, the greatest value of marling will not be seen. A small proportion of the clover may be used for mowing and grazing; and in a few years even this small share will far exceed all the grass that the fields furnished before marling and the limitation of grazing. This limitation, which is at first objected to as lessening the food of grazing stock, and their products, within a few years becomes the source of a far more abundant supply of both.

During the first few years of marling, but little attention can (or indeed ought to) be given to making putrescent manures, because the soil much more needs calcareous manure; and three or four acres may generally be supplied with the latter, as cheaply as one with the former. But putrescent manures cannot anywhere be used to so much advantage as upon land after being made calcareous; and no farmer can make and apply vegetable matter as manure to greater profit than he who has marled his poor fields, and can then withdraw his labour from applying the more to the less valuable manure. After the farm has been marled over at the light rate recommended at first (say 200 to 300 bushels), every effort should be made to accumulate and apply vegetable manures; and with their gradual extension over the fields, a second application of marl may be made, making the whole quantity, in both the first and second marling, 500 or 600 bushels to the acre, or even more; which quantity might have been hurtful if given at first, but which will now be not only harmless, but necessary to fix and retain so much putrescent and nutritive matter in the soil.

The above injunction, that "every effort should be made to accumulate and apply vegetable manures," should not be limited, as most new improvers would be apt to do, to the mere economical use of the vegetable materials for manure furnished by the crops, and those only as prepared by being first used as litter for animals. Not only these, but every other vegetable and putrescent material that is accessible should be saved and applied, and even without any intermediate process of preparation, and at any time of the year, and state of the fields, provided no growing or commencing crop be thereby molested. Surplus straw, not needed for food or litter, is most valuable and cheaply applied as top-dressing to clover or other grass; though it is an inconvenient and troublesome manure if soon after to be ploughed under. Leaves from the woods of the farm may be used most profitably in the same manner, to the full extent of the resources offered. And though the manuring operations on the Coggins Point farm have not yet been extended beyond the last-named putrescent material (and of that, not to much extent), it is believed that other and abundant sources yet remain untried and unproductive on that and most other farms, and

to use which would be but a waste of labour or money, if in advance of marling. Among the most abundant of such materials, may be mentioned marsh grasses and marsh or pond mud, especially if used in compost; and also the purchase of rich alimentary manures from towns, to be carried by land or by water carriage to much greater distances than has yet been done, or can be afforded to be done, on other lands. Even saw-dust and spent tanner's bark, which, because of their insolubility, are generally deemed of no value as manures, would form important and valuable materials for fertilization, in situations where they can be obtained cheaply and in great quantity. Mixing these or other insoluble vegetable substances with rich putrescent matters, and still more if with some alkaline matter also, would render them soluble, and convert them to food for plants. These inert substances would be most profitably used as litter for stables and cattle pens in summer, where the ordinary more decomposable materials are too quickly rotted, and subject to great loss thereby.

But putting aside the consideration of all such unusual or untried resources and operations for additional fertilization, and limiting the present view merely to the ordinary materials furnished by the fields of every farm, the progress and profit of improvement by such means only, after marling, will be greater than will be at first believed by most cultivators of acid soils, not yet marled or limed. If, on such soils, the general course above advised be pursued (and using merely the resources of the farm after marling), the products of crops on all the marled land usually will be doubled in the first course of the rotation—often in the first crop immediately following the marling; and the original product may be expected to be tripled by the third return of the rotation. And this may be from merely applying marl in sufficient (and not excessive) quantities, and giving the land two years' rest in four without grazing. But on the parts having the aid of farm-yard and other putrescent manures, and of clover, still greater returns may be obtained.

## CHAPTER XXI.

### ACTUAL IMPROVEMENTS AND RESULTS OF MARLING. PECULIAR VALUE OF SANDY SOILS.

#### PROPOSITION 5—*continued.*

When such promises of improvement and of profit from marling are stated as in the preceding chapter, there will naturally occur to the mind of every inexperienced reader the questions, "Has the writer himself met with so much success—and what have been the actual results of his labours in the mode of improvement which he so strongly recommends?" From these questions the writer has no excuse for shrinking; though to answer them there must necessarily be obtruded much egotism, and references made to many trivial details, which are certainly not worth being offered to public notice, except as explanatory and in support of the more general and important facts asserted in this essay.

In answer, then, to these supposed questions, I have to admit that, in my earlier marling labours, the progress of fertilization was not so rapid, in general, and the average profits therefrom not so great, as might be expected from the general views and anticipations stated in the last preceding chapter; though, more recently, the benefits have been much greater, and full as profitable as were anticipated, or could be counted upon, from the foregoing views applied to the existing circumstances of the lands under the operations. Among the sufficient causes of the stated slower improvement, and lower profits of my earlier labours, were the following:

1st. The greater part of my land, on the Coggins Point farm in Prince George county, was not of either such surface or soil as is adapted for the greatest improvement by calxing: some having been naturally calcareous, and therefore not needing marl; and a large part of the farm, where hilly or even of undulating surface, having lost more or less of its soil—and on very many slopes, all the soil—by the washing rains acting on bad tillage.

2d. Having at first everything to learn in regard to the practice, and to prove by actual trial, without any light from either experience, or the prior or cotemporary operations of other farmers, much of my labour was lost uselessly in wrong procedure, or was worse spent in excessive applications of marl, which subsequently proved to be injurious.

3d. The fitness given to the before acid soil, by marling, to produce clover, was not found out, until several years after that best auxiliary to the first improvement ought to have been in full use.

4th. Because of the want of enough labour to use properly both calcareous and putrescent manures, the collecting and applying of the latter were greatly neglected as long as there was full employment in and need for marling.

5th. The adoption of cotton culture, for five years, occupied for that crop and for that time the best land of the farm, and sometimes the whole of the very good land, and took all the prepared putrescent manure, to the great diminution of other crops; while this culture caused (by its clean and continual tillage) more wasting of soil, and more detriment to general fertilization, than grain and clover husbandry.

6th. The general bad practical management, and want of economy in details, which, I have to confess, have attended all my business, and throughout my life, of course injuriously affected this important branch of my farming; though in a less degree, because it was, as much as possible, kept under my personal and close attention.

7th. In 1827, my residence was removed from my farm, and my personal attention much decreased; and some years later was entirely withdrawn.

To what extent all these drawbacks to full success operated, as well as the actual degree of success achieved, may be inferred from the tabular statement of the crops made, both before and since marling, and from 1813 to 1851. The much greater increase of production obtained in later years on the Coggins Point farm was mainly owing to the adoption of a better rotation of crops, including clover-fallow for wheat, and to the residence, and personal and judicious direction of my eldest son, who since the beginning of 1839 has been the occupant of the farm (and more lately the sole proprietor), and, throughout this time, the sole director of its cultivation and general management. Until this change of direction occurred, the actual measure of productive power in the land, which had been created by the marling, was not known. A large share of this power, before dormant and concealed, was now brought for the first time into action, and made apparent. The like conditions of residence, attentive supervision, and a better system of rotation, in my own case, also greatly hastened and increased the success of my later marling labours (resumed after a long diversion of my efforts to different objects), in a new locality, and under very difficult and also very different circumstances from those of my earlier farming. These recent labours, and the results, will again be brought forward.

The following general statement of the then condition of the farm was published in 1842. The still later and much greater productiveness will appear in the annexed table of crops, which will be now extended so as to include the latest obtained.

The many and extensive old galled parts of sloping land,

wherever dressed with marl, and even without the further help of barn-yard manure, are now nearly all *skinned over* by a newly formed soil; and though such soil is still both poor and thin, and may yet long remain so, the *whole* of its present productive power is due to marling; as such galled land was before naked, entirely barren, and irreclaimable by other manures. Where much or rich putrescent matter has been also applied to galls, with or after marl, both rich and durable soil has been formed, though at great cost.

The more level parts of the old and greatly exhausted fields, and the newly cleared wood-land (both kinds being naturally poor, thin, and acid soils), are the only lands which have enjoyed anything like the full beneficial effects of marling. These have been increased in product from 5 and 10 bushels of corn per acre (which may be considered the usual minimum and maximum rates), to at least 20, and in some cases to 30 bushels, even without the aid of barn-yard manure. Where putrescent manures have been also applied, they have raised the products much higher; and these manures are now as durable and as profitable as formerly they were fleeting and profitless in effect.

The before poor and light soil which formed the greater part of the old arable lands, and which was not above three inches in depth (and scarcely two inches when in its natural forest state), is now seven inches or more, and requires three-horse ploughs to break it to proper depth, where the one-horse ploughs formerly would frequently reach and bring up the barren sub-soil.

The fertilizing operation of marl has increased with time, even where the effects were also the most speedy, and most profitable on the first crop after the application.

The soil, which before was totally unable to support red clover, is now (except on the most sandy spots) well adapted to the growth, and capable, according to the grade of fertility, of receiving the great benefit which is offered by that most valuable of improving crops.

And generally—notwithstanding all the many and great errors committed in my marling (for want of experience), and of still worse general farm management—and though a considerable proportion of the old land was either but little or not at all fit to be improved by marling—and though the land added since by new clearings was all very poor, and worthless for its natural producing power—still, the general annual grain products of the farm have been increased from three to four-fold, and the net profit of cultivation and the intrinsic value of the land have been increased in a still greater proportion.—[1842.]

Statement of marling and crops, on Coggins Point (now Beechwood) Farm.\*\*

Year.	Acres marled.	WHEAT.			CORN.			Acres in Cotton.	Bales of Cotton.
		Acres in Wheat.	Product in Bushels.	Average to acre.	Acres.	Bushels.	Average to acre.		
1813	0	145	810	5.58	125	2250	18.		
1814	0	110	550	5.	163	1340	8.18		
1815	0	78	520	6.67	186	1955	14.38		
1816	0	104	896	8.61	144	2300	16.90		
1817	0	79	595	7.52	188	2050	10.90		
1818	15	63	450	7.14	*160	*2670	16.68		
1819	62	132	1015	7.69	*137	*2000	14.59		
1820	25	119	1020	8.57	*164	*2780	17.		
1821	80	160	1049	6.56	*77	‡1775	23.		
1822	93	154	1627	10.56	*114	*2250	19.73		
1823	100	139	1475	10.61	158	*3000	19.		
1824	80	194	1850	9.54	156	*3405	21.80		
1825	50	195	1452	7.45	70	1254	17.91		
1826	24	170	1390	8.17	138	*2275	16.48		
1827	27	151	1366	9.04	104	*1665	16.		
1828	.0	153	936	6.12	112	1750	15.62		37½
1829	.0	134	908	6.78	133	2300	17.37		55
1830	50	—	—	—	—	—	—	50½	33
1831	0	—	2160	—	—	—	—	0	—
1832	0	—	—	—	126	2830	22.46		
1833	—	—	—	—	—	—	—		
1834	—	—	—	—	—	—	—		
1835	—	—	—	—	—	—	—		
1836	10	184	*394	2.17	—	4000	—		
1837	0	147	2056	13.98	—	4415	—		
1838	0	150	2117	14.11	—	2620	—		
1839	2	167	†1252	7.49	190	†2070	23.68		
1840	12	228	1942	8.61	148	4500	24.40	80	5.
1841	32	212	2475	11.62	146	3540	25.33	50	10.
1842	30	250	3377	13.50	155	3800	25.33	10	10.
1843	{ 4 13 }	807	4725	15.89	166	3380	20.36	50	10.
1844	{ 5 15 }	270	4800	17.04	100	2500	25.		
1845	{ 5 17 }	270	3600	13.33	100	1600	16.		
1846	{ 7 17 }	290	3000	†10.34	140	3115	22.25		
1847	{ 9 17 }	234	2571	u10.99	144	5070	35.20		
1848	{ 5 17 }	274	3544	12.93	150	4625	30.83		
1849	{ 4 17 }	225	2600	x11.55	170	5010	29.47		
1850	{ 9 17 }	321	4112	12.81	110	3150	28.64		
1851	{ 10 25 }	263	4420	16.81	118	3750	32.61		

\*\* After 1827, I ceased to keep a regular farm journal, as had been done before. Hence the blanks in the table which appear afterwards to 1836. The occupancy and direction of the present proprietor, Edmund Ruffin, jr., began with the year 1839.

*Explanatory Remarks on the Land and its Management.*

Quantity of land for cultivation (exclusive of waste parts), at first 472 acres; increased by new clearings to 602 by 1826; to 652 in 1832; and no more in 1842, though 80 more acres have since been cleared and tilled, because as much in 1836 converted to a permanent pasture. All the new land added by clearing was poor, and very few acres of it would have produced more than 10 bushels of corn, or 5 of wheat (without the marling), after the 3 or 4 first crops. Of course the new land added served to reduce instead of increasing the general average product per acre.

Rotation at first of three-shifts, viz.: 1 corn, 2 wheat on the richer half, 3 at rest, and after 1814 not grazed. This changed gradually to 4 shifts (by 1823) of 1 corn, 2 wheat, 3 and 4 at rest. 1820, began to fallow for wheat, in part and only in some years. In 1826 or 1827 began to sow the wheat fields generally in clover, and about 1835, to fallow a part (say one-fourth to one-third) of each clover field for wheat the year preceding the crop of corn. This changed in 1840 to a five-shift rotation, one-fifth of the arable land being in corn, two-fifths in wheat (and oats), and two-fifths in clover (or weeds), or other green or manuring crops.

The crops of wheat for first six years (1818 to 1818) raised on the richer parts of each shift, making not much more than one-half the land only; the remainder being then much too poor to be sown. As these poorest parts were marled, all were sown in wheat, in their turn. Therefore, the earlier average products of wheat per acre as stated, were for the richer part of the land, while since 1822 the average is for the worst as well as the best land of each shift.

Grazing the clover fields commenced partially about 1830, and increased since. Latterly about 20 head of cattle and 100 of hogs on the clover during the grazing season.

The crops of hay, corn-fodder, &c., being all consumed on the farm, their products have not been estimated.

*Notes on Particular Crops, &c.*

\* 1818 to 1822, inclusive, 27 acres of rich embanked marsh in corn every year, which served to increase these crops, and their average—which land sunk too low after 1823 for corn, and has since been under the tide.

- † In 1818, the first marling.

1828, oats on 17 acres.

1826 to 1830, a succession of bad seasons for wheat, or of crops—made much worse (as I afterwards believed), by the land having been so long kept from being grazed and trodden by cattle.

\* These crops not actually measured, but amounts otherwise estimated. All other quantities measured, unless stated otherwise.

‡ The richer half of the shift only cultivated in corn this year (1821).

§ Marling nearly extended over all the cleared arable land requiring it, and injurious where too thick.

From 1825 to 1830 inclusive, the richest land of the farm kept under cotton, which served greatly to lessen the general products, and still more the average product per acre of the wheat crops, during that time. Also, fallowing for wheat had ceased (the suitable land being occupied by cotton), and this had served still more to reduce the crops of wheat. The largest crops of wheat raised previously (1819 to 1825) were partly owing to the crop being in part raised on summer fallow. And though this was in advance of having the all-important aid of clover, as green manure, still wheat on fallow always produced much better than would the same land if in wheat after corn, as usual. My first largely increased crop of wheat



(in 1822), was in part owing to the fallow process on a large space. But as the same land had been then marled, and this was its first wheat crop after the marling, I incorrectly ascribed all the great improvement of production to the new fertility caused by marling. In after time, when the same field yielded a much lighter crop of wheat, following-corn, there was great disappointment, for the supposed diminished fertility. In truth, there was great improvement of fertility at first, from marling, and no diminution afterwards. But a still greater measure of temporary production was superadded at first by the fallow preparation—which increase ceased when this kind of preparation was not used. So generally now is known this superiority of the yield of fallow wheat, that no farmer could be deceived in this respect. Nevertheless, not only was I so deceived formerly, in the beginning and partial use of summer fallow, but most other persons were as ill-informed. For nearly all other improving farmers, in addition to whatever means of fertilization they employed, soon also began to fallow for wheat, and on clover, if the land had been enabled to bring clover. The first and all succeeding crops so prepared for, would be more than double any made previously on the same land, in the formerly universal course, after corn. And this more than doubled production of the next succeeding crop, when published, was supposed by all to be the result of a doubled degree of fertility so quickly induced. Several such reports appeared from different and excellent improving farmers in the "Farmers' Register;" and great as were the actual measures of new fertility in all these cases, it is certain that the writers of these reports, as well as the readers, were deceived by the then new and little known peculiar benefits of the summer fallow preparation for wheat—and consequently ascribing less benefit to the mode of tillage, and more to the newly created fertility of the field, than was proper. It was not until about 1835 that fallow preparation had become my annual procedure, even to small extent; nor until 1839 that it was made a regular part of the rotation, extending to one-fifth of the farm each year. Afterwards, as will be seen, the crops of wheat were greatly and permanently increased over the general former products; they then having all the before produced fertility, caused by marling, together with the surface under wheat being extended to two-fifths of the land, and half of that quantity of fallow preparation, and with clover, so far as this manuring crop could be made to grow.

‡ 13,027 lbs. of cotton, net weight as sold, or 170 lbs. to the acre.

• 1836, the wheat crop nearly destroyed by rust, as was general through eastern Virginia.

† Corn crop of 1838 and wheat crop of 1839 very much lessened by the ravages of the chinch-bug.

cc On 26 of these acres the marling was a second application.

• The root crops (turnips and beets), and pumpkins and cymplings, occupied part of the most highly enriched land—all consumed on the farm, and products not estimated.

sss Second dressings of marl, at about 250 bushels the acre; applied where first dressings had been lightest, or where more seemed to be wanting.

∇ Severe drought in 1845 cut short the corn crop.

† Remarkable wet time for harvest in 1846, and much loss of wheat.

u In 1847, much Hessian fly in wheat.

x In 1849, three freezing nights in April cut down all the forward wheat.

---

In 1844, my residence and labours were removed to the farm, Marlbourne, in Hanover, which had been recently bought, and

which I then began to marl, and to cultivate. I here brought to bear much experience, and also judgment, both of which had been wanting to my first marling labours, and therefore I now had more speedy and complete success. Still there were important counter-vailing obstacles; in the great existing differences of the soil and level of my new farm, from the hilly lands on which my earlier labours had been bestowed. Owing to my want of knowing the peculiar requisitions for land entirely new to me, each field had to pass once at least through its course of culture, before I learned, from my errors, what should be its proper tillage and management. The arable land of Marlbourne, about 750 acres, was nearly all of Pamunkey flats of high level, or "second low-grounds." The surface generally is so level and also so much of it in shallow basin-shaped depressions, as to need much labour and judgment in draining; the soils of all shades of texture between very sandy and light, and very stiff and intractable, under tillage. The original qualities had varied between rich and less than medium fertility. The cultivation had been very exhausting; all the land (not too wet to cultivate), had been greatly reduced; and much of it was extremely poor. About 80 acres, in many separated spots, of cleared land, had been the bottoms of formerly existing ponds. These "black-lands" only still were rich, and also of very stiff soil. Most of the other clay lands were the poorest of the farm, and extremely poor. The sandy soils all bore sorrel, thus giving evidence of their then acid condition. About 60 acres had been marled, but quite insufficiently, and required full as much more marl as had been laid on. All the remaining land had to be marled for the first time. Of the procedure and the results, this occasion permits only the general statement which will follow, of the quantities of marl carried out (obtained from an adjacent farm), and the crops made. It is understood that no previous crop of wheat, made on the farm for many years before my occupancy, had reached the amount of 1000 bushels; and even my first crop (reaped in the second year) was increased by being partly on land I had marled, and also by having an over-proportion of the richest ground, taken in detached spots.

## CROPS OF MARLBORNE.

Statement of Marl applied and Grain Crops made on Marlbourne Farm, from 1844 to 1851.

Year.	Marl, heaped bushels.	WHEAT.					OATS.					CORN.				Total acres in grain.
		Acres.	Bush. seed.	Crop, bushels.	Sold bush.	Average to acre.	Acres.	Bush. seed.	Crop.	Acres.	Crop, bush.	Bushels sold.	Average to acre.			
1844	67,875	No	wheat	1848.		131	154	2000	156	2880	1562	18.14	287			
1845	75,512	134	140	1977	1764	14.75	92	120	112	1600	796	14.28	838			
1846	85,545	201	213	2432	2162	11.42	20	250	120	8600	2508	80.	841			
1847	42,575	235	270	8511	3287	15.32	16	200	175	4500	8060	25.71	426			
1848	55,106	256	224	5127	4869	20.02	2	40	106	3080	1601	28.12	864			
1849	56,169	263	258	*3375	3150	*12.88	0	0	140	5431	8753	88.80	403			
1850	84,685	238	225	4596	4317	19.78	0	0	124	3500	1859	28.	852			
1851	850	267	278	6072	5772	22.74			180	8600		27.70	897			
Total	868,317															

\* The wheat crop of 1849 was greatly injured, and lessened in product, by three successive freezing nights preceding the 15th, 16th, and 17th of April. On these mornings, respectively, at sunrise, my thermometer stood at 28°, 23½°, and 26½°. Much the greater number of plants had jointed—and all of which were cut down.

[1832.] With all the increase of products that I have ascribed to marling, the heaviest amounts stated may appear inconsiderable to farmers who till soils more favoured by nature. Corn yielding twenty-five or thirty bushels to the acre, is doubled by many natural soils in the western states; and ten or twelve bushels of wheat (following corn) will still less compare with the product of the best lime-stone clay land. The cultivators of our poor region, however, know that such products, without any future increase, would be a prodigious addition to their present gains. Still it is doubtful whether these rewards are sufficiently high to tempt many of my countrymen speedily to accept them. The opinions of many farmers have been so long fixed, and their habits are so uniform and unvarying, that it is difficult to excite them to adopt any new plan of improvement, except by promises of profits so great that an uncommon share of credulity would be necessary to expect their fulfilment. The net profits of marling, if estimated at twenty or even fifty per cent. per annum, on the expense, for ever—or the assurance, by good evidence, of doubling the crops of a farm in ten years or less—will scarcely attract the attention of those who would embrace, without any scrutiny, the most absurd plan that promised five times as much. Hall's scheme for cultivating corn was a stimulus exactly suited to their lethargic state; and that impudent Irish impostor found many steady old-fashioned farmers who had always eschewed experiments, and held "book-farming" in utter contempt, willing to pay for his pretended patent-right and directions for making five hundred barrels of corn without ploughing, and with the hand labour of two men only.

The products and profits derived from the use of marl, as presented in the preceding pages, considerable as they are, have been kept down, or lessened in amount, by my then want of experience, and ignorance of the danger of injudicious applications. My errors may at least enable others to avoid similar losses, and thereby to reach equal profits with half the expense of time and labour. But are we to consider even the greatest known increase of product that has been yet gained, in a few years after marling, as showing the full amount of improvement and profit to be derived? Certainly not; and if we may venture to leave the sure ground of practical experience, and look forward to what is promised by the theory of the operation of calcareous manures, we must anticipate future crops far exceeding what have yet been obtained. To this, the ready objection may be opposed, that the sandiness of the greater part of our lands will always prevent their being raised to a high state of productiveness—and, particularly, that no care or improvement can make heavy crops of wheat on such soils. This very general opinion is far from being correct; and as the error is important, it

may be useful to offer some evidence in support of the great value to which sandy soils may arrive.

We are so accustomed to find sandy soils poor, that it is difficult for us to connect with them the idea of fertility, and still less of durability. Yet British agriculturists, who were acquainted with clays and clay loams of as great value, and as well managed under tillage, as any in the world, speak in still higher terms of certain soils which are even more sandy than most of ours. For example—"Rich sandy soils, however," says Sir John Sinclair, "such as those of Frodsham in Cheshire, are invaluable. They are cultivated at a moderate expense; and at all times have a dry soundness, accompanied by moisture, which secures excellent crops, even in the driest summers."\* Robert Brown (one of the very few who have deserved the character of being both able writers and successful practical cultivators) says—"Perhaps a true sandy loam, incumbent on a sound sub-soil, is the most valuable of all soils."† Arthur Young, when describing the soils of France, in his agricultural survey of that country, in several places speaks in the highest terms of different bodies of light or sandy soils, of which the following example, of the extensive district which he calls the plain of the Garonne, will be enough to quote: "It is entered about Creisensac, and improves all the way to Montauban and Toulouse, where it is one of the finest bodies of fertile soil that can anywhere be seen."—"Through all this plain, wherever the soil is found excellent, it consists usually of a deep mellow friable sandy loam, with moisture sufficient for anything; much of it is calcareous."‡ The soil of Belgium, so celebrated for its high improvement and remarkable productiveness, is mostly sandy. The author last quoted, in another work describes a body of land in the county of Norfolk, as "one of the finest tracts that is anywhere to be seen"—"a fine, deep, mellow, putrid sandy loam, adhesive enough to fear no drought, and friable enough to strain off superfluous moisture, so that all seasons suit it; from texture free to work, and from chemical qualities sure to produce in luxuriance whatever the industry of man commits to its friendly bosom."§ Mr. Coke, the great Norfolk farmer, made on the average 24 bushels of wheat to the acre, on an estate of as sandy soil as our Southampton (where probably a general average of two bushels could not be obtained, if general wheat culture were attempted)—and many other farms in Norfolk yielded much better wheat than Mr. Coke's in 1804, when Young's survey was made. Several farms

---

\* Code of Agriculture, p. 12.

† Brown's Treatise on Agriculture, p. 218, of "Agriculture" in Edin. Ency.

‡ Young's Tour in France.

§ Young's Survey of Norfolk, p. 4.

averaged 36 bushels, and one of 40 is stated; and the general average of the county was 24 bushels.\* Yet the county of Norfolk was formerly pronounced by Charles II. to be only fit "to cut up into strips, to make roads of for the remainder of the kingdom"—and that sportive description expressed strongly the sandy nature of the soil, as well as its then state of poverty and utter worthlessness.

Because certain qualities of poor clay soils (particularly their absorbent power) make them better than poor sands for producing wheat, we most strangely attach a value to the stiffness and intractability of the former. Yet if all the absorbent quality and productive power of clay could be given to sand, surely the latter would be the more valuable in proportion to its being friable and easy to cultivate. The causes of all the valuable qualities and productive power of the rich sands that have been referred to, are only calcareous and putrescent manures, and depth of soil; and if the same means can be used, our now poor sands may also be made as productive and valuable. I do not mean to assert that the most highly improved sandy soils can produce as much wheat as the best clay soils; but they will not fall so far short as to prevent their being the more valuable lands, for wheat as well as other crops, on account of their being more easily cultivated, and less liable to suffer from bad seasons, or bad management.

The greatest objection to the poor sandy lands of lower Virginia, as subjects for improvement by calcareous manures, is not their excess of sand, nor yet their poverty—great as may be both these disadvantages—but it is the *shallowness* of the poor and sandy soil. The natural soil of a large portion of these lands, before cultivation, is not more than from one to two inches deep, lying on a barren sub-soil of sand. Now suppose this very shallow soil to be doubled or even tripled in fertility by marling, or a productive power of 6 or 9 bushels of corn be raised to 18 bushels, still it would be but mean land. And a long succession of annual vegetable covers to be left on the land, or a great quantity of prepared putrescent manure furnished at once, would be required to make such soil both rich and deep. If the original soil had been ten inches deep, the fertility before marling might have been but little more than on the shallowest soil. But heavy marling and deep and good tillage would have served speedily to make a rich and productive soil, approaching in value to those rich sands of Europe mentioned above.

Another large class of the poor lands of lower Virginia are the close stiff clays, of which the soil is still more shallow than the sands. Such land was described at page 124 and formed the subjects of experiments 5, 6, and 7. This is the very worst soil known

---

\* Young's Survey of Norfolk, p. 300 to 304.

before being marled, and also the most worthless of all known marled soils. And yet a three-fold product has been usually obtained on these lands by marling alone, within four or at most eight years after the application of marl. Still, this land, as well as the most sandy, wants only greater depth of soil and abundance of vegetable matter, to become fertile and valuable.

While then calcareous manures may be counted on to produce great improvement on all soils not naturally provided with them—and to show a greater *percentage* of increase on the worst than on better soils, and a remunerating profit on all (—except those few already calcareous—) still, it will be far more profitable to marl some soils than others. Dung, or other alimentary manure in the best condition for use, increases vegetation nearly in proportion to the quantity of the manure, and without regard or proportion to the previous product of the soil. Thus, a wasteful application of dung might, in a single year, increase the production of an acre of very poor land, from 5 bushels to 50 bushels of corn. But calcareous manures improve production somewhat in proportion to the previous power of the soil; and if the original product was very low, the addition thereto of 100 or even 200 per cent., made on the first crops after marling, will show still but a poor product. These remarks and illustrations are designed for the instruction of those beginners who deem it important to learn on what kinds of soil to apply their marl. In more general terms I would answer, “apply it to all soils not already calcareous;” for however different may be the measure of profit, I have never known marl applied unprofitably in regard to place, if applied judiciously in manner. Of course I refer to soils having some previous productive power and some tenacity; and not to such naked sands, drifting with the winds, as are seen in parts of North Carolina, South Carolina, and Georgia.

---

## CHAPTER XXII.

### THE EXTENT OF DURATION OF THE EFFECTS OF CALCAREOUS MANURES.

#### PROPOSITION 5—*continued.*

In advance of the discussion of the general question of the permanency of calcareous manures, I will here state the facts in regard to duration of effects observed and known of my own oldest practice. This extent of experience is indeed much too short to be considered as the slightest evidence of such permanency of effect as

I ascribe to, and shall claim for, calcareous manures; nor are these facts presented for that purpose. Still, even this comparatively short experience shows an undiminished duration of benefit from calxing, which is long compared to that of any other manuring. And, therefore, for practical instruction, these and other like facts, if brought from other sources, may be of more use than any reasoning upon theoretical grounds, though going to prove a degree of duration of calcareous manures immeasurably greater than any experience of man.

At this time of my writing (1852), thirty-four years have passed since my first application of marl (in January 1818), and which was the beginning of regular and continued labours in the same way. The dressings given in 1818, and also in 1819, were all very light; and were soon inferred to be insufficient, even for the immediate wants of the land. Therefore, more marl was added to all these places, with the next succeeding tillage crop. This early repetition prevented any observation of the oldest dressings, as to their separate and continued effects. In 1820, my error as to quantity was in the opposite extreme, the marl being then laid on so heavily as to produce injury to the crops, after some years. For these different reasons, the marling for the corn of 1821 is the oldest of my applications which was both heavy enough, and not so excessive as to cause any subsequent abatement (by disease) of the increase of crops produced in the first few years. No second marling has there been given. The crops were increased always in the first year after the marling; and continued to show more and more increase for ten or more years afterwards. Nor has there been any known diminution of the highest productive power thus obtained, to this time, in thirty-one years of tillage and rest, according to the rotations in use, since the first marling. These remarks apply especially and strictly to the eleven acres of newly cleared (and then poor and acid) land, forming the subject of experiment 1 (page 117 of this edition); and the like results, though for different shorter times, have been experienced on the adjoining and similar land, subsequently cleared and marled, to the amount of eighty or ninety acres. Of nearly all the other lands, also marled, on Coggins farm, for crops of 1821, or soon after, of different soils and conditions, the same statements should be made, in respect to there having been no known abatement of the early increase of crops. To this general rule there are two limited exceptions, apparent or real. The first has just been adverted to, and was before described at length (p. 155). This injury, by disease, however great, was not at all a diminution of effect of the marl, but the result of excess of quantity, and of improper effect. With time, and supplying vegetable matter in proportion,



this excess of marl has been moderated in effect ; and those applications now, as the others, show continuing good effects only. The other exception, though not yet well understood, seems more real. It applies only to some small spaces of land, sometimes slightly oozy, on clay sub-soil. The surface of these spots is generally sloping, though, in some cases, too level to lose much soil by washing rains. The soil is shallow, and receives the excess of filtrating rain-water from the more level and higher land, in wet seasons, and which is discharged over its surface, when most abundant ; or otherwise beneath the shallow soil, to the lower grounds, or to streams. Such spots, being too wet only in winter and spring, and of small extent, were either not drained at all, or, where covered drains had been made and had failed, they were not renewed. In land of this kind, it seems as if the oozing water dissolves and carries off the organic and nutritive ingredients of the soil. All soil of this character, on the farm named, together makes but some ten or twelve acres, in many small, irregular-shaped spots, and always of small value for tillage, which circumstances caused their being neglected. In all such cases, and even after being marled, and an early improvement being thereby produced, these spots have become more poor, and the soil itself seeming to diminish in quantity, as if lost by being washed away, which, however, is not the case. Previous and proper drainage would, no doubt, have prevented the existence of this only known real exception to the continued and unabated good effect of marling. It is stated here thus particularly, not only as due to truth, but also because the facts will be again referred to, in another connexion.

It should be observed, as to my general practice, and in regard to all land referred to on which no repetition of the first marling of early date has been made, or has been needed—and where no abatement of the highest productive power has occurred—that the following conditions existed, and were (as I suppose) essential for the results stated : The marling had been heavy (perhaps furnishing  $1\frac{1}{2}$  to 2 per cent. of carbonate of lime to the tilled layer of soil), and the land subsequently kept under sufficiently mild cropping and treatment, which allowed it to be supplied, through its own growth of grass, and by help of atmospheric influences, with more organic or nutritive matter than the cultivated crops took away. On some marled land, on other farms, where the general course of cultivation was exhausting, and not compensated by enough of natural or other supplies of vegetable and alimentary matter, the early increase of product has been subsequently lowered. In some such cases, within my observation, of most scourging tillage, in eight or ten years after marling, and after excellent early effects, the land was reduced to as low a state as before being marled.

Such results, to this extent, have occurred only where the temporary occupants of the land thought they had no interest in preserving fertility for future use, or otherwise were grossly ignorant or neglectful of their own interests.

But though the first dressing of marl being heavy, and not subsequently repeated, the conditions best suited for showing the long duration of effects, that course is not economical or proper in any other respect. When a heavy dressing is applied at once, perhaps half the amount (even if not afterwards hurtful by its excess) is superfluous, and lies useless and as dead capital for ten or twenty years. It would be far cheaper, and more conformable to the theoretical views of the action of calcareous manures, if half the quantity of such heavy first applications had been withheld until the addition was required by the increased store of organic matter in the soil, and by the prospective continued supply, which would call for more calcareous matter, for the purpose of combining with what otherwise would be a useless and wasting excess of vegetable or other organic matter.

Except where the first dressing was very light, and therefore was very soon after added to, there were no re-marlings on the Coggins farm until about 1843. The want of more calcareous matter then seemed to be indicated on parts of the farm, which either had at first been the least heavily covered, or otherwise had since received the most putrescent manure from the stock pens, or other supplies of vegetable matter. These indications were understood when, after a long time, scattering plants of sorrel began to reappear; when there was evidence of great increase of organic matter in the soil shown by the larger products of grain; and never by any decrease of production, except of clover alone. Believing that it was time for re-marling to be beneficial, that operation was then begun, and has been continued annually since on the parts of the land supposed to require it, on each field, preceding its next corn crop. The soils so re-marled, of course, were neutral before (from the first marling); or, at most, had very little excess of newly-formed acid; and, of course, no perceptible or manifest benefit from the re-marling was expected, or has been found, in the next succeeding grain crops.

In these cases, the want of additional calcareous matter was not caused by the waste or disappearance of the first supply; but because the first supply, still remaining with very slight diminution of quantity, and none of effect, had served so to increase the organic matter of the soil, that a larger quantity of calcareous matter could be put to use and profit. This is altogether different from the supposed exhaustion, by use and by waste, of the first supply of calcareous matter, as occurs of putrescent manure, and the consequent necessity for replacing it by a new supply. And this latter

is the cause requiring second and repeated applications of lime or marl, as generally and erroneously supposed to operate, not only by the ignorant, but by the scientific authorities whose opinions I shall presently notice, and endeavour to controvert.

So far, I have merely aimed to show, by facts and from experience, that the increased productiveness of soils, induced by calcareous manures, has not ceased, nor, in general, been at all diminished within such short time of experience as belongs to the agriculture of this country, and of which only we can know and estimate all the conditions and circumstances. But, however important may be the value of these evidences of durable effect, bearing on the question of the profit of practical operations, they go but little way towards fixing the limit of duration, and of the undiminished operation of calcareous manures.

In the first sketch of this essay, published in 1821, as well as in all the subsequent editions, I asserted and argued for the absolute permanency of calcareous earth, acting as manure in soil; and the remaining in the soil of the lime, with but very little appreciable diminution of its quantity, through all its chemical changes and different successive combinations. In this opinion I have found myself opposed to nearly if not quite all known authorities, whether of scientific writers, or the practical European cultivators whose reported practices and results have been quoted as evidence. Under such circumstances, it was proper that my grounds should be carefully reconsidered, in connexion with the opposing reasoning. This has been done; and while deeming it proper to yield something of the breadth of my previous position to newer and better information, and while ready to admit the previous errors, and their recent correction, I have still to maintain my former opinion in its most important points. And, without exception, I deny the counter opinions, either asserted by authors of high reputation, or necessary deductions from their assertions, viz. : *that calcareous manures, though long continuing in soils, still are liable to be nearly exhausted by waste and use in terms of say twenty or thirty years;* and that they then require being replaced, and may be so repeated, profitably, and without limitation of the number.

No calcareous manurings made by man can possibly be old enough, or capable of being clearly enough traced through their actual progress, to afford evidence of even very long duration, much less entire permanency of effect. But, however weak for this purpose, such facts, of long abiding effects, will at least serve to rebut the assertions of the much earlier and necessary cessation of all the effects of lime. For such opposition even my own experience of unabated effects, from applications not repeated, now extends to thirty-one years. Another much older application (stated at page 114), after long neglect, and under the worst treatment for its operation,

showed visible effects at the end of sixty years. Lord Kames mentions a particular case of the continued beneficial effects of an application of calcareous manure for one hundred and twenty years (Gentleman Farmer, p. 266, Edin. Ed.), and even Professor Johnston, whose reasoning I shall have mainly to oppose, quotes, with apparent assent, the opinion of "an intelligent and experienced farmer," that certain lands in Scotland "would never forget an application of forty to sixty bushels of lime to the acre."

I shall take from the Lectures of Professor Johnston, the argument in support of the temporary continuance and operation of lime in soils, and its final entire loss and disappearance. No more able advocate of the opinions I shall oppose, nor one of higher authority, could be presented. His observations on lime as manure are the most recent, and fullest of any known; and in most of the points, his opinions command my approval. In regard to this branch of the subject, his views are as follows:—

"A certain proportion of lime," says this author, "is indispensable in our climate to the production of the greatest possible fertility. Let us suppose a soil to be wholly destitute of lime—the first step of the improver would be to add this indispensable proportion. This would necessarily be a large quantity; and therefore, to land limed for the first time, theory indicates the propriety of giving a large dose. Every year, however, a certain variable proportion of the lime is removed from the soil by natural causes. The effect of the removal in a few years becomes sensibly apparent in the diminished productiveness of the land. After a lapse of five or six years, during which it has been gradually mixing with the soil, the beneficial effects of the lime are generally the most striking; after this, they gradually lessen, till, at the end of a longer or shorter period, the land reverts to *its original condition*." (p. 383, 384.) He states the usage in Roxburgh (Scotland), where most lands are leased for nineteen or twenty-one years. On entering upon a farm, the new tenant begins with applying 240 to 300 bushels of [unslaked] quick-lime to the acre, and continues equal progress with his rotation of tillage, until all the farm is limed, within the time of four or five years. He then continues to crop without more liming for fourteen or sixteen years; when, if he is sure of remaining on his farm for another lease, he begins to lime again, at the same rate as before. The author speaks of no limit to these repeated heavy limings; and therefore it may be fairly inferred, that he considers the repetitions, and the alternations of full supply and disappearance of the lime, to be indefinite, or that at no future time will such repetitions of liming cease to be required. Indeed, such inference is unavoidable, if his previous statement be correct, that land "reverts to its original condition," of being "wholly destitute of lime." In such case, the land certainly would as much need

lime again, as if it had never been applied before. Elsewhere this author speaks of twenty years as the ordinary duration of heavy limings; and that in some cases, on grass land, the effect lasted thirty years. (p. 396.) "A heavy marling or chalking in the southern and midland counties of England is said to last for thirty years, and the same period is assigned for the sensible effects of the ordinary doses of lime-sand in Ireland, and of shell-sands and marls in several parts of France." (p. 396, 397.)

There is no subject of practical agriculture on which it is more difficult to gather truth from the evidence of alleged facts than in regard to applications of calcareous manures, made by persons having no knowledge or conception of their true action. The "facts," as understood and reported by the most truthful men, may be deceptive, and lead to false conclusions. There is a general accordance in the practices of the re-limings, as above described, and the repetitions of my own early marlings—yet how different in the causes supposed in the two cases! The British re-limings are required because the first dose was supposed to be either nearly or entirely gone, "and the land had reverted to its original condition, destitute of lime." In the other case, the lime certainly still remained in quantity, and was believed to be not appreciably lessened; but more was required to balance and combine with the increased organic matter. Besides these two causes, supposed and real, for land needing re-liming, it may be wanting, and more than one repetition, because the previous dose was much too small for the then wants of the soil. And in numerous cases, when no need truly exists for more lime, and when indeed the land has been already limed too heavily for its condition, but is exhausted of its organic matter, and thereby impoverished by severe tillage, still more lime is sometimes ignorantly added, and uselessly for its resuscitation, if not injuriously. Yet all these different cases of proper and improper applications, would be confounded by ordinary report. And all that we can be sure of from such facts reported to and published by Prof. Johnston, is that re-limings, at intervals of twenty or more years, are common in Britain; and that sometimes, or generally, they have done good, and sometimes harm. The statements of experience rarely extend so far as to include the third or fourth application. When these shall be known, I predict that there will be found many cases in which the last application is in excess, and will do more harm than good. Yet, strictly in accordance with the views of Prof. Johnston, the fourth or the hundredth application, after proper intervals, would be as much needed, and therefore should be as beneficial as the first.

So much for the facts, and the very imperfect knowledge we can

have of them. I proceed to quote the author's explanations of the manner in which he infers that the lime is lost to the land.

1. "A considerable quantity of lime," he says, "is annually removed from the soil by the crops reaped from it. We have already seen (Lecture X., § 4, p. 221) that in a four-years' rotation of alternate green and corn crops, the quantity of lime contained in the average produce of good land amounts to 149 lbs.\* This is equal to 37.5 lbs. of quick-lime, or 67 lbs. of carbonate of lime, [per acre] for each year. The whole, however, is not usually lost to the land. Part, at least, is restored in the manure, into which a large portion of the produce is usually converted. Yet a considerable portion is always lost—escaping chiefly in the liquid manure and drainings of dung-heaps." (p. 399.)

*Answer.*—To some extent, the loss of lime to soil, by being taken up into the crops, is certain; and I always before admitted it expressly. But, on the author's own showing, the quantity lost in this manner is very much smaller than would appear from the above statement, if received without examination. The table given previously in the "Lectures," and referred to above, of the amounts of various inorganic matters abstracted from the soil by all the crops of the ordinary Norfolk rotation, in four years, shows the following amounts of lime so lost per acre:—

	lbs. Lime.	Lime.	Total.
1st Year, Turnips (25 tons of roots), contains in roots and leaves }	45.8		
2d Year, { Barley (38 bushels), grain, . . .		2.1	
{ Straw of same, . . . . .	12.9		
3d Year, { Clover, 1 ton of hay, . . . . .	68.0		
{ Rye grass, 1 ton, . . . . .	16.5		
4th Year, { Wheat, (25 bushels), grain, . . .		1.5	
{ Straw of same, . . . . .	7.2		
	lbs. 145.4	+3.6	=149

By my thus presenting separately the respective quantities of lime taken up by the grain alone, barley and wheat, which may be supposed to be mostly sold and removed from the farm, and of the turnips, hay, and straw, which mostly are consumed on the farm, and the lime in them again returned to the fields somewhere in the manure, it appears that the total loss of pure lime per acre, in four years, by removal from the farm in the grain crops, is only 3.6 lbs.; and annually, the average (0.9 lbs.) less than 1 lb. per

\* This is stated as 248 lbs., and the numbers following in proportion. But it is manifestly by mistake, as is seen by the table referred to (in Lect. X.), and by which I have corrected the sums above. The difference, however, does not materially affect the argument or conclusion. E. R.

acre. And if the lime abstracted by the retained straw and other home-consumed crops be added as lost, unfair and incorrect as would be that assumption, the whole annual loss would be but 37.25 lbs. of lime, or say about one bushel of quick and slaked lime. If then, 300 bushels of quick-lime had been applied, or as much lime in marl, it would require the total removal of 300 successive crops (and as heavy crops as those above stated) to take away the lime applied. If considering only the loss of lime in the grain, that annual waste, of less than a pound per acre, would require 11,175 successive and as heavy crops for the complete using of the lime applied. In the one case or the other, these respective quantities of lime, annually resupplied to the land, would be enough to compensate for the supposed waste. If the barn-yard and other organic manures of the farm were all saved and applied in time regularly to every part of the fields, then less than a pound of lime added thereto for each acre, annually, would restore the whole amount lost in the sold and removed crops. This is very much less than I had before supposed, and admitted, from more imperfect information than that now furnished by Prof. Johnston.

Boussingault reports, among other results of his many analyses, the mineral, or inorganic parts composing the ashes of samples of all the crops of his five-field rotation at Bechelbronn, which was referred to above, for a different purpose. The amount of each crop to the acre, throughout the rotation, had been ascertained. And having, by analysis, determined the constituent elementary parts of a certain quantity of each product, calculation correctly showed the respective quantities of these constituent parts, in the crops of each year, and for the whole rotation of five years. I will extract below, from two of his tables, the statements of the average crops and these inorganic parts, which were taken up, and may be supposed were as much of these matters as the crops required. There was an abundance of these matters in the soil; for, besides the natural original supply in the manure for the rotation, there was furnished, of each inorganic matter, more than all that the crops took up. Of the lime, this supply in the manure was more than quadruple the quantity taken up.

AVERAGE CROP PER ACRE, ON THE FIVE FIELDS OF THE ROTATION.	Lbs.	Mineral sub- stances in the crops.	Acids.		Chlorine.	Lime.	Magnesia.	Potash & Soda.	Silica.
			Phos- phoric.	Sul- phuric.					
1. Potatoes,	11,733	lbs.113	13	8	3	2	6	58	0
2. Wheat, lbs. 1231,	2,752	50	24			1	8	15	
4. Wheat, lbs. 1521,									
Wheat straw, of same, 2798, 3456, }	6,254	358	11	4	2	30	18	34	242
3. Clover hay,	4,675	284	18	7	7	70	18	77	15
5. Oats,	1,232	39	6			1	3	5	20
Oat straw of same,	1,650	60	13	2½	3	5	1½	17	24
Turnips, secondary crop, after wheat of 4th year, }	8,754	50	3	5	1	5	2	19	3

According to this statement, during the rotation of five years, the total amount of pure lime taken up by the potato crop, and three grain crops, was 4 lbs. The turnips, straw, and clover, took up 120 lbs. The former quantity, equal to the yearly average of 0.8 lbs., is all that may be supposed to be removed from the farm. The latter, of 24 lbs. a year in the turnips, litter and hay, must be returned to the farm in manure. Both these quantities are still less than by the foregoing estimate, quoted by Johnston. Both are so minute as scarcely to be appreciable; and all such loss would scarce deserve consideration, as a practical matter, but for the false importance which has been given to this manner of abstraction of lime from land.

The ordinary farm-made manures, with some purchased peat-ashes, composed the manure applied by Boussingault, in each rotation; and which served to supply to the soil much more of all the mineral parts than were taken up by the crops of all kinds. Of course, there could have been no deficiency of supply of lime for the use of the growing plants, nor any less taken up by them than they required.

2. Another waste of lime alleged by Prof. Johnston is by solution in rain (or other) water. He says: "In the quick or caustic state, lime is soluble in pure water, 750 lbs. of water serving to dissolve 1 lb. of lime. The rains that fall cannot fail, as they sink through the soil, to dissolve and carry away a portion of the lime so long as it remains in the caustic state. Again, quick-lime, mixed with the soil, speedily attracts carbonic acid, and in time becomes the carbonate, which is nearly insoluble in pure water, but is soluble in water impregnated with carbonic acid; and as the drops of rain in falling absorb this acid from the air, they become capable, when they reach the soil, of dissolving an appreciable quantity of the finely-divided carbonate of lime on cultivated fields.



Hence the water that flows from the drains upon such lands is always impregnated with lime, and sometimes to so great a degree as to form calcareous deposits in the interior of the drains themselves. . . . The loss of lime from these causes cannot be estimated, and must vary with the exposure to rains, and slope of surface, &c. But the cause is universal and continually operating, and would alone therefore render necessary, after the lapse of years, the applications of new doses of lime." (p. 399.)

*Answer.*—These several chemical powers, &c., are fully admitted. But their action, under usual and proper conditions of limed or marled land, must be very limited, even when any such agency of waste can be produced. Caustic lime, as stated above, may be sparingly dissolved in pure water. But lime, applied as manure, does not long remain caustic, and, after ceasing to be so, is no longer the least exposed to this particular source of loss; and marl, or carbonated lime, is not at all so exposed. As *carbonate* of lime, however, and while so remaining, another means of solution is operating, in the carbonic acid of the air. But the quantity of this acid is so small, and its tendency to be absorbed by water so great, that a very light rain, or merely the beginning of a long or heavy rain, must bring all the then floating carbonic acid to the soil. This fluid would immediately sink into the pores of the earth, with its dissolved carbonate of lime, if any; and there be preserved, either mechanically or chemically (by further and speedy combination with other matters of the soil), so as to be very little if at all subject to removal in superfluous water before being saved and put to use as manure in later-formed and more fixed chemical combinations. This particular source of waste cannot apply at all but to lime in the form of carbonate. And, according to my previously expressed views, that form is soon changed (with moderate and proper dressings) to other salts of lime, or combinations with the organic parts and the other earths of the soil. In such case, the last considered outlet for waste is also closed; but, possibly, and as Prof. Johnston supposes certainly, others are opened, and will operate, as thus:—

3. "During the decay of vegetable matter, and the decomposition of mineral compounds, which take place in the soil where lime is present, new combinations are formed in variable quantities, which are more soluble than the carbonate, and which therefore hasten and facilitate this washing out of the lime by the action of rains. Thus chloride of calcium, nitrate of lime, and gypsum, are all produced—of which the two former are eminently soluble in water—while organic acids [as humic, acetic, &c. &c.] also result from the decay of the organic matter, with some of which the lime forms readily soluble compounds (salts), easily removed by water." (p. 399.)

*Answer.*—Admitted fully, as to the supposed chemical changes, and the solubility of some of the new compounds. But these new compounds are produced only so long as the lime remains either caustic or carbonated in the soil, neither of which conditions extends beyond a few years, if dressings be not excessively heavy, and if the material is finely divided and well diffused through the soil; and while in progress, the formation of these acid products, and their resulting salts of lime, must be so extremely slow and gradual, that probably nearly as fast as produced they are further combined with other solid matters, and secured from the waste which possibly might be caused by their solution in water. Of course, it is impossible to estimate the measure of this supposed saving process. The general effects are inferred from the known, unquestionable, and grand results of thousands of years old, seen in the still preserved constituents of lime and of fertilizing organic matter in combination, in all the natural moderately calcareous and rich neutral soils known. If we were to admit the full operation of causes of waste of lime, as supposed by Professor Johnston, then every natural and moderately calcareous soil must long ago have lost nearly or all its lime, by one or all of the several preceding operations of solution and removal. And if deprived of the lime, it would be a certain consequence (according to my views) that the soluble and useful organic matter, however abundant, under ordinary circumstances of soils, would also be carried off, leaving the uncultivated land throughout the world destitute of both lime and organic matter, and therefore completely and hopelessly barren. Such results, or even any approaching thereto, are unknown; and their possible existence is as much opposed to all known facts of natural soils, as they would be to our belief in final causes and the all-benevolent care and protection of his works and creatures by Almighty God.

But however strong may be these general reasons for denying the wasting of lime and its resulting salts, there is a particular chemical power asserted by recent authority, which, if true, covers and sustains nearly my whole ground of objection. Professor Gardner, in his late work, "The Farmer's Dictionary" (published 1846), in the article "Humus," refers to, as a known and undisputed chemical truth, that the *humate of lime* is nearly insoluble in water.\* Now, though the humic acid is but one of four or five

---

\* Of the fact of the insolubility of *humate of lime*, the authority of Prof. Gardner, or of any recent chemical writer, must be sufficient. But I would deny his deduction from that property, that therefore humate of lime cannot directly act to feed plants. Vegetable life can exert dissolving and decomposing powers that the chemist in his laboratory cannot imitate or approach. If the property of insolubility in pure water rendered any substance necessarily useless as a direct manuring agent, we should be compelled

acids of soil, of vegetable origin, which chemists have recently ascertained, the humic acid is by far the most frequent, abundant, and important of all. Of course when lime is applied to an acid soil (i. e., any one needing the chemical action of calcareous earth), the most abundant resulting salt will be the humate of lime, which being insoluble in water (or very nearly so), is entirely secured from the waste to which a soluble salt might possibly be, but is not necessarily liable.

4. "The ultimate resolution of all vegetable matter in the soil" continues Professor Johnston, "into carbonic acid and water, likewise aids the removal of the lime. For if the soil be everywhere impregnated with carbonic acid, the rain and spring waters that flow through it will also become charged with this gas, and thus be enabled to dissolve so much the larger portion of carbonate of lime. Thus, theory indicates, what I believe experience confirms, that a given quantity of lime will disappear the sooner from a field, the more abundant the animal and vegetable matter it contains." (p. 399, 400.)—*Answer*.—First, to the last incidental passage, I will merely state unqualified dissent. So far from the quantity of vegetable matter promoting the escape of the lime, it would tend to prevent such waste, if otherwise likely to occur. According to my theory of the action, the lime and vegetable matter in soils combine with each other, and with other parts of the soil, each one thus serving to retain the others, if otherwise liable to waste.

Whatever may occur in old manure heaps, or in the chemist's laboratory, it is not likely that much, if any, vegetable matter *in soil* (and when not in great excess), can pass through all the various stages of decomposition, to the last, that of being resolved into carbonic acid and water. Previous changes would slowly render the parts soluble, and fit to be drawn up by the roots of plants; and probably all would be so used, so that very little reaches the gaseous state. But if carbonic acid should be formed, the production would be very slow, so that the results would be all required for, and taken up, by plants in aid of their support and growth, almost as fast as they were produced. Thus, there would be but little if any opportunity for the alleged waste of lime, in consequence of the organic matters in the soil reaching the last stage of decomposition, and being reduced to carbonic acid and water.

So far, the sundry particular reasons offered in support of the alleged transitory operation and existence of lime in soils have been opposed by particular objections. But still stronger grounds of objection may be assumed in general views, which will now be brought forward.

---

to place in the same class both carbonate and phosphate of lime entirely; and also caustic lime, for much the greater part of the bulk of an ordinary application as manure.

Most farmers are so accustomed to consider manures as being fleeting in their operation and existence in soil, as are the ordinary putrescent manures, that it is difficult for them to have any conception of any kind lasting and acting for ever. And this difficulty of conception, stands much in the way of my argument. But, however little used by farmers, or even thought of, in this light, it is obvious and undeniable, that certain mineral manures will continue in operation, and without abatement of effects, as long as the soil, or the habitable globe itself, shall exist. Thus, clay is a manure for sandy soil, serving to stiffen and compact its before too light, loose, and open texture. Sand also is a manure for stiff clay soils, serving to correct their tenacity when wet, and their obduracy when dry, and make them more open, light, and permeable; more easy to cultivate, and more safe for production. And in either of these manuring operations, it is self-evident, and not admitting of question, that the continuance of these manures, and their good effects, will be eternal.

Carbonate of lime in soil, whether supplied by nature or art, like sand and clay, is a ponderous earth, and but to small extent liable to waste or loss by any natural agency. It is insoluble by water, except so far as water may contain carbonic acid, which renders water a solvent of carbonate of lime. But this impregnation of water in soil is very limited. It can scarcely occur at all except in the usual mode, by rain-water, when descending through the atmosphere, absorbing and bringing to the earth the very small and strictly limited quantity of carbonic acid in the lower atmosphere. Except in this respect, and for the still more minute and scarcely appreciable quantity of lime taken up by growing plants, (as stated above), carbonate of lime in soil would seem to be as indestructible, and as surely abiding through all future time, as the clay or the sand which might also have been given as manure, or otherwise held as natural ingredients of the same soil. As rain-water always brings to the earth some carbonic acid, though in extremely small quantity, still, to that small extent, the carbonate of lime in the soil is liable to be dissolved; and when so dissolved, if there were no counteracting agencies, some of the dissolved earth might be lost (possibly) by filtration through the soil, or, less improbably, by being floated off from the surface, in the flowing away of any excess of rain-water. But there are counteracting agencies operating to prevent the loss of lime in this, and also in other soluble forms. According to my own early (and then unsupported) views of the formation of acid in soil, as well as according to the now received general opinions on that subject, the carbonate of lime would soon begin to be changed to other salts of lime, by combination with other acids in the soil. Some one or more of these newly formed salts might be much more soluble in water than the carbo-

nate, and therefore more liable to be wasted by rain-water surcharging the soil. This result can neither be affirmed nor denied, from any positive knowledge of such facts, or of the chemical changes necessary for them. We do not know which of the vegetable acids, nor how many of them, at once or successively, may combine with the lime; and therefore cannot know what other salts of lime will be produced. The humate of lime, which, it may be presumed, will be the most abundant of such products, is difficult of solution by water. If oxalate of lime should be formed (as is probable, where sorrel was before an abundant growth), that is an insoluble salt, and therefore safe from this manner of loss. The acetate of lime, another probable result, is easily soluble in water; and perhaps other vegetable and soluble salts may be formed in soils, though more rarely and in less quantity than the humate and oxalate of lime. Besides, there are other soluble salts of lime named by Prof. Johnston, and quoted above. But, however little may be known by chemists or others of the kinds and quantities of these salts into which carbonate of lime is gradually changed, by access of different vegetable or other acids, it appears, from the general and abiding effects on fertilization and production, that all these different salts of lime continue to perform, and as fully, all the *enduring* functions of carbonate of lime. For when a soil, after having been made slightly calcareous, has in time become neutral (and of course its carbonate of lime has been all converted to other salts of lime), the soil thereby loses none of its so acquired fertility or value, through any succeeding known time. This could not be the case if the lime in its new condition was liable to certain and rapid, and finally complete waste, by dissolving and escaping waters. In a former chapter (pp. 96, 97,) I maintained that the serviceable and acting lime in soil (for of course any quantity in excess is not so considered) becomes chemically combined with the organic, or alimentary manuring principles present, and all these with other earthy parts of the soil. Judging from the abiding effects, and in regard to neutral soils, it may be safely inferred that such combinations occur not only with the carbonate, but with nearly all the later produced salts of lime, resulting from the carbonate. And if so, such combination with other insoluble and permanent matters of the soil, would render as fixed and permanent even the salts most soluble and liable to waste when alone. Of this, I will state an example that will be familiar to every one. Sulphate of iron (copperas) is easily soluble in water; and, if alone, would be soon removed completely by the dissolving water passing away. The red juice of fresh nut-galls would be nearly as easily taken up, and washed off by water. But these two substances, if meeting together, would chemically combine, making ordinary black ink; which cannot be washed away by water from any substance to which it is attached;

nor can either of the before soluble parts be thus taken from the other. It is in this manner that lime, even in its soluble forms, is fixed permanently in soils. And whether in this manner, or otherwise, it is sufficiently manifest that such results are produced, by reference to the great manuring operations of nature, unlimited as to both space and time, and compared to which the largest experience and greatest labours of man are as nothing. To these great operations I now appeal for proof of the long-abiding and unending benefits of calcareous manures.

Soils naturally supplied with lime, in proper proportions, are as much cases of calcareous manuring, as if performed as early by agricultural art and industry. All such naturally limed lands, throughout the known world, have always been, and still continue to be, among the most valuable and fertile. Such lands, in Europe and Asia, remarkable for their productiveness thousands of years ago, have lost nothing of that character to this day. In America, our agriculture is comparatively new, and therefore our historical proofs of such facts are comparatively limited. But even in this new country, the rich soils of the valley of Virginia have continued to bring fine crops for more than a century. And no one acquainted with these and other similar naturally fertile lands has ever doubted that they will, under judicious culture, and equal circumstances, maintain their present superiority over other poorer lands, through all time. Yet these fine lands owe their value and superiority to their natural lime constitution; and their continued fertility, for a century, is but the effect and evidence of the original liming having operated as long. It is true that many such lands, in this country, have already been greatly reduced in fertility by long-continued exhausting cultivation, which has been used to take as much from, and return as little as possible to the soil. But though such exhausting tillage is capable of consuming and destroying most of the organic matter, and thereby inducing comparative barrenness for the time, yet it does not lessen the lime ingredient and quality, nor the recuperative powers which the soil derived from the lime; and which, if left again to act, for sufficient time, will restore the former condition of productiveness. Scourged as such soils have been in many cases, by continued exhausting tillage, they still show, in their most reduced and barren condition, as much as ever before, the possession of the peculiar qualities derived from their lime ingredient. When such soils, by time, or cultivation, shall have lost their dark colour, their power of absorbing and retaining moisture, and of retaining putrescent manures, and their peculiar fitness for producing leguminous plants, then, and not before, it may be asserted with some plausibility that the salts of lime, which had formerly induced fertility, have been since entirely lost by the soil.

If the lime in soil was indeed subject to waste and loss in the manner and to the extent maintained by Prof. Johnston, the ill consequences would necessarily be general, and so disastrous that there could be no possible mistake of the operation and its results. Upon his own premises, the actual (and always admitted) removal of lime from the soil *in its crops*, though certain, is too small to be appreciable. It is a theoretical truth, of which the practical operation is imperceptible. And this imperceptible part of the alleged loss of lime is all that is caused by tillage and the removal of the crops. It is by the lime (either as quick-lime, carbonate, or other salts) being dissolved in water, according to Prof. Johnston's views, that the great loss is incurred, and that all, or nearly all, the lime furnished for manure is finally lost, and within not very long periods of time. This, the great cause of waste, is operating (as asserted) by every considerable or excessive rain, on all soils containing lime, and through all time. This operation, too, would not be less sure on lime existing naturally in soils, than if supplied as manure, and as thoroughly incorporated as in a natural calcareous or neutral soil. And if twenty or thirty years' operation of the solvent power of rain-water suffices (as asserted) usually to remove either mostly or completely the lime before furnished to the land as manure, then, surely, the same universally operating power of rain-water must as completely remove and utterly waste any barely sufficient natural ingredient of lime, say in 100 years. So, all lands throughout the world, moderately and properly supplied by nature with lime, would thus have lost the whole thousands of years ago. And they would all have thenceforward remained thus destitute of lime, until being re-supplied by man. This kind of artificial manuring has never been used on but a very small proportion of all the lands of the world under tillage; and even on such small proportion, for but a short portion of all the time in which tillage has been in use. Of course, then, on all other lands not containing an excessive store of lime, the whole of this essential ingredient, in every form of combination, should be entirely wanting; and, therefore (according to my views of the absolute necessity for, and the action of lime), much the greater portion of the surface of the earth would have been thus rendered perfectly barren. For, without lime to combine with and fix organic matter, there would be nothing to retain the latter; and the complete waste of the lime would be necessarily followed by the waste of all the enriching matter in the soil, and the inducing of complete sterility. The known fact that no such effects are produced, or any even approaching to them, is alone sufficient proof that the waste of lime in soil cannot occur, as supposed by Prof. Johnston.

Enough has been said in opposition both to the alleged fact of the natural waste of the acting and requisite lime in soil, and the

supposed manner of the waste being produced. But there is another connected and similar subject which deserves notice.

The salts of lime are not *all* the salts, nor the only soluble matters, usually present in soils. The inorganic parts of plants, forming their ashes, after their being burnt, consist mostly of various salts, not only of lime, but also of other bases, as magnesia, potash, soda, &c. These salts, of course, were drawn by the plants from the soils on which they grew. From their being universally present in plants (so far as known), modern chemists have inferred that all these various salts are essential to the health, if not to the existence of the plants, and, of course, essential to the productiveness of the soil for these plants. But most or all of these salts, of magnesia, potash, soda, &c., are soluble in water, and some very easily soluble. If, then, as Prof. Johnston argues as to lime, water necessarily dissolves and removes whatever soluble salt or earth is existing in soils, I would ask why have not all these other soluble matters been removed from all soils? These are present usually in much smaller proportions than lime or its salts, and therefore could be more easily dissolved and removed. That no such complete loss of these other salts has been produced in any soil, so far as known, is another sufficient reason for inferring that neither is lime, nor its more soluble salts, likely to be taken away from the soil, when acting usefully as fertilizing matters, by the solvent action of water. This view of the case is still stronger in another aspect. Liming in England and Scotland is usually renewed (as stated above), or requires renewal, in twenty years or thereabout. The farmers of Norfolk (England) also renew their heavy marlings every eight years or sooner. Hence it is argued that the calcareous manure is exhausted in some such limited times. But the other salts, of magnesia, potash, soda, deemed by modern chemists as essential to soils and to their production, are almost never replaced by artificial applications, or by design, even under the highest and best farming, and absolutely never (unless by rare accident) in ruder culture. Hence it would seem legitimately deduced from Prof. Johnston's reasoning as to the disappearance of lime, that even in the highly-limed and cultivated lands of Britain, the other elements of fertile soil, all deemed as essential to production as lime, ought to have been exhausted long ago. On nearly all other parts of the world, not only all these other substances, but also the lime itself, ought to have been entirely removed, and every soil rendered barren. This reduction to an absurd conclusion would alone be enough to disprove the argument I oppose.

Prof. Johnston, in his attempt to prove the transitory existence and operation of lime as manure, has committed an error to which scientific men who treat on practical agriculture are extremely prone. This is to suppose that matters in the soil act with and



are acted on by others present, as they would in the chemist's laboratory. In the soil, there are many other matters present, and some, perhaps, whose presence is not suspected; and very complex and extensive and varying combinations may exist of various matters, whose characters and powers are certainly not understood. But while denying the correctness of his application to the soil of correct and unquestioned chemical laws in regard to the *known* matters and agencies under consideration, and while striving to restrict his estimate of the extent of the operation of other agencies, still I readily admit that valuable truth and good instruction are to be gathered from his opinions on this branch of his subject. He has enabled me to see errors in, or exceptions to the extent of my own first opinion, as heretofore stated. That opinion, which claimed absolute permanency for *all* the lime in soil (always excepting the minute portion taken up by plants), and Prof. Johnston's opinion of the great waste and speedy removal of *all* the lime used as manure, were both carried to very erroneous extremes. The true doctrine will be found between those extremes; which I trust that I have now reached, and will endeavour to indicate.

As strenuously as formerly, I still assert and maintain the permanency of lime in soil, for such amount of quantity as is at the time acting chemically, or as manure. That quantity is very small, compared to what is in some highly calcareous soils—perhaps not usually more than 1 per cent. of the whole tilled layer. Yet this small quantity performs all the useful manuring functions of lime; and any excess of this earth, beyond that amount, has no manuring or beneficial action. It is merely a mechanical earthy ingredient—which, if large, may do some good, or, as likely, some harm by its presence and its mechanical bearing on the texture of the soil, but is not in the least a fertilizing agent. Upon any such surplus quantities of either lime or carbonate of lime in soil (and perhaps also some other salts of lime not required by and combined with the soil, and therefore in excess), the solvent power of rain-water may act, and the lime be gradually thereby removed, according to the operation of chemical laws, in the manner stated by Prof. Johnston. But with regard to the small quantity of lime required as manure, it is (according to my original views before presented, p. 96) combined chemically with the alimentary organic matter, and both these, with the soil itself, and this state of combination, is safe from solution or loss. The quantity of lime which may be required and used as manure by a soil, varies at different times according to the changes of condition. The more putrescent matter the soil receives, as manure, the more lime will be required to combine with, preserve, and properly utilize the organic and alimentary matter. Any excess of lime, whether bestowed by nature,

or as manure by man, beyond the present wants of the soil, is only of value so far as being there ready for any future increased demand of the soil, and so may supersede the necessity of another supply being required as soon. Therefore, however active may be the solvent power of water, and however rapid the consequent waste of the excess of lime in the soil, the operation can detract nothing from any manuring value, or quantity of the lime, previously and then existing.

The statements and reasoning of Prof. Johnston brought to prove the waste and final disappearance of all lime used as manure, however inconclusive for his object, furnish important truths for practical use. We may thence deduce additional reasons for the impropriety of laying on at once too much marl or lime for the then wants of the soil; and also of the usual unequal diffusion, which serves to make even a light dressing excessive in many spots, while entirely wanting in others. Not only, as I had before urged, is all such excess of quantity, whether general or partial, a waste of labour, a conversion of active to dead capital, and the causing danger of actual injury to crops—but further, such excess of lime, or carbonate of lime, is subject to more or less waste, by solution and removal, so long as it remains superfluous, and not required for immediate use by either the soil or growing plants. It is such excess as this in soils, that furnished all the wasted lime found by chemists in the waters discharged by drainage from limed lands. Still more extensive natural operations of the same kind, and stronger proofs, are to be seen in all lime-stone and highly calcareous regions. The rain-water filtrating through such rocks and soils, becomes universally and highly charged with lime; of which a large portion is removed and lost to the place of its origin, by flowing off into sources of springs and streams. Another portion, by filtration, may sink deep into the earth. In limestone and chalk regions, indications of the quantity of lime dissolved by rain-water, from the rocks and soil, and carried off by springs, may be observed not only in the lime-impregnation of spring-water, but also in the deposition of travertine, or calcareous tufa, at the rapids of streams; and of the loss by filtration in the stalactite deposits in every cavern of the earth.

There remains to state one other manner of the loss of lime in soil, which is mentioned by Prof. Johnston, and also other authors, as being a common, if not a general result in England. This loss is caused by the tendency of lime, which has been applied, to sink below the upper soil. "It has long been familiar to practical men," says Johnston, "that when grass lands, which have been limed on the sward, are after a time broken up, a white layer or band of lime is seen at a greater or less depth beneath the surface, but lodging generally, where it has attained its greatest depth between

the upper, loose, and fertile, and the lower, more or less impervious and unproductive soil. In arable lands, the action of the plough counteracts this tendency in some measure, bringing up the lime again from beneath, and keeping it mixed with the surface mould. Yet through ploughed land it sinks at length, especially where the ploughing is shallow; and even the industry of the gardener can scarcely prevent it from descending beyond the reach of his spade." (p. 397.)

Such results, frequent as they doubtless are in England, are certainly very rare, and of no material disadvantage in this country. Indeed, until very lately (in 1851), I had never heard of any such case. But then I learned from Mr. John A. Selden, that he has observed this effect on his highly improved and well limed farm, Westover. I had before inferred that this sinking of lime, in its separate and pure state, could not occur except where it had been applied in excess—as must be generally done in the usual heavy applications in England; and that it was only the excess of lime, which the soil did not then need, and with which, therefore, the organic matter could not combine, that could thus continue separate, and sink through the open soil. If such combination had taken place (as I suppose of a barely sufficient application), of all the lime with the organic matter, and of both with the other earthy parts of the soil, then the lime could not separate from its combination, and of course could not sink alone. Neither could it carry with it the other matters in combination. This sinking, it seems, does not occur with marl, or other "impure calcareous manures," but with the finely powdered burnt lime only. When breaking up land for a second cultivation subsequent to its having been marled, I have often seen the plough bring up marl, unchanged in appearance, from the bottom of the furrow. But this had been before turned under (when first spread) to that depth, and had not been reached and intermixed by the after tillage. Caustic lime is applied in England very heavily—often as much as 300 bushels, or more, unslaked, to the acre—and repeated at intervals of about twenty years. And these, or lighter dressings, must often occur on soils before calcareous, either naturally, or made so by previous liming. In either of these cases, I would deem any addition of lime, however small, to be in excess, for the time; and of course such excessive quantity would remain uncombined, and therefore subject to waste. In this country, all liming has been given in comparatively light dressings, and very rarely, if ever, to a calcareous soil; and therefore it was rare that any portion of the lime was in excess, and consequently remained separate and uncombined. And it is because of these very different conditions that the sinking of lime, an effect so common and notorious in England, should be so

uncommon, and not to be counted as a loss or disadvantage in practice, in this country.

The foregoing reasoning, and the conclusions thereby reached, in regard to the duration of calcareous manures, may be deemed a continuation of the subject of Chap. VIII., "on the mode of operation by which calcareous earth increases the fertility and productiveness of soils." It may be useful here to recapitulate, and bring together in a small space, the main positions which I have asserted and maintained.

1. Besides the chemical power and action of calcareous earth as manure, to neutralize acids, to alter and improve the texture of soils and their relation to moisture, and also other beneficial agencies, before discussed at length, the principal and most important action of the carbonate and other subsequently resulting salts of lime, in soils, is the combining with organic or alimentary manures, and also with other earthy parts of the soil. The several matters, so combined, are rendered, by their combination, fixed in the whole soil, and secure from waste—and from other diminution, except for the supply of alimentary matter to growing plants. To this extent, then, and with the exceptions stated, the combined matters would be permanent. For this purpose, and to the extent required by growing plants, their vital forces can decompose the combination of organic, calcareous, and other earthy constituents, and take from it freely the parts which the plants require from the soil for their support. The organic part of the compound is mainly drawn upon, and diminished by growing plants; the calcareous (or other lime) part thus furnishes an extremely small amount only. Putrescent matter, if again supplied to the soil, will replace in the combination whatever organic matter had been withdrawn by growing plants. If the soil is not allowed to obtain the requisite supply of organic or putrescent matter, the fertility of the soil will continue to be reduced by growing crops gradually exhausting the previous supply; although the lime parts of the soil may not be appreciably lessened. If, on the contrary, putrescent matter shall be furnished to a calxed soil, or be permitted to accumulate in it by natural means, in greater quantity than the lime parts can combine with, more lime will be required.

2. If without such state of combination existing, owing to the absence or insufficient quantity of either part, the excess of the other part would be subject to, and continually undergoing waste. If the part in excess was the putrescent, or organic, it would rapidly and entirely be removed by decomposition, solution, and other natural modes of its waste. If the excessive matter was in lime, whether caustic, or carbonated, or as any other soluble salts of lime, this also would be gradually dissolved, and lost; and though the progress of such waste would be very slow, yet in the

course of long time it might be very considerable, or possibly (as asserted by other authority) nearly complete.

8. According, then; to the condition of excess of either of the parts necessary for the fertilizing combination above stated, either the organic matter or the lime in soil might be wasting, and the other part for the time remain fixed, and safe from diminution—always excepting the portion, large or small, taken up by and removed in the crops.

If I have succeeded in establishing the foregoing views of the permanent operation of calcareous manures, it will involve the strong probability, if not certainty, of another result, to which assent would be still more difficult to obtain, without good reasons being shown.

Though probably all observing and practical farmers would be ready to admit the proposition, that the natural and peculiar qualities of good soils, including their measure of productive power, are permanent, (which is but stating, in other words, that the good effects of calcareous manures are permanent), still perhaps few would grant the possibility of permanency of effect to putrescent manures also, when added thereafter. Yet this latter proposition is as legitimate a deduction from the former, as the former proposition is from the theory which has been maintained of the action of calcareous manures. The attention of the reader is requested to the argument which will now be offered to sustain this important deduction.

We have all been trained to consider farm-yard and stable-manures, dung, and all vegetable and other putrescent matters, when applied to soils, as having temporary effects only; and whether the effects lasted for but the first crop, as on acid sandy soils, or for four, six, or even eight years on well constituted natural soils, still the effects were truly, as usually considered, only for a limited time, and would at some period be totally lost; and the ground so manured would return to the same state of less productiveness, as of the surrounding land, previously equal, and which had received no such manuring. Such views are almost universal; and the utmost that would be claimed by the most zealous and sanguine advocate for extending the effect of such manures, would be a protracted though still limited and temporary duration of action. And the actual results would always accord with these opinions, (and also with my theory of the action of calcareous manures), both on good and on bad soils, before making them more calcareous. All natural soils (not excessively and injuriously calcareous) have secured by their natural powers and facilities, and have had fixed in them, as much alimentary or organic matter as their natural ingredient of lime could combine with. If that ingredient had been very small, the soil would be poor; if large, and not so large as to be hurtful,

then the soil would be rich. But in neither case would there be power in the soil to combine with an additional supply of alimentary manure; and if such were applied, it would be exhausted and pass away, rapidly on the bad soil, and more slowly on the good; but certainly, in the end, on both.

Again, suppose the soils to be more or less exhausted by scourging cultivation. Then their actual amount of alimentary matter would have been reduced below what their respective shares of lime could combine with and retain, under a state of nature, or of mild tillage. Then, if alimentary manures were applied, so much as was required for combination by the lime present would be as permanently fixed as if the original fertility had never been abstracted; and any additional quantity and excess of manure, not being so combined and fixed, would be totally lost in more or less time, as in the previously supposed case.

Lest these propositions may not appear, because of their novelty, perfectly clear and unquestionable to every reader, an illustration will be offered which can scarcely fail to induce their general and ready admission. Suppose a cultivator to have two fields, one of bad and poor soil naturally, and the other of the best natural quality—and both having been brought under cultivation together, and kept under the same rotation of crops and other management. Suppose further that the equal and uniform course of cropping has been such (whether taking one or two or three grain crops to one year-of rest and resuscitation), that both fields have neither been reduced nor increased in average product, since brought under regular tillage; and that such average product, when of corn, is equal to 10 bushels per acre on the poor, and 50 bushels on the rich soil. Now, these different products are derived from the different funds of alimentary and putrescent manure originally supplied to the soil by nature, (which were just so much as the lime of each soil could combine with); and, under the supposed degrees of exaction and relief, counteracting each other under tillage, the same rates of product may be obtained for ever. And the yielding of 50 bushels by the one soil operates no more to reduce its after-power of production, than the yield of the other of but one-fifth of that amount of crop. The yield from each soil, at and for the time, is certainly so much reduction of its productive power; but the recuperative power of each (to seize upon and retain new supplies for fertilization, drawn from the atmosphere, and from the grass and weeds grown and suffered to decay on the land,) is in proportion to the yield; and the vegetable growth serving for manure, and atmospherical influences, during a year of rest, will continually give to the good soil the renewed power of producing again its large crop, as certainly as to the poor soil the power of still continuing to produce its small crop. It is not that the natural alimentary

manure in the soil is not taken away in part, by the growth and removal of every crop, but that such waste is continually compensated by new acquisitions. And whether such new supplies of alimentary matter be furnished in part during every day, or in every year, or only during the one term of rest in the whole course of crops, the practical result is the same, of the natural or original amount of alimentary manure remaining finally undiminished.

So far as to the absolute permanency of putrescent or alimentary manures supplied by nature. Next let us see whether the same reasoning, and also experience, so far as yet obtained, do not in like manner prove the permanency of putrescent manures applied after calcareous manures. The poor soil just adduced for illustration, while having its natural alimentary ingredient and its natural supply of lime thus balanced and proportioned to each other, was supposed to produce at the rate of 10 bushels of corn to the acre, and to remain at or near that rate of productive power. Suppose then marl to be applied in such quantity as would give enough calcareous earth to combine with twice as much new alimentary matter as the soil before held. Suppose further, that the soil so marled is not left to draw and store up this now needed stock of alimentary manure by its newly increased power, (and as would be done in sufficient time, if under favourable circumstances of tillage), but that so much putrescent manure is applied to the soil, gradually and judiciously, as can be combined with and held by the supply of calcareous earth; and that such addition of manure gives to the soil a power to produce 30 bushels of corn. As soon as this combination is completely made, the soil is in precisely the same condition as to its newly increased rate of product of 30 bushels, as before to that of 10 bushels; and the new and larger supply of putrescent manure must be as permanent as was the natural and smaller supply.

But it is not contended that the mere application of vegetable or other putrescent manure, under such circumstances, secures the permanency of effect of all thus applied, but only of so much as can be and is combined with the calcareous earth. And many circumstances may and do usually obstruct the immediate and complete combination from taking place. To insure the perfect and full result, the intermixture of the calcareous and the putrescent matters, and in due proportions, must be perfect, and no excess of the latter must remain anywhere in the soil; the putrescent matter must also be in the particular state of decomposition (whatever that may be) to enter into combination; and moreover there must be enough and equally diffused moisture, without which no chemical combination can take place. Now, as some and probably all these conditions must necessarily be deficient in every case of applying putrescent matters to marled land, it must follow that much

of the manure must remain uncombined for some length of time; and during that time is as liable to be wasted and exhausted as if in any other soil. And hence, and the more as the dressing is lavish, farm-yard and stable manure so applied must be expected to yield more for the first and second year, while the excess is wasting, than afterwards. But after this first waste and exhaustion has been suffered, whatever of the manure remains to the soil, say for the next ensuing rotation at latest, must be fully combined with and fixed in the soil, and will be permanent for all future time, under proper, judicious, and also the most profitable course of cropping. This first waste probably cannot be entirely prevented; but it can be much lessened by care. And to this end, putrescent manure should not be applied heavily at once, but lightly, and repeated subsequently, and should be well scattered and equally diffused over the ground. Its subsequent decomposition being slow, and the products being gradually, as well as surely, presented to the lime diffused previously throughout the soil, will also tend to remove as much as possible of the manure from the condition of being fleeting and wasting, to that of being fixed and permanent.

Next let us see how far facts and experience sustain this reasoning. It is conceded that the time since marling was commenced in Virginia, and since correct views of the action of calcareous manures were entertained and acted on in any case, has been too short to furnish decisive proofs. But so far as accurate facts can thus be referred to, they fully sustain the foregoing doctrine, not only of the permanency of calcareous manures, but also of putrescent manures in combination therewith. Some of these facts will be mentioned generally.

However much in accordance with the theory of the action of calcareous manures, this absolute permanency of effect given thereby to putrescent manures was not at first counted on or expected, and was not known until it was forced on my observation by long-continued results. My own practice is not only the oldest, but is all that I can refer to for proofs. And until all my marling was completed, and indeed for some time after, but little care was used by me to make and apply putrescent manures. This culpable neglect was the result of the habits caused by the disappointments and losses experienced in manuring long before. From the same ignorance and carelessness in this respect, no experiments on the durability of putrescent manures were made until long after, and then injudiciously. Thus, in experiments 4, 9, and 11 (pp. 120, 131, 134), the putrescent manure applied was in quantity much too great for the calcareous earth to combine with at once, even if the recent and irregular scattering of both kinds of manure had not prevented their meeting in proper proportions. For like reasons, of all the putrescent manures applied on the farm, and since larger



quantities have been used, there is much more of *early* than *continued* effect. Still, so far as known and believed, there is always more or less of abiding effect, and which I infer will be permanent.

But wider scope for observation has been afforded in the increasing productiveness of all the marled lands, kept under what was deemed not too frequent tillage. Neither has the tillage been always mild, nor the rotation uniform; and latterly the grain crops have been made more frequent than before, and much more grazing permitted.\* Still, even where no prepared putrescent manures have ever been applied, and putrescent matters have been furnished only from the growth of the land itself during its share of rest in each course of crops, there has been a regular increase of productiveness of the grain crops, in every successive rotation.—[1842.] In one connected clearing, of what I found as poor forest land, now making 85 acres, the marling was commenced in 1818, and has been continued, as the successive clearings extended, to 1841. The earliest effects of the applications were always satisfactory, but they have regularly and largely increased with time. Thus, when under the last crop of corn (in 1839), the crop on the last finished-marling, though perhaps thereby nearly doubled in product, was obviously and considerably less than that of four to six years earlier—that again as inferior to that of the marling of ten to fifteen years—and the crop on the marling of 1821 and earlier, decidedly the best of all, under circumstances otherwise equal. For the limited time of twenty-three years, and without any careful and accurate experiment or observation having been made for this special object, there could not well be stronger practical proof of the permanency of the vegetable manures stored up by the marl.

If we keep in mind the mode by which calcareous manure acts, its effects may be anticipated for a much longer time than my experience extends. Let us trace the supposed effects, from the causes, on an acid soil kept under meliorating culture. As soon as applied, the calcareous earth combines with all the acid then present, and to that extent is changed to the humate and other *vegetable salts of lime*. The remaining calcareous earth continues to take up the after formations of acid, and (together with the salts so produced) to fix putrescent manures, as fast as these substances are presented, until all the lime has been combined with acid, and all their product is combined with putrescent matter. Both those actions then cease. During all the time necessary for those changes, the soil has been regularly increasing in productiveness; and it may be supposed that, before their completion, the

---

\* The land, however much improved in richness by being secured from grazing so long, had in consequence become too "puffy" for wheat, and also full of insects and bad weeds; for all which grazing at some proper time of the rotation is beneficial, and indeed essential.

product had risen from ten to thirty bushels of corn to the acre. The soil has then become neutral. It can never lose its ability (under the mild rotation supposed) of producing thirty bushels; but it has no power to rise above that product. Vegetable food for plants continues to form, but is mostly wasted, because the salts of lime are already combined with as much as they can act on; and whatever excess of vegetable matter remains in the soil, is kept useless by acid also newly formed, and left free and noxious as before the application of calcareous earth. But though this excess of acid may balance and keep useless the excess of vegetable matter, it cannot affect the previously fixed fertility, nor lessen the power of the soil to yield its then maximum product of thirty bushels. In this state of things, sorrel may again begin to grow, and its return may be taken as notice that a new marling is needed, and will afford additional profit, in the same manner as before, by destroying the last formed acid, and fixing the last supply of vegetable matter. Thus perhaps five or ten bushels more may be added to the previous product, and a power given to the soil gradually to increase as much more, before it will stop again for similar reasons, at a second maximum product of forty or fifty bushels. I pretend not to fix the time necessary for the completion of one or more of these gradual changes; but as the termination of each, and the consequent additional marling, will add new profits, they ought to be desired by the farmer, instead of his wishing that his first labour of marling each acre may also be the last required. Every permanent addition of five bushels of corn, to the previous average crop, will more than repay the heaviest expenses that have yet been encountered in marling. But whether a second application of marl is made or not, I cannot imagine such a consequence, under judicious tillage, as the actual decrease of the product once obtained. My earliest marled land has been severely cropped, compared to the rotation supposed above, and yet has continued to improve, though at a slow rate. The part first marled, in 1818, had only four years of rest in the next fifteen; and yielded nine crops of grain, one of cotton, and one year clover twice mowed. This piece, however, besides being sown with gypsum (with little benefit), once received a light cover of rotted corn-stalk manure. The balance of the same piece of land (Exp. 1) was marled for the crop of 1821—has borne the same treatment since, and has had no other manure, except gypsum once (given in the natural gypseous earth found on the farm),\* in 1830, which acted well. These periods of twelve and fifteen years (even though now extended to and confirmed by nine years more of experience) are very short to serve as grounds to decide on the

\* See accounts of this bed of "gypseous earth" in vol. 1 of Farmers' Register, and of its effects, in success and failure, in vol. 10.

eternal duration of a manure. But it can scarcely be believed that the effect of any temporary manure, would not have been somewhat abated by such a course of severe tillage. Under milder treatment, there can be no doubt that there would have been much greater improvement.—[1842.]

If subjected to a long course of the most severe cultivation, a soil could not by such course alone be deprived of its calcareous ingredient, whether natural or artificial: but though still calcareous, it would be, in the end, reduced to barrenness, by the exhaustion of its vegetable matter. Under the usual system of exhausting cultivation, marl certainly improves the product of acid soils, and may continue to add to the previous amount of crop, for a considerable time; yet the theory of its action instructs us, that the ultimate result of marling, under such circumstances, must be the more complete destruction of the land, by enabling it to yield all its vegetable food to growing plants, which would have been prevented by the continuance of its former acid state. An acid soil yielding only five bushels of corn may contain enough food for plants to bring fifteen bushels; and its production will be raised to that mark, as soon as marling sets free its dormant powers. But a calcareous soil reduced to a product of five bushels, can furnish food for no more; and nothing but an expensive application of putrescent manures can render it worth the labour of cultivation. Thus it is, that soils, the improvement of which is the most hopeless without calcareous manures, will be the most certainly improved with profit by their use.

---

### CHAPTER XXIII.

#### GENERAL OBSERVATIONS ON THE VALUATIONS OF LANDS AND THEIR IMPROVEMENTS, AND THE EXPENSES AND PROFITS OF MARLING.

##### PROPOSITION 5—*concluded.*

At this time there are but few persons among us who doubt the great benefit to be derived from the use of marl; and many of those who formerly deemed the early practice the result of folly, and a fit subject for ridicule, now give that manure credit for virtues which it certainly does not possess; and, from their manner of applying it, seem to believe it a universal cure for sterility. Such erroneous views have been a principal cause of the many injudicious and even injurious applications of marl. It is as

necessary to moderate the ill-founded expectations which many entertain, as to excite the too feeble hopes of others.\*

The great improvement of land and its products, to be caused by marling, and its long duration, if not absolute permanency, have been established, I trust, beyond question, by the foregoing argument and proofs. Still, any degree of improvement may be paid for too dearly; and the propriety of the practice must depend on the amount of its clear profits, ascertained by fair estimates of the expenses incurred.

With those who attempt any calculations of this kind, it is very common to set out on the mistaken ground that the expense of marling should bear some proportion to the selling price of the land; and without in the least underrating the effects of marl, they conclude that the improvement cannot justify an expense of six dollars on an acre of land that would not previously sell for four dollars. Such a conclusion would be correct if the land were held as an article for sale, and intended to be disposed of as soon as possible; as the expense in that case might not be returned in immediate profit, and certainly would not be added to the price of the land by the purchaser, under present circumstances. But if the land is held as a possession of any permanency, its previous price, or its subsequent valuation, has no bearing whatever on the amount which it may be profitable to expend for its improvement. Land that sells at four dollars, is often too dear at as many cents, because its product will not pay the expense of cultivation. But if by laying out for the improvement ten dollars, or even one hundred dollars to the acre, the average increased annual profit would certainly and permanently be worth ten per cent. on that cost of improvement, then the expenditure would be highly expedient and profitable. We are so generally influenced by a rage for extending our domain, that another farm is often bought, stocked, and cultivated, when a liberal estimate of its expected products, would not show an annual clear profit of three per cent.: and any one would mortgage his estate to buy another thousand acres, that was supposed fully capable of yielding ten per cent. on its price. Yet the advantage would be precisely the same, if the principal money was used to enrich the land already in possession (without regard to its extent, or previous value), with equal assurance of its yielding the same amount of profit.

Nothing is more general, or has had a worse influence on the state of agriculture, than the desire to extend our cultivation and landed possessions. One of the consequences of this disposition has been to give an artificial value to the poorest land, considered

---

\* This introductory paragraph was prepared for and first appeared in the edition of 1832, to which time it was especially applicable.

merely as so much territory, while various causes have concurred to depress the price of all good soils much below their real worth. Whatever a farm will sell for, fixes its market value; but by no means is it a fair measure of its value as permanent farming capital.

The true value of land, and also of any permanent improvements to land, I would estimate in the following manner: Ascertain as nearly as possible the average clear and permanent annual income, and the land is worth as much money as would securely yield that amount of income, in the form of interest—which may be considered as worth six per cent. For example, if a field brings ten dollars average value of crops to the acre, in the course of a four-shift rotation, and the average expense of every kind necessary to carry on the cultivation is also ten dollars, then the land yields no clear profit, and is worth nothing. If the average clear profit was but two dollars and forty cents in the term, or only sixty cents a year, it would raise the value of the land to ten dollars; and if six dollars could be made annually, clear of all expense, it is equally certain that one hundred dollars would be the fair value of the acre. Yet if lands of precisely these rates of profit were offered for sale at this time, the poorest would probably sell for four dollars, and the richest for less than twenty dollars. In like manner, if any field, that paid the expense of cultivation before, has its average annual net product increased six dollars for each acre, by some permanent improvement, the value thereby added to the field is one hundred dollars the acre, without regard to its former worth. Let the cost and value of marling be compared by this rule, and it will be found that the capital laid out in that mode of improvement will seldom return an annual interest of less than twenty per cent.—that it will more often reach to forty—and in very many cases will exceed one hundred per cent. of annual and permanent interest on the investment, or total cost of the marling. The application of this rule for the valuation of such improvements will raise them to so large an amount, that the magnitude of the sum may be deemed a sufficient contradiction of my estimates. But before this mode of estimating values is rejected, merely for the supposed absurdity of an acid soil being considered as raised from one dollar, or nothing, to thirty dollars, or more, per acre, by a single marling, let it at least be examined, and if erroneous, its fallacy exposed.

If the reader will accompany me through some detailed estimates of values, and arithmetical calculations, in regard to the grounds of which we cannot differ, the truth of the results which I claim will be made manifest, however startling and monstrous they may appear to some persons at first glance.

Assuming as sound and unquestionable the grounds for estimat-

ing the intrinsic value of lands, as stated generally above, let us illustrate the position more particularly. The principle of valuation is that the land is worth to its proprietor and cultivator such sum of money as would yield in annual interest the same amount as the net annual product of the land, after paying for all labour, attention, expenses, and risks. Further, to simplify the calculation, and also to suit the course of culture to the more general practice of the country, let us suppose the land in question to be cultivated under the ordinary three-shift rotation, of 1st, corn, 2d, wheat (or oats), 3d, at rest, with no grazing when the land is poor, and with but partial and moderate grazing (or mowing of clover) when improved or rich.

Then suppose a field of the poor and thin soil most common in lower Virginia, under this treatment for some years previously, to produce, on the general average, 10 bushels of corn to the acre, and five bushels of wheat, or its equivalent value of oats; and the value of the corn, at the barn, to be 50 cents the bushel, and of the wheat \$1. And let the joint and total expenses of preparation, tillage, seed, harvesting, thrashing, &c., for market (or for home use), and of superintendence and care of both the corn and wheat or oat crops, be counted as being over and above the value of the offal (stalks, straw, &c.) of the crops, by \$10 for the two years. Then the full statement will be as follows:

First year, product in corn per acre, 10 bushels, at 50 cents . . . . .	\$5
Second year, wheat, 5 bushels, at \$1 . . . . .	5
Third year, no crop or money product, and no expense . . . . .	0
	<hr/>
Total product of the three years' rotation . . . . .	\$10
Cost of cultivation, &c., of the crops . . . . .	10
	<hr/>
Net profit . . . . .	00

However wretched may be the foregoing exhibition of products, it will be admitted to be abundantly liberal by all persons acquainted with lower and middle Virginia, for a very large proportion of the cultivated lands. Yet such lands might sell at prices varying from \$3 to \$6 the acre; and that without a view to their being improved, and even before calcareous manures were thought of as means for improvement. Yet the conclusion is evident, that such land, no matter what may be its then selling price, (or speculative appreciation sometimes caused by the effects of paper-money and fraudulent bank issues), is worth not one cent for cultivation, or for the benefit of the proprietor and cultivator.

Next, suppose the land in question to be properly marled, and at the unusually heavy expense of \$7 the acre. This rate is more than double the usual expense for a full and sufficient dressing, when the marl is obtained on the farm where applied. Suppose

also that the increase of products, as shown in the second course of the rotation (beginning three years after the application), is equal to 100 per cent. on the production previous to marling. This estimate is quite low enough, as all experience has shown. Upon such land, and so treated, this degree of increase may very often be obtained upon the first crop of the first course; and, even if no auxiliary means of enriching be afterwards used, the rate of increase will be more and more for each of sundry succeeding courses of crops thereafter. Then let us test the value of the returns by figures as before:

First year, product in corn per acre, 20 bushels, at 50 cents .	\$10
Second year, wheat, 10 bushels, at \$1 . . . . .	10
Third year, clover, most of it left as manure to the land, and no present pecuniary profit counted here . . . . .	00
	20
Total expenses of cultivation, &c., as before, in two years .	10

Net product, or clear profit of cultivation in the term of three years . . . . . \$10

This is all so much *increase of net annual product* upon the previous rate; and the amount, \$3.33 yearly, is the interest (at 6 per cent.) of something more than a capital of \$55. And therefore, according to these grounds of estimate, \$55 per acre is the *increase of intrinsic value* given to the land by marling alone, or \$48 the *clear gain* made by the operation, after deducting \$7 paid for the marling of the land; and this without regard to what might have been its previous intrinsic value, or its former or its more recent market price. The more rigidly this mode of estimate is scrutinized, the more manifestly true will be found the results. The premises assumed, in the supposed effects and profits of marling, will not be objected to (unless as being too low) by any person who is well informed by practice and experience.

But there is one important apparent omission of a proper charge in the last statement of expenses. This is the *increase of labour* of tillage, harvesting, &c., caused by the crop being doubled in quantity. This is certainly a fair ground of charge; and, if estimated alone, would serve to reduce considerably the statement of increased net product, and consequently of increased value of land. But there were also omitted sundry items of increased production, which together would undoubtedly much more than compensate for the increase of labour in tilling a deeper and richer soil, and in harvesting, removing, and preparing for sale or use, a double quantity of crops. These items of gain are, first, the additional offal, in corn-stalks, fodder, and shucks, and wheat or oat straw and chaff; second, the limited proportion of clover grazed or mowed;

and third, the further gradual increase of crops, in subsequent time. Probably the first class of items alone would balance the increased expense of labour; if not, the addition of the second (the clover) certainly would be enough. And if that be doubted, the subsequent annual increase upon the first doubling of the crops (which only is estimated above) will not only furnish a fund to meet any such deficiency, but also will greatly, and beyond any calculation here attempted, augment the whole profit of marling, and consequently the intrinsic value of the land to the proprietor.

I admit the practical difficulty of applying this rule for estimating the value of land, or of its improvement, however certain may be its theoretical truth. It is not possible to fix on the precise clear annual profit of any farm to its owner and cultivator; and any error made in these premises is increased sixteen and two-third times in the estimate of value founded on them. Still we may approximate the truth most nearly by using this guide. The early increase of crops from marling will, in most cases, be a full equal increase of clear profit, (for the subsequent improvement and the additional offal will surely pay for the increase of labour); and it is not very difficult to fix a value for that actual increase of crop, and thereby to estimate the value of the improvement, as newly created farming capital.\*

This mode of valuing land, under a different form, is universally received as correct in England. Cultivation there is carried on almost entirely by tenants; and the annual rent which any farm brings, on a long lease, fixes beyond question what is its annual clear profit to the owner. The price, or value of land, is generally estimated at so many "years' purchase," which means as many years' rent as will return the purchaser's money. There, the interest of money being lower, increases the value of land according to this mode of estimation; and it is generally sold as high as twenty years' purchase. My estimate is less favourable for raising the value of our lands, as it fixes them at sixteen and two-thirds years' purchase, according to our higher rate of interest on money.

But though this rule for estimating the true value of land, and of the improvements made by marling, may be unquestionable in theory, still a practical objection will be presented by the well known fact that the income and profits of farmers are not usually increased in proportion to such supposed values of improvements, nor is there found such a vast disproportion, as this rule of estimating values would show, between the profits of the tillers of poor and of rich lands. These positions are admitted to be generally

---

\* No degree of uncertainty in the application, however, detracts from the truth of this rule. For if the annual average net profit derived from marling be considered as an *unknown quantity*, ( $x$ ), it is not therefore the less certain that  $x \times 16\frac{2}{3}$  = the increased intrinsic value of the land.



well founded—but it is denied that they invalidate the previous estimates. A farmer may, and generally does, obtain less gross product from a large or a rich farm, than his more necessitous, and therefore more attentive and economical neighbour gets from a smaller or poorer farm, in proportion to the producing power of each; and even the same persons, when young and needy, have often made more profit according to their means, than afterwards when relieved from want, and having lands increased to a double power of production. These, and similar facts, however general, are only examples of the obvious truth, that the profits of land depend principally on the industry, economy, and good management of the cultivator; and that many a farmer, who can manage well a small or poor farm, is more deficient in industry, economy, or the increased degree of knowledge required, when possessed of much more abundant resources. In short, if these considerations were to direct or influence our estimates, we should not be comparing and estimating the value of lands, but the value of the care and industry bestowed on their management by their proprietors.

Another objector may ask, "If any poor land is raised in intrinsic value (according to this estimate) from one dollar to thirty, by marling, would a purchaser make a judicious investment of his capital, by buying this improved land at thirty dollars?" I would answer in the affirmative, if the view was confined to this particular means of investing farming capital. The purchaser would get a clear interest of six per cent., which has always been deemed a good return from land, and is twice as much as all lower Virginia now yields, on a general average of the unimproved lands. But if such a purchase is compared with other means of acquiring land so improved, it would be extremely injudicious; because thirty dollars expended in purchasing and marling suitable land, would serve both to acquire and improve, to as high a value, five or six acres.

The immense quantity of rich and low-priced land held for sale by our government, and always in market, and the flood of emigration thereby drawn from the old states, and especially from Virginia, have served more than all other causes to depress the selling prices of our lands, and to discourage their being improved. So long as rich land can be bought in any quantity for \$1.25 the acre, though it may be under forest growth, and on the frontier of civilization, there will be thousands of improvident or adventurous landholders in the old states always striving to sell their impoverished farms, and to buy new settlements in the west—rather than resort to what they deem the slow and costly means for restoring or increasing fertility. And though very many others now believe that it is far more profitable to improve their own poor land than to emigrate to new and rich—and act upon that belief in buying

to improve, as well as improving the land held previously—still their very limited numbers and action can go but little way to lessen the excess of supply of land offered for sale, over the existing demand of purchasers. We all know that a great excess of supply over demand of any commodity, no matter how essential for the use or even existence of the consumers, is enough to reduce the market price to almost any extent. Even in regard to corn, which every man requires for sustaining life, and which will be wanting by every one, in certain and known quantity, for the next as well as the present year, still a great excess of supply may reduce the price of this most indispensable commodity to one-third, or even one-tenth, of what it may command when the demand as greatly exceeds the supply. The market price of Indian corn in Virginia, where it is the principal grain consumed by both man and beast, has frequently, within a few years' time, ranged from 40 to 100 cents the bushel, according to the preponderance of supply and demand. Indeed, within my farming life, it has sold as low as 20 cents; and at another time, at \$2 the bushel. No matter what may be deemed the intrinsic value of any commodity, no buyer will pay for it even half that rate, so long as eager or necessitous sellers offer the like to him for a fourth, or for less. So it is with our land. Such considerations, and the existing state of our land market, may (and ought to) operate to prevent a buyer from paying as much as \$10 for the land which under different circumstances of market price he would gladly buy at \$50. Yet in both cases of prices so different, the intrinsic value of the land, and also its net product, might be the same.

The excess of supply over demand not only serves to depress the selling prices of both good and improvable lands greatly below their true and productive value, but also it acts with much force to repress the desire for and prevent the results of improving the land in possession. For whatever may be the productive value of any improvements of land, they must be estimated and depreciated in market price by the same law of supply and demand as determines the selling prices of other lands of like value. Many particular farms in lower Virginia, by marling, have been doubled in gross product, and thereby, perhaps, increased ten-fold in net product and in true intrinsic value. And yet, when the death of the proprietor, and the consequent division of his estate, or other causes, have compelled the sale of such a farm, the additional price obtained over the market estimation before marling, perhaps has not paid even the small cost of that improvement. Hence arises a great discouragement, at this time, to all improvement of land in Virginia, which acts not only on those proprietors who look forward to a future sale of their farms, but also on most other persons who have no such expectations.

But the principal discouragement to the proper extension of marling proceeds from the erroneous and exaggerated estimates of the difficulty and cost. Estimates of the expenses required for marling are commonly erected on as improper grounds, as those of its profits. We never calculate the cost of any old practice. We are content to clear wood-land that afterwards will not pay for the expense of tillage; to keep under the plough, land reduced to five bushels of corn to the acre; to build and continue to repair miles of useless and perishable fences; to make farm-yard manure (though not much of this fault), and apply it to acid soils; without once calculating whether we lose or gain by any of these operations. But let any new practice be proposed, and then every one begins to count its cost; and on such erroneous premises, that if applied to every kind of farm labour, the estimate would prove that the most fertile land known could scarcely defray the expenses of its cultivation.

The usual injudicious modes of conducting marling operations have served greatly to increase the actual cost. Some farmers, even after some years of such work and experience, still waste nearly or quite half their labour so employed. Many new beginners, by their greater mismanagement and consequent loss, are so discouraged as to be stopped almost at the very outset. Thus, a little, but insufficient amount of experience in marling, is likely to magnify the supposed difficulties. By such deficiency of judgment and economy in directing and executing the labours, marling is often made very costly. But so it would be, without information or experience, with any other new farming operation. It is as easy in this as in any other business to work judiciously and economically; and if so conducted, marling (or liming), where properly available, will be found the cheapest as well as the most productive means for fertilization.

The expenses of particular operations of marling, or liming, have been, and of others may be, easily and correctly ascertained. So have been, and may be, the early products and probable abiding profits of particular applications. But these two actual results cannot be fairly combined, so as to indicate in general the balance of profit exceeding the expense. For the measure of increased product is in proportion to the quantity of marl applied, and the previous want of the land for the application; and not to the expense of that application. It may happen that the most expensive marling may be on land so little requiring that improvement, or so little fitted to receive such improvement, that but small benefit is produced. In other cases, where the expense of marling is the least, because of great facilities, the benefit to the land may be the greatest. In the former case, of maximum labour and minimum increase of production, the net profit of the marling

might not exceed 10 per cent. per annum, on the cost—(though I have never known so little, from any *proper* application). In the latter case, of minimum expense and maximum effect of marling, the net profit might be 200 per cent. per annum on the cost. Most operations would be much within these extreme results. In much the greater number of cases of my own labours, and of all others which have come under my personal observation, and were conducted and applied with ordinary judgment, the net profits have not fallen short of 50 per cent. per annum on the expense, for the whole time which has elapsed since the application. How long such operation may continue, and whether increasing or decreasing, I leave to be inferred from the preceding facts and reasoning, in regard to the duration of the effects of calcareous manures. The grounds of this belief have been already in part submitted, in sundry statements of particular products, the results of particular applications. The expenses of particular and large marling operations have been as carefully noted, and will hereafter be reported in detail. But for the better understanding of these details, and more methodical arrangement, they must be postponed until other explanatory matters shall have been presented. I will therefore here merely state the general results. In four extensive marling operations, on three different farms, under different circumstances, and nearly all of which were unusually difficult and laborious, the total expenses were severally 142, 97½, 86, and 94 cents for the 100 heaped bushels of marl, spread upon the fields.

Most of marling labours, under ordinary circumstances of facility and difficulty, ought not to exceed in cost \$1 for the 100 bushels of marl applied; while the ordinary profits thereon will well repay an expenditure of \$6, under existing circumstances; or of twice or thrice as much, if lands and their permanent improvements in Virginia were priced according to their producing and intrinsic value, and not according to the excess of supply over demand in the land market.

The argument in support of the several propositions which were advanced, and have been discussed through so many chapters, is now concluded. However unskillfully, I flatter myself that it has been effectually urged; and that the general deficiency in our soils of calcareous earth, the necessity of supplying it, the profit by that means to be derived, and the high importance of all these considerations, have been established too firmly to be shaken by either arguments or facts.

There remain, however, and will be presented in order, other important matters; which though not necessary for the maintenance of the series of propositions which have been argued, and which were too long to have been properly included in that discussion, are not the less deserving of consideration.

## CHAPTER XXIV.

### OTHER FERTILIZING POWERS AND EFFECTS OF CALCAREOUS EARTH.

WHEN stating the supposed powers, or modes of operation, of calcareous earth, or of the salts of lime generally, as ingredients of soils, by which their presence caused fertility, and their absence or great deficiency maintained barrenness (Chap. VIII.), no power or quality was named which had not been either inferred in advance of any known results of calxing, or observed in natural soils, or otherwise, soon after the commencement of my practical applications. Also, subsequently, in Chap. XIX., when either recapitulating, or stating for the first time, the results of calxing, none were named (unless incidentally and slightly), which had not been obtained from my own practice, or by personal observation of the practice of intelligent and trustworthy co-labourers in this mode of improvement. There remain to be presented other or greater effects than had been anticipated, or known early from experience; and also other auxiliary and important causes for such unexpected measure of benefit produced by calcareous manures.

My own early practice in calxing was mostly on acid soils. The much smaller surface of neutral soils, though also marled, was not observed for the effects through a course of years—nor carefully, by experiment, for less time, in but few cases. On such soils, my theory promised no early perceptible benefits; and late returns could not well be known and estimated, except from large surfaces, as a whole field, or the greater part of a farm.

But though my high and hilly farm of Coggins had but a small proportion of neutral soil, most of the lower and level lands on the tide-water of James river consisted principally of soil of that kind. These best lands of the lower James (as of all the other tide-waters of Virginia) have evidently been formed by the deposit of alluvial earth, subsequent to the general "upheaving" of the higher-lying and greater body of the surrounding lands from below the bottom of the ancient ocean; yet long before the present degree of elevation of the general surface had been completed, by the producing geological causes. These ancient alluvial lands are always low, in comparison to the adjacent lands of different and earlier formation; yet so much elevated above the present greatest height of the river, that they have as little of the characteristic defects of "low-ground," as if not of alluvial formation. The common geological origin of these lands, and their common sources of materials, have served to give to them a general uniformity of character and

qualities, though with considerable variations of texture and fertility. Such were the natural soils, generally, of the farms of Sandy Point, Brandon, Wyanoke, Westover, Eppes' Island, Jordan's Point, Shirley, Curle's Neck, and smaller parts of many other lands along James river. Some small portions, as on Wyanoke, were so sandy as to suffer loss of soil from high winds, before being improved by lime, which stopped the further progress of that injury. Other parts are made objectionably stiff and intractable, by containing too much clay. More generally, the texture is of, or approaches to medium, or is between the extremes of sandy loam and clayey loam. The surface is nearly level, but generally is very slightly undulating, and exhibiting, in the direction of the depressions and elevations, the course and degree of violence of the ancient flood of turbid water, which deposited the soil, and also thus furrowed the surface. All such lands were originally rich, and of course neutral; but nearly all had been much reduced in fertility by the exhausting and bad cultivation formerly general in lower Virginia. A large proportion of these lands were of that peculiar and best kind of soil known as "mulatto," or chocolate-coloured. They are reddish brown, showing by this colour a considerable ingredient of red oxide of iron; while the darker tint, friable texture, and growth of these soils, would seem to indicate a calcareous character and constitution formerly, though none have been known to be more than neutral, before the artificial calxing. Before this improvement on all the best of such soils, clover would grow, and gypsum acted on clover. These "mulatto" soils have before been incidentally mentioned in this essay; and more particular descriptions of several of the best tracts, and of their recent improvement by calxing, were published in different parts of the Farmers' Register.\*

Reasoning from the modes of operation ascribed to calcareous earth in Chap. VIII., and in advance of all experience of the effects of calcareous manures on these fine neutral soils, I had not supposed them capable of deriving much benefit from that mode of improvement. But very different have been the results. The effects of calxing thereon, whether by marling or liming, are (as was expected), scarcely, if at all, perceptible on the first crop; and even the earliest appreciable benefit is as nothing compared to the speedy and wonderful effects on acid soils. Still, the improvement is not long in becoming manifest; and within the first round of the rotation of crops, and especially when clover becomes the growth of the field, the benefit from the previous calxing is great, and in the succeeding grain crops is amply remunerating, though

---

\* As of Lower Wyanoke, Shirley, and Curle's Neck, in vol. i.; Westover, in vol. i.; Sandy Point, in vol. ix.; Brandon, in vol. x.; besides many other slighter references to these or other similar lands.

still falling much short of what it will reach some years later. All these fine lands, on James river (owing to their fresh-water alluvial formation), are destitute of the marl (of fossil sea-shells), which is so generally abundant lying under the adjacent higher lands. Still, nearly all have been covered either by marl water-borne from other places, or by lime brought from Pennsylvania, or burnt from purchased oyster-shells. The percentage of increase in the crops, even after the full effect is produced by calxing, is much less on these lands, than of the poorest acid soils. But the absolute increase of crop, and also the profit compared to the expense of the manuring, on these neutral and especially the hazel or "mulatto" soils, after some years, are as great as the absolute increase of product, and the profit, on any acid or other poor soils. The original production, and even the much reduced production of these best soils, was so much higher than that of acid soils, that an improvement of 50 per cent. in the crops of the former may well be a greater absolute increase and profit, than an increase of 100 or even 150 per cent. on much poorer lands.

On all the other tide-water rivers of Virginia, there are flat lands of like geological formation, and having general resemblance to those of James river; while all such, on each different river, have still more of general similarity of character to each other, and of general difference from such lands on other rivers. Such results might be inferred, from the great sources and materials of the ancient alluvium having been different on each of the rivers. Such lands on the Pamunkey river are the most extensive, the most elevated (being in most cases full 30 feet above the present level of the river, and far above the highest freshes), and also the most valuable. Not much of this land is as clayey or was as rich originally as the smaller extent of best lands on the tide-water of James river. But for ease of tillage, and cheapness of improvement by marl, and for profit on the capital and labour employed, no lands are superior. Since the beginning of 1844, I have been a proprietor and cultivator of a farm of this description, bordering on the Pamunkey (Marlbourne); and within the next seven years, applied marl to the amount of nearly 370,000 bushels. The increase and profits therefrom have already much exceeded my previous expectations; though both (from the lateness of the manurings) are still much below the mark they will reach, when time enough shall have passed to bring the manure into full operation. It is proper, however, to state that the marl used on the Pamunkey flats is the *green-sand eocene*—of peculiar character, and of more than the beneficial operation of mere calx, or carbonate of lime. It is indeed not rich in calcareous earth (having from 25 to 30, and very rarely 35 to 40 per cent.); but, in addition, it contains some gypsum, and a considerable proportion of green-sand. And,

judging from the effects as manure, it seems probable that some phosphate of lime is also present. By these auxiliary ingredients, added to the main source of fertility, the calx of the manuring earth, the vigour and luxuriance of clover is peculiarly promoted—beyond any effect of calxing alone known elsewhere—and the succeeding wheat crop is also increased in proportion to the clover-manure grown and turned under to prepare for the wheat.

Some small portions of the Pamunkey flats are of close and impermeable pale yellowish clay, and the value much the less for this objectionable quality. But most of such lands are of light sandy loam, and some very sandy. Some of the sands are of mulatto soil, and some gray, and even approaching to acid character. No red clay soil, or sub-soil, is there known.

It has been deemed proper to speak thus fully of these neutral soils, and their improvement by calxing, because the circumstances serve most clearly to establish the opinion stated formerly (in the edition of 1842), that calcareous manures must possess some other and important fertilizing action, besides the several kinds before asserted (in Chap. VIII.). Of these several powers, neutral soils did not require, and therefore could not profit by that of neutralizing acids; nor of altering the texture, absorbency, &c., of the soil. Such soil had already been provided by natural constitution with enough lime for these purposes. Therefore, the only other fertilizing property there claimed, in advance of experience, for calcareous earth, that of combining with, preserving, and fixing putrescent manures in soils, was all that could be counted upon to improve neutral soils. But this slow and merely conservative action, however valuable for improvement, could not possibly be the sole cause of the great and progressively increasing production of neutral soils, which was manifest within a few years after their being calxed; and other and important causes had evidently been operating. And although the circumstances of neutral soils led more immediately to this conclusion, those of the acid soils also concurred. As was intimated in former editions, on all soils and crops which were improved by calcareous manures, though the experienced effects were strictly in accordance with the theory of their operation, they seemed in measure and amount to surpass their supposed causes. I will now proceed to set forth other auxiliary causes of fertilizing action and power of calcareous earth, or lime salts generally, in soils; which causes have been suggested by or deduced from the more recent lights furnished by the progress of the science of agricultural chemistry, and in part are the results of my own later observations or experience. The most important of these additional powers or operations of lime in soil are the following:



I. Causing the more rapid decomposition and perfect solubility of vegetable matters, otherwise inert or insoluble.

II. Enabling either the soil, or the plants growing thereon, to draw from the atmosphere greater supplies of manuring or alimentary principles, viz. :

1. Carbon, to growing plants;
2. Azote (nitrogen), from the atmosphere, through the instrumentality of leguminous plants;
3. Nitric acid, and nitrates, to the soil, and thereby increasing the supplies of azotic principles to growing plants.

III. Giving to all growing plants a more healthy constitution, and more vigorous vital powers, and thereby more ability to withstand dangers and injuries of all kinds.

These several branches of the subject will be discussed in the following pages; and so far as they admit of separation, in the order stated.

§ I. *Lime and Carbonate (and other Salts) of Lime render Vegetable and Organic matters more soluble.*

It is a well established chemical action of the fixed alkalis proper (potash and soda), on vegetable or other organic matter, to render it more soluble, and thereby more speedily and effectually to reduce insoluble and inert organic manures to the state fit to be taken up by the roots of plants; and enable them to be more completely consumed as food for plants. It may well be inferred, from the general resemblance of chemical properties, that this solvent action of the alkalis proper must also belong to the alkaline earths, lime and magnesia, even though in combination with carbonic acid. That caustic or pure lime exerts this solvent power was stated previously (page 103), when treating of its manuring action. Like effects, as exhibited in the rapid disappearance of leaves, &c., on calcareous and neutral soils, were also stated (page 98), from which effects it might be inferred that this solvent power attended lime in all its ordinary combinations or conditions in soil; though perhaps then exerting this power more slowly than either caustic lime, or carbonate of potash. These well-known effects on natural soils, and also the quicker and better effects of unrotted putrescent manures when applied to calxed lands, I had ascribed altogether to the indirect action of calcareous earth, in its having neutralized the previously existing acid, which was antiseptic, and prevented or retarded the rotting and solubility of the vegetable matters. But besides this indirect action, there seems good reason to believe that there is also a direct solvent power exerted by salts of lime, similar to that of the alkalis proper, and their salts, or combinations with acids. Rennie and Thaer have expressly extended this known chemical action of the alkalis proper to the alkaline earths, even

when in the state of carbonates.\* That such extension is correct is further confirmed by some of the effects of calcareous manures, as adduced by Prof. Johnston, and as understood by practical limers in England. He says, of the action of lime, "it changes the inert vegetable matter in the soil, so as gradually to render it useful to vegetation (p. 400); and further (p. 401), that "under the influence of lime, the organic matter disappears more rapidly than it would otherwise do; and that, after it has thus disappeared, fresh additions of lime produce no further good effect." These results, in substance, have been maintained in the preceding portion of this essay; but were ascribed there to other than the general solvent action of calcareous earth—which I would now suppose to be one of the important concurring causes.

According to the treatment of the land while this solvent action of calx is proceeding, through a course of years, the general and final results will be either injurious, in the removal and destruction of the organic matter (as stated by Johnston), or beneficial, by its being stored up and fixed in the soil, under reverse circumstances. If the system of cropping be continually exhausting—taking as much as possible from the land and returning nothing—then the lessening and disappearance of the organic matter, whether slowly or speedily, will finally be complete; and equally sure will be the so induced and almost hopeless subsequent sterility of the soil. It was upon such ignorant and destructive cropping as this that was founded the often quoted old proverb in England, that "liming makes rich fathers and poor sons." And this saying will be certainly true, if understood of liming (or of calxing in general), followed by continued or generally exhausting tillage; though entirely false if followed by mild meliorating cultivation, and judicious management. Doubtless there were formerly in England, in times of ignorance and bad farming, numerous cases of the destructive results of calcareous manures; and it is much to be feared, that, from as ignorant practice, and at some time hence, there will be many such results in this country. Some such have already

---

\* Both passages have before been quoted, in reference to other subjects. Rennie says of *insoluble* humic acid, that it "readily combines with many of the substances found in soils and manures, and not only renders them, but itself also, *easy to be dissolved in water, which in their separate state could not take place.* In this way humic acid will combine with lime, potash, ammonia, in the form of humates, and the smallest portion of these [alkaline matters] will render it [the humic acid] soluble in water, and fit to be taken up by the spongelets of the root fibres."—(*Alphabet of Scientific Gardening.*)

Thaer says—"It is well known that with the aid of alkalies, ashes, lime, and marl, humus may be deprived of its acidity, and rendered *easyly solubla.*" (p. 538.)

been produced; and many more are in progress, in spite of all warnings of the danger.

Though Johnston uses the word "lime" alone in the above passages, or in immediate connexion with them, it is evident from his context that he meant carbonate of lime, or such condition as lime would be in some years after its having been applied as manure; and this condition would certainly not be that of caustic or pure lime. If admitting to the fullest extent the solvent action claimed according to his views, the extreme cases would stand thus: The unrotted and then insoluble organic matter in a soil, which, without calxing the land, might require (suppose) twenty years gradually and slowly to become soluble and fit for use, and to be used by plants as becoming fit, might otherwise become soluble and as fit for feeding plants in the course of ten years, if in soil made calcareous. In the former case, the most relentless exhausting tillage could not totally consume or remove all the organic matter in less than twenty years, because it could not be used or exhausted before becoming soluble. In the latter case it might be done (possibly) in ten years, admitting the extreme deduction from Johnston's views; or according to mine (if allowing for the preservative as well as the solvent operation of calx), all the first existing organic matter might be used, and the land made sterile, say in fifteen years. Supposing further, to be produced but an ordinary increase of crops from the calxing, then the total products even in the ten and fifteen years respectively required to reduce the land to a state of unproductiveness would amount to twice or thrice the amount that could have been obtained in twenty years from the land if not calxed. Thus, even in such extreme and similar circumstances of unmitigated exhausting tillage, the advantage in profit would still be greatly in favour of the calxed land.

But why should we waste arguments or words on such supposed cases of absurd and destructive tillage, pushed to the extremity of reducing the land to barrenness? Whether land be limed or not, a continued exhausting course of tillage, even with some, but insufficient intermission, can only, sooner or later, lead to the same result of the greatest possible exhaustion, and with certain eventual loss to the proprietor.

Even if nothing be allowed for the important preservative action of calx (which in truth would hold and fix all the organic matters made soluble, until they were used by growing plants, however long that use might be deferred), still I would deny that the solvent action of calcareous manures would be of itself destructive or injurious to the future productive power of the land. It is indeed true, that the fertilizing elements thus offered so readily (by earlier solution of inert vegetable matters) *might* be so much the more readily wasted and exhausted by an ignorant and improvident cul-

tivator. But on the other hand they might as readily be used profitably, in part reinvested, and increased by partial accumulation, while still producing good profit, by judicious farming. If a merchant's capital, in ships, warehouses, and merchandise, could, at any instant when desired, be converted, partly or wholly, to the value in ready money, surely no one would deem that facility as other than an immense advantage to his business and means for increasing his wealth. Or suppose that the merchant's trade with remote countries, usually requiring three years to return his ventures and the profits, could, by some change, bring the like returns every three months; would any one contend that this more rapid "turning over his money" would be a loss to him? Yet both facilities would enable him, if so inclined, so much the sooner to spend his income and his capital stock. Just so, and no more, is the farmer's land necessarily to be exhausted, or his total income and capital spent, because calxing has enabled him to obtain a certain amount of income in half the time previously required; or even to draw out his whole landed capital in annual income, and to waste the whole, if he is so foolish a prodigal as to take that course.

In truth, if but a small proportion of the new products, or increase created by calxing, be given back as manure to sustain the productive powers of the land—whether in prepared putrescent manures, or in green crops used as manure, or merely by giving rest, and the natural growth during rest to be left on the land—so that the draughts from the land will be less than the supplies furnished to it from all sources, there will be no continued exhaustion even in the slightest degree, no diminution of average products—and the sons, no less than the fathers, may be made rich by the operation of lime.

On all cultivated lands, whether rich or poor, calxed or not, proper considerations of farming profit alone would require that the crops should take no more of fertilizing principles from the land, than are restored, and exceeded, if possible, in the returns made to the soil. In making these returns, bountiful Nature adds three and four-fold to all that the farmer can give in manure or other improvement. The earth, water, and the air, are all continually preparing and furnishing manuring principles to the soil and to the crops. The richer and better constituted the soil, or the more it is enriched by putrescent manures and rest, the more, and in a far increased proportion, does Nature furnish in addition, other aids to resuscitation or increase of fertility. Hence, the more that the farmer gives to the land, the more, and in increased proportion, will it return to him. Therefore, it is no certain course of cropping, and of intermission or melioration, that can be stated as always improving the fertility of land, or otherwise exhausting it. The results of a certain rotation may be improving to a good

and rich soil, and yet would be exhausting to a bad and poor one. A good and rich soil may, in some cases, yield three crops of grain in four years, and yet improve by the rest and self-manuring (by its own vegetable growth) of the fourth year only—while very poor land may not increase its scant products, though cropped but one year in three. Yet the rule of resuscitation, and its working, are alike in both cases. The one-fourth of the product of the best soil serves to give it more manuring, even in proportion to all its large crops removed, than two-thirds of the whole product of the poorest soil, in proportion to its very small yield for consumption and sale. This greater supply of fertilization to a good soil in shorter time is not altogether in the mere quantity of vegetable matter furnished. The greater part probably is due to the superior power of a lime soil to fix and so retain the enriching products of vegetable decomposition, which, on an acid soil, wanting this fixing power, would be mostly wasted. This is another illustration of the important economy of calxing all lands not abundantly supplied with lime by nature.

The allowing to land, after having been marled or limed, a due share of rest from tillage, so as to permit its being manured by its own growth during the times of rest, even if not essential, would be one of the most important of the accompanying benefits to the farmer; for by such means of furnishing the necessary supply of organic or putrescent matters to the soil, the same value of manuring is given at very far less expense than if by manures artificially prepared in the stables and barn-yard. Highly valuable and important as are the latter, and more especially profitable to the calxing farmer, still their amount is limited by the measure of both the supply of materials and of labour to be given for preparing and applying the manure. But to manure a field by its own growth, requires very little more than to *let it alone*. If merely left a year untilled and ungrazed, an important gain is secured without any cost of labour or material. And if, as part of a proper rotation, to the resting there is added the seeding of the land in clover, or any suitable leguminous growth for green manuring, the additional benefit will be much more than the additional expense.

This essential and also highly profitable accompaniment to liming or marling is precisely the condition which is most generally objected to by those who wish to begin such improvements—and the most frequently neglected by those who have already limed or marled. In the reasoning of the one class, and the practice of the other, it seems to be required that calxing shall do everything for fertilization and production, without aid, and be proof against all powers of exhaustion and destruction by tillage. And if such unreasonable demands be pronounced impossible to be complied with, it serves with many as sufficient ground to deem

the use of calcareous manures unprofitable; or if already used, to charge to them the subsequent deterioration or exhaustion of the land which had been allowed neither sufficient rest, nor returns of putrescent matters.

In the year 1843, when acting as Agricultural Surveyor of South Carolina, my most earnest effort was to induce the planters to make proper use of marl; which is there more rich, more abundant, and more easy of access through a large portion of that state than a stranger can well conceive, and of which almost no use had then been made. Gov. Hammond and a few others made the only exceptions to this general neglect; which cases of exception were stated in the "Report of the Agricultural Survey of South Carolina." My failure then to persuade more than a few planters to try this richest and also cheapest of means for fertilization, and the neglect to use these means which still continues very generally in South Carolina, were mainly owing to the required condition of giving due rest and vegetable growth for manuring to the marled lands. This condition I always and strongly urged as essential; and it was so contrary to the general system of tillage there in use, and therefore was deemed so objectionable, that but few persons were willing to make the required change for any expected benefits from marling. Nearly all who before or since have there tried marling, have failed to add these necessary accompaniments; and of course their early returns have not been half what they would otherwise have been, and the ultimate results will be still more deficient.

The general usage in South Carolina was to take a crop for market or consumption (generally either cotton or corn) every year. As there was no other than tillage land (arable, and not before worn out), if a planter were to spare a field, or any smaller space from culture, it would be equivalent to losing just so much of his usual crop and income, for that year. This was deemed a sacrifice which very few were willing to make, and none to sufficient extent. It is true that new clearings, where there was forest land to clear, were added every year to the tilled land. But this additional surface was required (as supposed) either to substitute the older land utterly worn out, and turned out of culture, or otherwise to serve for the planter's increased means for labour.

This very bad usage of continual tillage was indeed made the less exhausting, and the more tolerable, by a system of collecting and applying vegetable manures, admirable for the energy with which it was pursued, and for the great extent to which it was carried. I have never known so much of the labour of farms to be devoted to making and applying putrescent manures, nor so much of the tilled surface to be so manured, as in lower South Carolina. For this purpose, large stocks of cattle are kept (in

very poor condition indeed), and vegetable matter in great quantity is gathered in leaves from the wood-land, and sedge and rushes and other growth of the tide-marshes, to be used as litter. The manure is applied in the row or drill, so as to go as far, and act as quickly, as possible. This large but slight and poor manuring required frequent renewal; and by some planters it was renewed every year over their whole extent of cotton, which was much the largest of all the tilled surface. All these efforts barely served to keep up the manured land to its previous moderate rate of production; and if that could be done, the planter was content to make no absolute or abiding increase of fertility by his continual applications of wasting and fleeting manures. When urging on such persons the use of marl or lime, I was frequently met by the question "Will marling enable me to dispense with other manuring?" and the negative to that question, always promptly given in answer, was generally assumed as sufficient reason for failing to use calcareous manures. Yet never was there a greater mistake, or more false reasoning, than led to this conclusion.

Besides all other benefits to be gained by thus improving the constitution of the soil, marling would have made half the usual dose of putrescent manuring do more good than the whole. By giving rest and its own self-manuring, say to one-third of the arable surface, the other two-thirds would soon surpass the previous production of the whole. And much more crop would be obtained both from the land and the labour employed, than before marling and resting, or than with marling and without resting, besides a continued growing increase of fertility and production.

But the idea of even the present gain of a proprietor being made the greater, or the early lessening of crops being avoided, by continual culture, is entirely fallacious. The renter of another's land, for one or two years only, may indeed reap most crop and profit by tilling the whole surface. But his successor will lose in proportion to the previous excess of cropping. So the man who hires a horse for a day only may get from him the greatest quantity of labour and at least expense, by working him the whole time, without food or rest. But it is as true economy and profit to allow food and rest to the land in an occupancy of but a few years, as to the horse if employed but for a few days. In either case, the expense of such allowance is an investment which will return a higher rate of profit than all that could be gained without such expense.

Further: unless when the application of putrescent manures is very frequently renewed, and therefore is very expensive, the resting of the land is not the less certain to occur, and for as long intervals, as if allowed by the most lenient rotation of crops. In the latter case, perhaps the land (after being calked) yields three

grain or other crops for market in a five-years rotation; the other two years being given to rest, self-manuring by the vegetable growth remaining, or part of the land being in pasture. With such respite, the three-fifths of the land will very soon surpass the previous product of the whole, and continue long to increase still more in product. In the other case, of continual annual cropping, and even with much care given to applying prepared manures, the land may perhaps bear such treatment for twenty, thirty, or in rare cases forty years, before being so reduced as to be no longer worth cultivating. It is then "turned out," and left useless and profitless for some thirty years, until, under a new growth of trees, it is brought back partially to a state fit for a second and expensive clearing, and renewed cultivation. Nature will not permit the soil to be utterly robbed of its due claim for rest and resuscitation. And if the cultivator will not of his own accord grant one or two years in four or five, he will be compelled to lose a much larger proportion of time, after longer delay. In the one case, the rest is accompanied by increasing fertility; in the other it is the result of exhaustion, and is followed by long-continued and total unproductiveness.

The amount of rest for land required for its progressive improvement after being marled, after all, is inconsiderable, and is, usually, fully compensated in the greater product of the two next succeeding crops of grain. In lower Virginia, the system of continual tillage formerly was as prevalent as now in South Carolina. Yet there are very few of even the most improvident and exhausting cultivators who do not now know that more grain and more profit are to be obtained in a three-years course (for example), including one year of rest, than if taking a crop every year. And on calked and well conducted farms, making regular advances in production, three grain-crops and one of clover are taken off in a five-years' rotation, leaving but one year of the term in which the land is unproductive of profit for that time—though not unproductive in preparing for future returns.

Whether the question be considered and tested by facts and experience, or by reasoning, there cannot be a shadow of reason or excuse for the custom of continual tillage, except in a newly settled and uncleared country, of great fertility, and where labour is very costly, and land priced very low. Not one of these conditions now exists in lower South Carolina to justify the general system of tillage. And that so intelligent, well educated, and withal so industrious a class as is found in the planters generally of that state, should so strangely persist in such a system, and, for its preservation, reject the means of doubling their products and their wealth by marling, is not the result of the teachings either of reasoning or of experience, but of the supremacy of habits long established, and in almost universal use.



§ II. *Calcareous earth enables the soil, or the plants growing thereon, to draw much more nutriment from the atmosphere.*

Every plant, after being completely burned, leaves a small proportion of its previous quantity in ashes. This portion, indestructible by burning, is distinguished by chemists (not with much accuracy of signification) as the inorganic parts of plants; and these are found to consist of different salts, or chemical compounds of different acids with alkalies proper, and alkaline or other earths, and also some oxides of metals. All these matters, making the whole residue in ashes, in any one plant, or part or product of any plant, rarely amount to as much as one-tenth of the original dry weight; and in more of other cases fall below the one-hundredth part.\*

The other and much larger portion of all vegetable matters, called by chemists the organic, or that which is destructible by burning, is composed either of three or most generally all four of these elements, carbon, hydrogen, oxygen, and nitrogen or azote.

The like division of products, destructible or indestructible by burning, applies to all animal matters, and also the general constitution of their different parts; but in very different proportions. Excepting the solid bony or shelly parts of animal matters, the portion indestructible by burning is extremely small. Of the destructible parts of animal matter, azote (or nitrogen), always forms a considerable proportion; while in most vegetable products it is in very small proportion, and in others entirely wanting. It is, however, always present either in some part, or element, or product of every plant. It is the proportion of azote, small as it is, which mainly determines the degree of richness and nutritive value of any substance, whether as food for animals, or as manure for growing plants. And according to the quantity of azote contained, is the tendency of either vegetable or animal matter to putrescence, and to give out offensive odours while putrefying. Thus, in a rough way, common observation and experience, and the sense of smell, may afford tolerably accurate tests of the amount of azotic principles in materials of manures for plants, or food for animals.

It follows from the consideration of the questions of which the general results only are here stated, that whatever serves to furnish most azote to the soil, in manure, is most conducive to its immediate fertility; and whatever abstracts most azote from the soil, without return, is the most exhausting of its immediate productive powers.

Having presented these general propositions (which seem to be received by all authorities), let us proceed to inquire as to the sources of the mode of supply of azote, and of the other much more abundant constituents of plants.

---

\* See tables of proportions for ashes from many vegetable products reported by Boussingault, p. 53, 4, Rural Economy, Am. Ed. of Eng. Trans.

Putting aside for the present the minute proportion of inorganic elements (or ashes) of plants—or supposing their amount to be always ascertained separately, or understood—the great remainder of all plants, amounting from more than nine-tenths of the dry weight of some products to more than ninety-nine-hundredths of others, consists of elements which also constitute air and water, or are always present in the atmosphere; and which therefore are always surrounding all growing plants, and in unlimited quantities. But though so abundant and inexhaustible, these elements cannot be taken up by growing plants except under certain conditions; and these conditions are but slightly under the control of cultivators, or even known to the present researches of science.

Of the four great elements of organic bodies, carbon only is ever presented to our senses, alone and as a solid. Charcoal is nearly pure carbon; and the brilliant and precious diamond is pure crystallized carbon. Of the three other great elements, oxygen, hydrogen, and azote, each one in its separate state is only known to us as gas, or air; and however different and potent their qualities, they are all as little perceptible by our sight or touch, as the atmosphere. Further: carbon, though existing nearly pure, and visible and tangible, as charcoal, yet, when in that state, is incapable of affording any direct support to plants; for which office it is necessary that carbon shall be combined with oxygen; which combination also forms a gas (carbonic acid), in which state it is diffused throughout the atmosphere, and in which only it is fit to be received into plants, through their leaves, and thus to furnish to them their essential element, carbon.

Thus, the materials of nearly the whole solid substance of all plants and all animal bodies, are supplied wholly by four gases, or different kinds of air. This proposition (than which none in agricultural chemistry is better established), when first heard, may well seem too mysterious for comprehension, and the results too wonderful for belief. And after the proposition has been fully assented to, there must occur to the mind of every student of this interesting subject another question involving as much of mystery and wonder, if not also of doubt. This question is, "If the atmosphere always contains all the organic constituents of plants in inexhaustible quantities—and if plants derive from the atmosphere nearly all of their constituent parts—why should they ever suffer for want of a sufficient supply of nourishment, whether growing on rich or poor soils?" The answer is, that the laws of nature forbid some of these gaseous bodies to be taken up directly by growing plants—or, at least, only under certain conditions; and these conditions are not dependent on the quantities of these gases present in the surrounding atmosphere, and are but slightly under the control of man, limited in knowledge as at present.

Should the progress of science ever serve to place these conditions under man's control, then exhaustless stores of the richest nourishment to plants, and the sure means of universal and exuberant productiveness from the poorest soils, will also be at his command. Food for land and plants and brutes and men will be as unlimited and almost as available as the air we breathe. But to indulge in such speculations of the possible future, is now mere dreaming anticipation. My object is more practical. It is to gather and display such faint lights as now may be drawn from previous scientific researches upon this dark and yet interesting subject of inquiry. As little as has been discovered and established by agricultural chemists, and still less put to practical use, I believe that new and very important and useful deductions may be derived from the scattered and unconnected truths already ascertained in regard to the nutrition of plants, and, through the medium of plants, the nutrition and fertilization of soils.

The following table is given by Boussingault as the results of his investigations, showing the proportions of the constituent elements of various ordinary vegetable products.

Substances—dried at 230° Fahr. 100 parts.	Carbon.	Hydrogen.	Oxygen.	Azote.	Ashes.
Wheat . . . . .	46.1	05.8	43.4	02.3	02.4
Rye . . . . .	46.2	05.6	44.2	01.7	02.8
Oats . . . . .	50.7	06.4	36.7	02.2	04.
Wheat straw . . . . .	48.4	05.3	38.9	00.4	07.
Rye straw . . . . .	49.9	05.6	40.6	00.3	03.6
Oat straw . . . . .	50.1	05.4	39.	00.4	05.1
Potato . . . . .	44.	05.8	44.7	01.5	04.
Field beet . . . . .	42.8	05.8	43.4	01.7	06.8
Turnip . . . . .	42.9	05.5	42.3	01.7	07.6
Jerusalem artichoke (or potato) . . . . .	43.3	05.8	43.3	01.6	06.
Peas . . . . .	46.5	06.2	40.	04.2	03.1
Pea-straw . . . . .	45.8	05.	35.6	02.3	11.3
Clover hay . . . . .	47.4	05.	37.3	02.1	07.7
Jerusalem artichoke stems . . . . .	45.7	05.4	45.7	00.4	02.8

From these propositions of the vegetable products stated, it would appear that the per centage of each of its elements is between the following extremes :

Organic parts	{	Carbon from	42.8	to	50.7	per cent.
		Hydrogen	5.	to	6.4	
		Oxygen	35.6	to	45.7	
		Azote	00.4	to	4.2	
Inorganic parts—Ashes				2.4	to	11.3

Of the first-named four and great constituent parts, carbon

only is furnished by nature otherwise than in the greatest profusion. Oxygen gas makes about one-fifth, and nitrogen or azote about four-fifths of atmospheric air; and pure water is a compound of 8 parts of oxygen and 1 of hydrogen. Carbon in the form of carbonic acid gas is universally present in the atmosphere, and in variable proportions; but usually (over land) making about  $\frac{1}{1000}$  only of the whole bulk. In weight, the proportion of carbonic acid is  $\frac{1}{1000}$  of the atmosphere. Small as is this proportion, still, as it is present in the air surrounding and in contact with all growing plants, their supply might be deemed inexhaustible, provided they possessed the power of attracting and arresting it, and taking up and assimilating the carbon of the gas. But this power seems to be not fully exerted under ordinary circumstances. The other great elements, oxygen, hydrogen, and azote are in unlimited quantity surrounding plants, as constituents of the atmosphere, or entering and filling the bodies of plants as the constituents of water. And as the atmosphere always contains, in large proportion, water dissolved by heat, that is, the water itself being in gaseous form, therefore the ordinary atmosphere alone offers to plants all the four great elements required to constitute nearly their whole substance. If then we suppose that the very small proportions of necessary salts, found in the ashes of plants, are already in the soil (as is generally the case), or, if not naturally present, to be supplied by art, it is manifest that all cultivated plants, on all soils—and on the most barren not appreciably less than on the richest—have at hand unlimited supplies of all materials required for their sustenance and growth. But the power to seize upon these materials is either wanting, or possessed but to a strictly limited extent. And it is in proportion to the power to use them, and not to the abundance of the resources present, that the support and growth of plants are regulated.

The proportions of the atmospheric constituents of each particular vegetable product (as gluten, starch, sugar, wax, &c.) seem to be uniform; and of each of the more compound products of a particular plant (as its seeds, flowers and leaves, bark, wood, &c., of like age and kind), the constituents seem to approach uniformity of proportions; so that it may be inferred that the differences are caused by differences of conditions, of wants and supplies; and that, under like conditions, the constituents, organic and inorganic, would be in like propositions. But the quantities of the simpler products of plants of like kind (as gluten or starch in wheat, sugar in beets, &c.) vary greatly, and of course cause variation in the proportions of elementary constituents of the entire plant. Especially does the proportion of azote vary in like plants, under different circumstances of supply, even when the other constituents vary but little. Boussingault found the following proportions in

wheat of the same variety, but of which one sample was taken from garden ground, very rich, and the other from the ordinary soil of his field, and of course comparatively poor. The growths were of the same year, and the same farm, and therefore the influences of weather the same.

"FROM THE OPEN FIELD.		FROM THE GARDEN GROUND.	
Carbon,	46.10		45.51
Hydrogen,	5.80		5.67
Oxygen,	43.40		43.00
Azote,	2.29		3.51
Ashes,	2.41		2.31
	<hr/>		<hr/>
	100.00		100.00

"In the produce of the garden ground there were 21.94 per cent. of gluten and albumen [the products of wheat which only contained azote]; in that of the open field no more than 14.31 per cent. of the same principles."—(*Rural Economy, &c.*, p. 176.)

The cursory reader would perhaps be struck only by the general agreement of the proportions of the constituents of these two samples of wheat grown on such different soils. But while there is such near approach to equal proportions of the three larger constituents, the azote, smallest in quantity, but the most important for its quality, is shown to be increased in proportion more than 50 per cent. by the richer soil.

Thus the smallest but richest element, azote, would seem to be obtained by plants principally or entirely through their roots, and from the soil. Therefore, the supply to plants is in no degree increased by the prodigious quantity of azote in the atmosphere. On the other hand, the carbon, which constitutes about half the dry weight of all plants, is supplied, for much the larger part, from the carbonic acid gas of the atmosphere, through the leaves, and thus is fixed in and assimilated to the plant. Carbon is the only one of the four great elements found in air or water which is presented (by the atmosphere) to plants in small quantity, and apparently in insufficient quantity for the supply of their leaves. Therefore, I infer that to increase the nourishment and growth of plants it is not only necessary to increase the supply of azotized manures through the soil to their roots, but also (if possible), to increase the supply of carbonic acid to the leaves; or to increase their power to take up the supply actually present in the surrounding atmosphere.\* As to the oxygen and hydrogen, they will be sup-

\* Professor Liebig maintains that all the azote taken up by plants is through their roots, and of course derived immediately from the soil. Boussingault infers, from some very interesting experiments, to which I shall again advert, that some azote is also taken directly from the atmosphere, at least by leguminous plants. The latter author, agreeing with

plied from the air and water in any quantities required in proportion to the amount of carbon and azote derived from all sources. Chemists seem to concur in the opinion that plants exert the power to decompose water received through their roots into their sap vessels, and to assimilate the results of the decomposition, hydrogen and oxygen, in requisite proportions. Besides all other reasons in support of this opinion, its truth may be inferred from the established fact that in many vegetable substances the constituents of hydrogen and oxygen are present in precisely the proportions which serve to constitute water.

If then enough azote and carbon be furnished to growing plants, enough of oxygen and hydrogen will be at the same time taken up and assimilated, by the plant's own natural powers.

The foregoing views seem to offer the only plausible explanation of that great mystery of vegetable life, that plants on barren land should pine or starve, when surrounded by unlimited supplies, in air and water, of their necessary elements.

The supply of azote to the roots must be limited to the amount of azotized matters already in the soil, and to such subsequent additions as can be furnished in prepared putrescent manures, or in the azotized green or dry products of the land left there to decay. If we could also increase the supply of carbonic acid in the atmosphere, the benefit to plants would be as great as the giving of azote in manure. It has been proved by experiments, that of different plants kept in confined artificially composed atmospheres, those grew best, which had carbonic acid in much larger proportion than is in the natural atmosphere. (Boussingault, p. 36.) To increase the quantity of carbonic acid diffused through the atmosphere, to any useful or even appreciable extent, is beyond the power of man. But the desired results of such increase would be reached in some measure by enabling plants to inhale and assimilate more than their share of the general supply of carbonic acid in the whole atmosphere. This is partially effected for all vegetable growth by the winds, which continually renew the air in con-

---

most other late and high authorities, supposes the carbon of plants to be derived principally from the atmosphere, and through the leaves, but also in part from the earth and through the roots. Liebig asserts that carbon is furnished altogether through the leaves, except during germination; and none through the roots, after the opening of the earliest leaves from the seed. This opinion seems to involve the absurd position that the carbonaceous (dark-coloured) part of manure, usually deemed evidence of richness in manure and in soil, is of no use to plants through their roots; nor otherwise, except to furnish more carbonic acid to the atmosphere. In this event, the manure, by its carbonaceous part, may possibly assist the growth (through the leaves) of the plants growing nearest. But if any wind was blowing when the gas rose from the earth, the manure would be as likely to take effect on distant as on the nearest plants, even if not carried out of reach of all for the time being.

tact with plants, removing that which had given up its carbonic acid, and bringing new supplies from the upper or lower air. It has also been proved that plants grow faster in agitated than in still air. (Boussingault, p. 42.) This effect of winds is general—operating with nearly equal benefit on all neighbouring localities; and this also of course is not within man's control, or even under his partial direction.

There is still another mean, by which possibly the desired end may be attained. Though we cannot increase the supply of carbonic acid, or bring more of the actually existing supply in contact with the leaves of plants, yet if we can stimulate the plants to attract, seize upon, and rapidly absorb the contiguous carbonic acid, instead of the much greater part passing by and escaping from the otherwise feebler attracting powers of plants, then the same object would be effected as if by actual increase of the supply of carbonic acid. There is good reason to believe that such greater stimulation of the appetite of plants and increased power of taking up carbonic acid is to be conferred by the application of various manures; but more especially and in greater measure by the use of calcareous manures; as I shall endeavour to show.

Universal as is this function of growing plants of absorbing and fixing the carbon of the atmosphere—essential as it is to their existence—and largely as it is exercised to the extent of thereby obtaining much the larger part of one-half the whole dry weights of plants—still this power is strictly limited by, or only exerted under, certain known conditions. It is by their *green matter* only that plants absorb carbonic acid, and that under the stimulating influence of *light*. Through all the day, and by all their leaves and other green parts, plants are absorbing carbonic acid from the air, and assimilating and fixing its carbon, and evolving the oxygen gas, the other constituent element of the carbonic acid. But this operation always ceases with the withdrawal of light; and even a reverse operation, to smaller extent, proceeds during the night, when the leaves actually evolve some of the larger quantity of carbonic acid which had been absorbed during the previous daylight. It is well known that any plant, or single branch of a plant, secluded from light, does not acquire the usual green colour, but remains white. In this state, the white leaves and stems exert very little power, if any, in absorbing carbon. If the whole of any plant is kept in the dark during its growing state, it must soon die, for want of this essential source of sustenance.

1. *Calcareous earth causes plants to draw more carbon from the atmosphere.*

The vigorous growth of plants, and the intensity or depth of their green colour, always go together and in proportion to each

other. We must correctly infer that the deeper the green colour, from whatever cause it may proceed in part (as rich manuring, bright sunlight, or moist season), the greater must be the absorption of carbon by the leaves of the plant. Therefore, if in any manner the intensity of the green colour of plants is increased, it is equivalent to giving them the power of absorbing and assimilating more carbon, and with that (as before stated), the power of taking up and assimilating the required proportional quantities of oxygen and hydrogen.

Now one of the earliest and most manifest effects produced by adding calcareous earth to a soil before extremely needing that manure, is to give a deeper green colour to the plants. This effect is so remarkable on young corn, growing on soil previously acid and recently marled, that before the plants are four inches high, the outlines of the spot made calcareous may be distinctly seen and easily traced by any observer, merely by the strong contrast between the deep green colour of the plants on one side, and the pale, yellowish, and sickly green of the other; and this before there is any obvious difference of size of the plants. And this difference of colour remains so strongly impressed, that a strip of corn thus treated, when of more advanced growth, may be distinguished at the distance of half a mile, if exposed to view so far.

This early and marked effect of calcareous manures, of giving a deep green colour to plants, I had formerly ascribed solely to the neutralizing of the noxious acid of the soil. And this is doubtless the cause in part. But more extended observations, and the abiding effects of this kind, induced me to believe that a direct, as well as the supposed indirect action was produced. But from whatever cause it proceeds, it is unquestionable that the increase of green colour is accompanied by proportionate increase of supplies of atmospheric food to the plants, and proportionate increased products of the crops for the food of animals, and for food (or manure) for the soil.

One other well-known agricultural fact will be cited in support of this position. When gypsum (sulphate of lime) is applied to clover, on a neutral soil (where there is no injurious excess of acid to affect the crop, or to be removed by lime), and the gypsum acts well, one of the earliest and most striking evidences of its beneficial action is seen in the deeper green colour of the clover dressed, compared to any omitted portions. This effect, however produced (as said before), is equivalent and proportioned to an increased absorption of carbon from the atmosphere; and, as in the previous case, must be ascribed to the increased power of absorption given to the clover by the lime which is the base of the gypsum.

It may perhaps be questioned that such great effect can be produced by the operation of so small a quantity of lime as is con-



tained in a bushel of gypsum, the ordinary dressing for an acre. But gypsum is easily soluble in enough pure water, and would find enough in the earth furnished by rain for its speedy solution; whereas carbonate of lime is insoluble in water, unless with the addition of carbonic acid. Therefore it may follow, that even from a bushel of the soluble gypsum, the crop may draw up lime more readily and abundantly for the time, than from 100 bushels, or more, of insoluble carbonate of lime. Boussingault ascribes the great effect of gypsum to its easy solubility in water, and its thus readily furnishing dissolved lime to the roots and to the body of the plant. Though this is not at all a satisfactory cause for all the wonderful operation of gypsum on clover (and still less to explain its very frequent want of effect), there can be no doubt of the authority for the fact that the gypsum (or its lime) may be easily so received into the sap of the body of the clover. And, as analysis has shown that 1000 lbs. of dry clover hay contains 27 lbs. of lime (Sprengel, quoted by Johnston, p. 220), and 100 lbs. of sulphate of lime freed from water contains 41.5 lbs. of lime, it follows that this quantity would suffice for the healthful constitution of as much clover as would be converted to more than 1500 lbs. of dry hay.

The chemical facts which have been cited are well established, and the agricultural facts have been observed by very many practical cultivators; and both would seem sufficient to establish the position that lime gives to plants greatly increased power for absorbing carbon from the air. But, in addition to these, some very interesting and apparently accurate experiments have furnished more direct and certain proof of the results above mentioned. These will now be reported.

When nearly all the sheets of the preceding edition of this essay (1842) had been printed, embracing the whole except part of the Appendix, I first heard of the discovery having been made by Dr. Wm. L. Wight, of Goochland, of the important property of calcareous earth now under consideration. Forthwith I sought and obtained from him information of his experiments and deductions; and with his permission, a concise report of their substance, together with such introductory and explanatory remarks as I deemed required, was published among the papers of the Appendix which then remained to be printed.

Soon after my publication as above stated, Dr. Wight placed his discovery before the public more at length in his "Observations on Vegetable and Animal Physiology," printed in 1843; from which publication will be here copied all that applies to this subject.

After referring to the previous edition of the "Essay on Calcareous Manures" especially, and also to other confirmatory publications, tending to establish both the fertilizing and health-preserving

actions of calcareous earth in soils, Dr. Wight proceeded to say that in his consideration of the subject "it became a question of deep interest to determine what was the peculiar influence of lime in the process of vegetation; and for this purpose the following experiments were instituted. Seeds of wheat, resting upon moistened cotton, were first placed in glasses of water, and thus allowed to germinate. When two or more plants had put forth five roots, which is their complement, or an equal number, taking especial care that those experimented with should have an equal number of roots, this being the test of their being equally healthy, they were immediately transferred, half of them to vessels of pure rain-water, the other half to vessels of rain-water in which a small portion of the hydrate of lime [or slaked quick lime] had been dissolved.

"As soon as the first leaf had attained sufficient length, they were introduced under separate receivers, and supplied with carbonic acid. It was soon apparent, however, that the plants growing in the pure rain-water threw off more oxygen than the others, though the difference was slight. The experiment was repeated with the other leaves, as they were successively unfolded, but with no better success.

"The carbonate of lime, or lime in the state it is found as a natural production, was now substituted for the hydrate. Selecting the thin pellicle which collects upon lime-water, and reducing it to a fine powder, as much was previously dissolved in the rain-water in which half of the plants were to grow as could be, by brisk agitation for a few minutes in a closed bottle. The plants to be experimented with being always transferred from the glasses as soon as it was perceived that they had an equal number of roots. Previous to the period at which plants become dependent upon exterior influences, the effect of the carbonate of lime was rather to retard than to quicken the decomposing process; but generally, by the time the second leaf had fully unfolded itself, and always in the case of the third, the greater resistance offered to the touch, and the deeper and more polished tint of green, inspired anticipations of a successful result. When introduced under the receiver, and supplied with carbonic acid, these anticipations were more than fully realized—the plants growing in rain-water in which carbonate of lime had been previously dissolved, giving off two, three, and sometimes four volumes of oxygen to one disengaged by those growing in pure rain-water; and for every volume of oxygen emitted, an equal quantity of carbonic acid disappeared from the jar containing it. These experiments were frequently and carefully repeated with the other plants cultivated in this latitude, until it seemed to be fully ascertained that the influence of the carbonate of lime in the process of vegetable nutrition consists in increasing the action of plants upon the light—in so modifying

their constitution as to dispose them to reflect, under the ordinary defects of climate and season, their natural green; and, by connecting this power with the other and well-known events in the series, viz. the more active decomposition of carbonic acid, whereby more carbon, the basis of vegetable matter, is assimilated, and more oxygen returned to the atmosphere, we obtain, as is conceived, a consistent explanation of the action of lime, both in the promotion of the fertility of the soil, and in the restoration of the air to its purity." *Observations, &c.*, pp. 9, 10.

These interesting experiments have still later been repeated by Dr. Wight, and always with the like results. There can be no question of the care and accuracy with which they have been conducted; and very little ground to object to the conclusiveness of the position which the results demand—that is, that the effect of carbonate of lime, acting through the roots of the plants, enabled them to absorb and to assimilate at least more than a doubled quantity of carbon, and consequently to disengage more than a doubled quantity of oxygen gas, formed by the decomposition of the carbonic acid taken in by the plants. The only apparent defect in the process is one which is unavoidable. This is, that the wheat (or other) plants were made to grow with their roots in water, a situation contrary to their nature and wants; instead of in dry soil, conformable to both. But in naming this unavoidable defect, I do not mean to convey that it can invalidate the results of the experiments, or even reduce their measure in any very important extent.

But there is one deduction which Dr. Wight seems to have made, to which it is scarcely necessary for me to announce my dissent. While I fully admit that he has first indicated, and at least gone far to establish by his experiments, one of the very important properties and powers of calcareous earth, as a fertilizing manure (and also as a sanitary agent), still I do not agree that this is its sole or even the most important mode of operating, for either end.

The bearing of Dr. Wight's experiments on the effect of calcareous manures in preserving health, will be referred to when that subject shall come under consideration. All reference to this branch of the subject in this chapter was incidental and in advance of the designed and more appropriate place.

The power given by calcareous earth to plants to draw carbonic acid much more copiously from the atmosphere, which Dr. Wight so admirably deduced from actual experiments, might previously have been inferred from the observations of alleged facts made by practical cultivators. But the statement, hidden in the German of the agricultural chemist Sprengel, probably first was disclosed in this country in the recently published "Lectures" of Johnston, whose words I will quote. This author, referring to Sprengel, says: "He states that it has very frequently been observed in

Holstein, that if, on an extent of level ground sown with corn, some fields be marled and others left unmarled, the corn on the latter portions will grow *less luxuriantly*, and will *yield a poorer crop than if the whole had been unmarled*. Hence, he adds, if the occupier of the unmarled field would not have a succession of poor crops, he must marl *his* land also.

"Can it really be," continues Johnston, "that Nature thus rewards the diligent and the improver? Do the plants which grow on a soil in higher condition take from the air more than their due share of the carbonic acid or other vegetable food it may contain, and leave to the tenants of the poorer soil a less proportion than they might otherwise draw from it?" (p. 101.) Like most other readers, probably, I cannot venture to answer these questions affirmatively. But if indeed calcareous earth in soil gives to plants the power to seize upon and assimilate a much larger amount of carbonic acid, it may well follow that other adjacent plants, not so endowed, may in the contest fail to obtain their previously due share of the always very small proportion of carbonic acid gas in the atmosphere.

In connexion with these interesting statements, I will add another, which is fully believed by many persons, and which I have also heard asserted by one of the best practical farmers of Virginia, and who is also an intelligent and judicious observer. The opinion referred to is, that if a narrow strip of a clover-field be omitted, for experiment and observation, when all the adjoining ground is dressed with gypsum (sulphate of lime), and the manure acts well, that the omitted strip will produce worse clover than it would have done if no gypsum was near. The farmers who maintain this proposition, do so simply upon having observed (as they conceive) such facts. They had no theoretical views to support by such a fact, and indeed they did not pretend to offer a supposed cause for such an effect. For my own part, I have had no opportunity of observing any such facts, and will neither affirm nor deny such to have been accurately observed by others. But such results seemed so unsupported by reason, that at first I deemed the observations mistaken, and the statements not worth any consideration. But by applying the obvious deductions from Dr. Wight's experiments, these before (supposed) irrational and incredible results may appear well sustained, both in regard to their accuracy and their causation.

2. *Lime in soil increases the effect of azotized manures, and, through leguminous plants, draws azote also from the atmosphere.*

The quantity of carbon in plants, or in different products of plants, amounts, in some subjects, to more than one-half of the whole weight of the dry plant or product; and in all other cases it

falls not much below that proportion. According to Professor Liebig, the whole of the carbon in plants is derived, through their leaves, from the atmosphere; and Boussingault, whose authority I respect much more highly, says: "From all we have seen up to this time, we feel authorized to conclude that the greater proportion, if not the whole, of the carbon which enters into the composition of vegetables, is derived from the atmosphere." (p. 42.) All other chemical authorities concur in maintaining that at least much the larger part of the carbon received by and fixed in plants, is taken from the atmosphere through the leaves. How very great, then, must be the proportion of vegetable nutriment and support, and of materials for growth and increase, derived exclusively from the air! For it is not only that nearly half their quantity is thus obtained in their carbon alone, and they also take up from water, whether in the air or in the soil, nearly as much as of carbon, in hydrogen and oxygen; which, though always present in enormous superabundance, cannot be thus used by plants, except in strict proportion to the carbon assimilated. All these quantities, then, which the atmosphere supplies either exclusively, or may supply, as in regard to water, probably amount always to full four-fifths of the substance of all vegetable products; leaving but one-fifth, at most, to be derived from the soil, or having any direct dependence on the condition of fertility of the soil.

Further: of this small proportion of vegetable growth and substance derived from and dependent on the contents of the soil—say one-fifth, at most, and generally not more than one-tenth part—a quantity which varies much in different plants, but on an average making more than half of this proportion derived from the soil alone, consists of inorganic elements; while the remainder, of about 1 to 4 per cent. only of the whole plant, is of azote, which is either wholly or principally a part of the matter derived from the contents of the soil. (See Table on p. 244.) Yet is this very small supply of azote all-important to the support and product of plants; and its being duly supplied in organic manures, or otherwise, is the great and essential operation of all improvement of crops through the improvement of soils. In considering, then, the value of azote, we must take care not to measure its importance by its always small quantity in soils, manures, or plants, but by the great and essential operation of this element, and which even in this small quantity it produces. Azote is eminently the enriching part of all putrescent manures, and of all vegetable products serving as food for animals. The most enriching of animal manures abound most in azote; and, above all, the excrements of carnivorous animals, whose food is also rich in azote. Next in order stand the excrements of animals fed on the most highly azotized vegetable food. Vegetable matters, compared to animal, in general have but

little azote; and, as we all know, when used alone, make much poorer manure. But even among different vegetables forming ordinary farm products, there are great differences in their proportions of azote, and also in their sources of supply of this rich ingredient; and according to such differences are the respective values of crops for food, and more especially their powers as improvers or exhausters of the soils on which they grow. The investigation and attempt at elucidation of this last branch of the subject is the object of the next following pages.

Boussingault reports (from the results of analyses by himself and Payen, in conjunction) the proportions of azote contained in numerous vegetable and animal substances (at p. 297, *Rural Economy*), from which the following extracts of some ordinary manuring materials will serve as examples:—

Ordinary farm-yard manure, 100 parts, dry, contained of azote	1.95
Richer manure, from an inn-yard	2.08
Wheat-straw of Alsace [presumed from ordinary soil]	0.30
Do., from environs of Paris [presumed much richer soil]	0.53
Rye-straw of Alsace	0.20
Do., environs of Paris	0.50
Oat-straw	0.36
Barley-straw	0.26
Wheat-chaff	0.94
Pea-straw [or vines, &c.]	1.95
Clover roots	1.77
Oilcake of flax-seed	6.00
Do. cotton-seed	4.52
Solid cow-dung	2.30
Solid horse-dung	2.21
Guano	6.20
Dried muscular flesh	14.25
Woollen rags	20.26

While I do not deem the azotic as the only fertilizing parts of putrescent manures, nor concur in all that Boussingault seems to claim for their preponderance of operation, still it cannot be denied that the azote of all organic manures constitutes their principal and greatest fertilizing quality. Hence, we may learn, that if by any means, and from new or additional sources, there can be given to plants an additional supply of azote, of which the absolute quantity would be so small as to seem scarcely worth consideration, yet that there would be added relatively as much amount of manuring value as a larger dressing of ordinary manure could supply. And a due consideration of these premises will serve to increase the estimate

of the importance of the sources of supplies of azote which will be indicated.\*

Azote is mostly derived by plants from the soil and through their roots. This is made evident by the obvious effects of all putrescent manures, and the superior effects of those known to be richest in azote. But it seems from some delicate and careful experiments of Boussingault's, that some particular plants, and, as far as known, those belonging to the leguminous or pod-bearing kind only, possess the power of also deriving azote from the atmosphere. This power, if certain, would be enough to explain the reason of the well known and peculiar value of leguminous plants as manuring crops.

This eminent chemist and practical agriculturist sowed known quantities of the seeds of different kinds of plants in artificial soils, composed of either burnt clay or silicious sand, which had been deprived of all azotic and other alimentary manuring principles by sufficient exposure to a high degree of heat. In other cases, young plants were removed from natural soils to such artificial soil, after being completely cleared of all adhering earth. The vessels containing the soils and plants were protected from receiving dust, or anything else from without, and the seeds and plants therein were duly moistened with distilled water. The plants, in some cases, stood until mature; in others, for shorter terms. Finally, the several kinds were analyzed, as had been done of the like kinds of seeds, or transplanted plants, from which they grew, and the differences of contents noted (omitting the ashes, or inorganic parts), as shown in the following summary of the results:—

---

\* Ordinary barn-yard manure, which has been heaped, partially fermented, and is half rotted, is the kind which M. Boussingault used on his farm and in his analyses. Such manure was considerably richer than ours, made with fewer and worse-fed cattle, compared to the large proportion of litter, and used without being heaped or fermented. His manure, also, in a heap, would necessarily have less water: Yet he estimates the water alone at from 75 to 80 per cent. of his manure. Of course, when dried, as stated in the preceding table, 100 parts of such manure is equal to at least 400 parts in the heap; and, therefore, these 400 parts in ordinary condition contain only 1.95 parts of azote—or less than the half of one per cent. serving to constitute the principal enriching value of the manure.

	Weight (grams.)	Carbon.	Hydrogen.	Oxygen.	Azote.
1st. Clover seed sown	24.48 consisting of	12.44	1.466	8.815	1.769
Plants at 3 months, from same	63.38	32.141	4.183	24.155	2.406
Gain by growth . . . . .	38.90	+19.70	+2.717	+15.840	+0.649
2d. Peas sown . . . . .	16.549	7.950	1.065	6.523	0.710
Plants (with seeds ripe) from same . . . . .	68.560	36.680	4.334	25.930	1.550
Gain by growth . . . . .	52.02	+28.73	+3.319	+19.11	+0.849
3d. Wheat seed sown . . . . .	25.38	11.84	1.46	11.19	0.87
Plants from same, at 14 to 15 inches high . . . . .	45.65	22.47	2.67	20.57	0.92
Gain by growth . . . . .	21.27	+10.63	+1.21	+9.38	+0.05
4th. Young clover plants . . . . .	13.64	5.92	0.74	6.46	0.50
Same after 68 days' growth . . . . .	34.96	18.52	2.23	13.32	0.864
Gain by growth . . . . .	21.32	+12.60	+1.49	+6.86	+0.35
5th. Young oat plants . . . . .		12.967	1.636	8.770	0.910
Same after 48 days' growth . . . . .		23.157	2.979	21.180	0.818
Gain and loss in growth . . . . .		+10.190	+1.343	+12.410	-0.062

The above table is an epitome of the results of the five experiments which, with the full explanations, occupy about five pages of the author's work. The analyses made of seeds and plants at the earliest times, were, of course, of other samples, of like kind and quantities of seeds to those sown, and, as nearly as could be, of the plants, compared to those transplanted. The results show the following facts:—

As the artificial soils were devoid of all organic or nutritive matter, the gains made by the plants were derived entirely from pure (distilled) water, and from the atmosphere. The increase in azote, of course, could have been obtained from the atmosphere only.

Besides the large gains made during growth, by all the plants, of carbon, hydrogen, and oxygen, the clover of 1st experiment increased its azote by more than half the quantity contained in the seeds; in the clover of 4th experiment, the azote of the young plants was nearly doubled; and in 2d experiment, the azote of the peas sown was more than doubled in the crop.

In the growth of wheat, the gain of azote was scarcely appreciable (and, therefore, perhaps doubtful); and in the growth of oats, there was an absolute loss of azote.

The results of these very interesting and apparently very accurate experiments (as seen in the author's full details), exhibit, in a striking manner, how largely all the kinds of plants possess them-



selves of and assimilate carbon, hydrogen, and oxygen, all drawn from water and the air only; and also, that in addition to these elements, the leguminous plants, and these only, drew azote from the air, assimilated or fixed it in their bodies, and thus could give it to the soil as manure. When other plants contain azote, and give it to the soil as manure, they had derived the whole supply previously from the soil, and therefore there was no gain in regard to that richest element. But the leguminous plants, deriving part of their azote from the atmosphere, give so much to the soil, if used as manure, more than the soil had before furnished. This peculiar power of leguminous plants is an important cause of their well-known peculiar value as manuring crops.

It has long been a received and unquestioned opinion among intelligent farmers, that the growth of clover, and other leguminous crops, drew away from the soil less of the fertilizing principles, and returned to it more, than any others. This opinion prevailed in districts where most of the product of clover was usually removed from the fields, as well as in other places where the clover was mostly left on the ground, to be ploughed under as manure. In Lower Virginia, wherever improvements by calcareous manures and by clover have correctly gone together, and however the rotations of crops may differ in other respects, there is one part of the courses of crops generally alike, viz., the succession of—1st, Indian corn; 2d, wheat; 3d, clover; and 4th, wheat. On some farms (of best soil, which only can bear such severe cropping), this is the whole course constituting a four-shift rotation. On others, and more generally, a fifth year is added, of rest, or at most of pasturage only, and interposed between the fourth crop, wheat on clover, and the subsequent recurrence of the first crop in the series, Indian corn. In either case, it is generally believed that the product of the second crop of wheat, sown upon clover turned under as manure, is usually about double that of the first crop of wheat following corn, though the immediately preceding corn crop had received all the prepared putrescent manure given. This great difference of production, however, is not altogether due to the clover manure for the second, or "fallow" crop of wheat, but partly to the circumstance of the first crop of wheat having followed another grain crop, which is a vile succession, and must always lessen the second or immediately succeeding crop more than in proportion to the then actual productive powers of the land. In my own practice, as in general of others, there have been no separate measurements of these two nearest crops of wheat, or any parts thereof, from the same land. But the same estimate of difference has been made upon merely general observation, viz., that the wheat after clover was usually double as much as the previous wheat after corn on the same field. My own putrescent manure, from stable and stock-

pens, has been given exclusively as top-dressing to the clover, which is so much the more in favour of the succeeding wheat.

The scientific and practical farmer as well as able-chemist, Boussingault, has with great care ascertained the usual or average quantities, and also the chemical contents, of the clover and all the other crops of his rotation, so as to make certain the results which with other persons would rest merely on supposition, or loose estimates. On his farm, Bechelbronn in Alsace, he says—"For a long time a five years' rotation has there been adopted in the following order:—

1st year, Potatoes, or beet-root, manured.

2d " Wheat, sown the autumn of the first year; clover in the spring.

3d " Clover, two crops [mown]; the third ploughed in.

4th " Wheat on the clover break; turnips after the wheat.

5th " Oats.

It should be observed of this rotation that the first crop of wheat was preceded by potatoes, a forerunner very favourable to the product of the succeeding wheat; and still more so, as the potato crop had all the manure of the farm. This crop of wheat, to the acre, averaged 20 bushels and 31 lbs. of grain; and of both straw and grain 4029 lbs. The clover following the next year yielded 2 crops of hay, making 4675 lbs. dry (or in state of hay), and a third-crop, ploughed in for manure. It is the usage in Alsace to mow clover very young, when it is just beginning to get in blossom; hence the two mowings must have been removed so early, as to allow the third growth to be as heavy as each of the two first. Counting it then as one-third of the whole, the year's product of clover, if all had been made into hay, would have weighed (4675 + 2337 =) 7012 lbs.; of which one-third only was left on the land as manure. After all this abstraction from the land, and also the prepared manure having been applied to the first crop of the rotation, the wheat following the clover yielded the average of 25 bush. 21 lbs. of grain, and straw and grain together 4979 lbs.

This rotation is general in Alsace; and speaking of general results, M. Boussingault says—"The remarkable effect of clover [as a manure crop] has not failed to arrest the attention of the most unobserving. The wheat crop which comes after our drill crop in Alsace, beets or potatoes, averages from 18 to 20 bushels per acre; but the wheat succeeding clover averages from 23 to 24 bushels." (p. 360.)

There is another important subject for consideration and comparison of clover and other crops (not leguminous), in their relative quantities of roots, stubble, or other residues, or offal parts, left on the land. In the same year (1839), when the season was not propitious to either crop, the residues were taken by M. Boussingault

from equal spaces, and after being perfectly cleared of the adhering earth, were dried, weighed, and also portions of each analyzed. Of the two crops of wheat of that year, averaged, he found the whole residue of stubble and roots to be per acre :

	(from grain, weighing, lbs. 1075)	lbs. 644
Residue of clover		
stubble and roots	(from hay, lbs. 2292)	“ 1838
Residue of oat stubble and roots	(from grain, lbs. 1862)	“ 836

The residues of wheat and oats each contained per acre 2 lbs. of azote only; while the residue of the clover contained 26 lbs. Of course the superiority of the latter in quantity, great as it was over the other residues, was still greater in richness, or quality for manuring.

While all persons have concurred in asserting the meliorating effects of clover and other leguminous crops, there has been as general an erroneous agreement as to the cause of this quality. It has been assumed by our scientific instructors, and their doctrine was received without question, that plants with broad leaves absorbed more carbon from the air, and hence the superiority in this respect of leguminous plants over all of the narrow-leaved tribes. Never was there an opinion more generally admitted on a weaker foundation, or more easy to overthrow. Several cultivated crops, as tobacco, palma-christi, cabbage, turnip, pumpkin, and other like vines, have much broader leaves than any of the legumes; but neither of these has ever been deemed to have any peculiar power for manuring by its growth and decay on the land. Nearly all forest trees also have very broad leaves, and they exhibit no superiority of manuring qualities on that account, whether compared with narrow-leaved trees, or with leguminous crops. But is enough to refer to the numerous analyses of plants reported by chemists, all of which, like those in the table copied on a preceding page (244) go to show that clover, beans, peas, vetches, &c., have in general no larger proportions of carbon than other and even the most exhausting plants. Indeed, of this element there is a close approximation to equal proportions in all plants whose constituent parts have been reported. The proportion usually varies between 45 and 50 per cent. of the whole dry weight of the plant. From all these facts, it may be inferred as being nearly a correct rule, that in general the plants or crops which yield the greatest quantity of total product to the acre, in dry weight, will have taken up (from all sources, and of course mostly from the atmosphere) the largest amount of carbon; and therefore will return more to the land if left to act as manure. We must then look to other powers than that of absorbing carbon for the cause of the superiority of clover as manure—which, as Boussingault says, is out of all proportion

to the quantity of the crop given to the soil. That cause, I presume, will be found partly in the greater product and quantity of residue to the acre than is left by most other crops; but still more because of the greater quantity of azote contained in the residue of roots and stubble, as well as of the crops consumed as forage, or left to be ploughed under, and in both cases, though in different ways, serving as manure to the land.

Of grain crops, or any others which take all their contents of azote from the soil, and, if sold or removed from the farm, those which have taken up and removed the most azote from the land, must be the most exhausting of its fertilizing principles. And such would be the leguminous crops, far beyond all others, if they came under the conditions named, as they contain much the largest quantities of azote. As they are known by observation to be among the least exhausting, even when removed from the farm, that alone would strongly indicate, what Boussingault's experiments have proved, that these crops take a portion, and probably the larger portion, of their azote from the atmosphere. Of course, when returned to the earth as manure, the azote so drawn from the air is so much of supply of the richest principle, in addition to all others contained, in common with other vegetable substances. We can supply barn-yard and other animalized and azotized manures to our farms only in limited and insufficient quantities. But by ploughing in leguminous manuring crops, azote may be furnished to much greater extent.

Field peas, such as are raised in England, and in our Northern States, are varieties of and very like to the kinds we know here only as garden vegetables. These field peas contain even more azote than clover does. Lucerne is also superior to clover in that respect, and European field beans not inferior. All these plants are unsuited to our climate, or unprofitable for culture on extensive spaces.

But we have a leguminous plant, in numerous varieties, native to our country, and little known except in Virginia and the more Southern States, which, as a green manure, and meliorating crop, is scarcely inferior to clover—and for some qualities, and always in more southern regions, is preferable to clover. This is our southern, or "corn-field pea," as commonly called, from being most generally raised as a secondary crop among corn. In truth it is not a *pea*, but a *bean*.\* Of this plant, I know of no chemical analysis. But

---

\* Miller's Gardener's Dictionary states a sufficiently plain distinction between beans and peas, by describing the seeds of the former as "kidney-shaped," and the latter as "roundish." The only pea known to me as a cultivated plant, other than our European garden peas, has very small and "roundish" pale green seeds, in a black pod. Even this is more like the vetch (*vicia sativa*) or our bad weed the "partridge pea," as to seeds and

it may be safely inferred, from its being a legume, from its luxuriance of growth, and also from all of the little careful observation that has been yet directed to it, that our native southern pea or bean is a fertilizer of great value, and whose value in this respect is just beginning to be understood. My own experience of this plant, in field culture, is but a few years old. But it has been so encouraging in the results, that I have already extended this growth, so as to make it occupy an entire field, and to make an important part of my rotation. It is too soon yet to rely on such recent facts and observations. But so far as tested by my experience, I have every reason to value highly this as a manuring crop, and especially as a preparatory crop for wheat.\*

If this plant was not an annual, and requiring (when sown separately as a fallow or manure crop) to have the land ploughed for its seeding, it would be more valuable than clover. This defect is however in one aspect an advantage; as we can raise the crop in three or four months from the seeding, to the state of full growth fit for ploughing under, with more certainty of success, both in the standing and producing, than with clover in sixteen months from the sowing. Farther south, the growth and production of the bean crop becomes better, in proportion as clover becomes more precarious and generally unproductive.

In the preceding pages I have endeavoured to explain and to establish these opinions:

1. That azote, the smallest but richest, and for its quantity by far the most important element and ingredient of plants, is derived by most plants exclusively from the soil;

2. That plants of the leguminous tribe, and they alone, so far as known, possess and exert the power also to draw azote directly from the atmosphere, assimilate and fix in their bodies this richest material, and to give it as manure to the soil on which they grow, and are left to decay;

3. That owing to this peculiar power, leguminous plants are the most highly enriching to soil, as manure.

---

Pods, than to any known pea. But unlike the vetch, it is not a vine, but a shrub.

\* The varieties of these beans are innumerable. The most common and best known as an excellent table vegetable, is the "black-eyed pea," of which the seed is white with a black spot around the eye or germ. This name, made doubly incorrect, is extended in common parlance, and in lists of prices-current, to all the varieties of this crop, and seeds of various colours. All the white kinds are the least valuable for green manuring crops, because producing least vine and leaf. The greatest "runners," or producers of vines, and making the heaviest cover to the ground, are all late peas, and either black, red, or pale buff colour. There are many varieties, with differences of time and manner of growth, even of these colours; and the seeds of one colour not distinguishable from other kinds of like colour.

And that the important benefits thus to be derived are available only through the aid of lime in soil, is the important deduction from the foregoing positions, as premises, which I now design to maintain.

It is not necessary to repeat the many statements, in the foregoing portion of this essay, of the peculiar and all-important aid and support which calcareous matter in soils furnishes for the growth and luxuriance of leguminous plants especially. In some small proportion, lime in soil is essential to the life of all plants, and to even the poorest product from all cultivated crops. In larger, though it may still be but very small proportion, it further and greatly improves the growth and production of all cultivated crops, and all except acid plants. And lime in greater quantity still, in amount serving to constitute truly calcareous soil, is especially promotive of the vigour and luxuriance of growth of all leguminous plants, and even essential to the existence of some of them. Saint-foin, a valuable forage plant of highly calcareous lands in Europe, cannot live in any natural (non-calcareous) soil of our Atlantic slope. Lucerne, for the same reason, rarely thrives here, and never except in the best artificial soils. Red clover, the chief of manuring and forage plants, and which now serves as one of the principal and essential elements of our present improving agricultural system, in connexion with the use of calcareous manures, had no existence and could not exist in field culture in the tide-water region before the fitting the soils for its support, by the use of marl and lime.

To the next most important legume and manuring plant, our field pea or bean, lime in quantity is as much conducive to its greatest production, as to clover; but it is not so essential for the existence, and moderate productiveness, of this kind of bean.

### 3. *Operation of calcareous earth to produce nitrates in soil, and compost heaps.*

In sundry marginal notes to the foregoing pages, the recent words or opinions of Prof. Johnston have been quoted, to show their concurrence with my own earlier stated positions. It is highly gratifying to me that such confirmation, having such authority, may be adduced to support nearly every deduction of mine that bears strongly upon, or would either direct or divert practical operations. His lecture "on the use of lime as a manure," especially offers a copious mass of information on this subject, both scientific and practical, which is generally correct, and more instructive than all that had been before published by preceding English chemists and agriculturists. When so many points of agreement appear of this scientific work with mine, which has so little pretension to science, it is well that my priority of publication must secure me from any possible charge of plagiarism. I am altogether unqualified

to judge of many of the chemical doctrines and facts presented by Johnston; but infer that they are among the unquestioned results of the latest and ablest chemical researches. As a matter of course, the scientific author may be supposed to have no personal acquaintance with practical farming. But his numerous agricultural facts, though received from other persons, are not less the fruits of practice and observation, and therefore are worthy of much respect, even when not to be admitted as conclusive. Though knowing nothing of this author, except from his book, and confessedly unfit to decide on the correctness of many of its scientific positions, still I accept this work as the latest and fullest embodiment and digest of the now received doctrines of agricultural chemistry in Europe, and of agriculture in England; and so esteeming the work, it will be again referred to, as has been done before, whether for support of my own positions, as in many previous citations—or to derive new lights and information, as now,—or to oppose or refute, as has been attempted in other cases.

This section will present additional effects and valuable operations of calcareous manures, for which subjects, either wholly or in part, I am indebted to Johnston, and to whom the credit due will be particularly as well as thus generally awarded. The most interesting and important of such new or additional positions, is the power of calcareous earth, in soil, or in compost heaps of manure, to form nitrates from atmospheric supply of material.

The same two elements, oxygen and nitrogen, which when intermixed in gaseous form, and in certain uniform proportions, serve to make atmospheric air, will, when chemically combined, constitute nitric acid. Such combination is produced by electricity. "It is known," says Boussingault, "that so often as a succession of electrical sparks passes through moist air, there is formation and combination of nitric acid and ammonia. Now nitrate of ammonia is one of the constant ingredients in the rain of thunder-storms." (p. 494.) "The currents of electricity which in nature traverse the atmosphere must produce the same effect [of forming nitric acid], and the passage of each flash of lightning through the air must be attended by the formation of some portion of this acid." (Johnston, p. 160.)

Ammonia, the volatile or acriform alkali, is a chemical compound of nitrogen (azote), one of the two elements of atmospheric air, and hydrogen, one of the two elements of water. Hence, of ammonia, as of nitric acid, there are in the ordinary moist air of the atmosphere, the most abundant materials for both these compound products. There is wanting only the agency for their formation, which is exercised by nature only (as by lightning), and that sparingly, though incessantly, in some or other regions of the atmosphere. Both ammonia and the nitrates (the certain and imme-

diate products of nitric acid on the soil), are well known to be highly fertilizing. The foregoing passages show (besides other known sources) that the air supplies both, and that the surface of the earth, everywhere, is sure to be more or less supplied from the air, with ammonia and nitric acid. Nitrogen, which is one of the two constituent parts of both these fertilizing compounds, is also the richest and the most important element (for the small proportion required), in the nutriment of plants, and the most powerful promoter of their luxuriance and perfection of growth. It may be inferred, that it is by furnishing their element nitrogen to plants, that both ammonia and the nitrates are such important aids to vegetable growth, and to the fertility of soils. Ammonia is produced and evolved in large quantity by the putrefaction of all animal substances. Also, "during the decay of vegetable substances in moist air, ammonia is formed at the expense of the hydrogen of the water and of the nitrogen of the air. In consequence of, or in connexion with, such decay, nitric acid is also largely produced in nature."—(Johnston, p. 161.)

"The most familiar, as well as the most instructive examples of this formation of nitric acid, is in the artificial nitre-beds of France and the north of Europe. These are formed of earth [calcareous in part], stable manure, or other animal and vegetable matters, the mixture laid in ridges, occasionally watered with liquid manure, and turned over, to expose fresh portions to the air. After a time, perhaps once a year, the whole is washed, when the water which comes off is found to contain a variable quantity of the nitrates of potash, soda, lime, and magnesia, which are employed for the manufacture of saltpetre. In these nitre-beds, it has been observed that the production of nitric acid either does not take place at all, or only with extreme slowness, unless animal and vegetable matter be present in considerable proportion. And yet the quantity of nitric acid which is formed is much greater than could be produced by the oxydation of the whole of the nitrogen contained in the organic matters present in the mixture. . . . It appears, therefore, that organic matters are, in our climate, necessary to cause the formation of nitric acid to *commence*; but that after it has begun, it will proceed in the same heap for an indefinite period, and at the expense apparently of the *nitrogen of the air only*.

"Compost heaps [of manure, formed of rich soil, animal manure, and lime or calcareous earth] are in general only *artificial nitre-beds*, often unskilfully prepared, and badly managed, producing, however, a certain quantity of nitrates, to the presence of which, their effect on vegetation may not unfrequently be ascribed. . . . The soils in the plains of India, and in other similar spots in the tropical regions, may be regarded as *natural nitre-beds*, in which the decay of organic matter being vastly more rapid than in our



temperate regions, the production of nitric acid is rapid in proportion."—(Johnston, p. 161.)

Thus, and in other modes, by the presence and agency of calcareous earth, it may be supposed that nitrogen (or azote), which is the essential element of all rich putrescent manures, is continually produced from the atmosphere; and that the results, in nitrates, are given to growing plants, by which they obtain and assimilate the necessary nitrogen, which could not be otherwise obtained, except from large supplies of rich animal manures.

If these views are sound, they lead to most important consequences, and suggest the existence of before unknown enriching and fructifying agencies of lime, continually at work, in drawing rich manure from the air, and giving the supplies to each successive crop of growing plants, so long as the lime and organic matter remain together in the soil.

These views also serve to throw much light on some opinions and facts in reference to the benefits of lime, which I formerly brought before the public, because of their interest, but of which the causes were then left in all their obscurity. One class of facts were presented in the very light limings of La Sarthe, in France, of about 11 bushels only to the acre (though repeated in every round of four crops), and showing undoubted good effects. This was stated in Puviss' "Essay on Lime,"\* which I translated and published in the third volume of the "Farmers' Register." The other facts referred to, doubtless were produced by that publication. Mr. Peter Mellett, of Sumpter, S. C., pursued a similar course of liming, and even with still lighter though more frequent dressings, giving but 2½ bushels to the acre, annually, and yet with satisfactory results, and manifest and progressively increasing improvement of both land and crops.† The process in both cases was to form compost heaps of alternate layers of earth, putrescent manures, and lime in very small proportion. In both cases, the evidences of the results seemed unquestionable. Yet to me, the reported effects then seemed to exceed the operation of all the then known causes, in enormous disproportion. But the difficulties of comprehension will be removed by explanations suggested by the passages quoted above. These compost heaps were in fact nitre-beds; and the lime acted much less by its quantity, and directly, as manure, than by inducing the formation of nitrates, and thereby furnishing supplies of nitrogen to the crops. Another circumstance strengthens this conjecture. Puviss states of this practice, which was extensively

---

\* "*Des differens moyens d'amender le sol,*" in the "*Annales d'Agriculture Française,*" for 1835-6.

† These facts were more fully stated in my "Report of the Agricultural Survey of South Carolina," made in 1843, under the order and appointment of the government of that State.

in use in Normandy, that the longer the compost heaps were kept before being carried out as manure, and the more often they were out down, the parts mixed, and again heaped, the richer and more efficient would be the manure. Now this seemed scarcely less strange than the general result. For, after as many mixings and turnings of the mass as would serve for thoroughly separating each ingredient, and mingling the whole together, with enough of time for the combining chemical action between the different elements, there appeared no reason why the compound mass could gain more in richness, and the putrescent parts would probably lose, by continued exposure and further decomposition. But even if such were the case as to the original materials of the compost, yet doubtless the formation of nitrates continued, and their quantity was increased with every new exposure of surface, and through the whole course of time.

Under these impressions, I now deem much more valuable and worthy of imitation the very light limings, in compost, of La Sarthe; and as especially suitable when a farm throughout has once been well calxed, and it is yet too soon to repeat the application in any considerable quantity. This plan, of very light limings, in compost, offers ample remuneration for using lime as manure in localities so distant from the source of supply, that the carriage of enough for ordinary dressings might be more expensive than profitable.\*

### § III. *Improving the health, and promoting the vigour and perfection of plants.*

The beneficial effects of calxing are not to be measured by the mere increase of the bulk or quantity of products, and still less in comparison with crops on similar land not yet calxed, in seasons when both lands, according to their different qualities, yield well. The addition of calcareous earth, when before greatly deficient, serves to so improve the fitness of the land for vegetable production, that

---

\* It may be of use to some readers, who have no access to either of the works above referred to, to state here concisely the mode of making this compost in Normandy, and also in Belgium, as reported by Puvis. He says:—"There is first made a bed of earth, mould, or turf [peat], of a foot or thereabout in thickness. The lumps are chopped down, and then is spread over a layer of unslaked lime, of a hectolitre [ $2\frac{1}{4}$  bushels] for every 20 cubic feet of earth. Upon this lime is to be placed another layer of earth [of like kind], equal in thickness to the first, then a second layer of lime; and then the heap is finished by a third layer of earth." As soon as the lime is fully slaked, by the moisture of the earth, "the heap is cut down, and well mixed; and this operation is repeated afterwards, before using the manure, which is postponed as long as possible, because the power of the effect on the soil is increased with the age of the compost, and especially if it has been made with earth containing much vegetable mould."

all plants grown thereon will be more healthy, more able to resist all causes of disease and disaster, to bear up unhurt under injuries of season, insects, &c., which would have either destroyed, or greatly injured the feebler and diseased growth of a soil deficient in lime. Plants thus receive that endowment which in regard to animals is called a *good physical constitution*. And the difference between the possession of this good constitution and the want of it, whether in animals or plants, in most times for comparison, would be as the difference between perfect health and full ability on the one side, and of disease or decay on the other.

In this aspect, the superiority of product from calxed land, however great it may be over the uncalxed, in any particular season not disastrous to the growth of either, is of less account and value than the ability of the former to maintain good products, under circumstances of injury which would greatly reduce the production of the latter.

In addition to this much greater certainty of calxed land producing crops proportioned to its fertility, than of the un-calxed, in proportion to its lesser rate there is the further advantage that the growth of the former is in comparison more perfect and more valuable than would be indicated by mere quantities. The grain of wheat is heavier to the measure, has a thinner skin, and yields more flour, on calxed soils, or those naturally calcareous; "while this flour is said also to be richer in gluten," and of course will make more and better bread.—(Johnston, p. 391.) These benefits are in addition to the greater quantity and also the greater certainty of production. Though the millers of this country have been slow to learn these truths, still they are beginning to know that the wheat produced on calxed lands is the most valuable. Johnston says that liming "improves the quality of almost every cultivated crop."—"All fodder [grass, &c.], whether natural or artificial, is said to be sounder and more nourishing when grown upon land to which lime has been abundantly applied."—"Potatoes are made more mealy and palatable, especially on moist lands needing draining. Turnips, peas, and beans are also improved for food, in addition to the increase of crops."

## CHAPTER XXV.

### THE USE OF CALCAREOUS EARTH RECOMMENDED TO PRESERVE PUTRESCENT MANURES, AND TO PROMOTE CLEANLINESS AND HEALTH.

THE operation of calcareous earth in enriching barren soils has been, in a former part of this essay, ascribed mainly to the chemical power possessed by that earth of combining with putrescent matters, or with the products of their decomposition; and in that manner preserving them from waste, for the use of the soil, and for the food of growing plants. That power was exemplified by the details of an experiment (page 95), in which the carcass of an animal was so acted on, and its enriching properties secured. That trial of the putrefaction of animal matter in contact with calcareous earth, was commenced with a view to results very different from those which were obtained. Darwin says that *nitrous acid* is produced in the process of fermentation, and he supposes the *nitrate of lime* to be very serviceable to vegetation.\* As the nitrous acid is a gas, it must pass off into the air, under ordinary circumstances, as fast as it is formed, and be entirely lost. But as it is strongly attracted by lime, it was supposed that a cover of calcareous earth would arrest it, and form a new combination, which, if not precisely nitrate of lime, would at least be composed of the same elements, though in different proportions. To ascertain whether any such combination had taken place, when the manure was used, a handful of the marl was taken, which had been in immediate contact with the carcass, and thrown into a glass of hot water. After remaining half an hour, the fluid was poured off, filtered, and evaporated, and left a considerable proportion of a white soluble salt (supposed eight or ten grains). I could not ascertain its kind; but it was not deliquescent, and therefore could not have been the nitrate of lime. The spot on which the carcass lay was so strongly impregnated by this salt, that it remained bare of vegetation for several years, and until the field was ploughed for cultivation.

But whatever were the products of decomposition saved by this experiment, the absence of all offensive effluvia throughout the process sufficiently proved that little or nothing was lost, as every atom must be, when flesh putrefies in the open air; and I presume that a cover of equal thickness of clay, or sand, or any mixture of both, without calcareous earth, would have had very little effect

---

\* Darwin's *Phytologia*, pp. 210 and 224. Dublin edition.

in arresting and retaining the aeriform products of putrefaction. All the circumstances of this experiment, and particularly the good effect exhibited by the manure when put to use, proved the propriety of extending a similar practice. In the neighbourhood of towns, or wherever else the carcasses of animals, or any other animal substances subject to rapid and wasteful putrefaction, can be obtained in great quantity, all their enriching powers might be secured, by depositing them between layers of marl, or calcareous earth in any other form. It is said that on the borders of the Chowan, herrings are often used as manure, when purchasers cannot take off the quantities supplied by the seines. A herring is buried under each corn-hill, and fine crops are thus made as far as this singular mode of manuring is extended. But whatever benefits have been thus derived, the sense of smelling, as well as the known chemical products of the process of animal putrefaction, make it certain that nine-tenths of all this rich manure, when so applied, must be wasted in the air. If those who fortunately possess this supply of animal manure would cause the fermentation to take place and be completely mixed with and enclosed by marl, in pits of suitable size, they would increase prodigiously both the amount and permanency of their acting animal manure, besides obtaining the benefit of the calcareous earth mixed with it.\*

But without regarding such uncommon or abundant sources for supplying animal matter, every farmer may considerably increase his stock of putrescent manure by using the preservative power of marl; and all the substances that might be so saved are not only now lost to the land, but serve to contaminate the air while putrefying, and perhaps to engender disease. The last consideration is of most importance to towns, though worthy of attention everywhere. Whoever will make the trial will be surprised to find how much putrescent matter may be collected from the dwelling-house, kitchen, and laundry of a family; and which if accumulated (without mixture with calcareous earth), would soon become so offensive as to show the necessity of putting an end to the practice. Yet it must be admitted that when all such matters are scattered about (as is usual both in town and country), over an extended surface, the same putrefaction must ensue, and the same noxious effluvia be evolved, though not enough concentrated to be very offensive, or even always perceptible. The same amount is in-

---

\* I have since heard that this mode of manuring, but with the garbage of the herrings, is a general and very extensive practice on the borders of Albemarle Sound. By the enormous seines there used, herrings are taken in numbers that seem scarcely credible; and all the fish are trimmed and salted at the fisheries. This great and regular supply of garbage used as manure, is of great value, even with all the usual waste in the air; but would be of ten-fold value if treated as recommended above.

haled—but in a very diluted state, and in small though incessantly repeated doses. But if mild calcareous earth in any form (and fossil shells or marl present much the cheapest) is used to cover and mix with the putrescent matters so collected, they will be prevented from discharging offensive effluvia, and preserved to enrich the soil. A malignant and ever acting enemy will be converted to a friend and benefactor.

The usual dispersion and waste of such putrescent and excrementitious matters about a farm-house, though a considerable loss to agriculture, may take place without being very offensive to the senses, or manifestly injurious to health. But the case is widely different in towns. There, unless great care is continually used to remove or destroy filth of every kind, it soon becomes offensive, if not pestilential. During the summer of 1832, when that most horrible scourge of the human race, the Asiatic cholera, was desolating some of the towns of the United States, and all were expected to be visited by its fatal ravages, great and unusual exertions were everywhere used to remove and prevent the accumulation of filth, which, if allowed to remain, it was supposed would invite the approach, and aid the effects of the pestilence. The efforts made for that purpose served to show what a vast amount of putrescent matter existed in every town, and which was so rapidly reproduced, that its complete riddance was impossible. Immense quantities of the richest manures, or materials for them, were washed away into the rivers—caustic lime was used to destroy them—and the chloride of lime to decompose the offensive products of their fermentation, when that process had already occurred. All this amount of labour and expense was directed to the complete destruction of what might have given fertility to many adjacent fields—and yet served to cleanse the towns but imperfectly, and for a very short time. Yet the object in view might have been better attained by the previous adoption of the proper means for preserving these putrescent matters, than by destroying them. These means would be to mix or cover all accumulations of such matters with rich marl (which would be the better for the purpose if its shells were in small particles), and in such quantity as the effect would show to be sufficient. But much the greater part of the filth of a town is not, and cannot be accumulated; and from being dispersed is the most difficult to remove, and is probably the most noxious in its usual course of fermentation. This would be guarded against by covering thickly with marl the floor of every cellar and stable, back-yard and stable lot. Every other vacant space should be lightly covered. The same course pursued on the gardens and other cultivated grounds would be sufficiently compensated by their increased products that would be obtained. But independent of that consideration, the manures there applied would be prevented from escaping

into the air; and being wholly retained by the soil, much smaller applications would serve. The level streets ought also to be sprinkled with marl, and as often as circumstances might require. The various putrescent matters usually left in the streets of a town alone serve to make the dirt scraped from them a valuable manure; for the principal part of the bulk of street dirt is composed merely of the barren clay brought in upon the wheels of wagons from the country roads. Such a cover of calcareous earth would be the most effectual absorbent and preserver of putrescent matter, as well as the cheapest mode of keeping a town always clean. There would be less noxious or offensive effluvia than is generated in spite of all the ordinary means of prevention; and by scraping up and removing the marl after it had combined with and secured enough of putrescent matter, a compost would be obtained for the use of the surrounding country, so rich and so abundant, that its use would repay a large part, if not the whole of the expense incurred in its production. Probably one covering of marl for each year would serve for most yards, cellars, &c.; but if required oftener, it would only prove the necessity for the operation, and show the greater value in the results. The compost that might be obtained from spaces equal to 500 acres, in a populous town, would durably enrich thrice as many acres of the adjacent country; and after twenty years of such a course, the surrounding farms might be capable of returning to the town a ten-fold increased surplus product. After the qualities and value of the manure so formed were properly appreciated, it would be used for farms that would be out of the reach of all other calcareous manures. Carts bringing country produce to market might with profit carry back loads of this compost eight or ten miles. The annual supply that the country might be furnished with would produce very different effects from the putrescent and fleeting manure now obtained from the town stables. Of the little durable benefit heretofore derived from such means, the appearance of the country offers sufficient testimony. At three miles distance from some of the principal towns in Virginia, more than half the cultivated land is too poor to yield any farming profit. The surplus grain sent to market is very inconsiderable—and the coarse hay from the wet natural meadows can only be sold to tavern-keepers, or those who feed horses belonging to other persons—and to whom that hay is the most desirable that is least likely to be eaten.

But even if the waste and destruction of manure in towns were counted as nothing, and the preservation of health by keeping the air pure were the only object sought, still calcareous earth, as presented by rich marl, would serve the purpose far better than quick-lime. It is true that the latter substance acts powerfully in decomposing putrescent animal matter, and destroys its texture

and qualities so completely, that the operation is commonly and expressively called "burning" the substances acted on. But to use a sufficient quantity of quick-lime to meet and decompose all putrescent animal matters in a town would be intolerably expensive, and still more objectionable in other respects. If a cover of dry quick-lime in powder was spread over all the surfaces requiring it for this purpose, the town would be unfit to live in; and the nuisance would be scarcely less, when rain had changed the suffocating dust to an adhesive mortar. Woollen clothing, carpets, and even living flesh, would be continually sustaining injury from the contact. No such objections would attend the use of mild calcareous earth; and this could be obtained probably for less than one-third of the cost of quick-lime, supposing an equal quantity of pure calcareous matter to be obtained in each case. At this time the richest marl on James river may be obtained at merely the cost of digging, and its carriage by water, which, if undertaken on a large scale, could not exceed, and probably would not equal, two cents the bushel.\*

The putrescent animal matters that would be preserved and rendered innocuous by the general marling of the site of a town, would be mostly such as are so dispersed and imperceptible that they would otherwise be entirely lost. But all such as are usually saved in part would be doubled in quantity and value, and deprived of their offensive and noxious qualities, by being kept mixed with calcareous earth. The importance of this plan being adopted with the products of privies, &c., is still greater in town than country. The various matters so collected and combined should never be applied to the soil alone, as the salt derived from the kitchen, and the potash and soap from the laundry, might be injurious in so concentrated a form. When the pit for receiving this compound is emptied, the contents should be spread over other and weaker manure before being applied to the field.

Towns might furnish many other kinds of rich manure, which are now lost entirely. Some of these particularly require the aid of calcareous earth to be secured from destruction by putrefaction, and others, though not putrescent, are equally wasted. The blood of slaughtered animals, and the waste and rejected articles of wool, hair, feathers, skin, horn, and bones, all are manures of great richness. We not only give the flesh of dead animals to infect the air, instead of using it to fertilize the land, but their bones, which might be so easily saved, are as completely thrown away. Bones are composed of phosphate of lime and gelatinous animal matter,

---

\* Such was the case in 1833 when this part was first published; but now a half cent the bushel is the usual price charged for the best marl, as it lies in the river banks.



and, when crushed, form one of the richest and most convenient manures in the world: They are shipped in quantities from the continent of Europe, and latterly even from this country, to be sold for manure in England. The fields of battle have been gleaned, and their shallow graves emptied for this purpose: and the bones of the ten thousand British heroes, who fell on the field of Waterloo, are now performing the less glorious, but more useful purpose of producing, as manure, bread for their brothers at home.

There prevails a vulgar but useful superstition, that there is "bad luck" in throwing into the fire anything, however small may be its amount or value, that can serve for the food of any living animal. It is a pity that the same belief does not extend to every thing that as manure can serve to feed growing plants—and that even the parings of nails and clippings of beards are not saved (as in China) for this purpose. - However small each particular source might be, the amount of all the manures that might be saved, and which are now wasted, would add incalculably to the usual means for fertilization. Human excrement, which is scarcely used at all in this country, is stated to be even richer than that of birds; and if all the enriching matters were preserved that are derived not only from the food, but from all the habits of man, there can be no question but that a town of ten thousand inhabitants, from those sources alone, might enrich more land than can be done from as many cattle.

The opinions here presented are principally founded on the theory of the operation of calcareous manures, as maintained in the foregoing part of this Essay (Chap. VIII.), but they are also sustained to considerable extent by facts and experience. The most undeniable practical proof of one of my positions is the power of a cover of marl to prevent the escape of all offensive effluvia from the most putrescent animal matters. Of this power I have long made use, and know it to be more effectual than quick-lime, even if the destructive action of the latter were not objectionable. Quick-lime forms new combinations with putrescent substances, and, in thus combining, throws off effluvia, which, though different from the products of putrescent matter alone, are still disagreeable and offensive. Mild lime on the contrary absorbs and preserves everything—or at least prevents the escape of any offensive odour being perceived. Whether putrescent vegetable matter is acted on in like manner by calcareous earth cannot be as well tested by our senses, and therefore the proof is less satisfactory. But if it is true that calcareous earth acts by combining putrescent matters with the soil, and thus preventing their loss (as I have endeavoured to prove in Chapter VIII.), it must follow that, to the extent of such combination, the formation and escape of all volatile products of putrefaction will also be prevented.

But it will be considered that the most important inquiry remains to be answered, to wit: Has the application of calcareous manures been found in practice decidedly beneficial to the health of the residents on the land? I answer, that long experience, and the collection and comparison of numerous facts derived from various sources, will be required to remove all doubts from this question; and it would be presumptuous in any individual to offer as sufficient proof, the experience of only ten or twelve years on any one farm. But while admitting the insufficiency of such testimony, I assert that, so far [to 1833], my experience decidedly supports my position. My principal farm [Coggins], until within some four or five years, was subject in a remarkable degree to the common mild autumnal diseases of our low country. Whether it is owing to marling, or other unknown causes, these bilious diseases have since become comparatively very rare. Neither does my opinion in this respect, nor the facts that have occurred on my farm, stand alone. Many other persons are equally convinced of this change on other land as well as on mine. But in most cases where I have made inquiries as to such results, nothing decisive had then been observed. The hope that other persons may be induced to observe and report facts bearing on this important point, has in part caused the first appearance of these crude and perhaps premature views.

Even if my opinions and reasonings should appear sound, I am aware that the practical application is not to be looked for soon; and that the scheme of using marl in towns is more likely to be met by ridicule, than to receive a serious and attentive examination. Notwithstanding this anticipation, and however hopeless of making converts, either of individuals or of corporate bodies, I will offer a few concluding remarks on the most obvious objections to, and benefits of the plan. The objections will all be resolved into one—namely, the expense to be encountered. The expense certainly would be considerable; but it would be amply compensated by the gains and benefits. In the first place, the general use of marl as proposed, for towns, would serve to insure cleanliness, and purity of the air, more than all the labours of their boards of health and their scavengers, even when acting under the dread of approaching pestilence. Secondly, the putrescent manures produced in towns, by being merely preserved from waste, would be increased ten-fold in quantity and value. Thirdly, all existing nuisances and abominations of filth would be at an end; and the beautiful city of Richmond (for example) would not give offence to our nostrils, almost as often as it offers gratification to our eyes. Lastly, the marl (or mild lime), after being used until saturated with putrescent matter, would retain all its first value as calcareous earth, and be well worth purchasing and removing to the adjacent farms, independent of the enriching manure with which it would be

loaded. If these advantages can indeed be obtained, they would be cheaply bought at any price necessary to be encountered for the purpose.

The foregoing part of this chapter was first published in the *Farmers' Register* (for July, 1833), as supplementary to the previous edition of this Essay. That publication drew some attention from others to the subject, and served to elicit many important facts, of which I had been before altogether ignorant, in support of the operation of calcareous earth in arresting the effects of *malaria*, and the usual autumnal diseases of the Southern States and other similar regions. These facts, together with the result of my own personal experience, extended through two more autumns (or sickly seasons, as commonly called here and farther south), since the first publication of these views, will now be submitted. Most of the facts derived from other persons relate to one region, the "rotten lime-stone lands" of southern Alabama; but that region is extensive, is of remarkable and well known character and peculiarities, and the evidence comes from various sources, and is full, and consistent in purport. The facts will be here presented in an abridged form. The several more full communications, from which they are drawn, may be referred to in the *Farmers' Register*, vol. I., pp. 152, 214, and 277.

The first fact brought out was that, in the town of Mobile, near the Gulf of Mexico, the streets actually had been paved or covered with shells—thus presenting precisely such a case as I recommended, though not with any view to promoting cleanliness or health. The shells had been used merely as a substitute for stones, which could not be so cheaply obtained. Nor had the greatly improved healthiness of Mobile, since the streets were so covered (of which there is the most ample and undoubted testimony), been attributed to that cause, until the publication of the foregoing opinions served to connect them as cause and effect. This can scarcely be doubted by those who will admit the theory of the action of calcareous earth; and the remarkable change from unhealthiness in Mobile, to comparative healthiness, is a very strong exemplification of the truth of the theory. But it is not strange, when so many other causes might (and probably did) operate to arrest disease, that none should have considered the chemical operation of the shelly pavement as one of them, and still less as the one by far the most important. The paving of streets (with any material); draining and filling up wet places, substituting for rotting wooden buildings new ones of brick and stone—and especially the operation of destructive and extensive fires—all, we know, operate (and particularly the last) to improve the healthiness of towns; and all these operated at Mobile, as well as shelling the streets. Neither was the shelling so ordered as to produce

its best effect for health. The streets, alleys, and many yards and small vacant lots were covered, and so far the formation and evolving of pestilential effluvia were lessened. But as this was not the object in view, and indeed the chemical action of shells was not thought of, the process was incomplete, and must necessarily have been less effectual than it might have been made. The shelling ought to have been extended to every open spot where filth could accumulate—to every back-yard, in every cellar, and made the material of the floor of every stable, and every other building of which the floor would otherwise be of common earth. In addition, after a sufficient lapse of time to saturate with putrescent matters the upper part of the calcareous layer, and thus to make it a very rich compound, there should have been a partial or total removal of the mass, and a new coating of shells laid down. The value of the old material, as manure, would probably go far towards paying for this renewal. If it is not so renewed, the calcareous matter cannot combine with more than a certain amount of putrescent matters; and, after being so saturated, can have no further effect in saving such matters for use, or preventing them from having their usual evil course.

The burning of towns is well known to be a cause of the healthiness of the places being greatly improved, and that such effect continues after as many buildings, or more, have replaced those destroyed by fire. Indeed this improvement is considered so permanent, as well as considerable, that the most sweeping and destructive conflagrations of some of our southern towns have been afterwards acknowledged to have proved a gain and a blessing. The principal and immediate mode of operation of this universally acknowledged cause is usually supposed to be the total destruction, by the fire, of all filth and putrescent matters; and in a less degree, and more gradually, by afterwards substituting brick and stone for wooden buildings, which are always in a more or less decayed state. But though these reasons have served heretofore to satisfy all, as to the beneficial consequences of fires, surely they are altogether inadequate as causes for such great and durable effects. The mere destruction of all putrescent matters in a town, at any one time, would certainly leave a clear atmosphere, and give strong assurance of health being improved for a short time afterwards. But these matters would be replaced probably in the course of a few months, by the residence of as many inhabitants, and the continuance of the same general habits; and most certainly this cause would lose all its operation by the time the town was rebuilt. But there is one operation produced by the burning of a town, which is far more powerful—which in fact is indirectly the very practice which has been advocated—and the effect of which, if given its due weight, furnishes proof of the theory set forth, by

the experience of every unhealthy town which has suffered much from fire. If a fair estimate is made of the immense quantity of mild calcareous earth which is contained in the plastering and brick-work of even the wooden dwelling-houses of a town, and still more of those built of masonry, it must be admitted that all that material being separated, broken down (soon or late), and spread, by the burning of the houses and pulling down their ruins, is enough to give a very heavy cover of calcareous earth to the whole space of land burnt over. It is to this operation, in a far greater degree than to all others, that I attribute the beneficial effects to health of the burning of towns.

I proceed to the facts derived from the extensive body of prairie lands in Alabama which rest on a substratum of soft lime-stone, or rich indurated clay marl. It was from these remarkable soils that the specimens were obtained which were described at pp. 66, 67. Some of these, indeed all that have been examined by chemical tests, of the high and dry prairie lands, contain calcareous earth in larger proportions than any soils of considerable extent in the United States that I have seen or tested. The specimens not containing free calcareous earth are of the class of neutral soils; and the calcareous earth, which doubtless they formerly contained, and from which they derived their peculiar and valuable qualities, may be supposed only to be concealed by the accumulation of vegetable matter, according to the general views submitted in Chapter VII.

The more full descriptions of the soils of this remarkable and extensive region before referred to render it unnecessary to enlarge much here. It will be sufficient to sum up concisely the facts there exhibited, and which agree with various other private accounts which have been received from undoubted sources of information. The deductions from these facts, and their accordance with the theory of the operation of calcareous matter, are matters of reasoning, and, as such, are submitted to the consideration and judgment of readers.

The soil of these prairie lands is very rich, except the spots where the soft lime-stone rises to the surface, and makes the calcareous ingredient excessive. In the specimen formerly mentioned, the pure calcareous matter formed 59 parts in the 100 of this "bald prairie" land. The soil generally has so little of sand, that nothing but the calcareous matter which enters so largely into its composition prevents it being so stiff and intractable, that its tillage would be almost impracticable. Yet it is friable and light when dry, and easy to till. But the superfluous rain-water cannot sink and pass off, as in sandy or other pervious lands, but is held in this close and highly absorbent soil, which throughout winter is thereby made a deep mire, unfit to prepare for tillage, and scarcely practicable to travel over. This water-holding quality of the soil, and

the nearness to the surface of the hard and impervious marly substratum, deprive the country of natural springs and running streams; and before the important discovery was made that pure water might be obtained by boring from 300 to 700 feet through the solid calcareous rock, the inhabitants used the stagnant rain-water collected in pits, which was very far from being either pure or palatable. Under all these circumstances, added to the rank herbage of millions of acres annually dying and decomposing under a southern sun, it might have been counted on, as almost certain, that such a country would have proved very unhealthy. Yet the reverse is the fact, and in a remarkable degree. The healthiness of this region is so connected with and limited by the calcareous substratum and soil, that it could not escape observation; and they have been considered as cause and effect by those who had no theory to support, and who did not spend a thought upon the mode in which was produced the important result they so readily admitted. Their testimony therefore is in this respect the more valuable, because it cannot be suspected of having any such bias.

To the time when this last publication is made (1842) there has been no reason to doubt the actual facts of autumnal diseases (the effects of *malaria*) being greatly lessened by even the partial use of marling; nor the inference that they would almost cease to occur (if no mill-ponds and undrained lands remained), if all the surface of a considerable extent of country were made calcareous, and all rapidly putrescent and otherwise offensive matter were preserved and kept harmless by being combined with marl, applied from time to time as required. But it should be remembered that, as yet, rapid and extensive as has been the progress of marling in Virginia, there has been no instance of the greater part of any whole neighbourhood of so much as a few miles in extent being marled; nor even of all the surface of any one farm; and that, therefore, we have no means of judging by experience of the full measure of benefit to be derived from such a general change of the character of the soil. The most that has yet been done anywhere is the marling of all the cultivated and arable land; leaving unmarled, and as much as ever the abundant sources of vegetable decomposition and of disease, all the wood-land, steep hill-sides, and the wet bottoms. Now, as the remaining wood-lands are generally among the poorest of our soils, that is, (according to the theory maintained), soils incapable of combining with and retaining the products of decomposition—and as they are covered annually with leaves, which in time all rot and their gaseous products finally pass off into the air—it follows, that the lands so left must be among the most fruitful of malaria. It is obvious that the remedy is but partially and inefficiently in operation, so long as from one-third to one-half

of every farm is left unmarled, and as free as ever to evolve the agent of disease. So sure does this opinion seem to me, that I have commenced acting on it, by marling the wood-land that is not designed to be cleared for cultivation—and shall continue, as more necessary labours permit, to do so, until not an acre of the farm is left without being changed in character by calcareous earth.

It is proper to add, as an opinion founded on but limited experience as yet, that though the cases of sickness on Coggins Point farm have certainly diminished very greatly—there not being one case of late years of bilious disease, where there were twenty formerly—still that the diseases seem to have changed in kind, and to have increased in severity and danger. Formerly, there was almost no sickness except from ague and fever (or, very rarely, a case of mild bilious fever), from which, though few persons escaped through the autumn, and some suffered several relapses, the attacks were rarely dangerous, and required little skill, and but a few days to cure, for that time. Bad as was this state of things, it seemed that the ague and fever acted as a safety-valve to the system, and while it seldom permitted the enjoyment of long-continued robust health, it prevented the occurrence of more dangerous or fatal diseases, such as are the most common among the fewer diseases of what are deemed healthy regions. The fewer diseases of my adult negroes for the last twelve or thirteen years have been of a more inflammatory kind, and are not confined to autumn; and there have been certainly more severe and fatal diseases, and more that required medical aid, than formerly, when there was so much more of sickness of one kind, and confined to one season. In short, it seems that the diseases are no longer (or but in few cases) those of the low country and of a bilious climate, but are more like those of the upper country, which, though occurring but rarely, are generally of a more serious nature. The facts on which this particular opinion has been formed, are still too few, and of too short continuance, to attach to them much importance; and even if they were less doubtful, I have not the medical knowledge to trace these new effects back to their causes. Still, it is deemed due to candour, and to the desire for a fair and full investigation of the subject, even if making against my own views, that these opinions should be stated. There is no other subject, than this, taken in general, which more deserves and requires investigation; and in the present inchoate state of the discussion, the expression of even erroneous opinions will not be useless, if it should serve to elicit more full or correct ones from other sources.

Nothing better than this one subject deserves investigation by medical men, acting under the direction of government. The materials for information are now abundant, in the experience and observation of the numerous farmers who have marled or limed

their lands long enough to judge of the effects on health; and whether upon true or false grounds, the opinion among such persons seems now (1842) almost universal (so far as I have heard opinions expressed), that the prevalence of autumnal diseases, the product of malaria, has been invariably and manifestly lessened since the lands were in part marled or limed. My individual experience and observations on this point, now of nine years' more extent than when the first fruits thereof were stated in a foregoing part of this chapter, concur with the more general and loose information derived from others, in confirming my position. It sometimes happens that the very fact of an opinion being universally admitted prevents the obtaining such proofs of its truth as would certainly have been ready, if the opinion had been questioned and denied by many sceptics. And such is the state of the proposition now under consideration. Even in the few years which have passed since I first advanced the opinion that the use of calcareous manures served to improve health, that opinion has become so general, and is deemed so certain and unquestionable, by those persons who have used those manures, that but few facts can be learned of them sufficiently exact to serve as proofs—because no person has deemed it necessary to collect and preserve proofs of what none doubted. When asking for such proofs, as I have often done, of cultivators and residents in various parts of the marl region, I have rarely obtained any, except new declarations, from every person interrogated, of concurrence and entire faith in the general opinion that marling or liming had served greatly to abate the prevalence of autumnal diseases. Such general belief and confidence in an opinion so recently promulgated, cannot be altogether founded on error. (1842.)

When my opinions of the beneficial operation of calcareous earth in soil, or mixed with putrescent matter, in destroying or disarming the sources of disease, were first published, and until after the second publication of the same in 1835, I had no knowledge that similar grounds had been taken by any other person. But since, in the recent publications of a French writer, M. Puvis, I have found the same general opinion expressed, and many important facts given in confirmation. However, while I gladly accept the important aid of M. Puvis's facts, as proof, I do not admit the correctness of his reasoning thereupon. Some of the former will be quoted in the following passages. For his full views, see the translations of his essays "On Lime as Manure," and "On Marl," both contained in vol. iii. of the Farmers' Register.

"The results of marling may be considered in a point of view more elevated, and still more important than that of the fertility which it gives to the soil; they may perhaps have much influence on the healthiness of a country where it becomes a general practice.



“Although it may not have been yet uttered by others, this opinion appears founded on strong probabilities, on strong analogies and precise facts, all of which appear to give it a sufficient certainty.

“It is known that the calcareous principle is one of the most powerful agents to resist putrefaction. It is employed to make healthy places inhabited by men and animals, in which sickness or contagion is feared; it serves to neutralize the emanations of dead bodies undergoing putrefaction; it destroys the deleterious exhalations which escape from privies, and which sometimes cause the death of those who are employed to cleanse them.

“It even seems that calcareous countries are unhealthy only when they are interspersed with marshes, or when some causes, foreign to the soil and climate, determine the unhealthiness, as in countries on the borders of the sea, where the flowing of the tide and the mingling of salt and fresh waters infect the air, by the deleterious emanations of their combination. This cause of unhealthiness is regarded as a certain fact; for salubrity is generally seen to appear whenever this mixture of waters is prevented.

“In the valleys of rivers bordered by calcareous mountains, which enclose unhealthy countries in their interior, insalubrity commences there only as the calcareous soil, which is attached to the mountain, gives place to silicious soil. In the same plain, and far from a mountain, salubrity is seen to diminish in the same proportion that the calcareous soil of the surface does; and the *communes* of Bresse, which have an abundance of marly or calcareous soils, are much more remarkable for their salubrity than those on the white lands (*terrain blanc*\*). While the ponds of Dombe, which are on the silicious soil, appear to be one of the greatest causes of unhealthiness, those of Bresse, which are on calcareous lands, do not show such effects in the country where they are found; so, likewise, the ponds of the country situated between the Veyle and the Reyssouze, to the north-west of Bourg, which are generally on calcareous soil, do not appear to injure the healthiness of the country in any manner.

“For the support of this system, we will also cite the ponds of Berri on calcareous soil, whose emanations have nothing unhealthy; the laying dry of the ponds of Parraçay, in the canton of Lignieres, has added nothing to the healthiness of a calcareous country na-

---

\* The reader of M. Puvis's essays on lime and marl, which were inserted in vol. iii. of *Farmers' Register*, may remember that this provincial term and others (*plateaux argillo-silicieux*, &c.) were there used to designate a peculiar kind of soil, destitute of calcareous matter, stiff, intractable, and poor—and which seems precisely of the character of the poor ridge lands of lower Virginia, to which calcareous manures are so peculiarly adapted.  
—Translator.

turally healthy. And in the same canton, the pond of Villiers, which is said to be seven leagues in circumference, does not cause diseases on its borders. Besides, during the month of August, the water of the ponds on calcareous soil does not become blackish, as often happens in silicious ponds. The water would then be made wholesome by the calcareous principle, in the same way as their emanations.

"In fine, Dombe and Sologne, and a number of other countries, are unhealthy, and subject to intermittent fevers, without being marshy; but their soil is likewise silicious, and the land moist. Puisaye, and a part of Bresse, in similar land, which contain little or no calcareous soil, have also many autumnal fevers."—*Translation from "Essai sur la Marne."*\*

In addition to these opinions of Puvis, and his facts in regard to France, I may add the later testimony of two other eminent agricultural writers, whose information may be inferred to have been derived from the experience of England and Scotland. In a small pamphlet written by Sir John Sinclair, and dated 1833, on the means for preventing the ill effects of *malaria*,† he names as among the most important the use of calcareous manures. "The effect of burnt limestone," he adds, "in improving the quality of the soil is hardly to be credited. It either absorbs any noxious matter, or annihilates any deleterious properties it possesses; and it may be relied upon as an established fact 'that a soil full of calcareous matter never produces an unwholesome atmosphere.'" And again: "The introduction of immense quantities of calcareous matter into the soil not only contributes to its improvement, but is the best means of preventing malaria."

Professor Johnston, still more recently, speaks as follows: "The liming of the land is the harbinger of health as well as of abundance. It salubrifies no less than it enriches. . . . The lime arrests the noxious effluvia which tend to rise more or less from every soil at certain seasons of the year, decomposes them, or causes their elements to assume new forms of chemical combination, in which they no longer exert the same injurious influence on animal life."—*Lectures, &c.*, pp. 392-3.

Thus there is now good evidence and high authority for this opinion, which I at first advanced with much hesitation and fear; and which then met with distrust or incredulity with almost all

\* This work was published in Paris in 1826. The first known (and probably still the only) copy brought to America, was in 1835, by my order, made soon after seeing M. Puvis's essays on lime and marl in the "*Annales d'Agriculture Française*," both of which I translated and published in the *Farmers' Register*, vol. iii.

† This pamphlet was republished in the *Farmers' Register*, vol. i., p. 556.

who had not experience or information of the sanitary influence of calcareous manures.

But however strong the conviction of these authors of such effects of calcareous manures, they offer no satisfactory explanation of the manner in which the effects are produced. But whether lime, in soil, exerts its health-preserving power by "arresting the noxious effluvia which tend to rise from every soil," &c.—or by absorbing noxious matter, or annihilating any deleterious properties it possesses"—or, according to my previously expressed doctrine, by the power of lime (calx) to combine with the first results of putrefaction, and so fix them in the soil, there to serve only as food for plants—the end is the same, of converting to the purpose of fertilization and production what would otherwise escape into the air in the form of pestilential gases.

The important facts, recently made known by Dr. Wight, as stated in a previous chapter, that the calxing of soil causes the plants grown thereon to absorb from the atmosphere much increased quantities of carbonic acid, and to evolve proportionately increased quantities of oxygen gas, serve to add greatly to the before supposed sanitary operation of calxing land. Both the asserted actions, co-operating, are abundant and satisfactory causes for the beneficial effects to health; and of which effects there can be no longer room to doubt, seeing the testimony adduced from France and England, in addition to all that I had before offered.

---

## CHAPTER XXVI.

### THE EXCAVATION OF MARL PITS, AND CARRYING OUT AND APPLYING OF MARL.

THE natural features of marl beds, and their exposures, are different at almost every locality; and therefore no one manner of working will suit precisely for different diggings. Still, all the marl beds of Virginia may be classed under three heads, in reference to the excavation and removal of the marl.

I. The first class is of marl exposed (or "cropping out") high up on hill-sides, with but little overlying earth to remove for large excavations of the marl below—the marl and the adjacent ground dry and free from springs—and the proper sites for roads, leading to the fields, either descending, or nearly level, or with not much ascent. Marl so lying is often of the richest kind, containing from 60 to more than 80 per cent. of pure shelly matter, and that mostly

finely divided. Many of these richest and also almost easily worked bodies of marl are in the middle range across the rivers and the marl region of Virginia; for example, in the counties of Nansemond, Isle of Wight, Surry, James City, York, New Kent, and the lower part of King William. Under these very favourable circumstances, special directions for working such marls would be superfluous. The labours required are as simple, and almost as cheap, as the digging and carting away of earth from a hill-side to construct a mill-dam.

II. The second class of exposures and diggings is usually of much poorer marl, and attended with much more difficulty and cost than the preceding. In high lands, cut through by deep ravines, or narrow valleys, the natural "out-croppings" of the marl are usually low down the sides, or at the bottoms of steep hill-sides, the marl often wet from springs oozing over the top, and also from water percolating slowly through the mass of marl. The lower adjacent grounds are also wet, by springs or streams. The overlying earth is very thick, and costly to remove; and a steep or a long-ascending road is required to draw the marl to the higher lands where it is to be applied.

In hilly lands, the bed of marl usually "crops out" on the swells, or convex curves of the hill-sides, and thus is naturally exposed to view. If this is at a considerable elevation above the bottom of the ravine or narrow valley which is usually at the foot of the hill, the marl will generally be dry. But its being dry will depend on some one of the following conditions: 1st. When the overlying beds of earth have not enough extent of surface to allow springs to be formed by infiltration of rain-water; or there is no impervious bed, either of the marl or its overlay, on which spring water can be borne, if it flows from distant sources: 2d. Or even if there be any such impervious and water-bearing stratum, that its "dip" is in a direction leading from the "out-cropping" of the marl; so that all spring-water, or infiltrated rain-water, must necessarily flow in a direction leading from the exposure. In the reversed circumstances, the marl will be wet, and proper drainage of the pits will be necessary. Bodies of marl of this second class are most common in the high and broken lands lying between the localities named above, and the falls of the rivers.

III. The third class of marl generally belongs to the more level lands, but in some cases to the low bottoms and ravines of the highest and most hilly. But in either case, the surface of the marl is lower than that of all the surrounding land (unless perhaps of the mere outlet for the water); and the excavations and the roads all need careful and perfect drainage.

I will now return to the consideration, principally, of excavations of the second class; though they will in part suit also for the third class.

There is a general dip of the marl to the east, through lower Virginia. But this so slight, and irregular withal, that it does not always direct the course of the spring-water above according to the general course of the dip. At each particular locality, the marl stratum may be considered as nearly horizontal. The upper surface of the dry marls is often very irregular in outline, owing to the washing operation of ancient currents of the sea, or later floods, and whirlpools, subsequent to the deposition of the beds of shells.

Unless very sandy and poor, and also oozy, all our marls are sufficiently firm before being dug, for the sides of a pit to stand secure when cut perpendicularly. The dry beds, of course, are much easier to be worked than the wet. Where the bed is dry, no directions are required for pit-work; except that the pit shall be long enough to allow the carts to descend therein, and to rise out, loaded, on a graduated and gently sloping road-way. This will obviate the necessity existing when pits are short and steep, of twice throwing the marl—first out of the pit, and afterwards into the carts. No machine or contrivance yet known will serve as well for cheapness to raise marl from the bottom of a pit, or digging, as a cart; and no care or labour will be lost in draining and enlarging the pit, and graduating the ascent out from it, if thereby carts can easily and safely draw from the bottom. These remarks may apply to any excavation made by sinking pits below the level of the general surface.

*Profile, or cross-section of marl diggings, of class II.*

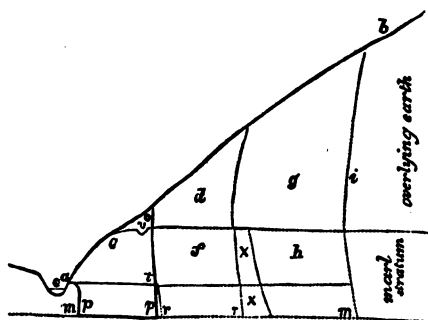

*Explanations.*

- b, a,* Face of hill-side.
- s,* Stream, or bottom of valley.
- p, c, f, h, m,* Bed of marl, out-cropping at *c*.
- m, m,* Bottom of workable marl.
- o, d, g,* Overlying earth.

I will describe an ordinary case of hill-side excavation.

Suppose the marl to "crop out," or otherwise to come near to the surface near the foot of a high hill-side (as at *c*), a ravine and stream being at the bottom (*s*), and table-land at the top of the hill-side, over which the marl is to be carted to the fields, after rising the hill-side by a graduated road. These are common natural features of marl localities, in hilly lands (and of class II). The out-crop, or natural exposure of the marl (*c*) is on a convex curve of the hill-side. The first operation is to clear off the little overlay of earth, from above the out-crop (*o*), so as to uncover a sufficient space for digging and carting (*o, c*.) This space should be (if practicable), 15 feet across, of horizontal width, to permit single-carts to turn upon; and as long (with the course of the stream) as the ground may permit, say 30 feet or more. This small amount of overlying earth (*o*) is easily disposed of, by being thrown into the ravine, or across the stream. The uncovering reaches to the top of the marl stratum, which is supposed 12 feet thick; of which, 8 feet are above and 4 below the level of the stream. A road is next laid off, graduated to best advantage, and constructed, descending from the upper table land to the uncovered marl, the lower end of the road being on a level about 1 foot higher than the stream, and of course 5 feet above the bottom (*m, m*), of the marl fit for use. (The lowest part is usually too poor, and sometimes too much affected by water, to be worth being removed.) If springs ooze out over the top of the marl, a little trench (*v*) of about 4 inches wide and as many deep, must be made along the back line of the uncovering, to cut off and convey away the spring water. The uncovered and drained marl (*c, t*) is then dug and carted out; the work being so conducted as to level the surface, and enable the carts as soon as the surface is enough lowered, to pass over, turn about, and be loaded upon the marl. When the whole space has been dug down to the level of the lower end of the road (*a, t*), then a perpendicular pit should be dug at the end of the area farthest from the descending road, and across its whole width. This pit (*p p*) will be 15 feet long, about 6 to 9 wide, as may be most convenient, and 5 deep when finished to the bottom. The carts turn on the area (*a, t*) and are loaded at the edge of this pit. When finished, another similar pit is dug alongside; and others in succession, until the whole area of the first uncovered marl has been so pitted out. The overlay (*d*) is then dug and thrown off from the next range or section of marl (*f*), so as to uncover another width of 15 feet. The removed earth here (*d*), where highest, might have been more than 10 feet thick. But the space excavated for the first range of marl (*c p*) has more than room enough to receive all this earth.

The carts now have to be supplied from the second range of marl (*f*). As this is throughout of the full thickness of the bed,

and rising 7 feet above the lower end of the road, it may be convenient to make a branch to the road running on a level to the top of the marl. This branch will be used until the lowering of the upper marl, by its excavation, shall render the lower branch of the road again more suitable. This range of the marl is drained, worked out to the level of  $a t$ , and then the lower part ( $r, r$ ) excavated in successive perpendicular pits, in the same manner as the previous range. Then a third range of overlay ( $g$ ) is dug and thrown off into the finished previous excavation ( $f, r, r$ ); and by its increased thickness perhaps fills it up as high as the top of the marl stratum. But this does no serious harm. It will however require the leaving a wall of marl ( $x, x$ ) when digging out the marl below ( $h$ ) to keep out the earth and water of this heap; and also cross walls for support, between the lower perpendicular pits.

It will now be much more laborious to uncover another range (at  $t$ ), still deeper in the hill-side; and it will become a question for the operator to decide, whether to proceed farther with this work here, or to begin another uncovering in some more favourable situation.

For any extensive operation, it is much cheaper to take off a cover of earth 20 feet thick, to obtain marl of equal depth, than if both the covering earth and marl were only three feet each. Whether the cover be thick or thin, two parts of the operation are equally troublesome, viz. to take off the mat of roots, and perhaps some large trees on the surface soil, and to clean off the surface of the marl, which is sometimes very irregular. The greater part of the thickest cover would be much easier to work. But the most important advantage in taking off earth of ten or more feet in thickness, is saving digging by causing the earth to come down by its own weight. If time can be allowed to aid this operation, the driest earth will mostly fall, by being repeatedly undermined a little. But this is greatly facilitated by the oozing water, which generally fills the earth lying immediately on beds of wet marl. In uncovering a bed of this description, for one of my early operations, where the marl was to be dug 14 feet, and 10 to 12 feet of earth to remove, my labour was made ten-fold heavier by digging altogether. The surface bore living trees, and was full of roots—there was enough stone to keep the edges of the hoes battered—and small springs and oozing water came out everywhere, after digging a few feet deep. A considerable part of the earth was a tough, adhesive clay, wet throughout, and which it was equally difficult to get on the shovels, and to get rid of. Some years after, another pit was uncovered on the same bed, and under like circumstances, except that the time was the last of summer, and there was less water oozing through the earth. This digging was begun at the lowest part of the earth, which was a layer of sand, kept

quite wet and soft by the water oozing through it. With gravel shovels, this was easily cut under from one to two feet along the whole length of the old pit, and, as fast as was desirable, the upper earth, thus undermined, fell into the old pit; and afterwards, when that did not take place of itself, the fallen earth was easily thrown there by shovels. As the earth fell separated into small but compact masses, it was not much affected by the water, even when it remained through the night before being shoveled away. No digging was required, except this continued shoveling out of the lowest sand stratum; and whether clay, or stones, or roots, were mixed with the falling earth, they were easy to throw off. The numerous roots, which were so troublesome in the former operation, were now an advantage; as they supported the earth sufficiently to let it fall only gradually and safely; and before the roots fell, they were almost clear of earth. The whole body of earth, notwithstanding all its difficulties, was moved off as easily as the driest and softest could have been by digging altogether. The thicker the overlying earth, the greater is the facility of undermining, and causing it to fall by its own weight.

In working a pit of low-lying and wet marl, covered and surrounded by higher ground (class III.), no pains should be spared to drain it as effectually as possible. Very few beds of marl are penetrated by veins of running water which would deserve the name of springs; but water generally oozes very slowly through every part of wet marl, and many small springs often burst out immediately over its surface. After the form of the pit and situation of the road are determined, a ditch to receive and draw off all the water should be commenced lower down the valley, as deep as the bottom of the area where the carts are to stand is expected to be made; and the ditch opened up to the work, deepening as it extends, so as to keep the bottom of the ditch on as low a level as the bottom of the area. It may be cheaper, and will serve as well, to deepen this ditch as the deepening of the pit proceeds. After the surface of the marl is uncovered for the full size intended for the area (which ought to be at least large enough for carts to turn about on), a little drain of three or four inches wide, and as many deep (or the size made by the grubbing-hoe used to cut it), should be carried all around to intercept the surface or spring-water, and conduct it to the main drain. The marl will now be dry enough for the carts to be brought on and loaded. But as the digging proceeds, oozing water will collect slowly; and, aided by the wheels of loaded carts, the surface of the firmest marl would soon be rendered a puddle, and next a quagmire. This may easily be prevented by the inclination of the surface. The first course dug off should be much the deepest next the surface drain (leaving a margin of a few inches of firm marl, as a bank to keep in the stream),



so that the digging shall be the lowest around the outside, and gradually rise in level to the middle of the area; or next to the old diggings, now heaped with the later removed overlay. Whatever water may find its way within the work, whether from oozing, rain, or accidental bursting of the little surface drain, will run to the outside, the dip of which should lead to the lower main drain. After this form has once been given to the surface of the area, very little attention is required to preserve it; for if the successive courses are dug of equal depth from side to side, the previous shape will not be altered. The sides or walls of the pit should be out (in descending), something without the perpendicular, so that the pit is made 12 or 15 inches wider at bottom than top. The usual firm texture of marl will prevent any danger from this overhanging shape, and several advantages will be gained from it. It gives more space for work—prevents the wheels running on the lowest and wettest parts—allows more earth to be disposed of, in opening for the next pit—and prevents that earth from tumbling as easily into the next digging, when the separating wall of marl is afterwards cut away. The upper and larger drain of the pit, which takes the surface water, will hang over the small one below, kept for the oozing water. The former remains unaltered throughout the job, and may still convey the stream when six feet above the heads of the labourers in the pit. The lower drain of course sinks with the digging. Should the pit be dug deeper than the level of the main receiving ditch can be sunk, a wall should be left between, and the remainder of the oozing water must be conducted to a little basin near the wall, and thence be bailed or pumped into the receiving ditch. The passage for the carts to ascend from the pit should be kept on a suitable slope; and the marl forming that slope may be cut out in small pits, after all the other digging has been completed.

If the marl is so situated that carts cannot be driven as low as the bottom, either because of the danger of flooding, or that the ascent would be too steep for sufficiently easy draught, then the area must be cut out in small pits, as before stated, beginning at the back part, and extending as they proceed, towards the road leading out of the pit.

It is the less required to extend directions for the mode of working low-lying marl, covered and surrounded by higher land, and by its springs, because large excavations under these difficulties, will be described in a later part of this work, and the whole course of procedure minutely stated.

In some cases, either because of the great liability of the overlying oozy earth to cave and fall in, and thus continually to choke the surrounding marl drains, or of rain-floods to fill and damage the excavations, it is too hazardous to leave diggings unfinished for any length of time; and still more for the unfinished work to be

suspended through winter. In such cases, it is better to bestow more labour to obtain security. Under such circumstances perpendicular pits should be sunk first through the over-layer and then the marl. If not too great a height, the marl, as dug, should be thrown to the top of the remaining firm earth, there to be thrown into and removed by the carts. When the digging is carried so low that the throwing exceeds 10 feet in perpendicular height, a scaffold should be made, or a shelf of marl left, at the side of the pit next to which the carts approach, and at a convenient height for the remainder of the digging. The lower marl will be thrown first upon the scaffold, thence to the surface of the ground above, and then into the carts. Thus, the marl may be thrown up from the bottom of the bed, if that be not more than 20 feet below the surface, for loading. The length and breadth of such pits should not be greater than to permit each pit to be finished in a few days after its commencement. Then an adjoining like space may be uncovered, the earth being thrown into the previous digging, and the marl excavated in like manner. Should a flood of rain-water, or the caving in of wet earth fill such a pit, when the digging had not been sunk but a few feet, the damage may be remedied and the remaining marl saved. Or if but a few feet thickness of marl be left, and is covered by earth or water in too great quantity to be worth clearing out, then the loss of the bottom marl will not be very important.

For such situations as these, in some cases lifting machines have been used successfully. One used by Wm. Carmichael, Esq., of Maryland, was described by him in a communication to the Farmers' Register, as follows :

"In your 'Essay on Calcareous Manures,' you give instructions for digging and carting marl. This method I pursued for many years, but found the labour hard on my hands, and tedious. Marl here is generally found in deep ravines or in wet grounds. My operations have been slow, from the difficulty of making firm and lasting ways, and the labour of ascending steep hills. Last winter I made a model, and this spring I built a machine for raising marl, to be worked by a horse. I have been using it to advantage, and now send you a draught of it, as it may be useful to those who have wet marl pits like mine. By means of a pump to throw off the water, pits may be worked at a considerable depth; and even if marl is dry, but lies deep, I think the crane might be used to advantage. I use two boxes, and by means of hinges and a latch the marl is discharged from the bottom. I have double blocks; the rope passes through the swoop about eighteen inches from the end, and runs down to the post which supports the swoop, and passes through it on a small roller, and in like manner through the next post to the cylinder, to which a reel is attached to increase the motion. The post which holds the swoop and the cylinder,

runs on iron pins let into thimbles. The lever is in two pieces, one fastened in the cylinder with a groove at the end, into which the other is let, and secured by a sliding iron clamp. When the marl is discharged from the box, and the swoop swung round over the pit, in nautical phrase, by unshipping the end of the lever, the rope unwinds, and the box descends without moving the horse. The circle in which the horse travels ought to be twenty-one feet in diameter. The second and third posts are supported by side braces.

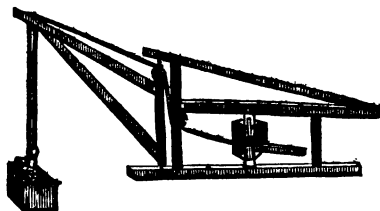

“The cost of the machine is small, though I cannot make an exact estimate. The carpenter who did the work was hired by the day on the farm, and was taken off with other jobs; but his bill could not exceed eight dollars. The cost of the iron-work was ten, and one hundred and sixty-five feet of inch rope, at eighteen and a half cents a pound. The timber, taken from my own woods, may be estimated at five dollars. The rope I find soon wears out, and I intend to supply its place with a light iron chain.

“When the marl is uncovered, with one efficient hand in the pit and a less efficient one to discharge the boxes and drive the horse, five hundred bushels may be raised in a day. The work is not oppressive to the labourers. The teams stand on high, dry ground; no sloughs to plunge through, and no hill to climb. The swoop is turned by a small rope over the carts, and the marl immediately discharged into them. I work four carts, with two sets of oxen to each. They came out of the winter lean and weak; and now, with green clover for their food, at the distance of a half to three-quarters of a mile I draw out from four to five hundred bushels a day, and my oxen have improved. My work goes on with ease and expedition, without stoppage to mend roads, or to clean ditches.”

The machine which will be described below is used at Fortress Monroe for raising sand from the fosse to fill the ramparts; and has been found by experience to be the best contrivance of all which have been tried for that operation, and for which an immense amount of labour was necessary in constructing the defences of the fortress. Precisely the same manner of operation is required for raising marl from deep pits, and there can be no doubt of this being a more effective machine for that purpose than any worked by hand. The force applied is the weight of the labourers, on

the principle of the tread-mill, which, though heavy labour, is the most effective manner in which the power of men can be applied. I am indebted for the suggestion of this machine for raising marl to the observation and scientific knowledge of mechanics of my friend Professor M. Tuomey, and also for the following description, and the drawings for the engraved figures. Mr. Tuomey, when making a transient visit to the fortress, had seen the machine at work; and after reading in the foregoing part of this work the remarks on the different modes of raising marl, and having witnessed some of the usual modes in practice, this machine and what he had seen of its power appeared greatly superior, wherever circumstances may require the use of machinery. Upon being thus informed, I applied to Dr. Robert Archer, U. S. A. Surgeon at Fortress Monroe, for a rough plan, and accurate statement of the dimensions of the machine, both of which he kindly furnished; and with the aid of these, Mr. Tuomey has been enabled to give such particular description and correct delineation as will serve for full instruction for the building and working of the machine.

Fig. 1.

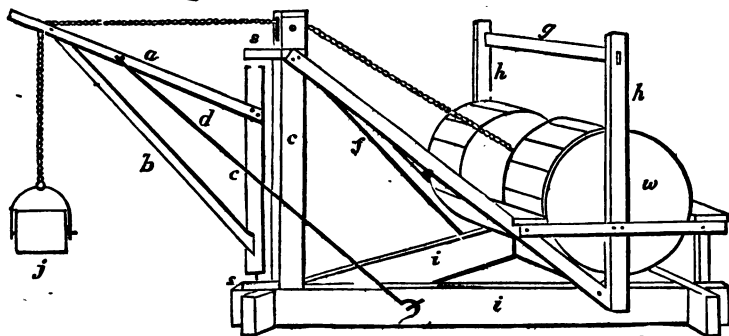

“1. Figure 1 is a side view, in perspective.

*i, i*, The base, consisting of 3 pieces of scantling, each 12 feet long, and 11 inches by 5, notched on to each other about 6 inches from the end, so as to be flush on top, forming an equilateral triangle.

*e*, The principal post 8 feet, 8 by 6 inches, secured to the base, and braced by the braces *f*. Near the top of this post 2 iron sheeves or pulleys are placed, one on each side, and secured by pieces spiked over them. The chains pass over these pulleys.

*f*, 2 braces 11 feet long, 4 inches by 6.

*h, h*, Two uprights, in which the gudgeons of the wheel turn; they are bolted to the base and connected at the top by the piece *g*, 10 feet 6 inches long, 4½ by 6 inches, which also serves as a hand rail for the men to steady by when working on the wheel. These uprights are further secured by cross-pieces connected with the braces, and bearing in front

- and rear of the wheel two steps on which the men stand as they go on or off the wheel.
- w. The wheel 4 feet in diameter, the steps  $3\frac{1}{2}$  feet long 8 inches wide, made of  $1\frac{1}{2}$  inch plank. The ends of the wheels are formed of two thicknesses of inch plank placed crosswise, the inside being grooved to receive the steps which are placed about 8 inches apart. The axle of the wheel is 10 feet 6 inches long and 8 inches in diameter, the portion round which the rope winds is enlarged, so as to suit the force employed on the wheel, or the weight to be raised, by nailing on strips of plank, over which a few turns of old rope may be placed to prevent the slipping of the chain. To prevent confusion, only one crane (or arm) is represented in this figure. The crane post is represented as turning on two iron pivots in pieces *s*, *s*, one bolted to the principal post *e*, and the other spiked to the base. The crane post is 6 inches square.
- a. The crane jib, 7 feet 6 inches long, 6 by 7 inches.
- b. The strut to the jib, 8 feet 6 inches long, 4 by 6 inches. Near the extremity of the jib an iron sheave is fixed over which the chain passes.
- c. Is a three-quarter inch rod of iron secured to *a* by means of a staple, and having a hook at the other end, which drops into a staple at *i*. This rod serves the double purpose of a stay and a guide, by which (when unhooked) the arm is drawn to one side for the purpose of landing the box. When fixed as represented in the drawing, it serves to retain the crane in its proper position. When the box is raised the rod is unhooked, and by means of it the box is landed.

Fig. 2.

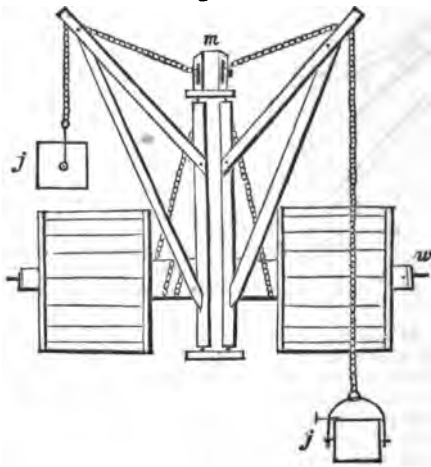

Figure 2 is a front view, showing the relative position of the cranes, which are represented as turned aside. The chain is seen winding around the axle. It is evident that the men must pass to the opposite side of the wheel as each box is drawn up.

- jj. Represents 2 views of the boxes, which are square and may be each about 21 inches every way. They will then contain nearly 6 cubic feet each. They are suspended by two pins, placed a little below and to one

side of the centre so as to turn over and empty themselves when a small iron pin seen at *j*, figure 2, is withdrawn. Three men can be employed to advantage at the wheel, two remaining on, whilst the third gets off to land the box. Should the box not be heavy enough, the diameter of the axle can be enlarged, so as to make up in time what is lost in weight. Should it be too heavy for the force employed, the diameter may be lessened."

The above dimensions of timbers were those of the particular machine measured by Dr. Archer; but they vary in all the machines of this kind used at the fortress. The length of the arms of course should be proportioned to the height to which the loaded buckets are to be raised. For marl, any sized timbers on hand, or logs, that are long enough, would serve for the base (*i, i*). It is however desirable that the machine should be as light as is consistent with strength, for the greater facility of moving it; and for strength alone (as in all other machines) the large size of timbers is of less importance than their being well put together. Two thick and narrow planks, firmly spiked together, and with a space left between of proper size for the sheave to play in at the upper end, would be a cheaper substitute for the *ab*. When carts are removing the marl at the same time it is raised, there would be much advantage gained in having the boxes of such size as to be emptied into the carts, and the measure or load of a box, to be some aliquot part of the loads for the carts.

Machines of this kind will be required, and will be most profitable, whenever marl is to be taken from deep and wet pits, and in extended operations.

### *Making Roads.*

On high and hilly land, marl is generally found near the bottom of ravines, and separated from the field to which it is to be carried by a high and steep hill-side. The difficulty of cutting roads in such situations is much less than any inexperienced person would suppose. We cannot get rid of any of the actual elevation—but the ascent may be made as gradual as is desired, by a proper location of the road. The intended course must be laid off by the eye, and the upper side of the road marked. If it passes through woods, it will be necessary to use grubbing hoes for the digging. With these, the digging should be begun at the distance of four or five feet below the marked line, and carried horizontally onward to it. The earth so dug is to be pulled back with the broad hoes, and laid over a width of three or four feet below the place from which it was taken. Thus the upper side of the road is formed by cutting down, and the lower side by filling up with the earth taken from above.

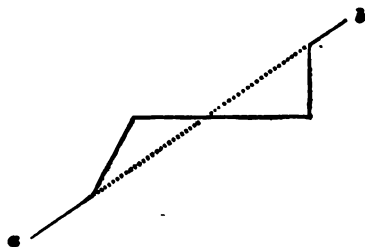

The annexed figure will prevent these directions being misunderstood. The straight line from *a* to *b* represents the original slope of the hill-side, of which the whole figure is a section. The upper end of the dotted part of the line is in the mark for laying off the upper side of the road. The upper triangle is a section of the earth dug out of the hill-side, and the lower triangle of the part filled up by its removal. The horizontal line is the level of the road formed by cutting in on the upper, and filling up on the lower side. After shaping the road roughly, the deficiencies will be seen, and may be corrected in the finishing work, by deepening some places and filling up others, so as to graduate the whole properly. A width of ten feet of firm road will be sufficient for carting marl up a short hill.

If the land through which the road is to be cut is not very steep, and is free from trees and roots, the operation may be made much cheaper by using the plough. The first furrow should be run along the line of the lower side of the intended road, and turned down hill; the plough then returns empty, to carry a second furrow by the first. In this manner it proceeds, cutting deeply, and throwing the slices far (both of which are easily done on a hill-side), until rather more than the required width for the road is ploughed. The ploughman then begins again over his first furrow, and ploughs the whole over as at first, and this course is repeated perhaps once or twice more, until enough earth is cut from the upper and put on the lower side of the road. After the first ploughing, broad hoes should aid and complete the work, by pulling down the earth from the higher to the lower side, and particularly in those places where the hill-side is steepest. After the proper shape is given, carts, at first empty, and then with light loads, should be driven over every part of the surface of the road until it is firm. - If a heavy rain should fall before it has been thus trodden, the road would be rendered useless for a considerable time.

*Implements and Means for facilitating the Labours—Application of Marl.*

These directions are mostly suited for greater difficulties than usually occur, though they are such as attended most of my labours in marling. In the great majority of cases, there will be less labour, and care, and skill required, because there will not be encountered such obstacles as high and steep hills to ascend, thick over-lying earth to remove, or wet pits and roads to keep drained.

In large operations and in dry and compact marl, much labour of digging may be saved by slightly undermining the face of a perpendicular body of marl, and then splitting off large masses, by driving in a line of large wooden wedges on the upper surface.

For very hard marl, narrow and heavy pickaxes are the best digging implements. For softer marl, though still of close and compact texture, heavy and narrow grubbing hoes are better. They should weigh near or quite 7 lbs. when new, and have the cutting edge 3 to 3½ inches. Gravel shovels (with rounded points and long handles), of the best quality, are the cheapest and most effective tools for throwing out the marl, and loading the carts, as well as for afterwards spreading the heaps in the field.

Tumbrel or tilting carts, drawn by one horse or mule, are the most convenient for conveying marl very short distances; and even for longer distances, if on hilly roads and fields. Every part of such carts should be as light as will serve for strength, and the body should be so small as to hold only the load it is designed to carry. This enables the drivers to measure every load; which advantage, on trial, will be found very important. If carts of common and much larger sizes are used, the careless labourers will generally load too lightly, and yet will sometimes injure the horse by too heavy loading. The small-sized cart-bodies prevent both these faults. Their loads cannot be made much too heavy; and if too light, the deficiency is detected at a glance. When there is much or steep ascent in the carriage way, 5 heaped bushels of ordinary wet marl, or 6 of dry, will make a full load for a good mule, or ordinary horse. The larger quantity may be put in by heaping somewhat above the level of the cart. The greatest objection to these carts is that they are too small to carry loads of anything but marl. On roads nearly level, tumbrels drawn by two mules are much preferable. There is the saving of another driver, and the cost and weight of another cart; and though the cart is large and heavy, it is so much lighter than two small carts, that two mules together in the former, will draw full as much weight as if separate and with the latter. The larger carts should hold about 15 heaped bushels of marl, when the load is level with the top of the body; and which may be increased to 18 or 19 bushels (the proper load



for two mules on level land and firm roads) by heaping. Two mules together will draw this load, or about 1900 lbs. ; or one mule, in a light cart, 9 bushels, as easily as the latter will draw 5 bushels on hilly land. But on hilly land, two-mule carts cannot well be used. For when drawing up a hill, if one mule ceases to pull for ever so short a time, the whole load, and a doubled labour, is put upon the other mule, which is thus over-strained, and taught to balk, if not otherwise damaged.

Strong labourers are required for digging and shovelling marl. Boys of 12 to 14 years old may drive single-mule carts. The animals kept regularly at such hauling soon become so gentle and tractable, that very little skill or strength is required in the driver. But for a two-mule cart, an active and careful young man should drive, because his strength is required at some times, and his judgment and care always to load properly, and to make the mules draw equally.

One of the most general and injurious errors in marling, is the unequal and irregular spreading of the marl on the land. From this cause it often happens that there is too much and too little marl applied to the same quarter-acre; and sorrel still remaining and growing, and "marl-burnt" corn, may be seen not many yards apart. The only effectual means which I have found to attain anything like equal distribution, has been to measure by stepping, and marking with a hoe, each distance for a heap to be dropped. This has been done by myself for much the greater quantity of all the marl I have had carried out; as I never could have the measuring and marking of distances done with sufficient accuracy by the drivers. If the field had been left in beds, or the rows of the last previous ploughing are visible, it will much facilitate the marking. Otherwise, rows must be marked by the plough in one direction, or measuring poles must be set up at each extremity of the rows for marl, to mark the cross-distance as well as to guide the direction of the rows. The thus placing the heaps at regular or average distances is the best security for regular distribution of the marl in spreading. But, nevertheless, the latter operation ought to be carefully watched, and made as uniform as will serve for thorough and equal diffusion through the soil, with the subsequent aid in tillage, of ploughing and harrowing.

Some extensive marlers, before commencing on a field, have it marked off by a plough for the placing of the heaps of marl. If the land is in beds, cross-furrows only are needed. If the surface is smooth, it must also be marked at right-angles. In either case, the field is thus marked off into rectangular spaces, in each of which a heap of marl is dropped, and over the whole of which space it is afterwards to be spread. But I found this mode more objectionable than the former. The drivers have so much latitude, that

they are very careless as to where they drop their heaps within each rectangle; and the spreaders have more labour to distribute the marl equally, and therefore are more apt to neglect it. Besides, it is often requisite to alter the distances of the heaps, either because of change of soil, or because of change in the sizes of the loads, owing to altered condition of the roads.

*Marling Tables and Estimates.*

The following tables may be useful in facilitating calculations, and promoting the important object of applying marl in equal and uniform quantities, according to the quality of the marl and the wants of the soil; which object, however, is generally so little regarded, that few persons attempt by calculation to reach any of the results which these tables are designed to show by mere reference.

TABLE I. *Showing the number of cubic feet of dug marl (as compressed by its weight in the loaded carts), necessary to furnish one per cent. of carbonate of lime to the acre of soil, for the ploughed depths stated:*

Marl containing of carb. lime.	3 inches.	4 inches.	5 inches.	6 inches.	7 inches.	8 inches.
per cent.	cubic feet.	cubic feet.	cubic feet.	cubic feet.	cubic feet.	cubic feet.
10	1089.	1452.	1815.	2178.	2541.	2904.
20	544.5	726.	907.5	1089.	1270.5	1452.
30	368.	484.	605.	726.	847.	968.
40	272.25	368.	453.75	544.5	635.25	726.
50	217.8	290.4	368.	435.6	508.2	580.8
60	181.5	242.	302.5	368.	423.5	480.66
70	155.57	207.43	259.28	211.14	363.	414.86
80	136.12	181.5	226.87	272.25	317.62	368.
90	121.	161.33	201.66	242.	282.33	322.66
100	108.9	145.2	181.5	217.8	254.1	290.4

TABLE II. *Showing the number of even bushels of marl, as compressed by its weight in the carts, necessary to furnish one per cent. of carbonate of lime to the soil, for the tilled depths stated:*

Marl cont'ing per cent of carb. lime.	3 inches.	4 inches.	5 inches.	6 inches.	7 inches.	8 inches.
	bushels.	bushels.	bushels.	bushels.	bushels.	bushels.
10	875.1	1166.8	1458.5	1750.2	2041.9	2333.6
20	437.55	583.4	729.25	875.1	1020.95	1166.8
30	291.7	388.93	486.17	583.4	680.63	777.87
40	218.77	291.7	364.62	437.55	510.47	583.4
50	175.02	233.86	291.7	350.04	408.38	466.72
60	145.85	194.46	243.08	291.7	340.31	388.93
70	125.01	180.97	208.36	250.08	291.7	333.37
80	109.38	145.85	182.31	218.77	255.23	291.7
90	97.23	129.64	162.05	194.46	226.88	259.29
100	87.51	116.58	145.85	175.02	204.19	233.86

TABLE III., showing the number of rectangular spaces, of various dimensions, in an acre of land.

Yards.	Sq. yds.	Rectan- gular Spaces.	Yards.	Sq. yds.	Rectan- gular Spaces.
15x15	=225	22	12x10	=120	40
15x14	=210	23	12x 9	=108	44
15x13	195	25	12x 8	96	50
15x12	180	27	12x 7	84	57
15x11	165	29	12x 6	72	67
15x10	150	32	11x11	121	40
15x 9	135	36	11x10	110	44
15x 8	120	40	11x 9	99	48
14x14	196	24	11x 8	88	54
14x13	182	26	11x 7	77	62
14x12	168	29	11x 6	66	73
14x11	154	31	10x10	100	48
14x10	140	34	10x 9	90	53
14x 9	126	38	10x 8	80	60
14x 8	112	43	10x 7	70	69
14x 7	98	49	10x 6	60	80
13x13	169	28	10x 5	50	96
13x12	156	31	9x 9	81	59
13x11	143	34	9x 8	72	67
13x10	130	37	9x 7	63	76
13x 9	117	41	8x 8	64	75
13x 8	104	46	8x 7	56	86
13x 7	91	53	7x 7	49	98
12x12	144	33	7x 6	42	114
12x11	132	36	6x 6	36	133

It is scarcely necessary to direct the application of these tables to practical operations; and therefore a single example only will be offered. Suppose a farmer's marl contains about 40 per cent. of carbonate of lime, and he wishes to give 1 per cent. to his designed tilled depth of 5 inches. He takes the number 40 per cent. in the first column of Table II., and passes thence in the same horizontal line across the table until reaching the column headed "5 inches." The number at the intersection is 364.62, the number of bushels of marl required. Next, to apportion this quantity to the acre. The heaps he can most conveniently make, we will suppose, will be 8 bushels. Dividing 364.62 by eight, gives about 45½ heaps required for the acre. Then referring to Table III., for that number of spaces, or the nearest to that number, in an acre, it is seen that the distances of

14 × 8 yards, will make 43 heaps.

13 × 8 " " 46 "

11 × 10 " " 44 "

Either of these quantities would be suitable enough; and the farmer would choose the distances which will best suit his width

of ploughing. If desiring more perfect exactness, it could be easily obtained by adding to or deducting from one of the dimensions the necessary fraction of a yard.

Heaped bushels of loose marl, as measured separately, do not vary much from the same number of even bushels, as compressed in a cart body, by its own weight, and by the travel to the field. I find reference to bushels more convenient than to cubic feet. But if preferred, the same desired results may be reached by using Table I., and cubic feet as the measure instead of bushels.

The measuring of marl, in a half-bushel measure, for the purpose of determining larger quantities, is but a rough and uncertain method, which is only to be relied on when the average is taken of many such trials. The irregularity of the lumps of marl, when first dug, and the uncertainty of the degree of heaping of the measure, may make even the same kind and condition of marl appear to vary in quantity and weight, by 6 or 8 pounds in the bushel. Besides other smaller trials, at other times, I made the following measurements and weighings of a single load of marl, of which the report may be of use for comparison:—

A load of marl, just dug, was thrown into the cart, as usual, by shovels. The heaping of the load rose 7 inches, in the middle, above the top of the cart body. (Lumpy and moist marl may be heaped much higher than dry and pulverized.) This was about the ordinary degree of heaping, when the roads were in the firmest state. The load was drawn to my barn, 2000 yards of the route to the field, and there measured by the half-bushel, heaped, and each separate measure weighed. The weights varied from 49 to 56½ lbs. of the 39 half-bushel measures (19½ bushels) which the load filled. The whole load weighed 2050 lbs., and the average weight of the heaped bushel was 105.16 lbs. This marl was of the kind I have altogether used at Marlbourne [to 1850]—compact clayey marl, partly in lumps, moist naturally in its bed, but free from any other water.

The inside dimensions of this two-mule cart body were these:

Average of length, inches,	60.87
“ width, “	40
“ depth, “	15.16;

which make 21.36 cubic feet, or 17.12 even bushels of capacity. (A bushel contains 2150.6 cubic inches.) But, it should be observed, that the compression of the marl by its own weight, as thrown into the cart, and still more by the settling during the travel to the field, permits and causes more bushels of marl (if previously measured) to be put into the body than would be indicated by its cubic capacity. Thus, into the cart described above, at another time, the marl was put in at the pit by a half-bushel measure, heaped as usual—and which heaping certainly added as much as

20 per cent. to the even measure. Yet 16 bushels (the measure being thus heaped), were required to fill the cart even. (If thrown in, as usual, by shovels, still more marl would have been put into the same space, by its falling more heavily from the shovels than from the half-bushel.) Upon this even filling of the cart (the 16 heaped bushels), more marl was added, to the amount of 5 bushels of like heaping measurement, making 21 heaped bushels in all. This raised the heaping of the cart higher than usual, though not too much to be carried without waste. After being driven to the field, rather more than  $1\frac{1}{2}$  miles, the then heaping part of the load alone was carefully taken off, and measured by *even* half-bushels; but each filling being pressed into the measure moderately, which was supposed to give a degree of compactness equal to the remaining lower part of the load, caused by its weight and the travel. This quantity made  $3\frac{1}{2}$  of such even bushels; the difference between which and the 5 heaped bushels put on in heaping at the pit, was owing to the settling of the whole load by its weight and the travel.

The remaining *even* and compressed filling of the cart body, by cubic measurement of its capacity, as stated above, was (21.36 cubic feet, or) 17.12 even bushels. Add to this the  $3\frac{1}{2}$  even and compressed bushels of the heaping (after its being settled by the travel), and the quantity of the whole load is  $(17.12 + 3.50 =) 20.62$  compressed and even bushels, equal to 21, loose and heaped, as measured at the loading. Therefore it may be considered that a *heaped* bushel of loose and moist marl is about equal, when compressed, to the same measure *even* full.

From all these and other trials and observations, combined and compared, I consider the following quantities as sufficiently close approximations to the truth:—

A heaped bushel of this and similar marl, loose, as dug, weighs 105.16 lbs.

An even bushel, compressed, weighs about the same.

The load of a proper two-mule cart, for roads in good order and over firm land not varying much from level, is 18 to 19 heaped bushels—or 1900 to 2000 lbs.

Weight of a cubic foot of this marl, in the bed, is  $120\frac{1}{2}$  lbs. (determined by trial of a smaller measured solid). By two different trials, of pits measured by their cubic dimensions in the bed, one of 1052 cubic feet yielded 1103 heaped bushels of marl, as dug, and measured by the estimated cart-loads; and the other, of 1475 cubic feet in the bed, yielded 1675 heaped bushels. These estimates would respectively make the cubic foot weigh about 111 and 119 lbs. Of course these were not exact measurements, either in the bed, of feet, or in the carts, of bushels.

10 cubic feet of marl, measured in the cart body, and as com-

pact as made by its own pressure and the travel, are equal to 8.03 (say 8) even bushels, in the same state of compactness; and may be taken as equal to the same number (8) of heaped bushels, loose as when dug.

In marls of equal degrees of moisture, the weight will be greater in proportion to the quantity of silicious sand in each; and, in a less degree, also to the soundness and compactness of any shells contained. In marls similar in these respects, of course the weight will be in proportion to the wetness. The lightest marl I ever worked, which was as dry as any earth could naturally be, did not weigh less than 100 lbs. to the heaped bushel.

Some or all the foregoing suggestions of facilities and expedients, or perhaps some better plans, might perhaps occur to most persons before they are long engaged in marling. Still these directions may help to smooth away some of the obstructions in the way of the inexperienced; and they will not be entirely useless, if they can serve to prevent even small losses of time and labour.

It is impossible to carry on marling to advantage, or with anything like economy, unless it is made a regular business, to be continued throughout the year, or a specified portion of it, by a labouring force devoted to that purpose, and not allowed to be withdrawn for any other. Instead of proceeding on this plan, most persons who have begun to marl, attempt it in the short intervals of leisure afforded between their different farming operations—and without lessening, for this purpose, the extent of their usual cultivation. Let us suppose that preparations have been made for such an attempt, and on the first opportunity, a farmer commences marling with zeal and spirit. Every new labour, however, is attended by causes of difficulty and delay; and a full share of these will be found in the first few days of marling. The road is soft for want of previous use, and, if the least wet, soon becomes miry. The horses, unaccustomed to carting, balk at the hills, or carry only half loads. Other difficulties occur from the awkwardness of the labourers, and the inexperience of their master—and still more from the usual unwillingness of the overseer to devote any labour to improvements which are not expected to add to the crop of that year. Before matters can get straight, the leisure time is at an end. The work is stopped, and the road and pit are left to get out of order, before making another attempt some six months after, when all the same vexatious difficulties are again to be encountered. It is therefore not at all surprising that many zealous beginners have been discouraged by the bad management of their first operations; and have abandoned all effort to marl, until after years of delay, and when again induced to resume, by the success and profit of others who had not limited their marling labours to leisure times only.

If one horse or mule, only, is employed in drawing marl through-

out the year, at the moderate allowance of 200 working days, and 100 bushels carried out for each day, the year's work will amount to 20,000 bushels; or enough for the first dressing of 80 acres, at 250 bushels. This alone would be creating a great value, and obtaining a great profit upon the outlay of expense. But, besides, this operation would allow the profitable employment of any amount of additional and available force. When, at any time, other teams and labourers could be spared to assist, even if but for a day or two, everything would be ready for them to go immediately to work. The pit is well drained, the road is firm, the bridges in good order, and the ground for the marl marked off and ready to receive the loads. In this manner, much work may be obtained in the course of the year, from teams which would otherwise be idle, and labourers whose other employment would be but of little importance. Also the spreading of marl on the field is a job that will be always ready to occupy spare labour (unless the marl is clayey and also very wet); and the removing of earth to uncover marl may be done when rain, snow, or severe freezing weather has rendered the earth unfit for almost every other kind of work.

---

## CHAPTER XXVII.

### DIRECTIONS FOR THE SEARCHING FOR AND TESTING OF MARL.

IN the order of time and of operations, the searching for marl, when required for any one locality, must precede the labours directed or described in the foregoing chapter. Nevertheless, the reverse order will be better for the clear understanding of directions by those persons who are without any experience in this business. To know how best to search for marl, it is essential to know the general position, and other characters of the beds; and the necessary lights on these points were given in the preceding chapter as the most suitable place.

It is not only on farms, or in larger spaces, where no marl has been seen, that the search for it may be necessary. On large farms where it is most abundant, and easily accessible, in some places, it is usually very important to trace the bed to some other place, where the working will be more useful or convenient. The being thus enabled to bring the excavations a few hundred yards nearer to the fields may save twice as many hundred dollars in the expense of carting the marl within one or two years.

The farmer who has seen (and still better if he has worked) marl in some one spot of his land, or his neighbourhood, has thereby

obtained the best possible indications of the probable existence of the same bed in a more desirable situation. As the beds usually lie nearly horizontal, and are continuous for considerable distances, the search should be extended upon nearly the same level. Natural exposures may have been made by the courses of rivers or smaller streams—or artificial, by the digging of ditches, wells, or other excavations. If none of these serve to expose marl to view, the next resort will be to boring. And in using the auger, the same rule should be pursued of being guided by the supposed level of the bed sought. Of course, any nearly horizontal lower bed will have the least covering of upper earth where the surface is most depressed. Thus, under swamps, or in deep bottoms or ravines, a hidden bed of marl may be expected to be reached with less depth of boring than on the higher land. But it will not do to rely upon borings in these lowest depressions only. For in many cases, the marl itself, or the upper part of the bed, has been washed away and removed by the ancient action of running water, and the cavity subsequently filled by other washings of earth, forming the present surface soil and lower layers. Therefore, besides boring in the lowest ground, the nearest rise of the adjacent slope of high land should be tried. There the marl would have been left, even though removed in the former lower channel of the ancient strong current of water.

If marl reaches the surface, or is cut into anywhere by the washing of rapid streams, it may probably be found by examining the deepest parts of these cuttings. Any of the smallest particles of shells found in the lower part of the course of the stream will clearly indicate that the water has cut into marl somewhere above; and which place may be found by carefully examining the bed of the stream above.

The auger most convenient for the ordinary searching for marl is a very simple and cheap implement. It is made by welding a straight cylindrical iron rod, five-eighths of an inch in diameter, to the stem of a common screw auger of about one and a half inches bore. If the auger has been so much worn in use as a carpenter's tool, as to be unfit for that work, it will serve well enough for boring in earth. A cross-piece for a handle, also of iron, and 14 inches long, should be fitted to slide along the stem (which passes through a hole in the handle), and small indentations are made, two feet apart, on the stem, at which the handle is fixed, at any desired height, by a small thumb-screw, passing through one side of the handle, and the point pressing into the indentation on the stem. The lowest indentation should be 4 feet from the lower end of the auger, and the others at every 2 feet above. An auger of 12 feet length will serve for all ordinary operations, and is not too unhandy in use. But, it will be more convenient,



if much boring is to be done, to have two augers, of equal bore (or the short one something the larger), one of 8 feet length, and the other 14. The shorter will be used first, and the longer only when more than the depth of 8 feet is required. The auger is not only useful to find the upper surface of the bed of marl, but also to pierce the bed deeply enough to know whether it is thick and rich enough to be worth the labour of uncovering and excavating. Not more than about 6 inches depth should be bored at one time, when the auger should be drawn up, and the cutting part cleared of the adhering earth. If more boring is done at once than the auger can lift completely, the bored hole is soon obstructed by loose earth, and the design of the boring is impeded by the greater haste of the labour.

It is seldom that the shorter length of 8 feet will not be enough for these uses of a marl auger; and the greater length of 12, or at most 14 feet, will be ample. But, if for peculiar circumstances, greater depth is required, additional pieces, of 4 feet each, may be attached to and so lengthen the stem of the auger. The working of so long an auger is excessively inconvenient, when it has to be drawn up so frequently.

For the suggestion of this very useful tool, I was indebted to Dr. William J. Cocke, who first introduced it; and who, by its aid, was enabled to find and to use extensively a very valuable bed of marl under the low and level surface of his land (on Blackwater, in Sussex), where its presence had not been reached or suspected before.

When it is desired to use an auger longer than 14 feet, by attaching one or more extra joints, the great inconvenience of lifting and returning the auger may be much lessened by a simple contrivance introduced by Mr. Williams Carter, of Hanover. This is to have a bench of narrow and thin plank, 7 or 8 feet long, with legs of 8 or 10 feet. A hole large enough for the auger to turn in freely is in the middle of the bench. As soon as it is necessary to attach another piece to the stem of the auger, the bench is set over the boring, with the hole immediately above, through which the stem is passed. Thus, when the auger is lifted, it is supported in its perpendicular position by the bench above.

Such means as these, imperfect as they are, will be found more convenient and effective in use, and much cheaper, than the heavy and complicated augers used to search for coal.

When I first began to apply marl, in Prince George county, it had attracted so little observation, even as a matter of curiosity or singularity, that the deposit was supposed by the few observers to be limited to the few places where it was both exposed and also manifest to the eye. These places were indeed very few in lower Virginia. For not only was the natural exposure of a section of the

bed required, but also that the fossil shells should be sufficiently preserved to be recognised as such at a glance. The most numerous, most extensive, and also the richest beds, exposed to the eye, in some of the steep and broken banks of the rivers, and which are now known to the most ignorant labourer as marl, were then not distinguished from other earth, because the shelly matter was so reduced as not to be obvious to view.

But as soon as the value of these beds was made known, discoveries or observations of their presence and accessibility were rapidly extended. And in advance of all scientific instruction (from which the general extension of any such formations might have been inferred), marl had been found on thousands of farms, where its presence had not been known or thought of, previous to my earliest publication on this subject. Even in Prince George, and after the highest interest had been excited on this subject, for some years the only known exposures of marl were in either the cliffs, or the neighbouring sloping borders of James River, and in the ravines of the hilly lands of some streams emptying therein. Since, besides other places, under all or nearly all the level swampy borders of the Blackwater and its many branches, marl has been found, at no great depth, though concealed from view; and numerous extensive excavations have been made, and for great improvements. New discoveries of marl are still continually made in localities where it was not before known. There can be little question of the general fact that marl underlies nearly all the lands between the sea coast and the falls of the rivers, and stretching from Maryland to Florida; and increasing in thickness, and generally in richness also, as proceeding southward. In Virginia, the workable thickness of marl is not often more than 12 feet; and if in some cases as much as 25 feet, it is much oftener less than 8 feet. In South Carolina, I ascertained the extensive bed of very rich marl to be more than 300 feet in thickness.

But generally extended as are the marl deposits through lower Virginia, the overlying earth is most generally too thick for the economical working of the marl below. Under most lands, the marl is more than thirty feet below the surface; and even if reached by digging, would be covered by spring-water, so as greatly to increase the difficulty and expense of obtaining it from such depths. Will these obstacles always debar the proprietors from the benefit of this treasure, through more than half the great region under which it lies, now useless and concealed? I think not. Though it would be ridiculous now to propose such undertakings, it will at some future time be found profitable to descend to still greater depths for good marl; and shafts will be sunk, and the water and the marl will both be drawn up by machinery worked by horse-power or steam engines, and the excavations conducted in the same

manner as is now done in coal mines. When such means shall be resorted to, it is probable that there will be but a small proportion of all the great tide-water region (or the region lying eastward of the granite range), in which marl may not be found sufficiently accessible for profitable use. For example: from a mile south of Petersburg, along the line of the railway to the Roanoke, no marl had been found either by the excavations for the road, or in the much deeper wells dug long before in the vicinity of the route. The well for the water-station nine miles from Petersburg did not at all times supply enough water for the engines, and it was determined to dig one deep enough for that purpose. Disregarding the small veins of water usually reached at less than 20 feet, the digging was sunk to 50 feet, when marl was reached. Its quality at top was rather poor; but it became more and more rich, as well as of firmer consistence (though never very hard), until the well had been sunk to 80 feet, without reaching the bottom of the marl, or finding any other vein of water. The lower part of this marl was from eighty to ninety per cent. of carbonate of lime, as I found by several analyses. It would have served to make good lime, by burning, for cement or for manure, to be transported to a distance on the railway; besides being of more value to be used unprepared to enrich the nearer land. Though covered by fifty feet of earth, and the excavation impeded by the water from above, this marl might have been profitably raised eighty feet, or as much lower as the bed may extend. And so firm was its texture, that the excavation might have been safely enlarged gradually as it was deepened, as is done in the chalk-pits of England, so that the digging should form a hollow cone, communicating from its apex by the narrower cylindrical well through the fifty feet of earth above to the surface. Thus, though the earth might have been twice the thickness of the marl below, the greater diameter of excavation in the latter would have furnished much the greater quantity of contents. Of this most valuable deposit, found in a region before supposed destitute, and where its transportation to a long line of destitute land was so convenient, no use has been made, except of the quantity necessarily drawn up in digging this well. And this means for enriching the undertaker, and fertilizing a vast extent of surface of acid and poor land, will probably remain totally neglected for the next fifty years. It is most probable that this same thick and rich body of marl may be found at many miles' distance on the line of railroad, and indeed wherever the surface is in the same position relative to the granite range. (1842.)

After marl has been found, whether by natural exposure or by boring, it may still be difficult to distinguish it by the eye. If fossil sea-shells are intermixed, and enough preserved in form to be distinguishable, that is certain proof that the object sought has

been found. But sometimes, and more usually in the richest marls, the shells are so reduced as to be scarcely (if at all) distinguishable, and the mass may appear to the eye either as a barren sand or as barren clay sub-soil, according to its mechanical texture, or of no worth or interest whatever. The touch of muriatic, or other strong acid, to the earth, first moistened by water, is the only sure test. If there is shelly matter (or carbonate of lime) present, the acid will produce immediate effervescence and discharge of carbonic acid gas. If there is no such action, the earth is not calcareous, and of no value as marl (or for *calxing*), whatever it may contain of other fertilizing ingredients.

More than a hundred species of sea-shells are found in the beds of marl which I have worked. Generally the shells, though very fragile, are entire, though much broken by the digging and after-operations. The white shells are rapidly reduced, after being mixed with an acid soil; but some gray kinds, as the scallop (*pecten*) and the oyster, are so hard as to be very long before they can act as manure. Some beds, and they are generally the richest, have scarcely any whole shells, but are formed principally of small broken fragments. Of course the value of marl as a manure depends in some measure on which kinds of shells are most numerous, and their state of division, as well as upon the total amount of the calcareous earth contained. The last is, however, by far the most important criterion of value. The most experienced eye may be much deceived in the strength of marl; and still more gross and dangerous errors would be made by an inexperienced marler. The strength of a body of marl often changes materially in sinking a foot in depth—although the same changes may be expected to occur very regularly, in every pit sunk through the same bed. The annexed figure will serve better to illustrate both these changes in perpendicular extension in a marl-bed, and the regularity of quality in horizontal extension.

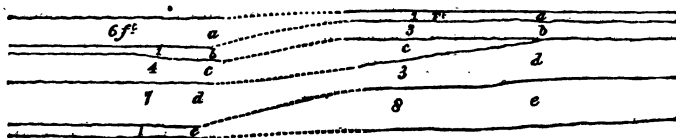

Such as this is no uncommon character of a bed of marl, and such I have worked, and could recognise the identity of the several layers, by their appearance, in different diggings, half a mile or more apart. Thus, suppose the two ends of the section

to be at such considerable distance. The upper layer, *a* (say, for example, finely-rubbed-down fragments of shells, making 55 per cent. of the layer), may be 6 feet thick at one part, and only 1 foot or less at the other. The next layer, *b* (indurated or stony, 85 per cent. of carbonate of lime), may vary at the same two distant places from 1 foot to 3. The next, *c* (sandy and fine, 20 per cent.), is 4 feet in one digging, and runs out to nothing before reaching the other. The next, *d* (firm, with entire shells, 40 per cent.), is 7 feet in the one and but 3 in the other place. Now it would require a careful analysis of each of these layers of different qualities, and observation of their comparative thickness, to know the average strength of the whole section of marl at one excavation. But these same observations would usually serve for estimating nearly enough the averages of the like layers whenever they were found and identified, by allowing for the changes in thickness of each layer.

Whoever uses marl ought to know how to analyze it, which a little care will enable any one to do with sufficient accuracy. The method described, at page 56, for ascertaining the proportions of calcareous earth in soils, will of course serve for the same purpose with marl. But as more particular and minute directions may be necessary for many persons who will use this manure, and who ought to be able to judge of its value, such directions will be here given, and which any one can follow, by merely applying sufficient attention and care. To perform this process will require no other chemical tests than muriatic acid and carbonate of potash, and no apparatus, except correct scales and weights, a glass funnel, and some blotting or very porous printing paper—all of which may be bought at any apothecary's shop.

*Directions for analyzing Marl by solution and precipitation.*

1st. Take a lump of marl, fossil shells, &c., large enough to furnish a fair sample of the particular body under consideration—dry it perfectly near the fire—pound the whole to a coarse powder (in a metal mortar), and mix the whole together. Take from the mixture a small sample, which reduce to a finely-divided state, and weigh of it a certain portion, say 50 grains, for trial.

2d. To this known quantity, in a glass, pour slowly and at different times muriatic acid diluted with three or four times its bulk of water (any except lime-stone, or *hard* water.) The acid will dissolve all the lime in the calcareous earth, and let loose the carbonic acid, with which it was previously combined, in the form of gas, or air, which causes the effervescence, which so plainly marks

the progress of such solution. The addition of the muriatic acid must be continued as long as it produces effervescence; and but very little after that effect has ceased. The mixture should be well and often stirred, and should have enough excess of acid to be sour after standing thirty or forty minutes. (So much of the acid as the lime combines with loses its sour taste, as well as its other peculiar qualities.)

The mixture now consists of: 1, the lime combined chemically with muriatic acid, forming *muriate of lime*, which is a salt, and which is dissolved in the water; 2, a small excess of muriatic acid mixed with the fluid; and 3, the sand, clay, and any other insoluble parts of the sample of marl. To separate the solid from the fluid and soluble parts is the next step required.

3d. Take a piece of filtering or blotting paper, about six or eight inches square (some spongy and unsized newspapers serve well), fold it so as to fit within a glass funnel, which will act better if its inner surface is fluted. Pour water first into the filter, so as to see whether it is free from any hole or defect; if the filtering paper operates well, throw out the water, and pour into it the whole mixture. The fluid will slowly pass through into a glass under the funnel, leaving on the filter all the solid parts, on which water must be poured once or twice, so as to wash out and convey to the solution every remaining particle of the dissolved lime.

4th. The solid matter left, after being thus washed, must be taken out of the funnel on the paper, and carefully and thoroughly dried—then scraped off the paper and weighed. The weight, say 27 grains, being deducted from the original quantity, 50, would make the part dissolved ( $50 - 27 = 23$ ) 46 per cent. of the whole. And such may be taken as very nearly the proportion of calcareous earth (or carbonate of lime) in the earth examined. But as there will necessarily be some loss in the process, and every grain taken from the solid parts appears in the result as a grain added to the carbonate of lime, it will be right in such partial trials to allow about two per cent. for loss, which allowance will reduce the foregoing statement to 44 per cent. of carbonate of lime.

5th. But it is not necessary to rely altogether on the estimate obtained by subtraction, as it may be proved by comparison with the next step of the process. Into the solution (and the washings) which passed through the filter, pour gradually a solution of *carbonate of potash*. The first effect of the alkaline substance, thus added, will be to take up any excess of muriatic acid in the fluid—and next, to precipitate the lime (now converted again to carbonate of lime), in a thick curd-like form. When the precipitation is ended, and the fluid retains a strong taste of the carbonate of potash (showing it to remain in excess), the whole must be poured on another filtering paper, and (as before) the solid matter left

thereon repeatedly washed by pouring on water, then dried, scraped off, and weighed. This will be the actual proportion of the calcareous part of the sample, except, perhaps, a loss of one or two grains in the hundred. The loss, therefore, in this part of the process apparently lessens, as the loss in the earlier part increases the statement of the strength of the manure. The whole may be supposed to stand then :

27	grains of sand and clay	}	= 50.
21	“ of carbonate of lime		
2	“ of loss		

If the loss be divided between the carbonate of lime and the other worthless parts of the manure, it will make the proportion 28 and 22, which will be probably near the actual proportions.

The foregoing method is not the most exact, but is sufficiently so for practical use. All the errors to which it is liable will not much affect the reported result—unless magnesia is present, and that is not often in manures of this nature. I have never found carbonate of magnesia in any of the deposits of fossil shells in Virginia, though it was in many cases sought for.\* If, however, any considerable proportion of carbonate of magnesia should ever be present in marl tried by the foregoing method, it may be suspected by the effervescence being very slow compared to that of carbonate of lime alone; and the proportions of these two earths may be ascertained as follows: The magnesia as well as the lime would be dissolved by the muriatic acid (applied as above directed), but the magnesia would not be precipitated with the carbonate of lime, but would remain dissolved in the alkaline solution, last separated by filtering. If this liquor is poured into a Florence flask and boiled for a quarter of an hour, the carbonate of magnesia will fall to the bottom, and may then be separated by filtering and washing, and its quantity ascertained by being dried and weighed.—(Davy.) This part of the process may be added to the foregoing, but it will very rarely be required.

If desired, the proportions of sand and clay (besides the calcareous parts of each) may be ascertained with enough truth for practical purposes, by stirring well the remaining solid matter in a

---

\* Carbonate of magnesia is known to me only in one case. This is of a peculiar compound of carbonates of lime and magnesia with other common earths, found on Bear Creek Island in Hanover county, above the falls of Pamunkey. I have seen it only in a specimen sent to me fifteen years ago, and of which analyses were made both by Prof. W. B. Rogers and myself, in different modes, with like results. I presume this earth must have been found in very small quantity, as I have never heard of its being used as manure, nor indeed anything else about it.

Prof. C. U. Shepherd reports magnesia found by him in some of the rich eocene marls of South Carolina. I had before sought for it in vain, in many other specimens of the same general kind of marl.

glass of water, and, after letting it stand a minute, for the sand to subside, pouring off the fluid, with the lighter and still floating clay, into another glass. The sand will be left, and the clay will be poured off with the water; and each may be collected on filtering paper, dried, and weighed separately.

The proportion of carbonate of lime in marl may also be conveniently and correctly determined by the diminution of weight from the escape of the carbonic acid; the quantity of which is always in an invariable proportion to the lime with which it is combined. For this purpose, weigh (in a thin and open-mouth vial) a certain quantity (say 200 grains) of muriatic acid. Then of well dried and powdered marl, weigh half as much (100 grains), and then add the weighed marl, very slowly and gradually, to the acid. After all effervescence has ceased, the whole will fall short of the original weights (300 grains), by that of the carbonic acid evolved. This bears the fixed proportion (very nearly) to the carbonate of lime, of 45 parts in the 100. Therefore for every 4.5 grains weight lost, estimate 10 grains of carbonate of lime in the marl tried.—(Davy.)

For want of attention to the only safe guide, the chemical analysis of marl, gross errors are often committed, and losses continually sustained. By relying on the eye only, I have known marl, or rather a calcareous sand, to be rejected as worthless, and thrown off at considerable cost of labour, to uncover worse marl below, in which whole shells were visible; and on the contrary, earth has been taken for marl, and used as such, which had no calcareous ingredient whatever. The best marls for profitable use are generally such as show the fewest whole shells, or even large fragments, and would be passed by unnoticed in some cases, or considered only as barren sand, or equally worthless clay. But even if such mistakes as these are avoided, every farmer using marl, without analyzing specimens frequently and accurately, will incur much loss by applying it in quantities either too great or too small.

#### *Distant transportation of Marl.*

An interesting question respecting the expense of this improvement is, to what distance from the pit may marl be profitably carried? If the amount of labour necessary to carry it half a mile is known, it is easy to calculate how much more will be required for two or three miles. The cost of teams and drivers is in proportion to the distance travelled; but the pit and field labours are not affected by that circumstance. At present, when so much poor land, abundantly supplied with fossil shells, may be bought at from two dollars to four dollars the acre, perhaps a farmer had better buy and marl a new farm, than to move marl even three miles



to his land in possession.\* But this would be merely declining one considerable profit, for the purpose of taking another much greater. Whenever the value of marl shall be properly understood, and our lands are priced according to their improvement, or their capability of being improved from that source, as must be the case hereafter, then this choice of advantages will no longer be offered. Then rich marl will be profitably carted eight or more miles from the pits, and perhaps conveyed by water as far as it may be needed. A bushel of such marl as the bed on James river, described page 144, containing 62 per cent. of carbonate of lime, is as rich in calcareous earth alone, as a bushel of slaked lime, will be after it becomes carbonated; and the greater weight of the first is a less disadvantage for water carriage, than the price of the latter. Many marls, in other places, are much richer than this, and also dry, and easy to work. Farmers on James river, who have used lime as manure to great extent and advantage, might more cheaply have moved rich marl forty miles by water, as it would cost nothing but the labour of digging and transportation. (1832.)

Within the short time that has elapsed since the first publication of the foregoing passages in the previous edition of this essay, the transportation of marl by water carriage has been commenced on James river, and has been carried on with more facility and at less expense than was anticipated. The farmers who may profit by this new mode of using marl will be indebted to the enterprise of C. H. Minge, Esq., of Charles City, for having made the first full and satisfactory experiment of the business on a large scale. (1835.) I induced this gentleman to undertake this operation, for improving his farm in Charles City county (now known as Sherwood Forest, and the property and residence of President Tyler), not only by advice, but by offering to him the gratuitous use of my marl on Coggins Point. His operations were continued through two years. His example was subsequently followed by some other farmers to less extent, and at much greater cost, as they hired the freighting, though obtaining the marl from me, in the bed, without

---

\* This statement of prices, though correct when first published (in 1832), is no longer so. Some little land may yet be so low; but, in general, the prices of lands having marl have already advanced from 50 to 100 per cent. within fifteen years (1842). The lowest of the above-named prices was much above the former minimum rate. The various tracts of land in James City county, belonging to Mrs. Paradise's large estate, when sold some 12 or 14 years ago, brought prices that averaged only about \$1.25 the acre. Most of the lands were poor, but easily improvable, and all having plenty of rich marl. One of the tracts of that description, of 800 acres, was bought at 75 cents the acre; and after being held for three or four years, without being in any respect improved, was re-sold by the purchaser for \$2.50 the acre. Where marl has been actually applied, the increased intrinsic or productive value of the land always considerably exceeds the increased market price, even though the latter may be already doubled or tripled.

charge. Since, the business has greatly increased, and is now carried on by many flat-bottomed vessels (or lighters, decked and rigged), from other places on James river, as a regular and continuous business. But still the business is badly conducted in general, and therefore is much more costly than it would be under better and proper direction. Farmers are averse to being engaged in the management of vessels, or any other business away from their farms, and therefore they have always preferred to buy the marl from vessels, even at higher prices, rather than to have it dug by their own labourers and transported in their own vessels. And this division of labour would be right in all respects, if the owners of the river lighters were better managers of their business, and their hands were industrious and sober. For rich marl thus obtained and transported, the prices at the purchasers' landings have usually been from 4 to 5 cents the heaped bushel. And at these high prices, the lazy and worthless and ill provided navigators have rarely realized any profit. The highest price charged for marl, in beds on the river banks, is a half cent the bushel. Under existing circumstances, the cheapest and best mode of obtaining water-borne marl is for the farmer to also carry on the digging and the navigating. And if the several operations were properly conducted, the entire expense of water-borne marl, say 10 to 30 miles, will rarely exceed 3 cents the bushel when landed, and under favourable circumstances may fall short of 2 cents. Collier H. Minge, Esq., and Gen. Corbin Braxton, of King William county, who have carried on this business extensively, and for years in succession, for marling their own farms, have furnished me with careful and detailed estimates of their expenses, which have been published at length in the *Farmer's Register* (p. 567, vol. i., and p. 691, vol. viii.). According to the estimate of Mr. Minge, the entire cost of thus procuring marl, carried 15 miles on the broad water of James river, amounted to less than 2 cents the heaped bushel when landed. And Gen. Braxton's total expense, the transportation being for eight miles on the narrow and smooth Pamunkey, was but little more than half a cent the bushel, placed at his landing. No charge was made for the marl in either case, but every other charge or expense was included. The labour and difficulties on James river, both of uncovering and digging the marl (at Coggins Point) and unloading (on a shallow creek) were unusually great; and on the Pamunkey these labours were very light. A vessel and also a mode of loading, which would be safe in strong winds, were necessary on James river; while no such danger had to be feared, or was guarded against, on the well-sheltered Pamunkey river. So much of the business, in both these cases, as was conducted from home, necessarily was wanting of proper superintendence; and, no doubt, both of these undertakings suffered for that important de-

iciency, as in all cases where labour is on a small scale of operations, and more especially when slave labour is employed.\*

Another source for obtaining calcareous manures has been opened to the farmers of lower Virginia, which they think cheaper than either transporting marl or burning shells, and they are availing themselves of it to great extent. This is northern stone-lime, which is brought in bulk, ready slaked, and sold by the vessel-load at prices varying from 8 to 10 cents the bushel. Slaked lime, even if pure, from its extreme lightness, cannot be as much to the bushel as rich marl contains of pure lime, even though the marl may have 30 per cent. of other earths. Therefore the lime is much the most costly, as marl may be procured and transported at from 3 to 5 cents the bushel. Still, the lime is so much more readily obtained in large quantities, and a farm can by that means be so much more speedily covered, that the purchase of lime is often the more desirable and also the more profitable operation of the two. (1842.)

In making this improvement, more than in any other business, "time is money." Marling is usually effected by the farmer's labour, whereas the expense of liming is mostly in the purchase. By the use of water-borne marl, few farmers could dress a fourth of their tillage field in a year, whereas by purchasing lime the whole field might be limed, and the whole farm covered in one-fourth of the time required for marling. If then the lime were even thrice the cost of marl (for equal quantities of pure lime), it would still be the cheapest mode of improvement, because yielding its products in one-fourth of the time required for marling. The difference of amount of net product in the first crop, between an acre marled or limed, and another acre not so improved, would usually pay the cost of marling or liming the acre. Therefore, on every acre cultivated by any farmer, and not marled or limed until

---

\* Since 1843, the water-carriage of marl on James river has greatly increased. About ten decked and rigged flat-bottomed vessels have generally been employed in carrying marl from what may be considered one locality, in the neighbourhood of my former residence, in Prince George county, though on the close adjacent lands of three proprietors. Half a cent the bushel is paid for the marl in its bed. For the labour and expense of removing the overlay of earth, digging the marl and carrying it on board, and conveying to distances from 15 to 40 miles, the carriers charge from 3½ to 4 cents—making the total cost at the buyer's landing place from 4 to 4½ cents. A still larger business has been at the same time carried on in bringing slaked stone-lime, in sea vessels, to James river, from the kilns on the Schuylkill and Hudson, and elsewhere in the Northern States. This lime has latterly been sold as low as 7 cents the bushel, usually, and in some cases still lower. The principal demand for and use of both the water-borne marl and lime is on the lands of Charles City county, where marl is not found on any of the river lands, and in but few cases near to the river. (1849.) The Schuylkill lime contains about 35 per cent. of magnesia. The New-York lime contains much silex.

*after* making the crop, there is as much loss of crop suffered by the delay, as would have paid for making the improvement.

The objections to carrying marl unusual distances, admitted above, apply merely to improvements proposed for field culture. But it would be profitable, even under existing circumstances, for rich marl to be carried 10 miles by land, or 200 miles by water, for the purpose of being applied to gardens, or other land kept under perpetual tillage, and receiving frequent and heavy coverings of putrescent manure. In such cases, independent of the direct benefit which the calcareous earth might afford to the crops, its power of combining with putrescent matters, and preventing their waste, would be of the utmost importance. If the soil is acid, the making it calcareous will enable half the usual supplies of manure to be more effective and durable than the whole had been. There are other uses for marl, about dwelling-houses and in towns, which should induce its being carried much farther than mere agricultural purposes would warrant. I allude to the use of calcareous earth in preserving putrescent matters, and thereby promoting cleanliness and health; which subject has been already discussed.

Either lime or good marl may hereafter be profitably distributed over a remote strip of poor land, by means of the railroad now constructing from Petersburg to the Roanoke [1831]; provided the proprietors do not imitate the over greedy policy of the legislature of Virginia in imposing tolls on manures passing through the James River canal. If there were no object whatever in view but to draw the greatest possible income from tolls on canals and roads, true policy would direct that all manures should pass from town to country toll free. Every bushel of lime, marl, or gypsum thus conveyed, would be the means of bringing back, in future time, more than as much wheat or corn; and there would be an actual gain in tolls, besides the twenty-fold greater increase to the wealth of individuals and the state.

## CHAPTER XXVIII.

### ESTIMATES OF THE COST OF LABOUR APPLIED TO MARLING.

BEFORE we can estimate with any precision the expense of improving land by marling, it is necessary to fix the fair cost of every kind of labour necessary for the purpose, and for a length of time not less than one year. We very often hear *guesses* of how much a day's labour of a man, a horse, or a wagon and team, may be worth; and all are wide of the truth, because they are made on wrong premises, or no premises whatever. The only correct method is to reduce every kind of labour to its elements, and to fix the cost of every particular necessary to furnish it. This I shall attempt; and if my estimates are erroneous in any particular, other persons better informed may easily correct my calculation in that respect, and make the necessary allowance on the final amount. Thus, even my mistakes in the grounds of these estimates will not prevent true and useful results being derived from them.

The following estimates of the cost of labour were first prepared in 1828, according to the actual prices of that year, and so appeared in the three preceding editions of this essay. The lapse of time and changes of average prices of some of the elements of cost required correction of some of the particulars. The corrected estimates now submitted are not (as before) of the actual prices of any one particular year, but the supposed average prices of a number of years, to the end of the year 1846. In making the necessary corrections for this purpose, some of the original charges were deemed too high for the average statement desired, and others of larger amount were too low. The difference is small (making less than 3 per cent. of general increase), but has so far served to raise, on the whole, the estimated costs of marling.

But no such estimates (even if at any one time correct in the premises of prices assumed) can more than approach to accuracy for any average of extended time, and still less for any particular subsequent year, owing to the great and irregular fluctuations of prices. Therefore, neither these nor any other estimates of costs can be relied on to show the expense of labour always, or even generally. But these may at least supply a convenient form and rule for the true mode of estimating such values; and every person may easily change the particular charges as required to suit other circumstances. Thus, even if other times and circumstances should require changes of price of every element of labour, the form of

these estimates will still serve greatly to facilitate such alterations and new calculations, and serve better to secure the accuracy of the general results.\*

*Average prices of different elements of labour, applied to Marling operations.*

<i>For a negro man—</i>	
Hire for the year, payable at the end . . . . .	\$50 00
Food—19½ bushels of Indian corn, at 45 cents	\$8 77½
Add 10 per cent. for loss in keeping	88
130 lbs. bacon, at 7 cents . . . . .	9 10
	<hr/>
	\$18 75½
Interest on \$18.75½ for a year . . . . .	1 12½
	<hr/>
	19 88
Clothing—6 yards of strong woollen cloth, at 50 cents	\$3 00
13 yards of cotton, for shirts and summer clothes, at 10 . . . . .	1 30
Woollen hat 50 cents, blanket \$1.30, each once in two years, is yearly	90
Shoes and mending . . . . .	2 00
	<hr/>
	7 20
Taxes—State, 47 cents, county and poor, 80, labour on public road, suppose two days, 68 cents, . . . . .	1 95
For nursing when sick (exclusive of medical aid and medicines), and share of expenses for quarters, fuel, and sending to mill . . . . .	6 00
	<hr/>
	\$85 03
Add to this amount, 10 per cent. for superintendence	8 50
	<hr/>
Total expenses per year, . . . . .	\$93 53

\* As stated above, these estimates were designed to suit the average prices of a series of years preceding and including 1846. But since they were prepared, owing to temporary causes, the prices of both hand and mule labour have greatly advanced. Therefore, if any person designed to begin a job of marling now, and had to incur for that purpose the recent and still continuing high prices of mules and of hire of hands, the actual advances on each of these particular expenses only should be added to the general costs as here estimated. But, in fact, very few of our farmers have to buy or to hire more than a small proportion of the force, if any, that they apply to marling. Most landholders own enough, or nearly enough labouring force, and had before kept it at less profitable employments, to carry on marling in addition. This is known to be the case with nine in ten of such operations. And so far as a farmer had been before the owner of the labouring force he will devote to marling, and would have kept it,

Time lost—Sundays and usual holidays,	56 days.
Bad weather and half holidays, and	
sickness, suppose	30
	—
Making in all	88
Deducting 88 lost days from 365 leaves for working days	
277, and makes the cost of each day ( $\$93.58 \div 277 =$ )	
not quite,	cents 34
A boy of 13 or 14 years, might hire for	\$25 00
Food and clothing, two-thirds as much as a man's	18 12
Taxes (county and poor only) 80c., nursing, fuel,	
&c., &c., \$4	4 80
	—
	\$47 92
10 per cent. for superintendence	4 80
	—

Total yearly expense \$52 72

And daily, for 277 working days, not quite, cents 19½  
*Women and girls over 13 years, may be averaged at the same expense, though worth less for labour.*

According to the established custom, all the expenses of medical attendance, and loss of time from the death of a slave occurring when he is hired, are paid, or deducted from the hire, by the owner, and therefore are omitted in this estimate. By supposing the slave to be hired by his employer, instead of being owned, the calculation is made more simple, and therefore more correct. Yet it is well known that the labour of slaves owned by their employer is much more profitable, and therefore should be estimated as cheaper, than the labour of actual hirelings.

*A work-horse.* First cost in buying, at five years old, say \$75—  
supposed to last six years, makes the annual wear \$12 50

Interest for one year on \$75, and tax, 12½ cents	4 62½
96 bushels of corn (2½ gallons for working days, and	
2 gallons when idle) at 45 cents, and 8500 lbs. of hay	
or fodder at 50 cents the 100 lbs.	\$60 70
Add 10 per cent, for expense and loss in	
keeping	6 07
	—
	66 77
Interest on \$66 77 for one year	4 00½
	—
	Total yearly cost, \$87 89

whether going to marling or not, it is manifest that he is not affected by any temporary fluctuations of prices of labour. The prices which will be here stated as fair averages may fall or rise to any extent for a year or two, without lessening or increasing the expenses of a proprietor who neither hired, bought, nor sold labouring force during that time (1852).

Lost time, suppose 98 days, leaves 267 working days, at nearly 83 cents, cost for each.

A mule, young, and of better than ordinary or average ability, usually may be bought for less price than a young horse. A mule may be kept at work on much less grain than is necessary for a horse, and with coarser and cheaper long forage. The mule is also more long-lived. All these considerations will make the cost of a mule's labour, less than that of a horse by at least one-fifth; each being deducted, leaves,  $(33 - 6.30 =) 26\frac{1}{2}$  cents for the cost of each working day.

A light tumbrel or tilting cart, for one horse or mule, may be bought for \$25. Suppose it to last at marling (and other uses) for four years without repair; or that at the end of that time it would be worth as much only as all the previous cost of repairs. Then the annual cost of "wear and tear" would be one-fourth of the first cost (\$6 25) and the interest on \$25, or \$1.50, or annually, \$7.75; and daily (say for 190 days) 4 cents.

A tumbrel for two mules will cost \$34, and will last at least five years marling, with but slight repairs. Suppose the cart at that time to be worth the previous cost of all repairs, the annual cost will be one-fifth of \$34, and of its interest \$2.04, making  $(\$34 \div 5 = \$6.80 + \$2.04 =) \$8.84$  for the yearly cost, and daily for 190 days, nearly 5 cents.

Harness for each horse or mule, annual average cost may be supposed \$4, and daily for 267 days in use,  $1\frac{1}{2}$  cents.

Of the utensils used for uncovering, digging, loading, and spreading marl, as a scraper (used very rarely), grubbing hoes, picks and shovels, the cost of use and wear, supposed to be fully covered by 3 cents the 100 bushels of marl put out and spread.

In the estimate of the cost of horse labour, no charge is made for attendance, because that is part of the labour of the driver, and forms part of his expense. No charge is made for grazing, because enough corn and hay are allowed for every day in the year; and when grass is part of his food, more than as much in value is saved in his dry food. No charge is made for stable or litter, as the manure made is supposed to compensate those expenses.

It may be supposed that the prices fixed for corn, and fodder or hay, are too low for an average. Such is not my opinion. The price is fixed at the beginning of the year, when it is always comparatively low, because it is too soon for purchasers to keep shelled corn in bulk, and the market is glutted. Besides, the allowance for waste during the year's use (10 per cent.) makes the actual price, equal to  $49\frac{1}{2}$  cents the bushel for corn, and 55 cents the hundred for hay on July 1st. The nominal country price of corn in January is almost always on credit; and small debts for corn are the latest and worst paid of all. The farmer who can consume



any additional portion of his crop, in employing profitable labour, becomes his own best customer. The corn supposed to be used, by these estimates, is transferred on the 1st of January, without even the trouble of shelling or measuring, from A. B. *corn-seller*, to A. B. *marler*, and instantly paid for. Forty-five cents the bushel, at that early time, and obtained with as little trouble, from any purchaser, would be a better regular sale than the general average of prices and payments.

*The estimates of labours applied to particular marling operations.*

According to such estimates as the foregoing of the elements of labour, or as corrected in any particulars which may be deemed wanting, the expenses of marling operations ought to be estimated. And if conducted with proper attention and judgment, it will be found that, in the majority of cases in lower Virginia, the total cost of applying marl, on farms furnishing the marl, would not exceed one cent the bushel. In many other cases, of very favourable circumstances, half a cent the bushel would cover all the expenses. In but very few cases of any known actual operations, and of rare and great difficulties to encounter, ought the total cost to have reached 2 cents. Yet even if amounting to 6 cents (for rich marl), there would still be great profit on the outlay; which is sufficiently proved by the great and increasing recent use of water-borne marl, which is sold at 4 and 5 cents the bushel, delivered at the buyer's landing, and which is further increased, for the carting to and spreading on the field.

In my own long-continued and extensive marling labours, over nearly all the arable land of three several farms in succession, I have but in few cases, and those of small extent, had very easy work. Nearly all my marling has been of more than ordinary difficulty, owing to the natural features of the land, and the position and character of the marl; besides the other early and great difficulties always attending the first beginnings of new operations, without experience or other guidance. Yet, throughout all my marlings (now extended to some 1500 acres, at more than the general average rate of 400 bushels), the average of the whole expenses ought not (as I would now conduct such) to have exceeded one cent the bushel, spread on the field.

Such general opinions and statements, however, will be much less satisfactory than statements of actual labours and the actual costs. I know of no such estimates of the easier and cheaper marlings—which indeed are so easy and cheap that no one would care to calculate the cost. None of my cheapest operations were extensive enough to furnish subjects for fair estimates. For, unless the labours, especially of the teams, are continued nearly regularly for some months, the accuracy of the estimates of cost may well be

doubted. It is necessary for the labours to be continued through enough time to test the ability of the teams to perform them, and still keep in good condition.

At different periods, and under varying difficulties and circumstances, I have carefully estimated the expenses of four considerable jobs of marling, each of which was but a portion of the usual, and as heavy labours of the teams, extending much beyond the portions of time and labour particularly estimated. And all the four operations, in greater or less degree, were attended with more natural obstacles and difficulties than are generally to be encountered on other farms. I will describe in general the circumstances, facilities, and difficulties of each of these jobs, and give the results of the estimates of costs. The details of the operations, though carefully noted, and some of the earlier of them before published, in the preceding editions, will be omitted here, except as to a more recent and much the largest operation, of which the facts were observed so minutely, that they are deemed worth reporting in detail; and which will be so reported in a subsequent chapter.

The labours and expenses of marling come under the following four different heads: 1. Removing the overlay of earth; 2. Digging the marl and shovelling it into carts; 3. The carting to the field; and 4. The spreading. It rarely happens that all these different operations are very easy—which would constitute the cheapest possible marling; and if all were very difficult, the whole would be (or at least so deemed by most persons) too costly to be compensated by the eventual improvement. It usually happens that the unusual facilities for some of these particular labours serve to compensate in some measure the obstacles presented in others.

The first job estimated was attended with such uncommon disadvantages that it may be deemed a failure, or as mostly lost labour, and therefore not a fair subject for estimating costs. But as the operations had been carefully noted, and as this work immediately preceded, without any intermission, the second job, I will state the first also.

The two operations were but a small part of the excavation and removal of a very large quantity of marl from this locality, enough perhaps for 200 acres; of which the portions estimated were among the latest executed; and the most expensive, because of the then much increased thickness of the overlying earth.

The marl "cropped out," or was exposed at the surface of a steep hill-side (in large forest growth). The upper 6 feet of the marl was dry and firm, but easy enough to dig; the shelly portion in small fragments, and amounting to 45 per cent. of the mass. Below 6 feet, it was much poorer (not 20 per cent.), and was not used, except for very short distances.

I. The excavations for the first job, as usual on hill-side expo-

tures, was carried on by first cutting down the exposed and nearly naked marl, which required but little labour for uncovering. The next succeeding stretch reaching higher up the hill, had perhaps as much overlying earth as of good marl beneath. The next had much more overlay; and indeed it was not worth uncovering so deeply, when other places could be more cheaply worked. This last stretch formed the subject of the first estimate. In reference to the four divisions of the labour and expenses—

1. The removing of the overlay of earth was here unusually heavy, compared to the thickness of the marl, rising to 16 feet where thickest, and averaged 11 to 12. 2. The digging and loading, and also the spreading, were very easy. 3. The carriage easy as to distance (997 yards average from pit to field), but bad in having a hill to rise of about 40 feet perpendicular height, and also a valley to cross, of about 80 perpendicular depth.

One-fourth of the uncovered marl was lost by the falling in of a large body of earth from above; so that only  $4\frac{1}{2}$  feet of marl was actually carried out, thus increasing the before heavy cost of the uncovering, for the quantity of marl saved.

Under these circumstances, the total costs, obtained by noting every day's work, and its elements, and at the foregoing prices (omitting the details), were as follows:—

Expense of removing overlay of earth (11 to 12 feet thick on an average)	\$24 70
Digging, loading, and carting marl (3844 heaped bushels)	26 18
Spreading, at 50 cents the 500 bushels	3 84

Total, \$54 72

Which makes the cost per 100 bushels, \$1.42; and per acre, as applied, at 572 bushels, \$8.12; or if for 300 bushels, \$4.26.

The quantity actually applied was much too heavy; and by the excess increased, by one-third, the otherwise heavy expense. The thickness of the dressing, however, made the spreading cheaper for the quantity, the heaps being so much the closer to each other.

II. The second job followed on immediately, but on the opposite slope (across the narrow ravine), where the overlay was  $8\frac{1}{2}$  to 9 feet average depth, and all the 6 feet of good marl was used. The average distance from pit to field (over the same hilly road), was 887 yards. The marl being precisely as in the first job, the facilities for digging, loading, and spreading were the same. But the loads (for a single horse or mule-cart), which before were  $5\frac{1}{2}$  heaped bushels, were now  $5\frac{1}{4}$ —the marl weighing 101 lbs.

Removing overlay	\$14 15
Digging and carting marl (4036 bushels)	20 75
Spreading, at 50 cents the 500 bushels	4 36

Total, \$39 26

Which makes the cost, per hundred bushels, 97½ cents; or, per acre, as applied, at 598 bushels, \$5.81½; or, if at 300 bushels, which would have been an abundant first dressing, \$2.91½ per acre.

These two jobs extended, without interruption, except from bad weather or accidents to carts, from April 20th to May 31st, 1824. Two ordinary horses and a very good mule were worked in light single carts. The best of the two horses was seventeen years old. The two had been kept at hauling marl, whenever weather permitted, from the beginning of the preceding November; and, indeed, the same two horses had carried out nearly all the marl on Coggins farm, since the commencement in 1818. The day's travel from pit to field and back, for both the two jobs, varied from 22 to 23½ miles, besides about 1½ miles in all from and to the stable. For the digging, loading, and carting, two men and two small boys were employed.

III. The third estimated job was on Shellbanks farm, also in Prince George county, over a much larger surface than the preceding, but from sundry different pits, over different routes, and to different fields. The overlay was mostly thinner than the marl beneath, and both were dry in most cases; the working of both easier than usual; the distances moderate, the average from pits to fields being not more than half a mile; though the land being hilly, almost every load had to rise a hill from the pit, from 40 to 100 feet of perpendicular height. In 1828, soon after buying this poor farm, I began the marling, and in about 4 months finished 120½ acres at rates between 230 and 280 bushels per acre. The time taken up in this work was five days in January, and all February and March, with two single mule carts (and but ordinary mules), and from August 5th to September 27th, with a much stronger force.

Taking everything into consideration, I should suppose that the labour and cost of this large job of marling will be equal to, if not greater than the average of all that may be undertaken, and judiciously executed, on farms having plenty of this means for improvement, at convenient distances. The whole cost of this large job was as follows:—

Preparatory work, including uncovering marl, cutting and repairing the necessary roads, and bringing corn (from another farm) for the teams—digging, carrying out, and spreading 6892 loads of marl (4½ heaped bushels only, because of the steep hills, and sometimes wet marl), 31,014 bushels on 120½ acres,	\$265 90
At the average rate of 57½ loads, or 259 bushels per acre, the average expense was to the acre,	2 28
Or \$2.58, if for 300 bushels to the acre.	
And to the bushel,	86-100ths of a cent.

In this job, the quantity of labour of every kind employed, was accurately noted, and also the amount of marl carried out; so that the cost could be very exactly calculated. But owing to the great and frequent variation of distances from the various pits opened, there was no measurement of the travel made, and of course the proportion of work performed to the force engaged was not known.

IV. The next job of marling estimated was in 1844, on Marlbourne, a farm on the Pamunkey river then recently bought, and made my residence. This is the operation of which the facts in detail will be given hereafter. Therefore it is enough to state here that the total cost of 7803 bushels, carried to the average distance of 1486 yards from pit to field, amounted to 94 cents for the 100 bushels of marl, spread on the land.

Thus, of these four considerable operations, performed at different periods, and under different circumstances, of which one only can be deemed of ordinary facility and cheapness, and one other was excessively laborious and expensive, the costs brought together are as follows:—

	Cost per 100 heaped bushels.	Cost per acre if at 300 bushels.
1st, on Coggins Point farm, - - -	\$1 42	\$4 26
2d, " " " " - - -	0 97½	2 92
3d, " Shellbanks, - - -	0 86	2 58
4th, " Marlbourne, - - -	0 94	2 82

But not one of these operations was as judiciously and cheaply executed as my more full experience would now direct; and if either one were now to be done, I could save much of the labour before expended. Nor does this rest on supposition, but has been actually tested by further and large operations in the same locality and circumstances as of the fourth in the above statement. By improving the processes, or avoiding previous waste of means, something has been saved in every branch of labour, as will hereafter be shown.

## CHAPTER XXIX.

### DETAILS OF ACTUAL AND EXTENSIVE MARLING LABOURS.

THE largest known uncovering and excavation of marl is that which was begun by me in 1844, soon after my resuming marling labours in a new locality, and under new circumstances; and which work was in progress to 1850. This work is deemed worthy of being particularly described, for the extent and the mode of operation; and still more because some or all of the same general features of the locality, and advantages and difficulties, belong to very many other situations, of low-lying marl. It will not be my aim, in this place, to describe the general character or to note differences of the extensive marl formations of the Pamunkey river; but to state minutely the particular conditions of this one locality, and the labours there actually performed.

The place is on the Newcastle farm, belonging to Carter Braxton, Esq., and adjoining my own. The ground is part of a long and narrow stretch of the lower and more sandy land of the broad flats bordering the Pamunkey. The surface soil, covering the diggings to be described, is nearly level, but gradually rises, and the earth overlying the marl increases in thickness from 4 feet, in the earlier work, to 6½ at its greatest present enlargement. The surface of the bed of marl is also very nearly horizontal; and the variations from the level do not agree with those of the surface soil.

The marl originally was here exposed to view by being partly cut through by a narrow gully conveying a small stream; which stream received all the drainage of the adjacent land, and thereby was subject to be swollen by heavy rains. The stream, naturally, was about 2 feet below the highest exposed marl, and about 4 feet above the bottom of the bed at the same place. Except the continuation of this stream, and the narrow ravine conveying it, which very gradually descended to the river, all the adjacent ground was at least four feet higher than the upper surface of the marl. The annexed figure will show the profile of the different layers, at the distance of 40 to 60 feet from the stream.

FIGURE 1.

		Feet.
Overlay.	Sandy surface soil, about 6 inches	0½
	Sandy sub-soil, dry and firm } Loose and dry sandy gravel }	3
	Indurated ferruginous sandy } gravel, wet, 1 foot }	1
	Wet and adhesive green clay, ("olive earth") 1 foot	1
Marl.	Soft and pervious clay marl, 6 inches	0½
	Compact and impervious clay marl, 5 feet	5
	Softer layer, 1 foot	1
	Layer of stony lumps, 1 foot	1
	Gypseous, or green-sand earth, with very little shelly matter, of great and unknown thickness—at least 40 feet }	40

The soil of the overlying land is a rich black sandy loam (before drained and cultivated), 6 or 8 inches deep, lying on a sandy subsoil, firm and dry, and becoming more coarse and loose as descending, until it is more of fine gravel than sand. All the above layers, varying from 2½ to 4 feet in the successive uncoverings, are dry and easy to dig and remove. Below these, the gravelly sand is more or less cemented into a hard and almost stony bed, by the percolation of ferruginous spring water. Under this layer, which is full of veins of springs, coming from beneath the higher ground, there lies a very uniform layer, from 8 to 14 inches thick, of green clay, which is the water-bearing stratum, and keeps the lower part of the gravel above full of water. This green clay has a very peculiar appearance and texture. Though very largely constituted of pure clay, and extremely adhesive and close after being moved, yet in its bed it is very soft and pervious to slowly-oozing water, and, of course, is saturated by the numerous veins of springs above. I think that this green clay was formerly the upper part of the marl; and has had all its former shelly matter decomposed and carried off by the constant access and passage of water containing salts of iron. The upper 4 to 6 inches of the marl immediately below this clay, seems as if in transition to the same state. It is soft, permeable by water, miry, and adhesive, all which are qualities of the clay above, and entirely different from the compact marl

below. Although this lower marl also contains a large proportion of clay, yet the carbonate of lime present, in finely-divided state, not only preserves a very firm natural texture, but also prevents adhesiveness in working; unless the marl is permitted to receive water after being dug and finely reduced. Then, indeed, it is made a sticky mass; and the labour of shovelling it is more than doubled.

The whole bed of marl at this place varies from 6 to 8 feet in thickness, and generally is more than 7 feet, through the extent of my work. The much larger part, of 4 to 6 feet thick, is perfectly impervious to the passage of water, though highly absorbent of moisture, and always moist in its bed. This requires to be dug by a heavy and narrow grubbing-hoe, which, in the hands of a good pit-man, can be sunk barely 3 inches into this marl at a stroke. Still lower, for a foot or more, the marl is softer, and the shells are less reduced. And lowest, also for about a foot, the marl is in large stony masses, lying so closely as to form a connected pavement. The breaking up of this stony layer requires heavy and strong picks, and the work is laborious and slow. But these hard lumps are much richer in lime than the marl above. The excavation is carried no deeper than through this stony layer; and even that has often been omitted, on account of the greater labour to dig, and to throw it up from the greatest depth.

Next below this stony layer is the green-sand earth, of great and unknown depth. Here, this contains only about 2 or 3 per cent. of carbonate of lime, in a few widely dispersed shells, with the usual and considerable proportion of green-sand. I do not use this earth, nor deem it worth using as manure, where the upper marl is to be obtained. Nevertheless, this lowest bed was formerly used by the proprietor, and by others, in this neighbourhood, as "marl," without discrimination; and it was then even preferred by most persons to rich calcareous marl, if the latter were without green-sand.\*

#### *Excavation of Marl in small perpendicular pits.*

The first working was begun by digging and throwing off the overlay adjoining a part of the narrow "out-crop" or exposed marl, on the side of the natural gully through which the stream flowed, so as to uncover a surface of marl 5 or 6 feet wide and 8 or 9 in length (marked 1, in fig. 2). So narrow was the gully, and so little fall had the stream, that it was difficult to dispose of the earth from even this small uncovering. The marl was then dug out, so

---

\* The description of the strata is here generally confined to such features as materially affected the labours of excavation, and removal of the overlay and marl, or the supposed manuring values of the lower beds. In a subsequent part, in connexion with the marls of Virginia in general, the Pamunkey beds will be more fully described.



MANNER OF EXCAVATION.

FIG. II,  
Horizontal Plan of Marl Diggings.

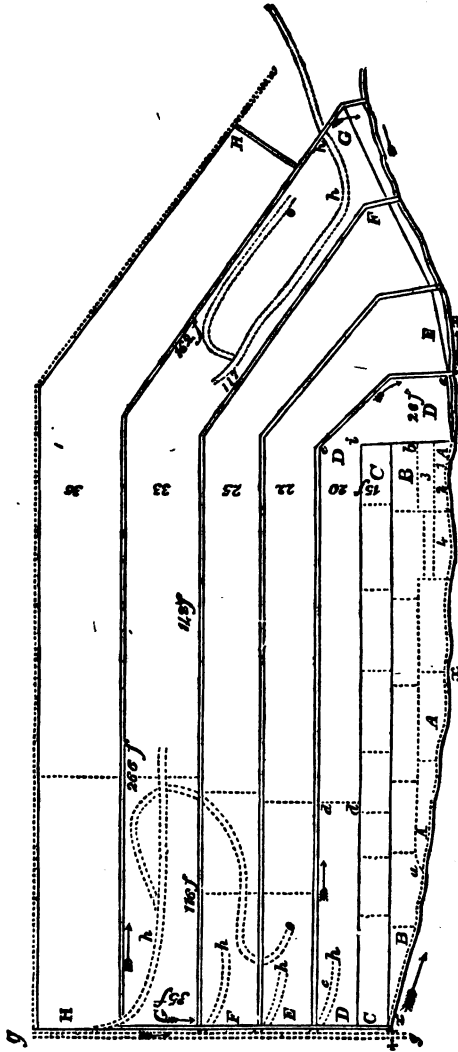

*Explanations.* FIG. II.

- x, x*—Stream, in a small natural ravine, on the sides of which some of the marl was exposed, at the out-cropping.
- A, A*—the first range of marl, successively uncovered and excavated in the small perpendicular pits 1, 2, 3, 4, &c.
- B, B, and C, C*—second and third ranges of diggings, in like manner, but increased in sizes of pits.
- D, D, D*—at first the natural surface of ground (5 feet above the marl), on which the marl was thrown out of the pits of range C; and next after, *D, D, D*, was the first range of graduated digging.
- c, d*—the upper part of *D*, 96 feet long, the overlay but partly removed at first, so as to form an inclined plane for the roadway. The same descending grade continued in excavating the marl from *d* to *c*.
- c, d, e, e*—narrow drain cut first down to, and afterwards into the marl, to intercept spring water, and turn it into the stream *x*—and thus to drain the space *D D*.
- g, g*—farm road, on level, opposite ranges *D, E, F, G*, rising from 5 to 6½ feet above the marl.
- h, h, h, h*—upper ends of roads successively used from the graduated diggings.
- o, o*—lower ends of descending roadways in the marl.
- E, F, G*—successive ranges, uncovered and excavated in graduated diggings, similar to *D*, but increased in extent.
- H, H*—range 36 feet wide, uncovered for next working—and less than half the marl of which was excavated, when my operations at this place were finally closed in December, 1850.

N. B. The Fig. II. is drawn on the scale of 80 feet to the inch, for the dimensions of ranges, and the general outline and space. But small sizes, and distances, as width of drains, &c., are necessarily irregular, and much larger than the scale.

as to form a pit with perpendicular sides, and thrown upon the adjoining firm ground (on 3), whence the carts removed it nearly or quite as fast as supplied from the digging. This small excavation served to receive the removed overlay from the next adjoining and larger uncovering (2), which, when pitted, in like manner, received the overlay from a still larger space (3). In this manner, successively digging out small pits with perpendicular sides, and then filling each one with the earth removed to uncover adjoining and enlarged spaces, the whole of the first irregular range (A A A) was worked out, between the stream ( $x$ ) and the line  $a b$ , then the lower limit of the firm overlying surface ground, on which the marl had been thrown for the carts, from the previously dug range of pits. So far, the work had been on the thinner out-running of the strata, and the sloping overlay not any where more than 4 feet thick. But thin as it was, and close to the places where thrown, the removal was laborious, owing to the oozing spring-water, and the adhesive clay, made much worse by the quantity of water. Of course, for such small and frequent uncoverings the previous cutting off of the access of springs was out of the question. This difficulty, caused by the water being necessarily worked up with the clay and other earth, increased with the increased width of the uncoverings, and the distances to throw off the earth. Each small uncovering of marl, after all its overlay had been removed, was separately drained, by a small trench being dug in the marl along its land side, and catching and leading the intercepted oozing springs into the previously made and still partly open excavations. As the marl was thrown up across these draining trenches, they were frequently choked by the marl, falling back. This was partially guarded against by laying a thick plank over the trench. Walls of marl, 15 to 20 inches thick, were left between each completed pit and the next one begun, to keep out of the newer work the mud and water which filled the older. But after each pit was finished, more or less of the wall previously left was cut down, and so much of the marl saved. Still, there was much loss of marl in what was necessarily left of these walls. Besides, other losses were sometimes caused by floods from heavy rains, or the breaking down of walls, filling unfinished diggings with water or mud too deep to be worth the cleaning out.

Along the first range of digging (A A A), the stream was higher than the bottom of the pits, from 2 feet at the beginning (1), to 4 feet at the upper end ( $a$ ). Its water was kept out of the diggings by leaving a narrow wall of marl alongside of the stream. This served as a barrier until each pit was finished; after which the entrance of water caused no serious inconvenience. As the pitting was extended up the course of the stream, the thickness of the marl stratum increased to 8 feet. The lowest stony layer, however,

was then generally left; being not deemed worth the great labour of throwing it up so high. The overlay being there 4 feet thick, the extreme height to raise the marl was 12 feet from the bottom of the marl to the surface of the ground where the carts were loaded.

In this manner of working, were successively uncovered and excavated the next ranges, B B and C C. But before either range of marl was near being finished, the removal of the next succeeding overlay had been begun and was extended at convenient times, and especially when the wet or frozen condition of the land forbade most other farm labours. At such times, the worst previous weather but slightly impedes the uncovering of marl; and thus a large proportion of this heavy labour has been performed when scarcely any other farm work could be done. This circumstance greatly diminishes what would otherwise be the expense.

The digging of the first marl (1 in A) was begun on June 28th, 1844. The excavation of the third range of pits, C C, was finished the following April. This last range was 250 feet long, 15 feet wide on an average; and measured 25,800 cubic feet in the bed (allowing a proper deduction for lost walls and bottoms), which would expand to about 29,670 heaped bushels after being dug.

The separate pits of the wider and more regular range C C were much longer, as well as much wider, than those of the earlier ranges. They were the full width permitted by that of the uncovered marl, clear of the narrow drain on the land-side, and the wall left on the opposite side—or about 13 feet. In length, they were 15 to 20 feet, or more, to suit the amount of labour engaged. In the usually dry weather of summer and autumn, and even in winter when a strong force was employed, there was the less danger of having unfinished work suspended by rain, and lost by overflow of water, or caving earth; and then larger diggings were opened. By increasing the size of the pits, there was the less trouble in constructing new drains, less loss in the dividing walls left, and more space and convenience for the pit-men. Besides, there was the benefit of equalizing the labour of throwing out the marl, by keeping the digging on two different levels at the same time.

The still slightly increasing thickness of the overlying earth made that of the next range (D) 5 feet; to which height, of course, the marl was thrown from the pits of C, making the perpendicular height from the top of the marl 5 feet, and from the bottom, 13 feet, when all was dug; or 12 feet when the stony bottom layer was left, as was now usual. But to make sure of the thrown marl not falling back into the pit, and especially when there was some quantity of marl remaining in the pile in advance of the carting, the height of the pit-man's cast was necessarily considerably more than the mere depth of the then excavation. Added to this was

all the lateral distance, which where greatest of the range C, and from the outside of the pit across to the loading place, was usually 14 and in some wider parts 17 feet. This throwing of the marl from the greatest depth and width of the pit was very heavy and slow work.

It was after the usual steady work of my then regular marling force, begun the 24th of the preceding January at another digging, and continued whenever the state of the weather and roads permitted, that the excavation and carting were begun at this digging on June 28th, 1844. On April 29th, previously, I had begun to measure and to note the quantity of marl carried every day by each cart, and the distances travelled; and of which the record was carefully and accurately continued until Sept. 11th (with the exception of a few days only, when the teams were at other work), for every day when the weather and roads permitted marling. Though noting thus the work of every separate cart and team, whether regularly or rarely so employed, the trial was especially designed for one particular mule, which was always kept at hauling marl (when that work was going on), and which has continued to be so employed to this time, in 1849. This mule is rather above average size, and might have been sold for \$65, according to the prices usual in and before 1844. She had begun this labour in January, when poor; had improved while so employed; and was in excellent working condition when marling was suspended in September, for the purpose of all the mules being used for the heavier labours of fallow-ploughing for wheat, and afterwards harrowing in the seed. I could extend the statement of this mule's daily work, as particularly, by embracing what had been previously observed and noted from April 29th; and also of all the other teams, irregularly employed. But it will be enough to present the portion of work done by this one, and only from the beginning of the excavations at this locality, of which the circumstances, and for this purpose, have been so minutely stated above. It is only by such careful observations, and actual measurements of quantities and distances, and these, moreover, continued for a considerable extent of time, that any fair and unquestionable evidence can be afforded of the amount and cost of any labour that can be performed in a certain time, by men or beasts, and especially of the latter. For a few days, or perhaps for a few weeks, there might be performed labours which the teams would sink under if continued much longer. But when a certain measure of work has been done regularly for months together, without any apparent difficulty or hardship to hands or teams, still more, when the teams have improved in flesh while continuing and even increasing their daily labour (as in this case), there can remain no question as to

the ability of all to continue to perform the same amount of labour for any length of time, under like circumstances.

From the commencement of my marling on my then newly-purchased farm, Marlbourne, two mules were assigned to this work, to be regularly so employed in all time fit for hauling marl, except during the greater pressure of certain other farm labours. These times were to be during wheat harvest (when only for eight or ten days all the mules usually would be idle, because all the drivers were needed as harvest hands), when hauling out the stable and winter-made manure—hauling in and thrashing the wheat crop, and delivering the grain for market at the river landing—for the ploughing for fallow wheat, and ploughing and harrowing when seeding—and to plough the corn for a few days both before and after wheat harvest—and sometimes when hauling in the corn crop, if hands could not then be spared to dig marl. None of these labours, except hauling in wheat and corn from the fields, are lighter than would be the continuation of hauling marl; and some of them (fallow-ploughing, harrowing, and thrashing) are much heavier. All these different operations usually kept the marling suspended for times amounting to about half the working days of each year. But not so much in 1844, as there was then no wheat crop to harvest or thrash, and very little manure made to be carried out. All these abstractions of the regular marling teams are much more than compensated by the irregular employment, at marling, of the ploughing teams at what would otherwise be their idle or leisure times. There is much convenience and gain in having labour thus to be exchanged. At the pressing seasons of harvesting, fallowing, for seeding and thrashing wheat, the regular farm force is insufficient, and no supply of extra force can be hired. Then the other force kept for marling becomes an important aid, and is worth much more than the cost, or than the marling labours thereby postponed. On the other hand, the regular carrying on of marling operations by an extra force so applied, enables the farmer to increase it at any leisure time, by any surplus force, of hands or teams necessarily kept for farm labour; and whose surplus or spare time, for short intervals, could not otherwise be put to any profitable use. In the one case, force that would be cheaply hired at double of average price of hires, is obtained for the lowest rates; and in the other, for no more than the cost of maintenance. Without both these reciprocal aids thus exchanged, I am sure that my wheat crop would necessarily be curtailed by one-sixth, and my marling by more than one-half.

The statement to be here offered of a connected portion of the marling labours of 1844, will be of what was actually done, under the then existing circumstances, and with the then defective mode of working—and not of what might have been done with better

appliances and more experience, or with such improvements of operations as I have since introduced.

The distances from the pit were accurately measured; except for inconsiderable and daily variations from, or extensions of known distances, which were estimated by the less exact measure of my stepping. For every new route, and every considerable alteration, the measuring tape was used. The contents of the cart-bodies were ascertained both by cubic measurement and by the heaped half-bushels of marl which could be put in. After enough of such trials had been made for fixing an average, each cart-load, according to its being filled even, or slightly heaped, or fully heaped (which variations might be required by different conditions of teams, marl, or roads), was respectively taken as the measure of a stated number of bushels.

Single mule carts were used this year, which was one of the errors afterwards abandoned. The loads of the one mule whose work will be separately stated, was at first made 8 heaped bushels, afterwards increased to 8½. Her driver was a boy of 15 years old. Two other mules which were generally but not regularly hauling marl during the same time, were driven, one by a boy, and the other by a girl, neither driver exceeding 13 years old. Tasks were assigned to each mule cart. Marling is the only kind of farm labour that I ever could have performed advantageously by task-work. For this, tasks were found very advantageous; and no other work which has been under my direction has been executed so faithfully, or with so little superintendence or difficulty. This peculiar adaptation to task-work is owing to the uniformity of the labours, when conducted on a regular plan of operations.

The marl was very generally free from all extraneous water. Though moist in its bed, and when dug, it is as little so as any highly absorbent earth could be, if in like manner covered by wet and water-soaked clay. The marl, just after being dug, weighs 105 lbs. to the heaped bushel. If allowed to become wetter, its weight is much increased. I found, by trial, that a bushel of this marl, as moist as when dug, would absorb two gallons more of water (16 lbs.), without being so surcharged that any would drip away. Yet many of those persons who work marl having springs oozing out above, allow so much water to have access, as to add much more than 16 lbs. to the weight of the bushel of marl, and to increase the labours of shovelling and loading in still greater proportion.

The degree of inclination of the surface of the land on which marl is carted, and its being rough or smooth, soft or firm, all have important influence on the labour of marling. The land to which mine was then applied, as well as all over which the routes passed, was part of the broad flats bordering on the Pamunkey. The very gradual ascent from the margin of the pit (where the marl was

thrown up, ready for filling the carts), was not more than 10 feet of perpendicular height, to the highest summit; after which, the routes to all the different places of deposit pass over slight and gradual undulations of surface, as much descending as ascending, and which variations of level, in their extremes, scarcely exceed 6 feet. So level a way is of course a great advantage, and enables me to carry much heavier loads than on the high and hilly lands which I formerly marled elsewhere. But, on the other hand, this almost level surface requires the land everywhere to be ridged; and the water furrows (or deep alleys), and the many deeper cross "grips" (or very narrow and shallow ditches), together present greater obstacles to the passage of carts over the fields, than would be found with much more of ascent and inequality of surface, but with smooth tillage. Another disadvantage, suffered then, and generally for some years after on nearly all my land, was, that as it had not been recently grazed and trodden by cattle, the soil was not firm, but puffy and soft; and therefore, even when dry, and still more when wet, this soft soil greatly increased the labour of carting on the fields.

The marl contains, on the average, 38 to 40 per cent. of carbonate of lime. It was applied at about 350 bushels to the acre—in heaps, 11 yards each way, of the whole load of a single mule, or half the load of two mules, or two oxen.

After all these matters of preliminary explanation, I will now present the particular statement designed, showing for an entire job of 64 consecutive working days, the daily travel, and number and amount of loads of a single mule; and also the total quantity of marl dug for and carried out by other and less regular teams, whose work, though noted separately, it is not necessary to give more particularly in this abstract from the fuller record in my farm journal. The work stated in the following table comprised all the marl of the ranges A and B, and a large part of the next and wider range C.



HAULING BY ONE MULE.						Whole Work.		
Days.	Loads.	Heaped Mounds.	Average distance from pit to field (and back).	Additional distance from stable.	Whole day's journey, including distances to and from stable.		Horsemen.	Total bu's carried out.
					Miles.	Yards.		
June 28	12	of 8	1770 × 2	380 × 4	25.		2	310
" 29	12	" "	" "	" "	25.		"	306
Monday, July 1	11 <sup>00</sup>	" "	" "	" "	22.1740		"	302
" 2	12	" "	" "	" "	25.		"	304
" 3	12	" "	" "	" "	25.		"	310
" 4	12	" "	" "	" "	25.		"	346
" 5	12	" "	1825	296	25. 964		"	346
" 6	11	" "	1866	274	23.1576		"	316
M. " 8	11	" "	1883	208	24. 18		"	316
" 9	10	" "	2248	none.	25. 900		"	272
" 10	7 <sup>00</sup>	" "	" "	" "	15.1510		"	154
" 11	13 <sup>00</sup>	" "	" "	" "	" "		"	274
" 12	10	" "	2245	none.	25. 900		"	246
" 13	20	" "	966	1005	24. 380		"	274
M. " 15	20	" "	915	955	22.1000		"	274
" 16	20	" "	" "	" "	22.1000		"	274
" 17	20	" "	989	" "	23. 980		"	274
" 18	20	" "	963	" "	24. 100	3	"	354
" 19	20	" "	971	" "	24. 420	"	"	402
" 20	12 <sup>00</sup>	" "	964	955 × 2	23. 253	"	"	250
M. " 22	20	" "	995	955 × 4	24.1300	"	"	330
" 23	17 <sup>00</sup>	" "	" "	" "	20.1450	5	"	604
" 24	21 <sup>00</sup>	" "	1012	855	23. 160	"	"	716
" 25	19	" "	" "	" "	23.1396	"	"	746
" 26	13 <sup>00</sup>	" "	1878	662	23.1156	"	"	532
" 27								
M. " 29	15	" "	1406	" "	25. 848	2	"	324
" 30	15	" "	" "	" "	25. 848	3	"	500
" 31	15	" "	" "	" "	25. 848	"	"	514
Aug. 1	15	" "	" "	" "	25. 848	"	"	496
" 2	14 <sup>00</sup>	" "	1263	707	20. 164	"	"	506
" 3	16	" "	" "	" "	24.1004	"	"	536
M. " 5	16	" "	" "	" "	24.1004	"	"	500
" 6	16	" "	1293	677	25. 184	"	"	500
" 7	18	" "	1069	901	23.1696	"	"	530
" 8	16	" "	1323	647	25. 924	"	"	529
" 9	16	" "	" "	" "	25. 924	"	"	510
" 10	16	" "	" "	" "	25. 924	"	"	450
M. " 12	16	" "	1363	607	26. 284	"	"	514
" 13	15	" "	1374	596	24.1364	"	"	592
" 14	15	" "	1395	575	25. 184	"	"	596
" 15	15	" "	" "	" "	25. 184	"	"	596
" 16	19	" "	1091	890	25. 978	"	"	585
" 17	19	" "	" "	" "	25. 978	"	"	585
M. " 19	15	" "	1428	522	25. 928	"	"	543
" 20	15	" "	" "	" "	25. 928	"	"	470
" 21	19	" "	1110	857	25.1608	2	"	283
" 22	19	" "	1234 × 2	836 × 4	26. 676	2	"	278
" 23	18	of 8 <sup>1</sup> / <sub>2</sub>	1154	816	25. 808	"	"	271
" 24	18	of 8 <sup>1</sup> / <sub>2</sub>	" "	" "	25. 808	"	"	271
M. " 26	12	" "	1865	none.	25. 760	3	"	530
" 27	18	" "	1154	816	25. 808	3	"	540
" 28	18	" "	1176	794	25.1512	"	"	579
" 29	18	" "	" "	" "	25.1512	"	"	556
" 30	18	" "	1200	772	26. 528	"	"	489
" 31	10 <sup>00</sup>	of 8 <sup>1</sup> / <sub>2</sub>	" "	" "	15.1668	"	"	283
M. Sept. 2	17	of 8 <sup>1</sup> / <sub>2</sub>	1222	750	25. 448	"	"	513
" 3	12	" "	1865	none.	25. 760	"	"	408
" 4	12	" "	" "	" "	25. 760	2 <sup>1</sup> / <sub>2</sub>	"	408
" 5	12	" "	" "	" "	25. 760	2 <sup>1</sup> / <sub>2</sub>	"	450
" 6	13	" "	" "	" "	27. 970	2	"	428
" 7	12	" "	" "	" "	25. 760	2	"	283
M. " 9	12	" "	" "	" "	25. 760	3	"	639
" 10	12	" "	" "	" "	25. 760	4	"	672
" 11	10 <sup>00</sup>	" "	" "	" "	21. 340	4	"	384

965 Loads.

1547. 270

## REMARKS.

\* The numbers marked thus (\*) are short of full day's work, for causes to be stated.

\*\* July 1, one load, or one-twelfth of the task, lost by rain.

\*† July 10, rain prevented 3 loads, or three-tenths of the task.

† July 11, full but irregular work at another place, and distances not ascertained—the ordinary road being too wet to use.

\*‡ July 20, stopped at 12 o'clock for half holiday—8-20ths of full day's work wanting.

†† July 23, rain caused loss of 3 loads, or 3-20ths of task.

‡ July 24, a load too much, by mistake.

\*a A good rain in afternoon—2 loads (2-15ths) lost. Next day (27th) earth too wet for marling, and the mules at the harder work of ploughing for wheat.

\*b Aug. 2, rain caused loss of 2 loads, or 2-16ths of task.

\*c Aug. 31, stopped at 12 o'clock for half holiday, 8 loads, or 8-18ths wanted of full day's work.

\*d Sept. 11, rain, after long drought, stopped all work at 4 P. M. Next day more and heavy rain, and this mule, and all others fit, put to ploughing for wheat. For two weeks previous to these rains, the ground had been excessively dry, so that the road, and tracks across the fields, which were constantly travelled over, were so deep in fine dust that it was very unpleasant, and even an impediment to the teams.

The foregoing table gives the following results :—

The mule, whose work is stated separately, in 65 consecutive days, omitting the Sundays only, travelled in marling labour 1572 miles and 408 yards. Of these 65 days, 1 (July 27th), the teams were at other labour. One other day (July 11), of full but not measured marling labour, being estimated and added in at the general average, and of 8 other days,\* of which the work was broken by rains, the idle parts being deducted, leave 62½ of full working days of hauling marl. This makes the daily average travel of the mule 25 miles and 138 yards, including the distances from the stable and back.

The whole number of loads actually carried out by the one mule was 965; the average load, in heaped bushels, 8.095, weighing 105 lbs. to the bushel, and 850 lbs. the load. The average number of loads daily (for full day's work), was 15.4; and the average travel for each load, 2867.4 yards.

The quantity of marl carried out in 62½ full days' work, 7803 bushels; which makes the daily average quantity carried, 124.85 bushels.

And as to the general operations of all the force employed—

The whole quantity of marl dug, and carried out by all the teams, in this time, 26,271 bushels.

---

\* The parts of the 8½ days lost by rain or otherwise, amounted in time to much more than 1½ days. But the loss in work was no more, because in every such interruption, the hauling, or task-work for the day, was in advance of the hour when operations were suspended.

The whole digging and throwing out of the marl, and assisting the drivers generally to load (which assistance by one of the pit-men was required always, but not always given to all of the extra teams), was equal to 177 days' labour of a single pit-man; which makes the average quantity of marl, dug, thrown out, and partly also loaded, for each pit-man, 142.42 bushels.

So much for the labours actually performed. I shall now proceed to estimate their cost. For this purpose, the different kinds of labour will be charged at the prices stated in the previous chapter.

*Estimate of the cost of Marling.*

Carting.—The mule per working day, cents, . . .	26.75	
Her driver, (boy of 15 years,) cents, . . .	22	
Cart and gear, suppose, cents, . . .	5.50	
For daily work, an average of 124.85 bushels, . . .	54.25	
Or, for the 100 bushels, cents, . . . . .		44.26
<i>Digging and assisting to load.</i> —Pit-man, per day, cents, . . . . .	34	
His share of tools, suppose, cents, . . . . .	4.50*	
For his average daily work, of 148.42 bushels, . . .	38.50	
Or, for the 100 bushels, . . . . .		26.
<i>Throwing off overlay of earth to uncover marl</i> (its thickness compared to that of the marl about in proportion of 3 to 5), supposed to be one-half the labour of pit-work of the marl below; or per 100 bushels of marl dug, . . . . .		13.
<i>Spreading marl</i> (340 bushels to the acre,) per 100 bushels, . . . . .		†10.
Total cost of applying 100 bushels, . . . . .		93.26

\* This charge includes all the use of tools for as much marl as one pit-man supplies in a day, not only for his own digging and throwing up, but also for the loading and subsequent spreading of the same marl.

† The spreading of this marl requires very unequal labour according to its condition. When recently carried out, and still moist, and much of it in firm lumps—or otherwise, after mouldering by exposure, and then being saturated by rain-water—it is twice as difficult to spread as after being left in heaps for some months of summer weather, or until dry after being frozen. When in good order, a man can easily spread 60 heaps of 8 to 9 bushels, at 11 yards distance. When but in tolerable order, and in winter days, I have had 50 such heaps spread by good hands; and when in bad order, barely 40 heaps. Thinner dressings, or more distant heaps, would require more labour for spreading, in proportion to the quantity. The charge above, a man (at 34 cents a day) is allowed to spread per day no more than 40 heaps, of 8½ bushels to the acre. This is very light work, unless the marl is in bad condition.

Small as is this cost for a durable manuring, it far exceeds what would be required on most farms possessing marl-beds. In many localities in Virginia marl may be uncovered, excavated, and carried to the field for one-half of my expenses for the same; and in some cases in Virginia, and in numerous situations in South Carolina, the necessary expenses would scarcely be more than a fourth of mine. The spreading is not included in this comparison, as its cost has no relation to the greater or less cost of the other labours. The obstacles to my operations were unusually great—in the soft and adhesive overlying clay—the numerous small springs necessary to be diverted—the liability of the loose sand above to be washed down by rains—the low level of the marl compared to the surrounding land—and the great distance from the pit to the field: But whether the difficulties of other marlings be greater or less than mine, their costs may be estimated by my rules and prices, with due regard paid to difference of circumstances. Before, however, making such application, regard should be paid to the improved processes and reductions of expense in my subsequent operations, which will presently be stated.

It may, perhaps, be objected to the foregoing statements and estimates, that the work was done in the long days of summer, and in dry weather, when there would be the least obstruction to, or loss of labour from bad weather and bad roads. And I will admit further, that the expense incurred was not increased by sickness of any one of the regular marling hands, nor by any other important loss in labour or materials. All these would be good grounds for objection, if no allowances had been made for average losses on these scores. But, in the general estimates of the cost of labour, there were made the ample allowances of 30 days' labour of the year lost on the average by each man and boy, by bad weather, sickness, and half holidays (besides the 58 of Sundays and regular holidays), and 40 days for each mule; and also enough for wear and breakage of carts and utensils. Therefore the proper proportion of these losses is in fact fully charged in the estimate, though scarcely any of such losses occurred.

It is true that winter marling would be much more costly, owing to the then generally muddy or slightly frozen and rough roads. And therefore during that season, and when the earth is wet and soft, it will be generally better to suspend marling labours, if the teams can be employed at other, easier, and as necessary work. My marling, however, was not thus suspended. For the extra expense of the more disadvantageous and costly winter marling was deemed of less amount than would be lost in the difference of productive value of land marled, and the same if left unmarled. Thus it is cheaper to pay \$4 an acre, for marling a field before taking its crop from it for that year, than to take the crop first, and afterwards

marl it for \$2. And, therefore, *deeming the omission or delay of marling to be by far the most expensive thing in regard to the operation*, I marled even in unsuitable seasons, so as to avoid the necessity of ever again bearing the much heavier loss of cultivating any unmarled ground.

*Excavating Marl in large graduated pits*

The excavation of the range of perpendicular pits C (Fig. II.), was finished in April, 1845. The marl carried out from that and the two previously worked ranges, A and B, amounted to 71,541 heaped bushels—according to the number of loads counted on the fields, and their estimated quantities. Previous to beginning to work at this digging, there had been carried out from another, not far off, 26,600 bushels, from January 24th, 1844, to June 28th, the time of beginning the second excavation. Of the earlier job, it is enough to say that it was very laborious, owing to the overlay to remove, of 7 to 8 feet, which was double the thickness of the marl below. This, my first excavation here, was worked upon the plan I had used elsewhere; the carts descending by a gently graded slope to the bottom of the marl. But every considerable rain caused the loose sand and gravel to fall in and choke the small drain cut around on the top of the marl, and then the spring and rain water flooded the pit; the bottom of the digging (when deep) being lower than any outlet for the water. The many such disasters which were suffered and repaired, and the consequent losses of time and labour, induced me, for the next work, to pursue the more laborious, but less hazardous plan of excavating by small perpendicular pits, as described in the foregoing pages. But after thus working out the ranges A, B, and C, I thought that with my then better experience, and by using better safeguards than before, I might venture to return to the plan of graduated excavations. With this intention, the range D (Fig. II.), had been laid off, and cleared of its overlay, during the winter and spring of 1845, at my leisure and convenience, while the latter excavations of the range C were still in progress. The same plan has been since continued, with improvements, for the successive and adjacent ranges, E, F, and G, which last is not quite exhausted of its marl, at this time (October 1849), and another range, H, has nearly been cleared of its overlay, and made ready for its excavation to be begun. It will be unnecessary to keep separate the incidents of these different large workings, when referring to such processes as may be deemed worth being mentioned. The natural features continued the same as to the marl, and also of the overlay, excepting its increasing in thickness, as the distance from the stream was extended. The different means used for saving labour were mostly adopted in the working

of the first graduated range, D, in 1845; but some of them were introduced more recently.

The range D (Fig. II.), when completely uncovered and ready for the carts to descend into, and to be loaded on the surface of the marl, was 20 feet wide, including the space for the narrow drain along its land-side (*c, d, e, e*), for the greater part of its length—narrower at the angle (*i*) and then widened to 26 feet at lower end, to give room for a wagon to turn. The whole length was 255 feet; but of this, 96 at the upper end (*c, d*) had but half the overlay removed at first; the earth being left in an inclined plane, sloping downward from the road (*gg*) on the surface of the land, to the surface of the uncovered marl. The thickness of the overlay here having been 5 feet, the graded road served to rise that height in 96 feet of the slope. The same grade was not exceeded in excavating the marl; and it would have served to descend, if required, two feet lower than the usual level of the bottom of the marl, at the lower end of the digging. The digging and removal of the marl was begun at the lower end (*i, e, x*) and carried on in successive layers; but always keeping the floor of the pit sloping downward towards the lowest end (*x*), and also laterally towards the land-side (*e, e*). At the lower end was a short, narrow ditch (*e, x*), serving as an outlet into the stream, which had been deepened so as to be lower than the lowest designed digging. Thus, whatever water might get into the digging, from rain-floods, or from the side-drain being choked by caving sand, and thereby turning in the spring-water, it would necessarily keep to the lower side, and flow out at the lower end into the stream. The figures II., III., and IV., show severally the horizontal plan, and the longitudinal and cross sections, or profiles of the work.

The first improved operation adopted was in removing the overlay, by using, where practicable and convenient, the plough to loosen the earth, and the scraper (such as is used for road-making) to move it into the finished ranges of pitting. The difference between these and the former modes of hand-labour, with hoes, picks, and shovels, was not accurately observed, nor could it be; as these large operations were extended through several months (and more lately, through a whole year), at such irregular times as labour could be best spared, and especially when previous rain, snow, or freezing had put a stop to usual farming operations. Any farmer can nearly enough estimate the superiority of ploughing over hoeing to loosen earth. The hoeing would certainly cost four times, and perhaps ten times as much as ploughing. The scraper is also very far cheaper than shovels, for removing earth to all distances between 30 and 40 feet. For short distances, for which one throw of the shovel is enough, the latter is the cheapest. The excavation by plough and scraper was not only, as anticipated, much easier

FIG. III.

*Longitudinal Section or Profile of Graduated Diggings (at range D, in Fig. II.) Scale 40 feet to inch.*



EXPLANATIONS.

- a, a*, Surface of ground, and level of highest part of graded roadway.
- m, m*, Overlying earth, 6 feet thick.
- s, s*, Marl, 7 to 8 feet thick.
- e, e*, Green-sand earth, of unknown thickness.
- a, o, r*, Roadway, descending 6 feet in 96, from surface of land *a*, to bottom of marl, *r*.
- v, v, v*, Successive perpendicular excavations, beginning at *r*, made after digging down to the inclined plane, *o, r*.
- s, o*, Marl either excavated like *v, v*, or subsequently by a reversed direction of descending grade.

FIG. IV.

Cross Section or Profile of Graduated Diggings (as of range G, in Fig. II.) Scale 20 feet to inch.

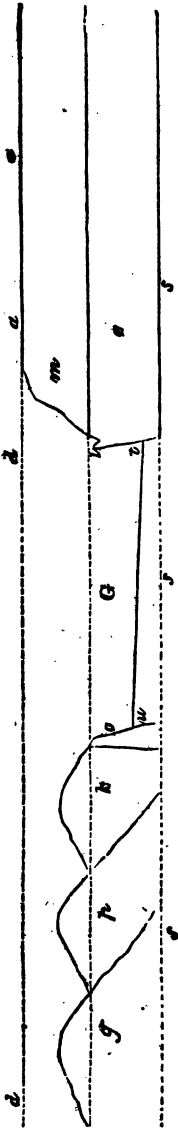

EXPLANATIONS.

- a, a*, Surface of ground (and overlay of next range to be uncovered.)
- d, d*, Former extension of surface, now removed.
- m*, Overlying earth, here 7 feet thick.
- n*, Marl, 8 feet thick.
- s, s, s*, Green-sand earth.
- G*, The bed of marl, here removed from its original height, the dotted line next above *G* *i*, to the line below—and the lower part, *w, t*, still to be removed, to the bottom, at *s*.
- i*, Small drain, to intercept and lead off the springs coming out of *m*.
- t*, Lowest graded side, or drain, to receive and discharge accidental floods into the stream.
- o*, Wall of marl, left to be last dug out, to keep out the water and earth from
- g, p, k*, Successive fillings of previous excavations, by the overlay removed from the next uncovered.



where the overlay was dry and sandy, but also lower down in the wet springy gravel, often indurated by ferruginous cement; and even to some extent, in the wet, miry, and sticky clay still lower. Difficult as was this lowest part of the uncovering, in every mode, the scraper took up the clay, and let it drop because of the weight of the mass, much better than any hand utensils. In this, the plough was not needed, nor could the scraper be used much, because the feet of the horses sank through both the miry clay and the upper thin layer of soft marl (Fig. I.), and would have worked up both together.

But the plough and scraper could not serve for all the overlay. Not only for the miry clay layer, but for much of the other overlay, either because of its texture, or its place, it was still cheapest to remove by hand implements, as previously; and especially for giving the final shaping to the opening. If the job had been continuous and regular, and the labourers all able men, it would probably have been cheaper to remove the whole overlay at once in wheel-barrows, in the manner of excavating for canals and railroads. As it was executed, the saving of labour in removing the overlay was fully one-half of the former cost.

To return to my actual labours. As soon as the wet gravel (Fig. I.) was laid naked, the land-side outline of the range was marked off, and a narrow ditch (*c, d, e, e, x*, Fig. II.) dug along it down to the marl, intercepting the numerous small springs, and conveying the water into the stream (at *e, x*, Fig. II.). After remaining thus drained for some weeks, the clay, though still miry and sticky, is worked much more easily; and in later operations, has been mostly removed in carts, which were drawn upon the then partly excavated and firm marl. The scrapers' work had previously served to fill the sinks and pools in the older ranges, with dry sand and gravel; forming a drained, firm, and nearly level surface, on which the carts carried and dropped the remaining clay overlay.

The design of the plan of operations was to have the carts to descend upon the marl, and to draw loads ultimately from the lowest digging. For this purpose, as has been stated, part of the overlay had been left on the upper end of the range (*a, m, o*, Fig. III.), forming a sloping roadway for 96 feet of length, and rising 5 feet in that distance, from the marl to the road on the surface of the land. A few yards of "poling" over the soft clay bottom layer served to make a firm passage from the marl to the dry sandy earth. The marl, except its upper 6 inches, was at first firm enough for the loaded carts; and soon became dryer and firmer in drying. The slope, given by the digging and removal of the marl, descending always to one side and to the lower end, where there was a discharging outlet into the stream for all water,

served to keep the marl as dry as was possible for a naturally moist and extremely absorbent bed. This preservation from all extraneous water, as well as losing some of its own by exposure, rendered the marl easier to dig and to load, and something lighter of carriage.

Further—the digging was no longer impeded by the necessity of having to leave, shape, and secure cross-walls, which had before caused much trouble, and much loss of marl. Now there was but one wall to be left, which was along the whole length (o, Fig. IV.), to keep out the earth and water which filled the old diggings; which wall was afterwards cut down, and mostly saved, in the closing operations of each range, in succession. The unlimited room for their work permitted the pit-men to dig the marl in much larger masses, which saved much of the labour of digging, and something in that of loading. For the earthy portion of this marl, compact as it is, is composed of thin horizontal laminæ, the result of slow and uniform sedimentary deposition. In consequence, it may be cleaved in the direction of its "grain" much more easily than cut or fractured in any other direction. This facility is best availed of when a wide area is worked; and not in small pits, confined by perpendicular sides. The shovelling was also much easier—first, because the marl was more in large lumps, and less in a finely reduced state than before; and secondly and mainly, because the height of the cart was the greatest extent to which it had to be thrown, instead of double throwing, as before, and the throw out of the pit, which at the maximum, was 13 feet in height, besides the lateral distance. This change, taking away all the throwing out of the pit, saved much more than one-half of the pit labour. The average quantity of marl obtained before from each pit-man's daily labour was 148.42 bushels. Now, one man only was usually employed, who dug for the carts from 400 to 600 bushels a day. It is true, that he was now relieved from assisting to load, which work was put upon the drivers. In the closing operations of the digging, when small pits still had to be sunk, and through the bottom stony layer, and the marl from them thrown up on the sloping roadway, and walls to cut down, the result of the pit-man's work was much less. But even then, when the difficulty was greatest, the least amount of marl obtained was 160 bushels for each man in the pit. It is certain, that throughout the whole excavation of the range, the pit-man's labour furnished on the average more than twice the quantity of marl. This part of the cost then also was reduced fully one-half. But this is in advance of describing the later of the operations of which the cost was so reduced.

The digging down and removing the marl in the pit to the grade of 5 to 6 feet depression in the 100 of length, served to reach the

bottom green-earth, and leave it naked, for the extent of some 70 or 80 feet length of the lower end of the range ( $r$ , in Fig. III.). This completing of the excavation through the lowest marl was begun at the lower end, where is the outlet for water from the pit. And as soon as each successive few yards in length had been so deepened to the bottom, the side-wall of marl was cut down, and its marl mostly saved. Then, indeed, the earth, which this wall had been left as a barrier to keep out, fell in, and more or less of the old confined water beneath the earth flowed in also, from the old diggings. But this now did no harm. The bottom (green-earth) where the caving earth fell, and the water overflowed, was not needed; and the water, after rising a few inches thereupon, passed off through the outlet into the stream. The next few yards length of bottom marl was then removed, and then its part of the side-wall taken down in like manner, until the whole lower 70 or 80 feet ( $z$ ,  $r$ , in Fig. III.) had been taken out, including its adjoining side-wall. Next, the lowest part of the sloping roadway of marl ( $v$ ,  $r$ , Fig. III.) was dug out, the carts turning and loading on the adjoining space next above, which also was next dug out. Thus, the whole slope of marl was dug out in the manner of successive perpendicular pits ( $v$ ,  $v$ ,  $v$ , &c.), each of the full width of the range, and 6 or 8 feet in the direction of the range. The first or lowest of these perpendicular diggings was not a foot deep at the upper side. Each increased in thickness, until the last and highest ( $o$ , Fig. III.) at beginning of the slope of the overlay forming the road, was 8 feet thick. Still, though this digging was according to the former mode, by perpendicular pits, this operation was much less laborious; as the throwing up of the marl varied in height from less than one foot, to at most but 8. As fast as each of these pits was finished to the bottom, the adjoining part of the side-wall ( $o$ , Fig. IV.) was cut down, and as much saved as was not prevented by the coming in of earth and water.

The thinner part of the overlay forming the slope ( $m$ ,  $o$ , Fig. III.) was next thrown, in successive uncoverings, into the last finished pits, and the marl below in like manner dug out. But when the thickness of this earth had reached some 3 feet, and about 50 feet of the length remained, this remnant was left to be taken out with the next succeeding range of marl; when carts, by having a longer route, could descend on this part of the marl by a slope made in a reverse direction (as space  $h o h$ , in ranges E and F, Fig. II.) This postponement of the complete uncovering and the digging out of the marl of the upper 50 feet of each range, for the benefit of more easy access at a later time, has been since continued. It is including all these more costly labours with the principal and usual operation, that the excavation is deemed reduced in cost fully one-half of that of the former mode.

The labours of the teams and their drivers were slightly increased by the change of plan. The carts had to be drawn from the bottom of the digging, and also, for a large part of the time, from the bottom of the bed of marl. But the ascent was so gradual, and the way so firm, that no greater effort was made necessary than many of the obstructions on the nearly level ground, of roads or field, encountered afterwards. The drivers also had now to put in the whole of their loads, instead of being assisted by a pit-man, as previously. But because of the greater distances in 1845, and generally since, there were fewer trips, and of course fewer loads to be put in and out, which kept the loading labours to the drivers nearly the same in general. These circumstances then added nothing to the former cost of hauling and loading.

Another gain was made in increasing the loads (by heaping higher in the carts), from the heaviest of the preceding year to 9 bushels for the single-mule cart, and 18 bushels for the two-mule carts. Of the latter, one was now regularly worked, and two others frequently, and found to be much preferable. For if carrying a double quantity, a two-mule cart was much cheaper than double the price of a single-mule cart; and also was cheaper in working, than two small carts, in requiring one driver instead of two—though a driver of more ability and value. The increase of loads to 9 bushels to the mule (whether in single or double carts,) had been made in April 1845, and has been maintained since, whenever the ground was firm, and the road good. Particularly, the marling mules continued regularly to haul these loads through all the time when so engaged that year, until in September, when marling was suspended. They kept in excellent condition; and better than I have ever had the ploughing teams during summer. The average day's travel, in hauling marl, had also been increased, for weeks together, to as much as 26 miles; and from April to September was not less than an average of 25 miles. Any greater distance was not desired; but could not be always avoided, when the trips were very long. The increasing the sizes of loads made a diminution of cost, nearly equal to one-ninth, certainly to full one-tenth of the previous cost of transportation.

The values of the several diminutions of cost of labour stated above will be more clearly exhibited by comparative statement of the expenses in 1844, before presented, and those of 1845.

*Total cost of applying marl, per 100 bushels, at the average distance of 1433 yards from pit to field; or with 25 miles and 138 yards, of total daily travel.*

In 1844.		In 1845.	
	Cts.	Reduced by	Cents.
Labour of pit-man, for 100 bushels . . . . .	26.00	Half, or . . . . .	18.00
Carting . . . . .	44.26	One-tenth . . . . .	4.42
Throwing off overlay . . . . .	13.00	One-half . . . . .	6.50
Spreading marl . . . . .	10.00		0.
<b>Total expense, cents,</b>	<b>98.26</b>		
			Leaves cost . . . . .
			. . . . .
			. . . . .
			. . . . .
			. . . . .
			<b>Total expense, cts.</b>
			<b>Former cost . . . . .</b>
			<b>Reduction of ex. . . . .</b>

From all these detailed premises the conclusion has been reached that, under the circumstances stated, or others not of greater difficulty, the total cost of applying marl is less than 70 cents for the hundred bushels—(69.34). The circumstances, and the elements of cost, of course must vary with every locality, and even frequently at the same locality. Nevertheless, the foregoing estimates and results may be applied to any other operations, with due allowances for differences; and thus may be facilitated the calculations of the amounts and the costs of other marling operations.

From my large experience, not only of the years 1844 and 5, but since to the present time, there can be no doubt of the ability of carrying 1890 lbs. (18 bushels) of marl as the regular loading of a two mule cart, on nearly level routes, and on firm ground and good roads; and that the regular and continued daily travel of the carts, from pit to field loaded, and returning empty, may be 25 miles and 138 yards each day. Upon these grounds, it will be easy to calculate the cost of marling at any greater or less distances than the average of mine (2867 yards from pit to field and back) in the particularly noted trial in 1844. The transportation is usually the main expense of marling. This, alone, increases with and is in proportion to the distance; the other expenses are not affected by the distance of carriage, but remain in proportion to the quantity of marl carried out, under like circumstances. With the conditions last stated (for 1845, page 204), my expense for carting alone of 100 bushels of marl, in trips to and fro of 2867 yards average distance, and making 25 miles and 138 yards of total travel daily, amounted to 39.84 cents. All the other expenses of applying the 100 bushels made 29.5 cents. These facts furnish premises upon which to calculate what the total costs would be for any other length of trips, as follows:

Bushels.	Carting yards, to and fro.	cost	Cents, for carting.	and	Cents, for all other labours.
100	2867		39.84		29.5
1	2867		0.3984		
1	1760 (1 mile)		0.2446		
100	1760		24.46		+29.5
					24.46

Total cost of 100 bushels, trips of 1 mile to and fro, 53.96

Upon these grounds the following table is constructed, showing the cost of applying 100 bushels, for trips to and fro of all lengths from 1 mile to 25; or of distances from pit to field of half the extent, or from half a mile to 12½ miles; if there is no extra travel to be included.

Length of trip to and fro.	Cost of carting of 100 bushels. (Cents.)	Cost of all other labours. (Cents.)	Total cost of 100 bushels applied at such lengths of travel. (Cents.)
Miles.		{ Uncovering . . . 6.5 Pit work . . . 18. Spreading . . . 10. }	
1	×24.46 = 24.46	. . . . .	+29.5 = 53.96
2	×24.46 = 48.92	. . . . .	+29.5 = 78.43
3	×24.46 = 73.38	. . . . .	+29.5 = 102.88
4	×24.46 = 97.84	. . . . .	+29.5 = 127.34
5	×24.46 = 122.30	. . . . .	+29.5 = 151.80
6	×24.46 = 146.76	. . . . .	+29.5 = 176.26
7	×24.46 = 171.22	. . . . .	+29.5 = 201.72
8	×24.46 = 195.68	. . . . .	+29.5 = 225.18
9	×24.46 = 220.14	. . . . .	+29.5 = 249.64
10	×24.46 = 244.60	. . . . .	+29.5 = 274.10
11	×24.46 = 269.06	. . . . .	+29.5 = 298.56
12	×24.46 = 293.52	. . . . .	+29.5 = 323.02
13	×24.46 = 317.98	. . . . .	+29.5 = 347.48
14	×24.46 = 342.44	. . . . .	+29.5 = 371.94
15	×24.46 = 366.90	. . . . .	+29.5 = 396.40
16	×24.46 = 391.36	. . . . .	+29.5 = 420.86
17	×24.46 = 415.82	. . . . .	+29.5 = 445.32
18	×24.46 = 440.28	. . . . .	+29.5 = 469.78
19	×24.46 = 464.74	. . . . .	+29.5 = 494.24
20	×24.46 = 489.20	. . . . .	+29.5 = 518.70
21	×24.46 = 513.66	. . . . .	+29.5 = 543.16
22	×24.46 = 538.12	. . . . .	+29.5 = 567.62
23	×24.46 = 562.58	. . . . .	+29.5 = 592.08
24	×24.46 = 587.04	. . . . .	+29.5 = 616.54
25	×24.46 = 611.50	. . . . .	+29.5 = 641.00

Thus it appears, that if 100 bushels of marl had been carted to 12½ miles distance from the pit (making the trip to and fro 25 miles), the cost of carting would be \$6.11½, which added to the other fixed expenses, 29.5 cents, shows the total cost to be \$6.41 the 100 bushels.

Superior in general advantage as is the mode of working of marl in large graduated excavations, it is very hazardous in wet situations, without much care. The liability to damage is especially great when the work of an unfinished excavation is suspended through winter. Then the caving in of the side-walls, both of overlay and of the marl, caused by frequent rain floods, and still more by the frequent alternate freezing and thawing of the exposed marl, may operate first to choke the passage, and soon to crumble down the entire side-drain. The outlet of water from the pit is thus obstructed, and the quantity dammed up in the pit converts the caved earth and marl to a mire. The successive freezing and thawing continue to throw down successive layers of the walls, serving still more to raise the water, and filling the pit with mire. It has happened in my much earlier labours, elsewhere, that the unfinished bottom of large spaces of marl was thus so covered in deep mire, as to be given up, because not worth the great labour of being again uncovered.

The surest safeguard against such dangers is to complete the excavations of each such large digging before freezing weather; also to throw in enough of the next overlying earth to cover the naked upright wall of marl, and thus protect it from freezing. Then the marl under the sloping roadways may be safely worked through winter, in perpendicular pits, and each excavation, as soon as finished, filled with earth, in uncovering another space of marl.

But when the extent of the range, or the insufficiency of the force compels the large excavation to remain unfinished through a winter, other means may be used, varying according to the features of each locality, to prevent much loss, and which will be suggested by the peculiar circumstances to the mind of every observing marler.

In removing overlying earth, the excavation should not be limited precisely to the laying-naked a sufficient surface of marl, and leaving the section of earth above nearly perpendicular. Even if there is no likelihood of the earth so left caving down in masses, and endangering the labourers below, the earth will be washed down by every rain in small quantities; and crumbled down by alternate freezing and thawing, if in winter. The face of the overlying earth should be cut to a slope (as seen in Fig. IV.) Then if a layer is crumbled by freezing, or by drying, the loose earth is kept in its place by its gravity. It is even cheaper, or

more convenient, when removing the overlay by the plough and scraper, to cut out as much beyond the outline of the designed uncovering, as will give the slope of section recommended.

During 1846 and 1847, the next ranges, E and F (Fig. II.), respectively of 22 and 25 feet width, and each increased in length, were uncovered and excavated. The next range G was 33 feet wide throughout, and 428 feet long. The excavation of the marl of G was begun in January 1847, and was not entirely completed by October 1849. At that time there had been uncovered another still longer range, H, 36 feet wide and about 450 long, which was nearly ready, and could be so as soon as required to begin the excavation of the marl. This last uncovering had been in progress more than a year, having been worked at when most convenient to spare, or to apply the labour. In each of the ranges since D, the upper end of the marl, for 50 feet in length, had been left to be taken out with the next succeeding range, for greater facility in carting. Therefore so much of the range G still remains in the bed. [1849.] All the ranges excavated, omitting the unfinished part of G (and all of H) and including the work at another earlier digging, have furnished the following quantities of marl, as estimated by the heaps counted on the fields.

Carried out in	1844,	heaped bushels,	67,875.
“ “	1845,	“ “	75,512
“ “	1846,	“ “	35,546
“ “	1847,	“ “	42,575
“ “	1848,	“ “	55,106
“ “	1849,	“ “	56,169
To Dec. 1850,		(parts of range H.)	34,684
Total			<hr/> 367,466.

When my operations at this place ceased (December, 1850), there then remained more than half of the marl of range H uncovered and not excavated.



## CHAPTER XXX.

### THE PROGRESS OF MARLING IN VIRGINIA.

MY designed task is at last completed. Whether I shall be able to persuade my countrymen to prize the treasures, and seize the profits which are within their reach, or whether my testimony and arguments shall be fruitless, soon or late a time must arrive when my expectations will be realized. The use of calcareous manures is destined to change a large portion of the soil of lower Virginia from barrenness to fertility; which, added to the advantages we already possess—our navigable waters and convenient markets, the facility of tilling our lands, and the choice of crops offered by our climate—will all concur to increase ten-fold the present value of our land; and produce more farming profit than has been found elsewhere on soils far more favoured by nature. Population, wealth and learning, will keep pace with the improvement of the soil; and we or our children will have reason to rejoice, not only as farmers, but as Virginians, and as patriots. [1832.]

Such, as appear in the last paragraph, were the concluding words of this essay, as published in 1832, and substantially as the work had been prepared for the press six years before that publication was made. Such was then the language of hope and anticipation. It may now [1842] be both interesting and useful to examine to what extent such hopes and sanguine anticipations have been so far realized.

Every new and great improvement in agriculture has had to work its way slowly and in opposition to every possible discouragement and obstacle. It would seem that the agricultural classes are, of all classes and professions, always the least ready to receive benefit from instruction—the most distrustful of instructors, and the least thankful for their services—even after the benefit is the most completely proved, and established by actual practice and unquestionable facts. The novel improvement by marling has not presented an exception to this universal rule. But still, it may be confidently asserted, that *no other agricultural improvement has been so rapidly extended, so widely and generally received in such short time, or has been so generally and greatly profitable to all who have availed themselves of the benefits thereby offered to their acceptance.* When my first trials were made in 1818, so far as I then knew, I had no forerunner in success. For the few and small

and long abandoned experiments, then known, and the opinions deduced therefrom, stood as warnings against, and not in the least as encouragements to repetition; and the then actually proceeding use of marl, silent and unknown, and to small extent but successful, had not even been heard of. A few more years served to dispel all doubts of those who had tried or could witness the results of the applications of marl. Still, ignorance of the mode of operation has not been dispelled by the knowledge of the great benefits of marl; and therefore the grossest errors of practice accompanied and greatly lessened the full advantages of the continually extending use of marl. It required but little time for all to learn and assent to the propriety of the one main and simple instruction, "apply marl;" but few would consent to learn anything else; or would believe that there was anything else necessary to learn or to do, except merely to "apply marl." They would not learn from anything but their own dearly bought experience of error. And very many have thus learned, and have paid the cost to their own pecuniary loss of thousands of dollars in value—whether in delay by misapplied effort, or in positive loss and injury sustained by wrong practice—which the outlay of a few dimes, and the attentive reading for a few hours, might have effectually guarded them against. And so it still goes on, and will go on, with all who are new beginners and learners, and who have not yet paid each their hundreds or thousands of dollars in loss, in preference to less than as many cents, in both money and labour, in acquiring proper instruction, and security from all such loss.

But with all such enormous drawbacks of loss, which if avoided would have doubled the actually achieved benefits, the extension of marling and liming, and the amount of benefit thence derived and realized in lower Virginia, since 1818, have had no precedent in the annals of agricultural improvement by any mode of manuring. The following extract from a more general report, recently made by the writer to the State Board of Agriculture (in 1842), will present this branch of the subject in its proper aspect.

*"Marling, or manuring from beds of fossil shells.—This mode of fertilization, now so general through all the marl region of lower Virginia, was not practised except on three or four detached farms, and that to but small extent before 1820. Some few and small experimental applications of marl had indeed been made by different individuals, from 15 to as far back as 45 years earlier; but which applications, from total misconception of the true mode of action of calcareous manures, had been deemed failures; and, without exception, had been abandoned by the experimenters as worthless; and the experiments had been almost forgotten, until again brought to notice, after and in consequence of the much later and fully successful introduction of the practice.*

*"Henley Taylor and Archer Hankins, two plain and illiterate farmers, and near neighbours in James City county, were the earliest successful and*

continuing appliers of marl in Virginia. But at what time they began, and which of them was the first, I have not been able to learn; though visiting Mr. Hankins' farm for that purpose, as well as to see his marling, and making inquiries of him personally, in 1838. Mr. Taylor had then been long dead, and his improvements said to be almost lost, by the exhausting tillage of the then occupant of his land. Mr. Hankins was unable to say when he and his neighbour began to try marl. He was only certain that it was before 1816. Yet, though these farms are within 12 or 15 miles of Williamsburg, to which place I had made visits once a year or oftener, yet I never heard an intimation of their having begun such practice, until some time after my own first trials in 1818. At that time, when led to the use, as I was, altogether by theoretical views, and by reasoning (in advance) on the supposed constitution of the soil, as well as the known constitution of the manure, it would have been to me the most acceptable and beneficial information to have heard that any other person had already proved practically the value of marling. The slow progress of the knowledge of the mere fact of marl having been successfully used before that time, was a strong illustration of the then almost total want of communication among farmers, as well as of their general apathy and ignorance in regard to the means of improving their lands.\*

"Much earlier than the commencement of marling in James City, the practice had been commenced (in 1805), in Talbot county, Maryland, by Mr. Singleton. His account of his practice is in the 4th volume of the 'Memoirs of the Philadelphia Agricultural Society,' dated December 31, 1817, and first published some time in 1818. But successful as was his practice, and also that of Mr. Taylor and Mr. Hankins in connexion with much worse farming, it is certain that neither of these individuals had the least idea of the true action of marl; and they were indebted to their good fortune, more than to any exercise of reasoning, that they received profitable returns, and did no injury by marling. — They all three applied their putrescent manures with the marl. But though this was the safest and most beneficial plan, the thus uniting them prevented the separate action and value of putrescent and calcareous manures being known, compared, and duly appreciated.

"My own application of marl, on Coggins Point farm, Prince George county, which in 1818 extended only to 15 acres (of which but 3 or 4 were under the crop of that year), by 1821 had been increased to above 80 acres a year, and so continued until nearly all the then arable land on that farm requiring it (more than 600 acres), had been covered. In 1821, my earliest publication on the subject was made. Though the facts and reasoning thus made known by that time were beginning to attract much notice, and to induce many persons to begin to marl, still it was some years later before incredulity and ridicule had generally given place to full confidence in the value of the improvement. Even at this time, when nearly 25 years of my own experience of marling and its benefits have passed, and the results are open to public notice and scrutiny, half the persons who could marl are either not engaged at it, or are marling to but little purpose; and of all who are using marl, nineteen in twenty are proceeding injudiciously, without regard to the mode of operation of the manure, and therefore are either doing harm, or losing profit, almost as often, though in less degree, as doing good. At this time, however, there are scarcely any persons, however negligent or mistaken in practice, who do not fully admit the great value and certain profit of applying marl, wherever it is available.

---

\* See a more full account at page 108, vol. I., Farmers' Register.

"But with all the existing neglect of using this means of fertilization, and with all the still worse ignorance of or inattention to its manner of operating, there never has been a new improvement in agriculture more rapidly extended, or with such beneficial and profitable results. In Prince George county there is not one farmer having marl on or near his land, who has not applied it to greater or less extent, and always with more or less profit—and, in most cases, largely as well as profitably. In James City county there has been perhaps the next largest as well as the oldest practice. In York county, as in James City, some of the most valuable and profitable improvements by marling have been made. And some of the farms of both counties, adjoining Williamsburg, and having the benefit of putrescent town manures, show, more strikingly than any others known, the remarkable power of calcareous manure to fix the putrescent in the soil, and make them more efficient and far more durable. In Surry, Isle of Wight, Nansemond, Charles City, New Kent, Hanover, King William, King and Queen, Gloucester, and Middlesex counties, in the middle of the marl region of Virginia, marl has been already extensively applied, and the profits therefrom are annually increasing. And in other surrounding counties, less abundantly supplied with marl, the practice has been carried on in proportion to the facilities, and to the more scanty experience and degree of information on the subject. It would be a most important statistical fact, if it could be ascertained how much land in Virginia has already been marled. The quantity however is very great; and all the land marled has been thereby increased in *net* product, on the general average, fully 8 bushels of corn or oats, or 4 bushels of wheat, if following corn, and the land increased in intrinsic value fully 200 per cent. on its previous value or market price. Where the marling has been judiciously conducted, these rates of increase have been more than doubled. From these data, might be calculated something like the already prodigiously increased values and products due solely to marling, and which will be still more increasing from year to year. If not already reached, the result *will* soon be reached, of new value to the amount of millions of dollars having been thus created. \* \* \* \* \*

"It required the improvement by marling, on originally poor and mid-dling soils (or liming, which in final or general results is the same thing), to render as generally available the best (and otherwise but rarely found) benefits of the two kinds of vegetable manuring recommended by Taylor. When such soils have been made calcareous, by marling or liming, then, and not until then, all the benefits, present and future, that his readers might have been induced to expect, may be confidently counted upon. In my own earlier practice—and Taylor had no greater admirer, or more implicit follower—I found my farm-yard manurings on acid soils scarcely to pay the expense of application, and to leave no trace of the effect after a very short time. And land, allowed to receive for its support all its vegetable growth (of weeds and natural grass) of two and a half years in every four, and the products in corn having been measured and compared, showed no certain increase in more than twenty years of such mild-treatment. Since, on the same fields, farm-yard manures, in every mode of preparation and application, always tell well, both in early effect and in duration. And even the leaves raked up on wood-land, spread immediately and without any preparation as top-dressing on clover, always produce most manifest improvement, and are believed to give more *net* profit than any application of the much richer farm-yard manure, per acre, made on like land before it is marled. This utilizing and fixing of other manures, and the fitting land to produce clover (and to receive benefit from gypsum on clo-

ver), which effects of marling are in addition to all the *direct* benefit produced, would alone serve to give a new face to the agriculture of the country. Whatever may be done by clover, and almost every thing that can be done to profit by vegetable manures, on the much larger proportion of the lands of lower Virginia, will be due to the application of marl or lime.

"*Liming.*—The kindred improvement by liming began to be extensively practised on some of the best James river lands, where no marl was found, soon after the use of the latter began to extend. Who may have made the earliest and small applications of lime is not known, nor is it at all important. The earlier profitable use of lime in Pennsylvania, and the much earlier and more extended use in Britain, were known to every well informed or reading farmer. Such a one was Fielding Lewis, of Charles City, as well as a most attentive, judicious, and successful practical cultivator and improver. He is believed to have been the earliest considerable limer, and the one who obtained the most manifest profits therefrom, and whose example had most effect in spreading the practice. Some of his disciples and followers have since, in greater rapidity and wider extent of operations, far surpassed their teacher and leader—to whom, however, they award the highest meed of praise for bringing into use, and establishing, this great benefit to the agriculture of lower Virginia. Nearly all the best soils on James river are comparatively of low level, as if of ancient alluvial formation, and have no marl, with which the neighbouring higher and poorer lands are mostly supplied. Of such rich lands are the farms of Weyanoke, Sandy Point, Westover, and Shirley, &c., in Charles City, and Brandon (Upper and Lower), in Prince George—and on all these lands, as well as some others, lime has been largely applied. The use is extending to the lands on and near to all the tide-waters of the state; and it has recently received a new impulse from the low price at which northern stone-lime is now brought and sold. It is ready slaked, and the vessels are loaded in bulk. The lime is sold on James river at 10 cents the bushel, and even may be contracted for at 8 cents, from vessels that come for cargoes of wood, and would come empty but for bringing lime. The greater lightness and cheaper transportation of lime will enable it to be applied where marl could not be carried with profit; and with the two, there will be but little of lower Virginia which may not be profitably improved by calcareous manures."\*

With all the caution proper to be used in a report made to a Board of Agriculture, and through it to the government of the commonwealth, the writer dared to predict, in 1842 (as quoted above), of the increased value of lands caused by marling, that "if not already reached, the result *will* soon be reached, of new value to the amount of millions of dollars having been thus created." Because of the then deficiency of statistical and documentary evidence (since partially and imperfectly supplied), he was not then aware that this prediction had already been more than fulfilled.

---

\* Extract from "Report to the State Board of Agriculture, on the most important improvements of agriculture in lower Virginia, and the most important defects yet remaining." Published by order of the General Assembly, as a state document, and also in Farmers' Register, p. 257, vol. x.

The message of the present Governor of Virginia to the legislature, in January, 1852, stated, upon the evidence of official documents, that the assessed values of lands in the tide-water district, had been increased more than 17 millions of dollars in the twelve years preceding the last assessment of 1850. The governor properly ascribed this increased value of lands of this region to the recent fertilization of particular portions. With all well-informed residents, or those acquainted generally with the past and present circumstances of this region, there will be no question as to the *whole* of the increased value being due to the use of calcareous manures. For before the introduction of this still recent practice, both the intrinsic and the market values of lands had decreased—as they have continued since to decrease in the neighbouring counties in which there has been very little or no use of marl or lime. All other improvements of agricultural practices, great as they certainly have been, have not sufficed to replace the productive power wasted by the generally exhausting tillage.

But great as is this declared general increase of value of the lands of this tide-water region alone—and, as I maintain, from the effects of calxing alone—it is not near so much as can be truly asserted, and satisfactorily proved from the public documents and statistical tables, defective as they are for this course of investigation. This is not the place to offer in detail the authorities and proofs of these important facts. But this shall be done in another paper, which will be a communication to the State Agricultural Society. In that paper I will maintain, and expect to establish, the following propositions, of which the enunciation will be here stated concisely, in advance of the proofs, and deductions therefrom, which will hereafter appear :

1. The parts of lower Virginia, long settled and cultivated, and also the neighbouring upper counties, had been decreasing in production, in population, and especially in productive or labouring population, in wealth generally, in the intrinsic or productive value, and also the selling and assessed values of lands, for more or less time, previous to the commencement of the improvement by marling; and such decrease has continued to this time, and is still proceeding, wherever there has been no marling or liming.

2. In the counties in which most land has been improved by marling or liming, and only since these improvements were in progress, there has been a marked change from the former declining condition, just stated, to increase of value of lands, of wealth generally, and of products of taxation—and as a later and as yet less advanced effect, an increase of population also.

3. This change from decrease to increase of the values of lands, though not indicated by official documents earlier than the assessment of 1838, (there having been no previous assessment later than

that of 1819), had in fact begun about 1828, when there existed a much lower state of depression of production and of value; from which lower rate, and earlier time, the selling value of lands, and much more the productive or intrinsic value, had been increasing for 22 years preceding the last assessment of 1850—and (at least) to the amount of nearly 30 millions of dollars; instead of 17½ millions increase in 12 years, as computed in the governor's message.

4. All this stated increase of value of lands is much less than is the actual increase; and though stated as for the whole tide-water district, in truth it has been achieved upon a very small proportion of the surface of that district—the great remainder (more than twenty times as much in quantity)—still being without any such improvement, or increase of either assessed or productive value. Even on the very small proportion marled or limed, the improvements are of less than half the value which judicious procedure would have effected, and earlier, at less cost, and also permanently. Hence, the actual calxings may yet be doubled in effect and value, and twenty times as much space may be raised to like increased production and value.

5. Therefore, the admitted newly created value of land, of 17½ millions of dollars between the two latest assessments, and the asserted increase of nearly 30 millions from 1828, are both, beyond comparison, far below the available increase for the whole of the tide-water district alone—to say nothing of the other parts of Virginia, improvable by like means. The whole available increase of value on lands alone, and for the tide-water district alone, on the premises stated, may reach to 500 millions of dollars—with proportional increase of value of other farming capital and connected movable property, and of population and products of taxation.

Enormous or incredible as these predicted results may appear, I maintain that there is more ground now to expect the complete fulfilment within the next 35 years, than there was, 35 years past, in the then desperate condition of agriculture, to expect, not only the now actual increase of values in lower Virginia, but even any smaller general increase. The main thing needed to aid and hasten the fulfilment should be a measure which heretofore has been entirely neglected and scornfully refused, in this and in all other relations to agriculture, viz.: that the government of Virginia shall in proper manner induce investigation, and encourage the diffusion of knowledge, in this and every other department of agricultural research and labour.

In the report, part of which was quoted above, it was recommended, and again more formally in the general report of the Board of Agriculture to the legislature, that the amount of land marled and limed should be obtained by the commissioners of the revenue,

and reported by the government. This small and costless aid to agricultural knowledge, and encouragement to further improvement (as well as all aid of greater value), the legislature of Virginia denied. If it had been granted, and thereby had been shown the real extent of these improvements in every county, and even as it might be on every farm, these facts, in connexion with the values shown by the different assessments, would have exhibited clearly and fully the results which can now only be inferred generally, loosely, and accompanied necessarily by many errors. Such important results, so fully established, and made so obvious to all, would have operated more strongly than any and all other existing incitements, to encourage the extension and the judicious procedure of improvements by calcareous manures. It would then clearly appear which individuals had secured to themselves this 30 millions of dollars of already increased value of property, and by what easy means. And all other persons, who could follow the example, and secure their shares of as rich rewards, would be imperatively called to use the like procedure, and so obtain the like benefit for themselves and for the commonwealth. It would have been to the before and still listless and inert proprietors and cultivators of our poor and unimproved lands similar in effect with the first announcement of the gold of California being ready for every needy adventurer who was able to go and dig for it. In the use of calcareous manures, on all the poor or exhausted land where their use is available, there are offered rewards to all judicious adventurers far richer, and more certainly and largely productive, than the golden products of California—and the former would be as much conducive to public and private weal, as the gold of California has been and will be injurious to both.





## APPENDIX.

---

### INTRODUCTORY REMARKS.

IN the foregoing exposition of theory and practice, it has been the object and effort of the author to embrace whatever seemed necessary for proof or for illustration; and to omit everything else, lest too much of amplification or digression should weaken rather than strengthen the main positions. Thus it is believed that the foregoing chapters, as argument and proof, serve to establish the series of propositions which were at first advanced and throughout contended for. Still there remained many minor but interesting subjects, more or less intimately connected with the investigation, or serving for more full proof, and which well deserved more extended discussion, and the consideration of those readers who should desire to pursue farther the general object of this essay. These subjects will be treated separately in the different articles of this appendix; which may be read, it is believed, with both interest and benefit by the more inquiring class of readers; or may be passed over, by the more cursory and careless, without much detriment to the arguments and facts of the preceding portion and regular body of the work.

---

#### NOTE I.—EXTENSION OF THE SUBJECT OF PAGES 92—97.

*Additional proof, offered in the production and existence of black waters, of the action of lime in combining vegetable matters with soil.*

Every person who has seen much of the different parts of lower Virginia (to go no farther for examples), must have remarked the dark permanent colour of the waters of many streams and mill-ponds; and that others, whether when clear or when turbid, are at all times and entirely without any tinge of this peculiar colouring matter. The waters thus coloured by vegetable matter are more deeply tinted at some times than at others; but are always strongly

thus marked. These waters, when several feet in depth, appear to the eye quite black or very dark brown. The same if viewed in a drinking glass would appear of the colour of Sherry wine, and might present some shade between the palest and deepest tints of such wine. This colour has nothing of muddiness; for these waters are as clear from suspended clay or mud as any other waters not so coloured in the slightest degree. In the county in which nearly all my life has been passed, Prince George, these different kinds of waters are to be seen in stronger contrast, because of their close neighbourhood. All the streams which flow into Blackwater river, as well as the main stream which that name so well describes, from its head to its outlet, are coloured deeply, and it is believed without exception. On the contrary, the streams which flow into James river are all without the least tint of colour, though they often rise from sources very near to some of the others, the head-springs being on opposite sides of the same dividing ridge of level table land, and in lands precisely alike. Some of these lands are of close and stiff soil, and some more sandy and quite light; but all are level, poor, and acid lands, and are mostly still under forest growth.

All persons, whether of the most or the least observant class, would concur in the opinion that this colour proceeds from vegetable matter. This is obvious even in the waters of heavy rains, which when more than the level ridge lands can absorb, flow off, and are sometimes for a day or more thus passing in temporary streams to the nearest valley, or other descent. These surplus waters, while yet on the highest woodland, are coloured to a greater or less depth of tint; and just as much in those which take their course towards James river, as the others which flow in the opposite direction to the Blackwater. The difference is that the former soon lose all such colouring matter, and in no case carry it to or even near James river, whilst the other waters increase in depth of colour with the length of their course, or the duration of time they remain in the mill-ponds they pass through, or in the sluggish Blackwater river.

The supply of colouring matter is principally furnished by the dead and fallen leaves in the poor forest land, and is doubtless increased afterwards, both by the partial evaporation of the water, and by its dissolving still more of the soluble vegetable extract in the flat swampy grounds through which the streams flow into the Blackwater. This might indeed satisfactorily account for these waters being *more deeply* coloured than those which pass by a more rapid descent to James river. But these different circumstances do not serve at all to explain why the latter waters should soon lose, if they had it at first, the slightest trace of colour.

The like circumstances are probably to be found to more or less

extent in most of the counties on our tide-water rivers, as most of them have poor forest lands and some swampy streams in the interior.

As the opposite circumstances of the presence or absence of colour in different waters is certainly not caused by such difference in the sources of supply, they must be caused by some subsequent action, which serves to clear the waters in one locality, by combining with and taking off the dissolved colouring matter, and which action does not take place elsewhere, because there is no such efficient agent present. That agent I take to be carbonate of lime, or some other salt of lime in the soil in the one case, and which is present in quantity altogether insufficient for such action in the other case. According to the views which were presented (page 96) in regard to the power of calcareous earth to combine chemically with vegetable matter, if the coloured waters should flow over soils furnished with calcareous matter, or into streams impregnated with any salts of lime, it would follow that the suspended or dissolved vegetable extract would combine with the calcareous matter of the soil in the water, and the new combination be precipitated, and be given to the soil, as manure, either immediately or remotely. This effect would be greatly aided if the streams swollen by rains actually passed in contact with and washed away exposed banks of marl. All recent rain-water contains a small amount of carbonic acid, and that impregnation enables water to dissolve a proportional quantity of carbonate of lime, which is insoluble in water without this addition of carbonic acid. Therefore, in such circumstances the swollen streams and land floods would necessarily dissolve some carbonate of lime, which would be thus placed immediately and fully in mixture and perfect contact with the before dissolved vegetable colouring matter, and next must take place the combination of the two, and precipitation of the compound manure. The consequence must be, that the lands thus overflowed must be more or less enriched by every heavy rain; while the lands overflowed by the coloured waters receive, or retain, nothing of soluble vegetable matter from this source, and may even lose part of what they had before received from the decay of their own growth, or other sources, by its being dissolved and carried off by such overflowing waters.

Now let us see how the actual results agree with these different causes, so far as the causes are known to exist. In the limited region particularly referred to above, the low grounds, subject to inundation by rains in a state of nature, and having beds of marl which the stream cuts through, are of much richer soil than any others, though the quantity of marl displaced by the stream (if indeed any such displacing be perceptible) would seem altogether too small in amount to produce such extent of fertilisation by direct

action. And it is believed, whether marl beds be so exposed or not, that the low grounds on the streams of colourless water are always much better soils, and of more durable fertility, than those washed by coloured waters. The latter soils being often swampy, are full of vegetable matter, and of course would be very productive when first drained and cultivated. But these soils are far from being among the most durable, and they are even at first, and when in best condition, very inferior lands to most low grounds of prime quality; and the latter are always penetrated by streams, or had been sometimes covered by floods, which, however turbid at certain times with suspended clay and mud, are never coloured by vegetable extractive or soluble matter alone.

If we go farther for examples, the effects will be found to be still more striking. None of the lime-stone streams are ever coloured; and their remarkable transparency, very far surpassing that of the most pure and limpid waters of the low country, show that the dissolved lime, which the mountain streams contain, serves to remove everything of colouring matter. These lime-stone waters, and land floods from rains which also necessarily carry dissolved carbonate of lime, form the principal supply of the upper James river. But long before the waters reach the head of tide, not a particle of lime remains. The dissolved lime had been continually uniting with the suspended or dissolved vegetable matter, until no lime was left, and the precipitated compound had served to add more manure to the extensive low-grounds along the whole course of the upper James river, and which are so well known and deservedly celebrated for their great and enduring fertility and high value.

When a resident of the lower country first visits our mountain and lime-stone region, he cannot avoid observing and being forcibly impressed by the remarkable clearness of the waters. Pools and basins in the streams containing six feet depth of water, will appear to his unpractised eye as not deeper than two or three feet. And it is only by comparison, and by becoming acquainted with this really and perfectly clear lime-stone water, he learns that he had, in truth, never before seen a stream or pond of perfectly clear water. Though the dissolved matters may be in too small quantity to produce any appearance of colour, they serve to impair the transparency of the water. And when any such colouring or vegetable matters are received into and intermixed with lime-stone streams, the vegetable matter is immediately combined with lime, and the compound precipitated; still leaving in the water a great excess of dissolved lime, scarcely diminished by the loss of the small part acting to clear the water of all colouring and vegetable impregnation.

From the large proportion of lime held in solution by lime-stone

springs, and the streams proceeding from them, and also by rain floods passing over lime-stone soils, it must be inferred (according to my views), that such waters must very quickly combine with and precipitate all colouring matters, and, when not turbid with earthy matter, be as transparent as water can possibly be. Hence, the well known and remarkable transparency of such water is not directly caused (as commonly understood) by lime being contained in them—but because of the other adulterations being totally removed in combination with a part of that dissolved lime. Thus, the water is not in the least made crystalline and transparent because of what it *contains*, but because of what it has been *deprived of*. And, therefore, even after all the lime may have been precipitated, the water must retain its previous perfect transparency, unless subsequently impregnated with other colouring matter.

The additional supply of carbonic acid to water, which alone gives to it the power to dissolve or to retain in solution even the smallest proportion of carbonate of lime, is not strongly held. It is given off by the lime-stone water in its partial evaporation, and to every contact of atmospheric air; and this operation is increased by such agitation of the water as exposes a larger surface to the air. Hence, at all rapids of lime-stone streams, there is a peculiarly rapid and large deposition of carbonate of lime, let loose by the water because of the loss of the proportion of carbonic acid which before served to hold the lime dissolved in the water. This precipitation and gradual accumulation of carbonate of lime, at the rapids and cascades of streams, is the formation called calcareous tufa or travertine, and vulgarly called "marl" in our mountain region, and which is presented in great quantity, and sometimes in enormous masses.

As lime-stone water so easily parts with the carbonic acid which enables it to hold lime in solution, it can scarcely be supposed that any of the acid remains after the water collects and remains long in the great reservoirs formed in lakes. But whether the water remains impregnated with carbonic acid, and of course with lime, or has lost both, the effect is the same, and is exhibited most strongly in the remarkable transparency of lakes so formed. Of such, I have never myself witnessed any but of Lake George, in New York. And after the long lapse of time since my short visit to this lake, I cannot remember to what extent the transparency of its waters was asserted, or what my own personal observation ascertained. I only remember certainly that the depth of water through which very small objects were distinctly visible was very great, and that no ground was left to doubt what is generally asserted and received as true on that head.

To return to the lands and waters of Prince George county. The water left by heavy rains, standing in shallow pools on the

high level wood-land, and flowing off in temporary rivulets, is seen to be coloured by vegetable matter even within a mile of James river, just as it is found on the other lands sloping towards the Blackwater. But in either and every known case of such discoloration being caused, it is on poor and acid land. No such effect takes place on calcareous or even neutral soil, no matter how abundantly it is provided with dead leaves or other vegetable matter. Therefore it is manifest that it is not difference of locality, but difference of soil, which causes the different effects of the surplus rain-water becoming tinged, and remaining tinged with vegetable-extract, or otherwise remaining colourless. And also, after the water has been so tinged, that it depends on the difference of chemical composition in the soils over which it passes, or of the streams into which it is discharged, whether the colour remains or is quickly discharged. And, as already stated, this difference of action and effect depends on the absence or presence of lime in the soils or waters to which the coloured excess of rain-water flows.

It is only in the surplus quantity of rain-water, or that which is more than the soil can absorb, that this colouring matter is *seen*. But it is not the less certain that all of the much greater quantity of water from more gentle and more frequent rains which soak into the earth, must also be more or less tinged with the colouring matter of the leaves and other dead vegetable matter through which the water passes, and must take up, in passing, all that is then easily soluble, and not chemically combined with some other body. Thus, every gentle and soaking rain probably carries into the soil the greater part of all the then soluble vegetable matter, and that only which is soluble is all that is then completely ready to act as food for plants. The same rain, and the subsequent chemical action of air and warmth, cause the decomposition of the before insoluble vegetable matter to recommence, and in a few days there is a renewed supply of soluble or extractive matter formed in the vegetable cover of the soil, ready to be dissolved and to be carried into the earth by the next succeeding rain.

Such is nature's process of furnishing alimentary manure, or the food of plants, to soils. And the source of supply is unlimited; for it is principally from the atmosphere and water, and by fixing their elements (oxygen, nitrogen, hydrogen, and carbon), that the vegetable growths of soils, and consequently all alimentary manures, are formed.

Enormous then as is the continual waste of vegetable extractive matter and manure that is caused by every heavy rain, and which is always evident to the eye in the black waters of so many ponds and streams, all this lost fertilizing matter must be in very small proportion, compared to the greater quantity that is carried more gradually and frequently into the earth. Much the greater

part of the wood-land of lower Virginia is most freely and abundantly thus supplied, not only because of the abundant sources presented in a thick layer of fallen leaves, the growth of many successive years, but also because of the very level surface of the land, which obstructs the flowing off of the surplus rain-water, and the general sandy and open texture of the soil and sub-soil, which operate to absorb quickly the water and its dissolved vegetable matter. Yet it is more especially these lands that show the least remaining and abiding store of this supply of vegetable manure. The soil, or all of the upper part which shows any colour from containing vegetable matter, is usually not more than two inches thick on sandy soils, and still less on the stiffest; and all the portion below (though necessarily manured by being often soaked to a foot or more with rain-water conveying all its dissolved vegetable extract), is entirely barren and worthless. Such results would be as inexplicable as they are wonderful, but for the reasons afforded by the doctrine of the combining and fixing powers of carbonate of lime and vegetable salts of lime; the absence of which ingredients is the sole defect in these cases, and which, when present in soils, show results of fertilization altogether the reverse of these. Where lime is present in sufficient quantity, no colouring or manuring matter is lost to the soil in the flowing off of surplus water, nor in the wasteful and profitless decomposition of the greater quantity of colouring and alimentary matter soaked into the earth.

My observation was not attracted to the cause of the existence of black waters, and this application of the facts, until nearly the close of my residence in the country, and of my opportunities for personal and accurate observation. And I am well aware, and ready to admit, that previous observations, made by mere chance and without object, are worth very little comparatively. I therefore would be glad to have the attention of other observers drawn to this point, and any facts to be elicited that will either confirm or disprove my positions. From inquiries made of persons who have had ample opportunity to observe what waters were either permanently black or without tinge of such vegetable stain, I have heard the following general statement of facts, on which my comments will be offered as the facts are presented.

Streams and ponds of black waters are rarely seen above the falls of the rivers; and are believed to be very rarely found even twenty to thirty miles above. They are never seen in the still higher lime-stone region. If this opinion be correct, then these waters are confined exclusively (as they certainly are mainly) to the region of soil of the most *acid quality*. At the distance above the falls where black waters are never found, the high land was naturally in general of good quality, and the bottom or alluvial lands, on small streams, invariably of good soil. Of course these qualities indi-



cate more of lime in the soil ; and, according to my views, also the inability of water to become black, or at least to remain coloured.\*

The waters of Blackwater river and its tributary streams and swamps become darker in autumn, owing to the low level of the surface at that season. This is according to sound reason ; as evaporation of the solvent fluid necessarily increases the strength of the solution. But this cause is held by most persons as secondary in force to another, viz. : the dropping of the leaves, and especially of the numerous black-gum trees, and their berries, at that season, on the swamps and in the streams. Of course such is the source of the colouring matter ; but it would produce no notable or abiding effect, but for the want of lime both in the soil and in the water. The extensive tide swamps on the creeks of James river, are covered with a dense growth of trees, of which a large proportion are black-gums. Yet in the numerous rills trickling or oozing out of these soils, after some days of low tides, I have never observed the water to be dark, or in the least discoloured. Yet the soil of these tide swamps is as much of vegetable formation as any capable of bearing trees, and is believed to be more so than the swamp lands of Blackwater river and its tributaries. Therefore it is not the abundance of dead vegetable matter in a soil, nor the quantity or kind of leaves furnished by the trees growing on it, which alone or together produce coloured waters. The earthy portion of the soil of these tide marshes and swamps, small as is its amount, is not acid, but neutral, and the lime contained serves to prevent the water remaining discoloured.

Yet this is not always the case on tide swamps. The waters of Pocomoke river, flowing into the Chesapeake, are black, which I presume is owing to the deficiency of lime in the water and in the surface soil of the lands from which the waters flow.

The great Dismal Swamp of Virginia and its lake, and the still more extensive swamps and lakes of North Carolina, all present black waters, and which may all be accounted for by the reasons here given.

Neither is it necessary that marl beds should be wanting to produce the effect of black waters. It is only necessary that the marl (no matter how abundant) should be so far below the surface as not to affect the overflowing waters, and that the soil of the higher lands should be generally of acid quality. Such are the lands on Blackwater river and its tributaries. And though marl was scarcely

---

\* The extract translated from M. Puvis' "*Essai sur la Marne*," and introduced at page 150 of this essay, affords testimony that the facts in regard to the existence and localities of black waters in France accord strictly with the views presented in this article. This writer says that, "during the month of August, the water of the ponds on calcareous soil does not become blackish, as often happens in silicious ponds."

known anywhere there twenty years ago, it is now known to be abundant, and generally to be found, though almost always a few feet below the surface of the low lands.

Many persons who would concur with me as to the premises and results, would yet ascribe the colouring of certain waters to the more level surface of the land, and the more sluggish and stagnant state of the waters; and would suppose the absence of colouring-matter in the waters of the upper country to be caused by the rapidity of the descent and of the passage of the streams. This would be a correct view, if the matter in question were the degree of *intensity* of colour, instead of the *existence or entire absence* of colour. It is true, and obvious, that if the coloured waters which now creep and stagnate over the level lands below the falls, had as rapid a descent and free discharge as the mountain torrents, their colour could not become darker, with time, by long infusion of the leaves, nor by evaporation of still waters. But though the colour would be much more pale, its existence would not be the less certain. The source of colouring matter, the soaking of dead leaves, &c., in rain-water, is as abundant in the upper as in the lower country; and the more rapid discharge of the waters, if no other cause of clearing them operated, would not prevent their becoming and remaining coloured, as generally, and, however more pale in tint, would be seen as obviously, as in the most level lands. But this is not all. Though there is almost no level land, and therefore no swamps in the hilly or still less in the mountain region, there are mill-ponds in the lower hilly country, and natural lakes in the mountain region. If there was the slightest tint of dissolved colouring matter in the streams, the waters when collected in these deep reservoirs could not fail to exhibit the colour much more deeply. Yet no one such fact is known, or is believed to have existence.

---

NOTE II.—EXTENSION OF THE SUBJECT OF PAGES 108—113.

*The statements of British authors on marl, and their applications of the name, generally incorrect, and often contradictory. Both the terms "marl" and "marling" have different significations in Britain and in Virginia.*

CUSTOM has compelled me to apply improperly the name *marl* to our deposits of fossil shells. But as I have defined the manuring by means of this substance, which is called *marling* (and for which I suggested *calxing* as a much better and also more comprehensive name), to be simply *rendering a soil calcareous*—any term used for that operation would serve, if its meaning was always kept in view. But, unfortunately, this term (*marling*) is of old

and frequent use in English books, with very different meanings. The existence of these differences, and errors, has been stated generally in a foregoing part of this Essay, and here will be adduced the proofs, in quotations from many authors. I maintain, and will establish the following propositions:—

1. By nearly or quite all of the older (and even some of the modern) British authors, the term marl was applied to clays (or earths) containing no calcareous matter; and even when calcareous earth was known to be contained in marl, that ingredient was not deemed (if indeed it was) the essential or the most valuable fertilizing quality of the manure.

2. The marls of Europe, whether as correctly defined or understood by modern writers and scientific agriculturists, or as often miscalled and misunderstood by illiterate cultivators—are very different from the deposits of fossil shells, called marl in this country.

3. Even when the chemical character, and the manuring action (in like applications) of the marls of England and Virginia are the same (that is, agreeing in being both calcareous)—still the ordinary marlings of the former are quite a different manuring operation from the marling (or calxing) advised in this Essay—inasmuch as the lands so manured in England were mostly calcareous before, either by natural constitution, or by previous marling—and therefore were not *made calcareous* (or calxed) by the dressing in question.

4. In many cases of published statements of, or references to marling labours or improvements in England, the reader is left in doubt whether the marl or the soil was calcareous—or which the most so—and therefore, whether the “marling” served to increase or to lessen, or had not materially altered the proportion of the previous calcareous contents of the soil.

5. The marling of England, especially, has been almost entirely empirical—and not directed by theory, reasoning, or by inferences drawn from the known (or even surmised) chemical constitution of either the soil or the earthy manure applied.

These assertions refer principally, but not exclusively, to the writers on agriculture of former and less enlightened times than the present or recent. Scarcely any exception is known in works much older than the institution of the British Board of Agriculture, in 1795. Before that time, the errors which I shall adduce prevailed almost universally, in books as well as in vulgar language and opinion. And these older writers were, to much later times, the unquestioned authorities of the earliest agricultural writers of America, as well as of all our other readers and thinkers. And the aid of all the more correct information as to the true character of marl, afforded by the more recent British writers, it seems has

cleared away but little of the before general obscurity on this subject in their own country. Of such remaining ignorance, or its appearance, striking and recent examples will be presented.

The passages to be quoted will exhibit so fully the contradictions and ignorance generally prevailing as to the nature of whatever was called marl, and the operation of calcareous manures generally, that it will not be required for me to express dissent in every case, or to point out the errors of facts or of reasoning, which will appear so manifestly and abundantly in some of the quotations.

But besides the errors and even absurdities of opinions and practices in regard to marl or lime, which some of these passages will show, there will be presented in connexion some correct, precise, and very interesting facts. Among these will be definitions and descriptions by recent authors of marl proper, and also the varieties known in Britain by the provincial names of "clay" or "clay marl," and the "shell marl" formed only in ancient lakes, since changed to peat bogs. These passages, though some of them are the very latest in the order of time, will be offered first—so that what is sound and true may be kept in view, through all the mass of error that will be afterwards presented.

1. "Compact limestone, by an increase of argillaceous matter, passes into marl." "Marl is essentially composed of carbonate of lime and clay, in various proportions."—*Cleveland's Mineralogy*.

2. "Marl is a compound of carbonate of lime, argil [finest clay] and of silicious sand. The sand appears to be only in a state of mixture, and may be, when not very fine, separated easily. But the argil and carbonate of lime in marl (like the alumina and silica in argil), seem to be a [chemical] combination, and not a simple mixture."—*Puvit—Essai sur la Marne*.

"Marl seems to be, in most cases, a formation of fresh water."—*Puvit—Translation, Farmers' Register*, vol. iii. p. 692.

3. "Marl is a combination of carbonate of lime and clay. These two bodies are usually found in so complete a state of amalgamation, that it is impossible to distinguish the particles of one from those of the other, either with the naked eye, or with the aid of the microscope." "When water is poured upon marl, that fluid penetrates, with greater or less facility, into all its pores, destroys the cohesion of the parts, separates them from one another, and reduces them to a fine powder. This is one of the essential properties, which serves as the first distinction of marl," &c.

"It certainly cannot be admitted as a principle that any kind of earth which loses its aggregation in water must necessarily be marl, since some very poor clays are affected in the same manner; but if any kind of earth is not spontaneously reduced to powder by the action of water, we may feel convinced that it is not marl. Every kind of marl, even that which is called 'stony,' becomes soft and pulverized in water."—*Von Thaer's Principles of Agriculture*.

It appears from different authors that the proportions of carbonate of lime in marl usually vary from 20 to more than 60 per

cent. When much richer, say near or quite 80 per cent., it becomes of stony hardness, or passes into lime-stone.

In Britain the marls most abounding in clay are called "clay marl," and vulgarly "clay" simply. This is the kind most generally used, and in enormous quantities. Stephens (in the latest edition of his "Book of the Farm"), offers the first precise information that I have seen, as it is also the most recent of the component parts of this marl, as follows:—from *Johnston on the Use of Lime*.

4. "The following analysis may give a fair idea of the composition of a clay-marl." This specimen was found in Ayrshire.

Carbonate of lime	.	:	.	.	8.4
Oxide of iron and alumina	.	.	.	.	2.2
Organic matter	.	.	.	.	2.8
Clay, and silicious matter	.	.	.	.	84.9
Water	.	.	.	.	1.4
					99.7

Every one who has observed what is called marl in lower Virginia will recognise its entire disagreement with the true marl described in all the foregoing quotations, in every physical or mechanical property, in texture, and in its manifest origin or formation.

5. "*Shell Marl*.—In some parts of the country, as in Forfarshire [Scotland,] this substance is found in great quantities associated with peat. . . . It is taken out of the bogs by means of a boat mounted with a dredging apparatus. When of fine quality and in a dry state, it is as white as lime, not crumbling down into powder like quick-lime, but cutting something like cheese, with the spade. . . . It is applied at 40 to 50 bolls (8 cubic feet) to the acre. When applied as lime, it is beneficial; but, as is often the case, when *applied solely as manure*, in quantities of 35 to 45 cubic yards to the acre, it never fails to be mischievous. It does not easily injure new fresh land; [Qu. the first time applied?] but *when repeated frequently, as a sole manuring*, I have seen land reduced to such a state of pulverization, that the foot, with a stamp, sank into the ground as deep as the ankle. Applied to lands followed by severe cropping, it has reduced them to a state of utter sterility, which they have not recovered from to this day."—(*Stephens' Book of the Farm, or Farmers' Guide, 1850; Headrick's Survey of Forfarshire.*)

This "shell marl" consists of	Top of bed.	Bottom of bed.
"Carbonate of lime	77.6	81.7
Oxide of iron and alumina	1.8	0.6
Organic matter	14.6	14.6
Insoluble, chiefly silicious matters	6.0	8.1
	100.	100.

This substance, according to its analysis above, is undoubtedly the most valuable of all calcareous manures. But still it is not

marl, either as understood by mineralogists and scientific agriculturists in Europe, or as marl is known in this country. This peculiar formation (the deposit of the shells of fresh-water molluscs in what had been ancient lakes, and which since became peat-bogs), has been referred to previously, and will be again, in another connexion.

So far, all the earths called marl have been calcareous. But all are not so that are recognised under that name, even by modern and well informed writers, who certainly knew the chemical character (in this respect), of the earths referred to. In "British Husbandry," a recent work of authority, prepared for and published by the "Society for the Diffusion of Knowledge," in treating of marl, the following passages occur:—

6. "A bluish marl much used in some parts of Ireland, and long celebrated as a manure, makes no ebullition with acids; neither do several of the red marls; yet many of them are known to be productive of great improvement to land." p. 265. "Out of 12 specimens of marl submitted to Sir Humphrey Davy, 11 were found to contain calcareous earth; but the result of many other trials of marls, from different parts of the country, and found by farmers to produce an ameliorating effect on the land, yet proves them to be, in many instances, wholly deficient in that substance." See "Marl" in Holland's *Report on Cheshire*.

Now whatever of fertilizing properties these earths contained, they were not marl in the proper understanding of that term, nor do they agree with our marl in any stated character, either chemical or physical.

An earlier, though yet a modern writer, Marshall, has also described a valuable "marl" of Norfolk, England, which is almost destitute of calcareous matter.

7. "The red earth which has been set upon the lands of this district, in great abundance, as 'marl,' is much of it in a manner destitute of calcareous matter; and, of course, cannot, with propriety, be classed among marls. Nevertheless, a red fossil is found, in some parts of the district, which contains a proportion of calcareous matter. The marl of Croxall (in part of a stone-like, or slaty texture, and of a light red colour) is the richest in calcareosity; one hundred grains of it afford *thirty grains* of calcareous matter; and seventy grains of fine, impalpable, red-bark-like powder.\* And a marl of Elford (in colour and texture various, but resembling those of the Croxall marl) affords near *twenty grains*. Yet the

---

\* This marl is singularly tenacious of its calcareous matter; dissolving remarkably slowly. One hundred grains, roughly pounded, was twenty-four hours in dissolving; and another hundred, though pulverized to mere dust, continued to effervesce twelve hours; notwithstanding it was first saturated with water, and afterward shaken repeatedly. The Breedon stone, roughly pounded, dissolved in half the time; notwithstanding its extreme hardness. [I strongly suspect that Marshall used nitric acid in this trial, and was deceived by the slow solution of carbonate of iron, with some ebullition, and that there was as little calcareous earth as in the other cases. I have never experienced such slow solution of carbonate of lime, in strong acid. E. R.]

marl of Barton, on the opposite side of the Trent—though somewhat of a similar contexture, but of a darker, more dusky colour—is in a manner destitute of calcareosity! one hundred grains of it yielding little more than one grain—not *two grains* of calcareous matter. Nevertheless, the pit, from which I took the specimens analyzed, is an immense excavation, out of which many thousand loads have been taken. And the marls of this neighbourhood (which mostly differ in appearance from those described, having generally that of a blood-red clay, interlayered, and sometimes intermingled with a white gritty substance) are equally poor in calcareosity. One hundred grains of the marl of Statford (which I believe may be taken as a fair specimen of the red clays of this quarter of the district) afford little more than *two grains* of calcareous matter—lodged not in the substance of the clay, but in its natural cracks, or fissures. Yet this is said to be 'famous marl;' and from the pits which now appear, has been laid on in great abundance.

"I do not mean to intimate, that these clays are altogether destitute of fertilizing properties, on their first application. It is not likely that the large pits which abound in almost every part of the district, and which must have been formed at a very great expense, should have been dug, without their contents being productive of some evidently, or at least apparently good effect, on the lands on which they have been spread. I confess, however, that this is but conjecture; and it may be, that the good effect of the marls first described being experienced, the *fashion* was set; and the distinguishing quality being unknown, or not attended to, marls and clays were indiscriminately used."—*Marshall's Midland Counties*, vol. i. p. 152.

8. "On the southern banks of the Anker, is found a gray marl; resembling in general appearance the marl of Norfolk, or rather the fuller's earth of Surrey. In contexture it is loose and friable. This earth is singularly prodigal of its calcareosity. The acid being dropped on its surface, it flies into bubbles as the Norfolk marl. This circumstance, added to that of a striking improvement, which I was shown as being effected by this earth, led me to imagine that it was of quality similar to the marls of Norfolk. But, from the results of two experiments—one of them made with granules formed by the weather, and collected on the site of improvement, the other with a specimen taken from the pit, it appears that one hundred grains of this earth contain no more than *six grains* of calcareous matter! the residuum a cream-coloured saponaceous clay, with a small proportion of coarse sand."—*Marshall's Midland Counties*, vol. i. p. 155.

In the latter quotations are presented separately the proofs from authors fully competent to try and know the remarkable facts stated of many well approved "marls," so called, being nearly or entirely destitute of calcareous earth! I will now go back to older writers, who treat of marls without noticing that ingredient as being present, or without seeming to be aware that its presence would be useful.

The learned and also practical Miller thus defines and describes marl, in the *Abridgment of the Gardener's Dictionary*, fifth London edition, 1763, at the article *marl*:

"Marl is a kind of clay which is become fatter and of a more enriching quality, by a better fermentation, and by its having lain so deep in the earth as not to have spent or weakened its fertilizing quality by any product.

"Marls are of different qualities in different counties of England. There are reckoned four kinds of marl in Sussex, a gray, a blue, a yellow, and a red; of these the blue is accounted the best, the yellow the next, and the gray the next to that; and as for the red, that is the least valuable.

"In Cheshire they reckon six sorts of marl:

"1. The cowshut marl, which is of a brownish colour, with blue veins in it, and little lumps of chalk or limestone; it is commonly found under clay, or low black land, seven or eight feet deep, and is very hard to dig.

"2. Stone, slate, or flag marl, which is a kind of soft stone, or rather slate, of a blue or bluish colour, that will easily dissolve with frost or rain. This is found near rivers, and the sides of hills, and is a very lasting sort of marl.

"3. Peat marl, or delving marl, which is close, strong,\* and very fat, of a brown colour, and is found on the sides of hills, and in wet or boggy grounds, which have a light sand in them about two feet or a yard deep.

"4. Clay marl; this resembles clay, and is pretty near akin to it, but is fatter, and sometimes mixed with chalk stones.

"5. Steel marl, which lies commonly in the bottom of pits that are dug, and is of itself apt to break into cubical bits; this is sometimes under sandy land.

"6. Paper marl, which resembles leaves or pieces of brown paper, but something of a lighter colour; this lies near coals.

"The properties of any sorts of marls, by which the goodness of them may be best known, are better judged of by their purity and uncompound-ness, than their colour: as if it will break in pieces like dice, or into thin flakes, or is smooth like lead ore, and is without a mixture of gravel or sand; if it will slake like slate-stones and shatter after wet, or will tumble into dust, when it has been exposed to the sun; or will not hang and stick together when it is thoroughly dry, like tough clay; but is fat and tender, and will open the land it is laid on, and not bind; it may be taken for granted that it will be beneficial to it."

In all these descriptions, so minutely stated, both general and particular, and of ten different varieties of marl, there is no indication that calcareous earth is an essential constituent part; nor indeed does it appear that it was deemed a constituent part, proper, even in the two varieties, in which bits of chalk are found. For these are accidental admixtures, as would be any silicious sand, or gravel, or land, or even river shells; none of which, if found therein, would properly belong to true marl.

The well-deserved reputation of Miller is a sufficient guaranty that there was no more full or correct knowledge of marl, in his time, than he possessed, and taught in the foregoing extracts.

9. *Johnson's Dictionary* (octavo edition) defines marl in precisely the words of the first sentence of Miller, as quoted above.

10. *Walker's Dictionary* (octavo edition) gives only the following definition—"Marl—a kind of clay much used for manure."

---

\* "*Strong*" applied to soil in England means stiff or clayey—and in this sense I presume the word is used above. E. R.



11. Kirwan, on the authority of Arthur Young and the *Bath Memoirs* [1783,] states that,

"In some parts of England, where husbandry is successfully practised, any loose clay is called *marl*; in others, *marl* is called *chalk*, and in others, *clay* is called *loam*."—*Kirwan on Manures*, p. 4.

12. *A Practical Treatise on Husbandry* (second London edition, 4to. 1762,) which professes to be principally compiled from the writings of Duhamel, Evelyn, Home, and Miller, supplies the following quotations :

"But of all the manures for sandy soils, none is so good as marl. There are many different kinds and colours of it, severally distinguished by many writers; but their virtue is the same; they may be all used upon the same ground, without the smallest difference in their effect. The colour is either red, brown, yellow, gray, or mixed. It is to be known by its pure and uncompounded nature. There are many marks to distinguish it by; such as its breaking into little square bits; its falling easily into pieces, by the force of a blow, or upon being exposed to the sun and the frost; its feeling fat and oily, and shining when it is dry. *But the most unerring way to judge of marl, and know it from any other substance, is to break a piece as big as a nutmeg, and when it is quite dry, drop it into a glass of clear water, where, if it be right, it will dissolve and crumble, as it were, to dust, in a little time, shooting up sparkles to the surface of the water.*"—p. 27.

Not the slightest hint is here of any calcareous ingredient being necessary, or even serving in any manner to distinguish marl. But afterwards, in another part of this work, when *shell marl* is slightly noticed, it is said :

"This effervesces strongly with all acids, which is perhaps chiefly owing to the shells. *There are very good marls which show nothing of this effervescence; and therefore the author of the New System of Agriculture judged right in making its solution in water the distinguishing mark.*"—p. 29.

The last sentence declares, as clearly as any words could do, that, in the opinion of the author, no calcareous ingredient is necessary, either to constitute the character, or the value of marl. And though it may be gathered from other parts of this work, that what is called marl generally contains calcareous earth, yet no importance seems attached to that quality, any more than to the particular colour of the earth, or any other accidental or immaterial appearance of some of the varieties described.

The "shell marl" alluded to above, without explanation might be supposed to be similar to our beds of fossil shells, which are called marl. The two manures are very different in form, appearance, and value, though agreeing in both being calcareous. The manure called shell marl by the work last quoted from, is described there with sufficient precision, and more fully in several parts of the *Edinburgh Farmers' Magazine*,\* and in the *Memoirs of the Phila-*

\* See *Farmers' Register*, vol. i., p. 90.

delphia Agricultural Society,\* [and in the late edition of Stephens' Book of the Farm, as quoted above]. It is still more unlike *marl*, properly so called, than any of the substances described under that name, in the foregoing quotations. This manure is almost a pure calcareous earth, being formed of the remains of small fresh-water shells deposited on what were once the bottoms of lakes, but which have since become covered with *bog* or *peat* soil. If I may judge from our beds of mussel shells (to which this manure seems to bear most resemblance), much putrescent animal matter is combined with, and serves to give additional value to these bodies of shells. This kind of manure is sold in Scotland by the bushel, at such prices as show that it is very highly prized. It seems to be found but in few situations, and though called a kind of marl, is never meant when that term alone is used by British writers.

13. A much older work than either of these referred to furnishes in part the definitions and even the words used above. This is the "*Systema Agriculturae, the Mystery of Husbandry discovered*," published in 1687; and the author or compiler of that old work was probably indebted to others still older for his description of marl. For new books on agriculture, more especially, have been most generally made by compiling and copying from older ones.

"Marle is a very excellent thing, commended of all that either write or practise any thing in husbandry. There are several kinds of it, some *stony*, some *soft*, *white*, *gray*, *russet*, *yellow*, *blew*, black, and some *red*: It is of a cold nature and saddens land exceedingly; and very heavy it is, and will go downward, though not so much as lime doth. The goodness or badness thereof is not known so much by the colour, as by the purity and uncompactness of it; for if it will break into bits like a dye, or smooth like lead oar, without any composition of sand or gravel; or if it will slake like slate-stones, and slake or shatter after a shower of rain, or being exposed to the sun or air, and shortly after turn to dust when it's thoroughly dry again, and not congeal like tough clay, question not the fruitfulness of it, notwithstanding the difference of *colours*, which are no certain signs of the goodness of the *marle*. As for the *slipperiness*, viscosness, fattiness, or oilyness thereof, although it be commonly esteemed a sign of good *marle*, yet the best authors affirm the contrary—*viz.* that there is very good *marle* which is not so, but lieth in the *mine* pure, dry and short, yet nevertheless if you water it, you will find it slippery. But the best and truest rule to know the richness and profit of your *marle*, is to try a load or two on your lands, in several places and in different proportions.

"They usually lay the same on in small heaps, and disperse it over the whole field, as they do their *dung*; and this *marle* will keep the land whereon it is laid, in some places ten or fifteen, and in some places thirty years in heart: it is most profitable in dry, light, and barren lands, such as is most kind and natural for *rye*, as is evident by Mr. *Blieth's* experiment in his chapter of *marle*. It also affordeth not its vertue or strength the first year, so much as in the subsequent years. It yields a very great increase

---

\* Vol. iii. p. 206.

and advantage on high, sandy, gravelly, or mixed lands. Though never so barren, strong clay ground is unsuitable to it; yet if it can be laid dry, *marle* may be profitable on that also."

The author then proceeds to direct the mode of application more particularly; and if there were any doubt as to his total ignorance (or otherwise denial) of calcareous earth being necessary to the constitution of marl, that doubt would be removed by a subsequent sentence.

"You shall observe (saith Markham,) that if you cannot get dry, perfect, and rich marle, if then you can get of that earth which is called fuller's earth (and where the one is not, commonly the other is), then you may use it in the same manner as you should do marle, and it is found to be very near as profitable."

14. Evelyn's *Terra, or Philosophical Discourse of Earths, &c.*, delivered before the Royal Society in 1675, has the following passage :

"Of marle (of a cold sad nature, a substance between clay and chalk), seldom have we such quantities in layers as we have of forementioned earth; but we commonly meet with it in places affected to it, and it is taken out of pits, at different depths, and of divers colours, red, white, gray, blue, all of them unctuous, and of a slippery nature, and differing in goodness; for being pure and immixt, it sooner relents after a shower, and when dried again, slackens, and crumbles into dust, without induration, and growing hard again. They are profitable for barren grounds, as abounding in nitre; and sometimes there has been found in marle, *delfs*, a vitriolic wood, which will kindle like coal."

The opinions expressed in the foregoing extracts, prove sufficiently that it was not the ignorant cultivators only, who either did not know of, or attached no importance to the calcareous ingredient in marl; and it was impossible that, from any number of such authors, an American reader could learn that either the object or the effect of *marling* was to render a soil more calcareous—or that our bodies of fossil shells resembled marl in character, or in operation as a manure. Of this, the following quotation from a modern and also an American agriculturist and author, Bordley, will furnish striking proof—and the more so as he refers frequently to the works of Anderson, and of Young, who treated of marl and of calcareous manures, in a more scientific and correct manner than had then been usual. This author cannot be justly charged with inattention to the instruction to be gained from books; for his greatest fault, as an agriculturist, is his fondness for applying the practices of the most improved husbandry of England, to our lands and situations, however different and unsuitable—which he carried to an extent that is ridiculous as theory, and would be ruinous to the farmer who should so shape his general practice.

15. "I farmed in a country [the Eastern Shore of Maryland] where habits are against a due attention to manures: but having read of the ap-

plication of marl as a manure, I inquired where there was any in the peninsula of the Chesapeake *in vain*. My own farm had a grayish clay which to the eye was marl: but because it did not effervesce with acids, it was given up when it ought to have been tried on the land, especially as it rapidly crumbled and fell to mud, in water, with some appearance of effervescence."—*Bordley's Husbandry*, 2d ed., p. 55.

That peninsula, through which Mr. Bordley in vain inquired for marl, has immense quantities of the fossil shells which we improperly call by that name. But as his search was directed to marl as described by English authors—and not to *calcareous earth* simply—it is not to be wondered at that he, well-read and intelligent as he was, should neither find the former substance, nor attach enough importance to the latter, to induce the slightest remark on its probable use as manure.

16. The *Practical Treatise on Husbandry*, among the directions for improving clay land, has what follows:

"Sea sand and sea shells are used to great advantage as a manure, chiefly for cold strong [i. e. clay] land, and loam inclining to clay. They separate the parts; and the *salts* which are contained in them are a very great improvement to the land. Coral, and such kind of stony plants which grow on the rocks, are filled with salts, which are very beneficial to land. But as these bodies are hard, the improvement is not the first or second year after they are laid on the ground, because they require time to pulverize them, before their salts can mix with the earth to impregnate it. The consequence of this is, that their manure is lasting. Sand, and the smaller kind of sea weeds, will enrich land for six or seven years; and shells, coral, and other hard bodies, will continue many years longer.

"In some countries *fossil shells* have been used with success as manure; but they are not near so full of salts, as those shells which are taken from the sea-shore; and therefore the latter are always to be preferred. Sea sand is much used as manure in Cornwall. The best is that which is intimately mixed with coral."—p. 21.

After stating the manner in which this "excellent manure" is taken up from the bottom, in barges, its character is thus continued:

"It [i. e. the sea sand mixed with coral, as it may happen] gives the heat of lime, and the fatness of oil, to the land it is laid upon. Being more solid than shells, it conveys a greater quantity of fermenting earth in equal space. Besides, it does not dissolve in the ground so soon as shells, but decaying more gradually, continues longer to impart its warmth to the juices of the earth."

Here are described manures which are known to be calcareous, which are strongly recommended—but solely for their supposed mechanical effect in separating the parts of close clays, and on account of the salts derived from sea-water, which they contain. Indeed, no allusion is made to any supposed value, or even to the presence of calcareous earth, which forms so large a proportion of these manures; and the fossil shells (in which that ingredient is

more abundant, more finely reduced, and consequently more fit for both immediate and durable effects) are considered as less efficacious than solid sea shells, and inferior to sea sand. All these substances, besides whatever service their salts may render, are precisely the same kind of calcareous manure, as our beds of fossil shells furnish in a different form. Yet neither here nor elsewhere, does the author intimate that these manures and marl have similar powers for improving soils.

The foregoing quotations show what opinions have been expressed by English writers of reputation, and what opinion would thence necessarily be formed by a general reader of these and other agricultural works, of the nature of what is called marl in England, as well as what is so named in this part of our country. I do not mean that other authors have not thought more correctly, and sometimes expressed themselves with precision on this subject. Mineralogists define *marl* to be a *calcareous clay*; and in this correct sense, the term is used by Davy, and other chemical agriculturists. Such authors as Young and Sinclair also could not have been ignorant of the true composition of marl; yet even they have used so little precision or clearness, when speaking of the effects of marling, that their statements (however correct they may be in the sense they intended them) convey no exact information, and have not served to remove the erroneous impressions made by the great body of their predecessors. Knowing as Young did [see above, 11] the confusion in which this subject was involved, it was the more incumbent on him to be guarded in his use of terms so generally misapplied. Yet considering his practical and scientific knowledge as an agriculturist, his extensive personal observations, and the quantity of matter he has published on soils and calcareous manures, his omissions are more remarkable than those of any other writer. In such of his works as I have met with, though full of strong recommendations of marling, in no case does he state the composition of the soil (as respects its calcareous ingredient), or the proportion added by the operation; and generally notices neither, as if he viewed marling just in the same loose and incorrect manner as most others have done. These charges are supported by the following extracts and references.

17. Young's *Farmer's Calendar*, 10th London edition, page 40.—On marling. Through nearly four pages this practice is strongly recommended—but the manures spoken of, are regularly called “marl or clay,” and their application, “marling or claying.” Mr. Rodwell's account of his practice (which I before referred to, p. 111,) is inserted at length. On leased land he “clayed or marled” eight hundred and twenty acres with one hundred and forty thousand loads, and at a cost of four thousand nine hundred and fifty-eight pounds—and the business is stated to have been attended

with great profit. At last, the author lets us know that it is not the same substance that he has been calling "marl or clay"—and that the marl effervesces strongly with acids, and the clay slightly. But we are told nothing more precise as to the amount of calcareous ingredients, either in the manures, or the soil; and even if we were informed on those heads (without which we can know little or nothing of what the operation really is), we are left ignorant of how much was clayed, and how much marled. It is to be inferred, however, that the clay was thought most serviceable, as Mr. Rodwell says—

"Clay is much to be preferred to marl on those sandy soils, some of which are loose, poor, and even a black sand."

18. Young's *Survey of Norfolk* (a large and closely printed octavo volume) has fourteen pages filled with a minute description of the soils of that county; but without any indication whatever of the proportion, presence, or absence, of calcareous earth in that extensive district of sandy soils, so celebrated for their improvement by marling—nor in any other part of the county. The wastes are very extensive: one of them (page 385) eighteen miles across, quite a desert of sand, "yet highly improvable." Why it is improvable he does not say, as of this also, no information is given as to its calcareous constitution.

19. The section on marl (page 402, of the same work) gives concise statements of its application, with general notices of its effects, on near fifty different parishes, neighbourhoods, or separate farms. Among all these, the only statements from which the calcareous nature of the manure may be gathered, are (page 406), of a marl that "ferments strongly with acids"—another (page 409), that marling at a particular place destroys sorrel—and (page 410) that the marl is generally calcareous, and that *that containing the most clay, and the least calcareous earth*, is preferred by most persons, but not by all.

20. Young's *General View of the Agriculture of Suffolk* (an octavo of 432 pages of close print), in the description of soils, affords no information as to any of them being calcareous, or otherwise; yet the author mentions (page 3) having analyzed some of the soils, and reports their aluminous and silicious ingredients. Nor can more be learned in this respect, in the long account afterwards given of the "marl" which has been very extensively applied also in the county of Suffolk. We may gather, however, from the following extracts, that the "marl or clay" of Suffolk is generally calcareous, but that this quality is not considered the principal cause of its value; and further, that *crag*, a much richer calcareous manure (which seems to be the same with our richest beds of fossil

shells, or marl), is held to be injurious to the sandy soils, which are so generally improved by what is *there* called marl.

"Claying—a term in Suffolk, which includes marling; and indeed the earth carried under this term is very generally a clay marl; though a *pure, or nearly a pure clay, is preferred for very loose sands.*"—*Young's Suffolk*, p. 186.

After speaking of the great value of this manure on light lands, he adds:

"But when the clay is not of a good sort, that is, when there is really none, or scarcely any clay in it, but is an imperfect and even a hard chalk, there are great doubts how far it answers and in some cases has been spread to little profit."—p. 187.

"Part of the under stratum of the county is a singular body of cockle and other shells, found in great masses in various parts of the country, from Dunwich quite to the river Orwell, &c."—"I have seen pits of it to the depth of fifteen or twenty feet, from which great quantities had been taken for the purpose of improving the heaths. It is both red and white, and the shells so broken as to resemble sand. On lands long in tillage, *the use is discontinued*, as it is found to make the sands blow more." [That is, to be moved by the winds.]—p. 6.

21. The *Essay on Manures*, by Arthur Young, for which the author was honoured with the Bedford medal, speaks distinctly enough of the value of marl being due to its calcareous ingredient (as this author doubtless always knew, notwithstanding the looseness of most of his remarks on this head); but at the same time he furnishes some of the strongest examples of absurd inferences, or of gross ignorance of the mode in which calcareous earth acts as an ingredient of soil, and the proportion which soils ought to contain. These are his statements, and his reasoning thereon:

"It is extremely difficult to discover, from the knowledge at present possessed by the public, what ought to be the quantity of calcareous earth in a soil. The best specimen analyzed by Giobert had 6 per cent.; by Bergman, 30 per cent.; by Dr. Fordyce, 2 per cent.; a rich soil, quoted by Mr. Davy, in his lecture at the Royal Institution, 11 per cent. This is an inquiry, concerning which I have made many experiments, and on soils of the most extraordinary fertility. In one, the proportion was equal to 9 per cent.; in another 20 per cent.; another, 3 per cent.; and in a specimen of famous land, which I procured from Flanders, 17 per cent. But the circumstance which much perplexes the inquiry is, that many poor soils possess the same or nearly the same proportions as these most fertile ones. To attain the truth, in so important a point, induced me to repeat many trials, and to compare every circumstance; and I am disposed to conclude, *that the necessity of there being a large proportion of calcareous earth in a soil depends on the deficiency of organic* [i. e. vegetable or animal] *matter; of that organic matter which is* [partly] *convertible into hydrogen gas. If the farmer finds, by experiment, that his soil has but a small quantity of organic matter, or knows by his practice that it is poor, and not worth more than 10s., 15s. or 20s. an acre, he may then conclude that there ought to be 20 per cent. of calcareous earth in it; but, if, on the contrary, it abound with organic matter, and be worth in practice a much larger rent,*

in that case his marl cart will not be called for, though there be but 5 per cent. or even less, of calcareous matter."—*Young's Essay on Manures*—Sect. 2.

It is scarcely necessary to state, that the opinion of calcareous matter being needed in larger quantities in proportion to the *deficiency* of the "organic" or putrescent matter, is directly opposed to the reasoning of this essay. If a poor soil were made to contain twenty per cent. of calcareous matter, by applying lime, chalk, or marl, the quantity and the expense would be so enormous as not to be justified by any possible return; and besides, it would lessen rather than increase the product of a poor soil. The fact named as strange by Young, that some rich soils contain very small, and others very large proportions of calcareous earth, is easily explained. If a natural soil contains any excess of calcareous earth, even though but one per cent., it shows that there is so much to spare, after its having served every purpose of neutralizing acids and combining with putrescent matter. If there were twenty per cent. more of calcareous matter, it would be useless, and indeed probably hurtful, until met by an additional supply of putrescent matter. Young's statement that some poor soils agree precisely with other rich soils, in their contents of calcareous earth, does not necessarily contradict my doctrine that a proper proportion of calcareous earth will enable any soil to become rich, either in a state of nature, or under mild cultivation, and for the following reasons:

22. 1st. The correctness of Young's analyses of soils may be well doubted; and if he used the then usual process for separating calcareous earth, he was obliged to be incorrect on account of its unavoidable imperfection, as has been already explained at page 57. 2d. It cannot be known positively what was the original state of fertility of most cultivated soils in England, nor whether they were subjected to exhausting or improving cultivation, for centuries before our information from history begins. 3d. Lime has been there used for a long time, and to great extent; and chalk and marl were applied as manures before the time of the Roman conquest, as stated by Pliny (or more than 1800 years ago); so that it cannot be always known whether a soil has received its calcareous ingredient from nature, or the industry of man. 4th. It is known that severe cropping after liming, and also excessive doses of calcareous earth, have rendered land almost barren; of which the following extracts offer sufficient proof:—

"Before 1778 [in East Lothian], the *out-field* did not receive any dung except what was left by the animals grazed upon it. In many cases, *out-field* land was limed; and often with singular advantage. The after management was uniformly bad; it being customary to crop the limed *out-field* with barley and oats successively, so long as the crop was worth cutting. In this way numerous fields suffered so severely as to be rendered almost sterile for half a century afterwards."—*Farmer's Magazine*, p. 53, vol. xii.



"An overdose of shell marl [that from under peat, above described], laid perhaps an inch thick, produces for a time large crops. But at last it renders the soil a *caput mortuum*, capable of bearing neither corn nor grass; of which, there are too many examples in Scotland, &c.—*Gentleman Farmer*, p. 378.

23. Yet the last-quoted writer (Lord Kames) elsewhere states (at page 379), that as much clay marl as contains 1500 bolls (or 9000 bushels), of pure calcareous earth to the acre, is not an overdose in Scotland.

The next following evidences have been referred to, and some of them at greater length, in previous parts of this essay. They will be again adduced here, because of their peculiar importance in sustaining my positions. The particular opinions here to be quoted are from writers of high character and authority, as scientific agriculturists, or chemists. The names of Sinclair, Davy, and Morton (and also Young, before quoted), deservedly stand among the highest. Moreover, they are all modern authorities. They severally had all the lights on calcareous manures which existed before the last thirty years (or later); and certainly each of them well knew what was true marl, its mineralogical and chemical character, and also what was calcareous soil. Sir John Sinclair will be the first of these quoted.

24. "*Marl*. Of this substance, there are four sorts, rock—slate—clay—and shell marl. The three former are of so heavy a nature that they are seldom conveyed to any distance; though useful when found below a *lighter* soil, to which they can be applied without incurring much expense. But shell marl is specifically lighter, and consists entirely of calcareous matter (the broken and partially decayed shells of fish), which may be applied as a top-dressing to wheat and grass, when it would be less advantageous to use quick-lime." [This is the kind of manure referred to in extract 12, and there more particularly described.] "In Lancashire and Cheshire, clay, or red marl, is the great source of fertilization, &c."—"The quantity used is enormous; in many cases about three hundred middling cart loads per acre, and the fields are sometimes so thickly covered as to have the appearance of a red soiled fallow, fresh ploughed".—*Sinclair's Code of Agriculture*, Amer. ed. (Hartford) p. 138, and 5th London ed.

This account of the Lancashire improvements made by red clay marl closes with the statement that "the effects are represented to be beneficial in the highest degree," which is fully as exact an account of profit, or increased production, as we can obtain of any other marling. Throughout, there is no hint as to the calcareous constituents of the soil or the manure, or whether either rock, clay, or slate marls, generally, are valuable for that or for other reasons; nor indeed could we guess that they contained any calcareous earth, but for their being classed with many other substances, under the general head of calcareous manures.

But we may learn from other sources that the "red marl" of Lancashire is calcareous, and that the soil to which it was applied is also calcareous. This character of the marl is distinctly stated

by the Agricultural Surveyor of Lancashire, in his Report to the Board of Agriculture (of which Sir John Sinclair was president), and the calcareous character of the soil is inferred from its being of the "new red sand-stone formation," which is highly calcareous, and also from Morton's speaking of the "red marl" in some parts forming the surface soil.

25. The Report of the Agricultural Survey of Lancashire (made to and published by the Board of Agriculture) states the general practice, and also particular cases of the enormous quantities and consequent great cost of the marlings of that country. All the marl (or "clay" as called in some cases) is calcareous. It lies under the surface generally of every field, and at no great depth, and sometimes forms the surface soil. Of course the access to and working the marl could not well be cheaper. Yet so heavy are the usual dressings, 3000 to more than 10,000 bushels to the statute acre, that the improvement is very costly. Actual expenditures are stated ranging from \$35 to \$65 the acre, for a single marling, at short distances and with the other usual facilities of the locality. We might safely infer that these great labours are not necessary or even useful for the purpose of furnishing lime to the soil; and still less if to a soil already calcareous. And of the correctness of this inference the author leaves no doubt in the following subsequent passage of his Report:—

"Undoubtedly the calcareous matter contained in either marl [i. e. the "richer marl" having 40 per cent. or more, or the "clay," of 20 or 22 per cent. of carbonate of lime]; is of the highest importance; but obviating the natural deficiencies of the soil, by adding sand to clay, or clay to sand, is of more consequence than the mere calcareous stimulus, which might be obtained at a much lighter expense" [by liming].

26. Of the agricultural character of the lands on the "new red sand-stone formation" (which includes the red marl land of Lancashire), Morton says—

"In Devon and Somersetshire, this is an unctuous friable clay, or red marly soil of the first quality. It is friable enough for turnips, yet sufficiently tenacious for beans and wheat, and produces the richest and most luxuriant crops of any soil in the kingdom; and the only manure that seems necessary is the application of lime, with which it produces increased crops on every repetition. The effects of lime on the red marl, are much greater in Somerset and Devonshire than in any other portion of the soil of this formation.

"Wherever the red marl comes to the surface, it forms a rich red friable loam," &c.—"The nature of the soil is clay, calcareous matter or marl, slippery and greasy when wet, and of a soapy feel when dry," &c. (*Morton on Soils*, 4th London ed., pp. 70, 71.)

Now whatever may be the benefits, and however great, of applying lime to these already calcareous soils (if the so called "marl" is indeed calcareous), the operation is most certainly not that of calcing, or the marling which I have recommended.

27. The marling of Norfolk county is the most celebrated in England for the great extent of the operation, and the great improvements thereby made. Yet the following passage from the same writer will clearly show that the ordinary operation called "marling" in Norfolk is entirely different from the chemical action I propose :

"So convinced" (says Morton, at p. 29), "are the farmers of Norfolk and Suffolk of the value of the clay or chalk marl [both certainly calcareous] as an *alterative* to their sandy surface, that they generally chalk or clay their land *once in eight years at least*, and sometimes oftener; and by allowing 100 cubic yards to the acre, incur an expense of 50s. [more than \$12] per acre, for digging, wheeling, and spreading. It is solely by this process, that the Norfolk sandy soil, which naturally was of the most worthless kind, and produced nothing but heath and bent, for a few starving sheep, is now converted into good sandy loam, which yields large crops of turnips, barley, and wheat."

Now the first application certainly included the chemical operation which I call marling (or calxing) the soil—if it was not before calcareous. If calcareous by nature, even the first artificial application would have no such chemical action. But much more than half of even the first application, and all of each of the subsequent applications, made every eight years or oftener, in great quantity and at great expense, was merely mechanical in its action, was not rendering the soil calcareous (it being enough so before), and, in short, was in no respect the chemical process which I have defined and recommended, as marling. We may infer that in all these later applications, the carbonate of lime in the marl produced no chemical effect, and acted only mechanically, if at all; and that it was the clay that acted most beneficially, and altogether mechanically.

28. "In Hampshire and Berks, 2880 bushels per acre [of chalk, nearly pure carbonate of lime] are applied with great advantage, at the expense of 42s." (*Morton on Soils*, p. 164.)

29. There can be no higher authority than Sir Humphrey Davy's, for established scientific opinions, at the time he wrote, as to the characters of soils and mineral manures. His "Lectures on Agricultural Chemistry" contain the following passage—which with others of similar import remained unaltered in his latest published edition :—

"Chalk and marl, or carbonate of lime, *will only improve the texture of a soil, or its relation to absorption; it acts merely as one of its earthy ingredients.*" (*Agr. Chem.* 4th London ed. of 1835, Lecture vii.)

Of course, neither this illustrious chemist, nor Professor John Davy, who issued, with his notes, this edition of his then deceased brother's great work, could have had any conception of the *chemical* action of carbonate of lime, when applied in such small quan-

tities as merely to make its presence evident to the analyzer, in a soil before entirely deficient.

30. The next following quotation offers the most remarkable evidence of erroneous opinions of the chemical action of different mineral manures, uttered by a modern author of the highest reputation as a scientific agriculturist. Sir John Sinclair was a voluminous and able writer. Presiding over the British Board of Agriculture, he mainly directed its operations, and of course was familiar with all the lights of British agriculture brought together in the published reports of all the agricultural surveys of the counties of Great Britain and Ireland. Moreover, the professed object of his latest work, the "Code of Agriculture" was to present a digest of all the valuable facts and instructions elicited by all those voluminous surveys and reports, and tested and established by judicious and authoritative approval. Yet in the 5th London edition of his "Code of Agriculture," as late as 1832, and with numerous recent additions and improvements to the work, the following passages stand in an article with the title below—

"On bones as a manure, and on the use of shells, shell-marl and coral for the same beneficial purposes."

—"Were the advantages of the discovery restricted to the use of bones alone, as they might possibly be exhausted, or raised in price, it would be less important; but fortunately the shells of oysters, and other fish, are found to be equally effectual. Shell marl also, which abounds in many parts of the kingdom, may be applied to similar purposes; and coral, the banks of which are abundant even on our own coasts, is found to be equally useful. In short, it is impossible to foresee what may be the ultimate results of this new source of improvement, for by a small quantity [25 bushels to the acre, as elsewhere directed] of pounded bones or shells, great crops of turnips may be raised; and with the manure which these turnips produce, abundant crops of corn may be obtained even on the poorest soils, with the aid of a judicious rotation." (*Code of Agr.*, 5th Lon. ed. p. 141, Appendix.) \* \* \* "As bones are likely to become a scarce article, it is a most fortunate circumstance that the shells of oysters and other shell-fish, when properly reduced in size, have been found equally useful as a manure. Their utility would be much increased if they were sprinkled with sulphuric acid, by the addition of which they would be converted into gypsum." (p. 146.)

Thus, the distinguished author, as late as 1832, asserts that substances whose manuring principles are almost exclusively composed of *carbonate of lime*, will serve to substitute, and act alike and as effectually, as those which are almost exclusively composed of *phosphate of lime* (and of fatty and gelatinous animal matter, if these remain); and then recommends, as still better, the converting the *carbonate* to the *sulphate of lime* or gypsum! This last-named manure, moreover, has not been found of benefit but in few cases in England. It is unnecessary to expose, by further comments, this confounding of the action and effects of three manuring substances, all valuable in their places, yet each very different in action from the others.

31. The means of ameliorating the texture of *chalky soils*, are either by the application of clayey and sandy loams, pure clay, or *marl*.—"The chalk stratum sometimes lies upon a thick vein of black tenacious marl, of a rich quality, which ought to be dug up and mixed with the chalk."—*Code of Agriculture*, p. 19.

32. Dickson's *Farmer's Companion*.—The author recommends "argillaceous marl" for the improvement of *chalky soils*; and for sandy soils, "where the calcareous principle is in sufficient abundance, *argillaceous marl*, and clayey loams," are recommended as manures.

33. "Chalky loam. The best manure for this soil is clay, or *argillaceous marl*, if clay cannot be had; because this soil is defective principally in the argillaceous ingredient."—*Kirwan on Manures*, p. 80.

The evident intention and effect of the marling recommended in all the three last extracts, is to *diminish* the proportion of calcareous earth in the soil.

34. In a *Traveller's Notes* of an agricultural tour in England, in 1811, which is published in the third volume of the *Edinburgh Farmers' Magazine*, the following passages relate to Mr. Coke's estate, Holkham, and to Norfolk generally.

"Holkham.—The soil here is naturally very poor, being a mixture of sand, *chalk*, and flint stones, with apparently little mixture of argillaceous earth—the *sub-soil, chalk or lime-stone everywhere*." p. 486. "As the soil of the territory [of Norfolk generally] through which I passed, seems to have a *sufficient mixture of calcareous earth naturally*, I learn they do not often lime their lands; but *clay marl* has been found to have the most beneficial consequences on most of the Norfolk soils." p. 487.

35. "In Norfolk, they seem to *value clay more than marl*, probably because their sandy soils already contain *calcareous parts*."—*Kirwan on Manures*, p. 87.

From this and the preceding quotation it would follow, that the great and celebrated improvements in Norfolk, made by marling, had actually operated to *lessen the calcareous proportion of the soil*, instead of increasing it. Or, otherwise (as may be deduced from what will follow), if so scientific and diligent an inquirer as Kirwan was deceived on this very important point, it furnishes additional proof of the impossibility of drawing correct conclusions on this subject from European books—when it is left doubtful, whether the most extensive, the most profitable, and the most celebrated improvements by "marling" in Europe, have in fact served to make the soil *more or less* calcareous.

If the "clay marl" offered above (4) by Stephens as a fair average, and which contained only 8.40 per cent. of carbonate of lime, is indeed as rich as the "clay marls" or "clays" spoken of in the latter extracts, it would convert the doubt to certainty, that many soils in England were more calcareous than such marl; and that its application (though truly a calcareous manure), served often

to lessen rather than to increase the previous calcareous constitution of the soil.

36. In connexion with this statement of the poor "clay marls" of Britain, it is worthy of notice that of six kinds of "clay" (not "clay marls," but presented simply as clays), of New York, analyzed and reported by Professor Emmons (and quoted in Browne's Muck Book), the calcareous proportion in five was either nearly as large, or larger, than in the above stated British "clay marl." The specimens reported by Professor Emmons were as follows:—

"Tertiary or Albany clay, contains carbonate of lime per cent. . . . .	8.00
Niagara clay . . . . .	14.62
Cayuga clay . . . . .	16.48
Adonirach clay. . . . .	0.94
Brick (?) clay, near Caldwell . . . . .	8.92
Reddish clay of Christian Hollow . . . . .	8.29"

*Browne's Muck Book* (1852).

All but one of these New York "clays" would be "clay marls" in Britain, according to Stephens, the latest and a high British authority.

Most of the extracts which I have presented, are from British agriculturists of high character and authority. If such writers as these, while giving long and (in some respects) minute statements of marl and marling, omit to tell, or leave their readers to doubt, whether the manure or the soil is the most calcareous—or what proportion of calcareous earth, or whether any is present in either—then have I fully established that the American reader who may attempt to draw instruction from such sources, as to the operation, effects, and profits of either marl or calcareous manures in general, will be more apt to be deceived and misled than enlightened.

I have now to refer to an author, whose works, well known as they may be to others, had not come under my view until after the earliest publication of most of the foregoing extracts. Otherwise, Marshall would have been stated as an exception to the general silence of British authors as to the true and precise nature of what they treated of as *marl*. But though he has not been, like others, so faulty as to leave in doubt what was the character and value of the marls of which he spoke, and the nature of their operation on the soils to which they were applied, still no other writer furnishes stronger proof of the general ignorance and disregard of the nature of marls and calcareous manures, and of their mode of operation; and even the author himself is not free from the same charge, as will be shown. I shall quote the more at length from Marshall, because he presents the strongest opposition to what I have stated as to the general purport of publications on marling; and also, because whatever may be their character, there is much to interest the reader in his accounts of the opinions and practices of those

who have used calcareous manures longest and most extensively, although without knowing what they were doing.

In his "*Rural Economy of Norfolk*," the "marls" and "clays" most used in the celebrated improvements of that county are minutely described, and the chemical composition stated, showing that both are highly calcareous. Of the "marls" or chalks, most used for manure in Norfolk, he analyzed three specimens, and one of clay, and found the proportions of pure calcareous matter as follows:—

Chalk marl of Thorp-market, contained, per cent. . . . .	85
Soft chalk of Thorp-next-Norwich, . . . . .	98
Hard chalk of Swaffham, almost pure,—nearly . . . . .	100
Clay marl of Hemsby . . . . .	43

37. Of these he spoke previously and in general terms, thus:

"The central and northern parts of the district abound, universally, with a whitish-coloured chalk marl; while the Fleg hundreds, and the eastern coast, are equally fortunate in a gray-coloured clay marl. The first has, in all probability, been in use as a manure many centuries; there are oaks of considerable size now going to decay in pits which have obviously been heretofore in use, and which, perhaps, still remain in use, as marl-pits.

"The use of clay marl, as a manure, seems to be a much later discovery; even yet, there are farmers who are blind to its good effect; because it is not marl, but "clay;" by which name it is universally known. The name, however, would be a thing of no import, were it not indiscriminately applied to unctuous earths in general, whether they contain, or not, any portion of calcareous matter. Nothing is "marl" which is not white; for, notwithstanding the county has been so long and so largely indebted to its fertilizing quality, her husbandmen, even in this enlightened age, remain totally ignorant of its distinguishing properties; through which want of information much labour and expense is frequently thrown away. One man, seeing the good effect of the Fleg clay, for instance, concludes that all clays are fertile, and finding a bed of strong brick earth upon his farm, falls to work, at a great expense, to "claying"—while another, observing this man's miscarriage, concludes that all clays are unprofitable; and, in consequence, is at an expense, equally ill applied, of fetching "marl" from a great distance; while he has, perhaps, in his own farm, if judiciously sought after, an earth of a quality equally fertilizing with that he is throwing away his time and his money in fetching.—*Marshall's Norfolk*, vol. i., p. 16.

Yet it is remarkable, that Marshall should not have intimated whether the Norfolk soils were naturally calcareous (as the two writers just before quoted declare) or not; and therefore we are still left to guess whether these manures served to increase the calcareous quality of soils already possessing that quality in a high degree, or to give it to soils devoid of it before.

Other passages will now be quoted from the same, and from other similar works of Marshall's, to show the prevailing ignorance of the ingredients and operation of the marls, sometimes prized and sometimes contemned, with as little reason in the one case as the other, by farmers in various parts of England.

38. "The principal part of his estate, however, is of a much shallower soil, not deeper than the plough goes; and its present very amazing fertility he ascribes in a great measure to his having clayed it. Indeed, to this species of improvement the fertility of the Fleg Hundred is allowed to be principally owing.

"Mr. F. gave me an opportunity of examining his clay pit, which is very commodious; the uncallow [i. e. overlying earth] is trifling, and the depth of the bed or jam he has not been able to ascertain. It is worked, at present, about ten or twelve feet deep. The colour of the fossil, when moist, is dark brown, interspersed with specks of white, and dries to a colour lighter than that of fuller's earth; on being exposed to the air, it breaks into small die-like pieces.

"From Mr. F.'s account of the manner of its acting, and more particularly from its appearance, I judged it to be a brown marl, rather than a clay; and, on trying it in acid, it proves to be strongly calcareous; effervescing, and hissing more violently than most of the white marls of this neighbourhood: and what is still more interesting, the Hemsby clay is equally turbulent in acid as the Norwich marl, which is brought by water forty miles into this country, at the excessive expense of four shillings a load upon the staith; besides the land carriage. [The strength of this Hemsby clay is stated above.]

"It is somewhat extraordinary that Mr. F., sensible and intelligent as he is, should be entirely unacquainted with this quality of his clay; a circumstance, however, the less to be wondered at, as the Norfolk farmers, in general, are equally uninformed of the nature and properties of marl."—*Marshall's Norfolk*, vol. ii., p. 192.

The following is a remarkable instance, in a particular district, of a clay very poor in calcareous matter, being considered and used as valuable manure, and a very rich marl equally accessible, being deemed inferior.

39. "The marl is either an adulterate chalk, found near the foot of the chalky steeps of the West Downs, lying between the chalk rock and the Maam soil, partaking of them both—in truth, a marl of the first quality—or a sort of blue mud, or clay, dug out of the area of this district, particularly, I believe, on the south side of the river. This is said to have been set on with good effect, while the former is spoken of as of less value; whereas, the white is more than three-fourths of it calcareous; while the blue does not contain ten grains, per cent., of calcareous matter.—*Marshall's Southern Counties*, p. 175.

There have before been given some extracts from this author, showing that sundry other valued "marls" (so called) were scarcely at all calcareous. Whatever manuring effects all these have, must be owing to some other and unknown ingredient.

The first extracts from Marshall (just referred to) suggested a remark, which ought to have been made earlier. When there is so much general ignorance prevailing among practical farmers as to what they call marl, it cannot be expected that the most intelligent writers can be correct, when attempting to record their practices. When Arthur Young, for example, reports the effects of marl in fifty different localities, as known from the practice of several hundreds of individuals, it must be inferred that he uses



the term, generally, as they did from whom his information was gathered, and in very few cases, if at all, as learned by his own analyses. Therefore, it may well be doubted whether the uncertainty as to the character of marl does not extend very generally to even the most scientific writers on agriculture.

As some of the foregoing extracts exhibit the use of "marls" (so called) destitute of calcareous earth, so the following shows, under the name of *sea sand*, a manure which is in its chemical qualities a rich *marl* (in our sense) or calcareous manure.

40. "*Sea sand*. This has been a manure of the district, beyond memory or tradition. There are two species still in use: the one bearing the ordinary appearances of sea sand, as found at the mouths of rivers; namely a compound of the common sand and mud; the other appears to the eye clean fragments of broken shells without mixture; resembling, in colour and particles, clean-dressed bran of wheat.

"By analysis, one hundred grains of the former contain about thirty grains of common silicious sea sand, with a few grains of fine silt or mud; the rest is calcareous earth mixed with the animal matter of marine shells.

"One hundred grains of the latter contain eighty-five grains of the matter of shells, and fifteen grains of an earthy substance, which resembles, in colour and particles, minute fragments of burnt clay or common red brick.

"These sands are raised in different parts of Plymouth Sound, or in the harbour; and are carried up the estuaries in barges; and from these on horseback, perhaps five or six miles into the country; of course at a very great expense, yet without discrimination, by men in general, as to their specific qualities. The shelly kind, no doubt, brought them into repute, and induced landlords to bind their tenants to the use of them; but without specifying the sort—and the bargemen, of course, bring such as they can raise and convey at the least labour and expense. It is probable that the specimen first mentioned, is above par, as to quality: I have seen sand of a much cleaner appearance, travelling towards the fields of this quarter of the country; and near Beddiford, in North Devonshire, I collected a specimen under the operation of "melling" with mould, which contains eighty grains per cent. of clean silicious sand!"—*Marshall's West of England*, vol. i., p. 154.

It might be inferred from all these proofs of Marshall's knowledge of calcareous earth constituting the real value of marls, that he could scarcely miss the obvious corollary to that proposition, that the valuable operation of calcareous manures is to render soils calcareous, and that the knowledge of the nature of the manure and the soil would sufficiently indicate when the application of the one to the other is judicious or not. But the following expression of opinion (*Marshall's Yorkshire*, vol. i., p. 377) is not only strongly opposed to those deductions, but to the general purport of all his truths which I have before quoted.

41. "Nothing at present but comparative experiments can determine the value of a given lime, to a given soil; and no man can with common prudence lime any land upon a large scale, until a moral certainty of improvement has been established by experience."

If this be true, then indeed is there no true or known theory, or

established principles or precepts, for applying either lime or any calcareous manure. It amounts to saying, that every new application is a mere experiment, the result of which cannot even be conjectured from any facts previously known of other soils and other manures.

42. The next quotation, which is from an editorial article in the *Farmers' Journal* of July 28, 1823, shows that the old opinion still prevails, that marl is profitable only on sandy lands; which opinion carries with it the certain inference that it is the argillaceous quality, rather than the calcareous, that operates. The editor is remarking on a new agricultural compilation by a Mr. Elkinson, and ridiculing the author for his solemn annunciation of the truism (in the editor's opinion), that "marling on sand is more useful than on clay land." The reputation of Mr. Elkinson, says the editor, "may remain undisturbed among the farmers of Lincolnshire for a long time, who may never have chanced to meet with the old proverb, or have taken a journey into the sandy district of Norfolk. We really do not know whether it be as old as Jarvis Markham or not: but we have seen the following lines in black letter:—

He that marls sand, may buy land;  
He that marls moss, shall have loss;  
He that marls clay, throws all away!"

The editor then passes to a subject on which his admitted ignorance serves to prove that the improvement gained by marling could not be simply the making a soil calcareous—for, upon that ground, when marl has once been plentifully given, and the land afterwards worked poor, there can be neither reason nor profit in a second marling. Yet, as if the mode of operation was altogether unknown, this passage follows:

"It was once asked of the editor by a very good practical Norfolk farmer, 'whether land which had been once marled and worn out would receive the same benefit from a second marling?' It was answered, that an experiment made on one field, or on one acre, would decide the point, but *conjecture led to nothing conclusive*. It has often been observed that loose land, after having been marled and out-cropped, deposited its marl in the sub-soil, which therefore became more retentive [of water]; and it has been suggested, that deep ploughing ought to be tried, to bring this marl again to the top. We hope that the point here in question has before now been settled by practice in both ways; though at the above period (about 1806), such facts had not reached the gentleman alluded to, although a very intelligent man."

There are copious descriptions of marl, and accounts of its use and operation in several modern French works which I have seen only since the first publication of this essay.\* In all of these, marl is correctly described, as being composed of carbonate of lime

---

\* "Cours Complet," &c., par l'Abbé Rozier; "Maison Rustique, &c." "Essai sur la Marne," par M. Puvion.

and clay, or as what I have distinguished as true marl. Neither in these very minute descriptions (nor in any others known to me), are shells mentioned as forming either a universal or general constituent part of ordinary marls; or as having furnished directly and immediately the main supply of the carbonate of lime of ordinary and true marls. It is true that shells, or their fragments, are mentioned as being sometimes contained; but these may be presumed to be accidental ingredients. They are either land shells (and sometimes so described) swept from the surface of the calcareous lands from which the essential materials of the marl were brought in the floods of turbid water; or in other cases, shells of fresh-water molluscs which lived in the ancient lakes under which the marl was deposited, and of course, the shells of such dead animals would be enveloped in the marl, though not necessarily or properly belonging to it.

Again: "Shell marl" is mentioned by sundry authors, but this is even a more different formation from true marl than it is from our fossil shells. Its peculiar character was stated above (page 374). This is the "shell marl" to which Sir John Sinclair refers above.

If any one can still suppose that these European writers, when speaking of marl, could possibly mean to include such beds as ours, or would so include them, if known there, I have a sufficient answer ready in the fact that such beds of fossil shells as are here called marl exist in Europe and in great extent—that they were known to and were described by authors who wrote most extensively on marl—and that in no case have they been termed or considered as marl.

Many and extensive beds of fossil marine shells are known to exist in Europe, which, in their general features, physical and chemical, and fitness for agricultural uses, must be similar to ours. Of these deposits, both in England and France, there have been applications to the land, though to very limited extent comparatively, and the fertilizing value is recognised. Scientific observers, of course, know that these beds agree with true marl in the important and main characteristic of being in part composed of carbonate of lime. Still, in the only three agricultural notices of these beds of fossil shells which I have seen, and all are from scientific agriculturists, this substance is not called marl; and it is noticed under a different head, and treated as if a different manure. The practical cultivators who have applied it, doubtless deemed this manure as different from marl in substance and qualities as in name.

One of the notices referred to has already been quoted above, (20, page 383), in the words of Arthur Young, concerning the Suffolk "*crag*," the name used for this deposit in England. This

scant notice is all that is taken of this kind of fossil manure, in that author's voluminous Agricultural Survey of Suffolk, and of which a large portion is devoted to marl and marling. It is manifest from his expressions, that neither Young nor the Suffolk farmers had any idea of this "crag" being marl.

The other and more full accounts are by French authors. The latest is by M. Puvis, who has written so extensively on lime and marl, and whose views of calcareous manures are worth more than those of any other European writer, previous to the general digest in the recent Lectures of Prof. Johnston. Puvis' remarks on this subject, of which all will be translated and given below, follow his Essay on Marl in the *Annales*, but as one of several different though connected subjects—under the different divisions and titles of "Platras, or remains of demolished buildings"—"*Falunage*, or use of shells as an improver"—"Gypsum"—and "Wood-ashes." Under the head of *falunage* the following remarks occur :

"43. *Of Falunage, or the use of shells, as an improver of soil.*

"The name *faluns* has been given to those beds of fossil shells which are found, whether on the borders of the sea, or in the interior of the land. In certain places the *falun* is used under the name of shell marl;\* but it is only the *falun* of Touraine [in France], of which the use in agriculture is well known. The *faluniere* there forms a bed of three leagues in length, and of variable width and thickness. The *falun* is taken out from many feet in depth; and as there is much water, it is obtained by the force of many hands, of which some draw off the water while others get out the *falun*. It is put on the land at from 30 to 60 wagon loads to the hectare [nearly 2½ acres] according to the nature of the soil. Its action appears at least as efficacious as that of marl; and the effects last long.

"They use in England a much lighter dressing; not more than one-half of the lightest dressing in Touraine. The particular qualities and fertilizing forces may be different, as the beds are composed of very different families of shells; so that each region may be right in its practice. The duration of a *falunage* in England is longer than that of marl; and its energy is renewed by a compost of barn-yard manure and shells, as in regard to marl and lime. The soil is greatly meliorated; still more, as it seems, than by lime or marl. It may well be true that these shell beds may in fact contain some albuminous substances, some animal parts, which add to the effect of the carbonate of lime, which forms the principal base of the manure.

"There are found in France these shelly beds in many places. They are spoken of in the environs of Dax, of Grignon (Seine-et-Oise), of Courtagnon (in Marne); but the conchologists seem to have made more use of them than the agriculturists. Doubtless, they are to be found in many other

---

\* It is manifest that the author, in reporting this provincial and particular application of the name "shell marl" does not adopt it, or approve it. He never himself uses the words marl (*marne*) or marling (*marnage*) applied to this earth; but always *falun* for the substance, *falunage* for the application of it as manure; and *faluniere* for the bed, or deposit in its natural place, or for the excavations therein, as understood in the next succeeding article. E. R.

places. These deposits are one of our mineral treasures, from which we are far from deriving proper advantages. For if using the *falun* at the rate of 100 hectolitres to the hectare, as in England, it might be transported to a distance, either by water or land carriage. And what further recommends its use, at least as much, the *falun* is not accused of having impoverished the soil. On the contrary it is found everywhere improved."\*  
—*Annales d'Agriculture Française*, 1835.

The next passages are translated extracts of the article "*Falun*" in the "*Cours Complet*," &c., which is a joint contribution by Rozier and Cadet-de-Vaux.

44. "This name is given to a great body of marine remains which exist in Touraine, over an extent of about three leagues in length, and of less breadth. Neither the exact limits nor the depth of this bed is known. The excavations have not been sunk lower than 20 feet, because of the water which oozes from all sides into these *falunieres*. What a deposit! What immense quantity of shells! We may also add, what a treasure! For these spoils of the ocean are an excellent improver of soil.

We will then merely consider the *falun* as an improver. After being extracted from the pit, suffered to drain and become dry, it is spread on the fields the same as marl; and the proportion varies according to the quality of the lands on which it is spread—in the same manner as of marl.

"Here is the difference which exists between these two improvers: Marl is a calcareous earth, of the same nature as the *falun*, but it is mixed with sand and argil; so that the first thing to do when one marls a field is to know well the [degree of purity of the] marl. This knowledge is easy to acquire by the most simple analysis.

The *falun* is pure calcareous earth; but which contains more or less of the principles which were united to the calcareous earth in the formation of the shells. Unless constantly soaked in water, it may not have lost these principles. Then the *falun* can no longer be considered as a pure calcareous earth, and destined to act only mechanically. We will observe that the *falun* has, in common with marl, no influence on the fertility of the field which receives it until the second year; and the effects of both these earths become enfeebled at length; when it is necessary to apply them again."

I have omitted of the last article as much as could be separated of the superfluous, useless, and mistaken statements—and there is not much else. But all is left that refers to what I designed to show, i. e., that the authors had no thought that the *falun* was marl.

This last description of the *falun* of Touraine goes to show that the mass was of shells or their fragments alone, or without the

---

\* This ground of superior value assumed for the *falun*, I take as indirect evidence, in addition to the author's direct assertion, that this kind of manure has been but little used, or that little is known of the effects. The use of calcareous manures in Europe has been almost entirely empirical, and not directed by any theory, or rational rules. Hence damage has often been done by improper applications of both lime and marl; and if the *falun* has been harmless, rich and abundant as it is, and easy to apply, it must be because of its very limited use. E. R.

usual admixture of sand or clay. I have worked a particular layer nearly as pure, and which had the same disadvantage of water pouring in through the very open texture of the broken shells. There is an extensive bed of as pure and unmixed fossil shells, near to the surface of the earth, and there quite dry, near the northern limit of sea-coast of South Carolina.\*

45. The next evidence is from a report of the Rev. John Clayton, Rector of Crofton, in Yorkshire, to the Royal Society of England, in 1688. The writer visited Virginia, and this was the report of his personal and somewhat scientific examinations. It was republished in the 4th vol. of *Farmers' Register*. The writer saw, with astonishment, and describes the beds of fossil shells in the river cliffs—and though with much looseness and inaccuracy, still there is no doubt that he included in his observations not only the actual beds of loose oyster shells, but the petrified oyster shells in other places, and also the beds of other and various fossil sea shells, which since have obtained in Virginia the provincial term of marl. For though he calls all of them "oyster shells," it is manifest that he also referred to the sea shells, as he particularly describes the "shark's teeth" and large vertebræ which are so common in these beds, and never known in the deposits of oyster shells alone. Now this gentleman, from his residence, and his information, could not possibly have been ignorant of marl in England. Yet in all his remarks and speculations (some very wild), on these beds in Virginia, he does not call them marl, or refer to any similarity of these beds to marl—nor even suppose any use for ours, other than that before known, of burning the shells to make lime for cement. (See *Farmers' Register*, vol. iv., pp. 642-3.)

From all the foregoing quotations and evidences, I claim that the propositions enumerated in the beginning of this article, have been sustained fully; and that the following deductions must necessarily be made:—

1. For centuries after marling had been recommended by English books on agriculture, and extensively practised by very many farmers of England, it was not generally, if at all, understood by either writers or farmers that calcareous earth was the all-important or even an essential ingredient of marl, as a manuring agent; and many clays used for and as marl, certainly contained no carbonate of lime.

2. Though more lately, English writers have taught correctly that marl is calcareous, and also (generally) that the value of the manure depends mainly on the lime contained, still the previous

---

\* Described in the supplement to my Report of the Agricultural Survey of South Carolina. The deposit is on and near Price's creek, in Horry—and is of the post-pliocene division. E. R.

ignorance continued to prevail among the more illiterate farmers; and even some writers of reputation, to recent times, have shown in their expressions the influence remaining of the previous and universal ignorance on this subject. Long after these more correct views of the constitution and true source of value of marl had been published by the then most enlightened writers, their readers did not learn from them enough of their truth to dispel the previously long existing and prevailing erroneous views. Hence the "soapy feel," and clayey constitution, and the crumbling in water, still continued to be regarded by all as essential qualities and important values of any manure operating as marl; and comparatively little importance was attached to the calcareous ingredient—even when that was not entirely disregarded or unknown.

Hence Bordley, an extensive reader of the best and newest English agricultural books, himself an agricultural author, and moreover a practical and wealthy farmer, on the "marl region" (now so known) of Maryland, did not learn from his English teachers and guides that marl was necessarily calcareous; and never suspected that the beds of fossil shells, so abundant in his own neighbourhood (if not on his own farm), either were marl, or had any value as manure. We may also infer that our great Virginian agriculturist, John Taylor of Caroline, a much later writer than Bordley, and also well acquainted with English agricultural authors, had learned nothing more either of true marl, or of our beds of fossil shells being (as indicated by the vulgar name), identical with marl. Further: Philip Tabb, of Toddsbury, in Gloucester county, was one of the earliest good farmers of Virginia, and deservedly the most celebrated in his time for his judicious management, and for his success in improving his farm and its productions. Yet from all his lights, and doubtless his general knowledge of English marling, he never suspected to be marl, and never thought of using as such, or for manure, the bed of what is now called marl, which underlies the whole farm, and is generally accessible within 4 or 5 feet of the surface. It has been only in latter days, that this most abundant and easily accessible bed has been opened, and used largely and advantageously as manure for this farm.

3. And further: No person, deriving his information solely from the descriptions of marl by English writers, and their remarks on the subject, and searching for marl by aid of their directions, would have supposed he had found the object of his search in the marine fossil shell formation of this region—so entirely different as is this from all the marls (true or false) described by those writers, in outward appearance, texture, and other physical qualities always; and in some cases there is no less difference in the more important chemical constitution, in regard to calcareous earth being an ingredient or not.

*Marl and Marling of the Ancients.*

I will add to these extracts, though merely as a matter of curiosity, the most ancient notices of marl extant, translated from the works of Varro and Pliny, respectively nearly 1900 and 1800 years old. Their great antiquity would alone serve to invest these statements with much interest. And it is also interesting and amusing to observe that nearly as much was known of the properties of marl by the then barbarous Britons, more than 1800 years ago, as by their enlightened descendants 1700 years later. For if, in the report by Pliny, the proper names were omitted, and the piece appeared without date or authority, it might well be supposed to be from some one of the English publications on marl which appeared after the middle of the last century. Pliny, and the Gaulish and British farmers from whom his statements were indirectly derived, were as ignorant of the true character and action of marl, as were the farmers, and also most of the best agricultural writers, as late as 1780—but not more ignorant. Like these much later writers, Pliny seems not to have known, or, if knowing, not to have attached any importance to the *calcareous* quality of marl; nor was he, more than they, at all precise in distinguishing between marl and non-calcareous clay. Still it may be inferred, from the context, and from indirect testimony rather than the direct statements of the author, that either true marl or chalk was always referred to; and of course that it was truly *calcareous* manure of which he spoke. The manure referred to as being used by the Edui and Pictones; *calx*, is named with sufficient exactness; and if not *lime*, as rendered in the translation, it must have been carbonate of lime in some form, as *calx* properly means. But by using the word *calx* in this case, and *creta* when chalk obviously was meant, it seems likely that the former was designed for calcined lime.

Translated from "*De Re Rustica*," Var. Lib. I. Cap. 7.

"In Transalpine Gaul as far as the Rhine, when I commanded the army, I went into some regions, where neither the vine, the olive, nor apples grew, and where they manured their fields with a white chalk dug out of the earth [*candida fossicia creta*].

Translated from *Plin. Nat. Hist. Lib. XVII., Cap. 5, 6, 7, 8.*

"To improve land (as some conceive) by the application of rich earth to poor, or of porous and sandy to moist and very fertile, is the work of folly. What can he hope who pursues such practice?

"There is another method, which was discovered in Britain and Gaul, of fertilizing land with a kind of earth which they call marl [*marga*]. Greater fertility is perceived. There is a peculiar fatness [*adeps*] of this earth which like the glandules in bodies serves as a nucleus for increased fertility.

"The Greeks also have not neglected this plan; for what have they failed



to try? A white clay [*candida argilla*] which they use in Megaris, but only on moist and cold soils, they call *Leucargillon*.

"It is proper to describe with care that used to enrich the soils of Gaul and Britain. At first there were two kinds, but of late several others have begun to be used as their information increased. There is the white, red, dove-coloured, argillaceous, porous [*tophacea*], and sandy. Its character is two-fold, rough or unctuous [*aspera aut pinguis*]. Specimens of both are at hand. Its effect is likewise two-fold, either to bring grain alone, or also to nourish grass. The white porous [*tophacea alba*] marl nourishes grain, and if found among springs is immensely rich. It is rough to the touch, and if applied in too large quantities it burns the land. The next is the red marl, which they call *capnumargos*, from the stone being intermixed with fine sandy earth. The stone is crushed in the field itself, and for a few years the stalks (of grain) are cut with difficulty on account of the pieces of stone. Yet in consequence of its lightness it is applied at very little expense, less than one-half the cost of the others. It is spread thin, and is thought to be mixed with salt. Each kind once applied will last for fifty years, increasing the product both of grain and grass.

"The white is the main variety of those which are known to be unctuous [*pingues*]. Of this there are several kinds. The most caustic [*mordacissimum*] is that of which we have spoken above. Another is a kind of white chalk [*alba creta*] used to scour silver. It is brought up out of the earth, shafts being sunk often a hundred feet deep, narrow at the mouth, but enlarging within as in mines. This kind is principally used in Britain, and lasts eighty years. Nor is there an instance of any one who has twice applied it to the same land during his life. A third kind of white they call *glischromargon*. It is a fuller's chalk (*creta fullonia*) mixed with unctuous [*pinguis*] earth, better for grass than grain, so that one crop being taken off, before the next sowing, the richest grass can again be cut. When it is in grain, it brings no grass in addition. It lasts thirty years, but when too thick it stifles the land like *siguinum* [old cement of terras, gypsum, &c.]. The dove-coloured the Gauls call by their name of *Eglecopala*. It is gotten out in clods like stones, but by exposure to sun and frost it separates into very thin laminæ. This is equally rich. The sandy is used in default of other kinds; in wet, oozy [*uliginosis*] places, however, it is used even when others can be had. The Ubii are the only people we know, who when they cultivate very rich land, manure it by digging up the earth more than three feet deep and spreading it on to a foot's thickness [*quacunq; terra infra tres pedes effossa, et pedali crassitudine injecta lactifera*]. But it does good for not more than ten years.

"The Edui and Pictones\* made their fields very rich with lime [*calx*] which likewise is found of the greatest benefit to both olives and vines. All marl [*marga*] must be put on ploughed land; so that its fertilizing properties may be quickly absorbed; and that which at first is too harsh [*aspera*] and does not at once produce an abundance of herbage [*qua in herbas non effunditur*], requires a small amount of dung, or else by its freshness [*novitate*] it injures the soil, and is not fertilizing till after the first year. It is also important to note the kind of soil on which it is to be put. A dry marl, whether the chalk [*creta*] or the dove-coloured [*columbina*], is best adapted to a moist soil, and an unctuous marl (*pinguis*) to an arid soil, the one quality serving to temper the other."

\* The Edui and Pictones were the ancient Gaulish inhabitants of the modern Autun and Poitiers, respectively, of France.—*London Quarterly Review*.

### NOTE III.

#### THE EARLIEST KNOWN SUCCESSFUL APPLICATIONS OF FOSSIL SHELLS AS MANURE.

THE two old experiments described at pp. 114-15, though the only applications of fossil shells known to me previous to the commencement of my use of this manure, were not all that had been made, and, which being deemed failures, had been abandoned and forgotten. Another, within a few miles of my residence, was brought to light and notice afterwards, by an old negro, who was perhaps the only person then living who had any knowledge of the facts. After I had found enough success in using this manure to attract to it some attention, Mr. Thomas Cocke of Aberdeen, was one of those who began, but still with doubt and hesitation, to use marl to some considerable extent. One of his early applications was to his garden. The old gardener opposed this, and told his master that he knew "the stuff was good for nothing, because, when he was a boy, his old master (Mr. Cocke's father) had used some at Bonaccord, and it had never done the least good." Being asked whether he could show the spot where this trial had been made, he answered that he could easily, as he drove the cart which carried out the marl. The place was immediately sought. It was on the most elevated part of a very poor field, which had been cleared and exhausted fully a century before. The marled space (a square of about half an acre), though still poor, was at least twice as productive as the surrounding land, though a slight manuring from the farm-yard had been applied a few years before to the surrounding land, and omitted on this spot, which was supposed, from its appearance, to have been the site of some former dwelling-house and yard, of which every trace had disappeared except the permanent improvement of the soil usual from that cause. A close examination showed some fragments of the hardest shells remaining, so as to prove that the old man had not mistaken the spot. This, like other early applications, had been made on ground too poor for the marl to show but very slight early effect; and as only one kind of operation of any manure was then thought of (that which dung produces), it is not strange that both the master and servant should have agreed in the opinion that the application was useless, and that all persons who knew of the application remained under that opinion until almost all remembrance of the experiment had been lost.

Since the printing of the previous pages in which references were made to the earliest application of marl in Virginia, I have obtained some further information thereupon, which, however imperfect, may yet be interesting. In a recent conversation (1842) with William Short, Esq., now of Philadelphia, the son of Major William Short who made the experiment, he told me that he well re-

collected when his father's first and accidental discovery of marl was made on the Spring Garden farm in Surry (in digging a ditch across a wet swamp), and his sanguine and confident anticipations of deriving from its use great improvement and profit. Mr. Short further stated that he was then so young, and always so little acquainted with agriculture, that he did not know what were the precise facts in regard to the failure of his father's experiment and hopes; but he well remembers that the result was deemed an entire failure, and that it caused total disappointment.

Such a conclusion I had supposed before being so informed. I had also inferred, and no doubt correctly, that the supposed failure and truly slight benefit, and the mistaken deductions from the results, were such as have been stated. I have since written to the present proprietor of the land, Francis Ruffin, Esq., to obtain the latest information concerning the results of this application, now some sixty-five years old; and the most recent effects, as learned from him, will be here stated in connexion with the earlier, which will be repeated.

It was before said (page 114) that this old marling (of about 10 acres) was done on poor sandy land, kept (as was the then universal course of tillage) under exhausting culture and close grazing for many years thereafter; that from 1812 the treatment had been lenient; and that in 1819, the superiority of the marled part was visible, and that part of the outline could be then distinctly traced. In 1834, Mr. F. Ruffin applied to this and some acres of adjoining land, pine leaves at the rate of 75 one-horse cart-loads to the acre. The benefit from this vegetable cover was so much greater on the marled part, that the superior growth of the next crop of corn and of the succeeding crop of wheat, "marked out the limits of the old marling very conspicuously." The whole was sown in clover in the spring while under wheat; that on the marled part lived and stood pretty well, while nearly every plant of clover on the part not marled died in the course of the year. In 1837, the whole field was marled, without excepting the old marled part; and the whole was again littered with pine leaves. The crops of corn and wheat since have shown less improvement from these applications on the piece thus re-marled, than on the adjoining land then marled for the first time. Indeed, the recent and additional increase of corn and wheat, since re-marling, has been very little. These results, early and late, are precisely such as might have been anticipated from the action of calcareous manures, and the condition of this land and its management.

Another experiment of marling, made earlier than my first, by Mr. Richard Hill, in King William county, has been heard of since the publication of the last edition, and of which the circumstances were given at length at pages 22 and 27 of vol. ix. Far-

mers' Register, to which the reader is referred. It is enough here to state, that the effects were beneficial at first; but so injurious (because of the excessive quantity) on several succeeding crops, that this trial also was deemed a failure, and the marling a source of loss; and there was no repetition of marling in that neighbourhood until about 1820, when other and better views began there to be first entertained.

There was also successful and continued use of this manure in James City county, in Virginia, made earlier than mine; and still earlier by Mr. John Singleton, in Talbot county, Maryland. It appears that the early (though chance-directed) combination of putrescent manures with marl, in both these places, served to prove the value of the latter, and perhaps to prevent it being there also abandoned as worthless, as in the other cases. But though the application was continued, and with great success and profit, the knowledge of these facts and the example extended very slowly; and the then want of communication among farmers kept all ignorant of these practices for years, except in the immediate vicinity of the commencement of each. I have since endeavoured to ascertain the time of the first applications in James City, and have been informed that it was in 1816. Mr. Singleton's, in Maryland, were begun as early as 1805. His own account of his practice (which will be annexed, as an interesting statement of the earliest profitable use of this manure), was first published in 1818, in the 4th volume of the *Memoirs of the Philadelphia Agricultural Society* (page 238). The date of his letter is Dec. 31, 1817. My first experiment was made the following month (Jan. 1818), but more than a year before I met with Mr. Singleton's publication, or had heard of any application of fossil shells, except the two failures mentioned in page 115. But, however beneficial may have been found the operation of marl in Talbot and in James City, it is evident, from Mr. Singleton's letter, and from all other sources of information, that the mode of operation remained altogether unsuspected by those who used it; and this was perhaps the principal cause why the practice was so slow in spreading. It is now [1835] thirty years since the first proofs were exhibited on the land of Mr. Singleton; yet, according to the report of the geological survey of the lower part of Maryland (submitted to the legislature of Maryland at its recent session of 1834-5), it appears, though the value of marl is well understood, and much use of it made in Talbot county, and part of Queen Ann's county, yet that almost no use has been made of it on the other and much more extensive parts of the Eastern Shore of Maryland—and none whatever west of the Chesapeake in that state, where it is found in abundance. Such at least are the inferences from Dr. Ducatel's report, though in part drawn from indirect testimony, more than direct and particular assertions.

The slight, and almost contemptuous manner, in which marl is mentioned by so well informed an agriculturist as Taylor, as late as 1814, when his *Arator* was published (and which remained unaltered in his 3d edition of 1817), proves that almost nothing was then known of the value of this manure. All that seems to relate to our abundant deposits of fossil shells, or to marl generally, is contained in the two following passages:—

“Without new accessions of vegetable matter, successive heavy dressings with lime, gypsum, and even marl, have been frequently found to terminate in impoverishment. Hence it is inferred, that minerals operate as an excitement only to the manure furnished by the atmosphere. From this fact results the impossibility of renovating an exhausted soil, by resorting to fossils, which will expel the poor remnant of life; and indeed it is hardly probable that divine wisdom has lodged in the bowels of the earth the manure necessary for its surface.”—*Arator*, p. 52, 2d edition, Baltimore.

“Of lime and marl we have an abundance, but experience does not entitle me to say anything of either.”—*Id.* p. 80.

*From John Singleton to the Hon. Wm. Tilghman.*

\* \* \* \* \*

“Your first question is, ‘whether what I use be marl, or soil mixed with shells?’

“Whether it be marl or not, I will not pretend to determine, as I have seen no description of marl that answers exactly to it; but Mr. Tench Tilghman informed me he had seen a description of marl used in Scotland, exactly similar to what I use on the farm on which I reside, and which is the improved land you mention. I have not seen the account myself. However, this, and all mixtures of broken marine shells, of which there is a great variety, are now denominated marl, here. What I consider the best, and which I most use, is composed of small parts of marine shells, chiefly scallop shell, about one-eighth of an inch square, or somewhat longer or smaller, with scarce any sand or soil with it: some of it seems to be petrified, and is dug up in lumps, like stone, from four or five, to forty or fifty pounds in weight, hard to break even with the eye of an axe, and will remain for years, tumbled about with the plough, before it is entirely broken to pieces, and mixed with the soil; indeed you may observe it in some parts of the bank, where the soil has been washed from it, appearing like rock stone; but if broken and pulverized a little, it effervesces very much with acids. \* \* \* \* \*

“I have applied it to all the soils on my farm, some of which is a cold white clay, and wet; others a light loam, and sandy. I find it useful to each kind, and manure my land all over with it, without distinction, and to advantage; putting a smaller quantity upon the looser soils. I have applied it as a top dressing on clover, and also where clover has not been sown, with a view to improving the grass, and also to be satisfied whether it would not be best for the ground, to let it lie spread on the surface, for a year before the ground was put into cultivation. But it has not answered my expectation. I could not perceive any advantage from that mode of application. I now constantly apply it to the ground cultivated in corn; carting it out in the winter and spring, and putting on from twenty to forty cart-loads per acre, according to the ground, and the previous quantity

that had been put on, in former cultivations, dividing each load into from four to eight small heaps, for the greater ease in spreading, according to the size of the load. Some is put on before, and some after the ground is broken up, but it is all worked into the soil by the cultivation of the corn, and it never fails of considerably improving the crop of corn, as also the ground wherever the marl is, especially in largest quantity. There is a small green moss, and black moist appearance, on the surface of the ground, when not cultivated; as you perceive about old walls, and in strong ground. Though the preceding is the common mode in which I use the marl, I do not think it the best; I mix some in my farm-yard, with the farm-yard and stable manure; and would prefer mixing and applying all that I use thus mixed, but for the labour of double cartage which I cannot as yet accomplish, manuring so largely as I do. I cultivate one hundred acres yearly, and constantly manure the whole of what I cultivate; employing only four carts, and four hands with the carts, which do all the manuring and carting on the farm.

“Your next question is, ‘what has been my rotation of crops, and mode of cultivating, since I have used this manure?’

“Since I began to use the marl, and bend my attention to improvement by manure, I have cultivated only corn and wheat, sowing my ground in clover, and using the plaster. Instead of cultivating all my ground in corn, and sowing wheat on it as heretofore, I divided my cultivation into two parts, of fifty acres each, putting one part into corn, which I was able to accomplish manuring time enough for the corn, and making a fallow of the other part, manuring as much of it as I could accomplish before the time for sowing wheat; and disregarding, in a degree, all smaller crops, which I could not attend to, as an object, without increasing my number of hands, and interfering with the main business. I went on in this manner, till I found I could easily accomplish manuring one hundred acres and upwards, per annum. Having got my ground to that state that I can risk making a crop without manure, I am now about discarding fallow, being able to manure my whole hundred acres time enough for cropping in the spring, by beginning to manure for the next year as soon as the spring manuring is finished. I shall in future have no wheat in fallow, but sow it after corn and other crops, from which I am satisfied I can make more from my ground than by naked fallow, which I always considered unprofitable, though you made more wheat, except for the advantage of having more time to manure. \* \* \* \* \*

“In saving my corn crop, I cut it up without pulling it from the stalk as usual, and cart it in all together, then husk it out, leaving the husk to the stalk: I lay these near my feeding yard, and throw them into it twice a day: this gives us a large quantity of strong healthy food for the cattle, which serves them all winter, and keeps them in good condition without any other food; makes a large quantity of excellent manure, and a fine dry feeding yard. As opportunity can be found, we cart marl, fuller's earth, clay, and any good soil that is convenient, into this yard, which being mixed with the stalks, and straw, or anything else, penning the cattle on it through the winter and summer, instead of penning on the field, in the common way, we have a large quantity of manure to go out in the fall, and next winter; it is put into the field, in the intermediate rows, between the rows of marl, as far as it will go, and they will get mixed in the cultivation. We also convert the scouring of our ditches, the head-lands of the fields, and all waste-ground that we can, into manure, by carting litter, from the woods, yard manure, or litter, &c., and mixing with them; so that I can nearly, or quite, now, accomplish making farm-yard and this

kind of manure, sufficient to go over my whole hundred acres annually. For the last two years, I have made more manure than I could accomplish or effect carrying out, though I have manured from ten to twenty acres more than my hundred, each year, with part marl and part farm-yard, but not the whole with both, as I hope to be able to do in future; but it will be necessary to increase my carting force to effect it, and I clearly see I can raise sufficient manure for the purpose; heretofore I have manured my corn ground, fifty acres, with marl, and my fallow with part farm-yard manure, and part marl, as mentioned before; so that you will perceive the improvement made on my soil has not been effected by marl alone, but in conjunction with farm-yard manure, clover, and plaster, and by making it a point to manure with something all the ground I put into cultivation; so that every time I cultivated a field, that field was improved, and not in any degree impoverished by the cultivation. By this means, and the Divine assistance, I have effected that improvement of my farm, which is so very striking to the observation of every person acquainted with it. \* \* \*

"In August, 1805, in digging down a bank on the side of a cove, for the purpose of making a causeway, I observed a shelly appearance, which it struck me might improve clay soil; I took some of it immediately to the house, and putting it into a glass, with vinegar, found it effervesced very much; this determined me to try it as a manure; accordingly, in September, I carted out about eighty cart-loads, and put it on a piece of ground, fallow, preparing for wheat, trying it in different proportions, at the rate of from twenty-seven to about a hundred loads per acre, and the ground was sown in wheat. I could not, myself, be satisfied that there was any difference through the winter and spring, although General Lloyd, who was viewing it with me in the spring, thought he could perceive some difference in favour of the marl; but at harvest time, the wheat, though not more luxuriant in growth, or better head, was considerably thicker on the ground; and after the wheat was taken off, the ground where the marl had been put was set with white clover, no clover being on the ground on either side of it. The next year, 1806, I discovered it in the drain into the head of the cove, which I immediately ditched, and from the ditch put out seven hundred loads, on the fallow ground. The effect, as to the wheat and clover, was the same (this was put, for experiment, at the rate of from forty to a hundred and twenty cart-loads per acre), though the marl was not of the same kind as the other, but more mixed with sand and surface soil, being taken from the low ground, by ditching, and all mixed together. I also tried it on corn ground, spread out as above mentioned, and found the effect immediate, as to the corn; and in the same manner as above described, as to the wheat sown on the corn ground. This induced me to persevere in the use of it, which I have done ever since, adopting the mode I mentioned before, and putting it at first from forty to seventy loads per acre, till I have now come down as low as eighteen or twenty loads per acre, going the third time over the ground with it." \* \* \*

## NOTE IV.

### FIRST VIEWS WHICH LED TO MARLING IN PRINCE GEORGE COUNTY.

(From the *Farmers' Register*, Nov. 1839, with additions.)

AMONG the persons who have read with interest the "Essay on Calcareous Manures," and have received as sound the novel theory and doctrines there maintained, several have expressed their curiosity which had been excited to learn the earliest facts, or the train of reasoning, which led to the suggestion of the causes of the defect of naturally barren soils, and the remedy. Such inquiries have been made of the writer by persons of investigating and well informed minds, but of very different education and pursuits; and they were pleased to say, in regard to the concise verbal answers made to their inquiries, that they deemed the details likely to be interesting to many, and that if given to the public, they might serve better to induce the consideration and enforcement of the doctrines, than had been done by the mere arguments which had been already published, convincing as they considered these arguments to be.

Though, without these reasons and solicitations, the writer might have still refrained from touching this subject, it was not that he had not held the same opinion; and, except in his own case, would have urged the same course. It is certain, that the tracing of the steps by which any new discovery or improvement has been reached, must always be interesting in proportion to the admitted importance of the results; and, indeed, such a statement seems almost necessary to induce the reader to accompany the author from his first premises to the remote conclusion, and which otherwise is only reached through a devious and tedious passage, and by a course of reasoning which is wanting in interest, because the application and tendency of the arguments and proofs are not seen when they are first presented. The objection which restrained the writer from before pursuing a course which he would have highly approved in others, was, that such a narrative of opinions and facts would be entirely a personal narrative, and therefore obnoxious to the charge of egotism throughout. The statement of the reasoning which led to the successful use of fossil shells on the poor lands of lower Virginia, would be incomplete if not accompanied by a narrative of early labours, and the early as well as latest results and effects. In the whole of this, there would be scarcely anything but statements of what the writer thought, and reasoned, and performed. But the subject must be so treated, or not at all; and having consented to give the narrative, the writer will throw aside all scruples and objections, and endeavour to enter as much into detail, as he, if a reader of others' agricultural improvements and practical operations, would desire there to find.



With the beginning of the year 1813, when barely nineteen years of age, the easy indulgence of my guardian gave to me the possession and direction of my property; which consisted of the Coggins Point farm, with the necessary and yet very insufficient stock of every kind. It is scarcely necessary to add that, at my very early commencement, I was totally ignorant of practical agriculture; and such would have been the case, according to the then and now usual want of training of farmers of Virginia, even if my farming labours had been postponed to a mature age. But I had always been fond of reading for amusement, and the few books on agriculture (then very scarce in this country) which I had met with, had been studied, merely for the pleasure they afforded, at a still earlier time of my boyhood. The earliest known of these works was an English book, in four volumes, the "Complete Body of Husbandry," of which I have not seen the only known copy since I was fifteen years old. This work was probably a mere compilation, and of little value or authority; but it gave me a fondness for agricultural studies, and filled my head with notions which were, even if proper in England, totally unsuitable to this country. "Bordley's Husbandry" next fell into my hands, and its contents were as greedily devoured. This was indeed written in America, and by an American cultivator; but as he drew almost all his notions from English writers, his work is essentially also of foreign materials.

Thus prepared, I commenced farming, ignorant indeed, but not in my own conceit. The agriculture of my neighbourhood, like all that I had ever witnessed, was wretched in execution, and as erroneous as well could be in system, whether subjected to the test of sound doctrine, or the improper notions which I had formed from English writers. I was right in condemning the general practice of my neighbours; but decidedly mistaken in my self-satisfied estimate of my own better information and plans.

Just about the time that my business as a cultivator was commenced, Col. John Taylor's "Arator" was published; and never has any book on agriculture been received with so much enthusiastic applause, nor has any other had such wide-spread early effects in affecting opinion, and stimulating to exertion and attempts for improvement. The ground had before no occupant, and therefore this work had to contend with no rival. The larger land-owners, of lower Virginia especially, had previously treated their own proper employment, and their only source of income, with total neglect; and very few country gentlemen took any personal and regular direction of their farming operations. It was considered enough for them to hire overseers (and that class then was greatly inferior in grade and respectability to what it is now), and to leave the daily superintendence to them entirely. The agricultural

practices, and also the products, were consequently, and almost universally, at a very low ebb. The work of Taylor appeared when these evils had become manifest; and it was received with a welcome which in warmth was proportioned to the magnitude of the evil, and to the exaggeration of the promises of speedy and effectual remedy which the author made, with entire good faith no doubt, but which were proved, by results, to be anything but correct to the great majority of his sanguine followers.

Of course, I was among the most enthusiastic admirers of "Arator;" and not only received as sound and true every opinion and precept, but even went beyond the author's intention (perhaps), and applied his rules for tillage to lands of surface and soil altogether different from the level and originally rich sandy soils of the Rappahannock, where his labours and system had been so successful. However, this error was by no means confined to myself; for his other disciples fully as much misunderstood the directions, and misapplied the practices.

It was my main object to enrich my then very poor land; and, for that, Taylor offered means that seemed to be sure and speedy. According to his views, it was only necessary to protect the arable land from all grazing, and thus let the vegetable cover of the land, when resting, serve as manure—to plough deep, and in ridges—to convert all the corn-stalks and other offal to manure, and plough it under, unrotted, for the corn—to put the farm under clover as fast as manured—and the desired result would be sure. I hoped at first to be able to manure, say 10 or 12 acres a year very heavily, with the barn-yard manure, and expected that such manuring would give a crop of 50 bushels of corn to the acre. The space, so enriched, when in the succeeding crop of wheat, would be put under clover—and its acquired productiveness be made permanent, by the lenient rotation of two crops only taken from the land in four years. But utter disappointment followed. The manure was put on the poorest (and naturally poor) land; and it produced very little of the expected effect in the first course of crops, and was scarcely to be perceived on the second. Clover could not be made to live on land of this kind; and even on much better, or where more enriched, it was a very precarious crop, and which, where the growth was best, was certain to yield the entire occupancy of the ground to natural weeds after one year. The general non-grazing of the fields under grass, or rather under weeds, produced no visible enriching effect, and the ploughing of hilly land (as mine mostly was) into ridges, caused the most destructive washing away of the soil by heavy rains. These results were not speedily made manifest; and before being convinced of their certainty, I had laboured for four or five years in using these means of supposed improvement of the soil, but all of which

proved either profitless, entirely useless, or absolutely and in some cases greatly injurious. And even after trying to avoid the first known errors, and using all other supposed means for giving durable and increasing fertility to my worn and poor fields, at the end of six years, instead of having already achieved great improvement, I was compelled to confess that no part of my poor land was more productive than when my labours commenced, and that on much of it, a ten-fold increase had been made of the previously large space of galled and gullied hill-sides and slopes.

When more correct opinions had been formed in after-time of the actual condition and requirements of such poor soils, it seemed an astonishing delusion, which would have been altogether ludicrous but for its serious effects, that I should have counted so much on improving such a soil, and by such means. With the exception of a small part near the river banks (perhaps one-fifth of the then cleared and cultivated land), which had been originally of very fine quality, and, however abused and exhausted, was still good land, the farm generally consisted of a soil of sandy loam, usually about three inches deep, and through which a single-horse plough could easily penetrate and turn up the barren and more sandy yellow sub-soil. Grazing the fields, when not under tillage, had been the regular practice; and under it very little growth was to be seen except the light and diminutive "hen's nest grass" (*aristida gracilis*), which formed the almost universal cover of the poor fields of lower Virginia, in the intervals between tillage. Add to these circumstances of very poor and shallow soil, and barren and sandy sub-soil, and almost no vegetable cover to turn under, that every field was more or less hilly, and liable to be washed by heavy rains—and the judicious reader will see nothing but false confidence and ignorance displayed in my bold adoption of Taylor's system. Nor was I convinced of my error until after nearly all the fields had been successively thrown into ridges by two-horse ploughs, and all the hilly and more slightly inclined surface had been awfully washed and gullied, by the exposure of the loose sub-soil to the action of the streams of rain-water.

While these my supposed measures of improvement were in progress, I was in habits of frequent and familiar intercourse with my oldest and best friend, and former guardian, Thomas Cocke, who resided then on his Aberdeen farm, and since and now, on Tarbay, adjoining my own land. My friend was a man for whose mind and mental cultivation I could not but entertain a very high estimation. But, though all his life a practical and assiduous cultivator, and finding his greatest pleasure in his farming labours, he yet was a careless, slovenly, and bad manager, and of course an unprofitable farmer. Therefore, on this subject, I held in but light esteem the opinions which he maintained, which were opposed to my own.

One of these (and which he had first gathered from some old and ignorant, but experienced practical cultivators of his neighbourhood), was the opinion that our land which was naturally poor could not "hold manure," to any extent or profit, and therefore could not be enriched. For years I heard this opinion frequently expressed by him, and the evident inference therefrom, that the far greater part of our lands, and of the whole country, was doomed to hopeless sterility; and as often as heard, I rejected it as a monstrous agricultural heresy—as treason, indeed, to the authority of Taylor, and of every other author on agriculture whom I had read or heard of. But at last I was compelled, most reluctantly, to concur in this opinion.

What was then to be done? I could not bear the idea of pursuing the general system of the country in continuing to lessen the already small productiveness of my fields, by their course of cultivation. The whole income, and more, was required for the most economical support of a then small but fast growing family; and for any increase of income or net profit, there was no hope, save in the universal approved resort in all such cases, of emigrating to the rich western wilderness. And accordingly such became my intention, fully considered and decided upon, and which was only prevented being carried into effect by subsequent occurrences.

Just before this time Davy's "Agricultural Chemistry" had been first published in this country; and I read it with delight, notwithstanding my then total ignorance of chemical science, and even of chemical names, except as learned by that perusal. There was one passage of this author which seemed to afford both light and hope on the point in which disappointment had led me to despair. As an illustration of defects in the chemical constitution of soils, and of the remedies which proper investigation might point out, he adduced the fact of a soil "of good apparent texture," which was sterile, and seemed incapable of being enriched. The fact which struck so forcibly on my mind was presented in the following concise passage of Lect. iv. "If on washing [for analyzing] a sterile soil, it is found to contain the salt of iron, or any acid matter, it may be ameliorated by the application of quick-lime. A soil of good apparent texture from Lincolnshire, was put into my hands by Sir Joseph Banks as remarkable for sterility. On examining it, I found that it contained sulphate of iron; and I offered the obvious remedy of top-dressing with lime, which converts the sulphate into a manure."

Much the greater part of my land, and of all the land of lower Virginia, seemed to me just such as Davy described in this single and peculiar soil. It was certainly of "good apparent texture," that is, it was neither much too clayey or too sandy, nor had it any other apparent defect to forbid its being fertile in a very high

degree. Yet it was and always had been sterile, and, as my experience now concurred with that of my older friend in showing, it could not be either durably or profitably enriched by putrescent manures. Could it be possible that the sulphate of iron (copperas) which Davy found in this soil, and which he evidently spoke of as a rare example of peculiar constitution, could exist in nineteenth-tenths of all the lands of lower Virginia? This could scarcely be; and yet, in despair of finding other causes, I set about searching for this one.

It was not difficult, even for a reader so little instructed in chemistry, to apply the test for copperas. It was only necessary to let a specimen of the suspected soil remain soaking in pure water, until any copperas, if present, would be dissolved; then to separate the fluid by pouring off and filtration, and then to add to the fluid some of the infusion of nut-galls. If copperas had been held in solution, the mixture would produce a true ink, of which the smallest proportion would be made visible in the before perfectly transparent water. But all these first attempts were fruitless, and I was obliged to conclude that the great defect, or impediment to improvement, in most of our soils, was *not* the presence of the salts of iron. But though not a salt, of which one of the component parts was an acid, might not the poisonous quality be a *pure or uncombined acid*? This question was raised in my mind, and the readiness produced to suppose the affirmative to be true, by several circumstances. These were, 1st. That certain plants known to contain acid, as sheep-sorrel and pine, preferred these soils, and indeed were almost confined to them, and grew there with luxuriance and vigour proportioned to the unfitness of the land for producing cultivated crops. 2d. That of all the soils supposed to be acid which I examined by chemical tests, not one contained any calcareous earth.\* 3d. That the small proportion of my land, and of all within the range of my observation, which was *shelly*, and of course calcareous, was entirely free from pine and sorrel, and moreover was as remarkable for great and lasting fertility, as the lands supposed to be acid for the reverse qualities. Shells, or lime, would necessarily combine with, and destroy, all the previous properties of any acid placed in contact; and therefore, if acid were present universally, and acting as a poison to cultivated plants, it seemed plain enough why the shelly lands were free from this bad

---

\* I was not then aware of the important and novel fact which I afterwards ascertained and established, and which is now fully received (with very slight acknowledgment of its source) by the geologists of this country, that *almost all the soils* on the Atlantic slope of this country, and even including nearly all limestone soils, are also entirely destitute of *carbonate of lime*, though that ingredient seems nearly if not quite universal in all the best soils of England and the continent of Europe.

quality, and by its absence had been permitted to grow rich, and to continue productive. Every new observation served to add strength to this notion; and in our tide-water region generally, and even in my own neighbourhood, there were plenty of subjects for observation and comparison, both in small shelly and fertile spots, and a vast extent of poor pine and sorrel-producing lands. Still, I could obtain no direct evidence of the presence of acid, either free or combined, by applying chemical tests to soils (as was tried in many cases), nor was there any authority in my oracle, Davy's "Agricultural Chemistry," nor in any other work which I had read, for supposing *vegetable* acid to be present in any soil. Though Davy adds to the supposition of the presence of the "salt of iron," "or any acid matter," it is clear from the whole context that he had in view the possible and extremely rare presence of a *mineral* acid (as the sulphuric), and not *vegetable* acid, which my views required, and my proofs were afterwards brought to maintain. Sulphuric acid is sometimes found in certain clays, and in combination with iron is also in peat soils; but these facts have no application to ordinary soils of any country. Of course, this absence of authority would, to most inquirers, have seemed fatal to the position of an acid principle being *generally* present in the soils of Virginia, and in great quantity and power of injurious action. This was, indeed, a great obstacle opposed to the establishment of my newly formed opinion; but it was not yielded to as insuperable. Diffident as I then was of any such views of my own, and holding the *dicta* of Davy as the highest authority, and even his omission of any position as evidence that it was untrue, or unknown, still I was not daunted, and supposed it possible that the soils of this country might vary essentially in composition, in this respect, from those of England; or *barely possible* that even the great chemical philosopher might not have observed the presence of vegetable acid in the comparatively few cases of its existence in English soils. The later observations of subsequent years added much to my evidences of the existence of acid in soils; and still later and scientific investigations of chemists have served to establish that there is an acid principle in most soils, in the *humic* or *geic* acid. But these discoveries of chemists had not been published in 1817 (if indeed known to any), nor had my own observations reached to all the proofs which I afterwards (in 1832) published in the first edition (in book form) of the "Essay on Calcareous Manures," and which were still in advance of the publication of the now generally received opinions of the *geic* or *humic* acid. It must therefore be confessed, that if I reached a correct conclusion, it was not on sufficiently established premises, and known chemical facts. However, reached it was, whether by right or by wrong reasoning; and however little supported by direct proof or authority, I was almost sure,

in advance of any known experiment, first, that the cause of the unproductiveness and unfitness for being enriched of most of our lands, was the presence of acid—and secondly, and consequently, that the application of lime, or calcareous earth, would, by taking up and destroying the poisonous principle, leave the soil free to receive and to profit by enriching manures.

But even if this theoretical position had been demonstrated, still it might furnish no *profitable* practical remedy. For, admitting that the application of calcareous matters would relieve the soil of its great evil, and make it capable of receiving subsequent improvement, yet after being so relieved, the land, I supposed, would be still as poor as before, and would require all the manure, labour, and time, necessary to enrich any very poor soil; and these might be so expensive, that the improvement of the land would cost more than it would afterwards be worth. These considerations served to lessen my estimation of the practical utility of the theoretical truth, and to make my earliest applications of the theory to practice hesitating, and very limited in extent.

Having settled that calcareous matter was the medicine to be applied to the diseased or ill constituted soil, I was luckily at no loss to find the materials. In some of the many ravines which passed through my land, and on sundry parts of the river bank, were exposed some portions of the beds of fossil shells which underlie nearly all the eastern parts of Virginia and several other southern states; the deposit which then had obtained in this region, though improperly, and still retains the name of *marl*. I began operations in February, 1818, at one of the spots most accessible to a cart. The overlying earth was thrown off, and a few feet in width of the marl exposed, in which a pit was sunk to the depth of but three or four feet. When night stopped the very slow digging and throwing out of the marl, the slowly oozing water filled the pit; and as no proper plan of draining had been adopted, the first shallow pit was abandoned, and another opened. In this laborious and wasteful manner there was as much marl obtained as I was then willing to apply. It served to give a covering of 125 to 200 bushels per acre, to 2½ acres of new ground. The wood on the land had been cut down three years before, and suffered to lie and rot until cleared up for cultivation in 1818. Though poor ridge land, and of what I deemed of the most acid class of soils, still the previous treatment had given to it so much decomposed vegetable matter, that its product would necessarily be made the best which such a soil was capable of bringing. And because of the superabundance of food for plants then ready to act, this was not a good subject to show the earliest and greatest benefit of neutralizing the acid. However, notwithstanding this circumstance, and the small amount and poverty of the marl (which contained

but one-third of calcareous matter), the improvement produced was greater and more speedy in showing than I had dared to hope for. When the plants were but a few inches high, and before I had expected to see the slightest improvement (indeed none had been expected to show in the first year), the superiority of the marled corn was manifest, and which continued to increase as the growth advanced. My high gratification can only be appreciated by a schemer and projector; but such a one can well imagine my feelings and sympathize in my triumph. The increase of the first crop, corn, I stated by guess, in reporting the experiment, to be fully 40 per cent., and that of the wheat which succeeded was much greater. Later measurements of other products of experiments have induced me to believe that I had underrated the amount of increase in this first application. [This experiment is the first stated, and at length, at page 117 of "Essay on Calcareous Manures," 5th edition. Throughout this republished article, the references to the pages of the "Essay on Calcareous Manures," will be changed from the previous to the present edition.]

Great as had been the labour of this application, and small as its increased product (comparing both with later operations), the results served completely to sustain my theoretical views, and also showed the remedy for the general evil to be far more quick, and more profitable, than I had counted on. Another person would probably have despised this small increase to the acre, if supposing the effect to be but temporary; and this all would have inferred, whether judging by comparison with all other manures known in practice, or even if by the authority of books. For the best informed of the old writers (even Lord Kames, for example), while claiming for the effects of marl great durability, still consider that at some period, say twenty or a hundred years, the effects are to cease. But my views were not limited within any practical experience, or authority, but by my own theory of the action; and that theory taught me to infer that the benefit gained would never be lost, and that under proper cultivation, the increase of product would still more increase, instead of being lessened in the course of time. In thus fully confiding in the permanency of the improvement, I was at once convinced of the operation being both cheap and profitable. All doubt and hesitation were thrown aside, and I determined to increase my labours in marling to the utmost extent of my views. Still the want of spare labour, and the established routine of farm operations which occupied all the force, retarded my operations so much, that no more than twelve more acres (for the next year's crop) were marled in that year (1818).

It forms an essential part of the character of an enthusiastic and successful projector, and especially an agricultural projector, to be as anxious to inform others as to profit himself. Of course I tried



to bestow upon and share my lights with all my neighbours and other farmers whom my then humble position and secluded life permitted me to meet. This disposition also caused my earliest attempt at writing for even so small a portion of the public as constituted a little agricultural society of which I had induced the establishment in my neighbourhood. To show my earliest opinions and statements on this subject, I will here quote the material part of a communication made to that society, and which was written in October of the year of my first experiment in 1818. I copy the extract just as it then stood, and with all its defects of form and of substance. I then shrunk in fear from the greater publicity which the press would have afforded, and had not the remotest anticipation that my first effort, then made, would lead me to the extended intercourse since established and maintained with the public, both by writing and printing.

\* \* \* \* "We should be induced to infer from the remarks of those writers who have treated on the improvement of land, that a soil artificially enriched is equally valuable with one which would produce the same amount of crop from its natural fertility; and that a soil originally good, but impoverished by injudicious cultivation, is no better than if it never had been rich. If this conclusion be just (and the contrary has not been even hinted by them), it is in direct contradiction to the opinion of many intelligent practical farmers, with whom my own observations concur, in pronouncing that soils naturally rich (although completely worn out), will sooner recover by rest—can be enriched with less manure—and will longer resist the effects of the severest course of cropping, than soils of as good apparent texture and constitution, and in similar situations, but poor before they were brought into cultivation. Should the latter opinion be correct, it is of the utmost importance that the subject should be investigated; as the only conclusion that can be drawn from it is, that such land must have some secret defect in its constitution, some principle adverse to improvement; and until this is discovered and corrected, it is an almost hopeless undertaking to make a barren country permanently fertile, by means of animal and vegetable manure.

"That *enclosing*\* has but little effect in improving land naturally barren, is sufficiently proved by poor wood-land. This has had the benefit of enclosing for perhaps thousands of years, and is yet miserably poor. It may be said that leaves are not to be compared in value to grass or weeds; but surely leaves ought to improve as much in a thousand years, as grass or weeds in twenty. Besides, it is well known, that leaves taken from this very land, and applied elsewhere, have produced much benefit; and the advocates of en-

---

\* The non-grazing system, or manuring land by its own growth.

closing must agree with me in ascribing to this cause the *natural* fertility of the most valuable [wood] land.

"As to manuring, there are but few farmers who have not, like me, experienced complete disappointment in endeavouring to improve land so little favoured by nature. In the usual method of summer manuring, by movable cow-pens, the most negligent farmers give the heaviest covering, by suffering their pens to remain stationary sometimes six or eight weeks. I have known the surface in this manner to be covered an inch thick with the richest of manures, and yet, after going through the same course of crops and grazing with the adjoining unmanured land for six years, it could not be distinguished. \* \* \* \* \*

"If any one principle should be always found in one kind of soil, and as invariably absent in the other, we might reasonably infer that *that* was the cause of fertility or barrenness. Judging from my very limited observations, it appears evident that *calcareous earth* constitutes a part of every soil rich in its natural state, and that whenever a soil is entirely or nearly deficient, it never can become rich of itself, and if made so by heavy doses of dung, will soon relapse into its former sterility.

"Let us observe how facts coincide with this opinion. The lower part of Virginia is generally poor; narrow stripes along the rivers and smaller watercourses are nearly all the high lands that are valuable, and in this class, exclusively, shells are seen so frequently, and in such abundance, that it seems highly probable that they are universally present, but so finely divided as not to be visible. When we know the change produced by calcareous earth in the colour and texture of soil, and in a field of an hundred acres, all of the same dark-coloured mellow soil, shells may be seen in only a few detached spots, we cannot but attribute the same effects to the same cause, and allow calcareous matter to be present in every part.

"The durable fertility of land which contains shells in abundance is so wonderful, that I should not dare to describe it, were not the facts supported by the best authority. The calcareous matter for ages has been collecting and fixing in the soil such an immense supply of vegetable matter, that near two centuries of almost continual exhaustion have not materially injured its value. I have seen fields on York, James, and Nansemond rivers, now extremely productive, which are said to have been under cultivation for thirty and forty years, without any aid worthy mentioning, from rest or manure.

"The same cause operates on low lands, formed by alluvion, and situated on streams accustomed to overflow. Such land is, with very few exceptions, of the first quality; and it is made so by the calcareous matter which the currents must necessarily convey from

the strata of marl through which they pass; and which being intimately mixed with sand, clay, and vegetable matter, is sufficient to form the finest and deepest soil. All the rich low grounds which I have had an opportunity of observing, have marl on some of the streams which fall into them, and I have not heard of any on those few which are poor. Not a solitary instance of shells being found in poor land of any description has come to my knowledge.

“If these premises are correct, no other conclusion can be drawn from them but that a proportion of calcareous earth gives to soil a capacity for improvement which it has not without; and it also follows, that by an application of shell marl, the worst land would be enabled to digest and retain that food, which has hitherto been of little or no advantage. \* \* \* \* \*

“The property of fixing manures is not more important in marl, than that of destroying acids. The unproductiveness of our lands arises not so much from the absence of food as the presence of poison. We are so much accustomed to see a luxuriant and rapid growth of pines cover land on which no crop can thrive, that we cannot readily see the impropriety of calling such a soil absolutely barren.

“From the circumstance of this soil being so congenial to the growth of pine and sorrel (both of which are acid plants), it seems probable that it abounds in acidity, or acid combinations, which (although destructive to all valuable crops) are their food while living, and product when dead. The most common forest trees are furnishing the earth with poison as liberally as food, while it depends entirely on the presence of the antidote, whether one or the other takes effect. I have observed a very luxuriant growth of sorrel on land too poor to support vegetables of any kind, from green pine brush having been buried to stop gullies; and it is well known how much land on which pines have rotted is infested with this pernicious plant. Marl will immediately neutralize the acid, and this noxious principle being removed, the land will then for the first time yield according to its actual capacity. Sorrel will no longer be troublesome; and, by a very heavy covering, I have known a spot rendered incapable of producing it, although the adjoining land was thickly set to the edge. Pines do not thrive on shelly land, whether fertile or exhausted. To this cause I attribute the great and immediate benefit I derived from marl on new ground. The acid produced by the pine leaves is destroyed, and the soil is capable of supporting much heavier crops, without being (as yet) at all richer than it was.” \* \* \* \* \*

—*Communication to Prince George Agricultural Society, 1818.*

Before proceeding to state later experiments, and general prac-

ties and results, it will be necessary to recur to some other connected branches of the subject. The reader will pardon the apparent digression.

So well established and general has the opinion now become that this *marl* is a manure, and a most valuable one, that it may seem strange that I should have only arrived at such an opinion indirectly, by the train of reasoning indicated above. There were hundreds of persons who afterwards said, "Oh! I never doubted that marl was a good manure;" but not one of whom had been induced before me to try its operation. But passing by these *postponing* believers, and all others who confessedly never attached any value to this great deposit, it may require explanation why I had not learned its value from English works which treat so extensively on marl, even though I had then had access to but few of them. It was precisely because I *had* read attentively some of the English accounts of marl that I was *deterred* from using *our marl*, which agreed with it (apparently) in nothing but name. Struck with the importance attached to marl in England, I had earnestly desired to find it, and had searched for it in vain, years before the early beginning of my farming. The name induced a close examination of what was called marl here; but the "soapy feel," the absence of grit, the crumbling and melting of lumps in water, &c., which were the most distinguishing characteristics of the marl of the English writers, were in vain looked for in our shell beds—of which the earth was generally sandy, never "soapy," and of which the lumps were often of almost stony hardness, and if not, at least showed nothing of the melting disposition of the English marls. I had before this found, however, in the American edition of the "Edinburgh Encyclopædia," more modern and correct views of marl, and had thereby learned to prize *calcareous matter* in general as an ingredient of soil, whether natural or artificial. But even admitting that the shelly portion of our marl would slowly decompose, and gradually furnish some manure to the soil, still it seemed that there was little prospect of its operating as the English marl, of such very different texture and qualities. I then supposed that the shells which had resisted decomposition, even where exposed on the surface of the beds, for centuries, would be as slow to dissolve, and to act as manure, if laid upon the fields. Still, notwithstanding these grounds of objection, the general idea of the value of calcareous manures would have induced me earlier to try fossil shells, but for being *deterred* therefrom by the only actual facts then known of the use. When speaking of my thought of trying marl to my friend Mr. Thomas Cocks, he told me that it was not worth the trouble; that he (attracted merely by the name of "marl"), had made several small applications, in 1803, on soils of different kinds, and that he had found almost no visible benefit; and he had attached so little

importance to the trial, that he had never thought to mention it to me, until induced by my remark. This communication was enough to check my then slight disposition to try marl. The old experiments of Mr. Cocke, as well as some much older, heard of afterwards, and, like his, considered worthless by the makers and almost forgotten, are stated at page 115 of this edition of the "Essay on Calcareous Manures."

As soon as I was satisfied that I had found in marl a remedy for the general and fixed disease of our poor lands, it became very desirable to know the strength of different beds, and of the different parts of the same bed. The rules of Davy for determining the proportion of carbonate of lime were easy to apply; and having provided myself with the necessary tests and other means, I was soon enabled to analyze the specimens with ease and accuracy. This was a delightful and profitable direction of my very small amount of chemical acquirements, and served to stimulate to further study. The amount of my knowledge was indeed very small—and is still so, with all later acquirements added. But little as I had been enabled to learn of chemistry, the possession led me to adopt my views of the constitution of soils, and enabled me to double the product, and to much more than double the clear profit and pecuniary value of my land, in the course of a few years thereafter.

Though my own doubts as to the propriety and profit of marling had been removed by my first experiments, it was not so with my neighbours. Induced by my example, small applications were indeed made by two of them only, in the next year after my first trial. But either because the land had been kept too much exhausted of its vegetable matter by grazing as well as by cropping, or because the experimenters could not think of the operation of the manure as different from that of dung, or stable manure, or for both these reasons, it is certain that they were not encouraged by the results to persevere. They stopped marling with their first trial, until several years after, when both recommenced, then fully convinced of the benefit by my results, and were afterwards among the largest and most successful early marlers. One of these persons was the late Edward Marks, of Old Town, and the other my old friend Thomas Cocke—who, though he had led me to find out the disease, could not himself be speedily convinced of its true nature, or of the value of the remedy. As late indeed as 1822, when he walked with me to an enormous excavation which I was then making in uncovering and carrying out marl, he said to me, "In future time, if marling shall then have been abandoned as unprofitable, this place will probably be known by the name of 'Ruffin's Folly.'" For some years, my marling was a subject for ridicule with some of my neighbours; and this was renewed, when in after-time the

great damage caused by improper applications began to be seen, and which will be described in due order.

Having had in view from the beginning the true action of marl, and fully believing that its good effects would be permanent, and even increasing with time under a proper system of tillage, I was no more discouraged by what some deemed small profits, than I was annoyed by the incredulity and ridicule of other persons. Almost all the farms in the neighbourhood, except mine, were regularly and closely grazed when not under a crop, and of course they had not stored up in the soil much either of inert vegetable matter, or its acid product. Mine had not been grazed since 1814, and had been rested two years in every four; and the poorest land three years in four. And though, in truth, no increased production had been obtained by this lenient treatment, inasmuch as the increase of acid counterbalanced the increase of vegetable food, still, when marl was applied, the acid was immediately destroyed, and the food left free to act. The effect of marling was generally shown most plainly on the first crop of corn, and the limits could be easily traced by the deep green colour of the plants before they were five inches high; and the increased product of the first crop on acid soils rarely fell under 50 per cent., was most generally 100, and has been known to be 200 per cent. But even such increase was not satisfactory to many persons, until the action of marl came to be better understood, and the permanency of the effects was credited. In five or six years after my commencement, there were few if any of those of my neighbours, who had marl visible on their lands, who had not begun to apply it. And though it has been injudiciously as well as insufficiently applied since, and not one-fourth of the full benefit obtained, still the general improvement and increased products of the marl farms of Prince George have been very great. The existence of marl, too, which was known at first but on a few farms in my own neighbourhood, has been since discovered in many other and remote parts of the county; and wherever accessible it is valued and used. The like observations will now apply to most of the other counties of lower Virginia. Wherever the effects of marling could be seen for a few years, the early incredulity not only disappeared, but most persons were even too ready to believe in marl's possessing virtues to which it has no claim. Thus, ignorant or careless of its true mode of operation, they crop the marled lands more severely than before; and if they are not thereby soon reduced as low as their former state of sterility, they are made to approach it as nearly as possible, and at a sacrifice of nine-tenths of the profit from marling which a more lenient and judicious system of cultivation would have insured.

In 1819, the second year of my operations, my marling was increased to 62 acres, but most of it at much too thin a rate. In

1820, only 25 acres were covered, though at 600 bushels or even more to the acre. Up to this time I had done as most other persons have, that is, attempted to marl "at leisure times," and without making it a regular employment for a certain additional force, or reducing the amount of cultivation, or of other operations on the farm. No person will ever marl to much advantage who does not avoid this error; and this year's labours showed the necessity of an alteration. The next year, two horses and carts, with the necessary drivers and pit-men, were appropriated to marling at all times when weather permitted, except during harvest, thrashing, and wheat-sowing times. Viewing marling too as the most profitable operation, except the saving of a crop already made, it was made a fixed rule of the farm that marling was to be interrupted for nothing else. My corn shift for that year was reduced in size one-half—so that one-half could be marled while the other was under cultivation. By these means, I marled 80 acres this year, 1821 (and that much too heavily), and had all the lessened corn-field on marled land. The product of the half was equal to what the whole had brought before, and I was enabled thereafter to have every field marled over in advance of its next cultivation. In 1822, the land marled was 93 acres, 100 in 1823, and 80 in 1824, which served to cover nearly all of the then cleared land requiring marling. The next three years' marling amounted respectively to 50 acres, 24 acres, and 27 acres, being principally upon land subsequently cleared and brought into cultivation. Since then, there has been no marling on the farm, except on wood-land, not yet cleared, and on small spots formerly omitted, and of which no account was taken. With the exception of such spots (and some such still remain, because of their inconvenient position), all the land which was not naturally calcareous, or too wet, or too steep for carting on, had been marled by 1827; and none has required any additional dose, though some of the thinnest covered places had been re-marled long before that time, so as to bring them to a proper constitution. (1842.)

In 1824, I first observed (and had never before suspected such effect), the injury caused by having marled acid soil too heavily. To show my first impressions, I will copy the words of my farm journal, written on the very day on which the discovery was fully made.

"June 13th, 1824. Observed a new and alarming disease in a large proportion of my corn; and, what makes the matter much worse, the evil is certainly caused by marling. The disease seems to have commenced when the corn was from 6 to 10 inches high, and to have stopped its growth. Its general colour is a pale sickly green, and the leaves appear so thin as to be almost transparent: next, they become streaked with rusty red, and then begin to die at the upper ends. Several pulled up, showed no defect, or injury

from insects, among the roots. All the land marled from pits Nos. 7 and 9 (both yellow) from 1820 to 1822, is so much diseased as to promise not more than half a crop. The corn is twice as large as on the spaces left for experiment without marl, yet looks much worse; though three weeks ago its superiority in colour and vigour was even more than in size. With but few exceptions, the land *newly* marled from the same pits, and the old marling from Nos. 1 and 8 (both blue), as well as that not marled, are free from this disease. The parts most affected are those which were driest and poorest, and of course were least covered with vegetable matter. Yet though the corn on this old marling is generally so bad, it is yet evident that the land is more benefited by the manure than at first. Flourishing stalks of corn, 18 to 24 inches high, are seen frequently within a few feet of those most hurt by this disease."

Subsequently, when the whole extent of injury could be seen, the following remarks were written in the journal, at the date below.

"October 15th. The damage caused by marl to this crop I suppose to be about one-third of what the land would otherwise have made, judging from the present and former measurements of the same land, where experiments were made.

"Nearly all the heavy marling in Finnies (at 800 bushels), about 20 acres,\* suffered by it; the poorest and lightest most injured, here and in Court-House field. The few rich spots escaped, as did most of the piece plastered (on the heavy marling) in 1820. The marks of this experiment were destroyed, and the superiority was not so regular as to enable me to trace the outlines of the gypseous earth—but an acre of corn might be taken which certainly was plastered, better than any other acre in the old land. This at least proves that *gypsum* contained [if any] in the marl has not caused the disease. The poor land, lightly marled in 1819, showed but little of the disease, and none was found in the piece not marled, nor in any marled since the last crop [or now first cultivated since being marled.]

"In Court-House field the injury was confined to 19 acres, the poorest part of the field, which was in corn in 1821,† marled and fallowed 1822, and in wheat 1823, corn 1824. The remainder of the old land, which had not been cropped so severely, and was covered as heavily with *blue marl*, brought a fine crop, quite free from the disease. The new ground was mostly marled very heavy (800 bushels of 45 per cent.),‡ and this and all my former clearings (some marled equally heavy) were also quite free. These

---

\* See Exp. 10, p. 132, Essay on Cal. Man.

† Exp. 11, p. 135.

‡ Exp. 1 to 4, pp. 117 to 121.



facts satisfy me that it was not the quality, but the over quantity of marl which has caused the evil; and that the land which has escaped, owes its safety to its containing more vegetable matter. I forgot to state that on some of the lightest spots of South field the wheat was much injured, though blue marl was used there.

"If I had followed my own advice to others, 'to put no more marl at first than would but little more than neutralize the soil, and repeat the dressing afterwards,' this evil would not have fallen on me. The present loss is not much; but it makes me expect the same on all similar land, marled as heavily. I shall endeavour to avoid it, by giving vegetable matter to the soil; either by manuring, or by allowing one or two more years of grass in the first term of the rotation. *Why* the quantity of marl applied should do harm in *any* case, is more than I can tell; but I draw this consolation from the discovery—if a certain quantity (say 500 bushels per acre) is too much for present use of the soil, it proves that it will combine with more vegetable matter, and fix more fertility in the soil, than I had supposed. That the second crop should be injured, and not the first, is owing to the unbroken state of the shells at first, and, by their being reduced, twice as much calcareous matter is in action after a few years."

Thus it will be seen, from these entries made at the time, that I took a correct view of this great and unlooked-for evil, and was by no means discouraged, or induced to lessen my efforts in marling. But in all later operations on poor land, the quantity was lessened from 500 and 600 bushels (and even more of the poorest marl), to about 300 bushels. With this alteration, the operation was continued with as much zeal as before; and also at a later time on another farm (Shellbanks) purchased afterwards, and where I marled upwards of 400 acres.

When this injury was first discovered, about 250 acres of very similar land had been marled so heavily that the like mischief was to be looked for in the next crop, and thenceforward, if not guarded against. For a more full account of this disease, and my opinions thereon, I must refer to what has been before published.\* It is sufficient here to say that by pursuing the means there advised—in allowing more rest from grain crops, furnishing vegetable matter to the land, in its natural cover of weeds, in clover, and in farm-yard manure so far as the limited supply sufficed—that no very great loss was subsequently suffered, except in the field where the disease was first discovered, and which was marled in 1819. This field was too remote and inconveniently situated, to be manured from the barn-yard; and from that and other causes (including the failure of the first seeding of clover), that field only still shows in-

---

\* Essay on Calcareous Manures, ante, 155.

jury from marling in the present crop (1839); so much diminished, however, that its general average product this year. [1842] is fully twice as much as the land could have brought before being marled.

---

NOTE V.

DESCRIPTION AND ACCOUNT OF THE DIFFERENT KINDS OF MARL,  
AND OF THE GYPSEOUS EARTH, OF THE TIDE-WATER REGION OF  
VIRGINIA.

*Report to the State Board of Agriculture, by Edmund Ruffin,  
Member and Corresponding Secretary of the Board, made in  
1842, and now corrected, altered, and enlarged.*

WITHIN the last twenty-five years there have been produced from the application of calcareous manures more improvement and benefit, both agricultural and general, in lower Virginia, than from all other means and sources, numerous and valuable as have been the agricultural improvements made. And for the latter half of that time, no one agricultural subject has been treated of more at length in the publications of this state. Still, there is much required to be known; and it has very often, and not less so recently than formerly, been required of the writer, who has furnished to the press the larger part of all that has thence proceeded on this subject, to give answers to inquiries, which, however variously worded, amounted in substance to the question, "What is marl?"—or "Is my marl (or whatever earth was so termed) *good* marl, and likely to be profitable as manure?" It has therefore appeared to the writer that it would be useful to prepare something like a natural history, or general and full description of the marls of lower Virginia; and also of the kindred and yet very different mineral manure, the gypseous earth, or "green-sand" earth, concerning which latter so much error and delusion have been spread and long maintained, and so little of truth or useful information derived from the scientific sources generally respected as the highest authority.

The main difficulty in the treating of this subject is presented in the outset in the very term "*marl*," which is altogether misapplied now in this country, though not so much as it has been, and perhaps still is in England. Since this general course of misapplication was set forth by the writer at length in the "Essay on Calcareous Manures," there have become general in this country still other misapplications of this always misapplied term. For the "green-sand" earth of New Jersey, which before had been called

"marl" by illiterate farmers only, has been since received under that name by chemists and the scientific reporters of geological surveys; and thus confusion has become still "worse confounded." In the following pages, I shall be compelled, as heretofore, to yield in part to such misapplication of the term; but at the expense of some otherwise useless repetition, and frequent explanation, shall hope to avoid misleading readers as to each of the particular earths under consideration. And I shall in no case apply the term *marl* to any but a *calcareous earth*, or mixture of earths, and of which the calcareous ingredient or proportion of carbonate of lime is deemed sufficient to constitute the most important, if not indeed forming the only important or appreciable agent of fertilization; and therefore I shall not so designate either the fine clays (not calcareous, or very slightly so), and formerly, if not now, called marl, in England, or the green-sand earths of New Jersey, Delaware or Virginia, when containing very little or no carbonate of lime.

*True marl*, as correctly understood by mineralogists, is a fine calcareous clay, containing very little silicious sand, and none coarse or separate; of firm texture—not plastic, or very adhesive; does not bend under pressure, but breaks easily, and after being dried, the lumps speedily crumble when immersed in water. It is manifest, from its laminated appearance and fracture, that this true marl had been originally suspended in rapidly flowing waters, and deposited at the bottom by subsidence, when the waters became comparatively still; as when a rapid river, turbid with calcareous clay, reached a lake. Thus, from its manner of formation, such marl, however argillaceous, was of a texture very different from the almost pure or the most tenacious clays. The carbonate of lime also tends to preserve an open and mellow texture in true marls, disposing the lumps readily to yield and crumble, or fall to powder or to thin flakes, under atmospherical influences, which would only affect clay by making it an intractable sticky mortar when wet, or lumps of almost stony hardness when dry. Moreover, there seems good reason to believe that in true marl there is a *chemical combination* (and not merely a mixture) of the argillaceous and calcareous ingredients, induced by their suspension in water, when the particles of both were in the finest possible state of division, and most intimate intermixture, while so suspended. Besides the crumbling quality just stated, so different from clay, there is a still stronger reason for believing that the calcareous and the silicious parts of true marl are chemically combined, which is, as I have found, that they cannot be separated by mechanical means, such as agitation and subsidence in water.\* For the suggestion that the different

---

\*The siliceous and alumina which compose the purest clay, are chemically combined in the proportions of nearly 65 parts of siliceous to 85 of alumina;

earthy parts of true marl are in a state of chemical combination with each other, I am indebted to the "*Essai sur la Marne*," of M. Puvis, which work, in an abridged form, I translated and published in the third volume of the Farmers' Register. The author there also states that the marls of France are principally, if not always, of fresh-water formation, as is shown by the shells they contain being either such as belong to rivers and lakes, or to the land. This is different from anything known in lower Virginia; all our known marls, whether properly or improperly so termed, being deposits made in a former sea, and the shells being those of sea-animals.\*

But though it is proper to describe that which only is truly "marl," before speaking of what is improperly so called, it is also true that there is nothing to tell of the use of any true marl in Virginia, and scarcely of its existence in the tide-water region.—I have as yet seen it in but few places, and there in thin layers only, and then overlying ordinary beds of fossil shells, and intermixed therewith.

---

and with this, to constitute true marl, carbonate of lime is also combined, forming a triple earthy compound, or perhaps a quadruple compound, if including the small proportion of oxide of iron, which is a general or universal constituent part of all clays.

\* "It may be of some interest to scientific investigators to know more particularly the shells of these marls of France. In a catalogue annexed to the original '*Essai sur la Marne*,' the author names the following shells:

In a marl sent from St. Trivier—yellowish, compact, of homogeneous appearance, and coming to pieces finely and easily in water—

*Land shell*—Turbo elegans.

*River shells*—Helix fascicularis, Helix vivipara, †Helix tentacula, †Mya Pictorum.

In a marl from Cuiseaux, Saone et Loire—

*River shell*—Melanopside (of Lamarck.)

In a marl from Leugny, in Yonne—

*Land shell*—†Chassiliè ridee (of Lamarck, and Draparnaud, †Helix lubrica.

In a marl from St. Priest in Dauphiny—earthy, yellowish, very easy to crumble in water—

*Land shell*—†Ambrette alongee, of Lamarck and Draparnaud, †Helix hispida.

In an analogous formation of marl, in the basin of the Rhone, between Meximieux and Montluel, the Helix striee, a land species, is found in great abundance."

M. Puvis states that among these, and among all the species of shells found in the marls of the basin of the three great rivers, Saone, Rhone, and Yonne, there are no remains of sea shells. All seem to have been formed under fresh water. "But (he continues) as these marls contain land shells, often in great abundance, we must conclude, that the revolution which heaped up the marls, has been preceded by a time in which the land was not covered by water, in which the earth producing vegetables, permitted the multiplication of the species of land shells which were found in these marls."—*Essai sur la Marne*, p. 8 to p. 24, and translation in *Farmers' Register*, iii., note to p. 692.

†Living species are still found in the same region similar to those marked thus.

This marl was thus found in two of my diggings, one on Coggins Point farm, and the other at Shellbanks, in Prince George county. In both cases, though perfectly characterized, the quantity of true marl was too small to be used separately from the more calcareous and much thicker stratum of shell marl below. This true marl was in many horizontal layers, few of which were severally more than an inch in thickness, separated by other layers, sometimes very thin, of almost pure shells, broken very small, with some only of the very smallest entire. The pure argillaceous marl is blue (though sometimes of buff colour), firm and compact, breaks easily, but does not bend however moist, and is cut smooth by a knife, leaving a surface like that of hard soap. This marl contained, in the argillaceous part, free from the shelly parts, only 10 per cent. of calcareous matter. Several other specimens, from other localities in the same region, were about the same strength. Therefore, even if more plenty, there would seem to be no inducement to use our true marl where the beds of fossil shells, called marl, and usually so much richer in calcareous matter, can be drawn from. But in Europe, clay marl is reported as rich as 40 to 60 per cent. of calcareous matter, and indeed richer, gradually running into lime-stone or impure chalk.\*

But though it is proper to know, and to bear in mind, what is understood by the term marl, by mineralogists, and by the best informed English and French agricultural writers, in regard to the extensive marlings in those countries, yet it is necessary in Virginia to conform generally to the usage which gives the name of marl to all earths largely mixed with fossil shells, or their fragments; and as the term is so far improperly extended, I would carry it still farther, and make it embrace all natural calcareous earths not of stony hardness. This arrangement then would indeed include true marl, but merely as one class, and that one the least noticeable for abundance or value of all in this country. The following scheme of classification will conform to this view, and serve to make more clear the descriptions that will follow:—

---

\*Such cases as are named above can scarcely be deemed exceptions to the entire non-existence of true marl in this region. These limited deposits were doubtless formed by the abrading, stirring up, and suspension of the upper part of the beds of shelly earth, by some strong current or agitation of the sea, and the subsequent deposition of the finest parts in tranquil water. The small shells and shelly powder sometimes seen between these layers of clay marl, were brought and deposited during other intervals of more agitated water. I have often seen such deposits of perfect true marl, artificially produced, in the small open drains of marl-pits (of our fossil shells), by the gradual settling of the suspended fine earthy matters from the turbid water.

*CALX, or calcareous matters in general, whether pure, or more or less mixed with other earths, &c.*

**I. Stony texture.**

- 1. Lime-stone proper.
- 2. Marl-stone.
- 3. Recent oyster or other hard shells.

**II. Earthy texture, or marl in general and in most extended sense.**

- 4. Argillo-calcareous marl, or true marl (of mineralogists).
- 5. Shelly sea-sand.
- 6. Shell-marl.

**A. Fossil fresh-water shells.**

**B. Tertiary fossil sea-shells.**

**B 1. Miocene Marl.**

- a. Sandy miocene marl.
- b. Clayey miocene marl.

**B. 2. Eocene Marl.**

- c. Calcareous eocene marl, with very little if any green-sand.
- d. Calcareous matter and green-sand, both considerable.
- e. Gypseous or green-sand earth, with little if any calcareous matter.

This plan of classification has reference to the agricultural or manuring characters only of the substances named. Those which do not come under the head of marl, in the extended sense adopted above, and which are not important in Virginia, will be dismissed with but slight notice.

The general and very comprehensive term *calx* is here used to include every natural (or indeed artificial) formation of earth, stone, or shells, separate or in mixture, in which carbonate of lime is a considerable and the most important part. All such substances belong to one or the other of the two great divisions—I., of stony hardness, and II., of softer or earthy texture.

I. The stony bodies require to be burnt to quick-lime, to be used profitably as manure. Such are, 1, compact or ordinary limestones; 2, marl-stone, or the hardest and largest stony nodules or continuous layers in softer marl; and 3, oyster or other recent and hard shells.

II. The calcareous substances of earthy texture, soft enough to be used as manures, without being reduced by calcination, all come under the general and extended term marl, as here used. The most important substances to be included under this head, are the following:—

1. Chalk proper (nearly pure carbonate of lime), such as is abundant in parts of England and France, is said by geologists not to exist in North America. But there is what may be deemed, in agricultural sense, an impure chalk, (2,) which spreads over or under an immense extent of this continent. This is in Alabama and Mississippi called "rotten limestone." It underlies, in beds of several hundred feet of thickness, large portions of these states, and of Florida and Arkansas; much of Texas, and, as I believe, most of the vast prairie region between the Mississippi river and the Rocky Mountains. This earth, so far as known to me by specimens only, is composed of carbonate of lime principally, but with some 20 to 35 per cent. of clay. It is of a dingy whitish colour when dry; has about the degree of hardness of chalk, to which this earth approaches more nearly in composition, texture, and colour, than to either limestone or to true marl. It may be inferred from the words of description in Fremont's Report, that this is the earth which forms the great region through which part of the river Platte passes, and which is found from the lowest visible depths to the summits of the crumbling cliffs, some of which are many hundreds of feet high, so remarkable along the banks of that river. I further infer that it is this chalky and highly calcareous character of the surface-soil and sub-soil which renders this region generally so barren, and usually so destitute of water; while the continual crumbling of the banks of the same barren earth into the river, and the earth being carried down by the floods, intermixed with other suspended earths, and

finally deposited upon the lands flooded by the Mississippi, serve to constitute the wonderfully fertile borders of that river.

3. Travertin, or calcareous tufa, is another subject of the many provincial and improper applications of the term marl. It is the deposit made by the precipitation of carbonate of lime from its previous solution in lime-stone water. The rain-water, in falling through the atmosphere, absorbs carbonic acid; which impregnation enables water to dissolve and hold in solution carbonate of lime, with which the water meets in abundance in lime-stone regions. Thus the springs and streams of lime-stone water are produced. But the carbonic acid absorbed by the water is retained with but little force, and parted with to the atmosphere very easily. This occurs wherever the water, so charged, is in contact with the atmosphere; and consequently the more in proportion to the exposure of its surface by the agitation of the water. Hence, at rapids and cascades of lime-stone streams, this precipitation is always found most abundant; and sometimes in immense quantity. It is principally of carbonate of lime (about 70 or 75 per cent. in the trials I have made), of cellular and open, though hard consistence, when of newest formation, and not difficult to reduce; and much more loose and soft in other cases. This deposit will be found the cheapest, and also a very rich calcareous manure (though never yet used, to my knowledge), for the neighbouring lands. It is the product only of lime-stone streams, either ancient or existing.

4. Argillo-calcareous marl, or true marl, has already been described, as to its texture and constitution. This marl is not properly shelly, though shells may be accidentally intermixed during the deposition. Nor can any coarse or separate sand belong to it, nor any other coarse and heavy matters, which would not remain suspended in water flowing with but a moderate current.

This true marl is formed by the washing away and suspension of calcareous and other earth in the waters of transient land floods of rain-waters, or of rapid rivers and smaller streams. The finer parts only of the different earths can remain long suspended in the flowing waters, after the current ceases to be violent. These finest parts of all, aluminous and silicious as well as calcareous, are most intimately mixed, and chemically combined, while suspended; and finally are deposited in the form and quality of marl, when reaching a lake, or other comparatively still part of the water. Of course no such marl could have been formed unless the source of original supply of materials existed, and also the manner of abrasion, transportation, and subsidence; and no such source of calcareous earth could be presented except in higher chalk or chalky beds, or otherwise highly calcareous soils and sub-soils. Compact lime-stone alone, no matter how abundant, because of its hardness, could scarcely serve as a source of supply. It follows, that such



marl may be presumed to have been found and to exist in the places of ancient lakes, or other still waters, in all chalk regions—in the vast “rotten lime-stone” and prairie region of the southern and western (or interior) parts of North America—rarely, if ever, in our mountain lime-stone region, and certainly never in our tide-water region. The calcareous beds of the tide-water region have entirely a different origin, having been originally deposited or formed and grown on the bottom of the ancient ocean, and since upheaved to their present higher elevation. And it would be as useless to search for the latter formation in the higher country. Hence, the geological character of any region will indicate very accurately whether either one, and which of these kinds of marl, or neither of them, can be found.

5. Sea-sand is used to great advantage as manure in some parts of France, and Britain and Ireland. A large, and sometimes the larger part of this sand consists of finely reduced shells, rubbed to granular state by the power of the waves; and this calcareous ingredient is the all-important fertilizing part of this manure, though its operation and even its presence may be sometimes unknown to the ignorant users.\*

6. Shell marl may be divided into (A) fossil fresh-water shell marl, and (B) fossil sea-shell marl.

A. The first of these kinds is what is usually, if not always, understood by the name “shell marl” by English writers. It is formed by the gradual accumulation of the shells of small fresh-water shell-fish, of existing species, on the bottoms of the shallow lakes and ponds where the animals had lived and died. When the bottom had been raised by this long-continued accumulation, and perhaps increased by like deposits washed from higher sources, nearly to the level of the surface of the water, then water-plants began to grow and to form a new accumulation of vegetable matter, intermixed with the continuing deposits of earthy matter from occasional turbid floods. Finally, by these means, the lake was changed to a peat-bog, wet and miry, though usually free from standing water. It is usually under peat, and sometimes at considerable depths, that this peculiar and very rich calcareous manure is found. It is almost pure carbonate of lime. It has been sold in Scotland by the bushel, at a high price, and in great quantity, for manure.†

---

\* A notice of the English sand, showing old opinions of its value and operation, was quoted at page 881 of this Essay.

† In the Edinburgh Farmers' Magazine, vol. iv. p. 153, there is an interesting article (most of which was republished in the Farmers' Register, vol. i. p. 90), describing a large body of this kind of shell marl, under Resteneth peat-moss, Forfar, Scotland. Most of the shells are of the wa-

This formation has been found in Vermont, in western New York, and probably exists in many parts of all the other northern states. I have never heard of its existence in Virginia, but infer that it is to be found in the western and mountainous region. It may be sought for with the greatest probability of success, in regions where ancient lakes or pools had been filled by gradual depositions—and especially if such waters had been impregnated by carbonate of lime, affording abundant supply of material for the shells of the animals. A cool and moist mountain region also favours the formation of peat. The presence of this substance is connected with that of such shelly deposits below only so far as this: that the collections of waters which would produce and finally be filled up by the gradual deposition of shells, in such a climate, would be most apt to invite the formation of peat subsequently. Therefore, under peat, if in hollows, the deposits of such shell marl are most likely to be found.

#### B. *Tertiary fossil sea-shell Marl.*

The second division of shell marl is the great and almost only marl of the tide-water region of Virginia—and also of Maryland, the Carolinas, and Georgia. It was produced by the gradual deposition and accumulation of the shells left by the animals, mostly of species now extinct, which had lived and died in them, on the bottom of the ancient ocean. This former bottom of the ocean was subsequently elevated, by some great convulsion of the earth, much above the original level, and generally much higher than the surface of the ocean waters. Thus, these wide-spread beds of shells, with the various admixtures of sand, clay, or pulverized shells, brought by currents, or the force of the waves, became high land; and the different conditions and qualities are such as might be inferred from the different operations of the original producing causes, with the additional aid of a subsequent state of rest for countless ages. After the production and accumulation of these beds of shells, to depths varying with circumstances, a mighty flood, proceeding from the direction of the present higher lands, swept over this great region, washing off and carrying away much of the higher parts of these shelly beds, and then covering the remainder with the drift of various earths brought and deposited by this great land flood. Thus the beds of fossil sea-shells are generally thin in lower Virginia, and entirely wanting in many and wide intervals; and are mostly covered by a far greater thickness

---

ter snail (*helix putris*, Linnæus), others are bivalves (generally *tellina*, animal *tethys*, Lin.) From this deposit, the proprietor had sold as much for manure as brought him £12,000 sterling, in the twelve years after its use had been begun.

of layers of drifted and barren sands or clays, or both, with a surface-soil usually poor and thin. Farther south, the denuding and destructive power of this flood was so much less, that the shell bed is left several hundred feet in thickness. In Virginia, the remaining bed is in most cases less than fifteen feet in thickness, and rarely much more.

As there is good reason for believing that all the present great tide-water region of the countries last named was formerly the bottom of the ocean, for an immense length of time, we may infer that the whole was originally covered, to greater or less depth, with a continuous bed of shells. Wherever this formation is now wanting, it must have been removed by the subsequent washing flood, previous to its later action of depositing the enormous bed of drifted earth, which overlies the shells, or their former place.

The fossil shell beds of Virginia, which will be the main subject to be treated of here, may be again conveniently divided, for description and observation, into two kinds, of (B 1) Miocene, and (B 2) Eocene. These terms (with others) were introduced by Professor Lyell, and designate the formations of different geological eras. As they are now of general acceptance by geologists, and also are generally understood by agricultural readers, these terms will be convenient, and will be here used to designate the different marls to which they belong. If the difference between these two kinds were merely geological, or in regard to comparative ages of formation, or to the respective fossils of each, it would be useless to preserve it in writing on agriculture, however marked the difference, and however interesting to the geologist. But there is also a difference of agricultural character and value in these two kinds of marl. In relation merely to each other, the terms *eocene* and *miocene* may be sufficiently understood as the *older* and *newer* formations. But it will not do as well to substitute the latter terms, because, though correct as to each other, they are not so generally, or in relation to other marls and geological formations. For there are some (of secondary formation) much older than the *eocene*, and others (older and newer pliocenes and post-pliocene) much more recently formed than the *miocene*. With neither of these is it necessary to encumber this report, by other than slight notice, as neither are known in Virginia; nor elsewhere do they present important differences of agricultural character and qualities.

The different periods of time of these two different deposits of shells were very remote from each other, and the latest of them was also very remote from the present time. In the miocene marl of Virginia, or later of the two, of the numerous species of shells found, there are but few kinds belonging to races of animals known or believed to be yet existing; and in the eocene marl of Virginia there are almost none that now exist, and very few that belong

also to the miocene marls. According to the highest geological authority, most of the races of animals whose remains formed the latest as well as the earliest of these deposits, were extinct before the creation of man.

Although it might be more conformable to regular or scientific arrangement to commence a general description with the older and lower deposit, the eocene marls, yet it will better suit the purpose of agricultural instruction to reverse the order, by describing first the miocene marls, as the highest in the series and the first reached, and by very far the most abundant and extensively accessible; and which, therefore, though usually less powerful for fertilization, are much the most important to agriculture in Virginia in general. I shall therefore proceed first to treat of the miocene marls, which are the only kinds known to me in Virginia, with the exceptions of the two comparatively small districts of eocene marl, which will be hereafter treated of in their order.

#### *Miocene Marls.*

When my investigations and practical labours on this subject were commenced, more than twenty-four years ago (in 1818), the existence of marl of any kind, or rather its shells, obvious to the sight, had been noticed in lower Virginia at but a few places, where naturally exposed along steep river banks, and where cut through by deep ravines, and thus rendered conspicuous; and the deposit was supposed to be very limited, by the few persons who had ever cast a thought upon the subject. But the attention and observation subsequently directed to the search, soon showed that the quantity was very far more extensive; and now, though not generally near the surface of the earth, nor everywhere accessible, it seems probable that beds of fossil shells underlie much the greater part of all the region between the falls of the rivers and the sea-shore. Except at or near the places where exposed on the surface, as above mentioned, the overlying (drift) earth is generally 20 or 30 and sometimes even 50 feet thick. All the marl-beds appear to be nearly horizontal, and of course are the most deeply covered under the highest lands, and are most easily accessible in low depressions. The deposit dips gently towards the east, so that it lies too deep to be visible near the sea-coast. At Norfolk, the marl has been recently reached, in boring deep for water, at 40 feet below that low surface, and, of course, much below the sea.

The marl is formed by the deposit and gradual accumulation of sea-shells, mostly left where the animals died; and the vacancies between the shells were filled by the sand or clay, or mixtures of both, with fragments of older shells, brought by tide and currents, and deposited in what was then the bottom of the sea. The remarkably perfect state of preservation of many very thin and

always fragile shells, and still more the many pairs of bivalve shells that yet are found connected or in contact, prove that such shells could not have been transported, or even much agitated, by the force of the water. But other beds of marl, and also frequently the upper layers of such as have been just referred to, show as clearly the action of currents, or of water in violent and long-continued motion, which served to grind down the shells to small fragments, and which also left, in shaping the surface of the marl, the marks of whirlpools or other violent disturbance. From such supposed causes might be expected such effects as many of the various marl-beds actually exhibit. In different places, and sometimes in the same place, the shells and their fragments are found of all sizes, and of all conditions of preservation; and intermixed, in various proportions, with such clay, or fine sand, as might be suspended in or borne by currents, or waves of the sea; so as to form beds of every degree of texture and shade of colour. The shells, and their fragments, or the carbonate of lime, are in various proportions of quantity, from 10 per cent. (or even less in rare cases) to 90 per cent. or more, of the mixture, or whole mass. In different beds, and sometimes in contiguous layers of the same bed, the shells are in every state of preservation or of decay; from that of being firm, and often entire in their calcareous structure, and the most delicate parts of their beautiful forms preserved, to that of being mostly broken down, and almost reduced to a coarse powder, and sometimes even forming a homogeneous mass of still finer particles, in which the forms of but few if any shells are distinguishable. The original bright and various colours of the shells are lost, and they are nearly all white—a few of the hardest kinds only being brown or gray. The texture of the mass also varies, from a loose sand to a firm body of almost stony hardness. The earth intermixed with the shells is generally much more sandy than clayey, and more especially in the poorer marls. Even when the admixture of earth is clay, it rarely makes the marl appear the least clayey in texture, or plastic or adhesive, because the clay is usually but in small proportion to the shelly matter. Even when the proportion of clay is great, the carbonate of lime, according to its quantity and degree of reduction, counteracts the tendency of the clay, and prevents the mass being tough, adhesive, or obdurate. The colour of the miocene marls is also various—generally either pale yellow or dingy white, or blue, sometimes bright, but more often a dull blue, or ash colour. The richest marls, of homogeneous texture, are nearly white when dry, and approach in appearance to a coarse or impure chalk.

The shell marls of Virginia are confined almost entirely to the tide-water region, or the space eastward of the granite which forms the falls of all our eastern rivers. But near Petersburg (on the

farm of Dr. William I. Dupuy, and other adjoining lands) there is an exception to this general rule, the marl being found about a mile farther west, overlapping the eastern and lowest part of the granite, and passing under a small stream which empties into the Appomattox, a mile above the lowest falls.

The only important fertilizing ingredient of the miocene marls is the carbonate of lime, or shelly matter. There may be, and probably is, some slight additional benefit sometimes, from accidental or peculiar admixtures of other substances; as, of animal matter still remaining, or, in limited spaces, the phosphate of lime supplied by bones of large fish or sea reptiles; or of vegetable extract in blue marls, of the oxide of iron, of a very small proportion of green-sand generally; and even of the clay or the sand, respectively for soils deficient in either. But either and all of these additional matters, though giving some value as manure, are of but little importance in miocene marls, in comparison to the main and great agent of fertilization, the shelly or calcareous matter. According then to the greater or less proportion of this main ingredient, and to its state of division or readiness to be reduced to a state of minute division in the soil, may be rated the comparative values of marls for manure. In regard to the much larger proportions of green-sand in miocene marls, as asserted by other authority, and denied by me, some additional remarks will be hereafter submitted, in the proper order for consideration.

As might be inferred from the obvious manner of the deposition of the marl, as before stated, by waters of the sea in violent and yet varying degrees of motion, the different horizontal layers of marl, successively deposited in the same bed, and even within a few inches of perpendicular distance of each other, sometimes exhibit remarkable differences of appearance, composition, and of value; while there is also generally as remarkable a uniformity of character of each particular layer (though differing much in thickness at different places) throughout not only the different diggings of the same place, but sometimes for miles in extent. I have seen often, in diggings on different farms, and several miles apart, layers of marl so precisely alike, and so marked in peculiar character, that there could be no doubt of their being parts of the same particular deposit, made at the same time, and by the same operating natural causes. Under such circumstances, a practised eye can by comparison fix very nearly the chemical composition of similar varieties, and even more correctly, for general averages of value, than would be usually obtained from the accurate chemical analysis of one or two specimens only. For the usual danger of error is, not in the chemical analysis (which is easily enough made, and the mode sufficiently correct), but in the selection of equal and fair specimens of marl to exhibit the average strength of the whole body

excavated; which requires much more experience and accuracy than are usually exercised by most operators, and still more in regard to proprietors who send specimens of their marls to be analyzed by other persons. It is highly important to the farmer to know the strength of the marl he is using. And to this end, it is necessary that every layer should be carefully analyzed, or, what is better, a specimen from an equal and continuous shaving of the whole vertical section of a digging, so as to furnish a fair average of the whole body. But after this trouble is once taken, the general result will serve for all the future diggings at the same place, and also for similar bodies more or less remote.

The layers of marls formed by shells left "in place," or where the animals died, are in general the poorest; and for this obvious reason, that all the hollows of and interstices between the shells are filled by what is mostly earth (but mixed with more or less of shelly fragments), and that earth is principally silicious sand. Marl so formed, will not have more than 35 to at most 40 per cent. of calcareous matter, and more often only from 25 to 35. The sand or earth that would be required to fill all the hollows and chinks of a body of entire shells, of ordinary form, though touching each other at their edges and points, would necessarily be as much as 65 to 75 per cent. of the whole mass. And therefore, it is only because of, and in proportion to, the quantity of shelly particles mixed and borne along with the earth brought by currents and deposited among the whole shells, that such marl is sometimes richer than 25 to 35 per cent. in calcareous matter. The degree of admixture of shelly fragments in this filling earth, may be easily judged of by an experienced eye, and the proportion of shells and large fragments will depend much on the forms of the prevailing kinds of shells. It is easy to know the marls formed by shells left in their original place, by the state of the shells. Either the shells being whole, and especially the more fragile varieties, or the two sides of bivalve shells being found in close contact, as when the animal was living, will show clearly that the dead shells had not been much agitated, or borne along by currents. The beds or layers formed by removal, are as easily known by the broken and finely reduced state of the shells. These marls are usually much the richest in calcareous matter; for, by the grinding operation of the currents, and the difference of specific gravity in the particles carried along, the calcareous powder and clay are deposited together, with but little silicious sand. Among the richest marls are some having whole shells in their original places, but of which the interstices are filled by such fine calcareous and clayey earth as could have been deposited only in waters nearly still. Such are the rich marls in and about Williamsburg, and in Surry, and that belt of country generally, containing 70 to 80 per cent. of carbonate of lime.

The different varieties of miocene marls, which will now be more particularly described, are not always separated in different beds, but sometimes form some of the different and even adjoining layers of the same bed or digging. The differences of colour, &c., caused by the greater or less quantity of various accidental ingredients, however striking to the eye, are not often of much importance to the value of the marl; but only (or principally) such differences as are caused by the greater or less proportion of shelly matter, and its state of disintegration and division.

*Brownish yellow marl.*—This kind, wherever found, always forms the highest layers of the particular body. That is, if there be layers both of yellow and blue marl in the same body, the yellow is always above and the blue below, and never in the reverse position. But sometimes the yellow continues to the bottom, and sometimes the blue forms the top as well as the bottom.

Yellow marl is usually found dry; that is, having no springs or oozing waters, which are generally reached on digging lower in the body. But the lower part, where wet, is sometimes, though rarely, of the same yellowish or dingy white tint, so as to make it manifest that the colour is not dependent on the degree of moisture or dryness. The yellowish tint is owing to the presence of oxide of iron, and is pale or deep, approaching sometimes to reddish brown, according to the quantity of that colouring matter.

*Yellow sandy marl* is the kind most abundant in Prince George county on and at some miles distance from the banks of James river, and from which some farms entirely, and others principally, in that neighbourhood, have been marled. It is of shells left in their original place, the filling earth being mostly of coarse sand, and the whole body poor in calcareous matter, varying in its proportion usually from 20 to 30 per cent. and rarely richer than 35 per cent. But it is of such open and loose texture (and the more so as the sand is the more abundant), that this marl is easily and cheaply worked, and the labour so applied is therefore often better compensated than in diggings of much richer marl. In this variety of marl, the shells are usually entire, or in large fragments, but are not firm or well preserved. In some beds, or thick layers, they are so finely reduced that the mass seems to the eye to be wholly, as it is indeed principally, a body of silicious sand. From one bed of this kind, which its proprietor supposed from its appearance to be merely silicious, the earth was used as sand to mix in lime-mortar for masonry, and it was found to serve well for that purpose. Subsequently this bed of sand was found to be enough calcareous to be used as manure; and was so used, and to such good profit, that the proprietor supposed it to be *rich* marl. In that opinion, however, he was mistaken, at least as to the proportion of calcareous contents.

*Yellow clay marl.*—But most of the richest as well as of the



poorest miocene marls, are yellowish. When rich, say containing proportions of carbonate of lime from 45 to 80 per cent., the marl is usually formed of shells broken down, when under the sea, to small fragments or to powder, by the grinding action of the water in violent motion, and left afterwards to settle in stiller water, according to the specific gravity. Or it is the same kind of rich and finely divided water-borne matter deposited on and filling the hollows in and between whole shells remaining in their original place. In either case, the small quantity of earth first suspended in the current, and then deposited with the finely reduced shelly matter, is mostly if not entirely clay; as silicious sand, having more specific weight, could not be suspended by the current so long, or carried so far, before being deposited. The few rich clay marls of Prince George are of the first-named variety, or composed entirely of fine fragments of shells intermixed with clay. The much richer marls in and about Williamsburg are of the other kind, there being also numerous whole shells in place, as well as the interstices being filled almost entirely by water-borne fragments, and fine powder of other shells. The other contents, making from 15 to 25 per cent. of the body, are principally of a very fine clay of pale yellow, and much less of silicious or white quartz sand, oxide of iron, and a little green-sand. Much of the same kind of rich marl is also in other parts of James City and York, in the lower part of Surry, and in Isle of Wight, New Kent, and King William counties, which I have seen—and probably throughout the middle belt of the marl region of Virginia. There has been little or none of this rich clay marl seen by me in the upper range of marl counties (those next the falls of the rivers), and not much more near to the eastern limits, or next to where the marl dips so deeply, as to disappear from the surface, and is accessible only by deep digging. Perhaps observations more extended than mine have been, might present different conclusions.

The rich marls just described, when separated mechanically (by the sieve, and by carefully washing in water), seem to consist, for the much greater part, of pure shelly matter, mostly in large or small fragments, slightly coloured brown by oxide of iron, and the remainder of a very fine and apparently pure pale yellow clay. But this clay is also composed in part of finely divided carbonate of lime; and the fine shelly matter is intermixed with some silicious sand and a little green-sand. The bed of marl near Surry Court House (which is similar to the marl at most other places thereabout) is of this kind and general character; and from it, a large body of land has been manured with great benefit. This body of marl was reputed, upon the authority of the State Geological Surveyor, to be among the richest in green-sand. From a much larger sample of the marl of this bed, carefully selected by the proprietor, at my re-

quest, and for my examination, an average portion taken was composed as follows :—

1780 grains, separated mechanically, by the sieve and by washing and subsidence in water, consisted of

	Carbonate of lime.	Fine argillaceous earth.	Silicious sand.	Green-sand.
1086 grains of shells and coarse fragments, nearly pure, and so counted, -	1086			
488 grains of fine shelly fragments, &c., which consisted of -	268	-	120	45
277 grains fine yellow clay, &c., which consisted of -	65	212		
34 loss in the process.				
<hr/> 1780	<hr/> 1869	<hr/> 212	<hr/> 120	<hr/> 45

Which may be stated of parts to the hundred, thus :

100 grains of marl contained of carbonate of lime, -	77 grains.
Silicious or quartz sand, very pure and white, -	6½ "
Green-sand, -	2½ "
Fine yellow clay or argillaceous earth (and the loss in the latter process), -	13¼ "
	<hr/> 100 "

The richest bodies of these marls show very few shells, or even fragments, and have a homogeneous texture and appearance to the eye, like a very impure chalk or sandy clay. Such marls are found in James City, New Kent, King William, and Middlesex counties. The following are some of them of which I have analyzed specimens :—

FROM	
King William, (Lipscomb's land)	—82 pr. ct. of carbonate of lime.
" (Slaughter's land)	—88 " " "
New Kent, (Mount Prospect)	—88 " " "
Middlesex, (Oaks' land)	—88 " " "

Most of these marls are soft enough to be used for manure as dug from the pits; but the hardest lumps may need burning to lime. Any marl hard enough to need burning, and as rich as 85 per cent., will make good lime for cement, as well as for manure.

Under a peculiar combination of circumstances, the great richness of some marls operates to lessen the value of the body as manure. Rain-water, when just fallen, always contains some carbonic acid, which admixture causes it to be a solvent of carbonate of lime. When rain-water then can descend by percolation into rich dry marl, in its passage it dissolves some of the calcareous matter,

which is again left solid, and in crystals, by the slow evaporation of the fluid. These crystals of carbonate of lime are slowly added to by every recurrence of the like causes, until the cavities of large shells, and other openings into which the water had settled, are completely filled with crystallization. If layers of marl, less pervious to water than in general, oppose the descent of the water, the crystallization forms in connected horizontal layers, separated by the thicker layers of softer marl. Such crystallized layers are found abundantly in the very rich marl in the cliffs at Yorktown, serving by their stony hardness to impair the otherwise great value of the manure. At Belfield, Col. Robert McCandlish's farm, a few miles higher on York river, the hollows of large shells have been filled with beautiful and brilliant crystals thus formed. In Surry also, on the land of the late William Jones, such crystallization is abundant. For such effect to be produced, there are several conditions necessary. The superincumbent earth must be of open texture, and not very thick—or rain-water could not pass through. It must not be a hill-side—as the water would flow off the surface and not penetrate to the marl. And the marl must be dry—or evaporation could not take place, and, of course, crystallization could not.

Gloucester, though one of the outside marl counties to the east, is most abundantly supplied with marl, accessible on almost every farm, whether of high or of low grounds. It is generally of the poorer yellow kind. But three marked exceptions were seen, which as such deserve to be named. One is the rich clay marl forming the north bank of Ware river on the farm of Mr. Alexander Taliaferro. Another is the general sub-soil (as it may be considered from its position) of the lowest land of the farm of Mr. Jefferson Sinclair, near the mouth of Severn river. This is an almost pure body of coarse shelly powder, or fragments, seldom found larger than two or three grains in weight, and a very few shells, of as minute size, entire enough to be distinguished. This mass of shelly matter is as loose and incohesive as coarse sand, yet is tinged slightly with green by the admixture of greenish clay. A specimen analyzed contained 72 per cent. of carbonate of lime. (See more full account at page 181, vol. vi. Farmers' Register). The third is the marl used by Capt. P. E. Tabb, and dug from beneath the low grounds on North river. It is a mass of pulverized shells, coloured by red or brown oxide of iron.\*

*Blue marl.*—This is the most common kind in the upper range, or near the western limits of the great marl deposit. Thereabout,

\* This is the marl so abundant, and of easy access, on Toddsbury, the property and residence of the deceased Philip Tabb; and of which marl the value as manure had not been tried, or suspected, by that experienced and deservedly distinguished farmer, during his long life on that farm.

blue marl usually forms the whole thickness of the bed. More eastward, and lower down the country, it sometimes forms the whole of low-lying beds, but more usually only the lower layers of a bed, of which the upper part is yellow.

Blue marl is generally such as remains "in place," or where the shells were left by the death of the enclosed animals, and the intermixed earth is mostly silicious sand; and therefore (and not because of its colour), this marl is rarely found as rich as 45 per cent., and is still more rarely equal to the yellow clay marls, though generally richer than the yellow sandy marls.

Blue marl in the bed is always wet, being made so by water slowly oozing from every part, though seldom fast anywhere, or showing springs or veins of running water. The blue colour is not caused by moisture (for some yellow marls are also permanently wet), but by vegetable extract or other dark-coloured organic matter, brought in the percolating water. This inference I have drawn from extensive observation of the natural beds, and also from several accurate though accidental experiments, of which the first that was observed will be here stated. A small stable yard was covered 6 to 10 inches thick with a rich dry yellow marl, for the purpose of retaining by chemical combination the juices of the putrescent manure which was to be thrown there from the stable. After remaining for this use a year or more, this flooring of marl was dug up and carried out for manure; when it was found to be changed in colour to a deep and vivid blue, and precisely like the natural colour and appearance of the under-stratum of the same body of marl, which being an open and almost pure mass of pulverized (and water-borne) fragments of shells, was readily penetrated by and always full of water. A general fact confirming this view is that all marls found lying immediately under swampy soils, full of vegetable matter, are blue. And this colouring vegetable matter in marl is not merely intermixed with, but must be held in chemical combination by the calcareous matter; and serves, according to its quantity, in blue marls, as an addition to the fertilizing power of the calcareous matter alone. The particular body of marl above referred to, the under-stratum of which is the most marked or vivid blue ever seen in marl, is at Shellbanks farm, Prince George, and from which I dug and applied a large quantity. The greater part, and all the richest layers, seemed to be of shells broken down to a coarse powder, or of sizes less than fine gravel, through which clear water rose and passed so freely as to forbid digging to the bottom. The small quantity of clay or other earth intermixed with the calcareous earth of this marl is altogether insufficient to hold so much colouring matter; and moreover, if the colouring matter were not *chemically* combined with the calcareous, the continued free passage of water must have dissolved and washed off any uncombined

vegetable extract. This whole body of marl, both the dry and yellow lying at top, as well as the blue and wet below, was all brought and deposited by currents, as is manifest by the different layers of different specific gravity, and still more by the many intervening layers of a fine calcareous clay (before mentioned), which may be considered as the true marl of mineralogy, though in very small quantity. Analyses were carefully made of every different quality, and the results may be interesting as showing how much one layer may vary from the one next adjoining; and different specimens not more than a few inches of perpendicular distance apart.

Upper dry part, yellow, and loose as sand, varying (by unevenness of surface) from 3 to 7 feet, contained of carbonate of lime . . . . .	53 per cent.
Next layer below, brownish yellow, through which water passes, . . . . .	25 "
About 12 inches lower, in the blue, . . . . .	64 "
" " " " " " " another specimen below . . . . .	69 "
Layers of clay marl, interspersed through the above	9 "

And in a subsequent digging, the strength of four specimens of the blue part of the marl was as follows:—

In the first foot depth of blue under-stratum . . . . .	32 per cent.
In the second foot . . . . .	33 "
At 8½ feet . . . . .	76 "
At 4 feet, and lowest digging then effected . . . . .	70 "

It may readily be inferred, from these various results, that if one or two specimens only had been analyzed, and these taken with no more care than is commonly used, that a very deceptive report would have been furnished from making even the most accurate analyses.

Conchologists and geologists, who have treated so much of marls, but merely in reference to the shells they furnish, or to their geological character, speak of the blue marl as formed by shells being imbedded in a *blue clay*. But the earth is not generally a clay, nor anything even approaching to a clay, but is mostly of silicious sand. The ordinary blue marl contains usually from three to four times as much pure and separable silicious sand as of clay. From various specimens of two diggings in such marl, from which more than 800 acres were marled of the Coggins Point farm, the following results were found by analysis:—

Yellow marl (wet) thin layer at top, contained of carbonate of lime . . . . .	24 grains.
---	------------

Within 24 inches of top, shelly matter finely divided, and the mass uniform dull blue colour, 100 grains contained :

Carbonate of lime, . . . . .	34 grains.
White silicious sand, . . . . .	47 "
Clay, black when moist, and dark gray when dried, . . . . .	19 "
	100

Of similar blue marl from another pit in the same body, 100 grains contained :

Carbonate of lime, . . . . .	34 grains.
Silicious sand, . . . . .	52 "
Clay, . . . . .	14 "
	100

Of another specimen from the same, and of similar marl, 100 grains contained of carbonate of lime, . . . . .	29 "
At 6 feet deep (the shell not much reduced), carbonate of lime . . . . .	44 "
At 13 feet deep, and one foot from bottom, . . . . .	33 "
Some few hard lumps of conglomerated shells and earth scattered through the general mass, . . . . .	73 "

From a digging at three-fourths of a mile distant, of marl of the same appearance and believed to be the same body as the preceding, the general average of strength, as obtained from several trials at different depths, was in 100 grains of marl, 35 of carbonate of lime. The thickness of this body, where penetrated, varied from 11 to 14 feet; where there was a marked lessening, though not entire absence of shelly matter, and increase of silicious sand of the same blue tint. The deeper removal was stopped because of the obvious poverty, and no further examination of more than a foot or two in depth was made in this poor substratum. In but few of all the various diggings made by myself, or of others heard of, has the bottom of the marl been reached—though in many, and most generally when penetrated deeply enough, it becomes so poor as to be not worth the labour of removing. In most of the few known cases, when digging the marl for manure, that the bottom of the miocene was reached, the stratum below was of eocene green-sand earth, or eocene marl. In digging a well, at Shellbanks, my then residence, after passing through a bed of firm blue marl, of broken (or water-worn) shells, obviously the same kind dug at another place for manure, and described at page 445, a soft brown sand was reached, apparently destitute of calcareous matter, and from which rose an abundant supply of pure and soft water to the height of 13 feet, which stood altogether in this blue marl, without its purity being affected either by the calcareous matter of the marl, or its colour-

ing matter. The continued purity of this water is an additional proof that the blue colouring matter is chemically combined with the carbonate of lime—and the combination is a visible illustration of the manner in which marl holds to and fixes putrescent manures.

Mr. William Carmichael, of Queen Ann's county, Maryland, an intelligent agriculturist, and an experienced and observant marler, is of opinion that there is a perceptible superiority of effect of blue marls over others of equal (and even greater) strength in calcareous matter. (*Farmers' Register*, vol. vii. p. 106.) This superiority of effect probably is caused by the vegetable or other putrescent and alimentary matter being combined with the calcareous, and by its presence giving colour to the blue marl. And that the blue colour is thus produced is fully proved by the facts stated at page 445, and by my more general observation.

Excepting then the additional value in the vegetable extract which gives the colour, there is no difference between the blue and the yellow marls, other than the difference, as of any marls of similar colour, in their respective amounts of calcareous matter. And the same may be said of wet and dry marls, which are generally, but not always, distinguished by the above colours; and also of any other miocene marls, excepting for such small proportion of "greensand" as is sometimes present. But there is reason to believe that wet marls, in many cases, have lost some of their ancient strength, by the continued though very slow percolation and subsequent discharge of water through the mass. If recent rain-water penetrates wet marl, it dissolves some carbonate of lime (by means of the carbonic acid in the rain-water); and, as the water slowly flows off, or oozes out, instead of being evaporated, the dissolved lime is washed into the nearest stream, and is lost, instead of being left, crystallized or otherwise, as in dry marl. Again—if water flows over having sulphate of iron (copperas) in solution, (which is not a very rare case,) that dissolved salt acts with the carbonate of lime to produce the decomposition of both the sulphate of iron and the carbonate of lime, and from two of their component parts to form sulphate of lime. And as this is slightly soluble in water, it must be carried off by the slowly oozing water, as long as any of these new salts remain. In this case, the carbonic acid is evolved, and the iron is precipitated—and often fills, or coats the interior of the spaces before filled by the shells which this chemical process had decomposed and removed. This effect, when produced, is seen at the upper part of the marl, where the copperas water first touches the shelly matter. In Henrico, near the western limit of the marl, and in Hanover, more eastward, there is generally over the present highest shells a body of earth of colour and general appearance very similar to the marl below, and full of hollow impressions

of shells, though no shelly nor even any calcareous matter now remains. In other marls, there is often seen an upper layer coloured brown by this deposit of iron. Both these are different modes of the same operation; the waters charged with sulphate of iron having in the latter case decomposed and removed but part, and in the former all the calcareous matter, to some depth below the former top of the stratum of marl. The marl, in the upper part of which the shells have been thus dissolved and removed, has a decided sulphureous odour, which is left very perceptible on the hands, after handling the marl as dug; and this odour is still more manifest in the marl when it has been dug and thrown out, and exposed some days to the weather. Such marl is within a few miles of Richmond, at Dr. Chamberlayne's and Col. C. W. Gooch's farms. It is poor in calcareous matter.

The comparative values of marls are fixed by the comparative proportions of carbonate of lime contained, other circumstances being alike; yet if these other circumstances are very different, they may make a marl containing but 25 per cent. worth more than another of 50 per cent. The more finely reduced, or the more soft the shells, the quicker the action will be, and the more profitable the marling. But all the white shells, however hard and entire when applied, are dissolved in a few years, if the soil really needs so much lime—that is (according to my views), if there be *acid of soil* enough to combine with the lime. But the gray or slate-coloured shells seem to be insoluble and almost indestructible, and do very little good as manure. These shells are the several species of scallop (*pecten*) and of fossil oyster (*ostrea*), and some few others, all fortunately being but in small proportion compared to the numerous white and softer shells. Some beds of marl, however, or layers, have mostly these hard shells, and therefore are worth very little compared to what their chemical analysis would indicate.

It is not necessary to speak otherwise than very concisely as to the practical applications and effects of miocene shell marl; for this is the kind in general use throughout lower Virginia and Maryland, and to such small extent as has been used in North Carolina, and therefore the operation is well known. All the usual and general and highly beneficial effects of marl known, with but few exceptions in the limited districts of eocene marl (hereafter to be described), are due to the miocene marls. And of such effects there have been numerous statements, general and particular. The operation of the eocene marls, and especially those largely mixed with "green-sand," is different, and superior; but their use has been so limited, and so few statements of effects published, that nearly all the particular results and general statements of effects



yet laid before the public, in the "Essay on Calcareous Manures" or elsewhere, have been in relation to the miocene marls.

My personal examinations of marl, in place, have not been extended to the Rappahannock. From such information as has reached me, I infer that the marls of that basin are generally much poorer in calcareous matter than those of the basins of James river, York, Mobjack bay, and Piankatuck river.

#### *Eocene Marl.*

(c) *Calcareous marl, containing but little green-sand.*—The existence in Virginia of the marl now known as *eocene*, was first discovered in 1819 by myself, in the south bank of James river, underlying the promontory of Coggins Point; and in the same year it was tried as manure. The texture and general appearance of this marl were obviously peculiar; and its effects as manure were soon also observed to be in some measure different from and superior to those of the other marls, which I had then used, and which were all of the kind now distinguished as *miocene*. At that time these terms had not been introduced, and for perhaps fifteen years afterwards, I did not so much as hear of the terms "*eocene*" and "*miocene*;" but the difference of age, appearance, and agricultural character of the two kinds were not therefore the less evident and obvious to my un instructed observation. The manifest difference of effect, as manure, was then ascribed by me to the general if not universal presence of a small proportion of sulphate of lime, or gypsum, in the *eocene* marl. The belief in the general presence of gypsum was very early induced by my seeing in a few places small crystals overlying and in contact with the surface of the bed of marl; and also by the apparent results of such poor attempts as I subsequently made to ascertain the presence of this substance, by means of chemical tests. Upon such imperfect trials, and the still more imperfect knowledge and skill which I could apply to the investigation, very little reliance ought to have been placed. Nevertheless, I thence inferred that there was universally present and diffused through the body of this marl a small proportion of sulphate of lime, and subsequent agricultural practice has supplied the confirmation, which has not yet been sought for by the superior chemical knowledge and skill of any other and later investigator. In the earliest publication of my views on calcareous manures in 1821, the *gypseous* character of this particular body of marl was affirmed, and the peculiar character of the results of the first experiments with it stated.\* And in the edition of 1832 of the "Essay on Calcareous Manures," the general and full descrip-

\* American Farmer, vol. iii., p. 317, and also the same experiments numbered 18, 19, 20, of the present edition of "Essay on Calcareous Manures."

tion of this marl was given precisely as it now stands in pages 144, 145, of the latest edition. My still earlier discovery of and observations upon the peculiar character of the underlying bed of *gypseous* or "green-sand" earth (which will be treated of subsequently), led me to observe the peculiarities of the eocene marl, which being less distinctly marked, might otherwise have escaped my notice.

As stated above, it was not from any knowledge of geological theories of successive formations, and different ages and periods, of all which I was profoundly ignorant, that my opinion of the peculiar character of this marl was influenced. But judging solely from the more rotten and disintegrated state of the shells, and their entire disappearance generally, even though their calcareous material remains—and from the total difference of kind of the few shells remaining whole, or of which the shape is distinctly marked, from any others of the many shells then known to me in any other marls, I very early formed the opinion that this bed was one of the remains or ruins of a condition of the earth much more ancient than that in which the ordinary marls had been formed. I remember having stated this opinion to one of the earliest of the several geologists who at different times visited my dwelling-place and my marl excavations. This was the since notorious Featherstonhaugh, to whom I pointed out this curious and to me highly interesting deposit, and directed his attention to the more modern and very different (miocene) marl lying immediately upon and in close contact with the much more ancient formation below. This remarkable feature I also showed at a later time to Professor William B. Rogers, who was much struck with the fact, and attached so much importance to it, that he has referred to it in several of his subsequent publications.

The most ready and certain mode of distinguishing eocene marl, is by reference to some of the shells belonging to this kind, and which are never found in miocene marls. There are many such; but the most common and well marked are the two following: 1st. The *cardita planicosta*, a bivalve white shell, having numerous regularly formed flat ridges running from the point at the hinge of the valves to the circumference of the outer or opening parts, and widening as the ridges extend—both valves alike, and having outlines approaching to circular—sometimes seen four inches across, and the connected valves two inches through; but generally of much smaller and various sizes. 2d. The *ostrea sellæformis*, or saddle oyster, a curiously and variously contorted gray and very hard bivalve shell, the larger valve of which approaches the shape and reversed curves of a saddle. This shell is sometimes found more than five inches in length. Both of these shells are abundant, especially the *cardita planicosta*, in this particular bed of eocene

marl, and also in the upper part of all the other eocene marls since known elsewhere in Virginia. Without reference to these, or to some other characteristic shells, the eocene marl might not always be distinguishable by its texture or general appearance from the miocene. And even these two shells, the most abundant and characteristic of the eocene formation generally, are neither to be found in the lower layers of any bed that I have been enabled to examine.

For some years after the first discovery and application of this calcareous eocene marl on Coggins Point farm, it was not known to exist elsewhere. For even where then visible, and at later times used, its different character was neither known nor suspected by its proprietors. As chance furnished to me opportunities of seeing the beds, or as small specimens of the marl were sent to me for examination, I gradually came to know the greater extent of this bed. It is now known at various points in an area of about twelve miles in length, from east to west, and eight or ten miles wide, which area takes in parts of the counties of Prince George (which has much the larger *known* portion), Charles City, and the lower point of Chesterfield. And in this area also is the broad bed of James river, and the lower parts of its tributaries, Appomattox river, and Bailey's, Powell's, and Herring creeks. The marl is exposed to view on the southern side of James river, at the following several points: Coggins Point, Maycox (a mile below, and the most eastern exposure as yet known), Tarbay, Wm. H. Harrison's farm, and Beaver Castle, all above on the river—Eelbank and Hawksnest (the most southern exposure), on Powell's creek—the Old Court House tract and Spring Garden farm, both on Bailey's creek, and the latter from one to two miles above the head of its tide, and three miles south of the Appomattox where opposite. The last is the most western exposure. On the northern side of the Appomattox, it is seen in the river bank at Bermuda Hundred, and north of James river, and of Herring creek, at Neston and Evelynton.

Through nearly all this large area, this bed of marl preserves remarkable uniformity of appearance, texture, chemical character and composition, and even of the thickness of the stratum, and of the succession and variations of character of the several smaller layers of the general body. The bed lies nearly horizontal, but dips slightly and irregularly eastward and northward. At Coggins Point, its lower part is 10 to 12 feet above high tide, while at Maycox, a mile to the east, and at Evelynton, three miles north, it is lower than high tide mark. Yet not so much difference of elevation as this is seen in all the greater extension westward to Bermuda Hundred. The stratum varies from 4 to 10 feet thick, being thinnest at its south-western exposure, Spring Garden,

and thickest at the north-eastern, Neston and Evelynton. At Coggins Point, where traced along the face of the river cliff continuously for more than half a mile, it is usually 6 feet thick, never more than 8, and never less than 4 feet, except where terminating. The general and almost uniform colour is a pale dingy yellow. The few shells remaining are not perceptible without careful observation, and the whole mass, when dug down for use, is scarcely distinguishable from many common and barren sub-soils, or clay river cliffs, of like colour. Two thin but continuous and separate layers of almost stony hardness extend through the whole bed. These contain from 85 to 90 per cent. of carbonate of lime, and may be burnt to excellent quick-lime for cement. The marl intervening with these hard layers is similar to them in colour and general appearance; but is quite soft and mellow in handling, and in that respect differs from all other known marls. The very uniform calcareous proportion of this part is about 58 per cent.; and taking an equal section of the whole thickness of the bed, and with the greatest care to obtain a fair average sample, the strength in carbonate of lime was found to be 62 per cent. This is far less of calcareous matter than is contained by many miocene marls which show less effect than this as manure. But besides its calcareous matter, this eocene marl has some little gypsum, some kind of saline matter which cattle are fond of licking (believed to be sulphate of alumina) and some amount of the granules of "green-sand"—and more of this than most of the miocene marls. The other earth of this marl is mostly of yellowish clay, and composed more of argillaceous than silicious matter. I confess that all these additional ingredients, together, do not seem to me sufficient to account for the superiority which this marl exhibits as manure.

Though this peculiar kind of marl was so early known, and its value appreciated, and, though it underlies the whole of Coggins Point, yet it is covered there so deeply by the overlying earth, and is therefore so difficult to work extensively, and, moreover, is so distant from the main body of the farm, that this has not been applied to more than 65 acres, out of some 700 marled on that farm. Other proprietors have elsewhere made much more extensive applications of this marl. The peculiar effects of this kind of marl were tested with the most accuracy by Messrs. Collier H. Minge, then of Walnut Hill, and Hill Carter, of Shirley; both of whom used this marl from Coggins Point, water-borne to distances of twelve and fifteen miles. Though the marl was given to them (in the bed), it was yet very costly in the labour of digging and transportation; and therefore they used it with strict economy, and carefully estimated the results. But highly as they both thought

of, and have reported the effects,\* in comparison with either lime or miocene marls, the expense and trouble were so great, that it is now considered by some of the most judicious farmers on the tide-water rivers, that they can better afford to buy stone-lime, at its present low price (8 to 10 cents the bushel), than to transport marl of any kind by water. This, however, is an erroneous estimate. A bushel of such marl is worth more as manure, than a bushel of slaked lime (though slower in operation), and can be transported twenty to forty miles by water, and delivered for 4 cents the bushel.

Since the foregoing pages were written, I have learned of two farther exposures of this body of eocene marl. One is four miles north of Evelynton (in Charles City county), where the marl was reached and penetrated by the digging of a well in 1814. At about thirty feet deep, after passing through the marl, and a layer of rock, water was reached, which rose to the top of the well, and continues to flow over, forming the only Artesian well known in this region. The other locality is in Henrico county, on Turkey Island creek, its eastern boundary, and about eight miles north of City Point. This marl I recognised to be the same, by a specimen recently brought me for examination. It is below the surface of swampy ground, and is coloured dark gray. It is much fuller of green-sand, and indeed in that respect makes some approach to the green-sand marls of the Pamunkey, of which the nearest exposure is only sixteen miles from this place. It is probable that the marl extends continuously from the one place to the other, and may be found throughout the interval by deep digging.†

(e) *The Gypseous Earth or Green Earth of James River.*

Before proceeding to consider the next and only remaining known variety of our marls, the eocene green-sand marl, it is ne-

\* See *Farmers' Register*, vol. v., pp. 189, 247, 511.

† After the publication of this report, I first learned, from the examination of hand specimens, that eocene marl was exposed on the new railway route between Fredericksburg and the Potomac river. The specimens exhibited to me were very hard, and seemed (to the eye) to be also poor.

The most extensive, rich, and valuable body of marl, of the Atlantic States, is eocene, and which I first knew, and then examined extensively, during my Agricultural Survey of South Carolina, in 1843. This immense body extends across lower South Carolina, and also the connected parts of both North Carolina and Georgia. The bed is full 800 feet thick under Charleston, and of unknown depth elsewhere. It contains usually from 65 to 90 per cent. of carbonate of lime—has but few whole or distinguishable fragments of shells remaining—and is of more homogeneous appearance and firm or stony texture than any other beds of marl.

cessary to treat in advance and separately of the peculiar earthy compound, called "green-sand" by geological writers, of which the large admixture, and sometimes even larger proportion, or otherwise some other ingredient usually accompanying the green-sand, gives additional value and peculiar character and action to the greater number and quantity of the eocene marls yet known in Virginia. But important and valuable as may be the green-sand in itself, and necessary to be considered in connexion with the subject of eocene marl, with which it is so inseparably connected, I wish especially to avoid confounding the two earths under one name or one character; and to be understood as protesting against the prevalent error, in giving currency to which scientific writers have concurred with the unlearned cultivators, of applying to the non-calcareous green-sand earth the name of "marl," and thus adding another, and the most important, to the many previous misapplications of this wonderfully misused and misunderstood term. This misapplication is universal in New Jersey, where the green-sand earth is most abundant, and is generally very rich in its distinguishing ingredient (usually containing 75 to 90 per cent. of pure green-sand), and where this earth has been long and is now extensively used as a manure, and has been found to be of great value as a fertilizer. I shall hereafter refer to both the points of resemblance and of difference (both of which are important and interesting,) between this green earth of New Jersey and that of James river; but, for the present, my remarks will be confined to the latter, and its use as manure, as known principally, and indeed almost entirely, from my own observations and practical experience, there having as yet been but few trials of it made by other persons.

It was mentioned in the foregoing section, that the first notice or observation of the eocene marl, on James river, was induced by the previous discovery and examination of the green or gypseous earth—the latter being the universal underlying bed of the former, and connected with it in more respects than merely its subjacent position. It was my chance, or the result of habits of observation of marls and other earths, and not of any scientific knowledge or previous preparation for such investigations, which led me, in 1817, to be the first to observe this bed of green earth in the river banks of Evergreen and Coggins Point, and to trace it where visible along the intermediate ground, a distance of about eight miles. Since then, it is known to be much more extended; for it not only underlies all the eocene marl of the same neighbourhood, wherever that is found, and part of the yellow sandy miocene, but also extends beyond, and is found at various places where no eocene or even miocene marl is present. The most western limit, seen after a long interval, or concealed existence of this formation, is at Petersburg, where it shows in the ravines south of Poplar Lawn.

What first directed my attention to this earth was the existence in the river bank at Evergreen (the place of my birth, and of residence in early life,) of curiously shaped and beautiful crystals, which subsequently I learned were selenite or gypsum. The like crystals (though much smaller in size) I soon after found in different places at Coggins Point, my own farm and then residence. And, in making examinations for this purpose, I observed that wherever any gypsum could be found, it was always in a peculiar kind of earth, which, though varying much in appearance in different places, and at different elevations at the same place, yet possessed characteristic marks by which it could be easily distinguished from all others. This was the earth in question. For want of any known or more appropriate name, I at first applied the term "gypseous earth" to this deposit; and though I subsequently abandoned this name in (undeserved) deference to scientific authority, and have used instead, in my later publications, the name "green-sand earth," I now believe that my original term (in reference to the more general and universal manuring qualities) was the better of the two, for reasons which will appear in the course of these remarks. And besides that "green-sand earth" is inconvenient for its length, it is not truly descriptive; for the entire granules from which the peculiar character of the earth is derived, are not green, but black superficially, or so appear; and are not what is usually understood as *sand*, but in texture are like fine and unctuous clay. Still worse is it to term the whole mass "green-sand," as is usually done when the pure "green-sand," even if that were properly named, may not form one-fourth or even one-tenth of the whole mass of earth. I therefore would prefer for the deposit, and shall use indifferently, either my first designation of gypseous earth, or the name of *green earth*, which latter is convenient, is sufficiently descriptive, and, moreover, affirms nothing except as to the colour, which is generally manifest in the whole mass, and, if not, is certainly so in the separated and mashed granules, which distinguish the earth.

As the lower part of the river bank is mostly exposed and kept bare by the frequent washing by the waves driven by strong winds and high tides, the bed of gypseous earth can be easily traced through nearly its whole course along the river side. As thus exposed to view, it has generally a green colour, most frequently intermixed and mottled with smaller streaks and spots of bright yellow. The earth, as seen firm in the bank, and with a smooth washed surface, might be supposed to be somewhat of a clay; but, on handling it, and breaking down a lump, its texture is more like sand; as indeed the larger proportion of the mass is silicious sand. A very general distinguishing mark of this earth is its containing numerous hollow impressions of eocene shells, of which the forms

remain perfect, though neither the shells themselves nor any portion of their calcareous substance remain, as the earth in this part, and where most generally seen, contains not a particle of carbonate of lime. Among the yellow spots there are also other small spots and streaks of reddish brown-coloured clay, very pure, soft and unctuous to the touch. The bright yellow clay is doubtless largely impregnated with iron, or is a true ochre. Though soft within the bed, this yellow ochre hardens when exposed to the air on the outside, and even when under water. Many of the yellow spots made by this ochre, as seen on the surface of a smooth section of the bed, have a faint resemblance to the shape of sections of bivalve shells; and these contrasted with the general green ground, and with the exception of the colours being different, give to such a section of the bank somewhat the appearance of the beautiful black marble used sometimes for mantel-pieces, in which the white traces of what were formerly shells show throughout. In some places near to and below the beach, the earth is seen much darker coloured, indeed is almost black when moist in the bank, though more of dark and dull green when dry. This deeper colour is owing to the green granules being present in larger quantity; and generally, if not always, the lower part of the bed of earth is richer in that ingredient than the upper. The empty impressions which were formerly filled by shells are still found in penetrating below; but as the depth increases, first are seen some fragments, and then whole shells, though greatly decayed, and the parts having scarcely any coherence. Still, generally, even below, where these shells are most abundant, their quantity would not furnish as much as two per cent., and generally not one per cent., to the whole thickness of the bed; and, therefore, the carbonate of lime, though of course useful in proportion to its quantity, can give no appreciable addition of value to the mass as manure.

Here and there, but rarely, in the upper and dry part of this bed, crystals of gypsum are found, generally so small as to be barely distinguishable by the eye. In the lower and wet part, gypsum is never visible; but it is nevertheless believed to be always present in some proportion.

But the important and most characteristic mark of the green earth is present in the black granules called "green-sand," which give colour to the mass. To ascertain the presence of these granules, let a small sample of the earth or marl supposed to contain them be dried, and then crumbled between the fingers, or, if too hard for that, by being rubbed in a mortar, not too finely and closely. Then take a pinch of the powder between the thumb and finger, and sprinkle it very thinly over a piece of white paper. If any of the separated grains appear black (or green), mash one of them with



the moistened point of a pen-knife; and if it be "green-sand," the granule will mash like fine soapy clay, and make a vivid green smear.

For greater accuracy, let the earth (or marl) be well washed by agitation in water, and pour off the pure clay and other lighter matters which will remain longer suspended in the fluid. The grains of green-sand will then be left with nothing else but the quartz or silicious sand, and moreover the former will be made more perceptible, in consequence of being cleared by the washing of any previous covering of fine clay.

My first published account of this earth was made in or about the year 1828, in the old series of the "American Farmer." A much more extended article "On the Gypseous Earth of James River," I afterwards published, July, 1833, in the first volume of the Farmers' Register, beginning at page 207. Though up to that time I had never so much as heard of the term "green-sand," and though I adopted and used the new and unauthorized designation of "gypseous earth," the earth in question was described so minutely and accurately that it was impossible for any intelligent and attentive reader of the article, and subsequent observer of the kind of earth in question, to mistake the subject of description. In this piece I also asserted the identity of this gypseous earth with the "green marl" of New Jersey. I trust that I may be pardoned for thus specifying my claim to the first discovery of this earth in Virginia, inasmuch as that merit (if it be one) would be ascribed by every otherwise uninformed reader of the first report of the geological survey of Virginia, and some other of the publications from the same source, to the author of these pieces.\* Upon this occasion, it would be improper to say more on this question than thus concisely and explicitly to assert my just rights.

Before proceeding to offer the more precise and more valuable information concerning this earth obtained by very recent investigations, it will be proper to state something of the progress and changes of opinion on this subject, which operated at different times either to encourage or to obstruct the use of this earth as manure.

From 1818 to 1835 inclusive, I made numerous trials, and in some cases extensive applications of the Coggins Point gypseous earth as manure. The results of my general practice, and also of many particular experiments, noted at the times when made, were reported in a communication to the Farmers' Register, commencing at page 118, vol. ix. The effects stated were very different and apparently contradictory—sometimes beneficial and profitable in a remarkable degree, but more generally of little value, or of no

---

\* Professor W. B. Rogers, formerly Geological Surveyor of Virginia.

benefit whatever. The inferences which I drew from all my experience (and there existed scarcely any other known facts or experiments), were that this earth as manure acted in the same manner as gypsum, though more powerfully—and in no other manner than as gypsum would under like circumstances; that like gypsum, on my land certainly, and as I inferred in our tide-water region generally, this earth had no effect whatever on any acid soils—and rarely on any other crop than clover (and other leguminous plants), even when properly applied on neutral or calcareous soils; and that when naturally acid soils were made calcareous by being marled, this green earth then became generally operative thereon as a manure for clover (and for other plants of the clover or pea tribe), in the same manner as is usual in regard to gypsum.\* And though the effects, when any were produced, were greater than those of any usual or known dressings of gypsum, and sometimes in a very remarkable degree, still the failures and disappointments were so many that I did not deem the practice worth being continued. In 1841, my son, the present occupant of the Coggins Point farm, at my request, recommenced the applications of gypseous earth, for experiment; and on the clover of this year, 1842, he has extended the dressings over more than 60 acres.† The results were, as in former years, very unequal, and for the greater space of ground covered, unprofitable, and barely if at all perceptible. But on 25 to 30 acres the benefit was remarkably great, and in some cases (of summer dressings) improvement was obvious within ten days after the application. But what was most interesting in the results was, that a clue seemed to be thereby furnished to explain the frequent previous failures of this manure, even when applied to clover growing on neutral or calcareous soil, which are the only circumstances in which it has ever been found profitable in practice. My former applications had been generally made from the upper and greener stratum of the gypseous earth (designated in a succeeding page as *C*), or if from the lower and blacker part (*D*), the digging did not penetrate more than a foot, or, at most and rarely, two feet below the before exposed outer surface. But in the recent larger operation, the digging (made on the river beach) was so much more extensive, as to furnish earth from depths of three or four feet, as well as of portions nearer to and at the surface. I ascribed the remarkable differences of effect to the kind and place of the earth; inferring that the exposed parts, and all perhaps near the surface, had, by exposure to air or water, lost a large proportion of the soluble or

\* See these views more fully set forth in the article above referred to, and also in another on the green-sand marls of Pamunkey, at pp. 679 and 690, vol. viii. Farmers' Register.

† See the facts and results stated in two communications to Farmers' Register, pp. 86, 135 and 252, vol. x.

decomposable fertilising ingredients. As the applications had not been made with any view to this question, the experiments are not to be deemed as conclusive, and the correctness of this inference is yet to be fairly tested by future experiments.\* But the benefits from some of the dressings, and all of these supposed to be from the deeper digging, were so great, and so speedily produced, that renewed and strong interest was excited in regard to this manure. The quantity applied was generally 40 bushels of the earth to the acre. And this quantity seemed (from an accurate comparative experiment) to produce as much benefit as 200 bushels. The growth of clover was increased in degrees varying from 100 to 300 per cent. And where the application was most successful, the increase and profit were sufficient to compensate the expense, even though no further benefit shall be found than in this one crop—or that a new application shall be required, and be made, for every succeeding crop of clover, or once in each round of the rotation of crops.

An observation made by accident last spring led to further chemical as well as other examinations of this earth, and to important results. Upon heating a lump of it to red heat, I found that strong fumes were thereby extricated, which were almost suffocating if inhaled incautiously. The odour was manifestly sulphureous in part, and principally; but it seemed not altogether so, but to be mixed with some other, much like that of muriatic acid gas. Similar trials were made on many specimens, and all the darker and (as supposed) richer layers of the green earth at Coggin's Point showed the like result. From specimens of the upper and lighter green stratum (*C*) when heated red, there was nothing of this suffocating odour produced. And it may be useful to state here, in anticipation of subjects to be hereafter more fully considered, that I subsequently found that the New Jersey green-sand earths yielded not a particle of this gaseous product.

This odour, so far as it was sulphureous, was obviously the product of the decomposition (by red heat) of sulphuret [or bi-sulphuret] of iron—which was thus proved to be universally diffused, though invisible, through all the darker and better kinds of this earth. Sulphur would have shown like results, with a much less degree of heat; but it could not be that, because the heat sufficient to decompose sulphur (and to evolve its fumes) had no such effect on the earth. I also observed that lumps of the earth, after having been applied as manure, and exposed on the surface of the ground for some months, often had a smell of sulphur; and, in some cases,

\* Subsequent experiments have not sustained the above idea. But the results, though not uniform, have been so generally beneficial on clover, that this earth is applied to from 60 to 80 acres every year.

the same effect was exhibited in specimens taken from the diggings, and kept dry. The sulphuret of iron, if universally present, would, by its decomposition in contact with carbonate of lime (as when on calcareous land), form sulphate of lime (gypsum). This showed a source for the universal supply of that manure to some extent. Further, my friend Mr. M. Tuomey,\* had found sulphate of lime ready formed in specimens of *wet earth*, which I supposed the least likely to retain that ingredient—and thus was indicated another and more general supply of gypsum already formed.

The increased interest excited by these new observations, and also the new views as to the cause of the failures of most of the former applications of this manure, induced the sinking of a pit in the gypseous earth, on the river beach at Coggins Point, to the depth of 18 feet below ordinary high tide. This digging for the lower 13 feet was in a very compact and fine clay (*E*), or clay marl, as it would have been designated in England, from its texture and sensible qualities, but which contained no visible or apparent fertilizing ingredient, except a very small sprinkling of shells, and elsewhere some little sulphuret of iron in small lumps and in minute crystals, visible in a few detached spots only. The appearances promised so little of value or remuneration (and less so as the digging was sunk lower), that the work was suspended. But the blacker earth above (*D*) and also the clay (*E*) were carried out for experiment on clover (May 26th), of which the first crop had just been grazed off closely, and the cattle removed. As the season was so far advanced, and benefit so little counted on, the covering was made heavier than in the winter and early spring before (and of which the full benefit had been already seen on the first or spring crop of clover); 100 bushels of the upper and better earth, or 150 of the clay, being applied to the acre. A good rain fell the next night; and in less than ten days there were visible and manifest beneficial effects from both kinds of earth, but better from the upper—which effects increased to fully the doubling of the growth by the 1st of August. The hard lumps of the compact clay soon split and crumbled when exposed to the air, and even without rain. The remarkable benefits of these applications induced the resuming of the digging, and another and much deeper pit was dug as early as the other labours of the farm permitted, and a statement will presently be made of the section thereby exposed. But previous to this, it is proper to describe another like operation, and its results, at a more interesting locality.

The same general appearance of the gypseous earth, and mostly of the poorer kind of greenish colour, mottled with pale yellow clay,

---

\* Now Professor of Geology and Agricultural Chemistry in the University of Alabama.

is exhibited all along the river bank of Coggins Point and the lands above, to the Evergreen farm—interrupted only by the parts of marshy or more ancient alluvial lands; or where the stratum has been broken and concealed by the ancient land-slips which have greatly altered the original levels and form of the surface of that whole stretch of land bordering on the river and overlying the gypseous earth formation. This operation by the land slipping and sinking continues, and some new effects are seen every year. At many places along this stretch, gypsum is perceptible in the green earth, either in crystals or in powder, and sometimes, and rarely, in considerable proportion, say from 5 to 15 per cent. of the whole mass for very limited spaces. At the upper part of the river line of the Evergreen farm (at the mouth of Bayley's creek, and two miles below City Point), the river bank has peculiar and remarkable features, which deserve particular notice. It was here, in 1817, that I first discovered this green earth formation, and thence traced it to my own farm and then residence, Coggins Point, and elsewhere in that neighbourhood.

The lower visible part of the body of gypseous earth at Evergreen is laid bare by the wasting encroachment of the river (by which it is rapidly washing away), for 200 yards in length. The southern or upper extremity, for some 20 yards, approaches nearly in appearance to the general character of the upper stratum before described. But all the remainder is different, and much richer in the dark or green granules than generally elsewhere.

Since this article was commenced, Capt. H. H. Cocke, the present proprietor of Evergreen, at my suggestion and request, had a shaft dug for examination, which, with an extension of my own after he had ceased his operations, added to the natural and higher exposure of the section, 27 feet below the beach, and 25 below common high tide. The several strata of the whole section, and their variations, will be described in their descending order.

At top—

1st. Surface soil (sloping back irregularly to the table land, which is much higher), on (2d) gravelly and sandy sub-soil, pervious to water, of various depths—lying on strata nearly all horizontal.

Next,

10 feet of yellow sandy miocene marl.

8 feet of yellowish clay (supposed eocene), intermixed throughout with very small crystals and powder of sulphate of lime—the clay not compact or solid, but open and loose throughout. (Query: Is not this the equivalent of the eocene marl at Coggins Point, with its former shells and carbonate of lime completely changed to sulphate of lime, and the greatest proportion dissolved and lost?)

5 feet of gypseous earth—the general colour, green mottled and

streaked with yellow ochre, and full throughout of very minute crystals of sulphate of lime, supposed by the eye to be about 10 to 15 per cent. of the whole mass. No shells or casts seen in the part exposed by digging for examination.

- 7 feet of brownish mottled clay, feeling smooth and soapy, containing numerous small crystals of sulphate of lime.
- 9 feet very pure white clay or fuller's-earth, in horizontal layers, separated by veins of the yellow clay (or iron ochre) before-mentioned, other veins of the same sometimes also inclined and crossing the horizontal veins—the outsides of the lumps of clay coloured by oxide of iron. The clay all broken into irregular lumps, as if the fissures had been formed by the contraction in drying of clay soft and distended with wetness. No shells, nor appearance of them, but many pure and transparent and beautiful crystals of sulphate of lime here and there, some weighing several ounces. This stratum changing gradually into the next of
- 4 feet of dark bluish clay, the colouring matter being green-sand, mottled with irregular streaks of bright yellow, becoming brown below where oozing water begins to show and is reddish with sulphate of iron, or other ferruginous matter in solution. This stratum full of large and solid crystals of sulphate of lime, amounting apparently to from 20 to 25 per cent. of the whole mass—the crystals coloured dark gray, because of some impurities in small grains (green-sand?) being enclosed and diffused through them. No shells. This changing into the next, of
- 11 feet of same dark or nearly black clay, nearly uniform colour, and still compact texture, and feeling smooth and soapy—with very few crystals, and much less sulphate of lime than the preceding, but many small and scattered eocene white shells, quite rotten, and being moist, as soft as dough. The shells, mostly several kinds of very large turritellæ. Fewer shells as descending. At top of the stratum some large and very perfect specimens of the *ostrea compressirostra* (?) To level of the river at common high tide.
- Below high tide.
- 14 feet very similar to the last, the shells very few for the greater part, but increasing near the next. No crystals or other sulphate of lime visible. The green-sand granules coarser—sometimes in small lumps quite pure, or unmixed with anything else. These granules breaking easily, though as if hard or brittle, and not like a soft soapy clay as usual—though as green as before. Many small cylindrical tubes seen (made by the burrowing of *pholades*, or other shell-fish of the like habits), which seem to be formed on, or coated with pure green-sand in mass, and green in colour, and the hollows filled with looser black granules.
- 11 feet of shells lying generally close together, and serving to

make the whole stratum a calcareous marl, of perhaps 30 per cent. or more of carbonate of lime—the earth filling the shells and between them being the same black earth, as rich as before in green-sand. At top, some very large and perfect shells of *ostrea compressirostra*, and another much thicker *ostrea*, not known.\* The shells mostly very large *turritellæ* of different species—near bottom fewer of these, and mostly *crassatella*. The shells nearly as numerous as before, at this depth, at which the digging was abandoned, at 25 feet below tide.

The whole section, from the top of the highest undoubted eocene stratum to where the digging ceased (without any indication of being near the end), is 61 feet—and if the clay and gypsum stratum below the miocene be added, which, though not certain, I believe to be eocene, there would be 69 feet. And if this and the two other lower clay strata be deducted, there will still remain 45 feet of strata exposed, all rich in green-sand, and of it 9 feet very rich also in sulphate of lime or gypsum, and 11 feet moderately rich in carbonate of lime. Such a deposit is well worth the examination of geologists and chemists, and the trial of farmers.†

It was remarkable that at this place only of all the usual strata of all the then known deposits of green-sand or eocene marl in Virginia, were found exposed, the shells of the *ostrea compressirostra*—and below tide the other before unknown and very thick and heavy *ostrea*;‡ and that at this place there has not been found a single shell of either the *ostrea sellæformis* or *cardita planicosta*, the latter of which is so abundant through all other known eocene deposits, and the former in the calcareous eocene elsewhere. These facts seemed to indicate (as well as the general dip to the eastward) that the strata at Evergreen are much more elevated than the same at Coggins Point—and that by digging deeper, the lower and all the strata of the former might be found

---

\* One of these last (both valves) weighed 5 lbs. Mr. M. Tuomey, to whose much better information on this subject I ought to defer, supposes this very large and heavy shell to be an *O. compressirostra* of unusual age and growth. If so, however, it is certainly very different in appearance from that shell, as usually seen higher up in this bed, even when wider than this very thick and heavy *ostrea*.

[† The lowest known layer of this rich deposit has since been traced three miles westward to City Point; and from the latter place the marl has been used extensively, and to much benefit. 1851.]

‡ This last shell I have since learned (by specimen) is also found in the green-sand marl at North Wales, near the upper termination of the Pamunkey bed—and near the bottom of the marl. And later personal inspection has shown clearly the identity of the deposits and the fossils at these two points; one being the bottom of the Pamunkey bed, and the other nearly (as is presumed) to the bottom of the James river bed of green-sand marl.

at other parts of the known area (before described) of the eocene formation.

This inference added to other considerations caused to be sunk the second shaft above-mentioned in the beach of Coggins' Point, 130 yards distant from the first one, which by this time had been filled completely by the sand driven by storms and high tides. The digging was made at a low part of the bank, and which therefore did not show either the eocene marl or the miocene, the former of which is seen in the higher bank at a short distance, and both together at the distance of a mile. The different strata of the actual section at the new digging, taken descending from the top of the bank, were as follows:—

- 1 foot, surface soil—gray loam.
- 7 feet of (drift) pale yellow clay, containing much coarse silicious sand.
- 4 feet (drift) rounded or water-worn pebbles, of all sizes, from 4 inches through to coarse gravel, held together by enough clay and ferruginous earth to fill the interstices between the pebbles. None of the pebbles calcareous.
- 2 feet of (drift) very thin layers of hard and gritty gray clay, alternating with others of coarse ferruginous sand.
- 2 feet of poor greenish earth, more than half the surface of the section brown in spots, and indurated with oxide of iron.

(Here should be, as elsewhere in the neighbourhood, though absent at this particular locality, either one or both, the miocene marl (A), and next below the eocene calcareous marl (B) described in the preceding pages).

- (C) 9 feet of the ordinary upper layer of gypseous earth—green colour, mottled with spots of bright yellow clay (or ochre), and some other spots of unctuous reddish brown clay. Very slight efflorescence of gypsum on the surface.
- (D) 3 feet of darker and nearly uniform colour, almost black, from the greater proportion of green-sand. This and the preceding, containing many impressions of shells, but no shells or fragments, and no carbonate of lime. More efflorescence of gypsum, and also on next—
- (D) 3 feet of same, except that some shells are seen—and increase in the next to level of river at common high tide.
- (D) 6 feet of same (next below tide)—the shells mostly *cardita planicosta*—fewer of *cytherea* and *corbula*. No *ostrea* or *turritella*. Small and slender shark's teeth (so called) in perfect preservation, the points and edges being as sharp as in teeth of the living animal.
- (E) 15 feet bluish gray or lead-coloured clay (from 6 to 22 feet below tide), having nearly the texture of clay marl. Very compact and firm in texture—unctuous to the touch, but not adhe-



- sive or tough—does not bend to pressure, but breaks—cuts smooth, except when the edge of the knife meets parts of shells, or grains of silicious sand, which, as well as granules of green-sand, are irregularly intermixed throughout. The shells very rotten, and flattened by pressure. Sometimes in masses, or thin bands or regular layers, becoming less and less in quantity as descending, and but few seen at and below 10 feet of this stratum. Numerous particles of mica throughout. Changing gradually to next. At 12 to 13 feet of its depth, many hard lumps of sulphuret of iron. The upper three or four feet of this penetrated by numerous hollow cylinders, of an inch or more in diameter, and in every direction—obviously having been bored by shell-fish. These hollows are filled by the green earth of the stratum above, which thus makes nearly half the mass. (This clay and the layer above (D) were the kinds used for manure from the first opened pit.)
- 8 feet (22 to 25 below tide) of brownish and more friable clay, intermixing at first with the above. Green-sand much more abundant than in the preceding, and partly in very large granules.
- 3½ feet (25 to 28 below tide) of very smooth and firm clay, of delicate lilac colour at first, but becoming paler as descending, until nearly white. Splits easily into flakes like thick slate; and still thinner laminæ show that the earth was a deposit in tranquil waters. Thin flakes (not thicker than writing paper), and sometimes a mere powder of pure sulphuret of iron visible between many of the layers of clay, and causing them to separate easily. The upper foot of this penetrated everywhere by small hollow tubes (from an eighth to the third of an inch in diameter), which are filled by the brown and green variegated earth of the stratum above—causing a lump when cut smooth to appear like a conglomerate of differently coloured marbles. Except in these borings, no green-sand deposit, and no shelly matter. The sulphuret of iron, which is through this stratum visible in powder, or thin layers, and above in small masses or lumps, is diffused through all the strata containing green-sand, except the highest (C). Through this and the upper gray clay (E) some small black pebbles seen, which appear as if formed by melting. The same found in the eocene marl. A sudden change to the next—
- 2½ feet (28½ to 31 below high tide) of remarkably smooth and unctuous, but firm clay of reddish brown colour (or dull brick red), and homogeneous texture as well as colour. Cuts as smooth as the best hard soap. Deposited in thin laminæ, and breaks or splits easily in straight lines both in the direction of the laminæ and lengthwise at right-angles to their direction—the grain and fracture appearing like that of rotten wood. Across these two directions, the fracture very uneven. Near the bottom of the

richest green stratum (*D*) there is a barely perceptible oozing of water. All below dry, and the two last strata remarkably dry. They could not be more so if within three feet of the surface of a high knoll, and in summer.

- 1 foot (31 to 32 below tide) of same as the last in texture, but of pale blue colour.
- 1 foot (32 to 33 below tide) mixture of the last, in small lumps imbedded in the next, as if broken up by a violent current, and deposited in rapid water.
- 17 feet (33 to 49 below tide, the lowest digging) black earth—richest in green-sand (supposed to be 40 per cent.) mixed with a few fragments (less than 2 per cent. on an average) of shells, mostly small, and all very rotten. Kinds, mostly of *turritella* (some of which are large), *mytilus*, *corbula*, and *crassatella*. Many small and a few large shells of *ostrea compressirostra* near the top of this stratum and again near the lowest part, where the work was stopped by the water rising from below.

The whole, so far as dug, added to the before exposed bank, amounted to 66 feet of the eocene deposit, of which 49 feet was below the level of high tide. The last stratum, which was penetrated for 17 feet before the rise of spring water compelled the work to be discontinued, was manifestly the same with that at Evergreen which was even with high tide (and extending above and below), and which was there 25 feet thick. It was a subject of much regret, after so much labour, that the still lower stratum, full of shells, could not be reached, and which probably might have been done in 8 feet more of digging. However, enough was done to show that the quantity is inexhaustible of the layers richest in green-sand (whatever may be that degree of richness), independent of the other layers.

Besides the main object of this laborious examination by digging as low as possible, to learn more of the quality and quantity of the earth for manure, and as a matter of curiosity, there was another inducement. The whole bottom of the river across to Berkley (below the thin covering of loose and soft mud), according to its variation of depth, must be formed of one or another of the same layers shown in this digging of 49 feet below the water level; and, of course, Harrison's Bar, which lies between the Coggins and Berkley shores, must be so formed. No earth more strongly resists the washing action of water than the gypseous earth, even when the least mixed with clay. This peculiar quality must be the cause of the existence of this bar, which presents so serious an obstacle to the navigation of the river; and it may be thence inferred what would be the degree of difficulty of its removal, and also that the removal, if effected, would be permanent.

Various and contradictory as had been many of the results of

my experiments of the green earth as manure, there had been perfect agreement in some respects. Thus, as before stated generally, the earth has never been beneficial as manure on acid soil—but rarely on corn, and never (directly) on wheat; and (on proper soils) generally and greatly beneficial on clover, and perhaps all plants of the clover and pea tribe—and the effects, when produced, have never been permanent, nor even very durable. And the effects shown in these points of agreement were nearly all the reverse of those ascribed to the New Jersey green-sand. In regard to these effects, in the absence of all certain and particular information to be obtained otherwise, I found it necessary to seek information in person. The results of my inquiries and personal examinations, in general, showed that the green-sand (called marl) of New Jersey, though agreeing in some respects with ours in action as manure, is operative generally on the greater number of soils, and on most crops, and is also very durable in effect. On the other hand, much larger quantities are applied there (usually 200 bushels, and sometimes 400, or more, to the acre) than I have done with ours; and something of the more general benefit and longer duration may perhaps be owing to that circumstance.\* Whether the green-sand is indeed the principal, or a very important manuring agent, of the James river earth, or whether the other ingredients may not be still more active than its green-sand, is yet undecided.†

It is indeed strange that such doubts should exist at this late day as to the manuring action and effect of this earth—and still more so that the chemical composition and ingredients of the earth should not have been long ago ascertained. Yet previous to the recent imperfect application of tests above referred to, there had been no known full or correct chemical analysis made of the earth in question; nor even any partial examination for and report of the ingredients, that was entitled to any respect for accuracy and fidelity. For these reasons I engaged the services of Professor C. U. Shepard, for the analyses of specimens which I selected from the different strata of the earth, at Coggins Point, exposed in recent diggings, including several which had been tried as manure, and had operated with remarkable power and benefit. His report of the partial analyses, which has been received since the preceding and subsequent portions of this article were written, will now be

---

\* See report at length on the New Jersey green-sand, and its operation, at page 418, vol. x., Farmers' Register. This deposit is of secondary formation, while that of Virginia is of the *tertiary*. This difference of age and probably of the materials of the formation would seem to indicate a difference of chemical constitution—as there certainly is of manuring operation.

† [I have lately heard that phosphate of lime had been discovered as an ordinary accompaniment of the green-sand of New Jersey, in the clay which is a regularly existing ingredient. I do not know what reliance may be placed on this report.—1851.]

presented. It enables me to furnish more of what is valuable, because more certain than everything else I could offer, or than has before been offered to the public on this subject—prominent as it has been made in the reports of the geological survey of Virginia.

“*New Haven, October 26, 1842.*”

“Dear Sir—The specimens of green-sand and accompanying earths have, agreeably to your request, received my particular attention; and I now proceed to apprise you of the results at which I have arrived.

“Commencing with the mechanical analysis of the green-sand, I was not a little surprised to find that the green particles, when cleared by washing of a slight investment of clay, assumed the aspect of chlorite and green earth, and more rarely of grains of serpentine and fine scales of mica. The other ingredients of the earth were chiefly grains of quartz (some of which were penetrated by chlorite), and more rarely specks of garnet, iron pyrites, and what appeared to be yellow phosphate of lime. Fragments of shells, in a very decayed state, occur disseminated through the earth; and I detected also small teeth and bones of fishes. The proportions of the leading ingredients are very difficult to establish with precision; and after all my examinations I can only give them approximatively, and within wide limits. Thus, the quartz grains may be said to constitute from 60 to 80 per cent., the chloritic and micaceous grains from 10 to 15 per cent., and the fine clay from 3 to 5 per cent.

“Nothing is plainer than that the green particles possess the character here attributed to them; since they put on all the properties so common to chlorite, being sometimes in regular hexagonal plates, though usually in little granules made up of impalpable grains, which under the pestle easily separate, with an oily feel, into bright green specks. Subjected to acids and heat, it agrees with true chlorite.

“The existence of such a mineral in the present formation offers nothing remarkable in a geological point of view, since it may have originated in the decomposition of chlorite slate rocks, or of veins in primitive rocks (in which chlorite often abounds), and in both cases iron pyrites is its common attendant. Besides, it may have been derived from the metamorphosis of pyroxene, or from amygdaloidal traps, a source of green earth very often recognised in Europe and America. Indeed, chlorite (which is but another name for green talc) is often interchanged for mica, as an ingredient of primitive rocks, and is everywhere little prone to decomposition, being, on the whole, one of the most persistent of the simple minerals.

“Neither can it be objected that its chemical constitution is incompatible with the results obtained for green earth; for here we must bear in mind, also, that it is impossible accurately to separate the green particles from the mica, serpentine, and other ingredients with which they are associated.

“M. Berthier found the following composition in the green grains from the green-sand of Havre (France)—

Silica . . . . .	50.00
Prot oxide of iron . . . . .	21.00
Alumina . . . . .	7.00
Potassa . . . . .	10.00
Alumina . . . . .	11.00
	—99.00*

“Mr. Seybert found in that of New Jersey—

\* Geological Manual, by H. T. de la Beche, Phila., 1832, p. 255.

Silica . . . . .	49.83
Alumina . . . . .	6.00
Magnesia . . . . .	1.83
Potassa . . . . .	10.12
Water . . . . .	9.80
Protoxide of iron . . . . .	21.53
Loss . . . . .	89
	100.00*

“Prof. Wm. B. Rogers found in the green-sand of Virginia—

Silica . . . . .	51.70
Protoxide of iron . . . . .	25.20
Potassa . . . . .	10.83
Water . . . . .	10.
Magnesia, a trace. . . . .	

97.23†

“The foregoing may be taken as a fair exhibition of the composition of the green particles in green-sand; and the following analyses may serve to show the constitution of such chlorites and mica as may be presumed to be most analogous to the green substances in the earth under consideration.

M. Vauquelin found in the green-earth of Verona—

Silica . . . . .	52.00
Magnesia . . . . .	6.00
Alumina . . . . .	7.00
Protoxide of iron . . . . .	23.00
Potassa . . . . .	7.50
Water . . . . .	4.00

99.50‡

“Dr. Thomson found in the chlorite-earth, from the highlands of Scotland—

Silica . . . . .	48.166
Magnesia . . . . .	2.916
Alumina . . . . .	16.851
Oxide of iron . . . . .	19.000
Potassa . . . . .	6.558
Lime . . . . .	2.675
Water . . . . .	2.350

98.718§

“The composition of the most common silvery mica from Zinwald (Bohemia) was ascertained by M. Klaproth to be the following—

Silica . . . . .	47.00
Alumina . . . . .	20.00
Potassa . . . . .	14.50
Ox. iron . . . . .	15.50
Ox. manganese . . . . .	1.75

98.75||

“Having described the grounds on which I arrive at the conclusion that

\* American Journal of Science, vol. xvii., p. 277.

† Farmers' Register, vol. ii., p. 131.

‡ Shepards' Mineralogy, vol. ii., p. 225.

§ Idem, ii., p. 225.

|| Idem, ii., p. 41.

the green grains of this earth are chlorite, or chlorite blended with mica, and rarely specks of serpentine, I cannot but express the opinion, that as a mineral manure the efficacy of the green particles has been greatly over-rated. As these particles are very little liable to decomposition, their action, whatever it may be, must be slow, and, I should infer, nearly imperceptible. Indeed, I am rather disposed to regard its favourable operation, if indeed it has any, as flowing from a mechanical agency, after the manner of a clay, than as arising from the liberation of its potassa through chemical decomposition. Not that I would call in question the usefulness of the earth taken as a whole, for happily this is too well established. But when I find a decided content of sulphate of lime, with carbonate and phosphate of lime in addition thereto, together with distinct traces of organic matter, it appears to me unnecessary to look any farther in order to account for the phenomena in the case.

"I now proceed to state my method of examination, together with the results obtained.

"The specimens were kept in a dry room, exposed to air in shallow dishes, for several weeks; after which, portions free from crystals of sulphate of lime visible by the naked eye, and large fragments of shells, were heated in a platina capsule to 300°, Fah., in order to expel hygrometric moisture, and subsequently to low redness, to decompose organic matter.\* The organic matter is very inconsiderable, and was in no instances rigidly determined.

"Having ascertained by experiment that the iron-pyrites was not decomposable by tepid dilute hydrochloric acid, the following method was resorted to for the determination of the phosphate of lime. Two hundred grains of the triturated earth were suffered to stand (with occasional agitation) in contact with a dilute hydrochloric acid for three hours. The whole was then transferred to a filter, and the earth well washed thereon, with abundance of tepid water. The clear fluid and washings thus obtained were super-saturated with ammonia, and the precipitate subsequently digested in a warm potassic solution for the removal of the silica and the alumina. The per-oxide of iron and phosphate of lime now remaining, after being well washed, were treated with a cold, dilute acetic acid, whereby the phosphate alone was taken into solution. It was then precipitated by ammonia, dried, ignited, and weighed. Having found reason to believe that the proportion of finely divided phosphate of lime was pretty uniform in the different specimens of the green-sand, I was only at the pains to determine its exact proportion in specimen No. 1.† Having ascertained how much per-oxide of iron each sample contained, this amount was deducted from that yielded by the treatment of the same specimen with nitro-hydrochloric acid (aided by gentle heat), whereby the sulphuret of iron was decomposed. Thus the exact quantity of iron which was engaged by the sulphur (and consequently the amount of bi-sulphuret of iron) was ascertained.

"The carbonate of lime was determined in the usual way, viz., by treating the first obtained solution in hydrochloric acid with ammonia, whereby the

---

\* This last step was always attended with the extrication of a little sulphur.

† I will here observe that, by the process now described, it was ascertained that had the whole of the precipitate by ammonia from the hydrochloric acid solution been taken for phosphate of lime, it would have involved the error of an over-estimate of the phosphate by nearly 800 per cent.

silica, alumina, per-oxide of iron, and phosphate of lime were thrown down, leaving the lime and magnesia alone in a state of suspension. The former was precipitated by oxalate of ammonia, and subsequently the latter by phosphoric acid.

"The sulphate of lime was ascertained by boiling a determinate quantity of the green-sand in water until the whole of this salt present was taken into solution. The clear solution was treated with chloride of barium, and the sulphate of baryta ignited and weighed. The sulphuric acid present in the earth was thus arrived at, and, by subsequent calculation, the sulphate of lime originally present was ascertained.

"Sulphate of alumina (but no sulphate of iron) was found to exist, in traces, by the precipitation of alumina, occasioned on the treatment of the water boiled on the earth with ammonia. But in each case it was too inconsiderable for the determination of its proportion. Chloride of calcium (muriate of lime) was ascertained by treating the same fluid with nitrate of silver. Its proportion did not exceed that in which it exists also in common soils.

"Results obtained on specimens of green-sand earth from Coggins Point, James river.

"No. 1. From 8 inches within the exposed side of a ravine, where a stream flowed by, and 15 feet from the top of the green earth.\* [Middle part of stratum *D*, see page 465.]

Hygrometric moisture (lost at 300°) . . . . .	5.50
By heating to low redness, it lost in addition . . . . .	2.03
Phosphate of lime . . . . .	0.25
Carbonate of magnesia, in decided traces.	
Sulphate of alumina, in traces.	

"No. 3. Same as number 1, except from a deeper excavation.'

Hygrometric moisture (lost at 300°) . . . . .	4.600
By heating to low redness, it lost in addition . . . . .	2.200
Carbonate of lime . . . . .	1.560
Bi-sulphuret of iron . . . . .	8.066
Carbonate of magnesia and sulphate of alumina in traces.	
Phosphate of lime, about as in number 1.	
Sulphate of lime . . . . .	0.818

"No. 6. Three feet below the river beach [from pit, lower part of *D*, half a mile distant from preceding.]

Hygrometric moisture . . . . .	5.400
By heating to low redness, it lost in addition . . . . .	2.060
Carbonate of lime . . . . .	0.585
Bi-sulphuret of iron . . . . .	2.060
Sulphate of lime . . . . .	0.661
Carbonate of magnesia and sulphate of alumina in traces.	
Phosphate of lime as in number 1.	

"No. 9. See foregoing, page 465. This alone having sulphuret of iron visible in powder, or minute crystals; [taken from 14 feet below the beach, in *E*.]

\* This specimen was not thoroughly analyzed, and therefore the contents are reported but in part. The next (No. 3) was deemed the most important, and a more correct specimen of this layer (*D*), and therefore to it the examination of Prof. Shepard was especially requested, and was so directed. It is therefore that the contents of bi-sulphuret of iron, carbonate of lime, and sulphate of lime are not stated of No. 1, as in No. 3. E. R.

Carbonate of lime . . . . .	2.850
Bi-sulphuret of iron . . . . .	5.821
Sulphate of lime . . . . .	2.309
(Carbonate of magnesia not found.)	

“No. 10. Several thin layers of compressed shells, 1 to 3 inches thick”  
[contained in stratum E.]

Carbonate of lime . . . . .	56.00
Phosphate of lime . . . . .	0.84

“No. 2. [D] from 4 feet lower than number 1, was examined, with results similar to 1 and 3.

“No. 4. [D] from 4 feet below beach, and half a mile from number 1, was found to be rich in sulphate of lime and to contain bi-sulphuret of iron.

“No. 5. [D] ‘From another spot, and has since been exposed to the weather from last winter to June on the field where applied as manure.’ Is richer than No. 2 or 4 in sulphate of lime, but inferior to either in bi-sulphuret of iron. It likewise affords more sulphate of alumina than any sample examined.

“No. 11. The clay at 16 to 18 feet deep;’ [supposed when selected to be the poorest part of stratum E.]

Carbonate of lime . . . . .	1.45
-----------------------------	------

“It is rich in sulphate of lime, and has traces of sulphate of alumina, and bi-sulphuret of iron.

“It is to be kept in mind that in these analyses no account is taken of such sized crystals of sulphate of lime as readily meet the eye, or of large fragments of shells, the occasional presence of both which must often essentially enhance the gypseous and calcareous contents of these samples. The proportions in which they may occur at different depths and localities can readily be determined, however, by the practical agriculturist. The same may be said of the phosphatic ingredient so far as the teeth and bones of fishes are concerned.

If we assume the average proportion of bi-sulphuret of iron in these earths to be 2 per cent., and suppose the whole of the sulphate to become oxydized, it would give rise to 2.722 per cent. of sulphuric acid; to saturate which would require 1.905 of lime, and thereby produce 4.627 per cent. of (anhydrous) sulphate of lime. But 2.722 of lime would demand 3.888 per cent. of carbonate of lime in the soil. Now in the three analyses (Nos. 8, 6, and 9), made, the bi-sulphuret of iron, by average, equals 3.649 per cent., and the carbonate of lime in the same equals but 1.478 per cent.—a quantity too small for the saturation of the acid, even after a liberal allowance is made for the increase of calcareous matter from the occasional presence of large fragments of shells.

“It would therefore appear to be an obvious deduction from these inquiries, that dressings of lime, and especially of calcareous bands, like No. 10, should be employed in conjunction with the green-sand soil.

“Having now replied in the best way I am able to your various inquiries, I leave it for you to make such other practical inferences from the information afforded as in your more experienced judgment it may seem to authorize—and remain, very respectfully, your obedient servant,

CHARLES UPHAM SHEPARD.”

“EDMUND RUFFIN, Esq.”

The specimens numbered above 1, 2, 3, were from one locality, and of earth which was used as manure for clover of this year, on marled land, with effect as great as any ever known; and with no certain benefit on an adjoining space (also in clover), of the



same soil naturally, but not marled. Numbers 4, 5, and 6, were from the pit dug in the beach, half a mile distant, apparently similar to each other, and to the preceding specimens. All these are of the dark stratam (*D*) richest in green-sand (except the lowest, *E*), and all before rated by me as containing 50 per cent. of the pure granules. Professor Rogers stated the same to contain 60 to 70 per cent. (See *F. Register*, vol. ii., p. 750.) Even if leaving the green-sand out of consideration, and out of the estimate of value, there would still remain enough of active manuring principles to produce a large share (at least) of the beneficial effects which I have found from the use of this earth; and I have heard of but few other applications in Virginia, other than those made on Coggins Point farm, and of none with different or better *certain* effects. With the help of surplus carbonate of lime in the soil (furnished by nature or by previous marling or liming), 100 bushels of this earth, averaging in strength the ingredients of these specimens analyzed by Professor Shepard, would furnish nearly 5 bushels of pure sulphate of lime (gypsum); and 40 bushels to the acre would furnish 2 bushels of sulphate of lime. Not one of these specimens contained any gypsum visible to the eye; and but one specimen (number 9) contained any visible sulphuret of iron; and therefore these ingredients may be fairly supposed to be at least as abundant in the earth dug in any considerable operation. What the green-sand or any other ingredients may do in addition, I pretend not to estimate. But so far as I have learned from my own experience and all known experience of other persons, the whole operation of this earth, when used alone, is precisely of such kind as I would anticipate from gypsum, though yielding more of benefit in measure and value. Nor should I therefore be understood as placing a low estimate on the value of the effects produced. Since seeing the effects this year, and especially since having formed the opinion that the upper and exposed parts (most generally used formerly) are comparatively worthless and should be avoided, I count on much benefit being derived from this manure, and am desirous that it shall be largely used; as my son and partner, and the sole director of our farming, proposes to do for the next year's growth of clover. Still, I am now as far as ever from believing in or expecting such great and regular benefit as would be inferred to be certain from views and statements which rest upon the authority of the former geological surveyor of Virginia.\*

---

\* Professor Shepard, in the above letter, asserts the identity of the granules of "green-sand," with chlorite, or green talc. The proportions of the constituents of chlorite are far from being uniform; though the same kinds are usually found, in various proportions. Of these, magnesia seems to be always present. If so, may not this be an important manuring ele-

It may not be useless to note another point of recent resemblance between these two manures, both of which seem so capricious and uncertain in operation in general. This year (1842), the applications of the green earth on the Coggins Point farm, whether made in the beginning of the winter preceding, in March, or in the beginning of summer, have acted more quickly and powerfully than any known before. This I had ascribed to the earth being mostly obtained from deeper excavations. But I have lately heard, from Messrs. Hill Carter and John A. Selden, both extensive and experienced and successful users of gypsum, that they have never before known the good effects of that manure to be so remarkable as in all their applications of this year.

(d.) *Eocene green-sand marl.*

Except in the lower stratum exposed in the pit recently dug at Evergreen, this peculiar and valuable kind of marl has not yet been known to me in Virginia elsewhere than on and near the borders of the Pamunkey river; though there can be but little doubt that this or other eocene deposits are to be found elsewhere than within the limits here stated of the now known localities. It is more than probable that other rivers cut through and expose some of the eocene as well as miocene deposits; and that deep diggings would reach them also in the intervening high lands. The Pamunkey eocene formation is seen first, or exposed most south-eastward, at North-bury in New Kent county; and it is found (either as marl or gypseous earth) on nearly every farm above, to South Wales, in Hanover, the farm of Mr. William F. Wickham, just below the junction of the North Anna and South Anna rivers, and on North Wales, the farm of Mr. Williams Carter, across the Pamunkey, in Caroline county. This distance in a straight line is about 22 miles; and

ment of our green-sand earth, as well as that of New Jersey? Cleaveland gives the following contents of three different kinds of chlorite, ascertained by different chemists:

Chlorite—analyzed by	Vauquelin.	Klaproth	Hoepfner.
100 parts consisted of			
Silex . . . . .	26.	53.	41.15
Alumina . . . . .	18.5	12.	6.18
Magnesia . . . . .	8.	3.5	39.47
Lime . . . . .	0.	2.5	1.5
Oxide of iron . . . . .	43.	17.	10.15
Muriate of soda and potash . . . . .	2.	0.	0.
Water . . . . .	2.	11.	1.5
	99.50	99.	99.90

Vauquelin found a specimen of common tale to contain 27 per cent. of magnesia.—*Cleaveland.*

the very winding course of the Pamunkey serves to make the exposure of the bed of marl show an average width of three or more miles. Throughout this area, it is found in great abundance at numerous points—though of great variety of appearance and of value at different elevations, and in very different degrees of access, or ease of working.

This marl everywhere has its calcareous portion (which is usually small in comparison to good miocene marls) intermixed with a large proportion of green-sand. The calcareous earth varies from 10 to 40 per cent. at different diggings, or different layers at the same locality; and the green-sand perhaps from 10 to 30 per cent. as estimated by the eye. In some places, the one ingredient predominates in quantity, and elsewhere the other. No one specimen has been found rich in both of these ingredients.

There are various and very different kinds of earth, if considered in reference to their chemical constitution and qualities, and values as manure, which together make up this extensive area and great depth of the eocene formation; and all of which varieties, however different, have in common been deemed and termed marl by the people of the neighbourhood. That all these various earths belong to the same eocene formation is evident from the fossil remains, or from other as certain proofs where there are no such remains visible. The principal and most notable of these different earths will be here described.

The most extensive exposure of calcareous marl, which I will designate as L, (and embraces beds 4 and 5 in the profile view, which will be hereafter given), is along the river for five or six miles in a straight course, above and below Newcastle ferry; and a very much longer course, if following the crooked course of the Pamunkey. This marl is more than 24 feet thick at Clifton, the farm of Mr. J. W. Tomlin, next below Newcastle ferry. From that locality, it becomes thinner in the extensions both up and down the river. At two miles above the thickest part, it gradually thins out to nothing, in Marlbourne farm (my own property); and before reaching the nearest outline of Marlbourne, this marl (L) is barely 2 feet thick, and not worth for use the cost of removing the overlying drift or other earth. This marl and all the other accompanying beds, are inclined; the dip being towards the east or south-east. The ancient flood proceeding from the north-west had washed away the highest raised western parts of all these beds, and reduced them to their now nearly horizontal surface; and this ancient "denuding" action is the cause of this marl, and the other beds, successively thinning out at the surface as proceeding up the river.

This most extensively exposed body of marl is of four principal kinds, without noticing some less important differences. The lower 6 or 7 feet of its thickness ( $x$ ) and which includes all of 4 in the

figure, except the black line at bottom), is the richest in calcareous matter, and much the best as manure. This is mostly of compact and uniform earthy texture and appearance—of dark gray colour, with a greenish tint in some cases. The shelly matter, for the greater part, is finely reduced, the fragments being generally so small as not to be obvious to the sight. But few shells, mostly of the harder gray kinds, remain entire; and of these, the saddle oyster furnishes nearly all of the perfect and still very hard specimens. Near to the bottom of this layer the marl is somewhat softer and poorer, and yet the entire though very soft shells are there numerous. This marl (*x*) contains from 35 to more than 40 per cent. of carbonate of lime, on an average.

Above this richer part (*x*), the marl (marked 5 in the figure) is softer, and in some degree admits the slow penetration of water, to which the other marl (*x*) is a perfect barrier. In other respects this (*y*) appears to the eye very similar, and not less rich in calcareous matter than that below. But in fact it does not contain more than proportions varying from 30 to as little as 11 per cent., and usually becoming poorer as nearer to the top of this layer. This marl (*y*), more generally than the richer below, I have found to contain finely divided sulphuret (or bi-sulphuret) of iron, as does the gypseous earth of James river, and also the gypseous earth of Pamunkey. This combination of sulphur and iron, when exposed to air, changes gradually to sulphate of iron (copperas); and this last, and the carbonate of lime of the marl, decompose each other, and one of the new products is sulphate of lime (gypsum), in place of proportional quantities of the decomposed copperas and shelly matter. This process has doubtless been proceeding for ages in the bed, though very slowly for want of air; and has served to remove much of the formerly existing shelly matter—which was first thus changed to sulphate of lime, and this soluble substance was then mostly carried off by the slowly percolating water. This decomposition and subsequent removal of the lime also served to make pervious the before compact and impervious marl, and thus permitted more easily the progress of further decomposition and removal of the former calcareous portion. However much of the produced gypsum has been thus slowly dissolved and removed, there is still a considerable proportion remaining. Thus, this part (*y*), especially, not only contains a notable proportion of gypsum before formed by this process, and not yet removed in solution by the slowly percolating water—but there is also generally present (in *y* especially), more of material, in the as yet undecomposed sulphuret, to form more gypsum hereafter. I infer that this mode of conversion of part of the carbonate to sulphate of lime has served to more or less diminish, and in some layers to remove entirely, the considerable amount of carbonate of lime formerly contained. More

carbonate must be so changed to sulphate of lime, after any marl which still contains sulphuret of iron, is applied as manure. The exposure to air (and attraction of oxygen) will soon convert the yet remaining sulphuret to sulphate of iron; and this will immediately act on the carbonate of lime, in contact, and so form sulphate of lime. This proportion of gypsum, either ready formed, or soon to be formed, making altogether from 2 to 6 per cent. of the marl, is one of the main sources of the early (but, as I anticipate, transient) fertilizing effects of this and other varieties, which are poor in calcareous matter. The long continued action of the sulphuret of iron (which seems to be still generally present, and may be inferred to have been universal at first in all the beds) is sufficient to account for the partial or total disappearance of shells, and of carbonate of lime, in nearly all these layers of the one great eocene bed of marl and gypseous earth, both of Pamunkey and James river.

A third variety (*u*) exists but in few places, and on the northern side of the river. It is the highest of this whole calcareous bed—is dry and yellowish (being nearly or quite destitute of green-sand and organic colouring matter), and though as rich in carbonate of lime as the average of the whole stratum (and richer than all *y*), it is much inferior in fertilizing effects, at least for some years, and as long as they have been separately observed. It may be inferred that this light-coloured marl is not only without the potash (which green-sand contains in small proportion), but also without gypsum; and, like nearly all miocene marls, acts only by its carbonate of lime.

A fourth variety (*x*) is the universal thin bottom layer of this calcareous stratum (and below *x*—represented by the broad black line in the figure), which forms a continuous layer of separate stony lumps, like a pavement, and varying from 6 to 15 inches thick. These stony masses contain 60 per cent. or more of carbonate of lime. Being difficult to dig, and to raise, this layer is usually left by most marlers. On account of its greater richness, I deem it the most valuable for its quantity. In a few years after being ploughed under the soil, most of these lumps are softened enough to crumble.

These several layers of this one general calcareous stratum constitute the marl mostly used in latter years, by the marling farmers of this neighbourhood. My own use has embraced all these varieties, but was mostly of the more compact earthy marl (*x*), as that was in greatest quantity.

Another bed of rich calcareous marl (*M*), is exposed for the few miles of the most western extremity of the general eocene formation, in the farms of South Wales in Hanover, and North Wales in Caroline county, and extending nearly to the lowest part of the

granite range, which makes the falls of this and other rivers. This marl is darker coloured (nearly black in the bed), and apparently richer in green-sand than the former kinds, and also nearly as rich as the best ( $x$ ) in carbonate of lime. I found of this bed, in different specimens selected by myself from the pits of Messrs. Wm. F. Wickham and Williams Carter, proportions varying from 32.50 to 44 per cent. This kind also contains some finely divided and diffused sulphuret of iron; and consequently, gypsum, if not already present (as I infer is always the case), must be formed from the changes of the sulphuret after the application of the marl.

This bed, though lying the highest, where exposed, in its present level and elevation, is the lowest in order of all the different beds of this great eocene formation. Below it is a bed of gravelly sand and rounded pebbles, without any appearance of fossil remains, or marine deposition.

For some 12 miles (if in a straight line, but following the much longer course of the river), and stretching from the final thinning out of the marl ( $x$ , or 4), in Marlbourne farm to the first appearance (of M, or 1) in South Wales, the whole interval is filled by different layers and kinds of green or gypseous earth. The general appearance is much like that of Coggins Point, before described, but generally containing some little admixture of shells. For a considerable part of this exposure, this gypseous earth is as destitute of shelly matter, and as deficient in other fertilizing matters, as I have found, or supposed, to be the upper or exposed parts of the James river gypseous earth. In some layers there is enough of shelly matter to make from 2 to 5 per cent. of the mass. Also there are some bands of a few inches thick only, quite rich in shells. In other places, there is no carbonate of lime; and although some gypsum and less potash must be present (as in general of all these eocene beds), this poorer earth (miscalled "marl") has been found, when used as manure, of little effect, and less profit.

Overlying all the exposed upper marl and green earth of this whole eocene formation (and also extending south-eastward over the nearest miocene) is an unconformable layer of variable but always small thickness of what is here known as "olive earth," from its greenish brown colour. (It is designated by the broad irregular band  $o, o$ , in the figure.) It varies from a few inches to 4 feet of thickness—is not uniform in texture—but usually very adhesive (as found wet in the bed), and difficult to remove. My observations have satisfied me that this earth was formerly marl, or rather a mixture of all the different layers of marl and green earth now below, which after being washed up by the violent current of the ancient denuding flood, was, during a cessation of the greatest violence of the current, deposited over the whole before denuded and then bare surface. Subsequently, the violence of the

current was renewed, and with it were brought and deposited the layers of drifted pebbles, sandy gravel first, and next sand, which now overlie all the olive earth and eocene formation. This lower sandy gravel is ferruginous, and everywhere supplies ferruginous spring-water, and probably the impregnation being partly in the form of sulphate of iron. Both the sulphates of iron and of alumina are sometimes perceptible to the sight and taste, in these strata. The slowly oozing spring-water thus bringing either of these salts of sulphuric acid, must gradually decompose any carbonate of lime in contact. And hence, the higher deposit of what is now olive earth, being permeable by water, has had all its former carbonate of lime changed to gypsum, and this, in solution, mostly removed by the water passing off. If these suppositions are correct, the olive earth ought still to contain all that it did formerly, when it was marl, except the carbonate of lime; and with some increase of sulphate of lime. Hence, this earth ought to have more or less of fertilizing value—and enough to be worth using, especially as its very laborious excavation and removal have always to be effected, for the purpose of reaching the marl below. But it was universally believed that the olive earth was useless; and it was put to no use, not only by those farmers who had good marl below, but by others who encountered all the labour of uncovering, and removing this sticky and troublesome layer, to reach merely the gypseous earth below, probably worth no more than the olive earth, except for its very small proportion of carbonate of lime. While I drew marl from other land to my present farm, the distance was too great for me to try this olive earth as manure. But since I have (very lately) discovered good marl, of workable thickness, on Marlbourne farm, I have carried out all the overlying olive earth, though it is more sandy here than is usually found. I had begun this course before having heard of any useful effect of such application. But since (in the summer of 1852), I have learned very remarkable effects of other (and probably much richer) olive earth, as tried by two neighbouring farmers, Messrs. Henry Jones and John Beale. The most accurate and conclusive of these trials (though all were very beneficial) was an application of this earth alone, 400 bushels to the acre, on stiff and poor (long exhausted) land. The application was made for the corn crop of 1850, and produced not much, if any, perceptible effect. The benefit was much greater, though still small, on the succeeding crop of wheat. But of the next following clover, which I saw in May and June, 1852, the growth was more luxuriant than any on the richest other land; and the effect of the olive earth alone, was greater on the clover (as compared with adjacent ground without this or other dressing) than from marl, with its unquestionable accompaniment of gypsum, or other manure elsewhere on similar lands of this

neighbourhood. Still, I believe that gypsum is the principal manuring principle—and that these wonderful effects will therefore be confined mostly to clover (or other leguminous plants), during its temporary action. The remains of bones and teeth also are more numerous in this olive earth (immediately above the marl) than anywhere lower; and hence this layer, apparently, is better supplied with phosphate of lime—a manure of very great and peculiar value for other crops, and especially for wheat.

All these different beds, or thinner layers and varieties, of this great eocene formation, except the high yellowish layer (*u*), contain either a considerable or a large proportion of green-sand—and of course some little potash—which, as chemists inform us, is a universal though small proportion of green-sand. Also, from the very general indications either of white and tasteless efflorescence, or of manifest sulphuret of iron, or both, I infer that gypsum also is a very general, if not a universal ingredient, to some amount.

Until within the few latter years, all the various layers and qualities of the whole eocene formation, were confounded in common understanding and parlance, through this neighbourhood, under the one name of “marl.” The green or gypseous earth was used indiscriminately with the calcareous marl, by those proprietors who had both exposed by the same excavations, without their looking for or observing any difference of operation. The existence of this strange error, and its general continuance (in this neighbourhood) for eight or ten years, can only be accounted for by the following circumstances: The two different layers were generally obtained in the same excavations, and were more or less mixed in use—and never kept entirely separate for experiment: The soils (of Pamunkey low-ground) being mostly or nearly neutral, did not exhibit much effect from marl on the earlier grain crops, (as acid and much worse soils would have done—) and when clover followed, the great benefit which that crop always received from the large quantity of gypsum in the green earth, even if with very little admixture of calcareous matter, would make nearly as much show on that crop as the marl alone. And before these early and transient benefits of gypsum would be ended, perhaps another slight dressing of marl would be applied, or some other treatment which would help to conceal the respective operations of these different manuring earths.

But more lately, no farmer of this neighbourhood has deemed the green earth worth applying as manure, if he could obtain marl. Still, some who have easy access to the former only, have begun its use within the last few years, and so far, they report encouraging results—which the gypsum, with very little shelly matter, can furnish for a few years. And so inveterate is established error, that some other farmers, even to this day, would



prefer a green-sand marl, however poor in carbonate of lime, to any miocene (or other) marl thrice as rich in the latter and all-important ingredient, but destitute of the misunderstood and therefore highly prized green-sand. This erroneous view is the result (and the only abiding result to agriculture known to me) of the statements and instructions of the late geological surveyor, and his exaggerated and unmodified panegyrics on the asserted value of green-sand as manure—the “discovery” of which in Virginia was claimed as his own, and cried up as the greatest possible benefit to agricultural improvement. Yet still (and long before that gentleman had either written about green-sand, or seen so much as a hand-specimen), my own use of this earth alone, far exceeded in quantity all other applications in Virginia, and has only since been exceeded in amount by the later applications of my son and successor on Coggins Point farm; and no user of it has yet been rewarded for his labour, from any possible effects of the green-sand *alone*. All the *appreciable* and known benefits have been produced by the gypsum, or the carbonate of lime, or both, used generally in conjunction. Where neither of these aids was present, either in the manure or the soil, I have never yet heard of a profitable use, in Virginia, of the earth having no manuring ingredient save the green-sand. Still, I do not deny that it may be valuable—and should be much gratified and greatly profited as a farmer, to be assured that such value and profit as have been claimed for this earth are indeed available. In my own extensive trials of the green earth of James river, and the still more extended and more beneficial recent applications on my former property, by the present proprietor, there has been no effect found that could be ascribed to green-sand, or to its potash—or to anything but the gypsum, and that only on either marled or naturally calcareous or neutral soil. And in the much more extended practice of my neighbours on the Pamunkey, who have largely used this earth as marl, but almost always more or less intermixed with some carbonate of lime, there is nothing in the known effects which would go to contradict the opinions on this subject which I have here concisely, and formerly at greater length, expressed. It is important to know all the value of this earth as manure, and to avail ourselves of it fully; but to do that, it is essential that the true source of the beneficial operation should be known, and that the delusion produced by the influence of scientific but undeserved authority, should end, as it surely will, soon or late.

The occurrence of the very different appearances and qualities of this formation, as found by digging, or in the natural exposures on the river banks, has been generally deemed altogether irregular and subject to no rule of position. Hence it was supposed that the

finding of marl, by boring in places where the existence was not before known, and the variety or quality of whatever could be so reached, were matters of chance. Of course all searches for marl, by boring, were directed by no rule except that of selecting surfaces of low level. And this one object was mistaken, and would often cause the concealed marl bed to be missed by borings made in its close neighbourhood. For if in land of alluvial formation, the ancient flood most generally had swept off all the previously existing marl, and the vacancy so made was afterwards filled by either the succeeding drifted earth, in part, or entirely by still later alluvial deposits.

But if proper attention is given to the general dip of the whole formation, and the succession of the different layers, as exposed naturally, and nearer the surface, or to some extent in perpendicular cuts and excavations, there may be found reliable indications of the position of each layer in other places. With the aid of this guide it might be generally known, in advance of all searching, and for miles of surface upon which the seeker for marl had never trod, whether and where marl would probably be found, and of what quality, and where there would be none worth working.

This very thick formation, or bed of many layers of different qualities, as has been stated, has a general dip to the south-east, or down the general course of the river. In the opposite direction, up the river, or as proceeding north-westward, all the layers, (unless running out earlier,) in succession, rise above the level of the river; and consequently, each of these layers, in succession, becomes the upper one at some locality, and is there the first and perhaps the only one to be reached by digging. And as the ancient flood had, by its denuding action, washed away all these raised edges of layers, and so made a new surface approaching to horizontal, it follows that each layer, after appearing as the highest and most accessible at some place, thence thins out as proceeding westward, until that layer disappears, and the next one in order, below, becomes there the highest and most accessible layer. The figure of the following section, though for much the greater part conjectural, will serve for better explanation, and may serve to indicate, either as to this or other beds and localities, how to direct searches for concealed marl, with the best prospect of success, and to avoid the loss of useless examinations. The supposed surface line is designed for the southern side of the Pamunkey, and the eocene beds (and overlying miocene also, in part) where exposed nearest to the river. The inclination of the dip, and also the perpendicular distances, are both greatly magnified in proportion to the horizontal distance, for the purpose of making the successive layers more distinct, and of bringing the whole extent of surface within convenient size.

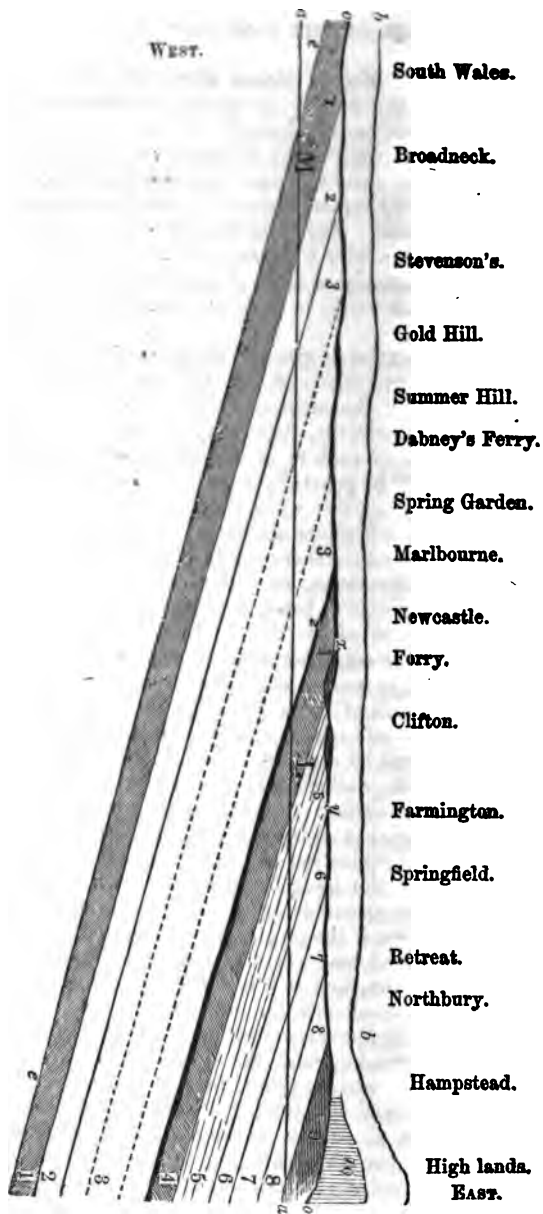

*Explanations of profile, or perpendicular section.*

- a, a*, Level, or surface of Pamunkey river—air-line between extremes of section, 26 miles.
- b, b*, Surface of land, "second low ground" nearest to river.
- 1, 1, The lowest, and 8, 8, the highest bed of the whole eocene formation, of marl and gypseous earth of various kinds.
- o, o*, Layer of olive earth laying on the raised and denuded ends of lower beds, forming the present upper surface of the eocene formation.
- e, e*, Sandy gravel and rounded pebbles, lying beneath the lowest eocene bed.
- 1, 1, Lowest bed—rich marl, rising above river and exposed at South Wales.
- 2, 2, Green or gypseous earth, without calcareous matter.
- 3, 3, 8, 8, Green or gypseous earth beds, with very small and variable amounts of shells, either in thin bands, or very slight general admixture. All poor as manure, and mostly not worth using. More shelly, and richer otherwise, where highest and next to
- 4, Lower and richer part of the upper calcareous beds of the eocene, (designated as *L* and *x* and *y*), in foregoing general description, stony layer (*z*) at bottom.
- 5, Upper and softer part of the good eocene marl—poorer in calcareous matter, and containing bi-sulphuret of iron, generally.
- 6, Green or gypseous earth, with some calcareous matter—or poor marl.
- 7, Green earth, destitute of calcareous matter, and worthless as manure.
- 8, Green earth, with some calcareous matter, or poor marl.
- 9, Miocene marl of Hampstead, lying immediately on the eocene bed.
- 10, Ordinary miocene marl, lying higher than the Hampstead bed.

The various beds of this formation, in regard to extent, succession, and particular qualities (as before intimated), are represented mostly upon conjecture. Even of the actual exposures above the water-line (*a, a*), I have seen but a small extent; and, of course, as to what is below the depth of actual excavations and the river, all rests on conjecture, or reasoning from analogy. Neither is it designed to be conveyed that the different strata or layers preserve the regular proportions of thickness, as represented in the figure. On the contrary, it is more usual for each different layer to vary much in thickness, in a long stretch of distance, and in some cases to "run out," and come to an end. Still, after making due allowance for all such sources of uncertainty and error, this figure, and the judicious deductions which every reader may make for the features of his own locality, may be of great use in searching for the richest layers of marl, and still more in avoiding such labour when certain to be disappointed. According to this conjectural section, if it were possible and useful to sink a shaft, or boring, deep enough on the most eastern point exhibited, every separate layer or bed would be reached in regular succession. It might be as low as 300 feet or more—but at some depth it is probable that the rich marl (*M.*) now only known (and accessible) at the north-western extreme, could be reached under the south-eastern, or more than twenty miles

distant. But omitting such merely speculative matters, there are practicable and profitable operations to be based on the knowledge of the succession and dip of the strata. Thus, when the existence of rich marl is known in any point, and its depth, it is almost certain that it will thin out towards the north-west, and either thicken, or maintain its then thickness, as proceeding south-eastward. On land north-westward of the disappearance (at top) of a rich bed, (as 4), and however near, it would be in vain to search for the like. The boring for any practicable depth on most of the river land of Marlbourne (for example) could reach only the poor beds exposed at the surface for some ten miles, including the beds marked 3 and 2, perhaps, also. But on land south-eastward, and near to the surface exposure of any rich marl, it might be expected to reach the like at some greater depth. The lowest eocene marl which I reached by sinking the pit for examination 25 feet below tide on Evergreen (described p. 462), and which must have been near to the bottom of the lowest bed, exhibited the same peculiar appearance, and some of the peculiar fossils, which are also to be seen in (M) the lowest of the Pamunkey layers, and at an exposure thirty miles distant. In no other localities had I seen either the same appearance of marl, or the same rare shells, as some of both common to these places only. In the much deeper pit sunk for examination on Coggins Point (p. 465), though the rising of water at 49 feet prevented deeper digging, the fossils then reached indicated the near approach to the same lowest marl found at less depth at Evergreen, and exposed much above the river at North and South Wales. Hence, it may be inferred that this lowest and very peculiar bed of this great formation, as well as the formation generally, is continuous under all this broad surface of territory.

Many specimens of the marl and gypseous earth of the Pamunkey beds, were made partially red hot, for the purpose of showing whether sulphureous fumes were so disengaged, as was stated on a foregoing page (460) to be the case with most specimens tried of the James river gypseous earth. This result was obtained in all of sundry trials of the gypseous earth (3) below the marl (4)—in the marl at South Wales (M), and in some cases, but not generally, of the richer marl 4. In the still higher and poorer marl (5), which I lately have excavated extensively in the Clifton bank, the sulphureous fumes were obtained in every trial. A specimen of marl from Pipingtree, and many specimens of the gypseous earth (upper part of 3) from Newcastle ferry, Newcastle farm, and from Marlbourne, all gave out these fumes. Sundry other specimens of calcareous green-sand marl which were thus treated, yielded no fumes. The latter results were found in specimens from the several diggings at Newcastle (both sides of the river), and at Mr. G. W. Bassett's bank, Farmington. It may not be useless to repeat here,

and thus to place in connexion with these results, that all the dark green or blackish earth (*D*) of Coggins Point gave out these suffocating fumes, and also the gray clay (*E*) below, and most powerfully—and that no such product was found from any of the very shelly bands. Thus it would seem that most generally the non-calcareous earths (or nearly non-calcareous) gave out fumes, and the calcareous not. But exceptions were found to both. And of the New Jersey green-sands, containing no carbonate of lime, six specimens were tried at red heat, of the beds most esteemed for manure, and not the slightest disengagement of such fumes was produced.\*

This extrication of sulphureous fumes by the first beginning of red heat, is a sure indication of the presence of sulphuret (or bi-sulphuret) of iron. And wherever this exists in contact with marl, and with the access of air and water, first the sulphate of iron will be formed, and next this salt will decompose as much carbonate of lime as its quantity will act upon, and so form gypsum. Therefore, wherever the sulphuret of iron is present in marl, or is put in contact with it, in soil, it is certain that, in the same proportion, carbonate of lime will be decomposed, and sulphate of lime formed. Of course no addition of other gypsum is needed, or could act if applied, on land recently supplied, in marl, with enough sulphuret of iron, even if the partial previous decomposition of the latter had not already formed gypsum in the bed of marl, as is usually the case.

#### *Of Green-sand as an ingredient of Miocene Marls.*

In a previous page (439), the presence of green-sand in miocene marls, as an important and general ingredient, was denied; and the subject then passed by, with the promise of its being subsequently resumed. Having treated of the gypseous earth and of eocene green-sand marls, of both of which green-sand forms large and important proportions, it is now most appropriate to inquire into the alleged extent and operation of this substance in miocene marls.

In 1834, Professor William B. Rogers (then and long before a resident of lower Virginia) announced that he had discovered green-sand to be a considerable ingredient of nearly all the many ordinary miocene marls which he had examined either in place or by specimens; and from which observations he inferred the same admix-

---

\* The New Jersey "marls" thus tried were selected by the writer from the pits of Josiah Heritage and Thomas Bee of Gloucester, and Henry Allen, Allen Wallace, J. Riley, and J. Cauley, Salem county. The same results were found as to the poorer (or less valued) overlying strata of Heritage, R. Dickenson, J. Cauley, and also of the barren green clay or sub-soil. See all described in my report, on the New Jersey green-sand earths, *Farmers' Register*, vol. x. p. 429.

ture to be general as to other miocene marls; and that the proportions of green-sand so contained were large enough to form useful additions to, and in some cases the most valuable portion of the manuring ingredients of such marls (*Farmers' Register*, vol. ii., p. 129). At a later time, he added to like general opinions and statements the following: "In some of these deposits [marl beds in the vicinity of Williamsburg], so large a proportion as 30 and in some specimens 40 per cent. [of pure green-sand] has been found; and in cases like this, if we are to trust to the experience of New Jersey, a very marked addition to the fertilizing power of marl must be ascribed to the presence of this ingredient." (*Farmers' Register*, vol. ii., p. 747.) In a subsequent communication to the Philosophical Society of Philadelphia in 1835, and again in the first report of the geological survey of Virginia, the material parts of the above statements are re-asserted, in substance, and nearly in the same words. These statements and opinions were received, when announced, as undoubted, and they have not since been questioned in any publication; nor have they since been either confirmed by any additional proof or testimony, nor have they, in direct terms, been modified or retracted by their author. Yet the correctness or incorrectness of the assertion of such abundance and general diffusion of green-sand in the miocene marls of Virginia is a matter of great interest; and, in its bearing on the application of marl and the rationale of its operation, of great importance to agricultural improvement. It is certain that to this day [1842], many proprietors consider that their marls are peculiarly valuable because of the supposed large proportions of green-sand therein; such opinions being founded either on the publications, or, with still more confidence, upon the personal examinations and verbally expressed opinions of the former state geologist.

My own personal examinations of marls in place, and analyses of specimens of other beds, have been very extensive; and my attention has been given especially in regard to this point to sundry specimens, including several of the particular bodies of marl which it is understood that Professor Rogers had pronounced to be very rich in green-sand—containing, say, 20 to 30 per cent. of the black granules so called. I have found some green-sand (but generally in very small proportion) in nearly all the specimens examined particularly for this substance; and believe that Professor Rogers was correct so far as inferring that it is a very frequent ingredient. And for the first observation of this curious and interesting fact he is justly entitled to the entire credit. To such extent as green-sand is present, and according to the manner of the operation of that earth (whatever that may be), the green-sand in the miocene marls must be effective and useful. But whether such effect be of any distinguishable and appreciable value, or not, depends on the quan-

tity and proportion of green-sand in the marl; and, so far as all my experience and observation enable me to judge, I cannot but believe that the above stated estimates of quantities and proportions of green-sand are greatly exaggerated, and extremely incorrect and delusive. I do not mean to assert, and cannot be expected to prove, the *negative* of the assertion of such abundance of green-sand. But, from all my means for arriving at conclusions, it is my confident belief that but few of the bodies of miocene marls in Virginia contain as much as 2 per cent. of green-sand—if even as much as 1 per cent.; and that an average proportion, throughout any considerable digging for manure, of as much as 5 per cent. of green-sand is extremely rare. With but a single peculiar exception, which will be described presently, the largest proportion (estimated by the eye) that I ever found was supposed to be 5 per cent.; and that was in a very peculiar marl, found at Coggins Point farm and elsewhere in that neighbourhood, or rather a loose calcareous sand, which forms the overlying layer of a compact blue marl. This sand contains only about 20 per cent. of finely divided shelly matter, and the whole mass would appear, to slight observation, similar to, and as poor and as loose, as the deep sands of the roads through a sandy country. But few persons would have used this sand for manure, or would have dignified it by the name of marl. However, the ease with which it could be worked, and the necessity for removing it to uncover the better marl below, induced me to carry out and apply it as a second dressing to an adjacent part of a field which had been just before marled from the richer blue layer. The effects were so marked, and so superior to the single marling, that I was ready to believe that the green-sand caused the difference. The loose calcareous sand mentioned at page 443, which one of my neighbours supposed (from its good effects) to be rich in calcareous earth, is precisely like mine in general appearance, and in position in the bed; and appears to have a like unusually large proportion of green-sand, which no doubt served to produce some small part of the benefit which was ascribed wholly to the carbonate of lime. This peculiar deposit furnishes the only cases known to me of any ordinary miocene marl (if this loose sand can be so termed) being rich enough in green-sand for the benefit from the latter to be known. And even this benefit would not have been distinguished or suspected, but that the poverty of the earth in calcareous matter required it to be applied very heavily. The much thicker body of compact marl, lying under this poor calcareous sand, contains (by supposition) not so much as 2 per cent. of green-sand.

But it is true, that when attention was not particularly directed to green-sand, proportions not exceeding 5 or 6 per cent. might have escaped the notice of one who had handled and examined the specimens of marl, or who even analyzed them, merely with a



view to their proportions of calcareous matter. But proportions so large as 40, 30, or even 20 per cent. of green-sand could not thus escape even careless and superficial observation; for even the smallest of these proportions would give a very manifest greenish or gray tint to any otherwise light-coloured marl. Knowing the great uncertainty of the guessings at proportions of green-sand naturally intermixed with marl or other earth, I did not rely on them except as to the absence of any very large proportion. For more accurate testing, the clayey parts were washed off in water; in others the calcareous parts were also removed by weak acid. And for still better means of judging by comparison, I mixed together, in different and known proportions, measured quantities of light-coloured marl (such as are all those about Williamsburg), and pure green-sand prepared by washing some obtained from the richest beds in New Jersey. And of such artificial compounds, examined by the eye both when dry and in powder, and wet, and also after being again dried in mass, the admixture of green-sand, even when as small as 10 per cent., was obviously more abundant than in the miocene marls reputed to be among the richest in green-sand. Under these circumstances, without denying the possible existence of such cases, it is proper to wait for and to require further proofs of assertions of such large proportions as 20 to 40 per cent.

But there is much better support for my position, of the general scarcity of green-sand in miocene marls, than any proofs, positive or negative, that I can adduce, presented by Prof. Rogers himself, in his "Report of the Progress of the Geological Survey" for 1837. He therein gives a tabular statement of 148 specimens selected by his assistants, and their analyses made under his own direction. It is to be presumed that so many specimens, and thus obtained, must present a fair and correct average of general quality of the marls of the region in which they were found; or at least that their contents would not be too little favourable to the geologist's preconceived opinions, or assertions. The specimens were from eighteen counties, viz.: Lancaster, Westmoreland, Richmond, Northumberland, King George, Mathews, Middlesex, Gloucester, King and Queen, King William, Essex, Isle of Wight, Nansemond, Elizabeth City, Surry, Prince George, James City, and Warwick. Of these 148 specimens, of one only (S. Downing's, Lancaster) is the quantity or proportion of green-sand stated with any approach to precision. This is said (no doubt by *guess*) to contain "10 or 12 per cent. of green-sand," and only 17 per cent. of carbonate of lime. Of five others, the green-sand would seem to be in notable quantities, but as no numbers or proportions are named, it may be inferred that the proportions were deemed less than the one just stated. These five are described as follows, in regard to this ingredient: Callahan's, Lancaster, "large grains of green-sand in considerable quan-

tity;" Gloucester Town, "richly specked with green-sand;" Saunders', Isle of Wight (one only of three strata), "considerable green-sand." Stith's, Surry, "quite richly specked with green-sand." A. C. Jones's, Surry, and at Kingsmill, James City, "intermixed with green-sand." Now what proportions these descriptions designate, it is not for me to determine; but 3 or 4 per cent., at most, would abundantly serve to meet all their requisitions. There are also 7 other of the specimens named marked in less degrees by the presence of this ingredient, and which are described in this respect in such phrases as these: containing "a little green-sand"—"specked with green-sand"—"quite perceptibly specked with green-sand"—"tinged with green-sand"—and "slightly intermixed with green-sand." There remain of the list 135 other specimens, of which 48 are stated to contain of "green-sand a trace" (by which term chemists understand a proportion so small that its presence is barely certain), and of the other 87 specimens no green-sand is mentioned, and therefore it may be inferred that not even "a trace" could be found.

If this list of marls and statements of their fertilizing contents had been presented by the author distinctly as a designed refutation of his previously and repeatedly published assertions of the frequent abundance and general presence in useful quantity of green-sand in miocene marls, nothing could have been more to the purpose, or more conclusive.

Nevertheless, few and rare as may be the cases in which the value and beneficial effects of miocene marls are increased in any considerable degree by the presence of green-sand, or of any other ingredient than carbonate of lime, it is important that such auxiliary fertilizing matters should be searched for, and their absence or presence known. The great value and uniform fertilizing effects of *carbonate of lime* will be the most highly appreciated by those farmers who understand and estimate them separately and alone; without confounding the operation of that manuring earth with those of any other intermixed and unknown substances, no matter what increase of benefit such intermixture may produce in particular cases.

---

Some years after the publication of the first edition of this Report (as originally made to the State Board of Agriculture of Virginia, and published, with other reports, by order of the legislature), I learned that a particular bed of marl, worked at Hampstead in New Kent, and more lately found and now worked both at Oak Spring and Liberty Hall, in King William county, furnished an exception to the general rule above asserted, of the absence of any large proportion of green-sand in miocene marl. This particular

bed has been found (by boring) on both sides of the Pamunkey river, near to and in the same general range with the cocene bed, and within a mile of two different excavations of cocene marl, a gypseous earth, in different directions. Further, this Hampstead marl contains apparently as much green-sand as the neighbouring cocene bed; and there is no obvious difference in the texture, colour, or general appearance of the two kinds. When I first visited this locality (May, 1842), the digging had been suspended, and the pits were full of water; so that no marl or shells could be seen in the bed. My examinations therefore were limited to heaps of the marl which remained unsprayed upon the field. I was surprised to find all of the few shells which met my eye in this imperfect view, of species such as were unknown to me, and which I had not seen in any other marl. But this did not induce me to suspect that the formation was not cocene, as I was not then acquainted with many cocene shells. Subsequently, however, by more full examination, and aided by the scientific knowledge of my friend M. Tuomey, Esq., whom I induced to visit with me this singular deposit, I learned that the shells, so far as recognised, were miocene; though mostly not known in any other of the miocene beds in Virginia—of which, sundry exposures, with numerous different shells, are within a few miles of the Hampstead bed. There are three shells only, of some 22 species, which I found here, known to me also in the other miocene marls of Virginia.\*

This bed is underlaid by the ordinary cocene of the neighbourhood. Suspecting this to be the fact in advance of any proof, I procured an excavation to be sunk much lower than any had been done before; and, without any obvious change of general appearance and texture, the cocene marl was reached—as was made evident by the finding of perfect shells of the *ostrea sellaformis*.

From all the circumstances it would seem that the earthy materials of this miocene formation had been mainly derived from the earlier formed and close adjacent cocene bed below, and which spreads out to the westward; and that while some flood had torn up, swept along, and suspended for a time, and then deposited, this fine green earth for the matrix, that the peculiar conditions permitted the existence, with a few exceptions only, of shell-fish not belonging to the ordinary miocene. The supposed position of this peculiar miocene is represented (at 9) in the annexed profile of all the strata.

This peculiar deposit, and this alone so far as known to me, would accord with the cases asserted by Professor Rogers, of the frequent and general occurrence of green-sand in large proportions, in ordinary miocene marls. But even this case afforded no support to his

---

\* There three are *cardita granulata*, an *astarte*, and one other.

assertion, when it was published. This bed is of peculiar character, in this respect. No other similar marl is yet known. It was everywhere concealed by its depth, and was found only by boring. The discovery of the marl itself did not occur until long after Professor Rogers had published these assertions; and it was much later still, before it was even suspected that it belonged to the miocene formation. Therefore, however conveniently the peculiar character of this marl might have been used, if known earlier, as at least one evidence for Professor Rogers's assertions—as the facts are, it affords to them, as made, not the slightest support.

THE END.

---

STEREOTYPED BY E. B. MEARS, PHILADELPHIA.

---

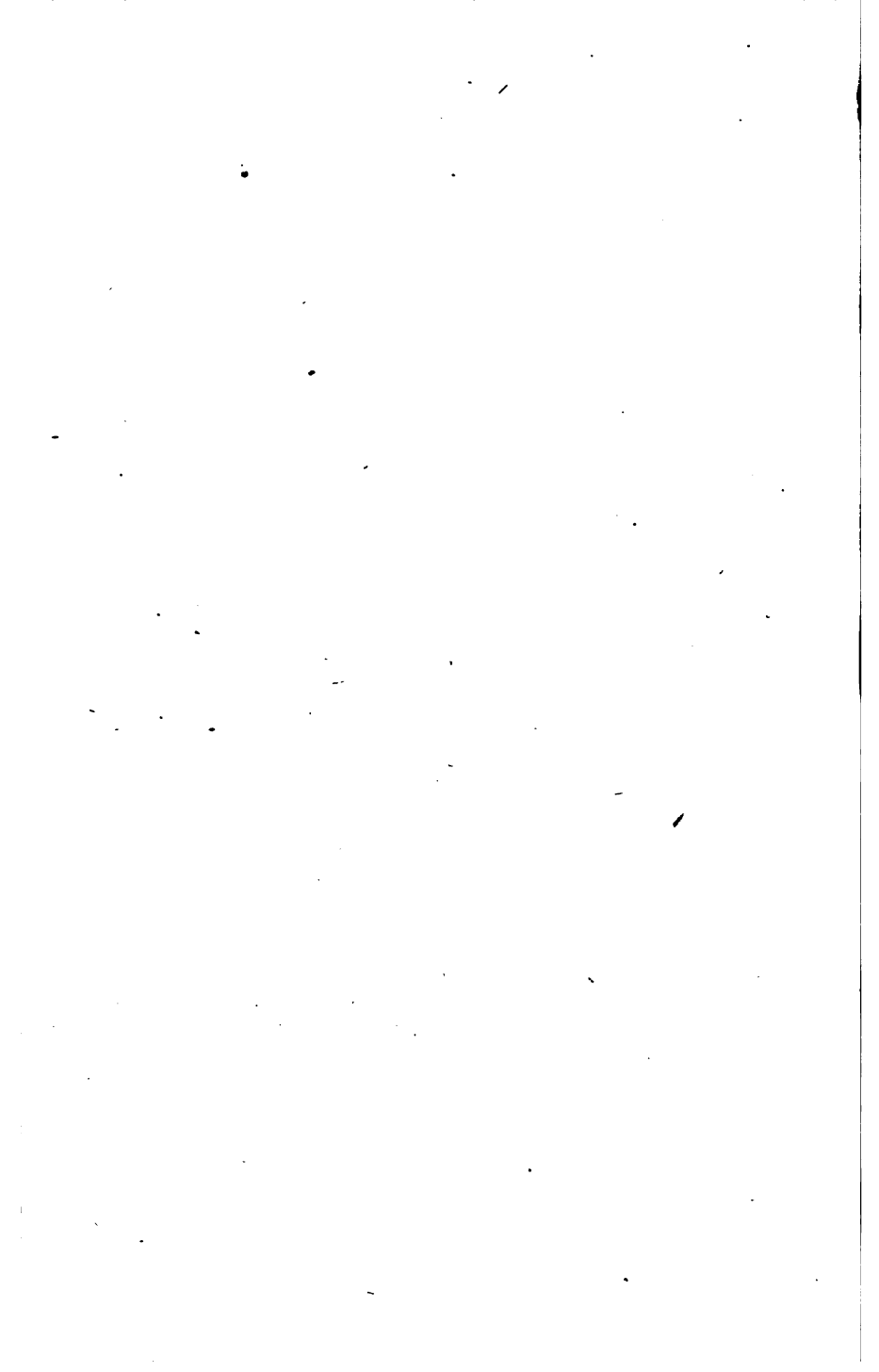

---

# J. W. RANDOLPH,

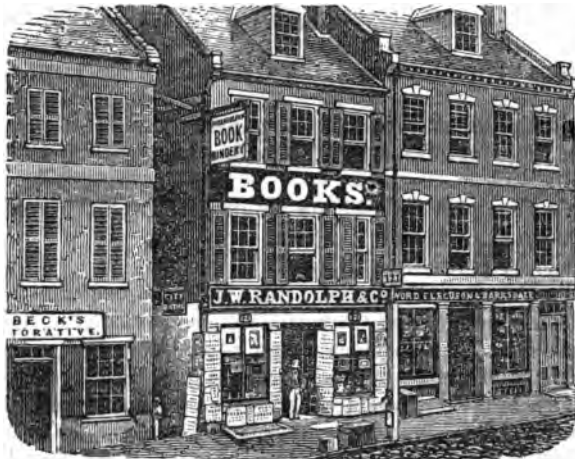

*Publisher, Bookseller, Stationer, Binder, Music and Fancy Dealer, 121 Main Street, Richmond, Va.,*

**OFFERS TO THE TRADE, and for sale in any quantity,**

Munford's Virginia Reports, 6 volumes, 8vo., sheep.

Randolph's Virginia Reports, 6 volumes, 8vo., sheep.

Wythe's Virginia Reports, 8vo., sheep.

Jefferson's Virginia Reports, 8vo., half calf.

Hall's Digested Index to the Virginia Reports, 2 volumes, 8vo., sheep.

Branch and Hening's Maxims in Law and Equity, 8vo., calf.

Mathew's Guide to Commissioners in Chancery, 8vo., sheep.

Hening's Lawyers' Guide, volume 2, 8vo., sheep.

Mayo's Guide to Magistrates, 8vo., sheep.

Virginia Criminal Cases, from 1789 to 1826, new and improved edition, two volumes in one, 8vo., sheep.

Tucker's Lectures on Natural Law and Government, 12mo., muslin.

Tucker's Lectures on Constitution, Law, 12mo., muslin.

Upshur's Review of Story on the Constitution, 8vo., half calf.

Westover Manuscripts, 8vo.

Dew's Essay on Slavery, 8vo., paper.

**Virginia Resolutions and Debates of 1798-'9**, a new and improved edition, 8vo., half calf.

**Journal, Acts and Proceedings of Virginia Convention 1850**, 8vo., half calf.

**Statistics of Virginia to 1850**, from official documents, 8vo., calf.

**Constitution of Virginia**, 8vo., paper.

**Proceedings and Debates of Virginia Convention, 1829-'30**, 8vo., calf.

**Ruffin's Essay on Calcareous Manures**, 5th edition, enlarged and improved., 8vo. and 12mo., sheep.

**Sermons by Rev. J. D. Blair**, 8vo., sheep.

**Bland's Papers and Memoir**, 8vo., half morocco.

**Jefferson's Memoir and Correspondence**, 4 vols, 8vo., half calf.

**Edgar's Sportsman's Herald and Stud Book**, 8vo., sheep.

**Winckler's Hints to Piano Forte Players**, 12mo., boards.

**Southern and South-western Sketches ; Fun, Sentiment and Adventures**, 12mo., paper.

**Justices' Record Book of Judgments**, cap, half bound.

**Martin and Brookenbrough's History of Virginia**, 8vo., sheep.

**Campbell's History of Virginia**, 8vo., muslin.

**Howe's History of Virginia**, 8vo., sheep.

**Cottom's edition of Richardson's Virginia, North Carolina, Maryland and District of Columbia Almanac.**

**Randolph's Pocket Diary and Almanac.**

**Lee's Strictures on the Writings of Jefferson**, 8vo., muslin.

**Plantation and Farm Instruction, Regulation, Record, Inventory and Account Book ; by a Southern Planter**, 4to, half morocco.

**BOOKS IN PRESS** :—**Jefferson's Notes on Virginia**, a new edition, with Mr. Jefferson's last corrections and additions, 8vo., with plates.

**Uncle Robin in his Cabin in Virginia, and Tom without one in Boston ; by a gentleman of Virginia**, 12mo.

**Burke's Virginia Springs**, new edition, 12mo.

**BOOKS IN PREPARATION** :—**Hening and Munford's Virginia Reports**, 4 vols., new edition, with notes.

**Digest of the Laws of Virginia adapted to new Code.**

**Practice adapted to new Code.**

**Barradall's Virginia Reports**, 8vo.

**Randolph's Gardening**, 12mo.

**Book of Forms**, adapted to the Code of Virginia, 8vo.

J. W. RANDOLPH has just published SOUTHERN and SOUTHWESTERN SKETCHES; FUN, SENTIMENT and ADVENTURE. Edited by a gentleman of Richmond. Price 37 cents.

It is believed that the present volume contains as great a variety of mirth-moving and interesting matter as any like work which has ever been published. The peculiar humor of the South, and its characteristic qualities of reckless daring and profuse generosity are happily illustrated in many of these Sketches. Those who love that innocent mirth which leaves no pain, and relish the honey of wit, without the poison which it sometimes leaves, will find in these pages ample sources of entertainment.

"The Book is a collection of Tales, which had their origin chiefly in the South and Southwest. We most heartily commend it to the attention of the public. The selections are very judicious, and as it is Southern in character, and in every respect home made, it is particularly deserving public encouragement. We trust it will meet with a wide sale. There are many stories in it that are alone worth the price of the Book."—*Dispatch*.

---

## PLANTATION BOOK.

J. W. RANDOLPH, Richmond, Va., has just published the PLANTATION and FARM INSTRUCTION, REGULATION, RECORD INVENTORY and ACCOUNT BOOK, for the use of managers of estates, and for the better ordering and management of plantation and farm business in every particular, by a Southern planter.

"Order is Heaven's first law."—*Pope*.

A larger edition is also published for the use of Cotton Plantations.

This Book is by one of the best and most systematic farmers in Virginia, and experienced farmers have expressed the opinion that those who use it, will save hundreds of dollars.

This work is designed to aid the manager of a plantation, or other large estate, by the useful and valuable suggestions which it contains; by the method and system which it will enable him to es-



tablish; and by the order in which all accounts may be kept in its pages. In such cases it must prove an invaluable work.

[*New York Book Trade.*]

Every farmer who will get one of these Books, and regulate all his movements by its suggestions, cannot fail to realize great benefits from it. We cannot too highly commend it to the consideration of agriculturists.—*Richmond Whig.*

It will prove a most valuable assistant to the planter, manager or overseer, and a work that will facilitate them greatly in the transaction of business.—*Richmond Dispatch.*

The Book we should suppose to be indispensable to any one having the management of a large estate.—*Richmond Republican.*

We hope many farmers will buy the work, and make an effort to keep things straight.—*Southern Planter.*

It is full of useful information, and is well calculated to induce a methodical system, industry and energy, especially vital to a successful and profitable cultivation of mother earth.—*Richmond Enquirer.*

We have received a copy of this work, which is designed as a record of the daily services performed on the plantation or farm, with every item of expense for labor, cattle, tools, purchasing of clothes, provisions, &c., &c., and of all sales, with annual and quarterly inventories. The form is concise and methodical, while it embraces every thing appropriate to such records. It is well executed, on good paper, and must prove very serviceable to those for whom it is intended.

[*Plough, Loom and Anvil.*]

We should think that this Book would be a valuable acquisition to farmers, for the orderly management of every department of agricultural business. It is the result of mature experience and observation.—*Methodist Quarterly Review.*

A friend, in whose judgment we have great confidence, and who is one of the best farmers in Virginia, assures us that this publication is one of real value to Southern agriculturists; as there is a wide field before it, the publisher ought therefore to expect for it a large circulation. To such of our readers as may not have an opportunity of examining the Book, we may say that it contains formulas for a daily record of plantation work; for an inventory of negroes, with the quantity of clothing, tools and medicines given them, and a register of their births, deaths and marriages; for a list of stock; for a statement of produce made by the proprietor, &c., &c.: to all of which are

---

prefixed some useful hints to overseers as to plantation management. The Book is well gotten up, and is offered at a very moderate price.

[*Southern Literary Messenger.*]

A Southern planter has reduced to a complete system the entire business of a plantation, and publishes it as a guide to others. The minuteness with which the detail of all the operations on a plantation is treated, is a model for farmers.—*The Cultivator.*

J. W. RANDOLPH, of Richmond, Virginia, has published a most admirable work, one which every planter and farmer should not only possess, but carry out its objects and aims, both in the letter and in the spirit, for they all tend to the introduction of system in the management of landed estates. The Book purports to have been gotten up as a guide to overseers and managers; but is so filled, so arranged, that the proprietors of such estates would themselves be equally benefited by personally carrying out its numerous plans, hints and suggestions; for after carefully looking through and studying its details, we most conscientiously say, that they are founded in wisdom, and, if practised upon, would be promotive alike of economy and humanity—economy in the management of the farm or plantation—and humanity in providing for the comfort and health of the slaves, as well as stock.

It contains a chapter explanatory of the manager's duty—shows how his journal or daily record should be kept. Upon this head, as well as upon the employment and treatment of the negroes and management of the plantation, the remarks are alike copious and judicious; so also are those upon the manner in which the stock of all kinds are to be cared for. Its observations upon the saving and application of manure, the cultivation of the plantation or farm, as well as upon the proper rotation of crops, are sensible, and show an acquaintance with the several subjects on the part of the author. The tables, illustrative of the three, four and five field systems of rotation, are full of instruction, and may be studied with decided advantage.

It contains a useful "table, showing the number of spaces contained in an acre of land at various given distances, which will be found useful in fixing the proper distances to place marl, lime or other manures, so as to give any desired quantity to the acre"—a rule for measuring the contents of a corn crib—two rules for ploughmen—a table showing the actual number of pounds in a bushel of different kinds of grain, potatoes, bran, clover seed, timothy and Kentucky blue grass seed, flax seed, hemp seed, castor beans, dried peaches and apples, onions and salt—a table of planting distances—a table showing how the contents of any bulk of grain may be ascertained—one showing the weight of various materials—an instructive chapter upon

mechanical power—tables of weights and measures—of the United States currency—English currency—rule for reducing sterling money into United States currency—data in mechanics and rural economy. Besides which, there are ruled blanks for recording all the details of farm and plantation duties, from the beginning to the end of the year, so arranged as to make the labor so plain and easy, that if anything can induce farmers and planters to record the operations of their estates, this work will lure them to it. That it may find a ready sale we most fervently wish, as it is pregnant with much good.

[*American Farmer.*]

---

## WYTHE'S REPORTS

J. W. RANDOLPH has just published in one 8vo. volume.  
Price \$4 in sheep, and \$4 50 in calf binding.

Decisions of cases in Virginia, by the High Court of Chancery, with remarks upon decrees by the Court of Appeals, reversing some of those decisions, by George Wythe, Chancellor of said court; second and only complete edition, with a memoir of the author, analysis of the cases, and an Index, by B. B. Minor, L. B., of the Richmond Bar, and with an Appendix, containing references to cases in *Pari Materia*, and an essay on lapse, joint tenants, and tenants in common, &c., by William Green, Esq.

In *Orr's heirs v. Irwin's heirs and devisees*, 2 Carolina Law Repository 465, TAYLOR, C. J., delivering the opinion of the court, says: "To these [*English*] cases may be added a decision made by the late Chancellor WYTHE, in *Virginia*, which may be cited as equal in point of authority, if not superior, to any of the *British* decisions, from the luminous and conclusive reasoning on which that upright and truly estimable Judge founds it—*clarum et venerabile nomen.*" He then makes an extract of several pages consecutively, from the report of *Farley v. Skipper*, in Wythe, (1st edition,) 135, (2d edition,) 254; and concludes his opinion in these words: "We have transcribed thus largely from the work of the *Chancellor*, because it is not in every library, and the discussion of the question, which is new in this court, being the most able and copious we have anywhere met with, cannot fail to be instructive to the student, and acceptable to the practitioner, who will both be disposed to allow that the excellence of the matter atones for the length of the extract."—*Laus laudari a laudato viro.*

All of the old editions of this work are imperfect, and yet copies have been sold at auction as high as \$10, such has been the demand for it.

---

For sale by J. W. RANDOLPH, Richmond, CAMPBELL'S HISTORY OF THE COLONY and ANCIENT DOMINION OF VIRGINIA. Price \$1 50.

CHARLES CAMPBELL, Esq., of Petersburg, a gentleman better informed upon the History of Eastern Virginia than any one we have met in the course of our investigation, and to whom we are indebted for much valuable information."—*Henry Howe, Editor of Historical Collections of Virginia.*

We do not doubt that this is the most authentic History of Virginia, as a Colony, which has yet appeared.—*Petersburg Intelligencer.*

We take great pleasure in giving our cordial recommendation to the work.—*Watchman and Observer.*

No work in Virginia, we will venture to say, has appeared for many years, which has been enriched and illustrated with so many original facts and explanations.—*Literary World.*

We are of those who love a straight forward and unvarnished chronicle; we, therefore, like Mr. Campbell's Book.—*Princeton Review.*

No one can even glance at the work without imbibing the conviction, that its author has been a long and loving student of Virginia History, and has his mind embodied with the result of his extensive experience and ripe discrimination, in a style at once terse, vigorous and pleasing.—*Literary World.*

You have presented the outline of early Virginia History in an unusually attractive form, and one well fitted to lead the reader to pursue more fully its minuter details.

[*Professor Gammell, of Brown University.*

The Book will be a very useful compend for the inhabitants of Virginia, as well as for general readers in other parts of the country.

[*Jared Sparks.*

MR. CAMPBELL'S HISTORY OF VIRGINIA is presented to the public in a very unpretending form, and is written in a clear, agreeable and manly style, without affectation, with new and elaborate conceits of ex-

pression, and defaced by no ambitious and deliberate flights of rhetoric. The subject is a good one, and it is treated as if the author felt assured of its intrinsic attractions. He has evidently scrutinized the appropriate evidences in their sources, and the reader may repose with confidence in his statements.—*North American Review*.

*An Essay on Slavery*, by Thomas R. Dew, late President of William and Mary College, Williamsburg, Va. Second edition, Richmond, Va. J. W. Randolph, 121 Main Street.

This Essay has peculiar claims to the attention of the Virginian, and is not wanting in interest to the statesman everywhere. We do not think we err in saying, that it is the clearest and ablest defence of the institution to be found in the English language. The writer views that institution in its historical and its scriptural aspects, and discusses at large the plans for the abolition of negro slavery. While we cannot accord with all the views he has expressed in regard to the colonization movement, we yet think the facts he arrays, and the principles he urges, are entitled to the gravest consideration, as the results of unwearied labor, and of a mind well balanced and well trained. We believe that all parties are agreed as to the evil of emancipation, without removal. The painting of the scenes, which would ensure such an event, is drawn with a master hand.—*Republican*.

*A Guide to Commissioners in Chancery*, with practical forms for the discharge of their duties; adapted to the new Code of Virginia, by James M. Matthews, Attorney at Law, Richmond. J. W. Randolph, 121 Main Street.

Mr. Matthews has in this publication furnished a valuable addition to the small stock of Virginia Law Books. The Work is not only of essential service to the Commissioner; it is also a valuable *vade mecum* to the Chancery Lawyer. The following opinion is expressed of it by a legal friend:

“I have had occasion to use Mr. Matthews’ Guide to Commissioners as a book of reference in the course of my practice at the Bar. I have uniformly found it to be correct, and it materially aided me while attending the settlement of accounts before the Commissioner.”

The following table of contents may be acceptable to our legal readers in the country:

Chapter I. Of the origin of Commissioners in Chancery, their ap-

pointment, the reference of accounts to them, and the proceedings thereupon.—Chap. II. Of fiduciaries generally, and the settlement of their accounts by Commissioners in Chancery.—Chap. III. Of Guardians and Wards.—Chap. IV. Proceedings under decrees and orders in the Commissioner's Office, and herein:—Of References and Reports; The examination of parties upon interrogatories; Admissions of parties; Of the *onus probandi*; The examination of witnesses upon interrogatories; Enquiries as to heirs at law, next of kin, &c.; Production of documents; Of scandal and impertinence; Of the principles on which accounts of executor or administrator should be stated; When interest not to be involved in administration account; When account of executor or administrator should be closed; What payments not to enter into the general account; When annual rests are to be made; Formula in stating account of executor or administrator; Principles on which Guardians' account should be stated; How to state the account of one who is in name an executor, but is in fact a guardian or trustee; How to ascertain value of life estate or annuity; Table of longevity; Adjournment by Commissioner; Report and Exceptions; Review of Report.—Chap. V. Of surcharge and falsification.—Chap. VI. of Notices.—Chap. VII. Of Evidence.—Chap. VIII. Of means for compelling debtor to discover and surrender his estate. Chap. IX. Of fees of Commissioner in Chancery.—Chap. X. Of descents and distributions.—Chap. XI. Of the payment of debts according to their priority.—Chap. XII. For preventing commission of crimes.

By the Code of Virginia, Chapter 201, Section 1, Commissioners in Chancery are constituted conservators of the peace, and the last chapter is a summary of the proceedings on peace warrant, &c. Every Commissioner should have a copy of this Work.—*Republican*.

### VIRGINIA REPORT on the Resolutions of '98-'99, concerning the ALIEN and SEDITION LAWS.

We have received from our friend, J. W. RANDOLPH, a neat and well printed copy of the "Virginia Report on the Resolutions of '98-'99, concerning the Alien and Sedition laws." We were struck with the truth of the remark of the editor of the first mentioned volume, that this "report had been more praised than read." Every statesman should be familiar with its contents. It is certainly a valuable commentary on the Federal Constitution, and both parties may find here some of the strongest arguments in support of their several theories. We shall notice this WORK more at large hereafter.

[*Richmond Republican*.

A comprehensive DESCRIPTION OF VIRGINIA and the DISTRICT OF COLUMBIA, containing a copious collection of geographical, statistical, political, commercial, religious, moral and miscellaneous information, chiefly from original sources, by Joseph Martin; to which is added A HISTORY OF VIRGINIA, from its first settlement to the year 1754, with an abstract of the principal events from that period to the INDEPENDENCE OF VIRGINIA, by W. H. Brockenbrough, formerly Librarian at the University of Virginia, and afterwards Judge of the United States Court in Florida.

The above Book contains 686 printed pages, 8vo., bound in strong sheep. Price \$2.

J. W. RANDOLPH, 121 Main Street, Richmond, Virginia, having bought the remainder of the edition, will supply the work in any quantity. Copies sent by mail postpaid to all who remit the price in money or stamps.

J. W. RANDOLPH has published a Catalogue of his stock of Books, (amounting to \$20,000,) with size, binding, and price of each, which may be had gratis at 121 Main Street, Richmond, Va.

Books sent by mail postpaid to all who remit the price in money or stamps.

Gentlemen or societies forming or adding to their libraries will save money by sending their orders to J. W. RANDOLPH.

Rare old works bought and sold.

**HANDSOME BINDING.**—In J. W. RANDOLPH'S window, at No. 121 Main Street, may be seen a BIBLE, bound in his establishment by one of his workmen, which in point of neatness of finish, beauty of style and durability, cannot be excelled. Our citizens would do well to bear these facts in mind, and have their Books bound at home, instead of sending them to the Northern abolitionists.

*[Republican.]*

COUNTRY MERCHANTS, Teachers and others, can buy on the best terms Standard, School and Miscellaneous Books, Stationery, &c.

BLANK BOOKS made to order, and BINDING done in any quantity and style.





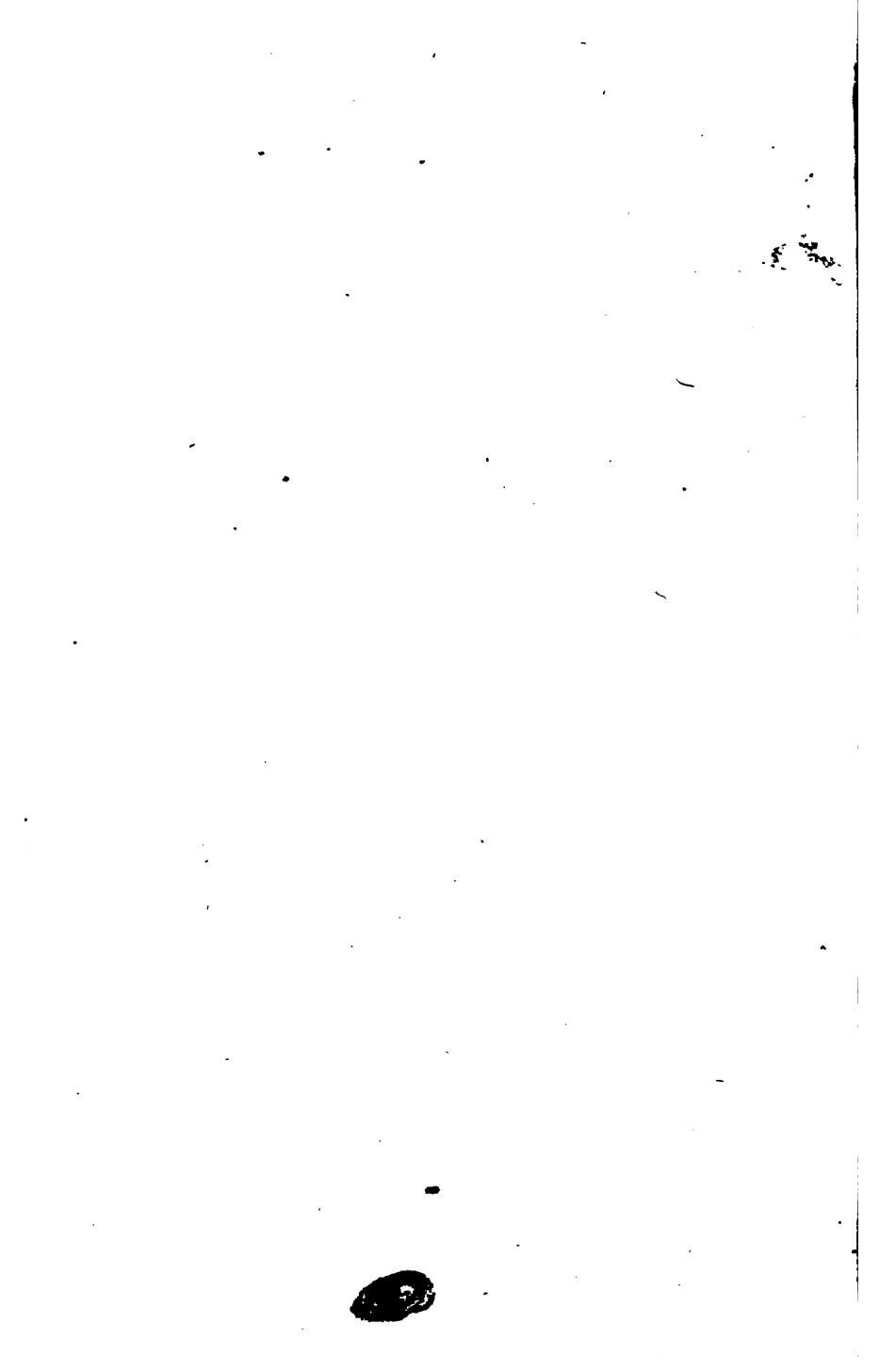



UNIVERSITY OF CALIFORNIA LIBRARY  
BERKELEY

Return to desk from which borrowed.  
This book is DUE on the last date stamped below.

14 May 51 VW

DEC 22 1952 LU

9 Mar 57 RK

REC'D LD

MAR 1 1957

MAR 8 1982

April 8, 1982

May 8, 1982

REL. CIR. MAY 06 1982

YB 16459

MAR - 8 1982

LD-9 80m 11/80 (BayView)

678992

S643

R8

1852

UNIVERSITY OF CALIFORNIA LIBRARY

