

19  
20  
21  
22  
23  
24  
25  
26  
27  
28  
29  
30  
31  
32  
33  
34  
35  
36  
37  
38  
39  
40  
41  
42  
43

$\frac{1}{2}$  320  
846.2  
24

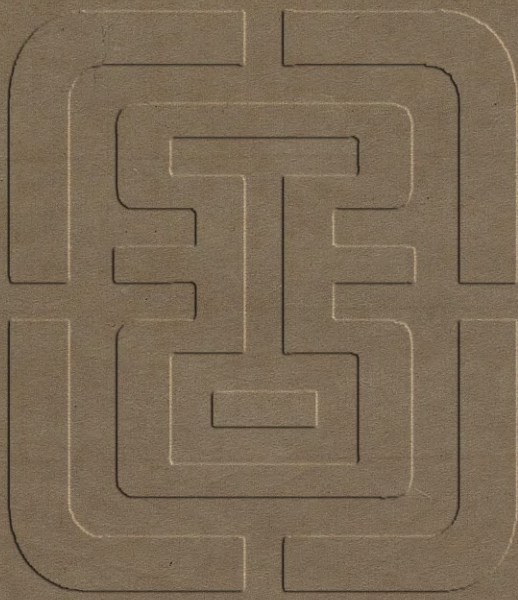

周  
禮  
記

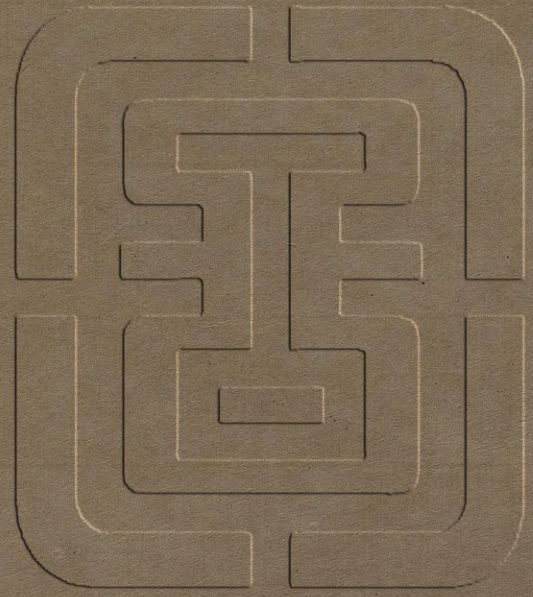
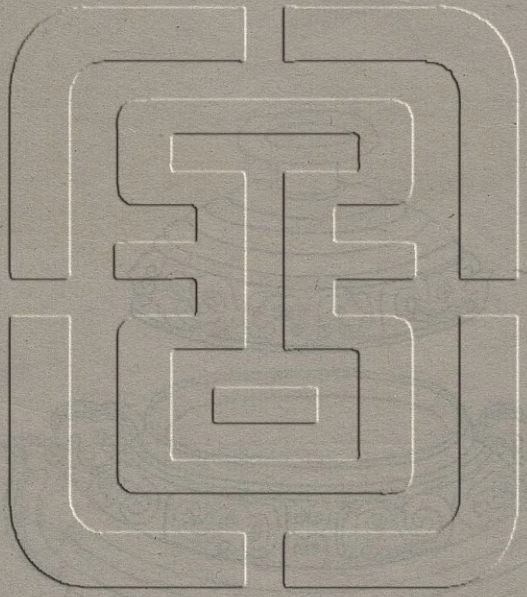

周翼敦

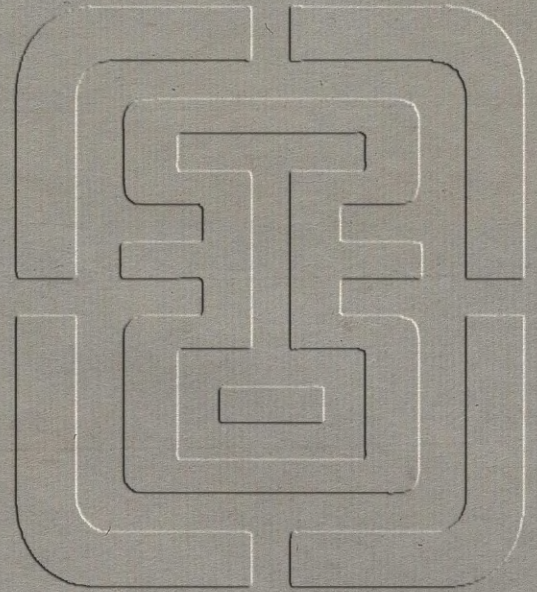
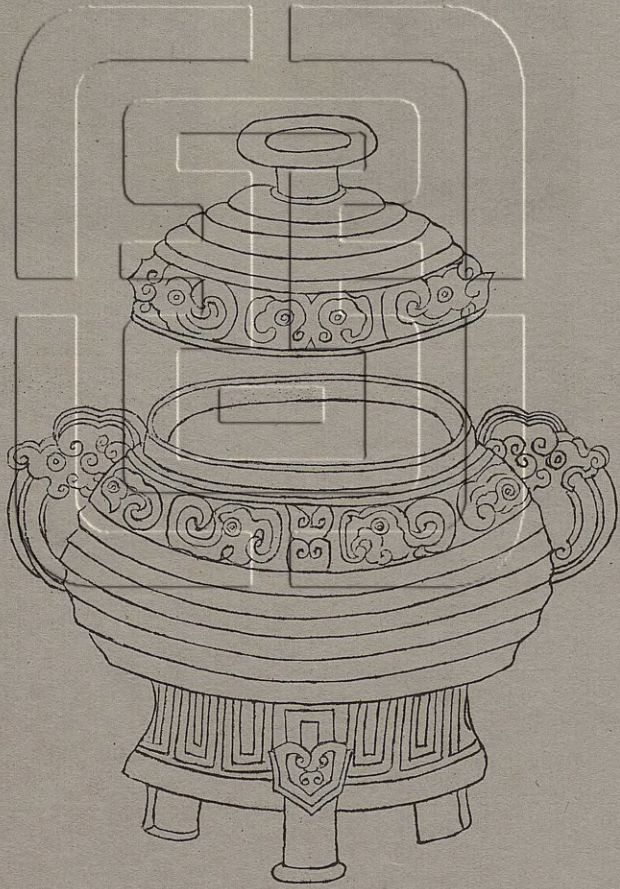

盖

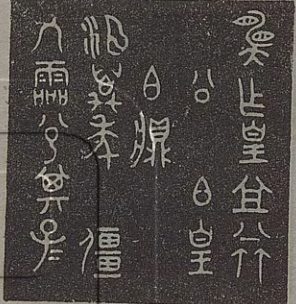

翼作皇祖益  
公伯皇

伯彙

○萬年 疆  
終命。其子

器

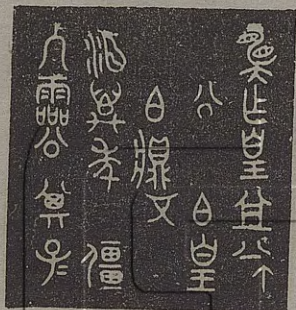

音釋同前

右通盖高七寸六分深三寸六分口径四寸七

分腹圍二尺五寸重一百七十兩兩耳有珥按  
博古圖錄鐘鼎款識集古錄悉載此器銘文按  
翼即願字從大篆省文也

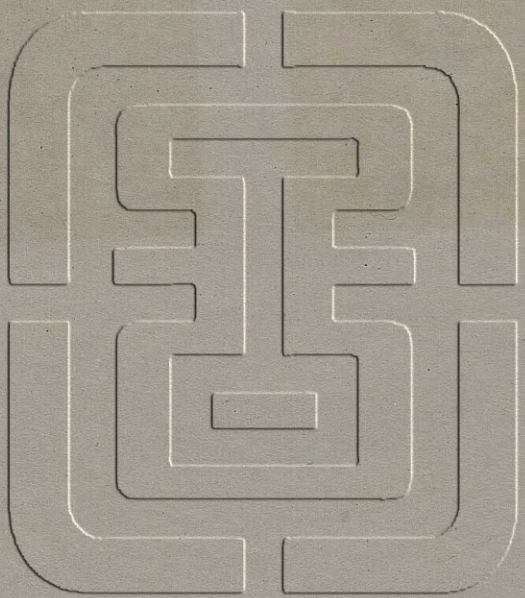

周叔孫敦

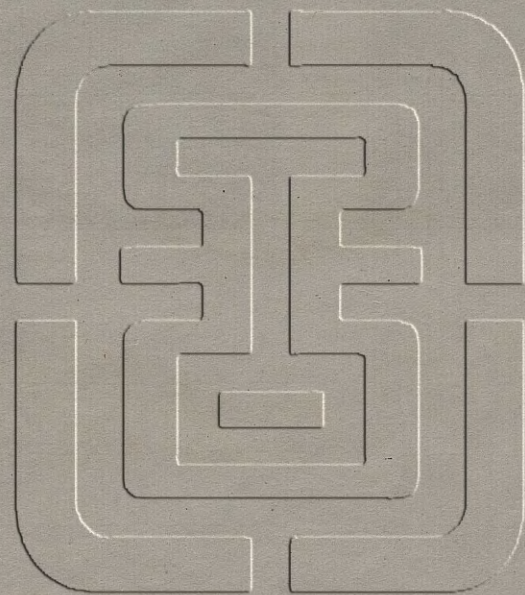
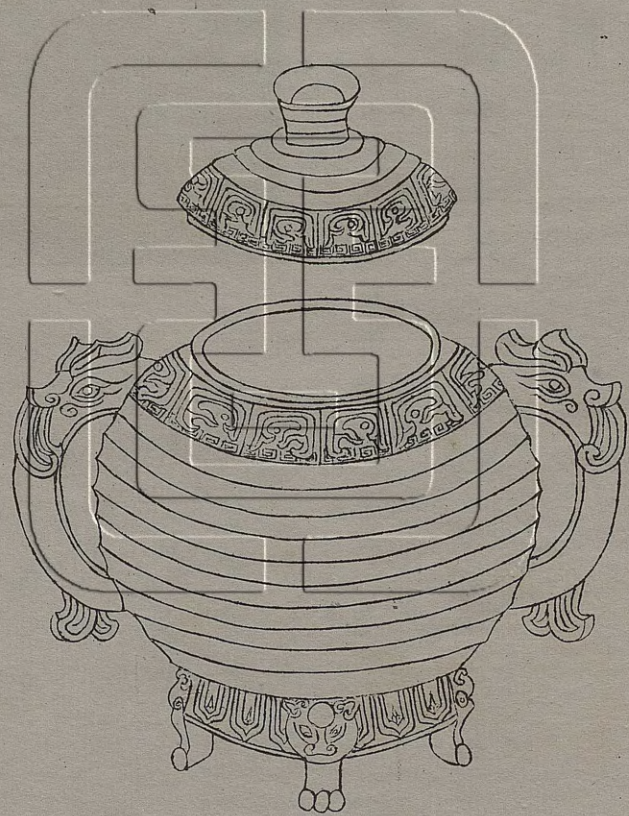

周叔孫敦

周叔孫敦

周叔孫敦

叔孫父作孟  
 敦。敦。敦。  
 永命。永命。  
 生。生。  
 永寶用享。永寶用享。

叔孫父作孟  
 敦。敦。敦。  
 永命。永命。  
 生。生。  
 永寶用享。永寶用享。

右通蓋高一尺一寸四分深六寸八分口徑六寸五分腹圍三尺二寸四分重三百二十三兩兩耳有珥

周毀敦



盖

唯王九年正月丁亥  
 伯和父若曰師設乃祖考  
 有。家汝右惟小子  
 余命汝 我家繼治我西  
 偏東偏 百工牧臣言  
 東裁內外母敢不善錫汝  
 戈矛戟編鞞形弓矢十五  
 鐘一磬五金敬乃夙夜用事  
 設拜稽首敢對揚皇君  
 休用作朕文考乙仲彙敷  
 敷其萬年子孫永寶用享

唯王九年正月初吉丁亥  
 伯和父若曰師設乃祖考  
 有。家汝右惟小子  
 余命汝 我家繼治我西  
 偏東偏 百工牧臣言  
 東裁內外母敢不善錫汝  
 戈矛戟編鞞形弓矢十五  
 鐘一磬五金敬乃夙夜用事  
 設拜稽首敢對揚皇君  
 休用作朕文考乙仲彙敷  
 敷其萬年子孫永寶用享

器

唯王九年正月丁亥  
 伯和父若曰師設乃祖考  
 有。家汝右惟小子  
 余命汝 我家繼治我西  
 偏東偏 百工牧臣言  
 東裁內外母敢不善錫汝  
 戈矛戟編鞞形弓矢十五  
 鐘一磬五金敬乃夙夜用事  
 設拜稽首敢對揚皇君  
 休用作朕文考乙仲彙敷  
 敷其萬年子孫永寶用享

音釋同前

右通蓋高一尺一寸二分深四寸六分口徑七寸腹圍二尺五寸重四百八十兩兩可銘與博古圖師毀敦同舊說以伯和父為衛武公稱若曰者代王而言師毀為周室之媼姬舊族故云乃祖考有婚于我家今此款婚于我三字已漫漶莫辨繼治我西偏東偏以下美其治而錫以戈矛鐘磬之屬也至其世系所出則前史既闕無可攷證云

### 周毅敦

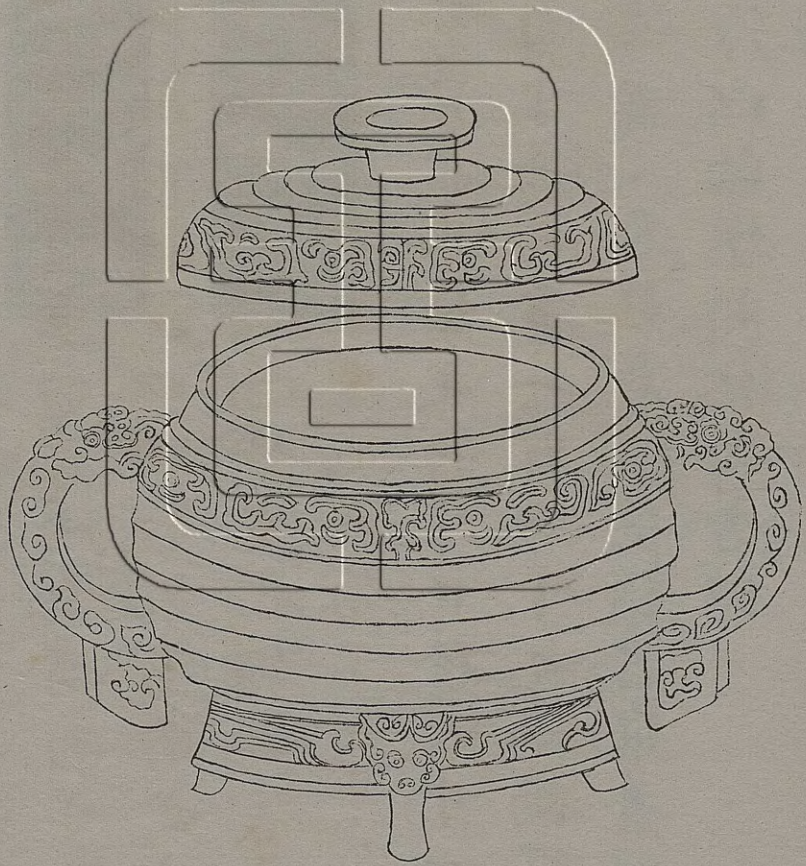



蓋

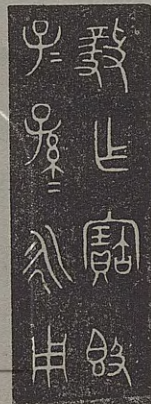

殺作寶敦

子孫永用

器

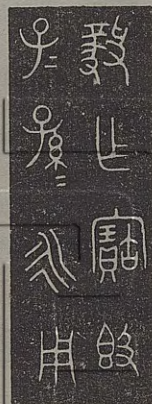

音釋同前

右通蓋高七寸二分深四寸口徑六寸四分腹圍二尺四寸六分重一百四十九兩兩耳有珥銘曰殺作周人名殺者惟望諸君寢著則此器或其所作以貽樂間樂林者耶

周邠歸敦

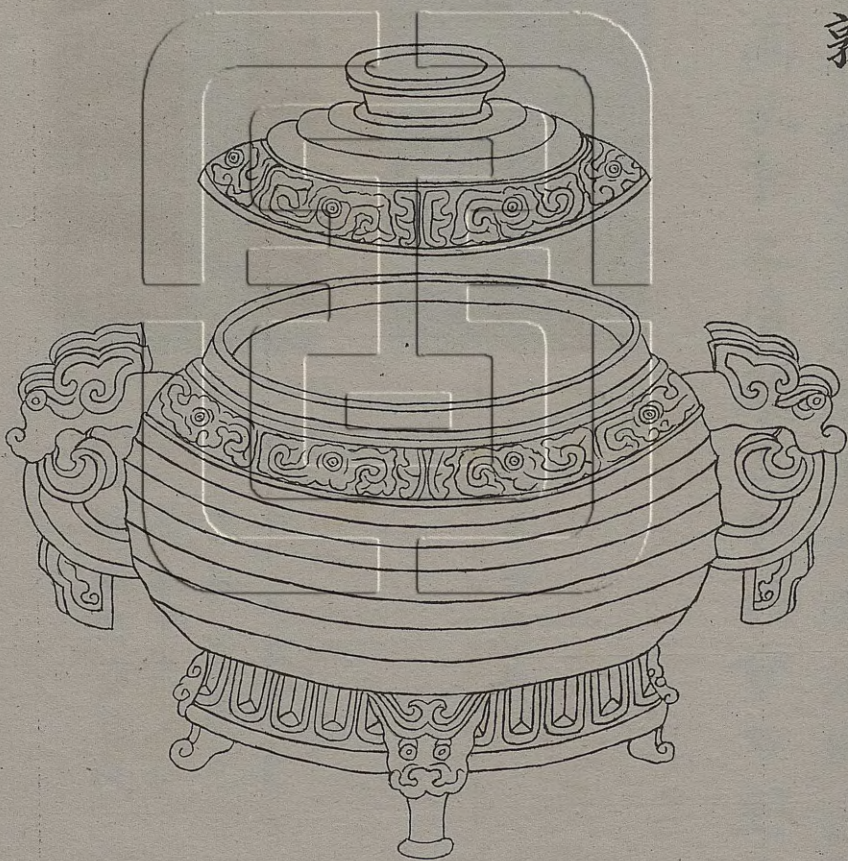

盖

邠歸作寶敦用  
 追孝于其父母  
 用錫永壽子  
 孫永寶用享

器

邠歸作寶敦用  
 追孝于其父母  
 用錫永壽子  
 孫永寶用享

音釋同前

右通盖高七寸二分深三寸六分口徑六寸二分腹圍二尺三寸重一百八十七兩兩耳有珥

按邠字音捕玉為廣韻並同邠歸無攷或係人名耶

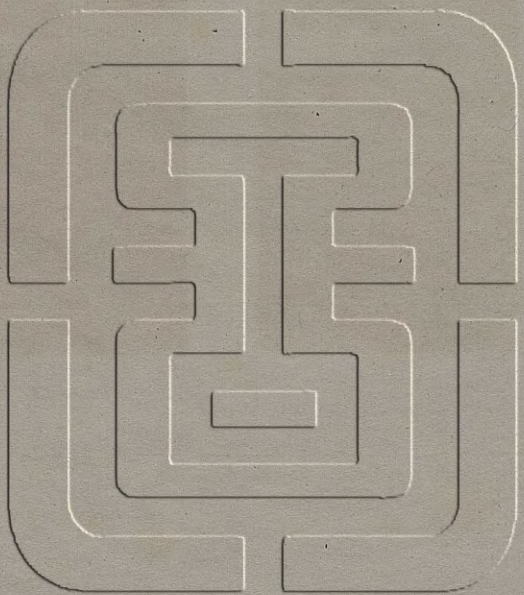

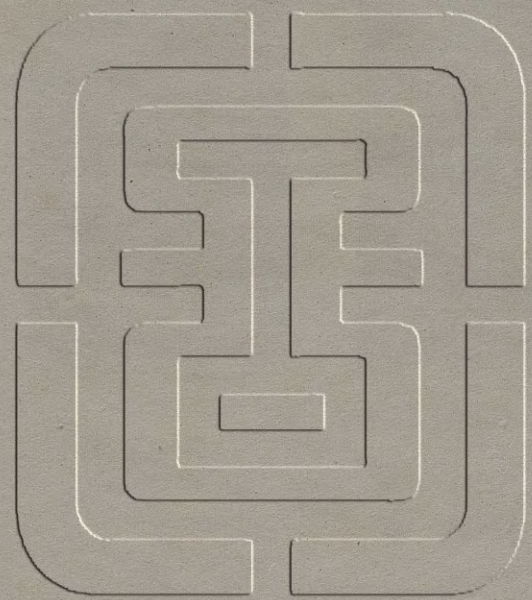

周伯敦

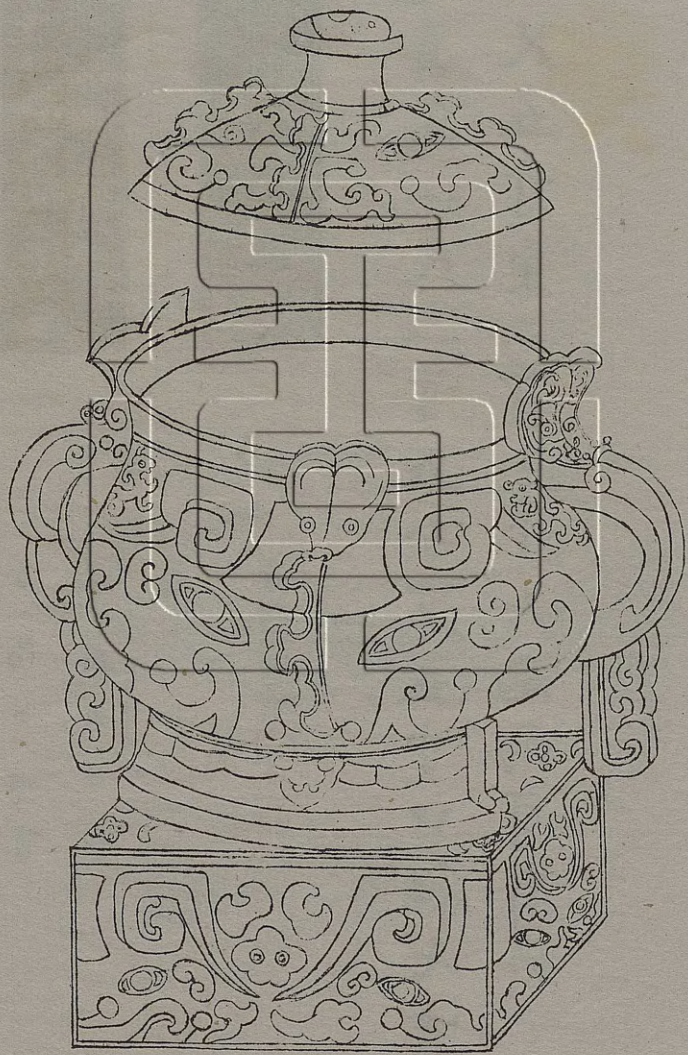

蓋

考曰 夬止 夬  
博 齋 曰 珩 三 拜

。伯。作寶  
尊 彛 貝。朋

器

考曰 夬止 夬  
博 齋 曰 珩 三 拜

音釋同前

右通蓋高一尺二寸五分深五寸口徑七寸腹  
圍二尺五寸重二百三十六兩兩耳有珩

周大中敦

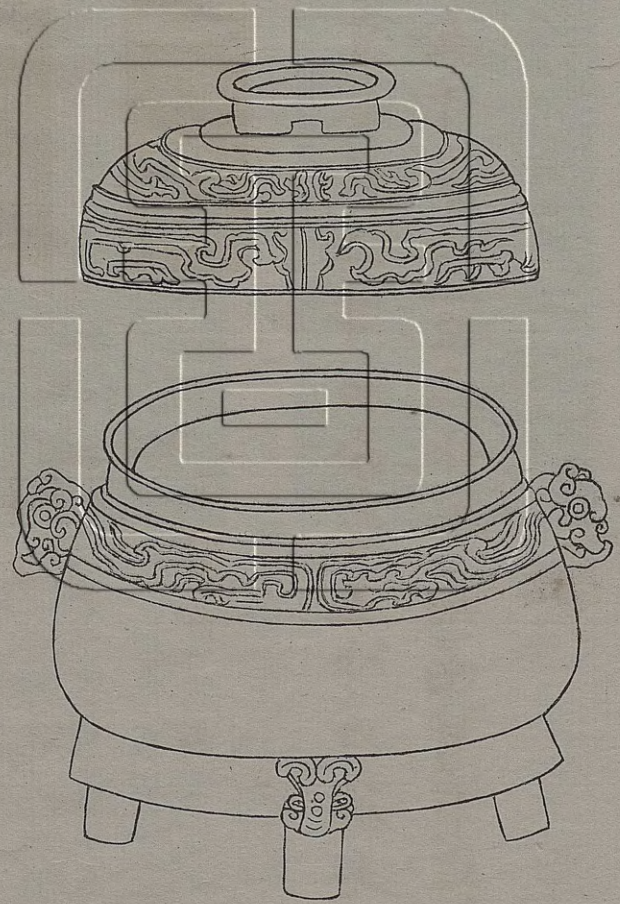

蓋

唯六月初吉丁子王  
在鄭箋失應錫。○  
○曰用諦于乃考矢  
拜稽首對揚王休用  
作朕皇考大中尊敦

唯六月初吉丁子王  
在鄭箋失應錫。○  
○曰用諦于乃考矢  
拜稽首對揚王休用  
作朕皇考大中尊敦

器

唯六月初吉丁子王  
在鄭箋失應錫。○  
○曰用諦于乃考矢  
拜稽首對揚王休用  
作朕皇考大中尊敦

音釋同前

右通蓋高六寸深三寸四分口徑五寸四分腹

圍一尺九寸重一百三兩兩耳鄭地本號咸林  
在西周畿內至宣王時封弟友于此乃名為鄭  
銘云王在鄭是宣王以後之器也天字應是人  
名其篆法與大字微異許慎說文音阻力切茂  
者精微之意應當訓為治蓋王以矢精微于治  
是以有所錫賚也又攷後漢書祭祀志曰禘之  
為言諦也諦諛昭穆尊卑之義則此諦字當以  
饗祀釋之鐘鼎款識有大中或即其人歟  
丁之子銘稱皇考大中或即其人歟

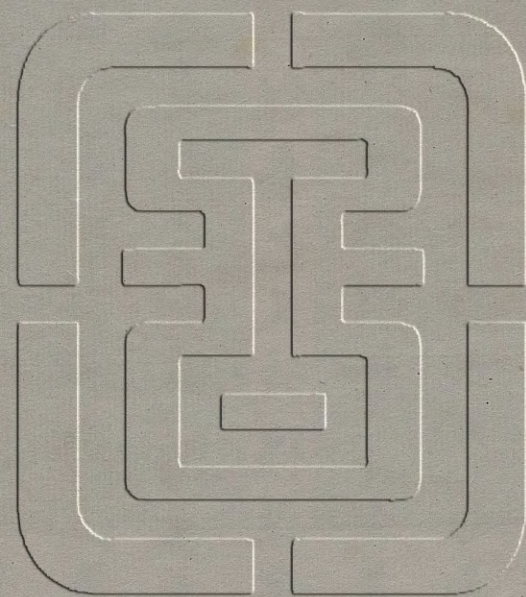

周仲父敦

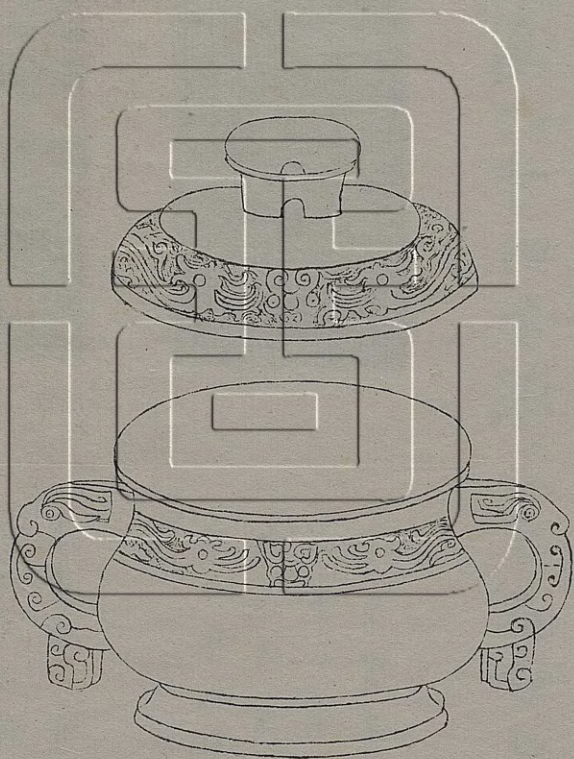

敦

盖

𠄎又曰𠄎十五  
𠄎𠄎以𠄎𠄎  
考用止以𠄎𠄎

唯五月辰在壬寅  
伯仲父。夜。  
考用作乃寶尊敦

器

𠄎𠄎𠄎𠄎𠄎  
𠄎𠄎𠄎𠄎𠄎  
𠄎𠄎𠄎𠄎𠄎  
𠄎𠄎𠄎𠄎𠄎

唯五月辰在壬  
寅伯仲父夙  
夜事。考用  
作乃寶尊敦

右通盖高六寸四分深三寸五分口徑六寸二分腹圍二尺七分重七十九兩兩耳有珥按左傳決辰之間杜注以辰為日辰在壬寅者紀其

作器之日可曰夙夜者盖夙夜以將祀事之意

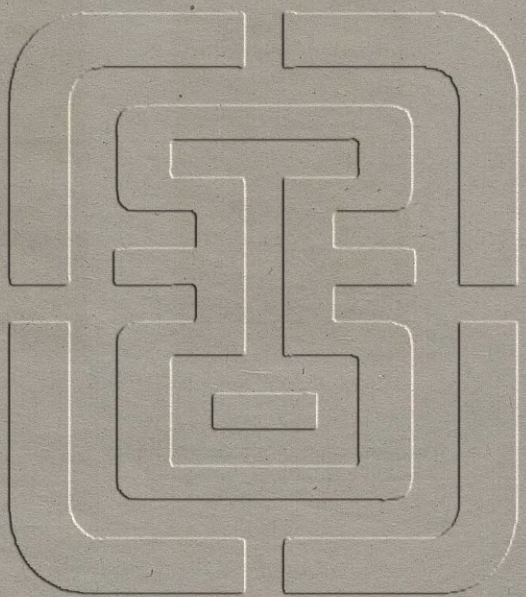

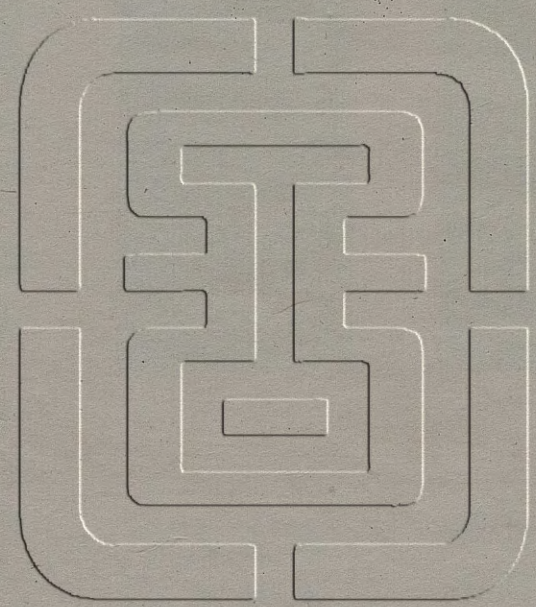

周徒敦

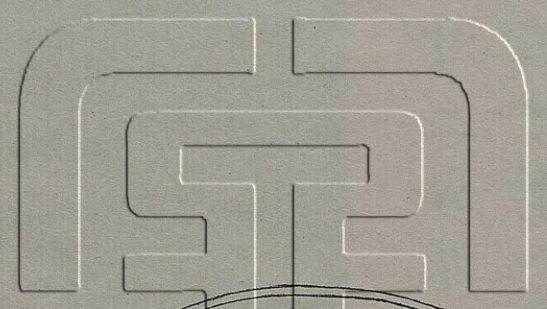
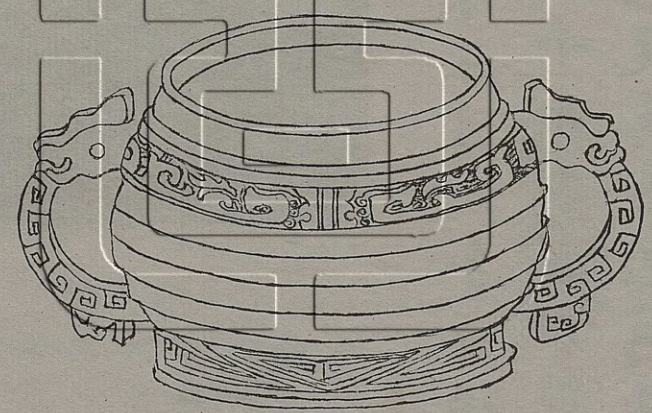



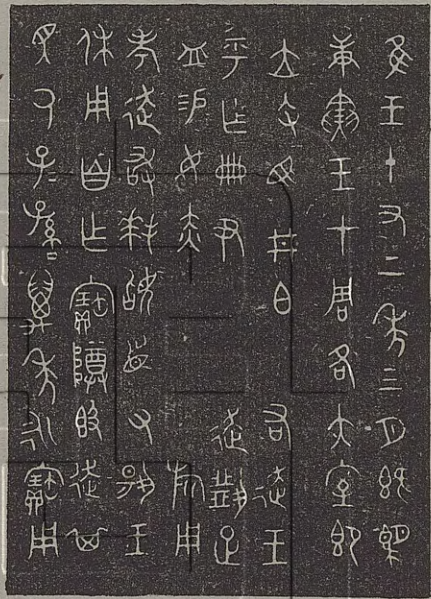

唯王十有二年三月既望  
 庚寅王在周格太室即  
 立。○邢伯 右徒王  
 呼作册尹 徒。足  
 ○錫汝赤 旂用  
 考徒敢拜稽首對揚王  
 休用自作寶尊敦徒其  
 暨乃子孫萬年永寶用

右高四寸二分深三寸八分口徑六寸二分腹  
 圍二尺三寸重八十九兩兩耳有珥按邢為姬  
 姓國名伯其爵也徒其名也周禮夏官有司右  
 掌羣右之政此蓋諸侯入事王朝者故稱國稱

爵復稱官也

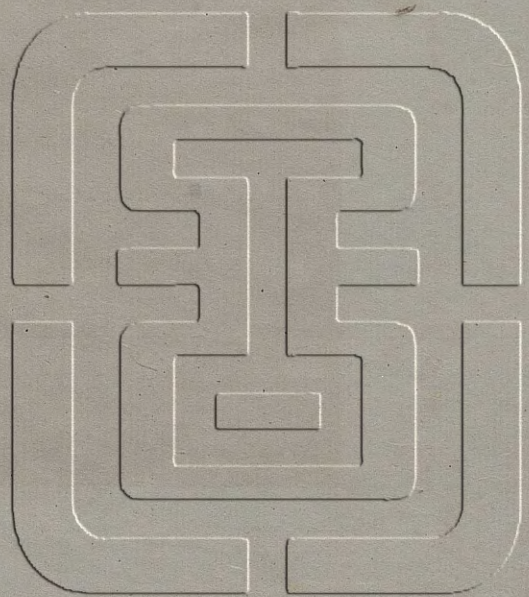

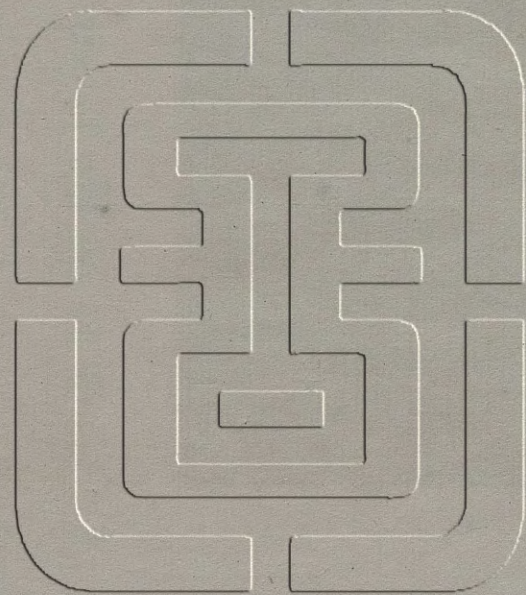

周列伯敦

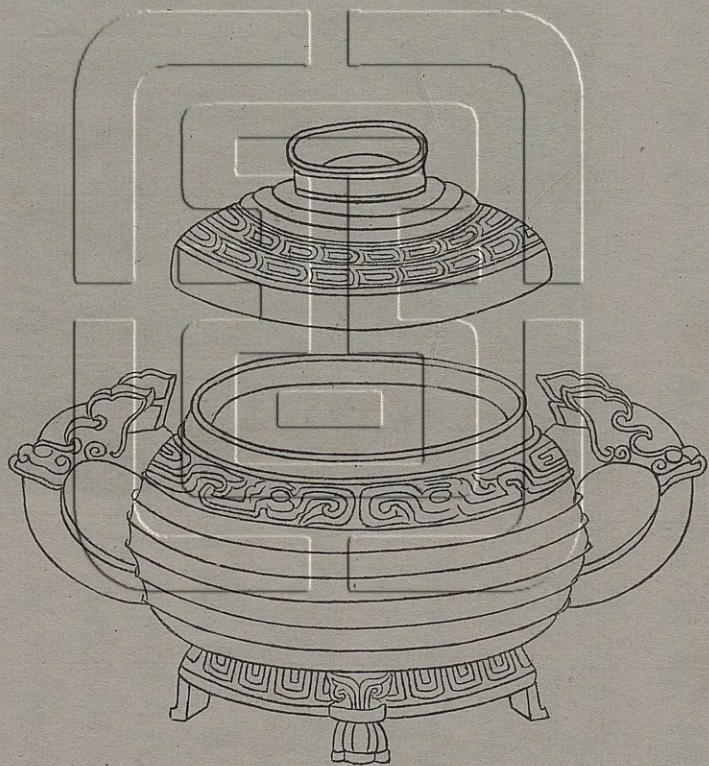

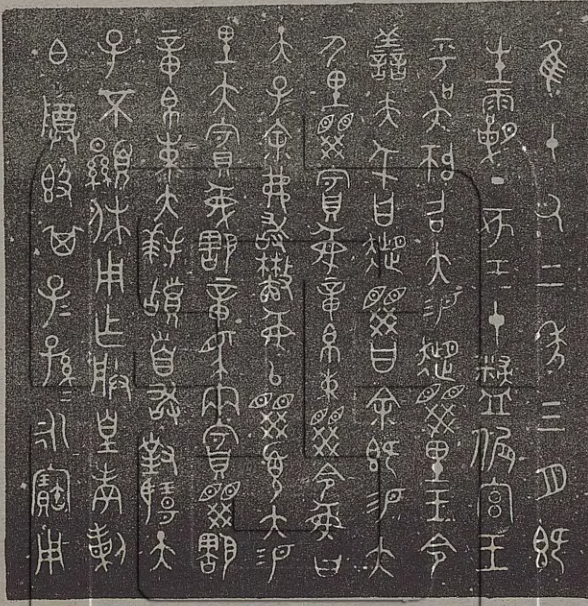

唯十有二年三月既生霸丁亥王在。宮王呼吳師名大錫。里王命善夫。曰。曰余既錫大里。賓。章帛束。命。曰天子余弗敢。以。大錫里大賓。章馬兩賓。章帛束大拜稽首敢對揚天子丕顯休用作朕皇考列伯尊敦其子孫永寶用

右通蓋高七寸二分深四寸口径五寸七分腹圍二尺五寸二分重一百九十五兩兩耳按銘

文前曰名大後曰大拜稽首則大為受賜者之名也王呼吳師如前伯姬鼎王呼史滅之類爾雅曰里邑也詩傳曰里居也錫里者賜之居邑也他器銘有曰錫章者有曰錫馬兩者此銘中間字多不可辨以意求之是言章服車馬之賜後云皇考列伯列疑烈字省文謚法有功安民曰烈秉德遵業亦曰烈史記韓趙世家皆有烈侯此係伯爵故易侯以伯也

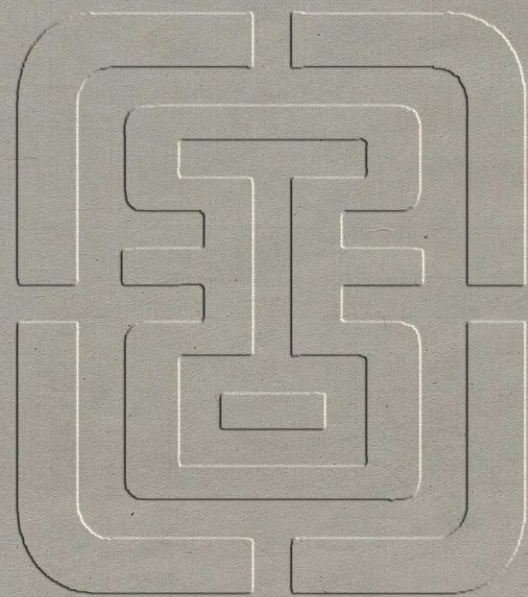

周中伯敦

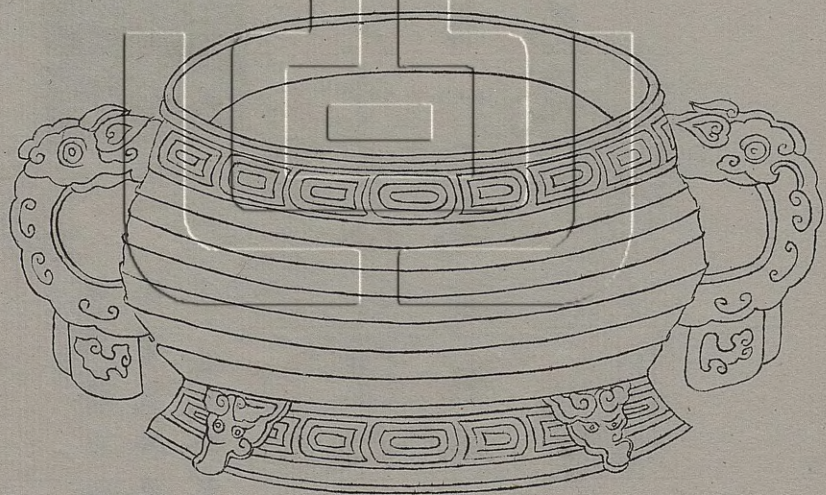

伯作止平其節  
寶敦其萬年  
子孫永寶用

中伯作。姬鑿  
節寶敦其萬年  
子孫永寶用

右高四寸二分深三寸五分口徑六寸八分腹  
圍二尺四寸重一百一兩兩耳有珥銘與西清  
古鑑中伯敦同說已見前

周遲伯敦

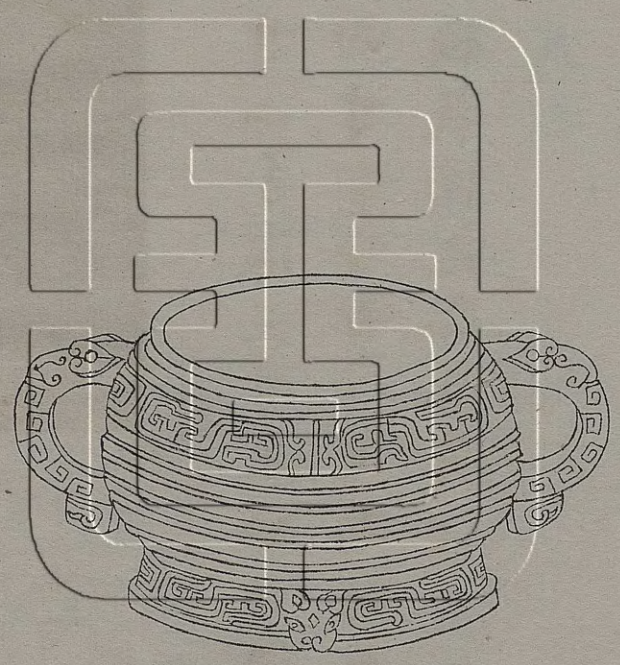

伯 啟 父 作 朕  
皇 考 遲 伯 吳  
姬 尊 敦 其 萬  
年 子 孫 永 寶 用

右高四寸一分深三寸五分口徑五寸七分腹  
圍二尺三寸一分重八十三兩兩耳有珥攷集  
韻啟即敦字說文音渠云切讀若羣銘稱伯啟  
父未詳其人

周寶敦一

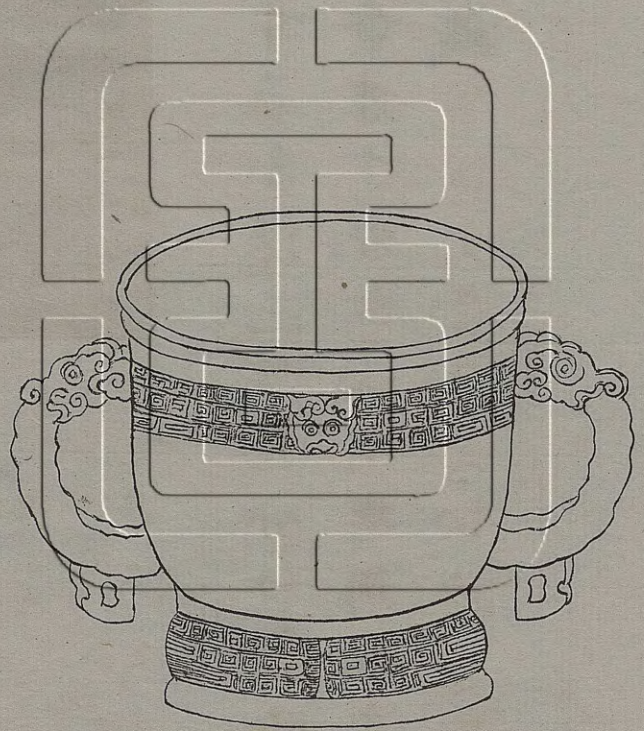

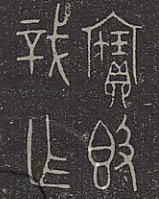

寶敦

。作

右高四寸五分深三寸五分口徑六寸腹圍一尺八寸重五十九兩兩耳有珥銘左旋讀首一字不可識

周寶敦二

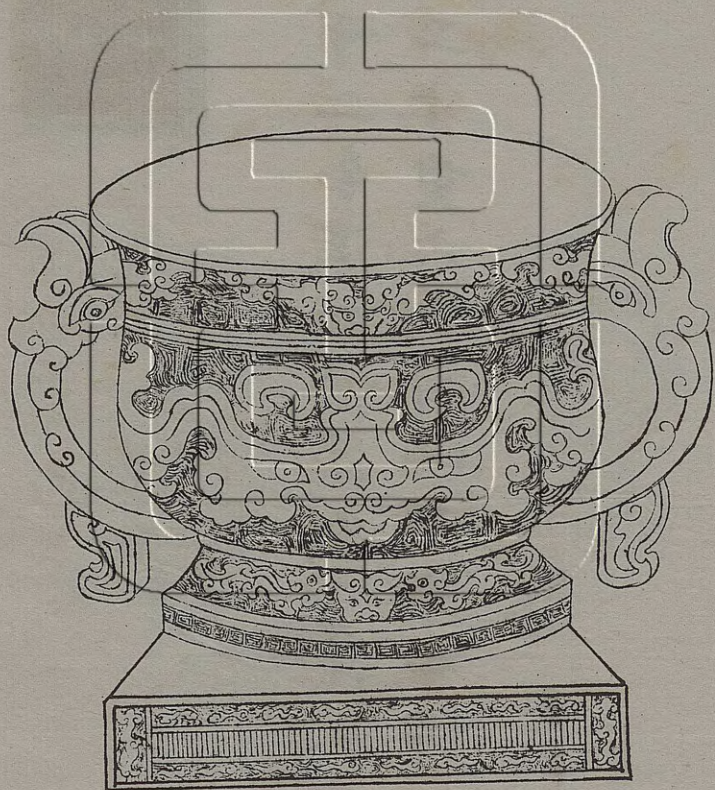

敦

止  
尊

作寶  
尊彝

右高六寸二分深四寸三分口徑五寸二分腹  
圍二尺二寸重六十四兩兩耳有珮

周饗簋敦





右高八寸二分深四寸六分口徑五寸三分腹圍二尺二寸重八十三兩兩耳有珮

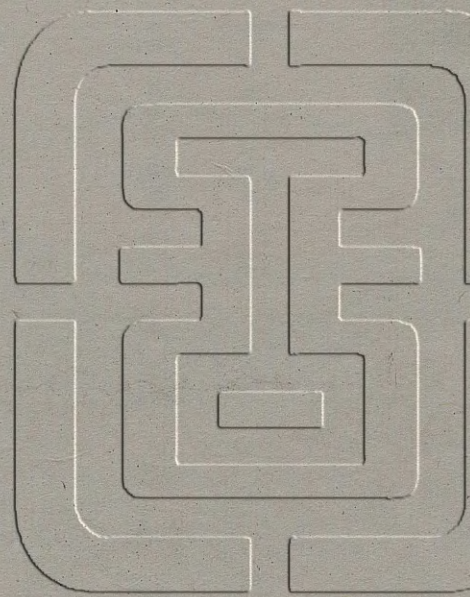

周蟠夔敦一

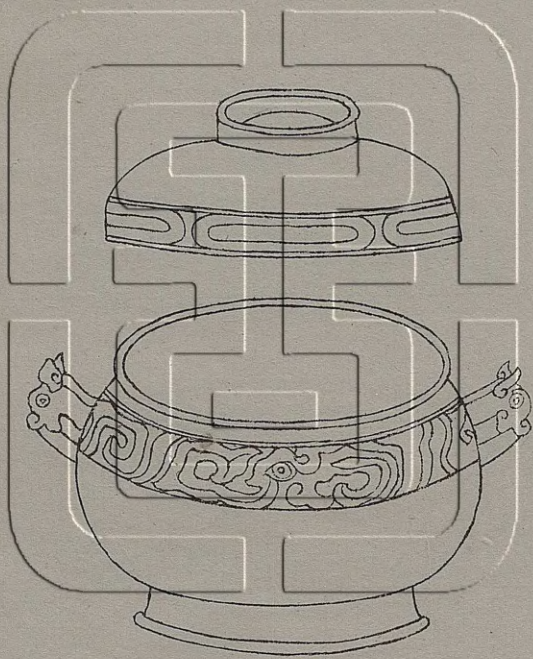

右通蓋高三寸深一寸八分口徑二寸五分腹圍一尺七分重三十兩兩耳

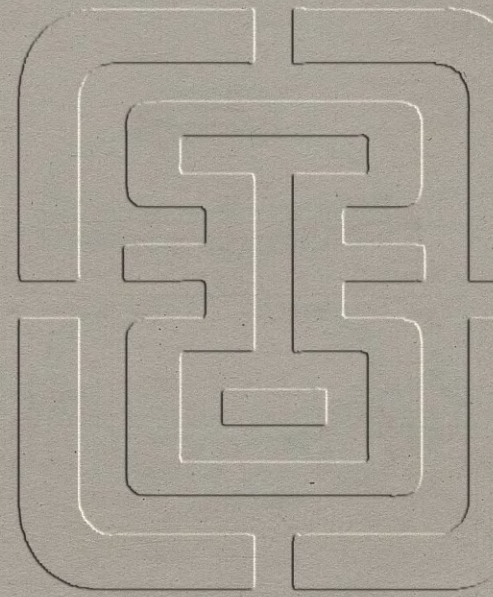

周蟠夔敦二

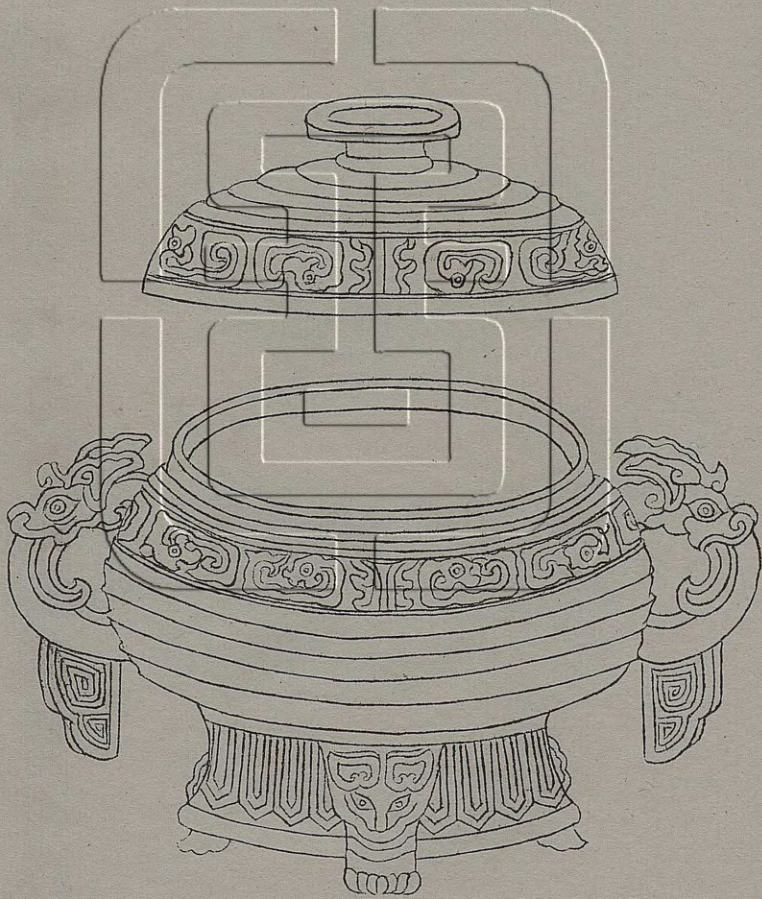

敦

右通蓋高八寸二分深四寸口徑六寸二分腹圍二尺六寸重一百九十九兩兩耳有珥

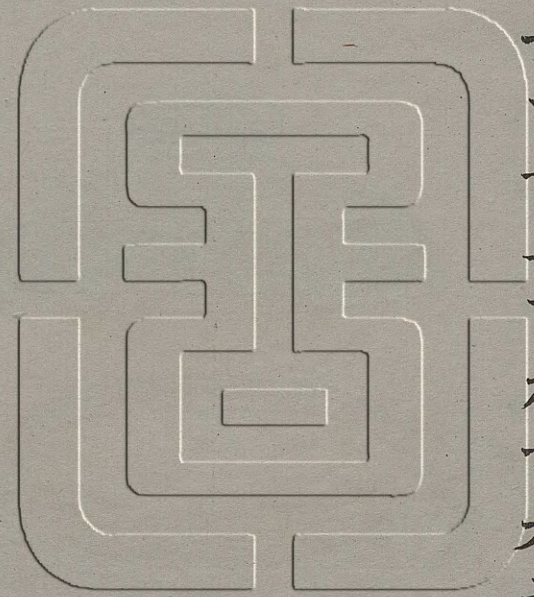

周蟠夔敦三

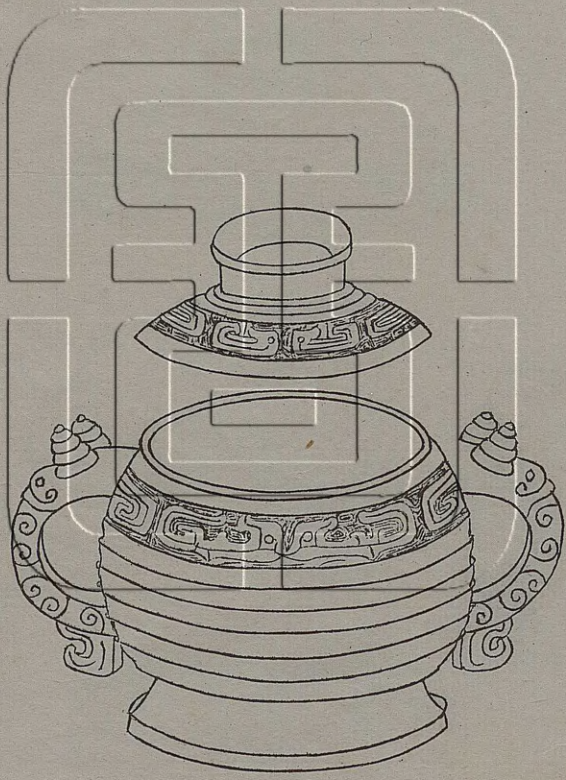

右通蓋高七寸五分深三寸五分口徑五寸七分腹圍二尺三寸重一百六十五兩兩耳有珮

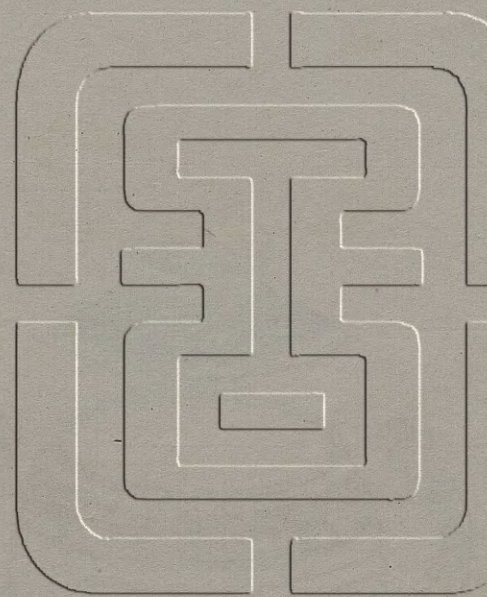

周螭夔敦四

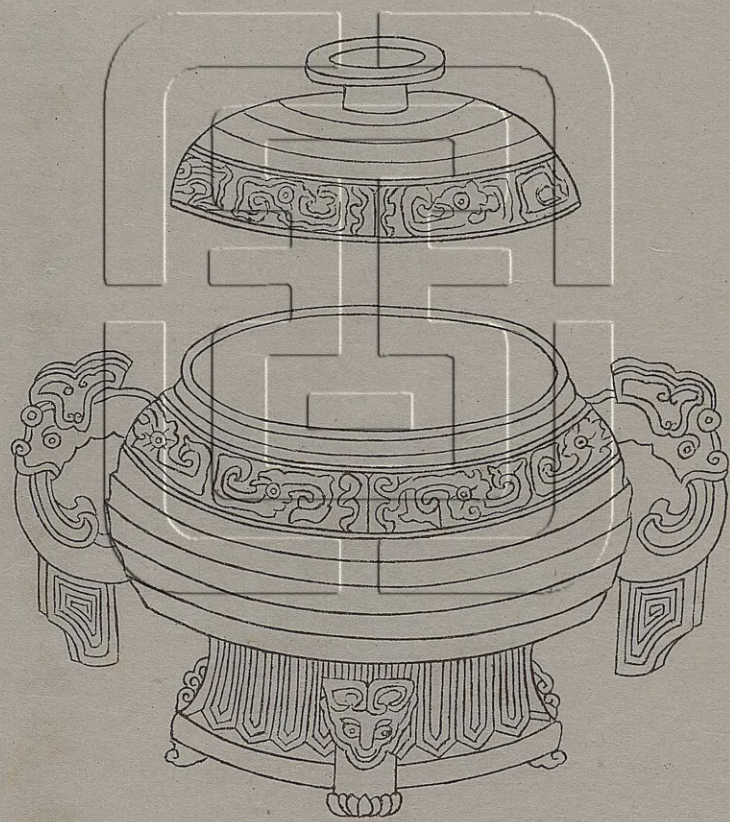

敦

右通蓋高六寸九分深三寸二分口径六寸腹圍二尺四寸八分重二百三兩兩耳有珮

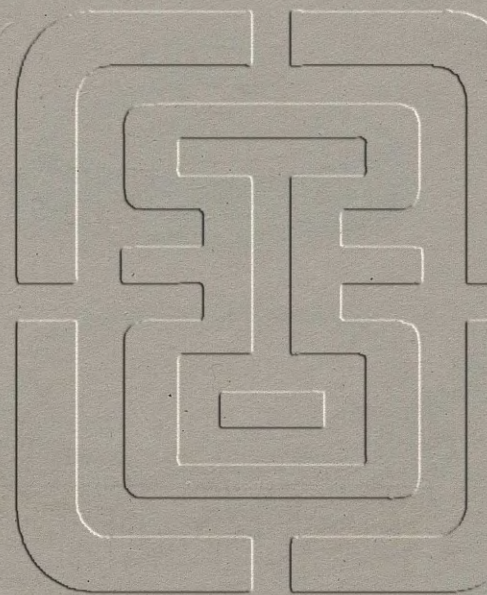

周蟠夔敦五



右高二寸八分深二寸一分口徑三寸八分腹圍一尺二寸重三十九兩兩耳

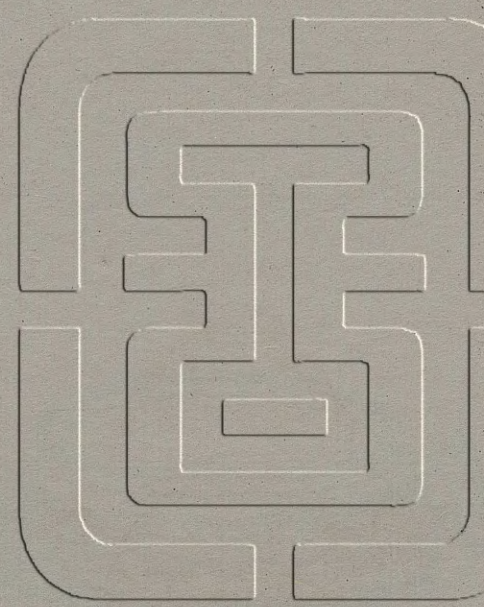

周夔紋敦

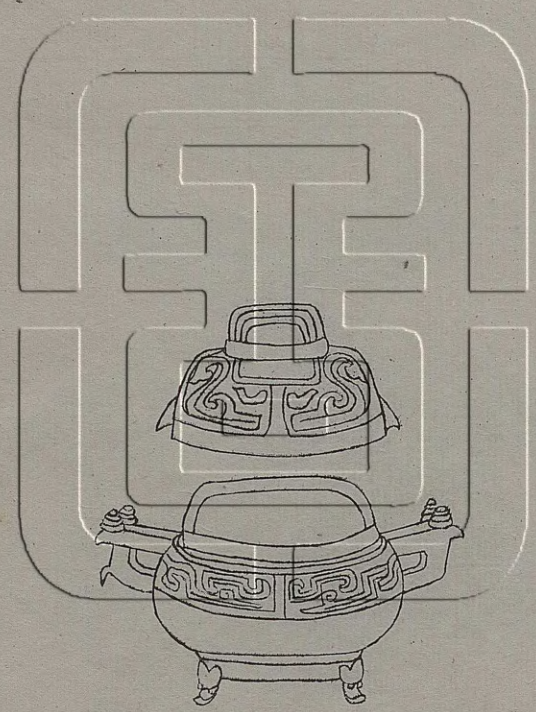

右通蓋高三寸一分深一寸五分口徑二寸九分腹圍一尺一寸八分重二十五兩兩耳

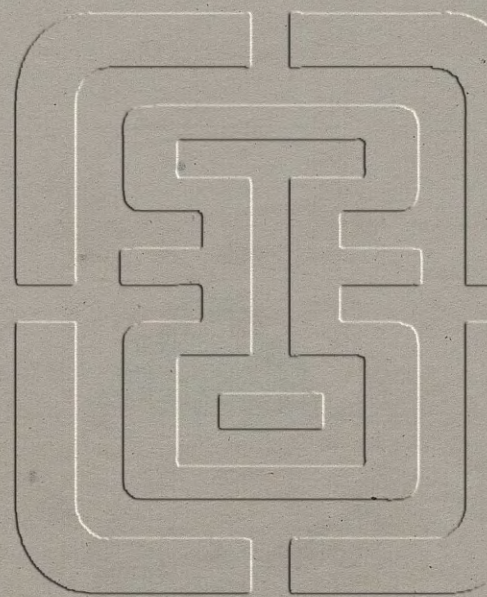

周雲紋敦

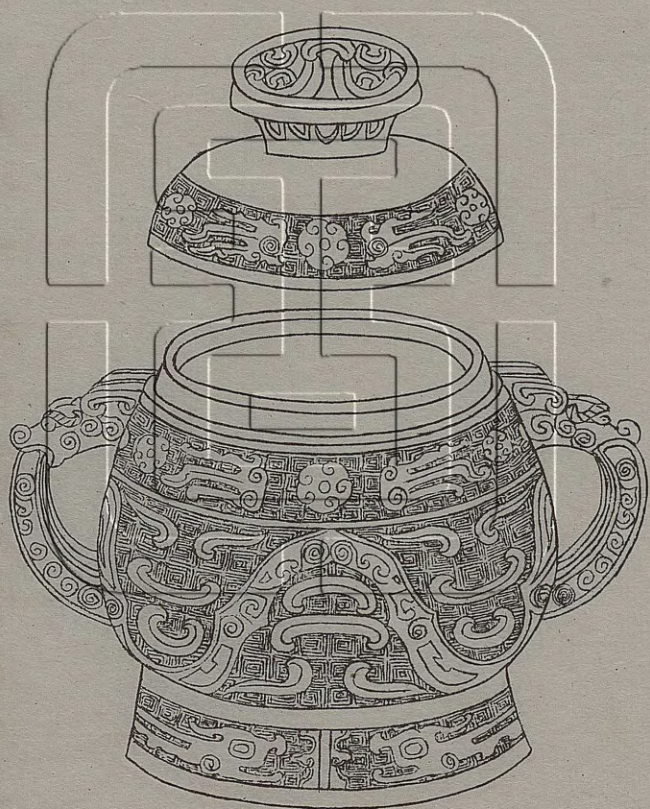

右通蓋高六寸六分深三寸九分口徑四寸五分腹圍一尺八寸六分重一百二十三兩兩耳金銀錯

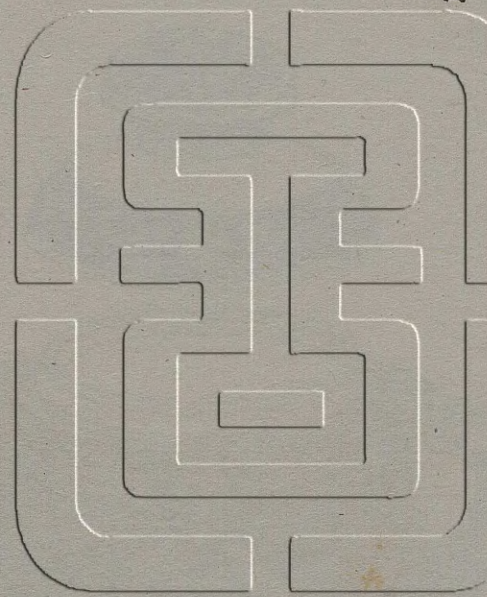

周環紋敦一

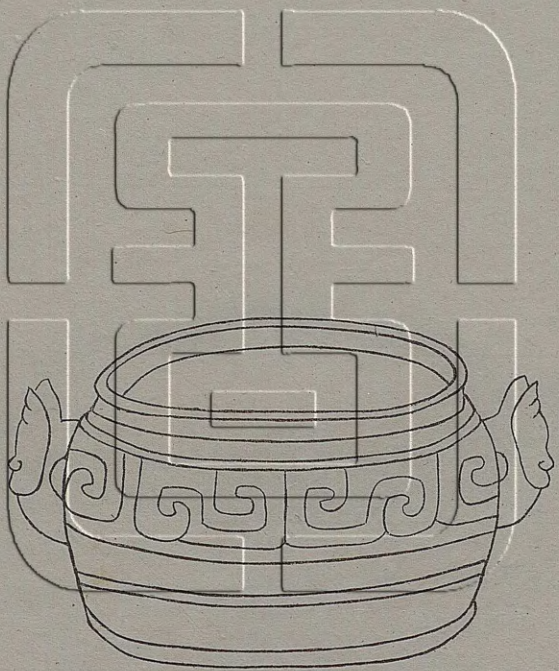



右高二寸深一寸六分口徑二寸九分腹圍一尺一寸六分重二十三兩兩耳

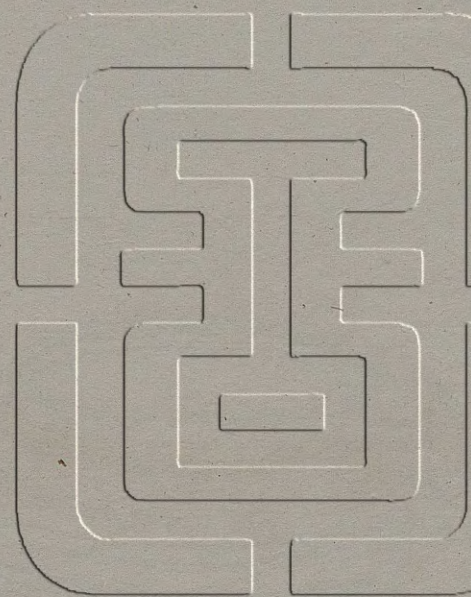

周環紋敦二

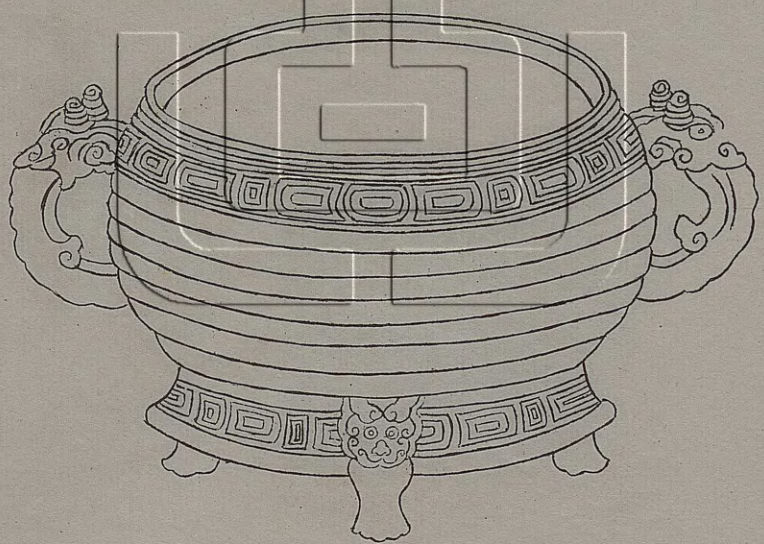

右高四寸九分深三寸三分口徑六寸腹圍二尺三寸五分重一百四兩兩耳

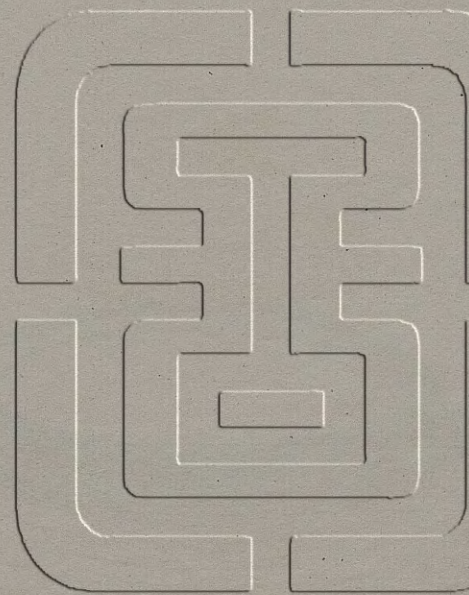

周環紋敦三

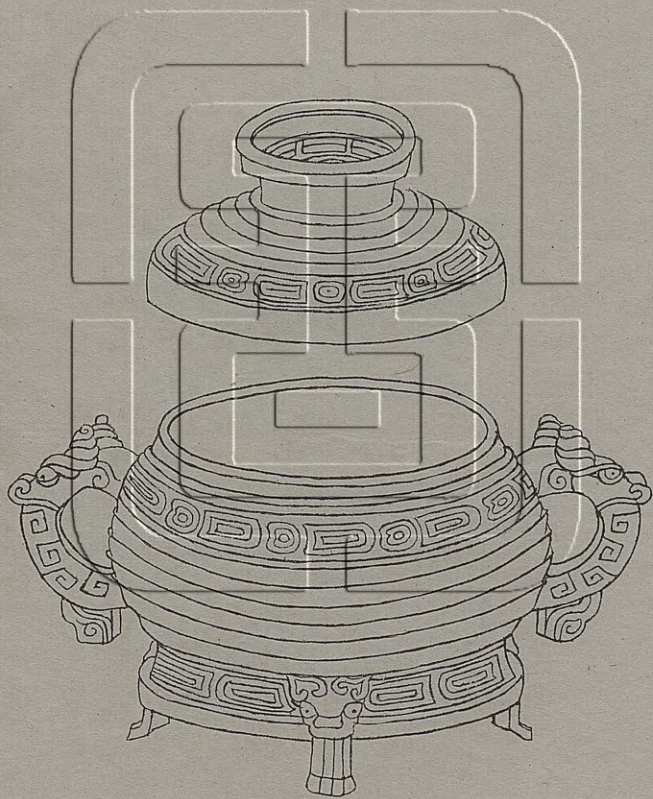

右通蓋高六寸九分深三寸六分口徑六寸腹圍二尺四分重一百五十三兩兩耳有珥

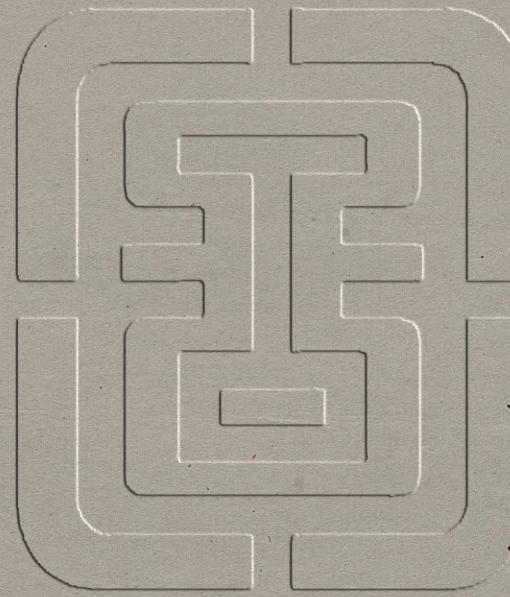

周環紋敦四

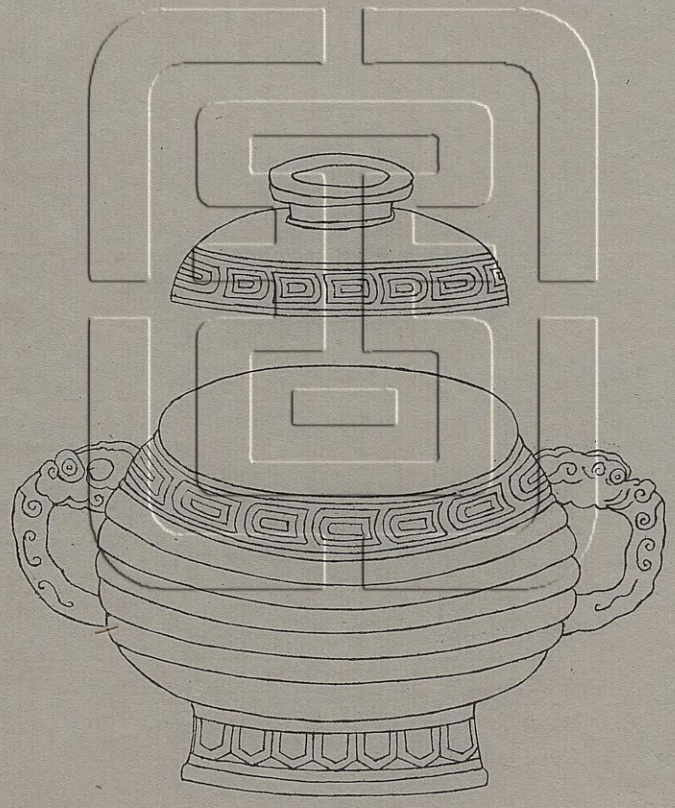

右通蓋高五寸六分深三寸二分口徑五寸腹圍一尺九寸八分重七十八兩兩耳

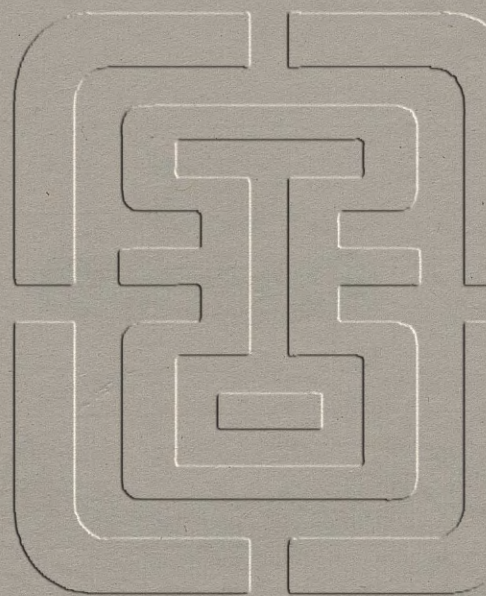

周獸耳敦

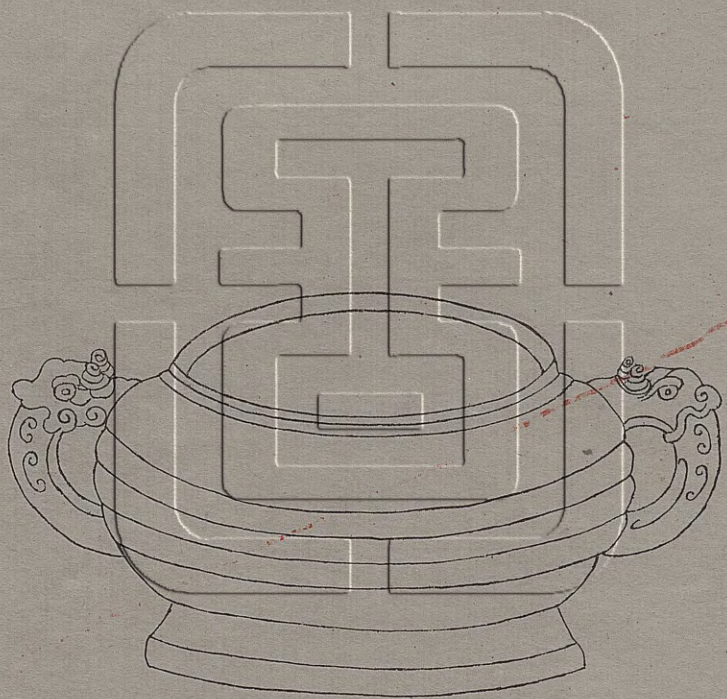

右高二寸八分深一寸四分口徑四寸腹圍一尺六寸重五十三兩兩耳

