

欽定西清古鑑

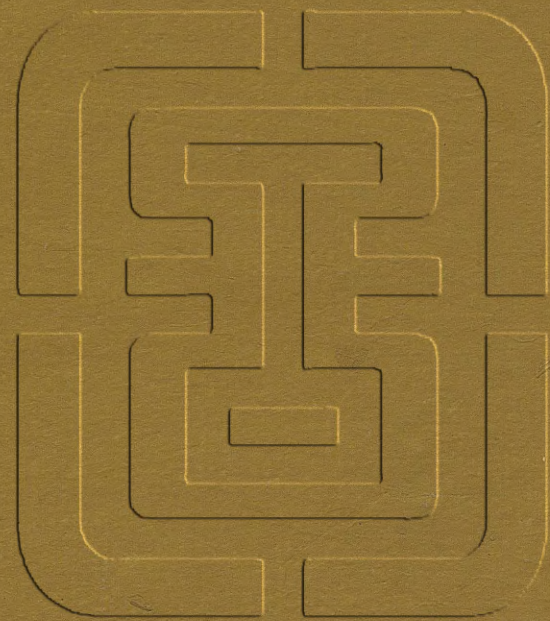

16
17
18
19
20
21
22
23
24
25
26
27
28
29
30
31
32
33
34
35
36
37
38
39
40

古
320
846
= 19

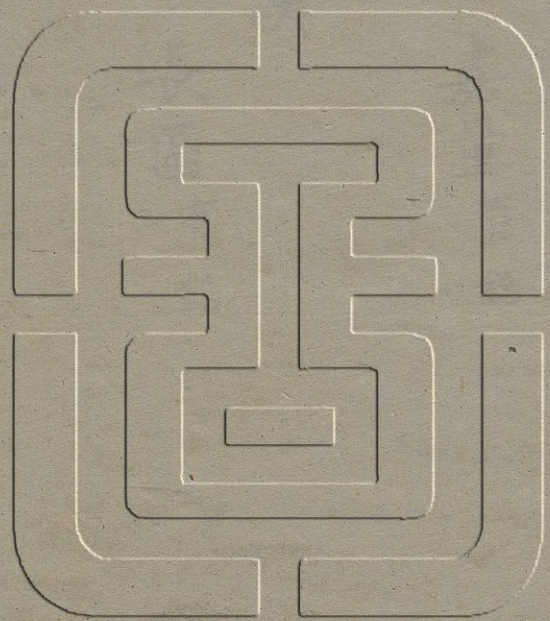

西清古鑑卷三十四目錄

量

漢

嘉量
有銘

區

漢

長區
有銘

鍾

漢

食官鍾
一有銘

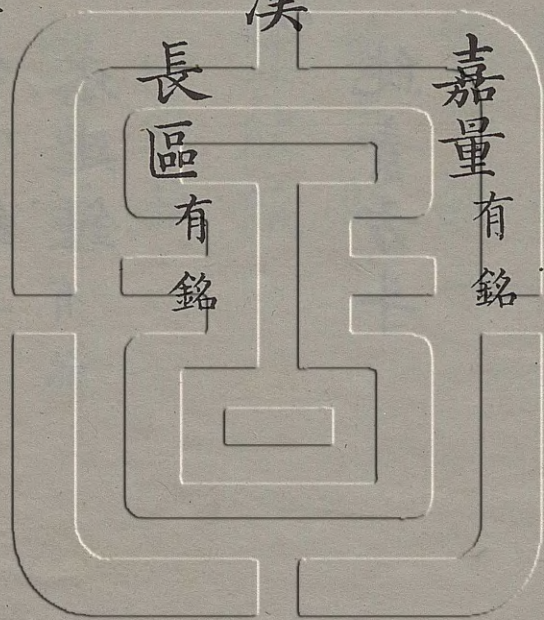
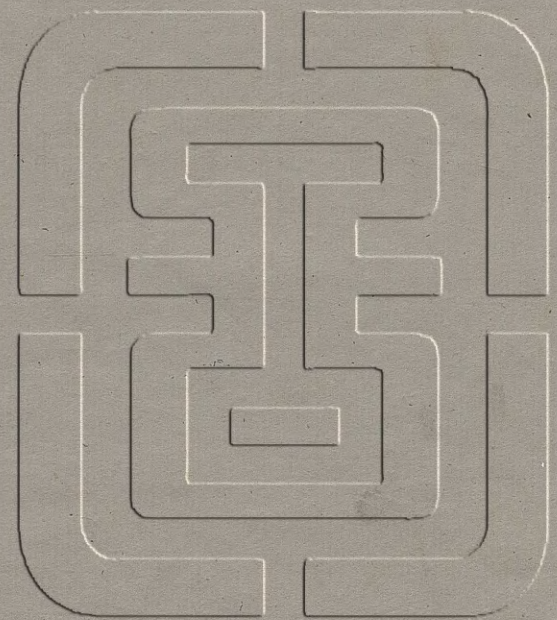

食官鍾二 有銘

食官鍾三 有銘

永建鍾 有銘

斗

漢

純素方斗

甗

周

夔龍甗

蟠夔甗

蟠虺甗

蟠虬甗

饗饗甗一

饗饗甗二

夔文甗

蠶紋甗

山紋甗

獸鼻甗

繩耳甗

素甗

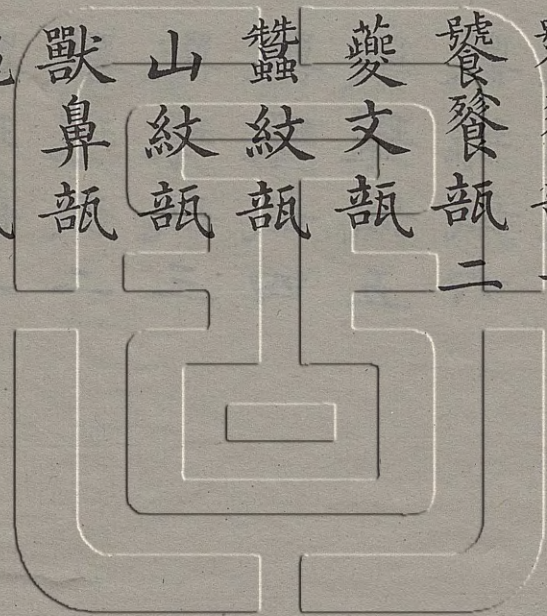

漢

獸環甗一

獸環甗二

獸環甗三

獸環甗四

獸環甗五

獸環甗六

獸環甗七

獸耳甗一

獸耳甗二

獸耳甗三

獸耳甗四

三鷹甗

山紋甗

星紋甗

素甗一

素甗二

素甗三

素甗四

缶

周

素缶

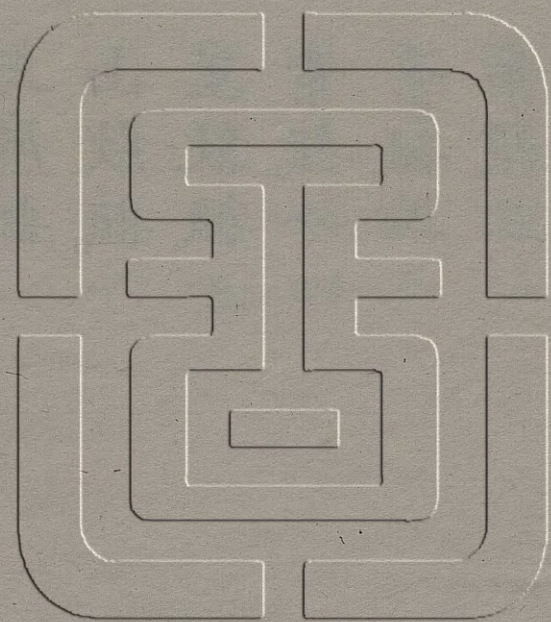

漢嘉量

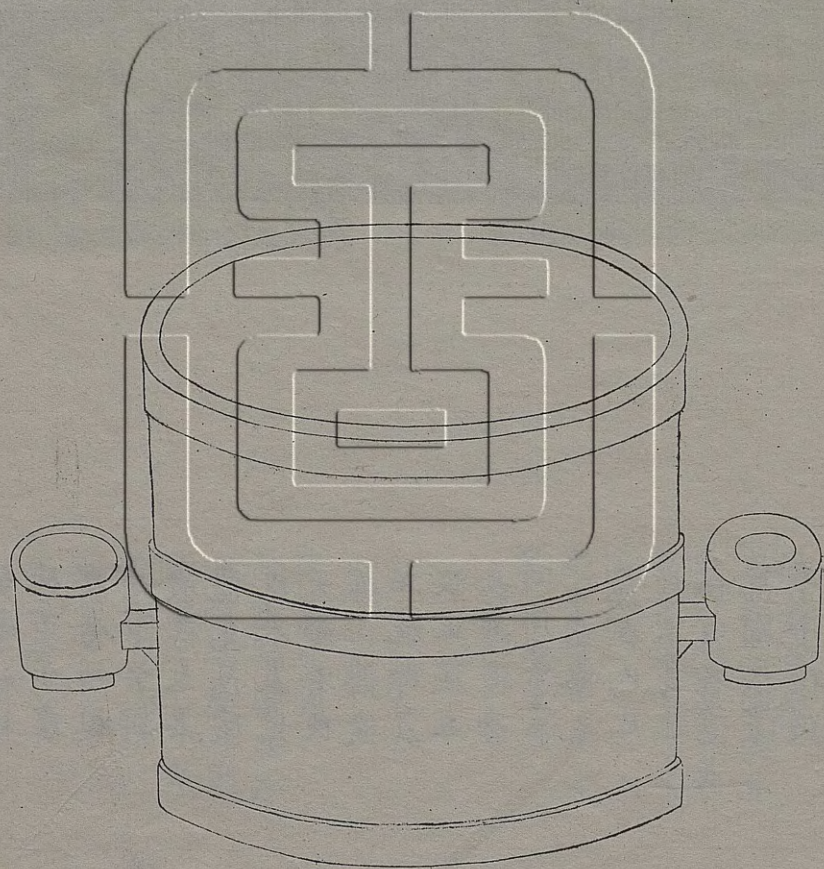

黃帝初祖
 德而于虞
 虞帝始祖
 德而于新
 歲在大梁
 龍集戊辰
 戊辰直定
 天命有民
 據土德受
 正號即真
 改正建丑
 長壽隆崇
 同律度量衡
 稽當前人
 龍在己巳
 歲次實沈
 初班天下
 萬國永遵
 子子孫孫
 享傳億年

黃帝初祖
 德而于虞
 虞帝始祖
 德而于新
 歲在大梁
 龍集戊辰
 戊辰直定
 天命有民
 據土德受
 正號即真
 改正建丑
 長壽隆崇
 同律度量衡
 稽當前人
 龍在己巳
 歲次實沈
 初班天下
 萬國永遵
 子子孫孫
 享傳億年

律嘉量斛
 方尺而圍其外
 庭旁九釐五豪
 寬百六十二寸
 深尺
 積千六百廿寸
 容十斗

律嘉量斛
 方尺而圍其外
 庭旁九釐五豪
 寬百六十二寸
 深尺
 積千六百廿寸
 容十斗

律嘉量斗
 方尺而圍其外
 庭旁九釐五豪
 寬百六十二寸
 深寸
 積百六十二寸
 容十升

律嘉量斗
 方尺而圍其外
 庭旁九釐五豪
 寬百六十二寸
 深寸
 積百六十二寸
 容十升

律嘉量升

方二寸而圍其外

應廣一釐九豪

厚六分

廣六分

積萬六千二百分

容十合

律嘉量升

方二寸而圍其外

應廣一釐九豪

厚六分

廣六分

積萬六千二百分

容十合

律嘉量合

方二寸而圍其外

應廣一釐九豪

厚六分

廣六分

積千六百廿分

容二龠

律嘉量合

方二寸而圍其外

應廣一釐九豪

厚六分

廣六分

積千六百廿分

容二龠

律嘉量龠

方二寸而圍其外

應廣一釐九豪

厚六分

廣六分

積八百一十分

容如黃鍾

律嘉量龠

方二寸而圍其外

應廣一釐九豪

厚六分

廣六分

積八百一十分

容如黃鍾

右斛斗升合龠凡五統曰量為一器合今尺通
高八寸二分通濶一尺六寸五分斛深七寸二
分徑一尺四分斗深七分有二徑與斛同升深
一寸八分有一徑二寸一分合深七分有二徑
一寸一分龠深三分有六徑一寸蓋莽尺每一

尺當今七寸二分通重三百六十三兩王莽篡漢號曰新其偽詔曰予伏念皇初祖考黃帝皇始祖考虞帝此銘首四語是也歲在大梁龍集戊辰則居攝之三年改元初始矣戊辰直定則始篡之日按漢書以戊辰直定御王冠顏師古注謂其日當定則猶言定日也莽妄稱火德銷盡土德當代故言據土德其曰改正建丑蓋莽以戊辰十二月朔癸酉為建國元年正月之朔也又漢書莽策羣司有曰白煒象平考量以銓攷其時為建國元年今銘云龍在巳巳歲次實沈適合蓋銘詞先叙其篡位之始而制器則建國元年也大梁昴星季春之月實沈商星孟夏之月故戊辰曰歲在大梁巳巳曰歲次實沈皆歲星所在也周禮臬氏為量銘曰嘉量既成以觀四國而此器亦名嘉量莽假周禮以愚惑天下於此亦見又據黃鐘之律積龠為合積合為升以至於斛居然有虞氏之制度故曰律嘉量也龐旁云云龐吐彫切廣韻謂不滿之貌莽為漢臣而盜竊名號至於改正朔異器制其銘詞曰初班天下萬國永遵子子孫孫享傳億年與

秦一世二世傳之萬世者同一妄誕今採入圖
錄不書新而仍命之曰漢亦春秋遺意耳

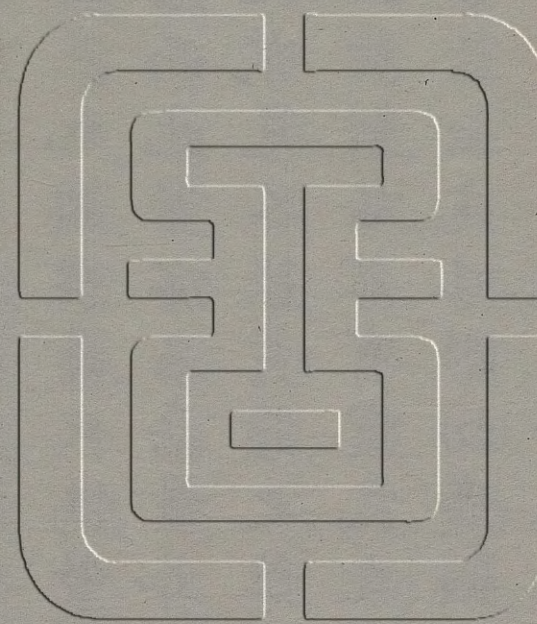

漢長區

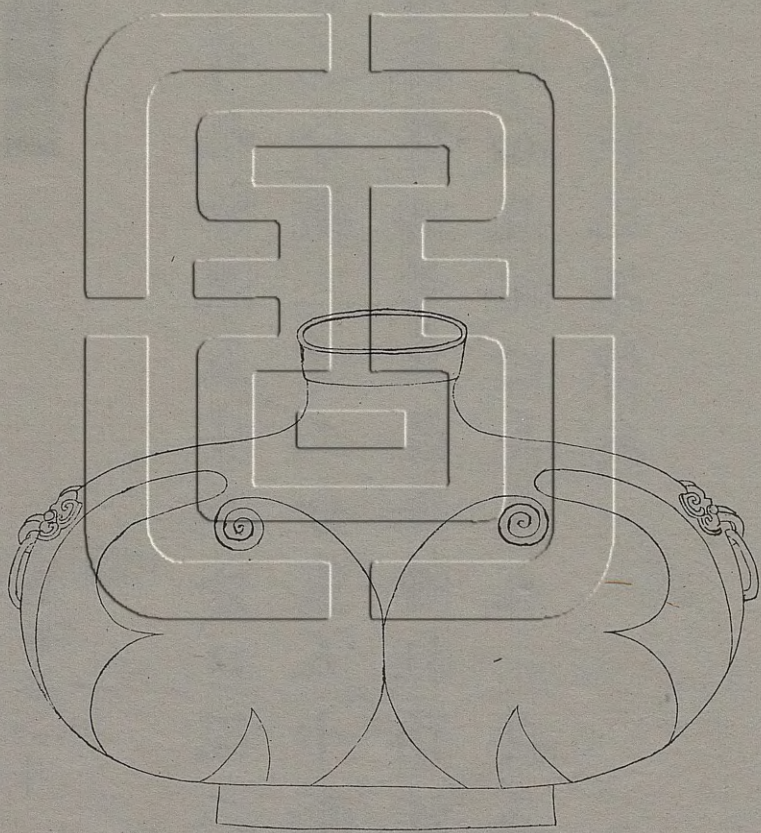

長區周一斗

長區容一斗

右高六寸九分深五寸二分口徑二寸一分腹
 縱七寸二分橫三寸二分重五十兩兩耳有環
 左氏傳齊舊四量豆區釜鍾杜預注四豆為區
 容十六升而此銘曰長區容一斗蓋自春秋至
 漢制之廣狹已不侔矣

漢食官鍾一

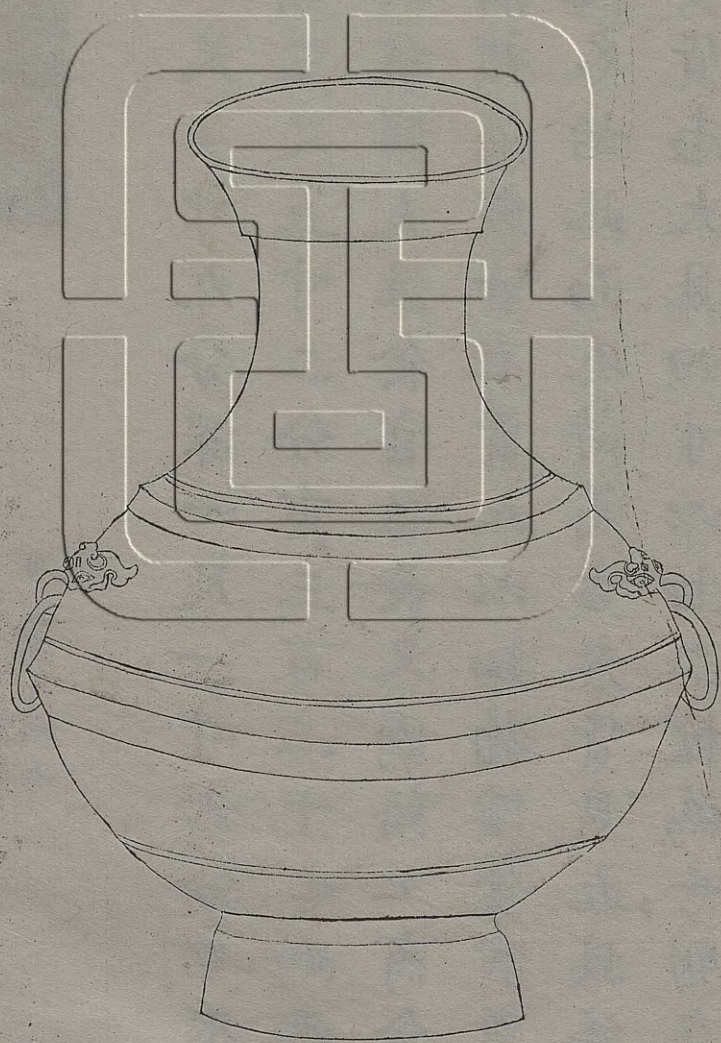

食周(一)季造
重五十斤四兩

食官一朋造
重五十斤四兩

右高一尺三寸九分深一尺一寸六分口徑六寸腹圍三尺五寸二分重三百二十七兩兩耳有環周禮膳夫注食官之長又國語工商食官注謂周禮府藏皆有賈人以知物價食官稟之食官之名始此而毛詩箋古者貨貝五貝為朋漢書食貨志大貝四寸以上二枚為一朋直二百一十六此銘一朋蓋其直也下識云五十斤四兩按律歷志三百八十四銖為一斤合易二篇之文又十六兩成斤者四時成四方之象也則斤為十六兩古今所同此五十斤四兩當為八百四兩今權重三百二十七兩則漢之每百兩今四十兩六錢七分有奇也

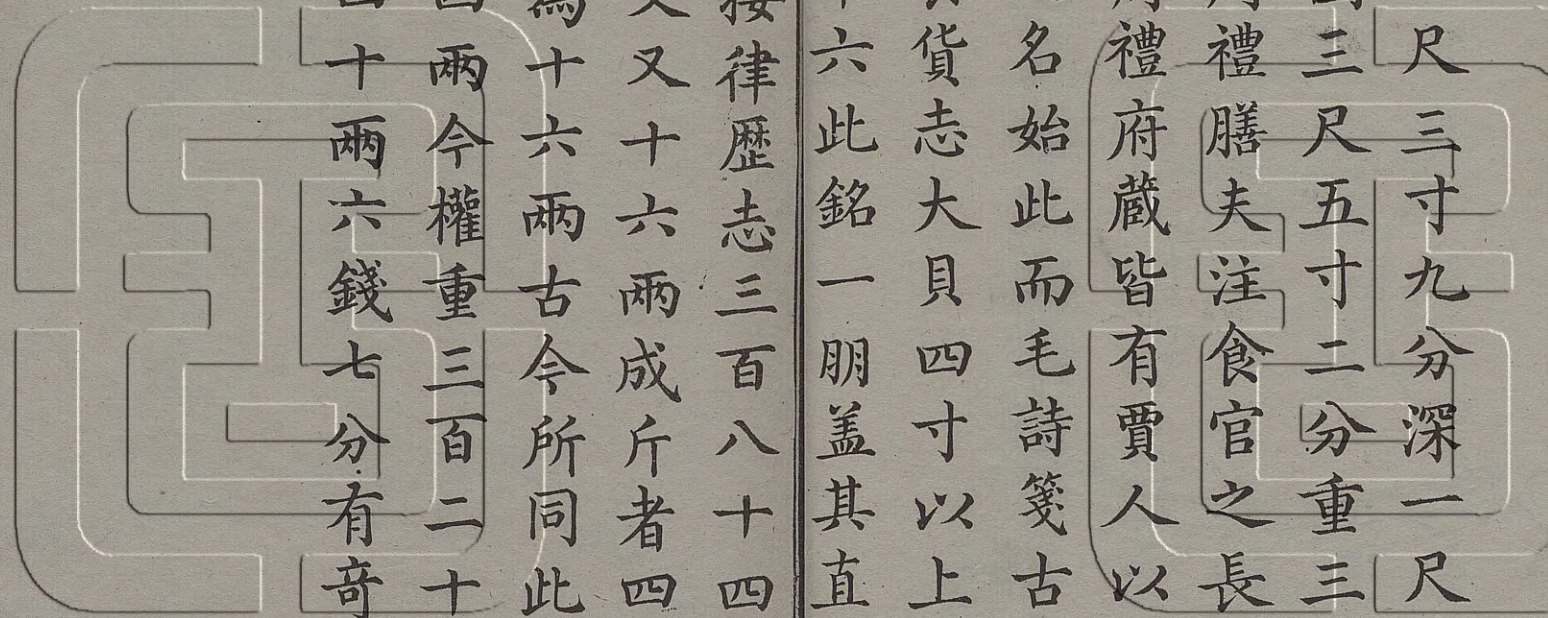

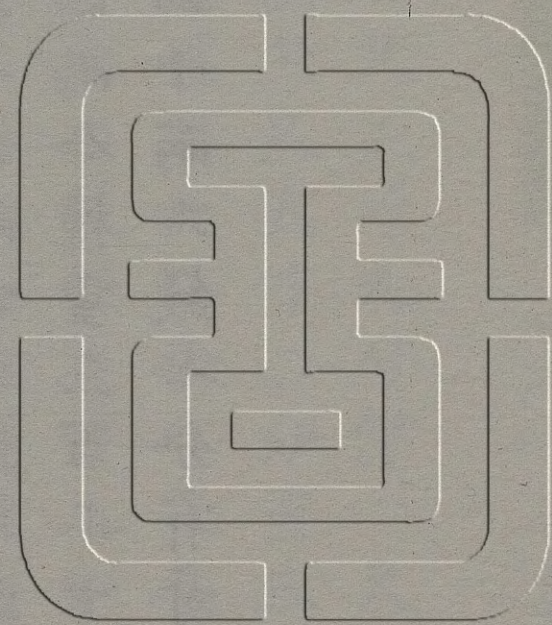

漢食官鍾二

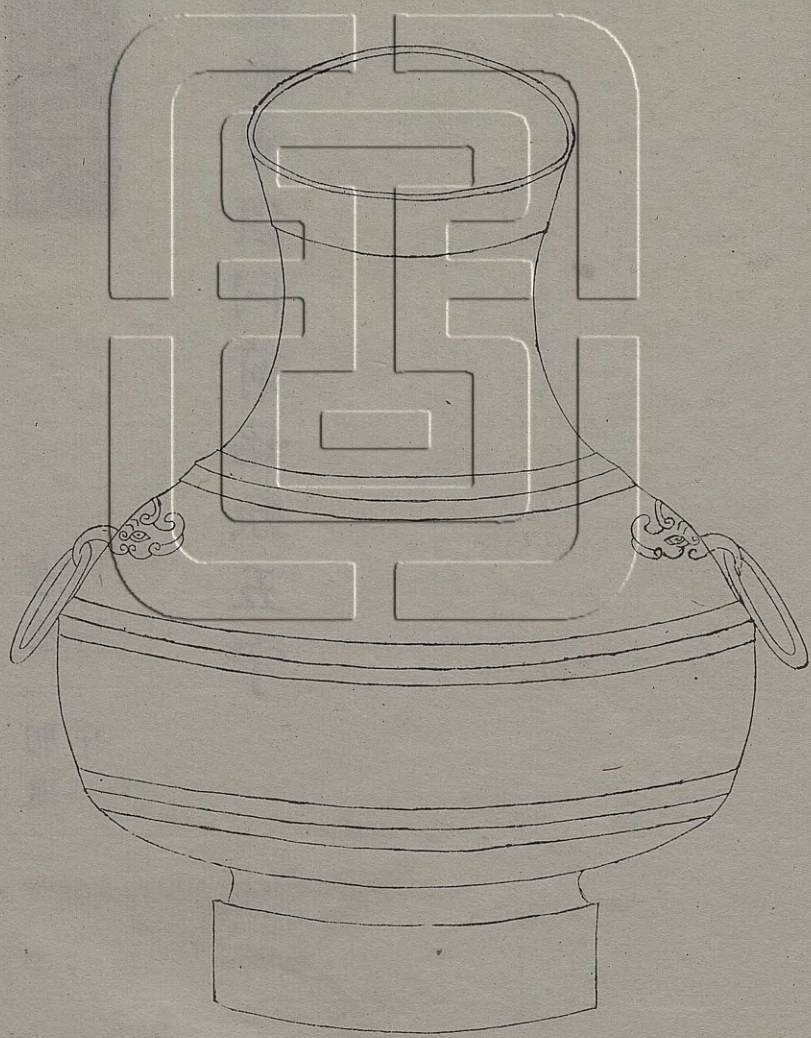

食庖一弄造
斤

食官一朋造
斤

右尺度輕重俱同前銘缺五字

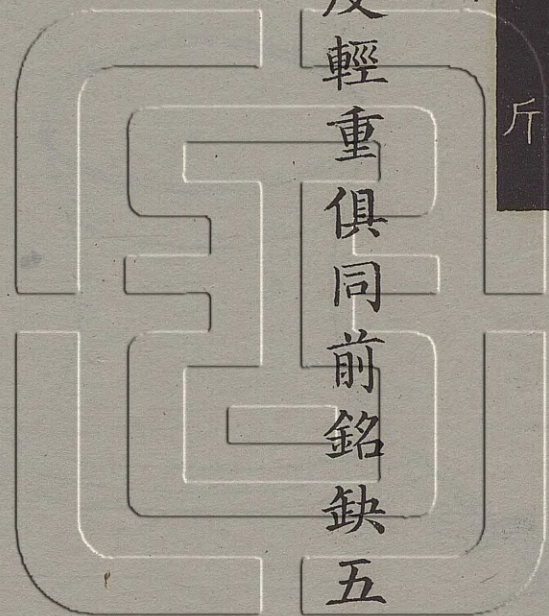

漢食官鍾三

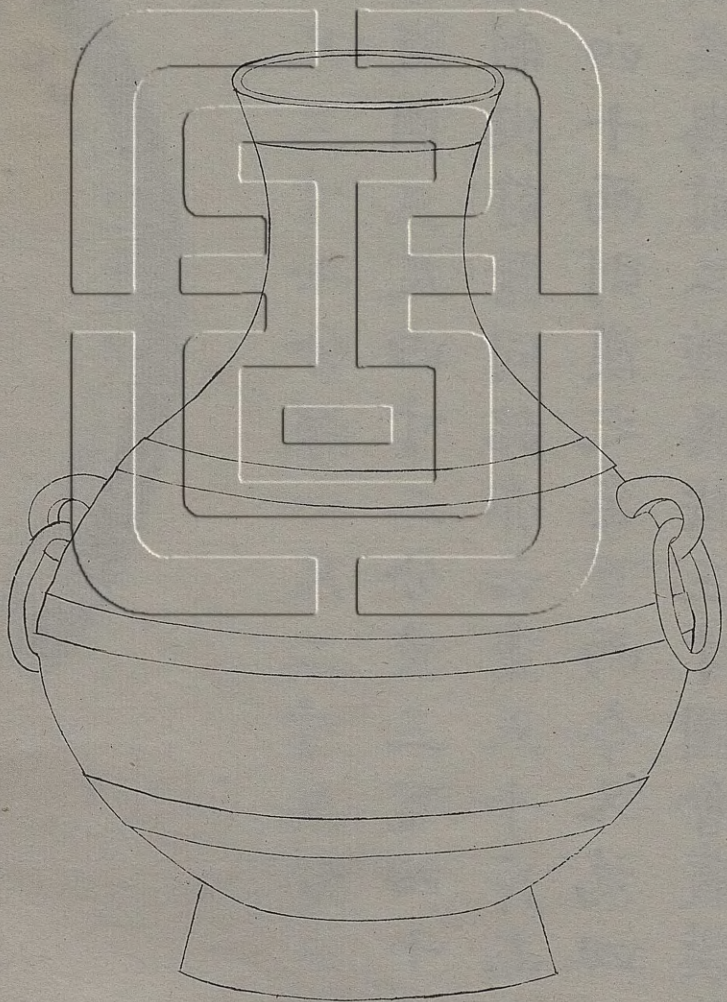

鐘重五十斤十年六月乙未
鐘重五十斤十年六月乙未
鐘重五十斤十年六月乙未
鐘重五十斤十年六月乙未
鐘重五十斤十年六月乙未
鐘重五十斤十年六月乙未
鐘重五十斤十年六月乙未
鐘重五十斤十年六月乙未
鐘重五十斤十年六月乙未
鐘重五十斤十年六月乙未

右高一尺三寸七分深一尺二寸五分口徑五寸二分腹圍三尺四寸二分重三百四十兩兩耳有環制與前器同銘亦云重五十斤而今權重三百四十兩則漢之每百兩今又為四十二兩五錢矣與前二鍾異按三才圖會載漢薰鑪重一斤三兩銘云重五斤六兩以今權較之三

兩十二銖八釵有奇當漢之一斤觀此器則六兩一十九銖二釵當漢一斤矣與圖會亦弗合

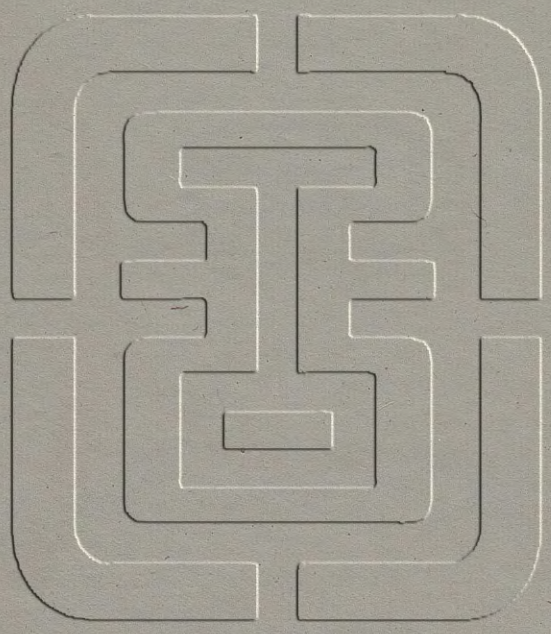

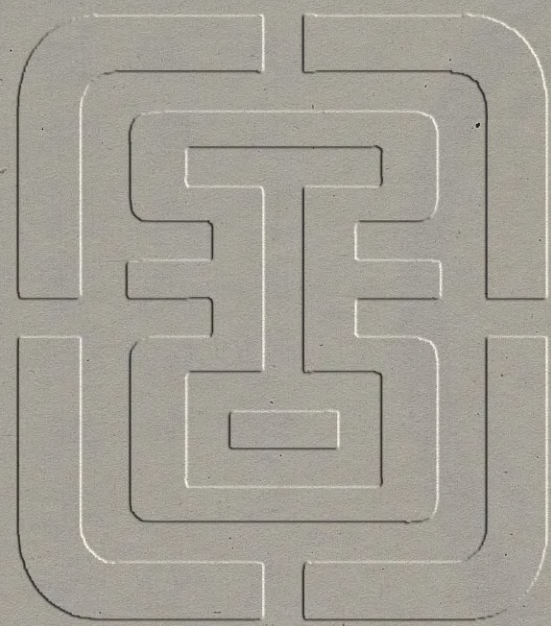

漢永建鍾

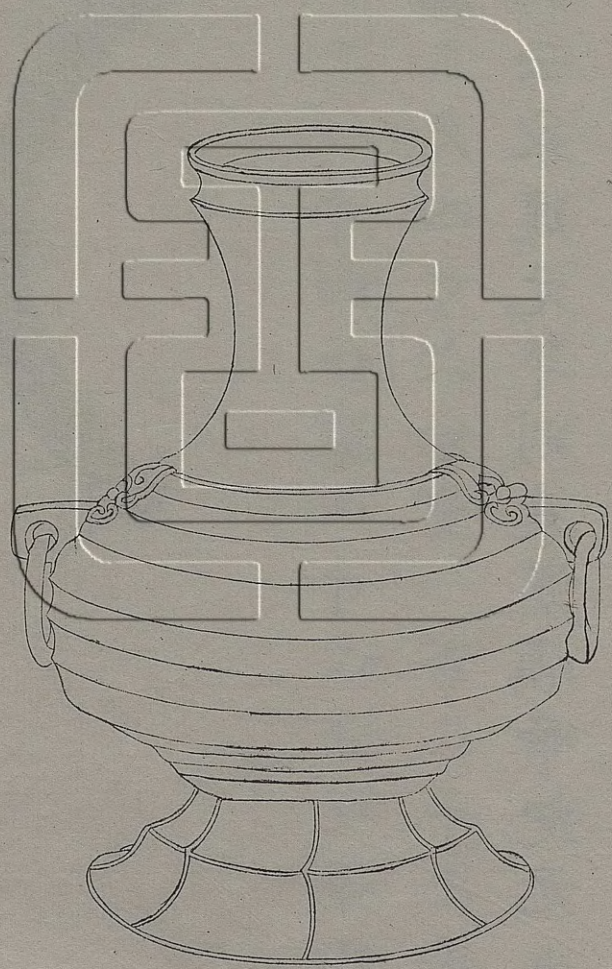

右高四寸七分深四寸口徑五寸九分足徑三寸六分重六十六兩按許氏說文斗大升也此與飲器自別

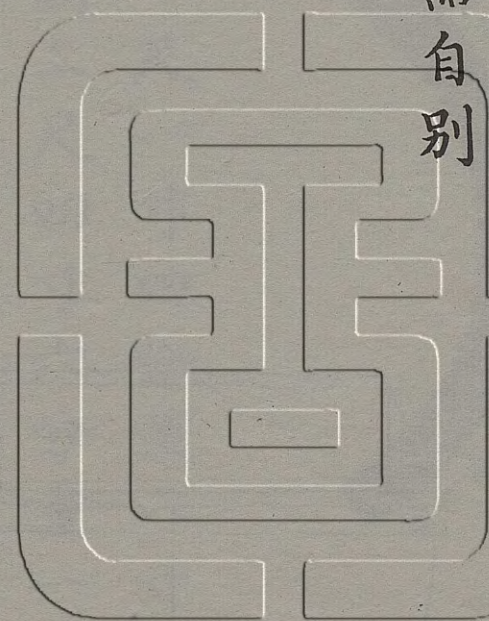

周夔龍觚



右高八寸一分深七寸九分口徑五寸一分腹圍二尺九寸五分重一百五十三兩按爾雅釋器甌謂之甌戰國策有壺醢甌醬之語漢書顏師古注曰甌小甌也博古圖謂以具醢醢醬其制亦不一大率為食器耳又揚子方言大者謂之甌中者謂之甌甌至於小口為甌則前人已辨之矣

周蟠夔甌

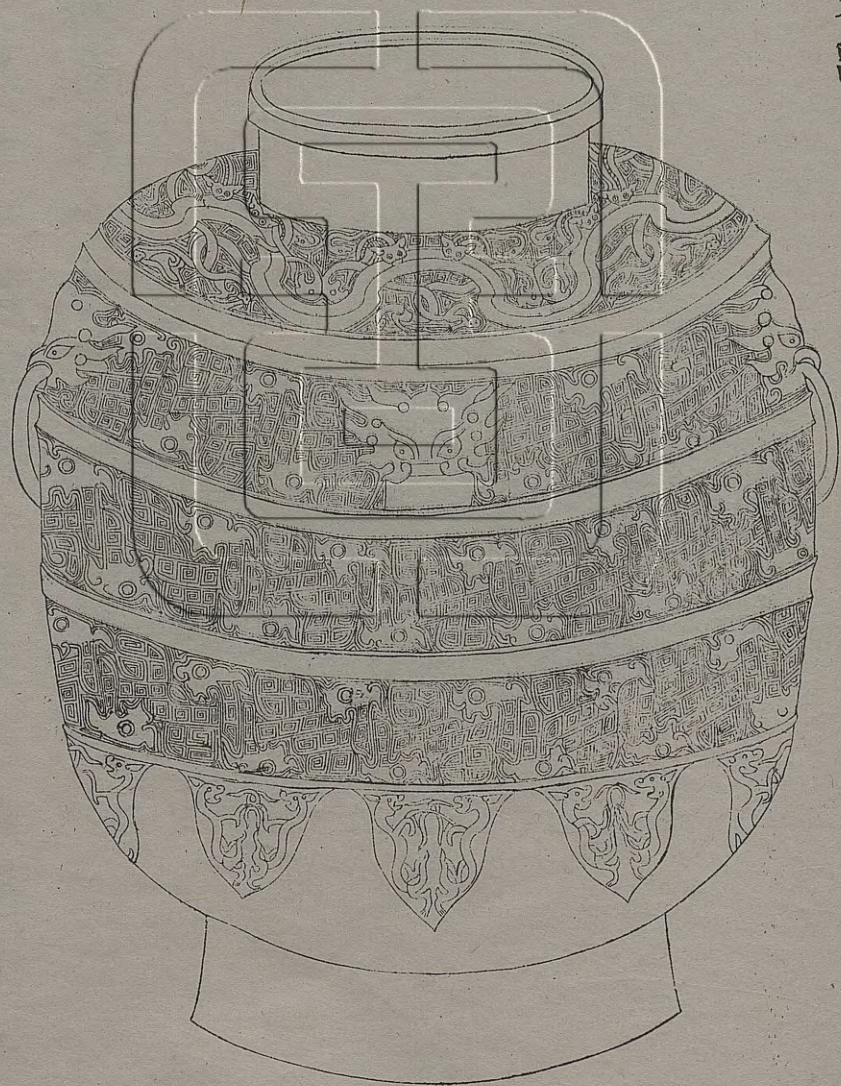

右高一尺七寸四分深一尺五寸口徑七寸七分腹圍五尺一寸重九百七兩

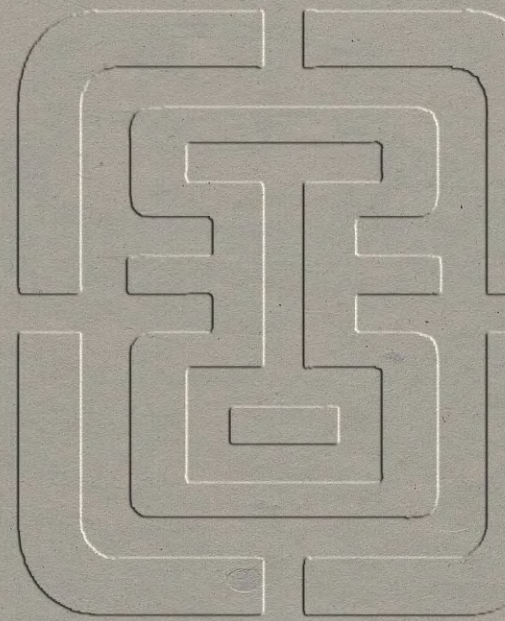

周蟠虺斝

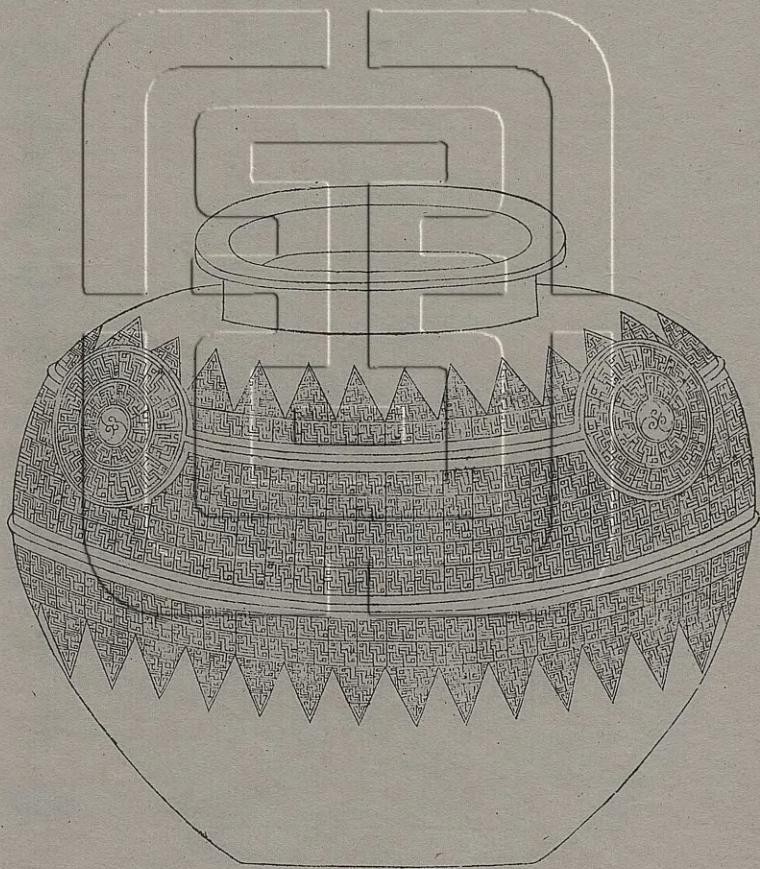

右高八寸七分深八寸三分口徑六寸五分腹圍三尺六寸五分重一百八十七兩

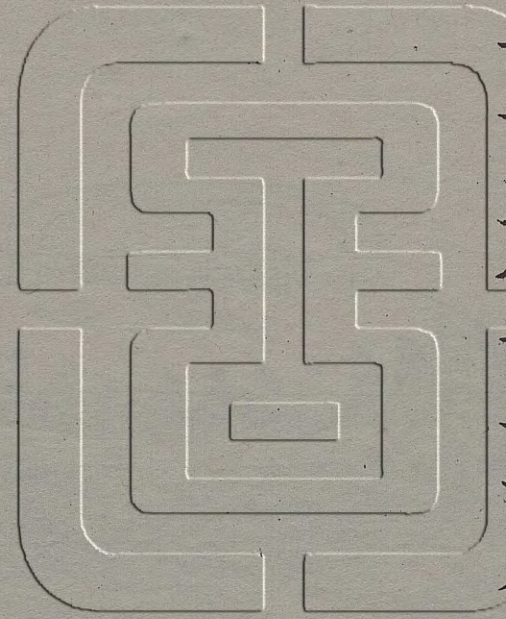

周蟠虬



右高九寸三分深八寸八分口徑五寸五分腹圍三尺六分重一百八十七兩

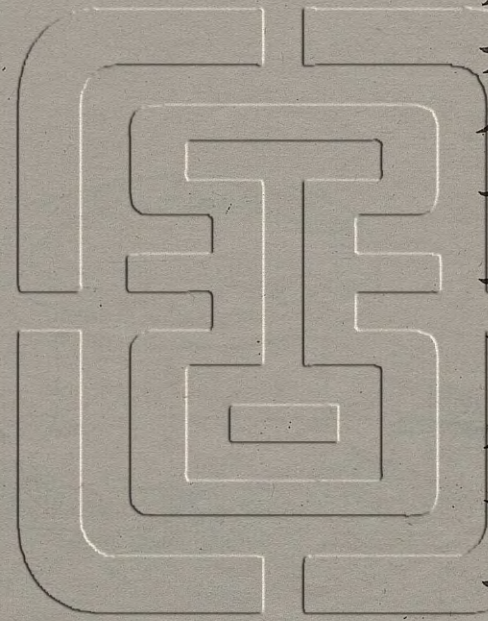

周饗餐甗一

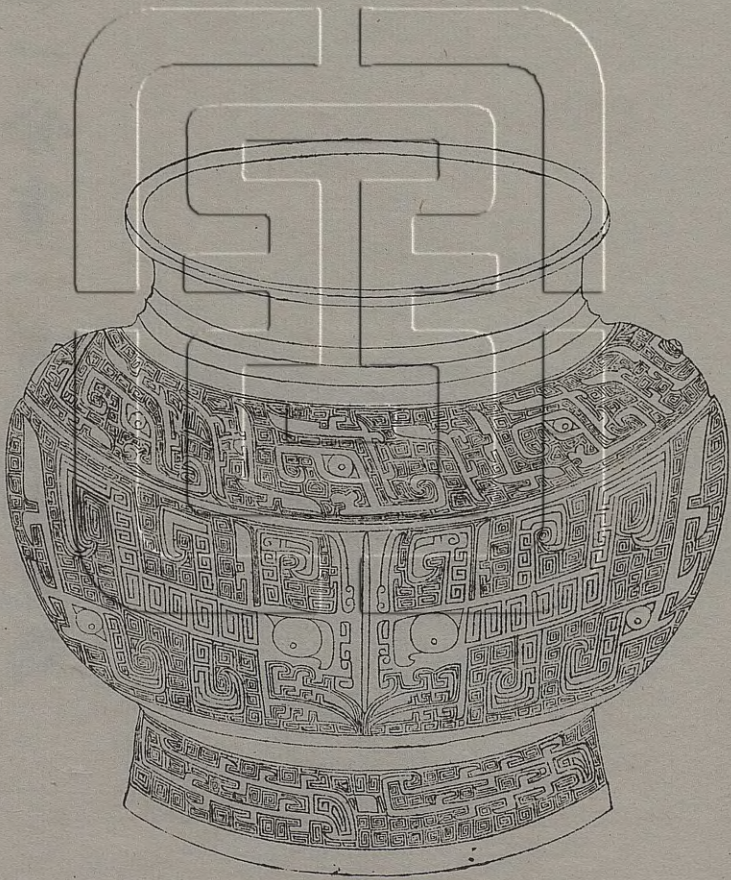

右高七寸八分深六寸三分口徑六寸四分腹圍三尺一分重一百六十九兩

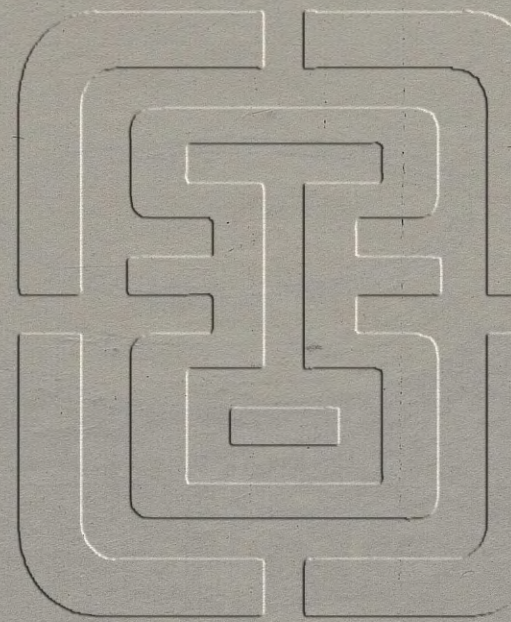

周饗餐甗二

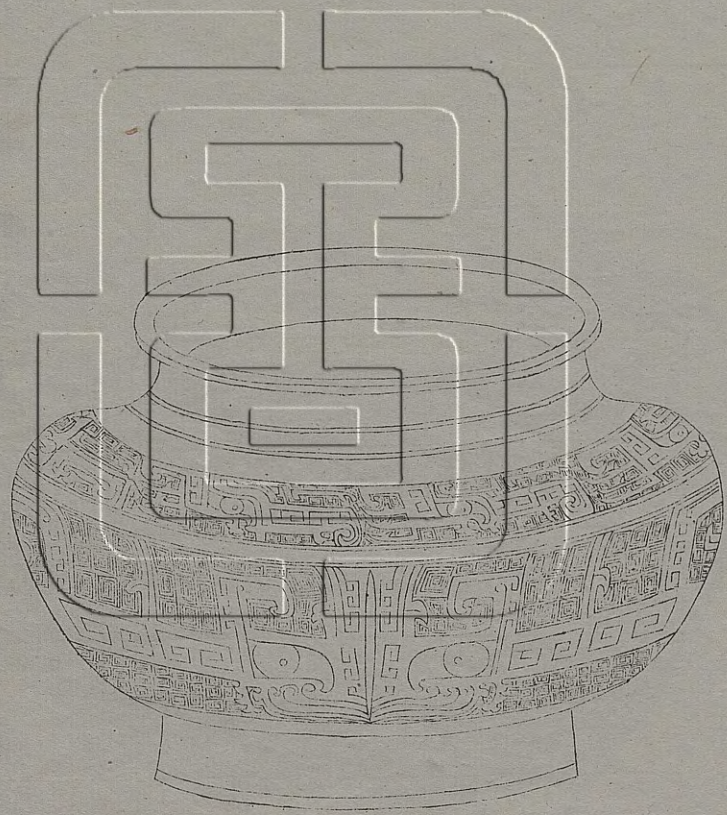

右高六寸三分深五寸七分口徑七寸五分腹圍三尺一寸九分重一百一十五兩

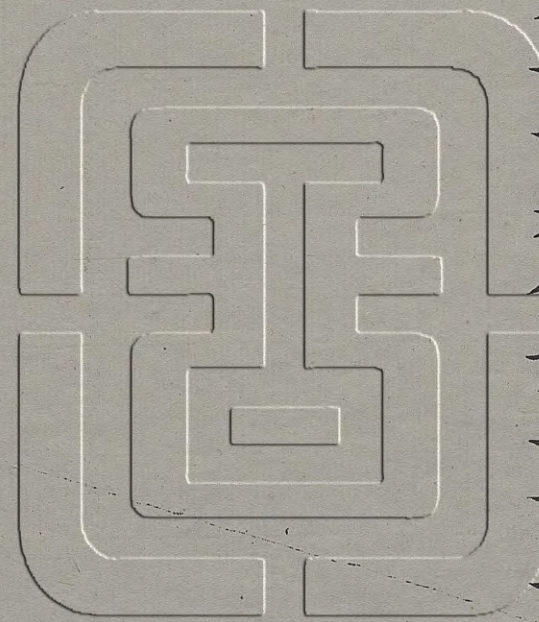

周夔紋甗

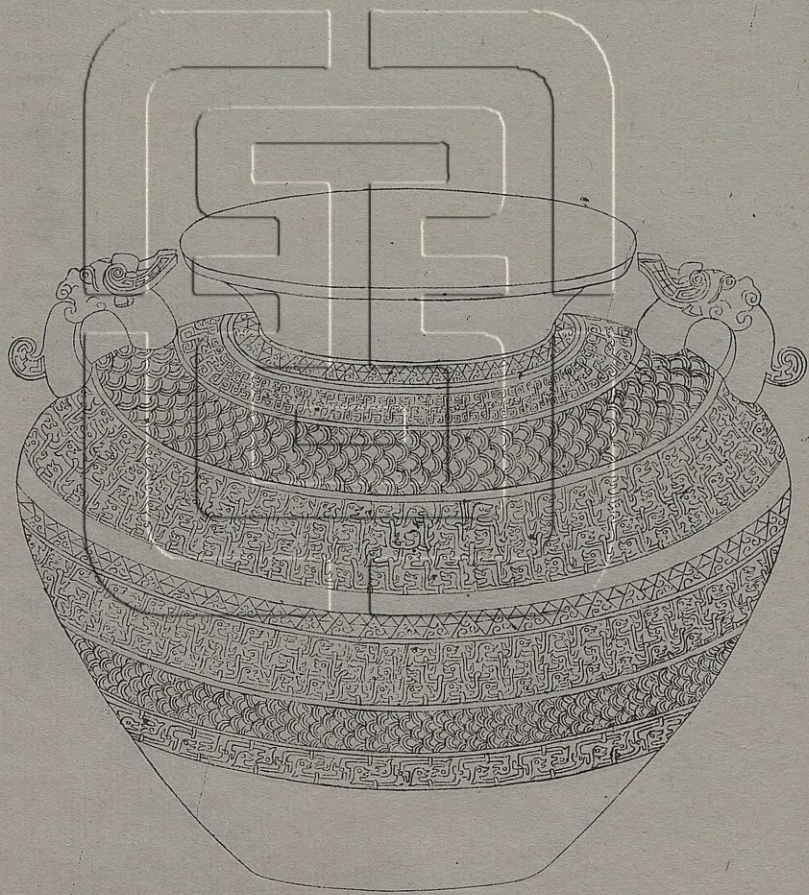

右高九寸九分深九寸四分口徑七寸六分腹圍四尺二分重二百五十九兩

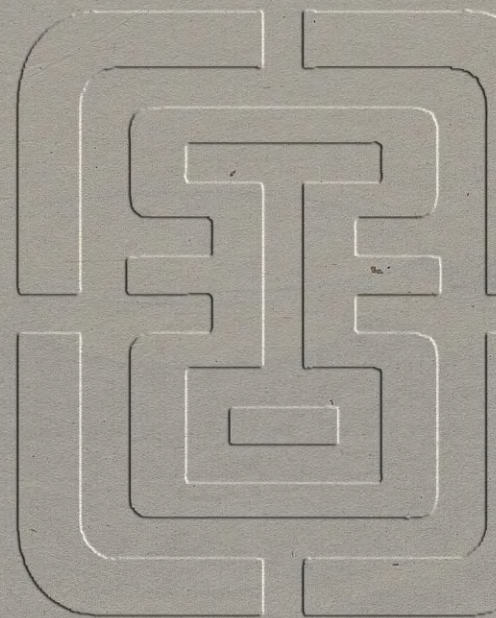

周饗螭紋甗

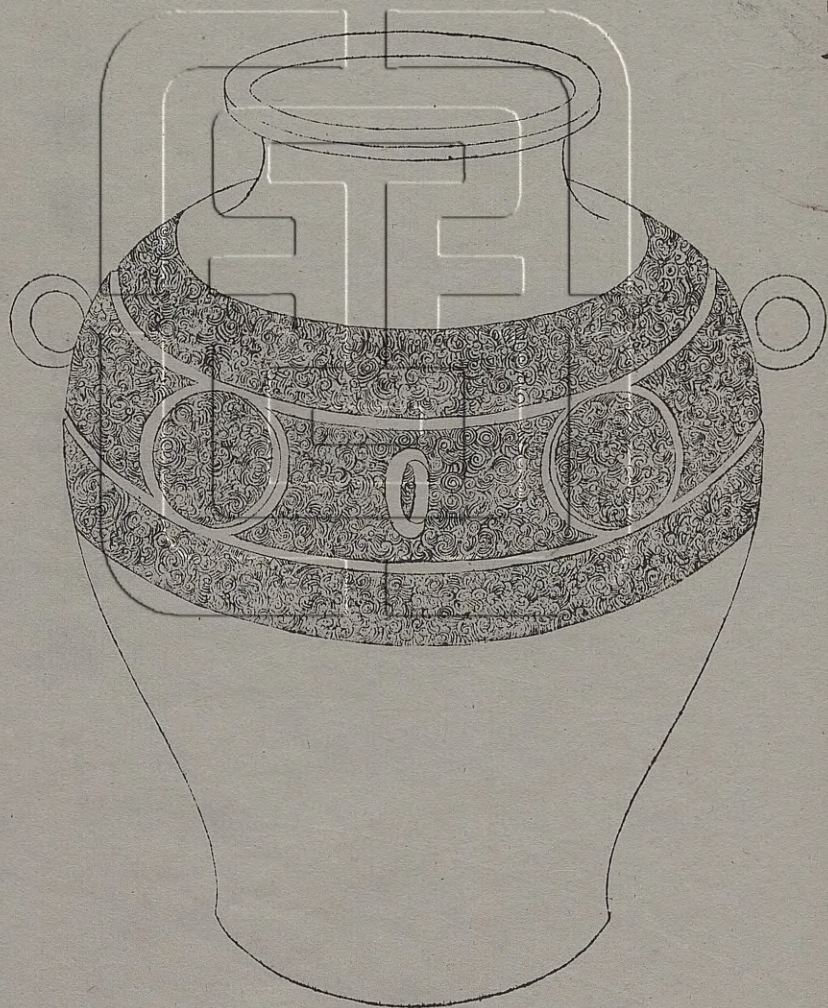

右高一尺一分深一尺口徑五寸五分腹圍三尺一寸二分重一百九十一兩

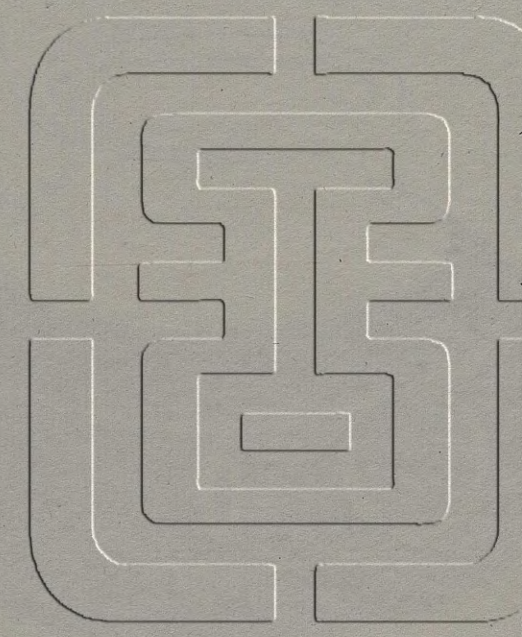

周山紋甗

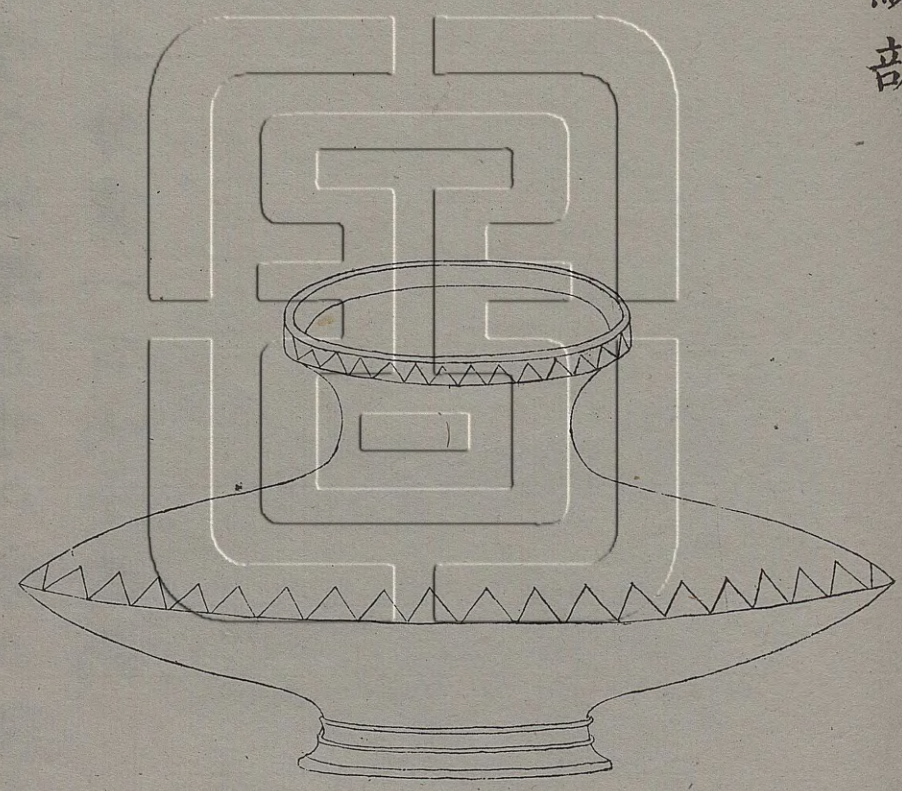

右高六寸六分深五寸八分口徑六寸腹圍三尺五寸七分重一百六十五兩

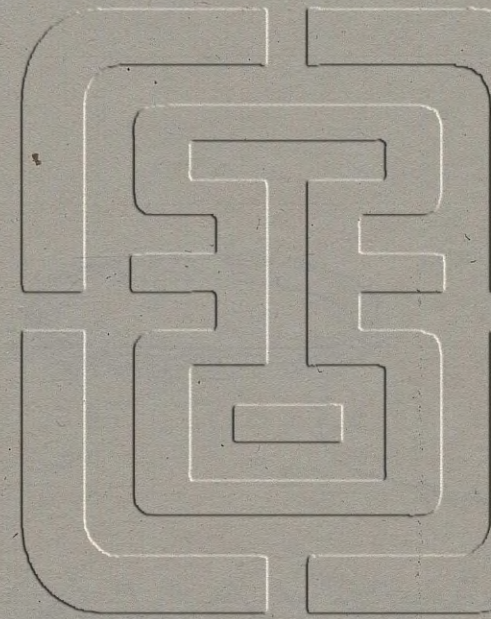

周獸鼻甗

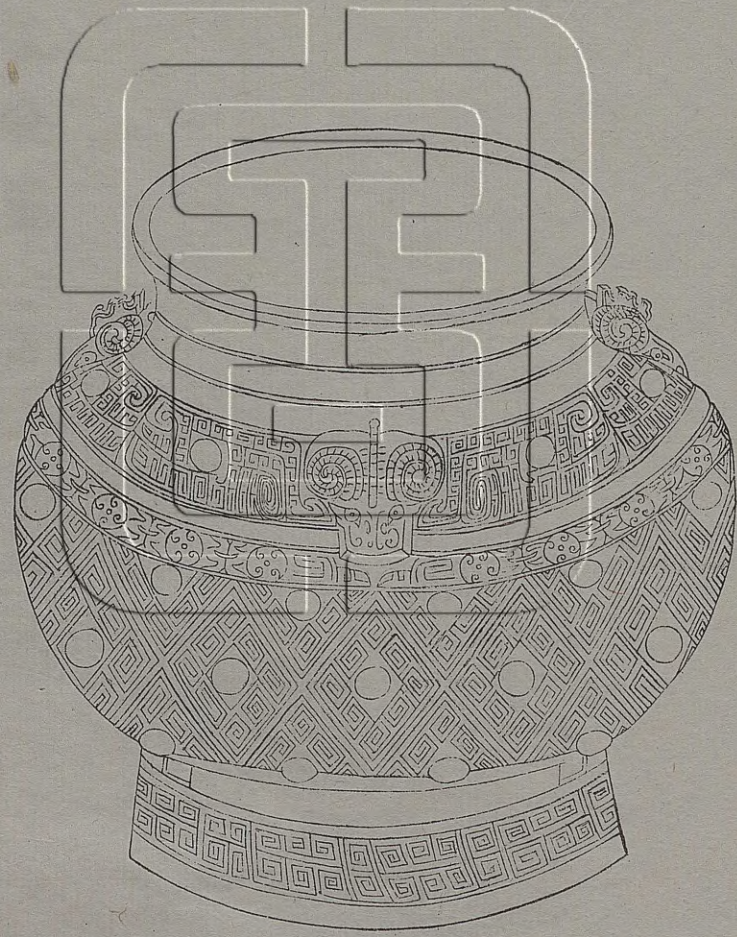

右高八寸六分深六寸五分口徑八寸腹圍三尺四寸七分重二百一十一兩

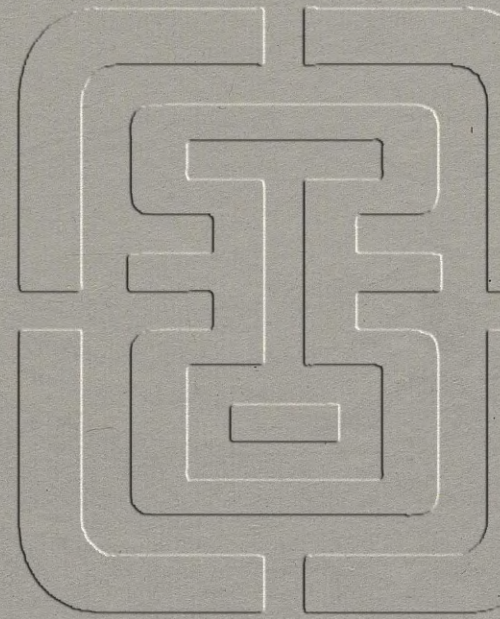

周繩耳甗

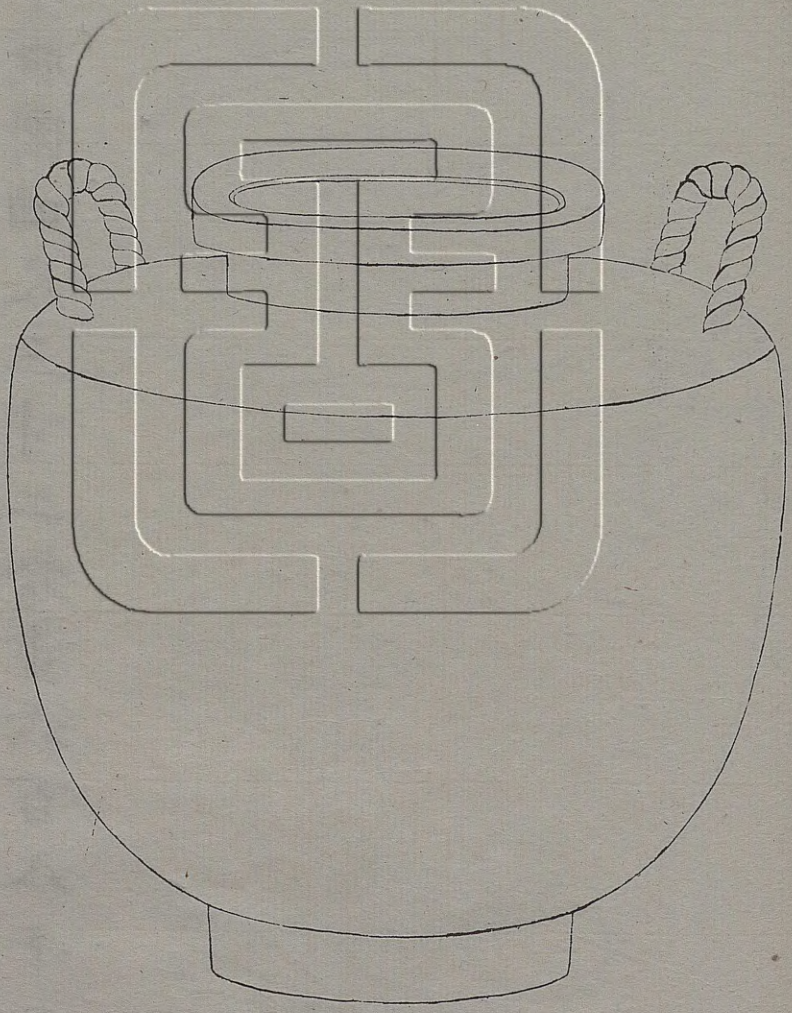

右高一尺五寸七分深一尺三寸三分口徑七寸八分腹圍四尺三寸二分重六百八十三兩

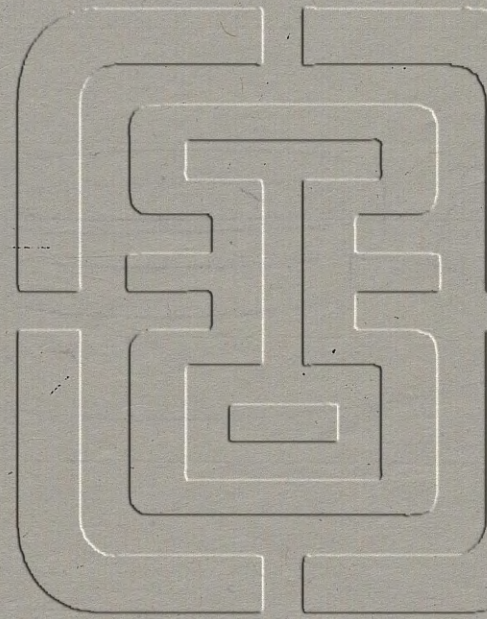

周素甗

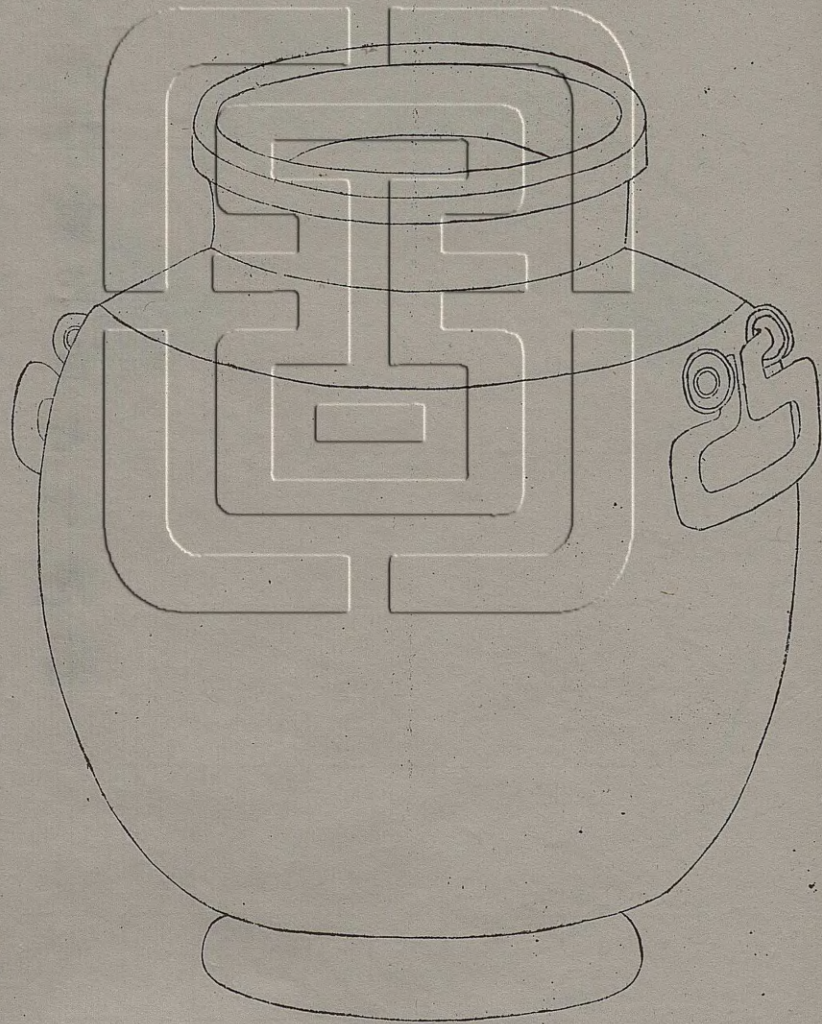

右高一尺六分深一尺口徑五寸九分腹圍三尺二寸九分重三百七十九兩

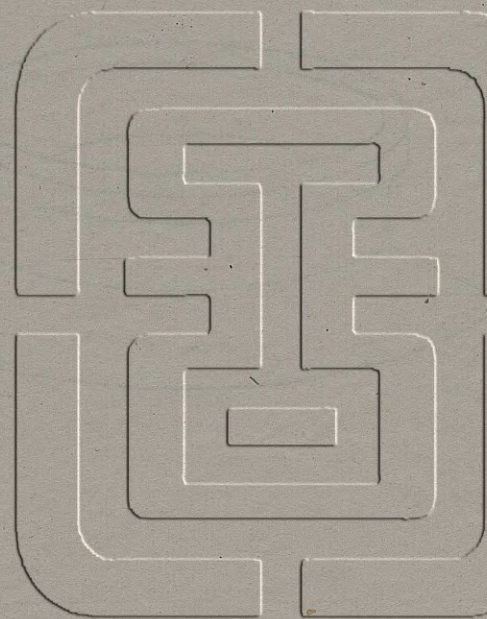

漢獸環瓠一

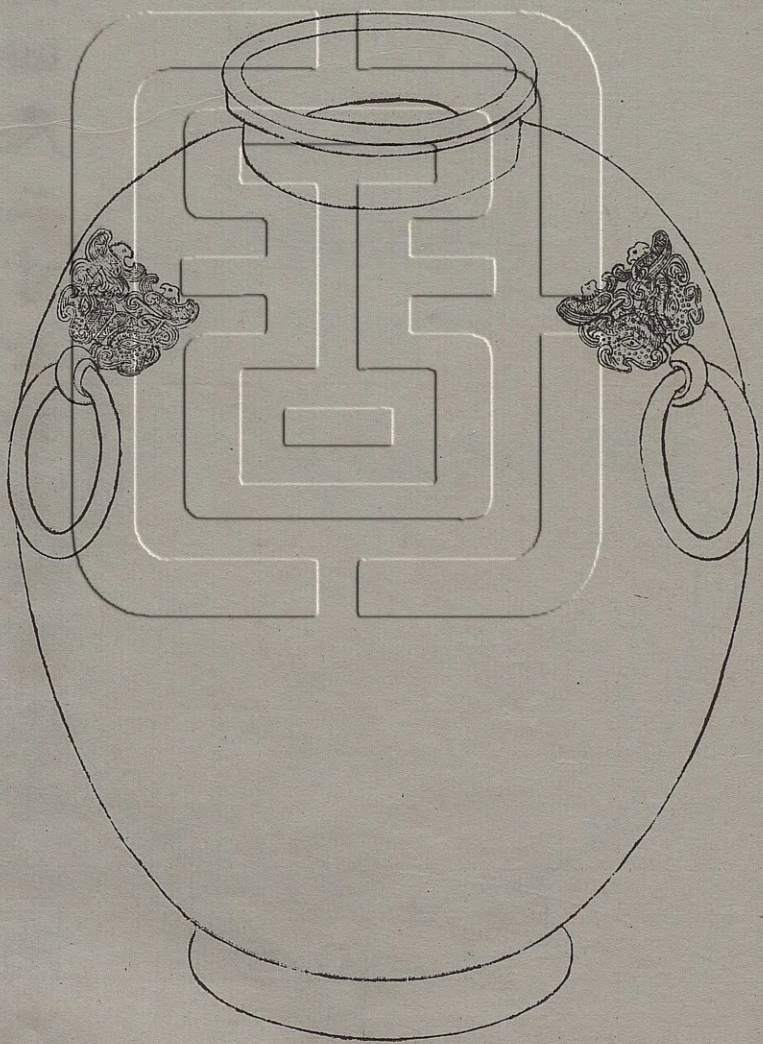

西清古鑑
卷三十四
瓠

右高一尺四寸一分深一尺三寸口徑六寸五分腹圍四尺二寸七分重六百六十一兩

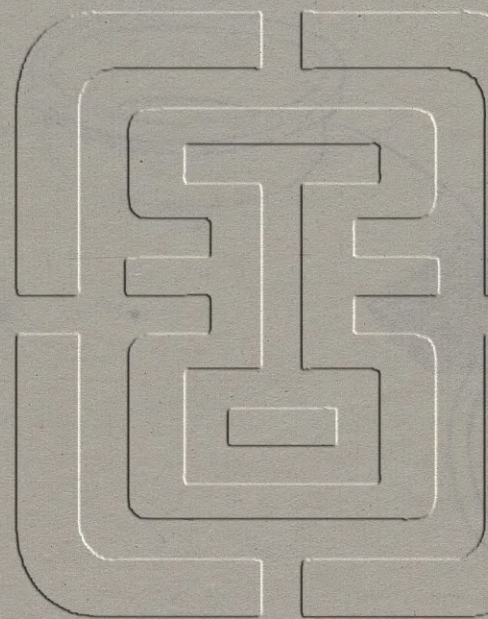

漢獸環甗二

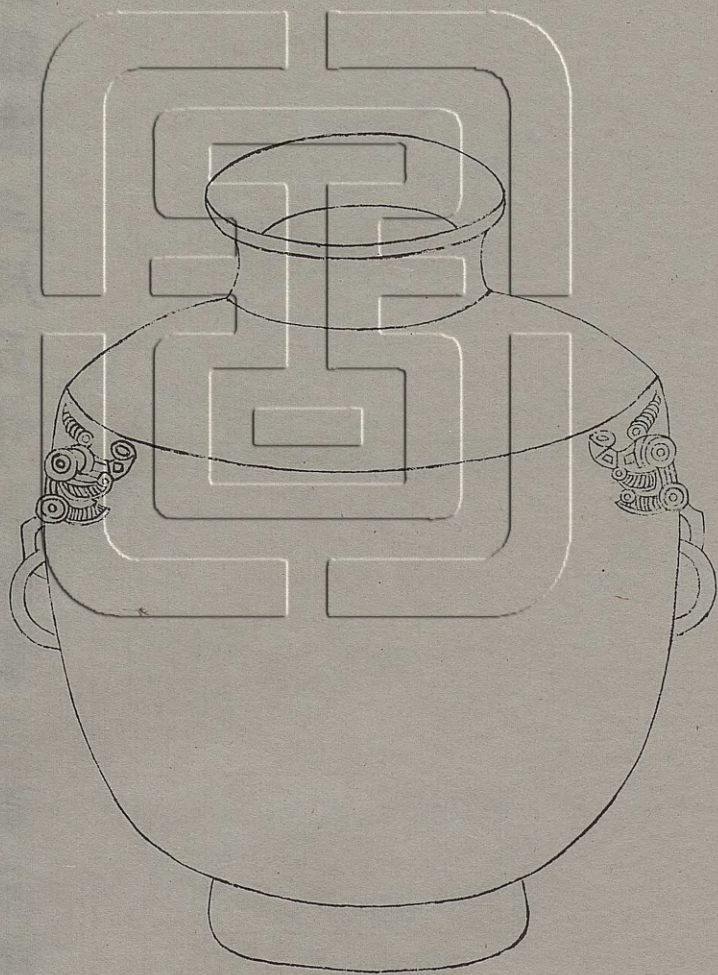

右高一尺一寸九分深一尺一寸六分口徑六寸五分腹圍三尺五寸五分重二百三兩

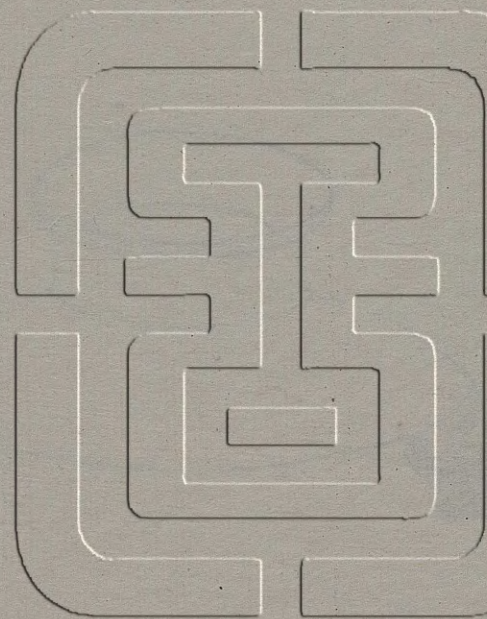

漢獸環甗三

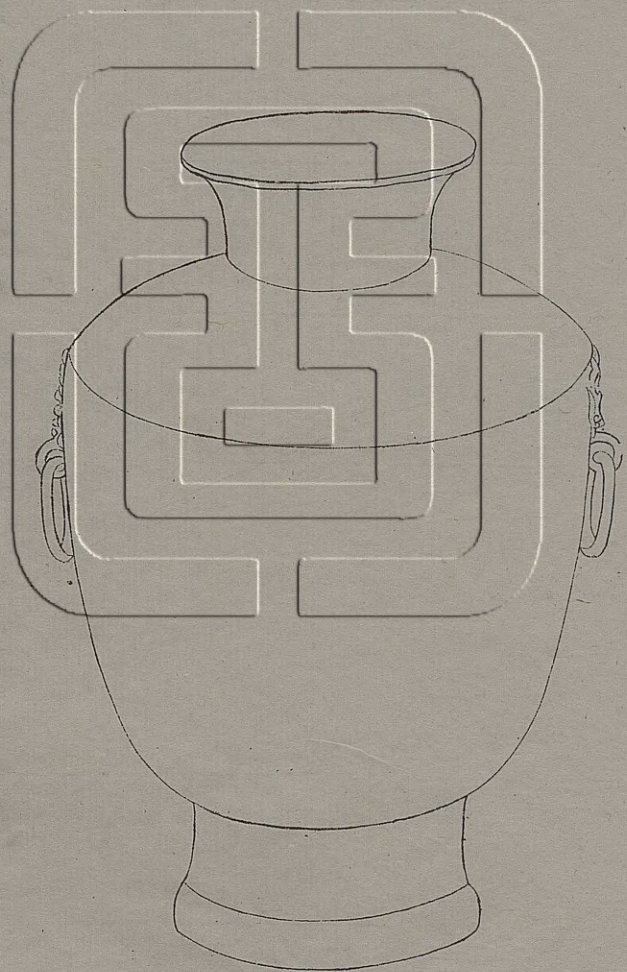

右高九寸一分深七寸九分口徑四寸四分腹圍二尺三寸七分重一百五十五兩

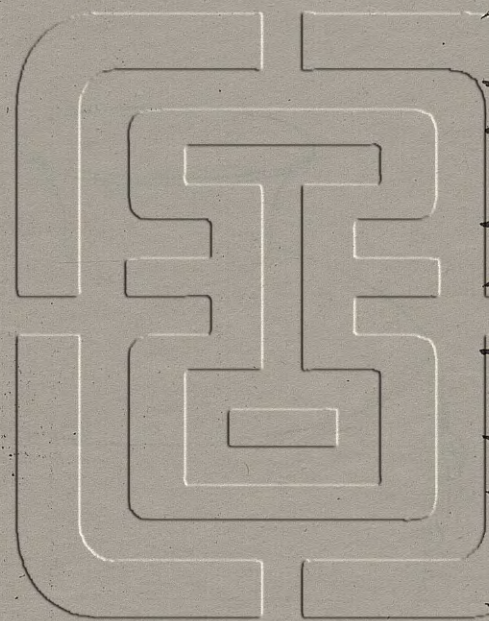

漢獸環甌四

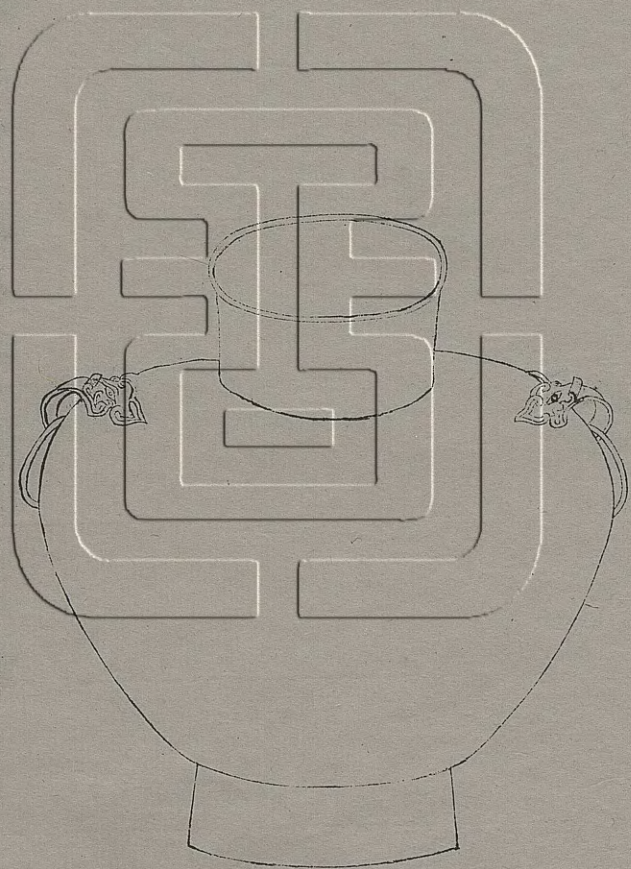

右高六寸九分深五寸九分口徑三寸四分腹圍一尺二寸三分重七十三兩

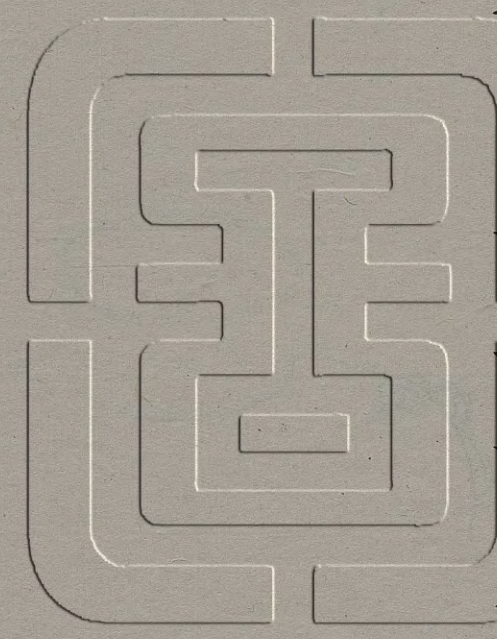

漢獸環甌五

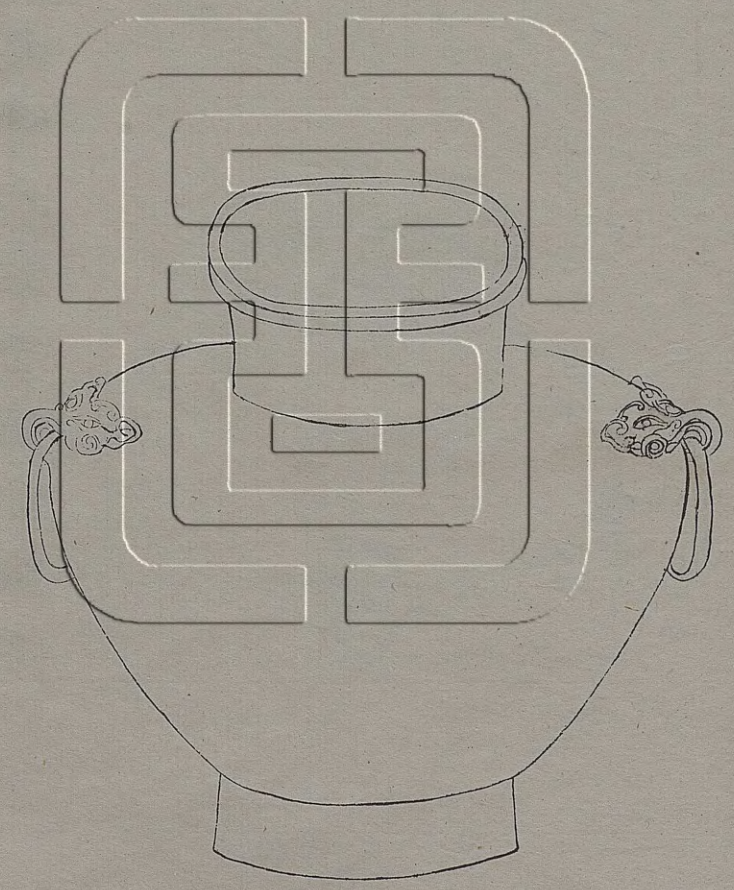

西清古鑑
卷三十一
四

右高五寸八分深五寸一分口徑三寸五分腹圍一尺九寸八分重五十四兩

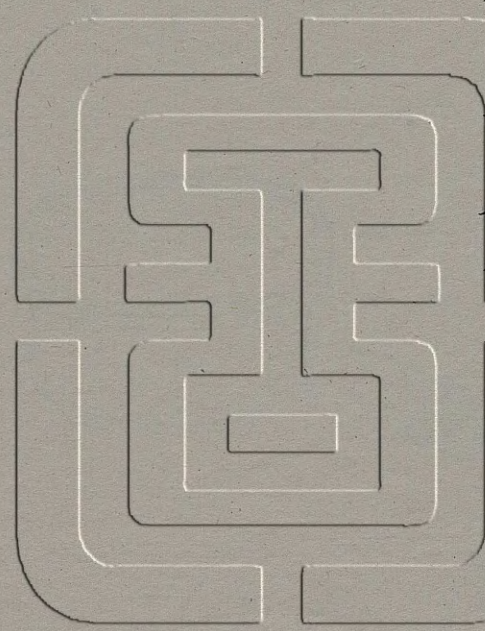

漢獸環甗六

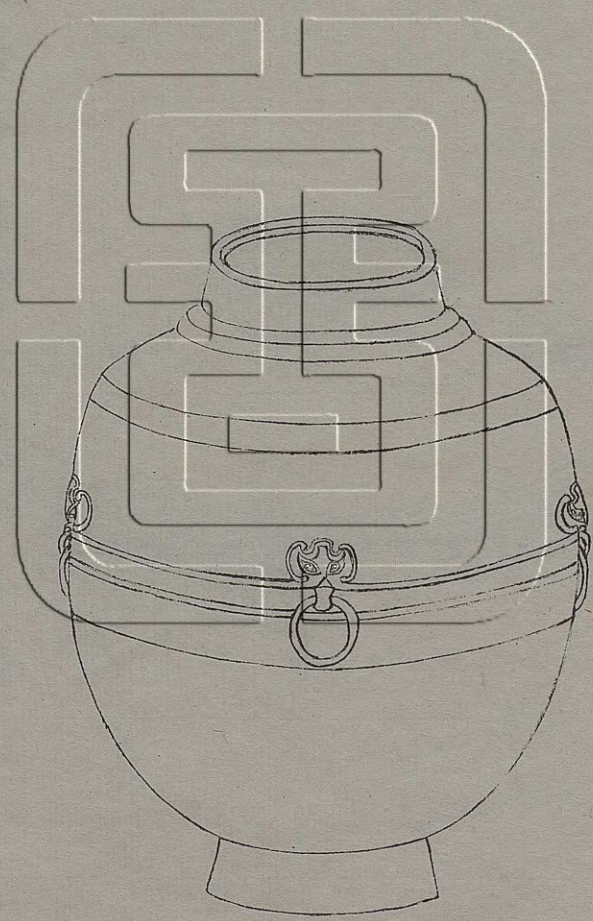

西清古鑑
卷三十一
甗

右高六寸三分深五寸八分口徑二寸六分腹圍一尺六寸六分重三十八兩

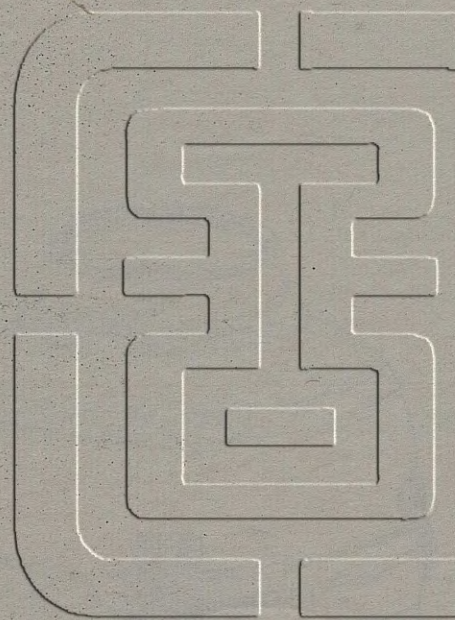

漢獸環甗七

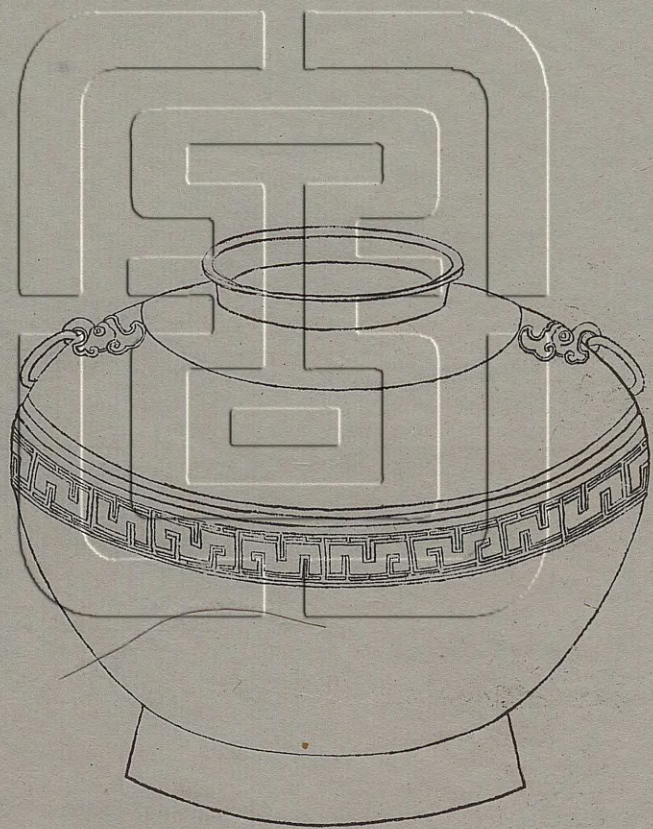

右高五寸一分深四寸五分口徑二寸八分腹圍一尺九寸四分重三十一兩

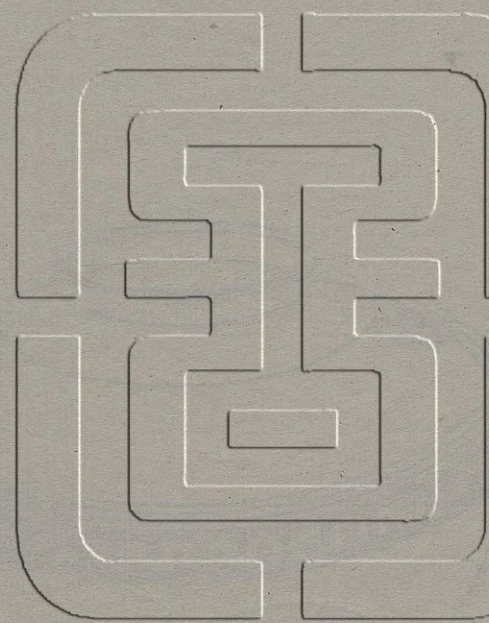

漢獸耳甗一

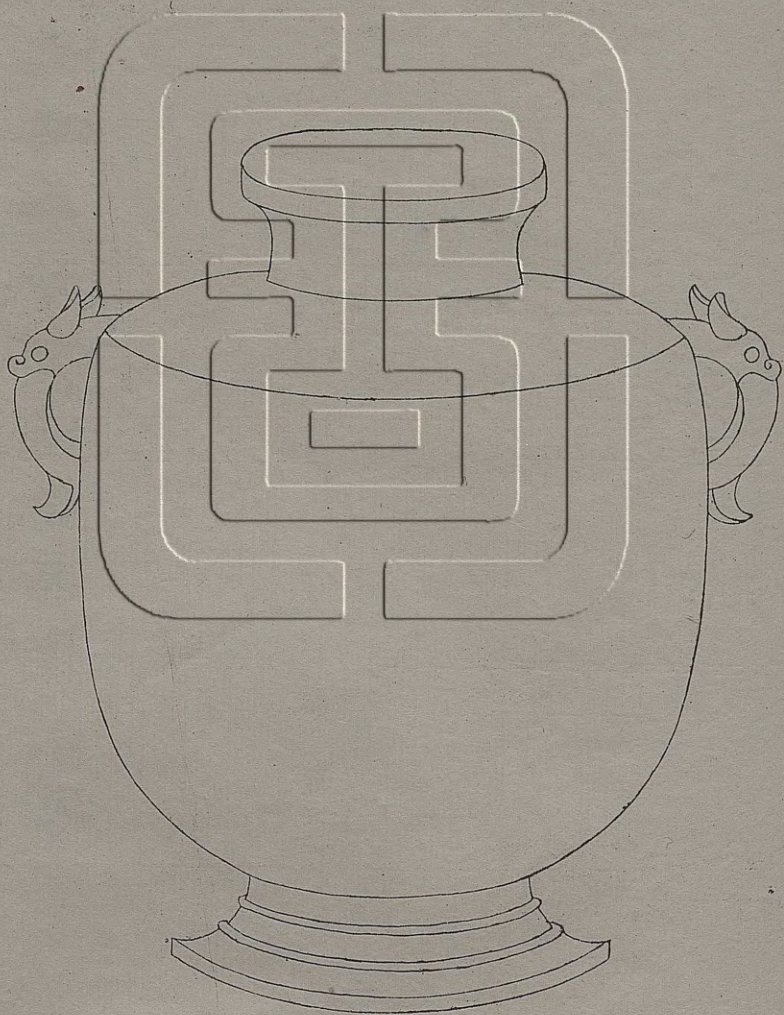

右高一尺二分深八寸七分口徑五寸二分腹圍二尺六寸八分重一百五十九兩

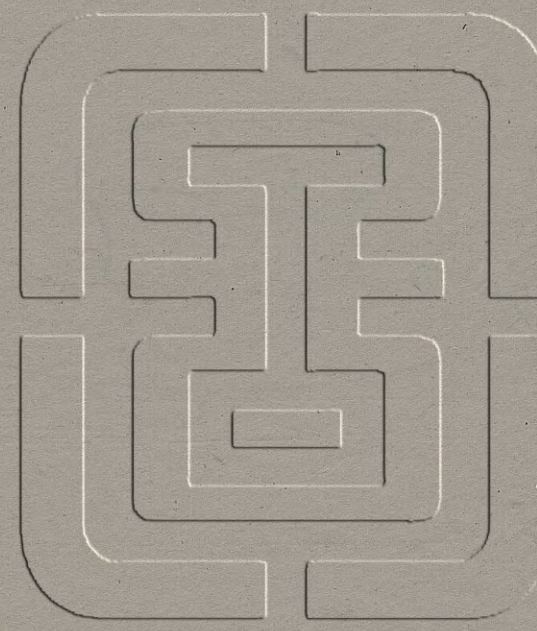

漢獸耳甬二

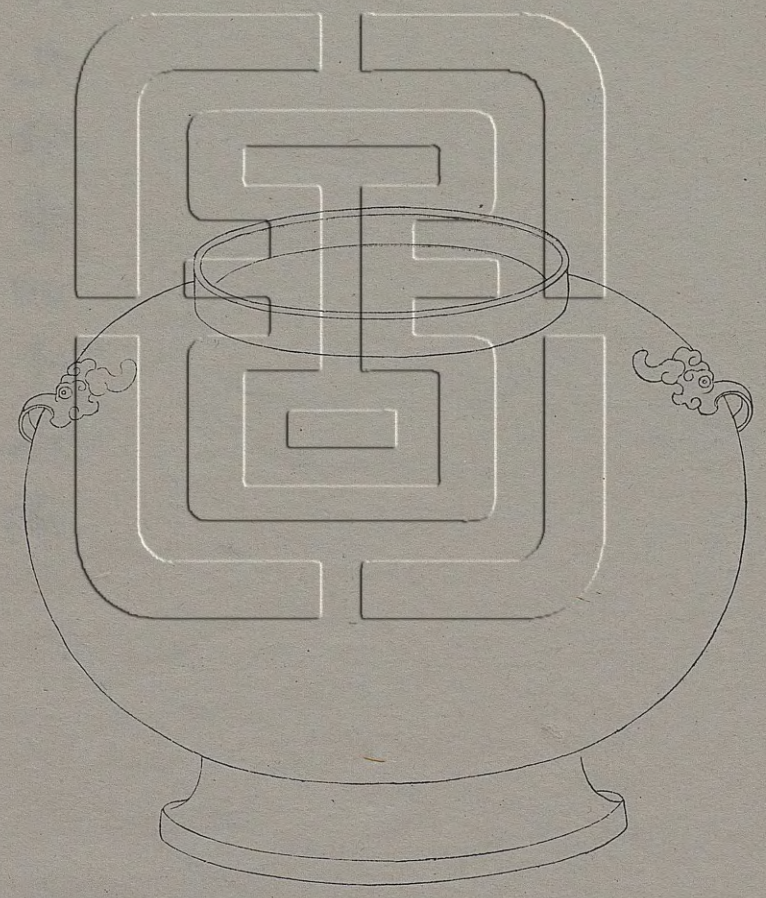

右高五寸三分深四寸五分口徑四寸八分腹圍二尺九分重四十八兩

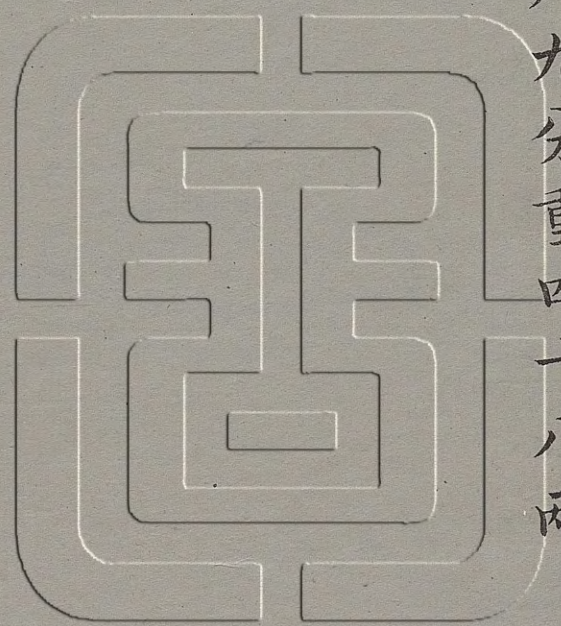

漢獸耳甬三

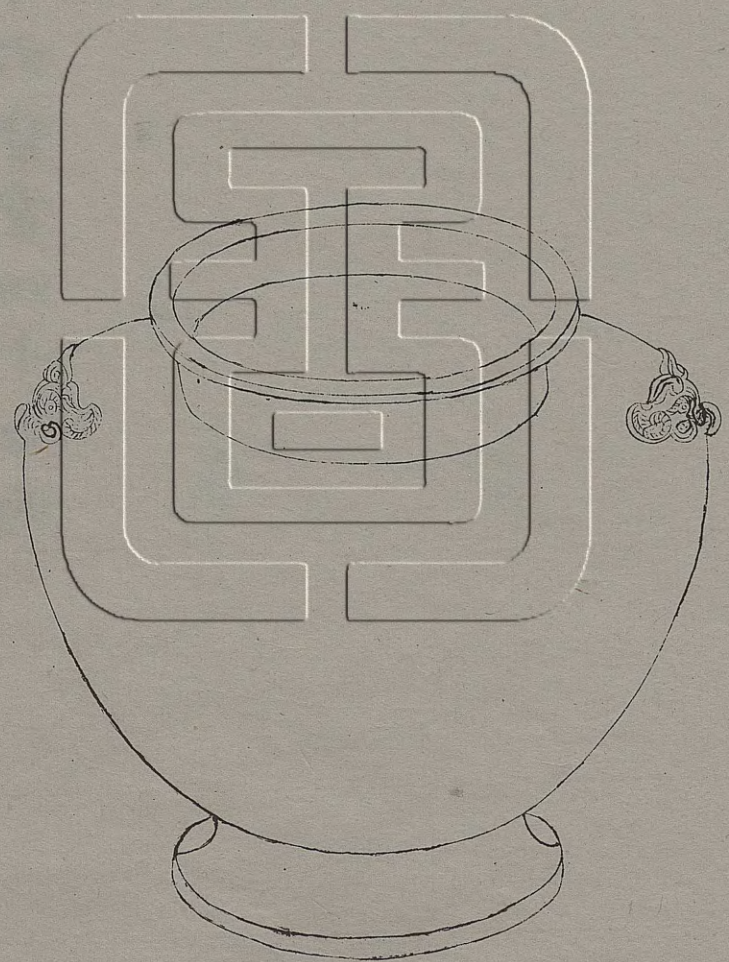

右高四寸八分深四寸四分口徑四寸腹圍一尺九寸六分重四十七兩

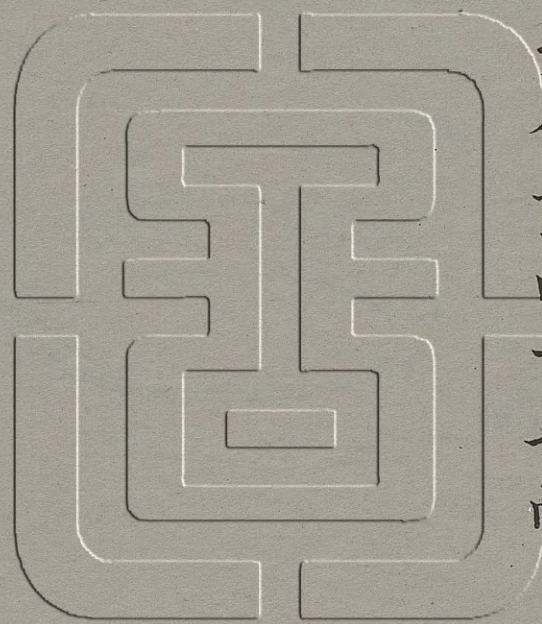

漢獸耳甗四

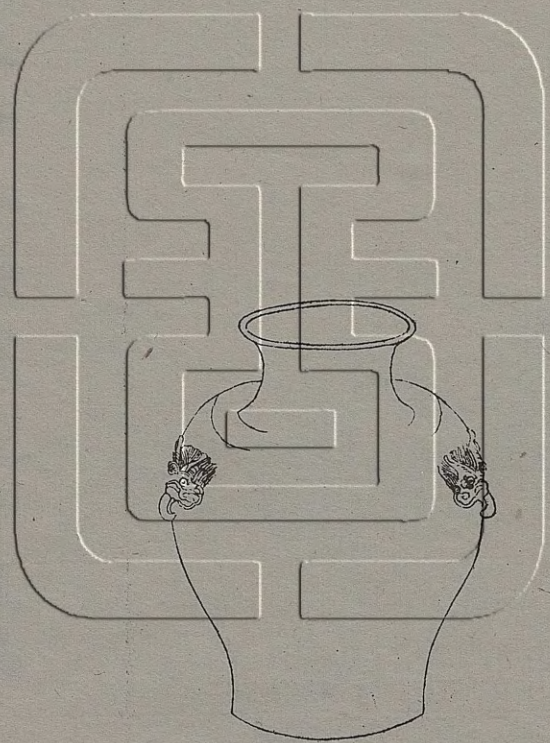

右高四寸六分深四寸四分口徑二寸三分腹圍一尺二寸一分重三十五兩

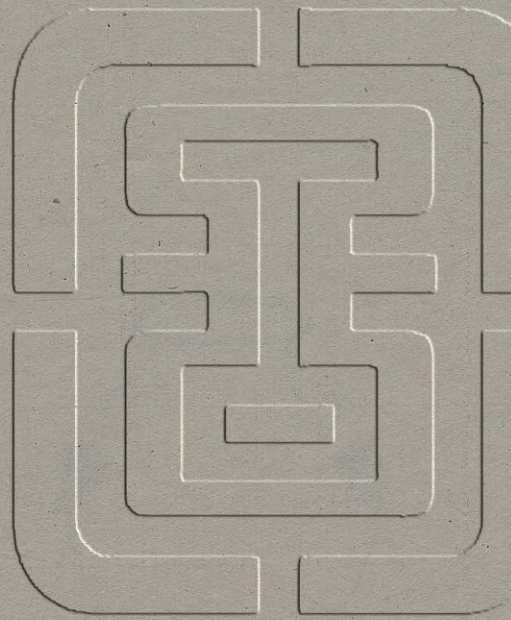

漢三鷹甗

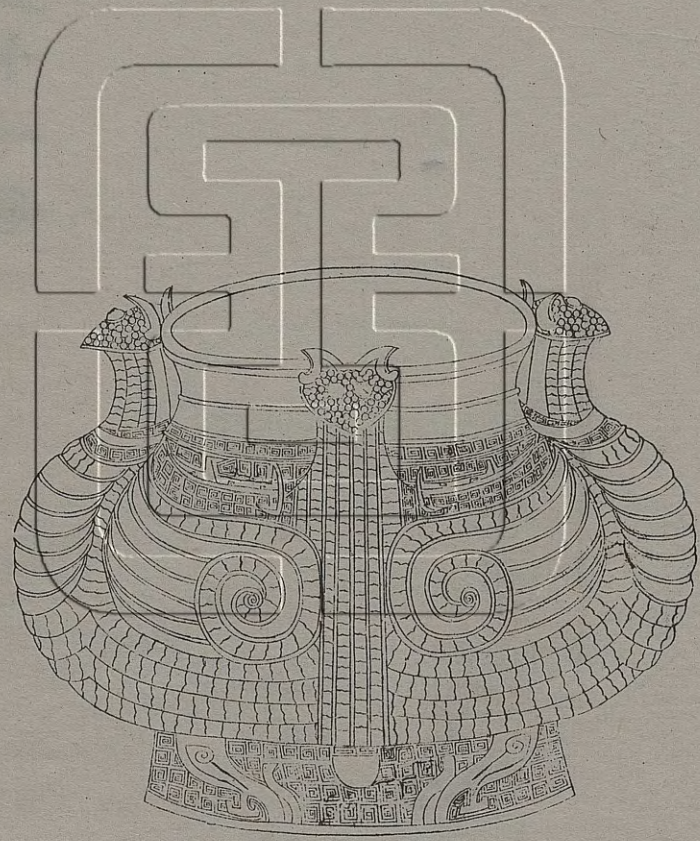

右高四寸八分深四寸口徑四寸二分腹圍二尺重五十一兩

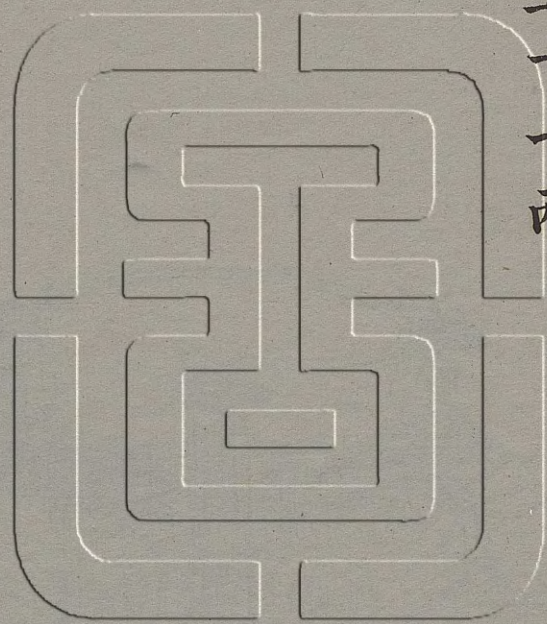

漢山紋甗

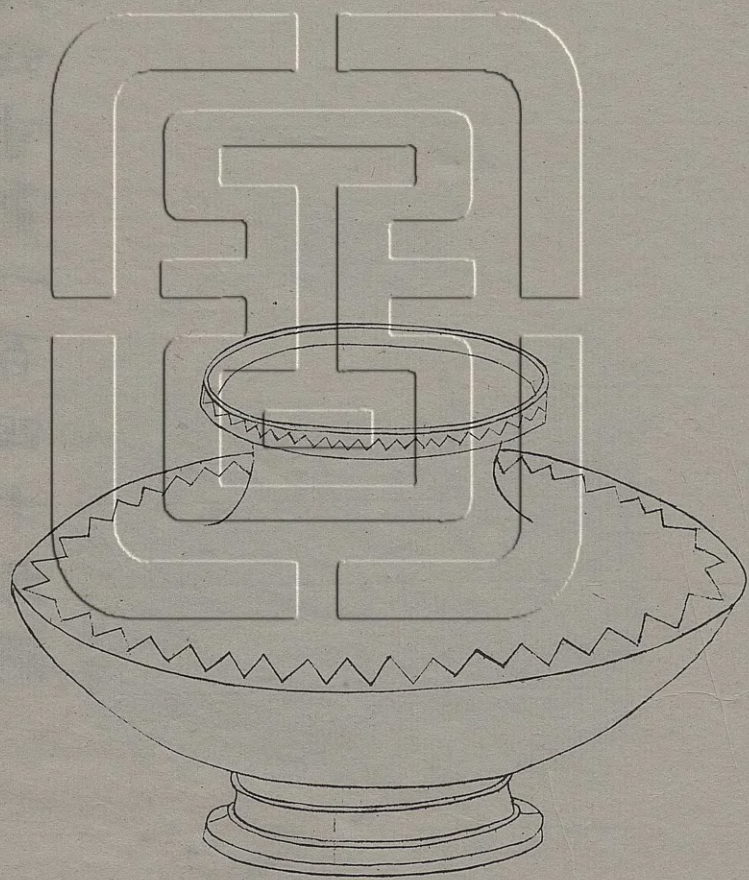

右高六寸七分深五寸九分口徑五寸九分腹圍三尺四寸重一百四十九兩

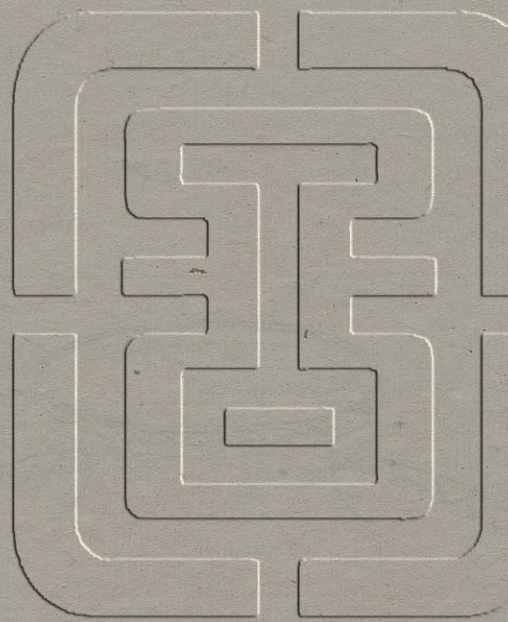

漢星紋甗

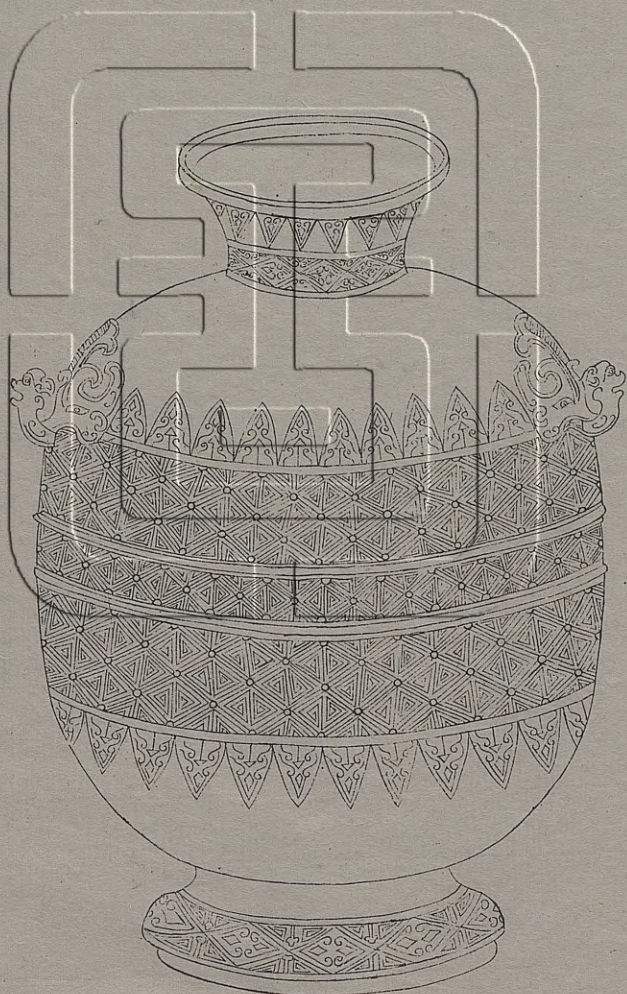

右高七寸四分深六寸一分口徑三寸五分腹圍一尺八寸八分重七十二兩

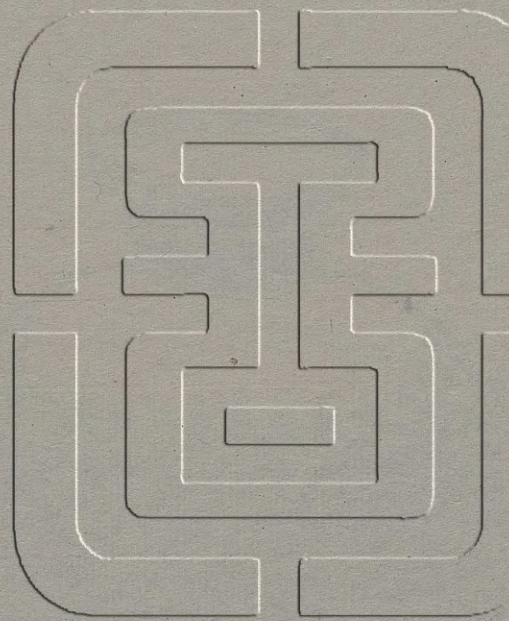

漢素甌一

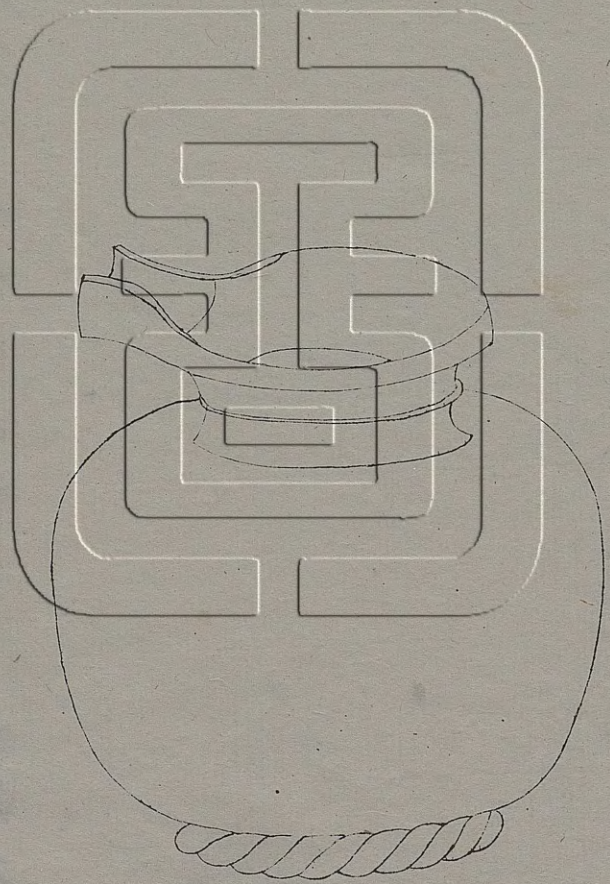

右高七寸三分深六寸九分口徑四寸五分腹圍二尺三寸八分重一百一十三兩有流

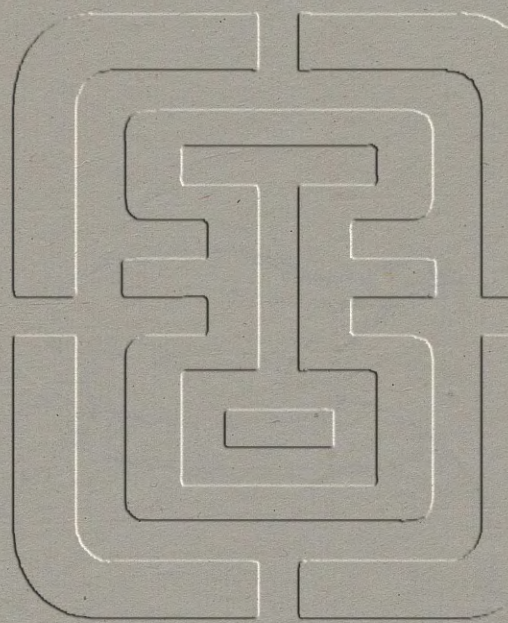

漢素甌二

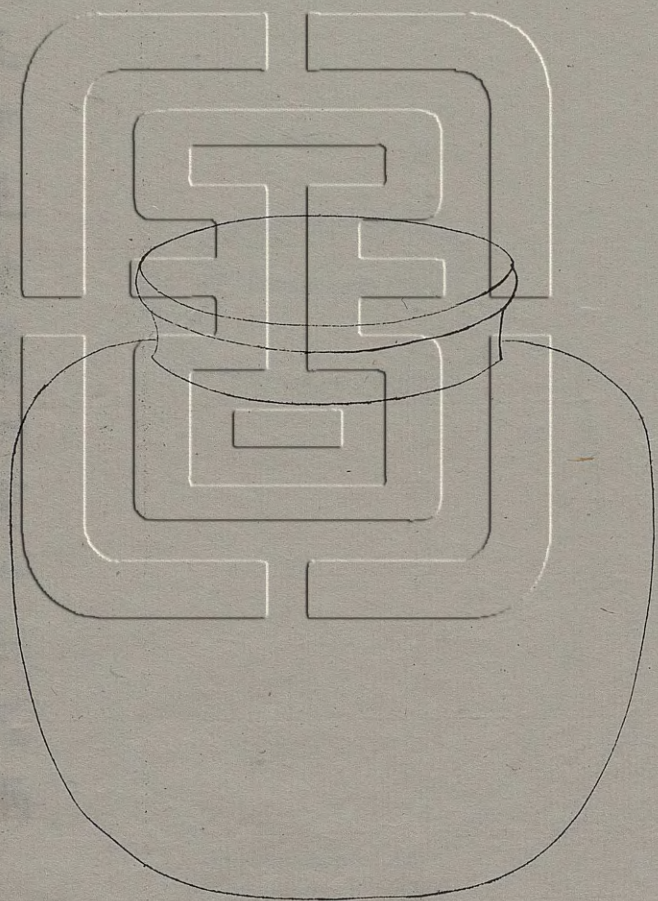

右高七寸一分深六寸九分口徑四寸二分腹
圍二尺三寸五分重一百一十三兩

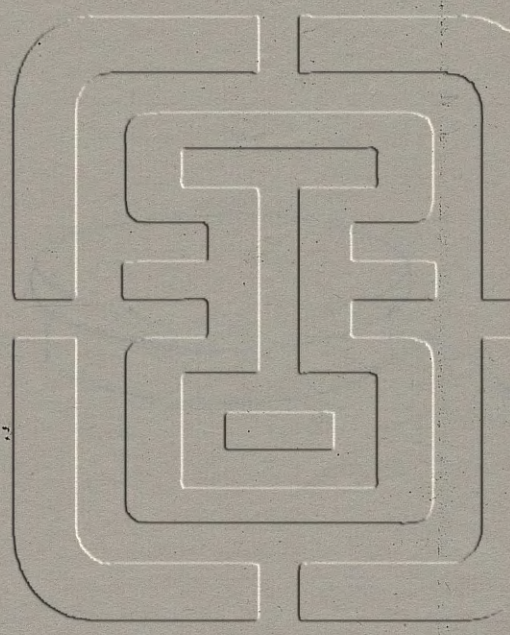

漢素甗三

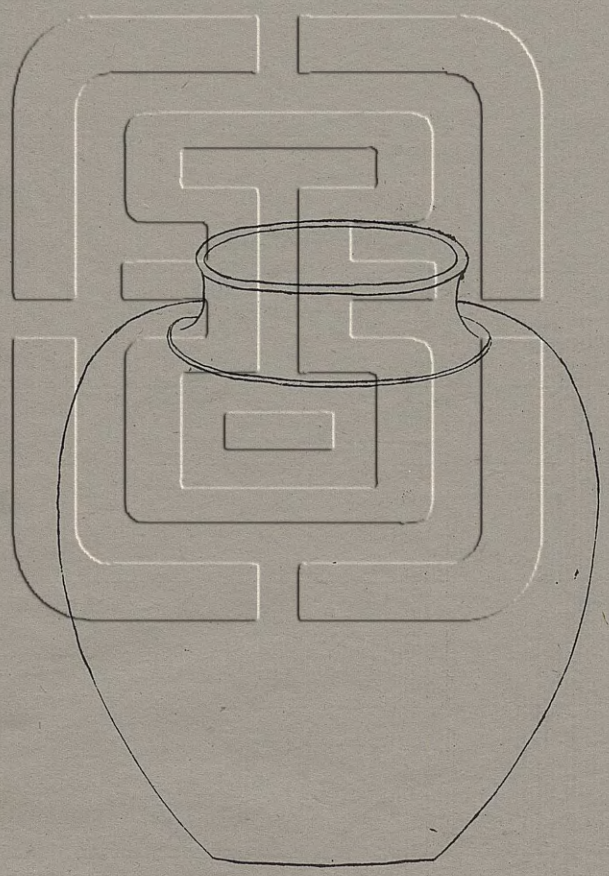

右高四寸六分深四寸五分口徑二寸一分腹
圍一尺二寸重二十五兩

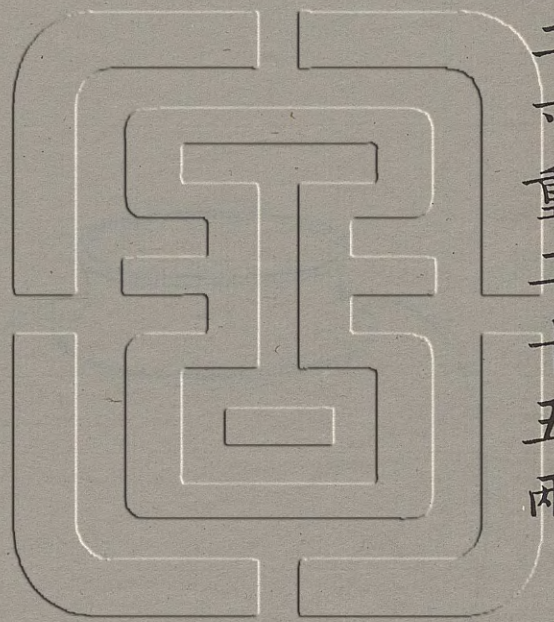

漢素甌四

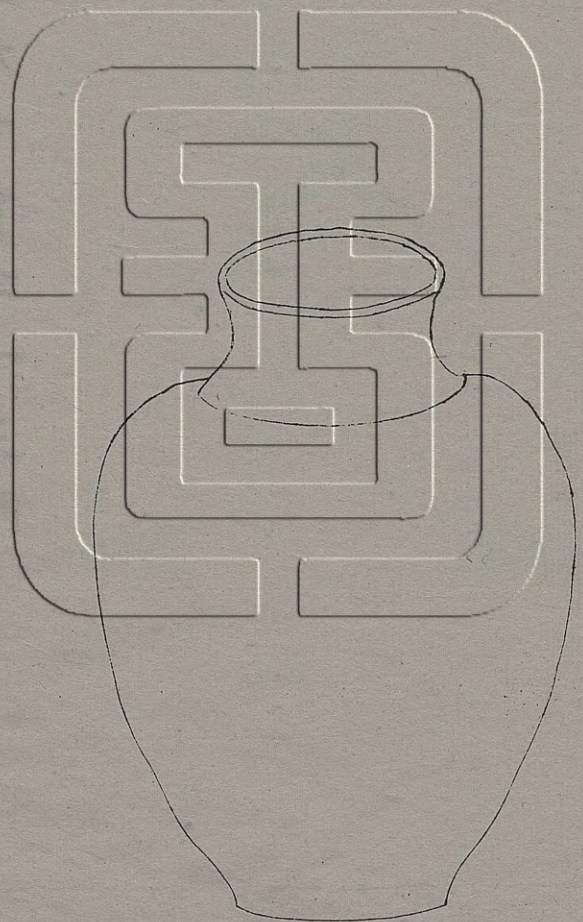

右高五寸九分深五寸六分口徑三寸三分腹圍一尺九寸重六十三兩

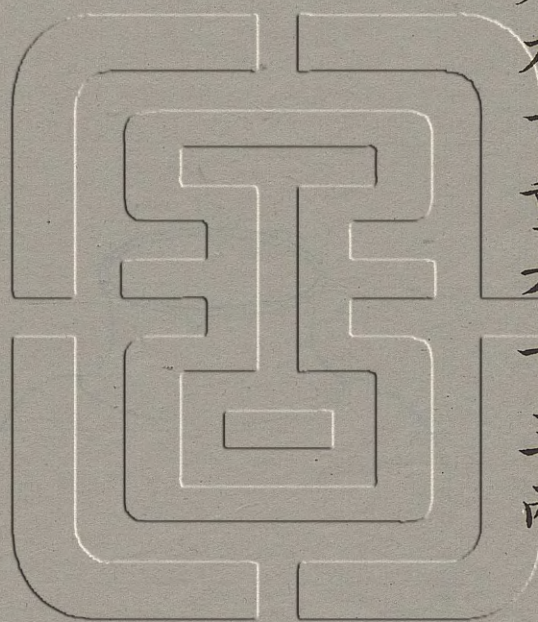

周素缶

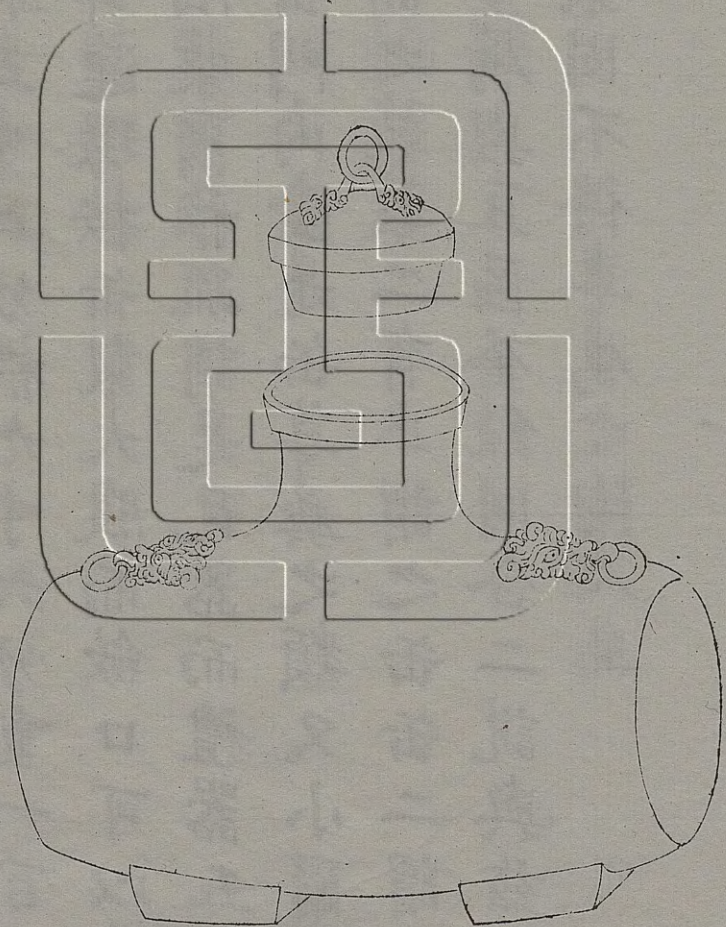

右通蓋高八寸二分深六寸五分口徑二寸八分腹縱五寸五分橫九寸六分重一百二十八兩兩耳連環按缶製大腹而斂口可以節樂可以盛酒漿爾雅疏謂是瓦器而禮器五獻之尊門外缶門內壺是缶尊彝之類又小爾雅釜二有半謂之藪藪二有半謂之缶缶二謂之鍾是缶亦量屬與豆區釜鍾同合二說與茲器觀之則缶製固不得專屬之陶人矣

西清古鑑卷三十五目錄

盦

漢

螭耳盦一

螭耳盦二

螭耳盦三

獸耳盦

盤雲盦

素盦

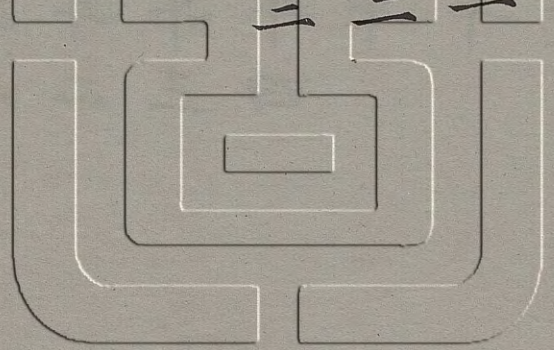

鑊斗

漢

龍首鏃斗一

龍首鏃斗二

龍首鏃斗三

龍首鏃斗四

鳧首鏃斗

如意鏃斗

熊足鏃斗

素鏃斗一

素鏃斗二

奩

漢

帶紋奩

雲紋奩

饗餐奩

夔龍奩一

夔龍奩二

獸環奩一

獸環奩二

罐

漢

澡豆罐一

澡豆罐二

澡豆罐三

白

漢

雙螭白

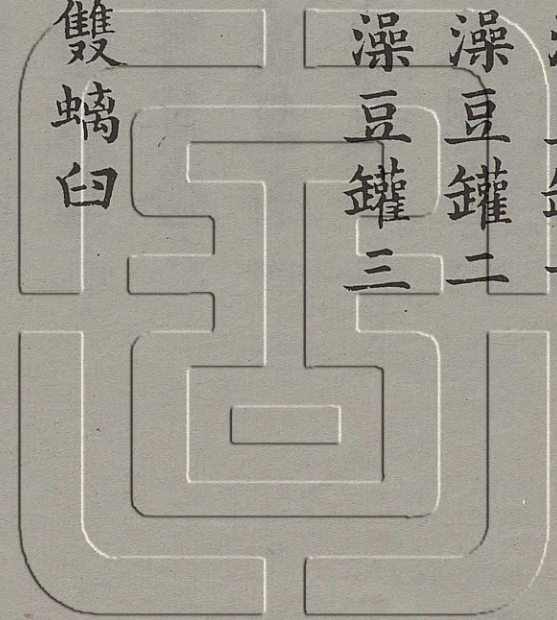

漢螭耳盒一

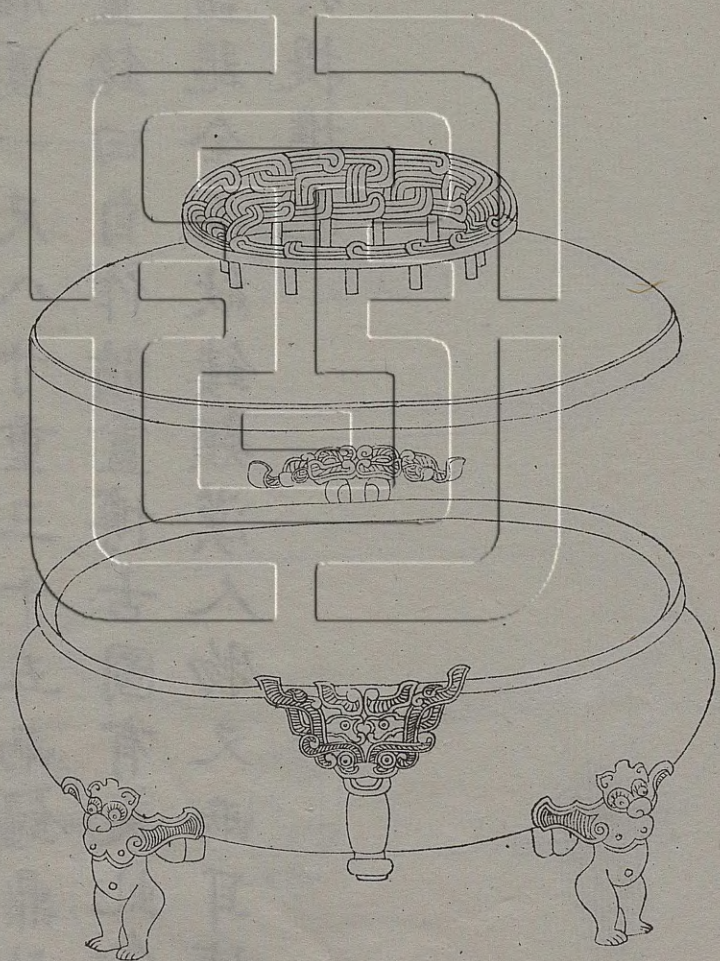

右通蓋高四寸深二寸二分口縱四寸三分橫六寸腹圍一尺八寸重三十五兩鐘鼎款識有卬仲盦銘曰自作饋盦博古圖有交虬盦缺蓋此則蓋器全而紋鏤類漢人物又兩耳博古圖謂便於提攜也



漢螭耳盦二

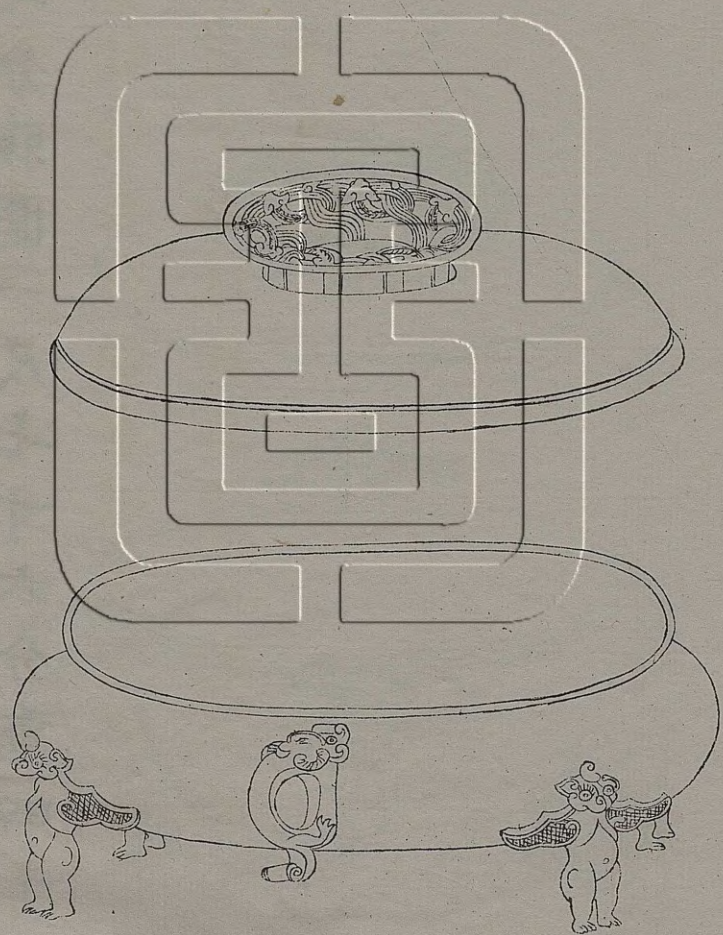

右通蓋高四寸深二寸一分口縱四寸二分橫五寸七分腹圍一尺七寸六分重四十二兩

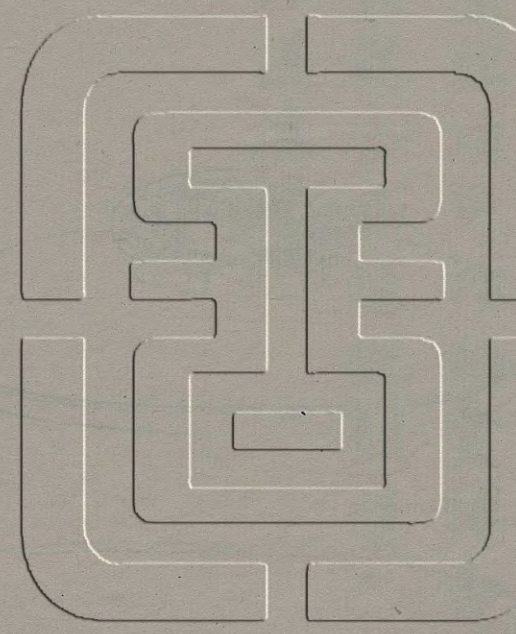

漢螭耳盒三

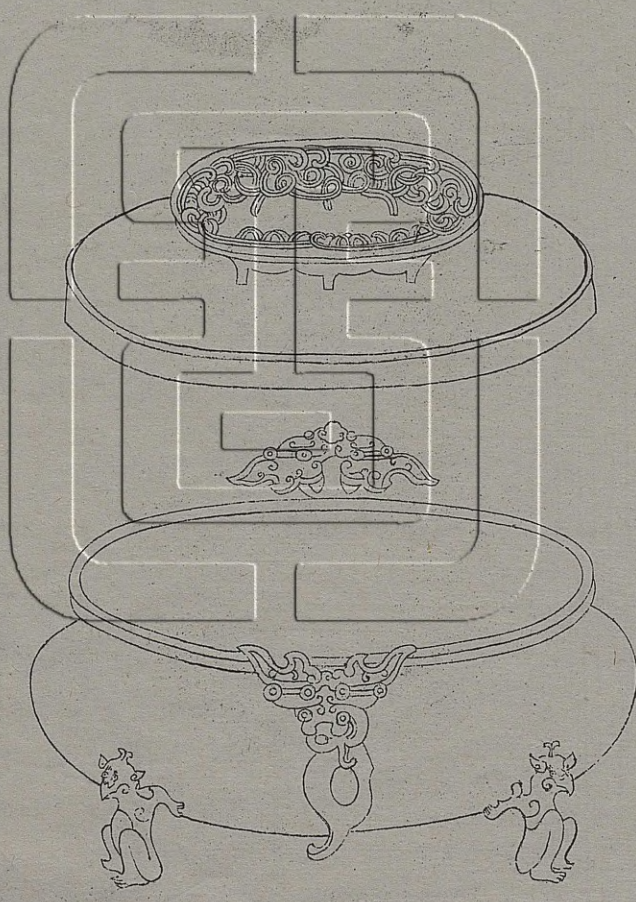

右通蓋高四寸四分深二寸五分口縱四寸五分
 分橫六寸一分腹圍一尺八寸五分重四十七
 兩

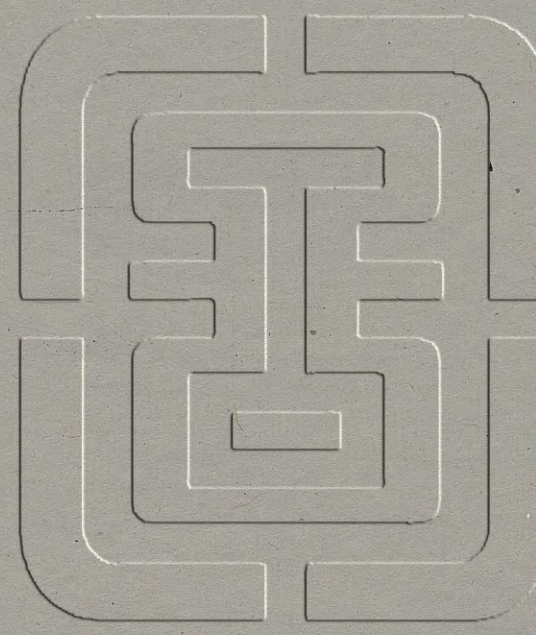

漢獸耳盒

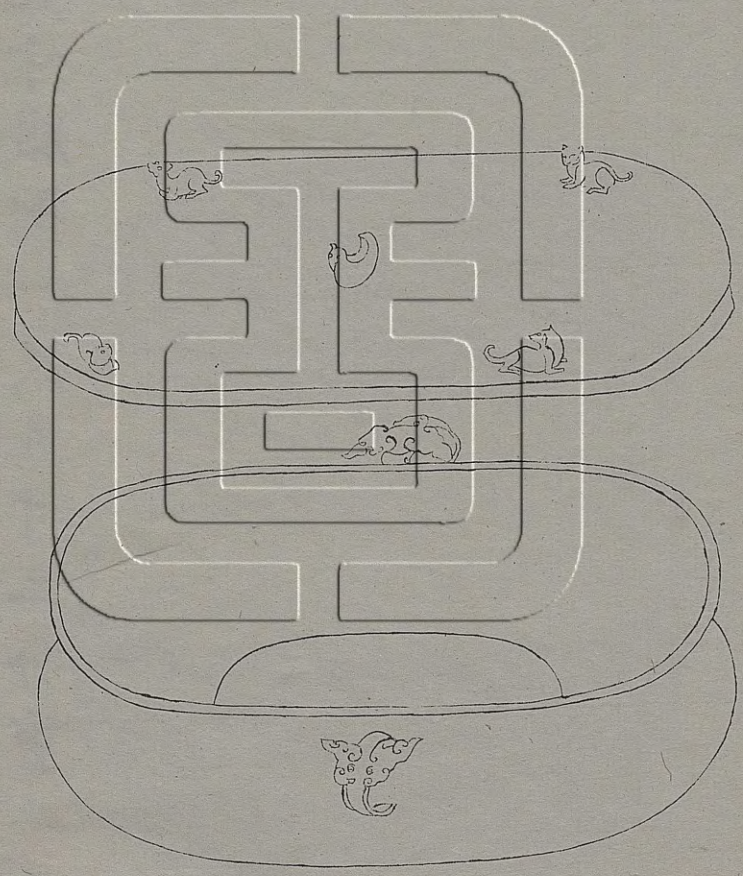

右通蓋高二寸七分深一寸九分口縱三寸七分橫五寸腹圍一尺五寸二分重二十一兩

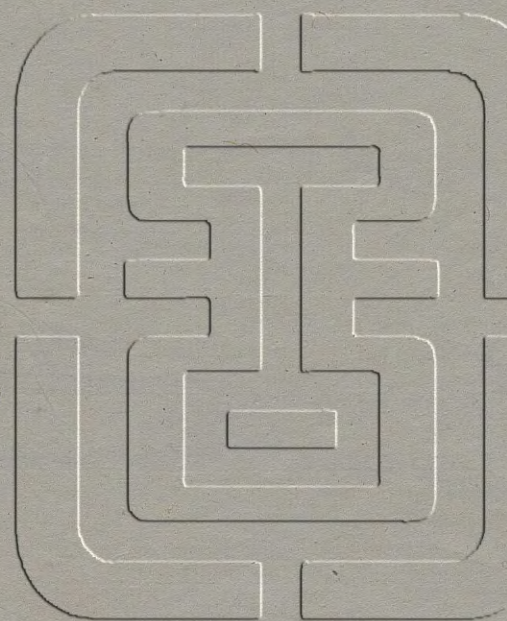

漢盤雲盒



西清古鑑

卷三十五

盒

五

右通蓋高三寸五分深二寸七分口縱五寸一分橫六寸腹圍一尺八寸重四十五兩

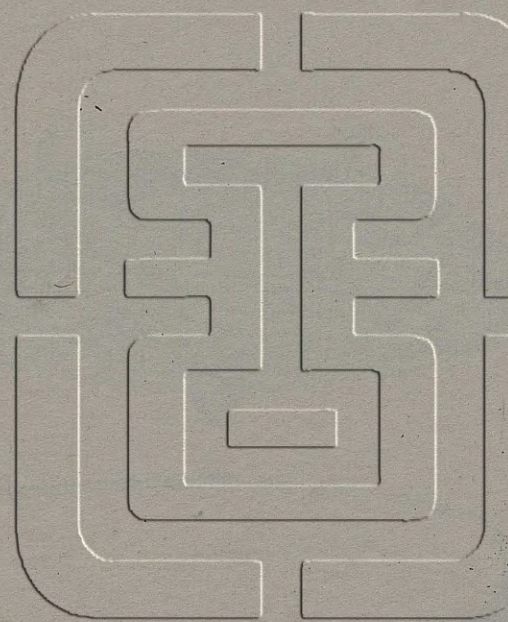

漢素盦

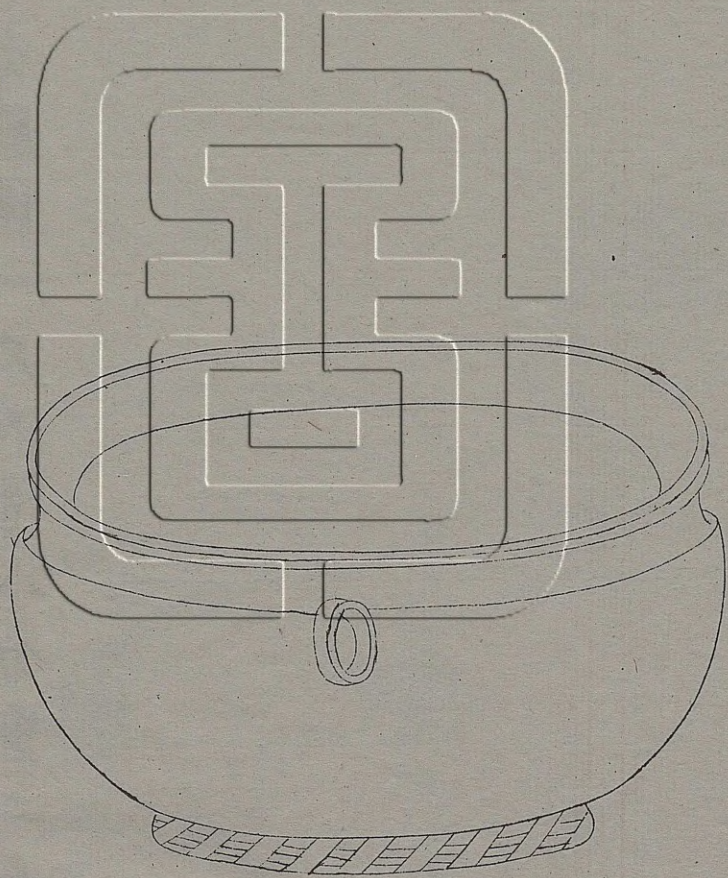

右高二寸九分深二寸七分口縱四寸七分橫
 五寸六分腹圍一尺六寸八分重二十七兩缺
 蓋

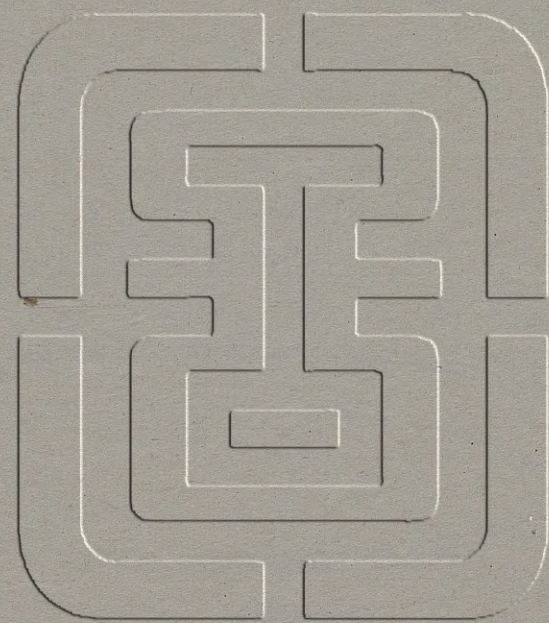

漢龍首鏃斗一

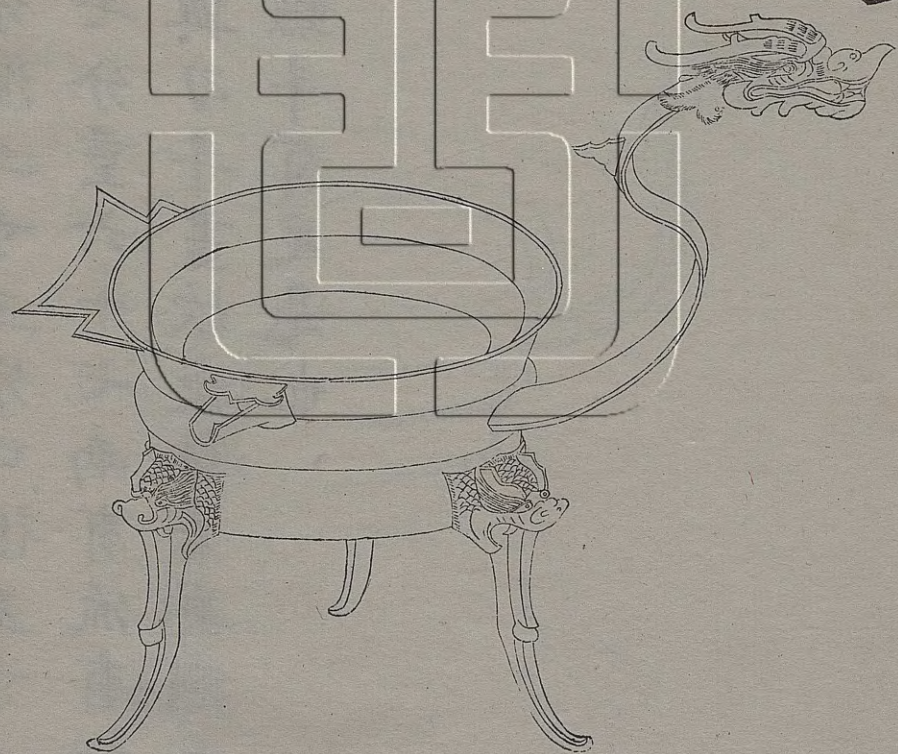

右高四寸七分深二寸三分口徑五寸一分腹圍一尺三寸七分重六十七兩有流有柄三足鑊斗為溫器與斗畫炊夜擊者異洞天清錄謂刁斗無足鑊斗有足是也

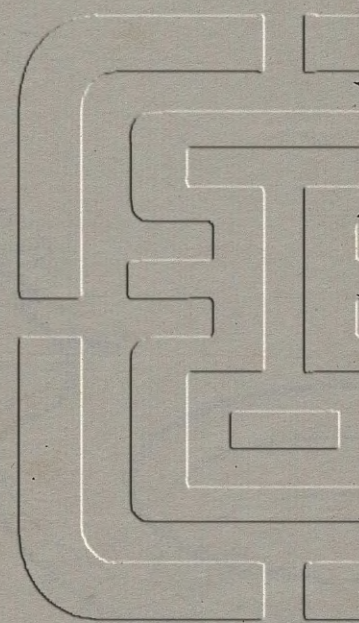

漢龍首鑊斗二

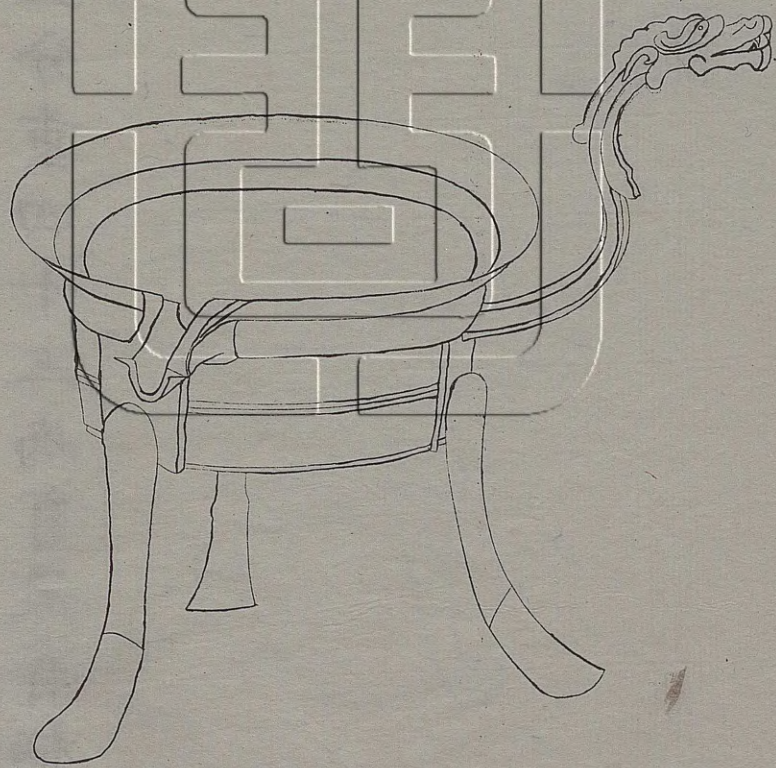

右高五寸三分深二寸三分口徑五寸五分腹圍一尺三寸三分重四十三兩有流有柄三足

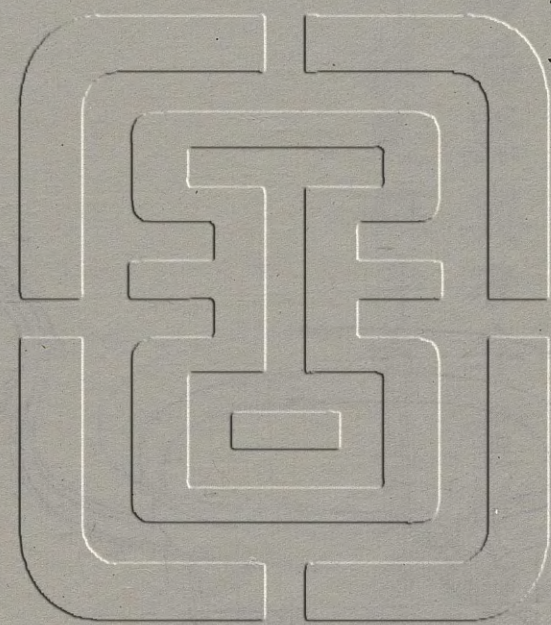

漢龍首鍤斗三



右高四寸五分深二寸二分口徑四寸四分腹圍一尺一寸四分重四十四兩有流有柄三足

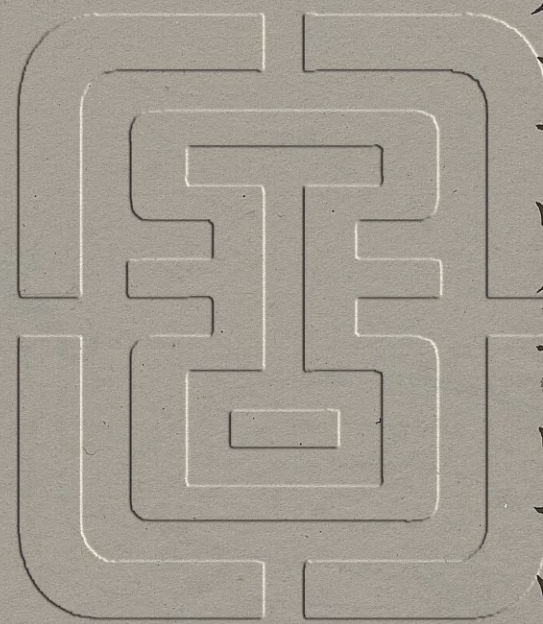

漢龍首鏃斗四

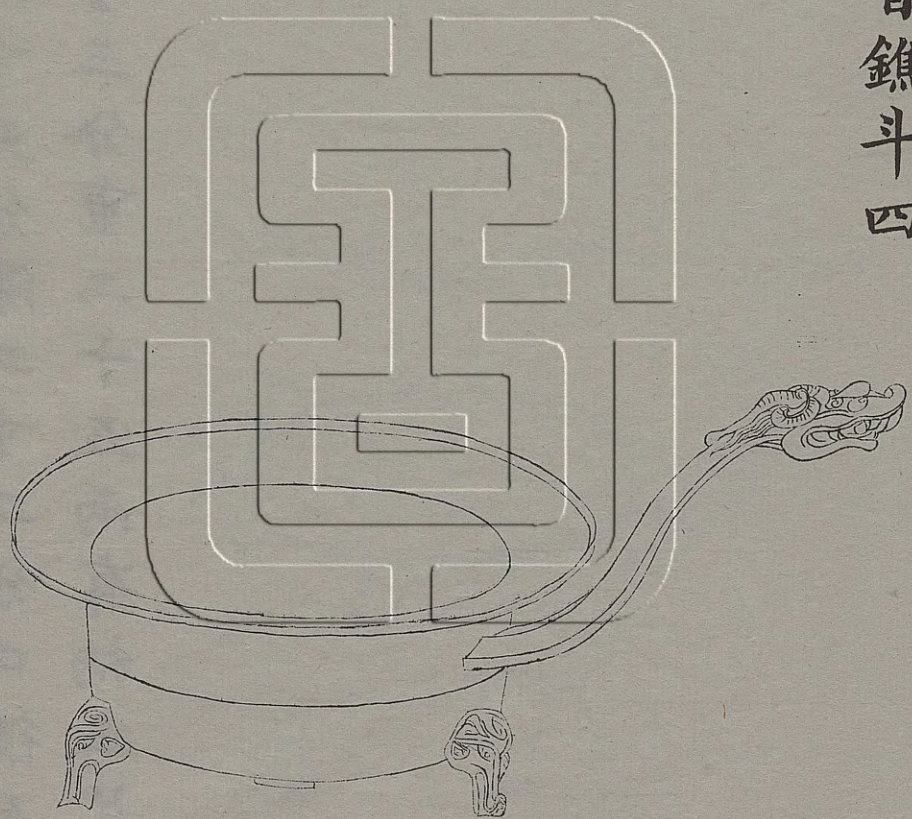

右高二寸五分深二寸二分口徑五寸腹圍一尺二寸三分重二十五兩有柄三足

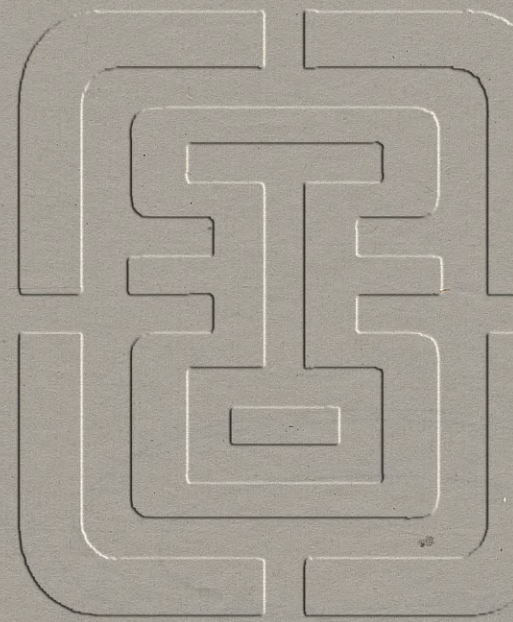

漢鳧首鐺斗

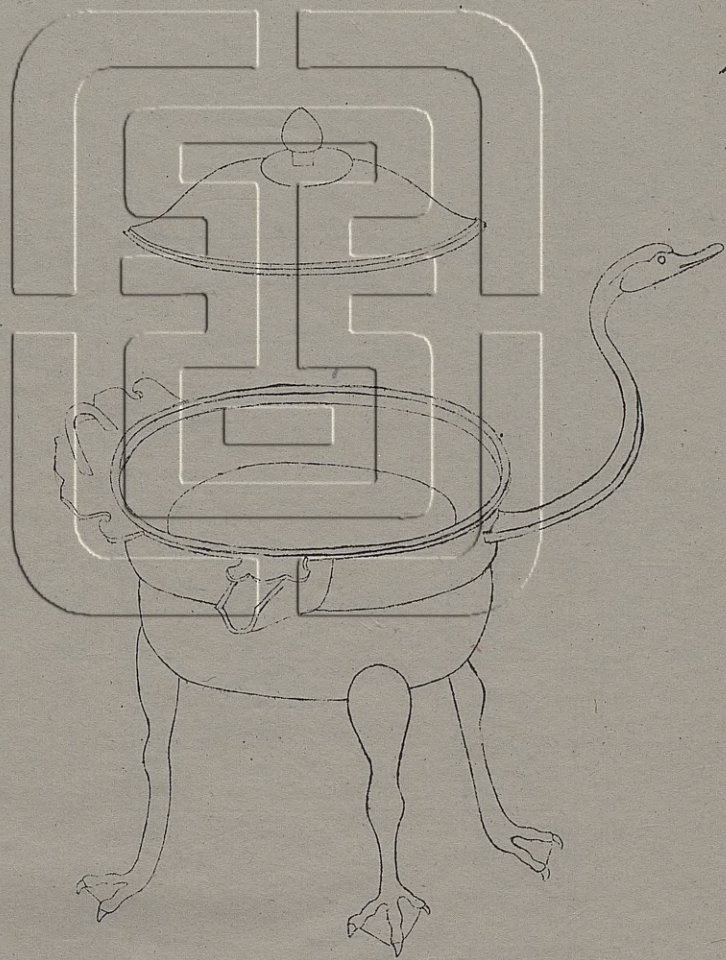

右通蓋高四寸深一寸六分口徑三寸五分腹圍九寸一分重二十兩有流有柄三足

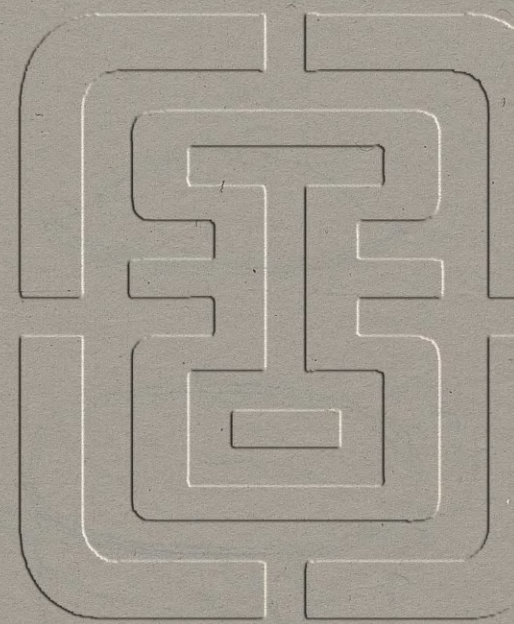

漢如意鏹斗

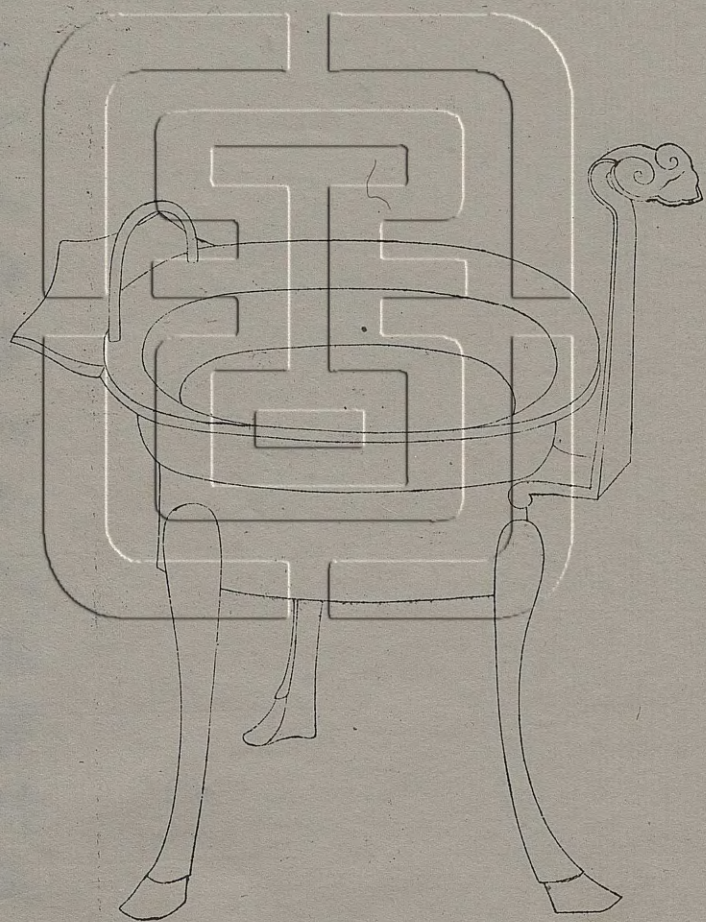

右高五寸二分深二寸三分口徑五寸二分腹圍一尺二寸七分重四十二兩有柄三足

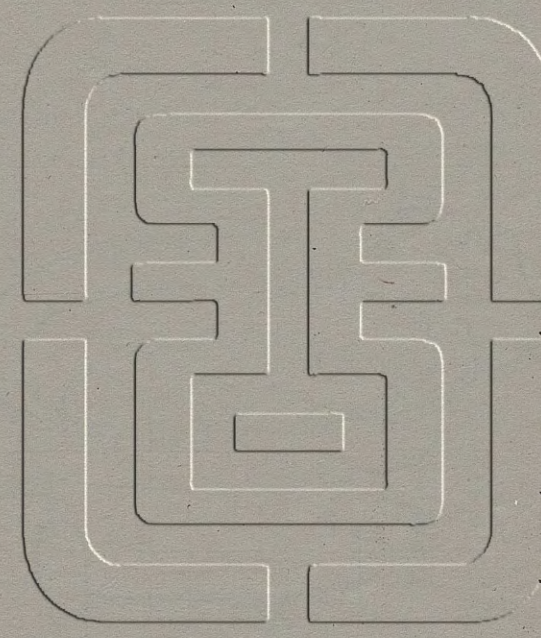

漢熊足錐斗

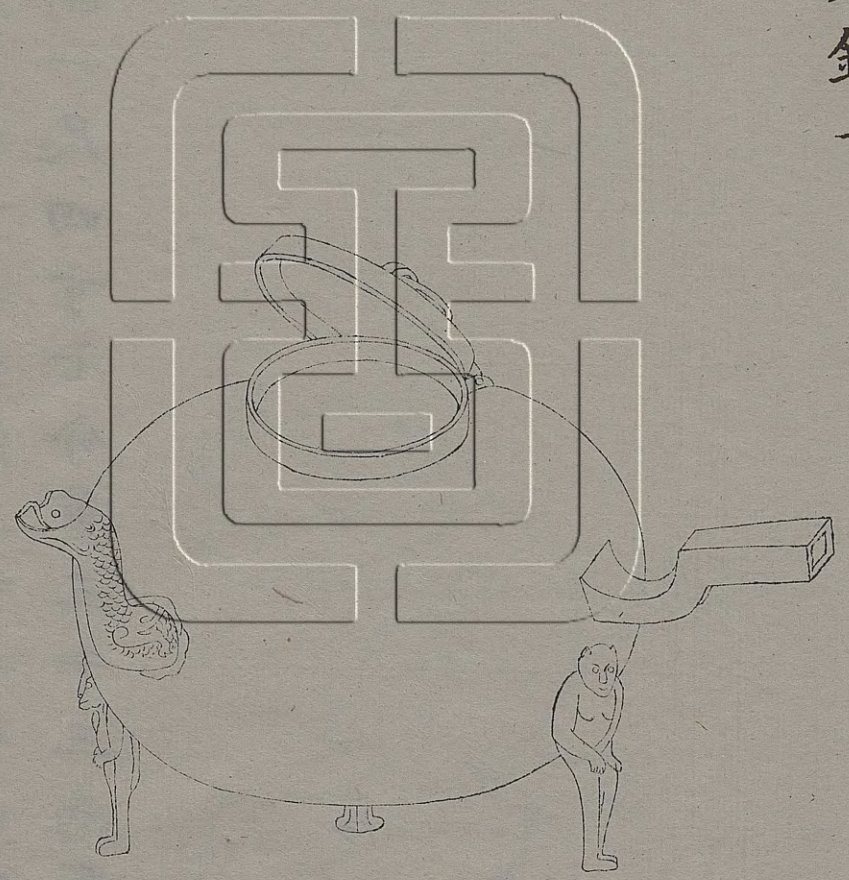

西清... 錐斗

右通盖高四寸二分深三寸一分口径二寸四分腹圍一尺四寸七分重三十三两有流有柄三足

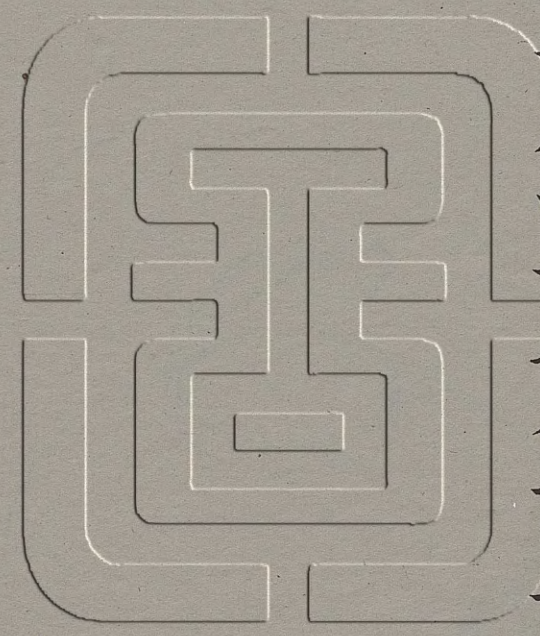

漢素鏹斗一

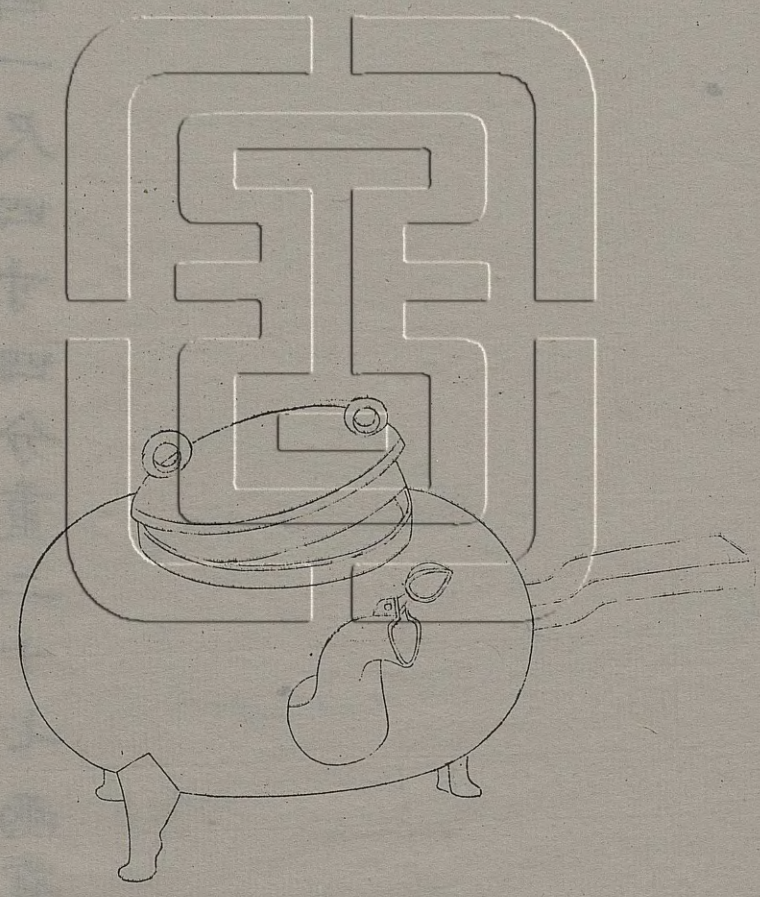

西清古金 卷三十一 鏹斗

右通盖高三寸五分深二寸六分口径二寸八分腹圍一尺四寸四分重二十七兩有流有柄三足

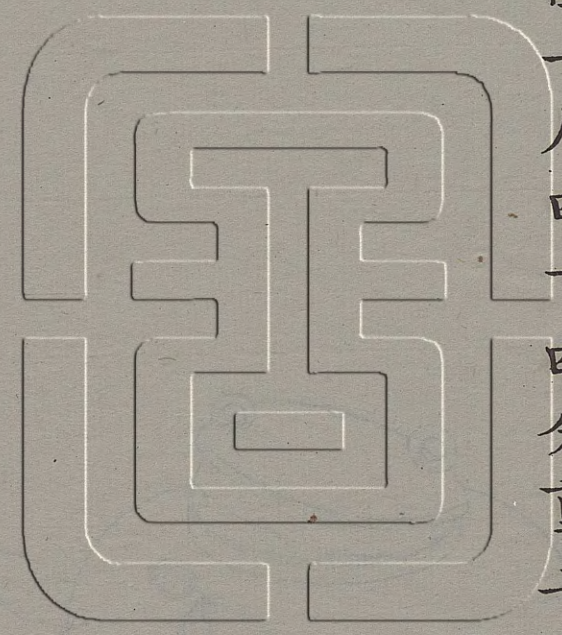

漢素錫斗二

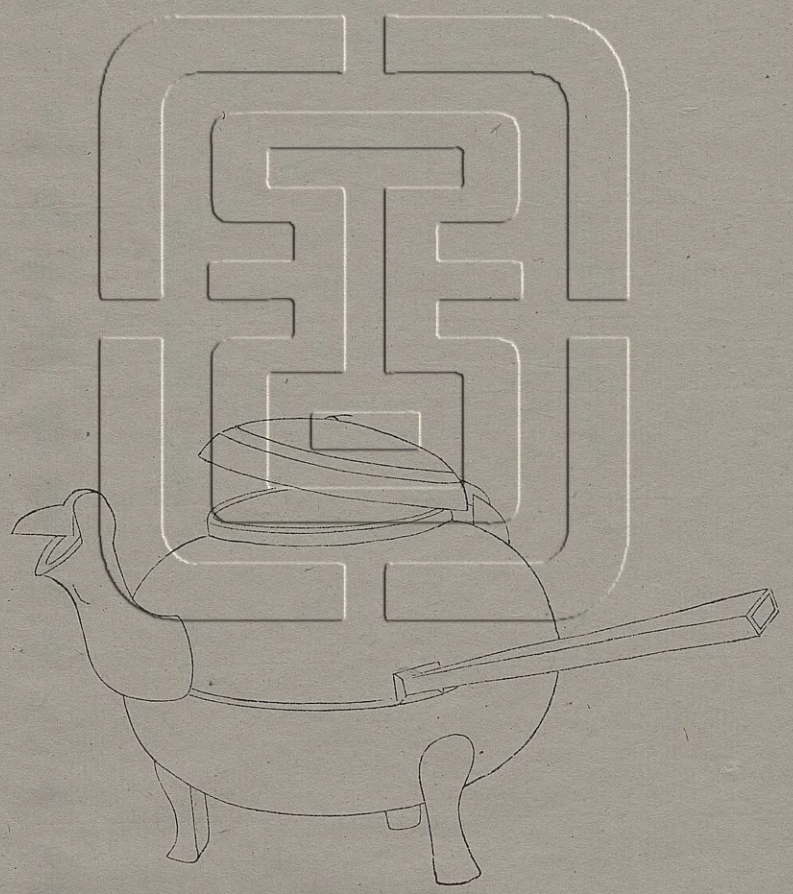

右通蓋高四寸五分深三寸三分口徑二寸二分腹圍一尺五寸七分重三十六兩有流有柄三足

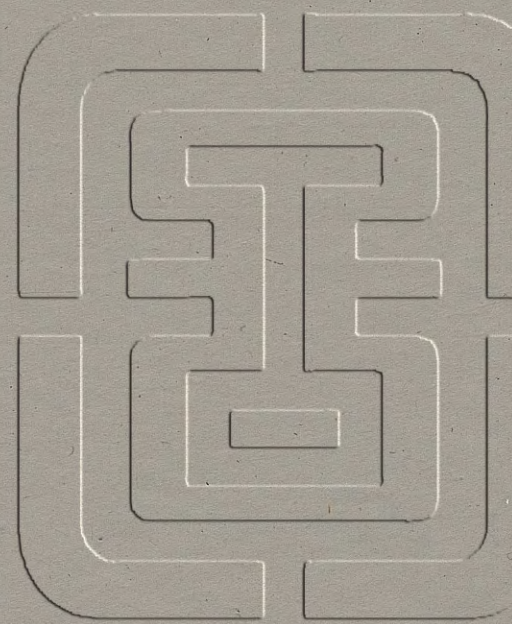

漢帶紋奩

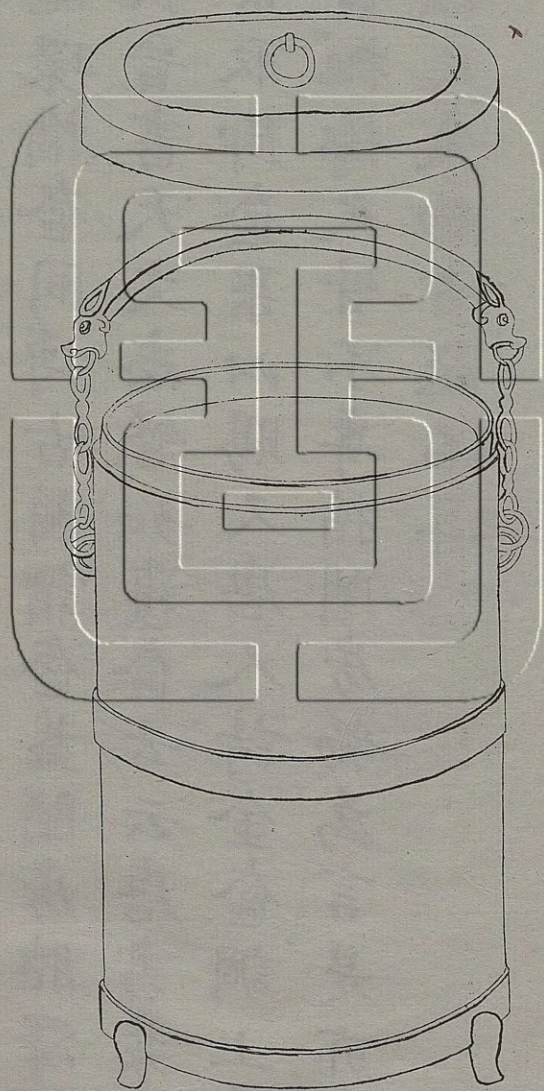

右通蓋高六寸二分深五寸口徑三寸七分腹圍一尺二寸四分重三十八兩有提梁與博古圖連環攜奩同博古圖謂奩蓋閨房胎澤之具然攷晉書天文志譬如覆奩云云唐書裴諗傳宣宗取御奩果以賜又唐人詩金奩調上藥及寶奩拋擲久皆不專指閨房物為言是亦奩之類凡盛物者總名耳

漢雲紋奩

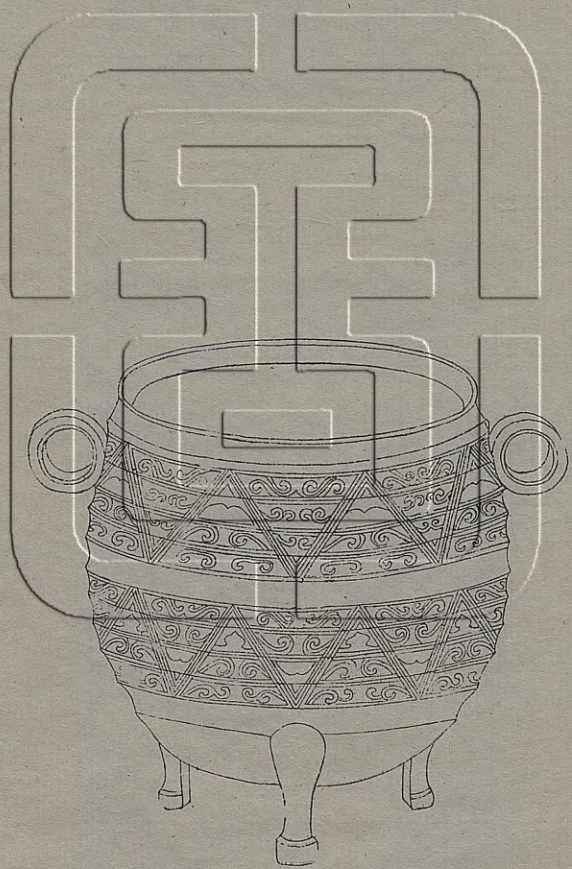

右高四寸深三寸四分口徑三寸三分腹圍一尺二寸四分重三十一兩

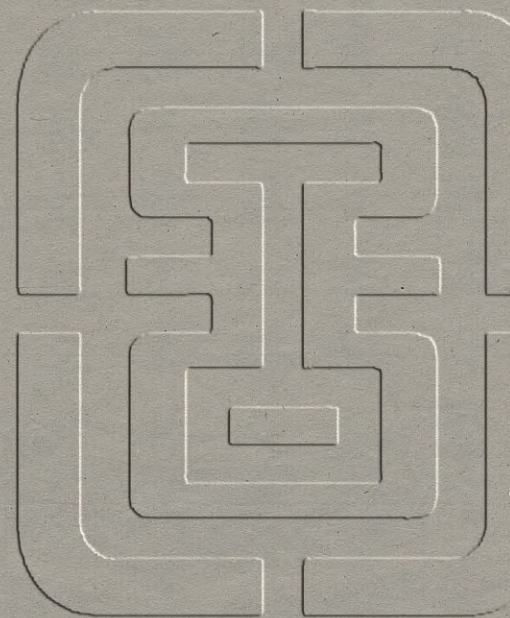

漢饗餐奩

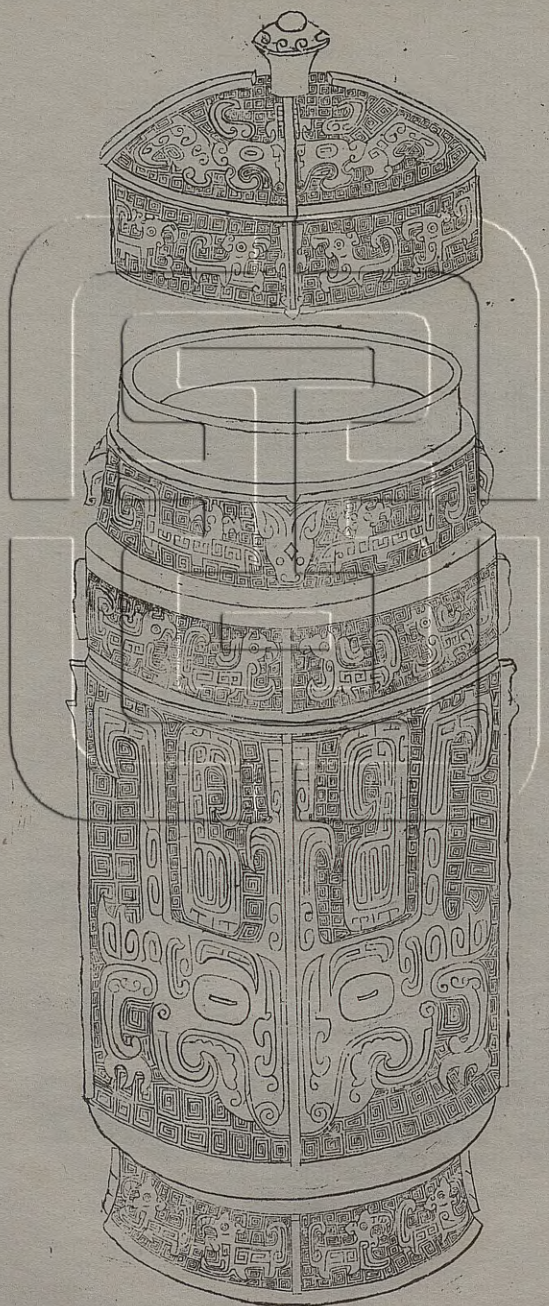

右通蓋高一尺二分深八寸口徑三寸七分腹
圍一尺五寸三分重一百二十三兩

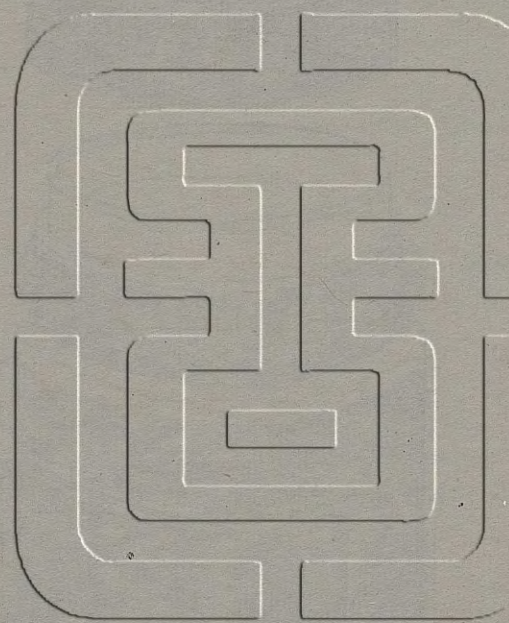

漢夔龍奩一

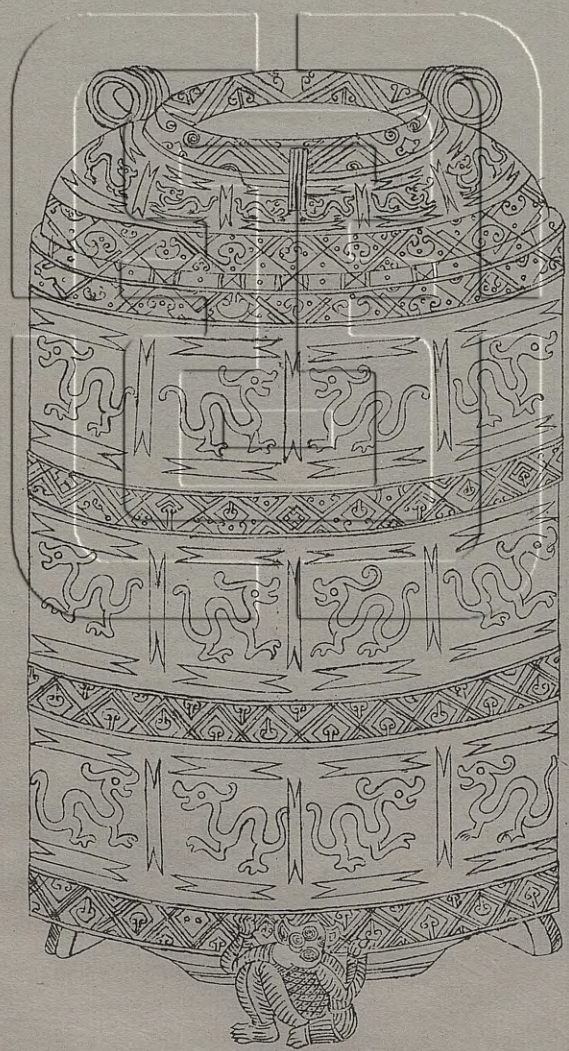

右高九寸一分深八寸六分口徑三寸六分腹圍二尺一寸五分重一百九十三兩

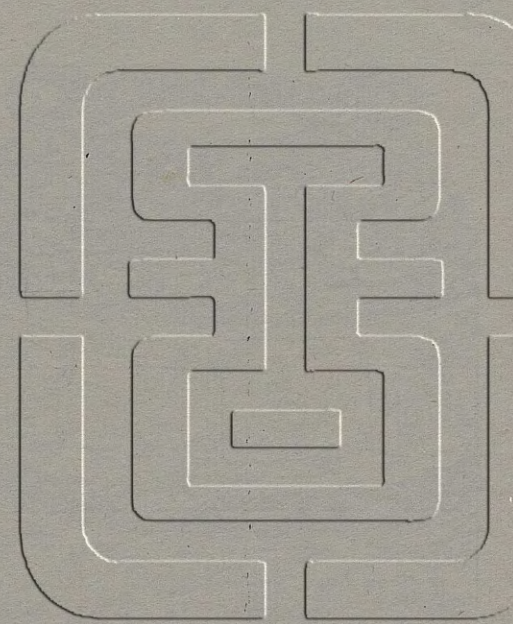

漢夔龍奩二

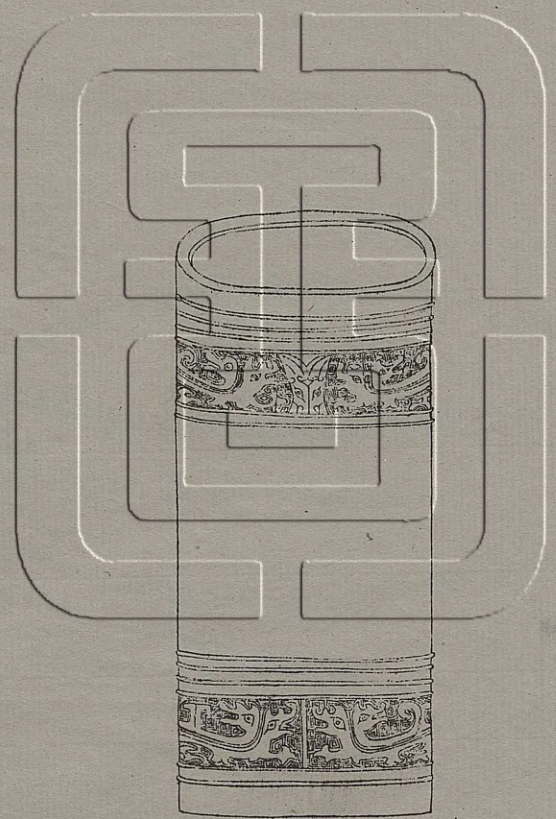

右高六寸深五寸七分口徑三寸二分腹圍九寸八分重三十七兩

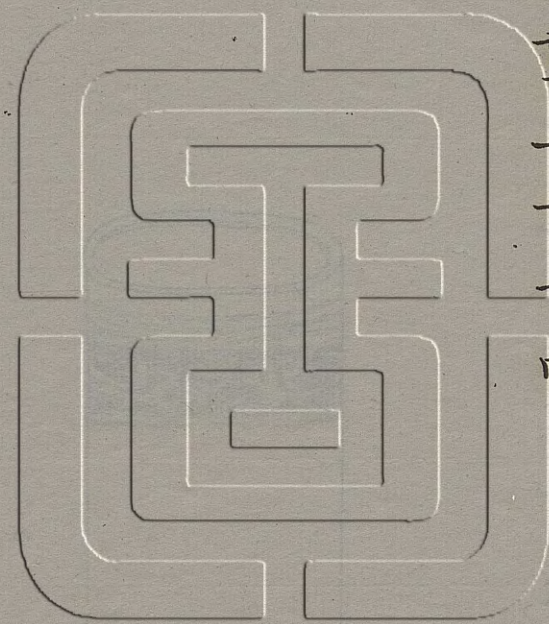

漢獸環奩一

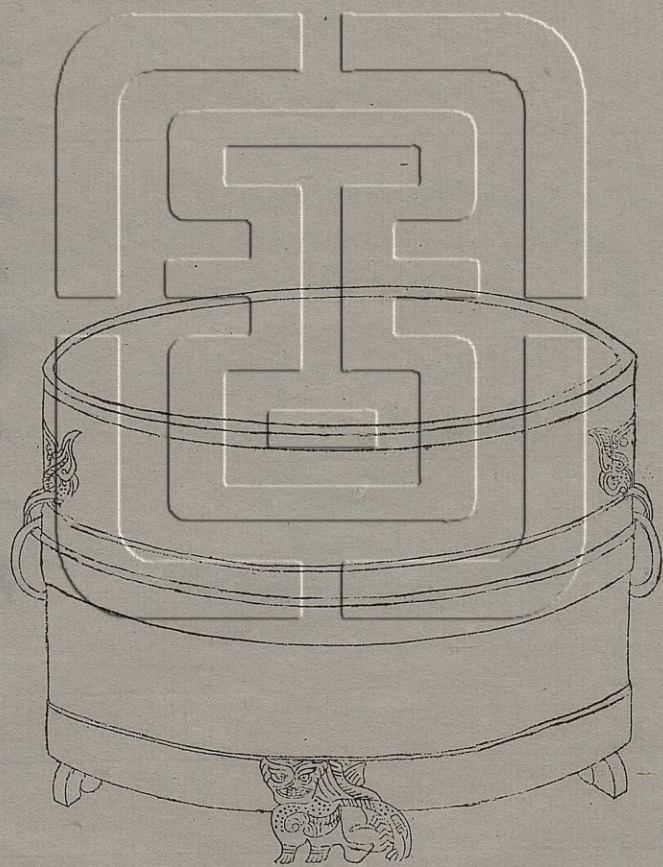

右高四寸九分深四寸一分口徑七寸三分腹圍二尺二寸九分重八十兩

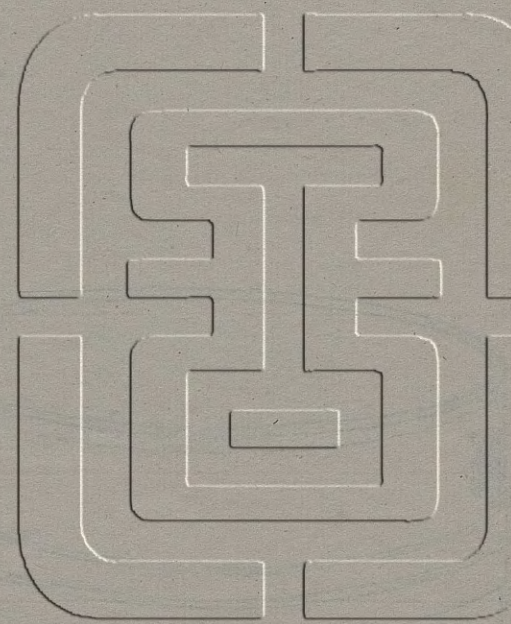

漢獸環奩二

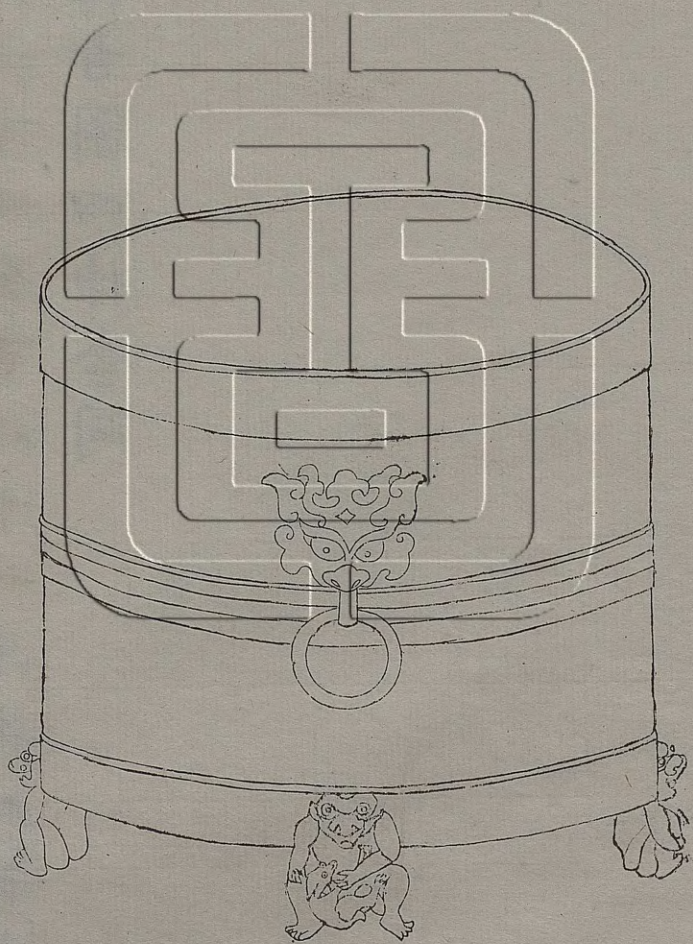

右高四寸八分深四寸三分口徑六寸八分腹
 圍二尺一寸七分重八十一兩按此并前一器
 俱與博古圖四神奩同

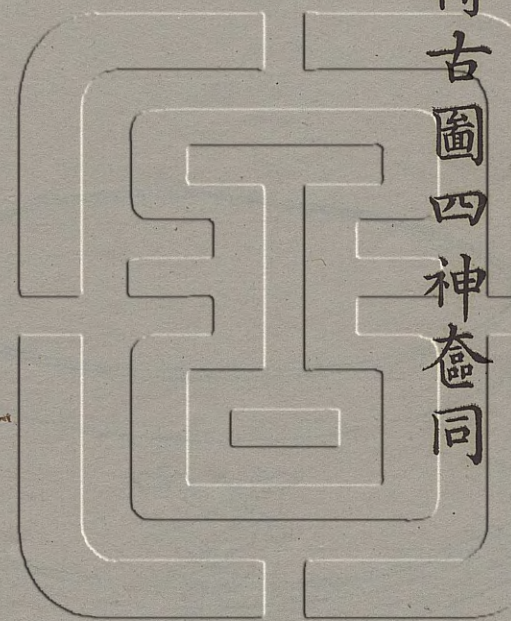

漢澡豆罐一

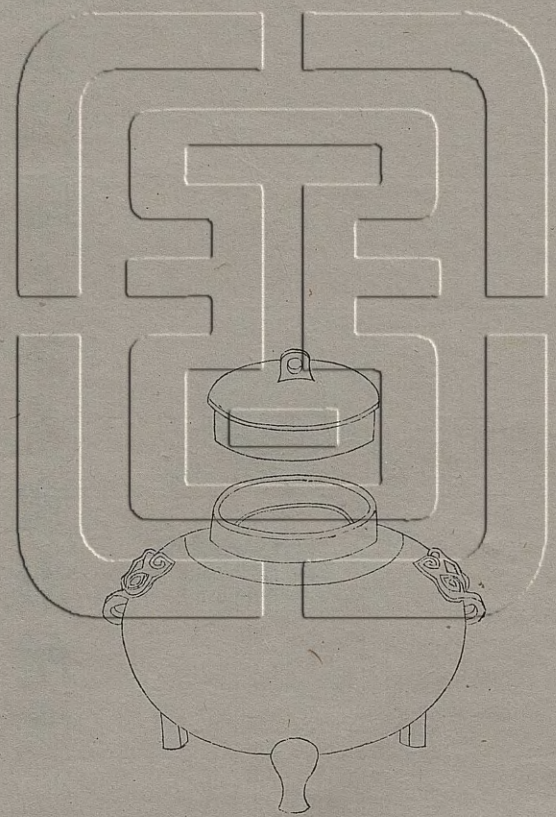

右通蓋高二寸四分深一寸八分口徑一寸三分腹圍七寸七分重八兩按陶弘景十賚文有賚爾鍤石澡罐之語蓋盥漱所需也

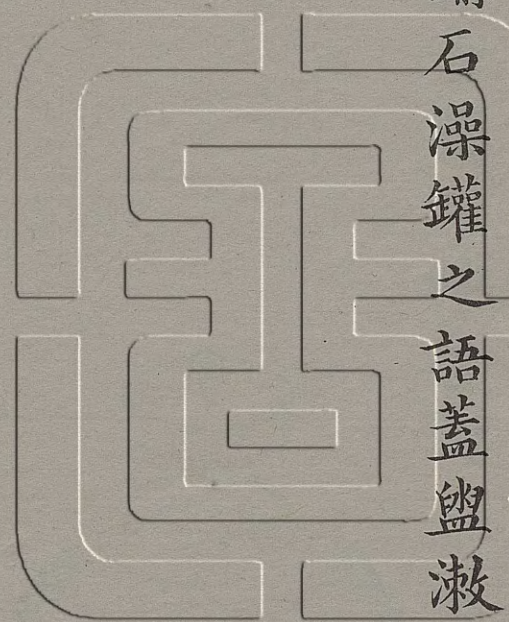

漢澡豆罐二

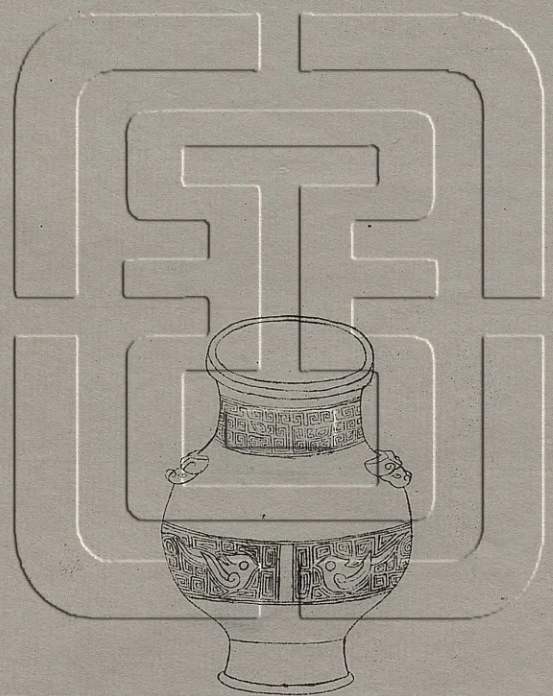

右高二寸八分深二寸三分口徑一寸四分腹圍六寸二分重六兩

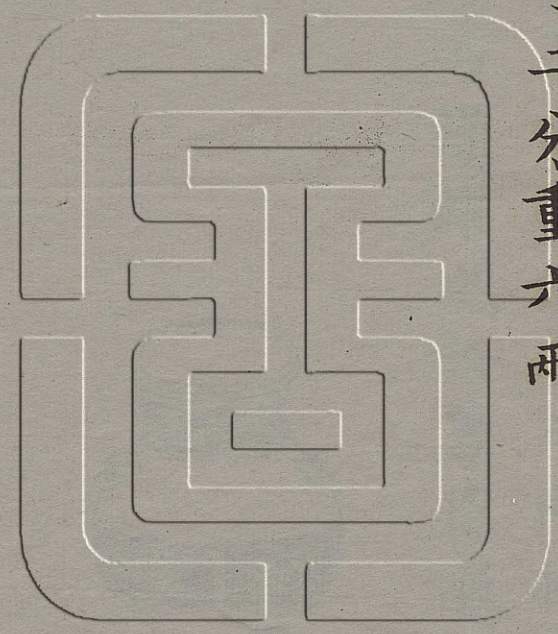

漢澡豆罐三

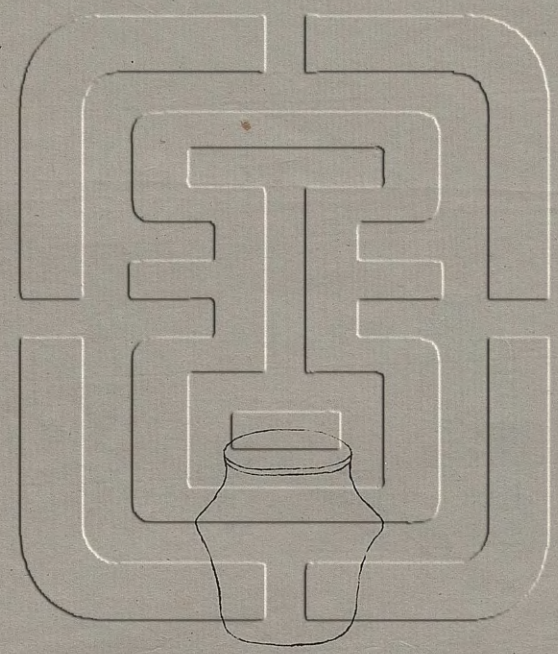

右高一寸六分深一寸四分口徑一寸二分腹圍四寸九分重六兩

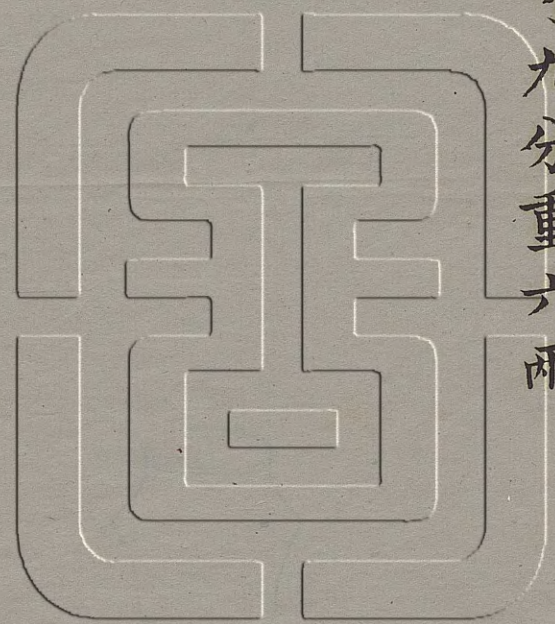

漢雙螭白

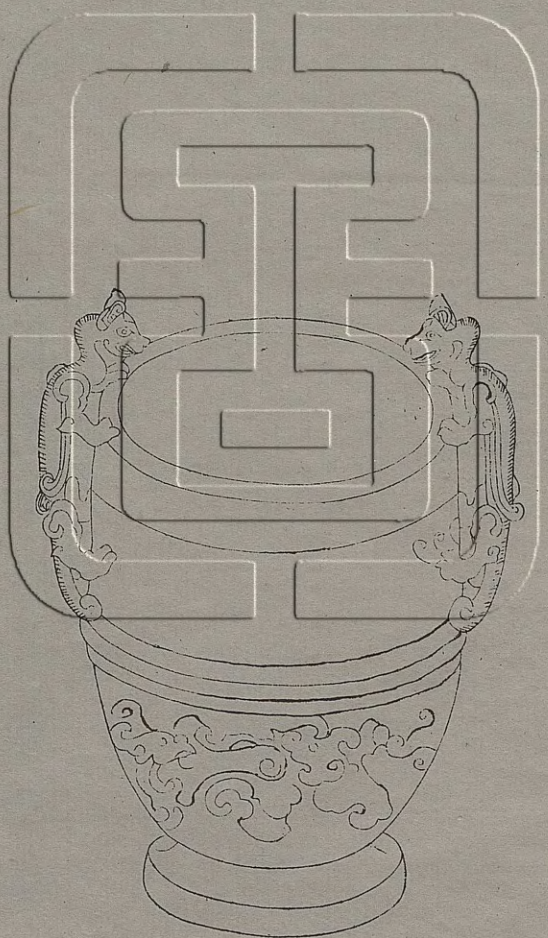

右高四寸深三寸三分口徑三寸三分腹圍一尺一寸七分重八十七兩按白之名自易稱白杵之利已有之此器蓋後世物蓋白茶臼之類耳

