

U.S. Army Training and Doctrine Command

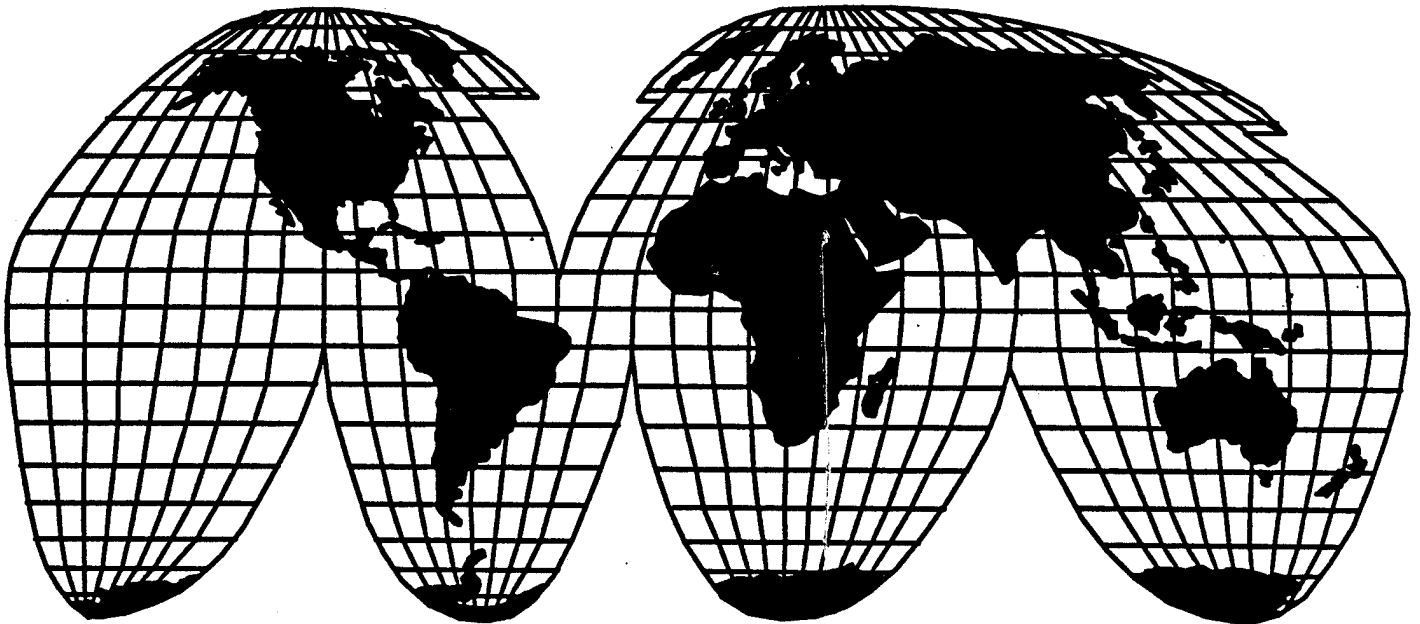
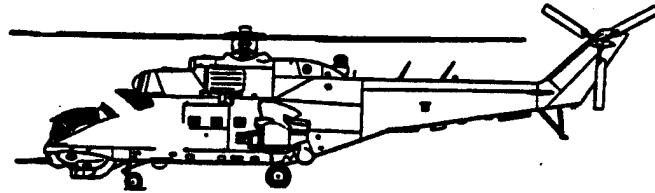

DISTRIBUTION STATEMENT A

Approved for public release;
Distribution Unlimited

**HEAVY OPPOSING
FORCE (OPFOR)
ORGANIZATION GUIDE**

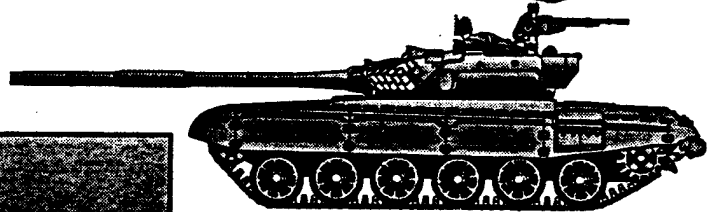

19960220 053

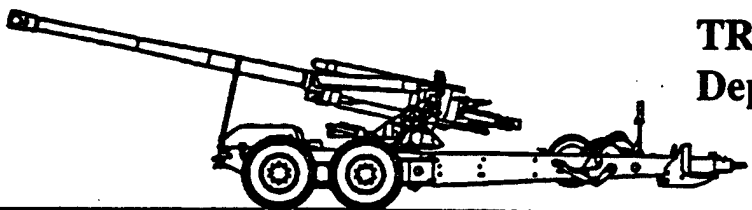

TRADOC
Deputy Chief of Staff for Intelligence

DISCLAIMER NOTICE



THIS DOCUMENT IS BEST QUALITY AVAILABLE. THE COPY FURNISHED TO DTIC CONTAINED A SIGNIFICANT NUMBER OF PAGES WHICH DO NOT REPRODUCE LEGIBLY.

TRADOC Pamphlet 350-12

DEPARTMENT OF THE ARMY
HEADQUARTERS
U.S. ARMY TRAINING AND DOCTRINE COMMAND
Deputy Chief of Staff for Intelligence (DCSINT)
Fort Monroe, Virginia 23651-5000

15 September 1994

Training

**Heavy Opposing Force (OPFOR)
Organization Guide**

Preface

This organization guide is the first in a series of six Training and Doctrine Command Pamphlets that documents the capabilities-based OPFOR model. The capabilities-based OPFOR model will become the basis for the forces and doctrine used by the OPFOR units at the Combat Training Centers (CTC) and in the TRADOC Common Teaching Scenario.

The proponent for this pamphlet is the TRADOC Deputy Chief of Staff for Intelligence. This pamphlet serves as the coordinating draft for the guide's final publication as a Department of the Army Information Pamphlet. Users are encouraged to send comments and suggested improvements on DA Form 2028 (Recommended Changes to Publications and Blank Forms) directly to the TRADOC ODCSINT, Threat Support Division, ATTN: ATZL-CST, Fort Leavenworth, Kansas 66027-5310. Suggested improvements may also be submitted using DA Form 1045 (Army Ideas for Excellence Program (AIEP) Proposal).

Unless otherwise stated, whenever the masculine gender is used, both men and women are included.

DISTRIBUTION RESTRICTION: Approved for public release; distribution is unlimited.

Introduction

Concept

This Organization Guide is one of a series of six Training and Doctrine Command Pamphlets that document the capabilities-based Opposing Force (OPFOR) model. This model was developed to provide a flexible training threat that can be tailored to represent a wide range of potential threat capabilities and organizations. The model features a heavy and a light OPFOR package, each containing three documents: an organization guide, an operations handbook and a tactics handbook.

The capabilities-based OPFOR model represents a break from past practice in two principal respects. First, while the heavy and light packages are based on the doctrine and organization of foreign armies, they are not simply unclassified handbooks on the forces of a particular nation. The OPFOR packages are composites that were deliberately constructed to provide a wide range of capabilities. Second, the packages are not associated with a fixed order of battle but, rather, provide the building blocks from which a large number of potential orders of battle can be derived.

The capabilities-based OPFOR model will become the basis for the forces and doctrine used by the OPFOR units at the Combat Training Centers (CTC) and in the TRADOC Common Teaching Scenarios. The heavy and light packages were designed to accommodate the existing CTC OPFORs at the time of publication with relatively minor changes but have the flexibility to adapt to the changing training requirements of the force-projection Army.

Heavy OPFOR Package

The Heavy OPFOR is based in part on the military forces of the Former Soviet Union (FSU), with a well-documented military doctrine. While Russia and other countries emerging from the FSU may modify that doctrine, it will continue to be the basis for their doctrines and those of numerous other countries whose military forces have been patterned after those of the FSU. Organizationally, the Heavy OPFOR takes a "building block" approach, which provides a great deal of flexibility.

Heavy OPFOR Organization Guide

The Heavy OPFOR Organization Guide is the first of the Heavy OPFOR series of handbooks. Unlike previous OPFOR publications which provided a fixed structure, this guide provides the customer with an organizational menu from which to draw the forces needed to fulfill his training requirements. For principal customers, such as the CTCs and the TRADOC Centers and Schools, this is a collaborative process. For the concept to work successfully, both the Threat Support Division (TSD) and the individual customer must work together to tailor the most appropriate force structure and order of battle for the training required. TSD is solely responsible for production of the guide; however,

order of battle development is a joint responsibility between TSD and the user. This joint effort is expected between TSD and TRADOC trainers and instructors; however, TSD stands ready to provide assistance to all customers in building their training products.

Equipment

Former Soviet systems provide the equipment baseline for the guide. This was done for two primary reasons. First, many potential threat countries are equipped predominantly with FSU systems, which are widely proliferated throughout the world. Second, the equipment listed within the organizations is intended to be *representative* of a unit's or organization's capability. Listing these familiar, well-documented systems paints an immediate, concrete picture, whereas listing generic descriptors such as *Medium Tank* or *Antitank Guided Missile* would not. Moreover, generic descriptors would not lead to the development of consistent equipment sets.

To achieve specific training objectives or merely to provide variety within the organizations, "gray" systems can be substituted for those within the equipment lists. Appendix A contains several substitution matrices for major systems, as well as general guidelines for the substitution process. The matrices are guides; they are not intended to be all-inclusive, listing every conceivable system. In constructing an order of battle, therefore, trainers may substitute systems not listed in the matrices. However, they should follow the same general philosophy and guidelines detailed in Appendix A. System substitution is another aspect covered during the joint order of battle development process.

Structure

The Heavy OPFOR Organization Guide depicts the forces of a country with standing divisions or brigades, and armies or army corps. Most of these formations are stationed within military districts in peacetime and would become subordinate to *fronts* during wartime. Armies, army corps, and *fronts* can vary widely in their strengths and capabilities. If a trainer finds that his scenario does not require a large array of standing forces, it may be that the Light OPFOR Organization Guide better suits his training needs.

As an alternative to motorized rifle and tank formations based on the FSU model, this guide presents infantry divisions. These infantry divisions and their subordinates are composites of forces found in various countries.

Presentation of Information

The organization charts in this guide focus on maneuver units. They range from the lowest level (motorized rifle, infantry, airborne, or tank squad) up to the highest level (*front*). At each level, the guide breaks down subordinate combat support and combat service support units and subunits whenever feasible, for greater detail. To avoid extensive duplication, subunits common to several unit types are depicted once and cross-referenced thereafter. Subunits defined in greater detail have a page reference underneath their box in the organization chart; subunits with no page reference are not further defined. As a rule, equipment listings only account for individual weapons up to and including the maneuver battalion. Unless organic to the battalion, individual weapon totals for combat support and combat service support units are not listed.

The guide begins with the structure of motorized rifle and tank divisions. Next, it focuses more closely on motorized rifle and tank regiment and then on motorized rifle and tank battalions. The independent motorized rifle brigade is presented as an alternative to the regiment-division structure, although based on many of the same "building blocks". Next come the more flexible structures for army corps and armies and finally the various possibilities for a *front* organization. The next section deals with airborne forces, which may take the form of either divisions or independent brigades. The final portion depicts the structure of the infantry division and its subordinates.

CONTENTS

Preface	i
Introduction	ii
MOTORIZED RIFLE AND TANK DIVISIONS	
Motorized Rifle Division (Type I)	1
Motorized Rifle Division (Type II)	1
Tank Division	3
MOTORIZED RIFLE AND TANK REGIMENTS	
Motorized Rifle Regiment (BMP), MRD	78
Motorized Rifle Regiment (BMP), TD	81
Motorized Rifle Regiment (BTR), MRD	84
Tank Regiment, MRD	87
Tank Regiment, TD	90
MOTORIZED RIFLE AND TANK BATTALIONS	
Motorized Rifle Battalion (BMP), MRR (BMP) and TR, MRD and TD or IMRB	113
Motorized Rifle Battalion (BTR), MRR (BTR), MRD or IMRB	127
Tank Battalion (Standard), MRR (BMP or BTR) and TR, MRD and TD	136
Tank Battalion (40-Tank Variant), MRR (BMP or BTR), MRD and TD	138
INDEPENDENT MOTORIZED RIFLE BRIGADE (IMRB)	
Independent Motorized Rifle Brigade, Army Corps or Army or <i>Front</i>	140
ARMY CORPS	
Army Corps	151
Combined Arms Army	159
Tank Army	160
Infantry Army	161

FRONT

Front 184

AIRBORNE FORCES

Independent Airborne Brigade 202

Parachute Battalion, IAB 204

Airborne Division 213

Airborne Regiment (BMD), Airborne Div 215

Airborne Battalion (BMD), Airborne Regt, Airborne Div 217

INFANTRY DIVISION

Infantry Regiment, ID 229

Light Assault Battalion, ID 259

Independent Tank Battalion, ID 268

APPENDIX A: Substitution Matrices A-1

APPENDIX B: Cargo Trucks, Trailers and Radio Substitution B-1

GLOSSARY GLOSSARY-1

INDEX INDEX-1

Motorized Rifle Division (TYPE I)

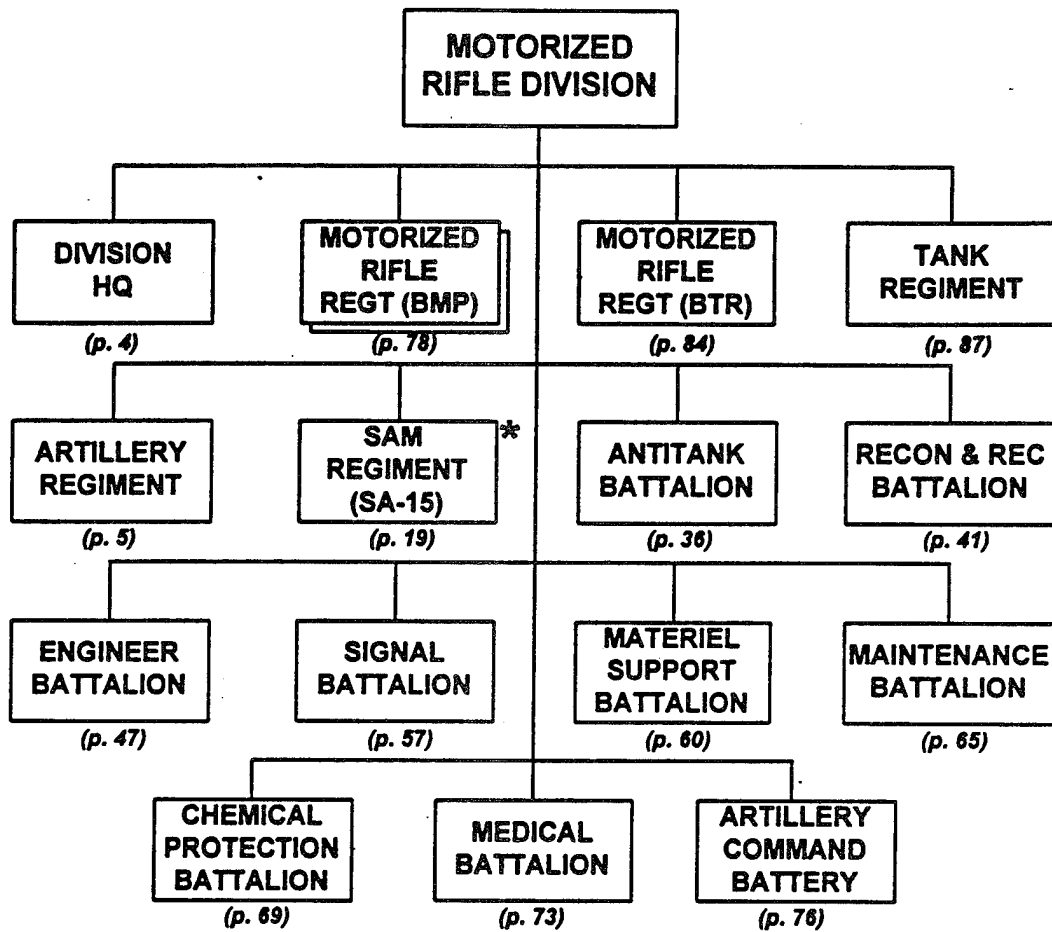

NOTE: The MRD (Type I) has two MRR (BMP) and one MRR (BTR), while the MRD (Type II) has two MRR (BTR) and one MRR (BMP). Otherwise, the two division types are identical.

FOOTNOTE: * Instead of the SA-15 SAM regiment, the MRD may have a SAM regiment equipped with the SA-6 (p. 23) or SA-8 (p. 21) or an AAA regiment equipped with the S-60 AA gun (p. 35).

Motorized Rifle Division (TYPE II)

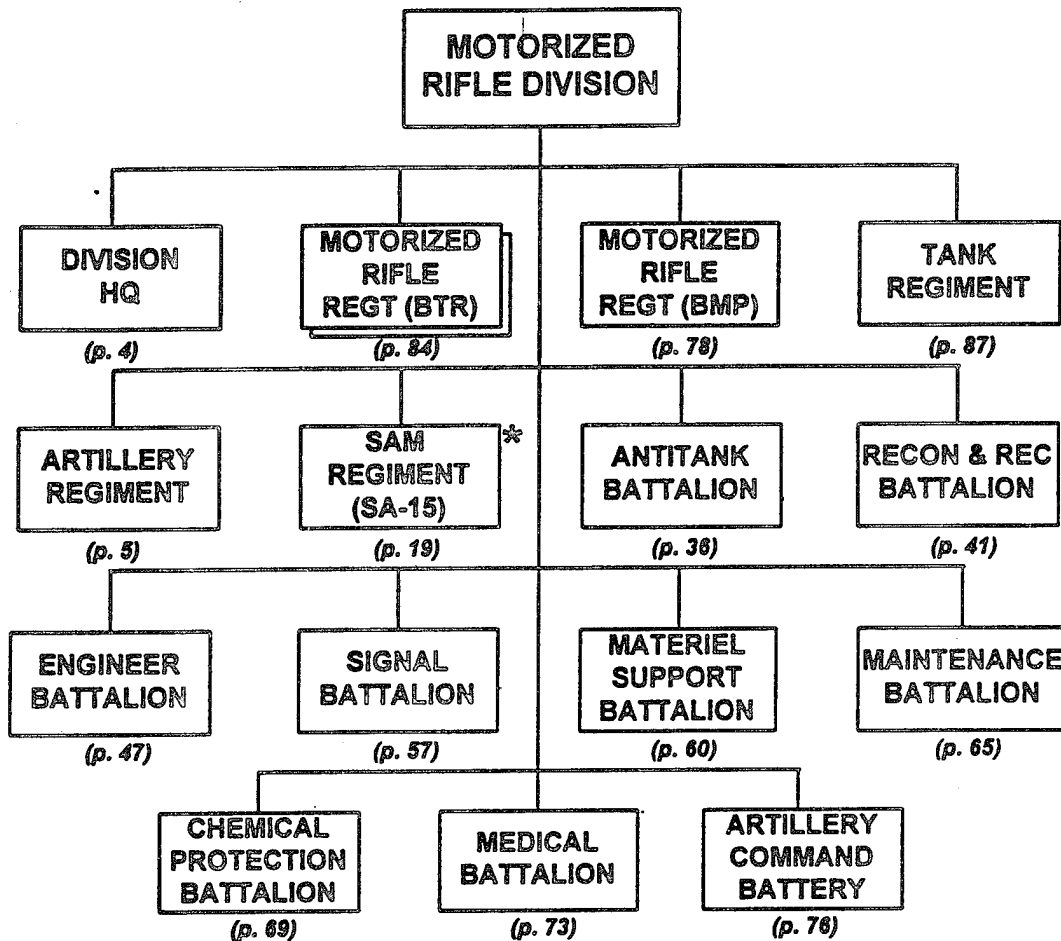

NOTE: The MRD (Type I) has two MRR (BMP) and one MRR (BTR), while the MRD (Type II) has two MRR (BTR) and one MRR (BMP). Otherwise, the two division types are identical.

FOOTNOTE: * Instead of the SA-15 SAM regiment, the MRD may have a SAM regiment equipped with the SA-6 (p. 23) or SA-8 (p. 21) or an AAA regiment equipped with the S-60 AA gun (p. 35).

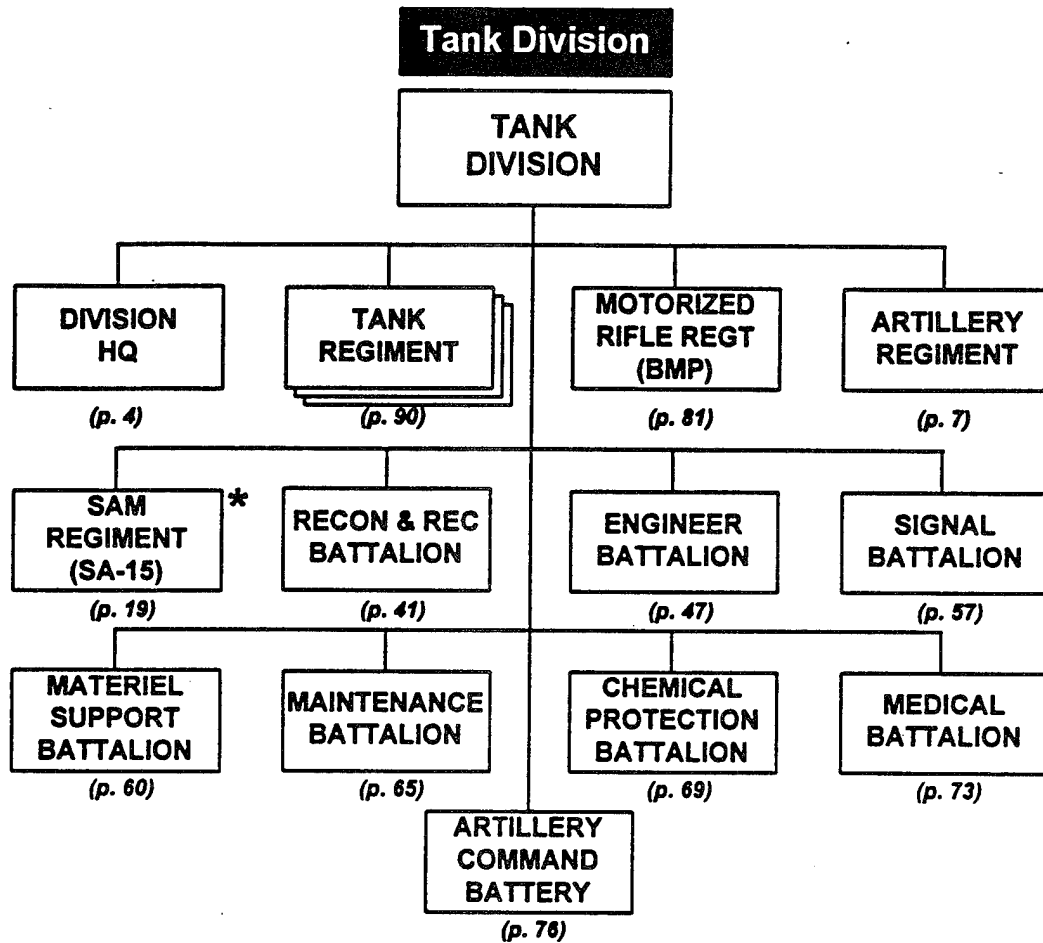

FOOTNOTE: * Instead of the SA-15 SAM regiment, the MRD may have a SAM regiment equipped with the SA-6 (p. 23) or SA-8 (p. 21) or an AAA regiment equipped with the S-60 AA gun (p. 35).

Division Headquarters, MRD and TD

**DIVISION
HEADQUARTERS**

PRINCIPAL ITEMS OF EQUIPMENT

<u>Equipment</u>	<u>Total</u>	<u>Equipment</u>	<u>Total</u>
SAM, SA-16/18	6	Truck, POL (4,000 or 5,200-Liter)	1
ATGL, RPG-7V	3	Ambulance	1
5.45-mm LMG, RPK-74	3	Sedan	2
APC, BTR-60/70/80	3	Trailer, Cargo, 1-Axle	4
Truck, Utility	12	Trailer, Generator	3
Truck, Light	9	Trailer, POL (900-Liter)	1
Truck, Medium	4	Trailer, Water (900-Liter)	1
Van, Command	12	Trailer, Kitchen	3
Van, Maintenance	1	Radio, VHF, Vehicle Mount, Medium-Power	3
Van, Signal	2		

Artillery Regiment, MRD

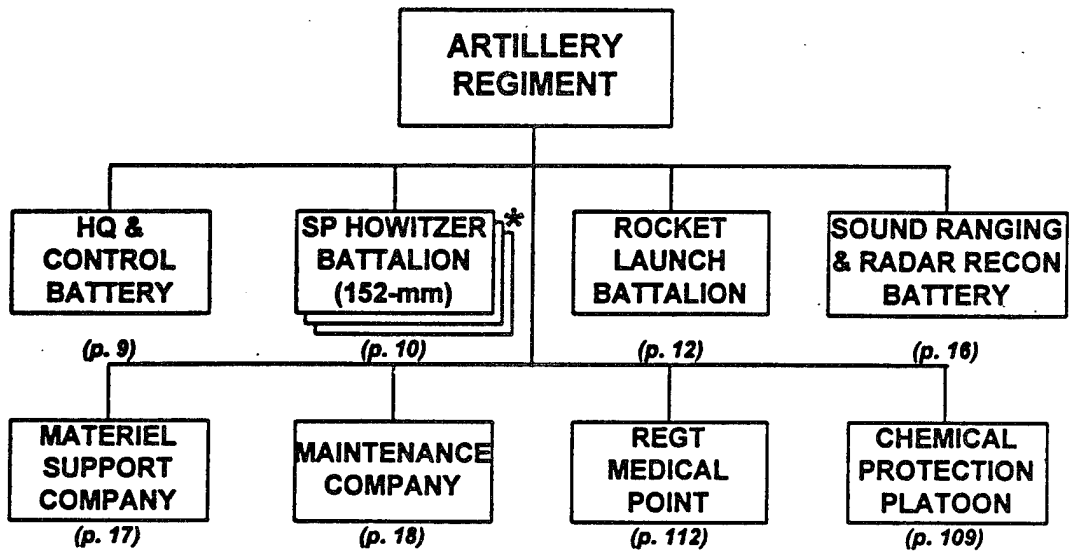

FOOTNOTE: * The artillery regiment has three SP howitzer battalions in the MRD but only two in the TD.

ARTILLERY REGIMENT, MRD									
<i>Principal Items of Equipment</i>	<i>HO & Control Coy</i>	<i>SP Howitzer Bn (162-mm) (3x)</i>	<i>Rocket Launcher Bn</i>	<i>Sound Range & Radar Recon Bty</i>	<i>Material Support Co</i>	<i>Maintenance Co</i>	<i>Regt Medical Point</i>	<i>Chem Protection Plt</i>	TOTAL
ARMORED VEHICLES									
APC, BTR-60/70/80	1								1
ACV, BTR (R-145BM)	2			1					3
Chemical Recon Vehicle, BRDM-2RJC/RKbM	1							3	4
Mobile Recon Post, PRP-3/4	1	3		1					5
APC, Radar, MT-LB (SNAR-10)				1					1
ACRV, 1V13/1V13M/1V22		9							9
ACRV, 1V14/1V14M/1V23		9							9
ACRV, 1V15/1V15M/1V24		3							3
ACRV, 1V16/1V16M/1V25		3							3
ACRV, 1V18			3						3
ACRV, 1V19			1						1
Armored Recovery Vehicle						1			1
WEAPONS									
152-mm SP Howitzer, 2S3 or 2S19		54							54
122-mm Rocket Launcher, BM-21			18						18
SAM, SA-16/18	3								3
TRUCKS									
ACRV, 1V110 (Battery FDC)			3						3
ACRV, 1V111 (Battalion FDC)			1						1
Truck, Utility	6		1		1	1			9
Truck, Light	2			2	1		1		6
Truck, Medium	1	60	37	3	43	3	2		149
Truck, Decon, ARS-12U/14								3	3
Truck, Decon, DDA-53/66							1	1	2
Truck, POL (4,000/5,200-L)		12	2		8				22
Truck, Water (2,000-L)					3			2	5
Van, Hospital							1		1
Van, Maintenance	1	6	3	4	2	8			24
Van, Signal	2	12	4						18
Van, Survey				1					1
Ambulance		3	1				4		8
TRAILERS									
Trailer, Cargo, 1-Axle				1					1
Trailer, Cargo, 2-Axle	1	51	27		30	3			112
Trailer, Generator	2	6	2	2		2			14
Trailer, Kitchen	1	9	3	1			1		15
Trailer, POL (1,200-L)		12	2		8				22
Trailer, Water (900/1,200-L)	1	3	1	1			1	2	9
RADARS									
Radar, CM/CB, ARK-1				1					1
RADIOS									
VHF, Manpack, Low-Power	6	30	18	13	1	1	1		70
VHF, Portable, Low-Power	1								1
VHF, Vehicle Mount, Medium-Power	5	84		4				3	96
HF, Manpack, Low-Power	1							1	2
HF, Vehicle Mount, Medium-Power	5								5
HF/VHF, Vehicle Mount, Medium-Power	3		2						5
HF/VHF, Vehicle Mount, High-Power	1								1
Radio Relay, VHF/UHF	1								1
Warning Receiver	1	6	1	1					9
MISCELLANEOUS									
Rangefinder, Laser, SAGE GLOSS	1	12		2					15
Sound Ranging Set				1					1

Artillery Regiment, TD

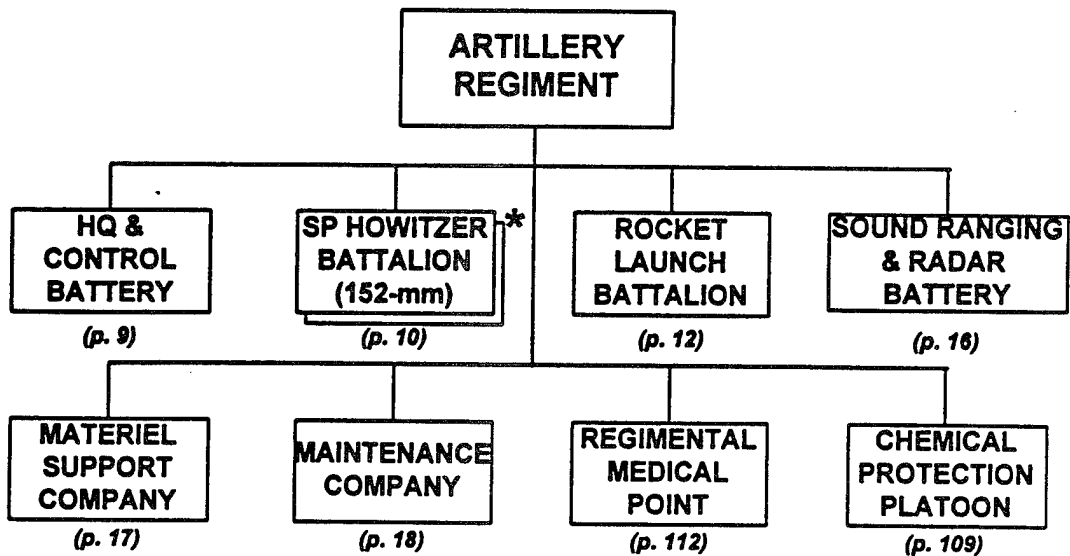

FOOTNOTE: * The artillery regiment has three SP howitzer battalions in the MRD but only two in the TD.

ARTILLERY REGIMENT, TD									
Principal Items of Equipment	HQ & Central Btry	SP Howitzer Bn (152-mm) (2x)	Rocket Launcher Bn	Sound Range & Radar Recon Btry	Material Support Co	Maintenance Co	Regt Medical Plt	Chem Protection Plt	TOTAL
ARMORED VEHICLES									
APC, BTR-60/70/80	1								1
ACV, BTR (R-145BM)	2			1					3
Chemical Recon Vehicle, BRDM-2RKh/RKAM	1							3	4
Mobile Recon Post, PRP-3/4	1	2		1					4
APC, Radar, MT-LB (SNAR-10)				1					1
ACRV, 1V13/1V13M/1V22		6							6
ACRV, 1V14/1V14M/1V23		6							6
ACRV, 1V15/1V15M/1V24		2							2
ACRV, 1V16/1V16M/1V25		2							2
ACRV, 1V18			3						3
ACRV, 1V19			1						1
Armored Recovery Vehicle						1			1
WEAPONS									
152-mm SP Howitzer, 2S3 or 2S19		36							36
122-mm Rocket Launcher, BM-21			18						18
SAM, SA-16/18	3								3
TRUCKS									
ACRV, 1V110 (Battery FDC)			3						3
ACRV, 1V111 (Battalion FDC)			1						1
Truck, Utility	6		1		1	1			9
Truck, Light	2			2	1		1		6
Truck, Medium	1	40	37	3	32	3	2		118
Truck, Decca, ARS-12U/14								3	3
Truck, Decca, DDA-53/65							1	1	2
Truck, POL (4,000/5,200-L)		8	2		8				18
Truck, Water (2,000-L)					3			2	5
Van, Hospital							1		1
Van, Maintenance	1	4	3	4	2	6			20
Van, Signal	2	8	4						14
Van, Survey				1					1
Ambulance		2	1				4		7
TRAILERS									
Trailer, Cargo, 1-Axle				1					1
Trailer, Cargo, 2-Axle	1	34	27		20	3			85
Trailer, Generator	2	4	2	2		2			12
Trailer, Kitchen	1	6	3	1			1		12
Trailer, POL (1,200-L)		8	2		8				18
Trailer, Water (900-1,200-L)	1	2	1	1			1	2	8
RADARS									
Radar, CM/CB, ARK-1				1					1
RADIOS									
VHF, Manpack, Low-Power	6	20	18	13	1	1	1		60
VHF, Portable, Low-Power	1								1
VHF, Vehicle Mount, Medium-Power	5	56		4				3	68
HF, Manpack, Low Power	1							1	2
HF, Vehicle Mount, Med. Power	5								5
HF/VHF, Vehicle Mount, Medium-Power	3		2						5
HF/VHF, Vehicle Mount, High-Power	1								1
Radio Relay, VHF/UHF	1								1
Warning Receiver	1	4	1	1					7
MISCELLANEOUS									
Rangefinder, Laser, SAGE GLOSS	1	8		2					11
Sound Ranging Set				1					1

Headquarters and Control Battery, Arty Regt, MRD and TD

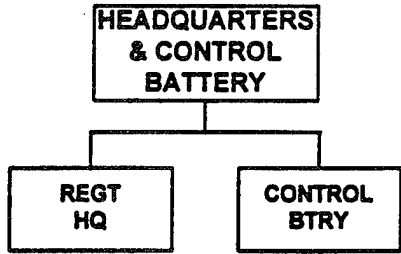

PRINCIPAL ITEMS OF EQUIPMENT

Equipment	Total	Equipment	Total
ATGL, RPG-7V	4	Trailer, Water (900-Liter)	1
Mobile Recon Post, PRP-3/4*	1	Rangefinder, Laser, SAGE GLOSS	1
APC, BTR-60/70/80	1	Radios:	
SAM, SA-16/18	3	HF, Manpack, Low-Power	1
ACV, BTR (R-145BM)	2	VHF, Portable, Low-Power or	
Truck, Utility	6	Very-Low-Power	1
Truck, Light	2	VHF, Vehicle Mount, Medium-Power ..	5
Truck, Medium	1	VHF, Manpack, Low-Power	6
Chemical Recon Vehicle,		HF, Vehicle Mount, Medium-Power	5
BRDM-2RKh/RKhM	1	HF/VHF, Vehicle Mount,	
Van, Signal	2	Medium-Power	3
Van, Maintenance	1	HF/VHF, Vehicle Mount,	
Trailer, Cargo, 2-Axle	1	High-Power	1
Trailer, Generator	2	Radio Relay, VHF/UHF	1
Trailer, Kitchen	1	Warning Receiver	1

FOOTNOTE: * This system includes the SMALL FRED or TALL MIKE battlefield surveillance radar.

**152-mm SP Howitzer Battalion, Arty Regt, MRD
and TD or IMRB**

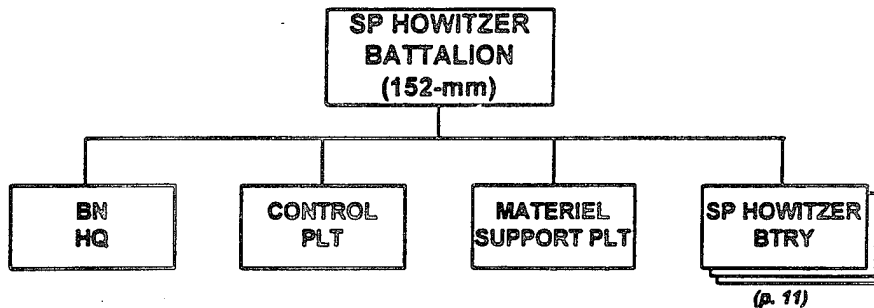

PRINCIPAL ITEMS OF EQUIPMENT

<u>Equipment</u>	<u>Total</u>	<u>Equipment</u>	<u>Total</u>
152-mm SP Howitzer, 2S3 or 2S19.....	18	Ambulance	1
ATGL, RPG-7V	6	Trailer, Cargo, 2-Axle.....	17
5.45-mm LGM, RPK-74.....	18	Trailer, Generator.....	2
Mobile Recon Post, PRP-3/4*	1	Trailer, Water (1,200-Liter)	1
ACRV, 1V13/1V13M/1V22 (Btry FDC)	3	Trailer, Kitchen.....	3
ACRV, 1V14/1V14M/1V23 (Btry COP)	3	Trailer, POL (1,200-Liter)	4
ACRV, 1V15/1V15M/1V24 (Bn COP).....	1	Rangefinder, Laser, SAGE GLOSS.....	4
ACRV, 1V16/1V16M/1V25 (Bn FDC).....	1	Radios:	
Truck, Medium	20	VHF, Manpack, Low-Power.....	10
Van, Maintenance	2	VHF, Vehicle Mount,	
Truck, POL (4,000 or 5,200-Liter)	4	Medium-Power	28
Van, Signal.....	4	Warning Receiver	2

FOOTNOTE: * This system includes the SMALL FRED or TALL MIKE battlefield surveillance radar.

**152-mm SP Howitzer Battery, 152-mm SP Howitzer Bn,
Arty Regt, MRD and TD or IMRB**

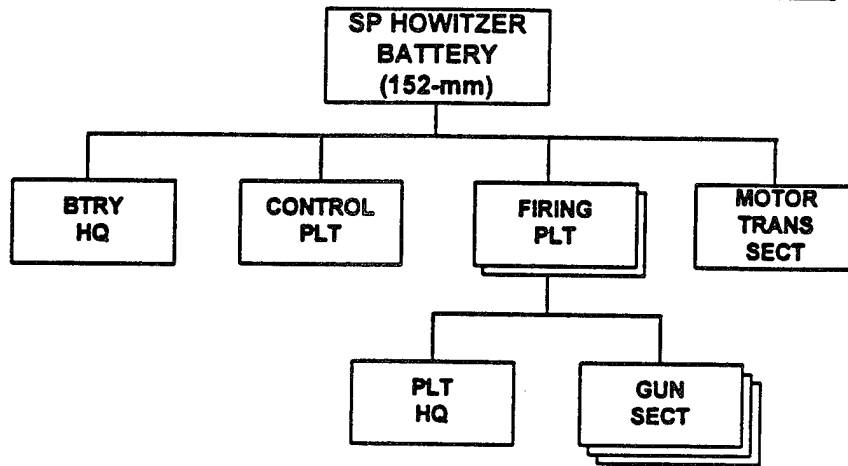

PRINCIPAL ITEMS OF EQUIPMENT

Equipment	Total
152-mm SP Howitzer, 2S3 or 2S19.....	6
ATGL, RPG-7V.....	2
5.45-mm LGM, RPK-74.....	6
ACRV, 1V13/1V13M/1V22 (Btry FDC)	1
ACRV, 1V14/1V14M/1V23 (Btry COP)	1
Van, Signal.....	1

Equipment	Total
Truck, Medium	3
Trailer, Cargo, 2-Axle.....	3
Rangefinder, Laser, SAGE GLOSS.....	1
Radios:	
VHF, Manpack, Low-Power.....	2
VHF, Vehicle Mount, Medium-Power ..	8

Rocket Launcher Battalion, Arty Regt, MRD and TD

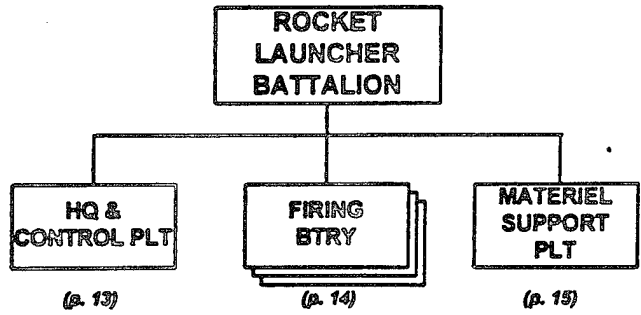

PRINCIPAL ITEMS OF EQUIPMENT

<u>Equipment</u>	<u>Total</u>
122-mm Rocket Launcher, BM-21 (Grad)	18
ATGL, RPG-7V	6
ACRV, 1V18 (Btry COP)	3
ACRV, 1V19 (Bn COP)	1
ACRV, 1V110 (Btry FDC)	3
ACRV, 1V111 (Bn FDC)	1
Truck, Utility	1
Truck, Medium	37
Van, Signal	4
Van, Maintenance	3
Truck, POL (4,000 or 5,200-Liter)	2

<u>Equipment</u>	<u>Total</u>
Ambulance	1
Trailer, Cargo, 2-Axle	27
Trailer, Generator	2
Trailer, Water (1,200-Liter)	1
Trailer, POL (1,200-Liter)	2
Trailer, Kitchen	3
Radios:	
VHF, Manpack, Low-Power	18
HF/VHF, Vehicle Mount, Medium-Power	2
Warning Receiver	1

**Headquarters and Control Platoon, Rocket Launcher Bn,
Arty Regt, MRD and TD**

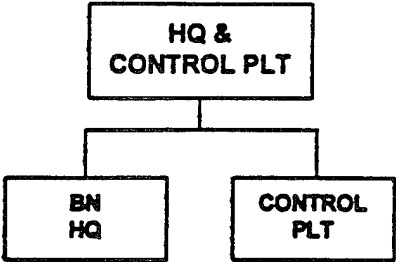

PRINCIPAL ITEMS OF EQUIPMENT

Equipment	Total	Equipment	Total
ACRV, 1V19 (Bn COP)	1	Trailer, Generator.....	1
ACRV, 1V111 (Bn FDC)	1	Radios:	
Truck, Utility.....	1	VHF, Manpack, Low-Power.....	5
Truck, Medium	1	HF/VHF, Vehicle Mount,	
Van, Signal.....	1	Medium-Power	2
Ambulance	1	Warning Receiver	1

Firing Battery, Rocket Launcher Bn, Arty Regt, MRD and TD

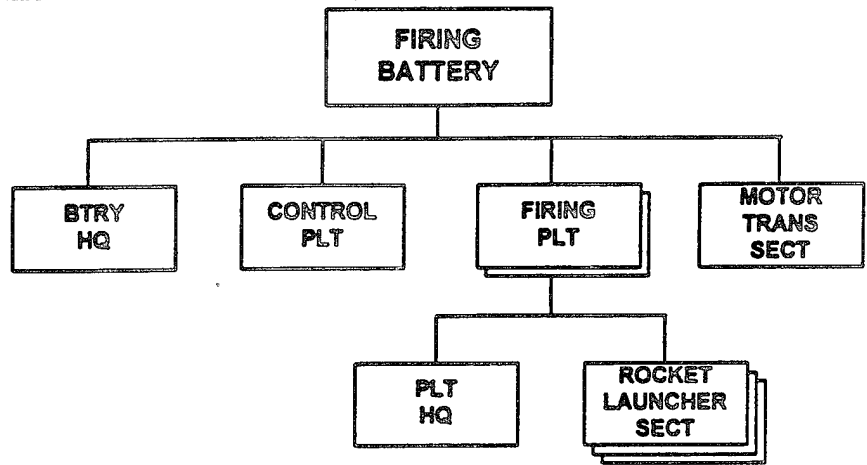

PRINCIPAL ITEMS OF EQUIPMENT

<u>Equipment</u>	<u>Total</u>
122-mm Rocket Launcher, BM-21 (Grad) ..6	
ACRV, 1V18 (Btry COP).....1	
ACRV, 1V110 (Btry FDC).....1	
ATGL, RPG-7V.....2	

<u>Equipment</u>	<u>Total</u>
Truck, Medium	6
Van, Signal.....	1
Trailer, Cargo, 2-Axle.....	3
Radio, VHF, Manpack, Low-Power	4

**Materiel Support Platoon, Rocket Launcher Bn,
Arty Regt, MRD and TD**

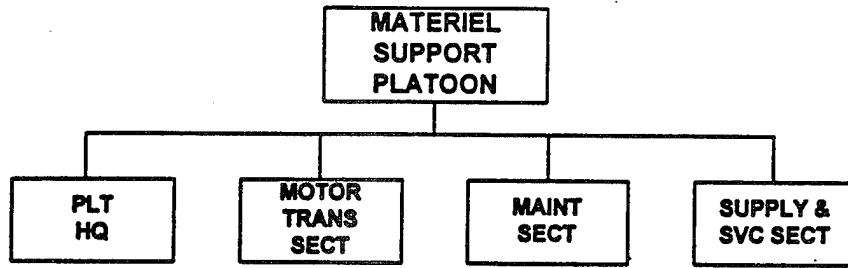

PRINCIPAL ITEMS OF EQUIPMENT

Equipment	Total	Equipment	Total
Truck, Medium	18	Trailer, Water (1,200-Liter)	1
Van, Maintenance	3	Trailer, POL (1,200-Liter)	2
Truck, POL (4,000 or 5,200-Liter)	2	Trailer, Kitchen	3
Trailer, Cargo, 2-Axle	18	Radio, VHF, Manpack, Low-Power	1
Trailer, Generator	1		

**Sound Ranging and Radar Reconnaissance Battery,
Arty Regt, MRD and TD**

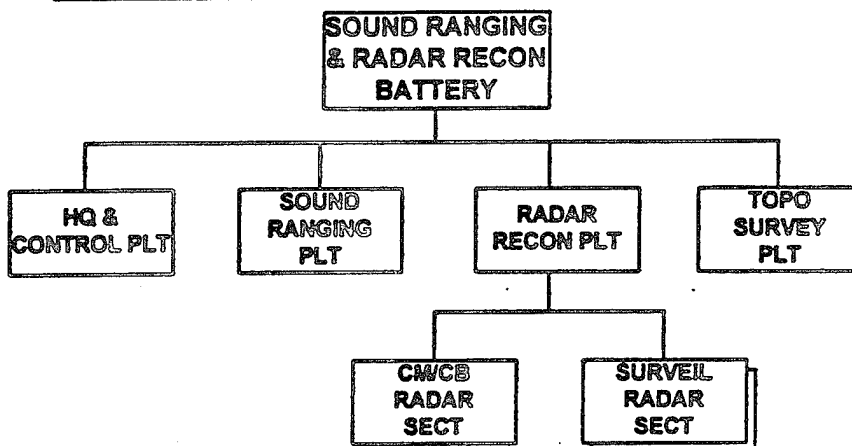

PRINCIPAL ITEMS OF EQUIPMENT

<u>Equipment</u>	<u>Total</u>	<u>Equipment</u>	<u>Total</u>
ACV, BTR (R-145BM)	1	Trailer, Cargo, 1-Axle.....	1
APC, Radar, MT-LB (SNAR-10)*	1	Trailer, Kitchen.....	1
Mobile Recon Post, PRP-3/4**	1	Trailer, Water (900-Liter)	1
Truck, Light	2	Radar, Countermortar/Counterbattery, ARK-1***	1
Truck, Medium	3	Radios:	
Van, Maintenance	4	VHF, Manpack, Low-Power.....	13
Van, Survey.....	1	VHF, Vehicle Mount, Medium-Power ..	4
Trailer, Generator.....	2	Warning Receiver	1
Rangefinder, Laser, SAGE GLOSS.....	2		
Sound Ranging Set.....	1		

FOOTNOTES:

- * This system includes the BIG FRED battlefield surveillance radar.
- ** This system includes the SMALL FRED or TALL MIKE battlefield surveillance radar.
- *** This system includes the RICE BAG countermortar/counterbattery radar.

Materiel Support Company, Arty Regt, MRD and TD

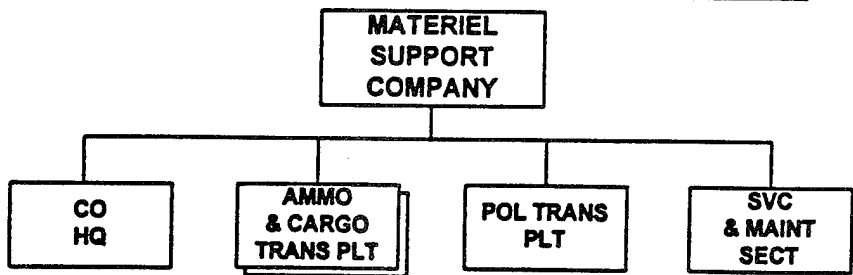

PRINCIPAL ITEMS OF EQUIPMENT

<u>Equipment</u>	<u>Total</u>	<u>Equipment</u>	<u>Total</u>
Truck, Utility.....	1	Truck, POL (4,000 or 5,200-Liter)	8
Truck, Light	1	Trailer, POL (1,200-Liter)	8
Truck, Medium	43/32*	Trailer, Cargo, 2-Axle.....	30/20*
Van, Maintenance	2	Radio, VHF, Manpack, Low-Power	1
Truck, Water (2,000-Liter).....	3		

FOOTNOTE: * Equipment levels for this company in MRD/TD. The artillery regiment in the TD has one less SP howitzer battalion and thus requires less materiel support.

Maintenance Company, Arty Regt, MRD and TD

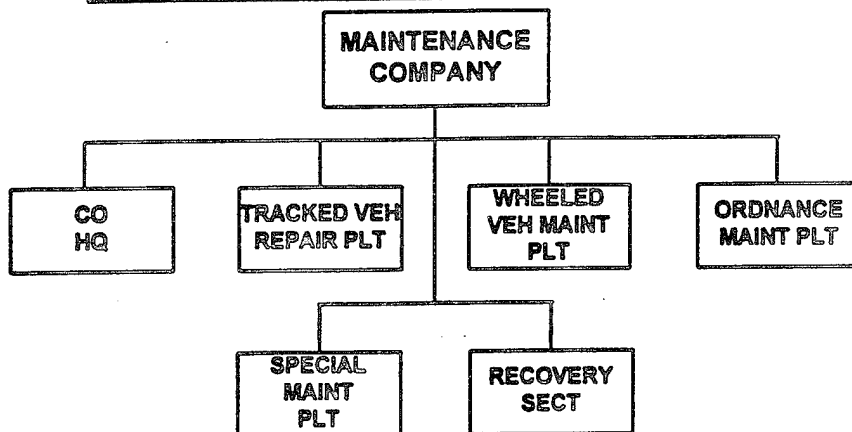

PRINCIPAL ITEMS OF EQUIPMENT

<u>Equipment</u>	<u>Total</u>	<u>Equipment</u>	<u>Total</u>
ATGL, RPG-7V	4	Armored Recovery Vehicle	1
5.45-mm LMG, RPK-74	2	Trailer, Cargo, 2-Axle	3
Truck, Utility	1	Trailer, Generator	2
Truck, Medium	3	Radio, VHF, Manpack, Low-Power	1
Van, Maintenance	8/6*		

FOOTNOTE: * Equipment levels for this company in MRD/TD. The artillery regiment in the TD has one less SP howitzer battalion and thus requires less maintenance support.

SAM Regiment (SA-15), MRD and TD

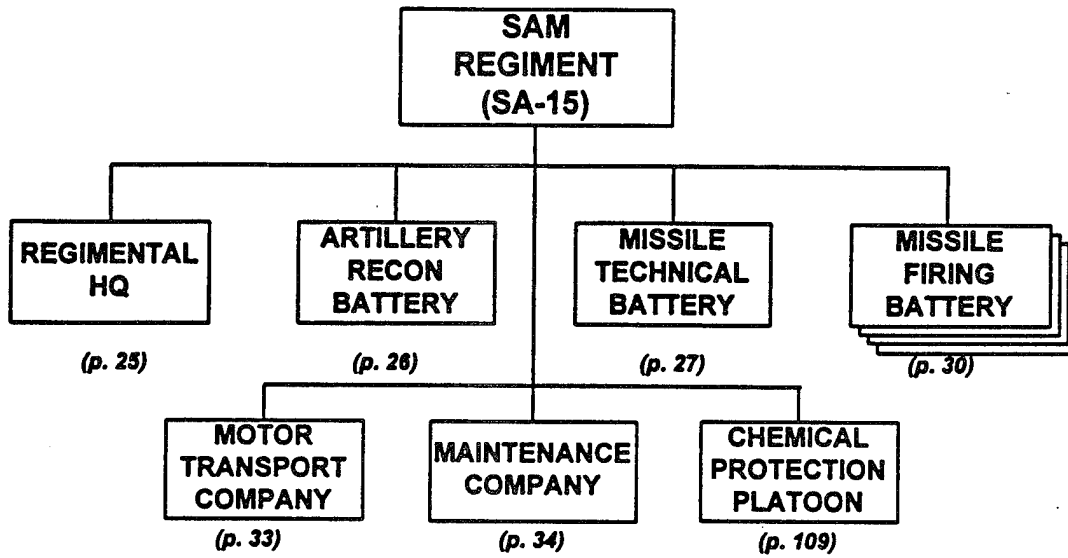

SAM REGIMENT (SA-15), MRD and TD								
Principal Items of Equipment	Regt HQ	Arty Recon Btry	Missile Technical Btry	Missile Firing Btry (4x)	Motor Transport Co	Maintenance Co	Chem Protection Plt	TOTAL
	ARMORED VEHICLES							
Chemical Recon Vehicle BRDM-2RKh/RKhM							3	3
ACV, BTR-60 (PU-12)	1			4				5
WEAPONS								
SAM, SA-15/GAUNTLET				16				16
SAM, SA-16/18	3		3	12				18
TRUCKS								
Truck, Utility	1	3	1		1	1		7
Truck, Light	3	1	5	4	1	3		17
Truck, Medium			4		33	3		40
Truck, Decon, ARS-12U/14							3	3
Truck, Decon, DDA-53/66							1	1
Truck, Crane			2					2
Truck, POL (4,000/5,200-L)					15			15
Truck, Water (2,000-L)							2	2
Van	2			4	4			10
Van, Computer		1						1
Van, Maintenance		1			3	8		12
Van, Missile Testing			5					5
Van, Signal	4							4
Ambulance	2							2
TRAILERS								
Trailer, Cargo, 2-Axle		1	1	4	5	3		14
Trailer, Generator	2		1		3	7		13
Trailer, Kitchen	1	1	2	4	1	1		10
Trailer, POL (1,200-L)					7			7
Trailer, Van	4	1	1	4	2			12
Trailer, Water (1,200-L)					3	1	2	6
RADARS								
Aer. Surv/Tgt Acq, LONGTRACK		2						2
Rader, Height Finding, THIN SKIN		1						1
RADIOS								
VHF, Manpack, Low-Power	1	2	1	4	1	1		10
VHF, Portable, Low-Power			3					3
VHF, Vehicle Mount, Medium-Power	1	3		24			3	31
HF, Manpack, Low-Power		2					1	3
HF/VHF, Vehicle Mount, Medium-Power	4							4
HF/VHF, Vehicle Mount, High-Power	2							2
Radio Relay, VHF/UHF	1							1
Warning Receiver	2			4				6
MISCELLANEOUS								
SA-15 Transloader (TELAR Chassis)				8				8

SAM Regiment (SA-8), MRD and TD

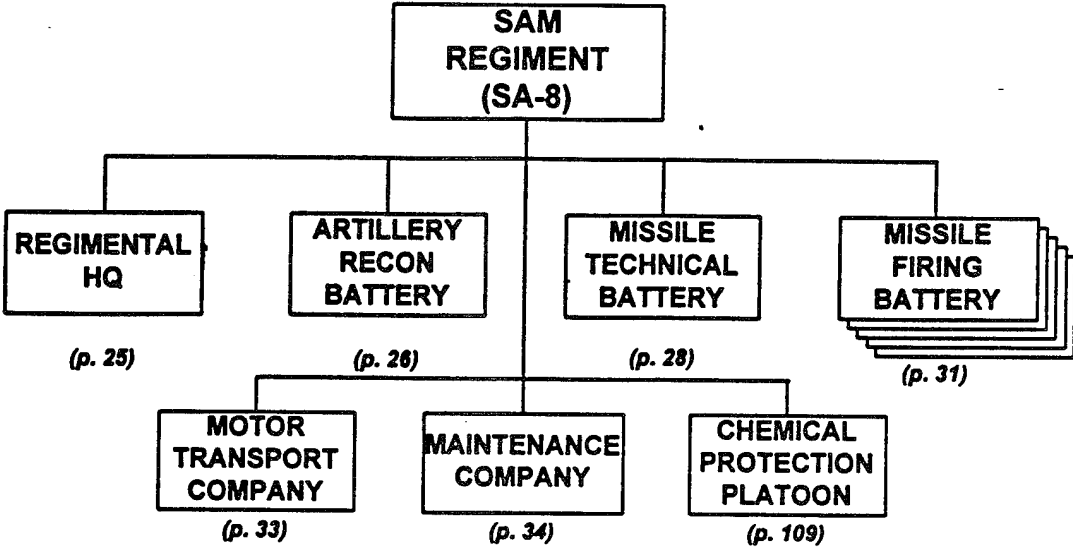

SAM REGIMENT (SA-8), MRD and TD								
<i>Principal Items of Equipment</i>	<i>Regt HQ</i>	<i>Arty Recon Btry</i>	<i>Missile Technical Btry</i>	<i>Missile Firing Btry (5x)</i>	<i>Motor Transport Co</i>	<i>Maintenance Co</i>	<i>Chem Protection Plt</i>	<i>TOTAL</i>
ARMORED VEHICLES								
Chemical Recon Vehicle, BRDM-2RKh/2RKhM							3	3
ACV, BTR-60 (PU-12)	1			5				6
WEAPONS								
SAM, SA-8/GECKO				20				20
SAM, SA-16/18	3		3	15				21
TRUCKS								
Truck, Utility	1	3	1		1	1		7
Truck, Light	3	1	5	5	1	3		18
Truck, Medium			4		22	3		29
Truck, Decon, ARS-12U/14							3	3
Truck, Decon, DDA-53/66							1	1
Truck, Crane			2					2
Truck, POL (4,000/5,200-L)					15			15
Truck, Water (2,000-L)							2	2
Van	2			5	4			11
Van, Computer		1						1
Van, Maintenance		1			3	8		12
Van, Missile Testing			5					5
Van, Signal	4							4
Ambulance	2							2
TRAILERS								
Trailer, Cargo, 2-Axle		1	1	5	5	3		15
Trailer, Generator	2		1		3	7		13
Trailer, Kitchen	1	1	2	5	1	1		11
Trailer, POL (1,200-L)					7			7
Trailer, Van	4	1	1	5	2			13
Trailer, Water (1,200-L)					3	1	2	6
RADARS								
Aer. Surv/Tgt Acq, LONGTRACK		2						2
Radar, Height Finding, THIN,SKIN		1						1
RADIOS								
VHF, Manpack, Low-Power	1	2	1	5	1	1		11
VHF, Portable, Low-Power			3					3
VHF, Vehicle Mount, Medium-Power	1	3		30			3	37
HF, Manpack, Low-Power		2					1	3
HF/VHF, Vehicle Mount, Medium-Power	4							4
HF/VHF, Vehicle Mount, High-Power	2							2
Radio Relay, VHF/UHF	1							1
Warning Receiver	2			5				7
MISCELLANEOUS								
SA-8 Transloader (TELAR Chassis)				10				10

SAM Regiment (SA-6), MRD and TD

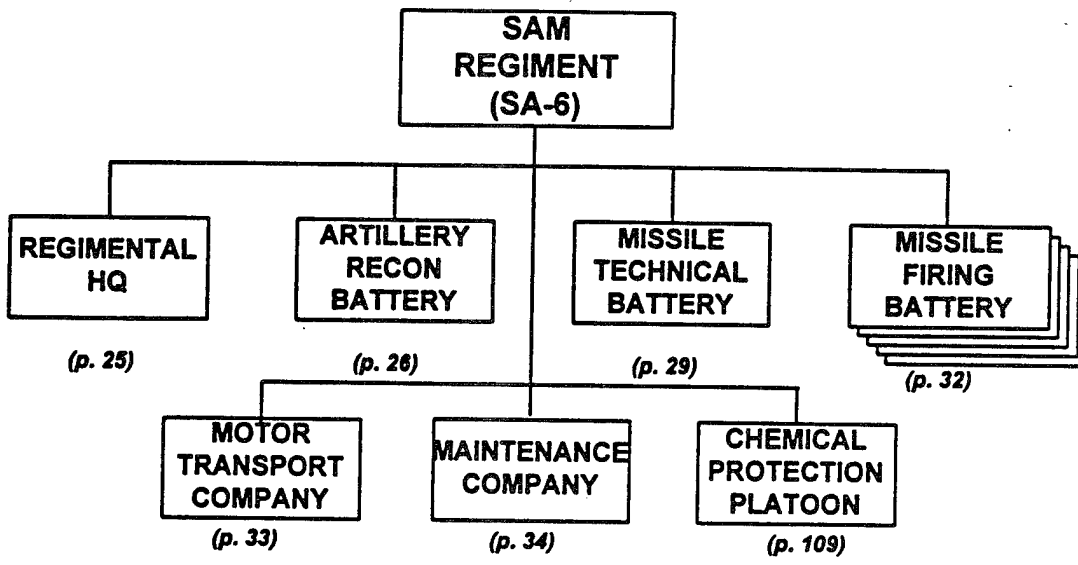

SAM REGIMENT (SA-6), MRD and TD								
<i>Principal Items of Equipment</i>	<i>Regt HQ</i>	<i>Arty Recon Btry</i>	<i>Missile Technical Btry</i>	<i>Missile Firing Btry (5x)</i>	<i>Motor Transport Co</i>	<i>Maintenance Co</i>	<i>Chem Protection Plt</i>	<i>TOTAL</i>
ARMORED VEHICLES								
ACV, BRDM-2U				5				5
Chemical Recon Vehicle, BRDM-2RKh/RKhM							3	3
ACV, BTR-60 (PU-12)	1							1
WEAPONS								
SAM, SA-6/GAINFUL				20				20
SAM, SA-16/18	3		3	15				21
TRUCKS								
Truck, Utility	1	3	1		1	1		7
Truck, Light	3	1	6	5	1	3		19
Truck, Medium			5		22	3		30
Truck, Decon, ARS-12U/14							3	3
Truck, Decon, DDA-53/66							1	1
Truck, Crane			2					2
Truck, POL (4,000/5,200-L)					15			15
Truck, POL (2,000-L)							2	2
Van	2			5	4			11
Van, Computer		1						1
Van, Maintenance		1			3	8		12
Van, Missile Testing			6					6
Van, Signal	4							4
Ambulance	2							2
TRAILERS								
Trailer, Cargo, 2-Axle		1	1	5	5	3		15
Trailer, Generator	2		1		3	7		13
Trailer, Kitchen	1	1	2	5	1	1		11
Trailer, POL (1,200-L)					7			7
Trailer, Van	4	1	1	5	2			13
Trailer, Water (1,200-L)					3	1	2	6
RADARS								
Aer. Surv/Tgt Acq, LONGTRACK		2						2
Radar, Fire Control, STRAIGHT FLUSH				5				5
Radar, Height Finding, THIN SKIN		1						1
RADIOS								
VHF, Manpack, Low-Power	1	2	1	5	1	1		11
VHF, Portable, Low-Power			3					3
VHF, Vehicle Mount, Medium-Power	1	3		30			3	37
HF, Manpack, Low-Power		2					1	3
HF/VHF, Vehicle Mount, Medium-Power	4							4
HF/VHF, Vehicle Mount, High-Power	2							2
Radio Relay, VHF/UHF	1							1
Warning Receiver	2			5				7
MISCELLANEOUS								
SA-6 Canister Transporter (Tractor-Trailer)			15					15
SA-6 Missile Transloader (Truck)			5	10				15

Regimental Headquarters, SAM Regt, MRD and TD

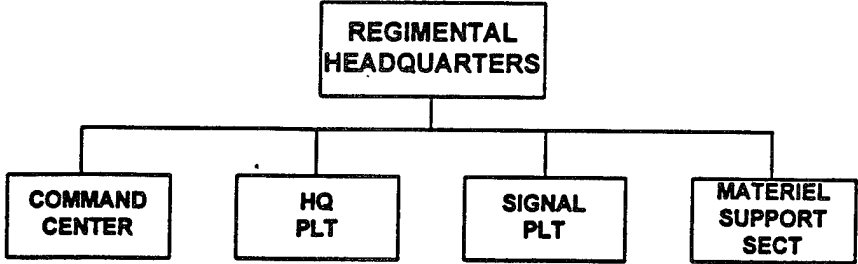

PRINCIPAL ITEMS OF EQUIPMENT

<u>Equipment</u>	<u>Total</u>	<u>Equipment</u>	<u>Total</u>
SAM, SA-16/18	3	Trailer, Kitchen	1
ACV, BTR-60 (PU-12)	1	Radios:	
Truck, Utility	1	HF/VHF, Vehicle Mount,	
Truck, Light	3	Medium-Power	4
Van	2	HF/VHF, Vehicle Mount, High-Power ..	2
Van, Signal	4	VHF, Manpack, Low-Power	1
Ambulance	2	VHF, Vehicle Mount, Medium-Power ..	1
Trailer, Van	4	Radio Relay, VHF/UHF	1
Trailer, Generator	2	Warning Receiver	2

**Artillery Reconnaissance (Target Acquisition/Early Warning)
Battery, SAM Regt, MRD and TD**

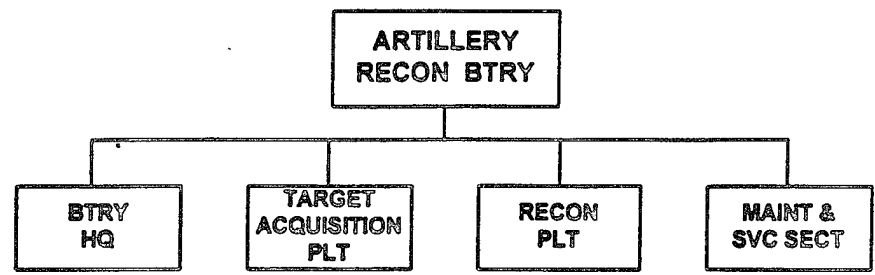

PRINCIPAL ITEMS OF EQUIPMENT

<u>Equipment</u>	<u>Total</u>
Truck, Utility.....	3
Truck, Light	1
Van, Maintenance	1
Van, Computer.....	1
Trailer, Cargo, 2-Axle.....	1
Trailer, Van.....	1
Trailer, Kitchen.....	1

<u>Equipment</u>	<u>Total</u>
Radars:	
Aerial Surveillance/Target Acquisition, LONG TRACK	2
Height Finding, THIN SKIN	1
Radios:	
HF, Manpack, Low-Power.....	2
VHF, Manpack, Low-Power.....	2
VHF, Vehicle Mount, Medium-Power ..	3

Missile Technical Battery, SAM Regt (SA-15), MRD and TD

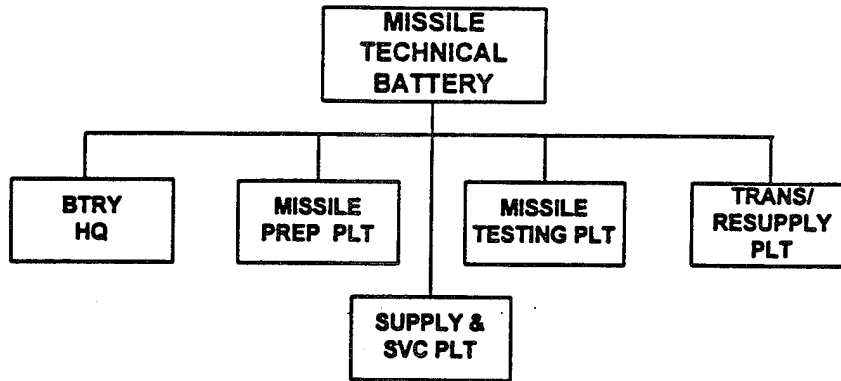

PRINCIPAL ITEMS OF EQUIPMENT

Equipment	Total
SAM, SA-16/18	3
Truck, Utility	1
Truck, Light	5
Truck, Medium	4
Truck, Crane	2
Van, Missile Testing	5
Trailer, Cargo, 2-Axle	1

Equipment	Total
Trailer, Generator	1
Trailer, Van	1
Trailer, Kitchen	2
Radios:	
VHF, Portable, Low-Power	3
VHF, Manpack, Low-Power	1

Missile Technical Battery, SAM Regt (SA-8), MRD and TD

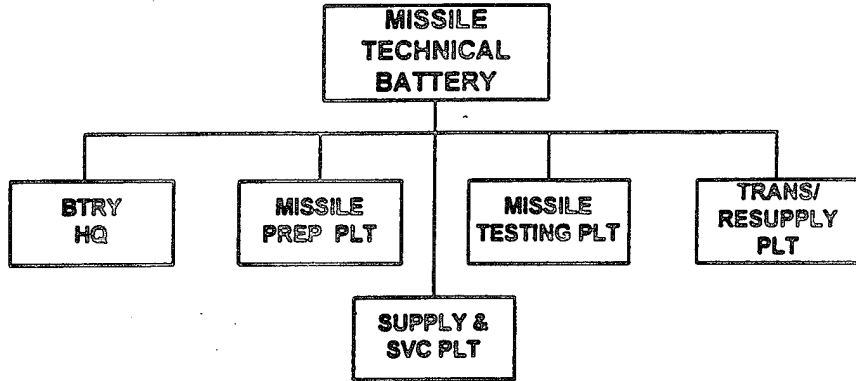

PRINCIPAL ITEMS OF EQUIPMENT

<u>Equipment</u>	<u>Total</u>	<u>Equipment</u>	<u>Total</u>
SAM, SA-16/18	3	Trailer, Generator	1
Truck, Utility	1	Trailer, Van	1
Truck, Light	5	Trailer, Kitchen	2
Truck, Medium	4	Radios:	
Truck, Crane	2	VHF, Portable, Low-Power	3
Van, Missile Testing	5	VHF, Manpack, Low-Power	1
Trailer, Cargo, 2-Axle	1		

Missile Technical Battery, SAM Regt (SA-6), MRD and TD

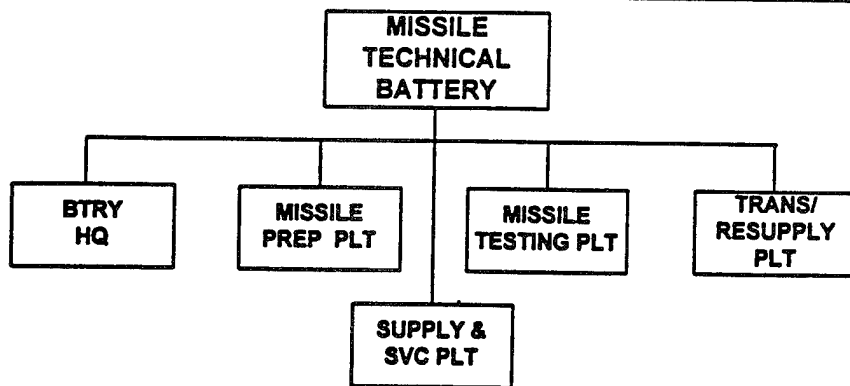

PRINCIPAL ITEMS OF EQUIPMENT

<u>Equipment</u>	<u>Total</u>	<u>Equipment</u>	<u>Total</u>
SAM, SA-16/18	3	SA-6 Missile Transloader (Truck)	5
Truck, Utility	1	Trailer, Cargo, 2-Axle	1
Truck, Light	6	Trailer, Generator	1
Truck, Medium	5	Trailer, Van	1
Truck, Crane	2	Trailer, Kitchen	2
Van, Missile Testing	6	Radios:	
SA-6 Canister Transporter		VHF, Portable, Low-Power	3
(Tractor-Trailer)	15	VHF, Manpack, Low-Power	1

Missile Firing Battery, SAM Regt (SA-15), MRD and TD

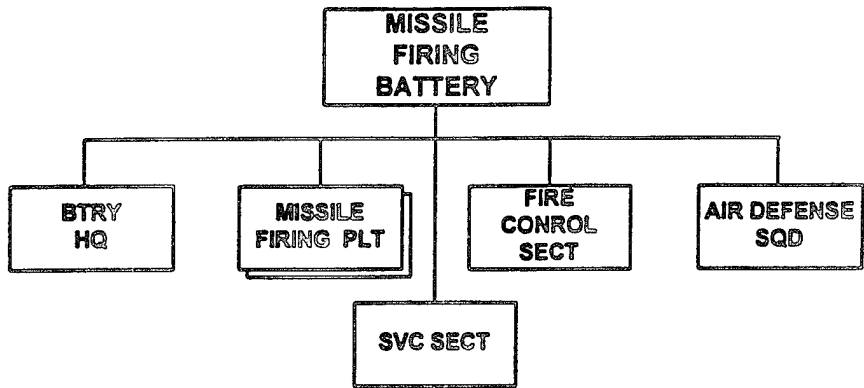

PRINCIPAL ITEMS OF EQUIPMENT

<u>Equipment</u>	<u>Total</u>
SAM, SA-15/GAUNTLET TELAR*	4
SAM, SA-16/18	3
ACV, BTR-60 (PU-12)	1
Truck, Light	1
Van	1
SA-15 Missile Transloader (TELAR Chassis)	2

<u>Equipment</u>	<u>Total</u>
Trailer, Cargo, 2-Axle	1
Trailer, Van	1
Trailer, Kitchen	1
Radios:	
VHF, Manpack, Low-Power	1
VHF, Vehicle Mount, Medium-Power ..	6
Warning Receiver	1

NOTE: * The TELAR includes the SCRUM HALF fire control/target acquisition radar.

Missile Firing Battery, SAM Regt (SA-8), MRD and TD

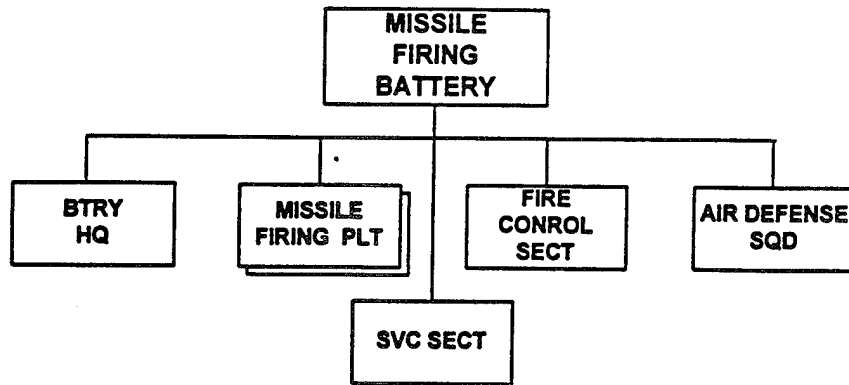

PRINCIPAL ITEMS OF EQUIPMENT

<u>Equipment</u>	<u>Total</u>	<u>Equipment</u>	<u>Total</u>
SAM, SA-8/GECKO TELAR*	4	Trailer, Cargo, 2-Axle	1
SAM, SA-16/18	3	Trailer, Van	1
ACV, BTR-60 (PU-12)	1	Trailer, Kitchen	1
Truck, Light	1	Radios:	
Van	1	VHF, Manpack, Low-Power	1
SA-8 Missile Transloader		VHF, Vehicle Mount, Medium-Power ..	6
(TELAR Chassis)	2	Warning Receiver	1

NOTE: * The TELAR includes the LAND ROLL fire control/target acquisition radar.

Missile Firing Battery, SAM Regt (SA-6), MRD and TD

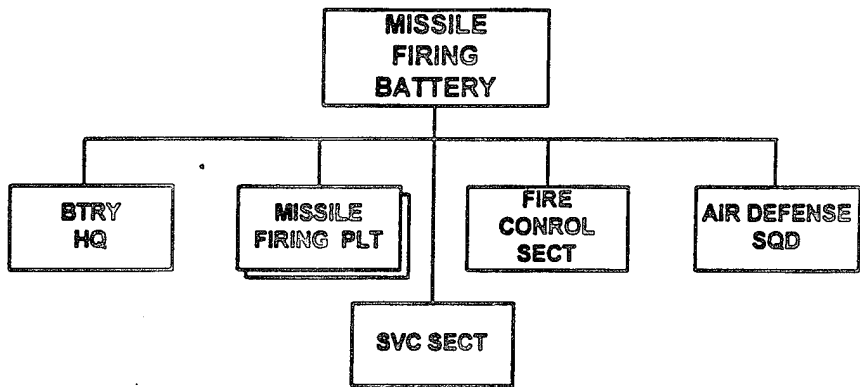

PRINCIPAL ITEMS OF EQUIPMENT

<u>Equipment</u>	<u>Total</u>	<u>Equipment</u>	<u>Total</u>
SAM, SA-6a/GAINFUL TEL or SA-6b/GAINFUL TELAR*	4	Trailer, Van	1
SAM, SA-16/18	3	Trailer, Kitchen	1
ACV, BRDM-2U	1	Radar, Fire Control, STRAIGHT FLUSH...1	
Truck, Light	1	Radios:	
Van	1	VHF, Manpack, Low-Power	1
SA-6 Missile Transloader (Truck)	2	VHF, Vehicle Mount, Medium-Power	6
Trailer, Cargo, 2-Axle	1	Warning Receiver	1

FOOTNOTE: * The SA-6b system includes the FIRE DOME target engagement radar.

Motor Transport Company, SAM Regt, MRD and TD

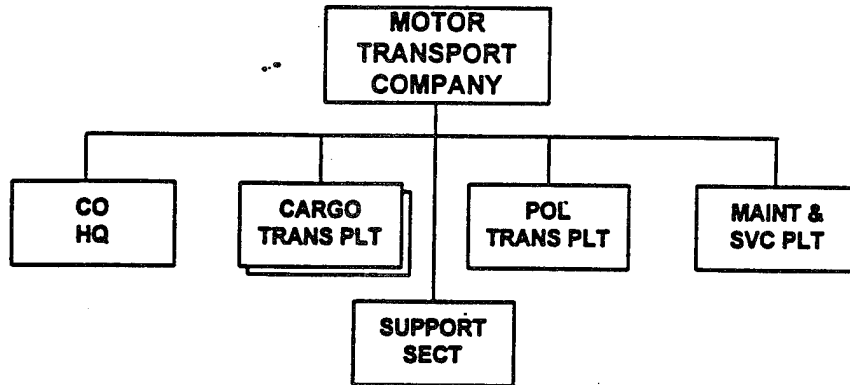

PRINCIPAL ITEMS OF EQUIPMENT

<u>Equipment</u>	<u>Total</u>	<u>Equipment</u>	<u>Total</u>
Truck, Utility.....	1	Trailer, POL (1,200-Liter)	7
Truck, Light	1	Trailer, Generator.....	3
Truck, Medium	33	Trailer, Water (1,200-Liter)	3
Truck, POL (4,000 or 5,200-Liter)	15	Trailer, Kitchen	1
Van.....	4	Trailer, Van.....	2
Van, Maintenance	3	Radio, VHF, Manpack, Low-Power	1
Trailer, Cargo, 2-Axle.....	5		

Maintenance Company, SAM Regt, MRD and TD

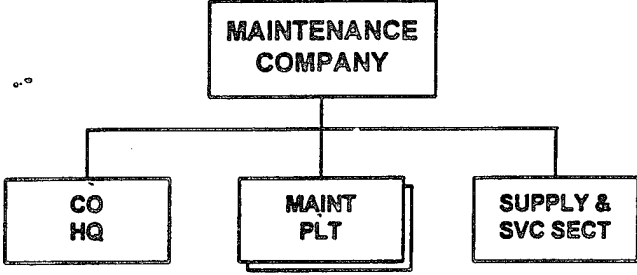

PRINCIPAL ITEMS OF EQUIPMENT

<u>Equipment</u>	<u>Total</u>
Truck, Utility.....	1
Truck, Light	3
Truck, Medium	3
Van, Maintenance	8
Trailer, Cargo, 2-Axle.....	3

<u>Equipment</u>	<u>Total</u>
Trailer, Generator.....	7
Trailer, Water (1,200-Liter)	1
Trailer, Kitchen	1
Radio, VHF, Manpack, Low-Power	1

Antiaircraft Artillery Regiment (S-60), MRD and TD (Variant)

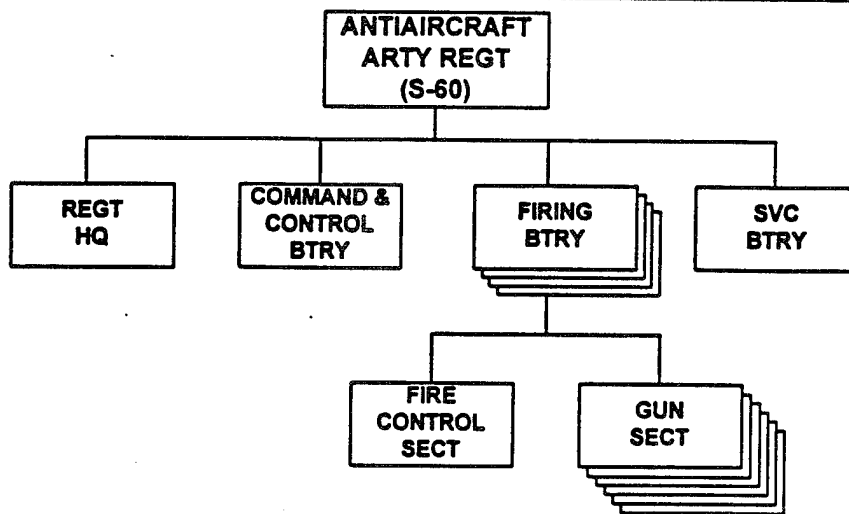

PRINCIPAL ITEMS OF EQUIPMENT

<u>Equipment</u>	<u>Total</u>	<u>Equipment</u>	<u>Total</u>
57-mm AA Gun, S-60.....	24	Trailer, Generator.....	8
SAM, SA-16/18	15	Trailer, Kitchen	8
ACV, BTR-60 (PU-12).....	2	Trailer, Water (1,200-Liter)	7
Truck, Utility.....	10	Radars:	
Truck, Light	3	Radar, Fire Control, FLAP WHEEL.....	4
Truck, Medium	77	Radar, Aerial Surveillance/Target	
Van, Signal.....	2	Acquisition, FLAT FACE.....	2
Van, Radar	6	Radios:	
Truck, POL (4,000 or 5,200-Liter)	4	HF, Manpack, Low-Power.....	1
Truck, Crane	1	HF, Vehicle Mount, Medium-Power	2
Truck, Water (2,000-Liter).....	1	HF/VHF, Vehicle Mount, High-Power..	2
Ambulance	1	VHF, Portable, Very-Low-Power	15
Truck, Chemical Recon, UAZ-69RKh	1	VHF, Manpack, Low-Power.....	24
Trailer, POL (1,200-Liter)	2	VHF, Vehicle Mount, Medium-Power ..	2
Trailer, Cargo, 2-Axle.....	5	Warning Receiver	5

Antitank Battalion, MRD

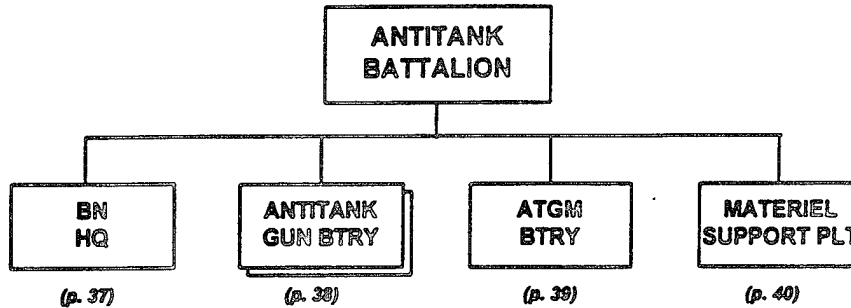

PRINCIPAL ITEMS OF EQUIPMENT

<u>Equipment</u>	<u>Total</u>	<u>Equipment</u>	<u>Total</u>
ATGM Vehicle, 9P148		Trailer, POL (900-Liter)	1
w/ AT-5/SPANDREL	9-12	Trailer, Generator	1
100/125-mm Antitank Gun,		Trailer, Water (900-Liter)	1
MT-12/2A45M	12	Trailer, Kitchen	1
ATGL, RPG-7V	9	Rangefinder	3
ACV, BTR (R-145BM)/BRDM-2U	5	Radar, Battlefield Surveillance,	
Mobile Recon Post, PRP-3/4*	1	Man-Portable, PSNR-1	3
Prime Mover, MT-LBT	14	Radios:	
Truck, Utility	3	VHF, Manpack, Low-Power	10
Truck, Light	4	VHF, Vehicle Mount,	
Truck, Medium	12	Medium-Power	28
Van, Signal	2	HF, Vehicle Mount, Medium-Power	1
Van, Maintenance	2	HF/VHF, Vehicle Mount,	
Truck, POL (4,000 or 5,200-Liter)	2	Medium-Power	3
Ambulance	1	Radio Relay, VHF/UHF	1
Trailer, Cargo, 2-Axle	10	Warning Receiver	1

FOOTNOTE: * This system includes the SMALL FRED or TALL MIKE battlefield surveillance radar.

**Battalion Headquarters, AT Bn, MRD or AT Bn (Variant),
MRR (BMP or BTR) or AT Bn, IMRB**

**BATTALION
HEADQUARTERS**

PRINCIPAL ITEMS OF EQUIPMENT

Equipment	Total	Equipment	Total
ACV, BTR (R-145BM)/BRDM-2U	1	Radios:	
Mobile Recon Post, PRP-3/4*	1	HF, Vehicle Mount, Medium-Power	1
Truck, Utility.....	2	HF/VHF, Vehicle Mount, Medium-Power	2
		VHF, Manpack, Low-Power.....	1
		VHF, Vehicle Mount, Medium-Power ..	1
		Warning Receiver	1

FOOTNOTE: * This system includes the SMALL FRED or TALL MIKE battlefield surveillance radar.

Antitank Gun Battery, AT Bn, MRD or AT Bn (Variant), MRR (BMP or BTR) or AT Bn, IMRB or AT Regt, Army Corps or Army or AT Bde, Arty Div, Front

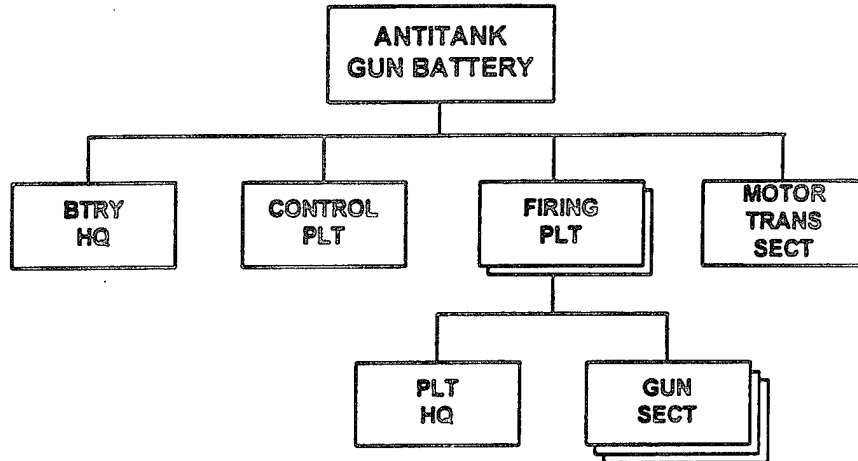

PRINCIPAL ITEMS OF EQUIPMENT

<u>Equipment</u>	<u>Total</u>	<u>Equipment</u>	<u>Total</u>
100/125-mm Antitank Gun, MT-12/2A45M*	6	Radar, Battlefield Surveillance, Man-Portable, PSNR-1	1
Prime Mover, MT-LBT	7	Radio:	
Truck, Medium	1	VHF, Manpack, Low-Power	1
Trailer, Cargo, 2-Axle	1	VHF, Vehicle Mount, Medium-Power ..	7
Rangefinder	1		

FOOTNOTE: * Antitank gun batteries in MRRs, MRDs, and IMRBs are more likely to have 100-mm guns, and similarly organized batteries at army corps, army, or *front* level are more likely to have 125-mm guns.

**ATGM Battery, AT Bn, MRD or AT Bn (Variant),
MRR (BMP or BTR)**

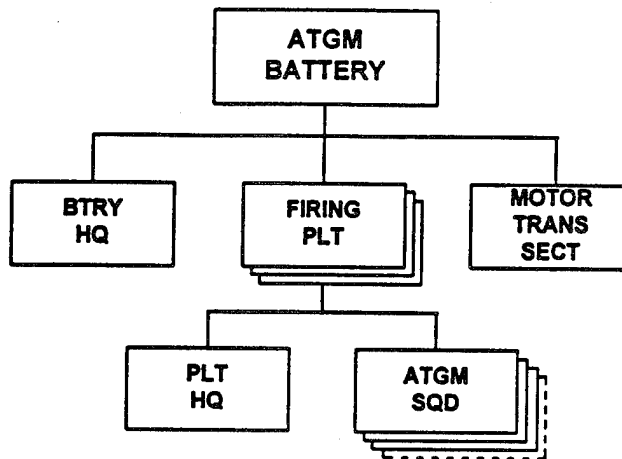

PRINCIPAL ITEMS OF EQUIPMENT

Equipment	Total	Equipment	Total
ATGM Vehicle, 9P148 w/ AT-5/SPANDREL	9-12	Radar, Battlefield Surveillance, Man-Portable, PSNR-1	1
ATGL, RPG-7V	9-12	Radios:	
ACV, BRDM-2U	4	VHF, Manpack, Low-Power	4
Truck, Medium	3	VHF, Vehicle Mount, Medium-Power	13-16
Rangefinder	1		

**Materiel Support Platoon, AT Bn, MRD or AT Bn (Variant), MRR (BMP or BTR)
or AT Bn, IMRB or AT Regt, Army Corps or Army or AT Bde, Arty Div, Front**

**MATERIEL
SUPPORT
PLATOON**

PRINCIPAL ITEMS OF EQUIPMENT

<u>Equipment</u>	<u>Total</u>	<u>Equipment</u>	<u>Total</u>
Truck, Utility.....	1	Trailer, Generator.....	1
Truck, Light.....	4	Trailer, Water (900-Liter).....	1
Truck, Medium.....	7	Trailer, Kitchen.....	1
Van, Signal.....	2	Radios:	
Van, Maintenance.....	2	VHF, Manpack, Low-Power.....	3
Truck, POL (4,200 or 5,000-Liter).....	2	HF/VHF, Vehicle Mount,	
Ambulance.....	1	Medium-Power.....	1
Trailer, Cargo, 2-Axle.....	8	Radio Relay, VHF/UHF.....	1
Trailer, POL (900-Liter).....	1		

**Reconnaissance and Radioelectronic Combat Battalion,
MRD and TD**

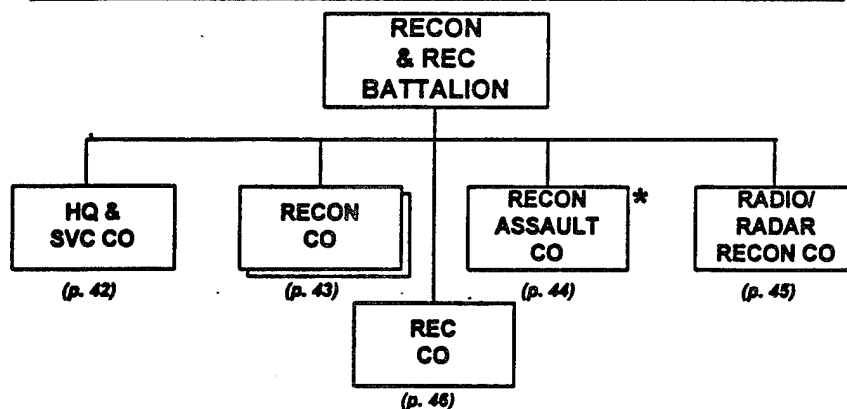

PRINCIPAL ITEMS OF EQUIPMENT

<u>Equipment</u>	<u>Total</u>	<u>Equipment</u>	<u>Total</u>
ATGL, RPG-7V	29	Trailer, POL (1,200-Liter)	2
5.45-mm LMG, RPK-74	29	Radar Intercept/Direction Finder	3
ACV, BRDM-2U	1	Radio Intercept/Direction Finder, HF/VHF	10
ACV, BTR (R-145BM)	2	Communications Jammer, VHF	6
ACV, Recon BRM-1K**	10	Communications Jammer, HF	3
AICV, BMP-1/2/3	14	Proximity Fuze Jammer, SPR-1	9
ASC, BRDM-2	6	Radios:	
APC, BTR-60/70/80	6	VHF, Manpack, Low-Power	12
Truck, Utility	5	VHF, Vehicle Mount, Medium-Power	59
Truck, Light	2	HF, Manpack, Low-Power	6
Truck, Medium	9	HF, Vehicle Mount, Medium-Power	2
Van, Command	6	HF/VHF, Vehicle Mount, Medium-Power	6
Van, Radio/Radar Recon	13	HF/VHF, Vehicle Mount, High-Power	2
Van, Maintenance	2	Radio Relay, VHF/UHF	1
Van, Signal	6	Radio Telegraph	6
Truck, POL (4,000 or 5,200-Liter)	2	Warning Receiver	6
Ambulance	1		
Trailer, Generator	2		
Trailer, Water (1,200-Liter)	1		
Trailer, Kitchen	4		

FOOTNOTES:

* The recon assault company is also called the long-range reconnaissance company or the airborne reconnaissance company.

** This system includes the TALL MIKE battlefield surveillance radar.

**Headquarters and Services Company, Recon &
REC Bn, MRD and TD**

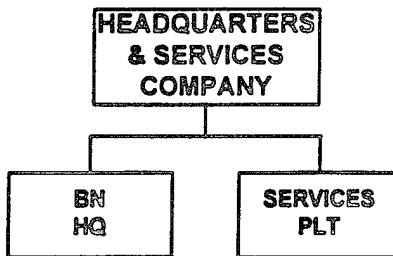

PRINCIPAL ITEMS OF EQUIPMENT

<u>Equipment</u>	<u>Total</u>	<u>Equipment</u>	<u>Total</u>
AICV, BMP-1/2/3.....	2	Radio Intercept Receiver/Direction Finder, HF/VHF.....	1
ACV, Recon BRM-1K*	2	Radios:	
ACV, BTR (R-145BM).....	2	VHF, Manpack, Low-Power.....	2
Truck, Utility.....	4	VHF, Vehicle Mount, Medium-Power..	6
Truck, Medium.....	9	HF, Manpack, Low-Power.....	2
Van, Command.....	2	HF, Vehicle Mount, Medium-Power.....	1
Van, Maintenance.....	1	HF/VHF, Vehicle Mount, Medium-Power.....	2
Truck, POL (4,000 or 5,200-Liter).....	2	HF/VHF, Vehicle Mount, High-Power..	1
Ambulance.....	1	Radio Relay, VHF/UHF.....	1
Trailer, POL (1,200-Liter).....	2	Radio Telegraph.....	6
Trailer, Generator.....	2	Warning Receiver.....	2
Trailer, Water (1,200-Liter).....	1		
Trailer, Kitchen.....	4		

FOOTNOTE:

* This system includes the TALL MIKE battlefield surveillance radar.

Reconnaissance Company, Recon & REC Bn, MRD and TD

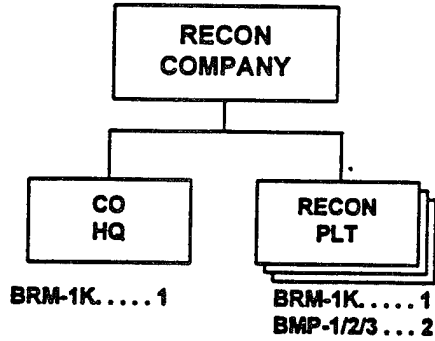

PRINCIPAL ITEMS OF EQUIPMENT

<u>Equipment</u>	<u>Total</u>	<u>Equipment</u>	<u>Total</u>
ATGL, RPG-7V.....	8	Radios:	
5.45-mm LMG, RPK-74.....	8	VHF, Vehicle Mount,	
ACV, BRM-1K*.....	4	Medium-Power.....	10
AICV, BMP-1/2/3.....	6	Warning Receiver.....	1
Truck, Light.....	1		

NOTE: The mix of BRM-1K and BMP vehicles can vary.

FOOTNOTE: * This system includes the TALL MIKE battlefield surveillance radar.

**Reconnaissance Assault Company, Recon & REC Bn,
MRD and TD**

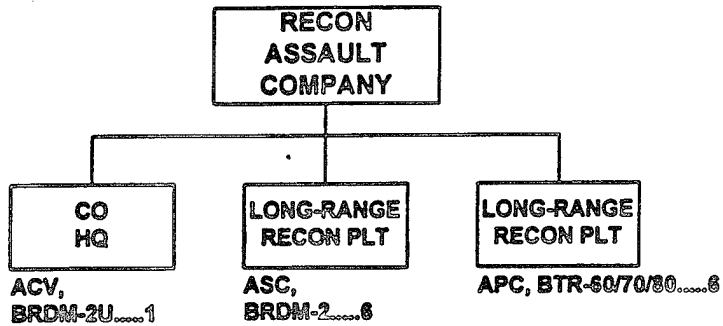

PRINCIPAL ITEMS OF EQUIPMENT

<u>Equipment</u>	<u>Total</u>	<u>Equipment</u>	<u>Total</u>
ATGL, RPG-7V	13	Radios:	
5.45-mm LMG, RPK-74	13	HF, Vehicle Mount, Medium-Power	1
ACV, BRDM-2U	1	VHF, Manpack, Low-Power	3
ASC, BRDM-2	6	VHF, Vehicle Mount,	
APC, BTR-60/70/80	6	Medium-Power	13
		Warning Receiver	1

NOTE: Personnel in the reconnaissance assault company (also called the long-range reconnaissance company) have parachute training. Small teams of five to six men can enter the enemy rear area by parachute, helicopter, vehicle or on foot. They can also land by transport helicopter (Mi-6A/HOOK or Mi-26/HALO A) along with their combat vehicles.

**Radio/Radar Reconnaissance Company, Recon & REC Bn,
MRD and TD**

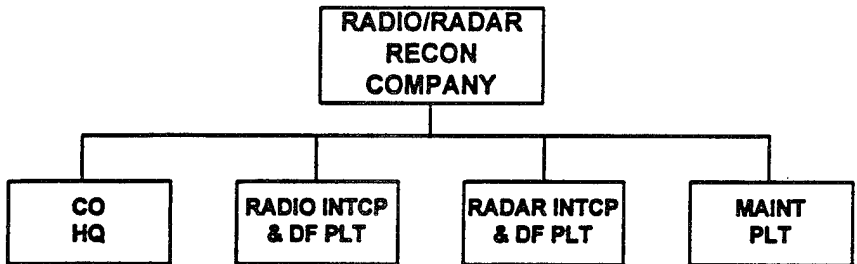

PRINCIPAL ITEMS OF EQUIPMENT

Equipment	Total	Equipment	Total
Truck, Utility.....	1	Radios:	
Van, Command	2	VHF, Manpack, Low-Power.....	7
Van, Radio/Radar Recon	13	HF, Manpack, Low-Power.....	4
Van, Maintenance	1	HF/VHF, Vehicle Mount,	
Van, Signal.....	6	Medium-Power	4
Radio Intercept/Direction Finder,		HF/VHF, Vehicle Mount, High-Power..	1
HF/VHF	7	Warning Receiver	1
Radar Intercept/Direction Finder	3		

NOTE: The current trend is to replace older van-mounted intercept and DF systems with newer versions mounted on modified MT-LBu armored, tracked vehicles.

**Radioelectronic Combat Company, Recon & REC Bn,
MRD and TD**

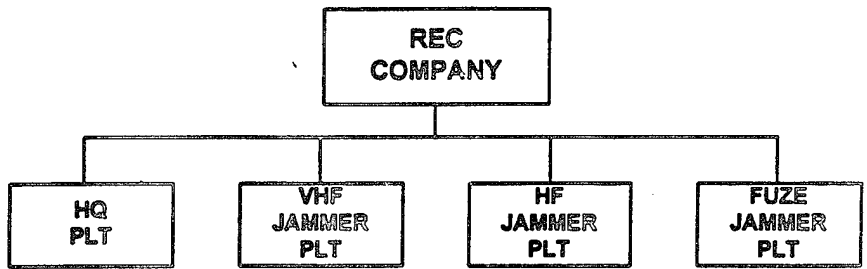

PRINCIPAL ITEMS OF EQUIPMENT

<u>Equipment</u>	<u>Total</u>	<u>Equipment</u>	<u>Total</u>
Van, Command	2	Communications Jammer, HF	3
Radio Intercept/Direction Finder, HF/VHF	2	Proximity Fuze Jammer, SPR-1.....	9
Communications Jammer, VHF.....	6	Radio, VHF, Vehicle Mount, Medium-Power	20

NOTE: The current trend is to replace older van-mounted jammers with newer versions mounted on modified MT-LBu armored, tracked vehicles.

Engineer Battalion, MRD and TD

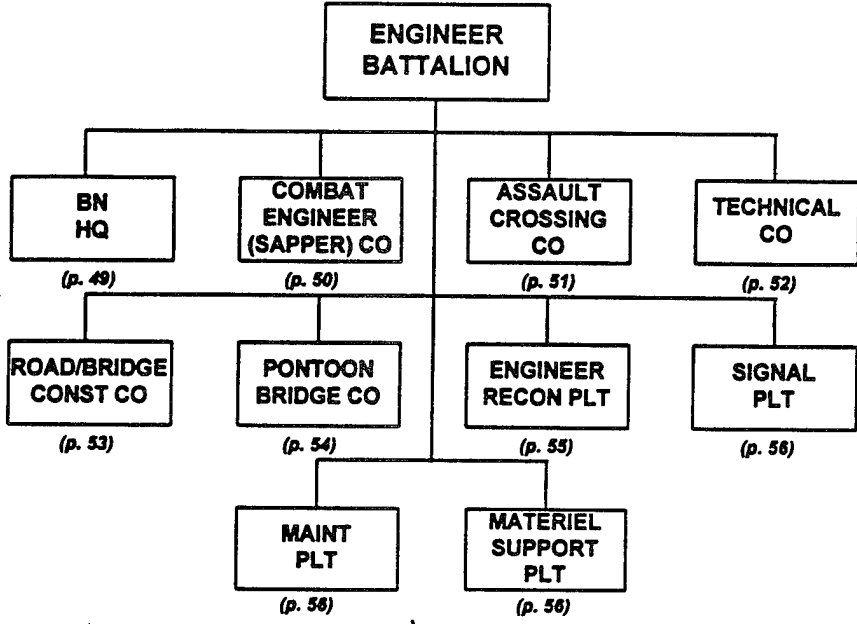

ENGINEER BATTALION, MRD and TD											
Principal Items of Equipment	Battalion HQ	Combat Engr (Sapper) Co	Assault Crossing Co	Technical Co	Road/Bridge Const Co	Pontoon Bridge Co	Engineer Recon Plt	Signal Plt	Maintenance Plt	Material Support Plt	TOTAL
ARMORED VEHICLES											
APC, BTR-60/70/80							3				3
ACV, BTR (R-145BM)		1									1
ACV, BRDM-2U			1								1
ENGINEER EQUIPMENT											
Bridge, Truck-Launched					8						8
Tracked Amphibian, K-61/PTS			12								12
Trailer, Amphibious, PKP			3								3
Tracked Ferry, GSP/PMM-2			6								6
Bridge, PMP Center						16					16
Bridge, PMP Ramp						2					2
Bridge, PMP Service						1					1
Assault Boat			10								10
Power Boat						6					6
Piledriver Set, KMS				1							1
Mine-layer, GMZ		3									3
Mine-clearer, MTK/MTK-2		2									2
Mine Detector, DIM		2					1				3
Engineer Recon Vehicle, IRM							2				2
Armored Engineer Tractor, IMR		2									2
Ditching Machine, BTM/MDK				4							4
Dozer				6	2						8
Tractor				2							2
Truck, Sawmill					1						1
Trailer, Saw					1						1
Grader					2						2
Concrete Mixer					1						1
Truck, Water Purification				1							1
TRUCKS											
Truck, Utility	2			1	1	1	2	1		1	9
Truck, Medium	1	5	2	13	2		1	1	1	1	27
Truck, Dump				1	2						3
Truck, Crane			1								1
Truck, Crane Shovel				2	1						3
Van										1	1
Van, Maintenance									4		4
Van, Signal	1							1			2
TRAILERS											
Trailer, Cargo, 1-Axle	1	2			1						4
Trailer, Cargo, 2-Axle			1	1					1		3
Trailer, Compressor			1								1
Trailer, Generator				1	1			1	1	1	5
RADIOS											
VHF, Vehicle Mount, Medium-Power		8	3	3	3	4	3				24
HF, Manpack, Low-Power	1	1	1	1	1	1	3				9
HF/VHF, Vehicle Mount, Medium-Power	1							1			2
HF/VHF, Vehicle Mount, High-Power	1							1			2
Warning Receiver								1			1

Battalion Headquarters, Engr Bn, MRD and TD

**BATTALION
HEADQUARTERS**

PRINCIPAL ITEMS OF EQUIPMENT

<u>Equipment</u>	<u>Total</u>	<u>Equipment</u>	<u>Total</u>
Truck, Utility.....	2	Radios:	
Truck, Medium	1	HF, Manpack, Low-Power.....	1
Van, Signal.....	1	HF/VHF, Vehicle Mount,	
Trailer, Cargo, 1-Axle.....	1	Medium-Power	1
		HF/VHF, Vehicle Mount, High-Power..	1

Combat Engineer (Sapper) Company, Engr Bn, MRD and TD

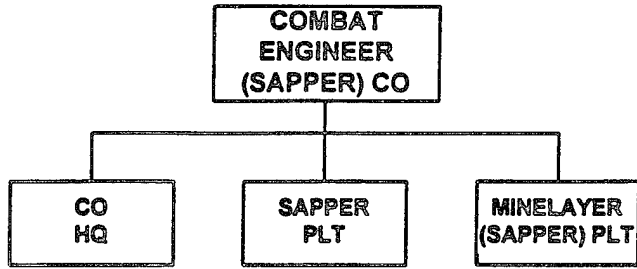

PRINCIPAL ITEMS OF EQUIPMENT

<u>Equipment</u>	<u>Total</u>
ACV, BTR (R-145BM)	1
ATGL, RPG-7V	2
Armored Engineer Tractor, IMR	2
Mineclearer, MTK/MTK-2	2
Mine Detector, DIM	2
Minelayer, GMZ	3

<u>Equipment</u>	<u>Total</u>
Truck, Medium	5
Trailer, Cargo, 1-Axle	2
Radios:	
HF, Manpack, Low-Power	1
VHF, Vehicle Mount, Medium-Power ..	8

Assault Crossing Company, Engr Bn, MRD and TD

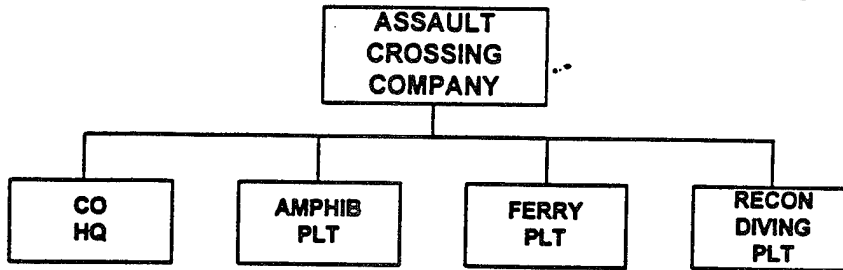

PRINCIPAL ITEMS OF EQUIPMENT

Equipment	Total	Equipment	Total
ACV, BRDM-2U	1	Trailer, Amphibious, PKP	3
Truck, Medium	2	Trailer, Cargo, 2-Axle	1
Truck, Crane	1	Trailer, Compressor	1
Tracked Amphibian, K-61/PTS	12	Radios:	
Tracked Ferry, GSP/PMM-2	6	HF, Manpack, Low-Power	1
Assault Boat	10	VHF, Vehicle Mount, Medium-Power ..	3

NOTE: Two GSP heavy amphibious ferry vehicles make up on ferry; the twelve-right and -left half-ferries in MRD and TD engineer battalions form six ferries. With the PMM-2 system, six vehicles can form six ferries.

Technical Company, Engr Bn, MRD and TD

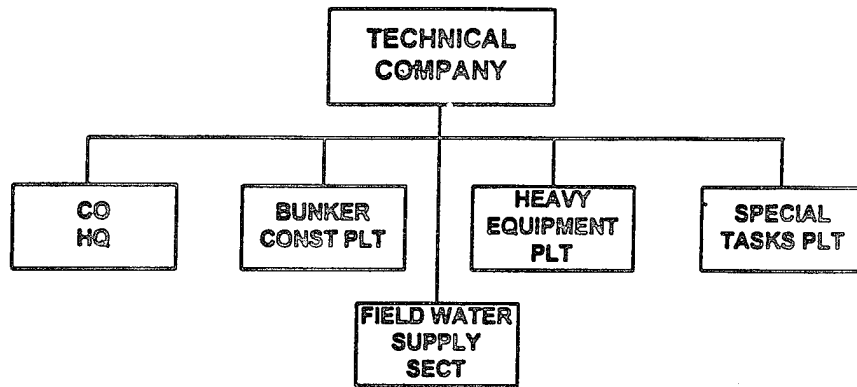

PRINCIPAL ITEMS OF EQUIPMENT

<u>Equipment</u>	<u>Total</u>	<u>Equipment</u>	<u>Total</u>
Truck, Utility.....	1	Piledriver Set, KMS.....	1
Truck, Medium	13	Tractor.....	2
Truck, Crane Shovel	2	Trailer, Cargo, 2-Axle.....	1
Truck, Dump.....	1	Trailer, Generator.....	1
Truck, Water Purification	1	Radios:	
Ditching Machine, BTM/MDK	4	HF, Manpack, Low-Power.....	1
Dozer.....	6	VHF, Vehicle Mount, Medium-Power ..	3

Road/Bridge Construction Company, Engr Bn, MRD and TD

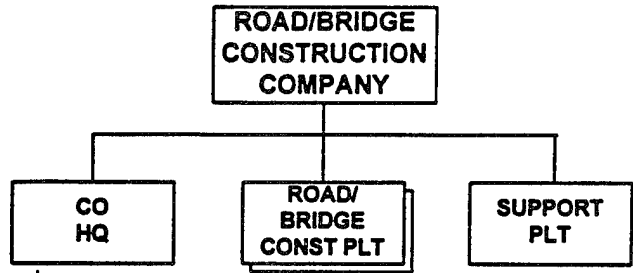

PRINCIPAL ITEMS OF EQUIPMENT

Equipment	Total	Equipment	Total
Truck, Utility.....	1	Concrete Mixer	1
Truck, Medium	2	Trailer, Cargo, 1-Axle.....	1
Truck, Crane Shovel	1	Trailer, Generator.....	1
Truck, Dump.....	2	Trailer, Saw.....	1
Truck, Sawmill.....	1	Radios:	
Bridge, Truck-Launched	8	HF, Manpack, Low-Power.....	1
Dozer.....	2	VHF, Vehicle Mount, Medium-Power ..	3
Grader	2		

NOTE: The eight truck-launched bridge spans make up two bridge sets.

Pontoon Bridge Company, Engr Bn, MRD and TD

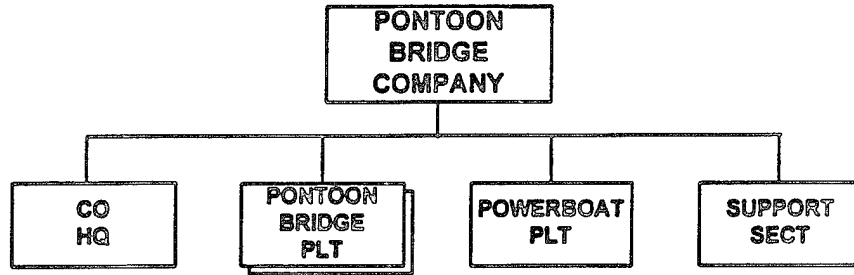

PRINCIPAL ITEMS OF EQUIPMENT

<u>Equipment</u>	<u>Total</u>	<u>Equipment</u>	<u>Total</u>
Truck, Utility.....	1	Powerboat	6
Bridge, PMP Center.....	16	Radios:	
Bridge, PMP Ramp.....	2	HF, Manpack, Low-Power.....	1
Bridge, PMP Service.....	1	VHF, Vehicle Mount, Medium-Power ..	4

NOTE: A full bridge set consists of 32 center and 4 ramp sections. The half-set held by the engineer battalion can make up a bridge or several rafts.

Engineer Reconnaissance Platoon, Engr Bn, MRD and TD

**ENGINEER
RECON
PLATOON**

PRINCIPAL ITEMS OF EQUIPMENT

<u>Equipment</u>	<u>Total</u>	<u>Equipment</u>	<u>Total</u>
ATGL, RPG-7V	6	Mine Detector, DIM.....	1
APC, BTR-60/70/80	3	Radios:	
Engineer Recon Vehicle, IRM.....	2	HF, Manpack, Low-Power.....	3
Truck, Utility.....	2	VHF, Vehicle Mount, Medium-Power ..	3
Truck, Medium	1		

Signal Platoon, Engr Bn, MRD and TD

**SIGNAL
PLATOON**

PRINCIPAL ITEMS OF EQUIPMENT

<u>Equipment</u>	<u>Total</u>	<u>Equipment</u>	<u>Total</u>
Truck, Utility.....	1	Radios:	
Truck, Medium	1	HF/VHF, Vehicle Mount,	
Van, Signal.....	1	Medium-Power	1
Trailer, Generator.....	1	HF/VHF, Vehicle Mount, High-Power..	1
		Warning Receiver	1

Maintenance Platoon, Engr Bn, MRD and TD

**MAINTENANCE
PLATOON**

PRINCIPAL ITEMS OF EQUIPMENT

<u>Equipment</u>	<u>Total</u>	<u>Equipment</u>	<u>Total</u>
Truck, Medium	1	Trailer, Cargo, 2-Axle.....	1
Van, Maintenance	4	Trailer, Generator.....	1

Materiel Support Platoon, Engr Bn, MRD and TD

**MATERIEL
SUPPORT
PLATOON**

PRINCIPAL ITEMS OF EQUIPMENT

<u>Equipment</u>	<u>Total</u>	<u>Equipment</u>	<u>Total</u>
Truck, Utility.....	1	Van.....	1
Truck, Medium	1	Trailer, Generator.....	1

Signal Battalion, MRD and TD or IMRB or Army Corps

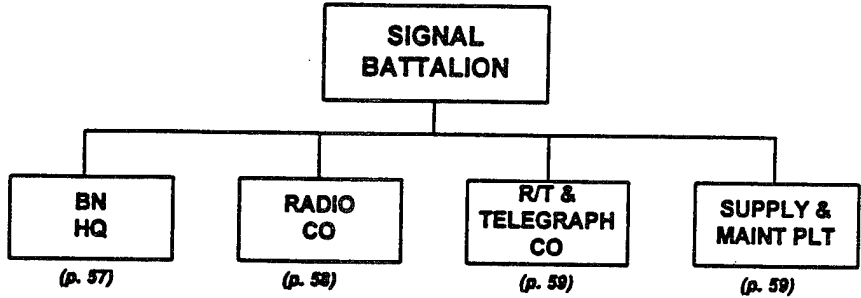

PRINCIPAL ITEMS OF EQUIPMENT

<u>Equipment</u>	<u>Total</u>	<u>Equipment</u>	<u>Total</u>
ACV, BTR (R-145BM)	8	Trailer, Water (900-Liter)	1
Truck, Utility	12	Trailer, Kitchen	2
Truck, Light	7	Radios:	
Truck, Medium	9	VHF, Manpack, Low-Power	20
Van, Maintenance	4	VHF, Vehicle Mount, Medium-Power ..	6
Van, Signal	33	HF, Manpack, Low-Power	5
Truck, POL (4,000 or 5,200-Liter)	1	HF, Vehicle Mount, Medium-Power	8
Ambulance	1	HF/VHF, Vehicle Mount,	
Bus	1	Medium-Power	7
Motorcycle	13	HF/VHF, Vehicle Mount, High-Power ..	8
Trailer, Cargo, 1-Axle	10	Radio Relay, VHF/UHF	6
Trailer, POL (1,200-Liter)	1	Communications Center	2
Trailer, Generator	10	Warning Receiver	3

Battalion Headquarters, Signal Bn, MRD and TD or IMRB or Army Corps



PRINCIPAL ITEMS OF EQUIPMENT

<u>Equipment</u>	<u>Total</u>	<u>Equipment</u>	<u>Total</u>
Truck, Utility	4	Radio, HF, Manpack, Low-Power	1

Radio Company, Signal Bn, MRD and TD or IMRB or Army Corps

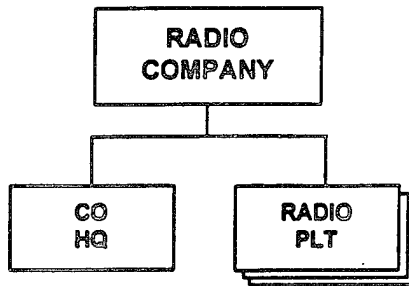

PRINCIPAL ITEMS OF EQUIPMENT

<u>Equipment</u>	<u>Total</u>
ACV, BTR (R-145BM)	8
Truck, Utility.....	4
Truck, Medium	1
Van, Signal.....	12
Trailer, Cargo, 1-Axle.....	1
Trailer, Generator.....	3

<u>Equipment</u>	<u>Total</u>
Radios:	
VHF, Manpack, Low-Power	7
VHF, Vehicle Mount, Medium-Power ..	6
HF, Manpack, Low-Power.....	1
HF, Vehicle Mount, Medium-Power	8
HF/VHF, Vehicle Mount, Medium-Power	6
HF/VHF, Vehicle Mount, High-Power..	8
Warning Receiver	1

**Radio Telephone and Telegraph Company, Signal Bn,
MRD and TD or IMRB or Army Corps**

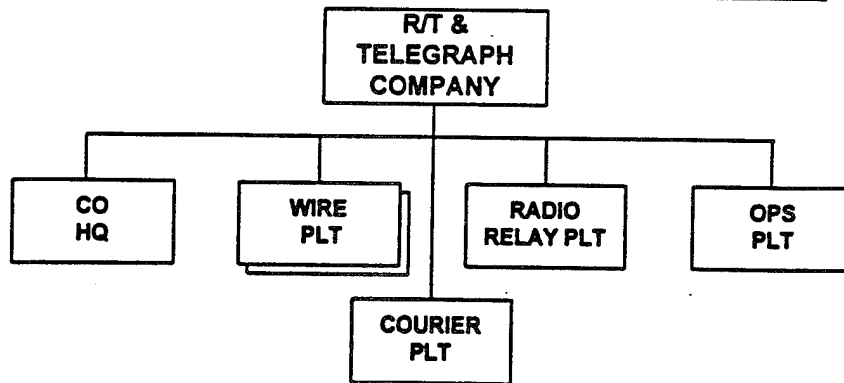

PRINCIPAL ITEMS OF EQUIPMENT

<u>Equipment</u>	<u>Total</u>	<u>Equipment</u>	<u>Total</u>
Truck, Utility.....	3	Radios:	
Truck, Light	4	VHF, Manpack, Low-Power.....	13
Truck, Medium	2	HF, Manpack, Low-Power.....	2
Van, Signal.....	21	HF/VHF, Vehicle Mount,	
Motorcycle	13	Medium-Power	1
Trailer, Cargo, 1-Axle.....	4	Radio Relay, VHF/UHF.....	6
Trailer, Generator.....	5	Communications Center.....	2
		Warning Receiver	2

**Supply and Maintenance Platoon, Signal Bn,
MRD and TD or IMRB or Army Corps**



PRINCIPAL ITEMS OF EQUIPMENT

<u>Equipment</u>	<u>Total</u>	<u>Equipment</u>	<u>Total</u>
Truck, Utility.....	1	Trailer, Cargo, 1-Axle.....	5
Truck, Light	3	Trailer, POL (1,200-Liter)	1
Truck, Medium	6	Trailer, Generator.....	2
Van, Maintenance	4	Trailer, Water (900-Liter)	1
Truck, POL (4,000 or 5,200-Liter)	1	Trailer, Kitchen.....	2
Ambulance	1	Radio, HF, Manpack, Low-Power	2
Bus	1		

Materiel Support Battalion, MRD and TD or IMRB

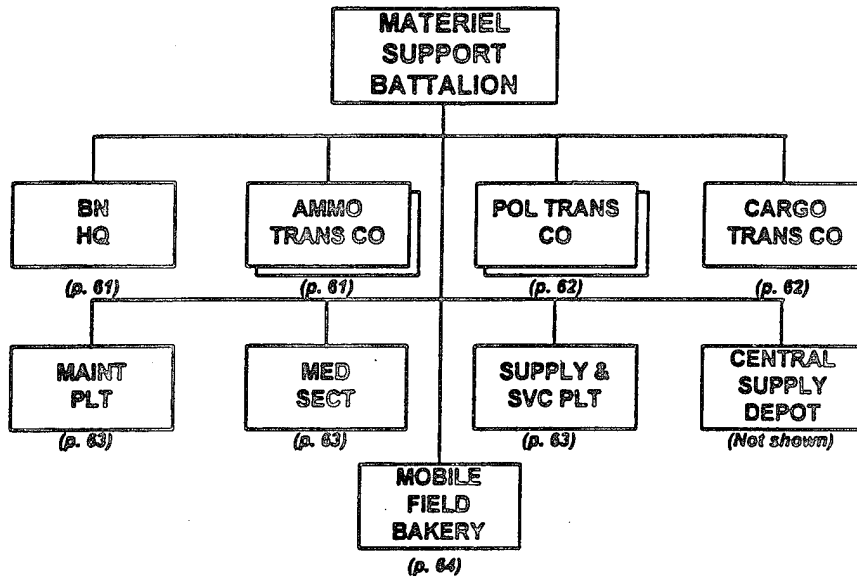

PRINCIPAL ITEMS OF EQUIPMENT

<u>Equipment</u>	<u>Total</u>
ATGL, RPG-7V.....	19
Truck, Utility.....	7
Truck, Light.....	33
Truck, Medium.....	158
Van.....	1
Van, Signal.....	1
Van, Maintenance.....	11
Truck, POL (5,200-Liter).....	160
Truck, Crane.....	6
Truck, Water (2,000-Liter).....	6
Van, Mobile Field Bakery.....	4
Van, Kitchen.....	2
Ambulance.....	1

<u>Equipment</u>	<u>Total</u>
Trailer, Cargo, 2-Axle.....	124
Trailer, Cargo, 1-Axle.....	2
Trailer, POL (1,200-Liter).....	160
Trailer, Generator.....	6
Trailer, Water (1,200-Liter).....	7
Radios:	
VHF, Manpack, Low-Power.....	5
HF, Manpack, Low-Power.....	1
HF/VHF, Vehicle Mount, Medium-Power.....	1
Warning Receiver.....	1

**Battalion Headquarters, Materiel Support Bn,
MRD and TD or IMRB**

**BATTALION
HEADQUARTERS**

PRINCIPAL ITEMS OF EQUIPMENT

<u>Equipment</u>	<u>Total</u>	<u>Equipment</u>	<u>Total</u>
Truck, Utility.....	2	Radios:	
Van, Signal.....	1	HF, Manpack, Low-Power.....	1
Van, Maintenance	1	HF/VHF, Vehicle Mount, Medium-Power	1
Trailer, Cargo, 2-Axle.....	2	Warning Receiver	1

**Ammunition Transport Company, Materiel Support Bn,
MRD and TD or IMRB**

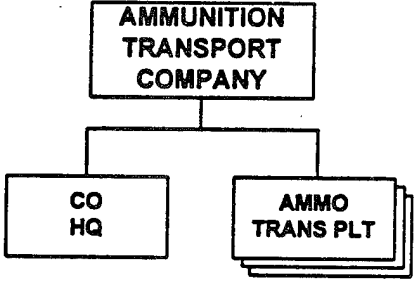

PRINCIPAL ITEMS OF EQUIPMENT

<u>Equipment</u>	<u>Total</u>	<u>Equipment</u>	<u>Total</u>
ATGL, RPG-7V.....	3	Truck, Crane	1
Truck, Utility.....	1	Trailer, Cargo, 2-Axle.....	60
Truck, Medium	60	Radio, VHF, Manpack, Low-Power	1

**POL Transport Company, Materiel Support Bn,
MRD and TD or IMRB**

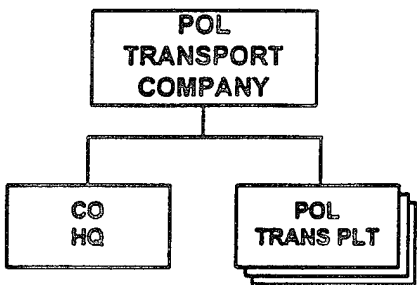

PRINCIPAL ITEMS OF EQUIPMENT

<u>Equipment</u>	<u>Total</u>	<u>Equipment</u>	<u>Total</u>
ATGL, RPG-7V	4	Truck, Crane	1
Truck, Utility	1	Trailer, POL (1,200-Liter)	80
Truck, POL (5,200-Liter)	80	Radio, VHF, Manpack, Low-Power	1

**Cargo Transport Company, Materiel Support Bn,
MRD and TD or IMRB**

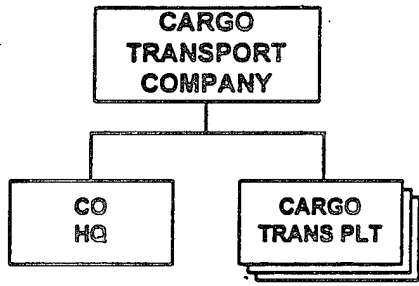

PRINCIPAL ITEMS OF EQUIPMENT

<u>Equipment</u>	<u>Total</u>	<u>Equipment</u>	<u>Total</u>
ATGL, RPG-7V	3	Truck, Medium	30
Truck, Utility	1	Truck, Crane	1
Truck, Light	30	Radio, VHF, Manpack, Low-Power	1

**Maintenance Platoon, Materiel Support Bn,
MRD and TD or IMRB**

**MAINTENANCE
PLATOON**

PRINCIPAL ITEMS OF EQUIPMENT

<u>Equipment</u>	<u>Total</u>	<u>Equipment</u>	<u>Total</u>
ATGL, RPG-7V	1	Truck, Crane	1
Van, Maintenance	9	Trailer, Generator.....	6

**Medical Section, Materiel Support Bn,
MRD and TD or IMRB**

**MEDICAL
SECTION**

PRINCIPAL ITEMS OF EQUIPMENT

<u>Equipment</u>	<u>Total</u>
Ambulance	1

**Supply and Service Platoon, Materiel Support Bn,
MRD and TD or IMRB**

**SUPPLY &
SERVICE
PLATOON**

PRINCIPAL ITEMS OF EQUIPMENT

<u>Equipment</u>	<u>Total</u>	<u>Equipment</u>	<u>Total</u>
ATGL, RPG-7V	1	Truck, Water (2,000-Liter).....	6
Truck, Light	3	Trailer, Cargo, 1-Axle.....	2
Van, Maintenance	1	Trailer, Cargo, 2-Axle.....	2
Van.....	1	Trailer, Water (1,200-Liter).....	3
Van, Kitchen	2		

**Mobile Field Bakery, Materiel Support Bn,
MRD and TD or IMRB**

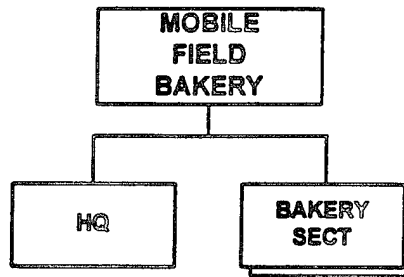

PRINCIPAL ITEMS OF EQUIPMENT

<u>Equipment</u>	<u>Total</u>	<u>Equipment</u>	<u>Total</u>
Truck, Medium	8	Trailer, Water (1,200-Liter)	4
Van, Mobile Field Bakery.....	4		

Maintenance Battalion, MRD and TD or IMRB or Army Corps or Army

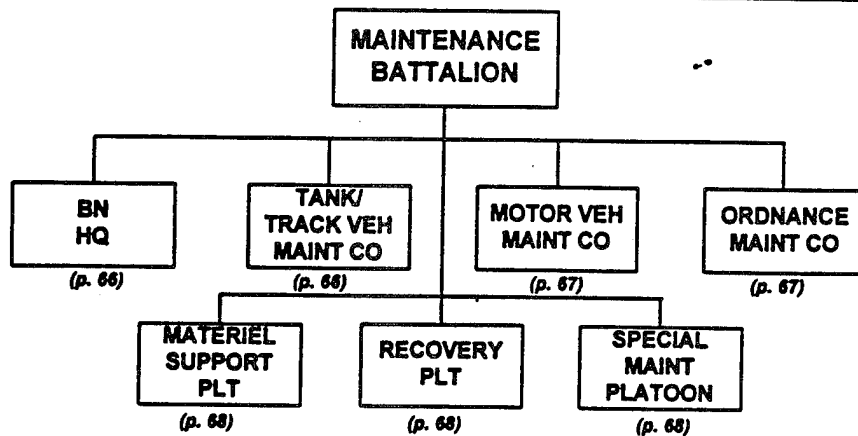

PRINCIPAL ITEMS OF EQUIPMENT

<u>Equipment</u>	<u>Total</u>	<u>Equipment</u>	<u>Total</u>
ATGL, RPG-7V	11/12*	Motorcycle	3
Truck, Utility	5	Armored Recovery Vehicle	5
Truck, Light	4	Trailer, Cargo, 2-Axle	13/14*
Truck, Medium	20/21*	Trailer, Generator	7
Truck, Heavy	1	Trailer, POL (1,200-Liter)	4
Van	3	Trailer, Water (1,200-Liter)	1
Van, Signal	1	Trailer, Kitchen	3
Van, Maintenance	40/42*	Radios:	
Truck, POL (4,000 or 5,200-Liter)	4	VHF, Manpack, Low-Power	5
Tractor-Trailer, Lowboy	2	VHF, Vehicle Mount, Medium-Power	4
Truck, Crane	3	HF, Vehicle Mount, Medium-Power	1
Truck, Recovery	2	HF/VHF, Vehicle Mount, Medium-Power	1
Truck, Water (2,000-Liter)	1	Warning Receiver	1
Ambulance	1		
Tracked Amphibian, K-61/PTS	1		
Tractor, Artillery, AT-S	1		

FOOTNOTE: * Equipment levels for maintenance battalion in MRD/TD, IMRB, army corps or army. The MRD has fewer tanks and thus requires less maintenance support.

**Battalion Headquarters, Maint Bn, MRD and TD
or IMRB or Army Corps or Army**



PRINCIPAL ITEMS OF EQUIPMENT

<u>Equipment</u>	<u>Total</u>	<u>Equipment</u>	<u>Total</u>
Truck, Utility.....	2	Radios:	
Van, Signal.....	1	VHF, Manpack, Low-Power.....	1
Motorcycle.....	3	HF/VHF, Vehicle Mount, Medium-Power.....	1
		Warning Receiver.....	1

**Tank/Tracked Vehicle Maintenance Company, Maint Bn, MRD and TD
or IMRB or Army Corps or Army**

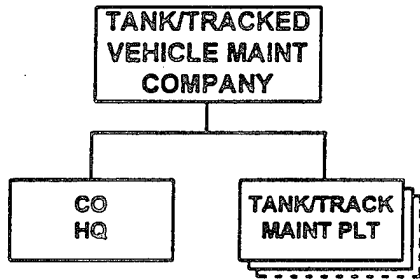

PRINCIPAL ITEMS OF EQUIPMENT

<u>Equipment</u>	<u>Total</u>	<u>Equipment</u>	<u>Total</u>
ATGL, RPG-7V.....	3/4*	Truck, Crane.....	1
Truck, Utility.....	1	Trailer, Cargo, 2-Axle.....	3/4*
Truck, Medium.....	4/6*	Trailer, Generator.....	2
Van.....	1	Radio, VHF, Manpack, Low-Power.....	1
Van, Maintenance.....	12/14*		

FOOTNOTE: * Equipment levels for this company in MRD/TD, IMRB, army corps or army. The MRD has fewer tanks and thus requires less maintenance support.

**Motor Vehicle Maintenance Company, Maint Bn, MRD and TD
or IMRB or Army Corps or Army**

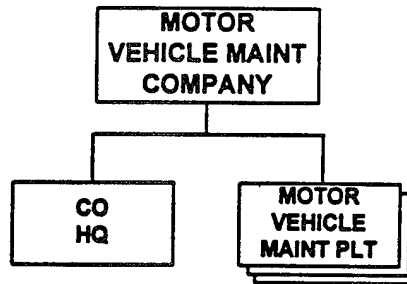

PRINCIPAL ITEMS OF EQUIPMENT

<u>Equipment</u>	<u>Total</u>	<u>Equipment</u>	<u>Total</u>
ATGL, RPG-7V	4	Truck, Crane	1
Truck, Utility.....	1	Trailer, Cargo, 2-Axle.....	4
Truck, Medium	6	Trailer, Generator.....	2
Van.....	1	Radio, VHF, Manpack, Low-Power	1
Van, Maintenance	14		

**Ordnance Maintenance Company, Maint Bn, MRD and TD
or IMRB or Army Corps or Army**

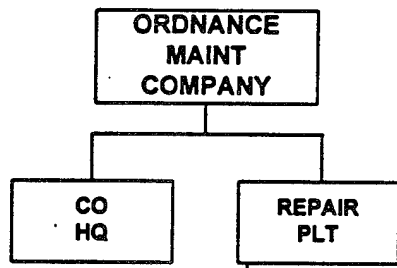

PRINCIPAL ITEMS OF EQUIPMENT

<u>Equipment</u>	<u>Total</u>	<u>Equipment</u>	<u>Total</u>
ATGL, RPG-7V	3	Truck, Crane	1
Truck, Utility.....	1	Trailer, Cargo, 2-Axle.....	2
Van.....	1	Trailer, Generator.....	2
Van, Maintenance	8	Radio, VHF, Manpack, Low-Power	1

**Materiel Support Platoon, Maint Bn, MRD and TD
or IMRB or Army Corps or Army**

**MATERIEL
SUPPORT
PLATOON**

PRINCIPAL ITEMS OF EQUIPMENT

<u>Equipment</u>	<u>Total</u>	<u>Equipment</u>	<u>Total</u>
ATGL, RPG-7V.....	1	Trailer, Cargo, 2-Axle.....	4
Truck, Light.....	4	Trailer, POL (1,200-Liter).....	4
Truck, Medium.....	10	Trailer, Water (1,200-Liter).....	1
Truck, Heavy.....	1	Trailer, Kitchen.....	3
Truck, POL (4,000 or 5,200-Liter).....	4	Radio, VHF, Manpack, Low-Power.....	1
Truck, Water (2,000-Liter).....	1		
Ambulance.....	1		

**Recovery Platoon, Maint Bn, MRD and TD
or IMRB or Army Corps or Army**

**RECOVERY
PLATOON**

PRINCIPAL ITEMS OF EQUIPMENT

<u>Equipment</u>	<u>Total</u>	<u>Equipment</u>	<u>Total</u>
Truck, Recovery.....	2	Tractor-Trailer, Lowboy.....	2
Tracked Amphibian, K-61/PTS.....	1	Radios:	
Tractor, Artillery, AT-S.....	1	VHF, Vehicle Mount, Medium-Power..	4
Armored Recovery Vehicle.....	5	HF, Vehicle Mount, Medium-Power.....	1

**Special Maintenance Platoon, Maint Bn, MRD and TD
or IMRB or Army Corps or Army**

**SPECIAL
MAINTENANCE
PLATOON**

PRINCIPAL ITEMS OF EQUIPMENT

<u>Equipment</u>	<u>Total</u>	<u>Equipment</u>	<u>Total</u>
Van, Maintenance.....	6	Trailer, Generator.....	1

Chemical Protection Battalion, MRD and TD

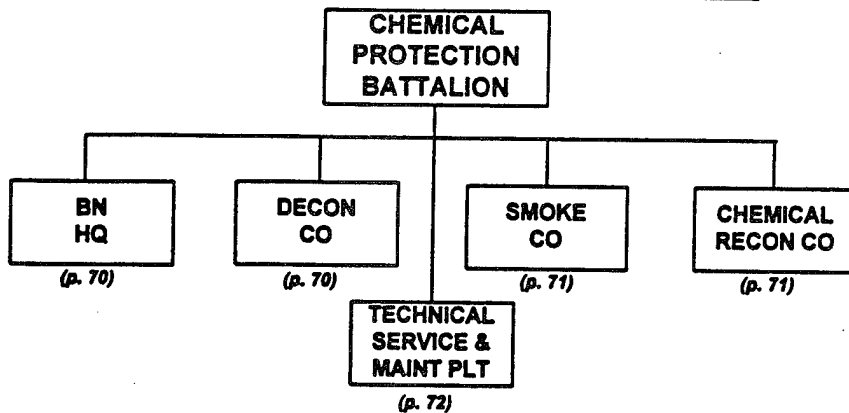

PRINCIPAL ITEMS OF EQUIPMENT

<u>Equipment</u>	<u>Total</u>	<u>Equipment</u>	<u>Total</u>
Truck, Utility.....	4	Trailer, Decon, DDP	4
Truck, Light	5	Trailer, POL (1,200-Liter)	2
Truck, Medium	27	Trailer, Generator.....	3
Chemical Recon Vehicle, BRDM-2RKh/RKhM.....	9	Trailer, Cargo, 2-Axle.....	6
Van, Signal.....	1	Trailer, Water (900-Liter)	21
Van.....	1	Trailer, Kitchen	4
Van, Maintenance	3	Radios:	
Truck, POL (4,000 or 5,200-Liter)	4	VHF, Manpack, Low-Power.....	3
Truck, Decon, ARS-12U/14	20	VHF, Vehicle Mount, Medium-Power	18
Truck, Decon, DDA-53/66.....	4	HF, Manpack, Low-Power.....	2
Truck, Decon, TMS-65	4	HF/VHF, Vehicle Mount Medium-Power,	1
Truck, Smoke Generator, TDA-M.....	9	Warning Receiver	1
Truck, Water (2,000-Liter).....	4		
Ambulance	1		

**Battalion Headquarters, Chemical Protection Bn, MRD and TD
or Army Corps or Army**

**BATTALION
HEADQUARTERS**

PRINCIPAL ITEMS OF EQUIPMENT

<u>Equipment</u>	<u>Total</u>	<u>Equipment</u>	<u>Total</u>
Truck, Utility.....	1	Radios:	
Van.....	1	VHF, Manpack, Low-Power.....	1
Van, Signal.....	1	HF, Manpack, Low-Power.....	1
		HF/VHF, Vehicle Mount	
		Medium-Power	1
		Warning Receiver	1

**Decontamination Company, Chemical Protection Bn, MRD and TD
or Army Corps or Army**

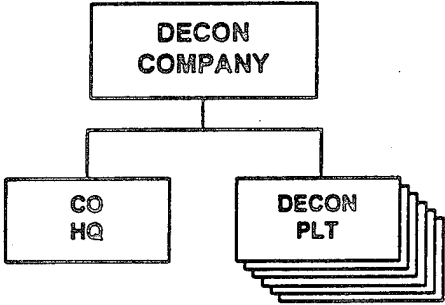

PRINCIPAL ITEMS OF EQUIPMENT

<u>Equipment</u>	<u>Total</u>	<u>Equipment</u>	<u>Total</u>
Truck, Utility.....	1	Truck, Decon, TMS-65	4
Truck, Light	4	Trailer, Decon, DDP	4
Truck, Medium	12	Truck, Water (2,000-Liter).....	4
Truck, Decon, ARS-12U/14	16	Trailer, Water (900-Liter)	20
Truck, Decon, DDA-53/66.....	4	Radio, VHF, Manpack, Low-Power	1

Smoke Company, Chemical Protection Bn, MRD and TD

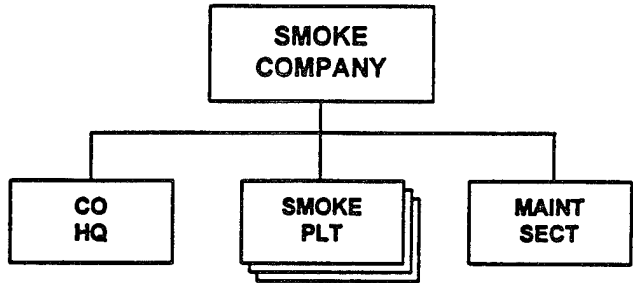

PRINCIPAL ITEMS OF EQUIPMENT

<u>Equipment</u>	<u>Total</u>	<u>Equipment</u>	<u>Total</u>
Truck, Light	1	Trailer, Water (1,200-Liter)	1
Truck, Medium	4	Trailer, Kitchen	1
Van, Maintenance	1	Radio, VHF, Vehicle Mount, Medium-Power	9
Truck, Smoke Generator, TDA-M.....	9		
Trailer, Cargo, 2-Axle.....	2		

**Chemical Reconnaissance Company, Chem Protection Bn,
MRD and TD or Army Corps or Army**

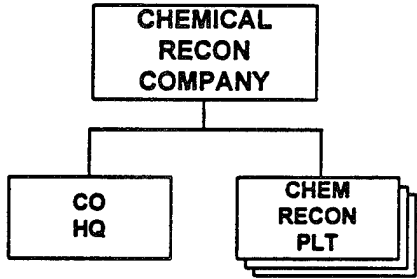

PRINCIPAL ITEMS OF EQUIPMENT

<u>Equipment</u>	<u>Total</u>	<u>Equipment</u>	<u>Total</u>
Truck, Utility.....	1	Radios:	
Chemical Recon Vehicle, BRDM-2RKh/RKhM.....	9	VHF, Manpack, Low-Power	1
		VHF, Vehicle Mount, Medium-Power ..	9
		HF, Manpack, Low-Power.....	1

**Technical Service and Maintenance Platoon, Chem Protection
Bn, MRD and TD or Army Corps or Army**

**TECHNICAL
SERVICE &
MAINT PLT**

PRINCIPAL ITEMS OF EQUIPMENT

<u>Equipment</u>	<u>Total</u>	<u>Equipment</u>	<u>Total</u>
Truck, Utility.....	1	Ambulance	1
Truck, Medium	11	Trailer, Generator	3
Van, Maintenance	2	Trailer, POL (1,200-Liter)	2
Truck, POL (4,000 or 5,200-Liter)	4	Trailer, Cargo, 2-Axle.....	4
Truck, Decon, ARS-12U/14	4	Trailer, Kitchen	3

Medical Battalion, MRD and TD or Army Corps

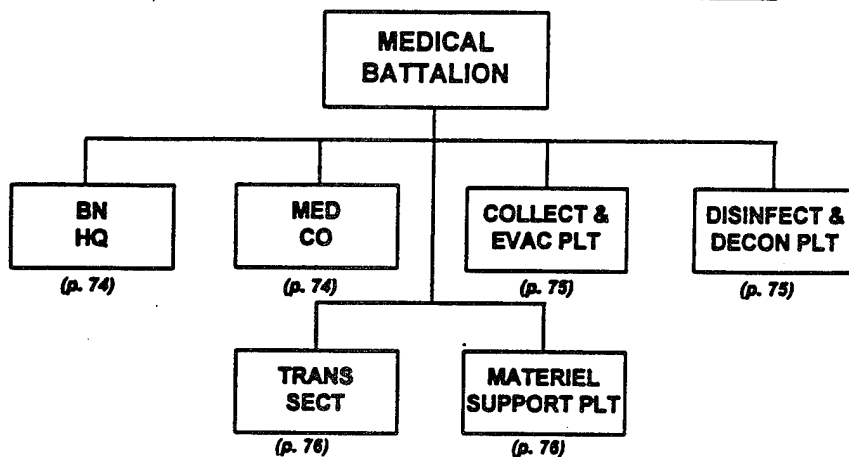

PRINCIPAL ITEMS OF EQUIPMENT

Equipment	Total	Equipment	Total
Truck, Utility.....	5	Trailer, Cargo, 2-Axle.....	10
Truck, Medium	21	Trailer, Generator.....	2
Van, Signal.....	1	Trailer, POL (1,200-Liter)	2
Van, Maintenance	2	Trailer, Decon, DDP	3
Van.....	1	Trailer, Kitchen	4
Van, Generator.....	1	Trailer, Water (900-Liter)	1
Van, Hospital	9	Radios:	
Truck, POL (5,200-Liter).....	2	VHF, Manpack, Low-Power.....	3
Truck, Decon, DDA-53/66.....	1	HF, Manpack, Low-Power.....	1
Truck, Decon, ARS-12U/14	3	HF/VHF, Vehicle Mount,	
Ambulance	20	Medium-Power	1
Truck, Water (2,000-Liter).....	3	Warning Receiver	1

Battalion Headquarters, Med Bn, MRD and TD or Army Corps

BATTALION HEADQUARTERS

PRINCIPAL ITEMS OF EQUIPMENT

<u>Equipment</u>	<u>Total</u>	<u>Equipment</u>	<u>Total</u>
Truck, Utility.....	1	Radios:	
Van, Signal.....	1	HF, Manpack, Low-Power.....	1
		HF/VHF, Vehicle Mount, Medium-Power	1
		Warning Receiver	1

Medical Company, Med Bn, MRD and TD or Army Corps

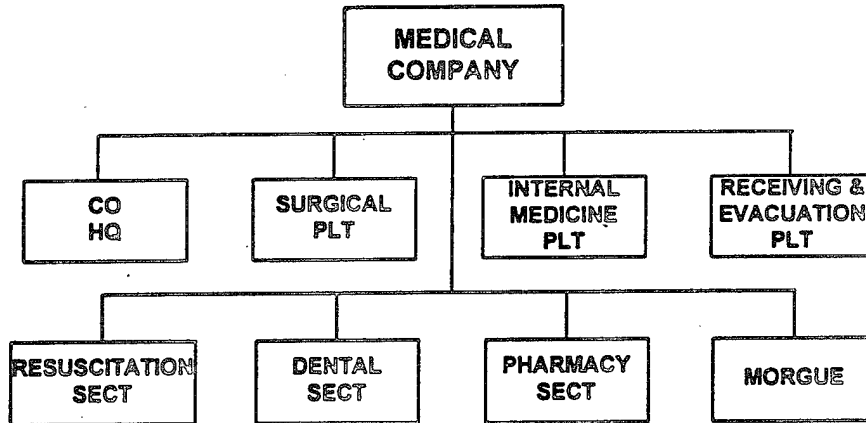

PRINCIPAL ITEMS OF EQUIPMENT

<u>Equipment</u>	<u>Total</u>	<u>Equipment</u>	<u>Total</u>
Truck, Utility.....	1	Trailer, Cargo, 2-Axle.....	7
Truck, Medium	7	Radio, HF, Manpack, Low-Power	1

**Collection and Evacuation Platoon, Med Bn,
MRD and TD or Army Corps**

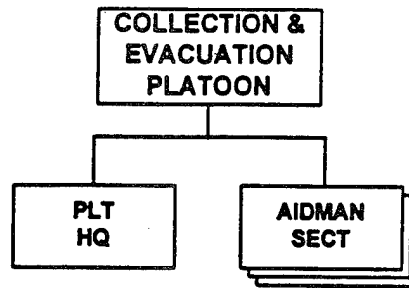

PRINCIPAL ITEMS OF EQUIPMENT

<u>Equipment</u>	<u>Total</u>	<u>Equipment</u>	<u>Total</u>
Truck, Utility.....	1	Van, Hospital	9
Van.....	1	Radio, HF, Manpack, Low-Power	1
Van, Generator	1		

**Disinfection and Decontamination Platoon, Med Bn,
MRD and TD or Army Corps**

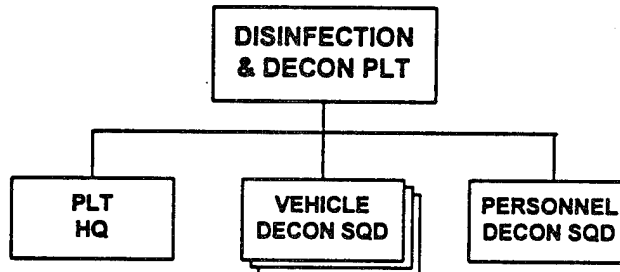

PRINCIPAL ITEMS OF EQUIPMENT

<u>Equipment</u>	<u>Total</u>	<u>Equipment</u>	<u>Total</u>
Truck, Utility.....	1	Trailer, Cargo, 2-Axle.....	1
Truck, Decon, DDA-53/66.....	1	Trailer, Decon, DDP	3
Truck, Decon, ARS-12U/14	3	Trailer, Water (900-Liter)	1

Transport Section, Med Bn, MRD and TD or Army Corps

**TRANSPORT
SECTION**

PRINCIPAL ITEMS OF EQUIPMENT

<u>Equipment</u>	<u>Total</u>	<u>Equipment</u>	<u>Total</u>
Truck, Utility.....	1	Ambulance.....	20
Truck, Medium.....	8	Trailer, Generator.....	2
Van, Maintenance.....	2	Trailer, POL (1,200-Liter).....	2
Truck, POL (5,200-Liter).....	2	Radio, HF, Manpack, Low-Power.....	1

**Materiel Support Platoon, Med Bn, MRD and TD
or Army Corps**

**MATERIEL
SUPPORT
PLATOON**

PRINCIPAL ITEMS OF EQUIPMENT

<u>Equipment</u>	<u>Total</u>	<u>Equipment</u>	<u>Total</u>
Truck, Medium.....	6	Trailer, Cargo, 2-Axle.....	2
Truck, Water (2,000-Liter).....	3	Trailer, Kitchen.....	4

Artillery Command Battery, MRD and TD

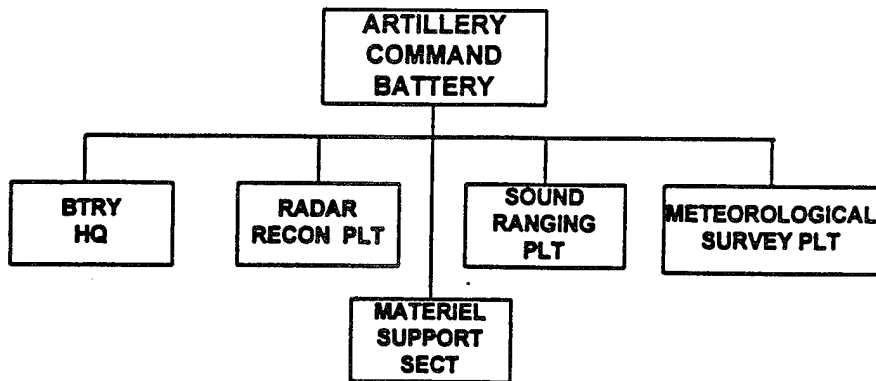

PRINCIPAL ITEMS OF EQUIPMENT

<u>Equipment</u>	<u>Total</u>	<u>Equipment</u>	<u>Total</u>
ATGL, RPG-7V	4	Rangefinder	2
5.45-mm LMG, RPK-74	4	Radar:	
Mobile Recon Post, PRP-3/4*	1	Meteorological, END TRAY	2
APC, Radar, MT-LB (SNAR-10)**	1	Countermortar/Counterbattery,	
Sound Ranging Set.....	1	ARK-1***	1
ACV, BTR (R-145BM)	2	Radios:	
Truck, Light	5	VHF, Manpack, Low-Power	6
Truck, Medium	3	VHF, Vehicle Mount, Medium-Power ..	6
Van, Signal.....	1	HF, Manpack, Low-Power.....	2
Van, Meteorological.....	2	HF/VHF, Vehicle Mount,	
Trailer, Cargo, 2-Axle.....	2	Medium-Power	4
Trailer, Generator.....	2		

FOOTNOTES:

- * This system includes the SMALL FRED or TALL MIKE battlefield surveillance radar.
- ** This system includes the BIG FRED battlefield surveillance radar.
- *** This system includes the RICE BAG countermortar/counterbattery radar.

Motorized Rifle Regiment (BMP), MRD

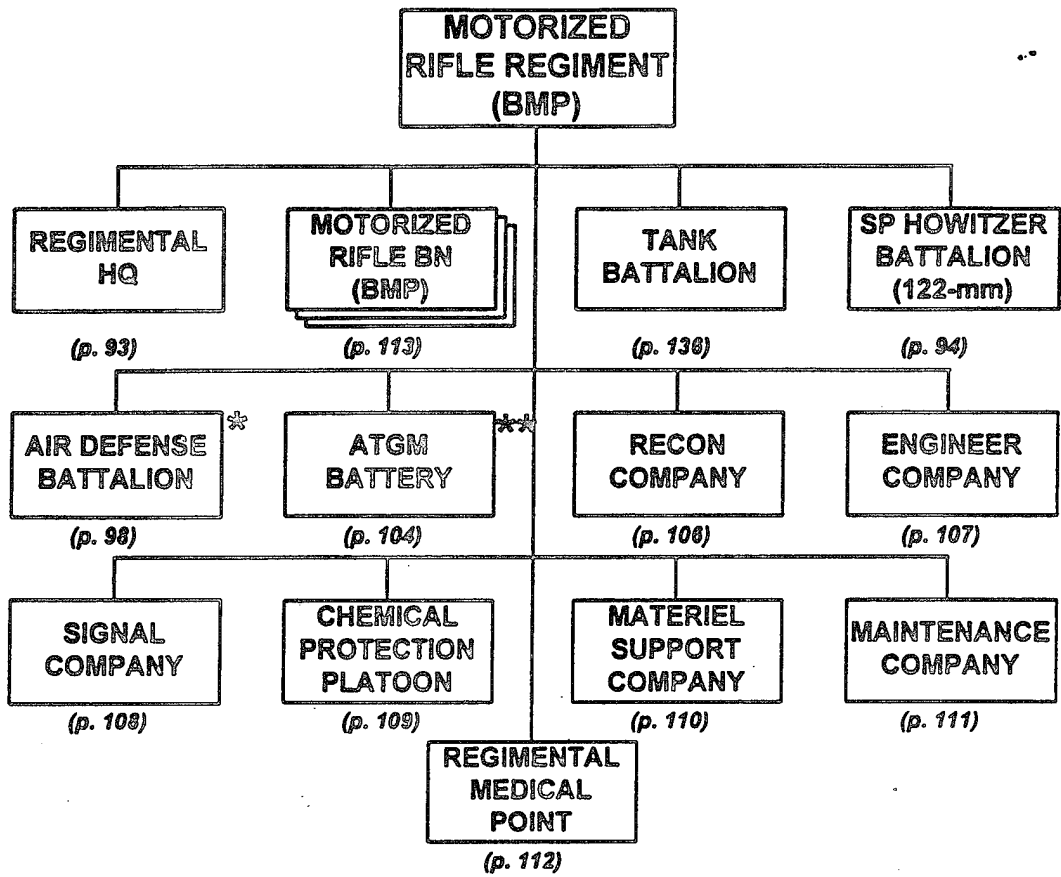

FOOTNOTES:

- * Some MRRs may still have a single air defense battery equipped with ZSU-23-4, 23-mm SP anti-aircraft guns and SA-13/GOPHER SAM systems (see p. 103).
- ** Some MRRs may have an antitank battalion (see p. 105) rather than just an ATGM battery.

MOTORIZED RIFLE REGIMENT (BMP), MRD

Principal Items of Equipment	Regt HQ	Motorized Rifle Bn (3x)	Tank Bn	SP Howitzer Bn	Air Defense Bn	ATGM Btry	Recon Co	Engineer Co	Signal Co	Chem Protection Plt	Material Support Co	Maintenance Co	Regt Medical Point	TOTAL
	ARMORED VEHICLES													
Medium Tank, T-64K/72K/80K			1											1
Medium Tank, T-64/72/80			30											30
ACV, BMP-1K/2K/3K		3	1											4
AICV, BMP-1/2/3		123			6		4							133
ACV, BMP-1KSh		3							5					8
ACV, BRM-1K w/TALL MIKE		3					3							6
APC, BTR-60/70/80	1							1						2
ACV, BTR (R-145BM)		6	1						3					10
APC, BTR-60PA (FAC)	1													1
ASC, BRDM-2							4							4
ACV, BRDM-2U						4								4
Chem Recon Vehicle, BRDM-2RKh/RKhM										3				3
Mobile Recon Post, PRP-3/4				1										1
ACRV, 1V13/1V13M/1V22				3										3
ACRV, 1V14/1V14M/1V23				3										3
ACRV, 1V15/1V15M/1V24				1										1
ACRV, 1V16/1V16M/1V25				1										1
ACV, PPRU (DOG EAR)					2									2
ACV, BTR-60 (PU-12)					2									2
Armored Recovery Vehicle												3		3
WEAPONS														
30-mm Auto Grenade Launcher, AGS-17		18												18
120-mm Mortar, M1943/2S12 or 82-mm Automatic Mortar, 2B9		18												18
122-mm SP Howitzer, 2S1				18										18
ATGM Manpack, AT-4/SPIGOT		18												18
ATGM Vehicle, 9P148 w/ AT-5/SPANDREL						9								9
30-mm SPAA System, 2S6					6									6
SAM, SA-13/GOPHER					6									6
SAM, SA-16/18	3	27			18									48
ENGINEER EQUIPMENT														
Bridge, Tank-Launched								1						1
Bridge, Truck-Launched								4						4
Minelayer, GMZ								3						3
Mineclearing Plow								9						9
Mine Roller-Plow								3						3
Mine Detector, DIM								1						1
Armored Engineer Tractor, IMR								1						1
Ditching Machine, BTM/MDK								1						1
Ditching Machine, PZM/TMK								3						3
Dozer								1						1
Truck, Water Purification								1						1

MOTORIZED RIFLE REGIMENT (BMP), MRD (Continued)

<i>Principal Items of Equipment</i>	MOTORIZED RIFLE REGIMENT (BMP), MRD (Continued)													
	Regt HQ	Motorized Rifle Bn (3d)	Tank Bn	SP Howitzer Bn	Air Defense Bn	ATGM Btry	Recon Co	Engineer Co	Signal Co	Chem Protection Plt	Material Support Co	Maintenance Co	Regt Medical Point	TOTAL
TRUCKS														
Truck, Utility	3	9						1	5		2	1		21
Truck, Light		39		4	3				3		4		1	54
Truck, Medium	1	12	7	14	4	3		8			45	2	2	98
Truck, Decon, ARS-12U/14										3				3
Truck, Decon, DDA-53/66										1			1	2
Truck, Dump								2						2
Truck, Crane								1						1
Truck, Crane Shovel								1						1
Truck, POL (4,000/5,200-L)		6	3	2	2						15			28
Truck, Water (2,000-L)										2	4			6
Van, Command	3													3
Van, Hospital													1	1
Van, Kitchen		3	1											4
Van, Maintenance		3	1	2				1			1	12		20
Van, Signal				3					5					8
Ambulance		3	1	1									4	9
Sedan	1													1
TRAILERS														
Trailer, Cargo, 1-Axle		6	1											7
Trailer, Cargo, 2-Axle			6	16				2			30	6		60
Trailer, Generator		3	1	2	2				1		1	3		13
Trailer, Kitchen		9		3							2		1	15
Trailer, POL (900/1,200-L)		3		2							15			20
Trailer, Water (900/1,200-L)		3	1	1						2	1		1	9
RADIOS														
VHF, Manpack, Low-Power	3	42	1	10		4	4	4	7		1	1	1	78
VHF, Portable, Low-Power		66			4									70
VHF, Portable, Very-Low-Power		12			4									16
VHF, Vehicle Mount, Medium-Power	2	138	33	28	22	13	11	6	2			6		261
HF, Manpack, Low-Power			2				1		2	1				6
HF, Vehicle Mount, Medium-Power		9	5		1		1		2	3				21
HF/VHF, Vehicle Mount, Medium-Power									2					2
HF/VHF, Vehicle Mount, High-Power									2					2
HF, Vehicle Mount, High-Power									1					1
Radio Relay, VHF/UHF									2					2
Warning Receiver		3	1	2	4		1		3					14
MISCELLANEOUS														
Armored Maintenance Vehicle, MTP												3		3
Rangefinder						1								1
Rangefinder, Laser, SAGE GLOSS				4										4
Rangefinder, Stereoscopic		3												3
Periscopic Aiming Circle		3												3
Collimator (Aiming Stakes)		18												18
Motorcycle								3						3

Motorized Rifle Regiment (BMP), TD

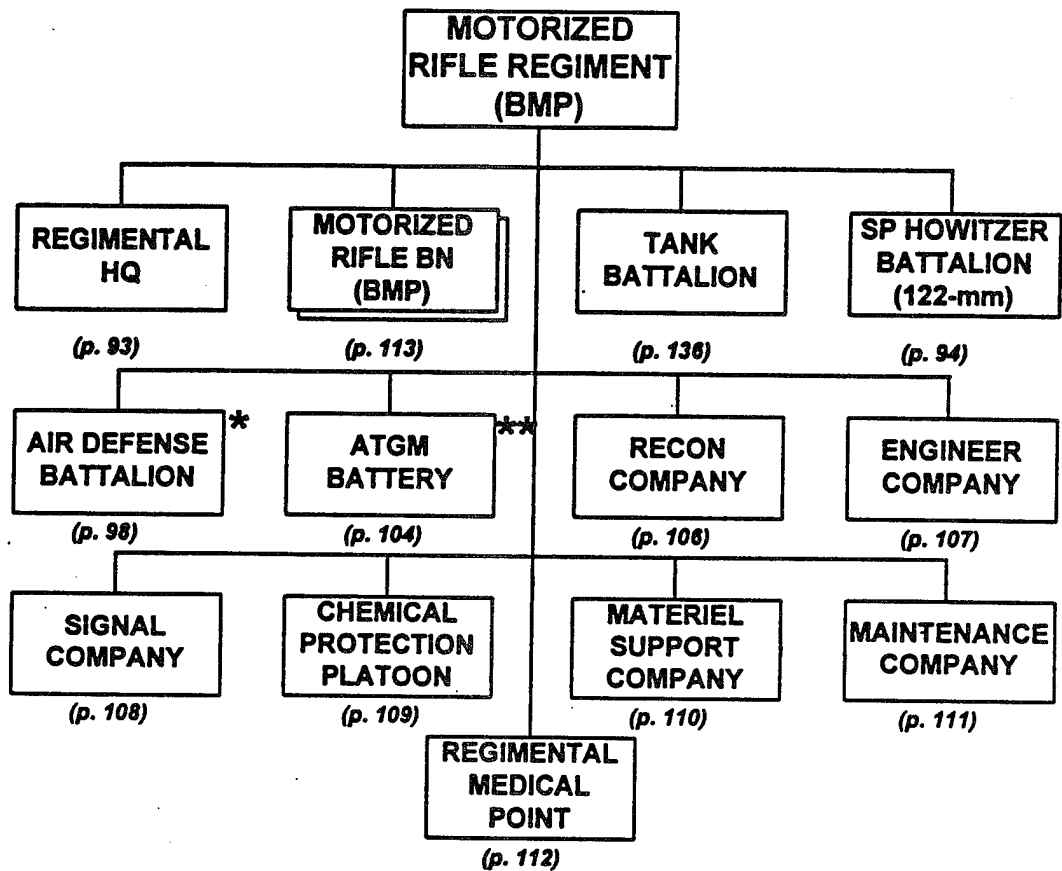

FOOTNOTES:

- * Some MRRs may still have a single air defense battery equipped with ZSU-23-4, 23-mm SP anti-aircraft guns and SA-13/GOPHER SAM systems (see p. 103).
- ** Some MRRs may have an antitank battalion (see p. 105) rather than just an ATGM battery.

MOTORIZED RIFLE REGIMENT (BMP), TD

Principal Items of Equipment	MOTORIZED RIFLE REGIMENT (BMP), TD													TOTAL
	Regt HQ	Motorized Rifls Bn (2x)	Tank Bn	SP Howitzer Bn	Ar Defense Bn	ATGM Btry	Recon Co	Engineer Co	Signal Co	Chem Protection Plt	Material Support Co	Maintenance Co	Regt Medical Point	
ARMORED VEHICLES														
Medium Tank, T-64K/72K/80K			1											1
Medium Tank, T-64/72/80			30											30
ACV, BMP-1K/2K/3K		2	1											3
AICV, BMP-1/2/3		82			6		4							92
ACV, BMP-1KSb		2							5					7
ACV, BRM-1K wTALL MIKE		2					3							5
APC, BTR-60/70/80	1							1						2
ACV, BTR (R-145BM)	1	4	1						3					9
APC, BTR-60PA (FAC)	1													1
ASC, BRDM-2							4							4
ACV, BRDM-2U						4								4
Chem Recon Vehicle, BRDM-2RKh/RKhM									3					3
Mobile Recon Post, PRP-3/4				1										1
ACRV, 1V13/1V13M/1V22				3										3
ACRV, 1V14/1V14M/1V23				3										3
ACRV, 1V15/1V15M/1V24				1										1
ACRV, 1V16/1V16M/1V25				1										1
ACV, PPRU (DOG EAR)					2									2
ACV, BTR-60 (PU-12)					2									2
Armored Recovery Vehicle												3		3
WEAPONS														
30-mm Auto Grenade Launcher, AGS-17		12												12
120-mm Mortar, M1943/2S12 or 82-mm Automatic Mortar, 2B9		12												12
122-mm SP Howitzer, 2S1				18										18
ATGM Manpack, AT-4/SPIGOT		12												12
ATGM Vehicle, 9P148 w/ AT-5/SPANDREL						9								9
30-mm SPAA System, 2S6					6									6
SAM, SA-13/GOPHER					6									6
SAM, SA-16/18	3	18			18									39
ENGINEER EQUIPMENT														
Bridge, Tank-Launched								1						1
Bridge, Truck-Launched								4						4
Minelayer, GMZ								3						3
Mineclearing Plow								9						9
Mine Roller-Plow								3						3
Mine Detector, DIM								1						1
Armored Engineer Tractor, IMR								1						1
Ditching Machine, BTM/MDK								1						1
Ditching Machine, PZM/TMK								3						3
Dozer								1						1
Truck, Water Purification								1						1

MOTORIZED RIFLE REGIMENT (BMP), TD (Continued)														
Principal Items of Equipment	Regt HQ	Motorized Rifle Bn (3x)	Tank Bn	SP Howitzer Bn	Air Defense Bn	ATGM Btry	Recon Co	Engineer Co	Signal Co	Chem Protection Pnt	Material Support Co	Maintenance Co	Regt Medical Point	TOTAL
TRUCKS														
Truck, Utility	3	6						1	5		2	1		18
Truck, Light		26		4	3				3		4		1	41
Truck, Medium	1	8	7	14	4	3		8			45	2	2	94
Truck, Decon, ARS-12U/14										3				3
Truck, Decon, DDA-53/66										1			1	2
Truck, Dump								2						2
Truck, Crane								1						1
Truck, Crane Shovel								1						1
Truck, POL (4,000/5,200-L)		4	3	2	2						15			26
Truck, Water (2,000-L)										2	4			6
Van, Command	3													3
Van, Hospital													1	1
Van, Kitchen		2	1											3
Van, Maintenance		2	1	2				1			1	12		19
Van, Signal				3					5					8
Ambulance		2	1	1									4	8
Sedan	1													1
TRAILERS														
Trailer, Cargo, 1-Axle		4	1											5
Trailer, Cargo, 2-Axle			6	16				2			30	6		60
Trailer, Generator		2	1	2	2				1		1	3		12
Trailer, Kitchen		6		3							2		1	12
Trailer, POL (900/1,200-L)		2		2							15			19
Trailer, Water (900/1,200-L)		2	1	1						2	1		1	8
RADIOS														
VHF, Manpack, Low-Power	3	28	1	10		4	4	4	7		1	1	1	64
VHF, Portable, Low-Power		44			4									48
VHF, Portable, Very-Low-Power		8			4									12
VHF, Vehicle Mount, Medium-Power	2	92	33	28	22	13	11	6	2			6		215
HF, Manpack, Low-Power			2				1		2	1				6
HF, Vehicle Mount, Medium-Power		6	5		1		1		2	3				18
HF/VHF, Vehicle Mount, Medium-Power									2					2
HF/VHF, Vehicle Mount, High-Power									2					2
HF, Vehicle Mount, High-Power									1					1
Radio Relay, VHF/UHF									2					2
Warning Receiver		2	1	2	4		1		3					13
MISCELLANEOUS														
Armored Maintenance Vehicle, MTP												3		3
Rangefinder						1								1
Rangefinder, Laser, SAGE GLOSS				4										4
Rangefinder, Stereoscopic		2												2
Periscopic Aiming Circle		2												2
Collimator (Aiming Stakes)		12												12
Motorcycle									3					3

Motorized Rifle Regiment (BTR), MRD

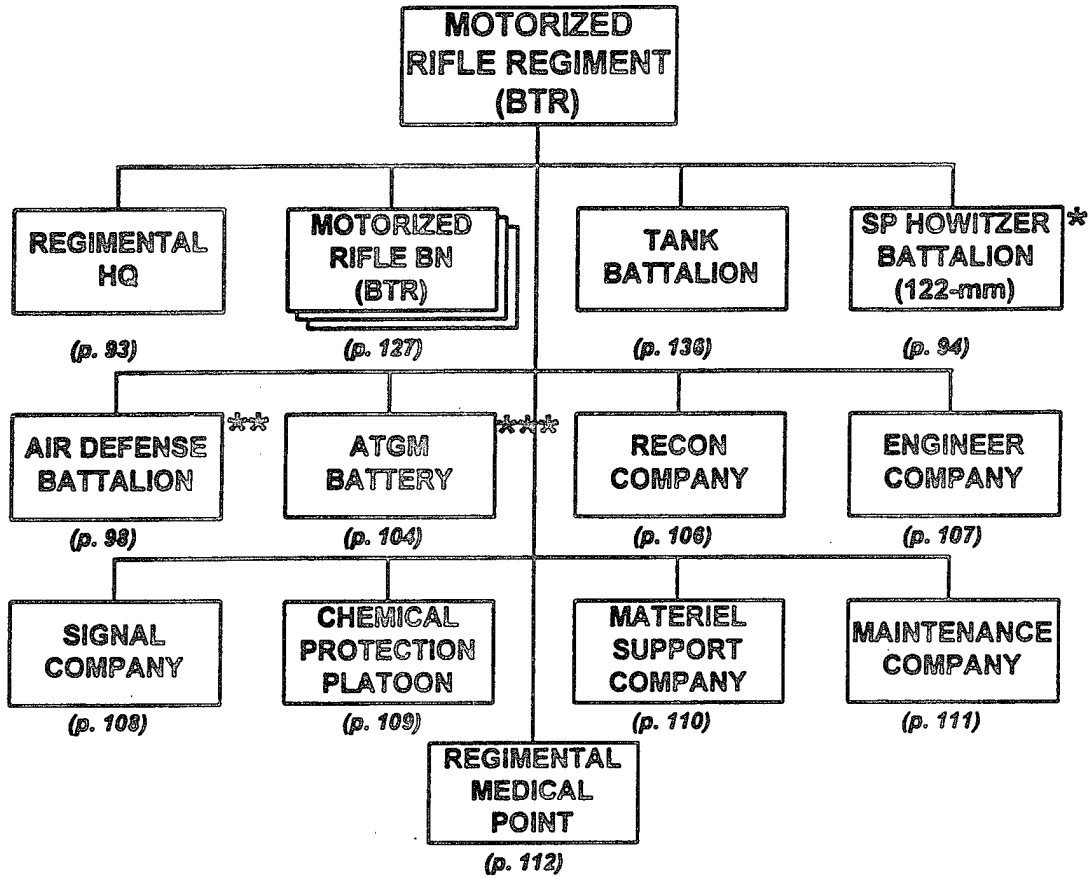

FOOTNOTES:

* The MRR (BTR) may have a battalion of 122-mm towed howitzers (D-30), instead of this SP howitzer battalion (see p. 96).

** Some MRRs may still have a single air defense battery equipped with ZSU-23-4, 23-mm SP anti-aircraft guns and SA-13/GOPHER SAM systems (see p. 102).

*** Some MRRs may have an antitank battalion (see p. 105) rather than just an ATGM battery.

MOTORIZED RIFLE REGIMENT (BTR), MRD														
Principal Items of Equipment	Regt HQ	Motorized Rifle Bn (3x)	Tank Bn	SP Howitzer Bn	Air Defense Bn	ATGM Btry	Recon Co	Engineer Co	Signal Co	Chem Protection Plt	Material Support Co	Maintenance Co	Regt Medical Point	TOTAL
	ARMORED VEHICLES													
Medium Tank, T-64K/72K/80K			1											1
Medium Tank, T-64/72/80			30											30
ACV, BMP-1K/2K/3K			1											1
AICV, BMP-1/2/3					6		4							10
ACV, BRM-1K w/TALL MIKE							3							3
ACV, BTR-60PBK/70K/80K	1	3												4
APC, BTR-60/70/80		141						1						142
ACV, BTR (R-145BM)		9	1						8					18
APC, BTR-60PA (FAC)	1													1
ASC, BRDM-2							4							4
ACV, BRDM-2U						4								4
Chem Recon Vehicle, BRDM-2RKh/RKhM										3				3
Mobile Recon Post, PRP-3/4				1										1
ACRV, 1V13/1V13M/1V22				3										3
ACRV, 1V14/1V14M/1V23				3										3
ACRV, 1V15/1V15M/1V24				1										1
ACRV, 1V16/1V16M/1V25				1										1
ACV, PPRU (DOG EAR)					2									2
ACV, BTR-60 (PU-12)					2									2
Armored Recovery Vehicle												3		3
WEAPONS														
30-mm Auto Grenade Launcher, AGS-17		18												18
120-mm Mortar, M1943/2S12 or 82-mm Automatic Mortar, 2B9		18												18
122-mm SP Howitzer, 2S1				18										18
73-mm Recoilless Gun, SPG-9		9												9
ATGM Manpack, AT-4/SPIGOT		18												18
ATGM Manpack, AT-7/SAXHORN		27												27
ATGM Vehicle, 9P148 w/ AT-5/SPANDREL						9								9
30-mm SPAA System, 2S6					6									6
SAM, SA-13/GOPHER					6									6
SAM, SA-16/18	3	27			18									48
ENGINEER EQUIPMENT														
Bridge, Tank-Launched								1						1
Bridge, Truck-Launched								4						4
Minelayer, GMZ								3						3
Mineclearing Plow								9						9
Mine Roller-Plow								3						3
Mine Detector, DIM								1						1
Armored Engineer Tractor, IMR								1						1
Ditching Machine, BTM/MDK								1						1
Ditching Machine, PZM/TMK								3						3
Dozer								1						1
Truck, Water Purification								1						1

MOTORIZED RIFLE REGIMENT (BTR), MRD (Continued)

<i>Principal Items of Equipment</i>	<i>Regt HQ</i>	<i>Motorized Rifle Bn (3x)</i>	<i>Tank Bn</i>	<i>SP Howitzer Bn</i>	<i>Air Defense Bn</i>	<i>ATGM Btry</i>	<i>Recon Co</i>	<i>Engineer Co</i>	<i>Signal Co</i>	<i>Chem Protection Plt</i>	<i>Material Support Co.</i>	<i>Maintenance Co</i>	<i>Regt Medical Point</i>	<i>TOTAL</i>
TRUCKS														
Truck, Utility	3	9						1	5		2	1		21
Truck, Light		39		4	3				3		4		1	54
Truck, Medium	1	12	7	14	4	3		8			45	2	2	98
Truck, Decon, ARS-12U/14										3				3
Truck, Decon, DDA-53/66										1			1	2
Truck, Dump								2						2
Truck, Crane								1						1
Truck, Crane Shovel								1						1
Truck, POL (4,000/5,200-L)		6	3	2	2						15			28
Truck, Water (2,000-L)										2	4			6
Van, Command	3													3
Van, Hospital													1	1
Van, Kitchen		3	1											4
Van, Maintenance		3	1	2				1			1	12		20
Van, Signal				3					5					8
Ambulance		3	1	1									4	9
Sedan	1													1
TRAILERS														
Trailer, Cargo, 1-Axle		6	1											7
Trailer, Cargo, 2-Axle			6	16				2			30	6		60
Trailer, Generator		3	1	2	2				1		1	3		13
Trailer, Kitchen		9		3							2		1	15
Trailer, POL (900/1,200-L)		3		2							15			20
Trailer, Water (900/1,200-L)		3	1	1						2	1		1	9
RADIOS														
VHF, Manpack, Low-Power	3	42	1	10		4	4	4	7		1	1	1	78
VHF, Portable, Low-Power		84			4									88
VHF, Portable, Very-Low-Power		12			4									16
VHF, Vehicle Mount, Medium-Power	2	153	33	28	22	13	11	6	2			3		273
HF, Manpack, Low-Power			2				1		2	1				6
HF, Vehicle Mount, Medium-Power		9	5		1		1		2	3				21
HF/VHF, Vehicle Mount, Medium-Power									2					2
HF/VHF, Vehicle Mount, High-Power									2					2
HF, Vehicle Mount, High-Power									1					1
Radio Relay, VHF/UHF									2					2
Warning Receiver		3	1	2	4		1		3					14
MISCELLANEOUS														
Rangefinder						1								1
Rangefinder, Laser, SAGE GLOSS				4										4
Rangefinder, Stereoscopic		3												3
Periscopic Aiming Circle		3												3
Collimator (Aiming Stakes)		18												18
Motorcycle									3					3

Tank Regiment, MRD

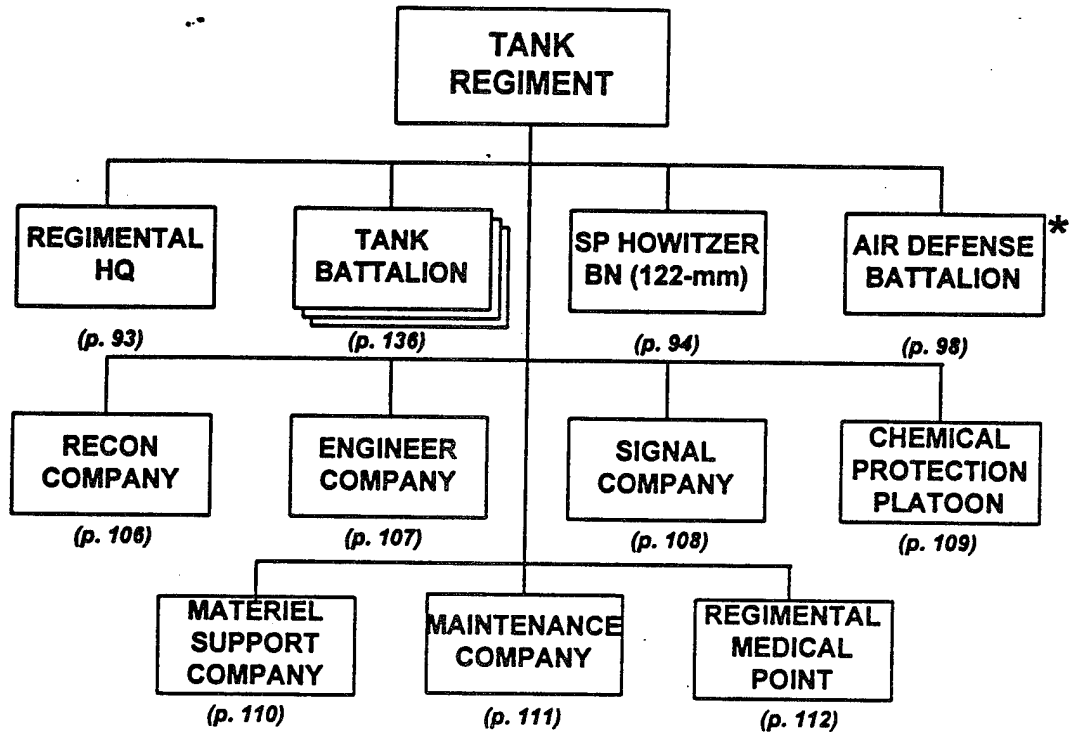

FOOTNOTE: * Some TRs may still have a single air defense battery equipped with ZSU-23-4, 23-mm SP anti-aircraft guns and SA-13/GOPHER SAM systems (see p. 103).

TANK REGIMENT, MRD

<i>Principal Items of Equipment</i>	TANK REGIMENT, MRD											
	<i>Regt HQ</i>	<i>Tank Bn (3x)</i>	<i>SP Howitzer Bn</i>	<i>Air Defense Bn</i>	<i>Recon Co</i>	<i>Engineer Co</i>	<i>Signal Co</i>	<i>Chem Protection Plt</i>	<i>Material Support Co</i>	<i>Maintenance Co</i>	<i>Regt Medical Point</i>	<i>TOTAL</i>
ARMORED VEHICLES												
Medium Tank, T-64K/72K/80K	1	3										4
Medium Tank, T-64/72/80		90										90
ACV, BMP-1K/2K/3K		3										3
AICV, BMP-1/2/3				6	4							10
ACV, BMP-1KSh							5					5
ACV, BRM-1K w/TALL MIKE					3							3
APC, BTR-60/70/80	1					1						2
ACV, BTR (R-145BM)		3					3					6
APC, BTR-60PA (FAC)	1											1
ASC, BRDM-2					4							4
Chem Recon Vehicle, BRDM-2RKh/RKhM							3					3
Mobile Recon Post, PRP-3/4			1									1
ACRV, 1V13/1V13M/1V22			3									3
ACRV, 1V14/1V14M/1V23			3									3
ACRV, 1V15/1V15M/1V24			1									1
ACRV, 1V16/1V16M/1V25			1									1
ACV, PPRU (DOG EAR)				2								2
ACV, BTR-60 (PU-12)				2								2
Armored Recovery Vehicle									5			5
WEAPONS												
122-mm SP Howitzer, 2S1			18									18
30-mm SPAA System, 2S6				6								6
SAM, SA-13/GOPHER				6								6
SAM, SA-16/18	3			18								21
ENGINEER EQUIPMENT												
Bridge, Tank-Launched						3						3
Bridge, Truck-Launched						4						4
Minelayer, GMZ						3						3
Mineclearing Plow						27						27
Mine Roller-Plow						9						9
Mine Detector, DIM						1						1
Armored Engineer Tractor, IMR						1						1
Ditching Machine, BTM/MDK						1						1
Ditching Machine, PZM/TMK						3						3
Dozer						1						1
Truck, Water Purification						1						1

TANK REGIMENT, MRD (Continued)												
<i>Principal Items of Equipment</i>	<i>Regt HQ</i>	<i>Tank Bn (3x)</i>	<i>SP Howitzer Bn</i>	<i>Air Defense Bn</i>	<i>Recon Co</i>	<i>Engineer Co</i>	<i>Signal Co</i>	<i>Chem Protection Plt</i>	<i>Material Support Co</i>	<i>Maintenance Co</i>	<i>Regt Medical Point</i>	<i>TOTAL</i>
TRUCKS												
Truck, Utility	3					1	5		2	1		12
Truck, Light			4	3			3		4		1	15
Truck, Medium	1	21	14	4		9			45	2	2	98
Truck, Decon, ARS-12U/14								3				3
Truck, Decon, DDA-53/66								1			1	2
Truck, Dump						2						2
Truck, Crane						1						1
Truck, Crane Shovel						1						1
Truck, POL (4,000/5,200-L)		9	2	2					15			28
Truck, Water (2,000-L)								2	4			6
Van, Command	3											3
Van, Kitchen		3										3
Van, Maintenance		3	2			1			1	12		19
Van, Signal			3				5					8
Ambulance		3	1								4	8
Sedan	1											1
TRAILERS												
Trailer, Cargo, 1-Axle		3										3
Trailer, Cargo, 2-Axle		18	16			2			30	6		72
Trailer, Generator		3	2	2			1		1	3		12
Trailer, Kitchen			3						2		1	6
Trailer, POL (900/1,200-L)			2						15			17
Trailer, Water (900/1,200-L)		3	1					2	1		1	8
RADIOS												
VHF, Manpack, Low-Power	2	3	10		4	4	7		1	1	1	33
VHF, Portable, Low-Power				4								4
VHF, Portable, Very-Low-Power				4								4
VHF, Vehicle Mount, Medium-Power	2	99	28	22	11	8	2			5		177
HF, Manpack, Low-Power		6			1		2	1				10
HF, Vehicle Mount, Medium-Power	1	15		1	1		2	3				23
HF/VHF, Vehicle, Medium-Power							2					2
HF/VHF, Vehicle Mount, High-Power							2					2
HF, Vehicle Mount, High-Power							1					1
Radio Relay, VHF/UHF							2					2
Warning Receiver		3	2	4	1		3					13
MISCELLANEOUS												0
Rangefinder, Laser, SAGE GLOSS			4									4
Motorcycle							3					3

Tank Regiment, TD

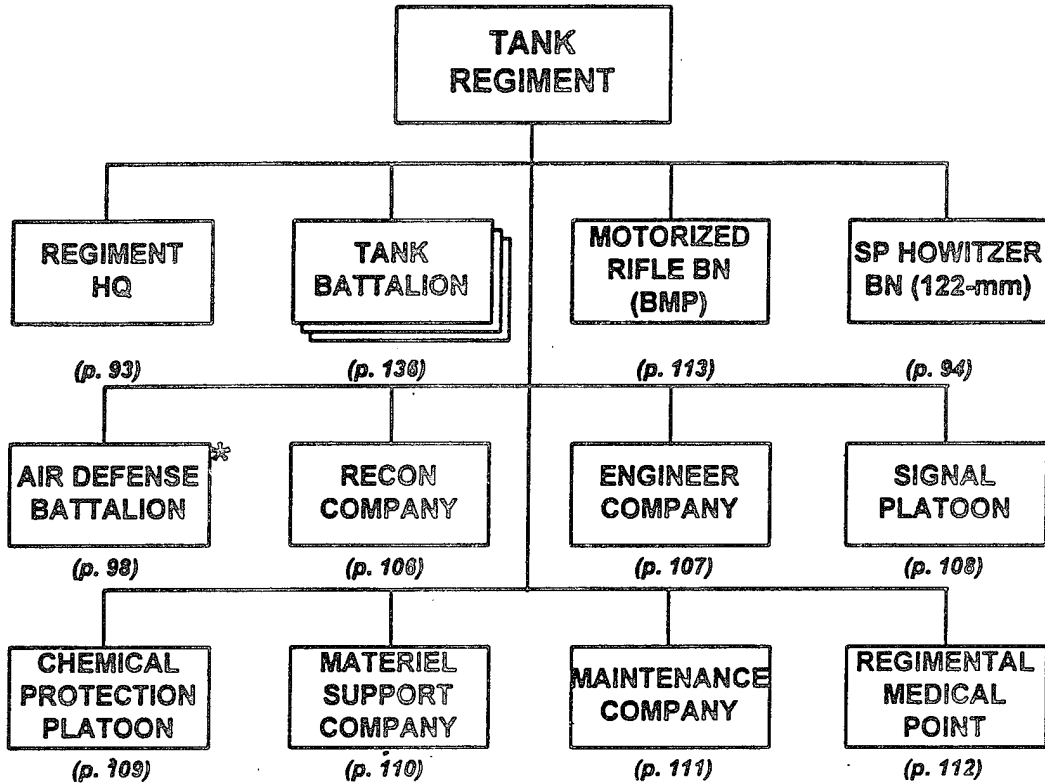

FOOTNOTE: * Some TRs may still have a single air defense battery equipped with ZSU-23-4, 23-mm SP antiaircraft guns and SA-13/GOPHER SAM systems (see p. 103).

TANK REGIMENT, TD													
Principal Items of Equipment	Regt HQ	Tank Bn (3x)	Motorized Rifle Bn (BMP)	SP Howitzer Bn	Air Defense Bn	Recon Co	Engineer Co	Signal Co	Chem Protection Plt	Material Support Co	Maintenance Co	Regt Medical Point	TOTAL
	ARMORED VEHICLES												
Medium Tank, T-64K/72K/80K	1	3											4
Medium Tank, T-64/72/80		90											90
ACV, BMP-1K/2K/3K		3	1										4
AICV, BMP-1/2/3			41		6	4							51
ACV, BMP-1KSh			1					5					6
ACV, BRM-1K w/ TALL MIKE			1			3							4
APC, BTR-60/70/80	1						1						2
ACV, BTR (R-145BM)		3	2					3					8
APC, BTR-60PA (FAC)	1												1
ASC, BRDM-2						4							4
Chem Recon Vehicle, BRDM-2RKh/RKhM									3				3
Mobile Recon Post, PRP-3/4				1									1
ACRV, 1V13/1V13M/1V22				3									3
ACRV, 1V14/1V14M/1V23				3									3
ACRV, 1V15/1V15M/1V24				1									1
ACRV, 1V16/1V16M/1V25				1									1
ACV, PPRU (DOG EAR)					2								2
ACV, BTR-60 (PU-12)					2								2
Armored Recovery Vehicle											5		5
WEAPONS													
30-mm Auto Grenade Launcher, AGS-17			6										6
120-mm Mortar, M1943/2S12 or 82-mm Automatic Mortar, 2B9			6										6
ATGM Manpack, AT-4/SPIGOT			6										6
122-mm SP Howitzer, 2S1				18									18
30-mm SPAA System, 2S6					6								6
SAM, SA-13/GOPHER					6								6
SAM, SA-16/18	3		9		18								30
ENGINEER EQUIPMENT													
Bridge, Tank-Launched							3						3
Bridge, Truck-Launched							4						4
Minelayer, GMZ							3						3
Mineclearing Plow							27						27
Mine Roller-Plow							9						9
Mine Detector, DIM							1						1
Armored Engineer Tractor, IMR							1						1
Ditching Machine, BTM/MDK							1						1
Ditching Machine, PZM/TMK							3						3
Dozer							1						1
Truck, Water Purification							1						1

TANK REGIMENT, TD (Continued)

<i>Principal Items of Equipment</i>	<i>Regt HQ</i>	<i>Tank Bn (3x)</i>	<i>Motorized Rifle Bn (BMP)</i>	<i>SP Howitzer Bn</i>	<i>Air Defense Bn</i>	<i>Recon Co</i>	<i>Engineer Co</i>	<i>Signal Co</i>	<i>Chem Protection Plt</i>	<i>Material Support Co</i>	<i>Maintenance Co</i>	<i>Regt Medical Point</i>	<i>TOTAL</i>
TRUCKS													
Truck, Utility	3		3				1	5		2	1		15
Truck, Light			13	4	3			3		4		1	28
Truck, Medium	1	21	4	14	4		9			45	2	2	102
Truck, Decon, ARS-12U/14									3				3
Truck, Decon, DDA-53/66									1			1	2
Truck, Dump							2						2
Truck, Crane							1						1
Truck, Crane Shovel							1						1
Truck, POL (4,000/5,200-L)		9	2	2	2					15			30
Truck, Water (2,000-L)									2	4			6
Van, Command	3												3
Van, Kitchen		3	1										4
Van, Maintenance		3	1	2			1			1	12		20
Van, Signal				3				5					8
Ambulance		3	1	1								4	9
Sedan	1												1
TRAILERS													
Trailer, Cargo, 1-Axle		3	2										5
Trailer, Cargo, 2-Axle		18		16			2			30	6		72
Trailer, Generator		3	1	2	2			1		1	3		13
Trailer, Kitchen			3	3						2		1	9
Trailer, POL (900/1,200-L)			1	2						15			18
Trailer, Water (900/1,200-L)		3	1	1					2	1		1	9
RADIOS													
VHF, Manpack, Low-Power	2	3	14	10		4	4	7		1	1	1	47
VHF, Portable, Low-Power			22		4								26
VHF, Portable, Very-Low-Power			4		4								8
VHF, Vehicle Mount, Medium-Power	2	99	46	28	22	11	8	2			5		223
HF, Manpack, Low-Power		6				1		2	1				10
HF, Vehicle Mount, Medium-Power	1	15	3		1	1		2	3				26
HF/VHF, Vehicle Mount, Medium-Power								2					2
HF/VHF, Vehicle Mount, High-Power								2					2
HF, Vehicle Mount, High-Power								1					1
Radio Relay, VHF/UHF								2					2
Warning Receiver		3	1	2	4	1		3					14
MISCELLANEOUS													
Rangefinder, Laser, SAGE GLOSS				4									4
Rangefinder, Stereoscopic			1										1
Periscopic, Aiming Circle			1										1
Collimator (Aiming Stakes)			6										6
Motorcycle								3					3

**Regimental Headquarters, MRR (BMP or BTR) and TR,
MRD and TD**

**REGIMENTAL
HEADQUARTERS**

PRINCIPAL ITEMS OF EQUIPMENT

Equipment	MRR	TR	Equipment	MRR	TR
SAM, SA-16/18	3	3	Sedan.....	1	1
Medium Tank,			Radios:		
T-64K/72K/80K			VHF, Manpack,		
(Command Vehicle).....	0	1*	Low-Power.....	3	2
APC, BTR-60/70/80	1	1	VHF, Vehicle Mount,		
APC, BTR-60PA (FAC).....	1	1	Medium-Power	2	2
Truck, Utility.....	3	3	HF, Vehicle Mount,		
Truck, Medium	1	1	Medium-Power	0	1
Van, Command	3	3			

FOOTNOTE: * In a TD, one of the three TRs has a second command tank, probably for the TD commander.

**122-mm SP Howitzer Battalion, MRR (BMP or BTR)
and TR, MRD and TD or IMRB**

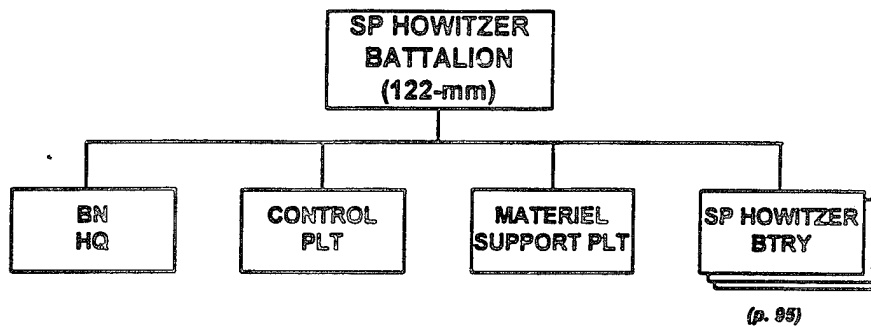

PRINCIPAL ITEMS OF EQUIPMENT

<u>Equipment</u>	<u>Total</u>	<u>Equipment</u>	<u>Total</u>
122-mm SP Howitzer, 2S1	18	Van, Signal	3
ATGL, RPG-7V	6	Trailer, Cargo, 2-Axle	16
5.45-mm LMG, RPK-74	18	Trailer, Generator	2
ACRV, 1V13/1V13M/1V22 (Btry FDC)	3	Trailer, POL (1,200-Liter)	2
ACRV, 1V14/1V14M/1V23 (Btry COP)	3	Trailer, Water (1,200-Liter)	1
ACRV, 1V15/1V15M/1V24 (Bn COP)	1	Trailer, Kitchen	3
ACRV, 1V16/1V16M/1V25 (Bn FDC)	1	Rangefinder, Laser, SAGE GLOSS	4
Mobile Recon Post, PRP-3/4*	1	Radios:	
Truck, Light	4	VHF, Manpack, Low-Power	10
Truck, Medium	14	VHF, Vehicle Mount,	
Truck, POL (4,000 or 5,200-Liter)	2	Medium-Power	28
Van, Maintenance	2	Warning Receiver	2
Ambulance	1		

NOTE: The MRR (BTR) may have a battalion of 122-mm towed howitzers (D-30), instead of this SP howitzer battalion (see p. 96).

FOOTNOTE: * This system includes the SMALL FRED or TALL MIKE battlefield surveillance radar.

**122-mm SP Howitzer Battery, 122-mm SP Howitzer Bn,
MRR (BMP or BTR) and TR, MRD and TD or IMRB**

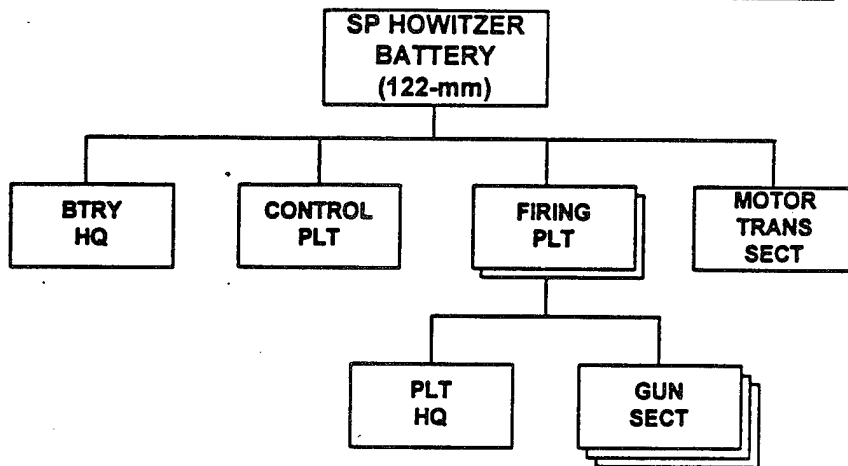

PRINCIPAL ITEMS OF EQUIPMENT

Equipment	Total
122-mm SP Howitzer, 2S1	6
ATGL, RPG-7V	2
5.45-mm LMG, RPK-74	6
ACRV, 1V13/1V13M/1V22 (Btry FDC)	1
ACRV, 1V14/1V14M/1V23 (Btry COP)	1
Van, Signal.....	1

Equipment	Total
Truck, Medium	3
Trailer, Cargo, 2-Axle.....	3
Rangefinder, Laser, SAGE GLOSS.....	1
Radios:	
VHF, Manpack, Low-Power.....	2
VHF, Vehicle Mount, Medium-Power ..	8

**122-mm Howitzer Battalion, MRR (BTR), MRD or Howitzer
Bde. Arty Div, Front or IAB**

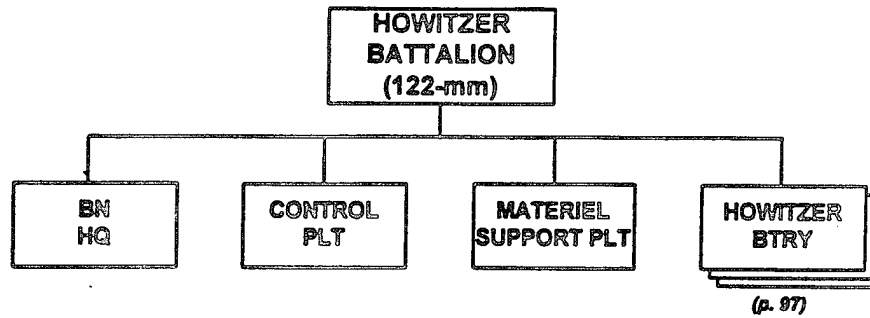

PRINCIPAL ITEMS OF EQUIPMENT

<u>Equipment</u>	<u>Total</u>	<u>Equipment</u>	<u>Total</u>
122-mm Howitzer, D-30.....	18	Ambulance	1
ATGL, RPG-7V	6	Trailer, Cargo, 2-Axle.....	17
5.45-mm LMG, RPK-74.....	18	Trailer, Generator.....	2
ACRV, 1V110 (Btry FDC).....	3	Trailer, POL (900-Liter)	2
ACRV, 1V18 (Btry COP).....	3	Trailer, Water (900-Liter)	1
ACRV, 1V19 (Bn COP)	1	Trailer, Kitchen	4
ACRV, 1V111 (Bn FDC)	1	Rangefinder, Laser, SAGE GLOSS.....	4
Mobile Recon Post, PRP-3/4*	1	Radios:	
Truck, Light	9	HF/VHF, Vehicle Mount,	
Truck, Medium	34	Medium-Power	4
Truck, POL (4,000 or 5,200-Liter)	2	VHF, Portable, Very Low-Power	23
Van, Maintenance	1	VHF, Manpack, Low-Power.....	14
Van, Signal.....	3	Warning Receiver	2

FOOTNOTE: * This system includes the SMALL FRED or TALL MIKE battlefield surveillance radar.

122-mm Howitzer Battery, 122-mm Howitzer Bn, MRR (BTR), MRD or Howitzer Bde, Arty Div, Front or IAB or Arty Regt, Airborne Div

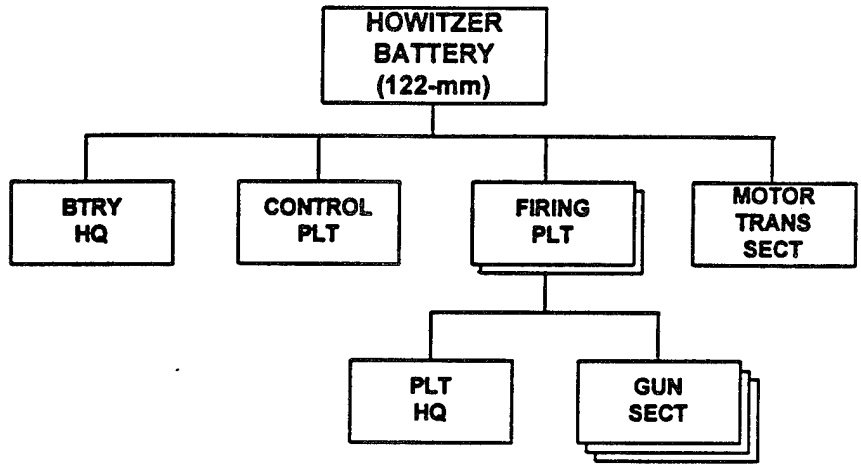

PRINCIPAL ITEMS OF EQUIPMENT

Equipment	Total	Equipment	Total
122-mm Howitzer, D-30.....	6	Trailer, Cargo, 2-Axle.....	3
ATGL, RPG-7V.....	2	Rangefinder, Laser, SAGE GLOSS.....	1
5.45-mm LMG, RPK-74.....	6	Radios:	
Van, Signal.....	1	VHF, Manpack, Low-Power.....	2
Truck, Medium.....	8	VHF, Portable, Very-Low-Power.....	7
ACRV, 1V110 (Btry FDC).....	1	VHF, Vehicle Mount, Medium-Power ..	1
ACRV, 1V18 (Btry COP).....	1		

**Air Defense Battalion, MRR (BMP or BTR) and TR,
MRD and TD**

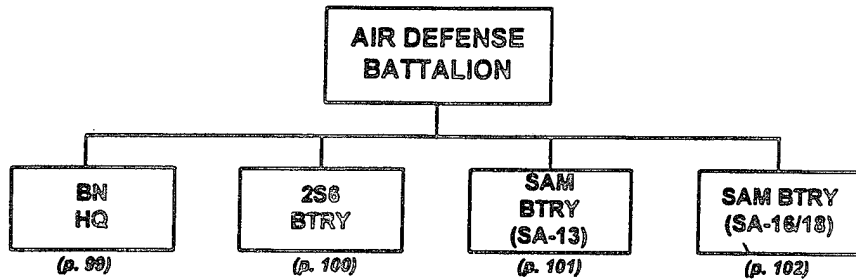

PRINCIPAL ITEMS OF EQUIPMENT

<u>Equipment</u>	<u>Total</u>	<u>Equipment</u>	<u>Total</u>
30-mm SPAA System, 2S6*	6	Trailer, Generator	2
SAM, SA-13/GOPHER TELAR**	6	Radios:	
SAM, SA-16/18	18	VHF, Portable, Low-Power	4
AICV, BMP-2***	6	VHF, Vehicle Mount,	
ACV, PPRU****	2	Medium-Power	22
ACV, BTR-60 (PU-12)	2	VHF, Portable, Very Low-Power	4
Truck, Light	3	HF, Vehicle Mount, Medium-Power	1
Truck, Medium	4	Warning Receiver	4
Truck, POL (4,000 or 5,200-Liter)	2		

NOTES:

1. Some MRRs and TRs may still have a single air defense battery equipped with ZSU-23-4 23-mm SP antiaircraft guns and SA-13/GOPHER SAM systems (see p. 103).
2. Some regimental air defense battalions may not include the SA-13-equipped air defense missile battery.

FOOTNOTES:

- * This system includes SA-19/GRISON SAM launchers and HOT SHOT target acquisition and fire control radars.
- ** This system includes a ranging system.
- *** In the MRR (BTR), this battalion may have BTR-60/70/80 APCs in lieu of the BMP-2.
- **** This system includes the DOG EAR target acquisition radar.

**Battalion Headquarters, Air Defense Bn, MRR (BMP or BTR)
and TR, MRD and TD or IMRB**

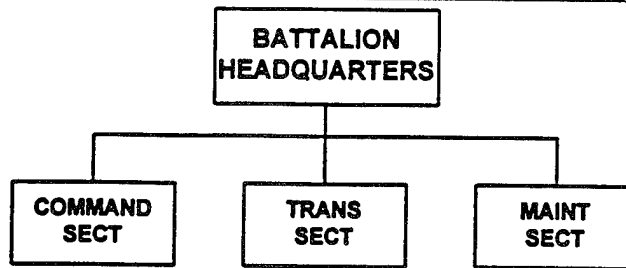

PRINCIPAL ITEMS OF EQUIPMENT

<u>Equipment</u>	<u>Total</u>	<u>Equipment</u>	<u>Total</u>
ACV, PPRU*	1	Radios:	
Truck, Medium	4	VHF, Portable, Low-Power	1
Trailer, Generator.....	2	VHF, Vehicle Mount, Medium-Power ..	1
		HF, Vehicle Mount, Medium-Power	1
		Warning Receiver	1

FOOTNOTE: * This system includes the DOG EAR target acquisition radar.

**2S6 Battery, Air Defense Bn, MRR (BMP or BTR) and TR,
MRD and TD or IMRB**

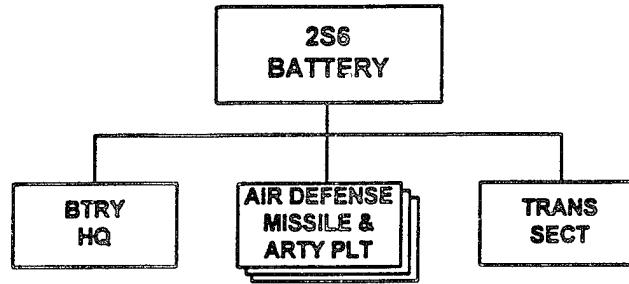

PRINCIPAL ITEMS OF EQUIPMENT

<u>Equipment</u>	<u>Total</u>	<u>Equipment</u>	<u>Total</u>
30-mm SPAA System, 2S6*	6	Radios:	
ACV, BTR-60 (PU-12)	1	VHF, Portable, Low-Power	1
Truck, Light	1	VHF, Vehicle Mount, Medium-Power	7
Truck, Medium	4	Warning Receiver	1
Trailer, Generator	2		

FOOTNOTE: * -This system includes SA-19/GRISON SAM launchers and HOT SHOT target acquisition and fire control radars.

**SAM Battery (SA-13), Air Defense Bn, MRR (BMP or BTR)
and TR, MRD and TD or IMRB**

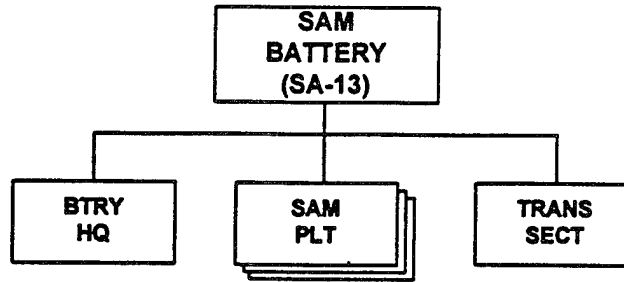

PRINCIPAL ITEMS OF EQUIPMENT

Equipment	Total	Equipment	Total
SAM, SA-13/GOPHER TELAR*	6	Radios:	
ACV, PPRU**	1	VHF, Portable, Low-Power	1
Truck, Light	1	VHF, Vehicle Mount, Medium-Power	7
		Warning Receiver	1

FOOTNOTES:

- * This system includes a ranging radar.
- ** This system includes the DOG EAR target acquisition radar.

**SAM Battery (SA-16/18), Air Defense Bn, MRR (BMP or BTR)
and TR, MRD and TD or IMRB**

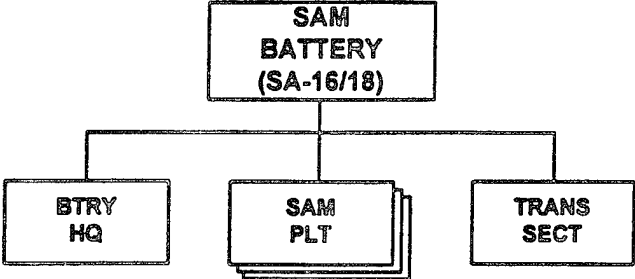

PRINCIPAL ITEMS OF EQUIPMENT

<u>Equipment</u>	<u>Total</u>	<u>Equipment</u>	<u>Total</u>
AICV, BMP-2.....	6*	Radios:	
SAM, SA-16/18	18	VHF, Portable, Low-Power	1
ACV, BTR-60 (PU-12).....	1	VHF, Vehicle Mount, Medium-Power ...	7
Truck, Light	1	VHF, Portable, Very-Low-Power	4
		Warning Receiver	1

FOOTNOTE: * In the MRR (BTR), this battery may have BTR-60/70/80 APCs in lieu of the BMP-2.

**Air Defense Battery (Variant), MRR (BMP and BTR) and TR,
MRD and TD**

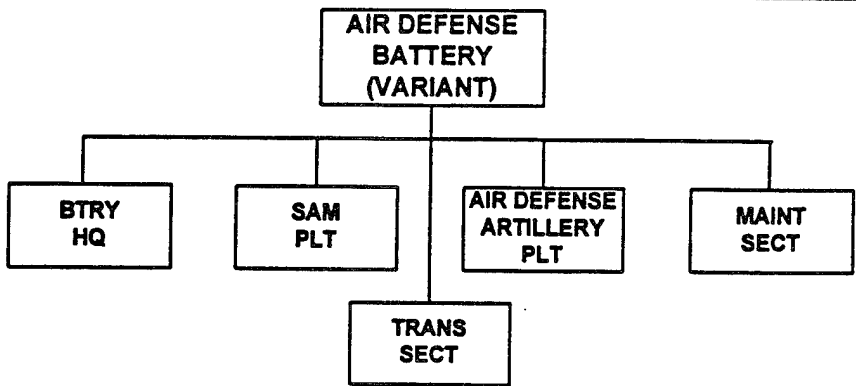

PRINCIPAL ITEMS OF EQUIPMENT

Equipment	Total	Equipment	Total
SAM, SA-9/GASKIN TEL		Trailer, Generator.....	2
or SA-13/GOPHER TELAR*	4	Radios:	
23-mm SPAA Gun, ZSU-23-4**	4	VHF, Manpack, Low-Power.....	2
ACV, BTR-60 (PU-12).....	3	VHF, Vehicle Mount,	
Truck, Light	2	Medium-Power	11
Truck, Medium	4	Warning Receiver	3
Truck, POL (4,000 or 5,200-Liter)	1		

FOOTNOTES:

- * The SA-13 system includes a ranging radar.
- ** This system includes the GUN DISH fire control radar.

ATGM Battery, MRR (BMP or BTR)

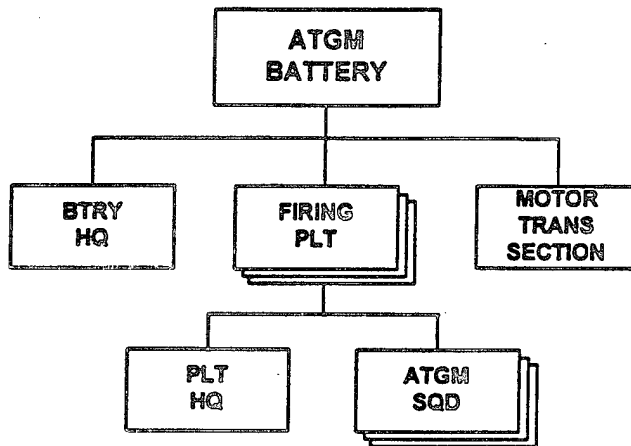

PRINCIPAL ITEMS OF EQUIPMENT

<u>Equipment</u>	<u>Total</u>
ATGM, Vehicle, 9P148 w/ AT-5/SPANDREL	9
ATGL, RPG-7V	9
ACV, BRDM-2U	4
Truck, Medium	3

<u>Equipment</u>	<u>Total</u>
Rangefinder	1
Radios:	
VHF, Manpack, Low-Power	4
VHF, Vehicle Mount, Medium-Power	13

**Antitank Battalion (Variant), MRR (BMP or BTR),
MRD and TD**

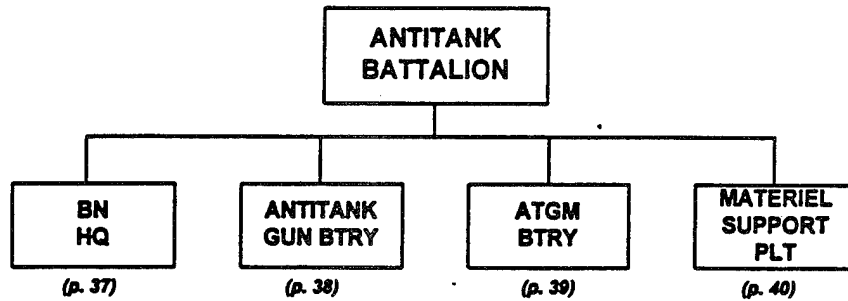

PRINCIPAL ITEMS OF EQUIPMENT

<u>Equipment</u>	<u>Total</u>	<u>Equipment</u>	<u>Total</u>
ATGM Vehicle, 9P148		Trailer, Generator.....	1
w/ AT-5/SPANDREL	9-12	Trailer, Water (900-Liter)	1
100/25-mm Antitank Gun,		Trailer, Kitchen	2
MT-12/2A45M.....	6	Rangefinder.....	2
ATGL, RPG-7V	9	Radar, Battlefield Surveillance,	
ACV, BTR(R-145BM)/BRDM-2U	5	Man-Portable, PSNR-1	2
Prime Mover, MT-LBT	7	Radios:	
Truck, Utility.....	3	VHF, Manpack, Low-Power.....	9
Truck, Light	4	VHF, Vehicle Mount,	
Truck, Medium	11	Medium-Power	21
Van, Signal.....	2	HF, Vehicle Mount, Medium-Power	1
Van, Maintenance	2	HF/VHF, Vehicle Mount,	
Truck, POL (4,000 or 5,200-Liter)	2	Medium-Power	3
Ambulance	1	Radio Relay, VHF/UHF.....	1
Trailer, Cargo, 2-Axle.....	9	Warning Receiver	1
Trailer, POL (900-Liter)	1		

**Reconnaissance Company, MRR (BMP or BTR) and TR,
MRD and TD**

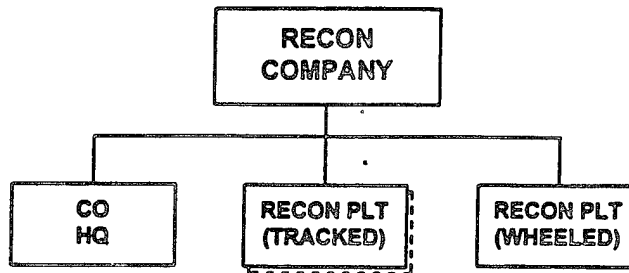

PRINCIPAL ITEMS OF EQUIPMENT

<u>Equipment</u>	<u>Total</u>	<u>Equipment</u>	<u>Total</u>
ATGL, RPG-7V	4-7	Radios:	
5.45-mm LMG, RPK-74	4-7	VHF, Manpack, Low-Power	3-4
ACV, BRM-1K*	2-3	VHF, Vehicle Mount, Medium-Power	8-11
AICV, BMP-1/2/3	2-4	HF, Manpack, Low-Power	1
ASC, BRDM-2	4	HF, Vehicle Mount, Medium-Power	1
		Warning Receiver	1

NOTES:

1. The total number of BMP/BRM tracked vehicles (and associated equipment) can vary from four to seven, depending on whether the company has one or two tracked recon platoons. (The MRR and TR equipment totals in this handbook include the larger numbers.)
2. The mix of BMP and BRM vehicles within a tracked recon platoon can also vary.

FOOTNOTE: * This system includes the TALL MIKE battlefield surveillance radar.

**Engineer Company, MRR (BMP or BTR) and TR,
MRD and TD**

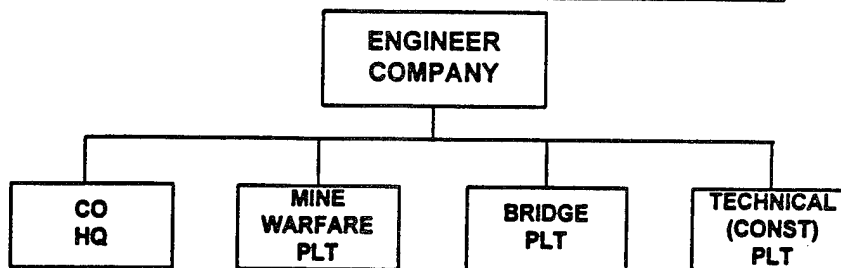

PRINCIPAL ITEMS OF EQUIPMENT

Equipment	Total	Equipment	Total
ATGL, RPG-7V	4	Dozer	1
APC, BTR-60/70/80	1	Ditching Machine, PZM/TMK	3
Truck, Utility	1	Minelayer, GMZ	3
Truck, Medium	8*/9**	Mineclearing Plow	9*/27**
Truck, Dump	2	Mine Roller-Plow	3*/9**
Van, Maintenance	1	Mine Detector, DIM	1
Truck, Crane	1	Truck, Water Purification	1
Truck, Crane Shovel	1	Trailer, Cargo, 2-Axle	2
Bridge, Tank-Launched	1*/3**	Radios:	
Bridge, Truck-Launched	4	VHF, Vehicle Mount,	
Armored Engineer Tractor, IMR	1	Medium-Power	6*/8**
Ditching Machine, BTM/MDK	1	HF or VHF, Manpack, Low-Power	4

NOTES: The following variations may exist:

1. Frogmen may be attached to assist in the reconnaissance of water obstacles.
2. Some companies may have five KMM truck-launched bridge spans instead of four TMM bridge spans.
3. Some units may have PMR towed minelayers instead of GMZ armored tracked minelayers. Trucks normally tow PMR minelayers. Some units may have BTR-152s for this purpose.
4. Some units may have up to six one-axle cargo trailers besides the two-axle cargo trailers.
5. Some units may have tractor-trailers to carry heavy tracked equipment on long road movements.

FOOTNOTES:

- * Equipment levels for the engineer company, MRR (BMP or BTR).
- ** Equipment levels for the engineer company, TR.

**Signal Company, MRR (BMP or BTR) and TR,
MRD and TD**

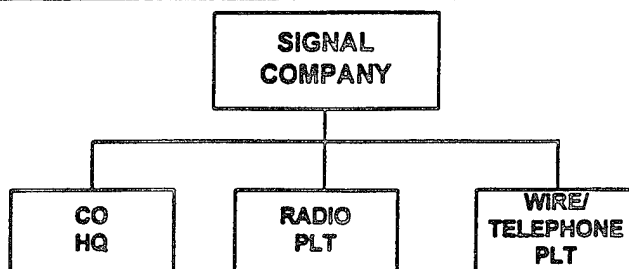

PRINCIPAL ITEMS OF EQUIPMENT

<u>Equipment</u>	<u>Total</u>	<u>Equipment</u>	<u>Total</u>
ACV, BMP-1KSh.....	5*/0**	Radios:	
ACV, BTR (R-145BM)	3*/8**	VHF, Manpack, Low-Power.....	7
Truck, Utility.....	5	VHF, Vehicle Mount, Medium-Power ..	2
Truck, Light	3	HF, Manpack, Low-Power.....	2
Van, Signal.....	5	HF, Vehicle Mount, Medium-Power	2
Motorcycle	3	HF, Vehicle Mount, High-Power.....	1
Trailer, Generator.....	1	HF/VHF, Vehicle Mount, Medium-Power	2
		HF/VHF, Vehicle Mount, High-Power..	2
		Radio Relay, VHF/UHF.....	2
		Warning Receiver	3

NOTES:

1. The radios listed support the regimental headquarters, but some maybe attached to subordinate headquarters.
2. Motorcycles provide the regimental commander with messenger/courier service.

FOOTNOTES:

- * Equipment levels for the signal company, MRR (BMP) and TR.
- ** Equipment levels for the signal company, MRR (BTR).

**Chemical Protection Platoon, MRR (BMP or BTR) and TR
or Arty Regt or SAM Regt, MRD and TD**

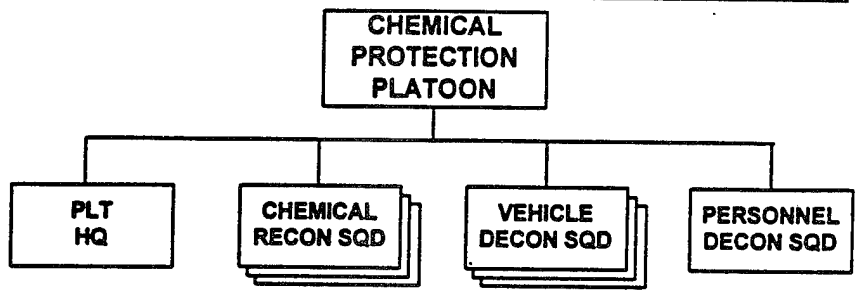

PRINCIPAL ITEMS OF EQUIPMENT

Equipment	Total	Equipment	Total
Chemical Recon Vehicle, BRDM-2RKh or RKhM	3	Trailer, Water (1,200-Liter)	2
Truck, Decon, ARS-12U/14	3	Radios:	
Truck, Decon, DDA-53/66.....	1	VHF, Vehicle Mount,	
Truck, Water (2,000-Liter).....	2	Medium-Power	3
		HF, Manpack, Low-Power.....	1

**Matériel Support Company, MRR (BMP or BTR) and TR,
MRD and TD**

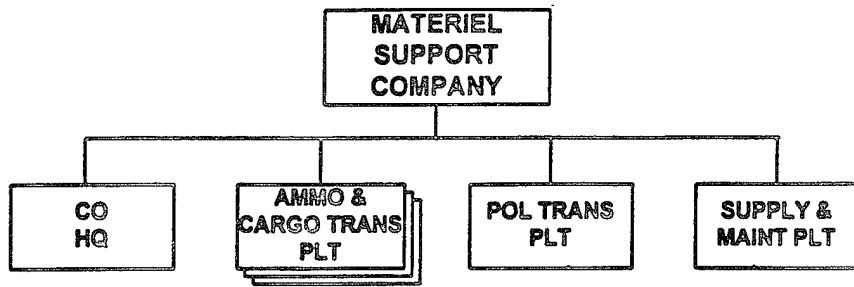

PRINCIPAL ITEMS OF EQUIPMENT

<u>Equipment</u>	<u>Total</u>	<u>Equipment</u>	<u>Total</u>
Truck, Utility.....	2	Trailer, Cargo, 2-Axle.....	30
Truck, Light.....	4	Trailer, POL (1,200-Liter).....	15
Truck, Medium.....	45	Trailer, Kitchen.....	2
Van, Maintenance.....	1	Trailer, Water (1,200-Liter).....	1
Truck, Water (2,000-Liter).....	4	Trailer, Generator.....	1
Truck, POL (4,000 or 5,200-Liter).....	15	Radio, VHF, Manpack, Low-Power.....	1

**Maintenance Company, MRR (BMP or BTR) and TR,
MRD and TD**

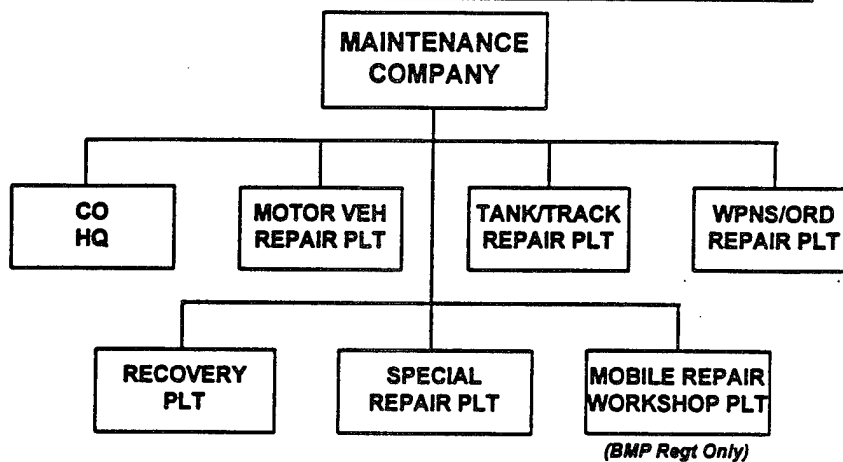

PRINCIPAL ITEMS OF EQUIPMENT

<u>Equipment</u>	<u>MRR</u>	<u>TR</u>	<u>Equipment</u>	<u>MRR</u>	<u>TR</u>
ATGL, RPG-7V.....	4.....	4	Trailer, Cargo, 2-Axle.....	6.....	6
Truck, Utility.....	1.....	1	Trailer, Generator.....	3.....	3
Truck, Medium.....	2.....	2	Radios:		
Van, Maintenance.....	12.....	12	VHF, Manpack,		
Armored Maintenance			Low-Power.....	1.....	1
Vehicle, MTP.....	3/0*	0	VHF, Vehicle Mount,		
Armored Recovery Vehicle.....	3.....	5	Medium-Power.....	6/3*	5

NOTES:

1. The special repair platoon consists of an arc and gas welding section, battery repair and recharging section, and electrical repair section.
2. The mobile repair workshop platoon consists of three sections, each equipped with an MTP armored maintenance vehicle. During field operations, one MTP will support each MRB (BMP).

FOOTNOTE: * Equipment levels for MRR (BMP)/MRR(BTR).

**Regimental Medical Point, MRR (BMP or BTR) and TR or
Arty Regt, MRD and TD**

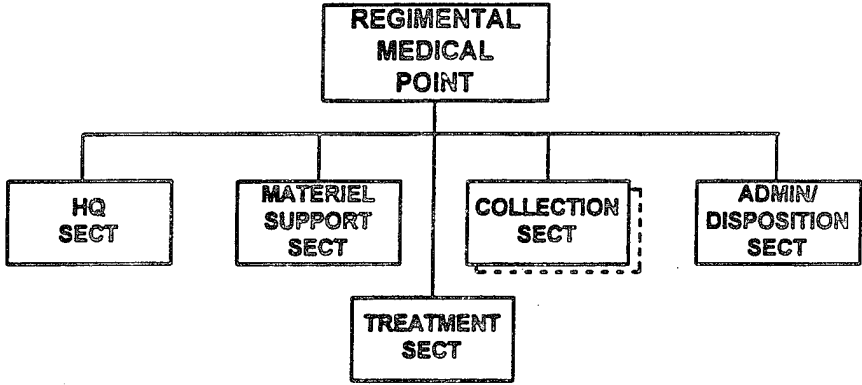

PRINCIPAL ITEMS OF EQUIPMENT

<u>Equipment</u>	<u>Total</u>	<u>Equipment</u>	<u>Total</u>
Van, Hospital	1	Trailer, Kitchen	1
Truck, Medium	2	Trailer, Water (1,200-Liter)	1
Truck, Decon, DDA-53/66.....	1	Radio, VHF, Manpack, Low-Power	1
Truck, Light	1		
Ambulance	4		

- NOTE:**
1. General purpose trucks may serve as ambulances.
 2. If there are two collection sections, there is a second hospital van.

**Motorized Rifle Battalion (BMP), MRR (BMP) and TR,
MRD and TD or IMRB**

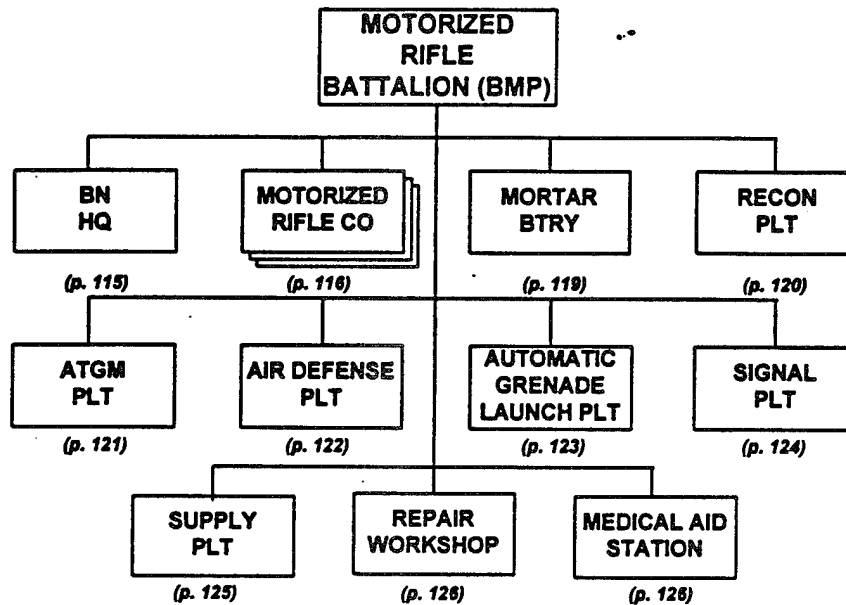

PRINCIPAL ITEMS OF EQUIPMENT

<u>Equipment</u>	<u>Total</u>
AICV, BMP-1/2/3.....	41
ACV, BMP-1K/2K/3K	1
ACV, BMP-1KSh.....	1
ACV, BRM-1K*.....	1
ACV, BTR (R-145BM)	2
120-mm Mortar, M1943/2S12 or 82-mm Automatic Mortar, 2B9.....	6
ATGL, RPG-7V.....	36
ATGM Manpack, AT-4/SPIGOT	6
SAM, SA-16/18	9
9-mm Pistol, PM.....	158
5.45-mm Assault Rifle, AK-74.....	290
5.45-mm LMG, RPK-74.....	30
7.62-mm Sniper Rifle, SVD.....	10
30-mm Automatic Grenade Launcher, AGS-17	6
Truck, Utility.....	3
Truck, Light	13
Truck, Medium	4
Van, Maintenance	1

<u>Equipment</u>	<u>Total</u>
Van, Kitchen	1
Truck, POL (4,000 or 5,200-Liter)	2
Ambulance	1
Trailer, POL (900-Liter)	1
Trailer, Cargo, 1-Axle.....	2
Trailer, Generator.....	1
Trailer, Water (900-Liter)	1
Trailer, Kitchen	3
Rangefinder, Stereoscopic, DS-1 or DM-09/DAK-1.....	1
Perscopic Aiming Circle, PAB2A	1
Collimator (Aiming Stakes).....	6
Radios:	
VHF, Manpack, Low-Power.....	14
VHF, Portable, Low-Power	22
VHF, Portable, Very-Low-Power	4
VHF, Vehicle Mount, Medium-Power	46
HF, Vehicle Mount, Medium-Power	3
Warning Receiver	1

NOTES:

1. The same BMP battalion organization is also found in the TR, TD. However, the TR, MRD has no BMP battalion.
2. The ATGM platoon may be equipped with nine AT-7/SAXHORN launchers rather than the six AT-4/SPIGOT launchers shown here. In either case, its ATGM assets and vehicles may be divided among the three MRCs.

FOOTNOTE: * This system includes the TALL MIKE battlefield surveillance radar.

**Headquarters, MRB (BMP), MRR (BMP) and TR,
MRD and TD or IMRB**

**BATTALION
HEADQUARTERS**

PRINCIPAL ITEMS OF EQUIPMENT

Equipment	Total	Equipment	Total
9-mm Pistol, PM.....	6	Radios:	
5.45-mm Assault Rifle, AK-74.....	8	VHF, Manpack, Low-Power.....	2
ACV, BMP-1K/2K/3K.....	1	VHF, Portable, Low-Power.....	1
ACV, BMP-1KSh*.....	1	VHF, Vehicle Mount,	
Truck, Utility.....	1	Medium-Power.....	2
Truck, Light.....	1	HF, Vehicle Mount, Medium-Power.....	2
		Warning Receiver.....	1

FOOTNOTE: * In lieu of this BMP-1KSh, some battalion headquarters may have an ACV, BTR (R-145BM).

**Motorized Rifle Company (BMP), MRB, MRR (BMP)
and TR, MRD and TD or IMRB**

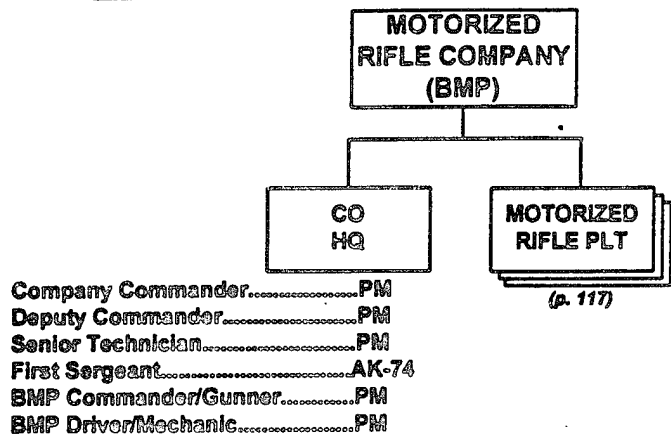

PRINCIPAL ITEMS OF EQUIPMENT

<u>Equipment</u>	<u>Total</u>	<u>Equipment</u>	<u>Total</u>
AICV, BMP-1/2/3	10	Radios:	
9-mm Pistol, PM	35	VHF, Manpack, Low-Power	1
5.45-mm Assault Rifle, AK-74	46	VHF, Portable, Low-Power	4
5.45-mm LMG, RPK-74	9	VHF, Vehicle Mount,	
7.62-mm Sniper Rifle, SVD	3	Medium-Power	10
ATGL, RPG-7V	9		

NOTES:

1. The company headquarters has one BMP.
2. The manpack ATGM launchers of the MRB's ATGM platoon may be divided among the battalion's three MRCs. In this case, the company would have one additional BMP carrying two AT-4/SPIGOT launchers (or three AT-7/SAXHORN launchers).

**Motorized Rifle Platoon (BMP), MRC, MRB, MRR (BMP) and TR,
MRD and TD or IMRB**

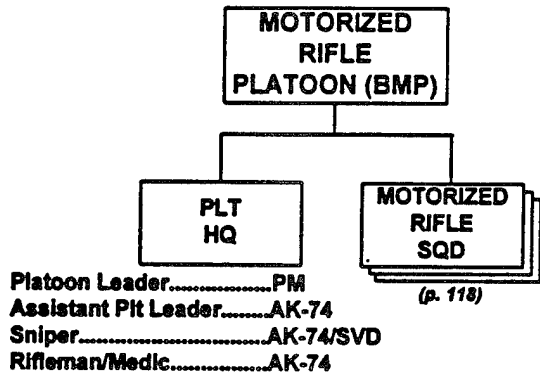

PRINCIPAL ITEMS OF EQUIPMENT

<u>Equipment</u>	<u>Total</u>	<u>Equipment</u>	<u>Total</u>
AICV, BMP-1/2/3.....	3	ATGL, RPG-7V.....	3
9-mm Pistol, PM.....	10	Radios:	
5.45-mm Assault Rifle, AK-74.....	15	VHF, Portable, Low-Power	1
5.45-mm LMG, RPK-74.....	3	VHF, Vehicle Mount, Medium-Power ..	3
7.62-mm Sniper Rifle, SVD.....	1		

NOTE: With a standard eight-man squad, each BMP has two or three empty seats. The platoon leader and sniper normally ride in the first squad vehicle, the assistant platoon leader in the second, and the rifleman/medic in the third.

**Motorized Rifle Squad (BMP), MRP, MRC, MRB, MRR (BMP)
and TR, MRD and TD or IMRB**

**MOTORIZED
RIFLE
SQUAD (BMP)**

Squad Leader/BMP Commander.....AK-74
 Asst. Squad Leader/BMP Gunner.....PM
 BMP Driver/Mechanic.....PM
 Machine Gunner.....RPK-74
 Grenadier.....RPG-7V, PM
 Senior Rifleman.....AK-74
 Rifleman/Asst. Grenadier.....AK-74
 Rifleman.....AK-74

PRINCIPAL ITEMS OF EQUIPMENT

<u>Equipment</u>	<u>Total</u>	<u>Equipment</u>	<u>Total</u>
AICV, BMP-1/2/3.....	1	ATGL, RPG-7V.....	1
9-mm Pistol, PM.....	3	Radio, VHF, Vehicle Mount, Medium-Power.....	1
5.45-mm Assault Rifle, AK-74.....	4		
5.45-mm LMG, RPK-74.....	1		

NOTES:

1. The dismounted squad assault element consists of six personnel. The BMP driver/mechanic and assistant squad leader/BMP gunner remain with the BMP to provide fire support. The dismounted squad does not have a portable radio.
2. Some squads may have a second machine gunner in lieu of the rifleman.

**Mortar Battery, MRB, MRR (BMP or BTR) and TR,
MRD and TD or IMRB**

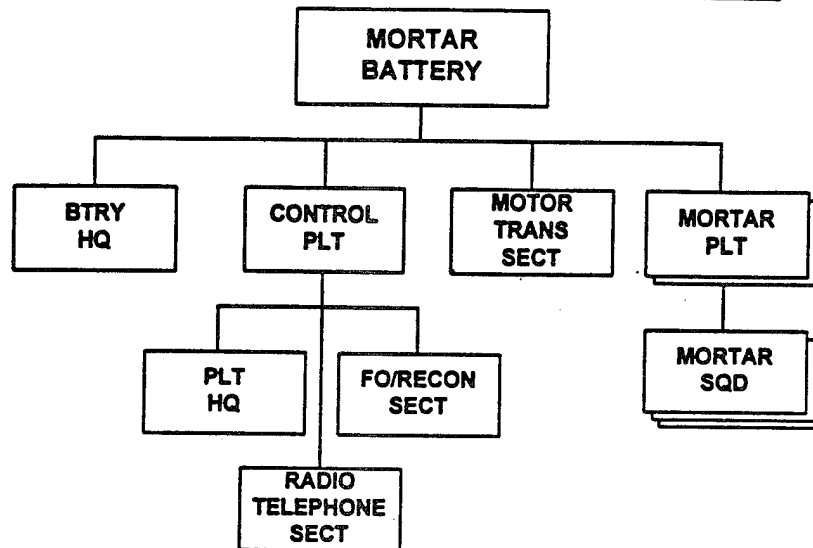

PRINCIPAL ITEMS OF EQUIPMENT

Equipment	Total	Equipment	Total
120-mm Mortar, M1943/2S12 or 82-mm Automatic Mortar, 2B9	6	Stereoscopic Rangefinder, DS-1 or DM-09/DAK-1	1
9-mm Pistol, PM	14	Periscopic Aiming Circle, PAB2A	1
5.45-mm Assault Rifle, AK-74	47	Collimator (Aiming Stakes)	6
ATGL, RPG-7V	6	Radio, VHF, Manpack, Low-Power	4
Truck, Utility	1		
Truck, Light	7		

**Reconnaissance Platoon, MRB (BMP), MRR (BMP) and TR,
MRD and TD or IMRB**

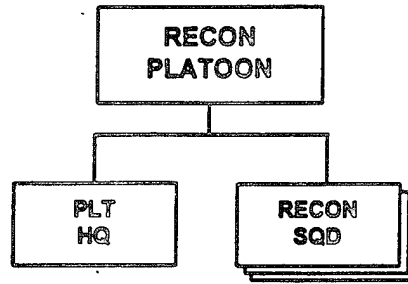

PRINCIPAL ITEMS OF EQUIPMENT

<u>Equipment</u>	<u>Total</u>	<u>Equipment</u>	<u>Total</u>
AICV, BMP-1/2/3.....	2	7.62-mm Sniper Rifle, SVD.....	1
ACV, BRM-1K*.....	1	ATGL, RPG-7V.....	3
9-mm Pistol, PM.....	10	Radios:	
5.45-mm Assault Rifle, AK-74.....	15	VHF, Portable, Low-Power.....	1
5.45-mm LMG, RPK-74.....	3	VHF, Vehicle Mount, Medium-Power..	3

NOTE: The platoon leader, assistant platoon leader, sniper, and rifleman/medic ride in extra seats in the recon squad vehicles.

FOOTNOTE: * This system includes the TALL MIKE battlefield surveillance radar.

**ATGM Platoon, MRB (BMP), MRR (BMP) and TR,
MRD and TD or IMRB**

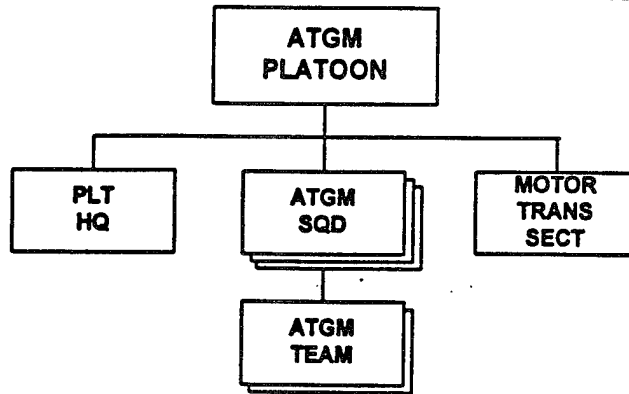

PRINCIPAL ITEMS OF EQUIPMENT

<u>Equipment</u>	<u>Total</u>	<u>Equipment</u>	<u>Total</u>
ATGM, Manpack, AT-4/SPIGOT	6	Radios:	
AICV, BMP-1/2/3	3	VHF, Portable, Low-Power	4
9-mm Pistol, PM	7	VHF, Vehicle Mount, Medium-Power ..	3
5.45-mm Assault Rifle, AK-74	18		

NOTES:

1. The ATGM platoon of the BMP-equipped MRB may be equipped with the nine AT-7/SAXHORN launchers rather than the six AT-4/SPIGOT launchers shown here.
2. The ATGM launchers and vehicles of this platoon may be divided among the battalion's three MRCs.

**Air Defense Platoon, MRB (BMP), MRR (BMP) and TR,
MRD and TD or IMRB**

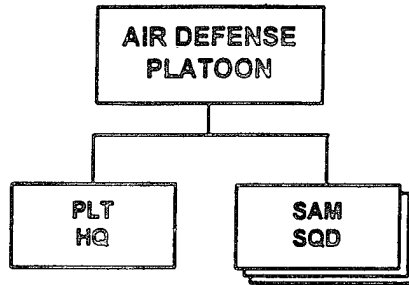

PRINCIPAL ITEMS OF EQUIPMENT

<u>Equipment</u>	<u>Total</u>	<u>Equipment</u>	<u>Total</u>
SAM, SA-16/18	9	Radios:	
AICV, BMP-1/2/3	3	VHF, Portable, Very-Low-Power	4
9-mm Pistol, PM	4	VHF, Vehicle Mount, Medium-Power ..	3
5.45-mm Assault Rifle, AK-74	9		

NOTE: Each MRC normally has one SAM squad attached.

**Automatic Grenade Launcher Platoon, MRB (BMP),
MRR (BMP) and TR, MRD and TD or IMRB**

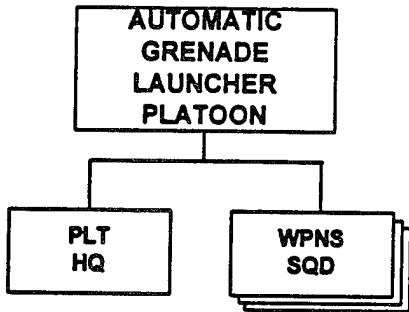

PRINCIPAL ITEMS OF EQUIPMENT

<u>Equipment</u>	<u>Total</u>	<u>Equipment</u>	<u>Total</u>
30-mm Automatic Grenade Launcher, AGS-17	6	5.45-mm Assault Rifle, AK-74	12
AICV, BMP-1/2/3	3	Radios:	
9-mm Pistol, PM	10	VHF, Vehicle Mount, Medium-Power ..	3
		VHF, Portable, Low-Power	4

**Signal Platoon, MRB, MRR (BMP or BTR) and TR,
MRD and TD or IMRB**

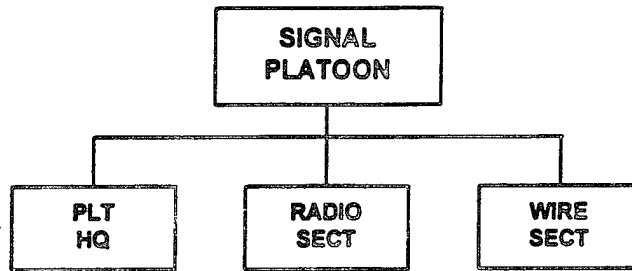

PRINCIPAL ITEMS OF EQUIPMENT

<u>Equipment</u>	<u>Total</u>
ACV, BTR (R-145BM)	2
9-mm Pistol, PM	1
5.45-mm Assault Rifle, AK-74	13
Truck, Utility.....	1
Truck, Light	1

<u>Equipment</u>	<u>Total</u>
Radios:	
VHF, Manpack, Low-Power	3
VHF, Vehicle Mount, Medium-Power ..	2
HF, Vehicle Mount, Medium-Power	1

**Supply Platoon, MRB, MRR (BMP or BTR) and TR,
MRD and TD or IMRB**

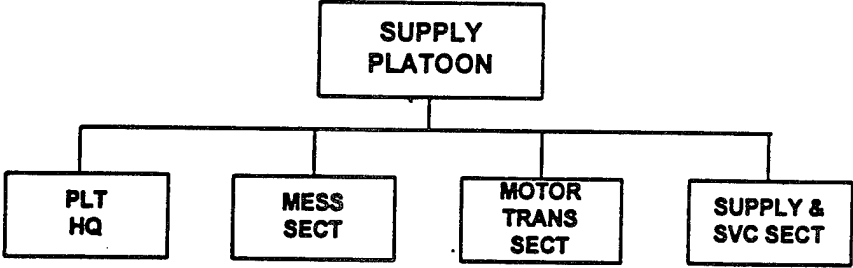

PRINCIPAL ITEMS OF EQUIPMENT

Equipment	Total	Equipment	Total
9-mm Pistol, PM.....	1	Trailer, POL (900-Liter)	1
5.45-mm Assault Rifle, AK-74.....	19	Trailer, Cargo, 1-Axle.....	1
Truck, Light	4	Trailer, Water (900-Liter)	1
Truck, Medium	4	Trailer, Kitchen.....	3
Truck, POL (4,000 or 5,200-Liter)	2	Radios, VHF, Manpack, Low-Power.....	1
Van, Kitchen	1		

**Repair Workshop, MRB, MRR (BMP or BTR) and TR,
MRD and TD or IMRB**

**REPAIR
WORKSHOP**

PRINCIPAL ITEMS OF EQUIPMENT

<u>Equipment</u>	<u>Total</u>	<u>Equipment</u>	<u>Total</u>
5.45-mm Assault Rifle, AK-74.....	7	Trailer, Generator.....	1
Van, Maintenance	1		

**Medical Aid Station, MRB, MRR (BMP or BTR) and TR,
MRD and TD or IMRB**

**MEDICAL
AID STATION**

PRINCIPAL ITEMS OF EQUIPMENT

<u>Equipment</u>	<u>Total</u>	<u>Equipment</u>	<u>Total</u>
5.45-mm Assault Rifle, AK-74.....	4	Trailer, Cargo, 1-Axle.....	1
Ambulance	1	Radio, VHF, Manpack, Low-Power	1

Motorized Rifle Battalion (BTR), MRR (BTR), MRD or IMRB

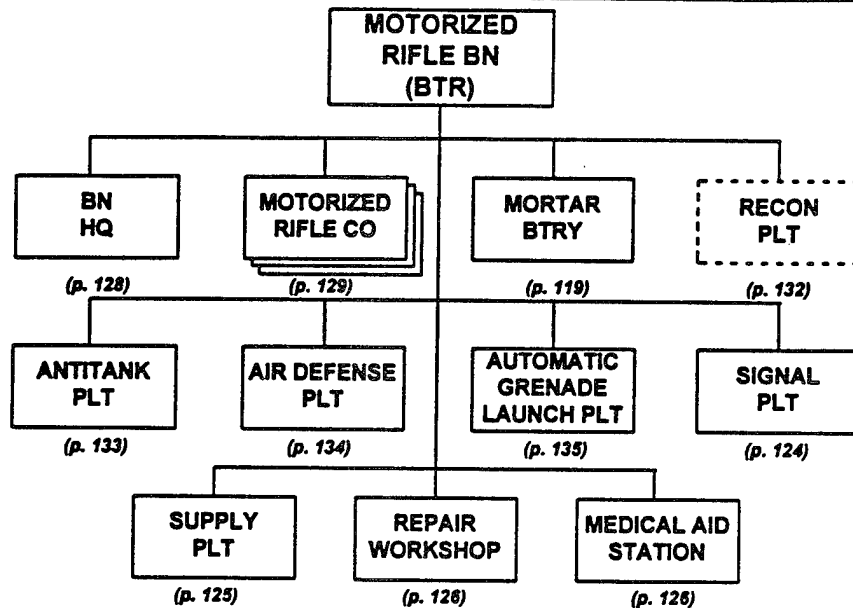

PRINCIPAL ITEMS OF EQUIPMENT

<u>Equipment</u>	<u>Total</u>	<u>Equipment</u>	<u>Total</u>
APC, BTR-60/70/80	47	Van, Kitchen	1
ACV, BTR-60PBK/70K/80K	1	Truck, POL (4,000 or 5,200-Liter)	2
ACV, BTR (R-145BM)	3	Ambulance	1
9-mm Pistol, PM	171	Trailer, POL (900-Liter)	1
5.45-mm Assault Rifle, AK-74	315	Trailer, Cargo, 1-Axle	2
5.45-mm LMG, RPK-74	30	Trailer, Generator	1
7.62-mm Sniper Rifle, SVD	10	Trailer, Water (900-Liter)	1
30-mm Automatic Grenade Launcher, AGS-17	6	Trailer, Kitchen	3
120-mm Mortar, M1943/2S12 or 82-mm Automatic Mortar, 2B9	6	Rangefinder, Stereoscopic, DS-1 or DM-09/DAK-1	1
ATGL, RPG-7V	36	Periscopic Aiming Circle, PAB2A	1
73-mm Recoilless Gun, SPG-9	3	Collimator (Aiming Stakes)	6
ATGM Manpack, AT-4/SPIGOT	6	Radios:	
ATGM Manpack, AT-7/SAXHORN	9	VHF, Manpack, Low-Power	14
SAM, SA-16/18	9	VHF, Portable, Low-Power	28
Truck, Utility	3	VHF, Portable, Very-Low-Power	4
Truck, Light	13	VHF, Vehicle Mount, Medium-Power	51
Truck, Medium	4	HF, Vehicle Mount, Medium-Power	3
Van, Maintenance	1	Warning Receiver	1

NOTE: Some BTR-equipped MRBs do not have a reconnaissance platoon. However, the battalion's equipment totals shown here include that platoon.

Headquarters, MRB (BTR), MRR (BTR), MRD or IMRB

**BATTALION
HEADQUARTERS**

PRINCIPAL ITEMS OF EQUIPMENT

<u>Equipment</u>	<u>Total</u>	<u>Equipment</u>	<u>Total</u>
9-mm Pistol, PM	6	Radios:	
5.45-mm Assault Rifle, AK-74	8	VHF, Manpack, Low-Power	2
ACV, BTR-60PBK/70K/80K	1	VHF, Portable, Low-Power	1
ACV, BTR (R-145BM)	1	VHF, Vehicle Mount, Medium-Power ..	2
Truck, Utility	1	HF, Vehicle Mount, Medium-Power	2
Truck, Light	1	Warning Receiver	1

**Motorized Rifle Company (BTR), MRB,
MRR (BTR), MRD or IMRB**

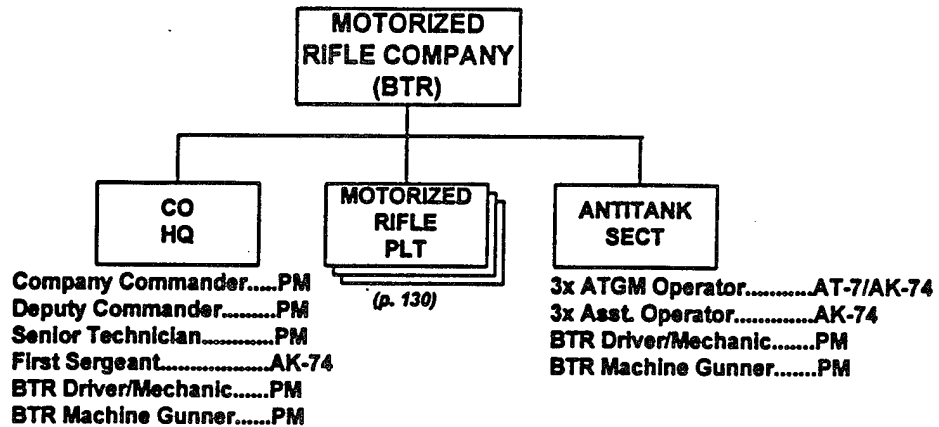

PRINCIPAL ITEMS OF EQUIPMENT

Equipment	Total	Equipment	Total
APC, BTR-60/70/80	11	ATGM Manpack, AT-7/SAXHORN.....	3
9-mm Pistol, PM.....	37	Radios:	
5.45-mm Assault Rifle, AK-74.....	52	VHF, Manpack, Low-Power.....	1
5.45-mm LMG, RPK-74.....	9	VHF, Portable, Low-Power.....	5
7.62-mm Sniper Rifle, SVD.....	3	VHF, Vehicle Mount,	
ATGL, RPG-7V.....	9	Medium-Power.....	11

NOTE: The company headquarters and the antitank section each have one BTR.

**Motorized Rifle Platoon (BTR), MRC, MRB,
MRR (BTR), MRD or IMRB**

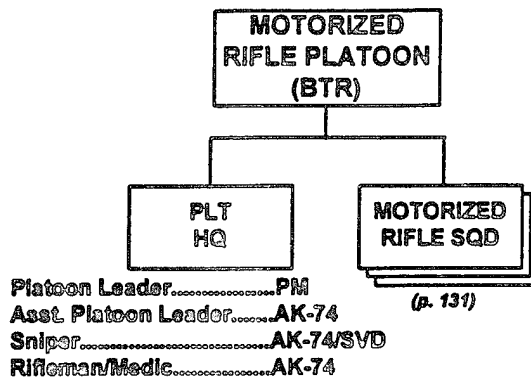

PRINCIPAL ITEMS OF EQUIPMENT

<u>Equipment</u>	<u>Total</u>	<u>Equipment</u>	<u>Total</u>
APC, BTR-60/70/80	3	ATGL, RPG-7V	3
9-mm Pistol, PM.....	10	Radios:	
5.45-mm Assault Rifle, AK-74.....	15	VHF, Portable, Low-Power	1
5.45-mm LMG, RPK-74.....	3	VHF, Vehicle Mount, Medium-Power ..	3
7.62-mm Sniper Rifle, SVD.....	1		

NOTE: With a standard eight-man squad, each BTR has three empty seats. The platoon leader and the sniper normally ride in the first squad vehicle, the assistant platoon leader in the second, and the rifleman/medic in the third.

**Motorized Rifle Squad (BTR), MRP, MRC, MRB,
MRR (BTR), MRD or IMRB**

**MOTORIZED
RIFLE SQUAD
(BTR)**

Squad Leader/BTR Commander.....AK-74
 BTR Driver/Mechanic.....PM
 BTR Machine Gunner.....PM
 Machine Gunner.....RPK-74
 Grenadier.....RPG-7V, PM
 Rifleman/Asst. Grenadier.....AK-74
 Senior Rifleman/Asst. Squad Leader...AK-74
 Rifleman.....AK-74

PRINCIPAL ITEMS OF EQUIPMENT

<u>Equipment</u>	<u>Total</u>	<u>Equipment</u>	<u>Total</u>
APC, BTR-60/70/80	1	5.45-mm LMG, RPK-74	1
9-mm Pistol, PM	3	ATGL, RPG-7V	1
5.45-mm Assault Rifle, AK-74	4		

NOTES:

1. The dismounted squad element consists of six personnel. The BTR driver/mechanic and BTR machine gunner remain with the BTR to provide fire support. The dismounted squad does not have a portable radio.
2. Some squads may have a second machine gunner in lieu of the rifleman.

Reconnaissance Platoon, MRB (BTR), MRR (BTR), MRD or IMRB

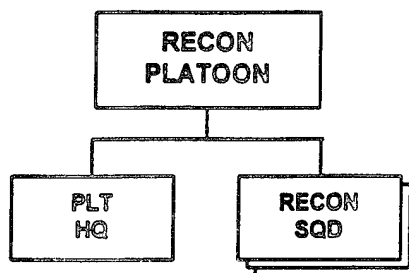

PRINCIPAL ITEMS OF EQUIPMENT

<u>Equipment</u>	<u>Total</u>	<u>Equipment</u>	<u>Total</u>
APC, BTR-60/70/80	3	ATGL, RPG-7V	3
9-mm Pistol, PM	10	Radios:	
5.45-mm Assault Rifle, AK-74	15	VHF, Portable, Low-Power	1
5.45-mm LMG, RPK-74	3	VHF, Vehicle Mount, Medium-Power ..	3
7.62-mm Sniper Rifle, SVD	1		

NOTES:

1. The platoon leader, assistant platoon leader, sniper, and rifleman/medic ride in extra seats in the reconnaissance squad vehicles.
2. This platoon is not always present in BTR-equipped MRBs.

**Antitank Platoon, MRB (BTR), MRR (BTR),
MRD or IMRB**

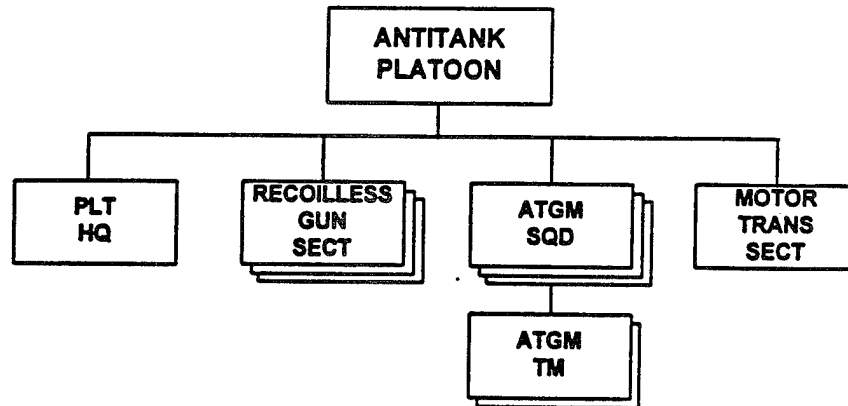

PRINCIPAL ITEMS OF EQUIPMENT

Equipment	Total	Equipment	Total
APC, BTR-60/70/80	5	5.45-mm Assault Rifle, AK-74	25
ATGM Manpack, AT-4/SPIGOT	6	Radios:	
73-mm Recoilless Gun, SPG-9	3	VHF, Portable, Low-Power	7
9-mm Pistol, PM	14	VHF, Vehicle Mount, Medium-Power ..	5

NOTES:

1. Each BTR can carry one or two recoilless gun sections or two ATGM teams.
2. The platoon leader and assistant platoon leader ride in extra seats in the recoilless gun and ATGM squad vehicles.

**Air Defense Platoon, MRB (BTR), MRR (BTR),
MRD or IMRB**

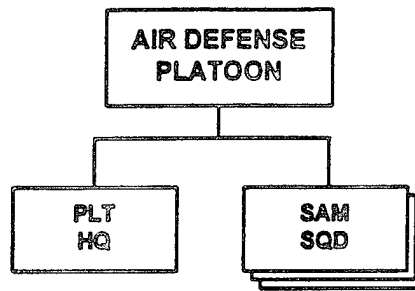

PRINCIPAL ITEMS OF EQUIPMENT

<u>Equipment</u>	<u>Total</u>	<u>Equipment</u>	<u>Total</u>
SAM, SA-16/18	9	Radios:	
APC, BTR-60/70/80	3	VHF, Portable, Very-Low-Power	4
9-mm Pistol, PM	4	VHF, Vehicle Mount, Medium-Power ..	3
5.45-mm Assault Rifle, AK-74	9		

NOTE: Each MRC normally has one SAM squad attached.

**Automatic Grenade Launcher Platoon, MRB (BTR),
MRR (BTR), MRD or IMRB**

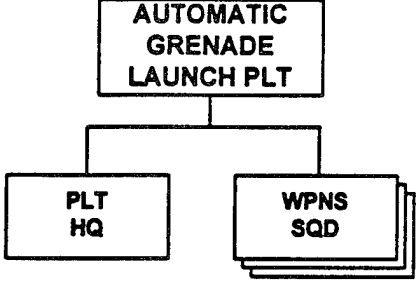

PRINCIPAL ITEMS OF EQUIPMENT

<u>Equipment</u>	<u>Total</u>
30-mm Automatic Grenade Launcher, AGS-17	6
APC, BTR-60/70/80	3
9-mm Pistol, PM.....	10

<u>Equipment</u>	<u>Total</u>
5.45-mm Assault Rifle, AK-74.....	12
Radios:	
VHF, Portable, Low-Power	4
VHF, Vehicle Mount, Medium-Power ..	3

**Tank Battalion (Standard), MRR (BMP or BTR) and TR,
MRR and TD**

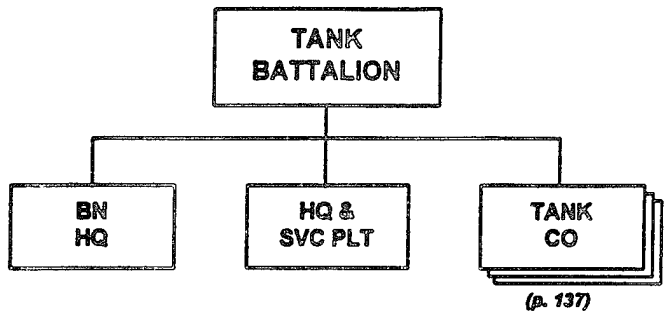

PRINCIPAL ITEMS OF EQUIPMENT

<u>Equipment</u>	<u>Total</u>	<u>Equipment</u>	<u>Total</u>
Medium Tank, T-64K/72K/80K (Command Vehicle).....	1	Trailer, Cargo, 1-Axle.....	1
Medium Tank, T-64/72/80.....	30	Trailer, Generator.....	1
ATGL, RPG-7V.....	2	Trailer, Water (900-Liter).....	1
ACV, BMP-1K/2K/3K.....	1	Radios:	
ACV, BTR (R-145BM).....	1	VHF, Manpack, Low-Power.....	1
Truck, Medium.....	7	VHF, Vehicle Mount, Medium-Power.....	33
Truck, POL (4,000 or 5,200-Liter).....	3	HF, Manpack, Low-Power.....	2
Van, Maintenance.....	1	HF, Vehicle Mount, Medium-Power.....	5
Van, Kitchen.....	1	Warning Receiver.....	1
Ambulance.....	1		
Trailer, Cargo, 2-Axle.....	6		

**Tank Company (Standard), TB, MRR (BMP or BTR)
and TR, MRD and TD or IMRB**

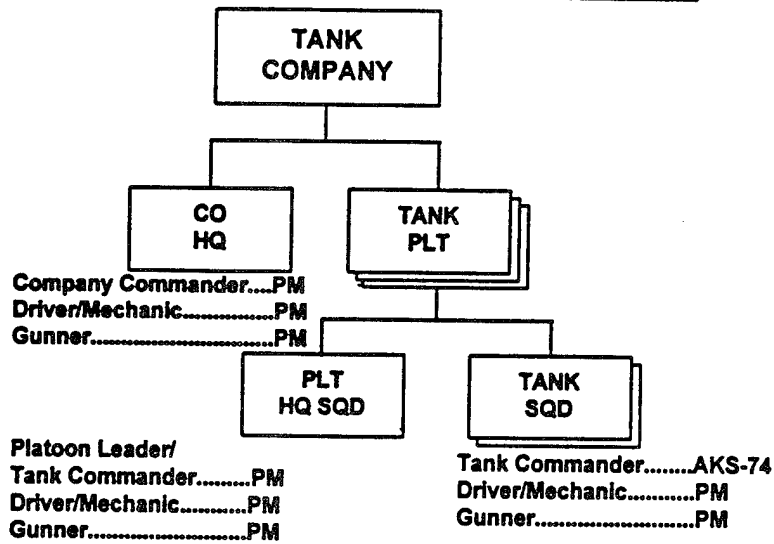

PRINCIPAL ITEMS OF EQUIPMENT

<u>Equipment</u>	<u>Total</u>	<u>Equipment</u>	<u>Total</u>
Medium Tank, T-64/72/80.....	10	Radios:	
9-mm Pistol, PM.....	24	VHF, Vehicle Mount,	
5.45-mm Assault Rifle, AKS-74.....	6	Medium-Power	10
		HF, Vehicle Mount, Medium-Power	1

NOTE: In companies equipped with tanks (such as T-54/55/62) without automatic loaders, each tank would have one additional crew member, a loader. The loader carries a PM pistol.

Tank Battalion (40-Tank Variant), MRR (BMP or BTR), MRD and TD

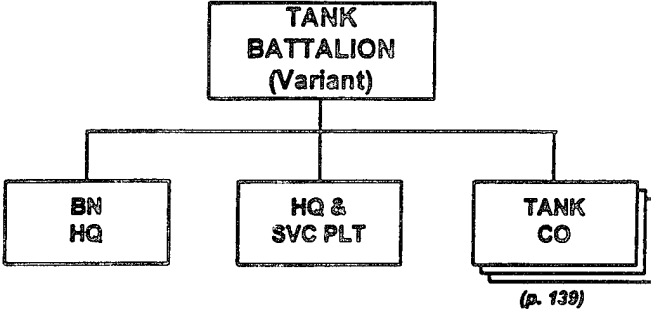

PRINCIPAL ITEMS OF EQUIPMENT

<u>Equipment</u>	<u>Total</u>	<u>Equipment</u>	<u>Total</u>
Medium Tank, T-64K/72K/80K (Command Vehicle).....	1	Trailer, Cargo, 2-Axle.....	8
Medium Tank, T-64/72/80.....	39	Trailer, Cargo, 1-Axle.....	1
ATGL, RPG-7V.....	2	Trailer, Generator.....	1
ACV, BMP-1K/2K/3K.....	1	Trailer, Water (900-Liter).....	1
ACV, BTR (R-145BM).....	1	Radios:	
Truck, Medium.....	7	VHF, Manpack, Low-Power.....	1
Truck, POL (4,000 or 5,200-Liter).....	3	VHF, Vehicle Mount,	
Van, Maintenance.....	1	Medium-Power.....	42
Van, Kitchen.....	1	HF, Manpack, Low-Power.....	2
Ambulance.....	1	HF, Vehicle Mount, Medium-Power.....	5
		Warning Receiver.....	1

NOTE: This variant differs from the standard 31-tank battalion by having 13 tanks per company rather than the normal 10.

Tank Company (13-Tank Variant), TB (40-Tank Variant), MRR (BMP or BTR), MRD and TD

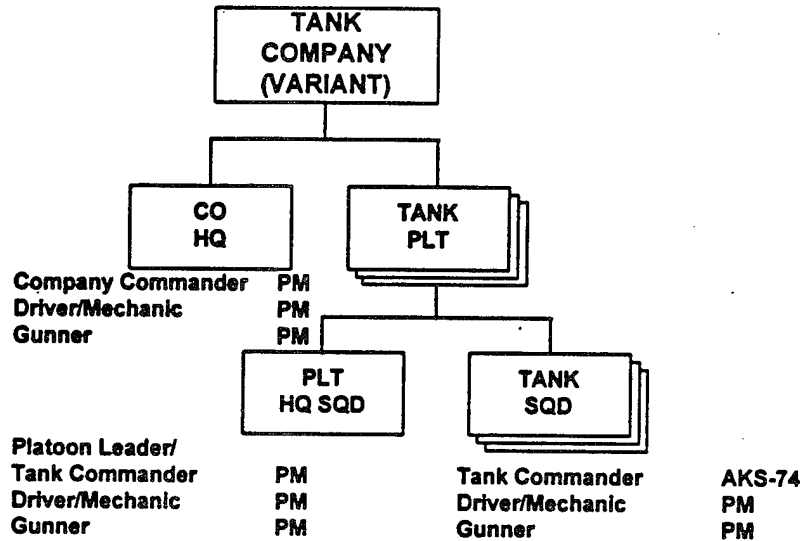

PRINCIPAL ITEMS OF EQUIPMENT

<u>Equipment</u>	<u>Total</u>	<u>Equipment</u>	<u>Total</u>
Medium Tank, T-64/72/80.....	13	Radios:	
9-mm Pistol, PM.....	30	HF, Vehicle Mount, Medium-Power	1
5.45-mm Assault Rifle, AKS-74.....	9	VHF, Vehicle Mount,	
		Medium-Power	13

NOTES:

1. This variant differs from the standard 10-tank company by having 4 tanks per platoon rather than the normal 3.
2. In companies equipped with tanks (such as T-54/55/62) without automatic loaders, each tank would have one additional crew member, a loader. The loader carries a PM pistol.

Independent Motorized Rifle Brigade, Army Corps or Army or Front

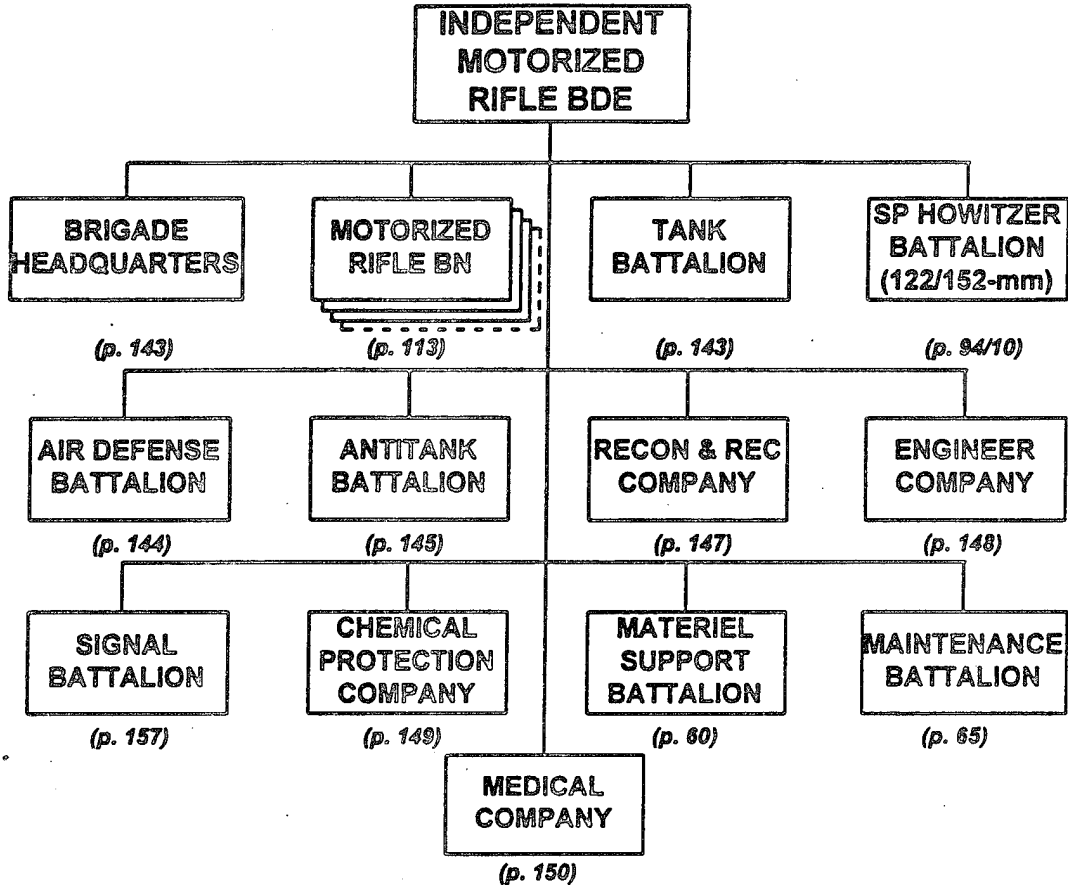

NOTES:

1. An independent motorized rifle brigade most likely has four MRBs and one 51-tank TB. However, the mix might be three MRBs and two 31-tank TBs. The MRBs are most likely BMP-equipped (see p. 113), although there may be some BTR-equipped battalions (see p. 127).
2. When there is a single SP howitzer battalion, it may be either 122-mm or 152-mm, with 152-mm most likely. When there are two battalions, there may be one 122-mm and one 152-mm or, more likely, both 152-mm.

INDEPENDENT MOTORIZED RIFLE BRIGADE														
Principal Items of Equipment	Brigade HQ	Motorized Rifle Bn (BMF) (4x)	Tank Bn	SP Howitzer Bn (2x)	Air Defense Bn	Amphibian Bn	Recon & REC Co	Engineer Co	Signal Bn	Chem Protection Co	Material Support Bn	Maintenance Bn	Medical Co	TOTAL
ARMORED VEHICLES														
Medium Tank, T-64K/72K/80K			1											1
Medium Tank, T-64/72/80			50											50
ACV, BMP-1K/2K/3K		4	1											5
AICV, BMP-1/2/3		164					4							168
AICV, BMP-2					6									6
ACV, BRM-1K w/ TALL MIKE		4					3							7
ACV, BTR-60PBK/70K/80K	1													1
APC, BTR-60/70/80								3						3
ACV, BTR (R-145BM)		8	1			5			8					22
APC, BTR-60PA (FAC)	1													1
ASC, BRDM-2							4							4
Chem Recon Vehicle, BRDM-2RKh/RKhM									4					4
Mobile Recon Post, PRP-3/4				2										2
Prime Mover, MT-LBT						14								14
ACRV, 1V13/1V13M/1V22				6										6
ACRV, 1V14/1V14M/1V23				6										6
ACRV, 1V15/1V15M/1V24				2										2
ACRV, 1V16/1V16M/1V25				2										2
ACV, PPRU (DOG EAR)					2									2
ACV, BTR-60 (PU-12)					4									4
Armored Recovery Vehicle												5		5
WEAPONS														
30-mm Auto Grenade Launcher, AGS-17		24												24
120-mm Mortar, M1943/2S12 or 82-mm Automatic Mortar, 2B9		24												24
152-mm SP Howitzer, 2S3 or 2S19				36										36
100/125mm AT Gun, MT-12/2A45M						12								12
ATGM Manpack, AT-4/SPIGOT		24												24
ATGM Vehicle, 9P148 w/ AT-5/SPANDREL						12								12
30-mm SPAA System, 2S6					6									6
SAM, SA-13/GOPHER					6									6
SAM, SA-15/GAUNTLET					8									8
SAM, SA-16/18	3	36		24										63
ENGINEER EQUIPMENT														
Bridge, Tank-Launched							2							2
Bridge, Truck-Launched							4							4
Tracked Amphibian, K-61/PTS											1			1
Minelayer, GMZ							3							3
Mineclearing Plow							15							15
Mine Roller-Plow							5							5
Mine Detector, DIM							1							1
Armored Engineer Tractor, IMR							1							1
Ditching Machine, BTM/MDK							1							1
Ditching Machine, PZM/TMK							3							3
Dozer							1							1
Truck, Water Purification							1							1

INDEPENDENT MOTORIZED RIFLE BRIGADE (Continued)														
Principal Items of Equipment														
	Brigade HQ	Motorized Rifle Bn (BMP) (4x)	Tank Bn	SP Howitzer Bn (2x)	Air Defense Bn	AntiTank Bn	Recen & REC Co	Engineer Co	Signal Bn	Chem Protection Co	Material Support Bn	Maintenance Bn	Medical Co	TOTAL
TRUCKS														
Truck, Utility	3	12				3		1	12	2	7	5	1	46
Truck, Light		52			7	4		7	3	33	4			110
Truck, Medium	1	16	11	40	6	12		8	9	6	158	21	7	295
Truck, Heavy												1		1
Truck, Decca, ARS-12U/14										8				8
Truck, Decca, DDA-53/66										4				4
Truck, Decca, TMS-65										2				2
Truck, Dump								2						2
Truck, Crane					1			1			6	3		11
Truck, Crane Shovel								2						2
Truck, POL (4000-5200-L)		8	5	8		2			1	2	160	4		190
Truck, Recovery												2		2
Truck, Water (2000-L)										2	6	1		9
Tractor-Trailer, Lowboy												2		2
Van											1	3		4
Van, Command	3													3
Van, Kitchen		4	1								2			7
Van, Maintenance		4	1	4		2		1	4		11	42		69
Van, Mobile Field Bakery											4			4
Van, Signal				8		2			33		1	1		45
Ambulance		4	1	2		1			1		1	1	4	15
Bus									1					1
Sedan	1													1
TRAILERS														
Trailer, Cargo, 1-Axle		8	1						10		2			21
Trailer, Cargo, 2-Axle			10	34	5	10		2			124	14	7	206
Trailer, Generator		4	1	4	2	1			10		6	7		35
Trailer, Kitchen		12		6	3	2			2			3		28
Trailer, POL (900-1200-L)		4		8		1			1		160	4		178
Trailer, Water (900-1200-L)		4	1	2		1			1	4	7	1		21
RADARS														
Radar, BS, Man-Portable, PSNR-1						3								3
RADIOS														
VHF, Manpack, Low-Power	3	56	1	20	2	10	4		20	4	5	5	1	131
VHF, Portable, Low-Power		88			4									92
VHF, Portable, Very-Low-Power		16			4									20
VHF, Vehicle Mount, Medium-Power	2	184	53	56	32	31	11	9	6	4		4		392
HF or VHF, Manpack, Low-Power								4						4
HF, Manpack, Low-Power			2				1		5	2	1			11
HF, Vehicle Mount, Medium-Power		12	7		1	1	1		8			1		31
HF/VHF, Vehicle Mount, High-Power									8					8
HF/VHF, Vehicle Mount, Medium-Power					3				7		1	1		12
Communication Center									2					2
Radio Relay, VHF/UHF						1			6					7
Warning Receiver		4	1	4	6	1	1		3		1	1		22
MISCELLANEOUS														
Rangefinder						3								3
Rangefinder, Laser, SAGE GLOSS				8										8
Rangefinder, Stereoscopic		4												4
Periscopic Aiming Circle		4												4
Collimator (Aiming Stakes)		24												24
SA-15 Transloader (TELAR Chassis)					4									4
Motorcycle									13			3		16

Headquarters, IMRB

**BRIGADE
HEADQUARTERS**

PRINCIPAL ITEMS OF EQUIPMENT

Equipment	Total	Equipment	Total
ACV, BTR-60PBK/70K/80K	1	Sedan	1
APC, BTR-60PA (FAC)	1	Radios:	
SAM, SA-16/18	3	VHF, Manpack, Low-Power	3
Truck, Utility	3	VHF, Vehicle Mount, Medium-Power	2
Truck, Medium	1		
Van, Command	3		

Tank Battalion, IMRB

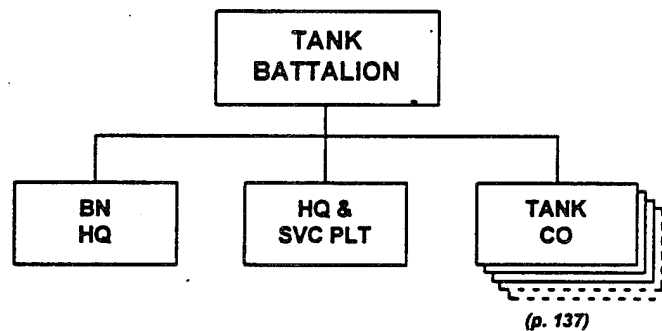

PRINCIPAL ITEMS OF EQUIPMENT

Equipment	Total	Equipment	Total
Medium Tank, T-64K/72K/80K (Command Vehicle)	1	Trailer, Cargo, 1-Axle	1
Medium Tank, T-64/72/80	30-50	Trailer, Generator	1
ATGL, RPG-7V	2	Trailer, Water (1,200-Liter)	1
ACV, BMP-1K/2K/3K	1	Radios:	
ACV, BTR (R-145BM)	1	VHF, Manpack, Low-Power	1
Truck, Medium	7-11	VHF, Vehicle Mount, Medium-Power	33-53
Truck, POL (4,000 or 5,200-Liter)	3-5	HF, Manpack, Low-Power	2
Van, Maintenance	1	HF, Vehicle Mount, Medium-Power	5-7
Van, Kitchen	1	Warning Receiver	1
Ambulance	1		
Trailer, Cargo, 2-Axle	6-10		

Air Defense Battalion, IMRB

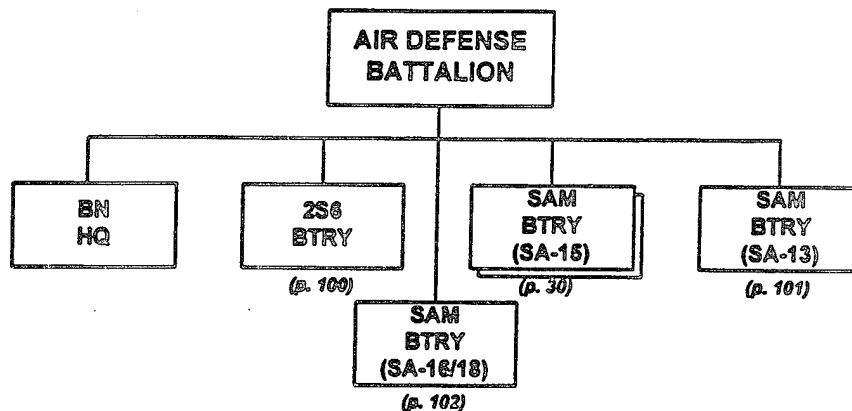

PRINCIPAL ITEMS OF EQUIPMENT

<u>Equipment</u>	<u>Total</u>	<u>Equipment</u>	<u>Total</u>
30-mm SPAA System, 2S6*	6	Trailer, Cargo, 2-Axle	5
SAM, SA-15/GAUNTLET TELAR**	8	Trailer, Generator	2
SAM, SA-13/GOPHER TELAR***	6	Trailer, Kitchen	3
SAM, SA-16/18	24	Radios:	
AICV, BMP-2	6	VHF, Manpack, Low-Power	2
ACV, PPRU****	2	VHF, Portable, Very-Low-Power	4
ACV, BTR-60 (PU-12)	4	VHF, Portable, Low-Power	4
SA-15 Missile Transloader (TELAR		VHF, Vehicle Mount,	
Chassis)	4	Medium-Power	32
Truck, Crane	1	HF, Vehicle Mount, Medium-Power	1
Truck, Light	7	Warning Receiver	6
Truck, Medium	6		

NOTE: In some IMRBs, the air defense battalion may have SA-8 equipped SAM batteries (see p. 31) rather than the SA-15 batteries shown here.

FOOTNOTES:

- * This system includes SA-19/GRISON SAM launchers and HOT SHOT target acquisition and fire control radars.
- ** This system includes the SCRUM HALF fire control/target acquisition radar.
- *** This system includes a raging radar.
- **** This system includes the the DOG EAR target acquisition and fire control radar.

Antitank Battalion, IMRB

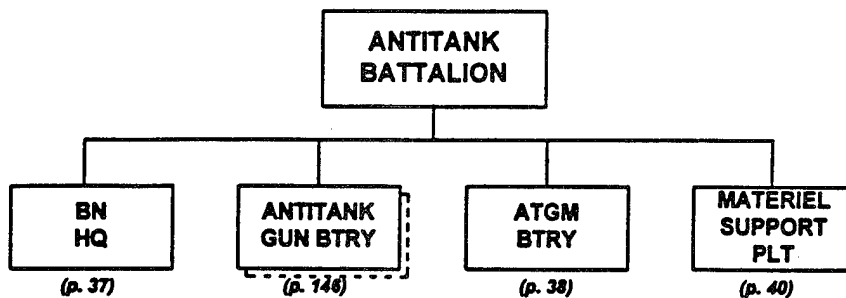

PRINCIPAL ITEMS OF EQUIPMENT

Equipment	Total	Equipment	Total
ATGM Vehicle , 9P148		Trailer, Generator.....	1
w/ AT-5/SPANDREL	12	Trailer, Water (900-Liter)	1
100/125-mm Antitank Gun,		Trailer, Kitchen	2
MT-12/2A45M.....	6-12	Rangefinder.....	2-3
ATGL, RPG-7V	12	Radar, Battlefield Surveillance,	
ACV, BTR (R-145BM)/BRDM-2U	5	Man-Portable, PSNR-1	2-3
Prime Mover, MT-LBT	7-14	Radios:	
Truck, Utility.....	3	VHF Manpack, Low-Power.....	9-10
Truck, Light	4	VHF, Vehicle Mount,	
Truck, Medium	12	Medium-Power	24-31
Van, Signal.....	2	HF, Vehicle Mount, Medium-Power	1
Van, Maintenance	2	HF/VHF, Vehicle Mount,	
Truck, POL (4,000 or 5,200-Liter)	2	Medium-Power	3
Ambulance	1	Radio Relay, VHF/UHF.....	1
Trailer, Cargo, 2-Axle.....	10	Warning Receiver	1
Trailer, POL (900-Liter)	1		

ATGM Battery, Antitank Bn, IMRB

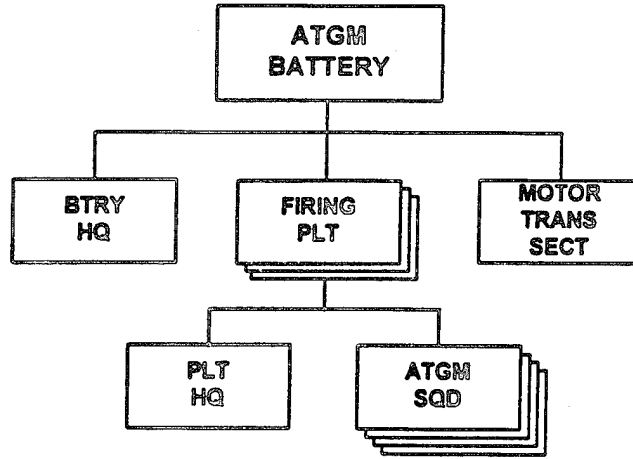

PRINCIPAL ITEMS OF EQUIPMENT

<u>Equipment</u>	<u>Total</u>	<u>Equipment</u>	<u>Total</u>
ATGM Vehicle, 9P148		Radar, Battlefield Surveillance,	
w/ AT-5/SPANDREL	12	Man -Portable, PSNR-1	1
ATGL, RPG-7V	12	Radios:	
ACV, BRDM-2U	4	VHF, Manpack, Low-Power	4
Truck, Medium	3	VHF, Vehicle Mount,	
Rangefinder	1	Medium-Power	16

**Reconnaissance and Radioelectronic Combat
Company, IMRB**

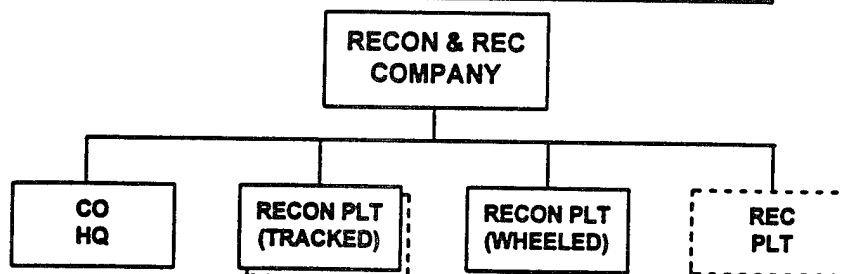

PRINCIPAL ITEMS OF EQUIPMENT

<u>Equipment</u>	<u>Total</u>	<u>Equipment</u>	<u>Total</u>
ATGL, RPG-7V	4-7	Radios:	
5.45-mm LMG, RPK-74	4-7	VHF, Manpack, Low-Power	3-4
ACV, BRM-1K*	2-3	VHF, Vehicle Mount,	
AICV, BMP-1/2/3	2-4	Medium-Power	8-11
ASC, BRDM-2	4	HF, Manpack, Low-Power	1
		HF, Vehicle Mount, Medium-Power	1
		Warning Receiver	1

NOTES:

1. The total number of BMP/BRM tracked vehicles (and associated equipment) can vary from four to seven, depending on whether the company has one or two tracked recon platoons. (The IMRB equipment totals in this handbook include the larger numbers.)
2. The mix of BMP and BRM vehicles within a tracked recon platoon can also vary.
3. This company may have REC assets including SPR fuze jammers.

FOOTNOTE: * This system includes the TALL MIKE battlefield surveillance radar.

Engineer Company, IMRB

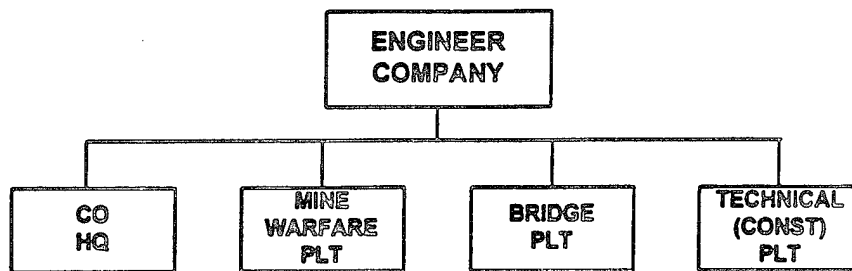

PRINCIPAL ITEMS OF EQUIPMENT

<u>Equipment</u>	<u>Total</u>	<u>Equipment</u>	<u>Total</u>
ATGL, RPG-7V	4	Dozer	1
APC, BTR-60/70/80	3	Ditching Machine, PZM/TMK	3
Truck, Utility	1	Minelayer, GMZ	3
Truck, Medium	8	Mineclearing Plow	9-15
Truck, Dump	2	Mine Roller-Plow	3-5
Truck, Maintenance	1	Mine Detector, DIM	1
Truck, Crane	1	Truck, Water Purification	1
Truck, Crane Shovel	2	Trailer, Cargo, 2-Axle	2
Bridge, Tank-Launched	1-2	Radios:	
Bridge, Truck-Launched	4	VHF, Vehicle Mount,	
Armored Engineer Tractor, IMR	1	Medium-Power	8-9
Ditching Machine, BTM/MDK	1	HF or VHF, Manpack, Low-Power	4

NOTES:

1. Especially when the parent army or army corps has only an engineer battalion instead of a brigade, the IMRB's engineer company may be expanded to include the following: 2 x Mineclearer, MTK/MTK-2; 2 x Armored Engineer Tractor, IMR; 2 x Mine Detector, DIM; and possibly the Tracked Ferry, PMM-2.
2. The following variations may exist:
 - a. Frogmen may be attached to assist in the reconnaissance of water obstacles.
 - b. Some companies may have five KMM truck-launched bridge spans instead of four TMM bridge spans.
 - c. Some units may have up to six one-axle cargo trailers besides the two-axle cargo trailers.
 - d. Some units may have tractor-trailers to carry heavy tracked equipment on long road movements.

Chemical Protection Company, IMRB

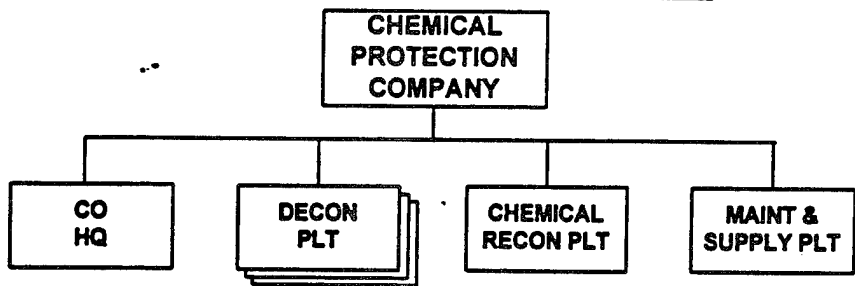

PRINCIPAL ITEMS OF EQUIPMENT

Equipment	Total
Truck, Utility.....	2
Truck, Light	3
Truck, Medium	6
Chemical Recon Vehicle, BRDM-2RKh/RKhM.....	4
Truck, POL (4,000-Liter).....	2
Truck, Water (2,000-Liter).....	2
Truck, Decon, ARS-12U/14	8
Truck, Decon, DDA-53/66.....	4

Equipment	Total
Truck, Decon, TMS-65	2
Trailer, Water (1,200-Liter)	2
Trailer, Water (900-Liter)	2
Radios:	
VHF, Manpack, Low-Power	4
VHF, Vehicle Mount, Medium-Power	4
HF, Manpack, Low-Power.....	2

Medical Company, IMRB

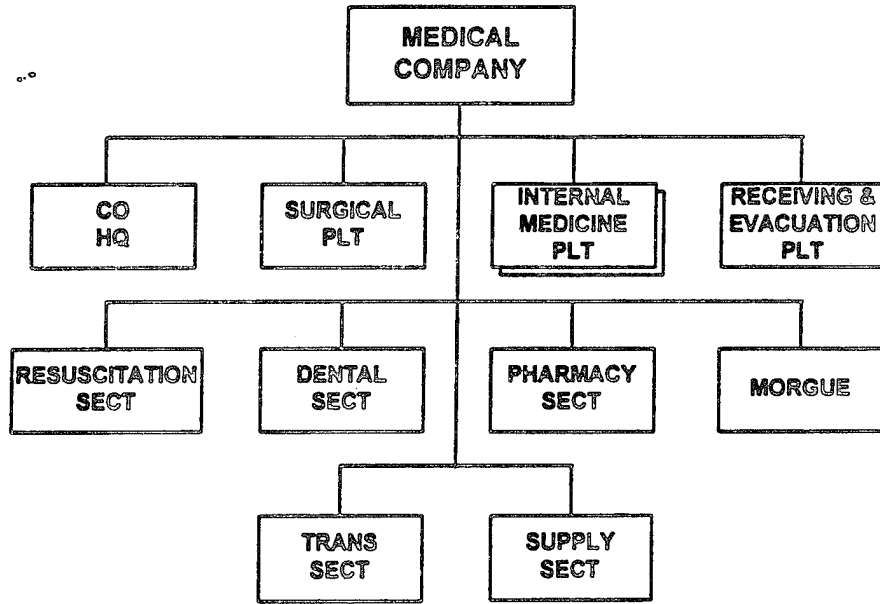

PRINCIPAL ITEMS OF EQUIPMENT

<u>Equipment</u>	<u>Total</u>	<u>Equipment</u>	<u>Total</u>
Truck, Utility.....	1	Trailer, Cargo, 2-Axle.....	7
Truck, Medium	7	Radio, VHF, Manpack, Low-Power	1
Ambulance	4		

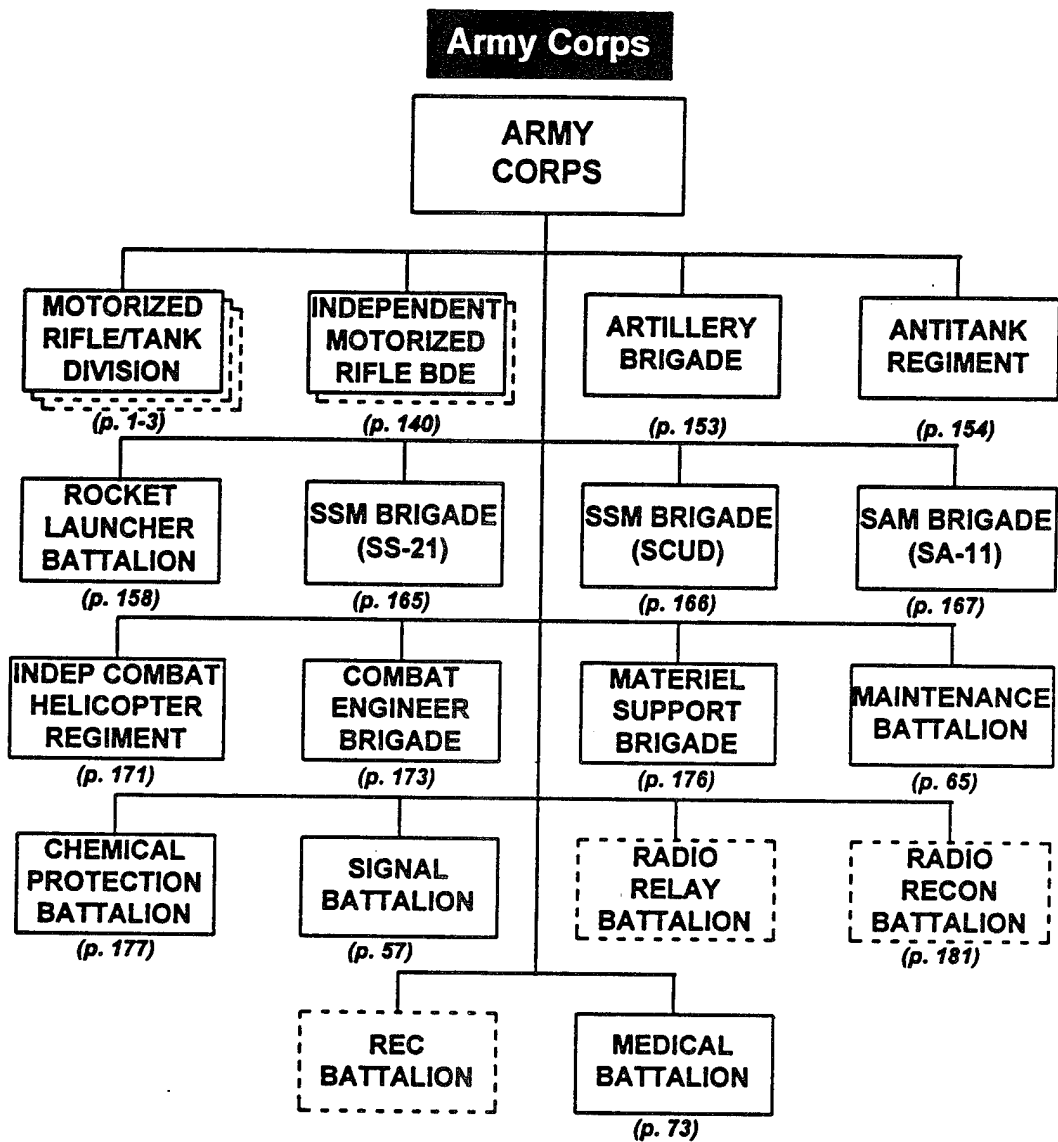

NOTES:

1. A typical army corps has one or two divisions and perhaps one or two IMRBs. The Divisions are most likely to be MRDs.
2. It is also possible that some army corps could consist of IMRBs rather than divisions. In this case there could be more than two IMRBs.

Additional Army Corps Assets

In addition to the most common elements, shown above, an army corps may include the following:

Rocket Launcher Regiment* (in lieu of Rocket Launcher Battalion)

Independent Helicopter Squadron** (in lieu of Independent Combat Helicopter Regiment)

Airfield Technical Support Battalion

Independent Engineer Battalion*** (in lieu of Combat Engineer Brigade)

FOOTNOTES:

* See Rocket Launcher Regiment, Army (p. 164).

** See Independent Helicopter Squadron, Army or Army Corps (p. 172).

*** See Engineer Battalion, MRD and TD (p. 47).

Artillery Brigade, Army Corps

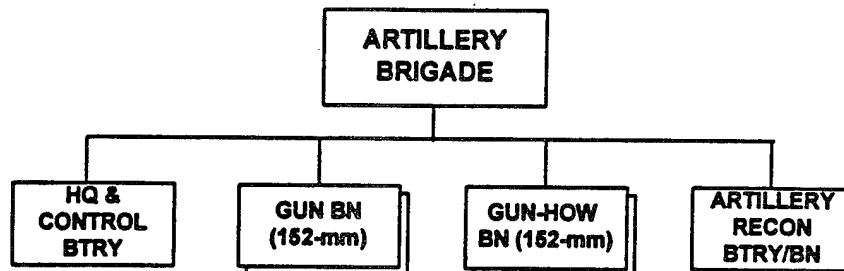

PRINCIPAL ITEMS OF EQUIPMENT

Equipment	Total	Equipment	Total
152-mm Field Gun, 2A36 or		Mobile Recon Post, PRP-3/4**	5-7
152-mm SP Gun, 2S5	36	APC, Radar, MT-LB (SNAR-10)***	1-3
152-mm Gun Howitzer, D-20 or		Radars:	
2A65.....	36	Countermortar/Counterbattery,	
ACRV, 1V12 /1V12M/1V21 or		ARK-1****	1-3
1V17 Series*	32	Meteorological, END TRAY	1-3
ACV, BTR (R-145BM)	5-7	Sound Ranging Set.....	1-3

FOOTNOTES:

- * Self-propelled artillery units use the tracked ACRVs of the 1V12/1V12M/1V21 series, while towed artillery units use the wheeled 1V17 series.
- ** This system includes the SMALL FRED or TALL MIKE battlefield surveillance radar.
- *** This system includes the BIG FRED battlefield surveillance radar.
- **** This system includes the RICE BAG countermortar/counterbattery radar.

Antitank Regiment, Army Corps

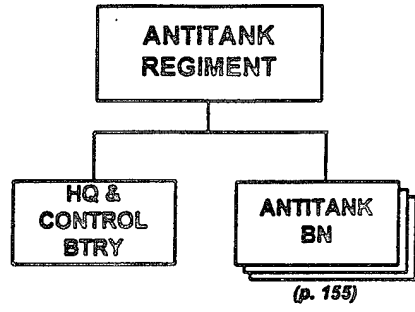

PRINCIPAL ITEMS OF EQUIPMENT

<u>Equipment</u>	<u>Total</u>	<u>Equipment</u>	<u>Total</u>
125/100-mm Antitank Gun		ATGM Vehicle, 9P149	
2A45M/MT-12.....	36	w/ AT-6/SPIRAL.....	27
Prime Mover, MT-LBT	42		

NOTE: Each antitank battalion has 12 antitank guns (2 batteries of 6) and 9 ATGM launchers (one battery).

Antitank Battalion, Antitank Regt, Army Corps

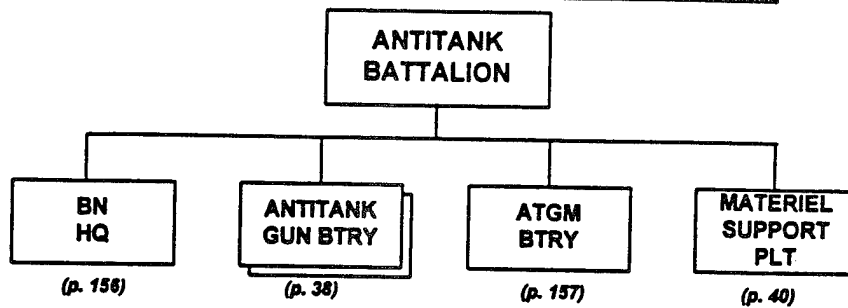

PRINCIPAL ITEMS OF EQUIPMENT

Equipment	Total	Equipment	Total
ATGM Vehicle , 9P149 w/ AT-6/SPIRAL	9	Trailer, Generator.....	1
125/100-mm Antitank Gun, 2A45M/MT-12.....	12	Trailer, Water (900-Liter)	1
ATGL, RPG-7V.....	9	Trailer, Kitchen.....	2
ACV, MT-LBu.....	5	Rangefinder.....	3
Prime Mover, MT-LBT	14	Radar, Battlefield Surveillance, Man-Portable, PSNR-1	3
Truck, Utility.....	3	Radios:	
Truck, Light	4	VHF, Manpack, Low-Power.....	10
Truck, Medium	12	VHF, Vehicle Mount, Medium-Power	28
Van, Signal.....	2	HF, Vehicle Mount, Medium-Power	1
Van, Maintenance	2	HF/VHF, Vehicle Mount, Medium-Power	3
Truck, POL (4,000 or 5,200-Liter)	2	Radio Relay, VHF/UHF.....	1
Ambulance	1	Warning Receiver	1
Trailer, Cargo, 2-Axle.....	10		
Trailer, POL (900-Liter)	1		

Rocket Launcher Battalion, Army Corps

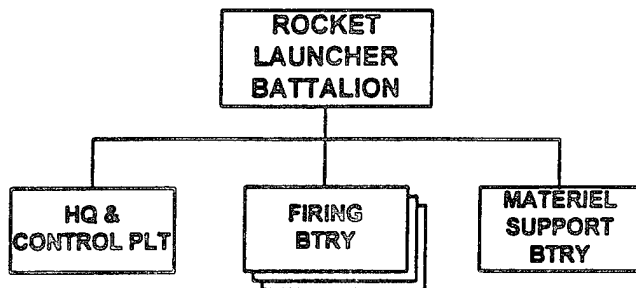

PRINCIPAL ITEMS OF EQUIPMENT

<u>Equipment</u>	<u>Total</u>	<u>Equipment</u>	<u>Total</u>
220-mm Rocket Launcher, 9P140 (Uragan)*	18	ACRV, 1V110 (Btry FDC)	3
ACRV, 1V18 (Btry COP)	3	ACRV, 1V111 (Bn FDC)	1
ACRV, 1V19 (Bn COP)	1	Mobile Recon Post, PRP-3/4**	1
		ACV, BTR (R-145BM)	1

FOOTNOTES:

* Previously known as BM-22.

** This system includes the SMALL FRED or TALL MIKE battlefield surveillance radar.

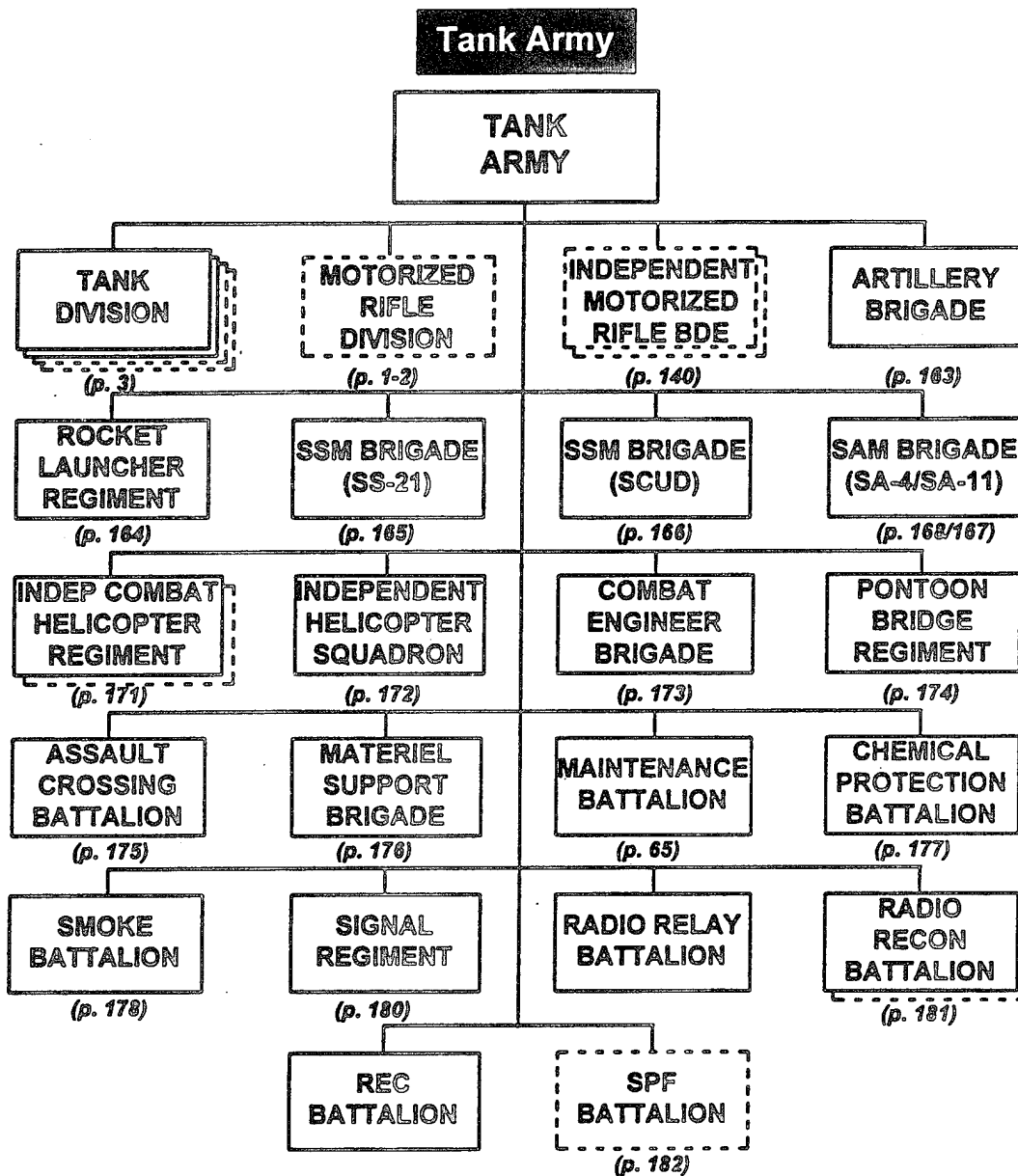

NOTE: A typical tank army has three to five divisions, with four being the most common. These normally include at least two TD and no more than one MRD.

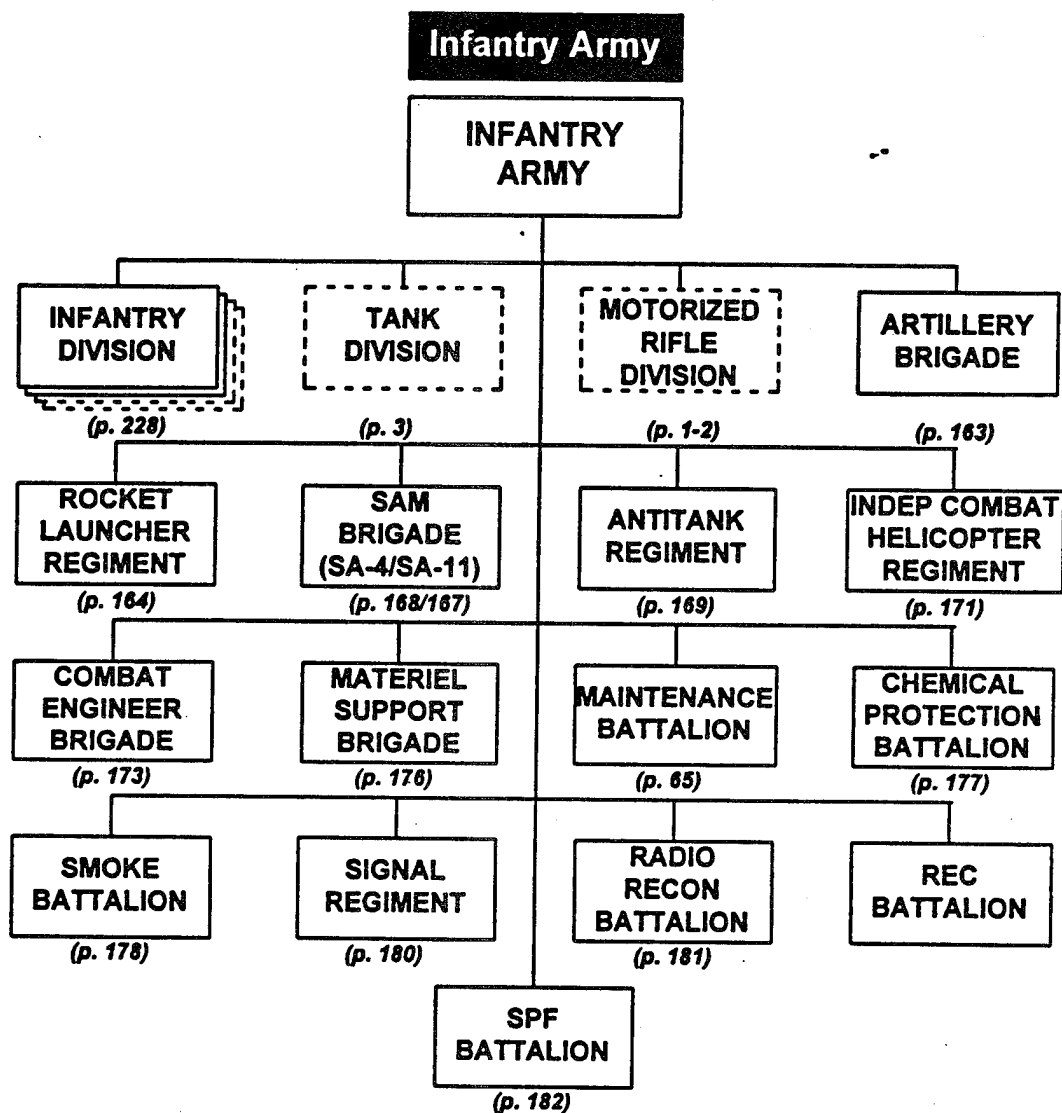

NOTE: A typical infantry army has four divisions. Organization varies from four IDs, to three IDs and one TD or MRD, to two IDs, one MRD, and one TD. The latter is the most common organization.

Additional Army Assets

In addition to the most common elements, shown above, an army (CAA, Tank or Infantry) may include the following:

- Artillery Regiment (in lieu of Artillery Brigade)
- Artillery Reconnaissance Regiment (or Battalion)
- Artillery Command and Control Battalion
- Mixed Aviation Squadron
- Drone Regiment (or Squadron)
- Airfield Technical Support Battalion
- Air Signals Company
- Independent Signal Battalion (in lieu of Signal Regiment)
- Independent Troposcatter Communications Battalion (in addition to Signal Regiment)
- Radio Reconnaissance Regiment (in lieu of Radio Reconnaissance Battalion)
- Radioelectronic Combat (REC) Regiment (in lieu of REC Battalion)
- Combat Engineer Battalion (in lieu of Combat Engineer Brigade)
- Fortified Region (organization with machinegun-artillery units)
- Tank Transport Heavy Lift Regiment (see Materiel Support Bde chart, p. 176)
- Mobile Missile Technical Base
- Air Defense Missile Technical Base
- NBC Reconnaissance Battalion
- Personnel and Equipment Decontamination Battalion
- Flamethrower Battalion
- Smoke Battalion
- Mobile Computation and Analysis Station (aka Mobile Analytical Plotting Station)
- Nuclear Burst Direction-Finding Battalion
- Medical Brigade
- Medical Transportation Brigade
- Railroad Construction Brigade
- Traffic Control Battalion
- Special Propaganda Detachment
- Early Warning Battalion
- Armored Vehicle Repair Battalion
- Security and Support Services Battalion

Artillery Brigade, Army

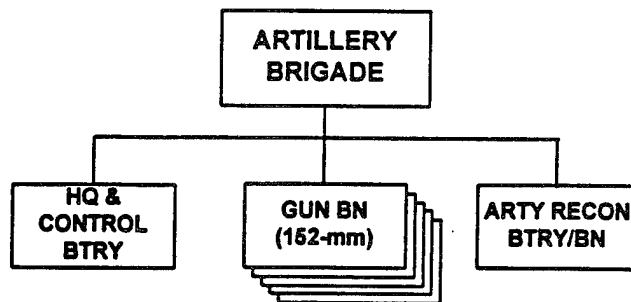

PRINCIPAL ITEMS OF EQUIPMENT

<u>Equipment</u>	<u>Total</u>	<u>Equipment</u>	<u>Total</u>
152-mm Field Gun, 2A36 or 152-mm SP Gun, 2S5	90	APC, Radar, MT-LB (SNAR-10)***	1-3
ACRV, 1V12/1V12M/1V21 or 1V17 Series*	40	Radars:	
ACV, BTR (R-145BM)	6-8	Countermortar/Counterbattery, ARK-1****	1-3
Mobile Recon Post, PRP-3/4**	6-8	Meteorological, END TRAY	1-3
		Sound Ranging Set.....	1-3

NOTES:

1. A few battalions still have the older 130-mm field gun M-46.
2. Some organizations with the structure of five 18-tube battalions may be called an artillery regiment (rather than brigade).

FOOTNOTES:

- * Self-propelled artillery units use the tracked ACRVs of the 1V12/1V12M/1V21 series, while towed artillery units use the wheeled 1V17 series.
- ** This system includes the SMALL FRED or TALL MIKE battlefield surveillance radar.
- *** This system includes the BIG FRED battlefield surveillance radar.
- **** This system includes the RICE BAG countermortar/counterbattery radar.

Rocket Launcher Regiment, Army

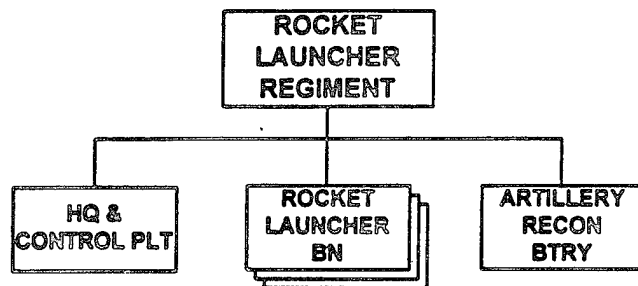

PRINCIPAL ITEMS OF EQUIPMENT

<u>Equipment</u>	<u>Total</u>	<u>Equipment</u>	<u>Total</u>
220-mm Rocket Launcher, 9P140 (Uragan, BM-22) or 122-mm Rocket Launcher, BM-21 (Grad).....	54	ACRV, BTR (R-145BM).....	4
ACRV, 1V18 (Btry COP).....	9	APC, Radar, MT-LB (SNAR-10)**	1
ACRV, 1V19 (Bn COP)	3	Radars:	
ACRV, 1V110 (Btry FDC).....	9	Countermortar/Counterbattery,	
ACRV, 1V111 (Bn FDC)	3	ARK-1***	1
Mobile Recon Post, PRP-3/4*	1	Meteorological, END TRAY	1
		Sound Ranging Set.....	1

FOOTNOTES:

- * This system includes the SMALL FRED or TALL MIKE battlefield surveillance radar.
- ** This system includes the BIG FRED battlefield surveillance radar.
- *** This system includes the RICE BAG countermortar/counterbattery radar.

SSM Brigade (SS-21), Army or Army Corps

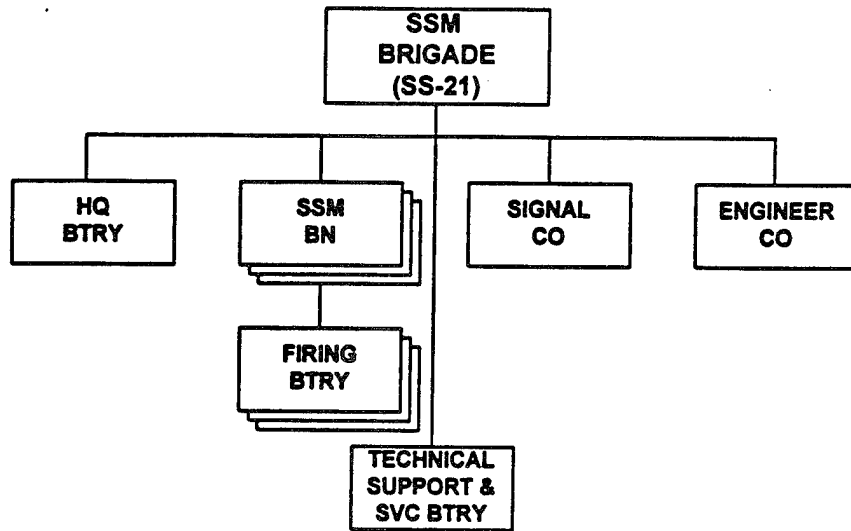

PRINCIPAL ITEMS OF EQUIPMENT

Equipment	Total
SSM, SS-21/SCARAB.....	18

SSM Brigade (SCUD), Army or Army Corps

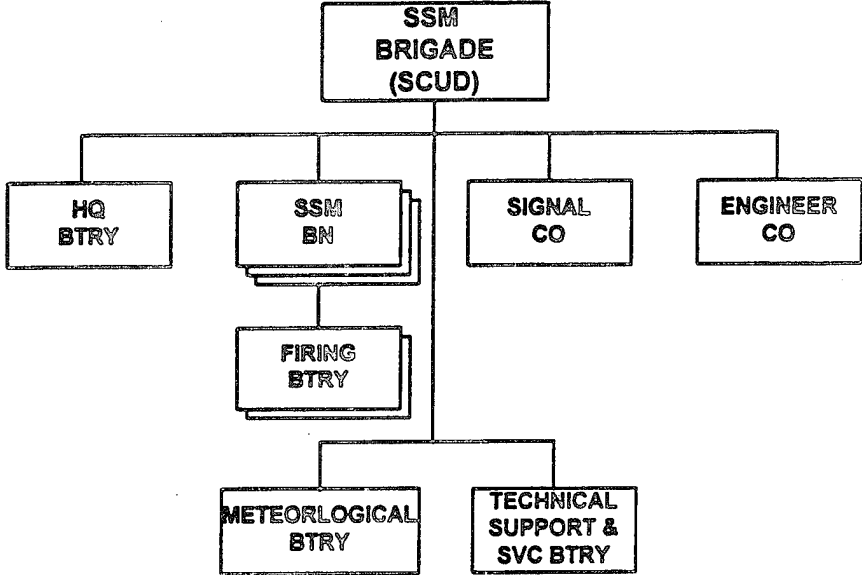

PRINCIPAL ITEMS OF EQUIPMENT

<u>Equipment</u>	<u>Total</u>	<u>Equipment</u>	<u>Total</u>
SSM, SS-1c/SCUD B TEL	12	Radar, Meteorological, END TRAY.....	3

NOTE: An SSM battalion may consist of either two or three firing batteries; therefore, a battalion may have 4 or 6 TELs, and a brigade may have 12 TELs (at army or army corps level) or 18 TELs (at *front* level). There is at least one reload per TEL.

SAM Brigade (SA-11), Army or Army Corps

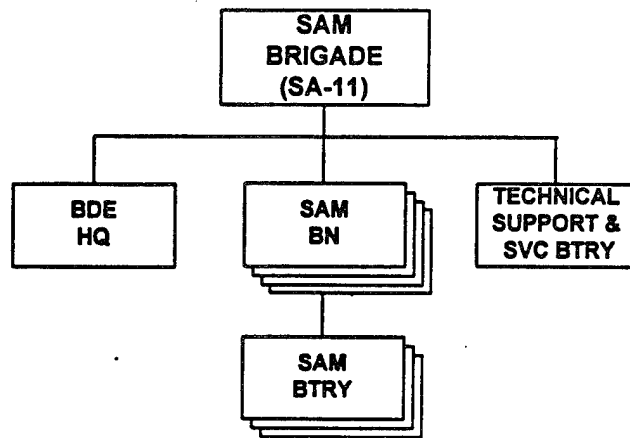

PRINCIPAL ITEMS OF EQUIPMENT

Equipment	Total	Equipment	Total
SAM, SA-11/GADFLY TELAR*	24	SA-11 Missile Transloader	
Radar, Target Acquisition, TUBE ARM		(TELAR Chassis).....	12
or SNOW DRIFT	4		

NOTE: Some armies may still have SAM brigades equipped with the older SA-4 system. (See p. 168). However, the SA-11 is standard for armies and army corps.

FOOTNOTE: * This system includes the FIRE DOME target engagement radar.

SAM Brigade (SA-4), Army or Army Corps

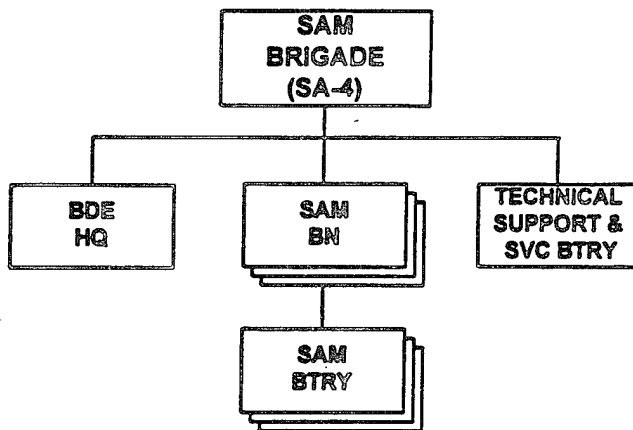

PRINCIPAL ITEMS OF EQUIPMENT

<u>Equipment</u>	<u>Total</u>	<u>Equipment</u>	<u>Total</u>
SAM, SA-4/GANEF TEL.....	27	Radars:	
		Fire Control, PAT HAND.....	9
		Aerial Surveillance/Target Acquisition, LONG TRACK.....	5
		Height Finding, THIN SKIN	1

NOTE: The SA-11 is replacing the SA-4 in army-level SAM brigades, but under a different organization (see p. 167). The SA-12a/GLADIATOR and the SA-12b/GIANT are replacing the SA-4 in *front*-level SAM units, but under an organization different from that of the SA-4 or the SA-11 (see p. 197).

Antitank Regiment, Army

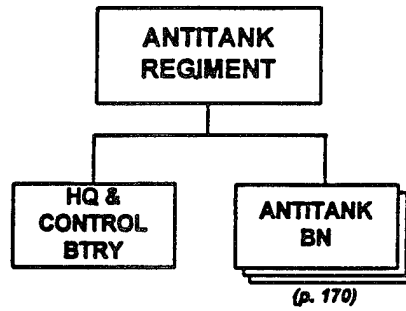

PRINCIPAL ITEMS OF EQUIPMENT

Equipment	Total	Equipment	Total
125/100-mm Antitank Gun, 2A45M/MT-12.....	54	ATGM Vehicle, 9P149 w/ AT-6/SPIRAL.....	27
Prime Mover, MT-LBT	63		

NOTE: Each antitank battalion has 18 antitank guns (3 batteries of 6) and 9 ATGM launchers (one battery).

**Antitank Battalion, Antitank Regt, Army or Antitank Bde,
Arty Div, Front**

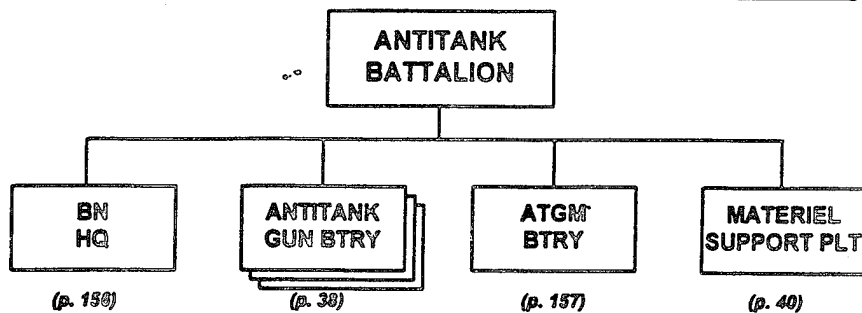

PRINCIPAL ITEMS OF EQUIPMENT

<u>Equipment</u>	<u>Total</u>	<u>Equipment</u>	<u>Total</u>
ATGM Vehicle, 9P149 w/ AT-6/SPIRAL	9	Trailer, Generator	1
125/100-mm Antitank Gun, 2A45M/MT-12	18	Trailer, Water (900-Liter)	1
ATGL, RPG-7V	9	Trailer, Kitchen	2
ACV, MT-LBu	5	Rangefinder	4
Prime Mover, MT-LBT	21	Radar, Battlefield Surveillance, Man-Portable, PSNR-1	4
Truck, Utility	3	Radios:	
Truck, Light	4	VHF, Manpack, Low-Power	11
Truck, Medium	13	VHF, Vehicle Mount, Medium-Power	35
Van, Signal	2	HF, Vehicle Mount, Medium-Power	1
Van, Maintenance	2	HF/VHF, Vehicle Mount, Medium-Power	3
Truck, POL (4,000 or 5,200-Liter)	2	Radio Relay, VHF/UHF	1
Ambulance	1	Warning Receiver	1
Trailer, Cargo, 2-Axle	11		
Trailer, POL (900-Liter)	1		

**Independent Combat Helicopter Regiment, Army
or Army Corps**

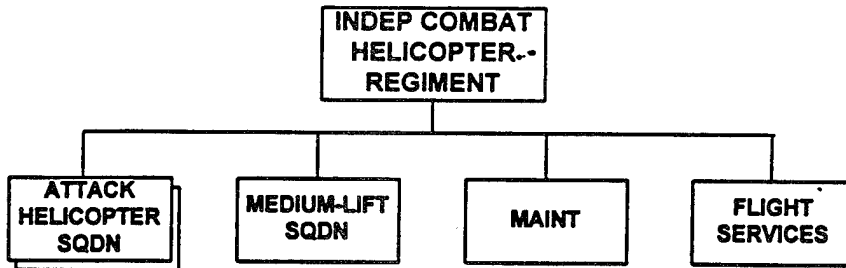

PRINCIPAL ITEMS OF EQUIPMENT

<u>Equipment</u>	<u>Total</u>	<u>Equipment</u>	<u>Total</u>
Attack Helicopter, Mi-24/HIND D/E/F or Mi-28/HAVOC or Ka-50/HOKUM	40	Medium Helicopter, Mi-8T/HIP C/E or Mi-8MT(Mi-17)/HIP H	20

NOTE: Some combat helicopter regiments may also include six Mi-24R/HIND G1 NBC sampling helicopters and six Mi-24K/HIND G2 photo reconnaissance helicopters.

**Independent Helicopter Squadron, Army
or Army Corps**

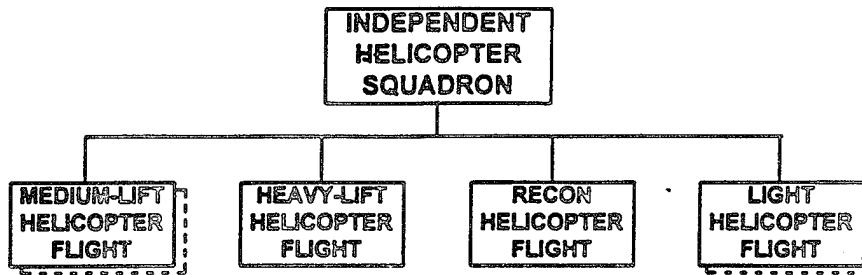

PRINCIPAL ITEMS OF EQUIPMENT

<u>Equipment</u>	<u>Total</u>	<u>Equipment</u>	<u>Total</u>
Medium Helicopter, Mi-8T/HIP C/E or Mi-8MT(Mi-17)/HIP H	3-6	NBC-Sampling Helicopter, Mi-24R/HIND G1	2
Heavy-Lift Helicopter, Mi-6A/HOOK or Mi-26/HALO A	1-2	Photo-Recon Helicopter, Mi-24K/HIND G2.....	2
		Light Helicopter, Mi-2/HOPLITE	6-12

NOTES:

1. Some independent helicopter squadrons may also have two or three Mi-8SMV/HIP K and two or three Mi-8PPA/HIP J or Mi-8MT(Mi-17)/HIP H ECM (jamming) helicopters. Some squadrons may also have one or two Mi-8VKP airborne command post helicopters.
2. Some armies may have an independent mixed aviation squadron with helicopter assets similar to those of an independent helicopter squadron (less the reconnaissance and ECM helicopters), plus 12 to 24 light-to-medium fixed-wing transport aircraft.

Combat Engineer Brigade, Army or Army Corps or Front

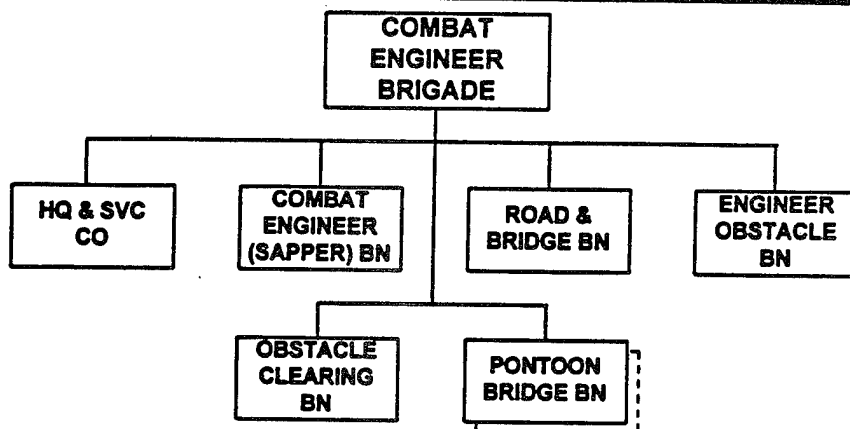

PRINCIPAL ITEMS OF EQUIPMENT

Equipment	Total	Equipment	Total
ACV, BRDM-2U	4	Bridge, PMP Service.....	2
APC, BTR-60/70/80	6-13	Tracked Ferry, GSP/PMM-2.....	24
Truck, Utility.....	19	Tracked Amphibian, K-61/PTS	28
Truck, Medium	82	Ditching Machine, BTM/MDK	12
Truck, Heavy.....	25	Dozer.....	15
Armored Recovery Vehicle	6	Powerboat	15
Bridge, Truck-Launched	20	Minelayer, PMR/GMZ.....	13
Bridge, Tank-Launched	12-14	Armored Engineer Tractor, IMR	6
Bridge, PMP Center.....	32	Mineclearer, MTK/MTK-2	8-13
Bridge, PMP Ramp.....	4	Engineer Recon Vehicle, IRM.....	8-15

NOTES:

1. Structure and number/type of equipment may vary. Additional battalions may greatly expand the brigade. Engineer brigades can have twice as many battalions and twice as much equipment as shown above.
2. In addition to the battalions shown above, the brigade could include a second pontoon bridge battalion, an engineer construction battalion, a fabrication battalion, and a water supply battalion.

Pontoon Bridge Regiment, Army or Front

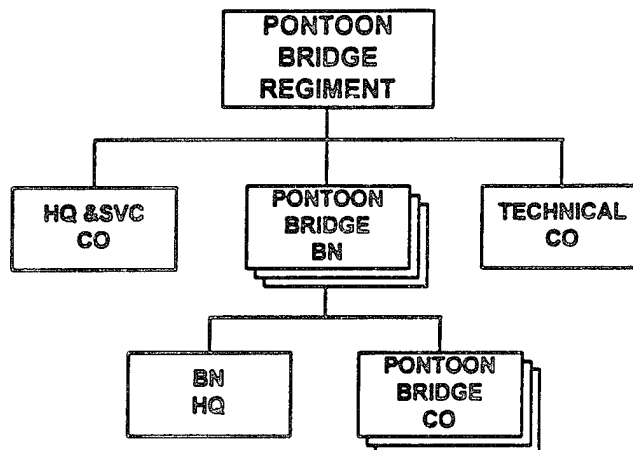

PRINCIPAL ITEMS OF EQUIPMENT

<u>Equipment</u>	<u>Total</u>
ACV, BRDM-2U	10
Truck, Utility.....	5
Truck, Medium	60
Truck, Heavy.....	5
Armored Recovery Vehicle	3
Bridge, Truck-Launched	4
Bridge, PMP Center.....	96

<u>Equipment</u>	<u>Total</u>
Bridge, PMP Ramp	12
Bridge, PMP Service.....	6
Tracked Amphibian, K-61/PTS	8
Ditching Machine, BTM/MDK	3
Dozer.....	7
Powerboat	36
Engineer Recon Vehicle, IRM.....	1-8

Assault Crossing Battalion, Army or Front

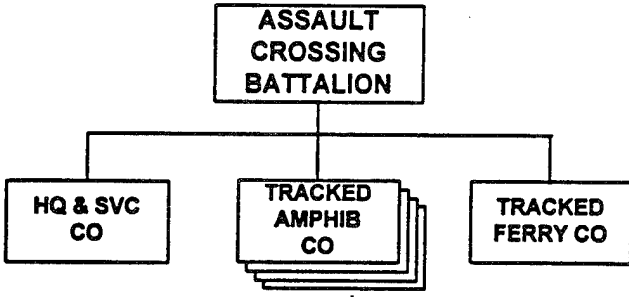

PRINCIPAL ITEMS OF EQUIPMENT

<u>Equipment</u>	<u>Total</u>	<u>Equipment</u>	<u>Total</u>
ACV, BRDM-2U	4	Engineer Recon Vehicle, IRM	2-3
Truck, Utility	2	Tracked Ferry, GSP/PMM-2	40
Truck, Medium	10	Tracked Amphibian, K-61/PTS	36
Armored Engineer Tractor, IMR	3	Ditching Machine, BTM/MDK	3
Armored Recovery Vehicle	3	Dozer	3

Smoke Battalion, Army or Chemical Protection Bde, Front

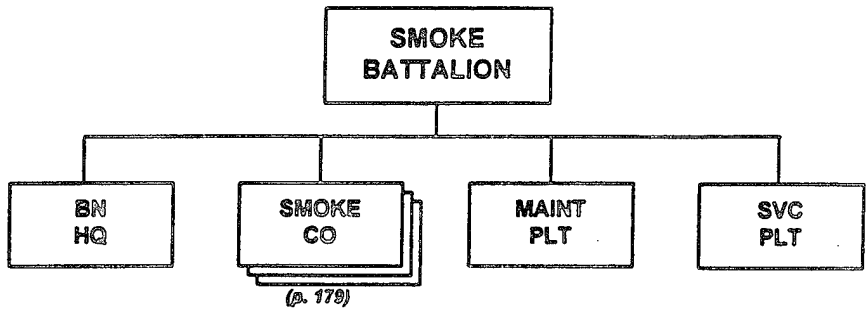

PRINCIPAL ITEMS OF EQUIPMENT

<u>Equipment</u>	<u>Total</u>
Truck, Smoke Generator, TDA-M.....	27
Truck, Light	5
Truck, Medium	24
Van, Maintenance	5
Trailer, Cargo, 2-Axle.....	10
Trailer, Water (1,200-Liter).....	4
Trailer, Kitchen.....	6
Trailer, POL (1,200-Liter).....	2

<u>Equipment</u>	<u>Total</u>
Trailer, Generator.....	3
Radios:	
VHF, Manpack, Low-Power.....	3
VHF, Vehicle Mount,	
Medium-Power	29
HF/VHF, Vehicle Mount,	
Medium-Power	1

**Smoke Company, Smoke Bn, Army or Chemical
Protection Bde, Front**

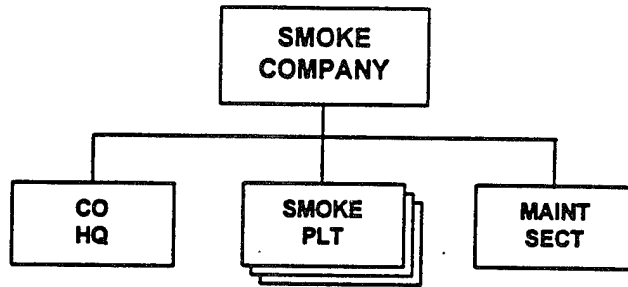

PRINCIPAL ITEMS OF EQUIPMENT

<u>Equipment</u>	<u>Total</u>	<u>Equipment</u>	<u>Total</u>
Truck, Smoke Generator, TDA-M.....	9	Trailer, Water (1,200-Liter).....	1
Truck, Medium	4	Trailer, Kitchen.....	1
Van, Maintenance	1	Radio, VHF, Vehicle Mount,	
Trailer, Cargo, 2-Axle.....	2	Medium-Power	9

Signal Regiment, Army

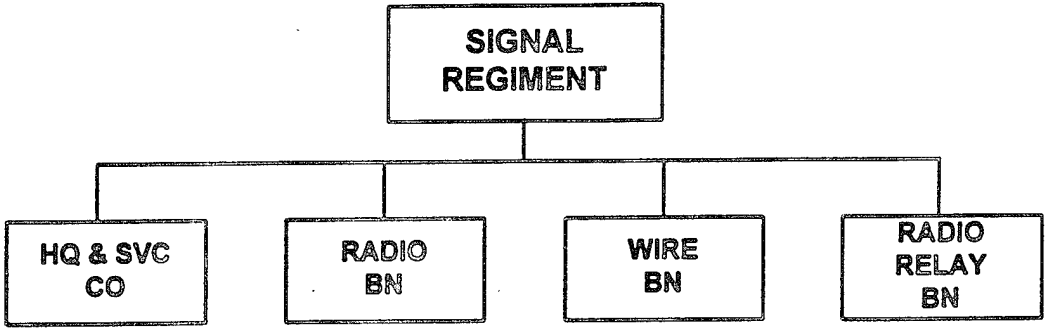

Radio Reconnaissance Battalion, Army or Army Corps

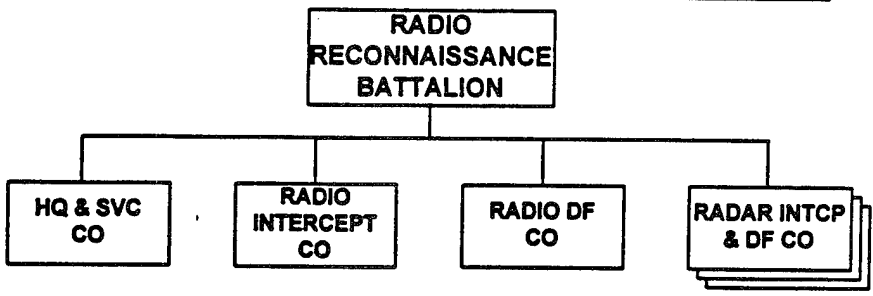

NOTE: This battalion is also known as a radio and radar intercept and direction-finding battalion or as a radiotechnical reconnaissance battalion.

Special Purpose Forces Battalion, Army

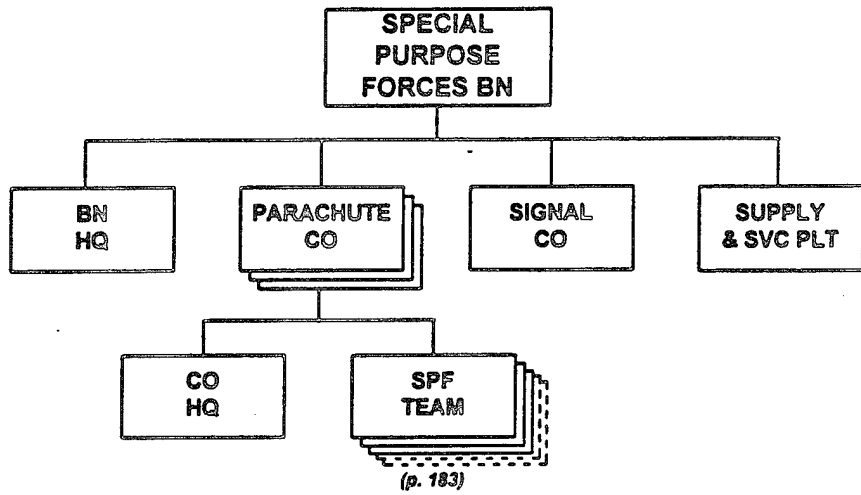

NOTES:

1. The battalion structure is not fixed.
2. The total number of teams which an army-level SPF battalion can deploy varies from 10 to 15.

**Special Purpose Forces Team, SPF Bn, Army
or SPF Bde, Front**

**SPECIAL
PURPOSE
FORCES TEAM**

Team Leader (Officer).....AKS-74 or AKSU, PM
 Assistant Team Leader (Warrant Officer or Sergeant).....AKS-74 or AKSU, PM
 1-2 x Radio Operator.....Radio, AKS-74 or AKSU-74, PM
 1-2 x Weapons Specialist.....RPG-16D, PM
 1-2 x Demolition Specialist.....AKS-74 or AKSU-74, PM
 0-4 x Reconnaissance Specialist.....AKS-74 or AKSU-74, PM

PRINCIPAL ITEMS OF EQUIPMENT

<u>Equipment</u>	<u>Total</u>	<u>Equipment</u>	<u>Total</u>
9-mm Pistol, PM.....	5-12	7.62-mm Sniper Rifle, SVD.....	1
5.45-mm Assault Rifle, AKS-74 or 5.45-mm Submachinegun, AKSU-74	4-10	ATGL, RPG-16D	1-2
		Radio, Burst-Transmission	1-2

NOTES:

1. Team composition is not fixed. The organization above shows the variations which may exist within what may be a typical SPF team.
2. In keeping with its behind-the-lines missions, the SPF team is lightly equipped. Each soldier normally has an assault rifle, a silenced pistol, a knife, and up to eight hand grenades of various types. In addition, the team's equipment normally includes an SVD sniper rifle, directional mines, and explosives. The team can also receive SA-16/18 shoulder-fired SAMs or man-portable ATGMs.

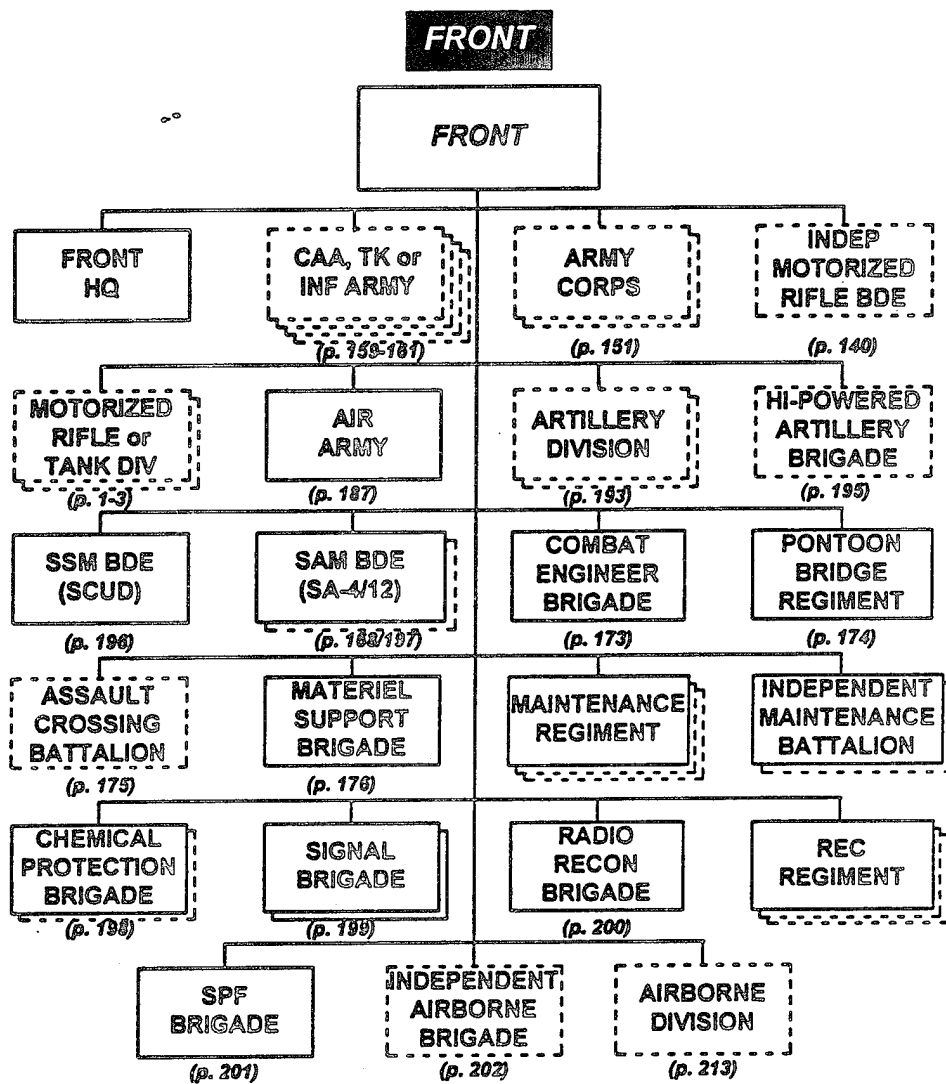

NOTES:

1. There is no fixed organization for a *front*. The organizations shown above represent those elements found in most of the military districts, which could become *fronts* in wartime. Dashed lines indicate those elements which may not be present, or at least not in the numbers found in some *fronts*.
2. A typical *front* would contain a varying number of armies. However, some *fronts* might only have the smaller army corps organizations. Some might comprise a mixture of armies and army corps. Some might also include independent motorized rifle brigades or motorized rifle/tank divisions which are not part of an army or army corps.
3. Airborne forces are not organic to a *front*. However, higher command may allocate such forces in a brigade or division size to support a *front* in a given operation.
4. Higher command may also allocate a *front* one or more artillery divisions and/or a high-powered artillery brigade.

Additional *Front* Assets

In addition to the most common elements, shown on the previous page, a *front* may include the following:

- Motorized Rifle Regiment *
- Tank Regiment *
- Independent Transport Helicopter Regiment **
- Independent Combat C² Helicopter Regiment **
- Independent Mixed Aviation Squadron **
- Independent Airfield Technical Support Battalion **
- Artillery Brigade (in lieu of Artillery Division)
- Rocket Launcher Regiment (in addition to Artillery Division) ***
- Antitank Regiment or Brigade (in addition to Artillery Division)
- Artillery Reconnaissance Regiment (or Battalion)
- Independent SAM Regiment (in addition to SAM Brigade)
- Combat Engineer Regiment (in lieu of or in addition to Combat Engineer Brigade)
- Combat Engineer Battalion (in lieu of or in addition to Combat Engineer Brigade)
- Ponton Bridge Battalion (in lieu of Ponton Bridge Regiment)
- Ponton Bridge Brigade (in lieu of Ponton Bridge Regiment)
- Independent Engineer Road/Bridge-Building Battalion
- Motor Transport Brigade (in lieu of Materiel Support Brigade)
 - Independent Motor Transport Regiment (in addition to either type brigade)
 - Independent Motor Transport Battalion (in addition to the regiment and/or brigade)
- Independent Automotive Maintenance Battalion
- Independent Chemical Protection Battalion (in lieu of or in addition to Chemical Protection Brigade)
- Independent Signal Regiment or Battalion (in addition to Signal Brigade)
- Independent Radio Relay Battalion (in addition to Signal Brigade)
- Independent Troposcatter Communications Battalion (in addition to Signal Brigade)
- Independent Radio Reconnaissance Battalion (in lieu of or in addition to Radio Recon Brigade)
- Independent Special-Purpose Radio Reconnaissance Brigade
- Independent Radioelectronic Combat (REC) Battalion (in lieu of or in addition to one or more REC regiments)
- Independent Route Traffic Control Brigade (or Battalion)
- Independent Communications and Automated Troop Control Regiment

FOOTNOTES:

- * Not subordinate to an MRD or TD or to an army.
- ** Aviation units subordinate to the Ground Forces (*front*) rather than to the Air Forces (air army) assigned to the *front*.
- *** Rocket launcher regiments outside the artillery division have only 54 launchers (3 battalions of 18), which may be the older 122-mm rocket launcher BM-21 (Grad).

Additional *Front* Assets (continued)

Pipeline Brigade
Independent Pipeline Battalion (in addition to Pipeline Brigade)
Medical Brigade
Medical Transport Battalion
Rear Area Security Division
Independent Commandant Regiment
Independent Communications & Electronic Support Services Battalion
Independent C² Facility Construction Engineer Battalion
Independent Topographic/Geodetic Detachment
Independent Air Assault Battalion (in lieu of Air Assault Brigade)
Independent Security and Support Services Battalion (or Regiment)
Tank Transport/Heavy Lift Regiment
Missile Transport Battalion
Missile Fuel Battalion
Mobile Missile Technical Base
Air Defense Missile Technical Base
Mobile Hospital Base
Rear Hospital Base
Epidemic Control Detachment (or Battalion)
Railroad Construction Brigade
Special Propaganda Company
Early Warning Regiment (or Brigade)

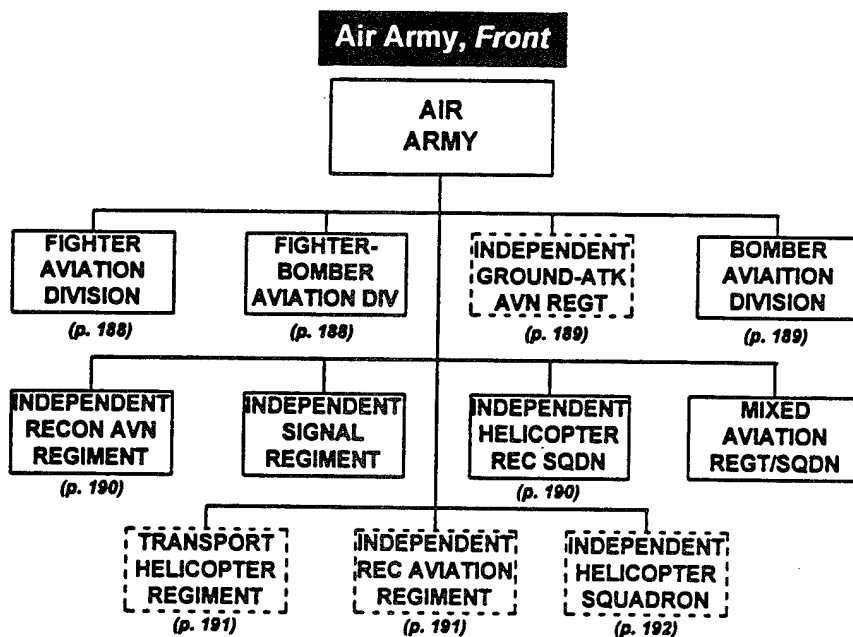

NOTES:

1. An air army has no fixed organization and may tailor its structure to meet specific needs of the ground forces within the supported *front*. The numbers of aircraft can vary greatly, even down to the squadron level.
2. Most air armies have a fighter aviation division and either a fighter-bomber or bomber aviation division; an independent reconnaissance aviation regiment; an independent helicopter REC squadron, an independent mixed aviation regiment (or squadron); and an independent signal regiment (or battalion).
3. Some air armies may also have one or more of the following: an independent ground-attack aviation regiment, a transport helicopter regiment, an independent REC aviation regiment, an independent helicopter squadron.

Fighter Aviation Division, Air Army, Front

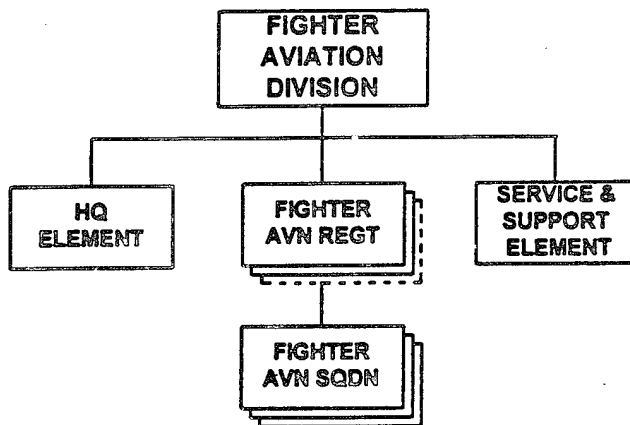

NOTES:

1. The fighter aviation regiments of this division normally have the MiG-23/FLOGGER B/G or MiG-29/FULCRUM A, plus a number of MiG-23UB trainers that can also serve as combat aircraft. Alternatively, some of these regiments may have the Su-27/FLANKER B, plus Su-27UB trainers.
2. In lieu of one of these fighter aviation regiments, some fighter aviation divisions may have a fighter-bomber aviation regiment equipped with the Su-17/FITTER D/H.

Fighter-Bomber Aviation Division, Air Army, Front

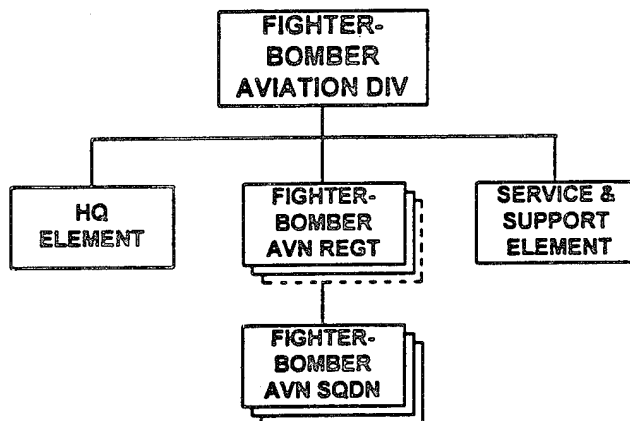

NOTES:

1. The fighter-bomber aviation regiments of this division normally have the MiG-27/FLOGGER D/J, plus a number of MiG-23UB trainers that can also serve as combat aircraft. Alternatively, some of these regiments may have the Su-17/FITTER D/H, plus a number of Su-17UB trainers.
2. In lieu of one of the fighter-bomber aviation regiments, some fighter-bomber divisions may have a fighter aviation regiment equipped with the Su-27/FLANKER B, plus Su-27UB trainers.

Independent Ground Attack Aviation Regiment, Air Army, Front

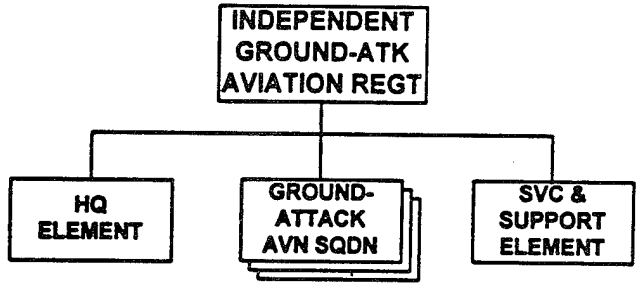

NOTE: This regiment has the Su-25/FROGFOOT ground-attack aircraft, plus a number of Su-25UB trainers than can also serve as combat aircraft.

Bomber Aviation Division, Air Army, Front

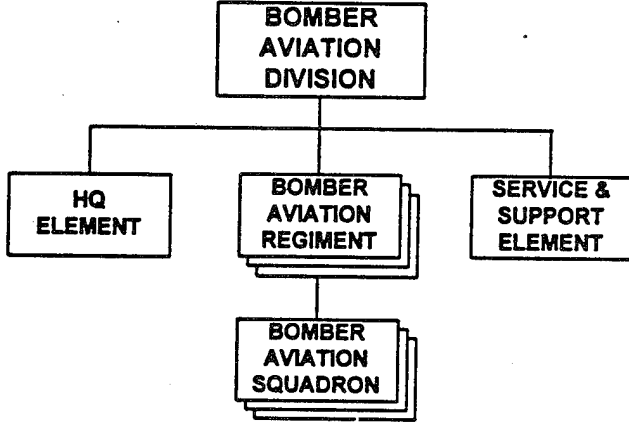

- NOTES:**
1. The bomber aviation regiments of this division normally have the Su-24/FENCER.
 2. Alternatively, one of the regiments may have the Su-27/FLANKER B.

Independent Reconnaissance Aviation Regiment, Air Army, Front

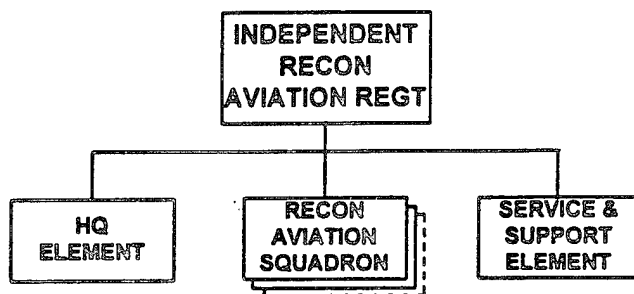

NOTE: The reconnaissance aviation squadrons of this regiment may have reconnaissance variants of the following aircraft: Su-24/FENCER, Su-17/FITTER, or MiG-25/FOXBAT B/D.

Independent Helicopter Radioelectronic Combat Squadron, Air Army, Front

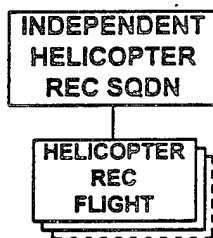

NOTE: This squadron may have one or two Mi-8T/HIP C/E or Mi-8MT(Mi-17)/HIP H medium helicopters and 14 to 21 electronic countermeasure (ECM) variants of the types Mi-8SMV/HIP J, or Mi-8PPA/HIP K, or Mi-8MT(Mi-17P)/HIP H.

Transport Helicopter Regiment, Air Army, Front

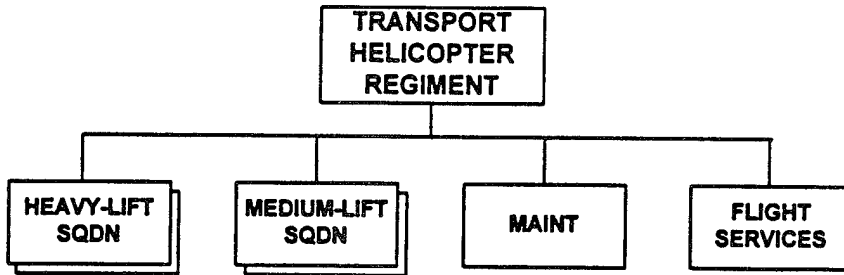

PRINCIPAL ITEMS OF EQUIPMENT

Equipment	Total	Equipment	Total
Heavy-Lift Helicopter, Mi-6A/HOOK or Mi-26/HALO A	24	Medium Helicopter, Mi-8T/HIP C or Mi-8MT(Mi-17)/HIP H	24

NOTE: Some of the medium helicopters may be Mi-8S VIP variants or Mi-8VKP/HIP D airborne command post variants.

Independent Radioelectronic Combat Aviation Regiment, Air Army, Front

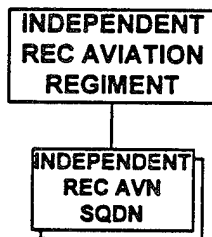

NOTE: This regiment may have a squadron of Su-24/FENCER electronic countermeasure (ECM) variants and a squadron of Yak-28/BREWER E ECM variants.

Independent Helicopter Squadron, Air Army, Front

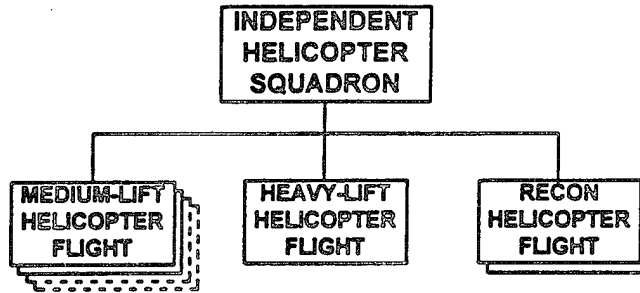

PRINCIPAL ITEMS OF EQUIPMENT

<u>Equipment</u>	<u>Total</u>	<u>Equipment</u>	<u>Total</u>
Medium Helicopter, Mi-8T/HIP C/E or Mi-8 MT(Mi-17)/HIP H	6-12	NBC-Sampling Helicopter, Mi-24R/HIND G1	2
Heavy-Lift Helicopter, Mi-6A/HOOK or Mi-26/HALO A	1-2	Photo-Recon Helicopter, Mi-24K/HIND G2	2

NOTES:

1. Some independent helicopter squadrons may also have two or three Mi-8SMV/HIP J or Mi-8PPA/HIP K or Mi-8MT(Mi-17P)/HIP H ECM (jamming) helicopters. Some squadrons may also have one or two Mi-8VKP/HIP D airborne command post helicopters.
2. Some *fronts* may have an independent mixed aviation squadron with helicopter assets similar to those of an independent helicopter squadron (less the reconnaissance and ECM helicopters), plus 12 to 24 light-to-medium fixed-wing transport aircraft.

Artillery Division, Front

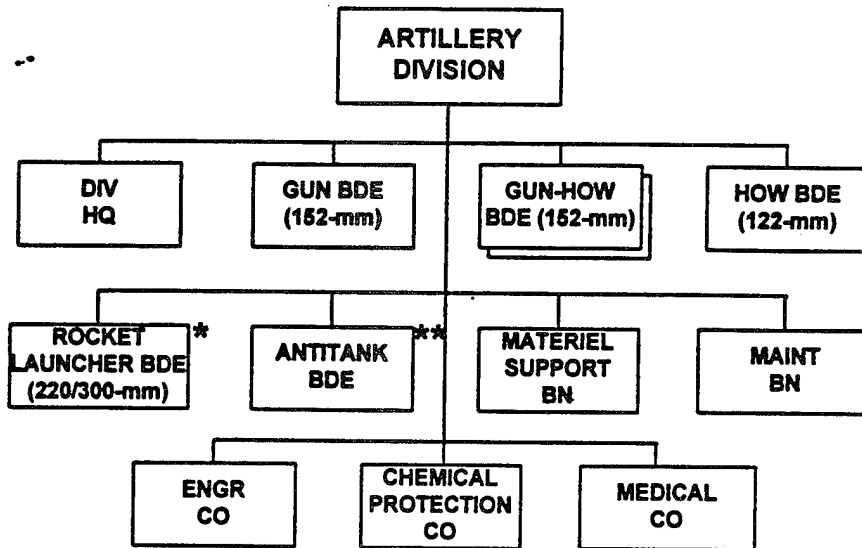

PRINCIPAL ITEMS OF EQUIPMENT

<u>Equipment</u>	<u>Total</u>	<u>Equipment</u>	<u>Total</u>
122-mm Howitzer, D-30	72	ACRV, 1V19 (Bn COP)	20
152-mm Gun-Howitzer, D-20 or 2A65.....	144	ACRV, 1V110 (Btry FDC).....	60
152-mm Field Gun, 2A36.....	72	ACRV, 1V111 (Bn FDC).....	20
220-mm Rocket Launcher, 9P140 (Uragan) or 300-mm Rocket Launcher, 9A52 (Smerch).....	72/48*	Mobile Recon Post, PRP-3/4***	30
125-mm/100-mm Antitank Gun, 2A45M/MT-12.....	72	ACV, Radar, MT-LB (SNAR-10)****	7
ATGM Vehicle, 9P149 w/ AT-6/SPIRAL	36	Radars: Countermortar/Counterbattery, ARK-1*****	6
ACRV, 1V18 (Btry COP).....	60	Meterorological, END TRAY	6
		Sound Ranging Set.....	6
		Prime Mover, MT-LBT	184
		ACV, BTR (R-145BM)	16

NOTES:

1. The gun, gun-howitzer, and howitzer brigades may be known as regiments in peacetime, but probably would resume the status of brigades in wartime.
2. In most artillery divisions, howitzer, gun-howitzer, and gun brigades consist of four 18-tube battalions and an artillery reconnaissance battery. The equipment totals above reflect this standard brigade structure. In other artillery divisions, these brigades could have four 24-tube battalions.

FOOTNOTES:

* The 220-mm rocket launcher brigade normally consists of four battalions, each with 18 9P140 rocket launchers (previously known as BM-22). However, the 300-mm rocket launcher brigade has only 48 of the 9A52 launchers (four battalions of 12).

** The antitank brigade has four antitank battalions like those found at army level (each with 18 antitank guns and 9 ATGM launcher vehicles (9P149).

*** This system includes the SMALL FRED or TALL MIKE battlefield surveillance radar.

**** This system includes the BIG FRED battlefield surveillance radar.

***** This system includes the RICE BAG countermortar/counterbattery radar.

High-Powered Artillery Brigade, *Front*

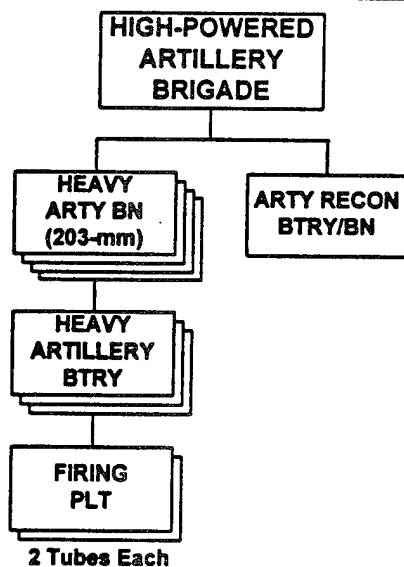

PRINCIPAL ITEMS OF EQUIPMENT

<u>Equipment</u>	<u>Total</u>	<u>Equipment</u>	<u>Total</u>
203-mm SP Gun, 2S7	48	APC, Radar, MT-LB (SNAR-10)**	1-3
ACRV, 1V13/1V13M/1V22 (Btry FDC) ..	12	Radars:	
ACRV, 1V14/1V14M/1V23 (Btry COP) ..	12	Countermortar/Counterbattery,	
ACRV, 1V15/1V15M/1V24 (Bn COP).....	4	ARK-1***	1-3
ACRV, 1V16/1V16M/1V25 (Bn FDC).....	4	Meteorological, END TRAY	1-3
Mobile Recon Post, PRP-3/4*	4-6	Sound Ranging Set.....	1-3

NOTE: This brigade is not organic to a *front*. However, a higher command may allocate a high-powered artillery brigade to a *front*. This nuclear-capable brigade is not part of the *front's* artillery division. In some high-powered artillery brigades, two of the battalions may be equipped with the 240-mm SP Mortar 2S4, rather than the 2S7.

FOOTNOTES:

- * This system includes the SMALL FRED or TALL MIKE battlefield surveillance radar.
- ** This system includes the BIG FRED battlefield surveillance radar.
- *** This system includes the RICE BAG countermortar/counterbattery radar.

SSM Brigade (SCUD), Front

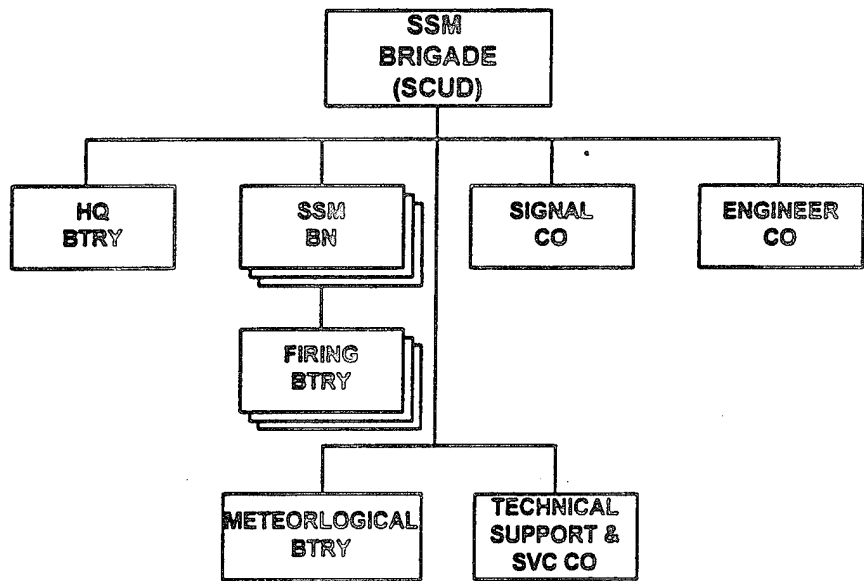

PRINCIPAL ITEMS OF EQUIPMENT

<u>Equipment</u>	<u>Total</u>	<u>Equipment</u>	<u>Total</u>
SSM, SS-1c/SCUD B TEL	18	Radar, Meteorological, END TRAY.....	3

NOTE: An SSM battalion may consist of either two or three firing batteries; therefore, a battalion may have 4 or 6 TELs, and a brigade may have 12 TELs (at army or army corps level) or 18 TELs (at *front* level). There is at least one reload per TEL.

SAM Brigade (SA-12), Front

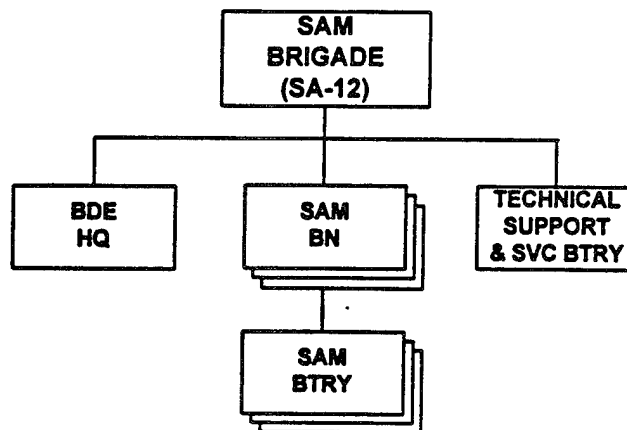

4 LAUNCHERS PER BTRY
(2 X SA-12a, 2 X SA-12b)

PRINCIPAL ITEMS OF EQUIPMENT

Equipment	Total	Equipment	Total
SAM, SA-12a/GLADIATOR		Radars:	
TELAR *.....	18	Target Acquisition, BILL BOARD.....	4
SAM, SA-12b/GIANT TELAR *.....	18	Target Engagement, GRILL PAN.....	9
SA-12a, Missile Transloader		Target Acquisition, HIGH SCREEN.....	9
(TELAR Chassis).....	9	Early Warning, BOX SPRING.....	1
SA-12b, Missile Transloader		Missile-Tracking and Guidance.....	36
(TELAR Chassis).....	9		

NOTE: Some fronts may still have SAM brigades equipped with the older SA-4 system (See p. 168).

FOOTNOTE: * Each TELAR includes an (unidentified) missile-tracking and guidance radar, which appears separately in this list.

Chemical Protection Brigade, Front

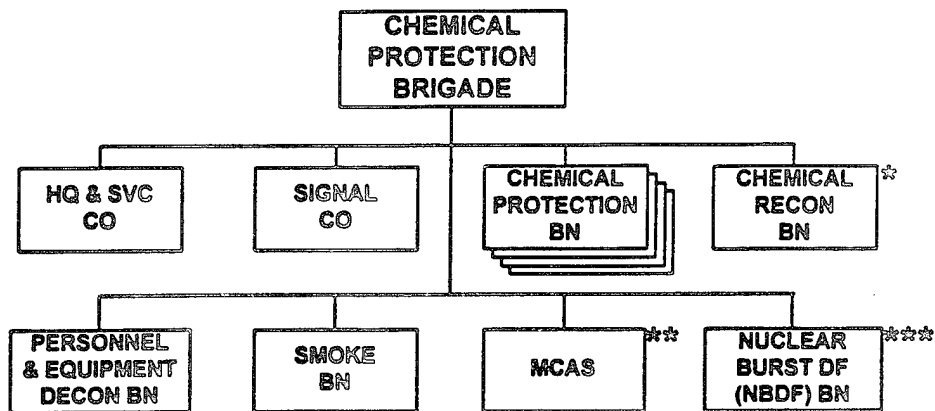

FOOTNOTES:

- * Radiological and chemical reconnaissance battalion is the full name.
- ** The mobile computation and analysis station (MCAS) is also known as a mobile analytical plotting station .
- *** Nuclear burst direction finding (NBDF) battalion.

Signal Brigade, Front

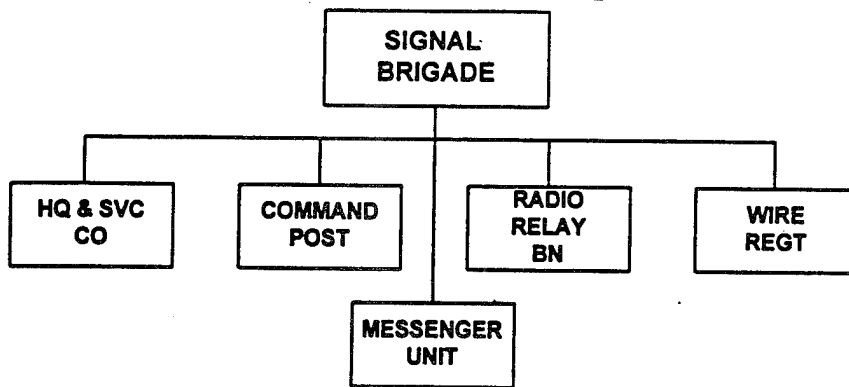

Radio Reconnaissance Brigade, Front

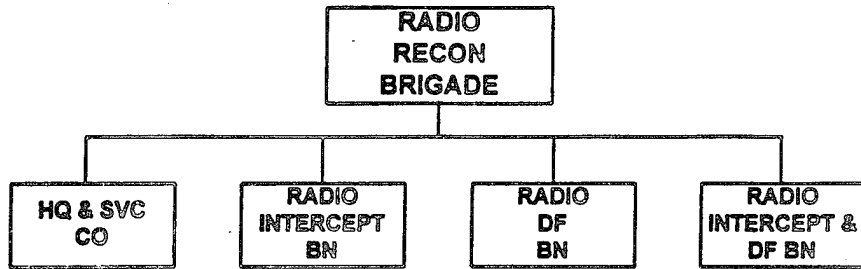

NOTE: This brigade is also known as a radio and radar intercept and direction finding brigade or as a radiotechnical reconnaissance brigade.

Special Purpose Forces Brigade, Front

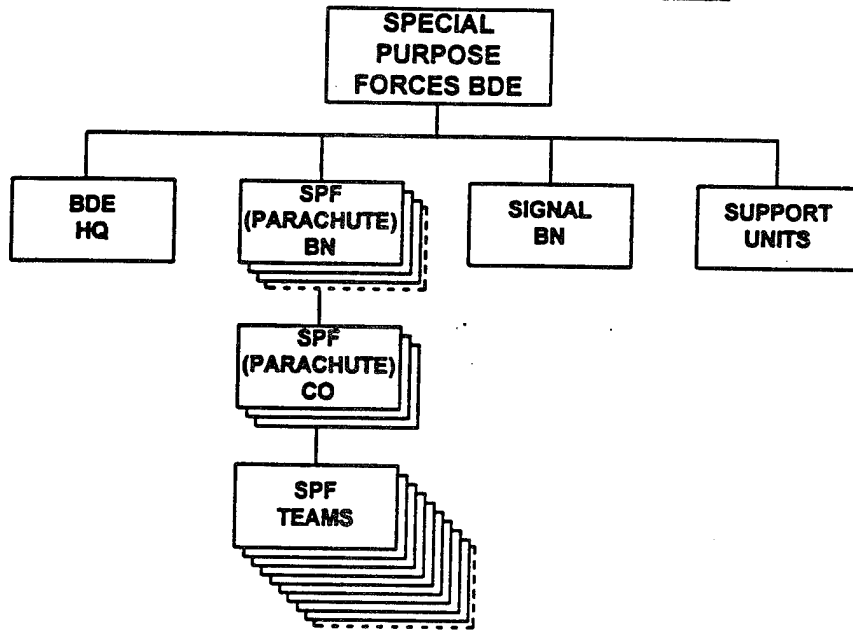

NOTES:

1. Brigade structure is not fixed. This chart represents what may be the organization of a typical brigade.
2. A brigade may deploy about 80 to 100 SPF teams.

Independent Airborne Brigade

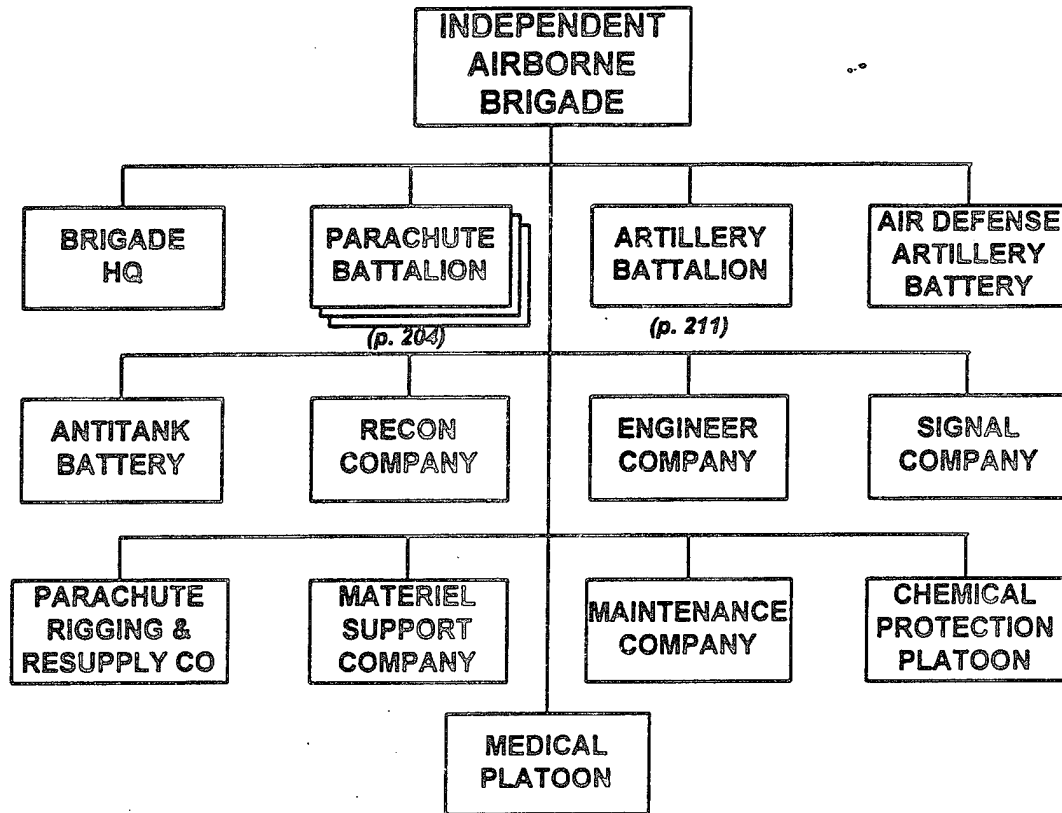

NOTE: Air transport support units required for deployment may be allocated to the brigade from military transport aviation assets. Either transport aircraft or heavy-lift helicopters could air-land the brigade or to insert the parachute battalions by parachute.

INDEPENDENT AIRBORNE BRIGADE														
Principal Items of Equipment	Brigade HQ	Parachute Bn (3X)	Artillery Bn	Air Defense Arty Btry	AntiAft Btry	Recon Co	Engineer Co	Signal Co	Parachute Rig & Resupply Co	Material Support Co	Maintenance Co	Chem Protection Plt	Medical Plt	TOTAL
WEAPONS														
30-mm Auto Grenade Launcher, AGS-17		18												18
82-mm Mortar		24												24
122-mm Howitzer, D-30			18											18
73-mm Recoilless Gun, SPG-9		9			9									18
ATGM Manpack, AT-4/SPIGOT		18			12									30
ATGM Manpack, AT-7/SAXHORN		27												27
23-mm AA Gun, ZU-23				6										6
SAM, SA-16/18	3	27		12										42
TRUCKS														
ACRV, 1V110 (Battery FDC)			3											3
ACRV, 1V111 (Battalion FDC)			1											1
Truck, Utility	8	30	1	1	1	10	1	8		1				61
Truck, Light		75	34	10	12		7		30	38			2	208
Truck, Medium			9						31	8				48
Truck, Chem Recon, UAZ-69RKh												4		4
Truck, POL (4,000-L)		6	2						12					20
Van, Maintenance		3	1								9			13
Van, Signal		3	4					3						10
Ambulance		3	1										2	6
TRAILERS														
Trailer, Cargo, 1-Axle	2	6								6				14
Trailer, Cargo, 2-Axle			9											9
Trailer, Generator		3	2											5
Trailer, Kitchen		9	3				1	1	2	4	1		1	22
Trailer, POL (900-L)		3	2											5
Trailer, Water (900-L)		6	1				1	1	1	1	1		1	13
RADARS														
Radar, BS, Man-Portable, PSNR-1					1	3								4
RADIOS														
VHF, Manpack, Low-Power	2	42	14	1	4	1	1	10	1		1	4	2	83
VHF, Portable, Low-Power		69			19	4								92
VHF, Portable, Very-Low-Power		93	23	8		12								136
VHF, Vehicle Mount, Medium-Power					13									13
HF, Manpack, Low-Power						1						1		2
HF/VHF, Vehicle Mount, Medium-Power	8	3	4					3						18
HF/VHF, Vehicle Mount, High-Power								1						1
Ground-to-Air Set	2	6		1				1						10
Warning Receiver	1	3	2	1		1		1						9
MISCELLANEOUS														
Rangefinder					1									1
Rangefinder, Laser, SAGE GLOSS			4											4
Rangefinder, Stereoscopic,		3												3
Periscopic Aiming Circle		3												3
Collimator (Aiming Stakes)		24												24
Motorcycle						3								3

Parachute Battalion, IAB

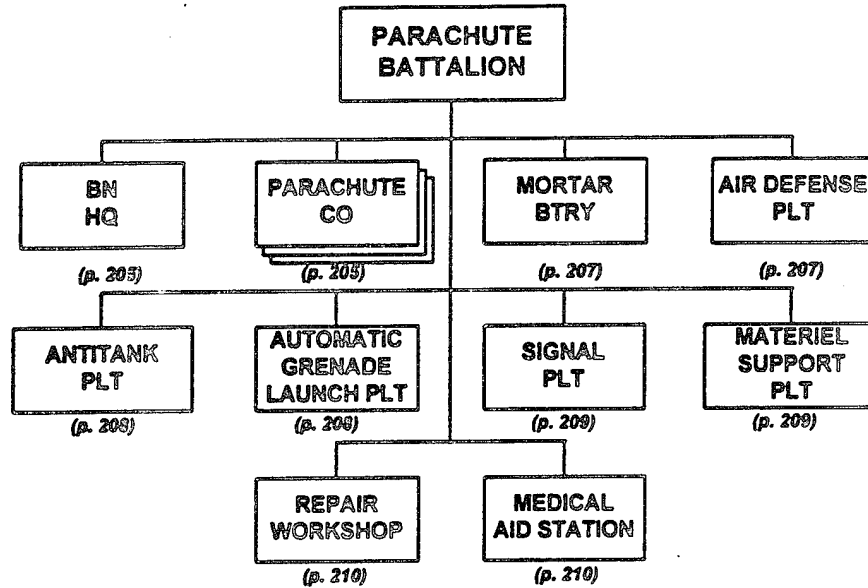

PRINCIPAL ITEMS OF EQUIPMENT

<u>Equipment</u>	<u>Total</u>
9-mm Pistol, PM.....	81
5.45-mm Assault Rifle, AKS-74.....	288
5.45-mm LMG, RPKS-74.....	27
7.62-mm Sniper Rifle, SVD.....	27
30-mm Automatic Grenade Launcher, AGS-17.....	6
82-mm Mortar.....	8
ATGL, RPG-16D.....	30
73-mm Recoilless Gun, SPG-9.....	3
ATGM Manpack, AT-4/SPIGOT.....	6
ATGM Manpack, AT-7/SAXHORN.....	9
SAM, SA-16/18.....	9
Truck, Utility.....	10
Truck, Light.....	25
Truck, POL (4,000-Liter).....	2
Van, Maintenance.....	1
Van, Signal.....	1
Ambulance.....	1

<u>Equipment</u>	<u>Total</u>
Trailer, Cargo, 1-Axle.....	2
Trailer, Generator.....	1
Trailer, Kitchen.....	3
Trailer, POL (900-Liter).....	1
Trailer, Water (900-Liter).....	2
Rangefinder, Stereoscopic, DS-1 or DM-09/DAK-1.....	1
Periscopic Aiming Circle, PAB2A.....	1
Collimator (Aiming Stakes).....	8
Radios:	
VHF, Manpack, Low-Power.....	14
VHF, Portable, Low-Power.....	23
VHF, Portable, Very-Low-Power.....	31
HF/VHF, Vehicle Mount, Medium-Power.....	1
Ground-to-Air Set.....	2
Warning Receiver.....	1

Battalion Headquarters, Parachute Bn, IAB

**BATTALION
HEADQUARTERS**

PRINCIPAL ITEMS OF EQUIPMENT

<u>Equipment</u>	<u>Total</u>	<u>Equipment</u>	<u>Total</u>
9-mm Pistol, PM.....	4	Radio, VHF, Manpack, Low-Power	1
5.45-mm Assault Rifle, AKS-74.....	4		

Parachute Company, Parachute Bn, IAB

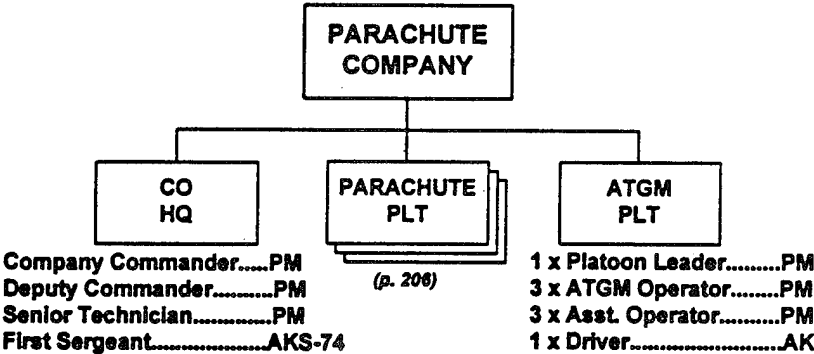

PRINCIPAL ITEMS OF EQUIPMENT

<u>Equipment</u>	<u>Total</u>	<u>Equipment</u>	<u>Total</u>
9-mm Pistol, PM.....	16	Truck, Light	1
5.45-mm Assault Rifle, AKS-74.....	44	Radios:	
5.45-mm LMG, RPKS-74.....	9	VHF, Manpack, Low-Power	1
7.62-mm Sniper Rifle, SVD.....	9	VHF, Portable, Low-Power	4
ATGL, RPG-16D	9	VHF, Portable, Very-Low-Power	9
ATGM Manpack, AT-7/SAXHORN.....	3		

NOTE: The ATGM platoon includes one light truck.

Parachute Platoon, Parachute Co, Parachute Bn, IAB

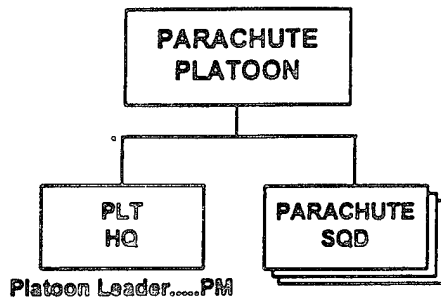

PRINCIPAL ITEMS OF EQUIPMENT

<u>Equipment</u>	<u>Total</u>	<u>Equipment</u>	<u>Total</u>
9-mm Pistol, PM	4	ATGL, RPG-16D	3
5.45-mm Assault Rifle, AKS-74.....	12	Radios:	
5.45-mm LMG, RPKS-74.....	3	VHF, Portable, Low-Power	1
7.62-mm Sniper Rifle, SVD.....	3	VHF, Portable, Very-Low-Power	3

NOTE: One squad leader is also the assistant platoon leader.

Parachute Squad, Parachute Plt, Parachute Co, Parachute Bn, IAB



- Squad Leader.....AKS-74
- Machine Gunner.....RPKS-74
- Grenadier.....RPG-16D, PM
- Assistant Grenadier.....AKS-74
- Assistant Squad Leader
- Senior Rifleman.....AKS-74
- Rifleman.....AKS-74
- Sniper.....SVD

PRINCIPAL ITEMS OF EQUIPMENT

<u>Equipment</u>	<u>Total</u>	<u>Equipment</u>	<u>Total</u>
9-mm Pistol, PM.....	1	7.62-mm Sniper Rifle, SVD.....	1
5.45-mm Assault Rifle, AKS-74.....	4	ATGL, RPG-16D.....	1
5.45-mm LMG, RPKS-74.....	1	Radio, VHF, Portable, Very-Low-Power.....	1

Mortar Battery, Parachute Bn, IAB

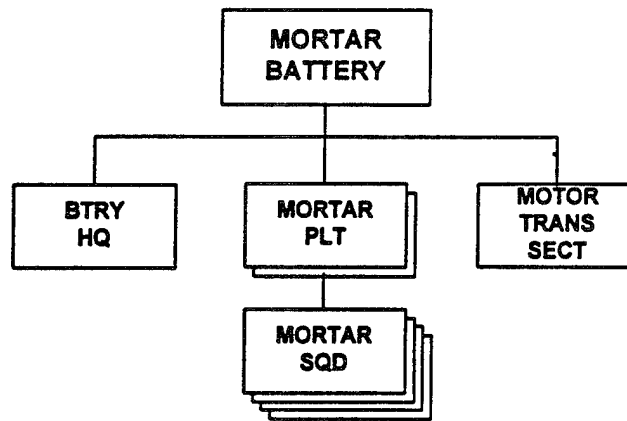

PRINCIPAL ITEMS OF EQUIPMENT

<u>Equipment</u>	<u>Total</u>	<u>Equipment</u>	<u>Total</u>
82-mm Mortar	8	Rangefinder, Stereoscopic, DS-1 or	
9-mm Pistol, PM	15	DM-09/DAK-1	1
5.45-mm Assault Rifle, AKS-74	54	Periscopic Aiming Circle, PAB2A	1
ATGL, RPG-16D	3	Collimator (Aiming Stakes)	8
Truck, Utility	9	Radio, VHF, Manpack, Low-Power	4

Air Defense Platoon, Parachute Bn, IAB

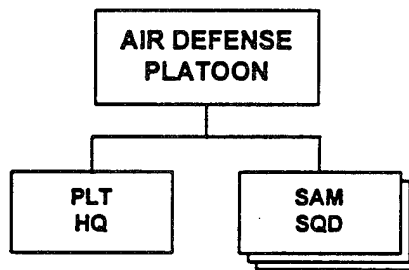

PRINCIPAL ITEMS OF EQUIPMENT

<u>Equipment</u>	<u>Total</u>	<u>Equipment</u>	<u>Total</u>
SAM, SA-16/18	9	Truck, Light	3
9-mm Pistol, PM	4	Radio, VHF, Portable, Very-Low-Power	4
5.45-mm Assault Rifle, AKS-74	9		

NOTE: Each parachute company normally has one SAM squad attached.

Antitank Platoon, Parachute Bn, IAB

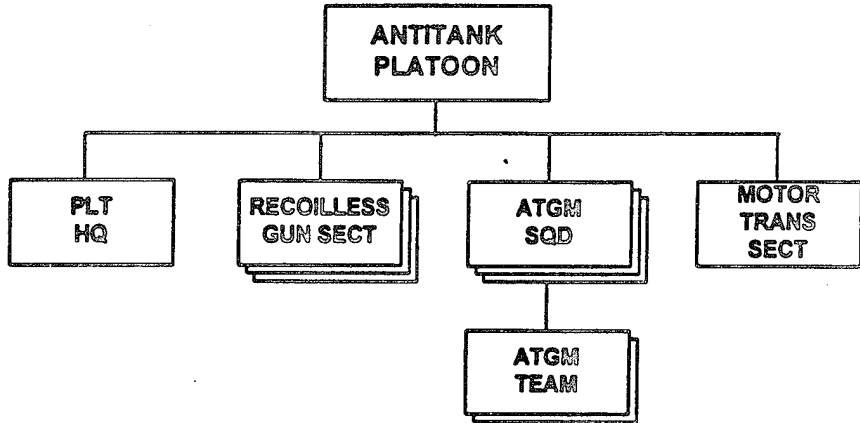

PRINCIPAL ITEMS OF EQUIPMENT

<u>Equipment</u>	<u>Total</u>	<u>Equipment</u>	<u>Total</u>
ATGM Manpack, AT-4/SPIGOT	6	Truck, Light	5
73-mm Recoilless Gun, SPG-9	3	Radios:	
9-mm Pistol, PM	4	VHF, Portable, Low-Power	7
5.45-mm Assault Rifle, AKS-74.....	30	VHF, Manpack, Low-Power	1

Automatic Grenade Launcher Platoon, Parachute Bn, IAB

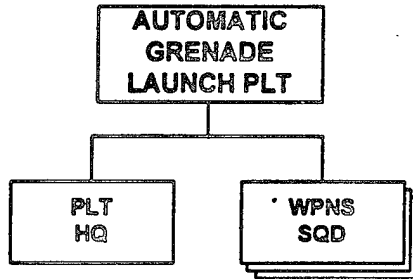

PRINCIPAL ITEMS OF EQUIPMENT

<u>Equipment</u>	<u>Total</u>	<u>Equipment</u>	<u>Total</u>
30-mm Automatic Grenade Launcher, AGS-17	6	5.45-mm Assault Rifle, AKS-74.....	15
9-mm Pistol, PM	4	Truck, Light	3
		Radio, VHF, Portable, Low-Power	4

Signal Platoon, Parachute Bn, IAB

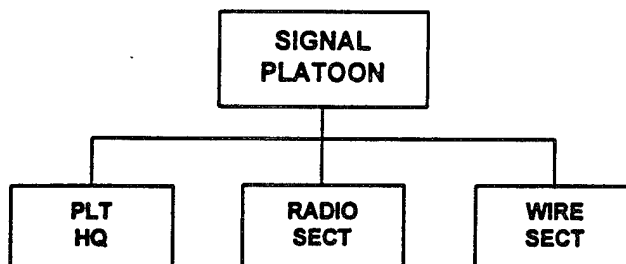

PRINCIPAL ITEMS OF EQUIPMENT

<u>Equipment</u>	<u>Total</u>	<u>Equipment</u>	<u>Total</u>
Van, Signal.....	1	Radios:	
9-mm Pistol, PM.....	1	HF/VHF, Vehicle Mount,	
5.45-mm Assault Rifle, AKS-74.....	13	Medium-Power	1
Truck, Light	1	VHF, Manpack, Low-Power.....	3
Truck, Utility.....	1	Ground-to-Air Set.....	2
		Warning Receiver	1

Materiel Support Platoon, Parachute Bn, IAB

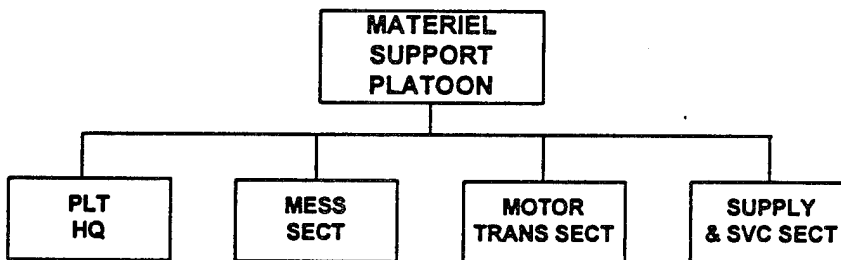

PRINCIPAL ITEMS OF EQUIPMENT

<u>Equipment</u>	<u>Total</u>	<u>Equipment</u>	<u>Total</u>
9-mm Pistol, PM.....	1	Trailer, Cargo, 1-Axle.....	1
5.45-mm Assault Rifle, AKS-74.....	20	Trailer, Water (900-Liter)	2
Truck, Light	10	Trailer, Kitchen	3
Truck, POL (4,000-Liter).....	2	Radio, VHF, Manpack, Low-Power	1
Trailer, POL (900-Liter)	1		

Repair Workshop, Parachute Bn, IAB

**REPAIR
WORKSHOP**

PRINCIPAL ITEMS OF EQUIPMENT

<u>Equipment</u>	<u>Total</u>	<u>Equipment</u>	<u>Total</u>
Van, Maintenance	1	Trailer, Generator	1
5.45-mm Assault Rifle, AKS-74.....	7		

Medical Aid Station, Parachute Bn, IAB

**MEDICAL
AID STATION**

PRINCIPAL ITEMS OF EQUIPMENT

<u>Equipment</u>	<u>Total</u>	<u>Equipment</u>	<u>Total</u>
Ambulance	1	Trailer, Cargo, 1-Axle.....	1
5.45-mm Assault Rifle, AKS-74.....	4	Radio, VHF, Manpack, Low-Power	1

Artillery Battalion, IAB

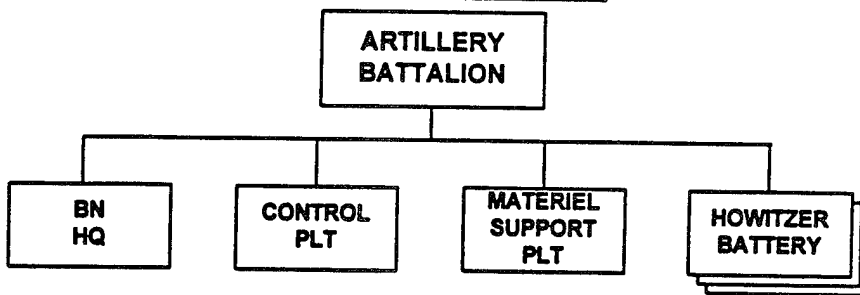

PRINCIPAL ITEMS OF EQUIPMENT

Equipment	Total	Equipment	Total
122-mm Howitzer, D-30.....	18	Trailer, Generator.....	2
ATGL, RPG-16D.....	6	Trailer, Kitchen.....	3
ACRV, 1V110 (Btry FDC).....	3	Trailer, POL (900-Liter).....	2
ACRV, 1V111 (Bn FDC).....	1	Trailer, Water (900-Liter).....	1
Truck, Utility.....	1	Rangefinder, Laser, SAGE GLOSS.....	4
Truck, Light.....	34	Radios:	
Truck, Medium.....	9	VHF, Manpack, Low-Power.....	14
Truck, POL (4,000-Liter).....	2	VHF, Portable, Very-Low-Power.....	23
Van, Maintenance.....	1	HF/VHF, Vehicle Mount,	
Van, Signal.....	4	Medium-Power.....	4
Ambulance.....	1	Warning Receiver.....	2
Trailer, Cargo, 2-Axle.....	9		

Howitzer Battery, Arty Bn, IAB or Arty Regt, Airborne Div

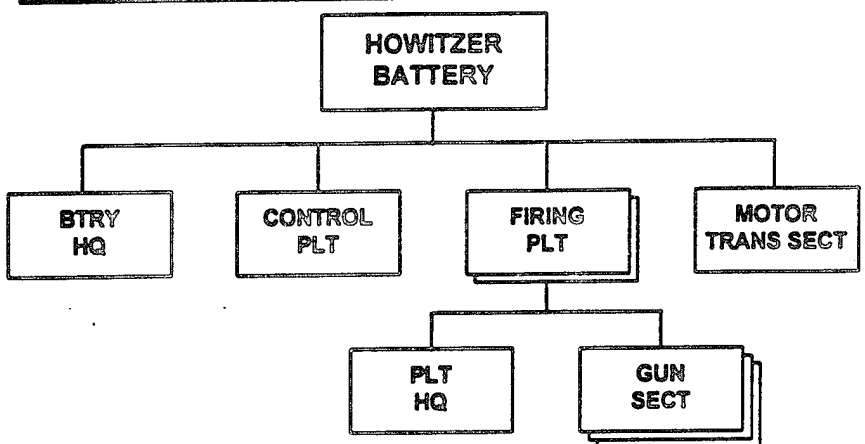

PRINCIPAL ITEMS OF EQUIPMENT

<u>Equipment</u>	<u>Total</u>
122-mm Howitzer, D-30.....	6
ATGL, RPG-16D.....	2
Van, Signal.....	1
Truck, Light.....	7
ACRV, 1V110 (Btry FDC).....	1

<u>Equipment</u>	<u>Total</u>
Rangefinder, Laser, SAGE GLOSS.....	1
Radios:	
VHF, Manpack, Low-Power.....	2
VHF, Portable, Very-Low-Power.....	7

Airborne Division

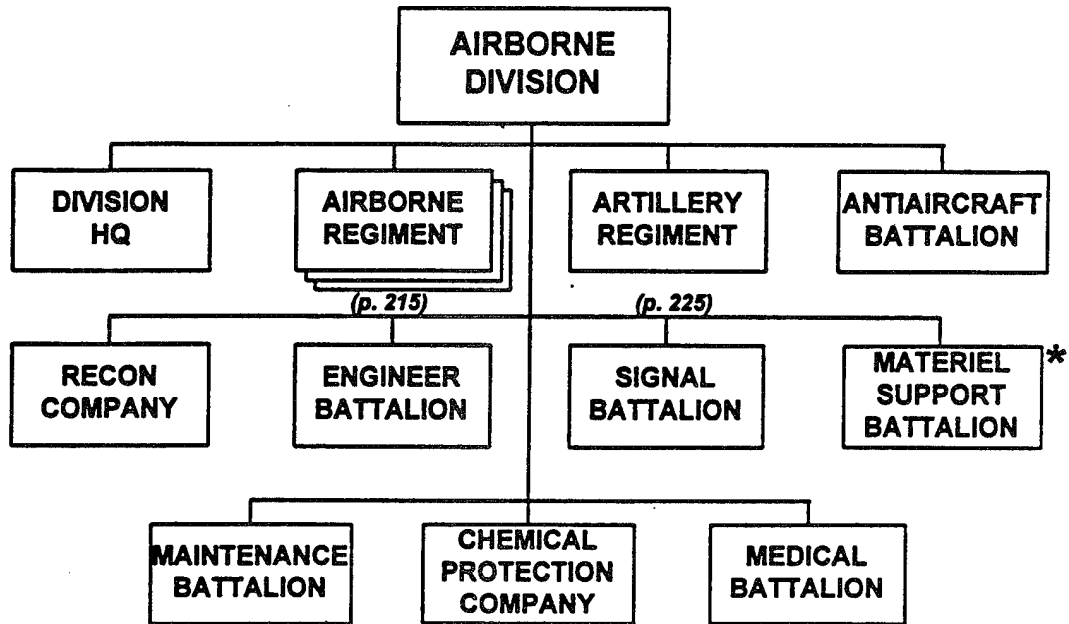

FOOTNOTE: * Also known as the parachute rigging and materiel support battalion.

AIRBORNE DIVISION												
Principal Items of Equipment	Division HQ	Airborne Regt (BMD) (3x)	Army Regt	Anti-aircraft Bn	Recon Co	Engineer Bn	Signal Bn	Material Support Bn	Maintenance Bn	Chem Protection Co	Medical Bn	TOTAL
ARMORED VEHICLES												
AAICV, BMD-1/2/3	9	303			6							318
APC, BTR-D	12	69	5		6	11	3		1			107
APC, BTR-RD		18	18									36
APC, BTR-ZD	1	39	3	4								47
ACV, BMD-1KSh	2	24	2	1	1	1	12					43
ASC, BRDM-2		12			6							18
ACRV, IV119	1	30	10									41
Armored Recovery Vehicle						3			1			4
WEAPONS												
30-mm Auto Grenade Launcher, AGS-17		54										54
120-mm Combaticus Gun, 2S9		54	18									72
122-mm Howitzer, D-30			6									6
ATGM Manpack, AT-4/SPIGOT		36	36									72
23-mm AA Gun, ZU-23		18		18								36
SAM, SA-16/18	3	117	9	12								141
TRUCKS												
ACRV, IV110 (Btry FDC)			1									1
Truck, Utility	16	33	9	1		10	7	10	6	6	4	102
Truck, Light	6	249	73	25		20	2	60			1	436
Truck, Medium		207	17				3	50	50		10	113
Truck, Decon, DDA-53/66										3		3
Truck, Decon, DDP/DDA										1	1	2
Truck, Chem Recon, UAZ-69RKh		12	1							7		20
Truck, POL (4,000-L)		42	12	1		1	1	15	4	1	1	36
Van	8										1	9
Van, Hospital											5	5
Van, Maintenance		42	7						18			67
Van, Signal		27	7				9					43
Ambulance	1	18	2	1		1		1			10	34
TRAILERS												
Trailer, Cargo, 1-Axle	4	66	35					20			3	128
Trailer, Cargo, 2-Axle			5						20			25
Trailer, Generator	2	15	5				3				2	27
Trailer, Kitchen	2	69	10			3	1	1	1		2	89
Trailer, POL (900/1,200-L)		24	11									35
Trailer, Water (900/1,200-L)	1	30	9	2		2	1	1	1	2	3	52
RADARS												
Radar, BS, Man-Portable, PSNR-1		9			4							13
RADIOS												
VHF, Manpack, Low-Power	3	195	50	10	5	8	1	3	2	10	2	289
VHF, Portable, Low-Power		153	1									154
VHF, Portable, Very-Low-Power		48	11									59
VHF, Vehicle Mount, Medium-Power	25	546	52	5	19	12	15					674
HF, Manpack, Low-Power		6			1							7
HF, Vehicle Mount, Medium-Power	10	36	5	1	1		4					57
HF/VHF, Vehicle Mount, Medium-Power		3	5				1				1	10
HF/VHF, Vehicle Mount, High-Power		3	1				1					5
Ground-to-Air Radio Set	2	33	2	1	1		4			1		44
Warning Receiver	1	36	4	1	1	1	1		1	1		47
Radio Relay, VHF/UHF			1				1					1
MISCELLANEOUS												
Rangefinder		3	3									6
Rangefinder, Laser, SAGE GLOSS		12	6									18

Airborne Regiment (BMD), Airborne Div

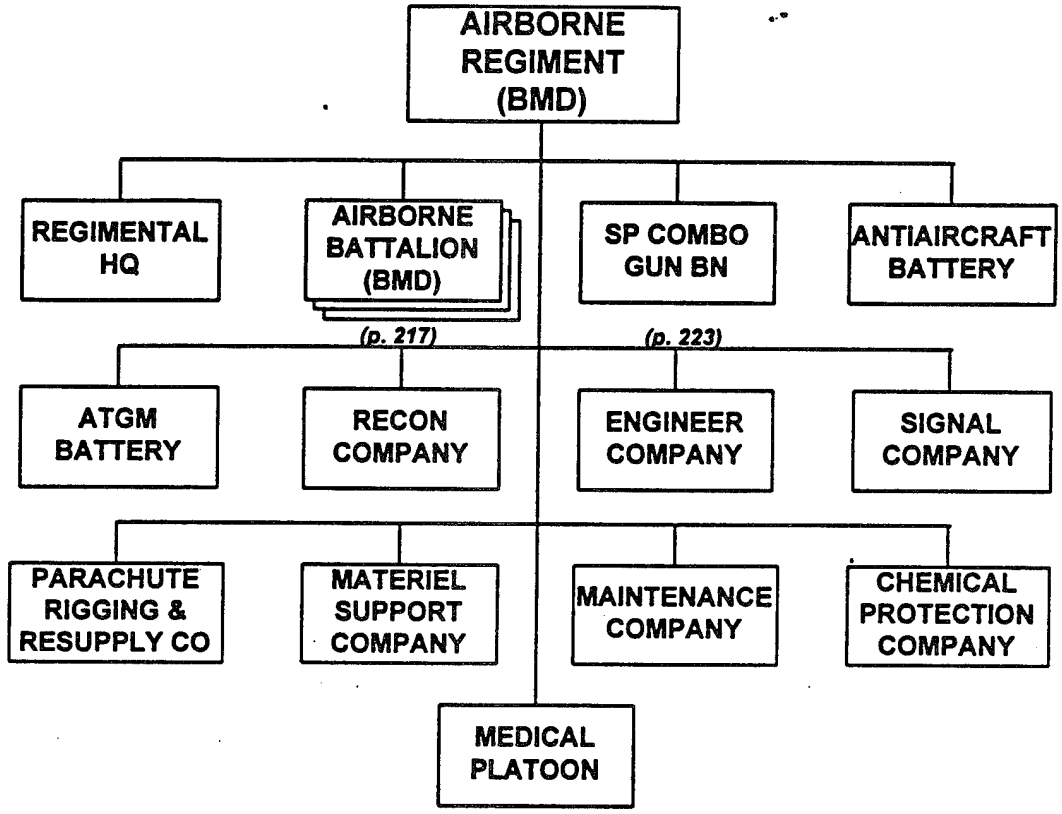

AIRBORNE REGIMENT, AIRBORNE DIV														
Principal Items of Equipment	Regt HQ	Alphemo Bn (BMD) (3X)	SP Comdo Gun Bn	Air Defense Btry	Antitank Btry	Recon Co	Engineer Co	Signal Co	Parachute Rig & Resupply Co	Material Support Plt	Maintenance Co	Chem Protection Plt	Medical Plt	TOTAL
ARMORED VEHICLES														
AAICV, BMD-1/2/3		99				2								101
AFC, BTR-D	3	9			1	5	3	2						23
AFC, BTR-RD					6									6
AFC, BTR-ZD		9		4										13
ACV, BMD-1KSh		6						2						8
ASC, BRDM-2						4								4
ACRV, IV119	1		8		1									10
WEAPONS														
30-mm Auto Grande Launcher, AGS-17		18												18
120-mm Combustion Gun, 259			18											18
ATGM Manpack, AT-4/SPIGOT					12									12
23-mm AA Gun, ZU-23				6										6
SAM, SA-16/18		27		12										39
TRUCKS														
Truck, Utility		3	1	1			1	4		1				11
Truck, Light		12	21	6			4		30	8			2	83
Truck, Medium		12	4						31	38				69
Truck, Chem Recon, UAZ-69RKh												4		4
Truck, POL (4,000-L)		6	2						12					14
Van, Maintenance		3	2								9			14
Van, Signal		3	3					3						9
Ambulance		3	1										2	6
TRAILERS														
Trailer, Cargo, 1-Axle		6	10							6				22
Trailer, Generator		3	2											5
Trailer, Kitchen		9	3		1		1	1	2	4	1		1	23
Trailer, POL (1,200-L)		6	2											8
Trailer, Water (900/1,200-L)		3	1				1	1	1	1	1		1	10
RADARS														
Radar, BS, Man-Portable, PSNR-1						3								3
RADIOS														
VHF, Manpack, Low-Power		27	10		9	4	1	6	1		1	4	2	65
VHF, Portable, Low-Power		51												51
VHF, Portable, Very-Low-Power		12		4										16
VHF, Vehicle Mount, Medium-Power	3	123	26	4	8	11	3	4						182
HF, Manpack, Low-Power						1						1		2
HF, Vehicle Mount, Medium-Power	3	3		1		1		4						12
HF/VHF, Vehicle Mount, Medium-Power								1						1
HF/VHF, Vehicle Mount, High-Power								1						1
Ground-to-Air Radio Set	2	6		1		1		1						11
Warning Receiver	1	6	2	1		1		1						12
MISCELLANEOUS														
Rangefinder					1									
Rangefinder, Laser, SAGE GLOSS			4											4

Airborne Battalion, Airborne Regt (BMD), Airborne Div

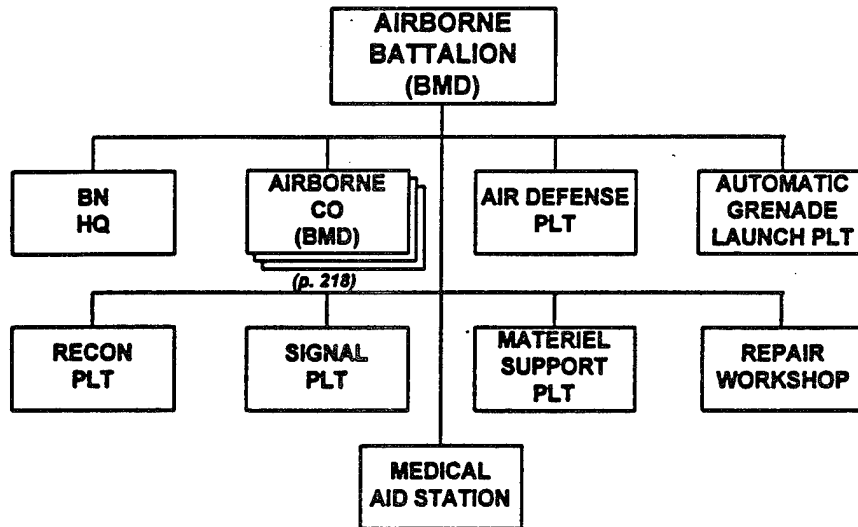

PRINCIPAL ITEMS OF EQUIPMENT

Equipment	Total	Equipment	Total
AAICV, BMD-1/2/3	33	Van, Maintenance	1
APC, BTR-D.....	3	Van, Signal.....	1
APC, BTR-ZD	3	Ambulance	1
ACV, BMD-1KSh.....	2	Trailer, Cargo, 1-Axle.....	2
9-mm Pistol, PM.....	53	Trailer, Generator.....	1
5.45-mm Assault Rifle, AKS-74.....	146	Trailer, Kitchen	3
5.45-mm Submachinegun, AKSU-74	80	Trailer, POL (1,200-Liter)	2
5.45-mm LMG, RPKS-74.....	30	Trailer, Water (1,200-Liter)	1
7.62-mm Sniper Rifle, SVD.....	1	Radios:	
30-mm Automatic Grenade Launcher,		VHF, Manpack, Low-Power.....	9
AGS-17	6	VHF, Portable, Low-Power	17
ATGL, RPG-16D	30	VHF, Portable, Very-Low-Power	4
SAM, SA-16/18	9	VHF, Vehicle Mount,	
Truck, Utility.....	1	Medium-Power	41
Truck, Light	4	HF, Vehicle Mount, Medium-Power	1
Truck, Medium	4	Ground-to-Air Set	2
Truck, POL (4,000-Liter).....	2	Warning Receiver	2

**Battalion Headquarters, Airborne Bn, Airborne Regt,
Airborne Div**

**BATTALION
HEADQUARTERS**

PRINCIPAL ITEMS OF EQUIPMENT

<u>Equipment</u>	<u>Total</u>	<u>Equipment</u>	<u>Total</u>
ACV, BMD-1KSh.....	1	Radios:	
9-mm Pistol, PM.....	3	VHF, Manpack, Low-Power.....	1
5.45-mm Assault Rifle, AKS-74.....	2	VHF, Vehicle Mount,	
5.45-mm Submachinegun, AKSU-74.....	1	Medium-Power.....	1
		HF, Vehicle Mount, Medium-Power.....	1
		Ground-to-Air Set.....	1
		Warning Receiver.....	1

**Airborne Company (BMD), Airborne Bn, Airborne Regt,
Airborne Div**

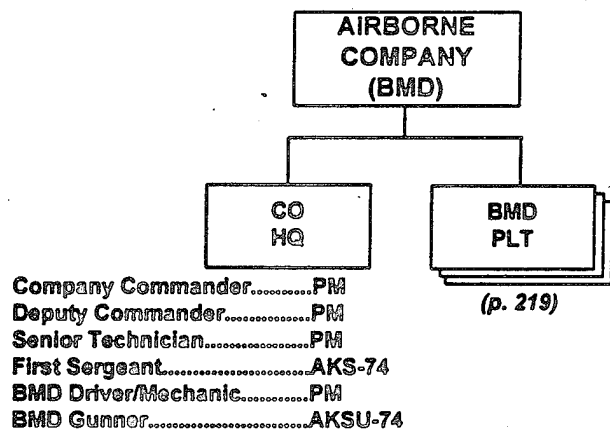

PRINCIPAL ITEMS OF EQUIPMENT

<u>Equipment</u>	<u>Total</u>	<u>Equipment</u>	<u>Total</u>
AAICV, BMD-1/2/3.....	10	Radios:	
9-mm Pistol, PM.....	13	VHF, Manpack, Low-Power.....	1
5.45-mm Assault Rifle, AKS-74.....	28	VHF, Portable, Low-Power.....	4
5.45-mm Submachinegun, AKSU-74.....	19	VHF, Vehicle Mount,	
5.45-mm LMG, RPKS-74.....	9	Medium-Power.....	10
ATGL, RPG-16D.....	9		

NOTE: The company headquarters has its own BMD.

**BMD Platoon, Airborne Co, Airborne Bn, Airborne Regt,
Airborne Div**

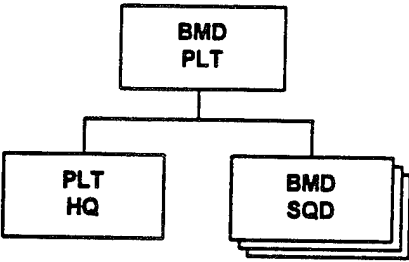

PRINCIPAL ITEMS OF EQUIPMENT

Equipment	Total	Equipment	Total
AAICV, BMD-1/2/3	3	ATGL, RPG-16D	3
9-mm Pistol, PM	3	Radios:	
5.45-mm Assault Rifle, AKS-74.....	9	VHF, Portable, Low-Power	1
5.45-mm Submachinegun, AKSU-74	6	VHF, Vehicle Mount,	
5.45-mm LMG, RPKS-74.....	3	Medium-Power	3

NOTE: In one squad vehicle, the platoon leader takes the place of the squad leader. One of the other squad leaders is also the assistant platoon leader.

**BMD Squad, BMD Plt, Airborne Co, Airborne Bn,
Airborne Regt, Airborne Div**



- Squad Leader.....AKS-74
- BMD Driver/Mechanic.....PM
- BMD Gunner.....AKSU-74
- Machine Gunner.....RPKS-74
- Grenadier.....RPG-16D, AKSU-74
- Rifleman/Assistant Grenadier.....AKS-74
- Assistand Squad Leader/Senior Rifleman.....AKS-74

PRINCIPAL ITEMS OF EQUIPMENT

Equipment	Total	Equipment	Total
AAICV, BMD-1/2/3	1	5.45-mm LMG, RPKS-74.....	1
9-mm Pistol, PM	1	ATGL, RPG-16D	1
5.45-mm Assault Rifle, AKS-74.....	3	Radio, VHF, Vehicle Mount,	
5.45-mm Submachinegun, AKSU-74	2	Medium-Power	1

NOTE: The dismounted squad element consists of five personnel. The BMD driver/mechanic and BMD gunner remain with the BMD to provide fire support. The dismounted squad does not have a portable radio.

**Air Defense Platoon, Arty Regt or Airborne Bn,
Airborne Regt, Airborne Div**

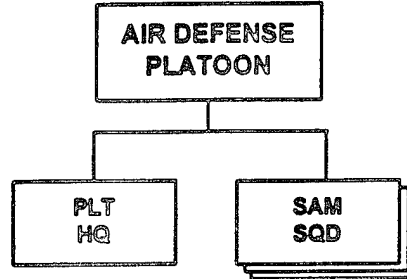

PRINCIPAL ITEMS OF EQUIPMENT

<u>Equipment</u>	<u>Total</u>	<u>Equipment</u>	<u>Total</u>
SAM, SA-16/18	9	Radios:	
9-mm Pistol, PM	3	VHF, Portable, Very-Low-Power	4
5.45-mm Submachinegun, AKSU-74	10	VHF, Vehicle Mount,	
APC, BTR-ZD	3	Medium-Power	3

**Automatic Grenade Launcher Platoon, Airborne Bn,
Airborne Regt, Airborne Div**

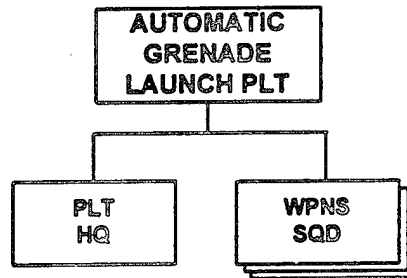

PRINCIPAL ITEMS OF EQUIPMENT

<u>Equipment</u>	<u>Total</u>	<u>Equipment</u>	<u>Total</u>
30-mm Automatic Grenade Launcher,		APC, BTR-D	3
AGS-17	6	Radios:	
9-mm Pistol, PM	3	VHF, Portable, Low-Power	4
5.45-mm Assault Rifle, AKS-74	9	HVF, Vehicle Mount,	
5.45-mm Submachinegun, AKSU-74	6	Medium-Power	3

**Reconnaissance Platoon, Airborne Bn, Airborne Regt,
Airborne Div**

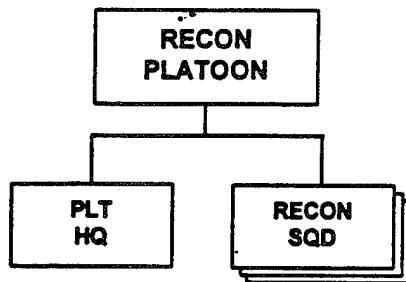

PRINCIPAL ITEMS OF EQUIPMENT

Equipment	Total	Equipment	Total
AAICV, BMD-1/2/3	3	ATGL, RPG-16D	3
9-mm Pistol, PM	3	Radios:	
5.45-mm Assault Rifle, AKS-74	8	VHF, Portable, Low-Power	1
5.45-mm Submachinegun, AKSU-74	6	VHF, Vehicle Mount,	
5.45-mm LMG, RPKS-74	3	Medium-Power	3
7.62-mm Sniper Rifle, SVD	1		

Signal Platoon, Airborne Bn, Airborne Regt, Airborne Div

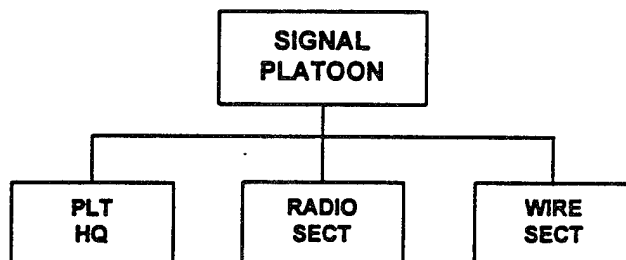

PRINCIPAL ITEMS OF EQUIPMENT

Equipment	Total	Equipment	Total
ACV, BMD-1KSh	1	Radios:	
Van, Signal	1	VHF, Manpack, Low-Power	3
9-mm Pistol, PM	1	HF, Vehicle Mount, Medium-Power	1
5.45-mm Assault Rifle, AKS-74	13	VHF, Vehicle Mount,	
Truck, Utility	1	Medium-Power	1
		Ground-to-Air Set	1
		Warning Receiver	1

**Materiel Support Platoon, Airborne Bn, Airborne Regt,
Airborne Div**

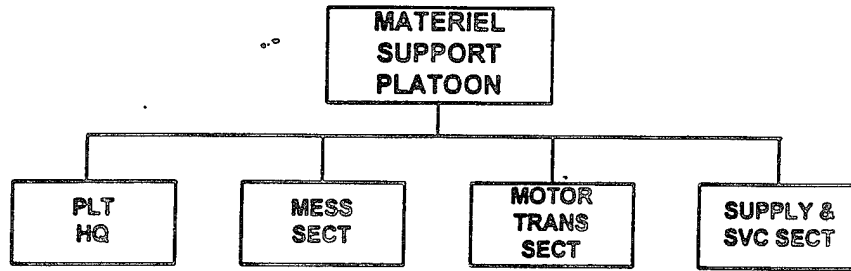

PRINCIPAL ITEMS OF EQUIPMENT

<u>Equipment</u>	<u>Total</u>
9-mm Pistol, PM.....	1
5.45-mm Assault Rifle, AKS-74.....	19
Truck, Light.....	4
Truck, Medium.....	4
Truck, POL (4,000-Liter).....	2

<u>Equipment</u>	<u>Total</u>
Trailer, POL (1,200-Liter).....	2
Trailer, Cargo, 1-Axle.....	1
Trailer, Kitchen.....	3
Trailer, Water (1,200-Liter).....	1
Radio, VHF, Manpack, Low-Power.....	1

**SP Combination Gun Battalion, Airborne Regt
and Arty Regt, Airborne Div**

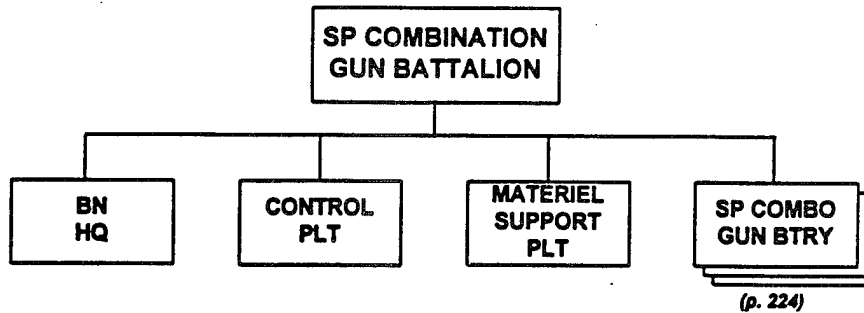

PRINCIPAL ITEMS OF EQUIPMENT

Equipment	Total
120-mm Combination Gun, 2S9.....	18
ATGL, RPG-16D.....	6
ACRV, 1V119 (Btry/Bn COP/FDC).....	8
Truck, Utility.....	1
Truck, Light.....	21
Truck, Medium.....	4
Truck, POL (4,000-Liter).....	2
Van, Maintenance.....	2
Van, Signal.....	3
Ambulance.....	1
Trailer, Cargo, 1-Axle.....	10

Equipment	Total
Trailer, Generator.....	2
Trailer, Kitchen.....	3
Trailer, POL (1,200-Liter).....	2
Trailer, Water (1,200-Liter).....	1
Rangefinder, Laser, SAGE GLOSS.....	4
Radios:	
VHF, Manpack, Low-Power.....	10
VHF, Vehicle Mount, Medium-Power.....	26
Warning Receiver.....	2

**SP Combination Gun Battery, SP Combo Gun Bn,
Airborne Regt and Arty Regt, Airborne Div**

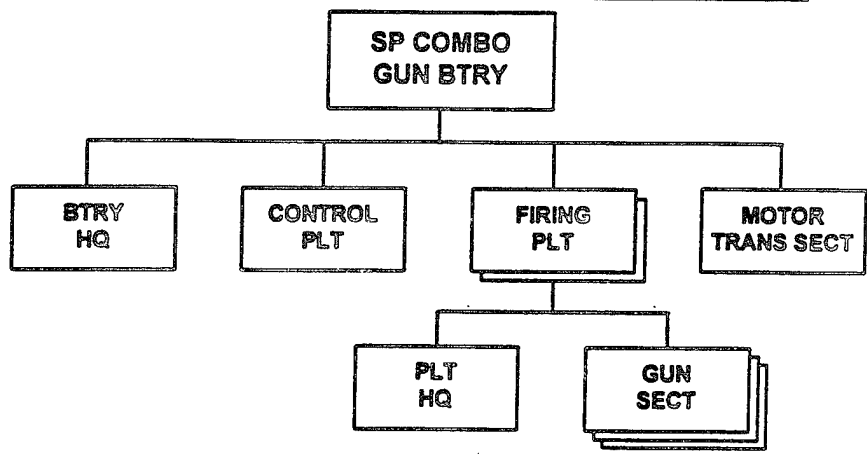

PRINCIPAL ITEMS OF EQUIPMENT

<u>Equipment</u>	<u>Total</u>
120-mm Combination Gun, 2S9	6
ATGL, RPG-16D	2
Van, Signal	1
Truck, Light	7
ACRV, 1V119 (Btry FDC/COP)	2
Trailer, Cargo, 1-Axle	3

<u>Equipment</u>	<u>Total</u>
Rangefinder, Laser, SAGE GLOSS	1
Radios:	
VHF, Manpack, Low-Power	2
VHF, Vehicle Mount, Medium-Power	8

Artillery Regiment, Airborne Div

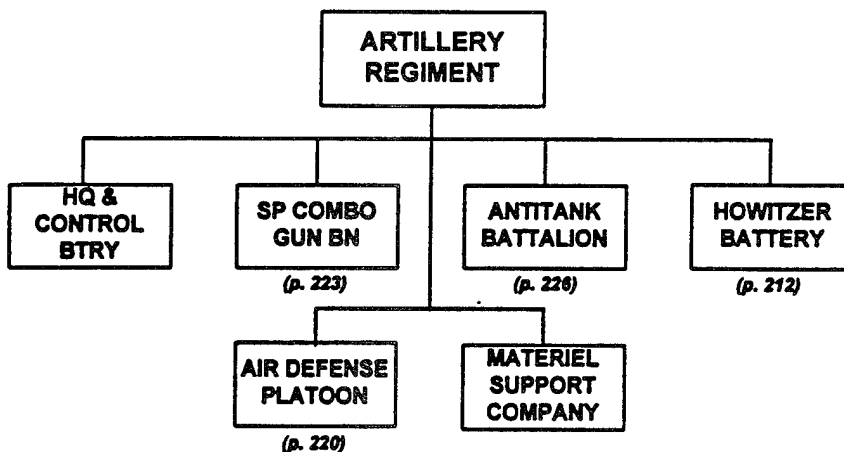

ARTILLERY REGIMENT, AIRBORNE DIV							
Principal Items of Equipment	HQ & Control Btry	SP Combo Gun Bn	Antitank Bn	Howitzer Btry	Air Defense Pl	Materiel Support Co	TOTAL
ARMORED VEHICLES							
APC, BTR-D	1		4				5
APC, BTR-AD			18				18
APC, BTR-2D					3		3
ACV, BMD-1KSh	2						2
ACRV, IV119	1	8	1				10
WEAPONS							
120-mm Combination Gun, 2S9		18					18
122-mm Howitzer, D-30				6			6
ATGM Manpack, AT-4/SPIGOT			36				36
SAM, SA-16/18					9		9
TRUCKS							
ACRV, IV110 (Btry FDC)				1			1
Truck, Utility	6	1	1			1	9
Truck, Light	2	21	7	7			36
Truck, Medium	1	4	4			8	17
Truck, Chem Recon, UAZ-49RUB	1						1
Truck, POL (4000-L)		2	2			8	12
Van, Maintenance	1	2	2			2	7
Van, Signal	2	3	2				7
Ambulance		1	1				2
TRAILERS							
Trailer, Cargo, 1-Axis		10				25	35
Trailer, Cargo, 2-Axis	1		4				5
Trailer, Generator	2	2	1				5
Trailer, Kitchen	1	3	2			4	10
Trailer, POL (900-1200-L)		2	1			8	11
Trailer, Water (900-1200-L)	1	1	1			6	9
RADIOS							
VHF, Manpack, Low-Power	6	10	31	2		1	50
VHF, Portable, Low-Power	1						1
VHF, Portable, Very-Low-Power				7	4		11
VHF, Vehicle Mount, Medium-Power		26	23		3		52
HF, Vehicle Mount, Medium-Power	3		2				5
HF/VHF, Vehicle, Medium-Power	5						5
HF/VHF, Vehicle, High-Power	1						1
Ground-to-Air Radio Set	2						2
Warning Receiver	1	2	1				4
Radio Relay, VHF/UHF	1						1
MISCELLANEOUS							
Rangefinder			3				3
Rangefinder, Laser, SAGE GLOSS	1	4		1			6

Antitank Battalion, Arty Regt, Airborne Div

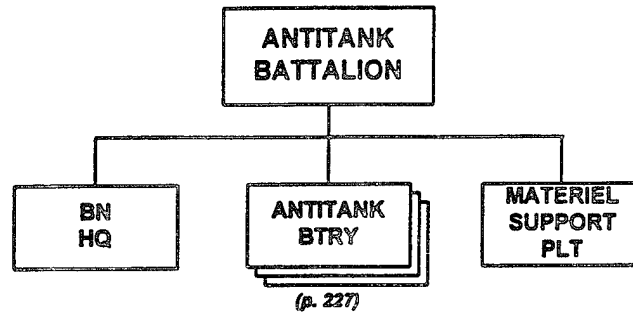

PRINCIPAL ITEMS OF EQUIPMENT

<u>Equipment</u>	<u>Total</u>
ATGM, Manpack, AT-4/SPIGOT	36
APC, BTR-RD	18
APC, BTR-D	4
ACRV, 1V119	1
Truck, Utility	1
Truck, Light	7
Truck, Medium	4
Truck, POL (4,000-Liter)	2
Van, Signal	2
Van, Maintenance	2
Ambulance	1
Trailer, Cargo, 2-Axle	4

<u>Equipment</u>	<u>Total</u>
Trailer, Generator	1
Trailer, Kitchen	2
Trailer, POL (900-Liter)	1
Trailer, Water (900-Liter)	1
Rangefinder	3
Radios:	
VHF, Manpack, Low-Power	31
VHF, Vehicle Mount, Medium-Power	23
HF, Vehicle Mount, Medium-Power	2
Warning Receiver	1

**Antitank Battery, Airborne Regt or Antitank Bn,
Arty Regt, Airborne Div**

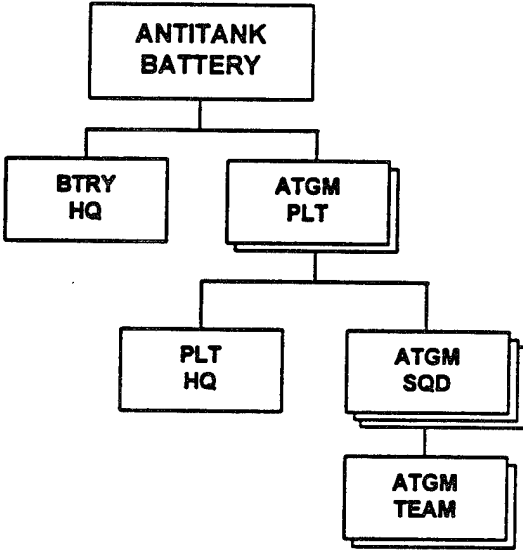

PRINCIPAL ITEMS OF EQUIPMENT

<u>Equipment</u>	<u>Total</u>	<u>Equipment</u>	<u>Total</u>
ATGM, Manpack, AT-4/SPIGOT	12	Radios:	
APC, BTR-RD	6	VHF, Manpack, Low-Power	9
APC, BTR-D	1	VHF, Vehicle Mount,	
Rangefinder	1	Medium-Power	7

NOTE: In the airborne regiment, this battery may also have a 1V119 command vehicle.

Infantry Division

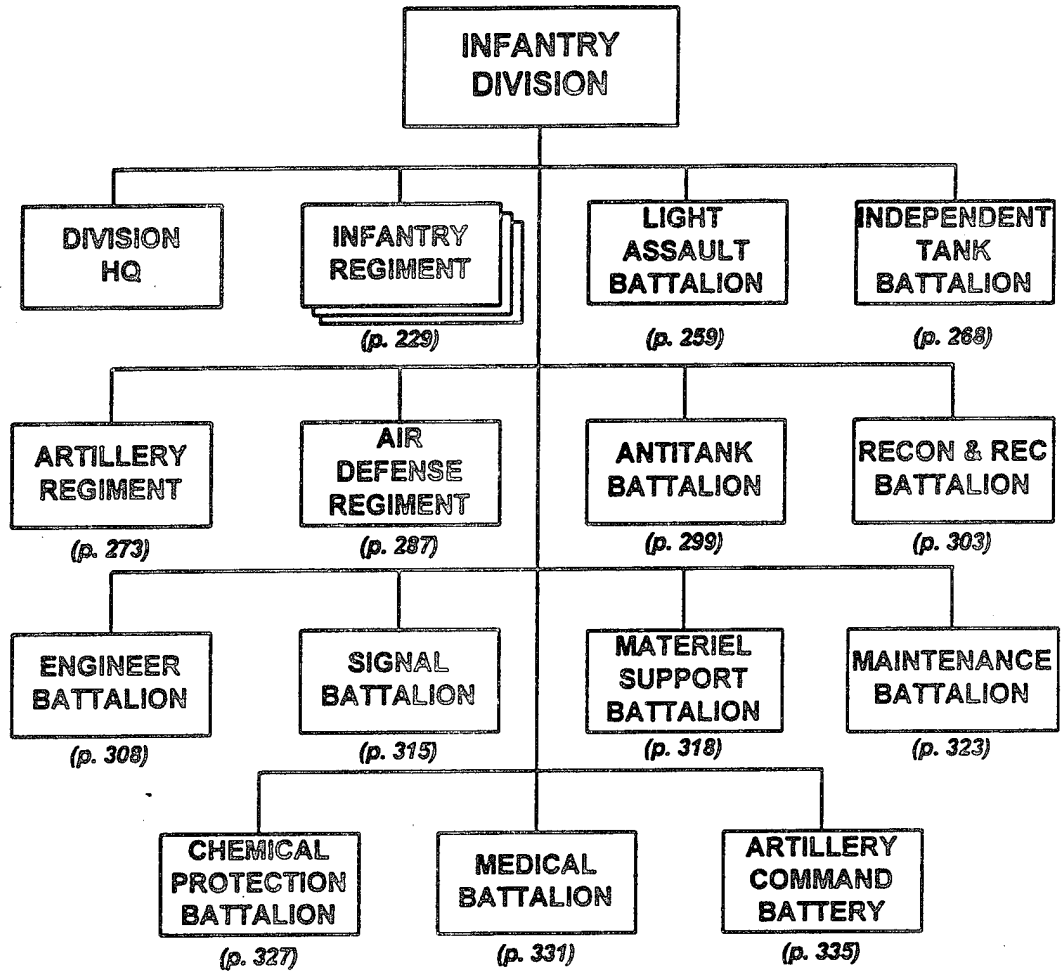

Infantry Regiment, ID

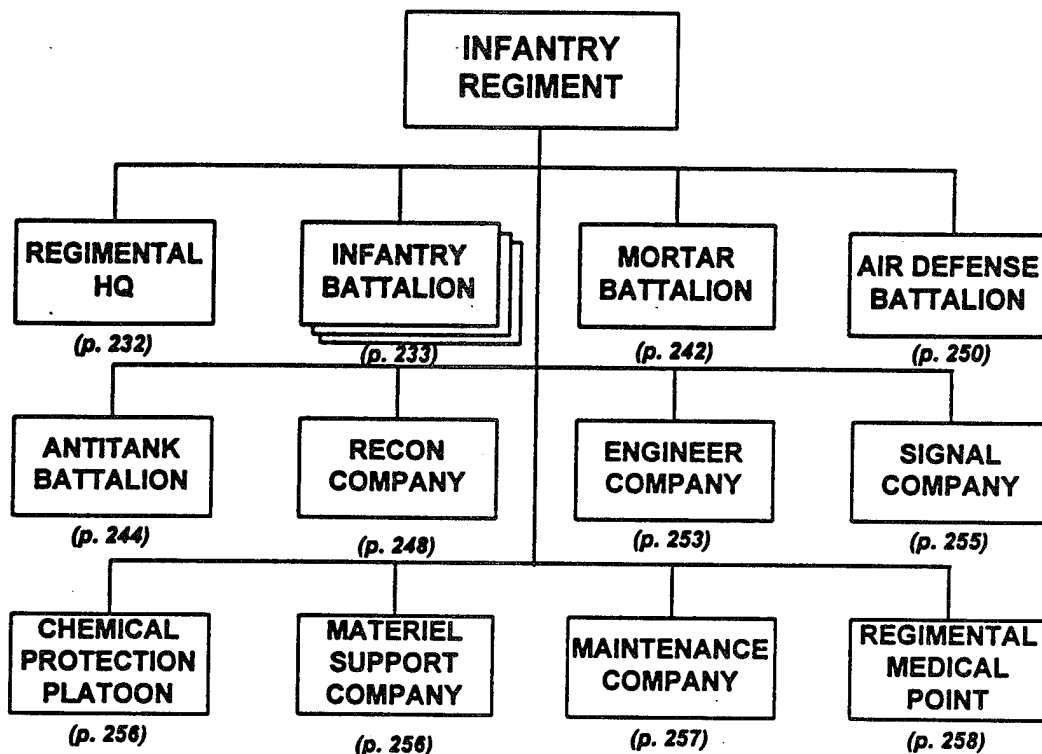

INFANTRY REGIMENT, ID													
Principal Items of Equipment	Regt HQ	Infantry Bn (3x)	Mortar Bn	Antitank Bn	Recon Co	Air Defense Bn	Engineer Co	Signal Co	Chem Protection Plt	Material Support Co	Maintenance Co	Regt Medical Point	TOTAL
ARMORED VEHICLES													
ACV, BTR (R-145BM)	1	3		5			2	3					14
ASC, BRDM-2					8								8
ACV, BRDM-2U					1								1
Chemical Recon Vehicle, BRDM-2RKb/RKbM									3				3
WEAPONS													
30-mm Auto Grenade Launcher, AGS-17		18											18
120-mm Mortar, M1943/2S12 or 82-mm Auto Mortar, 2B9		18	18										36
73-mm Recoilless Gun, SPG-9		9											9
100/125mm AT Gun, MT-12/2A45M				12									12
ATGM Manpack, AT-4/SPIGOT		18											18
ATGM Manpack, AT-7/SAXHORN		27											27
ATGM Vehicle, w/ AT-5/SPANDREL				9									9
23-mm AA Gun, ZU-23						6							6
SAM, SA-9/GASKIN or SA-13/GOPHER						6							6
SAM, SA-16/18	3	27				18							48
ENGINEER EQUIPMENT													
Minelayer, PMR							3						3
Ditching Machine, BTM/MDK							1						1
Ditching Machine, PZM/TMK							4						4
Dozer							2						2
Truck, Water Purification w/Trailer							1						1
TRUCKS													
Truck, Utility	3	12	1	18		1	1	5		2	2	1	46
Truck, Light	6	147	27	4		21		3		4			212
Truck, Medium		57		12		6	10			45	3	2	135
Truck, Decon, ARS-12U/14									3				3
Truck, Decon, DDA-53/66									1			1	2
Truck, Dump							1						1
Truck, Crane Shovel							2						2
Truck, Kitchen	1												1
Truck, POL (4,000/3,200-L)		9	2	2						15			28
Truck, Recovery											3		3
Truck, Water (2,000-L)	1	3							2	4			10
Van			2	2								1	5
Van, Command	3												3
Van, Kitchen		3											3
Van, Maintenance		6	1	2			1			1	6		17
Van, Signal				2				5					7
Ambulance		3	1	1								4	9

INFANTRY REGIMENT, ID (Continued)													
<i>Principal Items of Equipment</i>	<i>Regt HQ</i>	<i>Infantry Bn (3x)</i>	<i>Mortar Bn</i>	<i>Antitank Bn</i>	<i>Recon Co</i>	<i>Air Defense Bn</i>	<i>Engineer Co</i>	<i>Signal Co</i>	<i>Chem Protection Plt</i>	<i>Material Support Co</i>	<i>Maintenance Co</i>	<i>Regt Medical Point</i>	<i>TOTAL</i>
TRAILERS													
Trailer, Cargo, 1-Axle		6									6		12
Trailer, Cargo, 2-Axle			11	9			2			30			52
Trailer, Generator				1		2		4		1	3		11
Trailer, Kitchen		9	4	2						2		3	17
Trailer, POL (900/1,200-L)		6	2	2						15			25
Trailer, Water (900/1,200-L)		3	1	1					2	1		1	8
RADARS													
Radar, BS, Man-Portable, PSNR-1			1	4	1								6
RADIOS													
VHF, Manpack, Low-Power	3	36	15	10		2	3	7			1	1	77
VHF, Portable, Very-Low-Power		12											
VHF, Portable, Low-Power		144	2		10	6							162
VHF, Vehicle Mount, Medium-Power	3	63		28	8	6	2	2	3		3		118
HF, Manpack, Low-Power					1			2	1	1			5
HF, Vehicle Mount, Medium-Power	1	3		1	1			2					8
HF, Van Mount, High-Power								1					1
HF/VHF, Vehicle Mount, Medium-Power			4	3				2					9
HF/VHF, Vehicle Mount, High-Power								2					2
Radio Relay, VHF/UHF				1				2					3
Warning Receiver	1	3	2	1	1	4		3					15
MISCELLANEOUS													
Rangefinder				7									7
Rangefinder, Stereoscopic		3	4										7
Periscopic Aiming Circle		3	3										6
Collimator (Aiming Stakes)		18	18										36
Motorcycle					10			3					13

Regimental Headquarters, Inf Regt. ID

**REGIMENTAL
HEADQUARTERS**

PRINCIPAL ITEMS OF EQUIPMENT

<u>Equipment</u>	<u>Total</u>	<u>Equipment</u>	<u>Total</u>
ACV, BTR (R-145BM)	1	Radios:	
SAM, SA-16/18	3	VHF, Manpack, Low-Power	3
Truck, Utility	3	VHF, Vehicle Mount,	
Truck, Light	6	Medium-Power	3
Van, Command	3	HF, Vehicle Mount, Medium-Power	1
Truck, Water (2,000-Liter)	1	Warning Receiver	1
Truck, Kitchen	1		

Infantry Battalion, Inf Regt, ID

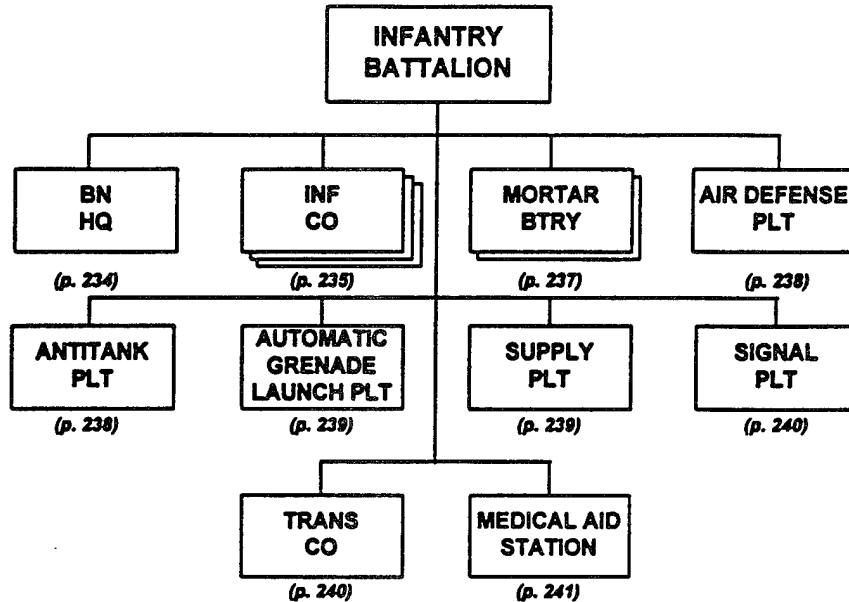

PRINCIPAL ITEMS OF EQUIPMENT

<u>Equipment</u>	<u>Total</u>
ACV, BTR (R-145BM)	1
9-mm Pistol, PM	104
5.45-mm Assault Rifle, AK-74	426
7.62-mm GP MG, PKM	36
7.62-mm Sniper Rifle, SVD	9
30-mm Automatic Grenade Launcher, AGS-17	6
40-mm Under-Barrel Grenade Launcher, BG-15	54
73-mm Recoilless Gun, SPG-9	3
120-mm Mortar, M1943/2S12 or	
82-mm Automatic Mortar, 2B9	6
ATGL, RPG-7V	83
ATRL, RPG-18/22	54
SAM, SA-16/18	9
ATGM Manpack, AT-4/SPIGOT	6
ATGM Manpack, AT-7/SAXHORN	9
Truck, Utility	4
Truck, Light	49
Truck, Medium	19

<u>Equipment</u>	<u>Total</u>
Truck, POL (4,000 or 5,200-Liter)	3
Truck, Water (2,000-Liter)	1
Trailer, POL (900-Liter)	2
Trailer, Cargo, 1-Axle	2
Trailer, Water (900 or 1,200-Liter)	1
Trailer, Kitchen	3
Ambulance	1
Van, Kitchen	1
Van, Maintenance	2
Rangefinder, Stereoscopic, DS-1 or DM/90/DAK-1	1
Periscopic Aiming Circle, PAB2A	1
Collimator (Aiming Stakes)	6
Radios:	
VHF, Manpack, Low-Power	12
VHF, Portable, Low-Power	48
VHF, Portable, Very-Low-Power	4
VHF, Vehicle Mount, Medium-Power	21
HF, Vehicle Mount, Medium-Power	1
Warning Receiver	1

Battalion Headquarters, Inf Bn, Inf Regt, ID

**BATTALION
HEADQUARTERS**

PRINCIPAL ITEMS OF EQUIPMENT

<u>Equipment</u>	<u>Total</u>	<u>Equipment</u>	<u>Total</u>
9-mm Pistol, PM	4	VHF, Portable, Low-Power	1
5.45-mm Assault Rifle, AK-74	8	VHF, Manpack, Low-Power	2
ACV, BTR (R-145BM)	1	VHF, Vehicle Mount, Medium-Power	1
Truck, Utility	1	HF, Vehicle Mount, Medium-Power	1
Truck, Light	1	Warning Receiver	1
Truck, Water (2,000-Liter)	1		
Radios:			

NOTE: The signal platoon leader is also the battalion communications officer.

Infantry Company, Inf Bn, Inf Regt, ID

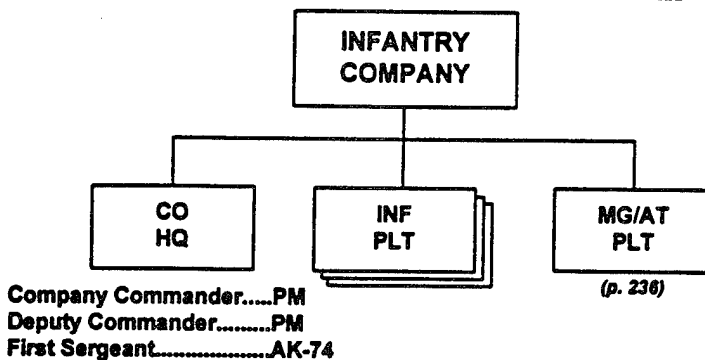

PRINCIPAL ITEMS OF EQUIPMENT

<u>Equipment</u>	<u>Total</u>	<u>Equipment</u>	<u>Total</u>
9-mm Pistol, PM.....	25	ATGL, RPG-7V.....	18
5.45-mm Assault Rifle, AK-74.....	97	ATGM Manpack, AT-7/SAXHORN.....	3
7.62-mm GP MG, PKM.....	12	Truck, Light.....	2
7.62-mm, Sniper Rifle, SVD.....	3	Radios:	
40-mm Under-Barrel Grenade Launcher, BG-15.....	18	VHF, Portable, Low-Power.....	13
ATRL, RPG-18/22.....	18	VHF, Vehicle Mount, Medium-Power ..	2

**Infantry Platoon, Inf Co, Inf Bn,
Inf Regt, ID**

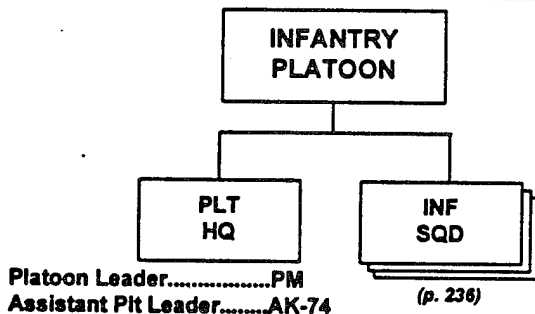

PRINCIPAL ITEMS OF EQUIPMENT

<u>Equipment</u>	<u>Total</u>	<u>Equipment</u>	<u>Total</u>
9-mm Pistol, PM.....	7	ATGL, RPG-7V.....	6
5.45-mm Assault Rifle, AK-74.....	30	40-mm Under-Barrel Grenade Launcher, BG-15.....	6
7.62-mm GP MG, PKM.....	3	Radio, VHF, Portable, Low-Power.....	4
7.62-mm Sniper Rifle, SVD.....	1		
ATRL, RPG-18/22.....	6		

**Infantry Squad, Inf Plt, Inf Co, Inf Bn,
Inf Regt, ID**

**INFANTRY
SQUAD**

PRINCIPAL ITEMS OF EQUIPMENT

<u>Equipment</u>	<u>Total</u>	<u>Equipment</u>	<u>Total</u>
9-mm Pistol, PM.....	2*	7.62-mm Sniper Rifle, SVD.....	1**
5.45-mm Assault Rifle, AK-74.....	10**	ATRL, RPG-18/22.....	2
7.62-mm GP MG, PKM.....	1	ATGL, RPG-7V.....	2
40-mm Under-Barrel Grenade Launcher, BG-15.....	2	Radio, VHF, Portable, Low-power.....	1

FOOTNOTES:

- * The two grenadiers each have a 9-mm Pistol, PM.
- ** One squad per platoon has an SVD sniper rifle.

**Machinegun/Antitank Platoon, Inf Co, Inf Bn,
Inf Regt, ID**

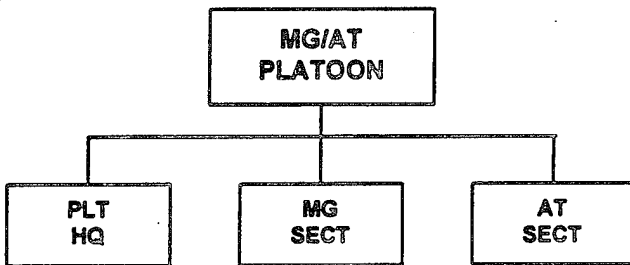

Platoon Leader.....PM
 Machine Gunner (x3).....PKM/PM
 Assistant Gunner (x3).....AK-74
 ATGM Operator (x3).....AT-7
 Assistant ATGM Operator (x3).....AK-74
 Driver, Truck, Utility.....AK-74

PRINCIPAL ITEMS OF EQUIPMENT

<u>Equipment</u>	<u>Total</u>	<u>Equipment</u>	<u>Total</u>
ATGM Manpack, AT-7/SAXHORN.....	3	Radios:	
7.62-mm GP MG, PKM.....	3	VHF, Vehicle Mount,	
9-mm Pistol, PM.....	4	Medium-Power.....	2
5.45-mm Assault Rifle, AK-74.....	7	VHF, Portable, Low-Power.....	1
Truck, Light.....	2		

Mortar Battery, Inf Bn, Inf Regt, ID

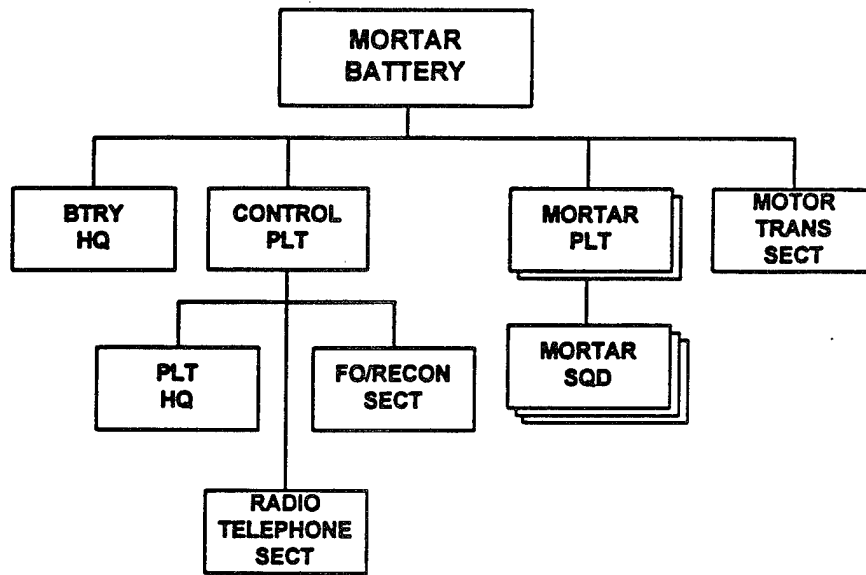

PRINCIPAL ITEMS OF EQUIPMENT

<u>Equipment</u>	<u>Total</u>
120-mm Mortar M1943/2S12 or 82-mm Automatic Mortar, 2B9.....	6
9-mm Pistol, PM.....	15
5.45-mm Assault Rifle, AK-74.....	62
ATGL, RPG-7V.....	8
Truck, Utility.....	1
Truck, Light.....	9

<u>Equipment</u>	<u>Total</u>
Rangefinder, Stereoscopic, DS-1 or DM-09/DAK-1.....	1
Periscopic Aiming Circle, PAB2A.....	1
Collimator (Aiming Stakes).....	6
Radio, VHF, Manpack, Low-Power.....	4

Antitank Platoon, Inf Bn, Inf Regt, ID

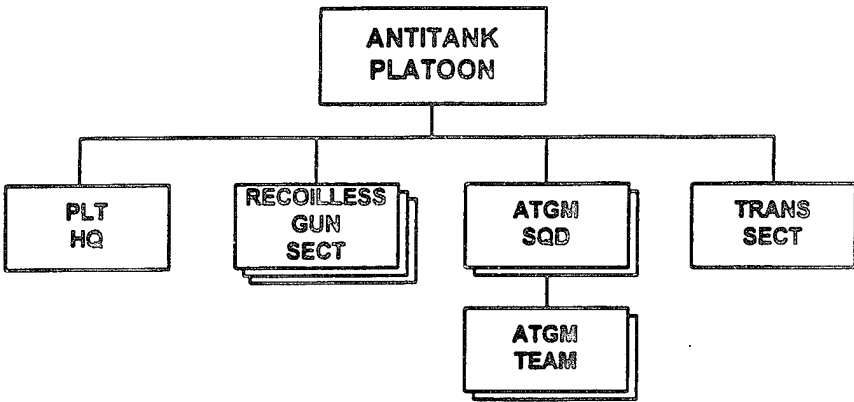

PRINCIPAL ITEMS OF EQUIPMENT

<u>Equipment</u>	<u>Total</u>	<u>Equipment</u>	<u>Total</u>
ATGM, Manpack, AT-4/SPIGOT	6	Radios:	
73-mm Recoilless Gun, SPG-9	3	VHF, Portable, Low-Power	4
ATGL, RPG-7V	18	VHF, Vehicle Mount,	
Truck, Light	5	Medium-Power	5

Air Defense Platoon, Inf Bn, Inf Regt, ID

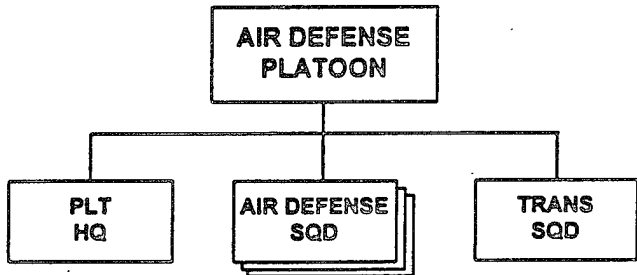

PRINCIPAL ITEMS OF EQUIPMENT

<u>Equipment</u>	<u>Total</u>	<u>Equipment</u>	<u>Total</u>
SAM, SA-16/18	9	Radios:	
Truck, Light	3	VHF, Portable, Very-Low-Power	4
		VHF, Vehicle Mount,	
		Medium-Power	3

**Automatic Grenade Launcher Platoon, Inf Bn,
Inf Regt, ID**

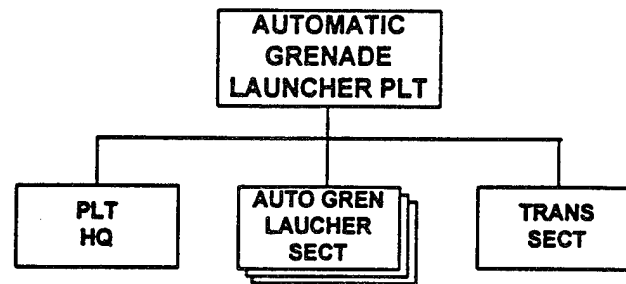

Platoon Leader.....PM
 Grenadier (x6).....AGS-17, PM
 Driver (x3).....AK-74
 Squad Leader (x3).....AK-74
 Assistant Grenadier (x6).....AK-47

PRINCIPAL ITEMS OF EQUIPMENT

<u>Equipment</u>	<u>Total</u>	<u>Equipment</u>	<u>Total</u>
30-mm Automatic Grenade Launcher, AGS-17	6	Radios:	
9-mm Pistol, PM	7	VHF, Vehicle Mount, Medium-Power	3
5.45-mm Assault Rifle, AK-74	12	VHF, Portable, Low-Power	4
Truck, Light	3		

Supply Platoon, Inf Bn, Inf Regt, ID

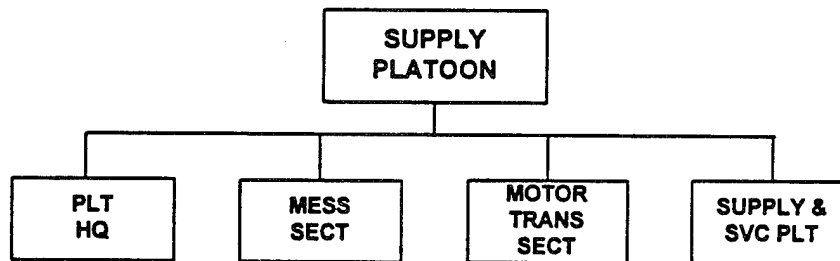

PRINCIPAL ITEMS OF EQUIPMENT

<u>Equipment</u>	<u>Total</u>	<u>Equipment</u>	<u>Total</u>
9-mm Pistol, PM	1	Trailer, POL (900-Liter)	1
5.45-mm Assault Rifle, AK-74	19	Trailer, Cargo, 1-Axle	1
Truck, Light	4	Trailer, Water (900 or 1,200-Liter)	1
Truck, Medium	4	Trailer, Kitchen	3
Truck, POL (4,000 or 5,200-Liter)	2	Radio, VHF, Manpack, Low-Power	1
Van, Kitchen	1		

Signal Platoon, Inf Bn, Inf Regt, ID

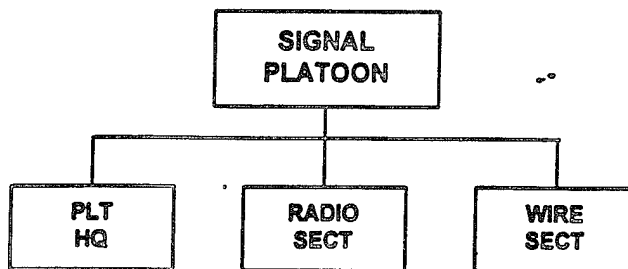

PRINCIPAL ITEMS OF EQUIPMENT

<u>Equipment</u>	<u>Total</u>	<u>Equipment</u>	<u>Total</u>
9-mm Pistol, PM.....	1	Radios:	
5.45-mm Assault Rifle, AK-74.....	13	VHF, Vehicle Mount,	
Truck, Utility.....	1	Medium-Power	3
Truck, Light	3	VHF, Manpack, Low-Power	3

Transportation Company, Inf Bn, Inf Regt, ID

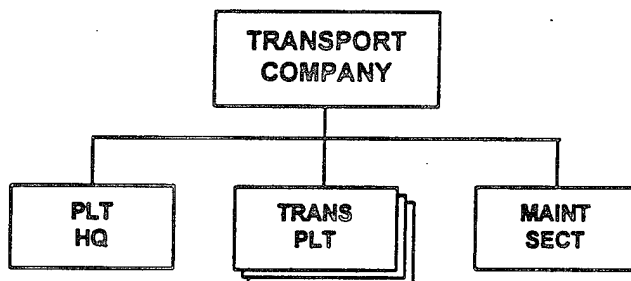

PRINCIPAL ITEMS OF EQUIPMENT

<u>Equipment</u>	<u>Total</u>	<u>Equipment</u>	<u>Total</u>
9-mm Pistol, PM.....	1	Truck, Medium	15
5.45-mm Assault Rifle, AK-74.....	17	Van, Maintenance	2
ATGL, RPG-7V	3	Truck, POL (4,000 or 5,200-Liter)	1
Truck, Utility.....	1	Trailer, POL (900-Liter)	1
Truck, Light	15	Radio, VHF, Manpack, Low-Power	1

Medical Aid Station, Inf Bn, Inf Regt, ID

**MEDICAL AID
STATION**

PRINCIPAL ITEMS OF EQUIPMENT

<u>Equipment</u>	<u>Total</u>	<u>Equipment</u>	<u>Total</u>
Ambulance	1	Trailer, Cargo, 1-Axle	1
5.45-mm Assault Rifle, AK-74	4	Radio, VHF, Manpack, Low-Power	1

120-mm Mortar Battalion, Inf Regt, ID

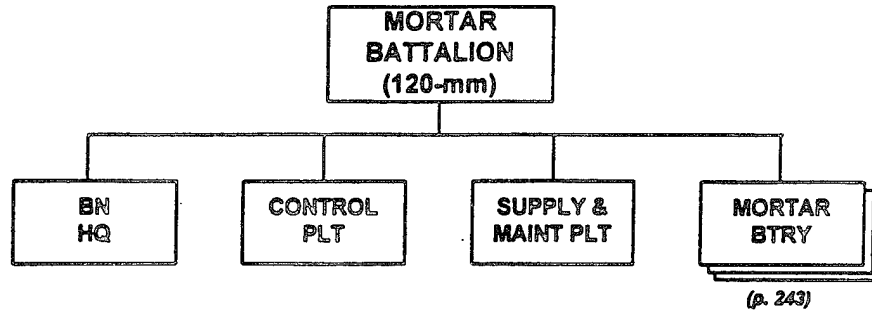

PRINCIPAL ITEMS OF EQUIPMENT

<u>Equipment</u>	<u>Total</u>	<u>Equipment</u>	<u>Total</u>
120-mm Mortar, M1943/2S12	18	Radar, Battlefield Surveillance,	
ATGL, RPG-7V	24	Man Portable, PSNR-1	1
5.45-mm LMG, RPK-74	18	Rangefinder, Stereoscopic, DS or	
Truck, Utility	1	DM-09/DAK-1	4
Truck, Light	27	Periscopic Aiming Circle	3
Truck, POL (4,000 or 5,200-Liter)	2	Collimator (Aiming Stakes)	18
Van, Signal	2	Radios:	
Van, Maintenance	1	VHF, Manpack, Low-Power	15
Ambulance	1	VHF, Portable, Low-Power or	
Trailer, Cargo, 2-Axle	11	Very-Low-Power	2
Trailer, POL (900-Liter)	2	HF/VHF, Vehicle Mount,	
Trailer, Water (900-Liter)	1	Medium-Power	4
Trailer, Kitchen	4	Warning Receiver	2

NOTE: The infantry regiment may have a towed 122-mm D-30 howitzer battalion in lieu of a 120-mm mortar battalion. See page 96 for the D-30 howitzer battalion.

**120-mm Mortar Battery, 120-mm Mortar Bn, Inf Bn,
Inf Regt, ID**

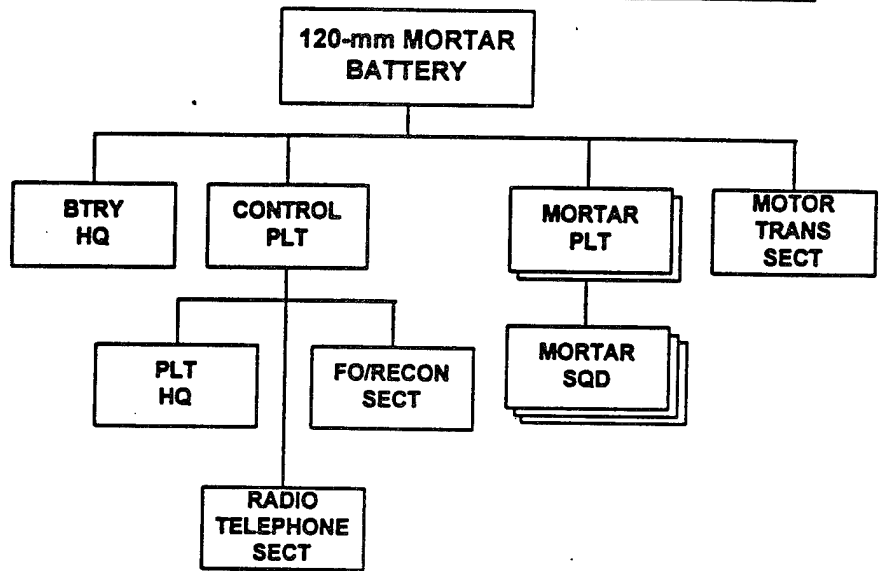

PRINCIPAL ITEMS OF EQUIPMENT

<u>Equipment</u>	<u>Total</u>
120-mm Mortar, M1943/2S12	6
9-mm Pistol, PM	15
5.45-mm Assault Rifle, AK-74	62
ATGL, RPG-7V	8
Truck, Utility	1
Truck, Light	9

<u>Equipment</u>	<u>Total</u>
Rangefinder, Stereoscopic, DS-1 or DM-09/DAK-1	1
Periscopic Aiming Circle	1
Collimator (Aiming Stakes)	6
Radio, VHF, Manpack, Low-Power	4

Antitank Battalion, Inf Regt, ID

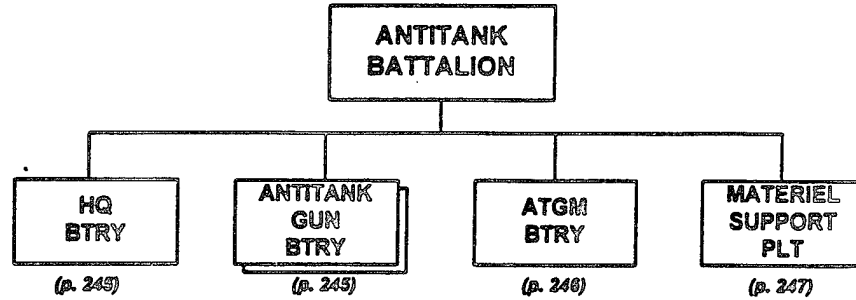

PRINCIPAL ITEMS OF EQUIPMENT

<u>Equipment</u>	<u>Total</u>	<u>Equipment</u>	<u>Total</u>
ATGM Vehicle, 9P148		Trailer, Water (900-Liter)	1
w/ AT-5/SPANDREL	9	Trailer, Kitchen	1
100-mm Antitank Gun, T-12/MT-12	12	Rangefinder	3
ACV, BTR (R-145BM)	5	Radar, Battlefield Surveillance, Man-Portable, PSNR-1	3
ATGL, RPG-7V	9	Radios:	
Truck, Utility	17	VHF Manpack, Low-Power	22
Truck, Light	4	VHF, Vehicle Mount, Medium-Power	14
Truck, Medium	12	HF, Vehicle Mount, Medium-Power	1
Van, Signal	2	HF/VHF, Vehicle Mount, Medium-Power	2
Van, Maintenance	2	Radio Relay, VHF/UHF	1
Truck, POL (4,000 or 5,200-Liter)	2	Warning Receiver	1
Ambulance	1		
Trailer, Cargo, 2-Axle	9		
Trailer, POL (900-Liter)	2		
Trailer, Generator	1		

Headquarters Battery, Antitank Bn, Inf Regt, ID

**HEADQUARTERS
BATTERY**

PRINCIPAL ITEMS OF EQUIPMENT

<u>Equipment</u>	<u>Total</u>	<u>Equipment</u>	<u>Total</u>
ACV, BTR (R-145BM)	1	Radios:	
Truck, Utility.....	2	HF, Vehicle Mount, Medium-Power	1
		HF/VHF, Vehicle Mount, Medium-Power	1
		VHF Manpack, Low-Power	1
		VHF, Vehicle Mount, Medium-Power ..	1
		Warning Receiver	1

Antitank Gun Battery, Antitank Bn, Inf Regt, ID

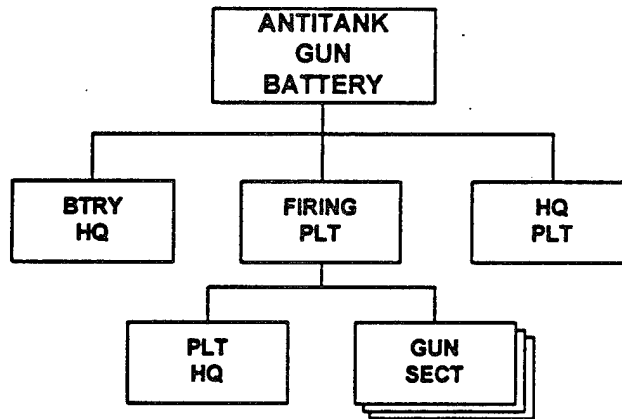

PRINCIPAL ITEMS OF EQUIPMENT

<u>Equipment</u>	<u>Total</u>	<u>Equipment</u>	<u>Total</u>
100-mm Antitank Gun, T-12/MT-12.....	6	Rangefinder.....	1
Truck, Utility (Prime Mover).....	7	Radar, Battlefield Surveillance, Man-Portable, PSNR-1	1
Truck, Medium	1	Radio, VHF Manpack, Low-Power	7
Trailer, Cargo, 2-Axle.....	1		

ATGM Battery, Antitank Bn, Inf Regt, ID

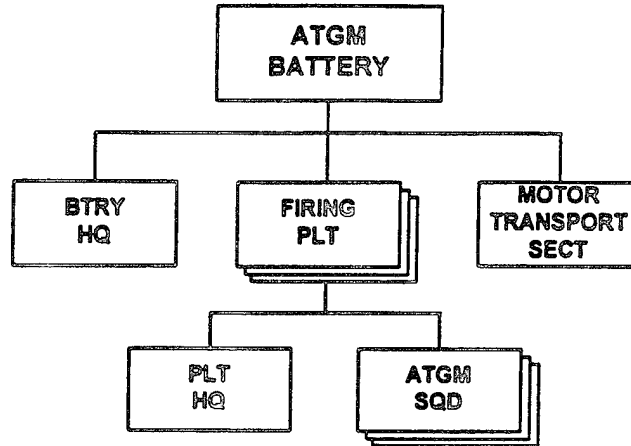

PRINCIPAL ITEMS OF EQUIPMENT

<u>Equipment</u>	<u>Total</u>	<u>Equipment</u>	<u>Total</u>
ATGM Vehicle, 9P148 w/ AT-5/SPANDREL	9	Radar, Battlefield Surveillance, Man-Portable, PSNR-1	1
ACV, BTR (R-145BM)	4	Radios:	
ATGL, RPG-7V	9	VHF Manpack, Low-Power	4
Truck, Medium	3	VHF, Vehicle Mount, Medium-Power	13
Rangefinder	1		

Material Support Platoon, Antitank Bn, Inf Regt, ID

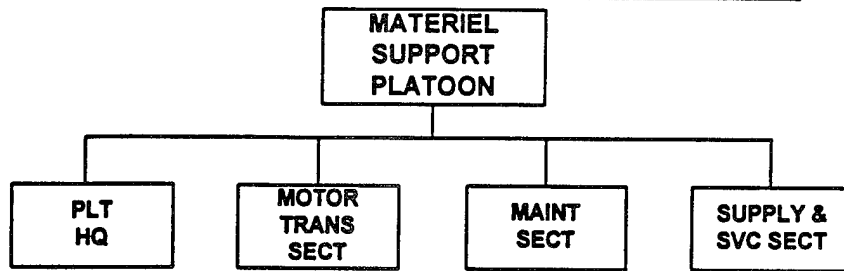

PRINCIPAL ITEMS OF EQUIPMENT

Equipment	Total	Equipment	Total
Truck, Utility.....	1	Trailer, Generator.....	1
Truck, Light.....	4	Trailer, Water (900-Liter).....	1
Truck, Medium.....	7	Trailer, Kitchen.....	1
Van, Signal.....	2	Radios:	
Van, Maintenance.....	2	VHF, Manpack, Low-Power.....	3
Truck, POL (4,000 or 5,200-Liter).....	2	HF/VHF, Vehicle Mount,	
Ambulance.....	1	Medium-Power.....	1
Trailer, Cargo, 2-Axle.....	8	Radio Relay, VHF/UHF.....	1
Trailer, POL (900-Liter).....	1		

Reconnaissance Company, Inf Regt, ID

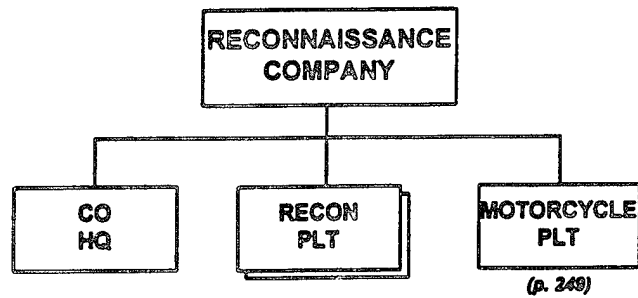

PRINCIPAL ITEMS OF EQUIPMENT

<u>Equipment</u>	<u>Total</u>	<u>Equipment</u>	<u>Total</u>
ACV, BRDM-2U	1	Radios:	
ASC, BRDM-2.....	8	VHF, Portable, Low-Power	10
ATGL, RPG-7V	8	VHF, Vehicle Mount,	
5.45-mm LMG, RPK-74	9	Medium-Power	8
Motorcycle	10	HF, Manpack, Low-Power	1
Radar, Battlefield Surveillance,		HF, Vehicle Mount,	
PSNR-1	1	Medium-Power	1
		Warning Receiver	1

Reconnaissance Platoon, Recon Co, Inf Regt, ID

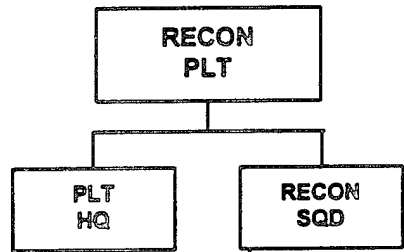

PRINCIPAL ITEMS OF EQUIPMENT

<u>Equipment</u>	<u>Total</u>	<u>Equipment</u>	<u>Total</u>
ASC, BRDM-2.....	4	Radio, VHF, Vehicle Mount,	
ATGL, RPG-7V	4	Medium-Power	4

Motorcycle Platoon, Recon Co, Inf Regt, ID

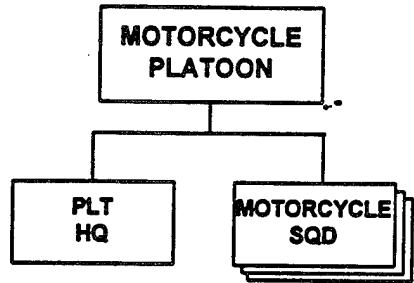

PRINCIPAL ITEMS OF EQUIPMENT

<u>Equipment</u>	<u>Total</u>	<u>Equipment</u>	<u>Total</u>
Motorcycle	10	Radio, VHF, Portable, Low-Power.....	10
5.45-mm LMG, RPK-74	9		

Air Defense Battalion, Inf Regt, ID

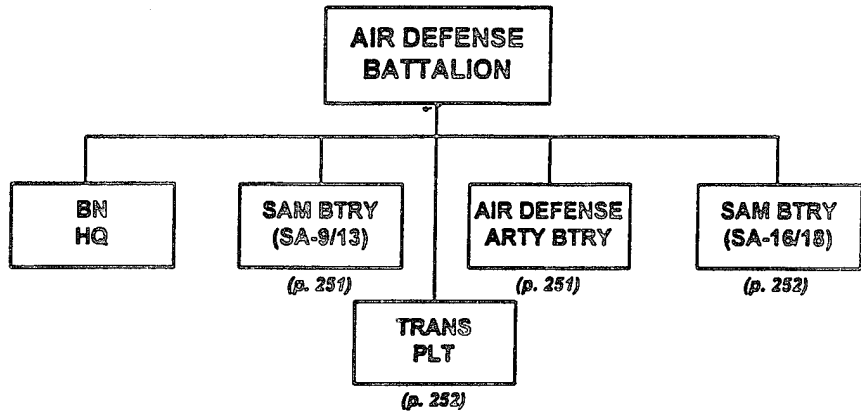

PRINCIPAL ITEMS OF EQUIPMENT

<u>Equipment</u>	<u>Total</u>	<u>Equipment</u>	<u>Total</u>
SAM, SA-9/GASKIN TEL or SA-13/GOPHER TELAR *	6	Trailer, Generator	2
SAM, SA-16/18	18	Radios:	
ACV, BTR-60 (PU-12)	1	VHF, Manpack, Low-Power	2
23-mm AA Gun, ZU-23	6	VHF, Portable, Low-Power	6
Truck, Utility	1	VHF, Vehicle Mount, Medium-Power	6
Truck, Light	21	Warning Receiver	4
Truck, Medium	6		

FOOTNOTE: * The SA-13 system includes a ranging radar.

**SAM Battery (SA-9/13), Air Defense Bn,
Inf Regt, ID**

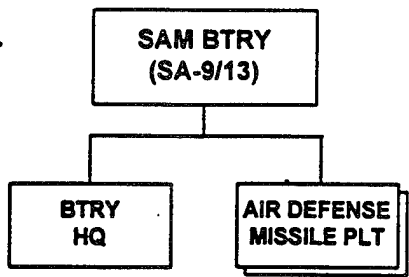

PRINCIPAL ITEMS OF EQUIPMENT

<u>Equipment</u>	<u>Total</u>	<u>Equipment</u>	<u>Total</u>
SAM, SA-9/GASKIN TEL or SA-13/GOPHER TELAR *	6	Radios:	
Truck, Light	2	VHF, Vehicle Mount, Medium-Power	6
Truck, Medium	1	Warning Receiver	1

FOOTNOTE: * The SA-13 system includes a ranging radar.

**Air Defense Artillery Battery, Air Defense Bn,
Inf Regt, ID**

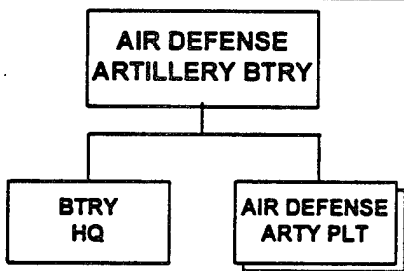

PRINCIPAL ITEMS OF EQUIPMENT

<u>Equipment</u>	<u>Total</u>	<u>Equipment</u>	<u>Total</u>
23-mm AA Gun, ZU-23	6	Radios:	
Truck, Light	6	VHF, Portable, Low-Power	1
Truck, Medium	1	Warning Receiver	1

SAM Battery (SA-16/18), Air Defense Bn, Inf Regt, ID

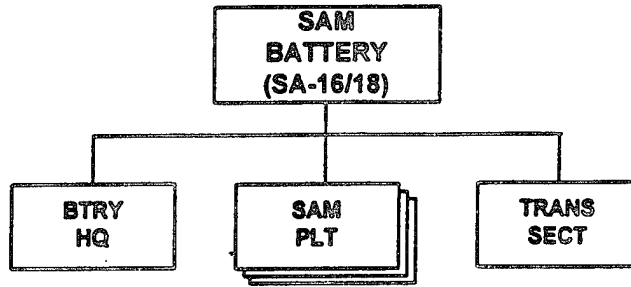

PRINCIPAL ITEMS OF EQUIPMENT

<u>Equipment</u>	<u>Total</u>	<u>Equipment</u>	<u>Total</u>
SAM, SA-16/18	18	Radios:	
ACV, BTR-60(PU-12).....	1	VHF, Portable, Low-Power	5
Truck, Light	7	Warning Receiver	1

Transportation Platoon, Air Defense Bn, Inf Regt, ID



PRINCIPAL ITEMS OF EQUIPMENT

<u>Equipment</u>	<u>Total</u>	<u>Equipment</u>	<u>Total</u>
Truck, Light	4	Trailer, Generator	2
Truck, Medium	4	Radio, VHF, Manpack, Low-Power	1

Engineer Company, Inf Regt, ID

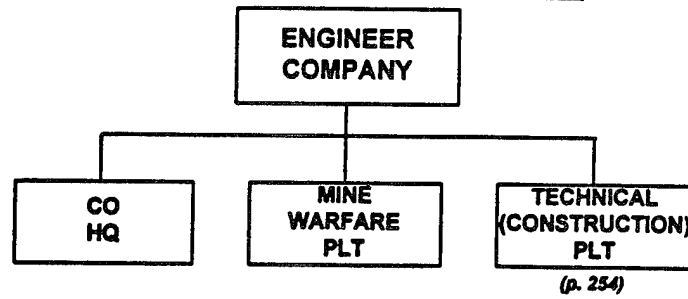

PRINCIPAL ITEMS OF EQUIPMENT

Equipment	Total	Equipment	Total
ACV, BTR (R-145BM)	2	Dozer	2
ATGL, RPG-7V	4	Minelayer, PMR.....	3
Truck, Utility.....	1	Truck, Water Purification	1
Truck, Medium	10	Trailer, Cargo, 2-Axle.....	2
Truck, Dump	1	Radios:	
Van, Maintenance	1	VHF, Manpack, Low-Power.....	3
Truck, Crane Shovel	2	VHF, Vehicle Mount, Medium-Power	2
Ditching Machine, PZM/TMK	4		

Mine Warfare Platoon, Engr Co, Inf Regt, ID

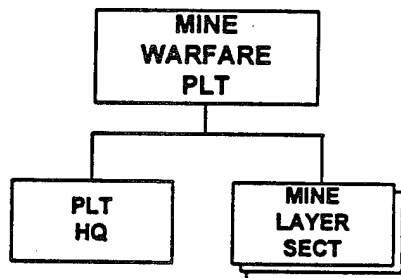

PRINCIPAL ITEMS OF EQUIPMENT

Equipment	Total	Equipment	Total
Truck, Light	4	Trailer, Generator.....	2
Truck, Medium	4	Radio, VHF, Manpack, Low-Power	1
Minelayer, PMR.....	3		

**Technical (Construction) Platoon, Engr Co,
Inf Regt, ID**

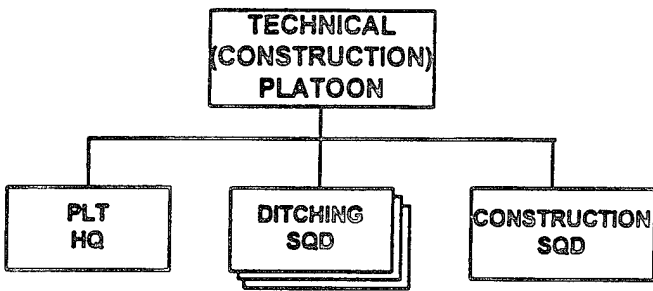

PRINCIPAL ITEMS OF EQUIPMENT

<u>Equipment</u>	<u>Total</u>	<u>Equipment</u>	<u>Total</u>
Truck, Utility.....	1	Ditching Machine, PZM/TMK	4
Truck, Medium	6	Dozer.....	2
Truck, Dump.....	1	Truck, Water Purification	1
Van, Maintenance	1	Trailer, Cargo, 2-Axle.....	2
Truck, Crane Shovel	2	Radio, VHF, Manpack, Low-Power	1

Signal Company, Inf Regt, ID

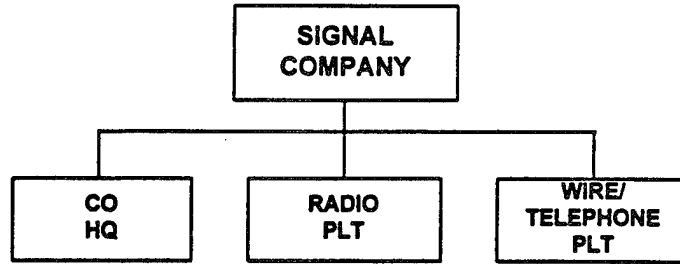

PRINCIPAL ITEMS OF EQUIPMENT

Equipment	Total
ACV, BTR (R-145BM)	3
Truck, Utility.....	5
Truck, Light	3
Van, Signal.....	5
Motorcycle	3
Trailer, Generator	4

Equipment	Total
Radios:	
VHF, Manpack, Low-Power.....	7
VHF, Vehicle Mount, Medium-Power	2
HF, Manpack, Low-Power.....	2
HF, Vehicle Mount, Medium-Power	2
HF/VHF, Vehicle Mount, Medium-Power	2
HF/VHF, Vehicle Mount, High-Power	2
HF, Van Mount, High-Power.....	1
Radio Relay, VHF/UHF.....	2
Warning Receiver	3

NOTES:

1. The radios listed support the regimental headquarters.
2. Motorcycles provide the regimental commander with messenger/courier service.

Chemical Protection Platoon, Inf Regt, ID

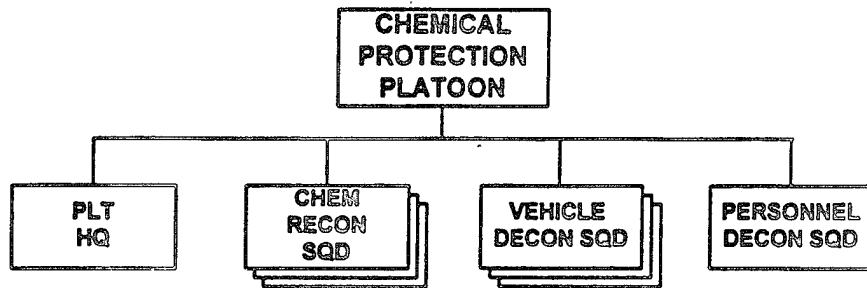

PRINCIPAL ITEMS OF EQUIPMENT

<u>Equipment</u>	<u>Total</u>	<u>Equipment</u>	<u>Total</u>
Chemical Recon Vehicle, BRDM-2RKH or RKHM	3	Trailer, Water (900-Liter)	2
Truck, Decon, AR-12u/14.....	3	Radios:	
Truck, Decon, DDA-53/66.....	1	VHF, Vehicle Mount,	
Truck, Water (2,000-Liter).....	2	Medium-Power	3
		HF, Manpack, Low-Power.....	1

Materiel Support Company, Inf Regt, ID

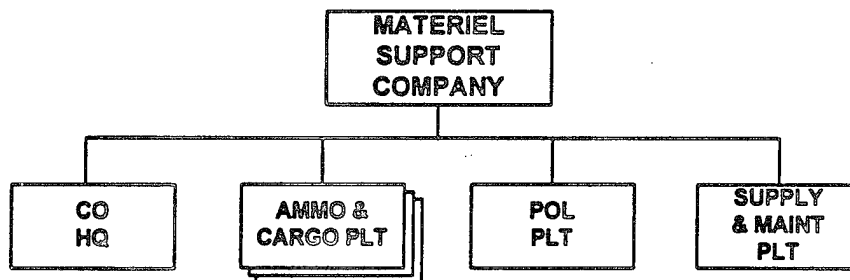

PRINCIPAL ITEMS OF EQUIPMENT

<u>Equipment</u>	<u>Total</u>	<u>Equipment</u>	<u>Total</u>
Truck, Utility	2	Trailer, Cargo, 2-Axle.....	30
Truck, Light	4	Trailer, POL (1,200-Liter)	15
Truck, Medium	45	Trailer, Kitchen	2
Van, Maintenance	1	Trailer, Water (900-Liter)	1
Truck, Water (2,000-Liter).....	4	Trailer, Generator.....	1
Truck, POL (4,000 or 5,200-Liter)	15	Radio, HF, Manpack, Low-Power	1

Maintenance Company, Inf Regt, ID

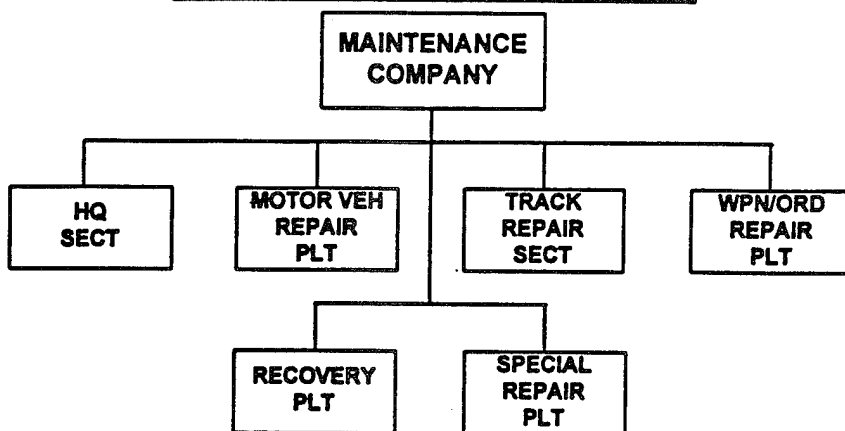

PRINCIPAL ITEMS OF EQUIPMENT

Equipment	Total	Equipment	Total
ATGL, RPG-7V	4	Trailer, Generator.....	3
Truck, Utility.....	2	Radios:	
Truck, Medium	3	VHF, Manpack, Low-Power.....	1
Van, Maintenance	6	VHF, Vehicle Mount,	
Truck, Recovery.....	3	Medium-Power	3
Trailer, Cargo, 1-Axle.....	6		

NOTE: The special repair platoon consists of an arc and gas welding section, battery repair and recharging section, and electrical repair section.

Regimental Medical Point, Inf Regt, ID

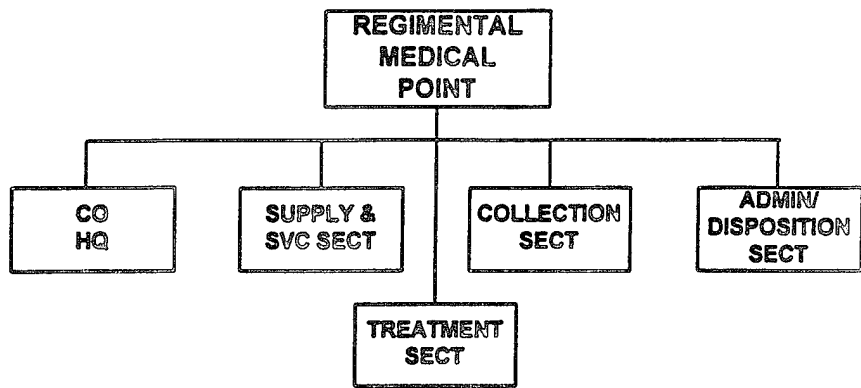

PRINCIPAL ITEMS OF EQUIPMENT

<u>Equipment</u>	<u>Total</u>	<u>Equipment</u>	<u>Total</u>
Van.....	1	Ambulance	4
Truck, Medium	2	Trailer, Kitchen	3
Truck, Decon, DDA-53/66.....	1	Trailer, Water (1,200-Liter)	1
Truck, Utility.....	1	Radio, VHF, Manpack, Low-Power	1

NOTES:

1. General purpose trucks may serve as ambulances.
2. There may be two collection sections.

Light Assault Battalion, ID

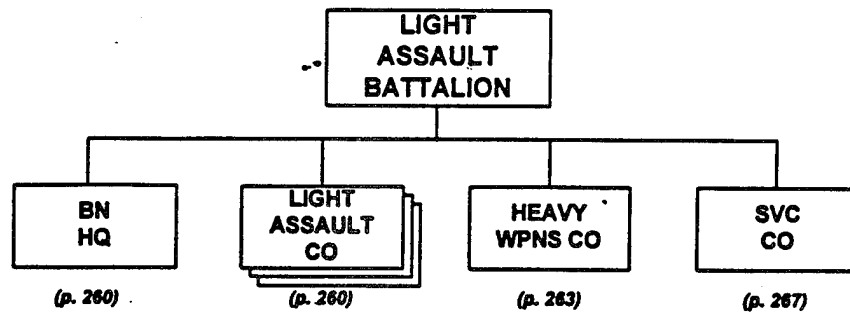

PRINCIPAL ITEMS OF EQUIPMENT

Equipment	Total
9-mm Pistol, PM.....	128
5.45-mm Assault Rifle, AK-74.....	374
7.62-mm GP MG, PKM.....	54
7.62-mm Sniper Rifle, SVD.....	27
12.7-mm Heavy Machine Gun, NSV.....	4
40-mm Under-Barrel Grenade Launcher, BG-15.....	83
30-mm Automatic Grenade Launcher, AGS-17.....	6
60-mm Mortar, Light.....	9
73-mm Recoilless Antitank Gun, SPG-9.....	2
ATRL, RPG-18/22.....	135
ATGL, RPG-7V.....	57
ATGM Manpack, AT-7/SAXHORN.....	3

Equipment	Total
SAM, SA-16/18.....	10
Truck, Utility.....	1
Truck, Light.....	32
Trailer, POL (900-Liter).....	2
Trailer, Cargo, 1-Axle.....	2
Trailer, Water (900-Liter).....	2
Van, Maintenance.....	1
Radio:	
VHF, Manpack, Low-Power.....	2
VHF, Portable, Low-Power.....	71
VHF, Vehicle Mount, Medium-Power.....	1
HF, Vehicle Mount, Medium-Power.....	1
Warning Receiver.....	1

Battalion Headquarters, Light Assault Bn, ID

BATTALION HEADQUARTERS

PRINCIPAL ITEMS OF EQUIPMENT

<u>Equipment</u>	<u>Total</u>	<u>Equipment</u>	<u>Total</u>
9-mm Pistol, PM.....	4	Radios:	
5.45-mm Assault Rifle, AK-74.....	8	HF, Vehicle Mount, Medium-Power	1
40-mm Under-Barrel Grenade		VHF, Portable, Low-Power	1
Launcher, BG-15.....	2	VHF, Manpack, Low-Power.....	2
ATRL, RPG-18/22.....	4	VHF, Vehicle Mount,	
SAM, SA-16/18	2	Medium-Power	1
Truck, Utility.....	1	Warning, Receiver	1
Truck, Light	3		

Light Assault Company, Light Assault Bn, ID

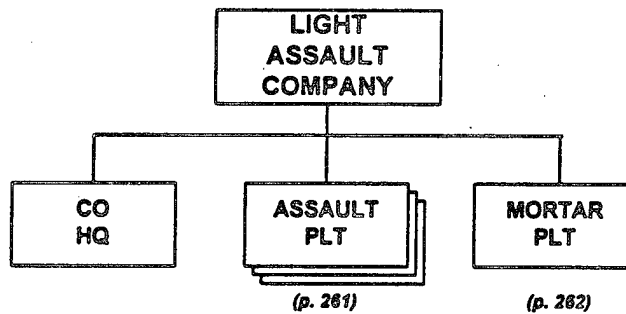

Company Commander.....PM
 Deputy Company Commander.....AK-74
 First Sergeant.....AK-47

PRINCIPAL ITEMS OF EQUIPMENT

<u>Equipment</u>	<u>Total</u>	<u>Equipment</u>	<u>Total</u>
9-mm Pistol, PM.....	36	40-mm Under-Barrel Grenade	
5.45-mm Assault Rifle, AK-74.....	93	Launcher, BG-15.....	20
7.62-mm GPMG, PKM.....	18	ATGL, RPG-7V.....	18
7.62-mm Sniper Rifle, SVD.....	9	ATRL, RPG-18/22.....	40
		60-mm Mortar, Light	3
		Radio, VHF, Portable, Low-Power.....	17

Assault Platoon, Light Assault Co, Light Assault Bn, ID

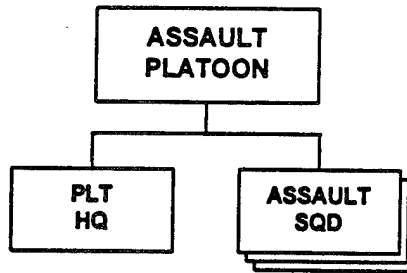

PRINCIPAL ITEMS OF EQUIPMENT

Equipment	Total	Equipment	Total
9-mm Pistol, PM.....	12	40-mm Under-Barrel Grenade	
5.45-mm Assault Rifle, AK-74.....	26	Launcher, BG-15.....	6
7.62-mm GP MG, PKM.....	6	ATGL, RPG-7V.....	6
7.62-mm Sniper Rifle, SVD.....	3	ATRL, RPG-18/22.....	12
		Radio, VHF, Portable, Low-Power.....	4

Assault Squad, Assault Plt, Light Assault Co, Light Assault Bn, ID



- Squad Leader.....AK-74
- Senior Rifleman (2x).....BG-15, AK-74
- Grenadier (2x).....RPG, PM
- Machine Gunner (2x).....PRM, PM
- Rifleman (5x).....AK-74
- Rifleman (1x).....SVD

PRINCIPAL ITEMS OF EQUIPMENT

Equipment	Total	Equipment	Total
9-mm Pistol, PM.....	4	40-mm Under-Barrel Grenade	
5.45-mm Assault Rifle, AK-74.....	8	Launcher, BG-15.....	2
7.62-mm GP MG, PKM.....	2	ATGL, RPG-7V.....	2
7.62-mm Sniper Rifle, SVD.....	1	ATRL, RPG-18/22.....	4
		Radio, VHF, Portable, Low-Power.....	1

Mortar Platoon, Light Assault Co, Light Assault Bn, ID

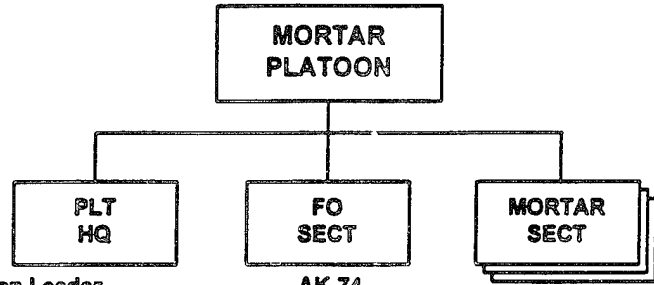

Platoon Leader.....AK-74
 Assistant Platoon Leader.....BG-15, AK-74
 Mortar Gunner (6x).....AK-74
 Forward Observer.....RPG, BG-15, AK-74
 Mortar Section Leader (3x).....RPG, AK-74

PRINCIPAL ITEMS OF EQUIPMENT

<u>Equipment</u>	<u>Total</u>	<u>Equipment</u>	<u>Total</u>
60-mm Mortar, Light	3	ATRL, RPG-18/22	4
5.45-mm Assault Rifle, AK-74	15	Radio, VHF, Portable, Low-Power	5
40-mm Under-Barrel Grenade Launcher, BG-15	2		

Heavy Weapons Company, Light Assault Bn, ID

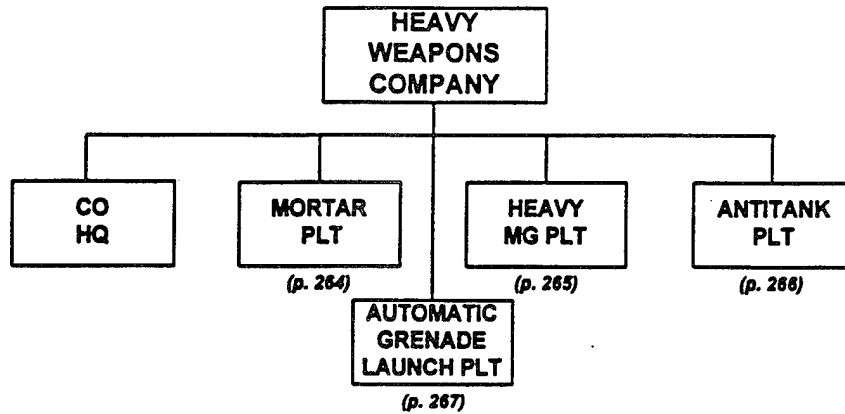

Company Commander.....AK-74
 First Sergeant.....BG-15, AK-74
 Deputy Company Commander.....AK-74

PRINCIPAL ITEMS OF EQUIPMENT

Equipment	Total	Equipment	Total
9-mm Pistol, PM.....	15	SAM, SA-16/18.....	8
82-mm Mortar.....	4	ATGM Manpack, AT-7/SAXHORN.....	3
5.45-mm Assault Rifle, AK-74.....	70	73-mm Recoilless Antitank Gun, SPG-9.....	2
12.7-mm Heavy Machine Gun, NSV.....	4	ATGL, RPG-7V.....	3
30-mm Automatic Grenade Launcher, AGS-17.....	6	ATRL, RPG-18/22.....	8
40-mm Under-Barrel Grenade Launcher, BG-15.....	18	Truck, Light.....	15
		Radio, VHF, Portable, Low-Power.....	17

Mortar Platoon, Heavy Wpns Co, Light Assault Bn, ID

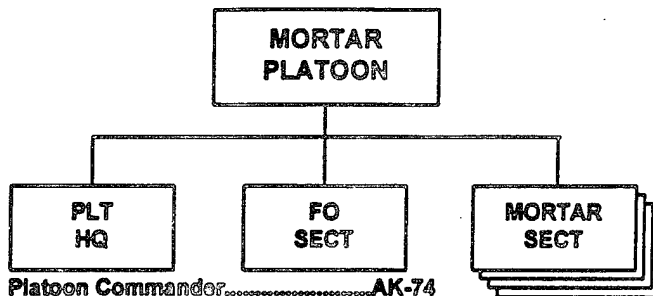

Platoon Commander.....AK-74
 Assistant Platoon Commander.....AK-74
 Mortar Section Leader (4x).....BG-16, AK-74
 Mortar Gunner (12x).....AK-74
 Ammo Bearer (8x).....AK-74
 Forward Observer (2x).....BG-16, AK-74

PRINCIPAL ITEMS OF EQUIPMENT

<u>Equipment</u>	<u>Total</u>	<u>Equipment</u>	<u>Total</u>
82-mm Mortar	4	SAM, SA-16/18	2
5.45-mm Assault Rifle, AK-74.....	28	ATRL, RPG-18/22.....	2
40-mm Under-Barrel Grenade		Truck, Light	5
Launcher, BG-15.....	6	Radio, VHF, Portable, Low-Power.....	5

**Heavy Machingun Platoon, Heavy Wpns Co, Light
Assault Bn, ID**

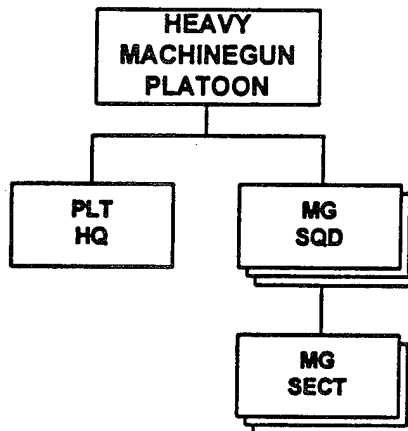

Platoon Commander.....AK-74
 Assistant Platoon Commander.....AK-74
 Machine Gunner (4x).....PM
 Assistant Machine Gunner (4x).....AK-74
 Rifleman (4x).....SAM, AK-74
 Rifleman (5x).....RPG, BG-15, AK-74

PRINCIPAL ITEMS OF EQUIPMENT

<u>Equipment</u>	<u>Total</u>	<u>Equipment</u>	<u>Total</u>
12.7-mm Heavy Machine Gun, NSV.....	4	5.45-mm Assault Rifle, AK-74.....	15
SAM, SA-16/18.....	2	40-mm Under-Barrel Grenade	
ATRL, RPG-18/22.....	2	Launcher, BG-15.....	5
ATGL, RPG-7V.....	3	Truck, Light.....	3
9-mm Pistol, PM.....	4	Radio, VHF, Portable, Low-Power.....	3

Antitank Platoon, Heavy Weapons Co, Light Assault Bn, ID

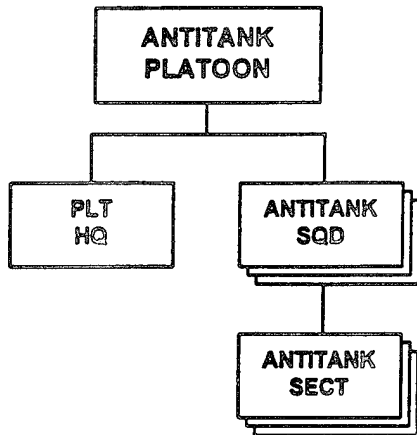

Platoon Commander.....AK-74
 Assistant Platoon Commander.....BG-15, AK-74
 Gunner (SPG) (2x).....PM
 ATGM Gunner (3x).....PM
 Assistant ATGM Gunner (6x).....BG-15, AK-74
 Assistant SPG Gunners (4x).....AK-74

PRINCIPAL ITEMS OF EQUIPMENT

<u>Equipment</u>	<u>Total</u>	<u>Equipment</u>	<u>Total</u>
ATGM Manpack, AT-7/SAXHORN.....	3	SAM, SA-16/18	2
73-mm Recoilless Antitank Gun, SPG-9.....	2	ATRL, RPG-18/22.....	2
9-mm Pistol, PM.....	5	Truck, Light	4
5.45-mm Assault Rifle, AK-74.....	12	Radio, VHF, Portable, Low-Power.....	5
40-mm Under-Barrel Grenade Launcher, BG-15.....	7		

**Automatic Grenade Launcher Platoon, Heavy Wpns Co,
Light Assault Bn, ID**

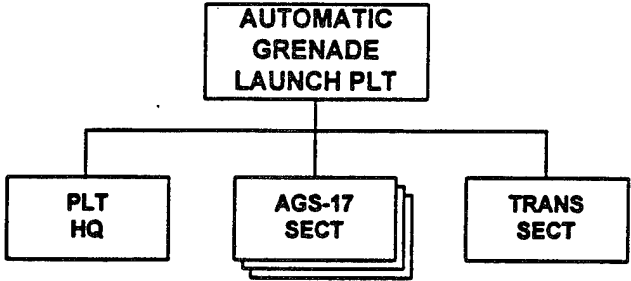

PRINCIPAL ITEMS OF EQUIPMENT

<u>Equipment</u>	<u>Total</u>	<u>Equipment</u>	<u>Total</u>
30-mm Automatic Grenade Launcher, AGS-17	6	SAM, SA-16/18	2
9-mm Pistol, PM	6	ATRL, RPG-18/22	2
5.45-mm Assault Rifle, AK-74	14	Truck, Light	3
		Radio, VHF, Portable, Low-Power	4

Service Company, Light Assault Bn, ID

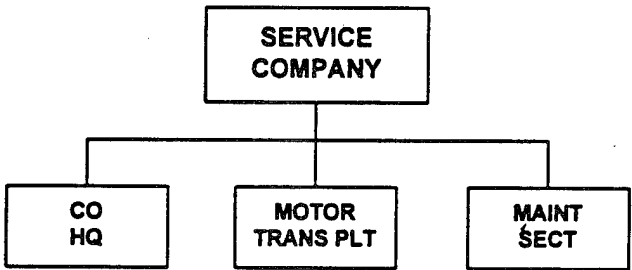

PRINCIPAL ITEMS OF EQUIPMENT

<u>Equipment</u>	<u>Total</u>	<u>Equipment</u>	<u>Total</u>
9-mm Pistol, PM	1	Trailer, POL (900-Liter)	5
5.45-mm Assault Rifle, AK-74	17	Trailer, Cargo, 1-Axle	5
40-mm Under-Barrel Grenade Launcher, BG-15	3	Trailer, Water (900-Liter)	2
ATRL, RPG-18/22	3	Van, Maintenance	1
Truck, Light	14	Radio, VHF, Portable, Low-Power	2

Independent Tank Battalion, ID

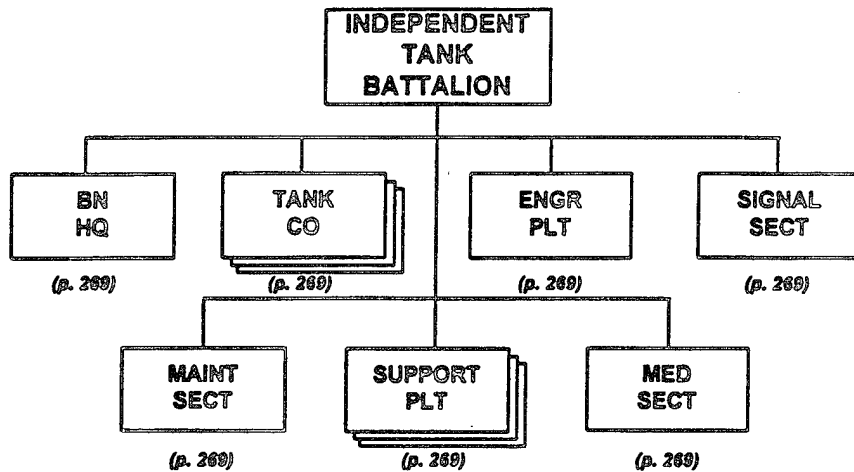

PRINCIPAL ITEMS OF EQUIPMENT

<u>Equipment</u>	<u>Total</u>	<u>Equipment</u>	<u>Total</u>
Medium Tank, T-64K/72K/80K (Command Vehicle).....	1	Ditching Machine, BTM/MDK	1
Medium Tank, T-64/72/80.....	39	Mineclearing Plow	9
ACV, BTR (R-145BM)	1	Mine Roller-Plow.....	3
ASC, BRDM-2.....	1	Dozer.....	1
ATGL, RPG-7V.....	3	Trailer, Cargo, 2-Axle.....	5
Truck, Utility.....	2	Trailer, Generator.....	1
Truck, Light	1	Trailer, POL (1,200-Liter)	2
Truck, Medium	14	Trailer, Water (900-Liter).....	1
Van, Signal.....	1	Radios:	
Van, Maintenance	1	VHF, Manpack, Low-Power.....	3
Truck, POL (5,200-Liter).....	2	VHF, Vehicle Mount, Medium-Power	43
Ambulance	1	HF, Manpack, Low-Power.....	2
Truck, Crane	1	HF, Vehicle Mount, Medium-Power	6
Van, Kitchen	1	Radio Relay, VHF/UHF.....	2
Armored Recovery Vehicle	2	Warning Receiver	1
Bridge, Tank-Launched	1		

NOTE: The independent tank battalion may have 31 tanks (10 per company) rather than the standard 40 (13 tanks per company).

Battalion Headquarters, Indep Tank Bn, ID

BATTALION HEADQUARTERS

PRINCIPAL ITEMS OF EQUIPMENT

Equipment	Total	Equipment	Total
Medium Tank, T-64K/72K/80K (Command Vehicle).....1		Radios:	
ACV, BTR (R-145BM)1		HF, Vehicle Mount, Medium-Power2	
Truck, Utility.....1		HF, Manpack, Low-Power.....1	
ATGL, RPG-7V3		VHF, Vehicle Mount, Medium-Power2	
		Radio Relay, VHF/UHF.....2	
		Warning Receiver1	

Tank Company, Indep Tank Bn, ID

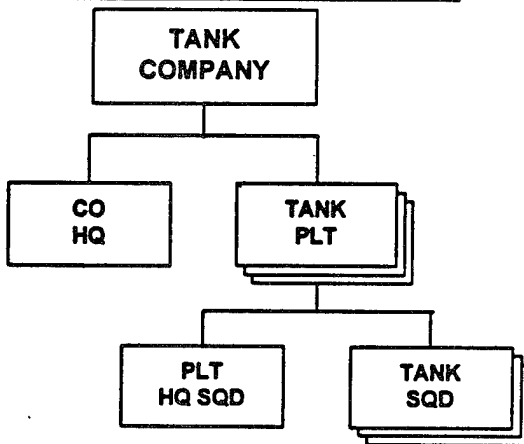

PRINCIPAL ITEMS OF EQUIPMENT

Equipment	Total	Equipment	Total
Medium Tank, T-64/72/80.....13		Radios:	
9-mm Pistol, PM.....24		VHF, Vehicle Mount, Medium-Power13	
5.45-mm Assault Rifle, AKS-74.....6		HF, Vehicle Mount, Medium-Power ...13	
Truck, Medium1			

NOTE: This variant differs from the 10-tank company by having four tanks per platoon rather than the normal three.

10-Tank Company, Indep Tank Bn, ID

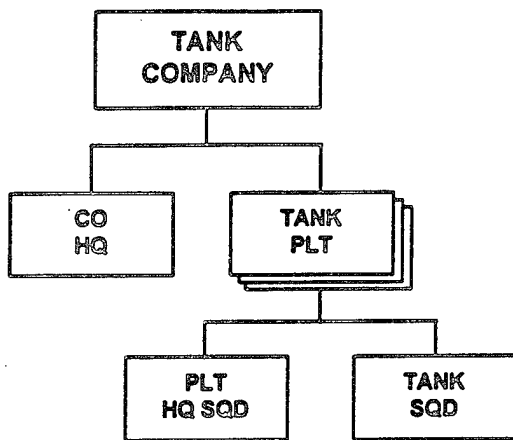

PRINCIPAL ITEMS OF EQUIPMENT

<u>Equipment</u>	<u>Total</u>	<u>Equipment</u>	<u>Total</u>
Medium Tank, T-64/72/80.....	10	Radios:	
9-mm Pistol, PM.....	24	HF, Vehicle Mount, Medium-Power	1
5.45-mm Assault Rifle, AKS-74.....	6	VHF, Vehicle Mount, Medium-Power	10

Engineer Platoon, Indep Tank Bn, ID

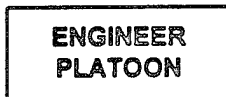

PRINCIPAL ITEMS OF EQUIPMENT

<u>Equipment</u>	<u>Total</u>	<u>Equipment</u>	<u>Total</u>
Bridge, Tank-Launched	1	Trailer, Cargo, 2-Axle.....	3
Ditching Machine, BTM/MDK	1	Radio:	
Dozer.....	1	VHF, Vehicle Mount, Medium-Power	1
Mineclearing Plow.....	9	VHF, Manpack, Low-Power.....	3
Mine Roller-Plow.....	3		
Truck, Medium	3		

Signal Section, Indep Tank Bn, ID

**SIGNAL
SECTION**

PRINCIPAL ITEMS OF EQUIPMENT

Equipment	Total	Equipment	Total
ASC, BRDM-2.....	1	Radios:	
Truck, Utility.....	1	HF, Manpack, Low-Power.....	1
Van, Signal.....	1	HF, Vehicle Mount, Medium-Power	1
		VHF, Vehicle Mount, Medium-Power	1

Maintenance Section, Indep Tank Bn, ID

**MAINTENANCE
SECTION**

PRINCIPAL ITEMS OF EQUIPMENT

Equipment	Total	Equipment	Total
Van, Maintenance	1	Armored Recovery Vehicle	2
Truck, Crane	1	Trailer, Generator.....	1

Support Platoon, Indep Tank Bn, ID

**SUPPORT
PLATOON**

PRINCIPAL ITEMS OF EQUIPMENT

<u>Equipment</u>	<u>Total</u>	<u>Equipment</u>	<u>Total</u>
Truck, Light	1	Trailer, Cargo, 2-Axle	2
Truck, Medium	8	Trailer, POL (1,200-Liter)	2
Truck, POL (5,200-Liter)	2	Trailer, Water (900-Liter)	1
Van, Kitchen	1		

Medical Section, Indep Tank Bn, ID

**MEDICAL
SECTION**

PRINCIPAL ITEMS OF EQUIPMENT

<u>Equipment</u>	<u>Total</u>
Ambulance	1

Artillery Regiment, ID

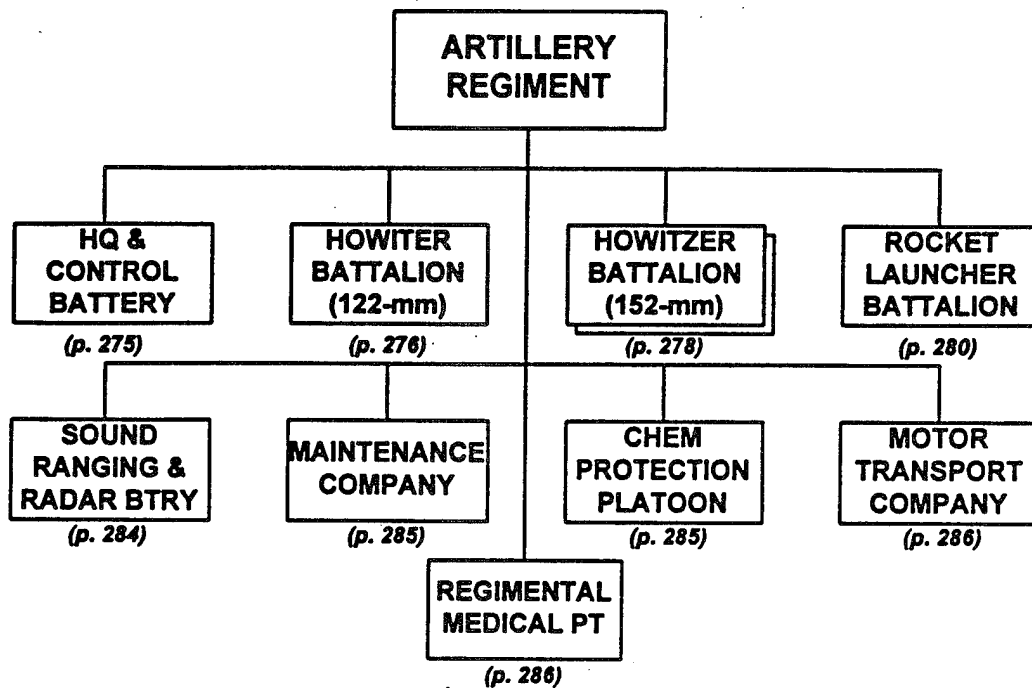

ARTILLERY REGIMENT, ID										
Principal Items of Equipment	HQ & Control Btry	Howitzer Bn (122-mm)	Howitzer Bn (162-mm) (2x)	Rocket Launcher Bn	Sound Range & Radar Recon Btry	Maintenance Co	Chem Protection Plt	Regt Medical Point	Motor Transport Co	TOTAL
ARMORED VEHICLES										
ACV, BTR (R-145BM)	2			1	2					5
Chemical Recon Vehicle, BRDM-2RKh/RKhM	1						3			4
Mobile Recon Post, PRP-3/4		4	4		1					9
APC, Radar, MT-LB (SNAR-10)					1					1
ACRV, 1V110		3	3	3						9
ACRV, 1V111		1	1	1						3
ACRV, 1V18		3	3	3						9
ACRV, 1V19		1	1	1						3
Armored Recovery Vehicle						1				1
WEAPONS										
5.45-mm LMG, RPK-74		18	18			2				38
122-mm Howitzer, D-30		18								18
152-mm Gun Howitzer, D-20 or 2A65			18							18
122-mm Rocket Launcher, BM-21				18						18
ATGL, RPG-7V	4	18	18			4				44
TRUCKS										
Truck, Utility		1	1	5	6	1			1	15
Truck, Light	8	12	12	6	7			1	1	47
Truck, Medium	1	34	34	42		1		2	36	150
Truck, Decon, ARS-12U/14							3			
Truck, Decon, DDA-53/66							1	1		2
Truck, POL (4,000/5,200-L)		2	2	2					8	14
Truck, Water (900/1,200-L)							2		3	5
Van, Survey					1					1
Van, Command				1						1
Van, Maintenance		1	1	3		6			2	13
Van, Signal	3	2	2	2	4	2		2		17
Ambulance		1	1	1				4		7
TRAILERS										
Trailer, Cargo, 1-Axle	1									1
Trailer, Cargo, 2-Axle		11	11	36		3			30	91
Trailer, Generator				2	2	2				6
Trailer, Kitchen		4	4	3				1		12
Trailer, POL (900/1,200-L)		2	2	2					8	14
Trailer, Water (900/1,200-L)		1	1	1			2	1		6
RADARS										
CM/CB, ARK-1					1					1
RADIOS										
VHF, Manpack, Low-Power	6	24	24	18	13	1			1	87
VHF, Portable, Low-Power	1	2	2							5
VHF, Vehicle Mount, Medium-Power	3				4		3			10
HF, Manpack, Low-Power	1						1	1		3
HF, Vehicle Mount, Medium-Power	3									5
HF/VHF, Vehicle Mount, Medium-Power	3	4	4	2						13
HF/VHF, Vehicle Mount, High-Power	1									1
Radio Relay, VHF/UHF	1									1
Warning Receiver	1	1	1	1	1					5
MISCELLANEOUS										
Rangefinder, Laser, SAGE GLOSS	1	4	4		2					11
Sound Ranging Set					1					1

Headquarters and Control Battery, Arty Regt, ID

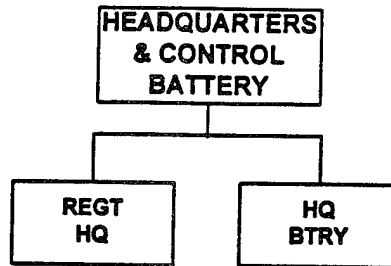

PRINCIPAL ITEMS OF EQUIPMENT

<u>Equipment</u>	<u>Total</u>
ACV, BTR (R-145BM)	2
ATGL, RPG-7V	4
Truck, Light	8
Truck, Medium	1
Chemical Recon Vehicle, BRDM-2RKh/RKhM.....	1
Van, Signal.....	3
Trailer, Cargo, 1-Axle.....	1
Rangefinder, Laser, SAGE GLOSS.....	1

<u>Equipment</u>	<u>Total</u>
Radios:	
VHF, Manpack, Low-Power.....	6
VHF, Portable, Low-Power or Very-Low-Power	1
VHF, Vehicle Mount, Medium-Power	3
HF, Manpack, Low-Power.....	1
HF, Vehicle Mount, Medium-Power	5
HF/VHF, Vehicle Mount, Medium-Power	3
HF/VHF, Vehicle Mount, High-Power	1
Radio Relay, VHF/UHF.....	1
Warning Receiver	1

122-mm Howitzer Battalion , Arty Regt, ID

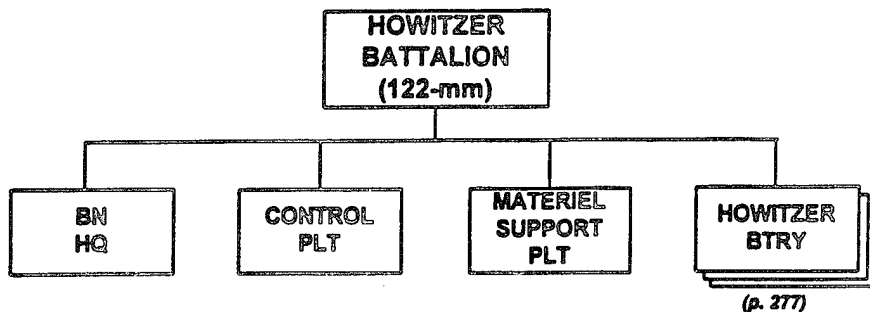

PRINCIPAL ITEMS OF EQUIPMENT

<u>Equipment</u>	<u>Total</u>	<u>Equipment</u>	<u>Total</u>
122-mm Howitzer, D-30	18	Ambulance	1
ACRV, 1V110 (Battery FDC)	3	Trailer, Cargo, 2-Axle	11
ACRV, 1V18 (Battery COP)	3	Trailer, POL (1,200-Liter)	2
ACRV, 1V19 (Battalion COP)	1	Trailer, Water (900-Liter)	1
ACRV, 1V111 (Battalion FDC)	1	Trailer, Kitchen	4
Mobile Recon Post, PRP-3/4 *	4	Rangefinder, Laser, SAGE GLOSS	4
ATGL, RPG-7V	18	Radios:	
5.45-mm LMG, RPK-74	18	VHF, Manpack, Low-Power	24
Truck, Utility	1	VHF, Portable, Low-Power or	
Truck, Light	12	Very-Low-Power	2
Truck, Medium	34	HF/VHF, Vehicle Mount,	
Truck, POL (4000 or 5,200-Liter)	2	Medium-Power	4
Van, Signal	2	Warning Receiver	1
Van, Maintenance	1		

NOTE: * This system includes the SMALL FRED battlefield surveillance radar.

**122-mm Howitzer Battery, 122-mm Howitzer Bn,
Arty Regt, ID**

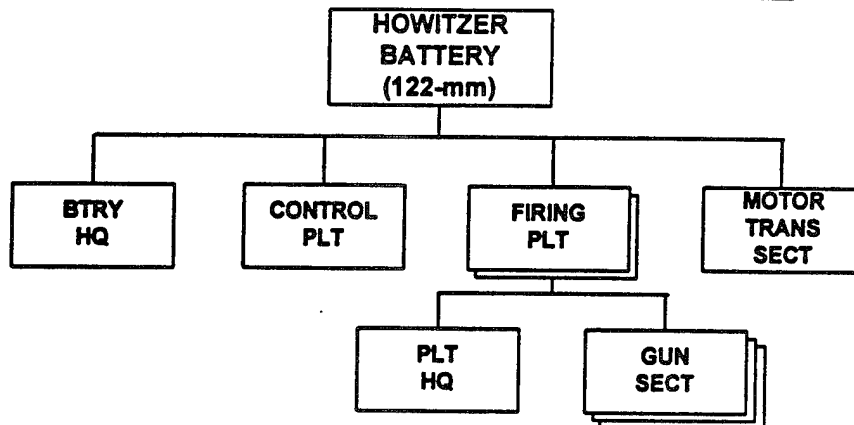

PRINCIPAL ITEMS OF EQUIPMENT

Equipment	Total
122-mm Howitzer, D-30	6
ACRV, 1V110 (Battery FDC)	1
ACRV, 1V18 (Battery COP)	1
ATGL, RPG-7V	6
5.45-mm LMG, RPK-74	6
Truck, Light	1
Truck, Medium	8

Equipment	Total
Trailer, Cargo, 2-Axle	1
Rangefinder, Laser, SAGE GLOSS	1
Radios:	
VHF, Manpack, Low-Power	8
VHF, Vehicle Mount, Medium-Power	2

152-mm Howitzer Battalion, Arty Regt, ID

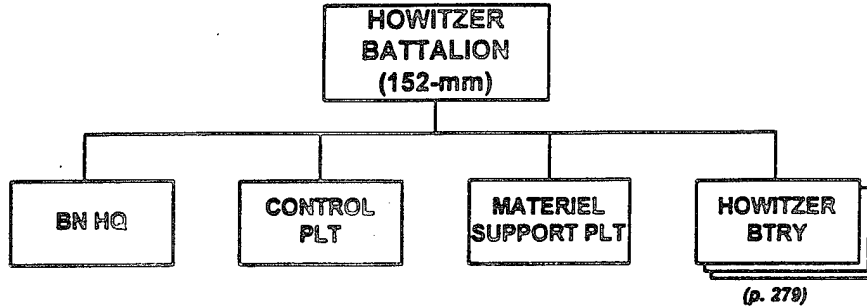

PRINCIPAL ITEMS OF EQUIPMENT

<u>Equipment</u>	<u>Total</u>	<u>Equipment</u>	<u>Total</u>
152-mm Gun-Howitzer, D-20 or 2A65.....	18	Van, Maintenance	1
ACV, BTR (R-145BM)	1	Ambulance	1
ACRV, 1V110 (Battery FDC)	3	Trailer, Cargo, 2-Axle.....	11
ACRV, 1V18 (Battery COP)	3	Trailer, POL (1,200-Liter)	2
ACRV, 1V19 (Battalion COP)	1	Trailer, Water (900-Liter)	1
ACRV, 1V111 (Battalion FDC)	1	Trailer, Kitchen	4
Mobile Recon Post, PRP-3/4*	4	Rangefinder, Laser, SAGE GLOSS.....	4
ATGL, RPG-7V	18	Radios:	
5.45-mm LMG, RPK-74	18	VHF, Manpack, Low-Power	24
Truck, Utility.....	1	VHF, Portable, Low-Power or	
Truck, Light	12	Very-Low-Power	2
Truck, Medium	34	HF/VHF, Vehicle Mount,	
Truck, POL (4,000 to 5,200-Liter).....	2	Medium-Power	4
Van, Signal.....	2	Warning Receiver	1

FOOTNOTE: * This system includes the SMALL FRED battlefield surveillance radar.

**152-mm Howitzer Battery, 152-mm Howitzer Bn,
Arty Regt, ID**

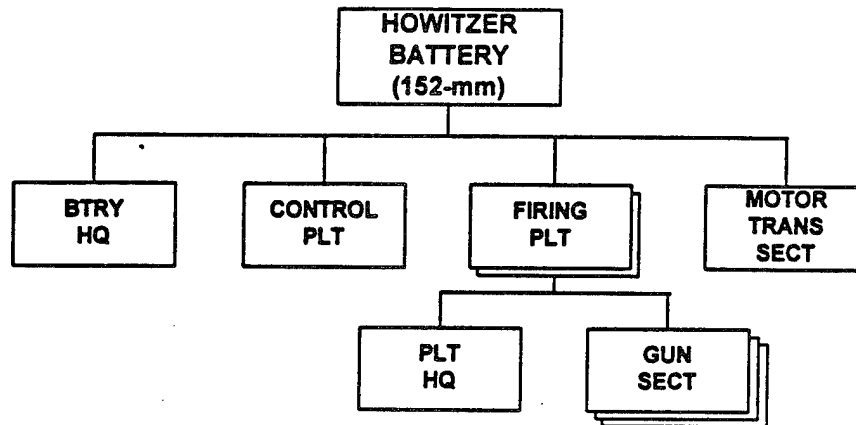

PRINCIPAL ITEMS OF EQUIPMENT

Equipment	Total
152-mm Gun-Howitzer, D-20 or 2A65.....	6
ACRV, 1V110 (Battery FDC)	1
ACRV, 1V18 (Battery COP)	1
ATGL, RPG-7V	6
5.45-mm LMG, RPK-74	6
Truck, Light	1
Truck, Medium	8

Equipment	Total
Trailer, Cargo, 2-Axle	1
Rangefinder, Laser, SAGE GLOSS	1
Radios:	
VHF, Manpack, Low-Power	8
VHF, Vehicle Mount, Medium-Power	2

Rocket Launcher Battalion, Arty Regt, ID

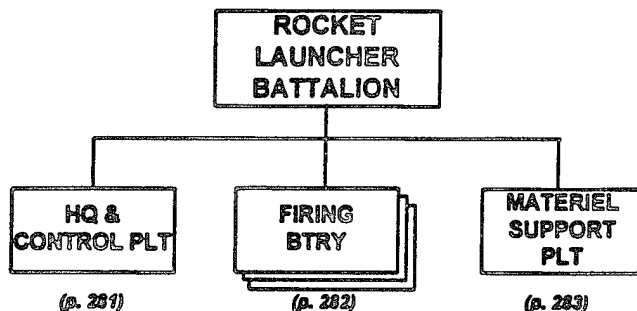

PRINCIPAL ITEMS OF EQUIPMENT

<u>Equipment</u>	<u>Total</u>	<u>Equipment</u>	<u>Total</u>
122-mm Rocket Launcher, BM-21(Grad)	18	Truck, POL (4,000-Liter).....	2
ACV, BTR (R-145BM)	1	Ambulance	1
ACRV, 1V110 (Battery FDC)	3	Trailer, Cargo, 2-Axle.....	36
ACRV, 1V18 (Battery COP)	3	Trailer, Generator.....	2
ACRV, 1V19 Battalion COP).....	1	Trailer, Water (900-Liter)	1
ACRV, 1V111 (Battalion FDC)	1	Trailer, POL (1,200-Liter)	2
Truck, Utility.....	5	Trailer, Kitchen	3
Truck, Light	6	Radios:	
Truck, Medium	42	VHF, Manpack, Low-Power.....	18
Van, Command	1	HF/VHF, Vehicle Mount,	
Van, Signal.....	2	Medium-Power	2
Van, Maintenance	3	Warning Receiver	1

**Headquarters and Control Platoon, Rocket Launcher
Bn, Arty Regt, ID**

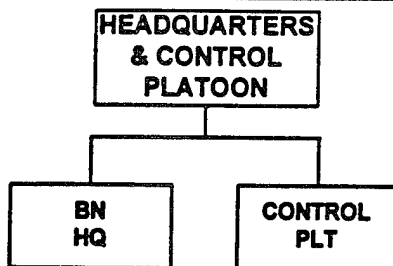

PRINCIPAL ITEMS OF EQUIPMENT

<u>Equipment</u>	<u>Total</u>	<u>Equipment</u>	<u>Total</u>
ACV, BTR (R-145BM)	1	Ambulance	1
ACRV, 1V19 (Battalion COP)	1	Trailer, Generator	1
ACRV, 1V111 (Battalion FDC)	1	Radios:	
Truck, Utility	1	VHF, Manpack, Low-Power	5
Truck, Medium	1	HF/VHF, Vehicle Mount,	
Van, Command	1	Medium-Power	2
Van, Signal	2	Warning Receiver	1

**Firing Battery, Rocket Launcher Bn, Arty
Regt, ID**

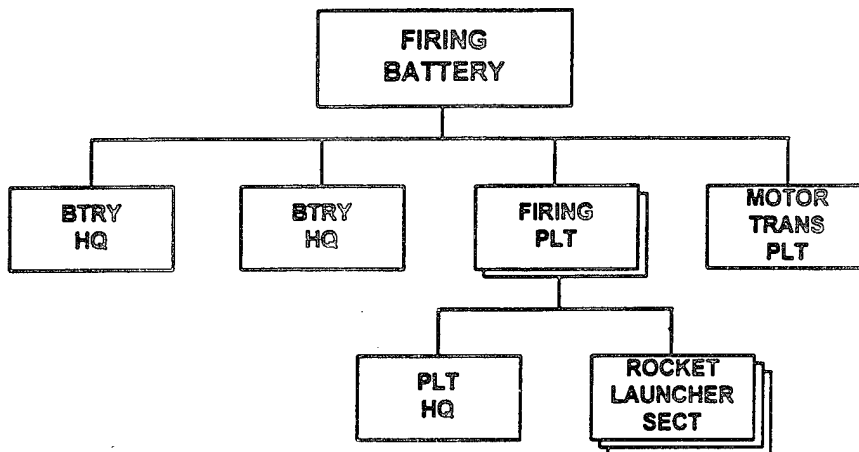

PRINCIPAL ITEMS OF EQUIPMENT

<u>Equipment</u>	<u>Total</u>
122-mm Rocket Launcher, BM-21 (Grad)	6
ACRV, 1V110 (Battery FDC)	1
ACRV, 1V18 (Battery COP)	1
Truck, Utility.....	1

<u>Equipment</u>	<u>Total</u>
Truck, Light	2
Truck, Medium	6
Trailer, Cargo, 2-Axle.....	6
Radio, VHF, Manpack, Low-Power	4

**Materiel Support Platoon, Rocket Launcher Bn,
Arty Regt, ID**

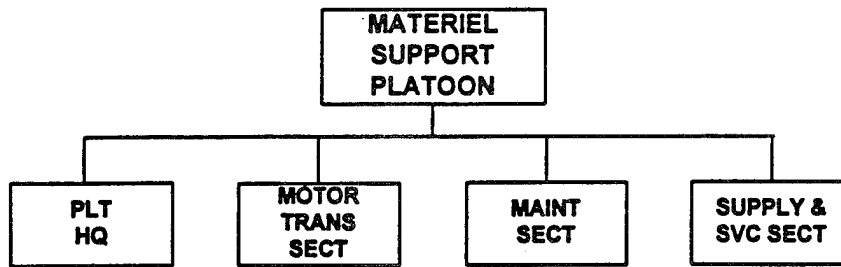

PRINCIPAL ITEMS OF EQUIPMENT

<u>Equipment</u>	<u>Total</u>	<u>Equipment</u>	<u>Total</u>
Truck, Utility.....	1	Trailer, Generator.....	1
Truck, Medium	23	Trailer, Water (900-Liter)	1
Van, Maintenance	3	Trailer, POL (1,200-Liter)	2
Truck, POL (4,000-Liter).....	2	Trailer, Kitchen.....	3
Trailer, Cargo, 2-Axle.....	18	Radio, VHF, Manpack, Low-Power	1

Sound Ranging and Radar Recon Battery, Arty Regt, ID

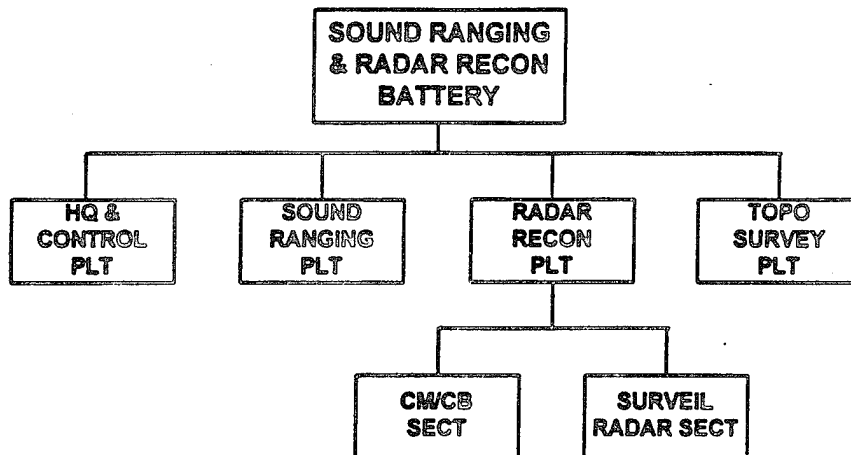

PRINCIPAL ITEMS OF EQUIPMENT

<u>Equipment</u>	<u>Total</u>	<u>Equipment</u>	<u>Total</u>
ACV, BTR (R-145BM)	2	Rangefinder, Laser, SAGE GLOSS	2
APC, Radar, MT-LB (SNAR 10)*	1	Sound Ranging Set.....	1
Mobile Recon Post, PRP-3**	1	Radar, Countermortar/Counterbattery, ARK-1	1
Truck, Utility.....	6	Radios:	
Truck, Light	7	VHF, Manpack, Low-Power.....	13
Van, Signal.....	4	VHF, Vehicle Mount, Medium-Power	4
Van, Survey.....	1	Warning Receiver	1
Trailer, Generator.....	2		
Trailer, Cargo, 1-Axle.....	4		
Trailer, Kitchen	1		

FOOTNOTES:

- * This system includes the BIG FRED battlefield surveillance radar.
- ** This system includes the SMALL FRED or TALL MIKE battlefield surveillance radar.

Maintenance Company, Arty Regt, ID

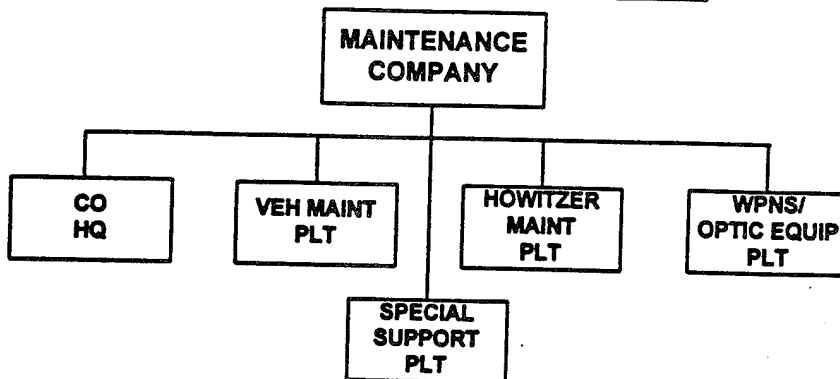

PRINCIPAL ITEMS OF EQUIPMENT

<u>Equipment</u>	<u>Total</u>	<u>Equipment</u>	<u>Total</u>
ATGL, RPG-7V	4	Van, Signal	2
5.45-mm LMG, RPK-74	2	Armored Recovery Vehicle	1
Truck, Utility	1	Trailer, Cargo, 2-Axle	3
Truck, Medium	1	Trailer, Generator	2
Van, Maintenance	6	Radio, VHF, Manpack, Low-Power	1

Chemical Protection Platoon, Air Defense Regt, ID

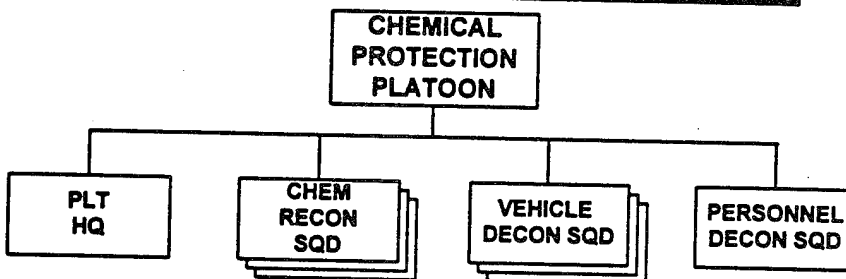

PRINCIPAL ITEMS OF EQUIPMENT

<u>Equipment</u>	<u>Total</u>	<u>Equipment</u>	<u>Total</u>
Chemical Recon Vehicle, BRDM-2RKh or RKhM	3	Trailer, Water (900-Liter)	2
Truck, Decon, AR-12u/14	3	Radios:	
Truck, Decon, DDA-53/66	1	VHF, Vehicle Mount, Medium-Power	3
Truck, Water (2,000-Liter)	2	HF, Manpack, Low-Power	1

Motor Transport Company, Arty Regt, ID

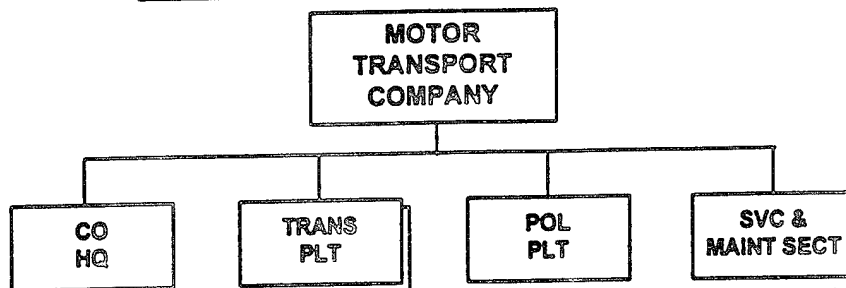

PRINCIPAL ITEMS OF EQUIPMENT

<u>Equipment</u>	<u>Total</u>	<u>Equipment</u>	<u>Total</u>
Truck, Utility	1	Truck, POL (4,000-Liter).....	8
Truck, Light	1	Trailer, POL (1,200-Liter)	8
Truck, Medium	36	Trailer, Cargo, 2-Axle.....	30
Van, Maintenance	2	Radio, VHF, Manpack, Low-Power	1
Truck, Water (900 or 1,200-Liter)	3		

Regimental Medical Point, Arty Regt, ID

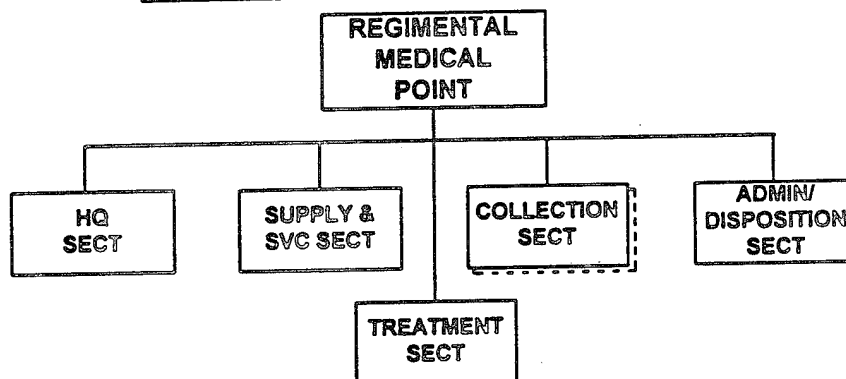

PRINCIPAL ITEMS OF EQUIPMENT

<u>Equipment</u>	<u>Total</u>	<u>Equipment</u>	<u>Total</u>
Ambulance	4	Truck, Decon, DDA-53/66.....	1
Van, Signal.....	1	Trailer, Kitchen	1
Truck, Light	1	Trailer, Water (900-Liter)	1
Truck, Medium	2	Radio, HF, Manpack, Low-Power	1

NOTES:

1. Other trucks may serve as ambulances.
2. There may be two collection sections.

Air Defense Regiment, ID

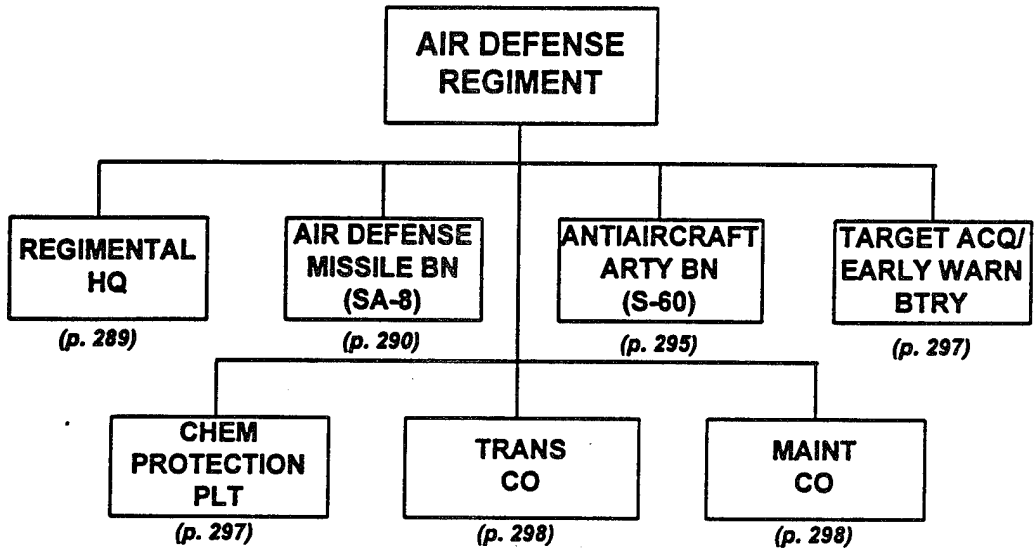

AIR DEFENSE REGIMENT, ID								
Principal Items of Equipment	Regt HQ	Air Defense Missile Bn (SA-8)	Antiaircraft Arty Bn (S-60)	Target Acq/EW Btry	Chem Protection Plt	Transport Co	Maintenance Co	TOTAL
	ARMORED VEHICLES							
APC, BTR-60 (PU-12)	1	3	1					5
Chemical Recon Vehicle, BRDM-2RKh/RKhM			1		3			4
WEAPONS								
57-mm AA Gun, S-60			18					18
SAM, SA-8/GECKO		8						8
SAM, SA-16/18	3	9	12					24
TRUCKS								
Truck, Utility	1	5	5	3		1	1	16
Truck, Light	3	7	4	1		1	3	19
Truck, Medium	2	20	60			36	3	121
Truck, Decon, ARS-12U/14					3			3
Truck, Decon, DDA-53/66					1			1
Truck, Crane		2	1					3
Truck, POL (4,000/5,200-L)		8	4			8		20
Truck, Water (2,000-L)			1			3		4
Van	2	4	2					8
Van, Computer				1				1
Van, Maintenance		5	3	1		2	8	19
Van, Missile Testing		2						2
Van, Radar			4					4
Van, Signal	4	2	2					8
Ambulance	2		1					3
TRAILERS								
Trailer, Cargo, 2-Axle		6	5	1		7	3	22
Trailer, Generator	2	5	4			3	7	21
Trailer, Kitchen	1	6	4	1		1	1	14
Trailer, POL (900/1,200-L)		3	3			8		14
Trailer, Van	4	4		1		2		11
Trailer, Water (900/1,200-L)		2	4	1			1	8
RADARS								
Aer. Surv./Tgt. Acq., LONG TRACK				2				2
Aer. Surv./Tgt. Acq., FLAT FACE			1					1
Fire Control, FLAP WHEEL			3					3
Height Finding, THIN SKIN				1				1
RADIOS								
VHF, Manpack, Low-Power	1	7	21	2		1	1	33
VHF, Portable, Low-Power		3						3
VHF, Portable, Very-Low-Power			9					9
VHF, Vehicle Mount, Medium-Power	1	15	1	3	3			23
HF, Manpack, Low-Power			1	2				3
HF/VHF, Vehicle Mount, Medium-Power	4	2	2					8
HF/VHF, Vehicle Mount, High-Power	2	2	2					6
Radio Relay, VHF/UHF	1	1						2
Warning Receiver	2	3	4					9
MISCELLANEOUS								
SA-8 Transloader (TELAR Chassis)		4						4

Regimental Headquarters, Air Defense Regt, ID

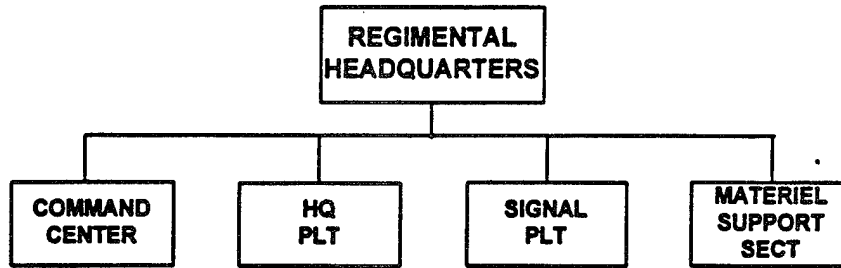

PRINCIPAL ITEMS OF EQUIPMENT

Equipment	Total
SAM, SA-16/18	3
ACV, BTR-60 (PU-12).....	1
Truck, Utility.....	1
Truck, Light	3
Truck, Medium	2
Van, Medium	2
Van, Signal.....	4
Trailer, Van	4
Trailer, Generator.....	2
Trailer, Kitchen	1
Ambulance	2

Equipment	Total
Radios:	
VHF, Manpack, Low-Power	1
VHF, Vehicle Mount, Medium-Power	1
HF/VHF, Vehicle Mount, Medium-Power	4
HF/VHF, Vehicle Mount, High-Power	2
Radio Relay, VHF/UHF.....	1
Warning Receiver	2

**Air Defense Missile Battalion (SA-8), Air Defense
Regt, ID**

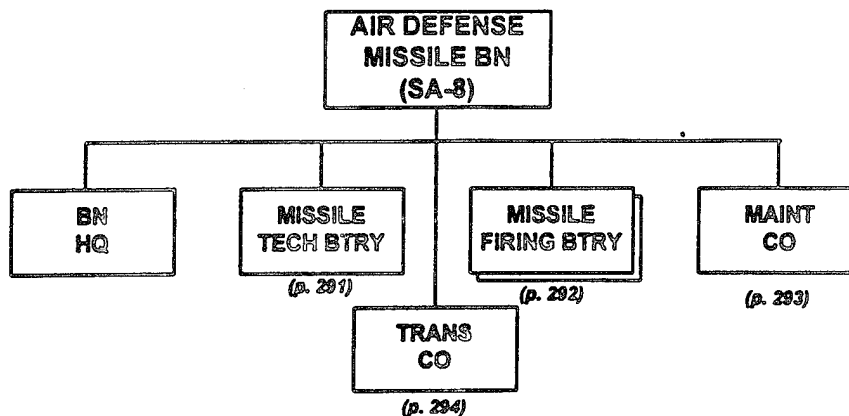

PRINCIPAL ITEMS OF EQUIPMENT

<u>Equipment</u>	<u>Total</u>	<u>Equipment</u>	<u>Total</u>
SAM, SA-8/GECKO TELAR*	8	Trailer, Van	4
SAM, SA-16/18	9	Trailer, Generator	5
ACV, BTR-60 (PU-12)	3	Trailer, Water (1,200-Liter)	2
Truck, Utility	5	Trailer, Kitchen	6
Truck, Light	7	Radios:	
Truck, Medium	20	VHF, Manpack, Low-Power	7
Van	4	VHF, Portable, Low-Power	3
Van, Signal	2	VHF, Vehicle Mount,	
Van, Maintenance	5	Medium-Power	15
Truck, POL (4,000 or 5,200-Liter)	8	HF/VHF, Vehicle Mount,	
SA-8 Missile Transloader		Medium-Power	2
(TELAR Chassis)	4	HF/VHF, Vehicle Mount,	
Truck, Crane	2	High-Power	2
Trailer, POL (1,200-Liter)	3	Radio Relay, VHF/UHF	1
Trailer, Cargo, 2-Axle	6	Warning Receiver	3

FOOTNOTE: * The TELAR includes the LAND ROLL fire control/target acquisition radar.

**Missile Technical Battery, Air Defense Missile Bn
(SA-8), Air Defense Regt, ID**

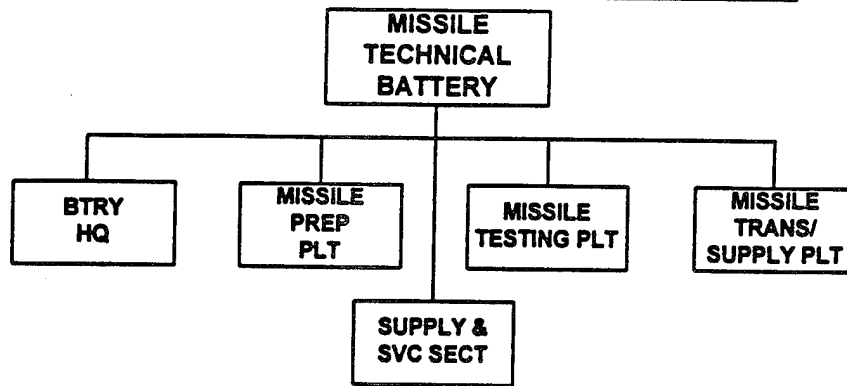

PRINCIPAL ITEMS OF EQUIPMENT

<u>Equipment</u>	<u>Total</u>	<u>Equipment</u>	<u>Total</u>
SAM, SA-16/18	3	Trailer, Generator	1
Truck, Utility	1	Trailer, Van	1
Truck, Light	5	Trailer, Kitchen	2
Truck, Medium	4	Radios:	
Truck, Crane	2	VHF, Manpack, Low-Power	1
Van, Missile Testing	2	VHF, Portable, Low-Power	3
Trailer, Cargo, 2-Axle	1		

**Missile Firing Battery, Air Defense Missile Bn
(SA-8), Air Defense Regt, ID**

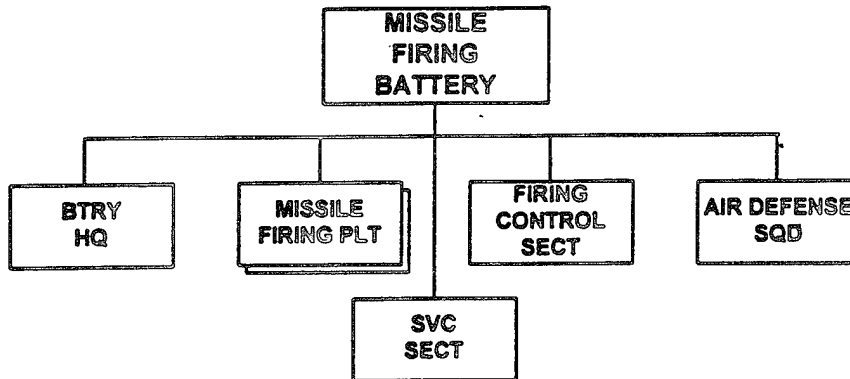

PRINCIPAL ITEMS OF EQUIPMENT

<u>Equipment</u>	<u>Total</u>	<u>Equipment</u>	<u>Total</u>
SAM, SA-8/GECKO TELAR*	4	Trailer, Van	1
SAM, SA-16/18	3	Trailer, Kitchen	1
ACV, BTR 60 (PU-12)	1	Radios:	
Truck, Utility	1	VHF, Manpack, Low-Power	1
Van	2	VHF, Vehicle Mount,	
SA-8 Missile Transloader		Medium-Power	6
(TELAR Chassis)	2	Warning Receiver	1
Trailer, Cargo, 2-Axle	1		

FOOTNOTE: * The TELAR includes the LAND ROLL fire control/target acquisition radar.

**Maintenance Company, Air Defense Bn (SA-8),
Air Defense Regt, ID**

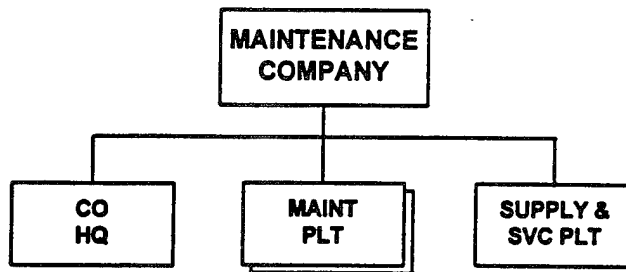

PRINCIPAL ITEMS OF EQUIPMENT

Equipment	Total	Equipment	Total
Truck, Utility.....	1	Trailer, Generator.....	3
Truck, Light.....	1	Trailer, Water (900-Liter).....	1
Truck, Medium.....	1	Trailer, Kitchen.....	1
Van, Maintenance.....	4	Radio, VHF, Manpack, Low-Power.....	1
Trailer, Cargo, 2-Axle.....	1		

**Transport Company, Air Defense Missile Bn
(SA-8), Air Defense Regt, ID**

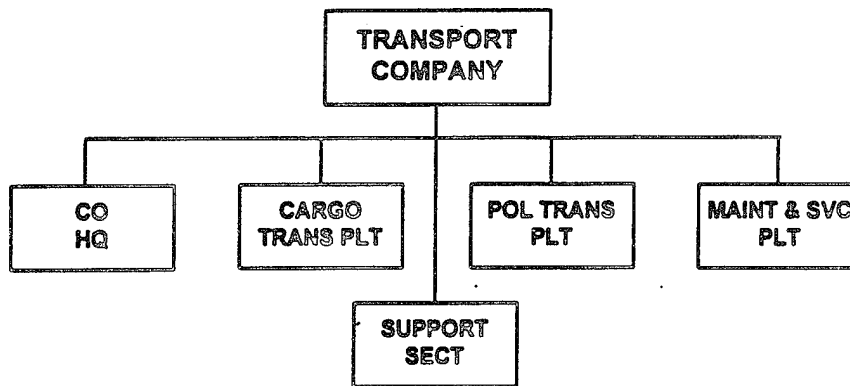

PRINCIPAL ITEMS OF EQUIPMENT

<u>Equipment</u>	<u>Total</u>	<u>Equipment</u>	<u>Total</u>
Truck, Utility.....	1	Trailer, POL (1,200-Liter)	3
Truck, Light	1	Trailer, Generator.....	1
Truck, POL (4,000 or 5,200-Liter)	8	Trailer, Water (900-Liter)	1
Truck, Medium	15	Trailer, Kitchen.....	1
Van, Maintenance	1	Trailer, Van.....	1
Trailer, Cargo, 2-Axle.....	2	Radio, VHF, Manpack, Low-Power	1

Antiaircraft Artillery Battalion (S-60), Air Defense Regt, ID

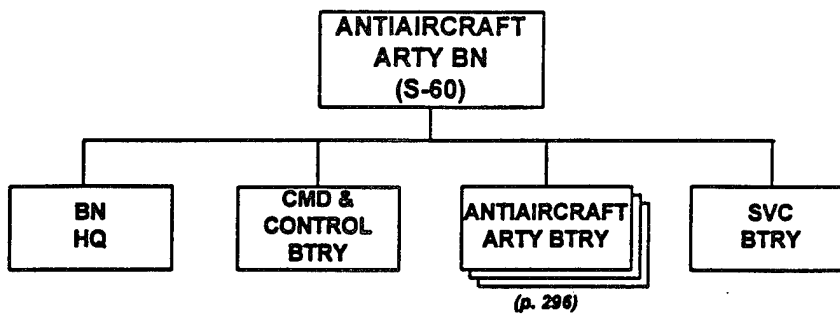

PRINCIPAL ITEMS OF EQUIPMENT

Equipment	Total
57-mm AA Gun, S-60.....	18
SAM, SA-16/18	12
ACV, BTR-60 (PU-12).....	1
Truck, Utility.....	5
Truck, Light	4
Truck, Medium	60
Van, Signal.....	2
Van, Maintenance	3
Van, Radar	4
Truck, POL (4,000 or 5,200-Liter)	4
Truck, Crane	1
Truck, Water (2,000-Liter)	1
Ambulance	1
Chemical Recon Vehicle, BRDM-2RKh/RKhM.....	1
Trailer, POL (1,200-Liter)	3
Trailer, Cargo, 2-Axle.....	5
Trailer, Generator.....	4

Equipment	Total
Trailer, Kitchen	4
Trailer, Water (900-Liter)	4
Radars:	
Fire Control, FLAP WHEEL	3
Aerial Surveillance/Target Acquisition, FLAT FACE.....	1
Radios:	
VHF, Manpack, Low-Power	21
VHF, Portable, Very-Low-Power	9
VHF, Vehicle Mount, Medium-Power	1
HF, Manpack, Low-Power.....	1
HF/VHF, Vehicle Mount, Medium-Power	2
HF/VHF, Vehicle Mount, High-Power	2
Warning Receiver	4

**Antiaircraft Artillery Battery, Antiaircraft Arty Bn,
Air Defense Regt, ID**

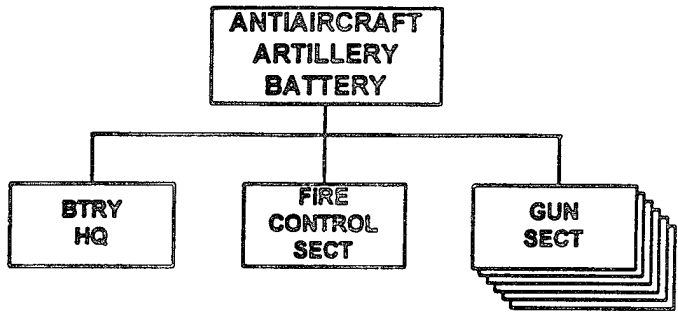

PRINCIPAL ITEMS OF EQUIPMENT

<u>Equipment</u>	<u>Total</u>
57-mm AA Gun, S-60.....	6
SAM, SA-16/18	3
Truck, Light	1
Truck, Medium	15
Truck, POL (4,000 or 5,200-Liter)	1
Van, Radar	1
Trailer, Generator.....	1
Trailer, POL (1,200-Liter)	1

<u>Equipment</u>	<u>Total</u>
Trailer, Water (900-Liter)	1
Trailer, Kitchen	1
Radar, Fire Control, FLAP WHEEL.....	1
Radios:	
VHF, Portable, Very-Low-Power	3
VHF, Manpack, Low-Power	6
Warning Receiver	1

**Target Acquisition/Early Warning Battery,
Air Defense Regt, ID**

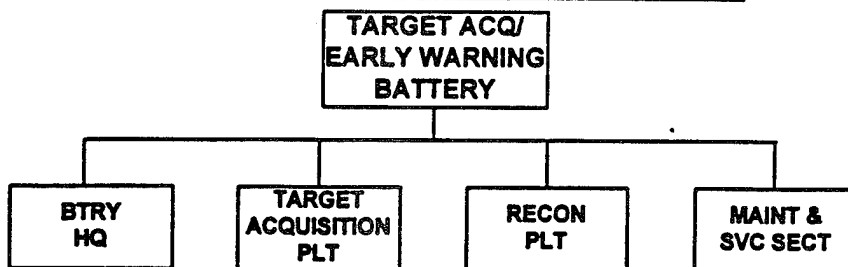

PRINCIPAL ITEMS OF EQUIPMENT

<u>Equipment</u>	<u>Total</u>	<u>Equipment</u>	<u>Total</u>
Truck, Utility.....	3	Radars:	
Truck, Light	1	Aerial Surveillance/Target	
Van, Maintenance	1	Acquisition, LONG TRACK	2
Van, Computer.....	1	Height Finding, THIN SKIN	1
Trailer, Cargo, 2-Axle.....	1	Radios:	
Trailer, Van	1	VHF, Manpack, Low-Power.....	2
Trailer, Kitchen.....	1	VHF, Vehicle Mount,	
Trailer, Water (900-Liter)	1	Medium-Power	3
		HF, Manpack, Low-Power.....	2

Chemical Protection Platoon, Air Defense Regt, ID

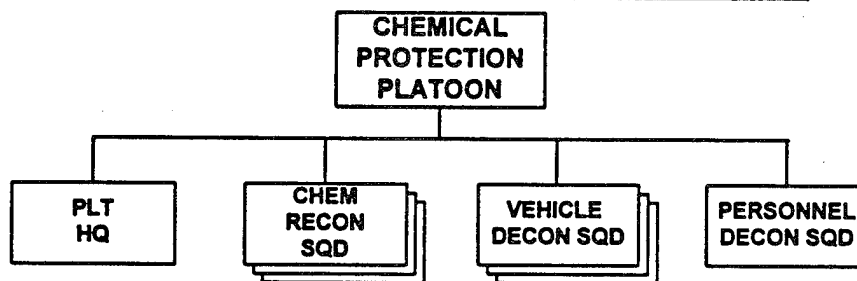

PRINCIPAL ITEMS OF EQUIPMENT

<u>Equipment</u>	<u>Total</u>	<u>Equipment</u>	<u>Total</u>
Chemical Recon Vehicle, BRDM-2RKh or RKhM	3	Trailer, Water (900-Liter)	2
Truck, Decon, ARS-12U/14	3	Radios:	
Truck, Decon, DDA-53/66.....	1	VHF, Vehicle Mount,	
Truck, Water (2,000-Liter).....	2	Medium-Power	3
		HF, Manpack, Low-Power.....	1

Transport Company, Air Defense Regt, ID

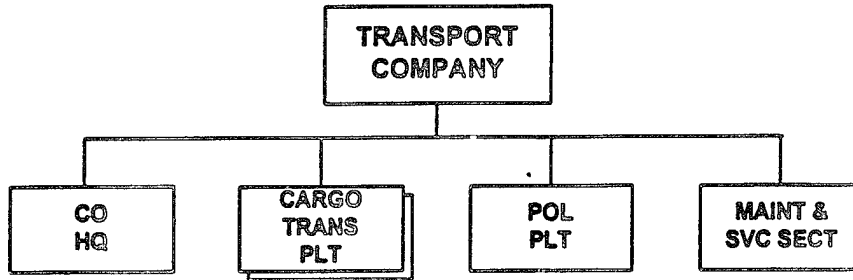

PRINCIPAL ITEMS OF EQUIPMENT

<u>Equipment</u>	<u>Total</u>	<u>Equipment</u>	<u>Total</u>
Truck, Utility	1	Trailer, Cargo, 2-Axle	7
Truck, Light	1	Trailer, Kitchen	1
Truck, Medium	36	Trailer, POL (1,200-Liter)	8
Van, Maintenance	2	Trailer, Van	2
Truck, Water (2,000-Liter).....	3	Radio, VHF, Manpack, Low-Power	1
Truck, POL (4,000-Liter).....	8		

Maintenance Company, Air Defense Regt, ID

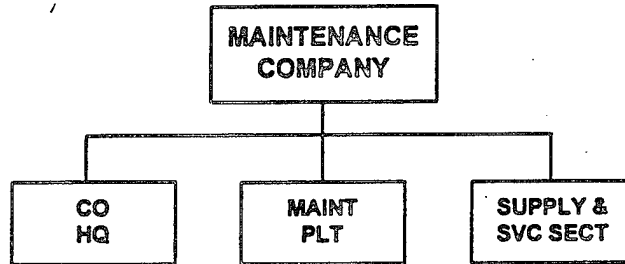

PRINCIPAL ITEMS OF EQUIPMENT

<u>Equipment</u>	<u>Total</u>	<u>Equipment</u>	<u>Total</u>
Truck, Utility.....	1	Trailer, Generator.....	7
Truck, Light	3	Trailer, Water (900-Liter)	1
Truck, Medium	3	Trailer, Kitchen	1
Van, Maintenance	8	Radio, VHF, Manpack, Low-Power	1
Trailer, Cargo, 2-Axle.....	3		

Antitank Battalion, ID

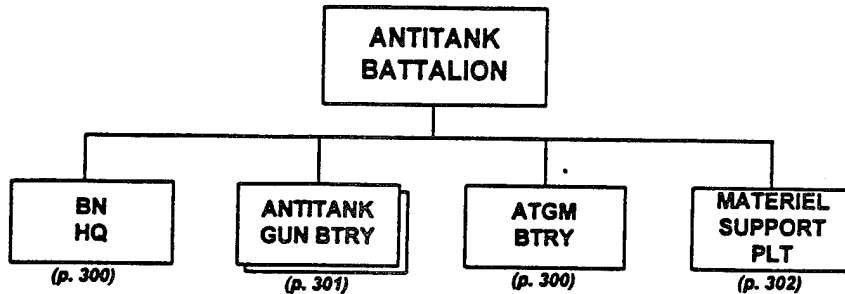

PRINCIPAL ITEMS OF EQUIPMENT

Equipment	Total	Equipment	Total
ATGM Vehicle, 9P148 w/ AT-5/SPANDREL	9	Trailer, Generator	1
100/125-mm Antitank Gun, MT-12/2A45M	12	Trailer, Water (900-Liter)	1
ATGL, RPG-7V	9	Trailer, Kitchen	1
ACV, BTR (R-145BM)	5	Rangefinder	3
Truck, Utility	17	Radar, Battlefield Surveillance, Man-Portable, PSNR-1	3
Truck, Light	4	Radios:	
Truck, Medium	12	VHF, Manpack, Low-Power	22
Van, Signal	2	VHF, Vehicle Mount, Medium-Power	14
Van, Maintenance	2	HF, Vehicle Mount, Medium-Power	1
Truck, POL (4,000 to 5,200-Liter)	2	HF/VHF, Vehicle Mount, Medium-Power	2
Ambulance	1	Radio Relay, VHF/UHF	1
Trailer, Cargo, 2-Axle	10	Warning Receiver	1
Trailer, POL (900-Liter)	1		

Battalion Headquarters, Antitank Bn, ID

**BATTALION
HEADQUARTERS**

PRINCIPAL ITEMS OF EQUIPMENT

<u>Equipment</u>	<u>Total</u>	<u>Equipment</u>	<u>Total</u>
ACV, BTR (R-145BM)	1	Radios:	
Truck, Utility	2	VHF Manpack, Low-Power	1
		VHF, Vehicle Mount, Medium-Power	1
		HF, Vehicle Mount, Medium-Power	1
		HF/VHF, Vehicle Mount, Medium-Power	1
		Warning Receiver	1

ATGM Battery, Antitank Bn, ID

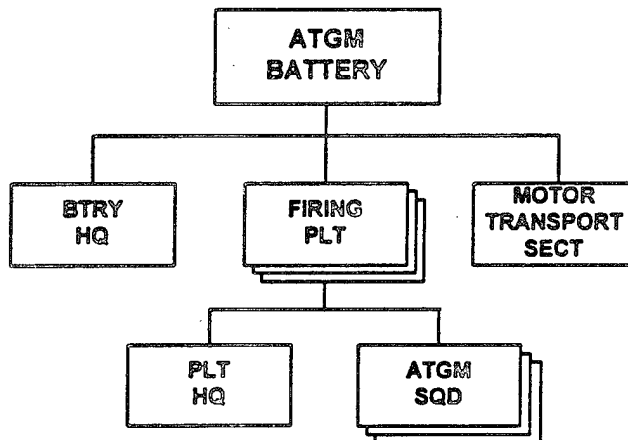

PRINCIPAL ITEMS OF EQUIPMENT

<u>Equipment</u>	<u>Total</u>	<u>Equipment</u>	<u>Total</u>
ATGM Vehicle, 9P148 w/ AT-5/SPANDREL	9	Radar, Battlefield Surveillance, Man-Portable, PSNR-1	1
ACV, BTR (R-145BM)	4	Radios:	
ATGL, RPG-7V	9	VHF Manpack, Low-Power	4
Truck, Medium	3	VHF, Vehicle Mount, Medium-Power	13
Rangefinder	1		

Antitank Gun Battery, Antitank Bn, ID

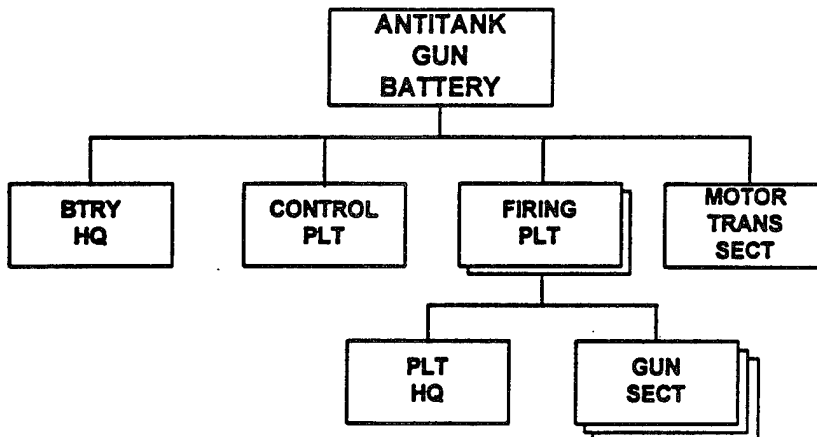

PRINCIPAL ITEMS OF EQUIPMENT

Equipment	Total	Equipment	Total
100/125-mm Antitank Gun, MT-12/2A45M.....	6	Rangefinder.....	1
Truck, Utility (Prime Mover).....	7	Radar, Battlefield Surveillance, Man-Portable, PSNR-1	1
Truck, Medium	1	Radio, VHF Manpack, Low-Power	7
Trailer, Cargo, 2-Axle.....	1		

Materiel Support Platoon, Antitank Bn, ID

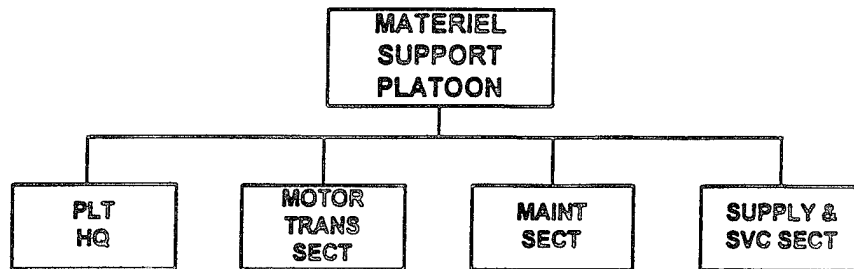

PRINCIPAL ITEMS OF EQUIPMENT

<u>Equipment</u>	<u>Total</u>
Truck, Utility.....	1
Truck, Light	4
Truck, Medium	7
Van, Signal.....	2
Van, Maintenance	2
Truck, POL (4,000 or 5,200-Liter)	2
Ambulance	1
Trailer, Cargo, 2-Axle.....	8
Trailer, POL (900-Liter)	1

<u>Equipment</u>	<u>Total</u>
Trailer, Generator.....	1
Trailer, Water (900-Liter)	1
Trailer, Kitchen.....	1
Radios:	
VHF Manpack, Low-Power.....	3
HF/VHF, Vehicle Mount,	
Medium-Power	1
Radio Relay, VHF/UHF.....	1

Reconnaissance and Radioelectronic Combat Battalion, ID

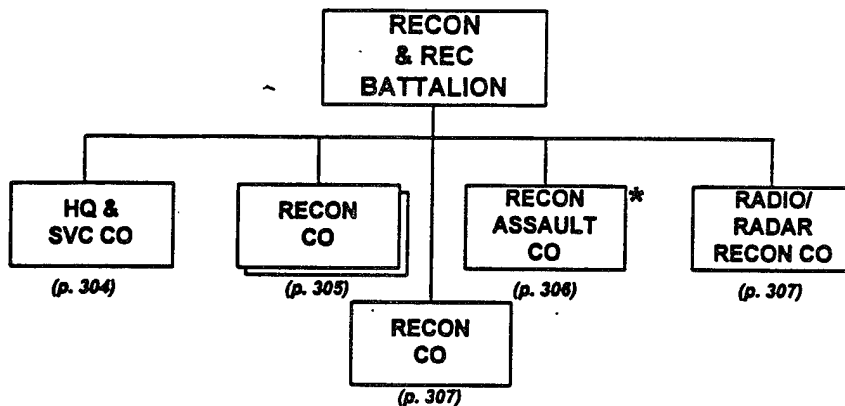

PRINCIPAL ITEMS OF EQUIPMENT

<u>Equipment</u>	<u>Total</u>	<u>Equipment</u>	<u>Total</u>
ACV, BRDM-2U	1	Radar Intercept/Direction Finder	3
ACV, BTR (R-145BM)	2	Radio Intercept/Direction Finder, VHF/HF	10
ACV, BRM-1K**	8	Communications Jammer, VHF	6
ASC, BRDM-2	12	Communications Jammer, HF	3
APC, BTR-60/70/80	12	Proximity Fuze Jammer, SPR-1	9
ATGL, RPG-7V	31	Radios:	
5.45-mm LMG, RPK-74	31	VHF Manpack, Low-Power	12
Truck, Utility	5	VHF, Vehicle Mount, Medium-Power	55
Truck, Light	7	HF, Manpack, Low-Power	6
Truck, Medium	4	HF, Vehicle Mount, Medium-Power	2
Van, Command	6	HF/VHF, Vehicle Mount, Medium-Power	6
Van, Radio/Radar Recon	13	HF/VHF, Vehicle Mount, High-Power	2
Van, Maintenance	2	Radio Relay, VHF/UHF	1
Van, Signal	6	Radio Telegraph	6
Truck, POL (4,000 or 5,200-Liter)	2	Warning Receiver	6
Ambulance	1		
Trailer, Generator	2		
Trailer, Water (900-Liter)	1		
Trailer, Kitchen	4		
Trailer, POL (1,200-Liter)	2		

FOOTNOTES:

* The recon assault company is also called the long-range reconnaissance company or the airborne reconnaissance company.

** This system includes the TALL MIKE battlefield surveillance radar.

Headquarters and Services Company, Recon & REC Bn, ID

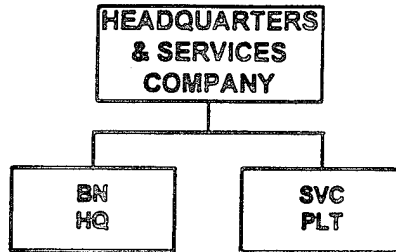

PRINCIPAL ITEMS OF EQUIPMENT

<u>Equipment</u>	<u>Total</u>	<u>Equipment</u>	<u>Total</u>
ACV, BRM-1K*	2	Radios:	
ACV, BTR (R-145BM)	2	VHF, Manpack, Low-Power	2
Truck, Utility	4	VHF, Vehicle Mount,	
Truck, Light	5	Medium-Power	4
Truck, Medium	4	HF, Manpack, Low-Power	2
Van, Command	2	HF, Vehicle Mount,	
Van, Maintenance	1	Medium-Power	1
Truck, POL (4,000 or 5,200-Liter)	2	HF/VHF, Vehicle Mount,	
Ambulance	1	Medium-Power	2
Trailer, POL (1,200-Liter)	2	HF/VHF, Vehicle Mount,	
Trailer, Generator	2	High-Power	1
Trailer, Water (900-Liter)	1	Radio Relay, VHF/UHF	1
Trailer, Kitchen	4	Radio Telegraph	6
Radio Intercept/Direction Finder,		Warning Receiver	2
HF/VHF	1		

FOOTNOTE: * This system includes the TALL MIKE battlefield surveillance radar.

Reconnaissance Company, Recon & REC Bn, ID

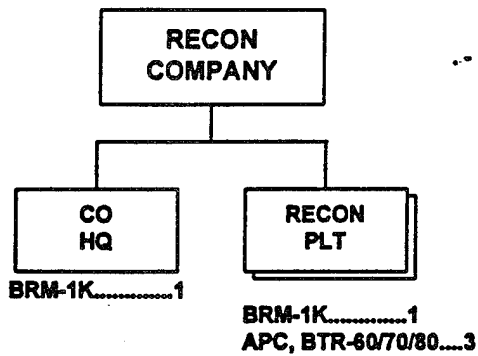

PRINCIPAL ITEMS OF EQUIPMENT

<u>Equipment</u>	<u>Total</u>	<u>Equipment</u>	<u>Total</u>
ACV, BRM-1K*	3	Radios:	
APC, BTR-60/70/80	6	VHF, Vehicle Mount,	
ATGL, RPG-7V	9	Medium-Power	9
5.45-mm LMG, RPK-74	9	Warning Receiver	1
Truck, Light	1		

FOOTNOTE: * This system includes the TALL MIKE battlefield surveillance radar.

Reconnaissance Assault Company, Recon & REC Bn, ID

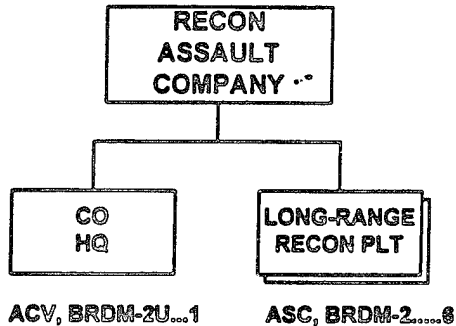

PRINCIPAL ITEMS OF EQUIPMENT

<u>Equipment</u>	<u>Total</u>	<u>Equipment</u>	<u>Total</u>
ACV, BRDM-2U	1	Radios:	
ASC, BRDM-2.....	12	VHF, Manpack, Low-Power	3
ATGL, RPG-7V	13	VHF, Vehicle Mount,	
5.45-mm LMG, RPK-74	13	Medium-Power	13
		HF, Vehicle Mount,	
		Medium-Power	1
		Warning Receiver	1

NOTE: Personnel in the reconnaissance assault company (also called the long-range reconnaissance company) have parachute training. Small teams of five to six men can enter the enemy rear area by parachute, helicopter, and vehicle, or on foot. They can also land by transport helicopter with their combat vehicles.

**Radio/Radar Reconnaissance Company, Recon &
REC Bn, ID**

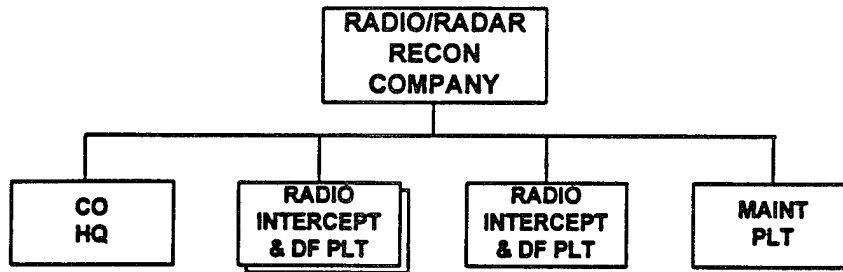

PRINCIPAL ITEMS OF EQUIPMENT

<u>Equipment</u>	<u>Total</u>	<u>Equipment</u>	<u>Total</u>
Truck, Utility.....	1	Radios:	
Van, Command	2	VHF, Manpack, Low-Power.....	7
Van, Radio/Radar Recon	13	HF, Manpack, Low-Power.....	4
Van, Maintenance	1	HF/VHF, Vehicle Mount,	
Van, Signal.....	6	Medium-Power	4
Radio Intercept/Direction Finder,		HF/VHF, Vehicle Mount,	
HF/VHF	7	High-Power	1
Radar Intercept/Direction Finder	3	Warning Receiver	1

**Radioelectronic Combat Company, Recon &
REC Bn, ID**

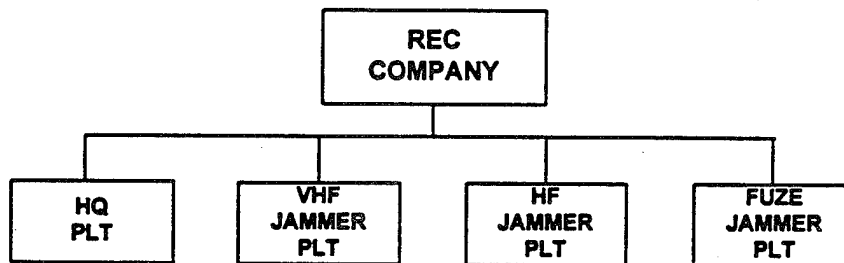

PRINCIPAL ITEMS OF EQUIPMENT

<u>Equipment</u>	<u>Total</u>	<u>Equipment</u>	<u>Total</u>
Van, Command	2	Communications Jammer, HF	3
Radio Intercept/Direction Finder,		Proximity Fuze Jammer, SPR-1.....	9
HF/VHF	2	Radio, VHF, Vehicle Mount,	
Communications Jammer, VHF.....	6	Medium-Power	20

Engineer Battalion, ID

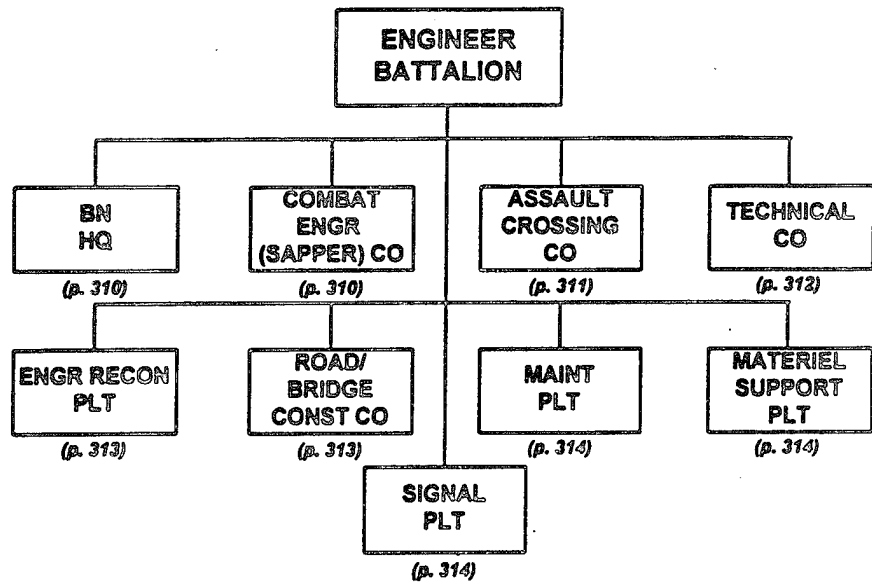

ENGINEER BATTALION, ID										
Principal Items of Equipment	En HQ	Combat Engr (Sapper) Co	Assault Crossing Co	Technical Co	Engineer Recon Plt	Road/Bridge Const Co	Maintenance Plt	Material Support Plt	Signal Plt	TOTAL
APC, BTR-60/70/80					3					3
ACV, BTR (R-145BM)		1								1
ACV, BRDM-2U			1							1
WEAPONS										
ATGL, RPG-7V		2			6					8
ENGINEER EQUIPMENT										
Bridge, Truck-Launched						8				8
Tracked Amphibian, K-61/PTS			12							12
Trailer, Amphibious, PKP			3							3
Tracked Ferry, GSP/PMM-2			6							6
Assault Boat			10							10
Piledriver Set, KMS				1						1
Minelayer, PMR		6								6
Mine Detector, DIM		4			1					5
Ditching Machine, PZM-2/TMK-2				4						4
Dozer				6		2				8
Tractor				2						2
Truck, Sawmill						1				1
Trailer, Saw						1				1
Grader						2				2
Concrete Mixer						1				1
Truck, Water Purification				1						1
TRUCKS										
Truck, Utility	2			1		1		1		5
Truck, Light	1									1
Truck, Medium		8	2	13	3	2	1	1	2	32
Truck, Dump				1						1
Truck, Crane			1							1
Truck, Crane Shovel				2						2
Van, Maintenance							4			4
Van, Signal	1								1	2
TRAILERS										
Trailer, Cargo, 1-Axle	1									1
Trailer, Cargo, 2-Axle		2	1	1		1	1			6
Trailer, Compressor			1							1
Trailer, Generator				1		1	1	1	1	5
RADIOS										
VHF, Manpack, Low-Power				3						3
VHF, Vehicle Mount, Medium-Power		1	3		3	3				10
HF, Manpack, Low-Power	1	1	1	1	3	1				8
HF/VHF, Vehicle Mount, Medium-Power	1		3					1	1	6
HF/VHF, Vehicle Mount, High-Power	1							1	1	3
Warning Receiver								1	1	2

Battalion Headquarters, Engr Bn, ID

**BATTALION
HEADQUARTERS**

PRINCIPAL ITEMS OF EQUIPMENT

<u>Equipment</u>	<u>Total</u>	<u>Equipment</u>	<u>Total</u>
Truck, Utility.....	2	Radios:	
Truck, Medium	1	HF, Manpack, Low-Power.....	1
Van, Signal.....	1	HF/VHF, Vehicle Mount, Medium-Power	1
Trailer, Cargo, 1-Axle.....	1	HF/VHF, Vehicle Mount, High-Power.....	1

Combat Engineer (Sapper) Company, Engr Bn, ID

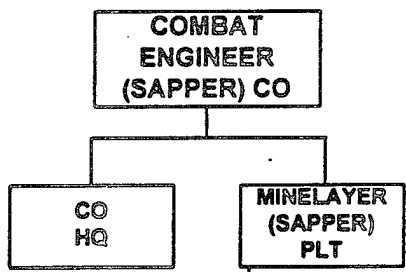

PRINCIPAL ITEMS OF EQUIPMENT

<u>Equipment</u>	<u>Total</u>	<u>Equipment</u>	<u>Total</u>
ACV, BTR (R-145BM)	1	Trailer, Cargo, 2-Axle.....	2
ATGL, RPG-7V	2	Radios:	
Truck, Medium	8	VHF, Vehicle Mount, Medium-Power	1
Mine Detector, DIM.....	4	HF, Manpack, Low-Power.....	1
Minelayer, PMR.....	6		

Assault Crossing Company, Engr Bn, ID

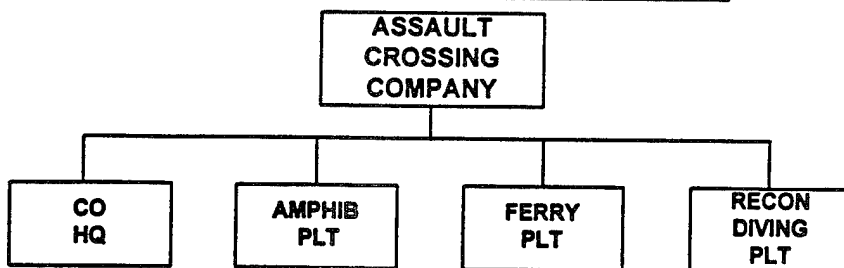

PRINCIPAL ITEMS OF EQUIPMENT

Equipment	Total	Equipment	Total
ACV, BRDM-2U	1	Trailer, Cargo, 2-Axle.....	1
Truck, Medium	2	Trailer, Compressor	1
Truck, Crane	1	Radios:	
Tracked Amphibian, K-61/PTS	12	HF, Manpack, Low-Power.....	1
Tracked Ferry, GSP/PMM-2.....	6	VHF, Vehicle Mount,	
Assault Boat.....	10	Medium-Power	3
Trailer, Amphibious, PKP.....	3		

NOTE: Two GSP heavy amphibious ferry vehicles make up one ferry. One PMM-2 can make up one ferry.

Technical Company, Engr Bn, ID

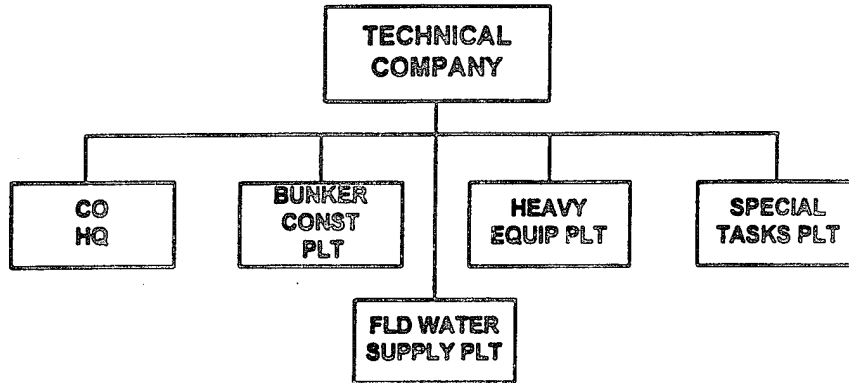

PRINCIPAL ITEMS OF EQUIPMENT

<u>Equipment</u>	<u>Total</u>	<u>Equipment</u>	<u>Total</u>
Truck, Utility	1	Tractor.....	2
Truck, Medium	13	Trailer, Cargo, 2-Axle.....	1
Truck, Crane Shovel	2	Trailer, Generator.....	1
Truck, Dump.....	1	Radios:	
Truck, Water Purification	1	VHF, Manpack, Low-Power.....	3
Ditching Machine, PZM/TMK	4	HF, Manpack, Low-Power.....	1
Dozer.....	6		
Piledriver Set, KMS.....	1		

**Engineer Reconnaissance Platoon,
Engr Bn, ID**

**ENGINEER
RECON
PLATOON**

PRINCIPAL ITEMS OF EQUIPMENT

Equipment	Total	Equipment	Total
APC, BTR-60/70/80	3	Radios:	
ATGL, RPG-7V	6	HF, Manpack, Low-Power	3
Truck, Medium	3	VHF, Vehicle Mount, Medium-Power	3
Mine Detector, DIM.....	1		

Road/Bridge Construction Company, Engr Bn, ID

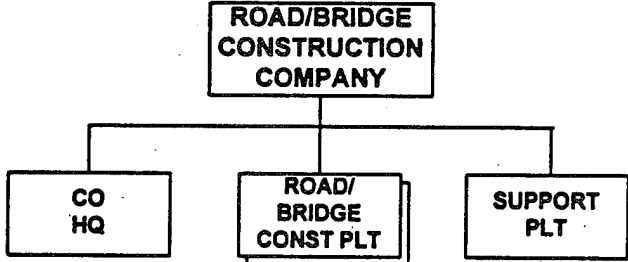

PRINCIPAL ITEMS OF EQUIPMENT

Equipment	Total	Equipment	Total
Truck, Utility.....	1	Concrete Mixer	1
Truck, Medium	2	Trailer, Cargo, 2-Axle	1
Truck, Crane Shovel	1	Trailer, Generator.....	1
Truck, Dump	2	Trailer, Saw.....	1
Truck, Sawmill.....	1	Radios:	
Bridge, Truck-Launched	8	VHF, Vehicle Mount, Medium-Power	3
Dozer.....	2	HF, Manpack, Low-Power.....	1
Grader	2		

NOTE: The eight truck-launched spans make two bridge sets.

Signal Platoon, Engr Bn, ID

**SIGNAL
PLATOON**

PRINCIPAL ITEMS OF EQUIPMENT

<u>Equipment</u>	<u>Total</u>	<u>Equipment</u>	<u>Total</u>
Truck, Medium	2	Radios:	
Van, Signal.....	1	HF/VHF, Vehcile Mount,	
Trailer, Generator.....	1	Medium-Power	1
		HF/VHF, Vehicle Mount,	
		High-Power	1
		Warning Receiver	1

Maintenance Platoon, Engr Bn, ID

**MAINTENANCE
PLATOON**

PRINCIPAL ITEMS OF EQUIPMENT

<u>Equipment</u>	<u>Total</u>	<u>Equipment</u>	<u>Total</u>
Truck, Medium	1	Trailer, Cargo, 2-Axle.....	1
Van, Maintenance	4	Trailer, Generator.....	1

Materiel Support Platoon, Engr Bn, ID

**MATERIEL
SUPPORT
PLATOON**

PRINCIPAL ITEMS OF EQUIPMENT

<u>Equipment</u>	<u>Total</u>	<u>Equipment</u>	<u>Total</u>
Truck, Utility.....	1	Trailer, Generator.....	1
Truck, Medium	1		

Signal Battalion, ID

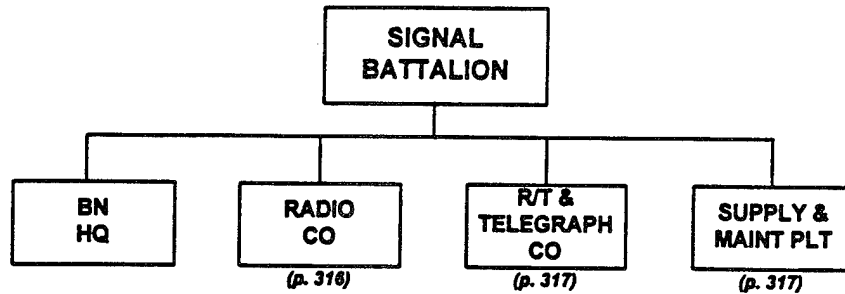

PRINCIPAL ITEMS OF EQUIPMENT

Equipment	Total	Equipment	Total
ACV, BTR (R-145BM)	8	Trailer, Kitchen	2
Truck, Utility	12	Radios:	
Truck, Light	7	VHF, Manpack, Low-Power	20
Truck, Medium	9	VHF, Vehicle Mount,	
Van, Maintenance	4	Medium-Power	8
Van, Signal	33	HF, Manpack, Low-Power	6
Truck, POL (4,000 or 5,200-Liter)	1	HF, Vehicle Mount, Medium-Power	8
Ambulance	1	HF/VHF, Vehicle Mount,	
Bus	1	Medium-Power	7
Motorcycle	13	HF/VHF, Vehicle Mount,	
Trailer, Cargo 1-Axle	10	High-Power	8
Trailer, POL (1,200-Liter)	1	Radio Relay, VHF/UHF	6
Trailer, Generator	10	Communication Center	2
Trailer, Water (900-Liter)	1	Warning Receiver	3

Battalion Headquarters, Signal Bn, ID



PRINCIPAL ITEMS OF EQUIPMENT

Equipment	Total	Equipment	Total
Truck, Utility	4	Radio, HF, Manpack, Low-Power	1

Radio Company, Signal Bn, ID

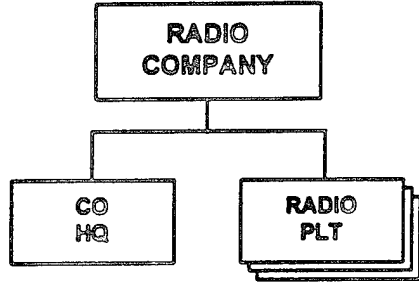

PRINCIPAL ITEMS OF EQUIPMENT

<u>Equipment</u>	<u>Total</u>
ACV, BTR (R-145BM)	8
Truck, Utility	4
Truck, Medium	1
Van, Signal	12
Trailer, Cargo, 1-Axle	1
Trailer, Generator	3

<u>Equipment</u>	<u>Total</u>
Radios:	
VHF, Manpack, Low-Power	7
VHF, Vehicle Mount, Medium-Power	8
HF, Manpack, Low-Power	1
HF, Vehicle Mount, Medium-Power	8
HF/VHF, Vehicle Mount, Medium-Power	6
HF/VHF, Vehicle Mount, High-Power	8
Warning Receiver	1

Radio Telephone and Telegraph Company, Signal Bn, ID

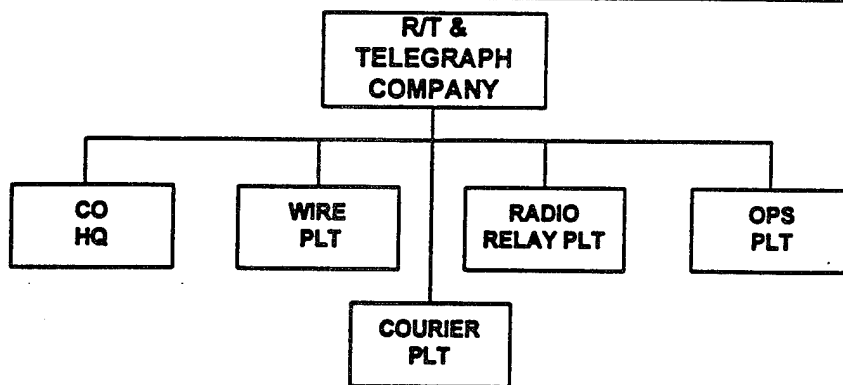

PRINCIPAL ITEMS OF EQUIPMENT

<u>Equipment</u>	<u>Total</u>	<u>Equipment</u>	<u>Total</u>
Truck, Utility.....	3	Radios:	
Truck, Light	4	VHF, Manpack, Low-Power.....	13
Truck, Medium	2	HF, Manpack, Low-Power.....	2
Van, Signal.....	21	HF/VHF, Vehicle Mount,	
Motorcycle	13	Medium-Power	1
Trailer, Cargo, 1-Axle.....	4	Radio Relay, VHF/UHF.....	6
Trailer, Generator.....	5	Communications Center.....	2
		Warning Receiver	2

Supply and Maintenance Platoon, Signal Bn, ID



PRINCIPAL ITEMS OF EQUIPMENT

<u>Equipment</u>	<u>Total</u>	<u>Equipment</u>	<u>Total</u>
Truck, Utility.....	1	Trailer, Cargo, 1-Axle.....	5
Truck, Medium	6	Trailer, POL (1,200-Liter)	1
Van, Light	3	Trailer, Generator.....	2
Van, Maintenance	4	Trailer, Water (900-Liter)	1
Truck, POL (4,000 or 5,200-Liter)	1	Trailer, Kitchen	2
Ambulance	1	Radio, HF, Manpack, Low-Power	2
Bus	1		

Materiel Support Battalion, ID

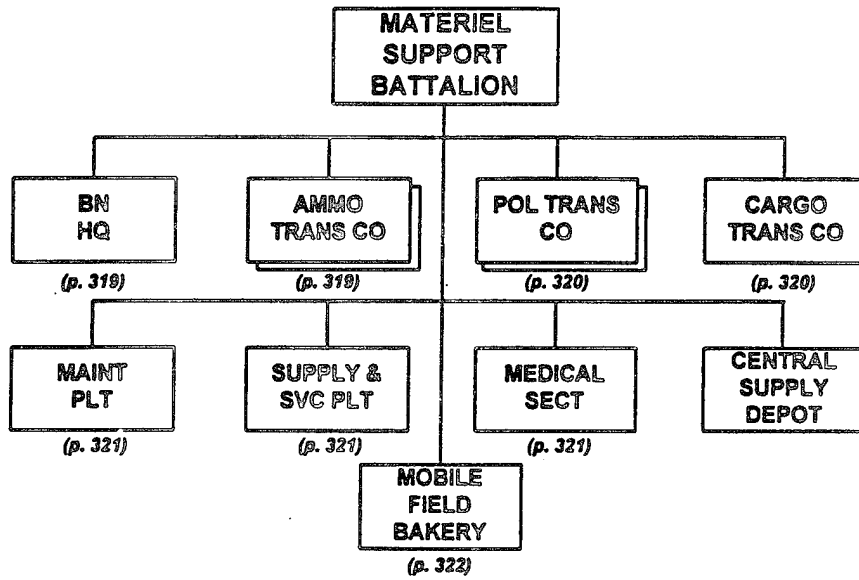

PRINCIPAL ITEMS OF EQUIPMENT

<u>Equipment</u>	<u>Total</u>
ATGL, RPG-7.....	19
Truck, Utility.....	7
Truck, Light.....	33
Truck, Medium.....	158
Van.....	1
Van, Maintenance.....	11
Van, Signal.....	1
Truck, POL (5,200-Liter).....	160
Truck, Crane.....	6
Truck, Water (2,000-Liter).....	6
Van, Mobile Bakery.....	4
Van, Kitchen.....	2

<u>Equipment</u>	<u>Total</u>
Ambulance.....	1
Trailer, Cargo, 2-Axle.....	124
Trailer, Cargo, 1-Axle.....	2
Trailer, POL (1,200-Liter).....	160
Trailer, Generator.....	6
Trailer, Water (900-Liter).....	7
Radios:	
VHF, Manpack, Low-Power.....	5
HF/VHF, Vehicle Mount, Medium-Power.....	1
HF, Manpack, Low-Power.....	1
Warning Receiver.....	1

Battalion Headquarters, Materiel Support Bn, ID

**BATTALION
HEADQUARTERS**

PRINCIPAL ITEMS OF EQUIPMENT

<u>Equipment</u>	<u>Total</u>	<u>Equipment</u>	<u>Total</u>
Truck, Utility.....	2	Radios:	
Van, Signal.....	1	HF, Manpack, Low-Power.....	1
Van, Maintenance	1	HF/VHF, Vehicle Mount,	
Trailer, Cargo, 2-Axle.....	2	Medium-Power	1
		Warning Receiver	1

Ammunition Transport Company, Materiel Support Bn, ID

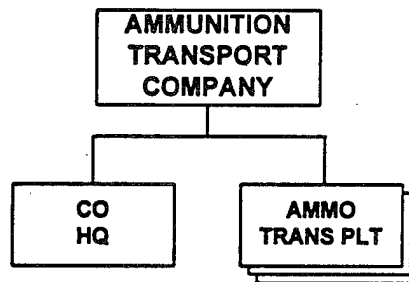

PRINCIPAL ITEMS OF EQUIPMENT

<u>Equipment</u>	<u>Total</u>	<u>Equipment</u>	<u>Total</u>
ATGL, RPG-7V.....	3	Truck, Crane	1
Truck, Utility.....	1	Trailer, Cargo, 2-Axle.....	60
Truck, Medium	60	Radio, VHF, Manpack, Low-Power	1

POL Transport Company, Materiel Support Bn, ID

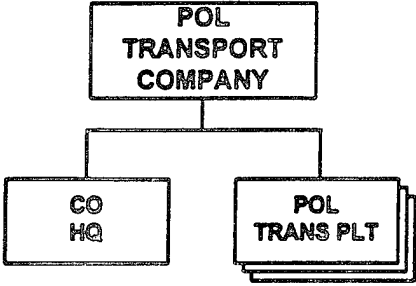

PRINCIPAL ITEMS OF EQUIPMENT

<u>Equipment</u>	<u>Total</u>	<u>Equipment</u>	<u>Total</u>
ATGL, RPG-7V	4	Truck, Crane	1
Truck, Utility.....	1	Trailer, POL (1,200-Liter)	80
Truck, POL (5,200-Liter).....	80	Radio, VHF, Manpack, Low-Power	1

Cargo Transport Company, Materiel Support Bn, ID

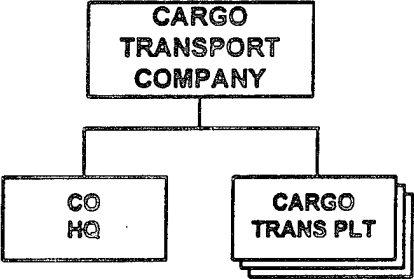

PRINCIPAL ITEMS OF EQUIPMENT

<u>Equipment</u>	<u>Total</u>	<u>Equipment</u>	<u>Total</u>
ATGL, RPG-7V	3	Truck, Medium	30
Truck, Utility.....	1	Truck, Crane	1
Truck, Light	30	Radio, VHF, Manpack, Low-Power	1

Maintenance Platoon, Materiel Support Bn, ID

**MAINTENANCE
PLATOON**

PRINCIPAL ITEMS OF EQUIPMENT

Equipment	Total	Equipment	Total
ATGL, RPG-7V	1	Truck, Crane	1
Van, Maintenance	9	Trailer, Generator	6

Medical Section, Materiel Support Bn, ID

**MEDICAL
SECTION**

PRINCIPAL ITEMS OF EQUIPMENT

Equipment	Total
Ambulance	1

Supply and Service Platoon, Materiel Support Bn, ID

**SUPPLY &
SERVICE
PLATOON**

PRINCIPAL ITEMS OF EQUIPMENT

Equipment	Total	Equipment	Total
ATGL, RPG-7V	1	Truck, Water (2,000-Liter)	6
Truck, Light	3	Trailer, Cargo, 1-Axle	2
Van	1	Trailer, Cargo, 2-Axle	2
Van, Kitchen	2	Trailer, Water (900-Liter)	3
Van, Maintenance	1		

Mobile Field Bakery, Materiel Support Bn, ID

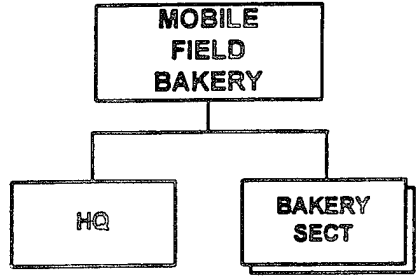

PRINCIPAL ITEMS OF EQUIPMENT

<u>Equipment</u>	<u>Total</u>	<u>Equipment</u>	<u>Total</u>
Truck, Medium	8	Trailer, Water (900-Liter)	4
Van, Mobile Field Bakery	4		

Maintenance Bn, ID

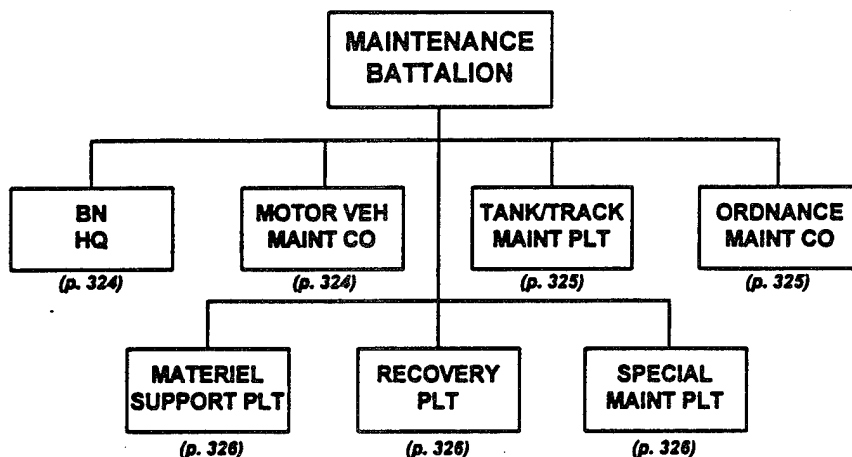

PRINCIPAL ITEMS OF EQUIPMENT

Equipment	Total	Equipment	Total
ATGL, RPG-7V	9	Motorcycle	3
Truck, Utility	5	Trailer, Cargo, 2-Axle	12
Truck, Light	4	Trailer, Generator	6
Truck, Medium	18	Trailer, POL (1,200-Liter)	4
Truck, Heavy	1	Tractor-Trailer, Lowboy	2
Van, Light	3	Trailer, Water (900-Liter)	1
Van, Maintenance	34	Trailer, Kitchen	3
Van, Signal	1	Radios:	
Armored Recovery Vehicle	2	VHF, Manpack, Low-Power	5
Truck, POL (4,000 or 5,200-Liter)	4	VHF, Vehicle Mount,	
Truck, Crane	3	Medium-Power	4
Truck, Recovery	2	HF, Vehicle Mount, Medium-Power	1
Truck, Water (2,000-Liter)	1	HF/VHF, Vehicle Mount,	
Ambulance	1	Medium-Power	1
Tracked Amphibian, K-61/PTS	1	Warning Receiver	1
Tractor, Artillery, AT-S	1		

Battalion Headquarters; Maint Bn, ID

**BATTALION
HEADQUARTERS**

PRINCIPAL ITEMS OF EQUIPMENT

<u>Equipment</u>	<u>Total</u>	<u>Equipment</u>	<u>Total</u>
Truck, Utility.....	2	Radios:	
Van, Signal.....	1	HF/VHF, Vehicle Mount,	
Motorcycle.....	3	Medium-Power	1
		VHF, Manpack, Low-Power.....	1
		Warning Receiver	1

Motor Vehicle Maintenance Company, Maint Bn, ID

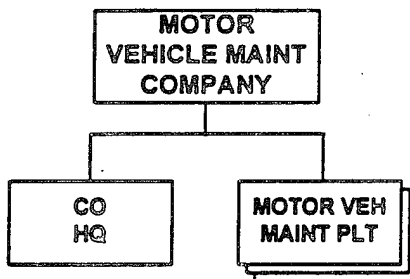

PRINCIPAL ITEMS OF EQUIPMENT

<u>Equipment</u>	<u>Total</u>	<u>Equipment</u>	<u>Total</u>
ATGL, RPG-7V.....	4	Truck, Crane	1
Truck, Utility.....	1	Trailer, Cargo, 2-Axle.....	4
Truck, Medium	6	Trailer, Generator.....	2
Van, Light	1	Radio, VHF, Manpack, Low-Power	1
Van, Maintenance	14		

Tank/Track Maintenance Platoon, Maint Bn, ID

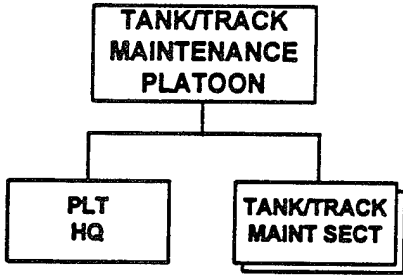

PRINCIPAL ITEMS OF EQUIPMENT

<u>Equipment</u>	<u>Total</u>	<u>Equipment</u>	<u>Total</u>
ATGL, RPG-7V	1	Truck, Crane	1
Truck, Utility.....	1	Trailer, Cargo, 2-Axle.....	2
Truck, Medium	2	Trailer, Generator.....	1
Van, Light	1	Radio, VHF, Manpack, Low-Power	1
Van, Maintenance	6		

Ordnance Maintenance Company, Maint Bn, ID

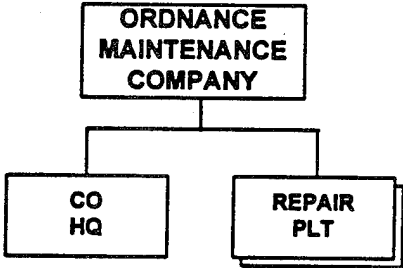

PRINCIPAL ITEMS OF EQUIPMENT

<u>Equipment</u>	<u>Total</u>	<u>Equipment</u>	<u>Total</u>
ATGL, RPG-7V	3	Truck, Crane	1
Truck, Utility.....	1	Trailer, Cargo, 2-Axle.....	2
Van, Light	1	Trailer, Generator.....	2
Van, Maintenance	8	Radio, VHF, Manpack, Low-Power	1

Material Support Platoon, Maint Bn, ID

**MATERIEL
SUPPORT
PLATOON**

PRINCIPAL ITEMS OF EQUIPMENT

<u>Equipment</u>	<u>Total</u>	<u>Equipment</u>	<u>Total</u>
ATGL, RPG-7V	1	Ambulance	1
Truck, Light	4	Trailer, Cargo, 2-Axle	4
Truck, Medium	10	Trailer, POL (1,200-Liter)	4
Truck, Heavy	1	Trailer, Water (900-Liter)	1
Truck, POL (4,000 or 5,200-Liter)	4	Trailer, Kitchen	3
Truck, Water (2,000-Liter)	1	Radio, VHF, Manpack, Low-Power	1

Recovery Platoon, Maint Bn, ID

**RECOVERY
PLATOON**

PRINCIPAL ITEMS OF EQUIPMENT

<u>Equipment</u>	<u>Total</u>	<u>Equipment</u>	<u>Total</u>
Truck, Recovery	2	Radios:	
Tracked Amphibian, K-61/PTS	1	VHF, Vehicle Mount,	
Tractor, Artillery, AT-S	1	Medium-Power	4
Armored Recovery Vehicle	2	HF, Vehicle Mount, Medium-Power	1
Tractor-Trailer, Lowboy	2		

Special Maintenance Platoon, Maint Bn, ID

**SPECIAL
MAINTENANCE
PLATOON**

PRINCIPAL ITEMS OF EQUIPMENT

<u>Equipment</u>	<u>Total</u>	<u>Equipment</u>	<u>Total</u>
Van, Maintenance	6	Trailer, Generator	1

Chemical Protection Battalion, ID

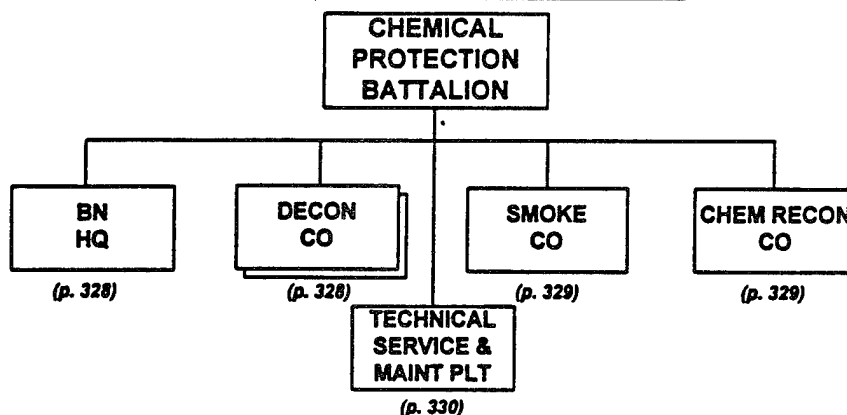

PRINCIPAL ITEMS OF EQUIPMENT

<u>Equipment</u>	<u>Total</u>	<u>Equipment</u>	<u>Total</u>
Truck, Utility.....	3	Ambulance	1
Truck, Light	4	Trailer, POL (1,200-Liter)	2
Truck, Medium	27	Trailer, Generator.....	3
Chemical Recon Vehicle, BRDM-2RKh/RKhM.....	9	Trailer, Cargo, 2-Axle.....	6
Van.....	1	Trailer, Water (900-Liter)	20
Van, Signal.....	2	Trailer, Kitchen	4
Van, Maintenance	3	Radios:	
Truck, POL (4,000-Liter).....	4	VHF, Manpack, Low-Power.....	3
Truck, Decon, ARS-12U/14	20	VHF, Vehicle Mount, Medium-Power	9
Truck, Decon, DDA-53/66.....	4	HF, Manpack, Low-Power.....	2
Truck, Decon, TMS-65	4	Warning Receiver	1
Truck, Smoke Generator, TDA-M.....	9		

Battalion Headquarters, Chem Protection Bn, ID

**BATTALION
HEADQUARTERS**

PRINCIPAL ITEMS OF EQUIPMENT

<u>Equipment</u>	<u>Total</u>	<u>Equipment</u>	<u>Total</u>
Truck, Utility.....	1	Radios:	
Van, Signal.....	1	VHF, Manpack, Low-Power.....	1
Van.....	1	HF, Manpack, Low-Power.....	1
		HF/VHF, Vehicle Mount	
		Medium-Power	1
		Warning Receiver	1

Decontamination Company, Chemical Protection Bn, ID

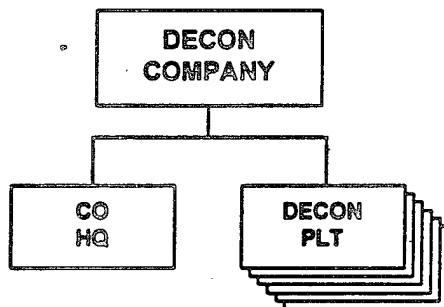

PRINCIPAL ITEMS OF EQUIPMENT

<u>Equipment</u>	<u>Total</u>	<u>Equipment</u>	<u>Total</u>
Truck, Utility.....	1	Truck, Decon, TMS-65	4
Truck, Light	4	Trailer, Decon, DDP	4
Truck, Medium	12	Truck, Water (2,000-Liter).....	4
Truck, Decon, ARS-12U/14	16	Trailer, Water (900-Liter)	20
Truck, Decon, DDA-53/66.....	4	Radio, VHF, Manpack, Low-Power	1

Smoke Company, Chem Protection Bn, ID

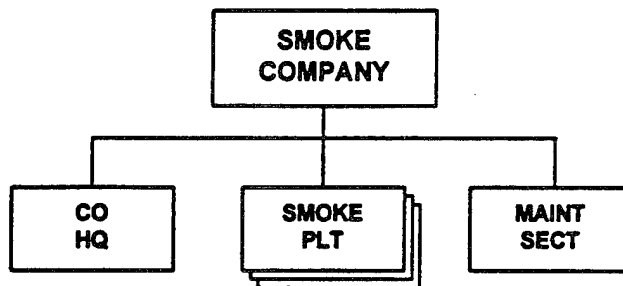

PRINCIPAL ITEMS OF EQUIPMENT

Equipment	Total	Equipment	Total
Truck, Light	1	Trailer, Water (900-Liter)	1
Truck, Medium	4	Trailer, Kitchen	1
Van, Maintenance	1	Radio, VHF, Vehicle Mount, Medium-Power	9
Truck, Smoke Generator, TDA-M.....	9		
Trailer, Cargo, 2-Axle.....	2		

Chemical Reconnaissance Company, Chem Protection Bn, ID



PRINCIPAL ITEMS OF EQUIPMENT

Equipment	Total	Equipment	Total
Chemical Recon Vehicle, BRDM-2RKh/RKhM.....	9	Radios: VHF, Manpack, Low-Power	1
Truck, Utility.....	1	VHF, Vehicle Mount, Medium-Power	9
		HF, Manpack, Low-Power.....	1

**Technical Service and Maintenance Platoon,
Chem Protection Bn, ID**

**TECHINCAL
SERVICE &
MAINT PLT**

PRINCIPAL ITEMS OF EQUIPMENT

<u>Equipment</u>	<u>Total</u>	<u>Equipment</u>	<u>Total</u>
Truck, Utility.....	1	Truck, Decon, ARS-12U/14	4
Truck, Medium	11	Trailer, Generator.....	3
Van, Maintenance	2	Trailer, POL (1,200-Liter)	2
Truck, POL (4,000 or 5,200-Liter)	4	Trailer, Cargo, 2-Axle.....	4
Ambulance	1	Trailer, Kitchen.....	3

Medical Battalion, ID

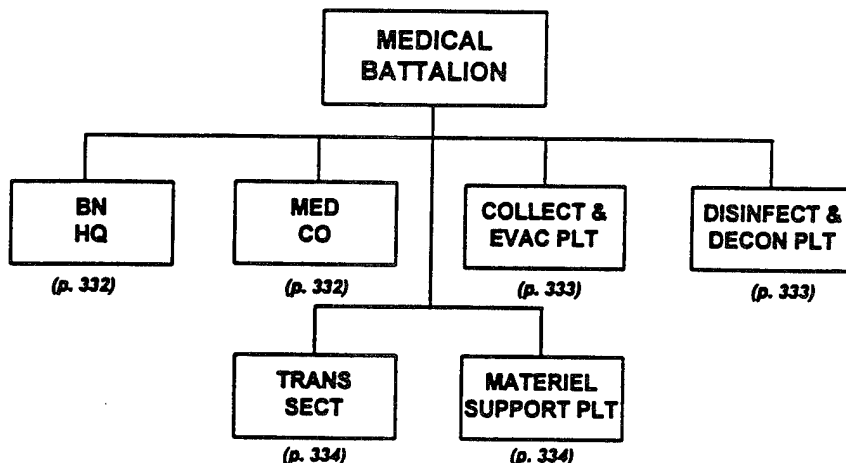

PRINCIPAL ITEMS OF EQUIPMENT

Equipment	Total	Equipment	Total
Ambulance	20	Trailer, Cargo, 2-Axle	10
Truck, Utility	5	Trailer, Generator	2
Truck, Medium	21	Trailer, POL (1,200-Liter)	2
Truck, POL (4,000 or 5,200-Liter)	2	Trailer, Decon, DDP	3
Truck, Decon, DDA-53/66	1	Trailer, Kitchen	4
Truck, Decon, ARS-12U/14	3	Trailer, Water (900-Liter)	3
Truck, Water (2,000-Liter)	3	Radios:	
Van, Signal	1	VHF, Manpack, Low-Power	3
Van, Light	1	HF, Manpack, Low-Power	1
Van, Maintenance	2	HF/VHF, Vehicle Mount,	
Van, Generator	1	Medium-Power	1
Van, Hospital	9	Warning Receiver	1

Battalion Headquarters, Med Bn, ID

BATTALION HEADQUARTERS

PRINCIPAL ITEMS OF EQUIPMENT

<u>Equipment</u>	<u>Total</u>	<u>Equipment</u>	<u>Total</u>
Truck, Utility.....	1	Radios:	
Van, Signal.....	1	HF, Manpack, Low-Power.....	1
		HF/VHF, Vehicle Mount, Medium-Power	1
		Warning Receiver	1

Medical Company, Med Bn, ID

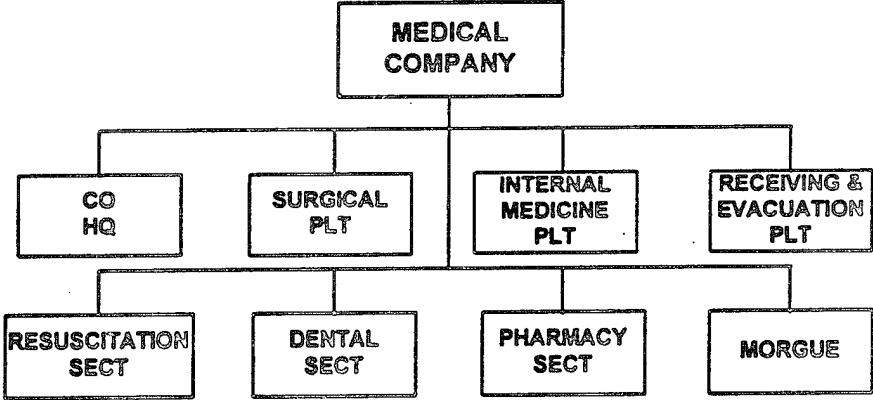

PRINCIPAL ITEMS OF EQUIPMENT

<u>Equipment</u>	<u>Total</u>	<u>Equipment</u>	<u>Total</u>
Truck, Utility.....	1	Trailer, Cargo, 2-Axle.....	7
Truck, Medium	7	Radio, VHF, Manpack, Low-Power	1

Collection and Evacuation Platoon, Med Bn, ID

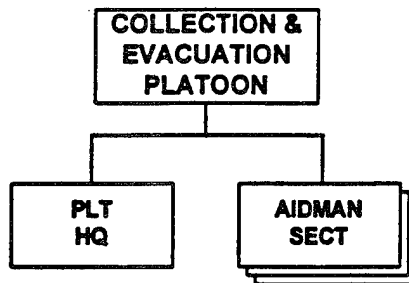

PRINCIPAL ITEMS OF EQUIPMENT

<u>Equipment</u>	<u>Total</u>	<u>Equipment</u>	<u>Total</u>
Truck, Utility.....	1	Van, Hospital	9
Van, Light	1	Radio, VHF, Manpack, Low-Power	1
Van, Generator	1		

Disinfection and Decontamination Platoon, Med Bn, ID



PRINCIPAL ITEMS OF EQUIPMENT

<u>Equipment</u>	<u>Total</u>	<u>Equipment</u>	<u>Total</u>
Truck, Utility.....	1	Trailer, Cargo, 2-Axle.....	1
Truck, Decon, DDA-53/66.....	1	Trailer, Decon, DDP	3
Truck, Decon, ARS-12U/14	3	Trailer, Water (1,200-Liter)	1

Transport Section, Med Bn, ID

**TRANSPORT
SECTION**

PRINCIPAL ITEMS OF EQUIPMENT

<u>Equipment</u>	<u>Total</u>	<u>Equipment</u>	<u>Total</u>
Truck, Utility	1	Van, Maintenance	2
Truck, Medium	8	Trailer, Generator.....	2
Truck, POL (5,200-Liter).....	2	Trailer, POL (1,200-Liter)	2
Ambulance	20	Radio, VHF, Manpack, Low-Power	1

Materiel Support Platoon, Med Bn, ID

**MATERIEL
SUPPORT
PLATOON**

PRINCIPAL ITEMS OF EQUIPMENT

<u>Equipment</u>	<u>Total</u>	<u>Equipment</u>	<u>Total</u>
Truck, Medium	6	Trailer, Cargo, 2-Axle.....	2
Truck, Water (2,000-Liter).....	3	Trailer, Kitchen	4

Artillery Command Battery, ID

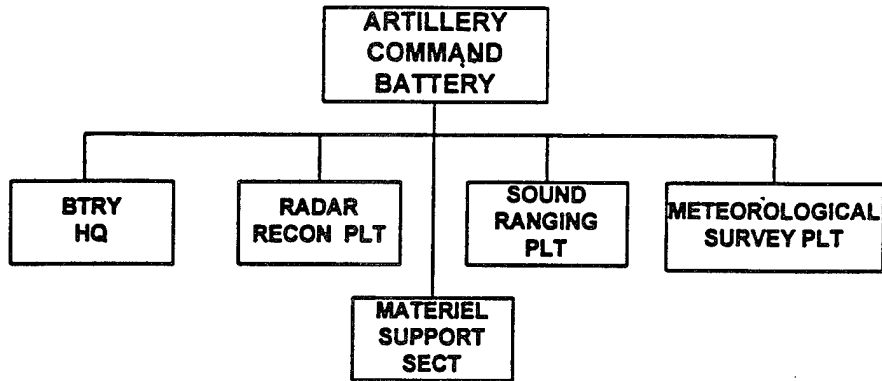

PRINCIPAL ITEMS OF EQUIPMENT

<u>Equipment</u>	<u>Total</u>	<u>Equipment</u>	<u>Total</u>
ATGL, RPG-7V	4	Rangefinder	2
5.45-mm LMG, RPK-74	4	Radars:	
Mobile Recon Post, PRP-3/4*	1	Meteorological, END TRAY	2
APC, Radar, MT-LB (SNAR-10)**	1	Countermortar/Counterbattery,	
Sound Ranging Set.....	1	ARK-1***	1
ACV, BTR (R-145BM)	2	Radios:	
Truck, Light	5	VHF, Manpack, Low-Power	6
Truck, Medium	3	VHF, Vehicle Mount, Medium-Power ..	6
Van, Signal.....	1	HF, Manpack, Low-Power.....	2
Van, Meteorological.....	2	HF/VHF, Vehicle Mount,	
Trailer, Cargo, 2-Axle.....	2	Medium-Power	4
Trailer, Generator.....	2		

FOOTNOTES:

- * This system includes the SMALL FRED or TALL MIKE battlefield surveillance radar.
- ** This system includes the BIG FRED battlefield surveillance radar.
- *** This system includes the RICE BAG countermortar/counterbattery radar.

APPENDIX A: EQUIPMENT SUBSTITUTION MATRICES

The matrices contained in this appendix illustrate some of the different equipment options available to scenario and order of battle developers. Although FSU systems are used throughout this organization guide, the intent of the capabilities-based OPFOR is to allow users to tailor their orders of battle by substituting other foreign systems. Deviations from the baseline systems should be tied to specific training objectives. Examples include attempting to mirror the actual mix of equipment found in a particular region or to introduce a particular weapons capability or vulnerability.

The matrices list most of the major baseline systems contained in the organization guide and provide a number of potential substitutes for each. While the lists of substitutes are not all inclusive, they contain most common "gray" systems that have roughly comparable capabilities.

Users substituting systems from the matrices or considering other foreign weapons systems for use in an OPFOR order of battle should evaluate candidate substitutes against the following criteria:

- Is the system available to potential adversaries? This criteria would be satisfied if the system was in service with the armed forces of countries traditionally hostile to the United States or if it were widely exported on the world market.

- Has the system been produced in large enough quantities to justify training against it? At a minimum, total system production should at least equal the numbers contained in a proposed order of battle. Moreover, developmental systems that have not reached initial operational capability (IOC) should not be played.

- Does the mix and variety of systems in an order of battle conform to some logical pattern? Some users constructing a large order of battle may want to pattern the mix of system types and generations on some actual country. Others may wish to standardize systems throughout the order of battle for simplicity or ease in modeling. In any case, systems should be portrayed in unit sets generally of regimental or battalion size. Considering the logistical and training challenges involved in supporting a weapon system, excessive variety should be avoided.

MAIN BATTLE TANK SUBSTITUTION MATRIX

Baseline Systems	Potential Substitutes	
<p align="center">T-80 (125-mm) (crew: 3)</p>	<p align="center">LEOPARD II (120-mm) (crew: 4)</p> <p align="center">LECLERC (120-mm) (crew: 3)</p> <p align="center">CHALLENGER (120-mm) (crew: 4)</p>	<p align="center">GM</p> <p align="center">FR</p> <p align="center">UK</p>
<p align="center">T-72 (125-mm) (crew: 3)</p> <p align="center">T-64 (125-mm) (crew: 3)</p>	<p align="center">AMX-30S (105-mm) (crew: 4)</p> <p align="center">CHIEFTAN (120-mm) (crew: 4)</p> <p align="center">TYPE 69 II (100-mm) (crew: 4)</p>	<p align="center">FR</p> <p align="center">UK</p> <p align="center">CH</p>
<p align="center">T-62 (115-mm) (crew: 4)</p> <p align="center">T-55 (100-mm) (crew: 4)</p>	<p align="center">CENTURION (105-mm) (crew: 4)</p> <p align="center">AMX-30 (105-mm) (crew: 4)</p> <p align="center">TYPE 59 (100-mm) (crew: 4)</p>	<p align="center">UK</p> <p align="center">FR</p> <p align="center">CH</p>

APC/IFV SUBSTITUTION MATRIX		
Baseline Systems	Potential Substitutes	
BMP-3 (30/100-mm)	WARRIOR (30-mm)	UK
	MARDER 1A3 (20-mm)	GM
BMP-2 (30-mm)	STORMER (25-mm)	UK
BMP-1 (73-mm)	WZ 501 (73-mm)	CH
	BVP M80A	YO
	AMX-10P	FR
	BMP-23	BU
BRDM-2 (14.5-mm)	BRDM-1 (7.62-mm)	FSU
	V-150 Commando (7.62-mm)	US
BTR-80 (14.5-mm)	BRDM-1 (7.62-mm)	FSU
	AMX-10RC (105-mm)	FSU
	SALADIN (76-mm)	FR
	MT-LB (7.62-mm)	UK
	VAB (12.7-mm)	FR
	FUCHS (20-mm)	GM
	V-300 Commando (14.5-mm)	US
	WZ 551 (25-mm)	CH
BTR-70 (14.5-mm)	OT-64C1 (14.5-mm)	CZ
BTR-60 (14.5-mm)	PSZH-1V (14.5-mm)	HU

TOWED ARTILLERY SUBSTITUTION MATRIX

76-mm to 122-mm

Baseline Systems	Potential Substitutes	
D-30 (122-mm)	SADDAM (122-mm)	IZ
	D-74 (122-mm)	FSU
	LGI (105-mm)	FR
	SD-44 (85-mm)	FSU
	LT GUN (105-mm)	UK
	M56 (105-mm)	YO

152-mm to 155-mm

Baseline Systems	Potential Substitutes	
2A65 (152-mm)	GNH-45 (155-MM)	AU
	MF-45 (155-mm)	CH
	G5 (155-mm)	SF
2A36 (152-mm)	FH-77B (155-mm)	SW
	TYPE 83 G (152-mm)	CH
	M84 (152-mm)	YO

SELF-PROPELLED ARTILLERY SUBSTITUTION MATRIX		
105-mm to 122-mm		
Baseline Systems	Potential Substitutes	
2S1 (122-mm)	ABBOT (105-mm)	UK
	TYPE 85 (122-mm)	CH
2S9 (120-mm)	TYPE 54-1SP (122-mm)	CH
152-mm to 155-mm		
Baseline Systems	Potential Substitutes	
2S19 (152-mm)	AS-90 (155-mm)	UK
	AU-F1 (155-mm)	FR
	G6 (155-mm)	SF
	PzH-2000 (155-mm)	GM
2S3 (152-mm)	Mk F3 (155-mm)	FR
	TYPE 83 GH (152-mm)	CH
	PAL-MARIA (155-mm)	IT

MULTIPLE ROCKET LAUNCHER (MRL) SUBSTITUTION MATRIX

Baseline Systems	Potential Substitutes	
<p>9A52 (300-mm)</p> <p>9P140(220-mm)</p>	<p>M-87 (262-mm)</p> <p>WS-1 (320-mm)</p> <p>TYPE 83 (273-mm)</p> <p>ASTROS II (300-mm)</p> <p>ASTROS II (180-mm)</p> <p>M1985/91 (240-mm)</p>	<p>YO</p> <p>CH</p> <p>CH</p> <p>BR</p> <p>BR</p> <p>KN</p>
<p>BM-21 (122-mm)</p>	<p>RM-70 (122-mm)</p> <p>BM-11 (P) (122-mm)</p> <p>122 MRS (122-mm)</p> <p>M-77 (128-mm)</p> <p>TYPE 90 (122-mm)</p> <p>TYPE 85 (130-mm)</p> <p>FIROS (122-mm)</p> <p>ASTROS II (127-mm)</p> <p>SAKR (122-mm)</p>	<p>CZ</p> <p>NK</p> <p>RO</p> <p>YO</p> <p>CH</p> <p>CH</p> <p>IT</p> <p>BR</p> <p>EG</p>
<p>RPU-14 (140-mm)</p>	<p>TYPE 70 (130-mm)</p> <p>M-63 (128-mm)</p> <p>TYPE 63 (107-mm)</p> <p>PRLS (107-mm)</p>	<p>CH</p> <p>YO</p> <p>CH</p> <p>IZ</p>

MAN PORTABLE SURFACE-TO-AIR MISSILE (SAM) SUBSTITUTION MATRIX		
Baseline Systems	Potential Substitutes	
SA-18	RBS-70	SW
	STINGER RMP	US
	MISTRAL	FR
SA-16 SA-14	STINGER	US
SA-7	REDEYE	US
	BLOWPIPE	UK
	HN-5A	CH

SELF-PROPELLED ANTI-AIRCRAFT GUN (SPAAG) SUBSTITUTION MATRIX		
Baseline Systems	Potential Substitutes	
2S6 (4 x 30-mm) ZSU-23-4 (4 x 23-mm)	TWIN 37 (2 x 37-mm)	CH
	GEPARD (2 x 35-mm)	GM
	MARKSMAN (2 x 35-mm)	UK
	TYPE 80 (2 x 57-mm)	CH
ZSU-57-2 (2 x 57-mm)	S530 (2 x 20-mm)	FR
	M53/59 (2 x 30-mm)	CZ

TOWED ANTI-AIRCRAFT GUN (AAA) SUBSTITUTION MATRIX

Baseline Systems	Potential Substitutes	
<p>S-60 (57-mm)</p> <p>M1939 (37-mm)</p>	<p>TYPE 59 (57-mm)</p> <p>TYPE 85 (2 x 25-mm)</p> <p>M53 (30) (2 x 30-mm)</p> <p>ARROW (2 x 30-mm)</p> <p>GDF-005 (2 x 35-mm)</p>	<p>CH</p> <p>CH</p> <p>CZ</p> <p>GM</p> <p>SZ</p>
<p>ZU-23 (2 x 23-mm)</p>	<p>TYPE 80 (2 x 23-mm)</p> <p>76T2 (2 x 20-mm)</p> <p>GAI-D01 (2 x 20-mm)</p> <p>M55A4 (3 x 20-mm)</p> <p>Mk 1 (40-mm)</p>	<p>CH</p> <p>FR</p> <p>SZ</p> <p>YO</p> <p>UK</p>
<p>ZPU-2 (2 x 14.5-mm)</p>	<p>TYPE 56 (4 x 14.5-mm)</p> <p>TYPE 58 (2 x 14.5-mm)</p> <p>M53 (12.7) (4 x 12.7-mm)</p>	<p>CH</p> <p>CH</p> <p>CZ</p>

SURFACE-TO-AIR MISSILE (SAM) SUBSTITUTION MATRIX		
Baseline Systems	Potential Substitutes	
SA-8	ROLAND	EURO
SA-6	RF-61A	CH
SA-11	CROTALE	FR
SA-13	RAPIER	UK
SA-9	TIGERCAT	UK

APPENDIX B: Cargo Truck, Trailer and Radio Substitution

Generic terminology has been used throughout the handbook to indicate truck and trailer capacity and radio capabilities. The following list, based on FSU equipment, provides a definition of terms. However, the reader may substitute any piece of equipment which falls within the range of capabilities for each system.

TRUCKS AND TRAILERS:

Utility Truck -- 4 x 4 drive vehicle with a 500 to 600 kg carrying capacity. Examples include the GAZ-69 (FSU) and the UAZ-469 (FSU), Land Rover Defender 130 (UK), and the IMR A-0.75 (YO).

Light Truck -- 4 x 4 drive vehicle with a 1 to 2.5 mt carrying capacity. Examples include the GAZ-66 (FSU), GAZ-3301 (FSU), TAM 110 T7 BV (YO) and the Renault TRM 2000 (FR).

Medium Truck -- 6 x 6 drive vehicle with a 2.5 to 7 mt carrying capacity. Examples include the ZIL-131/132 and the ZIL-157.

Heavy Truck -- 6 x 6 drive vehicle with a 7.5 mt or greater carrying capacity. Examples include the KrAZ-255B (FSU), KrAZ-260 (FSU), IVECO Magirus 160-23 ANWM (GM) or the AWD Bedford TM (UK).

Cargo Trailer, 1-Axle -- has a 0.5 mt carrying capacity. Examples include the GAZ-704 trailer used with the UAZ-469 (FSU), UAZ-8190 used with the UAZ-3151(FSU) and the GKN Defence 1t Special Purpose (UK).

Cargo Trailer, 2-Axle -- has a 3.0 to 4.0 mt carrying capacity. Examples include the IAPZ-759V trailer used with the URAL-375D(FSU) and the 782V trailer used with the URAL-4320(FSU) and the M104 Series (US).

RADIOS:

HF, Manpack, Low-Power -- An example is the R-104M, a transceiver operating in the 1.5 to 4.25 MHz frequency range with a 30 to 50 km range.

HF, Vehicle Mount, Medium-Power -- An example is the R-130, a transceiver/receiver operating in the 1.5 to 10.99 frequency range with a 50 to 70 km range.

VHF, Portable, Low-Power -- An example is the R-148, a transceiver operating in the 37.0 to 51.95 frequency range with range of 5 km.

VHF, Manpack, Low-Power -- An example is the R-107, a transceiver operating in the 20 to 52 MHz frequency range with a 6 to 25 km range.

VHF, Vehicle Mount, Medium-Power -- An example is the R-123, a transceiver operating in the 20 to 51.5 MHz frequency range with a 20 to 50 km range.

Warning Receiver -- An example is the R-311, a receiver operating in the 1 to 15 MHz band.

Radio Relay -- An example is the R-401, a VHF/FM transceiver operating in the 60 to 70 MHz band with a range of 40 to 50 km.

GLOSSARY

AA - Antiaircraft
AAA - Antiaircraft Artillery
AAICV - Amphibious Airborne Infantry Combat Vehicle
acq - acquisition
ACRV - Artillery Command and Reconnaissance Vehicle
ACV - Armored Command Vehicle
AD - Air Defense
Admin - administrative
Aer Surv - Aerial Surveillance
AGL - Automatic Grenade Launcher
AICV - Amphibious Infantry Combat Vehicle
ALT - altitude
Ammo - ammunition
Amphib - amphibious
APC - Armored Personnel Carrier
ARTY - artillery
ASC - Armored Scout Car
AT - Antitank
ATGL - Antitank Grenade Launcher
ATGM - Antitank Guided Missile
ATK - attack
AUS - Austria
Auto - automatic
AVN - Aviation

Bde - Brigade
BMP - Russian abbreviation for infantry combat vehicle
Bn - Battalion
BOS - Battle Operating System
BR - Brazil
BS - Battlefield Surveillance
BTR - Russian abbreviation for Armored Personnel Carrier
BTRY - Battery
BU - Bulgaria

CAA - Combined Arms Army
CAC - Combined Arms Command
CC&D - Camouflage, Concealment & Deception
CH - China
chem - chemical
CM/CB - Countermortar/Counterbattery
CMD - Command
CMDO - Commando
Co - Company

collect - collection
como - communication
Comb - combination
Const - construction
cont - control
COP - Command Observation Post
CS - Combat Support
CSS - Combat Service Support
CTC - Combat Training Center
CZ - Czechoslovakia

Decon - decontamination
Def - Defense
DF - Direction Finding
disinfect - disinfection
DIV - Division

ECM - Electronic Counter Measures
Eng - engagement
Engr - Engineer
EURO - Europe
evac - evacuation
EW - Early Warning

FAC - Forward Air Controller
FC - Fire Control
FDC - Fire Direction Center
FG - Field Gun
FLD - field
FM - Frequency Modulation
FO - Forward Observer
FOP - Forward Observation Post
FR - France
FSU - Former Soviet Union

GM - Germany
GND - ground
GP - Group ; general purpose [helicopter]
GP MG - General Purpose Machine Gun
Gren - Grenade

helo - helicopter
HF - High Frequency ; Height Finding
HHB - Headquarters & Headquarters Battery
HHC - Headquarters & Headquarters Company
How - howitzer
HQ - Headquarters
Hvy - heavy

LAB - Independent Airborne Brigade
IMRB - Independent Motorized Rifle Brigade
Indep - independent
Inf - Infantry
Intcp - intercept
Intel - intelligence
IOC- Initial Operational Capability
IT - Italy
IZ - Iraq

K - kilo
kg - kilogram
km - kilometer
KN - Korea (North)
KS - Korea (South)

L - liter
LMG - Light Machine Gun

m - meter
maint - maintenance
man - Manpack
mat - material
MCAS - Mobile Computation and Analysis
Station
mech - Mechanized
MED - medical ; medium
meteor - meteorological
MG - Machine Gun
mil - military
mm - millimeter
Mort - Mortar
mount - mounted
MP - Military Police
MR - Motorized Rifle
MRB - Motorized Rifle Battalion
MRC - Motorized Rifle Company
MRD - Motorized Rifle Division
MRL - Multiple Rocket Launcher
MRP - Motorized Rifle Platoon
MRR - Motorized Rifle Regiment
MTZD - Motorized

N/A - non applicable
NBC - Nuclear, Biological, and Chemical
NBDF - Nuclear Burst Direction Finding
Battalion
NVD - Night Vision Devices
NVG - Night Vision Goggles
NVS - Night Vision Sight

OPFOR - Opposing Force
Ops/Opms - operations
optic - optical
Ord - ordnance

Plt - Platoon
POL - Petroleum, Oils, and Lubricants
port - portable
PRC - People Republic of China
prep - preparation
PSYOPS - Psychological Operations

R/T - Radio/Telephone
REC - Radioelectronic Combat
Recon - reconnaissance
Regt - Regiment
RF - range finder

SA - US designation for Russian Surface-to-Air
Missiles
SAM - Surface-to-Air Missile
SECT - section
Sep - separate
SIG - Signal
SIGINT - Signal Intelligence
SF - South Africa
SP - self-propelled ; special
SPAAG - self-propelled Antiaircraft Gun
SPF - Special Forces
SPT - support
SQD - Squad
Sqdn - Squadron
SR & RR - Sound Ranging & Radar
Reconnaissance
SSM - Surface-to-Surface Missile
Surveil/Surv - Surveillance
SVC/SVCS - service(s)
SW - Sweden

TB - Tank Battalion
TC - Tank Company
TD - Tank Division
Tech - technical
TEL - Transporter-Erector-Launcher
TELAR - Transporter-Erector-Launcher and Radar
Tgt - Target
Tgt Acq - target acquisition
TM - team
TOPO - topography
Torp - torpedo
Tow - towed
TR - Tank Regiment
trail - trailer
Trans or transp - transportation; transporter ; transloader

UK - United Kingdom
UHF - Ultra High Frequency

Veh - vehicle
VHF - Very High Frequency

Warn - warning
Wpn/Wpns - weapon

YO - Yugoslavia

INDEX

10-Tank Company, Indep TB, ID, 270

--

122-mm Howitzer Battalion, MRR (BTR), MRD or Howitzer Bde, Arty Div, *Front* or Indep Airborne Bde, 96

122-mm Howitzer Battery, 122-mm Howitzer Bn, MRR (BTR), MRD or Howitzer Bde, Arty Div, *Front* or Indep Airborne Bde or Arty Regt, Airborne Div, 97

122-mm SP Howitzer Battalion, MRR (BMP or BTR) and TR, MRD and TD or IMRB, 94

122-mm SP Howitzer Battery, 122-mm SP Howitzer Bn, MRR (BMP or BTR) and TR, MRD and TD or IMRB, 95

152-mm SP Howitzer Battalion, Arty Regt, MRD and TD or IMRB, 10

152-mm SP Howitzer Battery, 152-mm SP Howitzer Bn, Arty Regt, MRD and TD or IMRB, 11

2S6 Battery, Air Defense Bn, MRR (BMP or BTR) and TR, MRD and TD or IMRB, 100

-A-

Air Army, *Front*, 187

Air Defense Artillery Battery, Air Defense Bn, Inf Regt, ID, 251

Air Defense Battalion, IMRB, 144

Air Defense Battalion, Inf Regt, ID, 250

Air Defense Battalion, MRR (BMP or BTR) and TR, MRD and TD, 98

Air Defense Battery (Variant), MRR (BMP or BTR) and TR, MRD and TD, 103

Air Defense Missile Battalion (SA-8), Air Defense Regt, ID, 290

Air Defense Platoon, Arty Regt or Airborne Bn, Airborne Regt, Airborne Div, 220

Air Defense Platoon, Inf Bn, Inf Regt, ID, 238

Air Defense Platoon, MRB (BMP), MRR (BMP) and TR, MRD and TD or IMRB, 122

Air Defense Platoon, MRB (BTR), MRR (BTR), MRD or IMRB, 134

Air Defense Platoon, Parachute Bn, IAB, 207

Air Defense Regiment, ID, 287

Airborne Battalion (BMD), Airborne Regt, Airborne Div, 217

Airborne Company (BMD), Airborne Bn, Airborne Regt, Airborne Div, 218

Airborne Division, 213

Airborne Regiment (BMD), Airborne Div, 215

Ammunition Transport Company, Materiel Support Bn, MRD and TD or IMRB, 61

Antiaircraft Artillery Battalion (S-60), Air Defense Regt, ID, 295

Antiaircraft Artillery Battery, AAA Bn, Air Defense Regt, ID, 296

Antiaircraft Artillery Regiment (S-60), MRD and TD (Variant), 35

Antitank Battalion (Variant), MRR (BMP or BTR), MRD and TD, 105

Antitank Battalion, Antitank Regt, Army Corps, 155

Antitank Battalion, Antitank Regt, Army or Antitank Bde, Arty Div, *Front*, 170

Antitank Battalion, Artillery Regt, Airborne Division, 226

Antitank Battalion, ID, 299

Antitank Battalion, IMRB, 145

Antitank Battalion, Inf Regt, ID, 244

Antitank Battalion, MRD, 36

Antitank Battery, Airborne Regt or AT Bn, Artillery Regt, Airborne Division, 227

Antitank Gun Battery, Antitank Bn, ID, 300

Antitank Gun Battery, Antitank Bn, Inf Regt, ID, 245

Antitank Gun Battery, AT Bn, MRD or AT Bn (Variant), MRR or AT BN, IMRB or AT Regt, Army Corps or Army or AT Bde, Arty Div, *Front*), 38

Antitank Platoon, Heavy Wpns Co, Light Assault Bn, ID, 266

Antitank Platoon, Inf Bn, Inf Regt, ID, 238

Antitank Platoon, Parachute Bn, IAB, 208

Antitank Regiment, Army Corps, 154

Antitank Regiment, Army, 169

Army Corps, 151

Artillery Battalion, IAB, 211

Artillery Brigade, Army Corps, 153

Artillery Brigade, Army, 163

Artillery Command Battery, ID, 335

Artillery Command Battery, MRD and TD, 77

Artillery Division, *Front*, 193

Artillery Reconnaissance (Target Acquisition/Early Warning) Battery, SAM Regt,

Artillery Regiment, Airborne Division, 225

Artillery Regiment, ID, 273

Artillery Regiment, MRD, 5

Artillery Regiment, TD, 7

Assault Crossing Battalion, Army or *Front*, 175

Assault Crossing Company, Engr Bn, ID, 311

Assault Crossing Company, Engr Bn, MRD and TD, 51

Assault Platoon, Light Assault Co, Light Assault Bn, ID, 261

Assault Squad, Assault Plt, Light Assault Co, Light Assault Bn, ID, 261

ATGM Battery, Antitank Bn, Antitank Regt, Army Corps or Army or Antitank Bde, Arty Div, *Front*, 157

ATGM Battery, Antitank Bn, ID, 301

ATGM Battery, Antitank Bn, Inf Regt, ID, 246

ATGM Battery, AT Bn, IMRB, 146

ATGM Battery, AT Bn, MRD or AT Bn (Variant), MRR (BMP or BTR), 39

ATGM Battery, MRR (BMP or BTR) or Antitank Bn (Variant), MRR (BMP or BTR), MRD and TD, 104

ATGM Platoon, MRB (BMP), MRR (BMP) and TR, MRD and TD or IMRB, 121

ATGM Platoon, MRB (BTR), MRR (BTR), MRD or IMRB, 133

Automatic Grenade Launcher Platoon, Airborne Bn, Airborne Regt, Airborne Div, 220

Automatic Grenade Launcher Platoon, Heavy Wpns Co, Light Assault Bn, ID, 267

Automatic Grenade Launcher Platoon, Inf Bn, Inf Regt, ID, 239

Automatic Grenade Launcher Platoon, MRB (BMP), MRR (BMP) and TR, MRD and TD or IMRB, 123

Automatic Grenade Launcher Platoon, MRB (BTR), MRR (BTR), MRD or IMRB, 135

-B-

Automatic Grenade Launcher Platoon, Parachute Bn, IAB, 208

Battalion Headquarters, Air Defense Bn, MRR (BMP or BTR) and TR, MRD and TD or IMRB, 99

Battalion Headquarters, Antitank Bn, AT Regt, Army Corps or Army or AT Bde, Arty Div, *Front*, 156

Battalion Headquarters, AT Bn, MRD or AT Bn (Variant), MRR (BMP or BTR) or AT Bn, IMRB, 37

Battalion Headquarters, Chem Protection Bn, MRD and TD or Army Corps or Army, 70

Battalion Headquarters, Engr Bn, MRD and TD, 49

Battalion Headquarters, Maint Bn, MRD and TD or IMRB or Army Corps or Army, 66

Battalion Headquarters, Materiel Support Bn, MRD and TD or IMRB, 61

Battalion Headquarters, Med Bn, MRD and TD or Army Corps, 74

Battalion Headquarters, Parachute Bn, IAB, 205

Battalion Headquarters, Signal Bn, MRD and TD or IMRB or Army Corps, 57

BMD Platoon, Airborne Co, Airborne Bn, Airborne Regt, Airborne Div, 219

BMD Squad, Airborne Co, Airborne Bn, Airborne Regt, Airborne Div, 219

Bomber Aviation Division, 189

-C-

Cargo Transport Company, Materiel Support Bn, MRD and TD or IMRB, 62

Cargo Transportation Company, Materiel Support Bn, ID, 320

Chemical Protection Battalion, Army or Army Corps, 177

Chemical Protection Battalion, ID, 327

Chemical Protection Battalion, MRD and TD, 69

Chemical Protection Brigade, *Front*, 198

Chemical Protection Company, IMRB, 149

Chemical Protection Platoon, Air Defense Regt, ID, 297

Chemical Protection Platoon, Arty Regt, ID, 285

Chemical Protection Platoon, Inf Regt, ID, 256

Chemical Protection Platoon, MRR (BMP or BTR) and TR or Arty Regt or SAM Regt, MRD and TD, 109

Chemical Reconnaissance Company, Chem Protection Bn, MRD and TD or Army Corps or Army, 71

Chemical Reconnaissance Company, Chem Protection Bn, ID, 329

Collection & Evacuation Platoon, Med Bn, ID, 333

Collection and Evacuation Platoon, Med Bn, MRD and TD or Army Corps, 75

Combat Engineer (Sapper) Company, Engr Bn, ID, 310

Combat Engineer (Sapper) Company, Engr Bn, MRD and TD, 50

Combat Engineer Brigade, Army, Army Corps, or *Front*, 173

Combined Arms Army, 159

-D-

Decontamination Company, Chem Protection Bn, ID, 328

Decontamination Company, Chem Protection Bn, MRD and TD or Army Corps or Army, 70

Disinfection & Decontamination Platoon, Med Bn, ID, 333

Disinfection and Decontamination Platoon, Med Bn, MRD and TD or Army Corps, 75

Division Headquarters, MRD and TD, 4

-E-

Engineer Battalion, ID, 308

Engineer Battalion, MRD and TD, 47

Engineer Company, IMRE, 148

Engineer Company, Inf Regt, ID, 253

Engineer Company, MRR (BMP or BTR) and TR, MRD and TD, 107

Engineer Platoon, Indep TB, ID, 270

Engineer Reconnaissance Platoon, Engr Bn, ID, 313

Engineer Reconnaissance Platoon, Engr Bn, MRD and TD, 55

-F-

Fighter Aviation Division, Air Army, *Front*, 188

Fighter-Bomber Aviation Division, 188

Firing Battery, Rocket Launcher Bn, Arty Regt, ID, 282

Firing Battery, Rocket Launcher Bn, Arty Regt, MRD and TD, 14

Front, 184

-H-

Headquarters & Control Battery, Arty Regt, ID, 275

Headquarters & Control Platoon, Rocket Launcher Bn, Arty Regt, ID, 281

Headquarters & Headquarters Company, Inf Bn, Inf Regt, ID, 234

Headquarters & Services Company, Recon & REC Bn, ID, 304

Headquarters and Control Battery, Arty Regt, MRD and TD, 9

Headquarters and Control Platoon, Rocket Launcher Bn, Arty Regt, MRD and TD, 13

Headquarters and Services Company, Recon/REC Bn, MRD and TD, 42

Regimental Headquarters, Air Defense Regt, ID, 289
Headquarters, Airborne Bn (BMD), Airborne Regt, Airborne Div, 218
Battalion Headquarters, Antitank Bn, ID, 300
Headquarters, Antitank Bn, Inf Regt, ID, 245
Headquarters, Chem Protection Bn, ID, 328
Headquarters, Engr Bn, ID, 310
Headquarters, Indep Tank Bn, ID, 269
Headquarters, Light Assault Bn, ID, 260
Headquarters, Maint Bn, ID, 324
Headquarters, Materiel Support Bn, ID, 319
Headquarters, Med Bn, ID, 332
Headquarters, MRB (BMP), MRR (BMP) and TR, MRD and TD or IMRB, 115
Headquarters, MRB (BTR), MRR (BTR), MRD or IMRB, 128
Headquarters, Signal Bn, ID, 315
Heavy Machine Gun Platoon, Heavy Wpns Co, Light Assault Bn, ID, 265
Heavy Weapons Company, Light Assault Bn, ID, 263
High-Powered Artillery Brigade, *Front*, 195
Howitzer Battalion (122-mm), Arty Regt, ID, 276
Howitzer Battalion (152-mm), Arty Regt, ID, 278
Howitzer Battery, Arty Bn, IAB or Arty Regt, Airborne Div, 212
Howitzer Battery, Howitzer Bn, Arty Regt, ID, 277
Howitzer Battery, Howitzer Bn, Arty Regt, ID, 279

-I-

Independent Airborne Brigade, 202
Independent Combat Helicopter Regiment, Army or Army Corps, 171
Independent Ground-Attack Aviation Regiment, 189

Independent Helicopter Radioelectronic Combat Squadron, Air Army, *Front*, 190

Independent Helicopter Squadron, Air Army, *Front*, 192

Independent Helicopter Squadron, Army or Army Corps, 172

Independent Motorized Rifle Brigade, Army Corps or Army or *Front*, 140

Independent Radioelectronic Combat Aviation Regiment, Air Army, *Front*, 191

Independent Reconnaissance Aviation Regiment, 190

Independent Tank Battalion, ID, 268

Infantry Army, 161

Infantry Battalion, Inf Regt, ID, 233

Infantry Company, Inf Bn, Inf Regt, ID, 235

Infantry Division, 228

Infantry Platoon, Inf Co, Inf Bn, Inf Regt, ID, 235

Infantry Regiment, ID, 229

Infantry Squad, Inf Plt, Inf Co, Inf Bn, Inf Regt, ID, 236

-L-

Light Assault Battalion, ID, 259

Light Assault Company, Light Assault Bn, ID, 260

-M-

Machine Gun/Antitank Platoon, Inf Co, Inf Bn, Inf Regt, ID, 236

Maintenance Section, Indep TB, ID, 271

Maintenance Battalion, ID, 323

Maintenance Battalion, MRD and TD or IMRB or Army Corps or Army, 65

Maintenance Company, Air Defense Missile Bn, Air Defense Regt, ID, 293

Maintenance Company, Air Defense Regt, ID, 298

Maintenance Company, Arty Regt, ID, 285

Maintenance Company, Arty Regt, MRD and TD, 18

Maintenance Company, Inf Regt, ID, 257

Maintenance Company, MRR (BMP or BTR) and TR, MRD and TD, 111

Maintenance Company, SAM Regt, MRD and TD, 34

Maintenance Platoon, Engr Bn, ID, 314

Maintenance Platoon, Engr Bn, MRD and TD, 56

Maintenance Platoon, Materiel Support Bn, ID, 321

Maintenance Platoon, Materiel Support Bn, MRD and TD or IMRB, 63

Materiel Support Battalion, ID, 318

Materiel Support Battalion, MRD and TD or IMRB, 60

Materiel Support Brigade, Army, Army Corps, or *Front*, 176

Materiel Support Company, Arty Regt, MRD and TD, 17

Materiel Support Company, Inf Regt, ID, 256

Materiel Support Company, MRR (BMP or BTR) and TR, MRD and TD, 110

Materiel Support Platoon, Airborne Bn, Airborne Regt, Airborne Div, 222

Materiel Support Platoon, Antitank Bn, ID, 302

Materiel Support Platoon, Antitank Bn, Inf Regt, ID, 247

Materiel Support Platoon, AT Bn, MRD or AT Bn (Variant), MRR (BMP or BTR) or AT Bn, IMRB or AT Regt, Army Corps or Army or AT Bde, Arty Div, *Front*, 40

Materiel Support Platoon, Engr Bn, ID, 314

Materiel Support Platoon, Engr Bn, MRD and TD, 56

Materiel Support Platoon, Maint Bn, ID, 326

Materiel Support Platoon, Maint Bn, MRD and TD or IMRB or Army Corps or Army, 68

Materiel Support Platoon, Med Bn, ID, 334

Materiel Support Platoon, Med Bn, MRD and TD or Army Corps, 76

Materiel Support Platoon, Parachute Bn, IAB, 209

Materiel Support Platoon, Rocket Launcher Bn, Arty Regt, ID, 283

Materiel Support Platoon, Rocket Launcher Bn, Arty Regt, MRD and TD, 15

Medical Aid Station, Inf Bn, Inf Regt, ID, 241

Medical Aid Station, MRB, MRR (BMP or BTR) and TR, MRD and TD or IMRB, 126

Medical Aid Station, Parachute Bn, IAB, 210

Medical Battalion, ID, 331

Medical Battalion, MRD and TD or Army Corps, 73

Medical Company, IMRB, 150

Medical Company, Med Bn, ID, 332

Medical Company, Med Bn, MRD and TD or Army Corps, 74

Medical Section, Indep TB, ID, 272

Medical Section, Materiel Support Bn, ID, 321

Medical Section, Materiel Support Bn, MRD and TD or IMRB, 63

Mine Warfare Platoon, Engr Co, Inf Regt, ID, 253

Missile Firing Battery, Air Defense Missile Bn, Air Defense Regt, ID, 292

Missile Firing Battery, SAM Regt (SA-15), MRD and TD, 30

Missile Firing Battery, SAM Regt (SA-6), MRD and TD, 32

Missile Firing Battery, SAM Regt (SA-8), MRD and TD, 31

Missile Technical Battery, Air Defense Missile Bn, Air Defense Regt, ID, 291

Missile Technical Battery, SAM Regt (SA-15), MRD and TD, 27

Missile Technical Battery, SAM Regt (SA-6), MRD and TD, 29

Missile Technical Battery, SAM Regt (SA-8), MRD and TD, 28

Mobile Field Bakery, Materiel Support Bn, ID, 322

Mobile Field Bakery, Materiel Support Bn, MRD and TD or IMRB, 64

Mortar Battalion, Inf Regt, ID, 242

Mortar Battery (120-mm), Mort Bn, Inf Regt, ID, 243

Mortar Battery, Inf Bn, Inf Regt, ID, 237

Mortar Battery, MRB, MRR (BMP or BTR) and TR, MRD and TD or IMRB, 119

Mortar Battery, Parachute Bn, IAB, 207

Mortar Platoon, Heavy Wpns Co, Light Assault Bn, ID, 264
Mortar Platoon, Light Assault Co, Light Assault Bn, ID, 262
Motor Transport Company, SAM Regt, MRD and TD, 33
Motor Transportation Company, Arty Regt, ID, 286
Motor Vehicle Maintenance Company, Maint Bn, ID, 324
Motor Vehicle Maintenance Company, Maint Bn, MRD and TD or IMRB or Army Corps or Army, 67
Motorcycle Platoon, Recon Co, Inf Regt, ID, 249
Motorized Rifle Battalion (BMP), MRR (BMP) and TR, MRD and TD or IMRB, 113
Motorized Rifle Battalion (BTR), MRR (BTR), MRD or IMRB, 127
Motorized Rifle Company (BMP), MRB, MRR (BMP) and TR, MRD and TD or IMRB, 116
Motorized Rifle Company (BTR), MRB, MRR (BTR), MRD or IMRB, 129
Motorized Rifle Division (Type I), 1
Motorized Rifle Division (Type II), 2
Motorized Rifle Platoon (BMP), MRC, MRB, MRR (BMP) and TR, MRD and TD or IMRB, 117
Motorized Rifle Platoon (BTR), MRC, MRB, MRR (BTR), MRD or IMRB, 130
Motorized Rifle Regiment (BMP), MRD, 78
Motorized Rifle Regiment (BMP), TD, 81
Motorized Rifle Regiment (BTR), MRD, 84
Motorized Rifle Squad (BMP), MRP, MRC, MRB, MRR (BMP) and TR, MRD and TD or IMRB, 118
Motorized Rifle Squad (BTR), MRP, MRC, MRB, MRR (BTR), MRD or IMRB, 131
MRD and TD, 26

-O-

Ordnance Maintenance Company, Maint Bn, ID, 325
Ordnance Maintenance Company, Maint Bn, MRD and TD or IMRB or Army Corps or Army, 67

-P-

Parachute Battalion, IAB, 204

Parachute Company, Parachute Bn, IAB, 205

Parachute Platoon, Parachute Co, Parachute Bn, IAB, 206

Parachute Squad, Parachute Plt, Parachute Co, Parachute Bn, IAB, 206

POL Transport Company, Materiel Support Bn, MRD and TD or IMRB, 62

POL Transportation Company, Materiel Support Bn, ID, 320

Pontoon Bridge Company, Engr Bn, MRD and TD, 54

Pontoon Bridge Regiment, Army or *Front*, 174

-R-

Radio Company, Signal Bn, ID, 316

Radio Company, Signal Bn, MRD and TD or IMRB or Army Corps, 58

Radio Reconnaissance Battalion, Army or Army Corps, 181

Radio Reconnaissance Brigade, *Front*, 200

Radio Telephone and Telegraph Company, Signal Bn, MRD and TD or IMRB or Army Corps, 59

Radio/Radar Reconnaissance Company, Recon & REC Bn, ID, 307

Radio/Radar Reconnaissance Company, Recon/REC Bn, MRD and TD, 45

Radio/Telephone & Telegraph Company, Signal Bn, ID, 317

Radioelectronic Combat Company, Recon/REC Bn, MRD and TD, 46

Radioelectronic Company, Recon & REC Bn, ID, 307

Reconnaissance and Radioelectronic Combat Battalion, MRD and TD, 41

Reconnaissance and Radioelectronic Combat Company, IMRB, 147

Reconnaissance Assault Company, Recon & REC Bn, ID, 306

Reconnaissance Assault Company, Recon/REC Bn, MRD and TD, 44

Reconnaissance Company, Recon & REC Bn, ID, 305

Reconnaissance Company, Inf Regt, ID, 248

Reconnaissance Company, MRR (BMP or BTR) and TR, MRD and TD, 106

Reconnaissance Company, Recon/REC Bn, MRD and TD, 43

Reconnaissance Platoon, Airborne Bn, Airborne Regt, Airborne Div, 221

Reconnaissance Platoon, MRB (BMP), MRR (BMP) and TR, MRD and TD or IMRB, 120

Reconnaissance Platoon, MRB (BTR), MRR (BTR), MRD or IMRB, 132

Reconnaissance Platoon, Recon Co, Inf Regt, ID, 248

Reconnaissance/Radio Electronic Combat Bn, ID, 303

Recovery Platoon, Maint Bn, ID, 326

Recovery Platoon, Maint Bn, MRD and TD or IMRB or Army or Army Corps, 68

Regimental Headquarters, Inf Regt, ID, 232

Regimental Headquarters, MRR (BMP or BTR) and TR, MRD and TD, 93

Regimental Headquarters, SAM Regt, MRD and TD, 25

Regimental Medical Point, Arty Regt, ID, 286

Regimental Medical Point, Inf Regt, ID, 258

Regimental Medical Point, MRR (BMP or BTR) and TR or Arty Regt, MRD and TD, 112

Repair Workshop, MRB, MRR (BMP or BTR) and TR, MRD and TD or IMRB, 126

Repair Workshop, Parachute Bn, IAB, 210

Road/Bridge Construction Company, Engr Bn, ID, 313

Road/Bridge Construction Company, Engr Bn, MRD and TD, 53

Rocket Launcher Battalion, Army Corps, 158

Rocket Launcher Battalion, Arty Regt, ID, 280

Rocket Launcher Battalion, Arty Regt, MRD and TD, 12

Rocket Launcher Regiment, Army, 164

-S-

SAM Battery (SA-13), Air Defense Bn, MRR (BMP or BTR) and TR, MRD and TD or IMRB, 101

SAM Battery (SA-16/18), Air Defense Bn, Inf Regt, ID, 252

SAM Battery (SA-16/18), Air Defense Bn, MRR (BMP or BTR) and TR, MRD and TD or IMRB, 102
SAM Battery (SA-9/13), AD Bn, Inf Regt, ID, 251
SAM Brigade (SA-11), Army or Army Corps, 167
SAM Brigade (SA-12), *Front*, 197
SAM Brigade (SA-4), Army, 168
SAM Regiment (SA-15), MRD and TD, 19
SAM Regiment (SA-6), MRD and TD, 23
SAM Regiment (SA-8), MRD and TD, 21
Service Company, Light Assault Bn, ID, 267
Signal Battalion, ID, 315
Signal Battalion, MRD and TD or IMRB or Army Corps, 57
Signal Brigade, *Front*, 199
Signal Company, Inf Regt, ID, 255
Signal Company, MRR (BMP or BTR) and TR, MRD and TD, 108
Signal Platoon, Airborne Bn, Airborne Regt, Airborne Div, 221
Signal Platoon, Engr Bn, ID, 314
Signal Platoon, Engr Bn, MRD and TD, 55
Signal Platoon, Inf Bn, Inf Regt, ID, 240
Signal Platoon, MRE, MRR (BMP or BTR) and TR, MRD and TD or IMRB, 124
Signal Platoon, Parachute Bn, IAB, 209
Signal Regiment, Army, 180
Signal Section, Indep TB, ID, 271
Smoke Battalion, Army or Chemical Protection Brigade, *Front*, 178
Smoke Company, Chem Protection Bn, ID, 329
Smoke Company, Chem Protection Bn, MRD and TD, 71
Smoke Company, Smoke Bn, Army or Chemical Protection Bde, *Front* or Chemical Protection Bn, *Front*, 179
Sound Ranging & Radar Recon Battery, Arty Regt, ID, 284

Sound Ranging and Radar Reconnaissance Battery, Arty Regt, MRD and TD, 16

SP Combination Gun Battalion, Airborne Regt, and Arty Regt, Airborne Div, 223

SP Combination Gun Battery, SP Combo Gun Bn, Airborne Regt and Arty Regt,

SP Howitzer Battalion (122-mm), MRR (BMP or BTR) and TR, MRD and TD or IMRB, 94

SP Howitzer Battalion (152-mm), Arty Regt, MRD and TD or IMRB, 10

SP Howitzer Battery (122-mm), 122-mm SP Howitzer Bn, MRR (BMP or BTR) and TR, MRD and TD or IMRB, 95

SP Howitzer Battery (152-mm), 152-mm SP Howitzer Bn, Arty Regt, MRD and TD or IMRB, 11

Special Maintenance Platoon, Maint Bn, ID, 326

Special Maintenance Platoon, Maint Bn, MRD and TD or IMRB or Army Corps or Army, 68

Special Purpose Forces Battalion, Army, 182

Special Purpose Forces Brigade, *Front*, 201

Special Purpose Forces Team, SPF Bn, Army or SPF Bde, *Front*, 183

SSM Brigade (SCUD), Army or Army Corps, 166

SSM Brigade (SCUD), *Front*, 196

SSM Brigade (SS-21), Army or Army Corps, 165

Supply & Maintenance Platoon, Signal Bn, ID, 317

Supply & Service Platoon, Materiel Support Bn, ID, 321

Supply and Maintenance Platoon, Signal Bn, MRD and TD or IMRB or Army Corps, 59

Supply and Service Platoon, Materiel Support Bn, MRD and TD or IMRB, 63

Supply Platoon, Inf Bn, Inf Regt, ID, 239

Supply Platoon, MRB, MRR (BMP or BTR) and TR, MRD and TD or IMRB, 125

Support Platoon, Indep TB, Inf Regt, ID, 272

-T-

Tank Army, 160

Tank Battalion (40-Tank Variant), MRR (BMP or BTR), MRD and TD, 138

Tank Battalion (Standard), MRR (BMP or BTR) and TR, MRD and TD, 136

Tank Battalion IMRB, 143

Tank Company (10-Tank), Indep TB, ID, 270

Tank Company (13-Tank Variant), TB (40-Tank Variant), MRR (BMP or BTR), MRD and TD, 139

Tank Company (Standard), TB, MRR (BMP or BTR) and TR, MRD and TD or IMRB, 137

Tank Company (13-Tank), Indep TB, ID, 269

Tank Division, 3

Tank Regiment, MRD, 87

Tank Regiment, TD, 90

Tank/Track Maintenance Platoon, Maint Bn, ID, 325

Tank/Tracked Vehicle Maintenance Company, Maint Bn, MRD and TD or IMRB or Army Corps or Army, 66

Target Acquisition/Early Warning Battery, Air Defense Regt, ID, 297

Technical Company, Engr Bn, ID, 312

Technical Company, Engr Bn, MRD and TD, 52

Technical Construction Platoon, Engr Co, Inf Regt, ID, 254

Technical Service & Maintenance Platoon, Chem Protection Bn, ID, 330

Technical Service and Maint Platoon, Chem Protection Bn, MRD and TD or Army Corps or Army, 72

Transport Helicopter Regiment, Air Army, *Front*, 191

Transport Section, Med Bn, MRD and TD or Army Corps, 76

Transportation Company, Air Defense Missile Bn, Air Defense Regt, ID, 294

Transportation Company, Air Defense Regt, ID, 298

Transportation Company, Inf Bn, Inf Regt, ID, 240

Transportation Platoon, Air Defense Bn, Inf Regt, ID, 252

Transportation Section, Med Bn, ID, 334

15 September 1994

The proponent of this pamphlet is the TRADOC Deputy Chief of Staff for Intelligence. This pamphlet is the definitive source for heavy OPFOR organization for use at the Combat Training Centers and TRADOC centers and schools. It will also serve as the coordinating draft for a subsequent edition of the guide in the form of a Department of the Army Information Pamphlet. Users are encouraged to send comments and suggested improvements on DA Form 2028 (Recommended Changes to Publications and Blank Forms) through channels to the TRADOC ODCSINT, Threat Support Division, ATTN: ATZL-CST, Fort Leavenworth Kansas 66027-5310. Suggested improvements may also be submitted using DA Form 1045 (Army Ideas for Excellence Program (AIEP) Proposal).

FOR THE COMMANDER:

OFFICIAL:

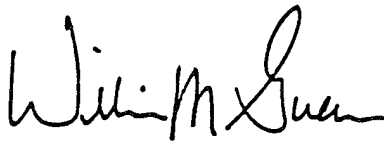

WILLIAM M. GUERRA
Colonel, GS
Deputy Chief of Staff
for Information Management

JOHN P. HERRLING
Major General, GS
Chief of Staff

DISTRIBUTION:
Special