

3 1761 05107617 2

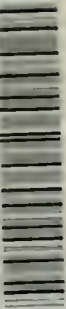



Digitized by the Internet Archive
in 2011 with funding from
University of Toronto



YALE
HISTORICAL PUBLICATIONS
MANUSCRIPTS AND EDITED TEXTS
III
PUBLISHED UNDER THE DIRECTION OF THE
DEPARTMENT OF HISTORY
ON
THE JOHN E. PARSONS FOUNDATION

Law
Eng
B797d

Bracton, Henry de

BRACTON
DE LEGIBUS ET
CONSUECUDINIBUS
ANGLIÆ

Edited by
GEORGE E. WOODBINE

VOLUME ONE



137933
6/3/16

NEW HAVEN: YALE UNIVERSITY PRESS
LONDON: HUMPHREY MILFORD
OXFORD UNIVERSITY PRESS
MDCCCCXV

COPYRIGHT 1915
BY
YALE UNIVERSITY PRESS

Printed from type, February, 1915, 400 copies

TO
GEORGE BURTON ADAMS
IN APPRECIATION OF
HIS TEACHING AND HIS FRIENDSHIP
THIS WORK IS DEDICATED

BRAC^TON
DE LEGIBUS ET
CONSUE^TUDINIBUS
ANGLIÆ

PREFACE

This volume is not intended as an introduction to Bracton. It simply represents the work which had to be done to clear the way for a new text of the *De Legibus*. Before any attempt could be made to reconstruct the correct text two all important questions had to be answered: (1) What manuscripts should be used as the basis of the new text? (2) What passages in the printed text are additions or interpolations? The following pages have been devoted to answering these questions in their different ramifications, it is hoped satisfactorily. Nothing else has been attempted. The Latin text, with variant readings and commentary, will appear in volumes two and three. Volumes four and five will contain an English translation of the Latin text. The introduction will be reserved until the sixth, and last, volume, after a continued study of Bracton's work has rendered the editor more competent to write it.

In this edition the traditional name of Bracton has been kept. Granted that to his contemporaries the author was known as Henry of Bratton, by all the world since he has been called Bracton, and the associations which connect him with others great in the history of English law cluster about the latter name. For the same reasons the traditional *Angliæ* in the title has not been changed to the probably more correct *Anglicanis*.

It will become apparent to those who read farther into this book that some of the traditions connected with Bracton's text have not been so readily retained. The refusal to divide the treatise into a number of books may seem to some a piece of undesirable iconoclasm. But the facts on this point, given in their proper place below, speak for themselves. I may add, however, that a continued study of the manuscript texts has made me more and more positive that Bracton never divided his own *De Legibus* into books. Had I known five or six years ago some of the facts which I have learned since, it would have been possible to make the case against a division into books even more strong. My estimate of the Digby manuscript does not at all agree with the generally accepted estimate of that manuscript. It has been no

pleasure to have to differ with the late Professor Maitland on these two matters of the Digby manuscript and a division of the treatise into books. Though it was not given to me to know him personally, in the plan for a new edition of Bracton his influence has been at least as great as that of any other one person. I have drawn on his writings and on the enthusiasm which they have been able to inspire; it is in no spirit of controversy that I have taken exception to some of his statements. Again, if some of my contentions in regard to the *addiciones* savor of heresy my plea must be that it is the evidence of the manuscripts, and not I, that is speaking.

A not inconsiderable amount of space has been devoted to the collation of the selected passages of text. This was not only justified but made necessary by the importance of the collation, which, because of the vast amount of evidence that it furnishes, represents in some respects the most vital part of this volume. No pains have been spared to make it correct to the least detail. Though much of the work has had to be done at a distance from the original manuscripts, this fact can hardly have affected the results arrived at in the collation, inasmuch as a two years' acquaintance with the manuscripts themselves at the beginning has been supplemented by a very free use of photographs. For all but two or three of the more inaccessible manuscripts each passage has been collated four times, twice in the original and twice from photographs.

In one way or another many people have had a share in the making of this book. The encouragement of friends in a lengthy and laborious undertaking has proved just as real a help as the assistance which has had a more direct bearing upon the work itself.

Any work of this sort is rendered possible only through the kindness and coöperation of those into whose keeping the original manuscripts have come. My debt to the libraries has been great. I am most deeply indebted to the authorities of the British Museum, the Bodleian Library, and the Cambridge University Library, not only for the free use of the many Bracton manuscripts therein contained, but also for the generously given permission to photograph those manuscripts, a permission which, though many times asked, has never been refused.

For the same reasons my thanks are due to the library authorities of Trinity College (Cambridge), Trinity Hall (Cambridge), Pembroke College (Cambridge), Merton College (Oxford), Eton College, and Lambeth Palace, in all of which places Bracton manuscripts have been freely placed at my disposal both for study and for photographing.

PREFACE

My thanks are also due to the Directors of the Bibliothèque Nationale for allowing me to consult and photograph the Bracton manuscript Latin 4674.

Likewise my thanks are due to the Honorable Society of Lincoln's Inn for the kind permission which allowed me freely to use, and to photograph parts of, their manuscripts of Bracton; also to the Honorable Society of Gray's Inn for the use of the Godbold manuscript; also to the Honorable Society of the Middle Temple for the use of the Bracton manuscript in their possession.

I should especially thank those who very generously sent manuscripts from their own libraries to other places for my inspection: the Marquis of Bath for sending the Longleat manuscript to the British Museum; the Librarian of Pembroke, Mr. E. H. Minns, whose active interest and coöperation made my work at Cambridge exceptionally pleasant, for depositing the Pembroke manuscript for a long time in the University Library; the Librarian of Trinity Hall, Reverend W. S. Cronin, for a similar kindness; the Librarian of Lambeth Palace, Reverend Claude Jenkins, for sending Lambeth manuscript 92 to the British Museum to be rotographed; and the Librarian of York Minster for allowing a manuscript to be used outside the Library with increased facilities for study.

I would acknowledge, also, the generosity of the Director of the Fitzwilliam Museum, Mr. Sydney C. Cockerell, in readily permitting me to have rotographed entire manuscript McClean 145, which I had not seen in the original.

To Canon J. M. Wilson I am under obligations for the kindness which gave me every facility for studying the Bracton manuscript in the Cathedral Library at Worcester.

I have to thank the Librarian of the Harvard Law School, Mr. J. H. Arnold, for the courtesy which enabled me to examine thoroughly the two Bracton manuscripts in the Dunn collection.

My interest in Bracton began with a study of the manuscript in Yale University Library. That manuscript first known I have probably used most, if for no other reason than that of propinquity. Much of my work has been done in that library. To the Librarian and staff I am under obligations for favors stretching over many years.

Among those who have helped me abroad I am indebted to Professor Vinogradoff not only for helpful suggestions in regard to Bracton, but for much kindness during the time that I was in Oxford. I have to thank

PREFACE

Sir Frederick Pollock for many courtesies which have aided my work at Lincoln's Inn and elsewhere. Mr. Hubert Hall has my thanks for the generous help he has given me on more than one occasion.

To him to whom this book is dedicated I tender my truest thanks for a never wavering interest that has always found time to consider any question connected with the work. To other of my associates in the University I would express my appreciation for many helpful suggestions.

My sincere thanks are due to the Yale University Press, and especially to its Director, Mr. E. Byrne Hackett, for having relieved me from all care in the actual making of this book. The printer has done well a piece of work which was in many places far from easy. His proof-reader has my grateful thanks for a painstaking carefulness which has corrected many a slip of my own.

I should acknowledge the good work of the Oxford University Press, of Mr. R. B. Fleming of Harrow, and of Mr. W. F. Dunn of the Cambridge University Library, which by reproducing for me entire ten manuscripts and larger or smaller portions of twenty-eight others has made it possible for me to study Bracton's text at first hand on this side of the Atlantic.

This work is yet far from completion; it will be many years before it is finished. In the meanwhile, new manuscripts of Bracton may be discovered in hitherto unsuspected places. It would be a real help if those who may become cognizant of the whereabouts of such manuscripts should inform me of them. It is my hope, too, that information relative to Bracton or to Bracton's text may come to me otherwise than merely through the medium of book reviews.

Lastly, as befitting its importance in connection with the work, it should be said that the publication of this edition has been made possible through the generosity of the late Mr. John E. Parsons, of New York, whose interest in the work and in Yale led him to establish a University fund for that purpose.

G. E. W.

NEW HAVEN, CONN.

February, 1915.

CONTENTS

THE MANUSCRIPTS	1
PEDIGREE OF THE MANUSCRIPTS	
General Features of the Manuscripts	21
The Division of the Treatise into Parts	28
Differences in the Order of Presenting Subjects	64
The <i>Addiciones</i> in Relation to the Pedigree	91
The Passages Chosen for Collation	94
Nature and Value of the Different Types of Variants	98
Collation of the Selected Passages	111
Arrangement of the Manuscripts by Groups	186
Graphical Representation of Relationship	240
The Choice of Manuscripts	287
THE <i>ADDICIONES</i>	312
List of Additional and Doubtful Passages	372

THE MANUSCRIPTS

Including those which are fragmentary, abridged, or incomplete, there are forty-six manuscripts of Bracton's treatise accessible to scholars, with two, possibly three, others in existence which are not accessible.¹ All of these are written on vellum, varying greatly in size of sheet and quality of material, mostly in late thirteenth or early fourteenth century hands of different styles and types. Some have been carefully and neatly written, while others show very evident signs of haste and negligence. In many of the copies the capital letters at the beginning of titles or paragraphs have been worked out in colors, in some cases ornamented capitals in gold and colors mark the more prominent points of division, but the majority are exceedingly plain in appearance, and in some even the rubrics are written in black ink. In these, as in other manuscripts of the same period, dragons, centaurs, and monsters of many shapes and sorts, illustrate the love of the medieval mind for the grotesque; but there is nothing of the illumination and wealth of decoration found in the books of a slightly later time. Very few of these Bracton manuscripts are complete. Not only are large portions at the beginning or end frequently lacking, but there are often folios or quires missing from other parts, or extensive gaps in the text itself.² On the other hand, not a few of the texts contain extraneous matter of considerable extent—little treatises like those on consanguinity or affinity, references to or comments on the statutes of Henry III and Edward I, glosses, and notes of various kinds. Usually the *De Legibus* occupies a volume by itself, but in several instances it forms only part of a volume made up of very diversified contents. Of abbreviated Bracton texts there are several different types, some of them omitting only the cases, or the cases and writs, others being the results of deliberate attempts to cut down the rather lengthy treatise, which at times must have proved cumbersome, as

¹ Of the five Bracton MSS. formerly in the Phillipps Library at Cheltenham only one remains, and that is rendered practically inaccessible by the prohibitive fee of a guinea a day charged for consulting it. Three others are now in libraries which generously place them at the disposal of scholars. (See HA, HB, CM, below.) The other has disappeared, presumably into some private collection. There may also be a Bracton MS. at Stamford Court, Worcestershire. See below, p. 20.

² Due, in all probability, to the loss of pages or quires in the exemplar. Notice a case of this in OB as described below.

well as expensive in copying, and parts of which very soon became obsolete as a result of more modern legislation.

In the following descriptions, which have purposely been made brief, the object has been to furnish data which might be used in identifying the individual manuscript rather than to give any special features of excellence or inferiority, the worth of each text being considered further on. No attempt has been made, as might have been, to trace the manuscripts back to their seventeenth, sixteenth, or fifteenth century owners. Such a procedure doubtless would have been interesting, perhaps to some degree successful, but it could not be expected to throw any light upon the real problem involved—the question of just what Bracton himself wrote. Throughout, everything in the manuscripts has been treated from the standpoint of the student of legal history, and not from that of the antiquary or genealogist.

It will be noticed that three sets of measurements are given for the size of each manuscript. Ordinarily the outside dimensions of the volume would be sufficient in this matter. But we can not be certain that any particular manuscript will always retain its present binding; legally or illegally it may change hands, and a new cover be substituted for the old. The binder may cut down the margins so that even the size of the pages is changed.¹ One measurement which can not be altered, unless the text itself is mutilated, is the space actually covered by the writing. Therefore three sets of measurements have been made, as, 14x12, 13x10, 6x4, representing in the order given the size of cover or binding, size of page, and size of space written upon by the original scribe.²

In addition to these measurements there has been given the number of columns on a page, the number of lines to a column,³ the character and approximate date of the writing; incompleteness at beginning or end, the number of folios, lost folios, gaps in the text, the presence or absence of a table of contents, any special or peculiar feature—have all been noted.

¹ Thus it would be possible to cut down such a MS. as ML, free as it is from marginal matter, without interfering with the writing, and even leaving a not ungenerous margin, by almost three inches all around.

² This measurement would naturally never be as exact as a similar one taken from a printed book, but pages written by the same hand are so nearly alike in this respect, that, except in very unusual cases, any page would come within a fraction of an inch of the average measurement. When this third measurement is given as (10)9½x6(6½), it means that the written space varies from 10 to 9½ inches in length and from 6 to 6½ inches in width, with most of the pages approximating 9½x6.

³ It will be seen that often the number of lines of writing to a column is a variable quantity. This is especially, though not alone, true of those MSS. which have been written by several different copyists, and is due both to the differences in the size and character of the letters, and to the amount of writing space used by the scribe, some leaving much wider margins than others.

Though this sort of description becomes stereotyped and mechanical it nevertheless has the advantage of being brief, and of furnishing a set of data which will remain permanent for purposes of identification, especially when supplemented by the collation to which certain portions of the text of all the manuscripts have been subjected.¹

A word should be said here on two other points—the dating of the manuscripts under consideration, and the determination of the number of hands which have had a part in the making of those copied by more than one scribe. There is always the desire, sometimes a strong one, to assign a manuscript definitely to an exact date. But in the case of those manuscripts in which the character of the writing alone furnishes the evidence of their date of composition, such a thing is impossible. A given style of writing, more or less marked by peculiar characteristics, will usually last through at least two generations; and while the temptation always is to assign the earlier date, the latter would perhaps more often be correct.² When, therefore, in the descriptions given below a codex has been labelled “late thirteenth century” or “early fourteenth century,” it simply means that the more distinctive marks in the writing rather strongly suggest a date on one side or the other of 1300. A more careful way, one which has been followed in the case of some copies, would be to use the form “thirteenth-fourteenth century,” which would make 1300 the central point of a period reaching some twenty-five or thirty years in either direction. It is from this period that by far the larger number of the extant Bracton manuscripts date.

In regard to the number of copyists employed on those manuscripts which have been written in several different hands, no hard and fast statements have been made. Here again the tendency is usually to make assertions more positive than the clearness of proof rightly allows. As far as our manuscripts are concerned we have as extremes the “book hand” proper and the “court hand” proper. Within these two types there are various styles, especially in the court hand. Between the two extremes are hands which lean more strongly towards one than towards the other; some are rightly neither one nor the other. “Semi-book hand” might at times convey a better impression of the actual style of writing than “charter hand.” For while charter hand as a

¹ Though all the MSS. have been collated by quires, this collation has not been given, being unnecessary where the MSS. have undergone a detailed examination and extensive text collation.

² This permanence of certain characteristics in the same type of writing from different periods is seen in dated documents such as the Plea Rolls. The peculiarities of a “time of Edward I” hand will be found to begin before 1272 and last after 1307.

type is distinct enough, the varieties of that type differ among themselves.¹ Doubtless all of the scribes would be able to write at least one other style of hand in addition to the formal book hand; and doubtless, also, it would be difficult to discover enough points of similarity between two such hands to make them appear the work of the same man. Sometimes a manuscript will contain several different styles of handwriting. This brings up the question as to whether the same scribe has written in more than one hand, especially in the case of those copies which have the text proper in one type of hand and the marginal *addiciones* in another. Probably the scribe would confine himself to one style of writing in a single manuscript. Many, of course, do; but we can not be certain that this is always the case. It is quite possible that a scribe commissioned to write a quire for the beginning of a book might copy it in book hand, and later might write a quire at the end of the book in charter hand, especially if in the interval some other scribe, for the same book, had copied other quires in charter hand. For this sort of mingling of hands is to be found in the written copies of the *De Legibus*. In a situation of this sort all that can be said is that so many hands, i. e., different kinds of handwriting, are in evidence. But even here there is sometimes difficulty. It is often far from easy to pick out the different hands in a manuscript. Not only may the same scribe form the same letter in different ways in different places—which makes even the test of comparing individual letters not altogether satisfactory—but a change of ink, or pen, or vellum, will sometimes cause a very decided difference in the general appearance of the writing. A fact very noticeable in some of these manuscripts is that the same hand, changing by really imperceptible degrees, writes very differently at the end of the volume from what it did at the beginning. That this is sometimes due to haste there can be no doubt, for there are often signs of hurry at the end of a scribe's work which make it evident that he has been willing to sacrifice much in its appearance for speed. On the other hand, it should be borne in mind that even under the most favorable conditions the copying by a single scribe of a treatise as long as Bracton's would require a long time; if interrupted in his task to any considerable degree, a copyist might be forced to

¹ There are a considerable number of charters from the same period as that in which the Bracton MSS. were written to be found in facsimile in the photographic reproductions of MSS. published by the Palæographical Society and the New Palæographical Society. A comparison of these will show in what different hands charters of even the same period might be written. For the general subject of the official and legal cursive script in England see Thompson, *An Introduction to Greek and Latin Palæography* (1912), 505 *et seq.* For the use of charter hand in English written books of legal literature, and for the mixing of charter and book hand forms, see *ibid.*, 456, 460, 464.

spread the work over a period long enough to have allowed his handwriting to change noticeably. In view of these facts the present writer would not care to be too insistent upon the number of hands employed in some of the manuscripts. For the same reason, also, he has probably underestimated rather than overestimated the number in some cases.

OA. Bodleian Library, MS. Digby 222. XIII-XIV cent., single columns, in six hands of various styles.¹ 183 folios, of which the first eight are devoted to a table of contents. $14 \times 9\frac{1}{4}$, $13\frac{3}{4} \times 8\frac{3}{4}$, $10(\frac{3}{8}) \times 5\frac{3}{4}(6\frac{1}{4})$. 54-70 lines to a page. Incomplete, lacking the whole treatise on Dower, and ending with *in manu domini regis detineat* on f. 440b of the printed text. A detailed description of this MS. is given in Vol. VIII of the Selden Society Publications (*Bracton and Azo*), pp. 239-250.²

OB. Bodleian Library, MS. Bodley 170. Late XIII cent., court hand, single columns. A table of contents occupies the first 18 folios, the text proper extending over fs. 19-385. $11\frac{1}{8} \times 8\frac{1}{8}$, $10\frac{3}{8} \times 7\frac{1}{8}$, $7\frac{1}{2}(6\frac{5}{8}) \times 5$. 30-36 lines to a page. Incomplete because of a *lacuna* on f. 219, where the text reads, *se habuerit vel stricte. Si autem plures fructuarium valebit inpetratio*, thus omitting fs. 230-261 of the printed text.³ The name of Bracton occurs in the text on f. 1, *Ego H. de Bractone talis animum crexi*. (In both the *Incipit* and the *Explicit* the name is spelled *Brattone*.) This MS. has been referred to as "Corbet," the name of Joannes Corbet being on f. 1, and *Codex Corbetti dominum non muto libenter illi charus ego charus et ille mihi* on f. 385b.

OC. Bodleian Library, MS. Rawlinson C. 159. XIII-XIV cent., charter hand, double columns. A kalendar of $4\frac{1}{2}$ folios; the text on fs. 6-204. $13\frac{1}{4} \times 8\frac{3}{4}$, $13 \times 8\frac{1}{2}$, $10\frac{1}{4} \times 5\frac{3}{4}$. 60-56-60 lines to a page. A much later hand has divided the text into divisions similar to those of the printed editions. A note

¹ We would divide the hands as follows: I, fs. 1-8 (the table of contents). II, fs. 9-12, 58-101. III, fs. 13-36, 52-57. IV, fs. 37-51, 102-110, 119-143. V, fs. 111-118. VI, fs. 144-183. It will be noticed that this is a somewhat different arrangement from that given in *Bracton and Azo* (pp. 240-242). In our assignment the number of folios written by hand IV is 48, viz., $14\frac{1}{2} + 8\frac{1}{2} + 25$. At the bottom of f. 143b the scribe, or some one contemporaneous with him, has scribbled *XLVIII folia*. Moreover, the rubrics in these particular quires are written in a red ink of very distinctive color, quite different from that in which the rubrics of other sections are written.

² For a fuller discussion of this manuscript see below, p. 68 *et seq.*

³ The chapter headings for this omitted portion are in the table of contents, in which a note by the original scribe points out the *lacuna* in the text.

on a fly leaf (*circ.* 1500) shows that this volume was formerly in the library of St. Augustine, Canterbury. At the bottom of f. 204, in a XVII cent. hand, over the name of Manwood, is "Itt was my father his booke and lay in hys studdy att Seargeants Inn." Many passages are marked as additional, most of them being in the main body of the text, though some appear as marginal notes, which, with possibly two exceptions, are written in the same hand as the text. The first chapter of the Action for Dower, which occurs again in its regular place, immediately precedes *De Actionibus*. On f. 29 a writ of Edward (I) to the sheriff of Leicestershire has been inserted in the text.

OD. Bodleian Library, MS. Rawlinson C. 160. XIV cent., charter hand, double columns, 230 folios, without a kalendar. $14\frac{1}{8}\times 10$, $13\frac{5}{8}\times 9\frac{1}{2}$, $10\frac{1}{2}\times 6\frac{1}{2}$. 52 lines to a page. Incomplete, ending with *quod distringi possit* on f. 443 of the editions. OD has some marginal *addiciones*. Much extraneous matter has been incorporated in the text. There is mention of Edward I in a passage on fs. 53b-54 of the codex; and on fs. 36, 37, 38, treatises on affinity and consanguinity.

OE. Bodleian Library, MS. Rawlinson C. 158. XIV cent., double columns, court hands by probably eight different scribes.¹ 119 folios, the first 13 given over to a table of contents. 14×10 , $13\frac{1}{2}\times 9\frac{1}{2}$, $9\frac{1}{2}(10\frac{3}{4})\times 7\frac{1}{4}$, (in one hand $11\frac{1}{2}\times 8\frac{1}{2}$). 49, 40, 39, 51, 50 lines to a page. So many portions of OE have been lost—over 250 folios of the printed book—that what remains is no more than a large fragment. The principal gaps in the text, due to missing pages, come in between the following folios of the MS.: 17-18, 24-25, 41-42, 48-49, 58-59, 70-71, 78-79 (this gap extends over 213 folios of print), 103-104. Some *addiciones* in the first part are marked. In the text are several references to the statutes of Edward I. The *Incipit*, which is mixed up with the first rubric, is *Incipit liber Henrici de Bractone*.

OF. Bodleian Library, MS. Bodley 344. XIV cent., book hand, double columns, 505 pages including a kalendar of 11 (12) pages which begins *Incipit liber domini H. de Bracton*. $14\times 9\frac{1}{2}$, $13\frac{1}{2}\times 9$, $10\times 6\frac{1}{2}$. 50 lines to a page. A few *addiciones* are marked. The Action for Dower, though in the table of contents it follows *Utrum* regularly, is inserted after *quod non ponit (potuit)* at l. 2, f. 436. All between this point and the beginning of cap.

¹ There may have been as many as nine different writers.

XXXI, f. 439, is omitted. The name of Edward Fletwoode is on the first page of the kalendar; and at the foot of the second page is a note in the handwriting of Gerard Langbaine (*circa*. 1650) calling attention to a missing folio in the kalendar. Pages 501, 502, should change places with 495, 496. This MS. has its text divided into 1077 chapters which are arranged by *centenæ*.

OG. Bodleian Library, MS. Tanner 189. Late XIII cent., charter hand, single columns. The mutilated remains of a kalendar precedes the text which begins on f. 1 and ends on f. 304. Many pages of the book are mutilated, stained, or stuck together. $9 \times 6\frac{1}{2}$, $8\frac{5}{8} \times 6\frac{1}{4}$, $6\frac{1}{2}(\frac{3}{4}) \times 4\frac{1}{4}(\frac{1}{2})$. 37, 38, 34, 35 lines to a page. The spaces which were left for rubrics and capital letters have not been filled in. This is a much abbreviated copy of Bracton, due not to any loss of folios,¹ but to a deliberate attempt to cut down the material, as is shown not only by the omission of large blocks of text but also by the leaving out at the beginning and ending of passages of those phrases which refer to something above or below, as, *ut infra videri poterit, ut supra, secundum quod inferius plenius dicetur, etc.*²

OM. Merton College, Oxford, MS. CCCXX. XIV cent., book hand, double columns. A table of contents, 7 pages in single columns, precedes the main text, which is numbered by folios through 136, and then by pages with the numbering 1-105.³ $13\frac{3}{4} \times 10\frac{1}{2}$, $13\frac{1}{2} \times 9\frac{7}{8}$, $10\frac{1}{2}(\frac{7}{8}) \times 6\frac{3}{8}(\frac{5}{8})$. 72-70 lines to a page. At the beginning of the kalendar is *Incipiunt tituli tractatus domini Henrici de Brattone quondam iusticiarius in Anglia editi super legibus et consuetudinibus regni Anglicani, tam super placitis coronæ quam placitis terræ, cum formis brevium competentium utriusque*. The main text is preceded by *Incipit liber domini Henrici de Brattone super legibus et consuetudinibus*

¹ F. 176 is 177 in the old numbering, which is wrong; then come two blank folios, 177, 178 (old numbers 186, 187). Probably 9 folios are missing here. The table of contents has subjects marked for fs. 179, 180, 181, 182, 183, and the headings are those for *De Actione Dotis*, which is missing in OG.

² In the first 170 folios there are some 175 gaps in the text. On f. 170b, after a passage on f. 438b of the editions, comes sect. 4, f. 63. Following this comes a succession of passages, broken, but in regular order and going through the first part of the Assise of Novel Disseisin, which contain much that was at first left out. Cap. XIX, f. 187b, comes on f. 289 of OG; the next page is blank; f. 290 begins with a passage on f. 338 of the editions, the next few pages containing a broken continuation of this portion of Bracton and ending in cap. XII, f. 358.

³ Some of these pages are bound in the wrong order, which being corrected should read 8, 11, 12, 15, 16, 19, 20, 13, 14, 9, 10, 27, 28, 23, 24, 17, 18, 21, 22, 25, 26, 29, 30, 31, etc. In *Testamenta Eboracensia* (Surtees Soc.), 101, is noted the fact that in 1378 the Chancellor of York, Thomas Farnylaw, bequeathed to Merton College a copy of Bracton.

regni Anglicani. On f. 48b this MS. skips from f. 104b to f. 129b of the printed book. Many references to the statutes of Edward I, and some unusual *addiciones*, have become a part of the text.

MA. British Museum, MS. Add. 11353. Late XIII cent., double columns, court hand. After 11 pages of kalendar the text begins on f. 9, ending on f. 189b. $14\frac{1}{4} \times 10\frac{1}{8}$, $13\frac{5}{8} \times 9\frac{1}{4}$, $10\frac{3}{4}(11) \times 7$. 47, 48, 49 lines to a page. An illuminated first page represents the king seated on his throne, holding a sword in his right hand and a charter in his left. On the right are six knights, and on the left a group of six men and women, one of whom is receiving the charter from the king. On a leaf at the end is the name of Charles Buck. A pencilled note at the beginning states that this MS. was formerly in the library of Sir Thomas Crewe, King's Sergeant in the time of James I. For this reason the codex has at times been referred to as "Crewe." Fly leaf notes record two transfers of the volume—"Bought at the Harrold sale, Sept. 1805, J. B.;" "Purchased of Lilly, 3 March. 1838."

MB. British Museum, MS. Stowe 380. Late XIII cent., double columns, charter hand. A table of contents takes up the first 10 folios, and the main text fs. 11-202b. $13\frac{3}{4} \times 9\frac{3}{8}$, $13\frac{1}{8} \times 8\frac{5}{8}$, $10(\frac{1}{8}) \times 6(\frac{1}{4})$. 50 lines to a page. Incomplete, ending with *illud tempus possit qui ius* on f. 436b. The order of certain folios should be rearranged to fit the order 133, 137, 138, 139, 140, 141, 142, 134, 135, 136, 143. MB is divided into sections containing from 2 to 190 titles, each section taking as its heading the rubric of the first title in its division, as *Capitula de eo quod dicitur quæ sunt rege necessaria* and *Capitula de eo quod dicitur quid sit iusticia*. The statement in the printed catalogue that MB is divided into sixteen books should be changed to read "sixteen quires," the large Roman numerals at the top of the pages representing quires instead of books, and the partial division of the table of contents into books being based on a misinterpretation of this same quire arrangement.

MC. British Museum, MS. Reg. 9. E. XV. *Circ.* 1300, double columns, book hand. A table of contents in a contemporary court hand takes up $9\frac{1}{2}$ folios; the text beginning on f. 11 and ending on f. 216—*Explicit liber domini Henrici de Brattone de viribus (for iuribus) et consuetudinibus Anglicanis*. On f. 52b there is a break in the text extending over fs. 95-96b of the printed book. $13\frac{3}{8} \times 10\frac{1}{4}$, $12\frac{5}{8} \times 9\frac{5}{8}$, $10(\frac{1}{4}) \times 7(\frac{1}{4})$. 46 lines to a page.

MANUSCRIPTS

Following the Bracton proper is about a page of extraneous matter on various legal subjects, written in the same hand as the text.¹

MD. British Museum, MS. Harley 817. XIV cent., court hand, double columns. Three folios of vellum before the table of contents are covered with miscellaneous legal matter, mostly definitions of terms and phrases, in XIV-XV cent. hands. Following a kalendar of four folios the text begins on f. 8 and goes to f. 236. At the end are three folios of Latin notes on various subjects. $14\frac{1}{2} \times 9$, $14\frac{1}{8} \times 8\frac{3}{4}$, $11(\frac{1}{4}) \times 6\frac{5}{8}$. 57, 47, 53 lines to a page. There are many marked *addiciones* in the text and some in the lower margins. This MS. has been much used, and is freely annotated by a later hand. The name of Elizabeth Willington, XVI-XVII cent., is written on f. 136. At the bottom of f. 236, in the same hand as the text, is the name of Simon de Ednesouere, by which name the MS. is sometimes referred to.

ME. British Museum, MS. Harley 656. Early XIV cent., double columns, court hands. In four hands, viz., I, table of contents, $8\frac{1}{2}$ folios; II, fs. 12-75, 100-315; III, fs. 75-99b; IV, marginal notes and *addiciones*. The main text occupies fs. 12-315. $14\frac{1}{2} \times 9\frac{1}{2}$, $13\frac{3}{4} \times 8\frac{3}{4}$, $10\frac{1}{2}(\frac{3}{4}) \times 6$. Hand II has 49, hand III, 47-50, lines to a page. This MS., written on fine parchment, is very neat and in a fine state of preservation. On f. 94, at the end of cap. XIX, f. 138 in the printed book, is a whole folio of outside matter, beginning with references to the Edwardian statutes, which are also referred to in other parts of the text.

MF. British Museum, MS. Harley 653. Early XIV cent., court hand, double columns. No table of contents. The text begins on f. 3 and ends on f. 212b at the end of cap. XIX, f. 420b of the printed book. $14\frac{3}{8} \times 9\frac{7}{8}$, $13\frac{2}{4} \times 9\frac{1}{4}$, $10\frac{1}{4} \times 7$. 50 lines to a page. MF has a large amount of non-Bracton matter, including the treatises on consanguinity and affinity, and references to the statutes. Large gaps in the text occur at the following folios: 67-68,

¹ This same matter is found at the end of LA. The headings of the sections begin as follows: 1. Inquiratur inprimis de cambio sic. Qui cambierint novam monetam pro veteri sine warranto . . . ; 2. Concordatum est per consilium domini regis et iusticiarios suos London. quod breve quo warranto de hundredis versus talem non est vitiosum . . . ; 3. Bene concordatum est per magistrum Thom. Becke, J. de Hyrlieby, R. de Hengham, N. de Stapeltone, W. de Wymburne, T. de Weylaunde, W. de Helium, J. de Lovetoft, W. de Brumpton, et R. de Leycestre. quod breve quod dicitur quo warranto . . . ; 4. Edwardus dei gratia rex Angliæ, etc.—a writ addressed to Robert de Ufford, justiciar in Ireland, concerning archbishop John de Darlington and the church at Dublin, and dated 28 April, 1279; 5. Die Jovis post festum Sancti Marci evangelistæ frater Johannis de Derlington de ordine prædicatorum electus Dublin . . . The last two entries are from the patent rolls and close rolls, and may be found in *Cal. of Docs. Relating to Ireland, 1252-1284*, nos. 1549, 1550.

108-109, 133-134, 139-140, 149-150, 155-156; altogether some forty folios seem to be missing. Most of the cases, and some of the other parts, have been marked through with red ink. The last page contains a document dated 1411 to which is affixed the seal and signature of Robert Ayer, presbyter of the diocese of York.

MG. British Museum, MS. Add. 24067. XIV cent., double columns, book hand. Lacks a table of contents; the text begins on f. 2 and ends on f. 221. $15\frac{1}{8} \times 10\frac{1}{8}$, $14\frac{1}{2} \times 9\frac{1}{4}$, $10 \times 6\frac{1}{2}$. 50 lines to a page. Well written, with many well-made capitals; vellum of a fine quality. The Action for Dower is inserted on f. 436 of the printed text after being omitted at the regular place, and all between this point and cap. XXXI, f. 439, is omitted, as in OF. Some of the *addiciones* are marked. A note at the beginning reads, "Liber qui dicitur Bretton de perquisitione Fratris Thomæ de Ocham." A memorandum at the end shows that in 1530 this volume was the property of the Abbot of Chertsey.

MH. British Museum, MS. Add. 21614. XIV cent., double columns, book hands. The text occupies fs. 2-204b. $14\frac{3}{8} \times 9\frac{7}{8}$, $13\frac{7}{8} \times 9$, $10\frac{1}{2} \times 6\frac{3}{8}$. Two hands have written the text. 57 lines to a page. On a fly leaf, in a different hand from the text, is, "Liber monasterii Glastoniae de perquisito bonæ memoriæ Walteri de Monitona quondam abbatis ibidem, in quo continetur videlicet Henricus Bractone de iuribus et consuetudinibus Angliæ." In a modern pencil is added, "A. D. 1341-1374." On f. 2b are the abbot's initials, "W. N.", with the letter "A" and an abbot's mitre above. The record of one transfer is preserved on a fly leaf, "Purchased of Messers. Willis and Sotheran, 6 Dec. 1856. (From Sale at Sotheby's, 4 July. Lot 325.)"

MI. British Museum, MS. Harley 3416. XIV cent., double columns, charter hand. $13\frac{3}{4} \times 9\frac{1}{2}$, $13\frac{1}{4} \times 8\frac{1}{2}$, $10\frac{1}{2} \times 6\frac{1}{2}$. 54, 55 lines to a page. Mutilated at the beginning, starting with a passage on f. 24b of the printed text. Folios 1-208 are occupied by the text, with an incomplete index taking up what is left of f. 208, the first folio of a new quire. An inserted slip, numbered f. 104, contains a passage omitted from the text on f. 103. There are large gaps in the text at fs. 138-139, two folios missing; at fs. 169-170, four folios missing; and at fs. 171-172, twelve folios missing.

MK. British Museum, MS. Harley 3422. XIV cent., double columns, four hands of different types. There is no table of contents; the text occupies fs. 1-227. 13×9 , $12\frac{1}{4} \times 8\frac{1}{4}$, $10(9\frac{1}{2}) \times 5\frac{3}{4}$. 50, 51 lines to a page. F. 61 should come after f. 209. F. 60b ends with, "res iudicatae vel finis factus vel" (f. 104 of the editions), and f. 62 begins with, "et responsione appellati et recordo" (f. 140b in the printed book). Folios have been cut away between those now numbered 85-86, 93-94, 122-123, 127-128, 136-137. The Action for Dower is omitted. 178, 177, 180, 179 is the correct order for the folios so numbered.

ML. British Museum, MS. Harley 1242. XIV cent., double columns, book hand. A table of contents (five folios, single lines) divides the text, which takes up fs. 6-224, into 380 sections, or chapters. $14\frac{3}{4} \times 10\frac{1}{4}$, $14 \times 9\frac{1}{2}$, $9\frac{3}{4}(10\frac{1}{4}) \times 6$. 48-50 lines to a page. Exceptionally well written on an extra fine quality of vellum. There is considerable variation from the usual order of subjects. Changes in order of subjects or omissions of noticeable extent occur on fs. 12, 92, 109, 179b, 205, 207, 208, 213b, 214, 215, 220b, 221, 222, 223. The Action for Dower follows sect. 4, f. 98 of the editions.

MM. British Museum, MS. Harley 763. XIV cent., double columns, court hand. An imperfect volume of 134 folios, beginning with, "Si fiat donatio viro," and ending with, "ipsi inde nihil fecerunt. Et ideo," (fs. 262b-442 of the printed text). $12\frac{1}{2} \times 8\frac{1}{2}$, $12 \times 8\frac{1}{4}$, $9\frac{1}{2} \times 6$. 39, 40 lines to a page.

MN. British Museum, MS. Add. 32340. XIII-XIV cent., double columns, in at least six different hands. Five folios (+ a slip) of kalendar; the text on fs. 7-145. $14\frac{1}{4} \times 9\frac{7}{8}$, $12\frac{7}{8} \times 8\frac{3}{4}$, $10\frac{1}{2} \times 6\frac{3}{4}$. 47, 58, 61, 63, 60, 58, 65, 68 lines to a page. Between fs. 42 and 43 is a gap extending over fs. 111-181 of the editions. On the inside of the front cover is a book plate with the name of Wm. Hulbert Sheppard, and on a fly leaf is the name of J. L. Sheppard.

Fragment. British Museum, MS. Add. 27632. Folios 26, 27. XIV cent., double columns, book hand. Size of page, etc., $11\frac{3}{4} \times 7\frac{1}{2}$, $10 \times 6\frac{1}{4}$. 50 lines to a page. These two leaves contain that portion of the text which is found on fs. 341-345 of the printed book.

Notes and Excerpts from Bracton. British Museum, MS. Hargrave 429. A paper quarto, late, and of no use for text purposes.

CA. Cambridge University Library, MS. Dd. VII. 6. Early XIV cent., double columns, charter hand. This volume is one of miscellaneous legal matter, Bracton beginning on f. aaaa 3, and ending on f. aaaa 75 in a passage found on f. 278 of the printed text. $20\frac{3}{8} \times 13\frac{1}{4}$, $19\frac{1}{4} \times 12\frac{1}{4}$, $14\frac{1}{4}(\frac{1}{3}) \times 9(\frac{1}{4})$. 65 lines to a page, usually (f. aaaa 10 has 70). CA has a large amount of marginal matter in both French and Latin, much of it consisting of commentaries on the text.¹ In the margin of f. 62, in the same hand as the text, is a reference to the second Statute of Westminster. Two extensive *lacunæ* occur in the text, one covering fs. 52b-98 of the printed Bracton, and the other taking in fs. 101-120b. Previous to the Bracton (on f. 66—in the old numbering 157) occurs the “Arbor Consanguinitatis,” which follows matter headed “Placita.” The treatise on consanguinity, which takes up about three pages, is followed by one on affinity, which occupies not quite a page and a half.

CB. Cambridge University Library, MS. Dd. VII. 14.² Another large volume of miscellaneous legal writings, the Bracton text occupying fs. 21-224, and being written in at least six different styles of court or charter hand, all of XIII-XIV cent., in double columns. $16\frac{7}{8} \times 11\frac{1}{2}$, $15\frac{5}{8} \times 10\frac{1}{4}$, $11\frac{1}{2}(\frac{3}{4}) \times 7\frac{1}{2}(\frac{3}{4})$. From 41 to 59 lines to a page, the number varying with the hand. There is an immense amount of matter in the margins, *addiciones*, corrections of the text, comments, references to the statutes or to judgments.³ On its fortieth folio CB ends cap. XXVIII, f. 62b, and begins a new chapter with De Actionibus (f. 98b). Bracton ends regularly on f. 186b of the codex. F. 193 (the intervening leaves are missing) begins in a different hand, a passage on f. 299 of the printed book. On f. 202b ends the treatise on Dower, which is complete. Then comes half a column of space, after which the text begins with cap. XXIX, f. 62b. (“De Actione Dotis” begins

¹ Many of the marginal notes in French read like passages from the Year Books. They may, however, be fictitious cases used to illustrate points. A more detailed description of this MS. is given in *The Court Baron* (*Selden Soc. Publ.*, IV), pp. 13-15.

² A full enumeration of the contents of CB will be found in the *Rolls Series*, *Year Book 20-21 Edward I*, pp. xi-xviii.

³ Decisions given by W. de Helyun are referred to frequently. Another type of marginal note is that found at the top of f. 31b—“Item in Westmarelond sunt multi qui tenent per cornagium et dant custodiam et maritagium et homagium et relevant terram qui sunt plenæ ætatis ad valentiam terræ suæ unius anni et annuus redditus illorum vocatur cornagium.” Practically all of these notes are written in hands contemporaneous with those which have written the text.

regularly on f. 126; f. 128 ends with "quoad successione[m]" (f. 299). On f. 128 begins the treatise on Entry (cap. I, f. 317b), and it is not till f. 193 that the Action for Dower begins again.) One whole quire, fs. 157-168, is missing. F. 119 is inserted between two folios which go on regularly. Many of the cases are omitted from the main part of the text and later put in the margin by a different hand. Some references to the Edwardian Statutes have crept into the text.

CC. Cambridge University Library, MS. Ee. IV. 4. XIII-XIV cent., double columns, court hand. Eight folios of kalendar, at the top of the first of which is, "Liber Antonii Stapleton armigeri socii interioris templi London., ac magistri ibidem de Banco." The text occupies 200 folios. $13 \times 8\frac{3}{4}$, $12\frac{1}{2} \times 8\frac{3}{4}$, $10\frac{1}{4}(10) \times 7(6\frac{3}{4})$. 54, 55 lines to a page. At the end of the volume is, "Liber Fra. Tate."

CD. Cambridge University Library, MS. Ee. I. 1. A collection of legal, and other, writings for the monastery at Luffield, the Bracton text being on fs. 41b-127b, 136-143b. Early XIV cent., double columns, court hands—of which some eight have written the *De Legibus*. $11\frac{1}{2} \times 8$, $11\frac{1}{4} \times 8$, $9\frac{1}{2} \times 6(\frac{1}{4})$. 40 to 56 lines to a page. The text of Bracton begins with cap. XI, f. 7, goes to f. 14b, and then goes back to the beginning of the treatise, introducing the omitted part with the rubric, "Incipit quidam tractatus secundum Breton." After the first few folios the text is so abridged as to be practically useless for purposes of text collation. F. 127b ends with sect. 4, f. 432; f. 136 begins with sect. 12, f. 80b.

CE. Pembroke College, Cambridge, MS. 298. *Circ.* 1300, double columns, in three charter hands. A kalendar of 9 folios, damaged by a hole burnt through the center, precedes 204 folios of text. $12\frac{3}{4} \times 9\frac{1}{2}$, $12\frac{1}{4} \times 8\frac{1}{2}$, $10\frac{1}{2} \times 7$. 54 lines to a page. This is one of the few complete MSS. of the better class. The name of Elis Saunders is written at the top of f. 17, and that of Elizabeth Gyffoun at the bottom of f. 145.

CF. Trinity College, Cambridge, MS. O. 9. 24. XIV cent., single columns, court hand. A plain volume of 213 folios, without a table of contents. Incomplete, ending with a passage in sect. 4, f. 354. $10\frac{3}{8} \times 7\frac{1}{8}$, $9\frac{3}{4} \times 6\frac{3}{4}$, $8\frac{1}{4}(\frac{1}{2}) \times 5$. 41 to 51 lines to a page. On f. 162b is the end of the treatise on Novel Disseisin, f. 237b of the printed text; immediately after it comes,

“præmortuorum ut videri poterit,” f. 262b, and in the margin of the opposite page, in the same hand as the text, is, “hic deficit maxima pars tertii tractatus libri quarti de assisa mortis antecessoris, videlicet totum principium usque hoc, de hoc quod dicit in dominico, etc.”

CH. Trinity Hall, Cambridge, Early XIV cent., double columns, charter hand. Sixty folios, beginning at cap. IV, f. 2b, with the rubric *Incipit* “Breton liber primus incipit de iuribus Angliæ,” and ending at cap. XXI, f. 421b. This is an abridgment of Bracton, too shortened for comparison and collation with regular texts, divided into seven books. Some of the writs are kept in the text, as also some of the cases; many cases have been put in the margins. There are a number of marginal *addiciones* in the text hand. A few *Notas* have crept into the main body of the text. $11\frac{7}{8} \times 8\frac{3}{4}$, $11\frac{1}{2} \times 8\frac{3}{8}$, $9\frac{1}{4} \times 6$. 62-53 lines to a page.

CI. Trinity College, Cambridge, MS. O. 3. 52. XIV cent., single column. A volume of miscellaneous legal writings. Fs. 1-113b contain an abridged text of Bracton, called “Breton.” (Fs. 127-270 contain a text of the Anglo-French *Britton*, which is here also called “Breton.”) Although it begins “Regalem potestatem non solum armis set legibus oportet esse armatam ut utrumque tempus bellorum et pacis recte gubernetur” (cf. *Glanvill*, *Fleta*, and *Regiam Maiestatem*), the language is that of Bracton, both writs and cases being preserved. It is too abridged for text comparison. At the end is considerable extraneous matter, including a reference to “H. de Breton” and the Statute of Westminster. $9\frac{1}{2} \times 6\frac{3}{4}$, 9×6 , $7\frac{1}{4} \times 5$. 44-45 lines to a page.

CM. Fitzwilliam Museum, Cambridge, McClean MS. 145. (Formerly Phillipps MS. 8126.) *Circ.* 1300, double columns, small, but carefully written, hand. $10\frac{1}{2} \times 6\frac{1}{4}$, $10\frac{1}{8} \times 6$, $8\frac{1}{2} \times 5$.¹ 80, 84, 76, 75, 76 lines to a page. The text of Bracton takes up 144 folios. Many of the *addiciones* are marked. References to the Edwardian Statutes are to be found in the text. A number of deeds copied at the end of the volume prove that it once belonged to the Priory of Llanthony, near Gloucester.

LA. Lambeth Palace Library, MS. 92. XIII-XIV cent., double columns, in two hands, court and book. A table of contents of $10(9\frac{1}{4})$ folios

¹ For the measurements of this MS., which I have never seen, I am indebted to Mr. R. B. Fleming, who photographed the MS. for me. A description of this volume will be found in James's *A Descriptive Catalogue of the McClean Collection of Manuscripts in the Fitzwilliam Museum*.

is followed by 159 folios of text. $13\frac{1}{4} \times 9\frac{1}{2}$, $12\frac{3}{4} \times 9$, $9(\frac{1}{4}) \times 6\frac{1}{4}$. 51, 43 lines to a page. In the margin are many *addiciones*, written in the hands which wrote the text. At the end is a little more than a page of extra matter, which is the same as that found at the end of MC. "Sum Augustini seneschalli liber" is written at the very end of the volume; underneath a coat of arms on f. 10b is, "Arma Nicholi Stewarde de hospitio vocat le Temple"; a note pasted on the inside of the front cover reads, "Belonged to Nicholas Steward of the Middle Temple and afterwards to Augustine Steward. The coat of arms of Nicholas Stewarde are painted therein and the name of Augustine is written at the end of the book."¹

LB. Lambeth Palace Library, MS. 93. Early XIV cent., double columns, in at least three court hands which are not coincident in their beginnings with either new quires or new folios. Incomplete, beginning on f. 33b of the printed text, and ending on f. 375. 197 folios, with 40-46 (usually 43, 44) lines to a page. 13×9 , $12\frac{1}{2} \times 8\frac{1}{4}$, $9\frac{3}{4} \times 6\frac{1}{4}$. The quires, from which some of the leaves originally bound in have been removed, are lettered at the top of the pages. The folios constituting quires P and Q have been bound in the wrong order.

LC. Eton College Library, MS. 176. Bl. a. 5. XIII-XIV cent., double columns, in two charter hands. A kalendar of 10 folios precedes 289 folios of text. $11\frac{3}{4} \times 8\frac{5}{8}$, $11\frac{1}{8} \times 8$, $9\frac{3}{8} \times 6\frac{1}{4}$. 47-53 lines to a page in the first hand, 42 in the second. Many corrections have been made in that part of the text written by hand II. Some *addiciones* have been inserted on slips.

LD. Lincoln's Inn Library, MS. "Hobhouse." XIII-XIV cent., double columns, in five or six different court hands. There is no table of contents, the text occupying fs. 1-203. $13\frac{1}{4} \times 9\frac{1}{8}$, 13×9 , $11\frac{1}{2} \times 6\frac{3}{4}$. 54, 62, 50, 59, 60, 57, 58 lines to a page. On its f. 25b LD skips from cap. XXIX, f. 62b, to cap. I, f. 98. This is later inserted after cap. XXX,

¹ In connection with the vacant spaces which are left in the text of some of the Bracton MSS. (for OA see pp. 80, 87 below), there should be noted the following empty places in LA: end of cap. VIII, f. 123b, 12 lines; end cap. XIII, f. 131, 7 lines; end sect. 7, f. 132, 15 lines; end sect. 17, f. 134, 6 lines; end cap. XIV, f. 134b, 10 lines; after "quis vulneratus fuerit usque ad." f. 135, comes a space of 11 lines + a whole page, and then, "mortem et vixerit," etc.; end cap. XX, f. 141b, 21 lines; end cap. XXIV, f. 145, 18 lines; end cap. XXV, f. 146, 6 lines; end cap. XXIX, f. 148b, 7 lines; end cap. XXX, f. 150, 10 lines; end cap. XXXI, f. 150b, 7 lines; end cap. XXXVI, f. 155b, 23 lines; end of sect. 13, f. 159b, one column; after "personæ et plegii," f. 182b, is a space of nearly a page, "Item in adventu" beginning a new folio; end sect. 3, f. 199, one column; after "quod tamen non fuit concessum," f. 288, 7 lines; end sect. 11, f. 301, 9 lines; end cap. XVII, f. 364, 23 lines. Vacant spaces ranging in extent from 15 lines to a page are found at the end of quires K, L, N, O.

f. 439, and is followed by the Action for Dower, which arrangement gives this MS. the same order of subjects as that found in LE (see below). There are a few slight gaps in the text, some extraneous matter has crept in, and a slip of parchment has once or twice been inserted between folios. On a fly leaf is the name of Edward Henden in two different places, and again, "liber quondam Edwardi Henden servientis ad legem." The records of two transfers of the MS. are found in the notes, "Bought at an auction of Mr. Le Neve's Books in March 1730. N. Hardinge," and "Bought at an auction of Mr. P. C. Webb's Books. March 1771. J. Lowes." There is no mention of this MS. in Hunter's catalogue of the MSS. in Lincoln's Inn, as the catalogue was published in 1838, and the MS. was not presented to the Society until 1866.

LE. Lincoln's Inn Library, MS. Hale 135. Late XIII cent., single columns, court hand. $14 \times 9\frac{1}{8}$, $13\frac{1}{2} \times 8\frac{3}{4}$, $10\frac{1}{2} \times 6\frac{1}{2}$. 59-45 lines to a page. This MS., which is an abridgment of Bracton, is in all probability a copy of Gilbert de Thornton's *Summa*. For a description of the MS. from this standpoint see the *Law Quarterly Review*, Jan., 1909, Vol. XXV, p. 44.¹

LF. Lincoln's Inn Library, MS. "Cholmeley." XIV cent., book hand, double columns. 392 folios of well-written text, with broad margins, and in an excellent state of preservation. $12\frac{1}{2} \times 9$, $12 \times 7\frac{3}{4}$, $6\frac{3}{4}(\frac{7}{8}) \times 4\frac{1}{8}(\frac{1}{4})$. 36 lines to a page. In LF not only are cases and writs usually omitted, but sometimes also the whole block of text which contains them. Fs. 30, 31 are lacking. On f. 184b the text reads, "Secundum quod pastura large se habuerit vel stricte. Item si capitalis dominus vendat alicui custodiam," thus omitting fs. 230-261 of the printed text (see OB above). Cap. XXIX, f. 62b, to cap. VIII, f. 107, is omitted in its regular place and inserted at the end of the treatise, forming book V of LF.

LG. Gray's Inn Library, MS. "Godbold." *Circ.* 1300, double columns, court hand. A kalendar of 11 folios followed by 230 folios of text. $12\frac{3}{4} \times 9\frac{1}{4}$, $12\frac{5}{8} \times 8\frac{3}{4}$, $10\frac{3}{4} \times 6\frac{3}{4}$. 46, 51, 45 lines to a page. As in OB, the name of Bracton occurs in the text on f. 1, "ego H. de Brattonne." Like OB and LF, LG has the *lacuna* near the end of the treatise of Novel Disseisin, the text reading, "vel stricte. Si autem plures fructuarium valebit." In the

¹ An interesting Middle English poem, from about 1300, is to be found imbedded in a mass of memoranda written upon what were originally empty leaves at the end of the volume. See *Modern Language Review*, Jan., 1909, and Jan., 1910.

Incipit and *Explicit* the name of the author is spelled Brattone or Bratone. The name of John Godbold, Recorder of St. Edmundsbury and serjeant at law, occurs twice at the end of the volume.

LT. Library of the Middle Temple, MS. 6 Seat A. F. 15. XIII-XIV cent., single columns, court hand. $10\frac{7}{8} \times 7\frac{3}{8}$, $10\frac{1}{4} \times 6\frac{3}{4}$, $8 \times 4\frac{3}{4}$. 41-43 lines to a page. 361 folios of text are preceded by a table of contents of 12 folios which begins, "Incipit tractatus de legibus et consuetudinibus regni Angliæ tempore regis Henrici compositus iustitiæ Gubernacula tenente ab illustri viro Henrico de Brattone iuris regni et antiquarum consuetudinum eo tempore peritissimo. Et illas solas leges continet et consuetudines secundum quas placitatur in curia Regis ad scaccarium et coram iusticiariis ubicumque fuerint. Incipit Prologus. Regiam potestatem non solum armis contra rebelles et gentes," etc.¹ After the end of the treatise on Novel Disseisin a new paragraph begins, "præmortuorum ut videtur" as on f. 262b of the printed text. In the margin is a note to the effect that twelve leaves are missing here. (Notice the same irregularity, with accompanying note, in CF above.) The name of Gilbert Atwyll is written on a fly leaf.

B. Library of the Marquis of Bath, Longleat, Warminster. Early XIV cent., double columns, charter hand. A table of contents of 9 folios+256 folios of text, Bracton being followed by the tracts *Cum sit necessarium*, *Cadit Assisa*, and *Iudicium Essoniorum*. $10\frac{7}{8} \times 7\frac{7}{8}$, $10\frac{1}{4} \times 7$, $7\frac{1}{2} \times 5(5\frac{1}{4})$. 50 lines to a page. Many of the *addiciones* are marked, some portions of the text are omitted, and references to the statutes of Edward I have become part of the text. The Action for Dower, omitted in the usual place, is inserted near the end of the treatise on f. 438b.

P. Bibliothèque Nationale, Paris, MS. Latin 4674. Early XIV cent., double columns, charter hand. A kalendar of 6 folios followed by 164 of text. After the Bracton comes a collection of statutes, writs, and short tracts.² $16\frac{1}{4} \times 10\frac{1}{4}$, $15\frac{3}{4} \times 9\frac{3}{4}$, $13\frac{1}{4} \times 7$. 67 lines to a page. Some of the *addiciones* are marked, and some have been put in the margins by a hand contemporaneous with that which wrote the text.

¹ The presence of this prologue in some of the Bracton MSS.—it is found in others besides LT—offers a simple explanation of the fact that the prologue to Glanvill precedes the text of *Fleta*. The author of the latter work in all probability used a manuscript text of Bracton which, like LT, was prefaced by Glanvill's prologue.

² For a further description of this MS. see the article by H. S. Milman in the *Law Magazine and Review*, N. S. II (1873), p. 397. See also the Rolls Series Bracton, I, p. lv.

PH. Phillipps Library, Cheltenham, MS. 8842. XIV cent., double columns, charter hand. A table of contents occupies pp. 17-41; the main text takes up pp. 47-529. $16\frac{1}{8} \times 10\frac{5}{8}$, $15\frac{1}{2} \times 10\frac{1}{4}$, $11\frac{1}{4} \times 7$. 53 lines to a page. On the first page of text is, "Roger Twyrden 1639." The names of Richard Dean and Edward Grafton are on the fly leaves. Incomplete, ending in sect. 2, f. 439.

W. Worcester Cathedral Library, MS. F. 87. XIII-XIV cent., double columns, court hands. A volume of legal writings (including *Glanvill* and the *Laws of William the Conqueror*) of which Bracton occupies fs. 23-217. 14×9 , $14 \times 8\frac{3}{4}$, $10 \times 6\frac{3}{4}$. 48-61 lines to a page. Five hands have had a share in writing the Bracton text. On f. 25b the end of what in the printed book is cap. XI, f. 7b, is followed by sect. 3, f. 63. On f. 29b, after cap. XXXI, f. 69, in the printed text, comes cap. XII, f. 7b. The Action for Dower is omitted on f. 164 of the MS. The end of the Bracton text is followed by "Incipit quot modis essonia sunt calumpnianda," a tract in twenty-one sections, after which is, "Explicit liber qui vocatur Bretun, et componebatur a quodam magistro Henrico de Bractone, doctore in iure civili et canonico, et postea iusticiario capitali Henrici regis per XX annos et amplius." Extraneous matter, including treatises on consanguinity and affinity, and references to Edward I and his statutes, has become a part of portions of the text.

X. York Minster Library. Early XIV cent., single columns, book hands. A single folio of kalendar + text proper (fs. 1-302 in MS.) + an incomplete table of contents. $12 \times 7\frac{7}{8}$, $11\frac{1}{2} \times 7\frac{1}{8}$, $9 \times 5(\frac{1}{8})$. 38-55 lines to a page. The main part of the text has been written by five different hands. Preceding the single folio of kalendar is, "Incipit liber de legibus et consuetudinibus Angliæ compositus a Roberto de Bractona, etc." On f. 302, at the end of the text, is, "Explicit liber de legibus et consuetudinibus Anglicanis compositus a Roberto de Bractona, etc." The name of Thomas Fairfax is on the first blank leaf of vellum. In some places references to the statutes of Edward have crept into the text. This MS. was formerly in the Library of St. Augustine, Canterbury.

Y. Yale University Library. Late XIII cent., double columns, in three hands. $12\frac{1}{4} \times 8\frac{3}{4}$, $11\frac{3}{4} \times 8$, 9×6 . 41-46, 41, 41-44 lines to a page. Lacking a table of contents. The text occupies pp. 1-645. The pages are sometimes numbered incorrectly, though the figures are in a hand as old as that of the

text, and the following are missing: 11-14, 45-46, 57-64, 133-136, 173-176, 199-204, 219-220, 310-311, 316-323, 385-390, 448-451, 559-560, 611-614. There are a number of marginal *addiciones*, especially in that portion of the book written by hand II. The names of A. Crevor, Robert Goldestone, and Willm. Bouschier are found in the margins. This MS. seems to have come originally from Bracton's own district, the name of Walter de Stapelton (Bishop of Exeter, and founder of Exeter College, Oxford) being written on p. 119,¹ and the town of South Moulton being frequently mentioned in a series of XVI cent. legal notes and memoranda in the margins of the later pages.

HA. Harvard Law School Library. (Formerly Phillipps MS. 136.) XIII-XIV cent., double columns, charter hand. 187 folios, no table of contents. $13\frac{1}{4} \times 9$, $12\frac{5}{8} \times 8\frac{1}{2}$, $9\frac{7}{8} (10\frac{1}{8}) \times 6\frac{1}{2} (6\frac{3}{8})$. 63, 59 lines to a page. The initial letters at the beginning of the books are in gold and colors, the first representing a king giving forth law. The leaf which should contain the beginning of book II (cap. III, f. 118, in the printed book) is missing. A number of the *addiciones* are marked with the red ink rubric *Addicio*. This MS. has been corrected and annotated by a contemporary charter hand. In the margins is an unusually numerous set of references to cases pertaining to Devonshire, *tempo* Edward I. See below, p. 85.

HB. Harvard Law School Library. (Formerly Phillipps MS. 3510.) XIII-XIV cent., double columns. A volume of miscellaneous legal matter in different hands, Bracton occupying fs. I-CXLIX, and being written in book hand. $16 \times 10\frac{3}{8}$, $15\frac{3}{4} \times 10\frac{1}{4}$, $12\frac{3}{8} \times 8\frac{1}{4} (8)$. 65 lines to a page. A number of the folios have been bound out of their proper order, but directions for the correct order have been written at the end of fs. XIII, XXV, XXXV. A number of *addiciones* have been marked by *Addicio* in the margin.²

Phillipps MS. 3097. Sold by Sotheby, Wilkinson and Hodge on April 27, 1903. Described in the catalogue of sale as follows, "Lot 176. Bracton (Henr. de) De Legibus et Consuetudinibus Angliæ Libri II, very fine manuscript of the thirteenth century written in a bold hand in double columns, on stout vellum, with decorated and colored capitals, titles rubricated, russia

¹ In a hand which is very similar to, if not the same as, that which wrote the text.

² Descriptions of both HA and HB will be found in the catalogue of the first portion of the Dunn Library, sold by Sotheby, Wilkinson and Hodge, 11-14 February, 1913.

tooled. Folio. XIII cent." This book was bought at the sale by Mr. Quaritch, and afterwards sold again, its present whereabouts not being made known.

Phillipps MS. 8126. See CM above.¹

In a list of some thirty MSS. of Bracton's treatise occurring in the article by Mr. Milman, "A Plea for a New Print of Bracton," in the *Law Magazine and Review*, N. S., Vol. I (1872), there is mention of one said to have been at that time in the possession of Sir Thomas Winnington at Stamford Court. All attempts to ascertain if the MS. is yet at the same place have proved unavailing.²

Though a stray folio or two of some Bracton MS. may be found occasionally, bound out of place in some other manuscript volume, and though there may yet be brought to light entire texts of the treatise which are now hidden, the manuscripts described above must, for the present at least, form the basic material from which a new text of Bracton is to be derived.

In the following pages the printed text (the texts of the three editions are practically identical), using the method of notation applied to the MSS., is referred to as V.³

¹ The entry in H. Ormont's *Catalogue des Manuscrits Latins et Français de la Collection Phillipps* (Paris, 1909, p. 195), "3098. Breton de Legibus Angliæ. Cambridge. McClean MS. 143," refers to a *Britton* and not to a manuscript of the earlier treatise in Latin. Until the appearance of James's *Catalogue of the McClean MSS. in the Fitzwilliam Museum* (1912) the whereabouts of the Phillipps MS. 8126 (= McClean 145), which had been sold from the Phillipps Library in June, 1896, was unknown to me. The kindness of the Director of the Fitzwilliam Museum, Sydney C. Cockerell, Esq., who very graciously allowed the MS. to be photographed entire, has since made it possible for me to examine the MS. in detail.

² By this same list Queens' College, Cambridge, is credited with a Bracton MS., but James's catalogue of the MSS. in that college shows a *Britton* instead of a Bracton.

³ For *Vulgate*. This name has already been applied to it by Maitland. See *Bracton and Azo*, p. xxxvii, and footnotes in following pages.

PEDIGREE OF THE MANUSCRIPTS

GENERAL FEATURES OF THE MANUSCRIPTS

If arguments were needed to prove the necessity of making a pedigree of the extant manuscripts of the treatise as the first step in the editing of a new text of Bracton, the three editions of his book which have been printed would furnish an abundance. In no spirit of cavilling we may say that the printed text of this work has been so far below the standard largely because the editors in their choice of manuscripts have shown little power of discrimination, and even less knowledge of the relationship of the different codices. Such knowledge could have come only as the result of a detailed study and comparison of all the manuscripts, and this, apparently, they did not undertake. Consequently it has come about that the main object of this volume is to establish a pedigree which will clear up once and for all the question of the relation of the many Bracton manuscripts to one another, and show their relative value for purposes of text production. The need of this is so apparent, and the doing of it so fundamentally necessary as a preparation for a correct text, that the time and space which have been devoted to the task can in no way be considered wasted.

For the present we are not considering the question of the correct text of any particular portion of Bracton's treatise. The work of making a pedigree of any set of manuscripts is quite different from that of ascertaining the correct text of the piece of writing which they represent. While for purposes of text criticism the manuscripts vary in value, one is just as important as another when we are determining the place which each must occupy in the family tree. A very little study would suffice to show that some of the Bracton manuscripts are practically worthless from a textual standpoint, and yet these same manuscripts must be subjected to just as close a scrutiny as the best of their kind when the matter of pedigree is under consideration. Indeed, it is upon the poorer class of manuscripts, the corrupt texts of which furnish a larger number of variants, that the greater amount of time and work

has to be expended. Even though the correct reading may be perfectly evident, and the variant an impossible form, it is the variant which is the important thing in deciding the lineage.

It should be kept in mind that everything pertaining to Bracton, even his use of Roman law, is thoroughly medieval. To understand any question connected with his book we must approach it from the standpoint of the medievalist rather than from that of the classical scholar or the modern lawyer. This applies, also, to the problems associated with the manuscripts of his treatise. Though written in Latin they are not like the written texts of early classical authors, and can not be treated as such. On first thought it might seem that the thirteenth and fourteenth century copies of this work on English law would have to be studied in much the same way as that in which the editor of a classical Latin text might study a copy of Cicero or Livy from the same period. Up to a certain point, along the broader lines of criticism, this would be true. In their entirety, however, the two cases are different, certain unusual circumstances connected with the multiplication of the Bracton manuscripts uniting to form a complexity of problems peculiar to themselves alone, and demanding special methods of solution. What the problems are in this product of medieval England, how they differ from those which confront the editor of an Augustan writer, will be seen better as the subject is taken up more in detail.

Viewed from any standpoint the *De Legibus* is a long work, as the four hundred and forty-four folios of the first edition, or the six volumes in the Rolls Series, testify. This bulkiness has had important bearings in more than one direction. Not only has its great length offered more opportunities than a shorter work would have done for the usual mistakes of every kind in copying, but the large number of folios—nearly four hundred of them in some of the manuscripts—has tended to increase the almost inevitable loss of some and the binding in wrong order of others. Moreover, the size of the treatise led to abridgments from the very first. When parchment was expensive, and the work of the scribe both slow and expensive, the copying of a Bracton was a matter of no small moment. To many a man desirous of possessing it and counting the cost of a new copy, the *De Legibus* must have seemed unnecessarily long and extended. Anything which could be cut out or passed over briefly, so as to decrease the amount of parchment required and lessen the scribe's work, would mean a real saving which we can hardly appreciate. To this consideration was added the fact that the steady stream of statutory

enactment after 1272 made increasing portions of Bracton's book more and more out of date. So we get shortened Bractons, mere epitomes of the original, some of them, which finally come to be hardly Bractons at all, but of as much use to their owners, perhaps, as the longer treatise would have been. These abridgments are of all sorts. One type is represented by LF, in which the cases and writs are regularly, and some other parts occasionally, omitted; OG illustrates another type which adheres closely to the language of its exemplar in those parts which it copies, but omits large sections seemingly at random. Much that was first omitted in OG has been inserted later in what is really a second division of the manuscript, making it appear that the first abridgment might not have been altogether satisfactory. CH, CD, CI, all represent the type in which excessive abridgment has made the text so unlike Bracton that collation is at best difficult, and in many places next to impossible. Among the abridgments must be included Thornton's *Summa* (see LE above), Fleta, and the popular Britton in Anglo-French—though all of these are attempts at rejuvenating and modernizing rather than shortening. The *Summa Cadit Assisa*, quite extensively copied in early fourteenth century collections of legal writings, is the rearranged text of a portion of Bracton with the language unaltered. To this list should also be added the *Magna Summa* of Hengham.¹ These compilations were made by or for individuals who were doubtless not all moved by the same motives in cutting down a work of recognized value, but many as the various reasons may have been, the fundamental one was clearly the excessive length of the parent treatise.

Two points in regard to these abbreviated Bractons should be noticed. First, that they are decidedly unprofitable in the work of establishing a pedigree, as they are in textual matters, requiring much time for examination and yielding but little evidence. In the second place they show, just as truly as the large number of unabridged manuscripts, that Bracton was exceedingly popular. Fifteenth century legal opinion has handed down to us the express statement that Bracton was never considered an authority in English law.² Be that as it may, it speaks well for the esteem in which the *De Legibus* was held, that instead of passing it over altogether, or of substituting for it a copy of the more modern Britton—itself based on Bracton, and probably more

¹ For the relation of Hengham's *Magna Summa* to the longer treatise, see *Four Thirteenth Century Law Tracts* (ed. Woodbine), pp. 15-20.

² "Bracton ne fuit unques tenus pur auctor en nostre ley," Fitzherbert, *Abridg.*, *Garde*, 71. But in contradiction to this, and as more indicative of the way in which the men nearer his own time thought of Bracton, notice that in the *Explicits* and *Incipits* of several of the MSS. he is called *dominus Henricus*. See especially the *Incipit* of LT and the *Explicit* of W, as given above in the descriptions of the MSS.

easily understood because written in the lawyers' own French—English lawyers of the second and third generation after Bracton should have gone to the trouble of making these condensed copies of his work. Some parts of his book, apparently, they were willing to omit; other parts, just as clearly, they were not well content to do without.

Of some writings, both classical and medieval, the number of extant manuscripts is so great as to form an almost unwieldy mass of material. The manuscripts of the *De Legibus*, though unusually plentiful when the size of the work and the short period of time during which they were produced are considered, are not so numerous as to make difficult the working out of a pedigree. Practically all of them come from the century after Bracton, many of them falling within a shorter limit of fifty years, and very few being written after 1350. Many of the classical authors have been preserved for us in sets of manuscripts which stretch over centuries, those of one age differentiated from those of another by certain distinguishing peculiarities which are of great assistance in solving many problems, especially in connection with the lines of descent. But here we have a set of manuscripts which, though multiplied sufficiently, are so limited in point of time as, with the exception of the very earliest and the very latest, to be lacking in distinct age characteristics. In compensation for this we might expect that among so many manuscripts, coming so soon after the death of an author at no great distance in the past, there would be preserved one which was very close to the original. Unfortunately, this is not the case. No one of the extant manuscripts is nearer than the third generation to the original, at the nearest; the majority fall in generations much further on. There is hardly a manuscript whose immediate ancestry has not disappeared. Numerous gaps in every line, from the beginning on, prove that the half a hundred copies now existing are only part of the number actually written. These gaps in the line of descent have more than overbalanced the advantage of a not too large number of manuscripts.

More serious even than this loss of intermediate manuscripts is the difficulty occasioned by what was the practice of some scribes of using more than one copy as an exemplar. Even among the earlier manuscripts we get evidence to show that the scribe either had at least two models before him, or that he was copying from one which had been derived from more than one source. This does not apply to all the manuscripts, but to a number large enough to deserve notice. Over and over again we come upon variants, usually connected by *alias*, inserted in the text. A very good example of this is found

in the collation, p. 137 below. As explained by the reference in the footnote at that place, an original *XX* had very early become *XV*, which one branch of manuscripts had altered to *XVIII* by changing the abbreviation of a following *modo* (three vertical strokes with a little *o* over them) into *III*. Before long this difference resulted in *XV* *alias XVIII* appearing in some codex. That it must have been an early one is made evident by its numerous progeny, one out of every five of the extant copies having this variant reading. An individual case of this same thing is the *telo vel telis* of CA, p. 150 below. On p. 159 the *voce voci* of LG illustrates the same tendency, *alias* being omitted.¹ Another proof of the comparison of texts is found in the way in which attention is drawn to the fact that the *addiciones* are really additional matter. Not only are they often marked by *plus*, *addicio*, or *extra*, but they are even introduced by such statements as, *hec clausula non reperitur in quibusdam libris, plus continetur in isto libro quam in alio, hic est plus quam in alio*. A study of the collated parts will show that some of the manuscripts agree with one line in the text proper, and with another line in the *addiciones*. But the chief difficulty in the work of assigning each manuscript its proper place in the family tree, lies in the fact that the great length of the treatise often led to its being copied by more than one scribe. Though some manuscripts, as OB for instance, may have the kalendar, text, and even the rubrics, in the same hand, an examination of the descriptions given above will show that in considerably more than a third of the extant manuscripts the text alone has been written in two or more different hands. That the size of the treatise was responsible for this there can be no doubt. Circumstances often must have made it impossible for a single copyist to have completed the whole work. In some instances it is clear that different parts of the work were apportioned to different scribes who worked independently of one another, perhaps simultaneously in some scriptorium. There are copies in which one scribe follows another, apparently in the most haphazard sort of way, as where in CD in the space of three folios as many different hands have done the writing, one to the amount of less than a page.

But the important point in connection with these manuscripts written by more than one hand is, as the collation shows, that often the different hands do not agree in their family lines, showing that frequently the various scribes

¹ Other instances of the same sort will be found in the collation below. Notice especially the *dividitur alias derivatur* of OF, f. 2b, l. 39; the *alias iudicium videlicet curiam videlicet* of X, f. 34, l. 38; the *aliquo sive alio* of LD, f. 414b, l. 6, the *aliquo alio* of MC, f. 415, l. 24; and the *servitium vel servitus* of HB, f. 35, l. 18.

of the same copy did not make use of the same exemplar. This fact is not hard to explain. A man might have borrowed several volumes from friends, and set to work at once as many copyists as they would supply—in a scriptorium, perhaps, or elsewhere.¹ If scribes many miles apart were working at the same time on a new codex they would naturally use different exemplars. The transition from one hand to another is at times so marked as to suggest that considerable time had elapsed after one copyist had finished his work before the other began. In the interval the unfinished book may have changed owners and been carried far away from the place of its inception, so that the very circumstances of difference in time and place may have forced the second writer to have used a model quite different from that of the first.² On the other hand, there may well have been instances in which many hands copied out a new book from one original, as in the easily supposed case of a monastery where various monks took turns at reproducing a Bracton belonging to the library. MN is perhaps a manuscript of this sort, four of its six hands being collated in the passages below, and all belonging to the same line. In order to be certain of the exact relationship of all the different hands in every manuscript it would be necessary to collate portions of them with corresponding parts in every other manuscript, a task of such proportions as to be practically coextensive with a complete collation of the whole treatise. And this, of course, is out of the question. Moreover, the main facts in the situation are clearly enough shown in the collation here given. It is only necessary to add that this practice of copying and recopying from more than one exemplar began early and lasted late, and has produced a complicated network of lines of descent which it is almost impossible to straighten out.

¹ We have records of the loaning of Bracton MSS. See in regard to the loan of a Bracton (for several months) made by Robert Burnell, Lord Chancellor, in 1277, *Selden, Diss. ad Fletam*, II. 2. See also *Bracton and Azo* (Seld. Soc. V11), 240.

² MS. Y offers a case in point. The first scribe ended his work with *tamen misericordia compassionis est* (near the very end of f. 107b of V) in a broken line about four-fifths of the way down the first column of p. 143. The second scribe began at the point where the first left off and wrote through *mentio in brevi de dignitate* (f. 189b, l. 42 of V), completing the first column on page 266. Copyist number three finished the book from this place on, besides writing most of the rubrics. But the work of the first scribe had been done so long before that of the third that two folios in the first hand had already been lost, so that the last scribe was forced to rewrite the first folio in the book and that which now is paged as 119, 120. Each of the hands follows a different text tradition, and there is every indication of a lack of any preconcerted arrangement between the scribes. Everything points to the probability of the third scribe having been deliberately set to work to round out and complete a fragmentary portion of the *De Legibus* on which two scribes had already worked at different times. It is possible that the work may have been done for Walter de Stapelton, bishop of Exeter, whose name occurs on one of the pages which the third scribe had to insert to make up for missing folios in the work of hand I.

This subject of recopying can not be dismissed without a reference to the correcting hands in the Bracton manuscripts. The ease with which corrections in one text are absorbed into another makes them important in any set of manuscripts. But our case is not comparable to that of correcting hands in manuscripts of classical texts. In the early copies of the *De Legibus* the corrector is very seldom concerned with the question of making an incorrect text sound. The changes are made by men who are interested not in grammar or syntax but in practical law. It is not a scribe or grammarian who alters the text, but a working lawyer, who does it for his own convenience, in order to make the passage before him more clear to himself, to correct what he considers wrong law, or to modernize a rather obsolete statement. And often he does this in no sparing way. Then this corrector may not only alter and delete, but may even make additions of his own, sometimes very extensive ones, as we shall see. At times, too, he uses the margins of his manuscript as space in which to write down legal matter, and often other matter, in no way relating to that part of the text opposite which it stands. Several sets of these corrections and additions extending over a number of generations may be found in some volumes, but as touching the matter of pedigree the problem is simplified by the fact that as none of our extant manuscripts comes from a later date than 1400, the question of sixteenth and seventeenth century corrections can have no important bearing.

It would simplify our work of making a pedigree if at the beginning, by some easily noted differences, we could classify the manuscripts in certain well-defined groups. But here again we come face to face with a very unusual situation. In probably no other set of manuscripts, ancient or medieval, is there such a diversity of external form independent of differences in the text. Anything more than a cursory examination will show that these thirteenth and fourteenth century copies of Bracton's book differ among themselves in three broad lines of divergence, namely, in regard to the points of division in the treatise, the order of subjects, and the treatment of the *addiciones*. That much is plainly evident. But when we attempt to go further, and on the basis of these differences build up groups in which the differentiation is distinct enough to make them at the same time inclusive and exclusive, we find a definite classification impossible. Some sort of information these sets of differences do give us, but it is of the broadest and most general kind, and of little determining value unless aided by the far more precise evidence derived from collation.

THE DIVISION OF THE TREATISE INTO PARTS

Consider first the division of the treatise into parts. The printed edition is divided into five books, of which the first is a very short one of eight folios, and the third, fourth, and fifth, composite books, being made up of, respectively, two, seven, and five separate treatises. This is, for the most part, a reasonable and natural division, and one backed up by the authority of several manuscripts. But it is not the only one which might rest on such authority, nor is it the one followed by either the majority or the best of those copies which have come down to us. That Bracton for his own convenience must have worked with some broad outline of his work in mind probably no one will deny. His very method—clearly he was forced to write by subjects—presupposes as inevitable such a plan. This scheme, at least in a general way, we might expect to find in all the copies of the original treatise; even in the differences we might look for a certain broad similarity. When one codex makes a division into four books, and another into five books, all but one of the points of division might be expected to agree. But such is far from being the rule. So great a dissimilarity is there in this respect, that it is not at all unusual for two manuscripts to agree as to the number of books and be wholly at variance as to the portions of text which the respective books should contain. Often the only division is one of chapters or sections, in which again there is no agreement as to content. It would naturally be supposed that the greatest differences in this matter would be found in manuscripts most widely apart in the lines of descent, while similarity would point to close relationship. Inevitably this must be true in some cases. But the exceptions are so numerous that it can not be accepted as a general rule. Take for instance the case of OB, LG, LF. As the collation shows, all three agree very closely in every place where the text is compared. The first two are divided into five books. LF agrees with them as to the place where the second book should begin, but continues it through their third and fourth books, beginning its third book where they begin their fifth. Then at what is the end of the treatise in the other codices LF adds a fourth book made up of a hitherto omitted portion of the first book. OF and MG agree even more closely than OB, LG, LF, showing a remarkable similarity throughout the entire collation. Each is written from beginning to end by the same hand. Yet MG is divided into four books, while OF is carefully arranged into blocks of a hundred chapters, or *centenæ*, without even the suggestion of a division

into books. LE, which is likewise divided into *centenæ*, does not at all agree with OF. Sometimes the table of contents will furnish a scheme of division which the text will ignore, or *vice versa*. This may be due to the fact that the kalendar is often written in a hand different from that of the text, perhaps from a different exemplar. Taken altogether the variety of differentiation is so great as to require a statement of details before any conclusion can be reached.

These details can be given most clearly in the following rather tabulated form. OD, PH, CF, LT, have the same, or about the same, arrangement as that given in the Vulgate; OC has been divided according to the same scheme by hands much later than that of the text; MF, only partially arranged, follows this order.

Book two begins at cap. IX, f. 107—*Cum autem de regimine sacerdotii*, in OA, OB, OE, MC (not in text, but in table of contents, and by different hand in lower margin), MD (marked in margin by different hand), MI, CE (marked in margin by contemporary hand), LC, LF, LG, P; at cap. III, f. 118—*Cum sint quædam crimina capitalia*, in X, MA (marked in table of contents by large capital letter, and in text by later hand), MD (in table of contents, in text by large capital in gold and colors, in margin by different hand), MG, HA, CB; at cap. IV, f. 120b—*Est etiam inter alia crimina*, in Y.

Book three begins at cap. III, f. 161—*Dictum est supra qualiter possessio*, in OA, OB, OE (in kalendar, text skips passage), (MA has figure 3 in margin), MC (in kalendar, and by *lib 3* in contemporary hand in margin), MG, MI, CA, CB, CE (marked by *Liber tertius* in margin), HA, LC, LG, X, Y, P; at cap. I, f. 159b (as in V), in MA, MD.

Book four begins at cap. I, f. 327b—*Expedito tractatu de assisis et recognitionibus*, in OA, OB, OE (in kalendar, text skips passage), MA, MC (in table of contents, and by *Liber 4* in margin), MD, MG, MK (by *L IIII* in margin), MN (by *Liber quartus* in margin), HA, HB, CB, CE (by *Liber quartus* in margin), LC (by late *Liber 4* at top of page), LG, P, X; at sect. 6, f. 328b—*Rex ballivis suis de tali villa salutem*, in MI. (At cap. I, f. 327b, LF begins book three.)

Book five begins at cap. II, f. 400b—*Est etiam iurisdictio quædam ordinaria*, in OA, OB, OE, MC (in kalendar, and by *Liber 5* in margin), MI, CE (by *Liber quintus* in margin), LG, P. (At this point LF begins book four, adding at the end of the treatise as a fifth book fs. 62b-107 which have been previously omitted.)

MB and LB are divided by quires. OM is divided into eight books, the points of division being: cap. XII, f. 7b; cap. XXIX, f. 62b; cap. I, f. 98b; cap. I, f. 159b; cap. I, f. 296; cap. I, f. 317b; cap. I, f. 327b. CH is divided into seven books, of which the first ends on f. 34b of the printed text and the second begins at sect. 3, f. 38b. Book III begins with cap. I, f. 98b; IV with the treatise *De Corona* (the second treatise of the third book in V); V with the Assise of Novel Disseisin; VI with a passage from f. 207b; VII with the Writ of Right. OF and LE, as already noted, are divided into *centenæ*. In ML the kalendar divides the text into 380 sections or chapters; similarly MC is divided into sections as follows—bk. I, 254; II, 326 (corr. to 322); III, 443; IV, 340; V, 244 + 4 of extraneous matter. Attention has already been called in the description of MB to the fact that this manuscript is arranged in its index by sections and chapters. Those manuscripts not mentioned here have been passed over because they show no noticeable plan of division.

Taken altogether this evidence is far from satisfactory. Instead of answering the old questions it raises new ones. It does not definitely tell us into how many parts or at what points the *De Legibus* should be divided. What it does show is that there is no one scheme of division which the manuscripts as a whole follow. So far as a given number of books is concerned the codices seem to choose five, though an apparent agreement in this particular is weakened by their failure to decide upon the same points of division. The point which stands out most prominently in these various schemes is the beginning of the treatise on the Writ of Right (f. 327b), marking the commencement of book four in one set of codices, of book five in another, and in individual copies of book three, seven, eight. Next in prominence is the place at which the Assise of Novel Disseisin begins. Book three in one group, book four in another group of manuscripts starts here, though it should be noticed that the latter put the beginning of this subject two short chapters in advance of the place where it starts in the other group. This same inability on the part of these two sets of manuscripts to agree upon the point at which the treatment of a new subject begins—due probably to the ease with which Bracton passes from one topic to another—is seen at another place, namely, at what in V is the beginning of *De Exceptionibus*.¹ OA, OB, OE, etc., begin their fifth book at the second chapter of the last treatise in the printed text and its authorities. The first chapter is short—about a folio in

¹ F. 399b.

length—and it is evident that in each case the intention is to mark the point at which the treatment of warranty ends and a new subject begins. As will be shown below,¹ this new subject is that of exceptions, but because chapter two takes up the consideration of exceptions which may be raised against jurisdictions, and because a general discussion of jurisdiction continues through chapter sixteen, OA, OB, etc., would start their fifth book with the title *De Iurisdictionibus* instead of *De Exceptionibus*. An even greater variety of choice is offered earlier in the treatise. There seems to have been a feeling on the part of those who were making the different schemes of division that a break should occur at the point where Bracton turns from the discussion of actions in general to the more limited and specific topic of criminal actions in English courts. The printed book puts this point at f. 115b; the manuscripts variously choose f. 107, 118, or 120. Such confusion hardly settles anything definitely.

As far as there is any general division into books we have two principal schemes, that of V, and the one followed by OA, OB, etc. Each has been laid out on the basis of a division of subjects. That of V is perhaps the more obvious; even a very rapid glancing over of the text will show what it is. The other scheme has been outlined in the rubrics of some of the manuscripts which have been preserved. All of these manuscripts belong to the same family; somewhere back in their line of descent they had a common ancestor with these long rubrics at the beginning of the books.² Numerically considered, therefore, they should count as one instead of many, since they represent a single head. The fact that, by chance, a large number of descendants of this progenitor have come down to us, does not make that particular codex count for any more than the head of another line whose progeny have disappeared. For the present the important thing about these manuscripts is not their number, but these unusual rubrics. For purposes of comparison we will give with these rubrics those lines in the text of V which have determined its division.

At the beginning of book two (f. 8b) V has, “*Dictum est supra de rerum divisione, nunc autem dicendum est qualiter dominia rerum acquiruntur, de iure naturali sive gentium.*” Preceding its second book (f. 107 of V) OE

¹ See below, p. 59.

² These MSS. are OB, OE, MA, MD, MI, LG. Not all of the rubrics are found in each MS. MA and MD are the least closely connected with the others. OE, which is written in more than one hand, agrees with more than one line, but principally with this. In OB and LG large portions of vacant space, in addition to the rubrics, precede the new books.

has, "Expeditis tractatibus de iure personarum et rerum divisione, et distinctione cartarum, de obligationibus et actionibus cum eorum adminiculis. Nunc autem dicendum erit in secundo tractatu de divisione iurisdictionis sacerdotii et regni, et differentia iusticiariorum, et placitis coronæ, et de possessione nuda, et quare dicitur nuda, et qualiter nova disseisina in parte sapit naturam intrusionis quod dicitur nuda possessio." The rubric for OB at the same place reads, "Incipit liber secundus de regimine iurisdictionis regni. Et primo ad quod certatus (for creatus) sit rex et eius potestate, et qualiter iusticarii sunt instituendi, et eorum potestate, et de omnibus placitis coronæ, tam de pace et plagis quam de feloniam et murthero, et omnibus appellatis, tam de feloniam quam de aliis rebus, ut supra in kalendariis."

In V the text of the third book (f. 98b) begins, "Dictum est supra de personis et rebus, nunc autem dicendum est de actionibus." OB has as a rubric at the beginning of its third book (f. 161 of V), "Incipit liber tertius de assisis, tam de possessionibus quam de iure. Et primo de nova disseisina et eius pertinentibus, qualiter fieri debeat, tam de iure et pertinentibus quam de possessionibus. Et de assisa ultimæ præsentationis et eius specibus, et quare impedit, et quare non permittit, et de assisa utrum, et assisa mortis antecessoris, et variis eius specibus, de attinctis et convictionibus et certificationibus, de actione dotis, quid sit dos et qualiter contrahatur, et omnibus suis pertinentibus, et de wasto et de huiusmodi, et de placito de ingressu et intrusione, et aliis ut supra in kalendariis qualiter amissa possessio dictum est supra."

V has at the beginning of its fourth book (f. 159b), "Dictum est supra de actionibus criminalibus, et iniuriarum quæ personales sunt, et pertinent ad coronam domini regis. Nunc autem dicendum est de actionibus civilibus." The rubric to the fourth book of OB (f. 327b of V) is, "Incipit liber quartus de iure et proprietate de tractatu super brevi de recto, de essoniis et dilationibus in eodem brevi accidentibus, de cartis producendis et warentis vocandis, de exceptionibus diversis, et aliis quam pluribus dicto tractatui pertinentibus."

The fifth book of V, starting at the same place as the fourth book of OB, begins, "Expedito tractatu de assisis et recognitionibus, quæ proditæ sunt iure possessorio, ad seisinam propriam, vel alicuius antecessoris ut de feodo recuperandam: et similiter expedito tractatu placitorum de ingressu assequendo, consequenter agendum erit de placito super iure et proprietate, de seisina propria vel alicuius antecessoris," etc. Preceding the fifth book in the other scheme (f. 400b of V) OE has the rubric, "Dictum est supra in quarto

tractatu de placito super iure et proprietate, de seisina propria vel alicuius antecessoris, et de essoniis et aliis dilationibus in dicto placito accidentibus, et de cartis producendis et warantis vocandis et de diversis exceptionibus. Nunc autem in quinto tractatu dicendum est de iurisdictionibus, et de hiis quæ pertinent ad forum seculare et ad forum ecclesiasticum, et de diversis prohibitionibus, et de brevi quod dicitur Indicavit, de minoribus infra ætatem existentibus, et de diversis warantiis de exceptione bastardia, et aliis diversis exceptionibus de solempnitate attachiamentorum in quibuscumque actionibus. In fine autem quarti libri agitur de exceptione quæ proponitur contra iurisdictionem. Et ideo nunc primo videndum est quid sit iurisdictionis, et quæ sint eius divisiones."¹

From the foregoing, two things are evident. First, that the new books in V have been begun at points where the text itself notes a change from one subject to another; and second, that although OB, OE, etc., start their new books with new subjects, the change to the new subject is not, with one exception, so plainly marked in the text. Moreover, the rubrics of OB and OE look as though they had been made up from the perusal of some table of contents rather than from a study of the text. Those of OB deliberately refer to the table of contents with, "et aliis ut supra in kalendariis." Subjects are not always arranged according to order, as in the rubric to book three. A smaller subject is sometimes given equal prominence with a larger subject, as in OE's rubric to the second book. The supposition which will best explain them is that at first some kalendar was divided into books by simple marks of I, II, or *liber secundus*, *liber tertius*, etc., in the margin, and that later some copyist or rubricator made the briefest kind of synopsis of the matter included between these marks in the form of a rubric to stand at the beginning of the books so divided. From their form it is certain that they were not written by the author of the text, or by any one who understood thoroughly the subject-matter of the treatise. They have inherent in themselves no more authority for their arrangement of books than the rubrics in LT have for the arrangement found in V.² In both cases we shall have to get

¹ MI starts this rubric with, "Quarto libro finito. Incipit liber quintus," etc. OB has, "Incipit liber quintus. Decimo libro pertinens de iurisdictionibus," etc. LG reads, "Incipit liber secundus (*sic*) decimo libro pertinens de iurisdictionibus," etc. The *decimo* has of course come from the Roman numeral V with a small *o* or *to* over it having been changed to X merely by the prolongation of one or both of the downward strokes. The reversal of this by the shortening of the strokes has caused an original XX in Bracton's text (f. 96) to become XV.

² In the kalendar at book III, LT has in red ink, "Capitula libri tertii. Et dividitur iste liber in duos tractatus quorum primus tractatus est de actionibus civilibus. Et incipit ibi, Dictum est supra de personis et rebus. Secundus tractatus est de actionibus criminalibus, id est de corona. Et incipit ibi, Acta coram Iusticiariis Itinerantibus."

behind the rubrics to discover the relative merits of the two divisions. This can be done most easily by the comparison of at least a portion of their respective schemes.

V begins its second book at the point where Bracton turns from the discussion of the division of Things to a consideration of the ways in which dominion over Things may be acquired. The words at the beginning, "Dictum est supra Nunc autem dicendum est," seem to mark a new starting point in the text. They do, but not necessarily the beginning of a new book. These are the words with which Bracton over and over again, throughout the length and breadth of his treatise, starts a new subject. Four times in this short first book we find chapters beginning with the same mode of expression as that with which this second book begins.¹ In a hundred and one other places we may see the same words performing this duty of introducing a new chapter. If Bracton were going to begin a new book anywhere in this part of his text we might most reasonably expect it one chapter earlier, when he turns from Persons to take up Things. He is following Azo's *Summa* of the Institutes closely in this section of his treatise, and both Azo and the Institutes begin a new book with the subject of Things. The reason why V's manuscript exemplars have made this non-Roman division at what is in the midst of a title of the Institutes, is because the main subject of the next 90 folios—*De acquirendo rerum dominio*—begins at this point. If Bracton himself had made the division, we fancy he would have followed more closely the leading in Azo's rubric, "Incipit (liber) secundus de rerum divisione et acquisitione."

The third book of the printed text begins at a place where there is a distinct change from one subject to another. Bracton has treated of Persons briefly, of Things at considerable length, and now starts on an entirely new subject, that of Actions. The point at which this subject begins is clear enough. But where did the author intend to have it end? V marks out for it a division which is at variance with the plan followed in many of the better manuscripts; yet this arrangement in the printed book is a logical one. Moreover, it is altogether probable that it is the correct one, that V, and not OA, OB, etc., has divided the treatise at this place as Bracton intended.

¹ Very often in the MSS. the chapters are not divided as in V. Where *Dictum est supra* occurs in the midst of a section in V there is often the beginning of a chapter in the MSS. Following at least some of the MSS. we would begin a new chapter with *Dictum est supra* at the end of sect. 3, f. 3b; with sect. 8, f. 4; with cap. VI, f. 4b; with cap. IX, f. 6 (omitting new beginnings at cap. VII and VIII); at cap. IX and X; and at sect. 2, f. 6b. "Title," rather than "chapter," should be the word used to designate one of these larger divisions of Bracton's text. See below.

Glancing again at the rubric with which OE begins its second book we notice that it makes a reference to the treatises (*Expeditis tractatibus*) contained in the first section of the work. Quite evidently in OE's family it was considered that the first book of the *De Legibus* was subdivided into parts. Those parts were apparently three (the commas are ours, as there are no marks of punctuation in the original), namely, *de iure personarum et rerum divisione*, *de distinctione cartarum*, and *de obligationibus et actionibus*. The first division agrees with book one of V; the second is a single chapter, the sixteenth, of V's second book; the third is the subject of Actions. Having thus referred to the first book, in retrospect as it were, OE enumerates some of the matters to be found in the second. It does not call it a *liber*, but a *tractatus*. That it means *liber* in this connection there can be no doubt. After dividing the first book into at least three treatises, OE could not well speak of something coming after as the second treatise. Moreover OB, which makes the same divisions and has about the same rubric, calls it a *liber*. The word is used more than once again in these rubrics, by OB at the beginning of the fourth book to denote a treatise—*de tractatu super brevi de recto*—and twice in OE at book five to designate a *liber*—*quarto tractatu* and *quinto tractatu*. According to these rubrics, then, *tractatus* may mean either one of the books into which the *De Legibus* may be divided, or a subdivision of one of those books. How does Bracton himself use the word in connection with the work he is writing? On f. 1b it is to be met with twice, "in hoc autem tractatu, sicut in aliis tractatibus," and "et de hiis habere tractatum." In both these places the context shows that he is thinking of his whole work when he writes *tractatus*. But he uses the word in other senses also. Near the end of f. 21 we read, "secundum quod inferius dicetur in tractatu de dote." On f. 39 he speaks of the treatise of Novel Disseisin.¹ On f. 327b, at the very beginning of the Writ of Right, he uses it twice, each time in a different sense, once in a collective way, as *liber*, to include the several treatises on the possessory assises, and again to denote the single treatise on Entry.² In any one of these last three cases the word refers to a portion of the work, and not to the whole work, in this respect being used with the same meaning as in OB and OE. In other words, Bracton definitely thought of his book as being composed of certain treatises.

¹ See also f. 414b, "secundum quod superius dicitur in tractatu de disseisinis"; and sect. 3, f. 329 b. "De summonitionibus . . . nolo inserere huic tractatui propter diversas consuetudines . . ."

² Worthy of notice in this connection is a passage on f. 265, ". . . pertinet ad tractatum de bastardia, ut infra dicetur plenius, ubi apponitur bastardia in modum exceptionis."

Turn once more to the place where OA, OB, etc., begin their second book, f. 107. Chapter eight ends with the statement that there is a great difference between the *sacerdotium* and the *regnum*. "But," says Bracton at the very start of his next chapter, "since nothing in regard to the regulation of the priesthood has to do with this treatise, therefore we must consider those things which pertain to the kingdom." To what does *ad tractatum istum* here refer? Is it to the work as a whole, or to this particular treatise on Actions? The word itself will not tell us, because from Bracton's use of it elsewhere it might be taken in either sense. The context may. Let *regimen* be kept in its Latin form; an English equivalent might narrow its meaning. *De Legibus* is not a work in which the *regimen sacerdotii*, as a subject by itself, is considered. Though in one place or another considerable space is devoted to a discussion of the relation of the clergy and of the courts Christian to the secular arm of the law, there is no special section of the treatise as a whole given over to the subject of the priesthood. From this standpoint *tractatus* on f. 107 might refer to the entire work. But is that what it is meant to do? It is hardly in so broad a setting as all that. These first words of chapter nine reach back rather than forward; they are connected by every essential of continuity with what has immediately preceded. Chapter eight has been devoted to the general subject of judges and judgments. Its last two sections begin the more specific topic of jurisdiction, which is also the subject of chapter nine. So close is the connection that on reading the text there is no feeling of any break between the two chapters. In section four of chapter eight the main ideas are these: he who judges should have jurisdiction; jurisdiction may be ordinary or delegated; with jurisdiction should go the power to put a judgment into execution; not every judge has jurisdiction and power in every case. Section five in its bearing on the point under consideration is important enough to be given in full, together with the first sentence of chapter nine:

"Sunt enim causæ spirituales, in quibus iudex secularis non habet cognitionem nec executionem, cum non habeat coercionem. In hiis enim causis pertinet cognitio ad iudices ecclesiasticos, qui regunt et defendunt sacerdotium. Sunt autem causæ seculares quarum cognitio pertinet ad reges et principes, qui defendunt regnum, et de quibus iudices ecclesiastici se intrmittere non debent, cum eorum iura sive iurisdictiones limitatæ sunt et separatæ, nisi ita sit quod gladius iuvare debeat gladium, est enim magna differentia inter sacerdotium et regnum.

“Cum autem de regimine sacerdotii nihil pertineat ad tractatum istum, ideo videndum erit de iis quæ pertinent ad regnum, quis primo et principaliter possit et debeat iudicare.”

Here one idea follows another in the closest kind of way. Chapter nine begins no new subject, nor does chapter ten, for the principal topic of the one is ordinary jurisdiction, and of the other delegated jurisdiction, both of which subjects have already been started in section four of chapter eight. The main thought lying in section five is the difference in the jurisdiction of the two sets of courts. Just as the cognizance of secular cases belongs to the king and leaders, *qui defendunt regnum*, so that of spiritual cases belongs to the ecclesiastical judges, *qui regunt et defendunt sacerdotium*. In the author's mind there is apparently a connection between *regunt* and *regimine*, he is thinking of the ecclesiastical judges, of the jurisdiction of the spiritual courts, when he writes *sacerdotium*, just as the thought lying behind his frequent use of *regnum* is clearly that of the jurisdiction which pertains to the *regnum*. Nothing could be more evident than that he is mentally contrasting one jurisdiction with the other. His “de regimine sacerdotii” means “de regimine iurisdictionis quæ pertinet ad sacerdotium.” This is the sense given to it by the context, and the sense, also, in which it was understood by the rubricator, as the rubrics to sections five and one will show.¹ In this sense it will not allow *tractatus* as used at the same place to refer to the whole work, for the jurisdiction of the priesthood and the ecclesiastical forum is discussed elsewhere, especially after Bracton again takes up the subject of jurisdiction on f. 400b.² *Tractatus* must, therefore, have reference to the treatise on Actions. Its use connects chapter nine with chapter eight, as does the text as a whole, and shows that the author has not yet come to the end of the special treatise of which these two chapters form a part. But whether this subject of Actions should end at the place where it does in V or go on further, is a question open to discussion.

Of Actions, in one form or another, Bracton continues to treat for the rest of his book. Yet in the text he very clearly subdivides this large subject. Civil actions in English courts are separated from English criminal actions;

¹ The general subject of the rubrics will be considered later. In spite of many differences there is a rather remarkable agreement in the rubrics of the different lines.

² That *tractatus* at this place did not refer to the whole treatise, was the opinion of at least one man (and perhaps two), who lived not long after the work had been finished and was responsible for the rubrics in Y and MA: “De regimine iurisdictionis regni quia de sacerdotio nihil ad præsens.” LA has this same rubric in its table of contents. In MB's arrangement “De regimine iurisdictionum et regni” comes as the fourth rubric under “Capitula de eo quod dicitur quid sit iudicium et in quibus consistit officium.”

criminal actions just as plainly form a section by themselves, but the point at which this subject branches off from that of Actions in general is not so easily seen. In the first place it should be pointed out that the rubrics of OB, OE, etc., which seem to answer the question so satisfactorily by putting all between fs. 107 and 161 into one book on the general subject of the jurisdiction of the kingdom, considered under the topics of the king, his justices, the pleas of the crown, have made a division which is specious rather than real. These rubrics would apply equally well if OA, OB, etc., had begun the second book two, yes, even four, chapters earlier, for chapter five is just as thoroughly devoted to the subject of pleas of the crown—English criminal law—as any chapter in the following treatise of *De Corona*. Moreover, as has been pointed out, the subject of jurisdiction begins before chapter nine. Professor Maitland, taking OA as his model for this matter of a division into books, decided that the beginning of chapter nine would be a very natural place for Bracton to have begun a new book, as being the point at which he turns from Roman to pure English law.¹ But chapter nine does not mark that point. Bracton begins his borrowing from Roman law at the very start of his work. And almost from the start, sections that are thoroughly English follow sections which are thoroughly Roman in their origin. In some portions the English predominates, in other the Roman; there are large sections in which the balance between the two is nearly equal; but for the first 115 folios there is this mingling of the two kinds of law. The treatise on Actions is made up of alternate layers of law from the two sources. In the first three chapters the matter is either largely taken from, or suggested by, Azo or the Institutes. Chapter four is a mixture of both English and Roman material. The fifth chapter is English law pure and simple; the sixth is again largely taken from the Roman; in the seventh, Bracton once more reverts to English law. The eighth, at least at the beginning, is Roman. But Bracton's references to his Roman sources do not end with chapter eight any more than his purely English law begins with chapter nine. Chapter ten treats of the delegated jurisdiction of the judges, their power, and how that power may be brought to an end. Then follows a chapter, consisting largely of the forms of writs, on the itinerant justices. Section one, and a part of section two, of chapter twelve continue this topic of the justices, but the remainder of this last

¹ "He has run through the Institutes, taken them as his guide, and borrowed from them all that seemed useful. . . . The remainder of his treatise will indeed be devoted to actions, but he has now won his way to safe English ground, and in his arrangement of topics he will no longer be guided by the Roman text book. . . . Nevertheless, there is a close connection between his second book and his first." *Bracton and Azo*, 199.

chapter in *De Actionibus*, dealing with the order of actions, is in very close dependence on Roman exemplars. In fact, it is this last chapter which contains "the most learned piece of Romanism in the whole of Bracton's treatise."¹ With chapter twelve Bracton finishes with his Roman law books; with the same chapter he finishes the subject of jurisdiction which he had begun in chapter eight.² It is the end of chapter twelve, not of eight, which marks the real break; it is at chapter one on f. 115b that he ceases to speculate and theorize on Roman suggestions, and turns to a straightforward exposition of the law of English criminal actions.³ With *De Corona* begins a new portion of the treatise on one kind of actions, just as truly as with the Assise of Novel Disseisin begins another portion on another kind. The arrangement of *De Actionibus* in V is therefore both logical and justifiable.

It may be objected that this is going contrary to the scheme of division in the "better" manuscripts. In this matter there are no "better" manuscripts. It is something quite apart from the question of text value; and usually, also, external to the text of the individual manuscript. As has been noticed above, one line of codices, which for convenience we may call the OB line, is clearly divided into books by rubrics in either the kalendar or the text, or in both. But there are very few manuscripts in which the division has been made coincident with the writing of the text, or in the same hand. Usually a different hand from that of the text, sometimes a later hand, has written at the top of the page or in the side margin, of either the text or the table of contents, a *Liber quartus*, or *IIII*, or a plain 4. More than one set of these divisions may be found in the same volume. MB, for instance, originally divided by *capitula*, has been again divided according to quires by large, colored Roman numerals at the top of the pages, while a portion of the kalendar has been divided into books corresponding to the quires. MC is not divided into books in its text, but in the table of contents a different hand has made such a division, and this is again noted by yet another hand in the margin of those pages on which the points of division occur. MA and MD

¹ *Bracton and Azo*, 211. It may be pointed out that though Professor Maitland, following OA, would end book I on f. 107, in *Bracton and Azo* he continues Bracton's text through f. 115, up to the point where V ends *De Actionibus*. This is because he is comparing this portion of *De Legibus* with its Roman exemplars, and f. 115 rather than f. 107 is the natural stopping place for such comparison.

² Though he had OA's scheme in mind, the author of *Bracton and Azo*, p. 199, could not fail to notice the continuity of this subject of jurisdiction. "From this point (i.e., cap. VIII where he takes up the subject of the *iudex*) onwards until he begins his account of the criminal procedure before justices in eyre, he is concerned with the question of jurisdiction."

³ "And now at last, all speculative questions being solved, Bracton can turn to the procedure of the justices in eyre." *Bracton and Azo*, 218.

mark the beginning of their second and third books by large ornamented letters in the text, but in both these manuscripts, hands different from the text have, by directions in the margin, begun these books elsewhere. It is not necessary to multiply examples. It is important to emphasize the fact that most of these divisions of the text by books stand apart from the text itself. There is always the suspicion that divisions made in this external sort of way have been taken from a source other than that from which the text has been derived. With so many of the manuscripts copied from more than one exemplar we can not be at all sure as to the origin of the external features of a codex. When the evidence is thoroughly analyzed the manuscripts really give us but little authority to begin a book at any special place. Consider the case of the second book which has just been taken up. Referring to the data above it will be seen that the authority for beginning book two at f. 107 rests on eleven manuscripts. This is about one-fourth of the total number examined; actually in point of numbers it stands for considerably more than one-fourth, for many of the copies have no scheme of book division. On first sight it would appear that the authority for adopting the plan of these manuscripts was quite adequate. But of the eleven codices, OB, OE, MI, LC, LF, LG, are so closely related as to count as one. Of the other five, MD has been marked by a different hand at the wrong place, its text and kalendar both showing that it began the second book on f. 118. MC, CE, P, are not divided in the text, but by different hands in kalendar or text margin. This leaves OA to be considered. Here is a codex about which more has been written than about all the other Bracton manuscripts combined; it is one of the best which has been preserved, the very best as far as the *addiciones* are concerned; from it we might expect to get some definite information about this second book. We are not disappointed. The information it gives is very definite as far as it is itself concerned. It tells us most plainly that in the manuscript from which this portion of OA was copied, the second book did not begin at the place now marked. Turn to f. 55b of OA and 107 of the printed text. At the top of the page OA has in large colored capitals, *Liber Secundus*. The next most noticeable thing on the page is a large ornamented C, drawn in the margin, as close to the line of the text as possible, opposite the beginning of chapter nine in V. Now look at the text in the manuscript. The last words of V's eighth chapter have ended a line, neatly and evenly. The next line begins even with the line above, *Cum autem*, etc. *Cum* has a capital C, but it is the small, plain capital which begins a sentence or a section, not the large capital which

starts a chapter. That sort of capital is seen near the bottom of the page in the D of *Dictum* (chapter X of V). In other words, there was not only no new book at this point in OA's exemplar, but not even a new chapter. If there had been, the scribe would have left the usual indented space for the capital C as he did below for the capital D. At a later time some one, a rubricator probably, wrote the bold *Liber Secundus* at the top of the page, and in the margin made the redundant, though ornamented, C for which no space had been left in the text area.¹ Definitely, therefore, OA tells us two things here—that the text might be taken from one model and the scheme of division from another, and that some manuscripts made the close connection between the end of chapter eight and the beginning of chapter nine which we have noticed already. The authority of the "better" manuscripts turns out to be the authority of a single line, or rather of the direct ancestor of that line. Nor are we allowed to suppose that this progenitor was Bracton's own copy of his work. MA, MB, MN, are related to OB, MI, etc., but the common father of them all is at least one manuscript generation earlier than the codex which first had all the long rubrics. It is probably even further removed. OB and LG, together with LF, have come from an ancestor in which a whole quire of the text was lacking. MI, which also has the long rubrics at the beginning of new books, has not OB's *lacuna* in the text, though it is nearer to OB than to MA. MN and MB have no schemes of division by books, but MA—with MD which is very closely related to it—has its second and third books at places different from those chosen by OB. Thus even among codices coming from a common ancestry there are decided differences in external arrangement. If the whims of individual copyists or correctors are to be seen in altered text and variant readings, much more clearly are they to be discerned in the contradictory schemes of divisional adjustment. Whence comes all this diversity in the manuscripts as to the proper way of dividing and subdividing the *De Legibus*? Here are some forty different codices with almost half as many different schemes of division. Which one of them shall we choose as being Bracton's own? The answer must be that he is not responsible for the making of any one of them. It is inconceivable that such tremendous differences should ever have developed if there had been a single model to begin with; dissimilarity so extensive practically precludes the

¹ The third book of OA is similarly marked with a *Liber Tertius* at the top of the page. The capital at the beginning is the usual chapter capital. Two lines of vacant space precede the chapter at which book four is marked to begin, but they represent merely the regular space left for the rubric which has not been filled in. On f. 135 OA begins its fourth book with a special form of capital letter for the E of *Expedito*.

possibility of a common original. The disagreements and variations can be explained only by the supposition that later men in attempting to make logical divisions in a long work which the author had not specifically divided, were influenced rather by their individual tastes and fancies than by any scheme inherent in the text itself. This is why there are no "better" manuscripts when authority is wanted for a division into books.

But to return to a discussion of the two schemes which are under consideration. Next in order it is necessary to take up the question as to where the Assise of Novel Disseisin should begin. OA, OB, etc., decide upon a place two chapters beyond that selected by V (f. 159b). The rubric to OE's second book expressly states that book two should include what V has made the first two chapters of the first treatise in its fourth book; OB includes it in the matter pertaining to the second book under the more general term of "and other things as above in the table of contents." Now it is another weakness in the arrangement of OA, OB, etc., that they should include in their second book, a book devoted to criminal actions, two chapters that are foreign to the subject. What have these two chapters to do with criminal actions, what has *nuda possessio* or *intrusio* to do with *placita coronæ*? Nothing whatsoever. On the other hand, they are intimately connected with what follows them. Bracton himself distinctly tells us that he begins his treatment of civil actions with chapter one on f. 159b—"Dictum est supra de actionibus criminalibus, et iniuriarum quæ personales sunt, et pertinent ad coronam domini regis. Nunc autem dicendum est de actionibus civilibus." If this short chapter is read carefully in connection with what follows, it will be seen to form an introduction not only to the Assise of Novel Disseisin but also to the other civil actions. In its distinctions between real and personal actions, between possession and property, between the different kinds of possession with varying degrees of right, is found a hint of what is to come even as far as the Writ of Right.¹ Chapter two discusses at some length the subject of intrusion which has been introduced in the first chapter, for the reason that intrusion, as the author tells us, "partakes in a way of the nature of disseisin." This subject out of the way, he can treat of actual disseisin, that which is made "unjustly and without judgment." But his real starting point for both the Assise of

¹ With the expressions in this chapter referring to possession, property, and right, compare the opening lines of the treatises *De Assisa Utrum*, *De Ingressu*, and *De Brevi de Recto*. Subjects have been treated according to the order outlined in cap. I, f. 159b. Real actions have come before personal, possession has been discussed before property, much possession and much right have followed little possession and no right. Bracton had outlined his work a long way ahead when he wrote this chapter.

Novel Disseisin and the whole subject of civil actions is at chapter one, as in V, and not as in OA and OB at chapter three.

Further on other dividing lines in the *De Legibus* will be examined. It is interesting to note here that the arrangement in V—so far as we have examined it—is to be preferred to that which is found in some of the best of the manuscripts. The authority for V's plan rests upon only four of the extant manuscripts, and they in no wise the best.¹ Referring to the collation below it will be seen that of these four codices OD and PH are related to one another, and that CF and LT are even more closely related. But the two groups are not related; one has come along quite another line of descent from the other. They could not all, therefore, have derived this plan of division from a common ancestor. One of the groups, at least, has borrowed it from another line; both may have. The other members in the larger groups of their respective families do not show the same scheme; it could not have come, for this reason, from the fountain head of either line. So this arrangement which V uses has, at the best, no more manuscript authority behind it than the one in place of which it is seen to be preferable. In a way it has not as much, for three of the four exemplars of V in this matter are not as good manuscripts in many respects as those on the other side. This being so it might seem that in upholding V in this particular we were preferring the inferior to the better copies. But it has already been shown that one codex is no better than another in the scheme which it proposes for a division of the work into parts, because each scheme was originally the peculiar property of a single copy, or at the most of a single line, and does not go back to the common head of any large group. The arrangement in the printed text has been preferred not because it is supported by any manuscript or group of manuscripts, but because it coincides with the plan of division which Bracton himself has noted in his text. Why some of the inferior manuscripts have the better scheme is a question which the evidence at hand will not answer. Whether their arrangement was made earlier or later than some of the other schemes we can not tell. Its basis seems to have been a study of the text itself; its value is that from the standpoint of the text it is logical.

There is no evidence to show either that Bracton divided his treatise into books or that he intended so to divide it. Nowhere does he use the word *liber* in this connection. We have grown accustomed to talking and thinking about the "books" in the *De Legibus* because of the way in which the first editor of

¹ MSS. like OC, which have been divided according to this scheme at a late date, can not be considered as sanctioning it.

the work divided it. For a long time references to passages, when not cited by folio, have been cited by book, treatise, chapter, and section, because the codex which he happened to choose as his model was so arranged. On just as good authority he might have used many another scheme, might even have arranged the matter by *centenæ* or *capitula*. As it is, he has succeeded in making it inevitable that the idea of component books should be associated in our minds with the thought of Bracton's treatise. The codices are not responsible for this idea. Of the thousands who have read Bracton in the last three hundred and fifty years only a few have gone back to the manuscripts. It is only within the last generation that there has appeared in print even a hint that the arrangement in V was not the only one found in the manuscripts.¹ A habit of thought is hard to change. It will be difficult for any one who has used any of the three present editions of Bracton to think of his work as not being arranged according to books, even though it be known that the manuscript evidence does not sanction such a device as the author's own.² The text itself—and it is to the text that we must turn now that the external features of the codices are discredited—shows two things in regard to this matter of division, namely, that Bracton wrote by subjects and treatises, and that he did not finish his book. Some subjects he could practically finish on the first draft. To others he seems to have found it necessary to turn back from time to time. That part of the treatise which is made into one book by so many of the manuscripts, and so distinctly marked off by him in the text, that portion from the beginning of the civil actions up to the Writ of Right, was quite likely finished at the first writing.³ In it he was dealing with familiar subjects, with the law of his own English courts. There would be little that second thought might lead him to add to Novel Disseisin, Mort D'ancestor, etc. He knew all that pertained to these subjects from the first. References to cases, perhaps, or illustrations of one sort or another, he might put in later for the sake of added clearness or emphasis; but he would never

¹ That is, with the exception of some scattered remarks found in Selden's Latin works, which would be known only to so small a body of readers as not to affect the general truth of this statement.

² Outside of the editions themselves, *Bracton and Azo* has done most to perpetuate this idea that the *De Legibus* should be divided into books. As the study to which this book was devoted neither called for nor permitted anything more than a very cursory examination of the subject of division into parts, it was quite proper that its author should follow the arrangement found in OA and other of the better manuscripts. The devotion to a single MS., OD, on the part of the editor of the edition in the Rolls Series is probably responsible for the continuance of the traditional arrangement in that edition.

³ Such a reference as that found on f. 39, "secundum quod inferius videri poterit in tractatu de assisa novæ disseisinæ," would suggest that this block of text on the assises may have been completed before some of those portions which now precede it. See also, on f. 20, the direct citation of a case from the assise of Mort D'ancestor.

have to work over that part of his book as over the more academical and theoretical first part which he had drawn so largely from the not so well understood Roman sources. This portion on the assises he may well have set apart by itself at the very beginning.¹ He may have intended ultimately to make this one of a number of definite divisions in his book when it had been worked into a satisfactory final form. If so, that time never came; the book was left imperfect in this respect as it was in the matter of text. But we can not be sure that Bracton ever intended to arrange his finished treatise by books. For him to have done so would have been very natural. His Roman law models were divided into books. So also was his English predecessor, and in a way exemplar, *Glanvill*. Moreover, *Fleta* and *Britton*, based on the *De Legibus* and coming not long after, were likewise to be divided into books. It was usual and customary that a long work like his should have divisions of this kind; we should expect to find them. But if Bracton ever formulated a plan of this sort all external evidences of it have disappeared.²

From internal evidence, from hints dropped here and there in the body of the text, we are able to get an inkling of the plan on which Bracton worked. A treatise of such length he could not well write in a haphazard sort of way. The scope of the work would compel him to map out at the very beginning some sort of outline for his own guidance. Now and then we come upon some of this framework not entirely concealed by the text built up around it. Not much of it shows, yet enough to reveal some of its more important lines. There are direct statements as to his purpose in writing the book, and indirect information as to the method he followed. From both of these sources we are able to get a tolerably clear idea of what he was trying to do and how he went about it.

His reason for writing the book is told at the beginning. Briefly it is this. Almost all countries use written laws; England alone uses unwritten laws and customs. Since these unwritten laws are often perverted by judges not learned in the law, Bracton proposes to reduce them to writing.³ He is

¹ The *may* should be emphasized. This statement is more a concession to the fact that so many of the MSS. mark off this portion as a separate book than a probability in itself. The outline of the scheme on which Bracton worked—given below—shows plainly that in his mind the whole subject of civil actions formed a unit.

² The fact that so many of the codices are divided into books is proof only of the common practice of thus dividing long treatises. On this point compare *Britton* with *Glanvill* and *Fleta*.

³ The important part of the passage reads, "ad instructionem saltem minorum, ego (Henricus de Brattone), animum erexi ad vetera iudicia iustorum perscrutando diligenter non sine vigilis et labore, facta ipsorum, consilia et responsa, et quicquid inde nota dignum in unam summam redigendo sub ordine titulorum et paragraphorum, sine præiudicio melioris sententiæ, compilavi." With this, as showing that Bracton continued to keep in mind the *minores*, compare the beginning of cap. V, f. 347b, "Quia diversimode fit irrotulatio essioniorum secundum diversitatem brevium et placitorum, ad instructionem minorum, dicendum erit de irrotulatione." See also his further use of the expression *sine præiudicio melioris sententiæ* on f. 95b, f. 119b.

going to write a *Summa*, he says. The use of *Summa* here is natural enough; it was a word commonly employed to designate such a work as his. He was using Azo's two *Summæ*; at a little later time Hengham was to write his *Summa Magna* and *Summa Parva*, and Thornton his *Summa* based on the *De Legibus*. More than one of the numerous little legal tracts which sprang into being in the generation after Bracton was to be called a *Summa*. It was in the regular course of things that he should call his treatise a *Summa* rather than a *Liber*. This *Summa* was to be written "sub ordine titulorum et paragraphorum sine præiudicio melioris sententiæ." These are important words in considering the question as to whether or not Bracton meant to have his *Summa* divided into books. They present two problems—what is the *melior sententia* to which he refers, and just what meaning does he intend to have *titulorum* convey? It is necessary to discover not what the words might mean, but exactly the sense in which the author used them. As to *titulus*, does he wish to give it a broad or a narrow meaning? Shall *De Personis* be one "title," or shall such a subject be divided into many titles, as *De Ingenuis*, *De Libertinis*, etc.? Is it to be *De Rebus*, or twenty titles more or less in place of one general title on Things? Or will he follow Azo's rubric and make two titles on this subject, *De Rerum Divisione* and *De Rerum Adquisitione*? At the beginning of chapter VI on f. 4b there is a passage which may throw some light on this question.

"Dictum est supra de iure naturali, gentium et civili, sed quia omne ius de quo tractare proponimus pertinet vel ad personas, vel ad res, vel ad actiones secundum leges et consuetudines Anglicanas, et cum digniores sint personæ, quarum causa statuta sunt omnia iura, ideo de personis primo videamus. . . ."

Bracton has taken these words directly from Azo, but in the positive belief that they applied to English law as well as to Roman, as his "according to the English laws and customs" shows. It would appear, therefore, that at this point, after having given a number of fundamental Roman definitions, he had adopted from Azo and the Institutes three leading topics, Persons, Things, Actions. The *de iure naturali, gentium et civili* is a title in both Azo and the Institutes. If "Dictum est supra de iure," etc., meant to Bracton "Dictum est supra *de titulo* de iure," etc., then his "de personis" would naturally be equivalent in his mind to Azo's title "De iure personarum," and he would seem to be actually employing the titles in the Institutes for his titles. Moreover, his choice of material from this earlier law is made according to the written titles, some of which he has taken and some of which he has

passed over. Though this procedure might give to his "titulorum" a very definite significance as far as the Roman element in his treatise is concerned, it would not explain the meaning of the word in regard to the many times greater amount of pure English law which he writes. For the latter there were no nicely arranged titles in this sense which he could use. He would have to make his own titles as far as the greater part of his work was concerned. Considered from the standpoint of the whole treatise, *titulus*, as Bracton uses it, can not mean merely a title from his Roman exemplars. He does not intend it in such a restricted sense. Granted that he might take a title from the Institutes as one of his titles.¹ That would be because this particular heading in the Roman law book appealed to him as suitable for one of his larger divisions, not because there was anything peculiar to the title itself which made it inevitable that he should choose it. For what Bracton evidently had in mind was an arrangement of large topics with smaller subdivisions. His "paragraph" also, as applied to the treatise, is a somewhat flexible term. It can hardly mean the equivalent of one of the minor subdivisions in a title of the Institutes; it is more akin to the shorter chapter or longer section of the printed text. Bracton does not speak of "capitula." Very few of the manuscripts have, as MB, any definite reference to, or arrangement by, numbered chapters. In most of the codices the text is blocked off in portions—starting with an indented line, and introduced usually, though not invariably, by a rubric—which might be called either chapters, titles, or paragraphs, according to the size and importance of the particular portion and the standpoint from which it is regarded. They are not marked off as chapters generally are by any numerical notation. Often they are subdivided into lesser parts, the rubricator with his crescent marks of red or blue paint sometimes separating each sentence; but a great number of these subdivisions could hardly be called paragraphs in any sense of the word.² If *paragrophorum* on f. 1 is to refer to anything more than a small section, a section sometimes no more than a line or two in length, it must be applied to one of the larger blocks of text. What is, under the circumstances, a very instructive note on this subject is found in OE on the second page of its forty-second folio. After the first sentence of chapter XXXV, f. 77b of V, is over

¹ See f. 103b, "de quibus superius dictum est in titulo de donationibus." Cf. f. 19. The expression in *titulo de donationibus* will be found again on f. 100b and f. 265. See also f. 16, "dicetur plenius in titulo de acquirenda possessione," and f. 20, "secundum quod inferius dicetur de exceptionibus in titulo de prohibitionibus."

² In one MS. that portion of the text whose beginning we have quoted above (it includes caps. VI, VII, VIII of V on fs. 4b-5b) is divided into just thirty of these minor divisions.

half a column of blank space in which is written, "Et sciendum quod titulus de homagiis faciendis et capiendis secundum differentiam tenementorum debet continuari hic cum suis paragraffis sequentibus et durare usque ad titulum proximo hic sequentem." Here the title corresponds to a chapter in the printed book. The principle is clear enough. Bracton's *titulus* is to represent some broad, leading subject; his *paragraphus*,¹ one of the larger single divisions of text treating of a sub-topic of the title. This is his plan in general. Different subjects will require different treatment in detail, titles will vary in importance, paragraphs will be long or short, the purely English law with its forms of writs and references to cases will present a different appearance from the quotations from Azo, absolute uniformity it will be impossible to attain; but to the very end of his book we shall find him following this method of choosing a main subject and discussing it under the heads into which it naturally falls.

This plan he has adopted "without prejudice against any better method." By these words did he merely wish to imply, in a broad-minded sort of way, that there might be schemes better than this he was to follow, or is there here a tacit acknowledgment that his system is not that which most of his readers would be likely to consider the best? The words are open to either interpretation. His arrangement was not the usual one for a work of this sort, nor was it the arrangement of the models upon which he depended. Without going into a full discussion as to the various books from which Bracton may have borrowed matter, suggestions, or inspiration for certain parts of his work, it may be pointed out that those to which he was principally indebted were the Roman law books and the English *Glanvill*.² All of these had in their plan of arrangement something which he was not following—a division into books. Is not this the "melior sententia" of which he is thinking? To go back again to his own words. He is about to write a *Summa*. That is all he needed to have said; he could have ended his statement there; any one who read would have understood what he meant. Yet seemingly he feels the necessity of going further and explaining that this *Summa* is to be arranged in a certain way, but that his adoption of this plan must not lead the reader to believe

¹ That the paragraph continued to be regarded for some time after Bracton as the basis of the smaller divisions of the treatise would seem to be proved by the following passage from MC, f. 28. Near what in the printed text is the beginning of sect. 4, f. 41b is: "hic est plus quam in alio paragraffo *Item notandum* usque ad paragraffum *Et sciendum quod per se ipsum*. . . ." (Cf. ll. 10-11, f. 41 of V.) A similar use of the same word occurs on f. 27b of MC, and in both instances the reference is to the *addiciones* which the list of *addiciones* below shows are found in this portion of the treatise. Compare this with the terms used in OM at the beginning of the table of contents—"Incipiunt tituli tractatus domini Henrici de Brattone"

² The subject of Bracton's library is considered in *Bracton and Azo*, xxiv-xxvi.

that he is prejudiced against a system to which the reader is more accustomed. As though to emphasize the fact that this difference is only in the form of arrangement and not in his treatment of the material, he begins his next sentence with the words, "In hoc autem tractatu sicut in aliis tractatibus consideranda sunt hæc." Now the most satisfactory interpretation of this added explanation of Bracton is that in his association of ideas the word *Summa* brought up most vividly the thought of Azo's book, or books, from which he was to copy, and to which he was to refer for help and suggestion for a long time to come. Azo had reached a place of highest prominence as a legist, he was "master of all the masters of the laws."¹ It might be expected that any one who, in writing a book of law, was closely following his text would follow also his method of arrangement. For it was impossible to improve upon Azo. But for reasons of his own Bracton did not see fit to follow the scheme of the Bolognese master; he preferred to use an arrangement different from that found not only in Azo, but in the *Code*, *Digest* and *Institutes*, as well as in his English model *Glanvill*. And in making this choice he felt it necessary to half apologize for departing from the method used by so many eminent writers before him, just as earlier he had apologized for calling the unwritten laws of England *leges*.

Why Bracton decided to write by titles and paragraphs rather than by books is not an easy question to answer. It is clear that he felt a difference between his work and that of his Roman predecessors. From the very first he emphasized the fact that his treatise was to be one on English law. As this law had not been reduced to a written, definite arrangement, he may have felt that it was more or less chaotic, too unorganized for treatment under the orderly Roman scheme. Nor could he well follow *Glanvill*. Its material at times he would be able to use to advantage; but as a work the earlier *De Legibus* must have seemed to Bracton brief, fragmentary, ill-arranged, lacking the scope and finish which he intended to give to his own production. While he was working over the Roman elements, with Azo to guide him, it would be an easy matter to conform to the traditional division of books; but the situation would be quite otherwise when he got to that great mass of unwritten English law, with no model to help him, especially as this latter subject was to form by far the larger part of his treatise. In regard to this English law he knew the topics about which he wished to write—he had probably already drawn up a topical outline. But he could not at the beginning tell just what amount of

¹ For a paragraph on Azo and his work see *Bracton and Azo*, ix-x.

space in his book each topic would require for its treatment. When he chose *De iure personarum* for a title he could gauge the number of folios it would fill in his manuscript because he knew just how much space it occupied in his Roman exemplar. On the other hand, when "De assisa novæ disseisinæ" was taken for a title, though it was a subject large enough for a whole treatise in itself and would have to be divided into sub-titles, he could not tell the number of folios which would be devoted to it in the written book. There was no possible method of calculation whereby he might know at the start that Novel Disseisin was to be of almost exactly the same length as Last Presentation, Mort D'ancestor, Cosinage, Utrum, and Action for Dower combined. His leading English titles were broad enough to allow of wide expansion; that they did expand, that the *De Legibus* was a work which grew in scope under the author's pen, is evident beyond the shadow of a doubt. Moreover, it is not at all improbable that the work as he left it was quite different from what he had planned in the first draft. Until it was actually written he could only guess as to the probable final form of his text; he would have needed the power of some prophetic sight to have seen at the beginning the ultimate result of his labor. The only actual realities to him at first were the subjects about which he was going to write; his anticipated text could take shape in his fancy only through the medium of this series of topics. Nothing which had been written, or which he himself by any existing standard could compute, would give him an idea of English law in terms of *libri*. "Book two," "book three," would be at the most expressions of vaguest import until they were translated into the well-known terms of "placita coronæ," "assisa novæ disseisinæ," "actio dotis," etc. Bracton thought, planned, worked on the basis of subjects, as the text shows. What he was aiming at was a logical exposition of these subjects. So to write, "ut sciatur quæ competat actio, et quod breve, secundum quod placitum fuerit reale vel personale,"¹ was to him the important thing. He was apparently more interested in his text than in the arbitrary divisions of that text. In which respect we shall do well to follow his example.

After stating what his reason is for undertaking to write the treatise, Bracton, following Azo, sets forth his subject-matter and outlines his intention. He is going to write of events in everyday England, of everyday cases in English courts—"facta et casus qui quotidie emergunt et eveniunt in regno Angliæ," he says in the Latin, so that the proper form of writ, action, enroll-

¹ F. 1b.

ment, and general procedure may be known. His intention is "tractare de huiusmodi et instruere et docere omnes qui edoceri desiderant qualiter et quo ordine lites et placita decidentur secundum leges et consuetudines Anglicanas et de huiusmodi habere tractatum." In every possible way, here and elsewhere in the first two folios, he emphasizes the fact that his book is to be a treatise on English law. Yet he starts out with a quotation from the Roman law, and for the first fourth of his treatise, as it now stands, he writes with the Roman models always within reach. The scope of this volume does not include a discussion of Bracton's Romanism.¹ It is in place, however, to notice that in spite of extensive borrowing from these foreign sources Bracton did not consider his Roman material other than auxiliary law. He does not, as Glanvill or Britton, plunge at once *in medias res*; he builds up one point on another, leads from subject to subject, in a methodical sort of way. He wishes a well rounded out treatise, a finished work. In places the English law does not furnish him with just what he wants for a logical sequence of treatment, so he turns to the more orderly arranged Roman law for material to fill up the gaps. He takes as much or as little as he needs. He is especially indebted to it for fundamental legal definitions and for basic theories. But always it is subsidiary law, of secondary interest and importance. The often repeated assertion that Bracton's book is mainly Roman law in an English dress is utterly without foundation. Such an idea could come only from a superficial examination of the first part of his treatise; the statement is true of only comparatively small portions of his work. His mind is fixed neither on the courts of Justinian nor the lecture room of Azo. He is thinking of England. He does not wish to expound to his fellow countrymen the doctrines of the juriconsults or the teachings of the Italian doctors. His one aim is to put into permanent written form the everyday law which he himself administers and which Pateshul and Raleigh administered before him.

To the knowledge to be derived from Bracton's preliminary statement of purpose, is to be added the not inconsiderable amount of information which the text itself gives, in a more indirect sort of way, as to the composition of the book. For one thing we can see the progress he is making. He is often so conscious of having finished one subject and taken up another that he

¹ Güterbock, *Henricus de Bracton und sein Verhältniss zum römischen Recht* (Eng. trans. by Brinton Coxe), takes up the general subject of Bracton and his use of Roman sources. Maitland, *Bracton and Azo*, compares two sections of the printed text, fs. 1-10, 98b-115, with their Romanesque prototypes. In the appendices is shown Bracton's use of Tancred and of Bernard of Pavia. The Rolls Series edition has noted some, though by no means all, of the places where Bracton is following Roman exemplars in that portion of his treatise passed over in *Bracton and Azo*, viz., fs. 11-98. The references are not always correctly given, however.

unconsciously emphasizes the fact in the expressions he uses in starting out on the new topic. Many of his "dictum est supra . . . nunc autem dicendum est" beginnings show very clearly this transition. A careful study of this often recurring phrase in its many settings would probably reveal something of the speed with which Bracton worked, or at least would show some of the points at which he took up his work again after periods of inactivity. From the standpoint of the present discussion, however, the important thing is to find out, if possible, how his scheme actually worked out; to reconstruct, as far as the evidence will permit, the outline on which the text was developed. Now this is not quite the same thing as making an analysis of the text of the treatise. Such an analysis, if it were at all detailed, would produce an outline so involved as to make it unthinkable that the author had ever worked according to it. In a work of such magnitude, the composition of which must have been spread over many years, it was inevitable that digressions should occur, that something originally intended should be omitted and that something not planned for should be added. For this reason the mere dividing of the work in its present form into a bewildering series of topics and sub-topics will not give us what we wish. We need to discover the simpler scheme, the workable outline on which Bracton developed his book. By letting the text tell its story this is possible. Bracton starts on the basis of the old threefold division of Persons, Things, Actions.¹ Persons is treated very briefly on fs. 4b-7b.² Things is subdivided into two main divisions, *De rerum divisione*, and *De acquirendo rerum dominio*, occupying respectively fs. 7b-8b,³ 8b-98b.⁴ The second of these divisions is again divided into two principal divisions, *ex iure naturali*,⁵ and *ex iure civili*,⁶ this latter being further subdivided into many heads. There can be no question but that in Bracton's mind *De acquirendo rerum dominio* was the main subject for that large portion of his treatise so entitled in the printed text. The words at the

¹ According to his division "secundum leges et consuetudines Anglicanas," in cap. VI, f. 4b.

² Beginning "Dictum est supra de iure naturali, . . . ideo de personis primo videamus"; ending with chapter XI.

³ Beginning "Superius dictum est de personis et statu hominum et iure personarum, consequenter dicendum erit de rebus per divisionem."

⁴ Beginning "Dictum est supra de rerum divisione, nunc autem dicendum est qualiter dominia rerum adquiruntur."

⁵ Beginning with sect. 2, f. 8b, "Iure autem gentium sive naturali dominia rerum adquiruntur multis modis."

⁶ Beginning with cap. IV, f. 10b, "Adquiritur etiam iure civili multis modis." Güterbock, *Henricus de Bracton*, etc., in the analysis found in the second chapter of the first part of his book, makes the following scheme for this title: "BB. Ex iure civili. 1. Ex causa donationis inter vivos, a. rerum corporalium, b. rerum incorporalium; 2. ex causa donationis mortis causa; 3. ex causa emptionis; 4. de locato, conducto; 5. ex causa successionis."

beginning of chapter one on f. 8b show that he, following his Roman law books, is going to devote a section of his work to explaining how the dominion over things may be acquired by natural right and by civil right. After having finished with this subject from the side of natural right, he enumerates the ways in which dominion over things is acquired by the civil law.¹ Treating this part of his subject topically, he ends with a discussion of *de donationibus propter nuptias ob causam dotis*, this topic of dower taking up fs. 92-98. Two hundred folios further on, at the beginning of *De actione dotis*, he distinctly refers back to this earlier treatment of dower as forming a part of that section of the book devoted to the acquiring of dominion over things.² Actions begins on f. 98b.³ This subject is evidently divided into three parts in the author's plan, viz., a discussion of actions in general, English criminal actions, English civil actions.⁴ The dividing line between criminal actions and civil actions is plainly seen.⁵ The point at which criminal actions begin is not so easily determinable. In V it comes on f. 115b. As has been noticed above, Bracton first brings in the subject of English criminal actions on f. 104b; takes up the jurisdiction of the English king on f. 107; and devotes some three folios (109-112) to good English writs bearing on the itinerant justices.⁶ The mixed character of this particular portion of the *De Legibus* is so evident that Güterbock in his analysis of the book has the subject of actions in general end with chapter four on f. 104, and that of criminal actions begin with chapter three on f. 118, regarding all between as directly connected neither with what has preceded nor with what is to follow.⁷ The difficulty lies in the fact

¹ These are, "ex causa donationis, ex causa successionis, ex causa testamentaria, et aliis pluribus modis, secundum quod inferius dicitur."

² "Dictum est supra de acquirendo rerum dominio et causis acquirendi rerum dominia, et qualiter adquiruntur res ex causa dotis."

³ With "Dictum est supra de personis et rebus, nunc autem dicendum est de actionibus."

⁴ The last as to real actions. The subject of personal and mixed actions will be considered later.

⁵ At chapter I, f. 159b.

⁶ See above, p. 38.

⁷ "The transition from the first to the second part of Bracton's system is brought about by the commentary upon courts and jurisdictions, connected with the division of actions. The commentary upon procedure then begins on f. 118 and treats first of criminal matters." (Coxe's translation, p. 36.) Güterbock's attitude toward this particular portion of the *De Legibus* is explained by the fact that he is approaching it from the standpoint of the student of Roman law, and is emphasizing the Roman element. Bracton himself made most of the English element. The Roman principles in the general discussion lead up to the English practice. The topic of jurisdiction gave Bracton an opportunity to bring in considerable English law before he got through with it; but the subject of jurisdiction was, in Bracton's mind, intimately connected with the subject of actions. It begins with chapter eight, f. 106—"Videndum etiam ubi et coram quibus personis proponendæ sint actiones et probandæ, et sciendum quod in iudicio. Videndum est igitur quid sit iudicium." Güterbock apparently failed to notice the way in which Bracton, this subject of jurisdiction being disposed of, came back to his Roman sources and "De ordine actionum" in chapter twelve. As to any commentary on procedure beginning with f. 118, it is necessary only to point out that the subject of *placita coronæ* begins on f. 115b, and that the subject of treasure-trove on f. 119b is distinctly stated by Bracton on f. 10b to be "inter placita coronæ."

which has already been drawn to the reader's attention, that the whole of this general discussion on Actions is made up of alternate layers of Roman and English law.¹ As early as the third chapter we have one section with the rubric "De actionibus civilibus in rem" and another with the rubric "De actionibus civilibus in personam."² But no one would maintain that it is at this point that Bracton begins his real discourse on civil actions. No more does chapter five, English law though it be, in its opening words, "Ubi terminari debeant actiones sive placita videndum. Et sciendum quod si actiones criminales sint, in curia domini regis debent terminari" mark the place where the treatment of English criminal law begins. Let chapter five be compared with chapter seven.³ One is no more taken up with English criminal law than the other with English civil law. These two chapters are as much a part of the general discussion of actions as any of the Roman chapters which precede or follow them; the subjects which they introduce are brought in at this time simply because they have a place in this general discussion, and for no other reason. The subject of jurisdiction which occupies fs. 107-112 also comes naturally into this discussion, as we have seen, for both jurisdiction and the justices are but secondary topics under the more comprehensive subject of "de iudiciis et iudicibus." Even the long row of writs in the eleventh chapter is no more out of place from the standpoint of Roman law than the matter in regard to the king's court and the lord's court in sections two and three of chapter seven. As supporting the contention already made that the division assigned to *De Corona* in V is the correct one,⁴ certain passages may be cited. Bracton thought of one portion of his treatise as devoted to criminal actions, and of this portion the subject was either *De corona* or *De placitis coronæ*. Two sentences from different parts of the text show this. One is "Dictum est supra de actionibus criminalibus et iniuriarum quæ personales sunt, et pertinent ad coronam domini regis";⁵ the other, "Adquiritur et dominium per inventionem, ut si thesaurus inveniatur, secundum quod inferius dicetur inter placita coronæ."⁶ From f. 115b on, *placita coronæ* is the guiding thought in Bracton's mind and the topic emphasized in

¹ See above, p. 38.

² F. 103.

³ F. 105. Begins, "Dictum est superius in cuius curia actiones criminales debeant terminari Nunc autem dicendum ubi terminandæ sunt actiones civiles."

⁴ See above, p. 39.

⁵ F. 159b.

⁶ F. 10b. With this compare the discussion of treasure-trove on f. 119b and f. 122. Cf. "ut supra dictum est plenius inter placita coronæ," f. 311b.

his text.¹ The first chapter on that folio begins, "Facta coram iusticiariis itinerantibus generali summonitione² ad certos diem et locum, quæ ad minus continere debet spatium quindecim dierum, videndum erit in primis qualiter procedere debeat et quo ordine. Et sciendum quod in primis incipere debent de placitis coronæ, in quibus terminantur actiones criminales." Just one folio further on the pleas of the crown again stand out prominently, "In primis de veteribus placitis coronæ quæ alias fuerunt coram iusticiariis et non fuerunt terminata. De novis placitis coronæ quæ postea emergerunt," etc.³ We see "how things proceed and in what order" as the justices start out on their work. We hear the reading of the writ which gives them authority to make an iter,⁴ and one of the older of them explaining the cause of their coming and the utility of an iter. We follow them as they retire to some secluded spot and call to themselves some four or six of the more important men of the county, with whom they consult regarding the business in hand. We see the twelve knights coming forward and taking an oath to answer truly the questions which the justices shall ask them; we hear read to them the long list of articles concerning which they must have a verdict ready by a certain day. And then we are ready to consider the different crimes more in detail, and notice the method of procedure when the case comes into court.⁵ But from f. 115b up to the point where the civil actions begin it is always *de placitis coronæ* "in which are decided criminal actions, lesser as well as greater, unless perchance the lord the king himself shall order it otherwise."⁶

Following criminal actions come civil actions real. This subject, divided and subdivided, extending from f. 159b to 443, constitutes the great bulk—

¹ See f. 150b—"Inter alia placita coronæ non est omittendum de actione furti." The subject of theft is one of Bracton's titles. He refers to it on f. 62—"ut infra dicetur de furtis."

² A writ of general summons is to be found at sect. 7, f. 109b. This long chapter devoted to English writs bearing on the itinerant justices, together with the reference to the writ of general summons at the very beginning of *De Corona*, does more than probably anything else to obscure the fact that the subject of criminal actions really begins on f. 115b. But Bracton is constantly treating one part of a subject in one place and another part in another place, and often refers in the later to the earlier treatment. With this reference on f. 115b to the writ of summons on f. 109b compare his reference on f. 159b to the discussion of the precedence in action of possession over property on f. 113. The real setting of cap. XI (fs. 108b-112) can not be understood without comparing it with cap. VII (fs. 105-106); in fact, the whole of *De Actionibus* must be read before the full significance of any one of its parts can be appreciated.

³ Sect. 3, f. 116. These same expressions occur in the writ on fs. 117b-118.

⁴ This form of writ will be found at sect. 4, f. 109.

⁵ With cap. 111, f. 118, compare cap. V, f. 104b. Each makes use of the same material, uses the same expressions, and shows the influence of Glanvill.

⁶ F. 115b. The lesser actions referred to here are taken up at cap. XXXVI, f. 155—"Dictum est supra de maioribus criminibus, et appellis quæ criminaliter intentantur. . . . Nunc autem dicendum est de minoribus et levioribus criminibus quæ civiliter intentantur, sicut de actionibus iniuriarum personalibus, et pertinent ad coronam." This is but another proof that f. 115b is in the same treatise—*De Corona*—as f. 135.

about two-thirds—of the work. It has already been pointed out that in this portion of his book Bracton writes by treatises.¹ Fundamentally his plan of composition has not changed. By titles and sub-topics he continues to work, only now his main titles have become big enough, or rather his knowledge of the subject is extensive enough, to furnish material for a whole treatise. He is not writing by books any more than at the beginning; the subjects, or rather his treatment of them, are entities in themselves. His scheme in civil actions, as outlined at the start, is to treat of real before personal actions, and of possession before property—“*Dictum est supra de actionibus criminalibus . . . Nunc autem dicendum est de actionibus civilibus. Et huiusmodi quædam sunt reales et quædam sunt personales, sed primo de realibus actionibus dicatur. Et est rerum possessio et est proprietas, et primo dicendum est de possessione quam de proprietate ratione supradicta.*”² Under possession will come the Novel Disseisin, Mort D’ancestor, Last Presentation, Consanguinity, Utrum, Dower; under property, Entry and the Writ of Right. If anything more than the way in which these subjects are treated in the text is needed to prove that Bracton considered them entities in themselves, it is only necessary to turn to the places where he mentions them by name. As early as f. 39 he refers to the treatise of Novel Disseisin.³ Not only is the block of text devoted to the assise of *mort d’ancestor* so labelled,⁴ but on f. 20 there is a direct reference to it.⁵ The treatment of the assise *ultimæ præsentationis* as a subject in itself is noted on f. 237b.⁶ Consanguinity and Utrum are each introduced by passages which leave no doubt as to their identity.⁷ Dower has earmarks of its own in addition to the text matter itself.⁸ All of the above

¹ See above, p. 50.

² With the closing words of this passage compare the beginning of sect. 4, f. 113. “*Et quod de possessione prius agendum sit quam de proprietate, et quod causa possessionis est præmittenda, quamvis in fine debeat proprietas prævalere, videri poterit manifeste.*”

³ “*Item possessionum alia iusta alia iniusta, secundum quod inferius videri poterit in tractatu de assisa novæ disseisinæ.*” See also the end of sect. 5, f. 35, “*secundum quod inferius videri poterit de assisis.*” Another reference to the same treatise occurs on f. 51b.

⁴ Cap. 1, f. 252.

⁵ “*Ut infra de assisa mortis antecessoris, de herede Johannis Dacy.*”

⁶ “*Dictum est supra . . . Nunc autem dicendum est de pertinentiis quæ consistunt in iure et in proprio, sicut de seisina præsentandi . . .*”

⁷ On f. 281—“*Cum assisa mortis antecessoris infra certos gradus limitetur, . . . in subsidium assisæ mortis antecessoris provisum est quoddam breve quod dicitur breve de consanguinitate, ut causam possessionis terminet in gradibus et personis ad quos assisa se non extendit.*” On f. 285b—“*Est autem inter alias assisas quædam assisa quæ multum habet possessionis et iuris, quæ utrumque terminat, possessionem scilicet et ius (cf. cap. I, f. 159) . . . Per assisam istam recognoscitur utrum tenementum de quo agitur laicum sit feodum tenentis vel libera elemosina . . .*”

⁸ F. 296. “*Dictum est supra . . . Nunc autem dicendum est si contentiosa fuerit et non deliberata, qualiter recuperanda sit dos per actionem dotis, ideo de actione dotis videndum.*”

subjects are put into one group, and *De Ingressu* and *De Recto* individualized in passages which begin the two latter subjects.¹ On f. 105b there is a reference to the Writ of Right.² The Writ of Right ends civil actions real, because as the author tells us "Placitum³ vero de recto ultimum sibi locum vendicat in ordine placitorum."⁴ If the plan outlined on f. 159b is to be carried out these real actions should be followed by personal actions. The last folios in the *De Legibus* are given up to this subject.⁵ Whether these few words are all that Bracton wished to say on this topic,⁶ or whether he had projected a much longer treatment of it which he was not able to finish, we can not with certainty say.⁷ His main interest was in real actions, not in personal, and to them he devoted the greater part of his book. At the end he may have wished to take up very briefly personal and mixed actions to give a finished appearance to the work.⁸ The form in which the *De Legibus* ends will always leave open the question as to whether or not its writer intended ultimately to add more to it in this place. That question does not need to be answered here. It is more to the point to consider the question whether the last hundred folios in the section of civil actions should be divided as in the printed book into separate treatises on essoins, defaults, warranty and exceptions. It is very evident from even a casual examination that there are certain parts of the text devoted primarily to these subjects. A closer study will show that the divisions in V are again in harmony with the author's scheme, that Bracton considered these portions of the text as forming something complete in themselves, if not treatises on the same rank as that of Novel Disseisin, at least sub-treatises under *De Recto*. On f. 329b is a passage which marks out *De Recto* as a separate treatise and hints at a later discussion

¹ F. 317b—"Dictum est supra de causa possessionis quæ per assisas et recognitiones terminatur. Nunc autem dicendum de causa proprietatis quæ terminatur per iuram ex testimonio et probatione eorum qui probare possunt" F. 327b—"Expedito tractatu de assisis et recognitionibus quæ proditæ sunt super iure possessorio, ad seisinam propriam vel alicuius antecessoris ut de feodo recuperandam, et similiter expedito tractatu placitorum de ingressu assequendo, consequenter agendum erit de placito super iure et proprietate"

² "Et de hac materia habetis plenius infra de actionibus civilibus in rem, super ipsa proprietate per breve de recto."

³ For "placitum" in the sense of "actio" see f. 101b—"Et sciendum quod omnium actionum sive placitorum (ut inde utatur æquivoce)."

⁴ F. 328.

⁵ Beginning with cap. XXXI, f. 439.

⁶ The last chapter in the book takes up the subject of mixed actions. Here Bracton goes back again to his Roman sources.

⁷ See *Bracton and Azo*, xv; *Note Book*, I, 34; Holdsworth, *Hist. Eng. Law*, II, 189.

⁸ Personal and mixed actions have been taken up before in cap. III, f. 101b.

of essoins.¹ A little further on there occurs exactly the same kind of reference to Essoins that we have noticed elsewhere to Novel Disseisin and Mort D'ancestor.² This is in the chapter on summonses, a chapter introductory to both Essoins and Defaults, each of which refers to it in the opening sentences.³ The first words of *De Essoniis* prepare the reader for a discussion of the two subjects of essoins and defaults.⁴ The beginning of *De Defaltis* shows that the author has finished the treatment of essoins and is about to take up that of defaults.⁵ The individual character of the latter subject as one complete in itself is made apparent by two references to it in parts of the text outside its own limits.⁶ Defaults, contumacious absence from court, as a leading subject does not go beyond the end of chapter four on f. 372b. That Bracton intended both *De Essoniis* and *De Defaltis* to form sub-titles under the greater subject of *De Recto* is seen plainly enough from the way in which chapter five, essoins and defaults having been treated at sufficient length, takes up the procedure which obtains when, all delays being ended, the parties finally appear in court.⁷ In the next eight folios there are two main topics. One we may call "de proponenda intentione" and the other "de visu petendo." Warranty follows naturally on this latter subject, and extends to f. 399b, as a study of the text will show.⁸ The subject of exceptions begins

¹ "De summonitionibus vero ad curiam capitalis domini faciendis, quæ esse debeant vel quot sursiæ vel quot essonia fieri, nolo inserere huic tractatui propter diversas consuetudines quæ in diversis curiis diversimode observantur. Sed sciendum quod . . . observari debent prout in curia regia observantur."

² F. 333—"secundum diversitatem summonitionum et attachiametorum, ut inferius dicitur de essoniis."

³ With the beginnings of Essoins and Defaults compare the beginning of the chapter on personal actions, f. 439—"Redeamus igitur ad diem summonitionis. Dictum est supra qualiter quis excusatur si ad iudicum non venerit cum legitime summonitus fuerit, cum necesse habeat venire in actione reali."

⁴ F. 334b—"Ad diem vero summonitionis, sive legitima sit summonitio sive non, aut comparet summonitus vel se essoniat vel defaltam facit."

⁵ F. 364b—"Redeamus igitur ad diem summonitionis in actione reali. Dictum est supra qualiter quis excusatur per essonia si ad iudicum non venerit cum fuerit summonitus legitime. Nunc autem dicendum est de contumacibus et non venientibus ad iudicum, qualiter procedendum sit contra eos in actione reali secundum quod fuerit simplex, mixta, vel duplex."

⁶ F. 328—"Per iudicium dico, quia secus est si per defaltam, aliqua habita distinctione, sicut inferius dicitur de defaltis." F. 364—"et secundum quod dicitur infra plenius de defaltis." A similar reference to Essoins is to be found at the very end of f. 330b—"secundum quod inferius videri poterit de essoniis."

⁷ F. 372b—"Post essonia et dilationes vel ad primum diem summonitionis per breve de recto in iudicio comparentibus tam petente quam tenente, petens actionem qua agere velit et intentionem suam proponere debet coram iusticiariis, ut per hoc speciem futuræ litis demonstret."

⁸ F. 380—"Habito sic visu, . . . Sed quoniam quandoque melius erit et tutius tenenti warrantum vocare quam in personam suam defensionis periculum suscipere, . . . ideo prius tractandum erit de warranto et eius vocatione." And see sects. 1 and 2, f. 380, 380b. Cf. f. 62—"ut infra dicitur de warrantis"; and f. 330b—"De visu vero habendo et de exceptionibus et replicationibus, fiat sicut inferius dicitur"; and f. 331—"ut infra inter brevia de warrantia."

where that of warranty ends.¹ That Bracton meant to treat of exceptions as a separate title becomes evident as early as f. 376b, from a passage in which he gives his reasons for so doing. "Cum autem onerosum esset de singulis exceptionibus tractare suo loco et per se, utilius et facilius erit, ut videtur, omnes quasi in unum fasciculum colligere et de omnibus simul tractare per ordinem. Ideo omisso hic tractatu de exceptionibus, tractetur de visu petendo. . . . " That it is not going to be a treatise wholly independent by itself, but rather one of the minor treatises under *De Recto*, would appear from the words with which the writer turns from Warranty to the new subject.² It will be noticed that its reference to the day of summons after delays and essoins connect this passage with chapter five on f. 372b, the place at which the subject of defaults ends and the discussion of how the claimant ought to propound his declaration begins. And it is this latter topic whose treatment is followed immediately by the author's statement that he is going to pass by exceptions for the present and take up the consideration of "de visu petendo." This is the point to which Bracton's mind would revert when he started to write about exceptions. For it is probable that instead of regarding this as a new subject he looked at it rather as another side of an old subject, that of procedure. His one object was to give a clear exposition of what would happen, or might happen, when the actual case introduced by a Writ of Right came before the court. Like many another subject in the *De Legibus*, Exceptions begins with a definition as to what it is.³ In the last section of the first chapter is introduced the topic of exceptions which may be raised against jurisdiction,⁴ and this subject is continued from this point through chapter sixteen.⁵ Chapter seventeen then takes up the question of exceptions against the writ.⁶ In one form or another the subject of exceptions goes on to f. 439 and the personal actions.

¹ See above, p. 31. Cf. f. 319—"ut infra de exceptionibus plenius." References of this sort to the special treatment of exceptions are fairly frequent in the civil actions.

² F. 399b—"Ad diem summonitionis post dilaciones et essonia revertamur, ad quam cum partes comparerint si non habeat tenens warrantum quem vocare potest, vel se habuerit et nullum vocat, proposita in iudicio coram iusticiariis ut prædictum est intentione petentis, . . . ad elidendam actionem proponat tenens exceptionem si quam habuerit, et illam probet, et doceat quod exceptio ad illum pertineat, secundum quod dicitur de actionibus, et eodem modo. Exceptiones enim loco actionum sunt."

³ F. 399b—"Inprimis videndum quid sit exceptio et qualiter dividatur."

⁴ F. 400b—"Item inprimis dicatur de una illarum quæ generalis est ad omnes actiones, scilicet de illa quæ apponitur contra iurisdictionem."

⁵ A slight change of subject comes at cap. XV—"Dictum est supra de exceptionibus quæ competunt contra iurisdictionem. Nunc videndum si sit aliqua quæ competere possit contra personam iusticiarii."

⁶ F. 413—"Confirmata sic iurisdictione iudicis, consequenter audiatur breve per quod expediri et exponi debet."

From the facts given above, and with the help of a few others found in the text, it is possible to construct the following skeleton of the *De Legibus*.¹

I. De personis (f. 4b).²

II. De rebus:

1. De rerum divisione (7b).

2. De acquirendo rerum dominio (8b):

A. ex iure naturali (8b).

B. ex iure civili (10b):

a. ex causa donationis inter vivos (11).

(res corporales—donatio, possessio, traditio, usucap-
tio, etc. ;

res incorporales—iura, servitutes, etc.)³

b. ex causa donationis mortis causa (60).

c. ex causa emptionis (locatio, conductio) (61b).

d. ex causa successionis (62b).

(de hereditate, de gradibus successionis, de partu
supposito, de partitione inter heredes, de homagiis
faciendis et capiendis, de relevis dandis, de custodia
heredum, de maritagiis heredum, etc.)

e. de donationibus propter nuptias ob causam dotis (92).

III. De actionibus (98b):

1. De actionibus generaliter (98b).

(quid sit actio et unde oriatur, de obligationibus et stipulationi-
bus, de divisione actionum, cui et contra quem competant
actiones, ubi terminari debent actiones, de iudiciis et iudicibus,
de iusticiariis, de ordine actionum.)

2. De actionibus criminalibus (i. e., de placitis coronæ) (115b):

A. De criminibus quæ pertinent ad coronam (115b).

(Capitula itineris, etc.)

¹ What is practically the same scheme is found in *Güterbock, Henricus de Bracton, etc.*, pp. 35-38 (Coxe's translation). See also *Reeves, Hist. of Eng. Law*, chapter VIII; and *T. E. Scutton, Roman Law in Bracton*, in *Law Quarterly Rev.*, I, 429-440.

² The number within the parenthesis indicates the folio on which the treatment of the subject begins. The first four folios are given over to the introduction and definitions.

³ F. 52b—"Dictum est superius qualiter adquiruntur rerum corporalium dominia quæ traditionem patiuntur vel quasi, ex causa donationis, et qualiter postea transferuntur traditione Nunc autem dicendum est qualiter adquiruntur rerum incorporalium dominia et possessio, sicut iurium"

B. De criminibus capitalibus (118).

(de crimine læsæ maiestate, falsi, homicidii, etc., de officio coronatoris in diversis criminibus, de criminosis, de utlagatione, de inlagatione, de murdro, de exilio, de appellis—de duello vadiatione, de appello de pace et plagis factis contra pacem, de appello de plagis et mahemio, de appello de raptu virginum, de appellatis attachiandis, etc.,—de furto.)

C. De criminibus minoribus (155).¹

3. De actionibus civilibus (159b):

A. De actionibus realibus (159b):

AA. De possessione:²

a. De assisa novæ disseisinæ (161):

aa. de libero tenemento (161).

(de disseisina, cui et contra quem competit assisa, cui et quando fieri debet querela, de transferenda re disseisita ad alium, de modo procedendi in assisa novæ disseisinæ, de interrogationibus faciendis, de exceptionibus, de usu et habitatione.)³

bb. de iuribus et servitutibus (220b).⁴

(de communia pasturæ—de amensuratione, de placito quo iure, etc.,—de rationabilibus esto-veriis, de nocumentis iniuriosis.)

b. De assisa ultimæ præsentationis (237b).

c. De assisa mortis antecessoris (252).

d. De consanguinitate (281).

e. De assisa Utrum (285b).

f. De actione dotis (296).

¹ F. 155—"Dictum est supra de maioribus criminibus . . . Nunc autem dicendum est de minoribus et levioribus criminibus, quæ civiliter intentantur, sicut de actionibus iniuriarum personalibus, et pertinent ad coronam."

² Divided into "possessio propria" and "possessio aliena." F. 252—"Supradictum est de seisina propria . . . Nunc autem dicendum de seisina aliena."

³ F. 220—"Dictum est supra qualiter quis restituatur cum fuerit eiectus de libero tenemento suo. Nunc dicendum si quis eiciatur de usu fructu, vel usu et habitatione alicuius tenementi quod tenuerit ad terminum annorum ante terminum suum."

⁴ F. 220b—"Dictum est supra . . . quale remedium competit ei qui a tenemento suo eiectus fuerit . . . Nunc autem dicendum qualiter quis restituatur si fuerit eiectus iniuste de iis quæ pertinent ad liberum tenementum. Pertinent enim ad liberum tenementum iura sicut et corpora, iura sive servitutes diversis respectibus."

- BB. De proprietate:
- a. De ingressu (317b).
 - b. De brevi de recto (327b):
 - aa. de formis brevium de recto (328).
 - bb. de essoniis (334b).¹
 - cc. de defaultis (364).
 - dd. de warrantia (380b).²
 - ee. de exceptionibus (399b).³
- B. De actionibus personalibus et mixtis (439).

Such is the frame on which Bracton's book was built. Any mere outline of this sort can take into consideration only the major divisions; details have to be avoided. The object aimed at here has been to reproduce some such plan as the author may have used in writing his book.⁴ There has been no attempt to make a detailed analysis of the *De Legibus*, and consequently much has been left out which might have been inserted. The scheme is sufficiently full, however, to show that Bracton went about his task in a very methodical way. From a study of it we are able to comprehend the meaning of his "sub ordine titulorum et paragraphorum." It is evident, also, that while a work developed on such well-defined lines does not call for a further arrangement by books, it readily lends itself to a variety of arrangements because of the large number of points of natural division which it contains. The marvel is not that there are so many different systems of division to be found in the codices, but that there are not more. In leaving this subject, now that the old arrangement by books has been repudiated, it is perhaps not out of place to say a few words in regard to the system of divisional arrangement which will be used in the new edition. As it would be inexpedient to attempt to use for page headings any such varying subdivision of subjects as the outline given above contains, the main division and the principal subdivisions will have to be noted at the beginning of each new portion of text to which they appertain, and the larger subject under immediate discussion be

¹ Between aa and bb might be inserted "de summonitionibus."

² Between cc and dd might be inserted "de visu faciendo."

³ De Exceptionibus has as its principal subdivisions, de exceptionibus contra iurisdictione, de exceptionibus contra personam iusticiarii, de exceptionibus contra breve, de exceptione bastardiæ, de exceptionibus competentibus tenenti ex persona petentis (exceptiones peremptoriæ et dilatoriæ), de exceptionibus quæ competunt tenenti ex persona propria, de exceptionibus quæ competant tenenti ex ipsa re, de exceptionibus variis—ex taciturnitate, finis facti, de defectu probationis, etc.

⁴ It is hard to believe that the first draft of Bracton's outline could have been as complete as this.

PEDIGREE OF THE MANUSCRIPTS

kept as the running page heading. For instance, the subject of actions in general will be introduced by a title page inscribed:

PARS TERTIA
DE ACTIONIBUS.
I. DE ACTIONIBUS GENERALITER.

Criminal actions will be introduced by a similar page:

PARS TERTIA
DE ACTIONIBUS.
II. DE PLACITIS CORONÆ.

A printed page of text, at what is now f. 150b in V, would appear in part as follows:

400		401
De Placitis Coronæ		De Furto
.....	
.....	
.....	
Tit. XXII.	
De Furto.	
De ac- Inter alia placita coronæ non est	
tione omittendum de actione furti, et de	
furti
et
quid		Et si ille qui seisisus fuerit in hoc De
sit		ei non obtemperaverit, poterit adres- appel-
fur- lo de
tum. latro-
	 cinio.
Quot Species autem furti sunt duæ,	
spe- quia aliud publicum aliud privatum.	
cies
furti.
.....	

For the civil actions another line will be necessary on the title pages, and for *De Recto* a slightly different arrangement of the headings on the even numbered pages, when essoins, defaults, etc., are taken up. Thus on f. 483 at the top of the left hand page will be “De Recto. Exceptiones,” and on the right hand page, “De Exceptionibus Contra Breve.” In this way it will be possible to keep constantly before the reader both the title which is being treated, and the larger divisions of the work as a whole.

DIFFERENCES IN THE ORDER OF PRESENTING SUBJECTS

Having finished with this matter as to how the *De Legibus* should be divided, we may consider the problems which center around a difference in the order of presenting subjects. In by far the larger number of codices the order is the same as that found in V, but in considerably more than a fourth of the manuscripts there is a greater or less amount of variation from that order. This variation results from certain blocks of text being either transposed or omitted entirely. Expressed concisely the facts are as follows:

The text on fs. 11-98 is put after cap. XXX, f. 439,¹ in ML. Fs. 62b-98 is put after the Action for Dower, f. 317b, by CB; after cap. XXX, f. 439, by LD, LE; after "vel expresse voluntate," l. 1, f. 52b, by ML. The text of fs. 62b-118 is put after the regular end of the treatise by LF. *De Actionibus* follows cap. IV, f. 11, in ML; cap. XXII, f. 52b, in CA,² CD; cap. XXVIII, f. 62b, in CB, LD, LE.

The Action for Dower is omitted in OA, MK, W;³ it is put after cap. XL, f. 98, in ML, LD, LE;⁴ after "quod non ponit (potuit)," l. 2, f. 436, in MG, OF (both of which omit the rest of f. 436 and on through cap. XXX, f. 439); after a passage inserted in sect. 11, f. 438b—"sub conditione ut in statuto de Westmonasterio Edwardi regis et fiat remedium per brevia in eisdem statutis formata," in B;⁵ in CB the greater part of this treatise is put after the regular end of the book.

In connection with these facts, as having a bearing on another phase of the same subject, it should be pointed out that a passage on f. 262b of V is made the starting point of a new folio, or quire, or hand, in several of the manuscripts. On f. 92 of ML the Assise of Novel Disseisin ends. Following at once on this, beginning a new paragraph, comes the "præmortuorum ut videri poterit si fiat donatio," etc., on that folio of the printed text just mentioned. LT, which is not altogether regular as regards the position of

¹ It will be noticed that this point, at which so many of the MSS. make insertions, marks the end of the civil actions.

² As all after f. 278 of V is omitted in CA, we can not be sure that fs. 62b-98 were not inserted later, as in LD and LE.

³ In LT *Utrum* ends with "per iuratam unicam expediri," f. 296. The rest of that page is filled with the beginning of *De Ingressu*. With the next folio comes *De Actione Dotis*, and that part of Entry which has already been written is marked out. OG has folios missing at the place where Dower should come.

⁴ After the end of sect. 4, f. 98, OC has the first chapter of the Action for Dower. This is followed by *De Actionibus*. The first chapter of Dower is found later in its proper place.

⁵ OG has sect. 4, f. 63, come after a passage in sect. 12, f. 438b.

Dower, has the same arrangement as ML at this place.¹ CF, always agreeing closely with LT, does the same thing.² CC ends its f. 111b with a passage found in the middle of f. 261 of V, followed by 29 lines of vacant space; f. 112 has the first column empty, and the next column begins with "præmortuorum ut videri," etc.³ In LA the end of Novel Disseisin on one folio is followed by "præmortuorum ut videri," etc., beginning a new folio and a new hand.⁴ One of the quires in OA begins with these same words.

As showing the amount of variation from the usual order which may occur, it is not out of place to note that ML has many changes in addition to those just given, the principal ones being: a passage on f. 292 of V followed by one on f. 324—(et considerandum erit || nisi per C qui non); similarly, f. 66 and f. 78 (præmoriatur, per breve de recto, || et cum de alio tenere); f. 79 and f. 83b (quod semel ab initio. || Cum autem quis a domino suo); f. 92 and f. 95 (inde dotare posset || ita quod eorum instrumentum = "quod eam inde dotare poterit || posset ita interpretari instrumentum" of V); a passage on f. 96b is followed by sect. 4, f. 98, and this in turn is followed by the Action for Dower; fs. 304b and 308b run together (producta fuit secta. || Et ideo de brevi dotis); immediately after sect. 3, f. 315b, comes sect. 6, f. 442. There are many other minor omissions and variations in ML, but those enumerated here are sufficient to show that the manuscript is not one which could be used as a model for either the correct order or a complete text. In CB there is to be noticed another type of irregularity. The Action for Dower begins regularly on f. 126 of the codex. F. 128 ends with "defuncto patri quoad successionem" on f. 299 of V. F. 128b begins the treatise on Entry, and the text ends regularly on f. 186b. On f. 193—the intervening folios are missing—a new hand begins with "propter ignorantiam utriusque parentum," as on f. 299 of V. The subject of Dower is finished on f. 202b of the manuscript, and after an empty space of half a column, f. 203 begins with chapter twenty-nine on f. 62b of the printed book.

¹ In the margin is a note to the effect that twelve leaves are missing here. This may mean either that the exemplar of LT at this place began a new quire with "præmortuorum," or that from a comparison with other MSS. the omitted part was estimated to fill a quire of twelve leaves.

² A note in the margin, in the same hand as the text, reads, "hic deficit maxima pars tertii tractatus libri quarti de assisa mortis antecessoris, videlicet totum principium usque hoc—de hoc quod dicit in dominico, etc."

³ F. 112 is not the first, but the fourth, leaf of a quire.

⁴ Not the beginning of a new quire. This new hand is book hand, of which there are five folios going through sect. 1, f. 269, of V. After almost a whole page of empty space the earlier court hand begins again with sect. 2, f. 269, and goes to the end of cap. XIII, f. 274. A vacant space of nearly a whole folio follows, after which the same court hand continues from cap. XIV through the subject of cosinage and f. 285. After about a page of space the book hand begins a new folio.

Directly affected by this variation or omission of certain parts of the text are OA, OF, MG, MK, ML, CA, CB, CD, LD, LE, LF, B, W; and connected with at least two of this list because of the "præmortuorum" beginning, are CC, CF, LA, LT. By referring to the descriptions given of the manuscripts and to the collation below, it will be seen that this list, though there are good copies in it, can not be considered as representative of the best codices of Bracton's work. Most of the manuscripts here grouped together are distinctly second rate, or even worse. Four of them are abridgments in one form or another of the parent treatise. Seven of them are written in more than one hand; in five of them, at least five different copyists have had a share in making the book. Of those written throughout in a single hand six have been copied either from more than one exemplar, or from a model derived from more than one source, as they agree at different places with different lines. In other words, the majority of these manuscripts are just the kind in which we should expect to find evidence that different blocks of text had been copied at different times or from different originals. And clearly enough that is what has happened here. But very little else is clear. From the fact that the copies which make these changes practically agree as to the portions of text to be transposed, it would appear that the manuscripts are in some way related to one another; that they are not at all in agreement as to where the transposed parts should be inserted, indicates that they are not all closely connected. Just what the exact relationship is could be determined only by a thorough collation of each codex at those places where the variations occur.¹ But as those parts of the *De Legibus* do not, with one exception,² fall within the limits of the passages collated below, it becomes necessary to depend upon information of a more general character. Fortunately the collation which has been made shows well enough the general relationship of the many manuscripts, so that the explanation of the vagaries of these few becomes more a

¹ A collation of the few MSS. which have the same variation at any one point would not do; for any real comparison the collation of a large number would be necessary. Often all the MSS. agree against the printed text. Large groups differing from other large groups break up into smaller groups as a result of constant recopying. A difference of only two or three manuscript generations would be required to put MSS. sprung from the same ancestor into different smaller groups. For instance, as bearing directly on some of the MSS. here under discussion, take the collation on fs. 413-415b. OA, OF, MG, MK, CB, CC, B, X, part of a much larger group, are seen to form a distinct smaller group by themselves. This in turn is broken up into four smaller groups of OA and CC, OF and MG, MK and X, CB and B, any one of which frequently differs from the others. It would be possible within these three folios to pick out passages of considerable length, in which a collation of OA, OF, MK, CB, alone, would show nothing, or next to nothing, of the relationship existing between them. For the same reason the collation of parts of fs. 62b-98, etc., for the few MSS. concerned with a change of order there, could be expected to produce only meagre results.

² The short passage in sect. 2, f. 96.

matter of interest than of necessity. What we see is that there are principally concerned two large sections of text, fs. 62b-98, and *De Actione Dotis*. The former is found in three unusual places, or rather four, if we count the transposition of fs. 62b-118 in LF. Outside of its regular place Dower is found in three other places in addition to being sometimes omitted.¹ Taking into consideration either the block of text transposed or the place at which a change from the regular order occurs, there seems to be, in certain places at least, a close connection between OF and MG, CA and CD, LD and LE and ML, CB and LD and LE. Eliminating LD, LE, ML, which differ from the others in the place assigned to Dower, the position of *De Actione Dotis* is unusual in OA, OF, MG, MK, CB, B, W, all of which either omit it or put it near the end of the book. LF stands apart by itself. Unfortunately that is about all which this special set of facts, of and by themselves, tells us. The facts are clear enough, but the connection between them is not easily discovered; the evidence as a whole is vague, it conveys hints rather than actual information. To know that certain blocks of text have been treated as entities in themselves by some of the copyists, to know that several manuscripts insert one or the other of these blocks of text at, or near, the end of the book, is to know definitely very little except that in some of the codices a portion of the text has become misplaced. Nor is there much in these particular manuscripts to incite a further investigation; for the most part they are, as has been said, not in the first rank. If it were a set of the better codices which were under discussion there might be room for the suspicion that the order in V was not the correct one, or at least that the portions of text so clearly marked off in one way or another in these copies represented blocks of text likewise distinctly set apart in Bracton's own codex. Under the circumstances such suspicions do not arise, for it would be difficult to believe that the poorer manuscripts had kept intact the evidence of original divisions when these divisions had already been lost sight of in the better manuscripts. Yet the facts in regard to the variation shown by these manuscripts have a value

¹ There can be no doubt that the position of Dower in V is the correct one. It is easy to understand how, when the treatise on Dower, having been copied out as a quire by itself, had been removed from its proper position in the book, it should have been inserted at f. 98, after seven folios devoted to the subject of Dower. But in this earlier part of the book the subject is really that of acquisition—how property may be acquired “ex causa dotis” as is made plain by the opening words of *De Actione Dotis*. As a civil action it would naturally come in with the other civil actions. This is the probable reason why some of the MSS. have put it at the end of the civil actions. Dower is expressly mentioned by Bracton in that chapter which introduces the civil actions, f. 160. In his plan it could not have come after the Writ of Right, as some MSS. have it, for he expressly states that his plan is to treat the Writ of Right last—“Placitum vero de recto ultimum sibi locum vindicat in ordine placitorum,” etc., f. 328.

after all. Though practically useless in themselves alone, when taken in conjunction with information to be derived from other sources, they offer a possible explanation as to why so many of the codices have chosen the same large portions of text for transposition, and, in addition, throw considerable light upon some questions to which the peculiar construction of one of the best of the manuscripts gives rise.

That manuscript is OA. The immediate connection of OA with the situation is most visible in the fact that it omits Dower. Those copies which put the treatise on this subject near the end of the book or omit it entirely were seen to be OA, OF, MG, MK, CB, B, W. By consulting the collation of the last piece of text below, fs. 413-415b, OA, OF, MG, MK, CB, CC, B, X, will be found to constitute a single group closely related in this particular portion of their contents. This does not necessarily mean that they continue to agree for some twenty-five folios further on, but the presumption is that most of them, at any rate, do. In other words, OA at the end of the book is related to most of those copies which have the Action for Dower out of its usual place. Leaving this subject for the present and continuing with OA along another line, it will be found on examination that in the Bodleian manuscript the blocks of text marked off in the other manuscripts coincide with new quires and new hands. Thus fs. 62b-98 of V form quires F and G in OA. The disposition made of this part of the treatise by ML, CB, LD, LE, LF, has been noted already. Fs. 11-62b, which ML puts with fs. 62b-98 at the end of cap. XXX on f. 439 of V, form quires C, D, E, of OA. Quire R of OA begins with the "præmortuorum," etc., of f. 262b, which thus associates it in some way or other with ML, CF, CC, LT, LA. *De Actionibus* begins quire H of OA. Clearly the important manuscript in this discussion is OA; it seems to hold the key to an easy solution of the problems which have been brought up by the variation in the order of subjects. However, before its relation to the other manuscripts is considered it will be necessary to examine OA itself.

In a way this is a digression from the subject immediately in hand, but it brings up a topic which must be discussed somewhere in this connection, and which can be treated to the best advantage at this place. No less an authority than the late Professor Maitland has made the written statement that in the particular arrangement of its material by quires OA is reproducing some of the external traits of Bracton's original manuscript.¹ Manifestly,

¹ *Bracton and Azo*, 239-243. His attitude towards OA is well expressed by a sentence in the first paragraph on p. 239—"At present I think that it may well be a primary copy of the original MS., and that it may reproduce some external, or (if I may use the phrase) anatomical traits of its parent."

therefore, before we take up the matter of the disposition of certain blocks of text by other manuscripts, it will be well to consider just what it means to have these same portions of the text set apart in OA through its quire arrangement. So great has been the prominence given to OA by the learned author of *Bracton and Azo*, so alluringly has he expounded what he considered to be its claims to a position of preëminence among the Bracton manuscripts, that any one who would remove it from the pinnacle on which he has set it—even though it be but to lower it ever so little—must necessarily meet the arguments which he has brought forward in its favor. The present writer is forced to take exception to some of Professor Maitland's statements in regard to OA. He does so in no spirit of hostile criticism or controversy, but merely for the purpose of putting a truer valuation on one of the best of the written copies of Bracton.

The arguments in favor of OA hinge upon the peculiarities of its quire arrangement. New subjects frequently begin with new quires; at the end of the quires there is often blank parchment, and sometimes evidence that leaves not written on have been cut away. Professor Maitland saw in this a proof that the Digby manuscript had been copied from Bracton's own volume. His idea was that Bracton "might be compelled by the stress of circumstances and the gradual evolution of his plan to make new starts from time to time, to execute now one and now another part of his project, and perhaps to write the end of his book before he wrote the beginning."¹ As a result of this method "when the work of composition was finished, then he had on his hands various quires or *pecie* of parchment of various sizes which were to be bound together. Blank leaves he would probably cut away, for they might be useful at a future time; but still his MS. would probably display some traces of the process which produced it. In particular we shall be likely to find the beginning of a *Liber* or *Capitulum* coinciding with the beginning of a *pecia*, while at the end of a *pecia* we shall be likely to find either some blank parchment or some evidence that leaves or parts of leaves have been excised."² As this manuscript is copied, these external features may be reproduced in the earliest of its descendants, especially if the original is taken apart and given by quires to several different scribes; in the later copies, however, these features will disappear. "Hence we obtain two rules of presumption, namely, (1) that a MS., whose anatomy coincides with divisions of the subject-matter, or, in

¹ *Bracton and Azo*, 239.

² *Ibid.*, 239.

other words, whose division into quires answers to a division into books and chapters, is a MS. which stands near in order of derivation to the original MS., and (2) that any blank leaves at the end of a quire and any sign that blank leaves have been excised tend to prove that the MS. which is in our hand is reproducing the shape of its immediate ancestor."¹ Since OA measures up to the requirements of both these rules, it is therefore, on that basis, a primary copy of the original.

All this sounds plausible, the idea is very attractive. Yet every vital part of the theory is based upon supposition; there is not a single fact upon which it can be made to depend. In the first place it is assuming too much to suppose that the beginnings of prominent divisions in the *De Legibus* would in the author's own copy usually coincide with the beginnings of new quires. That they might, no one will deny; that they should do so of necessity is not at all apparent. Bracton's scheme was well laid out, as we have seen; its broader outlines would not admit of many changes. Granted that he might have written the latter part of his book before the beginning, it is not easy to think of him as working otherwise than consecutively after f. 159b, at the furthest. The words with which he starts so many new subjects, "Dictum est supra," etc., certainly lead us to infer that one subject was practically finished before another was begun, even for that part of the text earlier in order than f. 159b.² He did make a good many additions from time to time, but these were scattered through the different folios and not lumped at the end of the quire. As he wrote by titles rather than by books he could hardly begin a new *Liber* with a new quire. In many cases the transition from one large subject to another is so gradual as to preclude even the suggestion of a break. All things considered, it seems more reasonable to think of Bracton as working at his book in a regular way and taking up a new subject after finishing the one preceding it. And we are so thoroughly in sympathy with the dictum of him whose words we have quoted above—"In the middle ages parchment was valuable, and men did not willingly waste it. Any one familiar with medieval books will be struck by signs of a rigid economy"³—that we

¹ *Bracton and Azo*, 240.

² As a case in point take the text on the border line of quires G and H in OA. At the end of G is 1½ pages of empty space and one folio has been cut away. H begins *De Actionibus*—"Dictum est supra de personis et rebus, nunc autem dicendum est de actionibus." It does not seem as if Bracton would have used these words, even though he was following Roman models at this particular place, unless he had practically finished his discussion of Persons and Things. In which case there would have been no empty space at this point in the original, as Actions would have followed immediately on Things.

³ *Bracton and Azo*, 239.

can not believe Bracton would have followed a process of composition so wasteful of precious writing material. Then in the second place, in order to have the situation work out along the lines assumed above, it would be necessary not only to have the original *De Legibus* divided by quires as supposed, but to have that particular codex taken apart by quires and divided among several different scribes for purposes of copying. On the supposition that one scribe had done all the copying the vacant spaces would have disappeared in any book made from this original; so would they also have disappeared if a number of copyists, not working simultaneously, had followed one another in regular order, using the same exemplar either taken apart or left intact. In either case there would be no reason or necessity for keeping a certain amount of blank parchment at the end of quires. Now this is bringing the requirements within the narrowest of limits. It is really remarkable that OA should meet these strict requirements. We find plenty of manuscripts written in a single hand throughout, many, also, written by several different penmen; but in the Digby manuscript alone are there the undeniably evident signs that a number of scribes were working simultaneously on the same book. What a marvellous array of coincidences! Of all the codices which have come down to us one only had to be written in such a hurry that the many copyists had to work at one and the same time. Only one exemplar was to be had as a model.¹ This happened to be Bracton's own copy, which copy happened to be so arranged through a coincidence of quires and subject-matter that when the quires were taken apart and distributed the many scribes reproduced not only the text, but also the external features of the original. And thus it has come about that the anatomy of OA coincides with divisions of the subject-matter, and that at the end of its quires are blank pieces of parchment.

Now let us ask what could have been the effect upon OA if its six scribes working at the same time had copied their parts from several different manuscripts. The answer must be that OA would present the same appearance as in the first supposed case, that is, its anatomy would still coincide with divisions of the subject-matter, and at the end of its quires would be blank parchment. For if the copyists were working with different models before them the only way to gauge their work would be to pick out prominent places in the treatise, start one at this place and another at another place—

¹ Probably no one would wish to maintain that OA was the first copy made from the original *De Legibus*. Nor is this a necessary supposition in Maitland's theory.

estimating, of course, within reasonable limits the approximate number of folios or quires which would be produced from a certain block of text—and let them finish where they might. This would result in new quires starting new subjects, and in empty parchment at the end of different hands, for only very seldom, if ever, would the scribe just fill an even quire or number of quires with the amount of copy allotted to him.¹ In other words, OA could have been produced in its present shape by six penmen copying from several different exemplars. We will even go one step further and say that OA as it now stands might have resulted from its six writers having made use of a single manuscript divided among them, said manuscript being neither the original copy once in Bracton's own hands, nor having a single new subject begin on any new quire, nor a single column of blank parchment at the end of any one of those quires. The points at which in OA one hand finishes one subject and another hand takes up another subject might have come at the beginning, middle, or end, of any page, folio, or quire, in this model. Indeed, it is hardly correct to put these last statements in the form of a supposition, for there are certain peculiarities in the order in which the various scribes have written OA which suggest strongly that a single exemplar of the ordinary type formed the model for at least a considerable part of the Digby manuscript.² Under ordinary circumstances a single copy which was to be reproduced by several scribes working at the same time would naturally be taken apart and distributed by quires or folios to each of the penmen. But the portions allotted to any one copyist would in all probability be consecutive, for there would be usually no more expedient method of allotment. In a manuscript copied under these conditions we should be apt to find vacant spaces of parchment at the end of each scribe's work, but not new subjects beginning with new hands, as the exemplar would probably not admit of such a division. Now some unusual set of circumstances might cause the apportionment of material to the scribes to be made in another way. Suppose,

¹ In regard to the amount of space which a certain portion of text might occupy, the work of the average scribe was often uneven. Changes in pen, ink, or vellum, made decided differences in the amount of copy which could be, or rather would be, reproduced upon a given number of folios. Variation in sizes of the letters and in the size of the space used for writing would make one quire contain more or less than another. Quires J, K, L, M, N, in OA are each of eight folios and written by the same hand. They contain respectively some 22, 19, 18, 20, 18 folios of the printed text.

² Rather conclusive evidence that the important quire R was not copied from the same exemplar as the quire which precedes it is found in the ending of Q and the beginning of R—"de morte aliorum præmortuorum || postmortuorum ut videri" where the reading should be "de morte aliorum præmortuorum ut videri." The scribe of Q (hand V) would hardly have copied an extra word merely for the sake of filling up a line, as *præmort* comes at the end of one line and *orum* runs over into the beginning of another, which except for this is left blank with the rest of the page.

for instance, that some lawyer in the days of Edward the First was desirous of having a copy of the *De Legibus* made for him as soon as possible. He takes his order to some *scriptorium*, and the work is started at once, by several copyists. If the lawyer's demand for fast work is insistent, the manager of the *scriptorium* will probably set to work immediately as many copyists as possible, dividing the work in such a way as will allow him to assign portions of it to others whom he may be able to add from time to time. OA was apparently made in a hurry for some one who wanted a codex that would be useful rather than beautiful; everything connected with the book leads to that inference. Its anatomy would seem to indicate that its exemplar had been divided at points of more or less prominence in the text in such a way that nine scribes could have worked at one and the same time without their work in any way overlapping. Seemingly this number of scribes could not be procured, for all but two of the quires were written by four penmen who did the work planned for more. But the parts of the exemplar allotted to these scribes did not follow one another in regular order. The fact that the same page in the model would contain the end of one copyist's work and the beginning of another's made it necessary to assign the folios in such a way that the two men could use the same page at different times without interruption from one another. How this may have been done will be seen from the following tabulation of OA's quire scheme:

Quire A, 8 folios of kalendar. B, 4 folios, beginning "in rege" on f. 1 of V. C, 8 folios, beginning cap. V, f. 11. D, 8 folios, beginning "successionem videtur quod ad," f. 28. E, 8 folios, beginning "ad excambium versus suum," f. 47b. F, 8 folios, beginning "Est etiam alia causa," f. 62b. G, 7 folios, beginning "homagium dedicere non possit," f. 82b. H, 6 folios, beginning cap. I, f. 98b. J, 8 folios, beginning "tali quod assisam illam dictis," f. 110b. K, 8 folios, beginning "sine difficultate gratia tamen," f. 132b. L, 8 folios, beginning "fuerit warranto liberabitur ille," f. 151. M, 8 folios, beginning "Sine iudicio eiciatur," f. 169b. N, 8 folios, beginning "utrum quid fiat," f. 189. O, 4 folios, beginning "talis ante impetrationem," f. 206b. P, 8 folios, beginning "Et eodem modo erit procedendum," f. 214. Q, 9 folios. The first page is written by the hand that wrote P and finishes the Assise of Novel Disseisin. The second page is blank. A new hand begins the second folio with cap. 1, f. 237b. R, 8 folios, beginning "præmortuorum," etc., f. 262b. S, 8 folios, beginning cap. I, f. 285b. T, 9 folios, beginning "unius deficiat erit quasi," f. 327. V, 8 folios, beginning cap. V,

f. 347b. X, 8 folios, beginning "aliquam vacare quod sit," f. 365b. Y, 8 folios, beginning "ante hereditatis additionem," f. 383. Z, 6 folios, beginning sect. 5, f. 399b. Aa, 12 folios (last two lost), beginning sect. 8, f. 419. Large blank spaces are found at the end of quires B, E, G, H, O, T; and shorter spaces at the end of R and Y. Hand I wrote quire A; II, quires B, J, K, L, M, N, O; III, quires C, D, E, H; IV, quires F, G, P (+ one folio of Q), R, S, T; V, the last eight folios of quire Q; VI, quires V, X, Y, Z, Aa.¹ It would seem that the beginnings of quires A, B, C, F, H, J, P, S, V, Z, and the second folio of Q, mark the points at which the text of OA's exemplar had been divided for assignment to different copyists.

These assignments would appear to have been made in the following order. To hand I was given the kalendar for copying. Such an allotment would be most natural, as the table of contents almost always occupies a quire by itself. To hand II were given a number of folios estimated as sufficient for a short quire. But these folios contained more than hand II was expected to copy at this particular place. Hand III could not have taken up the copying at the point where II was going to leave it without either omitting something or interfering with II. So III was started at one of the most prominent places in the whole treatise, the place where Bracton takes up the discussion of Actions. A certain number of folios were given and he copied them all, making out of them a quire of six folios with a page and a half of empty parchment at the end. On account of the difference in the style of handwriting, the first quire written by III takes up more space than that written by II. But notice that in this first assignment of material from the exemplar they each received about the same amount.² Neither of them was to do his real work of copying at these places, but at others. They were

¹ See above, p. 5, n. 1. In his tabulation of the quire scheme of OA Prof. Maitland divides the work among eight copyists. This is in contradiction to his statement on p. 240 of *Bracton and Azo*. "I believe that the text (even when we have excluded the *Kalendare* or Table of Contents and take no notice of the rubricators) shows the work of at least five different penmen."

² In *Bracton and Azo*, pp. 241, 134, xv, emphasis is laid on the fact that the first quire (B) written by hand II ends at a point of prominent division in the treatise. Some of the statements there made should most certainly be modified. It is difficult to discover any authority for the statement, "We may infer that in Bracton's own MS. a break occurred here." In Bracton's scheme, as the outline given on p. 60 above will show, the more prominent break comes not at cap. V on f. 11, but at cap. IV on f. 10b, "De acquirendo rerum dominio ex causa donationis inter vivos" being but one of a number of subjects under the greater head of "De diversis modis acquirendi ex iure civili." Moreover, the amount of Roman law in fs. 11-98 is by no means as meager as we might be led to suppose. To be sure, the amount of pure English law in this portion of the text is relatively greater than in the preceding ten folios, but a study of the text will quickly show that it is by no means correct to think of Bracton's dependence on the Roman law as ending with f. 10. As far as any real break on f. 11 is concerned it is to be found in OA's quire arrangement rather than in Bracton's development of his subject-matter.

started on these shorter quires to get them out of each other's way, so to speak. When they turned to the more extensive portions of their work the quires were made much longer. As soon as II was through with that last folio of his first assignment, which contained also the beginning of III's larger block of text, he turned it over to the latter, and for himself started in on that folio in the exemplar immediately following the last one in III's first lot. From the point at which III began (f. 98b of V) there was counted back a number of folios estimated to be sufficient for about two quires in the new book, and hand IV was set to work at a prominent break in the text (f. 62b of V) somewhere near the place arrived at by that reckoning. But this amount of text was not quite enough for two quires of eight folios each in the kind of hand IV wrote, so he was left with waste vellum at the end of his second quire. As soon as IV had finished with the first folio from which he was copying he turned it over to III, who was thus able to copy all from the point at which II left off up to the place where IV began. Out of this amount of copy III made nearly, but not quite, three quires. Now we should expect to find some evidence of division at the point where the civil actions begin. This place might have been chosen as the beginning of a new assignment in the scheme of allotment, but all evidence as to that would have disappeared, of course, after II had been given consecutive work on either side of that point. If one of our former assumptions is correct, it would seem that before the work had been going on very long it became evident to the master of the *scriptorium* that the number of scribes whom he could set at this particular task was going to grow less rather than more, and that he was therefore compelled to give to a smaller number of men a relatively larger amount of work than he had originally planned for each. This would explain why the blocks of text written by the same hand show such a decided tendency to increase in length as the work goes on. After hand IV had finished his first section of text, ending on f. 98 of V, he was set to work on the passage beginning on f. 214 of V—quire P of OA. It is perfectly plain that folios had been counted backward from the end of Novel Disseisin in exactly the same way that they had been counted backward from the beginning of *De Actionibus*. It was estimated that from f. 214 to f. 237b there would be enough material to form a quire in the new book. But this time the estimate was too generous as before it had been too scant; the scribe was obliged to write an extra page over and above his quire of eight folios.¹ Hand V was commissioned to write a quire beginning with the Assise

¹ The basis of apportionment was without any doubt the quire (or quires) of eight folios.

of Last Presentation. His quire came to an end in the midst of a sentence on f. 262b of V. Hand IV then began quire S of OA¹ with the Assise Utrum and went to the end of cap. IV, f. 347b of V, hand VI having already finished with that folio of the exemplar which he had to use first and IV copy from afterwards. In this case again hand IV was obliged to run over the estimated number of folios, and so we have quire T of OA, nine folios with a blank space and an excised folio at the end. After finishing quire T, IV went back and took up the copying at the point where hand V had left it off, and wrote quire R of OA. This time the material pretty nearly fitted the quire, only the last quarter of a page being left blank. Hand VI wrote the last five quires. The vacant space at the end of quire Y would suggest that he started in with quires Z and Aa, and then, perhaps because no one had been found to do the work in the meantime, went back and copied quires V, X and Y.

On reading this possible, we might better, perhaps, say probable, explanation of the method used in making OA, the reader will naturally ask the question, "But why all this changing about? Why not adopt the far simpler plan of giving to each of the copyists his work, be it a less or greater amount, in regular order?" As we have before pointed out, a study of the quire arrangement in the Digby manuscript will show that at least nine scribes could have worked simultaneously on the single exemplar by this simple method of changing about. If another division, now obscured, had been made in the quires J-O block, ten men could have been writing at the same time from a single copy.² If, as we have supposed, and the appearance of OA leads us to infer, speed of production was the principal thing desired, the exemplar could not have been divided in a more skillful way. He who had charge of the *scriptorium* was willing to reproduce the original codex as quickly as he could. He would put on that work all the penmen available, more at one time than at another, presumably, but he could not tell at the beginning just how many he might be able to use. He did not divide the exemplar into four, or five, or six equal parts because he might be able to employ ten scribes. What he did do was to divide the parent book in such a way that one, two, or ten men might work simultaneously, or not at the same time, with the least amount of interference and the least waste of parchment. He had to have a flexible scheme, and to make it flexible enough to fit the undetermined possible

¹ In LA quire P, preceded by nearly a page of blank space, begins at the same point as quire S in OA, but ends in f. 304, the Action for Dower not being omitted in LA.

² It is to be remembered that the Action for Dower is missing in OA. This treatise was long enough for a quire by itself. As to the probable cause of its omission in OA we shall speak later.

number of copyists, he had to adopt the unusual expedient of having the same scribe copy non-contiguous portions.

We can not be sure, of course, that OA was made from a single exemplar. The suggestions which have just been made as to the probable way in which OA was constructed are all the more reasonable because they offer the best possible explanation of the seemingly erratic way in which the work was apportioned to the various scribes. The important fact to be kept in mind is that the peculiar arrangement of OA by quires does not in the least compel us to believe that its immediate ancestor was Bracton's own copy.¹ Any ordinary manuscript as an exemplar could have given it the same unusual form. For that form depended upon the plan of construction followed, not upon the exemplar; it would have been the same in principle whether OA had been derived directly from one or from ten models. What we can be sure of is that OA was copied from more than one exemplar, or from one derived from more than a single source, for, as the collation shows, the Digby manuscript agrees in different places with different lines. Be its ancestry what it may, it most certainly is not a primary copy of the original *De Legibus*.²

But a manuscript may not be a primary copy and yet be very close to the original. Before leaving OA it will be well to look into some of the other claims which have been advanced to show that it was near in order of derivation to the first book of its kind. At the end of chapter XXXI on f. 69 of V Bracton promises to give a writ, which is not, however, to be found in the text. OA on its thirty-ninth folio leaves a space of twenty-five lines at this place, presumably for the writ. A great deal is made out of this by the author of *Bracton and Azo* as showing that Digby 222 is reproducing here a vacant space in the original in which Bracton intended to, but did not, insert

¹ Proof positive that all the quires of OA were not made to correspond with quires taken from a single exemplar is found at the end of quire H and the beginning of quire J. The regular text reading (f. 110b, l. 25) is *vicecomiti nostro tali, quod assisam illam, dictis die et loco*. Quire H ends with *vicecomiti nostro tali, quod assisam illam*, and quire J begins, *tali quod assisam illam dictis die*. This is the place at which hand II follows hand III. It is quite evident that whatever may have been the mark which indicated the point of separation between the two hands, it did not prevent the overlapping of words, which would have been impossible if III had finished one quire in the exemplar and II had begun with another. It should be remembered, also, that in the same way quires Q and R overlap with *aliorum pramortuorum post mortuorum* for the regular *aliorum pramortuorum*.

² Maitland seems to have begun to realize this fact before he had finished with OA. On p. 248 of *Bracton and Azo* he says, "I must add, however, that even the Digby MS., faithful though it may be, has received into its text at least one passage which must have once stood in the margin. The case is an extremely clear one. On f. 220b the Vulgate gives a passage in which what is obviously a romanesque *addicio* derived from Paulus has forced its way into the middle of a sentence and made nonsense. . . . Useful, therefore, though that MS. will be when the treatise is to be edited, we can not accept it as a perfect copy of the autograph, and indeed in small matters it not unfrequently gives a worse text than may be found elsewhere."

the writ.¹ Only one other of the manuscripts, LA, leaves a space at this point. By referring to the description given of LA it will be seen that this codex frequently leaves a space vacant at the end of chapters, sometimes a space of greater extent than the twenty-one lines left empty here.² So the question naturally arises as to whether the lines of blank parchment at this place have any greater significance than an unwritten interval at the end of any other chapter, or title, as it may more properly be called. OA itself often leaves unwritten lines at the end of what are chapters and sections in V, but the spaces are not nearly as large as that left vacant here. However, the fact remains that the two codices which do have an empty space at this point are accustomed to leave lines blank at similar places elsewhere. It would mean much more if this particular space in OA and LA had come in the middle, rather than at the end, of a title. These two manuscripts are closely connected in places; their agreement here is quite in keeping with a number of peculiarities limited to themselves alone in other places; it proves nothing at all as to whether or not Bracton's own copy had a blank space at this particular spot. At other places besides this he promises writs which are not forthcoming, and from time to time the copyists are bothered by these unfulfilled promises. Every once in a while they leave a number of lines vacant at one or another of these points, apparently in the belief that their model is not quite complete in this special passage, and that the writ may be found in another exemplar. For instance, at the middle of f. 205b the writ which we would naturally look for is omitted in V and in all the manuscripts (which leave no space for it) with the exception of Y.³ Another writ should come at the end of sect. 7 on f. 300b.⁴ No codex gives it, but Y and CE leave each a space of eleven lines, MB a space of seven lines, MH a space of fourteen lines, CM a space of thirteen lines, MM a space of twelve lines, MN a space of three lines, and P a space of eleven lines. At the end of sect. 2, f. 358b, "fiat breve vicecomiti sub tali forma" is followed by the writ itself in

¹ "In some respects more important than those yet noticed, the copyists seem to have endeavoured to produce a facsimile of their model. On f. 69 of the Vulgate text Bracton says that he is going to give what in effect would be a writ of 'formedon in the remainder': *breve autem tale erit*, he says, but he gives no writ, and it is a controverted question whether in his day such a writ had become current. Now in our MS. these words are followed by a blank space, no less than five-and-twenty lines being left vacant. This waste of material can hardly be explained except by the supposition that in Bracton's own MS. a space was left at this point by the author, a space which he hoped to be able to fill up at some future time." *Bracton and Azo*, 243.

² See also n. 1, p. 87 below.

³ "quod recordari faciat, et recordum habeant ad certum diem per tale breve. Et de hac materia habetis"

⁴ "Forma brevis de summonitione. Rex vicecomiti salutem. Expectatur quandoque ætas"

section three. ML omits the writ and leaves a space of three lines. ME leaves a space of nineteen lines but gives the writ in section three. MH likewise has a blank space of nineteen lines at the end of section two, and CM a space of seven lines. P leaves an interval of six unwritten lines, following it with the red ink rubric, "Breve si essionatus surrexerit sine licentia quod milites mittantur ad videndum si ita surrexerit vel non post languor." ME, MH, CM, P, will be found to be in close agreement in many places in the passages collated. Their leaving a certain number of lines vacant on f. 358b is no more than a family trait, so to speak. We have already noticed that MB, CE, Y, left a space for the writ expected on f. 300b; these same copies also leave spaces after "alio modo coram tali iusticiario" on f. 308b, MB of four lines, Y of eleven lines, and CE of nineteen lines. This would indicate that some relationship existed between these three manuscripts in this particular portion of their treatise. In the same way the spaces left by OA and LA on f. 69 can be taken to mean nothing more than that some sort of connection, which is also made plain in other ways and places, exists between these two copies. From the instances which have been given it is perfectly evident that it was no unusual thing for a scribe to leave blank lines for an expected writ.¹ The leaving of such a space at one place gives to OA no more right to the claim of reproducing a blank in the author's own book, than similar spaces at other places give to many other manuscripts.

The amount of space left vacant by OA at one place or another is truly unusual. But it results from the irregular manner in which the manuscript was built up, and not from any extraordinary excellence in either OA itself or its immediate ancestor. The blank spaces themselves prove absolutely nothing

¹ All but "Rex vicecomiti salutem," or "Rex vicecomiti salutem. Præcipe," is usually omitted in the writ in cap. XXIV, f. 202. Sometimes the whole writ is lacking. In its place spaces of from two to five lines are found in several of the MSS. As illustrating how such a space might be regarded by a copyist it is interesting to notice that PH, which leaves two lines empty, has in the margin, "The rubric is lacking." Clearly the scribe of PH took the vacant space in his exemplar as the space left for a rubric. Attention may be called to another unfulfilled promise of Bracton's—that of the figure to illustrate descent and relationship, on f. 68b. The printed text reads "in figura superius picta," but most of the MSS. have "in figura inferius depicta." There is not the least probability that Bracton ever drew such a figure in his own copy, but space is left for it in several of the MSS. OD has such a figure on f. 37b (see Twiss's edition, 1, xxi-xxiii). OE leaves half a column of space, but makes no insertion. W inserts two short treatises on consanguinity. ME leaves a space of 22 lines, but is regular. Near the end of sect. 2, f. 68b, MF has two pages on the rubrics "Quibus modis arbor de consanguinitate debet fieri" and "De triplici cognatione." At the very end of the same section come four pages from Johannes de Deo, with the *arbor consanguinitatis*. M1 leaves a space of 22 lines, but inserts nothing. LA leaves about half a page of space in different, though adjacent, columns. LB leaves 12 lines blank. In the margin, in same hand, is "hic depingetur arbor." In LC 27 lines were originally left vacant. At the bottom of the page is inscribed "Hic deficit figura." CC leaves empty 20 lines on f. 28 and two-thirds of a page on f. 28b (a whole page of blank parchment being found also on fs. 26-26b). It was only natural that the copyists should often be puzzled by these promises which their exemplars did not make good. See *Law Quart. Rev.*, 1, 192, 193; 11, 278, 279.

as to its superiority or inferiority. Not only are unused lines or leaves of parchment found in the other written copies of Bracton, but there is not a single feature of OA in the matter of leaving blank spaces which can not be found in at least one, and usually in several, of the other codices.¹ To take up this subject in any sort of detail, even omitting such illustrations as have been given already in one place or another, would require too much time and space.² It is sufficient here to simply state that the more the other manuscripts are closely examined the less remarkable in any way seem the peculiar traits of Digby 222.

This is true of another feature of the same manuscript which should be touched upon in this place. In that masterly introduction to *Bracton's Note Book*³ OA again comes in for great praise because in its margins are jottings which would seem to connect it in some way with the Note Book, and thus more directly with Bracton. Briefly stated the facts are these. In the Note Book one of the annotators, who may or may not be Bracton himself, "notes up" certain cases. Opposite four of these cases he makes some allusion to *Corbyn*. On f. 269b of the printed Bracton is a reference to one of the cases⁴ in the form of an *addicio*, which in OA is marginal and has above it the words *Casus Corbin*. Another case⁵ in the Note Book has opposite in the margin the note, "Casus Radulphi de Arundelle similis isti in Cornubia." At the bottom of f. 98 in OA is the note, "Memorandum de casu R. de Arundelle."

¹ A reader of *Bracton and Azo*, p. 240, might get the impression that the margins of OA are unusually wide—"It has ample margins; these were required for the *addiciones*." By referring to the measurements in the description of the manuscripts given above it will be seen that many of the MSS. have as wide margins as OA, and some even wider.

² The following facts may be brought forward, however, as having a somewhat more important bearing on this subject. Before its third book OB leaves blank all of one page and all but five lines (which are used for the *Incipit*) on the next page. Preceding its fourth book are about two and one-half pages of empty space. The fifth book is preceded by about the same amount of blank parchment. LG has a space of half a column at the end of book I, and a column at the end of both book II and book III. CH ends its first book in sect. 6, f. 35 of V. A space of one and one-half columns follows. MM leaves a whole column of empty space between "dicebat quod nihil" and "tenuit de hereditate," f. 385 of V. In LD one quire ends with "ut de ter" + a column of space. The next quire begins "mino Paschæ anno," etc., as on f. 413 of V. In LA quire F begins cap. III, f. 118—a prominent place—and has two excised folios at the end. Quire G begins at another subject, cap. XVI, f. 135b. Quire L, after a space of nearly a column, begins with sect. 4, f. 199. M begins at sect. 5, f. 216b, after a blank space of 15 lines. At the end of quire N almost a whole page is blank, O beginning with sect. 2, f. 269, and leaving about a page of space at the end. Quire P begins with the Assise Utrum, as does quire S of OA. In other words, these portions of LA were apparently copied according to a method similar to that used in making OA. Points of more or less prominence were chosen in the exemplar to serve as the beginning of quires. These were not the same points as those chosen by the makers of OA, but the method pursued resulted in vacant spaces at the end of the quires for all that.

³ *Bracton's Note Book*, ed. F. W. Maitland. See especially pp. 93-104 of Vol. I.

⁴ Case 1827.

⁵ Case 266.

Again, on a roll of assises taken by Braeton in 1254 is a case between William Montacute and Andrew Wake.¹ On f. 101b of the Digby manuscript, in the margin, and without context, is *Wake. Munt agu.*² Now the Note Book itself does not need to enter into this discussion; there is no necessity of determining here the debatable question as to whether or not the annotator of these cases in the Note Book and Braeton are one and the same. Nor is it necessary to consider at this place the significance of the marginal *Casus* or *Nota Casus* which are found over and over again in the Braeton manuscripts, and are, indeed, among the most common of all the marginalia.³ Nor is the question as to whether Braeton or some one else wrote in the margins of an earlier copy the *Casus Corbin* and similar jottings which are found in OA the point of most importance just now. We are trying to determine whether on account of these marginalia OA is given any position of preëminence. An examination of the other codices shows that it is not. These same names, whoever may have been responsible for their appearance, are found in other manuscripts, and OA is not marked off as special and peculiar because of them.

In MC *Casus Corbin* has become part of the text at the place where it is found in OA.⁴ On page 283 of PH, in the margin and at the same place as in OA, is *Wake Muntagu.* Other manuscripts than OA have therefore these notes which have been so emphatically approved. The *Memorandum de casu de R. de Arundelle* on f. 98 of OA, which has been already alluded to, does not stand in at all the same relation to the rest of the manuscript as the *Casus Corbin* and *Wake Muntagu* jottings. It is something quite apart by itself, being written in a hand different from that of the text, rubrics, *addiciones*, or corrections. The writing is very similar to that of the J. de Beaupre note on f. 129b.⁵ It was written in all likelihood by the owner, or by one who at

¹ *Braeton's Note Book*, I, 40.

² Near the middle of f. 214 of V.

³ Even the *Fleta* MS. is not free from them. They have been reproduced in the margins of the 1647 edition of *Fleta*.

⁴ F. 133 of MC. In OA these words are in black ink, not in the hand which wrote the text, and perhaps not—though probably—in the same hand as the *addicio*. These short notes of a word or two are often hard to compare or contrast with other hands, as they contain so few letters for a comparison. In red ink on the inner margin of this same folio OA has *Casus Roberti de Shute*, the rubric of sect. 4, f. 270. ME has treated "Causus de priore de Kynelworth et Waltero de Insula," the rubric to sect. 2, f. 183, as MC has treated *Casus Corbin*, and made it part of the text.

⁵ See *Braeton's Note Book*, I, 99. The fact that OA was evidently made for a certain Ralph Arundell and so comes to have his name at the bottom of the first page of several of the quires, does not, of course, connect it with the *Casus Radulphi de Arundelle* in the Note Book. Neither does the half scribbled note which tells that seven and one-half quires are being sent to J. de Beaupre, and that he is held to answer for them to Ralph Arundell. These things have a bearing only on the possible ownership of the MS., and show nothing at all as to the sources from which it was derived or with which it was connected.

some time after the manuscript had been copied had charge of it. Its very position, so unlike that of the other *Casus*—it is put at almost the very bottom of the page and seemingly as far as possible away from the text—would indicate that it was in fact a simple memorandum, jotted down by some reader of the codex after its completion. Whatever its origin it can not be considered as coming from the exemplar of OA at this particular place. In such a case it would have occupied a different position, and have been written, if not in the same hand as the text, at least in that of the *addiciones*.¹ It is difficult to see how its occurrence here might in any way be construed as connecting OA with the Note Book.

These are not the only references of their kind found in the Digby codex. On its f. 44, in the margin opposite a passage near the end of f. 80b of V, is “*Casus Willelmi de Marisco in Hybernia.*” CF has the same thing at the same place. In the margin of f. 65b, opposite sect. 4, f. 131b of V, OA has in red ink “*De Johanne de Newenham.*” Moreover, other marginalia of a like nature are found in other copies. On f. 34 of OB, in the same hand as the text and opposite a passage near the end of f. 18 in V, is the marginal “*Casus de Grendel.*” In the margin of PH, near the beginning of sect. 3 on f. 65 of V, is “*Casus Ricardi Quintyn.*” In the same manuscript, near the middle of f. 200 in the printed book, there is written in the margin, in the same hand as the text, “*Nota de Willelmo de Raleigh et Priore.*” Again, opposite the case in sect. 9, f. 234b, PH has in the margin and in the same hand as the text, a word which is seemingly meant for “*Crey.*” In LA, written in the margin by the hand which wrote the text, opposite line 39, f. 168 of V, is *Tatersalle*. There is a case by this name on f. 169b of V, and the case itself is “noted up” in the Note Book.²

These annotations interest and fascinate us all the more because they arouse our curiosity. Since the truth in regard to them can not be known they lend themselves readily to all sorts of speculation. The real facts are so far beyond our ken that there is nothing to prevent us from revelling in the luxury of guessing, and that is always prone to confuse possibilities with probabilities. What theories and possible explanations could not be built up on the 33 lines of space after the rubric “*Casus de Jordano Wavasore*” on

¹ If this memorandum had stood in the margin of OA's exemplar it would have been treated as the *Wake Muntagu* and *Casus Roberti de Shute* (see note 4, p. 81) were treated, and like them have been written in red ink as a rubric. *Casus Corbin* is in black ink. This fact alone would be sufficient to connect it with the *addicio* rather than with the text proper. The question as to whether the *addiciones* in OA were derived from a different source from that of the main text will be discussed later.

² Case 1248.

f. 59b of CC?¹ Built up, that is, if it were not for ME and LB. For these two manuscripts cut short our theorizing by telling us that this is a case from 16 Edward I which has a direct bearing upon the fortunes of the discredited judge, Thomas de Weyland.² We shall probably never get any direct evidence in regard to the actual origin of the *Corbin*, *Wake Muntagn*, *Tattersalle*, *Grendel*, *Nrxenham*, and other notes. Yet until we do, different scholars will in all probability continue to offer different explanations as to the meaning of these particuar annotations. But it is assuming too much if we take the attitude that Bracton would be the only one, or even the one most likely, to make such references to cases in the margins of a *De Legibus*. Any lawyer might do it. And this point should be emphasized. These copies of Bracton's book were made for men interested in its context. The appearance of many of them shows plainly that the owner did not hesitate to annotate his copy to suit his convenience. An interesting proof that lawyers, even a long time after Bracton, would make the same kind of marginal references to cases that we have been considering is found in *W*. In the margin of f. 57, opposite

¹ It comes near the end of sect. 2, f. 136 of V, which see.

² This case as given in ME and LB is rather long for a footnote, but because it is interesting in itself, and also helps out the information given in the chronicles (see *Dict. Natl. Biog.* under Thomas de Weyland), we will give it here. It will at least show one type of *addicio* which has crept into the texts. There are a few minor differences in the text of the two MSS. Correcting one by the other we get the following passage: "Casus de Jordano de Vavasore. Sed nota hic casum qui contigit anno regis Edwardi filii Henrici sexto decimo de Jordano de Vavasore, qui a turri London in qua pro quodam crimine capitali vinculis detinebatur usque ad ecclesiam fratrum minorum eiusdem civitatis noctanter evasit, in qua se tenuit donec regnum abiuravit, sub hac forma: Hoc auditis vos coronatores domini regis fideles, quod ego Jordanus pro tali crimine quod nequiter perpetravi, exhibeo regnum Angliæ et nunquam in idem sine licentia domini regis vel heredum suorum postea redditurus sum, sic me deus, etc. Et sic secundum formam oportuit ipsum factum felonix suæ coram omni populo recognoscere, nec potuit sibi certum portum eligere, sed portus propinquior sibi nominabatur certæque dietæ dictum portum adeundi limitate sibi in scriptis tradebantur. Cui specialiter erat inhibutum ne a recta via regea alicubi declinaret donec regnum regis corporaliter exivisset. Qui usque ad portum de Dover legaliter accedens cum transitu promptum non haberet, in quadam domo secus litus maris de licentia autem ballivorum eiusdem portus tota nocte morabatur in crastino transitum expectando. Qui cum licet non multum extra viam regeam per inimicos suos exploratores esset deprehensus ad Turrim London, de qua prius evaserit, reduxerunt ibidem sollicitè custodiebatur donec capitali sententia plecteretur. Et sic patet diligenter intuenti qualiter consuetudo super prius huiusmodi usitata modernis temporibus est mutata. Sed hæc facta sunt providente T. de Weylande, tunc capitali iusticiario in banco domini regis apud Westmonasterium, ad cuius instantiam et consuetudinem immutatio perpetuis temporibus observanda decreta est. Quæ paulo post in personam eiusdem T. contigit observari. Quia cum de feloniam receptamenti rectatus exitisset, et per loci vicecomitem propter hoc arrestatus fuisset, usque ad domum fratrum minorum de Babewell iuxta burgum Sancti Edmundi callidis machinationibus evasit, habitumque religionis corundem cum tonsura deferebat, barba tamen sibi retenta, qui per multas tribulationes et famis sitisque tribulationes gratiæ regis se reddens ad Turrim London per custodes suos gratiam sibi promittentes adductus est. Cui rex de consilio suo gratiam exhibuit, scilicet talem quod ipse regnum suum abiuraret novem dietas a Turri London usque ad portum de Dover, eidem concedendo cui singulis noctibus in medio stratæ regeæ miserabiliter et irreverenter lectus parabatur sedensque in litore maris donec transitus sibi provideretur. Et sic quod in alterius persona propria ex post facto reprobari consuetudinis quidem immutatio (LB=mutatio) per eundem facta in dampnum eiusdem postea conversa pro statuto perpetuo modernis temporibus est observata. Et unde senex dixit, 'Oft owen dome ac owen durre charreth.'" My thanks are due to the Lambeth Librarian, Rev. Claude Jenkins, for having transcribed and sent to me the passage in LB.

a passage on f. 70 of V, written in a hand several generations later than that of the text, is "Nota de casu Willelmi de Coleman." Even in his own time Bracton would not have been the only one interested in the outcome of certain cases, nor would he alone have had access to the rolls. Some cases must always have made a deep impression upon the men of a particular time or district; the parties involved and their friends would have more reason than the judges for remembering them. Nor does the fact that these earlier cases which have been noted in the manuscripts have to do with Bracton's own country at all necessarily imply that he was in any way responsible for the annotations. Though Bracton himself may never have made a single one of these marginal references it was inevitable that the earliest cases noted in the margins should have to do with people and places in the southwest of England. For the original *De Legibus* must certainly have been produced in Devon or the counties close to it. During the last twenty years of his life Bracton had taken the assises in these districts.¹ With almost as much certainty we may assume that the earliest copies of the work were made in Devonshire and the surrounding country, and that the book spread from the southwestern counties outward. It could not happen otherwise than that the Devonshire men, lawyers and others, who owned the first copies of the book should be interested in those assises which for so long a time Bracton had taken among them. In the many years of his judicial career he had become acquainted with all the principal men of the region; many of them had been parties to suits which had come before him; their interest in some of the cases which he had decided had been even greater than his own. Small wonder then, if some few years after his death these men who had known him and had been associated with him, should have jotted down in those copies of his work which they then possessed, marginal notes of cases which had concerned and attracted both them and him.²

From the evidence in the manuscripts themselves we must regard the references to *Corbin*, *Montacute*, *Tateshall*, and other cases near to Bracton's own time, as standing in the same relationship to the earlier manuscripts that

¹ See *Bracton's Note Book*, I, 16, 17, 19.

² See *Note Book*, I, 103-104. The note against case 1884 in the *Note Book*, "Nota casum Hug. fil. Wymundi de Ralegha . . . coram H. de Brattona" (see also *Note Book*, I, 101), would indicate that these friends of Bracton were responsible for at least some of the annotations in the *Note Book*. For there would be no point at all in Bracton thus making mention of himself in a citation meant for his own use. If he remembered the case well enough to make a note of it, "Nota casum Hug. fil. Wymundi de Ralegha" would be all that was necessary. Some one else is here referring to a roll, and using Bracton's name as he used Raleigh's and Pateshull's, or as Hengham used that of Henry de Ba (Bracton or Bath?).

similar references of a later period have to the later copies. Full of interest and information as bearing on this subject is a set of marginalia to be found in HA. They come from the generation following Bracton. With possibly one exception they have been written by one who seems to have been the owner of the book, and who, in a fine bold charter hand, has made such corrections and annotations as would denote a use of the text. Two have been scribbled, and two have been scrawled in lead, but, apparently, by the same hand. They are in the margins, and have not been treated as rubrics, showing that they were not in the exemplar of HA.¹ We give them in the order in which they come: "Nota pro secta de Morleghe," "Nota pro Morleghe," "Nota pro H. fil. Alani," "Nota pro P. de Fyssacre apud Lyndewichetone," "Nota pro Eustachio le barun et aliis talibus," "Nota pro P. de Fyssacre contra dominum Johannem de Welygtone," "Nota pro P. de Fyssacre pro Stoke," "Nota pro P. de Fyssacre in Morleghe," "Nota contra opinionem Andree de Treloske," "Nota pro molend. de Wychenow," "Nota pro Ade de Hacche." These are scattered over, approximately, the first half of the book. Nearer the end (on f. 382 of the printed text) is "Nota pro domina Ysobella de Fyssacre." In lead are "Nota contra Andr. de Treloske," and "Nota contra Andr." Here is a typical, though rather numerous, set of this sort of annotations. It is quite evident that certain cases made a deep impression on the mind of the annotator, who kept referring to them in much the same way that the annotator of the Note Book kept bringing in the allusion to *Corbin*. What might be made out of this list of names if the rolls were consulted, supposing the rolls to exist, we can not say. But what we may learn, very easily, is that these references, like those of the earlier set, have to do with Bracton's own county of Devonshire. In *Feudal Aids*, under Devon, and the hundred of Stanburgh, for 1284-86, we find the entry, "Adam de Hache tenet Hache pro quarta parte," etc.² On the next page is a similar entry to the effect that "Petrus de Fisacre tenet morleghe pro un. f.

¹ Marginalia of this sort in an exemplar would be almost sure to become rubrics in the copy, or at least be copied in the red ink of the rubricator. A very good example of this is to be seen in HB. Written in the side margins, or at the bottom of the pages with marks in the side margins denoting the passages to which they refer, in red ink, are the following: "Nota casum filii domini Rogeri la Warre et Hauwysote," "Nota contra sororem Roberti de la Chamber apud Alvech," "Nota Cokton," "Nota Wicheford," "Nota contra testm. Baldwinide Frevylle de Walton," "Nota Cokton." On the other hand, the word *addicio*, which is used several times in both HA and HB to mark some of the additional passages, is written in red ink in the former MS. and in black ink in the latter, showing that these *addiciones* were in HA's exemplar—either in black or red—and that they were inserted in HB after the MS. was written.

² *Inquisitions and Assessments Relating to Feudal Aids*, I (1284-1413), 323. See also p. 351, where the same Adam is said to hold the eighth part of a fee in Hacche Arundel as late as 1303.

m.,” etc.¹ In the records of an inquisition taken at Exeter in 20 Edward I is the entry, “Dunterton. The manor with the advowson of a church, held by Andrew de Trollosk by service of a knight’s fee.”² In 25 Edward I, before the king’s judges at Westminster, testimony was taken in regard to the age of Eleanor, daughter of William de Mohoun. John de Asshele of Walsheburn, knight, “aged 60 years and more, distant three leagues from Stokefleming,” testified that she was born at Stokefleming in 9 Edward I. Eleanor de Fisshaker was her godmother. Further, “Andrew de Truslok, then of Brickenham, knight, aged 60 years and more, distant three leagues from Stokefleming, agrees with the above Roger.”³ It is not necessary to go any further in this direction. Here is evidence enough to show beyond any doubt that one of the earlier owners of HA, probably the first one, apparently a lawyer, made use of points in cases which had to do with the people among whom he was, or had been, living in a certain part of Devonshire, to emphasize or contradict statements in the text of his *De Legibus*. He did exactly the same thing as the man, or men, whoever he or they may have been, that wrote *Corbin*, and *Wake Montacute*, and *Tateshall*, in the earlier copies. And for the same purpose. Every element to be found in the first set of annotations is to be found also in the second, except that the latter have to do with cases which date from a period after Bracton’s death, and with which, therefore, he could have had no personal connection. But there is here the same personal touch which we find in the first set of annotations. Whether or not the annotator was a permanent resident of this part of Devonshire, he certainly knew the places and the people well. Only one thoroughly acquainted with the details of a case could get anything out of such notes as these; “pro Morleghe” and “contra Andr.” would mean nothing to a stranger. Moreover, both sets of annotations have to do with the same region, with those parts of southwestern England in which Bracton for so many years before his

¹ Peter Fishacre held two fees in Morlegh and Wodlegh in 1303, *Feudal Aids*, I, 351. The following tradition associates him with these same two places and shows that not all his differences with his neighbors were settled quietly in court: “Farther up in the country is *Morley*, remarkable for its Church, built upon this occasion. In the time of Edward I, Sir *Peter Fishacre* Knight (upon a controversie between him and the Parson of *Woodley* about tythes) kill’d the Parson in a rage; and, being constrain’d to answer the same at *Rome*, was by the Pope condemn’d to build this Church; where he lies bury’d.” *Camden’s Britannia* (*Gibson’s edit.* Lond. 1722), I, 37.

² *Inquisitions Post Mortem*, III (Edw. I), 26. In 1284-86 Andrew de Tresloske was holding half a fee in Dunterton of Hugh de Curtenay, *Feudal Aids*, I, 320. In 1303 he, with others, held the twentieth part of a fee in Aylesford, *ibid.*, 347. See also pp. 353, 355, 357, in the same volume.

³ *Inquisitions Post Mortem*, III (Edw. I), 328-329. Stoke in the annotations may not refer to Stoke Fleming, but to Stoke Rivers. “*Petrus de Fisacre tenet quartam partem un. f. in Stoke Ryvers de Johanna de Campo Arnulphi.*” *Feudal Aids*, I, 336.

death had taken the assises. The inference is clear. If the annotator of HA had lived a generation earlier, in the same or some other part of Devonshire, it would have been almost impossible for him to have made a similar set of marginal references to cases from his own locality without touching upon something which in some way or other would be connected with Bracton, so intimately for almost a quarter of a century had the great judge been associated with the judicial life of that county. We know that other men, practically from the beginning, referred in the margins of their copies of Bracton's book to cases in which they had, for one reason or another, a more than usual interest. We know that Bracton himself might have done so, but not that he actually did. We should therefore argue on the possibility, not on the probability, of his having been the author of the earlier case annotations.

But we are getting too far away from the point in hand. For the present, at least, the fact of importance, which should be remembered, is that whether Bracton himself or some one else is responsible for the *Casus* marginalia, OA is not at all unique in having them, nor is that codex raised to a position of special prominence because of them. What makes OA a good manuscript is not its quire arrangement or its case annotations, but the fact that it is preëminent in the matter of designating the *addiciones*, and that it has, for the most part, a good text.

Having ascertained that the peculiar features of OA do not in any way tend to mark it off as a primary copy of the original, we may revert to the subject which necessitated this discussion of the Digby manuscript, and consider again the meaning of the unusual order of certain blocks of text in some of the codices. Now that the facts as to the structure of OA have been given it is evident that these variations in the other copies are connected, in some way or other, with the quire scheme of hand IV in OA.¹ That hand wrote quires F, G, P, R, S, T; F and G contain the text of fs. 62b-98; R begins the "præmortuorum" passage; S is the quire in which the omitted Action for Dower should come regularly. One point about which we can be

¹ ML has to do also with hand III (see below). There is likewise a peculiar agreement between LA and that portion of OA written by hand II in regard to the leaving of space. LA omits from near the middle of f. 9 to the beginning of cap. V, f. 11 (OA leaves a page of blank space before cap. V, f. 11). At the end of cap. VIII, f. 123b, is a space of 12 lines (OA leaves 6 lines). At the end of cap. XIII, f. 131, is a space of 7 lines (OA leaves 5 lines). At the end of sect. 7, f. 132, is left a space of 15 lines (OA leaves 3 lines). At the end of sect. 17, f. 134, is left a space of 6 lines (OA leaves 5 lines). There is a vacant space of 21 lines after cap. XX, f. 141b (OA leaves 5 lines). At the end of cap. XXV, f. 146, is a space of 6 lines (OA leaves 3 lines). Spaces of from 5 to 23 lines (in OA, 2 to 7 lines) are found at the ends of chapters or sections on fs. 146b, 148b, 150, 150b, 152, 153b, 199, 205. In addition to these LA has similar spaces of from ten lines to a page on fs. (of the printed text) 134b, 135, 145, 159b, 182b, 205b. LA leaves many of the same kind of spaces in Dower, which it has at the usual place.

sure is that OA has been the cause of the variation in the other manuscripts rather than the result of it. That is proven beyond the shadow of a doubt by the fact that quire Q is written evenly, and full to the very end. There is not the least probability that hand V in this quire was making up a deficiency in the exemplar from which hand IV copied quires P and R. In such a case there would almost inevitably have resulted some vacant space or unevenness at the end of Q, for, as we have noticed, it was next to impossible to gauge the exact amount of copy which would just evenly fill a quire.¹ It is perfectly clear, therefore, that hand V was commissioned to write a quire beginning with the Assise of Last Presentation, and that this quire happened to go as far as "præmortuorum." When hand IV started in on quire R he was simply taking up the work at the point at which hand V had left it. At some time before the quires which now constitute OA had been bound together, the intervening quire Q became separated from quires P and R, probably through the work of hand IV being set aside by itself.² While thus set aside it, or at least quires P and R, came to be recopied by a scribe who did not understand that another whole quire should come in at the end of Novel Disseisin. As a more or less direct result of this mistake there have come down to us those manuscripts which omit Q's portion of the text, fs. 237b-262b of V.³ Another result of this setting apart of the work done by hand IV was the removing of quires F and G from their proper place. Why the manuscripts which have this portion of the text out of its usual position make such different dispositions of it we have no way of telling, but it will be noticed that in every case it is put either after the end of chapter XXX, f. 439, or after some other passage inserted at that point. It is significant, also, as yet further connecting hand IV with the situation, that by CB, ML, LD, LE, the text of quires F and G is put in juxtaposition to the Action for Dower, either preceding or following the latter. Now we should expect to find the Action for Dower in OA at either the regular place or the end of chapter XXX on f. 439. But as

¹ See above, p. 72.

² It is quite possible, of course, that Q was copied in some place apart from that in which hand IV did his work. Even if copied in the same place the work of the two scribes may very easily have been kept apart until the whole volume was ready to be bound.

³ Due probably both to direct copying and to comparison of MSS. The latter process would result in many queer discrepancies, due to individual attempts at correcting or filling in omissions. As far as this particular portion of the text is concerned, at least four sets among the extant MSS. are in some way connected through copying or comparison. OA has the matter in its single quire Q; CF, LA, LT, omit; CC on its f. 111b ends with "suus alium feoffaverit," l. 23, f. 261 of V, 29 lines of vacant space follow, the first column of 112 is empty and the next column begins with "præmortuorum," etc.; ME and LB both end with the "suus alium feoffaverit" as CB, ME leaving a space of 7 lines and LB a space of one and one-half columns, after which each begins with cap. VIII, f. 261b, ME on its f. 194, and LB on the second page of a folio.

a matter of fact it was never intended for either of these places in the Digby manuscript, as no breaks occur at these points. If copied at all it was as a quire—or two short quires—by itself. The intention of the one responsible for the making of the codex may have been to put it at the very end of the treatise, though there is no suggestion of any such arrangement in any of the other manuscripts.¹ It would have been very easy, however, to have inserted the treatise on Dower after quire G in OA. Not only did that quire end with a discussion of dower in one of its aspects, but the next quire began at such a point and in such a way that the insertion of an extra quire or two between G and H would in no way have interfered with the working out of the quire scheme. Whether or not the Action for Dower did occupy that position in OA before the quires were bound we have no means of knowing. The contiguous position of Dower and the text of quires F and G in CB, ML, LD, LE, would suggest at least the possibility of such an arrangement.²

There are so many manuscripts involved in one phase or another of this irregularity of order or omission of whole blocks of text that the situation is very complicated. There is no direct evidence which will satisfactorily explain it. Much might be accounted for if we could be sure that OA was only one of a number of Bractons which were being made at the same time in the same *scriptorium*, or at least under the same management. And indeed it is quite probable that such was the case. It would seem that more than one set of manuscripts were copied, at least in part, from the loose quires of the unbound OA. Seemingly also these loose quires got easily out of order. By the time that ML, or its exemplar, was copied, three more quires, C, D, E, in hand III, had gotten out of place, and were inserted with the contents of quires F and G and the Action for Dower after chapter XXX, f. 439. We know that some portions of the unbound OA moved so far away from the rest

¹ At the bottom of a page in the middle of quire S in OA (f. 129b) is this note: "Mittuntur J. de Bello Prato septem peciæ et dimidia subsequentes rubricam istam, videlicet *quod non est capienda convictio super convictionem*. Et de illis tenetur respondere domino R. de Arundelle. Sequitur continuatio multociens per recorda bene sequitur *convictio convictionem*, et durat titulus usque ad titulum *de actione dotis et qualiter dos constituatur*. (See *Bracton and Azo*, 242, n. 1.) This note may not refer to OA—in the Digby MS. Dower does not follow *Utrum* as according to this inscription it should—but there is every probability that it does. From the point at which this note occurs to the end of the volume there are now only six and one-half quires. As the last two folios in what is at present the last quire of OA are missing we cannot be sure that the manuscript ended at the same place as the printed text. The additional quire sent to John de Beaupre may have contained the Action for Dower, which was perhaps put at the end of the treatise as are fs. 62b-118 in LF. On the other hand, from a note in the table of contents which says that the MS. should contain twenty-five quires in addition to the kalendar (it now contains but twenty-three), we might infer that at one time OA had two short quires on Dower.

² It should be noticed that the kalendar of OA gives the rubrics for the Action for Dower in their proper place. In the same way the kalendar of OB is complete in spite of a *lacuna* in the text.

of the book that it became necessary to make memoranda of the facts.¹ It is quite possible that the sending away of those quires written by hand IV for the purpose of recopying, or even for some other reason, may have produced the irregularities in the other manuscripts. Whatever may be the true explanation of the variation from the normal order in these copies, it is certain that the ultimate cause of it is to be found in the fact that at least some of the detached quires of OA were recopied before being put together in an orderly volume.² This being so, the thing which immediately suggests itself as a solution of the problem is a collation of these particular quires of OA with the corresponding parts of the other manuscripts concerned. But a collation of the manuscripts affected in those portions of the text which are out of their customary place, would not necessarily solve the difficulty. To get results which would prove at all convincing it would be necessary to collate not only the manuscripts which have the unusual order, but all the others too. And even in that case the value of a collation would be vitiated by the many omissions in the manuscripts most directly concerned. ML, CF, LA, LT, which omit the equivalent of quire Q of OA, could not be compared with the Digby manuscript at this important place. Since OA itself omits the treatise on Dower, no amount of collation will ever make it possible for us to ascertain whether or not the manuscripts which put this portion of the text out of its usual place have derived *De Actione Dotis* from the same source as the probably lost quire of OA on this subject. The collation of fs. 319b-320, which comes only two folios after the end of Dower, shows that most of the other manuscripts which omit or misplace this subject do not agree closely with OA at this point, though they do agree more or less among themselves. The collation for f. 96 does not show those manuscripts which transpose fs. 62b-98 (ML, CB, LD, LE) in anything like the close agreement with Digby 222 which inevitably would result if they had been copied directly from its quires F and G. But it is not at all necessary to suppose that the manuscripts which make a change in the regular order of subjects were themselves directly copied from OA, or even from exemplars which had been so derived. They may be several generations, manuscript generations, later, and perhaps only indirectly affected. In many of the cases the effects may have been

¹ In addition to the memorandum relating to John de Beaupre we find two other notes of a similar nature. One is on f. 1—"Memorandum de uno quarterno qui est cum Johanne Long," and the other on f. 90—"Et sunt cum Johanne Longe duo quarterni de assisa novæ disseisinæ."

² Or the codex may have been taken apart after having been bound. The handwriting of several of the other MSS. affected is contemporaneous with that of OA.

produced by comparison rather than by recopying. It has been noticed that many of the codices which show the influence of OA's quire scheme in their altered order have been derived from more than a single copy, primarily or otherwise. We have abundant proof from the manuscripts themselves that some of the scribes worked with at least two models at hand.¹ It is quite conceivable that a copyist working with two exemplars as his guide, and finding fs. 62b-98 lacking in one of them at the regular place and inserted near the end of the treatise, might put it near the end in his book, though copying it from the model which had it in the earlier and correct position. But whatever a collation of these special parts of the text might show,² it is not necessary in order to prove the important point in this connection. From the facts which have been brought forward we can be sure that the peculiar quire arrangement of OA is responsible, either directly or indirectly, for the irregularities of the other manuscripts. Likewise we can be sure that in its quire arrangement OA is not reproducing the special features of an original *De Legibus*. Therefore, the several manuscripts which transpose or omit certain blocks of text are perpetuating divisions found first not in Bracton's own copy of his book, but in OA. That there exists a connection of some sort between these manuscripts and OA is evident. What the connection is, the irregularities of order do not tell; in the making of a pedigree they offer no direct help, nor are the problems which they bring up entirely solved when the pedigree is established.

THE *ADDICIONES* IN RELATION TO THE PEDIGREE

We now come to the question as to whether or not there are any data furnished by the *addiciones* which might make possible the speedy determination of the lines of descent. As the whole subject of additions to the text is to be

¹ A very interesting example of this is seen in the case of MD in the collation given below for fs. 413-415b. For the most part MD agrees very closely with MA and MA's line. In regard to a passage on f. 414, "Ut si unus petat per unum . . . de Ricardo filio Godefridi," there is a lack of agreement among the manuscripts, which results in the passage being found in some MSS. at one point and in other MSS. at another point. MD has it in both places, agreeing with MA in its variants when the position of the passage corresponds to its position in MA, and agreeing with the other set of MSS., against MA, when the passage occurs in the other place. Compare also the agreement of MA and MD, MD and OC, in the collation of fs. 161-162b. See p. 24 above.

² As a result of the omissions (noted above) and the constantly recurring gaps in the lines of descent, it is doubtful if a collation would give much definite assistance toward a solution of the problem.

fully considered further on, it is not necessary to take up the matter in any great detail at this place. At the beginning it may be said that the *addiciones*, when studied by themselves alone, do not make evident, except in a general sort of way, the relationship of the manuscripts to one another. This is largely because there is no definite basis of comparison. We are practically restricted to determining the presence or absence of additions in any manuscript. A classification based simply upon the incorporation of additional matter would divide the manuscripts into three principal groups: (I) those which have few or no additions, (II) those with the *addiciones* mainly in the margin, and (III) those in which the additions have become a part of the text. But if all the manuscripts are to be included in these three classes, the lines of limitation should not be made too rigid. Some of the manuscripts have *addiciones* in both text and margin; some have large portions of their text with additions, and other large portions without; in some manuscripts additional passages which have been incorporated into the main body of the text are yet distinguished from it by being marked as additional. Unfortunately a classification on these lines helps very little. The divisions thus made may or may not coincide with a division into family groups. So various might be the causes which determined the presence or position of an *addicio* in a manuscript, so different oftentimes was the source of the text from that of the additions, that a separate study of both text and *addicio* will always be necessary to determine the relationship of either. Several *addiciones* occur in those portions of the text which have been collated below. By that collation it is made plain that all the manuscripts which agree in omitting a certain *addicio*, do not necessarily follow the same line of descent. It shows, too, that those manuscripts which have this or that addition may be subdivided into smaller groups distinct from one another. Even more important still is the fact that a manuscript may agree with one line in its text proper, and with quite another line in its *addiciones*. Though oftentimes a particular *addicio*, or set of additions, may be found running through one line of manuscripts and omitted in another, this sort of evidence is too uncertain to be trustworthy until corroborated by facts from other sources. As in the case of the main text, nothing but a collation of the *addiciones* will reveal their relationship. This necessity becomes all the more apparent when it is understood that those manuscripts which have come from several different exemplars usually treat the additional passages differently in different places. Owing to the fact that some manuscripts pretty generally omit the additions it is almost impossible to

find a set of *addiciones* which can be collated for all the written copies; for this reason the collation of additional matter can not be as far-reaching in its results as the collation of passages from the text proper.

In character the *addiciones* divide broadly into two classes, those coming from Bracton himself, and those which have been added by some one other than the author. It would be a real help in many ways if there were any peculiarities in either the form or context of these two kinds of additions which would mark off one as distinct from the other. Sometimes the form of the *addicio* will stamp it as of probably non-Bracton origin, as where it begins with the not uncommon "Nota," for instance; once in a while something in the context will reveal its identity; but for the most part both types are similar, with nothing in their appearance to easily distinguish them one from another. Instead of the form and character of the *addicio* helping to determine the value of the manuscript in which it is found, it is usually necessary to know at least something of the manuscript in order to determine the probable authorship of the *addicio*—unless, of course, the latter has in it a reference to the Edwardian statutes, or some other reference which hints at its date of composition.

By referring to the list of additional passages given below it will be seen that some of the *addiciones* are found, in one or another of the codices, in as many as four or five different places. The reason for this will be discussed later. It should be pointed out here, however, that where there is such a decided disagreement as to the point where a particular addition should come in, manuscripts which are closely related will usually be found to have it at the same place. Yet the fact that two or more manuscripts agree as to the position assigned to any *addicio* can not always be taken as a proof of relationship, at least of close relationship, existing between them. In this as in any other point in regard to the additional matter, there is no fact or condition so invariable as to make possible the statement of a fixed rule.

When the additions are found in the margin of a manuscript it is not at all necessary to presuppose the existence of such marginalia in the exemplar of that manuscript. This statement holds true even when the marginal *addiciones* are in the same hand as the main text. A scribe having copied the treatise from one model might compare his finished book with another copy which contained more than his, writing in the margin of his own book such additional matter as he found in the other. CB illustrates very well what might happen when a book already written was compared with another which differed from it. In this particular codex many of the additional passages are found in the

margin. Some of them are also found in the text. It is perfectly clear that after CB had been written it was compared with another copy, the one making the comparison copying into the margin of CB such *addiciones* in the other book as CB did not have at the same place as this copy. The fact that CB might have the same *addicio* at another place apparently made no difference with this process of comparison and copying. On the other hand, we can not be sure that all the manuscripts which have no marginalia of this nature were copied from models which likewise had no additions in their margins. Some of the copyists omitted a great deal, as we have noticed; in how many instances, for one reason or another, the marginalia of a manuscript failed to pass over to its progeny we can not tell. In MA the scribe has several times written in the margins of his book, opposite the places where the additional passages should come, the single word *addicio*. This would seem to indicate that either he or the scribe of his exemplar was aware of the existence of *addiciones* which neither of them copied. This does not necessarily mean that there were passages in the margins of some ancestor of MA at these particular points, but it does show that there might be no insertion of the *addicio* even when the writer or reader of a particular manuscript was fully aware of the existence of such an addition.

From the foregoing it is evident that there is nothing in the *addiciones* which will offer us an easy way of determining the pedigree of the manuscripts. In general it may be said that any evidence of family relationship furnished by the *addiciones* is principally of value in supplementing that derived from the main text, by collations and otherwise. Of and by itself it is of little value.

THE PASSAGES CHOSEN FOR COLLATION

In addition to the larger and more widespread differences of division into parts, order of subjects, and treatment of the additional matter, there are other variations of a minor character, especially those which are peculiar and individual to a particular manuscript. These help us to form rather an estimate of the worth of the manuscript, its relative goodness or badness as compared with the other copies, than any definite idea as to its place in the family tree. In other words, there are none of the external or more special features of the early written texts which will give us anything more than a hazy notion as to how they are related to one another. Such trifles of information

on this subject as we may be able to gather from these other sources can be understood clearly only in the light of that more direct evidence which comes from an actual collation of the text.

There is no need to enumerate here the reasons which might make desirable a complete collation of the text of all the manuscripts when the question of pedigree is under consideration. Most of them are self-evident. The very desire for thoroughness would justify such a collation. But in the case of the Bracton manuscripts the task would be one of such proportions as to be well-nigh impossible. When one thinks of the number of words in the nearly nine hundred large pages of closely written and abbreviated Latin of the first edition, and then of the more than forty manuscripts which would have to be compared, the magnitude of the task becomes apparent. And even if time and energy for such a work could be found, the result of it would be to furnish an amount of material so bulky as to be unwieldy. This complete collation being at least inexpedient, the question arises as to how extensive a one is necessary. To some it may seem on first sight that the amount of collation—text and variants—given below is excessive, and more than is necessary under the circumstances. A consideration of the facts will probably alter that opinion. There have been collated twelve passages of various lengths aggregating some nine folios out of a total of four hundred and forty-four in the printed text, or an average of one folio in fifty. This certainly can not be regarded as an undue amount. If anything, the amount of collation errs in being too little rather than too much; at least double the amount, the collation of another twelve passages in chosen places, would be necessary to determine the exact relationship of all parts of the text in those manuscripts which have been copied by more than one hand. But for all practical purposes the collation which has been made is sufficient. While not solving all the problems connected with the genealogy of the manuscripts, it is quite enough to furnish us with a very fair estimate of their family relationship, and at the same time allows us to judge of their respective merits and failings. As a result of it we are able to pick out the better from the poorer copies, which is all that is necessary at this time. The complete collation of these better and representative manuscripts will ensue when the new text is made.

As to the choice of certain passages for collation—hundreds of similar passages might have been chosen in other parts of the book—a word or two may be said. It will be noticed that in nine cases (on fs. 2b, 5b, 96, 118, 132b, 179b, 253b, 319b, 411b) the portions of text chosen are rather short.

At the beginning of the work of collation it was thought that this selection of several short passages, scattered at intervals through the treatise, would be sufficient. These nine were accordingly selected, not in a haphazard way, but with the object of having each passage contain some representative problem in addition to mere divergences of text reading. For instance, the first passage was chosen because it contained a typical *addicio*, long enough to be of importance; the second, because it is one of the important, and contradictory, statements in the treatise as to the theory of kingship; in addition, these two selections gave an opportunity of comparing an Azonian passage with one not taken from Azo. The point of special interest in the section on f. 96 was the dating of the Statute of Merton; sect. 14, f. 132b, was chosen because it contained another kind of *addicio* problem, a sentence omitted in some manuscripts, inserted as an *addicio* in others, and used as a rubric in yet others; the writ on f. 253b was selected to determine the influence of an early correction; and so on. As the work progressed, however, it was seen that the amount of material in these passages was not enough to settle the questions involved. Not only were the resulting variants for some manuscripts too few to prove anything definite in regard to those manuscripts, but it was found that so many of the passages were omitted in one or another of the copies that there was far less actual collation than was desirable. To overcome these difficulties three more passages of considerable length were chosen, one each from somewhere near the beginning, the middle, and the end of the book. Of these three longer selections the first contained a very excellent collection of *addiciones* of more than usual interest; the second was concerned with both *addiciones* and the division into books, and in addition furnished several passages in which the recurrence of similar words or phrases could be counted upon to cause the scribes to make omissions and mistakes that would produce useful variants; for the third passage, the longest of all, was chosen a chapter which was full of a variety of problems, as a study of it will show.

These passages selected later were made so much longer than those originally chosen because the collation of the shorter ones had shown that the comparison of a few longer portions of text were at least desirable, if not actually necessary. It very early became apparent that all the variants obtained were not determinative; an unexpectedly large number were of such a sort as to render the evidence which might be derived from them inconclusive. A workable number of variants, a number large enough to cover every contingency of comparison, was to be had only through the collation of a

fairly lengthy section of text. Added to this was the fact that the agreement between some of the manuscripts and the text chosen for comparison was so close that these particular copies furnished only a few variants of any kind. This difficulty not even the collation of the longer passages was to do away with entirely. For instance, by referring to the collation of fs. 413-415b, it will be seen that while some of the manuscripts, as notably OA and CC, OC and CE, have an excessive number of variants, others, and ML in particular, afford hardly enough to supply the information which we are after. Moreover, as the collation of this same passage proves, even those copies which have, in their entirety, a more than usual number of variants, may in some places go for a considerable distance with very few. Thus it is quite possible that a short passage might fail to give a correct idea of the relative number of times any particular manuscript differs from the best text reading—an important point, and one which must be taken into consideration, in estimating the textual value of the different copies. It is no unusual thing to find among the variants irregular or chance combinations of manuscripts. In a long collation any danger from this source will be obviated by the larger number of regular combinations. As a case in point, in the collation for f. 414b it will be seen that for one variant OC and CE, MA and MD, ME and MH, MK and X—four pairs of manuscripts in four different lines—agree against all others. On account of the length of the collation at this place there are enough other variants to show beyond any doubt that this particular combination is not regular; in a short collation, in which there might be few or no variants showing the larger group combinations, a single chance grouping of this sort might easily convey a wrong impression as to the relationship of the manuscripts involved. Again, only in the collation of a passage of considerable length would there be any likelihood of discovering the repetition of a passage, such as occurs in MD on f. 414. It may seem to some that these longer passages in themselves would be quite enough to satisfy the purpose of collation, especially as they take in even more fully than the shorter selections the questions of the *addiciones*, cases, disputed passages, and purity of text. But the imperfections of the manuscripts render the long passages insufficient, for some copies omit one or more of the three, while OE contains not a single one of these longer sections of text, though it does have the shorter. Moreover, the descent of those manuscripts which have been copied in different parts from different originals in different lines can be discovered only through the comparison of a number of scattered passages.

In the case of abbreviated texts, such as CD, CH, CI, LE, etc., where the readings are often entirely different from the real *De Legibus*, no general collation has been attempted, though here and there a passage has been compared to show the kind and degree of difference existing.

NATURE AND VALUE OF THE DIFFERENT TYPES OF VARIANTS

Before attempting to interpret the text collation in terms of a pedigree it is necessary to consider certain facts of a palæographical nature connected with the Bracton manuscripts. These facts have to do almost entirely with questions of pedigree, and not with the matter of a correct text. As far as the actual handwriting is concerned, the reading of the manuscripts is easy enough; nor are there many passages in which the meaning of the text is not clear. From the textual standpoint the palæography of the copies is not important one way or another; but when we are studying the variants of collated passages for the purpose of establishing the lines of descent, it becomes a matter of considerable importance.

A surprisingly large number of variants are of a type which we may call "non-determinative," variants of such a nature that they help but very little or not at all in determining the relationship of the manuscripts. These non-determinative variants are due to a variety of reasons, but are all alike in this, that they spring from causes so general in their operation as to influence all scribes to make the same sort of mistakes, irrespective of the exemplars from which they may be copying. Variants of this character have to be disregarded for the most part when genealogical evidence is being sought for, because they are too inconclusive and untrustworthy. To be sure, a variant of this sort found in the head of a family line might be perpetuated in the progeny of that manuscript; but it might be found also in representatives of many another line. When looked at from every side and every angle, the only thing they definitely tell us is that given the same or similar conditions for their copying, different scribes were nearly certain to make the same, or similar, mistakes.

Of the causes which produced them the primary one was in all probability poor light. Any one who has worked over manuscripts in an unlighted library in the ever-failing gray light of a day in late autumn or winter understands the effect of poor light upon the written page of a medieval book. It is inconceivable that all the early copies of Bracton were written by their scribes always and only in the clear light of a bright day. Often on a dark day, or in late

afternoon or early evening before candles were lighted, they must have worked at their copying in the half gloom in which we of a later age are sometimes forced to read what they have written. Even under the best of conditions the light in a medieval room must have been subdued, to say the least; and the flickering light of a candle has ever played tricks on the eyes. The very circumstances under which the scribe had to work would often conspire to make many mistakes easy, and some practically unavoidable. The abbreviations, of which more will be said shortly, would be especially affected by this matter of a poor light; but its influence would be felt in every detail of copying, as tending to increase the number of misreadings and mistakes which were bound to result, apparently, under even the most favorable conditions. One mistake in particular which can be explained most naturally on the assumption that the scribe was working in a dim light is the misreading of such words as *recedat*, *amittat*, for *recedit*, *amittit*, the curved part of the *a*—written light, perhaps, or somewhat hidden by the last stroke of the preceding letter—being unnoticed by the scribe, who saw only the vertical stroke which he read for an *i*. Some letters, or combinations of letters, were so often written to look alike that the context alone would enable the copyist to determine their individuality. If he were careless, or either unwilling or unable to understand what he was writing, his mistakes along this line, especially when poor light added to his difficulties, were such as might be expected. The letters particularly affected—as usual, the abbreviations suffered most—were (*n*, *u*, *ii*; *m*, *in*, *ni*, *vi*, *iu*), (*b*, *u*, *v*), (*b*, *h*), (*e*, *t*), (*c*, *e*), (*f*, *s*).¹ Such words as *moneat*—*moveat*, *noluerit*—*voluerit*, *ius*—*vis*, *fuit*—*sint*, *sit*—*sic*—*fit*, were frequently interchanged.

A very common cause of non-determinative variants was the mistake often made by the scribes of confusing a word or phrase in one place with the same word or phrase in another place a little further on. There is probably no one of the present time who has done any appreciable amount of copying from medieval manuscripts but has been guilty at times of the same mistake, intent

¹ The use of the short dash above the line to represent *m* or *n* often led to mistakes in copying, especially if it was immediately preceded or followed by letters made from simple vertical strokes as *i*, *u*, *m*, *u*, etc., the scribe sometimes placing the dash over the wrong letter. Very clearly, also, the dashes were now and then omitted; or the actual letter *m* (or *n*) might be substituted for the dash, which by some other copyist might be used in place of the letter that it was meant to represent. An interesting example of how a word might be changed by this process is to be seen on f. 103b, l. 6, at which place the printed text reads *nominati* for a clearly required *innominati* (" . . . we should hardly do wrong in reading *innominati* instead of *nominati*, though we have no MS. which we can vouch for the emendation." *Bracton and Azo*, 178, *Notes*). Out of thirty-eight MSS. containing the passage only five, OG, OM, HA, X, Y, were found to have the correct *innominati* as an original reading. One, LA, had been corrected from a first-written *nominati*. More than once in the MSS. the same kind of mistake turns *iniuste* into *iuste*.

though he may have been upon the context of his exemplar; how much more often the medieval scribe, copying mechanically and paying little or no attention to the meaning of what was being copied, made this mistake, the collation clearly shows. In one way this particular type of variant has a determinative value in that an omission of this sort when found in some manuscripts of a certain group and not in others furnishes an excellent means of checking the order of recopying, it being perfectly evident, of course, that any copy containing the word or phrase could not have descended from one in which the omission occurs. Usually, however, the manuscripts affected by an omission of this kind represent such different lines that the variant has no determining value.¹

In the same class are variants which result from a change in the order of two or more consecutive words. *Esse ius* becomes *ius esse*, etc. The reason for the inverted order is not always clear; but the variation can be explained easily enough. Psychologically, what was read *esse ius* in the model might be transposed into *ius esse* on the newly written page through the mental processes of the copyist. As a mere change in the order of words would not affect the meaning of the passage, we may suppose that a scribe who had made an omission and discovered his mistake after writing the following word, would usually insert the omitted word after that which in the model it preceded, rather than make a correction above the line or in the margin. Seemingly, also, some of the scribes had ideas of their own as to the correct order of certain words or kinds of words, and went so far as to alter the text they were copying when, in this particular, it did not conform to those ideas. At times the variant due to a change in the order of words is found to exist solely in a single line of manuscripts, as in the case of *probationem habuerit* (for *habuerit probationem*) in chapter II on f. 320;² but more often the manuscripts involved represent a chance, or irregular, combination.³ The evidence to be derived from this sort of variant is so far from being of a decisive nature that it is better not to trust it at all when other variants of a more determinative

¹ Notice especially the collation for cap. IV, f. 162, for omissions of this sort. The recurrence of the same words or phrases sometimes caused the scribe to make just the opposite kind of mistake—that of repeating a passage already copied. For a repetition of this sort see the collation of f. 415. Here the word *serritium* occurring three times in the space of seventeen words has caused MG to repeat a passage of ten words. ML, on the other hand, has made the mistake of omitting all between the first and last *serritium*.

² See below, p. 160.

³ For instance, within the space of fourteen lines on f. 413 we find *competunt plures* (for *plures competunt*) given by eight MSS. in the same group and one MS. in another group, and *prius debet* (for *debet prius*) the reading of sixteen MSS., belonging to several different groups.

character are to be had. One *ubi* (for *in quo*) or *non* (for *numquam*) is worth many an *esse potest* (for *potest esse*).

The matter of proper names in the manuscripts should also be considered in this connection. Variants derived from proper names, though sometimes of a certain value when supplemented by more trustworthy evidence, of and by themselves are of small worth and little use. These proper names seem to have meant nothing to the copyists, who often entirely failed to read them aright, and made up for this failure by writing down in their places the most fantastical sort of guesses.¹ The large number of references to cases taken from the records gave to the copyists a wonderful opportunity for making the most remarkable mistakes imaginable in this respect.² Similar meaningless, and individual, mistakes were made in copying the citation of passages from the Roman law, which citations the scribes did not at all understand.

Among other variants of a non-determinative character is *etc.*, which is sometimes made to take the place of a long phrase, especially in writs and formulas. Apparently the copyists so often followed their own judgment, rather than their models, in deciding what portions of the writ should be represented by the *etc.* that we can place little or no dependence upon the significance of such a shortening of the text in any one manuscript.³ Variants caused by mere differences in spelling the same word are of the non-determinative sort. Doubtless the scribe many times preferred his own form to that which stood before him in the exemplar.⁴ Such differences in spelling as exist between

¹ In order to give examples of some of the kinds of errors which might creep into a writ, Bracton uses his own name, correctly or incorrectly spelled, five times on f. 188b. Here, if anywhere, the scribes might be expected to show something like a general agreement in this matter of proper names. But out of thirty-six MSS. compared at this place we get the following variants. (We give them here in groups corresponding to the order in which the names that they represent occur in the printed text. The abbreviated forms have not been extended because of their ambiguity; when *Brattonne*, *Brattona*, *Brattonia*, are found in the extended forms it is not well to tamper with the abbreviation *Bratton*. As some copyists omitted even the abbreviation sign, *Bracton*, *Bratton*, *Bretton*, etc., as they are given here, represent both the abbreviated and unabbreviated forms.) I, Brocton, Brochton, Bretton, Brocht, Broghton, Brocheton, Brotht, Liredechon, Brathon, Brotheton, Drecheton, Broche, Broctone, Brachton, Brothton, Brecton; II, Bratthton, Bracton, Braiton, Braghton, Barton, Bratton, Larton, Brathone, Brattone, Drocton, Brathon, Braketon, Brathton; III, Broctone, Bracton, Bratthton, Bampton, Batton, Bratton, Bractone, Bretton, Barton, Brocheton, Brothton, Barchton, Bracthomye, Bacton; IV, Bratthone, Bracton, Brampton, Brattona, Bractone, Bratton, Hette, Barton, Brathon, Brocton, Bratht, Brachton; V, Bratthone, Bracton, Bratton, Bratthona, Bractona, Bretton, Brattonia, Brachton, Barton. Many of the scribes did not even begin these names with a capital letter.

² Often the names of the counties suffered if the scribe attempted to write anything more than the abbreviation. See the collation of fs. 413-415b for cases which show mistakes of this kind made by the copyists.

³ Notice the use of *etc.* in the writ collated on f. 253b, p. 157, below.

⁴ At times even the word itself was changed to another word meaning the same thing. Thus *utlagatio*, *utlagaria*, *utlagio* may be used for one another at the same place by different scribes, while *inlagaria* and *inlagatio* may be likewise interchanged, as the collation of sect. 12, f. 132b shows.

donatorius—donatarius, saltem—saltim, inermis—inarmis—inhermis, summeatur—summoniat, sicut—sicud, warrantum—warantum—warentum, show no true variations, but only the preferences of individual scribes for certain vowels and consonants.¹ Of all the variations those due to differences in the matter of punctuation are the most widespread and numerous, and of the least determinative value. It would appear that most of the copyists very often put in their punctuation marks in the most haphazard sort of way, with no due use of care or reason.

In addition to variants of the types already discussed, there are others of not so general a character which from time to time prove to be non-determinative. They result largely from the fact that scribes who are not at all alike in most of the characteristics of their penmanship, may yet have certain little tricks or idiosyncrasies of writing or grammar which lead, at times, to mistakes which are identical. The variants so produced are of no value for purposes of comparison because they represent mere coincidences, and are therefore non-determinative. No general statement can be made in regard to them because they do not lend themselves to a classification. Moreover, it is not always evident at first sight that they are non-determinative, their real character not being discovered, perhaps, until a knowledge of the regular grouping of the manuscripts lays bare the facts that those manuscripts agreeing upon the variant in question form an irregular combination. Included in this class are the types of variants illustrated by the following examples. For the *si laici fuerint, si vero clerici* at the end of f. 413b, OC and CE, MK and X read, *si laici fuerint, si vero clerici fuerint*. These two sets of manuscripts are in different lines of descent. Their agreement here is in all probability explained by the fact that two scribes, working independently of each other, had each the feeling that the second *fuerint* should be added to balance the first. Again at the end of sect. 2, f. 162, we have *sive* (for *vel*) in OC, OG, MD, OF, MG, MC, LA, P, Y, MF, MI, LC, CA, X, fourteen manuscripts representing five different lines. How shall we explain this except on the basis that to at least five different scribes, *sive fuerit simplex vel violenta* sounded better, or looked better, as *sive fuerit simplex sive violenta*? Here, it

¹ *Ut* and *et* are interchanged so frequently by the scribes as to suggest that possibly at times no great distinction was made between them. Examples of this interchange of the two words will be found in the collation of the passages from fs. 2b, 5b, 33b-35, 118, 161-162b, 413-415b. *Et* and *vel* were constantly interchanged because of the similarity of their abbreviated forms. *Ut* had no abbreviation, but one form of the abbreviated *vel* might be taken sometimes for *ut*. Seven MSS. have *ut* for *vel* (collation of fs. 161-162b), and five MSS. read *vel* for *ut* (collation of f. 179b). Theoretically, it would be possible to explain the interchange of *ut* and *et* through *vel* as an intermediary; but such an explanation is far from simple.

would seem, was a deliberate attempt on the part of a number of copyists to make what each, of his own judgment and uninfluenced by the others, considered an improvement on the text from which he was copying. And here again the variants are non-determinative, being the results of a coincidence.¹ Earlier on this same f. 162 the confusion naturally arising from the repetition of what is nearly the same word in the passage . . . *sine violentia, et violenta sine armis, et violenta* . . . has resulted in the almost inevitable exchange of *violentia* for *violenta* by some of the copyists. Variants produced under these conditions can not be regarded as decisive in determining relationship. In the same category comes the omission of *et* between coördinate words—either with or without the insertion of a comma—as in the case of the *vino, oleo (vino et oleo)* on f. 180. There should be included also the variants which are due to the scribe following certain set expressions—independently of his model—in formulas and phrases that have become more or less stereotyped, as where for the usual *anno regis Henrici* some scribes invariably, or almost always, write *anno regni regis Henrici*.² In this same general group belong those variants which result from the joining together of different words or the separating of a single word. These mistakes might be made by any scribe at any time, being due largely to the fact that the spacing of words and letters was often far from uniform. Thus *re aliter* (for *re alicui*) becomes *realiter*,³ *liber erat* shortens to *liberat*,⁴ *actiones* changes to *actione scilicet*,⁵ *iure* may easily be read for *in re*; and we even find *ei obesse* turning to *esse*.⁶

All these non-determinative variants, whatever their cause, must be considered quite apart from those of a more conclusive character when the collation is being studied for evidence which will determine the pedigree of the manuscripts. This fact should be emphasized as we pass to a discussion of the abbreviations, for much of what has already been said in regard to variants in general applies with at least equal force to them. Of the total

¹ Nearly the same thing occurs again a little further on in f. 162b. In *Sed siue fuerit vis armata vel inermis* the *vel* has been changed to *siue* by OB, OM, MA, MB, MD, MI, LC, LF, LG, W, MF, ML. But here the variant *siue* is really a distinctive mark of relationship, the ten MSS. OB-W belonging to the same group. The very fact that this variant may at one time be determinative and at another time not, makes its evidence quite inconclusive unless supported by information from some other source.

² Notice the cases of this in the collation for fs. 413-415b.

³ F. 413b.

⁴ F. 161b.

⁵ F. 413. This is due to the abbreviation for *scilicet* being a simple *s* with a dot on either side of it. A second change has been made at this particular place by some MSS., their reading being *actiones scilicet*.

⁶ F. 162b.

number of variants a large proportion are due, either directly or indirectly, to the widespread use of abbreviations by the scribes; the true significance of the different variants it is not possible to judge until the part played by the abbreviations is understood. From what is now to be said of the abbreviations it will become apparent that words which are quite unlike one another when written out in full may look almost the same in their abbreviated form; and that many variants which appear at first sight to be quite distinct and determinative, may be found, when their origin is studied, to have come from one and the same abbreviation, and to be, therefore, of a non-determinative character.

To say that the text of the Bracton manuscripts is usually very fully abbreviated is to give no adequate impression as to just what the situation is in this respect. In the first place, there is no uniformity whatsoever in this matter, the difference between those texts which have the least abbreviations and those which have the most being very wide. In general, those written in book hand, where the scribe was often anxious to make as fine appearing a piece of work as possible, show fewer abbreviations than those written in court hand. In the latter the work was sometimes of so hurried and careless a nature that the abbreviations were multiplied to an excessive number, even the usual abbreviations being yet further abbreviated. Such a process led to the formation of undecipherable or ambiguous abbreviations, which other scribes—some of whom attempted to extend the abbreviated word in the light of the context—read and interpreted in different ways. Moreover, we get a decided lack of agreement among the scribes as to the way in which the abbreviations of many of the different words should be made. Though there is in all the hands a more or less uniform way of making a number of the more common abbreviations, in the wider application of the abbreviated forms the individual copyist allowed himself such leeway that there is sure to be found in the work of each penman a set of abbreviations peculiar to himself alone. Doubtless one reason why one scribe so often misunderstood the abbreviations used by another lay in the fact that the first was in the habit of making his abbreviation for a certain word very like the abbreviation made by the other scribe for quite a different word. Thus it comes about that in deciphering the abbreviations it is not possible to lay down hard and fast rules which must always hold, or to say that the same word will always be abbreviated in the same way, or even that a particular combination of marks and letters must always mean a certain word. Only a knowledge of the peculiarities of each scribe will enable one to correctly extend his shortened forms in every instance, and even that

knowledge is at times not sufficient to penetrate the ambiguity surrounding some of the abbreviations.

At this point it is necessary to consider to what extent the copyists of the Bracton manuscripts may have extended words abbreviated in their exemplars, or have abbreviated words written out in full. Ordinarily we work on the assumption that the medieval scribe copied his model, in so far as he could make it out, with a mechanical and almost absolute faithfulness. Usually we do not expect to find him making corrections or emendations or alterations of any kind. But a study of the Bracton manuscripts shows plainly that at least a considerable number of the men who copied them did not always adhere to an exact reproduction of their model in every particular.¹ We have already noticed the differences existing in the external features of the manuscripts, differences so great as to preclude the possibility of the scribes having followed even a general arrangement of divisional parts. We have seen, also, that some of the copyists changed the order of words to suit their own ideas of style; that some preferred *sive* to *vel* in certain connections. Often we find them using other words by preference, such as *seilicet* for *videlicet*, or *enim* for *autem*. Sometimes they make more out and out alterations in the text, as where the scribe of Edward's day—almost unconsciously, we may suppose—inserts an *Edwardus* for the original *Henricus* of some writ.² But it was in the matter of abbreviating and extending that they allowed themselves the greatest liberty of making changes.³ Not once or twice only, but hundreds and hundreds of times we come upon such words as the usual *ten.*, *diss.*, *homag.*, written *tenemento*, *disseisina*, *homagio*, in some manuscripts, and *tenementis*, *disseisinis*, *homagiis*, in others. In fact, it can be put down as a rule, that where some of the manuscripts vary between the singular and plural of the same word in this way, the majority of the texts will be found to have the ambiguous abbreviation, which is the same for both singular and plural. What this abbreviating and extending can do in the way of producing variants is well seen in the collation of f. 132b, where in thirty-five manuscripts the same word is

¹ When the scribe of MA writes *per ipsum catalla* for *per ipsum cancellarium* (f. 413b), we know that, even though he may have attempted to extend an abbreviation, he is doing his work mechanically and is not thinking of the sense of what he is writing. On the other hand, we find MSS. in which the scribe has apparently attempted to make an intelligent emendation of a corrupt passage in his model. All the copyists have not treated their originals in the same way; some have copied mechanically, others have not.

² As an illustration of this point see the comparison of the beginnings of the writs on f. 419, p. 185, below.

³ This is especially true as regards technical legal expressions and formulas. For the opening words of the charter in sect. 5, f. 34b (collated below), CH uses only the following letters with a few simple abbreviation signs: "Sciãnt p. + f. q. ego N. dedi co. + ha. p. car. mea cfi. B. p. hom. + s. s. tant. cu. pt. i. N. hnd. + ten. . . ."

given variously as *inlagatum*, *inlagatus*, *inlegatus*, *utlagatum*, *utlagatus*, *inlag.*, *inlagat.*, *inlags.*, *inlagatio*. Or take the even more remarkable case which occurs on f. 413. OA and CC, OF and MG, CB, HB, and B, MK and X, agree closely with one another in the same general group, while those forming pairs, as here arranged, are even more closely connected. For the correct *disseisinæ* of the printed text MK has the abbreviation *diss.*; X that of *dissois.*; OF, MG, CB, HB, B, the shortened and ambiguous *disseisitor.*; while OA and CC give the word in full, the former as *disseisitorum*, the latter as *disseisitoris*. Some three or four lines further on these same manuscripts illustrate the same point in their readings for the usual *disseisinæ*; MG, X, having *disseisitores*; OA, *disseisitorum*; OF, MK, CB, B, HB, *disseisitor.*; and CC, *diss.* As there is every reason for believing that in this part of their texts OA and CC were copied from the same exemplar, and OF and MG from another common original, we have here conclusive proof that some of the copyists took such liberties in extending or abbreviating the text which they were reproducing, that two scribes might get from one and the same model totally different readings for the same word.

Leaving out of account those which were so regular in their formation, or so generally recognized as meaning only one thing, that there could be no doubt as to their identity, we may divide the abbreviations into certain classes or groups on the basis of those special features which caused them to be misunderstood by the copyists. These groups are:

I. The same abbreviation used for two or more different words. *Vid* with the proper mark after it (*vid̄*) may mean either *videt* or *videlicet*,¹ an *i* with an *e* over it (*ī*) reads either *iste* or *ille*,² *dr.*, as used by different scribes, may mean *dicitur*, *derivatur*, or *dividitur*; an *i* with an *a* over it (*ī^a*) may be taken for *ita*, *ista*, or *illa*,³ *hi* with a curved mark after the *i*, may be either *hūis* or *huiusmodi*,⁴ *un* with a dash drawn above it (*uñ*) may be extended to either *unde* or *unum*; *pla* with a mark through the *l* (*pl̄a*) is *plura* or *placita*,⁵ *se* with the *ur* sign over the *e* (*sē*) may be written in full as *sequitur* or *sequuntur*,⁶ and so on.

¹ On f. 411b, l. 42, we get *videt*, *videlicet*, *vides*, *videtur*, *vide*, *iudicio*, as variants for *video*.

² As depending on this abbreviation see the following variants in the collation below: *ipse* for *ille*, f. 414b, l. 28; *iste* for *ille*, f. 415, l. 19; *ipse* for *iste*, f. 3, l. 33, notice also the *illo* for *ipso*, f. 413, l. 37.

³ *Ita* and *ista* for *illa*, f. 415b, l. 3; *illa* for *ipsa*, f. 413, l. 23.

⁴ Also at times for *huius*. See f. 118b, ll. 10, 21.

⁵ As on f. 96, l. 34; and f. 413, l. 26.

⁶ *Sequuntur* and *sequuntur* for *sequitur*, f. 34b, l. 9; *sequitur* and *sequuntur* for *sequuntur*, f. 96, l. 34.

II. Abbreviations formed of letters often made to look alike. Because of the similarity of *t* and *c*, *n* and *u*, *cu*, *tu*, *tn* (each with a dash over the last letter—*cū*, *tū*, *tū*), which rightly read *cum*, *tum*, *tamen*, are continually interchanged. For the same reason the *ca* and *tu* (*cā*, *tā*) of *cansu* and *tam* are often misinterpreted. The abbreviation for *breve* is *bre* and that of *habere* is *hre* (each of the shortened forms having a dash over it), but because of the similarity of *b* and *h* as these letters are frequently made, the two words not seldom were mistaken one for another by the scribes. Another letter sometimes made to look like *b* is one form of *u* (or *v*) which has a long first stroke; for this reason the abbreviated *bn* of *bene* and the *un* of *unde* are quite often misread.¹ *An* and *an* (with the single dash above), for *ante* and *autem*, also suffer at the hands of the copyists.² Often there is nothing to distinguish an *m* from *iu*, both being made by three vertical strokes which may be correctly or incorrectly connected, or not connected at all. So *mr* (for *mater*) becomes confused with *iur* (*iuris* or *iure*).³ *Nisi* and *ubi* are forever in dispute because of the similarity of $\overset{i}{n}$ and $\overset{i}{u}$. *Rom* and *roni* (with the dash above each) are identical in some manuscripts, so that *rationem* and *rationi* change places. *Ptin*, with a straight line through the lower part of the *p* and a mark over the *n*, for *pertinentiis*, nine times out of ten looks exactly like *ptiu* (with the same marks), for *partium*. *Alii* is mistaken for *aln* (the *n* with a dash over it), the abbreviation for *aliquando*, and vice versa.⁴ *Alit* (with an *er* sign over the *t*) and *alic* (with an *i* placed over the *c*) are so much alike when made by one of the less careful of the scribes, that *aliter* and *alicui* may readily become variants one of another.⁵ Likewise the abbreviations for *parvum* and *per unum* will often be identical;⁶ so also those of *cum* and *eum*. *Fr* and *sr* (each with the same simple abbreviation sign) look much alike in the best of hands, consequently *frater* and *super* are easily mistaken for one another. When *li* is made to look like *h*, the abbreviation for *licet* (*li*) is identical with that for *habet* (*h*). *G* with *i* over it is *igitur*, with *o* above, *ergo* ($\overset{i}{o}$, $\overset{o}{o}$);⁷ carelessly made *i*'s and *o*'s in this position show a remarkable similarity of appearance. Even more readily does

¹ As at l. 15, f. 3.

² Cf. the *an*, *ante*, *aut*, variants on f. 415, l. 34.

³ *Iure* for *mater* is found on f. 5b, l. 38.

⁴ *Aliquando* for *alii*, f. 34, l. 11. Cf. *alium* for *aliquando*, f. 162, l. 34; and *aliquando* for *alium*, f. 162, l. 35.

⁵ See f. 413, l. 19.

⁶ These two words are confused in l. 13, f. 413.

⁷ So *ergo*—*igitur* on f. 5b, l. 30.

the curled *us* sign take on the essential features of an *o*; thus *q* with the *us* sign above (*quibus*) becomes in another copy *quo* (*q* with an *o* above), or *p* with the curled sign above (*post*) is thought to be *primo* (*p* with an *o* above).¹

III. Abbreviations in which the sign used is misplaced or ambiguous. *Po* with the *ur* sign above is *ponitur* or *puro* according as the sign is over the *o* or the *p*.² *A* with a certain curved mark at its upper right hand extremity is *autem*, with a similar mark to the right and above it is *alius*. An *a* with another *a* of a certain kind placed above in one position is *alia*, with an *a* of another kind in another position above it is *aliqua*.³ *Aos* may represent either *alios* or *aliquos*, according to the position of the *o* and *s*.⁴ In all these cases the misplacement of the governing sign or letter is an easy matter unless the scribe exercises considerable care; all of these words have changed places with those abbreviated like them. *Debet* with a dash through the *b* is *deberet*, with the dash over the *e*, *debent*.⁵ It is often difficult to tell for which of these two letters the dash is intended. When the scribe dispenses with the usual *er* sign and uses a mere dash in place of it, we can not be sure whether his *huit* (with the sign over the middle of the word) is meant for *habuerit* or *habuit*. At times *ad* becomes mixed up with both *aliud* (*a* with *d* just above and a little to the right) and *aliquid* (*ad* with an *i* above and between).⁶ In the same way *id*, *idem*, (*id* with a mark through the *d*), and *illud* (*i* with *d* a little above and to the right) are confused.⁷ The abbreviation for *infra* is distinguished from that for *ita* by a dot on either side of the *i*; if either of these dots is omitted the longer word is quite apt to be turned into the shorter.⁸ *Etiam* is changed to *et* by the chance omission of the simple dash above the abbreviation for *et*. If a scribe forms the abbreviation for *id est* (a single vertical stroke with a dot on either side) hurriedly, without taking his pen from the page in doing it, we get something which looks like the English letter *Z*, and which may easily pass

¹ *Quo* for *quibus* is to be found on f. 162b, l. 1; *quocumque* for *quibuscumque* on f. 180, l. 5. Notice the *primonatus*, *postnatus*, on f. 3, l. 23.

² In l. 16, f. 33b, one scribe has made *deponitur* out of *de puro*.

³ These two words are constantly changing. See the collation of f. 33b, ll. 35, 36. In these two lines *alia* becomes *aliqua*, and vice versa.

⁴ *Aliquos* for *alios*, f. 414, l. 36. So also *aliquo* for *alio*, f. 414b, l. 6; and *alio* for *aliquo*, f. 118b, l. 15.

⁵ As an example notice the *deberet* for *debent*, f. 413b, l. 29.

⁶ *Aliquid* changes to *aliud* on f. 413, l. 37; *aliquid*, *aliquod*, *illud*, are variants of *aliud*, f. 180, l. 2.

⁷ As illustrations notice the following: f. 3, l. 6, *id* for *illud*; f. 179b, l. 44, *illud* for *id*; *idem* for *id*, f. 32b, l. 38; *illud* and *idem* for *id*, f. 34b, l. 38.

⁸ *Ita* for *infra*, f. 415b, l. 3. *Id est* is made as the abbreviation for *infra* except that the *a* above is omitted. *Id est* for *infra* is found on f. 118b, l. 11.

for the abbreviation of *et*.¹ We have already noticed the connection between the variants arising from *et*, *vel*, and *ut*. This is explained partly by the fact that one of the abbreviations for *vel* (merely an *l* with a slanting line drawn through it from the right) is sometimes made to look exactly like one of the abbreviations for *et*, whose simple sign is made in various ways by different scribes. The other shortened form of *vel* (*vl* or *ul* with the same stroke through the *l*) may on occasion have much the appearance of *ut*.² The single letter *s* with one kind of line through its base stands for *sed*; with a similar, though not identical, mark at the same place it means *secundum*. Not only are these two abbreviations mistaken for one another, but that for *sed* is sometimes taken for *si*.³ *Quod*, *quia*, *quasi*, *quæ*, are all abbreviated by adding the proper sign to the simple *q*. As a result of this similarity they—especially the first two—are not always distinguished from one another by the scribes.⁴ More or less connected with these are another troublesome set of abbreviations built on the letter *q*. *Q* with an *a* above is *qua*; *q* with a long comma-like mark through its base, from right to left, with a dash or simple curved line above, is *quem*; *q* marked with the same line through its base and with *a* above is *quam*; marked with the same base-line and with *m* above it is *quantum*; *qm* with an *a* above means *quam* to most of the scribes, though some interpret it as *quantum*.⁵

IV. Abbreviations which from their very form are ambiguous. These mean little or nothing definitely, and by themselves, and though their meaning is usually clear to us because of the context, they gave abundant opportunities for making mistakes to the copyist who was not troubling himself about the context. Many of them represent the quintessence of abbreviation. For the long word *consuetudinem* we get an inverted *c* (=con) to which is added an *s* with the simple curved line above.⁶ The manuscripts are undecided between *manifestum* and *manufactum*; the scribe of MG refuses to take sides by writing an abbreviation which would apply equally well to either word—*m* over *m*

¹ *Et* for *id est*, f. 34, l. 40.

² From a large number of examples the following may be chosen to show how these words are interchanged: *ut* for *et*, f. 34, l. 2; *et* for *ut*, f. 33b, l. 21; *vel* for *ut*, f. 161b, l. 38; *ut* for *vel*, f. 33b, l. 20. *Et* and *vel* are probably more often confused than any other two words.

³ *Si* for *sed*, f. 414, ll. 41, 44; *sed* for *si*, f. 33, l. 8; *sed* for *secundum*, f. 413b, l. 19.

⁴ *Quod* for *quia*, f. 34b, l. 34; *quia* for *quod*, f. 161b, l. 7; *quæ* for *quia*, f. 34b, l. 9; *quæ*, *quia*, *quam*, for *quod*, f. 161b, l. 12; *quod*, *quæ*, for *quia*, f. 162, l. 17; *quasi*, *quia*, *quæ*, *quam*, *quo*, for *qua*, f. 5b, l. 35. See the following note.

⁵ *Quam* for *quem*, f. 414, l. 15; *quem* for *quam*, f. 118, l. 2; *quam*, *quem*, for *quantum*, f. 414, l. 26; *aliquam*, *aliquod*, for *aliquem*, f. 413, l. 38.

⁶ As in MB, l. 14, f. 413.

(^m/_m).¹ In a similar way MN reads *hum* with *tis* above (_{hum}^{tis}) at a place where the copies disagree between *humilitatis* and *humanitatis*.² Who will tell us how to extend the shortened form *quiet.*, when the variants are *quiete*, *quietum*, *quietam*? When the text has *si mulier* and the variant is *similiter*, shall we read OA's *s* with *r* above (^r/_s) for *similiter* or *super*?³ Have we a right to extend the simple *R* to the usual *Rogerus* when *Robertus* occurs as a variant?⁴ When a scribe makes his initial *v* and *u* alike, shall we interpret his *v* with *m* over it (^m/_v) as *verum* where the other texts have *utrum*?⁵ When from the only four manuscripts which extend the word we get *clameo*, *clamio*, *clamore*, how shall we write out in full the abbreviation of the others, *clam.*?⁶ In such expressions as *ad probandam exceptionem* we can not be sure as to whether Bracton himself used the gerund or gerundive, because by far the greater number of the codices will be sure to give the ambiguous *proband.*, while the manuscripts which do write out the word in full will be about equally divided between the *um* and the *am* endings. There are two factors which tend to increase the inherent ambiguity of the abbreviations in this class. One is the fact that some of the copyists pretty generally dispense with the more distinguishing abbreviation signs, such as those for *is*, *os*, *us*, *er*, *re*, *ur*, etc., and use in their places the less discriminating dash. Moreover, the desire of the scribes to save time and space by abbreviating as much as possible formulas which were perfectly well-known in their own day, has led to some words in those formulas being so consistently abbreviated that we are left in doubt as to just what the full form of the word should be. In addition to *clam.*, and *proband.*, just now discussed, there are many other words, occurring especially in the writs, which are variously given by the few scribes who write them in full. Thus, for instance, we find both *summe* and *summeas* for the usual *sum.*,⁷ and *communia* and *communa* for the more often written *com.*⁸ It would be possible to go on giving examples of these ambiguous abbreviations, but enough have been brought forward to show the principal problems which result from them.

¹ F. 162, l. 4.

² F. 5b, l. 39.

³ See f. 414, l. 12.

⁴ As on f. 414, l. 19.

⁵ *Verum* for *utrum*, f. 413, l. 31; *utrum* for *verum*, f. 161b, l. 17.

⁶ In l. 30, f. 253b.

⁷ As in the writ in the collation of f. 253b.

⁸ *Communa*, *communam*, *commune*, for *communia*, f. 180, l. 18.

PEDIGREE OF THE MANUSCRIPTS

V. Abbreviations of a miscellaneous character. Many variants which in the manuscripts are only slightly abbreviated, or even written out in full, and in their more extended form appear quite different, often lose much of their dissimilarity and apparent significance when reduced to the original shortened forms. Thus *dicitur regula* and *domini regis* approach very closely to one another in the abbreviations *dr. reg.* and *dni. reg.*¹ That *viciarium* should come from *vi et armis* does not seem at all remarkable when we reduce the latter to the shortened *vi + arm.*, the *arm.* with a dash over the *m* making a perfectly good *arium*, and the + sign in one of its numerous forms being oftentimes like to a roughly made *ci.*² It requires but little more than careless spacing and the omission of one of the contiguous *a*'s to turn *genera actionum* in its abbreviated form in one copy into *generationem* in another.³ Variants of this sort are constantly met with, and for the most part have to be put among the non-determinatives, the reduction to their simplest form depriving them of their apparent individuality, and marking them as the mere misinterpretations by some scribe of the perfectly correct readings in his exemplar. Thus when OF has the *viciarium* just now alluded to, and MG the correct *vi et armis*, this particular variant does not at all militate against the very consistent evidence of agreement between these two copies based on variants of a more determinative type.

In these five classes will be found all the various kinds of non-determinative variants. But by no means all of the many abbreviations themselves have been given under these headings. There has been no attempt made to furnish anything like an exhaustive list of the abbreviations which are to be found in the Braeton manuscripts. The object aimed at has been to give only such an amount of this material as is necessary to show that in working over the collation care must be taken to determine, in so far as possible, the probable reason for, and origin of, each variant.

COLLATION OF THE SELECTED PASSAGES

In the collation itself abbreviations have been dispensed with for the most part. Almost always the shortened forms have been extended to suit the sense and context of the passage. When, however, the abbreviation is

¹ F. 413b, l. 26.

² F. 413, l. 35.

³ F. 413b, l. 20.

indefinite or ambiguous, and a comparison necessary, it is allowed to remain in its original form, as in the case of the ambiguous abbreviations considered on p. 110 above. For the sake of uniformity in printing, the superimposed forms of abbreviations have not been used, *hum* with *tis* over the last letter being written *humtis*. A period instead of a dash marks the abbreviation. Thus *diss.* represents the same word in the manuscripts with a dash over it.

By no means all of the corrections in the manuscripts are noted in the collation. In the case of some copies, which have been much corrected and recorrected in several different hands, such a task would be exceedingly difficult. But, apart from this, there would be no point in giving all the corrections. Since the main purpose here is to discover the pedigree of the individual manuscript, it is the original reading, and not the correction, which is important, except in so far as the correction may help to determine relationship. Consequently, corrections in the texts are not noted when they are plainly by another or later hand, or when a series of them agree with a manuscript in another line from that of the copy in which they occur. The necessity which the editor of a classical text is under of giving all such corrections is not present here. Not only do a large share of the changes made in the original texts date from a period much later than that in which any of the extant copies were written, but the facts of relationship existing between the many codices—with possibly two exceptions, no manuscript is the direct progenitor of any of the others—make it impossible that the corrections in any one of the manuscripts should have directly affected any of the others. Usually it is possible to tell from a change in ink or in the handwriting the difference between the text as first written and the correction. But sometimes the inks have faded, and show the same shade; or the correction may not be of sufficient length to prove definitely that there is any difference in the hand. In such cases, and in every case where there is any reasonable doubt, the correction has been noted.

Considerable space would doubtless have been saved by the use of arbitrary signs in place of such constantly recurring words as *omit*, *insert*, *corrected to*, *erasure*, etc. When a few chosen manuscripts, scarce in variants, are collated for the new text such signs may be used to advantage, and the reference to a particular word may be made by a line and not by number. But in the present circumstances, where the necessary collation of a large number of manuscripts has furnished an almost unwieldy number of variants, and where in places the interchange of words and phrases is well-nigh bewildering, it has

seemed best to sacrifice everything else to clearness. Therefore the variant footnotes have been numbered and arbitrary signs dispensed with, though a few simple abbreviations (om. for omit, ins. for insert, etc.) have been used.

FOLIO 2b. SECTION 3

Ius¹ ergo² derivatur³ a iustitia et habet⁴ varias⁵ significaciones. Ponitur enim⁶ quandoque⁷ pro⁸ ipsa arte, vel pro eo quod scriptum habemus de iure⁹, quod¹⁰ ius¹¹ dicitur¹² ars boni¹³ et æqui¹⁴, cuius¹⁵ merito quis¹⁶ nos¹⁷ sacerdotes appellat¹⁸. Iustitiam¹⁹ namque colimus et²⁰ sacra iura ministramus. Item ius²¹ quandoque²² supponitur²³ pro²⁴ iure naturali, quod semper²⁵ bonum²⁶ et æquum est²⁷, quandoque pro iure civili tantum²⁸, quandoque pro iure²⁹ prætorio³⁰ tantum³¹, quandoque³² pro³³ eo tantum³⁴ quod³⁵ competit ex³⁶ sententia³⁷. Prætor³⁸ enim³⁹

Collated for OA, OB, OC, OD, OE, OF, OG, OM, MA, MB, MC, MD, ME, MF, MG, MH, MK, ML, MN, CA, CB, CC, CD, CE, CF, LA, LC, LD, LE, LF, LG, LT, B, P, PH, W, X, Y, HA, HB, CM. For this whole passage CI has, "Ius dicitur (dr.) a iustitia, et dicitur (dr.) ius pluribus modis quandoque ponitur pro ipsa arte ut ius dicitur (dr.) ars boni et æqui. Item ius ponitur quandoque pro iure naturali quod semper bonum et æquum est, quandoque ponitur pro loco ubi redditur ius, ponitur autem quandoque pro necessitudine sicut pro iure cognationis vel affinitatis. Ponitur etiam ius pro proprietate rei, ut habet ius in re, quandoque pro potestate, ut iste est sui iuris. Quandoque pro rigore iuris ut cum dicitur inter ius et æquitatem, vel ponitur pro omni iure quod præcipit honeste vivere, alterum non lædere, ius suum unicuique tribuere."

1. Et ius, OM, HA. 2. autem, OB, OE, MB, MA, MD, MF, MK, MN, CE, CF, CM, LC, LF, LG, LT, X, Y; vero, ML. 3. dividatur, HA, B; vel differt dividatur, OM; dividitur alias derivatur, OF. 4. habeat, OB, OE (corr. to habet). 4-5. varias habet, OF, MG, MH, CM. 6. Om., MF. 7. aliquando, MF, MK, X, Y; ius quandoque, CA. 8. per, MK. 9. Ins. scilicet, CA. 10. quia, V, ML, LE; a corr., CB; om., LF. 11. Om., MA, MD (added later), LC, HA. 11-12. dicitur ius, MF. 13-14. æqui et boni, OC, OF, CM, ME, MG, MH, CA, CB, CC, CD, LD, LE, B, P, W, HB. 15. et cuius, MK; eius, CD, LD. 16. quid, OM. 16-17. nos quis, OF, MA, MD, MF, MK, CE, X, Y; quidam, LC. 17. Ins. above, OE; om., MB, MN; marked out, MC. 18. appellant, OM, CB (corr. to appellat), HB, CF, LC, LG, LT (corr. to appellat); ins. above, MN. 19. iustitia, MC, LD. 20. in, X. 21-22. quandoque ius, OM, HA. 22. quoque, MF. 23. ponitur, V, OC, OD, OF, OG, OM, MA, MD, ME, MG, MH, MK, CA, CB, CC, CD, CM, LD, B, P, PH, W (ponitur quandoque), X, HB, HA. 24. Ins. above, OF. 25. Ins. est, OE (above). 26-27. iustum et æquum est et bonum, MA, MD. 27. Om., OE; ins. Item, LE. 28. Om., OB, OE, OF, MB, MG, MH, MN, CA, CM, LC, LF, LG; ins. above, LD; ins. Item, LE. 29. iuris, MB. 30. prætorio, W; prætoria, MK; scripto, OE (erasure); a corr. in CD; om., HA (ins. above). 31. Ins. Item, LE. 32. Ins. tantum, CE (above). 32-34. Om., MK. 33. Ins. iure, CD. 34-35. quod tantum, W. 36. ei, OF, MG. 37. scientia, CA, P (corr. to sententia). 38. Prætor, V, OD, OF, OM, ME, MF, MG, MH, MK (pitor), ML, CA, CM, CB, CC, CD, LA, LD, LE, B, P, PH, W; prætorium, OA, OB, OC, OG, OE, X, MA, MB, MC, MD, MN, CE, CF, LF, LG, LT, Y, HB; OG, MA, MD, were originally prætorium, but have been changed. 39. autem, HA, OM; in erasure, MD.

ius¹ dicitur² reddere³, et⁴ cum⁵ inique⁶ decernit⁷, relatione⁸ facta⁹ non¹⁰ ad¹¹ id¹² quod¹³ prætor¹⁴ fecit, sed ad illud¹⁵ quod¹⁶ prætor¹⁷ facere¹⁸ debuit. Item supponit¹⁹ quandoque²⁰ ius²¹ pro²² loco in²³ quo²⁴ redditur²⁵ ius²⁶. Supponit²⁷ etiam²⁸ quandoque²⁹ pro³⁰ necessitudine³¹, sicut pro iure cognationis³² vel affinitatis. Supponit³³ etiam³⁴ ius³⁵ quandoque³⁶ pro actione, quandoque³⁷ pro obligatione qualibet³⁸, quandoque³⁹ pro hereditate⁴⁰, sicut⁴¹ pro⁴² proprietate rei, quandoque⁴³ pro bonorum⁴⁴ possessione⁴⁵, quandoque pro potestate⁴⁶, ut cum dicitur⁴⁷ *iste⁴⁸ est⁴⁹ sui iuris⁵⁰*, quandoque pro rigore⁵¹ iuris, ut cum⁵² dicitur⁵³ *inter ius et æquitatem⁵⁴*. Item ponitur⁵⁵ pro⁵⁶

1. iustum, OM, MA (corr. to ius), MD (erasure), ME, CB (erasure), CC, P, W, HA. 1-2. dicitur ius, OD, CF, LT. 2. debet, MD (erasure), W; marked out, tamen debet ins. above, CB. 3. Ins. iudicium, OM, MA (above), MD (above), ME, CC, CB (above), P, W, HA. 4. etiam, V. 5. tamen, OC (corr. from cum), OD, OG, X, Y; quod, ME. 5-6. causa, LD. 6. unicuique, X; undeque, ML. 7. discernit, MA (discernit), MD (decreverit added above), MF, W, X, Y; discernit, ME; decerint, HA; decrevit, CA; decreverit, LC, LE; dederint, OB, MB, MC (erasure), MN, LF, LG; in erasure, OE. 8-9. relatio est facta, HA, OM, CA; relationem factam, LD; relatio facienda est, LE. 10-11. Om., MK. 11. Om., X. 12. illud, OG; om., HB, CB (ins. above). 13. Om., LF. 14-16. Om., OB, OE (ins. later), MB, ME (ins. above fecit sed ad id quod), MN, LF, LG, P (marginal). 15. id, OF, CM, OG, OE (corr.), MA, MD, ME, MF, MH, MG, CA, CB, HB, CF, LC, LE, LT, P, W; aliud, OM. 17. Om., ME, LE. 18. faceret, OB. 19. supponitur, OB, OE, MB, MC, MF, MK, MN, CE, CF, LC, LD, LF, LG, LT, X, Y, HA, LE (corr. to ponitur); ponitur, V. 20. Om., OB, OE, MB, MN, LC, LF, LG. 20-21. ius quandoque, V, MF. 21. Om., OM, LE, HA. 22. quod, HA. 23-24. ubi, OB, OE, OM, MB, MN, LC, LF, LG. 25-26. ius redditur, OM. 26. Om., ME; iudicium, W. 27. supponitur, OB, MB, MF, MK, CF (by corr.), LE (corr. to ponitur), LF, LG; ponitur, V. 28. enim etiam, HB, CB; enim ius, X; etiam ius, MK, CA; et, CD; om., OE, W. 28-29. quandoque etiam, HA. 29. Ins. ius, ME; om., OB, OE, MA, MB, MD, MF, MK, MN, CE, CF, LC, LF, LG, LT, B, X, Y. 30-37. Om., CA. 31. incertitudine, OB, OE (corr. to necessitudine), LF, LG; vicissitudine, MA, MD, MH, CB (by corr. from necessitudine), CM, CC, CD, W (erasure), X; vissitudine, LD; consuetudine, CF, LT; a corr. in OF. 32. recognitionis, OE; cognitionis, X; cognationes, CD. 33. supponitur, V, OB, OF, MB, MG, MH, CF (by corr.), LF, LG, CM. 33-35. Item, LE. 34. autem, MA, MD. 35. Om., CC. 35-36. quandoque ius, OD, OM, MF, CF, LT, W (vis), HA. 36. Om., OB, OE, MB, MN, LC, LF, LG. 37. et, MB. 38. Om., W. 39. quando, MH; et quando, OF, MG. 40. In erasure, MA. 41. Ins. et, W (above). 42. Om., CM, OC, OD, MH, MK, CA, P (ins. above), PH, W; et, CD, LD. 43. Ins. unicuique, OM, HA. 44. In erasure, W. 45. Ins. quia est ius proprietatis et possessionis, ut infra. Item ponitur, LE. 46. proprietate, OC. In W the latter part of this paragraph (quandoque pro potestate—) has been marked by vacat, and the passage written over again at the bottom of the page in a different hand. In HA this same latter portion has been put at the bottom of the page by the corrector. 47. Om., OB, LF, LG. 48. ipse, LF. 48-53. Repeat, PH. 49. Ins. above, MN, Y. 50. Ins. Item, LE. 51. rigoro, MH. 52. Om., MK, X, HA. 53. dividitur, V, MK, ML, HA, X, CB (by corr. from dicitur); some of the manuscripts have dicitur in full, but most of them have the regular abbreviation for dicitur, dr. 54. æquietatem, OC, OG. 55. Partly in erasure, OC. 56. quandoque pro, MF.

ipsa arte, non¹ pro quolibet iure quod² invenitur³ in ipsa arte⁴, nec enim omne⁵ ius præcipit⁶, immo quoddam⁷ permittit, vel ponitur pro omni⁸ iure quod præcipit⁹ honeste vivere¹⁰, alterum¹¹ non lædere, ius suum¹² cuique¹³ tribuere.

Quia¹⁴ est ius proprietatis et ius possessionis. Item¹⁵ ius possessionis¹⁶ sicut feodum, et¹⁷ unde locum habet assisa¹⁸ mortis antecessoris. Item ius¹⁹ possessionis sicut liberum tenementum, si²⁰ quis²¹ tenuerit²² tantum²³ ad²⁴ vitam²⁵ quaecumque²⁶ ratione. Item ius proprietatis quod dicitur²⁷ ius merum²⁸, et unde²⁹ poterit³⁰ quis³¹ habere³² utrumque. Et dividi³³ poterit quandoque ius proprietatis a iure possessionis, quia proprietatis statim post mortem antecessoris³⁴ descendit³⁵ heredi propinquiore³⁶, minori³⁷ et³⁸ maiore³⁹, masculo et⁴⁰ feminae, furioso et⁴¹ stulto, sicut⁴² fatuo⁴³, surdo⁴⁴ et muto⁴⁵, præsentem et⁴⁶ absentem, et⁴⁷ ignorantem sicut⁴⁸ scientem⁴⁹. Sed tamen⁵⁰ non⁵¹ statim⁵² acquiritur talibus possessio, licet⁵³ possessio⁵⁴ et ius possessionis semper sequi debeat⁵⁵ proprietatem. Ius autem possessionis⁵⁶ descendere⁵⁷

1-4. Marginal, MA. 2 quæ, OB. 3. inveniatur, OF (corr. to invenitur). 5. Om., OF, MA, MG; followed by an erasure in OE. 6. recipit, CF, LT; repeat, LC; omit to following præcipit, W; quod præcipit, HB, MA, MB, HA, MN, LC (MC, CB, have inserted quod later). 7. quandoque, LD; quod, MD (dam ins. above), MF, OE (erasure), LC, HA. 8. ipso, MB. 9. præcepit, OM, LC (corr. to præcipit); recipit, CF (corr. to præcipit), LT. 10. Om., OM. 11. Item alterum, OM; alteri, OC. 12. Ins. above, CD. 13. unicuique, OC, OD, OF, OG, OM, MA, MD, CA, HB, CB; cui, OB. 14. This passage is a later addition to the original text. In OC, OD, OM, HA, MD, W, PH, it is found at the place where it occurs in the printed edition; it is given the position assigned to it here in OF, OG, MC, MG, MH, LD, CM, CB, HB, B; by CD it is put after civilibus, l. 22, f. 3; in OA, OC, OE, MC, MD, CB, LA, it is marked as additional or put in the margin; it is omitted in OB, MA, MB, ME, MF, MK, ML, MN, CA, CC, CE, CF, LC, LF, LE, LG, LT, P, X, Y. 15-16. Marginal, W; om., OM, HA. 17. Om., V, OC, OE, OF, OG, MD, MG, MH, CB, CD, LD, HB, CM. 18. assensu, CB (marked out, assisa ins. above), HB. 19. Om., OE, OF, MG, MH, HB, CM, CB; ins. ut, MD (above). 20. ut si, HB, OE, W; ins. ut, CB (above). 21. quid, OG. 22. tenuit, MG. 23. tenementum, OE; terram, LD, W (ins. above). 24-25. Om., OA. 25. Ins. tantum, W (marked out). 26. quantumque, LA. 27. dicit, OM. 28. A corr. in CD; morum, MH, CM. 29. bene, OC, OE, OF, OG, MD, MG, CM, MH, CB, CD, LD, B, W, HB. 30. Ins. above, OD. 30-31. quis poterit, W. 31. In an erasure, MC. 32. habere ius, OF, MG. 33. dici, OE. 34. antecessorum, OG. 35. Om., LA; decendit, OC, CD, LD; detendit, OE. 36. propinquorum, MC. 37. Om., OE, OF, MG, MH, CB, HB, CM. 37-39. maiori vel minori, W. 38. vel, OC. 40. vel, CD, LD, W. 41. Om., OC, OE, OF, MD, MG, MH, CD, LD, B, CM. 42. et, OC, OF, OG, MD, MG, MH, CM, CB, HB, CD, LD, B; om., OE. 42-43. Om., W. 43. fatue, OF; statue, MG. 44-45. Om., OC, OE, OF, OG, MD, MG, MH, CM, CB, HB, CD, LD. 46. Om., OC, OE, OF, MD, MG, MH, CM, CB, CD, HB, LD, B. 47-49. scientem et ignorantem, W. 48. Om., OG; item, CM, MH; vel, LD; et, CD. 50. Om., MD, HA. 51-52. statim non, CM, MH, HA. 52. Om., CD, LD, W. 53-54. Om., OG. 55. debeant, OF, MG, MH, HB, CM, CB; debiant, OE; debet, OM (corr. to debeat), W, HA. 56. Ins. semper sequi debeant proprietatem, OF (marked out). 57. defendere, OE; descendere, LD.

poterit per¹ se² ad alias³ personas et⁴ per⁵ alios gradus, ut si⁶ cum⁷ ius proprietatis descendat⁸ ad antenatum⁹ propinquiorem, postnatus¹⁰ frater¹¹ ponat¹² se¹³ in¹⁴ seisinam¹⁵, et sic¹⁶ moriatur seiscitus¹⁷, transmittit¹⁸ ad heredes suos quoddam¹⁹ ius proprietatis cum iure possessionis, quod²⁰ sequi debet²¹ primam²² proprietatem²³, et sic²⁴ de herede in heredem. Sed²⁵ primi heredes maius ius²⁶ habent²⁷ quam secundi heredes, sed semper præferri²⁸ debet²⁹ possessio, donec primi heredes evicerint³⁰ ius³¹ suum³². Et³³ si tamen frater postnatus³⁴ plures habuerit³⁵ filios³⁶, et postnatus³⁷ se³⁸ ponat³⁹ in seisinam⁴⁰, ita fieri⁴¹ debet⁴² de⁴³ eo⁴⁴ ut⁴⁵ supra. Et sic poterit ad plures⁴⁶ diversos heredes descendere⁴⁷ ius proprietatis in⁴⁸ infinitum, ut⁴⁹ cum⁵⁰ plures⁵¹ ius habeant⁵² proprietatis⁵³, unus vel plures possunt⁵⁴ habere ius maius⁵⁵.

1-2. Om., OF. 2. Ins. poterit, LD (marked out). 3. aliquas, OE. 4. Om., MG. 5. ad, OC (erasure). 6-7. sicut, OA, OF, OM, MC, MG, MH, HA, HB, CB; sirtut, OE; an erasure, CM. 8. descendit, V, OD, OF, OM, HA, PH, W; decendat, OE; desendat, LD. 9. agnatum, V, OF, OE, MG, MH, CB, HB, CD, B, W; angnatum, OG; cognatum, CM; ainatum, PH; annuatum, MC; in an erasure, W. 10. prinatus, CM, MH; primo natus, V. 11. tamen frater, OC (frater in an erasure); tamen super, MD; ins. super, W (marked out); om., OG, CB, HB. 12. ponet, OF, MG; supponat, OG, CB, HB. 12-13. se ponat, W. 13-14. Ins. above, OE. 15. Ins. suam, OE (marked out). 16. si, OG. 17. seiscitus, OA. 18. transmit, OE; transvertit, V. 19. quod, HB, CB (corr. to quasi). 20. Ins. semper, OF. 21. debent, OC (corr. to debet), OD, OE, OG, PH; deberet, OA, OF, OM, MG, MH, CB, CM, HA, HB, CD, LA, LD, B, W; deleret, MC; in an erasure, MD. 22-23. proprietatem primam, V, OD, OG, PH. 24. si, LD. 25. si, OE, OF, MG, MH, CM. 26. Om., OC, LD. 27. habiant, OE. 28. proferri, LD. 28-29. debet præferri, OE, MC, LA, W. 30. verifica- verint, V, OD, PH; evincerint, OE, OF, MD (corr. to evicerint), MG; emiserint, OG; emerint, LD. 30-32. ius suum evicerint, W. 31-32. suum ius, OF, MC. 33. Om., V; sed, CD. 34. Ins. filios, CD, LD; prinatus, CM. 35. habuit, MC, LD, PH; haberet, CM, MH. 36. Om., CD, LD; filias, OA, OD, OM, MC, LA, PH, HA. 37. primo natus, V; prinatus, CM. 38-39. ponat se, HA, OF, OM, LD (se ins. above); posuerit se, W. 40. seiscina, OE. 41-42. debet fieri, OE, OF, MG, MH, CM, CB, HB, W. 42. debeat, B. 43-44. Om., LA. 44. quo, OC; quolibet, MD. 45. sicut, OF, MG, MH, HB, CM, CB; siccut, OE. 46. Ins. et, OC, MH, W, CM. 47. decendere, OC, CD; dessendere, OE. 48. Om., CB, HB. 49. unde, CD, LD; et, MH, W, CM. 50-51. plures cum, LD. 52. habiant, OE; ins. ius, CD; habeant ius, B. 53. Om., OM, HA, W (marginal); ins. et, OF. 54. possint, MD (erasure). 55. Ins. Item ponitur ius, V; ins. Item supponit ius, OD, PH; ins. Item supponit, OM, W.

FOLIO 5b. SECTION 5

Sunt¹ etiam² sub rege milites, scilicet³ ad militiam⁴ exercendam⁵ electi⁶, ut⁷ cum rege et⁸ supradieitis⁹ militent¹⁰ et¹¹ defendant¹² patriam et populum dei. Sunt¹³ etiam¹⁴ sub rege liberi homines¹⁵ et¹⁶ servi¹⁷ et¹⁸ eius¹⁹ potestati²⁰ subiecti²¹, et omnes²² quidem²³ sub eo, et ipse sub nullo, nisi tantum sub deo²⁴.

Parem autem²⁵ non habet rex²⁶ in regno suo, quia sic amitteret præceptum, cum²⁷ par²⁸ in²⁹ parem³⁰ non habeat³¹ imperium³². Item³³ nec³⁴ multo³⁵ fortius³⁶ superiorem³⁷ neque³⁸ potentiorem³⁹ habere⁴⁰ debet⁴¹, quia⁴² sic⁴³ esset⁴⁴ inferior⁴⁵ sibi⁴⁶ subiectis⁴⁷, et inferiores pares⁴⁸ esse⁴⁹ non possunt⁵⁰ potentioribus. Ipsi⁵¹ autem⁵² rex⁵³ non debet⁵⁴ esse sub⁵⁵ homine, sed⁵⁶ sub deo⁵⁷ et⁵⁸ sub⁵⁹ lege⁶⁰.

Collated for OA, OB, OC, OD, OE, OF, OM, MA, MB, MC, MD, ME, MF, MG, MH, MK, ML, MN, CA, CB, CC, CD, CE, CF, CM, LA, LC, LD, LE, LF, LG, LT, B, P, PH, W, X, Y, HA, HB. For this passage CI reads, "Milites sunt militantes cum rege ad defendendam patriam et regnum. Similiter liberi et servi sunt sub domino rege, sed dominus non subest alicui nisi deo, et legibus absolutus est licet legibus vacare debeat propter deum, quia si alicui iniuriatur vel aliquid detineat supplicandum est ei quod factum corrigat, quod si non fecerit deum habet ultorem. Nemo contra facta sua disputare præsumat nec contra factum suum venire, quia principi placuit legis habet vigorem."

1-2. Item sunt, W. 2. et, V; ins. et alii, X, MK. 3. Om., OM, HA, CA, LE; quasi, W. 4. malitiam, P. 5. exercendum, W, B; exercentes, CD (corr.); the form exercendam is common. 5-6. electi exercendam, X. 7. et, OM, MA, HA. 8. Corr. to in, CB; in, HB. 9. Ins. militibus, MD (above), LC; supradieis, HA. 10. militant, LD, W. 11-12. Marginal, P. 12. defendent, OB, LG, HA, CM, W; ædificent, ME (corr. above); ins. pp, MK (marked out). 13-14. Item sunt, W. 15. Om., MB, W. 16. a, HB. 17. Ins. homines, MB. 18. Om., V, OD, OF, MG, MH, CM, ML, CB, PH, HB. 19. Ins. et, MH, CM. 20. potestate, MH, MN, CM, CB; peccati, OB (corr. to potestate above). 21. subditi, MB, LA. 22. quas, OF, MG, MH, CM. 23. qui, MK. 24. eo tamen (corr. to deo), HA. 25. Ins. above, LD. 26. Om., V, OA, OC, OD, ML, CA, CD, LA, LE, B, PH, HA. 27. quia, MA, MD; tamen, CC; tamen cum, OF. 27-28. cum pari quia par, OB. 28. Ins. above, MC; pari, LG. 28-29. Marginal, LC. 29. et, CC. 30. In erasure, OE. 31. habet, OB, OF, OM, MA, MD, ME, MF, MG, MK, CA, CC, CD, LD, LF, LG, P, W, X; om., MB. 32. imperpetuum, CC. 33. Om., W. 34. Ins. igitur, W. 35-37. superiorem multo fortius, CA. 36. Ins. in, OB (corr. to nec), OE, MA, MF, MK, CE, CF, HB, LF, LG, LT, X, Y; ins. inferior in, HA, OM; fortiorem, MB. 37. inferiorem, MN. 38. nec, V, CM. 39. sic potentiores, CB, HB. 40-41. habet, MA. 41. debeat, MH, CM. 42. qui, OE (corr. to quia). 43. si, CF. 44. esse, MA; om., MN; ins. ei, MK (marked out). 45. Ins. superior, OM. 46. Marginal, OF. 46-47. Om., OM. 47. subiectus, ME, MD (corr. to subiectis), MF, MN, CC, CF, LG; the usual abbreviation could be extended to either subiectis or subiectus. 48. partes, MB; ins. after possunt, MF. 48-49. esse pares, CD. 48-50. non possunt esse pares, LD. 49. Ins. above, W (erasure). 50. Ins. potentiores, OF (marked out). 51. Item., OM, ML, HA. 52. Om., HA, OM; enim, CA. 53. Om., LD. 54. deberet, X. 55. Om., MN (ins. above). 56-57. Marginal, ME. 56-60. sed sub lege et sub deo, CD, LD. 58. Ins. non, X (above). 58-60. Om., OB, MH (added), LF, LG. 59. Om., OC.

quia lex¹ facit regem². Attribuat³ igitur⁴ rex⁵ legi⁶, quod⁷ lex⁸ attribuit⁹ ei¹⁰, videlicet dominationem et potestatem. Non est¹¹ enim¹² rex ubi¹³ dominatur¹⁴ voluntas et¹⁵ non¹⁶ lex. Et¹⁷ quod¹⁸ sub lege¹⁹ esse²⁰ debeat²¹, cum sit²² dei vicarius evidenter apparet²³ ad similitudinem Jesu²⁴ Christi, cuius vices²⁵ gerit²⁶ in terris²⁷. Quia²⁸ verax dei²⁹ misericordia³⁰, cum³¹ ad recuperandum³² humanum³³ genus³⁴ ineffabiliter ei³⁵ multa³⁶ suppeterent, hanc³⁷ potissimam³⁸ elegit³⁹ viam⁴⁰, qua⁴¹ ad⁴² destruendum⁴³ opus diaboli⁴⁴ non⁴⁵ virtute⁴⁶ uteretur potentiae⁴⁷ sed iustitiae⁴⁸ ratione, et sic esse⁴⁹ voluit⁵⁰ sub lege⁵¹, ut⁵² eos⁵³ qui sub lege⁵⁴ erant redimeret⁵⁵. Noluit⁵⁶ enim⁵⁷ uti viribus, sed⁵⁸ iudicio⁵⁹. Sic⁶⁰ etiam⁶¹ beata dei⁶² genetrix, virgo⁶³ Maria⁶⁴, mater⁶⁵ domini⁶⁶, quæ⁶⁷ singulari⁶⁸ privilegio supra legem⁶⁹ fuit, pro⁷⁰ ostendendo⁷¹ tamen⁷²

1-2. rex facit legem, OF, MG, MH, CM, MK, X; lex facit legem, MB; lex regem facit, CF. 2. legem, B (corr. to regem). 3. attribuat, MK, X, HB. 4. ergo, MF, MK, LE, W, X; enim, ML; se, LD; ins. above, OE, CB; om., OC, OF, ME, MG, MH, MN, CA, CC, CD, CF, CM, LT, B, P. 5-6. legi rex, OF, MA, MD; lex regi, CB (corr.), CC (corr.), HB (corr.). 7. quia, MB, MK, CD, LD, W, X. 8. Om., MH (added). 9. attribuet, OC; attribuat, OM; attribui, LT. 10. Om., ME (regi ins. above). 11. Om., OM, MF, CC, HA. 11-12. enim est, OF, MG, MH, MK, CB, CM, LE, B, X, Y, HB. 12. Om., CD, LD; ins. dominatur, MF. 13. nisi, LA, LT, CF. 14. dominetur, MK, X; minatur, OB (corr. to dominatur). 15. Marked out, quæ ins. above, ME; ins. ibi, CC (above). 16. Ins. est, ME, MH, CC, CM, P, W. 17. sed, X (corr. to et). 18. Ins. rex, W. 19. rege, MA (corr. to lege); ins. rex, CA. 20. Ins. non, OF, MG. 20-21. debeat esse, OD. 22. Om., MA; sic, OF. 23. appareat (corr. to apparet), HA. 24. il, MG; semen, OD; seme, PH. 25. vicem, CF. 26. gerat, MH, CM. 27. terra, MG. 28. quod, LD. 29. dei est, MH, CM. 30. Ins. fuit, LE. 31. Om., CM, MH; tamen, OF, LC. 32. reparandum, V, OC, OD, OF, OM, ME, MG, MH, MK, CA, CB (corr. to recuperandum), CC, CD, CF, CM, LA, LD, LE, LT, B, P, PH, W, X, HA. 33-34. genus humanum, OM. 35. Om., MK; above an erasure, OE; ins. above, CA. 36. Om., CB. 37. ac, CC; hac, P. 38. potissimam, HA. 39. eligit, X. 40. vitam, W (corr. to viam). 41. quasi, V; quia, MK, X; quæ, OF, CM, MH; quam, MC; quo, ME, MG, CD, LD, P, W; om., CA, CC. 42. Om., OM, HA. 43. destruendi, OM; distribuendum, W. 44. diaboli, LD. 45. non ut, MF, CA (ins. ut above), W. 46. Ins. comparetur, MA. 47. potentem, OE (corr.), MK; potenti, X; potente, LC (corr.). 48. iuste, W; ratione iustitiæ, LF. 49. Om., CD. 49-50. voluit esse, OB, OE, OM, MB, MK, MN, CE, LC, LD (volunt), LF, LG, W, HA, X; om., OF (esse debuit in margin). 50. debuit, OF (marginal), MG, CM, MH; volunt, ME, LD (corr. to voluit). 50-51. sub lege voluit, MA, MD. 52. Ins. above, P. 53. hos, MN, LC (corr. to eos). 53-54. Ins. above, OE. 55. redimet, LD. 56. voluit (corr. to noluit), OB, OE; nolunt, LC (corr. to noluit). 57. Ins. above, MN; etiam, MB. 58. Om., OB (ins. above); ins. ratione et, V, HA, OM; ins. ratione, OD, PH. 59. iusticia dicio, MF (corr. to iudicio). 60. ut, LD. 60-62. sic ergo dei, W. 60-72. Om., LF. 61. et, V, OD, LE; om., MH, CM, ML; igitur, HB. 62. Om., MA, MD. 63. Ins. semper, CF, LT. 64. Ins. above, LD; om., CM. 65. iure, LD. 65-66. Om., W. 65-72. Om., OD, PH (marginal). 66. dei, OC. 67. qui, OB, OE, MA, MN, CB, CF, LC (corr. to quæ), LG, LT, X, Y, HB. 68. singulariter, CD. 69. Ins. ve, CC (above). 70. præ, HA, OM; per, CC. 71. ostendo, OE. 72. cum, OF, OM, HA, HB, MD, MG, LD; tantum, CF, LT; om., MA, MN, LE (ins. above).

humilitatis¹ exemplo² legalibus³ subdi⁴ non⁵ refugit⁶ institutis⁷. Sic ergo rex ne⁸ potestas sua⁹ maneat infrenata¹⁰. Igitur¹¹ non debet¹² esse maior eo¹³ in regno suo in exhibitione iuris¹⁴, minimus¹⁵ autem¹⁶ esse¹⁷ debet¹⁸, vel quasi, in¹⁰ iudicio²⁰ suscipiendo²¹ si²² petat²⁵. Si autem²⁴ ab²⁵ eo²⁶ petatur²⁷, cum²⁸ breve²⁹ non³⁰ currat³¹ contra³² ipsum³³, locus erit³⁴ supplicationi³⁵, quod³⁰ factum suum corrigat et⁵⁷ emendet³⁸, quod³⁰ quidem⁴⁰ si⁴¹ non fecerit⁴², satis⁴³ sufficit⁴⁴ ei⁴⁵ ad⁴⁶ poenam⁴⁷, quod⁴⁸ deum⁴⁹ expectet⁵⁰ ultorem. Nemo⁵¹ quidem⁵² de factis suis⁵³ præsumat⁵⁴ disputare⁵⁵, nec⁵⁶ multo fortius contra⁵⁷ factum suum⁵⁸ venire⁵⁹.

1-7. Om., LF. 1-3. Om., OD, PH (marginal). 1. humilitatem, OF, CM, MG, MH; humanitatis, OB, MB, MK, LC, LG, X; humtis., MN; in erasure, OE. 1-2. exemplo humilitatis, ME, CC, P, W. 2. eius, OF, MG, MH, CM. 4. sub dei, CD; subici, MK; subditi, ME (corr. to subdi). 5-7. institutis non refugit, CA, CD, LD. 6. reficit, MK. 8. nec, CM, MH, MN; neque, OC, OE, MB, LC, LT, X, Y; nocet, MK. 9. Om., MN. 10. infrenata, X; infirmata, OM. 11. ergo, MK, X. 12. Marginal, LD. 12-13. debet maior eo esse, MF, X; debet maior eo esset (corr. to esse), MK. 13. Om., OF, LE, LF (ins. above); ins. above, ME; ins. quod, B. 14. legis, OE (erasure), OF, CM, MG, MH, CB (corr. to iuris); legis id est iuris, HB. 15. minus, Y. 16. Om., ME, MF, MK, X. 17-18. debet esse, CE, X. 18. debeat, ME, CC, P; om., OF. 19. Ins. above, MC. 20. Ins. sibi, MA, MD. 21. excipiendo, X; suscipiendo, MA (by corr.), CM, MH; sussipiendo, MG. 22. sic, CC (corr. to si). 23. petit, OB, OE, MB, MN, LC, LF, LG; petant, W (by corr.); peccat, HA (by corr. from petat), CC, P (by corr. from petat), (LC has peccat in margin). 24. Om., CD. 25-26. a rege, W; ab eo rege, ME, CC, P. 25-27. per se vel per suos alias peccaverit placitaverit, MF. 27. Cross out and ins. aliquid, LC; ins. aliquid, MD. 28. In erasure, OC. 29. habere, MC (corr. to breve). 30-31. Om., MN. 31. Ins. breve, OE (marked out), MB, LC. 32. In erasure, OE. 33. Ins. sed, OC (above). 34. est, ME, CC, P; erat, MF. 35. stipulationi, OB (corr. in margin), LG; consultationi, LF (in erasure); an abbreviation and corr., LC. 36. quia, LD. 37. vel, MK, X. 38. emendat, MK, X; commendat, HB. 39. qui, X; quasi quod, OM. 40. quid, LD. 41. Om., MK. 42. perfecerit, CA, B. 43. fatis, LC; om., OF; ins. above, W. 43-48. Om., LE. 44. sufficiat, OC; an erasure, OE. 45. Ins. satis, OF; ins. above, W. 46. pro, W. 47. poena, W; poenamnam, MK (corr. to poenam). 49. dominum, V. 50. expectat, X; spectum, W; habebit, LE. 51-52. sed, LE. 52. enim, OF, MF, MG, CM, MH; qui, CB (corr. to quidem). 53. Om., ML, MN (ins. above); ins. propriis, CF; regis, CA; ins. nemo, LE. 54. Om., OB, OE (ins. above), MB, MF, MK, MN, CF, LC (ins. debet above), LF, LG, LT, X, Y. 54-55. disputare præsumat, MA, MD. 55. Ins. debet, OB, OE, MF, MK, LF, LG, X, Y; disputare, P. 56. non, CF, LT; om., V. 57. Ins. above, CD. 57-59. venire contra factum suum, OF, MG, MH, HB, CM, CB; contra ea venire, W (in erasure); contra factum suum venire præsumat, CF, LT. 58. Om., OB, LF, LG. 59. Marginal, OE, LC; venire, ME.

FOLIO 32b. *ADDICIO*

Item¹ qui proprietatem habet tantum², et³ alius⁴ possessionem⁵, scilicet⁶ liberum tenementum, id⁷ quod habet alteri dare⁸ potest⁹, scilicet¹⁰ proprietatem, salvo¹¹ tenenti libero tenemento suo et iure possessionis, ad vitam et quod¹² post mortem eius¹⁵ revertatur¹⁴ possessio¹⁵ ad proprietatem. Et¹⁶ quo¹⁷ casu attornari¹⁸ debet¹⁹ ille qui possidet, de servitio et²⁰ aliis²¹ ei²² qui²³ proprietatem habet²⁴, sicut prius attornatus²⁵ fuit²⁶ donatori²⁷. Et eodem modo, si quis²⁸ habens²⁹ utrumque ius³⁰ concesserit³¹ alicui usum fructum, videlicet³² ad terminum, id³³ quod habet alteri concedere³⁴ potest³⁵, salvo tamen³⁶ firmario termino³⁷ suo³⁸. Item si quis utrumque³⁹ ius⁴⁰ habuerit⁴¹ proprietatis⁴² et possessionis⁴³ alicui⁴⁴ concesserit⁴⁵ ius⁴⁶ utrumque, tali⁴⁷ adiecto modo ut⁴⁸ post tempus revertatur⁴⁹ ad ipsum⁵⁰ possessio, tenendi ad vitam, et⁵¹ ut⁵² tantum⁵³ habeat⁵⁴ liberum⁵⁵ tenementum⁵⁶, remanente⁵⁷ proprietate⁵⁸ cum donatario, non⁵⁹ statim ingrediatur⁶⁰ donator quocumque⁶¹ colore, sicut⁶² causa⁶³ hospitandi eodem die, nec in crastino, nec⁶⁴ ulterius recenter⁶⁵ utendo⁶⁶ ut⁶⁷ prius⁶⁸, quia per⁶⁹ hoc⁷⁰

This *addicio* is found in OC, OD, OF, OM, MD, MF, MG, MH, MI, MK, ML, LC, LD, CA, CB, CH, B, X, HA, HB, CM.

1. Om., ML. 2. Om., X. 3. Ins. habuit, X. 4. Ins. habeat, V; ins. tantum, MF. 5-6. Om., CA (marginal). 6. sed, V. 7. idem, MH; ad, LC (corr. to id); illud, X. 8. Ins. alteri, LC (marked out). 9. posset, MH, CM. 10. Ins. post, MG. 11. Ins. tamen, MF. 12. quæ, MD (corr. to quod). 13. Om., CA; ei, HA, OM. 14. revertitur, MI, LC, LD, B. 15. Om., X; ins. eius, LC. 16. Om., X; in, CA; ex, HB, HA, CM, OF, OM, MG, MH, MK, CB, B. 17. cum, ML. 18. attornare, V, MF, CA, X, CH; an abbreviation in MD, LC, LD. 19. Ins. se, X; ins. above, MI. 20. Om., HB (marked out in CB). 21. alius, MH, CM, MI (marked out), LC, OM. 22. Om., OF, OM, MG, MH, CM, MK, ML, CB, B, HB, HA. 23. Ins. non, X. 24. habeat, MF; om., MD; habent, HB, CB (by corr.). 25-26. fuit attornatus, V. 27. donatorii, LC. 28. aliquis, CA. 29. habet, MF; humane, MK. 30. cum, HA, CM, OF, OM, MG, MH, MK; et, B; om., CB, HB. 31. consenserit, MK. 32. usque, MI, LC; videt, HA. 33. illud, MI. 34-35. potest concedere, CB, HB. 35. poterit, OC, MD. 36. Om., OF, OM, MG, MH, MK, X, HA, CM. 37-38. suo termino, MK. 39-40. ius utrumque, OC, MD. 39-41. habens utrumque ius, V. 40. Ins. above, CA. 41. habet, OF, HA, OM, MG, MH, CM, MK, HB, CB; habuit, ML, LD; habens, OD (a corr.), CH (a corr.); ins. et, ML. 42-43. Om., CH; possessionis et proprietatis, MF, MI, X, CA, LC, LD. 43. Ins. et, HB, CB (above line), X. 44-45. concesserit alicui, V. 45. concederit, HA. 46. Om., CH. 47. ius hoc, CH. 48. Ins. prius et, MF. 49-50. ad ipsum revertatur, OM, MI, LC. 50. ipso, MK. 51. Om., MD, LD, X. 52. hoc, MK. 53. inde, V, OD; ins. liberum, MH; om., MF. 54. Om., HA, OM. 54-55. liberum habeat, OF, MF, MG, CM. 55. Marked out, MH. 55-56. tenementum liberum, OM. 57-58. proprietate remanente, OF, OM, MG, MH, MK, HA, CM. 59. tamen, MK. 60. ingrediatur, X. 61. quodam, X. 62. nec, OD (erasure). 63. tamen, MG. 64. ut, OC; om., MG. 65-66. recendo, ML, CA (corr. in margin). 67. ad, B. 68. Ins. ut, B. 69. Om., LD, CB (ins. above). 70. hos, OM.

præsuntur¹ quod nunquam² animum³ habuit⁴ recedendi⁵ a possessione⁶, cum⁷ utrumque⁸ concurrere⁹ debeat¹⁰ in¹¹ donatione¹², videlicet quod donator¹³ possessionem¹⁴ relinquat¹⁵ animo et corpore. Et post¹⁶ longum tempus ex conventionem¹⁷ si¹⁸ ingrediatur¹⁹, si²⁰ contra²¹ conventionem²² reiciatur²³, habet assisam²⁴ recuperandi²⁵ ex²⁶ conventionem²⁷. Si²⁸ autem alius²⁹, scilicet³⁰ donatarius, contra ipsum³¹ assisam³² portaverit³³, habebit³⁴ exceptionem ex³⁵ conventionem³⁶, et³⁷ si³⁸ forte³⁹ ingredi non possit⁴⁰ ex conventionem⁴¹ habebit⁴² actionem⁴³. Item⁴⁴ eodem modo si⁴⁵ ex recognitionem⁴⁶ post⁴⁷ aliquod tempus⁴⁸ facta⁴⁹ in curia domini regis quæ⁵⁰ recordum⁵¹ habet, dum⁵² tamen⁵³ recognitio⁵⁴ et⁵⁵ confessio⁵⁶ vera⁵⁷ sit⁵⁸, cum⁵⁹ oporteat⁶⁰ confessionem⁶¹ in iure⁶² factam⁶³ esse veram et⁶⁴ naturalibus⁶⁵ convenire⁶⁶, valebit quod actum erit⁶⁷. Et si⁶⁸ donator⁶⁹ forte⁷⁰ confiteatur⁷¹ donatarium fuisse in seisinam⁷² tempore confessionis⁷³ factæ, cum non sit non valebit⁷⁴ confessio, nec ea quæ sequuntur⁷⁵ locum habere debent⁷⁶. Si autem donator post tempus⁷⁷ longissimum⁷⁸, videlicet deem⁷⁹ annorum vel ulterius⁸⁰, quod quidem tempus⁸¹ oblivionem

1. præsuntur, MF. 2-3. animum nunquam, MF. 3-4. habuit animum, OM, MG, MI, ML, LC, X. 4. habuerit, MK, LD; ins. above, CA. 5. recededi, B. 6. Ins. sicut causa hospitandi eodem die, CB (marked out). 7. tamen, X. 8. utroque, X. 9. contrahere, CA. 10. debeant, ML; om., X. 11-12. Om., MF. 13. Om., CA, X. 13-14. possessionem donator, MF, MI, LC, LD. 14-15. relinquat possessionem, CH. 16. per, ML. 17. Ins. vel, LD. 18. Om., ML; sed, MK. 18-27. Om., CM, OM, MH, HA (marginal). 19. Ins. sed, ML, HA; ins. et, OC, CA. 20. sed si, HB; sed, CB (si ins. above), B. 21. Ins. quem, X. 22. conditionem, V; ventionem, B. 23. eiciatur, LD, HA. 24. actionem, MF, MI, LC; marked out, OD; ad seisinam, CA. 25. recuperandam, CA. 26. per, MF, CA; ins. above, MI. 26-27. Om., MK. 27. conditionem, MF; conventionem, CA. 28. illi, MK. 28-36. Om., OD. 29. Om., OM. 29-30. Om., MF, CH. 31. ipsam, OF, OM, HA, CM, MG, MH. 32-33. portaverit assisam, MF. 33. portavit, OM. 34. habet, MF. 35-43. Om., X. 37-39. Om., MK. 37-41. Om., HA (marginal), CM, MH. 38-40. Om., OM. 42-43. exactionem (corr. to actionem) habebit, HA. 44. Om., CH. 45. Om., MG. 46. conventionem, CA. 47-48. Omit here and insert after following regis, CH. 48. Ins. recognitio concessionis, CA. 49. factum, HB, CM, HA, OC, OD, OF, OM, MD, MG, MH, MK, CB, LD, B, X; facta fuerit, CA. 50. qui, MK. 51. hoc recordet et ille, CA. 52-53. dominum, MK. 52-55. tenementum secundum recognitionem sic est, CA. 54. Ins. sit, MF; ins. sic sit, CH. 55. Ins. ita, B. 55-57. Om., X. 56. concessio, OD, ML, CA, CH. 58. Om., MF, CA, CH; ins. ut, X, LC; ins. et, CB, HB. 59. quod, MK; ins. ut, MI (marked out). 59-66. Om., CH. 60. oportet, MF. 61. conventionem, LD; ins. factam, MF, MI, CA, LC, LD. 62. ea re, V. 63. Om., MF, MI, CA, LC, LD, X. 64. Om., CA; ins. qual, MF (marked out). 65. naturaliter, MD. 66. conveniri, MF. 67. est, MI, CH, LC, LD. 68. Om., MI. 69-70. forte donator, CA. 71. confitebatur, CB, HB. 72. Ins. in, CA, X; seisinam, HA. 73. confectionis, LD; confessionis ventionis, MF. 74. valeat, MG. 75. sequenter, HA. 76. debeant, CM. 77. Om., ML, LD (marginal). 77-78. longissimum tempus, X, MI, LC, CA, CH; longum tempus, MF. 78. legitimum, LD. 79. Om., LD. 80. amplius, CH; alterius, OM (corr. to ulterius); uterius, B. 81. Om., CA.

inducit, qualiter¹ tunc² utatur ut³ dominus vel aliter⁴, hoc⁵ donatario⁶ non⁷ nocebit propter tempus. Item si⁸ in⁹ omnibus istis¹⁰ casibus¹¹ supradictis, quandocumque¹² ingrediatur donator, refert si¹³ statum suum mutaverit omnino¹⁴ vel in parte vel¹⁵ non mutaverit¹⁶. Quia¹⁷ si omnino mutaverit¹⁸ statum¹⁹ suum²⁰, quod²¹ ubi²² prius²³ usus fuit²⁴ ut dominus²⁵ modo²⁶ utatur²⁷ ut serviens²⁸, vel²⁹ mercenarius, hoc donatario³⁰ non nocebit quia³¹ donator omnino³² statum³³ suum³⁴ mutavit³⁵. Et³⁶ valde inhumanum³⁷ esset³⁸ si filius vel³⁹ amicus⁴⁰ donatorem⁴¹ hospitio non⁴² reciperet⁴³, saltem ut⁴⁴ hospitem⁴⁵, cum se non⁴⁶ gerat⁴⁷ sicut⁴⁸ prius, vel⁴⁹ sicut dominum⁵⁰. Si⁵¹ autem ex⁵² toto vel in⁵³ parte ingressus, non ex⁵⁴ conventionem⁵⁵ vel⁵⁶ recognitionem⁵⁷, se⁵⁸ gerat⁵⁹ ut dominus⁶⁰, tunc⁶¹ aliud⁶² erit⁶³.

FOLIO 33 (AND FOLIO 34b). *ADDICIO* *

Ut⁶⁴ si quis donationem fecerit filio⁶⁵ suo⁶⁶ primogenito et heredi⁶⁷, vel frater⁶⁸ antenatus fratri suo⁶⁹ postnato⁷⁰,

* In V this *addicio* is found on f. 33, and again on f. 34b. OC, OG, MD, MI, CA, CD, CH, LC, LD, insert it in place of the *addicio de cartis* on f. 34; OF, OM, MG, MH, CM, MK, CB, HA, HB, LB, B, insert it on f. 34b; it is marginal in OD, ME, Y (which introduces it with *hæc clausula in quibusdam libris non reperitur*).

1. Ins. cumque, LC (above). 2. Om., LD; ins. inducit, OD (marked out). 3. vel, MF, MI (corr. to ut above), CH, LC, LD; vel ut, CA, X. 4. alter, LC. 5. licet, ML. 6. donatorium, CB, B, HB (corr. to donatario). 7. Om., OF, OM, MG, MH, CM, MK, CB (ins. above), HB, HA, B. 8. Om., MH, CM. 9. Om., MF. 10. Om., MF, MI, CA, CH, LC, X. 10-11. Om., LD. 12. quandoque, OM (corr. to quandocumque), MF. 13. utrum, MF, CA. 14-16. Marginal, LC. 15. Om., ML. 15-16. Om., CH. 17-18. Om., OM, MH, CM, CH, HA (marginal). 18-20. videlicet, CH. 19. factum, HA. 21. quem, LC; om., HB (ins. above). 22. nisi, ML; ut, CB, HB. 23. Om., OM. 24. fuerit, MG, CM, MH, ML. 25. Ins. fuit, B (marked out). 26. non, HB. 27. utitur, X. 28. servitus, MD; servus, X. 29. Ins. ut, ML. 30. donatarium, MI; donatorius, MK; donatar., MF. 31. quod, ML. 32-33. statum omnino, MF. 34. Om., MF, CH, X. 35. mutaverit, V, X. 36. quia, CA. 37. humanum, LD. 38. esse, OM. 39. et, MF, CA, CH, X. 40. amicos, MK. 41. donatorio donatorem, LC; donator in, ML; donator., MF; ins. in, MD; an erasure and corr., MI. 42. Om., MF. 43. acciperet, MF, MI, CA, CH, LC; acceperet, LD; receperet, MK; caperet, X; recipiet, OF, MG. 44. vel, LD; in, HA. 45. Ins. saltem, MF. 46. Ins. in, MI (above). 47. gerit, OC; ingerat, V, OF, OM, HA, CM, MG, MK; vingerat, MH; gerrit, X. 48. ut, MF, HB, CB; ins. et, CA, LC, LD, X; an erasure, MI. 49. et, X, MF, CA, CH. 50. dominus, MF. 51. sic, MK. 52. in, HB. 53. ex, MI, CA, CH, LC, LD, X. 54. Om., CM, MH. 55-57. recognitionem vel conventionem, X. 56-57. Marginal, B. 57. Ins. dicio, OF, OM, HA, CM, MG, MH, MK (dicto), CB, B, HB (dico). This is probably the last part of *addicio*, which, originally in the margin, has crept into the text. 58. si, ML. 59. gerit, V; girat, MK. 60. domino, OD. 61. cum, HA (corr. to tunc). 62-63. aderit, CA. 64. *addicio* ut, B; Item, CH; Et ut, CA, Y; Et, MD. 65-66. suo filio, V. 67. heres, CA, Y. 68. fratri, MK. 69. Om., CH. 70. nato, MI (corr. to postnato).

ne per homagium¹ excludatur heres vel² frater antenatus³ a successione, si⁴ forte donatarius sine herede de⁵ se⁶ decesserit⁷. Item poterit⁸ quis dare⁹ filio¹⁰ suo postnato sic¹¹ ut¹² primogenitus non excludatur ab hereditate. Ut si¹³ quis ita dederit¹⁴, *do tali filio meo postnato¹⁵ pro¹⁶ servitio suo¹⁷ tantam terram, tenendam¹⁸ de me¹⁹ tota vita²⁰ mea sibi et heredibus suis, et post mortem meam²¹ de capitalibus dominis²² pro servitio quod²³ ad illam²⁴ terram²⁵ pertinet*, si postnatus²⁶ præmoriatur²⁷ antenatus succedet²⁸ ei, quia homagium²⁹ non intervenerit³⁰. Si³¹ autem³² sic³³, *tenendam³⁴ de capitalibus dominis³⁵*, sic excludit se³⁶ a custodia. Item si sic³⁷ fiat donatio filio antenato³⁸ a³⁹ patre communi⁴⁰, pro servitio sive⁴¹ homagio tenendum⁴² de capitalibus⁴³ dominis⁴⁴, et talis in vita patris moriatur⁴⁵, postnatus frater⁴⁶, sive⁴⁷ fuerit maior, sive⁴⁸ minor⁴⁹, succedet⁵⁰ ei⁵¹, patre excluso a custodia⁵². Et⁵³ si minor⁵⁴ fuerit⁵⁵ ad dominum capitalem pertinebit custodia⁵⁶. Si⁵⁷ autem⁵⁸ maior, tunc⁵⁹ relevium⁶⁰.

1. hominem, OG. 2-3. Om., OF, MG, CH. 3. natus, MD (corr. to antenatus); annuatus, MK. 4-14. hac forma utatur, CH. 5-6. Om., MG, MI. 7. decesserint, MK. 8. potest, V; om., HB, CB (ins. above). 9. Om., MK. 9-10. Repeat, MI (marked out). 11-15. Om., HB, CB (marginal). 12. et, HA. 13. Repeat, MI. 14. diceret, OC. 16. præ, MH. 17. Om., MI, LC (ins. above), LD. 18. tenendum, B; tenend., OM, MD, LD, LC. 19. iure, MK. 20. terra, MI (corr. above). 21. Ins. tenendam, CA, Y. 22. Ins. pertinet, ME (crossed out); ins. feodi, V, MI, LC. 23. quantum, LD. 24-25. eam, CH; terram illam, OC, OD, OM, MD, MI, CA, LD, LC, Y. 25. Om., OG. 26. prinatus, OF. 27. moriatur, OC, OG, MG; primoriatur, MK. 28. succedit, OG, MD, MG, MK, LD; succedat, OF. 29-30. non intervenerit homagium, OC. 30. intervenit, MI, CA, CM, Y, CH, B, LD, LC, HB, CB; om., HA (marginal). 31. sed, CH. 32. Ins. dederit, CA, Y; om., CH. 33. Om., MD; sit, OF, OG, OM, HB, ME, MG, MH, CM, LB, LD. 34. tenendi, OC, OD, MD; tenenda, OG; ins. above, LD; tenendum, V (first passage); tenend., MSS. generally. 34-36. excluditur, CH. 35. Ins. feodi, Y. 37. Om., MI, CA, CH, LC, LD, Y, V (second passage). 38. aniato, MG; annuato, MK. 39. ab ipso, V (second passage). 40. commune, MG (corr. to communi). 41. A corr. from suo, MG. 42. tenendam, OG. 43-44. dominis capitalibus, OC, MI, CH, LC, LD. 44. Ins. feodi, OM, ME, MH, CM, LB, HA. 45. morietur, MG. 46. Om., V (first passage). 46-51. succedet ei sive fuerit maior sive minor, CH. 47. si, MI, CA, LC, LD, Y. 48-49. Om., OD. 50. succedit, V (second passage), OC, OG, MD, ME, MH, CM, MK, LD, HA. 51. Om., V (second passage), MK. 52. custode, OC; ins. quia capitalis dominus habet custodium et maritagium, CH. 53. etiam, MG; ut, OM; quia, CA, Y. 53-56. Om., MD. 54-55. fuerit minor, MI, LC. 54-58. Om., CH. 56. Ins. et maritagium, V (second passage); maritagium et custodia, MI, LC, LD, CA, Y. 59. tantum, HA, OM; ins. plenum, OC (above); om., CH. 60. Ins. et qui teneatur ad homagium et fidelitatem, etc., ME (marked by vacat); excæta, Y.

FOLIO 34. *ADDICIO*

Item¹ factum² regis³ nec⁴ cartam⁵ potest⁴ quis⁷ iudicare⁸, ita quod factum⁹ regis¹⁰ irritetur. Sed¹¹ dicere poterit¹² quis quod¹³ rex¹⁴ iustitiam¹⁵ fecerit¹⁶, et bene¹⁷, et¹⁸ si¹⁹ hoc eadem ratione quod²⁰ male, et ita imponere ei²¹ quod iniuriam²² emendet ne incidat rex²³ et²⁴ iusticiarii²⁵ in iudicium viventis²⁶ dei propter iniuriam²⁷. Rex²⁸ habet²⁹ superiorem³⁰, deum³¹ scilicet³². Item³³ legem per³⁴ quam factus est³⁵ rex³⁶. Item curiam³⁷ suam, videlicet³⁸ comites et³⁹ barones⁴⁰, quia⁴¹ comites dicuntur⁴² quasi⁴³ socii regis⁴⁴, et⁴⁵ qui socium⁴⁶ habet⁴⁷, habet⁴⁸ magistrum⁴⁹. Et ideo⁵⁰ si⁵¹ rex fuerit⁵² sine⁵³ fræno, id⁵⁴ est⁵⁵ sine⁵⁶ lege, debent⁵⁷ ei⁵⁸ frænum⁵⁹ apponere⁶⁰ nisi⁶¹ ipsimet⁶² fuerint⁶³ cum rege sine fræno⁶⁴. Et tunc⁶⁵ clamabunt⁶⁶ subditi et⁶⁷ dicent⁶⁸, “Domine⁶⁹ Jesu⁷⁰ in chamo⁷¹ et fræno⁷² maxillas⁷³ eorum⁷⁴ constringe⁷⁵.” Ad quos⁷⁶

This *addicio* is found in sect. 3, f. 34, in V, OD, OF, OM, MF, MG, MH, CM, X, HB, HA, MK, CB, LB, B; in OC, OG, MD, ME, MI, CA, CH, LC, LD, it is put at the end of sect. 2, f. 34; it is marginal in P.

1. Ins. nec, V; om., OC, OD, OG, MD, ME, MF, P; Ad item, HB (marked out).
 2. facti, CA; facta, X, CB (ins. above). 3. regia, X. 4. Om., CA; vel, MF, CH. 5. nihil, CA; ins. nemo, CH. 6. Om., MI, LC. 7. Om., CH. 8. Ins. debet, LC (above). 9. supra, MI; ins. domini, V, X. 9-10. Om., CH. 10. Crossed out and factum regis ins. above, MI.
 11. si, MF. 12. Ins. et, LC (marked out). 13. quia, ME. 13-17. domino rege quod bene, CH. 14. res, MG. 15. iusticiar., MF. 16. fecit, ME, MF, P. 17. brevi, MK, B.
 18. Om., MF, X. 18-21. fecerit vel male et imponere ei, CH. 19. sic, LC. 20. et, LD.
 21. Ins. above, MD. 22. Ins. fecit et quod hoc, CA. 23-24. ipse, CH. 24-25. Om., ME, MF, P. 25. Ins. sui, CH; iustitia, MD (by corr. from iustic); iustic., LC (corr. to iusticiam).
 26. Om., ME, MF, P. 27. Ins. quia, CA. 28. Ins. autem, X, V; ins. non, CA. 28 to end. Om., CH. 29. habebit, MI, LC. 30. Ins. iudicem, X. 30-31. deum superiorem, OF, MG.
 31. dominum nisi deum, CA. 31-32. scilicet deum, OG, MD, ME, MF, P. 33. rerum, OF, OM, MD (in an erasure), MG, MH, CM, MK, LB; om., HA, MI, LC, LD. 34. propter, ME, LB. 35-36. regem, LC (corr. to rex est). 37-38. alias iudicium videlicet curiam videlicet, X.
 39. Om., V, MF, MI, LC, LD (ins. above). 40. Ins. et barones, MK. 41. et, MI, LC. 41-42. Om., MF. 43. Om., OC, OG. 43-44. Marginal, MD. 45. Om., MH, CM. 46-47. habet socium, V, OM, ME, MF, P. 47. Erased, MI. 48. Ins. et, HB, CB, X. 48-49. magistrum habet, CM, MH, LB (habet ins. above). 50. id, CB. 51. Ins. ipse, OG.
 52. fuit, P. 53. Ins. above, MI. 54-55. et, OF, OM, MG, MH, CM, MK, CB, HA, HB, LB (corr. above to id est), B. 56. sue, MI. 57. debet, MI, LC (corr. to debent), LD. 57-58. ei deberent, MF. 58. eis, MK; om., CM. 59-60. apponere frenum, OF, OM, MG, MH, CM, MK, LB. 60. ponere, V; ins. scilicet ius, MI, LC, LD. 61. nec, OD, ME (corr. to nisi); ne, P, MF. 62. ipsi, MF. 63. fuerit, MK; fiant, ME (corr. to fuerint), MF, P. 64. freono, MG. 65. ne, P, ME (corr. to tunc above), MF. 66. clamant, ME (corr. to clamabunt), P; clament, MF. 67-68. Om., ME, MF, P. 69. domino, MK. 70. Ins. Christe, V, OD, ME, HA, MF, P. 71. clamo, HA. 72. frænas, OC. 73. maxillillas, MK. 73-75. constringe maxillas eorum, ME, MF, P. 74. Om., CM. 75. etc., X; confringe, OC. 76. quod, ME, MG, LB (erasure), P.

dominus¹, "Vocabo² super³ eos⁴ gentem robustam et⁵ longinquam et⁶ ignotam⁷, cuius linguam⁸ ignorabunt, quæ destruct⁹ eos¹⁰ et evellet¹¹ radices¹² eorum¹³ de terra, et a¹⁴ talibus iudicabuntur, quia¹⁵ subditos noluerunt¹⁶ iuste¹⁷ iudicare¹⁸." Et¹⁹ in fine ligatis²⁰ pedibus²¹ eorum²² et²³ manibus²⁴, mittet²⁵ eos²⁶ in²⁷ caminum²⁸ ignis²⁹ et³⁰ tenebras exteriores, ubi³¹ erit³² fletus et stridor dentium.

FOLIO 34b. *ADDICIO* *

Hoc videtur contrarium ei quod dicitur supra³³ de pluribus bastardis filiis de concubina, etc. Item quod fieri poterit donatio pluribus pueris, ubi dicitur quod pueris natis³⁴ et nascituris fieri poterit donatio. Sed non nominati et nascituri sunt incertæ personæ, ergo incertis personis fieri poterit donatio, et ita non est necesse, quod certa persona comprehendatur in donatione, cuius contrarium innuitur hic. Sed non est contra, quia³⁵ licet dicatur quod donator vult exprimere certam personam cui³⁶ facit donationem, cum eam tali personæ³⁷ fecit ut hic. Non tamen negat³⁸ per³⁹ hoc⁴⁰ quin fieri possit incertæ personæ, ut ibi.

FOLIO 33b. CHAPTER XVI †

Superius⁴¹ autem⁴² dictum est, quod⁴³ fit⁴⁴ donatio alicui⁴⁵ ob causam præteritam⁴⁶, quia⁴⁷ diu⁴⁸ servivit⁴⁹,

* This *addicio* is found only in V, X.

† Collated for: OA, OB, OC, OD, OF, OG, OM, MA, MB, MC, MD, ME, MF, MG, MH, MK, ML, MN, CA, CB, CC, CD (in parts), CE, CF, CH, CM, LA, LB, LC, LD, LF, MI, LG, LT, B, P, X, Y, HA, HB. OG starts with sect. 2, f. 33b; LB begins at l. 23, f. 33b.

1. Ins. dicet, CA; domino, MH, HA, CM (corr. to dominus). 2. Om., MK; repeat, MF; voca, ME (corr. to vocat), P; vocabit, LB (erasure); vocabulo, HA (corr. to vocabo). 3-4. superiores, OG. 5. vel, X; om., MF. 6-7. Om., MF; repeat, LB (marked out). 6-8. Om., MK. 7-8. Om., X. 8. linqum, P. 9. destinet, LD. 10. illos, ME. 11. evelles, LB (corr. to evellet). 12-13. eorum radices, MI, LC, LD, X. 14. de, CA. 15. qui, MD; et, MK; ins. above, LB. 16. noluerint, OC, OG, HB, MD, MH, LB; voluerint, HA, OF, OM, ME (corr. to noluerunt), MG, MK. 17. iniuste, OF, OM, MG, MH, MK, HA, LB, B (changed to iuste). 17-18. iudicare iuste, OG. 19. Ins. above, LB. 20. legatis, MI, B. 21-24. pedibus et manibus eorum, OD, MD. 22-23. et eorum, OM, HA. 24. Ins. et, OF, MG. 25. mittent, MF. 25-26. Repeat, LC. 27. Ins. above, MG. 28. Found also in the forms chaminum, camenum; ins. eorum MF (marked out). 29. ignum, MH, LB. 30. Ins. in, OM. 31. ibi, B. 32. est, OM, MH, CM, MI, LB, LC, LD, HA. 33. scilicet, X. 34. non nominatis, X. 35. quod, X. 36. cum, X. 37. Ins. certæ, X. 38. negatur, X. 39-40. Om., X. 41-49. Om., CH. 42. Om., OM (ins. above), MN, CF, LT. 43. Ins. si, ML. 44. fiat, ML; sit, CF, MK, X. 45. alia, CA. 46. Ins. ut, CA. 46-49. præteritam vel futuram quia bene servietit, LD. 47. quam, ME. 48. Marked out, bene ins. above, CB. 49. serviit, MI, LC; serviunt, OM.

vel¹ præsentem², quia bene servit³, vel⁴ futuram, quia⁵ bene serviet⁶, et⁷ talis⁸ donatio⁹ dici¹⁰ poterit¹¹ servitii¹² futuri¹³ remuneratio¹⁴. Item¹⁵ fit¹⁶ donatio¹⁷ pro homagio et servitio¹⁸ simul¹⁹. Et²⁰ sicut²¹ oportet, quod certa²² sit²³ res quæ datur, ita oportet²⁴ quod certa sint servitia²⁵ quæ²⁶ dantur pro²⁷ re data²⁸. Et²⁹ fiunt aliquando³⁰ donationes³¹ in scriptis³², sicut³³ in cartis³⁴, ad³⁵ perpetuam³⁶ memoriam, propter brevem³⁷ hominum³⁸ vitam, et³⁹ ut⁴⁰ facilius probari⁴¹ possit⁴² donatio. Et tamen⁴³ nihilominus⁴⁴ valet⁴⁵, licet⁴⁶ scriptura non inter- venerit⁴⁷, dum tamen alias⁴⁸ habeat⁴⁹ probationes⁵⁰.

Et⁵¹ sciendum⁵² quod cartarum alia regia, alia⁵³ privata⁵⁴. Et⁵⁵ regiarum alia privata⁵⁶, alia communis⁵⁷, alia universitatis. Item⁵⁸ privatarum⁵⁹ alia de puro⁶⁰ feoffamento et⁶¹ simplici, alia de feoffamento⁶² conditionali, sive⁶³ conven- tionali⁶⁴. Et⁶⁵ secundum omnia⁶⁶ genera feoffamentorum⁶⁷ fieri poterit⁶⁸. Item privatarum⁶⁹ alia de recognitione pura vel⁷⁰ conditionali⁷¹. Item⁷² alia⁷³ de⁷⁴

1-14. Om., CH. 1. Ins. ob causam, CA. 2. præsentem, MK; ins. ut, CA. 3. servivit, OF, MF, MG, MK, CB (corr. to servit), HA, B. 4-6. Marginal, ME. 5. eo quod, CA; quod, LC. 7. Om., MI, CA, LC. 8-9. donatio talis, MH, CM. 9. Ins. bene, V. 10-11. poterit dici, OM, X. 12. servitium, LT; servi, MI (corr. to servitii); ins. po., B (marked out); ins. præstiti præsentis vel, CA. 13. Om., MB. 14. renuntiatio, OM, HA. 15-17. Nunc de donationibus quæ dantur, V, OB, LF, LG. 16. si, MG. 18. Ins. suo, CA, CH. 19. similiter, MI (corr. to simul), LD; sil., B; similit, LC. 20. Om., LF. 21. successive, MA. 22. terra, ML. 22-23. sit certa, OF, OM, HA, MG, MH, CM, MK, CB, B, HB. 24. Ins. above, MG. 25. cervitia, MH. 26-28. Om., CH. 27-28. Repeat, CM (marked out). 29. Om., ME, CC, P. 30-31. donationes aliquando, ML. 31. donationis, OF. 32. scripturis, OD. 33. et, CA; om., X. 33-50. aliquando sine et tunc quidem valebit cum sufficienti probatione, CH. 34. carti, ME (corr. to cartis). 35. Repeat, ML. 36. Ins. rei, MF. 37. Om., CA. 38. hominis, OC, OM, HA, MH, CM, B; temporum, CB (hominum ins. above). 39. Om., OC, OM, HA, MA, MD, ME, MF, MH, CM, CB, HB, CC, P, Y. 39-40. vacillantem et decidentem ut per scripta, CA. 40. Om., MA; ubi, OB. 41-42. possit probari, CE, LA. 42. posset, OF, MG; poterit, MI, LC. 43. cum, CM. 44. nominus, MK. 45. Ins. donatio, CA, LD. 46. si, MK, X. 47. interveniat, CA. 48. alas, OF. 49. habet, OD (corr. in margin), HA, MA, MF, CF, LT, LD; habeant, CA. 50. donationes, B. 51. Om., OB, LF, LG. 51-8 next page. Unde cartarum alia regia, alia privata, alia communis, alia universitatis. Item privatorum aliud purum, aliud conditionale sive conventionale. Item alia de quietâ clamantis, alia de confirmatione. De hac materia habeatur inferius de finali concordia, CD. 52. Ins. est, OG. 53. Om., LF. 54. privatorum, V. 55. Item, CH; ins. cartarum, CA; ins. above, CB. 55-56. Om., OF, ME (marginal), MG. 57. communia, OG; ins. et, V, OD. 58. Ins. cartarum, CA. 59. privatorum, ME, CC, P. 60. Om., OF. 61. Om., MB; ins. above, MN. 61-62. Om., OB, OF, CC, LF, LG. 63-64. Om., OM, CM, MH, LD, HA (marginal). 64. conventuali, LT. 65. Ins. sic carta, CA. 65-68. Om., CH. 65-71. Om., LG. 66. quod omnia, CC; quod, MI (omnia ins. above). 67. feofatorum, MC (corr. to feofamentorum); ins. genera, B. 68. potest, V. HA, CM. OC, OF, OM, MC, MG, MH, MI, MK, ML, CA, CB, LA, LC, LD, B, BH, X; poterunt, CC. 69. privatorum, MD, ML, CC; ins. cartarum, CA. 70. et, Y. 71. Ins. sive conventionali, OB; ins. conventio, LF. 72. Om., MA, MD, CH. 73. Om., MH, CM, MI (marginal). 74. Om., ME.

quieta¹ clamantia. Item² alia de⁵ confirmatione. Et⁴ de hac materia inveniri⁵ poterit⁰ infra de⁷ finali concordia⁸. Carta⁹ vero de¹⁰ puro¹¹ feoffamento est¹² de¹⁵ simplici feoffamento¹⁴ sine aliqua¹⁵ adiectione¹⁰. Conditionalis¹⁷, ut¹⁸ si¹⁹ conditio²⁰ donationi²¹ sit²² adiecta²⁵, ut supra²⁴ videri poterit²⁵. Item²⁰ de recognitione, ut si tenens²⁷ rem²⁸ quam²⁹ detinet³⁰, et⁵¹ ab eo³² petitur³³, recognoverit⁵⁴ esse³⁵ ius³⁶ petentis³⁷. Vel e converso, si³⁴ petens rem³⁹ quam⁴⁰ tenens⁴¹ tenet⁴² recognoverit⁴³ esse⁴⁴ ius⁴⁵ tenentis⁴⁶, tenendam⁴⁷ de se vel⁴⁸ de alio⁴⁹, vel⁵⁰ si illam⁵¹ remisit⁵², et quietam⁵⁵ clamaverit⁵⁴. Item⁵⁵ de pura⁵⁶ quieta clamantia, ut⁵⁷ si petens pure⁵⁸ remisit⁵⁹ et⁶⁰ quietam⁶¹ clamaverit⁶² tenenti⁶³ terram⁶⁴, quam⁶⁵ petiit⁶⁶ ut ius suum⁶⁷.

1-3. Om., OM, HA. 2. et, MB; om., CH. 4-8. Om., CH. 5-6. Om., CM. 7. in, OG; om., LF. 9-25. Om., CD. 10-11. quæ deponitur, MB; deponitur, LG, OM. 12. et, OB, MI, LC, LF, LG, B; quæ est, CH; vel, ME, MF, P; eadem, Y (marked out, est ins. above); alia, X. 12-14. Om., OF, OM, MH, MG, HA, CM, MK, CB (marginal), CC, B (marginal). 13-14. Om., CH. 14. Ins. est, MF, MI (above line), LC. 15. alia, OB, MI, LF; om., CH, MK. 15-16. conditione aliqua, CF, LT. 16. Ins. carta, CA. 16-17. The reading is either adiectione conditionalis, or, adiectione. Conditionalis. Omit the period, OB, OC, OM, OF, MA, MB, MD, ME, MF, X, MG, MH, MI, MK, ML, MN, CB, CC, CM, LC, LF, LG, P, Y; retain the period, OA, OD, OG, CA, HA, CE, CF, CH, MC, LA, LD, LT. 17. conditionalis, OM, MA, MB, MD, ME, MF, MI, MH, CM, MN, CC, LG, HA, X, LC; conditional., OA, OB, OC, OD, OF, OG, MC, MG, ML, CB, CE, CF, CH, LA, LD, LF, LT, HB, P, Y. 18-20. Repeat, LC (crossed out). 18-25. cum adiectione, CH. 19. Om., OG. 21. Ins. non, OB, MB, ME, MF, LG, X, MH, CM, MI, MN, CC, LC, LF, P, HB, HA (above), CB (above). 21-22. ac si, MK. 21-23. adiecta non sit conditioni, MA (corr. to ditioni), MD. 22. Repeat, MN. 23. abiecta, LD. 24. infra, OM. 26. Ins. carta privata, CA. 26-67. Item de recognitione si a tenente petentis potest recognoscere tenementum esse ius petentis, vel petens recognoscere tenementum esse ius tenentis e contrario, tenendum de se vel de alio, vel quiet. clamavit tenementum, CD. 27. Ins. above, CH. 28-33. Om., CH. 30. tenet, V, X, MI, LC (corr. to detinet); detinet, Y. 30-40. Om., MK. 31. Om., OC. 32. aliquo, OC. 33. petatur, V, OC, LC, Y; petetur, MF; ins. et, OC. 34. recognovit, CA, LD; recognoscat, CH. 35-36. ius esse, V, MI, LC, LD, CH. 36. Om., OF, MG. 37. inpetentis, OF, MG. 37-45. Om., OM, HA (marginal), MA, B. 38-49. Om., CH. 39. Om., LT. 41. tenentes, Y. 41-42. tenet tenens, MG. 43. recognovist, LD (corr. to recognovit); recognovit, CA; recogn., MI, LC. 44-45. ius esse, V, LD. 45. Ins. petentis, MG (marked out). 46. Ins. vel e contrario, MA (above). 47. tenendum, V, MH; tenend., OB, OM, MA, MB, MD, ME, MF, MI, CA, CC, CM, LC, LD, LF, Y, P, LG. 48-49. Om., LA. 49. alia, OA (corr. to alio). 50. ut, OC, ME, MH, CC, P, CM. 51. illa, MK; illum, MB; om., CH. 52. dimiserit, MB; remisit, MF. 53. quietum, LG, X, V; quiet., OB, MA, MB, MD, MN, CH, LF. 54. Ins. (marginal), tenenti terram quam petiit ut ius suum, LC. 55-62. Om., OM, B, HA (marginal). 56. Ins. et, OG, MH, CM, CB, HB. 57. et, OA, OB, MA, MN, CF, LG, LT, Y; in an erasure, LF. 58. Om., MK. 58-59. remisit pure, OD. 60. Om., MI. 61. quietum, HA, LC, LF, LG; quiete, LD; inquietam, P; quiet., OB, MB, MD, MI, MN, CH. 62. clamavit, MK; clam., MB. 63. Om., MH, CM. 63-64. terram tenenti, MF. 64. Ins. illam, CF, LT; rem, OG. 64-67. Om., CH. 65-67. ut si ius suum quam petiit, MK. 66. petit, MI, CA, LC, LD.

Item carta¹ de² confirmatione³, quæ alterius factum consolidat et⁴ confirmat tantum, et⁵ nihil novi⁷ attribuit⁸, sed⁹ aliquando confirmat et addit¹⁰. Item earum¹¹ quæ¹² sunt privatae¹³ et¹⁴ simplices de¹⁵ pura donatione¹⁶, remanent¹⁷ donatario¹⁸ et eius¹⁹ heredibus²⁰. Si autem communes²¹ sint²² duplicari debent²⁵, quod quilibet²⁴ habeat²⁵ partem²⁶ suam²⁷, vel²⁸ deponi²⁹ in³⁰ æqua³¹ manu³² cuilibet partium³³, cum³⁴ necessarie fuerit exhibenda³⁵. Et si penes³⁶ donatarium³⁷ remanserit³⁸, donator³⁹ eo quod sua interest⁴⁰ petat⁴¹ exhibitionem, cum donatarius forte⁴² aliquid⁴³ petat⁴⁴ a⁴⁵ donatore⁴⁶, quod⁴⁷ donator negaverit⁴⁸ vel⁴⁹ de quo dubitetur⁵⁰, vel⁵¹ si donator petat⁵² et⁵³ donatarius⁵⁴ neget⁵⁵, tunc⁵⁶ donatarius⁵⁷ vel⁵⁸ exhibeat⁵⁹ instrumentum, vel ei denegetur actio si petens fuerit, vel si⁶⁰ ab eo petatur⁶¹, remaneat⁶² indefensus⁶³. Communis enim⁶⁴ esse⁶⁵ poterit⁶⁶,

1. Om., MK. 1-2. Om., CH. 1-3. confirmatio, CD. 2. Om., MI, LC, LD, CA. 3. confirmationis, MI, LD, CA, CH, LC; ins. carta, MK. 4-5. Om., CD. 4-10. Om., CH. 6. ei, ML; om., CD. 7-8. attribuit novi, MK, ML. 9. et, CD. 9-10. Om., OB, LF, LG. 11-20. si cartæ sint privatae remanent penes donatarium, CH. 11. Ins. cartarum, CA. 11-22. communis potest esse carta et, CD. 12. qui (corr. to quæ), ME. 13. privatarum, OC (a corr. from privatorum), HA, OM, MG, MI, LA, LC, LD; privatorum, OA, OF, MK, ML, CB, B, HB. 14. ut, MI. 15. et, HA. 16. conditione, CF. 17. remaneant, MD; remanet, CF, LT; ins. e, X. 18. donatorium, MK. 19. eiusdem, X. 20. heredum, MK, X. 21. Om., LA; ins. above, MC; commune, CF, LT. 21-22. sint communes, OC, OF, OG, OM, MG, MH, CM, MI, HA, MK (sit), ML, CA, CB, LB, LC, LD, B, HB. 22. Om., MB, CH; ins. above, MA; ins. aut, OC, OF, OG (marked out), OM, MD, MG, MI, CA, CB, CH, LB (marked out), HB, HA, LC, LD, B; ins. ad., MK (corr. to aliud). 23. Ins. ita, CA; debet, CD. 24. uterque, CD. 25. habeant, MK. 26-27. suam partem, CD. 28. Ins. debet, CA. 28-29. si non duplicetur desponenda erit carta communis, CD. 29. dampnum, ME (corr. to deponi above). 30. sub, CH. 31. qua, CF, LT; æquali, MA, ME, CD, X, CM. 32. Om., CF. 33. pertinentiis, LB (corr. to partium); eorum, CH; ins. exhibenda, MN; parti, CD; pertinenti, HA, OM (pertinent.); corr. to partem, MI. 34. nunc, B; om., LT. 35. Om., MN. 36. petierit, LD; petens, MI, MN (corr. above), LC (corr. in margin); tenens, CA. 37. donatario, X; dor., MI. 38. rem amiserit, CA; remisit, B, X; rem serit, Y (corr. to remanserit). 39. Ins. ex, MB. 39-50. donator cum sua intersit. petat exhibitionem cum donatarius contra scriptum aliquid sibi vendicet. quod donator neget vel econtrario, CD. 40. est, OM; ins. a, OG (marked out); ins. si, MC. 41. petit, CA; marginal, MH; ins. a donatorio, V, ME, X, MF, MH, CM, MI, CC, LB (above), LC, LD, P; ins. a donatore, Y. 42. Repeat, X; om., OB, LF, LG. 42-43. aliquid forte, MI, CA, CH, LC, LD. 43. quid, X. 44. peterat, MI; poterat, LC (corr. to peterat). 45-46. ad donatorem, OB. 47. quia, MA. 48. negavit, MK. 49-50. Om., MK. 50. Ins. vel si dubitetur, CA. 51. Om., CD. 52. Ins. et donator petat, CA. 53. a, LA; quod, MA; om., MG. 54. donatario, LA. 55. negat, V, X. 55-57. Om., LF. 56. etc., MI (tunc ins. above), LC (corr. above). 56-60. et si scriptum non exhibeatur. si petens sit. denegetur ei actio. si defendens remaneat. indefensus. et si casum. vel amissione allegaverit. casum probare tenetur. Alia scripta communia fiunt. ut de terris aliis traditis. ad certum terminum vel ad firmam, CD. 58. non, ME (corr. to vel above). 59. exhibebat, MC (corr. to exhibeat); bibeat, LB (corr. to exhibeat). 60. Ins. a, LA (marked out). 61. petat, CF, LT. 62-63. Marginal, ME. 64. Ins. above, OC. 65-66. Om., OM, HA (marginal). 66. Ins. aliqua ratione, V, X.

ut¹ si terra detur² ad terminum annorum vel³ ad firmam⁴. Item communis esse⁵ poterit⁶ alia⁷ ratione⁸ et perpetua, ut si quis⁹ donationem fecerit¹⁰ alicui¹¹ de aliqua¹² re¹³, retenta¹⁴ sibi¹⁵ aliqua¹⁶ parte illius¹⁷ rei¹⁸, ut si quis manerium¹⁹ dederit²⁰ retenta²¹ sibi quarta²² parte vel de²³ eius pertinentiis²⁴. Ut si²⁵ quis manerium²⁶ dederit²⁷ retenta sibi²⁸ advocacione ecclesie vel²⁹ huiusmodi, et³⁰ si tenens dicat³¹ se³² totum³³ tenere, cum donator petat³⁴ ostendere debet³⁵ tenens³⁶ cartam³⁷ ad probandam³⁸ exceptionem³⁹ suam⁴⁰, quod si non⁴¹ fecerit, exceptio⁴² sua⁴³ nulla⁴⁴ et amittat⁴⁵, sicut indefensus. Si autem cartam⁴⁶ forte⁴⁷ exhibere⁴⁸ non⁴⁹ possit⁵⁰, quia⁵¹ illam ad manum non habuerit⁵², de⁵³ necessitate⁵⁴ erit⁵⁵ ad patriam⁵⁶ recurrendum⁵⁷. Et⁵⁸ eodem modo si casum allegaverit⁵⁹ et⁶⁰ casum⁶¹ probaverit⁶². Et⁶³ sciendum quod privatorum⁶⁴ instrumentorum⁶⁵ tres⁶⁶ sunt⁶⁷ species⁶⁸, unde⁶⁹ facit⁷⁰ aliquando quis⁷¹ scripturam⁷² sibi ipsi⁷³, et⁷⁴ tali⁷⁵ scripturæ⁷⁶

1-6. Om., MN (in margin is, Item communis esse poterit ut si terra detur ad terminum annorum et ad firmam). 2. datur, V; tradatur, CH. 3. et, OA, OD, MA, MB, MC, ME, MF, ML, CC, CF, LA, LF, LT, P, LG. 3-4. Om., CE. 5. Om., MK. 5-6. poterit esse, MI, LC, LD. 5-8. Om., CH. 6. Om., CM. 7. aliqua, OM, MA, MB, MD, ML, MN, HA. 9. Ins. ad, CB (marked out), LB (marked out), HA, B. 10. Om., CF. 11-20. de manerio, CH. 12. alia, OG, MI. 13. Om., CF, MH (marginal). 14. retinenda, OC. 15. Ins. de, MI (marked out). 16. alia, OB, MI, LF, LG. 16-28. Om., MN (a part in margin). 17. ipsius, Y. 18. Om., MK. 19-20. dederit manerium, MI, CA, LC, LD. 21. recenta, ME. 22. aliqua, OC, CF, LT; quarte, OG. 22-28. Om., X, OB, OM, HA, MA, MB, MD, MF, MH, CM, LB, LF, LG. 23. Om., MI, LC, LD. 24. partium, MK. 25-27. Om., CH. 26-27. dederit manerium, CA. 29. et, MC, LA. 30. ut, OB, MA, MB, MD, MN, CB, HB, LF, LG. 31. deicat, LD (corr. to dicat). 32. Ins. non, MF, ML, LD, P (marked out). 33. Ins. non, MI, LC (marked out). 34. Ins. totum, ML. 35. Ins. petens, OA (marked out). 35-36. Om., LF. 36. petens, CB, HB, CC; om., CF, LT, MA (ins. above). 37. cartas, MK, LF; ins. suam, OG, LG. 38. probandum, OM, MK; proband., OF, MA, MB, MI, MN, CC, CH, LC, LF, LG. 39. Ins. illam, ME (marked out), CC, P. 40. illam, Y (corr. to suam above). 41. Marginal, MI. 42-44. omnino nulla exceptio, OM, HA. 43. Om., OF, MG, MK, CB, LB (ins. above), HB, B. 44. Ins. erit, CA; ins. est, MB. 45. amittet, OB, MA, MB, MD, MN, LF, LG; amittit, MG. 46. carta, MK, P. 46-47. forte cartam, MB, ME. 47. Om., CA, CH. 47-48. habere forte, OG. 48. habere, OA, OB, LG, OC, OG, MA, MB, MC, MD, ME, MF, MN, CC, CE, CF, LF, P, Y; adhibere, MI, LC (corr. to exhibere); exhiberi, CD. 48-49. non habere, MB. 48-50. non possit habere, MF. 50. poterit, CC. 51. quod, MK; eo quod, CA; quis, MC (corr. to quia). 52. habuit, OF, OG, MA, MD, MG, CM, ML, Y; habet, CH; ins. nequaquam, CA. 53-54. denuntiatam, OM, HA. 54-55. In an erasure, LB. 56. firmam, CA. 57. requirendam, CA. 58. Om., CH. 58-59. Marginal, MA; om., LG, LF, OB, MB, MN. 60-62. Om., OB, MA, MB, MN, CH, LF, LG. 61. Om., CF, LT. 63. Omit through quod inferius dicitur below, CH; Item, B. 64. privatarum, OM. 65. et sumentorum, MK. 66. tria, LA. 66-67. sunt tres, OM, MI, LC, LD, CA; sunt res, HA. 68. Om., LA, MC (marginal); speciales, HA. 69. nam, V, OC, OD, OF, OG, OM, MD, MG, MH, CM, MI, MK, ML, LB, HB, LC, LD, CA, CB, B, X; sed, MC, LA; non, HA. 70. facut, MK. 71. Om., MA. 72-73. sibi ipsi scripturam, OM, HA. 74. in, OC. 75. talis, CM. 76. scriptori, LT.

non¹ erit² fides adhibenda³, aliquando facit⁴ contra se, et⁵ tali scripturæ⁶ fides⁷ adhibetur⁸, aliquando⁹ tamen¹⁰ facit¹¹ quis¹² scripturam¹³ sibi¹⁴ et alii¹⁵, et¹⁶ contra se¹⁷ et pro¹⁸ se, quæ¹⁹ communis est²⁰ et de²¹ qua superius dicitur²², et²³ de²⁴ quibus²⁵ agitur²⁶ de conventionibus factis inter privatas personas²⁷, et talis scriptura dicitur²⁸ carta²⁹ cyrograffata³⁰, quæ³¹ scinditur³² per medium³³, et³⁴ unde³⁵ una³⁶ pars remanet³⁷ parti³⁸ uni³⁹, et⁴⁰ altera alteri⁴¹. Et unde⁴² quamvis non liceat alicui⁴³ partium⁴⁴ a⁴⁵ conventionibus⁴⁶ recedere, tamen⁴⁷ non⁴⁸ solet aliquando⁴⁹ necessitas imponi⁵⁰ curiæ⁵¹ domini regis, de huiusmodi conventionibus⁵² privatis⁵³ discutere. Sed⁵⁴ tamen, si quis⁵⁵ a conventionione recedat⁵⁶, succurritur alteri⁵⁷ parti⁵⁸ per actionem de conventionione, secundum quod inferius dicitur. Et notandum quod⁵⁹ omnium⁶⁰ scripturarum⁶¹ privatarum⁶², quibus⁶³ quis⁶⁴ uti⁶⁵ voluerit⁶⁶ in⁶⁷ iudicio⁶⁸ pro⁶⁹ se, copiam⁷⁰ faciat⁷¹ adversario suo⁷² contra se. Sed⁷³ petens petere⁷⁴ non debet quod tenentis⁷⁵ instrumenta

1. Om., LF (ins. above). 1-2. Repeat, MH. 1-6. Om., OF, CC. 2. est; MI, LC, LD. 3. exhibenda, MG, B; exhibendam, MK; ins. et, MA. 4. Om., MK. 5-17. Om., MN (ins. later). 6. scriptori, LT; est, X. 7. Repeat, MG. 7-8. adhibetur fides, V. 8. adhibentur, MK; adhibenda, X. 9. quando, MC; ins. p, MK (marked out). 9-10. quandoque, LA. 10. autem, MB; cum, CB, HB, CM, LB, LT; causa, MK. 10-11. facit tamen, OG, LD. 11-12. quis facit, CF, LT, X. 12. Om., CA. 12-13. scripturam quis, OF, OM, HA, MG, MH, CM, LB; scriptura quis, MK. 13. Ins. contra se et tali scripturæ fides adhibetur et aliquando facit quis scripturam, ML. 14. Ins. ipsi, V, MB. 15. aliquando, MA, MF, CF. 16. Om., OB, MA, MB, MD, ME, LG, MF, CC, CF, LF, LT, P, Y. 18. per, MK. 19. quia, MF; ins. quidem, CA. 20. Om., CF, LT. 21. Repeat, MN (marked out). 22. dictum est, MA, MD. 23. Om., ML. 24. Ins. above, MK. 25. Ins. de, MK (marked out); qua, OB, LF, LG; quo, OG. 26. consequitur, LC; an erasure and correction, MI. 27. Om., LT, X. 28. Om., MG. 29. Om., OM, MH, LB, CM. 30. cyrograffum, OF, OM, HA, MG, MH, MK, LB; cyrographi, CB (corr. to cyrographata), B; cyrogrffata, CE; cyrograph., CM. 31. Ins. above, MF. 32. cinditur, OC, OG, ME, MN, CA, CF, LG, X. 32-33. per medium scinditur, MF. 34-41. Marginal, LC. 35. Om., V, OM, HA, ME, MH, CM, CC, LB, P; cum, MI. 36. Om., MA. 37. remaneat, OM, MH, LB, LD, HA. 38. Om., ML. 38-39. uni parti, OB, MA, MB, MD, ME, MF, MK, MN, CC, CF, LF, LG, LT, P, Y, X. 39. Om., LA. 40. Om., OC. 42. tamen, LC (corr. to unde). 43-44. partium alicui, LD. 44. parti uni, MB. 45. ex, MK. 46. conventionione, OF, OM, MG, MH, CM, MK, LB, HA. 47. cum, OF, OM, MG, CM, MI, MK, CB, HB, LA, LB. 48. Om, ME, CC, LC (ins. above); marked out, P. 49. Om., OM, HA, MH, CM, LB; crossed out, MI. 50. Ins. in, LF (above). 50-51. imponituræ, OF. 51. in curia, MF. 52-53. privatis conventionibus, ML. 54. si, MF. 55. aliquis, CF. 56. recedit, OB, MA, MB, MD, ME, MF, MN, CC, LF, LG, P, Y. 57. aliquando, MK. 58. Ins. quia, OB, MB, MN, LF, LG. 59. Om., HA (ins. above), ME. 60. omni, CF. 61. scriptura, CC. 62. Om., MA, MD (marginal). 63. quo, OG. 64. Om., LA; ins. above, LB; prius, LD. 65. Om., MK. 66. voluit, HA; noluerit, LG, ML, LB. 67-68. Ins. above, CB. 69. per, MA, MD, CA. 70. Ins. non, HA (above). 71. faciet, V, OC, OD, OF, OG, OM, MC, HA, MG, MH, CM, MI, MK, ML, CA, CB (by corr. from faciat), HB, CH, LA, LB, LC, LD, B; facit, CF, LT, X. 72. Om., OF, OG (ins. above), OM, MG, MH, CM, MK, CB (ins. above), LB, B, HA. 73. et, MA. 74. ponere, CF, LT. 75. tenens, MH, LB; tenentes, HA.

exhibeantur¹ ad suam² intentionem³ fundandam⁴, cum non⁵ teneatur armare⁶ adversarium suum⁷ contra se, nisi forte instrumenta sua⁸ sint communia. Nec⁹ etiam¹⁰ poterit tenens¹¹ petere quod exhibeantur ei¹² instrumenta¹³ petentis ad exceptionem suam probandam¹⁴, secundum quod¹⁵ prædictum¹⁶ est¹⁷, maxime nisi¹⁸ sint¹⁹ communia²⁰.

De cartis vero regniis²¹ et factis²² regum²³, non debent²⁴ nec²⁵ possunt²⁶ iusticiarii²⁷ nec²⁸ privatæ personæ disputare, nec etiam²⁹ si³⁰ in³¹ illis³² dubitatio³³ oriatur possunt eam³⁴ interpretari³⁵. Etiam³⁶ in dubiis et³⁷ obscuris, vel si aliqua³⁸ dictio³⁹ duos⁴⁰ contineat intellectus, domini regis erit⁴¹ expectanda⁴² interpretatio⁴³ et voluntas⁴⁴, cum eius⁴⁵ sit⁴⁶ interpretari⁴⁷ cuius⁴⁸ est⁴⁹ condere⁵⁰. Et⁵¹ etiam⁵² si⁵³ omnino⁵⁴ sit⁵⁵ falsa⁵⁶ propter⁵⁷ rasuram⁵⁸, vel⁵⁹ quia⁶⁰ forte⁶¹ signum⁶²

1. exhibentur, LD; exhibeant, HA; exhibeantur, MK; adhibeantur, MB. 2. sua, MN. 3. Ins. probandam vel, ME, MF, CC, CH, P. 4. fundendam, OB, MB, MG, CH, CF, LF, LG, LT; faciendam, MA; ins. principalem sed ad exceptionem suam sui autem omnino ista probantur C. de edendo l. I et II e. l. qui accusare et maxime l. ult. cum glossa prima, X. 5. Ins. above, OG. 6. amare, MC (corr. to armare), MK, LT. 7. Om., LT. 8. Om., CA, CF, LD (ins. above); ins. sint, ME (marked out). 9-20. nec e converso, CH. 10. Om., OB, LF, LG. 11. petens, MA (corr. to tenens); tenens, OF. 12. sibi, CA. 13. instra strumenta, MK (corr. to instrumenta). 14. probandum, MK. 15. Ins. above, MI. 16. dictum, CC. 17. Om., MA, MB, MN, CF. 18. Om., MK. 19. sit, CA. 20. communis, CA; contraria, LG. 21. regia, MH, OG, CM. 22. Ins. vero, OG. 23. Om., OB, MA, MB, MN, LF, LG. 24. deberet, CC. 25. non, HB, CB (corr. to nec above), B. 25-26. Om., MA. 25-27. iusticiarii nec possunt, MF. 26. possent, LD. 27. Ins. disputare (and omit later), MA, MD. 28. non, B (corr. to nec); ne, MB. 29. et, LF. 29-32. Om., CH. 30. Om., ME (ins. above), CC, LC, P (ins. above before etiam). 30-32. nullo, MI (si in illis ins. above). 31. Ins. above, OC, MF. 32. aliis, CC; illa, V; illo, LC (corr. to illis); ins. ubi, OC, OG, MD, CC (marked out). 33. dubio (corr. to dubitatio), MI, LC; dubo., MG; disputatio, OC, OG, MK. 33-34. dubia, CH. 34. Ins. etiam, ME (marked out). 35. Ins. debent, MG (marked out); impretari, LD. 36. et, V, CF; om., ME; quia, CA. 36-45. quia eius, CH. 38. alia, MI, MK; ins. conditio vel, ME (marked out), MF, MI (marked out), LC (marked out), P, MA (above), CC; ins. dictio, OA (marked out). 39. Ins. above, LC (repeating), Y (erasure); ins. alias conditio, OG (above). 40. duo, MN (corr. to duos), CF, LT; duas, OM, MK, CC, LB, HA. 41. Ins. above, ME. 41-42. expectanda erit, MF. 42. expectando, P; expentanda, OD. 42-43. interpretand. (corr. to interpretatio) expectanda, CA; interpretatio expectanda, X. 43. interpretationem, ME (corr. to interpretatio). 43-44. voluntas et interpretatio, Y. 44. voluntatem, ME (corr. to voluntas). 45. cuius, OF, OM, MG, MH, CM, MK, LB, HA. 45-46. sit eius, MI, ML, LC, LD, CA. 46. Ins. above, OG; repeat, CM; est, CH. 47. interpretatio, OG. 48. eius, OF, OM, MG, MH, HA, CM, MK, LB; cum, MN. 49. sit, OF, MG. 50. concedere, V, OB (corr. to condere), HA, MK; conditio, OG. 51. Om., LD. 52. Om., CH, ML. 52-54. omnino etiam si, LC. 53. Ins. above, MH. 54. Om., X. 55. Om., OF; fit, Y. 56. plura, OF; ins. ut, CA, Y (above); fallacia, X. 57. per, X, HB. 58. rasura, MK. 59. Ins. propter aliud vitium in, CA. 60. quod, ME; qua, CA; om., MN (ins. above), LD; repeat, MI (marked out). 60-61. forte quia, Y. 61. Ins. quia, CC. 61-62. signum forte sit, ME (sit ins. above). 62. sigillum, Y; om., OB, MA (ins. above), MB, MN, LF, LG.

appositum¹ est² adulterinum³, melius⁴ et⁵ tutius⁶ est⁷ quod⁸ coram ipso⁹ rege¹⁰ procedat¹¹ iudicium¹².

Si¹³ privata¹⁴ persona fecerit donationem de re¹⁵ certa¹⁶ ex¹⁷ causa futura, oportet quod certa¹⁸ sint ea quæ donatori¹⁹ præstari²⁰ debent in retributionem²¹ pro re²² data²³, ut si²⁴ fiat²⁵ donatio²⁶ pro homagio et²⁷ servitio²⁸, vel²⁹ pro servitio³⁰ tantum³¹ sine homagio, fieri etiam³² poterit donatio pro homagio³³ et servitio³⁴ proprie³⁵ de feodo militari³⁶. Improprie³⁷ vero³⁸ fit³⁹ homagium de⁴⁰ sockagio, cum inde fieri⁴¹ deberet⁴² tantum⁴³ fidelitas⁴⁴ et non homagium⁴⁵. Et⁴⁶ si de facto fiat⁴⁷ homagium⁴⁸, non tamen⁴⁹ sequitur⁵⁰ propter hoc⁵¹ quod ad dominum capitalem pertineat custodia et⁵² maritagium⁵³, quia⁵⁴ custodia et⁵⁵ maritagium⁵⁶ non semper⁵⁷ sequitur⁵⁸ homagium, quia ad quem huiusmodi pertineant⁵⁹ per⁶⁰ homagium⁶¹ non determinatur,⁶² sed per servitium, secundum⁶³ quod tenementum⁶⁴ tenetur per servitium⁶⁵ militare⁶⁶ vel⁶⁷ per⁶⁸ sockagium.

1. positum, OA, OB, MA, MB, ME, MN, CC, LF, LG, P, Y; impositum, MF; om., CF, LT; in part erasure, LD. 2. Om., CH; est appositum, X. 3. Om., ME, B; sit, MN. 4. ad ultimum, CA, LA, LF; adulterinum, MD; adulterium, MB, MG, CB, HB, LG; ins. above, id est contrafactum, LB; ins. et, MB, LA. 5. Ins. est, Y. 6-7. Om., CH. 8. tutias, MK. 9. Om., Y. 10. Ins. above, CF. 11. Om., CH. 12. rege ipso, OC. 13. Om., MA, MK, LA. 14. procedatur, V; proceda, MK; ins. ad, V, MG, MH, CM, MK. 15-16. iudicium procedat, OF; ad iudicium procedat, B. 17. Ins. ad, LB, CB (marked out); ins. Item factum regis ut supra, LC, MI (omits ut). 18. Omit to l. 8, f. 55b, OG. 19. to end of section. Fieri etiam poterit donatio pro homagio et servitio proprie de feodo militari. Improprie autem fit homagium de socagio cum inde tantum debeatur fidelitas. Et si de facto fiat homagium non tamen sequitur custodia et maritagium, CH. 20. Repeat MK (marked out). 21-22. certa re, MI, CA, LC, LD. 23. et, B. 24. cerata, CB (corr. to certa), B. 25. a donatario, X; donari, Y (corr. to donator); donari et, ME; ins. vel, ML; ins. after debent, OF, MG. 26. prari, CF; præstare, B; priare, MB. 27. intributionem, LT. 28. Ins. tribu, OB (marked out). 29. da, OB. 30. Om., MK. 31. fia, LT. 32. Om., CA, LD. 33. vel, MB. 34-35. Om., MI, LC (ins. above). 36. Ins. proprie de feodo militari, CB (marked out). 37. et, MK. 38-40. Om., MB, ML. 41-43. Om., MA, MN, CA, CM, X; repeat, OF, MG. 44. Om., CF, LT. 45-48. Om., LA. 49. et, B; enim, V, MF; om., OD; autem, MK. 50. Ins. suo, OM, HA. 51. Om., CF, LT; ins. et, MD. 52. Ins. intllr., CA; militare, MK. 53. si proprie, LA. 54. Om., MK, LD; ut, LC, MI (corr. to vero). 55. fiunt, MK; sit, OF, OM. 56. in, LD. 57-58. Om., MK. 59-61. tantum deberet fieri, MB. 62. debeat, MF, CC, CE, LD, X; debet, ME, MN; debent, OC (corr. to debet), MD (a corr.), MI, LC (corr. to debeat), P. 63. fidelitatis, OB. 64. ut, MI. 65. Ins. above, ME. 66-67. homagium fiat, B. 68. Om., MK. 69-70. sequitur tamen, MA, MD. 71-72. propter hoc sequitur, Y. 73-74. Om., OM, MH, CM, LB, HA (ins. above). 75. et, ME (corr. to quia above); quæ, MA. 76-77. Om., MD (later ins.), MK, ML. 78. in, LC (et ins. above); a corr. in MI. 79. Om., ME. 80. sequuntur, LG, OM, HA, MB, ME, MF, MI, MN, CA, CC, CE, CF, LT, LB (by corr. from sequitur), P, X; sequuntur, LF. 81. pertineat, CM, LF; pertinent, MF, X; ins. ut, CA. 82. Om., MA, HB. 83-84. pro homagio, CF, LT, Y. 85. determinetur, V; determinantur, OM, CM, LC, Y, HA (by corr.). 86-88. Om., OF, HA, CM, OM, MG, MH, MK, LB. 89. Om., X. 90. militis, CF. 91. et, MK. 92. Om., MB.

Et¹ qui² teneatur³ ad homagium et⁴ fidelitatem⁵, et qui⁶ non⁷, et⁸ quæ⁹ sequantur¹⁰ homagio¹¹, dicitur¹² inferius¹³ plenius¹⁴ de homagiis¹⁵.

Fit¹⁶ autem¹⁷ donatio¹⁸ in¹⁹ scriptura²⁰ per hæc verba: *Sciant præscutes et futuri quod²¹ ego²² talis²³ dedi²⁴, concessi, et hac²⁵ præsentis carta mea²⁶ confirmavi tali²⁷, pro homagio et servitio suo²⁸, tantam terram²⁹ cum pertinentiis in tali³⁰ villa, etc., ut³¹ infra³². Et³³ unde³⁴ per hoc quod dicit³⁵, ego³⁶ talis³⁷, vult³⁸ quod³⁹ certa⁴⁰ persona⁴¹ comprehendatur in donatione quæ dat⁴². Et⁴³ per hoc quod⁴⁴ dicit, *dedi⁴⁵*, vult quod res⁴⁶ data⁴⁷ fiat⁴⁸ accipientis. Et⁴⁹ per hoc quod dicit⁵⁰, *concessi⁵¹*, perpendi⁵² poterit⁵³ ex⁵⁴ hoc⁵⁵ quod⁵⁶ donationi⁵⁷ consensum⁵⁸ præbuit⁵⁹, quia⁶⁰ non⁶¹ multum differt⁶² dicere⁶³ concessi⁶⁴ quam dicere⁶⁵ consensi⁶⁶. Item⁶⁷ per hoc quod⁶⁸ dicit⁶⁹, *præsentis⁷⁰ carta mea confirmavi*, per⁷¹ hoc⁷² innuit⁷³ quod⁷⁴ vult⁷⁵ quod⁷⁶ voluntas sua⁷⁷, per quam res transfertur⁷⁸ ad donatarium⁷⁹,*

1. Om., CA, CF. 2. quæ, X; quia, CF; si, OM, HA. 3. teneantur, V, MC, LD, X. 4. Om., OM. 5. ad similia, CA. 6. quæ, X. 7. Ins. above, ME. 8. Ins. above, MF. 9. qui, MH. 10. sequuntur, OB, OF (corr. to sequantur), OM, LG, HA, MB, ME, MG, MH, CM, MK, ML, LB, LD; sequentur, MN, LF. 11. homagium, LG, CM, MB, ME, CE, P, X; ad homagium, CF. 12-14. plenius dicitur inferius, V. 13-14. plenius inferius, OB, MA, MD, ME, MF, ML, MN, CC, LF, LG, P, X, Y; plenius infra, MB. 15. homagio, OC, OF, ME, MK, CA, CB, B, HB. 16. sit, LA; fiat, MD, CM, MH, LD; si, ML. 17. Om., MD, MK. 18. Ins. fiat, ML; 19-20. Om., ML. 20. scriptis, OM. 21. Ins. h, MN. 22. Om., CF. 23. N., CH. 24. Ins. et, V, OA, OM, MC, CB, HB, CE, X, LA. 25. hunc, MH; om., OM, HA. 26. Om., MB, MK, LB. 27. B., CH. 28. Om., MD, MF, CC, LD; scilicet, CH. 29. Om., CH. 30-1. 7. f. 35. H., CH. 31. et, OA, OD, OF, MA, MC, MD, ME, MF, MG, MH, MI (a corr.), MK, ML, CA, CB, CE, LA, LB, LC, P, HB, HA, CM, Y, B. 31-32. Om., OM. 32. supra, X; sic ultra, CA; †. (illa or ita), MA, MB, MD, MI, LC; ins. exposito omnium articulorum contentorum in carta, MI, LC; ita, HA. 33. Om., ME, CC; marked out in P. 33-34. Om., Y. 35. dici, OM; ins. quod, MD, X; ins. et, OB, MA, MB, MF, MN, CB (above), HB, CE, CF, LF, LT, Y, LG. 36. Ins. above, CB. 37. Om., LD. 38. Om., B; vel, LD. 39. ut, LC. 40-41. persona certa, MK. 42. datur, LA. 43. Om., CF; quod, LD. 43-45. par le dedi, CD. 44. Om., HB, CB (ins. above). 45. didi, MK. 45-50. Om., OF. 46-47. data res, MK. 47. Om., ME. 48. fit, MH (corr. to fiat). 49. Om., CF; sed, OD. 49-51. par le concessi, CD. 49-66. Om., HA (marginal), CM, LB (marginal), OM, MH. 52-53. poterit perpendi, HA, X. 53. Om., MK; ins. quod, CB (marked out) 54. Ins. above, MC (over erasure). 54-55. Om., X. 56. Ins. above, MD. 57. Ins. concessum, MG (marked out). 58. concessum, MB, MI, MK; consessum, MA; sensum, CF, LT; concensum, LB, P; a corr. in Y. 59. adhibuit, LB. 60. quod, CB, HB, B; et, ME, MI, CC, LB, LC, LD, P. 61. num, MK. 62. Ins. multum, MK. 63. Om., MA, MN, OB, LF, LG. 63-64. concessi dicere, CA. 65. Om., MB, LB, LT, CF. 66. concessi, MK; concensi, MA, MB, MD, MI. 67. Et, CM, OM, MH. 67-18 next page. par le confirmavi notatur quod voluntas transferentis firma debet haberi, CD. 68. Om., MF; ins. ipse, MB. 69. dixit, MB; om., CF, LT (ins. above); ins. et hac, ME. 70. Ins. above, CE. 71-72. Om., OC. 72. hæc, V, OD (a corr.); ins. vult et, X; om., CF. 73. innuitur, CF, LT. 74. Ins. voluntas, MG (marked out). 75-76. Om., X. 77. Om., CA, CF, LT; ins. fuit, X. 78. transfert, MH, HA. 79. donatorem, LC (corr. in margin).

et¹ quæ firma² esse³ debet, præsentī⁴ carta⁵ sigilli⁶ sui⁷ munimine⁸, confirmetur⁹. Est¹⁰ enim¹¹ confirmare¹² id¹³ quod prius¹⁴ firmum¹⁵ fuit¹⁶ simul¹⁷ firmare¹⁸. Item per¹⁹ hoc²⁰ quod²¹ dicit, *tali*, vult quod certa persona exprimat²² cui²³ fit donatio. Item per²⁴ hoc quod²⁵ dicit²⁶, *pro homagio et servitio suo*²⁷, vult²⁸ quod certa sit²⁹ causa³⁰ pro³¹ qua³² fit donatio. Et idem³³ si³⁴ dicat³⁵ pro³⁶ servitio³⁷ sine³⁸ homagio³⁹. Item per hoc quod dicit, *tantam*⁴⁰ *terram*⁴¹, vult⁴² quod certa⁴³ res deducta⁴⁴ sit⁴⁵ in donationem⁴⁶, et⁴⁷ certæ⁴⁸ pertinentiæ⁴⁹ quæ⁵⁰ tunc⁵¹ pertinuerunt⁵² cum⁵³ res venit⁵⁴ in⁵⁵ donationem⁵⁶. Item per hoc quod dicit⁵⁷, *in*⁵⁸ *tali*⁵⁹ *villa*⁶⁰, vult quod⁶¹ certus⁶² locus⁶³ comprehendatur⁶⁴, in⁶⁵ quo res⁶⁶ sita⁶⁷ est quæ datur⁶⁸. Item contineri debet⁶⁹, *habendam*⁷⁰ et *tenendam*⁷¹ *tali*⁷² et *heredibus suis*⁷³ *generaliter*⁷⁴, *vel*⁷⁵ *cum*⁷⁶ *coarctatione*⁷⁷ *heredum*⁷⁸, *libere et*⁷⁹ *quiete*⁸⁰, *honorifice*⁸¹, *bene*⁸² et *in pace*, *vel*⁸³ *in*⁸⁴ *liberum maritagium*⁸⁵, *tali* et *heredibus suis*⁸⁶ *talibus*⁸⁷, *vel tali abbati*⁸⁸, *vel priori*⁸⁹, et *successoribus*

1. Om., CA. 1-2. Om., MB. 2. sua, MA; for., LC (corr. in margin, firmat ins. above). 3. est, CF, LT; ins. sua, MB. 4. præsens, V. 4-5. Corr. to præsentis cartæ, LC; ins. mea, MA; ins. quæ, MB. 6. sigilla, MC; om., LA. 7. Om., MD, MI, CA, LC; mei, LD. 8. munime, LF; minime, MF; munitione, OC. 9. confirmatur, CC; confirmari, CF; ins. et, CC. 10. et, MB; ea, MK. 11. Om., CC; etiam, ML. 12. confirmatio, OC. 13. idem, MN; illud, MD, MF, CF, LT. 14. primum, CF, CM (corr. to prius). 15. primum, CB; factum, X; om., LA. 15-16. fuit firmum, MB, MC, CF, HA. 17. Ins. above, LD; om., HA. 17-18. firmare simul, MK. 19-20. Repeat, CA. 21. Ins. ipse, MB. 22. exprimetur, OF, MG, MH, CM, HA, LB; exprimitur, MK. 23. cum, MK, CE. 24-26. Om., ML. 25. Ins. ipse, MB. 26. dicitur, V. 27. Om., ME, CC, CF, P. 28. nisit, MK. 29-30. causa sit, CC. 31-32. per quam, OB, LF, LG. 33. similiter, X; ins. est, CE. 34. sit, MK; ins. sic, V. 35. Om., X. 36-37. per servitium, X. 37. Ins. suo, Y, MI, MN; ins. dicat, X. 37-39. homagio sine servitio, OM; homagio et servitio suo, MF. 38. suo, CC; sue, P; et, MK; et sine, X. 40. totam, CC, P. 40-41. terram tantam, MK. 41. Ins. cum pertinentiis, LD. 42. vel, LT, CF. 43-45. certa sit deducta sint, MK. 44. deducata, MN. 46. donatione, V, Y, MA, OM; donationi, LT. 47-56. Om., CM, OF, OM, MG, MH, MK, CB (marginal), HA (marginal), LB (marginal), B. 48. A corr. in MI. 49. pertinentem, HA. 50-51. Om., HB. 52. Ins. et, X; pertinuerint, MC, MD, ME, MN, LT, LC, LA. 52-54. venit, HA. 53. Item cum, MB. 54. venerit, LF, HB. 55. ad (corr. to in), Y. 56. donatione, HA, LA; donationi, CF. 57. Om., CF, LT. 58-59. Repeat, MD (marked out). 60. Om., X. 61. ut, OA, OD, ML, CB, CE, CF, LA, LT; an erasure, HB. 62. Ins. sit, MF. 63. Ins. et, MF; om., HA (ins. above). 64. contineatur, MB; comprehendantur, Y (corr. to comprehendatur). 65-68. Om., CM. 66. Om., MK; sua res, OM. 67. sitta, MB; om., OM. 68. data est, MC; data, MK; dicitur, OM, HA. 69. Ins. above, MF. 70-71. tenendam et habendam, X. 71. tenendum, HA. 72-78. Omit here and insert after following maritagium, MA, MD. 73. Om., CE. 74. Ins. above, ME. 74-87. Om., MB. 75. et, MA, MD; ut, ML; om., OM, HA. 76. Om., LF. 77. cantatione, ML. 78. Om., MG, CH; hereditare, OM. 79. Om., OB, OD, OM, MA, MD, MF, MI, ML, LG, HA, MN, CA, CF, CH, LB (ins. above), LC, LD, LF, Y, X. 79-80. quiete et, MG. 81. Ins. et, OB, P. 82. Om., OD. 83. et, OB, MA, MN, LF, LG; ut, ML. 83-84. Om., MK. 85. Ins. vel, MA, MD. 86. Om., MI, LC (ins. above), LD. 87. Om., ME. 88. At this point a folio is missing in Y. 88-89. priori vel abbati, MI, LD, LC (ins. tali above abbati), CA. 89. Ins. vel, MN (marked out).

*suis*¹ *in liberam et*² *puram elemosynam*. Item³ *tali*⁴ *et*⁵ *heredibus suis vel*⁶ *assignatis*⁷, secundum⁸ quod superius⁹ videri¹⁰ poterit¹¹ in¹² exemplo manifeste¹³. Et¹⁴ per hoc quod¹⁵ dicit¹⁶, *tali et heredibus*¹⁷ *suis*¹⁸, vult donator quod comprehendantur¹⁹ certæ personæ, ad quas²⁰ descendere debet²¹ res donata²² post mortem donatarii²³ per²⁴ modum donationis, et²⁵ per²⁶ quod²⁷ perpendi poterit, si tales²⁸ heredes²⁹ defecerint³⁰, quod³¹ per modum tacitum³² reverti debeat res donata ad donatorem. Item per³³ hoc quod³⁴ dicit, *libere*, non³⁵ vult³⁶ quod³⁷ rei³⁸ data³⁹ servitus⁴⁰ imponatur⁴¹, ut si quis⁴² velit⁴³ uti⁴⁴ aliquo⁴⁵ iure⁴⁶ in⁴⁷ re data⁴⁸, ad quem⁴⁹ servitus⁵⁰ non pertinet⁵¹, neque usus. Item per hoc quod⁵² dicit, *quiete*, vult quod quietem⁵³ habeat⁵⁴ et⁵⁵ pacem⁵⁶, quod uti⁵⁷ possit⁵⁸ donatarius⁵⁹ re data pacifice, et⁶⁰ quod⁶¹ non inquietetur⁶². Est⁶³ enim⁶⁴ quies idem quod requies sive pax, et⁶⁵ si⁶⁶ componatur⁶⁷ cum⁶⁸ hac præpositione *in*⁶⁹, erit ibi⁷⁰ inquietus⁷¹, id⁷² est⁷³ non quies⁷⁴. Et⁷⁵ non⁷⁶ refert ad hoc⁷⁷, quod⁷⁸ uti⁷⁹ non⁸⁰ possit⁸¹ omnino⁸² vel

1. Om., CE. 2. vel, CC. 3. Omit to end of paragraph, CH. 4. talibus, MB. 5. vel, CC; repeat, ME (marked out). 6. aut, MB. 7. Ins. suis, X. 8. servi, MK. 9. inferius, OB, MB, MN, LF, LG. 9-11. videri poterit inferius, MA, MD. 10. videre (corr. to videri), MN. 12. Om., LD. 13. Ins. scilicet si terra data sit bastardo, MF; manifesto, HA. 14. Om., MI, CE, LC. 15. Om., CF. 16. dicitur, V. 17. Ins. et, OB. 18. Om., CC. 19. comprehendatur, OB; apprehendantur, OC; a corr. in ME, LD. 20. quos, OC, MD. 21. Om., MB; debeat, OA, OC, OD, OF, OM, MC, MG, MH, CM, MI, MK, ML, CA, CB, CE, CF, LB, LA, HB, HA, LC, LD, LT, X. 22. data, MA, MD, MN. 23. Ins. et, CA; ins. vel per nomen vel, P (nomen vel marked out); ins. vel, ME, CC. 24. nomen vel, MF; om., P. 25. Om., CA. 26. Om., ME (ins. above), CF, LT; ins. hoc, CB, HB. 27. hoc, MA, MC, MD, LD. 28. tale, ME (corr. to tales). 29. Om., CA. 30. defecerint, MN. 31. Ins. per nomen vel, MF. 32. tactum, MI (corr. to tacitum), LC (corr. in margin). 33. Ins. above, OC. 34. Ins. above, CB; ins. ipse, MB. 35. Om., B. 36. Om., MA. 37. Om., MK. 38-39. res data, LA. 39. dare, MK. 40. servitium, OC, OF, OM, MG, MH, CM, MI, MK, CA, CB (ins. vel servitus above), HA, LB. LD, X; servitiis, LA; servitium vel servitus, HB. 40-41. imponatur servitium, LC. 41. An erasure and corr., MN. 42. aliquis, ME. 43. velut, LD (corr. to velit). 43-44. uti voluerit, X; uti velit, MA, MD. 44. Om., OM, MF. 44-46. aliquid exigere, ML. 45-46. iure aliquo, LD. 47-48. data in re, MK. 48. Ins. non, OB, LG, LF (erasure). 49. quam, V, MB, MC, LF, X. 50. servitium, CM, MH, OM, HA, MG. LB; servitium, MK. 50-51. non pertinet servitium, OM, HA. 52. Om., CF, LT. 53. quietam, OM, HA, MA, MD, MI, CF, LC, LD. 53-54. habeat quietam, X. 54. habeant, OM, MI, LC (corr. to habeat). 55. in, MK; om., OM, HA. 55-56. Om., MA. 56. Ins. et, OF, MC, MG, CC, P (ins. above, marked out); ins. ita, CA; ins. vel, MH (erased). 57. Om., MG, OF. 58. posset, CB. 59. Ins. in, MK; ins. de, MB; ins. uti, OF, MG. 60. Om., MB. 60-62. Om., CF, LT. 61. Om., V. 62. quietetur, MK (corr. in margin); inquietatur, OA, MC, CC, CE, P; inquiete, LG, LF; a corr. in ME. 63. fit, ML. 63-64. Om., LF, LG. 64. Ins. above, ME. 65. ut, MK. 66. Om., OB. 67. ponatur, MG. 68. Om., ME (ins. above), CC, P. 69. non, ML. 70. Om., CF, LT. 71. quies, MK; in requies, OB. 72-73. scilicet, V; et, CF, LT. 72-74. Om., ME, CC, P. 74. requies, OB; quietus, MB. 75-76. Repeat, ME. 77. Om., LD. 78. Om., B. 79. Om., CF. 79-81. non possit uti, V. 80. Om., LA. 80-81. Repeat, MI (marked out) 82. Om., X.

minus¹ commode, secundum quod inferius² videri poterit de³ assisis⁴.

FOLIO 96. SECTION 2 *

Si⁵ autem⁶ tota⁷ dos vacaverit⁸, tunc infra⁹ quadraginta dies¹⁰ assignetur¹¹ ei¹² dos sua legitima¹³, et¹⁴ secundum¹⁵ quod¹⁶ ad ostium¹⁷ ecclesiæ¹⁸ ei¹⁹ fuit²⁰ constituta²¹, secundum²² quod²³ tunc fuerit²⁴ culta²⁵ vel²⁶ inculta²⁷, cum fructibus et²⁸ redditibus²⁹, et³⁰ omnibus³¹ aliis pertinentiis. Et³² nihil³³ refundatur³⁴ executoribus³⁵ vel heredibus³⁶ pro cultura et³⁷ cura³⁸, quia³⁹ antiquitus solet observari, quod⁴⁰ sicut⁴¹ uxor⁴² dotem suam⁴³ recipit⁴⁴ post mortem viri⁴⁵ cultam⁴⁶ vel⁴⁷ incultam⁴⁸, ita post mortem⁴⁹ uxoris⁵⁰ solet⁵¹ restitui⁵² heredi⁵³ culta⁵⁴ vel⁵⁵ inculta⁵⁶, quia⁵⁷ de⁵⁸ bladis et fructibus a⁵⁹ tenemento⁶⁰ non⁶¹ separatis⁶² non⁶³ habuit⁶⁴ uxor⁶⁵ testamenti⁶⁶ factionem⁶⁷. Sed nova superveniente gratia⁶⁸

* Collated for OA, OB, OC, OD, OE, OF, OG, OM, MA, MB, MD, ME, MF, MG, MH, MI, MK, ML, MN, LA, LB, LC, LD, LE, LF, LG, LT, CB, CC, CE, CF, B, P, PH, W, X, Y, HA, HB, CM.

1. unus, MG, MK. 2. Om., MA, MK; ins. dicetur et, MB. 3. in, MB, CA; ins. consuetudinibus et servitiis præstandis in, V, X. 4. assisa, MC, LA, LC; assis., MSS. generally. 5-24. Et cum mulier dotata fuerit habebit terram secundum quod fuerit tempore assignationis, LE. 6. Ins. inde, LC (above). 7. Om., CC, LB, LF, X; dotata, LD. 8. vocaverit, MA, LD, B. 9. Om., OF; ita infra, ME, MH, P, B, CM. 10. Om., ME. 11. Om., ML. 12. et, ML. 13. Om., OB, MA, MB, MI, MN, CB, HB, LF, LG, B; marginal, LC; liberima, OC. 14. Om., ME, MH, B, CM. 15-21. Om., CC. 16. Ins. ei, V. 17. Usually in the form hostium. 18. Om., ME. 19. Om., V, OF, MG, LB, B, X. 19-20. fuit ei, ML, CF. 19-21. fuit constituta ei, LT. 20. fuerit, OC, OF, ME, MF, MG, MI, MN, CE, LA, LB, LC, LD, W, X, B, HB. 21. Ins. et, LB. 22-23. sine, B. 22-24. Om., ME. 22-26 next page. Om., LF. 24. fuit, MA, MD; terra, W. 25. certa, B; tulita, ME. 26. nec, CC. 27. incerta, B; intulita, ME. 28. Om., OC, ME, LE. 28-29. Om., OF, CC. 30. Ins. above, W. 31. Om., LE. 32. Om., CF. 32-33. Ins. above, CB. 34. fundatur, OF (corr. to refundatur); reficiatur, OC. 35. excutoribus, ME; excecutoribus, MB, MI (corr.); exequitoribus, OA; exsecutoribus, HA. 36. Ins. suis, OM, HA. 37. vel, MA, MD, B. 38. Ins. et, ME. 39. quod, B; qui, MN. 40. quia, MB, LD, LE, B, HA. 41. si cum, OG; repeat, CB (above). 42. Ins. after suam, MF. 42-43. de dote sua, OF, MG, CC, LB. 44. recipiat, ME, CM, MH; recepit, MF, ML, X; petierit, OC. 45. Ins. sui, V, OB, MA, MB, MD, MI, MN, CB, LG, X, HB. 46. culta, MI, W. 47. et, LC. 47-48. Om., LD. 48. inculta, MI, W; ins. seminatam vel non seminatam, LE. 49. Ins. viri, LD (marked out). 50-51. Repeat, LT. 51-52. restitui solet, OE, OF, OG, OM, ME, MF, MG, MH, CC, CM, LB, LD, P, W, X, Y, HA. 53. Om., OF, OG, CF. 54-56. Om., OE, LE, W. 55-56. Om., X. 57. quod, MF. 58. si de, OF, OG, ME (si ins. above), MF, MG, MH, CM, CC, HB, LB, LD, B, P, Y; sic de, X. 59. et, X, MD (corr. to a above). 60. tenementis, LA. 61. Om., OB, OF, OG, MA, MB, MF, MG, MI, MK, MN, CB, CC, LB, LC (marginal), LD, HB, LG, B, P (marginal), X, Y. 62. separantis, OE; separantur, W; ceparatis, MK; semperatis, OA (corr. to separatis). 63. Ins. above, LE. 64. habuerit, OF, OG, MK, CE, B, X, CM. 65. Om., OE; uxorem, LG. 66. A corr. in ME. 67. satisfactionem, OC, LD. 68. guerra, OF, MG; grerra, LB.

et¹ provisione², sicut³ patet⁴ de⁵ provisionibus⁶ apud⁷ Merton⁸, inter⁹ placita¹⁰ quæ sequuntur¹¹ regem¹² Henricum¹³ anno¹⁴ regni sui¹⁵ vicensimo¹⁶, modo¹⁷ poterit¹⁸ uxor de fructibus et¹⁹ bladis, sive²⁰ a solo separata²¹ fuerint²², sive non, testari²³, et²⁴ pro²⁵ voluntate sua disponere²⁶. Si autem²⁷ pars²⁸ dotis vacaverit²⁹ et³⁰ pars non, tunc³¹ illam³² partem³³ quæ vacaverit³⁴ recipiet³⁵. Et non³⁶ vacantem³⁷ petat³⁸ per³⁹ actionem⁴⁰ per breve de⁴¹ recto⁴² si⁴³ voluerit⁴⁴, nisi de consilio⁴⁵ duxerit⁴⁶ ad⁴⁷ tempus⁴⁸ abstinendum⁴⁹, ne⁵⁰ per receptionem⁵¹ partis⁵² sibi⁵³ præiudicet⁵⁴ quantum⁵⁵ ad exactionem residui⁵⁶, propter⁵⁷ dilationem⁵⁸ quæ evenire⁵⁹ poterit⁶⁰ per breve de recto⁶¹, si aliquid⁶² inde⁶³ reciperet⁶⁴, propter verba

1. de, OE (corr. from sit), LE. 1-3. ut, B. 2. promissione, OE, W; ins. facta, OE (above). 3. Om., MA. 3-7. Om., LE. 4. petet, HB. 4-6. Om., OE, W. 5. in, CM, ME; ins. in, P (above). 5-6. Om., MH. 5-8. in statuto de Merton, B. 8. Mertona, PH; Mertonam, LA; Mertone, ME, LE; Merton., MSS. generally; ins. cap. II ut, OM. 9-16. Om., W, OE (added in diff. hand). 9-19. per quam concessum est quod uxor legare potest fructus, LE. 9-26. Om., B. 10. plura, OG, LD (corr.); pla., OB, ME, Y. 11. sequuntur, LD; sequitur, MI; scetuntur, OE. 12. regis, OE. 12-15. regem anno regis H., ME. 13. Om., OF; Henrici, OE. 14. regem Angliæ, OG, Y. 15. Om., MA, MD. 16. None of the MSS. gives the correct date. For an explanation of the error see the Law Quarterly Review, April, 1910. XV, OB, OM, MA, MB, MF, MI, MN, HB, HA, CB, LC, LG; XVIII, V, OA, OD, MK, ML, LA, LT, CE, CF, PH; XV alias XVIII, OG, ME, CM, MG, MH, LB, X, Y; XIII, OE; XVI, LD; XVII, MD; XVIII, OC; VIII XV, OF; XV alias XVIII VIII, P; XV alias XV VIII, CC. 17. sic, OB, OG, OE, OF, MA, MB, MD, MF, MG, MI, MN, CB, HB, LB, LC, LG, P, W, X, Y; non, CC; other MSS. omit. 18. peteret, OC. 19. Om., OC; s et, ME (s marked out). 20. quæ, MH (corr. to sive). 20-26. a solo non separata, LE. 21. separate, MK, LC, Y (corr. to separata); separati, MN; om., ML; ins. s, W (marked out). 21-22. fuerint separatæ, MB. 22. sit, CF, LT. 23. testare, OC, CC, LB. 24. Om., MG, P (ins. above). 25. Om., ME, CM, MH. 26. disponare, LT. 27. Ins. quædam, CB (above), HB. 28. Ins. dos, OF. 29. vocaverit, MA; vccaverit, MK. 30. Om., CF; ins. quædam, CB (above), HB. 30-34. Om., OF, MI (marginal). 31. Om., OE, W. 32. illa, OA; aliam, HB. 33. Om., ML. 34. vocaverit, MA. 35. recipiat, ME, MH, CM. 36. Om., OB, LG. 37. vocantem, LG. 38. Om., MA; petit, HB. 38-64. Om., B. 38-40. per actionem petat, OG, Y. 39. p, MA. 39-40. Om., OE, ML, LE, W. 40. Ins. sed, CF. 41-42. suum, W, OE (ins. de recto above). 42. Omit to following recto, CF, LT. 43-44. de dote, LE. 44. noluerit, LD, W. 45. Ins. usque, OC. 46. duxit, OE, W; ins. usque, MD. 46-48. ad tempus duxerit, V, OA, OC, OD, MF, ML, LA, LE, PH. 47. Om., LC. 48. Ins. duxerit, CC. 49. sustinendum, OM, HA. 50. et nisi, OE, W; nisi, OB, OF, OG, MA, MB, MG, MK, MN, HB, CC, CE, LB, LC, LG, X, Y; nec, OM; ubi, MI (in erasure). 51. rescriptionem, MA; exceptionem, MD (later corr.). 52. pars, OB, OF, MA, MB, MD, MG, MI, MN, CB (corr. to partis sibi), CC, LB, LC, LG, P, X, HB. 53. Om., OB, MA, MB, MI (added), MN, CB, LC (ins. above), LF, LG, HB. 53-54. præiudicet sibi, LE. 55. quam, ME; a corr. in OD. 56. resedui, OE. 57-58. Om., ML. 58. elationem, MG. 59. venire, V, OC, OD, LE, PH; enire, MI (corr. later); eveniri, MH, ML; convenire, CC, LB. 60. Om., MN. 61. Ins. unde nihil habet, CB (above). 62. aliquod, V. 63. Om., CF. 64. recipiat, V; recipiet, OB, OF, MA, MD, MG, MK, CC, LB, LG, PH, X; recipit, OE, W; receperit, ME, CM, MH; recipit, LD, P; recuperet, MN.

in¹ brevi² de³ dote⁴ contenta, scilicet⁵, et⁶ unde nihil habet, secundum⁷ quod inferius⁸ dicitur inter actiones de⁹ exceptionibus¹⁰ contra¹¹ petitionem¹² dotis¹³.

FOLIO 118. CHAPTER 3*

Cum sint¹⁴ quædam¹⁵ crimina¹⁶ capitalia, quæ corporalem¹⁷ pœnam¹⁸ inducunt¹⁹, quandoque ultimum supplicium²⁰, quandoque membrorum truncationem²¹, secundum²² quod²³ fuerint²⁴ maiora vel minora, et quorum²⁵ quædam²⁶ sunt²⁷ publica²⁸, quædam privata²⁹. Et³⁰ publicorum quædam³¹ maiorem³² pœnam inferunt³³ propter personam contra³⁴ quam³⁵ præsumitur³⁶, sicut est³⁷ crimen læsæ maiestatis³⁸, ut³⁹ si⁴⁰ contra personam ipsius⁴¹ regis⁴² sit⁴³ præsumptum⁴⁴, quod⁴⁵ quidem⁴⁶ crimen⁴⁷ omnia⁴⁸ alia⁴⁹ crimina⁵⁰ excedit⁵¹ quoad pœnam⁵². Ideo primo⁵³ dicendum⁵⁴ est⁵⁵ de hoc crimine⁵⁶ læsæ maiestatis⁵⁷. Habet enim⁵⁸ crimine læsæ maiestatis⁵⁹ sub⁶⁰ se multas species⁶¹, quarum⁶² una est⁶³ ut⁶⁴ si quis⁶⁵ ausu⁶⁶ temerario machinatus⁶⁷ sit⁶⁸ in⁶⁹ mortem⁷⁰ regis,

* Collated for OA, OB, OC, OD, OE, OF, OG, MA, MB, MC, MD, ME, MG, MH, MI, ML, CB, CC, CE, CF, LA, LB, LC, LD, LF, LG, LT, B, P, PH, W, X, Y, HB, CM.

1-5. Om., B. 1-3. Om., OF. 2. Ins. in, LT. 3. Om., MH. 4. recto, CC, LB, LD (corr. to dote). 5. Ins. above, W. 6. Om., OE, OG, W, Y; ins. breve de, B. 6-13. Om., LE. 7-13. de cetero non prosternitur nisi secundum quod dicitur in statutis primis Westmonasterii capitulo ultimo. Similiter vidua recuperet dampna de tenemento unde vir suus seisitus, ut dicitur in statuto de Merton, B. 8. Om., OG, ME. 9. et, MI, LC. 9-10. Marginal, OE. 10. exceptiones, MI, LC. 11-12. Om., OB, MA, MB, MD, MI, MN, CB, LC (ins. later), LF, LG, HB. 12. pitionem, MH; pertitionem, CM. 14. autem, LD. 15-16. crimina quædam, OE, MI, LC. 16. criminalia, MB, MG. 17-19. inducunt corporalem pœnam, V. 18. Om., LD. 20. Ins. et, LD. 21. truncationem, W; ins. et, OB, LD, LF, LG. 22. sciendum, MA. 23. Om., OE, MI; quæ, MH, CB (corr. to quod); ins. quædam, LD; ins. delca, LC. 24. fuerunt, OF, MA, ME, MG, ML, HB. 25. quia, OG. 26. quidam, CC. 27. Om., LD, W. 27-31. Om., ME. 28. Ins. et, MH, CM, CC, CB, HB, P, V, W; privata, MA. 29. publica, MA. 30-31. Om., OC; et quædam publicorum, ML. 31. Marginal, OG. 32. Ins. habent, OF, MG, MH, LB, CM. 33. inducunt, ML, W; infligunt quædam minorum, ME. 34. propter, LD (corr. to contra above). 35. quem, OG, CF, MH. 36. præsumuntur, MA, MD, X; ins. facit, ME (marked out). 37. Om., MB, W. 38. Found also as magestatis. 39. et, ME, CC, P, W (corr. to ut). 40. scilicet, MA. 41. domini, MB. 42. Ins. above, W. 43. sic, MH, CM, CC; sicut, MA. 44. A corr. in W. 45. vel, MG; quem, LB. 46. quoddam, MB. 47. Om., OG. 48-49. alia omnia, OB, MB, MD, LF, LG. 49-50. crimina alia, ML. 50. Om., OC, OE, OG, MI, LA, LC. 51. excedet, OC, OG. 52. primam, B; ins. et, ME. 53. prius, MA, LD; om., P. 53-54. Insert after maiestatis, MC, LA, Y. 54. videndum, MA, MD. 55. Om., OC, OD, OF, OG, MC, MH, MG, ML, LA, LB, LD, LT, CB (ins. above), CC, CE, B, P, PH, Y, CM. 56. crimen, OB, LG, W. 56-57. Om., ME. 57. Om. to following maiestatis, MH, CC, LB, CM; ins. habet quod, CM (margin, and above). 58-59. Om., W. 60-61. multas species sub se, OA, OC, OG, LD, B; multas species sub, OF, MG, MH, CM, CB (sub marked out), LB; multas species, HB. 62. quorum, MH, LB. 63. Om., MI (ins. above). 64. Om., OF, MG. 65. Om., LD. 66. ausi, OB; austu, W (corr. to ausu). 67. machnatus, MG. 68. sit sit, ME; est, W. 69. Om., ME. 70. Ins. domini, V.

vel¹ aliquid² egerit vel agi³ procuraverit⁴ ad seditionem⁵ domini⁶ regis⁷, vel⁸ exercitus⁹ sui¹⁰, vel procurantibus¹¹ auxilium¹², consilium præbuerit¹³ vel consensum¹⁴, licet id¹⁵ quod in voluntate habuerit¹⁶ non perduxerit¹⁷ ad¹⁸ effectum¹⁹. Ad²⁰ accusationem²¹ vero²² huius²³ criminis²⁴ admittitur²⁵ quilibet de²⁶ populo, liber homo²⁷ et²⁸ servus²⁹ et³⁰ minor infra³¹ ætatem constitutus, dum³² tamen³³ accusatus³⁴ attachietur usque ad³⁵ ætatem³⁶ accusantis³⁷. Et³⁸ hoc dico³⁹, dum⁴⁰ tamen⁴¹ sit⁴² ille⁴³ qui accusat⁴⁴ integræ⁴⁵ famæ⁴⁶ et non⁴⁷ criminosus, quia⁴⁸ criminosi ab⁴⁹ omni⁵⁰ accusatione⁵¹ repelluntur⁵², ut⁵³ si accusans⁵⁴ fuerit latro⁵⁵ cognoscens⁵⁶ vel utlagatus⁵⁷, vel⁵⁸ aliquo⁵⁹ genere⁶⁰ feloniam convictus vel convincendus⁶¹. Nec etiam admittuntur ad⁶² accusationem⁶³ in crimine⁶⁴ læsæ maiestatis⁶⁵ aliquo⁶⁶ casu⁶⁷ conspiratores⁶⁸, vel crimini⁶⁹ consentientes⁷⁰, et in⁷¹ hoc casu⁷² pertinet⁷³ actio⁷⁴ tota⁷⁵ ad⁷⁶ accusantem⁷⁷, et⁷⁸ ad ipsum regem.

1-7. Om., CC. 2. aliquod, MI; aliud, X. 3. egi, OB, OE, MA, MB, MI, CF, LC, LF, LG, LT. 4. procuravit, OC, MD (corr. to procuraverit), B. 5. seductionem, OF, MG, MH, LB, CM, LD, CB, LT, W (changed from seditionem), HB. 6. Om., ME. 8-10. Ins. above, MD. 9. exeritus, OE; exercitus, various MSS. 9-10. sui exercitus, MD. 10. tui, LD. 11. procuratoribus, MA, ML, X; procurantibus, MI. 12. Ins. et, V, OD, ML, PH; ins. vel, OF, MG, MH, CM, CB, LB, B, X, HB. 13. præbuit, OE, OF, MB, MD (corr. to præbuerit), MG, MI, HB, CB, CE, CF, LB, LC (corr. to præbuerit in margin), LT; om, X. 14. assensum, MA. 15. idem, MG; illud, X; om., LD. 16. habuit, OA, OC, MD (corr. to habuerit), HB, CB, LD, LF, LG; haberent, MA. 17. perduxit, OC, MG, MH, CB, HB, CC, LB, B, P; produxerit, OA, OB, OE, OF, MB, MI, LC, CE; produxit, MA, MD (corr. to produxerit), LD, LG; reduxerint, CF, LT. 18. Om., MA (in ins. above), MI (ins. above); ins. above, OE, MD. 19. Ins. vero, MD (marked out). 20. Ins. autem, MH, LB (above), CM. 21. excusationem, MH, CM. 22. autem, OF, MG, CB, HB, B; om., MH, LB, CM. 23. A few MSS. have huius, a few huiusmodi, but the majority have hi', the usual abbreviation for huiusmodi; ins. after criminis, OB, LF, LG. 24. terminis, OC. 25. Om., ME. 26-27. liber homo de populo, MD. 27. Om., ME. 28. Om., MB, MH, CM, LB; vel, OC, ME. 29. Ins. maior, ME, W. 30. vel, ME; om., LA, X. 31. id est, OB. 32-34. Om., MA. 33. Ins. est, ME. 34-36. Om., P (marginal). 35. Ins. plenam, MB. 37. accusatis, CC, P. 38-39. Marginal, W. 40-41. cum, LF. 42. Om., W; sic, CF, LT; fit, ME. 43. Om., MA; iste, LF; i, OB, OC, LG. 44. Ins. sit, W. 45. bonæ, LD. 46. Ins. et bonæ, W (above); ins. et integræ, LD. 47. Om., LG. 48. qui, MA. 49-50. Repeat, CC. 50. Om., OG. 51. actione, CM. 52. expelluntur, ME. 53. et, MC. 54. accusatus, MA, MB, CF, LD; accusatis, LB; accusat', MH, CM. 55. locus, MH, CM, LB; latus, MI (corr. to latro). 56. cognitus, V; ins. fuerit, LD. 57. A corr. and erasure, MI; utlegatus, ML. 58. Om., HB, CB (ins. above); ins. in, LD. 59. alio, MA, MD. 60. Om., X. 61. conviscendus, LD. 62. in, W, CB (corr. to ad); repeat, B; om., CF. 63. actionem, CM. 64. crimen, MD, W (corr. to crimine). 65. Ins. in, ME. 66-67. Om., LA, Y. 68. conspirationis, CC; conspiratorum, LD; conspiratos, P (corr. to conspiratores). 68-72. Om., OF, MG, MH, CB (ins. above), LB, CM. 69. crimine, OE; criminosi, Y; termini, LD. 70. consentiens, OE; consentientes, Y. 71. Om., PH, X, Y. 72. Ins. non, CC. 73. continet, W (corr. to pertinet). 74. accusatio, CC, P. 74-75. tota actio, MD; tota accusatio, V, X. 75. contra, P (marked out, tota in margin); ins. contra, CC (marked out). 76. Repeat, CB (marked out), CF. 77. accusationem, OA, PH (corr. to accusantem). 78. vel, X.

Continet etiam¹ sub² se crimen³ læsæ maiestatis crimen⁴ falsi⁵, quod quidem multiplex⁶ est, ut⁷ si quis falsaverit sigillum domini regis, vel monetam⁸ reprobam⁹ fabricaverit¹⁰, et¹¹ huiusmodi¹², secundum quod¹³ inferius dicetur.

FOLIO 132b. SECTION 12 *

In omnibus vero¹⁴ casibus¹⁵ prædictis¹⁶, qualiscumque¹⁷ fuerit¹⁸ causa cum¹⁹ utlagatio²⁰ rite facta²¹ sit²² et²³ secundum legem terræ, non²⁴ restituitur²⁵ quis²⁶ nisi tantum²⁷ ad²⁸ pacem, quod²⁹ ire³⁰ possit³¹ et³² redire³³ et³⁴ de nove contrahere. Non enim³⁵ poterit id³⁶ quod per³⁷ utlagariam³⁸ fuit³⁹ dissolutum, per inlagariam⁴⁰ coniungi sine⁴¹ nova⁴² voluntate⁴³ eorum qui⁴⁴ prius contraxerunt⁴⁵. Non enim⁴⁶ poterit rex gratiam⁴⁷ facere cum⁴⁸ iniuria et⁴⁹ damno aliorum⁵⁰. Poterit quidem dare quod⁵¹ suum est⁵², hoc est⁵³ pacem suam⁵⁴, quam⁵⁵ utlagatus amisit propter fugam⁵⁶ et suam⁵⁷ contumaciam⁵⁸, quod⁵⁹ autem⁶⁰ alienum est⁶¹ dare⁶² non potest⁶³ per suam⁶⁴ gratiam⁶⁵.

* Collated for OA, OB, OC, OD, OE, OF, OG, OM, MA, MB, MC, MD, ME, MG, MH, MI, ML, CA, CB, CC, CE, CF, LA, LB, LC, LD, LF, LG, LT, B, P, PH, W, X, Y, HA, HB, CM.

1-2. in, OG. 2. Om., OC. 3. Ins. above, LD. 4. amem, MH. 5. falsum, CB (corr. to falsi). 6. multipliciter, OB, LG, X; videlicet, HB. 7. et, B. 8-9. reprobam monetam, MB. 9-10. fabricaverit reprobam, MA, MD, ML. 9. reprobria, LB (corr. to reprobam); om., OC, OG; ins. perpetuum, LD. 10. In erasure, LF; fabricavit, OB, LG; fabcaverit, OE. 11. vel, OG; etiam, MH. 12. huius, ML, Y. 13. Om., MI (ins. later), LT. 14. Om., LF. 15-16. prædictis casibus, X. 17. qualitercumque, OC, MH, CA, LD, CM. 18. Om., MH, CM. 19. Om., CM, MH; et, HB, CB; non, CC. 20. utlagaria, CA, CC, LD; utlagio, HB, OC, B; utlago., OF, MA, P, X; utlag., OG, MH, LB; utlagationis, CM. 21-22. sit facta, MD. 23. Om., ME, CF. 24. ubi, MA. 25. restituetur, MD, ME, W; resttentur, CF. 26. Om., CE. 27. Om., CA, LD. 28. a, Y. 29. quia, CM. 30. Ins. non, ME. 30-31. possit ire, MA, MD. 32. ac, OG, Y. 33. venire, W; ins. possit, LC (above). 34. Repeat, P (marked out); om., HA. 35. Om., MI (ins. above). 36. idem, OC, OF, MG, MH, CM, CB, HB, CC, B; om., CF. 37. post, OC. 38. utlagationem, OC, B, W, X; utlagat., OG; utlag., OF, MG, MH, CM; CB, HB, LB, LD, Y. 39. fuerit, OC, OD, OF, OG, OM, MC, MD, ME, MG, MH, CM, CB, CC, LA, LB, B, W, Y, HB. 40. inlagationem, OC, MH, CA, CB, HB, CM, CC, LB, LD, B, X; inlcgationem, OF, MG; inlagn., OG. 41. se, CF. 42. Om., CA. 42-43. voluntate nova, OF, OG, MG, MH, CM, CC, LB, X. 44. ubi, X. 45. contraxint, MI; contraxerint, W. 46. Om., MH, CM. 47. gravi, CF, LT; gratia, OC (corr. from gratiam). 48. in, OC. 49. Om., OB, OE (ins. above), MB, MI (ins. above), LC, LG. 50. aliquorum, MA. 51. id quod, HA. 52. Ins. et, MA, MD. 53. Ins. contra, ME (marked out). 54. Om., MA, ME; a corr. in MH. 55. quem, MH. 56. Ins. suam, OC, OF, MG, MH, CM, CA, CB, CC, LB, LD, B, X, HB. 57-58. contumaciam suam, OC, OF, MG, MH, CM, HB, CB, CC, LB, B, X. 59. quid, CF, LT. 60. enim, OC, OF, MG, MH, ML, CA, CB, CC, CM, LB, LD, B, X, HB. 61. Ins. above, W. 62-63. non potest dare, W. 63. Om., MA. 64-65. gratiam suam, X.

(Item¹ iuste utlagatus² et rite non³ restituitur⁴ nisi tantum ad pacem quod⁵ ire possit et redire et⁶ pacem habere⁷, et⁸ ad⁹ actiones¹⁰ restitui non¹¹ potest¹² nec¹³ ad alia¹⁴, quia est quasi¹⁵ infans modo genitus et homo¹⁶ quasi¹⁷ modo¹⁸ genitus¹⁹.) Item non²⁰ poterit²¹ inlagaria²² restituere²³ ad²⁴ actiones²⁵ et obligationes²⁶ præhibitas²⁷, neque²⁸ ad homagium²⁹, neque³⁰ fidelitates³¹, neque³² ad³³ sacramenta³⁴, neque³⁵ ad³⁶ alia³⁷ per utlagariam³⁸ dissoluta³⁹, contra voluntatem eorum de quorum⁴⁰ voluntate⁴¹ prius fuerunt⁴² coniuncta⁴³ et⁴⁴ firmata⁴⁵. Et ideo⁴⁶ neque⁴⁷ ad hereditates⁴⁸ neque ad tenementa⁴⁹ in præiudicium dominorum, et sic⁵⁰ ad ea quæ iuris⁵¹ sunt restitui⁵² non possunt⁵³. Ex obligationibus vero⁵⁴ præcedentibus nullus eis⁵⁵ tenetur, sed⁵⁶ ipsi⁵⁷ omnibus ne⁵⁸ sint⁵⁹ melioris⁶⁰ conditionis propter utlagariam⁶¹, cum⁶² deteriores⁶³ esse debeant⁶⁴.

1-19. *sic*, V, OD, MA, MD, PH; as rubric, OA, OB, CB, HB, CE, CF, LG, LT, X, (MH, LB, B for another section further along); om., OC, OE, OF, OG, OM, MB, MC, ME, MG, MI, ML, CA, CC, LA, LC, LD, HA, LF, P, W, Y; insert here the *addicio* on f. 132b, OC, OF, MC, MD, ME, MG, MH, CM, CA, CB, CC, LB, LD, HB, B, P, W, X. 2. utlagatus, CB, LG, HB. 3. Om., CE. 4. restituitur, CF. 5. quia, OD. 6-7. Om., B, LB. 8. Ins. non, MD (above); corr. to nec, CB (above). 9. Om., CF, LB, LT, B. 10. actionem, MA, MD, CB, CE, CF, LT, HB. 11-12. Om., OB, MA, MD, CB, CE, CF, LT, HB. 13. Ins. est, OB, MA, MD, CB; ins. ut est, HB. 14. Om., V. 15. sicut, V; quia, CF. 16. hoc, LB. 17. nous (a corr.) quasi, MD. 17-18. modo quasi, MA, CB, HB. 19. ingenuus, OB, MA, HB, CB; cognitus, CF, LT. 20. Om., OB, MA. 21. potest, V, ME, CA, P; ins. rex, MC. 22. inlagatum, OB, OG, OM, HA, MB, ME, LA, LF, Y; inlagatus, OD, MC, MD, CA, CC, LD; inlegatus, OF, MG; utlagatum, OE, MI, LC; utlagatus, B, W, X, HB; inlag., OA, OC, MH, CB, CM, LG, P, PH; inlagat., MA, ML; inlags., LB; inlagatio, CE, CF, LT. 23. restitui, OC, MD, CA, CB, CC, LD, W, X. 24. Om., CF, MI (ins. above). 25-26. obligationes et actiones, CB, W, HB. 27. prohibitas, OC, OF, MA, MG, MH, CM, CB, HB, CC, CF, LD; om., OE, MI, LC. 28. nec, V. 29. homagia, OC, X; homag., MSS. generally. 30. nec, V, OA, OB, OD, OM, HA, MA, MC, MD, CE, LA, LF, LG, PH; et, ML; ins. ad, ME, CA, LC, W. 31. fidelitatem, CA. 31-32. Om., P. 32. nec, V, OD, PH, X. 32-33. Om., CC. 32-34. Om., W. 33. Om., OB, OE, MA, MB, MI, CF, LC, LF, LG, LT. 34. sacramentum, MD. 35. nec, V, CE. 35-37. Om., CA. 36. Om., OC. 37. Ins. quæ, ML. 38. utlagationem, OB, OC, OF, ME, CC, W, X; utlagatio, CF; utlag., OG, CM, MH, LT, P, PH, Y; utlgat., LB; utleg., MG; ins. iustam, OB (above); ins. sunt, ML. 39. dissolutam, ME, CA; dissoluta, OF. 40-41. quibus, W. 42. fuerant, OB, OD, CM, OF, MA, MC, MD, ME, MG, MH, ML, CB, HB, CC, CE, LB, LD, LF, LG, B, P, W, X; fuerat, CF, LT; fuerint, OE, MB, MI, LC; fuerit, HA, OM, PH; fuerit aut, OC. 43. convicta, OF, ME, MG, MH, CM, LB, LD, B, W. 44. Ins. a, OE (marked out). 44-45. Om., P. 45. firma, LF; confirmata, HA, OM, ME, CB, LD, W; confuata, X; firmatata, HB (corr. to firmata). 46. omnino, CC. 47. nec, V, X. 48. hereditatem, CA, W. 49. tenementum, HB. 50. Ins. et, LB. 51. iure, OG; iur., OC, LD, P. 52. restitui, B. 53. posset, OC, OF, MG, MH, CM, CB (by corr. from possunt), CC, LB; possit, HB. 54. Om., OM, MA (ins. above), LD, HA. 55. ei, ML, CA, LD, LF, P, W. 56. si, OE. 56-64. Om., OD, LA (marginal), PH. 57. ipsis, OM. 58-59. ut, CA. 60. Ins. non sint, CA; repeat, OG (marked out). 61. utlagationem, OF, MG, CF, X; utlag., OC, OG, MA, MD, MH, CM, CB, HB, CC, LA, LB, LT, B, W. 62. Ins. non, CM. 63. deteriores, V, MA; deterior., OC, CC, CF. 64. debent, V, LD.

FOLIO 161. CHAPTER III

Dictum¹ est supra qualiter possessio² adquisita³ ex quacumque causa acquisitionis⁴, de voluntate possidentis ad⁵ alium transferatur⁶. Nunc⁷ autem⁸ dicendum est⁹ qualiter semel¹⁰ adquisita¹¹ contra voluntatem possessoris¹² per vim iniustam auferatur et¹³ amittatur¹⁴. Et qualiter et qua actione¹⁵, cum amissa fuerit¹⁶, spoliato¹⁷ restituatur¹⁸, quia¹⁹ nemo debet sine iudicio disseisiri²⁰ de libero tenemento suo²¹, nec respondere sine præcepto domini²² regis, nec²³ sine brevi²⁴. Sed²⁵ imprimis²⁶ videndum erit²⁷ qualiter fit²⁸ disseisina²⁹, et³⁰ quibus³¹ modis³², postea³³ vero quale³⁴ competat³⁵ remedium incontenti vel³⁶ ex post facto. Prius enim cognosci³⁷ debet³⁸ de³⁹ transgressione⁴⁰ vel⁴¹ iniuria, et facti⁴² qualitate⁴³, ut⁴⁴ postmodum⁴⁵ facilius⁴⁶ sciri⁴⁷ possit⁴⁸ quale sequatur⁴⁹ remedium, et⁵⁰ quæ⁵¹ pœna⁵². Fit⁵³ autem disseisina non solum⁵⁴ cum quis⁵⁵ præsens⁵⁶, vel⁵⁷ procurator, vel familia⁵⁸ qui⁵⁹ nomine suo fuerint⁶⁰ in

Collated for OA, OB, OC, OD, OF, OG, OM, MA, MB, MC, MD, ME, MF, MG, MH, MI, MK, ML, CA, CB, CC, CE, CF, CH, LA, LB, LC, LD, LE, LF, LG, LT, W, X, Y, P, HA, HB, CM. Third book begins here in OA, OB, X, Y, LC, MG, CA, LG, MI, OE, MC, CB, CE, HA, P.

1. At this place CA has very full marginal notes. 1-6. Om., OG. 1-11. Nunc dicendum est qualiter possessio sive seisina cum semel adquisita fuerit, LE. 1-24. Quia nemo debet sine brevi domini Regis de libero tenemento suo respondere, nec sine iudicio disseisiri, CH. 2. Om., OF, MG. 3. Ins. est, X; ins. et, OC, MD, ME, MG, MH, MK, CB, CC, HB, LB, LD; exquisita, CM. 4. acquisitione, OF; exquisitionis, MK. 5-12. Om., MA. 6. Ins. sicut in donationibus et conditionibus et aliis, CB. 7. Tunc, MK (corr. to nunc in margin). 8. Om., OG. 9. Om., OA, OB, OD, OG, MB, MC, MF, MI, ML, CC, CE, CF, CM, LA, LC, LD, LF, LG, LT, P, Y. 10. Om., MF. 11. Om., MB. 12. possidentis, X. 13. vel, MG (ins. et above). 14. admittatur, MG. 15. occasione, OM, MH, CM, CC, LC, ME, MI. 16. sit, CF, LT; om., OM. 17. speliato, ME. 17-18. restituatur spoliato, X, CA. 18. restituit, MA; reficiatur, CF. 19. et, CF. 20. disseisire, CC; asseysiri, MI (corr. to disseisiri); om., MH, CF, LT. 21. Om., MF. 22. Om., LE. 23. nisi et, Y. 23-24. Om., LE. 25. et, MB, MI, LC, CM. 25-52. Ideo videndum qualiter fieri potest disseisina, CH. 25-26. et, LE. 27. est, OB, OM, MA, MB, MD, MI, CA, CM, LC, LE, LF, LG, W, X, HA. 28. sit, OB, OC, OG, MI, CM, CF; si, CB (corr. in margin). 29. disseisitus, OC. 30. Ins. in, OB, ME (later crossed out), CA, X. 31. Om., MK (erasure). 32. Ins. et, MG, X; om., MK. 33. post, CC. 34. qualiter, MF; an erasure, MK. 34-38. Om., CA, X. 35. competit, OF, MA, MD, MI, CM, LC, P. 36. ut, MF; a corr. in MK. 37. cognoscere, ME (corr. to cognosci); congnosci, Y; om., CE. 39. Om., CF; in, HB. 40. transgressio, CB (corr. to transgressione). 41. et, ML, X. 42. facta, CC. 42-43. qualitate facti, CF, LT. 43. qualiter, MD (corr. to qualiterate). 44. et, MG, MK, ML; om., LD. 45. Om., CA, X. 46. Ins. postea, CA, X. 46-48. scire possit facilius, MD. 47-48. sciatur, Y, OG. 49. loquatur, OC; sequitur, CA, X; sequetur, MD (a corr.). 50-52. Marked out, LB. 51. quale, OC. 52. Ins. subsequatur, MC, ME, OD, OF, CC; ins. sequatur, MH, MK. 53. est, MA. 54. solummodo, CA, X. 55-56. præsens quis, MI, LC (ins. sit above), CM. 57. Om., P, LE. 58. femina, MI, LC, CM. 59. quæ, OM, MD, MK, CC, W, X. 60. fuerit, V, W, CC, LC; fuerat, LG, OB, MB, CM, MI; fuerant, LF; fuerunt, ML, P.

seisina¹, violenter², iniuste³, et sine iudicio de⁴ tenemento suo⁵ qualieumque⁶, eiceti⁷ fuerint⁸, verum⁹ etiam fit¹⁰ disseisina, cum¹¹ quis ad¹² nundinas¹³, vel¹⁴ peregre profectus¹⁵ fuerit¹⁶ nemine¹⁷ in possessione relicto¹⁸ alius¹⁹ possessionem²⁰ ingrediatur, et ipsum²¹ reversum²² non admittat²³, vel²⁴ cum²⁵ ingredi voluerit²⁶, per se, vel²⁷ assumptis viribus²⁸, violenter²⁹ repellat³⁰. Fit³¹ etiam³² disseisina non³³ solum³⁴ si quis verum dominum³⁵ præsentem³⁶, procuratorem, vel familiam³⁷ eiciat³⁸, vel³⁹ reversum a nundinis vel⁴⁰ peregrinatione⁴¹ non admittat⁴² vel⁴³ repellat, verum⁴⁴ etiam disseisinam⁴⁵ facit⁴⁶, si⁴⁷ ipsum⁴⁸ vel procuratorem⁴⁹, vel⁵⁰ familiam⁵¹ in possessione existentem⁵² uti⁵³ omnino⁵⁴ non permittat, vel saltem⁵⁵ impediatur quo minus commode uti possit⁵⁶. Et⁵⁷ quo⁵⁸ casu⁵⁹, licet⁶⁰ eum⁶¹ omnino⁶² non⁶³ expellat⁶⁴, tamen⁶⁵ facit ei⁶⁶ disseisinam⁶⁷, cum⁶⁸ commodum⁶⁹ utendi ei⁷⁰ omnino⁷¹ auferat⁷², vel⁷³ quo⁷⁴ minus⁷⁵ commode⁷⁶, quiete⁷⁷ et in⁷⁸ pace⁷⁹ uti⁸⁰ possit⁸¹

1. Ins. et, OC, MD. 2. Ins. et, OB, OM, MA, MB, LG, HA, MD, MI, CB, HB, CM, LF, LC, W; violenta, LT. 3. Om., OD. 3-6. Om., LE. 4. Ins. libero, V. 4-5. Om., CC. 6. qualecumque, OB, MA, MB, LF, LG; qualitercumque, OD, OF, ME, MD, MG, MH, MK, LB, LD, HB, CB, CC; om., MI, LC, CM. 7. deiecti, OG, Y; eiectæ, MA. 7-8. fuerint eiecti, LD, CH. 9. utrum, MB, CF, LT. 10. si (corr. to fit above), CB; sit, MI. 11. si, MA, MD. 12. Om., MK. 12-14. Om., CH. 15. perfectus, MK. 16. Om., CH. 17. nomine, CB (corr. to nemine in margin); non, HA, OM; veme (corr. to nemine), MK, ME; a corr. in MI. 17-18. nemine in domo relicto vel possessione, V. 18. relicta, LD. 19. Ins. in, V, OG, MB, MK, Y, CM. 20. Om., CA, CH, X. 21. Ins. alium, OF. 22. remissum, MA. 23. admittit, OM, MA, MD, HA, ML, CA, X, W; dimittit, LD; amittat, CC, CB (corr. to admittat), HB. 24. Om., MF. 25-28. Om., LE. 26. noluerit, MI, CC, LC, LD. 27. Om., CC. 28. Om., OG; aliis, CM, MI, LC; viri duo, MB; vicinis, LG, OB; vicinus, LF. 29. Om., X. 30. repellatur, CA, X; appellat, OC; om. to following repellat, LE. 31. fiat, OF, ME (corr. to fit), MH, MG. 32. autem, OA, MF, ML, CA, CE, LD; autem, autem, X. 33-46. Om., CH. 34. Om., MI, CB (ins. above); ins. modo, CA, X. 35. deum, ME (corr. to dominum above). 36. prosentem, MH. 37. famulum, MB. 38. Om., CA, X. 38-51. Om., OG, Y (in margin, diff. hand). 39. Ins. si, CA. 40. Ins. a, V, CA, X. 41. peregrinationem, MB, ME, MG, MH, LB; peregrinationi, OC. 42. amittat, ML, CC. 43. sed, X; repeat, CC. 44-46. Item facit quis disseisinam, LE. 45. disseisina, CC. 45-46. facit disseisinam, LT; om., CF. 47. scilicet, LT. 48. dominum, CH. 48-51. Om., LE. 49-50. Om., MF. 52. existentes, CF. 53. ut, MG; ubi, OG. 53-54. omnino uti, OC. 54. Repeat, W. 55. saltim, OB, MB, MI, LG, CM, ML, CA, CC, LF, LC; salt., LB, MH; om., CH. 56. possint, HB. 57. Om., W; om. to following possit, CC. 57-60. quia quamvis, CH. 58-59. qua causa, CA, X. 59. Ins. alias quo casu, CA (above). 61. Om., W. 61-62. omnino eum, OM, ML, CE. 62-63. non omnino, OG, Y. 63. Om. to following omnino, CF. 64. expelleret, X; expellit, MK. 65. cum, MG; om. through following possit, CH. 66. Om., MI; e, MG. 67. disseisina, MB, MH, P. 68. vel, CM. 69. commode, OG, OC; a corr. in MD; commod., various MSS. 70-71. omnino ei, OG, CA, LD, X, Y. 72. auferet, X; aufert, CA; in an erasure, LD. 73. et, LD. 74-75. cum, X. 76. Ins. et, OM, HA, CE, W; ins. uti possit, CF, LT. 78. Ins. above, OA. 78-79. pacifice, CA, X. 80-81. Om., CF, LT. 81. Ins. et, OG, MC, MI, LA, Y; ins. vel, ML.

impediat¹, possessionem² inquietando³ et⁴ perturbando. Item⁵ non⁶ solum⁷ fit⁸ disseisina, secundum⁹ quod prædictum¹⁰ est¹¹; fit¹² etiam¹³ si¹⁴ quis præpotens¹⁵ uti voluerit¹⁶ in alterius tenemento¹⁷ contra¹⁸ ipsius¹⁹ tenentis²⁰ voluntatem²¹, arando, fodiendo²², falcando²³, et²⁴ asportando²⁵, contendendo²⁶ tenementum²⁷ esse²⁸ suum quod est alterius. Si²⁹ autem³⁰ nihil clamaverit³¹ in tenemento³², aliud³³ erit, quia³⁴ tunc erit³⁵ transgressio, et³⁶ non³⁷ disseisina de libero³⁸ tenemento³⁹; vel⁴⁰ pecora⁴¹ immittendo⁴², vel alio quocumque⁴³ modo sic⁴⁴ servitutum⁴⁵ imponendo⁴⁶ fundo⁴⁷, qui⁴⁸ prius⁴⁹ liber⁵⁰ erat⁵¹. Et⁵² unde⁵³, quamvis⁵⁴ omnino⁵⁵ non⁵⁶ expellat⁵⁷ vel impediat⁵⁸, sic imponendo⁵⁹ servitutum⁶⁰, aufert⁶¹ libertatem quo minus possessor libere teneat⁶². Item facit quis disseisina⁶³ ei⁶⁴ qui possidet⁶⁵, ut⁶⁶ cum ius habeat⁶⁷ utendi fruendi⁶⁸ in⁶⁹ alieno⁷⁰, uti voluerit⁷¹ alio modo⁷², alio tempore, alio genere,

1. impedit tamen, CH. 1-2. Repeat, OC. 2. Corr. to possessorem in Y. 3. inequitando, OC. 4. vel, CA, X; om., OM, MF. 5-11. Om., CH. 6-7. Om., LE. 7. Repeat, LG. 8. sit, LG, LF, OB; sic, CC. 9. Ins. above, MF. 9-14. cum, LE. 10. dictum, OG; supradictum, X, MF. 12. sed, V, MD, MF, CA, X. 12-14. nisi, ML. 13. Om., MD; ins. disseisina, CH. 15. præponens, MA, MB, MD (corr. to præpotens in margin), OC. 16. voluit, OG (corr. to voluerit), Y; noluerit, OD, CC, CF, LT. 17. tenementum, CA; ten., MSS. generally. 18-22. Om., LD. 19-21. voluntatem ipsius tenentis, CF, LT, X; voluntatem ipsius, LE. 20. Om., CH. 21. vocem, CC; ins. ut, CA. 22. fodiando, CM, MI; faciendo, OF, MG. 23. calcando, X; saltando, MG; om., MK, HA. 23-25. et asportando, falcando, W. 24. Om., MC, CC. 24-25. Om., LA. 25. Ins. et, X; asptando, MG. 26. concedendo, OA, OD, MC, CE. 26-39. Om., OG, ML; marginal, OA, Y (diff. hand). 27. Repeat, OC. 27-28. esse tenementum, CF, LT. 28. Om., W. 29-39. et asportando, MC (ins. the omitted part after teneat following); om., LE (ins. after teneat). 30. enim, CA. 31. clamat, CA, X; clamaverint, LT; clam., various MSS. 32. tenementum, LG, OB, MB; ten., MSS. generally. 33. illud, MI. 33-34. Om., CH. 34. Ins. ex, CE (marked out). 35. non est nisi, CH; esset, MA, MD. 36. Ins. above, MK; om., OC, OF, MG (end of line), MH, ME (ins. later), CB, CC, LB, HB; om. through teneat following, CH. 37. Om., CE, Y; novæ, MI. 38-42. Om., MA. 39. Ins. extra, OC, OF, ME, MG, MH, LB, LT, CB, HB, CC, CF; ins. et asportando, LA. 40. sed, MD; Et etiam, CA. 40-42. Om., OB, MB, MI, LF, LG, CM, LC (ins. above). 41. pectora, OA, OD, ME, MG, LD, CF. 43. Om., LE. 44. Om., LE; sicut, MA; sit, HB, OD, OM. 45. servientem, MA, MB. 45-46. imponendo servitutum, CA. 46-47. fundo imponendo, MF. 47. Om., LE. 48. quæ (corr. to qui), MK. 49. primo, OF. 50-51. liberat, CF; liberaret, OD; erat liber, CC, LB, ME, MH. 52-58. quia, LE. 53. Ins. above, CB. 54. quamvisno, P (corr. to quamvis). 54-55. omnino quamvis, ME, MH, LB, CC. 55. Om., OF, MG. 55-56. non omnino, CB, HB. 56. Om., CF, LT. 57. impellat, MK; expediat, MF (corr. to occupat above), P (corr. to expelat). 59. ponendo, OM. 59-60. servitutum imponendo, X. 60. servientem, CC. 61. auferat, OG, LA, Y, LD; ins. tamen, MD (above), LC. 62. A corr. in CB. LE inserts, Et cum quis asportando seisinam alicuius perturbat et nihil clamaverit in tenemento, tunc est transgressio et non disseisina, nisi frequens fuerit iniuria, quia frequens iniuria trahit ad disseisina. 63. disseisina, OD, MH, HB. 64-68. cum, LE. 65. possideat, MB; præsidet, OB. 66. vel, CA, X; insert above, CC. 67. Om., HB. 69. tamen, MK; ins. alio, MG (marked out). 70. alio, X. 71. noluerit, CF, LT, HA. 72. Ins. et alio modo, P (marked out).

quam uti¹ deberet², vel aliter quam servitus³ fuerit⁴ constituta⁵. Item⁶ facit⁷ quis⁸ disseisinam⁹, non¹⁰ solum¹¹ si fiat ut¹² predictum¹³ est¹³, sed fit¹⁵, cum¹⁶ quis¹⁷ in¹⁸ seisinam¹⁹ fuerit²⁰ ut²¹ de libero tenemento²² et²³ ad vitam²⁴, vel²⁵ ad²⁶ terminum annorum, vel nomine custodiæ²⁷, vel²⁸ aliquo²⁹ alio³⁰ modo³¹, alium³² feoffaverit in³³ præiudicium veri domini, et facerit³⁴ alteri³⁵ liberum tenementum, cum duo³⁶ simul et semel de³⁷ eodem tenemento et in solidum esse³⁸ non possint³⁹ in seisinam⁴⁰. Item⁴¹ facere⁴² poterit quis⁴³ disseisinam⁴⁴ sub⁴⁵ colore⁴⁶ districtionis, ut si⁴⁷ quis dstringat⁴⁸ pro⁴⁹ servitio⁵⁰, cum⁵¹ nihil⁵² ei⁵³ debeatur⁵⁴, vel⁵⁵ cum⁵⁶ ei⁵⁷ solutum⁵⁸ fuerit⁵⁹, vel⁶⁰ cum⁶¹ modum districtionis⁶² excedat⁶³. Item⁶⁴ si quis⁶⁵ uti⁶⁶ voluerit⁶⁷ cum iuste⁶⁸ possidente, velit⁶⁹ nolit⁷⁰, et⁷¹ si⁷² contra suam⁷³ voluntatem⁷⁴ opus fecerit manifestum⁷⁵. Item⁷⁶

1. Om., CH. 1-2. debeat uti, X; deberat uti, CA. 2. debeat, ML; debent, CC. 3. Marginal, CB. 4. fuit, V. 4-5. constituta fuerit, OG. 6. Om. to end of chapter, ML, CE; the rest of this section is marginal in OA. 6-14. Om., CH. 7. facerit, CB. 7-8. quis facit, CF, LT. 8. Om., MF. 9. de seysinam, P. 10-15. Om., LE. 11. A corr. in HA. 12. sicut, X; ins. above, CA. 13. dictum, OG. 14. Ins. above, P. 15. sic, MA, MK; sit, MB, LF, CC; ins. etiam disseisina, CH. 16. ut, OA. 17. aliquis, MD (an erasure follows). 18-20. fuerit in seisinam, MF. 19. possessione, LE. 20. fuit, OF. 21. Om., CF, MF. 21-24. Crossed out in text and et alium de libero tenemento ad vitam put in margin, MD. 21-25. Om., LE. 22. Ins. suo, MH. 23. ut, OM, W; corr. to vel, P; om., CH. 25. et, OF, MF, MH, MI, MK; an erasure, MD. 26. Om., P, HB. 27. Om., CC. 28. Ins. above, P; repeat, HB. 28-31. et, LE. 29. Om., OC, CH, LD, P. 30. Ins. quocumque, OC. 31. Ins. et, CH. 32. Om., P; crossed out, MD; ins. inde (above), CH. 33. Repeat, MK (marked out). 34. fecit, OD, LA. 35. Om., LC. 36. Om., LF. 37. in, HA, OM, W. 38. Ins. after possint, X. 39. possit, HA, OM; posuit, LG; possunt, V, OG, MA, MD, ME, MF, MI, MK, CA, CM, CC, CF, LE, LD, LF, LT, W, X, Y; ins. esse, LG (marked out). 40. Ins. Ita quod feoffator et feoffatus coniunctim faciunt disseisinam, LE; ins. et sic habebuntur pro disseisina tam alienator quam donatarius, MF. 41. vel, CC. 41-44. Item poterit fieri disseisina, LE. 41-47. Fit etiam disseisina cum, CH. 42-43. poterit quis facere, OF, MG. 44. de seysinam, P; disseisina, HB. 45. Om., HA. 45-46. ob colorem, X; ob disseisinam coloratam et ob colorem, CA. 48. dstringit, CH. 49. per, Y. 50. servitiis, CA, X. 51. ubi, OC. 52-53. ei nihil, MF. 54. debeat, X; deliberatur, LC (corr. to debeatur). 55. ut, OB, HA, MA, MB, MI, CM, LC, LG, W. 56. Om., HB, CB; eum, OB. 57. Om., ME, CH; ins. solum, OF, ME, MG, MH, MK (crossed out), CB (crossed out), CC, LB. 57-61. Om., LE. 58. solutum, HB; soleutum, MB (corr. to solutum); ins. fecerit, CB (crossed out). 59. fit, CH. 60. et, MA, MD. 61. Om., Y, OG. 62. dstringendi, OG. 63. A corr. in HA; excedit, OB, MK (corr. to excedat), CH, LF, LG. At this place MF introduces a whole page of extra matter, making mention of the second Statute of Westminster and of "Henricus de Breitone." 64-76. Om., LE. 65-66. sicuti, CF. 66. Ins. et, HB. 66-67. voluerit uti, HA, OM. 67. noluerit, LT. 67-69. Om., HB (marginal). 68. iniuste, MB, LD. 69. Ins. et, OB, MA, MB, MI, LC (partly erased), CM, LF, LG. 70. Marginal, ME, CB; noluit, HB. 71. Ins. above, LC. 71-72. Om., MI. 72. Om., OB, OM, HA, MA, MB, MF, CM, LC, LF, W, LG. 73. Om., ME. 73-74. voluntatem suam, OC, MF, CA, W, X. 75. manufactum, V, OA, OD, MC, CH, LG; m., MG; miam., OG. 76 to end of chapter. Marginal in LA. Om. here and ins. after vacuum, l. 22, f. 162, P, MF (which has this passage also in the regular place).

facit¹ disseisinam², qui³ iuste⁴ possidentem⁵ impedit⁶, quo minus in⁷ pace et quiete uti⁹ possit¹⁰, faciendo¹¹ ei¹² contentionem¹³ iniustam¹⁴. Sed¹⁵ omnis¹⁶ contentio non erit¹⁷ iniusta¹⁸, ut¹⁹ si verus²⁰ dominus contentionem²¹ moveat²² ei²³, qui²⁴ rem suam²⁵ iniuste detinet, ne²⁶ pacificam²⁷ habeat possessionem sive²⁸ seisinam²⁹, sed³⁰ interruptam³¹ ne currat³² tempus³³ per³⁴ desidiam³⁵. Item³⁶ disseisiri³⁷ poterit³⁸ quis³⁹ iniuste⁴⁰ et sine iudicio⁴¹ de tenemento suo⁴², licet⁴³ tenementum⁴⁴ non teneat⁴⁵ libere, sed⁴⁶ ad⁴⁷ terminum⁴⁸ annorum⁴⁹, vel⁵⁰ de⁵¹ dominico⁵² regis, vel huiusmodi⁵³, talibus⁵⁴ iniuriari⁵⁵ poterit sicut⁵⁶ aliis⁵⁷ prædictis⁵⁸, sed⁵⁹ non⁶⁰ succurritur⁶¹ eis⁶² per tale⁶³ breve⁶⁴.

(Et⁶⁵ quæ pœna subsequatur⁶⁶.)

1-14. Om., LE. 1. An erasure, W; ins. quis, OB, OM, HA, MA, MB, LG, MD, MI, CB (above), HB, LC, LF, W. 1-2. Om., CH. 2. disseisina, HB, CB, P; dis., MH. 3. quis, OC; cum, LD. 4. iniuste, MK; om., CF, LT. 5. possidente, OC. 6. impediatur, MK. 7-8. Om., CH. 8. Ins. in, MK. 9-10. possit uti, Y, OG. 10. posset, MA. 11. faciendo, OC. 12. Ins. above, OG; om., CM. 13. Ins. suam, CC; conventionem, MB. 15. Et sciendum quod, LE; si, OF, MG. 16. communis, MA. 17. est, MA, MB, MD, MI, LC, CM. 18. iniustus, CB, HB. 19. Om., MB. 20-23. Om., CF. 21. intentionem, HB (corr. to contentionem), MG, P; om., OA. 22. moneat, OB, MB, ME, MG, MH, CC, LC, P; moviat, LE; mandat, OA; ins. vel, MF. 23. Ins. q, OF (marked out). 24. quem, CF, LT. 25. ei, HB; repeat, cross out, and ins. ei above, CB. 26. nec, CC. 27. pacificat, MC. 28. seu, MA, MD, CB, HB. 28-29. Om., CH, LE. 30. per, OD. 30-35. Om., X. 31. interruptis, MK. 32-33. tempus currat, MF. 34. propter, LF. 34-35. perfidiam, HA. 35. considerationem, ME, MH, CC, LB; desiderium, OC; desidium., MA, MD; disseisinam, LF; desz., P. 36. Om. rest of chapter, CH. 36-38. Repeat, MD (first marked out). 37. disseisinam, ME, CF, LT; disseisina, MH, HB, CB (corr. to disseisiri non above); disseys., MG; diss., OF, MA, MF, LE; dissiri, CM; disseisinam facere, CA, X; eici, MD; om., OC. 38. facit, OF; ins. quidem, CA. 39. Ins. facere, ME. 40. iuste, OC. 40-42. ut de libero tenemento, LE. 41. Ins. facere alicui, CF, LT. 42. Ins. et, MF. 42-44. Marginal, MK. 43-44. Om., MH. 44. Om., CC. 44-45. non teneat tenementum, MF (second passage). 46. Ins. licet, CB (above). 46-50. ut, LE. 47-48. de termino, MG. 49. anno (corr. to annorum), MI. 50. et, MC. 51. Om., OA; in, MG (corr. to de). 52. Ins. domini, V, OG, OD, MD, MF (second passage), CA, Y. 53. huius, HA. 54. testibus, MK (corr. in margin). 55. iuriari (corr. to iniuriari), MF. 56. Repeat (first crossed out), P; ins. etiam, OC. 56-58. Om., OG. 57. aii, MK. 58. Om., ME; ins. rationibus (above), MA. 59. et, OM, HA. 59-64. Item si quis uti voluerit cum iuste possidente velit nolit et si contra voluntatem opus fecerit manifestum, MF. 60. Ins. hic, V, OD. 61. succuratur, P; curritur, OD. 62. ei, OC, MA, CC, LD, MD (corr. to eis). 63. hoc, ME, MH, LB, CC. 63-64. breve novæ disseisinæ per aliud casui suo conveniens, LE. 65. This is an addition to the text as first written. It is found in the place assigned it in the printed text in OD, OF, OG, MC, ME, MF, MG, MH, MK, CB, HB, CC, LB, B, P, Y; in OC, CA, CF, CH, LD, LE, LT, X, it comes after repellat, l. 21, f. 161b; it is put after fuerit constituta, l. 40, f. 161b, in MA, MB, MD, MI, OB, OM, LC, LG, W, LF, HA, CM; it is marginal in OA, LA; CE, ML, om.; Item, LG, LF, OB; ex, LD. 65-66. Om., MC, ME, MF, MH, OF, OD, CC, MK, P. 65 to end. Et est pœna huiusmodi delicti triplex, persequitur enim querens ipsam rem persequitur etiam damna et nihilominus disseisitor in misericordia. Et si cum armis fecerit disseisinam Gaole tradatur. Dabit etiam principalis disseisitor unum bovem vicecomiti, vel V solidos nomine bovis ex consuetudine non de iure, CH. 66. sequatur, OG, MD, LE, Y, CA, X; ins. videndum, CA, Y (above).

In hoc¹ autem² iudicio novæ³ disseisinæ⁴ quod⁵ ex maleficio⁶ oritur, persequitur⁷ quis⁸ ipsam⁹ rem¹⁰ et persequitur¹¹ pœnam¹². Et¹³ est¹⁴ personalis¹⁵, sicut¹⁶ vis¹⁷ bonorum raptorum, et¹⁸ ibi¹⁹ pœna triplex²⁰, una²¹ propter spoliationem²² contra pacem, ubi²³ infligenda²⁴ est²⁵ pœna corporalis, alia propter iniustam²⁶ detentionem, ubi²⁷ infligenda²⁸ erit²⁹ pœna³⁰ peenniarum. Item persequitur³¹ quis³² damna³³ sua³⁴ quæ³⁵ sustinuit³⁶ medio tempore spoliationis. Est³⁷ etiam³⁸ pœna adiecta³⁹, quod⁴⁰ disseisitor⁴¹ principalis, unus⁴² et⁴³ non⁴⁴ omnes⁴⁵, cum per assisam convicti⁴⁶ fuerint⁴⁷, dant⁴⁸ vicecomiti⁴⁹ bovem⁵⁰ ex⁵¹ consuetudine, licet⁵² non de iure⁵³.)

FOLIO 162. CHAPTER IV

Dictum⁵⁴ est supra de qualitate⁵⁵ disseisinæ, et⁵⁶ quæ⁵⁷ aliquando potest⁵⁸ esse⁵⁹ violenta⁶⁰,

1. Om., MA, MD (ins. above); hac, LE. 2. Om., MD, CF, LT. 2-5. disseisina quæ, LE. 3-4. deseisinæ no, CB. 5. quia, CC. 6. An erasure follows in LF; ins. et sic criminalis et civilis, CA (above). 7. prosequitur, MA, MD, MK, CA, LF; et persequitur, HB. 8-9. ipsam quis, MB. 8-11. Om., LF. 9. Om., CC. 10. re, ME (marked out); secum, MC, LA; sicut, OG, Y (rem ins. above). 11. prosequitur, OC, CA, MD, MK. 12. pœna, LF. 13. etiam, LC; marked out, MK. 14. Om., MI, CM, LC; cum, OG, Y; præ, MK (marked out); ins. rationalis, MG (marked out). 15. pœnalis, LD; personale, V, OG, Y; personalem, MK, LC; personal., MSS. generally. 16. sic, MH; sit, OG, Y; ins. alias ius, CA (above); om., OB. 17. ius, OB, OG, LF, LG, CF, V, Y, HA; vi, OC, OF; either ius or vis, MG, MH, CC. 18. est, OD; ins. est, CF. 19. Ins. est, CA (above). 20. tripliciter, MC. 21. unde, OB, LG, LF; unam, LD. 22. suspicionem, MD (corr. in margin). 23. ibi, ME, MH, LG, LB, CC. 24. Om., MF. 25. Om., MF, LD. 25-28. Om., LG. 26. Om., CA, X. 27. ubi, MA; nisi, MK (corr. to ubi). 27-29. et ibi, LE. 29. est, OC, OG, HA, MA, MB, MC, MD, CA, CM, LA, X, Y; om., LD. 30. Om., OF, MG. 31. prosequitur, MA, CA, LF, P, X; a corr. in Y, MK. 32. Ins. propter, MF (above). 33. An erasure and correction, ME. 33-34. dampnum, CC; dampn., MH. 35. quod, CC; ins. resti, OF (marked out). 35-36. Om., CA, X. 36. sustinuerit, MA, MD; sustinuit (corr. to sustinuit), MG, MI; sustinuit, ME (corr. by erasure); ins. de, CA. 37. et, LA, OA, OC, MC; et est, OG, Y (a corr.), CA, CF, LT, LE. 38. autem, W; alia, CA, Y (ins. above); om., CF, LE, OG. 39. adiecti, OD. 40. quæ, MA, MB, MI, CM, LC; quam, OB; quia, OM, HA, LD, W; quod si, OG, Y. 41. disseisitor, ME. 42. Om., MB; dat, LE. 43. Erased, MK. 43-44. Om., HB (marginal). 44. Om., MA, CF; marked out, CB; si, LT. 45. omnis, MA (corr. to omnes), MB, MH; oms., MSS. generally; ins. simul (above), CB. 46. coniunctim, OB (corr. to coniuncti); coniuncti, LG. 47. fuerit, OC. 48. dabit, OC, MD; dat, OG, MF, CF, LD, LT, P, X, Y; dabunt, CA; videlicet, LE. 49. Ins. Wm. XXV, OC (above). 49-50. bovem vicecomiti, OC. 50. unum bovem vel precium videlicet (scilicet) quinque solidorum, et hoc, CA, Y (in an erasure, diff. hand); kanc., MC, OG, LA; unum bovem pretii quinque solidorum, LE. 51. de, V. 52. sed, CA, X; ins. after iure, CB. 52-53. vel quinque solidorum quatuor denariorum pro bove per statutum, MF. 54-60. Om., OG, CH. 56. Om., LE. 57. Corr. to quia, CB. 58. poterit, ME, LD. 58-59. esse potest, OB, OD, MA, MB, MC, MI, LA, LC, LF, P, LG. 59. Ins. cum, CF, LT; om., CM. 60. violentia, MH, LB (corr. to violenta), CF, LT, P.

et¹ aliquando² simplex³ sine⁴ violentia⁵, et⁶ violenta⁷ sine⁸ armis⁹, et¹⁰ violenta¹¹ cum armis¹². Est¹³ enim¹⁴ vis simplex¹⁵ et vis armata¹⁶, quia¹⁷ dicitur¹⁸ de vi, et¹⁹ vi²⁰ armata²¹. Et²² ideo de vi inprimis²³ videndum²⁴ quid²⁵ sit²⁶ vis²⁷.

Et²⁸ sciendum quod vis²⁹ est maioris rei³⁰ impetus, cui³¹ resisti³² non³³ potest³⁴. Dividitur³⁵ autem sic: quod³⁶ alia expulsiva³⁷ omnino³⁸, et³⁹ expulsiva⁴⁰ cum armis vel⁴¹ sine armis⁴². Item⁴³ alia⁴⁴ clandestina⁴⁵ et⁴⁶ de nocte, alia⁴⁷ palam et publica⁴⁸ et⁴⁹ de⁵⁰ die⁵¹. Item alia iusta, alia⁵² iniusta⁵³. Item alia⁵⁴ per violentiam⁵⁵, alia sine⁵⁶ violentia⁵⁷, sicut⁵⁸ in⁵⁹ rem vacuum⁶⁰. Item expulsiva⁶¹ locum⁶² habet in rebus corporalibus⁶³ et⁶⁴ immobilibus⁶⁵, sicut⁶⁶ in terris et⁶⁷ tenementis. Item⁶⁸ locum habet⁶⁹ in rebus⁷⁰ incorporalibus⁷¹, sicut⁷² in his⁷³ quæ⁷⁴ in⁷⁵ iure consistunt⁷⁶, sed⁷⁷ non⁷⁸ ita⁷⁹ omnino⁸⁰, sed in parte et⁸¹ alio modo. Item vis alia⁸² perturbativa⁸³, scilicet⁸⁴ ubi⁸⁵ quis⁸⁶

1-12. Om., OG, CH. 1. Ins. quæ, OM; om., MF, CF, LE, LT. 1-7. Om., LD. 2. quæ, OC. 3. Om., CF, LT. 4-15. Om., MA. 5. violenta, OD, OF, OM (corr. to violentia), CB, LD, MG, MK; violentam, LB. 6. est, MD (corr. to et above); om., OA, W. 6-7. Om., MG. 6-9. Ins. after following armis, CE. 6-11. cum armis sine violenta et, OF. 7. violentaa, V; violentia, OC, MD, MH, MI, MK (corr. to violenta), CM, CC, CF, LB (corr. to violenta), LT, P. 8-11. Om., OM. 10. Om., CE. 10-12. Om., ML. 11. violentia, MD, LB (corr. to violenta), LT, MI, P, CE, CF, CM. 12. Ins. et aliquando simplex sine violentia, LD. 13. Et, LE. 14. Om., OG, MB; autem, CH. 16. armanata, LG (corr. to armata). 17. quod, MB, HB, CB; et, MA; quæ, OF, ME, MF, MG, MH, MK, LB, W. 17-21. Om., MC, MI, CM, CC, LA, LC (marginal), Y. 17-27. Om., CH. 18. Om., LE. 19. Ins. de, LD (marked out); simplice et, ML. 19-20. Om., MA, MD (insert above), LT (ins. above). 22. Om., CA. 22-27. Om., LE. 23. Ins. erit, CE. 23-24. Om., MA. 24. dicendum est, CA, X; ins. est, HB, CB, CM, LD, P, W; ins. et, CA; ins. erit, MC. 25. quis, CB, HB. 26. Om., MG. 28-29. unde vis, CH. 29. Om., CM. 30. Om., OF, ME, MG, MH, MK, CC, LB. 31. cum, HA. 32. recisti, LD; resistere, CF, LT. 33-34. Om., CF, LT. 35. Om. rest of section, CH. 36. quia, OA, MA, CE, LD; ins. alia simplex, V, CA, X. 37. Ins. et, HB, CB; ex plurima, HA. 38-40. Om., LA, LD, Y (simplex alia expulsiva omnino ins. above, diff. hand). 39. Om., HB, CB; P (ins. above); ins. alia, OB, LG. 39-40. Om., OM, LE, W, HA. 41. et, MF, ML, CE, CF, LF, LT, P (corr. to vel); alia, LD. 41-42. Om., OF, ME, MG, MH, MK, LB, CC. 42. Om., LE. 43. Itam, Y. 44. Om., MA, CC. 45. clandestinata, CF, LT. 46. Ins. above, MB. 47. aliam, LD (corr. to alia); et alia, CA, X. 48-49. Ins. above, CA. 49. Om., OM, CF, HA. 50-51. desidie, LD. 52-53. Om., P. 54. Ins. above, MF. 55. molestiam, OC. 56. non, X, CA (ins. above). 57. Om., LE; violenta, CA, X. 58. sicum, OG. 59. Om., OB, LF, LG. 60. Ins. lines 4-13, f. 162, MF, P. 61. expulsive, MK. 62. Om., MH. 63. incorporalibus, HB. 63-70. Om., MA. 64-65. Om., CC. 64-71. Om., OM, HA (marginal). 65. in immobilibus, CB (by later corr.). 66. Repeat, OD; si cum, OG. 67. Ins. in, P. 68. Ins. expulsiva, MD. 68-69. Repeat, MK; et, LE. 71. corporalibus, MB, CC, LD, P, W, HA. 72. sicum, OG. 73. iis, V. 74. qui, MK, LD; ins. dicta, MI (marked out). 75. Om., OB. 76. concistunt, LD, HA. 77. sit, MK; et, CA, CF, LD, LT, X. 77-80. Om., ML. 78. Om., CM. 79. Om., MA, MD. 81. Om., OC. 82. Om., CA. 83. conturbativa, OG (corr. to perturbativa). 84. Om., LE. 85. ut, MC, MF, LA, P, Y. 85-86. quis ubi, OG. 86. si quis, P.

se¹ contendit² possidere³ cum⁴ ius⁵ non habeat⁶, et⁷ alius⁸ dicat⁹ se¹⁰ esse¹¹ in possessione¹² cum¹³ ius¹⁴ habeat¹⁵. Item¹⁶ alia vis¹⁷ inquietativa¹⁸, ubi¹⁹ quis non²⁰ permittit²¹ alium quiete²² uti²³ possessione²⁴ et²⁵ in²⁶ pace²⁷. Est²⁸ enim²⁹ quies et³⁰ non quies³¹, quod³² idem est³³ quod³⁴ inquit³⁵. Est³⁶ etiam³⁷ vis³⁸ ablativa³⁹, quæ concurrit⁴⁰ simul⁴¹ cum perturbativa⁴², cum aliquis⁴³ scilicet⁴⁴ fodiat⁴⁵ in⁴⁶ alieno⁴⁷ vel⁴⁸ falcet⁴⁹, et⁵⁰ sic⁵¹ perturbet⁵², ut⁵³ auferat⁵⁴ et⁵⁵ asportet⁵⁶ rem mobilem de re immobili. In⁵⁷ rebus autem⁵⁸ mobilibus⁵⁹ vel⁶⁰ se⁶¹ moventibus locum⁶² non⁶³ habet⁶⁴ per se, ut⁶⁵ in illis⁶⁶ quæ⁶⁷ per⁶⁸ vim⁶⁹ rapiuntur⁷⁰, auferuntur, et asportantur⁷¹. Item⁷² est⁷³ vis⁷⁴ compulsiva⁷⁵ quæ aliquando⁷⁶ metum inducit, ubi⁷⁷ scilicet⁷⁸ quis

1-2. contendit se, V, MD. 2. contenderit, CE, X; contendat, OB, OM, HA, MA, MF, MI, CM, LC, LF, W, LG. 3. Om., MI, CM, LC (marginal). 4. cumque, MC. 5. Om., MB, LA (margin); vis, MK (corr. in margin). 5-11. non sit, LE. 6. possideat, OF. 7. sed, LC (corr. to et). 7-15. Om., OG (marginal), MA, ME, MH, MK, CC, LB. 8. aliis, MI (corr. to alius). 9-10. se dicat, OB, OG, OM, MB, MF, MI, CM, LA, LC, LF, LG, P, W, Y. 11. Om., LC (marginal), MI, CM. 12. possessionem, OB, CM, LC, MI, LF, LG. 13-15. Om., LE. 14. Ins. non, OF, MG. 15. habet, MB. 16. Om., MD; ins. non, LE. 17. Om., MD (ins. above), LA, Y (ins. above); ins. idem est quod, CA; ius, OC, MK. 18. inequitiva, OC, OG (corr. in margin); inquietativa, MG; inquietantia, MH, CA, CC, LB (corr. to inquietativa); inquietiva, OM, HA, MB, MF, W; a corr. in ME. 19. ut, OC, MA, MC, MD, HA, MF, LA, Y; ut si, OG; ut cum, OM; et, P (ubi ins. above). 20-21. Repeat, CA (marked out). 21. permittat, MC, LA, P, Y; permittitur, CM. 22. Om., CF, LT. 22-23. Repeat, P; uti quiete, CA, X. 22-24. uti possessione quiete, V. 23. Ins. et in, OF; ins. nisi, CF (marked out). 24. Om., LE; ins. bene, LC. 25-27. Om., MA, CC, LE. 26. Om., MC, CB (ins. above). 27. Ins. Item, MI (marked out). 28-35. Om., LF. 29. etiam, V. 30-31. Om., CF, LT. 32. Om., MI, MF, CM, LC. 32-35. Om., CC. 33. Om., LC, CM. 33-34. pro, MI. 36-37. Item est, LE. 37. enim, MA, MB, MD, CA, LD, LG; om., P. 38. ius, OC, OG. 39. Ins. cum aliquis, CC. 40. convertitur, CA; convertur, X. 41. Om., LE; finis, OC. 42. Ins. ut, CA. 43. quis, MK, LE, Y; aliquid, OC; om., P (quis ins. above). 44. enim, LD; om., CA, X. 44-45. Om., LE. 45. fodiat, OB, OC, CF, LT; fodiet, ML; fodias, MH, LB (corr. to fodiat), CC; perfodiat, OM, HA, MA, MB, MD, MI, CM, LC, W; perfodiat, LF, LG. 46-49. vel falcet in alieno, ML. 47. Ins. fundo, LC; ins. solo, X. 48. Om., LE. 49. faset, LE; fosset, HA; faciet, CF, LT. 50-55. ut, LE. 51. Om., CE. 52. perturbat, OM, HA, MA, MD, ML, CA, CC, X, Y, LC (by corr. from perturbet). 53. aut, MC; et, HA. 54. auferet, MI, ML, CM, LD, LC (corr. to auferat). 56. asportat, MD, CA, CF, LT, X; asportet, MI (corr. to asportet). 57. Item in, OB, OM, HA, MA, MB, MD, MI, MK, CM, LC (Item erased), LF, LG, CB (in ins. above), HB, W. 58. Om., OB, LF, LG; autem, V. 59. immobilibus, OB (corr. to mobilibus), LF, LG. 60. et, MH, ML. 61. Ins. non, LF. 62. Repeat, ME. 62-63. non locum, OG. 63. Om., ML. 64. habent, OC, OG; habebit, CC. 65. Ins. si, OG. 65-66. Om., X. 66. hiis, CA, LE (his). 67. qui, LD. 68. Om., OF (marginal), LD, CA, X. 69. vi, CA, X. 70. capiuntur, ML; ins. et, ME. 71. asportantur, MG; asportentur, HA. 72-73. Est enim, CA; est etiam, X. 73. Ins. above, Y. 73-74. vis est, ME. 74. Om., MB (ins. above), CF, LT, P. 75. expulsiva, CB, HB, CF, LC (corr. to compulsiva), LT. 76. alium, ME (corr. to aliquando), MK. 77. ut, MF, P; nisi, MK (corr. in margin); ubi, MA. 77-78. cum, LE; scilicet ubi, X. 78. Om., ME, MH, CB, HB, CC, LB; si, OF.

alium¹ in carcere² et³ in⁴ vinculis⁵ detinuerit⁶, vel evaginato gladio⁷ compulerit⁸ ad⁹ aliquid¹⁰ dandum¹¹, vel¹² faciendum contra ipsius¹³ voluntatem¹⁴. Et¹⁵ exceptionem inducit, sive vis¹⁶ illata¹⁷ fuerit¹⁸ alicui vel¹⁹ filio vel²⁰ nepoti in²¹ patre²², vel²³ patri²⁴ in²⁵ filio²⁶ vel²⁷ nepote²⁸. Item est²⁹ vis³⁰ iniuriosa³¹ et³² illicita³³, et quædam³⁴ licita³⁵ et non iniuriosa³⁶, sive fuerit³⁷ simplex³⁸ vel³⁹ violenta⁴⁰, inermis⁴¹ vel⁴² armata.

Est etiam⁴³ vis⁴⁴ armata⁴⁵, armis⁴⁶ deiectum⁴⁷ dico⁴⁸ qualiscumque⁴⁹ fuerit vis⁵⁰ armata⁵¹, non⁵² solum si⁵³ quis venerit⁵⁴ cum telis⁵⁵, verum etiam⁵⁶ omnes⁵⁷ illos⁵⁸ dicimus⁵⁹ armatos⁶⁰, qui habent quod⁶¹ nocere⁶² potest⁶³. Telorum⁶⁴ autem⁶⁵ appellatione⁶⁶ omnia in quibus⁶⁷ singuli homines⁶⁸ nocere possunt⁶⁹ accipiuntur⁷⁰. Sed⁷¹ si⁷² quis venerit⁷³ sine⁷⁴ armis et in⁷⁵ ipsa concertatione⁷⁶ ligna⁷⁷ sumpserit⁷⁸

1. aliquando, OC, OG; illum, MG. 2. cratere, P. 2-4. Om., MA, MB, MI, CF, CM, LC (marginal), LF, LT. 2-5. vinculis et in carcere, MF. 3. vel, ML, LD, X; om., HA, MD, OM; ins. etiam, CA. 4. Om., Y. 6. detinuerint, MI. 7. Erasure, P. 8. compulserit, MA, MD, ML, CA, HB, CB; complerit, OG (corr. to compulerit in margin); compulit, CF; compleret, OC; a corr. in LC. 9. ad ad, LB. 10. aliquod, LB; aliquem, CC. 11. Ins. above, ME. 12. Ins. aliquid, MA. 13. Om., MF. 13-14. voluntatem ipsius, OA, CE. 14. Partly erased, P. 15. sive, MK. 16. ius, OC, MK. 16-28. pater aliquid dederit vel fecerit propter vim filio illatam vel econverso. Et sic de similibus, LE. 17. illa, P (corr. to illata); ablata, MK. 18. fuit, OF. 19. Om., OD; ut, Y. 19-20. Om., CC. 21. vel, OC. 21-22. Om., V, MI, LC, CM. 21-28. Om., OG. 23. in, CC. 24. matre, OC, MD, CC; in filio, CF; om., LT. 25. vel, OC. 26. filium, MA. 27. et, MC. 28. nepoti, CA. 29. Ins. above, P. 30. Om., MA, MB, MI, CM, LC (ins. above), LF; ubi, MC. 31. A corr. in LC. 32-36. Om., ME (marginal), W. 33. allicita, LC; illata, OG, MF (corr. to illicita), ML. 34. Om., LE. 35. illicita, CC. 37-38. simplex fuerit, MC. 39. sive, OC, OF, OG, MC, MF, MD, MG, MI, CM, CA, LA, LC, P, X, Y. 39-40. et, LE. 40. violentia, MK. 41. inermis, OC, OD, MC (by corr. from inermis), MI, MK, ML; inermis, MB. 42. et, OC. 43. enim, HA, OF, OM, MA, MB, MD, MG, MI, CM, LC, LF, LG, CA, HB, W; autem, CH; om., OB, ML, CB (enim ins. above). 44. Om., LE; ius, OB. 45. Ins. ubi, X. 46-51. Om., LE, CH. 47. deiecta, ML; deiectus, CA, X; directum, HA, MA, MD; derectum, W. 47-48. deiecio, LF. 48. dicor, X; a corr. in LD. 49. qualitercumque, V, OF, MB, MG, MK; qualiscum, OB; qualicumque, OM, HA, CF, LT; quacumque, MA, MD. 50. ius, MK. 52. Ins. above, P. 53. Ins. above, ME; cum, MF, LE. 54. tenuerit, MA. 55. telo, OF, CF, LD, LT; telo vel telis, CA; tel., OD, MA, MB, MC, MD, MG, MI, CB, HB, X, Y; cultellis, OG; talis, OC. 56. Om., CE; et, ME, MH, CC, LB. 57. omnis, OB (corr. to omnes). 58. Om., MA, MB, MI, CM, LC (marginal), LF. 59. Om., MK; deum, MB; ins. esse, CA. 60. Om., OB, MA, MB, MI, MK, CM, LC (marginal), LF, LG. 61. cum quo, V; quo, CA, CB (corr. to quod), X. 62. Corr. to noceri, LC. 63. possunt, OF, MG, CA, X; potesti, MK. 63-64. telorum potest, OM. 64. Celerum, OC. 65. enim, CA; ante, Y. 66. Ins. accipiuntur, OM; appellationem, MB. 67. quo, MB; om., LG. 68. omnes, MF. 69. possint, LC. 70. Om., OF, OM. 71. et, LE. 72. Om., CF. 73. tenuerit, MA. 74. in, ML; ins. am, OF (marked out). 75. Om., V. 76. contentione, CA, CF, CH, LD, LT, X; certatione, MF; consertatione, LE; conversatione, MH. 77. lingua (or lingna), OB, OG, MC, MK, CC, LD, P. 78. susceperit, CA, X.

fustes¹ et² lapides³, talis⁴ dicetur⁵ vis armata⁶. Si⁷ quis autem⁸ venerit⁹ cum armis, armis¹⁰ tamen¹¹ ad¹² deiciendum¹³ usus¹⁴ non¹⁵ fuerit¹⁶, et¹⁷ deiecerit¹⁸, vis¹⁹ armata dicitur esse²⁰ facta²¹. Sufficit²² enim²³ terror²⁴ armorum, ut videatur²⁵ armis²⁶ deiecisisse²⁷. Si autem cum²⁸ dominus²⁹ a peregrinatione vel³⁰ nundinis³¹ reversus³² fuerit³³, et³⁴ armati³⁵ qui³⁶ possessionem invaserint³⁷ cum³⁸ prohibuerint³⁹ ne ingrediatur⁴⁰, videri⁴¹ eum⁴² armis⁴³ eiectum⁴⁴, et⁴⁵ talis vis dici poterit⁴⁶ repulsiva⁴⁷. Item cum⁴⁸ procurator generalis⁴⁹ armatus⁵⁰ venerit⁵¹, et ipse⁵² dominus⁵³ videtur⁵⁴ armis⁵⁵ deiecisisse⁵⁶, sive hoc mandaverit⁵⁷ sive⁵⁸ ratum habuerit⁵⁹. Et⁶⁰ hoc quidem⁶¹ erit⁶² dicendum⁶³ in⁶⁴ familia⁶⁵, cum⁶⁶ familia⁶⁷ armata venerit⁶⁸. Ego⁶⁹ non⁷⁰

1. Om., CH; fuste, CM. 2. Om., LD; vel, OG, MA. 3. lampades, OC; lapide, LT. 4-5. dicetur talis, OM. 6. arma, OB, OG; armatura, LD. 7-47. Om., LF. 8. Om., CF, LT, P; vero, CA. 9. venit, LA. 10. Om., OF, MA, MD, ME, HB, MF, MG, MH, MK, CB, CC, LB; ins. dico, Y (above); vero licet, ML. 10-11. Om., LD. 11. cum, ME, LB, MG, MH, MK, OF, CB, HB, CC. 12-13. adiciendum, MI. 13. eiciendum, LD; devincendum, ML; deieciendum, ME (corr. to deiciendum). 14-15. non usus, V. 16. fuit, LD. 16-17. Om., CF, LT. 17-18. Ins. above, LE. 18. non deiecerit, HA, OM; deicerit, X; deiecerint, MC. 19. vi, ML. 20-21. facta esse, OC. 21. Om., LE. 22-27. propter terrorem armorum, CH. 23. tamen, HA, OM; in, MC. 23-24. Om., MB. 25. dideatur, MH, LB; ins. quis, LE. 26. aquis, ME (corr. above to armis); arma, X. 26-27. deiecisisse armis, MF. 27. deiecisisse, ME (corr. to deiecisisse); deiesisse, LE. 28. Om., LE, P, CH. 28-29. Om., Y (ins. above). 30. vel de, CA. 30-31. Om., LE. 31. incedinis, OG (corr. in margin). 32. regressus, CA. 33. Om., LE. 34. Om., CF. 34-40. prohibeatur per armatos ne ingrediatur, CH. 35. armato, MK; vi armata, LC; armata, OB, MI, LG. 36. Ins. in, X. 37. sic, V, OC, OF, OG, ME, MG, MH, CA, CB, HB, LB, LD, LT; invaserunt, MK, CC, CF; invaserant, OA, OD, OM, HA, MC, MF, ML, CE, LA, P, W, Y; evaserant, LG, OB, MB; evaserint, MA, MD, MI, CM, LC (corr. to invaserint above; to intraverint in margin), LE; manserint, X. 38. cum, LD; ins. et, LC (above). 39. prohibuerunt, OM, HA, CC. 40. ingrediantur, CA, LD; reingrediatur, W; ingrederetur, CC. 41. videtur, V, Y (by corr. from videri), MD (by corr. from videri); videlicet, OG, OC; ins. enim, MG (marked out). 41-47. vis armata dici potest, CH. 42. Om., MH; cum, OC, MC, MK, ML; a corr. in LD; poterit, CA; potest, X; ins. esse, V, LE. 43. Ins. esse, CA, Y (above), MD (above). 44. eicerit, MK; deiectum, CA; ins. constat, HA, OM; ins. cistat, W. 45. Om., CF. 45-47. Marginal, LE. 46. potest, MF. 47. impulsiva, CA, CF, LD, LT, X; expulsiva, LC; repulsitiva, HA, OM; ins. Item dicendum est de procuratore et familia cum nomine domini sui admissi non fuerint, LE. 48. est, CA, X. 49. Ins. si, CA, X. 50-51. venerit armatus, CE. 51. Ins. aliquem deicerit, X; ins. et aliquem eiecerit, LE. 52-53. dominus ipse, CA, X. 54. videretur, LD. 55. arma, LF. 55-56. deiecisisse armis, ML. 56. eiecisisse, LB (corr. to deiecisisse); ins. eum, LC, MD (above). 57-58. Om., MF. 58. Ins. hoc, OC, OF, OG, ME, MG, MH, MK, CA, CB, HB, CC, CF, LB, LD, LE, LT, X. 59. Ins. sive non, MF. 60-65. similiter, CH. 60-70. Om., LE. 61. quid, MB. 61-62. erit quidem, MH, CC, LB; erit quidam, ME. 62. est, MA, MD. 62-63. dicendum erit, MF, X. 64. de, V, CA, X; si, LC. 65. Ins. et, CB (above), HB. 66. si, HA, OM, W. 66-67. Om., MI, LC; quæ, CM. 68. fuerit, OB, OG, MA, MB, MD, MI, CM, LC, LF, LG; evenerit, MK; ins. above, P. 69. Ins. enim, V. 69-70. Om., CH. 70. enim, CA, X.

videor¹ venisse² armatus⁵ sed⁴ familia⁵, nisi⁶ iussi⁷ vel ratum habui⁸. Et secundum præcedentia qualitas⁹ facti¹⁰ facit¹¹ pœnam¹² graviorem vel¹⁵ minus gravem¹⁴. Sed¹⁵ sive fuerit¹⁶ vis armata vel¹⁷ inermis¹⁸, quælibet¹⁹ talis non²⁰ erit iniuriosa, quia²¹ armorum quædam²² sunt tuitionis²³, et²⁴ quod²⁵ quis²⁶ ob tutelam sui²⁷ corporis²⁸ fecerit vel sui iuris²⁹, iuste³⁰ fecisse videtur³¹. Item³² sunt³³ arma³⁴ pacis et iustitiæ³⁵, et³⁶ arma³⁷ perturbationis³⁸ pacis³⁹, et iniuriæ. Et⁴⁰ etiam⁴¹ arma⁴² usurpationis⁴³ rei alienæ, et⁴⁴ talis⁴⁵ vis⁴⁶ dici poterit⁴⁷ ablativa⁴⁸. Unde et⁴⁹ ei qui⁵⁰ iuste⁵¹ possidet licitum⁵² erit⁵³ cum⁵⁴ armis⁵⁵ contra pacem⁵⁶ venientem⁵⁷ ut expellat⁵⁸ cum⁵⁹ armis⁶⁰ repellere⁶¹, ut⁶² per arma tuitionis⁶³ et⁶⁴ pacis, quæ sunt⁶⁵ iustitiæ⁶⁶, repellat⁶⁷ iniuriam⁶⁸, et⁶⁹ vim⁷⁰ iniustam⁷¹ et⁷² arma⁷³ iniuriæ⁷⁴. Sed⁷⁵ tamen⁷⁶ cum⁷⁷ tali⁷⁸ discretionis⁷⁹ moderate⁸⁰, quod

1-32. Om., LE. 1-4. Om., CH. 1-7. armatus venisse videor ubi scilicet si familiam venire iussi, CA. 2-3. armatus venisse, OG, OM, X, HA. 4. neque, OC; scilicet si, X. 4-5. Om., CC. 5. familiam, MD (by corr. from familia), CF, LT, LD. 6. ubi, MH; misi, LT. 6-7. ibi misi, X; mandavi, MD. 7. Om., MA. 8. Ins. above, LC; habuit, OF. 9. qualita, LC (corr. to qualitas). 10. facta, HA, MC; ins. habet, MG (marked out). 11-12. pœnam facit, P. 13. et, ME. 14. graviorem, ME (corr. to gravem). At this place MF has thirteen lines dealing with the statutes of Gloucester and Westminster I. 15. oportet, OC, OG. 16. habuerit, MI; fuit, MA. 17. sive, OB, OM, MA, MB, MD, MF, MI, ML, CM, LC, LF, W, LG, HA. 18. inarmata, OC; inarmis, OD, MK; inermis, MB. 19. quilibet, OC, OG, MK, Y. 20. nam, MI (corr. to non). 21. Om., OM. 22. quidem, MG, MH, MI, MK, LB; quidam, ME. 23. tuitionis, CF, LT; tuitiones, MH, OC, OG. 24. Om., OC, MA, MD. 24-34. quædam, CH. 25. quædam, LG. 26. quidem, LD. 27-28. corporis sui, LD. 28. coris, MK. 29. Om., HA. 30. Om., MA; iustitiæ, P (corr. to iuste). 31. Ins. ff. de iusticia et iure ut vim, X. 32. sicut, ME (corr. to sint above), MH, CC; ins. etiam, LE; sint, LB (corr. to sunt in margin); cum, MK. 34. Ins. tuitionis, LE. 35. iuste (corr. in margin), HB. 36-37. quædam, CH. 38. Marginal, P. 39. Om., LC, CH. 40. sunt, V, OF, MF; est, OD, ME, MG, MH, MK, CB (corr. to et), HB, CC, LB, P. 41. est, CA; om., OF, MK, LE; in, ML. 42. Om., CF; ins. vel, ML. 43. perturbationis, OC, OG (corr. in margin). 44-48. Om., ML, CH. 45. Om., LE; tali, MI. 46. Om., MA, LC (ins. above), LE; repeat, P (second erased). 47. Ins. vis, LE. 48. Ins. et, CA, LE, LF, X. 49. Om., CA, LE, X. 50. Ins. above, ME. 51. iniuste, OC, OF, OG, ME, MH, MG, MK (corr. to iuste), CA, CB, CC, CH, CF, LB, LD, LT. 52-53. Om., MF. 53. est, HB, CB; ins. ei, OB, OD, LG, MA, MB, MD, CM, LC, LF, HB, CB (above); ei, MI. 54-55. Om., CA, X. 56. Om., MK; patientem, W. 57. Ins. cum armis, CA, X. 58. expellant, ME, MH, CC, LB; expulat, OF, MG; ins. eum, LC (above). 59-60. Om., LE, Y. 60. Repeat, CB; ins. et, CA, X. 61. Om., LE; expellere, LD; repelle, CC; repellentem, CF, LT; ins. enim debet, LC. 62. Om., CA; et, MI. 63. tuitiones, OC. 63-65. Om., LE. 64. Ins. above, LB. 66. Repeat, OF; ins. ut, LC. 67. Marginal, LD. 68-71. vim iniustam et iniuriam, OC, OF, OG, ME, MG, MH, MK, CA, CB, HB, CC, CF, CH, LB, LD, LT, X. 68-72. Om., LE. 69-2 next page. Om., Y (ins. at bottom of page, diff. hand). 70. unde, MI, LC. 72. Om., CF, LT (ins. above). 73-74. LC has been changed to vim defendat per arma iustitiæ. 74. iustitiæ, MB. 75. si, MK; ins. cum, P (above). 76. Om., OD, CF, LT; etiam, HB, CB; causa, MK. 77. Om., P. 78. Om., CA, X; talis, V, OG. 79. Om., LE; discretionis, CC, X, OG. 80. Ins. ita, CA.

iniuriam¹ non committat². Non enim³ poterit sub⁴ tali⁵ prætectu⁶ hominem interficere, vulnerare, vel male tractare, si⁷ alio modo suam⁸ tueri⁹ possit¹⁰ possessionem¹¹. Ei¹² igitur¹³ qui¹⁴ viribus¹⁵ vult¹⁶ uti¹⁷ erit viribus¹⁸ viriliter¹⁹ resistendum²⁰ cum armis vel²¹ sine, iuxta²² illud²³, *Cum*²⁴ *fortis*²⁵ *armatus*, etc.²⁶ Sed tamen²⁷ quolibet²⁸ tempore sine²⁹ causa non erit³⁰ cum³¹ armis incedendum³². Venit etiam³³ quis ut iuste possidentem³⁴ cum³⁵ viribus³⁶ eiciat³⁷, sed³⁸ cum³⁹ possidens ei resistat⁴⁰, quod opere adimplere non possit⁴¹, quod in⁴² animo⁴³ habuit⁴⁴ et⁴⁵ in⁴⁶ voluntate⁴⁷, in⁴⁸ assisam⁴⁹ non incidit⁵⁰, nec⁵¹ debet ei⁵² obesse⁵³ conatus⁵⁴, ubi⁵⁵ iniuria⁵⁶ nullum⁵⁷ habuit⁵⁸ effectum⁵⁹. Sunt⁶⁰ etiam⁶¹ qui⁶² dicunt⁶³ et⁶⁴ putant⁶⁵ vim⁶⁶ solum esse cum⁶⁷ homines⁶⁸ vulnerentur⁶⁹. Sed regulariter⁷⁰ verum⁷¹ est⁷² quod⁷³ vis⁷⁴ est⁷⁵

1. iniuria, CF; a corr. in LG, HA. 2. committit, ML, LD. 3. Om., MB. 4. Om., CF, MI (ins. above), LT; idem sub, ML. 5. taxli, LE. 5-6. prætectu tali, CF, LT. 6. A corr. in LE. 7. sed, MA, ML; s., CF; licet, LE. 8. Om., OB, MA, MB, MI, CM, LC, LF, LG. 8-9. tueri suam, MD. 8-10. possit tueri suam, OG; tueri possit suam, MF, P. 9. tantum, MA; tenere, CE; ins. non, MK (above). 9-10. possit tueri, CA, LE, X. 10. Om., ML; posset, MA, MD. 11. Ins. suam, LC (above); ins. si alio modo, HB. 12. Est, HB; et, OC, OF, OG, OM, HA, ME, MF, MG, MH, ML, CC, CE, CF, LB, LD, LT, W, P (corr. to ei). 13. Om., MA; enim, HB, CB, CH. 14. si, OC. 15. Om., OC, OG (marginal); iuribus, OB. 15-16. vult viribus, V. 16. Ins. above, P; vul, CC; illicitis velit, MK. 16-17. virtuti, MC, LE. 18. virilibus, MK (changed to viribus); iuribus, OB; a corr. in OG; om., MB. 19. Om., CH. 20. resistendus, ME, CF; resistandum, OA. 21. et, OC. 22. Marginal, P. 22-29. Om., HA, OM. 22-59. Om., CH. 23. etc., MB. 24. dum, LE. 25. foris, LA. 26. custodit acrium suum in pace sunt omnia quæ possidet. Et dicitur quod quis ob tutelam sui corporis fecerit vel sui iuris iuste fecisse videtur, LE. 27. cum, OD, MA, MG; ins. above, P. 28. quilibet, MK (corr. to quolibet); quodlibet, P (corr. to quolibet); quilibet, LE. 30. verit, OG (corr. in margin). 31. Ins. above, Y. 32. incidendum, LC (corr. to insistendum), MA, MD; incedendus, MH. 33. enim, OC, OF, OG, ME, MG, MH, MK, CB, HB, CC, CF, LB, LD, LE, LT; igitur, ML. 34. præsidentem, ME (corr. above to possidentem), MH, CC, LB (corr. to possidentem). 35. ut, OC. 35-36. Om., X. 35-37. eiciat cum viribus, MF. 36. iuribus, OB. 38. sive, CA. 38-39. et, LE. 40. resistit, MA, MF; recistat, LD. 41. posset, MA. 42. Om., X. 42-43. Om., LE. 43. anima, MA; ins. non, ME (marked out). 44. habuerit, OA, MC, MI, CA, CB, HB, CE, CF, LC, X; habet, MF. 45. Om., MA, LE. 46. Om., OF, OM, HA, ME, MG, MH, MI, LB, LC, LD, LT, MK, CA, CB, HB, CC, CF, P, X. 47. voluntatem, LD. 48. etiam, MC, P, LA; om., LD. 49. Corr. to disseisnam, LC. 50. inducit, OC, MD. 51. neque, MF, P. 52. Om., OG, LE, P; esse, MI (corr. above to ei). 53. esse, OG. 54. Om., OB, LF, LG; coatius, MA. 55. nisi, MK (corr. to ubi); nec, Y. 56. iniuriam, OC; iniuria cum, Y (alias ubi ins. above). 57. nulli, MI (corr. above). 58. habet, MG; habuerit, MC, MI, MK, CE, LC, CB. 59. affectum, MG. 60. sed, HA, MA, MB, MI, CM, LC; sed sunt, OM. 61. Om., CF, LT, P; ins. quidam, V, CA, X; ins. quædam, CF; et, Y. 62. quæ, CF, LT. 63. inducunt, CF, LT; dnt., MK. 63-65. putant et dicunt, MA, MD. 64-65. Om., LE, CH. 65. computant, X. 66. unum, CC. 67. in, OC, OG (corr. in margin). 68. omnes, CC. 69. vulnerantur, MB, ME, MF, LE, P. 70. Om., CF, LT; rationaliter, LD; qualiter, OC, OG (corr. in margin). 71-73. Om., CH. 72. Ins. contrarium, V. 74. vim, CM. 75. Ins. quod, MB.

quotiens¹ quis² quod³ sibi⁴ deberi⁵ putat⁶ non⁷ per⁸ iudicem⁹ reposit¹⁰. Hæc¹¹ autem de vi dicta ad¹² præsens sufficiant¹⁵. Sed¹⁴ quia vis¹⁵ aliquando metum inducit¹⁶, ideo¹⁷ videndum¹⁸ quid¹⁹ sit metus²⁰. Et²¹ dicendum²² ut²³ supra de²⁴ donationibus²⁵ plenius²⁶.

FOLIO 179b. SECTION 5 *

Videre autem debent²⁷ iuratores quale²⁸ sit²⁹ tenementum³⁰, et³¹ quid et quantum, quale³² videlicet³³, utrum³⁴ terra³⁵ vel³⁶ redditus, et³⁷ utrum³⁸ res sacra vel³⁹ privata⁴⁰. Item⁴¹ privatum⁴² vel commune⁴³, ut⁴⁴ infra⁴⁵. Item⁴⁶ quantum⁴⁷ querens⁴⁸ posuerit in visu⁴⁹ suo⁵⁰. Quid, scilicet⁵¹ utrum⁵² terram⁵³ et⁵⁴ tenementum aliud⁵⁵ de⁵⁶ quo facta⁵⁷ fuerit⁵⁸ disseisina⁵⁹,

* Collated for OA, OB, OC, OD, OF, OG, OM, MA, MB, MC, MD, ME, MF, MG, MH, MI, MK, ML, LA, LB, LC, LD, LE, LF, LG, LT, CA, CB, CC, CE, CF, B, P, PH, W, X, HA, HB, CM, Y.

1. quibus omnes, MI (corr. to quotiens in margin), LC (corr. above). 2. Ins. est, OC. 3. Om., OM, P. 4. si quis, MC. 5. videri, V; debetur, W. 6. petat, MK; om., W. 7-9. sine iudice, CH. 8. pro, LD. 10. reposit, OC, OF, HA, MA, MD, MG, LE; poscit, ML; ins. Incontinenti vim vi repelle est quam scito sciri possit vim esse illatam priusquam ille cui illata fuerit ad actum contrarium divertat, LD. 11. Etiam hæc, LD; hoc, CC. 11-26. Om., LE, CH. 12-13. sufficiant ad præsens, CA, X. 13. sufficiat, OF, CF, LT; sufficiunt, OM, HA; satisfiant, CM (corr. to sufficiant). 14-26. Om., LF. 15. ius, W, HA. 16. inducat, MD (corr. to inducit). 17. Item, OF, MG. 18. Ins. est, OC, OF, OG, ME, MF, MG, MH, MK, CA, CB, HB, CC, CF, LB, LD, LT, W, X. 19-20. Om., MF. 20. metum, MA. 21-26. Om., OG. 22. sciendum, V, OC, MD, CA, X; videndum, LD; dictum est, OM. 23. quod ut, CA; om., OM. 24-26. plenius de actionibus, CF, LT. 25. donatione, OB, LG, MA, MB, MI, CM, LC, Y; don., ML. 26. Ins. poterit inveniri, MF; ins. libro I cap. XII, OM. 27. oportet, MA, MD; marginal, LE. 28-34. Om., MF, P. 29. Om., ME, MH, CA. 29-30. tenementum sit, CC, LB. 29-32. Om., OC, CF, LT, X. 31-32. Om., OD, OF, OM, CA, CC, CE, MC, MG, MH, MK, LA, LB, LD, B, W, PH. 31-33. Om., OG, Y, CB, HB, HA. 31-34. Om., ME. 32. Om., OA, LE. 32-47. Om., OB, MA, MB, MD, MI, ML, CM, LC, LE (ins. after n. 50), LF, LG; marginal, OA. 33-40. Marginal, LC. 34. ut utrum, Y, OG; quando, MH. 34-35. terra utrum, OD. 35. Ins. sit, MF. 36. et, MH. 37. Om., CF, X. 37-38. Om., LE. 39. Om., LE. 40. prophana, V. 41. Om., ME, MH. 41-42. Om., LE. 42. privata, ME, PH. 43. communis, LE; ins. et quale sit tenementum, et quid et quantum, MF, P. 44. et, MF. 44-45. Om., OG. 44-59. Item si redditus, LE. 45. ita, OC, OD, ME, MF, CA, P, PH, X; ins. sit tenementum, OC; om., MH; a corr. in Y. 46. et, ME, MH, CA, CF, LT, X; et quid et, OC, OD, OG, MC, CB, CE, LA, Y, LD, B, PH, W, HB. 46-47. Om., OA, MF, P. 47. quem, ME, MH; quid et quantum, OF, OM, MG, HA, CC, LB; quod et quantum, MK. 47-50. Ins. after disseisina, l. 17, f. 180, OC. 48-50. Om., OG, CE, Y. 49. viso, V; visuo, CC; usu, CF. 51. sit, OM; si, HA; viderint, CA. 51-52. utrum scilicet, OG, Y. 53. terra, V, OG, Y, MF, MK, W; marginal, LD; terr., MD; terram, OM. 54. vel, MD, ME, MH, CA, CF, LD, LT, X. 55. illud, V, MI, CF, CM, LC, LD, LT; aliquid, OC, LF; aliquod, OM, HA, MF, W, X; autem, MA; ins. quam, CA; om., OG, Y. 56. Om., CF. 57. factum, X; repeat, OA (marked out). 58. fuit, OF, ML. 59. Om., MF; de seisina, P.

sicut¹ redditus² sive³ constat⁴ in solido vel⁵ in⁶ liquido. Et⁷ tunc videre⁸ debet⁹ tenementum de¹⁰ quo¹¹ redditus provenerit¹², sive constat¹³ in denariis¹⁴ sive¹⁵ in¹⁶ aliis rebus¹⁷ quibuscumque¹⁸, numero¹⁹, pondere, vel²⁰ mensura²¹. Mensura²², solida²³ vel²⁴ liquida²⁵, solida²⁶, sicut²⁷ in²⁸ frumento, ²⁹ liquida³⁰, sicut³¹ in³² vino³³, oleo³⁴, et huiusmodi³⁵. Item quantum, scilicet³⁶ utrum³⁷ plus vel minus³⁸. Item videre³⁹ debent⁴⁰ in quo comitatu⁴¹ sit⁴² tenementum⁴³, et⁴⁴ in⁴⁵ qua villa, et in quo loco⁴⁶, et in⁴⁷ qua parte loci, et⁴⁸ intra⁴⁹ quos fines et⁵⁰ quos⁵¹ terminos⁵² tenementum⁵³ contineatur⁵⁴, ut⁵⁵ si⁵⁶ de numero⁵⁷ aerarum vel⁵⁸ virgatarum⁵⁹ dubitetur⁶⁰, ut⁶¹ ad⁶² minus, si⁶³ quantitatem⁶⁴ rei distinguere⁶⁵ non⁶⁶ possint⁶⁷, quod⁶⁸ dicere⁶⁹ possint⁷⁰ certum⁷¹

1. sive, V, OB, MB, MI, CM, LC, LF, LG. 1-2. Om., CA, X. 1-3. Om., LE. 3. sicut, OB, LF, LG; sive si, HA. 4. consistat, V, OA, OD, OM, HA, Y, MC, ML, CE, LA, PH; consistit, MF; constet, MD (a corr. from constat), LE. 5. sive, OF, OM, ME, MG, MH, MK, CC, CF, LB, LT, X; repeat, HB. 6. Om., OM. 7-12. Om., LE. 8. videri, CE, CF, LT, X. 8-9. debet videre, W. 9. debent, ME, MH, CA, LC. 10-11. et, OC. 12. provenit, MD, ME, MH, LD, X; pervenerit, MB, CF, LT, P; provenient, OC. 13. consistat, V, OA, OC, OD, OG, OM, HA, MC, MF, Y, ML, CA, CE, LA, P, PH, W; constet, MD (by corr. from constat), LE. 14. donarii, ML; tenemento, MB; ten., OB, MA, MI, CM, LC, LF, LG. 15-16. vel, LA. 17-18. rebuscumque, P (quibus in margin). 18. quocumque, Y, OG, MA, MD, W; qualicumque, OM. 19. vero, P (corr. to numero); numere, OC; a double corr. in MK; om., PH. 20. et, OM; in, ML; om., LD. 21. mensura, OB (corr. to mensura). 22. Om., OF, MA, ME, MF, MG, MH, MK, CC, CF, CM, LB, LD, P. 23-25. liquida vel solida, ME, MH. 24. Om., CC; et, LD. 26. Om., MH. 26-28. Ins. after huiusmodi (n. 35), OF, MG, MK, CB, CC, LB, B, HB. 27. ut, OG, Y. 28-29. instrumento, MI, CF, LT (in part erasure). 30. Repeat, LT; om., CC. 31. sive, OF. 32. Om., CF. 33. Ins. et, OA, OF, OG, OM, HA, MC, MF, MG, MK, CA, CB, CE, B, P, W, X, HB, Y. 33-34. oleo vino, MA, MD, ME, CF. 34. Om., LE. 35. Ins. Item quantum scilicet plus vel minus, MC. 36. Om., MK, ML, X. 36-37. utrum scilicet, OF, MF; sicut, MA. 37. Om., ML, CE. 38. Ins. scilicet, MK. 39. videri, CF, LT. 40. poterint et debent, CC; tenementum, MG; ins. tenementa, ME, MH. 41. Om., V; casu, MF; ins. utrum in quo comitatu, CF. 42. sint, ME, MH; om., MK. 42-43. tenementum sit, V. 42-47. villa loco, LE. 43. Om., ME, MH. 44. Om., CF. 45. Om., LT. 46. loquo, Y. 47. Om., ME, MH. 48. Om., LE. 49. inter, V, OB, OC, OG, OM, HA, MA, MD, ME, MF, MI, MH, CM, CB (ins. above), HB, Y, LC, LE, LF, LG, P; infra, CC, LB, W. 50-52. Om., LE. 50-53. Om., MA, MD. 51. Om., ME, MH, CC, LB; inter quos, X; corr. to quæ, MK. 52. signa, MK (a corr.). 53. Ins. quod, OB. 53-54. tenementa contineantur, OG, ME; contineatur tenementum, MG, MK. 55. et, CF. 56. Om., MA, MF, ML. 57. una, CA. 58. et, ML. 59. Ins. terræ, CC; burgatarum, MK. 60. dubitatur, OM, HA, MA, MD, LG; ambiguous abbreviation, OB, MB, LF. 61. vel, ME, MH, CF, LF, LT; om., OG, Y. 61-62. an, MA. 63. ubi, ME, MH; secundum, MA, MD. 64. qualitatem, OC, MD. 65. distinguere, OF; diffinire, OM, HA. 66. Marked out, MD; om., ME, MH. 67. possunt, V, ME, MF, MH, CC, LB, PH; possit, MK, LA; possent, ML; ins. eo, MD (margin). 68. Om., MF; ins. disseisitores, MD; vel quod, HA, OM; quid, MC; quia, MH, LD. 68-70. Om., LA. 69. disseis., OC; ins. non, ME, MH, MK, CF, LD, LT. 69-70. possint dicere, OB, OG, Y, OM, MA, MB, MD, MI, CM, LC, LF, LG, W, HA. 70. possunt, V, ME, MF, MH, MK, CA, CC, LB; possent, ML. 71. verum vel certum, LC; incertum, ME, MH.

vel¹ circiter², vel³ saltem⁴ infra⁵ quas metas tenementum⁶ contineatur⁷. Item si⁸ de loco constiterit⁹, nesciant¹⁰ tamen¹¹ qua¹² parte loci¹³, tamen¹⁴ ad seisinam¹⁵ faciendam¹⁶, sufficit si¹⁷ in quacumque parte¹⁸ fiat¹⁹ seisina²⁰, et si²¹ in²² qua parte²³ constiterit²⁴, sed²⁵ tamen²⁶ nesciant²⁷ determinare²⁸ fines²⁹ tenementi³⁰, tamen³¹ sufficit³² si³³ fiat³⁴ seisina³⁵ ad³⁶ quantitatem³⁷ dicti³⁸ iuratorum³⁹ per rationabilem mensuram. Si⁴⁰ autem redditus, tunc⁴¹ fiat⁴² iuratoribus⁴³ visus⁴⁴ de tenemento unde⁴⁵ redditus⁴⁶ provenit⁴⁷. Item si⁴⁸ communia⁴⁹ pasturæ, tunc⁵⁰ fiat⁵¹ visus⁵² de⁵³ tenemento⁵⁴ in quo petitur⁵⁵ communia⁵⁶, et⁵⁷ similiter de⁵⁸ tenemento⁵⁹ ad quod⁶⁰ dicitur pertinere⁶¹.

(Quia⁶²

1-2. Om., OB, MI, CM, LC, LF, LG. 1-7. Om., OF, MG. 2. circa, OD, PH; circiter, ME; incertum, MD (erasure), MF, CC; cercitum, CF, LT. 3. Om., ME, MH, CF, LF, LT. 4. Ins. dicatur, MH; ins. dicat, ME. 5. inter, OB, MA, MD, LF, LG; in, MF (corr. to infra above). 6-7. Om., LE. 7. Ins. ll. 15-17, f. 180, ME. 8. Ins. above, MD. 9. consteterit, MK (corr. to constiterit); constiterint, OM. 10. nesciunt, V, MD (erasure); nescient, LE; vesciant, MK (corr. to vesciunt); nesciat, MF, MI, X, CM. 11. eam, CF (ins. above), LT; om., MB; ins. de, Y, OG; tam, HA. 12. Om. to l. 10, f. 183b, LB (two folios are lost); om., MC. 13. Ins. constiterit, LT (crossed out). 14. sic, OA, OD, OG, OF, MB, MC, MF, MG, MI, CB, HB, CE, CF, CM, LA, LC, LD, LE, LF, LG, LT, P, PH, W, X; tam, CC; other MSS. have cum. 15. assisam, OG, ML; disseisnam, CC, CE. 16. Ins. sic, CC. 17. Om., OB, OF, MF, MG, CF, LF, LG, LT, W; ei, ME, MH. 18. Ins. loci, V. 19-23. Om., ME, MH. 20. Ins. ad quantitatem dicti iuratorum, OA (marked out); om., MI (ins. above); assisa, CC. 21. Om., MF. 22. Om., ML. 24. Ins. nesciant tamen qua parte loci (marked out), ME, X (nesciat). 25. si, ME, MH, ML, CF, HA. 25-35. Om., OA, CE. 26. Om., Y, OG; in, MC; cum, MA, LA. 27. nesciat, ML, X; nescient, LE; nesciunt, MD (erasure). 28. terminare, MI, CM, LC; deteriari, LG. 29-30. Om., OM. 31. Om., MA; dum, MK; cum, MG, CA. 31-32. sufficit tamen, ME, MH. 32. sufficiat, LD. 33-35. seisina si fiat, ME, MH. 34. stat, OD. 36. in, CB (corr. to ad). 36-37. de quantitate, CA, X. 37. quante, MD. 38. dictorum, OF, OM, ME, MF, MG, MH, MK, CC, LC (by corr. from dicti), P; dictu, OC; dicto, MD; om., MA, CM. 38-39. Om., OB, LF, LG. 39. iuratoris, MA; iuratarum, HA (corr. to iuratorum); an erasure and corr., MD; iur., MB; iur., MI. 40-47. Om., LD. 40-61. Om., OB, OG, Y, OM, HA, MA, MB, MD, MI, ML, CM, LF, LG, CE, W; marginal, OA, LC. 41. Om., OF, MG, MK, CC, LC. 42. fit, LA; om., CF. 43. iuratorum, X; iurator., MK. 43-44. visus iuratoribus, ME, MH. 45. Om., LA. 45-54. Repeat, MA. 46. visus, LC; ins. ille, MH. 47. proveniebat, X; pervenit, CF, LT; ins. qualiscumque fuerit redditus, LE. 48. si de, ME, MH. 49. communia, various MSS.; comunam, OF, MG; commune, P. 50-51. Repeat, LD (marked out). 50-52. Om., CF, LT. 51. fiet, LE. 52-54. de tenemento visus de, LC. 53. Ins. quo, CC (marked out). 55. petit, MF, P. 56. communia, various MSS.; consequentia, MK (corr. in margin); comunam, OC, MF, P; ins. pasturæ, CB. 57. Om., CF. 58. Om., CA, X. 59. tenementis, CC; ins. above, CB. 60. Om., CF; quæ, CC. 62-48 next page. This *addicio* is marginal in OA, LC; it is inserted after minus, l. 7, f. 180, in MC, MF, LA, P; it follows contineatur, l. 9, f. 180, in ME, MH, CA, CF, LD, LT, X; it is omitted in OB, MA, MB, MD, MI, CM, ML, LE, LF, LG; by other MSS. and V it is put after suo, l. 43, f. 179b. 62. et, HA, OM, W; Item si videre iuratores, X; Item videre debent iuratores, ME, MH, CA, CF, LD, LT. 62-4 next page. Om., OD, OF, MG, CC, PH.

si¹ querens² posuerit in visu³ suo⁴ plus⁵ quam id⁶ de⁷ quo⁸ fuerit⁹ disseisitus¹⁰, cadet¹¹ in misericordiam¹² pro¹³ superdemanda¹⁴, si autem¹⁵ minus, non¹⁶. Et¹⁷ eodem¹⁸ modo¹⁹ in²⁰ assisa mortis antecessoris observetur, ut²¹ de²² itinere abbatis²³ de²⁴ Redinge²⁵ et Martini de Pateshull²⁶, anno²⁷ regis²⁸ Henrici²⁹ quinto³⁰, comitatu Warrewici³¹, assisa³² novæ³³ disseisinæ³⁴ si Willelmus de Ludington³⁵. Item³⁶ si³⁷ de³⁸ comitatu³⁹ constare⁴⁰ non⁴¹ possit⁴², cadit⁴³ assisa⁴⁴ in perambulationem per⁴⁵ illud idem⁴⁶ breve de⁴⁷ nova disseisina⁴⁸.)

FOLIO 253b. CHAPTER 2 *

Rex vicecomiti salutem⁴⁹. Si talis⁵⁰ fecerit te⁵¹ securum⁵² de⁵³ clameo⁵⁴ suo⁵⁵ prosequendo⁵⁶ etc.⁵⁷, tunc summo⁵⁸ per⁵⁹ bonos⁶⁰ summonitores⁶¹ duodecim liberos⁶² et⁶³ legales homines de⁶⁴ visneto⁶⁵ de⁶⁶ tali⁶⁷ villa⁶⁸, quod sint coram iusticiariis nostris⁶⁹ ad primam assisam, cum in partes illas venerint, parati sacramento recognoscere⁷⁰ si talis pater vel

* Collated for OA, OC, OD, OF, OG, OM, MA, MB, MC, MD, ME, MF, MG, MH, MI, MK, MN, CA, CB, CC, CE, LB, LC, LD, B, P, PH, W, X, Y, HA, HB, CM.

1. Ins. above, MK. 2. Om., OM, HA, W; ins. plus, OA, OG, OM, MC, MF, CA, CE, LA, P, W, X, HA, Y. 3. visuo, OC, MF (corr. to visu); usu, CF. 4. Om., OC. 5. Om., OA, OD, OG, OM, HA, MC, MF, CA, CE, LA, P, W, X, PH, Y. 6. illud, V; om., OG, Y. 7. Om., CF. 8. quod, CF; qua, OA. 9. Repeat, MF; fuit, OF. 9-10. disseisitus fuerit, ME, MH. 10. Ins. et si II plusquam fuerit disseisitus, X. 11. cadit, V, OD, OF, OG, MC, CF, LC, LT, PH, HA, Y. 12. misericordia, OC, OG, ME, MH, MK, CA, CB, HB, CC, CF, LB, LC, LT, B, P, X, Y. 13. Om., CF. 14. demanda, OM, HA. 15. Om., CF, LT; vero, CA. 16-17. et non, OM, HA. 17. et in, LB; om., CA, X. 18-19. illud idem, MK (a corr.). 20. si, MF. 21. quod, LC (corr. to ut). 22. in, Y, OG; om., CB, HB. 23. abbas, MK (corr. to abbatis). 24. Ins. Rale, B (marked out). 25. Spelled also Rading, Radinge, Radyngge, Radingel, Radinges. 26. pr., OG; Padesnowte, P. 27. Ins. regni, OC, OD, CA, CC, CF, LB, LD, LT, X, HB. 27-30. Om., LC. 27-35. Om., ME; in comitatu, MH (followed by vacant space). 28. Om., P. 28-29. Henrici regis, MC, LA; Henrici regis regni, CB; regni Henrici regis, B. 30. VI, LD; a corr. in MC; ins. in, V, OC, OD, OG, MG, CB, CC, CF, LB, LC, LD, LT, HB, Y. 31. Wareibu, W. 32-33. nova assisa, MC. 34. Om., MC, LA. 35. The MS. variants are Luddington, Lundington, Lidington, Hiddington, Lodyntone, Indington, Ludintona. 36-48. Ins. after mensuram, l. 15, f. 180, V. 37. si si, MK. 38. Om., Y, OG, MH; ins. eodem, HA, OM. 39. Om., OM; contem., OG; a corr. in Y. 40. stare, OG, Y (corr. to constare). 41. Om., CF, LT. 42. posset, MK. 43. cadet, OA, ME, MH, LA, LB, LC, LD, B, P, PH; cadat, MC; ins. in, P. 44. Ins. novæ disseisinæ, V. 45. Om., CF, LT. 46. Om., ME, MH, OM (ins. above); quod, MG (corr. to idem). 47. in, ME, MH, CF, LT; om., LD, X. 49. etc., MI. 50. A, OF. 51-56. Om., MD. 52-56. Om., OD, MA, MF, MH, MN, P, PH, W. 53-56. Om., OC, OF, OG, OM, MB, ME, MG, MI, MK, CC, CB, LB, LC, LD, B, X, HB, CM. 54. clamio, Y; clamore, OA, CA; clam., MSS. generally. 55. Ins. above, OA. 57. Om., OA, CA, CE, HA. 58. Or summoncas; sum., MSS. generally. 59-61. etc., OC, OF, OG, OM, MA, MD, MF, MG, MH, MK, CM, CB, LC, LD, B, P, W, X, HB. 59-70. etc., ME, MI, CC, LB. 60-61. bonum summonitorem, MN. 62-63. Om., LD. 64. in, HB. 65. visum, HB, CB, MK (corr. to visneto); visu, B. 66. Om., LD; ins. above, MB. 67-68. N, CA. 69. Om., CB, HB. 70. recognitio, OG (corr. to recognoscere in margin).

mater¹, vel² avunculus, vel³ amita, frater⁴ vel soror⁵, ipsius talis, fuit seisitus⁶ vel⁷ seisita⁸ in dominico suo ut de feodo, de⁹ tanto¹⁰ terræ, et¹¹ tanto¹² redditus¹³, cum¹⁴ pertinentiis¹⁵ in tali¹⁶ villa die¹⁷ quo¹⁸ obiit¹⁹, et²⁰ si obiit²¹ post²² ultimum redditum²³ regis²⁴ Johannis²⁵ patris nostri²⁶ de Hibernia²⁷ in Angliam²⁸. Et si²⁹ prædictus³⁰ talis³¹ eius³² heres³³ propinquior³⁴ sit³⁵. (Et³⁶ tempore regis Edwardi³⁷ mutatus³⁸ fuit³⁹ terminus iste⁴⁰ ad⁴¹ coronationem⁴² regis⁴³ Henrici⁴⁴, patris⁴⁵ ipsius⁴⁶ regis⁴⁷ Edwardi⁴⁸.)

FOLIO 319b. CHAPTER II *

Dictum⁴⁹ est⁵⁰ cum⁵¹ petens intentionem⁵² suam⁵³ simpliciter⁵⁴ proposuerit⁵⁵, et⁵⁶ tenens⁵⁷

* Collated for OA, OB, OC, OD, OF, OG, OM, MA, MB, MC, MD, ME, MF, MG, MH, MI, MK, MM, MN, CB, CC, CE, CF, LA, LB, LC, LD, LE, LF, LG, LT, B, P, PH, W, X, HA, HB, CM, Y.

1-2. Om., OA, OD, MA, MD, MN, CE, PH, Y. 2. Om., OC, OF, OG, MB, ME, MF, MG, MI, MK, CA, CB, CC, CM, LB, LC, LD, B, X, HB, HA. 3. Om., OF, MA, MD, MG, CB, B, Y, HB. 4. Om., OD, MA, MD, MH (marginal), MN, PH. 5. soros, ME (corr. to soror). 6. in seisina, HA. 6-8. in seisina sua, ME, CC, LB; in seisina, OF, MG, MI, CB, B, HB. 7-8. Om., OG, OC, MB. 9-10. tantæ, OF, OM, MG, MH, MI, MK, CB, HB, CM, CC, LB, LC, LD, B, P, X, W. 11. vel, OM, W, Y (by corr. from et). 11-13. Om., OC, OF, OG, MB, MG, CB (ins. et redditu above), B, HB. 11-15. cum pertinentiis vel de tanto redditu, CA. 12. tanti, OM, MH, CM, LC, P, W; tantæ, MK, LD, X. 13. redditus, OA, OM, MC, MH, CE, CM, LC, LD, PH, HA, W, Y; redditu, V and some MSS.; tenemento, ME, MI, CC, LB; om., MK, X. 14. tamen, MI. 15. Ins. redditus, OC; ins. redditibus, OG, MI; ins. et tanto redditus, MK; ins. et tanti redditus, X. 16. Repeat, OF. 17. de, V, OA, OD, MA, MI (corr. to die), MN, CC, CE (corr. to die), PH. 17-28. Om., MB. 18. qua, OA, OD, MA, MN, CE, PH, Y (corr. to quo). 18-19. quobiit, MK (corr. to quo obiit). 19. Ins. seisitus, CE. 20. Om., OC, OG, ME, MI, MK, CA, CC, LB, LC, P, X. 20-21. seisitus, OD, MA, MN, PH. 20-28. Om., OM, MH, CM, W; et si obiit post coronationem regis Henrici patris nostri, OF, MG, CB, B, LD, MD (domini Henrici regis), HB. 22. Repeat, Y (marked out). 23. obitum, ME; om., X. 24. e, MI. 25. Om., HA. 26. Henrici, CA. 27. Britannia, ME, MI (wrongly abbreviated), CC, LB. 29. Ins. idem, MB; om., ME, CC, LB. 30. idem, MD. 30-31. Om., MB. 32-34. propinquior heres eius, OA, OC, OG, MD, ME, MG, MK, MI, CA, CB, HB, CC, LB, LD, B, X; propinquior eius heres, OF, MB, CE. 32-35. sit heres eius propinquior, LC. 33-34. propinquior heres, MC, MF, Y, HA. 35. Om., OD; sint, CC. 36-48. This is an addition, inserted after obiit, n. 19, by OC, OG, OM, MC, ME, MF, MH, MI, MK, LB, LC, CM, CA, CC, P, W, X; V ins. after Angliam, n. 28. 36. Om., MC, CC; in, MF. 37. Om., CC; erased, MI. 38. Om., OC, OG, ME, MI, MK, CA, CC, LB, X. 39. fecit, OG. 40. ille, ME, CC, LB; i., OG. 41. et, MF; post, CA. 42. coronam, CC; ambiguous abbreviation, OG; ins. domini, OC, OG. 43. ipsius, MF. 43-44. Henrici regis, OC, OG. 45. Ins. nostri, LC (marked out). 46-47. regis ipsius, ME, MK. 47-48. patris nostri in Hibernia Anglia, W. 48. Ins. ista data fuit per statuta de Merton, MH, CM. 49. LE omits all of this section. 50. Ins. supra, V, MD, CC, CF, LB, LT. 51. tamen, OF. 52. intensionem, V. 53. Om., MA. 54. Om., CE; ins. se, OB (above). 55. proposuit, W. 56-57. Om., OB.

contra¹ intentionem² excipere noluerit³, sed⁴ simpliciter se⁵ posuerit⁶ in iuratum de ingressu. Nunc⁷ autem⁸ si⁹ tenens¹⁰ excipere voluerit¹¹ contra intentionem¹². Inprimis¹³ necesse¹⁴ est¹⁵ quod petens¹⁶ intentioni¹⁷ suae¹⁸ fundamentum imponat, scilicet¹⁹ quod doceat²⁰ ad ipsum²¹ pertinere²² actionem²³, quod²⁴ ipse²⁵ tradiderit²⁶ ad terminum, vel aliquis antecessor suus, cuius heres ipse sit²⁷. Et non sufficit quod doceat²⁸ rem²⁹ ita³⁰ esse traditam per³¹ ipsum³² vel³³ antecessores suos³⁴, nisi ostendat³⁵ quod³⁶ tenens talem³⁷ habuerit³⁸ ingressum³⁹, et⁴⁰ per tales⁴¹, sicut⁴² ipse⁴³ dicit. Item non sufficit ita⁴⁴ proponere⁴⁵ et⁴⁶ fundare intentionem⁴⁷, nisi propositam et⁴⁸ fundatam⁴⁹ probaverit⁵⁰, cum simplici voce⁵¹ alienius⁵² non sit⁵³ fides⁵⁴ adhibenda⁵⁵.

Constitutis⁵⁶ igitur⁵⁷ partibus in⁵⁸ iudicio⁵⁹, aut habet⁶⁰ petens⁶¹ probationem⁶²

1-2. Om., MF. 1-6. Om., OB. 2. Ins. suam, V, OD, MA, MB, MD, MH (marked out), HB, CB (added above), CC, PH; ins. inprimis necesse est, OM (marked out). 3. voluerit, OG, MA, MD, MH, MK (corr. to noluerit), HB, CB (corr. to noluerit), CF, LT, P, W, Y. 4. si, MD; et si, CM. 4-12. Marked out, ME. 5-6. posuit se, OF, MG, MK (se in margin), LB, LD; imposuit se, W; possint se, CC. 6. posuit, X, MK. 7. non, OF, MG, MK, CC, W; sicut, MA. 8. Repeat, CE; ins. dicendum est, HA, V; ins. dicendum, LC, MD (above). 9. Om., ME; ins. above, MA. 10. petens, OF, MG, MK, CC, LB, LD. 11. Om., MF; noluerit, OG, MD, ME, MI, CC, LB, LC (corr. to voluerit in margin), LD, B, Y. 12. Ins. petentis, LC. 13. Et primis, CB (corr. to inprimis), B; ipsius, MM. 13-17. Om., HA. 14-15. est necesse, MA, MD. 16. tenens, CC, LB. 17. intentionis, MA. 18. Om., OF; sive, HA. 19. secundum, OC; sed, OG. 20. Ins. quod, MD; dicat, HA. 21. se, CB, HB. 22. pertinente, OB (corr. to pertinere); ins. debet, MD. 23. actio eo, MD (erasure and insertion). 24. quia, V. 24-25. scilicet quod, LD, W. 26. tradiderat, OB, MA, MN, LF, LG; tradidit, MB (corr. to tradiderat); tradidit, ME, MF, MH, MI (erasure), MM, CF, CM, LC, LT, P, X; tradidit, OM. 27. est, CC, CE, LB, LC, HA, X; est (marked out) sit, CF. 28. Ins. ad ipsum pertinere actionem quod ipse tradidit ad terminum, ME (marked out). 29-30. ita rem, CF. 30. Om., MH, CM. 31. vel, OC, OG. 32. ipse, OG. 33. Ins. per, OF, MG, MK, LB, X; om., CE. 34. Om., OG, MF. 35. ostendatur, CC; ostendens, CB (corr. to ostendat); doceat, X; ostenderit, OB, LF, LG. 36. Ins. above, LB. 37. talis, ME, MH, CM, CF, LT, P; talis talem, MF; om., CB (ins. above), LC. 37-38. habuit talem, HB. 38. habuit, OF, MA, MC, MD, MF, MG, CB, W, X, HA. 39. Om., MH, CM. 40. Om., CF, LT. 41. talem, OF, OM, MF, MG, MK, CC, LB, W, X. 42-43. Repeat, OG (marked out). 44. Om., MF. 45. pponere, OB; ponere, OC, OG, X. 46. Om., MK (ins. above). 47. Ins. suam, V, CC, LB, X. 48. Om., CF. 49. funditam, OG; fundatum, CE; ins. intentionem, MF. 50. Om., OA (ins. above), CE; propaverit, X. 51. voci, V, OB, OF, MB, MD, MG, MI, Y, LA, LC, OA (by corr. from voce), ME (by corr. from voce); voce voci (marked out), LG; uti, MK (corr. to voci); voce, other MSS. 52. Ins. cuius, MN (above); ins. cui, CF, HA. 53. est, LC. 54. dies, OA (corr. to fides), CE. 55. Ins. cum partes in iudicio comparuerint, OF, MG, MK, CC, LB, LD, W, X; ins. the *additio* "secundum—Murdae" (see n. 32, p. 160), V, PH. 56. Cum constitutis, OC, OG. 57. Om., CF. 57-59. igitur in iudicio partibus, HA. 58-59. Om., OB, MA, MB, MI, MN, LF, LG, Y. 60. habeat, ME (corr. to habet), MH, CM. 60-61. tenens habet, X. 61. Om., OC, OG, ME (ins. above); tenens, OB, MB, MD, MI (corr. to petens), MN, LF, LG. 61-1 next page. Om., MF. 62-18 next page. instrumentum partis adversae terminum testificans aut non habet. Si autem nullum habuerit instrumentum de termino, LE.

aut non habet¹, vel² non³ nisi sectam tantum, quæ⁴ non⁵ inducit⁶ nisi tantum⁷ præsumptionem, et quæ non⁸ sufficit, quia⁹ in¹⁰ contrarium admittit¹¹ defensionem per legem¹². Si autem nullam¹³ omnino¹⁴ habuerit¹⁵ probationem¹⁶ pro¹⁷ se¹⁸, videtur¹⁹ quod²⁰ tenens²¹ non habet²² necesse²³ ei²⁴ in²⁵ aliquo²⁶ respondere propter defectum probationis, quia²⁷ deficere²⁸ poterit²⁹ probatio licet ius³⁰ numquam³¹ deficiat. (Secundum³² quod probatur in itinere episcopi Dunelmensis³³ et Martini de Pateshull in comitatu Eboraci, anno regis³⁴ Henrici³⁵ tertio³⁶ de Reginaldo³⁷ Murdac³⁸.)

FOLIO 411b. CHAPTER XV *

Dictum³⁹ est⁴⁰ de exceptionibus⁴¹ quæ competunt⁴² contra⁴³ iurisdictionem. Nunc⁴⁴ videndum⁴⁵ si⁴⁶ sit⁴⁷ aliqua⁴⁸ quæ⁴⁹ competere⁵⁰ possit⁵¹ contra

* Collated for OA, OB, OC, OD, OE, OF, OG, OM, MA, MB, MC, MD, ME, MF, MG, MH, MI, MK, ML, MM, MN, CB, CC, CE, CM, LA, LC, LD, LF, LG, LT, B, P, W, X, Y, HA, HB.

1. habeat, CM. 2-3. Om., MD. 4. qui, OB; quia, CF, LT. 5. Om., OD. 6. iudicat, X. 7. Om., LC. 8. Om., ME (ins. above), MH, CM. 9. Om., PH. 10. ibi, LC, P, CM. 11. amittit, OB (corr. to admittit), OC, OD, OG, MB, ME, MF, MH, CM, LA (corr. to admittit), LD, LG, LF, PH; amittet, W. 12. Ins. secundum—Murdac (see n. 32-38), OG, MC, HB (as rubric), CB (as rubric), B (as rubric). 13. Om., CE; nulla, MF. 13-14. omnino nullam, OF, MG, MK, CC, LB, LD, W, X. 13-15. nullam habuit omnino, CB, HB. 14. Om., LC. 15. habuit, MC, W, X. 15-16. probationem habuerit, OB, MB, MI, MN, LF, LG, Y. 17. pro, OA, OB, OD, OM (erasure), HA, MA, MB, MC, MD, MF, MH, MI, MM, MN, CE, CM, LA, LF, LG, B, P, Y, PH; per, other MSS. 17-18. sed, CF, LT. 19. videre, CC, LB. 20. Ins. above, MI. 21. Ins. q, OB (marked out). 22. habeat, MC, LA; licet, MI. 23. Om., LA; a corr. in MK. 24-26. in aliquo ei, OF, OM, MF, MG, MK, CC, LB, LD, W, X. 25. Ins. above, MH. 25-26. In an erasure, MB. 27. quod, LA; ins. possit, V. 27-38. Om., LE. 28. defecerit, W. 29. Om., V; possit, CB, MF; potest, OB, MA, MB, MD, MI, MN, LF, LG. 30. Om., V; ins. ius, MK (marked out). 30-31. numquam ius, OM, ME, MH, P, CM. 31. non, OB, MA, MB, MD, MI, MN, LC, LF, LG, HA, Y. 32-38. This *addicio* is omitted in OB, OC, Y, OD, HA, MA, MB, MD, ME, MH, MI, MM, MN, CE, CF, CM, LC, LF, LG, LT, P; it is marginal in OA, LA; in V, PH, it is put at the end of sect. 1; OG, MC, HB (as rubric), CB (as rubric), B (as rubric), ins. after legem, l. 9, f. 320; V has it again at this place. 33. Dunleli in ession., OG; annolmensis, HB; de melinenses, MC; found also as Dunholmensis, Dunilmensis. 34. regni regis, OG, CB, B, PH; om., CC, LB. 35. Om., CB. 36. duo, PH; quarto, CC, LB. 37. Raghensilda, OA, HB, CB; Avenilde, OG; Regenilda, OM; Ragenilde, MC; Raginalde, MG; Aghenada, PH. 38. Murdake, Mordak, Mordoke, Mordas, are other forms. 39-41. Videndum est autem si aliqua exceptio sit, HA. 40. Ins. superius, LT; ins. supra, OA, MK, X, HB. 41. Ins. supra, OF, CC, HB, CB, B; ins. scilicet, MG. 42-49. Om., HA. 43. Om., MI. 44. Om., MK, X; Item, OF, MG, CB (nunc ins. above), CC, B; ins. autem, OG. 45. Ins. est, OE, MI, LC; dicendum est, LD. 46. a, OB; an, LF, LG. 46-47. sit si, X; sit si sint, MK; sit si sit, HB, CB, B; si si sit, MD. 47. fit, CC. 48. alia, OC, OG, CE. 49-4 next page. Om., HB. 50-51. possit competere, MA, MD. 51. posset, OA, CC; possunt, MK, X; potest, LT.

personam¹ iusticiarii² ut³ si aliqua⁴ ratione habeatur⁵ suspectus⁶, timore, odio⁷ vel⁸ amore, et⁹ non¹⁰ video¹¹ quare¹² debeat¹³ recusari¹⁴, quia¹⁵ si¹⁶ male¹⁷ iudicaverit ex certa¹⁸ scientia¹⁹ litem suam²⁰ facit, et tenebitur²¹ ad²² restitutionem²³ damnorum²⁴, cum²⁵ de hoc per²⁶ superiorem²⁷ fuerit convictus²⁸. Si²⁹ autem³⁰ per imperitiam, non³¹ sic³² sed³³ summoniri³⁴ poterit³⁵ quod veniat³⁶ et faciat³⁷ recordum³⁸, ut ea³⁹ quae⁴⁰ correctione⁴¹ indigent⁴², corrigantur⁴³, et⁴⁴ in⁴⁵ statum⁴⁶ debitum⁴⁷ reformatur⁴⁸. Melius tamen est⁴⁹, ut videtur, in tempore occurrere⁵⁰ quam post⁵¹ causam⁵² vulneratam⁵³ remedium quærere⁵⁴. Ut⁵⁵ suspectus amoveatur⁵⁶ et⁵⁷ ei⁵⁸ substituatur⁵⁹ non⁶⁰ suspectus⁶¹, cum⁶² nihil gratius⁶³ detur⁶⁴ inimico⁶⁵ quam⁶⁶ si⁶⁷ detur⁶⁸ ei⁶⁹ quis⁷⁰ adiudicandus⁷¹, quem⁷² damnificare⁷³ intendit⁷⁴,

1-2. iusticiarii personam, OA. 3. quod, W. 5. habebatur, MC; habetur, MG, MK. 6. suspicio, MF. 7. Ins. favore, OA, OF, MG, CC; hodie, LG. 8. Om., MG; ill., MK. 9. Om., MK, X; vel, OG. 9-10. nec, OM. 10. ideo, HA. 11. vidio, MK; vides, MC, ML; videt, OB, OD, OE, MA, MB, LG, Y; videtur, LF; videlicet, MF, HA, MN; vide, W; iudicio, OC, OG, CE, LA; in erasure, MD, MI. 12. qualiter, OA, OC, OF, OG, MG, MK, CB, HB, CC, CE, LD, B, X; quia, MA; quod, LF; ins. non, V, OD, OE, MB, MA, OB, MF, MI, LG. 13. debent, ML; debebat, MA. 14. recusare, HB, V; om., MK, X. 15-16. quasi, CM. 16. sibi, MD (corr. to si). 17. Ins. recu, W (marked out). 18. Om., MM. 19. seisina, HA. 20. suum, LT. 21. teneberet, MA; conebitur, HB. 22-23. restitutioni, W. 24. dominorum, ME, MH, CM. 25. causa, MB. 26. Om., HA. 27. superiores, OA, CC. 28. evictus, OE. 29-32 next page. Om., OG. 30. Ins. non, MC. 31. ne, V, OD; nec, MF. 32. sit, OC, OE, MC, MF, MI, MK, CE, LA, LD, LG, X. 33. Om., MA, MD (marginal), MF, LT, W. 34. summonitores, W; summoneri, LA; summonire, MG; sun., OA. 35. potuit, MG. 36. conveniat, ML. 37. facit, OA, MA, MD, MF, MK, CB, X, HA, HB. 38. recognoscendum, MK. 39. Om., MA, MD (ins. above); eam, LA. 40. Om., LF. 41. correctioni, MM; correxionem, MB; correctionem, MC, ME, MH, CC, P; correctiorem, OA. 42. iudicent, LT. 43. exiguntur, MB (corr. to corrigantur in margin). 43-44. Om., ML. 44. Ins. above, OB. 45. Ins. actum, OC, CE; om., OB, OE, MA, MI (ins. above), LG; an erasure follows in MD; a corr. in OM. 45-46. instant, HB. 46-47. statu debito, OA; stat. debit., OB, MK. 47. proprium, LT. 48. Om., ME; reformantur, MB. 49. esset, OA, OC, OF, OM, ME, MG, MH, MK, ML, MM, CB, CC, CE, CM, LC, LD, LT, B, W, P, X, HB; om., HA. 50. occure, OA. 51. postquam, MB. 52. cauem, V; om., MB (marginal). 53. vulneratum, OF; ulneratum, ME (corr. to vulneratum). 54. requerere, W. 55. Ins. si, MC, LA. 56. summoneatur, OB, OD, OE, MA, MB, MD (corr. to amoveatur), MF, MI (corr. to amoveatur), LF, LG, Y; sumoiatur, MN. 57. ut, B. 57-58. rei, MK. 58. eis, OA, OF, MG, HB, CB, CC, B, W; om., LD. 58-59. substituatur ei, OC, CE. 59. subtrahitur, HA. 60. nec, OC, CE. 61. suspecte, OC, CE. 62-74. Om., LF. 63. gravius, OA, OF, ML, CB, CC, LC, X, B; gravis, MK; gravis, MG, LD. 63-64. detur gratis, LG; detur gratius, V, OB, OD, OE, MB, MN; detur gravius, MA, MD, MF; detur gravis, MI. 63-68. detur gravius quam cum inimico detur, MD (in part erasure). 65. alicui, LD; intentio, OA, CC. 65-68. Marginal, CB. 66-67. quasi, MA. 67. Om., W, HB. 69. Om., OM, MD (erasure); eis, MA; erased, MI. 70. qui, OF, W; quo, LT. 71. adiudicandum, MC, MG, ML, HB, LA, LD; ad iudicium, MK, X, CE; ad incitandum, OM, ME, MH, MM, CM, P, W; ad imitandum, LT. 72. quam, OB, OC, OD, ME, MH, CE, CM, LG, W, Y; ei qui, MF; qui, MD (erasure and corr.), ML, LD. 73. damnare vel damnificare, ML; damnificatur, MK. 74. incendit, OC, B; vitandum, CM.

et¹ valde² meticolosa³ res⁴ est⁵ sub⁶ iusticiario⁷ litigare⁸ suspecto⁹, quia sæpius tristissimum¹⁰ sortitur¹¹ eventum¹². Causa¹³ vero¹⁴ recusationis¹⁵ unica¹⁶ est¹⁷ scilicet¹⁸ suspicio¹⁹, quæ consurgit²⁰ multis²¹ ex²² causis²³, scilicet²⁴ si iusticiarius sit²⁵ consanguineus²⁶ petentis²⁷, homo²⁸ vel subditus²⁹, parens vel³⁰ amicus, vel inimicus tenentis³¹, affinis³² vel³³ familiaris³⁴, vel³⁵ commensalis³⁶, consiliarius³⁷, vel³⁸ narrator³⁹ suus extiterit⁴⁰ in causa illa, vel⁴¹ in⁴² alia⁴³, et⁴⁴ huiusmodi.

In⁴⁵ fine notandum⁴⁶ de⁴⁷ iurisdictione⁴⁸ maiorum et⁴⁹ minorum⁵⁰. Et⁵¹ in primis⁵² quod⁵³ sicut⁵⁴ dominus papa in spiritualibus super omnes⁵⁵ ordinariam⁵⁶ habet⁵⁷ iurisdictionem, ita⁵⁸ habet⁵⁹ rex⁶⁰ in⁶¹ regno⁶² suo⁶³ ordinariam⁶⁴ in⁶⁵ temporalibus⁶⁶,

1. quia, LF. 2. ulde, OF. 3. meticolosa, OF, MG; meculosa, ME, MH; maculosa, MA, MD (corr. to maculosum, later to meticolosa res), CB (by corr. from meticolosa), HB, LD; periculosa, HA, MC, ML, W; miraculosa, LA; veticulosa, MB; ins. est, MK (marked out). 4. Om., MD, MG, HA. 4-5. est res, ME. 5-6. scilicet, OC, CE. 7. iudice, LC. 8-9. suspecto litigare, MA, ML. 9. suspectis, W; in suspecto, MK; suspicio, LT. 10. Ins. non, MD (above); an erasure, MI; certissimum, HB. 11. fortitur, MK, W; sortitum (corr. to sortitur), P. 12. Ins. Iusticiarius potest recusari ex causa, V, LT. 13. cum, MB, ME (erasure), MH, CM. 14. Ins. alias, OF. 15. Om., ML. 16. Om., LD; una, LT; unia, MF (corr. to unica); iniusta, OC, OG, CE; iuncta, LA; multiplex, OA, OF, MG, MK, CB, CC, B, X. 17. esse poterit, MK, X. 18. Om., OB, OD, OE, OF, MA, MB, MD, MF, MI, MN, LF, LG, Y, HA. 19. suspectio, LD; sispicio, MI. 20. sortitur, OA, CC. 21. ex multis, OF, ML, LC; iustis, MM. 22. de, OF, MG, CC; om., ML, LC. 22-23. modis, OA. 23. causa, OB, MB, MF, LG; caucis, LD. 24. Om., MN, LF. 25. si, ME; ins. non, MF (marked out). 25-26. consanguineus sit, MB. 26. consamgueneus, LD. 27-28. Om., MK, X. 28. fratri, OC, CE; frater, OG; heres, LD. 29. subditis, OB (corr. to subditus). 30. Om., MG, LT. 31. tenens, OA. 32. affinus, OA. 32-34. familiaris affinus, MK. 32-43. Om., HA. 33. Om., OA, OC, OF, OG, OM, MC, ME, MG, MH, MK, ML, MM, CB, CC, CE, CM, LA, LC, LD, LT, B, P, W, X, Y, HB. 35. Om., LT. 35-36. vel convitalis vel veritate, MK. 36. Ins. vel, OE, MI; commentalis, HB, CB, B, X; communsalis, ME, MH; coniungalis, OC, MD, CE; coniugalis, OG; commencalis, LD. 37. Om., OM, ME, MH, MM, CM, LT, P, W; consciarius, OB, OD, MF, LF, LG. 38-39. Om., MB, MK. 39. varator, MM. 40. excidit, MB. 41-43. Om., OM. 42. Om., OA, OC, OF, OG, MC, ME, MH, MK, ML, MM, CB, CM, CC, CE, LA, LC, LD, LT, B, P, W, X, HB. 42-44. Om., MG. 43. aliæ, LC, W. 44. Om., OA, OF, MK, CB, CC, LC, LD, HB. 45-50. Used as a rubric, CB, HB. 45-52. Inprimis notandum, B. 46. Ins. est, LC. 47-48. Repeat, MH. 48. Ins. iudicium, CB (above), HB. 49. vel, OF, MG, MK, CB, LD (corr. to et), X, HB. 50. Ins. et in, MI (marked out). 51. Om., CB, B, HB. 52. Ins. notandum, CB, B, HB. 53. Om., V, OB, OD, MA, MD, MF, MI, LD, LF, LG; quia, MB, MN, HA. 53-54. sicut quod, MK. 55. omnibus, V; omnes alios, OA, CC, Y; a corr. in LC. 56. Om., OA, CC. 56-57. habeat ordinariam, V; ordinarios habet, MA, OG, OM; ordinarias habet, MD; ordinariam habent, ME; ordinariam habeat, OF, MG. 57. Om., MB; habent, P. 58. Item, MD. 59. Om., ML, W. 59-60. rex habet, HA. 60. dominus rex, MN. 61. de, W. 62-63. suo regno, OA, MI; suo rengno, CC. 63. Ins. super, OC, OG, CE; ins. re, HA (marked out). 64. ordinare, OA; ordinari., CC; ordinarios, OM; ins. iurisdictionem, OA, OF, MG, CC, CM. 65. et, MK; ins. rebus, OA, CC. 65-66. Om., OC, OG, CE.

et pares non habent¹, neque² superiores³. Et sunt qui sub⁴ eis⁵ ordinariam⁶ habent⁷ in multis, sed non⁸ ita meram sicut⁹ papa vel¹⁰ rex. Et pares esse¹¹ poterunt¹² illi¹³ qui¹⁴ inferiores sunt¹⁵ in¹⁶ iurisdictione¹⁷ sua multis¹⁸ rationibus, sed¹⁹ par²⁰ in²¹ parem²² non habebit²³ iurisdictionem non magis quam imperium, et multo²⁴ fortius nec²⁵ in²⁶ superiorem²⁷.

FOLIO 413. CHAPTER XVII *

Confirmata sic iurisdictione²⁸ iudicis²⁹, consequenter³⁰ audiatur breve per quod expediri³¹ et³² exponi³³ debet³⁴ ius actionis³⁵, quo audito, perpendere³⁶ poterit³⁷ tenens³⁸ an³⁹ ex⁴⁰ ipso⁴¹ brevi⁴² ei competere⁴³ possit⁴⁴ exceptio, quia⁴⁵ multæ⁴⁶ sunt⁴⁷ exceptiones⁴⁸ quæ competunt⁴⁹ tenenti⁵⁰ contra⁵¹ breve. Oportet quidem⁵² quod⁵³ breve⁵⁴ conveniat⁵⁵ actioni⁵⁶, et quod in⁵⁷ suo⁵⁸ casu⁵⁹ impetratum⁶⁰ sit, alioquin⁶¹ non valebit. Verbi gratia: si magnum breve

* Collated for OA, OB, OC, OD, OF, OG (fragmentary), OM, MA, MB, MC, MD, ME, MF, MG, MH, MI, MK, ML, MM, MN, CB, CC, CE, CM, LA, LC, LD, LF, LG, LT, B (in part), P, W, X, Y, HA, HB.

1. habet, V, OA, OG, OM, MA, MD, MF, MM, MK, CC, LD, X, HB. 2. Om., OB, OD, OE (nec ins. above), HA, MB, MI, MN, LF, LG; in, MC. 3. superius, MC; superiorem, MK; om., LF. 4. ab, W. 5. ei, MK. 6. ordinarios, OM (corr. to ordinariam). 7. habet, X. 8. Om., MB. 9. ut, LT. 10. et, OE, MA, MD, MI, Y. 11. Om., MB; erit, OB; ins. non, MA (above), MF, MK. 11-12. poterunt esse, MG, W. 13. Om., MG; illis, OM, MA, MF, MI, CC, LF, LG; illas, MB; ill., OB, OD, OE, MD. 14. Ins. infero, OF (marked out). 15. sint, B. 16. Om., MN. 17-23. Om., P. 18. in multis, MG; ins. mo, MN (marked out). 19. si, OB, MM; corr. to quia, MD. 20. Om., OA, OF, MG, CB (ins. above), CC, B. 21. Om., MK, X. 21-23. non habebit in parem, LC. 22. partem, OF, MC, MG, CC; tempore, OA; paran, LG. 23. habet, HA, MA, MD, MF, ML; habebunt, OA, OF, MG, CC; ins. imperium, HA (marked out). 24. multum, B; mult., CB, HB. 25. Ins. above, MA. 26. ut, X; nisi, OA; om., MD (ins. above), LD. 26-27. inferiorem, MF; inferiores, OC, CE; superiores, OG. 28. Corr. to iurisdictione, OC. 28-29. iudicis iurisdictione, CM. 29. iudicium, OM, LC, LT, W; iudicio, LF; iusticiarium, MK; iudic., OB, MM, CB, P, X, HB. 29-30. iurisdictione sequentis, OA. 30. consequentes, HA; consequentis, CC; om., MN. 31. expetiri, OG; ins. debet, OF, MD; ins. poterit, OC, OG, LD, CE; ins. potest, MG (marked out). 32. Ins. above, OF. 33. poni, CM. 34. Om., OF, MD; dicitur, ML. 35. accessionis, MI (corr. to actionis). 36. perpendi, OB, OD, OM, MF, LF, LG. 37. potest, MK, X. 38. Om., LT. 39. Om., MN. 40. in, LC, W. 41. ppo., W; po., MM. 42. Om., OB, OD, MA, MD (ins. above), MF, MI (ins. above), LF, LG; ins. si, MN. 43-44. competere, MN. 44. poterit, V, MC, ME, MF, ML, LA. 45. vel, W. 46. multi, B; mulre, OB. 47. autem, ML. 47-48. exceptiones sunt, LC, W. 49. competant, MD. 50. petenti, CB (corr. above), B, X. 51. Om., CM. 52. Om., W. 52-53. quod quidem, MG. 53. ita, OD, MF. 54. dicere, MF. 55. convenient, MF. 56. actionem, OD; ins. aliquando, MK (marked out). 57. Om., OA. 58. illo, LT. 59. Om., OD, CC. 60. inpetratus, ME (corr. to impetratum); ins. suum, MH (marked out). 61. aliquando, MK, W; alias, X.

de¹ recto patens² impetratum³ fuerit⁴ ubi⁵ parvum⁶ breve⁷ clausum impetrari⁸ deberet⁹ in dominicis¹⁰ domini regis¹¹ secundum¹² consuetudinem manerii, et¹³ sic cadit¹⁴ breve¹⁵, licet¹⁶ actio¹⁷ non cadat¹⁸ vel¹⁹ e²⁰ contrario²¹. Et²² nihilominus²³ redire poterit ad aliud²⁴ breve de recto quod competit²⁵ casui²⁶, non obstante eo quod prius egerit²⁷ cum brevi quod²⁸ non²⁹ competiit³⁰, quod³¹ pro³² nullo reputatur³³. Ut³⁴ de itinere R.³⁵ de Turkeby³⁶ anno³⁷ regni³⁸ regis³⁹ Henrici⁴⁰ XXIX⁴¹ comitatu Notinghamiæ⁴². Item si ordo brevium⁴³ non⁴⁴ observetur⁴⁵ ubi⁴⁶ alicui⁴⁷ plures⁴⁸ competunt⁴⁹ actiones⁵⁰, et⁵¹ primo⁵² agere⁵³ inceperit⁵⁴ per breve de⁵⁵ recto⁵⁶ super ipsa⁵⁷ proprietate, videlicet⁵⁸ super⁵⁹ ipso⁶⁰ iure⁶¹ et⁶² possessione simul⁶³, non⁶⁴ poterit⁶⁵ postmodum descendere⁶⁶ ad inferiores actiones de ipsa⁶⁷ possessione⁶⁸,

1-2. patens de recto, OC, OF, OG (petens), OM, MB (petens), MC, ME, MG, MH, MK, ML, MM, CM (rectum), MN, CB, CE, LA, LC, LD, LT, B, P, W, X, Y, HA, HB. 2. Om., OA, MD. 3. impetrandi, MK (corr. to impetratum). 4. sit, OF, MG, MK, CB, CC, HB, B, X; sibi, OA. 5. per, MA; ins. per, CM, CB (marked out), HB. 6. per unum, LC, P (corr. above), W. 7. Ins. above, CM. 8. impetrati, B. 9. debet, OA, MF, MG; debent, OB. 10. dominico, OA, OF, MG, CB, CC, HB, B; curia, OC, OG, CE; om., MI (ins. above). 11. Om., MB, MD (ins. above). 12. Om., CM. 13. Om., LD. 14. cadet, CM. 15. Om., OA, OF, MG, CB (ins. above), CC, B. 16. sicut, X. 17-18. non cadat actio, MD. 18. cadit, MM. 19. et, LC, W. 19-21. Om., MC, LA, LD, LF; repeat, CM. 20-21. econverso, OM; MSS. generally abbreviate. 22. cum, OC, CE; om., OF, MG. 22-23. Om., MI (ins. above). 22-l. 4, f. 413b. Om., OG. 23. Ins. econtrario, MG. 24. Om., MK. 25. competat, CB, HB, B; competiit, ME; ins. suo, MD (marginal). 26. ei, OA, OF, MG, CC; casu, MD (corr. to casui); tamen, MF. 27. egit, V; om., CC. 28. Om., OA, OF, MG, MH, CM, CC. 29. Om., LT. 30. competit, OM, MD, CB, MH, LC, LD, P, HB, HA, CM, W; competenti, OA, OF, MG, CC. 31. et, OA, OF, MG, MK, CB (ins. quod above), CC, B, X; et quod, MD (et ins. above), LC, HB. 32. Om., B, MK. 33. computatur, V, MB. 34-42. Om., OA, OF, MG, MK, CB, CC, LF, B, X, HB. 35-36. W. de Raleigh, V, OB, LG, OD, MA, MB, MD, MF, MI, MN, HA, B, Y. 36. Kirkeby, ME, CM. 37. Om., MC. 38. Om., OB, OM, MA, MB, MD, ME, MF, MH, MI, ML, MM, MN, CM, LA, LC, LG, LT, P, Y, HA. 39. Om., LD. 40. Om., CE, OC, MI. 41. XXX, OB, OD, MA, MB, MD, MF, MI, MN (ins. above), LG, W, Y, HA, LC; ins. in, V, OC, MC, ML, MM, MN, CE, LA, LD, Y, HA. 42. Northyngham, MN. 43. Om., OB. 44. Om., OB, MA. 45. observatur, OB, OD, MA, MF, LF, LG; ins. ut, OM (above). 46. ut si, V. 47. aliter, OF; om., MB. 48. Ins. alicui, MN. 48-49. competunt plures, OA, OF, MG, MK, CB, CC, HB, B, W, X; competant plures, MA, MD. 48-50. competunt actiones plures, ML. 49. competant, V, OB, OD, MB, MF, MI, MN, HA, LF, LG. 50. actione scilicet, P; actiones scilicet, ME, CM, MH; om., MN. 51. Om., ME. 52. prius, OA, OF, MG, MK, CB, HB, CC, B, X. 53. Om., CC. 53-54. inceperit agere, HA. 54. incepit, V, OB, OD, MF, MI, LF, LG, Y; inciperit, MH; incipit, MA, MD (corr. to inciperit). 55-56. Om., OB, OD, MA, MF, MI, LF, LG. 56. Ins. et, MM. 57. ipsius, MA, MD; ista, LA. 58. vel, V, OD; scilicet, OA, OF, CC; videtur, OB, LG, MF; et, LF; om., MG. 59. Om., OA, CC. 60. Om., ML. 61. Ins. scilicet, MG. 62. in, CE, OC; ins. above, LT. 62-63. Om., LF. 63. Om., MA; similiter, ML, MN. 63-68. Om., OA, LA. 64. nec, MK, X. 64-68. Om., W. 65. potest, LT; poterunt, CM. 66. transcendere, OD, MF. 67-68. possessione ipsa, MB.

quod¹ si² fecerit cadit actio³ de⁴ ipsa⁵ possessione⁶ simul⁷ cum⁸ brevi⁹. Sed¹⁰ licet¹¹ processum¹² sit¹³ per¹⁴ breve de recto quousque visus¹⁵ petatur¹⁶, ex pœnitentia poterit petens¹⁷ reverti¹⁸ ad inferiora placita¹⁹ sicut²⁰ ad²¹ assisam novæ disseisinæ, et²² mortis antecessoris²³, et²⁴ alia²⁵ placita²⁶. Ut²⁷ de termino²⁸ Paschæ anno²⁹ regis Henrici³⁰ duodecimo³¹ comitatu Berkeriæ³² de Henrico de³³ Scaccario³⁴, quia³⁵ ibi³⁶ descensum³⁷ est³⁸ ad³⁹ assisam novæ disseisinæ⁴⁰ post⁴¹ breve de recto⁴². De⁴³ ordine brevium⁴⁴ satis⁴⁵ perpendi poterit⁴⁶ per⁴⁷ ea⁴⁸ quæ⁴⁹ supradicta⁵⁰ sunt⁵¹. Item cadit breve si⁵² super modo et qualitate alicuius facti impetratum fuerit⁵³ breve⁵⁴, ubi⁵⁵ impetrari⁵⁶ deberet⁵⁷ super ipso⁵⁸ facto, per quod terminari posset⁵⁹ utrum⁶⁰ tam⁶¹ ipsum factum⁶² quam⁶³ modus et qualitas, quia semper debet⁶⁴ prius⁶⁵

1-6. Om., ME, MH, CM, ML; repeat, OF. 1-9. Om., LD. 2. Om., OB, OD, MF, LG. 3. Ins. simul, OB, OD, MF, LF, LG. 4-6. Om., MN (ins. above). 5. illa, OA, CC. 7. Om., V, OB, OD, MF, LF, LG. 8. Ins. illo, OA; ins. ipso, W. 9. breve, ME. 10. et, OA, OM; om., OF. 10-11. scilicet, OD, MF. 10-42. Om., LF. 12. processus, MB. 13. Om., MA (ins. above after licet). 14. Om., MD. 15-16. petatur visus, OA, OF, MG, CC. 16. portatur, MN (corr. to petatur); fiat, LD. 17. tenens, OA, OC, CE, CC, CM, MD (corr. to petens above). 18. descendere, OB, OD, MA, MB, MD, MF, MI, MN, Y, LG, HA. 19. Om., MB. 20. Om., X. 20-26. Om., LT. 21. Om., OD, MF, MI, CB, B, HB. 22. Om., V. 22-40. Om., HA. 23. antemortis, MG. 24. Ins. ad, OC, CE. 24-25. Om., OM (ins. above). 24-26. Om., OA, OF, MG, CC, LD, B, CB (marginal). 26. plura, V, OM; pla., OB, MB, LA, LG, LT, W, Y. 27-42. Om., OA, OF, MG, CC, B, CB (marginal), HB. 28. LD leaves a space of one column at this point; itinere, CM. 29. Ins. regni, OC, OD, CE, X, Y, V. 30. Om., MI. 31. Ins. in, V. 32. berch barker, LD; herk., OB; bereke, MC; de Berke, MK. 33. Ins. above, MK. 34. Usually either Scaccario or Siccario or abbreviation for same; Sutar., MA, MB, MK, X; Succario, MI; Siccarit, OB. 35. qui, ME; et, MM. 36. Om., MB. 37. decensus, MA; dessensum, LD. 38-39. cum, OB. 41. per, OC, CE, CM, LC, X. 42. Ins. per ea quæ supradicta sunt, MC, LA. 43-51. This sentence, an *addicio*, is inserted at this place by V, OB, OD, MA, MB, MD (which has also as OC), MF, MI, MN, LD, LG, Y; it is omitted in OM, HA, LF, LT; the other MSS. insert just before Sed licet processum sit above (in MC and LA the *addicio* is divided into two parts one of which is put at either place); satis de, OA, OF, MG, MK, CB, HB, CC, B, X; quia de, LC. 43-45. Om., LD. 44. brevi, MN. 45. Om., OA, OF, MG, MK, CB, CC, B, X, HB; et cum, CM. 46. possit, V. 47. de, CC. 48. eum, OB, LG. 49. qu, MN; om., LD. 50. prædicta, OC, CE, MD (first passage). 52-54. Om., LD. 53. fuit, HA. 54. Om., ME. 55. nisi, OB, LG, MB. 56. impetrare, ML, LD, W (corr. to impetrari); ins. non, OA, OF, MG, MK, MN, CB, HB, CC, B, X. 57. debent, OB; debuit, HA. 58. illo, MD. 59. potest, V, MA, MD, MF, MI, OB, LG, LF, OD; poterit, HA; possit, OC, OF, CM, MC, ME, MH, MK, CB, CE, LA, HB. 60. utrumque, OC, OM, ME, MH, MK (corr. to utrum), CM, ML, MM, CE, LC, LD, LT, P, W, X, Y, HA. 61. tantum, MF; tamen, MB. 62. Om., MB. 63. quod, MI (corr. to quam). 64. Om., MF. 64-65. prius debet, OC, OD, MC, ME, MI, ML, MM, MN, CE, LA, LC, LF, LG, HA, LT, P, Y; prius deberet, W. 64-1 next page. terminari debet prius, MG; terminare debent prius, MK; terminare debet prius, OA, B (corr. to determinar.), CC, X; terminare deberet prius, OF; determinare debet, HB; prius terminari debet, MB, CM, MH. 64-2 next page. terminare (corr. to determinare) debet, CB. 65. Om., MA, MD (ins. above); marginal, CB.

terminari¹ principale², cum quo³ terminari⁴ poterit⁵ accessorium⁶. Verbi gratia: si quis disseisitus fuerit⁷ de aliquo tenemento cum⁸ violentia⁹ et¹⁰ armis¹¹, et¹² impetraverit¹³ breve *Quare vi¹⁴ et armis¹⁵*, valere non debet¹⁶ breve¹⁷, quia¹⁸ per hoc agitur de¹⁹ qualitate²⁰ disseisinæ²¹ et non de²² ipsa re, videlicet²³ de ipso²⁴ tenemento pro²⁵ quo²⁶ fit²⁷ violentia²⁸, nec²⁹ acquirit³⁰ querens³¹ aliquid³² de ipso³³ tenemento. Sed si plura³⁴ brevia³⁵ impetrata fuerint³⁶ de uno³⁷ facto³⁸ contra aliquem³⁹ quod⁴⁰ sub se plures⁴¹ contineat⁴² actiones⁴³, sicut plures⁴⁴ disseisinæ⁴⁵, et⁴⁶ uno brevi et⁴⁷ una actione terminari⁴⁸ possint⁴⁹, si⁵⁰ sic⁵¹ agatur⁵², tamen⁵³ propter hoc⁵⁴ alia⁵⁵ brevia non cadunt⁵⁶ neque⁵⁷ actiones, sed terminantur⁵⁸, et⁵⁹ extunc erunt huiusmodi brevia supervacua⁶⁰. Et notandum quod esse⁶¹

1. determinare, W, MA (determinar.); terminare, MD, ME (corr. to terminari). 2. principali, MI; principalis, X; principal., MG, MK. 2-3. Marginal, CB. 2-4. Om., OM (marginal). 4. terminare, OA, OF, OC, CC, CE; om., HB, CB. 5. possit, OA, OD, MF, MG, MK, MN (corr. to posset), CC, LF, LG, X; non possit, OB; posset, MB, MI, Y; ins. ipsum, HA. 6. Om., OC, CE; antecessorium, OM; antecessor, MG; antecessorum, OF. 7. Marginal, LD. 8. per, OA, CC. 9. violentiam, OA, CC; violentam, CB, HB. 10-11. Marginal, MI. 12. Om., OA, OC, OF, MG, MK, CB (ins. above), CC, CE, B, X. 12-15. Om., OB. 13. impetravit, OA, MC, MK, ML, CC, LA, W, X. 14-15. vicarium, OF. 16. deberet, HA. 17. Om., OB, OD, LG, HA, MA, MB, MD (marginal), MF, MI, MN, LF, Y; ins. above, HB. 18. Om., OF; quia quia, OB; et, MH. 19-20. ad qualitatem, OA, OF, MG, MK, CB, HB, CC, B, X. 21. disseisitorum, OA; disseisitoris, CC; disseisitor., OF, MG, HB, CB, B; diss., MK; dissois., X. 22. Om., OD, ME, MH, CM, P. 23. scilicet, OA, CC. 24. Om., OA, OC, OM, MB, MC, ME, HA, MH, ML, MM, MN, CC, CE, CM, LA, LC, LD, LT, P, W, Y; illo, OB, OD, MA, MD, MF, MI, LG. 25. de, MG; per, OB, LG, OD, MF, MK, LF. 26. quod, OD, MF, LF. 27. Ins. ipsa, CM; fiat, V; sit, LD, LF; fuit, OA, OF, MG, MK, CB, HB, CC, LT, B, X. 28. violentam, HB. 29. ut, OA, MA, MD (corr. above); non, MI (corr. to nec above). 30. acquiret, MG; acquirens, OA, CC. 31. tenens, ML; queret, OA, CC. 32. sibi aliquid, LC; aliquid sibi, OM; aliud, OA, CC. 33. illo, MF. 34. plurium, X; ins. placita, CM (marked out). 35. Ins. et, LA. 36. Om., OB, LF, LG; fuerunt, LD; sunt, OA; sint, CC; ins. de ipso tenemento vel, LD (marked out). 37-38. facto uno, ML; vi facta, OA, OF, MG, CC. 39. aliquam, OB, OC, CE; aliquod, OD, MF. 40. qui (corr. to quod), MD; quæ, OC, CE; om., W. 41-42. contineat plures, V, OB, OD, MA, MB, MD, MF, MI, MN, CM, LF, LG; teneat plures, W. 42. continet, MK, X. 43-44. Om., MF. 45. disseisitores, MG, X; disseisinæ, CM; disseisitorum, OA; disseis., LD; disseisitor., OF, MK, CB, HB, B; diss., CE, CC, W, MF, MD. 46. Om., MF, LC; ins. in, V, OB, OC, HA, OD, MA, MB, MD, MF, MI, MK, MN, CB (marginal), HB, CE, LF, LG, X, Y; in, CM. 47. Ins. in, OB, OD, MA, MD, MF, LF, LG. 48. terminare, HB, CB. 49. possit, V; possunt, OC, ME, MK, CE, HA, CC, LC, W, X; non possint, LT. 50. Om., OC, CE; et, OA, OM, ME, MH, LA, LC, LT, MM, P, CM, W. 50-51. sic si, LF, LG, OB, OD, MB, MF, MI, MN; sicut si, MA, MD (corr. to sic si); sed si, HA. 52. agitur, MA, MD (corr. to agatur), LD. 53. cum, MK, X; tunc, OA, OF, MG, CB, HB, CC, B. 54. Om., OA, OF, MG, MK, CB (ins. above), CC, B, X. 55. aliqua, OB, OD, MA, MD, MF, MI, MN, LF, LG, Y, HA. 56. cadit, MK. 57. nec, V. 58. terminatur, MA, MK; terminabitur sic negotium, LC. 59. Om., HA, CM. 60. super natura, LT; supervacuata, MH, CM, ME. 61. omne, OC (corr. to esse above).

poterit¹ exceptio² peremptoria brevis³ et non iuris⁴, quia⁵ quandoque⁶ vertitur⁷ una actio in⁸ aliam⁹ propter privilegium heredum¹⁰ ad rem consequendam¹¹, et cadit omnino¹² breve¹³ super ipsa possessione, et retorquetur¹⁴ ad ipsum ius, sicut¹⁵ assisa mortis¹⁶ antecessoris non iacet inter¹⁷ coheredes et personas sanguine coniunctas, sed breve de recto¹⁸. Item¹⁹ peremptoria²⁰ esse²¹ poterit²², tam²³ brevis quam ipsius iuris²⁴, per²⁵ exceptionem²⁶ rei iudicatæ²⁷, recognitionis²⁸ et²⁹ remissionis³⁰ et³¹ quietæ³² clamantiæ³³. Et in omni casu³⁴ ubi perimitur³⁵ actio³⁶ perimitur³⁷ et³⁸ breve³⁹, sed⁴⁰ non e⁴¹ contrario,⁴² ut⁴³ prædictum est⁴⁴.

Breve quidem⁴⁵, cum⁴⁶ sit⁴⁷ formatum ad⁴⁸ similitudinem⁴⁹ regulæ⁵⁰ iuris, quia⁵¹ breviter et⁵² paucis⁵³ verbis intentionem proferentis⁵⁴ exponit⁵⁵ et explanat, sicut⁵⁶ regula⁵⁷ iuris⁵⁸, rem⁵⁹ quæ⁶⁰ est⁶¹ breviter enarrat⁶². Non tamen⁶³ ita breve⁶⁴ esse⁶⁵ debet⁶⁶ quin rationem⁶⁷ et vim intentionis contineat⁶⁸. Et sunt quædam brevia formata⁶⁹ super certis⁷⁰ casibus,

1. poterunt, CB, HB, B. 2. exceptiones, CB, HB, B. 3. brevi, CC. 4. veris, CE; an erasure and correction in OC. 5. Om., MF; et, ME. 5-6. Item, LD. 7. vertatur, OC, CE. 8-9. Om., CC. 10. heredis, V, OD, MG; heredem, MK; hered., OA, OC, OF, MA, MC, MD, MF, MM, LF, CC, CB, HB, CE, X. 11. consequendum, OD. 12. Om., MK. 13. Ins. omnia, MK. 14. extorquetur, LG, OB, OD, MA, MB, CB (by corr.), HB, MD (corr. to retorquetur), MF, MI (corr. to retorquetur), MN, LF, X; torquetur, W; extorquere, MK. 15. si, OA, OF, MG, CC, B; sic, LT; fit, MC. 16. Om., LD. 17. Repeat, Y. 18. proparte, LD. 19. Item quod, HA. 20. per emptorem, MK. 21. esset, ML. 21-22. poterit esse, OA, OF, MG, MK, CC, X. 22. Ins. exceptio, LC. 23. causa, LG, OB. 24. iurisdictio, OG (corr. to iuris). 25. Om., OM, ME, MH, CM, MM, LT, P, W. 26. exceptio, OM, ME, CM, MH; ins. ipsius, CB, B, HB. 27. Ins. et, MA; iudicare, MG. 28. recognitio ius, ML; recognitiones, V; cognitionis, OG. 28-29. Om., W. 29. Om., OA, OF, OM, MA, MB, MC, MD, MG, MH, MI, ML, MM, MN, CC, CB, HB, CM, LA, LC, LD, LT, B, P, Y, HA. 30. remissiones, V. 30-31. Om., OC, OG, CE. 31. Om., X; repeat, B. 32. quietum, V; quietæ, OC, OG, CE; inquiete, X; quiet., OA, OF, MG. 33. Om., OC, OG, CE; clamationis, MA, MK, CB, HB, LC, W; clamat., X; clam., OA, OF, MD, MG, CC, B, LD. 34. Om., MA. 35-36. perimuntur actiones, OC, OG, MD, CE. 36. Ins. et, OG. 37. Om., OM; perimituri, MC; perimuntur, MD, OC, CE. 38. Om., V, OA, OG, MA, MF. 39. brevi, MH; brevia, MD (by corr.). 40. et, MK, X. 41-42. e converso, OM; MSS. generally abbreviate; exceptio, MG. 43-44. Om., OG, HA. 45. quidam, ME; autem, MF. 46. est, MG; est cum, HA; tunc, LT; non, CM. 47. si, OA; sic, MG, CM. 48. Ins. modum regulæ vel ad, MK, X. 49. similitudinem, B. 50. ratione, MA. 51. Repeat, MI (marked out); om., LD; quæ, OA, OF, MG, CB, HB, CC. 51-58. Om., MK; et, X. 52. in, OG. 53. privatis, LD; ins. et, HB. 54. Om., LD; conferentis, OC, OG, CE. 55. exponat, LD. 56. quia, MF. 57. in actione, OC, OG, CE; regulam, HA. 58. Ins. et, OG, X, MK; ins. ut, OC, CE. 59. ratione, OA, OF, MG, CB (corr. above to rem), CC, B. 59-62. Om., HA. 60. quæ ut, MF. 60-61. certam, OG. 61. Ins. certam, OC, CE. 62. narrat, W. 63. tangit, OA, CC; ins. above, MI. 64-66. debet esse breve, W; esse debet breve, OG, OM, ME, CM, MH, LC, P. 65-66. debet esse, ML. 66. debeat, V, HA. 67. rationis, MA, MD; rationem ponit, ML. 68. conveniat, MF. At this place X repeats the last sentence of the preceding paragraph. 69. for, LA (an erasure). 70. ceteris, OM, ME, MH, MM, CM, P; ins. actionibus, OG (marked out).

et¹ de cursu² et³ de⁴ consilio totius regni concessa⁵ et approbata⁶ quæ quidem⁷ nullatenus mutari⁸ poterunt⁹ absque consensu¹⁰ eorum¹¹ et¹² voluntate¹³. Sunt¹⁴ etiam¹⁵ brevia ex¹⁶ eis¹⁷ sequentia¹⁸ quæ dicuntur iudicialia¹⁹, et sæpius variantur²⁰ secundum varietatem placitorum²¹ proponentis²² et²³ respondentis, petentis²⁴ et excipientis²⁵, secundum varietatem²⁶ responsionum²⁷. Sunt etiam²⁸ quædam²⁹ quæ dicuntur³⁰ magistralia³¹, et sæpius variantur secundum varietatem³² casuum³³ factorum³⁴ et querelarum³⁵. Et³⁶ quorum³⁷ quædam sunt personalia³⁸, quædam³⁹ realia⁴⁰, quædam mixta⁴¹, secundum⁴² quod sunt⁴³ actiones⁴⁴ diversæ et⁴⁵ variæ⁴⁶, quia tot erunt⁴⁷ formulæ⁴⁸ brevium⁴⁹ quot sunt genera⁵⁰ actionum⁵¹, quia non⁵² potest quis⁵³ sine brevi⁵⁴ agere⁵⁵, cum non teneatur alius⁵⁶ sine⁵⁷ brevi⁵⁸ respondere⁵⁹ nisi gratis⁶⁰ voluerit⁶¹, et ex⁶² hoc ei⁶³ non⁶⁴ iniuriatur, cum⁶⁵ volenti⁶⁶ et⁶⁷ scienti⁶⁸ non fiat⁶⁹ iniuria. Item⁷⁰ cum⁷¹

1. Om., V. 1-6. Om., OG. 2-4. Om., LC. 3. Om., ML. 4. Ins. communi, V, MK, X; om., MB, MG, LT, MF, HA. 5-6. approbata et concessa, HA. 6. comprobata, MF. 7. quidam, MB. 8. mutare, OA, OF, CC; ins. debent, Y (marked out). 9. possunt, OF, MA, MD, MG, LF, LG, LT, W; poterint, V, LD; poterit, MC, MK, LA. 10. contraria, OA, OC, OF, OG, OM, MC, ME, MG, MH, ML, MM, CB, HB, CC, CE, LA, LC, LD, LT, B, P, W; consensu, V, OD, MA, MB, MD, MF, MI, MK, LG, HA, MN, LF, X, Y; consensu de, OB; communi, CM; ins. et, V. 11. eorum, MA, MD, CM, MH, ML, LC, W; earundem, ME. 12. sic, OB, OD, MA, MB, MD, MF, MI, MK, MN, HA, LF, X, Y, LG. 11-13. voluntate eorum, V. 14. Om. through falsitatem, l. 26, f. 413b, OG. 15. Om., OC, CM, HB, CE; in, OA. 16. Om., LT. 17. hiis, OA, CC. 18. consequentia, MK, X. 19-30. Om., MB. 20. narrantur, B. 21. placiti, CM, MH, ME, MM; responsionum, MC. 22. proponentur, MK. 23-24. Om., HA. 24. ponentis, MF. 25. Ins. et, OC, OF, OM, MC, ME, MG, MH, CM, MK, ML, MM, CB, HB, CE, LA, LC, LD, LT, B, P, W, X. 26-27. responsionum varietatem, LC. 27. responsionem, MC, LA; responcionum, OC, CE. 28. autem, MI. 29. quidam, CE. 30. Ins. et, W. 31. matrimonialia, HA, MM; materialia, ME; viragistralia, X; magnalia, Y. 32. diversitatem, OC, OM, MC, ML, MN, MM, CE, LA, LC, LD, LT, P, W, Y. 33. Om., OB, OD, MA, MB, MD, MF, MI (ins. above), LC, LG, LF; ins. et varietatem placitorum, MN (partly marked out). 34. Om., MI, LD. 35. Ins. factorum, MI. 36. Om., OC, MG, CE, LT. 37. Om., V, OB, OD, LT, MF, LF, LG. 38. Ins. et, OA, OM, MB, ME, MF, MH, MM, CC, LC, LT, P, W, X, CM. 39-40. Om., V. 40. Ins. et, OF, MG, LC, X, Y. 41. mixtæ, OB, LG, HA, OC (corr. to mixta), OD, MB, MC, MD, ME, MF, MH, MI (corr. to mixta), CM, MK, ML, MM, MN, CB (corr. to mixta), CE, LA, LC, LD, LF, LT, P, W, X, Y, HB (corr. to mixta). 42. sed, LA. 43. sint, ME, MH. 44. Ins. variæ, MH (marked out); ins. et, X. 45. vel, MM, LC, LT, P; ins. above, ME. 46. Ins. quædam, MC, LA. 47. sunt, MA, MD. 48. formæ, MF. 49. Om., CC; breveum, MC. 50-51. generationem, W. 51. Ins. et, ME. 52. nobis, OF (corr. to non). 53. aliquis, MM. 54. breve, MI. 55-58. Om., OA. 56. aliquis, OM, MD, MG, MI (a corr.), MK, X; alii, MA (corr. to alius), MF; om., OC, CE. 57-59. respondere sine brevi, ME. 60. Ins. hoc, MN (marked out). 61. noluerit, CM, MM. 62. Om., OA. 63. sibi, OF, OA, MG, MK, CC, X; si, CB (corr. to ei), B. 64. Om., OB. 65-68. cum scienti et volenti, V, HA, OB, OD, MA, MB, MD, MF, MI, MN, LF, LG, Y. 66. violenti, ME. 67. in, MI (corr. to et). 69. fiat, OC, OM, MC, MD (a corr.), CM, MH, MM, CE, LA, LD, P, W, Y; sit, MK, LF; fit, other MSS. 70. Om., OA. 70-71. Et sciendum quod, OM.

de¹ eadem² re³ alicui¹ plures⁵ competunt⁶ actiones⁷, eodem⁸ modo⁹ competunt¹⁰ ei¹¹ plura¹² breviam¹³, sed¹⁴ uno oportet¹⁵ experiri¹⁶ sicut una actione¹⁷, ordine¹⁸ tamen¹⁹ ut²⁰ convenit²¹ observato. Breve²² quidem²³ domini²⁴ regis²⁵ in se nullam²⁶ continere²⁷ debet²⁸ falsitatem²⁹. Item³⁰ nullum³¹ errorem³². Apparere³³ etiam³⁴ debet³⁵ in prima³⁶ sui³⁷ figura³⁸ maxime si³⁹ fuerit⁴⁰ patens⁴¹ sive⁴² apertum⁴³, quia originalium⁴⁴ quaedam aperta⁴⁵ et⁴⁶ quaedam clausa⁴⁷, et⁴⁸ sive⁴⁹ clausa⁵⁰ sive⁵¹ aperta⁵² apparere debent⁵³ non abrasa⁵⁴, non abolita⁵⁵, et si⁵⁶ invenitur abrasio⁵⁷, tunc⁵⁸ refert quo loco⁵⁹ et⁶⁰ a quo et quando⁶¹. Quo⁶² loco⁶³, utrum⁶⁴ videlicet⁶⁵ in narratione facti⁶⁶ vel⁶⁷ iuris. Si autem in narratione facti⁶⁸, cadit breve quasi⁶⁹ suspectum⁷⁰, facta enim⁷¹ et⁷² nomina⁷³ mutari⁷⁴ non debent⁷⁵, sed iura⁷⁶ ubique⁷⁷ scribi⁷⁸ possunt⁷⁹. Item⁸⁰ a quo,

1. Om., OF; ins. above, MI; ins. una et, MD (above), LC. 2. ea, W. 3-4. realiter, OA, CC. 4. alienis, MA, MD (corr. above); aliter, CE. 5. Om., LF. 5-6. competant plures, ML. 6. competant, V, OB, OD, MA, MB, MD, MF, MI, MN, LF, Y, LG, HA. 7. Om., HB. 8-17. ut d, ME (marked out); om., OM, MH, MM, CM, LT. P, W. 9. Ins. plura, MG. 10. competant, MB. 11. Om., OF. 11-13. plura breviam ei, X. 12. Om., MG. 14. si, MA, MD (corr. to sed). 15. ordine, LC. 16. experi, LC. 17. actio, MA, MD. 18-19. Ins. above, MN. 20. non, OD. 20-21. Om., OA, ME. 21. conveniti, MN (corr. to convenit). 22. This sentence is a rubric in OA, CC. 23. quidam, HB, CB (by corr. from quidem). 24. Repeat, LA (marked out). 24-25. dicitur regula, MK, X. 26. nulla, OA. 26-27. continere nullam, OB. 27. continere re, OM. 27-28. debet continere, OA, OF, MA, MD, MG, MK, ML, CB, HB, CC, B, X. 29-35. Om., MI. 30-31. neque, HA. 31. nec nullum, LC. 31-32. nullus error, X; om., OA; absque errore, CC. 32. error, MK. 33. appetere, CB (corr. to apparere in margin); apparere appetere, HB. 34. Om., OA, OC, OF, OG, MG, MK, CB (ins. above), CC, CE, CM, LD, B, X; enim, OD, W. 35. Ins. et debet, OF, MG, CB (marked out), HB, CC, B; om., ML; ins. debet, OA. 36. persona, OC, OD, OG, MD, ME, MF, MM, CE, LG; sui prima, MC. 37. Om., MB; sive in, ME. 38. Om., OD (leaves a space); ins. non vitiosum, V, OM; ins. quod cadat breve multis rationibus, MA; ins. quod cadat breve multis temporibus, MD. 39. sive, ML. 39-40. Om., W. 40-41. patens fuerit, MN. 41. petens, HB, CB (by corr.). 42. Om., MN: seu, OA; siu, OC, CE; sui, MG, B; ins. non, CM. 42-43. Om., LD. 43. opertum, W. 44. originalia, OA, MA, MD (corr. to originalium), CC, LD; originalum, MI; original., OF, MG. 45. clausa, MF. 46. Om., V, OA, OF, MG, MN, CC, LT. 47. aperta, MF; inclusa, W. 48-50. Om., MA, MD, MI, ML, LF, LG. 48-52. Om., ME, MM. 50. aperta, MH, LT, OM, OF, LC, P, CM, MK, X, W. 51. si, ML. 52. clausa, MH, LT, MK, OF, OM, LC, P, CM, X, W. 53. deberet, MA, CC, W. 54. rasa, MF; obrasa, OA, CC, W, MK, LA, LT (corr. to abrasa), B (corr. to abrasa). 55. abolita, V, OA, CC; abolita, ME, MH; absoluta, MD (corr. to abolita); ablata, HA; oblita, LT (corr. to abolita); alio lerra, B; alio lita, HB, CB (by corr. from alio lerra?); assoluta, MI (corr. to abolita). 56. Om., OB, LG. 57. abrasia, OG; abratio, ME; abrasitio, MH; obrasio, LT; repeat, CB. 58. Om., LF, Y. 59. Ins. et quo case, MF. 60. Om., HA. 60-65. Om., OA, OF, CC. 61. Ins. et, MA, MD, ME. 62-63. Om., MG. 64. verum, MK. 65. vim, OA; valet, MD (corr. above). 66-67. Ins. above, MG. 67-68. Repeat, OA. 68. sunt, MC. 69. quia, ME, CM, ML, MH. 70. suspicium, LT. 71-72. etenim, X. 72. Om., LD. 73. Om., X. 74. Repeat, MH; om., MA, ML. 74-75. non debent mutari, OF. 75. deberent, MB. 76. iure, V. 77. ibique, MB; bique, MI; videlicet, CM. 78-79. possunt scribi, MC. 80. Om. to end of chap. XVII, OG.

utrum¹ videlicet² per ipsum cancellarium³ vel⁴ ausu⁵ temerario per alium, sicut⁶ per clericum iusticiarii⁷ vel⁸ vicecomitis⁹ ad procuracionem alicuius¹⁰ partis¹¹, ubi omnes¹² tam¹³ agentes quam consentientes¹⁴ de omnibus bonis¹⁵ suis sunt¹⁶ in misericordia et¹⁷ voluntate¹⁸ domini regis, et¹⁹ ipsi²⁰ tanquam falsarii²¹ nihilominus²² puniantur. Et²³ quod²⁴ tales argui possunt²⁵ falsitatis²⁶ probatur de termino Sancti Michaelis anno²⁷ regis²⁸ Henrici²⁹ quarto³⁰ incipienti³¹ quinto³² comitatu³³ Herefordiæ³⁴ de Radulpho³⁵ Harange³⁶. Item³⁷ quando³⁸, videlicet³⁹ utrum⁴⁰ hoc⁴¹ fiat⁴² antequam breve⁴³ fuerit⁴⁴ in⁴⁵ curia recitatum⁴⁶ et⁴⁷ publicatum⁴⁸ vel⁴⁹ post. Et sic⁵⁰ breve⁵¹ suspectum⁵² et⁵³ cadit⁵⁴ si⁵⁵ hoc⁵⁶ fuerit⁵⁷ a⁵⁸ petente⁵⁹ impetratum. Item cadit breve si in⁶⁰ se contineat⁶¹ talem⁶² falsitatem⁶³, quod⁶⁴ signum⁶⁵ appositum⁶⁶ sit⁶⁷ adulterinum⁶⁸ ipsius⁶⁹ domini⁷⁰ regis, sive omnino falsum sive verum, falso tamen⁷¹

1. Om., OA, OF, MG, CB (ins. above), CC, CM, B. 1-2. per alium sive per i ut invidet, HB (marked out). 2. Om., X, MK; ins. per, CM. 3. catalla, MA. 4. cum, ME, MH, CM, LC, P; non, W. 5. casu, OM, ME, CM, MH, MM, LT, P, W. 6. sive, HB, CB; sunt (corr. to sint), LD. 7. iusticiarium, LA. 8. sicut per, CC. 9. sunt, LD. 10-11. partis alicuius, MN. 12. omnis, MG (corr. to omnes). 13. Om., OA; causa, LG. 14. conscientes, LA. 15. Om., W. 16. Om., LD; ins. de omnia, LA; sint, HA. 17. Ins. ad, MD (above), CM, ML; ins. in, OC, CE. 17-18. Om., OA, OF, MG, CB, HB, CC. 18. voluntati, MH; voluntatem, MD, ML. 19. Om., ME. 20. Ins. nichilominus, OA, CC. 21. falsatores, OA; falsari, W; falsar., CC; ins. et, LT. 22. Om., OA, CC. 23-36. Om., LF. 24. quid, LD. 25. Ins. de, LC, V; ins. super, OM. 26. falsitate, OM, MK, LC, V; falsitas, LA; falsitates, OA, MD, ME, MH, CM, ML, CC; falsitat., MF, CE, CB; falsit., OF, MG, X. 27. Ins. regni, V, OC, OD, HB, CE, CB, P; ins. quarto, MG. 28. Om., OA. 28-29. Om., MC, LA, LT, MM, LD. 29. Om., ME (ins. above), LT, P. 30. Om., MG. 31. incipienture, LA. 31-32. Om., OA, OF, MA, MG, CC, HA. 32. sexto, MK; ins. in, V; ins. a, MK. 33-36. Ins. above, MN. 34. Hertford, MM, P; Heford, ME; H'ford, MH, HA. 35. Richardo, OC, CE, LC; eadem, ME, MH, CM, P, W. 36. Haring, OM; Rarange, CB, HB, MF; Harand, W; Herand, LC; Harage, LD, MC; ins. etc., OF, OA, MG, CC. 37. Om., OA, OF, MG, MK, CB (ins. above), CC, X. 38. quandoque, MA, MD, W, MF, MI (corr. to quando); quandoque refert, LC. 39. scilicet, OA, OF, MG, CC; om., MF, LC; videri debet, W. 40. Om., OA. 41-42. Om., HA. 42. fuit, MK, X; fuerit, OA. 42-43. Om., MF. 43. Om., CM. 44. fuit, OC, CE. 45. Om., W. 46. perpetratum, OA, OF, MG, CB (corr. below), CC; perpe inetratum, MK; impetratum, X; recitatum perpetratum, HB. 47. vel, OB, MC, LA; om., OC, MF, CE. 47-48. Repeat, Y. 48. publicanum, W. 49. et, OD, MF. 50. sit, CC. 51. brevis, W; ins. erit, LC, MD (above). 52. suspicinum, LT. 53. Om., OM; erased, MI. 53-54. Om., MA. 54. cadat, W; ins. et, ME. 55. et, OA, MH, CM, CC. 56. Om., MF. 57. fuit, OA, CC. 58-59. appetente, MC. 60. Om., OM (ins. above). 61-62. talem contineat, OB, HA, MI, LC, LF, Y, LG. 62. Om., MB, LT. 62-63. falsitatem talem, MA, MD. 63. firmitatem, MB. 64. et, OA, CC, Y. 65. signi, OA; signum, CC. 66. inpositum, MC, LA; appensum, CC. 67. sicut, OA, CC; fit, MC. 67-71. Om., ME, MH, CM, MM, LC, LT, P, W. 68. adulterium, LG; a corr. in MI; adulterium, MA, MF, MD, LA, LD, OB; adulterum, HA, Y, MN; adultinium, X; ad ultim., MB. 68-71. Om., OM. 69. Om., OA, OB, OF, MA, MB, MD, MG, MK, ML, CB, CC, HB, X. 70. Om., HA.

appositum¹ per industriam falsariorum². Et³ quo casu committitur⁴ crimen⁵ læsæ⁶ maiestatis, et puniuntur⁷ tales ultimo supplicio⁸ si laici fuerint, si⁹ vero¹⁰ clerici¹¹ pœnam degradationis¹² sustinebunt¹³ cum¹⁴ perpetua¹⁵ infamia¹⁶, nisi¹⁷ warrantum habuerint¹⁸, secundum¹⁹ quod inveniri²⁰ poterit²¹ in itinere M. de P. in²² comitatu Eboraci anno²³ regis²⁴ Henrici²⁵ decimo²⁶ de²⁷ Rogero de Farnburne²⁸ et Agnete uxore eius²⁹, qui protulerunt³⁰ quoddam³¹ breve de³² recto³³ cui³⁴ signum³⁵ verum³⁶ appensum fuit³⁷ falso³⁸ brevi³⁹ per industriam falsarii⁴⁰, et ubi⁴¹ ipse⁴² Rogerus⁴³ suspensus fuit⁴⁴, quia⁴⁵ warrantum⁴⁶ non⁴⁷ habuit⁴⁸, sed⁴⁹ uxor sua⁵⁰ liberata⁵¹, sive⁵² conscia⁵³ secleris⁵⁴ sive⁵⁵ non⁵⁶, quia fuit⁵⁷ sub virga viri⁵⁸ sui. Item cadit breve simul⁵⁹ cum actione⁶⁰ ad damnum ipsius⁶¹ impetrantis⁶², quod⁶³ impetratum⁶⁴ fuit⁶⁵ per⁶⁶ falsi⁶⁷

1. Om., ME, MH, CM, OM, MM, LC, LT, P, W. 2. falsariorum, LT; ins. ammoveatur, LC. 3. Ins. de, LD. 4. non mittitur, X. 5. Om., HA. 6. lege, W. 7. puniantur, OM, ME, MH, LC, CM. 8. supplici, CC; supplicatio, MC. 9-10. Om., LD. 10. Ins. fuerint, OC, MK, CE, X. 11. Ins. fuerint, CB, HB. 12. Ins. cum, CB (marked out). 13. sustinebit, CB, HB, MK, MI. 14. Om., HB, MG, CB (ins. above). 15. Ins. prisona, MN (marked out). 16. infancia, OD, CC. 17. ni, X; ubi, MG, CB (corr. to nisi), CC. 18. habuerit, OA, OC, MA, MD (corr. to habuerint), CC, CE, LT; habuerunt, MC, LA. 19-48. Marginal, LD. 19-58. Om., LF. 20. inveni (corr. to invenire), MG. 21. Om., LD; poterunt, W. 22. Om., OB, MA, MB, MD, MF, MI, LG, MN, CC. 23. Ins. regni, OC, OD, CB, HB, CE. 24-25. Henrici regis, OA. 25-26. decimo Henrici, MG. 26. Om., ML. 27. et, HB. 28. Farnborne, V; Franburne, OA, CC; Farumburne, OC, CB, HB, CE, X; Fraunburne, ML; Farinburne, MC; Fariburne, LA; Faynburne, MM; Farnburge, MA; Franbourne, LD; Sar., MD; Famburne, MF; paresborne, MG; parnbrurne, OF; Kareborne, CM; Farnbrune, MK; Fareburne, HA, MI; Famburne, Y. 29. Om., CM. 30. protulerint, MK; protulerit, MI; protulit, MN; protulunt, MB; tulerunt, MA, MD; tulerint, W (changed to protulerint); portaverunt, LD. 31. quod, CB (corr. to quoddam), HA, W. 32-33. Om., OB, OC, OD, MF, CE; directo, HB, CB (corr. to derecto). 34-37. cum singno vero appposito, HA. 35. sigillum, OM, ME, MH, MM, LC, LT, P, W, CM. 36. vetus, LC; vet, W; vetum, P; veteru, ME; vetitum, OM, CM, MH; vero, CC; erased, MI. 37. Om., MN. 38-39. Om., OM. 39. Ins. et, V, OA, OB, OD, OF, MF, CC, LG. 40. falsari, MK. 41. non, MK; om., HA. 42. Om., MB. 43. Rogero, MG. 44. fuis, ME. 45. qui, MF; quod, HA; eo quod, MB. 46. warrantus, OC, CE. 46-47. non warrantum, MB. 48. habuerit, CM, W; habent, MC; ins. quia, W (marked out). 49. sive, LD; et, MA, MD, MF. 50. Ins. et, MM; ins. fuit, X; om., MN. 51. libata, W; ins. fuit, OA, OF, MK, ML, CB, HB, CC, LC; ins. fuit libera, MG. 52. Om., MD (ins. above), ML; quia, MF; non, CM; ins. non fuit, LD. 53. concia, LA; cesteia, OA; costea, CC; quotiens, MK; conscientia, HA; consentiat, OC, CE; ins. fuit, LC, W. 54. Om., LC, W; celeris, OA, OF, MF, MM, MN, CB, HB. 55-56. Om., ML, LD (ins. above). 57. fuerit, LG. 58. Om., MA. 59. scilicet, W. 60. occasione, W. 61-64. Om., MK. 62-12 next page. Om. here and ins. after n. 34, next page, MM. 63. quia, OA, OC, OF, MA, MD, MG, ML, CB, HB, CC, CE, X; cum, LD; et, CM; eo quod, LC, HA. 63-12 next page. Om. here and ins. after n. 34, next page, OM, ME, MH, CM, LC, LT, P, W. 65. fuerit, OB, OD, OM, MA, MB, MC, MD, ME, MH, CM, MI, MN, LA, LC, LD, LF, LT, LG, P, W; om., OF, MF. 66. Om., CM. 67. falsi, OB, OD, OF, OM, MB, MC, ME, MF, MG, MH, MI, CM (changed to falsa), ML, MN, LA, LC, LG, LD, LF, LT, P, W, Y; falsam, other MSS.

suggestionem¹ vel² per³ veri⁴ suppressionem⁵. Per⁶ falsi⁷ suggestionem⁸, ut si dicat quis se⁹ esse¹⁰ heredem¹¹ cum non sit¹², ut¹³ de¹⁴ termino Sanctæ Trinitatis anno¹⁵ regis¹⁶ H.¹⁷ quarto¹⁸, comitatu Middlesexiæ¹⁹ de Hamone²⁰ de²¹ Brond²². Idem²³ erit²⁴ si²⁵ quis dicat²⁶ se²⁷ tenere²⁸ in feodo²⁹ cum non³⁰ teneat nisi³¹ ad terminum³² et³³ huiusmodi³⁴, vel³⁵ si³⁶ mulier³⁷ cum³⁸ dotem petierit³⁹ et⁴⁰ partem⁴¹ dotis⁴² habuerit⁴³, dicat⁴⁴ se⁴⁵ nihil⁴⁶ habere et⁴⁷ sic breve⁴⁸ de dote impetraverit⁴⁹ et huiusmodi⁵⁰. Item⁵¹ per⁵² veri⁵³ suppressionem⁵⁴ ut si quis dicat⁵⁵ se⁵⁶ habere⁵⁷ ingressum⁵⁸ per alium quam⁵⁹ per⁶⁰ illum⁶¹ per⁶² quem⁶³ ingressus⁶⁴ fuerit⁶⁵. Item cui⁶⁶ talis⁶⁷ dimiserit⁶⁸ qui⁶⁹ numquam dimisit⁷⁰, eo quod inde⁷¹ nullam⁷² seisinam⁷³ habuerit⁷⁴, vel⁷⁵ si⁷⁶ aliquem⁷⁷ gradum⁷⁸ impetrando⁷⁹ omiserit⁸⁰.

1. Ins. ut si dicat, P (marked out); suggestionem, CM. 2. et, LC. 2-8. Om., OA, OC, OF, MA, MD, CE, MM, HA. 2-4. ver pveri, LT. 3. Om., MG, MK, OD, CB, CC, X, HB. 5. Ins. quia, HB, CB; suppressionem, ME. 6. vel, X; vel per, CM. 6-8. Om., LA, LT. 7. falsam, CC. 9. Om., W. 10. Om., CM. 11. Om., MK. 13. Om., OB (ins. above), OF. 13-22. Om., OA, LF. 13-34. Om., ML; om. here and ins. after n. 50, MC, LA. 14. Om., MI. 15. Ins. regni, OC, OD, CB, CE, HB. 16-17. Om., OF, MC, MG, MM, LA, LD, LT. 18. Om., MI; duodecimo, MK; ins. in, V. 19. Hunt., X. 20. Havene, LD; Hayno, LC; Hamonde, X; Hovene, OF, MG, CB, CC; Hamo, ME, CM, MH, P; Amundo, MK. 20-22. honeum, HB; Hanebrond, OC, CE. 21. Om., OF, OM, MC, ME, MH, CM, MG, MM, CB, HB, CC, LA, LD, LT, P, W, X, Y. 22. Bronde (or Brond), OB, OD, OF, MC, MF, LG, MG, MN, MM, MI, CB (ins. above), LA, LT, Y; Gerende, LD; Neirbrond, LC; Brounde, X; Brocide, OM; Borde, CC; Brondone, MA, MB; Beredone, MD; Nebrande, MH; Nebrond, P; Neubrand, ME; Nebronde, W; Nebrandum, CM; Breude, MK; Brood, V. 23. Item, OC, MB, MH, CB, HB, CE. 24. Om., LT; cadit, OC; non cadit, CE. 25. cum, OA, CC. 26. Om., CB, HB. 27. Om., MB. 28. Ins. dicat, CB (above). 29. feodum, CC; feod., OA. 30. Om., OA, OF, ME (ins. above), MG, CB (ins. above), CC; hoc, MM. 31. Om., OA, CC; ins. ad vitam vel, LC, MD (in diff. hand). 32. Ins. vitæ, OA, CC. 33. vel, OA, CC. 35-50. Om., LA. 36-37. similiter, MM, MF, LT. 38. Om., OA, OC, ME, CE; ins. mulier, LT. 39. peterit, OA, CC. 40. Om., V, OB, OD, MF, LF, LG. 41. partis, LT. 41-42. dotis partem, LD. 42. Om., LT; dotem, MB. 43. habuit, MC; ins. cum, V, OB, OD, MF, LF, LG. 44-45. se dicat, OD. 46. Ins. se, MM. 47-48. Om., MA, MD. 48. Repeat, LT; si breve, HA. 49. impetravit, V, OA, MG (corr. to impetraverit), OB, OD, ME, MF, LF, LG, CC; impetraverat, MB; impeterint, MK. 51. Om., OM; ins. vel, MA, MD. 52-53. pueri, LT. 54. inpressionem, MK. 55. Om., MC. 56-58. inagressum se habere, OA. 57. breve, MC, ME. 57-58. ingressum habere, V. 58. inagressum, X (corr. to ingressum). 59. quem, MG. 60. Om., ME, MH, MK, CB (ins. above), CC, X. 61. alium, HA. 61-62. Om., CM. 63. quam, OA, OC, CC, CE. 64. Ins. est, MN (marked out); ingressum, W. 65. fuit, MK, X; habuit, W. 66. cum, MC, MK, LC, LD, LF, LT; quod, HA, W; si, CM, MH; om., MN. 67. tale, W (corr. to talis). 68. diviserit, MC; dimisit, CM, Y. 69. quod, MF, OB, OD, LF. 70. dimiserit, MK. 71. Om., OM, ME, MH, LC, P, W, CM. 71-72. nullam inde, MA, MD. 72. Ins. dimiserit eo quod nullam, W; in illam, HB; illam, MF, OB, OD. 72-73. seisinam nullam, MI. 73-74. habuerit seisinam, MD. 74. habuit, V, OB, OD, OM, HA, MB, MC, ME, MH, MM, MN, LA, LC, LT, W, P, CM (corr. to habuerit). 75. ut, MK, X. 76. Om., ME, MH, CM. 77. aliquam, OC, CE. 78. Ins. in, OM, ME, MC, MH, MM, LA, LC, LD, P, W; gradus, HA. 79. impetendo, LF. 79-80. emisit impetrando, OA; omiserit impetrando, CC, HA.

Et¹ de hac materia² inveniri⁵ poterit⁴ inter placita⁵ quæ sequuntur⁶ regem II.⁷ anno⁸ tricesimo⁹ primo¹⁰, inter Michaëlem¹¹ abbatem¹² Glastoniensem¹³ et Rogerum¹⁴ episcopum¹⁵ Bathoniensem¹⁶. Et unde idem¹⁷ abbas dixit¹⁸ quod¹⁹ episcopus²⁰ Rogerus²¹ non habuit²² ingressum²³ nisi per episcopum²⁴ J.²⁵ cui²⁶ prior Eustachius²⁷ terras²⁸ illas²⁹ dimisit, qui nunquam inde³⁰ seisinam³¹ habuit³². Et³³ illud³⁴ idem dici poterit in³⁵ brevi³⁶ de warrantia cartæ, ubi³⁷ impetrator³⁸ impetrando³⁹ dixerit⁴⁰ se⁴¹ tenere⁴² terram⁴³, quam non⁴⁴ tenuerit⁴⁵, et sic impetraverit⁴⁶ quo expresso⁴⁷ non⁴⁸ impetrasset⁴⁹ et huiusmodi. Et⁵⁰ cum breve ita⁵¹ in⁵² se⁵³ fuerit⁵⁴ vitiosum⁵⁵ in aliqua⁵⁶ parte, in⁵⁷ nulla⁵⁸ parte⁵⁹ valebit quantum⁶⁰ ad⁶¹ unam⁶² actionem, secus erit⁶³ si plures sint⁶⁴ ibi⁶⁵ actiones⁶⁶ ratione plurium⁶⁷ tenentium. Ut⁶⁸ si⁶⁹ unus petat⁷⁰ per unum breve feodum unius militis in⁷¹ una⁷² villa⁷³ et⁷⁴ versus⁷⁵ alium in⁷⁶ eodem brevi⁷⁷ feodum

1-32. Om., LF. 2. Om., MI. 3-4. Om., HA. 5. Om., MI; placitum, W. 6. Ins. dominum, LG, OB, OM, MB, MC, ME, MH, MI, MK, ML, HA, CM, MM, HB, CB, LA, LD, X, W, Y, P; sequentur, HA. 7. Om., OA, OD, MA, MD, ML, MN. 8. Ins. regis, ME; ins. Henrici, OA; ins. regis Henrici, MD, LT, ML; ins. regni regis Henrici, OD. 9-10. XXI, MF; XXX, MA, MD. 11. Om., MC, LA; Matheum, MF; Mach., CB. 12. Om., OA, CC; ins. de, OF, MA, MG, CB, HB. 13. Glastonie, MM; Gloston., LG, CC, W; Glastone, MC. 14. Robertum, OM; R., OA. 15. Repeat, ML; ins. de, CC. 16. Barton., Y. 17. idem idem, Y. 18. dicit, MB. 19. Ins. idem R., OA, OF, MG, CC. 20-21. R. episcopus, HA. 21. Om., V, OA, OF, MG, CC; M., OC, CE; Bath, CM. 22. habuerit, OB, OC, CE, X. 23. Om., LD. 24. ipsum, OC, CE. 25. Om., CM. 26. cum, W. 26-32. Om., LD. 27. Om., CM; Glaston. ius, OC, CE. 28-29. terram illam, MC, LA. 29. Om., ML. 30-31. seisinam inde, OA, MK, CC, X. 31. seisina, OC, CE. 32. habuerit, OF, HA, MB, MF, CB, X, HB. 33. Ins. etiam, LC. 34. istud, MI. 35-36. Om., OB, OD, MA, MB, MD, MF, MI, MN, LC, LF, LG. 37. nisi, CC. 38. impetrato, W; ins. in, OM, MH, MM, CM, LC, LD, P, W. 38-39. impetrando impetrator, OF, MB. 40. dixit, OA, CC. 41. Ins. non, OA. 41-42. tenere se, LF. 42-43. terram tenere, OF. 43. Ins. illam, MB. 44. Om., OC, CE; ins. above, MN. 45. renuerit, HB; tenuerat, V; tenuit, MK, X; tenerit, OC, LF; tenuerunt, MF. 46. impetraverat, V; impetravit, MK, X. 47. Ins. dicitur, LC; expressa, ME, MH, CM. 48. si, OD; sic, MF. 49. inpetrasse, LC. 50. Om., CC, MG (ins. above). 51-53. in se ita, OA, ML, CC. 51-54. in se fuerit ita, LD. 52-54. fuerit in se, MD. 52-55. fuerit vitiosum in se, LT. 54. habuerit, LA. 56. alia, OA, MB; ins. sui, LC. 57. Om., OA, OB, OC, OF, OM, MC, ME, MG, MH, MK, ML, MM, CB (ins. above), CC, CE, LC, CM, LA, LT, P, W, X. 58-59. Om., OB, OM, ML, LC, W. 60. quam, OC, CE; quem, OB, LG. 61. a, OB; ins. unam (above), CB. 62. unam, V, OB, OD, MA, MB, MC, MD, MF, MI, MN, LA, LG, LF, Y, HB, HA; vitam, OC, CE; unicam, OA, OF, OM, ME, MG, MH, MK, ML, MM, CB, CC, CM, LT, LC, LD, P, W, X. 63. esset, V, MF. 64. sunt, LG, LF; fuerint, LC. 65-66. actiones ibi, W. 67. pluralitatis, CM. 68. et, V, MB; Item, MD (second passage). 68-40 next page. Om., ML; put after alios, l. 36, f. 414, OC (marked *addicio*), MC, MD (marked *addicio*; MD has regularly also), CE, LA. 69. Ins. per, MB (marked out). 70. portat, MN. 71. cum, OD, OB, HA, MB, LF, LG; et, OF, MG, CC, CE; et in, OA. 72. eadem, MM (corr. to una). 73. Ins. above, MD (first passage); ins. vel diversis, MM (marked out). 74. Ins. above, MF; om., CC. 75. non, OA. 76-77. Om., MN. 77. breve (corr. to brevi), MD (first passage).

alterius militis in¹ eadem villa vel in² diversis³, quamvis⁴ cadat⁵ breve de feodo unius⁶ militis⁷, nihilominus⁸ stabit⁹ de feodo alterius militis¹⁰ versus¹¹ eundem¹², quia¹³ ibi¹⁴ sunt¹⁵ diversæ¹⁶ actiones propter¹⁷ diversitates¹⁸ tenementorum quamvis breve¹⁹ unicum²⁰. Et²¹ eodem modo erunt²² diversæ²³ actiones²⁴ ratione diversarum personarum²⁵ et²⁶ rerum²⁷ ubi²⁸ plures sunt²⁹ tenentes. Et³⁰ de hac materia inveniri³¹ poterit³² de³³ termino Sancti Hilarii³⁴, anno³⁵ regis³⁶ Henrici octavo³⁷, comitatu Herefordiæ³⁸, de Richardo filio³⁹ Godefridi⁴⁰. Et sic⁴¹ vel⁴² cadit breve⁴³ omnino⁴⁴ vel stabit quantum⁴⁵ ad quosdam, et⁴⁶ cadet⁴⁷ quantum⁴⁸ ad alios⁴⁹. Item⁵⁰ cadit breve⁵¹ per⁵² mortem unius⁵³ partis sive petentis⁵⁴ sive⁵⁵ tenentis⁵⁶, simul⁵⁷ cum actione⁵⁸. Item si plures⁵⁹ sint petentes⁶⁰ vel⁶¹ plures⁶² tenentes⁶³ qui sunt coheredes⁶⁴ et participes⁶⁵ et⁶⁶ unum⁶⁷ ius habentes, morte⁶⁸ unius vel⁶⁹ plurium⁷⁰ cadit⁷¹ breve, sed⁷² non actio⁷³, quia⁷⁴ quandoque cadit

1-7. Om., OA, OF, MG. 1-12. Om., CE (marginal), CC. 2. Om., OC, OM, MA, MB, MC, MD, ME, MH, HA, CM, MI, MK, MM, MN, CB, HB, CE, LA, LC, LD, P, W, X, Y. 3. diversum, MH. 4. A correction in ME. 5. cedat, W; cadit, MD (second passage), OC, CE. 6. ipsum, X. 7. Ins. in eadem villa, CM. 8-10. Marginal, LD; om., LF. 9. Ins. ut eundem, OA; ins. adversus eundem, OF; ins. versus eundem, MG, MK, X; stabat, OB. 11-12. Om., OA, OF, MG, MK, X, LD. 12. alium, MD (second passage). 13. Ins. sibi, MM (marked out). 14-15. sunt ibi, MK. 15. sint, MN. 15-16. diversæ sunt, HA. 17. ad, MG. 18. diversitatis, MI; diversitatem, OA, OC, OF, MA, MD (second passage), MF, MG, MN, CC, CE, LD, LT. 19-20. unicum breve, OA, OF, MG, CC; unicum et breve, CB (et erased), HB. 20. vincit, OD; uni, LA. 21. Item, V, OD, MF; in, LD; om., LF. 22. Om., LC, W. 23. Om., V, OB, OD, MA, MB, MD (first passage), MF, MI, MN, HA, LF, LG, Y; diversæ, ME. 24. Ins. plures, V, OB, OD, MA, MB, MD (first passage), MF, MI, MN, HA, LF, LG, Y; ins. propter diversitatem tenementorum, MG. 25-27. rerum et personarum, X. 26-27. Om., MA, MD (first passage, ins. above). 28. ibi, HB. 29. sint, OA, OF, MB, MG, CB, HB, CC, W. 30-40. Om., LF. 31. invenire, ME. 31-32. Om., MA, HA. 32. possit, OA, CC. 33. in, LD. 34. M., CM; erased in MH (was Michis.). 35. Ins. regni, OC, OD, MD (second passage), CB, HB, CE. 36. Om., OA. 37. III, OC, MD (second passage), CE; ins. in, V; om., CC. 38. Bed., OA, CC. 39. Om., CC. 40. Godefr., OB, MI, MK, MN, CC, W, X; Godefridi, MB; Godefray, CB, CE, MF, HB; Godefroi, LD; Godefrey, MD (second passage), OC, OF; Godfrey, V; God., MA, MD (first passage); G., OA; Gogfray, MG; ins. etc., OF, MG. 41. sit, W. 42. Om., OA; ins. above, CM. 43-44. omnino breve, OA, MD (first passage), CC, LC, W, X. 45. quem, OB. 46. vel, MK. 47. cadit, HA, HB, MC, X, LA, CB, OC, OF, MK, CE, LF; cadat, MB; stabit, OA, CC, MI (corr. above to cadet). 48. Om., MA. 49. aliquos, OC, CE. 50-58. Om., LF. 51. Ins. quantum, V. 52. ad, V; propter, MA. 53. Ins. breve, CM; om., ML. 54-55. Om., MG. 56. Ins. sive petentis, CB, HB. 57-58. Om., OF. 57-63. Om., HA. 59. plura, CC. 60. tenentes sive petentes, LC. 60-62. Om., OA, OF, OM, MG, CB (marginal), CC. 61-62. sive, MD, HB. 61. et et, MN. 61-63. Om., LG, W. 64. choheredes, MN. 64-65. participes et coheredes, CM. 65. partices, LT. 66. Om., HA. 67. unicum, OA, CC. 68. per mortem, MD, ML. 69-70. Ins. above, MN. 70. Ins. quandoque, MK. 71. cadet, Y. 72. Om., W; vel, MK. 73. Ins. Item si plures, P (marked out). 74. et, CB (corr. above). 74-2 next page. Om., OA, OB, OF, MB, ME, MF, MG, CC, LF, LG, X (marginal).

breve sed¹ non actio², et³ quandoque⁴ stat⁵ breve simul⁶ cum actione, sed⁷ corrigitur⁸ post⁹ errorem vel defectum, quandoque¹⁰ cadit breve¹¹ simul¹² cum¹³ actione¹⁴, quia ubi¹⁵ cadit actio¹⁶ ibi¹⁷ cadit¹⁸ breve¹⁹. Item²⁰ quandoque tenet²¹ breve²² et²³ differtur²⁴ actio²⁵, quia²⁶ ubicumque²⁷ tenet actio²⁸ et²⁹ breve³⁰, licet³¹ quandoque³² corrigatur³³ propter³⁴ errorem. Item quandoque³⁵ cadit breve³⁶ sed³⁷ mutatur petitio in aliam³⁸ actionem de eadem re, sed³⁹ per⁴⁰ aliud⁴¹ breve, secundum⁴² quod⁴³ superius dicitur⁴⁴ in⁴⁵ parte⁴⁶ super⁴⁷ possessione⁴⁸ et proprietate⁴⁹. De⁵⁰ hoc autem quod dicitur⁵¹ quod⁵² quandoque⁵³ stat⁵⁴ breve⁵⁵ simul cum actione, sed⁵⁶ corrigitur⁵⁷ propter errorem⁵⁸ vel⁵⁹ defectum de⁶⁰ errore⁶¹ impetrantis⁶², videndum⁶³. Et⁶⁴ sciendum quod error⁶⁵ multiplex⁶⁶ esse⁶⁷ poterit, scilicet⁶⁸ in personis⁶⁹, et⁷⁰ in⁷¹ nominibus⁷² et⁷³ cognominibus⁷⁴ personarum. Item in rebus et⁷⁵ in⁷⁶ locis⁷⁷, sicut⁷⁸ in comitatibus⁷⁹

1. et, OC, MD, CE, W. 3. Om., HA. 4. quando, OF, MI (corr. to quandoque). 5. stet, MD; stabit, MI. 6. Om., MF. 7. et, OA, CC; si, CE, CB (by corr.), Y. 7-14. Repeat, CE, X; om., LD, ML, HA. 8. corrigatur, MD, CB (by corr.), HB. 9. propter, V, MI, CB (by corr.). 10. quando, MH, MM, CM, LT, P, W, ME; ins. simul, MG. 11-12. simul breve, OF, CB, HB. 12. Om., MD, MG; sed non, W. 13. Om., MA. 15. nisi, OB; ibi, ME. 16. breve, OM, ME, CM, MH, LC, P. 16-21. Om., W. 17. ubi, OA, MN (corr. to ibi); ins. above, CB; ins. non, ME (marked out). 18. Ins. above, MN. 19. actio, ME, CM, MH, OM, LC, P. 20-22. Om., MC, LA. 20-30. Om., Y. 21. cadit, OF; tam, MA; repeat, CM. 21-25. differtur actio et tenet breve, MK, X. 22. Om., MA. 23-30. Om., MF. 24. defertur, OC, OF, MG, CB, HB, CE; deffertur, OA, LD; differt, MA. 26. quod, X; ins. ubi, MH (marked out). 27. ubi, CB, HB. 28. Ins. ibi, V. 29. tenet, CB, HB. 29-30. Repeat, CC. 30. actio, MN. 31. sed, OC, CE, W. 32-33. corrigatur quandoque, V. 34. per, MA, MD, MK, LT, X. 35. quando, ME, MF, LT. 35-36. cadit breve quandoque, MK. 36. Marginal, MN. 37. si, ME, Y; ins. non, LC, W. 38. alienam, OD, MF. 39. si, Y. 40. Om., LF. 41. alium, MG. 42-43. ut, LD. 42-49. ut supra dicitur, HA. 44-46. in parte dictum est, MN. 45-52. Om., MA. 47. sub, LA. 48-49. proprietate et possessione, W. 49. Ins. et, LF. 50-62. A rubric in HB, CB. 51. dicit, OA, CC, OF, OM, MC, ME, MG, MH, MK, ML, MM, CB, HB, CM, CC, CE, LA, LC, LD, LT, P, W, X, Y. 52. Om., MD (marginal); quia, MI. 53. Om., OC, CE; quancumque, CM; quando, OM (corr. to quandoque), MC. 53-54. non fiat, LA. 54. stet, MA; fiat, MC; om., OA, OF, MG, CC. 55. Ins. quandoque, OC, CE. 56. si, MK, LF. 57. corrigatur, V, OB, OD, MA, MF, ML, LF, LG. 58-59. Om., HA. 59. Om., OF; et, OA, MG, CC; ins. pro, OB. 60-61. Om., MF, ML. 61. Ins. et, MM. 63. Om., HB, CB; ins. est, V, OD, MF; ins. erit, MM. 64. Om., MA, MD (ins. above), HB, CB. 65. errorum, LF. 65-66. multiplex error, W. 66. multipliciter, CC. 67. esset, W (corr. to esse). 68. sed, LT; si, OB (corr. to scilicet). 69. persona, OA, CC; personibus, MG. 70. vel, MA, MD, CB, HB. 70-71. Om., LC, W. 71. Om., OF, MB, MG. 72. omnibus, MK, LD (corr. to hominibus); hominibus, MC. 73. Om., LF (ins. above); ins. in, MC, MI, MK, X, Y, LA. 74. cognitionibus, OA, OB, LG, OD, LA, OF, MF, LT, MG, MK, ME; cognitionibus, X; cognitionibus, CC; ins. a, OA. 75. Om., OA, OF, MC, ME, MG, MH, ML, MM, CM, CC, LA, LC, LD, LT, P, W, Y; vel, CB. 76. Om., OB, OC, CB, HB, CE, LF, LG. 77. loco, CC. 78. Om., LC, W; ins. et, MI. 79. comitatu, V; com., MSS. generally; cognominibus, CM, CB (corr. to comitatibus).

et¹ villis² et eorum nominibus³, secundum quod superius⁴ dicitur⁵ in⁶ tractatu⁷ de disseisinis⁸. Sed⁹ esto quod aliquis¹⁰ summoneatur¹¹ in alio¹² comitatu quam in¹³ quo res est¹⁴ de qua¹⁵ agitur, et ubi¹⁶ summonitus nullum tenementum¹⁷ habet¹⁸ nec¹⁹ feodum, in actione reali, licet²⁰ vicecomes²¹ præsint²² duobus²³ comitatibus, sicut²⁴ dici poterit de vicecomite Essexie²⁵ et²⁶ Herefordie²⁷, et nominatur in²⁸ brevi tantum²⁹ vicecomes³⁰ Essexie³¹ et res petita³² fuerit³³ in³⁴ comitatu³⁵ Herefordiæ³⁶, cadit breve. Si autem uterque³⁷ comitatus³⁸ nominatur³⁹ valet⁴⁰. Si autem actio⁴¹ fuerit personalis, videtur⁴² tamen⁴³ adhuc⁴⁴ quod⁴⁵ valere⁴⁶ debeat, licet⁴⁷ summonitus terram⁴⁸ non⁴⁹ habeat⁵⁰ in comitatu expresso⁵¹. Item cadit breve si impetratum fuerit contra ius⁵² et⁵³ regni⁵⁴ consuetudinem, et⁵⁵ maxime contra⁵⁶ cartam⁵⁷ libertatis⁵⁸, sicut breve quod vocatur⁵⁹ *Præcipe*⁶⁰ per⁶¹ quod⁶² liber homo posset⁶³ curiam⁶⁴ amittere⁶⁵. Si⁶⁶ autem præter⁶⁷ ius⁶⁸ fuerit⁶⁹

1. Om., HA, OA, MA, MB, MD, MK, CC, X; et in, MI; ac, CB, HB. 1-3. Om., Y. 2. villæ, OA; ins. aliorum, MG. 4. Om., MI. 5. Om., LG, LF, OB, CC. 6. de, LA. 6-7. Om., HA. 8. seisinis, LA; disseisina, MA, MD, ME, MF, X, MK. 9. Item, OC, MA, MD, CE. 10. Om., LF; quis, V, OB, LG, OD, MA, MB, MD, MF, MI, MN, HA. 11. sive moneatur, LD (corr.); summoniatur, MD, MH, ML, MM, CM, CB, HB, LC, P, W; summoneatur, CE, OC; sive nominatur, LT. 12. aliquo, OD, MB, MG, MC, ME, MH, MI (corr. to alio), LA, HA, CM, LT, P, W; aliquo sive alio, LD. 13. Ins. eo in, LD. 14. Om., OA, MK, CC. 15. quo, OC, MA, CE. 16. Om., LT; ibi, LC, W; nisi, ME, MH, P. 17-18. habet tenementum, OD, MB. 18. habuit, MA, MF; habeat, MC, LA. 19. vero, OB, LG. 20. Ins. unus, MD (above), LC, LD. 21. autem, OA, OF, MG, CB (marked out, vic. ins. above), CC; antec. vic. et, HB. 22. possit, MA, MB, MD, MF, MH, CM, MI, HA, CB (corr. to præsint); præsumpsit, OA, CC; ins. esse in, MD (above). 23. de nominibus, OA, CC. 24. Om., OC, CE. 25. Om., MK. 26. Om., OF. 26-31. Om., OA, MA, MD, ML, LA, LF, X (marginal). 27. Hertfordiæ (or Herteford.), OM, OD, ME, MH, CM, MM, CC, P. 28. tantum in, CC. 28-29. tantum in brevi, V, OB, OD, MA, MD, MB, MF, LG, MI, MN, LF, Y; tamen in brevi, HA. 30. Om., MH; sicut, OD, MF. 32. peta, ME. 33. fuit, MD. 34-35. Om., MK. 36. Ins. et, LA; ins. et nominatur tantum in brevi vicecomes Essexiæ, MA; ins. et nominatur tantum in brevi vicecomes Essexiæ, et res petita fuerit in comitatu Herefordie, MD; ins. in comitatu, MK; Hertfordiæ, OD, ME, MH, MM, P, OM, CM, HB, CB (by corr.). 37. Ins. above, ME (also marginal); uteri, MK. 38. Om., LT. 39. nominetur, V, OB, OD, OM, MA, MB, MD, LG, MF, MI, MK, LF, X, Y; nominantur, OC, CE; om., MH, W, CM. 40. Om., ME. 41. Om., ME. 42. videatur, OC, CE. 43. tantum, W, Y. 43-44. adhuc tantum, MF. 44. ad hoc, MB. 44-45. quod adhuc, MK, X. 45. et, Y; om., HA; ins. actio, OA, CC. 45-46. Repeat, MN. 47. lice, MM; nunc, X. 48. tantum, Y. 49. ne, MK. 50. habet, LA. 51. expressa, ME. 52-53. usum, OA, CB (ins. ius above); visum, OF, MG, CC (corr. to usum). 52-56. Om., W. 53. Om., MB. 53-54. regni et, OA, MG, MK, CB, HB, CC, X; regnum et, OF. 55. Om., MK, LC. 56. Om., MH. 57. Ins. de, MD (above). 58. libertationis, MA; libertatibus, MD (part erasure). 59. An erasure, MI. 60. Ins. in capite, V, MD (above). 61. et per, OF; per hoc, ML. 62. hoc, W. 63. possit, CM, OC, MA, MD, ME, MH, MK, CE, X; poterit, MF. 64. Ins. suam, OM, MB, MC, MD, ME, CM, MH, ML, MM, LA, LC, LT, HA, P, Y; curam, W. 64-65. amittere curiam, OA, MB, MD, HB, CB, CC. 65. Om., OF, MG. 66. sed, MM. 67. propter, MH, MI, CM. 67-68. posterius, MM. 68. A corr. in MD. 69. ferat, MM.

impetratum¹, dum² tamen⁵ fuerit⁴ rationi⁵ consonum⁶ et⁷ non⁸ iuri⁹ contrarium, erit¹⁰ sustinendum¹¹, dum tamen¹² a rege concessum et¹³ a¹⁴ consilio suo¹⁵ approbatum. Sed¹⁶ esse debet personale¹⁷, sed¹⁸ non debet¹⁹ concedi²⁰ nisi de gratis speciali²¹. Nec refert utrum²² magnates²³ expresse²⁴ præbuerint²⁵ assensum, dum tamen²⁶ expresse²⁷ non dissenserint²⁸, ostensa ratione sufficienti quare²⁹ valere³⁰ non debeat³¹. Pertinet³² enim³³ ad regem³⁴ ad³⁵ quamlibet³⁶ iniuriam compescendam³⁷ remedium competens³⁸ adhibere³⁹. Brevia tamen⁴⁰ communia inter⁴¹ omnes pro⁴² iure generaliter debent⁴³ observari⁴⁴, cum⁴⁵ sint⁴⁶ originalia et actionibus⁴⁷ originem præstent⁴⁸. Item⁴⁹ cadit⁵⁰ breve si tenens⁵¹ minus⁵² teneat quam⁵³ petens⁵⁴ petat⁵⁵, secus⁵⁶ tamen⁵⁷ si⁵⁸ plus⁵⁹. Item cadit breve si⁶⁰ tempore⁶¹ impetrationis nulla⁶² subfuit⁶³ causa impetrandi⁶⁴, quia⁶⁵ tempore⁶⁶ datæ⁶⁷ et⁶⁸ impetrationis nulla⁶⁹ petenti⁷⁰ competiit⁷¹ actio nec⁷² causa⁷³

1. implacitatum, MF; ins. valebit, LD. 2. cum, W. 2-11. Repeat, ME. 3. Om., CB, HB. 4. fuit, V, OA, OD, MF, CC. 4-12. Om., MK, LD. 5. ratione, OA, OC (corr.), OF, MB, ME, MG, MH, CB (corr.), HB, CC, CE. 5-6. secundum consuetudinem, MA, MD. 7. Om., OA, OC, OF, MG, MI, CB (ins. above), HB, CC, CE. 8. Om., HB. 8-9. iuri non, HA. 9. viri, OC (corr.), ME, CB (corr. above), CE; vur, MB. 10. est, MA, MD; erint, CC. 10-11. sustinendum erit, MF. 11. suspiciendum, W. 12. Om., OA, CC. 13. Om., ME, MH, CM, LT, P. 14. Om., OA, OC, OF, MG, MI, MK, CB (ins. above), CC, CE, LD, W, X. 15. Om., OF. 16-17. Om., LF; repeat, MI (second erased). 17. principale, W. 18. et, LD. 19. Om., LT; debitum, X. 20. Om., CE. 21. spirituali, OC, CE. 22-27. si, ML. 23. magnatos, OA, OC, CE; maiestas, MI. 24. Om., LT; ins. non, V. 25. præbuerunt, MA, MC, MD, LA, LC, Y; prohibuerint, OF, MG, CB (corr. in margin), CC; probibuerunt, OA, W; probaverint, MB. 25-27. Om., MM. 26-27. expresse tamen, MG. 28. dissentiverint, V; dicesserunt, OA; disserunt, CC; dissenserit, ML; dissencerint, MB, MC; dissentire, MK; dissensierunt, LC; dissentirent, X; dissenserunt, OF, ME, MG, CB; ins. nec, V; ins. nulla, LD. 29. vel, OF; quale, MH (corr. to quare). 30-31. non debeat valere, LD. 31. debeant, OA, OF, MA, MD (corr. to debeat), MG, CC. 32. pertinent, CC. 33. Om., MF. 34. Repeat, MK; ins. et, MC, MF, LG, OB, OC, CE. 35. Repeat, LT. 36. quemlibet, OC, CE; qualibet, LA. 37. compescendum, V; compescend., OA, OB, OD, OF, ME, MF, MH, MI, MN, CC, LG, CM, LF, LT, W. 38. A corr. by erasure, MD. 39. adhibendo, MK, X. 40. tantum, MN. 41. Om., MG. 42. per, CB, CC, HB. 43. deberet, OD, W. 44. observare, CC. 45. tamen, OC; si, CM, MH. 46. Om., X. 47. Ins. et, X. 48. præstant, HA, ME, CM, MH. 49-59. Om., MG, LF. 49-50. Repeat, ME. 51. Om., OC, OF, CB (ins. above), CE, LD. 51-53. Om., OA, CC; minus teneat tenens quam, HA, HB. 51-60. Om., ML, W. 52. unus, LT. 53. quod, MI (corr. to quam). 54. Ins. pe quam petens, Y. 54-55. petat petens, HA. 56. sicut, LT. 57. cum, MN; autem, ME; erit, LC. 58. Om., MC, LA. 59. Ins. teneat, V, MK, X; ins. petat, OA, OF, CC; ins. cadit, CM, MH. 61. tempus, OF, MG, CC; in illa re, W. 62. nullam, OC, MK. 63. subfuerit, OC, OF, MG, MK, CB, HB, CC, CE, LD, X; obfuerit, OA; obfuit, MA, MD, MI (corr. to subfuit). 64. impetranda, OA; petendi alias impetrandi, LD; in perpetrandi, CM. 65. Ins. si, MA, MD. 66. tempus, OF, MG, CC. 67. dato, MD; om., OC, MA, CE. 68. Om., OA, OC, MB, ML, CE, MI (ins. above); erased, ÓF. 69. nullam, OC, MI, CE. 70. competenti, MH. 71. competit, OA, LD, LF, MA, MB, MD, MF, LT. 72. nisi, W; in, OA. 72-73. misericordia, CC.

petendi¹. Item² nec³ causa conquerendi⁴, quia tunc nulla⁵ facta⁶ fuit⁷ disseisina⁸ nec alia⁹ iniuria. Item nec¹⁰ valet breve quia ille¹¹ qui nunc¹² tenet¹³ tempore¹⁴ impetrationis¹⁵ non fuit in seisina de¹⁶ re petita tota¹⁷ vel aliqua¹⁸ eius¹⁹ parte, et²⁰ licet²¹ statim²² visum²³ petierit²⁴ cum²⁵ nihil teneat vel non²⁶ totum²⁷, tamen²⁸ propter hoc non amittit²⁹ exceptionem³⁰ contra breve³¹. Et³² hæc vera sunt³³, licet³⁴ post impetrationem incipiat³⁵ tenens totum possidere, quamvis videatur³⁶ quod³⁷ actio³⁸ pervenerit³⁹ in⁴⁰ eum⁴¹ casum⁴² a quo incipere potuit⁴³. Item⁴⁴ cadit breve⁴⁵ si⁴⁶ cui⁴⁷ plures⁴⁸ competant⁴⁹ actiones de eadem re⁵⁰ et⁵¹ plura brevibus⁵², et una actione⁵³ agere⁵⁴ inceperit⁵⁵ facta⁵⁶ electione⁵⁷ et⁵⁸ per unum breve⁵⁹, si⁶⁰ pendente⁶¹ actione et⁶² brevi⁶³ illo ad⁶⁴ aliam⁶⁵ actionem⁶⁶ convolaverit⁶⁷, cadit breve posterius⁶⁸ impetratum, quia a⁶⁹ primo⁷⁰ non est recessum⁷¹,

1. petente, OC (corr. to petendi). 2. Om., OM. 2-4. Marginal, LD. 3. non, W. 4. conquerenti, OC, CE; querendi, MA, LA. 5-7. fuit nulla, MA. 6. Om., V; OB, OD, MB, MD, MF, MI, LF, LG, W; ins. non (marked out), HA. 7. Om., OA, OF, CB (ins. above), CC, MG, Y. 8. de seysina, OF, MG. 9. aliqua, V, OD, MF, LT. 10. Om., MG (ins. above), LA. 11. ipse, MI, CM. 12. non, MB, MK. 13. Ins. in, OA; ins. ipse, MI (marked out). 14. Ins. above, MI. 15. Ins. above, MB. 16. Ins. tota, V. 17. Om., V, OB, OD, MA, MB, MD, MF, MI, MN, LF, LG. 18. alia, OC; om., ML. 19. Om., LG, OB, OD, HA, MA, MB, MD, MI, MF, MN, LF, Y. 20. Om., MK, MG, OA, OC, OF, CC, CE, LD, X. 21. Ins. petit, CB (marked out), HB; ins. petens, ML, MC, LC; ins. pet., LA; ins. post, OM, LT, ME, MH, MM, CM, P, W; ins. tenens, OC, CE. 22. Om., LD. 22-23. visum statim, Y. 24. petit, OA, CC (changed to peterit). 25. tamen, MB. 26. Ins. above, MG. 27. tot, LG. 28. cum, MN, LD. 28-29. tamen non amittit propter hoc, OA, OF, MG, MK, CB, HB (cum), CC, X. 29. amittet, LT, V, OB, OD, MA, MB, MD, MI, MF, MN, LF, LG. 30. Ins. suam, V. 31. Ins. above, MI. 32. Om., MA, MD. 33. Item, CM. 34. Om., MA, MD, CC. 35. incipiet, MC, LA, LD. 36. videtur, OC, CE. 37. in eum, MF; om., OB, OD, LG, LF. 37-38. actio quod, HA. 39. pervenire, LF, LG. 40-41. Om., MF. 42. statum, MK, X. 43. poterit, V, OB, OD, HA, MF, LF; peterit, LG; posset, OA, CC; poterunt, OC, CE; poterint, OF. 44-45. Om., MC. 45. Om., CC, W; ins. mortuo eo qui impetravit vel deposito, LA. 46. Om., MA; sed, OB, OD, LF, LG. 46-71. Ins. after deposito, l. 44, f. 414b, MC. 47. cum, OB, LG, OD, HA, MA, MB, MD (corr. to cui above), MF, MI, MN; om., MC, LA, LD. 48. Om., OF; pluræ, MN; ins. alicui, LD. 48-49. competant plures, OA, MG, CB, HB, CC; competat plures, MK, X. 49. competunt, MD, CE, Y; om., ML. 50. Om., ME. 51. in, OC, CE. 52. Ins. competant, ML; om., HA. 53. Marginal, MB; ins. opus erit et, MF. 54-55. congregante parit, CB; parit, OA, OF, CC, MG. 55. incipiat, MA, MB, MD, MF, MI, MK, MN, LF, LG, HA, HB, OD, OB, X; inciperit, MH; incipit, Y. 56-57. fiat electionem, X. 58. Om., HA, LD; ins. si, MI. 59. Om., OM, ME, MH, MM, CM, LC, LT, P, W. 60. et, OA. 61. petente, OD, LG; præcedente, ML. 62. in, V, OD, MA, MB, MD, MF, MI, MK, MN, CB, HB, X, Y. 63. breve, LA, LF, OB. 64. Om., OF, Y. 65. illam, OC, CE, MF. 65-66. actionem aliam, LC. 67. sic, V, OC, OF, OM, MA, MD, ME, HA, CM, MG, MH, MK, ML, MM, MN, CE, LD, LT, P, W, X, Y; convalverint, MB; convalverit, OA, OB, OD, MC, MF, LA, LF, LG, CB, HB, CC, MI (corr. to convolaverit). 68. Om., Y. 69. Om., W. 70. prima, V.

ut¹ de² placitis quæ sequuntur regem³ anno⁴ tricesimo⁵ primo⁶, in⁷ loquela⁸ inter Petrum de⁹ Solandia¹⁰ et abbatem de Rivallis¹¹ de¹² forgiis¹³ in¹⁴ foresta de¹⁵ Glasdale¹⁶. Et hoc verum¹⁷ est¹⁸ si tempestive¹⁹ se²⁰ retraxerit²¹ ante iudicium²², post²³ iudicium²⁴ vero²⁵ non²⁶ poterit²⁷. Sed²⁸ quæritur²⁹ an quis³⁰ possit³¹ se³² retrahere³³ de³⁴ quibusdam³⁵ articulis brevis³⁶ et³⁷ de³⁸ quibusdam non? Sed³⁹ videndum⁴⁰ utrum ita⁴¹ sint⁴² connexi⁴³, quod unus⁴⁴ sine altero⁴⁵ terminari⁴⁶ possit⁴⁷ vel⁴⁸ non⁴⁹, et⁵⁰ secundum hoc procedatur vel non⁵¹. Item⁵² cadit breve mortuo⁵³ eo⁵⁴ qui impetravit⁵⁵, vel⁵⁶ deposito⁵⁷, si⁵⁸ forte⁵⁹ episcopus fuerit⁶⁰ abbas vel prior vel⁶¹ huiusmodi, sed⁶² non⁶³ e contrario⁶⁴ si episcopus, abbas vel prior⁶⁵ tenentes⁶⁶ fuerint⁶⁷, quia⁶⁸ dependet actio cum⁶⁹ brevi donec fuerit⁷⁰ alius⁷¹ ei⁷² substitutus⁷³, maxime si actio fuerit⁷⁴ civilis

1. Om., OF; et, OB, OD, MB, MF, LG. 1-16. Om., LF. 1-51. Om., LA. 2. in, MN. 3. Ins. Henricum, MK, X. 4. Ins. regni, MB; ins. regni H., CC; ins. H., CB (above); an vo, OB. 5-6. XXX, MA, MD; XXI, MF, ML. 7. de, OC, CE, LC. 7-8. Om., MM. 8. Ins. quæ est, MD. 9. et, LD. 10. Solundia, MA; Sabaudia, MC; Solanda, X; Solendia, OF; Soludia, HB; Salandio, OM; Salandia, ME, CM, MH; Selandia, Y; Selondia, LC; Molandia, MB, MN; T., LT; ins. cum, OB. 11. Ryevallis, OD; Rivallia, MB; Ryvans, MA; Rivans, MD; Ravallis, CM; Rivast, MK; Ruvallis, OF. 12. in, V; et, MI; om., W. 12-16. Om., OA, MA; etc., OF, MG, CC. 13. forgas, OC, CE. 13-14. Om., ML. 14. de, V; et, OC, CE. 15. et, HA. 16. Glaxtoll, V; Glastoll., OD, MF, Y; Glastall., LG, HA, MD, MI, MN; Glastellis, OB, MB; Glan., MC; Glasidale, HB, LD; Glisedale, X; Glastale, CM; Glasailis, ML; Giledale, MK; Giasidale, CB; Glaspale, W. 17. utrum, W. 18. Om., CC. 19. tempore, OC, MD, MI, CE; ins. scientiæ, MI. 19-20. se tempestive, V. 20. Ins. non, MD (above); om., ML. 21. retraxit, OD, CC; traxerit, MC; subtraxerit, CM, OM, ME, MH, MM, MI, LC, LT, P, W. 22. videndum, LD. 23-24. Om., ML. 23-27. Om., LF. 25. rero, OB. 26. Ins. above, CB; repeat, ME. 26-27. poterit non, X. 28. si, OB, LG, OD, MB. 29. quæro, V; quærat, MC. 30. aliquis, MC. 31. poterit, HA, V; posset, OM, MB, ME, MH, CM, MM, LC, LT, P, W; possint, CB. 32-33. retrahere se, V, OB, OD, MF, LF, LG. 33. trahere, W; subtrahere, LC. 34. a, V, OB, OD, MF, LF, LG. 35. quodam, CM. 36. Om., MD (ins. above), ML. 37. Om., MC, MI, P (ins. above). 38. Om., W, OM (ins. above). 39. Item, V, OD, MF; om., LD, LF; et tunc, LC. 40. videlicet, HB. 41. Om., ME, CM. 42. sit, OC, CE. 43. annexi, MB; connexa, MC, MI (corr. to connexi), W. 44. avius, MC. 45. termino, MB (corr. to altero in margin); alio, W. 46. Ins. non, OM, OA, OF, CB, CC, LD, HB, HA, MM, MB, MC, MK, LT, P (marked out), Y, X. 47. Ins. non, MG; posset, OA, CC, CM. 48. sive, MA, MD, MN (corr. to vel); an, W. 49. Ins. debet, OA, OF, CC, MG; possit, MK. 50-51. Om., MA, MB, MD, MF, MI, MN, HA, OB, OD, LF. 51. Om., MG. 52-57. Repeat after recessum (n. 71, p. 178), MC. 53. motuo, P. 54. illo, OA, CC. 55. impetraverit, MC, MF, MI; impetraverat, MB. 56. Ins. eo, LD. 57. Ins. ut, MN. 58. Ins. above, MF. 58-59. Repeat, MH. 59-60. fuerit forte episcopus, HA. 60. fuit, OA, OF, MA, MD, MG, MK, CC, Y; fueri, OB. 61-65. Om., OF, ML, Y, LT, LG. 62. et, W. 63. Om., LD. 63-64. Om., LF. 65. Ins. et huiusmodi, LC. 66. tenens, MN; om., MB. 66-67. fuerit tenens, OA, CC. 67. fuerit, MD, MN; fuerunt, LD. 68. quod, CC. 69. in, MD; de (corr. to cum), HA. 70. fuerat, ML. 71. Om., MF. 71-72. ei alius, OD, OM, MA, MC, ME, MH, CM, MI, MK, ML, MN, LA, LC, LF, LT, P, X, Y; eis alius, OB (corr. to ei), LG, W. 71-74. Om., MM, CC. 72. Om., OA, OF, MB, MD, MG, CB, HB, LD, HA. 73. Ins. et, ME.

et¹ non² pœnalis³. Et⁴ si⁵ civilis sit⁶ et⁷ pœnalis⁸, durabit actio quantum⁹ ad pœnam et quantum¹⁰ ad¹¹ restitutionem quamdiu depositus vixerit¹². Si autem depositus¹³ mortuus¹⁴ fuerit¹⁵ vel¹⁶ ante¹⁷ depositionem¹⁸, extinguitur¹⁹ pœna cum²⁰ persona²¹, sed²² durabit²³ in persona substituti²⁴ quoad restitutionem, sed tamen²⁵ per²⁶ aliud breve²⁷. Item²⁸ cadit breve²⁹, sed³⁰ non actio, per³¹ mortem tenentis in actione personali³² sive mortuus fuerit morte³³ civili³⁴ vel³⁵ naturali³⁶, dum tamen³⁷ per fraudem se³⁸ non dimiserit³⁹ post⁴⁰ impetrationem⁴¹, si mortuus⁴² fuerit⁴³ morte⁴⁴ civili⁴⁵. Item⁴⁶ cadit⁴⁷ breve⁴⁸ mortuo⁴⁹ eo⁵⁰ qui⁵¹ mandavit⁵² vel præcepit⁵³ re⁵⁴ integra. Item si⁵⁵ quis⁵⁶ pro⁵⁷ eadem re⁵⁸ duo breviam impetraverit⁵⁹, et⁶⁰ utroque simul⁶¹ et⁶² semel⁶³ agere⁶⁴ inceperit⁶⁵ tam⁶⁶ super⁶⁷ iure quam super⁶⁸ possessione⁶⁹, differtur⁷⁰ actio super ipso⁷¹ iure, et pendet breve donec discussum⁷² fuerit super⁷³ possessione⁷⁴, ut⁷⁵ de termino Sanctæ⁷⁶ Trinitatis⁷⁷ anno⁷⁸ regis⁷⁹ Henrici decimo quarto⁸⁰ comitatu⁸¹ Surreiæ⁸² de priore de Novo⁸³ Loco⁸⁴. Et⁸⁵ hoc⁸⁶ sive breviam⁸⁷

1. Om., W; vel, OA, OC, OF, MB, MG, CC, CE. 2. Om., MB. 3. criminalis, HA. 4. vel, CM. 4-5. si autem, V, OB, OD, HA, MA, MB, MD, MF, MK, MN, LF, LG, Y. 4-8. Om., MC, MI, ML, LA, X. 5. Om., W; licet, LC. 6. Om., OA; scit, MG. 6-8. vel pœnalis sit, MF. 7. Om., W; vel, LC. 8. Ins. sic, OA. 9. quam, OC, CE. 10. quam, OC, CE; quem, OB. 11. Marginal, OM. 12. vixerat, ML; vexerit, OB. 13. Om., MA; ins. vel, OM. 14. mortus, MI (corr. to mortuus). 14-15. fuerit mortuus, W, LC. 16. Om., OM. 16-18. Om., LF. 17. Ins. above, MI. 18. impetrationem, HB, CB (corr. above); dispositionem, LA. 19. distinguitur, CE (corr. to extinguitur); extinguntur, MK; contingitur, MD (corr. to extinguitur). 20-21. Om., ME, MH, CM. 22. si, MC. 23. durabet, OA; ins. actio, MN. 24. substitui, W. 25. Om., OC, CC, CE; pœnam, OF, MG. 26. propter, W. 27. Ins. id est de ingressu, CB (above). 28-29. Om., MI. 28-45. Repeat, ML. 29. Om., MF (ins. above). 30. et, LF. 31. Ins. above, HB. 32. persona, OA. 33. Om., MK. 34-36. naturali vel civili, OA, OF, MG, CC. 35-45. Om., LA; repeat, MB (marked out). 37. Om., Y. 38. sed, LT. 39. dimisit, X. 40-41. Om., ME, CM, MH. 41. impetrator, MG. 42. morte, Y. 43. Om., OM, ME, MH, CM, MM, P, W. 44-45. civili morte, MA, MD. 46. Ins. mor, ME (marked out). 47-48. Ins. above, MB. 48. Om., Y. 49-50. eo mortuo, ML. 50. Om., LD. 51. quod, ML, LA, MC. 52. mandaverit, OB, LF, LG. 53. præcepit, MB; præ præcipit, HB; præcedit, W. 54. Om., OF, CB (ins. above); de re, LT. 55-56. Ins. above, MF. 57. per, CC, HA; de, OC, CE. 58. Om., MA, ML, MD (ins. above), CC. 59. impetravit, LF, MA, MD, ML, MM, W; ins. et duo breviam, LA. 60. Ins. de, ML. 61-63. sit usus et sic, CM. 62-63. Om., LC. 64. Om., LF; ins. et, MG. 65. incepit, X, LG, V, OD, MA, MD, MF; ceperit, OF. 65-66. inceptam, LF. 66. causa, OB. 67. Ins. po, X; om., MD (ins. above). 68. Om., MA, MD, CB, HB. 69. Ins. et, X, V, OB, OD, MB, MF, MI, MK, MN, LG. 70. differtur, V, OB, OD, OM, MB, ME, MF, MH, CM, MI, MK, ML, MM, MN, LC, LF, P, LG, LT, W, X, Y; deffertur, LD; defertur, other MSS. 70-74. Om., MA, MD. 71. Om., MK. 72. dissensum, OA. 73. sub, LA. 75. Om., OA. 75-84. Om., LF, HA. 76. Om., MG; sancti, LT, OC, CE. 77. Michaelis, OC, LT, CE. 78. Ins. regni, OC, OD, CB, CE, HB. 79. Om., OA. 79-80. XIII regis Henrici, ME, MH, P, LA; XIII regis, LD. 80. Ins. in, V; XIII, MA, MD, OA. 81-82. Om., CC. 83-84. Loco Novo, MK. 84. Om., MG. 85. Om., OF. 86. hæc, V. 87. breve, OC, CE.

impetrata¹ fuerint² ab uno vel³ duobus vel pluribus⁴. Idem⁵ erit⁶ si⁷ mulier⁸ dotem⁹ petat¹⁰ per¹¹ breve de¹² dote aliquam¹³ partem¹⁴, et alius¹⁵ petat¹⁶ totum¹⁷ in actione proprietatis, suspenditur actio¹⁸ dotis¹⁹ donec de proprietate constituerit. Item²⁰ si duo²¹ unum de²² eadem²³ re implacitaverint²⁴ una²⁵ et²⁶ eadem actione²⁷ et²⁸ eodem²⁹ brevi, ille³⁰ præfertur³¹ qui³² prius³³ incepit³⁴ agere, et aliud³⁵ breve simul cum³⁶ actione in³⁷ suspensio remanebit³⁸, sive³⁹ hoc sit⁴⁰ in eadem curia⁴¹ sive in diversis⁴², excepta⁴³ curia⁴⁴ domini⁴⁵ regis⁴⁶, ubi⁴⁷ nulla⁴⁸ attenditur⁴⁹ prioritas⁵⁰ propter⁵¹ maioritatem⁵² et⁵³ dignitatem⁵⁴ suam, et ubi⁵⁵ fallit regula⁵⁶ *Qui⁵⁷ prius⁵⁸ incepit⁵⁹ agere⁶⁰ aliis⁶¹ præferatur⁶²*, ut⁶³ supra⁶⁴ de actionibus⁶⁵. Item cadit breve ubi⁶⁶ quis⁶⁷ clamat⁶⁸ tenere⁶⁹ de⁷⁰ rege⁷¹, et alius⁷² ab⁷³ alio⁷⁴ quam⁷⁵ a⁷⁶ rege⁷⁷. Et⁷⁸ eodem modo si duo tenere⁷⁹ clamaverint⁸⁰ de

1-2. fuerint impetrata, OA, OF, MK, CB, HB, CC, X; fuerunt impetrata, MG. 2. fuerit, OC, CE. 3. Ins. a, LC. 3-4. vel duobus, HA. 5. Item, MG. 6. Om., W. 7. super, OA. 7-8. similiter, MF; qui, CB (corr. to si mulier). 8. Om., OA; ins. si, MF (above). 9-10. petat dotem, MD. 10. An erasure and corr., MN. 11-16. Marginal, CB. 12. Om., MF. 13-14. Om., OB, OD, MA, MB, MD (ins. above), MF, MI, LF, LG, CB (ins. above scilicet aliquam partem), HA, HB. 14. parte, V; petat, ME; ins. habens, LD. 15. alium, MB. 17. Om., MB, LA; dotem, MM; totam, LT; ins. petat, ME. 18. actione (corr. to actio), HA. 19. de dote, HA; om., CM. 20. Idem, CE, OC; unde, MA, MD. 21. dono, MK. 22-26. implacitaverint de una et eadem re, et, V. 23. una, LD. 24. implacitaverit, OB, OF, MG, LA, W; implacitaverunt, OC, CE. 25. Om., CM. 26. Ins. una, MG (above). 27. ratione et actione, LC; occasione, MK, X. 28. Om., MN. 29. uno, MC, LA. 30. et ille, CC; iste, OB, MF, LF, LG. 31. profertur, MH, OM, MM, LT, P. 31-32. qui præfertur, MA; qui præfertur qui, MD (first qui marked out). 33. primus, OB, OD, MB, MI, LF; primo, MD, ML, MN. 34. incipit, MA, W; inceperit, OM; inceperit, MN. 35. ad aliud, MB; aliud, Y; ad, MD (corr. to aliud); ins. agere et aliud, LT. 36. et, OC, CE. 37. et in, OC, CE. 38. permanebit, Y. 39-40. Ins. above, MN. 40. fiat, Y. 41. Om., LG, OB, OD, MD (ins. above), MF, MI; re, MB. 42. Ins. curiis, MK. 43. excepto, MB; exceptionibus, HA. 43-44. exceptis curiis, V, MA, MD; except. cur., OB, OD, MK, CB, HB. 45. Om., MB, CB, HB. 45-46. regis domini, MK. 47. nisi, CC. 48. nullam, OC, CE. 49. Ins. et, ME. 50. Om., MD (ins. above); minoritas, LD; proprietatis, ME; proprietas, CM, MH. 51. quod, MI. 52. minoritatem, LD; prioritatem, LT (corr. to maioritatem). 53. Ins. prioritatem (marked out) et, W. 53-54. Om., LD. 55. ibi, OA, OF, MG, LC, LD, CM, CC. 56. illa, OB; ratio, LD; ins. scilicet hoc, MK, X. 57. quæ, OA, OF, MG, CC. 58. primus, OB, LF. 59. incipit, MA, MK, ML, W, X. 60. Ins. ille, V, OB, LG, HA, OD, MA, MB, MD, MF, MN, LF, Y. 61. Om., OB, OD, MA, MB, MD, MF, MI, MK, MN, LG, X, LF, Y; alii, CM. 62. proferatur, X, CC; præfertur, MA, MD. 63-64. et sequitur, OA, OF, MG, CC, CB (corr. to ut supra), HB. 63-65. Om., HA. 66. quando, MG, OF, OA, CC; ut, LG; ut cum, LF; ut si, X, MK, HB, CB. 67. Om., MK; aliquis, LC, W. 68. clamavit, X; clam., MK. 69. Om., LA, CB (marginal). 69-71. de rege tenere, Y. 70. a, LD. 72. aliis, ME, LT. 73. sub, OB, LG, OD, MF, W; de, LF, Y. 74. aliquo, LA; illo, MA, MD; aliquo alio, MC. 75. qui, MA, MD (corr. to quam). 76. de, V, MF, MN, LD, LF; ab, CB, HB. 76-77. Om., HA. 77. Ins. etc., MD (above). 78. Item, V, OD, MF; om., LF. 79. Om., OA, CC, LD. 79-80. clamaverit tenere, MI, MK; clamaverint tenere, LC, X, W; clamare tenuerint, MB (changed to clamavit teneri). 80. clam., MD; clamaverunt, MG. ~

rege per certum¹ servitium², quorum³ unus⁴ per minus servitium⁵ et⁶ alius⁷ per⁸ maius⁹, breve illius¹⁰ cadit qui per¹¹ minus servitium¹², propter regis¹³ utilitatem¹⁴. Item¹⁵ cadit¹⁶ breve¹⁷ si quis impetraverit¹⁸ super certa²⁰ re²¹ et²² certa actione²⁵, et²⁴ postmodum se retraxerit²⁵ et²⁶ in²⁷ alio iudicio velit agere de²⁸ eodem²⁹. Item quædam³⁰ exceptio³¹ contra breve³² substantiam capit ex³³ tempore. Sunt³⁴ quædam³⁵ brevia limitata³⁶ infra certa³⁷ tempora³⁸, sicut³⁹ sunt actiones⁴⁰ ultra⁴¹ quæ⁴² non extenditur⁴³ breve non⁴⁴ magis quam⁴⁵ actio propter defectum probationis, secundum quod⁴⁶ actio fuerit⁴⁷ prodita⁴⁸ super possessione⁴⁹ vel⁵⁰ super proprietate⁵¹, sicut assisa novæ⁵² disseisinæ⁵³, mortis antecessoris, assisa⁵⁴ utrum, breve de ingressu, aut⁵⁵ breve de recto, ut supra⁵⁶. Item cadit breve⁵⁷ si quis⁵⁸ per narrationem in iudicio factam⁵⁹ recesserit de⁶⁰ brevi suo⁶¹, excedendo⁶² virtutem⁶³ et⁶⁴ naturam⁶⁵ brevis, ut si⁶⁶ agatur⁶⁷ in causa⁶⁸ possessionis⁶⁹ per⁷⁰

1-2. servitium certum, MH, CM. 3-12. Om., ML. 4. Om., MA. 5. Om., MA, MD, ME. 6. Om., OF, LG, OM, MC, MG, MH, MM, CB, HB, LA, LD, LF, LT, P. 6-12. Om., CC, HA, W, CM, LC. 7. alter, OA. 7-12. Repeat, MG. 8. Om., MI. 9. magis, MG, CE, OC; ins. servitium, MK. 10. Om., MN; ipsius, X, MK. 11. propter, MF, OF. 12. Ins. tenere clamat, LF. 13-14. utilitatem regis, V, OD, MF. 14. valet, OA; utilitatem, OF; valitudinem, MG. 15. Idem, HA. 16. Om., W. 16-17. Om., HA. 17. Ins. ubi quis clamat tenere de rege et alius ab alio quam a rege, ML (marked out). 18. impetravit, OF. 18-21. super certa re impetraverit, LD. 20-23. Om., LF. 22. Ins. super, ML. 22-23. Repeat, ME. 24. Om., MF, MG; ins. per, OB. 25. retraxit, OF, MN; traxerit, W (corr. to retraxerit), OM, LA, CB, HB. 26. Om., X. 26-27. Om., OB (ins. above). 28-29. Om., LF. 29. Ins. breve, CB (marked out), HB. 30. quod, ME, CM, MH; quodam, OB; corr. to quadam, MD. 31. Corr. to exceptione, MD. 32. Ins. et, OC, CE; om., CB (marginal). 33. a, OA, CC. 34. ut sunt, X, MK; ins. etiam, LC; ins. autem, V, OM. 35. quidem, OB, MC, MI, MN, LA, LF, LG. 36. limitate, OF; legitimitate, MM; lima., W; lamta., LA. 37-38. tempora certa, MG. 38. Ins. limitata, OA (marked out). 39. sint, LG, OB. 39-40. Om., OA. 40. Om., CC. 41. vel, OC, CE; om., CM. 41-42. utraque, OB, MC. 42. quæ, LG, HA, OC, OD, OM, MA, MB, MD, ME, MH, MI, ML, MM, MN, CM, CB, HB, CE, LA, LC, LF, LT, P (corr. to quem), W, Y; om., LD; quas, other MSS. 43. contenditur, MI (corr. to extenditur); extenduntur, CM. 44. Om., OF, MG. 45. Om., OC, CE. 46. quo, OM (corr. to quod). 47. fuit, OB, MA, MB, MD, MI, LF, LG. 48. perdita, OC, CC, CE, LD; prohibita, MI. 49. proprietate, OF, MG. 50. et, OB. 51. possessione, OF, MG; prioritate, OB, LG, OD, MD. 52-54. Om., ML. 53. Ins. et, OC, CB, CE, HB. 54. Om., OF, MI, CB, LC, HB, LF; ins. de, V, OM, CM, MF; marked out, iurata de put above, MD. 55. Om., LC, LD (ins. vel above), CM, LF; an, LG, OB, OC, MA, ME, MB, MC, MD (marked out), MH, MI, MM, MN, CE, LA, P, W, Y; ante, OD, OM, MF, CB, HB. 55-56. etc. ut supra, HA. 56. sequitur, OA, OF, MG, CB, HB, CC. 57. Om., CB (marginal), LT; ins. ut, V, OA, OB, OD, MA, MB, MD, MF, MI, MN, LF, Y, LG, HA. 58. Om., LT. 59. facta, W. 60. a, MK; in, X. 61. Repeat, W. 61-62. excedendo suo, MG. 63. veritatem, OA, OF, MF, MG, CC. 64. vel, ME, CM, MH, MM, LT, P, W; an, OM. 65. verum, MB (corr. above). 66-67. sciatur, OM, ME, MH, CM, MM, LT, W, P; figuratur, MF. 68-69. possessionis causa, MG. 70. per, X, V, OB, OD, MA, MB, MD, MF, MI, MK, MN, LT, LF, LG, HA, Y; semper, MM; si per, ME; si, CM, MH; super, other MSS.

breve de¹ consanguinitate², et petens in narratione sua³ mentionem⁴ fecerit de ipso iure, vel si⁵ unum⁶ ore⁷ petat, et per⁸ breve¹⁰ diversum¹¹, nisi¹² ita sit¹⁵ cum¹⁴ dicat diversum¹⁵ quod¹⁶ dicat¹⁷ quod¹⁸ tantundem¹⁹ valet²⁰. Et²¹ fere²² omnes exceptiones quæ competunt²³ alicui vel²⁴ contra²⁵ aliquem²⁶, connumerari²⁷ poterunt²⁸ inter²⁹ exceptiones³⁰ contra³¹ breve³², quia³³ ubi³⁴ terminatur³⁵ actio³⁶ finitur³⁷ breve³⁸, et ubi³⁹ cadit⁴⁰ actio⁴¹ cadit⁴² et⁴³ breve, et⁴⁴ ubi differtur⁴⁵ actio⁴⁶ vel⁴⁷ suspenditur⁴⁸ vel⁴⁹ mutatur⁵⁰, ita⁵¹ et⁵² breve. Cum⁵³ autem⁵⁴ plures⁵⁵ competant⁵⁶ exceptiones⁵⁷ contra breve⁵⁸, bene⁵⁹ possunt⁶⁰ secundum⁶¹ quosdam proponi⁶² temporibus⁶³ diversis⁶⁴, sed⁶⁵ in potestate iudicis⁶⁶ erit⁶⁷ artandi⁶⁸ tenentem⁶⁹ quod simul⁷⁰ et⁷¹ semel⁷² et⁷³ una⁷⁴ die proponat omnes⁷⁵ exceptiones competentes⁷⁶

1. Om., OA. 2. assisa, MA. 3. Om., OA, OF, MD, MG, CB, HB, CC. 3-17. Om., MI. 4. intentionem, ME, MH, OM, MM, CM, P. 5. Om., MA; ins. later in erasure, MD. 5-6. unum si, ME. 6. uno, OC, CE. 6-7. minor, ML; ore unum, MA, MD. 6-11. ore breve unum et diversum breve, OF. 7. ominino, CM. 8. Om., X, OB, OD, MA, MB, MD (ins. nisi ita sit above), MF, LG, HB, HA, MN, W. 9. Om., OA, OC, MG, CB (ins. above), CC, CE, LA, LD. 10. Ins. de recto, W (marked out). 11. diverso, OC, CE; ins. cum, OA, OF, MG, CB, CC, HB. 12. ubi, OA, X. 12-15. Om., OB, OD, MA, MB, MD (ins. above nisi ita sint), MF, HA, LF, LG. 12-25. ubi terminatur actio finitur, LT. 13. scit, MG; ins. quod, ME. 14-15. Om., MN. 15. Ins. vel, OA, OF, MG, CC; ins. et, OC, CE, HB. 16. Om., ME; vel, LF; corr. to et above, CB. 17-18. Om., OA. 19. tantum de, MK. 20. valeat, OA, OF, OM, MC, ME, MG, HB, CM, MH, ML, MM, CB, LA, LC, LD, W, P; volet, X. 21-38. Om., LF. 22. Ins. et, W; feres, MK; forte, MF. 23. competit, OF; competant, CM, ML. 24. licet, OD, MF. 25. Om., OB. 25-26. Om., LD. 26. quem, OA, CC; aliquam, MC, MK. 27. connumerare, OC. 28. Om., OB, OD, MA, MB, MF, MI, LG, HA. 29. contra, Y (corr. to inter above); ins. omnes, CM. 30. Ins. quæ competunt, MN; ins. quæ competunt alicui vel, LT. 31-32. Om., OA, OF, MG, CC. 32. Om., CB (ins. above). 33. Om., X, ME, MK. 33-34. per quas, HA. 33-38. Om., LT. 34. cum, V, OB, OD, MA, MB, LG, MF, MI, MN. 35-39. Om., LA. 36. Ins. cadit (marked out) et, MN. 37. Ins. et, Y; cadit et, LC. 37-38. breve finitur, MM. 37-41. Om., W. 37-46. Om., MK. 38. Om., CC. 40-41. actio cadit, OB, OD, MA, MD, MF, MI, MN, HA, LF, LG. 42. Om., MD (ins. above), MI (ins. above), LD. 43. Om., OA, OC, OF, OM, MA, MB, MD (ins. above), MG, CB, HB, CC, CE, LT (ins. above). 44. vel, OF. 44-48. et ubi suspenditur actio, HA. 45. defertur, various MSS.; defenditur, OA, CC. 47. Om., OC, CE. 48. suspendatur, MD (corr. to suspenditur). 49. p, CB (marked out). 50. mutat, OB, OD, MB, MI, LF, LG. 51-52. et ita, MB (ins. above). 53-58. Om., CC. 54. Ins. et, OA; om., HA. 54-55. plures autem, X. 56. petant, MG; competunt, MC, LC; computant, MK. 57. actiones, X, OA, OC, OF, MB (corr. above to exceptiones), OM, MC, ME, MG, MH, CM, MM, LA, LC, LT, P, W, CB (corr. above). 59. non, V, OD, MF; breve, MK. 59-2 next page. Om., ML. 60. possit, MB. 61-64. diversis temporibus proponi secundum quosdam, CC. 62. Om., MI; poni, OM, ME, MH, CM, MM, LC, LT, P, W. 63-64. diversis temporibus, OA, OF, MG, MK, CB, HB, CC. 65. si, MA, MD (corr. to sed), LG. 66. iudicum, OM, W; ins. ordian., OA (marked out); iudicatis, MF. 67. est, MA, MD. 68. artandum, LC, W; artando, HA; accusandi, MF. 69. tenentes, MG. 70-72. semel et simul, CC. 71-72. Om., MB. 73. Om., V, OA (ins. above), Y; in, OB, OD, MF, CE, LF, LG. 74. uno, V. 75. Om., MF, LF. 76-9 next page. Om., MK.

contra¹ breve², et³ sic⁴ præcludi⁵ poterit via⁶ proponendi⁷ ulterius⁸ exceptiones⁹ contra¹⁰ breve¹¹. Sed cum¹² tenens¹³ unam¹⁴ proposuerit¹⁵ quod¹⁶ rem petitam totam¹⁷ non tenuerit, sed alius¹⁸, illa¹⁹ terminata²⁰ non²¹ redibit ulterius²² ad²³ consimilem²⁴, ut²⁵ infra²⁶ dicetur²⁷ plenius²⁸. Et²⁹ notandum³⁰ quod³¹ cum breve ceciderit³² per defectum et errorem, si³³ erigatur³⁴ consimile³⁵ sed³⁶ correctum³⁷, eadem³⁸ erit actio quæ prius³⁹ et⁴⁰ idem⁴¹ breve⁴² sed⁴³ correctum⁴⁴, licet⁴⁵ aliud pergamenum⁴⁶ et⁴⁷ aliud incaustum⁴⁸. Et⁴⁹ ideo nec⁵⁰ mutari⁵¹ debet⁵² narratio⁵³ prius⁵⁴ facta in iudicio, nec⁵⁵ attornatus qui prius⁵⁶ factus⁵⁷ fuerit⁵⁸, cum⁵⁹ eadem⁶⁰ sit⁶¹ hinc⁶² inde⁶³ actio⁶⁴ et⁶⁵ breve⁶⁶ idem⁶⁷.

1-11. Om., OM. 1-13. Om., ME, MH, MM, CM, LT, P, W. 3-4. nec, LF. 3-10. Repeat, MF. 3-11. Om., OA, CC. 5. procludendi, X. 5-12. Om., HA. 6. viam, ML; in, LC. 7-8. ulterius proponendi, CB; alterius proponendi, OF, MG. 9. os, OF (marked out). 12. si, OM. 14. una, OB, OD, LG; exceptionem unam, HA; si unam, CM. 15. posuerit, LT; proposuerunt, W. 16. et, LF; et quod, OA, OF, MG, CC; ad, LG; scilicet quod, OM; contra, W. 17. Om., W, MD, LA, LC; repeat, MB. 18. alter, MC, ML. 19. Om., MK; ita, MF; ista, OD, LF; i., OC, CE. 20. teriatur, OF, MF, MH. 21-22. ulterius non redibit, V, OB, OD, MA, MB, MD, LG, HA, LF, MF, MI, MN. 23. ut, OA, OF, MG, CC. 24. consimile, OF, LC, MH, MG, ML, LT, OM (by corr. from consimilem), P, W. 25. Om., OA, CC, LA. 25-28. Om., HA. 26. ita, OB, MC, MF, LG. 27-28. plenius dicetur, OC, CE. 29. Om., ML. 30. Om., MB. 31. Om., OF, MG, CB, HB, CM, CC, LA, X. 32. A corr. in W. 33. Ins. above, ME; sed, CC. 34. corrigatur, X, V, OB, OD, MA, MB, LG, HA, MF, MD, MN, MI (corr. to errigatur), MK, LF, Y; exigatur, ML, LD; ergatur, HB; ins. et, LF. 35. consimilem, MK, X; consimlem, HB. 36. Om., MN; et, OA, CC; sit, OD, MB, MF, LF, HA, HB, Y; licet, LC; si, OB, LG; fit, MA, MD; sed, OC, OF, OM, MC, ME, MG, CM, MH, MI (a corr.), ML, MM, CB (sit ins. above), CE, LA, LT, P, W; erit, V, MK, X. 36-42. Om., LD (eadem—correctum in margin). 37. Ins. et, X, V, MK. 38-39. eadem actione prius, CM. 38-44. Om., OF, MG. 39. primus, LG, OB. 40. Om., OD. 41. eodem, MD (corr. to illud above). 43. si, OB; ins. contra, HB (marked out). 43-44. Om., CC, LF. 45. sed, OA, OC, OF, MG, CC, CE; om., HB. 45-48. Om., HA. 46. Also as percamenum, parcarmenum. 47. Om., W. 48. encaustum, CE, OC; institutum, LD (corr. to incaustum). 49. Ins. aliud, LT (marked out). 50. Om., MA, MD (ins. above); ne, HA; non, OC, CE, LF, W. 51. mutare, HB, CB. 51-52. debet mutari, X, MD, MK. 53. mro., MC. 54. primus, OB, LG. 55. sed, MK, CB (by corr. from nec). 56. primus, OB, LF, LG; post, CM. 57. Om., V, MI; facta, OM. 58. fuit, MK. 59. in, MC; et cum, OC, CE; et tamen, X, MK. 60-61. sit eadem, CE, OC. 61. sic, CC; fit, MD; si, LA; sine, CB (marked out), LD; om., MK. 61-62. Marginal, CB. 62. narratio, OC, CE; hic, HA; huic, LT. 62-63. Om., OA, OF, MG, CC. 62-64. actio huic inde, ML. 62-65. eadem ratio idem actio et, MD (corr. to actio id). 63. idem, OC, CE; om., W. 66-67. idem breve, LF, MN.

For the purpose of yet further comparison along a more restricted line we give here the beginnings of four writs.

I Folio 299b, sect. 5. Collated for OB, OF, OM, MA, MB, MC, MD, ME, MF, MG, MH, MI, MM, MN, CM, CB, CC, CE, CF, LA, LB, LC, LD, LT, B, P, PH, X. Passage omitted in OA, OG, OE, MK, LF, W.

H. dei gratia, OB, MA, MB, MM, MN, CE, CF, LT, P, PH.

H. dei gratia rex Angliae, CB.

E. dei gratia, MD, ME.

Rex dei gratia, B.

A. dei gratia, MI.

Rex vicecomiti salutem, MC, MH, LA, LB, LC, CC, X, CM.

Rex vicecomiti, etc., LD.

Rex, etc., OF, OM, MF, MG.

II Folio 419, sect. 8. Collated for OA, OB, OC, OD, OE, OF, OM, MA, MB, MC, MD, ME, MF, MG, MH, MI, MK, ML, MM, MN, LA, LC, LD, LT, CB, CC, CE, CH, B, P, PH, W, X, Y, HA, HB, CM.

H.¹ dei² gratia³ venerabili patri⁴ in⁵ Christo⁶ A.⁷ eadem⁸ gratia⁹ London.¹⁰ episcopo¹¹ salutem.

This is the reading of OB, OC, OD, MB, MC, LA, LD (has *h* as a rubric guide). 1. E. (or Edwardus), OM, MA, MD, MK, ML (no capital, small *e* in margin as guide to rubricator), LT, CH, X; Rex, OA, OF, OE, MF, MG, MI, LC, CC, PH. 2. de, CE, Y. 2-3. Om., OA, MF, PH; etc., OF, OE, MG, MI, LC, CC. 3. Ins. etc., OM, MN, LT. 4. Om., MA, MF, MK, ML, CH, LC, LT, PH, X. 5-6. Om., OA, OE, OF, MG, MI, CC. 6. Ins. patri, MK, CH, LC, X: ins. etc., MF, PH; ins. et, LT. 7. W., OE, OF, MG, MI, CC; J., OA; om., CE. 8. dei, ME, MH, MK, MM, CM, LC, P, W, X; de eadem, CB, B, HB. 8-9. Om., OA, OE, OF, MG, MI, CC. 9. Om., MD. 10-11. episcopus London., HA.

III Folio 419, sect. 9. Collated for OA, OB, OC, OD, OE, OF, OG, OM, MA, MB, MC, MD, ME, MF, MG, MH, MI, MK, ML, MM, MN, CB, CC, CE, CH, LA, LC, LD, LT, B, P, PH, W, X, Y, HA, HB, CM.

H.¹ dei² gratia³ etc.⁴, venerabili⁵ patri⁶ in Christo⁷ vel⁸ tali⁹ officiali¹⁰ salutem¹¹.

This is the reading of OB, OC, OD, MB, MC, ME, MH, MM, MN, CE, LA, LD, P, W, Y. 1. E. (or Edwardus), OM, MA, MD, MK, ML (no capital, small *e* in margin as guide to rubricator), CB, HB, CH, B, X; N., LT (though a small *h* was put in margin as guide to rubricator); Rex, OA, OE, OF, MG, MI, CC, LC. 2-3. Om., OA, OE, OF, MG, MI, CC, CH, LC. 4. Om., MF, MK, CM, CC, LT, X. 5. Repeat, Y. 5-8. Om., OA, OE, OF, MG, MI, CC; tali episcopo vel, CH. 6. Omit here and insert after Christo, MK, LT, X; om., MF. 6-7. etc., PH. 7. Ins. etc., HA, CM, MF; ins. tali episcopo, OM. 8. et, B, HB. 9. Om., OG. 10. Ins. etc., CC. 11. etc., OA, OF, OE, MG, MI; om., OG.

IV Folio 443, sect. 9. Collated for OB, OC, OD, OE, OM, MA, MC, MD, ME, MG, MH, MI, MK, ML, MN, CB, CC, CE, LA, LC, LD, LT, B, P, W, X, CM.

H.¹ dei² gratia³ etc.⁴, venerabili patri⁵ in Christo B.⁶ eadem⁷ gratia⁸ London⁹ episcopo salutem.

1. E. (or Edwardus), OF, OM, MA, MD, ME, MG, ML (small *e* as guide to rubricator), LD, LT, B, W, CC; I. (or J.), OE, MI; A., MK; Rex, LC. 2-9. tali, LC. 3. Ins. rex, OC, CE; ins. rex Anglia, ME. 4. Om., MA, MD, MK, X; ins. C., MC. 5. Omit here and insert after Christo, MC, LA; om., ME. 6. h., OE; F., OM, ME, MH, CC, CM, P, W. 7-8. Om., MG, LD.

ARRANGEMENT OF THE MANUSCRIPTS BY GROUPS

By the collation of these twelve passages certain facts are made evident at the very first glance. It is seen that there are almost innumerable differences of reading in the many manuscripts. That such an amount of variation should have developed is all the more remarkable because of the comparatively short period during which the manuscripts were produced; even texts which come from the third or fourth generation of copies show very considerable differences. Some of the texts deviate from the correct reading more often and more radically than others in the same line or the same generation. Some are so consistently at variance with what the majority of the better copies in all lines regard as right and proper that it at once becomes evident that they are textually of little worth. Just what the relative text value of the better manuscripts is may not be so apparent, but it can be determined. And it is not out of place to point out that even if the pedigree of the manuscripts could have been discovered by some other and less involved method, the collation of considerable portions of the text would yet have been necessary, since only by such a collation is it possible to form an estimate of the relative goodness or badness of each copy from the standpoint of a correct text. That the manuscripts naturally fall into certain more or less well-defined groups is also readily seen, especially as regards the longer of the collated passages. It is plain, too, that in several instances there is an agreement by pairs, though it would require more of an examination to discover that the pair grouping is not the same for each passage.

The full significance of the evidence furnished by the collation can, however, be understood only after a detailed study. But it is asking too much of the reader to require him to work over this mass of miscellaneous material, with many of its important facts half hidden, and arrange its details

for himself. So it has seemed best to present those facts which have a direct bearing upon the question of pedigree in a form which is both more orderly and more discernible. In making this arrangement by groups, the object has been to work from the larger to the smaller. First of all are given those largest combinations of manuscripts—often at variance with one another—which center about a single variant, such, for instance, as are determined by the readings of *ergo* and *autem* at the very beginning of the passage on f. 2b. Following these have been placed the larger of the regular groups, which are divided into smaller sub-groups, and, whenever possible, into pairs. Thus in the collation for fs. 413-415b, the large group OB, OD, MA, MB, MD, MF, MI, MN, LF, LG, Y, breaks up into the groups (OB, OD, MF, LG, LF), (OB, LF, LG), (OD, MF), (MA, MD), with MB, MI, MN, Y, showing a less clearly defined relationship. After these regular groups are usually given a number of more or less irregular combinations which do not readily adjust themselves to the group arrangement.

Variants collected under each group heading are not specifically numbered as to folio and line. However, as even the longer of the collated passages are, after all, but short ones, and as the entries are made in the order in which they occur in the collation, any one who so desires will have no difficulty in checking up the variants assigned to each group. When a minus sign precedes the notation of a manuscript within a parenthesis, as (—MN), it means that this manuscript does not agree with the other manuscripts in the group at this particular place. A plus sign used in the same way (+MN) signifies that the manuscript should be added to the list of those which have the variant.

FOLIO 2b. SECTION 3

- | | |
|---|---|
| { | ergo, OA, OC, OD, OF, OG, OM, MC, ME, MG, MH, CA, CB, CC, CD, CM, LA, LD, LE, B, P, PH, W, HB, HA. |
| { | autem, OB, OE, MA, MB, MD, MF, MK, MN, CE, CF, LC, LF, LG, LT, X, Y. |
| { | vero, ML. |
| { | æqui et boni (b. e. a.), OC, OF, ME, MG, MH, CA, CB, CC, CD, LD, LE, B, P, W, HB, CM. |
| { | nos quis (quis nos), OF, MA, MD, MF, MK, CE, X, Y. |
| { | ponitur (supponitur), OC, OD, OF, OG, OM, MA, MD, ME, MG, MH, MK, CA, CB, HA, HB, CM, CC, CD, LD, B, P, PH, W (ponitur quandoque), X. |
| { | prætorium, OA, OB, OC, OE, OG, MA, MB, MC, MD, MN, CE, CF, LF, LG, LT, X, Y, HB. |
| { | prætor, OD, OF, OM, ME, MF, MG, MH, MK, ML, CA, CB, CC, CD, LA, LD, LE, B, P, PH, W, HA, CM. |

pro (quandoque pro), OB, OE, MA, MB, MD, MF, MK, MN, CE, CF, LC, LF, LG, LT, B, X, Y.

sicut (sicut pro), OC, OD, MH, MK, CA, P, PH, W, CM.

cuique, OA, OE, MB, MC, ME, MF, MG, MH, CM, MK, ML, MN, CC, CD, CE, CF, LA, LC, LD, LE, LF, LG, LT, B, P, PH, W, X, Y.

unicuique, OC, OD, OF, OG, OM, MA, MD, CA, CB, CI, HB.

cui, OB.

OB, OE, MB, MN, LC, LF, LG.

civili (civili tantum), (+OF, MG, MH, CM, CA), (CD ins. above).

dederint (decernit), (OE, MC, in erasure).

om. prætor fecit . . . quod, (+ME, P; -LC).

ius (quandoque ius).

ubi (in quo), (+OM).

pro (quandoque pro).

OB, LF, LG.

incertitudine (necessitudine), (+OE).

cum (cum dicitur).

OB, OE.

habeat (habet).

MB, MN.

quis (quis nos).

quod præcipit (præcipit), (+MA, LC).

MA, MD.

quod (quod ius), (+LC).

iustum et æquum est et bonum (b. et a. est).

vicissitudine (necessitudine), (+MH, CM, CC, CD, LD [vissitudine], W [erasure], X).

autem (etiam).

CF, LT.

dicitur ius (ius dicitur), (+OD).

consuetudine (necessitudine).

recipit (præcipit), (twice).

MK, X.

aliquando (quandoque), (+MF, Y).

enim ius (etiam), X; etiam ius, MK, CA.

ut (ut cum).

ME, CC, P, OM, W, HA.

iustum (ius), (in erasure MA, MD, CB).

iudicium et (et), (in erasure MA, MD, CB).

OM, HA.

et ius (Ius).

quandoque ius (i. q.).

autem (enim).

relatio est facta (relatione facta), (+CA).

quandoque (quandoque ius).

unicuique pro (pro).

OF, MG.

varias habet (habet varias), (+CM, MH).

ei (ex).

et quando (quandoque), (MH=quando).

ius (omne ius), (+MA).
 CB, HB.
 ad (ad id).
 enim etiam (etiam).
 CD, LD.
 eius (cuius).
 et (pro).
 OC, OG.
 æquietatem (æquitatem).

THE *ADDICIO*

After tribuere, OF, OG, MC, MG, MH, CB, HB, CM, LD, B; after civilibus, CD; as in V:
 OC, OD, OM, HA, MD, PH, W; marginal, OA, OE, LA; omitted, OB, MA, MB,
 ME, MF, MK, ML, MN, CA, CC, CE, CF, LC, LF, LG, LT, P, X, Y.
 ut si (si), OE, W, HB, CB (by corr.).
 descendit (descendat), OF, OM, W, OD, PH, HA.
 proprietatem primam (primam proprietatem), OD, PH, OG.
 maius (maius ius) OC, LD.
 debet præferri (præferri debet), OE, W, MC, LA.
 verificaverint (evicerint), OD, PH.
 filias (filios), OA, OD, PH, OM, MC, LA, HA.
 et diversos (diversos), OC, MH, W, CM.
 et (ut), MH, W, CM.
 { ins. Item supponit ius, OD, PH.
 { ins. Item supponit, OM, W.
 OC, OE, OF, OG, MD, MG, MH, CB, CD, LD, B, HB, CM.
 unde (et unde), (-B).
 bene (unde), (+W).
 stulto (et stulto), (-CB, OG, HB).
 et (sicut), (OE omits).
 om. surdo et muto, (-B).
 absenti (et absenti), (-OG).
 agnatum (antenatum), (-OC, MD, LD; +W), (agnatum, OG; cognatum, CM).
 OE, OF, MG, MH, CB, HB, CM.
 possessionis (ius possessionis).
 et (minori et).
 debeant (debeat).
 si (sed), (-CB, HB).
 debet fieri (fieri debet), (+W).
 sicut (ut).
 CB, HB.
 assensu (assisa).
 supponat (frater ponat), (+OG).
 quod (quoddam).
 infinitum (in infinitum).
 MH, CM.
 morum (merum).
 item (sicut).

statim non (n. s.).
 primatus (postnatus).
 haberet (habuerit).

OF, MG.

habere ius (habere).
 fatue—statue—(fatuo).
 ponet (ponat).

OM, HA, W.

om. Item ius possessionis (W marginal).
 debet (debeat).
 habeant (habeant proprietatis).

CD, LD.

decendit (descendit), (+OC).
 vel (et), (+W).
 non (non statim), (+W).
 postnatus filios (postnatus).
 et (filios et).
 unde (ut).

FOLIO 5b. SECTION 5

- { multo fortius in superiorem, OB, OE, MA, MF, MK, CE, CF, LF, LG, LT, X, Y, HB.
 multo fortius inferior in superiorem, OM, HA.
 multo fortiorem superiorem, MB.
 multo fortius inferiorem, MN.
 superiorem multo fortius, CA.
 multo fortius superiorem, OA, OC, OD, OF, MC, MD, ME, MG, MH, ML, CB, CC, CD,
 CM, LA, LC, LD, LE, B, P, PH, W.
- { igitur, OA, OB, OD, OM, MA, MB, MC, MD, CE, LA, LC, LF, LG, PH, Y, HB, HA.
 ergo, MF, MK, LE, W, X.
 se, LD.
 enim, ML.
 omit, OC, OF, MG, MH, CM, CB, B; ME, CC, P; OE, MN; CF, LT; CA, CD.
- { reparandum, OC, OD, OF, OM, ME, MG, MH, MK, CA, CB (corr.), CC, CD, CF, LA, LD,
 LE, LT, B, P, PH, W, X, HA, CM.
 recuperandum, OA, OB, OE, MA, MB, MC, MD, MF, ML, MN, CE, LC, LF, LG, Y, HB.
 OB, OE, MB, MN, LC, LF, LG.
 voluit esse (esse voluit), (+HA, OM, MK, CE, W, X).
 qui (quæ), (+MA, CB, HB, CF, LT, X, Y; -MB), (LF omits).
 humanitatis (humilitatis), (+MK, X), (LF omits, OE in erasure).
 petit (petat).
 disputare debet (præsumat disputare), (+MF, MK, X, Y), (disputare, MB, MN, CF, LT).
- OB, LF, LG.
 defendent (defendant), (-LF; +W, CM, OM).
 om. et sub lege, (+MH).
 stipulationi (supplicationi), (LF=consultationi in erasure).
 factum (factum suum).
 hos (eos), MN, LC.
 breve contra (contra), OE, MB, LC.

PEDIGREE OF THE MANUSCRIPTS

CF, LT.

virgo semper (virgo).
tantum (tamen).
non (nec).
contra factum suum venire præsumat (c. f. s. v.).

MA, MD.

quia (cum).
legi rex (rex legi), (+OF).
sub lege voluit (v. s. l.).
beata (beata dei).
iudicio sibi (iudicio).
disputare præsumat (præsumat disputare).

OF, MG, MH, MK, CB, B, X, HB, CM.

servi (servi et), (+OD, PH, ML; -MK, X, B).
rex facit legem (l. f. r.), (-CB, B, HB).
enim est (est enim), (+LE, Y).

OF, MG, MH, CM.

quas (omnes).
quæ (qua), (MG=quo).
debuit (voluit).
humilitatem (humilitatis).
eius (exemplo).
legis (iuris), (+CB), (legis id est iuris, HB).
enim (quidem), (+MF).
venire contra factum suum (c. f. s. v.), (+CB, HB).

MH, CM.

eius et (et eius).
debeat (debet).
gerat (gerit).
dei est (dei).
ad (cum ad).
beata (etiam beata), (+ML).
nec (ne), (+MN).
suspiciendo (susceptiendo).

OF, MG.

esse non (esse).

CB, HB

sic potentiores (potentiores).

ME, CC, P.

est lex (lex), (+MH, CM, W).
exemplo humilitatis (h. e.), (+W)
debeat (debet).
ab eo rege (ab eo), (W=a rege).
est (erit).

MK, X.

etiam et alii (etiam)
attribuatur (attribuat).
dominetur (dominatur).
quia (qua).

ergo (igitur).
 emendat (emendet).
 debet maior eo esse (d. esse m. e.), (+MF).

CD, LD.

esse pares (p. e.).
 sed sub lege et sub deo (s. s. d. e. s. l.).
 rex (enim rex).

OD, PH.

semen (Jesu), OD; seme, PH.
 sed ratione (sed).
 om. mater . . . legalibus.

OM, HA.

et (ut), (+MA).
 Item (Ipse), (+ML).
 rex (autem rex).
 facit (lex facit), (+MF, CC).
 qua (qua ad).
 sed ratione et (sed).
 præ (pro).

habet (habet rex), OA, OC, OD, PH, ML, CA, CD, LA, LE, B, HA.

habet (habeat), OB, OF, OM, MA, MD, ME, MF, MG, MK, CA, CC, CD, LD, LF, LG,
 P, W, X.

quo (qua), ME, P, W, CD, LD, MG, (CC, CA, omit).

militant (militent), LD, W.

liberi (liberi homines), MB, W.

potestate (potestati), MH, MN, CB, CM.

subditi (subiecti), MB, LA.

enim (est enim), OM, MF, CC.

ad (qua ad), CA, CC.

volunt (voluit), ME, LD.

minimus (minimus autem), ME, MF, MK, X.

debet esse (esse debet), CE, X.

perfecerit (fecerit), CA, B.

FOLIO 32b. (ADDICIO)

OF, OM, MG, MH, MK, CB, B, HB, HA, CM.

ex (et).

qui (ei qui), (+ML).

cum (ius), (et, B; om. CB, HB).

salvo (salvo tamen), (+X; -CB, B, HB).

habet (habuerit), (-B).

proprietate remanente (r. p.), (-CB, B, HB).

nocebit (non nocebit).

ingerat (gerat), (vingerat, MH), (-CB, B, HB).

dicio se (se), (dictio se, MK; dico se, HB).

OF, OM, MG, MH, HA, CM.

ipsam (ipsum).

OF, MG.

liberum habeat (h. l.), (+MF, CM).

PEDIGREE OF THE MANUSCRIPTS

recipiet (reciperet).

OM, MH, HA, CM.

alius (aliis), (+MI, LC).

om. si ingrediatur . . . ex conventione.

om. et si —ex conventione, (om. si —non possit, OM).

om. Quia si omnino mutaverit, (+CH).

OM, HA.

ci (eius).

tantum (tantum habeat).

CB, B, HB.

sed (si), (sed si, HB).

donatorium (donatario).

CB, HB.

utrumque (utrumque ius).

potest concedere (c. p.).

et alicui (alicui), (+X).

et cum (cum).

confitebatur (confiteatur).

ut (ubi).

MH, CM.

posset (potest).

in (si in).

non (non ex).

CH, MF, MI, CA, LC, LD, X.

possessionis et proprietatis (proprietatis et possessionis), (om., CH).

facta (factum), (+ML; —LD, X), (facta fuerit, CA).

factam in iure (in iure factam), (—CH), (in iure, X).

longissimum tempus (t. l.), (longum tempus, MF), (longissimum, LD, ML).

vel (ut), (vel ut, CA, X).

omnibus (omnibus istis).

acciperet (reciperet), (acceperet, LD; caperet, X).

ex (in), (—MF).

MF, CH, CA, X.

attornare (attornari).

cum (sit cum), (sit ut cum, X, LC).

statum (statum suum), (—CA).

et (vel).

MF, CH.

autem (autem alius scilicet).

MF, CA.

per (ex).

utrum (si).

CA, X.

quod (quod donator).

in tempore (tempore).

vel ut (ut).

MF, MI, LC, LD.

possessionem donator (d. p.).

- CH, MI, LC, LD.
est (erit).
- LC, LD, CA, X.
et prius (prius).
- MI, LC.
alius (aliis), (+OM, MH, CM).
usque (videlicet).
ad ipsum revertatur (r. a. i.), (+OM).
actionem (assisam), (+MF).
- OC, MD.
poterit (potest).
ius utrumque (u. i.).
- habuit (habuerit), ML, LD.
vitam (vitam et), MD, LD, X.
recendo (recenter untendo), ML, CA.
hoc (per hoc), CB, LD.
habuit animum (a. h.), OM, MG, ML, MI, LC, X.
et si (si), OC, CA.
concessio (confessio), OD, ML, CA, CH.
naturaliter (naturalibus), MD, MF.
post (post tempus), ML, LD.
fuerit (fuit), MG, MH, ML, CM.
ut (sicut), MF, CB, HB.

FOLIO 33. (*ADDICIO*)

- OC, OG, MD, MI, CA, CD, CH, LC, LD.
As to position.
- OF, OM, MG, MH, MK, CB, LB, B, HB, HA, CM.
As to position.
- OD, OC, OM, MD, MI, CA, LD, LC, Y.
terram illam (i. t.), (illam, OG; eam, CH).
- OG, MD, MG, MK, LD.
succedit (succedet).
succedit (succedet), (+OC, ME, CM, MH; -MG).
- MI, CA, LC, LD, Y (marginal).
si (si sic), (+CH).
si (sive).
maritagium et custodia (custodia).
- MI, LC, LD.
servitio (servitio suo).
dominis capitalibus (c. d.), (+OC, CH).
- MI, LC.
dominis feodi (dominis).
fuerit minor (minor fuerit).
- CA, Y (marginal).
Et ut (Et).

- heres (heredi).
 tenendam de (de).
 autem dederit (autem).
 quin (et).
 OM, MH, ME, LB, HA, CM.
 dominis feodi (dominis).
 OM, HA.
 tantum (tunc).
 OF, MG.
 heres (heres vel frater antenatus), (+CH).
 HB, CB.
 quis (poterit quis).
 om. sic ut primogenitus . . . meo postnato.
 moriatur (præmoriatur), OC, OG, MG.
 tenendi (tenendam), OD, OC, MD, (tenenda, OG).

FOLIO 34. (*ADDICIO*)

- OD, OF, OM, MF, MG, MH, MK, CB, LB, B, X, HB, HA, CM.
 As to position.
 OC, OG, MD, ME, MI, CA, CH, LC, LD.
 As to position.
 OC, OD, OG, MD, ME, MF, P.
 Factum (Item factum).
 OG, MD, ME, MF, P.
 scilicet deum (d. s.).
 OF, OM, MG, MH, MK, CB, LB, B, HB, HA, CM.
 rerum (Item), (-CB, B, HB, HA).
 et (id est).
 apponere frænum (f. a.), (-CB, B, HB, HA).
 iniuste (iuste), (-CB, HB, CM).
 OF, MG.
 deum superiorem (s. d.).
 manibus et (manibus).
 MH, CM.
 qui (et qui).
 domino (dominus), (+HA).
 CB, HB.
 habet et (habet), (+X).
 OM, HA.
 et eorum (eorum et).
 MH, LB, CM.
 magistrum habet (h. m.).
 ignum (ignis).
 est (erit), (+OM, MI, LC, LD, HA).
 MI, LC, LD.
 legem (Item legem), (+HA).
 comites (comites et), (+MF).

debet (debent).
 scilicet ius nisi (nisi).
 eorum radices (r. e.), (+X).

MI, LC.

cartam (cartam potest).
 habebit (habet).
 et (quia).

ME, MF, P (marginal).

fecit (fecerit).
 in (et iusticiarii in).
 dei (viventis dei).
 habet socium (s. h.), (+OM).
 nec (nisi), (ne, MF, P), (+OD).
 fiant (fuerint).
 ne (tunc).
 clamant (clamabunt), (clament, MF).
 subditi (subditi et dicent).
 Jesu Christe (Jesu), (+OD, HA).
 constringe maxillas eorum (m. e. c.).
 voca (vocabo), (vocabo vocabo, MF).

vel (nec), MF, CH.

brevi (bene), MK, B.

si (et si), MF, X.

propter (per), ME, LB.

socii (quasi socii), OC, OG.

habet et (habet), CB, X.

quod (quos), ME, P.

legatis (ligatis), MI, B.

pedibus et manibus eorum (p. e. et m.).

FOLIOS 33b-35

vitam (vitam et), OC, OM, MA, MD, ME, MF, MH, CB, CC, P, Y, HA, HB, CM.

potest (poterit), OC, OF, OM, MC, MH, MG, MI, MK, ML, CA, CB, LA, LC, LD, B, X,
 HA, HB, CM.

non sit (sit), OB, MA, MB, MD, ME, MF, MH, MI, MN, CC, LC, LF, LG, P, X, HB
 (CB above), CM.

{ privatarum (privatæ), OM, MG, MI, LA, LC, LD, HA.

{ privatorum, OA, OC, OF, MK, ML, CB, B, HB.

sint communes (c. s.), OC, OF, OG, OM, HA, HB, CM, MG, MH, MI, ML, CA, CB, LB,
 LC, LD, B, (sit communes, MK).

aut duplicari (duplicari), OC, OF, OG, OM, HA, HB, MD, MG, MI, CA, CB, CH, LB,
 LC, LD, B, (aliud duplicari, MK).

petat a donatorio (petat), ME, MF, MH, MI, CC, LC, LD, P, Y, X, CM.

{ habere, OA, OB, OC, OG, MA, MB, MC, MD, ME, MF, MN, CC, CE, CF, LF, LG, LT,
 P, Y.

{ adhibere, MI, LC.

{ exhibere, OD, OF, OM, HA, HB, MG, MH, MK, ML, CA, CB, CH, CM, LA, LB, LD,
 B, X; exhiberi, CD.

PEDIGREE OF THE MANUSCRIPTS

- unde, OA, OB, MA, MB, ME, MF, MN, CC, CE, CF, LF, LG, LT, P, Y.
 sed, MC, LA; non, HA.
- nam, OC, OD, OF, OG, OM, MD, MG, MH, MI, MK, ML, CA, CB, LB, LC, LD, B, X,
 HB, CM.
- contra (et contra), OB, MA, MB, MD, ME, MF, CC, CF, LF, LG, LT, P, Y.
- uni parti (p. n.), OB, MA, MB, MD, ME, MF, MK, MN, CC, CF, LF, LG, LT, P, X, Y,
 (uni, ML), (parti, LA).
- recedit (recedat), OB, MA, MB, MD, ME, MF, MN, CC, LF, LG, P, Y.
- faciat, OA, OB, MA, MB, MD, ME, MF, MN, CB, CC, CE, LF, LG, P, Y.
- facit, CF, LT, X.
- faciet, OC, OD, OF, OG, OM, MC, MG, MH, MI, MK, ML, CA, CB (by corr.), CH, LA,
 LB, LC, LD, B, HA, HB, CM.
- positum, OA, OB, MA, MB, ME, MN, CC, LF, LG, P, Y.
- impositum, MF.
- om., CF, LT; in erasure, LD.
- appositum, OC, OD, OF, OG, OM, MC, MD, MG, MH, MI, MK, ML, CA, CB, CE, LA,
 LB, LC, B, X, HA, HB, CM.
- plenius inferius (i. p.), OB, MA, MD, ME, MF, ML, MN, CC, LF, LG, P, X, Y, (plenius
 infra, MB).
- et (ut), OA, OD, OF, MA, MC, MD, ME, MF, MG, MH, MI, MK, ML, CA, CB, CE, LA,
 LB, LC, P, B, Y, HA, HB, CM.
- et ego (ego), OB, MA, MB, MF, MN, CE, CF, LF, LG, LT, Y, HB, (CB above).
- ut (quod), OA, OD, ML, CB, CE, CF, LA, LT.
- debeat, OA, OC, OD, OF, OM, MC, MG, MH, MI, MK, ML, CA, CB, CE, CF, LB, LA,
 LC, LD, LT, X, HA, HB, CM.
- om., MB.
- debet, OB, MA, MD, ME, MF, MN, LF, LG, CC, B, P, Y.
- servitium (servitus), OC, OF, OM, HA, MG, MH, CM, MI, MK, CA, CB, LB, LD, X,
 (servitiis, LA), (servitium vel servitus, HB).
- OB, MA, MB, MN, LG, LF, MD.
- ut (et), (+CB, HB).
- amittet (amittat).
- om. et eodem . . . allegaverit, (-MD).
- om. et casum probaverit, (+CH; -MD).
- quia per (per), (-MA, MD).
- factis (factis regum), (-MD).
- forte (forte sigum), (-MD).
- differt (differt dicere), (-MB, MD).
- et (vel), (-MB, MD).
- inferius (superius).
- OB, LF, LG.
- Nunc de donationibus quæ dantur (Item fit donatio).
 sciendum (et sciendum).
- om. et simplici, alia de feoffamento, (+OC, OF).
- quietum (quietam), (+HA, LC), (quiet., OB).
- om. sed aliquando confirmat et addit.
- aliquid (forte aliquid).
- alia (aliqua), (+MI).
- qua (quibus).

poterit (etiam poterit).
 per quam (pro qua).
 non ad (ad).

MA, MD.

alia (Item alia), (+CH).
 dictum est (dicitur).
 scripturarum (scripturarum privatarum).
 per (pro), (+CA).
 disputare nec (nec).
 sequitur tamen (t. s.).
 As to the position of tali et heredibus heredum.
 vel tali (tali).
 videri poterit inferius (superius videri poterit).
 data (donata), (+MN).
 hoc (quod), (+MC, LD).
 uti velit (velit uti).

ME, CC, P.

fiunt (et fiunt).
 privatorum (privatarum).
 nt (vel), (+OC, CM, MH).
 illam suam (suam).
 una (unde una), (+OM, HA, MH, CM, LB).
 solet (non solet), (+LC), (P has non marked out).
 intentionem probandum vel (intentionem), (+MF, CH).
 in (si in), (+LC).
 conditio vel dictio (dictio), (+MF, MI, LC).
 unde (et unde), (P has et marked out).
 et (quia), (+MI, LC, LD, LB).
 servitio (servitio suo), (+CF).
 totam (tantam), (-ME).
 vel per nomen vel modum (per modum), P (nomen vel marked out); vel per modum, ME,
 CC; nomen vel modum, MF.
 inquietatur (inquietetur), (a corr. in ME).
 hac (cum hac).
 om. id est non quies.

CF, LT.

conditione aliqua (aliqua adiectione).
 terram illam (terram).
 remanet (remanent).
 commune (communes).
 qua (æqua).
 petat (petatur).
 debet (debet tenens), (+MA).
 et (et casum).
 quis facit (f. q.), (+X).
 et (est et).
 facit (faciat), (+X).
 ponere (petere).
 duo (duos), (+MN).

PEDIGREE OF THE MANUSCRIPTS

est (appositum est).
 sine (tantum sine).
 de (proprie de).
 pro homagio (per homagium), (+Y).
 sensum (consensum).
 quod (quod dicit).
 innuitur (innuit).
 voluntas (voluntas sua), (+CA).
 est (esse).
 vel (vult).
 quod (quod dicit).
 et (et per), (+ME).
 dicit (quod dicit).
 om. et quod non inquietetur.
 erit (erit ibi).

superius (superius autem), OM, MN, CF, LT.

simplici (et simplici), MB, MN.

{ et (est), OB, LF, LG, MI, LC, B.
 vel, ME, MF, P, (om., CC).
 eadem, Y.

petens (penes), MN, MI, LC.

aliqua (alia), MA, MB, MD, MN, ML, OM, HA.

om. quarta parte . . . retenta sibi, OB, MA, MB, MD, LF, LG, OM, LB, MF, MH, X,
 HA, CM.

forte cartam (c. f), MB, ME.

fundendam (fundandam), OB, MB, LF, LG, CF, LT, MG, CH.

prædictum (prædictum est), MA, MB, MN, CF.

quam (quam dicere), MB, LB, LT, CF.

concensi (consensi), MA, MB, MD, MI.

servitio suo (servitio), MI, MN, Y.

inquiete (inquietetur), LF, LG.

quies (est enim quies), LF, LG.

in (de), MB, CA.

OF, OM, MG, MH, MK, CB, LB, B, HA, HB, CM.

servivit (servit), (-OM, MH, HB, CM, LB; +MF).

sit certa (c. s.), (-LB).

om. est de simplici feoffamento, (-HB, LB; +CC).

exceptio nulla (exceptio sua nulla), (-OM, HA, CM, MH).

scripturam quis (q. s.), (-CB, HB, B), (scriptura quis, MK).

cyrograffum (cyrograffata), (-HB, CB), (cyrographi, CB, B), (cirograph., CM).

conventionem (conventionibus), (-CB, HB, B).

adversario (adversario suo), (+OG; -HB).

cuius (eius), (-CB, HB, B).

eius (cuius), (-CB, HB, B).

{ proceda ad iudicium (procedat iudicium), MK.
 procedat ad iudicium, MG, MH, CM.
 iudicium procedat, OF.
 ad iudicium procedat, B.
 procedat iudicium ad, CB, LB.

om. secundum quod per servitium, (-CB, HB, B).
 exprimetur (exprimatur), (-OM, CB, HB, B), (exprimitur, MK).
 om. et certæ in donationem.

OM, MH, LB, HA, CM.

hominis (hominum), (-LB; +OC, B), (temporum, CB).

om. sive conventionali, (-LB; +LD).

pertinentiis (partium), (-MH, CM), (pertinenti, HA).

dicitur (dicitur carta).

una (unde una), (+ME, CC, P).

remaneat (remanet), (+LD; -CM).

solet (solet aliquando).

tenens (tenentis), (-OM, HA), (tens., CM).

duas (duos), (-MH, CM; +MK, CC).

custodia (custodia et maritagium).

om. et per hoc quod dicere consensi.

servitium (servitus), (+MG), (servitum, MK).

OM, HA.

de (alia de).

om. quieta clamantia. Item alia de.

om. petentis. Vel esse ius, (+MA, B).

om. Item de clamaverit, (+B).

Enim (enim esse poterit).

omnino nulla exceptio (exceptio sua nulla).

denuntiata (de necessitate).

sibi ipsi scripturam (scripturam s. i.).

si (qui).

et (et hac).

dicitur (datur).

cum (vel cum).

non pertinet servitium (s. n. p.).

pacem (et pacem).

OF, MG.

posset (possit).

om. et regiarum alia privata, (+ME).

inpetentis (ius petentis).

sit (est).

præstari debent donatori (donatori præstari debent).

repeat vel pro et servitio.

possit donatarius uti (u. p. d.).

MH, CM.

donatio talis (t. d.).

de (alia de), (+MI).

terram (tenenti terram).

regia (regiis), (+OG).

CB, B, HB.

ad donationem (donationem), (+LB, HA), (-HB).

non (nec).

cerata (certa), (-HB).

quod (quia).

CB, HB.

petens (tenens), (+CC).
 hoc (hoc quod).
 hoc quod (quod).

MI, LC, LD, CA.

talis (et talis), (-LD).
 similiter (simul), (-CA), (similit, LC).
 ius esse (c. i.), (-CA; +CH).
 petit (petiit).
 confirmationis (de confirmatione), (+CH).
 { petierit (penes), LD.
 petens, MI, LC, MN.
 tenens, CA.
 aliquid forte (f. a.), (+CH).
 poterit esse (e. p.), (-CA).
 dederit manerium (m. d.).
 eius (de eius), (-CA).
 sunt tres (t. s.), (+OM), (sunt res, HA).
 est (erit), (-CA).
 sit eius (e. s.), (+ML).
 certa re (r. e.).
 et (quia), (-CA; +ME, CC, P, LB).
 sigilli (sigilli sui), (+MD; sigilli mei, LD).
 heredibus (heredibus suis), (-CA).
 priori vel abbati (a. v. p.).

MI, LC.

serviit (servit).
 poterit (possit).
 est sine (sine), (+MF).
 tenet (detinet), (+X).
 etc. (tunc).
 non tenere (tenere).
 adhibere (exhibere).
 dubio (dubitatio).
 ins. Item factum regis ut supra.
 homagio (homagio et servitio).
 ut (vero).
 ins. expositio omnium articulorum contentorum in carta.
 per (et per), (+CE).
 tactum (tacitum).
 habeant (habeat), (+OM).

CA, LD.

valet donatio (valet).
 recognovit (recognoverit).
 sint (sua sint), (+CF).
 pro (donatio pro).

CA, CH.

servitio suo (servitio).
 cartam (cartam forte).

- possit probari (probari possit), CE, LA.
 *si (licet), MK, X.
 et quieta (quieta), OG, MH, CB, HB, CM.
 attribuit novi (n. a.), MK, ML.
 *heredum (heredibus), MK, X.
 remisit (remanserit), B, X.
 †et (vel), MC, LA.
 { se non totum (se totum), MF, ML, LD, P.
 se totum non, MI, LC.
 cartas (cartam), MK, LF.
 †sunt (sunt species), MC, LA.
 †sed (unde), MC, LA.
 { ubi disputatio (dubitatio), OC, OG.
 ubi dubitatio, MD, CC.
 disputatio, MK.
 ad ultimum (adulterinum), CA, LA, LF.
 ipso (ipso rege), MA, MK, LA.
 om. quia custodia et maritagium, MD, MK, ML.
 pertinent (pertineant), MF, X.
 fiat (fit), MD, LD, MH, CM.
 donatio (autem donatio), MD, MK.
 carta (carta mea), MB, MK, LB.
 servitio (servitio suo), MD, MF, CC, LD.
 illud (id), MD, MF, CF, LT.
 cum (cui), MK, CE.
 et quod (quod), OF, MG, CC, P, MC.
 inquietatur (inquietetur), OA, MC, CE, CC, P.

FOLIO 96. SECTION 2

- fuerit (fuit), OC, OF, ME, MF, MG, MI, MN, CE, LA, LB, LC, LD, W, X, B, HB.
 restitui solet (s. r.), OE, OF, OG, OM, ME, MF, MG, MH, CC, LB, LD, P, W, X, Y, HA,
 CM.
 tenemento (tenemento non), OB, OF, OG, MA, MB, MF, MG, MI, MK, MN, CB, HB, CC,
 LB, LC, LD, LG, B, P, X, Y.
 { XV, OB, OM, HA, MA, MB, MF, MI, MN, CB, HB, LC, LG, (LF, B, W, LE, omit; OE
 omits originally and inserts later in different hand).
 XVIII, OA, OD, MK, ML, LA, LT, CE, CF, PH, (XVII, MD; XVI, LD; XIII, OE;
 XVIII, OC).
 XV alias XVIII, OG, ME, MG, MH, CM, LB, X, Y, (XV alias XVIII VIII, P; XV alias
 XV VIII, CC).
 VIII XV, OF.
 modo poterit (poterit), OB, OG, OE, OF, MA, MB, MD, MF, MG, MI, MN, CB, HB, LB,
 LC, LG, P, W, X, Y, (non poterit, CC).
 { nisi, OB, OF, OG, MA, MB, MG, MK, MN, CC, CE, LB, LC, LG, X, Y, HB.
 et nisi, OE, W; ubi, MI (erasure); nec, OM.
 ne, OA, OC, OD, MD, ME, MF, MH, ML, LA, LD, LE, LF, LT, CB, CF, B, P, PH,
 HA, CM.

PEDIGREE OF THE MANUSCRIPTS

- pars (partis), OB, OF, MA, MB, MD, MG, MI, MN, CB, CC, LB, LC, LG, P, X, HB.
 recipiet (reciperet), OB, OF, MA, MD, MG, MK, CC, LB, LG, PH, X.
 recipit, OE, W.
 receperit, ME, MH, CM.
 reciperit, LD, P.
 recuperet, MM.
- OB, MA, MB, MD, MI, MN, CB, LC, (LF), LG, HB.
 sua (sua legitima), (-MD; +B).
 viri sui (viri), (-LC; +X), (LF omits passage).
 XV (XX), (+OM, HA, MF), (MD=XVII), (LF omits passage).
 præiudicet (sibi præiudicet), (-MD).
 om. contra petitionem.
- OB, LG.
 et (et non).
- MA, MD.
 fuit (fuerit).
 vel (et), (+B).
 regni (regni sui).
- MI, LC.
 et exceptiones (de exceptionibus).
- OG, Y.
 regem Angliæ (anno).
 per actionem petat (petat per actionem).
 unde (et unde), (+OE, W).
- OF, MG, CC, LB, B, X.
 ecclesiæ (ecclesiæ ei), (CC omits passage).
 si de (de), (+OG, Y, ME, MF, MH, HB, CM, LD, P), (sic de, X).
- OF, MG, CC, LB.
 de dote sua (uxor dotem suam).
- OF, MG.
 guerra (gratiam), (grerra, LB).
- CC, LB.
 dos (tota dos), (+LF, X).
 testare (testari), (+OC).
 convenire (evenire).
 recto (dote), (+LD).
- ME, MH, B, P, CM.
 ita infra (infra).
 secundum (et secundum), (-P).
- ME, MH, CM.
 recipiat (recipit).
 in (de), (om., MH).
 voluntate (pro voluntate).
 recipiat (recipiet).
 receperit (reciperet).
- CF, LT.
 sit (fuerit).
 om. si voluerit . . . breve de recto.

OM, HA.

heredibus suis (heredibus).
sustinendum (abstincendum).

OE, W.

om. culta vel inculta, (+LE).
separantis (separatis), (separantur, W).
promissione (provisione).
om. patet de provisionibus.
om. inter placita . . . sua disponere.
non (non tunc).
per (per actionem per), (+ML, LE).
suum (de recto).
duxit (duxerit).
et (nisi ne).
unde (et unde), (+OG, Y).

MI, W.

culta (cultam).
inculta (incultam).

ad tempus duxerit (d. a. t.), OA, OC, OD, MF, ML, LA, LE, PH.
venire (evenire), OC, OD, LE, PH.
fuit ei (e. f.), ML, CF.
fructibus (fructibus et redditibus), OF, CC.
recepit (recipit), MF, ML, X.
culta (heredi culta), OF, OG, CF.
et (a), MD, X.
satisfactionem (factionem), OC, LD.

FOLIO 118. CHAPTER I

dicendum (dicendum est), OC, OD, OF, OG, MC, MH, MG, ML, LA, LB, LD, LT, CB,
CC, CE, B, P, PH, Y, CM.

{ perduxit (perduxerit), OC, MG, MH, CC, CB, LB, B, P, HB.
{ produxit, MA, MD, LD, LG.
{ produxerit, OA, OB, OE, OF, MB, MI, LC, CE.
{ reduxerint, CF, LT.

OB, OE, MA, MB, MI, CF, LC, LF, LG, LT.
egi (agi).

OB, LF, LG.
et secundum (secundum), (+LD).
alia omnia (omnia alia), (+MB, MD).
crimen (crimine), (-LF; +W).
criminis huiusmodi (h. c.).
multipliciter (multiplex), (-LF; +X).
fabricavit (fabricaverit), (LF in erasure).

OE, MI, LC.
crimina quædam (q. c.).
secundum (secundum quod), (-LC).
alia (alia criminia), (+OC, OG, LA).

PEDIGREE OF THE MANUSCRIPTS

MA, MD.

- praesumuntur (praesumitur), (+X).
- videndum (dicendum).
- produxit (perduxerit), (+LD, LG).
- effectum (ad effectum), (+MI, OE).
- alio (aliquo).
- fabricaverit reprobam (r. f.), (+ML).

CF, LT.

- reducerint (perduxerit).

OF, MG, MH, CB, LB, B, HB, CM.

- { multas species sub (sub se multas species), (-B), (multas species, HB).
- { multas species sub se, OA, OC, OG, LD, B.
- seductionem (seditionem), (-B; +LD, LT, W).
- vel consilium (consilium), (+X).
- perduxit (perduxerit), (+OC, P; -CM), (produxerit, OF).
- om. conspiratores vel . . . in hoc casu, (-B, HB).

OF, MG, MH, LB, CM.

- habent pœnam (pœnam).

OF, MG, CB, B, HB.

- autem (vero), (om., MH, CM, LB).

HB, CB.

- aliquo (vel aliquo).

OF, MG.

- si (ut si).

MH, LB, CM.

- quorum (quarum), (-CM).
- ad autem (ad).
- huius (vero huius).
- om. Habet enim . . . maiestatis, (+CC).
- homo (homo et), (+MB).
- locus (latro).

MH, CM.

- excusationem (accusationem).

ME, CC, P, W.

- publica et (publica), (+MH, CM, HB, CB), (ME omits passage).
- et (ut).
- servus maior (servus), (-CC, P).
- accusatis (accusantis), (-ME, W).
- aceusatio (actio), (-ME, W).
- [contra (tota), (P contra marked out, tota in margin; tota contra, CC)].

OC, OG.

- excedet (excedit).
- se (sub se).
- monetam (monetam reprobam).

MC, LA, Y.

- position of dicendum est.
- maiestatis (maiestatis aliquo casu), (-MC).

OD, PH.

- et consilium (consilium), (+ML).

criminalia (crimina), MB, MG.
 quæ (quod), MH, CB.
 quædam (quædam sunt), LD, W.
 inducunt (inferunt), ML, W.
 quem (quam), OG, MH, CF.
 sicut (sicut est) MB, W.
 prius (primo), MA, LD.
 in (ad), CB, W.
 hoc (in hoc), PH, X, Y.
 accusationem (accusantem), OA, PH.

FOLIO 132b. SECTION 12

Position of Item iuste utlagatus . . . quasi modo genitus.

As in the printed text, OD, MA, MD, PH.

As a rubric, OA, OB, CB, HB, CE, CF, LG, LT, X, (MH, LB, B, have as rubric for a later section).

Omitted in OC, OE, OF, OG, OM, HA, MB, MC, ME, MG, MI, ML, CA, CC, LA, LC, LD, LF, P, W, Y.

(Insert here the *addicio* in sect. 11, OC, OF, MC, MD, ME, MG, MH, CM, CA, CB, HB, CC, LB, LD, B, P, W, X.)

{	inlagatum (inlagaria), OB, OG, OM, MB, ME, LA, LF, Y, HA.
	inlagatus, OD, MC, MD, CA, CC, LD.
	inlegatus, OF, MG.
	utlagatum, OE, MI, LC.
	utlagatus, B, W, X, HB.
	inlag., OA, OC, MH, CB, LG, P, PH, CM.
	inlagat., MA, ML.
	inlagatio, CE, CF, LT.
	inlags., ML.
	nec (neque), OA, OB, OD, OM, MA, MC, MD, CE, LA, LF, LG, PH, HA.
et, ML.	
neque ad, ME, CA, LC, W.	
{	fuerant (fuerunt), OB, OD, OF, MA, MC, MD, ME, MG, MH, CM, ML, CB, HB, CC, CE, LB, LD, LF, LG, B, P, W, X.
	fuerat, CF, LT.
	fuerint, OE, MB, MI, LC.
	fuerit, OM, PH, HA.
fuerit aut, OC.	
OB, OE, MA, MB, MI, LC, LF, LG, CF, LT.	
sacramenta (ad sacramenta).	
OB, MA, MD, CB, CE, CF, LT, HB.	
restitui (restitui non potest).	
OB, MA, MD, CB, HB.	
nec (est nec), (nec ut est, HB).	
OB, MA, CB, HB.	
ingenitus (genitus).	
MA, MD, CB, CE, CF, LT, HB.	
actionem (actiones).	

In the *addicio*, or rubric.

PEDIGREE OF THE MANUSCRIPTS

- OB, OE, MB, MI, LC, LG.
damno (et damno).
- OE, MI, LC.
utlagatum (inlagaria).
obligationes (obligationes praehibitae).
- MA, MD.
possit ire (i. p.).
et hoc (hoc).
- CF, LT.
gravi (gratiam).
quid (quod).
et (et ad), (+LB, B), (in the *addicio*, or rubric).
cognitus (genitus), (in the *addicio*, or rubric).
inlagatio (inlagaria) (+CF).
fuerat (fuerant).
- OF, MG, MH, CB, HB, CM, CC, LB, B, OC, X, CA, LD.
inlagationem (inlagariam), (inlegationem, OF, MG).
fugam suam (fugam).
contumaciam suam (s. e.), (-CA, LD).
enim (autem), (+ML).
[restitui (restituere), OC, X, CA, LD, CB, CC, MD, W].
- OF, MG, MH, CB, CC, LB, B, HB, CM.
idem (id), (+OC).
utlag. (utlagariam), (-CC; +LF, Y), (OC, B, X, =utlagationem).
voluntate nova (n. v.), (-CB, HB, B; +X, OG).
prohibitae (praehibitae), (+OC, MA, CF, LD; -LB, B).
utlagationem (utlagariam), (+OB, OC, ME, W, X; -CB, HB, B), (utlag., CM, MH;
utlgat., LB; utleg., MG).
convicta (coniuncta), (+ME, LD, W; -CB, HB, CC).
posset (possunt), (-B; +OC), (possit, HB.)
- MH, CM.
causa (fuerit causa cum).
non (non enim).
- OF, MG.
inlegationem (inlagariam).
inlegatus (inlagaria).
- LB, B (in the *addicio*, or rubric).
om. pacem habere.
et (et ad), (+CF, LT).
- CB, HB.
et (cum).
modo quasi (q. m.), (+MA).
- CA, LD.
qualitercumque (qualiscumque), (+OC, CM, MH).
utlagaria (utlagatio), (+CC).
nisi (nisi tantum).
- OC, X.
utlagationem (utlagariam), (+B, W).
(utlagatus (inlagaria), B, W, X, HB).
homagia (homagium).

OD, PH.

See above for the *addicio*, or rubric.

nec (neque), (+X).

OG, Y.

ac (et).

restituatur, MD, ME.

pacem (pacem suam), ME, MA.

utlegatus (utlagatus), CB, HB, LG, (in *addicio*, or rubric).

confirmata (firmata), HA, OM, ME, CB, LD, W, (confuata, X).

præcedentibus (vero præcedentibus), OM, HA, LD.

ei (eis), ML, CA, LD, LF, P, W.

FOLIOS 161-162b

dicendum (dicendum est), OA, OB, OD, OG, MB, MC, MF, MI, ML, CC, CE, CF, LA, LC,
LD, LF, LG, LT, P, Y, CM.

{ quaecumque (qualicumque), OB, MA, MB, LF, LG.

{ qualitercumque, OD, OF, ME, MD, MG, MH, MK, LB, LD, CC, CB, HB.

om., MI, LC, CM.

{ possit (possint), OM, HA.

{ possunt, OG, MA, MD, ME, MF, MI, MK, CA, CC, CF, LD, LE, LF, LT, W, X, Y, CM.

{ posuit, LG.

Position of the *addicio* Et quæ poena . . . non de iure.{ As in the printed text, OF, ME, MG, MH, MK, CB, CC, LB, MC, MF, P, OG, Y, OD,
HB.

{ After repellat, OC, CH, LE, CA, LD, X, CF, LT.

{ After fuerit constituta, OB, OM, MA, MB, MD, MI, LC, LF, LG, W, HA, CM.

{ Omitted in CE.

{ Marginal in OA, LA.

{ fodeat (fodiat), OB, OC, CF, LT.

fodiet, ML.

{ fodias, MH, CC, LB.

perfodiat, OM, MA, MB, MD, MI, LC, W, HA, CM.

{ perfodeat, LF, LG.

sive (vel), OC, OF, OG, MC, MD, MF, MG, MI, CA, LA, LC, P, X, Y, CM.

{ invaserint, OC, OF, OG, ME, MG, MH, CA, CB, LB, LD, LT, HB.

invaserant, OA, OD, OM, MC, MF, ML, CE, LA, P, W, Y, HA.

{ invaserunt, MK, CC, CF.

{ evaserant, OB, MB, LG, (LF omits passage).

{ evaserint, MA, MD, MI, LC, LE, CM.

{ manserint, X.

OB, OM, MA, MB, MD, MI, LC, LF, LG, W, HA, CM.

est (erit), (+CA, X, LE).

violenter et (violenter), (+CB, HB).

om. vel pecora immittendo (−OM, HA, MD, W), (om. libero . . . immittendo, OM).

ut (vel), (−OM, LF, MD).

velit et (velit), (−OM, W, HA, MD).

contra (si contra), (−MD; +MF).

PEDIGREE OF THE MANUSCRIPTS

facit quis (facit), [+11B, CB (above); -CM].

Position of the *addicio* Et quæ pecna . . . non de iure.

esse potest (p. e.), (-OM, HA, MD, W; +OD, MC, LA, P), (potest, CM).

contendat (contendit), (-MB, MD; +MF).

se dicat (d. s.), (-MA, HA, MD; +OG, MF, LA, P, Y).

Item in (In), (+MK, HB, CB).

enim (etiam), (+OF, MG, CA; OB omits).

qui (armatos qui), (-OM, HA, MD, W; +MK).

fuerit (venerit), (-OM, HA, W; +OG).

sive (vel), (+MF, ML).

ei cum (cum), (-OM, HA, W; +OD).

modo (modo suam), (-OM, HA, W, MD).

donatione (donationibus), (-OM, HA, W, MD; +Y; LF omits passage).

MA, MB, MD, MI, LC, CM.

competit (competat), (-MB; +OF, P).

ut (vel), (-MD; +OB, HA, LG, W).

est (erit).

quæ (quod), (-MD; quam, OB).

perfodiat (fodiat), (+OM, HA, W).

in (in carcere et in), (-MD; +CF, LT, LF).

est (est vis), (-MD; +LF).

omnes (omnes illos), (-MD; +LF).

sed (sunt), (-MD; +HA).

{ fuerat (fuerint), OB, MB, MI, LG, CM.

{ fuerant, LF.

{ fuerit, LC, W, CC.

admittit (admittat), OM, HA, W, MA, MD, CA, X, ML.

{ aliis (viribus), MI, LC, CM.

{ viri duo, MB.

{ vicinis, OB, LG; vicinus, LF.

saltim (saltem), OB, MB, MI, LC, LF, LG, ML, CA, CC, CM.

om. vel pecora immittendo, OB, MB, MI, LC, LF, LG, CM.

enim (etiam), MA, MB, MD, LG, CA, LD.

OB, LF, LG.

qualecumque (qualicumque), (+MA, MB).

sit (fit).

Item (Et).

unde (una).

et alia (et), (-LF).

rem (in rem).

possessionem (possessione), (+MI, CM, LC).

inmobilibus (autem mobilibus).

armata (armati), (+MI, LC; LF omits passage).

ubi (conatus ubi).

MI, LC, CM.

et (sed), (+MB).

præsens quis (q. p.).

femina (familia).

suo (suo qualicumque).

om. est.
 cum (possidere cum).
 in (esse in).
 quies (quies quod), (+MF).
 nepoti (nepoti in patre).
 armata (cum familia armata), (quæ armata, CM).
 unde (vim), (-CM).
 quibus omnes (quotiens), (-CM).

MA, MD.

si (cum).
 esset (erit).
 et (vel).
 seu (sive), (+CB, HB).
 desidiom. (desidiam).
 In (In hoc).
 sustinuerit (sustinuit).
 vi (vi et vi), (+LT).
 non (non ita).
 directum (deiectum), (+HA; directum, W).
 quacumque (qualiscumque).
 est (erit).
 quod (et quod), (+OC).
 posset (possit).
 putant et dicunt (d. e. p.).

OM, W, HA.

commode et (commode), (+CE).
 ut (et).
 in (de).
 quia (quod), (+LD).
 cum (et expulsiva cum), (+LE).
 inquietiva (inquietativa), (+MB, MF).
 constat et (et), (cistat et, W).
 si (cum).

OM, HA.

non (nemine).
 possit (possint).
 voluerit uti (u. v.).
 et (sed).
 de (et de).
 om. et immobilibus incorporalibus.
 in (et in), (+MD).
 et non (et).
 tamen (enim).
 prohibuerunt (prohibuerint), (+CC).
 repulsiva (repulsiva).
 om. iuxta illud tempora sine.
 sufficiunt (sufficiant).

MD, OC.

et ex (ex), (+other MSS.).

- seisina et (seisina).*
præponens (præpotens), (+MA, MB).
dabit (dant, in the addicio).
matre (patri), (+CC).
quod (et quod), (+MA).
inducit (incidit).
sciendum (dicendum), (+CA, X).
- OC, OF, OG, ME, MG, MH, MK, CA, CB, CC, CF, CH, LB, LD, LT, X, HB.**
hoc ratum (ratum), (-CH; +LE).
iniuste (iuste), (-HB, X).
vim iniustam et iniuriam (iniuriam et vim iniustam).
et (ei), (-MK, CA, CB, CH; +OM, HA, W, MF, P, ML, CE), (est, HB).
enim (etiam), (-CA, X; +LE), (CH omits passage).
et (et in), (-OC, OG; +OM, HA, MI, LC, P), (CH omits passage).
videndum est (videndum), (+MF, W), (CH omits passage).
- OF, ME, MG, MH, MK, CB, CC, LB, HB.**
et ex (ex), (-OF; +OC, MD, LD), (est ex, X).
qualitercumque (qualicumque), (+OD, MD, LD).
non (et non), (+OC).
tenemento extra (tenemento), (-MK; +OC, CF, LT).
solum solutum (solutum), (-HB).
quæ (quia), (+MF, W), (CC omits passage), (quod, CB, HB).
impetus (rei impetus), (-CB, HB).
armis (armis vel sine armis), (-CB, HB).
armis (armis, armis), (+MA, MD, MF, CF).
est (et), (+OD, P), (sunt, OF, MF).
- ME, MH, CC, LB.**
occasione (actione), (+OM, MI, CM, LC).
erat liber (l. e.).
omnino quamvis (q. o.).
considerationem (desidiam).
hoc (tale).
ibi (ubi), (+LG).
om. et alius . . . ius habeat, (+OG, MA, MK).
inquietantia (inquietativa), (-ME; +CA).
fodias (fodiat), (-ME).
quis (scilicet quis), (+CB, HB).
et (etiam).
dideatur (videatur), (-ME, CC).
erit quidem (q. e.), (erit quidam, ME).
sicut (sunt), (sint, LB).
expellant (expellat).
præsidentem (possidentem).
- OF, MG.**
qualiter (qualiter possessio).
fiat (fit), (+ME, MH).
faciendo (fodiendo).
non (omnino non).
poterit quis facere (f. p. q.).

si (sed).
 pecuniaria (pœna pecuniaria).
 ius non (ius).
 possunt (potest), (+CA, X).
 expulat (expellat).
 item (ideo).

CB, HB.

non omnino (o. n.).
 ei (cum ei).
 iniustus (iniusta).
 quis (quid).
 et omnino (o. e.).
 familia et (familia).
 est (erit).
 etiam (tamen).

CA, X.

restituatur spoliato (s. r.).
 om. quale competat . . . cognosci debet.
 ut (ut postmodum).
 facilius postea (facilius).
 sequitur (sequatur).
 solummodo (solum).
 ingrediatur (possessionem ingrediatur), (+CH).
 repellatur (repellat).
 solum modo (solum).
 familiam (familiam eiciat).
 vel a (vel).
 qua causa (quo casu).
 pacifice (in pace).
 vel (et).
 clamat (clamaverit).
 vel (ut).
 debeat uti—deberat uti—(uti deberet).
 ob colorem (sub colore), (ob disseisinam coloratam et ob colorem, CA).
 servitiis (servitio).
 disseisinam facere (disseisiri).
 propter (propter iniustam).
 medio (quæ sustinuit medio).
 sed (licet).
 dicendum est (videndum).
 alia simplex alia (alia).
 et alia (alia).
 non (sine).
 violenta (violentia).
 uti quiete (quiete uti).
 aliquis (aliquis scilicet).
 vi (per vim).
 est enim (item est), (est etiam, X).
 deiectus (deiectum).
 susceperit (sumpserit).

poterit (eum), (potest, X).
 est (eum).
 generalis si (generalis).
 dominus ipse (i. d.).
 de (in).
 enim (non).
 ei (et ei), (+LE).
 contra (cum armis contra).
 eum armis ut (ut).
 armis et (armis).
 eum (cum tali).
 etiam quidam (etiam).
 sufficiant ad præsens (a. p. s.).

CF, LT.

sit (fuerit).
 qualitate facit (f. q.).
 utrum (verum), (+MB).
 commode uti possit (commode).
 pace (pace uti possit).
 voluntatem ipsius tenentis (i. t. v.), (+X).
 esse tenementum (t. e.).
 omnino (omnino non).
 quis facit (f. q.).
 qui (qui iuste).
 quem (qui).
 disseisinam (disseisiri), (+ME).
 iudicio facere alicui (iudicio).
 esse cum (esse).
 aliquando (aliquando simplex).
 resistere (resisti).
 om. non potest.
 clandestinata (clandestina).
 alium (alium quiete).
 quies (quies et non quies).
 faciet (falcet).
 est (est vis), (+MB, P).
 qualicumque (qualiscumque), (+OM, HA).
 quis (quis autem), (+P).
 non (non fuerit et).
 familiam (familia), (+MD, LD).
 tuitiosis (tuitionis).
 repellentem (repellere).
 arma (et arma).
 cum (tamen cum), (+OD).
 prætextu tali (sub tali prætextu).
 sunt (sunt etiam), (+P).
 quæ (qui).
 inducunt (dicunt).
 sed (sed regulariter).

sufficiat (sufficiant), (+OF).
 plenius de actionibus (de d. p.).

OC, OG.

commode (commodum).
 inequitiva (inquietativa).
 ius (vis).
 habent (habet).
 aliquando (alium).
 videlicet (videri).
 oportet (sed).
 quilibet (quælibet), (+MK, Y).
 tuitiones (tuitionis), (+MH).
 perturbationis (usurpationis).
 vult (viribus vult).
 in (cum).
 qualiter (regulariter).

OG, Y.

sciatur (sciri possit).
 deiecti (eiecti).
 alius in (alius), (+MB, MK, CM).
 om. eiciat vel . . . vel familiam.
 non omnino (omnino non).
 omnino ei (ei omnino), (+CA, LD, X).
 voluit (voluerit).
 om. contendendo tenementum . . . libero tenemento, (+ML; marginal, OA, Y).
 vel (vel cum).
 possit uti (uti possit).
 sicut (rem).
 cum (est).
 personale (personalis).
 sit (sicut).
 et est (est).

MF, P.

Position of Item facit disseisinam . . . per tale breve, (marginal, LA).
 ut (ubi).
 tueri possit suam (s. t. p.).
 neque (nec).

MC, LA.

secum (rem), (in the *addicio*).
 et (est), (+OA, OC), (in the *addicio*).
 kanc. (bovem), (+OG; erasure, Y), (in the *addicio*).
 etiam (in), (+P).

OA, CE.

autem (etiam), (+ML, CA, LD, MF).
 concedendo (contendendo), (+OD, MC).
 om. Item facit quis . . . per tale breve, (+ML; marginal, OA).
 quia (quod), (+MA, LD).
 voluntatem ipsius (i. v.).

quale (quæ), OC, LA.

PEDIGREE OF THE MANUSCRIPTS

- amittat (admittat), ML, CC.
 omnino eum (e. o.), OM, ML, CE.
 sed (fit), CA, X, MD, MF.
 et (et non), CE, Y.
 pectora (pecora), OA, OD, ME, MG, LD, CF.
 auferat (aufert), OG, LA, LD, Y.
 alio (aliquo alio), OC, CH, LD, P.
 fecit (fecerit), OD, LA.
 possessionem (possessionem sive seisinam), CH, LE.
 ei (eis), OC, MA, CC, LD, MD.
 om. Dictum est . . . eum armis, CH, OG.
 violenta (et violenta), OA, W.
 { om. omnino et expulsiva, LA, LD, Y.
 ut (ubi), MC, MF, LA, P, Y.
 permittat (permittit), MC, LA, P, Y.
 alia (alia vis), MD, LA, Y.
 ut (ubi), MC, LA, Y, MF, OC, HA, MA, MD, (ut si, OG; et, P; et cum, OM).
 *contentione (concertatione), CA, CF, CH, LD, LT, X.
 { autem (autem eum), CH, LE, P.
 peregrinatione (peregrinatione vel nundinis), CH, LE.
 reversus (reversus fuerit), CH, LE.
 ingrediantur (ingrediantur), CA, LD.
 eum (eum), OC, MC, MK, ML.
 *impulsiva (repulsiva), CA, CF, LD, LT, X.
 et unde (unde), CA, X, LE, LF.
 ei (et ei), CA, X, LE.
 dicunt (dicunt et putant), CH, LE.
 vulnerantur (vulnerentur), MB, ME, MF, LE, P.
 om. Hæc autem de vi . . . de donationibus plenius, CH, LE.
 sciendum (dicendum), OC, MD, CA, X.

FOLIO 179b. SECTION 5

- Om. et quid et quantum quale, OD, OF, OM, MC, MG, MH, MK, CA, CC, CE, LA, LB,
 LD, B, W, PH, HA.
 { et quem, ME, MH.
 et quantum, CA, CF, LT, X.
 et quid et quantum, OC, OD, OG, MC, CB, CE, LA, LD, B, PH, W, HB, Y.
 item quid et quantum, OF, OM, MG, CC, LB, HA.
 item quod et quantum, MK.
 om., OA, MF, P, (OB, MA, MB, MD, MI, ML, CM, LC, LE, LF, LG, omit the whole
 passage; marginal, OA).
 vino et (vino), OA, OF, OG, OM, MC, MF, MG, MK, CA, CB, CE, B, P, W, X, HB, HA,
 Y.
 inter (intra), OB, OC, OG, OM, MA, MD, ME, MF, MI, MH, LC, LE, LF, LG, P, HB,
 HA, CM, Y.

OB, MA, MB, MD, MI, LC, LF, LG, OG, OM, W, HA, CM, Y.

possint dicere (d. p.).

om. Si autem redditus . . . dicitur pertinere, (+ML, CE; marginal, OA, LC).

OB, MA, MB, MD, MI, LC, LF, LG, CM.

sive (sicut), (-MA, MD).

tenementis (denariis), (-MD).

certum (certum vel circiter), (-MA, MB, MD).

inter (infra), (-MB, MI, CM, LC).

OB, LF, LG.

sicut (sive).

per (dicti iuratorum per).

MA, MD.

oportet (debent).

quocumque (quibuscumque), (+OG, W, Y).

oleo vino (vino oleo), (+ME, CF).

om. et quos terminos tenementum.

secundum (si).

MI, LC, CM.

terminare (determinare).

OG, Y.

ut utrum (utrum).

om. querens posuerit in visu suo (+CE).

utrum scilicet (s. u.).

de (aliud de).

ut (sicut).

ad (ut ad).

de qua (qua).

sed (sed tamen).

OF, OM, MG, MK, CC, LB, X, ME, MH, CF, LT.

sive (vel).

mensura (mensura. Mensura), (-OM, LT, X; +MF, P, MA, LD).

dictorum (dicti), (-CF, LT, LB, X; +MF, P).

OF, MG, MK, CC, LB.

Position of solida sicut in, (+CB, B, HB).

fiat (tunc fiat), (-LB; +LC).

ME, MH, CA, X, CF, LT, LD.

vel (et), (+MD).

ME, MH, CF, LT.

vel (ut), (+LF).

dicere non (dicere), (+MK, LD).

saltem (vel saltem), (+LF).

ME, MH, CC, LB.

et (et quos).

possunt (possint), (+MF, PH).

ME, MH.

quale (quale sit), (+CA).

privata (privata. Item).

debent (debet), (+CA, LC).

liquida vel solida (s. v. l.).

tenementa in quo comitatu sint (i. q. e. sit tenementum).

qua (in qua).

ubi (si).

distinguere (distinguere non).

incertum (certum).

saltem dicatur (saltem), (saltem dicat, ME).

ei (si).

om. fiat seisina . . . qua parte.

si (sed), (+ML, CF).

sufficit tamen (t. s.).

seisina si fiat (si f. s.).

visus iuratoribus (i. v.).

si de (si).

CC, LB.

tenementum sit (s. t.).

infra (intra), (+W).

OF, MG.

om. vel circiter . . . tenementum contineatur.

communam (communia).

CA, X.

sive (sicut redditus sive).

de quantitate (ad quantitatem).

tenemento (de tenemento).

CF, LT.

om. sit tenementum . . . quantum quale, (+OC, X).

illud (aliud), (+MI, LC, LD).

videri (videre), (+CE, X).

pervenerit (provenerit), (+MB, P).

instrumento (in frumento), (+MI).

videri (videre).

cercitum (circiter).

eam (tamen).

pervenit (provenit).

om. tunc fiat visus.

MF, P.

om. quale sit . . . quale videlicet.

commune, et quale sit tenementum, et quid et quantum (commune).

om. Item quantum, (+OA).

petit (petitur).

communam (communia), (+OC).

OA, CE, OD, PH, MC, LA, ML, OM, HA, Y.

consistat (constat), (consistit, MF).

consistat (constat), (+OC, OG, W, CA, MF, P).

OA, CE.

om. sed tamen . . . fiat seisina.

OM, HA.

aliquod (aliud), (+W, MF, X).

diffinire (distinguere).

vel quod (quod).

ita (*infra*), OC, OD, ME, MF, CA, P, PH, X.
 om. querens posuerit in visu suo, OG, CE.
 aliquid (*aliud*), OC, LF.
 utrum (*scilicet utrum*), MK, X.
 qualitatem (*quantitatem*), OC, MD.
 assisam (*seisinam*), OG, ML.
 disseisinam (*seisinam*), CC, CE.
 in (*si in*), OB, OF, MF, MG, CF, LT, LF, LG, W.

FOLIO 179b. SECTION 5. *ADDICIO*Position of *addicio*,

after minus, MC, LA, MF, P.
 after *contineatur*, ME, MH, CF, LT, CA, X, LD.
 omitted by OB, MA, MB, MD, MI, ML, LE, LF, LG, CM.
 marginal, OA, LC.
 after suo, the other MSS.

misericordia (*misericordiam*), OC, OG, ME, MH, MK, CA, CB, CC, CF, LB, LC, LT, B, P, X, HB, Y.

regni regis (*regis*), OC, OD, CA, CC, CF, LB, LD, LT, X, HB.

in *comitatu* (*comitatu*), OC, OD, OG, MG, CB, CC, CF, LB, LC, LD, LT, HB, Y.
 ME, MH, CA, X, CF, LT, LD.

Item videre debent iuratores (*Quia*), (*Item si videre iuratores*, X).

ME, MH, CF, LT.

in (*de*), (om. LD, X).

ME, MH.

disseisitus fuerit (*f. d.*).

om. anno regis Henrici . . . si Willelmus de Ludington, (*in comitatu*, MH).

breve (*idem breve*).

CF, LT.

si (*si autem*).

possit (*non possit*).

illud (*per illud*).

CA, X.

eodem (*et eodem*).

OA, OG, OM, MC, MF, CA, CE, LA, P, W, X, HA, Y.

plus posuerit (*posuerit*).

quam (*plus quam*), (+OD, PH).

OG, Y.

de (*id de*).

in (*de*).

si (*si de*), (+MH).

stare (*constare*).

MC, LA.

Henrici regis (*r. H.*).

si (*disseisinæ si*).

PEDIGREE OF THE MANUSCRIPTS

OM, W, HA.

et (Quia).

si (si querens).

OM, HA.

demanda (superdemanda).

et non (n. c.).

de eodem (de).

CB, B.

regni Henrici regis (regis Henrici), (Henrici regis regni, CB).

CB, HB.

itinere (de itinere).

om. Quia si . . . visu suo, OD, PH, OF, MG, CC.

cadit (cadet), OD, PH, OF, OG, MC, CF, LT, LC.

cadet (cadit), OA, ME, MH, LA, LB, LC, LD, B, P, PH, (cadat, MC).

si (si de), OG, MH.

FOLIO 253b. SECTION 2

(OB, OE, ML, MM, CD, CF, CI, LA, LE, LF, LG, LT, do not have this passage.)

OC, OF, OG, OM, ME, MG, MH, MI, MK, CA, CB, CC, LB, LC, LD, B, X, HB, CM.

om. de clameo suo prosequendo etc., (+MB; -MH, CA).

etc. (per bonos summonitores), (+MA, MD, MF, P, W; -CA), (cf. ME, MI, CC, LB).

avunculus (vel avunculus), (-OM, MH; +MB, HA, MF).

tantæ (de tanto), (-OC, OG, ME, CA; +P, W).

propinquior heres eius (eius heres propinquior), (-OF, OM, CM, MH; +OA, MD),

propinquior eius heres, OF; heres eius propinquior, LC).

position of *addicio*, (-OF, MG, CB, HB, LD, B; +MC, MF, P, W).

OC, OG, ME, MI, MK, CA, CC, LB, LC, X.

si (et si), (+P).

om. mutatus, (-LC).

OA, OD, MA, MN, CE, PH, Y.

(These have the correct period of limitation), (+HA).

om. securum de clameo suo prosequendo etc., (-Y, CE, OA; +MF, MH, P, W).

vel (vel mater vel), (+MD).

vel (frater vel), (+MD, MH; -OA, Y, CE).

de (die), (-Y; +MI, CC).

qua (quo).

seisitus (et si obiit), (-OA, CE, Y), (obiit seisitus et si obiit, CE).

ME, MI, CC, LB.

etc. (per bonos . . . sacramento recognoscere).

in seisina sua (seisitus vel seisita), (in seisina, MI).

tenemento (redditu).

Britannia (Hybernia).

et (et si), (-MI).

ille (iste), (-MI).

MH, CM.

Ins. ista data fuit per statuta de Merton.

OM, W.
 vel (et).
 tanti redditus (tanto reddito), (+MH, CM, LC, P).
 om. et si obiit . . . in Angliam, (+MH, CM).

OC, OG.
 seisitus (seisitus vel seisita), (+MB).
 redditus in (in), (reditibus in, OG).
 domini Henrici regis (regis Henrici).

MK, X.
 tantæ (tanto reddito).
 et tanto (tanti) redditus in (in).

OF, MG, CB, B, HB.
 in seisina (seisitus vel seisita), (+MI).
 om. et tanto redditus, (+OC, OG, MB).
 change in period of limitation, (+LD, MD).

OA, CE.
 prosequendo (prosequendo, etc.), (+CA).

CB, HB.
 visum (visneto), (+MK), (visu, B).
 iusticiariis (iusticiariis nostris).

FOLIO 319b. CHAPTER II

OB, MB, MI, MN, LF, LG, MA, MD, LC, HA, Y.
 non (numquam).

OB, MB, MI, MN, LF, LG.
 tradiderat (tradiderit), (tradidit, MI, LC), (+MA).
 partibus (partibus in iudicio), (+MA, Y).
 tenens (petens), (+MD).
 probationem habuerit (h. p.), (+Y).
 potest (poterit), (+MA, MD).

OB, LF, LG.
 ostenderit (ostendat).

MA, MD.
 est necesse (n. e.).

OF, MG, MK, CC, LB, LD, X, W.
 ins. cum partes in iudicio comparuerint.
 omnino nullam (n. o.).
 in aliquo ei (e. i. a.), (+OM, MF).

OF, MG, MK, CC, LB, X.
 posuit se (se posuerit), (possint se, CC), (+LD), (imposuit se, W).
 non (nunc), (-LB, X; +W).
 petens (tenens), (-X; +LD).
 vel per (vel), (-CC).
 talem (tales), (+OM, MF, W).

CC, LB.
 tenens (petens).
 est (sit), (+CE, LC, X, HA).

PEDIGREE OF THE MANUSCRIPTS

intentionem suam (intentionem), (+X).

videre (videtur).

anno (anno regis).

quarto (tertio).

LD, W.

scilicet quod (quod ipse).

ME, MH, P, CM.

talis (talem), (+CF, LT).

numquam ius (i. n.), (+OM).

ME, MH, CM.

habeat (habet).

quæ (quæ non).

MH, CM.

esse (ita esse).

habuerit (habuerit ingressum).

CF, LT.

est supra (est), (+CC, LB, MD).

per (et per).

quia (quæ).

sed (pro se).

CB, B, HB.

et primis (inprimis), (—HB).

use of the *addicio* as a rubric.

CB, HB.

se (ipsum).

habuit omnino (omnino habuerit).

OC, OG.

secundum (scilicet), (sed, OG).

vel (per).

ponere (proponere), (+X).

cum constitutis (constitutis).

probationem (petens probationem), (+ME).

OA, CE.

cum (probaverit cum).

dies (fides).

MC, LA.

habeat (habet).

intentionem suam (intentionem), OD, MA, MB, MD, MH, CC, PH, HB.

voci (voce), OB, OF, MB, MD, MG, MI, LA, LC, (voce voci, LG), Y.

ibi (in), CM, LC, P.

Position of the *addicio*, OG, MC, CB, B, HB.

regni regis (regis), OG, PH, CB, B.

FOLIO 411b. CHAPTER XV

- vidio (video), MK.
 vides, MC, ML.
 videt, OB, OD, OE, MA, MB, LG, Y.
 videtur, LF.
 videlicet, MF, MN, HA.
 vide, W.
 iudicio, OC, OG, CE, LA.
 in erasure, MD, MI.
 esset (est), OA, OC, OF, OM, ME, MG, MH, MK, ML, MM, CB, CC, CE, LC, LD, LT, B,
 W, P, X, HB, CM.
- detur gratius (gratius detur), OB, OD, OE, MB, MN.
 gravius detur, OA, OF, ML, CB, CC, LC, B, X.
 gravis detur, MK.
 gravis detur, MG, LD.
 detur gratis, LG.
 detur gravius, MA, MD, MF.
 detur gravis, MI.
 omit passage, LF.
- adiudicandum (adiudicandus), MC, MG, ML, LA, LD, HB.
 ad iudicium, MK, X, CE.
 ad incitandum, OM, ME, MH, MM, P, W, CM.
 ad imitandum, LT.
- communalis (commensalis), CB, B, X, HB.
 communsalis, ME, MH.
 coniungalis, OC, CE, MD.
 coniugalis, OG.
 commencalis, LD.
- vel (vel in), OA, OC, OF, OG, MC, ME, MH, MK, ML, MM, CB, CC, CE, LA, LC, LD,
 LT, B, P, W, X, HB, CM.
- OB, OD, OE, MA, MB, MD, MF, MI, MN, LF, LG, Y.
 summoneatur (amoveatur), (sumoiatur, MN).
 est (est scilicet), (+OF, HA).
 sicut (quod sicut), (-OE, Y; +LD), (quia sicut, MB, MN).
- OB, OD, OE, MB, MI, MN, LF, LG.
 habent (habent neque).
- OB, LF, LG.
 an (si), (a, OB).
 consiliaris (consiliarius), (+OD, MF).
- OE, MI.
 videndum est (videndum), (+LC).
 commensalis vel (commensalis).
- MN, MB.
 quia (quod), (+HA).
- MA, MD.
 possit competere (c. p.).
 summoniri (sed summoniri), (+MF, LT, W).

PEDIGREE OF THE MANUSCRIPTS

ut (ut ea).

maculosa (meticulosa), (+CB, LD, HB).

habet (habebit), (+MF, MI).

quare non (quare), OD, OE, MF, MI, LG.

statum (in statum), OB, OE, MA, MI, LG.

causa (causis), OB, MB, MF, LG.

et (vel), OE, MA, MD, MI, Y.

OA, OF, MG, MK, CB, CC, B, X, HB.

- | | |
|---|--|
| { | dictum est supra de exceptionibus, OA, MK, X. |
| | dictum est de exceptionibus supra, OF, CB, CC, B, (dictum est supra de exceptionibus supra, HB). |
| | dictum est de exceptionibus scilicet, MG. |
| | (dictum est superius de exceptionibus, LT). |
| | item (nunc), (-OA, HB; om., MK, X). |
| qualiter (quare), (+OC, OG, CE, LD). | |
| eis (ei), (-MK, X; +W). | |
| multiplex (unica), (-HB). | |
| huiusmodi (et huiusmodi), (-B, X; +LC, LD). | |
| vel (et), (-OA, CC, B; +LD). | |
| sed (sed par), (-MK, X, HB). | |

OA, OF, MG, CC.

odio favore (odio).

ordinariam iurisdictionem (ordinariam), (+CM).

partem (parem), (+MC; tempore, OA).

habebunt (habebit).

OA, CC.

posset (possit).

superiores (superiorem).

intentio (inimico).

omnes alios (omnes), (+Y).

habet (ordinariam habet).

in rebus (in).

OF, MG.

metriculosa (meticulosa).

habeat (habet).

MK, X.

possunt (possit).

non (et non).

debeat (debeat recusari).

esse poterit (est).

om. consanguineus petentis.

parem (in parem).

CB, B, HB.

sit si sit (si sit).

commentalis (commensalis), (+X).

inprimis (et inprimis).

notandum quod (quod).

CB, HB.

Use of In fine . . . et minorum as rubric.

ME, MH, P, CM.

correctionem (correctione), (+MC, CC; -CM).
 ad incitandum (adiudicandus), (+OM, W, MM).
 vel (consiliarius vel), (+OM, W, MM, LT).

ME, MH, CM.

dominorum (damnorum).
 meculosa (meticulosa), (-CM).
 cum (causa), (+MB).

OC, OG, CE.

alia (aliqua).
 iudicio (video), (+LA).
 iniusta (unica).
 fratri (homo), (frater, OG).
 super ordinariam (ordinariam).
 et (in temporalibus et).

OC, CE.

in actum (in).
 substituatur ei (e. s.).
 nec (non).
 suspecte (suspectus).
 scilicet (est sub).
 inferiores (superiorem).

MC, ML.

vides (video).
 adiudicandum (adiudicandus), (+LA, MG, LD).
 periculosa (meticulosa), (+W, HA).

MC, LA.

ut si (ut).

FOLIOS 413-415b. CHAPTER XVII

- { patens de recto, OC, OF, OG (petens), OM, MB (petens), MC, ME, MG, MH, MK, ML, MM, MN, CB, CE, LA, LC, LD, LT, B, P, W, X, Y, HB, HA, CM (rectum).
 de recto patens, OB, OD, MA, MF, MI, CC, LF, LG.
 de recto, OA, MD.
- { W. de Raleigh, OB, OD, MA, MB, MD, MF, MI, MN, LG, Y, HA.
 R. de Turkeby (Turkilby), OC, OG, OM, MC, MH, ML, MM, CE, LA, LC, LD, LT, P, W.
 R. de Kirkeby, ME, CM.
- { omit the case, OA, OF, MG, MK, CB, CC, LF, B, X, HB.
 tenemento (ipso tenemento), OA, OC, OM, MB, MC, ME, MH, ML, MM, MN, CC, CE, CM, LA, LC, LD, LT, P, W, Y.
- { contraria, OA, OC, OF, OG, OM, MC, ME, MG, MH, ML, MM, CB, CC, CE, LA, LC, LD, LT, B, P, W, HB.
- { consensu, OB, OD, MA, MB, MD, MF, MI, MK, MN, LF, LG, X, Y, HA, (communi, CM) et secundum (secundum), OC, OF, OM, MC, ME, MG, MH, MK, ML, MM, CB, CM, HB, CE, LA, LC, LD, LT, B, P, W, X.
 diversitatem (varietatem), OC, OM, MC, ML, MM, MN, CE, LA, LC, LD, LT, P, W, Y.
 mixtæ (mixta), OB, OC, OD, MB, MC, MD, ME, MF, MH, MI, MK, ML, MM, MN, CB, CM, HB, CE, LA, LC, LD, LT, LF, LG, HA, P, W, X, Y.

PEDIGREE OF THE MANUSCRIPTS

falsi (falsam), OB, OD, OF, OM, MB, MC, ME, MF, MG, MH, MI, ML, MN, LA, LC, LG, LT, LD, LF, P, W, Y, HA, CM.

dominum regem (regem), OB, OM, MB, MC, ME, MH, MI, MK, ML, MM, LA, LD, LG, CB, HB, P, W, X, Y, HA.

parte (parte in), OA, OB, OC, OF, OM, MC, ME, MG, MH, MK, ML, MM, CB, CC, CE, LA, LC, LT, CM, P, W, X.

unam, OB, OD, MA, MB, MC, MD, MF, MI, MN, LA, LF, LG, Y, HB, HA.

vitam, OC, CE.

unicam, OA, OF, OM, ME, MG, MH, MK, ML, MM, CB, CC, CM, LC, LD, LT, P, W, X.
vel diversis (vel in diversis), OC, OM, MA, MB, MC, MD, ME, MH, MI, MK, MM, MN, CB, HB, CE, CM, LA, LC, LD, P, W, X, Y, (CC omits passage).

dicit (dicitur), OA, OC, OF, OM, MC, ME, MG, MH, MK, ML, MM, CB, CC, CE, LA, LC, LD, LT, P, W, X, Y, HB, CM.

in (et in), OA, OF, MC, ME, MG, MH, ML, MM, CC, LA, LC, LD, LT, P, W, Y, CM.

curiam suam (curiam), OM, MB, MC, MD, ME, MH, ML, MM, LA, LC, LT, P, Y, HA, CM.

convolaverit, OC, OF, OM, MA, MD, ME, MG, MH, MK, ML, MM, MN, CE, LD, LT, P, X, Y, W, HA, CM.

convalverint, MB.

convalverit, OA, OB, OD, MC, MF, MI, LA, LF, LG, CC, CB, HB.

eis alius, OB, LG, W.

alius, OA, OF, MB, MD, MG, CB, LD.

ei alius (alius ei), OD, OM, MA, MC, ME, CM, MH, MI, MK, ML, MN, LA, LC, LF, LT, P, X, Y.

quæ (quas), OB, OC, OD, OM, MA, MB, MC, MD, ME, MH, MI, ML, MM, MN, CB, HB, CE, CM, LA, LC, LF, LG, LT, P, W, Y, HA.

an, OB, OC, MA, MB, MC, MD, MH, ME, MI, MM, MN, CE, LA, LG, P, W, Y.

ante, OD, OM, MF, CB, HB.

omit, LC, LD, LF, HA, CM.

aut, OA, OF, MG, MK, ML, CC, LT, X.

actiones (exceptiones), OA, OC, OF, OM, MB, MC, ME, MG, MH, CM, MM, LA, LC, LT, CB, P, W, X, (CC omits passage).

errigatur, OA, OC, OF, OM, MC, ME, MG, MH, MM, CB, CC, CE, LA, LC, LT, P, W.

corrigatur, OB, OD, MA, MB, MD, MF, MI, MK, MN, LF, LG, Y, X, HA.

exigatur, ML, LD; ergatur, HB.

sed, OC, OF, OM, MC, ME, MG, MH, ML, MM, CB, CE, LA, LT, P, W, (MI by corr.) CM.

sit, OD, MB, MF, LF, Y, HA, HB.

fit, MA, MD.

si, OB, LG.

licet, LC.

et, OA, CC.

erit, MK, LD, X.

omit, MN.

OB, OD, MA, MB, MD, MF, MI, MN, LF, LG, Y, HA.

XXX (XXIX), (+LC, W; LF omits passage).

competant (competunt), (-Y).

descendere (reverti), (LF omits passage).

Position of *addicio*, (+LD; LF, HA, omit).

potest (posset), (-MB, MN, Y), (poterit, HA).

debet (debet breve), (deberet, HA).
 contineat plures (plures contineat), (-Y, HA; +CM).
 in uno (uno), (+OC, CE, MK, X).
 sic si (si sic), (sicut si, MA, MD), (sed si, HA), (-Y).
 aliqua (alia), (-MB).
 extorquetur (retorquetur), (-Y, HA; +X, HB; extorquere, MK).
 et voluntate (voluntate), (+MK, X).
 factorum (casuum factorum), (-Y, HA).
 scienti et volenti (v. e. s.).
 plures competant (plures competunt).
 comitatu (in comitatu), (-OD, HA, Y; +CC), (LF omits passage).
 poterit (poterit in brevi), (-Y, HA; +LC).
 actiones plures (diversæ actiones).
 quis (aliquis), (-Y; om., LF).
 tantum in brevi (i. b. t.), (tamen in brevi, HA), (LF omits passage).
 nominetur (nominatur), (-MN, HA; +OM, MK, X).
 fuit (facta fuit), (-MN, HA, Y; +W).
 petita (petita tota), (-Y, HA).
 parte (eius parte).
 amittet (amittit), (-HA, Y; +LT).
 cum (cui), (-LF, Y).
 incipiat (inceperit), (incipit, Y), (+MK, X, HB).
 in (et), (-OB, LF, LG; +MK, X, CB).
 { Glastellis (Glasdale), OB, MB.
 Glastollis, OD, MF, Y.
 Glastallis, MD, MI, MN, LG, HA, (LF omits passage; MA omits).
 om. et secundum hoc procedatur vel non, (-Y).
 si autem (et si), (+MK; om., MI, X).
 possessione et (possessione), (-MA, MD, HA, LF, Y; +MK, X).
 dote (dote aliquam partem), (-Y, MN; +CB, HB).
 ille (aliis), (om., MI).
 ut si (si), (+OA).
 per (super), (+LT, MK, X).
 per (et per), (-LF, Y; +W, HB, X), (omit passage, MI).
 cum (ubi), (-MD, Y; LF omits passage), (per quas, HA).
 ulterius non redibit (n. r. u.), (-Y).

OB, OD, MF, LF, LG.

perpendi (perpendere), (+OM).
 ipso (ipso breve), (+MA, MD, MI).
 observatur (observetur), (+MA).
 breve (breve de recto), (+MA, MI).
 quod (quod si), (-LF).
 actio simul (actio).
 cum (simul cum).
 illo (ipso), (+MA, MD, MI; -LF).
 per (pro), (+MK).
 in una (una), (+MA, MD).
 quædam (quorum quædam), (+LT).
 partem (et partem).

PEDIGREE OF THE MANUSCRIPTS

habuerit cum (habuerit).
 cum (in), (-MF; +MB).
 corrigatur (corrigitur), (+MA).
 actio (quod actio), (in eum actio, MF).
 poterit (potuit), (peterit, LG).
 sed (si), (-MF).
 et (ut), (+MB; LF omits passage).
 si (sed), (-MF, LF; +MB).
 retrahere se (s. r.).
 a (de).
 iste (ille), (-OD).
 primus (prius), (+MB, MI; -MF), (primo, MD, ML, MN).
 eadem (eadem curia), (+MD, MI; -LF).
 sub (ab), (+W; de, LF, Y).
 prioritate (proprietate), (-LF, MF; +MD).
 om. nisi ita sit eum dicat diversum, (+MA, MB, MD).
 inter (poterunt inter), (+MA, MB, MI; LF omits passage).
 actio cadit (c. a.), (+MA, MD, MI, MN).
 mutat (mutatur), (-MF; +MB, MI).
 in (et), (+CE).

OB, LF, LG.

videtur (videlicet), (+MF; et, LF).
 eum (ea), (-LF).
 impetrata (impetrata fuerint).
 causa (tam), (-LF).
 sive (sive clausa sive), (-OB; +MI).
 et (et si), (-LF).
 quem (quantum), (-LF).
 sunt (sint), (-OB).
 superius (superius dicitur), (+CC).
 vero (nec), (-LF).
 pervenire (pervenerit), (-OB).
 eis alius (alius ei), (+W; ei alius, LF).
 mandaverit (mandavit).
 primus (prius).
 sint (sicut), (-LF).
 una (unam), (+OD; -LF).
 primus (prius), (-LF).
 primus (prius), (-LF).
 primus (prius).

OD, MF.

ita (quod).
 transcendere (descendere).
 scilicet (sed licet).
 quo (quod), (+LF).
 aliquod (aliquem).
 et (vel).
 si (non), (sic, LF).
 item (et).

alienam (aliam).
 videndum est (videndum).
 sicut (vicecomes).
 fuit (fuerit), (+OA, CC).
 aliqua (alia), (+LT).
 item (sed).
 item (et).
 utilitatem regis (r. u.).
 non (bene).

MA, MD.

competant plures (plures competunt).
 incipit (inceperit).
 ipsius (ipsa).
 debet (debet prius).
 ut (nec), (+OA).
 sicut si (si sic).
 agitur (agatur), (+LD).
 rationis (rationem).
 sunt (erunt).
 alienis (alicui).
 si (sed).
 actio (actione).
 ins. quod cadat breve multis rationibus (temporibus).
 clausa (clausa et sive clausa), (+ML).
 quando (quando et), (+ME).
 falsitatem talem (t. f.).
 tulerunt (protulerunt).
 et (sed), (+MF).
 om. falsi suggestionem suppressionem. Per.
 de (et sic breve de).
 item vel (item).
 nullam inde (i. n.).
 XXX (XXXI).
 secundum consuetudinem (rationi consonum).
 est (erit).
 obfuit (subfuit), (+MI).
 quia si (quia).
 hæc (et hæc).
 post (licet post), (+CC).
 XXX (XXXI).
 sive (vel), (+MN).
 civili morte (m. c.).
 quam (super quam), (+CB).
 om. defertur actio super possessione.
 unde (item).
 qui præfertur (p. q.), (qui præfertur qui, MD).
 exceptis curiis (excepta curia).
 præfertur (præferatur).
 illo (alio).

qui (quam).
 minus (minus servitium), (+ME).
 vel (vel si).
 ore unum (u. o.).
 si (sed), (+LG).
 est (erit).
 fit (erit).
 ideo (idco nec).

OA, OF, MG, MK, CB, CC, B, X, HB.

sit (fuerit), (sibi, OA).
 et (quod), (et quod, HB).
 om. ut de itinere . . . Notingham., (+LF).
 competunt plures (p. c.), (+W).
 prius (primo).
 satis de ordine brevium (d. o. b. s.).
 non deberet (deberet), (+MN).
 armis (armis et), (+OC, CE; -HB).
 ad qualitatem (de qualitate).

{ disseisitorum (disseisinæ), OA.
 disseisitoris, CC.
 disseisitor., OF, MG, CB, B, HB.
 dissois., X; diss., MK.
 fuit (fit), (+LT).

{ disseisitorum (disseisinas), OA.
 disseisitores, MG, X.
 disseisitor., OF, MK, CB, B, HB.
 diss., CC.

propter (propter hoc), (-HB).
 poterit esse (e. p.), (-CB, B, HB).
 sibi (ei), (si, CB, B), (-HB).
 debet continere (c. d.), (+MA, MD, ML).
 debet (etiam debet), (+OC, OG, CE, LD, CM).
 quando (item quando), (B is not collated beyond this point).
 perpetratum (recitatum), (perpe impetratum, MK; impetratum, X; recitatum perpetratum, HB).

domini (ipsius domini), (+OB, MA, MB, MD, ML).
 liberata fuit (liberata), (+ML, LC; fuit liberata, X).
 veri (per veri), (+OD; OA, OF, omit passage).
 stabit versus eundem (stabit), (stabit adversus eundem, OF; stabit ut eundem, OA; CB (marginal), CC, omit passage).

regni et (et regni), (regnum et, OF).
 consilio (a consilio), (+OC, MI, CE, LD, W), (-HB).

{ plus petat, OA, OF, CC.
 plus teneat, MK, X.
 omit passage, MG.

subfuerit (subfuit), (+OC, CE, LD; obfuerit, OA).
 tamen non amittit propter hoc (t. p. h. n. a.).
 licet (et licet), (+OC, CE, LD).
 competant plures (p. c.), (competat plures, MK, X; competant, OF).

fuerint impetrata (i. f.), (fuerunt impetrata, MG).

quando (ubi), (ut si, MK, CB, X, HB).

diversis temporibus (t. d.), (-X).

cum (quod cum), (-OA, CC; +LA).

OA, OF, MG, CB, CC, B, HB.

dominico (dominicis).

cadit (cadit breve), (-HB).

om. et alia placita, (+LD; -HB).

om. ut de termino . . . breve de recto.

tunc (tamen).

si (sicut).

quæ (quia).

ratione (rem), (-HB).

debet et debet (debet), (debet breve, OA).

quo (quo utrum), (+CM), (B is not collated beyond this point).

misericordia (misericordia et voluntate).

cum (cum non), (+ME; -HB).

de Glaston. (Glaston.), (+MA).

om. in eadem villa . . . unius militis, (om. in eadem villa . . . versus eundem, CB, CC), (-HB).

unicum breve (b. u.), (unicum et breve, HB, CB).

sint (sunt), (+MB, W).

om. petentes vel plures, (+OM; -HB).

autem (vicecomes), (anteccessor vicecomes et, HB).

visum (ius), (usum, OA, CB), (-HB).

ratione (rationi), (+OC, CE, ME, MH, MB).

non (et non), (+OC, CE, MI).

prohibuerint (præbuerint), (prohibuerunt, OA), (-HB).

dissenserunt (dissenserint), (+ME), (dicesserunt, OA; disserunt, CC).

facta (facta fuit), (+Y; -HB).

et sequitur (ut supra).

sequitur (supra).

narratione (narratione sua), (+MD).

diversum cum (diversum).

OA, OF, MG, CC.

ei (casui).

brevi (brevi quod), (+MH, CM).

competenti (competit).

scilicet (videlicet), (om., MG).

petatur visus (v. p.).

vi facta (uno facto).

quædam (et quædam), (+MN, LT).

om. et a quo et quando. Quo loco, (-MG).

om. incipiente quarto, (+MA).

Harange, etc. (Harange).

scilicet (videlicet).

idem R. episcopus (episcopus Rogerus).

et (in), (+CE; et in, OA).

breve (stat breve).

PEDIGREE OF THE MANUSCRIPTS

et (vel), (om., OF).
 tempus (tempore), (-OA).
 tempus (tempore), (-OA).
 perit (agere inceperit).
 om. de forgiis in foresta de Glasdale, (+MA; etc., OF, MG, CC).
 non debet (non).
 naturali vel civili (c. v. n.).
 ibi (ubi), (+LC, LD, CM).
 quæ (qui).
 quando (ubi).
 veritatem (virtutem), (+MF).
 diversum vel (diversum).
 exceptiones (exceptiones contra breve).
 et quod (quod).
 ut (ad).
 actio (hinc inde actio).

OA, OF, MG, CC, OC, CE.

diversitatem (diversitates), (+MA, MD, MF, MN, LD, LT).
 vel (et), (+MB).
 breve (per breve), (-OF; +CB, LA, LD).
 diversum vel (diversum), (diversum et, OC, CE).
 sed (licet).

OA, CC, OC, CE.

tenens (petens), (+MD, CM).
 aliter (alicui), (-OC).
 om. vel per veri . . . falsi suggestionem, (-CC; +OF, MM).
 dotem (cum dotem), (-CC; +ME).
 quam (quem).
 magnatos (magnates), (-CC).
 sed (sed tamen).
 perdita (prodita), (-OA; +LD).

OA, CC.

ipso (ipso super).
 illa (ipsa).
 per violentiam (cum violentia).
 scilicet (videlicet).
 acquirens queret (adquirat querens).
 aliud (aliquid).
 sunt (fuerint), (sint, CC).
 tangit (tamen).
 hiis (eis).
 breve quidem . . . falsitatem, used as rubric.
 abolita (abolita).
 ipsi nihilominus (ipsi).
 puniantur (nihilominus puniantur).
 et (si), (+MH, CM).
 fuit (fuerit).
 et (quod), (+Y).
 sicut (sit).

Franburne (Farnburne).
 cesteā (conscia), (costea, CC).
 cum (si).
 ad (nisi ad).
 vitæ vel (et).
 peterit (petierit).
 omiserit (emiserit) impetrando (i. o.).
 Michælem (Michælem abbatem).
 seisinam inde (i. s.), (+MK, X).
 dixit (dixerit).
 possit (poterit).
 Bedford (Hereford).
 unicum (unum).
 et (sed).
 persona (personis).
 res (res est), (+MK).
 præsumpsit (præsit).
 de nominibus (duobus).
 quod actio (quod).
 dum (dum tamen).
 om. tenens minus teneat quam.
 petit (petierit).
 posset (potuit).
 posset (possit), (+CM).
 illo (eo).
 fuerit tenens (tenentes fuerint).
 duo (duo tenere), (+LD).
 a (ex).
 quem (aliquem).
 defenditur (differtur).
 om. et sic præcludi . . . contra breve.
 infra (ut infra), (+LA).

OF, MG.

nihilominus (et nihilominus).
 acquiret (adquirat).
 Godfrey, etc. (Godefridi).
 nominibus (in nominibus), (+MB).
 curiam (curiam amittere).
 de seisina (disseisina).
 pœnam (tamen).
 magis (non magis).
 proprietate vel super possessione (possessione v. s. proprietate).
 alterius proponendi (proponendi ulterius).
 om. eadem erit actio . . . sed correctum.

CB, B, HB.

petenti (tenenti), (+X; -HB).
 competat (competit).
 ipsius rei (rei).
 poterunt exceptiones (poterit exceptio).

si (ei), (B is not collated beyond this point).

CB, HB.

ubi per (ubi), (+CM).
 poterit (terminari poterit).
 violentam (violentia).
 terminare (terminari).
 petens (patens).
 alio lita (abolita), (alio terra, B).
 sive (sicut).
 clerici fuerint (clerici).
 quia per (per).
 quis (quis dicit).
 tenentis sive petentis (tenentis).
 ubi (ubicumque).
 tenet (et).
 sciendum (videndum et sciendum).
 ae (et).
 dum (dum tamen).
 licet (licet petit).
 impetrationem (depositionem).
 breve. Item (Item).
 ab (a).
 mutare (mutari).

MK, X.

potest (poterit).
 nec (non).
 continet (contineat).
 ad modum regulæ vel ad (ad).
 iuris et (iuris), (+OG).
 de communi (de).
 consequentia (sequentia).
 dicitur regula (domini regis).
 per (videlicet per).
 fuit (fiat).
 vero fuerint (vero), (+OC, CE).
 fuit (fuerit).
 ut (vel).
 tenuit (tenuerit).
 impetravit (impetraverit).
 differtur actio et tenet breve (t. b. e. d. a.).
 et in (et), (+MI, MC, Y).
 quod adhuc (a. q.).
 adhibendo (adhibere).
 plus teneat (plus).
 statum (casum).
 competat plures (plures competant).
 regem Henricum (regem).
 occasione (actione).
 regula scilicet hoc (regula).

ipsius (illius).
 ut sunt (sunt).
 a (de), (in, X).
 ubi (quia ubi), (+ME).
 consimilem (consimile).
 et eadem (eadem).
 debet mutari (m. d.), (+MD).

OC, CE. (With OG for those passages contained in OG.)
 expediri poterit (expediri), (+OG, LD).
 curia (dominicis), (+OG).
 cum (et), (OG omits a long passage here).
 regis (regis Henrici), (+MI).
 in (et).
 prædicta (supradicta).
 et ad (et).
 regni regis (regis), (+OD, X).
 per (post), (+LC, CM, X).
 poterit (poterit accessorium).
 aliquam (aliquem), (+OB).
 quæ (quod).
 sic (si sic).
 vertatur (vertitur).
 om. remissionis et, (+OG, which begins again).
 quieta (quietæ clamantiæ), (+OG).
 in (et), (+OG).
 perimuntur actiones (perimitur actio), (+OG, MD).
 perimuntur (perimitur), (+MD).
 conferentis (proferentis), (+OG).
 in actione (regula), (+OG).
 iuris ut (iuris), (iuris et, OG).
 quæ est certam (quæ est), (certam, OG).
 sunt (sunt etiam), (+CM, HB), (OG omits a passage here).
 siu (sive).
 sine (alius sine), (OG begins again).
 et in (et), (OG omits to end of chapter).
 Richardo (Radulpho), (+LC).
 regni regis (regis), (+OD, CB).
 Farumburne, (Farnburne), (+CB, X).
 warrantus (warrantum).
 consentiat (conscia).
 Hanebrond (Hamone de Brond).
 cadit (erit), (non cadit, CE).
 dotem (cum dotem), (+OA, ME).
 aliquam (aliquem).
 ipsum (episcopum).
 Glaston. ius (Eustachius).
 seisina (seisinam).
 quam (quam non).
 quam (quantum).

vitam (unicam).
 endit (cadat), (+MD).
 III, (VIII), (+MD).
 Position of Et sic vel cadit ad alios, (+LA).
 aliquos (alios).
 et (sed), (+MD, W).
 sed (licet), (+W).
 stat breve quandoque (q. s. b.).
 item (sed), (+MA, MD).
 summonetur (summoniat).
 quo (qua), (+MA).
 dici (sicut dici).
 nominantur (nominatur).
 videatur (videtur).
 spirituali (speciali).
 nullam (nulla), (+MI).
 conquerenti (conquerendi).
 licet tenens (licet).
 videtur (videatur).
 poterunt (potuit).
 in (et).
 illam (aliam), (+MF).
 de (in), (+LC).
 forgas (forgiis).
 et (in).
 sit (sint).
 quam (quantum).
 quam (quantum).
 de (pro).
 Michaelis (Trinitatis), (+LT).
 regni regis (regis), (+OD, CB).
 breve (brevia).
 fuerit (fuerint).
 idem (item).
 implacitaverunt (implacitaverint).
 et (cum).
 et in (in).
 nullam (nulla).
 breve et (breve).
 vel (ultra).
 actio (quam actio).
 et mortis (mortis), (+CB).
 uno (unum).
 diverso (diversum).
 et quod (quod).
 actio (actio vel).
 plenius dicetur (d. p.).
 encaustum (incaustum).
 non (nec), (+LF, W).

et cum (cum).
 sit eadem (e. s.).
 narratio (hinc).
 idem (inde).

ME, MH, OM, P, LC, W, MM, LT, CM.

competit (competiit), (-ME, MM, LT; +MD, CB).
 utrumque (utrum), (+OC, CE, MK, X, ML, LD, Y).
 et (si), (+OA, LA).
 iuris (iuris per), (-LC).
 esse debet breve (b. e. d.), (-MM, LT; +OG; debet esse breve, W).
 ceteris (certis), (-LC, W, LT).
 et quædam (quaedam), (+OA, CC, MB, MF, X).
 fiat (fit), (-ME, LC, LT; +OC, CE, MC, LA, LD, Y).
 om. eodem modo competunt . . . una actione, (-LC; ut d, ME).
 cum (vel), (-OM, MM, LT; non, W).
 casu (ausu), (-LC).
 om. sit adulterinum . . . tamen appositum, (-OM).
 sigillum (signum).
 { vetitum (verum), OM, MH, CM.
 veteru, ME.
 vetum, P.
 vet., W; vetus, LC.
 { Neubrand (Bronde), ME.
 Neubrande, MH; Nebrandum, CM.
 Nebrond, P.
 Nebronde, W.
 Brocide, OM.
 Neirbronde, LC.
 Position of quod impetratum fuit . . . cum non sit.
 quod (quod inde), (-MM, LT).
 habuit (habuerit), (+OB, OD, MB, MC, MN, LA).
 gradum in (gradum), (-LT, CM; +MC, LA, LD).
 impetrator in (impetrator), (-ME, LT; +LD).
 Godefridi (Godefrey), (+OD, MC, LA, Y; Godefr., W, CM).
 quando (quandoque), (-OM, LC).
 breve (actio), (-MM, LT; W omits passage).
 actio (breve), (-MM, LT; W omits passage).
 { ibi (ubi), LC, W.
 nisi, ME, MH, P.
 om., LT.
 curiam suam (curiam), (+MB, MC, MD, ML, LA, Y; curam, W).
 licet post (licet), (licet petens, LC).
 unum (unum breve).
 subtraxerit (retraxerit), (+MI).
 posset (possit), (+MB).
 mortuus (mortuus fuerit), (-LC, LT).
 profertur (præfertur), (-ME, CM, LC, W).
 vel (et), (-LC; an, OM).
 sciatur (si agatur), (-LC).

{ si per (super), ME.
 si, MH, CM.
 per, LT.
 super, W, LC, P, OM.
 semper, MM.
 poni (proponi).

om. contra breve cum tenens, (om. contra breve contra breve, OM; -LC).

OM, ME, MH, P, CM.

non (non de), (-OM; +OD).

exceptio (exceptionem), (-P).

eadem (Radulpho), (-OM; +W).

puniantur (puniuntur), (-P; +LC).

Hamo (Hamone), (-OM).

concessum (concessum et), (-OM; +LT).

XIII regis Henrici (regis Henrici XIV), (-OM, CM; +LA).

intentionem (mentionem), (+MM).

ME, MH, CM.

actiones scilicet (actiones), (actione scilicet, P).

om. quod si fecerit possessione, (+ML).

supervacuata (supervacua).

placiti (placitorum), (+MM).

sint (sunt), (-CM).

aboliata (abolita), (-CM).

abratio (abrasio), (abrasitio, MH), (-CM).

quia (quasi), (+ML).

vel (vel si).

expressa (expresso).

præstant (præsent), (+HA).

Salandia (Solandia).

poena (poena cum persona).

dimiserit (dimiserit post impetrationem).

proprietas (prioritas), (proprietatis, ME).

quod (quædam).

MH, CM.

si (cui).

Michælis (Hilarii).

valet (nominatur valet), (+W).

propter (præter), (+MI).

plus cadit (plus).

servitium certum (c. s.).

si (per), (si per, ME).

LC, W.

iudicium (iudicis), (+OM, LT).

in (ex).

exceptiones sunt (s. e.).

per unum (parvum), (+P).

et (vel).

sibi aliquid (aliquid), (-W; aliquid sibi, OM).

fuit (sceleris).

modo (modo erunt).
 qui (vel plures tenentes qui).
 sed non (sed).
 nominibus (et in nominibus).
 in (sicut in).
 ibi (ubi).
 fuerit mortuus (m. f.).
 aliquis (quis).
 clamaverint tenere (t. c.), (+X).
 petitam (petitam totam), (+MD, LA).

MC, LA.

poterit (possit), (+ME, MF, ML).
 om. vel e contrario, (+LD, LF).
 Position of per ea quæ supradicta sunt.
 poterit (poterunt), (+MK).
 responsionem (responsionum).
 variæ quædam (variæ).
 impositum (appositum).
 habuerunt (habuerint).
 Farinburne (Farnburne), (Fariburne, LA).
 Position of ut de termino . . . et huiusmodi.
 terram illam (terras illas).
 Position of Ut si unus petat . . . filio Godefridi, (+OC, CE, MD).
 om. Item quandoque tenet breve et.
 præbuerunt (præbuerint), (+MA, MD, LC, Y).
 plus (si plus).
 licet petens (licet), (+ML, LC).
 incipiet (incipiat), (+LD).
 quod (qui), (+ML).
 uno (eodem).
 competunt (competant).

exponi (exponi debet), OF, MD.

suo (suo casu), OD, CC.

impetravit (impetraverit), OA, CC, MK, X, MC, LA, ML, W.

possunt (possint), OC, CE, CC, MK, X, LC, W, ME.

possunt (poterunt) OF, MG, MA, MD, LF, LG, LT, W.

*eorum (eorundem), MA, MD, MH, ML, LC, W, CM.

et (factorum et), MI, LD.

observato (ut convenit observato), OA, ME.

enim (etiam), OD, W.

deberet (debent), MA, CC, W.

refert (tunc refert), MF, Y.

*voluntatem (voluntate), MD, ML.

om. regis Henrici, MC, LA, MM, LT, LD.

sustinebit (sustinebunt), CB, MI, MK.

fuerit (fuit), OB, OD, OM, MB, MC, MA, MD, ME, MH, MI, MN, LA, LC, LD, LF, LG,

LT, P, W, CM.

om. vel per veri suppressionem. Per falsi suggestionem, OA, OC, OF, CE, MM, MA, MD, HA.

PEDIGREE OF THE MANUSCRIPTS

om. regis Henrici, OF, MG, MC, LA, LD, LT, MM.

Item (idem), OC, CE, CB, MB, MH, HB.

impetravit (impetraverit), OA, CC, OB, OD, LF, LG, MF, ME, MG.

breve (habere), MC, ME.

eum (eui), MK, LF, LT, LD, MC, LC.

*regem (regem Henricum), OA, OD, MA, MD, ML, MN.

*anno regis Henrici (anno), MD, ML, LT, (anno regni regis Henrici, OD).

habuerit (habuit), OB, OC, CE, X.

om. in nulla parte, OB, OM, ML, LC, W.

om. in eadem villa . . . versus eundem, CB, CC.

omnino breve (b. o.), OA, CC, LC, W, X, MD.

{ cadit (cadet), OC, CE, MK, X, LA, CB, OF.

{ cadat, MB.

{ stabit, OA, CC, MI.

*per mortem (morte), MD, ML.

repeat sed corrigitur post . . . simul cum actione, CE, X.

ubi (ibi), OA, MN.

per (propter), MA, MD, MK, X, LT.

defectum (defectum de errore), MF, ML.

omnibus (nominibus), MK, LD.

et in (et), MI, Y, MK, X, MC, LA.

locis (in locis), OB, LF, LG, OC, CE, CB.

comitatibus (comitatibus et), OA, CC, MA, MD, MB, MK, X.

aliquo (alio), OD, MB, ME, MH, LT, P, W, MI, MG, LA, MC, HA, CM.

habet tenementum (t. h.), OD, MB.

om. et Herefordiæ . . . vicecomes Essexiæ, OA, MA, MD, ML, LF, X, LA.

possit (posset), OC, CE, MA, MD, ME, MH, MK, X, CM.

om. fuerit rationi . . . dum tamen, MK, LD.

viri (iuri), OC, CE, ME, CB.

et ad (ad), OB, LG, MF, OC, CE, MC.

teneat (minus teneat), OC, CE, OF, CB, LD.

om. tenens minus teneat . . . breve si, ML, W.

non (nunc), MB, MK.

cadit (cadit breve), CC, W.

competunt (competant), MD, Y, CE.

aliam (ad aliam), OF, Y.

Molandia (Solandia), MB, MN.

retraxit (retraxerit), OD, CC.

videndum (sed videndum), LD, LF.

impetravit (impetraverit), MC, MF, MI.

om. vel huiusmodi . . . vel prior, OF, ML, LT, LG, Y.

quod (qui), ML, LA.

duo (re duo), MA, MD, ML, CC.

impetraverit (impetravit), MA, MD, ML, MM, LF, W.

regis (domini regis), MB, CB.

incipit (inceptit), MA, ML, W, MK, X.

aliis (alius), ME, LT.

de (a), MF, MN, LF, LD.

om. et alius per maius . . . minus servitium, OF, CC, LC, W, HA, CM.

utrum (*assisa utrum*), OF, MI, CB, LC, LF.

de utrum (*utrum*), OM, MF.

valeat (*valet*), OA, OF, MG, CB, OM, ME, MH, MM, LC, W, P, LD, MC, LA, ML, CM, HB.

breve (*et breve*), OA, OF, MG, CC, CB, OC, CE, OM, LT, MA, MD, MB, HB.

exceptiones (*omnes exceptiones*), MF, LF.

alter (*alius*), MC, ML.

consimile (*consimilem*), OF, MG, LC, W, LT, P, ML, MH.

breve (*breve sed correctum*), CC, LF.

idem breve (*b. i.*), MN, LF.

GRAPHICAL REPRESENTATION OF RELATIONSHIP

From the arrangement by groups, which gives the larger outlines of relationship in a general way, we come naturally to the more specific and graphic delineation of the lines of descent. It might seem from what has preceded that the drawing of a number of lines in their proper positions and places to represent the connection existing between the manuscripts would be a comparatively easy matter. But the task is far from being a simple one, even in its broader features, and is quite impossible for some of the details.

In the first place—and this point has been mentioned before—there is a decided lack of continuity of relationship among the manuscripts which are yet in existence. We have neither the original copy nor any of its descendants in the first generation. Our oldest manuscripts are not better than grandchildren, or possibly great-grandchildren, of the original. This means that instead of tracing back one line or two lines to a common ancestor we are compelled to work back along several lines to as many different heads of families, each occupying about the same relative position in regard to the original, and each, therefore, of about equal importance and authority. At many of the steps in this process we come upon gaps in the line of descent. So it happens that while the general family relationship of any manuscript is usually quite easily determined, the closer connection of one copy with another is at times hard to decide. Because of the loss of some one of the connecting links we often are unable to tell whether two manuscripts stand in the relative position of cousins, or of uncle and nephew, or of grandfather and grandson. What, for instance, shall be said of the exact relationship of MB, MI, MN, as shown by the collation of fs. 413-415b? Or in just what way are CB, B, related to the other members of the larger OF group at the

same place? Both of these questions will shortly be taken up, and it will then be seen that the lack of intermediate connections in each case makes the answer largely a matter of guesswork.

Again, many of the manuscripts follow one line of descent in one part of their text and quite a different line, or lines, in other parts. Some that were copied by more than one scribe even go so far as to follow a different text tradition with every change of penmanship. Yet it is not necessary that the manuscript should be written in several hands in order to show divergences from a single line. One written in six or eight different hands, from as many originals, might be copied entire by a single scribe, in which case all external signs of its many-sided origin would be lost. So many of the manuscripts come from more than one source that we can not be sure of the relationship of any one of them except for those parts which have been collated. There is every reason for believing that those which like OB and LG, CF and LT, agree closely in every place at which they are compared, agree throughout. It may be taken for granted, also, that those which consistently fall into the same family groups, and show the same family traits, in each passage which has been collated, continue throughout in the same family line. But, from the standpoint of one who is trying to establish an orderly and detailed pedigree, instances of such continued agreement are all too few, and more than offset by the constantly recurring contradictory agreements. To take a case in point. In the collation on f. 2b, OE is found to agree with the OB group, and OM with HA. In the collation of the passage on f. 96, OE clearly shows itself to be related to W. On f. 118, OE goes with MI and LC, which pair off in many of the collated passages. By the time fs. 161-162b are reached, W is in combination with OM and HA instead of with OE. In the collation for fs. 413-415b, OM is found in a group with ME, MH, B; W pairs with LC, the latter having become detached from MI, which remains in the OB group; HA follows the larger OB group rather than any other. It should be noticed that all this change really centers about the varying relationships of only three or four manuscripts, OE, OM, W, HA. The great difficulty lies in finding out just what change has taken place. Does OE leave the W tradition, or vice versa? Does OM go over to the side of W, or W to OM? Why do HA and OM separate? A collation of the entire text would probably answer these questions satisfactorily; when the answer depends upon such facts as may be found in a few short passages, it must at times be far from convincing. It might be expected that in this particular case the

changes had occurred in OE and W, written respectively in eight and five different hands, rather than in the uniformly written OM and HA. Yet even these latter two change their relative positions. The actual facts can not be determined by assumptions and possibilities; they have to be worked out on the basis of a detailed collation. And along this line, the chief fact which the collation already done makes evident, is that there are comparatively few of the manuscripts which do not show at some time or other an agreement with different family lines.

To the complications in the lines of descent produced by this changing about in so many of the manuscripts are added the difficulties resulting from the copying of corrected texts. When a manuscript in one line was corrected here and there to make its readings in places agree with those of another manuscript in another line, and then copied, the text of the new copy would agree consistently with neither line. Under certain conditions such corrections may stand out in a way which helps to determine the grouping of the manuscripts, as in the case of the *XV* *alias* *XVIII* in the collated passage on f. 96, but more usually they tend to increase the work of straightening out the tangled family lines. Perhaps the best illustration of the effect which may be produced by this sort of copying in its various stages is to be found in the case of the pair group MA, MD. The connection between these two codices has already been referred to (p. 91, n. 1). Usually they will be found in the larger OB group, always they maintain a close connection with one another. A study of the collation will show that at times they both disagree with the OB line, in which, without any doubt, they rightly belong. Often MD does not agree with MA, in many places giving a better reading than the latter, and agreeing with another line. At first sight it might very well seem that MD represents an earlier branch of the line along which MA has come, one less distant from the original. But because OC happens to be preserved for us it is possible to prove that MD has come along the same line as MA, the two being at least as closely related as cousins. It is altogether possible, not to say probable, that they are brothers, with MA the elder. For the circumstances seem to have been these: The codex from which MA was copied, for convenience we will call it *M*, belonged to the larger OB group. Before MA was written, *M* had been corrected at a few places of noticeable differences of reading by a manuscript closely related to OC. We may suppose, for instance, that the owner of *M* had access to a friend's copy of the *De Legibus*, and for some places liked the reading of the latter

better than the reading of his own, which was accordingly corrected. Then *M* was loaned that *MA* might be copied from it. This would account for the fact that *MA*, though in the larger *OB* group, agrees in places with *OC*'s group against *OB*. Sometime after *MA* had been made, *M* was again used as an exemplar, this time for *MD*. But in the meanwhile the owner of *M* had corrected his manuscript in several more places, so that it agreed more closely with the *OC* tradition. Hence *MD* agrees with *OC* in many places where *MA* agrees with the *OB* line. We are almost, if not quite, justified in going a step further and saying that at least in the latter part of his work the scribe of *MD* had before him both *M* and the codex by which *M* had been corrected. Such is certainly the indication of the duplicated passages in *MD* on fs. 413-415b, where *MD* faithfully follows both *M* and *OC* in spite of the very noticeable contradictions in both the position and the actual reading of the repeated passages. The same sort of contradictions as those existing between *MA* and *MD* are found in many other instances, but never so easily explained. Yet the principle on which the connection must be worked out is the same. And if it is not always possible to see just what has happened, we are better able to hit upon probabilities through understanding what might have happened. For many of the manuscripts inform us on this last point. Any one who glances at the multiplicity of corrections in *CB* realizes at once how difficult it would be to determine the relationship of a copy made from *CB*, supposing the corrections to have been made a regular part of the text, and *CB* itself to have been lost. In every instance where a text which agrees generally with one line agrees also occasionally with another line, there is always the suspicion—unless the case is one which depends upon a non-determinative variant—that the exemplar has been corrected. In making out the pedigree it should be kept in mind that because of such corrections, two manuscripts which are in reality very close to a common ancestor may have many points of difference.

On the other hand, an exceptionally close agreement between two texts does not prove that one was copied from the other. More than once in the collated passages a pair of manuscripts will agree in every essential so closely and for so long a time that the tendency to regard one as the offspring of the other becomes almost irresistible. Such differences of reading as exist can very often be explained on the basis of the scribe having misread his exemplar; mere differences of reading, therefore, furnish no means of checking up this relationship. Omission is the only real check. It will be noticed that in the

last of the passages collated, OA and CC agree together against all others some forty-odd times, in addition to being found together more than twice that number of times in variants affecting their larger groups. Now this is all within the space of two and one-half folios of the printed text; it suggests strongly that the texts are too closely related to be other than parent and child. When OA reads *brevi respondere* where CC and the other manuscripts read *brevi agere, cum non teneatur alius sine brevi respondere*, it is proof positive that CC could not have been copied from OA, though there is no reason why the latter might not have been copied from CC. When CC reads *Item absque errore apparere*, similarly to most of the other manuscripts, and OA has only *Item apparere*, there is yet the possibility, though not to so great an extent, that CC may have been the exemplar of OA in this part of its text. But when OA, agreeing with the reading accepted by the other texts, has *Item cadit breve si*, and *de Richardo filio Godefridi*, and *huiusmodi et cum brevi*, and *prius egerit cum*, and *agere inceperit*, where CC reads *Item cadit si,—de Richardo Godefridi,—huiusmodi cum brevi,—prius cum,—agere*, it is definitely settled that CC was not the parent of OA. We should be slow to say that in closely related pairs such as OC, CE, and CF, LT, one was copied from the other, even though no omissions which may constitute a check are found in the passages collated. These passages are short; two manuscripts copied from a third may go on for a considerable distance without any such check, which might, perhaps, be found in a section immediately preceding or following the passage collated.

For the reasons which have already been noticed, it is inevitable that the collation should be full of contradictions of agreement. In many cases one's first thought is that some manuscript has been read wrongly. But the contradictions do not disappear with a second reading, even the most glaring of them remain after the ground has been gone over several times, and particular attention paid to them. It is not necessary to give examples as they are perfectly apparent. In one way or another the situation is exceedingly mixed up. All that can be done is to take each collated part separately, draw as definite conclusions as possible from that particular passage, and from the evidence furnished by the different portions evolve some general scheme of relationship. The data is not sufficient to make possible the working out of a detailed pedigree of every portion of every manuscript. In view of the many copies which have been lost and the consequent lack of intermediate family lines, it is doubtful if even a complete collation would do that. But

we are able in a broader way to determine about what position each manuscript as a whole should occupy. The practical side of this matter of pedigree is in the choosing of those manuscripts which best represent the different text traditions. And this choice, in spite of confusing contradictions, can be made.

As the three longer passages which have been collated give a better basis on which to work than the shorter, it will be well to consider these longer portions first, and then compare the shorter sections with them. It has already been acknowledged that the shorter passages are not always long enough to meet the requirements for sufficient information on every manuscript. The question may well be asked as to why, when this was discovered, the passages were not extended to meet the requirements. The answer must be that at the beginning it was not possible to foresee just what was needed in the way of variants. The actual value of any one of the shorter passages could not be known until the collation as a whole had been finished. It was then too late to visit again the homes of all the manuscripts, especially of those single copies in the less accessible places. So the shorter collations, which indeed are valuable in themselves for the most part, are forced in a way to depend upon the longer. When there are not sufficient data in the shorter passages to determine satisfactorily the position of any particular manuscript, it will be necessary to decide what place that manuscript should occupy on the basis of the evidence in the longer passages. Inasmuch as there is always the possibility that those portions of a codex which fall within the longer passages may be from a different exemplar from that from which the portions containing the shorter passages were taken, this plan can not be entirely satisfactory. Nevertheless it can be used to good advantage. And as a matter of fact, a comparison of the shorter passages with the long passage nearest to them does bring out points which are not so apparent in the shorter passages themselves. As an example of how such a comparison may show what the shorter passages do not even suggest, we may take the following. In the collation for f. 118 Y is seen to agree with MC and LA. OC and OG also agree. In the collation for f. 132b there is no evidence of relationship between MC, LA, Y; but the passage in OG, which is found out of place in the second part of that manuscript, goes over from the OC line to that of Y. In the long passage on fs. 161-162b the text of OG is found in portions in the two parts of the codex, that in the first part agreeing as on f. 118 with OC, and that in the second part continuing to show a relationship with Y, as on f. 132b. In other words,

Y and the second part of OG have not changed their text tradition between fs. 132b and 161. MC and LA have not changed their general relationship in the collation between fs. 118 and 161. In the longer and later passage they frequently agree. Moreover, Y is several times found in agreement with them. There can be no doubt that the connection between these three manuscripts as shown by the variants on f. 118 continues through to f. 161, though no such connection is apparent from the collation of the short passage on f. 132b. Such a comparison of the two sets of passages, in spite of the manifest shortcomings of the shorter, works out very well.

For reasons which have already been given, the *addiciones* have to be considered apart by themselves, and the relationship of each *addicio* to the text proper discussed separately.

FOLIOS 33b-35

Forty manuscripts have been collated for this portion of the text. The general variants given at the beginning show that there are three large groups, the first two somewhat more distinct than the third, namely, (I) OB, MA, MB, MD, ME, MF, MN, CC, CF, LF, LG, LT, P, Y; (II) OC, OF, OG, OM, MG, MH, MI, MK, ML, CA, CB, CM, HA, HB, LB, LD, LC, B, X, CD, CH; (III) OA, CE, MC, LA, OD. (I) may be split up into (OB, MA, MB, MD, MN, LF, LG), (ME, CC, P, MF), (CF, LT), Y; and of these the first may be yet further subdivided into (OB, LF, LG), (MA, MD), MN, MB. Though MD is clearly enough in the first group, and in a pair group with MA, it yet agrees with (II) in some very distinctive readings—*nam, appositum, aut duplicari*, etc. This trait of MD will be noticed in the other collated passages, and is due to its exemplar having been corrected by a manuscript in the line of group (II). *Petat a donatorio* for *petat* occurs in ME, CC, P, MF, Y, +MH, CM, MI, LC, LD, X, in group (II), the variant in all probability having been transferred from one group to the other through comparison and a resultant correction—or corrections. The exact relationship of MB, MN, Y, is not altogether clear. Group (II) breaks up into (OF, OM, MG, MH, MK, CB, LB, HA, HB, B), (MI, LC, LD, CA, CD, CH), X, OC, OG, ML; and these again fall into smaller groups of (OF, MG), (OM, MH, CM, LB, HA), (MH, CM), (OM, HA), (CB, HB, B), (CB, HB), (MI, LC, LD, CA), (MI, LC), (CA, LD), (CA, CH). At times MI, LC, MH, X, agree with group (I) in variants which could be explained on the basis of

corrections having been made and copied. In two instances X agrees decisively with MK, this again being due apparently to a correction having been made in some exemplar, as X does not show any affiliation with the larger group of ten manuscripts which contain MK. The appearance of ML proves that great care was taken in the selection of parchment and the actual copying of the book; the fact that at both this and other places it agrees with more than one of the groups—for the most part it is found in agreement with either (III) or (II), or both—and the fact that its own peculiar variant readings are just double the number it has in common with one or another of the other manuscripts, would indicate that care had been exercised in more than the mere mechanical side of its composition, and that different texts had been compared—at least in places—for a choice of readings. OC is seen to agree at times with (I) and (III) against its own group (II). It does not come into close association with any other member of (II), except that its most decided point of agreement and disagreement is where it reads *ubi disputatio* for *dubitatio*, agreeing here with OG against all others. There is not, however, that noticeable agreement between OC and the first part of OG which we find in other of the collated passages. More than once one fails to follow the leading of the other. Yet they are most certainly related. Each has what is perhaps the most distinctive reading of (II)—*sint communes aut* for *communes sint*—and with (I) and most of (III) they have *habere* where the other manuscripts read *exhibere*.

The members of (III) at times follow the traditions of (I) and (II). OA, CE, MC, LA, agree with (I) in reading *habere* for *exhibere*. OA and CE follow (I) with *unde* and *faciat* for *nam* and *faciet*, in the first of these readings MC and LA disagreeing with all others and having *sed*. OA again agrees with (I) against (II) and the rest of (III) in having *positum* for *appositum*, but on the other hand it agrees with (II) against (I) by reading *privatorum* for *privatae*. MC and LA three times agree with the larger group (II)—*potest*, *faciet*, *appositum*—and three times agree together against all others, though they do not always coincide in their readings. CE does not always go with OA. OD goes contrary to the rest of (III) by following (II) in reading *exhibere*. OD is four times found in agreement with (II), each time contrary to OA, three times contrary to CE, twice to MC, and once to LA. In having *ut* for *quod* it agrees with OA, CE, LA, and two representatives each from groups (I) and (II). OA and CE lean rather towards (I), while MC, LA, OD, are more closely connected with (II). As a group, the manuscripts in

(III), in both the type and the number of their variants, are far less at variance with what has been chosen as a standard text for the collated passages than the manuscripts in either of the other two groups. Further on the relative value of the different traditions will be discussed in detail, and it will then be seen that there are reasons for believing that there may have been two originals of the *De Legibus*, so to speak. But for the present we may regard (III) as a middle group between (I) and (II). Thus:

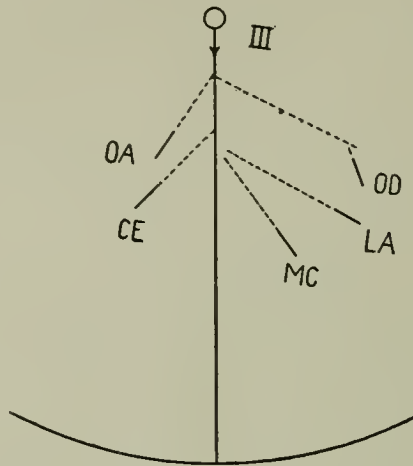

For group (I), OB, LF, LG are all either children or grandchildren of the same progenitor, and not many generations back their ancestor was the same as that of MA, MB, MD, MN. The exact positions of these four latter manuscripts are not made clear. It has already been said that the immediate ancestor of MA, MD, was corrected by some model in the line of OC. As bearing on this statement it may be pointed out that MD has the determinative *aut duplicari* of (II) in l. 26, f. 33b, and that in l. 28 of the next folio it follows OC and OG by inserting the unusual *ubi*. In the other sub-group, P is superior to CC and ME, and has probably affected them by direct copying. That is the conclusion which must almost certainly be drawn from a set of three readings in which the other two manuscripts agree with the corrected P. In l. 15, f. 34, ME and CC have *solet* for the usual *non solet*; the *non* is marked out in P. Near the end of f. 34b, CC and ME read *unde* where the other texts have *et unde*; P has *et* marked out. On f. 35, l. 15, P has *vel per nomen vel modum* (for *per modum*), and *nomen vel* is marked out. At the same place ME and CC read *vel per modum*. The agreement of ME, CC, P, with the group OM, HA, MH, CM, LB, in reading *una* for *unde una*,

in view of the lack of agreement between these two groups elsewhere at this place, must be regarded as the result either of a coincidence or of a correction made from one line to the other. Y and MF also belong in (I), with MF apparently nearer to P than to Y. CF and L'T form a closely related pair group which stands somewhat apart from the other members of (I). We may express the broader lines of relationship in (I) thus:¹

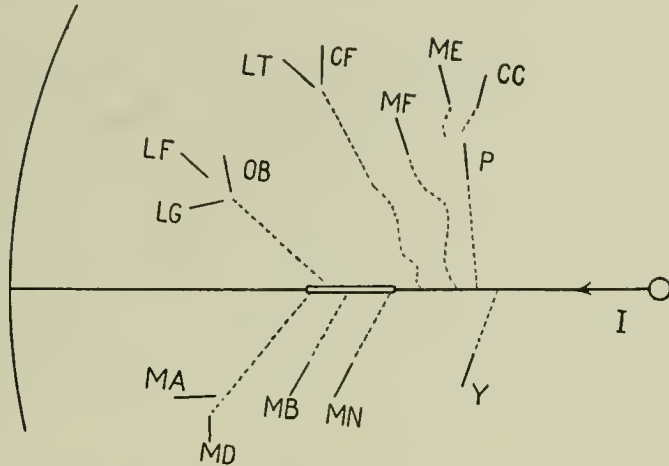

In (II) OF, OM, MG, MH, MK, CB, CM, LB, HA, HB, B, all belong in one large group, with the pair group OF, MG, occupying a position between the sub-groups MH, CM, LB, OM, HA, and CB, HB, B. OM and HA are manifestly nearer to one another than to either MH or LB, having had the same parent or grandparent. CB and B had a common ancestor some two or three generations back, while HB was copied from either CB or a descendant of CB. MH and CM are closely related. MK, the poorest manuscript in the whole group, fits in a niche by itself. The connection between MK and X has been noticed already. MI, LC, LD, CA, form a group distinct from that in which OF, MG, OM, MH, etc., are found, with CA agreeing less often in the characteristic readings of the group than any of the others, and

¹It is realized that the following figures can not be altogether satisfactory. Naturally they can not be more exact than the facts, which are not at all complete. At the most they can but represent the trend of relationship, the more or less approximate relative positions of the MSS. within the same group. And even that is not always to be known. On account of the changes which take place in the various combinations and groups of MSS. each passage will need to be treated independently of every other, but an effort will be made to keep the diagrams as near alike as possible, in order to facilitate the drawing of a single figure of more general scope. Such a large number of these figures is not altogether desirable, but they are necessary under the circumstances, no one figure being at all adequate. Considering the contradictions and complications which are met with in every line of descent it would have been far easier to have merely stated the facts and omitted the figures. The latter have been inserted for their graphical value. Whatever their shortcomings, they will in some measure help to illustrate the facts upon which they are based.

LD less often than MI and LC, a pair group. There can be no doubt that all four of these manuscripts belong in (II) because of the way in which they follow the traditions of that group. It should be noted, however, that at times they agree with one or more members of (I). This is particularly true of MI and LC, which though they show no decided preference for any branch line within the group have yet some distinctive readings not found outside of it. With ME, CC, P, MF, they have *conditio vel dictio* for *dictio*. MI, LC, LD, have *et* for *quia* with ME, CC, P. *Et* for *est* is the reading of MI and LC with OB, LF, LG, where ME, CC, P, have *vel*. MN, MI, and LC have *petens* for *penes*. But these exceptional agreements have come from the copying of corrections or are the result of chance and coincidence, for though both MI and LC are usually found in (I), they do not at this place make even a pretence of following that tradition. CA and LD are connected, though not so closely as MI and LC. The abbreviated texts CD and CH are associated most closely with LD and CA respectively. Group (II) may be represented thus:

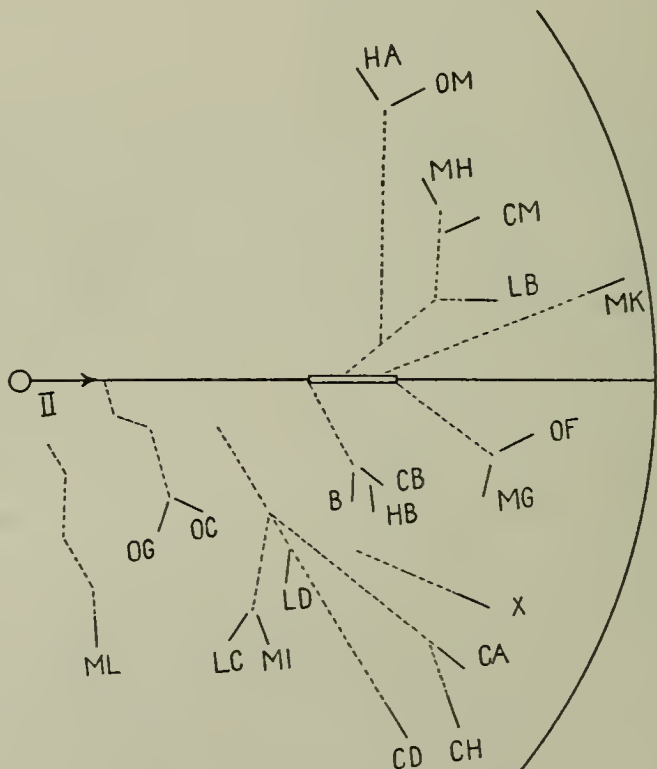

As far as the *addiciones* in this portion of the text are concerned, it will be seen that they have to do almost entirely with group (II). The *addicio* on

f. 32b is found in all the members of that group with the exception of OG, and it occurs also in OD, MD, MF. That portion of the text of LB which contains this passage has been lost, but there is every probability that LB followed the same tradition in this *addicio* as in the two which come after. In the main, the manuscripts follow the same side lines as in the text proper. OF, OM, MG, MH, MK, CB, B, HA, HB, B, again make up one large group which splits up into the sub-groups already noticed. MI, LC, LD, CA, CH, continue to show the same relationship, but now MF and X are associated with them, and more closely with CA and CH than with the others. MI and LC preserve their pair group relationship. OD and MD are more closely connected with OC than with any other of the manuscripts involved, MD being the nearer to OC. ML shows a tendency to agree with both LD and CA, more than once following the reading of one contrary to the other. The graphic representation of the relationship of the manuscripts will therefore remain the same as that already given, except that MD and MF have to be brought over from (I) to (II), and ML and X moved about, thus:



The *addicio* which occurs in the printed text on both f. 33 and f. 34b is found in practically the same manuscripts as the additional passage on f. 32b, except that this second *addicio* is found also in OG, ME, Y, LB, and is omitted in MF, ML, X. In OD, ME, Y, it is marginal. A scarcity of variants makes it difficult to work out the details, but we get enough information to assure us that the groups OF, OM, CB, etc., and MI, LC, LD, CA, CH, maintain their identity. OC, OD, OG, MD, are related. The marginal passage in Y has been taken either directly from CA or from an exemplar but one generation removed from CA. ME has derived its marginal passage from some manuscript in the line of OM, MH, LB, HA. The changes may be shown thus:

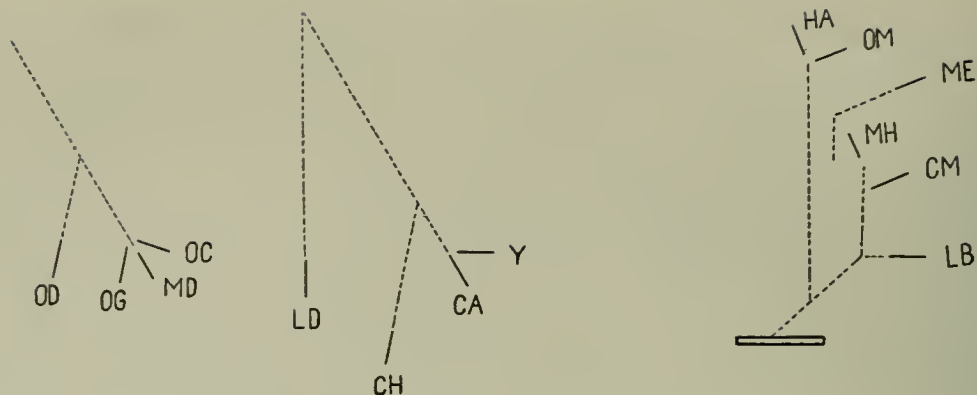

The *addicio de cartis* on f. 34, one of the most important in the whole treatise, is found in all the members of group (II) with the exception of ML, and also in OD, MD, ME, MF, P (marginal). The significance of these facts as bearing on the value of this addition itself will be discussed later when the subject of *addiciones* is treated in detail. Genealogically, it is evident that the larger OF group contains the same manuscripts as in the two former *addiciones*. OD and MF agree with this group as to where the *addicio* should be inserted. It may be pointed out that the agreement as to the position of the additional passage in this and the preceding *addicio* between OC, OG, MD, and the group containing MI, LD, etc., indicates only that the larger OF group chooses a place for the *addicio* different from that in which it is found in the other manuscripts. The sub-groups of the larger OF group remain the same. MI, LC, again form a pair group, and LD, as usual, is in agreement with them to form a larger group. CA and CH do not show up in the variants, but there is no reason for thinking that their position has changed. OC, OD, OG, MD, show a general relationship, OC and OG being the nearest to one another. P, ME, MF, are in some way connected with OD or its more immediate kin. MF agrees with OD and the larger OF group as to the position of the *addicio*, while ME selects the other position in the text, and P is marginal. This may mean that the passage in P was copied from an exemplar related to both MF and OD, but the more probable explanation is that P was copied—as far as the *addicio* is concerned—from a manuscript closely related to OD, and that ME and MF both derived the passage, either directly or indirectly, from P, each of them choosing, after a comparison with other manuscripts, a different position in the main body of the text for what in P was a marginal addition. Where OD agrees with ME in having *nec* for *nisi*, MF follows P and reads *ne*. There is here the suggestion that P was

taken more directly from a near relative of MF. But the acceptance of that suggestion would necessitate the difficult explanation of why P and ME have *quos* where MF has *quod*, and *voca* where MF has *vocabo vocabo* for the usual *vocabo*. MF, together with ME, P, OG, MD, has *scilicet deum* where OD and the other manuscripts have *deum scilicet*. This latter variant, however, is non-determinative. OD, ME, MF, P, OC, OG, MD, are brought together by their use of *Factum* for *Item factum*. Such changes as require a different representation from that already given for the *addicio* on f. 33 concern these manuscripts only. They may be shown thus:

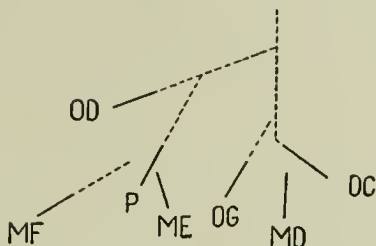

FOLIOS 161-162b

For this passage thirty-nine manuscripts have been collated. As in the passage on fs. 33b-35 the larger groups may be denoted by (I), (II), (III), with the arrangement as follows: (I) OB, OM, MA, MB, MD, MI, CM, LC, LF, LG, HA, W; (II) OC, OF, OG, ME, MG, MH, MK, CA, CB, CC, CF, CH, LB, LD, LE, LT, HB, X; (III) OA, CE, MC, LA, OD, ML, MF, P, Y. (I) breaks up into (OB, LF, LG), (OM, MA, MB, MD, MI, CM, LC, HA, W), (MA, MB, MD, MI, CM, LC), (OM, HA, W), (MA, MD), (MI, CM, LC), (OM, HA), with MD again showing the influence of corrections from another line in its exemplar. (II) contains the smaller groups (OF, ME, MG, MH, MK, CB, CC, LB, HB), (ME, MH, CC, LB), (OF, MG), (CB, HB), (CA, X), (CF, LT), (OC, OG—first part). (III) does not so decisively split up into such well-defined groups, but we get these combinations, (MC, MF, LA, P, Y), (MC, LA), (LA, Y), (MF, P), (OA, CE), (Y, OG—second part).

While most of the sub-groups in (I) stand apart quite clearly, there is some little question regarding the possible connection of MD with the group OM, HA, W. By referring to the arrangement of the manuscripts by groups

it will be seen that in two of the larger sub-groups of (I) which contain MD there stands out the combination (-OM, MD, HA, W) or (+OM, HA, W). This brings up the question as to whether or not MD goes directly with the other three manuscripts. Probably it does not. For at this place MD is again associated most closely with MA; again it shows that its exemplar had been corrected by some model in the line of (II)—as proved by the variants under OC, MD; and it follows (II) where OM, HA, W, do not, and vice versa. Without doubt, the reason for the apparent agreement of MD, OM, HA, W, is that though the last three of these manuscripts fall within group (I) they follow less the peculiar traditions of that group than do the other members of it. As a result of the correction made in MD's exemplar, that manuscript also is lacking in some of the more characteristic variants of (I). This causes all four of these texts at times to agree together against the rest of the larger group of which they form a part. But the point should be emphasized that in doing this they do not have variants peculiar to themselves. In disagreeing with the reading of their own group they simply agree with the reading of practically all the other manuscripts outside of it, so that their failure to follow the tradition of (I) in these places connects them no more closely with one another than with the majority of the manuscripts in general. A study of the collation will show that these particular codices have this sort of agreement with the other manuscripts against those in their own line some ten or a dozen times. The evidence furnished is pretty conclusive, and more than offsets the single time that MD (with MA) agrees with HA and W against all others. MA, MD, HA, have *directum*, W has *derectum*, but OM has the usual, and correct, *deiectum*. It would be going too far to even suggest that MD had been either copied from or corrected by a text in the line of W or HA, and MA copied from MD. In that case MA would be sure to agree at other times with the MD, OM, HA, W, combination. Such an agreement it altogether fails to show. Some text in the line of the common ancestor of OM, HA, W, may have been corrected by one in the line of MA, MD, to produce the variant, but this is not likely, because OM shows the correct reading. The variant is a most natural one—W changes *deiectum* to *derectum* by simply writing *r* for *i*. By far the simplest and most satisfactory explanation is that MA and MD, HA and W, have obtained this variant by a similar, though independent, process. This same sort of thing happens so often in the case of other non-related texts that it can not in any way be regarded as unusual. The briefest way of giving a clear indication of

PEDIGREE OF THE MANUSCRIPTS

the more general relationship of the particular manuscripts under discussion is by the following variants: *perfordiat* (*fodiat*), MA, MB, MD, MI, CM, LC, +OM, HA, W; *evaserint*, MA, MD, MI, CM, LC; *evaserant*, MB, +OB, LG; *invaserant*, OM, HA, W, +group (III); *invaserint*, group (II). OM and HA are more closely connected with each other than with W. Omissions in all three of these manuscripts produce a system of checks which prove conclusively that no one of them was copied from either of the other two.

The graphical representation of the relationship in group (I) will be different from what it was for fs. 33b-35. MN omits this later passage; CF, LT, CC, ME, go over to (II); OM, MI, CM, LC, HA, W, come over from (II); MF, P, Y. go over to (III).

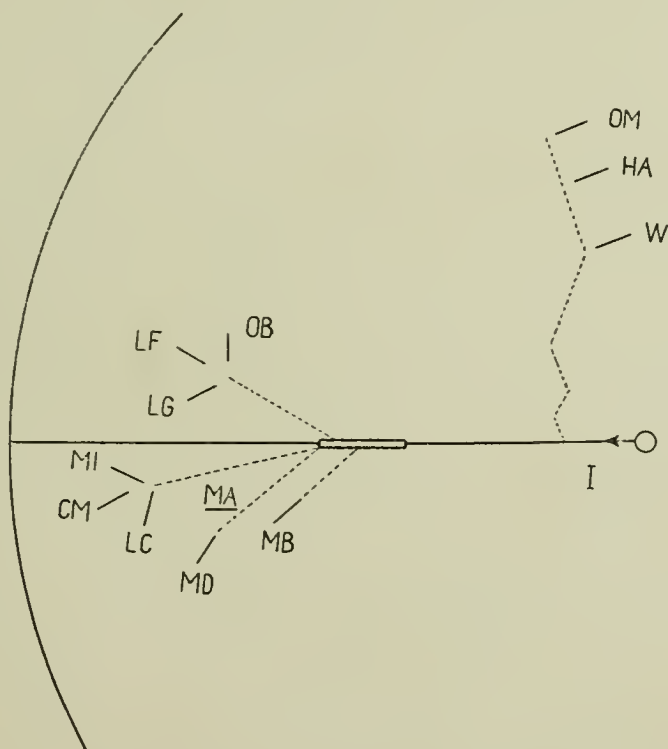

In (II) OF, MG, MH, MK, CB, LB, HB, remain as for fs. 33b-35, while ME and CC group themselves with MH and LB. The pair groups OF, MG, and CB, HB, are again prominent. CA and X, which because of the excessive number of their variants are easily the poorest texts of all, form another closely related pair group. CF and LT likewise make a very poor

showing, and are near of kin. The text of OG for the passage here collated is found partly on f. 273 and partly on f. 26b of that manuscript, which continues to agree with OC in its first part and with Y in its second part. LD is hard to place precisely. It clearly belongs in (II), but just where is not easily ascertained. It is found in agreement with different sub-groups of (II) and also with representatives of (III) in variants which are determinative. The indications are that some ancestor of LD had been corrected by other texts from more than one line. Two variants which we may regard as indicative of the general relationship of LD are *contentione* (for *concertatione*), CA, CF, CH, LD, LT, X, and *impulsiva* (*repulsiva*), CA, CF, LD, LT, X. There is what appears to be an agreement between CH and LE. This may be due to relationship, or only to the fact that in making these abbreviated texts the two scribes independently selected the same words and phrases for omission. The relationship of (II) may be expressed thus:

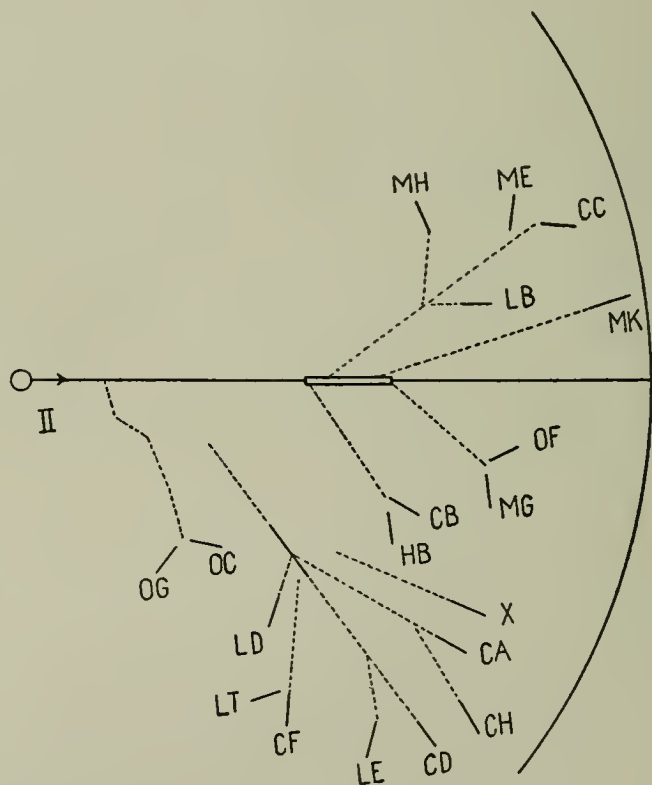

Group (III) includes those five manuscripts which constituted (III) for fs. 33b-35, plus four additional codices. The former—OA, OD, CE, MC, LA—continue to show a better text than the latter—Y, P, MF, ML. There

is no indication that the relationship of the first five has altered from what it was in the earlier passage, though the small number of variants furnished by these good texts gives hardly enough information to make the exact kinship clear. MC and LA, OA and CE, pair off in a way, but the association is not of the closest. The very failure of OD to agree, except in very unusual cases, with (I) and (II) puts it in (III), but within the latter group it stands apart by itself. Its variants are few, and follow consistently no one tradition. In having *qualitercumque* for *qualicumque* it follows (II). With the rest of (III) it has the distinctive *invaserant* in l. 7, f. 162b. It agrees with (I) in having *ei cum* for *cum*. With OA, CE, MC, it has *concedendo* for *contendendo*; with OA and four manuscripts in (II) it has *pectora* for *pecora*; like OA, MC, CH, LG, it has *manufactum* for *manifestum*; agreeing with OG, Y, MF, MD, it reads *domini regis* for *regis*. These last three variants are rather non-determinative. But it is evident that even in determinative variants OD does not confine itself to those of any one group. To some extent, at least, one or more of its ancestors had been corrected by texts in other lines. In itself it has omissions which would not admit of the suggestion that it might possibly have been the exemplar of any of the other copies in (III). ML is another manuscript which it is hard to place in an exact position because of its lack of consistent agreement. Attention has already been called to the fact that this manuscript appears to have been taken by comparison from several exemplars. Y, P, MF, are more closely related to MC and LA than to any other members of the group. Y is the best manuscript of the three, and MF the poorest. The latter not only brings in a whole page of extraneous matter—including references to the second statute of Westminster—but has a rather lengthy portion of the text, which is marginal in LA, in two different places, once regularly, and once misplaced, as in P. In its second part, OG stands in very close relation to Y. The outlines of the relationship in (III) may be represented thus:

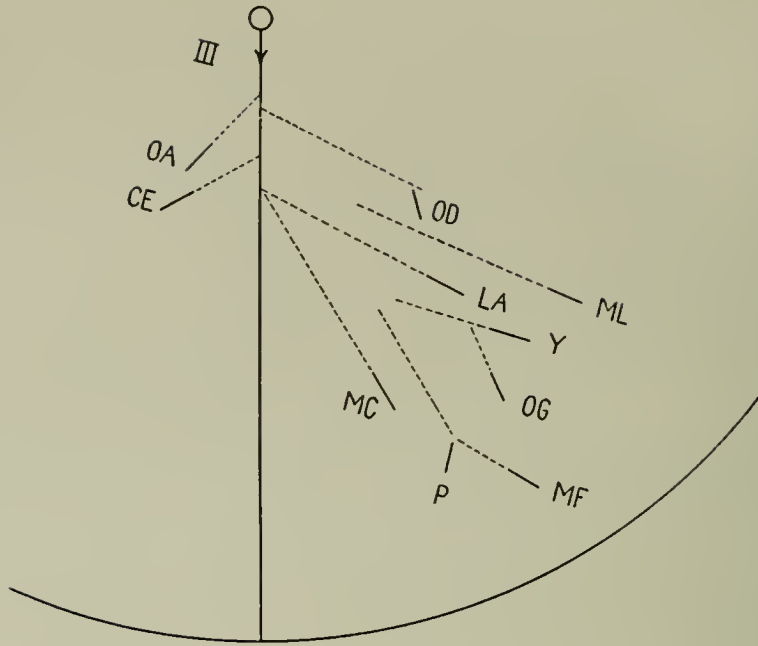

The *addicio*, without doubt one of Bracton's own additions, is found in all the texts with the exception of CE and ML, whose scribes probably omitted to copy a passage which was marginal in their exemplars. As far as position is concerned, we find that OD, MC, Y, P, MF, of (III) agree with (II); (I) as a group chooses a position distinct from others; OC goes in with the CA, CF, LD, etc., group. It shows a tendency also to follow this group in its readings. Y has been corrected by a manuscript closely akin to CA. Otherwise the relationship remains the same as in the text proper.

FOLIOS 413-415b

For this chapter thirty-seven manuscripts have been collated. Three groups stand out distinctly: (I) OB, OD, MA, MD, MB, MF, MI, MN, LF, LG, Y, HA; (II) OA, OF, MG, MK, CB, CC, HB, B, X; and (IV) OM, ME, MH, MM, LC, LT, CM, P, W. Outside of these three groups are OC, OG, CE, MC, LA, ML, LD, each of which will require separate discussion, but which together we may designate for convenience as (III).

In (I) occur the sub-groups (OB, OD, MF, LF, LG), (OB, LF, LG), (OD, MF), (MA, MD). MA, MD, MI, are nearer to the line of OB than are MB, MN, and Y, these latter three being more distant in the order named.

PEDIGREE OF THE MANUSCRIPTS

Y shows decidedly the best text of any of the manuscripts in this group, and in this respect it is followed by MN, LG, OD. Not much behind OD, and having each about the same number of variants, come OB, MB, LF, and MI. HA, MA, MD, MF, all show misreadings which in number are considerably in excess of those found in any other members of the group. These facts, when taken in connection with the more obvious points of agreement, give a fairly clear indication of the general relationship of group (I). The agreement of OD and MF in this passage may be compared with the agreement of the same two texts in the *Addicio de Cartis* on f. 34. In its repeated passages and double line of variants, which have already been pointed out, MD continues to show the results of corrections made in its exemplar from some copy not far removed from OC.

Of the twelve manuscripts constituting group (I) for fs. 413-415b, OB, LF, LG, MA, MB, MD, MI, HA, were in the same group for fs. 161-162b. MN, which omitted that portion of the text containing the beginning of the Assise of Novel Disseisin, is again found in (I) as on fs. 33b-35. OD, MF, and Y, have come over from (III). Thus:

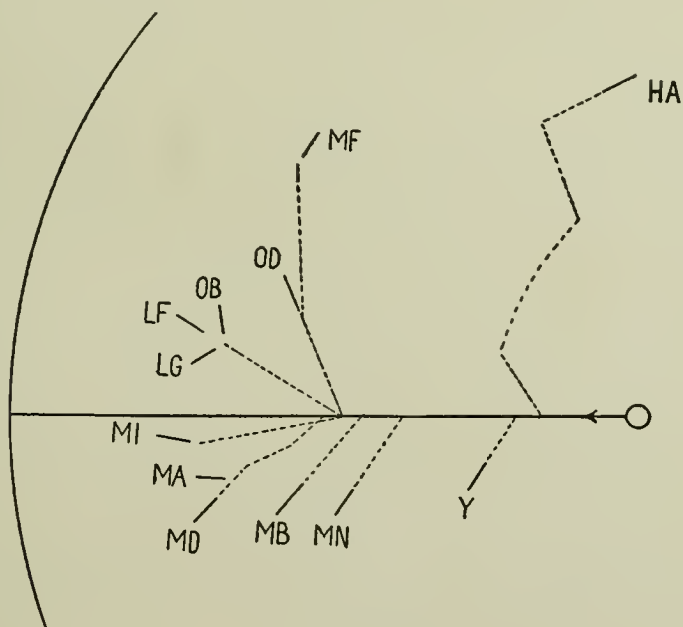

The nine members of (II) fall into the lesser groups of (OA, OF, MG, CB, CC, HB, B), (OA, OF, MG, CC), (OA, CC), (OF, MG), (CB, HB, B), (CB, HB), (MK, X). The pair group OA, CC, is related to OF, MG, at no

great distance. For the other seven manuscripts the positions are the same as those already assigned. MK, X, show what is clearly the result of corrections from a text in the line of (I) having been made in some exemplar. Taken collectively, the manuscripts in this group show by far the poorest texts of all those collated for this passage.

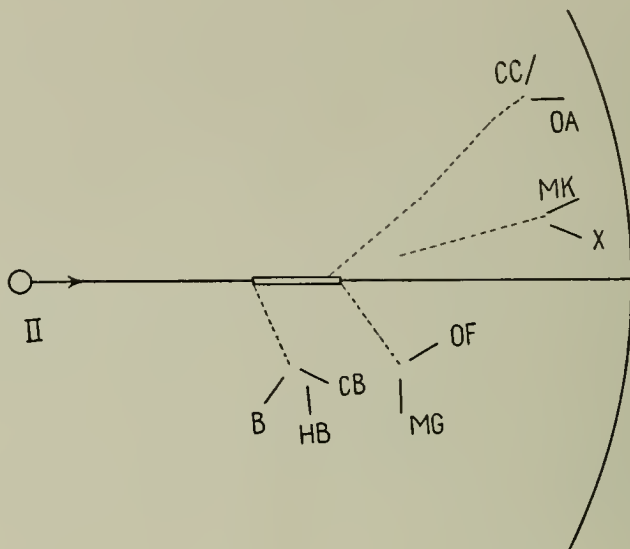

The manuscripts assigned to group (III) fall naturally into three divisions, OC, CE, and OG (which is fragmentary, and collated only in places) forming one combination, MC and LA constituting a pair group, and ML, LD, standing apart. It has been pointed out that all of these texts agree with group (IV), against all others, in assigning the case on f. 413 to Roger de Turkilby. In reading *diversitatem* for the usual *varietatem* they agree with most of the members of (IV) and two of the texts in (I). This may possibly be a case where the scribes have exercised a certain independence of choice; it may have been produced by comparison and copying; but it is more reasonable to regard the word as a variant belonging to the tradition of (III) and (IV), which are certainly related groups. On the other hand, OC and CE are in some way connected with (II), as is shown by the fairly large number of variants common to the two groups (OA, OF, OC, MG, CC, CE) and (OA, OC, CC, CE). But this relationship is not close. The agreement of OC and CE with these two sub-groups is not of the clear-cut and decisive kind. Many of the variants are of a not altogether determinative type; half of them are found in at least one other manuscript outside of the immediate group.

But the connection is too close to be explained on the basis of mere chance, and it is necessary to concede the probability of corrections having been made in some exemplar through comparison and cross-copying. The association may be even more direct than this, but compared with that which exists between the members of the OA, OF, group, and between OC, CE, and OG, it is not at all close. Whatever it may be, it involves LD, which is frequently found in agreement with OC and CE in these places. But LD follows traditions which are genealogically contradictory. Here, as in other places, this manuscript has all the earmarks of having been copied from a model, or models, which had been corrected by manuscripts in other lines. A number of times it agrees in determinative variants with (II) against (IV) or vice versa. Twice it agrees with ML against the other members of (III), as where MC and LA have *unam* (with group (I)), OC and CE have *vitam* (against all others), and ML and LD (with (II) and (IV)) have *unicam*; likewise ML and LD read *exigatur* where the rest of (III) follow (II) and (IV) in reading *errigatur*. Both ML and LD twice agree with the MC, LA, pair group, but at different places. Lest too much emphasis should be placed upon this, it may be pointed out that LD twice agrees with MK against all others in having *omnibus* for *nomnibus*, and in omitting *fuerit rationi . . . dum tamen*. In the same way ML goes with MD, these two alone reading *voluntatem* where the other manuscripts give *voluntate*, and having *per mortem* for the regular *morte*. And if ML has *quod* (for *qui*) with LA, it has also *alter* (for *alius*) with LC and *defectum* (for *defectum de errore*) with MF. Those who were responsible for the making of ML were concerned rather with having the best text in the finest appearing form than with the exact reproduction of any one exemplar. Its text has come from models in the lines of (III) and (IV), while LD has been affected by (II) in addition to (III) and (IV). MC has occupied the same position from the beginning. LA is near of kin to MC, the relationship between the two being more apparent in this passage than in some of the earlier ones. These two codices show the best texts of any of the manuscripts in group (III). On the basis of these facts the relationship of (III) may be represented thus:

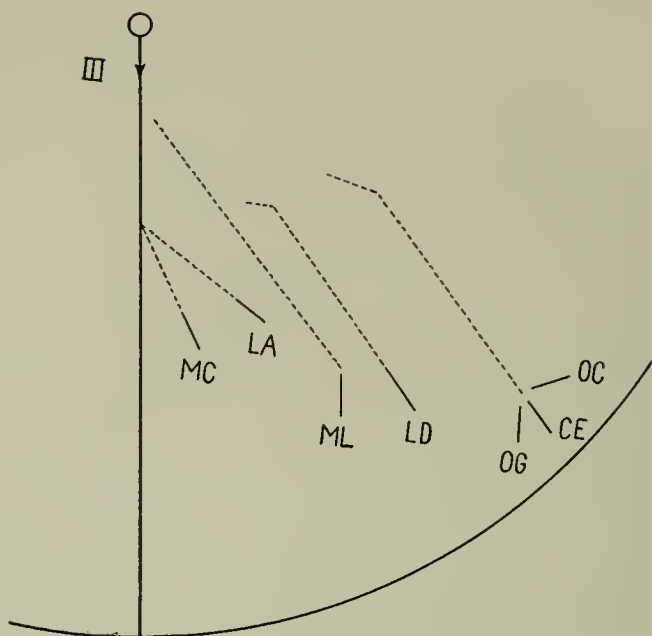

In its readings group (IV) is not associated with (I) because the latter follows traditions all its own. But (IV) is related to both (II) and (III), the question being with which of these two groups it stands in the closer connection. The manuscripts which make up this group do not at the other places collated come into a single combination. Nor do they, in the other places, follow any single tradition, individually or collectively. MM omits considerably more than one-half of the whole treatise and has therefore been collated for only the last three passages. In these it seems to maintain the same relative position. But the other eight manuscripts in this group are found agreeing with different lines at different places. They seem to occupy positions on the outskirts of the more usual combinations of manuscripts with fixed traditions. For this particular passage the position of (IV) is fairly well established. The variants for the case on f. 413 would seem to place it at once definitely on the side of (III), for while (II) omits the case entirely and (I) reads *W. de Raleigh*, (III) and (IV) agree on *R. de Turkeby*, which is correct. Yet what this special point really emphasizes is not an agreement between (III) and (IV), but the fact of the individuality of groups (I) and (II). For there is not a consistent agreement between (III) and (IV). By referring to the list of variants given at the beginnings of the groupings for fs. 413-415b, it will be seen that in having *patens de recto* and *contraria* (IV) agrees with both (III) and (II). In several other places where (IV) shows an agreement with both (II) and (III)

PEDIGREE OF THE MANUSCRIPTS

the members of the two latter groups are not always unanimous in their choice of readings, so that (IV) not infrequently disagrees with individuals in each of the other groups. It must be regarded as occupying a position between (II) and (III) rather than as associated with either. Thus:

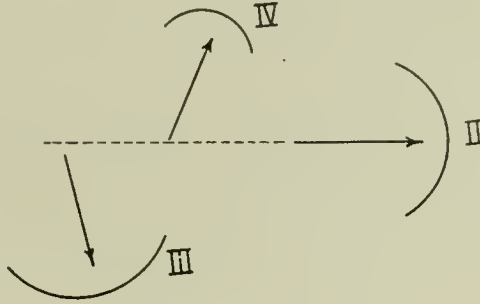

Within the large group there occur the smaller combinations (OM, ME, MH, P, CM), (ME, MH, CM), (MH, CM), (LC, W).

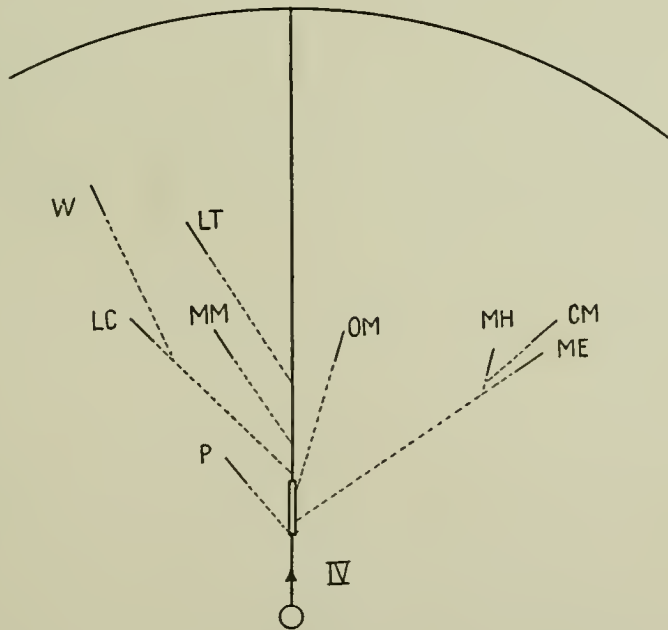

Before undertaking to compare the points of similarity and difference in the relationship of the manuscripts which is shown by these three longer passages, it will be well to take into consideration such information as may be given by the shorter collated portions of text.

FOLIOS 2b AND 5b

Here are two short passages for which forty manuscripts have been collated. They are near enough to each other to be considered as one, and in them it might be expected that the groups would be about the same as those for fs. 33b-35. Using group (I) of this latter place as a guide to what will probably be found in (I) for the earlier folios now under discussion, the following sub-groups may be brought together—(OB, OE, MB, MN, LC, LF, LG), (OB, LF, LG), (MA, MD), (MN, MB), (CF, LT). LC shows a tendency to agree with MB and MN. OE, in which the portion of text including fs. 33b-35 was missing, agrees with both the smaller OB group and the line of MB, MN. By following the leading of the variants *autem, pro, multo fortius in superiorem, and recuperandum* it is possible to form the larger group (OB, OE, MA, MB, MD, MF, MN, CE, LF, LG, Y, CF, LT). CF and LT are often in agreement with lines other than that of (I). OA is found at least three times in decisive agreement with (I) as a group. The connection of CE with (I) is very marked in the variants which determine the large group, but it does not come into the sub-groups. For fs. 33b-35 both OA and CE were put in (III), on the OB side of the middle line, though the inclination of CE towards (I) was not so marked there as in these earlier folios. ME, CC, P, again form a sub-group, but not under (I). The position of Y and MF is apparently the same as for fs. 33b-35. The main points of relationship may be shown thus:

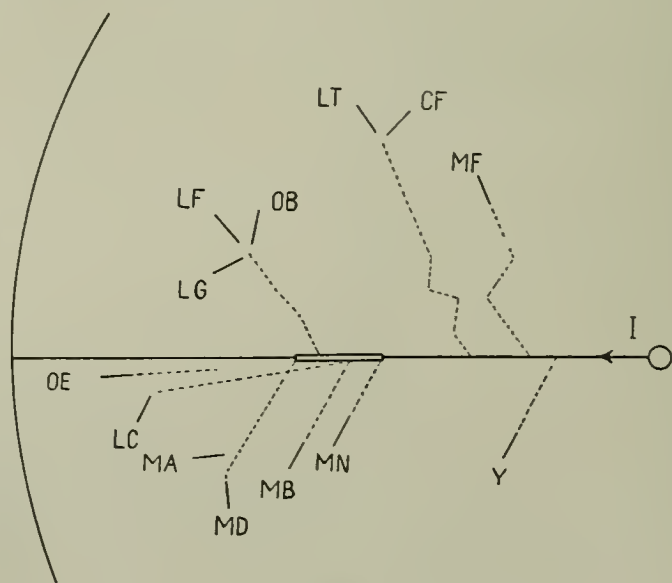

Following out this same comparison with fs. 33b-35 we get for (II) the sub-groups (OF, MG, MH, MK, CB, HB, CM, B, X), (OF, MG, MH, CM), (OF, MG), (MH, CM), (CB, HB), (MK, X), (CD, LD), (OM, HA, W, ME, CC, P), (OM, HA, W), (ME, CC, P), (OM, HA), (OC, OG). This makes a combined group of (OC, OF, OG, OM, ME, MG, MH, MK, CB, CC, CD, CM, HA, HB, LD, B, P, X, W). There is every probability that CA belongs in this group, as it is found agreeing with a number of other texts in (II)—with OF, MG, MH, CM, *civili* for *civili tantum; etiam (enim) ius* for *etiam*, with MK, X; *relatio est facta* for *relatione facta*, with OM, HA; an omission in place of *igitur*, with most of (II); and *ad* for *qua ad*, with CC. Here as elsewhere ML gives proof that it was compiled from models in both (II) and (III) by a scribe who used the utmost liberty in choosing the reading which seemed to him the most desirable. He even invented readings to suit his own idea of fitness if he could not find in his exemplars what he desired. Thus where all the other manuscripts are divided between *ergo* and *autem*, ML reads *vero*. Where the other texts have either *igitur*, *ergo*, or an omission (with the exception of LD which gives *se*), ML substitutes *enim*. As a matter of fact, ML follows no single tradition in any one particular place. With about equal propriety it might be put in either (II) or (III). OC and OG again have a place on the outskirts of (II), near to group (III). The connection of ME, CC, P, with the sub-group OM, HA, W, on f. 2b (reading *iustum* for *ius* and *iudicium et* for *et*) may possibly be due to one line having made a correction from the other, just as MA, MD, CB, have clearly been corrected in erasures to these particular variants. But a connection between ME, CC, P, and W, is shown in the passage on f. 5b, W having three of the five variants peculiar to ME, CC, P. In reading *quo* for *qua* ME, P, and W (CC omits passage) again come together. *Est lex* for *lex* as in ME, CC, P, is the reading also of MH and CM in addition to W. Later on, the connection of the combinations of manuscripts which run through the collated passages will be worked out, but it may be said here that ME and MH, usually with either P or CC, or both, are frequently found in combinations. Such was the group (ME, MH, CC, LB) occurring in the collation for fs. 161-162b, and the group (OM, ME, MH, P, W, + others) in fs. 413-415b. In this earlier part of the text the evidence which associates ME, CC, P, with both MH and W is probably not the result of mere chance combinations. For the present each passage is being treated separately, and for this place the variants order us to put ME, CC, P, at no great distance from OM, HA, W. We may express

the relationship in its outlines thus :

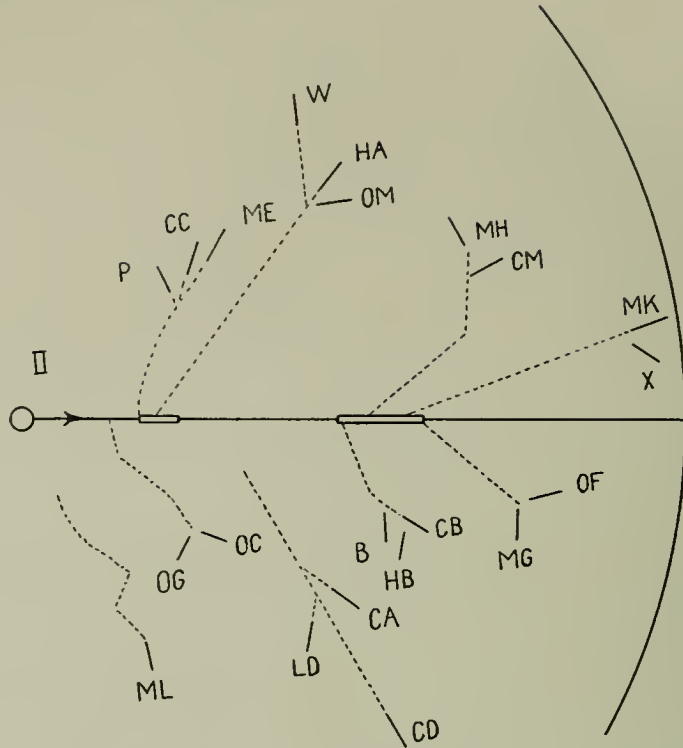

In group (III) MC and LA continue to hold a more central position, with OA inclining slightly towards (I) and CE leaning noticeably in that direction. OD and PH form a pair group. The small number of variants furnished by these two texts in this piece of collation makes impossible anything like an exact determination of the place which they should occupy, but it is clear that they belong on that side of (III) which is nearer (II). Thus :

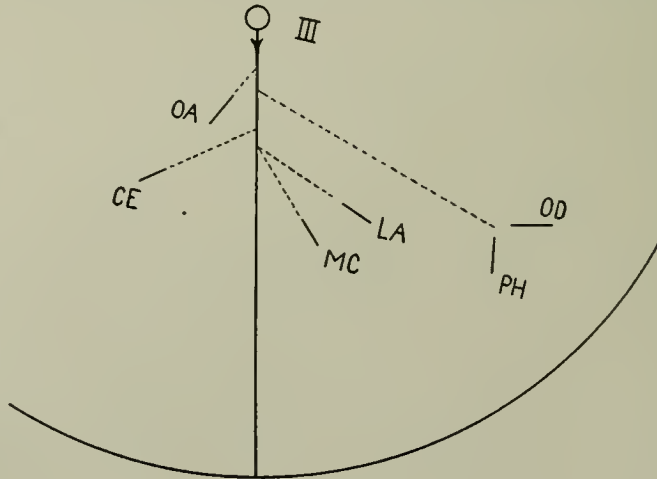

The *additio* on f. 3 is found in the text of less than half of the total number of manuscripts. It concerns groups (II) and (III), though not all the members in each of these groups contain it. Both OF and MD have clearly taken it from (II), agreeing with this group in their readings. It is evident, too, that OF's marginalia came from a text in the line of OF, MH, CB, etc., while MD goes rather with OC and LD. The question as to whether (II) derived this additional passage from (III), or vice versa, is one which may be left unanswered until the subject of the *addiciones* is discussed, as, with the exceptions just noted, the manuscripts are found in the same groups for the *additio* as for the text proper.

FOLIO 96

Forty manuscripts contain this passage. It is evident at once that the nucleus of (I) is (OB, MA, MB, MD, MI, MN, CB, HB, LG, LF); of (II), (OF, MG, CC, LB, X, and probably B); and of (III), (OA, OD, LA, PH, ML, CE). For (I) there are the sub-groups (OB, LG), (LF in this passage does not show the usual close connection with OB, LG), (MA, MD), (MI, LC); for (II), (OF, MG, CC, LB), (OF, MG), (CC, LB); and for (III), (OD, PH). In addition there occurs the combination (ME, MH, CM, P, B). Is this a fourth group or a sub-group in one of the larger combinations? Then there is the question as to the relative positions of the clearly distinguished sub-groups (OG, Y), (ME, MH, CM), (CF, LT), (OM, HA), (OE, W). Standing out more or less individually are OC, MF, MK, LD, LE, X, Y.

Among the variants in which (I) is found in combination with other manuscripts are: *tenemento* (*tenemento non*), (I) -MD, LF, +MF, OG, Y, OF, MG, CC, LB, B, P, X, MK, LD; *nisi* (*ne*), (I) -MD, LF, CB, +OG, Y, OF, MG, CC, LB, X, MK, CE; *pars* (*partis*), (I) -LF, +OF, MG, CC, LB, X, P; *modo poterit* (*poterit*), (I) -LF, +MF, OG, Y, OF, MG, CC=*non*, LB, X, P, W, OE. For (II) in a larger combination we have *si de* (*de*), in OF, MG, CC, LB, B, X, P, MF, OG, Y, ME, MH, CM, HB, LD. *Ne* (*nisi*) is the reading of (III) -CE, +CF, LT, OC, MD, LD, MF, ME, MH, CM, B, P, CB, LF, HA, OM=*nce*, LE. *Ad tempus duxerit* (*t.a.d.*), is found in (III) -CE, +OC, MF, LE. The dating of the Statute of Merton is most determinative, as will be seen by comparing the variants. Taking all these facts together we are forced to put OG, Y, ME, MH, CM, P, in (II), which group is more in agreement with (I) than with (III), although on

occasion some members of (II) agree with (III) against (I). CF and LT are more nearly in accord with the traditions of (III) than with either of the other groups. OM and HA agree with (I) for the date of the Statute of Merton, but follow (II) or (III) in other places. OE and W, in so far as they show a tendency to agree with other texts in disputed readings, incline towards (I) and (II) as against (III). MF follows no one tradition; in its date for the Statute of Merton it agrees with (I). MK agrees with (III) as to the date of the statute, but it is also found in combinations of (I) and (II). LE has apparently come down the line of (III). In connection with the other variants more or less peculiar to (III) which have been noticed above, the readings *venire* (*evenire*) in OD, PH, OC, LE, and *satisfactionem* (*factionem*) in OC, LD, would assign the two latter texts places near one another in (III). Graphically the relationship may be expressed thus:

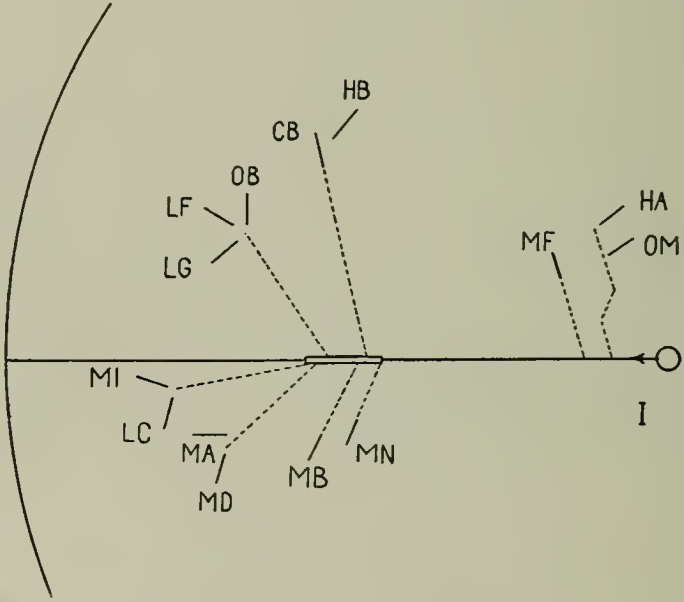

PEDIGREE OF THE MANUSCRIPTS

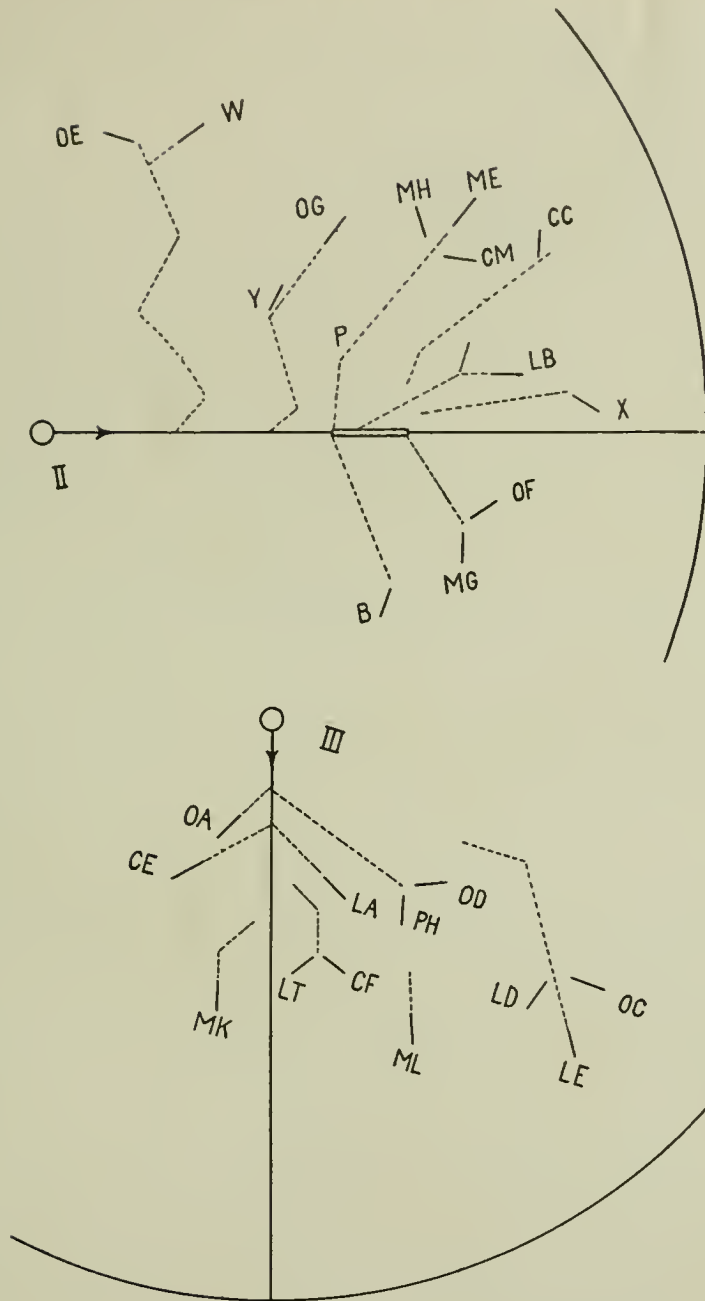

FOLIOS 118 AND 132b

Thirty-five manuscripts contain the first of these passages and thirty-eight the second. They may be considered together, both because of their nearness to one another, and because whether taken separately or together they are very

disappointing in the information which they give as to pedigree. A number of groups stand out distinctly enough, but their connection with one another is not always revealed. So little light is thrown on the kinship of some of the individual manuscripts that their relative position can only be guessed at. Only two of the manuscripts, OE and OG, change hands in the space of these fifteen folios, the change affecting OG but not OE. Whether any other of the texts have changed their tradition in the interval is a question that can be answered only by guessing. To make any inference on the basis of such meager information as is furnished by the variants would be both unprofitable and dangerous. All that can be done is to gather up such facts as may be of some use when the combined evidence of the twelve collated passages is discussed with the purpose of forming a general theory of relationship.

No difficulty is experienced in either of these passages as far as (I) is concerned. In both places the group consists of (OB, OE, MA, MB, (MD), MI, LC, CF, LF, LG, LT), with the sub-groups (OB, LF, LG), (OB, OE, MI, LC, (LF), LG), (OE, MI, LC), (MA, MD), (CF, LT). The graphical representation would be similar to that which has been made so many times before, with OE placed in close connection with MI and LC; and CF, LT, put a little apart from the rest of the group. For (II) the largest common group is (OF, MG, MH, CB, CM, HB, LB, B), which is split up into the smaller combinations (OF, MG, CB, HB, B), (MH, CM, LB), (OF, MG), (CB, HB), (MH, CM). These occupy the same positions that have been assigned to them before when they have come together; there is no need of drawing another diagram for them. In the passage on f. 132b, CC is added to this group of eight, and the whole group connected in some way with OC, X, CA, LD. These latter four pair off as (OC, X), (CA, LD). It is to be suspected that they lie on that side of (II) which is nearer (III). On f. 118 occur the groups (ME, CC, P, W), (ME, W), (CC, P), (OG, OC). A working hypothesis would put these in (II), where they have been found before, but there is far from enough evidence to prove that they belong in that place. To the whole group of (III) should go OA, OD, PH, MC, LA, CE, ML, Y. The position of the individual codices in this group seems to remain the same as for f. 96, except that Y, which has changed hands, now belongs in the line of MC and LA. The general agreement of OD and PH offsets such variants as *hoc (in hoc)*, PH, X, Y, and *accusationem (aecusantem)*, PH, OA. OM and HA, which omit the passage on f. 118, have so few variants that their immediate connection is not at all evident. In the general

trend of their texts they follow (III). Two variants, not altogether determinative, associate them with LD, which is found in agreement with both (II) and (III). W, which, like LD, shows a poor text in these passages, is almost hopelessly mixed in its agreements—(ME, CC, P, W), (OB, LG, W), (LD, W), (ML, W), (MB, W), (CB, W), + an agreement with the larger OF group, for f. 118; and (B, HB, X, W), (ME, CA, LC, W), (OC, X, B, W—this combination occurs twice), (OM, HA, ME, CB, LD, W), (ML, CA, LD, LF, P, W), on f. 132b. It would appear that there is some connection between OC, X, B, W, at this place, but from the evidence at hand it is not possible to make out just what the relationship is.

Comparatively so few of the texts have the *addicio*, or rubric, in the second of these passages that it need not be discussed here, though it will be seen to have an importance when the *addiciones* are considered. It may be pointed out in passing, however, that CE, CB, HB, and those members of (I) which have the rubric, show relationship; that MH, LB, B, are made into a group by the position they give the rubric; that MA and MD, though they agree with OD and PH as to the position of the passage, follow the line of OB, CE, CB, etc., in their text readings.

FOLIO 179b

Forty manuscripts have been collated for this passage, which on account of its proximity would naturally be compared with the passage on fs. 161-162b. In the main the agreement is the same. For (I) we have OB, MA, MB, MD, MI, LC, CM, LF, LG, and possibly OM, HA, W, OG, Y. The smaller groups are (OB, LF, LG), (MA, MD), (MI, LC, CM). There is a question as to the position of the pair group HA, OM, which is found also with (III). On fs. 161-162b, OM, HA, W, were seen to form a group. No such combination is visible here, perhaps because of the paucity of variants, or from the fact that W has changed its hand in the interval. These three manuscripts, together with OG and Y, twice agree with (I), but the variants which produce this agreement are not as decisive as might be wished, one being a mere transposition of two words and the other an omission which quite clearly is due to the confusion caused by two separate sentences beginning with the same words. The agreement of OM and HA with (III)—*consistat* for *constat*—is of a sort which it would not be well to regard as wholly determinative; it may be explained in more than one way, and does not at all

presuppose, or prove, an immediate common ancestry. In the *addicio* there is noticeable a more pronounced connection between OM, HA, W, and here these texts follow (III) rather than (I), as most of the members of the latter group omit the additional passage. There is also the suggestion of a connection between OG and W, but this might not be borne out by a more extensive collation. In OG this passage is in the second portion of the codex, that portion in which OG was found to agree with Y for the passage on fs. 161-162b. OG and Y form a pair group at this place. We are justified in keeping both of these manuscripts in (III), for while they follow (I) in the two non-determinative variants already noticed, they do not show a tendency to go with this group in a more general way. In some of their readings, more especially in the *addicio*, they agree with (II) or (III). Y has not changed its hand since fs. 161-162b, nor is there anything to suggest that it has changed its tradition. The agreement of OM with the larger OF group in reading *dictorum* for *dicti* may be the result of copying a corrected exemplar. Considered in its entirety the evidence in regard to OM, HA, W, is contradictory. For want of fuller information we may tentatively place these three manuscripts as on fs. 161-162b, which will permit group (I) to be represented as for these earlier folios.

In (II) the largest distinct group is OF, MG, MK, CC, LB, X, ME, MH, CF, LT, but there is no question that CA, X, LD, CB, B, HB, should be added to these to form a larger combination. The sub-groups which appear are (ME, MH, CF, LT), (ME, MH, CC, LB), (ME, MH), (CF, LT), (CC, LB), (OF, MG), (CA, X). CB, HB, B, probably constitute another group, with CB and HB in their usual pair relationship. OC is found in agreement with both (II) and (III), though not decidedly with either. There is no reason for changing its position as given for fs. 161-162b. The connection between OC and MD, which has been remarked upon frequently, is made evident again here, both of these manuscripts reading against all others *qualitatem* for *quantitatem*. A question which the collation raises, but does not answer, is that of the exact position of CF, LT, ME, MH, CA, X, within the group itself. It would seem that there had been a slight change in the actual positions occupied by at least the first four of these manuscripts. This impression might be changed by further collation; and it is perfectly certain, as far as the whole number of manuscripts is concerned, that the relative positions of these particular texts have not altered. The single agreement of MK and X against all others—*utrum* for *utrum scilicet*—carries little or no

weight because of their numerous disagreements. As far as can be judged from the rather meager data furnished by the collation of this passage, the position of the manuscripts in group (II) should remain practically the same as for fs. 161-162b.

This leaves OA, OD, MC, ML, LA, PH, OG, MF, P, Y, for group (III). The first seven of these are clearly in one large group, and while their exact positions are not readily discernible, there is no reason for not accepting the arrangement made for these same manuscripts on the basis of the collation some eighteen folios earlier. Both OC and OG show a tendency to agree more or less frequently with (III), but there is nothing to indicate that a relationship exists between the two. The agreement of OG and CE—omission of *querens posuerit in visu suo*—calls to mind the fairly constant agreement of OG, CE, OC, on fs. 413-415b. But it is only in its first part that OG agrees noticeably with OC or OC, CE. This passage is in that later second part, added after the abbreviated first part had not been found satisfactory, in which OG for fs. 161-162b showed a decided preference for the same tradition as that followed by Y. The natural conclusion is that OC follows the readings of (III) at times because it is on what may be called the border line between (II) and (III), and that the second part of OG continues in the same line as at the beginning of the Assise of Novel Disseisin. MF and P form a pair group, the exact position of which is not clear. They have the determinative *dictorum* for *dicti* of (II), follow in general the tradition of (III), and in the position which they give to the *addicio* agree with MC and LA against all others. If it were not for their use of *dictorum* there would be no hesitation in assigning them the same place as for fs. 161-162b, which is found only ten folios earlier in MF and even less distant, seven folios, in P. These two texts certainly follow (III) rather than (II), and in view of the fact that *dictorum* may very easily have come from a correction in some common ancestor, it will be well to allow them to retain their position in (III).

Such additional evidence as the *addicio* furnishes is largely of a supplementary nature. As already noticed, in the matter of the position of the *addicio*, MF and P agree with MC and LA. This is in line with the general connection of MC, LA, Y, P, MF, for fs. 118-162b, which has been discussed above. What stands out most distinctively is the combination of ME, MH, CF, LT, CA, X, LD. They agree against all others as to the place which the *addicio* should occupy, and have the longer *Item videre debent iuratores* for the usual *Quia*. In addition ME, MH, CF, LT, have *in* for *de*. The connection

between ME, MH, CC, LB, which may be found in the text proper at this and other places, as on fs. 161-162b, is altogether lacking here. There was something more than a suggestion of relationship between ME, MH, CF, LT, in the variants of the collation of the main text in this passage; the relationship is very marked here in the *addicio*. CF, LT, CA, X, LD, in the passage immediately preceding this were seen to have come down a single branch line; apparently they hold the same position here. It is therefore exceedingly probable that some ancestor of ME and MH was influenced by a manuscript in the CF-LD group, very greatly in the matter of the *addiciones*, and to a less degree in the main text. Both ME and MH (as CF and LT also for that matter) are of the type of manuscripts which show corrections and copying from more than one line. Their textual value is low, CA, X, LD, for this particular passage at least, showing far fewer mistakes and misreadings. The changed position of ME and MH in the *addicio* may be expressed thus:

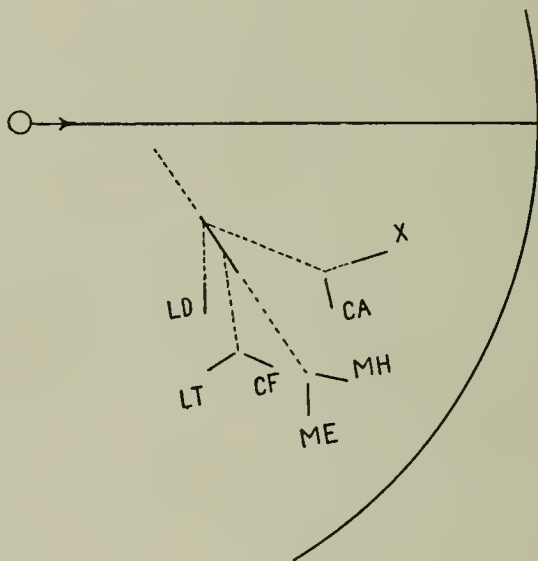

(I), by its omission of the *addicio*, is again marked off as a separate group. (II), including OC, has a place of its own for the additional passage, OD, CE, PH, OG, choosing the same position, but the other members of (III) either omitting it, having it as marginalia, or putting it at a different place in the text. The reason for this will be discussed when the subject of the inter-relationship of (II) and (III) as regards the *addiciones* is taken up. The sub-groups (CA, X), (MC, LA), (OM, W, HA), (CB, B), (CB, HB), (OM, HA), are more distinct than in the text proper. As supporting the right of

certain manuscripts to a place in (III) it may be pointed out that OG agrees with the reading of that group—*plus posuerit*, etc.,—and that OC does not, and that MF and P go with OG and (III) at this place.

FOLIO 253b

This very short passage is found in only thirty-three of the manuscripts. It was collated primarily to find out how many of the texts had been affected by the first Statute of Westminster for the period of limitation of the assise of Mort D'ancestor. Only eight manuscripts give the correct period, and these are members of groups (I) and (III). Judging from the reading of MA and MN (MB unfortunately omits just that part of the writ which contains the period of limitation), it is probable that the common ancestor of OB, LF, LG, gave the period correctly in that quire which is omitted in all three of its descendants. MC has the altered text, which would naturally lead to the inference that the exemplar of LA had the corrected reading. The collation brings out a number of sub-groups, most of them combinations which have been found elsewhere. But there should be noticed the combination of MI with ME, CC, LB, and the period of limitation assigned to the assise in MD and LD, which in this reading are associated with the group OF, MG, CB, HB, B. Though this short collation furnishes evidence which can be made use of in a general discussion of the relationship of the manuscripts, there are not sufficient facts to make possible a separate treatment of all the texts for this part of their contents.

FOLIO 319b

Forty manuscripts contain this passage. (I) is made up of OB, MA, MB, MD, MI, MN, LC, LF, LG, HA, Y, which split up into the sub-groups (OB, MB, MI, MN, LF, LG), (OB, LF, LG), (MA, MD), and occupy the positions already assigned to them within the group, as for fs. 161-162b, except perhaps LC, whose position is not sure. In all probability Y occupies here the same position as for fs. 413-415b. There is no large group definitely agreeing on characteristic readings which may be designated as (II), but as a nucleus for such a group we have the sub-group (OF, MG, MK, CC, LB, LD, X, W), to which should probably be added OM and MF. (OF, MG,

MK, CC, LB, X), form a smaller combination, and (CC, LB), (LD, W), stand out as pair groups. We find also the groups (CB, HB, B), (CB, HB), (OC, OG), which, as usual, doubtless belong in (II). CF and LT continue to form a pair group. The combination (ME, MH, CM, P), is subdivided into (ME, MH, CM), (MH, CM). From the evidence at hand it is not possible to tell where this group belongs, but it is not at all improbable that it here occupies the same place as for fs. 413-415b. At the latter place OM and LT (CF omitted the passage) were in the same group with these four codices. Of the two variants which help to bring ME, MH, CM, P, together at this place, CF and LT agree with one, and OM with the other. However, neither one of the variants is altogether determinative in itself, and as OM twice agrees with the OF group, and CF, LT, with CC, LB, there is no surety that the group should be the same as for fs. 413-415b. Among those manuscripts which up to this point in their text, in so far as we have examined it, have consistently been found in (III), OA, CE, and MC, LA, again pair off. All of which facts are far too inconsiderable to furnish data for a graphical illustration of relationship; but, as always in such cases, they will be found to have a value in the broader discussion of the pedigree.

The *addicio* is found in the texts of only seventeen manuscripts, and in the margins of two more. No member of (I) has it. In the group usually designated as (III) it was not a part of the original text in OD, CE, OA, LA. It is omitted in those texts which for fs. 413-415b were put in a group by themselves, namely ME, MH, CM, P, MM, CF, LT. This last is the only fact of importance in the *addicio* bearing on the question of the pedigree of the text proper. It has to do with the question raised in the last paragraph as to the connection of CF and LT with the group ME, MH, CM, P. Because of its lack of variants MM does not make its identity plain. In the text proper it has *ipsius* (alone) for *Inprimis*, and *tradidit* for *tradiderit* with ME, MH, CM, P, CF, LT, +MI, LC, MF, X. A variant of this latter kind, which is produced by the very common failure of a scribe to insert the *er* sign, which is almost always used in place of the letters themselves, can not be made use of with any degree of confidence, and for that reason, and for the fact that other variants of a different kind were usually available, it has hitherto been passed over for the most part. It would not be well to place too much emphasis on the variant here. But the use of *tradidit* and the omission of the *addicio* by MM, CF, LT, would put these manuscripts with the ME, MH, CM, P, combination rather than with group (II), or we may perhaps more properly

say with the OF nucleus of group (II), which have the *addicio* and *tradiderit*. Added value is given to the verb variant in this case because the original reading of group (I) is plainly *tradiderat*. (I) also omits the *addicio*. Except for such light as it throws upon this special point of relationship the *addicio* may be passed over for the present.

FOLIO 411b

The principal value of this collation, coming as it does only two folios before the longest of the collated passages, is that it shows the value and position of OE. That manuscript is found in (I), in the sub-group (OB, OD, OE, MB, MI, MN, LF, LG), and in the pair group (OE, MI). In other respects and for the other manuscripts, which are the same in both passages, the situation is exactly that of fs. 413-415b.

Each of the diagrams given above has been drawn on the basis of the evidence in the particular passage to which it applies. These diagrams differ because many of the manuscripts follow different traditions in different parts of their texts, or, if they remain in the same large combination, change their positions within the group itself. In many respects they are far from satisfactory. Yet they give a very good idea of how mixed up the relationship of the manuscripts really is. It will be noticed, however, that while some of the manuscripts change their traditions so frequently that no one graph is able to illustrate the relationship of all the different portions of each text, many of them are more or less constant in their adherence to a single line. In each of the three principal groups, (I), (II), (III), there are a number of codices which show up in the same position for at least the great majority of places in which they have been collated. To these manuscripts a fairly definite place in the family tree may be assigned, while to most of the others an approximate position can be given. On this basis, by using the combined information in all the collated passages, it is possible to draw a figure which will give a more comprehensive idea of the general relationship.

Taking the larger groups for all places collated, (I)—using (OB, MA, MB, MD, MI, MN, LC, LF, LG, OE), as a standard—is made up of the following: Fs. 33b-35—(), -MI, LC; +ME, CC, P, MF, Y, CF, LT. OE is lacking. Fs. 161-162b—(), +OM, HA, W, CM. OE, MN, lacking. Fs. 413-415b—(), -LC; +OD, MF, Y, HA, (and probably PH). OE, lacking.

Fs. 2b, 5b—(), +MF, Y, CF, LT. MI, lacking.

F. 96—(), -(OE?); +MF, HA, OM, CB, HB.

Fs. 118, 132b—(), +CF, LT. MN, lacking.

F. 179b—(), +CM, (OM, HA, W)? OE, MN, lacking.

F. 319b—(), +HA, Y. OE, lacking.

F. 411b—(), -LC; +OD, MF, Y, HA, (and probably PH).

Therefore OB, MA, MD, MB, MN, LF, LG, must be regarded as the nucleus of (I), being always found in that group. MI and OE are usually in (I); LC less often, but for the most part. Of the other manuscripts, MF, Y, HA, are most often in association with this group. CF, LT, OM, follow this tradition for a more or less considerable part of their contents.

Using as a standard (OF, MG, (OC, OG), MH, CM, MK, X, CB, HB, B, CC, LB, CA, LD), we have in group (II):

Fs. 33b-35—(), -CC; +ML, CD, CH, MI, LC, OM, HA. W, lacking.

Fs. 161-162b—(), -CM; +CF, LT, LE, ME. B is not collated.

Fs. 413-415b—(), -OC, OG, LD, MH, CM; +OA. CA, LB, lacking.

Fs. 2b, 5b—(), +ML, ME, P, OM, HA, W. LB, lacking.

F. 96—(), -CB, HB, LD, OC, MK; +ME, W, Y, P, (OE?). CA, lacking.

Fs. 118, 132b—(), -OG; +(ME, CC, P, W)? OM, CA, MK, are lacking in one or the other of the passages.

F. 179b—(), -OG, CM, (OC?); +CF, LT, ME.

F. 319b—(), -MH, CM; +W, (OM, MF?). CA, lacking.

F. 411b—As for fs. 413-415b.

OF, MG, X, are alone found in this group for all of the twelve passages. To them should be added B, which has been collated for eleven of the passages, and each time falls in (II). Like B, CA and LB occur in no other group; but as they are each lacking in three or more of the portions of text chosen for collation, their case is not quite so clear. CB, HB, MK, CC, only once go outside the group, MK lacking one of the passages. LD is found in (II) for the most part. MH and CM most frequently go over to other groups; and of the manuscripts not included in our standard group (II), ME most often is associated with it. W follows ME in this respect. P, CF, LT, belong in (II) at some places. OC and the first part of OG are in a position between (II) and (III) rather than within (II). As a nucleus for (II) should be taken OF, MG, X, B, CB, HB, MK, CC; with CA, LD, LB, MH, CM, ME, W, in less constant presence.

For (III) may be taken as a standard (OA, OD, MC, CE, LA, PH). For by far the greater portion of the text, if we may judge from the scattered pieces of collation, this group very rigidly maintains its identity; but it breaks down in the last two passages.

Fs. 33b-35—(). PH not collated.

Fs. 161-162b—(), +ML, P, MF, OG, Y. PH not collated.

Fs. 413-415—(), -OA, OD, (CE ?); +(OC, OG ?), LD, ML. PH not collated.

F. 2b-5b—().

F. 96—(), +MK, ML, CF, LT, (OC, LD, LE ?). MC, lacking.

Fs. 118, 132b—(), +ML, Y.

F. 179b—(), +ML, P, MF, OG, Y.

F. 319b—? Probably regular.

F. 411b—As for fs. 413-415b. PH not collated.

If any other manuscript is to be added to the six chosen to represent (III) that manuscript is ML, which follows more than one tradition, but keeps closer to that of (III) than to any other. It will be noticed that PH is not collated for any one of the three longer passages, nor for the last short one. In every place for which they are compared, with the exception of the passage on 319b, which is not fully determinative, OD and PH show a rather close relationship. The question is whether PH follows OD and goes over to (I) in the latter part of its text. On f. 319b it both agrees and disagrees with OD. For the beginnings of the two writs collated on f. 419, PH agrees most often with MF. As MF and OD form a pair group for fs. 413-415b it is to be inferred that there is a connection between OD and PH in this part of the text. For the passage on f. 410, where reference is made to the Digest, a number of manuscripts have been collated. In the few lines which have been compared PH manifests a decided tendency to go with the representatives of (I) rather than with those of any other group, as the following variants will show: *quasi*, OB, MA, MB, PH, Y, *qui si*, OA, OC, CC, CM, LA, P; *iusticia poterit*, OB, MA, MB, PH, *iusticia*, OA, OC, CM, LA, P, Y, CC; *auxilio*, OB, MA, MB, PH, CM, P, *auxilio potest (poterit)*, OA, OC, CC, LA, Y; *falsis*, OA, OC, CC, CM, LA, P, *similibus*, OB, MA, MB, PH, Y; *iudicem*, OB, MA, MB, PH, *mulier vero (non) iudicem*, OA, OC, CC, CM, LA, Y.

Much more difficult than the determination of the places which should be occupied by the manuscripts constituting groups (I), (II), (III), is the assign-

ing of proper positions to those which in the last passage collated were put into a separate group by themselves, (IV), (OM, ME, MH, CM, P, LC, W, LT, MM). To make the discussion complete there should be added to these CF (which though lacking in this part of the text is elsewhere always in a pair group with LT), HA (because of its close connection with OM), MF (related in places to P), and CC (because of the occurrence in more than one place of the sub-group ME, CC, P).

CF and LT are most easily disposed of for the present. Found in agreement at different places with all three of the principal groups, though usually with either (I) or (II), they follow no single line of descent though each is written throughout in the same hand. Somewhere back in their ancestry was a manuscript which had been copied from more than one model. Nearer to them was another ancestor which had been corrected in places by a text, or texts, in one or more different lines. The single position which will best receive them is the doubtful region between (I) and (II).

MM is a fragment, containing only fs. 262b-442 of the printed text. It has therefore been collated in only three of the passages. In all of these it shows an excellent text and occupies the position assigned to it for fs. 413-415b.

For the other members of (IV), and the allied manuscripts, it will be advisable to follow the method employed in discussing the other three groups and take up each passage in turn.

Fs. 33b-35—ME, CC, P, form a distinct sub-group in (I) with MF and Y not far removed from P. CF and LT are also in (I), but not closely related to any other group within it. OM, HA, MH, CM (and LB), are in a sub-group under (II); LC is in another sub-group with MI, LD, CA. MM and W are not collated. There are a few scattered variants, some of which have been noticed already (p. 248), which bring these manuscripts together at places, *viz.*, *una (unde una)*, ME, CC, P, +OM, HA, MH, CM, LB; *conditio vel dictio (dictio)*, ME, CC, P, +LC, MI, MF; *et (quia)*, ME, CC, P, +LC, MI, LD, LB; *solet (non solet)*, ME, CC, P, +LC; *in (si in)*, ME, CC, P, +LC; *ut (vel)*, ME, CC, P, +MH, CM, OC. In agreement on the first of these variants are all the manuscripts in (IV) which have been collated for this passage except LT. The second variant connects the LC, MI, pair group with both MF and P. Bearing yet further on this connection are *est sine (sine)*, MI, LC, MF, and *se totum non (se totum)*, MI, LC,—with P, MF, LD, ML, reading *se non totum*. More numerous are the variants which bring LC into association with the ME, CC, P, group. But all the above instances

are examples of the occasional and unusual variant. They go contrary to the general trend of agreement. This type of variant is best explained on the basis of corrections having been made in an exemplar. In this case, and at this place, no matter what may prove to be the relationship of these same manuscripts later in their texts, it is evident that a common ancestor of one group was influenced, through comparison and copying, by a common ancestor of another. So many other variants mark out the regular line of agreement that we can feel sure of it in spite of these results of seemingly casual corrections.

Fs. 161-162b—MM not collated. MF and P are in a pair group in (III) with MC, LA, Y, OG. OM, HA, W, form one sub-group in (I) and MI, LC, CM, another, the latter combining with MA, MB, MD. ME, MH, CC, LB, form a sub-group in (II), uniting in a larger group with OF, MG, MK, CB, HB. Here the split in (IV) is very noticeable, its members being found in all of the three principal groups and following five different branch lines—LT is in another branch of (II) from that in which ME, CC, MH, belong. Moreover, none of these manuscripts are found in the same large groups as on fs. 33b-35. ME, CC, P, MF, have gone into different larger divisions from (I), ME and CC keeping together though separated from P. OM and HA have kept together, though MH and CM have separated. For this passage there are only a few variants which could in any way connect these scattered groups. Group (II) which includes ME, MH, CC, has *et igitur* for *ei igitur*, this being the reading also of (OM, HA, W), (MF, P), ML, CE. Where this same group (II) has *et voluntate* for *et in voluntate*, OM, HA, MI, LC, P, likewise omit the *in*. ME, MH, CC, have *occasione* for *actione*, OM, MI, LC, CM, agreeing with them. Many theoretical explanations might be offered as to why these particular manuscripts have these particular variants. But if it is to be explained otherwise than on the ground of coincidence, if in these variants there is to be found a connection existing between the various members of (IV) at this place, the fact of importance will continue to be that these chance agreements are the result of corrections made in an exemplar.

Fs. 413-415b—For comparison with the smaller groups at other places it may be pointed out that the sub-groups of (IV) are (OM, ME, MH, P, CM), (ME, MH, CM), (MH, CM), (LC, W). Of manuscripts which at one time or another have been more or less closely associated with members of (IV), HA and MF go with (I), and CC with (II).

Fs. 2b, 5b—MM is lacking. OM, HA, W, ME, CC, P, come together in a large sub-group which splits up into (OM, HA, W), (OM, HA), (ME, CC, P). The pair group MH, CM, are near them in (II). (CF, LT), LC, MF, are in (I). The general relationship of these manuscripts in this passage has been discussed above (pp. 264-266).

F. 96—MM is lacking. In (I) are MF, LC, and the pair group HA, OM. CF, LT, have gone over to (III). Most of the members of (IV) are now in (II); ME, MH, CM, P, with B, forming one combination, of which ME, MH, CM, make yet a smaller group. CC and LB make up another pair group. The position of OE, W, which are closely related to one another, is not altogether determinable. These two manuscripts may belong nearer to OM, HA.

Fs. 118, 132b—MF, MM, lacking. HA and OM lack the first of these passages. (CF, LT), LC, are in (I), and MH, CM, LB,—(MH, CM) is a pair group—in (II) for both passages. ME, CC, P, W,—(ME, W), (CC, P)—are probably in (II) for the first passage. W is very mixed in its agreements, as already noticed on p. 271.

F. 179b—MM, lacking. MI, LC, CM, are a sub-group in (I). (OM, HA), W, possibly belong in the same large division. (MF, P), are probably in (III). In (II) is the combination ME, MH, CC, LB, CF, LT, which splits up into (ME, MH, CC, LB), (ME, MH), (CC, LB), (CF, LT). There should be taken into consideration the combination (ME, MH, CF, LT), +CA, LD, X, found in the text proper and in the *addicio* as well. The sub-group OM, HA, W, occurs in the *addicio*.

F. 253b—MM, CF, LT, are lacking. It is not apparent to which of the larger groups they belong, but the following sub-groups occur: (ME, CC, MI, LB), (MH, CM), (OM, W). Two variants of special significance are *tanti redditus (tanto redditu)*, OM, W, MH, CM, LC, P; and the omission of *et si obiit . . . in Angliam*, OM, W, MH, CM.

F. 319b—The pair groups CC, LB, and LD, W, are found in (II). OM may perhaps go with W in a group OM, MF, W. P forms a combination with ME, MH, CM, the last two making a pair group, as often in other places. Their position here is not made evident. As noted on p. 276, CF, LT, here, as elsewhere, a pair group, are put in association with the ME, MH, CM, P, group by a single variant. So also is OM. The position of LC is not certain. It agrees with (I) in having *non* for *numquam*, but it has *ibi* for *in* with P, CM. It does not show its usual agreement with MI for a pair

PEDIGREE OF THE MANUSCRIPTS

group. The handwriting in this manuscript has changed since the last collated passage, and this may mean a change of line. Yet there is not shown that preference for (IV) which is found on fs. 413-415b. As shown above (p. 276), ME, MH, CM, MM, CF, LT, LC, P, agree in their use of *tradidit* and the omission of the *addicio*.

To make this discussion more complete, the matter of the changes in handwriting should be considered. Though this subject at just this place concerns group (IV) rather than other manuscripts it may be well to show the changes occurring in those which have been written by more than one scribe. The numerals represent the different hands in the order in which they occur in each codex.

	2b	5b	32b	96	118	132b	161	179b	253b	319b	411b	413
OA	2	2	3	4	2	2	2	2	5	4	6	6
OE	2	2		3	3	8					2	
OG (parts)	1		1	2	1	2	1, 2	2	1	1	1	1
ME	2	2	2	2	3	3	2	2	2	2	2	2
MH	1	1	1	1	1	1	2	2	1	1	2	2
MK	1	1	1	2			3	3	4	1	3	3
MN	2	3	3	4					5	5	3	3
CB	1	1	1	6	1	1	2	2	3	2	2	2
LA	1	1	1	1	1	1	1	1	1	2	2	2
LC	1	2	2	2	2	2	2	2	1	1	1	1
LD	1	1	1	5	1	1	1	1	1	1	5	5
W	1	1		2	2	2	1	3	1	4	4	4
X	1	1	1	1	3, 4	4	4	4	4	4	6	6
Y	1	1	1	1	2	2	2	2	3	3	3	3

A comparison of this table with the facts already brought out in regard to the relationship of the manuscripts in group (IV) shows at once that a change of handwriting does not at all necessarily result in a change of line of descent. The tradition may or may not change with the writing. On f. 2b we have LC₁ and on f. 5b, LC₂, yet both belong in (I). On f. 413, LC₁ is in (IV); on f. 33b, LC₂ goes into (II), and on f. 161 it is found in (I). OE, which though not itself in (IV) was seen to be connected at times with both LC and W, shows the opposite characteristics, OE₂, OE₃, OE₈, all being found in (I), and even within the same sub-group (OE, MI, LC). No general rule which will in any way apply to all cases can be laid down for the connection between changes in hand and changes in tradition. Several scribes may have copied a

new book from a single exemplar which followed the same tradition throughout. Or the single exemplar may have followed several traditions. Or each copyist may have taken his portion of the new book from a different exemplar. On the other hand, the fact that a book is written in the same hand throughout does not make inevitable an allegiance to the same tradition in all places. For instance, P is found in different portions of its text in (I), (II), (III), (IV). Even ME and MH will not submit to any fixed rule in this particular. We have (ME₂, CC, P) in (I), and (MH₁, CM, LB, OM, HA) in (II), for fs. 33b-35; (ME₂, MH₂, CC, LB) in (II) for fs. 161-162b (P in (III)); (ME₂, MH₂, CM) +OM, P, in (IV) for fs. 413-415b; but (ME₂, MH₁, CM) +P, for f. 96 and f. 319b, in the first passage at least, in (II); (ME₃, CC, P, W₂) in (II), probably, for f. 118, and (MH₁, CM), CC, in (II) for f. 132b. W₁, (HA, OM), is found in both (I) and (II); W₂, with ME₃, CC, P, in (II); W₃, probably with (HA, OM), supposedly in (I); (W₄, LD₁) in (II); (W₄, LC₁) in (IV). There are also the combinations (W₁, OE₃) and (W₁, OM, MH₁, CM, LC₁, P).

A considerable number of facts have now been brought forward in regard to the relationship of the manuscripts in group (IV) and those most closely allied with them. To these facts may be added what has been said above on pp. 64 and 66 about the changed order of subjects or omission of certain portions of text in CF, LT, CC, LD, W. Several of the members of (IV) were seen to be involved in the matter of leaving blank spaces at certain points in the text (p. 78 above). Yet all that can be learned from all this information is that these particular manuscripts constitute, at least for the most part, a group which, though more or less inter-related at places, follows no line of relationship which is either constant or well defined. They represent no one tradition. Constant copying and recopying of texts derived from a mixed ancestry has produced a medley of traditions. Unless the gaps in the lines of descent are filled by the discovery of new manuscripts we shall never be able to know just what has happened. The same results could have been obtained in several generations of manuscripts through the gradual intermingling of traditions, or in a very short time if several exemplars were used for the production of each new copy. There are indications which would lead us to suspect that the real explanation lay in the fact that a number of Bractons, for the making of which a number of models in different lines had been brought together, were written at the same time in some *scriptorium* by various, and a varying number of, scribes who changed from one exemplar to another as

expediency or necessity demanded. But there is no adequate proof of this. It is, however, a supposition which would make possible the solving of some of the worst puzzles in the pedigree of the manuscripts. Some of the codices have corrections in a contemporaneous hand which are of such a nature as to suggest that as soon as the copyist had completed the book, his work was gone over by a sort of examiner, who corrected mistakes and supplied inadvertent omissions. In a *scriptorium* such examinations, at least of a cursory character to discover any great discrepancies, were usual. Under the conditions which we have supposed, it might happen that the newly finished book would be compared with some manuscript other than that from which it had been copied. If a series of such corrections were copied and recopied in a number of manuscripts made at the same place at about the same time, it would result in just such contradictions of traditions as we find existing in some of the extant early copies of the *De Legibus*. Fortunately it is not hard to pick out the better texts in (IV), but the exact positions of all the members of this group in the family tree no one diagram will be able to represent.

THE CHOICE OF MANUSCRIPTS

There is no one manuscript so superior to all the others as to stand out apart from them as preëminent. In order to ascertain what Bracton originally wrote, it will be necessary to select from the whole list of manuscripts those whose composite text, after each has been judged and corrected by the others, will exclude the additional matter found in some, and supply the portions omitted in others. In making this selection it is necessary to consider very carefully the nature of the individual texts—their general goodness or badness independently of the tradition which they are following—and the value of the different traditions themselves.

First, as to the texts individually considered. It need hardly be said that the handwriting is no criterion of the text value; the oldest type of writing does not in any way mean the oldest tradition or the best text, for a codex written in 1400 might very conceivably have been taken from a better exemplar than one which was copied a century earlier. On the principle that the poorest text is that which contains the greatest number of mistakes, it is possible by merely glancing over the collation to pick out a number of manuscripts which have very little claim to any degree of goodness. But the relative value of all the texts in this respect is not so readily apparent. Only by counting the number of variants for each manuscript, distinguishing the different kinds of mistakes, can an estimate of this sort be made. In every text there are mistakes of two kinds—those which result from the faithful copying of mistakes in an exemplar, and those which are due to the carelessness of the scribe or his inability to read his model. The first of these would include not only the variants peculiar to the tradition which the manuscript follows, but also a number of usual or natural mistakes of types that seem practically unavoidable in copying. They would be mistakes which the manuscript would be sure to have with others in the same line. The other kind of mistakes, out and out errors on the part of the copyist, would for the most part be limited to his text alone, though a few might be found in other texts as a result of different scribes having made identical blunders. In the lists given below, an attempt has been made to separate these two kinds of mistakes, the figures in one column representing the number of times the manuscript differs from the standard text in company with others, and the figures in the other column showing the number of variants peculiar to the individual codex. These figures, of course, have their limitations. For instance, it

would be foolish to maintain that there were just 20 mistakes in the exemplar of CA, and that the scribe of CA made 54 errors in copying, for that portion of the text collated on fs. 33b-35. Many a variant which in the reckoning has had to be put in the "Alone" column may have been copied from an exemplar which has since been lost, and the scribe of the extant copy may have been a good copyist who faithfully reproduced a very poor exemplar. But it is noticeable that usually the poorest manuscripts have the greatest number of "Alones," and it may pretty safely be taken for granted—especially when there are other extant manuscripts in the same line which can be used for comparison—that those texts which have the largest figures in the second column were written by the more careless and less dependable scribes. Certainly the two sets of figures give very much more than a mere indication of the comparative value of each scribe's exemplar, and of the accuracy and fidelity with which he reproduced it.

Though these figures have been taken from an actual count of the variants in the passages collated, not all of the total number of variants have been used. There have been omitted from the reckoning those variants which have clearly resulted from ambiguous abbreviations, such as *nisi* for *ubi*, *et* for *vel*, *cum* for *tamen*, *debent* for *deberet*, the use of the singular for the plural, etc. (See pp. 104-111 above.) Cases of inverted order of words, of mere differences in spelling—as *fodiat*, *fodeat*—, of the omission of a connecting *et*—*libere*, (*et*) *quiete*—, of gerund instead of gerundive, have all been passed over. (See pp. 99-104 above.) At places where there is a disagreement in regard to the verb, several different forms of the same verb being used with about equal authority, no count has been made. Nor is it possible to form any idea of the correct or incorrect reading in such a case as that found on f. 413b, where the manuscripts are divided between *diversitatem* and *varietatem*, either of which would fit the sense. In other words, only those variants which are clearly no part of the original text have been counted. It may seem that so many variants have been excepted that the figures in the tables are incomplete; as a matter of fact the total number of variants is so large that the exceptions make but little difference in that total.

In studying these figures it should be kept in mind that, though valuable in many respects, they can not be taken as an absolute guide. The evidence which they furnish must be used in connection with such other information as has been brought forward. Judged from these figures alone, HB shows up better than CB, and MD than MA. From other sources we know this to be

PEDIGREE OF THE MANUSCRIPTS

the result of corrections made in exemplars, both HB and MD being in later generations than the other two manuscripts. Another fact to be remembered is that in manuscripts of uneven value in different portions of the text the passages collated may have happened to come in places unusually good or unusually poor. Such a change as that which occurs in the figures for OM when the first long passage is compared with the last shows how much the same manuscript may vary in two places. A glance at the table on p. 283 will show how unevenly, in those manuscripts which are written in more than one hand, the work of the different copyists is distributed among the passages collated. It is altogether possible that a collation of the entire text might indicate a different relation of the manuscripts as regards the number of variants. Yet from the collation which has been done we may get at least an approximation of the relative percentage of mistakes in the different texts. The figures follow:

FOLIOS 33b-35. (WITHOUT ADDICIONES)

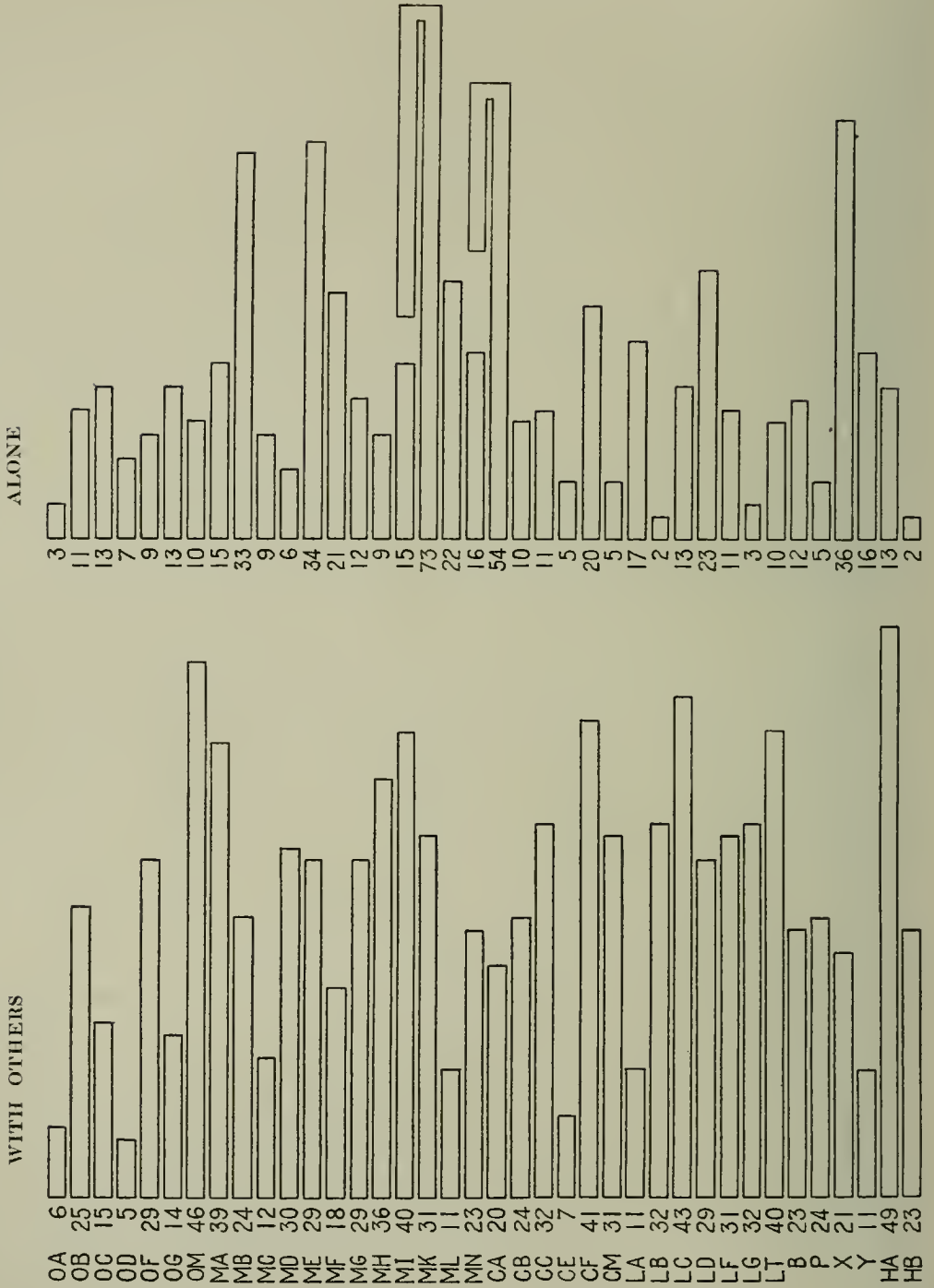

PEDIGREE OF THE MANUSCRIPTS

FOLIOS 161-162b. (WITHOUT THE *ADDICIO*)

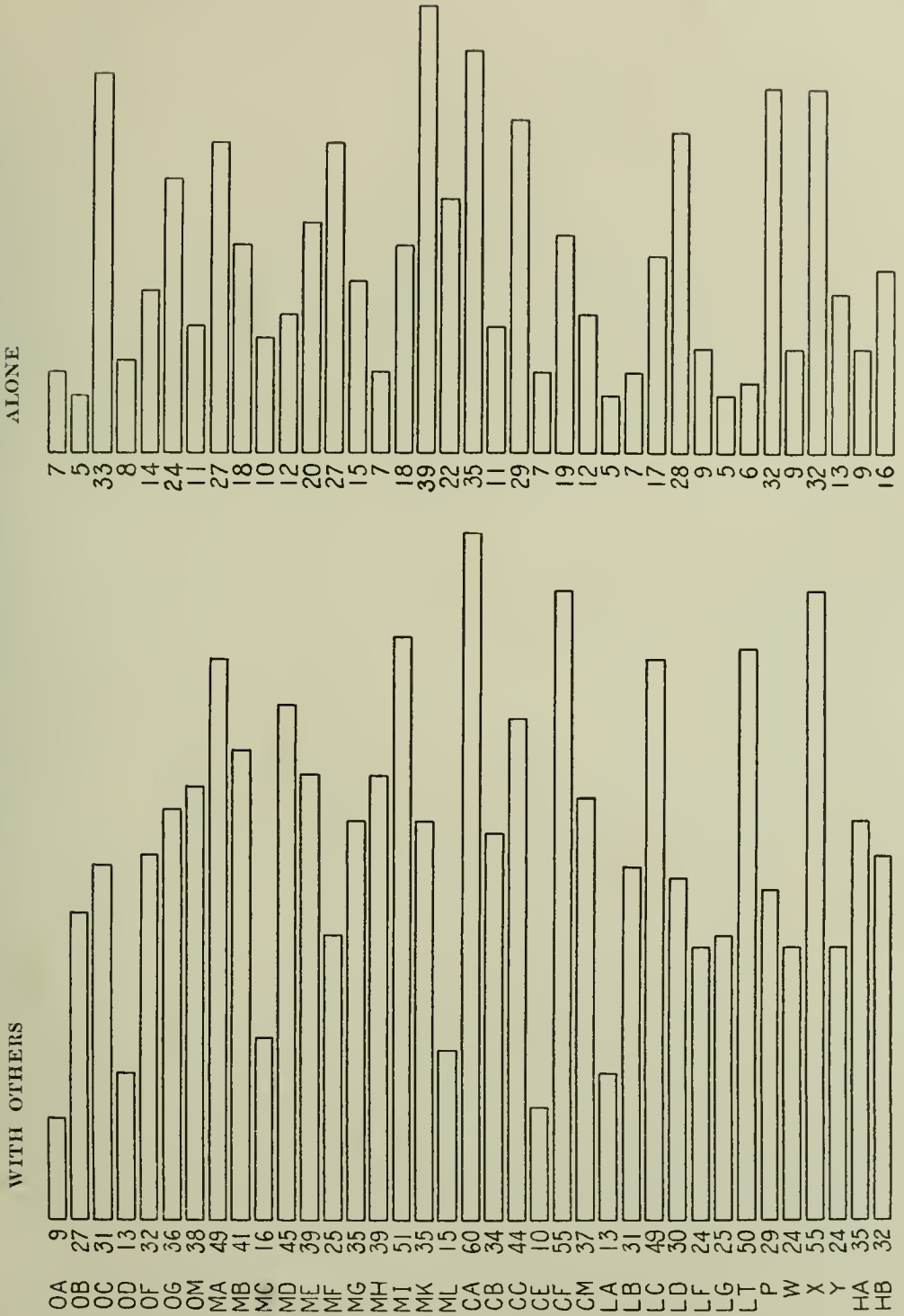

FOLIOS 413-415b



PEDIGREE OF THE MANUSCRIPTS

FOLIOS 2b, 5b. (WITHOUT THE *ADDICIO*)

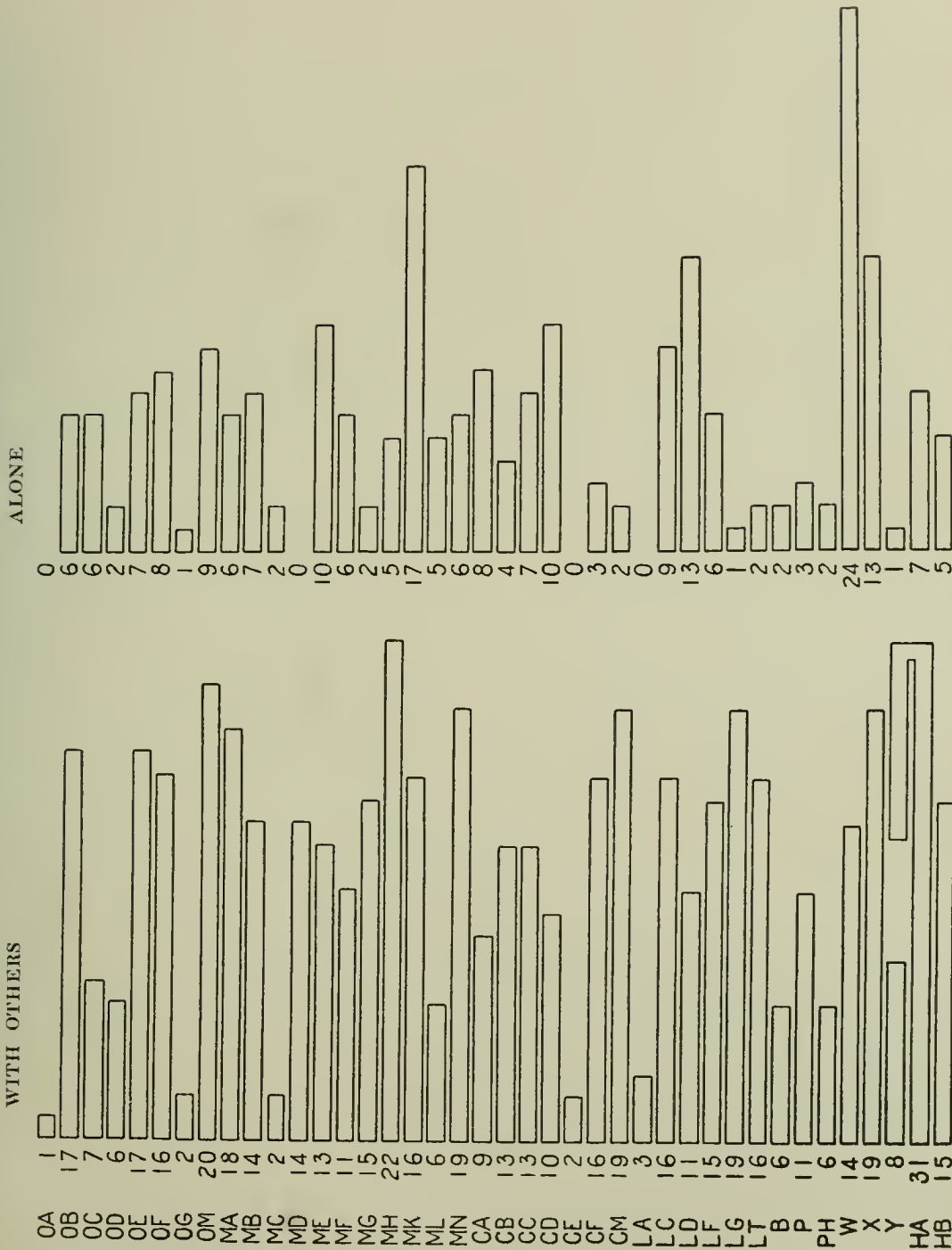

FOLIO 96

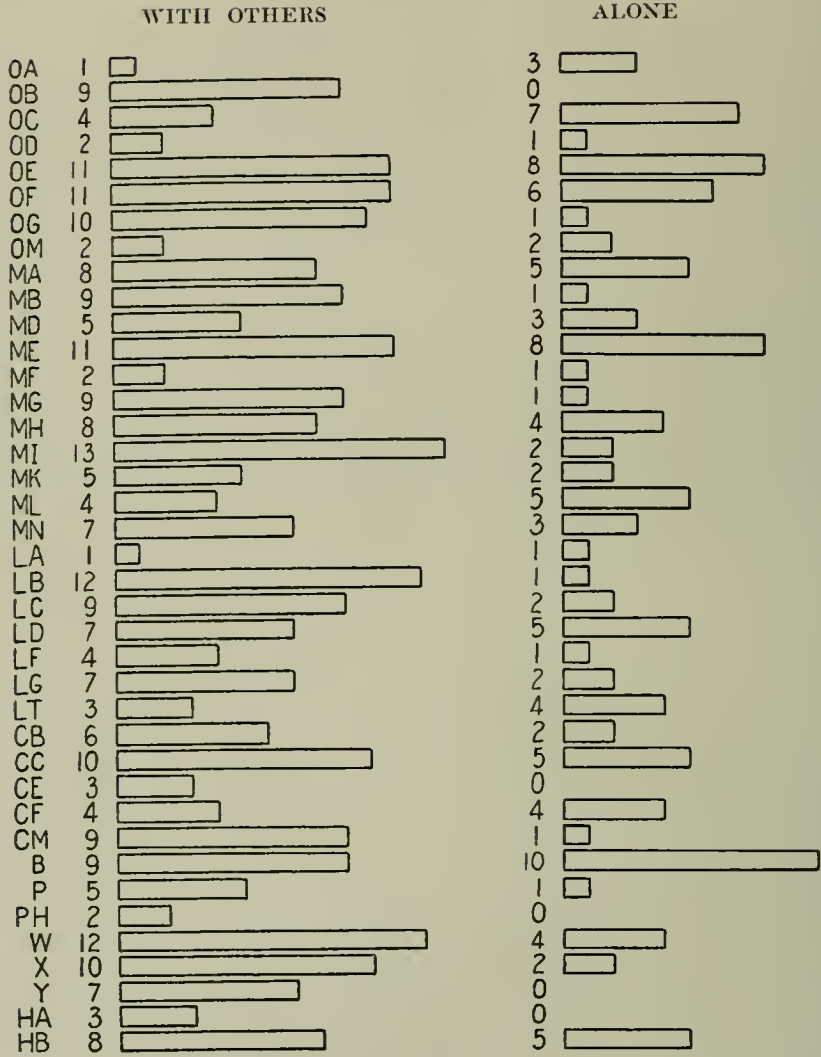

PEDIGREE OF THE MANUSCRIPTS

FOLIOS 118, 132b

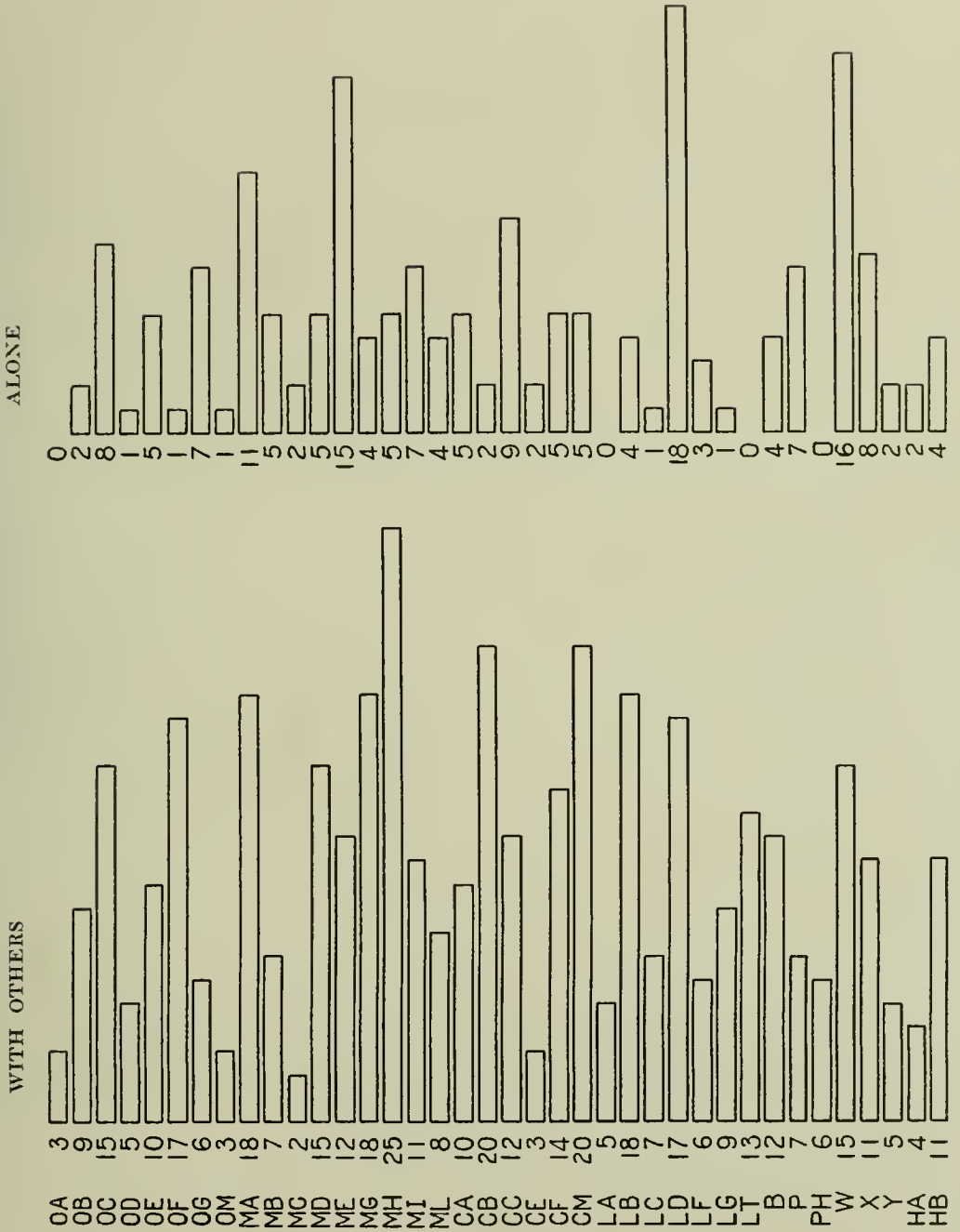

FOLIO 179b

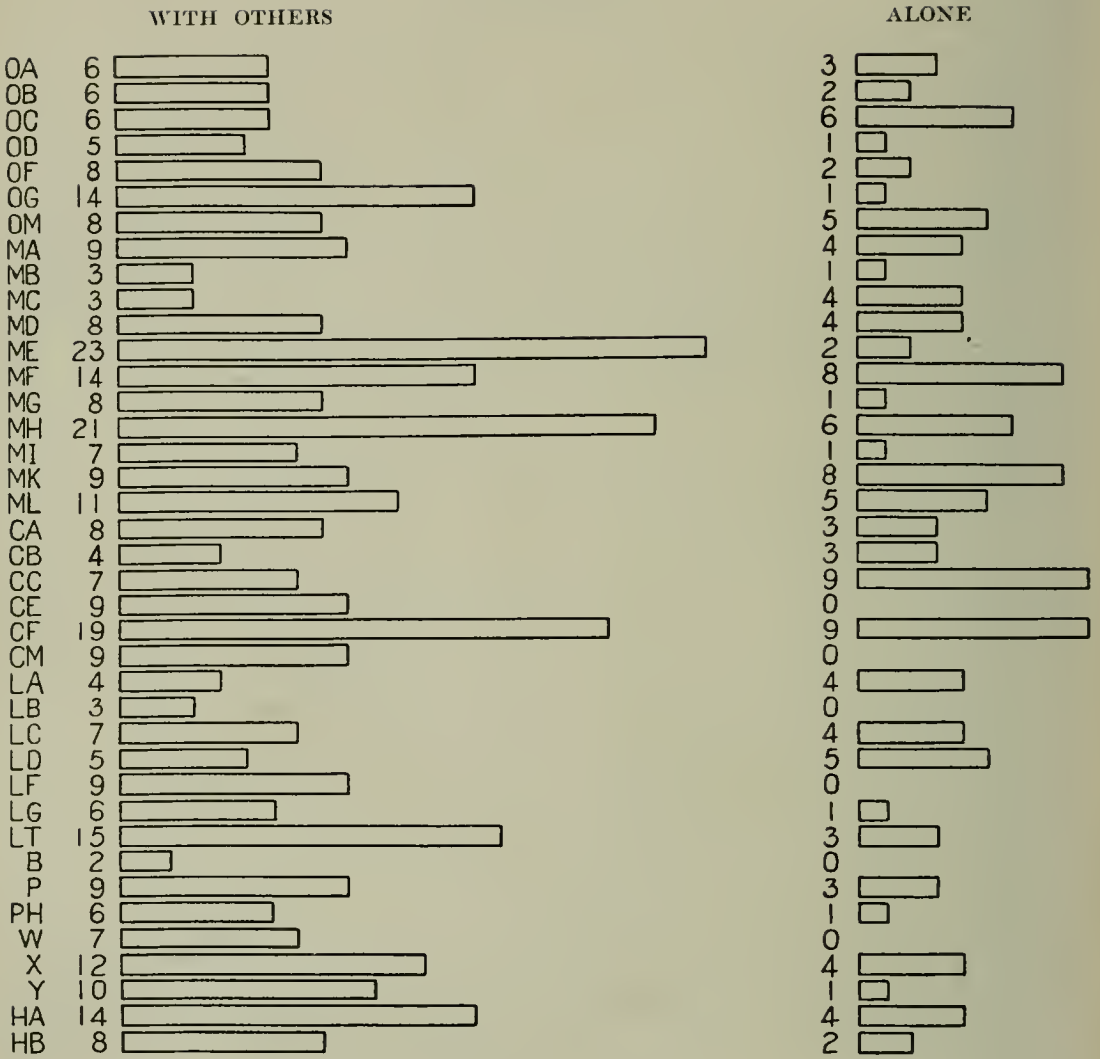

PEDIGREE OF THE MANUSCRIPTS

FOLIO 319b

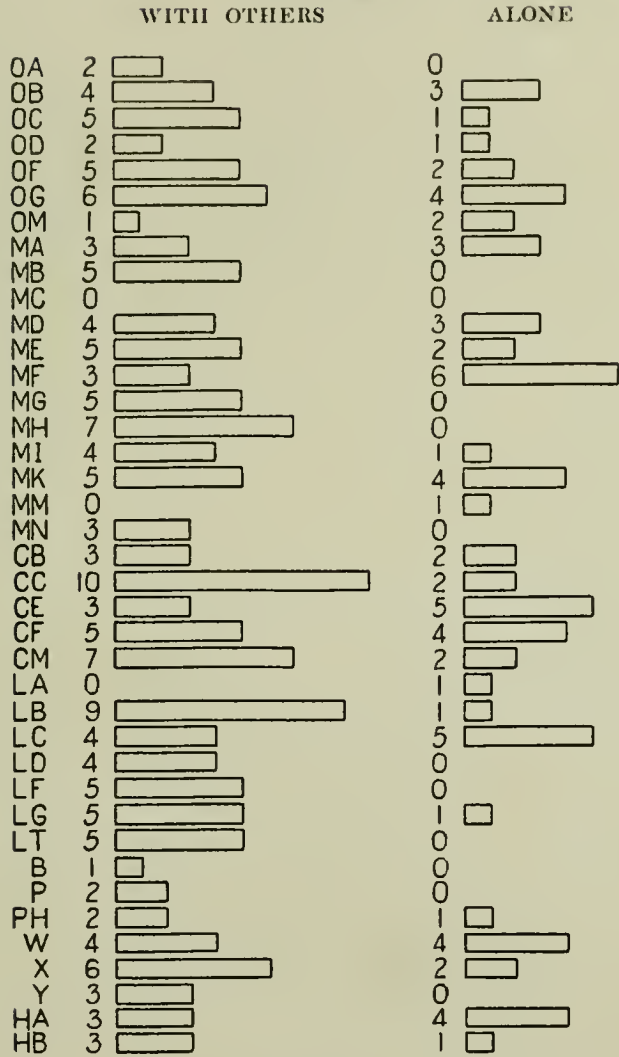

Folio 411b

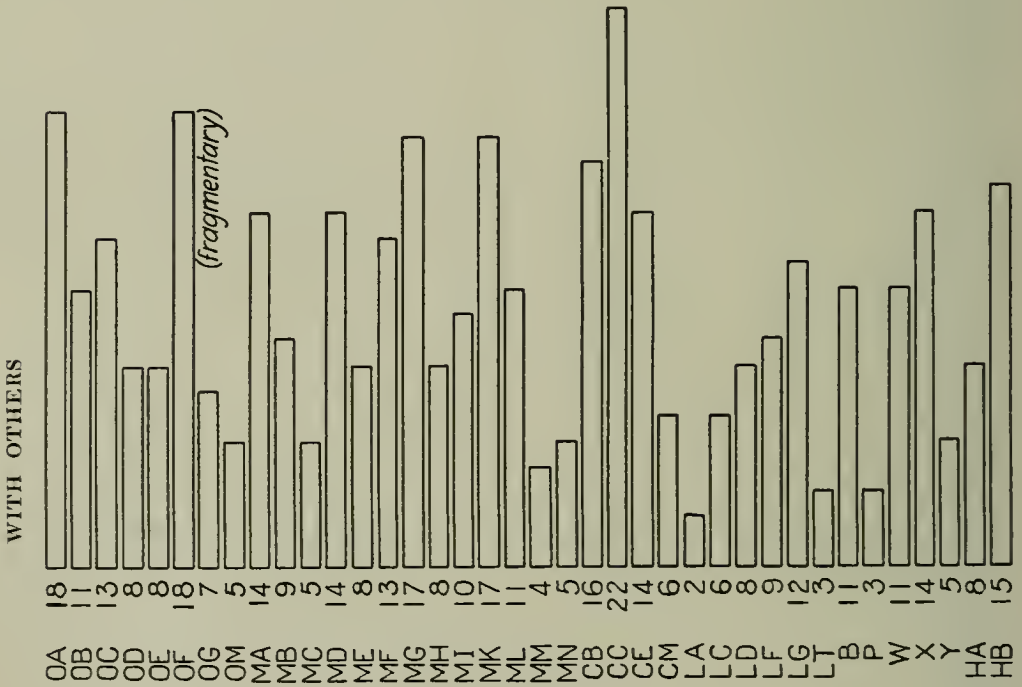
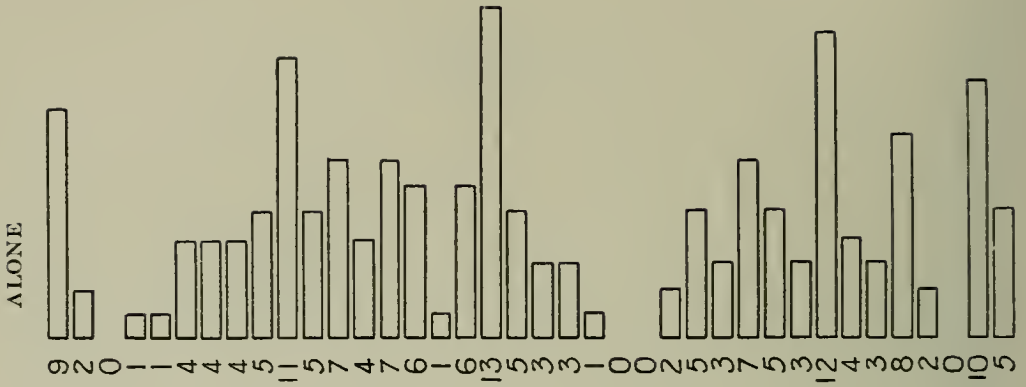

For any of the passages the number of variants is large. By far the larger portion of them are due to irregularities which concern at most only a few manuscripts at any one place. Many of them are found in only a single text. Usually there is no doubt as to what the correct reading should be. Thus when CF and LT give *qua*, and MA, ME, CD, CM, X, have *aquali*, we do not have to wonder if the reading of the other manuscripts, *aqua*, is correct. Yet it should be kept in mind that the mere fact that a majority of the manuscripts have a certain reading does not necessarily make that reading correct. The poor texts far outnumber the good, and if numbers alone were to count as authority the worse reading would often prevail. It is easy to eliminate the variant of the single manuscript, or the variant common to a scattering few. But when the case is one in which whole groups of texts follow, more or less consistently, each a different reading, it is another matter. So when the manuscripts are fairly evenly divided between *habere* and *exhibere* or *unde* and *nam* (see groupings for fs. 33b-35) it becomes necessary to discover the weight of authority on which either reading rests. The important thing is to get the different traditions; the exceptional or individual variant very seldom counts.

Of the three large groups into which we have divided the manuscripts (I) is the most distinctive, with (III) next, and (II) least distinctive of all. The earliest extant manuscripts are in (I) and (III). Throughout (II) is closer to (III) than to (I). (II) is the group in which the greatest number of *addiciones* are found, with (III) coming next in this respect, and (I) last. As a group, (II) is inferior to either (I) or (III); but as the traditions peculiar to each group developed at an early period, (II) has to be considered along with (I) and (III). Theoretically, enough manuscripts should be used to stop every line of descent, so to speak. Thus in the following figure

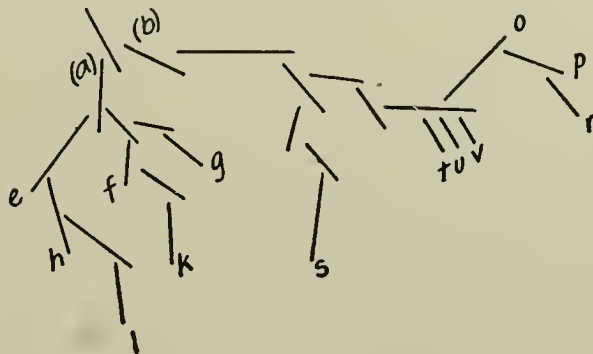

the extant e, f, g, would naturally be selected as the representatives of the

non-extant (a), while s, t, u, v, o, would be compared to ascertain the probable text of the no longer existing (b). But because of the gaps, the broken lines of descent, and the interweaving and crossing of lines in the pedigree, such a selection in the case of the Bracton manuscripts would involve practically every one of the forty-odd copies. And the use of so many originals in the formation of a new text would be inexpedient. Nor is it requisite. The only necessity is to use the codices in such a way as to discover every real difference of text reading among those groups which represent a different direct tradition.

No one tradition may be taken as the correct text. Each tradition must be gauged and weighed by the others. If the readings of any one line or group are even generally accepted as correct, it means that there will be a comparatively large number of variants in all the members of other lines or groups. One of the reasons why (III) shows up so well in the collation above is that the basis of the text was taken from manuscripts in that group rather than from members of (I) or (II). For every passage collated, the fact stands out that no one line or any single manuscript gives consistently Bracton's own words.

There is often a real question as to just what Bracton wrote. A detailed study of his entire book might possibly show that he had predilections for certain words or forms of expression; it might be found that he used the indicative in preference to the subjunctive, or had a tendency to write a present form where the future might be expected. But such information is not yet available. Even if it were it would not ensure a decision in all cases of contradiction. It is not always a question of the best word, or even of the right word. Time and again the manuscripts are divided between words, sometimes of practically the same meaning, either one of which would make sense. How shall we know, for instance, whether the original draft of the *De Legibus* had *recuperandum* or *reparandum* in the passage on f. 5b? What is to guide us in our choice of words at such a place? Did Bracton write *voce* or *voci* in l. 4 of f. 320? The *simplici* will not tell us, neither will the rest of the clause. In l. 21, f. 413b, did he use *fit* or *fiat*? And at the beginning of the very next sentence is the *cum* temporal or concessive? To be correct should the text read *cum competant* or *cum competunt*? Some ten lines above this *possunt* would go better than the usual *poterunt*. Did Bracton write it? The eight manuscripts which have *possunt* are from several different lines, and by no means the best. How shall we explain the

mixta (for *mixta*) at this same place? Out of the thirty-five manuscripts which contain this passage, twenty-nine, including the best, have *mixta* for a clearly needed *mixta*. We get the impression that Bracton, after having correctly written *personalia* and *realia* in the same construction forgot the *brevia* implied by the *quædam* and wrote *mixta*, and that at different times various correctors in individual manuscripts changed this word to the correct *mixta*. The fact should be emphasized that we can by no means take it for granted that the manuscript which gives the best reading for any single incorrect, ambiguous, or corrupt passage most nearly represents Bracton's own Latin. He may have been, probably was, guilty at times of writing poor Latin which would be corrected in the course of recopying. In the long run, conformity, or lack of conformity, to the best text-reading will determine the value of a particular manuscript. But in these instances of debatable variants the best manuscripts rather than the best reading will probably most often determine Bracton's own language. Even this will not always hold; the best texts are at times divided on the reading. Some of the best codices have *prætorium* for *prætor* in the fourth line of f. 3. In this particular instance it is evident that the trouble has come from an original *prætor .n.* (*prætor enim*), the first dot of the *enim* abbreviation having been taken to signify an abbreviated *prætor.*, which word was accordingly lengthened by some of the copyists to *prætorium* to agree with the following *ius*. Though these places at which it is a question as to which word should be used are fairly frequent, the choice of any reading seldom alters the meaning. What Bracton meant is often more easily discerned than just how he said it.

In connection with this subject of Bracton's language it should be pointed out that it is not possible to make much use of what on first thought might suggest itself as a standard by which to judge the excellence of a certain portion of the text—the fidelity with which the manuscripts follow the words of Azo in those places where Bracton is quoting from the Italian master. The editions of Azo differ among themselves; the manuscripts differ even more. It is probable that Bracton's manuscript copy of Azo was quite different from any of the printed texts; better perhaps, or worse. But the possession of that copy would be necessary to make us at all sure, in detail, of the reading of the Azonian passages which Bracton copied at times so extensively. We can not expect these particular passages in the manuscripts of the *De Legibus* to conform to the printed Azo in every respect, for the simple reason that Bracton did not copy from any one of the printed editions.

When differences occur they may many times be accounted for as mistakes in the Azo which Bracton was using. It is by no means necessary to always regard them as copyists' errors in the *De Legibus*. It is better to have Bracton say what his manuscripts make him say, even when that is contrary to Azo, rather than alter the text of the *De Legibus* to conform to the printed text of the *Summæ*.

A study of the *De Legibus* brings with it the conviction that Bracton spent considerable time in the work of revision without being able to finish his book. There is every indication that an original first draft, fairly complete, and itself in no way a meager piece of work, was gradually expanded and filled out in places. For a number of years, some ten or twelve, perhaps, or even more, the author kept adding a mass of afterthoughts, or additions, to what he had already written. That this revision left him no time to carry out all that the very comprehensive early plan called for is suggested by the general air of incompleteness in the last part of the book. We are forced to believe that the work grew larger, not smaller, as Bracton worked over it, and that the copy which he left when he died in 1268 was very different from the original draft from which that copy had grown.¹

This gradual development of the *De Legibus* must be carefully considered when the subject of the different traditions among the manuscripts is under discussion. For even in his lifetime, while he was yet working over it, Bracton may have allowed a copy of his book to have been made. Or it is possible that the margins in his original draft became so filled with additional matter that he was forced to have the whole copied into a new book with fresh margins for more afterthoughts. In this latter case the original draft might have been used as an exemplar by some scribe after Bracton's death. In either one of these cases the manuscripts which would descend from such a progenitor would inevitably be different in some respects from those whose ancestor had been the more finished work as Bracton left it. There is no doubt that the ancestors of (II) and (III) were copied from the revised *De Legibus* once in Bracton's possession. There is a considerable mass of evidence which strongly suggests, if it does not prove, that the common parent of the manuscripts in (I), or more correctly the nucleus of (I), had been copied from Bracton's own book before the revision was finished, or from an early draft not fully revised.

A cumbersome number of facts which help to bear out this last statement could be brought together, but it will be sufficient for purposes of illustration

¹ See *Bracton's Note Book*, I, 34-44.

if a number of examples are chosen from some of the passages already collated. Whatever may be the full significance of these variants which are to be discussed, they are important because they are so old as to go back further than any extant manuscript in the nucleus of group (I). This does not apply to all the variants common to (I) as a group, for there are traditional variants in that group which are on exactly the same basis as the traditional variants in other groups. It should also be kept in mind that not all the manuscripts which from time to time find themselves in (I) are concerned, but only those which consistently form the nucleus of the larger combination. This little group is well defined, but limited in numbers. It was not to be expected that their peculiarities would indefinitely continue among their descendants, for the very common practice of comparing one manuscript with another seems to have quite rapidly restored omitted passages of any proportions, and to have altered most of the decidedly different readings in any one line. Notice, for instance, how MD, which is in a pair group with MA, has been altered by corrections in the common exemplar of these two manuscripts in regard to the first variant considered below.

At the beginning of f. 34 Bracton is speaking of circumstances connected with the making of a donation which would render it necessary for a tenant to show his charter to prove an exception. There follow these words: "Si autem cartam forte exhibere non possit, quia illam ad manum non habuerit, de necessitate erit ad patriam recurrentum. (Et eodem modo si casum allegaverit et casum probaverit.) Et sciendum quod privatorum instrumentorum tres sunt species," The rest of the section is taken up with a discussion of instruments and contracts. It will be noticed that the sentence here enclosed in parentheses is not in any way necessary to the continuity of the rest of the passage. On the other hand it has every appearance of being an afterthought. It is just the kind of sentence which would be added on a rereading, short, concise, and adding a fact which is connected with, and yet apart from, the sequence of ideas in the rest of the paragraph. Everything about it suggests that it is something thrown in later. It is omitted in OB, MA, MB, MN, LF, LG. Near the middle of the same folio, at the beginning of section three, we have, "De cartis vero regiis et factis regum, non debent nec possunt iusticiarii nec privatae personae disputare," The *regum* is omitted in OB, MA, MB, MN, LF, LG. Is not the addition of this word another afterthought on Bracton's part? The passage would be complete without it; its presence does not alter the sense. On a rereading

did not "acts of kings" (notice it is *regum*, not *regis*) appeal to Bracton rather than "royal deeds"? This is far from being an unimportant question when taken in connection with the *addicio* which immediately follows. The authorship of the *addicio* is in doubt; Bracton may have written it. If so, he was at the same time in the mood to insert the *regum*, for the one who wrote the *Addicio de Cartis* was clearly of the opinion that *facta regum* were not always *regia facta* in the sense that they were befitting a king.¹ Not far along in sect. 5, f. 34b, the printed text reads, "quia non multum differt dicere concessi quam dicere consensi." The nucleus of (I) omits the first *dicere*. In the last sentence of the passage on f. 5b the text reads, "Nemo quidem de factis suis præsumat disputare," The variants suggest that the original reading for the nucleus of (I) at this place was, "Nemo . . . disputare debet." Significant omissions for this same group in the passage on fs. 161-162b are, "vel pecora immitendo," f. 161b; "armatos," f. 162; "suam," f. 162b. The short passage on f. 96 has a number of variants for (I) which bear directly upon the point under discussion, and show that this group is at least preserving a very old set of readings. In the sentence, "Si autem tota dos vacaverit, tunc infra quadraginta dies assignetur ei dos sua legitima,", the *legittima* is omitted by those manuscripts which are consistently in (I). It can not, of course, be proved that this word was not in the original draft; but it would be very hard to find an example of a word which would more naturally be left out of a first writing and inserted on a rereading, than *legittima* in this place. A few lines further on the manuscripts which omit *legittima* agree on inserting *sui* ("post mortem viri sui"), which is omitted in the other texts. This must not be regarded as necessarily weakening the arguments already brought forward. In his revision Bracton probably deleted but few words which he had at first written. Yet some may well have been scratched out. If the truth were known it might be discovered that a *sui* originally written at this place was not found in the author's revised copy. Some allowance must always be made for the character of the variant, and *sui* here is not at all of the same type as *si de* (for *de*) and the omission of *non* two lines further on. At the very end of this same passage is another very possible case of the insertion of an addition by Bracton himself. (I) gives what may well have been his first written words, "secundum quod inferius dicetur inter actiones de exceptionibus dotis," while the other manuscripts

¹ The *addicio* begins, "Item nec factum regis" For a discussion of this *addicio* see Bracton's *Note Book*, I, 29-33, and list of *addiciones* below.

give the fuller and therefore more likely later form, “secundum . . . de exceptionibus contra petitionem dotis.” An omission of exactly the same sort is found at the beginning of sect. 2, f. 320—“Constitutis igitur partibus (in iudicio), aut habet petens probationem aut non habet . . .”—*in iudicio* not being in the traditional text of group (I). These two words, which are not at all necessary as far as the meaning of the passage is concerned, might well have been omitted in the first draft. Just a few lines below this the reading of (I) is, “quia deficere potest probatio licet ius non deficiat,” where the other manuscripts have, “quia deficere poterit probatio licet ius numquam deficiat.” The change from *potest* to *poterit* need not be noticed; it could have come about in several ways. But the substitution of *numquam* for *non* is the very thing which makes most emphatic the contrast between *probatio* and *ius*, which is meant to be emphatic. If Bracton wrote *non* in his original draft, it is very easy to see why he should have changed it to *numquam* when revising his work. On the other hand it is difficult to see how an original *numquam* could have become *non*, and all the more so because it is indisputably evident that the latter reading came into existence very early. A consideration of all the variants in the last and longest of the collated passages which bear on this subject would make the discussion too long. Yet a few of them should be noticed. In the following passages: “ut suspectus *amoveatur* et ei substituatur non suspectus” (f. 412, l. 4), “ex pœnitentia poterit petens *reverti* ad inferiora placita” (f. 413, l. 22), “Item cum de eadem re alicui plures *competunt* actiones” (f. 413b, l. 22), “Si autem uterque comitatus *nominatur* valet” (f. 414b, l. 9), “*Et si* civilis sit et pœnalis” (f. 415, l. 1), “Qui prius incepit agere *aliis* præferatur” (f. 415, l. 20), “quia *ubi* terminatur actio finitur breve” (f. 415, l. 38), the words in italics, which are the readings of the manuscripts in (II) and (III), are replaced in (I) by *summonetur*, *descendere*, *competant*, *nominetur*, *Si autem, ille*, and *cum*. If the connection of each of these words with its passage is studied, and the probable and possible reasons for the changes examined, it will be seen that the assumption which offers the most satisfactory explanation is that the changes are due to the author’s revision. This same supposition is the only acceptable one in the case of l. 13, f. 413b, “quæ quidem nullatenus mutari poterunt absque consensu eorundem et voluntate.” *Consensu eorundem et* is the reading of (I), the other manuscripts having *contraria eorundem*, and omitting the *et*. Different as the words themselves are, the sense is not at all changed by the substitution of one for the other; in either case the meaning

remains the same—that these writs may not be changed except with the consent of those who have granted and approved them. It is hard to see how the change between *contraria* and *consensu et* could have come about except through some correction by the author. *Et* is really the key word here; *consensu* demands it, *contraria* does not. If the *et* is omitted *consensu* makes nonsense, while changing the latter word to *contraria* restores the sense. Such a change might have been made, by Bracton or others, but it would have required *consensu et* for the original reading. Of course, an original *contraria* might have been copied by the scribe of the common ancestor of (I) as *consensu* through the misreading of an abbreviation, and *et* put in to make sense. But this calls for two necessary changes at the same time, early in the life of the Bracton manuscripts, for this ancestor was a very early copy. Now usually, except where they might be made by the author himself, a double alteration of this sort would require at least two manuscript generations, the scribe of one copy making the first mistake, and some later copyist, or corrector, making the second change to restore the meaning which the first error had destroyed. Moreover, it is not easy to understand how the abbreviation of either one of these words could have been taken for the other, as the only point of similarity is the inverted *c* for *con*. The change came suddenly as it came early. All the texts agree with either one reading or the other; there are no intermediate forms between *consensu* and *contraria*. Unless we assume that a double correction was made in the process of revision by the author himself, whatever may have been his motive in so doing, this change must be regarded as unexplainable. As offering additional evidence of probable changes or additions by Bracton's own hand the following may be cited: the omission of *in brevi* by (I) in the sentence "Et illud idem dici poterit in brevi de warrantia cartæ" (f. 414, l. 20); *tantum in brevi* by (I) for *in brevi tantum* (f. 414b, l. 8), which could be explained on the basis that some scribe who was copying the first of these forms omitted the *tantum* but discovered his mistake in time to insert the word after *brevi*; the reading in (I) "Et eodem modo erunt actiones plures ratione" for "Et eodem modo erunt diversæ actiones ratione" (f. 414, l. 30); "non fuit in seisina de re petita vel aliqua parte" by (I), for "non fuit in seisina de re petita tota vel aliqua eius parte" (f. 414b, l. 27); and the omission of *aliquam partem* by (I) in "Idem erit si mulier dotem petat per breve de dote aliquam partem" (f. 415, l. 14). These passages need not be discussed in detail as their bearing on what has already been said is apparent.

The facts which have been brought together in the preceding paragraph have an added weight because of their number. By no means all the variants in the collated passages which would help to support the suggestion that (I) had sprung from some not fully revised draft of the *De Legibus* have been pointed out. From time to time the other groups make omissions similar to those we have just been considering. But omissions of this sort outside of (I) are exceptional, and that group alone makes a consistent claim for priority of descent. (II), for instance, omits the first case referred to on f. 413 for which (I) gives the wrong judge and year. But this is not an omission comparable to those typical of (I), as will be seen when the subject of *addiciones* is discussed. A few lines farther on (f. 413, l. 23), the omission of "et alia placita" by (II) represents yet another type of omission. As further contrasting the usual insertion or omission of (II) with a typical variant in (I) we may take some other readings on this same f. 413. In l. 28 the reading of (II) is "ubi impetrari non deberet"; in l. 31 (II) omits the enclosed *et*—"violentia et armis, (et) impetraverit breve"; in l. 32 (I) omits the *breve* in "valere non debet breve." Of these variants the *non* is clearly wrong, the omission of *et* is an out and out omission of a necessary word, but the *breve*, either absent or present, does not alter the sense of the passage. There are poor and incorrect readings in (I) just as there are corruptions in (II) and (III); out and out errors occur in all the lines. But these are usually more or less easily explainable. What can not be satisfactorily explained, except on the theory of a double-headed origin, are these peculiar variants in (I) which are found in such large numbers in all parts of the text.

We may therefore regard the nucleus of (I) as embodying a tradition which is certainly very old, and in all likelihood older than the texts of (II) or (III). The manuscripts which best represent this tradition are OB, MA, MB, MN, LF, LG, MD. Three of these, OB, LF, LG, are practically the same, with either OB or LG better than LF, which omits large sections of text. The scribe of LG may possibly have been slightly more trustworthy than he who copied OB. But there is little difference between the two manuscripts, and OB is far more accessible. MA and MD have both been influenced by corrections from outside, MA showing more of the typical readings of (I). MB has a relatively large number of variants peculiar to itself alone, but follows in the main the line of (I). The traditional readings of (I) may be secured by a comparison of OB, MA, MB, as any variant upon which they all agree may be regarded as giving us the reading of their common ancestor. In case

of contradictions, other manuscripts in the same line may be consulted. If both MA and MB agree against OB, the reading of LG should be looked up. Where either one of the other two manuscripts sides with OB against the other, MN should be brought into use. MN may also be used to supply the deficiency caused by the *lacuna* in OB and LG. In places where it may be thought necessary to have all possible information MI or LC may be consulted, provided of course that in these particular places they are to be found in (I). For the latter part of the book the readings of OD and Y will help to fix the traditional text of (I).

OA, OD, MC, CE, LA, PH, all give the traditions of (III), except in the latter part of the text. PH is quite inaccessible at the present time, but as in most places at least, and probably throughout, PH and OD are in close agreement, the latter manuscript may be used to represent the pair. OD, which was the manuscript most used by the editor of the Rolls Series edition of Bracton, has been very severely criticised because of the extraneous matter which is found in parts of its text. This brings up the question as to whether or not we should lay aside, once and for all, those manuscripts in which there is any considerable amount of additional or non-Bracton material. Not necessarily so. Each part of the manuscript must be judged separately. Because a reference to the statutes of Edward I occurs in one part it does not follow that all parts of the text are similarly corrupted. Though many of the texts which contain passages that Bracton never wrote are corrupt in their version of what he did write, there are some manuscripts which have not a little outside matter and yet, except for this, show a good text. OD must be put in the latter class. In all of the passages collated, it shows up well, far better than the majority of the manuscripts. Moreover, its non-Bracton passages are of a type which clearly reveal their identity; they stand out from the rest of the text. So while OD would not be a good manuscript to use alone in making a new text of Bracton, it may be used to advantage if a critical comparison with others is allowed to separate what is good in it from what is not. The related manuscripts MC and LA, which are consistently in (III) from beginning to end, are both important. MC has most of the *addiciones* in the text, while LA puts a large proportion of its additional passages in the margins. Attention has already been called to the fact that there is a noticeable agreement between LA and OA in the matter of the *addiciones*, the point at which some of the quires begin, and in the leaving of spaces. For this reason LA will have to be thoroughly compared with both

OA and MC. When this has been done for the whole text the connection existing between these three manuscripts, which is not altogether apparent as yet, will probably be made evident. OA and CE have good texts for the most part, but deteriorate toward the end to such an extent as to be practically useless textually. Each has peculiarities of its own, and both must be collated until the poorer latter portion is reached. Just where this portion begins, the collation itself will show. As far as the passages already collated are concerned these two manuscripts show a good text on f. 319b, but become very poor when the next point of comparison, f. 411b, is reached. Somewhere within the same limits OD goes over from (III) to (I), but the change does not affect the value of its text to anything like the degree that OA and CE are affected by their changes of tradition, and after the transition it may still be used to advantage, especially in cases of marked disagreement among the other manuscripts in group (I). It is to be suspected that in OA the change from (III) to (II) takes place at the point at which hand VI begins its first quire, f. 347b, as hands II, III, IV, V, are all represented in the first ten of the collated passages which in this manuscript show the readings of (III). However this may be, the judicious use of OA, OD, CE, MC, LA, will make it possible to establish the traditional readings of (III) as opposed to those of (I) and (II).

For (II) the best representative, all things considered, is either OF or MG. These manuscripts are of practically the same value textually (OF has a table of contents which MG lacks), and equally accessible. CB, B, HB, are in most places closely allied to OF and MG. Of these, either CB or B is better than HB because the latter has been so affected by corrections in an exemplar that its text does not show the peculiar traits of its own family line. A more extended comparison would perhaps show that B was a slightly better manuscript than CB, which is more immediately accessible than B, though the kindness of the owner of the latter, who has at least twice very kindly sent it where it could be freely consulted, leaves no doubt that it could be used to any such reasonable extent as the making of a new text demanded. As another member of this same larger sub-group, LB may be used in case of need, though the loss of something more than a hundred folios of the printed text makes it less useful than might be desired. However, if we may judge from the passages which have been collated, it has the advantage of being a representative of (II) throughout, in spite of the fact that it is written in at least three different hands. LD appears to be the best representative of another branch, though in all places and in all its hands it does not follow the same tradition.

Moreover, only two of its five or six different hands are represented in the passages which have been compared, and from the work already done, there is nothing which will indicate whether the scribes of these other portions have followed the same or a different exemplar. Hand I gives every indication of having been taken from a model in group (II) and hand V of following an exemplar which would be put in (III). The work of the other scribes is so little in amount as to be practically negligible—less than twenty folios having been written by hands II, III, IV. One hundred and thirty folios out of the two hundred and three have been written by hand I. We may, therefore, regard LD for considerably more than a half of its contents as representing one of the branch lines in (II). OC and the first part of OG, which is too fragmentary for use, follow almost a middle course between (II) and (III). The only text in (II) which need be collated entire is OF—or MG. Where this gives a different reading from either (I) or (III), reference may be had to CB or B, LB, LD, OC, the extent to which these other manuscripts should be consulted being determined by the nature of the variant readings and the importance of the passage in dispute. All of these manuscripts, and especially OC, are relatively more important in the matter of *addiciones* than in that of the text proper.

Three other manuscripts will be used to a greater or less extent in making the new text. They are MM, P, Y. The first named is only a fragment—it amounts to one hundred and eighty of the printed folios at the end of the treatise—but it shows up so well in those passages for which it has been collated that it can hardly be passed over. P contains a text which follows no one tradition, but in all the passages collated gives usually a good account of itself. Though in places better than at others it can never be termed decidedly poor, and for the long passage on fs. 413-415b, which because of its length probably subjects the manuscripts to the most severe and fairest test, it has the least number of variants of any of the thirty-five texts compared. MM and P also stand out as two of the best representatives of group (IV). Y is kept from occupying a position of high excellence only by the broken nature of its contents; one out of every twelve of its folios, on an average, is missing. It is written in three different hands, each of which follows a different type of exemplar, but has a good text throughout. Considerably more than half of the whole book is written in hand III and was copied from an exemplar of excellent text, if we may judge from the passages which have been collated from this portion of the work.

PEDIGREE OF THE MANUSCRIPTS

The three manuscripts OM, HA, W, which more than once occur in the same combination, are each of uneven value. In some places they are good and in other places poor. Their general value is impaired because it is difficult to tell where "good" leaves off and "bad" begins. The use of such manuscripts as these will hardly be necessary except in those comparatively few cases where it becomes desirable to get every possible reading for a very important and much disputed passage. If in the process of collating the more representative texts in groups (I), (II), (III), it is found that the manuscripts in (IV) and those at times associated with them have a tradition and importance of their own which the work thus far done has not made apparent, OM, HA, W, may take to themselves a value which can not rightly be granted to them at present.

Those manuscripts which have not been specifically mentioned have been passed over either because there are better texts in the same line, or because they are distinctly poor, as a glance at the tabulated number of variants will show. Though from time to time some special reason may make it expedient to compare one or another of them in this or that place, there is no likelihood that they will ever have to be consulted at great length. This is true even of ME and MH, MK and X, CA, which manuscripts—as CC also under certain conditions—would be of considerable assistance in determining the traditional readings of (II) if their texts were more trustworthy.

THE *ADDICIONES*

In one place or another not a little has already been said about the additional passages, or *addiciones*, which make up a noticeably large portion of the printed text of Bracton. Something more must yet be said, for the subject is very important. The determination of just what passages are *addiciones*, and more particularly additional passages not written by Bracton himself, is one of the hardest problems connected with the re-editing of the treatise.¹

There is too much matter in the traditional text of Bracton. A very casual examination of the manuscript material shows that. In the preface to the first edition, the unknown editor who signs himself "T. N." makes a number of statements which indicate that, to a certain extent at least, he was cognizant of the corrupt texts of the manuscripts, of a variety of readings in the different exemplars which he had looked over, and of interpolations in some of them.² From his words we might reasonably expect to find that he had remedied some of the worst features of the manuscript texts about which he was complaining. But though he claims to have used twelve manuscripts, only about forty variants are noted for the whole four hundred and forty-four folios of text. He seems to have made no effort at all to get rid of interpolations, and passes over without comment even those *addiciones* which some among his twelve manuscripts must have marked out for him. It is not necessary to consider how many of the extant manuscripts he may have made use of. That he either selected different codices as the basis of his text in different parts of the treatise, or happened to use a single manuscript derived from an exemplar, or exemplars, embodying different traditions, is made clear by a study of the collated passages. It is quite evident that any comparison

¹ See *Bracton's Note Book*, I, 26-33.

² "Ea vero quæ extiterunt exemplaria, frequenti et varia transcriptione, multorum et verborum atque etiam sententiarum additione, quæ ab iis, in quorum manibus hic author versatus est suæ memoriæ adiuvandæ causa adnotata, et a describentibus pro ipsius authoris verbis prave usurpata et inserta sunt, sæpissime autem indoctorum hominum et latina saltem nescientium scriptorum insectia (quod etiam plerosque alios vetustos scriptores, in inculto illo et superstitionum et ignorantia plenissimo seculo contaminavit) vitiosa, dissidentia alia ab aliis, omnia multis et insignibus erroribus scatebant. Quo sane incommodo evenit, ut non sine magna difficultate et sumptu etiam, unum ex plurimorum collatione fidum exemplar collectum . . ."

of manuscripts which he may have made did not have behind it the motive of discovering variant readings. He was not really intent on improving the text. Apparently his one object was to incorporate into his book everything which might have any possible claim of having been written by Bracton. And that part of his work was overdone; he brought in an excessive amount of extraneous matter which had no rightful place in the treatise. Yet it would be unfair to accuse him of having inserted everything for which manuscript authority could be found. Though the all too frequent repetition of passages shows that he did not always exercise due care, and though there are included in his text passages which are found in none, or in only a few, of the extant manuscripts, yet the absence of certain other passages—found often enough in the general run of manuscripts to make their discovery practically certain by any one who might be looking for such material—suggests at least the probability of his having made some sort of comparison and selection. Even such a thing as the insertion of the case of John de Metingham (f. 26) does not convict him of having shown no discrimination. This particular case is found in no one of the extant manuscripts; later research has proven it to be a case tried eight years after Bracton's death; but there is nothing in the reference itself by which the first editor could be expected to have known that some one other than Bracton had first written it. When all is said, however, the fact remains that there is far more in the present printed text than any future editor will ever be willing to include in a new *De Legibus*. Much must be cut out and thrown away. In order that the pruning may be done wisely, the whole subject of the additional passages must be carefully gone over, and then each *addicio* considered individually to determine its right, or lack of right, to a place in Bracton's book.

At the very beginning we can get rid of the repetitions in the printed text. More than once in V the same passage occurs in two different places. Thus the long *Ut si quis donationem fecerit Si autem maior tunc relevium* passage is found on f. 33 and again on f. 34b. Near the beginning and again near the end of f. 196 we have the same six lines, *Et cum (tamen) verus dominus sicut in persona domini*. On f. 309b is a repetition of another type, which gives us identical words for the end of section six and the beginning of section seven. A reference to a case from 3 Henry III is twice given within a space of ten lines on f. 320. A complete list of these repeated passages is not necessary at this place. The collation of the text will reveal them all. Most of them are *addiciones* and will be found in the list of such

passages below. Their appearance in two places is accounted for by the fact that some of the marginalia became what may be termed "floating" *addiciones*, and found resting places in the body of the text at different places in different manuscripts. When two manuscripts which contained the same additional passages but did not agree as to where these passages should come in were used as exemplars for a third, the latter might be expected to contain repeated passages. We have already noticed that the corrector of CB wrote in its margin many passages taken from the manuscript which he was using as a guide, apparently oblivious to the fact that the same passages occurred elsewhere in CB. If CB had been used as a model by some scribe who had the habit—as some of the scribes did—of putting the marginalia of his exemplar into the text of his own copy, it is obvious that the result would have been a manuscript abounding in repeated passages. Repetitions of this sort are fairly common in the manuscripts. Not to multiply instances, we may again call attention to the repeated passage in MD where the collation shows (fs. 413-415b) that this manuscript faithfully preserves two different traditions, not only in regard to the position assigned to the passage, but even in the variant readings. Another case of exactly the same thing is found earlier in MD (f. 46b, ll. 15-23), *Si tenens meus fecerit . . . ut supradictum est*. In MI the additional matter which makes up the most of fs. 282-282b in V (*Sine præiudicio sententiæ melioris . . . tam recenti seisina*) is given regularly in the usual place, and also occurs as two separate *addiciones* which are inserted at quite different places. The long *addicio* on f. 277 (*Et notandum quod fratri . . . supervenientem aufertur*) is to be found in OG on f. 278b and again on f. 280b. ME has in both text and margin the *addicio*, *Sed cum ante plenam . . . et huiusmodi* on f. 274b. A similar repetition of an *addicio* occurs in W, on f. 47 of V. It is much more probable that the first editor of the treatise used a manuscript which contained repeated passages of this sort than that he deliberately inserted them twice as a result of any comparison of manuscripts. Whatever the cause of their appearance in V, they are easily disposed of and present no difficulties.

As an antithesis to its repetitions, the printed text is lacking in some passages found more or less consistently in the manuscripts. Some of these occur so regularly in such a large number of manuscripts that there can be no doubt as to their having been part of the original text. While none of these passages are of any great length, they are fairly frequent. Many of them will be found in the list of *addiciones* below, in which have been placed all passages

whose right to a place in the text might for any reason be disputed. Two good types of these passages will be found on f. 15 and f. 233b. There are also in the manuscripts and not in V a number of passages, some of them long ones, which have all the characteristics of *addiciones* and were clearly not in the text as first written. As they likewise will be given, and their probable authorship discussed, in the list of *addiciones*, there is no need of further considering them here. Typical passages of this sort which may be referred to will be found in that portion of the text which in V is given on fs. 28, 210b, 235, 322, 370b.

Another matter which requires attention in passing is the subject of the rubrics. In the first place, not once or twice, but time after time, whole sentences in the printed book turn out to be nothing but rubrics which have become incorporated into the text. This fact becomes so apparent the moment the list of *addiciones* is looked over that specific illustrations of it need not be given here. In the second place, many of the longer rubrics in V are *addiciones*. Some of these are usually found in the manuscripts and some are not. In the third place, rubrics in V are sometimes so different from those found in the manuscripts that they must be changed for others. Not infrequently the rubrics in V are of excessive length as compared with those usually given by the manuscripts. Compare, for instance, the rubric to sect. 5, f. 399b,—so long that it practically amounts to a restatement of the whole first half of the section—with the brief rubric found in the manuscripts, *De exceptionibus in omni placito*.

Inasmuch as the thorough collation with many manuscripts to which the text of V must be subjected may be counted upon to straighten out this matter of the rubrics, the discussion of this subject could end here were it not for the fact that so many of the manuscripts are affected in the same manner as V in this respect that a general discussion of the subject of rubrics must necessarily precede the use of the rubrics in the manuscripts to correct those of V. The incorporation of so many rubrics in the text of the manuscripts and their being sometimes marked as *addiciones*, leads us to believe that in the original copy of Bracton the rubrics were written in the margin in black ink, as were the *addiciones*. And this is what we should naturally expect. The first draft of the *De Legibus* could hardly have been as mechanically finished a piece of work as many of the later copies. Ordinarily the rubrics in the extant manuscripts are written in red ink in the indented spaces which have been left for them. Sometimes they are written in the body of the text, in

the same hand and ink as the text, and underlined to mark them as rubrics. Doubtless the omission of this underlining in some of the copies which were later used as exemplars is largely responsible for so many of the rubrics having been made a part of different texts. An irregular arrangement of the rubrics—such as in MA, where some are written into the text and underlined, and some are in the places regularly left for rubrics—would also offer opportunities for misunderstandings and mistakes on the part of the next copyist. It is therefore not to be wondered at that now and then a rubric should have become part of the text proper.

As substantiating the statements made in the preceding paragraph the following typical instances of the use of rubrics may be brought forward. These are only a few of many. The last lines of cap. XI, fs. 126-126b, *si coram iusticiariis . . . sine alia secta*, are omitted in many of the manuscripts. MA uses them as a rubric for the following chapter. In MC they serve as the rubric for a new block of text beginning at *facta prius a iusticiariis*, l. 30, f. 126. OA and LA have this sentence as a rubric, in the margin, without any definite directions or marks as to where it should go, opposite the place at which it is found in MC. It is marked as additional and inserted after *ex parte regis*, l. 29, f. 126, in MD and B. A folio further on, the rubric to section ten in V is inserted by some manuscripts just before *ita quid primo*, l. 3, f. 128; by others it is put just before *alii quidem dicunt*, l. 5, f. 128. In each of these cases it is treated as a rubric, but B marks it additional and inserts at the end of sect. 9, f. 127b. In the passage collated on f. 132b, ll. 38-39, *Item iuste utlagatus . . . quasi modo genitus*, are given regularly in four manuscripts, are omitted in twenty, and are used as a rubric—not always in the same place—by nine others. Lines 4-5 on f. 346, *nisi quis habere . . . propter necessitatem* (notice that these words also form the rubric for section four, which begins only two lines further on), are by some of the manuscripts omitted entirely, by at least one other are made part of the text and inserted at the end of sect. 3, f. 346, and by yet others are used as a rubric for a block of text which begins in different manuscripts at two different places, neither of which is coincident with the beginning or ending of a section in V.

Such facts as these have to be known and taken into consideration if the differences in the manuscripts in regard to the rubrics are to be rightly interpreted. Ultimately the correct rubrics will have to be determined in the same manner as the corrected text, by the collation of the best manuscripts. But in the meantime questions arise which it is expedient to answer if that is

possible. The first question is one of authorship. In how far is Bracton himself responsible for the rubrics? Did he write all of them, or any part of them? There is nothing which makes it necessary for us to believe that he must have written them, and on the other hand there is no reason for doubting that he did.¹ It is easy to believe that as one generation of manuscript copies followed another the rubrics became somewhat more numerous. All that was required to create a new rubric was the making of a new paragraph with a short introductory line stating its purport. The manuscripts differ in their paragraph divisions, they do not always agree on the rubrics. It is manifestly impossible that Bracton should have been responsible for all these different points of division and all these different, and sometimes conflicting, rubrics. But in spite of numerous differences—glaring differences if we pick out manuscripts and rubrics which are most unlike—there is a general tendency of agreement in the matter of rubrics which can hardly be explained except on the basis of a common ancestry for most of them. Certainly there are no greater discrepancies between the different manuscripts as regards the rubrics, than in the matter of readings and external arrangement.

It is not necessary to make a very extended comparison of the manuscripts in order to get a general idea of the way in which they differ from one another and from V in their treatment of the rubrics. Comparing the rubrics in V on fs. 115b-120b with those in six manuscripts, OA, MA, LA, MB, CM, Y, which for this portion of the text represent as many different lines of descent, we get the following facts (the rubric in V is in each instance given first in order):

1. *Qualiter procedere debent iusticiarii in itinere suo et quo ordine.* OA, LA, MA, MB, have this also, in both their kalendars and their texts (in the first three the order of words is changed to read *iusticiarii procedere*). CM has it in the text, but in the table of contents reads, *Qualiter iusticiarii procedere debent in itinere suo.* Y, which has no kalendar, reads, *Qualiter et quo ordine procedere debeant iusticiarii in itinere.*

2. *De sacramento duodecim militum electorum ad dicendum veritatem in placitis coronæ.* MB agrees with V in kalendar and text. OA agrees in the text, but in its table of contents omits *electorum*. Y omits *electorum* and reads *placito* for *placitis*. MA and LA in both kalendar and text have *veredictum*

¹ What amounts to all but proof of Bracton's authorship is found in the rubric which in the printed text comes at sect. 1, f. 7. For this the better MSS. agree on, "De dominico domini regis et de condicione personarum tenentium de dominico: *non dico* de manerio." Bracton's use of verbs in the first person singular is rather noticeable; *dico*, *respondeo*, *quæro*, are frequently found in his text.

for *veritatem*. In the kalendar both read *placito*, and in the text insert *electorum*, which is omitted in the kalendar. In the text rubric LA has *plac.* and MA *placitis*. CM in its table of contents has, *Nota ibi de sacramento XII*, and has no rubric in its text at this place.

3. *Capitula de quibus duodecim respondere debent*. There is a general agreement on this rubric, the manuscripts replacing *respondere debent* with *respondebunt*.

4. *Breve de generali summonitione in itinere iusticiariorum itinerantium apud Shipwey in com. Kanc. infra libertatem Quinque portuum. Item capitula*. OA, LA, MA, MB, Y, agree upon *Breve de generali summonitione apud Shipwey* (the spelling of the word is different in each manuscript) *infra libertatem* (MA=*libertates*) *quinque portuum*. In its kalendar CM has, *Breve de generali summonitione*, and in its text, *Breve de generali summonitione ad faciendum venire XXVIII coram iustic. ad respondendum de capitulis subscriptis*.

5. *Breve vie. Norff. et Suff. quod scire faciat hominibus in Iermewe et Donewiz*. Leaving out of account the spelling of the proper names, and replacing *in* with *de*, the manuscripts may be said to agree upon this rubric. LA has *facit* in the text rubric. OA and MB have *faciant*, and the latter manuscript omits *hominibus*. MA has the abbreviation *fac.*, and omits the last two words in its table of contents; in its text the rubric is not found. Y has the abbreviation *fac.* CM omits in the kalendar, but has in the text with the ending *de Jernemue quod sint*, etc.

6. *De crimine læsæ maiestatis et suis specibus*. The manuscripts give the same, omitting the last three words.

7. *De crimine falsi et suis specibus*. This is generally accepted by the manuscripts. LA has no rubric in the text. CM reads *De crimine falsi* in its table of contents, but gives the longer form in its text. Y omits.

8. *De occultatione thesauri inventi*. Y agrees with this. CM twice omits the *inventi*, which is omitted by OA and MA in their text rubrics. OA, MA, LA (which omits in the text) have, *De occultatione inventi thesauri* in their kalendars. MB has this inverted form in both places.

9. *Quid est thesaurus*. This is omitted in the manuscripts.

10. *Quid sit wreckum, et de grosse pisee, scilicet sturgione et balena*. MB omits *scilicet* and reads *balnes*. MA has *et* for *scilicet* in its text rubric. CM omits the rubric in both places. Otherwise the manuscripts agree with V.

11. *De assisa regni iuratis si non observentur.* CM omits in the kalendar, and LA in the text. The other manuscripts are as V.

It would be easy to pick out places where such a comparison would show greater differences than exist here between the manuscripts, and between the manuscripts and V. But the comparison of these eleven rubrics gives typical examples of the more usual differences in both kind and amount. In spite of these differences the general agreement is rather marked; no difficulty is experienced in deciding upon the proper rubrics for this portion of the text.

Yet some of the disagreements are noticeable. Only in MB do the rubrics in both the table of contents and the text consistently agree. OA, LA, MA, CM, clearly could not have derived the rubrics in their texts from the headings in their kalendars. Nor could the table of contents in any one of these manuscripts have been made by merely copying down in order the rubrics in the texts. In either case there are too many omissions on one side and too many additions on the other to have made this possible. The scribe who wrote the table of contents for CM apparently tried to make his entries as brief as possible, with the result that they are regularly shorter than those in the text. But in the other manuscripts considered the general similarity shown by the two sets of rubrics leaves no doubt that the object of the writers of each was to give in either place the full and correct form of the rubric. This makes the differences all the more significant. Even from these few rubrics we get the suggestion that in some instances the table of contents might have been copied from another source than that from which the text had been taken. A more extended comparison proves this to have sometimes been the case; that kalendar and text may represent different traditions is apparent time and time again. It is not hard to account for this fact. When a manuscript which had no table of contents was copied, its descendants might easily be supplied with one from some other manuscript. How often this was done there is no means of knowing. Many of the manuscripts are without a kalendar. Many, as has already been noticed, were copied from more than a single exemplar. In manuscripts of this latter sort it is not likely that the kalendar would represent more than one of the exemplars. Facts already given amply prove that the presence or absence of a kalendar in the head of a family of manuscripts did not necessarily mean a continuation of the same feature among all of its descendants. No two of the manuscripts show throughout their text collation better evidence of a common ancestry than OF and MG. One has a kalendar, the other has not. Which one of them

reproduces the features of their common ancestor in this particular is immaterial as far as the point under discussion is concerned.

Not only might the table of contents be taken from a different source than that of the rubrics in the text, but the latter might come from another manuscript than the one which the scribe had used in copying the main text. In a large number of instances the rubrics have been inserted in the spaces left for them by a hand different from that which wrote the text. Some of the manuscripts have never had the rubric spaces filled in. This means, of course, not only that the rubricator and the copyist were often two different persons (frequently, however, the scribe who wrote the text wrote the rubrics also), but that the rubricating was not always done immediately after the text had been copied. That these differences in person and time, and therefore possibly also in place, led to the rubricator sometimes using another manuscript than that from which the text had been copied, is more than probable on the face of it. Actual proof of this is found in Y. In this manuscript, at the bottom of a page which corresponds to f. 92 in V, the scribe who wrote the text scrawled in lead the following rubrics, apparently from the exemplar which he was using and as a guide to the rubricator: *quid sit dos; quid sit dos rationabilis; quis possit dotem constituere; quando et ubi et de quare; quot sunt species dotis*. And the rubricator filled in the spaces which the first scribe had left for the rubrics with: *quid sit dos; quid sit rationabilis dos; cui* (no space had been left for this); *quando constituenda sit dos; ubi* (no space had been left for this); *dotis spes (sic) quæ sunt; de qua re*. The next four pages of Y are without any material of this sort for comparison, but on the fifth page the copyist of the main text has left scribbled in lead at the bottom: *quod uxor vidua remanere debeat in cap. mes. per XL dies post mortem viri donec dos fuerit ei assignata*, and *item qualiter dos fuerit assignanda*. Above in their proper places as before the rubricator has written, *quod uxor vidua remaneat in capli. mes. post mortem viri donec dos ei fuerit assignata*, and *qualiter dos sit assignanda* (see f. 96 of V). It may perhaps be argued that the rubricator copied his rubrics from those which he found written at the bottom of the pages, the difference between the two sets being accounted for by the fact that he shortened the sentences or changed the order of words to make them the more easily fit into spaces which had been reserved for them in the body of the text. This is possible, but not at all likely, especially as he inserts two rubrics, *cui* and *ubi*, for which the guides at the bottom of the page gave him no authority and for which no space had been left. Y is written in three

different hands. At this place the text and the rubrics scrawled at the bottom of the pages are in hand I; the rubrics in red ink are in hand III, which has written the greater portion of the text, the rubrics, and a large amount of marginalia of one kind or another. Everything points to a third scribe having finished a book left incomplete by two others. The different hands do not follow the same text tradition. They were therefore probably from different exemplars. In which case it may be taken for granted that the third scribe used as his model for the rubrics which he wrote in the text copied by the first scribe, not the rubrics which that copyist had written in lead at the bottom of the pages, but the rubrics which were to be found in the manuscript which he was using as the exemplar for his own portion of the work. In this connection it may be pointed out that the rubric which was discussed when the subject of the division of the treatise into parts was under consideration (f. 107, cap. IX, sect. 1), is given in Y in red ink as, *De regimine iurisdictionum regni*, and is scrawled at the bottom of the page in the form, *De regimine iurisdictionis regni quia de sacerdotio nihil ad præsens*. If additional evidence is needed to prove that the rubrics in a manuscript may represent a different tradition from that of the text it is only necessary to compare the relationship which OA, LA, MA, MB, CM, Y, show in their text for the passage collated on f. 118 with that which is made evident in these rubrics for fs. 115b-120b.

So much for the facts in regard to the rubrics. These facts explain why the rubrics in themselves, just as the *addiciones* in themselves, can not be depended upon to indicate the pedigree of the text. They reveal, too, a situation which made it almost inevitable that the same sentence should at times be made part of the text by some manuscripts, should be treated as an *addicio* by others, and by yet others should be written as a rubric.

As a preliminary to any direct discussion of the *addiciones* two questions must be answered: (1) What is an *addicio*? and (2) How is an *addicio* to be distinguished from the text proper? The simplest answer to the first question is that an *addicio* is any passage, irrespective of its length, which the manuscripts prove was added to Bracton's original draft of his work. Nothing is more plainly shown by the manuscripts than that after writing out the first copy of his treatise Bracton kept adding thereto. The definition of an "original draft" must not be made too rigid. As has already been suggested, the assumption which will best explain the peculiarities of the different text traditions is that a first copy, plus its marginalia added by Bracton, was copied as a new text, and that in this second copy Bracton wrote other marginalia,

both the first and second copies being used as exemplars for later manuscripts. But whether Bracton worked over one or more than one copy of his treatise would be immaterial as far as the *addiciones* are concerned, were it not for the fact that many of the owners or users of the manuscript descendants of the author's own copy followed his example and kept working over the text to suit their own ideas, and to keep it up to date, making corrections and adding marginal passages. It is these later additions which have so complicated the problem as to make it almost too difficult to be solved. The discovery of additional passages is easy enough; the determination as to whether or not a particular *addicio* was written by Bracton is often impossible.

In answer to the second question it must be said that there is no particular form or feature of an *addicio* by which it may readily be distinguished from the rest of the text. Not a few of the manuscripts mark some of the additional passages as such, but in any one codex or group the marked *addiciones* are only a comparatively small proportion of the total number of additional passages. Nor are all the passages marked as additional, *addiciones*. Aside from the fact already noted that rubrics are at times marked as additional, the word which denotes the additional character of the passage, such as *ADDI—CIO*, is sometimes so misplaced as not to stand opposite the piece of text for which it was originally intended. Proof that any particular passage is an *addicio* can be had only through the comparison of a number of manuscripts. The typical *addicio* is a passage absent from some manuscripts, found at different places in others, marked as additional by others, and marginal in yet others. Not all the *addiciones* combine all these features. Often the passage is not marked; often it is not found in the margin of any manuscript; there may be no disagreement among the manuscripts as to where the passage should be inserted. But in general these are the characteristic marks of an *addicio* which are revealed by a comparison of the manuscripts.

Some of the manuscripts are without marginalia; in others the amount is excessive. At times this marginal matter is composed almost entirely of *addiciones*; at other times they form but a small part of the total marginalia, or they may be lacking altogether. Usually there is little danger of mistaking an *addicio* for anything else, but sometimes there is the question as to whether writing in the margin which has every appearance of being an *addicio* is not after all an omitted passage put there by some corrector. Omissions of a word or two might be inserted between the lines above the place where they belonged, but the margin was the place which the corrector would of necessity

choose for omitted passages of any length. These omitted portions of text may be self-evident as such, especially if they come from the midst of a passage and by their omission make nonsense. On the other hand, they are often sentences complete in themselves, and are not necessary to the sense of that portion of the text of which they form a part. Such a sentence omitted from a manuscript which stood at the head of a family would gradually come to assume in the descendants of that manuscript the feature of an *addicio*, being omitted in some of them, written by a corrector in the margin of others, and probably, as a result of the comparison of two or more manuscripts by some of the copyists, found in the text of others. If this omitted sentence, as was sometimes the case, began or ended with the same words as the sentence which in the text immediately preceded or followed it, the similarity of words might cause other scribes to lose their place, and so result in its being omitted in other manuscripts outside of the line of that one which first failed to have it as a part of the text. This would make it appear even more like an *addicio*. Now the manuscripts furnish us with just these conditions in actual fact. The following may be cited as examples: F. 13, ll. 4-5, *Oportet quod . . . proprio vel alieno*. Here is a sentence which begins and ends with exactly the same words as the one immediately before it. In the manuscripts which have been examined MB and MG omit. MA has it in the margin. OA, LA, MC, MD, ME, MN, CM, Y, have it regularly. With these facts as evidence it at once becomes clear that this sentence was omitted by certain scribes who lost their place as they copied because two sentences close together began and ended with the same words. But one who had to depend for his information upon MA, MB, MC, MD, MG, alone, could not definitely determine whether this sentence was an *addicio* or a part of the main text. F. 57b, ll. 2-5, *et sic proferre . . . per eadem verba*. Marginal in MA. Omitted in OB, MB, MF, MN. Regular in OA, OC, CE, Y, MC, ME, CM, LA. From what we now know about the pedigree of the manuscripts it is evident that this sentence was omitted in an early ancestor of the manuscripts which make up group (I). But until the pedigree of these manuscripts had been established this omission had all the appearances of an *addicio*. F. 180, ll. 17-19, *Si autem redditus . . . dicitur pertinere*. This is in one of the twelve collated passages. Marginal in OA, LC. Omitted in OB, OG, OM, HA, MA, MB, MD, MI, ML, CM, Y, LF, LG, CE, W. Regular in the other twenty-five manuscripts collated. A real problem is presented by this passage. Is it an *addicio*, or is its omission in some manuscripts

(and the consequent marginalia in two others) due to the fact that two all but adjacent sentences began with the same three words? The latter is more probable, all things considered, but there is no definite proof either way.

F. 428, ll. 17-18, *vel ratione vicinitatis . . . ratione personarum*. This is similar in a way to the last example. Omitted in OA, MA, MD, CC, CE. Regular in OB, MB, MN, MC, ME, CM. At this place in the text MA and MD form a pair group; OA, CC, CE, are related. The passage being regular in OB, MB, MN, shows that it was regular in the common ancestor of group (I), to which MA and MD belong. We can know definitely, therefore, that this piece of marginalia is the result of an omission made in the two manuscripts which were the ancestors of MA, MD, and OA, CC, CE.

F. 239b, ll. 26-28, *Item non sufficit . . . illam deforciaverit*. Here is a passage omitted by OA, OC, OD, MA, MB, MC, ME, MN, CE, CM, MD, the only manuscripts which have been examined for it. Coupling this with the fact that the sentence as it occurs in V is but a repetition of the sentence which precedes it, we need have no hesitation in classifying this as an addition which has crept into the text of some manuscript used by the editor of V, though like the typical omitted passages it begins and ends with words similar to those beginning or ending near-by sentences.

Scores of cases of just such omissions which have the appearance of *addiciones* are to be found in the manuscripts. The comparison of the different codices has eliminated most of them. A few have been kept among the *addiciones* in the list below because like the passage on f. 180 just referred to they do not admit of a definite solution as to their exact nature.

It should be kept in mind that there is no manuscript so infallible in its marginalia that every one of its marginal passages must be regarded as an *addicio*. Even OA does not come up to that standard, and OA is by far the best manuscript in the matter of indicating *addiciones* by putting them in the margin. Most of the marginal passages in this manuscript prove to be *addiciones* when the other manuscripts are compared, but some of them seem hardly to come under this head. There are three classes of typical marginalia in which OA is not backed up by the other manuscripts. First, where OA has in the margin a passage which the other manuscripts omit. An example of this is found on f. 194b, l. 3. *Ut inter Thomam veteris pontis et Ricardum* is omitted in OB, OC, OD, OF, MA, MB, MC, ME, CE, LA, ten manuscripts representing at least seven lines of descent. In the margin of OA is, *Thomas de Veteri Ponte et Ricardus de Langesford*. Again, on the page which

contains the text to be found on fs. 252b-254b of V, OA has two *addiciones*, *Scilicet cum plures se faciant . . . ignoraret, aliud esset*, and, *Ut sciatur quæ sint . . . et nec inter tales*. Neither of these is to be found in the other manuscripts thus far examined, nor are they in V. The second type represents passages marginal in OA but given regularly in the other manuscripts. Thus the last eighteen lines on f. 195, *Si autem contra . . . sed contra*, which in OA are marginal, are given regularly in OB, OC, OD, OF, MA, MB, MC, ME, CE, CM, LA. The last lines of sect. 2, f. 238, *Per hoc autem . . . non expellat*, are marginal in OA but regular in the other manuscripts examined, OC, OD, OF, OG, MA, MB, MC, ME, MN, CE, CM. In the third class are passages which in OA are marginal, in the majority of manuscripts are regular, and in some few other manuscripts are either marginal or omitted. The passage on f. 180, ll. 17-19, already considered on p. 323 above, is of this type. F. 150, ll. 31-32, *quia (qui) convincitur . . . facere proposuit*, is marginal in OA and Y, is omitted in LA, and is regular in OB, OC, OD, OF, MA, MB, MC, MD, ME, CE. Here it is quite clear that OA, LA, Y, show their irregularities because one or more of the scribes mistook the *quia qui* in one line for the same words in the next line (in the manuscripts the *quia* of V in l. 32 reads *quia qui*).

This shows that the marginal passages in OA may be not only *addiciones* generally accepted by the manuscripts as such, but also extraneous matter which the majority of the manuscripts in all lines refuse to recognize as either *addiciones* or text. Among them also are passages which the other manuscripts regard as portions of the text proper. And yet other of the marginal entries in OA are there because the similarity of words in adjoining sentences caused one scribe to lose his place and omit what another scribe brought back by inserting in the margin as a correction. In other words, OA may by no means be thought of as preserving in its margin only such additional passages as come from Bracton. The value of a marginal entry in OA, or its authorship, can be determined only by such evidence as the manuscripts in general furnish. And this is true of the marginalia in any of the other manuscript copies of the *De Legibus*. In the margins of any of them which have any appreciable amount of writing outside the limits of the main text will usually be found *addiciones* from Bracton, *addiciones* from sources other than Bracton, and passages which are not *addiciones* at all. But these facts are particularly interesting and important because of the light they throw upon the circumstances which brought so many passages into the margins of OA. They make it evident

beyond any doubt that these insertions are found in the Digby manuscript, not because they were in Bracton's own copy of his work, but because the newly written text of OA was compared with one or more models other than the exemplar, and all passages found in these models and not in the new volume put in its margins. It is possible, of course, that OA exactly reproduced its exemplar in respect to marginalia, in which case the process of comparison will have to be put back one generation earlier. But in either OA or one of its ancestors this marginalia must have resulted from a comparison of one text with one or more other texts. Exactly the same thing would have come about if a manuscript which contained but few or no *addiciones*, as OB for instance, had been compared with one which like OC or CM was rich in them. In those quires of OA which have marginalia, the passages in the margin are naturally most frequent at those places where the text itself is lacking in *addiciones*, and conversely those parts of OA which have the larger number of *addiciones* in the text show fewer marginal passages. The fact that six of the quires in OA have no marginal *addiciones* (the four quires written by hand III and the last two quires in the book, written by hand VI) strongly hints that the comparison which produced the marginalia in the other quires was made not in OA's exemplar but in that manuscript itself, and that the scribes of these particular six quires either did not consult other models than those from which they drew their text, or compared that text with others which agreed with it. It may be pointed out, too, that the last two quires which do not contain marginalia (Z, Aa) were written by the same hand that was responsible for quires V, X, Y, which have the marginal passages. This is another indication that the work of hand VI was not portioned out to him in a single assignment. It rather helps to bear out the suggestion made on p. 76 above that this scribe probably began his work with quire Z, and after finishing that and the next quire went back and wrote quires V, X, Y. It will not be at all surprising if the complete collation of OA shows that the two parts of the work of hand VI follow different traditions. But even with much more to be learned we know enough to make it certain that the marginal passages in OA are not different in either type or value from most of the marginal passages of the manuscripts in general.

The positions assigned to the *addiciones* is a matter which should be considered. In this connection there are certain facts which stand out in a way which on first sight appears significant. Some of the *addiciones* occur regularly at the same place in all lines, some are found at different places in

different families of manuscripts or at different places in representatives of the same family. How far-reaching this difference is at times it requires hardly more than a glance at the list of *addiciones* to show. In answer to the question as to whether such regularity or irregularity of position proves anything in regard to authorship, it must be answered that no connection between origin and position can be discovered. All the *addiciones* from every source were doubtless at first in the margin. Presumably, also, most of them had some mark which indicated at what point in the text they were to come in. A fairly large proportion of the *addiciones* found in the margins of the extant manuscripts are thus marked. On the other hand, many have lost their place marks, or have been marked by later hands, sometimes more than once and with contradictory directions. Often they stand opposite, or nearly opposite, that place in the text to which they belong. But it is surprising to find how often this is not the case. If the side margin was narrow, or the *addicio* of more than usual length, the scribe may have been forced by the demand for space to begin at the top of the page. Sometimes so much additional matter was connected with a page of text that the marginal space on that page was not large enough to hold it all and it had to run over to the sides or bottom of the next page. This usually occurred where several marginal *addiciones* followed one another in quick succession. It is apparent, too, that some of the scribes preferred the bottom rather than the side of the page for these passages. Such conditions existing, it is clear that if the directing marks attached to an *addicio* in the margin were lost, the passage when taken from the margin of an exemplar into the main body of a new copy might find a resting place anywhere within the limits of that portion of text which covered the page on which it stood. So it has come about that different *addiciones* are found in different texts at points far apart. Not infrequently these points are so widely separated as to lie outside the limits of two whole folios in the printed book. *Addiciones* which had lost the distinguishing marks of position had a tendency to gravitate to the end of those titles or paragraphs to which they seemed most directly to apply. In this connection it should be kept in mind that the points of lesser division in the text vary greatly in the different manuscripts. Points which are in the midst of paragraphs in some texts are at the end of paragraphs in others. Thus MA and MB, for instance, often have clearly marked new divisions of text at places where V and the *addicio*-bearing manuscripts in (II) insert *addiciones* without the slightest indication of a break in the text. It will be noticed when the list of *addiciones* is studied

that in a varying number of manuscripts many of the *addiciones* whose places are not fixed are found at points which the printed text chooses for the end of sections or chapters. Thus by referring to the collation above it will be seen that the *addicio* on f. 3 is put at the end of section three by a larger number of manuscripts than those which follow the printed book and insert it in the midst of that section. The “*Addicio de Cartis*” on f. 34 is put at the end of section two by nine manuscripts and at the end of section three by fourteen others. Instances of this sort could be multiplied. All the evidence tends to show that the most likely resting place for a “floating” *addicio* was at the end of a division of text in that particular manuscript in which the *addicio* was moved from the margin into the text proper. And it is fairly certain that such an original point of text division might be rather easily lost in the descendants of this manuscript, by comparison, corrections, or otherwise. Apparently in some of the manuscripts spaces for *addiciones* were left at the end of prominent divisions of the text. Such spaces as are found in LA, for instance, can hardly be explained on the ground that they were left for the rubrics. This placing of *addiciones* at the end of sections of text accounts for the fact that some manuscripts have an *addicio* at the very point where other manuscripts have another and different *addicio*—a common occurrence. It is perfectly plain from what has been said that before some of the *addiciones* were brought into the text of such manuscripts as contain them, enough generations, measured by the reproduction of the manuscripts, had elapsed to create different points of paragraph division. On the face of it this would suggest that those *addiciones* which are most regular as to place are the older, while those which are put by the copyists in a number of different places are of later origin. But when we attempt on this basis to separate the Bracton from the non-Bracton *addiciones* we run into difficulties at once. The theory may be correct, but in this as in so many other things connected with the manuscripts, the very general practice of comparing one manuscript with another has produced a set of conditions so involved as to defy the operation of any rule or law. For the same reason no definite statement which will apply in all cases can be made in regard to those *addiciones* which occur in manuscripts which have additional matter in both margin and text, whether this is marked as additional or not. For these passages may or may not represent *addiciones* of different ages and from different sources. They may represent the exemplar only, or the exemplar plus additions due to later comparisons with other manuscripts. These later additions may have come from a manuscript in the same family

line as the exemplar or from a manuscript in another line, and therefore may be from either Bracton or some other source, or from several sources.

Before leaving this subject of the positions assigned to the *addiciones* two questions more should be asked: (1) What is the significance of the fact that in some manuscripts *addiciones* are found on separate slips of parchment which have been inserted between the regularly bound leaves? and (2) Why are the *addiciones* on fs. 13b-23b numbered by MD? Both these questions have been carefully considered in the hope that they might throw some light upon the authorship of the *addiciones* involved. But no such light has been forthcoming. If the facts which gave rise to the questions have any special or hidden significance it is not discernible. LC has the largest number of *addicio* slips; similar slips are found also in MI and LD. In every case they appear to have been inserted as an alternative to copying the *addicio* in the margin. This is the simplest, most natural, and almost inevitable explanation of the circumstances. What the motive behind this was, whether the length of the *addicio* made writing it on a separate slip easier for the scribe, whether the owner of the manuscript preferred to keep its margins clear, or whether the slip was copied from an exemplar at some distance from the book in which it came to be inserted, we have no means of knowing. The three manuscripts which contain these slips are very closely related in places as the collation of their texts has shown. Moreover, all three of them follow different traditions in different portions of their texts. They therefore belong to that class of manuscripts whose texts have been decidedly affected by the comparison of two or more exemplars in different family lines. There can be little doubt that these slips mean nothing more than that comparisons of texts have been made, either in the manuscripts directly affected or in some of their ancestors. With the exception of the *addicio prima*, which comes on f. 3, the *addiciones* numbered by MD (and given in the list of *addiciones*) are those five found on slips in LC between fs. 13b-23b of V. All of these will be discussed at their proper places in the list of *addiciones*. At best they are of doubtful origin. There is not the slightest likelihood that in this numbering MD is preserving either the order in which Bracton wrote certain additions to the text, or the order in which they should come. It has already been shown by the collation of the text that MD belongs regularly with MA in group (I), which is lacking in *addiciones* for this part of the treatise. It has been shown, too, that MD contains both additional and repeated passages not to be found in MA, having taken them from some manuscript related to OC. This is

exactly the situation in regard to these numbered *addiciones*. MA follows the other representative texts in (I) and omits them. MD and OC agree—often against all others—both as to the *addicio* itself and as to where it should be inserted. Inasmuch as this numbering refers to passages not found in the family line of MD, and as it is not given in OC or in any other manuscript in that group from some representative of which MD most certainly derived the *addiciones*, we must conclude that the numbering goes no further backward or forward than MD itself. Both the slips and the numbers are significant only in this, that they help in an unusual way to swell the mass of evidence which gives positive proof that the comparison of one Bracton manuscript with another was customary to an extraordinary degree.

When the subject of the pedigree of the manuscripts was under discussion, it was made clear that a manuscript might follow one tradition in its text proper and quite another tradition in its *addiciones*, and that for this reason it was necessary to treat the pedigree of the *addiciones* as a subject by itself. For ascertaining the relationship of the *addiciones* two possible sources of information are readily at hand, (1) the passages which have already been collated, and (2) the facts which are brought out by a comparison of the more important and representative manuscripts in different family lines—which comparison was a necessary part of the work of making a list of the additional passages. By using this material we are able to study a few *addiciones* intensively and for all the manuscripts, and to study all the *addiciones* for the most important manuscripts. This should give us a considerable mass of evidence bearing directly upon additional and doubtful passages.

The *addiciones* in the collated passages can be considered to the best advantage by taking up each one separately. That on f. 32b has been discussed on p. 251 above. By referring to the facts there brought out it will be seen that this particular *addicio* is to be found almost exclusively in manuscripts which belong in group (II), in which the manuscripts keep almost exactly the same relationship in the *addicio* that they show for the main text. The changed positions of ML and X within the group, and the transfer of MF from (I) to (II), need at present no further discussion, as it is quite clear that all three of these manuscripts have derived this *addicio* from some manuscript in the line represented by the sub-group (MI, LC, LD, CA). The real problem is to discover the significance of the appearance of the *addicio* in OD, which is the only text in group (III) to contain the passage. In the main text OD, OC, MD, belong each in a separate group. For this *addicio* they

come into a single group and are closely related. The relationship of OC and MD is easily explained, for by this time we have found out enough to be positively certain that MD, though belonging regularly in (I), has derived additional passages and a great many corrections from a manuscript closely akin to OC. But did OD get the *addicio* from some text in the line of OC, or vice versa? In other words, was this passage originally in the text tradition represented by group (III), or has the single individual in that group which gives it derived it from a manuscript in (II)? It has already been pointed out that in a way OC stands in an intermediate position between (III) and (II), so that theoretically at least there is the possibility of an *addicio* coming from (III) into (II) through the medium of some ancestor of OC. But this is not an *addicio* common to (III) as a group. We should not expect to find it in OA because this portion of the text of the Digby manuscript is in one of those quires lacking in marginalia. And this part of CE does not generally have *addiciones* either in the text or in the margins. But MC and LA usually give the additional passages upon which (III) as a group agrees, and we should expect one or the other of them to contain this passage if it had originally been a part of (III's) text tradition. From one source or another has come information which makes it plain that OD, either of itself or through its exemplar, has taken into what was primarily a good text in (III) not a few extensive passages of extraneous matter, even having references to the statutes of Edward I. Where OD got these passages is not evident, but it is very plain that the copyist who burdened the good text which OD at bottom represents with some of the other interpolated passages would not have hesitated to add this *addicio* to a text which did not originally contain it. We can be certain that the *addicio* did not come into (II) from OD itself, for that manuscript omits a long passage of thirteen words which is given by all the other manuscripts which have the *addicio*. In addition to this some of the variant readings in OD are of a sort which suggests that it does not give the traditional text of the additional passage. When everything is taken into consideration it has to be admitted that while positive proof is lacking, the whole weight of probability is on the side of OD having derived this *addicio* from some manuscript in (II). This passage must therefore be regarded as one peculiar to a single group of manuscripts, and that a group which contains the largest amount of interpolations, and one which is, all things considered, least representative of the original *De Legibus*. Under the circumstances one can hardly grant this passage a place in the treatise, even though it occurs in

twenty-one of the manuscripts. In the matter of *addiciones* as in that of actual text readings, when (I) and (III) combine against (II), the latter, except in exceptional circumstances, must yield.

With the *addicio* on f. 32b is to be compared that which comes on f. 33 (and in V is repeated on f. 34b). Both passages occur in nearly the same manuscripts. The later *addicio* is omitted in those three manuscripts, MF, ML, X, which in the earlier were seen to follow a tradition different from that of their texts. OC, OD, MD, again show the same relationship as for the *addicio* on f. 32b, but now OD has the passage in the margin instead of in the body of the text. This is yet another reason why it is hard to believe otherwise than that OD or its immediate ancestor derived both these *addiciones* from some near relative of OC, in which they had already become incorporated as part of the text. ME and Y have the passage in the margin, each following the tradition of a different sub-group of (II) and showing not at all the same relationship as for their texts proper. OG and LB, which did not give the *addicio* on f. 32b, have this passage and follow regularly the same lines of relationship as for the main text. On p. 252 above are shown graphically all these changes in relationship. Even more than the passage on f. 32b this *addicio* is seen to rest upon the authority of group (II) alone, and to lack all sanction from either (I) or (III). This fact is all the more striking because the passage occurs in twenty-three of the forty manuscripts in which this portion of the treatise is found. It furnishes good proof of the futility of basing an estimate of the value of any *addicio*, or hazarding a guess as to its probable origin, merely upon the number of manuscripts which contain it.

This brings us to the "*addicio de cartis*" on f. 34. First of all should be read what has been written in regard to this *addicio* on p. 252 above. The point which stands out is this—that while the passage is found in one representative of (III), OD, and in four manuscripts whose main text follows regularly the traditions of group (I), MD, ME, MF, P, all five of these manuscripts have derived the *addicio* from some text in the line of OC. The collation shows that MD and OD maintain the same relationship with OC as in the two previous *addiciones*; ME, MF, P, come down the same general line of descent. In each one of these three *addiciones* OC has been constant to a single tradition, that which it shows for the text proper. When manuscripts from (I) or (III) agree with OC in these passages they are representing OC's tradition, not that of their own text. Some of the *addiciones* in the treatise are vouched for by the combined traditions of (I) + (II) + (III), and a larger

number by the traditions of (II) + (III). But the passages just considered are not of these. To be sure, they are vouched for by manuscripts in all three groups, but because in these additional passages the manuscripts in (I) and (III) have left the line of their main text, the only tradition which is represented by these *addiciones* is that of (II). This brings up the question as to whether (II) may not in some instances preserve an *addicio* from Bracton himself which has not been preserved by either (I) or (III). Possibly, though it hardly seems probable. (II) is the group which especially contains interpolations from a variety of sources not connected with Bracton. A passage for which the manuscripts of this group alone act as sponsors must inevitably be regarded with suspicion. Moreover, there are several different side lines and sub-groups within (I) and (III), in some one of which, or among one or another of which, we might very reasonably expect to find all the additional passages from Bracton's own pen. Therefore, any doubtful passage which like the "*addicio de cartis*" is supported only by the tradition of (II), can hardly hope to be considered a part of the treatise. That this particular *addicio* is a very old one there can be no doubt—it seems to be a not very distant echo of the trouble between Henry III and his barons; but the authority on which it rests is far too insufficient to allow us to regard Bracton as the author of it.

With the three *addiciones* just considered should be compared that on f. 3, which has also been collated for all the extant manuscripts. For the main text, in spite of some real changes, the division of the manuscripts into groups is about the same as that for the collated passage on fs. 33-35b, group (III) especially including the same manuscripts. It is here made up of OA, OD, CE, MC, LA, PH, the latter manuscript not having been collated for fs. 33-35b. As a group (I) again omits the *addicio*. It occurs, however, in MD and OE, the latter putting it in the margin. Both of these manuscripts have clearly taken it from sources related to the texts in (II). Most of the manuscripts in group (II) give it. It is found in all the manuscripts in group (III) with the exception of CE, being put in the margin by OA and LA, and inserted in the text by MC, OD, PH. Here, as elsewhere at the different points at which they have been compared, OD and PH form a pair group. They agree with OC (and a few others) as to where the *addicio* should be inserted. This raises the question as to whether OD, and therefore PH, has taken the *addicio* from some manuscript in the line of OC. Apparently not. The combination now seems to be OC, MD, LD, rather than OC, MD, OD. In the first place, group (II), including OC, MD, LD, is distinguished by a

series of variants which OD, PH, and the other manuscripts in (III) do not have. Nor do these manuscripts in (III), one or all, show any affiliation with any of the sub-groups of (II). This holds true in spite of the fact that MC agrees as to the position of the *addicio* with some of the members of (II), which in this respect go contrary to OC. Seemingly the tradition of (III) is not the same as that of (II) for this *addicio*. The most noticeable point of difference is where the five manuscripts of (III), OD and PH included, agree on *filiis* for the regular *filios* of (II). Therefore, this *addicio*, unlike the three first considered, is backed up by the tradition of both (II) and (III) instead of by the former only. The inevitable question is as to whether or not some common ancestor of the manuscripts in (III) took this passage from a common ancestor of the manuscripts in (II). Though such a borrowing might be possible, theoretically at least, there is nothing in the manuscripts themselves to suggest it. For the *addiciones* on fs. 32b-35 it was plainly to be seen that manuscripts in (III) and (I) had taken over the additional matter from (II). Here no such borrowing is at all evident on the part of any member of (III), though for (I) MD continues to show the same close relationship with OC. The more the collation is studied the stronger grows the impression that at this place (III) and (II) represent totally different traditions for the *addicio*. We are practically forced to the conclusion that the common ancestor of (III) and the common ancestor of (II) both had this *addicio*. And when we get back that far we are not very distant from the manuscript which was Bracton's own. There is thus every indication that in giving this *addicio* both (III) and (II) are reproducing something which was in the original manuscript.

An *addicio* which is clearly from Bracton is that found in the collated passage on f. 161b. It is given in all but two of the forty manuscripts which have been examined, and is particularly interesting in this discussion as showing the way in which the manuscripts may treat an *addicio* from the author's own hand. Groups (I), (II), (III), are all represented. Each one of the main groups is further divided by the variants for the passage into sub-groups, which with possibly one exception are the same as those already derived for the text proper. In both text and *addicio* we get the sub-groups (OB, LF, LG), (MI, LC, CM), (MA, MD), (ME, MH, LB, CC), (CA, X), (OF, MG), (OM, HA, W), (OC, MD), (OG, Y), (CF, LT), (MC, LA), the last standing out more strongly in the *addicio* than in the main text. In the *addiciones* on fs. 32b-35, which belonged exclusively to group (II), sub-groups appeared for that main group only, although the other main groups were not lacking in

representatives which contained one or more of the three additional passages. In the *addicio* on f. 3, sub-groups appeared for (III) and (II), to both of which traditions the passage equally belonged. These facts would seem to prove that when an *addicio* comes down through a group—in contradistinction to having been copied into some members of that group from other groups—it will acquire distinctive readings in the individual members of the group, so that the sub-groups represented by variants in the *addicio* correspond to those in the main text. As was pointed out when the choice of manuscripts was being considered, (I) represents an older text form than (III), and (III) than (II). Coupled with what has just been said, this makes plain a number of points. In general, we can be fairly certain that any *addicio* which is vouched for by all three of the principal groups is one of the earliest set of additional passages and from Bracton's pen. An *addicio* which rests upon the authority of the combined traditions of (III) and (II) will usually belong to a somewhat later set of *addiciones*, but will probably have come from Bracton. An *addicio* which has the support of only a single one of these groups, be it (I), (II), or (III), may be either early or late, but can hardly have come from the same source as the main text. In making these general rules we have worked on the assumption made on p. 302 above, that the prototype of (I) was a manuscript taken from an unfinished copy of the treatise, and that (III) represents the more complete work as left by the author. This *addicio* on f. 161b furnishes just the kind of evidence to support such a contention. The mere fact that there are *addiciones* in the traditional text of (I) does away with the idea that this group represents only a text sprung from the same stock as (II) or (III) from which all additional passages have been carefully debarred. It is at least more than that. Nor is there the slightest chance that the *addicio* on f. 161b was ever a portion of the main text from which it might have become detached. The fact that the different groups assign it to three different positions in the text, while two of the manuscripts keep it in the margin, proves conclusively that it is a typical "floating" *addicio*. More *addiciones* of this type will be found in the list below. Their presence helps very decidedly to strengthen the claims which have been put forth for (I). And these statements hold true in spite of the fact that for fs. 45-151, group (I) gives in the text practically all the *addiciones*. The significance of this will be fully discussed below.

The evidence to be derived from the collation of fs. 179b-180 is somewhat contradictory as far as the main text is concerned. But the *addicio* found in

this passage is clearly one common to both (II) and (III), a general similarity being shown by the sub-groups of these two main groups in both text and *addicio*. It is of the same general type as the *addicio* on f. 3 already discussed. Because of the support given it by the manuscripts we need have no hesitation in ascribing it to Bracton, in spite of the fact that it is not found in (I).

Another fact which the collation makes evident is that some of the references to cases are *addiciones*. In this connection should be discussed the case of Reginald Murdac on f. 320, and the two cases on f. 413. But this discussion is deferred, as the whole subject of the case references is to be considered later.

As supplementing the collation there is to be used such evidence as may be derived from the presence or absence of different *addiciones* in particular manuscripts, as indicated in the list below. Here certain facts stand out prominently enough, but we can not always be sure of the meaning they convey. The information given is not at all detailed, and is of a sort which requires careful use. In making out this list only from one-third to one-half of the whole number of manuscripts have usually been compared for any one *addicio*. There are no variant readings to help out. But by selecting for comparison manuscripts which are representative of the larger groups and sub-groups it has been possible to get a very fair idea of to what extent the various family groups are willing to vouch for a given *addicio*. From the data furnished we are able to tell whether an *addicio* is found in the manuscripts generally, or in the members of only a single group, or in most manuscripts outside of a single group. The collation of the additional passages has shown very clearly that the mere fact of an *addicio* being found in a majority of the manuscripts is no proof of its having come from Bracton. For many portions of the text the manuscripts which belong in (II) outnumber those in (I) and (III) combined. If majorities are to decide the fate of some of the *addiciones* the counting must be by the larger groups and not by individual manuscripts. In determining the probable origin of an *addicio* it is necessary to know how many of the group traditions are behind it, rather than the number of manuscripts in which it is to be found. To discover this it was not necessary to compare all the manuscripts, but only enough to make clear beyond any doubt the attitude of the groups as such toward each *addicio*.

In the list are two types of *addiciones* which present no difficulties whatsoever—one the *addicio* which is found in practically all manuscripts in every line, and the other the *addicio* which the manuscripts almost without exception

refuse to receive. In nearly the same class as this latter type is the *addicio* which rests on the authority of some sub-group in (II) alone.

The crucial test in nearly all cases of doubtful origin is the treatment of an *addicio* by (III). By far the larger number of *addiciones* are found in the general run of manuscripts in both (III) and (II). If the manuscripts in each of these groups were always consistent and unanimous in their acceptance of an *addicio* there would be little reason for doubting its right to a place in the treatise. But frequently a few texts in one or the other of these groups—especially in (III)—omit an additional passage which the others give. This brings up the same question which was raised when the collated *addiciones* were being considered, whether in such a case it is the manuscripts which omit or those which give the passage that are following the tradition of their group. The problem is complicated because in probably the greater number of cases three of the manuscripts in (III), OA, CE, LA, omit the passages from their main text, and the position of (III) must be very largely determined by MC and OD, the latter of which can not be too readily trusted because of its tendency to borrow *addiciones* from (II). It is only by a thorough discussion of every point bearing on the treatment of the *addiciones* by (III), as brought out by the facts in the list below, that the real attitude of that group can be correctly understood.

For all the passages collated, except towards the very end of the treatise, (III) was seen to be made up of OA, CE, LA, MC, OD, with PH showing a close agreement with OD at those places in which it was collated. ML, which is made up of a combination of sources from (II) and (III), might also be considered in this group. But the structure of ML in one instance, and the inaccessibility of PH in the other, remove these two manuscripts from the present discussion. The other five manuscripts have been very closely examined as far as the *addiciones* are concerned. It should be kept in mind that OA and CE lean rather towards (I), that OD reaches out towards the OC side of (II), and that MC and LA occupy a middle position. For many parts of their text OA, CE, LA contain but comparatively few *addiciones*. In this respect they are decidedly more like (I) than like (II). Both MC and OD have *addiciones* in their texts, some of them marked, and the latter manuscript contains also considerable extraneous matter peculiar to itself alone. Of all the manuscripts, OA and LA have the largest number of additional passages in the margin. OA is particularly noteworthy in this respect, for with the exception of that part of the treatise contained in six of

its quires which have no marginalia, a very large proportion of all the *addiciones* found in all the other manuscripts combined are given in its margins. Such comparison of the manuscripts in (III) as is necessary to understand the way in which that group treats the *addiciones* naturally rests upon OA as a basis. Or it would perhaps be more correct to say that any detailed consideration of the Digby manuscript in this particular necessarily takes in the other members of the same group, especially CE and LA.

On first sight OA's treatment of the *addiciones*, just as its quire scheme, has a tendency to create the impression that it is following a model very close to the original copy of the *De Legibus*. The general high average of excellence of OA's text, its comparative freedom from corruptions and alterations, is sufficient proof that it comes from an immediate source far nearer to the original than that represented by most of the extant manuscripts. By no means may it be regarded merely as a copy of one of the more ordinary type of texts, with interpolations and additions removed to the margins. What appears most extraordinary, perhaps, as the manuscript is studied, is the fact that many *addiciones* which have become incorporated in the text not only of other manuscripts in (III), but also in the manuscripts of group (I), are either marginal or omitted in OA. On the face of it this seems to contradict what has already been emphasized—that the nucleus of (I) represents an older tradition than the more complete text as found in (III), OA included. If we were to go contrary to the evidence and assume that Bracton had but one copy of his treatise on which to continue to work and to which to make additions, we should be forced to acknowledge that all the author's *addiciones* must have stood in the margins of that single original. No other place could have received them. For they were not mere alterations or corrections which could have been written within the lines, but actual additions of such substantial length, and so evidently due to later and more mature consideration on some rereading, that it is impossible to think that any provision for space which they should later occupy could have been made for them in the text as first drafted, which went on smoothly and uninterruptedly without them. This being admitted, it would be necessary to go farther and admit that a manuscript which was very closely reproducing the author's original copy would also have the *addiciones* in the margins. In other words, that manuscript would present just such an appearance as OA in regard to its marginalia. But how little in addition to the external appearance of its marginal passages OA has which may give it any claim to be at all exactly

reproducing the marginalia in an assumed original will be seen from what follows.

The inevitable question, of course, is as to where OA got its marginal passages if not from some exemplar close to Bracton's own copy. This same, or a similar, question might be asked of any one of the manuscripts which have marginalia. In regard to none of them could a definite answer be given. But in the case of OA, while it is not necessary to trace the origin of its marginalia to another definite source in order to prove that they did not come from the original copy of the treatise, it is well to suggest probabilities or possibilities. We know that OA was copied in a scriptorium, and probably, though not necessarily, from more than a single exemplar. At any rate, different portions of the text represent different traditions, the later part being distinctly poorer than the first. By its quire scheme it shows itself to be connected with some of the manuscripts which have a changed order of subjects. The changing around of certain blocks of text in some of them suggests that other manuscripts besides OA were written in the same scriptorium at about the same time. Among them are manuscripts which have either themselves been derived from more than a single model or come from an exemplar so derived. Their peculiarities are such that an explanation of them practically demands that we assume that several manuscripts were copied in a single scriptorium to which two or more texts of the *De Legibus*, representing different traditions, had been brought to serve as models. The most likely guess as to the reason for OA's very evident connection with them is that it was written in the same scriptorium. If this be the true explanation, then OA's marginal passages have in all probability resulted from a comparison of its text with that of some other manuscript, or manuscripts, in the scriptorium. For there is one point on which we may be sure—that the main text of OA and its marginalia never came from the same immediate source. This is additional proof that the exemplar of the present complete OA was not the original *De Legibus*. Not only is it incredible that with the author's own copy available as a model a part of OA should have been copied from a third or fourth rate manuscript, but the theory of a single early derived source for the Digby manuscript is forever shattered when we find that the scribes who wrote the marginal passages copied on the side and bottom of the pages not only such *addiciones* as come from Bracton himself, but also matter which can never be accredited to him. Everything points to a comparison—and a very extended comparison at that—having been made with one or more other texts

after that of OA had been written, and the subsequent entry in the margins of such additional matter as was found. The suggestion that there may be several different layers of *addiciones* in OA can not be seriously considered because there is nothing in the handwriting or arrangement of the marginal passages to support it. Moreover, all kinds and types of *addiciones*, authentic, non-authentic, doubtful, are treated in exactly the same way. It should be remembered that while most of OA's main text is certainly of a very early type, the manuscript itself was copied so late that very far from perfect manuscripts had already come into existence, and that one of them had served as an exemplar for the latter portion of the book. That is, the manuscript was written late enough to make it possible for a comparison made at the time of writing to yield any *addicio* which OA contains. In this connection there should be pointed out a fact which is not readily apparent, that in at least one respect OA is similar to OD. This latter manuscript has been almost as severely criticised as OA has been praised. But each represents a text which in different places follows different traditions, and in each there has been added to a good basic text an immense amount of additional matter, not by any means all of which has good claims of having come from Bracton. The real difference is one of amount almost more than of kind. OA does not have as large an amount of clearly extraneous matter as OD, and keeps in the margin what the other manuscript puts in the main text. If OA had been copied and its marginalia put into the body of a new manuscript text there would have resulted a volume whose context in principle would have been not unlike OD.

This does not explain why OA fails to have in its text proper many *addiciones* which have already become a part of the text of the manuscripts in (I). And any explanation based on evidence furnished by the manuscripts themselves is seemingly impossible. There is something quite contradictory to any possible theory in the way in which OA, CE, and LA omit what are clearly *addiciones* from Bracton's own hand. This will become apparent when the list below is studied. What really prevents any working hypothesis from being developed is the fact that the three manuscripts just named contradict one another in their omissions of *addiciones*. Oftentimes two of them will give what the third omits, or one of them will have a passage not found in the other two. Speaking generally of all three of these manuscripts it may be said that a large proportion of all the *addiciones* are lacking in their main texts. But why CE should omit what OA has in the margin and LA puts in

the main text, or why CE should give regularly what LA has in the margin and OA omits, or why OA and CE should omit what LA has regularly, or LA omit what OA and CE have regularly, or OA have regularly what CE and LA omit, are questions which can not be answered because of the failure of these manuscripts to follow any apparent rule or reason in their omission of additional passages. Some of the discrepancies may be out and out omissions due to scribes' errors. Perhaps even more of the omissions may be due to the fact that some man for whom a new text was being copied may have ordered some passages in the exemplar to be left out. Yet it should be said that in any manuscript the omitted passages are of so many different types and kinds that it would be very difficult to discover on what basis any such selection of passages to be omitted was made. But it is perfectly certain that OA, CE, and LA all belong in (III), and it is far easier to accept their contradictions in the omission of *addiciones* as an unsolved problem than to explain the tradition of (I) as anything other than an older text tradition than that of (III). It goes without saying that no assumption of a single original with all Bracton's additions in its margin will ever explain the contradiction of omissions in OA, CE, and LA. If any one of them is following such an original in the matter of *addiciones* the other two most decidedly are not. In all probability no one of these manuscripts is at best nearer than grandchild (and more likely great-grandchild) to the original copy. They may all have had a common ancestor which was not that original. It looks as if in the case of each one of them there had been made somewhere back in the line an attempt to free the main text of a large part of the additional matter. But we can not be sure of this.

One point which is rather noteworthy in connection with these three manuscripts is that no one of them makes use of the word *ADDICIO* or a similar designation to mark the character of such additional passages as it gives. MC and OD, the other two manuscripts in (III), make use of such marks. We might reasonably expect any manuscript which was closely following Bracton's own copy to do this. For this *ADDICIO* is in very general use, not by a few manuscripts only, or by any one group, but by manuscripts in all groups. The widespread practice of thus marking additional matter would indicate an early origin. It is certainly as early as the tradition of the nucleus of (I). It would seem to have begun with Bracton himself, for it is difficult to explain its occurrence in all lines except on the ground that it existed in the common original of them all. And Bracton was the one who

would most naturally have used this mark *ADDICIO*. Other writers or commentators would in all probability have preferred *GLOSSA* to denote their contributions to the text. It is all a question of belief and not of proof, but it seems very reasonable to believe that this word *ADDICIO* was chosen by the author to make clear the fact that the passages so marked were out and out additions of his own and in no sense glosses of another. In one manuscript or another a noticeable amount of this additional matter is labelled as such. No one manuscript is at all complete in this respect. But it is clear, both that *addiciones* were very early marked and that no one line continued long to mark many of them, though every line preserved a few of the distinguishing signs—enough, as it were, to indicate the earlier abundance.

What proves conclusively that OA and its marginalia did not come from an original copy in which the author's additions appeared in the margins is the fact that there are to be found in the main text of even the best portions of that manuscript both *addiciones* from Bracton and those that are of doubtful origin. Inasmuch as *addiciones* are also to be found in the main text of both CE and LA, and even more frequently than in the Digby manuscript, neither of these two codices may claim the distinction denied to OA. In spite of their usual omissions so many *addiciones* are imbedded in the text of one or the other of these three manuscripts that they outnumber those to be found in (I). Regarded from the standpoint either of its main text or marginal passages (III) is a group abounding in *addiciones*, and in this respect as in the matter of text tradition it naturally occupies a position between (I) and (II). This group is, all things considered, on a higher plane of general excellence than either (I) or (II). But any prestige which it may have is not imparted to it by the chance combination of quire scheme and marginal *addiciones* to be found in OA.¹

Points of similarity or contradictions in regard to the matter of the absence or presence of particular additions in the members of (III) can be most concisely brought out in the following tabulated form. Fuller details may be had by reference to the list of *addiciones* below. In order to bring out all possible points of comparison the text of the treatise is taken up in portions corresponding to those written by the different hands in OA. As facts which may help to strengthen or modify conclusions it should be kept in mind that the collation of a number of *addiciones* has shown: (1) that OD may borrow

¹*Addiciones*, of different kinds, will be found in the text of OA at places corresponding to the following folios in V: 105b, 136b, 151, 156, 166, 170, 178b, 180b, 180b, 220b, 230, 339, 345b, 356b.

THE ADDICIONES

an *addicio* from (II) when the passage is not in (I) or (III), as on fs. 32b, 33; (2) that ML takes at least some *addiciones* from (II), as on fs. 32b, 33; (3) that ME and Y have marginal *addiciones* from (II), as on f. 33; (4) that OD, MD, ME, MF, P (representing different lines) take the *addicio de cartis* from a manuscript related to OC; (5) that CE may omit an *addicio* from Bracton himself which the other manuscripts in (III) give, as on f. 3; (6) that CE (and ML) may omit an *addicio* found in all the other manuscripts, as on f. 161b.

FOR HAND II OF OA, FOLIOS 1-11, 110b-214, OF V

FOLIO IN V	IN MAIN TEXT	MARGINAL	OMITTED
3	OD, MC, PH, + (II)	OA, LA, OE	(I), CE, Y, P, ML
6	(II)	CH, HB, ME	(I), CE, OA, OD, MC
7	OD, MC, + (II)	OA, LA, OE, LC	(I), CE, Y
7	OD, MC, LA, OC, + (II)	OA, LC	(I), CE, Y
10	OD		(I), CE, OA, OD, MC, MSS. gen.
113	OD, MC, CE, Y, (I), (II)	OA, LA, CB	
114	OD, MC, CE, Y, OC, ME, (I)	OA, LA, CB	OF, LD, MH, CM
115b	OD, LA, CE, Y, (I), (II)	OA, CB	
122	OD, MC, CE, Y, (I), (II)	OA	LA, OC
124b	OD, MC, CE, OC, Y, (I), (II)	OA, LA	
126	OD, MC, CE, (I), (II)	OA, LA, CB	
127b	OD, MC, CE, (I), (II)	OA, LA, W	
129	OD, CE, OC, Y, (I), (II)	OA, LA	MC
129	OD, MC, CE, OC, Y, (I), (II)	OA, LA	
130	OD, MC, CE, (I), (II)	OA, LA	Y
130b	OD, MC, CE, (I), (II)	OA, LA, Y	
132b	OD, CE, MC, (I), (II)	OA, LA, Y	
132b	OD, PH, MA, MD	(rubric in OA, CE, OB and others)	MSS. gen.
133	OA, Y, MSS. gen.	LA	OD, PH
133	MSS. gen.	OA, LA, Y	
141	MC, CE, Y, (I), (II)	OA	OD, LA, ME
142b	OD, CE, MC, (I), (II)	OA, LA, W	
142b	OD, MC, CE, OC, (I), (II)	OA,	LA, OG
144b	OD, MC, CE, (I), (II)	OA	OC, LA
147	OD, OC, CE, (I), (II)	OA, CB	MC, LA, Y, OG, W
150	OA, CE, MA, MB, MD	Y	LA
150	OD, MC, CE, (I), (II)	OA, Y	LA
150	OD, MC, CE, (I), (II)	OA, Y	LA
150b	OD, CE, MC, (I), (II)	OA, Y	LA, OG
151	OA, CE, MSS. gen.	Y	LA, MC (partially)
152	OC, MD, MH, OF	OA, LC, W	OD, CE, MC, LA, Y, (I)
155b	OD, MC, OC, OF, LD	OA, LA	CE, (I)
156	OA, MC, CE, MSS. gen.	LA	
159	OD, MC, CE, Y, (I), (II)	OA	LA, ML, P, LT

BRACTON: DE LEGIBUS

FOLIO IN V	IN MAIN TEXT	MARGINAL	OMITTED
161b	MSS. gen.	OA, LA	CE, ML
161b	OD, CE, LA, MSS. gen.	OA, Y	ML, OG, MC (in part)
161b	MSS. gen.	OA, LA (in part)	CE, ML
163	OD, MC, LD, (I)	OA, LA	CE, Y, OC, ML, MG, MH, ME
165	OD, MC, LD, OC, OF, MH	OA, LA	CE, Y, (I), ML
166b	MSS. gen., OA	LA, Y	ML
168	MSS. gen.	OA, LA, Y	
168	MSS. gen.	OA	CE
168b	MSS. gen.	OA, LA	CE, Y
169	MSS. gen.	OA, LA	
169	MSS. gen.	OA, LA	CE, Y
170	OA, CE, MC, LA, ME	Y	(I)
170	OD, MC, OC, MA, MB, MD	OA, LA	CE, Y, OB
170	MSS. gen.	OA, Y	
171b	OD, MC, CE, OC, OF, LD	OA, LA, Y	(I)
175b	OD, OC, OF, ME	OA	CE, Y, (I), MC, LA
176	MSS. gen.	OA, LA	CE
176b	MSS. gen.	OA, LA, CB	CE
177b	MSS. gen.	OA	LA
177b	OA, CE, MC, Y, (I)	LA	
178b	OA, CE, MC, Y, (I)	LA	
179b	MSS. gen.	OA, LC	(I), ML
180	MSS. gen.	OA, LC	CE, Y, (I), ML
180b	OA, MC, CE, Y, (I)	LA	ME, MH
181	OD, MC, OC, Y, (I)	OA, LA, CB (and in text)	CE, MH, ME
181	MSS. gen.	OA, LA	CE
182	MSS. gen.	OA	CE
183	OD	OA	CE, Y, (I), MC, LA, OC, MH
183b	OD, MC, OF, LD, MH, ME	OA, LA	CE, Y, (I), OC
184	OD, MC, OC, OF, MH	OA, LA	CE, Y, (I)
184b	OD, MC	OA, LA	CE, Y, (I), OC, OF, LD
186	OD, MC, OC, OF, ME	OA, LA	CE, Y, (I)
187b	OC, OF	OA	CE, Y, (I), OD, MC, LA
188b	OD, MC, OC, OF, ME	OA, LA	CE, Y, (I)
190b	OD, MC, OC, OF, ME	OA, LA	CE, Y, (I)
191b	OD, MC, OC, OF, (I)	OA, LA	CE, Y
191b	MSS. gen.	OA, LA	CE, Y
192	MSS. gen.	OA, LA	CE, Y
192b	OD, MC, OC, OF, ME	OA, LA	CE, Y, (I)
194b		OA	MSS. gen.
195	MSS. gen.	OA	
195b	MSS. gen.	OA	CE, Y, LA
195b	(II)	OA	CE, Y, (I), MC, LA
196b	MSS. gen.	OA	CE, Y
197	MSS. gen.	OA	CE, Y
197b	LA, MC, OC, OF	OA	CE, Y, (I), OC

THE ADDICIONES

FOLIO IN V	IN MAIN TEXT	MARGINAL	OMITTED
198	MSS. gen.	OA	
201	OD, MC, LA, OC, OF	OA	CE, Y, (I)
202b	OD, MC, LA, OC, OF, ME	OA	CE, Y, (I)
202b	OD, MC, LA, OC, OF	OA	CE, Y, (I), ME
203	OD, MC, LA, OF	OA	CE, Y, (I), ME
206	OD, MC, OC	OA, LA	CE, Y, (I), OF, MH
211	MSS. gen.	LA	
212	OD, MC, LA, OC, OF	OA	CE, Y, (I), ME
212b	MC, OC, OF	OA, LA	CE, Y, (I), ME
213b	OD, MC, OC, OF	OA, LA	CE, Y, (I), ME

HAND III OF OA, FOLIOS 11-62b, 98b-110b OF V. (WITHOUT MARGINALIA)

FOLIO IN V	IN MAIN TEXT	MARGINAL	OMITTED
12	OD, OC, OF, ME		OA, CE, Y, (I), LA, MC
13	OC, B, MG, CM		OA, CE, Y, (I), LA, MC
13b	OC, OF, MG, MH, CM	LC	OA, CE, Y, (I), LA, MC
14b	OC, MG, MH, ME, B	LC	OA, CE, Y, (I), LA, MC, OD
16	OC, MC, LA, ME, CM		OA, CE, Y, (I)
17b	OC, OF, MG, MH, B	LC	OA, CE, Y, (I), LA, MC
21b	OC, OF, MG, B	LC	OA, CE, Y, (I), LA, MC
23	OC, MG, CM, B		OA, CE, Y, (I), LA, MC
23b	OC, OF, MG, ME, CM, B	LC	OA, CE, Y, (I), LA, MC, OD
25	OD, MC, OC, MH, CM, B	LA, Y	OA, CE, (I)
26b	OD, MC, OC, LA, CM, B	ME	OA, CE, Y, (I)
27	MC, LA, MH, CM	OC, MA, MD	OA, CE, Y, (I)
27b	OC, MG, CM, B	ME	OA, CE, Y, (I), LA, MC
29	OD, MC, LA, LD, OF, MH, B	ME	OA, CE, Y, (I), OC
29b	MC, OC, MG, MH, CM	ME	OA, CE, Y, (I), LA
32	OD, MC, OC, OF, MG, MH, CM	ME	OA, CE, Y, (I)
32b	OD, OC, OF, LD, + (II) gen.		OA, CE, Y, (I), MC, LA
33	OC, OF, LD, + (II) gen.	OD, ME, Y	OA, CE, (I), MC, LA
34	OD, OC, OF, LD, + (II) gen.	P	OA, CE, Y, (I), MC, LA
36	OD, MC, OC, MG, LB, CM	MA, ME	OA, CE, (I), LA
37	MC, LA, OC, OF, LD, ML, LB		OA, CE, Y, (I), CC
40b	OD, MC, OC, OF, OM, LB	LA	OA, CE, Y, (I), CC, ME
41	OD, MC, OC, MG, MH, B	LA	OA, CE, Y, (I), ME, CC
41	OD, MC, OC, (II)	LA	OA, CE, Y, (I), ME
41b			
41b	OD, MC, OC, MH, CB	LA	OA, CE, Y, (I), ME, CC
43b	OC, (II)	LA	OA, CE, Y, (I), OD, MC
45	MSS. gen.	LA	OA
45b	MC, OC, CB, B, CM	LA	OA, CE, (I), ME, CC
46b	MSS. gen.	LA	OA
47	MSS. gen.	W	OA, LA
49b	MSS. gen.	LA	OA

BRACTON: DE LEGIBUS

FOLIO IN V	IN MAIN TEXT	MARGINAL	OMITTED
50b	MSS. gen.		OA, LA
52	MSS. gen.		OA, LA, ML
99b	MSS. gen.	LA	OA
100	MSS. gen.	LA	OA
100	MSS. gen.	LA	OA
100b	MSS. gen.	LA	OA
101	MSS. gen.		OA
101	MSS. gen.	LA	OA, ME, MH, CM
101	MSS. gen.		OA
102b	MSS. gen.	LA	OA
103	MSS. gen.	LA	OA
105b	OA, MC, MD, ME, CM (LA has lost leaves)		CE, Y, (I)

HAND IV OF OA, FOLIOS 62b-98, 214-237, 262b-347b of V

FOLIO IN V	IN MAIN TEXT	MARGINAL	OMITTED
65b	MSS. gen.	OA	LA, MC (in part)
65b	MSS. gen.	OA, LA	
67	MSS. gen.	OA, LA	
67b	MSS. gen.	OA, LA	
67b	MSS. gen.	OA	LA, OC
68	MSS. gen.	OA, LA	OD, OC
76b	MSS. gen.	OA, LA	
82	MSS. gen.	LA	
82b	MSS. gen.	OA, LA	
83b	MSS. gen.	OA	LA, MC, OC
86b	MSS. gen.	OA	LA, OC
88b	MSS. gen.	OA, OD	LA, OC, ML
92	MSS. gen.	OA	LA
95b	MSS. gen.	OA	LA, OC, MC
96	OD	OA	MSS. gen.
218	MC, ML, ME, MI, B	LA	OA, CE, Y, (I)
218b	OD, MC, CE, OC, OF, ME	OA, LA	Y, (I)
219	OD, MC, CE, OC, OF, ME	OA, LA	Y, (I)
219b	OD, MC, CE, LA, OC, OF, ME	OA	(I)
220	OD, MC, LA, CE, OC, OF	OA	(I), ME
221	OD, CE, MC, LA, OF, MI	OA	Y, (I), ME
221	OD, CE, MC, LA, OC, OF, MI	OA	Y, (I)
221b	MC, CE	OA, LA	Y, (I), OD, OC, OF, CM
221b	OD, CE, MC, LA, OC, ME, OF	OA, LA	Y, (I)
224b	MSS. gen.	LA	
225	OD, CE, MC, LA, OC, OF, MI	OA	Y, (I), ME
225	OA, CE, MC, Y, (I)	LA	ME, CM
226	OD, CE, MC, LA, OC, OF, ME	OA	Y, (I)
226	OA, CE, Y, (I), ME	LA	MC

THE ADDICIONES

FOLIO IN V	IN MAIN TEXT	MARGINAL	OMITTED
226b	OD, CE, MC, LA, OC, OF, ME	OA, MD	Y, (I)
228	OD, OC, MI	OA	(I), MC, CE, MC, LA
228b	OD	OA, OC	(I), CE, MC, LA, OF, ME, MI
230b	OD, MC, LA, OF, LD, MI	OA, OC	Y, (I), CE, ME
233	OD, MC, OF, MD, ME, MI	OA, OC, LA	Y, (I), CE
235	OC, MD	OA, LA	Y, (I), CE, OD, MC, OF, ME, MI
236	OD, MC, OF, MI	OA, OC, LA	Y, (I), CE, ME, OM
263b	MSS. gen.	LA	
265	OD, OC, OF, MD	OA	Y, (I), CE, MC, ME, MI, CM, LA
267	OD, OC, OF, MD	OA, Y	(I), CE, MC, LA, ME, MI
269b	OD, MC, CE, OC, OF, CB	OA	(I), Y, LA, ME, MI
270	OD, MC, LA, OC, Y, (I), OF	OA, ME	CE, CM
270b	OD, MC, OC, OF, MD, ME	OA	Y, (I), CE, LA
271	OD, OC, OF, ME, MD	OA	Y, (I), CE, MC, LA
272b	OD, CE, MC, OC, OF, ME	OA	(I), LA
273b	OD, CE, MC, OC, MD	OA	(I), LA, OF
274b	OD, CE, MC, OC, OF, ME	OA	(I), LA
274b	OD, CE, MC, OC, OF, OM, ME, MD	OA, (ME)	(I), LA
275	OD, CE, MC, OC, OF, OM, ME	OA	(I), LA
275b	OD, CE, MC, ME, OM	OA, OC	(I), LA
276	OA, CE, ME, (I)		MC, LA
276b	OF, OD, OC, OG	OA	(I), Y, CE, MC, LA, ME
277	OD, CE, MC, OF, MD, OG	OA, OC	Y, (I), ME, LA
277b	OD, MC, OC, OF, OG	OA	Y, (I) CE, LA, ME
277b	OD, OF	OA, CA	Y, (I), CE, MC, LA, ME
279b	MSS. gen.	OA	LA
280	OD, CE, MC, LA, OC, OF, ME, OM	OA	(I), Y
282	MSS. gen.	OA	LA
283b	OD, OC, OG	OA	Y, (I), CE, MC, LA
285b	PH, MC	OA, LA	Y, (I), OD, CE, OC, OF, P, B
287b	OD, OF, OG, MI, ME	OA, OC	Y, (I), CE, MC, LA
290	OD, OC, OF, OG, MD, MI	OA	Y, (I), CE, MC, LA, ME
291b	OD, ME, CM	OA	Y, (I), CE, MC, LA, OC, OF
296	OD, OC, OF, OG, ME, MM	OA	Y, (I), CE, MC, LA

OA OMITTS THE ACTION FOR DOWER, FOLIOS 296-317b

FOLIO IN V	IN MAIN TEXT	MARGINAL	OMITTED
296b	ME, CM		Y, (I), MC, LA, CE
297	OD, OC, ME, CM		Y, (I), CE, MC, LA
297	ME, CM		Y, (I), CE, MC, LA
297b	MD		Y, (I), CE, MC, LA
298	ME, CM		Y, (I), CE, MC, LA
310	ME, CM	LA	Y, (I), CE, OF, OC
311	ME, CM, MC, CE, Y, (I)	LA	
319	OD, MC, OF	OA, LA	Y, (I), CE, OC, OG, ME, CM

BRACTON: DE LEGIBUS

FOLIO IN V	IN MAIN TEXT	MARGINAL	OMITTED
320	PH, MC, (II)	OA, LA	Y, (I), CE, OD, OC, ME, MM, P
320b	OD, MC, OC, OF, ME	OA, LA	Y, (I), CE
321b	OD, MC, OC, MD, OF, ME	OA, LA	Y, (I), CE
322	MSS. gen.	OA	CE
324	OD, MC, OF, OM, ME	OA, LA	Y, (I), CE
335b	OD, MC, OF, OG, MD	OA, LA	Y, (I), CE, OC
336	OD, MC, CM	OA, LA	Y, (I), CE, OC, OF, OG
338	OD, MC, OC, MD, OF, OG, CB (part)	OA, LA, CB (part)	Y, (I), CE, ME, CM
339	OA, CE, Y, (I), MC, CB	LA	CM
341	OD, MC, OC, OF, ME	OA, LA	Y, (I), CE
346b	OD, OC, OF, OG	OA	Y, (I), CE, MC, LA, ME

HAND V OF OA, FOLIOS 238-262 OF V. (LA OMITTS THIS
PORTION OF THE TEXT)

FOLIO IN V	IN MAIN TEXT	MARGINAL	OMITTED
238	MSS. gen.	OA	
253b		OA	MSS. gen.
254		OA	MSS. gen.
254	CE, MC, MD, MN, CM, Y	CB	MB, ME, MI
258b	MSS. gen.	OA	

HAND VI OF OA, FOLIOS 347b-399, 399b-440b (WITHOUT
MARGINAL *ADDICIONES*)

FOLIO IN V	IN MAIN TEXT	MARGINAL	OMITTED
349	MC, LA, OC, OF, ME		(I), OD, CE, Y
350	OD, MC, OC, OF, ME	OA, LA	(I), CE, Y
350	OD, MC, OC, OF, Y, (I)	OA, LA, CB	CE
354	OA, OB, MB		MC, LA, OD, CE, Y, OC, MA
355	OD, CE, OC, OF, MD	OA	Y, (I), MC, LA, CM
356b	MSS. gen.	LA	
357	MC, OD, OF, MD, CM	OA, LA, OC	Y, (I), CE, OG
357	OD, MC, LA, OF, MD, CM	OA, OC	Y, (I), CE, OG
357	MC, LA, CM, ME, MD		Y, (I), OA, CE
357b	OD, MC, LA, CE, OC, OF, MD, ME	OA	(I), Y
359b	MSS. gen.		OD, ME, CM
366b	OD, CM	OA	MSS. gen.
370b	OC, ME, CM	OA	Y, (I), CE, OD, MC, LA
373	OD, CE, MC, LA, OC, MD, ME	OA	(I), OF, OG
373b	OD, CE, MC, LA, OC, OF, OG	OA	(I), Y, ME
374	OD, MC, LA, Y, (I)	OA	OC, CE, ME
375	OD, CE, MC, LA, OC, OF, ME	OA	(I), Y
375b	MSS. gen.	OA	ME, CM

THE ADDICIONES

FOLIO IN V	IN MAIN TEXT	MARGINAL	OMITTED
375b	OD, CE, MC, LA, OC, OF, ME	OA	(I), Y
375b	OD, CE, MC, LA, OC, MD	OA	(I), Y, ME, OF
376b	OD, CE, MC, LA, OC, MD	OA	(I), Y, OF, ME, OG
377	OD, CE, MC, OC, MD, ME	OA	Y, (I), OF
378	OD, MC, LA, ME, MH	OC	(I), Y, OA, CE, OF
381	OD, CE, OC, OF, OG, LC, ME	OA	(I), Y, MC, LA
382	OD, CE, MC, LA, OC, OF, ME, LC	OA	(I), Y
384b	MSS. gen.		ME, CM
385	CE, OC, OF, OG, MD	OA, LA, OE	(I), Y, OD, MC, LC
386b	MC, LC, LT, LD	LA	MSS. gen.
390b	MC, CE, OC, OF, LC	OA, LA	Y, (I), OD
409b	MC, CE, OC, MD, ME, LC	LA	Y, (I), OA, OD, OF, CC
411	MC, LC	LA, OC	(I), OA, CE, OD, ME, MH, LA
412b	MC, CE, OC, MD, ME, LC	LA	(I), OA, CC, Y
413	MSS. gen.		(II)
413	MSS. gen.	CB	(II)
413	MSS. gen.		OM, HA, LT, LF
414	MSS. gen. (different places)		ML
414b	MSS. gen.		LA, LF
416	MC, LA, OC, CE, MD, ME, MM, MH, P		Y, (I), OA, OD, MG, MF, ML
417	MSS. gen.		OA, OE, MG
417	MC, LA, ME, MM, MH, P		Y, (I), OA, OD, CE, OC, OF, MF
417b	MC, LA, OC, MD, CE, OA, MG, ME, MM, P		Y, (I), OD, MF, ML
418	MC, LA, OC, MD, CE, ME, MH, P		Y, (I), OA, OD, MG, MF, MM
418	MSS. gen. (different places)	LA	
419	MC, LA, OC, MD, CE		Y, (I), OA, OD, OF, ME
422b	MC, OA, CC		(I), CE, CM
426b	MC	LA	(I), Y, OA, OC, CE, ME
430	(I), MC, Y		OA, OC, CC, CE, ME, LA
430b	MSS. gen. (different places)		CE, OC
430b	MSS. gen.		ME, MH
435b	MSS. gen.		OA, OF, MG
436b	MSS. gen. (different places)		LA, OD, OC, CE

Here is a heterogeneous mass of information. Doubtless there is valuable evidence in this material. But just what the important points are is not made evident by the general impression created. The one fact which stands out so insistently as to throw all others into the background is that the manuscripts do not follow any consistent policy in their treatment of the *addiciones*. Nothing else is easily discernible. If there is any combination or association of facts which is of wide enough influence to make possible the formulation of a rule or law it must be discovered by a process of dissection. The real

question is as to whether or not it will in any way be possible to use the tabulated data just given so that it will show whether or not the manuscripts, especially in (III), maintain in their *addiciones* the same general relationship as for their main texts. In other words, will it be possible to treat the manuscripts in (III) as a group when the question of the authorship of the *addiciones* is under consideration, or will it be necessary to make a careful examination of each manuscript for each passage in order to determine the origin of the individual *addicio*?

No one of the other manuscripts considered, either within or without group (III), has any scheme for the *addiciones* which fits into that division of the text made by the different hands in OA. For hand II, OA has the additional passages mostly, though not entirely, in the margin. LA has something more than half of the passages in the margin, with about as many in the main text as are omitted altogether. OD and MC give nearly all the passages in their main text. CE most clearly shows lines of demarcation, having in its text all the *addiciones* between fs. 113-151, and omitting every one between fs. 181-213b. But a further scrutiny makes it plain that these are but sections of larger blocks of text in CE which show the same traits, and do not conform to the boundaries set by OA's different hands. On the basis of their own standards the manuscripts do not agree as to what is additional matter. OA has in the margin passages which the other manuscripts omit; it has also in the margin passages which they (including CE and LA) give regularly in the text. LA has in the margin passages which the other manuscripts (including OA and CE) have regularly. Both OA and LA have in the margin passages found in (I). CE gives in its main text many *addiciones* which are omitted from the text of OA and LA though found in (I). LA has in its text passages which are omitted in the texts of OA, CE, (I). CE, OA, LA, (I), omit in the main text many passages found in the other manuscripts. If other portions of text as marked off by the other hands in OA are examined at all in detail the same general conditions will be found to exist. LA has marginalia for some parts of its text, omits the *addiciones* in other places, and gives them in the main text at yet others. CE goes on for folio after folio with no *addiciones* in either text or margin, and then suddenly alters its method and for another long portion of the treatise incorporates all the additional passages. Changes occur in the way in which group (I) handles the additional passages, while OD, MC, and (II) for the most part continue to give them in the text. But whatever the

changes which take place, they will be seen to occur quite independently of any scheme of division connected with the different hands in OA.

But little better results are obtained by working along other lines. When taken individually some of the manuscripts show distinctly different methods of treating the *addiciones* for different and well-defined portions of text. At times, too, it is possible to arrange a scheme which for a certain amount of text will apply to a limited combination of manuscripts. But even after this has been done the significance of the result is not plain. No single manuscript has a plan for the treatment or arrangement of the *addiciones* which covers the whole treatise. Even the best defined schemes take in only fragments of the whole work. And there is not discoverable any continued connection between the plan followed by one manuscript or group and that adopted by another. For the three larger groups one of the facts made clear by the collation of the twelve passages is emphasized here, that considering the treatise as a whole, (I) usually omits the *addiciones*, (II) usually gives them in the main text, while in (III) some of the manuscripts give and some omit. From the standpoint of discovering any group policy for the treatment of additional matter, an analysis of the individual manuscripts in (III) is barren of results. Thus CE has the *addiciones* in the text for what in V are fs. 45-151, 218b-226, 272b-282, 373b-419; it omits the same kind of passages on fs. 12-43b, 181-218, 228-271, 283b-370; on fs. 152-180b, 422 to end, the *addiciones* are sometimes put in the text and sometimes omitted. The method followed by OA has already been discussed. LA has in the margin, with now and then a scattered omission, the *addiciones* which come on the following folios of the printed text: 40b-82b, 99b-142b, 155b-192b, 206-219, 310-341, 385-412b; they are omitted on fs. 12-23b, 32b-36, 83b-96, 141-152, 265-298; they are found in the text on fs. 196b-203-212, 357-382; in other places they are found in the text or in the margin or are omitted without any apparent regularity. MC usually gives the *addiciones* in the main text; they are now and then omitted, notably on fs. 12-23b, 32b-34, 283b-298—in this latter block in every instance. OD has even more of these passages in its text, its omissions or marginal passages being merely occasional. For two or three rather small blocks of text there is a general agreement in omissions between MC and LA. But for the text as a whole these two manuscripts are far from agreeing as to either the presence or absence of *addiciones*. The collation already made of parts of their main text and some few *addiciones* really tells us far more than any information which can be gathered from the fact of their having or not having

additional passages in certain blocks of text. CE agrees no better with MC or LA in this respect than it does with OA. No matter what the angle of approach, there is no method of dealing with the occurrence or omission of *addiciones* in (III) as a group which will suggest anything as to the origin of the passages themselves or the interrelationship of the manuscripts in the matter of such passages.

Though a consideration of the facts tabulated above does not by any ready method solve the problem of authorship of the *addiciones* or the relationship of the manuscripts in (III) in regard to them, it does result in raising questions, the attempt to answer which requires a still further sifting of the facts at hand. Not that these questions can always be answered. But some of the problems are workable enough to be carried at least a certain distance towards solution.

For instance, how may the position taken by (I) in this matter be explained? For by far the greater portion of the treatise the manuscripts in this group omit the additional passages, but there is one large section of text in which they are given almost without exception, and another portion in which they sometimes occur and are sometimes omitted. The *addiciones* on fs. 1-43b are omitted without exception. For fs. 45-151 they are given with practically no exceptions. On fs. 152-182 they are usually to be found in the text, though sometimes omitted; on fs. 183-198 they are more often omitted than given in the text. From f. 200 on, with some few exceptions, they are omitted. Comparing other manuscripts for these same blocks of text we find that only CE and Y at all come into the scheme of (I). For a certain number of *addiciones*, beginning on f. 12, it looks as though there was a combination of manuscripts, including OA, LA, MC, which agreed with (I), CE, and Y in omitting the additional passages. As soon as any detailed comparison is made, however, it is seen that though OA consistently omits the *addiciones* in its main text (as it for the most part does except towards the very end of the treatise), MC and LA follow several different courses. Though they omit the additional passages for fs. 12-23b they elsewhere within this particular section of text (fs. 1-43b) follow no regular rule for either giving or omitting the *addiciones*, and disagree with one another in their omissions. OD and OC, with the passages usually in the text, clearly run on their way independently of one another and of (I), CE, Y. Through f. 37 the passages are occasionally marginal in some manuscripts, particularly in LC and ME, and commencing with the *addicio* on f. 40b, LA gives half a score of consecutive *addiciones* in the

margin. But in none of these manuscripts do the places where changes occur coincide with the breaks in (I), CE, Y. When f. 45 is reached (I), CE, Y, make a sudden change which the other manuscripts do not follow. From this point on through f. 151 they have, with one or two exceptions, the additional passages in the main text, agreeing in this with the manuscripts generally. Inasmuch as this block of text takes in portions from three different hands in OA, two of which have marginal *addiciones*, and one of which does not, that manuscript either omits or has in the margin. LA is similar to OA in this respect, though the two manuscripts do not agree on either the marginal passages or the omissions. OC omits a fifth part of the passages—within a space of thirty folios, however, so that its omissions are not at all general. OD is once marginal; MC and ML omit once or twice. But it is only OA and LA that regularly omit the *addiciones* from their main text for this portion of the treatise. Between fs. 152 and 182 this same statement holds true for the most part, though LA now and then has an *addicio* in the text. But CE and Y do not follow (I) as faithfully as for fs. 45-151. Not only do these two manuscripts several times omit passages found in (I), but the latter group in turn refuses to receive *addiciones* which find a place in CE. For fs. 183-198 CE and Y regularly omit, and for a good two-thirds of the passages (I) agrees with them. OA is marginal throughout; LA is marginal for fs. 183b-192b, but from that point till f. 206 is reached gives the passages in the main text or omits them altogether. Fs. 200-444 do not need to be discussed in detail at this time. If the whole body of *addiciones* is looked over it will be seen that the manuscripts which may be regarded as in any large measure omitting these passages in their main texts—in contrast to those manuscripts which generally give them—are OA, LA, CE, Y, (I). Just at present we are more directly concerned with (I). How did it come about that for over one hundred folios of the printed text this group has incorporated all the *addiciones*?

Fortunately, the attempted answer to that question does not have to be made entirely on the basis of the information to be derived from the presence or absence in the texts of the *addiciones* themselves. Something more has been learned from the collation and comparison of the texts. And such knowledge as has been acquired makes it at once evident that the only explanation which will account for the incorporated *addiciones* in (I) on fs. 45-151 is either that this portion of the treatise had been thoroughly worked over by Bracton before (I) split off as a side line, or that some common

ancestor of that group had been supplied for this portion of the treatise with marginal *addiciones* which later became incorporated in the text of its descendants. No other explanation fits into all the circumstances of the case.

The first suggestion is not as fantastical as it may at first appear, in spite of the fact that it is not possible to hit upon any reasonable motive why Bracton should have first worked over a part of his text not limited or bounded by any of the natural divisions of the treatise. To begin with, the *addiciones* in this particular portion of the treatise for which (I) is willing to stand sponsor are supported by the manuscripts in general, including with hardly any exceptions OD, MC, CE, Y. Take the passage on f. 45. It is altogether probable that the manuscripts here follow in their main text the same lines of descent as were shown by the collation to apply to the passage on fs. 33-35. On this basis the seventeen manuscripts compared for the *addicio* on f. 45 represent four sub-groups in (I), four sub-groups in (III), and all the available manuscripts in (III). Out of these OA and LA are the only ones which omit from the main text, and the latter is marginal. This passage is therefore very generally supported by (I), (II), and (III). For the *addicio* on f. 46b there have been examined nineteen manuscripts which fully represent the principal sub-groups of (I), (II), and (III). Again OA and LA are the only manuscripts which omit in the main text, LA as before being marginal. For f. 47 sixteen manuscripts representing the usual sub-groups have been compared. OA and LA alone omit. The same statements apply to the passage on f. 49 for which eighteen broadly representative manuscripts have been compared. Even more striking is the result of the comparison of the *addicio* on f. 52. Out of thirty-nine manuscripts, all but four have the passage either at the end of section one or following section two. One manuscript has in both places. Two mark it as additional. Of the four which do not give it, ML and LF are semi-abbreviated texts, frequently omitting passages of very considerable length which are unquestionably parts of the text proper. This again places OA and LA by themselves. Out of thirty-seven typical manuscripts, representing all groups and sub-groups, they alone omit. In general, the same conditions are met with in the other additional passages within the limits of fs. 45-151. Now and then another manuscript or two will be found to omit the passage with OA and LA, but for the most part these two texts stand alone in this respect. It is possible, too, that in some cases, as notably in that of OC for fs. 67b-95b, the manuscripts tabulated as omitting may in reality have the passage in some part of the text so far removed from the regular place as to have

escaped detection. In the particular block of text just mentioned many of the *addiciones* are very short and not easily noticed, and OC has a number of them in more than usually out of the way places. In this manuscript the *addicio* on f. 92 is given at a point over three folios beyond the place where it occurs in V. But even when these occasional omissions are counted, the great majority, in fact almost all, of the *addiciones* incorporated by (I) in this large section of text are so unusually well recommended as to be distinctly noticeable in this respect.

There naturally arises the query as to whether at this place (I) may not be giving *addiciones* peculiar originally to (II), which have in some way become incorporated in the text of a group to which they did not at first belong. No indication of such a thing is in any way apparent. It should be kept in mind that in only a comparatively few cases is the *addicio* long enough to yield on collation a workable number of determinative variants. Several *addiciones* have been collated for this portion of text; they do not reveal anything which suggests a borrowing by (I) from (II). In fact, instead of showing any tendency to agree with (II), the manuscripts in (I) split off into the same sub-groups for the *addiciones* as for the main text. This means, of course, that these *addiciones* have been in (I) from the time when it began to develop as a group by itself, and this antedates the formation of (II). Of further significance in this connection is the omission made by (I) on f. 45b. Fifteen manuscripts representing four sub-groups in (I), four sub-groups in (II), and four of the five manuscripts in (III) have been compared. The passage is found in all the representatives of (II), which assign it to three different places. This indicates that it goes pretty well back to the fountain source of (II). MC has it in the text, but marks it as additional. LA gives it in the margin. But OA, CE, (I)—except MD, which as so often in the *addiciones* follows OC—omit. It is manifest that this passage rests upon authority quite different from that supporting either the *addicio* immediately before or the one next following, or most of the other passages of like nature in fs. 45-151. And there is here further proof that (I) has not taken its additional passages from (II).

This does not mean that the *addiciones* in (I) for this hundred folios may not have come from some source outside of the group itself. It is altogether possible that the common ancestor of the nucleus of (I) took into the margins of a certain number of its folios or quires additional passages from a source different from that from which its main text had been derived—just as OA

has done in its own case. But the fact which stands out, especially when the variant readings in the *addiciones* are studied, is that these passages have been a long time in the text of (I). In these variants this group often stands noticeably by itself. As bearing on the general relationship not only of (I), CE, Y, but also of LA and OA, the following variant readings may be given. The small number of determinative variants which even the long *addiciones* yield illustrates well the difficulty of trying to solve the whole problem of the additional passages merely by a collation of some of them. The two *addiciones* on fs. 114-114b (= sect. 5) give these variants: l. 20, *si mulier*, OA, LA, *similiter*, (I), CE, Y; l. 21, *L. prima quod autem ubi dicitur*, OA, LA, *L. . . . autem ibi dicitur*, CE; *L. . . . ubi autem dicitur*, (I), Y; l. 18, *cum*, (I), *quod cum*, OA, LA, CE, Y; l. 24, *mihi duas*, (I), *duas mihi*, other manuscripts; l. 27, *proponere possum*, (I), CE, Y, *possum proponere*, OA, LA; l. 45, *ubi*, (I), CE, Y, *ibi*, OA, LA; l. 8, *similes et*, (I), *similesque*, other manuscripts. There is no close connection between the manuscripts in (I) representing different sub-groups, as OB and MA for instance, nor between CE and Y; both OA and LA have so many omissions and readings peculiar to themselves alone that they could not possibly have been copied either one from the other, or even from a common original. CM, which omits the first of these passages, but not the second, shows no relationship with OA, LA, or (I), CE, Y. The *addicio* of ten lines on f. 132b yields but two variants which can be used in this discussion—l. 25, *poterit*, OA, LA, P, *potest*, CE, Y, (I), CM; l. 26, *contrarium*, (I), *probetur contrarium*, the other manuscripts. The long *addicio* which takes up most of sect. 13, f. 133, gives better variant material, as, l. 4, omit *et ubi nec de iure nec de gratia*, (I); l. 10, *vera causa*, (I); l. 12, *prædicta ratio*, OA, LA, *prædictarum*, (I), CE, Y, *prædictorum*, P, *prædictarum causa*, CM; l. 13, *debeat*, CE, Y, *debutit*, other manuscripts; l. 14, *vera*, (I), *causa vera*, CE, Y, *vera causa*, OA, LA, P, CM; l. 17, *factam*, (I), CE, Y, *rite factam*, other manuscripts; l. 20, *felone*, OA, LA, *feloniæ*, CM, (P seems to have been corrected from *feloniæ* to *felone*), *felonia*, (I), CE, Y; l. 22, *omnia*, (I), *ad omnia*, other manuscripts; l. 31, *sit*, CE, Y, other manuscripts have *fuit* or *fuerit*; l. 32, *alio*, OA, LA, *in alio*, other manuscripts; l. 33, *utlagari*, (I), CE, Y, *inlagari*, other manuscripts; l. 35, omit *omnino*, (I); l. 36, *de iure non*, (I), *non de iure*, other manuscripts; l. 39, *ex*, (I), CE, Y, *non ex*, other manuscripts; l. 46, *antenatus in vita patris utlagatus*, CE, Y, OA, *antenatus utlagatus in vita patris*, (I), LA, P, CM. Such indications of relationship for these passages as the variants bring out connect (I) with

CE and Y, and not with (II) or OA, LA. This is the same general relationship which is shown by the main text. It looks as though for fs. 45-151 at least, (I), CE and Y had all derived the *addiciones* from the same source. Such a source could not very well be far from the original itself. Doubtless some of the additions to the text which did not come from Bracton appeared very early in the life of the manuscripts' texts. Not for a moment can it be maintained that the age of an *addicio* is any sure proof of its authorship. And therefore the fact that these *addiciones* in (I) are very old does not stamp them at once as from Bracton. Like all the other additional matter they must each be subjected to individual examination before their case is decided. But their authenticity is so generally vouched for by the manuscripts at large that their presence in (I) does not at all make it necessary to alter the opinion expressed above, that the acceptance of an *addicio* by the representative members of (I), (II) and (III) is a very strong indication of its having come from Bracton's pen.

For fs. 152-183-198 there is no longer noticeable the decisive agreement between (I), CE, and Y, which is so clear for fs. 45-151. Not only does (I) more and more often omit, but both CE and Y frequently omit where (I) gives the *addicio* in the text. An omission by CE should not count against an *addicio*. Nor should the fact that it is omitted or marginal in OA or LA. That an additional passage from Bracton may meet with just such a reception from these three manuscripts is proven by the *subsequatur . . . de iure* passage on f. 161b, where out of forty manuscripts OA, LA, CE, and ML alone omit from the main text. These same four manuscripts are the only ones to omit the last nineteen lines of cap. III, f. 161b-162, *Item facit quis . . . per tale breve*, which may or may not be an *addicio*, but is most certainly from Bracton. In the case of both these passages (I) is clearly more correct than CE and ML and the text as originally written in OA and LA. Continuing this comparison for the next few *addiciones* we find: f. 163, ll. 7-9, in the main text of (I), OD, MC, P, X, W, OM, MF, LC, LD, omitted in CE, Y, ML, OC and (II) generally, marginal in OA, LA, CB; f. 163, l. 14, in the main text of (I), OD, MC, CE, Y, P, X, W, OM, MF, LC, LD, omitted in OC and (II) generally, marginal in OA and LA; f. 163, l. 40, in the main text of (I), CE, Y, OD, MC, OC and (II) generally, X, W, OM, LC, LD, omitted in ML, MF, P, marginal in OA and LA; fs. 165-165b, ll. 40-43, in the main text of OD, MC, OC and (II) generally, MF, LD, omitted in (I), CE, Y, P, ML, W, OM, marginal in OA and LA; f. 166, the rubric for section one, in the main text of OA, CE, MC, OD, (I), (II),

omitted in ML (both as rubric and in text), marginal in LA, Y; f. 166b, ll. 20-28, in the main text of OA, MC, CE, Y, (I), (II), omitted in ML, marginal in LA, Y. A comparison of these six *addiciones* is valuable because, as the figures in the list of *addiciones* below will show, a much larger number of manuscripts than usual have been examined for each one of them. In every instance the passage is omitted in ML and from the main text of LA. OA and Y (this is Y₂) also usually omit in the main text. CE omits only two out of the six, while (I) gives all the passages but one. In four of the six places (I) is unquestionably right in giving the passage; in the other two cases a decision as to what is correct is not so easily reached. The first *addicio* on f. 163 is omitted by CE and Y in addition to OC and the rest of (II). To offset this, OD and MC, as well as P, LD, W, X, and a number of other manuscripts, support (I) by giving it. Nothing can be learned from OA and LA, as they put in the margins all sorts of *addiciones* indiscriminately. And ML omits indiscriminately. The manuscripts are therefore about equally divided on the question as to whether this passage belongs in Bracton. Inasmuch as both CE and Y in this portion of their text omit passages which are clearly from Bracton (see fs. 161b, 166, 166b) too much weight must not be given to the fact that they omit here. Removing these two manuscripts from the discussion for the present leaves the manuscripts in group (II) alone to support the omission. This group usually gives the Bracton additions and others also, still it now and then omits a passage which is so generally accepted by both the other groups as to leave no doubt as to its authenticity. More significant than the omission in CE and Y is the backing which (I) receives from OD and MC. There is nowhere any indication that these two manuscripts in (III) have taken additional (or any other kind of) passages from (I). Nor is this a place where OD could have borrowed from (II), any more than (I) could have borrowed from CE, Y or (II). Moreover, the fact that P, W, MF, and other manuscripts support (I) is important. Turning to the passage itself, it may be seen that the position given it in V is not that in which it logically belongs. It should come at the end of the next or second next sentence. In either case this would cause two consecutive sentences to begin with *Incontinenti*. This raises the question as to whether the omission in (II) is not due to some scribe in the early history of that line having mistaken one *Incontinenti* for the other—most naturally a second for a first. This would be a very plausible explanation if there was anything to show that this sentence ever had such a position in the text. Doubtless it at first stood in the margin

opposite the place which has been indicated, whoever may have been the author of it. But in the two different places in which it has been found in the manuscripts examined it is further away from the correct spot than in V, and all three manuscripts which have it in the margin put it opposite the place where it is inserted in (I). Everything points to its having been an explanatory afterthought from some one's pen in the shape of a marginal *addicio*. Its exact status is not clear. We must regard it as of somewhat doubtful origin, while acknowledging that the manuscripts are rather favorable to its acceptance than otherwise. Fortunately, the passage amounts only to the definition, or explanation, of a phrase, the practical meaning of *incontinenti* being illustrated by typical examples on f. 163b.

The second passage about which there is a question as to the correctness of (I)'s position is that which comes on fs. 165-165b. Here as before OA and LA have in the margin, and Y, CE, ML omit, while OD and MC insert in the main text. But the position of (I) and (II) is just reversed, the former now omitting and the latter giving the *addicio*. P and W again follow (I), while LD and MF go over to the side of (II). This creates a situation very similar to that which exists for the passage on f. 163. For both these *addiciones* the evidence of OA, LA, CE, Y and ML may be discounted, as their attitude is the same in either place. In both cases the manuscripts which give the passage are OD, MC, LD; in one place they are supported by group (I) and in the other by the broadest combination of group (II), both (I) and (II) being further supported by a few manuscripts which for the main text—as shown by the collation of fs. 161-162b—do not belong within these particular groups. OD before this has been guilty of borrowing passages from (II), and so has LD. This passage is so short that a collation of it can not be expected to prove much one way or another, but it does not connect OD and LD in any way closely with OC, as was the case in some of the *addiciones* previously collated. In l. 41 OD omits the *tamen* which occurs in OC, LD, OA, MC, LA. For the last word on f. 165, LD, with CF and MF, has *secundum*, while the other manuscripts have the usual *secundo*. OA, MF, MC, LA, omit the *hoc* in the second line of f. 165b, though OD, LD, OC, MG, MH, ME, CB, CC, CF, do not. Of all the manuscripts collated, MC and LA alone omit *primam* in the last line of f. 165. This is fairly substantial proof that neither MC nor OD is following (II) as far as this particular *addicio* is concerned. While we can not be positive that this *addicio* has come from Bracton, the chances are rather in favor of his having been the author of it. It

is therefore on the same footing as the passage on f. 163, probably, though not positively, from Bracton. And all of this fits into the theory which has been advanced for the determination of the authorship of an *addicio* on the basis of the groups which vouch for it. According to that theory the following equations should, in general, be correct: (I) + (III) + (II) = an *addicio* from Bracton, (I) + (III) - (II) = an *addicio* from Bracton, (III) + (II) - (I) = an *addicio* from Bracton. The last two of these equations graphically represent the facts in regard to the two passages just considered. (I), then, is keeping within the demands of the theory in treating them as it does.

One other point should be discussed at this place. Judged on the basis of its marginal agreement we should expect to find LA agreeing in the readings of its *addiciones* with either OA or Y in this portion of the treatise. In the *addicio* near the beginning of f. 161b, LA agrees more closely with MC than with any other manuscript, while Y and OG have the largest number of variants in common. This is in keeping with the relationship which the manuscripts show for their main text. OA does not pair off with any other manuscript in its variants for the passage; CE omits. In the last *addicio* on f. 166b, which only ML omits and which LA and Y have in the margin, the relationship of the manuscripts has undergone a change. Most noticeable of all is the fact that out of the thirty manuscripts compared, OA, MC, CE and Y alone give *seisina* (instead of *feoffamento*) as the last word. In its readings, LA agrees no more closely with any one of these four than with any of the other twenty-five manuscripts collated. In l. 26, OA, CE and Y have *sicut* in place of *breve*; CE and Y omit the *firmarius* in the next line—the agreement in each instance being against all others. It is very clear that LA did not get this *addicio* from the same source as the manuscript with which it agrees in the text, MC, or from the same source as Y, which like LA is marginal here. If now we turn to the *addicio* already collated in sect. 5, f. 179b, which is marginal in OA and LC, omitted in (I), and inserted in the text of MC, LA, CE, Y, and manuscripts generally, we find MC and LA again pairing off as to variants, while Y agrees more closely with OG than with any other manuscript though showing in larger matters a fairly consistent agreement with CE. All these facts but emphasize what has before been stated, that a manuscript may agree with one line in its main text and with another line in the *addiciones*. It is clear also that the *addiciones* in the margin of a manuscript may have come down through a different tradition from the *addiciones* inserted in the text.

It is these aspects of the situation which make the facts pertaining to any scheme of omission or insertion of any block of *addiciones* by any combination of manuscripts so inadequate for the purpose of determining the authorship or value of those *addiciones*, either separately or together. If that portion of the text which has not yet been discussed were to be treated in the same way as fs. 1-43b, 45-151, 152-183-198, the same general sort of conditions would be found to exist. Here, as everywhere else in connection with the additional passages, there are numerous and constantly recurring contradictions. Taken as a whole, the *addiciones* when studied in detail bear out the evidence, which comes from many other sources, that even the earliest extant manuscripts are many removes from the original, and that every line has been affected to a greater or less degree by the results of a comparison with manuscripts in one or more other lines.

The details of relationship worked out for one portion of the treatise may not always be applied to other portions. Thus, as contradicting, or at least limiting, the evidence in regard to LA's marginalia on f. 166b, there may be cited the passage on f. 50b. This is important also because of the bearing it has upon the value of omissions in LA and OA. The text in V is incorrect because of an omission due to some scribe having lost his place in a repetition of similar words. It should read (ll. 7-12), *de quibusdam terris, et qui dixerunt quod sic apud Linc. Et qui dixerunt quod prædictus Rogerus domino rege apud Linc. . . .* Now just as V has jumped from one *et qui dixerunt quod* to the other, OA and LA have jumped from one *apud Linc.* to the other, reading, *et qui dixerunt quod sic apud Linc.* This is rather an agreement between these two manuscripts as regards the text than as to the *addiciones*. In more than one place earlier in this volume it has been pointed out that especially as regards structure, the leaving of space, and the beginning of new quires, there is so much similarity as to make evident some connection between certain parts of OA and LA. Just what the connection is the work thus far done has not made clear. For the passages collated, LA shows a closer textual relationship with MC than with OA, but it is not at all unlikely that when the manuscripts are collated entire, the Digby manuscript and the Lambeth manuscript for other portions of the text will reveal a much closer relationship. Moreover, it must not be forgotten that OA and LA have shown an agreement in variant readings for some of their *addiciones*, as was the case with the passages on fs. 114, 114b, 132b, 133. But it is not necessary to proceed longer on this line. The bringing together of more facts of this

sort would tend only to emphasize what is now plain enough—that none of the problems in connection with the *addiciones* can be worked out on the basis of either large or small combinations of manuscripts, or for large or small blocks of text.

This is discouraging in a way, but it does not at all necessarily imply that the data to be found in the list of *addiciones* are useless. Actually it means only that there is no apparent way of dealing with the *addiciones* in large numbers or for defined areas of text. Each *addicio* must be considered separately. This necessitates much more work, but it makes the general situation infinitely more simple. Not that even the individual treatment of each passage will clear up all questions. Some *addiciones* will have to remain on the doubtful list until the collation of the entire texts of several manuscripts has been completed, and even this may not be sufficient to settle the question of authorship in all cases. But for the larger number of passages, the facts stand out plainly enough to make a decision as to authorship possible. As far as (I) and (II) are concerned there is hardly ever any doubt. From the very nature of the manuscripts which make up that group it will not always be easy to decide whether or not (III) supports a given *addicio*, though the determination of such a fact is greatly simplified when the passages are taken up one by one. Moreover, the combined weight of many kinds of evidence, no one of which goes very far by itself, helps out materially when only a single *addicio* is being considered.

It is evident from the foregoing that a consideration of the problems presented by each *addicio* makes necessary the utilization of every possible bit of information, from every available source, bearing on the particular passage. In this connection it might be expected that some help could be got, sometimes at least, from the form or wording of the *addicio*, that the additions coming from Bracton would show certain characteristics of style or phrasing which would be lacking in *addiciones* from other sources. If the existence of such peculiarities could be established, it would be of great advantage in determining the probable authorship of doubtful passages. The subject is important enough to demand careful attention, notwithstanding the statement already made that *addiciones* from all sources are very much of a type. It is perfectly plain at the very beginning that no great differences in the matter of words and expressions would normally be found in *addiciones* from different sources. Whether Bracton or some one else did the writing, there were certain legal and technical expressions which could not be dispensed with.

And inasmuch as in almost every case the *addicio* would be but a further treatment of some suggestion in the main text, either supporting it or contradicting it or limiting it, the very same words and phrases would have to be employed in both places. It is altogether probable that any one reading Bracton with the intense interest which the writing of an *addicio* presupposes would have unconsciously absorbed so much of Bracton's style, so to speak, that his own marginal comments would more or less reflect not only the substance but also the form of the text which caused them. Bracton has no style which is peculiarly his own. Legal literature was hardly the ground on which style could flourish. The very demand for precision in the expression of legal ideas, the necessity of using constantly recurring phrases and formulas which had already become stereotyped, left but little opportunity for the development of anything which could be called literary characteristics. Taken as a whole, the *De Legibus* is unquestionably superior, both as regards diction and in general literary excellence, to either the earlier work of Glanvill or the numerous short tracts from the generation after Bracton. Yet if we choose certain portions of text in which the different writers are discussing the same subject, there is noticeable a very considerable degree of similarity both between Bracton and Glanvill and between Bracton and the later tracts.¹ Speaking broadly we may say that for small portions of text on the same subject the different legal writers of the thirteenth century show little, if any, difference of style or expression. Now if the exigencies of legal phraseology produce such a likeness between passages in Bracton and similar passages in other writers, much more do they produce this same likeness between the main text of the *De Legibus* and the intimately connected *addicio*. As a matter of fact, the *addicio* in most cases reads about as the text to which it refers. Broad lines of divergence being thus for the most part automatically excluded, it is inevitable that the *addiciones* should in most points of comparison be much alike. The form of the additional passage can therefore help but little in determining its authorship.

¹ The similarity between Bracton and Glanvill is not so readily apparent at first sight because of the different arrangement of matter in the two treatises. It shows up very plainly, however, when a detailed comparison of corresponding parts is made. Of the tracts, the *Magna Summa* of Hengham will be found to agree most closely with Bracton, chapters of the former corresponding to folios of the latter as follows: I—328, 329; II—329b, 330; IV—330, 330b; V—332 to 334; VI—334b; VII—337, 342, 343; VIII—365, 365b; IX—365b to 371b; X—375b to 379b; XI—367b to 368b; XII—380 to 383. In some passages *Hengham Magna* and the tract *Judicium Essoniorum* agree almost word for word. A similar agreement in the wording of some passages is found in the two tracts in Anglo-French, *Fet Asaver* and *Casus Placitorum*. A very interesting point of similarity is found in the use of the word *respondeo* to introduce the answer to a question already asked. It occurs in Bracton in both text proper and additional matter (as on fs. 148, 366b), and in *Hengham Magna* on pp. 43, 75. The writer of *Judicium Essoniorum* several times makes a similar use of the same word, usually in the phrase *ad quod sic respondeo*.

It should, however, be said that there are certain forms of expression which are found only in those *addiciones* which do not come from Bracton. They occur at the beginning of a passage and result from the desire of the writer to draw attention to a statement in the text rather than to explain or amplify it. Additional passages which begin with such expressions as *Nota*, *Ecc hic*, *Hoc videtur*, *Hoc quod dicitur*, are of this sort and can be classified at once. To the question as to whether or not there are some opening words which in the same way indicate that an *addicio* has come from Bracton, an answer cannot so readily be given. A study of the *addiciones* shows at once that while the passages may begin with almost any form of expression there are some words, or combination of words, used so often to introduce additional matter that they become marked as typical. Such are *Quia*, *Et* (or *Item*) *notandum*, *Si* (*Cum*) *autem*, *Item*, *Sed revera*, *Eodem* (*Et eodem*) *modo*. The reason for the frequent use of these words is at once apparent. They are the words which were most likely to be used for the bringing in of additional matter. What more natural than that the marginal explanation of a statement in the main text should begin with a *because*, or that an additional fact inserted on the page somewhere outside of the main text should be introduced with *and it is to be noted* or *and in the same way*? Bracton continually uses just these expressions in the main text, but that does not mean that he alone might use them in the *addiciones*. Some of the additional passages which undoubtedly come from the author begin with these words, but that is no proof that all the *addiciones* which have the same form of opening come from the same source. Some passages of very doubtful authorship begin with these typical expressions. The evidence as a whole warns us against too readily accepting all the *addiciones* with these beginnings as from Bracton's own pen.

On the other hand, the fact that an *addicio* reads contrary to its associated passage in the main text does not necessarily stamp it as of non-Bracton origin. There is every indication that Bracton finished the main part of his work some ten or twelve years before his death. Apparently, too, he never laid it aside as quite finished, but kept adding to it from time to time as opportunity or inclination prompted. Most of his *addiciones* probably come from this later period. This was a time of conflict and upheaval in England. We do not know with which of the parties Bracton sided; he may have had no strong partisan feeling. But in such a time of intense feeling he may well have come to alter some of his opinions. It is quite conceivable that a

passage written in the main text in 1250 might have quite a different ring from that of an *addicio* written fifteen years later.

Addiciones which have resulted from attempts to keep the treatise up to date are invariably from sources other than Bracton. The tremendous changes in the law introduced by Edward I seem to have affected the Bracton manuscripts at once. A very considerable portion of the total marginalia in these manuscripts has to do more or less directly with the legislation of that reign. We might expect that much the same sort of effect would have been produced upon Bracton by the Provisions of Westminster, if not by the Statute of Marlborough. But in his *addiciones* he nowhere seems to have made any effort to correct what the events of later years made either historical or legal anachronisms.

A question arises as to whether or not there is any special significance in the *Plus* with which some of the *addiciones* in MC are marked. The word itself tells plainly enough that the passage to which it refers has been taken into a text which did not originally contain it. But whether these additions were made by the scribe of MC itself, or by one or more of the copyists of the ancestors of MC, it is impossible to tell. In several places, MC expressly states that a particular passage is not found in another, or the other, book (*plus continetur in isto libro quam in alio*), but in every instance the statement has become a part of the body of the text, which is hardly the natural place for such a remark and leads us to infer that the copyist of MC has incorporated an explanatory side note found in the margin of an exemplar. Whatever its origin, the word is attached to passages of such varying degrees of authenticity that it can not be used as a safe guide to the authorship of the *addiciones* which it marks. The most reasonable explanation of its occurrence in MC is that it was used by some scribe to denote, indiscriminately, both passages taken from the margin of one manuscript into the main text of another, and passages in one manuscript which were found, on comparison, to be lacking in another.

A point of considerable actual importance, and of even greater interest, centers about the references to cases. In the printed book there are about five hundred of these references. The manuscripts show that some seventy of them are *addiciones*. Of these seventy some are undoubtedly from Bracton himself, some are clearly from other sources, but the majority must be put among the list of passages of doubtful origin. Ordinarily these case *addiciones* are not especially important except as they form parts of longer *addiciones*. At the best they are references to records and do not in any way affect the

meaning or import of the text. As the great majority of all the case references in the treatise go unchallenged there can not be the slightest doubt that Bracton himself is responsible for them. The fact that similar references are *addiciones* can not in any way affect Bracton's claim to be the first writer on English law to cite precedents of this sort. But these references in the doubtful *addiciones* do bear vitally on the question as to whether Bracton really invented this method of citing precedents or merely used in his book a custom which was common to the legal usage of his time. What was his object in making references to these cases? We can hardly believe that he expected his readers to look them up by referring to the rolls. Was he doing it because it had already become customary for lawyers to support their own contentions on a point of law by referring to cases already tried or to the decisions of great judges like Pateshull and Raleigh? In other words, was there such a generally well-understood way of citing cases of a former time that men after Bracton who wrote marginal *addiciones* in copies of his book naturally all used the same method, or were they following the fashion set by Bracton? We have already seen that while there is an abundance of cases, not mentioned in the treatise, in the margins of many manuscripts, these references are usually of an indefinite character, made chiefly for the annotator's own use and not at all in the usually exact form of Bracton's citations. Not all of Bracton's references are of the exact kind which refer definitely to a particular record. Some of them are of the sort that might easily have been made from memory, as will be seen later. But taken as a whole, Bracton's citations differ materially in form from most of those made by later annotators. While no citations similar in all respects to Bracton's can be found in the legal writings from the age immediately following him, there is abundant evidence to prove that the citing of precedents was common in the years which mark the end of Henry III's reign and the beginning of that of his son. In his *Magna Summa*, which was probably written between the years 1270-1275, Hengham refers to judgments of Henry de Bath (it is possible that Bracton is meant) and Roger de Turkilby. Rulings of these same two judges are to be found also in *Brevia Placitata*,¹ which in all probability comes from about the same time as the *Magna Summa*. Another tract from this same general period is the *Casus Placitorum*, or *Cas de Jugement* as it is called in some of the

¹ Thus in the Lambeth MS. 499, in the "defense" of the "Pone" is, "Solum Sire R. de Turkilby e H. de Baa lem deit dire quil en fu testmoine par la raison ke son perre ne savoit le quel il ioindreit bataille ou graunt assise." This same passage is found at the same place in *Brevia Placitata* in the Cambridge University Library MS. Ee, I, 1.

manuscripts. Its nature is explained by the longer title found in manuscript Lansdowne 467, *Casus quidam formati cum iudiciis redditis eisdem per insticiarios Regis*. In this tract reference is made to decisions not only of Bath and Turkilby, but also of Simon de Wauton, Alan de Wausand, Gilbert de Preston, and Henry of York.¹ The legislation of Edward I changed this practice at the same time that it changed the law. It became the fashion to cite not the judgments of Pateshull or Turkilby or Preston, but the statutes themselves. Thus Hengham in his later tract, the *Parva Summa*, written not long after 1285, refers to the Statutes of Merton, Gloucester, Westminster I, Westminster II. The *Modus Componendi Brevia*, another tract from after 1285, has references to the Statutes of Gloucester, Westminster I and Westminster II. The annotators of the Bracton manuscripts now began to make marginal references to the statutes by chapters, and in later written copies *addiciones* which are references to the statutes became imbedded in the text. But until this body of statutory law had developed, not only Bracton but many another thirteenth century legal writer in some way or other cited as precedents the decisions of great judges from the period immediately preceding. Bracton may have set this fashion. He was certainly not the only one to use such a method. We do not, therefore, have to regard an *addicio* as having come from Bracton merely because it is a reference to a case.

This matter of the references to cases which are *addiciones* is somewhat intimately connected with the question of the authorship and ownership of *Bracton's Note Book*. In the *Note Book* are nearly two thousand cases. Only a comparatively few of these are to be found in the treatise. A reference to a case in the *De Legibus*, either in the main text or as an *addicio*, may

¹ Some of these references in the *Casus* are especially interesting. Thus in MS. Ec, I, 1, f. 151b, "Nule assoyng de mal de lit ne igist fors al brief de dreyt overt ou clos, precipe in capite, solum sire H. de Ba la assoigne gist al brief de costome e de service apres graunt assise ou bataille gage." And on the same folio of the same MS., ". . . e purceo le excepcion ne fu pas mys avaunt vewe de tere demaundee en un brief de cosinage si estut le brief par Sir R. de Turk. e sire H. de Ba." From MS. Harley 1208 (f. 247b) we get, "Nul essoygne de mal de lit negist fors al bref de dreit overt ou clos, ceo est præcipe ou Cape. Teste R. de Thurkilby. Solum sire Henr. de Ba la essoygne igist en custime e de services, e apres grant assyse ou batayle gage." From the same (f. 244a), "Nul homme ne deit dire qe homme est weue, mes femme est weyve e homme utlage. Teste R. de Thurkilby," and, "Le bref qe lem apele Nuper obiit ne se estent plus avant qe sept annz ou quatorce a plus. Teste H. de Ba." From f. 249, "Si un homme demaunde vers un autre par bref de dreit, e il cunte vers son adversarie e il fayle quil ne die le tens le Rey, ou le tens de pes, ou des esplays en provaunt, e il seit avoyne il perd son cleym aremanaunt. Teste Andrea Crot, quia contingit ei." From f. 242b, "Le bref de entre ne curt pas plus loingain terme qe le bref de mort deauncestre. Teste W. de Ebor." From f. 243b, "Nul homme ne se put essonier apres ceo qe lun e lautre se unt mis en enqueste par lur emdegre si eu cas noun. Teste Alano de Wausande." From MS. Harley 748 (f. 199), "Le bref ke est apelle nuper obiit ne curt pas ontre vint annz apres la mort ses auncestres, e fu iuge a Norwyce. Teste N. de la Cour e mestre R. de Stanes." On f. 198b of this same MS., at the end of a passage having to do with a writ of cosinage, is, "Teste G. de Prestone." In other MSS. other judges are mentioned in a similar way.

therefore be authentic even if it is not in the *Note Book*. A vital question is as to whether or not every case which occurs in the *Note Book* and also in the treatise must have been inserted in the latter by the author. It is a noteworthy fact that the manuscripts give very doubtful support to some of the *addiciones* which are references to cases found in the *Note Book*. It is not always easy to explain this if we assume that Bracton wrote these additions. From such evidence as can be gotten together it seems so altogether probable as to be almost certain that the *Note Book* was made for Bracton and that he used it. But this does not preclude the possibility of some one else having made use of it after Bracton's death. Fitzherbert seems to have used it at a much later time.¹ It is quite within the limits of plausibility and reason that some one nearer to 1268 studied the book in connection with the treatise, much as Bracton did, and jotted down resulting marginalia in much the same way. More than one man annotated the *Note Book*.² Some of the most important annotations may not have come from Bracton at all. A later owner may have made far greater use of it than he. Whatever the facts on this point they can never be known. But there is nothing in what we do know that compels us to believe that everything in any way pertaining to the *Note Book* or associated with it is in some way also connected with Bracton. The case reference which is an *addicio* must be treated just the same as any other *addicio*, even though the case itself is found in the *Note Book*.

As all these case reference *addiciones* will be discussed in their proper places along with the other additional passages there is no need of considering them in order here. Some important points may, however, be brought out by comparing a few of them.

In the first place, the fact that the citation of a case agrees in form with Bracton's way of citing a case can not be depended on to prove anything about its authorship. The first three case *addiciones*, fs. 13, 23, 29, show this. The first two of these are in Bracton's regular style, and the second is found also in the *Note Book*, yet the manuscript authority on which they rest is so slight that at best they are of very doubtful origin. The third is in what must be regarded as an unusual form in spite of the fact that the same sort of comment occurs again on fs. 45, 49b. But because of the way in which it is supported by the manuscripts, this *addicio* has far better claims than either of the other two to be considered a part of the treatise. In many another

¹ *Bracton's Note Book*, I, 117.

² *Ibid.*, 61.

instance case *addiciones* which are similar to Bracton's references in form, and of which the case may be found in the *Note Book*, will be seen to rest upon what is anything but satisfactory manuscript authority. This is all the more worthy of consideration because at other times additions which are in this same correct form are clearly from Bracton. Compare, for instance, the three consecutive case reference *addiciones* on fs. 142b, 142b, 144b, one of which cases is found in the *Note Book* and the others not, but all of which are from Bracton's pen. From whatever point we may work it is difficult to explain the slender support given to some case *addiciones* and the general support given to others of exactly the same type if we proceed on the assumption that all these references which have the same form must have come from the same writer. And this is true in spite of the possibilities for contradictions and differences opened up by constant comparison and cross copying.

Nor does an irregularity in form in any way denote that the citation has been added by some person other than Bracton. The *sicut de itinere in comitatu Eborum* on f. 322, *sicut inveniri poterit in rotulo de termino* on f. 335b, *ex responso W. de Raleigh et G. de Segrave facto Ricardo Duket, qui expetiit eorum consilium in hoc casu* on f. 357, are references more or less blind, yet they are in additional passages whose authenticity is well attested by the manuscripts. The reference to Walter Muschet on f. 405, which is more unusual still, is even better supported by the manuscript texts. Of all the citations in irregular form, the one which would most naturally be regarded as having come from Bracton (f. 351b, *Martinus in banco anno septimo*) is very generally repudiated by the different text traditions, though the case itself is found in the *Note Book*. On the other hand, some of the references not in the usual form have most certainly not come from the author of the main text. Representative of this class of citations are those on fs. 194b, 292. These two *addiciones* also show that OA may have in the margin and OD in the main text references to cases not inserted by Bracton. Taken as a whole, the facts prove that an unusual form of citation can no more be depended on to prove or disprove any connection with Bracton than can the more regular forms.

The collated passages furnish three case reference *addiciones* which should be mentioned in passing, as the large number of manuscripts which have been compared at these places make possible fairly definite conclusions. The first two of these additions are important principally because they confirm what

has already been said as to the form of citation being no proof of origin one way or another. Both of them are of the Bracton type; each cites a case tried before that judge to whom Bracton was most fond of referring, Martin de Pateshull; in each instance the county, York, is the same; the dates are only two years apart, 5 and 3 Henry III. The *addicio* on f. 180 is strongly supported by the manuscripts, being found in every group and sub-group with the exception of (I); that on f. 320 is given only by (II) + MC, PH. Neither one of these cases is in the *Note Book*. The second is so consistently omitted by all the better manuscripts that only the fact that it corresponds in form so exactly to Bracton's own method of citation prevents us from at once refusing it a place in the treatise. The third of these citations is that found on f. 413, where the manuscripts differ both as to the judge and the year. (I) reads W. de Raleigh and 30 Henry III; (II) omits the passage entirely; the other manuscripts give Roger de Turkilby and the 29th year. In its reading (I) is wrong if no mistake has been made in the date by some scribe; the association of Turkilby and 29 Henry III is in all probability correct. The fact that this passage is found in all groups and sub-groups outside of (II) marks it as from Bracton. On this basis of authorship there are seemingly only two possible explanations for the disagreement in judge and year. One is that Bracton made an out and out mistake as he first wrote the citation and corrected it on his later revision of the treatise. This would explain why (I) has the wrong name and date, for, as has been stated several times before, this group evidently came from a very early and comparatively unrevised form of the treatise. The other explanation would be that Bracton cited a case tried before Raleigh, but not in 30 Henry III, which date, through the mistake of one of the earlier copyists, became almost immediately the year assigned to the case; an early attempt to remedy this made by some one other than Bracton almost as soon as the ancestor of (I) had been copied, resulted in Turkilby and the 29th year appearing in the other manuscripts. That Bracton was with Turkilby on his eyre for that year proves nothing one way or another. It can hardly be considered as strengthening the suggestion that Bracton made the citation wrongly at first and corrected it later, for it is difficult to understand how he could have been mistaken both as to the year and the judge when he himself had been on the same eyre. Still, he may have made such a slip. As bearing on the possibility of some copyist having made a mistake in the date of a case assigned to Raleigh, it should be pointed out that with this possible exception Bracton nowhere cites an

Eyre Roll which is not from either Raleigh or Pateshull, though in this manner he refers to these two judges some one hundred and thirty times.¹ Moreover, this was not the kind of a mistake about which a later annotator would be apt to concern himself; if some one besides the author made this correction it is unique. On the other hand, any one competent to make this emendation would in all likelihood know that Bracton was with Turkilby in 29 Henry III—it is even conceivable that the knowledge of this fact might have been the reason for the change in the citation having been made. The omission of the passage by group (II) can not be made to support any contention in this discussion because the very same manuscripts make exactly the same kind of an omission some few lines later in the reference to the case of Henry de Scaccario from 12 Henry III, which citation the other manuscripts, with the exception of OC, give regularly without the least indication that there is anything doubtful about it. What we can be certain about as regards this passage on f. 413 is that a mistake was made in a citation given by Bracton himself and later corrected; but whether the mistake was made by the author or by a copyist, whether the correcting was done by Bracton or some one after him, is uncertain.

Uncertainty in one form or another, or on one point or another, is a prevailing characteristic of the *addiciones* in general. All too often it is sufficient to prevent any positive assertion as to the authorship of a passage from being made. For this reason it is necessary to approach any question dealing with the actual origin of an *addicio* with considerable diffidence. It makes it necessary, also, to maintain a very conservative attitude in the matter of accepting or rejecting any particular *addicio*. So instead of eliminating much of the additional matter, all for which no thoroughly satisfactory authority can be found, it seems better and safer to eliminate only what is clearly not from Bracton, and to retain much as doubtful, marking it as such. By making use of this method of selection there will be no danger of repudiating anything which really belongs in the treatise. Moreover, there will in this way be preserved many thirteenth century *addiciones* which are instructive even if they do not come from Bracton. If mistakes are made in assigning to Bracton *addiciones* which do not belong to him, these mistakes will in all probability be rectified by the complete collation of many texts which is to follow. The discussion which accompanies each *addicio* in the list below enables us to balance uncertainties with a number of certainties, and furnishes

¹ *Note Book*, I, 55.

in most instances a fairly correct estimate of the relative, if not of the absolute, value and position of the different passages. The list of *addiciones* and doubtful passages follows.

LIST OF ADDITIONAL AND DOUBTFUL PASSAGES

Folio 3, lines 11-32.¹ *Quia est ius ius maius.* (Collated.) Regular in OC, OD, OM, MD, W, HA, PH. Omitted in OB, MA, MB, ME, MF, MK, ML, MN, CA, CE, CF, LC, LF, LG, LT, P, X, Y. Marginal (or marked additional) in OA, OC, OE, MC, MD, CB, LA. Inserted at the end of sect. 3, f. 3, in OF, OG, MC, MG, MH, LD, CB, B, CM, HB; after *civilibus*, l. 22, f. 3b, in CD. For a discussion of this passage see above, p. 333.

F. 6, ll. 25-27. *Hoc autem verum bona sua.* Regular in MG, MH, CM. Omitted in OA, OB, OC, OD, OE, MA, MB, MC, MD, CE, LA, P, Y, and manuscripts generally. Marginal in CB, HB, ME. Inserted at the end of cap. IX, f. 6b, in OF. Does not belong in the treatise. See *Bracton and Azo*, 71; *Law Quarterly Review*, I, 197.

F. 6, end of sect. 3. *Qui igitur ex vel pro avi.* Omitted in OA, OB, MA, MC, MD, MG, MN, CM, LA, P, and manuscripts generally. Does not belong in Bracton. See *Bracton and Azo*, 69, n. 2.

F. 7, ll. 20-24. *Sed si extra de imprisonmento.* Regular in OD. Omitted in OB, MB, MN, CE, Y. Marginal in OA, MA, LA, LC, OE (marked additional). Inserted after *qualitercumque apposuerit*, l. 6, in OF, MG, MH, CM, OE, B (marked additional); after *privilegium*, l. 9, in OC, MD; after *fugitivus*, l. 5, in MC. Origin doubtful; may well be one of Bracton's own additions. See *Bracton and Azo*, 81, n. 2.

F. 7, ll. 24-25. *Infra plus de et in fuga.* Omitted in OB, MB, MN, CE, Y, MG, MF. A rubric in red ink in OA, LA, MC; this means that in some ancestor, or ancestors, of these manuscripts the sentence once stood in the margin. Nothing can be told from the form of the sentence as it stands in the text. Bracton often uses *infra plus de hac materia* or a similar expression to direct the reader's attention onward, but there is no reason why later annotators should not have done the same thing. In some of the manuscripts this sentence regularly begins with *Invenies plus de hac*, which is

¹ In numbering the lines the headings of books and chapters have not been counted.

rather more like an annotator and less like Bracton. Since this *addicio* is at best no more than a mere notice, and as its presence does not in any way affect the rest of the text, the safest way is to retain it while emphasizing its doubtful origin. See *Bracton and Azo*, 81, n. 4.

F. 7, l. 42. *Nec compelli poterint . . . nisi voluerint.* Regular in OC, OD, OF, MC, MD, ME, MG, CM, LA. Omitted in OB, OE, MB, MN, CE, Y. Marked additional in B. Marginal in OA, MA, LC. Probably by Bracton himself; a typical afterthought. See *Bracton and Azo*, 83, n. 2.

F. 8, l. 10. *Nota hic . . . et commune.* Omitted in the manuscripts generally. Manifestly a late-written note.

F. 10, ll. 21-23. *Unde versus . . . radices egerit.* Regular in OD. Omitted in OA, OB, OC, OF, MA, MB, MC, CE, CM, and manuscripts generally. Not from Bracton. See *Bracton and Azo*, 121.

F. 12, ll. 14-17. *Et generaliter (regulariter) . . . ecclesie Dci.* Regular in OC, OD, OF, MD, CD (marks additional), ME, MG, CM. Omitted in OA, OB, MA, MB, MC, LA, CE, Y. Marked additional by B. Another *addicio* about whose origin it is hard to decide. The omission of the passage in OA and the members of group (I) can not be taken to mean anything of special significance, as these manuscripts do not give the *addiciones* in this portion of the treatise. But the omission by MC and LA is significant. The former codex especially is rich in additional passages, particularly those which the weight of evidence tends to assign to Bracton. The omission of this passage in MC, therefore, argues against its authenticity. In the form in which it is given in V, this sentence is, in a way, half contradictory to what has immediately preceded it. Bracton is giving a list of those kinds of persons who are not able to make a donation. A deaf man, *qui omnino non audit*, can not; but a person who is only hard of hearing may. A dumb person, *qui omnino loqui non potest*, may (*secundum quosdam*), for he is able to give his assent by signs and a nod. Then comes the *addicio*, *Et generaliter tenendum est quod mutus donationem facere non potest, quia donationi consentire non potest*, etc. But some of the manuscripts give a reading which supplements instead of opposes what has preceded—*Et generaliter tenendum est quod nullus donationem facere potest qui donationi consentire non possit*, etc. In this form the passage takes on the appearance of an afterthought by Bracton. Whether or not it is we can not with certainty say. Again the best way out of the difficulty is to retain the passage in the treatise while pointing out its doubtful authorship.

F. 13, ll. 35-37. *Vel procuratricem vel . . . in fine rotuli.* Regular in OC, MG, CM, B (marks additional). Omitted in OA, OB, MA, MB, MC, ME, MN, CC, CE, MD, LA, Y. This is clearly an added statement; the citation is made in the style of Bracton, but in view of the slender support given it by the manuscripts it is exceedingly doubtful if he was the author.

Fs. 13b-14, ll. 28-3. *Et sciendum quod . . . ad verum dominum.* Regular in OF, MG, MH, CM. Omitted in OA, OB, MA, MB, MC, MN, CE, LA, Y. On a separate slip of parchment in LC. Marked additional in B. Some manuscripts have divided this *addicio* into two parts, the second beginning with *Et generaliter poterit res*, and taking in the last five lines. MD marks the first part with *addicio tertia usque hoc*. W inserts the passage at the end of sect. 7, f. 14. The first part of it is put by OC and MD after *et alius terminum*, l. 25, f. 13b; the second part is inserted by MD after *procuratorem*, l. 35, f. 13, and in OC is put in the bottom margin and marked to come after *poterit donatio*, l. 34, f. 13b. This is clearly no part of the original text of Bracton. Its omission by group (I) is what we should expect. That it is also missing in the best manuscripts in (III) argues strongly for its having come from some other source than Bracton.

F. 14b, ll. 7-19. *Et notandum quod . . . et alius substituti.* Omitted in OA, OB, OD, MA, MB, MC, MN, CE, LA, Y. On a separate slip of parchment in LC. Inserted after *proprio vel alieno*, l. 5, f. 13, in OC, OG, MD (marks as *addicio secunda usque huc*); after *minoris*, l. 2, f. 13, in MH, MG, B (marks additional); at the end of sect. 5, f. 12b, in ME, W. This passage is clearly out of place in the position given to it in the printed text. Seemingly an early written *addicio*, but in all probability not from Bracton.

F. 15, end of sect. 9. For the *quod mediate subsequitur* of V read, *Breve autem de mittendo (ad mittendum) IIII milites ad impotentem ad audiendum confessionem suam et per (quod) breve istud procedit tale erit (breve)*, OA, OB, CE, LA, CM, MB, MC, MD, MG, MN, Y. Omitted in CC, ME. Used as a rubric in OC, MA. Apparently a part of the original text.

F. 16, l. 23. *Quia licet error . . . in re errant.* Regular in OC, CC, MC, MD, ME, CM, LA. Omitted in OA, OB, MA, MN, MB, CE, Y. Probably one of Bracton's own additions. A typical explanatory afterthought, introduced by the usual *quia*.

F. 16b, ll. 7-8. *Ut probatur C. . . . et L. sequenti.* Omitted in OA, OB, OC, OD, OE, OF, OG, MA, MB, MC, MD, ME, CE, CM, LA. Obviously not from Bracton.

Fs. 17b-18, ll. 43-24. *Notandum quod bene . . . quod non possit.* Omitted in OA, OB, OD, OE, MA, MB, MC, MN, CE, LA, Y. On a separate slip in LC. Inserted after *primus donator*, l. 14, f. 17b, in OF, MG, B (marks additional), MH (marks additional); after *de successioneibus*, l. 1, f. 17b, in OC, MD (marks as *quarta addicio usque hic*). Another additional passage of uncertain position, which the best manuscripts in groups (I) and (III) do not accept as a part of the treatise.

F. 21b, ll. 2-27. *Item liberum potest . . . teneat quam nullum.* Omitted in OA, OB, OD, MB, MN, MC, LA, CE, Y, MA (has four lines of this in margin). On a separate slip in LC. Marked as additional by OE. Inserted after *feodi possit pertinere*, last line, f. 21, in OF, MG, B (marks additional). In all three of these manuscripts (OF, MG, B) this applies only to the first part of the *addicio* through *inde forinseco servitio*, after which comes *et ita quod ille* (f. 21, last line) . . . *heres sit inclusivus* (l. 2, f. 21b). The rest of the *addicio*, beginning with *Item poterit quis dare*, follows *partem, vel non cadet*, l. 39, f. 22. The whole passage is inserted after *quod tenetur libere*, l. 22, f. 22, in OC (marks additional), MD (marks as *quinta addicio usque hic*). This is the fourth of those *addiciones* which are found on slips in LC. It is of the same type as the three which have preceded it, and what has been said of them applies in a general way to it also. Any *addicio* which, like this, is so generally repudiated by (I) and (III) has only the very slightest claims of having come from Bracton.

F. 23, ll. 25-27. *et de hac materia . . . de Ricardo le Hare.* Regular in OC, B (marks additional). Inserted after *expresse revocetur*, l. 31, f. 23, in MG, CM. Omitted in OA, OB, MA, MN, MC, MD, ME, CC, CE, LA, Y. This is one of the many passages which it is equally hard either to keep or throw away. The case cited is found in the *Note Book*; it has been annotated there; the point brought out in the case is identical with the explanation made by Bracton; the citation is in Bracton's regular form. Yet from the evidence of the manuscripts themselves we are hardly justified in making it a part of the treatise. At the best it is of extremely doubtful origin.

F. 23b, ll. 27-45. *Quia sicut tenementum succedere . . . decem, cuius loco succedit.* Regular in ME, OE (marks additional). On a separate slip in LC. Inserted after *suo feoffato*, l. 24, f. 23b, in OF, MG, CM, B (marks additional); after *tenentes remoti*, l. 6, f. 24, in OC (marks additional), MD (marks as *addicio sexta usque hic*). Omitted in OA, OB, OD, OG, MA, MB, MC, MN, CE, LA, Y. Another long *addicio* about whose authorship

we can not but be doubtful, with the weight of evidence against its having come from Bracton.

F. 25, ll. 6-13. *Et quid si dominus . . . et non prius.* Regular in OD, MD, MH, CM, OC (marks additional), B (marks additional). Marginal in LA, Y (later hand). Inserted at the end of sect. 1, f. 24b, in OE (marks additional), MC (marks *plus*). Omitted in OA, OB, MA, MB, ME, MN, CE. An early *addicio*, probably, though not certainly, from Bracton.

F. 26, ll. 14-20. *Dictum est . . . servus erit.* An interpolated reference to a case from the time of Edward I. Omitted by the manuscripts.

F. 26, ll. 32-33. *Ad hoc facit . . . regis per totum.* Omitted in OA, OC, OD, OF, OE, MA, MB, MC, CE, CM, LA, and manuscripts generally. Clearly not from Bracton.

F. 26b, ll. 39-42. *Hoc est quia si . . . sua revocatur.* Regular in OD, MD, CM, LA, MC (marks *plus*), B (marks additional), OC (marks additional). Marginal in ME. Omitted in OA, OB, OE, MA, MB, MN, CE, CC, Y. Though this *addicio* was written to explain a statement which hardly seems to need such an explanation, there is no reason why Bracton may not have been the author of it.

F. 27, ll. 1-6. *Et (si) per assisam . . . res donata.* Regular in LA, MC (marks *plus*). Marginal in OC, MA, MD. Inserted after *valebit testamentum*, l. 11, f. 27, in MH, CM. Omitted in OA, OB, MB, MN, CC, CE, ME, Y. In its nature this *addicio* is very similar to the one which almost immediately precedes it. In each case, taking into consideration the passage itself, its relation to the text, and the manuscript authority on which it rests, we can hardly do less than admit the probability of Bracton having been the writer.

F. 28, ll. 2-4. *Item pluribus . . . et successive.* Omitted in OC, OD, OE, CC. Used as a rubric in OA, OB, MA, MB, MC, MN, MG, MH, CE, CM, LA, Y, MD. Obviously this should not be made a part of the text proper.

F. 28. An *addicio* not in V—*Et imaginaria poterit esse donatio facta minori sicut maiori et colorata inter donatorem et curatorem quod quidem perpendi poterit multociens per subsequencia et per usum et per causas exteriores ut si donator tenetur creditores defraudare donatarios vel emptores.* Put at the end of cap. X, f. 28, in OC, MD. Inserted after *minorum*, l. 14, f. 28, in MG, CM, B (marks additional). Marginal in ME. Omitted in OA, OB, MA, MB, MC, MI, CE, LA, Y. One of the many *addiciones*—which can

hardly be accepted as Bracton's—found generally in the manuscripts of group (II), but repudiated by those in (I) and (III).

F. 28b, l. 28. *Et similiter animo presenti.* Regular in MD, CM, and some manuscripts in (II). Marginal in ME. Omitted in OA, OB, MA, MB, MC, MN, CC, CE, LA, Y. This addition savors of Bracton in both form and fitness, but the manuscripts do not give us sufficient authority to allow us to attribute it to him.

F. 29, ll. 37-40. *Contrarium tamen ipsius Godfridi.* Regular in OD, OF, MG, MH, CM, B (marks additional). Inserted after *debeant*, l. 42, LA, MC (marks *plus*); after *debent*, l. 43, LD. Marginal in ME. Omitted in OA, OB, OC, OE, MA, MB, MD, MN, CE, Y. References of this kind to bad judgments are found more than once in the *De Legibus*. See, for instance, *Casus iste evenit apud Clarindone et male fuit ibi terminatum* on f. 45, and *Male actum est in contrarium* on f. 49b. These two passages, which are additional, are so generally found in the manuscripts as to practically establish their right to a place in the treatise. This *addicio* on f. 29 is not so well supported by the manuscripts, but the evidence rather favors Bracton as the author. For documents bearing on Godfrey of Crewecombe and Robert of Muscegros, see Twiss's edition, II, xxii, 609, 610.

Fs. 29b-30, ll. 42-3. *Item nec pater heredibus suis.* Regular in MG, MH, CM. Inserted after *habuit*, l. 16, f. 30, MD, OC (marks additional); after *planum est*, l. 3, f. 30, OE (marks additional); after *capitalis*, l. 6, f. 30, MC (marks *plus*). Marginal in ME. Omitted in OA, OB, OD, MA, MB, MN, CC, CE, LA, Y. The evidence of the manuscripts against it puts this *addicio* in the doubtful list.

F. 32, ll. 5-31. *Vel quod id cum damno ecclesie.* Regular in OC (marks additional), OF (marks additional), MG (marks additional), MH (marks additional), MD, CM (marks additional). Marginal in ME. Inserted after *probationis*, l. 1, OD; after *constitutioni*, l. 36, MC (marks *plus*). Omitted in OA, OB, MA, MB, MN, CE, CC, LA, Y. This passage has so many of the earmarks of an *addicio* from Bracton that if form and content were the grounds on which the authorship of an *addicio* was to be decided it would naturally be attributed to the writer of the treatise. On the other hand, the authority of the manuscripts which challenge its authenticity is so considerable as to make its actual standing a matter of doubt.

Fs. 32b-33, ll. 37-29. *Item qui proprietatem aliud erit.* Regular in MD, OF, OC (marks additional), OD, OM, MF, MG, MH, MI, MK,

ML, CA, CB, CH, CM, LC, LD, HA, HB, B, X. Omitted in the other manuscripts. This *addicio* has been fully discussed on p. 330 above.

F. 33, last fifteen lines. *Ut si quis . . . tunc relevium*. Inserted in place of the *addicio de cartis*, end of sect. 3, f. 34, in OC, OG, MD, MI, CA, CD, CH, LC, LD; after *sockagium*, l. 12, f. 34b, in OF, OM, MG, MH, MK, CM, CB, HA, HB, LB, B. Marginal in OD, ME, Y. Omitted in the other manuscripts. A discussion of this passage will be found on p. 332, above.

Fs. 34-34b, ll. 33-1. *Item nec factum regis . . . et stridor dentium*. Regular in OD, OF, OM, MF, MG, MH, MK, CB, CM, HA, HB, LB, B, X. Inserted at the end of sect. 2, f. 34, in OC, OG, MD, ME, MI, CA, CH, LC, LD. Marginal in P. Omitted in the other manuscripts. For a full discussion of this important addition see p. 332, above.

F. 34b-35, ll. 39-2. *Hoc videtur . . . ut ibi*. Omitted in all the manuscripts except X.

F. 35b, ll. 29-32. *Ecce hic dicitur . . . ponit per exemplum*. Omitted by OA, OB, OC, OD, OF, MA, MB, MC, MD, MN, MG, MH, CC, CE, CM, LA. Clearly not from Bracton.

F. 36, ll. 38-41. *Sed quid . . . non poterit*. Regular in OC (marks additional), OD, MD (marks additional), MC (marks *plus*), MG, CC, CM (marks additional), LB (marks additional), MI. Marginal in MA, ME. Omitted in OA, OB, MB, MN, CE, LA. Judging from the passage itself and from the way in which it is vouched for by the manuscripts, this *addicio* should be assigned, tentatively at least, to Bracton.

F. 37, ll. 20-32. *In præiudicium domini regis . . . onerare se ipsum*. Regular in OC, OF, OM, W, MD, ME, MG, MH, MK, ML, LB, LD, CB. Insert after *cum evenerint*, l. 19, f. 37, MI, LC; after *regem*, l. 19, MC (marks *plus*), LA, X. Omitted in OA, OB, OD, MB, MF, MN, LF, MA, CC, CE, Y. To one studying the printed text, this passage might appear to be an omission rather than an *addicio* inasmuch as the words *potest et onerare se ipsum* both end it and immediately precede it. But the recurrence of these words in V is due to a repetition for which the manuscripts give no authority, the *remittere non potest . . . se ipsum* being found at but one place in the manuscript texts, the *addicio* itself either following or preceding. Without the additional passage, the text reads regularly as in group (I), *Ea vero quæ pertinent ad regem remittere non potest, obligare tamen potest et onerare se ipsum. Item poterit . . .* Group (II) agrees with V, except that all of the *addicio* after *alium* is omitted. OC and LA, with other manuscripts, insert the passage

after *pertinent ad regem*, reading at the end of the *addicio*, *alium*. *Remittere non potest obligare tamen potest et onerare se ipsum*. *Item* This is a very old *addicio*, but we can not be at all certain as to its authorship.

F. 38b, l. 20. *Ideo dicitur* *vel quasi*. Regular in OC. Used as a rubric in MI. Omitted in OA, OB, MA, MB, MC, MD, ME, MN, MG, CM, LA, Y. Clearly no part of the main text.

F. 40b, ll. 7-8. *Illud totum* *obligare potest*. Regular in OC, MD, MG, CM, MI. MB has as rubric. Omitted in OA, OB, MA, MN, MC, CE, LA, Y. This can hardly be from Bracton.

F. 40b, ll. 11-23. *Et cum animo* *qualis usus*. Regular in OD. Inserted after sect. 1, f. 39b, in MI; after *tenementum*, l. 23, f. 40, in OC (marks additional), OF (marks additional), OM, and MG, MH, LB, CM, all of which mark as additional; after *suis*, l. 9, f. 40, in MC (marks *plus*); after *commodum*, l. 26, f. 40, in MD. Marginal in LA. Omitted in OA, OB, MA, MB, ME, MN, CC, CE, Y. Before deciding on the authorship of this passage, it will be well to await such evidence as the collation of manuscripts in different lines may bring out. It is clearly an early *addicio*, possibly from Bracton himself.

F. 41, ll. 10-22. *Item videndum* *vel non procedat*. Regular in OD and OC, B (mark additional), MD, MG, MH, CM. Insert after *nomine suo*, l. 23, f. 41b, MC (marks *plus*). Marginal in LA. Omitted in OA, OB, MA, MB, ME, MN, CC, CE, Y. This *addicio* rests upon the same basis as the one immediately preceding, as far as its origin may be judged from the available data. If the collation which is to follow shows sub-groups to exist for it in (II), and distinct group characteristics in the manuscripts of group (III), it in all probability belongs to Bracton. Otherwise it must be put in the list of doubtful passages.

F. 41, ll. 22-46. *Acquiritur res* *suo proprio*. Regular in OD. Inserted after *sicut traditio*, l. 18, f. 40, in MC (which marks the whole of sect. 3 with *plus*, and inserts at this point); after *convalescit*, l. 40, f. 40, in OM, MH, CM, and OF, MG, LB (which mark additional); after *parit ius*, l. 33, f. 40, in MD, OC (marks additional). Marginal in LA. Omitted in OA, OB, MA, MB, MN, ME, CE, Y.

Fs. 41-41b, ll. 46-2. *Attornatus fuerit* *tempore, etc.* These lines have been given separately because they are clearly additional and are treated differently by different manuscripts. They are omitted by OA, OB, MA, MB, MN, MD, ME, CE, Y. In some manuscripts they are made part of

the preceding *addicio*. Inserted after *habet*, l. 28, f. 40b, in MH, CM, and other manuscripts.

F. 41b, ll. 2-19. *Item sufficit . . . datum vel venditum*. Regular in OD. Marginal in LA. Omitted in OA, OB, MA, MB, ME, MN, CE, Y. Inserted after *habet*, l. 28, f. 40b, with ll. 46-2, fs. 41-41b, preceding, in MH, CM, and OM, LB, B (which mark additional); after *dominum*, l. 6, f. 40b, in MD, OC (marks additional). The facts given in this and the two paragraphs immediately preceding mean that the whole of sect. 3 is additional, the passage being divided by different manuscripts at different points. There may be here either one long *addicio*, or two *addiciones* which in some of the manuscript texts have been brought together. The division of a single *addicio* into two parts would be more likely to happen than the joining into one of two such passages, though under certain conditions of juxtaposition this latter change might easily take place. We can be sure that at one time all of this stood in the margin—only marginalia would find so many different resting places in the body of the text. The evidence already at hand tends to assign it to Bracton; the passage itself is so long that the collation of it may be trusted to determine its origin.

F. 41b, ll. 29-38. *Desinit donator . . . libere intravit*. Regular in OD, MC (marks *plus*). Inserted after *infra de assisa*, l. 46, in MD, OC (marks additional); after *nihil sibi acquirit*, l. 11, f. 42, in OM, MI, and CB, B (which mark additional). Marginal in LA. Omitted in OA, OB, MA, MB, ME, MN, CC, CE, Y. This *addicio* should be considered in the same class as the one immediately preceding.

F. 43b, ll. 11-24. *Dum tamen . . . sicut aliis*. Regular in OM, MI, MH, CM, B (marks additional), OC (marks additional). Marginal in LA. Inserted after *procuratores*, l. 9, f. 43b, in MD. Omitted in OA, OB, OD, MA, MB, ME, MN, CE, Y. A portion of text equal to one and one-half folios of the printed text is missing in MC at this point. This passage has all the earmarks of having come from Bracton, but it is not possible to get positive assurance on that point.

F. 45, ll. 3-12. *Et quid si . . . et donatorem*. Regular in OB, OD, MA, MB, MC, MD, MN, ME, CE, OC (marks additional). Inserted after *feoffati*, l. 1, in OM, MH, CB, CM, B, all of which mark additional. Omitted in OA. Marginal in LA. This must be regarded as an *addicio* from Bracton. Notice that the passage contains a reference to a bad judgment on the part of John of Lexington.

F. 45b, ll. 25-27. *Et generaliter . . . possessione, ne possit.* Regular in CM, and CB, B, MC (which mark additional). Inserted after *damnum*, l. 21, in OC, MD; after *potest*, l. 23, in MI. Marginal in LA. Omitted in OA, OB, MB, ME, MN, CC, CE. As this passage occurs in a portion of the text where the *addiciones* are very generally given by group (I), the fact that these manuscripts repudiate this passage is strong evidence of a non-Bracton origin.

F. 46b, ll. 15-32. *Si tenens meus . . . supra dictum est.* Regular in OD, OF (marks additional). Inserted after *liccat*, l. 35, in MD, OC (marks additional); after *dissimulaverit*, l. 11, in OB, MA, MB, MC, ME, MD (which agrees also with OC), MN, CE, W; after *prohibetur*, l. 39, in OM, MH, and MG, B (which mark additional). Marginal in LA. Omitted in OA. An *addicio* which is clearly from Bracton himself.

F. 47, ll. 13, 14. *Videlicet, ut conditio . . . non ad donatorium.* Regular in W, OC, MD, MG, and OM, MH (which mark additional). Inserted after *feodo*, l. 12, in OB, MA, MB, MC, MN, CC, CE. Omitted in LA, OA. Marginal in W, which has also in text. Apparently from Bracton.

F. 49b, ll. 15-41. *Item si in carta . . . nihil acquirit.* Regular in OB, MA, MB, MC, MH, MN, MI, ME, CE. Inserted after *si Anselmus*, l. 30, f. 50, in OF, OM, CB; after *quarto*, l. 20, in OC, MD. Marginal in LA. Omitted in OA. Another *addicio* which contains within itself a reference to a judgment badly given. This should be compared with the similar remarks in the additional passages on fs. 29, 45. See *Note Book*, I, 39, 40, for a discussion of this case. On every basis of determination, this is an *addicio* from Bracton.

F. 50b, ll. 7-12. *Et qui dixerunt . . . dedit domino regi.* Inserted after *mortem*, l. 24, in CB (marks additional). Regular in OB, MA, MB, MC, MD, ME, MN, CM, CE. A slightly different portion of text is omitted in OA and LA. In all probability an omission and not an *addicio*. See a discussion of this passage on p. 361, above.

F. 51b, ll. 21-24. *Ecce hic . . . fructus.* Omitted in OA, OB, OC, MA, MN, CC, CE, Y, ME, LA, CM. A typical remark from one of the later writers of marginalia.

F. 52, ll. 7-9. *Et nota . . . veri domini.* Omitted by the manuscripts generally. This is a mere *Nota* by some later writer. It is really a repetition of ll. 34, 35 on this same folio.

F. 52, ll. 35-43. *Et sciendum quod . . . nec superiorem.* Regular in OB, OC (marks additional), OD, OF, OE (and at the end of sect. 2,

cap. XXII), MA, MB, MC, MD, ME, MF, MH, MI, MN, CC, CE, CF, CM, P, PH, LT, LC, X, Y. Inserted at the end of cap. XXII, f. 52b, in OG, OE, OM, W, MG, MK, LB (marks additional), LD, CA, CB, B. Omitted in OA, LA, ML, LF. On the evidence of the manuscripts themselves, we can not but regard this as a passage from Bracton.

F. 57b, ll. 2-5. *Et sic proferre . . . per eadem verba.* This passage is omitted by the manuscripts in group (I), but is given regularly in the other lines. Its omission in (I) is in all probability due to the copyist of the common ancestor of that group mistaking the *per eadem verba* in l. 5 for the same words in l. 2.

F. 59b, ll. 9-12. *In hoc passu habetur . . . sit in possessione.* Omitted by the manuscripts generally. Clearly from a source other than Bracton.

Fs. 59b-60, ll. 45-3. *Sed et diversæ . . . plenius dicitur.* Omitted by the manuscripts generally, for which reason it may not be ascribed to Bracton.

F. 65b, ll. 1-4. *Et ad hoc . . . et retinuit.* Regular in OB, OD, OE, OF, MA, MB, MD, MH, MN, CE, CM, Y, ME. Inserted at the end of cap. XXIX, f. 63b, in OC. Marginal in OA. Omitted in MC (partially), LA. A typical reference to a case, in the *Note Book* No. 303. The same case is cited, not in an *addicio*, on f. 63b. Apparently from Bracton.

F. 65b, ll. 19-24. *Possunt quidem esse . . . propinquitas successionis.* Regular in OB, OC (marks additional), OD, OE, MA, MB, MC, MD, ME, MN, CE, CM, Y. Marginal in OA, LA. This passage is clearly from Bracton.

F. 67, ll. 2-14. *Et notandum quod . . . per modum donationis.* Regular in OB, OC, OD, OF, OE, MA, MB, MC, MD, ME, MN, CE, CM, Y. Marginal in OA, LA. This is certainly from Bracton. Though it has every appearance of being an afterthought, a question as to its ever having stood in the margin of the original may well be raised.

F. 67b, ll. 10, 11. *Id est . . . antecessoribus.* Regular in OB, OD, OF, OE, MA, MB, MC, MD, ME, MN, CE, CM, Y. Omitted in OC, LA. Marginal in OA. This has the appearance of an afterthought by Bracton, and the strong support given it by the manuscripts still further increases that impression.

F. 67b, ll. 16-18. *Et frater antenatus . . . fratres præmortui.* Regular in OB, OD, OE, OF, MA, MB, MC, MD, ME, MN, CE, CM, Y. Omitted in OC, LA. Marginal in OA. This passage must be put on the same basis as the *addicio* immediately preceding.

F. 68, ll. 34-37. *Sed re vera . . . expectaret.* Regular in OB, OF, OE, MA, MB, MC, MD, ME, MN, CE, CM, Y. Omitted in OC. Marginal in LA, OA. Another *addicio* which gives every indication of having come from Bracton. It is quite possible that many of these short afterthoughts which in the manuscripts are found so regularly at the end of titles or paragraphs may never have stood in the margin.

F. 76b, ll. 14-18. *Si autem non sit . . . capitalibus mesuagiis.* Regular in OC, MC. Inserted after *quartam bestiam*, l. 43, in OB, MA, MB, MD, ME, MI, MN, CE, CM, Y. Marginal in OA, LA. On the evidence of the manuscripts this must be assigned to Bracton.

F. 79b, ll. 18-19. *Prout inferius . . . per statutum.* Omitted by OA, OB, OC, OD, OE, OF, MA, MB, MC, MD, CE, CM, LA, and by manuscripts generally. Obviously not from Bracton.

Fs. 82-82b, ll. 41-12. *Et iuste propter . . . et huiusmodi.* Regular in OA, OB, MA, MB, MD, ME, CC, CE, CM, Y. Inserted after *Galfrido*, l. 16, f. 82b, in MC. Marginal in LA. There need be no hesitation in ascribing this to Bracton.

F. 82b, ll. 35-39. *Et quid si . . . superioribus capitalibus.* Regular in MC, OD. Inserted after *feodo, etc.*, l. 4, f. 83, in OC; after *homagium*, l. 43, f. 82b, in OB, MA, MB, MD, ME, MN, OF, OE, CE, CM, Y. Marginal in OA, LA. From Bracton, if the manuscripts are to be believed.

F. 83b, ll. 28-37. *Et poterit tenens . . . procedendum est.* Regular in OD. Inserted after *de seisina*, l. 43, in OB, OE, OF, MA, MB, MD, ME, MI, MN, CE, CM, Y. Marginal in OA. Omitted in OC, MC, LA. Presumably from Bracton.

F. 86b, ll. 37-43. *Sed si ita . . . duodecimo.* Regular in OB, OF, OD, MA, MB, MC, MD, MN, CE, CM, Y. Marginal in OA. Omitted in OC, LA. This passage which is, in a measure, a repetition of what immediately precedes it in V, should be assigned to Bracton on the authority of the different groups and sub-groups which stand sponsor for it.

F. 88b, ll. 16-22. *Casus Henrici . . . in feodo.* Regular in OB, OE, OF, OM, MA, MB, MC, MD, MH, MN, CE, CM, LC, Y. Marginal in OA, OD. Omitted in OC, ML, LA. Inasmuch as this passage is supported by (I), (II), CE, Y, and one member of (III), in the text proper, in addition to being found in the margin of two other manuscripts in (III), the weight of evidence favors Bracton as the author. It is the citation of a case which has to do with Bracton's neighbors in Devonshire. See *Note Book*, I, 94, 169.

Fs. 92-92b, the whole of sect. 5. *Et dotis species . . . heredibus quibuscumque*. Regular in OB, OE, OF, MA, MB, MC, MD, MN, CE, CM, Y. Inserted at the end of cap. XXXIX, f. 95b, in OC. Marginal in OA. Omitted in LA. On account of its length this passage may be counted upon to furnish on collation variants sufficient to largely determine its origin. In the meanwhile it may be regarded as from Bracton.

F. 95b, ll. 3-11. *Sed sive . . . simul stat*. Regular in OB, OD, OF, OE, MA, MB, MD, MN, CE, Y. Inserted after *contrahentium*, l. 38, f. 95, in ML. Marginal in OA. Omitted in OC, LA. MC skips from f. 95 to f. 96b. We should assign this to Bracton. The *sine præiudicio melioris sententiæ* in ll. 3, 4, may be compared with the same words near the end of f. 1, which have already been discussed on p. 48 above.

F. 96, ll. 16-24. *Item quis . . . rationabilis causa*. Regular in OD. Marginal in OA. Omitted in OB, OC, OF, OE, MA, MB, MD, MH, MI, ML, MN, LC, CE, CM, LA, Y. Unless this passage has been so greatly misplaced in V as to make its discovery in the manuscripts impossible except by a complete collation, we must accept the verdict of the manuscripts as above and exclude it from the treatise.

F. 99b, ll. 33-35. *Eodem modo . . . tradi possit*. Regular in OB, OC, MA, MB, MC, MD, ME, MN, CE, CM, Y. Marginal in LA. Omitted in OA. This may not be an *addicio*; it is certainly from Bracton.

F. 100, ll. 2-5. *Item si de una . . . vel huiusmodi*. Regular in MC. Inserted after *bonis*, l. 10, in OB, MA, MB, MD, ME, MI, MN. CE, CM, Y. Marginal in LA. Omitted in OA. From Bracton.

F. 100, ll. 15-17. *Item crit inutilis . . . reicienda*. Regular in OB, MA, MB, MD, ME, MI, CE, CM. Inserted after sect 5, in MC, OC (marks additional). Marginal in LA. Omitted in OA. Also from Bracton. Cf. *Inst.* 3. 19. sect. 14; and for the *addicio* immediately before this, *Inst.* 3. 19. sect. 23, 24. See *Bracton and Azo*, 151, notes.

F. 100b, ll. 31-33. *Et per nosmet . . . acquiritur obligatio*. Regular in OC, MD. Inserted after *personas*, l. 29, in OB, MA, MB, ME, CE, CM; at end of sect. 12, MC. Marginal in LA. Omitted in OA. An *addicio* by Bracton. See *Bracton and Azo*, 160, notes.

F. 101, ll. 7-9. *Sive ipse solvat . . . et e contrario*. Though omitted in OA, this passage is found so generally in the manuscripts that there can be no doubt of its authenticity.

F. 101, ll. 12-17. *Et in partem . . . summa pecuniæ.* Regular in OB, OC, MA, MB, MC, MD, MN, CE. Marginal in LA. Omitted in OA, ME, MH, CM. There is some doubt about the authorship of this passage, but it is probably from Bracton.

F. 101, ll. 18-23. *Interventu enim . . . durat prima.* Regular in OB, MA, MB, MD, ME, MN, CE, CM. Inserted after *e contrario*, l. 9, in LA; at the end of sect. 13, MC. Omitted in OA. In all probability from Bracton.

F. 102b, ll. 37-42. *Item mixta esse . . . vel quasi.* Regular in OB, OC, MA, MB, MC, MD, ME, MN, CE, B (marks additional), CM. Marginal in LA. Omitted in OA. Clearly enough from Bracton; perhaps not an *addicio*.

F. 103, ll. 26-33. *Item in rem . . . vitæ vel annorum.* Insert at the end of sect. 6, MC; at the end of sect. 7, OB, OC, MA, MB, MD, ME, MI, MN, CE, Y, CM. Marginal in LA. Omitted in OA. Another passage about whose authorship there can be no reasonable doubt.

F. 105b, ll. 38-40. *In convictionibus . . . prohibitum quin.* Regular in OA, MC, MD, ME, CM. Omitted in OB, MA, MB, MI, MN, CE, Y. At this point LA has lost leaves. It is a question whether this is an *addicio* or an omission by the combination (I), CE, Y, due to the similarity of *convictionibus* in one line and *convictiones* in another, the reading of the manuscripts being somewhat different from that of V.

F. 113, ll. 2-14. *Item incidit . . . restitutione.* Regular in OB, OD, OE, MA, MB, MC, MD, ME, MI, CE, Y, B (marks additional). Inserted after *alicuius antecessoris*, l. 28, f. 112b, in OC; at the end of sect. 4, f. 114, in OF, CM, LD; at end of sect. 5, f. 114, in CB. Marginal in OA, LA, CB. An early *addicio* from Bracton which once stood in the margin.

F. 114, ll. 18-46. *Et notandum in fine . . . ut in Justic.* (*Institutionibus.*) Regular in OB, OC, OD, OE, OG, MA, MB, MC, MD, ME, MI, CE, LC, Y. Omitted in OF, MH, CM, LD. Marginal in OA, LA, CB. Any *addicio* which receives the support of the particular manuscripts that vouch for this passage can hardly be denied a place in the treatise. This is important as bearing on the question of Bracton's knowledge of Roman law, for this passage has been called by Maitland the most learned piece of Romanism in the whole of Bracton's book. See *Bracton and Azo*, 211. Notice the reference to Peter of Savoy, which occurs again on f. 414b.

Fs. 114-114b, ll. 46-11. *Item notandum . . . capax sit.* Regular in OB, OD, OE, OG, MA, MB, MC, MD, ME, MI, LC, CE, Y. Inserted

at the end of *De Actionibus*, f. 115, in OC, OF, MH, CB, CM. Marginal in OA, LA. Omitted in LD. On the basis of this evidence the passage must be ascribed to Bracton. See *Bracton and Azo*, 213.

Fs. 115b-116, ll. 31-1. *Ad quod notari . . . la bane*. Regular in OD. Inserted after *receptatoribus*, l. 28, in LA; after *monstrabunt*, l. 30, in OB, OE, MA, MB, MD, ME, MI, CE, Y; after *vel vic.*, l. 8, f. 116, in OC; at end of sect. 6, f. 115, CB, B (marks additional); in OF, MH it precedes the *addicio* on fs. 114-114b. Marginal in OA, CB. Clearly from Bracton.

F. 117, ll. 42-44. *Quantum valent . . . posita sunt*. Omitted in OA, OC, OD, OE, MA, MB, MC, MD, MH, CE, and manuscripts generally. This passage must be rejected.

F. 117b, ll. 28-33. *De felonibus . . . non observatis*. Omitted in OA, OB, OD, OC, OE, OG, MA, MB, MC, MH, LA, CE, Y. Obviously not from Bracton.

F. 122, ll. 14-20. *Item batelli . . . in mari*. Regular in OD. Put at the end, instead of at the beginning, of sect. 8, in OB, OE, OF, MA, MB, MC, MD, ME, MI, CE, LD, Y, B (marks additional). Marginal in OA. Omitted in OC, LA. This should be accepted as coming from Bracton.

F. 124b, ll. 15-18. *Sicut in . . . Henrici quinto*. Regular in OB, OC, OD, OE, OF, OG, MA, MB, MC, MD, CE, Y. Marginal in OA, LA. Marked additional in B. This case is not in the *Note Book*. A passage which unquestionably belongs to Bracton.

F. 126, ll. 17, 18. *Computatis . . . fuerit*. Regular in OB, OF, OD, MA, MB, MD, ME, CE. Inserted after *utlagetur*, l. 19, in OC, B; after *perficiatur*, l. 16, in MC. Marginal in OA, LA, CB. Bracton is undoubtedly the author.

Fs. 126-126b, ll. 46-2. *Si coram iusticiariis . . . alia secta*. MD and B mark this as additional and insert it after *regis*, l. 29, f. 126. It is used as a rubric in OA, OB, MA, MC, CE, LA. Omitted both as text and rubric in MB, ME, CM. This is a rubric which has become misplaced in some manuscripts.

F. 127b, ll. 25-41. *Facta autem . . . cum humana*. Regular in OB, OD, MA, MB, MC, ME, CE, CM. Inserted at the end of sect. 10, f. 128, in OF, B, OC, MD. Marginal in OA, LA, W. This, being supported by representative manuscripts in all groups, must be regarded as having come from Bracton.

F. 129, ll. 5-6. *Nec alios amisit.* Regular in OB, OC, OD, OF, MA, MB, MD, CE, ME, Y. Marginal in LA, OA. Omitted in MC. From Bracton.

F. 129, ll. 14-15. *Item cui propinquis.* Regular in OD. Inserted after *tenementa*, l. 16, in OC, OF, OB, MA, MB, MD, ME, MI, CE, Y; after *possidendi*, l. 11, in MC. Marginal in OA, LA. A floating *addicio*, apparently from Bracton.

F. 130, ll. 7-10. *Et notandum heredes suos.* Regular in OB, OC, OD, OE, OF, MA, MB, MC, MD, CE, B (marks additional). Marginal in OA, LA. Omitted in Y. From Bracton.

F. 130b, ll. 5-11. *Ut quibusdam et bona.* Regular in OD. Inserted after *revertitur*, l. 1, in OB, OC, OE, OF, OG, MA, MB, MC, MD, CE, B (marks additional). Marginal in OA, LA, Y. Notice the reference to the good reasoning of William of York on a certain point of law, at the end of the passage, and compare this with the statement of a difference of opinion between Martin de Pateshull and Stephen Segrave on another point of law, in the lines immediately following. Judged on the available evidence this *addicio* was written by Bracton.

F. 132b. The rubric to sect. 9 is marked additional, and inserted in the text, by B. In MB and Y it is missing. In OA, LA, MA, MC, MD, and most other manuscripts it is regular.

F. 132b, ll. 21-30. *Cum appellatus fugerit aliud fiat.* Regular in OB, OD, OE, MA, MB, MI, CE. Inserted after *suam gratiam*, l. 38, in OC, OF, W, X, MC, MD, ME, MG, MH, LB, LD, CA, CB, CC, CM (marks additional), B (marks additional); put after the following *addicio* in ML. Marginal in OA, LA, Y. This is one of Bracton's marginal additions.

F. 132b, ll. 38-41. *Item iuste modo genitus.* (Collated.) Regular in OD, MA, MD, PH. Used as a rubric in OA, OB, X, B, CB, CE, CF, LT, HB. Omitted in the other manuscripts. This is clearly no part of the main text of the *De Legibus*.

F. 133, ll. 1-2. *Sed ipsi debent.* Regular in OA, OB, OC, MA, MB, OF, CB, CC, CE, and manuscripts generally. Marginal in LA. Omitted in OD, PH. This sounds like an afterthought; it is certainly from Bracton's pen.

Fs. 133-133b, ll. 2-9. *Quid felo rite factam.* Regular in OF, MC, ML, W, CM (marks additional), B (marks additional). Inserted after *tenetur*, l. 1, f. 133, in OD; after *creati*, l. 10, f. 133b, in OC; after *gratiam*, l. 38,

f. 132b, in MD and ME (preceded by the *addicio* on f. 132b, ll. 21-30); at the end of sect. 13, f. 133b, in OB, OE, MA, MB, CE, OM, X. Marginal in OA, LA, Y. Omitted in OG. Manifestly an *addicio* from Bracton. For a discussion of this *addicio*, based on the variant readings in the manuscripts, see above, p. 356.

F. 134, sect. 19. The rubric for this section is made a part of the text of sect. 18 in some manuscripts, though in most codices it is given as a rubric or omitted altogether.

F. 135, ll. 22-25. *Nec deodanda docere poterit.* Regular in OB, OD, OE, MA, MB, MC, CE. Inserted after *eius*, l. 25, in OF, CM; after *erit*, l. 31, in MD. Marginal in OA, LA, Y. In all probability from Bracton.

F. 135b, ll. 5-6. *Vel ex parte tantum.* Regular in OD, MA, MD, OC. Inserted after *matris*, l. 4, in OB, OE, OF, MB, MC, CE, CM. Marginal in OA, LA, Y. It is barely possible that this is an omission (due to the recurrent *ex parte matris*) instead of an *addicio*. Bracton is undoubtedly the author.

F. 136, l. 33. *Cum sit latro publicus maxime.* Regular in OD. Inserted after *malus sit*, l. 32, in OB, MA, MB, MC, MD, ME, CE, LA, Y. Marginal in OA. Used as a rubric in OF, MH, OE, LB. Omitted in OC, CM. Apparently the very brevity of this *addicio* caused some of the scribes to regard it as a rubric. The presumption is that it came from Bracton.

F. 136b, ll. 13-14. *Et voluntas furandi.* Regular in OE, OF, MC, MH, MI, CM. Inserted after *debet*, l. 12, in OB, MA, MB, MD, CE; after *præbeat*, l. 17, ME. Marginal in OA, LA, Y. Apparently omitted in OD, OC. Though of a somewhat doubtful nature, this passage has probably come from the author of the treatise.

F. 136b, ll. 18-24. *Sed ibi aliis casibus.* Regular in OA, OB, OD, OE, MA, LA, MB, MC, MD, Y. Omitted in OC. In MH and CM the first few words of the passage, through *infortunium*, come immediately after the *addicio* in ll. 13-14, the rest occurring regularly at the end of cap. XVII. This must be ascribed to Bracton.

F. 140b, ll. 38-40. *Nota quod non minuere.* Inserted at the end of sect. 3, f. 140b, in OD. Used as a rubric in OA, OC, OE, MH. Omitted in OB, OF, MA, MB, MC, MD, ME, Y, CE, CM, LA. Obviously not from Bracton.

F. 141, ll. 14-15. *Sicut de Ricardo . . . filio Helicæ.* Regular in OB, OC, OF, OE, MB, MA, MD, MH, CE, Y, B (marks additional). MC reads, *sicut de Ric. et aliis. Item.* Marginal in OA. Omitted in OD, LA, ME. See *Note Book*, I, 169; III, 522, n. 1. Undoubtedly from Bracton.

F. 142b, ll. 6-16. *Item si cum . . . Godingham.* Regular in OB, OC, OD, OE, OF, MA, MB, MC, MD, MH, LC, ME, CE, B (marks additional). Marginal in OA, LA, W. See case 943 in *Note Book*. Another of Bracton's additions.

F. 142b, ll. 40-42. *Ut de itinere . . . ætatem.* Regular in OD. Inserted after *mahemium*, l. 44, in OB, MA, MB, CE; after *patriam*, l. 46, in OF, OE, MC, MH, ME, W; after *annorum*, l. 45, in OC. Omitted in LA, OG. Marginal in OA. This case is not found in the *Note Book*. The citation must, however, be assigned to Bracton.

F. 144b, ll. 21-23. *Sicut coram . . . perdonavit mortem.* Regular in OB, OD, OM, MA, MB, MC, MD, CE. Inserted after *erit*, l. 20, in OF, OE, MH, LC, LD, B (marks additional). Omitted in OC, LA. Marginal in OA. Though the case itself is not found in the *Note Book*, and the citation is not as definite as those usually made by Bracton, the way in which this *addicio* is supported by the manuscripts compels us to accept it as one made by the author of the treatise.

Fs. 147-147b, ll. 38-42. *Adelstane. Raptus mulier . . . consuetudinaria habetur.* Regular in OB, OM, MD, MA, MB, ME, CE, LC. Inserted after *necessitate*, l. 44, f. 148, in OD; after cap. XXVIII, f. 148b, in OC, OF, MH, LD. Marginal in OA, CB. Omitted in W, Y, MC, LA. CM leaves for it a space of nearly a column after sect. 1, cap. XXIX, f. 148b, and gives the passage in the first column of its next page. This *addicio* does not always occur in the form in which it is found in V. The evidence at hand is not quite sufficient to settle the question of its authorship. It should be regarded as of doubtful origin until the collation of it has furnished additional information, in the shape of variants, bearing on its source.

F. 150, ll. 17-18. *Quia sic . . . huiusmodi.* Regular in OA, OB, MA, MB, MD, CE, CM. Marginal in Y. Omitted in LA. It is difficult to explain these unusual omissions which occur from time to time in good manuscripts like Y and LA. This sentence sounds like an afterthought; it must be attributed to Bracton.

F. 150, ll. 24-28. *Qui autem . . . sustinere deberet.* Regular in OB, OC, MA, MB, MC, MD, CE, CM. Inserted after *interfecerint*, l. 22, in

OF; after *huiusmodi*, l. 18, in OD; after *confiscentur*, l. 30, in ME. Marginal in OA, Y. Omitted in LA. An *addicio* from Bracton which once stood in the margin.

F. 150, ll. 33-34. *Quia convincitur facere proposuit.* Regular in OB, OC, OD, OF, MA, MB, MC, MD, CE, CM, ME. Marginal in OA, Y. Omitted in LA. For a discussion of this passage, which in all probability is an omission due to similarity of words in two adjacent lines, see above, p. 325.

F. 150b, ll. 1-5. *De submersis poterit.* Regular in OB, OF, MA, MB, MC, MD, CM, ME, CE. Inserted after *confiscentur*, l. 30, f. 150, in OC; after *haberet*, l. 35, f. 150, in OD. Marginal in OA, Y. Omitted in LA, OG. Inasmuch as in all the manuscripts examined this *addicio* is omitted only in those which regularly omit the additional passages in this portion of their text, it must be ascribed to Bracton.

F. 151, l. 33. *Per auxilium curiæ et per breve.* Regular in OA, MD, ME. Omitted in OB, MA, MB, MC, LA, CE, CM, Y, and therefore of doubtful authorship.

Fs. 151-151b, ll. 33-2. *Si quis vero periculo erit.* Regular in OB, MA, MB, MD, ME, CE, CM, B (marks as additional). Marginal in Y. Omitted in LA. MC omits only the last sentence in sect. 5. OA inserts as a separate paragraph after *conductio*, l. 8, f. 151b. Seemingly from Bracton.

F. 152, ll. 8-12. *Et qui iudicatus.* Regular in OF, MH. Inserted after *abiuraverit*, l. 7, in ME; after *condemnabitur*, l. 19, in OC, MD. Marginal in OA, LC, W. Omitted in OB, OD, MA, MB, MC, LA, CE, CM. Of doubtful authorship.

Fs. 155b-156, ll. 33-5. *Et eodem modo extiterit.* Regular in OF, OC, OD, MC, MD, MH, ME, LD. In B this passage is marked as two *addiciones*, the second coming after *delinquit*, l. 10, f. 156; ME is similar to B in this respect. Marginal in OA, LA. Omitted in OB, MA, MB, MI, LC, CE, CM. As this *addicio* is supported by (II) + (III) it is presumably from Bracton.

F. 156, ll. 13-19. *Sicut pro damno vel extra.* Regular in OA, OB, MA, MB, MC, MD, CE, CM. Inserted after *concedat*, l. 25, in LD, ME, B (marks additional). Marginal in LA. Clearly from Bracton.

F. 156b, ll. 4-20. *Tu dic, quod si eodem distinxerit.* Omitted in OA, OC, OD, OF, OG, OM, MA, MB, MC, MD, MH, CE, and manuscripts generally. Obviously not from Bracton.

F. 159, ll. 13-15. The case of Peter of Savoy. Regular in OB, OC, OF, OG, OM, W, MA, MB, MC, LC, LD, CE, MD, MH, CC, CB, ME, PH, B, Y. Inserted after *breve*, l. 19, in OD. Marginal in OA. Omitted in LA, ML, P, LT. OG gives the date XLV; LC, XVI, in erasure; CC, XXLVI; W, XLVII; the other manuscripts read XLVI. Other references to Peter of Savoy will be found on f. 114, f. 414b. There can be no doubt that this citation came from Bracton.

F. 161b, ll. 6-14. *Subsequatur . . . de iure*. (Collated.) Regular in OD, OF, CC, CB, MK, MH, MG, MF, MC, ME, OG, HB, LB, B, P, Y. Inserted after *repellat*, l. 21, in OC, X, CA, LD, LT, CF, CH, LE; after *constituta*, l. 41, in OB, MA, MB, MD, MI, LC, W, OM, LF, LG, HA, CM. Marginal in OA, LA. Omitted in ML, CE. This *addicio* has been discussed on p. 324 above.

F. 161b, ll. 32-34. *Contendendo . . . tenemento*. (Collated.) Regular in OB, OC, OD, OF, OM, MA, MB, MD, ME, MF, MG, MH, MI, MK, HA, HB, CM, CA, CB, CC, CE, CF, LC, LB, LD, X, W, LF, LT, P. Inserted after *falcando*, l. 31, LA. MC and LE omit the second half of this, *si autem . . . tenemento*, and insert after *teneat*, l. 37. Marginal in OA, Y. Omitted in ML, OG. Whatever may be the cause of the disagreement among the manuscripts, the passage itself surely belongs in the treatise.

Fs. 161b-162, ll. 41-13. *Item facit . . . tale breve*. (Collated.) Regular in OB, MA, MB, MC, MD, ME, MF, MG, MH, MI, MK, CA, CB, CC, CF, LB, LC, LD, LF, LT, OC, OD, OF, OG, OM, P, W, X, Y. LA has as far as *manufactum*, l. 4, f. 162, in text, and the rest in the margin. P inserts the part marginal in LA after *vacuam*, l. 22, f. 162; MF follows P in this, but has the passage regularly also. Marginal in OA. Omitted in CE, ML. This is another passage which most certainly came from Bracton.

F. 163, ll. 7-9. *Incontinenti . . . divertat*. Inserted after *spoliantem*, l. 1, f. 163, in OB, OD, MA, MB, MC, MD, MF, OM, LC, P, W, X; after *reposit*, l. 33, f. 162b, in LD. Marginal in OA, LA, CB. Omitted in OC, CE, OF, ML, MH, ME, MG, MI, CC, CF, MK, Y. This passage has been fully discussed on p. 358 above.

F. 163, l. 14. *Scilicet xv dierum*. Regular in OB, OD, Y, MA, MB, MC, MD, MF, MI, LC, OM, W, X, P, LD, LF, CE, X. Marginal in OA, LA. Omitted in OC, OF, ML, MG, MH, ME, CF, CB, CC, MK. Presumably from Bracton.

F. 163, l. 40. *Vel ulterius ex causa.* Regular in OF, OD, OC, Y, MC, CE, LD, MG, MH, ME, MK, X, CB, CC. Inserted after *prædictum est*, l. 41, in OB, MA, MB, MD, MI, LF, OM, W, LC. Marginal in OA, LA. Omitted in ML, MF, P. This shows how brief might be some of the *addiciones* from Bracton's pen.

Fs. 165-165b, ll. 40-3. *Et cum neuter . . . possidendi.* Regular in OC, OD, OF, LD, MG, MH, MF, ME, CB, CC, CF, MK. Inserted after *exceptionem*, l. 6, f. 165b, in MC. Marginal in OA, LA. Omitted in OB, MA, MB, MD, MI, CE, Y, LF, ML, OM, P, W. This *addicio* has been discussed at length on p. 359 above.

F. 166, the rubric for sect. 2 in V. Inserted in text at end of sect. 1, in OA, OB, OC, OD, OM, MA, MB, MD, MG, MH, ME, MI, MF, MK, CB, CC, CE, CF, LD, LF, P. Inserted after *uxorem*, l. 37, in MC. Marginal in LA, Y. Omitted in ML. Clearly this should be not a rubric but a part of the text.

F. 166b, ll. 20-28. *Item si cum . . . de feoffamento.* Regular in OA, OB, OC, OF, OG, OM, MA, MB, MC, MD, ME, MF, MG, MH, MI, MK, CB, CC, CE, CF, CH, P. Marginal in LA, Y. Omitted in ML. We can not be certain that this is an *addicio*; it most surely comes from Bracton.

F. 168, ll. 22-24. *Nec puris . . . villano socagio.* Regular in OB, MA, MB, MD, CE, W. Inserted after *tale*, l. 25, in OC, OF, MC, ME; after *socagio*, l. 21, in OD. Marginal in OA, LA, Y. From Bracton.

Fs. 168-168b, ll. 46-3. *Item idem erit . . . exeuntibus.* Regular in OD. Inserted after *istorum*, l. 36, in Y; after *prohibitio*, l. 40, in Y (second insertion), OB, OC, OF, MA, MB, MC, MD, ME, LA, W. Marginal in OA. Omitted in CE. Undoubtedly from Bracton.

F. 168b, ll. 10-14. *Et competit eis . . . servitute viri.* Regular in OB, MA, MB, ME, MD, W. Inserted after *liberæ*, l. 9, in OD, after *villano*, l. 10, in OC, OF; after *liberatae*, l. 18, in MC. Marginal in OA, LA. Omitted in CE, Y. Because of the support back of it, this must be regarded as one of Bracton's additions.

F. 169, ll. 27-29. *Dum tamen . . . alibi.* Regular in OD. Inserted after *alium*, l. 29, in CE; after *dicetur*, l. 29, in OB, OC, OF, MB, MC, MD, ME, Y. Marginal in OA, LA. Another *addicio* supported by all three of the principal groups and therefore authentic.

F. 169, ll. 29-45. *Si autem tenens . . . non solverit.* Regular in OB, OC, OF, MB, MC, ME, MA, MD, ME. Marginal in LA, OA. Omitted in CE, Y. On the basis of the manuscript support presumably from Bracton.

F. 170, ll. 1-3. *Vel si habuerit , . . . supra eodem.* Inserted after *habuerint*, l. 1, in OA, LA, CE, MC, ME. Marginal in Y. Omitted in OB, MA, MB, MD. This is a case of (I) omitting an *addicio* from Bracton.

F. 170, ll. 15-16. *Dum tamen per breve et in suo casu.* Regular in OC, OD, OF, MC, ME. Inserted after *implacitaverit*, l. 15, MA, MB, MD, CM. Marginal in OA, LA. Omit from *tenemento* to *tenemento*, CE, Y; omit *de tenemento . . . arramata est*, OB. It is to be suspected that this is an omission rather than an *addicio*.

Fs. 170-170b, ll. 45-5. *Et illud idem . . . suum.* Regular in OC, OD, OF, MC, LA, ME, CE. Inserted after *provideant*, l. 6, f. 170b, in OB, MA, MB, MD. Marginal in OA, Y. From Bracton.

Fs. 171b-172, ll. 45-1. *Si autem . . . regis.* Regular in OC, OD, OF, MC, MD, MH, CE, LD. Marginal in OA, LA, Y. Omitted in OB, MA, MB, MI, CM. An *addicio* from Bracton omitted by group (I).

F. 175b, ll. 34-36. *Si præsens . . . excambium.* Regular in OD. Inserted after *suum*, l. 33, in OC, OF, MD, ME. Marginal in OA. Omitted in OB, MA, MB, MC, MI, LA, CE, Y. This is apparently an *addicio* belonging to (II) alone; it can not therefore be given a place in the treatise.

F. 176, ll. 4-8. *Non subvenitur . . . disseisitum.* Regular in OB, OD, MA, MB, MC, MD, ME, Y, OC, OF. Marginal in OA, LA. Omitted in CE. This is certainly from Bracton.

F. 176b, ll. 10-35. *Item transfertur . . . et unum.* Regular in OB, OD, MA, MB, MD, ME, Y. Inserted at the end of cap. XIV, in OC, OF, CB, B (marks additional); after *persecutionis*, l. 34, f. 176, in MC. Marginal in OA, LA, CB. Omitted in CE. Another additional passage which can be assigned to Bracton.

F. 177b, ll. 13-14. *Et sine alio . . . curiæ.* Regular in OC, OD, OF. Inserted after *tenemento*, l. 15, in MA, MB, MD, MI; after *suum*, l. 16, in CE, MC, Y. Marginal in OA. Omitted in LA. From Bracton.

F. 177b, ll. 38-39. *Et ultimo . . . excambium.* Regular in OA, OB, MA, MB, MC, CE, Y. Marginal in LA. This may or may not be an *addicio*; it is clearly a part of Bracton's text.

Fs. 178b-179, ll. 7-16. *Ex præmissis . . . non possit.* Regular in OA (as a separate paragraph), Y, OB, MA, MB, MD, ME, CE, B (marks addi-

tional). Inserted after *damnationis*, l. 2, f. 178, in MC. Marginal in LA. Probably one of the very early additions made to the first draft. Bracton was certainly the writer.

Fs. 179b-180, ll. 43-2, and f. 180, ll. 18-20. *Quia si querens . . . de Ludington* and *Item si de . . . nova disseisina*. In the manuscripts these two passages which are separated in V usually occur together. Regular in OC, OD, OM, OF, CB, CC, CE, MG, MK, HA, HB, LB, LC, B, PH, W, Y. Inserted after *minus*, l. 7, f. 180, in MC, MF, LA, P; after *continueatur*, l. 9, f. 180, in CA, CF, LD, LT, ME, MH, X. Marginal in OA, LC. Omitted in OB, MA, MB, MD, MI, CM, ML, LE, LF, LG. This passage has been collated. It has been discussed on p. 335 above.

F. 180, ll. 17-20. *Si autem redditus . . . pertinere*. (Collated.) Omitted in OB, OG, OM, MA, MB, MD, MI, LF, LG, CM, CE, HA, W, Y, ML. Marginal in OA, LC. Regular in the other manuscripts. This may be an *addicio*, but it is probably an omission due to similarity of words. See p. 323 above.

F. 180b, ll. 7-24. *Et sciendum quod . . . ut infra*. Regular in OA, OB, MA, MB, MD, CE, Y. Inserted after *disseisitus*, l. 5, in MC. Marginal in LA. Omitted in MH, ME. From Bracton.

F. 180b, ll. 26-44. *Non poterit . . . tenemento*. Regular in OD. Inserted after *simonia*, l. 2, in OA, OC, MC, CE, Y; after sect. 8, f. 180b, in OB, MA, MB, MD; after *pascendi*, l. 9, f. 181, ME, MH. Marginal in LA. One of Bracton's earlier additions, apparently.

F. 181, ll. 26-28. *Sed hoc . . . ducere nolit*. Regular in OD. Inserted after *pascendi*, l. 9, f. 181, in OC; after *servitutis*, l. 20, in MC; after *fraudaretur*, l. 21, in OB, MA, MB, MD, CB, Y. Marginal in OA, LA, CB. Omitted in OF, MH, ME, CE. This also must be assigned to Bracton.

F. 181, ll. 28-34. *Melius tamen . . . satisfactum*. Regular in OD. Inserted after *tenemento*, l. 44, f. 180b, in MC; after *pascendi*, l. 9, in OB, MA, MB, MD; after *vicino*, l. 26, in OC; after *nocitum est*, l. 37, in CB, B (marks additional), OF; after *pastura*, l. 41, in ME. Marginal in OA, LA. Omitted in CE. A good example of a marginal addition from Bracton which became a floating *addicio*.

Fs. 182-182b, ll. 41-2. *Si autem nulla . . . et plegii*. Regular in OB, OC, OD, OF, MA, MB, MC, ME, LA, Y. Marginal in OA. Omitted in CE. From Bracton.

F. 183, l. 28. *Imprimis de quo tenemento*. Regular in OD. Marginal in OA. Omitted in OB, OC, MA, MB, MC, MD, MH, MN, CE, LA, Y. Used as a rubric in OF, MI. Certainly no part of the text.

F. 183b, ll. 36-40. *Quia cum quis V. Q. C. V. I.* Regular in OF, MH, ME, LD, B (marks additional). Inserted after *plenius*, l. 27, in OD; after *iuratus*, l. 24, in MC. Marginal in OA, LA. Omitted in OB, OC, MA, MB, MD, MI, MN, CE, Y. Of doubtful authorship.

F. 184, ll. 3-8. *Quia qualitercumque de codem*. Inserted after *proprietatis*, l. 1, in OC, MD; after sect. 1, in OF, B (marks additional); after *disseisitus*, l. 18, in MH; after *disseisiri*, l. 36, f. 183b, in OD, MC. Marginal in OA, LA. Omitted in OB, MA, MB, ME, MI, MN, CE, Y. A floating *addicio* from Bracton.

F. 184b, ll. 23-26. *Item si conventionem*. Regular in OD, MC. Marginal in OA, LA. Omitted in OB, OC, OF, OG, MA, MB, MI, MN, LD, CE, Y, MD. It is barely possible that the complete collation of several of the manuscripts may discover this passage tucked away in some unusual place, but on the basis of the data here given it can not be assigned to Bracton, (I) and (II) agreeing on omission against (III).

F. 186, ll. 30-33. *Locus erit fuerint*. Regular in ME. Inserted after *probationem*, l. 40, in B (marks additional). Used as a rubric in MC, LA. Omitted in OA, OB, MA, MB, MD, MN, CM, CE, Y. Clearly no part of Bracton's text.

F. 186b, ll. 30-35. *Quia quamvis captionem assisæ*. Regular in OF. Inserted after *factam*, l. 24, in OD; after *disseisina*, l. 26, in MC; after *tenemento*, l. 35, in B (marks additional); after *impedimentum*, l. 39, in OC, MD, ME. Marginal in OA, LA. Omitted in OB, MA, MB, MI, MN, CE, Y. In all probability from Bracton.

F. 187b, ll. 20-21. *Et secundum hoc . . . et æqui*. Inserted after *lucro*, l. 22, in OC, MD; at the end of sect. 9, l. 24, in OF. Marginal in OA. Omitted in OB, OD, MA, MB, MC, MI, CE, CM, Y, LA. This can not be accepted as having come from Bracton.

F. 188b, ll. 34-37. *Item si quis ministerio*. Regular in OD. Inserted after *Walteri*, l. 8, in OC, OF, MD, B (marks additional); after *causam*, l. 29, in MC; after *adversarii*, l. 31, in ME. Marginal in OA, LA. Omitted in OB, MA, MB, MI, CE, Y. We may feel quite sure that this is one of the author's own additions.

F. 190b, ll. 32-37. *In restitutione ante fugam.* Regular in OD. Inserted after *spoliationis*, l. 29, in MC, ME; after *liberali*, l. 40, in OC, MD; after *alio*, l. 12, f. 191, in OF, B (marks additional). Marginal in OA, LA. Omitted in OB, MA, MB, MI, CE, Y. The manuscripts support this *addicio* too strongly to allow us to reject it.

F. 191b, ll. 30-32. *Competit tamen non habet actionem.* Regular in OB, OF, MA, MB. Inserted after *ipsum*, l. 24, in MC; after *domino suo*, l. 30, in MD; after *disseisina*, l. 46, in OD; after *tenet*, l. 13, f. 192, in OC. Marginal in OA, LA. Omitted in CE, Y. One of Bracton's earlier additions.

F. 191b, ll. 32-46. *Item esto disseisina.* Inserted after the *addicio* in ll. 30-32, in OC; after *domino suo*, l. 30, in OD; after *tenet*, l. 13, f. 192, in ME; after *exceptio*, l. 17, f. 192, in OB, MA, MB, MC, MD. Marginal in OA, LA. Omitted in CE, Y. This is another passage about whose right to a place in the treatise there can be no reasonable doubt.

F. 192, ll. 39-42. *Sive liber extra potestatem.* Regular in OB, OC, OD, OF, MA, MB, MC, MD, B (marks additional). Marginal in OA, LA. Omitted in CE, Y. Clearly from Bracton.

F. 192b, ll. 4-8. *Et ad probandam potestate domini.* Regular in OD, MC, ME. Inserted after *exceptio*, l. 17, f. 192, in OF, OC, MD, B (marks additional). Marginal in OA, LA. Omitted in OB, MA, MB, CE, Y. As this passage is supported by the representative manuscripts of (II) and (III) against (I), it must be assigned to Bracton.

F. 194b, ll. 3-4. *Ut inter Thomam et Ricardum.* Omitted in OB, OC, OF, OD, MA, MB, MC, ME, CE, LA, Y, and manuscripts generally. Marginal in OA. Clearly not from Bracton.

F. 195, last 18 lines. *Si autem contra sed contra.* Marginal in OA. Regular in OB, OC, OD, OF, MA, MB, MC, ME, CE, CM, LA, Y, and manuscripts generally. The reason why OA should have this passage in the margin is not apparent; it may not be an *addicio*; it is obviously from Bracton's pen.

F. 195b, ll. 10-13. *Habere poterit plenius.* Regular in OD. Inserted after *assisam*, l. 3, in OF, B (marks additional); after *huiusmodi*, l. 5, in OB, OC, MA, MB, MC, MD, CM; after *disseisinæ*, l. 8, in ME. Marginal in OA. Omitted in CE, LA, Y. From Bracton.

F. 195b, ll. 13-14. *Sed tamen non habet.* Regular in B (marks additional). Inserted after *intrusionem*, l. 8, in CM; after *videre*, l. 9, in ME.

Marginal in OA. Omitted in OB, LA, CE, Y, MA, MB, MC, MD. Seemingly an *addicio* belonging to (II) alone, and therefore not from Bracton.

F. 196, ll. 5-10. *Et cum verus domini.* In V this passage is duplicated in ll. 41-46, at which place it is found in OB, OD, OC, MA, MB, MD, ME, CM, Y. Inserted after *ipsum*, l. 37, in OF; after *iusticiarium*, l. 29, in LA, MC. Marginal in OA. Omitted in CE. From Bracton.

F. 196b, ll. 35-36. *Est enim servus et servus alterius.* Regular in OB, OF, OC, OD, MA, MB, MC, ME, LA. Marginal in OA. Omitted in CE, Y. This is accounted for by all three of the larger groups, and is therefore from Bracton.

F. 197, ll. 9-27. *De libertate licet assisam.* Regular in OB, OD, MA, MB, MC, MD, ME, LA. Inserted after *habuerit*, l. 20, f. 196b, in OF, B (marks additional). Marginal in OA. Omitted in CE, Y. A passage vouched for by the particular manuscripts which support this has almost certainly come from Bracton.

F. 197b, ll. 7-8. *Sed nemo respectibus.* Regular in OF, OC, MC, MD, MI, LA. Marginal in OA. Omitted in OB, OD, MA, MB, ME, CE, Y. In all probability from Bracton.

F. 198, ll. 11-25. *Nec præiudicabitur consensu partium.* Regular in OD, ME, LA. Inserted after *rebus suis*, l. 42, f. 197b, in OC; after *materia*, l. 26, f. 197b, in OF; after *seisina*, l. 26, in OB, MA, MB, MC, MD, CE, Y. Marginal in OA. Clearly an *addicio* from Bracton himself.

F. 199, ll. 13-26. *Vel iuratum aliud erit.* Regular in OA, OB, OD, MA, MB, MC, MD, LA, CE, Y. Inserted after *assisam*, l. 9, in OC, OF, CB. From Bracton.

F. 201, ll. 10-26. *Cum autem superflua.* Regular in OD. Inserted after *remanere*, l. 35, in OC, MC, MD, ME, LA, CA; after *principio*, l. 41, in OF, MI, B (marks additional). Marginal in OA. Omitted in OB, MA, MB, CE, Y. Another case of (II) and (III) vouching for an *addicio* from Bracton which (I) omits.

F. 202, ll. 14-20. The writ. Regular in Y. All after *salutem* is omitted in OF; all after *Præcipe* is omitted in OA, OB, OC, MA, MB, MD, LA, CE; the entire writ is omitted by ML, OD, MC. PH leaves a space of two lines between *Præcipe* and *Post mortem*, and in the margin is "Rubric is lacking." This looks as though some of the scribes had made an attempt to fill in a writ which Bracton promised but did not insert.

F. 202b, ll. 29-31. *Idem erit . . . in hoc casu.* Regular in OD. Inserted after *potuissct*, l. 15, in MC, LA; after *assisa*, l. 17, in OC, MD; after end of sect. 1, in OF, ME, MI, B (marks additional); after the following *addicio* in CA. Marginal in OA. Omitted in OB, MA, MB, CE, Y. Added by Bracton.

F. 202b, ll. 31-39. *Eadem forma . . . acquirendis.* Regular in OD. Inserted after *erit*, l. 13, f. 202, in CA; after *suam*, l. 20, in MC, LA; after *fraudem*, l. 28, in OC, MD; after *restitutionem*, l. 42, in OF, MI. Marginal in OA. Omitted in OB, MA, MB, ME, CE, Y. This passage, supported by (II) and (III), must be attributed to Bracton.

Fs. 203-203b, ll. 41-3. *Cum tenens . . . discutiendum.* Regular in OD. Inserted after *disseisiverit*, l. 27, f. 203, in OC, MD; after *assisa*, l. 8, f. 203b, in OF, MI, B (marks additional); after *domini*, l. 11, f. 203b, in MC, LA. Marginal in OA. Omitted in OB, MA, MB, ME, CE, Y. Another case of (II) and (III) vouching for a Bracton *addicio* not found in (I), CE, Y.

F. 205, ll. 15-18. *Iniuste quia . . . iudicio.* Omitted in OA, MA, MB, MD, ME, CE, Y, CM. OB omits from the *iudicio*, in l. 14 to the same word in l. 18. Marginal in LA. In spite of the fact that this passage is so generally omitted in the manuscripts it is difficult to determine whether it is an *addicio* or an omission due to similarity of words. *Sine iudicio* occurs five times and *iudicio* alone twice more within the space of seven lines in the printed text. These conditions actually invite an omission. Notice how OB has omitted. On the other hand, the fact that LA is marginal and that MC has the passage at a point other than that at which it occurs in V, tends to mark it as an *addicio*. We can not be certain of its status. Inasmuch as the manuscripts examined thoroughly, represent groups (I) and (III), such insertions or omissions as might be found in the manuscripts of (II) would leave the matter on the same doubtful basis.

F. 206, ll. 4-6. *Et multo fortius . . . eicctus.* Regular in OD. Inserted after *actionem*, l. 8, in OC, MD; after sect. 1, l. 16, in MC. Marginal in OA, LA. Omitted in OB, OF, MA, MB, MH, MI, CE, Y, CM. The omission of this passage by the representatives of (II) and (I) make its authorship very doubtful.

F. 207, ll. 31-34. *Item est . . . dedicationem.* Regular in OA, MA, MB, MC, OB, CE, CM, Y. Inserted at end of cap. XXVII, in LA. Marginal in LA. Whatever the reason for LA's irregularities may be, it is clear that this sentence belongs in Bracton's text.

F. 208b, ll. 21-25. *Item potest paxifica seisina.* Marginal in LA. Regular in OA, OB, MA, MB, MC, CE, CM, Y. These same manuscripts give regularly the passage in ll. 25-30, *Item potest in casu*, which is omitted by LA. Both passages clearly belong in the text.

F. 209, ll. 6-23. *Est etiam aliud sua conventio.* Marked as additional by B, but given regularly in OA, OB, MA, MB, MC, ME, LA, CM, Y, and therefore undoubtedly written by Bracton himself.

F. 210b. Not in V. *Sed revera nihilominus procedet assisa factu restitutione sed verus dominus in misericordia pro usurpatione.* Inserted at the end of cap. XXIX, in CM; after *percipiendis*, l. 17, in B (marks additional). Omitted in OA, MA, MB, MC, MD, LA, Y. This must be rejected as an interpolation.

F. 211, ll. 15-17. *Oportet per se.* Marginal in LA. Inserted after *alia*, l. 20, in OA, ME, CE, CM, MD, Y, and OB, MA, MB, which omit *oportet sit in alia*; after *dominia*, l. 26, in MC. An *addicio* from Bracton.

F. 212, ll. 33-40. *Et quid si uno.* Regular in OD. Inserted after sect. 1, l. 1, in OC, OG, MD; after *regis*, l. 11, in OF, MI; after *equitate*, l. 1, f. 212b, in MC, LA. Marginal in OA. Omitted in OB, MA, MB, ME, CE, Y. Presumably from Bracton.

F. 212b, ll. 37-38. *Item dicere prætere.* In the text of OC, and OF, MI, CM, which insert after *principalis*, l. 41. Used as a rubric in MC. Marginal in OA, LA. Omitted in OB, OD, MA, MB, CE, Y. MD omits the second *Item dicere iuratores*. This was certainly no part of the original text. It can not, therefore, be regarded as an omission. It has the appearance of a marginal note added by some one other than the author, who would hardly have repeated himself in this way.

Fs. 212b-213, ll. 43-1. *Et ei dico.* Regular in OF, MI. Inserted after *eognoscendi*, l. 2, f. 213, in OC, MD, MC. Marginal in OA, LA. Omitted in OB, MA, MB, ME, CE, CM, Y. This is clearly a note added to the text as first written. The *dico* would seem to attach it to Bracton, who rather frequently used the first person singular in this way. On his use of *respondeo* see above, p. 363, n. 1. See also, *credo aliud esse dicendum*, f. 321; *nolo inserere*, f. 329b; *quod ego non approbo*, f. 22; *non video quare non*, f. 217b.

F. 213b, ll. 39-43. *Et sive ut infra.* Regular in OC, OD, OF, MD, MI. Inserted after *donationibus*, l. 1, f. 214, in MC. Marginal in OA, LA. Omitted in OB, MA, MB, ME, CE, Y. Seemingly from Bracton.

F. 218, ll. 4-16. *Item terminatur ad warrantum.* Regular in MC, ME, CM. Inserted after *villenagium*, l. 39, f. 217, in MI, B (marks additional); after *specie*, l. 7, f. 217b, in MD (marks additional); ML inserts this at the end of cap. XXXIV, f. 218. Marginal in LA. Omitted in OA, OB, MA, MB, CE, Y. The omission of this passage in OA is offset by its insertion in MC, ME and ML. It is probably from Bracton.

Fs. 218b-219, ll. 21-1. *In omni casu vel præter.* Regular in OD, ME, CM. Inserted after *specie*, l. 7, f. 217b, in OF, MI; after sect. 7, f. 218, in OC, MD; after *dicetur*, l. 30, in MC, CE. Marginal in OA, LA. Omitted in OB, MA, MB, Y. As this passage is supported by (II) and (III) it should be assigned to Bracton.

F. 219, ll. 1-25. *Et esto quod feodo et iure.* Regular in OD, MC, CE. Inserted after *etc.*, l. 15, f. 218b, in OC, OF, MI, MD (marks additional); after *dicet*, l. 21, f. 219b, in ME, CM. Marginal in OA, LA. Omitted in OB, MA, MB, Y. This *addicio* contains a reference to a case not in the *Note Book*, but cited in a way typical of Bracton. Vouched for as it is, this passage must be attributed to Bracton.

F. 219b, ll. 21-25. *Item si quis ingressu.* Regular in OC, OD, OF, MI, ME. Inserted after *præmissis*, l. 33, in MC, CE, LA. (In ME this follows the *addicio* on f. 219.) Marginal in OA. Omitted in MA, MB, MD, OB. Y has lost folios at this point. Another *addicio* strongly supported by (II) and (III). From Bracton.

F. 220, ll. 31-40. *Vel sic: si firmarium eiecit.* Regular in OC, OD. Inserted after *etc.*, l. 2, f. 220b, in MC, LA, CE; after *supra*, l. 6, f. 220b, in OF, MI. Marginal in OA. Omitted in OB, MB, ME. MA and MD omit from one *qui dimisit* to the other, ll. 31-41. Bracton must be considered the author of this.

F. 220b, ll. 24-26. *Quia recte alterius esse.* Regular in (I), CE, OA. Inserted at end of cap. XXXVI, in CM and others; after *tenemento*, l. 28, in LA and others. See *Bracton and Azo*, 248, 249; *Law Quarterly Review*, I, 340, 341. Apparently one of Bracton's earlier additions which became a floating *addicio*.

F. 221, ll. 4-8. *Quia si possit.* Regular in OF, MI. Inserted after *tenementum*, l. 40, f. 220b, in OD; after *dominorum*, l. 12, MC, LA, CE. Marginal in OA. Omitted in OB, MA, MB, MD, ME, Y. From Bracton.

F. 221, ll. 19-28. *Quia si in commodato.* Regular in OD, OC, CE, MC, LA, MD. Inserted after *consensum*, l. 15, in OF, MI. Marginal

in OA. Omitted in OB, MA, MB, Y. All of these *addiciones* which are so consistently supported by (II) and (III) must be attributed to Bracton.

F. 221b, ll. 15-16. *Hoc quod . . . levatis*. Marginal in OA, LA. Inserted after *compendium*, l. 12, in MC, CE. Omitted in OB, OD, OC, OF, MA, MB, MD, MI, CM, Y. Of very doubtful authorship.

F. 221b, ll. 35-39. *Et in omnibus . . . constituta*. Regular in OD, MC, CE. Inserted after *velit (vellct)*, l. 10, f. 222, in ME; after sect. 2, f. 222b, in OC, MD; after *iniuste*, l. 44, f. 221b, in OF, MI. Marginal in OA, LA. Omitted in OB, MA, MB, Y. From Bracton.

F. 224b, l. 4. *Et primo confirmet personam suam*. Marginal in LA. Inserted after *brevis*, l. 3, in MC. Regular in OA, OB, MA, MB, MD, CE, Y, CM. Clearly from Bracton's pen; perhaps not even an *addicio*.

F. 225, ll. 6-10. *Poterit quis . . . assisam*. Regular in OD. Inserted after *potuit*, l. 12, in MC, CE, LA; after *usum*, l. 20, in OC, OF, MI. Marginal in OA. Omitted in OB, MA, MB, MD, ME, Y. From Bracton.

F. 225, l. 36. *Si recenter . . . civiliter*. Marginal in LA. Omitted in ME, CM. Regular in OA, OB, MA, MB, MC, CE, Y. This being vouched for by (I) and (III) should be assigned to Bracton.

F. 226, ll. 18-26. *Item competit . . . ex præsumptione*. Regular in OD. Inserted after *separale*, l. 29, in OC, OF, MD, ME, MI, CE, LA, MC. Marginal in OA. Omitted in OB, MA, MB, Y. From Bracton, on the same basis as the *addicio* immediately preceding.

F. 226, ll. 41-45. *Si seisinam . . . iuste*. Regular in OA, OB, MA, MB, MD, CE, Y. Inserted after *reconventionem*, l. 6, f. 226b, in ME, CM. Marginal in LA. Omitted in MC. An early *addicio* from Bracton, probably, though it is possible that the confusing of a *si seisinam* in one line with a *sibi seisinam* in another line (in the manuscripts *sibi* would be an *s* with a superimposed *i*, and might be made to look like a *si*) may have resulted in an early omission which took on the characteristic features of an *addicio*. The passage is certainly from Bracton.

Fs. 226b-227, ll. 21-12. *Cum iura . . . supra*. Regular in OC, OD, OF, MC, LA, CE, ME. Marginal in OA, MD (marked additional). Omitted in OB, MA, MB, Y. From Bracton.

F. 228, l. 46. *Omni tempore vel saltem aliquo et*. Regular in OC, OD, MD, MI. Marginal in OA. Omitted in OB, MA, MB, MC, LA, CE, CM. Apparently from (II) alone; it can hardly be ascribed to Bracton.

F. 228b, ll. 37-40. *Item dici alibi.* Regular in OD. Marginal in OA, OC (marked additional). Omitted in OB, OF, MA, MB, MC, MD, MI, ME, CE, LA, CM. This note fits better the context of the next chapter. We are not justified in assigning it to Bracton.

F. 230, ll. 25-33. *Cum autem post quæ petitur.* Regular in OD. Inserted after *dicetur*, l. 23, in OA, OC (marks additional), MA, MB, MC, MD, ME, MH, MN, CE, LA. Clearly from Bracton.

F. 230b, ll. 23-27. *Item se vel e contra.* Regular in OD, LA, MC. Inserted after *parva*, l. 15, f. 231, in OF, MI; after *talis est*, l. 25, f. 231, in MD. Marginal in OA, OC (marks additional). Omitted in MA, MB, ME, MN, CE, Y. In all probability one of Bracton's later additions.

F. 231, l. 15. *Sicut illam petit vel e contra.* Omitted in OA, LA, MA, MB, MC, MD, ME, Y, CE. Obviously not from Bracton.

F. 233, ll. 17-40. *Item si quis sed mensuris.* Omitted in MA, MB, MN, CE, Y. B marks additional. Inserted after cap. XLIII, in MD (marks additional); after *supra*, l. 22, f. 232, in OD; after *teneatur*, l. 24, f. 232b, MC (marks *plus*); after *consuetudine*, l. 27, f. 232b, in ME; after *damnum*, l. 1, f. 233b, in OF, MI, CB. Marginal in OA, LA, OC (marks additional). From Bracton.

F. 233b. At beginning of sect. 5 insert, *Si autem rex voluerit quod huiusmodi nocumenta terminentur coram iusticiariis suis quibuscumque tunc fiat breve in hac forma*, OA, LA, MB, MC, MN, ME, CE, CM, Y, and manuscripts generally.

Fs. 235-235b. A long passage not in V. *Iniuste, si nocumentum iniuriosum et damnosum in communi casu præferenda est private.* Marginal in LA, OA. Inserted at the end of cap. XLV, f. 235, in MD; at the end of cap. XLVI, f. 235b, in OC. Omitted in MA, MB, MC, MI, OF, ME, OD, CE, CM, Y. Judged from the slender support given it by the manuscripts this passage is at best of very doubtful authorship.

F. 235b, l. 29. *Cuiuscumque ætatis fuerit.* Omitted in OA, OC, OD, OF, MA, MB, MC, ME, CE, LA, and manuscripts generally. Obviously not from Bracton.

F. 236, ll. 30-34. *Si tamen talis reparare, etc.* Regular in OD, OF, MC, MI. Marginal in OA, LA, OC (marks additional). Omitted in OM, MA, MB, MD, ME, MN, Y, CE, CM. This passage is somewhat doubtful, but inasmuch as it is found in both MC and OD in addition to (II), there is at least a slight probability of its having come from Bracton.

F. 238, ll. 22-28. *Per hoc . . . expellat.* Regular in OC, OD, OF, OG, MA, MB, MC, ME, MN, CE, CM, Y. Marginal in OA. Without trying to account for OA's treatment of this passage we may safely assign it to Bracton.

F. 239b, ll. 27-28. *Item non sufficit . . . illam deforciaverit.* This, apparently some later annotator's note on the preceding sentence, is generally omitted by the manuscripts.

F. 251, ll. 21-22. *Super ipsa . . . recto.* Regular in OA, CE, MC, ME, CM, Y. Omitted in OD, MA, MB, OD, MN. It is altogether probable that instead of being in any sense an *addicio* this merely represents an omission extending from one *recto* to another. (See text.)

F. 253b, cap. II, sect. 2. Most of the manuscripts have changed the time of limitation in the writ to fit the law in the first Statute of Westminster. See above, p. 158.

Fs. 253b-254. OA has in the margin two passages—*Sed cum plures se faciant . . . ignoraret, aliud esset* and *Ut sciatur quæ sint . . . et nec inter tales*—which are omitted by the manuscripts generally and are not found in V.

F. 254, ll. 2-11. *Rex vicecomiti . . . teste, etc.* Omitted in MB, ME, MI. Marginal in CB. Regular in CE, MN, CM, Y, MC, OA, MD. This is probably an omission due to the two *teste, etc.*

F. 258b, ll. 4-9. *Et quod assisa . . . locis.* Marginal in OA. Regular in OC, OD, OF, MA, MB, MC, MD, ME, MN, CE, CM, Y. Clearly from Bracton; seemingly a part of the text proper. The case in this passage is cited to illustrate the point brought out in the marginal note to case 47 in the *Note Book*.

F. 263b, ll. 2-35. *Antecessoris statim . . . suo disseisinam.* Marginal in LA. Inserted after *moriatur*, l. 41, f. 263, in MC. Regular in OA, OB, MA, MB, MD, ME, MN, CE, CM, Y. If this is an *addicio* it is a very early one and from Bracton's own hand.

F. 265, ll. 29-33. *Item primus sive . . . continetur.* Regular in OF. Inserted after *heredis*, l. 27, in OC, MD; after *herede*, l. 37, in OD. Marginal in OA. Omitted in OB, MA, MB, MC, MI, ME, CE, CM, LA, Y. We can hardly accept this as an authentic part of the text.

F. 267, ll. 31-33. *Quia si talis . . . heredem.* Regular in OC, OD, OF, MD. Marginal in OA, Y. Omitted in OB, MA, MB, MC, ME, MI, CE, CM, LA. This passage begins with words typically characteristic of an *addicio*; but notice that the next sentence begins with the same three words,

quia si talis. In such a case there is always ground for the suspicion that irregularities are due to an omission, and in this particular instance the suspicion is increased because the passage is found at a single place in the text or omitted entirely. In spite of the fact that it is so generally repudiated by manuscripts in (I) and (III) the present editor is inclined to regard it as an omission rather than as an *addicio*. As to the value of an omission in LA for this part of the treatise see the remarks on the *addicio*, fs. 278b-279b, below.

Fs. 269b-270, ll. 24-2. *Et ideo cum . . . warrantia.* Regular in OD, CE, MC (which has just before it in the text, *Casus Corbyn*). Inserted at the end of sect. 2, f. 270, in OC (marks additional); after *debet*, l. 24, f. 270, in OF, CB. Marginal in OA (preceded by *Casus Corbin*). Omitted in OB, MA, MB, ME, MI, LA, Y, CM, MD. See *Note Book*, I, 95-98; III, 630, n. 2; and above, pp. 80-81. Though it is not unreasonable to accept this as having come from Bracton, we can not be sure that it has.

F. 270, ll. 38-39. *Item respondere . . . sit.* Regular in OD, OF, OG, OC, MC, LA. Inserted after *replicationem*, l. 29, f. 270b, in OB, MA, MB, MD, MI, MN, Y. Marginal in OA, ME. Omitted in CE, CM. This passage is certainly from Bracton.

F. 270b, ll. 1-6. *Item si quis . . . proprietatis.* Regular in OD, MC. Inserted after *tenuit*, l. 9, in OC, OG, MD, ME, CM; after *Turpin*, l. 35, f. 272, in OF. Marginal in OA. Omitted in OB, MA, MB, MI, MN, CE, LA, Y. It is impossible to form a definite opinion in regard to this passage; it may well be from Bracton.

F. 271, ll. 30-35. *Secundum quod . . . ut supra.* Regular in OC, OD, OG, MD, ME. Inserted after *Johanna*, l. 28, in OF. Marginal in OA. Omitted in OB, MA, MB, MC, MI, CE, LA, Y. The omission of this passage in both MC and LA, gives it the appearance of an *addicio* belonging to (II) alone and makes us hesitate to accept it as an addition written by Bracton.

F. 272b, ll. 4-15. *Sed si probari . . . ius merum.* Regular in OD. Inserted after *quare non*, l. 16, f. 272, in OF; after *deficiat*, l. 27, f. 272b, in CE, OG, and OC, MC, MD, ME, CM (which at this place go only through *auferunt*, l. 13); after *cadit assisa*, l. 4, f. 273, MC and CM insert the second part, *quia ius . . . ius merum*. Marginal in OA. Omitted in OB, MA, MB, MI, LA. Y has lost folios at this point. There may be two *addiciones* here. Bracton was probably the writer.

F. 272b, ll. 40-45. *Item casus. Filius . . . communis.* Regular in OD. Omitted in OA, OB, OC, OG, MA, MB, MC, MD, ME, MI, CE, LA, CM. Obviously not from Bracton.

F. 273b, ll. 38-42. *Sed contra esset . . . de nativis.* Regular in OC, OD, MC, MD, CE. Marginal in OA. Omitted in OB, OF, MA, MB, ME, MI, LA. Inserted after *seisitus*, l. 32, in CM. A passage of doubtful origin.

F. 274b, ll. 8-10. *Sed contra . . . a minore.* Regular in OC, OD, OF, OM, MD, ME. Inserted after sect. 1, f. 274b, in CE, MC. Marginal in OA. Omitted in OB, MA, MB, MI, LA. Doubtful, but probably from Bracton.

F. 274b, ll. 10-16. *Sed cum ante . . . huiusmodi.* Regular in OD. Omitted in OB, MA, MB, MI, LA. Marginal in OA, ME. Inserted after *militare*, l. 19, in OF; after *antecessoris*, l. 24, in OM, ME; after *maiolem*, l. 24, in CE, MC; after *fcoffato*, l. 16, f. 275, in MD. This also has probably come from Bracton.

F. 274b, l. 32. *Scilicet viginti et unius annorum.* Omitted by the manuscripts generally.

F. 275, ll. 16-32. *Item si capitalis . . . disseisiti.* OC, OD (for most part), MC, CE. Inserted after the *addicio* on f. 274b, ll. 10-16, in MD; after *supradictum est*, l. 2, in OF; after *Norfolciæ*, l. 39, in OM, ME, CM. Marginal in OA. Omitted in OB, MA, MB, MI, LA. See case 1827 in the *Note Book*. In all probability this belongs to Bracton.

F. 275b, ll. 32-42. *Sed qualiter Teste, etc.* Regular in OD, MC, CE. Inserted at the end of sect. 3, in OM, ME. Marginal in OA, OC. Omitted in OB, MA, MB, MD, MN, LA. This is another somewhat doubtful *addicio* which probably comes from Bracton.

F. 276, last line. MC and LA omit *Breve autem . . . inferius*, which is regular in OA, OB, MD, ME, CE, CM, and manuscripts generally.

F. 276b, ll. 32-35. *Prædictus Henricus habuit . . . communis.* Regular in OC, OD, OF, OG. Marginal in OA. Omitted in OB, MA, MB, MC, MD, ME, CE, CM, LA, Y. On the basis of the support given it by the manuscripts, we can hardly attribute this to Bracton.

F. 277, ll. 9-31. *Et notandum . . . aufertur.* Regular in OD, OF, MC, CE. Inserted after sect. 1, f. 279b, in MD (marks additional); OG inserts at the end of cap. XVII, f. 278b, and again after sect. 1, f. 280b. Marginal in OA, OC (marks additional). Omitted in OB, MA, MB, ME, OM, LA, Y, CM. The evidence to be derived from the mere fact that the

manuscripts examined do or do not contain this passage is not decisive enough to determine its origin one way or another. The collation of the texts of OD, MC, CE, will probably show whether they have derived this passage from (II) or represent for it a tradition in (III). For the present it must be regarded as an *addicio* of doubtful authorship, with the weight of evidence rather inclining towards Bracton as the writer.

F. 277b, end of sect. 2. *Ut de itinere filio Radulphi.* Regular in OD, MC. Inserted after *suam*, l. 13, in OF; after *Faber*, l. 14, in OC, OG. Marginal in OA. Omitted in OB, MA, MB, MD, ME, OM, CE, CM, LA, Y. Twice, elsewhere, Bracton cites this case, f. 200b and f. 421, each time in the main text, and in the latter instance in almost the same words as in this citation. The case itself is to be found in the *Note Book*, No. 1411, and *Appendix* to Vol. III, No. 8. But the manuscripts vouch for this particular *addicio* far less consistently than we could wish, and on the basis of their evidence we are not justified in saying anything more positive than that the passage may have come from Bracton.

F. 277b, ll. 23-27. *Sed contrarium minoris.* Regular in OD. Inserted after *successione*, l. 32, in OF. Marginal in OA, CA (both of which have the date *xlii*). Omitted in OB, OG, OM, MA, MB, MC, MD, ME, CE, CM, LA, Y. This citation is not at all in Bracton's customary form. The passage is supported by (II) +OD and repudiated by (I) + (III). Bracton can not be considered the author.

Fs. 278b-279b, ll. 25-30. *Item sicut non propinquiores.* Regular in OD, OC, OM, MB, MC, MD, ME, and OB, MA, MN, Y (which mark as additional). Inserted after *aufertur*, l. 31, f. 277, in CE; after sect. 3, f. 278, in OF, CA (marks additional); after *contra assisam*, l. 23, f. 278b, in OG. Marginal in OA. Omitted in LA. There can be no doubt that this has come from Bracton. It shows, too, that LA may omit an additional passage which is clearly from Bracton. Therefore, an omission by LA in this portion of the treatise should not count strongly against an *addicio*.

F. 280, ll. 5-8. *Idem dici ventris.* Regular in OD, OM, MC, LA, ME. Inserted after *consanguinitate*, l. 24, f. 278b, in CE; after *potuit*, l. 45, f. 279b, in OF; after *matre*, l. 2, f. 280, in OC, OG, MD. Marginal in OA. Omitted in OB, MA, MB, MI, Y. This should be assigned to Bracton.

F. 280b, ll. 42-43. *Remanebit possessio inter se.* Regular in OM. Omitted in OA, OC, OD, OF, MA, MB, MC, MD, ME, CE, LA, Y, and manuscripts generally.

F. 282, ll. 3-32. *Siue p̄iudicio . . . seisinam habuerit.* Regular in OB, OD, MA, MB, MD, ME, MN, MI, Y. Inserted after cap. II, f. 283, in OC, CE, MC; after the following *addicio*, in OF. Marginal in OA. Omitted in LA, CB (which inserts a folio that contains the omitted part). This is clearly from Bracton.

Fs. 282-282b, ll. 32-25. *Cum frater . . . recenti seisina.* Regular in OB, OD, MA, MB, MD, ME, MN, Y. Inserted at the end of cap. II, f. 283 (following the *addicio* immediately before this), in MC, CE; after cap. IV, f. 284, in OC, OF, OG, MI (followed by the *addicio* which should regularly precede, both *addiciones* occurring again in MI in regular order). Marginal in OA. Omitted in LA. Another addition by Bracton.

F. 283b, ll. 10-12. *Quia sicut in . . . ius merum.* Regular in OD. Inserted after cap. II, f. 283 (following the *addicio* on f. 282), in OG; after *proprietate*, l. 8, in OC. Marginal in OA. Omitted in OB, OF, MA, MB, MC, MI, CE, CM, LA, Y. In content and form of expression this is much the same as the *addicio* on f. 267, but unless the collation to be made later results in the discovery of this passage in out of the way places in some of the texts which are here given as omitting it, we can not accept it as one of Bracton's own additions.

F. 285b, ll. 6-11. *Inter eos inter quos . . . casus.* Regular in PH. Inserted after *tenente* (*petente*), l. 4, in MC (which has as a rubric for it, *Littera ista non reperitur in alio libro*). Marginal in OA, LA. Omitted in OB, OC, OD, OF, OG, OM, MA, MB, MF, MG, MH, MI, CE, LT, B, P, Y. This contains a reference to a case having to do with the Church of St. Mary, Oxford. The *addicio* itself is clearly one belonging to (III) alone and as such can not be given a place in the treatise.

Fs. 287b-288, ll. 35-1. *Si autem bastardus . . . fecerit, etc.* Regular in OD, ME. Inserted after *assisam*, l. 36, f. 287, in OG; after *concessum*, l. 27, f. 288, in OF, MI. Marginal in OA, OC. Omitted in OB, MA, MB, MC, MD, CE, LA, Y. A passage of doubtful authorship.

F. 290, ll. 12-19. *Sed admitti . . . opus esset.* Regular in OD. Inserted after *actio*, l. 10, in OC, OF, OG, MD, MI. Marginal in OA. Omitted in OB, MA, MB, MC, ME, CE, LA, Y. In this, as in the preceding *addicio*, the chances are that OD is giving an *addicio* from the tradition of (II)—see p. 331, above—while MC, LA and the main text of OA are keeping the original tradition of (III). This would mean that both (I) and (III) do not vouch for the passages, which on this

ground could not be assigned to Bracton. At the best, their authorship is doubtful.

F. 291b, ll. 25-30. *Et excipi poterit . . . parte aliqua.* Regular in OD. Inserted after *viginti quatuor*, l. 45, in CM, ME. Marginal in OA. Omitted in OB, OC, OF, OG, MA, MB, MC, MD, MI, CE, LA, Y. There is always the possibility that these short *addiciones* may have escaped the examiner in some of the texts through being hidden in out of the way places, but on the basis of the omissions, as here given, this passage can not be attributed to Bracton.

F. 292, ll. 39-42. *Si forte . . . in comitatu Somerset.* Regular in OD. Inserted after *capiantur*, l. 16, f. 292b, in ME, CM. Marginal in OA. Omitted in OB, OC, OF, OG, MA, MB, MC, MD, MI, LA, CE, Y. Apparently not from Bracton.

F. 296, ll. 10-25. *Contingit multociens . . . convictionem.* Regular in OD. Inserted after *iudicatae*, l. 27, f. 294b, in OC, OF, OG, MD, MG; after *capita*, l. 7, f. 295, in ME, MM. Marginal in OA. Omitted in OB, MA, MB, MC, MI, LF, LA, CE, Y. This *addicio* contains a citation given in Bracton's usual style. The case is not in the *Note Book*. The failure of LA and MC to vouch for it makes one suspect that OD has taken the passage from (II). Until the text has been collated it will be well to put this in the list of *addiciones* of doubtful authorship.

F. 296b, ll. 35-40. *Et quo casu . . . filium Roberti.* Regular in OD, ME, CM. Omitted in OB, MA, MB, MC, MI, LA, CE, Y. MD omits only the case reference, *ut coram . . . Roberti*. It should be remembered that OA and some of the other manuscripts omit the Action for Dower. This case is 1668 in the *Note Book*. We can not be positive, however, that this is one of Bracton's own additions.

F. 297, ll. 23-25. *Sed si nesciverint . . . de Berners.* Regular in OC, OD. Inserted after *habuerit*, l. 21, in ME, CM. Omitted in OB, MA, MB, MC, OF, CE, LA, Y. MD omits only the actual case reference, *ut de . . . Berners*. The case cited is 1937 in the *Note Book*. In the latter the last paragraph reads, *Et Rogerus venit et vocavit inde ad warantum filiam prædicti Roberti, sed nescivit eam nominare. Et ideo consideratum est quod Agnes recuperavit seisinam suam, et ipse in misericordia.* Opposite this as a side note is, *Nota quod cadit breve et tenens amittit cum nesciat nominare warantum suum.* All this is very similar to the *Sed si nesciverint warantum nominare, mulier statim recuperabit dotem suam, et tenens in misericordia* in the

treatise. There can be no doubt that the writer of the *addicio*, whoever he may have been, took it directly from the *Note Book*. But with the passage omitted not only in (1) but also in CE, Y, and OF, MC, LA, we can not be at all sure that Bracton was the writer. As to the possibility of some annotator after Bracton having made use of the *Note Book*, see above, p. 368.

F. 297, ll. 39-42. *Ut de itinere per totum*. Regular in ME, CM, OD. Omitted in OB, MA, MB, MC, MD, MN, CE, LA, Y. Here are cited two cases, neither of which is in the *Note Book*. The citations are made in regular form, but the manuscripts do not support them in a way to make us at all certain that Bracton was the writer.

Fs. 297b-298, ll. 41-2. *Idem erit dotem obtinebit*. Regular in MD. Omitted in OB, MA, MB, MC, ME, MN, CE, CM, LA, Y. The probabilities are decidedly against Bracton having written this.

F. 298, ll. 10-17. *Si mulier dotem Roberti Bryton*. Regular in ME, CM, OD. Omitted in OB, MA, MB, MC, MD, MN, CB, CE, LA, Y. Two cases are cited in this *addicio*. Neither one is in the *Note Book*. The statements made in regard to the *addicio* in ll. 39-42, f. 297, apply equally well here.

F. 298b, ll. 16-20 and 20-32. *Et eodem modo de gratia and quia dotis obtinebit*. These two passages are found in the manuscripts generally, but usually in the reverse order. It is difficult to tell which is really the additional passage inasmuch as though B marks the first additional, the second is omitted in LA. The collation of several entire texts may be trusted to straighten out this matter.

F. 309b, ll. 32-33. *Si quis in descendat*. This is a mere repetition of the first few words in sect. 7 following and is omitted by the manuscripts generally.

F. 310, ll. 33-35. *Et quod mulier filii Divæ*. Omitted in OB, OC, OF, MA, MB, MD, CE, Y. Marginal in LA. Inserted after *per iudicium*, l. 24, in MC, ME, CM. The case is not in the *Note Book*. The citation is regular in form, but in view of the many manuscripts which omit it, the passage must, for the present at least, be put among those of doubtful origin.

F. 311, ll. 14-17. *Secundum quod Pickednese*. Though marginal in LA, this passage is regular in OB, MA, MB, MC, MD, ME, MN, CE, CM, Y. It is therefore obviously from Bracton.

F. 311, ll. 23-27. *Sed hoc intelligendum de Nassendene*. Omitted in OB, OF, MA, MB, MD, MN, ML, CE, Y. Marginal in LA. Inserted

after *coronæ*, l. 2, f. 311b, in OC, MC, ME, CM. See case 1644 in the *Note Book*. This is somewhat better supported by the manuscripts than some of the similar case reference *addicioncs*, but it will be well to await the results of the fuller collation before deciding definitely as to its authorship.

F. 311b, ll. 15-17. *Sed iam amittere debet*. Omitted in OB, MA, MB, MC, MD, ME, MN, CE, CM, LA, Y, and manuscripts generally. Compare this with the first line of sect. 14 and the rubric.

F. 311b, ll. 27-29. *Iam videamus partem dotis*. Omitted in OB, MA, MB, MC, MD, ME, MN, CE, CM, LA, Y, and manuscripts generally. Similar to the *addicio* in ll. 15-17, above, in that it is based upon the opening lines of the next section. Neither of these passages has come from Bracton.

F. 315, ll. 10-11. *Nota quod facienda*. Omitted in the manuscripts generally. Obviously not from Bracton.

F. 319, ll. 27-29. *Item de hac tenente*. Regular in OF (in part). Inserted after *modo, etc.*, l. 10, in MC; after *dominico*, l. 22, in OD. Marginal in OA, LA. Omitted in OB, OC, OG, MA, MB, MD, MI, ME, CE, CM, Y. The case is not in the *Note Book*. Citation in regular form, but authorship not certain.

F. 320, ll. 5-6 and 12-14. *Secundum quod Murdac*. A repeated passage in V. Inserted at l. 12, in OF, OM, MG, CC, LB, X, W; after *legem*, l. 9, in OG, MC, CB, HB, B; at end of sect. 1, in PH. Marginal in OA, LA. Omitted in OB, OC, OD, MA, MB, MD, ME, MH, MI, MM, MN, CE, CF, CM, LC, LF, LG, LT, P, Y, HA. The case is not in the *Note Book*. The citation is in the regular form, but it would be very difficult to explain its omission in so many individual manuscripts in different groups if we were to assume that it was written by Bracton.

F. 320b, ll. 29-34. *Sed revera de termino*. Regular in OD. Inserted after *defensionem*, l. 43, in OC, OF, OG, MD (which omits the last sentence); after *W̄ndeslore*, l. 45, in OM; after *locis*, l. 46, in ME, CM, P; after *huiusmodi*, l. 5, f. 321, in MC. Marginal in OA, LA. Omitted in OB, MA, MB, MI, CE, Y. This is vouched for by (II) + (III) and is therefore from Bracton.

Fs. 321b-322, ll. 36-5. *Et notandum Eborum*. Regular in OD, OF, MC, ME, CM. Inserted after *e contrario*, l. 19, f. 322, in OC, OG; after *revocaret*, l. 45, f. 322, in MD. Marginal in OA, LA. Omitted in OB, MA, MB, MI, CE, Y. Here again the combined support of (II) and (III) outweighs the omission in (I).

F. 322. At the end of sect. 1, insert: *Competit hereditate breve si fuerit ex alio viro et si vir heredem habuerit ex aliqua (alia) uxore secundum quod supra dictum est per exemplum*, in LA, CM, ME. Marginal in OA. Omitted in OB, MA, MB, MC, MD, CE, Y, and manuscripts generally. Hardly from Bracton.

Fs. 322-322b, ll. 46-29. *Revera licet . . . mortem matris*. Regular in OB, OD, MA, MB, MC, ME, MI, MN, Y. Inserted after the *addicio* on fs. 321b-322, in OC, OG, MD; after *etc.*, l. 10, f. 323b, in OF; after *heredis*, l. 41, f. 322, in LA. Marginal in OA. Omitted in CE. An early *addicio* from Bracton.

F. 324b. At the end of sect. 1, insert: *Si autem ad terminum qui præterit satis dictum est supra de forma inquisitionis*, in OA, OB, MA, MB, MC, MD, ME, CE, CM, LA, Y, and manuscripts generally. Omitted in MN. This clearly belongs in the treatise.

F. 326b, ll. 22-23. *Et de hac . . . de malo lecti*. Omitted in OA, OB, MA, MB, MC, MD, ME, MN, CM, Y, and manuscripts generally. Used as a rubric in LA. An interpolation.

F. 334, ll. 31-43. *Sunt autem quidam . . . summonitionem*. Inserted at the end of the chapter in OD, OF, OG, OC (marks additional), MD (marks additional); after *suum*, l. 20, f. 334b, in OM, ME; after *notandum*, l. 31, f. 334b, in MC. Marginal in OA, LA. Omitted in OB, MA, MB, MI, CE, Y. This should be attributed to Bracton.

F. 335b, ll. 14-18. *Si petens se . . . termino ut supra*. *Ut supra* is omitted in a number of the manuscripts which contain the passage; MD adds, *de termino Paschæ anno regni regis Henrici octavo*. Regular in OD, OF, OG, MD. Inserted after *dictum est*, l. 9, in MC; after *iudicium*, l. 12, in OM, CM. Marginal in OA, LA. Omitted in OB, OC, MA, MB, MI, CE, Y. This is a very blind reference, quite unlike Bracton's usual citation; but inasmuch as the passage is so generally vouched for by the manuscripts in (II) and (III), we can hardly do otherwise than ascribe it to him. It may well be that in the original note a space was left after *termino* to be filled in later with the correct reference. In at least one of the manuscripts such a space is to be found. The reference to the year and term in MD was in all probability not added by Bracton (it would be given in other manuscripts were that the case), but it is important as showing how later users of the treatise could make a citation in Bracton's typical form.

F. 336, ll. 12-14. *De hac materia . . . querente*. Regular in OD, CM. Inserted after *præterit*, l. 29, in MC. Marginal in OA, LA. Omitted in

OB, OC, OF, OG, MA, MB, MD, MI, CE, Y. The citation is perhaps incorrect, the case (No. 10) in the *Note Book* coming from Trinity term, a.r. 2. The manuscripts do not give us sufficient authority to assign this to Bracton.

Fs. 338-339, ll. 13-3. *Habent etiam cssonia . . . damnosa*. Regular in OD. Inserted after *possessori*, l. 19, f. 336, in MC; at the end of cap. 1, f. 336b, in OC, OF, OG, MD (which has as a separate paragraph); after sect. 1, f. 337, in CB (through *ex alia parte*, l. 4, f. 338b, the rest being marginal). Marginal in OA, LA, CB (in part). Omitted in OB, MA, MB, ME, CM, CE, Y. This passage is far less generally supported by the manuscripts than could be wished in the case of one of its length and importance. It will be well to reserve a definite judgment as to its authorship until the collation of several manuscripts has furnished more detailed data.

F. 339, ll. 28-30. *Ad minus arbitrarie*. Inserted after *talem*, l. 23, in CB, MC; after *peregrinatio*, l. 23, in OA, OB, MA, MB, MD, CE, Y. Marginal in LA. Omitted in CM. From Bracton.

Fs. 341-341b, ll. 41-1. *Item non iacet controversia*. Regular in OC, OD, OF, ME, CM. Inserted after *beneficium*, l. 38, f. 341, in MC. Marginal in OA, LA. Omitted in OB, MA, MB, MD, CE, Y. From Bracton.

F. 342, ll. 38-41. *Et hæc vera villis auctoritas*. Omitted in OA, LA, MB, MC, MD, ME, MN, CM, Y, and manuscripts generally. Apparently an interpolation.

F. 345b, ll. 23-29. *Sed esto quod malo lecti*. Regular in OD, OB, MA, OA, MB, ME, MH, MN, MD, CE, LA, Y (in many of these as a separate paragraph). Inserted after *curiæ*, l. 32, in MC; after *primo casu*, l. 4, f. 346, in OC (marks additional). Marginal in CB. From Bracton.

F. 345b, ll. 29-32. *Quandoque vertitur consilio curiæ*. Inserted after *veniendi*, l. 23, in MC. Omitted in MA, LA, MN. Used as a rubric for the passage in ll. 23-29, OA, OB, MB, MD, CB, CE, CM, Y, and other manuscripts. Not more than a rubric.

F. 346, ll. 4-5. *Nisi quis habere necessitatem*. (Compare this with the rubric for sect. 4.) In the manuscripts this is usually omitted or used as a rubric for a paragraph beginning with *Ita quod ex*, l. 5.

F. 346b, ll. 13-17. *Et oportet quod malo lecti*. Inserted after *primo casu*, l. 4, f. 346, in MG (marks additional); after *est*, l. 18, f. 346b, in OC, OD, OF. Marginal in OA. Omitted in OB, MA, MB, MC, MD, ME, CE, LA, Y. This looks like an *addicio* from (II) alone; it must therefore be regarded as of doubtful authorship.

F. 349b, ll. 22-23. *Ut de termino S. Georgio.* Regular in LA, ME, CM. Inserted at end of cap. VII, f. 349b, in X; after *defectum*, l. 28, in MC; after *warrantizaverit*, l. 34, f. 350, in OF; after cap. VIII, f. 351, in OC (marks additional). Omitted in OA, OB, OD, MA, MB, MD, MN, CE, Y. The authorship of this passage must remain in doubt. The fact that it is found in MC and LA strengthens the suggestion that it may have come from Bracton.

F. 350, ll. 8-19. *Sed contra fine facto.* Regular in OC (marks additional), OD, ME, CM. Inserted after *fuert*, l. 25, f. 350, in MC; after sect. I, f. 350b, in OF. Marginal in OA, LA. Omitted in OB, MA, MB, MD, MN, CE, Y. Of the six cases here cited no one is in the *Note Book*; it is not at all unlikely, however, that the citations were made by Bracton.

Fs. 350-350b, ll. 35-32. *Item non iacet mortis antecessoris.* Regular in OB, OD, OF (with variations and omissions), MA, MB, MD, MN, Y. Inserted at the end of cap. VIII, f. 351, in OC (marks additional); after *veniendi*, l. 11, f. 349b, in MC (with changes of order). Marginal in OA, LA, CB. Omitted in CE. Six cases are cited here, none of which is found in the *Note Book*. From the way in which the passage is vouched for by the manuscripts there can be no doubt that Bracton was the author of it.

F. 351b, ll. 43-46. *Martinus in banco plegiaverunt.* Regular in MC, and ME, CM (which omit *Martinus septimo*). Omitted in OA, OB, MA, MB, MD, MN, CE, LA, Y. The reference to *Martinus* immediately suggests Bracton as the writer, but the refusal of the manuscripts to vouch for the citation makes its authorship extremely doubtful.

Fs. 355-355b, ll. 44-6. *Et quod licentia multis locis.* Regular in OC (marks additional), OF, MD (marks additional), CE. Put at the end of sect. 5, f. 355b, in OD. Marginal in OA. Omitted in OB, MA, MB, MC, LA, CM, Y. This *addicio* contains a reference to a case, No. 420, in the *Note Book*. In the latter a side note states, in much the same language, the very points brought out by the *addicio*. However, the failure of MC, LA, CM to give this passage in their texts makes us hesitate to unreservedly acknowledge Bracton as the writer of it.

F. 356b, ll. 22-31. *Item si petens uxore eius.* Regular in MC, CM, MH (marks additional), CB (which omits the citation of the case and puts it in the margin). Inserted after *summonitionibus*, l. 39, f. 356, in CE, OC (marks additional); after *testimonium*, l. 21, f. 356b, in OA, OB, OD, MA, MB, MD, MN, Y. Marginal in LA. Clearly from Bracton.

F. 357, ll. 11-16. *Sed sive . . . nisi velit.* Inserted after *dato*, l. 5, f. 357, in OF; after *petenti*, l. 22, f. 357, in OD, CM; after *iudicatis*, l. 19, f. 357, in MC; at end of cap. XI, f. 357b, in MD (marks additional). Marginal in OA, LA, OC (marks additional). Omitted in OB, OG, MA, MB, CE, Y. While the evidence of the manuscripts is not strongly favorable to Bracton as the author of this passage, it is not strongly against him. The *respondeo* certainly sounds like Bracton (see comment upon *addicio* on fs. 212b-213), but it is far from being positive proof of his authorship. We may say that probabilities rather point to Bracton as the writer of this *addicio*.

F. 357, ll. 23-30. *Vel si forte . . . in hoc casu.* Regular in OD, CM. Inserted after *petenti*, l. 22, in OF; after sect. 2, in MD (marks additional); after *culpa*, l. 33, in MC; after *deberet*, l. 30, in LA. Marginal in OA, OC (marks additional). Omitted in OB, OG, MA, MB, CE, Y. This *addicio*, apparently supported by (II) and (III), should be attributed to Bracton.

F. 357, ll. 44-45. *Sed quid si . . . ei subveniri.* Inserted after *legitimus*, l. 39, in MD, ME, CM; after *culpa*, l. 41, in MC, LA. Omitted in OB, OA, MA, MB, MN, CE, Y. Somewhat doubtful, but probably from Bracton.

F. 357b, ll. 22-23. *Licet ab . . . inter coheredes.* Regular in OC, OD, OF, MC, MD, ME, CE, CM, LA. Marginal in OA. Omitted in OB, MA, MB, MN, Y. Clearly from Bracton.

F. 359b, ll. 1-5. *Quia sic subductus . . . propter XVIII horas.* Regular in CE, OC (marks additional). Inserted after *unus*, l. 5, in OA, OB, MA, MB, MC, MD, MN, LA, Y. Omitted in OD, ME, CM. Another *addicio* about whose authorship there can be no doubt.

F. 366b, ll. 14-15. *Respondeo sufficit . . . reformatio.* Regular in OD, CM. Marginal in OA. Omitted in OB, OC, OE, OF, OG, MA, MB, MC, MD, CE, LA, Y. Bracton's use of *respondeo* has already been commented upon. It is altogether improbable, however, that he is responsible for this *addicio*.

F. 370b. A passage not in V. *Sed quid si vir primo . . . defensione per legem.* Marginal in OA. Inserted after sect. 6, f. 370b, in ME, CM; after sect. 8, f. 371, in OC (marks additional). Omitted in OB, OD, OE, OG, MA, MB, MC, LA, CE, Y. We are not justified in ascribing this to Bracton.

F. 373, ll. 17-22. *Et de tenera . . . recuperatione.* Regular in OD. Inserted after *petentis*, l. 15, in MC, ME, CE, CM, LA; after *probationis*,

l. 30, in OC and MD, which mark additional. Marginal in OA. Omitted in OB, OE, OF, OG, MA, MB, Y. (ME and CM omit the sentence immediately before this in V.) This *addicio* is sufficiently well vouched for to make it seem likely that it was written by Bracton.

F. 373b, ll. 32-34. *Sed caute eodem.* Inserted after *dividatur*, l. 38, in OD, MC, LA; after *petant*, l. 4, f. 374, in OC, OF, OG, CE. Marginal in OA. Omitted in OB, OE, MA, MB, MD, ME, Y. Another passage which may quite safely be assigned to Bracton.

F. 374, ll. 37-41. *Sed sunt quidam defecerint.* Regular in OD. Inserted after *est verum*, l. 36, in OB, MA, MB, MD, MN, Y; after *inconveniens*, l. 5, f. 374b, in MC, LA. Marginal in OA. Omitted in OC, CE, ME, CM. Notice the reference to William of York. From Bracton.

F. 374b, ll. 16-19. *Sed revera heredes sui.* Regular in (I), CE, Y, LA, and manuscripts generally. Omitted in ME, CM, and others of the same group. From Bracton, whether an *addicio* or not.

F. 375, ll. 25-27. *Et de hac Wellensis.* Regular in OD, MC, LA, ME, CM. Inserted after *permanebit*, l. 5, in OG; after *heredes*, l. 20, in OC, OF, CE, MK. Marginal in OA. Omitted in OB, OE, MA, MB, MD, Y. The case is given in the *Note Book*, not from Easter, but from Trinity, term, No. 411. In the margin opposite its first paragraph is the note, *Non fit mentio, ut de feodo, quia non sunt heredes.* This should be compared with that sentence in the treatise after which the *addicio* is inserted by OC, OF, CE. Inasmuch as this passage is supported by all the groups with the exception of (I), it may safely be assigned to Bracton.

F. 375b, ll. 19-22. *Et hoc acquiritur.* Regular in OB, OC, OD, OE, OF, MA, MB, MI, MN, CE, Y. Inserted after *supradicti*, l. 28, in MC, LA. Marginal in OA. Omitted in ME, CM. An *addicio* which is certainly from Bracton.

F. 375b, ll. 31-35. *Sed naturaliter corpore.* Regular in OC, OD, OF, OG, MC, MD, ME, CE, CM, LA. Marginal in OA. Omitted in OB, OE, MA, MB, MI, MN, Y. One of Bracton's later *addiciones*.

F. 375b, ll. 40-45. *Item poterit dominorum.* Regular in OD. Inserted after *supradicti*, l. 28, in MD (marks additional); after *descensu*, l. 5, f. 376, in MC, LA; after cap. VI, f. 376, in OC (marks additional). Marginal in OA. Omitted in OB, OE, OF, OG, MA, MB, MI, ME, Y. The omission of this passage by OF and ME makes its authorship somewhat doubtful, but it was probably written by Bracton.

F. 376b, ll. 12-17. *Sed revera faciendo.* Regular in OD, MD (marks additional). Inserted after *exceptio*, l. 27, f. 376, in CE, OC (marks additional); after cap. VII, f. 376, in MC, LA. Marginal in OA. Omitted in OB, OF, OE, OG, MA, MB, MI, ME, CM, Y. Another passage of rather uncertain origin which should probably be assigned to Bracton.

F. 377, ll. 3-5. *Item denegatur de eodem.* Regular in OD, OC (marks additional), MD (marks additional), MC, ME, CM, CE, LA. Inserted after *obiit*, l. 36, f. 376b, in OG. Marginal in OA. Omitted in OB, OF, OE, MA, MB, MI, Y. In all likelihood this also was written by Bracton.

F. 378, ll. 39-44. *Et (si autem) aliquando Nutlegh.* Regular in OD, LA, MC. Inserted after *petitur*, l. 25, in MH, ME, CM. Marginal in OC (marks additional). Omitted in OA, OB, OE, OG, MA, MB, MD, CE, Y. The case is not among those in the *Note Book*. There are several authentic citations in the treatise made in the same way and with the same date ("second year after the war"; see *Note Book*, I, 147); but the fact that OA does not have this passage as a marginal note, and that CE—which shows a strong tendency in this portion of its text to give the better authenticated *addiciones*—omits it, should make us hesitate to assign it definitely to Bracton.

F. 379, l. 1. *Cum autem visus hoc modo.* Regular in MC, ME, CE, CM, LA, and manuscripts generally. Omitted in (I). Probably not an *addicio*, but a mere omission by (I).

F. 381, ll. 15-16. *Nisi ita dominetur.* Regular in OD, OF, LC, ME, CM. Inserted after *nominetur*, l. 17, in OC, OG, CE. Marginal in OA. Omitted in OB, MA, MB, MC, MD, LA, MI, Y. This must be put among the doubtful passages.

F. 382, ll. 38-40. *Ut probatur obligatum.* Regular in OC, OD, OF, LC, ME, CE. Inserted at the end of sect. 7, in MC, LA. Marginal in OA. Omitted in OB, OE, MA, MB, MI, MD, Y. The date given is probably incorrect; it should more likely be Hilary term, a. r. 17. The case itself is in the *Note Book*, No. 748, annotated with three side notes, the last of which shows a remarkable similarity of expression to the last four lines of sect. 7 in the treatise. The manuscripts vouch for this *addicio* in a way which leaves no reasonable doubt that Bracton was the writer of it.

F. 384b, ll. 25-30. *Quandoque tamen decimo quarto.* Regular in MC, LA. Inserted after *teste*, l. 17, in ME, CM; after sect. 4, in CE. Omitted in OB, MA, MB, MD, MN, Y. OA has in place of it the rubric

to sect. 6. The case is not given in the *Note Book*. The passage is probably one of Bracton's additions.

F. 385, ll. 24-27. *Si autem unus . . . custos est.* Regular in OF, OC, OG, and CE, MD (which omit only *terra heredes. Si autem unus*). Marginal in OA, LA, OE. Omitted in OB, OD, MA, MB, MC, MI, LC, Y (omits *quod terra heres . . . custos est*), ME (omits *eum autem unus . . . custos est*). This passage is of doubtful origin.

F. 386, ll. 20-23. *Si post . . . irrotulatio.* Regular in OD. Used as a rubric in OA, OB, OC, OE, MB, MC, MI, MK, LA, CE, and manuscripts generally.

F. 386b, ll. 11-17. *Si Christianus vel . . . non sibi ipsis.* Regular in MC, LC, LD, LT. Marginal in LA. Omitted in OA, OB, OC, OD, OE, OF, OG, MA, MB, MD, ME, MK, CE, Y, and manuscripts generally. Not from Bracton.

F. 390b, ll. 6-10. *Si autem . . . esse heredem.* Regular in OC, OF, CE. Inserted after sect. 9, in MC; after *cuiuslibet*, l. 4, in LC; after *vel sic*, l. 4, in CM. Marginal in OA, LA. Omitted in OB, OD, OE, MA, MB, MD, MI, Y. Doubtful.

F. 407, ll. 23-24. *Nota quod . . . elemosina.* Omitted in the manuscripts generally. Obviously not from Bracton.

F. 409b, ll. 1-33. *Regulariter verum est . . . ab initio.* Regular in OC, MC, MD, ME, CE, LC. Marginal in LA. Omitted in OA, OB, OD, OE, OF, MA, MB, CC, Y. Case 11 in the *Note Book* may be an earlier stage of this case (see II, 11, n. 4). The manuscripts do not vouch for this passage in a way which makes one positive as to its origin. It should be kept on the doubtful list until the collation of manuscripts representative of different lines has revealed more of its history.

F. 411, ll. 1-25. *Et similiter creditor . . . ratione dilecti.* Regular in MC, LC. Marginal in LA, OC. Omitted in OA, OB, OD, OE, OG, MA, MB, MD, ME, MH, CC, CE, Y. *Et similiter . . . vetitum* (ll. 1-2) is treated as a separate passage by ME, MH, LA, OC. With such an array of manuscripts omitting this *addicio* we are forced to regard Bracton's authorship of it as extremely doubtful. This is yet another *addicio* of such length that the collation of the manuscripts may reasonably be expected to throw some further light on its origin.

F. 412b, ll. 10-15. *Sed revera locum . . . versus omnes.* Inserted after *quosdam*, l. 1, f. 412b, in LC, MH, ME; after *testamento*, l. 3, in OC, MC,

CE, MD. Marginal in LA. Omitted in OA, OB, OD, MA, MB, MI, CC, Y. It should be remembered that in this portion of the treatise, OA and CC are in (II) and OD and Y in (I). Therefore this *addicio* would seem to be supported by (III) and the new group (IV). Its authorship can not be definitely determined; the evidence of the manuscripts is in no way decisively against Bracton as the writer.

F. 413, ll. 17-18. *Ut de itinere Notinghamiæ.* Regular in OB, OC, OD, MA, MB, MC, ME, MH, MM, LA, LD, CE, P, Y, and manuscripts generally. Omitted in OA, OF, MG, MK, CB, CC, HB, B, X. The case cited is not in the *Note Book*. For a discussion of this *addicio* see above, p. 370. As group (II) alone omits this passage, it must be assigned to Bracton.

F. 413, ll. 26-28. *Ut de itinere de recto.* Regular in OB, OC, OD, MC, ME, MH, MM, LA, LD, CE, P, Y, and manuscripts generally. Marginal in CB. Omitted in OA, OF, MG, CC, HB, B. This passage has certainly come from Bracton. It may not be an *addicio*, but a mere omission of a case by the common ancestor of (II) which is the only group to repudiate it. Within these last one hundred folios of the treatise, both MA and LD, in different instances, omit not a few cases which are given regularly by the other manuscripts. The same sort of thing in an early exemplar of the group has probably resulted in the omission of these cases on f. 413 in (II).

F. 413, ll. 28-29. *De ordine brevium supradicta sunt.* Regular in OB, OD, MA, MB, MD (which has also as OC), MF, MI, MN, LD, LG, Y. Omitted in OM, HA, LF, LT. Inserted after *brevi*, l. 23, in OC, MD, OA, OF, MG, CC, CB, HB, B, X, and other manuscripts. MC and LA divide this *addicio* into two parts and insert a part at either place. This is most certainly from Bracton's pen.

F. 414, ll. 7-9. *Quod impetratum fuit cum non sit.* Inserted after *huiusmodi*, l. 14, in OM, ME, MH, MM, CM, LT, P, W. Regular in the manuscripts generally. This may or may not be an *addicio*; it is clearly from Bracton.

F. 414, ll. 27-35. *Et si unus filio Godfrey.* Regular in OA, OB, OD, OF, MA, MB, ME, MG, MH, MM, CC, CB, B, HB, LC, LD, P, W, X, Y, OM. Inserted after *alios*, l. 36, in OC (marks additional), MD (has regularly also), MC, LA, CE. Omitted in ML. The case cited is No. 227 in the *Note Book*. The passage itself is certainly from Bracton.

F. 414b, ll. 37-43. *Ut de placitis . . . vel non.* Omitted in LA, LF (in part). Regular in manuscripts generally, including ML. OC marks additional. Certainly from Bracton, probably not an *addicio*.

F. 416. A passage not in V. *Sed non refert utrum . . . sit bastardia (adlicta causa).* Inserted after *respondeat*, l. 33, in ME, MH, MM, P; after *incertitudo*, l. 31, in CE, and OC, MD (which mark additional); after *cognitio*, l. 32, in MC, LA. Omitted in OA, OB, OD, MA, MB, MF, MG, ML, MN, Y. This should at least be kept in the list of doubtful passages. It may have come from Bracton.

F. 417, ll. 12-23. This list of names, though omitted in OA, OE, MG, and other manuscripts in (II), is given regularly in OB, OC, OD, MA, MB, MC, MD, ME, MH, MM, MN, ML, MF, CE, LA, P, Y. Its right to a place in the treatise is therefore assured.

F. 417, ll. 37-41. *Et quod assisa . . . Norlington.* Regular in CM, ME, MH, MM, P. Inserted after *facienda*, l. 32, in MC, LA. Omitted in OA, OB, OC, OD, OE, OF, MA, MB, MD, MF, ML, MN, CE, Y, MG. This case is cited again on f. 418b, where it occurs not in an *addicio* but in the main text. See *Note Book*, case 1780. The *Note Book* reads, *Juratores dicunt quod Jeruasius et Rogerus non sunt propinquiores heredes quia nati fuerunt in adulterio ante matrimonium. Et idco consideratum est quod nihil capiant, etc.* The passage in the text on f. 418b, reads, *et de quibus dixerunt iuratores quod bastardi fuerunt, quia nati ante matrimonium, et procedit assisa mortis antecessoris in curia regis.* The *addicio* on f. 417 reads, *et ubi iurata dixit quod non fuerunt heredes propinquiores, quia nati fuerunt in adulterio ante matrimonium.* The words of the *addicio* are certainly more like those of the *Note Book* than are those in the authentic passage in the text. Both passages in the treatise bring out the point emphasized by the case and the marginal note in the *Note Book*, that a lay court has the power to determine special bastardy. In content, then, this *addicio* has everything necessary to recommend it as one of Bracton's own. But the fact that so many of the manuscripts repudiate it should make us hesitate to accept it too readily on that basis. The possibility of some one other than Bracton having used the *Note Book* for purposes of citation has to be taken into consideration in a case of this sort. We are not justified in doing more than labelling this *addicio* doubtful as to authorship.

F. 417b. A passage not in V. *Et ideo in nullo casu valet . . . patris.* Inserted after *iudicantur*, l. 20, in OA, LA, MC, CE, MG, OE, and OC, MD (which mark additional); after *obscure*, l. 20, in ME, MH, MM, P.

Omitted in OB, OD, MA, MB, MF, ML, MN, Y. Inasmuch as this passage is found in the manuscripts generally outside of (I) it should be assigned to Bracton.

F. 418, ll. 4-7. *Ut si pater ad uxorem (occulte)*. Inserted after *supposito*, l. 2, in CE, MD, OC (marks additional); after *maxime*, l. 7, in ME, MH, P; after *bastardus*, l. 10, in MC, LA. Omitted in OA, MA, MB, MG, ML, MF, MN, OD, OE, Y. It is possible that the collation of the texts will discover this *addicio* in some out of the way place, even in those manuscripts which are here listed as omitting it. As it is, enough manuscripts vouch for it to give it at least a place among the passages of doubtful authorship.

F. 418, ll. 31-40. *Et quod ad filio Radulphi*. Inserted after *capitalem*, l. 31, in OA, OE, ME, MH; after sect. 3, f. 418b, in MC, and OC, CE (which mark additional). Marginal in LA. Regular in OB, OD, MA, MB, MD, MN, Y. See case 287 in the *Note Book*. This is one of Bracton's earlier additions.

F. 419, ll. 27-28. *Sicut in aliis causis forum ecclesiasticum*. Regular in OC, LA, CE, CM, MD, MC (repeats). Omitted in OA, OB, OD, OE, OF, MA, MB, ME, MN, Y. It is possible that these few words represent an *addicio* inserted at this point, but it is far more likely that the omission in certain manuscripts has resulted from the scribes confusing one *ad forum ecclesiasticum* with the other. Notice that the words which Bracton expressly states should not be inserted in this particular writ (*et quoniam huiusmodi inquisitio (cognitio) pertinet ad forum ecclesiasticum*), and which really determine the point of the passage under discussion, occur in the writs following shortly after.

F. 422b, ll. 13-17. *Ut probatur Giseham*. Inserted after *tempus*, l. 41, f. 422, in LA; after *relicto*, l. 42, f. 422, in MC; after *huiusmodi*, l. 46, f. 422, in OA, CC. Omitted in OB, MA, MB, MD, MN, CE, CM. Two cases are cited here, one being in the *Note Book* and the other not. See *Note Book*, II, 684, n. 1. The fact that this is a floating *addicio* vouched for by (II) and (III)—irrespective of the fact that it is omitted in (I) and, apparently, in (IV)—suggests that it is one of Bracton's second set of marginalia. As the whole passage is nothing more than a citation of two cases, the question of its authorship is comparatively unimportant, except as it might help to determine to what extent others besides Bracton added these case references to his treatise.

F. 422b, ll. 26-28. *Quia vice de feodo.* Inserted after *feodo*, l. 20, in OB, OA, LA, CE, MC, MD. In some manuscripts it is used as a rubric for a block of text beginning with the sentence in l. 32. In other manuscripts it is omitted. This is another short passage the origin of which it is not easy to determine, but the fact that it is found in manuscripts representing so many different groups makes it seem very probable that it has come from Bracton.

F. 422b, ll. 32-39. *Minor etiam Lungesper.* Marginal in LA. MC has as a red ink rubric and also as a part of the text; ME is similar to MC in this, but omits the reference to W. Lungesper. OA, OB, MA, MB, CE, CC, MN, all have the passage regularly with the exception of the reference to W. Lungesper. This passage has certainly come from Bracton, but the reference to W. Lungesper must be rejected.

F. 426b, ll. 12-16. *Funestam personis.* Inserted after *anima*, l. 4, in MC. Marginal in LA. Omitted in OA, OB, MA, MB, MD, ME, CC, CE, CM, Y. Not from Bracton.

F. 428, ll. 18-19. All between the two *personarum* is omitted by OA, MA, MD, CC, CE; but as the passage is contained in OB, MB, MC, MN, Y, it is evident that there is here no *addicio*, but an omission due to similar words in adjacent lines.

F. 430, ll. 17-20. *Ut probatur uxore sua.* This passage, which contains references to two cases, the first not in the *Note Book*, the second being No. 1919, is found in the main text at the same point as in V, or after *communi*, l. 30, or after *respondere*, l. 21, in OA, OB, OD, OC (marks additional), OE, MA, MB, MC, ME, MH, MN, CC, CE, CM. It is therefore an addition made by Bracton himself.

F. 430, ll. 33-37. *Et quod Tusset.* A reference to a case not in the *Note Book*. Regular in OB, MA, MB, MD, MN, Y. Inserted after *teneatur*, l. 25, in MC; after *salutem*, l. 26, in LA. Omitted in OA, OC, CC, CE, CM, ME. As this *addicio* is found in the text of both (I) and (III), it is altogether probable that the passage comes from Bracton.

F. 430b, ll. 5-14. *Si autem dubitetur heredis etas.* OB, MA, MB, MD, MN, Y, have regularly. Inserted after *mortui*, l. 41, f. 430, in LA, MH, ME, CM; after *nominantur*, l. 43, f. 430, in MC; after *omnes*, l. 41, f. 430b, in OA, OE, CC. Omitted in CE, OC. The case cited is not in the *Note Book*. That this is one of Bracton's own additions there can be no doubt.

F. 430b, ll. 18-20. *Et ad hoc . . . de Ludwich.* Regular in OB, OD, OE, MA, MB, MD, MN, CC, CE, Y, OC (marks additional), LA. Inserted after *Somerset*, l. 5, in MC. Omitted in ME, MH, CM. The case is not in the *Note Book*; the citation is certainly from Bracton.

F. 435b, ll. 32-33. *Ut de . . . Berninghurst.* Regular in OB, OC, MB, MD, MN, MH, CE, Y. Inserted after *apposuerit*, l. 30, in MC, LA, ME. Omitted in OA, OF, MG. Another citation which must be regarded as having come from Bracton.

F. 436b, ll. 11-14. *Illud idem . . . non apposuerit.* Inserted at the end of sect. 2, MC; after *debutit*, l. 8, in OA, CC, ME; after sect. 3, l. 24, in OB, OE, MA, MD, MN, Y. LA uses as a rubric. Omitted in CE, OC. A floating *addicio* from Bracton.

F. 436b, ll. 44-46, + the rubric to sect. 6. *Ut si ipsi qui . . . finem allegat. Item si finis . . . cirographi.* Omitted in CE. Marginal in LA. Inserted after *similia*, l. 38, in OA; after *Batlegh*, l. 5, f. 437, in MC. Regular as to ll. 44-46, but the rubric inserted after *allegat*, OB, MA, MD, MB. From this it is evident that what is used as a rubric in V should be made a part of the text.

F. 438, ll. 27-28. *S. de Segrave . . . usitata.* Omitted in OA, OB, OC, OD, OE, MA, MC, MD, ME, MN, CC, CE, LA, and manuscripts generally. Obviously no part of Bracton's text.

F. 438b, ll. 3-5. *Si inutilia . . . habuerit.* Regular in OB, MA, MC, MD, CE, Y, LA. Inserted after *huiusmodi*, l. 2, in ME, CM; after *homo*, l. 46, f. 438, in OA. Clearly from Bracton.

F. 438b, ll. 5-7. *Et notandum . . . breve de recto.* Regular in OC (marks additional), OB, OD, OE, MA, MC, MN, LA, CE, Y. Inserted after *quinque*, l. 3, in OA, MH, ME, CM. Used as a rubric for sect. 11 in V. From Bracton.

157925

Law
Eng
B797d
vol.1

Author Bracton, Henry de

Title De legibus et consuetudinibus Angliæ

UNIVERSITY OF TORONTO
LIBRARY

—
Do not
remove
the card
from this
Pocket.
—

Acme Library Card Pocket
Under Pat. "Ref. Index File."
Made by LIBRARY BUREAU

UTL AT DOWNSVIEW



D RANGE BAY SHLF POS ITEM C
39 15 28 12 02 008 3