

## **Historic, Archive Document**

Do not assume content reflects current scientific knowledge, policies, or practices.



AUTUMN, 1900

WHOLESALE PRICE LIST

OF

# MICHELL'S

Strictly   
Highest Quality

# Bulbs

# SEEDS

AND

# Supplies

# FOR Florists.

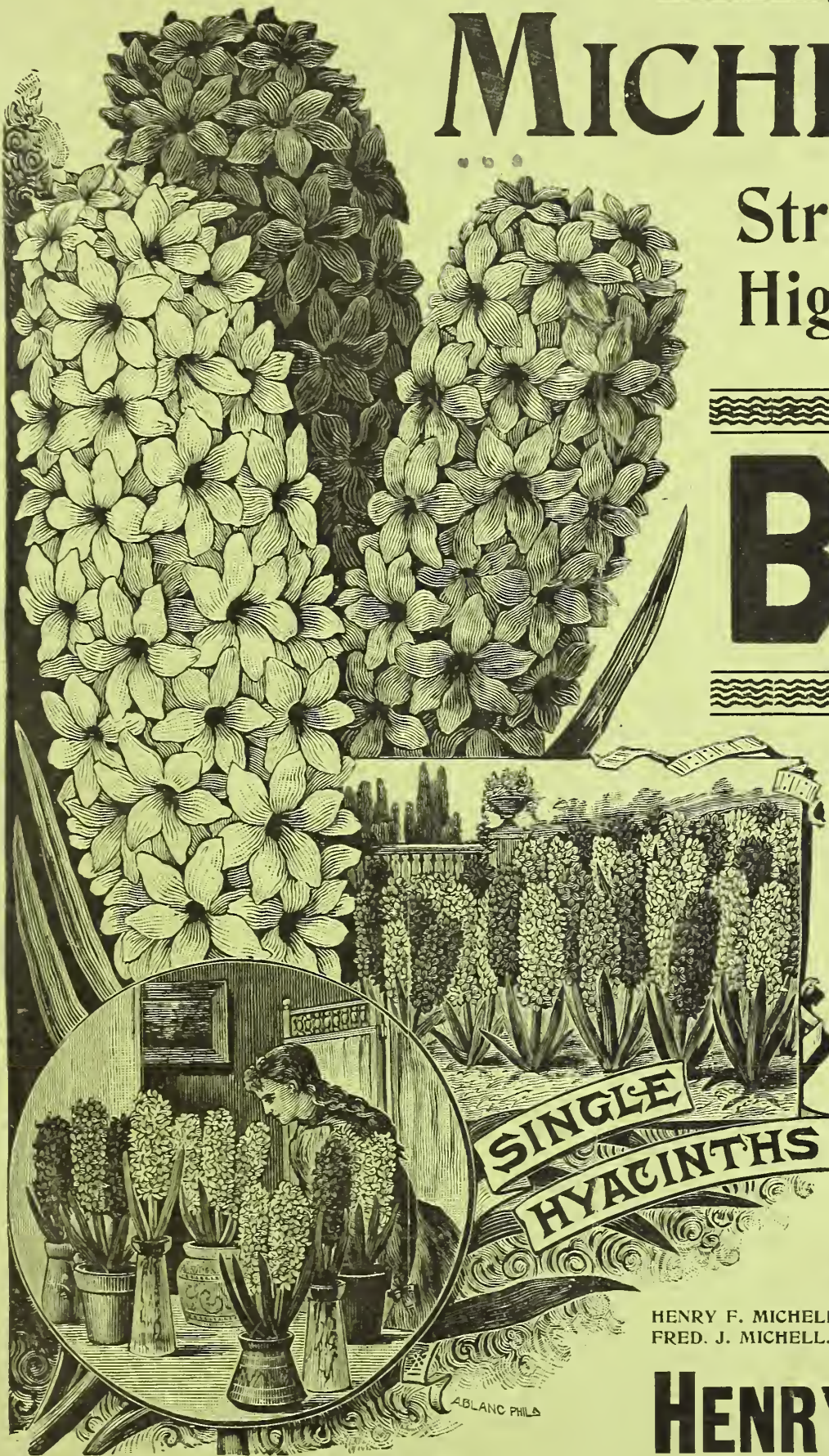

HENRY F. MICHELL.  
FRED. J. MICHELL.

Telephone 3-55-43 A.

# HENRY F. MICHELL

WAREHOUSE:

1019 Ludlow Street.



OFFICES AND STORE: { 1018 MARKET ST.

PHILADELPHIA.

# MICHELL'S HIGHEST QUALITY BULBS

L  
I  
L  
I  
U  
M



H  
A  
R  
R  
I  
S  
I  
I

Photograph of a house full of Easter Lilies (Lil. Harrisii), taken April 9th, 1900. Grown by H. I. Faust, Merion Sta., Pa.  
ALL BULBS SUPPLIED BY US.

Merion, Montgomery Co., Penna., 14th day of April, 1900.  
Mr. HENRY F. MICHELL, Seedsman, Etc.  
My Dear Sir:—I cannot refrain from congratulating you, as well as myself, upon the outcome of Harrisii Lilies purchased from you last August. They were the most satisfactory we have had for years. Out of 3800 bulbs we had 3300 salable plants. Please book me same quantity for next season. With kind regards, believe me,  
Very truly yours,  
HENRY I. FAUST.



Trenton, N. J., April 16th, 1900.  
Mr. HENRY F. MICHELL,  
Dear Sir:—Your lilies turned out the best I ever saw. The loss on them was only about two per cent. The flowers on them were from eight to fourteen on each plant. Please book me fifteen hundred more for next year.  
Yours truly,  
CARL E. TAUBE.

## Lilium Harrisii.

True Bermuda Easter Lily. Our "Superior Strain." Grown by the most reliable Grower in Bermuda.

Our grower reports to us that less than ten per cent. disease appeared on the plantation engaged and secured by us.

	Contents of original case.	Per doz.	Per 100.	Per 1000
5 to 7 in.	400 bulbs	\$0.75	\$4.50	\$42.00
7 to 9 in.	200 "	1.50	10.00	90.00
9 to 11 in.	100 "	3.00	20.00	180.00

## Lilium Longiflorum (Bermuda).

	Contents of original case.	Per doz.	Per 100.	Per 1000
5 to 7 in.	400 bulbs	\$0.75	\$4.50	\$42.00
7 to 9 in.	200 "	1.50	10.00	90.00
9 to 11 in.	100 "	3.00	20.00	180.00

## Lilium Longiflorum (Japanese).

Ready about October 5th.

	Per doz.	Per 100.	Per 1000
5 to 7 in.	\$0.50	\$2.50	\$22.50
6 to 8 in.	.75	3.75	32.50
7 to 9 in.	1.00	5.50	50.00
9 to 10 in.	1.50	9.00	80.00

## Lilium Candidum (or Annunciation Lily).

	Per doz.	Per 100.	Per 1000
First size bulbs	\$0.50	\$3.50	\$33.00
Extra Large Bulbs	.60	4.00	37.50

C  
A  
L  
L  
A



L  
I  
L  
I  
E  
S

## Calla Lilies (White).

Well Matured Dry Bulbs. Now Ready.

	Per doz.	Per 100.	Per 1000
Mammoth bulbs	\$1.40	\$10.00	\$95.00
First size	1.00	8.00	77.50
Second size	.75	6.00	57.50
Third size	.60	4.50	40.00
Fourth size	.45	3.00	25.00
LITTLE GEM CALLA	.75	6.00	
SPOTTED FOLIAGE CALLA (1st size only)	.50	3.00	27.50

Japan  
Lilies

	Per doz.	Per 100.	Per 1000
<b>AURATUM (Golden Banded).</b>			
8 to 9 in.	\$0.60	\$4.50	\$40.00
9 to 11 in.	1.00	6.75	65.00
11 to 13 in.	1.75	12.00	115.00
<b>SPECIOSUM (lancifolium) Album.</b>			
8 to 9 in.	.75	5.00	47.50
9 to 11 in.	1.00	6.00	57.50

	Per doz.	Per 100.	Per 1000
<b>SPECIOSUM (lancifolium) Roseum.</b>			
8 to 9 in.	\$0.60	\$4.50	\$40.00
9 to 11 in.	1.00	6.50	60.00
<b>Rubrum.</b>			
8 to 9 in.	.60	4.50	40.00
9 to 11 in.	1.00	6.50	60.00
<b>Melpomene.</b>			
8 to 9 in.	.75	5.00	47.50

The above varieties of Japan Lilies will arrive in October.

25 BULBS OF ANY ONE VARIETY AT 100 RATES; 250 OF ANY ONE VARIETY AT 1000 RATES.

# HIGHEST QUALITY BULBS

ALL PRICES INCLUDE DUTY.  
We do not charge for Packing or Cartage.



## ROMAN HYACINTHS. (FRENCH).

	Per doz.	Per 100	Per 1000	Original case lots only. Per 1000
11 to 12 cm., 1st size . . . . .	\$0 25	\$1 50	\$13.00	\$12.50
12 to 15 cm., all selected size . . . . .	.30	1.75	17.00	16.00
13 to 15 cm., mammoth bulbs . . . . .	.35	2.25	21.00	20.50
Rose or Pink (French) . . . . .	.25	1.50	13.00	
Blue (French) . . . . .	.30	1.75	15.00	
Italian White . . . . .	.30	1.75	15.50	

ONE OF OUR MANY UNSOLICITED TESTIMONIALS:

WILMINGTON, DEL., August 21st, 1899.

I have just received your Roman Hyacinths and Paper White Narcissus; am very much pleased with them. They are as good as ever I bought.

Very truly,  
L. E. BAYLIS,  
Florist.

## Best Miniature, or Dutch Roman Hyacinths.

### NAMED VARIETIES. FIRST SIZE BULBS.

Profitable for growing in pots or paus, blooming later than the French Romans.

	Per doz.	Per 100	Per 1000
Amy, rich red . . . . .	\$0 35	\$2.50	\$24.00
Gertrude, deep pink . . . . .	.35	2.50	24.00
Gigantea, light pink . . . . .	.35	2.75	26.50
Gen. Pelissier, dark red . . . . .	.35	2.50	24.00
Chas. Dickens, deep pink . . . . .	.40	3.00	27.50
Baroness van Thuyll, pure white . . . . .	.15	3.40	31.00
Grand A'Merveille, blush white . . . . .	.40	3.25	30.00
La Grandesse, pure white . . . . .	.60	4.50	42.00
Mad. Vander Hoop, creamy white . . . . .	.40	3.25	30.00
Chas. Dickens, light blue . . . . .	.35	2.75	25.00
Grand Maitre, rich porcelain . . . . .	.35	2.50	24.00
King of the Blues, deep blue . . . . .	.35	2.75	25.00

**SPECIAL NOTICE  
TO CUSTOMERS.**



*The latest advices from Holland are that all BULBS are finer this year than they have been for the three past seasons, and customers can fully rely upon getting the highest quality only, as we import only from reliable growers.*



## Dutch Hyacinths.

IN SEPARATE COLORS. VERY BEST QUALITY.

For bedding out doors, and also for forcing. They do not, however, produce as fine large spikes as the Second and First size named varieties. We specially recommend the Second size named varieties for forcing, as they are more profitable and certain to produce large flower heads.

*P. S.—Do not compare these First Quality Bulbs with such as are offered at a lower price. The size we quote will produce finer trusses.*

	Per doz.	Per 100	Per 1000
Single Red, all shades . . . . .	\$0.60	\$4.25	\$41.00
“ Pink . . . . .	.60	4.25	41.00
“ Deep Red . . . . .	.60	4.25	41.00
“ White, all shades . . . . .	.60	4.25	41.00
“ Pure White . . . . .	.65	4.50	43.00
“ Blush White . . . . .	.60	4.25	41.00
“ Blue, all shades . . . . .	.60	4.25	41.00
“ Light Blue . . . . .	.60	4.25	41.00
“ Deep Blue . . . . .	.60	4.25	41.00
“ Yellow, all shades . . . . .	.65	4.50	43.00
“ All Colors, Mixed . . . . .	.60	4.25	41.00
Double, Red, all shades . . . . .	.60	4.25	41.00
“ Pink, all shades . . . . .	.60	4.25	41.00
“ White, all shades . . . . .	.60	4.25	41.00
“ Blue, all shades . . . . .	.60	4.25	41.00
“ Mixed, All Colors . . . . .	.60	4.25	41.00

# STRICTLY FIRST SIZE NAMED HYACINTHS.

Desirable for the Very Choicest Trade, Where High Quality is Wanted.

SINGLE RED AND PINK.	Per doz.	Per 100
<b>Amy</b> , bright carmine, fine truss . . . . .	\$1.00	\$7.50
<b>Baron Van Thuyll</b> , fine rosy pink, early . . . . .	1.00	7.50
<b>General Pelissier</b> , crimson, early . . . . .	.85	6.50
<b>Gertrude</b> , clear pink, large truss . . . . .	.85	6.50
<b>Gigantea</b> , pink, large bells and truss . . . . .	1.00	7.50
<b>Lord Macaulay</b> , bright rosy carmine . . . . .	1.00	7.50
<b>Norma</b> , delicate waxy pink, early . . . . .	.95	7.50
<b>Roi des Belges</b> , scarlet . . . . .	.95	7.25
<b>Robert Stelger</b> , deep crimson red . . . . .	.80	6.25

SINGLE PURE AND TINTED WHITE.	Per doz.	Per 100
<b>Alba Superbissima</b> , pure white . . . . .	1.10	8.50
<b>Baroness Van Thuyll</b> , pure white, early . . . . .	1.10	8.50
<b>Grandeur A'Merveille</b> , rosy white fine . . . . .	.90	7.00
<b>La Grandesse</b> , pure white, fine bells and spike . . . . .	1.30	10 00
<b>Mme. Van der Hoop</b> , pure white, large . . . . .	1.10	8 50
<b>Queen of the Netherlands</b> , pure white, extra . . . . .	1 15	9 00

SINGLE BLUE, LAVENDER, PURPLE, &c.	Per doz.	Per 100
<b>Blue Mourant</b> , deep blue . . . . .	.95	7.00
<b>Chas. Dickens</b> , light blue . . . . .	1.00	7.50
<b>Czar Peter</b> , light porcelain blue, fine . . . . .	1.40	11.00
<b>Grand Maitre</b> , deep porcelain blue . . . . .	.95	7.75
<b>Hayden</b> , violet, large . . . . .	.90	6.50
<b>King of the Blues</b> , deep blue, extra large . . . . .	.90	7.00
<b>Leonidas</b> , bright porcelain blue . . . . .	.90	7.00

SINGLE YELLOW.	Per doz.	Per 100
<b>Herman</b> , orange yellow . . . . .	1.10	8.00
<b>Ida</b> , pure yellow, fine . . . . .	1.25	10 00
<b>King of the Yellows</b> , best deep yellow . . . . .	1.30	10.50

DOUBLE RED AND ROSE.	Per doz.	Per 100
<b>Bouquet Royale</b> , rose, red centre . . . . .	.90	6.50
<b>Bouquet Tendre</b> , dark carmine red . . . . .	.90	6.50
<b>Czar Nicholas</b> , delicate pink . . . . .	.90	6.50
<b>Noble par Merite</b> , deep rose, very large truss . . . . .	.90	6.75

DOUBLE PURE AND TINTED WHITE.	Per doz.	Per 100
<b>La Tour d'Auvergne</b> , pure white, early . . . . .	1.00	7.75
<b>La Virginite</b> , rosy white . . . . .	.85	6.25
<b>Prince of Waterloo</b> , pure white, fine . . . . .	1.10	8.50



Named Hyacinths for Forcing in Pots.

DOUBLE BLUE.	Per doz.	Per 100
<b>Blocksberg</b> , light blue . . . . .	\$1.10	\$8.00
<b>Garrick</b> , blue, darker centre . . . . .	1.00	7.50
<b>Mignon von Dryfhout</b> , light blue . . . . .	.95	7.25

DOUBLE YELLOW.	Per doz.	Per 100
<b>Bouquet Orange</b> , orange yellow . . . . .	1.00	8.00
<b>Gæthe</b> , citron . . . . .	.95	7 50

# FORCING NAMED HYACINTHS.

(SECOND SIZE.)

For Forcing and Fancy Outdoor Bedding where Correct Designs are Wanted.

The following sorts have proven to be the very best for the florist for growing in pots. They produce well shaped, full and compact spikes, and every pot will bring the best price, on account of its fine quality. It pays the florist to plant only the named sorts, as they are far superior to the regular separate color quality.

SINGLE PINK VARIETIES.	Per doz.	Per 100
<b>Baron Van Thuyll</b> . . . . .	\$0.80	\$6.25
<b>Gertrude</b> . . . . .	.75	5.75
<b>Gigantea</b> . . . . .	.80	6.25

SINGLE RED VARIETIES.	Per doz.	Per 100
<b>Lord Macaulay</b> . . . . .	.85	6.50
<b>Queen of Hyacinths</b> , rich red . . . . .	.80	6.00
<b>Robt. Stelger</b> . . . . .	.75	5.50
<b>Roi des Belges</b> (scarlet) . . . . .	.75	5.75

SINGLE WHITE VARIETIES.	Per doz.	Per 100
<b>Alba Superbissima</b> , pure . . . . .	.90	7.25
<b>Baron Van Thuyll</b> , pure . . . . .	.90	7.25
<b>Mme Van der Hoop</b> , pure . . . . .	.90	7.25
<b>La Grandesse</b> , pure . . . . .	1.10	8 50
<b>La Innocence</b> , pure white . . . . .	1.10	8.50

SINGLE WHITE VARIETIES. (Continued).	Per doz.	Per 100
<b>Grandeur A'Merveille</b> , blush . . . . .	\$0.80	\$6.25
<b>La Pucelle de Orleans</b> , pure white . . . . .	.85	7.00
<b>Queen of the Netherlands</b> (Pure) . . . . .	1.10	8 50

SINGLE BLUE VARIETIES.	Per doz.	Per 100
<b>Chas. Dickens</b> , light . . . . .	.80	6.25
<b>Baron Van Thuyll</b> , deep . . . . .	.75	6.00
<b>Czar Peter</b> , light . . . . .	1.10	8 50
<b>Grand Maitre</b> , rich . . . . .	.85	6.25
<b>King of the Blues</b> , deep . . . . .	.75	6.00
<b>Leonidas</b> , light . . . . .	.75	6.00

SINGLE YELLOW VARIETIES.	Per doz.	Per 100
<b>Heroine</b> , lemon yellow . . . . .	.85	6.75
<b>Herman</b> , bright yellow . . . . .	.95	7.00

# Michell's Highest Quality Bulbs

T  
U  
L  
I  
P  
S



## TULIPS

### Early Single (Named Varieties).

True to Color and Name.

All strictly first size Bulbs.

	Per 100	Per 1000
Artus. Scarlet	\$0.75	\$ 7.00
Belle Alliance. The best scarlet	1.25	10.00
Canary Bird. Light yellow	1.40	12.75
Cardinal's Hat. Scarlet	.90	7.50
Chrysolora. Yellow; bedding	1.25	11.50
Cottage Maid. Pink and white	1.25	11.00
Coulour de Cardinal. Scarlet; forcing	1.85	17.50
Colour Ponceau. Cherry and white	.85	8.00
Crimson King. Scarlet; forcing	.75	7.25
Duchesse de Parma. Red and yellow	.85	7.75
Duc Van Thol. Scarlet	1.00	9.00
" " Yellow	1.75	16.00
" " White	1.40	13.00
" " Pink	1.25	11.00
" " Gold striped	.90	8.00
" " Red and yellow	.90	8.00
Jaght Von Delft. Pure white	.95	9.00
Joost Van Vondel. Red striped with white	1.25	10.50
Kaiserkroon. Red and gold	1.25	12.00
La Reine. Blush white	1.25	10.75
L'Immaculee. Pure white	1.00	8.75
Pottebaker. Yellow	1.60	15.00
" White	1.40	13.00
" Scarlet	1.15	10.50
Proserpine. Bright pink; large	1.75	16.00
Rachel Ruisch. Pink	1.00	9.00
Rose Grisdelin. Pink	1.50	14.25
Rose Mundt. Bright pink	1.00	9.50
Silver Standard. White, crimson stripe	1.25	11.00
Yellow Prince	1.25	11.75
Vermilion Brilliant. Richest scarlet	2.25	21.00
Wouwerman. Purple violet	1.00	9.50

### IN MIXTURE.

Early Single. All colors, choice mixed	.70	6.50
Extra Choice. Superfine, mixed	.90	7.75

### Early Double Tulips.

Duc Van Thol. Red and yellow	.80	7.50
Duke of York. Red, with white edge	.90	7.75
Gloria Solus. Red, with yellow border	1.00	9.00
Imperator Rubrorum. Scarlet; fine forcer	1.75	16.00
La Candeur. Pure white	1.00	8.50
Le Blazon. Pink	1.50	14.00
Murillo. Pink; forcing	2.40	22.25
Rex Rubrorum. Scarlet	1.50	14.00
Rose Blanche. Pure white	.90	8.50
Tournesol. Red and yellow	1.60	14.50
" Yellow	3.00	28.50
Titian. Red and yellow	1.20	10.00
Yellow Rose	1.25	10.00
Fine Mixed. Early Double	.70	6.50
Superfine Mixed. Early double, selected	.95	8.25

### Late Flowering Tulips.

	Per 100	Per 1000
Parrot. Choicest mixed	.85	7.50
Byblooms. Single	1.00	8.50
Bizards. Single	.80	7.25
Gesneriana. Single scarlet	1.25	10.50
Pacony. Double red	1.25	10.50

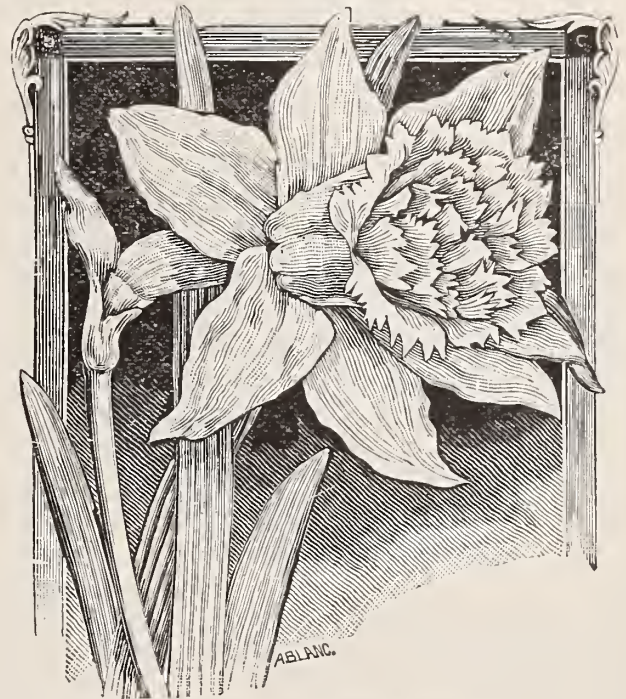

Narcissus Von Sion (Double).

## NARCISSUS.

	Per 100	Per 1000
Von Sion. Double yellow; good size blooming bulbs	\$1.25	\$12.00
" " Double yellow; selected first size bulbs	1.50	14.00
" " Extra large, double-nosed bulbs; will produce about 170 flowers from 100 bulbs	2.00	17.50
" " Double yellow, "Paris Market". Extra early; especially adapted and very profitable for Christmas forcing	2.00	16.00
Paper White	.75	6.75
Paper White Grandiflora. Extra size bulbs	1.00	8.25
" " Multiflora (new) choice	1.25	10.00
Double Roman	1.00	9.00
Trumpet Major. Single yellow trumpet-shaped flowers. (Best Holland grown)	1.25	10.00
Campernelle. Yellow	.60	5.00
Poeticus. Single white	.45	3.75
" Double (Alba Plena Odorata)	.85	7.25
" Ornatus. White; for forcing	1.00	9.00
Grand Soleil de O'r. Yellow Polyanthus	1.50	12.50
Orange Phoenix. Double, orange and white	1.75	16.00
Incomparable. Double, yellow	.75	7.00
Giant Princeps. Single yellow trumpet	1.00	9.00
Golden Spur. Large single golden trumpet	3.75	35.00
Incomparable Stella. Single white, with large yellow cup	.60	5.00
Campernelle Rugulosus. Extra large single yellow Jonquil	.75	6.00

## Chinese Sacred Lily.

READY IN OCTOBER.

Extra strong bulbs—65 cts. per doz.; \$1.50 per basket of 30 bulbs; \$5.75 for 4 baskets; per 1000, \$45.00.

Show Cards sent free with one basket or over.

<b>Allium Neapolitanum.</b>	Per 100	Per 1000
Very desirable white flowers for forcing .....	\$0.50	\$4.50

<b>Anemones.</b>	Per doz.	Per 100	Per 1000
Double, Mixed, all colors.....	\$0.15	\$1.00	\$7.50
Single, .....	.10	.60	5.00
Fulgen's Rich Scarlet.....	.25	1.50	13.50

<b>Amaryllis.</b>			
Belladonna, Pink.....	1.00	6.00	
Johnsoui, Red and White, extra large.....	2.50	20.00	
Formosissima (Jacobean Lily).....	.40	3.00	
New Seedlings, extra choice .....	.30	3.00	

<b>Begonia. (Tuberous Rooted).</b>			
Very choicest large flowering type. Extra fine large bulbs.			
READY IN NOVEMBER.			
<b>Single</b> Orange .....	Per doz. \$0.40	Per 100 \$2.50	Per 1000 \$20.00
Scarlet.....	.40	2.50	20.00
Pink .....	.40	2.50	20.00
White.....	.40	2.50	20.00
Yellow.....	.40	2.50	20.00
Mixed .....	.35	2.25	19.00
<b>Double</b> Crimson .....	.65	5.00	40.00
Scarlet.....	.65	5.00	40.00
Pink .....	.65	5.00	40.00
White.....	.65	5.00	40.00
Yellow.....	.65	5.00	40.00
Mixed .....	.60	4.50	37.50

<b>Chionodoxa. (Glory of the Snow).</b>			
Lucilla .....	.15	.75	6.00
Gigantea .....	.15	1.00	7.50
Sardensis .....	.15	.75	7.00

<b>Crown Imperial.</b>			
Mixed colors.....	.75	5.00	

<b>Crocus. (First Size Bulbs).</b>	Per 100	Per 1000
White .....	\$0.30	\$2.50
Blue .....	.30	2.50
Striped.....	.30	2.50
Yellow, extra large mammoth.....	.60	5.50
regular size.....	.30	2.50
Cloth of Gold.....	.40	3.25
Mixed, all colors.....	.25	2.25
Named Varieties.....	.50	4.25

<b>Dielytra Spectabilis. (Bleeding Heart.)</b>			
Strong Clumps.....per doz. 85c.	6.00	57.50	

<b>Freesia Refracta Alba.</b>			
First size.....	.50	4.00	
Selected.....	.75	6.00	
Extra mammoth bulbs.....	1.15	9.00	

<b>Gladiolus "Bride"</b>			
Excellent white variety for forcing .....	.50	4.50	
Colvilli Rubra (Pink Bride) .....	.75	6.50	

<b>Gladiolus. (For Forcing).</b>			
"May." The finest forcing variety now on the market, produces a large spike of very large flowers nearly pure white in color.....	2.50	23.50	
White and light colors.....	2.00	18.00	
Choice mixed.....	1.25	10.00	

<b>Gloxinia Crassifolia Grandiflora.</b>			
READY IN NOVEMBER.			
Extra large bulbs, of finest erect flowering varieties. Richest colors, containing also the tigered and spotted. 50c. per doz., \$4.00 per 100, \$30.00 per 1000.			

<b>Iris.</b>	Per doz.	Per 100	Per 1000
English Mixed.....	\$0.15	\$0.75	\$6.00
Spanish .....	.10	.30	2.50
<b>Spanish for forcing Blanche Superba.</b>			
Pure White.....	.12	.60	5.00
<b>Spanish for forcing Jaune Brillante. Yellow</b>	.12	.60	5.00
<b>Spanish for forcing Alex. Von Humbolt.</b>			
Blue.....	.12	.60	5.00

<b>Ixia.</b>			
Choice Mixed.....	.10	.50	4.00

<b>Lachenalia.</b>			
Pendula .....	1.00	7.50	



<b>Lily of the Valley.</b>	Selected Berlin 3-year-old Pips.		
Per 100.....	\$1.25	Per 1000.....	\$10.50
		Case of 2,500.....	\$25.00

<b>Michell's Excelsior or Russian XXX (3-year-old).</b>	Per 100	Per 1000	Per case of 2500
Very large spikes .....	\$1.50	\$14.00	\$32.00
<b>Hamburg (3-year-old). Late</b>	1.00	9.75	23.00
<b>Clumps of Lily of the Valley</b> .....	\$2.00 per doz.;	\$15.00 per 100	

<b>Oxalis.</b>	Per doz.	Per 100	Per 1000
<b>Bermuda Buttercup, large yellow, very popular, extra large bulbs</b> .....	\$0.18	\$1.00	\$9.00
Mixed, all colors.....	.10	.50	4.50
Separate colors, pink, white, yellow, red.....	.20	1.00	

<b>Ornithogalum Arabicum (Star of Bethlehem).</b>	Per doz.	Per 100	Per 1000
Large white flowers in clusters.....	\$0.25	\$1.60	\$14.00

<b>Paeonies.</b>	Sinensis Extra Choice Double.	Strong Original Clumps.	
READY IN NOVEMBER.			
Double White.....	Per doz. \$1.75	Per 100 \$12.50	
" Pink .....	1.75	12.50	
" Red .....	1.75	12.50	

<b>Ranunculus.</b>	Per doz.	Per 100	Per 1000
Double Turkish Mixed.....	\$0.10	\$0.50	\$3.00
Double Persian Mixed.....	.10	.50	3.00
Double French Mixed.....	.10	.50	3.00

<b>Spirea Astilbe. Selected Strong Clumps.</b>	Per doz.	Per 100	Per 1000
<b>Japonica</b> .....	\$0.50	\$3.50	\$30.00
<b>Compacta Multiflora, strong clumps</b> .....	.65	4.00	38.00
<b>Astilholdes Floribunda</b> .....	.65	4.25	40.00
<b>Washington (New). Extra large, and very free blooming. The finest of all spireas</b> .....	2.00	15.00	145.00

<b>Scilla.</b>			
<b>Siberica (Squill)</b> .....	.15	.60	5.50

<b>Snowdrops.</b>			
Single .....	.10	.60	5.00
Double .....	.15	1.00	9.00
Elwees Giant.....	.15	.60	5.25

<b>Sparaxis.</b>			
Mixed .....	.10	.50	4.00

<b>Tuberose. EXCELSIOR PEARL (for forcing).</b>			
Extra large. Ready in November.	Per 100	Per 1000	
Blooming Bulbs .....	\$1.00	\$7.50	

<b>Zephyranthes.</b>	Per doz.	Per 100
Pink .....	\$0.25	\$2.00
White .....	.25	1.50



# Flower Seeds

FOR SOWING IN  
August, September and October.

ALL OF NEW CROP AND CAN BE STRICTLY RELIED UPON:

**Antirrhinum;** (Snapdragon) Queen of the North. Large flowering, pure white, good forcer and ready seller. 15c. per trade pkt.; 50c. per oz.; also all other varieties.

**Asparagus Plumosa Nana.** \$1.00 per 100 seeds; \$9.00 per 1000 seeds.

New seeds ready in November.

**Asparagus Sprengeri.** 60c. per 100 seeds; \$5.00 per 1000 seeds.

**Browallia Speciosa Major.** A very choice Winter blooming plant, producing large, rich, blue flowers Per trade pkt. 25c.

## CALCEOLARIA.

Extra Choice Strain. Mixed Colors.

	Retail pkt.	Trade pkt.
<b>Compacta.</b> Dwarf . . . . .	\$0.27	\$0.60
<b>Grandiflora</b> . . . . .	.17	.60
<b>Rugosa (Shrubby)</b> . . . . .	.34	.60
<b>James' Superb English Strain.</b> Per pkt 75c.		
<b>Sutton's Perfection Mixed.</b> Per pkt. 75c.		



Michell's Special Strain of Cineraria "Giant Prize".

## CINERARIA.

**Dwarf Giant Prize.** Mixed. All colors; best sort as pot plants. 1/2 trade pkt. 60c.; trade pkt. \$1.00.

**Medium Tall Giant Prize.** Mixed. Desirable to grow as a decorative plant, also for cutting. 1/2 trade pkt. 60c.; trade pkt. \$1.00.

**Stellata.** Sutton's new type, mixed. 65c. per original pkt.

**James' English Giant Strain.** Per 1/2 trade pkt. 60c.; per trade pkt. \$1.00.

**Sutton's English Superb Strain.** 60c. per pkt.

**Dwarf Mixed.** Very desirable, producing large heads; flower not quite as large as the "Prize". Trade pkt. 50c.

**Tall Mixed.** Same as above, but taller in growth. Trade pkt. 50c.

**Choicest Double Mixed.** Beautiful. Trade pkt. 50c.

Please accept a testimonial of praise from the undersigned for Michell's Giant Prize Cineraria seed. My plants have over 100 flowers on each and measure the enormous size of 4 inches in diameter, or 12 inches in circumference.

Respectfully,

PAUL REINHART,

Gardener to H. T. Mason, Esq.

Germantown, Phila.

## CANDYTUFT—For Winter Forcing.

	Per trade pkt.	Per oz.
<b>Giant Empress.</b> White . . . . .	\$0.10	\$0.25
<b>White Rocket</b> . . . . .	.05	.10
<b>Little Prince (New).</b> White . . . . .	.25	1.00



## CYCLAMEN GIGANTEUM.

Grown by one of the leading growers in Europe, who has a world-wide reputation for this strain.

*P. S.*—All our Giant Cyclamen seed is grown in greenhouses and should not be compared with seed offered at lower price and which is usually outdoor grown seed, producing much smaller flowers than our Giant greenhouse grown seed.

	Per 100	Per 1000
Mixed, of four colors . . . . .	\$1.00	\$7.00
Red (Rubrum) . . . . .	1.00	7 50
White (Album) . . . . .	1.00	7 50
White, with Red Eye (Roseum) . . . . .	1.00	7 50
Pink . . . . .	1.00	7 50

Persicum, Wiggins' Best Mixed. Trade pkt. 50c.; oz. \$3.00.

**Bush Hill Pioneer.** New feathered type. 50c. per original pkt.; 6 pkts. for \$2.50.

## DOUBLE DAISY.

*Bellis Perennis.*

Sow in August and September, and treat similar to Pansies.

**Snowball.** Per trade pkt. 30c.

**Giant White.** 1/2 trade pkt. 30c.; trade pkt. 50c.

**Giant Mixed.** 1/2 trade pkt. 30c.; trade pkt. 50c.

**Longfellow Red.** Double. Per trade pkt. 30c.

**Choicest Double Mixed.** Per trade pkt. 30c.; \$2.00 per oz.

**Dracaena Indivisa.** Per pkt. 10c.; oz. 30c.

Sow now to make salable plants for next year.

**Dracaena Australis.** Broad green foliage. 25c. per trade pkt.; 85c. per oz.

**Fern Spores or Seeds.** (Fresh). Choice mixed, all varieties, 30c. per trade pkt. We can also supply Fern Spores of nearly all the good popular sorts of Adiantum, Pteris, etc., grown by a most careful, reliable fern grower. 30c. per liberal trade pkt. List of varieties sent on application.

**Grevillea Robusta.** Trade pkt. 15c.; oz. 40c.

# Michell's Reliable Flower Seeds

## Hollyhock.

THE FINEST DOUBLE.

	Trade pkt.	Per oz.
Chater's Improved Snowball, Pure White . . . . .	\$.20	\$.75
" " Brilliant Scarlet . . . . .	.20	.75
" " Bright Pink . . . . .	.20	.75
" " Salmon . . . . .	.20	.75
" " Yellow . . . . .	.20	.75
" " Choice Mixed . . . . .	.20	.60
"Allegheny", New Fringed Pink . . . . .	.25	3.00
" " " Red . . . . .	.25	3.00
" " " Mixed . . . . .	.25	2.00



COPYRIGHT  
1899  
C.H. ALLEN

### Allen's New Defiance Mignonette.

Mr. Allen's own growth, and in his own original packets containing 2000 seeds, \$1.00. Original half trade pkts., 60c.

## MIGNONETTE.

ALLEN'S DEFIANCE. New, Large Flowering.

Out-door grown, carefully selected seed. One of the greatest acquisitions of recent introduction. Selections have done as noble work with the Mignonette as with any other florists' flower, and this strain is beyond question the acme of perfection. Per trade pkt., 20 cts.; per ounce, 75 cts.

	Per trade pkt.	Per oz.
Gabriele Mammoth Dwarf . . . . .	\$.15	\$.50
Machet. Improved. Selected from the best specimens of blooms . . . . .	.15	.50
Miles' Spiral . . . . .	.10	.15
Bird's Mammoth. Very long spikes . . . . .	.25	.60

## MYOSOTIS (Forget-Me-Not.)

**Alpestris Victoria** (*New Forget-Me-Not*). This is, without exception, the proper sort for florists. The plants are compact, the flowers are of a rich blue with a white centre. Per trade pkt., 25c.; per oz., \$1.00.

**Eliza Fanrobert** (*Robusta Perfecta*). A general favorite for spring blooming, it also forms a compact bush, and is very large flowering. Per trade pkt., 20c.; per oz., 75c.

**Alpestris** (*Alpine Forget-Me-Not*). Blue. Per trade pkt., 15c.; per oz., 50c.

**Palustris**. The best sort for cut flowers. Per trade pkt., 25c.; per oz., \$1.50.

## POLYANTHUS.

Choice Mixed . . . . . per trade pkt., 30c.



Michell's Prize Fringed Primula.

## PRIMULA.

We have just received a very choice strain from the leading Primula Specialist, and florists may rely upon this strain to be of the very best. Size of flowers very large. Beautifully fringed, and of the brightest colors only.

### Michell's Choicest European Mixture.

Per 1/2 trade pkt., 60c.; per trade pkt., \$1.00; per 1/2 oz., \$2.50.

## KERMESSINA SPLENDENS—Fringed.

Bright Crimson with Large Eye.

Per 1/2 trade pkt., 60c.; per trade pkt., \$1.00.

	Per trade pkt.
<b>Coccinea.</b> Scarlet, fringed, fancy . . . . .	\$.75
<b>Alba Magnifica.</b> White, fringed, fancy . . . . .	.75
<b>Holborn Blue.</b> Blue, fringed, fancy . . . . .	.75
<b>Globosa.</b> Crimson, fringed, fancy . . . . .	.75
" Striped, fringed, fancy . . . . .	.75
" White, fringed, fancy . . . . .	.75
" Mixed, fringed, fancy . . . . .	.75
<b>Fern Leaved.</b> Mixed, fringed, fancy . . . . .	.75
<b>Double.</b> White, fringed . . . . .	1.00
" Mixed, fringed . . . . .	1.00
<b>Forbesi.</b> New Baby Primrose . . . . .	.30
<b>Stellata.</b> Sutton's New Star. Original pkt., \$1.25.	
<b>Veris.</b> Cowslip. Per pkt., 15c.; per oz., 50c.	
<b>Vulgaris</b> (English). Per pkt., 30c.; per oz., \$1.50.	
<b>Obconica Grandiflora.</b> Per trade pkt., 30c.	



  
**Michell's**  
**Choicest**  
**Pansy**  
**Seed**  

**MICHELL'S** GIANT EXHIBITION

SPECIAL SELECTED  
STOCK FOR FLORISTS

**Pansy Seed**

NEW CROP OF SEED JUST RECEIVED

**W**E HAVE received a large number of unsolicited testimonials from florists, stating that they never before had such fine colors and immense size blooms in Pansies. It is a mixture composed of the very best of the *German, French, Scotch* and *American* Strain which insures the best results—the seed as per test made by us germinated 98 per cent.

Trade pkt., 50c ; 1/8 oz., 85c.; 1/4 oz., \$1.50 ; 1/2 oz., \$2.50 ; oz., \$5 00.

**PANSY SEED. VARIOUS TYPES AND SEPARATE COLORS.**

	Per trade pkt.	Per oz.		Per trade pkt.	Per oz.
Bugnot's Giant French Mixed . . . . .	\$ .50	\$5.00	<b>Light Blue</b> . . . . .	\$ .20	\$ .80
Cassier's Fancy Mixed . . . . .	.50	4 00	<b>Emperor William.</b> Light, ultramarine blue . . .	.20	.80
Trimardeau Giant, Choicest Mixed . . . . .	.25	1.50	<b>Striped</b> . . . . .	.20	.80
Trimardeau Giant, Yellow . . . . .	.40	2.00	<b>Purple.</b> Silver edged . . . . .	.20	.80
Trimardeau Giant, White . . . . .	.40	2.00	<b>Mahogany Color</b> . . . . .	.20	.80
Snow Queen. Large White . . . . .	.20	.80	<b>Gold Margined</b> . . . . .	.20	.80
Golden Yellow, with eye . . . . .	.20	.80	<b>Silver Edged</b> . . . . .	.20	.80
Faust. Black . . . . .	.20	.80	<b>Very Large-flowering. German. Choicest</b>		
Yellow Gem . . . . .	.20	.80	mixed . . . . .	.25	1.00
Lord Beaconsfield. Purple violet . . . . .	.25	.80	<b>Choice Mixed.</b> First quality . . . . .	.15	.50
Bronze Shades . . . . .	.20	.80	<b>Michell's Giant Exhibition.</b> See description		
Havana Brown . . . . .	.20	.80	and illustration above. Choicest mixed . . .	.50	5.00

**FLOWER SEEDS FOR AUTUMN SOWING—CONTINUED.**

**SMILAX SEED.**

New crop just received. Per trade pkt. 15c.; per oz. 30c.; per lb. \$3.00.

**Sweet Peas FOR AUTUMN SOWING ... AND FORCING**

**LEADING MAMMOTH FLOWERING VARIETIES.**

	Per oz.	Per lb.
<b>Blanche Burpee.</b> Large pure white . . . . .	\$0.05	\$0.50
<b>Countesse of Radnor.</b> Best lavender . . . . .	.05	.40
<b>Emily Henderson.</b> Large white . . . . .	.05	.40
<b>Extra Early Blanche Ferry (True).</b> The most profitable variety for forcing; bright pink, with upper petals white . . . . .	.05	.40
<b>Katharine Tracy.</b> Light but brilliant pink, very large flowers. Excellent for forcing . . . . .	.05	.40
<b>Lady Mary Currie.</b> Best clear pink (long stem) . . . . .	.10	.75
<b>Lottie Eckford.</b> White, blue border . . . . .	.05	.40
<b>Mars.</b> The best deep pink . . . . .	.05	.50
<b>Queen of England.</b> White . . . . .	.05	.40
<b>Sadie Burpee.</b> Largest white . . . . .	.15	1.50
<b>Mixed Eckfords.</b> All colors . . . . .	.10	.40
Also other named varieties in our regular catalogue . . . . .	.05	.50

**TORENIA.**

**Fournierii Grandiflora.** The best variety for the florists. Per trade pkt. 30c.  
**Bailloni.** Yellow. Per trade pkt. 20c.

**WALLFLOWER.**

	Trade pkt.	Oz.
<b>Extra Fine Mixed Strain of Double</b> . . . . .	\$0.30	\$2.00
<b>Single Mixed</b> . . . . .	.10	.15

**STOCKS. (Ten Week.)**

The seed we offer is all grown in pots and will produce over 70 per cent. very double flowers:

	½ trade pkt.	Trade pkt.	Oz.
Pure White . . . . .	\$0.30	\$0.50	\$2.50
Blood Red . . . . .	.30	.50	2.50
Crimson . . . . .	.30	.50	2.50
Purple and Blue . . . . .	.30	.50	2.50
Mixed of all colors . . . . .	.30	.50	2.00
<b>Princess Alice (Cut and Come Again)</b> Without exception the best for outdoor culture, the flowers are very double and pure white . . . . .	.30	.50	3.00
<b>Snowflake (True).</b> The sort used principally for pot culture. Pure white, wall-flowered leaved . . . . .	.30	.50	8.00
<b>Wall-flower leaved, choice mixed</b> . . . . .	.30	.50	3.00
“ “ <b>White</b> . . . . .	.30	.50	3.50
“ “ <b>Blood Red</b> . . . . .	.30	.50	3.50
“ “ <b>Purple</b> . . . . .	.30	.50	3.50

**VERBENA.**

**Michell's Mammoth.** Choicest mixed. Our own special stock. Per trade pkt., 40 cts.; per oz., \$1.50.  
**Mammoth Scarlet.** Per trade pkt., 40 cts.; per oz., \$1.50.  
 “ **White.** Per trade pkt., 40 cts.; per oz., \$1.50.  
 “ **Pink.** Per trade pkt., 40 cts.; per oz., \$1.50.

**VINCA.**

	Trade pkt.	Oz.
<b>Rosea.</b> Pink . . . . .	\$0.20	\$0.75
<b>Alba Oculata.</b> White with red eye . . . . .	.20	.75
<b>Alba Pura.</b> Pure White . . . . .	.20	.75
<b>Mixed, all colors</b> . . . . .	.20	.75

**VEGETABLE SEEDS FOR AUTUMN SOWING.**

**CAULIFLOWER SEED.**

**Earliest Snowstorm.** The earliest and best of all for forcing; must be kept growing constantly; will not stand a check at any period of its growth. Per pkt., 20 cts.; per ¼ oz., 75 cts.; per oz., \$5.00; per ¼ lb., \$17.50.  
**Early Snowball.** Per pkt., 15 cts.; per ¼ oz., 65 cts.; per oz., \$2.50; per ¼ lb., \$8.00.  
**Michell's Selected Dwarf Erfurt.** Per pkt., 15 cts.; per ¼ oz., 65 cts.; per oz., \$2.50; per ¼ lb., \$8.00.  
**Lenormand's Short Stem.** Per pkt., 10 cts.; per oz., 50 cts.  
**Veitch's Autumn Giant.** Per pkt., 10 cts.; per oz., 40 cts.

**CUCUMBER SEED.**

**English Prize.**

**Tender and True.** Per pkt., 15 cts.  
**Long Gun.** (Pierson's.) The best of all. Per pkt., 15 cts.  
**Telegraph.** Per pkt., 15 cts.  
 Also all other varieties.

**CABBAGE SEED.**

**Early Jersey Wakefield.** The best for early use; of excellent quality, good size and sure to head; extra fine selected stock. Per oz., 25 cts.; per lb., \$2.75.  
**Large Jersey Wakefield.** Per oz., 30 cts.; per lb., \$3.25.  
**Henderson's Early Summer.** A second early sort with large, solid heads, coming in a few days later than the Wakefield. Per oz., 20 cts.; per lb., \$2.00.  
 Also all other varieties.

**KALE SEED.**

**Dwarf Green Curled.** Very hardy; leaves numerous, frilled, and of excellent quality. Per pkt., 5 cts.; per oz., 10 cts.; per ¼ lb., 15 cts.; per lb., 50 cts.  
**New Imperial, or Long Standing.** A beautiful curled and crimped sort. Per oz., 5 cts.; per ¼ lb., 15 cts.; per lb., 50 cts.

**CORN SALAD SEED.**

**Large Seeded.** Per ¼ lb., 15 cts.; per lb., 40 cts.; 5-lb. lots, \$1.75.

**LETTUCE SEED.**

**Silver Ball.** Per oz., 15 cts.; per ¼ lb., 40 cts.; per lb., \$1.50.  
**Forcing Emperor.** Per oz., 20 cts.; per ¼ lb., 50 cts.  
**Early Tennisball.** Per oz., 15 cts.; per ¼ lb., 30 cts.; per lb., \$1.00.  
**Boston Market.** Per pkt., 5 cts.; per oz., 15 cts.; per ¼ lb., 35 cts.; per lb., \$1.25.  
**Big Boston.** Per oz., 15 cts.; per ¼ lb., 40 cts.; per lb., \$1.50.  
**Early Dutch Butter, Spotted.** (True Stock.) Per oz., 15 cts.; per ¼ lb., 40 cts.; per lb., \$1.50.  
**Early Cabbage, or White Butter.** Per pkt., 5 cts.; per oz., 15 cts.; per ¼ lb., 35 cts.; per lb., \$1.25.  
 Also all other varieties.

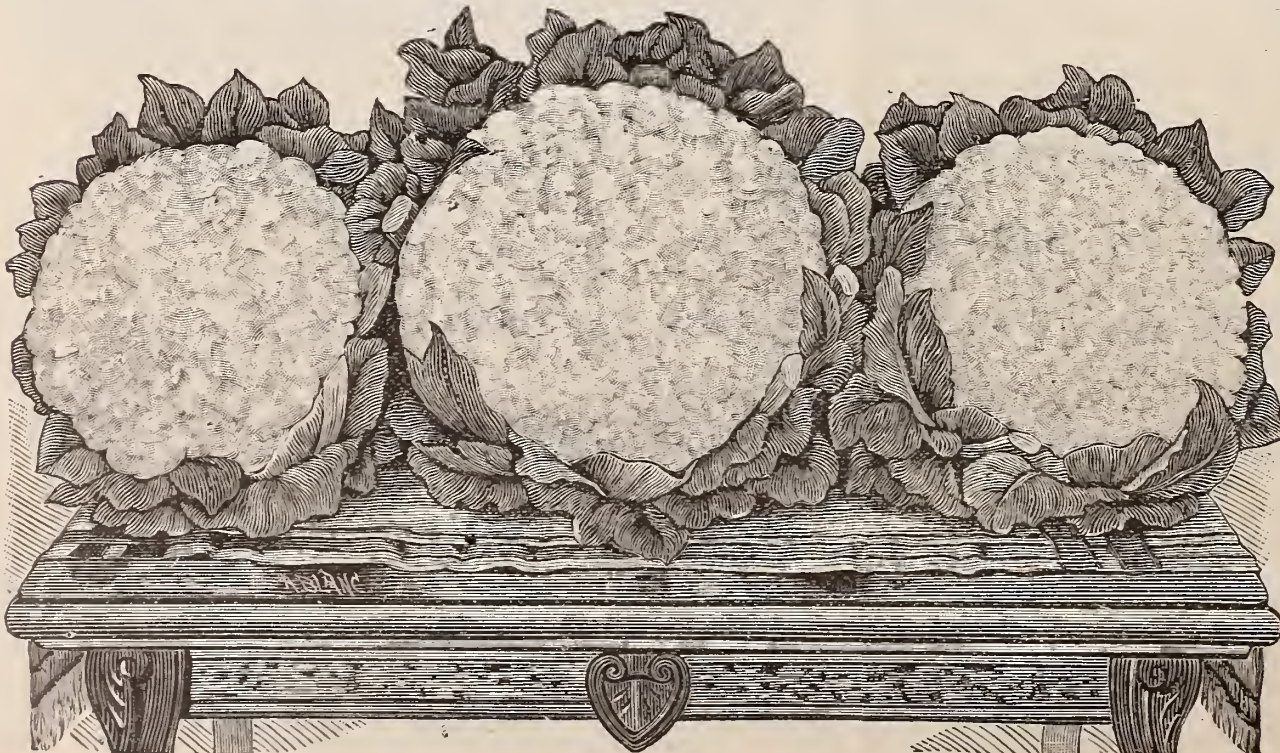

MICHELL'S SPECIAL STRAIN SELECTED ERFURT CAULIFLOWER.



**MUSHROOM SPAWN.**  
GENUINE ENGLISH MILLTRACK.  
"Michell's Superior Brand"

Fresh shipments are received every month from the best maker in England.

We have received a large number of testimonials from our customers stating that they never had such good, quick, large crops of the finest quality mushrooms as from spawn they purchased from us.

We have the pleasure of supplying a number of the largest Mushroom growers.

Per brick . . . . .	\$ .15
" dozen bricks . . . . .	1.50
" 50 lbs. . . . .	4.00
" 100 lbs. . . . .	6.50
" 1000 lbs. . . . .	60.00

Original case lots containing about 250 lbs. at 1000-lb. rate.

P. S.—Please do not compare price of our Spawn with any which may be offered at lower prices. Good reliable Spawn cannot be sold for less than prices we quote herewith.

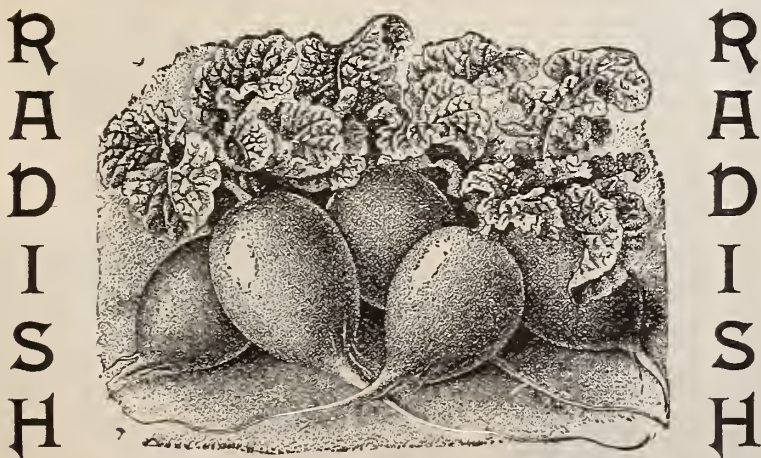

**RADISH SEED.**

- Cardinal Globe (True).** Per oz., 5c.; per lb., 60c.; 5 lbs. for \$2.75.
- Round Red Forcing, or Button.** Per oz., 5c.; per ¼ lb., 20c.; per lb., 60c.
- Round White Forcing.** Per oz., 5c.; per ¼ lb., 20c.; per lb., 60c.
- Fireball.** Per oz., 5c.; per ¼ lb., 20c.; per lb., 60c.
- Early French Breakfast.** Per oz., 5c.; per ¼ lb., 15c.; per lb., 45c.
- White Box (True).** Per oz., 5c.; per ¼ lb., 20c.; per lb., 60c.

FOR FORCING.

**TOMATO SEED.**

FOR FORCING.

- Lorillard.** The best. Per pkt., 7c.; per oz., 25c.; per ¼ lb., 65c.
- Livingston's Stone.** Excellent. Per pkt., 7c.; per oz., 15c.
- Playflower.** (True). Pkt., 10c.; per oz., 20c.; per lb., \$2.25.
- Sutton's.** (Imported). Best of all. Per original large pkt., 40c.

We can especially recommend this as the very best forcing tomato. If you want the true stock insist on getting it in Sutton's original packets.

Also all other varieties.

**SPINACH SEED.**

(Ten to twelve pounds are required for an acre).

- Bloomsdale Round-seeded Savoy.** Best home-grown seed. Per lb., 25c.; per peck, \$1.75; per bush., \$6.50.
- Long Standing Round-seeded.** Per lb., 20c.; per peck, \$1.50; per bush., \$6.00.
- Victoria Long Standing.** 25c. per lb.; \$1.75 per peck; \$6.50 per bush.

**Grass and Clover Seeds.**

**GRASS SEEDS.**

- Michell's Evergreen Lawn Grass.** Our very best mixture. (20 lbs. to the bushel). Qt., 20c.; peck, 85c.; bush., \$3.25.
  - Fairmount or Central Park Lawn Grass.** Excellent mixture of short growing grasses and white clover (15 lbs. to the bushel). Qt., 10c.; peck, 60c.; bush., \$2.25.
  - Fine Mixed Lawn Grass.** (15 lbs. per bush.). \$2.00 per bush.
  - Permanent Pasture Mixture.** (20 lbs. to the bush.). \$2.50 per bush.
- |   | Per peck. | Per bush. | Per 100 lbs. |
|---|-----------|-----------|--------------|
| <b>Herd, or Red Top.</b> Bush. of 10 lbs.                         | \$ .25    | \$ .80    | \$6.00       |
| <b>Fancy Cleaned Red Top.</b> Free from chaff. 32 lbs. per bushel | 1.30      | 4.75      | 14.00        |
| <b>Kentucky Blue.</b> Fancy triple cleaned                        | .50       | 1.65      | 10.50        |
| <b>Natural Green.</b> 14 lbs. to the bush.                        | .50       | 1.75      | 11.00        |
| <b>Wood Meadow.</b> Per qt. 25c.                                  | 1.25      | 4.00      | 26.00        |
| <b>Sweet Vernal.</b> (Annual). 20c. per lb.                       | 1.00      | 3.50      | 15.00        |
| <b>Sweet Vernal.</b> (Perennial). 40c. "                          | 1.50      | 5.50      | 35.00        |
| <b>Orchard Grass</b>  | .50       | 1.75      | 12.00        |
| <b>English Perennial Rye.</b> (24 lbs. to bu.)                    | .50       | 2.00      | 7.50         |

Also all other varieties of grass seed,

Special prices will be quoted to large buyers.

**CLOVER SEEDS.**

Prices may fluctuate.

	Per lb.	Per 10 lbs.	Per bush.
<b>White Dutch Clover.</b> Extra clean.	\$ .20	\$1.90	\$10.80
<b>Scarlet, or Crimson Clover</b>	.10	.95	5.40
<b>Alsike Clover</b>	.15	1.40	7.00
<b>Lucerne Clover</b>	.15	1.50	7.50
<b>Red Clover.</b> (Extra choice)	.12	1.10	6.00

**Millet Seed.**

- German, or Golden.** Best quality . . . . . about \$1.35
- Hungarian** . . . . . " 1.00

**Timothy Seed.**

- Extra Prime** . . . . . about \$2.15

**Seed Wheat.**

- Best varieties and quality . . . . . about \$1.25 per bush.

**Seed Rye.**

- Best varieties and quality . . . . . about \$1.00 per bush.

**BEST QUALITY  
Standard Flower Pots.**

Full Inside

Measurement.



P. S.—The prices herewith quoted are subject to discount of 10 per cent. for cash with order, or if paid within 30 days.

	Per 100	Per 1000
1 3/4 inch.....	\$0.35	\$3.15
2 ".....	.40	3.60
2 1/4 ".....	.45	4.05
2 1/2 ".....	.55	4.95
2 3/4 ".....	.60	5.63
3 ".....	.70	6.30
3 1/2 ".....	.85	7.65
3 3/4 ".....	.90	8.10
4 ".....	1.10	9.90
4 1/4 ".....	1.25	11.25
4 1/2 ".....	1.50	13.50
5 ".....	2.00	18.00
5 1/2 ".....	2.50	22.50
6 ".....	3.00	27.00
6 1/2 ".....	4.00	40.00
7 ".....	5.00	50.00
8 ".....	7.00	70.00
9 ".....	10.00	100.00
10 ".....	13.50	135.00
	Per 100	
11 inch.....	\$18.00	
12 ".....	25.00	
13 ".....	37.50	
	Each	
14 inch.....	\$0.50	
15 ".....	.75	
16 ".....	1.00	
18 ".....	1.50	
20 ".....	2.00	
22 ".....	3.00	
24 ".....	4.00	

The above prices are subject to 10 per cent. discount for cash with order, or if paid within 30 days.

**BULB PANS.  
(EARTHENWARE.)**

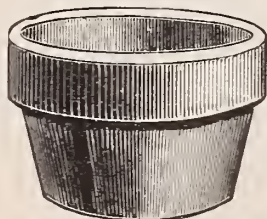

Height	Width	Per Doz.	Per 100
3	x 6	\$0.50	\$3.00
3 1/2	x 7	.60	4.00
4	x 8	.75	5.00
4 1/2	x 9	1.00	7.00
5	x 10	1.25	9.00
6	x 12	1.75	12.50
7	x 14	3.50	25.00
8	x 16	6.00	50.00
9	x 18	9.00	75.00

**FLOWER POT SAUCERS.  
(EARTHENWARE.)**



Size	per 100	per 1000
4 inch.....	\$0.90	
5 ".....	1.12	
6 ".....	1.50	
7 ".....	2.00	
8 ".....	3.00	
9 ".....	4.00	
10 ".....	5.00	
11 ".....	6.00	
12 ".....	7.50	
14 ".....	12.50	

**"NEPONSET"  
PAPER FLOWER POTS.**

They are the cheapest flower pots on the market. Made from the well-known NEPONSET WATER-PROOF FABRIC, and for lightness, cleanliness and cheapness have no equal. Especially valuable for shippers of small plants.

Size	Per 100	Per 1000	Weight per 1000 pots
2 1/4.....	\$0.25	\$2.20	20 pounds
2 1/2.....	.30	2.40	23 "
3.....	.45	3.90	33 "
3 1/2.....	.60	5.15	44 "
4.....	.80	6.90	38 "
5.....	1.20	10.35	56 "
6.....	1.65	14.55	74 "

Not less than Original Crates at 1000 Rates

**GLASS VASES for  
CUT FLOWERS.**

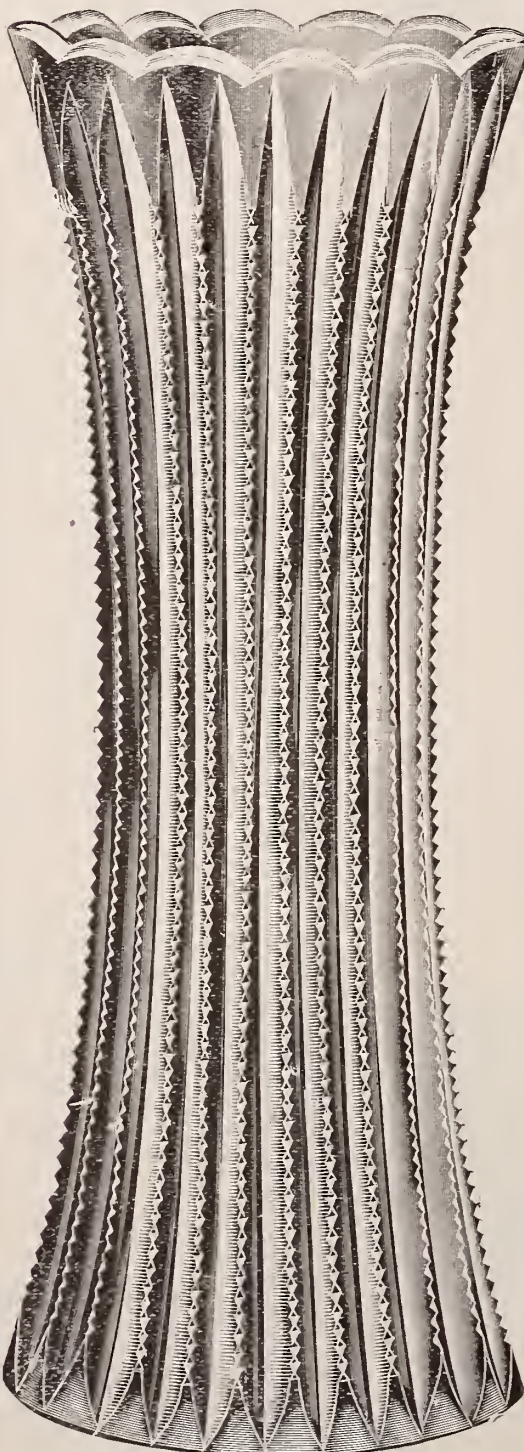

Style No. 625

No	Height	Each	Per Doz.
625.....	8 inch	\$0.25	\$2.50
736.....	12 "	.75	8.00

Also a large assortment of latest styles in Glass Vases at very low prices.



**REDUCED PRICES  
OF  
FLORISTS'  
CUT, FLOWER  
VASES.**

Made of Indurated Wood Fibre.

No.	Diam. inside	Depth inside	Each	Per Doz.
0.....	8	13	\$0.40	\$4.35
1.....	5 1/2	10	.35	3.80
2.....	4 1/2	9	.30	3.25
3.....	4	6	.25	2.75
4.....	3	4 1/2	.20	2.20
22.....	4 1/2	15	.40	4.35
33.....	4	12	.35	3.80
44.....	3	9	.30	3.25
00.....	9	21	.75	8.75

**FLOWER POT SAUCERS.**

Made of Wood Fibre.

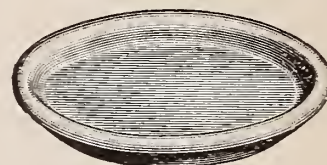

Unbreakable. Are not porous, and will protect woodwork, tables, etc., on which plants are to stand.

Size	Per Doz.	Per 100
4 inch.....	\$0.68	\$5.40
5 ".....	.72	5.63
6 ".....	.77	6.18
7 ".....	.81	6.39
8 ".....	.86	6.84
9 ".....	.90	7.38
10 ".....	.95	7.83
12 ".....	1.22	9.00
13 ".....	1.35	10.80
14 ".....	1.80	13.50

**ROLLING STANDS.**

For Heavy Plants and Palms.

Made of Indurated Fibre Ware.

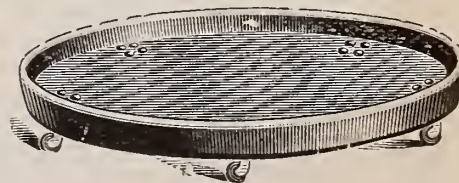

Will not soak or rust. Casters have ball bearings. Every heavy plant sold needs one to save carpets and floors.

Size	Each	Doz.
12 inch.....	\$0.59	\$6.48
14 ".....	.77	8.10
16 ".....	.86	9.00
18 ".....	.99	10.80
20 ".....	1.22	13.50
22 ".....	1.44	16.20

**THERMOMETERS.**

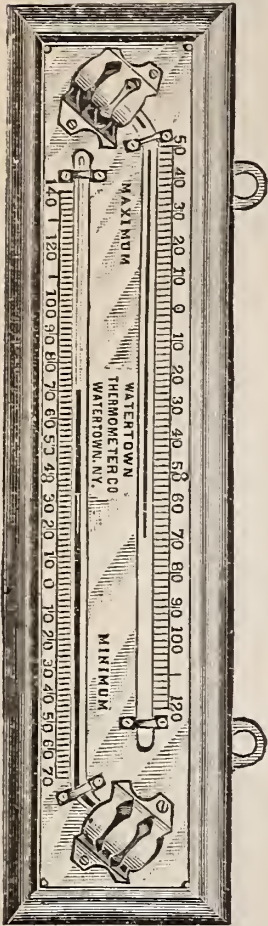

**Mushroom Bed Thermometers.**

Very best quality, with Brass Tip, \$1.50 each.

**Florists' Thermometers.**

8 in., tin, 15c. each; doz., \$1.60; 10 in., tin, 20c. each; doz., \$2.00.

**Maximum and Minimum.**

Registers the coldest and warmest point of temperature during the previous night.

Each. Per 1/4 doz.  
8 in., \$2.25 \$6.00  
10 " 2 50 6 75

**Sundries.**

Peat. (Jersey), \$1.15  
Moss, Sphagnum, 1 15  
" Green (lump) 1.25  
" Green (Sheet) 2.00

**Tin Foil.** Per lb., 15c.;  
4 lbs., 50c.; 10 lbs., \$1.20.

**Twine (Bouquet).** Per lb., 40c.; 3 lbs., \$1.00.

**Bouquet Wire.** All sizes, per lb., 10c.; per stone of 12 lbs., 80c. to \$1.50.

**Improved Bouquet Wire.** All sizes already cut in lengths. Per box of 12 lbs., \$1.30.

**RAFFEA. Fresh and Strong.**

Best material for tying up plants. 17c. per lb.; 10 lbs., \$1.50; \$14.00 per 100 lbs.

**Green Silkaline.**

For stringing Smilax and Asparagus. Fast color and will not fade; very strong and will not break. Coarse or fine, put up on 2 oz. spools, 8 in a box, 16 oz. of Silkaline guaranteed. Price, \$1.25 per lb.; per spool, 20c.

**TWINE.** (Jute). 2, 3 or 4-ply, 12c. per lb.

**TWINE.** All kinds at lowest prices.

**OILED MUSLIN OR FIBRE CLOTH**



Light grade, 4c. per yd.; piece of about 65 yards, 3 1/2 c. per yd.

Medium grade, 8c. per yd.; piece of about 60 yards, 7 1/2 c. per yd.

Heavy grade, 10 1/2 c. per yd.; per piece of about 40 yards, 10c. per yd.

These goods are now extensively used by florists for shading the greenhouses in preference to the old style of whitewashing the glass.



**Waters' Improved Tree Pruners.**

With Pole Attached.

Considered to be the most practical as well as the cheapest.

4-foot pole . . . \$ .80  
6 " . . . . .90  
8 " . . . . .1.00  
10 " . . . . .1.10  
12 " . . . . .1.20  
14 " . . . . .1.30

Extra Cutting Blade, 25c.

**PLANT STAKES.** Note these low prices. We are Headquarters.

**Galvanized Steel Plant Stakes.**

Used by nearly all the largest florists for Roses, Carnations, etc. They are neat and durable.

	Per 100	Per 1000
2 feet long . . . . .	\$ .50	\$3.55
2 1/2 " " . . . . .	.60	4.45
3 " " . . . . .	.70	5.35
3 1/2 " " . . . . .	.80	6.25
4 " " . . . . .	.90	7.10
4 1/2 " " . . . . .	1.00	8.00
5 " " . . . . .	1.10	8.90
6 " " . . . . .	1.30	10.65

**GALVANIZED WIRE.**

In rolls of 12 lbs each, Nos. 14, 16, 18, 20, at Soc. to \$1.20 per roll.

**Bamboo or Cane Plant Stakes.** Per 100 Per 1000  
8 to 12 feet long . . . . . \$ .75 \$5.00

Unpainted Stakes or Dowels.	Per 100	Per 1000
36 in. long, 3/16 in. diam. . . . .	\$.60	\$5.50
36 " " 1/4 " " . . . . .	.50	4.00
36 " " 3/8 " " . . . . .	.50	4.00
42 " " 1/4 " " . . . . .	.60	5.00
42 " " 3/8 " " . . . . .	.65	5.25
42 " " 1/2 " " . . . . .	.85	7.00

We can supply these Dowels, dyed green, at 50c. per 1000 additional.

**Green Painted Tapering Plant Stakes.**

Size	Per doz.	Per 100
1 1/2 feet . . . . .	\$.12	\$ .80
2 " " . . . . .	.22	1.40
2 1/2 " " . . . . .	.33	2.10
3 " " . . . . .	.40	2.65
3 1/2 " " . . . . .	.52	3.35
4 " " . . . . .	.60	3.85

**Green Painted Heavy or Dahlia Stakes.**

Size	Per doz.	Per 100
3 feet . . . . .	\$.60	\$3.85
3 1/2 " " . . . . .	.70	4.50
4 " " . . . . .	.80	5.15
5 " " . . . . .	1.00	6.40
6 " " . . . . .	1.20	7.65

**POT LABELS, PAINTED.**

	Per 1000	Per 1000
3 1/2 inch . . . . .	\$.60	6 inch . . . . . 1.25
4 " " . . . . .	.65	8 " " . . . . . 2.50
4 1/2 " " . . . . .	.70	10 " " . . . . . 3.50
5 " " . . . . .	.90	12 " " . . . . . 4.50

**Tree Labels, Notched.** Iron Wired . . . . .90  
" " " Copper Wired 1.00

**Indelible or Permanent Hanging Labels.**

The best and most durable made. Send for sample. Per doz., 15c.; per 100, \$1.00.

**Glass Labels.** (Permanent). 50c. per doz.; \$3.00 per 100.

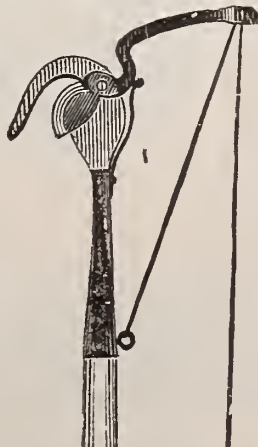

**Disston's Little Giant Pruner.**

Price \$1.00; with Saw, \$1.30

**German Hand Pruning Shears.**

Steel blades, coiled steel spring which cannot drop out. 8 in. 65c., 8 1/2 in. 90c.

**American Hand Pruning Shears.**

Price, 30c. each.

**Hedge Shears.**

8 in. . . . . \$1.50  
9 " . . . . . 1.75  
10 " . . . . . 2.00



The New "Superior" Iron Plant Stand showing a Palm in TILTING position.

**THE NEW PATENT**

**"Superior" Iron Plant Stands.**

We are the Sole Manufacturers' Agent for these.

This is the very best and only stand that fills a long felt want. You can tilt and set your plants at any angle desired to produce the proper decorative effect. (For Azaleas and similar style plants it is especially invaluable). They are neat, durable, very strong, and suitable for either parlor, store, hall, conservatory or greenhouse. They are also desirable for elevating plants above others to save space.

Height	Size of Plates	Price
12 inch . . . . .	5 x 7 . . . . .	\$.75
18 " " . . . . .	5 x 7 . . . . .	.80
18 " " . . . . .	8 x 10 1/2 . . . . .	.95
24 " " . . . . .	8 x 10 1/2 . . . . .	1.05
24 " " . . . . .	8 x 12 . . . . .	1.15
30 " " . . . . .	8 x 10 1/2 . . . . .	1.20
30 " " . . . . .	8 x 12 . . . . .	1.30
36 " " . . . . .	8 x 10 1/2 . . . . .	1.30
36 " " . . . . .	8 x 12 . . . . .	1.40
42 " " . . . . .	8 x 10 1/2 . . . . .	1.40
42 " " . . . . .	8 x 12 . . . . .	1.50
48 " " . . . . .	8 x 12 . . . . .	1.60
60 " " . . . . .	8 x 12 . . . . .	1.70
72 " " . . . . .	8 x 12 . . . . .	1.80

We can supply Iron Stands without tilting attachment at 10 per cent. less than above price.



**PRUNING AND BUDDING KNIVES**

A large assortment, 50c. to \$1.25 each.

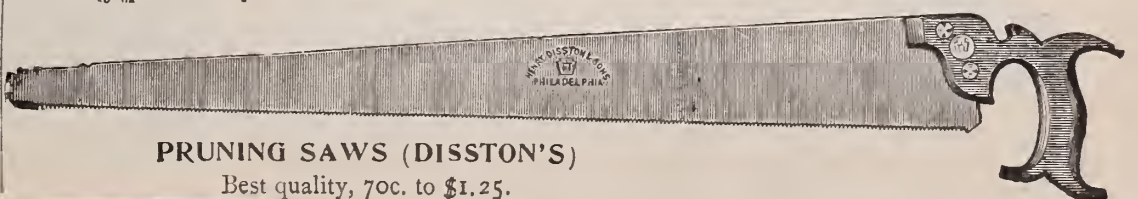

**PRUNING SAWS (DISSTON'S)**

Best quality, 70c. to \$1.25.

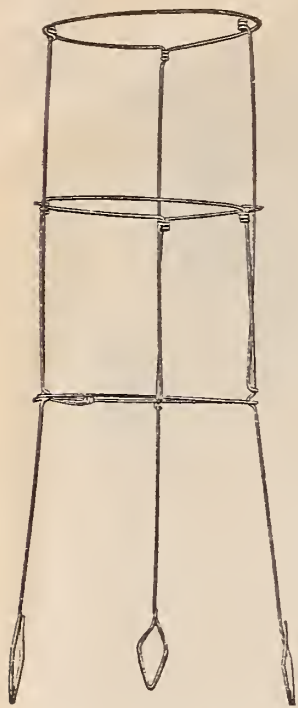

"Model" Three Ring.

## Carnation Supports.

### "MODEL."

Doz.	100	1000
2 rings...	\$.35	\$2.75
3 " ...	.50	3.25
		30.00

P. S.—Ask for special prices on lots of over 1000 Supports.

### "HAINES."

Consisting of one cypress wood stake and three copper wire rings.

Doz.	100	1000
\$	.30	\$2.00
		\$20.00

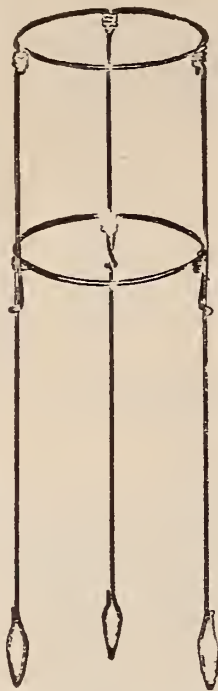

"Model" Two Ring.

## ZEMENTINE.

The very best material for shading greenhouse and hot bed sash. Far superior to whitewash. 15c. per lb. pkge.; 10lbs for \$1.40

## UNIVERSAL GLAZIERS' DIAMOND.

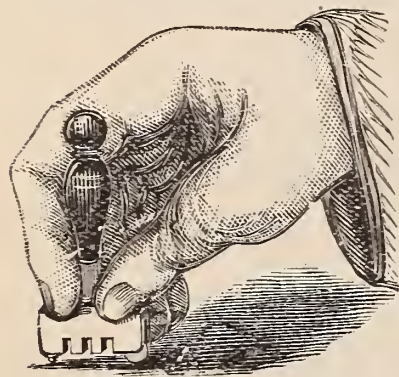

Hold the Diamond as shown in cut (against the ruler) Place it perpendicular on the glass, so that it rests on the Diamond and Guide Wheel—the Wheel towards you. Press on it gradually; until it makes a singing sound, not a harsh noise.

Draw over the glass slowly and uniformly, never cut twice in the same place. Price \$2.50.

## STEEL WHEEL GLASS CUTTERS. (Very good).

15 cents each; four for 50 cents.

## MASTICA

### FOR GLAZING GREENHOUSES.

(New or Old.)

Elastic, adhesive, easy to apply. Used now extensively and highly recommended by all the up-to-date gardeners and florists. Immense quantities were used last season.

One gallon will cover about 300 running feet, one side. Per gal., \$1.25; half gal., 65c.; 5 gals., \$5.75. 10 gallons and over, \$1.10 per gallon.

Machines for applying Mastica, \$1.00.

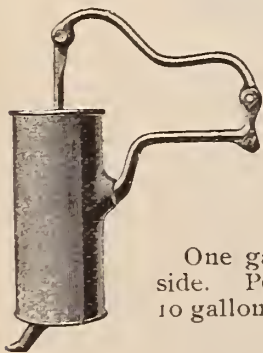

## The Van Reyper Perfect Glazing Points.

Made of steel wire and galvanized, having double points and lap over the glass in such a manner as to positively keep it from sliding. They may be used on either side of the sash bar, thus preventing the annoyance of rights and lefts.

Per box of 1000 60c.  
5000 lots at 55c. per 1000.  
Pincers for driving, 50c.

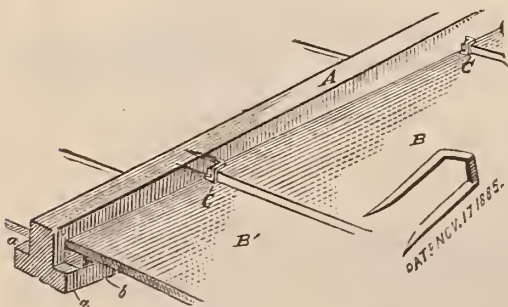

## Siebert's Practical Glazing Points.

Two sizes: 5/8 and 7/8 in. long.  
Per lb. .... 40c.

## SCOLLAY'S PUTTY DISTRIBUTOR.



The best appliance for distributing putty. It has been used by a large number of the leading florists, who have proven its merits. One day's work by the old method of glazing can easily be done in four hours by the use of the Distributor.

Price, each . . . . . 75 cts.  
By mail . . . . . 85 cts

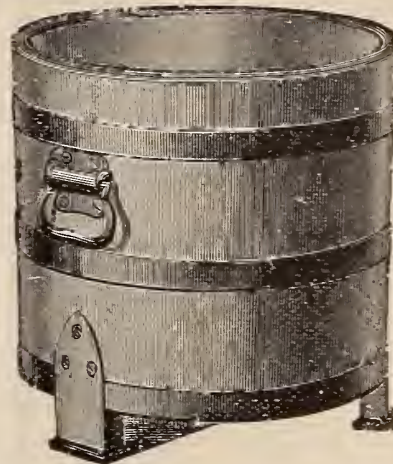

## Improved White Cedar Plant Tubs.

Made of white cedar, bound with extra heavy iron hoops. Drop handles of special pattern, serving as hooks. Substantial iron feet of original design. Removable perforated bottoms, painted green outside and brown inside.

No.	Outside Diam.	Length of Stave	
0	27 in.	24 in.	\$4.75
1	25 "	22 "	4.25
2	23 "	21 "	3.60
3	21 "	18 "	3.25
4	19 1/2 "	16 "	2.75
5	18 "	14 "	2.50
6	16 1/2 "	13 "	2.00
7	15 "	12 "	1.75
8	14 "	10 "	1.50

## "Union" Plant Tubs. Made of Cypress painted green, iron feet.

No.	1	2	3	4	5
Diameter inch.....	13	14 1/2	16	20	24
Length of staves, in. ....	11	13	15	18	21
Price .....	.68	1.12	1.53	2.00	2.50

## IMPROVED COLUMBIA

## Plant Tubs

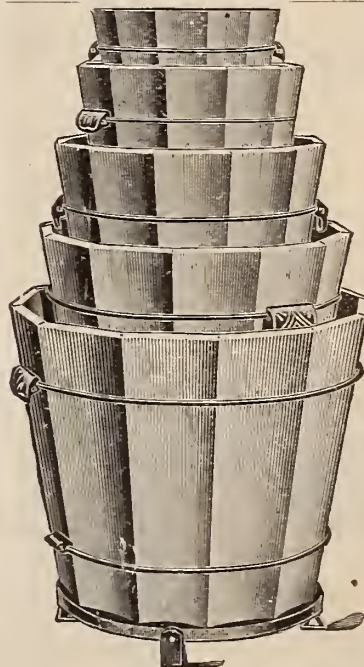

12 inch diameter . . .	\$0.90 each.
15 " " . . .	1.35 "
18 " " . . .	1.80 "
21 " " . . .	2.25 "
24 " " . . .	2.70 "

## PALMER'S HOT BED MATS

### FROST PROOF.

Made expressly for winter covering of hot beds, cold frames, plants and seeds of all kinds.

Indestructible, Cheap and warm.

Will not harbor mice or vermin. Easy handling. Have now been in practical use three years. Costing less than



half as much as old fashioned straw mats and entirely taking their place  
Size 76 x 76 inches, fully covering two regular size hot bed sash, \$1.10 each; \$13.00 per doz.  
Size 76 x 76 inches, fully covering one hot bed sash, 80c. each; \$9.25 per doz.



# MICHELL'S WHOLESALE PRICE LIST.

**SOLD WITH OUR GUARANTEE**

## FERTILIZERS

**..STRICTLY HIGHEST GRAD**

**Michell's Pure Bone Meal.** (Pierson's Brand.) This grade is the purest article on the market. It is prepared from fresh bones only, and contains not a particle of vegetable, ivory or oyster shell, often found in cheaper grades. Per ton \$29.00, per sack of 200 lbs. \$3.25, per 100 lbs. \$1.75, per 50 lbs. \$1.00.

**Native Poudrette.** We can recommend this very highly for a general greenhouse fertilizer. Per 100 lbs. \$1.50, 500 lbs. for \$5.50, \$15.00 per ton.

**Bowker's Greenhouse Chemicals.** One of the very best all around fertilizers for forcing and producing bloom. 5 lbs. 45c., 25 lbs., \$1.25, 100 lbs. \$4.50.

**Dried Blood.** \$3.00 per 100 lbs., per 200 lb. sack, \$5.75.

**"Jadoo" Fibre.** 5c. per lb., 10 lbs. for 35c., 25 lbs. 80c., per sack containing 125 lbs., 1 1/2c. per lb., per 1/4 ton \$6.25, per ton \$20.00.

**"Jadoo" Liquid.** For feeding plants. 2 gallons, \$1.30, 5 gallons, \$3.00, 20c. per pint bottle.

**Canada Uncached Hardwood Ashes, Pure.** Per bbl. of 250 lbs. \$2.50 per ton \$18.00, (\$11.00 per ton f. o. b. Canada).

**Bone Flour.** Ground perfectly fine. An excellent fertilizer for pot plants or beds where an immediate effect is wanted. 100 lbs. \$2.25, bag or bbl. of 200 lbs. \$4.00, per ton \$36.00.

**Phosphate.** Best quality. \$3.00 per sack of 200 lbs., \$25.00 per ton.

**Guano.** Per 5 lb. bag 20c., 25 lb. bag 90c., 100 lb. bag \$2.75, 200 lb. bag \$4.50, per ton \$40.00.

**Nitrate of Soda, Pure.** Per lb. 5c., 10 lbs. 40c., 25 lbs. 95c., 100 lbs. \$3.25, 200 lbs. \$6.00, per ton \$49.00.

**Pulverized Sheep Manure.** Best quality (Elliott's Brand). 5 lbs. 20c., 25 lbs. 75c., 100 lbs. \$2.00, per ton \$32.50, or \$30.00 per ton f. o. b. factory.

**Pulverized Sheep Manure.** (Ashman's Brand). \$1.75 per 100 lbs., \$25.00 per ton.

**Horn Shavings.** Per bag of 20 lbs. \$1.00, per 100 lbs. \$4.00.

**Special Notice.** We carry on hand or can supply all other FERTILIZERS at the very lowest wholesale prices. Quotations will be made on request. Also Horse and Cow Manure.

## INSECTICIDES OR INSECT DESTROYERS.

**Ant Exterminator.** A most effectual preparation for destruction of Ants in greenhouses and flower beds. 25c., 50c., \$1.00 per package.

**Bordeaux Mixture.** In liquid form. Per qt. 40c., per gal. \$1.00.

**Copper Soap (Permol).** Positive cure for mildew and rust. 75c per can.

**Copperdine** (For black spots, etc.). Per qt. 50c., per gal. \$1.50. Special price on large quantities. One quart makes 25 gallons wash.

**Fostite** (For preventing mildew). 5 lbs. 50c., 25 lbs. \$2.00, 50 lbs. \$3.50, 100 lbs. \$6.50.

**Fir Tree Oil.** Per qt. \$1.25, per 1/2 gal. \$2.00, \$3.75 per gallon.

**Fir Tree Oil Soap.** 2 lb. can 65c., 5 lb. can \$1.50.

**Grape Dust.** (For mildew). 5 lb. package 30c., \$5.00 per 100 lbs.

**Helibore.** Per lb. 20c.

**Kerosene Emulsion.** 15c per lb can, sufficient for 10 gallons of spray; 60c. per 5 lb. can, makes 50 gallons of spray; 25 lb. can \$2.50.

**Kraft's Palm Wash.** 75c. per qt., \$2.65 per gallon.

**Kraft's Plant Tonic.** 75c. per qt., \$2.65 per gallon.

**Lemon Oil.** 75c. per qt., \$1.25 for 2 qts., \$2.00 per gal., \$9.00 per 5 gallon keg.

**Nikoteen.** Per pt. \$1.50, 10 pts. for \$13.00. Outfit of pans, etc., \$3.00.

**Nikoteen Aphs Punk.** 60c. per roll, \$6.50 per doz.

**Paris Green.** Per lb. 20c., 10 lb. lots at 18c. per lb.

**Persian Insect Powder, Pure.** Per lb. 30c.

**Rose Leaf Extract of Tobacco.** Very extensively used now by all the leading growers for fumigating, doing away to a great extent with smoking with tobacco stems. Per gal. \$1.25, 5 gal can \$4.25.

**Rose Brand Sulpho Tobacco Soap.** A valuable and effective insecticide for nearly all purposes. Dissolve 2 ounces to the gallon of water. 10 lb. box \$3.00.

**Seal Oil Soap.** Recommended very highly for destroying scale and all other insects. 22c. per lb., 5 lbs. for \$1.00, 25 lb. cans at 19c. per lb.

**Sulphur.** Per lb. 6c., 5 lbs. 25c., 25 lbs. \$1.10, 100 lbs. \$3.50, full bbl. lots at 3c. per lb.

**Slug Shot.** 5 lbs. 25c., 100 lbs. \$4.50, per bbl. in bulk 3 3/4c. per lb.

**Tobacco Dust.** Best quality. 5 lbs. 20c., 100 lbs. \$2.25.

**Tobacco Stems.** In bales of 250 lbs. \$1.50, \$10.00 per ton.

**Whale Oil Soap, Pure.** Lb. 10c., 10 lbs. 80c., 100 lbs. \$7.00.

**Worm Eradicator.** Always sure. 50c., \$1.00 and \$3.00 per bottle.

**Weed Killer.** 75c. per 1/2 gal., \$1.25 per gal., 5 gals. for \$6.00.



## MacMichael's "Peerless" Sulphur Blower

Price \$4.75 each.

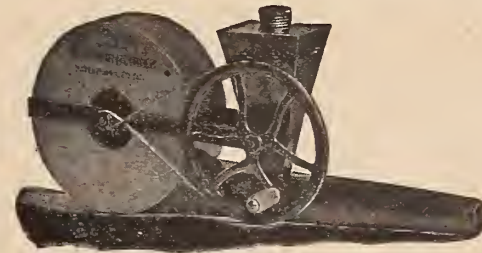

This Sulphur Blower has no equal for applying sulphur to the foliage in rose houses. It does the work quickly and perfectly, the distribution of the sulphur being so even that every leaf receives its due proportion, and *none being wasted*, thus making it more economical than the bellows.

The blower will also distribute with equal facility and thoroughness, Tobacco Dust, Slug Shot, Lime or any other powdery substance used in greenhouses. It is a great labor saver, as a 200 foot rose house can be sulphured in less than five minutes.

It is easily handled, is strong and durable, and is *Guaranteed for Ten Years*.

## PERFECTION FUMIGATOR.

Will fumigate and vaporize at the same time. The tank should be filled with water; when the stems are lighted the water boils and emits a dense mass of moistened smoke or steam.

Made in two separate bodies, detachable, does not become heated when in operation, harmless to the most tender plants.

No. 1, holds 1 peck of stems . . . . . \$2.75  
 No. 2, holds 1/2 bushel of stems . . . . . 3.25  
 No. 3, holds 3/4 bushel of stems . . . . . 3.75  
 No. 5, holds 1 bushel of stems . . . . . 5.00

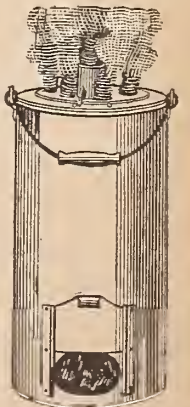

## EUREKA FUMIGATOR.

Made of extra heavy galvanized iron.

No. 1, \$1.00; No. 2, \$1.50; No. 3, \$2.00; No. 4, \$3.00.

## Woodason's Liquid Insecticide Bellows,

No. 1, \$1.00 each; No. 2, \$1.65 each.

## Woodason's Sulphur Bellows,

Price . . . . . \$1.50

## Woodason's Powder Bellows,

No. 1, 90c. each; No. 2, \$1.75 each; No. 3, \$2.70 each.

**Lemon Oil Insecticide.**

The Best and Cheapest Insecticide in the Market. Used now by nearly all the leading growers. It effectually destroys Mealy Bug, Scale, Thrip and Red Spider.

Half Pint, 25c.      Pint, 40c.  
 Quart, 75c.      Half Gal., \$1.25  
 Gal., \$2.00      5 Gal. Kegs, \$9.00  
 10 Gallon Kegs, \$17.50

\*\*\*\*\*

**LEMON OIL.**

\*\*\*\*\*

# MICHELL'S WHOLESALE PRICE LIST.

H  
O  
S  
E

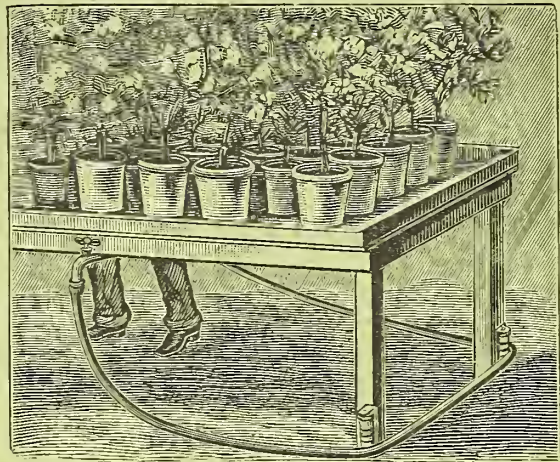

P  
R  
O  
T  
E  
C  
T  
O  
R

## SCHUCK'S HOSE PROTECTOR.

The best invention for protecting hose from breakage around greenhouse benches. 25 cents each; \$2.50 per dozen.

## RUBBER HOSE.

**Red Cross Brand.**  $\frac{3}{4}$  in. 7c. per foot.  
**Standard Brand.**  $\frac{3}{4}$  in. 10c. per foot.  
**Extra Standard Brand.**  $\frac{3}{4}$  in., 3-ply, 11 $\frac{1}{2}$ c. per foot. With our guarantee.  
**Extra Standard Brand.**  $\frac{3}{4}$  in., 4-ply, 14c. per foot. With our guarantee.  
**Chicago Electric (New).** 15c. per foot.  
**Wire Wrapped 3-Ply.**  $\frac{3}{4}$  in. 13c. per foot.  
**Wire Wrapped (Sphincter).**  $\frac{3}{4}$  in. 15c. per foot.

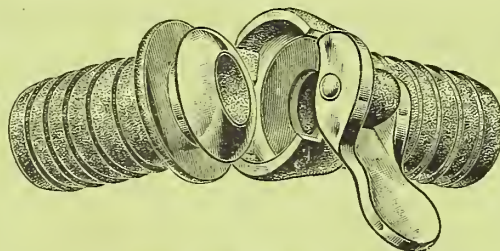
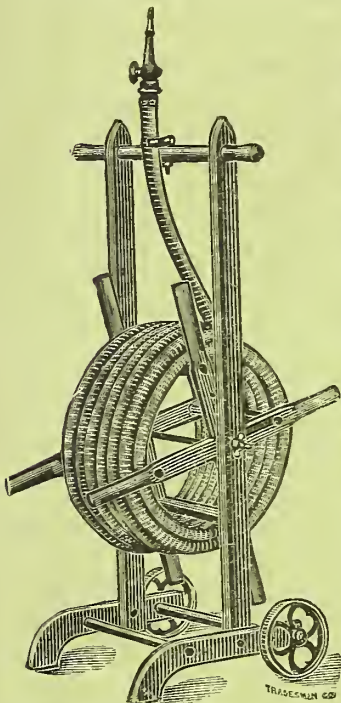

### Water Tight Hose Coupler.

Instantaneous in operation. Simplicity itself. Can be operated by a child. No screws to get out of order. Nothing to get damaged or broken. Per pair 22c.; per doz. pairs \$2.20.

**HOSE MENDERS (Woodason's).** One of the best. Each 5c.; per doz. 50c.  
**THE NEW "COOPER" HOSE MENDERS.** Specially recommended for mending old hose. For  $\frac{1}{2}$  inch or  $\frac{3}{4}$  inch hose. 8c. each; 75c. per doz.

## Hudson's Practical Hose Mender.

For mending rubber hose. One box contains 6 tubes, 20 bands, 1 pair pliers.

60c. for whole outfit.

Tubes and bands sold, also, separately.

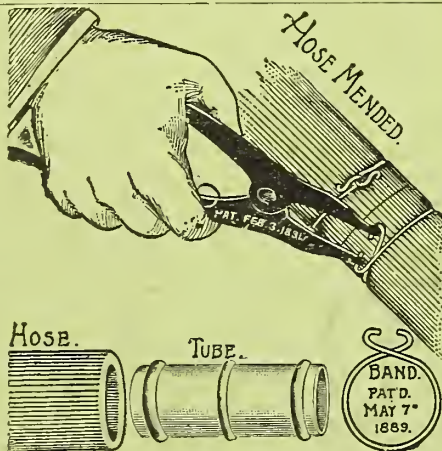

## THE "SIMPLICITY" HOSE ATTACHMENT OR COUPLER.

There is no simpler or more practical device for attaching hose to hydrant; one part is attached to hose, the other to the hydrant; by a slight turn the fastening is made.

Complete, 25c.; \$3.00 per doz.; parts separate, \$1.50 per doz.

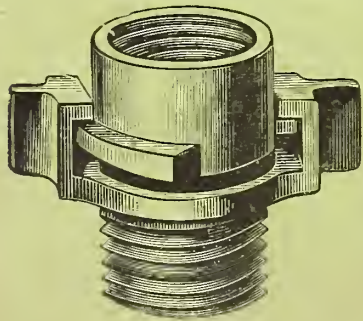

## Galvanized Water Pots.

(WOTHERSPOON'S MAKE.)

The best and most durable Water Pot made. Each has two roses—one fine and one coarse.

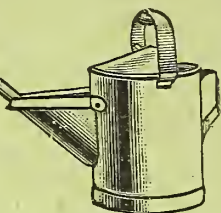

4 qt. . . . . \$1.50  
 6 qt. . . . . 1.75  
 8 qt. . . . . 2.00  
 10 qt. . . . . 2.25  
 12 qt. . . . . 2.50  
 16 qt. . . . . 3.00

### Manure Watering Cans.

12 quart capacity . . . \$2.75  
 Extra Heavy Galvanized.

## DEAKIN'S BRASS GARDEN SYRINGES.

Length of Barrel, 13 $\frac{1}{2}$  in.; diam. 1 $\frac{1}{8}$  in.

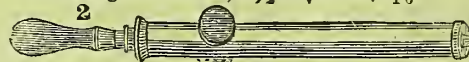

No. A. 1 stream and spray rose, 12 x 1 in. . . . . \$1.90  
 No. C. 1 " " " " 14 $\frac{1}{2}$  x 1 $\frac{1}{2}$  in. . . . . 3.00  
 No. 2. 1 " " " " 13 $\frac{1}{2}$  x 1 $\frac{1}{8}$  in. . . . . 3.75  
 No. 5. 1 " " " " 18 x 1 $\frac{1}{2}$  in. . . . . 5.50  
 Zinc Syringes, \$1.10 each.

## RAIN MAKER NOZZLE.

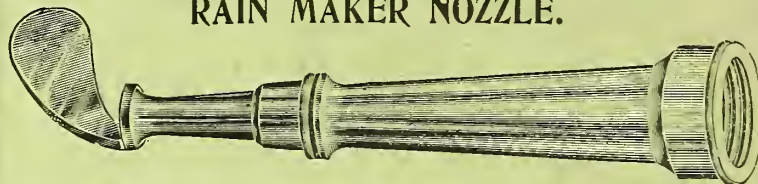

One of the best for spraying greenhouses or flower beds, taking the place of using the thumb. Each, 40 cents.

## THE BOSTON HOSE NOZZLE OR SPRAY ROSE.

This is the best nozzle for the florist. Having a flat face, it throws the water exactly where it is wanted without spreading. It is made of copper, and will last a lifetime.

Fine or Coarse Spray, 50 cents each.



## THE "SUCCESS" SPRAY PUMP.

FOR SPRAYING, PLANTS, &c., &c.

We can very highly recommend this pump. Perfect satisfaction guaranteed, or can be returned to us. Price, \$4.00.



## Scollay's Rubber Sprinkler.

Large size, price each 75c., \$7.80 per dozen.

Small size, 50c. each, \$5.20 per dozen.