

UC-NRLF



QB 197 202

Text-Books of Physical Chemistry

EDITED BY

SIR WILLIAM RAMSAY K.C.B., F.R.S.



BIOLOGY
LIBRARY

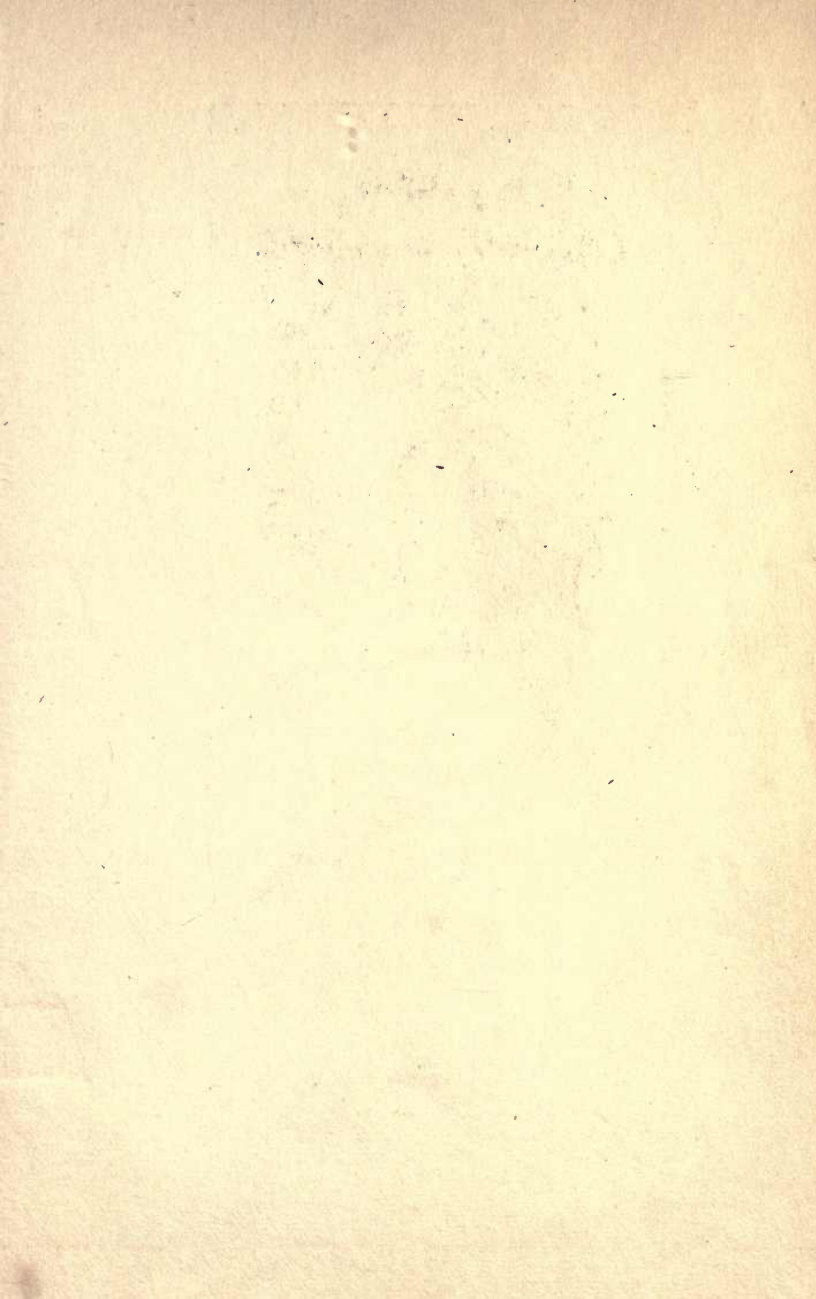

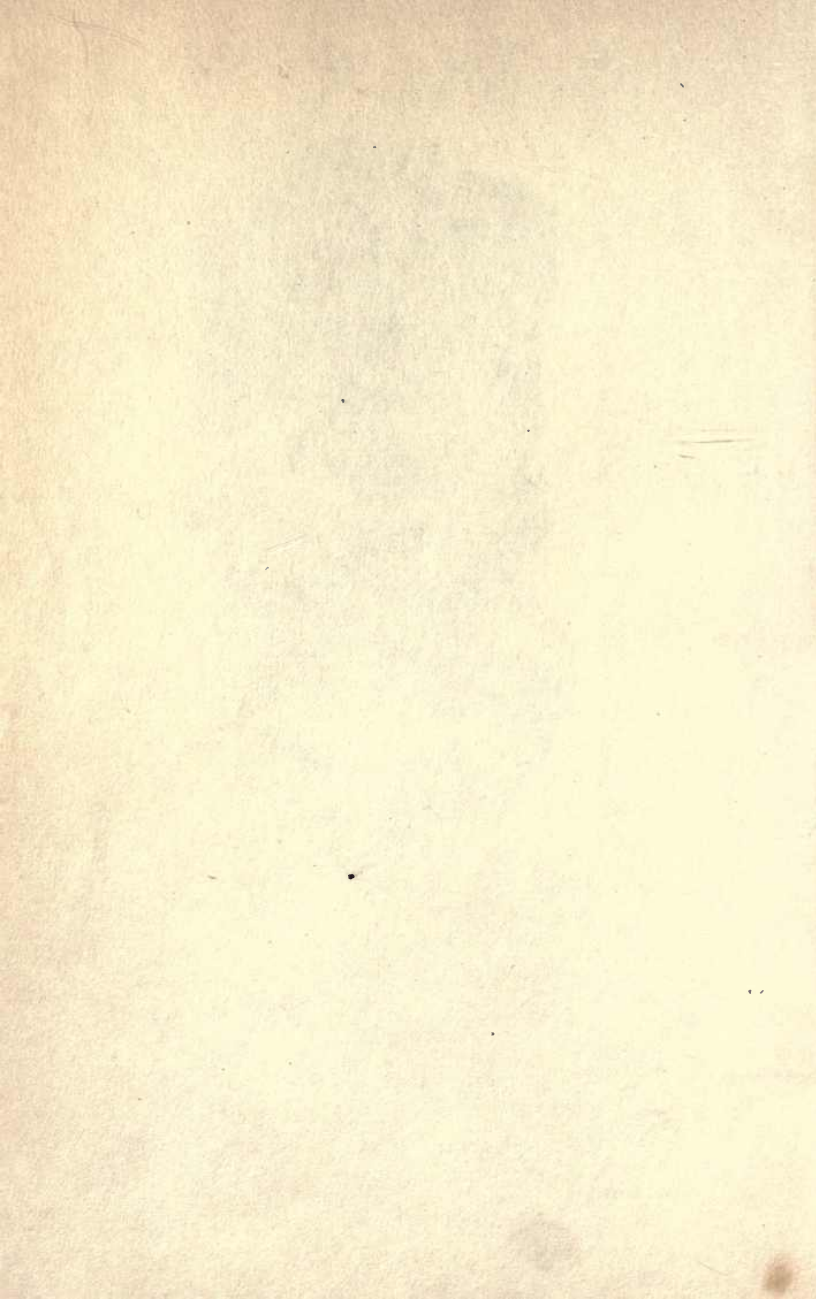

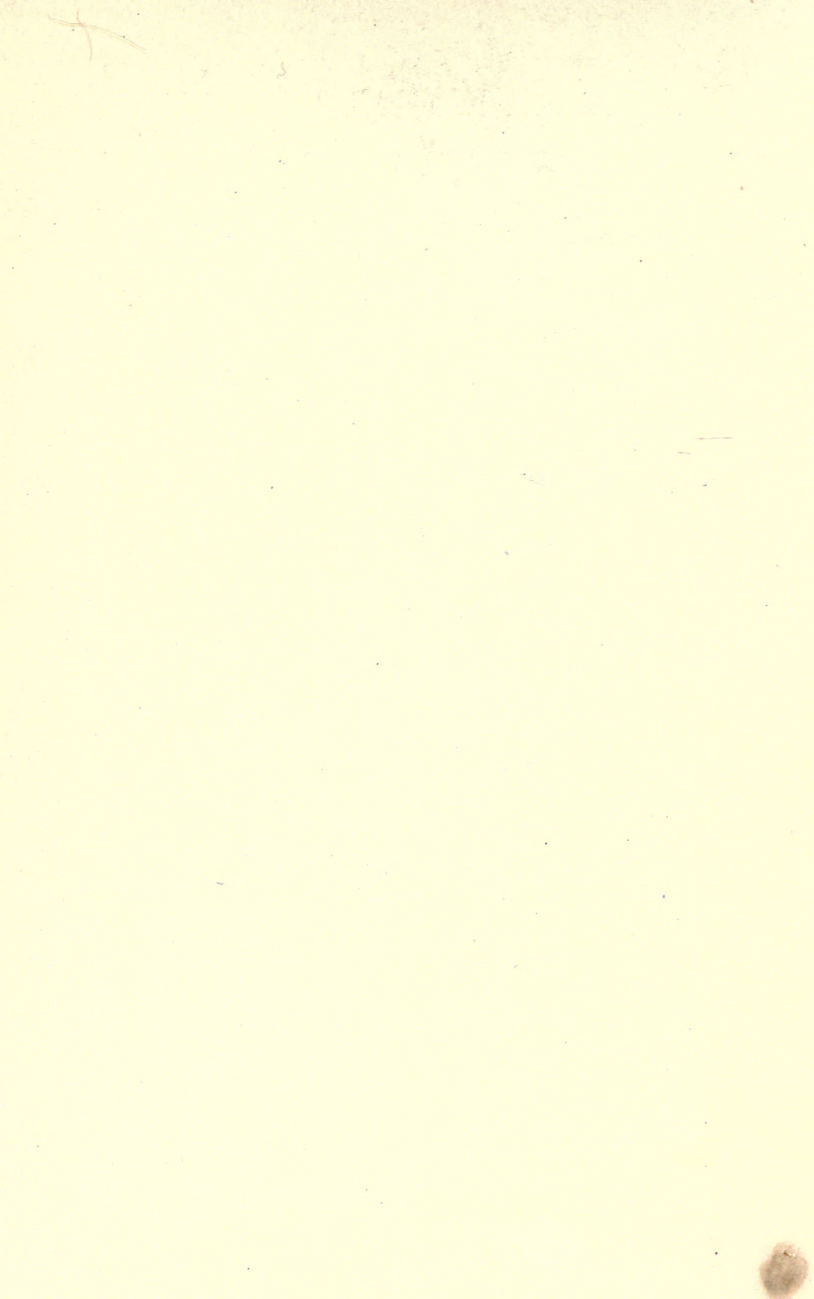

TEXT-BOOKS OF PHYSICAL
CHEMISTRY

EDITED BY SIR WILLIAM RAMSAY, K.C.B., F.R.S.

TEXT-BOOKS OF PHYSICAL CHEMISTRY.

EDITED BY SIR WILLIAM RAMSAY, K.C.B., F.R.S.

THE progress of Physical Chemistry is now so rapid, its domain is so extensive, and the number of journals devoted to its exposition is so great, that it has appeared desirable to issue a series of volumes, each of moderate compass, and each dealing with one branch of the subject. The rate of advance in various branches of the subject is not equal; while, for example, the basis of the science remains comparatively stationary (for methods of determining atomic and molecular weights, and the classification of compounds undergoes little modification), rapid progress is being made in other branches. Hence it has been thought proper to issue several short manuals, so that each individual one may be frequently brought up to date, independently of others. In this way, a statement of what is known on each subject will be made accessible to students and investigators. The subject has been divided as follows, among the authors mentioned:—

AN INTRODUCTION TO PHYSICAL CHEMISTRY.

BY SIR WILLIAM RAMSAY, K.C.B., F.R.S. 1s. net.¹

THE PHASE RULE. ALEXANDER FINDLAY, D.Sc. 5s.

ELECTRO-CHEMISTRY. PART I.—GENERAL THEORY, by R. A. LEHFELDT, D.Sc., including a Chapter on THE RELATION OF CHEMICAL CONSTITUTION TO CONDUCTIVITY, by T. S. MOORE, B.A., B.Sc. 5s.

PART II.—APPLICATIONS TO ELECTROLYSIS, PRIMARY AND SECONDARY BATTERIES, ETC.

SPECTROSCOPY. E. C. C. BALY, F.I.C.

THERMODYNAMICS. F. G. DONNAN, M.A., PH.D.

CHEMICAL DYNAMICS, AND REACTIONS. J. W. MELLOR, D.Sc.

STOICHIOMETRY. PROFESSOR SYDNEY YOUNG, D.Sc., F.R.S.

THE RELATION BETWEEN CHEMICAL CONSTITUTION AND PHYSICAL PROPERTIES. SAMUEL SMILES, D.Sc.

¹ This is the General Introduction to the series, and it also appears in Mr. Findlay's book on the Phase Rule.

ELECTRO-CHEMISTRY

PART I

GENERAL THEORY

BY

R. A. LEHFELDT, D.Sc.

PROFESSOR OF PHYSICS AT THE EAST LONDON TECHNICAL COLLEGE

INCLUDING

*A CHAPTER ON THE RELATION OF CHEMICAL
CONSTITUTION TO CONDUCTIVITY*

BY

T. S. MOORE, B.A., B.Sc.

LECTURER IN THE UNIVERSITY OF BIRMINGHAM



LONGMANS, GREEN, AND CO.

39 PATERNOSTER ROW, LONDON

NEW YORK AND BOMBAY

1904

All rights reserved

QD 353

L5

BIOLOGY
LIBRARY

CROCKER

BIOLOGY
LIBRARY

P R E F A C E

THE present volume deals with the general theory of electro-chemistry. This is divided into two parts, one giving the relation between quantity of electricity and quantity of chemical action; the other and more recent part forms the pendant to the first by giving the relation between electromotive force and intensity of chemical action. These subjects are dealt with in Chapters I. and III. Chapter II. is in the nature of an appendix to the first chapter, and may be omitted by those who are not interested in pure chemistry, without detriment to the continuity of the book.

In a subsequent volume it is hoped to discuss the most important applications of the theory, to primary and secondary cells, to electrolysis, and to the solution of chemical problems.

R. A. L.

May, 1904.



CONTENTS

CHAPTER I

By R. A. LEHFELDT, D.Sc.

MECHANISM OF CONDUCTION IN ELECTROLYTES

SECT.		PAGE
1.	Faraday's Laws : Measurement of Quantity of Electricity . . .	I
2.	Mechanism of Electrolysis	12
3.	Phenomena at the Electrodes	21
4.	Migration of Ions	32
5.	Conductivity of Electrolytes	43
6.	Equivalent and Ionic Conductivities	58
7.	Arrhenius' Theory of Dissociation	69
8.	The Law of Dilution	75
9.	Conductivity of Mixtures	81
10.	Non-aqueous Solutions	84
11.	Conduction of Fused Salts	89

CHAPTER II

By T. S. MOORE, B.A., B.Sc.

RELATION OF CHEMICAL CONSTITUTION TO CONDUCTIVITY

1.	Relation of Charge carried to Constitution	93
2.	Relation of Mobility to Constitution	94
3.	Relation of Number of Ions in Solution to Constitution	98
4.	Double and Complex Salts	133
5.	Pseudo Acids and Bases	140
6.	Amphoteric Electrolytes	143

CHAPTER III

By R. A. LEHFELDT, D.Sc.

THEORY OF CHEMI-ELECTROMOTIVE FORCE

SECT.	PAGE
1. Voltaic and Electrolytic Cells	146
2. Electromotive Force	153
3. Electrode Potential	156
4. Influence of Concentration	161
5. Concentration Polarisation	168
6. Chemical Polarisation	171
7. Thermodynamic Theory (i)	177
(ii) The Gibbs-Helmholtz Equation	185
(iii) Single Potential Differences at Electrodes	194
(iv) Potential Differences between Liquids	205
(v) Concentration Cells	210
(vi) Chemical Cells	220
Transition Cells	220
Cells with Reaction in a Homogeneous System	223
8. Methods of Measurement—	
A. Measurement of Electromotive Force	225
B. Measurement of Single Potential Differences	236
Standard Cells	241
 TABLES	 255
 INDEX	 261

SYMBOLS

- C = Concentration (gram-equivalents per litre).
E = Electromotive force.
 E_o = Electro-affinity (see p. 158).
F = Faraday (see p. 3).
K = Reaction (or ionisation) constant (see p. 76).
L = Latent heat (see p. 178).
Q = Heat of reaction (see pp. 154 and 179).
R = Gas constant (8.316 joules per mol).
T = Absolute temperature.
- $u_A u_C$ = Mobility of anion and cation (see p. 43).
W = Work (see p. 179).
 Λ = Equivalent conductivity (see p. 58).
 $\frac{dE}{dT}$ = Temperature coefficient of electromotive force.
 i = van't Hoff's factor (see p. 70).
 $l_A l_C$ = Ionic conductivity of anion and cation (see p. 62).
 v = Valency.
 t = Temperature (Centigrade).
- $u_A u_C$ = Velocity of anion and cation.
 v = Dilution (c.c. per gram-equivalent).
 x = Migration ratio of anion (see p. 35).
 γ = Degree of Ionisation (see p. 71).
 η = Concentration (gram-equivalents per c.c.).
 κ = Electric conductivity.



ELECTRO-CHEMISTRY

CHAPTER I

MECHANISM OF CONDUCTION IN ELECTROLYTES

§ I. FARADAY'S LAWS: MEASUREMENT OF QUANTITY OF ELECTRICITY

THERE is a group of substances which, when an electric current is passed through them, suffer chemical decomposition. These substances are called *electrolytes*; the process of decomposition *electrolysis*; and reactions occurring in electrolysis may be described as electro-chemical. It is the study of such electro-chemical reactions that forms the subject of the present book.

As a typical process of electrolysis we may take the decomposition of dilute sulphuric acid between platinum plates. Imagine, then, this arrangement of apparatus (Fig. 1)—Place some dilute sulphuric acid in a beaker; insert into it two plates of platinum, so as to be partially immersed, taking care that they do not touch each other; connect the upper parts of the plates by wires to a source of electric current (battery, dynamo, thermopile, etc.). Such an arrangement is known as an *electrolytic cell*. The platinum plates serve to convey the current into and out of the liquid, and are called *electrodes*; that by which the current is led in, the *anode*,

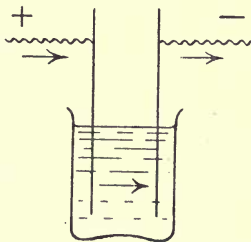

FIG. 1.

that by which it is led out the *cathode*. The liquid is the electrolyte, and the reaction that occurs when a current is passed through is the decomposition of water into its elements, oxygen and hydrogen.

Now, the leading peculiarity of this, as of all electro-chemical as distinguished from ordinary chemical reactions, lies in the appearance of the products of reaction at the electrodes only; not, as usual, throughout the mass of the reacting material. In the case chosen as example, all the oxygen appears at the surface of the anode, all the hydrogen at that of the cathode. It is therefore convenient to consider the amount of material evolved, or in the case of a solid deposited, at either electrode, and in order to arrive at the true nature of electrolysis, it is first necessary to find on what this amount depends. This was accomplished by Faraday, and the laws in which he formulated his observations are commonly known by his name. They are—

(i.) The amount of any substance deposited is proportional to the quantity of electricity which flows through the electrolyte.

(ii.) The amounts of different substances deposited by the same quantity of electricity are proportional to their chemical equivalent weights.

What is implied by the first of these is, essentially, that the rate at which the electricity flows is of no consequence, provided the total quantity be the same. If we follow the usual exposition of electrical science, and regard the current—defined by means of its magnetic action—as fundamental, we may say that the total quantity of electricity is measured by the product of the current into the time that it flows. Current is measured in *amperes*, and the meaning of Faraday's first law is illustrated by saying that five amperes will in two minutes effect exactly the same amount of electro-chemical reaction as ten amperes in one minute.

It is consequently more natural for our purpose to look upon quantity of electricity as fundamental; the unit in which this is measured is called the *coulomb*, the connection between the two being that (*a*) a coulomb is the quantity of electricity conveyed by a current of one ampere in a second, or (*b*) an

ampere is a flow of electricity at the rate of one coulomb per second.

The most exact measurements on the mass of substance deposited by the current have been made on silver, and it appears that one coulomb deposits 0.0011175 gm. of that metal. This quantity is known as the *electro-chemical equivalent* of silver, and by means of Faraday's second law we may calculate from it the electro-chemical equivalent of any other substance, e.g. that of oxygen. The atomic weight of silver is 107.93, and its equivalent weight the same; the atomic weight of oxygen is 16, but, being a divalent substance, its equivalent weight is 8. Hence the weights of silver and of oxygen liberated by the same quantity of electricity are in the ratio 107.93 : 8, and the electro-chemical equivalent of oxygen is $\frac{8}{107.93} \times 0.0011175 = 0.00008283$ gm. per coulomb. For other numbers, see table, p. 255.

Faraday's two laws may be conveniently summed up in one statement. In accordance with the second law a gram-equivalent (the chemical equivalent weight taken in grams) of any substance must require the same quantity of electricity to deposit it. This quantity may be calculated from the data for silver just given; to deposit one gram-equivalent of silver will require $\frac{107.93}{0.0011175} = 96580$ coulombs. (As the fourth significant figure has not been settled with certainty we shall adopt the approximate value 96600.) Therefore—

96600 coulombs are required for the deposition of one gram equivalent of any substance.

This fundamental quantity of electricity, which occurs constantly in all writings on electro-chemistry, is called by the Germans a "*faraday*,"¹ a term which we in England may very well adopt.

Faraday's laws have been found to hold exactly in all cases that have been satisfactorily measured—that is to say, the passage of one faraday through an electrolyte is always accompanied by the appearance at the anode of one gram-equivalent of new material, and at the cathode of one gram-equivalent;

¹ To be carefully distinguished from the unit of electrostatic capacity known as a "farad."

for instance, in the electrolytic cell of Fig. 1 by the appearance of 8 grms. of oxygen at the anode and 1'0075 grms. of hydrogen at the cathode. But it often happens that more than one reaction occur simultaneously : in this case the laws must be taken as meaning that the total amount of material deposited at the anode makes up one gram-equivalent, and the same at the cathode. Thus, if current were passed through a solution containing copper and nickel under such conditions that they come down together, one faraday might deposit (on the cathode) x equivalents of copper and y of nickel ; but it would be found that $x + y = 1$.

Substances deposited on the anode are called *anions*, those deposited on the cathode *cations*, the term ion being given by Faraday to the particles that he assumed to travel through the electrolyte. Accordingly, a cation travels in the nominal direction of the electric current (Fig. 1), while an anion travels against it. Cations include all the metals and hydrogen ; anions, chlorine, bromine, iodine, fluorine, groups such as NO_3 , SO_4 , and acid radicles generally (as well as OH).

It will be seen from the above classification that electrolytes are very commonly salts. Solutions of acids, bases, and salts in water are, indeed, the electrolytes most commonly dealt with ; but similar solutions in pyridine, liquid ammonia, and various other solvents are also electrolytes ; so are fused salts, and even a certain number of solids, to a slight degree ; while electrolytic decomposition of gases has also been observed.

When a process of electrolysis does occur in an unambiguous way, it may be used to determine the quantity of electricity flowing. A cell arranged for this purpose is known as a *voltmeter*. The chief forms of voltmeter are the following :—

1. **The Water Voltmeter.**—In nearly all cases it is the volume of gas evolved that is measured. The oxygen and hydrogen may be collected separately, but that is unnecessary for voltametric purposes, and the instrument takes a simpler form when they are allowed to mix. As electrolyte, dilute sulphuric acid has been much used, but caustic soda is better.

A very practical form of the apparatus is that of Oettel, shown in Fig. 2. It consists of a glass jar, some 15 cm. high by 5 in diameter, containing two cylindrical nickel electrodes. The leads to these are passed airtight through an indiarubber stopper, which also carries the gas delivery tube; the latter, conveniently with a rubber joint in it, is bent down to deliver into a gas-measuring tube standing over water. The solution used is 15 per cent. NaOH free from chlorine, and should nearly fill the jar.

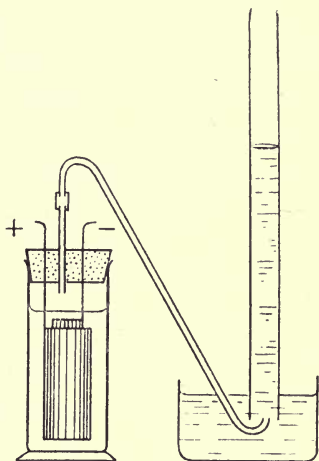

FIG. 2.

The reaction at both anode and cathode is quantitatively exact, so that one faraday evolves 8 grms. of O and 1.0075 of H. In order to calculate the weight of gas from the volume, corrections must be made for—

- (i.) Barometric pressure b (in millimetres).
- (ii.) Temperature of the gas t .
- (iii.) Difference in pressure between the gas and the external air, due to the column of water (height h) left in the gas tube at the time of measuring. This is equivalent to a mercury column of height $\frac{h}{13.6}$.

(iv.) The aqueous vapour with which the gas is saturated. The pressure of this p can be found from table, p. 255.

The actual pressure in the gas tube is $b - \frac{h}{13.6}$; that of the dry gas contained $b - \frac{h}{13.6} - p$; and one-third of this is oxygen. Hence, according to the laws of gases, if v is the measured volume of the mixed gas, the volume of oxygen reduced to normal temperature and pressure is—

$$\frac{v}{3} \times \frac{b - \frac{h}{13.6} - p}{760} \times \frac{273}{273 + t}$$

The specific volume of oxygen is 700.3 c.c. per gram (at N.T.P.) and 0.00008283 gm. corresponds to one coulomb, so that the quantity of electricity is—

$$\begin{aligned} \frac{v}{3} \times \frac{b - \frac{h}{13.6} - p}{760} \times \frac{273}{273 + t} \times \frac{1}{700.3 \times 0.00008283} \text{ coulombs} \\ = \frac{v(b - \frac{h}{13.6} - p)}{273 + t} \times 1.8373 \text{ coulombs} \end{aligned}$$

The calculation may, of course, be made in a similar way by means of the hydrogen.

At the average temperature and pressure of the laboratory this comes to about $5\frac{1}{2}$ coulombs per cubic centimetre of the mixed gases. Hence a 100 c.c. gas tube does conveniently for an experiment in which 500 coulombs of electricity are used; and further, it is easy to reckon roughly the strength of current flowing by observing how much gas is given off in 20 or 30 seconds.

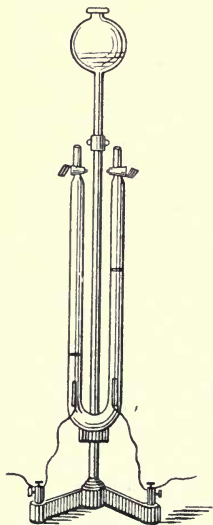

FIG. 3.

Another common form of the water voltameter is Hofmann's apparatus for the decomposition of water (Fig. 3). In this the electrodes are of platinum, and are sealed through the glass; carbon is not available on account of its power of absorbing gases largely. The gases are collected separately in the graduated tubes at the sides, and may be run off from time to time by the taps at the top. The volume of oxygen and hydrogen collected may be compared as a test of the accuracy of the voltameter. The mode of reduction of the

gas volume is similar to that with Oettel's form, but it must be remembered (i.) that as the liquid stands higher in the middle than the side tubes, the pressure in the latter will be greater than atmospheric; (ii.) the height h , representing this difference of level, is no longer of water—if the electrolyte be of density d the equivalent column of mercury is $\frac{hd}{13.6}$; (iii.) the saturation pressure of water vapour is less over a solution than over pure water: as a rough rule in the matter, it may be taken that over 15 per cent. NaOH it is 82 per cent., over 30 per cent. H_2SO_4 , 84 per cent. of the values given in table, p. 255.

Since the electrodes are of platinum, sulphuric acid may be used instead of soda. It will be found, however, that while the volume of hydrogen is exact, that of the oxygen is too low especially if the acid be strong, on account of formation of ozone and persulphuric acid.

The chief disadvantage of Hofmann's form is its considerable electrical resistance.

Both forms of voltameter work better after they have been running for a short time, as the electrolyte is then saturated with the gases.

For large currents the weight voltameter (Fig. 4) may be used. The mixed gases are passed through a small chamber full of strong sulphuric acid, to dry them, and allowed to escape. The apparatus is weighed before and after.

The water voltameter has been used as a meter for domestic electric supply. In this case, as readings are only taken at comparatively long intervals, the measurement is by the volume of liquid electrolysed away. As a meter, the instrument has the serious

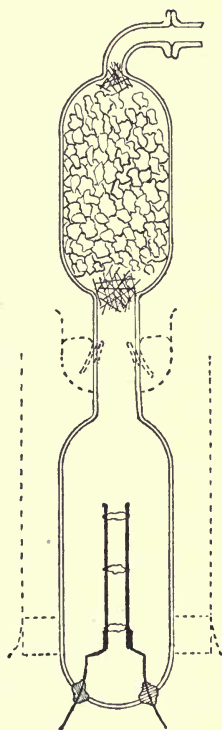

FIG. 4.

disadvantage of requiring nearly two volts to work it, and so absorbing an appreciable fraction of the electric energy it measures.

If a water voltameter be provided with a capillary tube, through which the gases have to escape, the pressure in the tube will be roughly proportional to the rate at which the gas is flowing, and may therefore be taken as a measure of the rate of flow of the electricity, *i.e.* of the current. Such an instrument, called an ampere-manometer,¹ has occasionally been used instead of an ordinary ampere-meter.

The electrolytic process is used for the preparation of oxygen and hydrogen commercially.² The vessels holding the electrolytes are of iron, as also the electrodes; 15 per cent. soda solution is employed, and as the water is electrolyzed away it must be replaced from time to time, distilled water being used to prevent accumulation of chlorides. The gases are collected separately in domes, under a pressure of about 60 mm. of water—greater pressure causes a risk of mixing. In order to reduce the resistance of the cell, it is packed in a wooden box with sand, so that the heat developed by the current keeps the temperature up to about 70° C. The voltage required is then only about 2·8 volts for each cell. The cells are constructed to take 600 amperes, and yield 220 litres of hydrogen and 110 of oxygen per hour, the purity of the gas being about 97 per cent.

2. **Silver Voltameter.**—This is undoubtedly the most accurate of all. The weight of silver deposited from a solution by a measured current in a measured time has been determined several times, the most important determinations being those of F. and W. Kohlrausch³ and Lord Rayleigh.⁴ The former found 0·0011183 gm. per coulomb, the latter 0·0011180. The greatest difficulty in such experiments is the measurement of the current in electromagnetic measure, *i.e.* in accordance with the definition of the ampere. Many subsequent experimenters

¹ Ostwald, *Zeitschr. phys. Chem.*, **35**, 36 (1900);

² *Zeitschr. f. Elektroch.*, **7**, 857 (1901).

³ *Wied.*, **27**, 1. (1886).

⁴ *Phil. Trans.*, **175**, 458 (84).

have studied the voltameter in itself, but their work is necessarily dependent on the electrical measurements referred to. Lord Rayleigh's form of voltameter consisted of a platinum bowl to serve as cathode, a wire or rod of pure silver for anode, suspended in the middle of the bowl, and a strong solution of silver nitrate or chlorate as electrolyte. The weight deposited on the cathode is determined: the loss of weight of the anode cannot be depended on, as partial oxidation takes place. This arrangement of apparatus is not quite free from irregularity in its action; it has been

subjected to careful chemical criticism by Richards,¹ who finds that the irregularities are due to a subsidiary reaction at the anode, and can be eliminated by enclosing the anode in a porous pot, to prevent diffusion between it and the cathode. The apparatus, in his hands, took the form shown in Fig. 5 (actual size). E is a platinum crucible, with lip; it contains 10 per cent. AgNO_3 solution, freshly prepared. C is the anode, of pure silver rod, suspended by a silver wire from a glass rod, A, which served to ensure good electrical insulation. Between anode and cathode is placed the

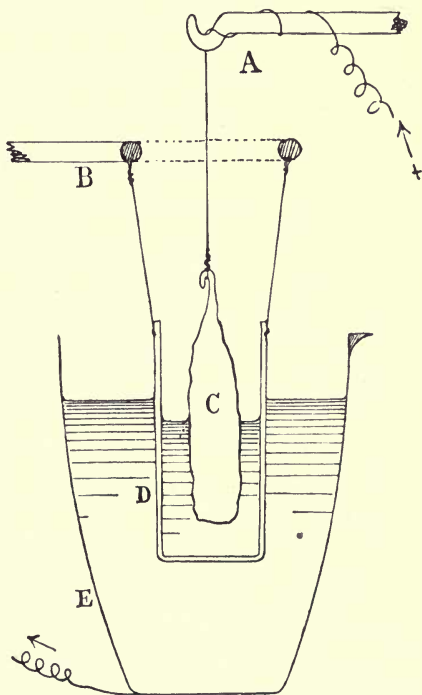

FIG. 5.

Between anode and cathode is placed the

¹ *Zeitschr. phys. Chem.*, **32**, 321 (1900) and **41** 302 (1902), or *Proc. Amer. Acad.*, **35**, 123 and 37.

cylinder D of porous earthenware (Pukal of Berlin). This, which is only 1 mm. thick, is thoroughly cleansed with nitric acid and water beforehand, and the level of liquid inside it being a trifle lower than outside, if any diffusion takes place it is towards the anode. The strength of current used may be about 0.01 ampere per square centimetre of cathode surface. The silver is deposited in a crystalline form, and needs to be very thoroughly washed with water, to remove the mother liquor from the crystals; it is finally washed with alcohol and dried at 160° C. After use the silver should be dissolved off with nitric acid and the bowl cleaned for further use. The bowl should be kept free from scratches, to ensure a good deposit.

Richards finds that Rayleigh's deposits were too heavy, the correct value being 0.0011175, and considers that the improved instrument can be relied upon to one part in ten thousand or more.

3. Copper Voltameter.—This is a convenient instrument, very simple in manipulation, and satisfactory when the highest degree of accuracy is not required. In its usual form it consists of a thin copper sheet for cathode, suspended between a pair of thicker sheets of copper for anode, the solution being any copper salt, commonly the sulphate. A convenient construction is shown in Fig. 6. A is a square glass jar, fitted with an ebonite lid. The anode plates B, B are bent out of one sheet of copper, and are fastened to the terminal D. The cathode C has a lug passing through a slot in the lid, and is provided with a detachable binding screw E.

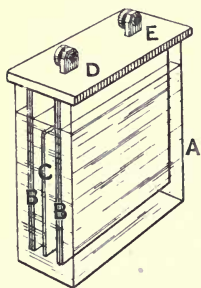

FIG. 6.

The electrolyte is 10 per cent. CuSO_4 . The anode oxidises on use, and consequently cannot be employed for measurement. The cathode, on the other hand, receives, under proper conditions, an adherent deposit of metallic copper. It is removed from the solution, washed, dried with filter paper, and weighed. The weight of copper obtained is always a little too low:¹ if the current

¹ Richards, *Zeitschr. phys. Chem.*, **32**. 328.

density is high, a little hydrogen is evolved instead of copper, while if the current density is too low, some of the copper goes to form a cuprous salt instead of being deposited. The most favourable results are obtained with a current density of about 0.01 ampere per square centimetre of cathode. The voltameter works most accurately at a low temperature and in the absence of oxygen. Used without any special precautions, however, it should give results to within two or three-tenths per cent.

4. **Mercury Voltameter.**—Mercurous salts are always used. If $\text{Hg}_2(\text{NO}_3)_2$ be taken in quantity sufficient to make a decinormal solution, shaken up with water, and enough nitric acid added just to dissolve the basic salt which forms, an electrolyte is obtained which can be used between mercury electrodes for voltametric purposes. The apparatus used by Bolton¹ (Fig. 7) consists of two glass spoons of mercury supported by the lid of the containing vessel. Contact is made with the mercury by platinum wires sealed through the glass. Mercury dissolves off the anode and is deposited on the cathode: hence there is a tendency to form a denser solution at the anode, and, if too strong current be used, crystals will form there; the anode should therefore be put at the top. The mercury of either electrode is removed after the experiment, washed with distilled water, dried—best by rolling it along a trough of filter paper—and weighed. The mercury behaves as a univalent metal, and the process at both anode and cathode is quantitative; the current density must not, however, exceed about 0.005 ampere per square centimetre. The mercury voltameter, therefore, has the advantage that the loss of weight of the anode can be used as a check on the gain by the cathode; but it is only available for small currents.

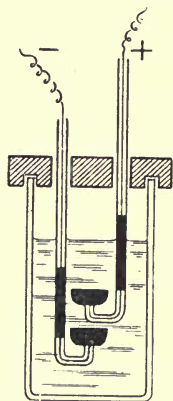

FIG. 7.

Minute currents of long duration can be measured con-

¹ *Zeitschr. f. Elektrochem.*, 2. 75.

veniently by a form described by Lehfeldt.¹ A glass tube of about 1 to 1.5 mm. bore is graduated and calibrated, and provided with two platinum electrodes sealed through the glass at opposite ends. It is filled with mercury, except for one drop of mercurous nitrate solution in the middle, which separates the mercury into two portions, and finally sealed up. The tube is placed vertically, and the upper part made the anode. Mercury then dissolves off this and is deposited on the cathode, so that the drop of solution creeps slowly up the tube, its movement being proportional to the quantity of electricity flowing. When the drop has reached the top of the scale, the tube may be inverted and used over again.

The mercury voltameter has recently been adapted for use as a meter for domestic purposes. The anode is mercury, the cathode a platinum cone; the mercury deposited on this drops into a measure glass. The whole apparatus is enclosed in glass and sealed up, so that there is no leakage or loss by evaporation; and when most of the mercury has been deposited, it is only necessary to invert the meter to make it flow back into the anode and start afresh.

§ 2. MECHANISM OF ELECTROLYSIS

The fact that the products of electrolysis do not appear in the interior of the electrolyte, but only at the electrodes, has from the first suggested a convective explanation. Faraday was sufficiently impressed with it to form the hypothesis of *ions*, *i.e.* of charged particles in the liquid, travelling under the action of the electric force; the movement of these electric charges would constitute the current, and on their reaching an electrode and giving up their charge to it, they would accumulate, and one might expect to distinguish in the ordinary chemical forms the substances of which the charged particles are made.

It appears that all electrolytes break up into two parts—one travelling in one direction (called, arbitrarily, the direction of the current); this consists of “*cations*,” positively charged and carried towards the cathode: the other of “*anions*,” negatively

¹ *Phil. Mag.* (6) 3. 158 (1902).

charged, carried in the reverse direction, and deposited on the anode. The former include hydrogen and the metals; the latter, most other atoms and atomic groups, such as Cl , NO_3 , SO_4 , CH_3COO , etc.

The typical electrolyte is a salt, and the dissociation is into (a) the metal; (b) the residue, described as the "acid radicle." Acids and bases are also electrolytes, the former being compounds of (positive) hydrogen ions with an acid radicle, the latter compounds of a metal with (negative) hydroxyl ions. The acid and basic properties of liquids are due merely to the presence of hydrogen and hydroxyl ions respectively. Water is slightly dissociated into hydrogen and hydroxyl, and is therefore capable of reacting either as a weak acid or a weak base.¹

The combination of Faraday's laws with the accepted atomic theory of chemistry leads at once to an atomic hypothesis as to electricity. For if, say, the silver in a solution of silver nitrate is made up of a large number of similar particles, the silver atoms, and if the amount of electricity conveyed is proportional to the amount of silver deposited on the cathode, it is natural to conclude that each atom carries the same quantity of electricity with it. Hence we arrive at the notion of an atomic charge of electricity.

Now, the masses of the different atoms are very unequal; but, Faraday found, an atom of sodium or of hydrogen carries with it the same quantity of electricity as one of silver. Here is a consideration that greatly strengthens the view that electricity is divided up into "charges" of equal magnitude, of which one may be associated with an atom of matter; and the view is only confirmed by the cases in which an atom does not carry the same charge as silver or hydrogen. For then it is found that the charge conveyed is a simple multiple of the unit, as, two by zinc, two or three by iron, three by aluminium, two or four by tin, and so on: never a fraction of the unit charge. The number, as was remarked in the previous section, is equal to the valency of the atom (or atomic group); indeed, on the electrical theory, valency comes to mean nothing else

¹ See Mellor, "Chemical Dynamics," in this series.

than the number of positive or negative unit charges associated with the chemical atom.

In view of this, it is convenient to extend the usual atomic symbolism of chemistry, by writing \oplus \ominus for unit (atomic) positive and negative charges of electricity; and, for shortness, to distinguish ions—*i.e.* charged atoms or groups—from uncharged ones, by the addition of \cdot for each positive charge, and $'$ for each negative. Thus, a silver ion is written $\text{Ag}\cdot$, a calcium ion $\text{Ca}\cdot\cdot$, the negative ion of sulphuric acid SO_4'' ; and we may make use of equations such as

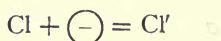

to indicate the assumption of a negative charge by a chlorine atom, and its conversion into a chlorion; or

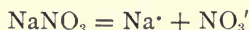

to indicate the dissociation of sodium nitrate into a sodion and a nitron.

To trace further the mechanism, Grotthuss put forward a suggestion, that the neutral molecules of dissolved substance, drawn into chains by the action of the electric force, exchanged partners in such a way as to leave the end links of the chain free. Thus—

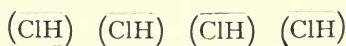

four molecules of hydrochloric acid, orientated by the electric force, might, by a small change, become—



i.e. three molecules, together with a free hydrogen atom at one end (that of the cathode), and a free chlorine atom at the other. This crude picture of the facts was brought more into harmony with physical ideas in general by Clausius, one of the founders of the atomic theory. Clausius assumed that salt molecules in solution occasionally dissociate into a positively and a negatively charged portion. These ions, when formed, will, according to the laws of electrostatics, move; the cations in the direction of the electric force (from anode to cathode), the

anions in the opposite sense. An ion may move as far as one of the electrodes and there give up its charge, and appear as a deposit of ordinary matter; but, if generated far in the interior of the solution, will more probably collide with other molecules. When this occurs the ion may travel on again free, or its collision may break up the molecule, and so form fresh ions; or it may, by colliding with an ion of the opposite kind, recombine. The decomposition and recombination of molecules thus continually taking place, leave at any moment a certain fraction of the ions free; the electric force imposes—apart from their irregular heat motions—a uniform drift on all the ions that are free; and so, although no one ion need move very far, the current is conveyed by a steady procession of them towards the electrodes.

It is not necessary to suppose that the electric force causes dissociation of the salt molecules; rather, since there are cases of electrolysis which will start on the application of any electric force, however small, it is more natural to assume that the dissociation is spontaneous, *i.e.* it is due to ordinary chemical action, and exists in a solution apart from the application of electric force at all.

This leaves open the question how much of the salt is at any moment dissociated. It was at first tacitly assumed that only an infinitesimal amount existed in the ionised condition, so that the properties of the salt would, on the whole, be the same in the dissolved condition as in the solid. It was Arrhenius¹ who first put forward reasons for supposing that an electrolyte might be largely, and in some cases almost completely, dissociated in solution. This view, though violently in opposition to the current chemical doctrine of the time, has continually gained support from experiment since, and may be looked upon as thoroughly established. We shall not attempt to give the arguments in its favour here, but shall adopt it as a working hypothesis, and allow the evidence in favour of it to accumulate, as the hypothesis is applied to various phenomena in turn.

The theory of atomic electric charges; of the convection of

¹ *Zeitschr. phys. Chem.*, 1. 631 (1887).

such charges as constituting a current; and the consequent theory of electrolytic dissociation, seemed, a few years ago, at variance with electrical science in general. In the most familiar case of electric conduction along wires, the current seemed continuous, and it was hardly imagined that it could be of a convective character. The theories of electric action that had been developed always regarded that action as being continuous in space, so that the notion of an atom of electricity was quite foreign to them, and the explanation of electrolysis that suggests itself was looked upon with some doubt in consequence. This want of harmony has now been resolved, but not by any serious modification of views on electrolysis: it is the rest of electricity that has been converted to the atomic theory. Recent discoveries on the discharge of electricity through gases are the cause of the change. It is found in dealing with electric currents through gases that a convective explanation is the only tenable one. There can be no doubt that positively and negatively charged particles—ions—exist in gases; that these move under the action of electric force; and that their motion constitutes a current. Further, that such ions can be produced within a gas in various ways: by the action of ultra-violet light, of Röntgen rays, etc. It has even been found possible to estimate the number of particles in a cubic centimetre of ionised air, and the mass and electric charge of each. It appears that the electric charge conveyed by particles in gases is identical with that conveyed by ions in electrolytes; but as regards mass there is an important distinction. The ratio $\frac{\text{charge}}{\text{mass}}$ in the case of hydrogen is $\frac{96600 \text{ coulombs}}{1 \text{ gram}}$, or roughly, 10^5 . But in several instances that have been measured, the corresponding ratio for the charged particles of a gas is about 10^8 . The particles for which this is true are, however, always negative ones. The explanation of this number might be either that the charge conveyed was much greater, or the mass much less than for hydrogen ions; J. J. Thomson showed that the latter reason is the true one, and that, consequently, negative particles in a gas have a mass of about one-thousandth that of hydrogen atoms.

Positively charged particles as small as this are not known, and the hypothesis thus arises that there is only one kind of electricity—the kind we conventionally call negative; that this exists in the form of unit charges, atoms of electricity, or, as they are now called, *electrons*; and that a negatively charged body is one containing an excess of electrons, a positively charged one, a defect; while in a neutral substance the electrons are so in equilibrium with the rest of the matter that no external electric field is produced. This is, in the barest outline, the electron theory, which is coming to be the basis of all explanations of electrical phenomena.

The charge on a single electron has been estimated at about 1.1×10^{-19} coulombs.¹ If this is correct, the number involved in the transport of one faraday of electricity must be $96600 \div 1.1 \times 10^{-19} = 9 \times 10^{23}$. In the case of an univalent ion such as chlorine, one electron is associated with each atom, and therefore this is the number of atoms of chlorine in a gram equivalent (35.4 grams). The number is so large that even in the most dilute solutions with which one has to deal, there must be a very large number of ions per cubic centimetre. Thus it has been estimated that in pure water 10^{-10} gram equivalents are dissociated per cubic centimetre; there is consequently 10^{-10} equivalent of hydrogen ions; *i.e.* about $10^{-10} \times 9 \times 10^{23} = 9 \times 10^{13}$, or ninety million million actual charged atoms of hydrogen, and the same number of hydroxyl. In all the cases that occur in practice, therefore, the current is carried by an enormously great number of ions, and a statistical method of treatment is fully justified.

Since electrons possess a definite, though small, mass, the association of an electric charge with matter must cause a certain difference in its mass. Thus when we write the equation



the masses involved are of chlorine 35.4, of electrons 0.001, so that the mass of chlorions formed will be 35.401. Similarly, to give a positive charge to sodium means to take away an

¹ J. J. Thomson, *Phil. Mag.*, 5, 346-355 (1903).

electron from each atom, so that the mass of sodions formed must be less than that of the sodium used. There is unfortunately no means of testing this conclusion by actual weighing. But the conclusion may serve to emphasise the distinction between sodium and sodions, between chlorine and chlorions, and so on. The chief objection raised against Arrhenius' theory was that it supposed thoroughly stable bodies like sodium chloride to break up, on mere solution in water, into such highly active and unstable ones as sodium and chlorine. This objection is at least diminished, if not removed, when we remember that the dissociation is not into sodium and chlorine, but into other substances, viz. sodions and chlorions, of which we know nothing but their behaviour in solution (and perhaps a little of the effects they produce in vapour form).

The electron theory naturally leads to a revision of the current notions on chemical atoms; and it has been suggested that there is only one kind of ultimate particle—the electron—and that atoms of ordinary matter are really constellations made up of these. In this way it would be as intelligible that one, two, or more electrons should be detached from a given atom, as added to it. We might, therefore, form this picture of the phenomena: the constellations known as a sodium and a chlorine atom attract one another, and unite to form a molecule of sodium chloride in which each of the two groups is somewhat, but not greatly, modified. It is difficult to break up the molecule into the atoms out of which it was formed, but comparatively easy to split it in a slightly different manner, so as to leave one extra electron with the chlorine and one less with the sodium: just as in a long chain carbon compound it may be difficult to break the chain at a certain link, and yet quite easy to break it at the next link.

It is, of course, pure convention to call the electricity that is carried by chlorine negative, that carried by hydrogen or sodium positive. The nomenclature was fixed long before study of the discharge through gases had led to the recognition of any qualitative distinction between the two. If one had to start afresh, it is probable that, in the light of that study, the terms positive and negative would be used the other way

round. As it is, to attempt such a change would only cause confusion, and we may, in electro-chemistry at any rate, be content to adhere to the current usage. The "direction of the current" will therefore mean the direction in which cations (H^+ , Na^+ , etc.), and the electricity associated with them, move.

It may be objected that these explanations drawn from the electron theory are too hypothetical. They are put forward in the belief that any tolerably consistent picture of the actions to be studied is better than none; provided, of course, it be recognised that if new facts are discovered which the explanation does not fit, the picture must be modified accordingly. We may, however, leave hypothesis for undoubted fact in considering how a convective current of electricity is to be measured.

Let a pair of parallel metal plates be connected to the poles of a battery or other generator of electricity: then between them there will be an

"electric field," *i.e.* a space in which electrical actions are exerted. Such a field will really arise, round the connecting wires, etc., and whether plates or any other conductors be used, but the circumstances are simpler and more marked in the case imagined. To make illustrative experiments we may suppose a pair of brass

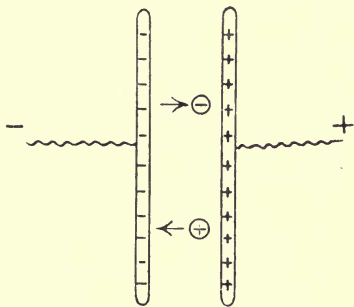

FIG. 8.

plates with a few centimetres of air-space between (Fig. 8). If now a gilt pith-ball suspended by a silk thread and positively charged be lowered into the space between the plates, it will be repelled by the positive, attracted by the negative, plate. The direction in which it will move is that of the electric field. If a negatively charged ball be used, it will be repelled by the negative, attracted by the positive, plate; and will consequently move in the direction opposite to that of the electric field. If a positively charged ball start from the positive plate and be

driven by the electric field across to the negative, and there gives up its charge, it has carried so much electricity across the intervening space ; its motion therefore constitutes an electric current, directed from the positive to the negative plate, *i.e.* in the direction of the field. If a negatively charged ball starts from the negative plate and is driven by the forces of the field to the positive, and there gives up its charge, this is also a current ; but as positive and negative electricity are identically opposite in their effects, the carrying of positive electricity in one sense is the same as the carrying of negative in the opposite sense. Hence the movement of the negative charges will constitute a current in the same direction as that of the positive, *i.e.* the direction of the electric field ; and *the total electric current is the sum of the currents due to the motion of positive charges in one sense and negative in the other* : we shall call these two currents *cationic* and *anionic* respectively.

All this is applicable to the electric field between the two plates of an electrolytic cell ; when a battery is joined up, so as to make one plate positive and the other negative, a stream of cations is set up in the direction of the cathode, where they give up their charges ; and one of anions towards the anode, where they give up their charges. Both these streams constitute electric current in the same direction, *i.e.* by convention, the direction from anode to cathode, and the total current is the sum of the two.

Now the current, being the rate of flow of electricity, is measured by the amount of electricity conveyed across a section of the conductor in a second ; or, on the ionic theory, it is the number of ions traversing a section of the conductor in a second, multiplied by the charge on each.

In an electrolyte, since under ordinary circumstances there is no perceptible electrification, the amount of positive and negative electricity contained must be the same. The anions and cations must precisely neutralise each other : they are not necessarily equal to each other in number, for an ion may carry two, three, or more charges ; thus in NaCl the number of sodions would be equal to that of chlorions ; but in Na₂SO₄ the number of sodions would be double that of sulphions. But if

we express the quantity of ions in gram-equivalents, we may say simply that there must be as many equivalents of positive as of negative ions.

Let η be the concentration of a solution, expressed in gram-equivalents per cubic centimetre,¹ *i.e.* of the total salt (acid, or base) weighed out in making up the solution. This salt is not all ionised. Let γ be the fraction that is; then $\gamma\eta$ is—also in gram-equivalents—the amount of ions, positive or negative, formed. γ is known as the *degree of dissociation*. But since a gram-equivalent of any ion carries the same charge, one faraday, there exists in the solution

$$96600 \gamma\eta \text{ coulombs per cubic centimetre}$$

of free positive electricity, and the same amount of negative. If the cations are moving with an average velocity u_c cms. per second, all those that exist in a length of u_c cms. will cross a given section of the electrolyte in a second, *i.e.* all those existing in u_c c.c. will cross one square centimetre of section in a second. This number is, of course, $u_c\gamma\eta$, and the quantity of electricity conveyed is $96600 u_c\gamma\eta$ per second: this is the current per square centimetre, or *current density* conveyed by the positive ions. Similarly if the anions are moving with an average velocity u_A in the opposite sense, they produce a current $96600 u_A\gamma\eta$, and the total current density is

$$96600 \gamma\eta (u_A + u_c)$$

It will be shown subsequently how by the aid of measurements of the current the various quantities in this expression may be determined.

§ 3. PHENOMENA AT THE ELECTRODES.

It is necessary to distinguish between the mode in which the current is conveyed in the interior of the electrolyte, on the one hand, and between the electrodes and electrolyte on the

¹ In order to adhere to the C.G.S. system, we shall (following Kohlrausch) express concentration in gram-equivalents for c.c., although it is not actually possible to put so much as a gram-equivalent of salt in that volume.

other. In accordance with the fundamental laws of electricity, the total current is the same across any section of the conducting circuit; and in any case the total current is the sum of the parts conveyed by positive and negative charges. But the ratio in which the current is shared between positive and negative carriers need not be the same throughout, and usually is not. Either the cationic or anionic current may, under some circumstances, vanish; in which case the total current conveyed is of the other kind. The proportion in which the current is shared between the available ions depends on local circumstances, and is usually different in the interior of a liquid conductor to what it is at the solid boundaries. We shall begin by considering the boundary conditions.

The most important ways in which current can be led in — at the anode—from electrode to electrolyte, are—

- (i) Formation of a cation.
- (ii) Discharge of an anion.

Since electrodes are usually simple pieces of metal, they are obviously capable of furnishing cations: usually only one kind of cations; but if an alloy or amalgam be used, more than one is available. Thus, a brass electrode might, according to circumstances, yield copper or zinc ions. When a cation is formed from a metal electrode, a positive charge is thereby conveyed into the liquid, *i.e.* in the nominal direction of the current. Sometimes the amount of metal dissolved exactly corresponds to the current according to Faraday's laws: in that case the whole current is carried in this way (the whole current is therefore a "cationic" one) and no other process can occur at the anode. Examples of this are to be found in the solution of zinc in an ordinary voltaic cell, and the solution of mercury at the anode of a mercury voltameter. These reactions may be written—

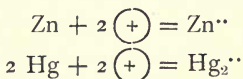

(the latter because it was shown by Ogg¹ that mercurous ions are really diatomic).

¹ *Zeitschr. phys. Chem.*, **27**, 285, 311 (1898).

On the other hand, there are always anions in the solution, and they may be discharged. This happens, *e.g.*, at the anode of the water voltameter. Here current could only be conveyed into the electrolyte by cations, if platinum were to dissolve (in the acid voltameter) or nickel (in the alkaline). But formation of these cations, though not impossible, is difficult, and actually the reaction occurring is an evolution of oxygen:—

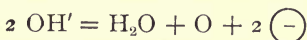

There are other ways in which current may be taken into a solution. We may mention, for completeness—

(iii) Oxidation of a positive ion. If a platinum anode be immersed in a ferrous salt, on leading in current the ferrous salt will (under certain circumstances) be converted to ferric. *I.e.* the reaction



will take place. The formation of a more highly charged cation, here, is obviously analogous to the formation of a new cation that occurs in case (i) and equally involves a transport of positive electricity from electrode to electrolyte.

(iv) Similarly a negative ion may be converted into another with a lower charge. If a platinum plate be immersed in a ferrocyanide solution, and it be used as anode, ferricyanide may be formed. Here the reaction is:—

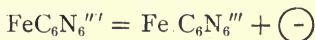

It appears therefore that *oxidation is an essentially anodic process*, reduction (in the chemical sense) a cathodic one.

There are other anodic reactions that cannot be so simply expressed. These will be considered in dealing with particular cases later.

At the cathode the possible reactions are the converse of those at the anode, *viz.*—

(i.) Discharge of a cation. The usual process: *e.g.* deposition of hydrogen, copper, silver, mercury, in the voltameters described in § 1.

(ii.) Formation of an anion. This is not possible when an ordinary metallic cathode is used, for there is no material to

form it out of. There are various devices, however, by which anions can be formed. Thus, if a platinum plate be surrounded by an electrolyte kept saturated with chlorine gas, and used as cathode, some of the chlorine will be converted into chlorions (p. 238).

(iii.) Diminution of the charge on a cation.

(iv.) Increase of the charge on an anion.

It is worth while to consider the view taken of these processes on the electron theory. As regards convection in the interior of the liquid, it is not necessary to postulate free electrons, for the evidence all goes to show the existence of positive and negative ions formed out of ordinary chemical atoms. Let us turn, then, to the transfer of electricity between the electrode and electrolyte, taking first the simple case of solution of zinc at the anode. We have represented it above as involving the addition of two positive charges to an atom of zinc, the ion thus formed being, unlike the neutral zinc atom, soluble in water. Now, free positive electric charges are unknown: the electrons are always negative. It would be more exact, therefore, to say that two negative charges are removed from a zinc atom, leaving a zinc ion. That is—

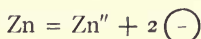

This leads to a brief consideration of the theory of conduction in metals, which, though not strictly a part of our subject, throws light on it. It is now supposed that the atoms of metals are to a certain extent dissociated into free electrons and the residua, *i.e.* the positively charged metal ion. The metal ions are probably, like the atoms, more or less fixed in position; but the electrons, on account of their small size, are capable of threading their way amongst the atoms of the metal: hence, when an electric field is applied to the metal, electrons will be driven in the direction opposite to the nominal direction of the field, and a current will be set up. Thus, even metallic conduction is now regarded as convective; and in particular, current in a metal is mainly, if not exclusively, “anionic.”

There exists, therefore, normally, in a metal dissociation of

the kind expressed in the above equation for zinc. Suppose, now, the zinc to be placed in an electrolyte, add a circuit to be completed. It is found that zinc ions have a strong tendency to come out of the metal into the liquid, a process which has been compared with ordinary solution of a solid. If this takes place, there will be left an excess of electrons in the metal, *i.e.* the zinc electrode will be negatively charged. Thus the reaction involves an electric current round the circuit; between the electrode and electrolyte it is carried by zinc ions dissolving, while along the metallic conductor it is carried by electrons, diffusing from the place where they are in excess to the other parts of the conductor. The current is therefore exclusively anionic in the metal, exclusively cationic in passing from metal to liquid, partly one, partly the other, in the mass of the liquid.

In case (ii.) at an anode it is to be supposed that each hydroxyl ion, on reaching the electrode, gives up its superfluous electron, which is carried by the action of the electric field into the metal. The atoms of oxygen and hydrogen are not capable of following it, since platinum (or nickel) only absorbs gases to a minute extent. They are therefore left at the boundary of the liquid, where they rearrange themselves in the most stable form, *viz.* by forming liquid water and gaseous oxygen. The current in passing between the metal and solution is in this case exclusively anionic.

Similarly, when a ferrous salt is oxidised at the anode, this means that the Fe^{++} ion gives up one more electron to the electrode. The reaction ought, therefore, to be written

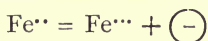

We shall in future commonly use the negative symbol by preference, as being, so far as known, in closer harmony with the facts.

Nothing has been said, so far, as to the causes that regulate which out of several possible reactions will actually take place at an electrode. This subject can only be completely discussed with the aid of the conception of potential, which will be introduced later; but we may go over it here in a

qualitative manner. As guiding principles it may be said that (i) of two possible reactions at an electrode, that which is the more easily effected will occur; (ii) each kind of ion is the more easily discharged, the more of it there is in solution. For elucidation of these rules, certain cases will be considered in detail.

(A) **Electrolysis of Copper Sulphate between Copper Plates** (copper voltameter). The ions in solution are Cu^{++} H^+ (from the water), SO_4^{--} OH^- (from the water). At the cathode the possible reactions are—

- (a) Discharge of Cu^{++}
- (b) Discharge of H^+
- (c) Reduction of Cu^{++} to Cu^+

Formation of negative ions is impossible, since there is no material in the electrode to make them out of. Of the three reactions (a) is the easiest, and is that which occurs, for the most part. It is found, however, that under normal conditions (c) also takes place to a small extent, so that the solution comes to contain a little cuprous sulphate. The formation of it does not go very far, because, if much cuprous ions were present, they, too, would be discharged.



Hence the two processes—reduction of Cu^{++} and discharge of Cu^+ —amount to a discharge of Cu^{++} in two stages. The effect at first is that the deposition of copper is less than that calculated from Faraday's law, but after a time a state of equilibrium is set up, with a small quantity of cupro-ions present, and then the behaviour of the voltameter is normal. As to reaction (b) discharge of hydrogen is, *ceteris paribus*, more difficult than of copper; and, further, the conditions are not equal, for while in a strong solution of CuSO_4 there is abundance of copper ions, there are very few of hydrogen, so that evolution of hydrogen is rendered still more difficult. Nevertheless, if too strong a current is used, some hydrogen will be evolved, and the explanation of this is an important illustration of theory. Deposition of copper on the cathode naturally tends to deplete the solution in the immediate neighbourhood of the cathode, of

copper ions. The supply is made up by diffusion from other parts of the liquid. If the current is strong (in proportion to the area of the cathode) it may very well happen that the cathode layer of liquid falls very far below the rest of the electrolytes in its content of copper ions, so much so, that on account of their scarcity it will no longer be easier to deposit them than hydrogen, so that some hydrogen will come down as well. Evolution of hydrogen is therefore favoured by a high current density, and opposed by anything that improves the interchanges between different parts of the liquid, such as stirring. The most effective kind of stirring is moving the cathode itself, since it is the layer in immediate contact with it that needs replenishing. Accordingly it has been found that whilst 0.02 amp. per sq. cm. is about the limit that can be safely used with a stationary cathode, 0.2 amp. per sq. cm. can be successfully applied to produce copper tubes on a rapidly rotating mandril.

Thus both the irregularities of the copper voltameter mentioned on p. 10 are explained satisfactorily by the theory.

At the anode in the copper voltameter the possible processes are—

- (a) Formation of copper ions (cations) from the electrode.
- (b) Discharge of hydroxyl ions.
- (c) Discharge of sulphions.

It is found that the facility of the three processes is in the order stated. Under ordinary circumstances, *a* (solution of copper) is the main reaction. No free oxygen is formed, but *(b)* must occur to a small extent, as the copper plates turn black from formation of copper oxide. An exact investigation of the reaction does not appear to have been made.

(B) Electrolysis of Copper Sulphate between Platinum Plates.—The phenomena at the cathode are the same as in the preceding case. At the anode reaction *(a)* is no longer possible. Instead of it we have—

- (a') Formation of platinum ions.

This is far more difficult, more so than processes *(b)* and *(c)*; consequently the platinum plates remain untouched (at

least, under ordinary conditions), and discharge of anions takes place. Accordingly, as OH' or SO_4'' is discharged we should have—

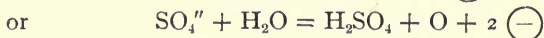
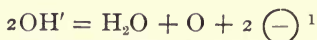

so that in either case gaseous oxygen would be liberated.

The exact course which this second reaction takes has been the subject of much discussion. We shall return to it when considering the relation of electrode potentials to the discharge ; for our immediate purposes it is immaterial which of the two we suppose to be the actual reaction.

(C) **Electrolysis of Sulphuric Acid between Platinum Plates** (Hofmann voltameter).

At the cathode the only possible reaction is discharge of hydrogen ions : the process is therefore quantitative, and excellently adapted for voltametric purposes. The only exception that can be taken to it is this : hydrogen and oxygen are both slightly soluble in water ; they will therefore dissolve at the electrodes, and diffuse across the liquid ; but the presence of hydrogen at the anode, or oxygen at the cathode, will give opportunity for recombination with the nascent gases there, in which case a trifle of the current will be wasted in reforming water. It is probable that this happens, but only to a minute extent, on account of the slight solubility of the gases. It may be minimised by keeping the anode and cathode well apart ; and even when this is not done the effect seems to be of small consequence, as it does not appreciably affect the exactness of Oettel's form of voltameter, in which the gases are evolved close side by side.

At the anode the circumstances are practically the same as in the electrolysis of copper sulphate, but they have been more closely studied.

The anions available for discharge are those of water and of sulphuric acid. So far we have tacitly assumed that the latter are SO_4'' only ; but there is good reason to believe that

¹ Very possibly H_2O_2 may be formed in the first instance ; but that is immaterial.

when a divalent substance dissociates, it usually does so in two stages ; thus, sulphuric acid would break up according to the equations—

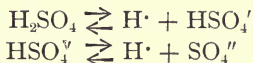

The presence of these intermediate ions HSO_4' offers the simplest explanation of the phenomena actually found, of which the most noteworthy is formation of persulphuric acid. We may suppose that discharge is partly by the intermediate ions, and that these, when neutral, unite to form the new acid—

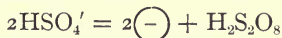

Such a view of the reaction is strengthened by considering the conditions that favour formation of persulphates.¹ It is to be expected that fairly strong sulphuric acid should contain a large proportion of HSO_4' , since dissociation is always favoured by increase of volume, and it is only on proceeding to considerable dilution that there is room for both stages of this process to be carried out. Accordingly, if 50 to 60 per cent. acid be electrolysed, only a small amount of oxygen is produced, and a considerable proportion of persulphuric acid remains in the liquid. As that acid breaks up easily on rise of temperature, the most favourable yield is at low temperatures ; at -2° 64 per cent. has been obtained. Again, acid potassium sulphate might be expected to dissociate in the two stages—

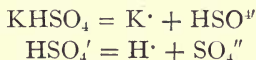

Accordingly, on electrolysing a solution (preferably saturated) of KHSO_4 , potassium persulphate is obtained in considerable quantities.

In acid as weak as that used in accumulators, or voltameters (usually about 1.2 density), only a small amount of persulphuric acid is formed ; the readings of a voltmeter may, however, be rendered slightly inaccurate from this cause.

(D) **Electrolysis of Caustic Soda between Nickel Plates** (Oettel voltmeter).

¹ F. M. Perkin, *Electrochemist.*, 1. 189 (1901).

The cations present are Na^+ and H^+ . Of these, hydrogen is much the more easily discharged; and even if sodium be discharged primarily, it reacts with water and forms more hydrogen. Thus the reaction at the cathode is exclusively formation of gaseous hydrogen.

The only anion present is hydroxyl. Of this there is a large quantity, since it is formed not only from water, which is very slightly dissociated, but from soda, which is largely so. We have, therefore, as alternatives—

(a) Formation of nickel ions.

(b) Discharge of hydroxyl ions.

Now, if an experiment were made using nickel as anode in dilute acid, it would be found that the metal dissolved, for it is much more ready to form ions than platinum, and the conditions are unfavourable to discharge of hydroxyl ions, as they are very scarce. But in a strong alkali the circumstances are different; there are plenty of hydroxyl ions, consequently they are discharged, and the nickel remains untouched. The reaction is then, as in the acid voltameter—

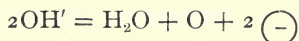

the oxygen produced being strictly proportional to the quantity of electricity. If, from any cause, the voltameter, after use, should show the green colour of nickel ions, this is an indication that the reaction is not proceeding as it should.

(E) **Electrolysis of Hydrochloric Acid between Platinum Plates.**—The only cation present is hydrogen, consequently the discharge at the cathode consists exclusively of that substance. Of anions, there are chlorine from the acid and hydroxyl from the water; either of these may be discharged, and as a rule appreciable amounts of each are produced. There is also, at the anode, the third possibility of solution of platinum, and this very commonly occurs to a small extent. The most interesting question is as to the relative proportions of chlorine and oxygen in the anode gas; it depends essentially on the relative proportions of chlorions and hydroxyl ions in the liquid. The former, being derived exclusively from the acid, are roughly proportional in number to the strength of the acid; the hydroxyl

ions, on the other hand, are very few in number in any acid solution; indeed, it is found that the number of hydrogen and hydroxyl ions vary inversely to each other, so that in a strong acid (*i.e.* strong solution of hydrogen ions) the amount of hydroxyl is much smaller than in pure water, even; and conversely, in a strong alkali the amount of hydrogen ions is proportionately reduced.¹ Hence with increase in the strength of acid, not only are the chlorions increased, but the hydroxyl ions decreased, and so in both ways production of chlorine favoured at the expense of oxygen. Haber and Grindberg give the following numbers:—²

Normal HCl,	1% oxygen	}	reckoned on the oxygen produced in a voltameter. Current density 0.02 ampere per square centimetre.
$\frac{1}{3}$ „	HCl, 9.5% „		
$\frac{1}{10}$ „	HCl, 30% „		
$\frac{1}{30}$ „	HCl, 40% „		

There are several secondary effects in this case. The loss due to diffusion and recombination, referred to on p. 28, in the case of oxygen and hydrogen, is much exaggerated here on account of the large solubility of chlorine, especially in weak acids. If the gases are produced side by side, a large loss of chlorine will occur. It can be minimised by placing a porous diaphragm between the anode and cathode.

Chlorine and hydroxyl produced together at the anode combine to produce several reactions that are not possible when either is produced separately. Thus

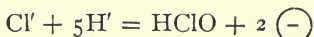

This hypochlorous acid is decomposed by the hydrochloric present, but may be demonstrated by passing a rapid current of CO_2 through the liquid.

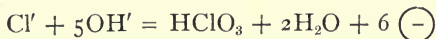

From 1 to 30 per cent. of chloric acid has been found. Since it requires five hydroxyl ions to one chlorine, it is naturally favoured by dilution of the acid.

¹ This is an instance of the "law of mass action." See further below, p. 174. See also Donnan, *Thermodynamics*, in this series.

² *Zeitschr. anorg. Chem.*, **16**, 198.

Again, the ion of chloric acid ClO_3' combines with another hydroxyl to form perchloric acid.

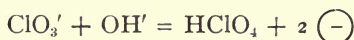

As this reaction depends on the previous formation of chloric acid, it occurs mainly when the electrolysis has been proceeding some time.

(F) **Electrolysis of Potassium Chloride between Platinum Electrodes.**—The process at the anode is the same as in the preceding case. There are two cations present, K' and H' ; so that at the cathode discharge may take place by either of these. Hydrogen is the more readily discharged, and if potassions are discharged, the metal formed will react with water, generating hydrogen: hence, as regards the substance liberated from the electrode, it is immaterial which ion actually carries the current. The secondary reaction of the potassium on the water, however, produces hydroxyl ions

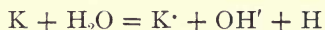

and the liquid round the cathode therefore turns alkaline. Further details will be considered later in dealing with the practical application of electrolysis for manufacture of caustic potash.

§ 4. MIGRATION OF IONS.

In the interior of an electrolyte anions and cations are always present in equal measures; they therefore both participate in carrying the current, in the way described in § 2. According to the formula there given the cationic current density is $96600 \gamma \eta \mu_{\text{K}}$, the anionic $96600 \gamma \eta \mu_{\text{A}}$; η , the concentration, refers to the dissolved salt as a whole, and γ , the degree of dissociation, is, of course, the same for both components of the dissociating substance, so the two parts of the current are in proportion to the velocities of the cations and anions respectively.

With regard to the velocity of an ion, however, some preliminary remarks are necessary. If a charged particle be placed in an electric field, there is a definite force on it, just as

when a heavy body is placed near the earth there is a force (of gravity) on it tending to make it move vertically downwards. If the field is uniform, the force is (like gravity) constant. Such a force will not cause the particle to move with uniform speed, but, like a falling body, with uniformly accelerated speed. But an ion moving in an electrolyte is not so much to be compared with a heavy mass falling freely, as with a raindrop falling through the air and suffering considerable resistance on that account. A raindrop does not increase constantly in speed in its fall from the clouds, but, on account of air-friction soon reaches a limiting velocity with which it will continue to move however far it falls. Now, an ion moving through a liquid experiences a very large resistance, and cannot travel any appreciable distance with constant acceleration; rather, owing to repeated collisions with molecules of solvent, its average speed is brought down to a fixed, and—as experiment shows—very moderate amount.

The limiting velocity that a raindrop reaches will depend on the intensity of the force of gravity that draws it down; and in the same way the velocity of an ion depends on the intensity of the electric field (known also as the *potential gradient*) driving it. We shall adopt the practical unit, the *volt*, as measure of the difference of potential between two points, and therefore *express the gradient of potential in volts per centimetre length*.

The precise way in which the velocity of ions depends on potential gradient is shown by the experimental result known as *Ohm's law*, which is that in any given conductor the electric current is proportional to the difference of potential driving it. This, of course, does not mean that other circumstances—temperature, concentration, etc.—may not affect the current, but merely that under similar conditions the potential difference affects it in the manner stated.

Ohm's law may, of course, be stated in the form that the *current density* is proportional to the *potential gradient* (this is equivalent to considering its application to a conductor 1 cm. long and of 1 sq. cm. cross-section).

Now, as the number of ions in a solution and the charges

on them do not depend on the application of a potential gradient, it follows that the only way in which the current density can be affected by varying gradients is in the velocity acquired by the ions. It is concluded, therefore, that the *ionic velocities are proportional to the potential gradients producing them*, and this may be taken as the true physical meaning of Ohm's law.

This conclusion has been verified by direct measurement of ionic velocities by the methods described below.

In accordance with Ohm's law we may express the actual velocity u of any ion as the product of two factors, the actual potential gradient, and the *velocity under a gradient of one volt per centimetre*; for the latter we shall use the symbol U , and refer to U_A and U_C as the *mobility* of the anion or cation.

The mobilities of various ions are different, according to their specific character, and methods have been worked out for measuring them. We shall begin with a method, invented by Hittorf, for comparing the mobility of an anion and a cation. The method may be explained by the aid of an experiment, as follows:—

Take a rectangular glass jar (Fig. 9): fix in it (by means of paraffin wax) two porous plates, in such a way as to divide it into three chambers. Put copper plates, for electrodes, into the two end compartments, fill up the whole with copper sulphate solution, and pass a current (of several amperes) through it for a few minutes. If specimens of the liquid be taken out and analysed it will be found that the solution in the middle chamber is unaltered in strength, but that the cathode liquid is weaker, the anode stronger than before. Qualitatively the change in colour of the electrolyte will be sufficient to show this.

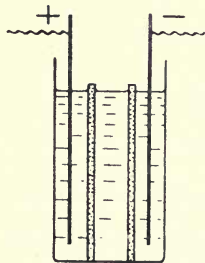

FIG. 9.

In order to account for these changes of concentration, let us make a list of the actions occurring in the three chambers. We will assume that x is the fraction of the whole current conveyed by the anion, so that $1-x$ is conveyed by

the cation. Hence, when one faraday of electricity is passed through the liquid, requiring on the whole one gram-equivalent of ions to convey it, there migrate across any section in the interior of the liquid, $1 - x$ equivalents of cations in the direction of the current, and x equivalents of anions in the opposite direction. x is called the *migration ratio*, or Hittorf's number (for the anion). Its relation to the mobilities of the ions is easily found, for we have seen that the currents produced by movement of the cation and anion are proportional to their mobilities. Hence—

$$\frac{\text{Cationic current}}{\text{Anionic current}} = \frac{U_C}{U_A} = \frac{1 - x}{x}$$

The actions in the three chambers during the passage of one faraday are then—

<i>Anode Chamber.</i>	<i>Middle Chamber.</i>	<i>Cathode Chamber.</i>
Formation of 1 equiv. Cu^{++} from anode.	Import of $1 - x$ equiv. Cu^{++} from anode chamber.	Discharge of 1 equiv. Cu^{++} on cathode.
Export of $1 - x$ equiv. Cu^{++} to middle chamber.	Export of $1 - x$ equiv. Cu^{++} to cathode chamber.	Import of $1 - x$ equiv. Cu^{++} from middle chamber.
Import of x equiv. SO_4^{--} from middle chamber.	Export of x equiv. SO_4^{--} to anode chamber.	Export of x equiv. SO_4^{--} to middle chamber.
-----	-----	-----
Net result:— Gain of x equiv. Cu^{++} and SO_4^{--} , <i>i.e.</i> x equiv. CuSO_4 .	Import of x equiv. SO_4^{--} from cathode chamber. ----- No change.	Net result:— Loss of x equiv. Cu^{++} and SO_4^{--} , <i>i.e.</i> x equiv. CuSO_4 .

In the experiment, if correctly carried out, there ought to be no change in the middle chamber, while of the others, the anode chamber should gain just as much salt as the cathode loses. If, *e.g.*, 0.2 faraday be used (conveniently measured by a copper voltameter put in series with the migration cell) and it be found that the change in each chamber is 0.124 equivalents, it follows that

$$x = \frac{0.124}{0.2} = 0.62$$

Again, suppose in the tripartite cell, the electrodes of platinum, the electrolyte dilute sulphuric acid; the action in anode

and cathode chambers is as follows (the middle chamber is always unchanged):—

<i>Anode Chamber.</i>	<i>Cathode Chamber.</i>
Discharge of 1 equiv. SO_4'' , which reacts with water, forming 1 equiv. gaseous oxygen + 1 equiv. H^{\cdot} , and reforming the SO_4''	Discharge of 1 equiv. H^{\cdot} .
[$\text{SO}_4 + \text{H}_2\text{O} = 2\text{H}^{\cdot} + \text{SO}_4'' + \text{O}$]	Import of $1 - x$ equiv. H^{\cdot} from middle chamber.
Export of $1 - x$ equiv. H^{\cdot} to middle chamber.	Export of x equiv. SO_4'' to middle chamber.
Import of x equiv. SO_4'' from middle chamber.	
Net result:—	Net result:—
Gain of x equiv. H^{\cdot} and the same of SO_4'' , <i>i.e.</i> of x equiv. H_2SO_4 .	Loss of x equiv. H^{\cdot} and the same of SO_4'' , <i>i.e.</i> of x equiv. H_2SO_4 .

In this case, too, the anode solution increases in strength at the expense of the cathode; the change is easily followed by titration. It is found that about 0.19 equivalents of acid migrate for each faraday, so that $x = 0.19$.

On comparing the results of such experiments with the changes occurring at the electrodes, we find that quite different conditions regulate the flow of current in the two cases, although the total current must be the same at each part of the circuit. At the electrodes when there are several available ions, the current will be conveyed by that whose formation or discharge is the least difficult, *i.e.* involves the least expenditure of energy. The whole current may be, and often is, conveyed by a single kind of ion, so that it may be exclusively anionic or exclusively cationic. In the interior of the solution, on the other hand, all the ions present necessarily share in the current, and the share that each takes is determined merely by the amount of it present and by its specific mobility. This is true, not merely in considering the relation of anion to cation, but also with regard to the shares taken by the various ions of the same sign, if more than one be present; for the expressions of p. 21 still hold, however many ions may exist in the solution. Thus, in the case of copper sulphate, besides Cu^{\cdot} there is H^{\cdot} in the liquid, although in very small proportion; hence a small part of the cationic current is carried by the hydrogen ions, and similarly a small part of the anionic by hydroxyl ions.

In passing from an electrode to the interior, then, each

partial current changes, while the total remains the same. Let i be the total current; then

$$i = i_c + i_a$$

where i_c and i_a are the cationic and anionic parts respectively. *E.g.* in CuSO_4 between copper electrodes the current at the anode is entirely cationic, in the solution only partially so; i_c therefore decreases, while i_a increases by the same amount. In electrolysing H_2SO_4 between platinum plates the current at the anode is exclusively anionic, so that i_c increases and i_a decreases in passing towards the interior.

The chief results of measurements on migration ratios are given on the table, p. 256. The numbers are interpolated by Kohlrausch and Holborn (*Leitvermögen der Elektrolyte*) from experiments by Hittorf, Kuschel, Loeb and Nernst, Kirmis, Bein, Hopfgartner, and Kümmell.

The apparatus required varies somewhat according to the case studied—concentration of the liquid, presence or absence of precipitates or gaseous products at the electrodes, etc. Many forms have been adopted by different experimenters: that of Nernst and Loeb¹ in their experiments on silver salts may be described as typical (Fig. 10).

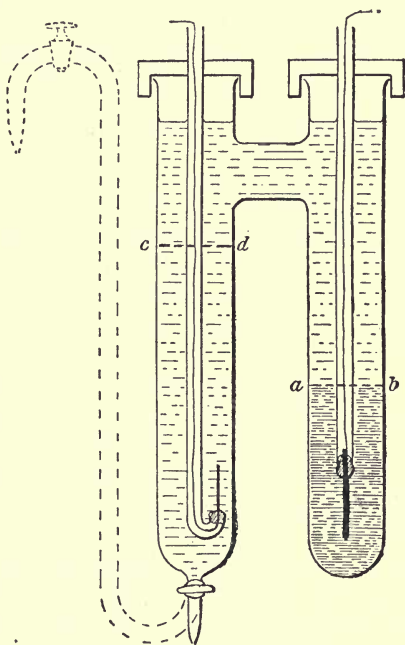

FIG. 10.

¹ *Zeitschr. phys. Chem.*, 2, 948 (1888).

The anode A is a silver wire, insulated for the greater part of its length by a glass tube, and opened out into a flat spiral below; the upper end of the wire is tightly enclosed by rubber tubing so as to be gas-tight. The cathode B is hung from a hook of platinum, and enclosed in a small side bulb, so that fragments of silver that fail to adhere to it may not fall on to the anode and so disturb the results. The whole is filled with the silver solution to be investigated, and as the action of the current is to make the solution denser near the anode and lighter near the cathode, it is necessary to avoid convection currents by placing the latter at a higher level than the former. In making an experiment, the apparatus is weighed; the liquid introduced by sucking at the small tube inserted by the side of the cathode—40 to 60 c.c. being required. The apparatus is then placed in a thermostat, and the electrolysis begun. On account of the long column of electrolyte needed in migration experiments the resistance is high, and a large voltage is required; nowadays the electric lighting supply is commonly used for the purpose. When the electrolysis is finished, portions are removed for analysis by blowing through the tube at B. The weight of each portion must be determined in order to find its total content of salt. The first portion should consist of so much of the liquid near the anode as to contain all the increase in salt due to the current. The next portion will then represent the middle of the electrolyte, and should be unchanged in concentration. The cathode portion will remain in the electrolyser, and may be weighed in that vessel, and then washed out and analysed.

In the above instance there are no secondary reactions at the electrodes to cause complications. It is only necessary to avoid convection currents, inequalities of temperature, and not to prolong the experiment so that diffusion sensibly interferes with it. In most cases formation of new ions at the electrodes and their migration introduces new difficulties. To see how these are met, we may take the case of sodium chloride, studied by Bein.¹ In electrolysing sodium chloride between platinum plates, the discharge at the anode would be of chlorine

¹ Bein, *Wied.*, **46**. 29 (1892); *Zeitschr. phys. Chem.*, **27**. 1-54 (1898).

and oxygen. The latter would be partly formed from water by the action of chlorine, *i.e.*—

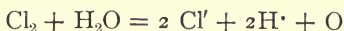

and hydrogen ions would thus appear in the liquid, and would at once begin to migrate towards the cathode. At the cathode the discharge of sodions generates gaseous hydrogen, and leaves hydroxyl ions in solution, which migrate towards the anode; in other words, the liquid turns acid at the anode and alkaline at the cathode. Now, hydrogen is the fastest of all ions, and hydroxyl the next; so that, if the process be allowed to take place as described above, it will not be possible to follow the movements of the original ions, on account of the migration of these new ions.

The more serious difficulty—that of the hydrogen—may be avoided by a device invented by Hittorf. Instead of platinum, he used cadmium for anode. The cadmium being an easily oxidisable metal, of course dissolves, so that there is no discharge of anions, and no gas formed—a preliminary advantage. The Cd^{++} ions formed migrate, it is true, towards the cathode, but as they have only about one-tenth of the mobility of hydrogen ions, this is of no consequence. Indeed, as they are amongst the slowest, they remain constantly behind the ions of sodium (or other metal studied), and cause no mixing of the different layers of liquid. The action may then be represented by Fig. 11. This shows

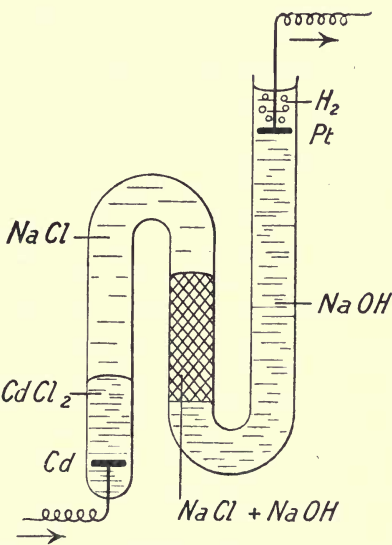

FIG. 11.

a bent tube, originally filled with NaCl solution; a cadmium anode Cd; and platinum cathode Pt. All the Na has migrated away from the anode, leaving a layer of CdCl_2 solution, and as the cadmium ions cannot overtake the sodions, the boundary between the two layers remains sharp. Again, all the Cl' has migrated away from the cathode, and been replaced by OH' ; but as the latter travels much the faster, there is no sharp boundary between the NaOH and NaCl solutions, but an intermediate region in which the two are mixed. The cathode tube is shown bent upwards, to allow hydrogen gas to escape without disturbing the rest of the liquid.

Bein found that with sulphates and chlorides a formation of basic salt at the anode occurs, although the cadmium may appear to be unchanged. He considers that the previous measurements of Hittorf and Hopfgartner are somewhat inaccurate from not taking that into account. Hittorf used rather wide and short electrolysing tubes, in order to reduce the resistance, and thus be able to employ a small voltage; this had the disadvantage, however, of requiring the use of partitions of porous material to prevent mixing by diffusion. Later observers, having at their disposal an electric supply at 100 volts or more, have preferred to use longer tubes without partitions (Bein usually 50 to 60 cms. from anode to cathode). Bein has made special observations¹ to determine whether partitions modify the rate of transport of ions, and concludes that they do: porous earthenware, parchment paper, gold-beater's skin, and animal membranes were tried. These substances, and especially the last, exercise a selective action on ions, usually retarding the cation more than the anion, so that the migration ratio of the anion determined with the aid of a diaphragm is too high. The action in such cases is still obscure, but is of much importance in connection with the physiological effect of the membranes of animals and plants.

An example (from Bein) will serve to show the method of calculation. The electrolyte was NaCl containing 0.01784 per cent. of chlorine. It was contained in an electrolyser provided

¹ *Zeitschr. phys. Chem.*, **28**, 439-452 (1899). See also Hittorf, *Zeitschr. phys. Chem.*, **39**, 612-629 (1902); **43**, 239-249 (1903).

with glass taps to separate it after the experiment into three portions. The weights of these were: anode portion, 226.99 grams; middle, 195.24; cathode, 331.49. The weights of chlorine that would be contained by these before electrolysis were 0.04048, 0.03482, 0.05913 respectively; the weights actually found after the experiment, 0.04671, 0.03483, 0.05289; hence the gain by the anode was 0.00623, the loss by cathode 0.00624, whilst the middle portion was practically unchanged. Temperature 11°; 150 volts applied for 108 minutes: weight of silver deposited in voltmeter in series with electrolyser was equivalent to 0.01021 grms. of chlorine. Hence migration ratio of chlorine

$$0.00624 \div 0.01021 = 0.611$$

The weakest point of such experiments is the very small weight of ions transported, and the consequent importance of small errors of analysis. Noyes¹ has suggested an improved process, and carried it out with solutions of K_2SO_4 , $BaCl_2$, and BaN_2O_6 . The method consists in supplying the anode with measured quantities of the base which is being removed by the current, and the cathode with the acid, so as to keep the liquid as nearly as possible of uniform concentration. The electrodes were of platinum; the vessel, a wide double U-tube; the electrolyte contained a small measured amount of phenolphthalein solution. Over the anode was supported a dropping funnel, containing (*e.g.*) caustic potash of concentration double that of the K_2SO_4 solution used. Before starting, a small amount was added, and similarly sulphuric acid to the cathode; and whenever the cathode liquid began to turn alkaline (every ten or twelve minutes) more acid and alkali were supplied. The current used was from 0.02 to 0.18 ampere, and was kept up for as much as seven hours. In this way fifty to a hundred times as many ions were transported as in Bein's experiments.

The most extensive series of experiments on migration ratios is that of Hittorf,² the earliest worker in the field. Hittorf considered particularly the degree of constancy of the ratios that he measured, and found that they are independent of the

¹ *Zeitschr. phys. Chem.*, **36**. 63-83 (1901).

² *Pogg.*, **89**. 177; **98**. 1; **103**. 1; **106**. 338, 513.

strength of current used. In the simplest cases, such as alkaline chlorides, they are also independent of concentration, at least when the concentration is moderate (see table, p. 256). When either ion is divalent a much greater change is produced by concentration; thus KCl gives 0.508 for decinormal, 0.514 for normal solution, a difference of only 0.006; but K_2CO_3 gives 0.40 and 0.434 for the same concentrations, showing a difference of 0.034; and $BaCl_2$ 0.585 and 0.640, a difference of 0.055. These anomalies are usually associated with the formation of intermediate ions, and will be further considered later. Besides the experiments already referred to may be mentioned those of Kümmell,¹ who measured zinc and cadmium salts in greater dilution than previously. He found that the halogen compounds attain to a constant value of x before reaching $\frac{1}{400}$ normal, and so presumably retain that value for all smaller concentrations; but that in the sulphates a constant value is not reached even for that dilution. Further references are to be found in Bein's paper.² Measurements of migration ratios have also been made indirectly by means of concentration cells (*vide infra*, p. 210). This has been done by—amongst others—Kendrick³ and W. Stark⁴ for the ions of the lead accumulator, and D. Macintosh⁵ for acids.

For a discussion of migration phenomena in mixed electrolytes, see McGregor and Archibald.⁶

Before leaving the subject, one instance may be considered in detail, in which the effect on migration ratio of changes in the reaction at the electrodes is seen. In the tripartite cell of p. 34 let sulphuric acid be used as electrolyte, but lead for electrodes. This makes no difference to the behaviour at the cathode, but at the anode there may be (i.) evolution of oxygen, as when a platinum anode is used, or (ii.) formation of lead sulphate, or (iii.) formation of lead peroxide. In the second case the action in the anode chamber must be written

¹ *Wied.*, **64**. 655-679 (1898).

² *Zeitschr. phys. Chem.* **27**. 1.

³ *Zeitschr. f. Elektroch.*, **7**. 52 (1901).

⁴ *Zeitschr. phys. Chem.*, **29**. 385-400 (1899).

⁵ *J. phys. Chem.*, **2**. 273-288 (1898).

⁶ *Phil. Mag.* (5) **45**. 151-157 (1898).

Discharge of 1 equiv. $\text{SO}_4^{''}$, which combines with 1 equiv. lead to form the solid sulphate.

Export of $1 - x$ equiv. H^{\cdot} to middle chamber.

Import of x equiv. $\text{SO}_4^{''}$ from middle chamber.

Net result:—

Loss of $1 - x$ equiv. each of H^{\cdot} and $\text{SO}_4^{''}$, *i.e.* loss of $1 - x$ equiv. H_2SO_4 .

Taking the migration ratio of the sulphion as 0.19, we see that reaction (ii.) at the anode causes a loss of 0.81 equiv. of acid, while reaction (i.) causes a gain of 0.19 equiv. If the actual change be measured, the result shows how much of the current is spent on each of these reactions; it is found that the strength of the acid is the principal condition on which the result depends.

§ 5. CONDUCTIVITY OF ELECTROLYTES.

The most important means towards determining the mechanism of electrolytic conduction, and the nature of electrolytes, is measurement of conductivity. We have seen that the current density in an electrolyte is the product of three factors: (i.) the charge on an ion, (ii.) the number of ions per cubic centimetre, (iii.) the velocity with which the ions are moving; or in symbols

$$96600 \gamma \eta (u_A + u_C) \quad (\text{p. 21})$$

Further, that the essential meaning of Ohm's law is proportionality between the current density and the potential gradient producing it; so that we may write the current density under unit potential gradient

$$96600 \gamma \eta (U_A + U_C)$$

where $U_A U_C$ are the mobilities of the ions, *i.e.* their velocities under unit potential gradient; and in any other case the current density will be this amount multiplied by the actual gradient. The amount just written—the *current density under unit potential gradient*—is called the *conductivity* of the liquid. If the current density be expressed in amperes per square centimetre and the

gradient in volts per centimetre, the conductivity will be in *mhos* (per cm. cube).

[Example.—Two parallel copper electrodes 40×30 cm. are immersed 6 cms. apart in a rectangular trough of 10 per cent. CuSO_4 solution of 0.032 conductivity, and a current of 60 amperes is passed between them. What voltage is required? Cross-section of trough, $40 \times 30 = 1200$ sq. cm.

Current density $60 \div 1200 = 0.05$ amp. per square centimetre.

$$\text{Conductivity} = 0.032 = \frac{\text{current density}}{\text{potential gradient}}$$

$$\therefore \text{potential gradient} = \frac{0.05}{0.032} = 1.56 \text{ volts per centimetre.}$$

This for a distance of 6 cms. amounts to 9.36 volts, which is therefore the total fall of potential in passing from the one plate to the other.]

The reciprocal of the conductivity is called the resistivity or specific resistance, and is measured in ohms (per cm. cube).

In a trough or tube of uniform cross-section, containing two parallel electrodes, the current density is uniform, viz., the total current divided by the cross-section; and the potential gradient is uniform, viz., the difference of potential between the electrodes divided by the distance between them; hence we may write

$$\text{Conductivity} = \frac{\text{current} \div \text{cross-section}}{\text{potential difference} \div \text{length}}$$

$$\text{or } \frac{\text{current}}{\text{potential difference}} = \text{conductivity} \times \frac{\text{cross-section}}{\text{length}}$$

The last quantity is called the *conductance* of the trough or tube, and even if the vessel is not regular in shape this name may still be retained for the ratio $\frac{\text{current}}{\text{potential difference}}$.

[Thus in the preceding examples the conductance of the trough is $0.032 \times \frac{40 \times 30}{6} = 6.4$ mhos.]

The reciprocal of the conductance is called the *resistance*, and is measured in ohms; hence we arrive at the usual expression of Ohm's law—

resistance = $\frac{\text{potential difference (or voltage, or electromotive force)}}{\text{current}}$

[The resistance of the trough is $\frac{I}{6.4} = 0.156$ ohms.]

In order to determine the conductivity of a solution the simplest method would be to place it in such a trough of uniform cross-section, pass a current through it, and use an ammeter to determine the strength of current and a voltmeter for the voltage between the electrodes. This method would not be satisfactory, however, on account of "polarisation" at the electrodes, *i.e.* change in the nature of the electrodes, especially evolution of gas, due to the current. There would not be much polarisation at copper electrodes in copper sulphate solution, and so the above method would be practicable; but, *e.g.*, with platinum plates in dilute sulphuric acid the polarisation would be so large as to cause quite erroneous results.

To avoid this error a separate pair of electrodes through which current is not passed may be used for the potential measurement, and the measurement made by an electrostatic voltmeter (electrometer), *i.e.* one which takes no current. The connections are shown in Fig. 12: current is taken in and out by the large electrodes HJ; the current density is found by

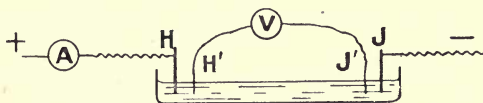

FIG. 12.

dividing the reading of the ammeter A placed in series with the electrolytic trough, by the cross-section of the latter. Thin wires H'J' are immersed in the liquid and lead to the electrostatic voltmeter V; the reading of the latter divided by the distance between the wires gives the potential gradient. This method is sometimes used for liquids of excessively low conductivity.

In ordinary cases an alternating current method is always used. Current is led alternately one way and the other through

the liquid, many times a second, so that the polarisation produced on a plate serving as cathode is immediately afterwards destroyed by its use as anode. The arrangement of apparatus is essentially similar to that employed in the case of solid conductors, viz. Wheatstone's bridge. We shall therefore proceed to describe in detail the method of carrying out conductivity measurements in this way.¹

Wheatstone's bridge consists of an arrangement of conductors shown schematically in Fig. 13. Current from a battery B is led to the point *a*, where it divides into the two branches *abc* and *adc*, reuniting at *c* to return to the other pole of the battery. Two intermediate points *b* and *d* of the branched conductors are connected through a galvanometer G:

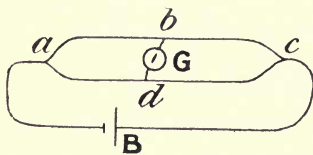

FIG. 13.

then it may be shown that no current flows through G, provided the resistances *ab*, *bc*, *ad*, *dc*, are chosen so as to satisfy the relation $ab \times cd = bc \times ad$.

Hence, if three of the resistances are known and the fourth is to be measured, the three can be adjusted until no current flows through the galvanometer, and the equation will then give the value of the unknown resistance. A battery and galvanometer are available in such an arrangement when a metallic resistance is to be measured; but for an electrolyte the battery must be replaced by a source of alternating current, the secondary of a small induction coil being the most convenient; and as with an alternating current an ordinary galvanometer will give no indication, some appropriate indicator must be used instead: an electro-dynamometer or a telephone, commonly.

Induction coils suitable for the purpose are now sold by the German scientific instrument-makers. They should be small enough to be worked by a single dry cell, or by an accumulator with a metallic resistance in circuit to reduce the

¹ The following details are nearly all taken from the admirable monograph of Kohlrausch and Holborn, *Leitvermögen der Elektrolyte* (Teubner, Leipzig, 1898).

current to about half an ampere. The secondary should have only a moderate number—say 1000—of turns, as high electromotive force introduces disturbing effects. The interruptor may be a light steel spring covered by platinum at the place where sparking occurs, working against a platinum point; or a platinum point dipping into mercury: in this case the mercury must be protected against oxidation by a layer of distilled water, and the mercury connected to the positive pole. If a telephone is used as indicator, the frequency of the spring must be such as to give the best effect on it; *i.e.* the spring must give out a clean singing tone of the pitch of a treble voice, 250 to 1000 vibrations per second. With an electro-dynamometer this is not necessary, but the frequency must in any case be fairly high in order to eliminate polarisation sufficiently.

Alternating current is now often supplied for domestic purposes; but if that is to be made use of, only a fraction of the voltage supplied must be employed on the bridge. The best plan is to feed a lamp (L) (Fig. 14), and a wire-resistance (R) of a few ohms, in series from the mains, and take off current from the ends of R to the bridge. But as the frequency of alterna-

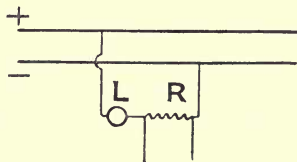

FIG. 14.

tion is usually only 100, the domestic supply gives a dull and unsatisfactory tone in the telephone, and is best used with an electro-dynamometer.

As observing instrument the ordinary commercial telephone is the most useful. The resistances of the bridge are to be adjusted so that no sound is produced in it, or if that condition is unattainable, at least a well-defined minimum of sound. The telephone should be pressed closely against one ear, while the other is stopped up. The telephone should have only a moderate resistance—say 10 ohms—and by choosing a good instrument and working under favourable conditions, it is possible to measure to $\frac{1}{100000}$ part, or even less; observation is easier if the tone is not too loud.

The chief defect of the telephone is that when the resistances in the bridge are out of balance, the telephone does not, like a galvanometer, show which way they should be altered to obtain balance. In this respect an electro-dynamometer is superior. It consists essentially of a coil suspended at the centre of a fixed coil, the planes of the two being at right angles. When current is led through both, the movable coil tends to set itself parallel to the fixed; the rotation is resisted by the suspending wire or wires, and the amount of turning measured with a telescope-mirror, and scale. For resistance measurements the fixed coil of the electro-dynamometer should be inserted in the main circuit (*i.e.* of the induction coil or that taken off the alternating mains), while the movable coil is put in the branch which otherwise carries the galvanometer or telephone. With this arrangement, when the unknown resistance is underbalanced by the three known, the movable coil will turn in one sense; if overbalanced, in the other; its use being therefore similar to that of the galvanometer in measuring metallic resistances.

With regard to the composition of the arms of the bridge, the chief determining factor, when a telephone is used, is facility of adjustment. Plug resistance-boxes, such as are

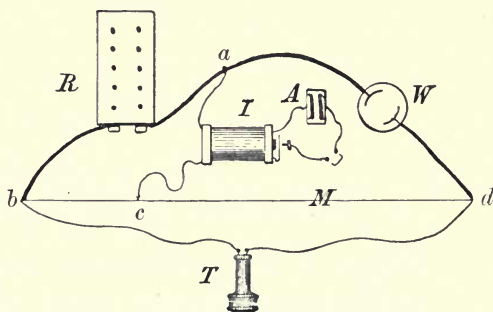

FIG. 15.

employed with a battery and galvanometer, would involve so much manipulation as to make it very tedious to find the minimum sound; hence the usual plan is to have a box for

one known arm, and make up the other two by a slide-wire. Fig. 15 shows this arrangement, as commonly used by Ostwald and Kohlrausch, in conjunction with the induction-coil. A is a cell connected to the primary terminals of the induction-coil I. A key, K, allows the coil to be put out of action when not wanted. The secondary terminals of the coil are connected to *ac*; the telephone to *b* and *d*. Arm *ab* consists of the resistance-box R; *ad* of the electrolyte cell W, the resistance of which is to be measured. *bc* and *cd* between them consist of a wire, usually a metre long, stretched over a millimetre scale and provided with a sliding contact-maker *c*. If the wire be uniform, the resistance of the two segments *bc cd* will be proportional to their lengths. Hence, in accordance with the rule on p. 46, we shall have

$$W = R \times \frac{\text{length } cd}{\text{length } bc}$$

The box R should be capable of considerable adjustment. If it is only to contain a few coils, Kohlrausch recommends that they should have the values 30, 70, 200, 700, 2000, 7000 ohms. It is better if a set of coils continuously adjustable from 1 to 10,000 ohms is available. The coils should be wound double to avoid self-induction, as is customary in resistance-boxes; but in coils of 1000 ohms or more this method of winding introduces so much electrostatic capacity as to make measurements of high electrolytic resistances uncertain. The larger coils should therefore be wound in the manner suggested by Chaperon, viz. in simple layers, but each layer in the reverse sense to the preceding.

The slide-wire *bd* should be made of an unoxidisable metal, and must not be so soft that the sliding contact-maker damages it. Platinum-iridium alloy and constantan (CuNi alloy) are about the best materials. It should not be more than $\frac{1}{4}$ mm. thick, or the resistance will be inconveniently low. The wire is usually stretched straight over a scale, but is easier to manipulate if wound on a drum.

The use of a slide-wire involves calibration from time to time, as it usually suffers a certain amount of injury from the working of the sliding contact. Measurements with it are

more exact when made near the middle of the wire: it is therefore desirable to choose R as nearly equal to W as may be; then cd will be nearly equal to bc . If a set of resistances adjustable by steps of 1 ohm be used, it is possible to confine the movement of the slider within quite small limits; e.g., suppose W is 30.5 ohms; then if 30 ohms be taken out of the box R , the position of the slider may be calculated from $30.5 = 30 \times \frac{cd}{bc}$. If bd (the entire length of the wire) is 1000 mm., this equation shows that cd must be 504 mm., bc 496; i.e. the slider need only be moved 4 mm. from the middle point. This suggests replacing the end parts of the wire by coils,

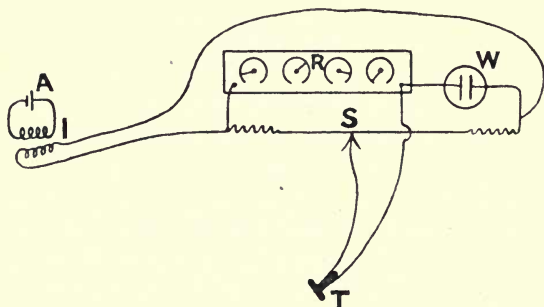

FIG. 16.

which are more handy, and less exposed to change. A convenient arrangement is to take a wire 10 metres long, and coil up both ends of it, leaving only 26 cms. in the middle, stretched over a scale. If the sliding contact be moved to one end of this, the ratio $\frac{cd}{bc} = 1.05$; at the other end $\frac{cd}{bc} = 0.95$; so that the resistance-box used must be capable of adjustment to within 5 per cent. of the resistance to be measured; the box should be of the dial-switch pattern, for facility of adjustment. The arrangement is shown in Fig. 16, where S is the slide-wire. The manipulation is then as follows: put the slider at the middle point of the wire, and keep it in contact with the wire; rotate the switches of the box (R) till the position is

found that gives the least sound in the telephone (T); then move the slider to and fro till the exact position for silence is found. With the short slide-wire just described errors of calibration are so small that they can usually be neglected in practice.

In Figs. 15, 16 the position of the induction-coil may be interchanged with that of the telephone. The arrangement shown in Fig. 15 is on the whole the better, as then the induction coil is not in action if the sliding contact is not pressed down; whilst if the telephone is connected to the sliding contact erratic noises are apt to be produced when the contact-maker is pressed or moved along.

If an electro-dynamometer be used instead of the telephone the sliding contact may be dispensed with altogether. The procedure is then identical with that for measuring a wire resistance with battery and galvanometer, and if desired the deflections of the electro-dynamometer may be used to determine the last place of decimals in the result.

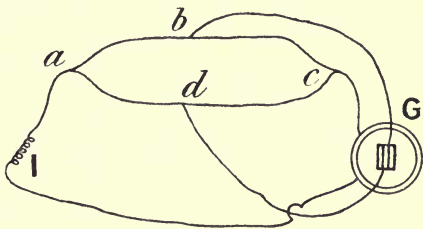

FIG. 17.

The arrangements for using an electro-dynamometer with alternating current are shown in Fig. 17. One coil of the dynamometer *G* is put in series with the induction coil *I* (between *a* and *c*), while the other coil is connected to *b* and *d*.

The electrolyte to be measured is always contained in a glass vessel and provided with a pair of electrodes of platinum or palladium. The size and character of the electrodes depends essentially on the conductivity of the liquid to be measured. Smooth platinum electrodes only give completely satisfactory measurements when the conductance of the liquid vessel does not exceed 0.0004 mho per square centimetre of electrode surface, but are available up to 0.002 mho. They can be made about thirty times as effective by "platinising." This is done by immersing in a solution containing 3 per cent. commercial platinum chloride with $\frac{1}{10}$ per cent. lead acetate,

and passing a weak current for about ten minutes in each direction between the pair of electrodes. Three or four volts are required, and the current should be so regulated as to cause a moderate evolution of gas. The electrodes become coated with a firmly adherent layer of platinum black, which greatly increases their effective surface and power of absorbing gases. Electrodes prepared in this way can be used with solutions of 0.01 mho per square centimetre perfectly, and 0.05 with fair success.¹ Even better than this is an electrolytic deposit of palladium black, which, according to Ostwald, gives perfect results up to 0.04 mho per square centimetre, and moderately good up to 0.2 ; but palladium is attacked by strongly oxidising liquids.

The shape of the electrolyte cell also depends on the conductivity of the liquid to be measured: if this is high, the electrodes may be separated by a long narrow tube; if low, they should be put close side by side. In any case it is important that they should be solidly made and fixed, so that they shall not be distorted, otherwise the resistance of the cell will vary from one experiment to another. A very convenient shape is shown in

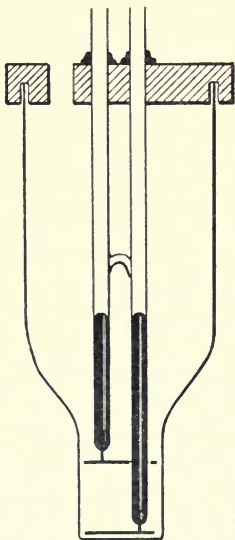

FIG. 18.

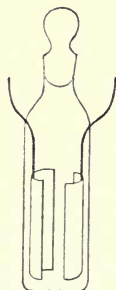

FIG. 19.

Fig. 18. The electrodes are of thick sheet platinum welded

¹ There are cases in which platinum black cannot be used on account of its catalytic action on the solution.

or gold-soldered on to thick platinum wires sealed through the ends of glass tubes. The tubes should be about 1 mm internal diameter, and contain a few drops of mercury so as to make good contact with wires inserted into them. The lower tube passes through a hole in the upper plate. The tubes are firmly cemented into an ebonite plate which forms the lid of the vessel and has a hole to admit a thermometer. Other forms are shown in Fig. 19 (for bad conductors), Fig. 20 (for good conductors). It is also convenient to have immersion electrodes (Fig. 21) which can be inserted into a bottle containing the solution, and

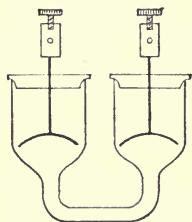

FIG. 20.

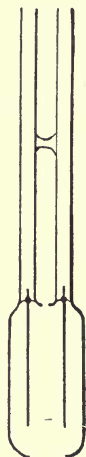

FIG. 21.

pipette electrodes (Fig. 22) that can be surrounded by a liquid or vapour jacket for measurements at a high temperature.

In all the forms so far described the electrodes are fixed so that when filled with a given liquid the conductance of the vessel is the same. It is necessary to determine the constant of the vessel, which is defined as

$$\frac{\text{conductivity of electrolyte}}{\text{conductance of electrolytic cell}}$$

E.g. if a cell contain two plates of 4 sq. cm. placed 1.6 cm. apart and be filled with an electrolyte of conductivity 0.02, its conductance (according to the rule on p. 44) will be $0.02 \times \frac{4}{1.6} = 0.05$ mho. The constant of this vessel is $\frac{4}{1.6} = 2.5$. But as conductivity vessels are never perfectly regular in shape, the conductivity is determined in practice by a measurement

made with a known electrolyte. Kohlrausch gives the following list of liquids suitable for the purpose:—

(1) Maximal¹ sulphuric acid: 30 per cent. H_2SO_4 by weight: density at 18° , 1.223. 206 c.c. strong acid are made up to a litre with water. Commercial "pure" acid is sufficiently good for use.

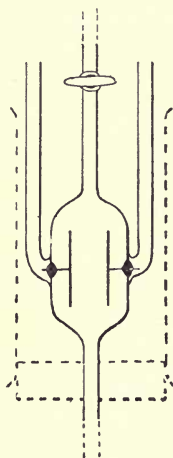

FIG. 22.

(2) Maximal MgSO_4 : 17.4 per cent.: density at 18° , 1.190. 424 gm. dry, not effloresced, $\text{MgSO}_4 + 7\text{H}_2\text{O}$ are made up to 1 litre. The commercially pure salt may be recrystallised with advantage.

(3) Saturated NaCl : About 450 gm. salt are made up to a litre. Some of the salt should be very finely powdered, and only added when the rest is mostly dissolved, in order to ensure saturation. The excess of salt is allowed to settle, and the liquid drawn off when required. The dry salt should be heated to drive off any free acid.

(4) Normal KCl solution; 74.59 gm. per litre at 18° ; density, 1.04492 at 18° . 74.555 gm. is the apparent weight in air required. If the temperature is $\pm 1^\circ$ from 18° the volume is to be taken ± 0.3 c.c. greater. The density should be measured for control.

The salt should be recrystallised, and strongly heated and cooled in a desiccator before weighing. It should colour a bunsen flame only moderately yellow, and show no noticeable reaction with sulphuric acid.

$\frac{1}{10}$ n. $\frac{1}{50}$ n. and $\frac{1}{100}$ n. KCl are prepared by diluting the normal solution.

(5) Saturated CaSO_4 solution. The substance must be finely powdered and well washed; the solution may be syphoned off into the conductivity vessel while still slightly turbid.

The following table shows the range of conductivity vessels for which the various liquids are suitable:—

¹ H_2SO_4 , MgSO_4 and some other solutions increase in conductivity up to a certain concentration, and then fall off again.

Standard liquid.	Conductivity at 18°.	Diff. for 1°.	Constant of vessel to be standardised.
Max. H ₂ SO ₄	0·7398	123 × 10 ⁻⁴	80 to 750
Sat. NaCl	0·2161	49 × 10 ⁻⁴	20 „ 200
Norm. KCl	0·09822	191 × 10 ⁻⁵	10 „ 100
Max. MgSO ₄	0·04922	124 × 10 ⁻⁵	6 „ 50
$\frac{1}{10}$ norm. KCl	0·01119	24 × 10 ⁻⁵	1 „ 10
$\frac{1}{50}$ norm. KCl	0·002397	52 × 10 ⁻⁶	0·2 „ 2
Sat. CaSO ₄	0·001891	50 × 10 ⁻⁶	0·2 „ 2
$\frac{1}{100}$ norm. KCl	0·001225	26 × 10 ⁻⁶	0·1 „ 1

Vessels of variable capacity have also been used. Fig. 23 shows a convenient shape. The electrodes are in the form of horizontal plates, and can be raised or lowered through the stoppers which support them; the graduations indicate the ratio conductivity ÷ conductance, and are determined by measurements with a standard liquid. With a vessel of this character the slide wire may be dispensed with; the plugs of a resistance-box forming the other three arms of the bridge are set to a definite value, and the electrodes moved up and down till there is silence in the telephone.

Finally, it may be mentioned that standard liquid resistances may be constructed, and sometimes used with advantage. It is, of course, important that they should be as little influenced by temperature as possible. Nernst recommends as having a negligibly small temperature coefficient a solution containing 121 grms. of mannite, 41 grms. boric acid, and 0·06 gm. KCl in a litre. Its conductivity is 0·00097 at 18°. By using such a liquid resistance to balance the electrolyte cell the arrangement is made more symmetrical, and it is easier to obtain satisfactory readings with the telephone.

Water.—In conductivity measurements it is indispensable to use very pure water. The conductivity of the purest water

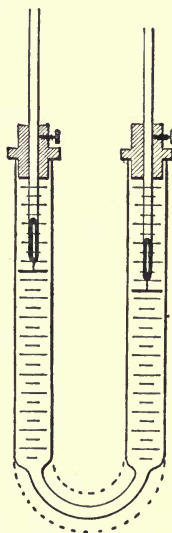

FIG. 23.

ever obtained¹ is only 0.04×10^{-6} ; but this is only possible when distilled and preserved out of contact with air. In air the conductivity rises to at least 0.7×10^{-6} , chiefly on account of absorption of carbon dioxide; and usually it is much greater than this, on account of ammonia compounds (and in laboratories hydrochloric acid) from the air, alkali dissolved from glass, dust, salts derived from contact with corks, the fingers, etc. Hence, when making up solutions to measure conductivity, the water should always be tested first: it cannot be considered satisfactory if its conductivity exceeds 5×10^{-6} .

To obtain a satisfactory specimen, the water should be distilled with a little caustic alkali; the first fractions rejected; if necessary, distilled again from sulphuric acid. Glass apparatus may be used provided it is of good quality (glasses vary very much as to solubility in water) and has been well steamed out beforehand. The collecting vessel must, of course, be protected from dust, flame-gases, etc.

Water that contains much calcium bicarbonate, on distillation contains an excess of carbon dioxide, and may be improved by drawing a current of air through it.

Porcelain vessels are recommended by Kohlrausch for keeping water in. Corks and india-rubber should be avoided.

Sources of Error in Conductivity Measurements.—Conductivity is very largely influenced by temperature, the average coefficient for an aqueous electrolyte being about 2 per cent. per degree. Consequently, in order to obtain an accuracy of only one-tenth per cent., it is necessary to make sure of the temperature to $\frac{1}{20}$ degree. The conductivity vessel should therefore always be placed in a thermostat.² The thermometer may best be put in the conductivity vessel itself, provided it does not come between the electrodes; or it may be put in the water of the thermostat near by. For high temperatures a vapour jacket is the most convenient heater, and the conductivity vessel should be adapted to suit it (Fig. 22).

¹ Kohlrausch, *Pogg. Ergzb.*, **8**, 1 (1878); K. and Heydweiller, *Wied.*, **53**, 209 (1894); Kohlrausch, *Zeitschr. phys. Chem.*, **42**, 193 (1902).

² For construction of thermostats, see Ostwald-Luther, *Physiko-chemische Messungen* (Leipzig, 1902).

The current used for measuring generates heat in the electrolyte, and so warms it. Care must be taken to avoid introducing error in this way; the current from the induction coil should not be too strong, and should be broken when not wanted. The arrangement of Fig. 15 is good in this respect, as the current then only flows for a few seconds, while the sliding contact is actually in use, and pressed down on the wire.

Electrolytic polarisation, self-induction, and electrostatic capacity in any of the four arms of the bridge affect the balance to a certain extent. Fortunately, their influence shows itself first in want of sharpness in the telephone minimum; the point of balance is only affected secondarily, so that no error in measurement is to be feared so long as the "minimum" is sufficiently definite to observe with precision. The mathematical theory¹ shows that the influence of

	Self-induction	Polarisation	Capacity
is great when the } frequency is }	great	small	great
and when the re- } sistance is }	small	small	great

Self-induction is diminished, as already mentioned, by double winding the coils of the resistance-box. It may similarly be diminished in the leads, etc., by laying out and return wires close alongside one another. Short straight conductors, such as electrolytic cells, have very little self-induction. With ordinarily good arrangements its effect should be negligible.

Polarisation, of course, exists in the liquid cells only. It may always be made vanishingly small by making the electrodes large enough, and covering them well with platinum or palladium black. If two arms of the bridge are made of liquid conductors it may be made approximately to balance out.

Capacity occurs in high-resistance coils, from which, however, it may be practically eliminated by Chaperon's method of winding; it is also appreciable in electrolytic cells when the electrolyte is of low conductivity, and between the electrolytic cell and a conductor outside the glass, such as the water of the

¹ See Kohlrausch and Holborn, *Leitvermögen d. Elektrolyte*, p. 70.

thermostat. The last difficulty may be got over by placing the cell in a beaker of non-conducting liquid such as paraffin, and that inside the thermostat.

If, despite these precautions, capacity causes trouble, a small condenser should be inserted in another arm of the bridge, for the effect is always lessened by symmetry. Thus, if there is too much capacity in the arm *c* (Fig. 24), the condenser *K* (made of tinfoil or paraffined paper) is placed in the adjacent arm *d*. The resistance balance is first found as nearly as may be, and the

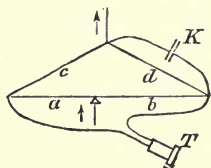

FIG. 24.

capacity of *K* then varied until the minimum in the telephone is quite sharp.

§ 6. EQUIVALENT AND IONIC CONDUCTIVITIES.

In order to express the results of conductivity measurements in a convenient form it is necessary to introduce a new definition—that of the *equivalent conductivity*. This is the *conductivity divided by the concentration*. We shall use the symbols κ for conductivity, and Λ for equivalent conductivity; then

$$\Lambda = \frac{\kappa}{\eta}, \text{ or } \Lambda = \kappa v$$

where η , as before, is the concentration in gram-equivalents per cubic centimetre, and v is the *dilution*, or volume, in cubic centimetres per gram-equivalent.

We have seen that the conductivity may be expressed in terms of the properties of ions by the equation—

$$\kappa = 96600 \gamma \eta (U_A + U_C)$$

It follows that

$$\Lambda = 96600 \gamma (U_A + U_C)$$

We may form a picture of the meaning of equivalent conductivity in this way. Suppose two metal plates of indefinite extent placed parallel and one centimetre apart; place between them 1 c.c. of solution (in the form of a prism or cylinder of 1 sq. cm. base). Then the conductance between

the plates is, according to definition, the conductivity of the solution. Next, if v is the number of cubic centimetres containing one gram-equivalent of the dissolved substance, place v c.c. of solution between the plates; then the conductance is v times as great as before. It is now a measure of the equivalent conductivity.

The most important result of experiment can be summed up by saying that, in general, while the actual conductivity κ falls off very much when the solution is diluted, the *equivalent conductivity* of a salt (acid or base) *increases with its dilution, but tends towards a finite limit for indefinitely great dilution*. The following example will serve to illustrate the rule; solutions of varying strengths being made up, and their conductivities measured, the values of the equivalent conductivities are—

$v = \frac{1}{\eta}$	Λ		
	KCl	CuSO ₄	CH ₃ COOH
100	—	—	0·049
1,000	98·2	25·8	1·32
10,000	111·9	45·0	4·60
100,000	122·5	72·2	14·3
1,000,000	127·6	101·6	41·0
10,000,000	129·5	113·3	107·0

} at 18°

In each case the increase with dilution is obvious. The approach to a finite maximum is clearly marked in the first case, and the limiting value can be obtained by extrapolation with some certainty: Kohlrausch gives it as 131·2. In the second case the limit is fairly obvious, but not calculable with certainty. With acetic acid it is not obvious; but there is indirect evidence that if it were possible to measure still more dilute solutions, it would be found.

Since the laws of dependence of the equivalent conductivity on concentration are not at all simple, it is of interest to draw curves showing the relations between the two quantities. But as measurements have to be taken over a very wide range of concentration, such diagrams would not be convenient to draw

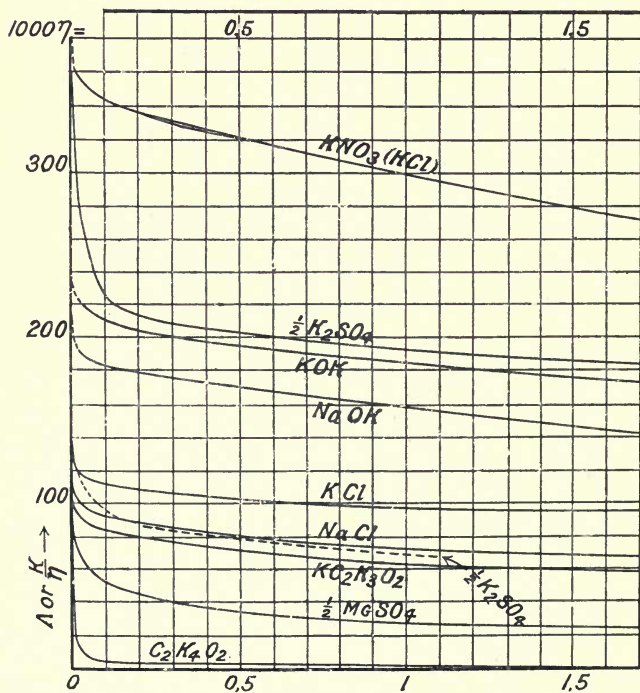
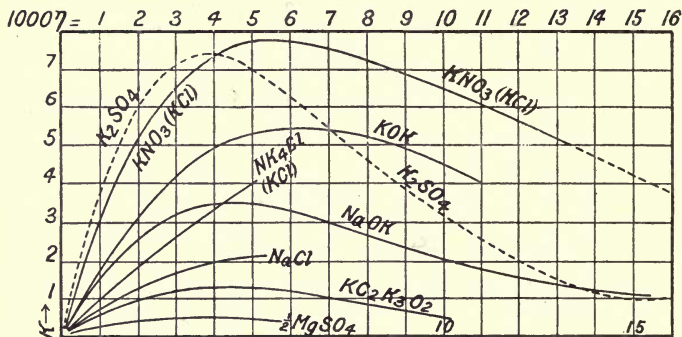
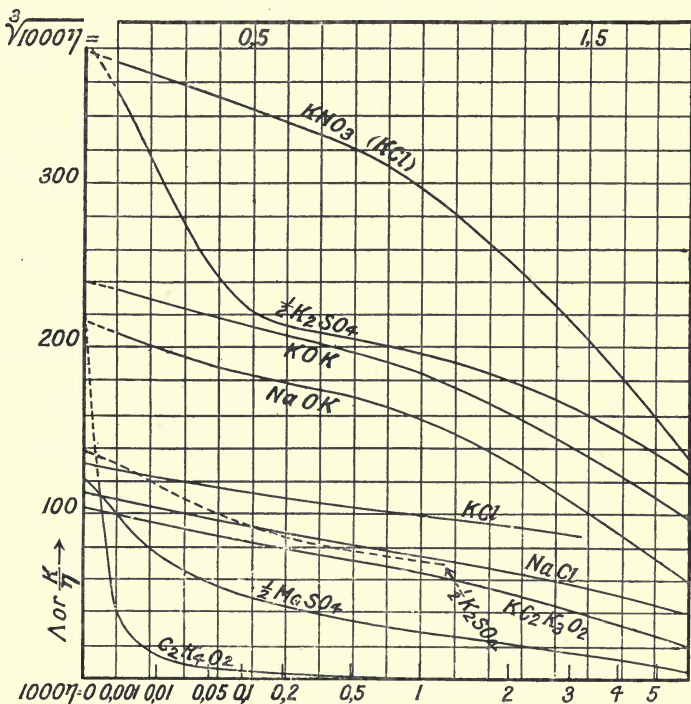

FIG.

except in the case of strong solutions. Kohlrausch recommends the use of diagrams in which the cube root of the concentration is taken as abscissa, the equivalent conductivity as ordinate; curves so drawn are often nearly linear (see Fig. 25). It is also often convenient to take the logarithm of the concentration as abscissa.

Since, according to the hypothesis we have used, the conductivity of a solution is the joint effect of convection by anions and cations in it, the next step is to analyse the equivalent conductivities into a part due to the anions and a part due to the cations. These are called the partial or *ionic conductivities*; they will be designated by l_A and l_C , so that, using the same symbols as before, we shall expect to have



$$l_c = 96600 \gamma U_c$$

$$l_A = 96600 \gamma U_A$$

and

$$l_c + l_A = \Lambda$$

Hittorf's migration ratios afford a means of effecting this analysis, and it is found that the ionic conductivities so determined are consistent amongst themselves. The most interesting numbers are the limiting values for infinite dilution, to which we shall return later; but at present, for a test of the theory, we will use a set of values referring to decinormal solution ($v = 10000$).

The molecular conductivity of KCl ($v = 10000$) is 111.9; that of NaNO₃, 87.4. The migration ratios of the anion in these salts have been found 0.508 and 0.615 respectively. From these data we calculate the ionic conductivities:—

$$K^{\cdot} = 0.492 \times 111.9 = 55.1$$

$$Cl' = 0.508 \times 111.9 = 55.8$$

$$Na^{\cdot} = 0.385 \times 87.4 = 33.6$$

$$NO_3' = 0.615 \times 87.4 = 53.8$$

Now, if these numbers really depend on the properties of the single ions, we should expect to be able to build up from them the conductivities of other salts. This can be done with fair success; *e.g.*—

$$KNO_3 = 55.1 + 53.8 = 108.9$$

$$NaCl = 33.6 + 55.8 = 89.4$$

whilst the experimental values are 104.4 and 92.5 respectively. By taking the mean of a large number of different combinations, more reliable values of the ionic conductivities can be calculated.

The ionic conductivities are closely related to ionic mobilities (p. 34). If the numbers given in Kohlrausch's table be divided by the charge per equivalent, 96600 coulombs, the quotient expresses a velocity in centimetres per second for unit potential gradient. Thus the conductivity of the K[·] in decinormal KCl, 55.1 yields $55.1 \div 96600 = 0.00057$ cms. per second; this expresses the mobility of the potassium ions in such a solution, but in a sense that requires careful note.

According to the equation of p. 59.

$$\frac{l}{96600} = \gamma U$$

Here U is the average velocity acquired by the ion when exposed to unit potential gradient, and has been defined as the mobility, or, as we will say for distinction, the *actual mobility*; while γ is a numerical factor known as the degree of dissociation.

There are two aspects to γ . In the first place, it represents the fraction of all the salt molecules which at any instant exist in the state of dissociation. But dissociation is a kinetic phenomenon. It is not that some molecules are always dissociated and others not, but that each molecule is broken up from time to time by some especially violent collision with its neighbours; and, again, that detached ions recombine frequently. In this way a certain average state of dissociation is kept up with considerable uniformity, but any individual atom may combine and dissociate again hundreds, possibly millions, of times per second. Accordingly, if we consider the history of a single atom (or ion), and average it over a long time, we may look upon γ as measuring the fraction of all the time during which that atom is uncombined. It is obvious that this fraction must be the same as that obtained by averaging over all the molecules at a given instant.

But an ion only travels under the electric field when it is free, for if it combines with an oppositely charged ion, it becomes neutral, and there is no electric force acting on it (or two equal and opposite forces which neutralise). If, then, the ion when it is free travels at the average speed U , but is only free for the fraction γ of the whole time, its velocity averaged over the whole time, whether free or not, is γU . In this way we obtain a conception that may be defined as the *effective mobility*. It may be regarded either as the average velocity of a single ion over a long time, intervals of rest¹ included, or the average velocity of all the ions, those which are for the time being combined included.

Accordingly, conductivity measurements only give, directly, the effective mobility of the ions; the conduction in any

¹ These remarks refer, of course, only to the uniform drift due to electric force; when the ions are not moving in this way they still possess their heat motions, but as these are indifferently in all directions they lead nowhere, and do not interfere with the electric mobility.



particular instance might conceivably be due either to the rapid motion of a few dissociated particles, or to the slow motion of many.

That it does measure a real velocity of convection is demonstrated by a method of experiment devised by Lodge,¹ which we must now proceed to describe.

A tube is filled with a jelly, made of gelatine and water, containing sodium chloride and a little phenolphthalein. One end of the tube is placed in contact with a solution of hydrochloric acid, and a current passed in from a platinum electrode, so that it flows from the HCl to the NaCl. The current involves transport of the cations in its own direction; H⁺ ions, consequently, penetrate the jelly, and, as they proceed, decolorise the phenolphthalein; this makes the movement of the ions visible, so that it can be measured by direct observation. Lodge found in this way that the velocity of the hydrogen ions was of the order of magnitude calculated by Kohlrausch.

Lodge's method, however, also only gives the effective mobility, for no single ion would produce an observable decolorisation; it is the general drift forwards of the multitude of ions that is observed, and this, of course, takes place with the average effective velocity, as defined above.

The velocity is a very small one, as we have seen (p. 63). Lodge's measurements gave 0.0024 to 0.0029 cm. per second, under a potential gradient of 1 volt per centimetre. The potential gradient was not correctly determined, so that the numbers can only be regarded as a demonstration of the existence of ionic movements; but the method has been developed with success by Whetham and others.

Whetham² avoided the use of gelatine, which offers a certain though small additional resistance to the ions. To do this the tube was arranged vertically, with the denser liquid below. It is, of course, easy to measure by a voltmeter the potential difference between the ends of the tube; but the gradient in the tube will not be uniform unless the conductivity is uniform through its length; so, to avoid difficulties in

¹ *Brit. Ass. Rep.*, 1886, p. 389.

² *Phil. Trans.*, A, 1893, pp. 337-359.

determining the potential gradient, Whetham used a pair of solutions, *e.g.* potassium bichromate and potassium carbonate, and adjusted their strengths so as to make the conductivity the same. As, further, there must be a colour difference between them, the choice is limited. There is, moreover, another condition that was not attended to in Lodge's experiments: the following ion must be specifically slower than the leading. Thus, *e.g.*, if copper ions are arranged to follow sodions, the former will be constantly behind the latter, and the boundary remain sharp; but if the direction of movement be reversed, the individual sodions, being more rapid, will gradually penetrate into the cupric solution, and cause the boundary to become diffused, and impossible to measure accurately. By paying attention to these points, Whetham succeeded in getting in certain cases a satisfactory agreement with the calculated mobilities. He gives these results in aqueous solution:—

Cu ⁺	0.000309	cm. per second	
Cl ⁻	58	"	"
Cr ₂ O ₇ ²⁻	47	"	"

He also made measurements with CoCl₂ and CoN₂O₆ in alcoholic solution, and found that the mobilities, about $\frac{1}{10}$ those in aqueous solution, were at least of the order of magnitude to be expected from the conductivity.

Orme Masson¹ has modified the method so as to make it available for a wider range of substances. His apparatus consists of a horizontal tube placed between two flasks with side tubes. The tube—15 cm. long by 2 mm. wide—is filled with a jelly of the material to be studied, say NaCl; the jelly was of agar-agar, 12 per cent., and contained enough salt to make a half-normal, normal, or twice normal solution. The flasks contained two indicating solutions, and large platinum electrodes placed just opposite the endings of the tube. The anode solution was normal CuSO₄, the cathode solution contained $\frac{1}{9}$ equiv. K₂Cr₂O₇ and $\frac{8}{9}$ equiv. K₂CrO₄ per litre. A potential difference of about 40 volts was applied; it causes the Na⁺ to move along the tube towards the cathode, and Cu⁺ ions to follow them,

¹ *Zeitschr. f. phys. Chem.*, **29**, 501–526 (1899), or *Phil. Trans.*, 1899, 331–350.

thus turning the jelly blue : the chlorions to move along the tube towards the anode, and the chromate- and bi-chromate ions to follow them, turning the jelly yellow. The time of passage of the coloured boundaries past each half centimetre of the tube was noted. The whole must be immersed in water, as a considerable amount of heat is generated in the narrow tube.

Masson only used the method to compare the mobilities of two ions, such as Na^+ and Cl^- . He points out that it is not the mobilities of the indicator ions that are compared in this way, for their conductivities being different, the potential gradients acting on them are different too ; but the Na and Cl ions being together in the same part of the tube are exposed to the same gradient, and their mobilities will be strictly in the same ratio as the velocity with which they move. That these velocities are truly measured by the movement of the coloured ions following was shown by chemical analysis of the coloured jellies ; all the Na^+ had disappeared from the blue jelly, all the Cl^- from the yellow. The method is therefore applicable to all ions which move faster than the cupro- and chromate ions.

Masson's measurements on alkaline chlorides and sulphates show agreement to about 2 or 3 per cent. with the numbers deduced from conductivity measurements. The method does not appear to be capable of a much greater accuracy.

B. D. Steele¹ has extended the work of Masson. He succeeded in dispensing with gelatine in the solution to be measured, and at the same time found that even colourless solutions could be satisfactorily observed on account of the differences of refractive index between them, thus avoiding the use of coloured indicators. Fig. 26 shows the apparatus which he used for most of his experiments. A and B are tubes of uniform bore, in which the movement of the boundary is to be observed. They are filled with an aqueous solution, bounded above by jellies (G) containing the "indicator ions:" the jellies are covered by a little liquid containing the same salt, in which the electrodes are immersed. When the tubes CC are employed for the jellies, FF are closed ; but, if the indicators

¹ *Phil. Trans.*, **198**. 105-145 (1902), or *Zeitschr. phys. Chem.*, **40**. 689-736 (1902).

are heavier than the solution experimented on, DD are used instead of CC, and the measuring-tubes closed at the top. The whole is placed in a water-bath with good plate-glass sides, and the height of the boundaries read by a cathetometer.

E.g. MgSO_4 was measured by placing its solution between jellies of CdSO_4 and NaAc , or between CuSO_4 and K_2CrO_4 , or between CuSO_4 and NaAc , the same result being obtained in each case. To avoid difficulties as to distribution of the potential difference in the apparatus, the *current* flowing through it was measured, and the cross-section of the tubes being known, the current density could be calculated: this was divided by the known conductivity of the solution used, to give the potential gradient

(p. 44). The electrical arrangements consisted of a battery (70 volts), an adjustable resistance, an ammeter, and the measuring cell, all in series. The current should not exceed about 0.03 ampere; the size of the tubes should be chosen to allow of this, otherwise the heat generated may be sufficient to melt the jellies; but, on the other hand, it is difficult to observe the boundary if the section of the tube be less than 0.08 sq. cm.

Steele discusses at length the conditions necessary for the production and maintenance of a good boundary. These differ in different cases, and reference must be made to the original memoir for details; but it appears that for each particular boundary the potential gradient must be within certain limits, even if all the other conditions are satisfied. Thus the boundary between BaCl_2 and BaAc_2 (the Ac' following the Cl') is fairly good with 1 volt per centimetre; very sharp and easy to read with 1.2; at 1.5 shows signs of "washing;" at 2 is undulating, and obscured by little eddies. The correct

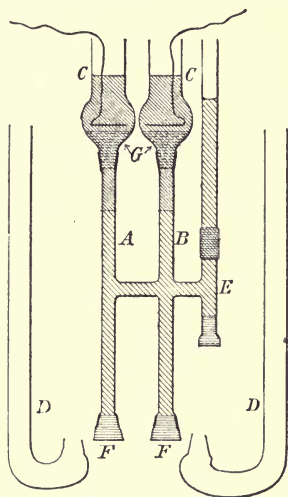

FIG. 26.

conditions for 38 pairs of salts are given, but in several other cases no good boundaries could be obtained.

The results obtained by Steele are—

	Normality.	Migration ratio of anion.		Normality.	Migration ratio of anion.
KCl	0·5	0·490	SrCl ₂	0·5	0·625
	1·0	0·488		1·0	0·665
	2·0	0·489		2·0	0·709
NaCl	0·5	0·597	CaCl ₂	0·5	0·681
	1·0	0·591		1·0	0·697
	2·0	0·590		2·0	0·715
KBr	0·1	0·483	MgCl ₂	0·5	0·705
	0·5	0·478		1·0	0·722
	1·0	0·473		2·0	0·740
	2·0	0·468		MgSO ₄	0·184
NaBr	0·5	0·595	0·5		0·693
	LiCl	0·5	0·716	1·0	0·715
1·0		0·751	2·0	0·737	
KOH	0·574	0·730	CuSO ₄	1·0	0·66
AgNO ₃	1·15	0·486		2·0	0·73
BaCl ₂	0·5	0·576	K ₂ CrO ₄	0·5	0·447
	1·0	0·619		2·0	0·403
	2·0	0·633	KFe ^{'''} Ox	0·603	0·331

The results appear to agree with Kohlrausch's conductivity measurements about as well as, or perhaps better than, those of migration ratios by Hittorf's method.

For a criticism of Steele's work, see Abegg and Gaus,¹ who give a method for measuring very slow ions, *i.e.* ions for which the usual method is impracticable for want of a still slower ion: and Denison.²

A theoretical discussion of the conditions on which direct observation of ionic velocities is based has been given by Kohlrausch.³

§ 7. ARRHENIUS' THEORY OF DISSOCIATION

So far we have hardly touched on the question as to what fraction of the dissolved salt molecules is broken up into ions. The effective mobility dealt with in the last section is no means of estimating the actual velocity with which ions travel when

¹ *Zeitschr. phys. Chem.*, **40**, 737-745 (1902).

² *Zeitschr. phys. Chem.*, **44**, 575-599 (1903).

³ *Wied.*, **62**, 209-239 (1897).

exposed to an electric field. The credit of having put forward a plausible and consistent theory is due to Arrhenius; his memoir¹ constitutes one of the most important steps in the history of electro-chemistry.

A solution is always capable of producing what is known as *osmotic pressure*, and which may, perhaps, best be regarded as a tendency to draw to itself more solvent, and so expand. This phenomenon is most clearly seen in the apparatus known as an osmometer. A porous earthenware jar is filled with copper sulphate solution and placed in a beaker of potassium ferrocyanide; a membranous precipitate of copper ferrocyanide is thus formed in the pores of the earthenware, which is found to possess the peculiar property of allowing water to flow through, but stopping the particles of dissolved substances, such as sugar; it is therefore called a *semipermeable* partition. The porous jar is now filled with a solution, say of sugar in water, tightly closed by an indiarubber stopper, through which passes the tube of a pressure-gauge, and the whole immersed in water. Since, then, water can enter the jar, but sugar cannot leave, it will be found that water enters, and so raises the pressure. The rise of pressure is an indication of the work that can be done by the sugar when expanding into a larger volume of water, and it will continue till the excess of pressure inside the apparatus just balances that tendency to expansion; then the work required to force more water in against the excess pressure is as great as that which can be done by the expansion, and the action stops. This excess pressure is described as measuring the osmotic pressure of the solution.

The resistance of a dissolved substance to diminution of the volume open to it is shown in other ways. Thus if a solution (say for simplicity aqueous) is frozen, water separates out, leaving the dissolved substance occupying a smaller space than before: the osmotic pressure accordingly opposes such a process, and it is found that the temperature must be lowered more to cause ice to crystallize out of a solution than out of pure water.

Again, if a solution is boiled, it is the solvent that goes away

¹ *Zeitschr. phys. Chem.*, 1. 631 (1887).

in form of vapour, leaving the residue more concentrated; this is resisted by osmotic pressure, and the boiling-point consequently raised.

In these ways many measurements of osmotic pressure have been obtained, and van't Hoff was enabled to make the very important and far-reaching generalisation that *a solution behaves like a gas*. That is, just as gas molecules, being free from each other's action, tend to fly in all directions, and so produce a pressure on the walls of a containing vessel; so molecules of dissolved substance, being practically free to move in all directions where there is any solvent, tend to occupy more and more of the solvent and so produce osmotic pressure on any semi-permeable boundary. Van't Hoff followed out this conception in detail by showing that the laws of gases—known as Boyle's, Charles' or Gay-Lussac's, and Avogadro's—are applicable in many instances to solutions.

There are, however, exceptions; these may conveniently be expressed by the ratio (*van't Hoff's factor*)

$$i = \frac{\text{observed osmotic pressure}}{\text{osmotic pressure calculated according to laws of gases}}$$

It was found that many common aqueous solutions gave values of i considerably greater than unity.

Arrhenius pointed out that the solutions which gave too high values of i were all electrolytes, and offered this explanation. The osmotic pressure of a solution—say of KCl—is calculated according to Avogadro's law on the assumption that the dissolved molecules of salt have the composition indicated by the ordinary chemical formula. If, however, they break up into ions K^+ and Cl^- , the number of free particles in the solution is increased, and so, according to Avogadro's law, the osmotic pressure should be. *E.g.*, if out of 100 molecules 86 are dissociated at any time, the total number of particles is 14 undissociated molecules + 86 cations + 86 anions = 186. The osmotic pressure would in this case be 86 per cent. greater than if no dissociation occurred, or $i = 1.86$.

More generally, if γ is the fraction of molecules dissociated (degree of dissociation), and each molecule forms two ions,

$$i = 1 + \gamma$$

if each molecule forms three ions $\text{Ca}(\text{NO}_3)_2$, ZnCl_2 , Na_2CO_3 , etc.,

$$i = 1 + 2\gamma$$

if four (FeCl_3 , tricarboxylic acids, etc.),

$$i = 1 + 3\gamma$$

or if n is the number of ions formed,

$$i = 1 + (n - 1)\gamma$$

whence

$$\gamma = \frac{i - 1}{n - 1}$$

We have, then, a method of calculating the quantity γ which enters into our equations, but so far has been unknown. Let us apply the values so obtained to the data arrived at by conductivity measurements. A set of numbers calculated by Jahn¹ from the freezing-points of Loomis and conductivities of Kohlrausch will serve—

KCl.

1000 η	γ	Λ	$\frac{\Lambda}{\gamma}$
0.1	0.8572	111.9	130.5
0.05	0.8858	115.9	130.8
0.02	0.9110	120.0	131.7
0.01	0.9407	122.5	130.2
		Mean	130.8

The first column gives the concentration in gram molecules per litre; the second, γ , as calculated from the freezing-point; the third, the equivalent conductivity; the fourth column serves to show how closely γ and Λ are proportional to each other.

It will be seen that the ratio $\frac{\Lambda}{\gamma}$ is very satisfactorily constant.

This is not all, however. Referring again to p. 59, and the equation

$$\Lambda = 96600 \gamma (U_A + U_C)$$

¹ *Zeitschr. phys. Chem.*, **37**, 492 (1901).

we see that if Λ is proportional to γ , U_A and U_C must be constant; *i.e.* the actual velocity with which any ion moves must be the same whatever the concentration of the ions. This result may, at least provisionally, be accepted as true, for the resistance to which a moving ion is exposed is due to collision with surrounding molecules, and these, unless the solution is exceptionally concentrated, will be nearly all water; we may expect, therefore, that the mobility will be little influenced by concentration, and the experimental numbers confirm this view.

If, then, Λ may be taken as a measure of γ , it must attain its greatest possible value when the dissociation is complete, *i.e.* when $\gamma = 1$. Reverting to the illustration given on p. 59, it is clear that if all the salt molecules are broken up into ions, the conduction due to the quantity (one equivalent) between the plates is the maximum. We have here an explanation of the tendency noted in the previous section, for the molecular conductivity to approach a maximum for very great dilution. It is, in fact, in accordance with what we know of ordinary gaseous dissociation that it should become complete when an indefinitely great volume is occupied by the dissociating substance. It is what may be expected, for dissociation of a molecule may occur spontaneously, but recombination requires the separated parts first to meet; if, then, the parts are so widely scattered that they practically never meet, there will be no recombination, and eventually all the substance will become dissociated.

We shall therefore use the symbol Λ_∞ —*i.e.* the equivalent conductivity at indefinitely great dilution—for this limiting, maximum value, due to complete dissociation. Then

$$\Lambda_\infty = 96600 (U_A + U_C)$$

and

$$\gamma = \frac{\Lambda}{\Lambda_\infty}$$

Arrhenius in establishing this formula gives (*loc. cit.*) a table in which the value of van't Hoff's factor as measured by two osmotic-pressure methods (plasmolysis and freezing-point)

is compared with $1 + (n - 1)\gamma$ as determined by the conductivity. The table is as follows:—

	Concentration (1000 n)	i Plasmolysis.	i Freezing-point.	i Conductivity.
Cane sugar	0.3	1.00	1.08	—
Acetic acid	0.33	—	1.04	1.01
KCl	0.14	1.81	1.93	1.86
LiCl	0.13	1.92	1.94	1.84
MgSO ₄	0.38	1.25	1.20	1.35
Ca(NO ₃) ₂	0.18	2.48	2.47	2.46
SrCl ₂	0.18	2.69	2.52	2.51
K ₄ FeC ₆ N ₆	0.356	3.09	—	3.07

The agreement is not so good as in the previous table for potassium chloride, because there were not such exact data available at the time of Arrhenius' paper. The table, however, brings out very plainly the general relation. Cane sugar is not a conductor at all; it accordingly, in solution, follows the ordinary laws of gases, and give the osmotic pressure calculated from its formula C₁₂H₂₂O₁₁. Acetic acid is a very poor conductor; it becomes considerably dissociated only when extremely dilute (p. 59). The other substances are all strong electrolytes, and give values for van't Hoff's factor very different from unity; and it may be noted that while the binary electrolytes never exceed two, the ternary (Ca(NO₃)₂, SrCl₂) approach three, and K₄FeC₆N₆, which breaks up into the group FeC₆N₆^{'''} and four K[•] ions, exceeds three.

It should be remarked that the simple laws of dilute solutions are not exact when the concentration much exceeds those in the above tables, *i.e.* when it approaches or exceeds normality. In particular, the conductivity is then an unsafe guide to the degree of dissociation, for the ionic mobilities are then probably different from those in very dilute solution. How great the discrepancy is, it is not at present possible to say. This point is, however, further considered below.

Since the equivalent conductivity is in any case the sum of two terms depending on the cation and anion respectively, particular importance attaches to the limiting values of the ionic conductivities.

These may be expressed by the symbols l_{c_e} and l_{A_x} , and we have the simple relation—

$$l_{\infty} = 96600 U$$

The conductivities are given in the table, p. 257. One example may serve to illustrate the mobilities; hydrogen is the most rapid ion, probably because it occupies the least space, and so threads its way more easily between water molecules. For hydrogen, $l_{\infty} = 318$ at 18° C. Hence $U = 0.00329$ cm. per second (for one volt per centimetre). Accordingly, under this potential gradient, a moderate one in practice, a hydrogen ion would, even if it were uncombined all the time, only travel the small distance of 12 cms. in an hour.

Temperature has an important influence on the conductivity of electrolytes. In nearly all cases the conductivity increases very fast with temperature, a fact closely related to the decrease in viscosity of water on heating. Certain empirical relations have lately been brought to light by systematic measurements of temperature coefficients, which are important, although their theoretical explanation is not clear. It is found¹ that the conductivity can be represented by a parabolic formula—

$$\kappa_t = \kappa_{18} [1 + a(t - 18) + 0.0177(a - 0.0177)(t - 18)^2]$$

where κ_t is the conductivity at t° .

$$,, \quad \kappa_{18} \quad ,, \quad ,, \quad ,, \quad 18^{\circ}.$$

a is a specific constant, which varies in the case of very dilute solutions from 0.0163 for HNO_3 to 0.0262 for Na_2CO_3 . Since the last term in the formula depends on the square of $t - 18$, it is unimportant at temperatures near the standard temperature 18° ; a may therefore be described as the coefficient at 18° ; *i.e.*

$$a = \frac{\text{increase in conductivity per } 1^{\circ}}{\text{conductivity at } 18^{\circ}}$$

when the range of temperature considered is not far from 18° . We see, then, that nitric acid changes 1.63 per cent., sodium carbonate 2.62 per cent. of its value, per degree.

The temperature coefficients of the ionic conductivities may

¹ Kohlrausch, *Berl. Sitzber.*, **24**. 1026-1033 (1901); **26**. 572-580 (1902).

be calculated from the same observations, and it is found that the coefficient regularly increases as the conductivity decreases, as the following table shows :—

Ion.	Ionic conductivity ($\times 10^9$).	Temp. coeff. ($\times 10^9$).
Li	33.44	0.0265
Na	43.55	0.0244
Ag	54.02	0.0229
K	64.67	0.0217
Cs	68.2	0.0212
H	318.0	0.0153

One consequence of this is that rise of temperature tends in the direction of making the mobilities of the ions all equal, and consequently tends to make the migration ratio of all electrolytes approach the value $\frac{1}{2}$.

§ 8. THE LAW OF DILUTION

The agreement observed between the degree of dissociation of electrolytes as measured by conductivity, and by osmotic pressure measurements, is not the only argument in favour of Arrhenius' theory. An important confirmation has been obtained by applying the law of mass action to electrolytes.

It has already been remarked that in an electrolyte there is a constant interchange of ions: molecules are broken up, and their dissociated parts recombine in different ways; and the state of equilibrium that exists at any time is of the statistical character familiar in the theory of gases. That is, a certain average proportion of molecules are dissociated, but no particular molecules are always so.

The main condition governing equilibrium of this character is the *law of mass action* (Guldberg and Waage's law), the mathematical consequences of which have been very fully worked out.¹ We need at present only consider its application to the special case of chemical equilibrium known as dissociation; *i.e.* when a single molecule breaks up into two or more parts.

¹ See Mellor, "Chemical Dynamics," in this series.

The simplest, and at the same time the most important case of this is the *dissociation of a binary electrolyte*, i.e. when each molecule forms two ions. If no other electrolyte is present, the number of anions is necessarily equal to that of cations.

If there be η equivalents of the electrolyte altogether in one cubic centimetre (*total concentration*), and of these the fraction γ be dissociated, $\gamma\eta$ is the number of equivalents of either anions or cations in one cubic centimetre (*ionic concentration*); while the concentration of the undissociated salt molecules is $\eta(1 - \gamma)$.

Then it may be shown that the law of mass action leads to the relation—

$$(\gamma\eta)^2 = K\eta(1 - \gamma)$$

or
$$\frac{\gamma^2\eta}{1 - \gamma} = K$$

where K is a numerical quantity known as the *dissociation constant* of the electrolyte in question.

This equation may be looked upon in the first place as a relation between the dissociation of a binary electrolyte and its concentration; other applications will be dealt with later.

As an example of the meaning, we may take a series of measurements on monochloroacetic acid by van't Hoff and Reicher.¹ They found that when one mol was dissolved in 205 litres of water, the equivalent conductivity was 132 (at 14.1°), the limiting value being 311. Accordingly $\gamma = 132 \div 311 = 0.423$, when $\eta = \frac{1}{205000}$. Therefore

$$K = \frac{(0.423)^2}{0.577 \times 205000} = 1.50 \times 10^{-6}$$

Again, when one mol was dissolved in 4080 litres, the molecular conductivity was 274. Hence $\gamma = 274 \div 311 = 0.881$,

$$K = \frac{(0.881)^2}{0.119 \times 4080000} = 1.60 \times 10^{-6}$$

or about the same.

The calculation just given somewhat exaggerates the discrepancy between different observations. The best test of the

¹ *Zeitschr. phys. Chem.*, 2, 781 (1888).

equation is to find, as above, K from each measurement, and from the mean of these, recalculate the values of γ . This is done in the following table:—

Dilution.	Equivalent conductivity.	γ from conductivity.	γ from dissociation constant.
20	51.6	0.166	0.163
205	132.0	0.423	0.430
408	170.0	0.547	0.543
2060	251.0	0.806	0.801
4080	274.0	0.881	0.880
10100	295.0	0.948	0.944
20700	300.0	0.963	0.971
∞	311.0	1.000	1.000

$$[K = 1.585 \times 10^{-6}]$$

It will be seen that the experimental numbers are in very satisfactory agreement with the law of mass action.

The application of the law of mass action to dissociation of electrolytes is often known as Ostwald's law of dilution, Ostwald¹ having applied it to his numerous measurements of conductivity. The measurements were all made in a thermostat at 25°, so that the equivalent conductivities are considerably greater than those given by Kohlrausch for 18°. They refer chiefly to organic acids; the law has also been shown by Bredig² to apply to many organic bases. The results obtained by these and other observers are given at length in Kohlrausch and Holborn's monograph, to which we must refer; they are, however, considered below (Chap. II.), on account of the important chemical meaning of the dissociation constant. This constant is, in fact, a measure of the "strength" of the acid, as a few examples may serve to show:—

	K.
Acetic acid	1.8×10^{-8}
Monochloroacetic acid .	155.0×10^{-8}
Dichloroacetic acid . .	5100.0×10^{-8}

¹ *Zeitschr. phys. Chem.*, **3**. 170, 241, 369 (1889); *Lehrbuch d. Allg. Chemie* (1893).

² *Zeitschr. phys. Chem.*, **13**. 289 (1894).

The substitution of each chlorine atom increases the strength of the acid considerably. (See Chap. II.)

Mineral acids and the strongest organic acids do not follow Ostwald's law, so that it is not possible to calculate a dissociation constant for them, in the sense given above. (Trichloroacetic acid belongs to this class.)

Among bases also it is only the weaker that follow the rule; thus for ammonia $K = 2.3 \times 10^{-8}$. But tetra-ethyl-ammonium hydroxide and similar bases, as well as the alkalis, deviate largely from the law of dilution.

Salts in all cases deviate from the rule.

It appears, then, that the law of dissociation in the form given by Ostwald is only applicable to weakly dissociated substances: strong electrolytes—*i.e.* salts and strong acids and bases, all of which are considerably dissociated even in moderately dilute solution—are subject to disturbing influences.

Many attempts at explaining the behaviour of strong electrolytes were made; but none of them are of value, except that of Jahn.¹ The usual theory of solutions, due chiefly to van't Hoff, is based on the assumption that there is an action between the solvent and the dissolved substance, but none between the parts of the dissolved substance itself; it being supposed that the molecules of dissolved substance are too widely separated for any appreciable forces to exist between them. It is by the mathematical expression of these views that Ostwald's law of dilution is obtained.

Jahn's explanation of the divergence from Ostwald's law by strong electrolytes, is that mutual action between the parts of the dissolved substance is too large to neglect. If this is so, there are two additional terms to be taken into account, one relating to mutual action between the ions (*i.e.* forces of attraction and repulsion, whilst the ions remain separate in the chemical sense) the other to influence of neutral molecules on ions. The former action is to be expected, for electrical forces exerted by ordinary charged bodies such as can be experimented with, are sensible at great distances, and it is therefore to be presumed that charged ions exert forces on

¹ *Zeitschr. phys. Chem.*, **37**. 490-503 (1901); **41**. 257-301 (1902).

each other even when at more than molecular distance apart, *i.e.* when outside the range of ordinary molecular forces. The second action, that of neutral molecules on ions, has been observed in many cases; as, for instance, when the addition of a neutral salt modifies the properties of an acid unrelated to it.

In the first of the two papers by Jahn quoted above, the mutual action of ions is introduced into the equations, and the results of calculation compared with the data obtained by freezing-point measurements. But as the modified theory of solutions affects the freezing-point formula also, Jahn in his second paper gives a complete theoretical discussion, in which all the usual laws of solutions are recalculated on the widened basis. He then applies his results to the data for KCl and NaCl. In doing so, however, it must be noted, he confines himself to the action of neutral molecules on ions, expressing the view that interaction of ions is not important over the range of concentration (0.1 to 0.01 normal) dealt with.

This view is not shared by Nernst,¹ who has also discussed the extended theory of solutions. Nernst's view, which seems to be the better founded, is that interaction of ions, and action of neutral molecules on ions, are of the same order of magnitude; interaction of neutral molecules being much less considerable. This being so, the two former actions should both be retained in the equations. Goebel² has worked out the data for KCl and NaCl on this assumption.

It appears from both Jahn's and Goebel's papers that the extended theory of solutions is capable of adequately representing the facts. The degree of dissociation is a function of the concentration of the electrolyte, though the formula expressing the relationship is not so simple as that of Ostwald; and consequently a "dissociation constant" can be calculated, though with a somewhat modified meaning, for strong electrolytes. The formula of Ostwald may be taken as practically correct up to a concentration of one hundredth normal or thereabouts; the formulæ of the new theory up to decinormal concentration; stronger solutions than that have not hitherto been

¹ *Zeitschr. phys. Chem.*, **38**, 487-500 (1901).

² *Zeitschr. phys. Chem.*, **42**, 59-67 (1902).

systematically considered. Unfortunately, the matter is not yet so far settled that it is possible to say with certainty whether Arrhenius' method of calculating the degree of dissociation is reliable or not. Jahn considers that the conductivity yields too high an estimate; *i.e.* $\gamma < \frac{\Lambda}{\Lambda_{\infty}}$ in strong solutions. But this view cannot be regarded as satisfactorily proved.

We may here conveniently summarize the various theoretical relations that have been found to hold with regard to the conductivity of electrolytes.

(i.) A gram-equivalent of ions carries a charge of 96600 coulombs. If there are η equivalents (say of cations) in 1 c.c. the quantity of (positive) electricity in 1 c.c. = 96600 η .

(ii.) If these cations are subjected to unit potential gradient they move with velocity U_c (mobility). The current produced by one equivalent of ions moving with this velocity is therefore = 96600 U_c . This is called the ionic conductivity (for complete dissociation) $l_{c_{\infty}}$.

(iii.) The conductivity of one equivalent of salt when completely dissociated is the sum of the conductivities of its ions. This is called the equivalent conductivity (for complete dissociation) $\Lambda_{\infty} = l_{c_{\infty}} + l_{a_{\infty}} = 96600 (U_c + U_a)$.

(iv.) If the dissociation is incomplete, and amounts to γ , the equivalent conductivity is—

$$\Lambda = 96600 \gamma (U_c + U_a)$$

(v.) The actual conductivity (of 1 cm. cube),

$$\kappa = \Lambda \eta = 96600 \eta \gamma (U_c + U_a)$$

(vi.) On the assumption (which is at least approximately true) that U_c and U_a are independent of η ,

$$\gamma = \frac{\Lambda}{\Lambda_{\infty}}$$

(vii.) According to the law of mass action (simplest theory) for binary electrolytes,

$$\frac{\gamma^2 \eta}{1 - \gamma} = K$$

the dissociation constant. Hence by (vi)

$$\frac{\Lambda^2 \eta}{(\Lambda_\infty - \Lambda) \Lambda_\infty} = K$$

For electrolytes yielding more than two ions, corresponding, but more complicated, relations hold. [For further discussion of the light thrown by conductivity measurements on dissociation, and on chemical constitution, *vide infra*, Chap. II.]

§ 9. CONDUCTIVITY OF MIXTURES

In a solution containing more than one electrolyte, the conductivity is that due to all the ions together. Stated formally, we may say, if there are in 1 c.c. η_1 equivalents of an ion having mobility U_1 , η_2 of another whose mobility is U_2 , and so on,

$$\kappa = 96600(\eta_1 U_1 + \eta_2 U_2 + \dots)$$

Here η_1, η_2 are, of course, to be taken as referring to the actual ions in solution without regard to any undissociated compounds from which they may have arisen.

So far the rule is quite simple and obvious. Complications come in, however, in determining the amount of ions present. In general, if two solutions are mixed, the mixture does not contain the same quantity of ions as the separate parts held between them.

The dissociation in mixtures of electrolytes, like other cases of chemical equilibrium, is regulated by the law of mass action. This must now be considered in a more general form than was required in § 8, where the ionisation of a single salt was dealt with.

It was there stated that for a binary electrolyte

$$(\gamma\eta)^2 = (1-\gamma)\eta K$$

where K is constant.

It will be more convenient to write this equation in a slightly different form. $\gamma\eta$ is the concentration of either the anion or the cation: $(1-\gamma)\eta$, that of the undissociated molecules. Writing η_A , η_C , and η_{CA} for these three quantities, the equation becomes

$$\eta_C \cdot \eta_A = \eta_{CA} K$$

Now, when more than one electrolyte is present in solution, η_c and η_A are not necessarily equal. *E.g.* if the cation and anion considered are hydrogen and the acetyl group, then, in a solution of acetic acid to which some sodium acetate has been added, there will clearly be more acetyl than hydrogen. Nevertheless, it is found that the same relation holds, the value of K being unaltered; so that the formula expressing the law of mass action comes to have a widened meaning.

For a numerical example we will suppose a quarter normal solution of acetic acid, to which sodium acetate is added sufficient to make it $\frac{1}{20}$ normal with respect to that salt.

In the original acid we have—

$$\eta = \frac{1}{4000}$$

$$\eta_{H^+} = \eta_{CH_3COO^-} = \gamma\eta = \frac{\gamma}{4000}$$

$$\eta_{CH_3COOH} = (1 - \gamma)\eta = \frac{1 - \gamma}{4000}$$

$$K = 1.8 \times 10^{-8}$$

Hence
$$\frac{\gamma^2}{4000^2} = \frac{1 - \gamma}{4000} \times 1.8 \times 10^{-8}$$

giving
$$\gamma = 0.0085$$

The dissociation of the acid is therefore a little less than 1 per cent. From this we may calculate the quantity of ions:

$\eta_{H^+} = \eta_{CH_3COO^-} = 0.0085 \times \frac{1}{4000} = 2.1 \times 10^{-6}$ equivalents per cubic centimetre.

Sodium acetate is a strongly dissociated substance. We shall not be far out if in $\frac{1}{20}$ n. solution we take it as completely dissociated. If this is so, the amount of acetyl ions in 1 c.c. is $\frac{1}{20000} = 50 \times 10^{-6}$ equivalents.

It appears, then, that the sodium acetate solution would contain about 24 times as much free acetyl as the acetic acid alone. In a mixed solution (though the exact mathematical treatment is difficult) we may take it that there are 24 or 25 times as many acetyl ions as in the pure acid. But we have the relation—

$$\eta_{H^+} \times \eta_{CH_3COO^-} = K\eta_{CH_3COOH}$$

As most of the acid remains undissociated in any case, we

may treat the right side of the equation as being the same in the two problems: *i.e.* take $\eta_{\text{CH}_3\text{COOH}}$, the concentration of the undissociated acid as being practically identical with η , the weighed amount of acid per cubic centimetre.

Practically, then, the equation becomes

$$\eta_{\text{H}^+} \times \eta_{\text{CH}_3\text{COO}^-} = \text{constant}$$

But addition of sodium acetate has made the amount of acetyl ions some 25 times as great as without it; it must, therefore, have made the amount of hydrogen ions about 25 times as small as before.

Remembering, then, that the strength of an acid means merely the amount of hydrogen ions it contains, we arrive at the important conclusion that, weak as the acetic acid is alone, it becomes about 25 times weaker by addition of the stated amount of sodium acetate. The rule is general that *a weak acid is greatly weakened by addition of its own neutral salts.*

This instance may serve to show the complexity of the conditions occurring in mixed solutions. The case of two electrolytes with a common ion¹ and that of double decomposition² have been partly worked out, on the basis of the ordinary formula for the law of mass action. To solve these problems strictly it would be necessary to make use of the extended theory of solutions (of Jahn and Nernst).

§ 10. NON-AQUEOUS SOLUTIONS

It was at one time thought that only aqueous solutions conduct electricity. This is not the case; some other liquids, notably the liquefied gases, ammonia, sulphur dioxide, and hydrocyanic acid, dissolve salts, and make excellently conducting solutions, frequently of higher conductivity than aqueous. Very little is at present known with regard to these solutions, but enough to show that their properties are in general more complicated than those of solutions in water. We have seen

¹ Arrhenius, *Zeitschr. phys. Chem.*, 5. 7.

² Arrhenius, *loc. cit.*, 2. 293. See also van't Hoff, *Theoretical and Physical Chemistry*, vol. i.

above that the osmotic pressure and conductivity of aqueous solutions follow simple laws fairly easy to discover. The hypothesis of electrolytic dissociation in accordance with the general laws of chemistry is sufficient to explain most of the phenomena observed. These laws, however, are only very partially applicable to non-aqueous solutions.

It may be remarked at the outset that water, which, according to the evidence of surface tension, is a highly "associated" liquid—*i.e.* consists largely of double molecules H_4O_2 —has little tendency to admit of double molecules in substances dissolved in it. This is the rule: when the solvent is associated, the dissolved molecules are mostly simple, and *vice versâ*. Ammonia, sulphur dioxide and pyridine, all good solvents, are unassociated, so that it is to be expected that salts dissolved in these media should tend to form molecular aggregates, and that these aggregates should give off ions of greater complexity than those occurring in water. It is not probable that a complete account of the behaviour of non-aqueous solutions can be derived from this principle, but it may at least indicate some of the difficulties in the way of an explanation.

Of the scanty data available, those about sulphur dioxide are the most extensive, thanks to the admirable work of Walden and Centnerschwer.¹

Sulphur dioxide in the liquid form has a conductivity about equal to that of pure water. It therefore presumably suffers a small amount of dissociation itself. This can hardly take place otherwise than

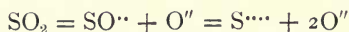

Either, or both, these pairs of ions may be formed, it is not known which; in favour of the existence of S^{\cdots} it may be mentioned that ions of tellurium with four positive charges are known.

The univalent halogen salts mostly dissolve in sulphur dioxide. Those tested include chlorides, bromides, iodides, and thiocyanates of K, Na, Rb, NH_4 , mono-, di-, tri-, and tetramethyl ammonium, as well as ethyl and benzyl bases. The

¹ *Zeitschr. phys. Chem.*, **39**, 513-596 (1902).

results at 0° are given in Fig. 27, in which the dilution (litres per gram-equivalent) is represented by the abscissæ, equivalent conductivity by the ordinates. It will be at once seen

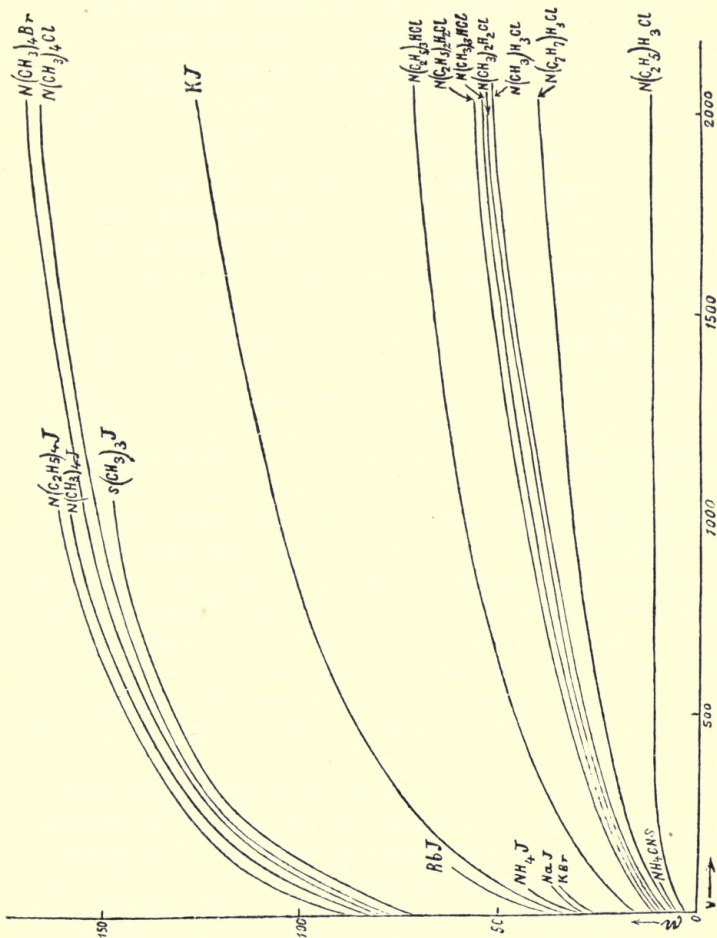

FIG. 27.

that a remarkable regularity exists in the behaviour of the various salts; but that the regularity is by no means identical with that of aqueous solutions.

For a dilution of 1024 litres, solutions of these salts in water (at 0°) show $\Lambda = 50$ to 80 . In SO_2 solution they vary from 12 to 163. Yet this does not appear to be due to varying degree of dissociation, for the lower curves show just as much indication of a limiting value of Λ as the higher. Again, these very divergent conductivities cannot be expressed in Kohlrausch's manner as the sum of two parts, one for each ion; for if the values of Λ be analysed in this way no constant values for L_A and L_C are obtained.

With regard to the law of dilution, the authors did not attempt to apply Jahn's theory of strong electrolytes; they tried empirical formulæ that had been found by Rudolphi¹ and van't Hoff² to hold for aqueous salts solutions; but neither formula is applicable to solutions in sulphur dioxide.

Walden and Centnerschwer next proceeded to make measurements on the temperature change of conductivity. These they extended over a far wider range than has been done for any other solvent; from near the freezing-point (-76°) to the critical point ($+157^{\circ}$). The results are therefore of unusually great interest.³ It was found that in all cases the conductivity first increases with rise of temperature, and then falls off; following, roughly, a parabolic formula. The maximum conductivity lies at very varying temperatures—from -70° for benzyl-ammonium chloride to $+7^{\circ}$ for tetra-ethyl-ammonium iodide; the temperature is higher for the better conducting salts.

At high temperatures the conductivity always falls off, and practically disappears at the critical point; this although some of the salts used remain dissolved in the gaseous SO_2 above the critical temperature.

Hagenbach⁴ has also measured the conductivity of solutions in SO_2 up to the critical temperature, and obtained on the whole similar results; he finds, however, that a trace of conductivity is shown by the gaseous solutions.

Liquid ammonia is another substance that possesses strong

¹ *Zeitschr. phys. Chem.*, **17**, 385 (1895).

² *Ibid.*, **18**, 301 (1895).

³ See also the important work of Kramers (p. 90, *infra*).

⁴ *Ann. d. Phys.*, **5**, 276-312 (1901).

ionising power, and whose solutions have been much studied. Franklin and Kraus,¹ especially, have measured the conductivity of a large number of solutions in ammonia, mostly at temperature -38° ; and have also collected data as to boiling-points and other physical properties of these solutions, as well as their facility for chemical reaction. The behaviour of ammoniacal solutions differs less from that of aqueous than do the SO_2 solutions studied by Walden; indeed, in one respect they have been found to follow even simpler laws than aqueous salt solutions. Alkaline salts, while freely dissolved by liquid ammonia, are less dissociated than in aqueous solutions of the same strength; but by pushing the dilution to an extreme (50,000 litres or more per equivalent) it was found possible to trace the equivalent conductivity till it approached the limit; and then, on calculating the degree of dissociation from $\frac{\Lambda}{\Lambda_{\infty}}$, it was found that the values so obtained agree with Ostwald's law of dilution. Thus certain salt solutions in ammonia follow the very simple conditions that hold only for weak acids and bases in aqueous solution, giving an important confirmation of the principles on which the conductivity of solutions has been explained. The limiting equivalent conductivity in ammonia is extraordinarily high, some three times as great as that in water; so that the frictional resistance experienced by the ions must be unusually small.

Very many other detached experiments have been made on solutions in hydrocyanic acid, organic nitrites, amines, in alcohol, ether, mixtures of water and alcohol, and other liquids, but hardly anything in the way of generalisations has yet been arrived at. Mention may be made of the work of Kahlenberg² and his students, who give a large collection of experimental data, but too hastily dismiss the possibility of bringing them into accordance with the dissociation theory.

The examination of a large number of solvents has, however, at least given some insight into the physical and chemical properties that are associated with ionising power. The first

¹ *Amer. Chem. Journ.*, **21**, 1, 8; **28**, 277; **24**, 83.

² *Journ. phys. Chem.*, **5**, 339 (1901) *et seq.*

suggestion was made by J. J. Thomson and by Nernst; they showed that it is liquids of high dielectric constant that afford good conducting solutions. The dielectric constant of water is about 80; other liquids with high values of it are hydrocyanic acid (95), methyl alcohol (32), formic acid (57), pyridine (20), ammonia (16), which all exercise considerable dissociating power; while the hydrocarbons, which do not form electrolytic solutions at all, have dielectric constants from 2 to 4. There is, however, only a rough parallelism between the two properties, many exceptions being found. It should be remarked that two electric charges separated by any medium possess an amount of energy inversely proportional to the dielectric constant of the medium. It will therefore require less work to separate a positive and negative ion in water or hydrocyanic acid than in other liquids. This fact, based on the principles of electrostatics, affords a certain theoretical justification for the Nernst-Thomson rule, since dissociation might be expected to occur most freely, *cet. par.*, in a medium that allows the ions to be separated with little expenditure of work.

Brühl¹ has given a widened meaning to the hypothesis, without, however, making it any more exact, by his conception of the *medial energy*. This is the energy of the medium on which its power of dielectric separation, tautomerisation, and ionisation depend, and which finds its simplest expression in the latent heat of evaporation, *i.e.* in the work required to break up the liquid entirely into a gas. It is true that large latent heat usually goes with high dielectric constant and considerable ionising power; but, again, the relation is an irregular one, evidently complicated by other factors. Brühl also points out that good dissociators have unsaturated chemical affinities (oxygen in water, nitrogen in ammonia, etc.); but, on the other hand, it is not all such unsaturated compounds that dissociate well.

Dutoit and others have attempted to bring dissociating power into connection with molecular complexity or "association" in the liquid state; but for this there is little evidence, as sulphur dioxide and ammonia are both unassociated.

¹ *Zeitschr. phys. Chem.*, 30. 1-63 (1899).

Walden and Centnerschwer, remarking that both dissociating power and surface tension practically vanish at the critical point, draws a parallel between these two properties, analogous to the Nernst-Thomson rule quoted above ; and with about as much, or perhaps more reason. For a discussion on the subject, with reference to previous work, we may refer to their paper (*loc. cit.*). The table (p. 259) is quoted from the same source.

It must not be supposed that different media behave similarly with respect to different groups of electrolytes. *E.g.* acetone shows considerable dissociating power for salts such as KCl, but hardly any for HCl, whereas in water these two substances are about equal in dissociation. No complete explanation can be found, therefore, that does not take into account the properties of the dissolved substance as well as the solvent.

§ 11. CONDUCTION OF FUSED SALTS.

The conductivity of pure substances at ordinary temperatures appears to be always small, when the conduction is electrolytic. Thus, SO_2 , HCN, NH_3 , the liquids which, with water, form the most highly conducting solutions, possess in themselves about the same conductivity as water—an amount almost negligibly small compared with that of electrolytes dissolved in these media.

At high temperatures it is different. One class of bodies—salts—is known to conduct excellently when fused ; another—certain metallic oxides—to conduct well in the solid form at still higher temperature. The conduction in the former is undoubtedly electrolytic ; in the latter probably so.

A considerable number of measurements of the specific conductivity of fused salts has been made. There is, however, no safe means, at present, of estimating either the degree of dissociation or the ionic velocities, for conduction causes no change in chemical composition except to set free products at the electrodes. Thus if LiCl be electrolysed (with carbon

electrodes) it is decomposed, metallic lithium being collected at the cathode, and chlorine at the anode. But there is no other change to enable us to trace the mechanism of conduction. Hence we are met with the difficulty which in the case of solutions has been turned—that of knowing whether there are a few ions moving with high speeds, or many with low. The conception of molecular or equivalent conductivity is then inappropriate, and it is best to compare the actual conductivities (per centimetre cube) with those of solutions. The following table (quoted from Haber's *Elektrochemie*) will show the main points. The conductivity usually increases much with rise of temperature, and often exceeds that of the best aqueous solutions.

	Temperature.	Conductivity (mhos.).
AgNO ₃	272° Cent.	0·97
	373° „	1·32
KCl	702° „	1·20
	800° „	2·40
NaCl	720° „	2·87
	780° „	4·05
CaCl ₂	710° „	1·00
	760° „	1·22
PbCl ₂	508° „	1·56
	730° „	2·66

Kramers¹ gives the conductivity of dissolved and fused potassium nitrate over a wide range of temperature. His object was to determine the conductivity of mixtures of water and potassium nitrate in all proportions. This was not possible for any one temperature, but the character of the different isothermals is so regular that the end was practically attained by combining the measurements belonging to different isothermals. The results may be seen from Fig. 28. Abscissæ represent percentage composition from 0 (pure H₂O) to 100 (pure KNO₃); ordinates conductivity; the curves drawn are isothermals, *i.e.* each summarises the conductivity measurements made at one temperature. The isothermals appear to start from zero

¹ *Arch. Neerl.*, 1. 455-494 (1896).

on both axes, for the conductivity of pure water is practically nothing, at least at low temperatures (at temperatures above

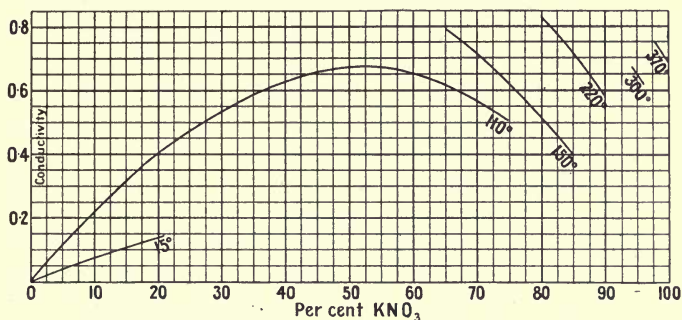

FIG. 28.

100° it has not been measured). They rise somewhat rapidly to a maximum which seems to occur for about the same percentage (53 per cent. KNO₃) for all temperatures; at least it is sensibly constant from 60° to 130°, which was the range of measurement for the middle concentrations. The isothermals then slope downwards, more slowly at high temperatures, since they lead to finite (and considerable) conductivities for pure KCl at 335° to 370°. The figure brings out in the clearest manner the favourable influence on their conductivity of mixing two electrolytes. It is much to be desired that such valuable researches should be extended to other substances, and in particular that the conductivity of solvents (water and others) at high temperatures should be measured.

It has been satisfactorily shown that fused salts follow Faraday's laws of electrolysis. This comes out, perhaps, best in the important papers by R. Lorenz.¹ Apparent exceptions to the laws may occur through certain secondary causes, of which the most important is that the products of electrolysis diffuse through the liquid and recombine, when, of course, the yield is less than that calculated from the quantity of electricity used. Diffusion can be prevented by mechanical means, such as surrounding the electrodes with tubes; this was done by Lorenz

¹ *Zeitschr. f. Elektroch.*, 7. 277-287 (1900); 753-761 (1901).

for ZnCl_2 , and then the theoretical yield was obtained, to within one or two per cent.

Certain metallic oxides conduct when raised to very high temperatures, and have been adopted, at the suggestion of Nernst, for the manufacture of incandescent lamps. It is possible to run current for many hours through these, in the same direction, and it would therefore seem at first sight as if they must conduct in the same manner as metals. Nernst,¹ however, gives reasons to the contrary. A body with so high conductivity of a metallic kind (*i.e.* due to movement of free electrons) should, according to the usual views on electromagnetism, be opaque, but the oxides are transparent. Also—and it is perhaps a more convincing argument—definite traces of electrolysis were found in some cases; the chemical composition at the cathode, after current has been running, is different from that at the anode. When mixtures of two earths were used, one of them was sometimes found to be aggregated near one electrode, as if migration had occurred in a manner comparable with that familiar in aqueous solutions. Moreover, the conductivity of mixtures is greatly in excess of that of each separate oxide, a phenomenon also strikingly reminiscent of the electrolytes known at low temperatures.

Nernst accordingly concludes that the current which flows through such bodies is really the “residual current” due to recombination; *i.e.* the products of electrolysis diffuse rapidly (though the oxides remain solid), and by recombining afford a constant new supply of ions. This phenomenon is observed to a small extent in aqueous solutions: at the very high temperature of the Nernst lamp filaments it appears to be the most important feature of conduction.

Fused salts, both pure and mixed, have been largely used for practical electrolysis, and should therefore in the future be the subject of valuable scientific observations. At present practice is ahead of theory. A few measurements of decomposition voltages have been made, however, and will be referred to later.

¹ *Zeitschr. f. Elektroch.*, 6. 41-43 (1899).

CHAPTER II

RELATION OF CHEMICAL CONSTITUTION TO CONDUCTIVITY

Written by T. S. MOORE, B.A., B.Sc., Lecturer and
Demonstrator in the University of Birmingham.

ALTHOUGH we are not at present able to express the relation between the chemical constitution of a substance and the conductivity of its solutions by simple rules, yet a close examination of the experimental results obtained with aqueous solutions has brought to light many regularities. Aqueous solutions only will be considered in this chapter, for practically no connection has been found between conductivity and constitution in other cases.

It has been shown in Chapter I. that the conductivity of a solution depends on the number of ions present, on their velocities, and on the charges they carry. We must, therefore, examine separately the connection between each of these properties and the chemical constitution.

§ I. RELATION OF CHARGE CARRIED TO CONSTITUTION.

We have already seen that the magnitude of the charge carried depends only on the valency¹ of the ion.

The valency of an element must at present be accepted as one of its primary properties ; but, as every student of chemistry

¹ Valency has here its more general meaning, *i.e.* it is applied to complex as well as simple ions.

knows, the valency of a combination of elements can be immediately deduced from a knowledge of the constitution of the combination, and of the valencies of its elements. The relation between the magnitude of the charge carried and the constitution is thus comparatively simple.

The sign of the charge carried is intimately connected with the nature of the ion. As has been mentioned in Chapter I., all the simple metallic ions, the hydrogen ion and certain complex ions, such as those derived from ammonium, NH_4 , phosphonium PH_4 , etc., carry positive charges. On the other hand, the halogens, hydroxyl, and an extremely large number of complex ions, carry negative charges.

The transition from an anion to a cation is generally accompanied by a large change of constitution, *e.g.* CrO_4^{--} to Cr^{++} , so that a comparison between the constitution of anions and of cations gives very little result. We can only say that an ion containing a large number of electro-negative atoms or groups—*e.g.* O, Cl, NO_2 —will probably be an anion.

Among the metal-ammonia compounds the change from anion to cation can be made to take place in stages, in each of which the change of constitution is comparatively small. In the example given on p. 136, the effect of successive introduction of negative groups into an anion is seen clearly.

§ 2. RELATION OF MOBILITY TO CONSTITUTION.

The numbers quoted in this section are not the actual velocities of the ions, but are proportional to them, being in fact the equivalent conductivities (in mhos¹) for infinite dilution at 25°. From them the following conclusions have been drawn:—

The mobility of elementary ions is a periodic function of the atomic weight, and rises with it in each series of analogous

¹ In cases where a different unit was used in the original memoirs, the numbers have been recalculated by means of the factors given by Kohlrausch and Holborn, *Leitvermögen der Elektrolyte*.

elements ; but analogous elements with atomic weights greater than 35 have approximately equal mobilities.¹

This is apparent from the curve (Fig. 28), which represents the following numbers :—

F 54.4
Cl 75.1
Br 78.1
I 77.0

Li 42.6
Na 52.6
K 75.5
Rb 78.6
Cs 78.8

Ag 63.2
Tl 74.4

$\frac{1}{2}$ Mg (62)
 $\frac{1}{2}$ Ca (66)
 $\frac{1}{2}$ Sr (67)
 $\frac{1}{2}$ Ba (68)

$\frac{1}{2}$ Cu (63)
 $\frac{1}{2}$ Zn (58)
 $\frac{1}{2}$ Cd (59)

$\frac{1}{3}$ Al (45)
 $\frac{1}{3}$ Cr (65)

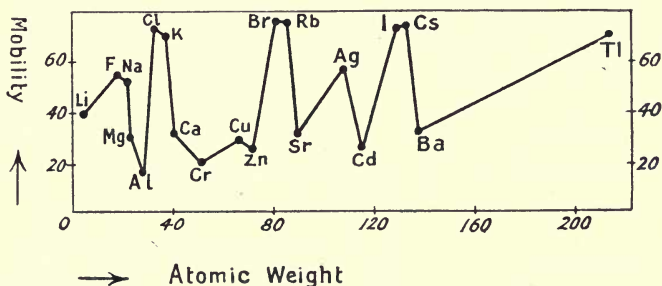

FIG. 29.

The mobility of hydrogen—364.9 at 25°²—is much greater than that of any other ion, and, like many other properties of hydrogen, finds no expression in the periodic law.

*Isomeric ions and metameric anions have the same mobility.*³

Name of acid.	Mobility of anion.	Name of acid.	Mobility of anion.
Butyric acid	32.8	o nitrobenzoic acid . . .	31.9
Isobutyric acid	33.1	p nitrobenzoic acid . . .	32.2
α Chlor-isocrotonic acid	34.1	o toluic acid	32.0
β Chlor-isocrotonic acid	33.9	m toluic acid	32.1
β Chlor-crotonic acid . . .	34.1	p toluic acid	31.7
		Phenylacetic acid	31.9

¹ Bredig, *Zeitschr. phys. Chem.*, **13**, 191 (1894).

² Noyes, *Jour. Amer. Chem. Soc.*, **24**, 944 (1902).

³ Bredig, *loc. cit.*

ISOMERS.

	Mobility of cation.		Mobility of cation.
$\left\{ \begin{array}{l} \text{Propylamine,} \\ \text{CH}_3\text{CH}_2\text{CH}_2\text{NH}_2 \\ \text{Isopropylamine,} \\ \text{CH}_3 > \text{CH.NH}_2 \\ \text{CH}_3 \end{array} \right\}$	42·9	$\left\{ \begin{array}{l} \text{Isobutylamine,} \\ \text{(CH}_3)_2\text{CH.CH}_2\text{NH}_2 \\ \text{Secondary butylamine,} \\ \text{CH}_3 > \text{CH.NH}_2 \\ \text{C}_2\text{H}_5 \end{array} \right\}$	38·8
	42·8		38·7
		$\left\{ \begin{array}{l} \text{Tertiary butylamine} \\ \text{(CH}_3)_3\text{CH.NH}_2 \end{array} \right\}$	39·2

Phenylacetic acid is metameric with the three toluic acids, and bears out the rule that metameric anions have the same mobility.

Metameric cations, on the other hand, have, in general, different mobilities. And Bredig found that among metameric cations of the ammonium type, the mobility is greater, the greater the number of carbon atoms joined directly to the nitrogen atom. That is, for ions of the same empirical formula, a quaternary substituted ammonium ion has a greater mobility than a tertiary ion, a tertiary ion a greater mobility than a secondary ion, and a secondary ion a greater mobility than a primary ion.

METAMERS.

$\left\{ \begin{array}{l} \text{Ethylamine } 50\cdot1 \\ \text{Dimethylamine } 53\cdot6 \end{array} \right\}$	$\left\{ \begin{array}{l} \text{Propylamine } 42\cdot9 \\ \text{Trimethylamine } 50\cdot3 \end{array} \right\}$
$\left\{ \begin{array}{l} \text{Butylamine, CH}_3\text{CH}_2\text{CH}_2\text{CH}_2\text{NH}_2 \text{ } 38\cdot9 \\ \text{Tetramethyl ammonium hydroxide } 46\cdot7 \end{array} \right\}$	

*Comparing anions with anions, and cations with cations, the mobility of an ion is the smaller the greater the number of atoms it contains.*¹

Cl' 75·1	ClO ₃ ' 63·1
Br' 78·1	BrO ₃ ' 54·0
I' 77·0	IO ₃ ' 40·6

Name of acid.	Mobility of anion.	Name of base.	Mobility of cation.
Formic acid	54·8	Ammonia	75·3
Acetic acid	41·0	Methylamine	61·6
Propionic acid	36·7	Ethylamine	50·1
Butyric acid	32·8	Propylamine	42·9

Both of these series of organic compounds are homologous,

¹ Bredig, *loc. cit.*

and it is seen that *the effect of substitution of CH₃ for hydrogen is less, the greater the number of atoms in the molecule.* It follows that substitution of CH₃ for hydrogen in an ion with a very large number of atoms, will cause a very small change in the mobility.

Formula of anion.	Mobility.
NH ₁₈ C ₁₄ O ₄ ·	25·6
NH ₂₀ C ₁₅ O ₄ ·	24·6

There are many cases among cations to which the rule that the mobility decreases with an increase in the number of atoms, does not apply. Such are those in which substitution of an alkyl radical causes an increase in the number of carbon atoms directly attached to nitrogen, so that the increase of mobility due to this cause is greater than the decrease in mobility due to the increase in the number of atoms in the ion, *e.g.*

	Mobility of anion.
Methyl diethylamine (tertiary)	38·3
Dimethyl diethyl ammonium hydroxide	40·9

An increase of CH₂ is here accompanied by an increase in mobility.

*The following changes diminish the mobility:*¹—

- (1) Addition of hydrogen, carbon, chlorine, or bromine.
- (2) The replacement of hydrogen by chlorine, bromine, or iodine, or by the methyl group (with the exceptions mentioned above), or by the amido group NH₂, or by the nitro group NO₂.
- (3) The substitution of an element in an ion by a chemically analogous element of greater atomic weight, *e.g.*

Name of base.	Mobility of cation.
Tetramethyl ammonium hydroxide	46·7
Tetramethyl phosphonium hydroxide	42·4
Tetramethyl arsonium hydroxide	40·7
Tetramethyl stibonium hydroxide	34·9

¹ Bredig, *loc cit.*

The substitution of sulphur for oxygen forms an exception to this rule, since it is accompanied by an increase in mobility.

In all cases the effect on the mobility of any particular change in constitution is less the greater the number of atoms in the ion. It follows that the mobility of ions tends to a minimum value, which, according to Bredig, is reached with ions of 50 or 60 atoms, and which appears to lie between 17 and 20, both for anions and cations. Moreover, the differences in the effects of different elements soon disappear as the number of atoms in the ion increases, and it has been found that the mobility of anions of more than 12 atoms (Ostwald), and of cations of more than 40 atoms (Bredig), depends only on the number of atoms in the ion, and not on their nature.

§ 3. RELATION OF NUMBER OF IONS IN SOLUTION TO CONSTITUTION.

The number of ions produced in the solution of a compound depends on the number of ions formed in the splitting up of one molecule, and on the number of molecules which split up.

(a) Number of Ions produced from One Molecule.

The number of ions given by a molecule of a compound on ionisation is determined by its constitution. The following cases are those which most often occur:—

(1) **Compounds giving primarily Two Ions.**—Such are mono-basic acids, mono-acid bases, and the salts formed by their interaction; and the salts formed by the interaction of di-basic acids and di-acid bases. This is the simplest mode of ionisation possible, but the case is complicated by the power which ions have of uniting with neutral molecules to form complex ions.

As will be seen later, there are but few univalent ions

which possess this power to any marked extent, so that the dissociation of a compound giving only univalent ions is generally quite simple. An exception is iodic acid, HIO_3 (see p. 103), which in concentrated solutions gives complex ions; in dilute solutions these complex ions are broken up.

The tendency to form complex ions is more marked among the divalent ions, and from observations of the transport numbers of the ions of copper and magnesium sulphates, it appears that concentrated solutions of these salts contain complex ions, *e.g.* $\left(\begin{array}{l} \text{SO}_4 \\ \text{SO}_4 \end{array} \right) \text{Mg}$ which on dilution of the solution are broken up (see p. 135).

(2) **Compounds giving Three Ions on Complete Dissociation.**—Such are the di-basic acids, the di-acid bases and salts formed by their action with mono-acid bases and mono-basic acids respectively.

Here, in addition to the disturbance caused by formation of complex ions, we have the possibility of *ionisation in stages*. Thus for a compound giving a divalent anion A'' and two univalent cations B' , we have—

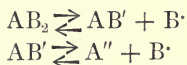

Ionisation in stages occurs with di-basic acids; *e.g.*, H_2SO_4 gives ions HSO_4' in addition to the H' and SO_4'' ions; and with acid salts, *e.g.* KHSO_4 , gives ions HSO_4' in addition to the simple ions; and possibly with a few salts formed from di-acid bases and mono-basic acids. If it occurs with salts formed from mono-acid bases and di-basic acids—*e.g.* K_2SO_4 —it is only to an extremely small extent.¹ It does not occur with di-acid bases except those of the organic series; but it must be remembered that the inorganic di-acid bases are not very soluble, so that an examination of concentrated solutions, in which the existence of complex ions is more likely, has not been possible.

Many irregularities occur among the salts in this class

¹ Noyes, *Zeitschr. phys. Chem.*, **36**, p. 63 (1901).

owing to the formation of complex ions by combination of the simple ions with neutral molecules. Thus it has been shown¹ that solutions of cadmium iodide, cadmium chloride, zinc iodide, and zinc chloride, all contain considerable numbers of complex ions at medium concentration. And Noyes² has found that similar ions exist to a smaller extent in solutions of the chlorides of barium, strontium and calcium. See p. 136.

(b) *Degree of Ionisation.*

We have now to consider the relation between constitution and power to dissociate into ions. This naturally involves comparison of the degree of ionisation for different compounds, and since the extent of ionisation depends largely on the dilution, and to a small extent on the temperature, it is necessary to take the dilution and temperature into account.

Most of the determinations have been carried out at 25°, and a great many at 18°. Data are available by which most of the measurements at 18° can be recalculated for 25°. The numbers quoted in the following pages refer to 25° unless otherwise stated. In taking the dilution into account, we may either compare the degree of ionisation of compounds at a fixed dilution, or compare the dilutions necessary to produce a fixed degree of ionisation. Both methods are used, the former for those compounds which do not give an ionisation-constant, and the latter for those that do. For the ionisation-constant of a binary electrolyte is the value of $\frac{\gamma^2}{v(1-\gamma)}$ where γ is the degree of dissociation, and v the dilution in cubic centimetres per gram-equivalent. If now γ be made equal to $\frac{1}{2}$, the value of the constant K becomes $\frac{1}{2v}$. That is, $2K$ is equal to the concentration (in the same system of units as v) at which

¹ Hittorf, *Pogg. Ann.*, **106**, 513 (1859).

² Noyes, *loc. cit.*

half the electrolyte is ionised; so that for binary electrolytes, in comparing the ionisation-constants, we are comparing the concentration necessary to produce a given degree of dissociation, viz. 50 per cent.

All electrolytes are, according to theory, entirely ionised at infinite dilution. Practically, a great many electrolytes are fully ionised at dilutions of 1024 or 2048 litres. In such solutions, the equivalent conductivity depends entirely on the ionic velocity and on the magnitude of the charges carried by the ions. This was discovered by Kohlrausch, and may be expressed in the form: *The equivalent conductivity of an electrolyte in very dilute solution is the sum of two quantities, one characteristic of the anion, and the other of the cation.* (For the meaning of equivalent conductivity, see p. 58.)

Since the mobility of the hydrogen ion is so much greater than that of any other ion, the conductivity of a solution of an acid is mainly due to the hydrogen ions present. From this it follows that the molecular conductivity of a di-basic acid is approximately double that of a mono-basic acid at dilutions at which both the compounds are fully ionised. (The molecular conductivity is the conductance of that volume of the solution which contains one gram-molecule of the electrolyte.) A similar statement applies to bases, since the mobility of OH', though much less than that of hydrogen, is still considerably larger than that of any other ion. Examples may be seen in the tables given (p. 102).

Inorganic Acids.—The inorganic acids, for the most part, belong to the class of good conductors, and do not obey Ostwald's dilution law. It is therefore necessary to compare the respective degrees of ionisation for each dilution. The following values for the molecular conductivity are taken from *Leitvermögen der Elektrolyte* (Kohlrausch and Holborn), pp. 160 and 167. The constants for carbonic acid, sulphuretted hydrogen, and hydrocyanic acid are taken from Walker's¹ results.

¹ *J. C. S.*, 77, p. 8 (1900).

MOLECULAR CONDUCTIVITY AT 25°.

$v =$ (in litres)	2	4	8	16	32	64	128	256	512	1024
Hydrochloric acid HCl	353	366	378	386	393	399	401	403	—	—
Chloric acid HClO ₃	353	364	373	381	387	391	399	402	402	402
Perchloric acid HClO ₄	358	372	383	390	399	404	406	407	407	407
Hydrobromic acid HBr	364	377	385	391	398	402	405	405	406	405
Bromic acid HBrO ₃	—	—	—	—	359	370	381	390	396	401
Hydriodic acid HI	364	376	384	391	397	402	405	406	406	404
Iodic acid HIO ₃	193	229	268	301	327	349	364	371	376	377
Periodic acid HIO ₄	—	108	139	179	223	270	312	348	374	387
Hydrofluoric acid HF	—	29·6	35·8	44·3	59·5	78·6	104·7	138	177	224
Hyposulphurous acid H ₂ S ₂ O ₄	—	720	726	754	773	790	806	815	822	829
Tetrathionic acid H ₂ S ₄ O ₆	—	—	729	748	773	788	808	822	830	843
Selenious acid H ₂ SeO ₃	34·6	44·1	57·0	74·9	98·4	128	164	204	246	285
Selenic acid H ₂ SeO ₄	440	468	498	533	575	626	674	720	744	769
Phosphoric acid H ₃ PO ₄	64	77	96	124	156	195	246	279	317	341
Hypophosphorous acid H ₃ PO ₂	140	172	207	245	281	312	335	352	361	367
Phosphorous acid H ₃ PO ₃	129	156	187	222	257	292	318	337	351	358
Thiocyanic acid HSCN	348	359	368	375	382	386	391	391	393	—
Permanganic acid HMnO ₄	336	354	371	377	385	392	398	403	403	401
Arsenic acid H ₃ AsO ₄	—	—	73·1	95·6	125·5	160·6	201·4	243·7	282·6	310·4
Sulphurous acid H ₂ SO ₃	—	—	—	—	189·2	229·1	264·9	297·4	323·3	346·0

MOLECULAR CONDUCTIVITY AT 18°.

$v =$ (in litres)	2	5	10	20	33·3	50	100	200	500	1000
Hydrochloric acid HCl	327	342	351	360	364	367	370	373	376	377
Nitric acid HNO ₃	324	340	350	357	361	364	368	371	374	375
Sulphuric acid H ₂ SO ₄	410	428	450	506	544	572	616	660	702	722

DISSOCIATION CONSTANTS AT 25°.

Sulphuretted hydrogen	0·57 × 10 ⁻¹⁰
Carbonic acid	3·0 × 10 ⁻¹⁰
Hydrocyanic acid	0·013 × 10 ⁻¹⁰

The first six acids on the table are practically completely ionised at a dilution of 1024 litres, and since their anions have approximately the same mobility, the molecular conductivity at this dilution is very nearly the same for all of them. Thus the values of the molecular conductivity for the different acids at any particular dilution are proportional to the respective degrees of ionisation. It is seen, therefore, that these acids follow the same scheme of ionisation, since the numbers for the molecular conductivity are practically the same for all of them at any particular dilution. The small increase in molecular conductivity from $v = 2$ litres to $v = 1024$ litres, shows that even in concentrated solution these acids are ionised to a very large extent. Permanganic acid is ionised to a slightly less extent than perchloric acid. Nitric acid follows the same scheme of ionisation as hydrochloric acid.

Iodic and periodic acids are not so near complete ionisation, at a dilution of 1024 litres, as the above acids. The large rise in the value of the molecular conductivity of these two acids with dilution is due to the presence in solution of complexes such as $(\text{HIO}_3)_2$, $(\text{HIO}_4)_2$, which break at first into two ions— H^+ and $(\text{H}(\text{IO}_3)_2)'$, H^+ and $(\text{H}(\text{IO}_4)_2)'$. The molecular conductivity is therefore less in concentrated solutions than it would be if the ionisation were normal. In dilute solutions these complex ions are split up into the simple ions, and the rise in conductivity with dilution is therefore greater than corresponds to a normal ionisation. A similar explanation probably applies to hydrofluoric acid. A large rise of molecular conductivity with dilution, due to the splitting up of complex ions, is also to be seen in selenic acid, sulphuric acid, selenious acid, and sulphurous acid.

Phosphoric, phosphorous, and hypophosphorous acids behave as somewhat weakly ionised monobasic acids. The relative degrees of ionisation of the three atoms of hydrogen in phosphorous acid may be deduced from the following facts. When phosphorous acid is titrated with an alkali, using methylorange as an indicator, it behaves as a monobasic acid, *i.e.* requires one molecule NaOH for each molecule of acid. If phenolphthaleïn is used as indicator, two molecules of

NaOH are required, *i.e.* the acid behaves as if it were dibasic. From the theory of indicators it follows that the ionisation of the second atom of hydrogen of phosphorous acid takes place to a smaller extent than the ionisation of methylorange, but to a greater extent than that of phenolphthaleïn, and that the third hydrogen atom is ionised to a smaller extent than phenolphthaleïn. Thus the ionisation of the second hydrogen atom is of the same order as that of an acid of the acetic series (see below), and the ionisation of the third hydrogen atom is of the same order as that of an alcohol, *i.e.* the third atom is practically not capable of ionisation. The same is true for phosphoric acid.

In general, the effect of addition of oxygen or sulphur to an acid is to increase its power of giving ions. Thus, hypsulphurous and tetra-thionic acids are as strongly ionised as the halogen acids. Sulphuric and selenic acid are ionised to a less extent than hypsulphurous and tetrathionic acids, and sulphurous and selenious acids to a less extent than sulphuric and selenic acids. The effect of addition of sulphur to hydrocyanic acid is seen to be enormous.

The three weak acids, carbonic acid, sulphuretted hydrogen, and hydrocyanic acid give constants. The following table¹ of the percentage degrees of ionisation shows the relation of these very weak acids to the stronger acids:—

Name of acid.	Percentage degree of dissociation in decinormal solution.
Hydrochloric acid	91·4
Carbonic acid	0·174
Hydrogen sulphide	0·075
Hydrocyanic acid	0·011

Organic Acids.—The connection between constitution and degree of ionisation is much more easily traced with organic acids than with inorganic, for our knowledge of chemical constitution is much more advanced for organic than for inorganic compounds.

The experiments on organic acids have been carried out chiefly by Ostwald and his pupils. Practically all these acids

¹ Walker, *loc. cit.*

follow Ostwald's dilution law. The numbers given are in terms of the ionisation-constants K , calculated from the equation $K = \frac{\gamma^2}{v(1 - \gamma)}$ where v is expressed in cubic centimetres.

For the fatty acids the following numbers were obtained :¹—

		$K \times 10^3$
Formic acid	HCOOH	0'021
Acetic acid	CH ₃ COOH	0'0018
Propionic acid	CH ₃ CH ₂ COOH	0'0013
Butyric acid	CH ₃ (CH ₂) ₂ COOH	0'0015
Isobutyric acid	(CH ₃) ₂ CH.COOH	0'0014
Normal valeric acid	CH ₃ (CH ₂) ₃ COOH	0'0016
Isovaleric acid	(CH ₃) ₂ CH.CH ₂ COOH	0'0017

The values of the first three constants are in descending order ; the others vary irregularly within small limits. Although the substitution of CH₃ in the simpler acids causes a decrease, the decrease is not constant, and indeed is less the further from the carboxyl group the substitution takes place. The constants for isomers are not generally so nearly of the same value as those for the butyric acids and the valeric acids.

		$K \times 10^3$
Monochloroacetic acid ²	CH ₂ Cl.COOH	0'155
Dichloroacetic acid	CHCl ₂ .COOH	5'14
Trichloroacetic acid	CCl ₃ .COOH (circa)	121'0
Monobromoacetic acid	CH ₂ Br.COOH	0'138
Monoiodoacetic acid ³	CH ₂ I.COOH	0'075
Cyanoacetic acid	NC.CH ₂ .COOH	0'370
Thiocyanoacetic acid	NCS.CH ₂ COOH	0'265

It is seen that the substitution of an atom of halogen for hydrogen in acetic acid causes a large increase in the ionisation-constant, the effect being greater for chlorine than for bromine, and greater for bromine than for iodine. The substitution of a second atom of chlorine has a smaller effect than the substitution of the first, and the substitution of the third atom a smaller effect than the substitution of the second, as is seen from the following ratios :—

¹ Franke, *Zeitschr. phys. Chem.*, **16**, 463 (1895).

² Ostwald, *Zeitschr. phys. Chem.*, **3**, 177 (1889).

³ Walker, *Zeitschr. phys. Chem.*, **10**, 563 (1892).

Ratio of K for monochloroacetic acid to K for acetic acid	= 86
„ „ K „ dichloroacetic acid „ „ K „ monochloroacetic acid	= 33
„ „ K „ trichloroacetic acid „ „ K „ dichloroacetic acid	= 23.5

All the substituent groups considered above, except cyanogen, form with hydrogen strongly dissociated acids: HCl, HSCN, etc. Cyanogen, on the other hand, although it causes a greater increase in the constant of acetic acid than the substitution of chlorine, gives with hydrogen one of the weakest acids known. It therefore seems probable that the cyanogen group in hydrocyanic acid is differently constituted from the group in cyanoacetic acid, which however is known to be $-C\equiv N$. It would thus appear that hydrocyanic acid has the formula $H-N=C$, an hypothesis which is supported by several other facts.

α -bromopropionic acid ¹	$CH_3.CHBr.COOH$	$K \times 10^5$
β	$CH_2Br.CH_2COOH$	0.108
$\alpha\alpha$ -dibromopropionic acid,	$CH_3.CBr_2.COOH$	0.0098
$\alpha\beta$	$CH_2Br.CHBr.COOH$	3.3
		0.67

Ratio of K for α -bromopropionic acid to K for propionic acid	= 80
„ „ K „ β „ „ „ K „ „ „	= 7.3
„ „ K „ $\alpha\beta$ -dibromopropionic acid to α -bromopropionic	= 6.1

The effect of substitution in the β position, which is further from the carboxyl than the α position, is much less than that of substitution in the α position. The effect of α substitution of bromine raises the constant in approximately the same ratio as a similar substitution in acetic acid (ratio of K for bromoacetic acid to k for acetic acid = 77). From the above ratios it also appears that the effect of β substitution of bromine is approximately the same for propionic and for α -bromopropionic acids. From the chlorinated acetic acids and brominated propionic acids it is seen that *the effect of two substituents together is less than that calculated on the assumption that each substituent acts as if the other were not there*. In only one of the above cases is the assumption even approximately true, viz. in $\alpha\beta$ dibromopropionic acid.

¹ Walker, *loc. cit.*

		$K \times 10^5$
Glycollic acid	$\text{CH}_2\text{OH}.\text{COOH}$	0'0152
Glyoxalic acid	$\text{CH}(\text{OH})_2.\text{COOH}$	0'0474
Lactic acid	$\text{CH}_3.\text{CHOH}.\text{COOH}$	0'0138
Ethylene-lactic acid	$\text{CH}_2\text{OH}.\text{CH}_2.\text{COOH}$	0'00311

Ratio of K for glycollic acid to K for acetic acid = 8
 ,, ,, K ,, glyoxalic acid ,, K ,, glycollic acid = 3'1
 ,, ,, K ,, lactic acid ,, K ,, propionic acid = 10'0

As in the substitution of chlorine in acetic acid, the substitution of the second hydroxyl has a much smaller effect than the substitution of the first hydroxyl. And, indeed, the ratios of the effects of the first and second substitutions are approximately the same for hydroxyl and chlorine (see p. 106).

		$K \times 10^5$
Thioacetic acid ¹	CH_3COSH	0'0469
Thioglycollic acid	$\text{CH}_2\text{SH}.\text{COOH}$	0'0225

The effect of the substitution of sulphur for oxygen is greater in thioacetic acid, in which the place of substitution is nearer the hydrogen atom which splits off.

		$K \times 10^5$
Crotonic acid	$\begin{array}{c} \text{CH}_3 \\ \diagdown \\ \text{C} = \text{C} \\ \diagup \\ \text{H} \end{array} \begin{array}{c} \diagup \\ \text{COOH} \\ \diagdown \\ \text{H} \end{array}$	0'00204
Isocrotonic acid	$\begin{array}{c} \text{H} \\ \diagdown \\ \text{C} = \text{C} \\ \diagup \\ \text{CH}_3 \end{array} \begin{array}{c} \diagup \\ \text{COOH} \\ \diagdown \\ \text{H} \end{array}$	0'00360
Tetrolic acid	$\text{CH}_3\text{C} \equiv \text{C}.\text{COOH}$	0'246

These substances are obtained by withdrawal of hydrogen from butyric acid ($K \times 10^5 = 0'0015$). It is seen from these numbers, and Ostwald has found it to be generally true, that unsaturated compounds ionise more readily than the corresponding saturated compounds. This is attributed to the electro-negative or acid-forming nature of carbon, and the electro-positive nature of hydrogen.

The explanation of the greater constant of iso-crotonic acid as compared with crotonic acid has not yet been found. From the acids of the acetic series it appears that the methyl group lowers the constants of acids in which it is substituted—a behaviour characteristic of positive groups. But there are

¹ Ostwald, *loc. cit.*

many cases in which the substitution of methyl causes an increase in the constant, and, indeed, since methane (CH_4) is neutral, and hydrogen electro-positive, we should expect the group CH_3 to be slightly electro-negative, and therefore, by analogy with other negative groups, to increase the value of the constant. If we assume that methyl in this case acts as a positive group, an explanation of the difference between the crotonic acids is given by stereo-chemistry, according to which the methyl group is nearer the carboxyl group in crotonic acid than in iso-crotonic acid, and thus exerts a greater influence on the ionisation of the former.

More regularities have appeared in the constants for aromatic acids than in those for fatty acids.

		$K' \times 10^5$
Benzoic acid ¹	$\text{C}_6\text{H}_5\text{COOH}$	0'0060
o Toluic acid	$\overset{2}{\text{CH}_3}\text{C}_6\text{H}_4\overset{1}{\text{COOH}}$	0'0120
m „ „	$\overset{3}{\text{CH}_3}\text{C}_6\text{H}_4\overset{1}{\text{COOH}}$	0'0051
p „ „	$\overset{4}{\text{CH}_3}\text{C}_6\text{H}_4\overset{1}{\text{COOH}}$	0'0051

The substitution of methyl has a much greater effect in the ortho than in the meta or para positions, as, indeed we should expect, since according to our conception of the benzene molecule, groups ortho to one another are nearer together than those which are meta or para to one another. The fact that the substitution of methyl raises the constant in one case and diminishes it in another very similar case has not been explained; it points to the conclusion that the constitutive influences which affect the power of dissociation of a compound are exceedingly complicated. Somewhat similar relations are found among the hydroxybenzoic acids.

		Ratio of K' to K' for ben- $K' \times 10^5$ zoic acid.	
o-hydroxybenzoic acid ² (salicylic acid)	$\text{OH}\overset{2}{\text{C}_6\text{H}_4}\overset{1}{\text{COOH}}$	0'102	17'0
m „ „	$\text{OH}\overset{3}{\text{C}_6\text{H}_4}\overset{1}{\text{COOH}}$	0'0087	1'5
p „ „	$\text{OH}\overset{4}{\text{C}_6\text{H}_4}\overset{1}{\text{COOH}}$	0'0029	0'5

¹ Ostwald, *loc. cit.*

² *Ibid.*

Again, the ortho substitution has a very large effect. Substitution in the meta position has caused a slight increase in the constant, but in the para position, a decrease to half its value. It may be remarked here that substitution of hydroxyl increases the constants of all acids, fatty and aromatic, except when the substitution is para to a carboxyl group in a benzene nucleus.

		$K \times 10^5$	Ratio to K for benzoic acid.
o-nitrobenzoic acid	$\overset{2}{\text{NO}_2} \cdot \text{C}_6\text{H}_4 \overset{1}{\text{COOH}}$	0.616	103.0
m " "	$\overset{3}{\text{NO}_2} \cdot \text{C}_6\text{H}_4 \overset{1}{\text{COOH}}$	0.0345	5.9
p " "	$\overset{4}{\text{NO}_2} \cdot \text{C}_6\text{H}_4 \overset{1}{\text{COOH}}$	0.0396	6.6
o-chlorobenzoic acid	$\overset{2}{\text{Cl}} \cdot \text{C}_6\text{H}_4 \overset{1}{\text{COOH}}$	0.132	22.0
m " "	$\overset{3}{\text{Cl}} \cdot \text{C}_6\text{H}_4 \overset{1}{\text{COOH}}$	0.0755	2.5
p " "	$\overset{4}{\text{Cl}} \cdot \text{C}_6\text{H}_4 \overset{1}{\text{COOH}}$	0.0093	1.5

Again, the effect is very great when the substituent is in the ortho position. The relative effects of the substitution in the meta and para positions seem to depend on the nature of the substituent.

		$K \times 10^5$	
o-amidobenzoic acid	$\overset{2}{\text{NH}_2} \cdot \text{C}_6\text{H}_4 \overset{1}{\text{COOH}}$	0.0009	} (approx.)
m " "	$\overset{3}{\text{NH}_2} \cdot \text{C}_6\text{H}_4 \overset{1}{\text{COOH}}$	0.0080	
p " "	$\overset{4}{\text{NH}_2} \cdot \text{C}_6\text{H}_4 \overset{1}{\text{COOH}}$	0.0010	

It is extremely surprising to find that the substitution of an electro-positive group in the meta position should raise the constant.

In the fatty series we have seen that the effect of two substituents together is less than that calculated on the assumption that each substituent group has the same effect as if the other were not there, although in $\alpha\beta$ -dibromopropionic acid the difference between the calculated and experimental values was not great. The following table gives the

¹ Ostwald, *loc. cit.*

experimental and calculated values of the constants for the dihydroxybenzoic acids:—

	$K \times 10^5$ (found)	$K \times 10^5$ (calc.)
2.3 dihydroxybenzoic acid ¹	0.114	0.253
2.5 „ „	0.108	0.153
2.4 „ „	0.0515	0.051
2.6 „ „	5.0	1.73
3.4 „ „	0.0033	0.0043
3.5 „ „	0.0091	0.0130

The observed constant is less than the calculated constant in nearly all cases, except that of diortho-dihydroxybenzoic acid, in which the effect of the two groups is very large. In only one case is the agreement very good. The agreement is better for the trihydroxybenzoic acids, using the experimental numbers for the dihydroxy acids as the basis of calculation.

	$K \times 10^5$ (found)	$K \times 10^5$ (calc.)
Gallic acid $C_6H_2COOH(OH)_3$	0.004	0.0045
Pyrogallol carboxylic acid $C_6H_2COOH(OH)_3$	0.055	0.067

A similar comparison has been made in the case of the chloronitrobenzoic acids,² the calculation being made from the numbers for the various chloro and nitro benzoic acids given on page 109.

	$K \times 10^5$ (found)	$K \times 10^5$ (calc.)
o-chloro m-nitrobenzoic acid $(COOH.Cl.NO_2)$	0.65	0.78
p „ m „ „ $(COOH.Cl.NO_2)$	0.046	0.055
o „ p „ „ $(COOH.Cl.NO_2)$	1.03	0.87
p „ o „ „ $(COOH.Cl.NO_2)$	1.00	0.96
m „ o „ „ $(COOH.Cl.NO_2)$	1.52	1.60

The agreement is very fair, considering the nature of the assumption made in the calculation. For, as Ostwald has pointed out, no two substitutions can be perfectly similar. For example, the substitution of a group in benzoic acid will affect the whole molecule, which will therefore not be affected in exactly the same way as benzoic acid by a further substitution.

¹ Ostwald, *loc. cit.*

² Bethman, *Zeitschr. phys. Chem.*, 5, 386 (1890).

The ionisation constants of certain sulphinic acids have been measured by Lovén.¹

	$K \times 10^5$
Benzenesulphinic acid $C_6H_5SO_2H$ (circa)	3·5
p-toluenesulphinic acid $CH_3C_6H_4SO_2H$ („)	2·5

The sulphonic acids are almost fully ionised in medium concentration, and belong to the class of strong acids. This was proved by observation of the rate of inversion of cane-sugar caused by solution of these acids. The sulphonic and sulphinic acids are therefore much more strongly ionised than the corresponding carboxylic compounds. The effect of the substitution of a basic group in a sulphonic acid is to reduce the ionisation to that of a comparatively weak acid.²

	$K \times 10^5$
Methylanilinesulphonic acid	0·0665

The transition from the benzoic to the pyridine series—*i.e.* the replacement of $-CH=$ by $-N=$ in the ring itself—is accompanied by a decrease in the ionisation-constant.³

	$K \times 10^5$
Picolinic acid $C_5H_4N.CO_2H$ ¹	0·0003
Nicotinic acid $C_5H_4N.CO_2H$ ²	0·0014
Isonicotinic acid $C_5H_4N.CO_2H$ ³	0·0011

The decrease is much greater when the carboxyl is attached to a carbon atom adjacent to the nitrogen atom than in any other case.

Dibasic Organic Acids.—The equations representing the ionisation of a dibasic acid AH_2 , are—

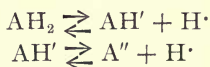

It will be seen from the numbers which follow that the ionisation-constant corresponding to the second equation (which will be called the second ionisation-constant) is

¹ *Zeitschr. phys. Chem.*, **19**. 456.

² Ebersbach, *Zeitschr. phys. Chem.*, **11**. 608.

³ Ostwald, *loc. cit.*

always very much smaller than the constant corresponding to the first stage of ionisation (or first ionisation-constant). Moreover, the second stage of ionisation is retarded by the action of the hydrogen ions which result from the first stage of ionisation, in accordance with the law of mass action, so that, except in dilute solution, the ionisation proceeds practically no farther than the first stage. The first ionisation-constant may therefore be calculated from the electrical conductivity, using the formula

$$K_1 = \frac{\Lambda_v^2}{\Lambda_x (\Lambda_x - \Lambda_v)}$$

where Λ_x is the molecular conductivity of the compound at infinite dilution calculated from the mobilities of the ions H' and HA' . It is obvious that if the ionisation according to the second equation proceeds to an appreciable extent, the numbers obtained for the ionisation constant K_1 will increase with the dilution. The following are the values of $K \times 10^5$ obtained for maleic and fumaric acids at various dilutions:—

v (in liters)	= 32	64	128	256	512	1024	2048
Maleic acid	—	1.21	1.16	1.14	1.15	1.17	—
Fumaric acid	0.093	0.094	0.095	0.097	0.099	0.116	0.140

The numbers for maleic acid are constant within the errors of experiment, while those for fumaric acid first show the influence of the second ionisation when the dilution is greater than 512 liters. At this dilution, the first ionisation of fumaric acid has proceeded to an extent of about 50 per cent. Ostwald has found that the influence of the second ionisation does not generally appear until the ionisation of the first hydrogen atom has reached 50 per cent., and that in many cases this influence cannot be observed until the ionisation of the first hydrogen atom has reached 70 or 80 per cent. So that the first ionisation-constant of dibasic organic acids can always be determined from the electric conductivity. The first ionisation-constant of a dibasic acid has not quite the same meaning as the ionisation-constant of a monobasic acid, as is seen from the following considerations:—¹

¹ Wegscheider, *Wien. Akad. Ber.*, 1895, 104.

An unsymmetrical dibasic acid, *e.g.* methyl succinic acid,

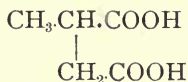

can undergo the first ionisation in two ways—

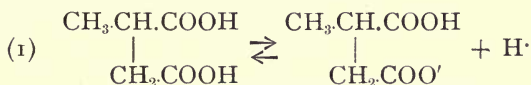

or

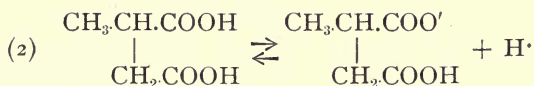

The anions thus produced, although isomeric, are obviously different; and these two ionisations must have different ionisation-constants. Let them be C_1 and C_2 respectively.

Then, if x and y be the respective degrees of ionisation, neglecting for the present the second stage of ionisation, we have for dilution v —

$$\text{concentration of H' ions} = \frac{x + y}{v}$$

$$,, \quad \text{of anion corresponding to first ionisation} = \frac{x}{v}$$

$$,, \quad ,, \quad ,, \quad ,, \quad \text{second} \quad ,, \quad = \frac{y}{v}$$

$$,, \quad \text{of non-ionised acid} \quad . \quad . \quad . \quad = \frac{1 - x - y}{v}$$

[N.B.— $x + y$ must be less than unity, for we are neglecting the second stage of ionisation.]

From the law of mass action it follows that

$$C_1 = \frac{x(x + y)}{v(1 - x - y)}$$

and

$$C_2 = \frac{y(x + y)}{v(1 - x - y)}$$

$$\therefore C_1 + C_2 = \frac{(x + y)^2}{v(1 - x - y)}$$

Now, if the electric conductivity of a solution of this acid

is measured, and the first ionisation-constant of the acid calculated in the usual way, leaving out any consideration of the possibility of two modes of ionisation, we shall have, since $x + y$ is the degree of ionisation,

$$K_1 = \frac{(x + y)^2}{v(1 - x - y)}$$

$$\therefore K_1 = C_1 + C_2.$$

If the acid is symmetrical, $C_1 = C_2$

$$\text{and } K_1 = 2C_1$$

That is, *the first ionisation-constant of a dibasic acid, as calculated from the electrical conductivity, is equal to the sum of two ionisation-constants, one corresponding to each carboxyl group; if the acid is symmetrical, these constants are equal.*

When the dibasic acids are compared with the monobasic acids, this distinction is of importance, for although the constants C_1 and C_2 may be compared with the ionisation-constants of monobasic acids, the ordinary ionisation-constant K_1 may not.

The second ionisation-constant has been measured for a large number of acids by measurement of the concentration of the hydrogen ions in solution of their acid salts, by observation of the rate of inversion of cane-sugar by these solutions.

The solutions used were of such a dilution that the acid salts (KHA) were completely split up into the ions K^{\cdot} and HA^{\cdot} . The ion HA^{\cdot} again splits up, but not completely.

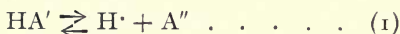

and a reaction between the ions follows.

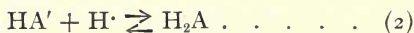

Let m = original concentration of acid salt

„ H = concentration of H ions

„ K_1 = first ionisation-constant of the acid (corresponding to the reverse reaction in equation (2))

„ K_2 = second ionisation-constant of the acid (corresponding to equation (1))

Then $C_{HA^{\cdot}} + C_{H_2A} + C_{A''} = m \quad \dots \quad (a)$

And since the sum of the negative charges on the ions must be equal to the sum of the positive charges,

$$C_{HA'} + 2C_{A''} = H + m \quad . \quad . \quad . \quad (b)$$

since m = concentration of K ions.

From the law of mass action

$$K_2 = \frac{H \times C_{A''}}{C_{HA'}} \quad . \quad . \quad . \quad (c)$$

$$K_1 = \frac{H \times C_{HA'}}{C_{H_2A}} \quad . \quad . \quad . \quad (d)$$

By elimination of $C_{HA'}$, $C_{A''}$, and C_{H_2A} from the equations (a), (b), (c), and (d), we get

$$K_1 K_2 = \frac{(K_1 + m + H)H^2}{m - H}$$

in which m is known, and H and K_1 may be determined, so that K_2 may be calculated.

The following tables are from a paper by W. H. Smith² (a pupil of Ostwald). The values of $K_1 \times 10^5$ were partly taken from Walden's results, and partly determined by Smith. Those for $K_2 \times 10^9$ are from Smith's experiments, which, since the concentration of hydrogen ions in the solution used was very small, were carried out at 100° C. Since the value of H in the above formula was determined for 100°, the value of K_1 used should correspond to the same temperature. As a matter of fact, the values corresponding to 25° were used, so that the numbers for K_2 are not altogether accurate, but probably show the order in which the acids come with regard to their power of undergoing the second stage of ionisation at 100° C.

		$K_1 \times 10^5$	$K_2 \times 10^9$
Malonic acid	HOOC.CH ₂ .COOH .	0'158	1'0
Succinic acid	HOOC.(CH ₂) ₂ .COOH .	0'00665	2'3
Glutaric acid	HOOC.(CH ₂) ₃ .COOH .	0'00473	2'7
Adipic acid	HOOC.(CH ₂) ₄ .COOH .	0'00376	2'4
Normal pimelic acid	HOOC.(CH ₂) ₅ .COOH .	0'00323	2'6
Suberic acid	HOOC.(CH ₂) ₆ .COOH .	0'00299	2'5

¹ Noyes, *Zeitschr. phys. Chem.*, **11**, 495.

² *Zeitschr. phys. Chem.*, **25**, 193.

On comparing the values of $\frac{1}{2} K_1$ for those acids with the constants for the corresponding acids in the acetic acid series, from which they are derived by the substitution of carboxyl for hydrogen, we see that this substitution causes always an increase in the constant; and that the increase is the less, the greater the number of CH_2 groups there are between the carboxyl groups.

The value of K_2 , on the other hand, at first increases and then varies irregularly within small limits, as the number of CH_2 groups between the carboxyl groups increases.

		$K_1 \times 10^5$	$K_2 \times 10^9$
Methylmalonic acid	$\text{HOOC.CH.CH}_3.\text{COOH}$	0.086	0.76
Methylsuccinic acid	$\text{HOOC.CH}_2.\text{CH}(\text{CH}_3).\text{COOH}$	0.0086	1.60
Ethylmalonic acid	$\text{HOOC.CH}(\text{C}_2\text{H}_5).\text{COOH}$	0.127	0.54
Ethylsuccinic acid	$\text{HOOC.CH}_2.\text{CHC}_2\text{H}_5.\text{COOH}$	0.0085	1.30
Dimethylmalonic acid			
	$\text{HOOC.C}(\text{CH}_3)_2.\text{COOH}$	0.0760	0.31
Mesodimethylsuccinic acid			
	$\text{HOOC.CH}(\text{CH}_3).\text{CH}(\text{CH}_3).\text{COOH}$	0.0123	0.53
Mesodimethylglutaric acid			
	$\text{HOOC.CH}(\text{CH}_3).\text{CH}_2.\text{CH}(\text{CH}_3).\text{COOH}$	0.0052	1.60
Mesodimethyladipic acid			
	$\text{HOOC.CH}(\text{CH}_3)(\text{CH}_2)_2.\text{CH}(\text{CH}_3).\text{COOH}$	0.0042	1.70
Paradimethylsuccinic acid			
	$\text{HOOC.CH}(\text{CH}_3).\text{CH}(\text{CH}_3).\text{COOH}$	0.0191	1.30
Paradimethylglutaric acid			
	$\text{HOOC.CH}(\text{CH}_3).\text{CH}_2.\text{CH}(\text{CH}_3).\text{COOH}$	0.0058	1.50
Paradimethyladipic acid			
	$\text{HOOC.CH}(\text{CH}_3)(\text{CH}_2)_2.\text{CH}(\text{CH}_3).\text{COOH}$	0.0042	1.70
Ethylmalonic acid	$\text{HOOC.CH}(\text{C}_2\text{H}_5).\text{COOH}$	0.127	0.54
Isopropylmalonic acid	$\text{HOOC.CH}(\text{C}_3\text{H}_7).\text{COOH}$	0.127	0.35
Propylmalonic acid	$\text{HOOC.CH}(\text{C}_3\text{H}_7).\text{COOH}$	0.112	—
Heptylmalonic acid	$\text{HOOC.CH}(\text{C}_7\text{H}_{15}).\text{COOH}$	0.102	0.61
Methylmalonic acid	$\text{HOOC.CH}(\text{CH}_3).\text{COOH}$	0.086	0.76
Dipropylmalonic acid	$\text{HOOC.C}(\text{C}_3\text{H}_7)_2.\text{COOH}$	1.12	0.05
Diethylmalonic acid	$\text{HOOC.C}(\text{C}_2\text{H}_5)_2.\text{COOH}$	0.74	0.18
Methylethylmalonic acid	$\text{HOOC.C}(\text{CH}_3)(\text{C}_2\text{H}_5).\text{COOH}$	0.161	0.17
Dimethylmalonic acid	$\text{HOOC.C}(\text{CH}_3)_2.\text{COOH}$	0.076	0.31

[NOTE.—Dialkylated succinic acids, in which each alkyl radical is attached to a separate carbon atom, can theoretically exist in four forms, corresponding to the four forms of dihydroxysuccinic or tartaric acid. Probably the paradialkylsuccinic acids are analogues of racemic acid, and the meso of mesotartaric acid.]

For purposes of comparison, acids of similar constitution are grouped together. In each group the acids are arranged in descending order of K_1 , and it is seen from the tables that this, with few exceptions, is the ascending order of K_2 for each group. That is to say, *of two analogous dibasic acids, that one has the larger second ionisation-constant, which has the smaller first ionisation-constant.*

This important result was first found by Ostwald, from a consideration of the dilutions at which the influence of the second stage of ionisation on the conductivity became appreciable. He explained this rule—assuming that the negative electrical charge on the anion is associated with the carboxyl to which the hydrogen ion was attached before ionisation—in the following way. The presence of a negative charge on the anion, caused by the splitting off of the first hydrogen ion, will cause a resistance to the appearance of a second negative charge, which, however, would necessarily appear if the second hydrogen atom were split off. And this resistance will be the greater, the nearer together the atoms with which the charges are associated, *i.e.* the nearer the two carboxyl groups. That is, other things being equal, the second ionisation-constant will be the less, the less the distance between the carboxyl groups. But we have seen that the first ionisation-constant is greater, the less the distance between the two carboxyls. It follows, therefore, that among acids which differ only with regard to the distances between the carboxyl groups, the second ionisation-constant will be the less, the greater the first ionisation-constant.

The fact that the alkylated malonic acids given in the last two groups obey the rule cannot be explained on this theory, unless the effect of an alkyl group is to alter the relative positions of the carboxyl groups to an extent depending on the nature of the alkyl group. For the rule is not a consequence of any direct relation between the ionisation-constants, but of the fact that both constants depend on the distance between the carboxyl groups. The introduction of any alkyl group into malonic acid diminishes the value of each of the constants K_1 and K_2 , and the decrease of K_2 is the less the greater the

decrease in K_1 . As may be seen from the numbers given in the fifth group, the methyl group has the greatest effect, and the other groups act in the order of the number of atoms they contain. Iso groups do not exert the same effect as the isomeric normal groups.

The substitution of a second alkyl group in a monoalkylated malonic acid (except the substitution of the methyl group in methylmalonic acid) causes an increase in K_1 , but again a decrease in K_2 ; and the decrease of K_2 is the greater, the greater the increase in K_1 . Dimethylmalonic acid has the smallest K_1 and the largest K_2 of any of the dialkylated malonic acids; and both are smaller than the corresponding constants for any monoalkylated malonic acid. All alkylated succinic acids have greater values for K_1 than succinic acid itself, and this constant increases with the number of alkyl groups. The constant K_2 suffers a corresponding decrease on the introduction of alkyl groups, the decrease being the greater, the greater the number of substituting groups.

CHARACTERISTIC EFFECT OF ISO-RADICALS.¹

	$K_1 \times 10^5$ for para acid.	$K_1 \times 10^5$ for meso acid.
Symm. dimethylsuccinic acid . . .	0'0196	0'0123
$\alpha\alpha_1$ -methylethylsuccinic acid . . .	0'0207	0'0201
$\alpha\alpha_1$ -methylpropylsuccinic acid . . .	0'0335	0'0271
$\alpha\alpha_1$ -methylisopropylsuccinic acid . . .	0'0158	0'066
$\alpha\alpha_1$ -methylisobutylsuccinic acid . . .	0'0226	0'056
$\alpha\alpha_1$ -methylisoamylsuccinic acid . . .	0'0236	0'0385

*So long as the radical substituted in methyl succinic acid is normal, the constants of both series increase with the number of atoms in the radical. But the substitution of an iso radical causes the constants of the para series to decrease, and the constants of the meso series to increase to a greater extent. The effect is greater, the nearer the characteristic grouping of the iso radical is to the carbon atom to which the group is attached.

Similar remarks apply to the symmetrical dialkyl acids. The difference between the effect of the propyl group and the isopropyl group is here very great.

¹ Bone and Sprankling, *J.C.S.*, 77. 1298 (1900).

	$K_1 \times 10^5$ for para.	$K_1 \times 10^5$ for meso.
Symm. dipropylsuccinic acid . . .	0.0250	0.049
Symm. diisopropylsuccinic acid . . .	0.0108	0.230

The effect of the substitution of an alkyl group for hydrogen varies, as we have seen, with the nature of the acid. Such a substitution causes always a decrease of the first dissociation constant in acids of the acetic series and in malonic acid, but an increase in the case of monoalkylated malonic acids and in succinic acid. We must either assume that no specific effect can be assigned to an alkyl group, or we must attribute these results to a secondary action. Such a secondary action is the probable alteration in the relative positions of the two carboxyl groups, caused by the substitution of alkyl groups. Of two dibasic acids in which the two carboxyl groups occupy different relative positions, we should expect that one to give an anhydride the more readily in which the carboxyls are the nearer together; but from their experiments on anhydride formation, Bone and Sprankling¹ concluded that the carboxyl groups of all dialkylated succinic acids are in the same relative position. It must, however, be remembered that such a rough method of measurement as this cannot be expected to give information as to the small changes of distance which, since the power of forming ions is such a highly constitutive property, would be sufficient to cause the variations observed.

It appears probable that the real explanation of the apparently irregular action of the alkyl groups is, that the substitution of these groups for hydrogen produces changes—perhaps small—in the configuration of the molecule of the acid, the nature of which depends on the alkyl groups and on the nature of the acid. This effect is superimposed on the specific effect of the alkyl groups, which would be observed if the substitution caused no change in configuration, and which varies with the nature of the group, and its distance from the carboxyl group. There is, of course, no reason to suppose that the action of an alkyl group is essentially

¹ *Loc. cit.* See also a later paper by Bone, Sudborough, and Sprankling (*J.C.S.*, **85**, p. 534 (1904), in which the conclusions arrived at are different from those described in the text.

different from that of any other substituent; but owing to the comparatively large specific volumes of these groups, the changes in configuration they cause are probably greater than those caused by such substituents as Cl or OH.

Halogen and other substitution-products of dibasic acids.		$K_1 \times 10^5$	
Monochloromalonic acid	$\text{HOOC} \cdot \text{CHCl} \cdot \text{COOH}$	4.0	Walden.
Monochlorosuccinic acid	$\text{HOOC} \cdot \text{CH}_2 \cdot \text{CHCl} \cdot \text{COOH}$	0.28	„
Tartronic acid	$\text{HOOC} \cdot \text{CHOH} \cdot \text{COOH}$	0.5	Skinner.
Malic acid	$\text{HOOC} \cdot \text{CH}_2 \cdot \text{CHOH} \cdot \text{COOH}$	0.0399	„
D-Tartaric acid	$\text{HOOC} \cdot \text{CHOH} \cdot \text{CHOH} \cdot \text{COOH}$	0.097	Ostwald.
L-Tartaric acid	„ „	0.097	„
Racemic acid	„ „	0.097	„
Mesotartaric acid	„ „	0.066	„
Tetrahydroxysuccinic acid	$\text{HOOC} \cdot \text{C}(\text{OH})_2 \cdot \text{C}(\text{OH})_2 \cdot \text{COOH}$	1.24	Skinner.

The effect of substitution of chlorine and of hydroxyl is seen to be similar to their effects in the monobasic acids. Chlorine has a smaller effect in malonic than in succinic acid, and the effect of chlorine in acetic acid is greater than in either.

As is required from the theory of stereo-isomerism, the constants of lævo- and dextro-tartaric acids are the same. Since the constant of racemic acid is equal to that for l- and d-tartaric acids, the solution of racemic acid must contain a mixture, and not a compound of these two acids.

Unsaturated dibasic acids.		$K_1 \times 10^5$	$K_2 \times 10^9$
Fumaric acid	$\text{H}-\text{C}-\text{COOH}$	0.093	18.0
	$\text{HOOC}-\text{C}-\text{H}$		
Maleic acid	$\text{H}-\text{C}-\text{COOH}$	1.17	0.39
	$\text{H}-\text{C}-\text{COOH}$		
Mesaconic acid	$\text{CH}_3-\text{C}-\text{COOH}$	0.079	6.8
	$\text{HOOC}-\text{C}-\text{H}$		
Citraconic acid	$\text{CH}_3-\text{C}-\text{COOH}$	0.340	0.24
	$\text{H}-\text{C}-\text{COOH}$		

The constants are seen to be greater than those of the saturated acids to which these acids correspond.

Isomers of this type show plainly the connection between the distance between the carboxyl groups and the values for the ionisation-constants. Comparing analogous compounds, K_1 is the greater, and K_2 the smaller, the nearer the

two carboxyls in the molecule. The introduction of methyl diminishes both K_1 and K_2 , but the decrease of K_2 is smaller for maleïc than for fumaric, while the decrease of K_1 is smaller for fumaric. This may be explained by assuming that in addition to its specific effect, the methyl group causes the distance between the carboxyl groups to increase, and that the increase is greater for maleïc than for fumaric acid.

		$K_1 \times 10^5$	$K_2 \times 10^9$
o-phthalic acid $C_6H_4(COOH)_2$. . .	0'121	2'2
m " "	. . .	0'029	10'0

As in other cases, the effect is greatest when the substitution takes place in the ortho position. It is seen that the usual relation between K_1 and K_2 again appears.

It has been proved (p. 114) that the ionisation-constant K_1 of a dibasic acid is the sum of the ionisation-constants corresponding to the two carboxyl groups. If, now, on esterifying one of the carboxyl groups, the effect is simply to take away the power of giving ions from one carboxyl group, and no change is produced in the ionising power of the other carboxyl group, the ionisation-constant of the ester-acid should be one-half the value of K_1 for the acid itself, if the acid is symmetrical. And the ionisation-constant (K_1) of an unsymmetrical dibasic acid should be the sum of the ionisation-constants of the two ester-acids derived from it.

The following numbers are from Walker's measurements :¹—

Name of acid.	$K_1 \times 10^5$ for acid.	$K_1 \times 10^5$ for ester-acid.	Ratio of diss. con- stant of acid to that of ester-acid.
Malonic acid . . .	0'158	0'0451	3'6
Succinic acid . . .	0'0066	0'00302	2'2
Methylmalonic acid	0'086	0'0387	2'2
Dimethylmalonic acid	0'076	0'0304	2'5
Ethylmalonic acid .	0'127	0'0401	3'2
Adipic acid . . .	0'00376	0'0025	1'5
Diethylmalonic acid	0'741	0'0231	32'0
Suberic acid . . .	0'00296	0'00146	2'0
Sebacic acid . . .	0'00276	0'00143	1'9
Fumaric acid . . .	0'093	0'0473	2'0
Maleïc acid . . .	1'17	0'110	10'6
Phthalic acid . . .	0'121	0'0551	2'2

¹ *J.C.S.*, 61. 696 (1892).

Leaving out the acids with large ionisation-constants ($K_1 \times 10^5$ greater than 0.1), we find that the ratio given in the third column varies between 2 and 2.5. If the substitution of ethyl for hydrogen had no effect except that of taking the power of forming ions away from the COOH group, the ratio would be in each case 2, since all these acids are symmetrical.

The following numbers for unsymmetrical acids are from the measurements of Wegscheider:—¹

	$K_1 \times 10^5$ for free acid.	$K_1 \times 10^5$ for α ester.	$K_1 \times 10^5$ for β ester.
3-nitrophthalic acid	1.31	0.21 *	1.6 *
Hemipinic acid	0.110	0.0144 †	0.093 †
Bromoterephthalic acid	0.62	0.0371 *	0.50 *
Nitroterephthalic acid	1.87	0.0770 *	1.90 *
Hydroxyterephthalic acid	0.269	0.0250 *	0.277 *

* Methyl ester.

† Propyl ester.

The mean of the ratios obtained by dividing the sum of the ionisation-constants of the ester-acids by the value of K_1 for the acid is, for methyl acid-esters, 1.07, and for propyl acid-esters (one example) 0.97. This ratio would be unity, if the alkyl groups themselves had no effect on the ionisation-constants.

Organic Tribasic Acids.—Three stages of ionisation are possible, *e.g.*—

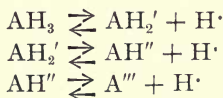

It has been found that the ionisation-constants calculated on the assumption that the ionisation takes place only according to the first equation, show no irregularity until large dilutions are reached. Thus, the second and third ionisation-constants must be small, compared with the first ionisation-constant.

For citric acid the three constants have been approximately determined:—²

¹ *Monatshefte für Chemie*, **23**, 316 (1902).

² W. H. Smith, *loc. cit.*

$$\begin{aligned}
 K_1 \times 10^5 &= 0.082 \\
 K_2 \times 10^5 &= 0.0032 \\
 K_3 \times 10^5 &= 0.00007
 \end{aligned}$$

[It is to be noted that the mode of ionisation of tribasic acids is probably very complicated. An acid such as citric acid can undergo the first stage of ionisation in two ways :—

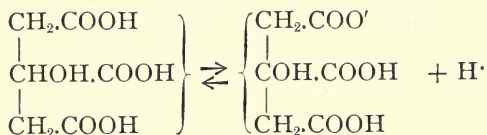

and

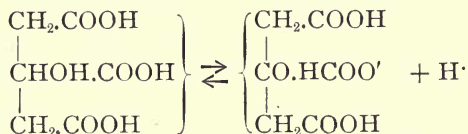

The anion produced according to the first of these equations could undergo the second ionisation in two ways, giving as anions,

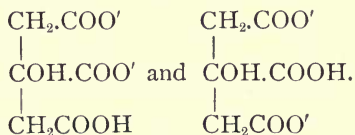

The anion produced according to the second equation could undergo the second stage of ionisation in only one way, giving an anion

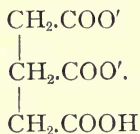

Then there would be two kinds of anion in solution capable of undergoing the third stage of ionisation. The case would be still more complicated with an unsymmetrical acid.]

The following rules have been found to apply to the

tribasic acids.¹ Of isomeric acids, those with two carboxyl groups attached to one carbon atom are stronger than those which have the three carboxyl groups attached each to a different carbon atom.

Substitution of alkyl groups for hydrogen increases the constant of a tribasic acid.

An unsaturated acid has a greater ionisation-constant than the saturated acid to which it corresponds.

Phenols.—There are classes of compounds, of which the most important are those derived from phenol, which, although they do not contain one of the characteristically acid groups such as COOH or SO₃H, are ionised to an appreciable extent in solution. A discussion of the results obtained would lead to no new conclusion, but the ionisation-constant of phenol is given in order to show the small tendency to ionise among compounds of this class.

$$\begin{array}{l} \text{Phenol} \quad K = 1.3 \times 10^{-13} \\ (\text{Acetic acid } K = 180000 \times 10^{-13}) \end{array}$$

Summary of the Results for Acids.—Wegscheider² has compiled, from his own and other measurements, a table of factors representing the effect of the substitution of various atoms and groups in monocarboxylic acids, on their ionisation-constants. The numbers—which do not apply to unsaturated acids or those exhibiting stereo-isomerism—are the factors with which the ionisation-constant of a monobasic acid must be multiplied to obtain the ionisation-constant of the compound in which the atoms or groups to which the factors refer have taken the place of hydrogen. In compiling this table, it has not been possible to take into account small differences of constitution, which, however, have an appreciable influence on the constant. So that these numbers, as will be seen from the calculations based on them, are only approximate.

¹ Walden, *Zeitschr. phys. Chem.*, **10**. 563 (1892).

² *Monatshefte für Chemie*, **23**. 289 (1902).

Radical.	Position in the chain of a saturated fatty acid in which the radical is substituted.				Position in an aromatic acid in which the radical is substituted.		
	α	β	γ	δ	o	m	p
Cl	90	6.2	2.0	1.27	22	2.58	1.55
Br	76	7.3	1.76	1.19	24	2.28	—
I	42	6.72	1.53	1.06	—	—	—
NO ₂	—	12.5	—	—	103	5.75	6.60
OH	8.4	2.31	—	—	17	1.45	0.48
CH ₃	{ 0.74	1.12	1.00	0.90	2.0	0.86	0.85
	{ 1.10						
	{ 0.62						
C ₂ H ₅	{ 0.83	1.20	0.98	0.81	—	—	—
	{ 1.31						
	{ 0.66						
COOH	34	2.41	1.67	1.2	10.2	2.39	2.62
COOCH ₃	—	2.4	—	—	11.0	—	2.8
COOC ₂ H ₅	27	2.25	—	—	9.2	—	—

From this table the ionisation-constant of any substituted monocarboxylic acid corresponding to the substituent radicals given, can be calculated from that of the acid itself. And, since the ionisation-constant of a polybasic acid is the sum of the ionisation-constants corresponding to the carboxyl groups it contains, we can calculate the constants of an extremely large number of substituted and unsubstituted polybasic acids, from the ionisation-constants of the simple monobasic acids. If the table were complete, we could in this way calculate the ionisation-constants of all other acids from those of the simple monobasic acids.

As was mentioned above, the numbers thus obtained are not accurate. The differences between the experimental and calculated numbers are greatest (*a*) in acids which have two carboxyl groups and a strongly negative group attached to one carbon atom; (*b*) in acids which are derived from succinic acid by substitution of two alkyl groups, one in each CH₂ group; and (*c*) in di-substituted aromatic acids in which the groups are in positions 1:2:6 or 1:2:3 (COOH = 1).

The following examples show the method of calculation and the degree of accuracy obtained:—

Succinic acid $\begin{array}{c} \text{CH}_2\text{COOH} \\ | \\ \text{CH}_2\text{COOH} \end{array}$ may be regarded as propionic

acid, in which the carboxyl group is substituted in the β position.

$$K_1 \times 10^5 \text{ for propionic acid} = 0.0013$$

$$\therefore \text{the constant for one carboxyl group} = 0.0013 \times 2.41$$

$$\therefore K_1 \times 10^5 \text{ for succinic acid (two carboxyls)} = 2 \times 0.0013 \times 2.41 \\ = 0.00627$$

$$K_1 \times 10^5 \text{ for succinic acid (Walden)} = 0.00665$$

Hydroxyterephthalic acid—

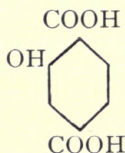

$$K_1 \times 10^5 \text{ for benzoic acid} = 0.0060$$

$$\text{Factor for ortho substitution of hydroxyl} = 17$$

$$\text{,, ,, para ,, ,, carboxyl} = 2.62$$

$$\therefore K_1 \times 10^5 \text{ for carboxyl group, ortho to } \widehat{\text{OH}} = 0.0060 \times 17 \times 2.62 \\ = 0.267$$

$$\text{Factor for meta substitutes of hydroxyl} = 1.45$$

$$\text{,, ,, para ,, ,, carboxyl} = 2.62$$

$$K_1 \times 10^5 \text{ for carboxyl group, meta to } \widehat{\text{OH}} = 0.0060 \times 1.45 \times 2.62 \\ = 0.023$$

$$\therefore K_1 \times 10^5 \text{ for hydroxyterephthalic acid} = 0.267 + 0.023 = 0.290$$

$$K_1 \times 10^4 \text{ for hydroxyterephthalic acid observed by Wegscheider} \\ = 0.269$$

Similarly, for the esters of this acid,

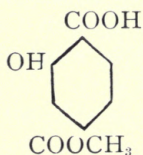

$$\text{(calculated)} \quad K_1 \times 10^5 \quad 0.286$$

$$\text{(found)} \quad K_1 \times 10^5 \quad 0.277$$

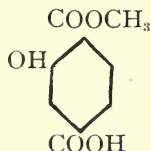

,, 0·0243 ,, 0·0250

Acids containing electropositive substituent groups will be discussed under amphoteric electrolytes.

Inorganic Bases.—The inorganic bases are very strongly ionised, and do not obey Ostwald's law of dilution.

MOLECULAR CONDUCTIVITY AT 18°.

$v =$	2	5	10	33·3	50	100	200	500	1000
Potassium hydroxide KOH	197	206	213	222	225	228	230	(233)	(234)
Sodium hydroxide NaOH	(172)	178	(183)	(194)	(197)	(200)	(203)	(206)	(208)

MOLECULAR CONDUCTIVITY AT 25°.

$v =$	2	4	8	16	32	64	128	256	512	1024
Calcium hydroxide Ca(OH) ₂	—	—	—	—	—	405	(469)	447	455	—
Barium hydroxide Ba(OH) ₂	—	—	372	392	410	429	448	461	465	469
Strontium hydroxide Sr(OH) ₂	—	—	—	—	405	419	432	446	451	452

It is seen that similarly constituted compounds are ionised to the same extent in solutions of the same dilution, *e.g.* KOH to the same extent as NaOH, and Ca(OH)₂, Ba(OH)₂, Sr(OH)₂ also to the same extent. Ammonia is best considered in connection with the organic bases.

Organic Bases.—Bredig¹ has measured the conductivity of a large number of organic bases, and from his numbers he has calculated the ionisation-constants in the usual way. Now, it is probable that in solutions of ammonia and amines only a fraction of the compound is really present as base, the rest being simply dissolved, or forming a hydrate with water

¹ *Zeitschr. phys. Chem.*, **13**. 289 (1894).

incapable of directly giving ions. *E.g.*, in a solution of ammonia we have probably only a small amount of NH_4OH and its ions, the rest of the base being either simply dissolved—whatever that term may mean—or forming a hydrate with water $\text{NH}_3 \cdot x(\text{H}_2\text{O})$ which does not give into ions.

The equilibrium in a solution of an ammonium base may be represented by the equations

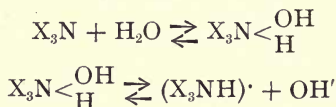

If K_2 be the reaction constant of the first reaction, and K_1 the real ionisation-constant of the base,

$$K_2 = \frac{C_{\text{X}_3\text{NHOH}}}{C_{\text{X}_3\text{N}}} \text{ since in dilute solution } C_{\text{H}_2\text{O}} \text{ is constant,}$$

$$\text{and} \quad K_1 = \frac{C_{\text{OH}'}}{C_{\text{X}_3\text{NHOH}}} \times C_{\text{X}_3\text{NH}'}$$

$$\therefore K_1 K_2 = \frac{C_{\text{OH}'}}{C_{\text{NX}_3}} \times C_{\text{X}_3\text{NH}'}$$

Now, if a be the number of gram-equivalents used in making one liter of the solution of base NX_3 ,

$$a = C_{\text{NX}_3} + C_{\text{NX}_3\text{HOH}} + C_{\text{NX}_3\text{H}'}$$

$$\text{Also} \quad C_{\text{OH}'} = C_{\text{NX}_3\text{H}'}$$

$$\text{and} \quad a - C_{\text{OH}'} = (1 + k_2) C_{\text{NX}_3}$$

$$\therefore \frac{K_1 K_2}{1 + K_2} = \frac{C_{\text{OH}'}}{a - C_{\text{OH}'}}$$

Bredig measured the electric conductivity of solutions of bases, and calculated the values of the expression $\frac{\Lambda_v^2}{v\Lambda_x(\Lambda_x - \Lambda_v)}$ —the ordinary formula for the ionisation-constant—and found that for many bases it was constant.

$$\text{But since} \quad \frac{\Lambda_v}{\Lambda_x} = \frac{C_{\text{OH}'}}{a}, \text{ and } v = \frac{1}{a}$$

$$\frac{C_{\text{OH}'}}{a - C_{\text{OH}'}} = \frac{\Lambda_v^2}{v\Lambda_x(\Lambda_x - \Lambda_v)} = K_3$$

$$\therefore K_3 = \frac{K_1 K_2}{1 + K_2}$$

Thus Bredig's constant (K_3) for a base, bears to the true ionisation-constant (K_1), the ratio $\frac{K_2}{1 + K_2}$ where K_2 is the ratio of non-ionised electrolyte to non-electrolyte in the solution.

K_2 , as well as K_1 , will vary with the nature of the compound, since the facility with which the nitrogen goes from the trivalent to the pentavalent form will depend on the nature of the groups already attached to the nitrogen atom. Therefore, a comparison of the constants K_3 of different compounds can give no accurate information as to the variation of ionisation with constitution. Since, however, it has not yet been found possible to determine K_2 , this comparison is the only one possible.

The numbers quoted from Bredig's paper are affected by another error, for recent work has shown that the value for the mobility of hydroxyl which was used by Bredig in the calculation of Λ_∞ for the bases is too low. Since the order of the ionisation-constants would not be affected by this, and the recalculated numbers would not be the true ionisation-constants, Bredig's numbers are given as they stand.

The following conclusions were drawn by Bredig:—

The quaternary bases from aliphatic amines are, in general, so strongly ionised that no constant can be obtained. The phosphonium, arsonium, stibonium, sulphinium, and tellurinium bases are also very strongly ionised, but the tin and mercury bases are only weakly ionised.

The following numbers are the values of the molecular conductivity of the above-mentioned bases at the dilutions given ($T = 25^\circ$):—

	v (in liters) =	16	64	256
Tetramethylammonium hydroxide	$(\text{CH}_3)_4\text{NOH}$	219	226	(228)
Tetramethylphosphonium hydroxide	$(\text{CH}_3)_4\text{POH}$	214	221	223
Tetramethylarsonium hydroxide	$(\text{CH}_3)_4\text{AsOH}$	211	216	218
Tetramethylstibonium hydroxide	$(\text{CH}_3)_4\text{SbOH}$	178	181	183
Triethylsulphonium hydroxide	$(\text{C}_2\text{H}_5)_3\text{SOH}$	211	217	(222)
Trimethyltellurinium hydroxide	$(\text{CH}_3)_3\text{TeOH}$	211	216	(214)
Ethylmercury hydroxide	$\text{C}_2\text{H}_5\text{HgOH}$	1.2	1.4	1.9
	v (in liters) =	17.3	69.2	276.8
Tintrimethyl hydroxide	$(\text{CH}_3)_3\text{SnOH}$	0.4	0.63	1.37

These are the true values of the molecular conductivity since all the base is present either as ions, or as non-ionised molecules corresponding to these ions.

Secondary bases are more strongly ionised than primary or tertiary bases.

	$K_3 \times 10^5$
Ammonia	0·0023
Methylamine	0·0500
Dimethylamine	0·0740
Trimethylamine	0·0074

It is, however, quite possible that this is due to the effect of the alkyl group in changing the power of the nitrogen to pass from the trivalent to the pentavalent form by taking up water.

Among metamers, constitutive influences have sometimes a very great effect.

	$K_3 \times 10^5$
Propylamine	0·047
Trimethylamine	0·0074

We should expect this rule to hold, for, leaving out any specific effect of the alkyl group on the ionisation, the power of the nitrogen atom of passing from the trivalent to the pentavalent condition is probably very different in two such compounds as those given. With compounds in which we should expect this influence to be less, we find the differences in the constants are much less, *e.g.*

	$K_3 \times 10^5$
{ Propylamine	0·047
{ Isopropylamine	0·053
{ Isobutylamine	0·031
{ Trimethylmethyamine	0·034

Organic Di-acid Bases.—No very striking relations have been observed among compounds of this class. Bredig¹ has found that those di-acid bases which ionise in stages show the same relation between the first and second ionisation as the dibasic acids; *i.e.* the greater the extent of the first ionisation, the less the extent of the second.

Neutral Salts.—Since salts are made up of the anions and

¹ *Loc. cit.*

cations of the acids and bases, we naturally look for relations between the degree of ionisation of a salt and the degree of ionisation of the acid and base from which it is formed. Such relations have not yet been found, and it seems that certain metals have so strong a tendency to go into the ionic form that it matters little whether they are combined with a complex which readily becomes an ion, or not.

The salts, like other very strongly ionised compounds, do not follow the dilution law of Ostwald.

The results may be summed up in one general rule.

Salts which have an analogous constitution are ionised to the same extent in dilute solutions of equal concentration.

The numbers given are calculated from the tables in the *Leitvermögen der Elektrolyte*, and correspond to a temperature of 18°, and a dilution of ten litres.

Salt.	KCl	NaCl	LiCl	NH ₄ Cl	KI	KNO ₃	AgNO ₃	KClO ₃	KC ₂ H ₃ O ₂
Degree of ionisation }	0·85	0·84	0·82	0·85	0·86	0·83	0·81	0·82	0·85
Salt.			K ₂ SO ₄		Na ₂ SO ₄		Li ₂ SO ₄		K ₂ C ₂ O ₄
Degree of ionisation			0·71		0·69		0·65		0·74
Salt.	BaCl ₂	SrCl ₂	CaCl ₂	Ba(C ₂ H ₃ O ₂) ₂	Ca(C ₂ H ₃ O ₂) ₂		Ba(NO ₃) ₂		ZnCl ₂
Degree of ionisation }	0·75	0·75	0·74	0·66		0·62	0·64		0·72
Salt.			MgSO ₄		ZnSO ₄		CuSO ₄		
Degree of ionisation			0·42		0·39		0·38		

It is worthy of remark that although acetic and hydrochloric acids, at a temperature of 18° and a dilution of 10 litres, are ionised to 1·3 per cent. and 91 per cent. respectively, potassium acetate and potassium chloride are both ionised to 85 per cent. at the same temperature and dilution.

Salts of the two last classes (*e.g.* BaCl₂, MgSO₄) are among the compounds which give complex ions. At the dilution to which the numbers refer, the concentration of the complex ions would be small. But the cadmium salts, which show a great tendency to give complex ions, are ionised to a much smaller extent than corresponding salts of other metals, and therefore form an exception to the general rule. The mercury salts are also very weakly ionised.

The Valence Rule.—An empirical rule has been found by Ostwald¹ and his pupils which shows a connection between the variation of conductivity with dilution, and the valencies of the anion and cation from which the salt is formed. It may be expressed in the form—

$$\Lambda_{\alpha} - \Lambda_{\nu} = n_1 n_2 C$$

where Λ_{α} and Λ_{ν} have their usual meanings, n_1 and n_2 are the valencies of the anion and cation, and C_{ν} is a number depending only on the dilution and temperature.

The rule applies only to those salts which ionise “normally,” *i.e.* which do not undergo hydrolysis or give complex ions; and it approximates most nearly to the fact when ν is such that $\Lambda_{\alpha} - \Lambda_{\nu}$ is comparatively small.

In practice the rule is generally used in the form—

$$\Lambda_{1024} - \Lambda_{32} = n_1 n_2 C$$

The value of C is found to be approximately 10 at 25°, *e.g.*

Sodium salt of		$n_1 n_2$	$\Lambda_{1024} - \Lambda_{32}$
Nicotinic acid	$C_5H_4N.COOH$	1	10'4 = 1 × 10'4
Quinolinic acid	$C_5H_3N.(COOH)_2$	2	19'8 = 2 × 9'9
Pyridinetricarboxylic acid	$C_5H_2N.(COOH)_3$	3	31'0 = 3 × 10'3
Pyridinetetracarboxylic acid	$C_5HN.(COOH)_4$	4	40'4 = 4 × 10'1
Pyridinepentacarboxylic acid	$C_5N.(COOH)_5$	5	50'1 = 5 × 10'0
Magnesium nitrate ²		2	19'7 = 2 × 9'9
Magnesium sulphate		4	41'0 = 4 × 10'3

This rule has been often used to determine the basicity of acids, and is especially useful as a test for hydrolysis in cases—*e.g.* sodium salts—where abnormality of ionisation can be only due to hydrolysis.

It has been found by this method that KH_2PO_4 , KH_2AsO_4 behave as salts of monobasic acids, and that K_2HPO_4 , K_2HAsO_4 behave as salts of dibasic acids, except in dilute solutions, when hydrolysis occurs.³

¹ *Zeitschr. phys. Chem.*, **1**, 109, 529 (1887); 2, 7901 (1888).

² Walden, *Zeitschr. phys. Chem.*, **2**, 49 (1888).

³ Walden, *loc. cit.*

§ 4. DOUBLE AND COMPLEX SALTS.

Hittorf,¹ from his work on the transport numbers for salts, divided double salts into two classes: (1) those which ionise simply, *i.e.* behave as ordinary salts, and (2) those which split up into the ions of the salts of which they are composed, *i.e.* behave in solution as mixtures of the salts from which they are formed. After Ostwald, the salts of the first class are called complex salts, and the name "double salts" is reserved for those of the second class.

It is easy to distinguish the two classes by means of ordinary chemical reactions. Thus, a solution of potassium ferrous sulphate gives the reactions of the ions K^+ , Fe^{2+} , and SO_4^{2-} , but a solution of potassium ferrocyanide gives no reaction for Fe^{2+} or CN^- , but only for K^+ and a complex ion $(FeC_6N_6)^{4-}$.

Examples of complex salts are—

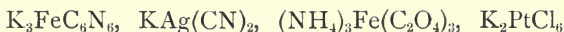

Examples of double salts are—

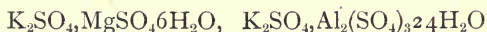

Later work has, however, shown that the distinction between complex and double salts is one of degree and not of kind.

The electrical conductivity of a mixture of solutions of two salts can be calculated from the conductivities of the separate solutions, if no reaction occurs between the salts or their ions. On mixing solutions of two salts which together form a complex salt, a reaction takes place—the formation of complex from simple ions—and the conductivity becomes less than that calculated. But a mixture of solutions of two salts which together form a double salt should give the calculated conductivity, since, according to the definitions of double salts, no reaction should take place. Now, it has been found² for

¹ *Pogg. Ann.*, **106**, 513 (1859).

² Jones and Mackay, *Amer. Chem. Jour.*, **19**, p. 83.

mixtures of solution of salts (such as K_2SO_4 and $Al_2(SO_4)_3$), which together give alums, that although in dilute solution the experimental and calculated numbers agree, yet in more concentrated solution the observed conductivity is less than the calculated. Similar results have been obtained for mixtures of solutions of the alkali sulphates and the vitriols, which together give salts of the type $K_2SO_4.MgSO_4.6H_2O$.¹

It thus appears that complex ions exist in solutions of double salts, except at great dilution. It has also been shown that simple ions exist to a very small extent in solutions of complex salts. Thus Morgan found² that a normal solution of potassium ferrocyanide contains 0.000533 gram-equivalents of the cyanogen ion $(CN)'$ per litre.

The scheme of ionisation for complex salts is therefore the same as that for double salts.

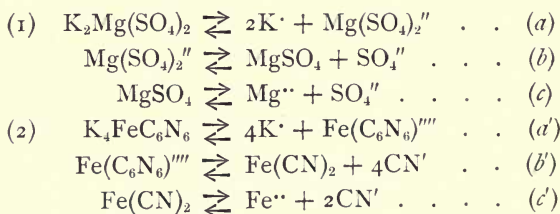

For double salts, the ionisation corresponding to equation (b) is practically complete, and for complex salts the reaction corresponding to equation (b') takes place only to a very small extent—so small, in the case quoted, that our chemical tests for the ion $Fe\cdot\cdot$ give no reaction. Of course, the concentration of the $Fe\cdot\cdot$ is much smaller than the small concentration of cyanogen given above.

The influence of successive ionisation such as that described above, on the transport numbers, may be conveniently examined here.

In the case of potassium magnesium sulphate, the ionisation (a) produces ions $2K\cdot$ and $(Mg(SO_4)_2)''$, and when a current is carried by these ions, for every $(Mg(SO_4)_2)''$ ion

¹ Archibald, *Trans. Nov. Scot. Inst. Sci.*, **9**, 307 (1891).

² *Zeitschr. phys. Chem.*, **17**, p. 513 (1895).

travelling to the anode, there are $2K^{\cdot}$ ions travelling to the cathode. But now, if the solution be diluted, the $(Mg(SO_4)_2)''$ ion will be replaced by ions $Mg^{\cdot\cdot}$ and $2SO_4''$, and thus for every $2SO_4''$ travelling to the anode, there are $2K^{\cdot}$ and $Mg^{\cdot\cdot}$ travelling to the cathode. It is easy to see from this that the changes of concentration at the anode and cathode caused by electrolysis (from which the transport numbers are calculated) must be different for the two solutions, and the difference will be greater the greater the splitting up of complex ions caused by dilution. Thus a variation of the transport numbers with dilution indicates the presence of complex ions. If, however, the variation is small, it may be due to other influences not yet fully investigated.

It has been found that in many cases the transport numbers determined from solutions of simple salts show variations with dilution. Thus the transport number for cadmium determined from a solution of cadmium iodide of medium concentration was found by Hittorf to be negative, while that for iodine determined from the same solution was greater than unity—*i.e.* it appeared that the current carried by the anion was greater than the total amount of current passed—which is absurd. In dilute solution, however, the transport numbers both for cadmium and iodine were positive and less than unity. Similar large variations were found with cadmium chloride, zinc chloride, and zinc iodide.¹ Smaller variations of the same kind were found with barium chloride, strontium chloride, calcium chloride, and magnesium chloride.²

The explanation is that all these solutions contain complex ions; and it has been determined that they are complex anions in the following way. Compounds of this type can either ionise in stages, giving in the first stage complex cations, *e.g.* $BaCl_2 \rightleftharpoons BaCl^{\cdot} + Cl'$; or can give complex anions of the type $BaCl_3'$ or $BaCl_4''$.

Now, the transport number for $Ba^{\cdot\cdot}$ determined from a solution containing ions $BaCl^{\cdot}$ will appear to be greater than

¹ Hittorf, *loc. cit.*

² Bein, *Zeitschr. phys. Chem.*, **27**, 1 (1898); **28**, 439 (1899). Noyes, *Zeitschr. phys. Chem.*, **36**, 61 (1901).

when determined from a solution containing only Ba^{++} and Cl' . And since $BaCl'$ splits up into Ba^{++} and Cl' in dilute solution, the transport number for Ba^{++} determined from a solution containing $BaCl'$ will appear to diminish with dilution. That is, the transport number for the cation, determined from solutions containing complex cations, will appear to diminish with dilution. And similar reasoning shows that the transport number for the anion, determined from solution containing a complex anion, will appear to diminish with dilution.

Since, in all the cases mentioned above the transport number for the anion diminished on dilution of the solution, the complex ions present are anions, *e.g.* in solution of CdI_2 we have probably CdI_4'' , and similarly for solutions of $CdCl_2$, ZnI_2 , and $ZnCl_2$ in solutions of the chlorides of barium, strontium, calcium, and magnesium, the complex ions are probably of type $BaCl_3'$ or $BaCl_4''$.

No account has been taken here of the effect of the differences in the velocities of the complex ions and the simple ions into which they dissociate. For a full discussion, see a paper on this subject by B. D. Steele.¹

Compounds of Metallic Salts with Ammonia.—The compounds of ammonia with the salts of chromium, platinum, and cobalt, have been examined by Werner² and others. The following is a slight sketch of their work on the ionisation of these compounds:—

Luteocobaltic chloride, $Co(NH_3)_6Cl_3$, contains six molecules of ammonia, which, according to Werner's theory of these compounds, are attached to the metal. For it has been shown that four ions are present in solution, and these are $[Co(NH_3)_6]^{+++}$ and $3Cl'$. The ammonia may be partly replaced by water, as in the compound $[Co.(NH_3)_3(H_2O)_3]Cl_3$, without any change in the mode of ionisation.

But if the number of molecules of ammonia and water together is made equal to five, it is found that one of the chlorine atoms cannot split off as an ion. Thus, chloropur-

¹ *Phil. Trans. A.* (1902), p. 105.

² Werner and Miolati, *Zeitschr. phys. Chem.*, **12**. 34; **14**. 506.

pureocobaltic chloride $\left[\text{Co}_{\left(\text{NH}_3 \right)_5}^{\text{Cl}} \right] \text{Cl}_2$ gives ions $\left[\text{Co}_{\left(\text{NH}_3 \right)_5}^{\text{Cl}} \right]^{\cdot\cdot}$ and $2\text{Cl}'$. And, as is expressed by the formula written for the compound, the explanation is that a chlorine atom has taken the place of the missing ammonia molecule, and now forms part of the radical, which, owing to the presence of the chlorine atom, has become divalent.

On again reducing the number of ammonia molecules, a precisely similar effect is observed; $\left[\text{Co}_{\left(\text{NO}_2 \right)_2}^{\left(\text{NH}_3 \right)_4} \right] \text{Cl}$ has two negative groups in the radical—which has become monovalent—and gives ions $\left[\text{Co}_{\left(\text{NO}_2 \right)_2}^{\left(\text{NH}_3 \right)_4} \right]^{\cdot}$ and Cl' .

The next compound in the series is $\left[\text{Co}_{\text{Cl}}^{\text{NH}_3} \left(\text{NO}_2 \right)_2 \right]$, which by the rules given should give no ions at all, *i.e.* should be a non-electrolyte. Experiment shows that under conditions unfavourable to the chemical alteration of the substance, which is not at all stable, the conductivity is extremely small.

Exactly similar remarks apply to the compounds derived from platinum chloride, which have the formulæ:—

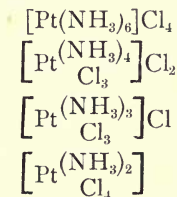

The second compound of the series, $\left[\text{Pt}_{\text{Cl}}^{\left(\text{NH}_3 \right)_5} \right] \text{Cl}_3$, has not yet been isolated.

The further withdrawal of ammonia from the neutral compound $\left[\text{Pt}_{\text{Cl}_4}^{\left(\text{NH}_3 \right)_2} \right]$ can be accomplished if the conditions are such that an anion is present which can go into the radical, *e.g.* in presence of potassium chloride, and the compound obtained is $\left[\text{Pt}_{\text{Cl}_5}^{\text{NH}_3} \right] \text{K}$, giving ions $\left[\text{Pt}_{\text{Cl}_5}^{\text{NH}_3} \right]^{\cdot}$ and K^{\cdot} .

The next compound in the series is $[\text{PtCl}_6]\text{K}_2$ —the ordinary potassium platinichloride.

These remarkable relations, which show the gradual transition from a tetravalent cation $[\text{Pt}(\text{NH}_3)_6]^{4+}$ to a divalent anion $[\text{PtCl}_4]^{2-}$, through the intermediate stage of a non-electrolyte, have been observed in various other series of similar compounds.

Electro-affinity.—We have seen (Chap. I.) that a cation is an atom minus an electron, and an anion an atom plus an electron. The theory of electro-affinity¹ deals with the forces by which the charges of electricity are bound to the ions, *i.e.* with the force by which an electron is bound to an atom to form an anion (affinity for negative electricity), and with the force between a cation and an electron opposing the formation of an atom (affinity for positive electricity).

It has not been found possible to measure these forces, which, however, remain constant for each ion. But the values of the electrode-potential (see p. 156) for the various ions follow the same order as these forces, and will be referred to as the electro-affinities of the ions.

According to Abegg and Bodländer, the ionisation of a simple salt is the effect of these affinities for electricity, which act in opposition to the chemical force between the atoms. And since the chemical forces in a molecule are different for each different compound, we must, in comparing the ionisation of different compounds, take the chemical forces, as well as the electro-affinity, into account. We now have an explanation of the fact that practically no connection has been found between the extent of ionisation of a salt and that of the acid and base from which it is formed. Thus, if the base is sodium hydrate and the acid acetic acid, although the affinity for positive electricity (or force producing ionisation) of the sodium is the same in caustic soda as in sodium acetate, and similarly, the affinity for negative electricity of the CH_3COO group the same in acetic acid as in sodium acetate, yet the chemical forces with which the sodium is bound to hydroxyl, hydrogen to the CH_3COO group, and sodium to the CH_3COO group (which,

¹ Abegg and Bodländer, *Zeitschr. f. Anorg. Chem.*, **20**, 453 (1899).

as stated above, act in opposition to the electro-affinity) are probably very different, so that no simple relation between the degrees of ionisation of these three compounds can appear.

The application of this theory to the formation of complex ions gives more positive results. Complex ions may be regarded as having been formed by the union of an ion with a neutral molecule; *e.g.* CdI_4'' is a compound of $2\text{I}'$ with CdI_2 . If the neutral part is a salt, as in the case quoted, the complex ion will the more readily split up, the greater the electro-affinities of its atoms. So that, on this theory, a complex ion will be the more stable the smaller the electro-affinities of the atoms forming the neutral part. We find that the salts of the alkali metals (which have large electro-affinities) practically never appear as neutral parts of complex ions. The salts of the alkaline earths (which have electro-affinities smaller than those of the alkali metals) form the neutral parts of many complex ions which are stable in concentrated solution, but which dissociate in dilute solution, *e.g.* MgCl_2' the anion of carnallite. Corresponding to the still smaller electro-affinity of cadmium, we have the more stable complex ions in solutions of cadmium salts. And among the salts of the trivalent metals (with still smaller electro-affinities) are AlF_3 , which is the neutral part of the cryolite anion $(\text{AlF}_6)'''$; $\text{Fe}(\text{CN})_2$, the neutral part of the ferrocyanide anion $(\text{Fe}(\text{CN})_6)''''$. The stability of this ion is largely due to the low electro-affinity of the $(\text{CN})'$ ion, for complex ions in which the neutral part is a compound of iron or aluminium, with an atom of large electro-affinity, are not so stable, *e.g.* the complex anions present in solutions of the alums.

Since, on the electrolysis of a complex salt, the complex ions practically never appear at the electrodes, but generally the simpler ions, it follows that the simple ions give up their electricity more easily than complex ions, *i.e.* that the electro-affinity of a simple ion is less than that of a complex ion of which it is a part. Since, therefore, the electro-affinity of a simple ion becomes greater on taking up a neutral molecule, we should naturally expect that ions with small electro-affinities will combine with neutral molecules more readily than those

with large electro-affinities. This is borne out by the facts. *E.g.* a solution of potassium chloride dissolves very little silver chloride; a solution of potassium bromide dissolves more silver bromide; a solution of potassium iodide dissolves a considerable amount of silver iodide, and potassium cyanide dissolves an equivalent amount of silver cyanide, forming indeed a complex salt. The series, chlorine, bromine, iodine, cyanogen, are in descending order of their electro-affinities. The distinction between complex and double salts is thus due to the different electro-affinities of the atoms.

This slight sketch of the theory is enough to show that useful results are obtained by assigning to each atom a specific electro-affinity, or tendency to ionise. By this theory, or a modification of it, we may hope to build up a comprehensive theory of ionisation.

§ 5. PSEUDO ACIDS AND BASES.

A few years ago Hantzsch¹ called attention to the fact that many neutral or slightly acid compounds form salts which behave as salts of strong acids, in that they are hydrolysed only to a very small extent. Such compounds are called *pseudo acids*, and it has been shown that in these cases salt formation is accompanied by a change in chemical constitution. For example, phenylnitromethane, $C_6H_5CH_2NO_2$, a neutral compound, gives a neutral strongly ionised sodium salt $C_6H_5\cdot CH=N-ONa$.



Another class of compounds is known, which form salts with acids, with intra-molecular change. These are called *pseudo bases*. Thus, pararosanine, $(NH_2C_6H_4)_2C \begin{matrix} \text{OH} \\ \diagdown \\ C_6H_4NH_2 \end{matrix}$, gives a hydrochloride (parafuchsine), $(NH_2C_6H_4)_2C = C_6H_4 = NH_2Cl$, which corresponds to $(NH_2C_6H_4)_2C = C_6H_4NH_2OH$, and not to pararosanine itself.

¹ *Ber. d. deutsch. Chem. Gesell.*, **32**, 576 (1899).

Among pseudo acids, two classes may be distinguished; (*a*) the pseudo acids proper, which give no ions; and (*b*) compounds giving the same anions as their salts, although these anions do not correspond in constitution with the non-ionised molecules. An example of the second class is nitroform, which in non-ionising solvents has the formula $\text{CH}(\text{NO}_2)_3$, but which in aqueous solution gives ions $((\text{NO}_2)_2\text{C}=\text{N}-\text{O})'$ and H^+ , and which gives salts of type

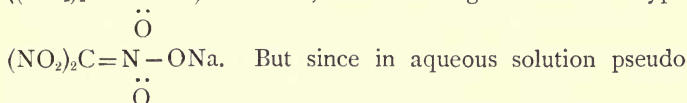

acids of the class (*a*) must to some, even if very small, extent, give anions corresponding to their salts—for otherwise the formation of the salts in alkaline aqueous solution would be difficult to explain—the distinction between (*a*) and (*b*) becomes one of degree and not of kind.

In a few cases it has been found possible to isolate the hydrogen compound corresponding to the salt, and these are found to be strongly ionised. The following numbers are for brom-phenylnitromethane at 0° .

Pseudo acid, $\text{BrC}_6\text{H}_4\cdot\text{CH}_2\cdot\text{NO}_2$. In saturated solution ($v = 2700$ litres) the electric conductivity of the water was raised to only a small extent.

$$v = 2780 \text{ litres} \quad \Lambda \text{ circa } 3\cdot00$$

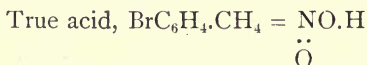

$$v = 388 \text{ litres} \quad \Lambda = 30\cdot5$$

The effect of a slight change in constitution is seen to be very large. In all cases, the true acid is obtained from the salt by decomposition with a stronger acid. Even if the true acid cannot be isolated, its presence in solution can be proved, unless the velocity with which it goes over into the pseudo acid is very large. For in a dilute solution of equivalent quantities of a salt of a pseudo acid, and of hydrochloric acid, both are completely ionised, and the conductivity of the solution is equal to that of equivalent quantities of sodium

chloride, and the true acid corresponding to the salt, at the particular dilution. But the true acid will change over to the non-conducting pseudo acid with a velocity depending on its constitution. So that after a time, the conductivity of the solution will be that of the sodium chloride present. And at any time the excess of the conductivity of the solution over the conductivity of the sodium chloride present is a measure of the amount of true acid present.

The following numbers show the variation of conductivity with time, of a mixture of equal volumes of $\frac{1}{32}$ normal hydrochloric acid and $\frac{1}{32}$ normal sodium phenylnitromethane ($t=0^\circ$)

Minutes after mixing.

3	$\Lambda = 69.6$
5	$= 68.1$
20	$= 67.0$
180	$= 62.0$

Conductivity of sodium chloride at 0° —

$v = 64$ (liters)	$\Lambda = 60.0$
-----------------------------	------------------

The difference in the value for sodium chloride and the final value for the mixture of solutions is due to the presence of a small amount of nitrous acid caused by the partial decomposition of the compound. As an example of a pseudo base we may take methylphenylacridonium hydrate,¹ which, according to its method of formation, should have the formula

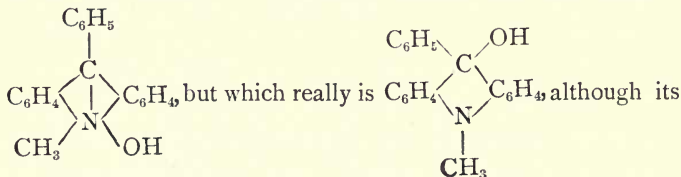

salts, with acids, correspond to the first formula. The conductivity at 0° of a mixture of equal quantities of $\frac{1}{128}$ normal solutions of the hydrochloride of the base and sodium hydrate are given by the numbers—

¹ Hantzsch and Kalb, *Ber. d. deutsch. Chem. Gesell.*, **32**, 3109 (1899).

At 0 minutes after mixing	178·1
„ 1 „ „	160·4
„ 2 „ „	150·0
„ 30 „ „	101·8
After 18 hours	61·6

Conductivity of NaCl at 0°.

$$v = 256$$

$$\Lambda = 61·1$$

The large value of the initial conductivity shows that the base present in the solution (corresponding to the first of the above formulæ) is very strongly ionised.

These examples suffice to show the nature of these phenomena. For further work on this important class of compounds, the papers of Hantzsch and his pupils must be consulted.

§ 6. AMPHOTERIC ELECTROLYTES.

There are many compounds which act both as acids and bases, *i.e.* which give both hydrogen and hydroxyl ions. Such are known as *amphoteric electrolytes*. For example, aluminium hydroxide dissolves in a solution of sodium hydrate to form a sodium salt $\text{Al}(\text{ONa})_3$. Since in this reaction, hydroxyl ions disappear from the solution, the aluminium hydroxide must furnish hydrogen ions. Similarly aluminium hydroxide dissolves in acids to give salts, and must therefore be capable of giving hydroxyl ions. This compound may therefore ionise according to either of the equations ¹—

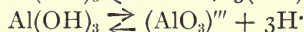

Similar phenomena have been observed with the oxides of gallium, zinc, lead, and tin.

The amido acids have been more fully investigated than other amphoteric electrolytes.² The mode of ionisation of these compounds, however, differs from that of the compounds mentioned above. For the hydroxyl and hydrogen ions come from different groups in the molecule of an amido acid, and

¹ These equations are illustrative only. See Hantzsch, *Zeitschr. f. Anorg. Chemie*, **30**, 289 (1902).

² Winkelblech, *Zeitschr. phys. Chem.*, **36**, 550 (1901).

are not formed by different modes of ionisation of the same group, as was the case with the above compounds. The presence of both a positive and a negative group in the molecule is accompanied by a weakening of both the acid and basic properties, so that in general, amido acids are weak acids and weak bases. But if one group is much more strongly positive than the other is negative, or *vice versa*, the weakening effect can proceed so far that either the acid or the basic property becomes immeasurably small. Thus, ortho-amidobenzene-sulphonic acid has no basic property (*i.e.* cannot form salts with acids) owing to the great influence of the strongly negative SO_3H group; and betaine gives no sodium salt, since the acid properties of the compound have disappeared, owing to the effect of the strongly positive $-\text{N}(\text{CH}_3)_3\text{OH}$. Since the $-\text{NH}_2-$ group is only weakly basic, all simple amido acids are more strongly acid than basic.

The ionisation-constants of these compounds cannot be determined from the conductivity, unless they have very much stronger acid properties than basic, as in the amido-sulphonic acids, or very much stronger basic properties than acid, as with betaine. For in other cases the mode of ionisation is complicated, and, moreover, the conductivity is very small. The ionisation-constants given below were calculated by Winkelblech from the results of his experiments on the hydrolysis of the salts of amido acids with acids and bases.

	Ionisation-constant for "acid" dissociation.	Ionisation-constant for "basic" dissociation.
oamidobenzoic acid	8.2×10^{-9}	2.0×10^{-15}
m " "	9.6×10^{-9}	1.9×10^{-14}
p " "	9.3×10^{-9}	3.6×10^{-15}
Asparagine	5.2×10^{-12}	1.8×10^{-15}
Glycocoll	3.4×10^{-13}	2.9×10^{-15}
Sarcosine	1.3×10^{-13}	1.8×10^{-15}
Betaine	—	7.6×10^{-16}

A comparison of the numbers for the amido-benzoic acids with those for aniline (1.1×10^{-11}) and benzoic acid (6.0×10^{-8}) shows that the decrease in ionising power of the basic group is much greater than that of the acid group. It is also seen that the NH_2 group and the COOH group have

the greatest effect on one another when they are nearest together, that is, when they are ortho to one another.

From the above numbers it appears that the stronger base is also the stronger acid, with the exception of asparagine. In the case of the amido-benzoic acids, this is easily explained by the weakening effect of the groups on one another, which is less the greater the distance between the groups. But no explanation has been found of the fact that in the series glycocoll, sarcosine, betaine, which in this order contain groups of increasing basic properties, the basic properties decrease almost as rapidly as the acid properties. It must, however, be borne in mind that the values given for the ionisation-constants for the "basic" ionisation are not the real ionisation-constants (see p. 128).

In the ionisation of such a compound as glycocoll $\text{CH}_2\text{NH}_3\text{OH}$
 $\begin{array}{c} | \\ \text{COOH} \end{array}$ (assuming the nitrogen to have gone over into

the pentavalent condition by taking up water) the ions CH_2NH_3^+ , $\text{CH}_2\text{NH}_3\text{OH}$, CH_2NH_3^- , COOH , COO' , OH' , H' , and COO' are possible.

Since the amphoteric electrolytes have only small ionisation-constants, the first two of these ions will be present to a very small extent. The last of the above ions carries equal positive and negative charges, and is therefore neutral. (Such ions are called *zwitter-ions*, or, according to the old nomenclature, intramolecular salts.) This ion can exist to only a small extent in aqueous solution, since its reaction with water is quite analogous to the hydrolysis of the salt of a very weak acid with a very weak base. And the concentration of OH' and H' will also be small. Thus, on the whole, a solution of an amphoteric electrolyte, the acid property of which is not very much greater than its basic property, contains mostly non-ionised molecules, and possesses only a small electric conductivity.¹

¹ For a full theoretical discussion of amphoteric electrolytes, see Walker, *Proc. Roy. Soc.*, **73**, 155 (1904).

CHAPTER III

THEORY OF CHEMI-ELECTROMOTIVE FORCE

§ I. VOLTAIC AND ELECTROLYTIC CELLS

FARADAY'S laws express in the most general form the part that quantity of electricity plays in chemical reaction; that, however, is only one aspect of the relations between chemistry and electricity. On the chemical side it is necessary to consider the intensity with which a reaction tends to occur, or what may be described as the affinity producing it; on the electrical side, not merely the quantity of electricity moved, but the work done in its motion. This last is expressed by *electromotive force* (or its synonyms *voltage* or *difference of potential*), and electromotive force and affinity answer to one another in the same way as quantity of electricity and amount of reaction do. To elucidate this abstract statement by examples and precise rules is the chief business of modern theoretical electro-chemistry.

An arrangement for performing an electro-chemical reaction is known either as a *voltaic* or an *electrolytic cell* (to the latter class belong the voltameters already considered). There is no difference in essential construction between them, however; the former term is applied to a cell in which the reaction is capable of yielding work, and therefore current; the latter when current has to be supplied at the expense of some external source of energy. So closely are the two related that the same appliance may act as both. The familiar lead accumulator is a voltaic cell whilst discharging, an electrolytic cell when being charged.

Each consists essentially of a pair of electrodes, with

their corresponding electrolytes, the electrolytes serving as connection between the electrodes. Thus the Daniell cell consists of (a) a zinc electrode in a solution of zinc sulphate (b), a copper electrode in a solution of copper sulphate; and the two half cells are combined by putting the solutions in conducting contact. The complete scheme is therefore—

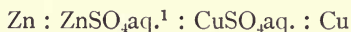

But there need not be two distinct electrolytes; thus, when dilute sulphuric acid is electrolysed between platinum plates, the scheme is



The first distinction to be drawn with a view to classifying cells is that the process occurring at a single electrode may or may not be reversible. The two cells just mentioned yield examples of this. When current is led through a Daniell cell from the zinc to the copper—the direction in which it naturally flows, more ions of zinc are formed from the solid electrode; if by means of another battery current be sent the reverse way through the cell, it will carry some of the zinc ions with it, and deposit them in the metallic state on the electrode. The two processes are the precise converse of one another, and no new substances are formed in them. This, then, is a case of a *reversible electrode*, and in particular it is reversible with respect to a cation, viz. Zn^{++} .

When current is led through the water voltameter, from left to right in the above scheme, the consequence at the left-hand electrode is the production of oxygen, which after a while appears in bubbles there. If, however, the current be led through in the opposite sense, it cannot produce the reverse effect of taking oxygen out of the electrode into the solution, for there is no oxygen in the electrode; what happens is liberation of hydrogen there; such an electrode is therefore *irreversible*. We shall at present consider only reversible electrodes, and make the further classification into those reversible with respect to a cation (first kind) or an anion (second kind).

¹ Aq. (aqua) means an indefinite quantity of water.

A reversible cell may therefore be made up of any combination of those two kinds.

The first kind of electrode consists usually of a metal, immersed in a solution of one of its own salts. We have already had one instance of this in the zinc of a Daniell cell; the copper of the same cell is another. It was pointed out on p. 23, however, that current may be led into a solution, not by formation of a new ion, but by raising the charge of one already existing. Hence arises another way of making an electrode of the first kind: if a platinum plate be immersed in a mixture of ferrous and ferric salt, when current is led in by it some Fe^{2+} (ferrous) ions will be converted into Fe^{3+} (ferric); when current is led out by the same electrode, ferric ions will be reduced to ferrous; *i.e.* we have a reversible electrode.

The second kind of electrode is not so simply made, as negative substances, oxygen, chlorine, and so on, are not themselves conductors. They may, however, be dissolved in platinum and similar metals. Thus, if a sheet of platinum be immersed half in a chloride solution and half in gaseous chlorine, the platinum is no longer to be regarded as in itself constituting the electrode; the chlorine is the active material. When the arrangement is used as anode, the current is led in by discharge of negative ions, *i.e.* formation of gaseous chlorine from the chlorions of the liquid: when as cathode, the reverse process occurs. But as the chlorine which the platinum can hold in solution is very limited in amount, it would be easy by passing too much current out to use it all up and reduce the electrode to the irreversible condition described above in the case of oxygen. Such an electrode is, however, strictly reversible if not spoilt by too much current, for if the chlorine contained by the platinum is only slowly used up, it will be continuously replaced by diffusion from the gaseous atmosphere above. For the actual construction of gas electrodes, whether for use with anionic gases such as chlorine and oxygen, or with the cationic hydrogen, see p. 239.

A more usual method of forming an electrode of the

second class is to cover a metal with an insoluble compound with the anion desired, and immerse in a solution of the anion. Thus, if mercury be covered with calomel (Hg_2Cl_2), and on this a normal solution of KCl be poured, we have the normal calomel electrode, which is much used for measuring purposes (p. 237). If current be led out of this it causes the deposition of mercury ions (Hg_2^{++}); for though calomel is only very slightly soluble, it is not quite insoluble, and the liquid near the electrode will be saturated with it. At the same time the corresponding chlorions are led away by the current in the opposite direction. Hence the solution near the electrode will cease to be saturated, and more solid calomel will dissolve. In this way the combination $\text{Hg} : \text{Hg}_2\text{Cl}_2$ serves as a reservoir of chlorions. If now the current be reversed, mercury will go into solution, combine with fresh chlorions which are moving towards the electrode, and excess of calomel be formed in solution: this will be precipitated and increase the store existing in the solid form. The electrode is therefore reversible, and practically it produces and consumes chlorine ions.

As instances of the combination of reversible electrodes we may take—

(i.) Two of the first kind: Daniell cell.

(ii.) One of each kind: Clark cell. This follows the scheme

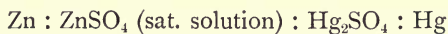

There is only one liquid electrolyte, the zinc sulphate solution which near the mercury is saturated with the very slightly soluble mercurous sulphate. The zinc is anode in the normal use of the arrangement as a voltaic cell: the anode is therefore an electrode of the first kind, reversible with respect to Zn^{++} ; the cathode one of the second kind reversible with respect to the sulphion SO_4^{--} .

(iii.) Two of the second kind. This is unusual. We may take

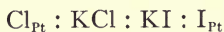

i.e. on the left a chlorine electrode as described above; on the right a similar arrangement in which the platinum plate (and

solution round it) is kept saturated with iodine. As chlorine has a stronger tendency to form ions than iodine, chlorions will be formed and iodions discharged; the chlorine will therefore be the cathode.

In the lead accumulator the negative pole is of the second type, but the positive, though perhaps to be regarded as of the first type, is somewhat difficult to classify; it will be dealt with separately.

The peculiarity of an electro-chemical reaction, *i.e.* of the process occurring in a voltaic or electrolytic cell, has already been remarked on: the reaction consists of two parts, located separately, at the anode and cathode, yet necessarily happening together in time. The action of the cell may then be summarized by an ordinary chemical equation, which expresses the total change in the constituents of the cell; but to follow it out in detail it is necessary to write two equations, each of an ionic character, for the two parts. We shall do this, in full, for three typical cells, the Daniell, Clark, and accumulator.

In the Daniell cell, during action, zinc dissolves from the anode (negative plate); but as the liquid round it may consist of neutral zinc sulphate, it is clear that ordinary chemical considerations will not account for the phenomenon. It is indispensable to take into account the migration of zinc ions, under the influence of the electric force, away from the zinc plate, and the migration of SO_4'' towards it. Similarly, at the cathode, copper is deposited; this can only be accounted for by the fact that copper ions are moving towards the plate, and SO_4'' away from it. The net result of the process is expressible as

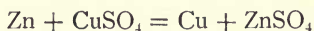

i.e. there is an increase in the quantity of zinc sulphate in solution and a decrease in that of copper sulphate; an increase in the quantity of metallic copper, a decrease in that of metallic zinc. But, on the ionic view, as the sulphion remains the same in amount (changing only in distribution between the anode and cathode chambers) we may leave it out and write

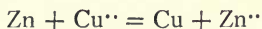

Further, we may analyse this process into its two parts, and say that at the anode we have the reaction

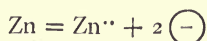

and at the cathode

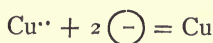

These equations represent (i.) the formation of a new zinc ion; (ii.) the discharge of a copper ion; (iii.) the consequent transfer of two positive electrons from the zinc through the solutions to the copper.¹

In the Clark cell, which is derivable from the Daniell by substitution of mercury for copper, the total reaction is

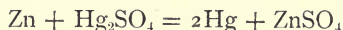

Here it is not convenient to leave out the sulphion in the equation, because there is a change in the amount of solid mercurous sulphate, which cannot be expressed unless the negative radicle be allowed a part in the statement. But we may, of course, proceed to divide up the reaction into its two components. That at the anode is, as before,

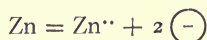

But at the cathode the process is somewhat more complicated, for the mercury that is deposited comes, practically, from the solid sulphate. We may put

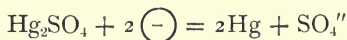

i.e. the decomposition of the sulphate leads to the deposition of liquid mercury, and the formation of a (negative) sulphion. As before, current is carried from the zinc plate, through the solution, to the mercury.

In the accumulator it has been shown by various chemical

¹ These equations are written in accordance with the fact that the only free electrons known are negative.

and electrical arguments that the total reaction during discharge is

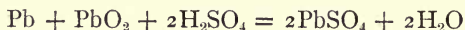

and that during charge the same reaction occurs in the opposite sense. The total effect of discharge is therefore consumption of the spongy lead and peroxide of the plates, formation of solid lead sulphate, and weakening of the acid.

At neither pole is there simple formation or discharge of an ion as in the Daniell. It is found that lead sulphate is produced in equal quantities on the two plates, and that a reduction in density of the acid occurs near both, though this effect is more marked at the positive. The simplest expression of the fact is, at the anode

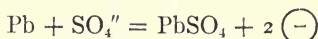

i.e. spongy lead from the plate combining with the sulphion in solution forms solid lead sulphate, the process being accompanied by the transfer of two units of electricity from electrode to electrolyte (in the direction of the current). Accordingly this pole may, like the positive of the Clark, be looked upon as reversible with respect to an anion, SO_4'' , and when current is taken from the accumulator the action consists in discharge of that anion.

At the cathode

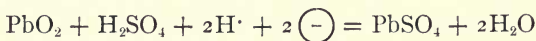

This must therefore be looked upon as an electrode of the first kind, since it discharges a cation; although the reaction, involving the various materials of the plate and the solution, is a more complex one.

We shall return to these reactions when considering the voltage of the cell and the changes of energy involved. For the present we may merely note that when the accumulator is charged all the processes are simply reversed.

§ 2. ELECTROMOTIVE FORCE

The tendency towards chemical reaction, and its accompanying transformation of energy, in a cell, is measured by the electromotive force or voltage. The precise definition of this quantity is *the work done per unit quantity of electricity flowing through the cell.*

Such a conception of voltage is familiar to the electrical engineer. For the power that has to be spent on a dynamo is the product of its voltage into the current it yields; or, in other words, the work done on it is the product of the voltage into the total quantity of electricity it yields. Hence the work done for unit quantity of electricity measures the voltage.

The unit of electromotive force practically employed—the *volt*—is systematically connected with the coulomb (and ampere) and the unit of energy known as the *joule*. Hence the definition, “The electromotive force between two points is one volt when the work done in transferring a coulomb from one point to the other is a joule;” or, briefly,

$$\text{volt} = \frac{\text{joule}}{\text{coulomb}}$$

But as working at the rate of a joule per second is called a “watt” (unit of power or activity), and a current flowing at the rate of a coulomb per second is called an “ampere,” we may equally well write

$$\text{volt} = \frac{\text{watt}}{\text{ampere}}$$

[**Examples.**—(i.) A dynamo is driven by a steam-engine of 6 horse-power (or 4476 watts); it is desired to yield 18 amperes: what is the greatest voltage at which it can be worked, if its efficiency is 90 per cent.? The amount of electrical power turned out by the dynamo is 90 per cent. of 4476 = 4028 watts; hence voltage = 4028 watts \div 18 amperes = 224 volts.

(ii.) A coppering bath contains two electrodes, 40 cm. \times 30, placed 8 cm. apart; it is made up with 10 per cent. CuSO_4 solution (conductivity 0.032 mho) and 2 volts applied to it. Then the conductance (p. 44) is $0.032 \times \frac{40 \times 30}{8} = 4.8$ mhos.

Consequently, 2 volts applied to it yield $2 \times 4.8 = 9.6$ amperes, and the power spent is 2 volts \times 9.6 amperes = 19.2 watts. All the work spent on the bath eventually results in heat, for no chemical work is done, the weight dissolved off the anode being equal to that deposited on the cathode. Hence in a minute the heat generated in the bath is $19.2 \times 60 = 1152$ joules.^{1]}

When the materials of a voltaic cell react, they lose a certain amount of chemical energy. For instance, the replacement of copper by zinc in solution of the sulphates is attended by a loss of energy, for the affinity of zinc for sulphuric acid is stronger than that of copper. If no precaution be taken to make use of this energy, it will all be converted into heat and dissipated. Thus, if a stick of zinc be immersed in copper sulphate solution, this reaction will take place and some heat be evolved, though the change is too slow to cause a very noticeable rise of temperature. Wherever a reaction takes place with any facility in the ordinary chemical way, the heat produced by it—the so-called *heat of reaction*—may be measured by making the reaction take place in a calorimeter. Many such data have been ascertained, as may be seen from the books on thermo-chemistry; and even when a reaction is too slow, or otherwise impracticable to carry out in a calorimeter, the heat of reaction may usually be estimated indirectly, by combining the results of several easier reactions.

The heat of reaction is expressed with regard to the quantities of reagents to which the chemical equation refers; and may be simply written at the end of the equation, *e.g.*—

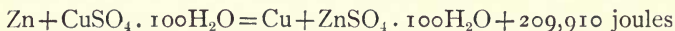

i.e. when zinc replaces copper in a solution of the sulphate containing 100 mols of water to one of salt, the evolution of heat amounts to 209,910 joules for every 65 grams of zinc dissolved. Hence the heat of reaction is the *loss of chemical energy* of the reacting substances.

¹ The joule is the most convenient unit of heat. The heat required to raise a gram of water through 1° centigrade is called a calorie, and is equal to 4.2 joules; but we shall not use the calorie in this book.

Such thermochemical data are of great importance in electrochemistry, for by their means an estimate can be made of the voltage of any electrolytic combination. The estimate was first made by Lord Kelvin many years ago, and it must be carefully noted that it is only an approximate one, based upon a certain assumption. *If in a voltaic cell all the chemical energy lost reappears in the electrical form*, then we may from its amount calculate the electromotive force of the combination. Thus in the Daniell cell, with the strengths of solution mentioned above, 209,910 joules of chemical energy are spent when two equivalents of zinc dissolve. But two equivalents of zinc carry with them two faradays of electricity; hence to get the voltage we must divide 209,910 by this quantity expressed in coulombs. The cell in question was carefully studied by Jahn,¹ and as he takes 96,540 coulombs as the value of the faraday, we shall do so in this instance. Hence the voltage calculated according to Kelvin's rule is—

$$209,910 \text{ joules} \div 193,080 \text{ coulombs} = 1.0872 \text{ volts}$$

Jahn found the voltage (at 0° C.) to be 1.0962 volts; hence the assumption in Kelvin's rule is nearly correct in the case of the Daniell cell.

The rule is, however, by no means always true. Thus the thermal phenomena of the Clark cell have been very carefully considered by Cohen,² who finds for the heat of reaction 340,700 joules at 18° C., the solution being saturated with zinc sulphate ($\text{ZnSO}_4 \cdot 7\text{H}_2\text{O}$), as is the case in the ordinary construction of the cell. The electromotive force at that temperature is, however, only 1.4291, so that when two equivalents of zinc dissolve, and two faradays flow from it, the electrical work done is only

$$1.4291 \times 2 \times 96,610 = 276,100 \text{ joules}$$

only about three-quarters of the chemical energy lost. In this case the considerable amount of energy left over appears as heat, and the cell would rise in temperature if it were possible to take current out of it at any considerable rate. In the

¹ *Wied.*, **28**, 21, 491 (1886).

² *Zeitschr. f. phys. Chem.*, **34**, 67 (1900).

Daniell, on the other hand, more electrical work—according to Jahn's measurements—is done by the cell than the chemical reaction can furnish. This is not a contradictory conclusion; it only means that some of the heat of the materials is converted into electrical energy, and the cell will cool slightly by its own action, just as a cylinder of compressed gas will cool itself when the gas is allowed to flow out.

The accumulator, as ordinarily constructed, belongs to the same class as the Daniell—it cools slightly on discharge. There is a density of acid, however, for which Kelvin's rule is precisely true. This is about 1.044, much below that used in practice; with such acid the chemical energy spent by the materials of the cell reappears precisely as electrical work. The heat of the reaction

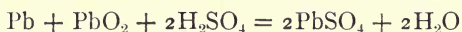

can only be determined very indirectly, and so is exposed to considerable experimental errors. It has been estimated by Streintz¹ and Tscheltzow.² For acid of the above-mentioned density it is 360,000 and 368,000 joules according to these two observers respectively. Since in the reaction two faradays are involved, we may, taking the mean of the two numbers, calculate the E.M.F. as

$$364,000 \text{ joules} \div (2 \times 96600) \text{ coulombs} = 1.88 \text{ volts}$$

Experiment gives, for the same strength of acid, 1.89 to 1.90 volt.

These points will be further considered below, and it will be seen that the discrepancy between Kelvin's rule and the facts has received a complete theoretical explanation. For the present it is enough if, by means of it, a definite conception of electromotive force has been arrived at.

§ 3. ELECTRODE POTENTIAL

The foregoing section shows how close is the relation between the transformations of energy accompanying a chemical reaction and the electromotive force it is capable of

¹ *Wied.*, **53**, 698 (1894).

² *C. R.*, **100**, 1458 (1885).

producing if carried out in a cell; shows, indeed, to a certain extent, that the electromotive force may be regarded as a measure of the energy change. To appreciate fully this intimate relation it is necessary to analyse the chemical changes taking place in a cell, to see where each part is located, and to trace the electromotive force corresponding to each.

If a cell such as a Daniell cell be examined and its electromotive force measured by a voltmeter or potentiometer (*vide infra*), it is the difference of potential between the copper wires attached to the electrodes that is really recorded on the instrument. Between these copper wires we have the chemical system

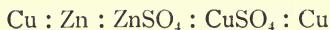

Here are four contacts of dissimilar substances, and each one gives rise to a certain electromotive force: *i.e.* as an electron passes across such a contact it either does work or work is done on it, and it consequently passes to a lower or higher level of potential. Of the four, however, two only need be considered, for the most part, *viz.* those between metal and electrolyte. That between metal and metal is apparently always very small; that between electrolyte and electrolyte likewise small in all but exceptional cases. We shall therefore devote attention to the potential difference between the zinc and its sulphate, on the one hand, and between the copper and its sulphate on the other, and use the term *electrode potential* for it. In dealing with methods of measurement below, an indication of the way in which electrode potentials have been determined will be given; for the present we assume the results.

The electrode potential then represents the work done in carrying unit quantity of electricity between electrode and electrolyte; and since on the ionic theory the carriage is effected by the formation or discharge of an ion, it is the work done in this chemical process that is involved. *E.g.* at the negative pole of the Daniell we have the reaction

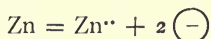

Now it is found that about half a volt difference of potential

exists in this case, the metal being negative to the solution. Again, at the other pole of the cell the reaction

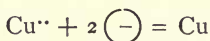

involves a slightly greater potential difference (about 0.6 volt), but here the metal is positive to the solution. Consequently the total difference of potential from one electrode to the other is the sum of these, viz. 1.1 volts, as measured.

These facts may be expressed by the simple diagram annexed, in which height represents potential: the small difference of potential between the two solutions is ignored.

It is a well-known fact that the chemical properties of a solution depend very much on its concentration; thus the

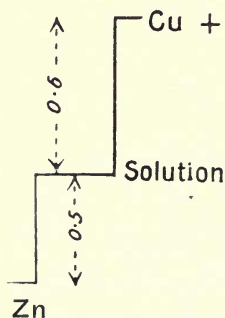

FIG. 29.

affinity that causes nitric acid to attack metals is lessened by diluting it with water. The same thing shows itself, of course, in electromotive force measurements, and therefore to get any standard of electrode potential it is necessary to define the concentration of the solution. *E.g.* zinc will show less tendency to form ions if there are already many zinc ions in the solution, *i.e.* if a strong solution of zinc sulphate be used. A concentration which is *normal* (1 gram-equivalent per litre) *with respect to the ion given off by the electrode* is taken as standard, and the term *electro-affinity* is used to express the electrode potential in this case.

The choice of this concentration as a standard is not altogether satisfactory. A normal solution¹ of most salts is far from being completely dissociated; and not only that, but the laws of dilute solutions are so far from being true for solutions of this strength that much difficulty exists in forming an opinion as to the degree of dissociation. Thus normal KCl is dissociated to the extent of 76 per cent., to judge by its

¹ Following Ostwald, "normal" is taken as 1 gram-equivalent per litre, "molar," as 1 gram-molecule per litre.

conductivity; normal ZnSO_4 , 23 per cent.; but the latter of these numbers, at any rate, may be many per cent. different from the truth, on account of uncertainty in the reasoning by which it is arrived at. A solution of zinc sulphate normal with respect to the ions—*i.e.* containing 32.5 grams of Zn^{++} per litre—is not obtainable, so that these numbers involve a certain imaginary extrapolation.

Taking the meaning of electro-affinity in accordance with current usage, however, the following table¹ contains the most important results:—

	E_0 volts.		E_0 volts.
Zn . . .	− 0.493	I . .	+ 0.797
Cd . . .	− 0.143	Br . .	+ 1.270
Fe . . .	− 0.063	O . .	+ 1.396 (?) ²
Tl . . .	− 0.045	Cl . .	+ 1.694
Co . . .	+ 0.045	NO_3 .	+ 1.75 (about)
Ni . . .	+ 0.049	SO_4 .	+ 1.9 (about)
Pb . . .	+ 0.129		
H . . .	+ 0.277		
Cu . . .	+ 0.606		
Hg . . .	+ 1.027		
Ag . . .	+ 1.048		

The convention³ as to sign adopted in the preceding table is as follows:—

A cation electrode is called positive when it is positive to a normal solution of its ion (*e.g.* Ag, Cu). Such metals have a strong tendency to come out of the ionic form, or, in other words, are easily deposited electrolytically, and indeed can do work whilst so depositing. When a metal ion is deposited it conveys its positive charge to the electrode, and so makes that positive to the solution; so in a solution of copper sulphate

¹ N. T. M. Wilsmore and W. Ostwald, *Zeitschr. phys. Chem.*, **36**. 92 (1901).

² This is for an oxygen electrode in a solution normal with respect to the hydrogen ion.

³ The German writers disagree as to this unavoidable convention: see Lorenz, *Elektrochemisches Prakticum*, p. 169.



with copper electrodes, we may suppose that incipient electrolysis takes place, and the electrode gets charged electrostatically till its potential is about 0.606 volts above that of the solution; to charge it any further would require more work than the ions are capable of doing, and so the process ceases, unless the charge on the electrode is led away by some means; if this be done—as, for example, in the Daniell cell, by a wire leading to the zinc—then more electrolysis occurs, and so on, indefinitely. On the other hand, if a metal has a strong tendency to form ions, it will do so to a certain extent, and leave the electrode depleted of positive electricity, *i.e.* negatively charged; this is the case with zinc, and still more with the alkali metals. Their electro-affinity is accordingly described as negative.

An anion electrode is called positive when it is positive to a normal solution of its ion (*e.g.* Cl). Such a substance has a strong tendency to form ions, or, in other words, is hard to liberate by electrolysis, and work needs to be done on it in order to obtain it in the gaseous (or solid) form. But since such a substance carries a negative charge, its tendency to form ions leaves the electrode depleted of negative electricity, *i.e.* positively charged: hence the convention.

If a cell (electrolytic or voltaic) be made of electrodes reversible with respect to any ions, its *electromotive force* (for normal concentration) is simply the algebraic difference between the electro-affinities of the two ions. *E.g.* the E.M.F. of the Daniell is, as we have already seen, the difference between -0.493 and $+0.606$, *i.e.* 1.099 volts, the copper being the positive. It is a voltaic cell as ordinarily used; that is, current is allowed to flow out of it, from the copper through the external circuit to the zinc, so that the cell affords 1.099 volts to drive the current in this direction. If current be forced through it the opposite way it will be an electrolytic cell, with a back electromotive force of 1.099, *i.e.* work will have to be done to drive the current through. Again, if a zinc electrode be combined with a chlorine electrode, the voltage obtained is the difference between -0.493 and $+1.694$, *i.e.* 2.187 volts; and, though this would not make a practically useful voltaic

cell, it shows what is the voltage required to decompose ZnCl_2 .

In the last instance, treated as a case of electrolysis, work is needed both to deprive the Zn^{++} and the Cl' of their charges; hence the high total. If, on the other hand, CuCl_2 be electrolysed (between unalterable, e.g. platinum electrodes), while work represented by 1.694 volts is needed to take the charge from the chlorine, no work is required to take that from the copper; on the contrary, the copper ion gives up its charge so readily as to help by work equivalent to 0.606 volt. Hence there only needs to be supplied from outside $1.694 + 0.606 = 1.088$.

To take an extreme case, in a solution of AgI the silver would have such a strong tendency to deposit, it would overpower that of the iodine to go into solution by 0.251 volt, and the solution would therefore break up spontaneously. This is, perhaps, an indication of the reason why AgI is a practically insoluble substance—although there are other factors in insolubility, for the above reasoning would not apply to salts like BaSO_4 .

If the rules given above as to sign be considered, it will be seen that in the case of a positive ion the work done by it on deposition is expressed by the electro-affinity; but in the case of a negative ion, the work done by it on deposition would be expressed by the electro-affinity with reversed sign: in both cases the work is calculated for so much of the substance as corresponds to a coulomb, *i.e.* $\frac{1}{96600}$ gram-equivalent.

§ 4. INFLUENCE OF CONCENTRATION

We have now to find how these numbers are modified by a change in concentration of the solution. Here the analogy between a solution and a gas helps. It is well known that a gas when allowed to expand and consequently fall in pressure, is capable of doing work; and that conversely, to compress it, work must be done on it. The corresponding changes in the case of a solution are its dilution and concentration. It is true that when water is mixed with a strong solution in the ordinary

way, no work is gained ; but work may be gained if the process of dilution be proceeded with in the right manner. To show this, suppose we have a vessel of salt solution and one of water side by side, at the same temperature : then, it is well known, the vapour pressure of the solution is less than that of the pure water. Provide the pair of vessels with a mechanism like that of a steam-engine, treating the water vessel as the boiler, the other as the condenser. Let some water evaporate under the piston in the cylinder ; cut off ; expand down to the vapour pressure of the solution ; and condense the vapour on to the solution. In this series of processes work will have been done by the steam, and the result is to make the salt solution more dilute than it was to start with.¹

It is of no consequence that the mechanism described is an almost impracticable one. The sole purpose of it is to help in finding out what the properties of solutions are ; and we find that a strong solution is more capable of doing work than a dilute one. This is sometimes expressed by saying that the strong solution possesses a greater "*free energy*" than the other, and that the work which it is capable of doing on dilution represents the loss of free energy. We shall return to this aspect of the matter later. Its application to the question at issue is as follows :—

For a *cation* the electrode potential in a normal solution (electro-affinity) is the work that the ion can do on deposition. But if the solution is more concentrated it is capable of doing more work ; therefore the *electrode potential* is higher, and *increases with the concentration*.

For an *anion* the electrode potential in a normal solution (electro-affinity) is the negative of the work that the ion can do on deposition. But if the solution is more concentrated it is capable of doing more work ; therefore the *electrode potential* is lower, and *decreases with increase of concentration*.

If the solution be assumed to be completely dissociated, and to follow precisely the laws of gases, it is easy to calculate

¹ An alternative method of argument is to consider the osmotic pressure of the solution and the work it can do by means of a semi-permeable membrane.

the change of free energy on dilution. This was done by Nernst, who obtained the well-known and important logarithmic formula, which may be written—

$$E = E_0 + 2.3026 \times \frac{RT}{rF} \log_{10} C$$

where—

- E = electrode potential for ionic concentration C ;
- E_0 = electro-affinity ;
- C = concentration in gram-equivalents per litre of the ion given off by the electrode ;
- R = the gas constant (8.32 joules per degree) ;
- T = absolute temperature (= temp. Centigrade + 273) ;
- r = valency of the ion ;
- F = one faraday (96600 coulombs).

Here r is to be taken with a positive or negative sign according as the ion is positively or negatively charged ; so that rF is the charge in coulombs associated with one "gram-ion" of the substance. With this convention the formula is equally applicable to cations and anions.

2.3026 is the factor required to convert common to natural logarithms.

If the temperature of the cell be 18° cent. (= 291 abs.)—an average atmospheric temperature, the equation becomes—

$$E = E_0 + \frac{2.3026 \times 8.32 \times 291}{r \times 96600} \log C = E_0 + \frac{0.058}{r} \log C$$

Accordingly, a change of tenfold in the concentration would cause a change of 0.058 volt in the electrode potential for a univalent ion, 0.029 for a divalent, or 0.0193 for a trivalent.

This result is probably strictly true for extremely dilute solutions, and has been satisfactorily verified in many cases. It is unfortunately less applicable to solutions of ordinary strength, as these—say from decinormal upwards—show very marked deviations from the laws of gases.

The meaning of the logarithmic formula may be conveniently illustrated by a diagram (Fig. 30) in which the electrode potential is represented by one axis, concentration

by the other. As a very great range of concentration has to be considered in practice, it would not be convenient

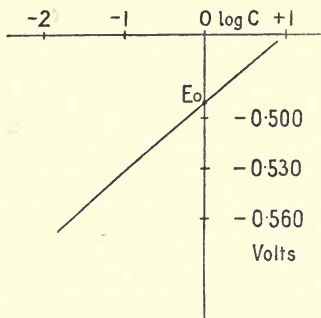

FIG. 30.

to take the abscissæ as proportional to the concentration; the formula itself suggests a logarithmic scale. This accordingly is adopted, and 0 representing normal concentration, + 1 will represent ten times normal ($\log C = 1$), - 1 decinormal ($\log C = -1$), etc.

Then taking zinc in zinc chloride solution as an example, the point E_0 representing the electro-affinity will lie at -0.493 on the axis of potential. If the concentration be made decinormal, the electrode potential becomes $-0.493 - 0.029 = -0.521$, in accordance with the rule given above, zinc being divalent; in centinormal solution -0.550 . Thus the line of electrode potentials given by Nernst's rule is straight. Actually the rule may be taken as true with regard to centinormal and more dilute solutions, but above that point the potential deviates considerably from the straight line, partly on account of the incomplete dissociation of the solutions, partly on account of deviations from the gaseous laws. The potential in a normal (not "normal ionic") solution has been found to be -0.502 volts. The influence of concentration on electromotive force may be illustrated by considering in detail the voltaic cells already mentioned, and the most important cases of electrolysis.

1. *The Daniell* consists of two electrodes of the first kind. Therefore at each, the electrode potential is raised by increase of concentration. This may be represented graphically as in Fig. 31, where the full lines are intended to show the potentials of the zinc and copper when the solutions are of normal (ionic) strength; the dotted lines a greater strength. The change is not in either case precisely that given by Nernst's law, but since both metals are divalent it is about the same for each,

and is in the same sense. Hence the rule, long known, that the electromotive force of a Daniell cell is practically independent of the density of the zinc and copper sulphates, provided they are equal. If one be changed without the other, the E.M.F. is of course changed, *e.g.* if the copper sulphate be diluted, the potential of the copper electrode is lowered towards that of the zinc. A curious experiment has been explained on these grounds. If potassium cyanide be added to the copper sulphate solution in a Daniell cell, it first precipitates the copper and then on adding more redissolves it; the solution, however, has no longer the blue colour indicative of copper ions. It is probable that the double cyanide $K_2Cu(CN)_4$ is formed, and that so far as this is dissociated, it is mainly into K^+ cations, only to a minute extent into Cu^{++} . The concentration of the Cu^{++} ions is thus enormously lowered, and the potential of the copper electrode is actually reduced below that of the zinc, so that the zinc becomes the positive terminal of the cell.

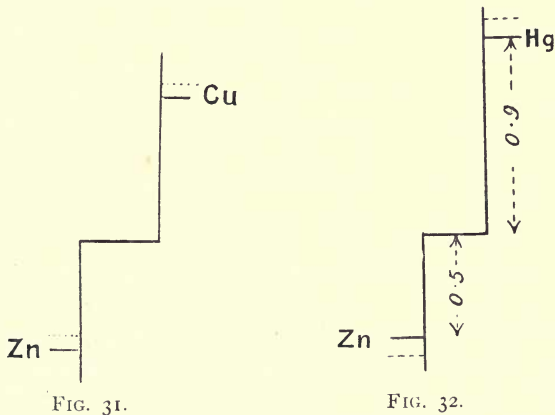

2. *The Clark Cell* consists of an anode of the first kind (reversible with respect to the cation) and a cathode of the second kind (reversible with respect to the anion). Fig. 32 shows the effect of change of concentration of the solution. The dotted lines show the effect of increase in concentration,

and it is seen that the effect is to raise the potential of the zinc and lower that of the mercury; hence on both accounts to diminish the E.M.F. of the cell. The Clark cell used as a standard is made up with saturated solution, containing about six gram-equivalents per litre. Its E.M.F. is 1.428 volts at 20°; a similar cell made with normal solution gives 1.464 volt. These concentrations refer, as usual, to the total weight of dissolved salt: a normal-ionic solution, as remarked on p. 159, is not obtainable.

3. *Electrolysis of Hydrochloric Acid between Platinum Plates.*—The platinum being unalterable, the electrolysis is

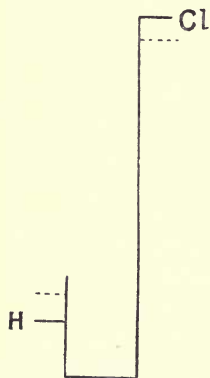

FIG. 33.

carried on by discharge of Cl at the anode and of H at the cathode. The potentials are shown in Fig. 33. A solution containing rather less than 5 per cent. of HCl by weight (1.4 normal in total concentration) is probably normal-ionic. For this the potentials are +0.277 and +1.694 (p. 159), the electromotive force required for the electrolysis consequently 1.417 volt. Increase of concentration raises the potential of the hydrogen and lowers that of the chlorine, hence on both accounts lowers the E.M.F. That is to say, as common sense would indicate, it takes less work

to electrolyse strong acid than weak: when there are many ions in the electrolyte it is easier to discharge a given number of them than when there are few.

The numerical values just given are from Wilsmore's papers. There seems to be considerable uncertainty, however; Le Blanc gives

$\frac{2}{1}$	norm. HCl.	1.26	volts
$\frac{1}{2}$	„	1.34	„
$\frac{1}{6}$	„	1.41	„
$\frac{1}{16}$	„	1.62	„
$\frac{1}{32}$	„	1.69	„

4. *The Lead Accumulator.*—The partial reactions in this are (p. 152), at the negative

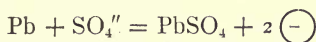

at the positive

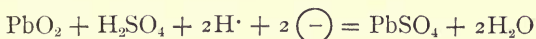

Both these are reversible, the phenomena of charge being the exact converse of those of discharge. Hence the negative

electrode may be regarded as one reversible with respect to an anion (SO_4''), *i.e.* of the second kind; the positive one of the first kind.

Accordingly increase in density of the acid causes the potential of the negative to be lowered, that of the positive to be raised, and so on both accounts increases the E.M.F. of the cell. This is the well-known fact discussed from the thermal point of view in § 2, and more fully below, page 183. It is indicated in Fig. 34, where, as usual, the dotted lines indicate an increase of concentration. Since, however, the strength of acid used in accumulator practice is far beyond what can be considered a dilute

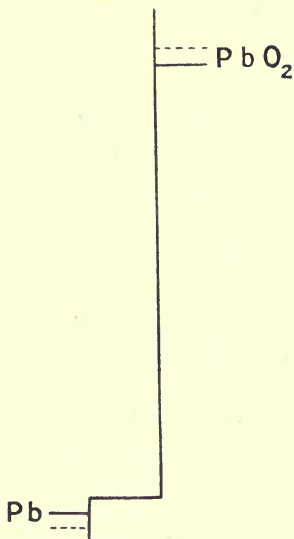
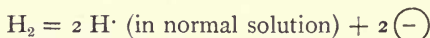

FIG. 34.

solution, the logarithmic rule must not be applied here. The numerical data will be given later. It may be noted, however, that neither of the electrode potentials can be taken from the table on p. 159, even if the acid were normal; for the electrodes are not of the simple kind implied in that table. The positive is effectively reversible with respect to hydrogen, it is true; but it is not a hydrogen electrode with an electroaffinity of 0.277, for elementary hydrogen does not exist in the electrode material, and there are other factors in the

reaction which must be taken account of, and which largely modify the potential. In fact, the electrode potential must always be looked on as a measure of the *work done in a particular reaction*; thus 0.277 volt is the measure of the reaction



This is obviously quite a different process from that occurring at the positive of an accumulator.

§ 5. CONCENTRATION POLARISATION

There is another aspect to the effect of change of concentration on electromotive force, which must now be dealt with. The electrolytic action itself tends to produce changes in the liquids of the cell, and so reacts on the electromotive force producing it; it is therefore not enough to determine the concentration of the solutions used in the cell at starting.

Take as example the electrolysis of copper sulphate between copper plates, as in the industry of copper refining. The chemical action consists merely in solution of copper at the anode and deposition of an equal amount at the cathode; in terms of the ionic theory, $\text{Cu} \rightleftharpoons \text{Cu}^{\cdot} + 2 \ominus$ at the anode, and the same reaction reversed at the cathode. There is, therefore, no chemical work to be done, and whatever potential difference occurs at one terminal should occur with reversed sign at the other, so that no electromotive force should be needed to electrolyse, beyond that required to overcome the resistance of the solution, in accordance with Ohm's law. It is true that when no current flows the two electrodes are at the same potential; but now consider more precisely what happens when a current is passed through. At the anode, fresh copper sulphate is formed in solution. We have already, in fact, calculated the amount (p. 35); it is, for one faraday, x gram-equivalent, (where x = migration ratio of the $\text{SO}_4^{\prime\prime}$). Similarly the combined effect at the cathode of deposition and migration is to remove x equivalents from the solution. Hence, according to the principles of the last section, the potential

of the anode copper relatively to the solution is raised, that of the cathode lowered (Fig. 35), where the dotted line shows the level of potential before electrolysis.

On the whole, then, a fall of potential occurs in passing through the cell, indicating work done by the current—the work required to produce the differences in concentration, in fact. This phenomenon is known as *concentration polarisation*. If the current be reversed, the polarisation

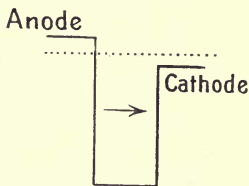

FIG. 35.

will of course be reversed, so that it is always a force opposing the battery, and involving a waste of energy. It plays an especially important part in the action of the accumulator.

Such changes of concentration occur in all electrolytic processes, so that the electromotive force is always modified by the process itself, if any appreciable amount of chemical action is produced, even if no polarisation of the electrodes in the ordinary sense takes place. Herein lies the cause of the influence that *current density* has on the course of an electrolytic process. We saw, in a general way (p. 26), that as in an electrolytic cell there is usually more than one way of effecting discharge, the ion which is most easily discharged will come down first; but that if the process is pushed, there will be a deficiency of such ions, and others, more tenacious of their charges, will be discharged. We can now, with the conception of voltage, give quantitative expression to this fact. The electrode potential of any ion depends partly on its chemical nature, partly on the concentration at which it exists in the solution. If, then, there be two cations (or anion) present together, their electrode potentials will in general be different; on electrolysis, that which has the higher potential (for an anion, the lower) will be discharged; but in this way its concentration will be reduced, and its potential lowered (for an anion, raised) till it becomes equal to that of the other. The two will then be discharged together.

To take an illustration of this—for convenience, one to which Nernst's logarithmic rule is fairly applicable—suppose a solution

containing $\frac{1}{10}$ gram-equivalent of $\text{Pb}(\text{NO}_3)_2$ and $\frac{1}{10}$ gram-equivalent of $\text{Ni}(\text{NO}_3)_2$ to be electrolysed (say with a lead cathode and platinum anode). The potential between the cathode and the lead salt alone would be $0.129 - 0.029 = 0.100$ volt; with respect to the nickel salt alone, $0.049 - 0.029 = 0.020$ volt, showing a difference of 0.080 volt; *i.e.* the lead has this much more tendency to deposit than the nickel. Now electrolyse this with a weak current (see below), such as is used for electrolytic analysis; lead alone will be deposited, until its concentration has fallen so much that it takes 0.080 volt more to bring it down than was the case to start with. As a ratio of $1 : 10$ changes the potential by 0.029 volt, it will require a ratio of rather less than $1 : 1000$ to cause this change; *i.e.* when the lead salt has fallen to $\frac{1}{10000}$ normal concentration, its potential ($0.129 - 4 \times 0.029$) will be about the same as that of the decinormal nickel. Beyond this point any current, however weak, will bring down the two metals together. It is, therefore, not possible to separate the remaining thousandth part of the lead from nickel electrolytically.¹

But now suppose a stronger current to be used. Lead is at first deposited, in the way described, but of course the ions discharged are those next to the electrode, and the weakening of the solution takes place there: it is not the average concentration through the liquid on which the potential depends, but that of the layer actually in contact with the electrode, so that even while no considerable change occurs in the mass of the liquid, an important difference may happen in the contact layer, if the processes of diffusion, etc., are insufficient to make up for the local depletion of lead ions. It is, in fact, a question of balance between the consumption of ions by electrolysis and the supply by diffusion and convection of the liquid, so that if a strong current be used, unless corresponding precautions are taken to keep the liquid well stirred, the working layer in contact with the electrode may be so weakened in lead ions as to allow nickel ions to be deposited too. It is for this reason that the voltage required to electrolyse a given salt is

¹ This method is not used in practice, owing to secondary difficulties, such as oxidation of the lead deposit.

not quite a fixed quantity; the numbers given in the tables give the least voltage required, or, in other words, the voltage required to perform the electrolysis very slowly, without introducing any disturbing factor. If, on the contrary, the process be pushed fast, by the application of a large current, concentration polarisation always occurs, and a greater voltage must be used.

§ 6. CHEMICAL POLARISATION

The reversibility of any electrode is limited in practice by the concentration polarisation that occurs when any appreciable current is passed through it; but in very many cases a more important cause of irreversibility lies in the formation of new chemical materials by the current: this is *polarisation* in the usual sense of the word.

Polarisation due to formation of a gas is a familiar and well-marked case of the phenomenon, and may serve as a typical instance. If current be passed through dilute sulphuric acid between platinum plates, oxygen is produced at the anode, hydrogen at the cathode; these substances appear as gas bubbles, clinging to the plates, and escaping into the air; but even before any visible bubbles have formed, a certain minute quantity of oxygen and hydrogen is liberated; this clings to the platinum, either in the form of a condensed layer on the surface, or actually in solution in the metal. (Much more markedly with a palladium electrode, for this metal, it is well known, dissolves hydrogen largely.) The platinum plates, neutral to start with, are thus transformed practically into electrodes of oxygen and hydrogen respectively, and come to have potentials corresponding to the position of those substances in the list of electro-affinities. That is, the oxygen is about 1.1 volt positive to the hydrogen. If now the decomposing current be stopped, and the cell examined with a voltmeter, it will be found that this difference of potential persists. We have, in fact, a voltaic combination—



capable of yielding a current, which will, of course, flow from the oxygen pole (+^{ve}) to the hydrogen (-^{ve}) through the

outside circuit, *i.e.* in the opposite direction to the original or charging current. The arrangement is, in fact, an "accumulator," which can be charged and subsequently discharged—but with this difference from the lead accumulator of practice, that its capacity is excessively small. The capacity, in fact, is only that due to the traces of gas absorbed by the plates. If the cell be made to yield a current, it does so by hydrogen going into solution at the negative, oxygen at the positive. Thus the "polarisation" by the gases is rapidly used up in production of current, and disappears.

So far the electrode has behaved in a reversible manner; but as soon as the supply of gas has disappeared, no more of this reverse current will flow, unless it be driven by some external power, and then it will be carried, not by the same ions as before, but by a different polarisation, *viz.* by discharge of oxygen at the plate which was formerly coated with hydrogen, and *vice versâ*. Thus the plate which was formerly at a high potential is now at a low; whereas in a reversible electrode (*e.g.* zinc in ZnSO_4 solution) the potential is the same whether it be used as anode or cathode (except for concentration polarisation).

In other words, the polarisation always acts in opposition to the working electromotive forces of the circuit.

The credit is due to Leblanc¹ for first disentangling the rather complex phenomena of polarisation, and showing that they depend on the same principles of potential difference as those of voltaic cells. He showed that to electrolyse a solution it is simply necessary to apply a difference of potential equal to that between the substance to be liberated at the two poles (taking account of concentration, of course). Thus to decompose copper sulphate (normal-ionic) we require, according to the table, p. 159, $1.9 - 0.6 = 1.3$ volts; to decompose zinc sulphate, $1.9 - (-0.5) = 2.4$ volts. Again, the decomposition potentials for hydrochloric acid were given on p. 166, and their dependence on both electro-affinity and concentration is clear; and further, if the dilution be made greater than that given in the table, the potential difference will rise above 1.7

¹ *Zeitschr. phys. Chem.*, **8**. 299-330 (1891); **12**. 333-358 (1893).

volts. But this is the amount ordinarily required to decompose water (*vide infra*, p. 177); hence, in accordance with the general principles stated, at this point oxygen will be liberated as well as chlorine.

We have, indeed, assumed Leblanc's conclusions in the preceding sections, and made no distinction between the treatment of voltaic and electrolytic cells. But this account of the phenomena would be very incomplete without mention of several minor points that tend to obscure the simplicity of the fundamental relations.

If an electrolytic cell containing dilute sulphuric acid between platinum plates be connected to an ammeter and voltmeter, and successively greater voltages be applied to it, the facts observed are as follows:—

When the voltage is small—say half a volt—at the first moment of turning it on a considerable deflexion of the ammeter is produced, which immediately drops to almost nothing. Before starting, the two electrodes, being quite similar, offer no back electromotive force, and consequently current flows in accordance with Ohm's law. This almost immediately produces enough oxygen and hydrogen on the plates to set up a back electromotive force of half a volt, and so stop the current. The platinum is, in fact, imperfectly converted into oxygen and hydrogen electrodes, and are said to be polarised to the extent of half a volt. The current does not altogether stop, however; oxygen and hydrogen, being both soluble in water, slowly pass off from the plates into the electrolyte; there they may either escape into the air, or, meeting, recombine. The polarisation of the plates, therefore, slowly disappears of its own accord—or would do so, but that it is kept up by renewed action of the applied electromotive force. The small steady current indicated by the ammeter is that required to keep up the polarisation that is being dissipated, and is usually called the "residual current." It is very small when oxygen and hydrogen are the products of electrolysis, for their solubility in water is very small; but when strong hydrochloric acid is electrolysed, chlorine, being freely soluble, diffuses over to the hydrogen on the cathode and recombines with it to a considerable

extent. In this case, then, there is an apparent departure from Faraday's laws, the production of gas being considerably less than that calculated from the quantity of electricity flowing.

An extreme instance of residual current is to be found in the Nernst lamp. Large quantities of electricity are passed through the white-hot metallic oxides of which this is made, without any visible decomposition taking place; yet there is, according to Nernst,¹ evidence to show that the conduction is electrolytic, and so presumably follows Faraday's laws: but all the products of decomposition diffuse and recombine. The whole current is therefore, if this view be correct, a "residual current."

Returning to the electrolysis of dilute acid, if the applied electromotive force be raised say from half a volt to a volt, a fresh quantity of electricity will flow momentarily through the cell, increasing the quantity of oxygen and hydrogen on the plates till the polarisation is raised to one volt; it will then stop, leaving only the residual current, which will be somewhat larger than before.

When the applied electromotive force is again raised, to about 1.11 volt, the electrodes become saturated with oxygen and hydrogen, and any further electrolysis will be without effect in this direction. They have then become effectively converted into oxygen and hydrogen electrodes, with the potentials due to those substances, and no further back electromotive force of polarisation is to be obtained. Hence if the applied E.M.F. be made still greater, the excess over 1.11 volts will be continuously available for production of current, in accordance with Ohm's law; gas will then be continuously evolved.

A peculiar consequence of the law of mass action should here be noted. By adding an acid to water we can increase the concentration of H^+ ions in it; by adding an alkali, the OH^- ions; but in neither case is the potential difference required for decomposition affected. For equilibrium must subsist between the concentration of the hydrogen ions (C_H), of the hydroxyl ions (C_{OH^-}), and of the water (C_{H_2O}); and,

¹ *Zeitschr. f. Elektroch.*, 6. 41-43.

according to the law of mass action, the condition of equilibrium is

$$C_{H^+} \times C_{OH^-} = \text{const.} \times C_{H_2O}$$

But the concentration of the water, which is overwhelmingly greater than that of the ions, is practically constant; therefore

$$C_{H^+} \propto \frac{1}{C_{OH^-}}$$

or, expressing the relation logarithmically,

$$\log C_{H^+} = \text{const.} - \log C_{OH^-}$$

i.e. if by any means the logarithm of the concentration of the hydrogen ions is increased, that of the hydroxyl ions is necessarily decreased by the same amount. Now, according to Nernst's law, the potential of the H^+ electrode *increases* in proportion to *increase* of $\log C_{H^+}$; that of the OH^- electrode *increases* in proportion to *decrease* of $\log C_{OH^-}$; hence the potentials of the two always rise or fall together, and the difference of potential between the two is fixed, amounting to about 1.11 volts.

Still another complicating circumstance has to be taken into account, however. The potential difference 1.11 volt is that found to exist between electrodes saturated with oxygen and hydrogen, when these are used to form a voltaic cell; it is that which corresponds to the energy change in the reaction $H^+ + OH^- = H_2O$, and may be described as the theoretical, or reversible electromotive force of this combination. But when the action is reversed, *i.e.* when water is electrolysed, the voltage required to separate visible quantities of gas is always greater than this, and varies according to the metal used for electrode. There is a specific "excess voltage" required, which may perhaps be regarded as corresponding to a state of supersaturation of the gases. The supersaturation most readily occurs when the absorptive power of the metal for the gas is slight; it is least, therefore, in the case of well-platinised platinum plates, and much less for hydrogen than for oxygen.

The phenomenon was studied by Caspari,¹ whose arrangement of apparatus is shown in Fig. 36. C is a platinised

¹ *Zeitschr. f. phys. Chem.*, 30. 89.

platinum electrode kept saturated with hydrogen; this served as a standard (see p. 238). B was another large platinised electrode, A, a small electrode of the metal to be studied. Connection between the electrodes was made by a narrow tube, and the electrolyte used, normal sulphuric acid. A polarising voltage of variable amount was applied from the battery E, to electrodes A and B; these, therefore, with the liquid between them, constituted the electrolytic cell. The difference of potential between

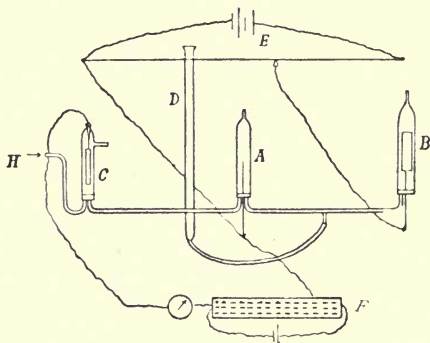

FIG. 36.

C and A or B was then measured by the potentiometer F. If the process at the electrodes were exactly reversible, the cathode of the electrolytic cell ought to exhibit no difference of potential from the standard hydrogen electrode, while the anode should be positive to it by 1.11 volt (Caspari gives 1.08 in accordance with the data then available; hence his values of the excess voltage at the anode have been reduced by 0.03).

The results obtained were these:—

Metal.	Cathodic excess.	Anodic excess (volts).
Pt (platinised)	0.005	0.36
Au	0.02	0.56
Fe in NaOH	0.08	—
Pt (polished)	0.09	0.59
Ag	0.15	—
Ni	0.21	—
Cu	0.23	—
Pd	0.46	0.36
Cd	0.48	—

Metal.	Cathodic excess.	Anodic excess.
Sn	0·53	—
Pb	0·64	—
Zn (in acid containing some zinc)	0·70	—
Hg	0·78	—
Cu (amalgamated)	0·51	—
Pb (ditto)	0·54	—
Cd (ditto)	0·68	—

The excess voltage varies but slightly with the mechanical condition of the metallic surface.

From the table it appears that to produce visible decomposition with platinised platinum electrodes requires

$$1\cdot11 + 0\cdot005 + 0\cdot36 = 1\cdot475 \text{ volt}$$

while with polished platinum it takes

$$1\cdot11 + 0\cdot09 + 0\cdot59 = 1\cdot79 \text{ volt.}$$

The latter number is about what is usually quoted as the practical decomposition potential.

As an extreme instance, it appears that by using a bright platinum anode and a mercury cathode it is possible to apply

$$1\cdot11 + 0\cdot59 + 0\cdot78 = 2\cdot48 \text{ volts}$$

to an aqueous solution before producing any visible evolution of gas.

§ 7. THERMODYNAMIC THEORY. (i)

The attempt made in § 2 to calculate the electromotive force of a voltaic cell led only to approximate results, and did not afford any means even of estimating the degree of approximation. The reason of this is in the assumption that the chemical energy spent by the materials of the cell is all converted into electrical energy; and as we then saw, this assumption is by no means always justified by the facts.

The complete theory of the energy transformations of the voltaic cell was given, independently, by Willard Gibbs¹ and

¹ *Trans. Connecticut Acad.*, 3. 108-248, 343-524 (1875); German translation in Ostwald's *Klassiker* (Engelmann: Leipzig).

by Helmholtz ;¹ their method of treatment is that of thermodynamics, so that the results arrived at may be regarded as forming a branch of that science. An outline of the results is given below ; for complete mathematical treatment we may refer to treatises on thermodynamics and in particular to the volume in this series by F. G. Donnan.

When the chemical energy lost by the materials of a cell in their action ("heat of reaction") is not all converted into electrical energy, the remainder of it appears as heat in the cell ; hence the energy equation should run—

$$\text{Heat of reaction} = \text{electrical work done} + \text{heat evolved}$$

There are, however, cases in which the electrical work done exceeds the chemical energy spent : this, we saw, is true both for the Daniell cell and for the accumulator ; the "heat evolved" is then negative, *i.e.* heat is absorbed. These voltaic combinations, in fact, serve as means of converting some of the heat stored up in their own materials into a useful form. Their action may be compared to that of a cylinder of compressed air : if the air is allowed to flow out and work an air-motor, it cools in doing so, and the work is done—partly at least—at the expense of surrounding heat. The immediate effect of the inequality between heat of reaction and electrical work is that the cell either rises or falls in temperature during action ; it will afterwards, of course, give out the excess to, or absorb the deficiency of heat from, surrounding bodies ; and for reasoning about the energy changes it is more convenient to suppose the action to take place slowly, so that the cell is always at the same temperature as its surroundings.

It is then natural to describe the last term in the equation as *latent heat* of action of the cell ; or rather, that term may be applied to the heat *absorbed*. For by "latent heat of evaporation" of a liquid we mean the heat which must be supplied from surrounding sources when the transformation of liquid into vapour takes place, in order to keep the temperature constant.

We may therefore rewrite the energy equation as—

¹ *Berl. Sitzber.*, 22-39 (1882).

Heat of reaction = electrical work done - latent heat

or, in symbols,

$$Q = W - L$$

It is this term L —positive in the Daniell and accumulator, negative in the Clark—that we ignored in § 2, and about which we have so far no information.

According to the definition of electromotive force (E), the electrical work done by the cell is the product of this into the quantity of electricity (F) flowing. Hence

$$W = EF = Q + L$$

or

$$E = \frac{Q + L}{F}$$

With regard to the latent heat of a voltaic cell it is to be noted (i.) that it is *reversible*; if taking current out of a cell (say, a lead accumulator) causes it to fall in temperature, charging it with current from an outside source will reverse the chemical reaction, and so cause heat to be evolved in the cell. In this way it is to be distinguished from the effect of resistance in the cell, which is always to cause heating (the so-called irreversible or “Joule” heating). (ii.) The heat absorbed or evolved is *proportional* to the amount of chemical action, and so to the current; whereas the “Joule” heating, due to resistance, is proportional to the square of the current.

Actual measurement of the latent heat has been accomplished in the case of the lead accumulator.¹ A small cell with electrodes 9.3×1.6 cms., cut from “Tudor” plates was placed inside the working chamber of a Bunsen ice calorimeter, and charged or discharged with a small constant current. In an experiment with acid of density 1.153, the voltage of the cell was 1.99, the current used 0.0678 amperes, the time of charge or discharge two hours, and it was found that during charge the heat evolved in the calorimeter was 0.0137 joules per second; during discharge, 0.00159. Now, in both cases the resistance heating was the same; but during charge there was a reversible heating to be added, during discharge a cooling to be subtracted. The reversible effect is

¹ Streintz, *Wied. Ann.*, 49, 564 (1893).

$$\frac{0.0137 - 0.00159}{2} = 0.0061, \text{ the irreversible}$$

$$\frac{0.0137 + 0.00159}{2} = 0.0076$$

This quantity, 0.0061 joule, is the heat absorbed when 0.0678 coulomb flows through the cell, but the chemical equation (p. 152) refers to 2×96600 coulombs. Hence the latent heat, reckoned for the quantity of reagents expressed in the chemical equation is

$$0.0061 \times \frac{2 \times 96600}{0.0678} = 17,400 \text{ joules}$$

The heat of reaction given in § 2 was for an accumulator with acid of abnormally low density; with stronger acid the heat of reaction is greater, and for 1.153 acid, such as Streintz used, about 368,600 joules (mean of Streintz and Tscheltzow's determinations).

We have therefore $Q = 368,600$, $L = 17,400$, and since two faradays correspond to the chemical reaction,

$$E = \frac{368600 + 17400}{2 \times 96600} = 1.998 \text{ volts}$$

in practically exact agreement with observation.

Here the latent heat is some 4 per cent. of the total energy transformed, and the approximate method of § 2 would be by so much in error.

In cells other than the accumulator the resistance is usually much greater, and the reversible heating effect is swamped by heating due to resistance, so that it would be impracticable to measure it directly. But the reversible heating effect may, of course, be deduced if the heat of reaction (Q) and electrical work (W) are known. To take the instances mentioned in § 2, we see that in the Daniell cell the latent heat is a small positive quantity, in the Clark a large negative one. In the Daniell cell, of composition used by Jahn, and at 0° ,

$$Q = 209,910 \text{ joules}$$

$$W = 1.0962 \text{ volt} \times 2 \times 96,540 \text{ coulombs} = 211,660 \text{ joules}$$

$$L = W - Q = 1750 \text{ joules}$$

This is less than 1 per cent. of the total; the Daniell cell, then, is an arrangement which transforms into electrical energy all the chemical energy lost by its materials, and a small quantity of heat besides.

In the Clark cell, according to E. Cohen,¹ at 18° Cent.

$$Q = 340,730 \text{ joules}$$

$$W = 1'4291 \times 2 \times 96,540 = 275,930 \text{ joules}$$

$$L = W - Q = -64,800 \text{ joules}$$

or about 24 per cent. of the total. The Clark cell, therefore only converts 76 per cent. of its chemical into electrical energy, the remainder into heat.

All that has been said so far is a simple consequence of the first law of thermodynamics, *i.e.* of the principle of conservation of energy, but further deductions can be made from the second law. The most important of these lies in the conception of *free energy*. The energy conveyed by an electric current is of a completely available kind; it can be converted into mechanical work by an electrometer, with no loss except that due to mechanical imperfections in the motor; it may be taken as a measure of the work that the chemical reaction is capable of doing. Further, the process of transformation of chemical into electrical energy is a reversible one in the sense in which that word is used in thermodynamics; that is to say, it can be carried out backwards (as in charging an accumulator) with as slight a change of circumstances as we please (by using only a small current). Now, reasoning based on the second law of thermodynamics shows that a chemical reaction, performed at a fixed temperature, is capable of doing the same amount of work, whatever form that work may take, provided only the transformation of energy takes place reversibly; and if the process is not reversible the work done is always less. Hence the electrical work done is not merely a fact of consequence to the voltaic cell considered; it is *the* measure of the capacity for work of a certain chemical action, under whatever circumstances. Whether that amount of possible work is realised depends only on how close an approach to

¹ *Zeitschr. phys. Chem.*, **34**. 62-68 (1900).

the ideal of reversibility can be made. It is therefore appropriate to speak of this amount of "free energy" being given out by the reaction, without specifying whether it is to be spent in generating electric current, in working against an osmotic pressure, or directly in mechanical form, or otherwise; the electrical measurement affords merely the most convenient means of estimating the loss of free energy by the reacting materials.

Accordingly, the calorimetric measurement Q gives the total energy—available or not—lost by the chemical materials during reaction: the electrical measurement W gives the free—or available—energy lost. The latter quantity may fall short of or exceed the former.

The extreme importance of the notion of free energy demands as complete illustration as possible; we shall therefore take in detail an instance in which there are two known ways of measuring it, and compare the results. The electromotive force of a lead accumulator increases with increase in strength of acid; consequently if two cells, one with strong acid, the other with weak, are coupled in opposition, the former will send a current through the latter. The cell with the strong acid will be discharged, that with weak acid charged. We may write the equations thus:—

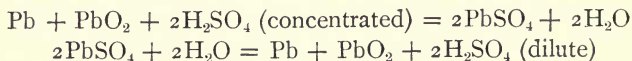

The total amount of each insoluble solid material remains the same as before, so that no change occurs in either the free or total energy possessed by these. The total amounts of acid and of water also remain the same, but their distribution is different; for in place of the original strong solution we have, in the first cell, a solution which has lost acid and gained water, and is consequently weaker; in place of the original weak solution we have in the second cell a stronger one. Now, the energy (whether free or total) of a solution depends on its composition, so that a certain change has been effected; in fact, it is as if the two acids had been partly mixed with each other. If the current were allowed to flow indefinitely it would

continue until the acid was of the same strength in each cell; this would be effectively the same as a complete mixture of the two liquids, and the electrical energy of the current that had flowed would measure the work that could be done by the acid on mixing—*i.e.* the loss of free energy attending mixture.

But again, if the two vessels of acid be placed side by side in an air-tight chamber, water from the weak acid (which has the higher vapour pressure) will distil over to the strong, until the same final result is obtained—*viz.* uniformity in strength. No work will be done thus—*i.e.* with no appropriate mechanism for making use of the energy; but if the evaporation and condensation be effected by the mechanism imagined on p. 162, work will be done, and according to the principles of thermodynamics, the amount of work must be the same as in the electrical method, for each amount is a measure of the loss of free energy.

Now, the electromotive force of accumulators with various strengths of acid has been measured at 0° by Streintz, Heim, Dolezalek, and others; the vapour pressure of sulphuric acid of various strengths has been measured at the same temperature by Dieterici; hence all the data are at hand for comparing the two quantities of work.

The calculation is easier if, instead of following the mixture out to an extreme, we suppose it to proceed only to a very small extent (the same in both cases), or, what comes to the same thing, suppose the quantity of acid in the cells indefinitely large, so that the transfer of one mol produces only a very small effect on its composition.

As numerical example we will take

	First cell.	Second cell.
	$\text{H}_2\text{SO}_4 \cdot 10\text{H}_2\text{O}$	$\text{H}_2\text{SO}_4 \cdot 20\text{H}_2\text{O}$
Percentage H_2SO_4	35'26	21'40
Density at 15°	1'266	1'154
Vapour pressure (mm. Hg. at 0°)	2'975	4'027

Then (1) we must suppose two faradays to flow through the cells; the net electromotive force is $2 \cdot 103 - 2 \cdot 001 = 0 \cdot 102$ volt, and the work done (reckoned for the quantities occurring in the chemical equation)

$$2 \times 96600 \times 0.102 = 19,700 \text{ joules}$$

(2) Distil two mols of water from the weak acid to the strong: this will effect the same change in distribution of water as in the electrical case. But further, we have to transfer two mols of H_2SO_4 from the strong acid to the weak. As H_2SO_4 has no measurable vapour pressure, we must proceed as follows: separate the quantity $2(\text{H}_2\text{SO}_4.10\text{H}_2\text{O})$ from the stronger acid; distil $20\text{H}_2\text{O}$ from the weak acid into this, so that its composition comes to be $2(\text{H}_2\text{SO}_4.20\text{H}_2\text{O})$. It can then be mixed without change of energy with the weaker acid, which possesses the same composition. The required amount of H_2SO_4 has now been transferred, but the vessel of weak acid contains $20\text{H}_2\text{O}$ more than it did. This excess must therefore be distilled back into the strong acid. The required changes are then accomplished. The amount of work done in these various processes has been calculated by Dolezalek.¹ It consists essentially of the work done by the aqueous vapour in expanding from higher to lower pressure, and for the particular case considered is 19,900 joules. The discrepancy of one per cent. between this and the electrical estimate is, of course, attributable to experimental errors—the agreement, in fact, is very good.

This method of calculating the change of free energy by the vapour pressure is only possible if no new chemical materials are involved in the reaction, consequently in only a few cases. The ordinary voltaic cell in which one metal displaces another from solution is beyond its reach. We cannot, then, compare the results of two methods of calculating free energy, and are thrown back on the electrical determination; but as the conclusion that any method will give the same result is deduced strictly from the fundamental principles of thermodynamics, it is worthy of entire confidence. *Measurement of electromotive force may then be looked upon as a means of determining the change of free energy in a chemical reaction, and the most widely applicable means.*

¹ See *Theorie des Blei-Akkumulator* (Knapp: Halle).

(ii) THE GIBBS-HELMHOLTZ EQUATION.

There are great experimental difficulties in measuring the latent heat of action of a voltaic cell. Fortunately, however, there is an indirect means that is quite easy. It is well known that a close connection holds between the latent heat of evaporation of a liquid and the temperature coefficient of its vapour pressure; a similar thermo-dynamic relation holds between the latent heat of a cell and the temperature coefficient of its electromotive force. This relation forms one of the most essential parts of the theory, as given by Gibbs, Helmholtz (*loc. cit.*), and others.

The relation is: Latent heat = quantity of electricity conveyed \times absolute temperature \times temperature coefficient of electromotive force; or, in symbols, if

F = electricity conveyed by the reaction in cell,

T = absolute temperature,

$\frac{dE}{dT}$ = increase of E (the electromotive force) per degree,

$$L = FT \frac{dE}{dT}$$

If this relation be introduced into the equation

$$Q + L = EF$$

we get

$$Q = F \left(E - T \frac{dE}{dT} \right)$$

The last equation gives the means of calculating heats of reaction by merely measuring the electromotive force of a cell at two (or more) temperatures.

Numerous examples of this equation have been worked out. We will first take Streintz's measurements on the lead accumulator referred to above. For acid of density 1.153 the E.M.F. of an accumulator is found to *increase* 0.00032 volts per 1° rise of temperature (Streintz), or 0.00037 (Dolezalek). We may then take the mean

$$\frac{dE}{dT} = 0.000345$$

The temperature of Streintz's measurement of latent heat was the freezing-point, *i.e.* 273° absolute. Hence

$$L = 2 \times 96,600 \times 273 \times 0.000345 = 18,200 \text{ joules}$$

whereas direct measurement gave 17,400.

The accumulator (with ordinary strength of acid) has a positive temperature coefficient, and therefore positive latent heat; the same is true of the Daniell. The Clark, on the other hand, has negative latent heat, and electromotive force decreasing with rise of temperature. The latter is the more frequent case.

Amongst the best verifications of the Gibbs-Helmholtz relation are those of Jahn¹ given in the following table. The last two columns show the latent heat as calculated from the heat of reaction and from the temperature coefficient respectively.

Cell.	E.M.F. at 0° . Volts.	Temperature coefficient. Volts per 1° .	Electrical ² work. W	Heat of reaction. Q	Latent heat. W-Q	$HT \frac{dE}{dT}$
Cu:CuSO ₄ +100H ₂ O :ZnSO ₄ +100H ₂ O:Zn	1.0962	+0.000034	50526	50110	-416	-428
Cu:CuAc ₂ aq :PbAc ₂ +100H ₂ O:Pb	0.47643	+0.000385	21684	17533	-4151	-4784
Ag:AgBr :ZnBr ₂ +25H ₂ O:Zn	0.84095	-0.000106	38276	39764	+1488	+1326
Ag:AgCl :ZnCl ₂ +25H ₂ O:Zn	0.9740	-0.000202	44332	46986	+2654	+2510

The first of these cells was taken as an instance of Kelvin's rule, in § 2. It will now be seen that even the slight discrepancy—one per cent.—that exists between the electrical work and the heat of reaction is accounted for by the thermodynamic treatment.

The Clark and cadmium cells have been carefully examined from the thermodynamic point of view by Cohen; they present certain points of interest in the treatment of the thermo-chemical data.

¹ *Wied. Ann.*, **28**, 21-43, 491-508 (86); **50**, 189-192 (93).

² The quantities of work and heat are given in calories. The heat was measured in a Bunsen calorimeter. Jahn gives at first 0.2394, afterwards 0.2362 cal. = 1 joule.

The Clark cell¹ at 18° (291° abs.) has an electromotive force of 1·4291 volts (mean of determinations by Kahle, Jaegar, and Callendar and Barnes); it falls off, in the neighbourhood of that temperature, by 0·0012345 volts per 1° rise of temperature. Hence, taking (with Cohen) the faraday as 96,540 coulombs, we have

$$W = 1·4291 \times 2 \times 96,540 = 275,920 \text{ joules}$$

$$L = 291 \times (-0·0012345) \times 2 \times 96,540 = -69,360 \text{ joules}$$

and

$$Q = W - L = 345280 \text{ joules.}$$

This, then, is the electrical determination of the heat of reaction in the Clark cell.

That reaction is usually described as

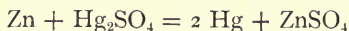

The data for calculating its thermal value are—

Heat of formation of ZnSO ₄ (Thomsen)	230,090	calories
" " Hg ₂ SO ₄ (Varet)	175,000	"
Difference	55,090	"

or about 233,000 joules. This is far too low; but the salt formed in the cell is really the hydrate ZnSO₄·7H₂O, which has a considerably greater heat of formation, as anhydrous zinc sulphate has a strong affinity for water. According to Thomsen, the "heat of hydration" is 22,690 cal.; adding this, Q becomes 77,780 cal., or about 327,000 joules. This is still six per cent. below the electrical determination. Now, Cohen points out that the heptahydrate is formed in a solution already saturated, and can only get its water of crystallisation by withdrawing some from the solution; this, however, is necessarily accompanied by precipitation of some salt already in solution; hence the reaction in the cell will not be completely expressed unless this is taken into account. If the saturated solution has composition ZnSO₄·*a*H₂O, then the water given up on crystallisation is *a* - 7, and the amount required for union with

¹ Cohen, *Zeitschr. phys. Chem.*, **34**, 62-68 (1900).

ZnSO_4 can be obtained from $\frac{7}{a-7}$ molecules of sulphate in solution. The complete reaction is therefore—

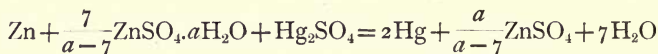

At 18° $a = 16.81$, and the measurements of J. Thomsen show that zinc sulphate in passing from the state of heptahydrate crystals to that of saturated solution absorbs 4694 cal. Introducing these numbers into the equation, we get for the total heat of reaction, $77,780 + \frac{7}{16.81-7} \times 4694 = 81,127$ cal. This, with Jahn's value for the mechanical equivalent of heat (0.2362 cal. = 1 joule)¹ gives 343,500 joules, about one-half per cent. below the electrical determination.

The cadmium cell² requires similar treatment, but as it is made with amalgam instead of pure cadmium there are three parts to the heat of reaction.

(a) 1 gram atom Cd is withdrawn from amalgam.

(b) The cadmium so set free reacts with Hg_2SO_4 to form $2\text{Hg} + \text{CdSO}_4$.

(c) The CdSO_4 withdraws water from saturated solution, to form the hydrate $\text{CdSO}_4 \cdot \frac{8}{3}\text{H}_2\text{O}$. The latter process follows the equation

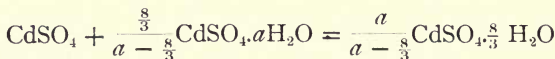

where a , as before, is the number of mols of water to one of salt, in the saturated solution.

To determine (a) a cell was constructed with one electrode of pure electrolytically deposited crystalline cadmium, the other of amalgam, in solution of CdSO_4 . The amalgam used was 14.3 per cent. It has since been found that this amalgam is subject to slow changes due to a "transition" to another state

¹ It may be remarked, however, that this value (4.234 joules = 1 cal.) is certainly incorrect; it is probably 4.184 (Day, *Phys. Rev.*, **6**, 193-222 (1898)).

² Cohen, *Zeitschr. phys. Chem.*, **34**, 612-620 (1900).

of aggregation, and 12.5 per cent., which is stable, is now always used; but Cohen's measurements are probably applicable without change to this. The electromotive force of the combination was measured at 0° and 25°, and found to be

$$0.0515 - 0.000233 (t - 18^\circ)$$

amalgam being positive. From this result, assuming the Gibbs-Helmholtz formula, the quantity of heat involved in process (a) was calculated. It is¹

$-2 \times 96,600 (0.0515 + 291 \times 0.000233) = -23,050$ joules
i.e. withdrawal of cadmium from the amalgam requires absorption of heat.

(b) Heat of formation of $\text{CdSO}_4 = 219,900$ calories
 „ „ $\text{Hg}_2\text{SO}_4 = 175,000$ „
 Difference . . . = 44,900 „

(c) At 18° $\alpha = 15.17$, so that the formation of hydrate is according to the equation

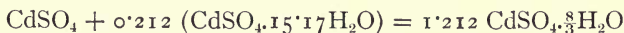

Now, the heat of solution of the anhydrous salt (to the great dilution of 400 H_2O) is

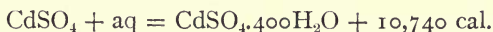

of the hydrate



and the heat of dilution

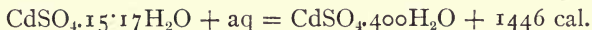

The total production of heat in the above reaction is therefore

$$10,740 + 0.212 \times 1446 - 1.212 \times 2660 = 7822 \text{ calories}$$

Adding together the quantities of heat, (b) and (c), we get $44,900 + 7822 = 52,722$.

The thermo-chemical measurements were made at 18° C.,

¹ The values of the faraday and the mechanical equivalent adopted in this book have been substituted for those of Cohen.

so this number should be multiplied by 4.184, and becomes 220,590 joules. Deducting (α), we get 197,540 joules as the heat of reaction in the cadmium cell (calorimetric determination).

The electromotive force at 18° is 1.0186 volt (Jaeger and Wachsmuth), the temperature co-efficient - 0.0000354 volt per 1°. Hence

$$F\left(E - T \frac{dE}{dT}\right) = 197,450 \text{ joules}$$

The agreement is more precise than that which Cohen deduces from a less trustworthy value of the dynamical equivalent of heat, and leaves nothing to be desired.

An interesting case is given by Bugarsky.¹ It is the combination Hg : HgCl + 0.01 norm. KCl : norm. KNO₃ : 0.01 norm. KOH + Hg₂O : Hg. Here KNO₃ is inserted between the two halves of the cell to avoid precipitation of mercurous chloride at the point of contact, but is otherwise without action. Current flows from the chloride to the hydroxide, the reaction being

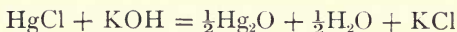

The electromotive force (at 18.5°) is 0.1483 volt, corresponding to a change of + 31,800 joules (*i.e.* a *loss* of free energy). But the term $FT \frac{dE}{dT} = + 47,400$ joules, so that

$$Q = 31,800 - 47,400 = - 15,600 \text{ joules}$$

i.e. the reaction occurs with *absorption* of heat, or *gain* of total energy (is "endothermic"). This is confirmed by calorimetric measurements.

Cells in which the electrolyte is a fused salt have been measured in a few instances; thus Buscemi² found for the combination

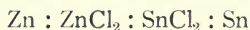

at 250° to 330°, 0.360 volts; this agrees with the value calculated from the heat of reaction, by Kelvin's rule. Further,

¹ *Zeitschr. anorg. Chem.*, **14**, 145 (1897).

² *Nuov. Cim.*, (5), **1**, 201-206 (1902).

$$\begin{array}{l} \text{Hg} : \text{HgCl}_2 : \text{ZnCl}_2 : \text{Zn} \left\{ \begin{array}{l} 0.627 \text{ volts at } 265^\circ \\ 0.740 \text{ ,, ,, } 315^\circ \end{array} \right. \\ \text{Zn} : \text{ZnCl}_2 : \text{CuCl}_2 : \text{Cu} \left\{ \begin{array}{l} 0.483 \text{ ,, ,, } 250^\circ \\ 0.404 \text{ ,, ,, } 330^\circ \end{array} \right. \end{array}$$

Considerable theoretical, as well as practical, interest attaches to the thermodynamic treatment of gas cells, *i.e.* cells of which the active materials at the electrodes are gases. These may be divided into two classes: (i.) when the substance formed in the cell is the solvent, *i.e.* when H and O are the electrode materials; (ii.) when the substance formed is the solute. An example of the latter is to be found in a cell with H and Cl for electrodes and HCl solution for electrolyte.

The oxyhydrogen cell, sometimes called after Grove (*Phil. Mag.*, 1842 and on), has been much studied. We may content ourselves with quoting the works of Smale,¹ E. Bose,² and Wilsmore.³ Bose gives a complete bibliography.

To construct the cell, two gas electrodes, such, *e.g.*, as those of Wilsmore described on p. 238 below, must be provided with hydrogen and oxygen respectively, and connected by pure water or an aqueous solution.

The reaction, whatever the electrolyte may be, is essentially the same—

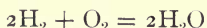

The reagents are taken in the same initial state—gas as atmospheric pressure; and delivered in the same final state—liquid water. Hence the charge of both total and free energy must be the same whatever the electrolyte; and we conclude that the electromotive force is also independent of the electrolyte: this fact has already been seen in a different light (p. 175).

This conclusion was nearly verified by Smale; for acid cells he found in good agreement, 1.071 to 1.073 volts, but with alkaline solutions, one to two per cent. higher numbers. Bose

¹ *Zeitschr. phys. Chem.*, **14**. 577 (1894), and **16**. 562 (1895).

² *Zeitschr. phys. Chem.*, **34**. 701-760 (1900); **38**. 1-27, and with H. Kochan, 28-55 (1901).

³ *Zeitschr. phys. Chem.*, **35**. 298 (1900).

concludes from his experiments that the final state of equilibrium was not reached by Smale, the attainment of equilibrium being very slow. He obtained electromotive forces up to 1.124 volt from a gas cell, and by reversing the current and then allowing the polarisation to subside—thereby approaching the state of equilibrium from the other side, 1.154 volts. He concludes, therefore, that the true equilibrium electromotive force lies between these two numbers. Wilsmore confirms the view that several days are needed to reach a steady electromotive force, but sets the limit at 1.119 (all at 25°). It is apparently the oxygen electrode that is so slow in action, for standard hydrogen electrodes can be made to acquire a steady electromotive force in a few minutes. This may be due to very slow diffusion of oxygen in the solid metal; Bose found it necessary to use metal foil only $\frac{1}{400}$ mm. thick; and also partly to formation of H_2O_2 , which takes part in the chemical equilibrium at the oxygen electrode.

Now, the heat of combination of gaseous oxygen and hydrogen is 143,600 joules per gram-equivalent. This would give, according to Kelvin's rule, $\frac{143600}{96600} = 1.48$ volt; or, according to the thermo-dynamic theory,

$$E - T \frac{dE}{dT} = 1.48$$

$$\text{Putting } E = 1.12, \text{ we have } \frac{dE}{dT} = \frac{1.12 - 1.48}{273 + 25} = -0.00121$$

Smale found -0.00142 . The discrepancy may be due to want of saturation of his oxygen electrodes. There is at least an approximate agreement; whereas if the potential were taken as 1.68 volt, at which gas is freely evolved on electrolysis, the temperature co-efficient $\left(\frac{1.68 - 1.48}{273 + 25}\right)$ should be positive. This may be regarded as a proof that the lower of the two points is the true reversible potential for the reaction $2H_2 + O_2 = 2H_2O$, the higher probably depending on phenomena of supersaturation, which, as we have seen (p. 176), vary from one metal to another.

As typical of a gas cell in which the solute is formed by the electrical action, we may take the combination

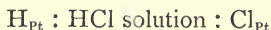

i.e. a hydrogen and a chlorine electrode immersed in aqueous hydrochloric acid. If both the electrodes were strictly reversible, the electromotive force of this would be identical with that required to electrolyse hydrochloric acid of the same strength; but on account of the phenomena of supersaturation (p. 176) it is actually less; and as the gas cell, rather than electrolysis, gives the proper reversible electromotive force, it is of more theoretical interest to measure it. That has been done by Smale (*loc. cit.*) and Erich Müller.¹ The electromotive force varies with concentration, for in the reaction

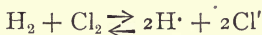

the substances on the left are always the same (gases at normal pressure), while those on the right (aqueous solution) possess more or less free energy according as they are more or less concentrated; the loss of free energy in the reaction is therefore greater when the product is more dilute, and the electromotive force greater accordingly. E. Müller finds in

Normal acid	1'3660	volts	}	at 25°	
$\frac{1}{10}$	" "	1'4849			"
$\frac{1}{100}$	" "	1'5460			"
$\frac{1}{1000}$	" "	1'5868			"

The differences between these numbers are not in accordance with the usual logarithmic rule (p. 163), according to which a change of tenfold in concentration ought to cause a change of nearly 0·12 volt (0·06 at each electrode). Müller partly accounts for the discrepancy by taking into account hydrolysis according to the equation

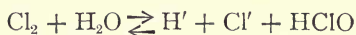

The difference in electromotive force between two HCl cells with acids of different strengths is closely similar to that

¹ *Zeitschr. phys. Chem.*, **40**. 158-168 (1902). See also a paper by Dolezalek, *ibid.*, **36**. 321-336 (1898), containing measurements and theory.

between two accumulators (p. 182), and can accordingly be treated by the method of vapour pressure. The treatment is, in fact, easier, for the vapour pressure of HCl over a solution of the acid is measurable; whereas that of H_2SO_4 is immeasurably small, and an indirect process, depending on the vapour pressure of water, has to be used instead. Dolezalek (*loc. cit.*) compares the vapour pressures and E.M.F.'s for hydrochloric acid of 5 to 12 times normal, with very satisfactory results.

(iii) SINGLE POTENTIAL DIFFERENCES AT ELECTRODES.

The same thermodynamic treatment may be applied to single electromotive junctions. We may consider separately the chemical reaction occurring at one pole of a cell; estimate its free energy by the potential difference it produces; and, if we have any means of measuring the heat of reaction, compare it, by the Gibbs-Helmholtz formula, with the change in free energy. Unfortunately, as the partial reaction necessarily involves the formation or destruction of free ions (unaccompanied by the corresponding ions of opposite sign), there is no means of studying it, independently of the complete electrochemical process of which it forms part; hence the heat of reaction in such cases cannot be measured. The measurements that can be made are of (*a*) the single potential difference, (*b*) the temperature coefficient, (*c*) the latent heat (sometimes called, in this case, the Peltier effect).

(*a*) Numerous measurements have been made, by the calomel or other standard electrode, of single potential differences; but the value of such measurements depends entirely on the absolute determination in some one case. Thus, suppose it is desired to know how much of the E.M.F. of an accumulator is produced at each pole, we may proceed to measure the cells—

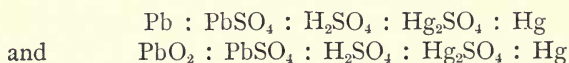

i.e. each half of the accumulator combined with a standard mercury electrode. The former E.M.F. may be written $C - A$, the latter $C - B$, where A , B are the potentials of the lead and

lead peroxide plates, C that of the standard. By this means A and B are referred to the same standard; but there is no means of knowing their actual values unless that of C is known. We need, therefore, an electrode whose potential either is zero, or is known by independent means. Two suggestions have been made, so far, for obtaining electrodes of no potential difference.

The Dropping Electrode.—This was suggested first by Lord Kelvin for measuring the potential of the air (water-dropper), and subsequently by Helmholtz and others for electrolyte measurements. For the latter purpose mercury is always used, and the electrode takes the form of a fine jet of mercury delivering drops into an electrolytic solution—usually of a mercury salt.

A mercury surface, in contact with an aqueous solution of a mercury salt, when at rest, assumes a definite potential with respect to the latter: say, a positive potential, as happens when any ordinary concentration of salt is used (p. 159). This means that a certain amount of (positive) electricity flows from the electrolyte to the electrode, or that the reaction

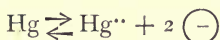

proceeds, to a small extent, from right to left. In this way some free positive electricity is imparted to the electrode, and its potential raised; that of the solution lowered. This, however, sets up electrostatic attraction between the excess of positive electricity in the electrode and negative in the solution; as soon as the work to be done in overcoming the electrostatic attraction is too great for the chemical forces to perform the process stops. There is then a distribution of positive electricity on the metal, and negative on the solution, constituting an electrical “double layer.”

Now, if the mercury, instead of being at rest, is in process of forming a drop, and consequently of extending the area of contact, more ions will be needed to constitute the double layer on the new surface. These must diffuse out of the mass of electrolyte, so that the process of obtaining them is not very rapid. Hence, so long as drops are being formed, the double

layer will be deficient, and even, if drops are formed very fast, almost absent, and the mercury will hardly differ in potential from the electrolyte.

This state of things is capable of realisation. Attempts at it were made by Ostwald,¹ but the experimental difficulties were first successfully met by Paschen.²

The apparatus of the latter consisted of a vertical tube about 200 cms. long, drawn out at the lower end to a bore of 0.002 to 0.005 cm. This is filled with mercury, which comes out in a fine jet, breaking up into drops; it delivers into a dish containing mercury, covered with the electrolyte. It is essential that the level of the electrolyte should be adjusted so that the mercury is on the point of breaking up into drops on entering it.

Palmaer³ finds the action of the electrode improved by making it with a glass stopper closing the bottom of the mercury tube, except for a number of fine rills in its edge, through which the mercury escapes (Fig. 37).

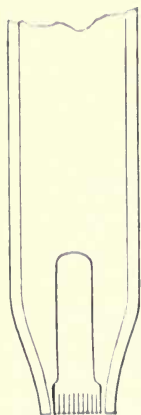

FIG. 37.

The potential difference to be measured is that between the mercury in the dropping-tube and that at rest in the dish below; or else between the dropping mercury and some other electrode put in connection with the electrolyte.

Paschen measured the potential difference in the dropping electrode for a number of solutions of HCl, NaCl, HBr, KBr, HI, and KI, obtaining consistent results, which were, moreover, in agreement with those of the capillary electrometer method (*vide infra*). He studied the influence of concentration, but without finding very intelligible variations on this account. It is on the strength of his measurements as well as those made with the capillary electrometer that the potential of the normal KCl electrode has been taken at + 0.560 volt, the decinormal

¹ *Zeitschr. phys. Chem.*, **1**, 583 (1887).

² *Wied. Ann.*, **41**, 42-70 (1890).

³ *Zeitschr. phys. Chem.*, **28**, 259 (1899).

at $+0.616$ volt. Palmaer¹ has recently carried out a suggestion of Nernst that renders the method more certain and exact. The electrolyte is made a solution of mercury ions, of such diluteness that there is no potential difference between it and the standard electrode. This can be done by adding a cyanide or H_2S to a mercurous solution. *E.g.*, when the composition $0.1KCl + 0.01KCN + 0.0008KOH + 0.00025Hg(CN)_2$ (equiv. per litre) was used for the electrolyte in the dish into which the dropping electrode delivered, it was found that practically no difference of potential existed between the dropping and the fixed electrodes; and at the same time a decinormal electrode was 0.5745 volts positive to the mercury in the dish. From the mean of several experiments the author concludes that the absolute potential of the decinormal electrode is $+0.572$ volt at atmospheric temperature, instead of 0.616 , as hitherto assumed.

Capillary Electrometer.--Another method that has been more frequently applied depends on the influence of electrification on the surface tension of mercury. This was discussed theoretically by Helmholtz, and worked out by Lippmann into the practical instrument for measuring electromotive forces described below (p. 235). If to such a capillary electrometer a potential difference is applied from outside, the surface tension of the mercury is changed: when the mercury in the tube is made positive, the surface tension decreases; when negative, it increases up to a maximum for about half a volt, and then decreases again. According to Helmholtz's theory, the existence of an electrical double layer at the surface between mercury and electrolyte reduces the surface tension, in whichever sense the double layer may lie, so that maximum surface tension occurs when the double layer is absent, *i.e.* when mercury and electrolyte have the same potential. Hence the observations are interpreted as meaning that the mercury in contact with an ordinary electrolyte is naturally positive, but that, by connecting it to the negative pole of an outside source of electromotive force of sufficient strength, the potential of the mercury may be reduced to that of the solution. The

¹ *Zeitschr. Elektrochemie*, **9**, 754 (1903).

applied electromotive force necessary to effect this is, then, a measure of the absolute potential of the mercury in its natural state.

The course of the phenomenon may be conveniently represented by a diagram (Fig. 38), in which the surface tension is plotted (as ordinate) against electromotive force (as abscissa). *A* represents the "natural" surface tension, *i.e.* without any outside electrification; *B*, the maximum; at *B*, therefore, the potential of the mercury is the same as that of the solution, while at *A* it differs by the amount *HK*. According to Helmholtz's theory, it makes no difference whether, in the double

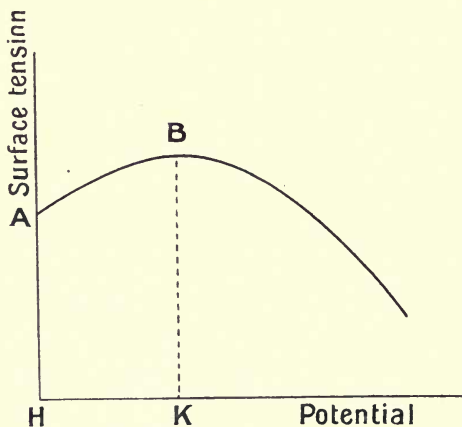

FIG. 38.

layer, the positive charge is on the one or the other; the curve should therefore be symmetrical about *B*, the surface tension being depressed equally by a given difference of potential from *K* on either side.

Experiments by Lippmann and others have confirmed this theory in its general lines. The curve is of approximately the parabolic shape of Fig. 38; in dilute sulphuric acid an applied E.M.F. of about 1 volt causes the maximum to be reached; and as according to the theory the maximum surface tension is found when the surface is entirely free from the effect of an electrical double layer, it should be, at least approximately, the

same for all solutions, though the applied potential necessary to produce it will vary from one electrolyte to another. This point was tested by Ostwald;¹ the surface tension was measured by the pressure of mercury required to keep the meniscus at a fixed point in the capillary tube. The natural surface tension, measured in sulphuric, phosphoric, hydrochloric, and hydrobromic acids of strength from centinormal to normal varied between 485 and 564 mm., whilst the maximum

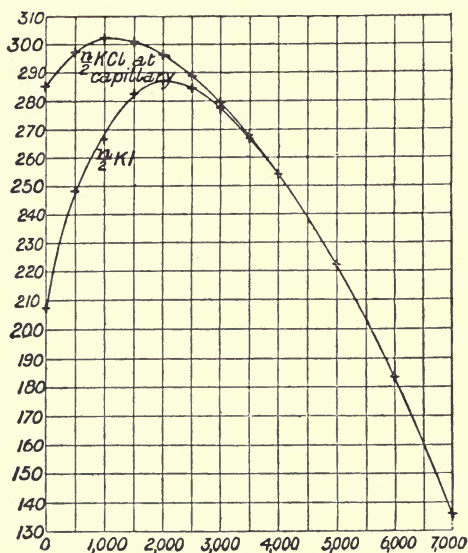

FIG. 39.

values varied only between 638 and 644, *i.e.* were practically the same throughout.

There are, however, other directions in which the phenomena are not satisfactorily covered by the simple theory; in particular, the variation in potential difference from one electrolyte to another is not what might be expected, and the curve is not, when closely examined, found to be symmetrical. These points are both clearly seen in Fig. 39, which is taken

¹ *Zeitschr. phys. Chem.*, 1. 598 (1887).

from the work of S. W. J. Smith.¹ The abscissæ represent electromotive force on an arbitrary scale (5000 = 1 volt, nearly). The curves are noticeably unsymmetrical, and while for a polarisation of 0.8 volt and more those for KI and KCl are identical, the two salts show marked differences, both in the position and height of the maximum. It is evident, then, that the chemical nature of the solution exercises an influence that is not allowed for in the Helmholtz theory.

An attempt has recently been made by van Laar² to extend the theory, and adapt it more precisely to the circumstances of the capillary electrometer. He considers the effect of the passage of a small quantity of mercurions from metal to electrolyte, and *vice versa*, together with the consequent changes in the ions in the boundary layer; the latter involve the introduction of a new term in the expression for the surface tension. This term, which was previously ignored, is not the same when the double layer is inverted, *i.e.* not the same for positive as for negative potentials of the mercury. Hence, in place of one equation—

$$s = a - cE^2$$

(s = surface tension, E = potential of metal against electrolyte, a and c constants), he gets two equations—

$$s = a + bE - cE^2$$

one for positive, the other for negative potentials. These equations were compared with Smith's measurements for $\frac{1}{10}\% \text{KCl}$, and found to represent the experimental results accurately. They are shown in Fig. 40. AP is the ascending branch of the experimental curve, *i.e.* for applied E.M.F. less than 0.6 volt, when the charge on the mercury is still positive. It shows a maximum at M. PB is the descending branch—negative charge on mercury. The dotted lines are prolongations of these curves; AP and PB are both parabolas, but sensibly different from each other.

According to van Laar's theory, the point of no electrification, P, is that at which one parabola passes over into the other;

¹ *Zeitschr. phys. Chem.*, **32**, 433-476 (1900).

² *Ibid.*, **41**, 385-398 (1902).

and this is not in general at the maximum, M. He concludes, therefore, that observation of the maximum surface tension by the capillary electrometer is not a means of determining absolute potentials. The difference, MP, in the case chosen is 0.04 volt. However, it should be remarked that van Laar's calculations are based on the value +0.616 volt for the decinormal electrode, derived from measurements with the dropping electrode. Palmaer's new value, 0.572 (p. 197), is practically coincident with M, and the two parabolas run so nearly together

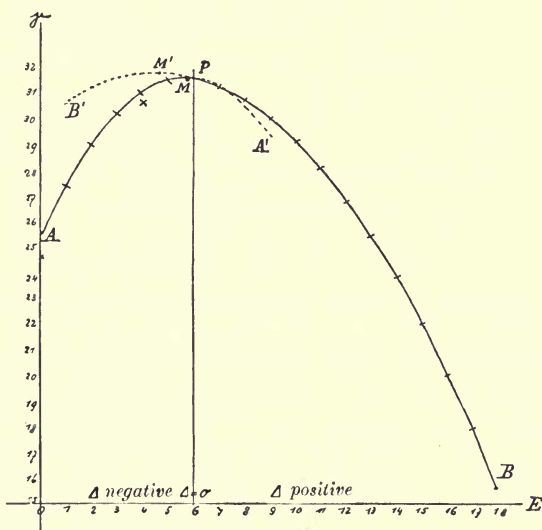

FIG. 40.

that it is impossible to say by inspection what their point of intersection is, within wide limits. Hence, in this case at least, the maximum is restored to its position as indicator of zero potential; it must, however, be taken as definitely proved that the two halves of the curve are unlike.

We conclude that the question of absolute potentials is at present only approximately settled. The values adopted by Wilsmore and Ostwald (p. 159) may be used provisionally: they are based on the decinormal electrode as 0.616,

and should eventually be corrected in accordance with new experiments.

Latent Heat.—The earliest experiments on temperature coefficients and latent heat at isolated junctions were by Bouty.¹ His method for the former measurement was to use as electrodes thermometers electroplated with the metal to be studied. On sending a current through these into or out of a solution a rise or fall of temperature was observed, from which the reversible thermal effect, or latent heat, could be estimated. The method, is, of course, a rough one, incapable of much accuracy; but it served to show that the latent heat was, so nearly as could be judged, that calculated from the thermodynamic formula $L = FT \frac{dE}{dT}$.

Direct measurement of temperature coefficients, though not free from difficulty, is easier. For this purpose a cell is made up of two parts, which, except for temperature, are identical, *e.g.*

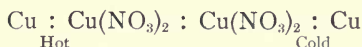

The potential difference between the electrodes may then be measured in the usual way. The result may, however, be erroneous on account of a potential difference at the contact between the hot and cold electrolytes. If this be ignored, we have a means of determining the temperature coefficient $\left(\frac{dE}{dT}\right)$ of potential for the electrode $\text{Cu} : \text{Cu}(\text{NO}_3)_2$.

The chief results of Bouty, Chroustschoff and Sitnikoff,² and Gockel³ are as follows:—

Copper	+ 0'00066 to 0'00078 volts per 1°
Zinc	+ 0'00056 ,, 0'00083 ,, ,,
Cadmium	+ 0'00050 ,, 0'00070 ,, ,,
Lead	+ 0'00009 ,, 0'00018 ,, ,,
Mercury	+ 0'00015 volts per 1°
Gold	+ 0'00003 ,, ,,
Platinum	+ 0'00081 ,, ,,

¹ *J. de Phys.*, **8**, 289, 341 (1879); **9**, 306 (1880); **10**, (1881).

² *C. R.* **108**, 937 (1889).

³ *Wied.*, **24**, 634 (1885). See, further, Nernst, *Zeitschr. phys. Chem.*, **2**, 613 (1888).

The small differences due to concentration and to the nature of the anion are hardly worth taking into account, in view of the uncertainty of the experiments.

The data given above allow of calculating the "heat of reaction" at the electrodes—or, to use the term more applicable to this case, the change in total energy. This is

$$Q = F \left(E - T \frac{dE}{dT} \right)$$

Taking copper as an instance, we have, for a normal ionic solution, $E = +0.606$. The temperature may be taken as 18°C ., or $T = 291$ and $\frac{dE}{dT} = +0.00072$. Hence

$$Q = 96,600 (0.606 - 291 \times 0.00072) = 38,300 \text{ joules per equivalent.}$$

This is the change in total energy accompanying the reaction

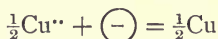

If the reaction could be performed—like an ordinary chemical one—without doing any work, this is the amount of heat that would be liberated. Actually, as the reaction must take place in a voltaic cell, it is accompanied by a performance of work, $W = HE = 58,500$ joules. This is very considerably in excess of the change in total energy. The difference, $20,200$ joules, is the latent heat, and is absorbed from surrounding bodies. Accordingly, the positive pole of a Daniell cell, at which the above reaction occurs, cools during action.

For zinc the quantities are

$$E = -0.493 \quad \frac{dE}{dT} = +0.00070$$

Here the changes in free and total energy in the reaction

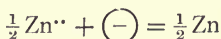

are both negative: work must be done on zinc to get it out of the ionic state, and it also gains in total energy in doing so.

$$W = FE = -47,700 \text{ joules}$$

$$Q = F \left(E - T \frac{dE}{dT} \right) = -67,400 \text{ joules}$$

At the negative terminal of a Daniell cell the above reaction is reversed ; there is therefore work done to the extent of 47,700 joules per equivalent of zinc dissolved, but as 67,400 joules of chemical energy are lost, 19,700 joules must appear as heat ; the zinc pole is warmed during the action of the cell.

The net result in the whole cell is production of 19,700 joules of heat at one pole and absorption of 20,200 at the other, or absorption of 500 joules. Now, Jahn's direct measurement (p. 155) gives 800 joules, which is in sufficient agreement, seeing that the quantity in question is the difference between two much larger ones, and so very difficult to measure.

Ostwald¹ has calculated the "heat of ionisation" for a number of metals, and the following table is quoted from him, with the sign reversed in accordance with the convention adopted here, and expressed in joules instead of calories ; *i.e.* the quantity Q in the equation

$M \cdot + \ominus = M + Q$ (joules), M being one *equivalent* of metal.

	Q		Q
Potassium	- 257,000	Nickel	- 29,400
Sodium	- 237,000	Zinc	- 69,500
Lithium	- 261,000	Cadmium	- 34,600
Strontium	- 244,000	Copper (Cu ⁺⁺)	+ 37,200
Calcium	- 226,000	Mercury (Hg ⁺)	+ 86,900
Magnesium	- 225,000	Silver	+ 110,900
Aluminium	- 165,000	Thallium	- 3,400
Manganese	- 102,000	Lead	+ 2,900
Iron ($\frac{1}{2}Fe^{++} \rightarrow \frac{1}{2}Fe$)	- 42,400	Tin	- 2,900
Iron ($Fe^{+++} \rightarrow Fe^{++}$)	+ 50,800	Hydrogen	+ 2,300
Chlorine ($Cl' \rightarrow \frac{1}{2}Cl_2$)	- 167,400	Iodine	- 57,500
Bromine	- 121,000	Oxygen ($OH' \rightarrow \frac{1}{2}O_2$)	- 88,600 ²
Cobalt	- 31,700		

Many of these numbers are not obtained directly from temperature coefficients of electromotive force, but by combination of ordinary thermo-chemical data with the value of Q for some other metal. Examples of this will be of interest.

We have

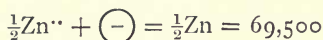

¹ *Lehrbuch d. Allg. Chem.*, II. (i.), 955.

² *I.e.* $OH' = \frac{1}{2}H_2O + \frac{1}{4}O_2 + \ominus - 88,600$

and for the heat of formation of zinc chloride in solution from its elements

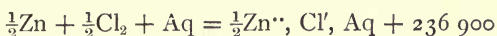

Adding, we get

$$\text{Cl}' = \frac{1}{2}\text{Cl}_2 + \ominus - 167,400$$

which indicates the strong tendency of chlorine to adhere to its negative charge.

Again,

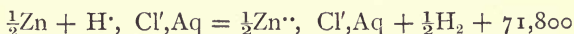

(zinc dissolved in hydrochloric acid gives out 71,800 jcales).

From this and the first equation we get

$$\text{H}^{\cdot\cdot} = \frac{1}{2}\text{H}_2 + 2300$$

The heat of ionisation of hydrogen is therefore so small as almost to lie within the margin of errors, and may be ignored. Hence the approximate rule that the heat of ionisation of a metal is practically equal to its heat of solution in dilute (*i.e.* completely dissociated) acid.

(iv) POTENTIAL DIFFERENCES BETWEEN LIQUIDS.

In order to complete the account of electro-chemical potential differences, it is necessary to consider the surfaces of contact between solutions. As already remarked, the potential differences arising here are usually small; they cannot, however, be neglected in an exact treatment of the subject.

The thermodynamic method so far followed cannot be applied without some loss of strictness here, because we have not to do with a state of equilibrium. Any two aqueous solutions put into contact necessarily diffuse into one another, and so suffer progressive change. Equilibrium would only be reached when the concentration of each dissolved substance was the same throughout, so that no potential difference could remain within the liquid. The state when diffusion is only beginning is nevertheless that of greatest practical importance; it is therefore necessary to find some means of discussing the

electrical conditions at the beginning of the diffusion, *i.e.* immediately after the voltaic combination is put together.

This is supplied by the molecular theory, due to Nernst¹ and Planck.² The simplest case to consider is when two solutions of the same electrolyte but of different concentrations are put in contact. For definiteness we will suppose the electrolyte to be hydrochloric acid. Now, at the boundary there is a tendency for the ions H⁺ and Cl⁻ which exist in the solution to diffuse from the vessel in which they are more concentrated to that in which they are less so. But H⁺ is a much more mobile ion than Cl⁻, and consequently diffuses faster; hence, after a short time, if there were no opposing force, a relative excess of hydrogen ions would have crossed the boundary, and the weaker solution would consequently have a positive charge; the strong solution would contain an excess of chlorine ions—for though it would have lost some chlorine, it would have lost more hydrogen—and be negatively charged. These positive and negative charges would, however, set up an electrostatic field tending to stop the process to which they were due; it would be so directed as to drive back the hydrogen ions, but help the negative chlorine ones forward from the strong solution to the weak. Hence, on the whole, diffusion will go on equally, positive and negative ions together; but an electrical double layer and its accompanying potential difference will be set up at the boundary between the two solutions.

It is not necessary that the boundary should be sharp. If the two solutions have partly diffused into one another, so that there is a gradient of concentration over a finite thickness, the argument is still the same.

It is easy to see from the above reasoning in which sense the electromotive force will be: the rule may be stated as follows:—

“The potential of the weak solution is of the same sign as the more mobile ion.”

¹ *Zeitschr. phys. Chem.*, **2**. 613 (1888); **4**. 129 (1889); *Wied. Ann.*, **45**. 360 (1892).

² *Wied. Ann.*, **39**. 161; **40**. 561 (1890).

Thus in acids the dilute solution is positive to the strong: in alkalis negative. If the two ions have the same mobility there is no electromotive force: this is approximately true for potassium chloride ($K^+ = 65.3$ $Cl^- = 65.9$).

It is not difficult to show that for two univalent ions

$$E = \frac{u - u'}{u + u'} \cdot \frac{RT}{F} \log_e \frac{C_2}{C_1}$$

where u u' are the mobilities of the ions, $C_1 C_2$ the concentration in the two solutions, and E the difference of potential produced (potential of solution 1 - that of solution 2). This is on the assumption of complete dissociation. In order to see the order of magnitude of this electromotive force, we will take as solutions 1 n. HCl against 0.1 n. HCl at a temperature of 18° (= 291° abs.)

$$E = \frac{318 - 66}{318 + 66} \times \frac{8.316 \times 291}{96600} \times \log_e 10 = 0.037 \text{ volt}$$

Actually E would be somewhat less than this on account of incomplete dissociation.

When the ions are not univalent the expression becomes

$$E = \frac{\frac{u}{r} - \frac{u'}{r'}}{u + u'} \cdot \frac{RT}{F} \log_e \frac{C_2}{C_1}$$

where r r' are their valencies.

When two solutions containing unlike ions are placed in contact, the same mode of argument shows that an electromotive force will arise, but the calculation is more difficult. For the special case of two binary electrolytes of the same concentration (*e.g.* normal KCl and normal $NaNO_3$), it has been shown that

$$E = \frac{RT}{F} \log_e \frac{u_1 + u_2'}{u_2 + u_1'}$$

where u_1 u_2 are the mobilities of the cations, u_1' u_2' of the anions. If all the ions are divalent, the electromotive force is one-half of this.

Certain deductions from the theory are important to note, both in regard to experimental verification of it, and to

measurements in cases where difficulties of calculation prevent its direct application.

When a pair of junctions is symmetrically placed, it has no resultant electromotive force. It sometimes happens that a whole series of liquid junctions can be divided into two symmetrical halves: in this case there is, of course, no electromotive force between the first and the last.

Two junctions which lie between similar pairs of solutions, with the same ratio of concentrations, have the same electromotive force, despite differences in absolute concentration. Thus, *e.g.*, the potential difference between *n*. HCl and *n*. KCl is the same as between $\frac{1}{10}$ *n*. HCl and $\frac{1}{10}$ *n*. KCl. (Nernst's principle of superposition).

A number of junctions between the same electrolyte in various concentrations have, jointly, the same electromotive force as would exist between the first and last. For, if C_1, C_2, C_3 , etc., to C_n , are the concentrations,

$$\begin{aligned} E &= \text{const.} \times \left(\log \frac{C_1}{C_2} + \log \frac{C_2}{C_3} + \dots + \log \frac{C_{n-1}}{C_n} \right) \\ &= \text{const.} \times \log \frac{C_1}{C_n} \end{aligned}$$

Hence, if the first and last solutions are of the same strength, there will be no electromotive force.

But this proposition is not true of solutions in general. Thus, if a ring be made of a number of solutions, say

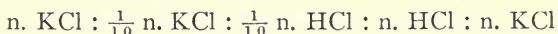

we are not entitled to conclude that the total electromotive force will be zero. On the contrary, if the last solution be put in direct contact with the first, there will in general be a current. This has been directly shown by the magnetic action of such currents.

Since it is never possible to have only one liquid junction without some asymmetry at the electrodes, measurements of such electromotive forces can only be made on groups of junctions. Nevertheless, by the use of certain devices, experiments may be made to test the theory. This was done by Nernst as follows:—

In the cell

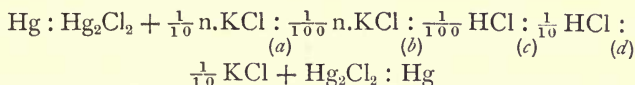

the electrodes are symmetrically placed, and consequently neutralise each other in electromotive force. Of the four liquid junctions those marked (b) and (d) are equal, in virtue of the superposition principle, and being oppositely directed, neutralize; (a) and (c) alone, therefore, contribute to the electromotive force. But each of these can be calculated by the formulæ given above; the sum may therefore be compared with experiment.

The results of measurement of several such groups were—

	E (observed).	E (calculated).
KCl.HCl	- 0.0357	- 0.0383
KCl.NaCl	+ 0.0111	+ 0.0132
KCl.LiCl	+ 0.0183	+ 0.0203
KCl.NH ₄ Cl	+ 0.0004	+ 0.0010
NH ₄ Cl.NaCl	+ 0.0098	+ 0.0122
KCl.HNO ₃	- 0.0378	- 0.0400
KCl.C ₉ H ₁₁ SO ₃ H	- 0.0469	- 0.0502

The observed values are regularly about 10 per cent. too low. This is, perhaps, due to incomplete dissociation. The theoretical treatment has not yet been extended to incompletely dissociated electrolytes.

While measurement of the potential difference due to a liquid contact is very difficult, there is fortunately a simple means of rendering it negligible that can very often be applied. This is to mix both solutions with a strong neutral electrolyte; then, as most of the current flows through the neutral electrolyte, the liquid is, with respect to it, homogeneous, and no potential difference arises. This was done, *e.g.*, by Palmaer, in the measurements quoted on p. 197. There the solution of the normal electrode was saturated with Hg₂Cl₂, while the liquid into which the dropping electrode dipped contained only Hg₂(CN)₂; this would cause a potential difference to occur between the two, were it not that the conductivity of both the mercurous salts is drowned by that of the KCl, which is

present equally in both. By this device (known as an electrolytic short circuit) the measurements of electrode potentials are freed from error due to liquid contacts.

For further information as to the influence of neutral electrolytes on liquid contacts, see Bugarsky,¹ Abegg and Bose,² and Sackur.³

(v)—CONCENTRATION CELLS.

A voltaic cell is essentially a means of employing any store of free energy by the transport of electric charges. Accordingly, cells may be grouped according to the nature of the energy they employ. The most ordinary kinds use energy of chemical combination, but cells can also be devised in which the active process is of the kind usually known as "physical" rather than "chemical," though there is no distinct line between the two. Among physical processes that have been so used are: falling under gravity, equalisation of gas-pressure, equalisation of the strength of solutions, of amalgams, etc. Cells based on these processes are rarely of any practical value, but have been much studied on theoretical grounds: it is often possible to calculate the change of free energy in them in a non-electrical way, and so obtain valuable confirmation of the principles involved. We shall discuss at length one or two cases, especially of the so-called "concentration cells," but first may be taken the gravity cell, on account of its simplicity:

Such a cell was realised by Des Coudres.⁴ He used two mercury electrodes and a solution of a mercurous salt. But for pressure differences this arrangement would be perfectly symmetrical, and so yield no electromotive force. In order to admit of difference of pressure, the masses of mercury were separated from the solution by stout membranes of parchment paper, which affords mechanical support without breaking the electrical circuit. Then if one of the electrodes consists of a

¹ *Zeitschr. phys. Chem.*, **14**, 150 (1894).

² *Ibid.*, **30**, 545 (1899).

³ *Ibid.*, **38**, 129-162 (1901).

⁴ *Wied. Ann.*, **46**, 292 (1892).

long column of mercury, the other a short column, there will be a tendency for the mercury to drop from the long to the short side; this will be accomplished by mercury going into solution on one side and coming out on the other, carrying with it, of course, an electrical charge. Now, gravitational energy is all "free," as is well known, for it is easy to devise a mechanism by which all the energy of a falling body shall be converted into work. Hence the calculation of electromotive force is very simple: in one of Des Coudres' experiments the pressure difference was 113 cms.; then one equivalent (200 grams) would in falling do 113×200 gram-cms.

$$= 113 \times 200 \times 981 \text{ ergs} = \frac{113 \times 200 \times 981}{10^7} \text{ joules}$$

of work, and would convey 96,600 coulombs. Hence

$$\text{E.M.F.} = \frac{113 \times 200 \times 981}{10^7 \times 96,600} = 23 \times 10^{-6} \text{ volts}$$

The observed amount was 21×10^{-6} —a satisfactory agreement, considering the smallness of the quantity to be measured.

Now, this process is independent of temperature, and accordingly in the fundamental equation

$$Q = W - L = F \left(E - T \frac{dE}{dT} \right)$$

L is zero, $\frac{dE}{dT}$ is zero, and $Q = W = FE$

We have here a case in which

- (i.) The free energy is identical with the total energy;
- (ii.) Consequently the latent heat is zero; and
- (iii.) The E.M.F. is independent of temperature.

Again, as a very simple instance of a cell which works by equalisation of concentration differences, we will take the combination

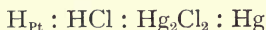

i.e. a platinum sheet saturated with hydrogen, and a calomel electrode both dipping in hydrochloric acid. Set up a pair of such, one with centinormal acid, the other with millinormal, and join them in opposition. These low concentrations are

chosen in order that we may assume the acid to be completely dissociated. Now, the only want of symmetry in the arrangement is in the strength of acid; and the two acids will tend to become equal in strength. There will, therefore, be a tendency for H⁺ and Cl⁻ ions to be discharged from the stronger electrolyte, and to be formed from the electrodes of the weaker until the two solutions are of the same strength.

The work this process is capable of doing may be calculated by means of the analogy between a solution and a gas. Since one equivalent of dissociated hydrochloric acid contains as many particles (in the sense of Avogadro's law) as two mols of gas, the work is

$$2RT \log_e \frac{C_2}{C_1}$$

where C_2C_1 are the concentrations of the two solutions.¹ In the present case $C_1 = \frac{1}{1000}$ and $C_2 = \frac{1}{100}$ normal, so that the work, or change of free energy, is

$$2RT \log_e 10$$

At atmospheric temperature (= 291° abs.) this is

$$2 \times 8.316 \times 291 \times 2.3026 = 11,200 \text{ joules}$$

But as one equivalent carries with it 96,600 coulombs, the E.M.F. is $\frac{11200}{96600} = 0.116$ volt.

The argument just given is essentially identical with that on p. 162, where the dependence of the separate electrode potentials on concentration was dealt with. It follows at once from what is there said that the potential of the hydrogen electrode of the cell with the stronger acid is 0.058 volt higher than that with the weak acid. The same difference, but with the opposite sign, exists between the calomel electrodes; for in these "electrodes of the second kind" the liquid is saturated with calomel; according to the law of mass action, therefore, the product of the concentrations of the ions Hg²⁺ and Cl⁻ must be constant; hence when, in passing from the first to the second cell the concentration of acid (and hence of Cl⁻) is decreased tenfold, that of the mercurio-ions is increased tenfold, and the potential of the mercury raised by 0.058 volt.

¹ See Donnan, *Thermodynamics* (in this series).

Thus, on the whole, the E.M.F. of the cell with stronger acid is 0.116 volt less than that of the other.

Thermodynamically this cell is very different to the gravity cell, and may be taken as an opposing type. Its action depends on the tendency to equalisation of strength between the two electrolytes. But, it is well known, no heat is evolved on mixing very dilute solutions. Hence the "heat of reaction" Q is zero, and in the fundamental equation

$$Q = W - L = F \left(E - T \frac{dE}{dT} \right)$$

we have $Q = 0$, $W = L$, and $\frac{E}{T} = \frac{dE}{dT}$, or

- (i.) The total energy of reaction is zero ;
- (ii.) Consequently the latent heat is equal to the free energy of the reaction ; and
- (iii.) The electromotive force is proportional to the absolute temperature.

In the gravity cell the electrical work is done entirely at the expense of gravitational energy, and no thermal changes occur ; in this concentration cell the electrical work is done entirely at the expense of the cell's own heat, and it accordingly cools in action.

The pair of accumulators discussed on p. 182 form a concentration cell of the same type as this hydrogen-mercury combination, except that the acid in them is far from dilute ; and as the mixture of sulphuric acid and water in moderate concentrations evolves a notable amount of heat, the deduction as to influence of temperature does not hold.

Another form of concentration cell is more familiar than the above ; viz. a cell in which the liquids of different concentration are put into immediate contact. This can be made from the preceding form by mere omission of the second (mercury) electrode. Thus



may serve as example. The action here, too, depends on equalisation between the strengths of the two solutions, and

so causes current to flow in the direction of the arrow ; but it is complicated by the migration of ions across the surface of contact. We see from the arguments on migration already given (p. 35) that when one faraday passes through the cell, the anode vessel (containing the weaker acid) gains x equivalents of HCl, at the expense of the cathode vessel, x being the migration ratio of the anion. Hence the change in free energy, and the electromotive force are both x times as much as in a concentration cell without migration ; the electromotive force is

$$\frac{2xRT}{F} \log_e \frac{C_2}{C_1}$$

where $F = 96,600$ coulombs, and $C_1 C_2$ are the concentrations. In the case of HCl x is only 0.172 , so that the electromotive force is only about one-sixth as much as if migration were avoided.

This electromotive force is made up of three portions : one at each of the electrodes, and one at the contact of the two solutions ; the former are (p. 162)

$$E_0 + 2.3026 \frac{RT}{F} \log_{10} C_1$$

and
$$E_0 + 2.3026 \frac{RT}{F} \log_{10} C_2$$

so that the difference is

$$2.3026 \frac{RT}{F} \log_{10} \frac{C_2}{C_1}$$

as before : the electrode in the strong solution being the more positive. The E.M.F. between the solutions is¹ (p. 207)

$$(1 - 2x) 2.3026 \frac{RT}{F} \log_{10} \frac{C_2}{C_1}$$

but this is so directed as to make the weak solution positive : it must therefore be subtracted from the foregoing, and we get

$$2 \times 2.3026x \frac{RT}{F} \log_{10} \frac{C_2}{C_1}$$

as above for the total electromotive force.

¹ Since $x = \frac{u'}{u + u'}$, we have $\frac{u - u'}{u + u'} = 1 - 2x$.

Similar cells may be made with a pair of electrodes reversible with respect to an anion, e.g.

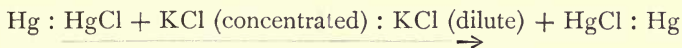

It is easily seen that the potential at the electrode with the dilute solution is now the greater; the current will flow through the cell from strong electrolyte to weak, and the E.M.F. between the solutions must be added to the others. But $1 + (1 - 2x) = 2(1 - x)$; the total E.M.F. is therefore

$$2(1 - x) \times 2.3026 \frac{RT}{F} \log_{10} \frac{C_2}{C_1}$$

This result may also be arrived at by considering the changes in concentration at the two electrodes due to the passage of one faraday through the cell.

If the ion concerned is divalent, the work done (per faraday), and therefore the electromotive force, is half that for a univalent ion; if trivalent, one-third. In a concentration cell "without migration," where there are two pairs of electrodes to consider, its proper electromotive difference must be attributed to each. Thus in a cell, each half of which takes the form $\text{Tl} : \text{TlCl} : \text{Hg}_2\text{Cl}_2 : \text{Hg}$, the E.M.F. for a ratio of 10 : 1 in the concentrations is 0.116 (0.058 on account of each ion Tl^+ and Cl^-). For $\text{Zn} : \text{ZnCl}_2 : \text{Hg}_2\text{Cl}_2 : \text{Hg}$ it is 0.087, viz. 0.058 due to the univalent Cl^- , 0.029 to the divalent Zn^{++} . While for $\text{Zn} : \text{ZnSO}_4 : \text{Hg}_2\text{SO}_4 : \text{Hg}$ it is only 0.058 (0.029 for each divalent ion).

The theory of concentration cells so far developed, is that of the ideal, limiting case of completely dissociated solutions which follow the laws of gases. It is, of course, only approximately verified by experiment: measurements on extremely dilute solutions are difficult on account of the influences of traces of impurity, while in stronger electrolytes the assumptions made in the theory do not hold strictly. Experiments have been made by numerous observers; Helmholtz¹ measured the difference in E.M.F. between two calomel cells ($\text{Zn} : \text{ZnCl}_2 : \text{Hg}_2\text{Cl}_2 : \text{Hg}$) with different concentrations of zinc

¹ *Berl. Sitzber.*, 1882.

chloride: these did not even approach the condition of being ideally dilute, and were not treated as such: they will be further considered below. Moser¹ measured cells both with and without migration, and by a comparison of their electromotive force determined the migration ratio. Later, Nernst expressed the theory for the limiting case of extreme dilution in the simple form quoted above, and made measurements on cells (with migration) of both the cation and anion type.² As an example we may take the combination

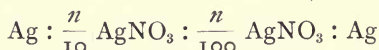

The migration ratio of the anion (from Hittorf's experiments) is 0.527. The calculated electromotive force at 18° is therefore

$$2 \times 0.527 \times 2.3026 \times \frac{8.316 \times 291}{96600} \times \log_{10} 10 = 0.0613 \text{ volt}$$

The measured value was 0.055. The discrepancy is on the side to be expected, as the decinormal solution is less dissociated than the centinormal, hence the ratio between the *concentration of silver ions* in the two is less than 10; according to conductivity measurements it is 8.72. Nernst takes the view that electromotive force in solutions is due exclusively to the ions of the electrode material; he puts, therefore, in the formula for a concentration cell γC , the ionic concentration, in place of C (γ = degree of dissociation). Using

$$\frac{\gamma_2 C_2}{\gamma_1 C_1} = 8.72$$

in the calculation, the E.M.F. comes to 0.0576, which is closer to the experimental value. A number of other cells, with concentrations of the order deci- to centinormal were measured, and mostly gave values in accord with this explanation, though occasionally divergences up to 15 per cent. were found.

Amongst later measurements may be mentioned those of Goodwin³ on cells of the type $\text{Zn} : \text{ZnCl}_2 : \text{Hg}_2\text{Cl}_2 : \text{Hg}$, *i.e.*

¹ *Wied. Ann.*, **14**. 62 (1881).

² *Zeitschr. phys. Chem.*, **4**. 155 (1889); **7**. 477 (1891).

³ *Ibid.*, **13**. 577 (1894).

without migration; ZnCl_2 and AgCl , and ZnSO_4 and PbSO_4 were also used, the concentrations being between 0.01 and 0.2 normal. The agreement with theory was of the same order as in Nernst's experiments.

To advance further it is necessary to take into account divergence from simplicity due to finite concentration of the electrolytes. That is, it is necessary to calculate more exactly the change of free energy associated with change of concentration.

This was first done by Helmholtz (*loc. cit.*). He used the method of vapour pressure (subsequently adopted by Dolezalek in considering the lead accumulator, and described on p. 183).

Helmholtz obtained a mathematical expression for the electromotive force of a concentration cell (of the type without migration) in terms of the vapour pressure of water over the electrolyte used. The expression (deduced thermodynamically) is applicable to electrolytes of all strengths, but it cannot be reduced to numerical results unless the vapour pressure is known, not only for the two concentrations used in the cell, but for all intermediate strengths.

Helmholtz applied his expression to a calomel cell, *i.e.* one in which each half is of the type

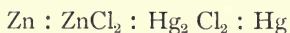

The electrolyte of one-half consisted of one part by weight of ZnCl_2 to 0.8 of water, in the other half of 1 of ZnCl_2 to 9.1992 of water, and he measured the vapour pressure over this range of concentration. He found a very close agreement between the observed and calculated value: the former was 0.1154 of a Daniell cell that was taken as standard (mean of numerous determinations); the latter 0.1152 (a little more or less according to the empirical formula adopted to express the vapour pressure in terms of the concentration).

If in Helmholtz's expression the concentration be put very small, we may use the well-known Raoult-van't Hoff rule¹ to calculate the vapour pressure. (The vapour pressure of the

¹ See S. Young, *Stoichiometry*, in this series.

pure solvent is lowered by a fraction equal to the number of dissolved molecules, or ions, divided by the number of water molecules.) By this means the expression obtained becomes identical with that given above (p. 212) for dilute solutions, in terms of the concentration, and may be evaluated numerically without further experiments. Thus the usual logarithmic formula is really the limiting case of Helmholtz's for very dilute solutions.

Nernst, in developing the logarithmic formula in this manner, showed also that it could be proved in a simpler way by means of the conception of osmotic pressure: the change in free energy is then calculated as the work that could be done by the strong solution in drawing water through a semipermeable partition, until its strength has fallen to that of the weaker solution (p. 162).

Following out this train of ideas, he was led to the conclusion that when the dissociation of the electrolyte was incomplete, the electromotive force ought to be calculated from the osmotic pressure exerted by the active ions; and this pressure is, according to the laws of gases, proportional to γC , the concentration of the free ions. Hence the method of calculation on p. 216.

Lehfeldt,¹ and subsequently Arrhenius,² showed how to calculate, thermodynamically, the electromotive force of a concentration cell of any strength in terms of the osmotic pressure. The expression given by them appeared to contradict that of Nernst for incompletely dissociated solutions; but it was pointed out by Sand³ that if in the thermodynamic formula the degree of dissociation be calculated by Ostwald's law of dilution (p. 77), *i.e.* by the law of mass action as usually applied, it leads to Nernst's expression. Hence Nernst's expression is thermodynamically correct for such solutions as show a dissociation constant, in the ordinary sense, but not when applied to silver nitrate (p. 78) or other strong electrolytes. The question is thus bound up with that of the

¹ *Zeitschr. phys. Chem.*, **35**, 257 (1900).

² *Ibid.*, **36**, 28 (1901).

³ *Ibid.*, **36**, 499 (1901).

dissociation of strong solutions, and may be treated by means of the new theory of Jahn and Nernst (p. 79).

If the osmotic pressure of strong solutions were known, it might be used to calculate the electromotive force ; but in the present state of our knowledge it is better to reverse the process. This was done by Lehfeldt (*loc. cit.*), who from electromotive force measurements on ZnCl_2 and ZnSO_4 calculated the osmotic pressure of those salts, and was able to show that it follows a course analogous to that of the gaseous pressure for gases at high densities (*i.e.* concentrations).

In conclusion, we may summarise the deviation from the simple laws of dilute solutions as follows :—

(a) For great dilution (say millinormal and under) the solutions of electrolytes may be regarded as completely ionised, and as giving osmotic pressure (with change of freezing and boiling-point) and electromotive force in accordance with the simple laws of gases ; and the conductivity calculated on the same assumptions together with the rule that the mobility of the ions is independent of their concentration.

(b) For somewhat greater concentrations the degree of ionisation must not be regarded as complete, but must be calculated by the law of mass action in the form of Ostwald's rule, otherwise the laws of dilute solutions still hold.

(c) For the next stage of concentration (deci- to centi-normal in the case of KCl, HCl, etc.), the law of mass action must be applied in the more complex form indicated by the new theory of Jahn and Nernst ; hence the logarithmic rule for electromotive force must be given up (as regards strong electrolytes) ; further, it is probable that the mobility of ions is sensibly affected by concentration, in which case the conductivity is no longer an exact measure of degree of ionisation. The osmotic pressure, however, probably still follows the laws of gases approximately.

(d) Finally, for strong solutions even the last statement no longer holds. The osmotic pressure may still be calculated from the electromotive force, but there is no safe guide to the degree of ionisation.

(vi) CHEMICAL CELLS.

Under the term "chemical cells" may be included all the practical voltaic combinations whose action depends on conversion of the energy of chemical combination—chiefly of solution of metals in acid. Such have, however, already been considered in their general aspect, and will be dealt with individually in succeeding chapters. In the present section the cells treated will be, rather, combinations of theoretical interest in which electromotive force serves as a measure of chemical affinity.

For this purpose the cells may be conveniently classified according to the character of the reaction taking place in them. This may be (a) a "transition" in a system of more than one phase, or (b) a reversible reaction in a homogeneous system; and in either case the reaction may be (i.) between the materials of the electrolyte only, or (ii.) may involve the electrodes.

Transition Cells.—Of these, which have been studied particularly by van't Hoff and Cohen, we may take the Clark as an example. The reaction in the Clark cell is

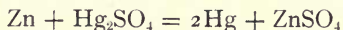

The cell is saturated with zinc sulphate, and the salt occurs in the form $\text{ZnSO}_4 \cdot 7\text{H}_2\text{O}$. This hydrate when heated to 39° suffers the transition ¹

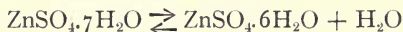

At 39° , then, the two hydrates are equally stable, and can exist in each other's presence indefinitely. If two Clark cells are made, one with heptahydrate, the other with hexahydrate crystals, and kept at 39° , they will possess the same electromotive force; but this is only true at 39° ; below that temperature the ordinary cell (with heptahydrate) has a greater E.M.F. than the other, so that if the two be coupled up in series it will drive current through the hexahydrate cell; more heptahydrate will be formed and some hexahydrate will be decomposed by this current, so that indirectly the above transition

¹ For transitions in general, see Findlay, *Phase Rule*, p. 34, in this series.

will be brought about, and the more stable form will gain at the expense of the less. Above 39° the relative stabilities are reversed, and so, too, the electromotive force: the hexahydrate cell becomes the stronger. These facts were brought out by the experiments of Callendar and Barnes,¹ shown in Fig. 41, though their explanation on physico-chemical grounds was given subsequently by Jaeger.² The cell with heptahydrate could be measured up to a temperature of a few degrees above the transition point, but thereafter became uncertain in E.M.F.,

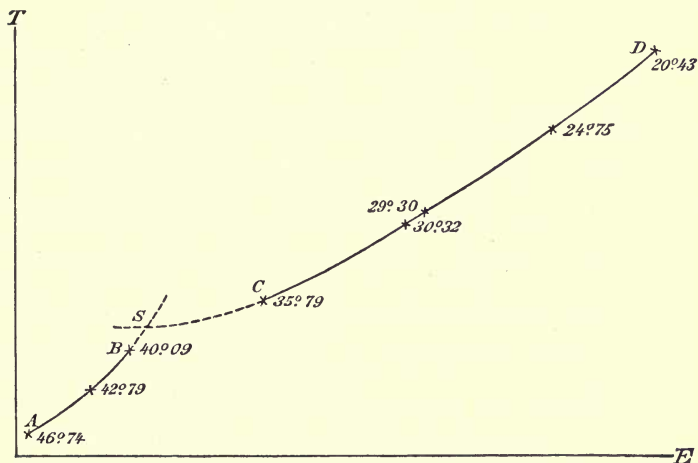

FIG. 41.

as the transition takes place of its own accord; the hexahydrate cell was measured down to the freezing-point, for although the hydrate is instable below 39° , it only changes with extreme slowness, on account of the low temperature. It will be noticed that the two curves cross at 39° , and that the larger E.M.F. is shown by the salt that is the more stable, whether below or above that temperature.

Other patterns of cells in which a transition occurs have

¹ *Proc. Roy. Soc.*, **62**. 117 (1897).

² *Wied. Ann.*, **63**. 354 (1897).

been enumerated by van't Hoff¹ and Cohen.² Amongst these are cases of transition in the electrode material. Thus Cohen discovered that ordinary, metallic, white tin undergoes a transition into a grey variety, and is in fact unstable at atmospheric temperature, although the transition, which is always very slow, may be suspended for apparently any length of time. If, then, a cell be made up with electrodes, one of white, the other of grey tin, it ought to show an electromotive force in such a direction that the resulting current will convert the less into the more stable phase. Accordingly a cell of the type

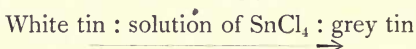

was set up and found to give a small electromotive force (a few millivolts) in the direction of the arrow at 5°, diminishing steadily to nothing at 20°; the latter temperature is the transition point, and below it, white tin dissolves in the cell and grey is deposited, showing the latter to be the more stable.

Another case is the transition of cadmium amalgam, which affects the behaviour of standard cadmium cells, and is considered below, p. 248.

The theory of chemical transitions has been given by van't Hoff³ in the following way. At the transition temperature the two phases are in equilibrium (like water and ice at 0°); neither has any tendency to conversion into the other: the free energy of the two is identical—for the difference in free energy between two systems measures the tendency towards conversion of the one into the other. There is, however, a change in total energy—the latent heat of transition (analogous to latent heat of fusion)—and this is always in such a sense that to convert the phase which is stable at low temperature into the other requires heat to be imparted to it. In the general equation (p. 179) we have

$$W = 0 \therefore Q = -L$$

But
$$L = FT \frac{dE}{dT} \text{ or } \frac{dE}{dT} = \frac{L}{FT} \text{ (p. 185)}$$

¹ *Zeitschr. phys. Chem.*, **16**. 453.

² *Ibid.*, **14**. 53; **25**. 300; **30**. 623; **31**. 164; **33**. 57; **34**. 62, 612, 621.

³ *Lectures on Theoretical Chemistry*, vol. i. p. 181.

i.e. the temperature coefficient of the electromotive force is proportional to the latent heat. These relations are shown graphically in Fig.

42. The abscissæ represent temperature T being the transition point; ordinates represent electromotive force in the transition cell; this is, of course, zero at T , and the rate of change of it is given by the slant line.

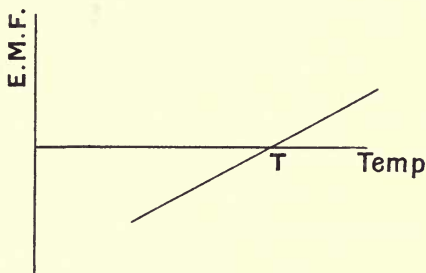

FIG. 42.

This line is practically straight near the transition point, for the latent heat is found to be almost independent of temperature, so that for points near

together in temperature $\frac{L}{FT}$ is constant. We see, then, from

the figure that the *electromotive force of a transition cell is (for a moderate range of temperature) proportional to the divergence of the temperature from the transition point*: if above the transition point, the E.M.F. is in one sense; if below, in the other. But electromotive force, here as elsewhere, is only one measure of the change in free energy. The rule may therefore be stated in a more general form: the work that can be done (electrically or otherwise) by a transition is zero at the transition temperature, and increases in proportion as the temperature is raised or lowered from that point.

The latent heat of transition of $\text{ZnSO}_4 \cdot 7\text{H}_2\text{O}$ into $\text{ZnSO}_4 \cdot 6\text{H}_2\text{O}$ is about 12,000 joules per equivalent. Hence the temperature coefficient in the transition cell is

$$\frac{L}{FT} = \frac{12000}{96600 \times (273 + 39)} = 0.0003 \text{ volts per degree}$$

Cell with Reaction in a Homogeneous System.—In the foregoing cases the chemical system yields work (and therefore electromotive force) because it is removed in temperature from the condition of equilibrium; but if it is made up of

several materials it may be removed from equilibrium as regards their relative quantities, and so be suitable for producing electromotive force. Instances of this are difficult to find in practice, as in reactions between salts very often equilibrium is only reached when the amount of some constituent becomes immeasurably small. Thus, if metallic copper be put into a solution of a silver salt, silver will be deposited: a reaction that may be written

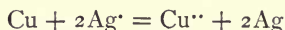

This is, presumably, a reversible reaction; *i.e.* deposition of silver will cease when the concentration of the silver ions is sufficiently reduced, and that of copper ions sufficiently increased. But the difference in free energy between the two metals (measured by difference in electro-affinity, p. 159) is so great that it will only be compensated by concentration difference when the ratio of copper to silver is to be reckoned by millions, and the residue of silver in solution has fallen below the possibilities of chemical analysis.

A case in which the connection between E.M.F. and concentration could be followed experimentally has been exhaustively worked out by Ogg.¹ Silver and mercury are near together on the scale of electro-affinity; hence, if one of these metals be allowed to act on a salt of the other, we have a reaction that is undoubtedly reversible, *viz.*—

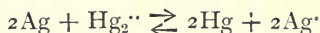

Here the mercurous ions are written $\text{Hg}_2^{\cdot\cdot}$, not 2Hg^{\cdot} , as Ogg showed, by several lines of reasoning, that mercury always forms divalent ions. This state of equilibrium was measured chemically by shaking up mercury with silver nitrate solution, or silver amalgam with mercurous nitrate solution, and analysing the resulting solution: both silver and mercury were found dissolved in appreciable quantity. Again, the equilibrium was established electro-chemically, by setting up a cell of the pattern

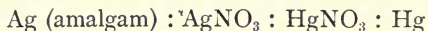

by varying the strengths of solution, either Ag or Hg could be

¹ *Zeitschr. phys. Chem.*, **22**. 535 (1897); **27**. 285-311 (1898).

made positive. Both classes of experiment were carried out quantitatively and shown to yield the same results as to the relative affinities of the two metals. These experiments will be more fully dealt with in the second volume.

§ 8. METHODS OF MEASUREMENT.

In measurements of electromotive force and electrode potential, the requirements are chiefly (i.) a source of current; (ii.) a standard of comparison; (iii.) an instrument to compare the electromotive force with the standard.

A.—MEASUREMENT OF ELECTROMOTIVE FORCE.

(i.) As source of current, a battery of accumulators is by far the most useful.¹ Full details as to the treatment of accumulators are to be found in various technical hand-books, but the manipulation is so easy that it will be sufficient to mention a few practical points only. Accumulators are usually made up with acid of 1·18 to 1·20 density; when charged they have an E.M.F. on open circuit of about 2·05 volts; but for charging 2·5 volts each should be allowed, hence only 44 cells can be charged from mains at 110 volts. A battery of a few cells such as is required for measuring and for electrolysis, should be joined up in series with an adequate resistance and charged off the mains till the cells gas freely. Once a week is enough to keep a battery in good order. If the cells have to be left for long they should be fully charged first.

As the water in the acid evaporates, distilled water should be added from time to time, so as to make it up without accumulation of chlorides: the liquid should be kept at least a centimetre above the top of the plates. Good insulation of the leads is important, as it allows the cells to retain their charge better, and keep a steady electromotive force. Glass

¹ In places where no means exist for charging accumulators, recourse must be had to primary cells. The "cupron" cell has been highly recommended for this purpose.

cells are the best in this respect, and may be paraffined to keep the acid from creeping.

Accumulators should not be discharged so that their voltage falls below 1·8. The maximum discharge rate is usually reckoned at 0·01 ampere per square centimetre of positive plate. The smallest size of ordinary cell, with one positive and two negative plates, designed to give two to three amperes is quite sufficient for most measuring purposes, especially for potentiometers; and if only used to give two or three centi-amperes, will maintain a practically unvarying voltage for a day. Traces of foreign metals (except mercury) are highly deleterious to the lead accumulator, and must be carefully avoided.

The public electric supply, when not alternating, can be used for many purposes, but not for potential measurements of any accuracy, as it constantly fluctuates within small limits (1 or 2 per cent.). Lamps serve satisfactorily as resistances to regulate current by, and are often inserted to avoid the risk of excessive currents.

For measurements in which currents neither large nor very constant are required, Leclanché cells—most conveniently “dry cells”—serve excellently. The voltage is about 1·4; cells of moderate size have a resistance of 0·5 to 5 ohms, and will give small currents (one or two centi-amperes) with good constancy. Dry cells will last for months without attention.

For some purposes it is necessary to have a source of current the potential difference of which will remain practically constant, independently of the current taken from it (within limits). When the required potential difference is that of one or more cells, there is, of course, no difficulty; but to obtain a steady potential difference of adjustable magnitude, the device

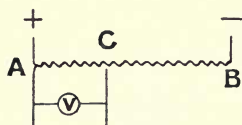

FIG. 43.

shown in Fig. 43 is used. Current from a battery (or the public supply if not alternating) is passed through a resistance AB, and wires from the ends of a part AC of this resistance are led away to the apparatus to be supplied. By adjusting the length AC the potential can be varied. It is necessary that the

current to be taken through the experimental circuit should be a good deal smaller than that flowing through AB. For use with a battery of a few volts AB may be a wire of a few ohms wound on a drum, with a sliding contact at C. If a high voltage supply is used, AC may be an adjustable resistance, and CB a lamp. A voltmeter may conveniently be put across the wires leading from AC to the experimental circuit.

(ii.) As standards of electromotive force, either the Clark or cadmium cell is nearly always used. These are described in full below (§ 9). The E.M.F. at temperature t is, according to Jaeger,¹ for the Clark

$$1.4328 - 0.00119(t - 15) - 0.000007(t - 15)^2$$

for the cadmium cell with saturated solution

$$1.0186 - 0.000038(t - 20) - 0.00000065(t - 20)^2$$

or the Weston form of cadmium cell

$$1.0190 \text{ constantly.}$$

Cadmium cells have the great advantage of being nearly independent of temperature, and so are rapidly replacing the Clark as practical standards.

(iii.) Instruments or arrangements of instruments for comparing voltages may be divided into direct reading and null; the former usually require some current to work them, and are used for approximate measurements; the latter in the form of the potentiometer measure electromotive forces on open circuit, and are capable of a high degree of accuracy.

Direct-reading voltmeters, designed for technical use, are to be had, of range from $\frac{1}{100}$ volt upwards. One of the most useful patterns is the "cell-tester" intended for use with accumulators, and reading to 3 volts as a maximum. Voltmeters are based upon the magnetic effects of electric currents, and usually contain either magnets or soft iron, which makes them liable to change with age. It is therefore well to recalibrate them from time to time. The readings of the instrument should be accurate to one per cent.; and a voltmeter cannot be regarded as satisfactory that takes more than about $\frac{1}{100}$

¹ See also tables, p. 260.

ampere when showing its maximum reading. Thus the cell-tester mentioned above should have a resistance of at least 300 ohms; instruments for high voltage are made by putting extra resistance coils in series with the working parts.

The terminals of a voltmeter are connected directly to the two points between which the potential difference is to be measured. Thus they may be applied to the positive and negative poles of an accumulator (whether an open circuit, charging or discharging); but attention must be paid to the internal resistance of the cell, etc., to be tested. Thus, if a voltmeter has a resistance of 300 ohms, and is connected to an accumulator of one-tenth ohm, only $\frac{1}{3000}$ of the total resistance of the circuit is external to the instrument; but the electromotive force in the circuit is distributed in proportion to the resistance to be overcome; nearly all of it will be spent on the voltmeter ($\frac{2999}{3000}$, to be exact), and the reading will be practically correct. But if the same instrument were used to test a cadmium cell of 200 ohms, no less than two-fifths of the resistance would be in the cell; only three-fifths of the electromotive force would be spent on the voltmeter, the readings of which would therefore be entirely wrong.

If, then, the internal resistance of the cell or other object to be measured is at all large, the voltmeter must be replaced by a more delicate instrument, requiring less current to work it.

Such an instrument is the D'Arsonval galvanometer; having a large fixed magnet it is practically independent of outside influences, and can be relied upon for constancy to the same extent as a good voltmeter. Galvanometers of 100 ohms (an average resistance) can be had, with pointer, to give their maximum deflexion for 0.0001 ampere, and to indicate to 0.000001 ampere; when used with telescope and scale they may be made a hundred times more sensitive. Thus, by putting large resistances in series with such instruments, they can be used to measure the electromotive force of voltaic combinations that are not adapted to give more than infinitesimal currents; but the percentage accuracy is not much greater than that of direct reading voltmeters.

A special position is occupied by electrostatic instruments. These take no current at all. They are often used for measuring from 100 volts upward, and in the form of a "quadrant electrometer" are sufficiently sensitive to measure voltaic cells; but they are not commonly to be relied upon within one per cent., and are troublesome to use.

The usual means for accurate measurement of electromotive forces is the arrangement of apparatus known as the *potentiometer*. This is essentially a balancing of

the electromotive force to be measured by that existing in a conductor through which a current is flowing. In its simplest form the potentiometer is shown

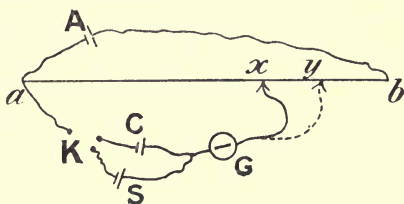

FIG. 44.

in Fig. 44. A uniform wire, ab , is stretched tightly over a scale, usually a metre long, and is supplied with current from a steady source, say one accumulator, A . Then there will be a fall of potential of about 2 volts from the end a , which is connected to the positive plate of the accumulator, to b . If now a cell to be tested, C , whose electromotive force is less than two volts, be connected with its positive terminal to a , and negative to some point x of the wire, a current will, in general, flow through it, and may be detected by the galvanometer G . But if x be slid along the wire, a point can always be found such that the current through G vanishes. This is when the potential difference from a to x is equal to the electromotive force of the cell: if contact be made to the left of this position, the galvanometer current will be in one sense; if to the right, in the opposite; hence it is easy to find the point of balance. Now substitute for C a standard cell S , and repeat the adjustment, obtaining balance at, say, y . Then if i is the current flowing through the wire, we have by Ohm's law that the potential difference between two points of it is equal to $i \times$ resistance between those points. Consequently—

Electromotive force of C = $i \times$ resistance of ax

Electromotive force of S = $i \times$ resistance of ay

and

$$\frac{\text{Electromotive force of C}}{\text{Electromotive force of S}} = \frac{\text{resistance } ax}{\text{resistance } ay}$$

But if the wire is uniform, the resistance is proportional to the length, hence the ratio of the two electromotive forces can be found by merely measuring the lengths ax , ay .

This simple form of apparatus is quite satisfactory for many measurements. Modifications of it have been introduced into it for greater accuracy and convenience, and for special classes of experiment. These we shall now consider in detail.

(a) **Source of Current.**—For this accumulators are nearly always to be preferred, as they give the steadiest currents. One is usually sufficient, as most cells have electromotive forces of less than two volts; but when an accumulator itself is to be studied, or when high decomposition potentials are to be measured, it may be necessary to use two or three in series. In any case the working current should be kept as small as possible. In a simple wire potentiometer on a metre scale it may amount to $\frac{1}{5}$ or even $\frac{1}{2}$ ampere; but in instruments with coils it can be reduced to $\frac{1}{100}$ or less. If the working current is less than $\frac{1}{100}$ ampere, two Leclanché or “dry” cells in series give fairly satisfactory results, and may be used instead of accumulators. The current should be left flowing all the time the instrument is in use, as repeated turning on and off causes it to fluctuate.

(b) **The Wire.**—In its simplest form this is a straight wire stretched over a metre scale, usually of wood, divided in millimetres; the wire being soldered at the ends to copper blocks provided with binding screws. The wire must not be too thin, else it soon becomes damaged with use; but as it is desirable to keep down the strength of current, it should not be thicker than about 0.3 to 0.4 mm., and it should be made of material of high resistivity. Platinum-iridium alloy is mechanically satisfactory, and has an untarnishable surface; the resistivity of an alloy containing 20 per cent. iridium is 31 microhms per

centimetre cube. Manganin¹ is also good mechanically, and has resistivity 43, but easily tarnishes; it may be protected by gilding, and it has the advantage of a very small thermo-electric effect in contact with copper and brass. Constantan² (resistivity about 50) is bad in the last respect, but good otherwise.

To make the resistance higher without making the instrument unwieldy, the greater part of the wire may be made up into coils soldered between studs as in a resistance box (Fig. 45). Here 1, 2, 3, etc., represent a series of coils (frequently nine) of equal resistance; these are soldered to studs, over which the contact-handle H works; the end of the first

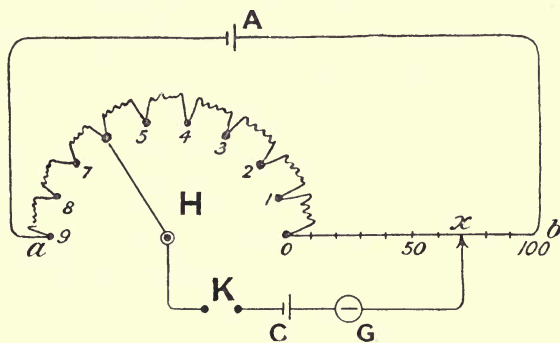

FIG. 45.

coil is soldered to the wire ob of resistance equal to that of one of the coils. This wire is stretched over a scale, and provided with a sliding contact in the usual way.³ Thus ob corresponds to the last tenth only of the wire ab (Fig. 44). In order to meet this modified form of apparatus, the cell to be tested with the galvanometer is not connected to a , but to the contact-handle; its electromotive force is then balanced against the potential difference existing in the coils and wire

¹ Cu 84 per cent. ; Mn 12 per cent. ; Ni 4 per cent.

² Cu 60 per cent. ; Ni 40 per cent.

³ To make the wire equal in resistance to each of the coils, it is best to choose a wire somewhat too thin, and put a shunt to it, adjusting the latter only.

from where the handle makes contact to the sliding contact *x*. Thus in the figure six coils, and (the wire being supposed divided into a hundred parts) seventy divisions; the reading of the instrument is then 670, and the electromotive force of the cell proportional to this.

Coils have, as compared with the stretched wire, not only the advantage of compactness, but of durability; it is also easier to arrange them so as to be free from thermo-electric effects; for the best form of potentiometers, therefore, the wire is replaced altogether by coils. If in Fig. 45 *ab* were replaced by ten coils each equal to one-tenth of those on the left of the figure, it would be possible to measure to one-hundredth part of the whole electromotive force between *a*

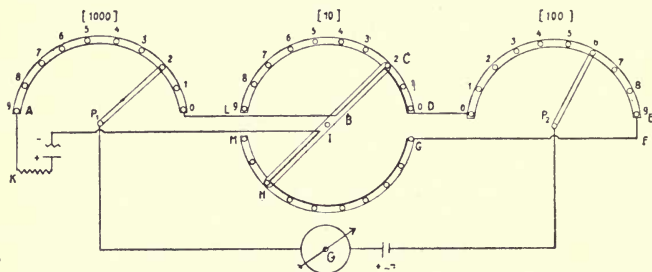

FIG. 46.

and *b* (the first decimal place by the setting of *H*, the second by that of the supposed other handle). This is not enough in practice, and devices have been introduced to extend the accuracy of adjustment of the coil potentiometer.

The earliest was to replace *ax* and *xb* (Fig. 44) by two independent resistance boxes of identical make. Whenever a plug is removed from one box, the corresponding one in the other is inserted, so that the joint resistance is always kept at the same amount—say 10,000 ohms. This somewhat clumsy method has been improved on by Feussner and by Varley. Feussner's method is shown in Fig. 46, which represents a three-dial potentiometer, capable of reading to 1 in 1000. The coils in the left-hand dial are of 100 ohms each, those in the right of one ohm each; but between these are placed two sets

of ten ohms each. These two sets are so arranged that the current from the accumulator always flows through half of them, whatever the position of the switch B. Thus in the position drawn, it flows through the two coils between C and D, then on to the unit dial, and on the return to the battery through the seven coils G to M. The total resistance between the terminals by which the current is led in and out is thus maintained at 1000 ohms; but between the terminals to which the cell under test is connected there lie only the right-hand coils of the hundreds dial, the left-hand of the units and those of the upper tens dial through which the current is flowing (in the figure 226 ohms). In this way the voltage between P and P_2 may be made equal to any number of thousandths of the total voltage between A and 1. By inserting two pairs of decades between the end decades, the instrument may be made to read to 1 in 10,000.

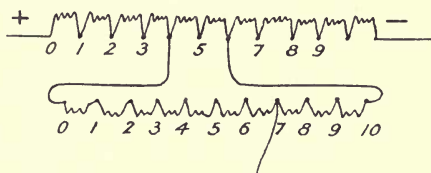

FIG. 47.

The other arrangement is shown in Fig. 47. A set of eleven coils—say hundreds—is traversed by the main current, two adjacent coils AB are shunted by a set, EF, of ten coils each of 20 ohms. The resistance between A and B is consequently 100 ohms, and one-tenth of the main voltage occurs there. This in EF is subdivided into ten parts, and the switch P can be used to make contact at some point along it. This principle also admits of repetition, so that the original voltage may be subdivided any number of times.

Whether the slide-wire or coils are used, it is often convenient to supplement the instrument with an adjustable resistance by which the current is reduced to a round number. Thus in Fig. 46 a rheostat K is shown in series with the coils and accumulator by means of which the potential difference

A to E can be made precisely two volts, and the current consequently two milliamperes.

The procedure, then, is to set the switches at the value appropriate to the standard cell (for a Clark cell of 1.434 volts, 717 ohms); adjust till no deflection of the galvanometer is obtained; then balance the experimental cell instead, and the switch reading multiplied by 0.002 will give the required voltage. This method is especially convenient when a Weston cell of zero temperature coefficient is used as standard, and the resistance between A and E can, by a modified construction of the box, be adjusted to 101.9, 1019, or 10190 ohms.

Sliding Contact.—In box potentiometers this is an ordinary contact lever, and presents no difficulties; but with the slide-wire the contact-maker has usually to be pressed down by hand. It consequently gets warmed, and may set up thermo-electromotive force. The best way to avoid this is to have two parallel stretched wires of the same metal, and a short sliding bridge to connect them. The main current flows through one; the other is connected to the galvanometer only. The symmetry of the arrangement makes the thermo-electric effects neutralise. It is also usually preferable to arrange for the slides to make contact always, and use a separate key to put the galvanometer into circuit.

In many complete potentiometers a special switch is provided by which any one of several cells can be put into action. This allows of measuring them quickly one after the other, without the trouble of unscrewing wires, and the risk of thermo-electric errors in doing so.

Indicating Instrument.—Either a galvanometer or capillary electrometer may be used. The former is the more sensitive and convenient, but is influenced by the resistance of the cell to be measured. If that resistance is very high, the galvanometer becomes less useful than the electrometer, which—for small potential differences—behaves as a static instrument. A good galvanometer of moderately high resistance should indicate 10^{-9} amperes, and so, even if the internal resistance of the cell being tested is 10,000 ohms, will allow of its electromotive force being measured to 10^{-5} volts. There are very few

chemical combinations whose electromotive force will remain steady to that extent.

The capillary electrometer consists essentially of two electrodes of mercury with sulphuric acid (or other electrolyte) between them, the contact of acid and metal being made, on one side, in a capillary tube. A good form is shown in Fig. 48. The wide tube *b* is filled with mercury and connected by a platinum wire, *d*, with one pole. The mercury extends to *a* in the capillary tube, and on account of the surface tension of the mercury *a* is below the level of the liquid in the wide tube. The other mass of mercury is contained in the bulb *e*, connection being made by a wire, *g*, sealed through a glass tube.

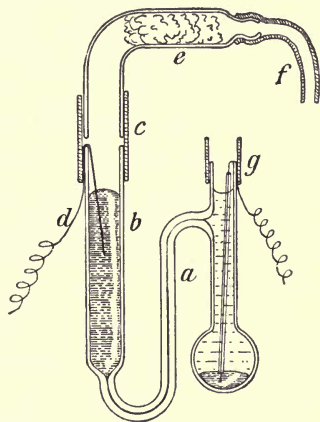

FIG. 48.

Electrification of mercury causes its surface-tension relatively to an electrolyte to change. Hence if an electromotive force be applied to the instrument, the mercury in *a* will rise or fall. The capillary mercury must not be made positive by more than one or two centivolts, but may be made considerably negative. In using the instrument with a potentiometer the voltage applied to it should be kept down as much as possible. The mercury meniscus may be observed with a microscope of moderate magnifying power, provided with a short ocular scale. It is then capable of indicating down to about 10^{-4} volts.

The electromotive force of any complete voltaic combination can be measured by connecting its electrodes to a voltmeter or potentiometer, and that whether current is flowing through it or not. *E.g.*, the potential differences between the terminals of an accumulator during charge and discharge can be studied in this manner. It must be borne in mind that if current is flowing, a certain difference of potential will occur between the poles in consequence of the resistance of the cell.

If this be R , and the strength of current (excluding any required by the voltmeter) i , then, in accordance with Ohm's law, the potential of the anode must be higher than that of the cathode by Ri , irrespective of any electromotive force in the cell. In order to obtain the true electromotive force when current is flowing, the resistance must be measured, and this correction applied.

B.—MEASUREMENT OF SINGLE POTENTIAL DIFFERENCES.

The same methods are applicable for determining single electrode potentials, if the electrode to be measured is combined with some standard electrode so as to make up a voltaic combination. Thus, the electrode



is very convenient for use with the lead accumulator. If some mercury be placed in a glass tube, covered with mercurous sulphate and dilute sulphuric acid, and the whole sunk in the acid of an accumulator, we may measure the potential difference between either plate and an insulated wire dipping in the mercury of this standard electrode.

In this way any electrode potential may be measured if only we know the absolute potential of any one standard. Absolute potentials have not, so far, been determined by any means quite free from objection, but certain approximate values have been obtained by the methods described above (p. 194), and may be accepted provisionally as correct.

In general an electromotive force is set up at the contact of two solutions, and consequently where the liquid of the standard electrode touches that of the electrode to be measured. For an accurate measurement of electrode potentials it is therefore necessary to allow for this, and as the correction, though small, is uncertain, it is important to choose standard electrodes that give rise to as little electromotive force of contact between solutions as possible.

The most important standard electrodes in use are the following:—

Calomel Electrode.—This consists of mercury covered with

mercurous chloride as depolariser, and immersed in a solution of potassium chloride, which may be either normal or decinormal. Potassium chloride is in most cases exceptionally favourable as to electromotive force of contact with other solutions, so the calomel electrode is usually a good one to use. It is also easy to set up, and the materials can be obtained pure without difficulty. The potential of the normal electrode is usually taken as $+0.5600$ (metal positive to solution) at 18° , increasing 0.0006 per degree above; that of the decinormal as $+0.6130$ at 18° , temperature coefficient 0.0008 .

A convenient construction of the electrode is shown in Fig. 49. The mercury at the bottom of the tube is covered, about

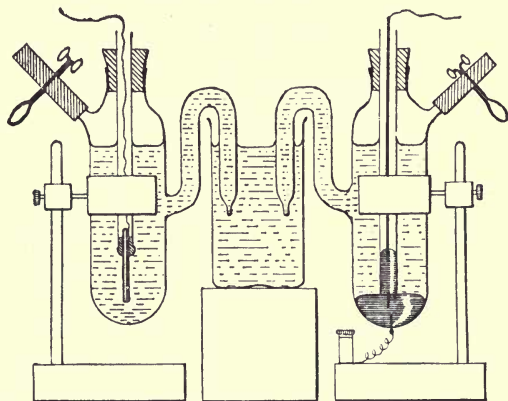

FIG. 49.

1 cm. deep, with calomel that has been several times washed with KCl solution, and shaken up with mercury to remove any mercuric chloride; the rest of the tube contains the KCl solution. It is placed with its point immersed in a beaker of the same solution, and the bent tube filled by blowing through the side tube on the right. After use a few drops of the liquid in the bent tube may be blown out, and the remainder sucked back. The other electrode whose potential is required may be made in similar form, and also allowed to dip in the beaker

of solution. Contact is made with the mercury of the normal electrode by a platinum wire sealed through a glass tube; or, as in Clark and cadmium cells, liquid mercury may be dispensed with, an amalgamated platinum sheet being immersed in the calomel paste instead.

When made up with due care, calomel electrodes agree amongst themselves to about $\frac{1}{10}$ millivolt.

The decinormal electrode is stated by Richards¹ to be more constant and less disturbed by vibration than the normal. According to Ostwald and Luther,² this is not the case if the electrode be properly made up; and the normal electrode has of course the advantage of a lower resistance.

The *mercurous sulphate electrode* referred to above, for use with accumulators, is similarly constructed. Its potential with equivalent normal acid is + 0.956 volt.

For alkaline solutions the combination Hg : HgO : $\frac{1}{4}$ n.NaOH may be used. Potential + 0.387.

Silver, coated with silver chloride or bromide, and immersed in the corresponding potassium solution, may be used instead of mercury.³

Besides electrodes of the calomel type, the most important standard that has been used is the *hydrogen electrode*. This, as used by Wilsmore,⁴ is shown in Fig. 50; the form is convenient and suitable for accurate work, and may be adopted for electrodes of other gases as well. The gas is led in through a Richardson wash-flask K; this is filled with the same solution as is to be used in contact with the electrode, in order that the gas should be saturated with the vapour of that solution, and so not cause any change in concentration as it bubbles past the electrode. From the wash-flask it enters the bottom of tube A. This is closed at the top by a rubber stopper, through which passes a glass tube carrying the metal sheet which is to act as electrode; the latter may be palladium, or well platinised

¹ *Zeitschr. phys. Chem.*, **24**, 37 (1897).

² *Physiko-Chemischen Messungen* (Leipzig: Engelmann), 2nd ed., 1902, *q.v.* for further details of potential measurements.

³ For details see Jahn, *Zeitschr. phys. Chem.* **33**, 555 (1900).

⁴ *Zeitschr. phys. Chem.*, **35**, 296 (1900).

platinum, and is arranged so as to lie half in the electrolyte, which fills the lower part of A, and half in the gas. The gas escapes through the mercury trap H which prevents air from getting backwards into the apparatus. The electrode vessel is

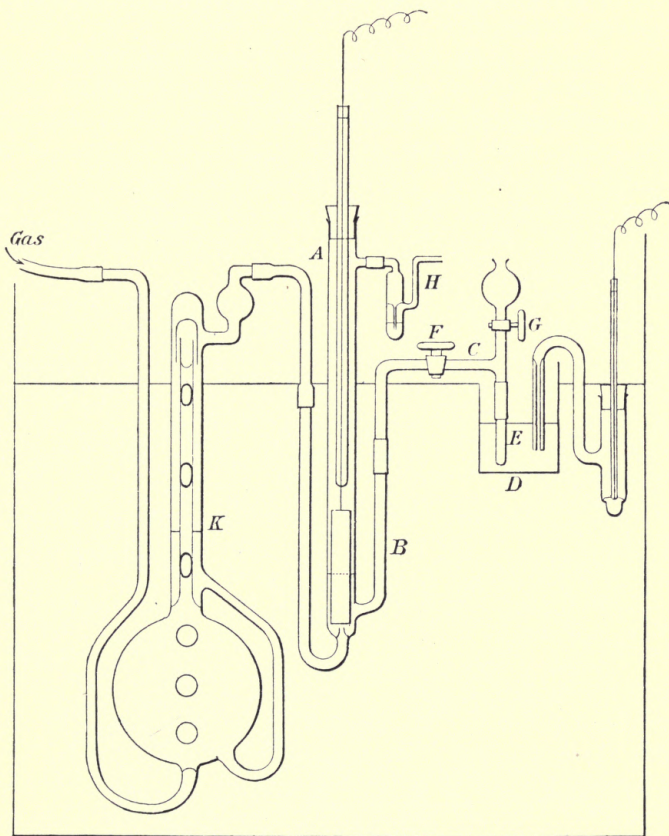

FIG. 50.

in communication through B with the beaker D, which is filled with the same electrolyte, and serves to receive the other electrode. A funnel is provided, with a tap, G, for convenience of washing out the end of the gas electrode. The

whole arrangement can be sunk in a thermostat. For successful working it is desirable that there should be but little electrolyte in A, so that it may be the more quickly saturated with gas. To keep the gas from going through by jerks, a glass tube drawn out very fine, to serve as a resistance, may be inserted between K and A.

Wilsmore finds that such an electrode made up with hydrogen in normal sulphuric acid, reaches a constant value in about a quarter of an hour, and can be relied on to nearly the same extent as the calomel electrode, *i.e.* to one or two tenths of a millivolt. It gives, with the Hg : Hg₂SO₄ electrode, also in normal acid, an electromotive force 0.6953 at 25°, with the normal calomel electrode 0.3276, mercury being positive, in both cases.

From the mean of several combinations Wilsmore concludes that H in normal *ionic* solution of hydrogen ions is 0.283 negative to the mercury of the normal calomel electrode, and therefore, taking the absolute potential of the latter as + 0.560, the absolute potential of hydrogen in such a solution is + 0.277. This is the number quoted in the table of electro-affinities (p. 159). There is, however, much uncertainty in the reduction to normal ionic concentration, so that for practical purposes it is better to take the electrode actually used for standard—preferably the normal calomel electrode.

For further particulars as to the use of the gas electrode reference may be made to the work of Emil Bose.¹

Another device used by Wilsmore is to polarise a platinum point cathodically with a definite E.M.F., and use it as a potential standard. The electrode in question should be very small (a wire sealed through glass and cut off short), but well platinised; it is used as cathode, with a large platinum anode, in normal sulphuric acid, 1.2 to 1.3 volts being applied to the combination. The point is then slightly polarised, and may serve as a standard electrode for the measurement of any other electrode immersed in the same solution. The potential of the point is as follows:—

¹ *Zeitschr. phys. Chem.*, **34**, 754 (1900).

Polarising E.M.F.	Potential of point electrode.
1'20	0'312
1'22	0'315
1'24	0'317
1'26	0'320
1'28	0'323
1'30	0'327

§ 9. STANDARD CELLS.¹

A standard, or normal, cell is one which, if made up with due care, can be relied upon to possess a definite and permanent electromotive force, so that it can be used as a standard in electrical measurements. Since all cells, when discharging, suffer a certain amount of concentration, if not also chemical polarisation, and since on account of resistance the potential difference between the terminals is reduced during discharge, it is evident that a cell can only be a completely satisfactory standard when used on open circuit. Standard cells are therefore normally used with the potentiometer: if employed to give current, it must be only minute compared with what the cell could give on short-circuiting. Thus if an accumulator (with acid of measured density) be designed to give ten amperes, then $\frac{1}{100}$ ampere may be regarded as a minute current for it; it will scarcely polarise at all when giving this small current, and may be regarded as a rough standard (reliable to 1 per cent.) when so used. But a Clark cell, which would perhaps only give $\frac{1}{200}$ ampere when short circuited, could not be treated as a good standard if yielding more than $\frac{1}{100000}$ ampere.

The conditions for a satisfactory standard cell are—

(i.) It must be made of materials so well defined chemically that it can be reproduced with exactness.

(ii.) When brought back to the same external conditions (especially temperature), it must give the same electromotive force.

¹ See the monograph by Jaeger, *Die Normal-Elemente* (Knapp: Hallé, 1902).

(iii.) When current is taken out of or put into the cell, though it may suffer temporary changes, it must recover completely, so that after repeated use the electromotive force shall be unaltered.

A cell such as the Daniell as commonly employed is an imperfect standard, even if made with absolutely definite chemical materials, because when current is taken out of it the concentration of the zinc sulphate is permanently increased, that of the copper sulphate permanently decreased; the electromotive force would therefore suffer a steady change (decrease) with lapse of time. To avoid such changes it is necessary that both solutions should be saturated, and be maintained so by a supply of the solid salts. Hence the combination

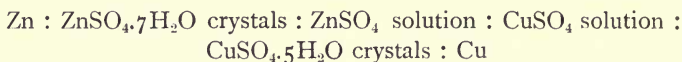

may serve, so far as the above conditions are concerned. But the permanence of the cell is affected by another consideration.

(iv.) The materials of the cell must constitute a system instable chemical equilibrium; or if this is not possible, the diffusive processes that occur must be extremely slow.

The Daniell cell does not constitute a system in equilibrium, for if the zinc rod be allowed to touch the copper sulphate solution, copper will be deposited on the zinc, and the electromotive force altered. Neither is the diffusive process slow enough in practice, for copper sulphate, being easily soluble, is present in large quantities in the electrolyte, and easily diffuses into the part of the cell containing the zinc. If a porous jar be used to keep the two liquids apart, it will only serve for a few days, or at best weeks.

No cell has been invented which satisfies condition (iv.) completely, and it is hardly conceivable that a *completely* stable system could be found to form a voltaic cell. But great practical improvement can be made on the Daniell in two ways: (a) by using a nearly insoluble salt, such as Hg_2SO_4 or AgCl_2 as depolariser; (b) by using in place of copper, mercury, because then the traces of mercury that, by diffusion, reach the active metal (say zinc) only serve to amalgamate it further, and

if it is already amalgamated, this makes an inconsiderable difference to the electromotive force.

Both these points are satisfied in the Clark and cadmium cells, which are by far the most important and practically useful cells; some others that have from time to time been used may be included in a list, as follows:—

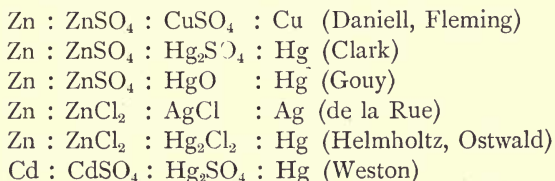

In the choice of a depolariser the least soluble is not, despite its less diffusion, always to be preferred; in practice the above cells with mercurous sulphate are found more satisfactory than those with the much more insoluble chlorides, because the latter polarise more readily. When current is taken out of a Clark cell, it is conveyed to the cathode by discharge of mercurio-ions; the number of these in solution is therefore temporarily diminished. The supply is, of course, made up by further solution of the solid mercurous salt, but as this takes time, there is temporary polarisation. Much more so is this the case in a chloride or oxide cell (Helmholtz or Gouy), where the stock of mercurio-ions in solution is perhaps a thousand times smaller. In working a potentiometer it is unavoidable to pass small currents through the standard cell before the final adjustment is arrived at; hence we arrive at another condition:—

(v.) The depolariser must not be so very insoluble as to make the cell excessively sensitive to polarisation.

The Clark cell was for long regarded as the best standard, but the cadmium cell possesses, as compared with it, the important advantage of a practically negligible temperature coefficient. It is therefore coming to replace the Clark as standard, and we shall first describe its construction in detail; most of the directions may, however, be regarded as applying

equally to the Clark cell. The reason for some of the directions will appear from the theoretical discussion following.

The *Cadmium* cell is usually constructed in an H form, as shown in Fig. 51. The containing vessel is of glass, and must of course be thoroughly cleaned and dried before use. The negative electrode consists of an amalgam containing $12\frac{1}{2}$ parts by weight of cadmium to $87\frac{1}{2}$ of mercury. The two metals combine on warming, and the amalgam may be preserved from

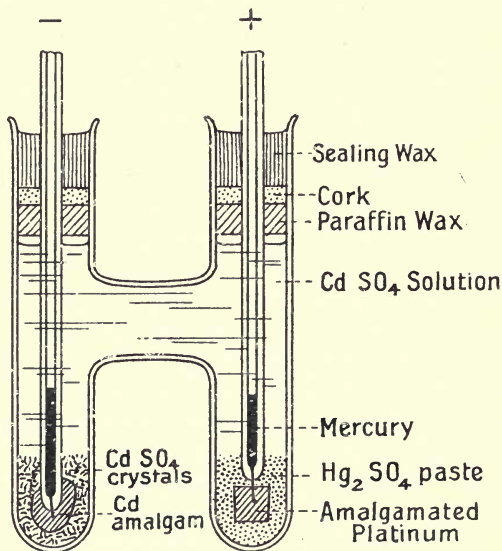

FIG. 51.

oxidation by a layer of paraffin. The amalgam, which is solid at ordinary temperature, may be poured into one limb of the H, or better, cast on a platinum wire as shown in the figure. The wire is first sealed through the end of a capillary glass tube (about 1 mm. internal diameter) with the aid of "Schmeltzglas," and then, some amalgam being melted in a glass tube, the wire is placed in it, and on cooling, the amalgam forms an adherent cap round the wire. Connection is made by means of a drop of mercury in the capillary. This method of

construction ensures good insulation of the cell when not in use. The positive pole may consist of liquid mercury (scrupulously purified), but is better made in a manner similar to the negative. A platinum wire is sealed in a glass tube, a piece of platinum foil about 1 cm. square welded to this, and the foil, after cleaning with aqua regia, is amalgamated by electrolysis in a solution of mercurous nitrate. Mercury obtained in this way can be relied on for purity, and as only a small amount adhering to the platinum is used, the cell is less liable to be damaged when carried about.

The electrolyte is made by mixing equal weights of cadmium sulphate crystals (free from zinc and iron) and water, and rubbing them well together. The arm of the H-tube containing the negative electrode is filled with this, the undissolved crystals being allowed to settle round the electrode so that it is completely covered with them. The other arm is similarly filled with a paste composed of cadmium sulphate solution and mercurous sulphate well rubbed together to the consistency of a thick cream. The mercurous sulphate must be very carefully freed from mercuric salts: if it shows any appreciable quantity of these it should be rejected, as satisfactorily pure mercurous sulphate is now to be had commercially. The paste settles down round the amalgamated platinum electrode, and eventually hardens so that the cell can be turned upside down without displacing it.

The cell must be sealed off so as to protect it completely against evaporation. The method shown in the figure is satisfactory. A layer of paraffin wax is poured on to the electrolyte, taking care, however, to leave an air-bubble, else there is risk of the glass cracking in the summer. A cork disc is then pushed down over the electrode tubes, to the level of the paraffin, and the top of the cell very carefully sealed with sealing-wax.

The cell may conveniently be packed with cotton wool inside a metal case. The electromotive force only varies $\frac{1}{30000}$ part per degree, but if the two electrodes are not at the same temperature, an error considerably greater than this may be introduced, as a thermoelement will be formed, the electromotive

force of which will be added to or subtracted from that of the chemical cell. The above arrangement avoids this error.

The electromotive force of cadmium cells made up as above is given by the formula

$$E = 1.0186 - 0.000038(t - 20^\circ) - 0.00000065(t - 20^\circ)^2 \text{ volts}$$

(see table, p. 260).

The earliest attempt at using cadmium for standard cells was by Czapski in 1884, who studied the combination

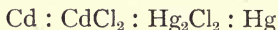

Such cells are open to objection with regard to condition (v.) above, and did not appear in practice to be satisfactorily constant; they have not come into use as standards.

The sulphate cell was introduced about 1890 by Weston, and is still manufactured by the European Weston electrical instrument company of Berlin. The so-called *Weston* cell, however, differs in one respect from the pattern described above. It contains no crystals of CdSO_4 , but is made up with a solution saturated at 4° . The solubility of the salt is a minimum about that temperature, so that when raised to higher temperatures the electrolyte of a Weston cell is slightly unsaturated. Its electromotive force at 4° necessarily coincides with that of the standard cell, viz.

$$1.0190 \text{ volts}$$

and as the Weston cell is found to have no measurable temperature coefficient, it may be taken at that value for any ordinary atmospheric temperature.

The cell with crystals, which we have described as the standard type, is that of the Berlin "Reichsanstalt," and has been studied principally by Jaeger, to whose work we are indebted for the table of electromotive force on p. 260.

The behaviour of cadmium amalgams is somewhat unusual, and the construction of cadmium cells is dependent chiefly on their peculiarities.

The electro-affinity of pure cadmium is about -0.143 volt. Addition of mercury raises this value appreciably, so that one cannot, as with most metals, amalgamate the surface without

seriously altering its nature. Addition of 85 per cent. of mercury raises the potential by about 0.05 volt, but at this point some definite compound (probably Cd_2Hg_7) is formed, the electro-affinity of which determines that of the amalgam until 95 per cent. of mercury is reached, when the potential again rises, approaching that of pure mercury. These changes are shown in Fig. 52. The range of constant electro-affinity

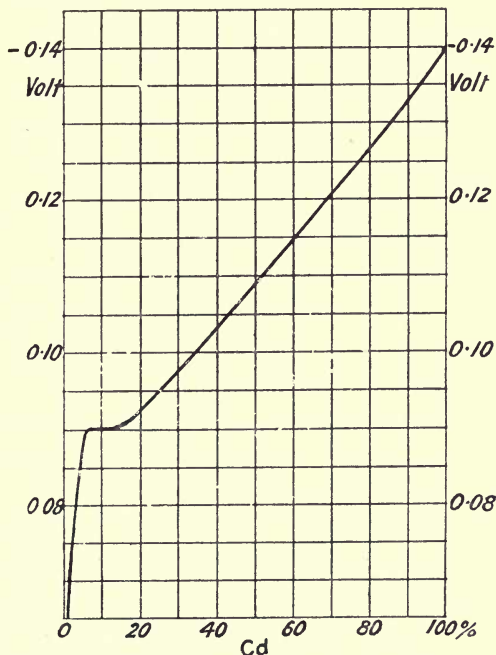

FIG. 52.

(5 to about 15 per cent. Cd) is clearly the most favourable to choose for making standard cells. Amalgams of less than 10 per cent. are liquid at ordinary temperature, and therefore less convenient than those containing a larger percentage of cadmium. Weston originally used 14.3 per cent. ($\frac{1}{7}$ th) Cd, which lies just within the range of constancy: but cells constructed with this material were found to show an erratic

behaviour, not always giving the same E.M.F. at the same temperature. These irregularities were eventually traced by Cohen¹ to a transition which the 14·3 per cent. amalgam undergoes at 23°. If the cell containing it be heated above that temperature and then cooled, the amalgam remains at first in the condition which is stable above 23°, and therefore unstable below it, but slowly changes to the other form, with concurrent change in electromotive force. Such a cell is, of course, entirely unsuitable as a standard. Fortunately it was shown by Jaeger and Lindeck² that amalgams with a smaller content of cadmium do not show this transition point—at least, within the range of temperature practically needed. Amalgams of from 10 to 13 per cent. can be used with perfect confidence from the freezing-point to at least 30°.

The physico-chemical behaviour of cadmium sulphate is also of importance for the cell. When the irregularities in electromotive force were first observed they were put down to a probable transition point of the salt (analogous to that of ZnSO₄ (p. 220)). This was found not to be the case, however. The saturated solution yields crystals of composition CdSO₄· $\frac{8}{3}$ H₂O at all temperatures up to 74°, when CdSO₄·H₂O separates instead; there is no transition below that temperature, therefore. The salt is very soluble; the solubility passes through a minimum at about 0° to 4°, being 75·5 parts by weight of CdSO₄ to 100 of water, corresponding to the formula CdSO₄·15·3H₂O. It increases very little in solubility over the ordinary range of temperature: this is partly the reason why cadmium cells vary so little in E.M.F. with change of temperature; and it has the further advantage that if the temperature be raised the extra salt needed to maintain saturation is soon dissolved, and there is little tendency for the E.M.F. to lag behind the temperature on this account.

Before the cadmium cell had established itself as a trustworthy standard, the cell designed by Latimer Clark in 1872

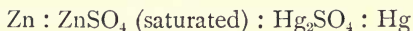

¹ *Zeitschr. phys. Chem.*, **34**, 621 (1901).

² *Ann. d. Phys.*, (4) **5**, 1 (1901), or *Zeitschr. phys. Chem.*, **37**, 641 (1901).

was almost exclusively used as standard of electromotive force.

The rules for constructing it are nearly the same as for the cadmium cell. The following differences are to be noted:—zinc (pure, redistilled) is used as anode: it may be amalgamated on the surface, and even dissolved in mercury, but no definite compound is formed as with cadmium. On the contrary, the presence of mercury makes practically no difference to its electromotive behaviour: even when the mercury reaches 98 or 99 per cent. the electro-affinity remains that of pure zinc, to within a fraction of a millivolt. The metal (or amalgam) should not be cast on a platinum wire sealed through glass, as zinc slowly alloys with platinum, causing it to expand and crack the glass. The zinc sulphate is used in the form $\text{ZnSO}_4 \cdot 7\text{H}_2\text{O}$; it must be free from acidity, and from iron. It must not be heated to 39° , on account of its transition point (p. 220); if raised above that temperature it suffers the change into hexahydrate, and does not always return to the other form on cooling, causing uncertainty in the electromotive force.

Clark cells have been made up in many forms, the most familiar being the "Board of Trade" pattern, shown in Fig. 53. This has the advantage of a low internal resistance, but is defective in certain respects. It is exposed to the danger that fragments of zinc may fall into the mercury below. This would at once destroy the accuracy of the cell. This danger may be avoided by using a sheet of amalgamated platinum instead of liquid mercury, and putting it side by side with the zinc.

Further, Clark cells are always apt to show temperature lag, and the Board of Trade pattern is bad in this respect. The lower part of the zinc rod is surrounded

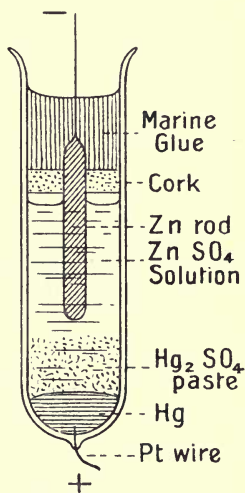

FIG. 53.

by crystals of sulphate, the upper by solution merely. If the temperature rises, the solution becomes unsaturated, and as, at the top, it can only get saturated again by the slow process of diffusion from below, the electromotive force takes a considerable time to adjust itself to the new temperature. Hence even if the temperature of the cell is accurately known, by a thermometer sealed into it, its electromotive force cannot be depended on unless the cell has been kept for a long time in a thermostat. The temperature lag may be reduced by filling the cell completely with crystals, or surrounding the zinc with a glass tube except at the tip.

Clark cells have also been made with the zinc in a porous pot, and also in H form.

The disadvantages of the Clark as compared with the cadmium are

- (i.) Temperature coefficient is thirty times as great.
- (ii.) Temperature lag ;
- (iii.) Liability to generate hydrogen. Zinc acts—very slowly—even upon pure water ; and, of course, if the electrolyte is at all acid the action is much more rapid. There is thus a risk of the negative pole becoming covered with a film of gas, which would polarise it, and choke off the current. Cadmium, from its position on the scale of electro-affinity, is much less likely to liberate hydrogen.

The electromotive force of the Clark cell has often been measured by means of standard resistances, and either an absolute current meter or the silver voltameter (p. 253, *infra*) Carhart¹ gives this table of results :—

Observer.	Date.	Method.	E.M.F. at 15°
Clark	1872	Absolute	1'4378
Carhart	1882	Silver voltameter	1'4329
Rayleigh	1884	Absolute	1'4345
Ettinghausen	1884	Silver voltameter	1'434
Glazebrook and Skinner	1892	" "	1'4344
Kahle	1896	Absolute	1'4322
Jaegar and Kahle	1898	Silver voltameter	1'4328
Carhart and Guthe	1899	Absolute	1'4333

¹ *Electrochemist*, 1. 37-39 (1901).

The temperature variation of the E.M.F. of a Clark cell is, according to Jaeger, given by the formula

$$E = 1.4328 - 0.00119(t - 15^\circ) - 0.000007(t - 15^\circ)^2$$

(valid between 0° and 30°).

When the zinc sulphate solution in a Clark cell is dilute, the electromotive force is greater than that of the ordinary cell with saturated solution at the same temperature. The temperature coefficient of such a cell is only half that of an ordinary cell. Fig. 54 shows the results of an experiment by Jaeger on this point. A saturated solution of $\text{ZnSO}_4 \cdot 7\text{H}_2\text{O}$

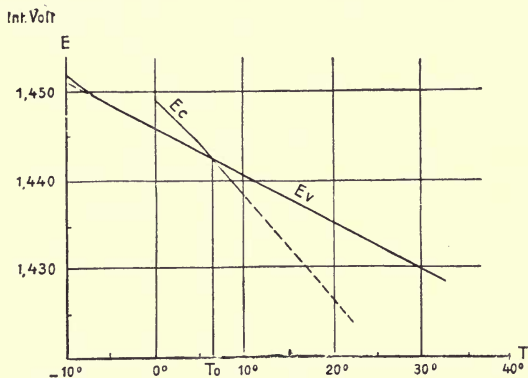

FIG. 54.

was prepared at 6.75° (T_0 , Fig. 54), separated from crystals, and used to make a cell. The E.M.F. was found to be

$$E = 1.4422 - 0.000530(t - 6.75^\circ)$$

(line E_v in figure). The solubility of zinc sulphate increases rapidly with rise of temperature: consequently, when a cell without crystals is warmed, the solution becomes unsaturated; its electromotive force must become greater than that of a saturated cell at the same temperature, and the corresponding line in the diagram must lie above that for a normal cell (E_c). But even if the cell without crystals be cooled, crystals do not separate out, so the solution becomes super-saturated, and it was found possible to measure it in this state

down to -10° (left of To, Fig. 54). It will be seen, then, that of the temperature coefficient of the ordinary Clark cell, about half is due to change in solubility of the salt.

The other cells that have been proposed as standards are unimportant. Helmholtz used the calomel cell

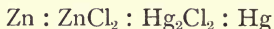

The very small solubility of mercurous chloride is against this, as it does not form a sufficiently active depolarising agent. Moreover, zinc chloride is a badly defined substance chemically. By properly adjusting the concentration of the electrolyte, this cell may be made to give exactly 1 volt. According to Ostwald, this requires (at 15°) a density of 1.409; according to Schoop, 1.391. Similar cells have been made by Hibbert. The temperature coefficient is $+0.00007$.

Gouy's cell

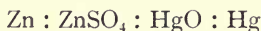

is unsatisfactory because in course of time mercurous sulphate is formed in it, so that it cannot be regarded as properly reversible. The voltage is about 1.4, the temperature coefficient about -0.0002 .

De la Rue's cell

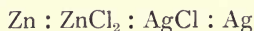

is comparable to the calomel cell. It gives a fairly steady electromotive force, and has been used to make up high voltage batteries, but has not been precisely studied as a standard.

Finally, a lead accumulator that has been charged and allowed to stand a few hours may be used as a standard for moderately accurate measurements. The density of the acid must be taken; the voltage can then be calculated from the following formula, which can be relied upon to within 1 per cent.,—

$$E = 2.048 + 0.97(d - 1.2)$$

where E is the electromotive force, d the density of the acid. The formula holds for temperature 15° , and for acid of density between 1.1 and 1.3.

To determine the electromotive force of a standard cell—

on which, in turn, all other determinations of electromotive force depend—the method used is to balance it against a measured current flowing through a known resistance. The current is measured either (a) absolutely, *i.e.* according to its electro-magnetic definition, by means of an electro-dynamometer, “current balance,” or other instrument, or (b) by the weight of silver deposited by it in a measured time. The former measurement, as well as the experiments by which the absolute value of the resistance standard is arrived at are beyond the range of this book. We may content ourselves with describing briefly the method of the silver voltameter.

The arrangement of apparatus is shown in Fig. 54. Current is taken from a large battery of accumulators—say 20 cells or

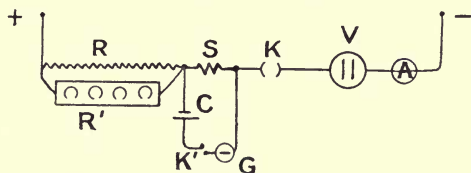

FIG. 55.

more. The advantage of using a large E.M.F. is that the resistance of the voltameter is then small compared with the other resistances in circuit, so that the inevitable variations in it do not much affect the current. A is an ammeter which is convenient for rough adjustment of the current; V is the silver voltameter; K, a key by which the current may be made and broken as rapidly as possible; S, a standard resistance of, say, 4 ohms, capable of carrying $\frac{1}{4}$ ampere without appreciable rise of temperature; C, the standard cell to be tested; G, a mirror galvanometer; K', a key. If C is a cadmium cell, and S 4 ohms, then for balance (shown by absence of current in G) the main current must be adjusted to $\frac{1.0186}{4} = 0.025465$ amperes.

To do this, using 20 accumulators, a resistance of about 150 ohms must be put in the circuit. This is done by means of R, a substantial wire resistance a trifle greater than 150 ohms,

and capable of carrying a quarter ampere without much heating, and R' , a dial resistance-box in parallel with R . R' , the resistance of which should be some thousands of ohms, serves as a fine adjustment. The current is allowed to flow for an exactly measured interval, say two hours, and kept adjusted by manipulating R' so that there is no deflection of G . The current is then calculated from the weight of silver, and when multiplied by the resistance S , gives the electromotive force of the standard cell.

TABLES

I. EQUIVALENT WEIGHTS (ω) AND ELECTRO-CHEMICAL EQUIVALENTS IN GRAMS (χ) OF IONS.

(The faraday is taken as 96,600 coulombs.)

	ω	χ		ω	χ
H	1'008	$104\cdot3 \times 10^{-7}$	Cl	35'45	3671×10^{-7}
K	39'14	4053	Br	79'96	8278
Na	23'05	2387	I	126'86	13134
NH ₄	18'07	1871	F	19'05	1972
Ag	107'93	11175	OH	17'01	1761
$\frac{1}{2}$ Zn	32'7	3386	CN	26'04	2696
$\frac{1}{2}$ Cd	56'05	5803	NO ₃	62'04	6423
$\frac{1}{2}$ Cu	31'8	3292	C ₂ H ₃ O ₂	59'02	6110
$\frac{1}{2}$ Pb	103'46	10711	$\frac{1}{2}$ O	8'00	828'3
Hg	200'3	20739	$\frac{1}{2}$ SO ₄	48'03	4973
			$\frac{1}{2}$ CO ₃	30'00	3106

2. VAPOUR PRESSURE OF WATER.

Temperature.	Pressure.	Difference.	Temperature.	Pressure.	Difference.
	mm.			mm.	
10	9'165	627	18	15'357	989
11	9'792	665	19	16'346	1045
12	10'457	705	20	17'391	1104
13	11'162	746	21	18'495	1164
14	11'908	791	22	19'659	1229
15	12'699	837	23	20'888	1296
16	13'536	885	24	22'184	1366
17	14'421	936	25	23'550	
18	15'357				

3. MIGRATION RATIOS OF ANION. (In aqueous solution of concentration m gram-equivalents per litre (Kohlrausch and Holborn).)

At atmospheric temperature. Small print indicates uncertain values.

$m =$	'01	'02	'05	'1	'2	'5	1	1'5	2	3	5	7	10
KCl													
KBr													
KI													
NH ₄ Cl													
NaCl													
LiCl	'63	'65	'67	'69	'71	'73	'739	'741	'745	'752	'763	'774	—
KNO ₃	—	—	—	'497	'496	'492	'487	'482	'479	—	—	—	—
NaNO ₃	—	—	—	'615	'614	'612	'611	'610	'608	'603	'585	—	—
AgNO ₃	'528	'528	'528	'528	'527	'519	'501	'487	'476	—	—	—	—
KC ₂ H ₃ O ₂	—	—	—	'33	'33	'33	'331	'332	'332	'333	'335	—	—
NaC ₂ H ₃ O ₂	—	—	—	'44	'43	'43	'425	'422	'421	'417	—	—	—
KOH	—	—	—	'735	'736	'738	'740	—	—	—	—	—	—
NaOH	—	—	'81	'82	'82	'82	'825	—	—	—	—	—	—
LiOH	—	—	—	'85	'85	'861	'873	'890	—	—	—	—	—
HCl	—	—	'172	'172	'172	'173	'176	'180	'18	'200	'238	'292	—
$\frac{1}{2}$ BaCl ₂	'56	'565	'575	'585	'595	'615	'640	'650	'657	—	—	—	—
$\frac{1}{2}$ CaCl ₂	'58	'59	'61	'64	'66	'675	'686	'695	'700	'710	'737	'764	'79
$\frac{1}{2}$ MgCl ₂	—	—	'63	'66	'68	'69	'709	'718	'729	'747	'776	'799	—
$\frac{1}{2}$ CdCl ₂	'57	'58	'59	'62	'65	'69	'72	'73	'745	'767	'865	'995	—
$\frac{1}{2}$ CdI ₂	'56	'59	'64	'71	'83	1'00	1'12	1'18	1'22	1'25	10	2'5	—
$\frac{1}{2}$ K ₂ CO ₃	—	—	'39	'40	'41	'435	'434	'421	'413	'404	'380	'355	—
$\frac{1}{2}$ Na ₂ CO ₃	—	—	'52	'53	'53	'54	'548	'546	'542	'530	—	—	—
$\frac{1}{2}$ MgSO ₄	—	—	'60	'64	'66	'70	'74	'75	'76	'760	—	—	—
$\frac{1}{2}$ CuSO ₄	—	'62	'626	'632	'643	'668	'696	'714	'720	—	—	—	—
$\frac{1}{2}$ H ₂ SO ₄	—	—	'193	'191	'188	'182	'174	'169	'168	'170	'190	'216	'268

The following are from more recent experiments:—

NOYES AND SAMMET, *Zeitschr. phys. Chem.* **43**, 49 (1902).

	m	α	Temperature.
HCl	$\frac{1}{60}$	0'1586	10°
"	$\frac{1}{30}$	0'1657	20°
"	$\frac{1}{60}$	0'1674	20°
"	$\frac{1}{180}$	0'1671	20°
"	$\frac{1}{60}$	0'1773	30°

JAHN, *Zeitschr. phys. Chem.*, **37**, 673 (1901).

Limiting values for indefinite dilution (Temperature 18–19°).

HCl	0'174	BaCl ₂	0'553
HNO ₃	0'170	CdCl ₂	0'568
KCl	0'503	CdBr ₂	0'568
KBr	0'504	CdI ₂	0'557
NaCl	0'604	AgNO ₃	0'529
NaBr	0'604	CuSO ₄	0'625
LiCl	0'670		

(See also table, p. 68).

4. CONDUCTIVITY OF STANDARD SOLUTIONS (see p. 55).

5. EQUIVALENT CONDUCTIVITIES OF AQUEOUS SOLUTIONS
(see diagrams, pp. 60, 61).

6. IONIC CONDUCTIVITIES AT 18° (KOHLEAUSCH AND HOLBORN).

Normality (<i>m</i>).	K.	Na.	Li.	NH ₄ .	Ag.	$\frac{1}{2}$ Ba.	$\frac{1}{2}$ Sr.	$\frac{1}{2}$ Ca.	$\frac{1}{2}$ Mg.	$\frac{1}{2}$ Zn.	H
0	65.3	44.4	35.5	64.2	55.7	57.3	54.0	53.0	49	47.5	318
0.0001	64.7	43.8	34.9	63.6	55.4	55.0	51.7	50.6	47	45.1	316
0.0002	64.4	43.6	34.7	63.4	55.1	54.3	51.0	50.0	46	44.5	316
0.0005	64.1	43.3	34.4	63.0	54.9	53.3	50.0	48.9	45	43.5	315
0.001	63.7	42.9	34.0	62.7	54.7	52.2	48.9	47.8	43	42.3	314
0.002	63.2	42.4	33.5	62.2	54.2	50.7	47.4	46.4	42	40.9	313
0.005	62.3	41.4	32.6	61.2	53.2	48.2	44.9	43.9	40	38.9	311
0.01	61.3	40.5	31.6	60.2	51.9	45.7	42.4	41.4	37	35.9	310
0.02	60.0	39.2	30.3	59.0	50.0	42.7	39.4	38.3	34	32.9	307
0.03	59.2	38.3	29.4	58.1	48.6	40.5	37.2	36.1	32	30.7	305
0.05	57.9	37.0	28.2	56.8	46.6	37.7	34.4	33.4	29	27.9	302
0.1	55.8	35.6	26.1	54.8	43.3	33.8	30.5	29.4	25	24.0	296

	Cl.	I.	NO ₃ .	ClO ₃ .	C ₂ H ₃ O ₂ .	$\frac{1}{2}$ SO ₄ .	$\frac{1}{2}$ C ₂ O ₄ .	$\frac{1}{2}$ CO ₃ .	OH.
0	65.9	66.7	60.8	56.2	33.7	69.7	63	—	174
0.0001	65.3	66.1	60.2	55.5	33.1	67.2	61	—	172
0.0002	65.1	65.9	60.0	55.2	33.0	66.6	60	—	172
0.0005	64.8	65.5	59.6	54.6	32.8	65.4	59	—	171
0.001	64.4	65.1	59.3	54.1	32.6	64.0	58	69	171
0.002	63.9	64.6	58.8	53.4	32.4	62.3	56	66	170
0.005	63.0	63.7	57.8	52.4	31.6	59.2	54	60	168
0.01	62.0	62.7	56.8	51.3	30.8	56.1	51	55	167
0.02	60.7	61.5	55.6	49.7	29.8	52.3	48	50	165
0.03	59.8	60.6	54.7	48.4	29.0	49.7	46	47	163
0.05	58.6	59.3	53.4	46.4	28.0	46.1	43	43	161
0.1	56.5	57.3	51.4	43.2	26.4	41.9	39	38	157

The above numbers serve to calculate approximately the equivalent conductivities of compounds of univalent ions, and of univalent with divalent ions (except H₂SO₄). For compounds of divalent anions with divalent cations the following table to be used:—

	$\frac{1}{2}$ Mg.	$\frac{1}{2}$ Zn.	$\frac{1}{2}$ Cu.	$\frac{1}{2}$ Cd.	$\frac{1}{2}$ Ba.	$\frac{1}{2}$ Sr.	$\frac{1}{2}$ Ca.	$\frac{1}{2}$ SO ₄ .	$\frac{1}{2}$ C ₂ O ₄ .
0	48	47	49	—	57	54	53	70	63
0·0001	44	43	47	—	53	49	49	66	61
0·0002	43	42	46	—	52	48	48	65	60
0·0005	42	40	44	—	50	45	46	63	58
0·001	40	38	41	37	47	43	44	60	56
0·002	38	36	37	35	—	—	41	57	53
0·005	34	31	31	30	—	—	35	51	—
0·01	31	27	27	26	—	—	31	46	—
0·02	27	24	22	21	—	—	—	41	—
0·03	25	22	20	18	—	—	—	38	—
0·05	23	19	17	16	—	—	—	34	—
0·1	20	17	15	13	—	—	—	30	—

The limiting values l_{18} for infinite dilution at 18°, and the temperature coefficients $\left(\frac{1}{l} \frac{dl}{dt}\right)_{18}$ are (Kohlrausch and von Steinwehr, *Berl. Akad. Sitzber.*, 26. 570, 581 (1902):—

Li	33·44	· 0·0265	C ₅ H ₉ O ₂	25·7	· 0·0244
Na	43·55	· 0·0244	IO ₃	33·87	· 0·0234
Ag	54·02	· 0·0229	C ₂ H ₃ O ₂	35·0	· 0·0238
NH ₄	54·4	· 0·0222	F	46·64	· 0·0238
K	64·67	· 0·0217	ClO ₃	55·03	· 0·0215
Tl	66·00	· 0·0215	CNS	56·63	· 0·0221
Rb	67·6	· 0·0214	NO ₃	61·78	· —
Cs	68·2	· 0·0212	Cl	65·44	· 0·0216
H	318·0	· 0·0153	I	66·40	· 0·0213
			Br	67·63	· 0·0215
$\frac{1}{2}$ Zn	45·6	· 0·0251	OH	174·0	· 0·0180
$\frac{1}{2}$ Mg	46·0	· 0·0256			
$\frac{1}{2}$ Ba	56·3	· 0·0238	$\frac{1}{2}$ SO ₄	68·7	· 0·0227
$\frac{1}{2}$ Pb	61·5	· 0·0243			

7. DISSOCIATION CONSTANTS K (calculated by Ostwald's equation from the MOLECULAR conductivity). At 25°.

	K × 10 ⁸		K × 10 ⁸
Formic acid	21·4	m. oxybenzoic acid	8·7
Acetic acid	1·8	p. oxybenzoic acid	2·9
Propionic acid	1·3	Ammonia	2·3
Glycolic acid	15·0	Methylamine	50·0
Malic acid	39·5	Ethylamine	56·0
Tartaric acid	6·6	Dimethylamine	74·0
Benzoic acid	6·0	Trimethylamine	7·4
Salicylic acid	102·0	Hydrazine	7·3

(See further, Chapter II.).

8. DIELECTRIC CONSTANTS, FACTOR OF ASSOCIATION, HEAT OF EVAPORATION, AND MOLECULAR SURFACE TENSION OF LIQUIDS. (WALDEN AND CENTNERSCHWER, *Zeitschr. phys. Chem.*, **39**. (561).

	Dielectric constants at 20°.	Association factor 20°.	Latent heat of evaporation.	Surface tension ÷ molecular weight.
Water	81·12	3·7	536·2	336·0
Formic acid	57·0	3·6	103·7	64·3
Nitromethane	56·4	> 1·5	127 calc.	42·5
Acetonitrile	ca. 40·0	1·6	170·7	52·8
Methyl alcohol	32·5	3·4	267·0	59·8
Propionitrile	ca. 30·0	1·77	112 or 135	34·8
Ethyl alcohol	26·8	27·0	205·1	38·5
Acetaldehyde	21·1	—	136·4	—
Acetone	20·7	1·0	125·3	33·6
Glycerine	16·5 or 56·2	2·92 or 1·8	158·4	—
Ethyl nitrate	19·6	1·0	82·0 calc.	23·5
Ammonia	16·2	1·0	329·0	2460·0
Sulphur dioxide	13·75	1·0	92·45	521·0
Pyridine	ca. 20·0	0·93	101·4	31·1
Piperidine	> 20·0	1·06	88·9	24·4
Acetyl chloride	15·4 or 25·3	1·06	—	—
Methyl iodide	7·2	ca. 1·0	46·1	18·5
Ethyl acetate	5·8	0·99	105·8	20·2
Chloroform	5·2	1·0	58·5	18·6
Ether	4·36	1·0	88·4	21·3
Benzene	2·29	1·0	92·9	27·3
Toluene	2·31	1·0	83·6	20·1
Aniline	7·31	1·05	93·3	25·5
Quinoline	8·9	0·81	—	17·2
Benzyl cyanide	15·0	1·0	—	—
Benzonitrile	26·0	1·02	121·0 calc.	20·6
Nitrobenzene	36·45	1·0	92·0	17·3

9. CALIBRATION BY WATER OR MERCURY (KOHLEAUSCH).

When a glass vessel at temperature t is weighed in air with brass weights, and appears to hold w grams of water or g of mercury, its volume at 18° is $w(1 + \delta)$ or gk cub. cms. The volume expansion of glass is taken as 0.000025.

t	δ	k	t	δ	k	t	δ	k
0	0.00164	0.073583	10	0.00153	0.073698	20	0.00278	0.073813
1	0.00156	0.073595	11	0.00160	0.073710	21	0.00297	0.073825
2	0.00150	0.073606	12	0.00169	0.073721	22	0.00317	0.073836
3	0.00145	0.073618	13	0.00178	0.073733	23	0.00338	0.073848
4	0.00142	0.073629	14	0.00189	0.073744	24	0.00360	0.073860
5	0.00140	0.073641	15	0.00201	0.073756	25	0.00383	0.073871
6	0.00140	0.073652	16	0.00214	0.073767	26	0.00407	0.073882
7	0.00141	0.073664	17	0.00229	0.073779	27	0.00431	0.073894
8	0.00143	0.073675	18	0.00244	0.073790	28	0.00457	0.073905
9	0.00147	0.073687	19	0.00260	0.073802	29	0.00484	0.073917
10	0.00153	0.073698	20	0.00278	0.073813	30	0.00512	0.073928

10. ELECTROMOTIVE FORCE OF STANDARD CELLS (JAEGER).

Temperature.	Cadmium.	Clark.	Temperature.	Cadmium.	Clark.
10	1.0189	1.4386	20	1.0186	1.4267
11	1.0189	1.4374	21	1.0186	1.4254
12	1.0189	1.4363	22	1.0185	1.4241
13	1.0188	1.4351	23	1.0185	1.4228
14	1.0188	1.4340	24	1.0184	1.4215
15	1.0188	1.4328	25	1.0184	1.4202
16	1.0187	1.4316	26	1.0183	1.4189
17	1.0187	1.4304	27	1.0183	1.4175
18	1.0187	1.4292	28	1.0183	1.4161
19	1.0186	1.4279	29	1.0182	1.4148
20	1.0186	1.4267	30	1.0182	1.4134

The above numbers refer to the cadmium cell with saturated electrolyte; the Weston cell is 1.0190 volt at all temperatures.

11. ELECTRO-AFFINITY OF IONS (see p. 159).

12. EXCESS POTENTIALS IN ELECTROLYTES (see p. 176).

13. TEMPERATURE CO-EFFICIENTS OF ELECTRODE POTENTIALS
(see p. 202).

14. HEATS OF IONISATION (see p. 204).

NAME INDEX

A

- Abegg and Bodländer, 138
 — and Bose, 210
 — and Gaus, 68
 Archibald, 134
 Arrhenius, 15, 69, 80, 84, 218

B

- Bein, 37, 38, 40, 135
 Bethmann, 110
 Bolton, 11
 Bone and Sprankling, 118
 —, Sudborough, and Sprankling,
 119
 Bose, E., 191, 240
 — and Kochan, 191
 Bouty, 202
 Bredig, 78, 95 *et seq.*, 127, 129
 Brühl, 88
 Bugarsky, 190, 210
 Buscemi, 190

C

- Callendar and Barnes, 187, 221
 Carhart, 250
 — and Guthe, 250
 Caspari, 175
 Chaperon, 49
 Chroustschoff and Sitnikoff, 202

- Clark, Latimer, 248, 250
 Clausius, 14
 Cohen, E., 155, 181, 186, 188, 220,
 222, 248

D

- Day, 188
 De la rue, 252
 Denison, 69
 Des Coudres, 210
 Dolezalek, 183, 184, 185, 193, 217
 Dutoit, 88

E

- Ebersbach, 111
 Ettinghausen, 250

F

- Faraday, 2, 13
 Feussner, 232
 Franke, 105
 Franklin and Kraus, 86

G

- Gibbs, Willard, 177, 185
 Glazebrook and Skinner, 250
 Gockel, 202

Goebel, 80
 Goodwin, 216
 Gouy, 252
 Grothuss, 14
 Grove, 191
 Guldberg and Waage, 76

H

Haber and Grindberg, 31, 90
 Hagenbach, 86
 Hantzs, 140, 143
 — and Kalb, 142
 Heim, 183
 Helmholtz, 178, 185, 195, 197, 215,
 217, 252
 Hittorf, 35, 37, 39, 40, 41, 100, 133,
 135
 Hofmann, 6
 Hopfgartner, 37, 40

J

Jaeger, 187, 221, 241, 246, 260
 — and Kahle, 250
 — and Lindeck, 248
 — and Wachsmuth, 190
 Jahn, 71, 78, 155, 180, 186, 188,
 204, 238, 256
 Jones and Mackay, 133

K

Kahle, 187, 250
 Kelvin, Lord, 155, 195
 Kendrick, 42
 Kermis, 37
 Kohlrausch, F., 21, 49, 54, 56, 59,
 61, 69, 71, 74, 101, 260
 — and Holborn, 37, 46, 57, 94,
 256, 257
 — and Heydweiller, 56

Kohlrausch, F. and v. Steinwehr,
 258
 —, F. and W., 8
 Kramers, 86, 90
 Kümmell, 37
 Kuschel, 37

L

Le Blanc, 166, 172, 173
 Lehfeldt, 12, 218
 Lippmann, 197
 Lodge, 64
 Loeb and Nernst, 37
 Loomis, 71
 Lorenz, R., 91, 159
 Lovén, 111

M

Macintosh, D., 42
 Masson, O., 65
 McGregor and Archibald, 42
 Morgan, 134
 Moser, 216
 Müller, Erich, 193

N

Nernst, 55, 79, 87, 92, 163, 174,
 197, 202, 206, 208, 216, 218
 Noyes, 41, 95, 99, 100, 115, 135
 — and Sammet, 256

O

Oettel, 5
 Ogg, 22, 224
 Ohm, 33
 Ostwald, 8, 49, 52, 77, 80, 87, 98,
 104 *et seq.*, 132, 158, 196, 199,
 204
 — and Luther, 56, 238

•P

Palmaer, 196
 Paschen, 196
 Perkin, F. M., 29
 Planck, 206

R

Raoult, 217
 Rayleigh, Lord, 8, 250
 Richards, 9, 238
 Rudolphi, 86

S

Sackur, 210
 Sand, 218
 Smale, 191
 Smith, S. W. J., 200
 Smith, W. H., 115, 122
 Stark, W., 42
 Steele, B. D., 66, 135
 Streintz, 156, 179, 183, 185

T

Thomsen, J., 188
 Thomson, J. J., 16, 87
 Tscheltzow, 156

V

Van Laar, 200
 Van't Hoff, 70, 78, 84, 86, 217,
 220, 222
 — and Reicher, 77
 Varley, 232

W

Walden, 124, 132
 — and Centnerschwer, 85, 88, 259
 Walker, 101, 104, 121, 144
 Wegscheider, 112, 122, 124
 Werner and Miolati, 136
 Weston, 246
 Wheatstone, 46
 Whetham, 65
 Wilsmore, 191, 238
 Wilsmore and Ostwald, 159, 166
 Winkelblech, 143, 144

SUBJECT INDEX

A

- Absolute potentials, 240
- Acetic acid, action of sodium acetate, 82
- Accumulator, as standard cell, 252
 - , free energy of, 182
 - , lead, 151, 156, 167, 179
 - , practical details of, 225
- Alloys for resistances, 231
- Alternating current method, 45, 47
- Amalgamated platinum, 245
- Amido acids, 143
- Ammonia, solutions in, 86
 - , compounds of salts, 136
- Ampere, 2
- Amphoteric electrolytes, 143
- Analogy between solution and gas, 70
- Anion, 4
- Anionic current, 20, 37
- Anode, 1
- Associated liquids, 84, 88
- Atomic charge, 13, 17

C

- Cadmium amalgam, behaviour of, 246
 - cell, 188, 227, 244
 - , mobility of, 39
 - salts, complex ions, of, 100, 139
- Cadmium sulphate, solubility of, 248
- Calomel cell, 252
 - —, E.M.F. of, 217
 - electrode, 149, 236, 238
- Capacity, avoidance of, 49
 - electrostatic, 57
- Cathode, 2
- Cation, 4
- Cationic current, 20, 37
- Chemical energy, 154
- Chloric acid, 31
- Chlorine, production of, 31
- Clark cell, 149, 151, 155, 165, 181, 220, 227, 248
 - —, E.M.F. of, 250
 - —, with dilute solution, 251
- Complex ions, 99, 103, 139
- Complex salts, 133
- Concentration cells, 210
 - cell, with migration, 213
 - , unit of, 21
- Condenser, use of, 58
- Conductance, 44
- Conductivity, 43
 - Constant of conductivity vessel, 53
 - Convection current, 16, 20
- Copper sulphate, electrolysis of, 26
 - voltameter, 10
- Coulomb, 2
- Critical temperature, conductivity at, 86
- Cupron cell, 225
- Cuprous salt, formation of, 26

Current density, 21, 33
 — —, effect of, 10, 27, 169
 Cyanide, effect on Daniell cell, 165

D

Daniell cell, 147, 150, 155, 158,
 164, 180, 242
 Decomposition potential, 172
 Depolariser, 243
 Deviation of solutions from laws of
 gases, 219
 Dielectric constant, 87
 Diffusion in fused salts, 91
 Dilution, 58
 —, effect on E.M.F., 215
 Dissociation, degree of, 21, 63, 71
 —, electrolytic, 15
 —, nature of, 14
 — (or ionisation) constant, 76
 Double salts, 133

E

Effective mobility, 64
 Electric double layer, 195
 — field, 19
 Electro-affinity, 138, 159
 Electro-chemical equivalent, 3
 Electrode, 1
 —, dropping, 195
 — potential, 138-156
 —, reversible, 147
 —, standard, 194
 Electrodynamometer, 48, 51
 Electrolysis, 1
 Electrolyte, 1
 Electrolytic conduction, laws of, 80
 — separation, 170
 Electrometer, capillary, 197, 235
 —, quadrant, 229

Electrometer, use of, 45
 Electromotive force, 146, 153, 160
 — —, measurement of, 253
 Electron, 17
 — theory, 24
 Endothermic reaction in cell, 190
 Equivalent conductivity, 58, 101
 Excess voltage, 175

F

Factor, van't Hoff's, 70
 Faraday, 3
 Ferrous salt, oxidation of, 23
 Free energy, 162, 181
 Friction, effect of, 33
 Fused salts, conduction in, 89

G

Galvanometer, D'Arsonal, 228
 Gas battery, 171, 175, 191
 — electrode, 171
 — volume, reduction of, 5
 Gases, laws of, 70
 Gravity cell, 210

H

Heat of hydration, 187
 — of ionisation, 203
 — of reaction, 154, 178
 — of solution of metals, 205
 Hydrochloric acid, electrolysis of,
 30, 166
 — —, reversible formation of,
 193
 Hydrogen electrode, 238
 —, preparation of, 8
 Hypochlorous acid, 31

I

- Incomplete disassociation, effect on
 E.M.F., 216
 Indicator ions, 67
 Induction coil, 46
 Inorganic acids, 101
 — bases, 127
 Intramolecular salts, 145
 Ion, 12, 18
 Ionic conductivity, 62, 74
 — mobility, 63, 74
 — velocity, 34
 Ionisation constant, second, 111
 —, degree of, 21, 100, 104
 — in stages, 99
 Ions, forces between, 79
 Isomeric ions, 95

J

- Jelly, conduction in, 64
 Joule, 153, 154

L

- Lamps as resistances, 226
 Latent heat, 178, 186, 202
 Laws of electrolysis, 2
 Liquid resistance, 55
 Logarithmic formula, 163, 212

M

- Mass action, law of, 31, 76
 — — —, and E.M.F., 218
 Mass of electrons, 17
 Medial energy, 88
 Mercurous ions diatomic, 22

- Mercury voltameter, 11
 Metals, conduction in, 24
 Mho, 44
 Migration, effect of concentration
 on, 42
 — of ions, 32
 Migration ratio, 35
 — — from concentration cells,
 216
 Mixtures, conductivity of, 81
 Mobility of ions, 34, 94
 Monochloroacetic acid, 77

N

- Neutral salts and acids, mutual
 action, 83
 Non-aqueous solutions, 84
 Number of ions, 98

O

- Ohm, 44
 Ohm's law, 33
 Organic acids, 104
 — bases, 127
 Osmotic pressure, 69, 162
 — — and E.M.F., 218
 Oxidation, 23
 Oxides, conduction in metallic, 92
 Oxygen, preparation of, 8
 Ozone, 7

P

- Peltier effect, 194
 Periodic system, mobility of elements
 in, 95
 Persulphuric acid, 7, 29

Phenols, 124
 Platin-ammonia compounds, 137
 Platinising, 51
 Polarisation, 45, 57
 —, chemical, 171
 —, concentration, 168
 —, potential of, 241
 Porous partitions, effect on electro-
 lysis, 40
 Potassium chloride, electrolysis of,
 32
 — —, ionisation, 72
 — nitrate, conductivity of, 90
 Potential, 146
 — difference between liquids, 205
 — gradient, 33, 68
 Potentiometer, 229
 Pseudo acids and bases, 140

R

Ratio of charge to mass, 16
 Reduction, 23
 Residual current, 92, 172
 Resistance, 44
 Reversible process, 179

S

Salts, ionisation of, 131
 Self-induction, 57
 Semipermeable partition, 69
 Short-circuit electrolytic, 209
 Silver and copper, equilibrium
 between, 224
 — and mercury, equilibrium
 between, 224
 — iodide, insolubility of, 161
 — salts, migration in, 37
 — voltameter, 8
 — single potential difference, 194
 Slide wire, 49, 230

Sliding contact, 234
 Soda, electrolysis of caustic, 29
 Standard cells, 241
 — of conductivity, 54
 Strength of acid, 78
 Strong electrolytes, theory of, 78
 Substitution, effect on conduction
 of organic compounds, 97
 Sulphuric acid, electrolysis of, 28
 Sulphur dioxide, solutions in, 85
 Superposition, principle of, 208
 Surface tension, maximum, 197
 — — and ionisation, 88
 Symmetrical cell, 208

T

Telephone, 47
 Temperature coefficient of con-
 ductivity, 75, 86
 — — of electromotive force,
 185
 Thermocouple, electrolytic, 202
 Thermodynamic theory, 177
 Thermometer, 56
 Tin, white and grey varieties, 222
 Transition cells, 220
 —, free energy in, 223
 Transport number of complex salts,
 135
 Tribasic acids, 122

V

Valence rule, 132
 Valency, 13, 93
 Vapour pressure and E.M.F., 217
 Volt, 33, 153
 Voltaic cell, 146
 Voltameter, 4
 Voltmeter, 227

W

Water, decomposition of, 177
—, ionisation of, 17
—, purity of, 56
— reversible electrolysis of, 192
—, voltameter, 4
Watt, 153
Wheatstone bridge, 46

Work done in ionisation, 203

Z

Zinc electrode, potential of, 164
— sulphate, transition in, 220
“Zwitter” ions, 145



THE END

THIS BOOK IS DUE ON THE LAST DATE
STAMPED BELOW

AN INITIAL FINE OF 25 CENTS
WILL BE ASSESSED FOR FAILURE TO RETURN
THIS BOOK ON THE DATE DUE. THE PENALTY
WILL INCREASE TO 50 CENTS ON THE FOURTH
DAY AND TO \$1.00 ON THE SEVENTH DAY
OVERDUE.

(BIOLOGY LIBRARY)

FEB 11 1935

~~NOV 22 1939~~

DEC 6 1935

NOV 2 1936

OCT 13 1939

OCT 6 1961

22 Se '61 W S

LD 21-100m-8,'34

man
p. no net

184420

QD553

L5

Biochem i

THE UNIVERSITY OF CALIFORNIA LIBRARY

