

RADIO THEORY

SIMPLIFIED
WITH



RADIO
DICTIONARY

MERLE DUSTON



**RADIO THEORY
SIMPLIFIED**

WITH

A RADIO DICTIONARY

RADIO THEORY SIMPLIFIED

WITH
A RADIO DICTIONARY

BY
MERLE DUSTON

AUTHOR OF
"RADIO CONSTRUCTION FOR THE AMATEUR"
AND OTHER RADIO BOOKS

Illustrated by
DOUGLAS G. HAWKSWORTH

WHITMAN PUBLISHING Co.
RACINE, WISCONSIN

TK 6550
. D 852

Copyright 1924 by
Duston Radio Laboratories, Inc.

Printed in U. S. A.

24-24464

OCT 15 1924

© CIA 807371

no 1

=====
**This book is respectfully dedicated to
our friend: THE RADIO FAN whose
desire for a more thorough knowledge of
Radio, we believe, justified us in the com-
pilation of this book.**

=====

PREFACE



NO EXCUSES are offered for the publication of this book. This book was written primarily for persons who are in the class known as the "Broadcast Listener." There have been many good books written that could be understood by anyone not wishing to take the time or the pains to really study the theory of Radio Transmission and Reception, but it is believed that in proportion to the number of people interested, these books are all too few.

If the subject be considered, it will be found that most of the books dealing with radio were written for the man who has applied or was willing to apply himself to the study of Radio in all its phases, and would concentrate his mind on the subject at hand. Consequently he could use a book which dealt with details regarding the more technical questions.

In this book, the intention has been merely to hit the high spots of Radio Theory, clearly defining and explaining sufficient subjects so that the Amateur who wishes to build or buy a Radio Receiving Set will have ample knowledge of the various types of sets and parts. He can then buy only those which will best fit his needs. It has been the aim to use comparisons of objects familiar to the

reader, but as radio waves are understood to be different in certain respects from other types of waves, these comparisons are used cautiously; however, it is hoped that the matter herein contained will give the reader a fair understanding of the underlying principles of Radio Transmission and Reception.

Some of the theories advanced will probably be disagreed with but as radio has had such a rapid growth and as comparatively little is known about it, criticisms are to be expected.

As this is the first edition of the book, the Author will be glad to have any errors or omissions called to his attention.

The Author also wishes to extend credit and express his appreciation to Prof. Harry O. Warner of the Electrical Engineering Department of the University of Detroit; and his co-workers, Theodore Schmalzriedt, Jr. and Douglas G. Hawksworth, for the many helpful suggestions which they gave in the compilation of this book.

THE AUTHOR,
Detroit, Mich., July 1, 1924.

TABLE OF CONTENTS

CHAPTER I. RADIO WAVES EXPLAINED

	Page
1. Ohms Law	19
2. Ether Waves	21
3. Ether	22
4. Radio Waves	22
5. Frequency of Radio Waves	23
6. Sound Waves	29
7. Harmonics	31
8. Damped Waves	31
9. Transmitting Stations	33

CHAPTER II. TRANSMITTING AND RECEIVING AERIALS

10. Use of the Aerial	37
11. Loop Aerials	40
12. Tuning the Antenna	41

CHAPTER III. THE OPERATION AND ACTION OF CRYSTAL DETECTORS AND AUDION BULBS

13. Rectification of Radio Frequency Waves	45
14. Crystal Detector Rectifier	46
15. The Audion Bulb	46
16. The Electron Theory	47
17. The Two Element Bulb	49
18. The Three Element Bulb	50
19. Grid Condenser and Leak	54
20. Audio Frequency Amplification	56
21. Audion Bulbs used for Amplification of Radio Frequency Waves	59
21A Audion Bulb used as a Generator of High Frequency Currents	60

CHAPTER IV. RECEIVING SETS

22. Facts about Receiving Sets	62
23. Theory of Regeneration	64
24. Re-radiation of Regenerative Sets	65
25. Single Coil Crystal Set	67
26. Two Coil Crystal Set	68
27. Single Circuit non-regenerative Set	69
28. Two Circuit non-regenerative Set	70
29. Single Circuit Regenerative Set	72

30.	Three Circuit Regenerative Set.....	74
31.	The Reinartz Receiver.....	77
32.	Neutrodyne Sets.....	78
33.	Reflex Circuits.....	80
34.	Audio Frequency Amplifiers.....	81
35.	Super-heterodyne.....	82
36.	The Acmedyne Circuit.....	84
37.	Inverse Duplex.....	86
38.	Radio Frequency Amplifiers (Transformer Coupled).....	90
39.	Radio Frequency Amplifiers..... (Tuned)	90
40.	Power Amplifiers.....	92

CHAPTER V. USE OF PARTS IN RECEIVING SETS

41.	"A" Battery.....	94
42.	Aerial Insulator.....	96
43.	Aerial Wire.....	96
43A	"B" Batteries.....	97
44.	"B" Batteries (chargeable).....	98
45.	Battery Chargers.....	99
46.	Bezels.....	100
47.	"C" Batteries.....	101
48.	Choke Coils.....	101
49.	Condensers (Fixed).....	101
50.	Condensers (Variable).....	102
51.	Crystal Detector.....	103
52.	Dials.....	104
53.	Grid Condensers.....	105
54.	Grid Leaks.....	105
55.	Ground Clamps.....	106
56.	Honeycomb Coils.....	107
57.	Hydrometers.....	108
58.	Inductance Switches.....	108
59.	Jacks.....	109
60.	Loose Couplers.....	110
61.	Loop Antennae.....	111
62.	Loud Speaking Units.....	112
63.	Panel Markers.....	114
64.	Plugs.....	115
65.	Potentiometers.....	115
66.	Resistance Units.....	116
67.	Rheostats.....	117
68.	Sockets.....	118
69.	Socket Brackets.....	119
70.	Soldering Lugs.....	119
71.	Spiderweb Coils.....	120
72.	Transformers (Audio Frequency).....	121
73.	Transformers (Radio Frequency).....	123

74. Vario-Couplers.....	124
75. Variometers.....	124
76. Bulbs used in Receiving Sets.....	125
77. Radiotron UV 199 and Cunningham C 299.....	126
78. Radiotron UV 201 and Cunningham C 301.....	128
79. Radiotron UV 201A and Cunningham C 301A.....	128
80. Radiotron WD 11 or Cunningham C 11.....	130
81. Radiotron WD 12 or Cunningham C 12.....	131
82. Northern Electric 215-A Bulb.....	133
83. Western Electric 216-A Bulb.....	135

CHAPTER VI. HISTORY OF RADIO ADVANCEMENT 1827-1924 137

APPENDIX "A" USEFUL TABLES AND CHARTS 157

- Table of Abbreviations.
- Symbols used in Radio Diagrams.
- Copper Wire Table.
- Common Radio Abbreviations.
- International Telegraphic Code.
- Table showing relation of wave length to frequency.
- International Radlotelegraphic List of Abbreviations.

APPENDIX "B" 169

- The Amateur Radio Operator and the A.R.R.L.
- The necessity for a better understanding between the broadcast listener and the Amateur Radio Operator.

APPENDIX "C" LOCATING TROUBLE IN RECEIVING SETS 175

- Hints on how to find the trouble if set fails to operate at all.
- Hints on how to find the trouble if noises can be heard in set but no signals can be received.
- Hints on how to find the trouble if weak signals can only be received.
- Hints on how to find the trouble when noises are present with signals.
- How to find cause of distorted signals.

INDEX—COMPLETE TO COVER SUBJECTS AND ITEMS DISCUSSED IN BOOK 178

PART II

A RADIO DICTIONARY OF RADIO TERMS AND WORDS 185

LIST OF ILLUSTRATIONS

Figure

1. Water Analogy used to explain Ohms Law.
2. Electrical Resistance compared to Resistance in water pipe.
3. Amplitude and wave-length measurement of un-damped wave.
4. Amplitude and wave-length measurement of damped wave.
5. Change in amplitude of modulated wave.
6. Direct flow of water compared to direct flow of electricity.
7. Alternating flow of water compared to alternating current of electricity.
8. Radio wave with frequency of one cycle per second.
9. Radio wave with frequency of ten cycles per second.
10. Radio wave with frequency of thirty cycles per second.
11. Undamped waves explained.
12. Damped waves explained.
13. Series of damped wave trains.
14. Transmission and reception of continuous radio waves.
15. Transmission and reception of radio waves.
16. Large metal plates could be used as antenna.
17. Antenna using ground as one side of condenser.
18. Antenna using counterpoise as one side of condenser.
19. Inefficient aerial having trees, buildings, etc. in condenser field.
20. Tuning the antenna by using tapped coil and variable condenser.
21. Method of using tapped coil between aerial and ground.
22. Method of using variable condensers to tune fixed coils.
23. Crystal detector rectification of radio waves.
24. Electron flow between filament and plate.
25. Circuit using two element bulb.
26. Water analogy showing use of grid.
27. Action of three element bulb when grid is positive.
28. Action of three element bulb when grid is negative.
29. Modulated radio wave train.
30. Modulated wave.
31. Circuit showing transformer coupled audio frequency amplifier.
32. Circuit showing resistance coupled audio frequency amplifier.

33. Circuit showing transformer coupled radio frequency amplifier.
- 33A Effect of Radio frequency amplification.
34. Original Armstrong Regenerative circuit.
35. Theoretical operation of crystal detector circuit
36. Crystal detector circuit.
37. Two coil crystal detector circuits.
38. Single circuit non-regenerative hook-up.
39. Two coil non-regenerative circuits.
40. Theoretical operation of single circuit regenerative set
41. Vario-coupler single circuit regenerative hook-up.
42. Two coil single circuit regenerative hook-up.
43. Standard three circuit receiver.
44. Three coil regenerative receiver.
45. Original Reinartz Circuit.
46. Five bulb Neutrodyne Receiver.
47. Drawing showing Reflex action of bulbs.
48. Two bulb Reflex Circuit.
- 49A Condensed drawing of super-heterodyne. **Note:** Radio frequency amplifier unit generally consists of three bulbs and audio frequency unit of two.
- 49B Super-Heterodyne lay-out.
50. Four bulb Acmedyne Circuit. **Note:** Also known as Tele-
monic Circuit.
51. Drawing showing inverse duplex action of bulbs.
52. Three bulb Grimes inverse Duplex Circuit.
53. Un-tuned transformer coupled radio and audio frequency cir-
cuit.
54. Tuned radio frequency five bulb circuit.
55. Two bulb push-pull amplifying unit.
56. Radio "A" storage battery.
57. Aerial insulator.
58. Dry "B" battery.
59. Storage "B" battery.
60. Storage "A" and "B" battery charger.
61. Ventilator or bezel.
62. "C" battery.
63. Fixed condenser.
64. Variable condenser.
65. Crystal detector. Adjustable.
66. Dial.

67. Grid condenser.
68. Grid leak.
69. Ground clamp.
70. Honeycomb or Duolateral coil.
71. Hydrometer or storage battery tester
72. Inductance switch.
73. Jacks.
74. Loop antenna.
75. Loud speaker or radio horn.
76. Phonograph loud speaking attachment.
77. Panel markers.
78. Phone plug.
79. "A" battery potentiometer.
80. Resistance Unit.
81. Filament Rheostat.
82. Tube sockets.
83. Socket and transformer brackets.
84. Soldering lugs.
85. Spiderweb coil.
86. Audio frequency transformer.
87. Radio frequency transformer.
88. Vario-coupler.
89. Variometer.
90. UV 199 or C 299 audion bulb.
91. Hook-up showing proper place for "C" or Grid Bias Battery.
92. Hook-up showing proper connections for grid return.
93. UV 200 or C 300 audion bulb.
94. WD 11 or C 11 audion bulb.
95. WD 12 or C 12 audion bulb.
96. Northern Electric type 215A audion bulb.
97. Western Electric type 216A audion bulb.

CHAPTER I.

RADIO WAVES EXPLAINED

1. OHMS LAW. The most commonly known and understood law of electricity is Ohms Law. As this law can only be applied thoroughly to direct current, it has a limited application in radio work in which A. C. (alternating current) is mostly used; but in order that the reader may not become confused between what might be his understanding of electricity and the high frequency waves used in radio, a short illustration of Ohms Law will be given.

Referring to Fig. 1, there are two large tanks—one of these is filled with water and the other is empty. To transmit this water it is necessary to have the pipe shown at 'A' and the pump, or generator, shown at "B." The rate at which the water flows through the pipe, applied in electrical terms, would be the "Current" or "Amperes."

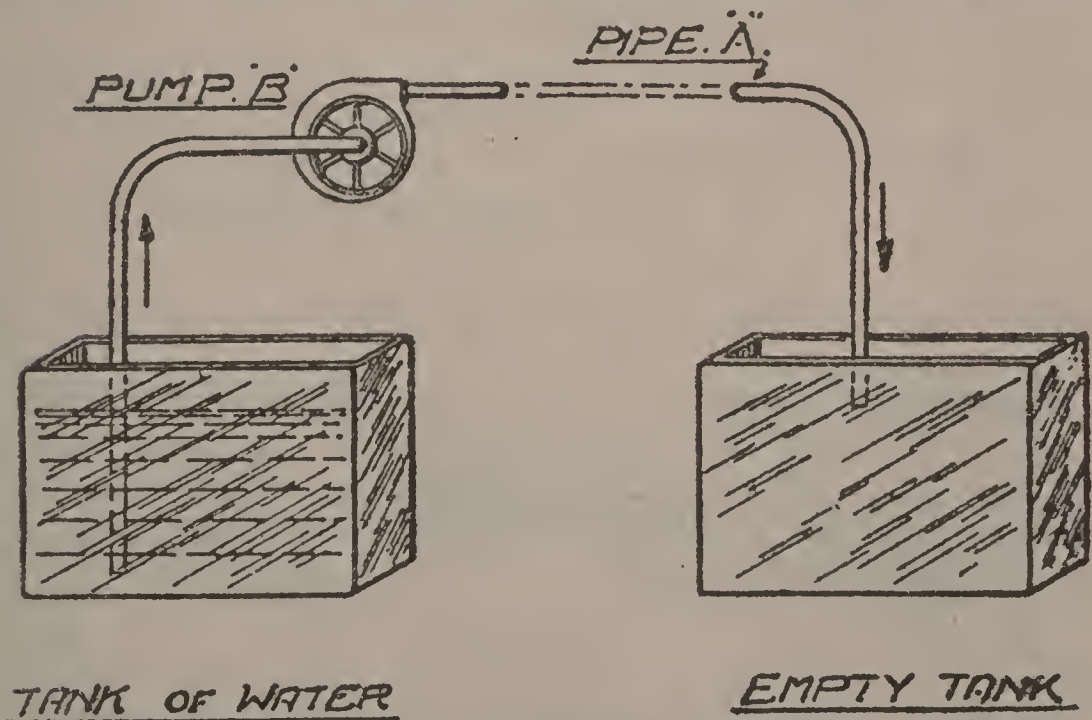

Fig. 1—Water Analogy Used to Explain Ohms Law.

The number of pounds pressure on the pipe would correspond to the volts. (This is also called Electromotive Force, E. M. F.) The resistance to the flow of water through the pipe is called "resistance" and is measured in Ohms. By this can be seen that if the quantity of any two of these are known, the other can be found. This can also be explained by referring to Fig. 2. Here there is a water pump connected to a pipe, a pressure gauge showing the pounds of pressure available at station "A." There is also a meter which shows the rate of flow of the water through the pipe. There is also the same pressure gauge at station "B." The resistance of the pipe and the amount of power lost in transmission can then be determined. The pressure gauge can be compared to a volt meter, and the flow meter would show the amount of current the same as an Ammeter. The power expended to overcome friction resistance in the pipe is lost the same as some power is lost to overcome resistance when using electricity. If this principle is understood it can be applied to some parts used in a radio set.

From the above it can be seen that:

$$\text{Ohms or Resistance} = \frac{\text{E.M.F. or Volts}}{\text{Amperes or Current}}$$

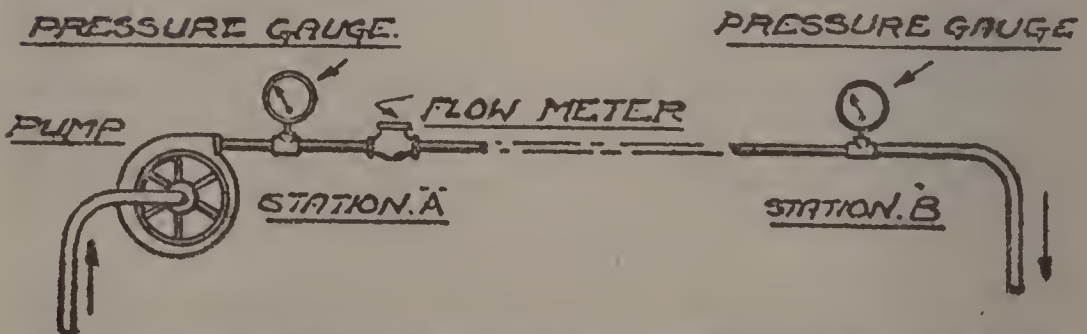

Fig. 2—Electrical Resistance Compared to Resistance in Water Pipe.

RADIO THEORY SIMPLIFIED

The following symbols are generally used in working out formulae by Ohms Law: "R" stands for Resistance; "E" for Electromotive Force and "I" for Amperes or current, so that

$$R = \frac{E}{I}$$

$$I = \frac{E}{R}$$

$$E = I \times R$$

A Potentiometer has so many ohms resistance, say 200 or 600 ohms. Reference will again be made to these in the chapter where they will be taken up individually.

In Chapter Five will also be explained what is meant by the number of Amperes which it takes to operate certain types of bulbs.

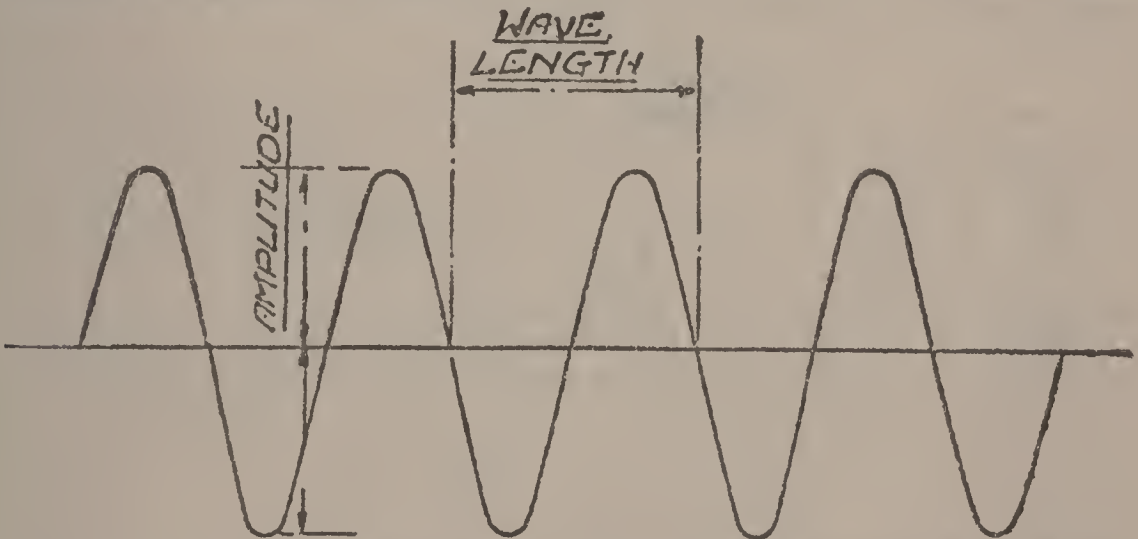

Fig. 3—Amplitude and Wave-length Measurement of Un-damped Wave.

2. ETHER WAVES: The first questions that arise in the mind of the beginner in radio are: "how and what are radio waves; how are they made; how do they travel; and how can they be used?" There are many kinds of waves; such as, Heat Waves, Light Waves, Ultra-Violet Waves, X-Ray Waves and several unknown Waves as well as Radio Waves, in which we are most interested. Light Waves and Radio Waves are the same insofar as they travel at the speed of 186,000 miles per second.

3. **ETHER:** All of the above waves travel through what is known as Ether (has no connection with the chemical of the same name.) Now just what the Ether is or its extent is a question which the most eminent scientists of the day cannot decide. Suffice then to know it is some means in nature which carries Radio Waves, and this Ether is everywhere; inside the earth, outside the earth, and between the planets. It is known that there is some power which controls the universe and although the extent of this power is unknown, one sees His manifestations and a name is given Him. So the same can be said of that which carries Radio Waves. Exactly what it is, is unknown; but it is known to be there and we know some of its activities, so it is given a name and that name is "ETHER."

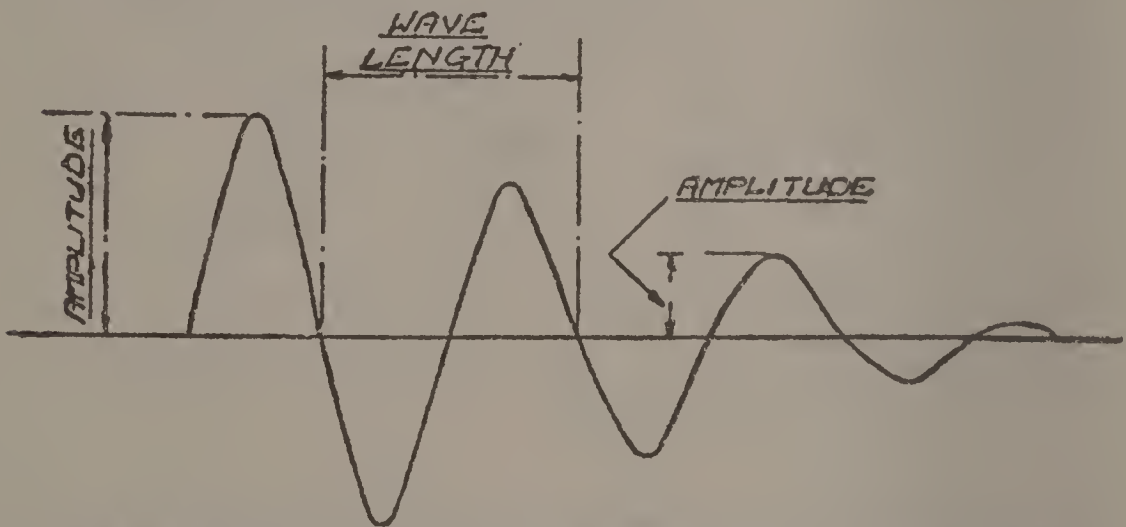

Fig. 4—Amplitude and Wave-length Measurement of Damped Wave.

4. **RADIO WAVES:** The Radio Transmitting Stations set up a wave in the Ether the same as a wave could be set up in a body of water by throwing a stone, or some other object, into the water. These waves can be of different lengths just as the wave in a body of water can be of different lengths. Waves are measured as shown in Figs. 3 and 4. (Remember this, *That the length of the wave can remain the same and the amplitude or height,*

change); so that Fig. 5 illustrates such a wave train. How this wave train is obtained will be shown later in the chapter.

5. FREQUENCY OF RADIO WAVES: A continuous or direct current is one which does not change its polarity, but travels in a given direction at all times. In an alternating current we have what is known as Frequency. As the electricity changes from positive to negative, one complete revolution or change is called a cycle. In Fig. 6 and Fig. 7, a water analogy is used to explain the difference between an alternating and direct current. In Fig. 6 a water pump is connected to a pipe line in which is installed a water motor. The water is always flowing in one direction and consequently the forces are applied

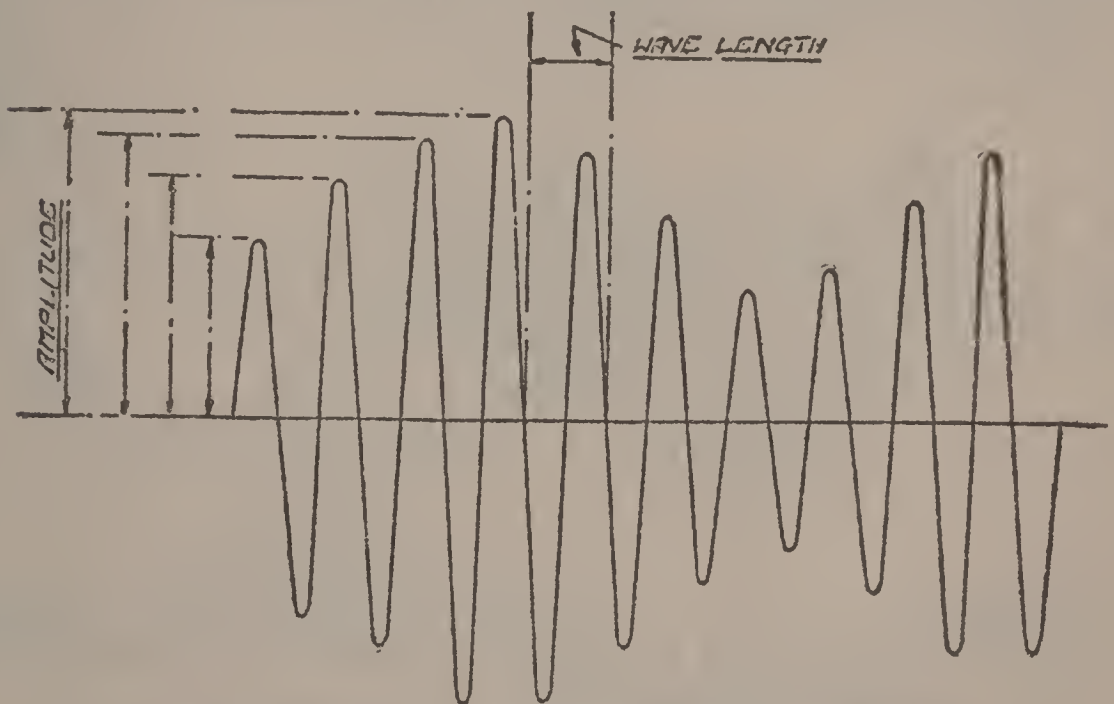

Fig. 5—Change in Amplitude of Modulated Wave.

to the water motor in the one direction and it always turns the same way. Now in Fig. 7 a different type of pump is used, which first forces the water in one direction and then forces it in the other. This alternating in the directional flow of water will also force the water motor

in one direction for a certain period of time and then reverse it and force it in the other direction. Comparing this again to electricity, it is the same with an alternating current. When starting the cycle the piston forces the water in one direction and then back in the other, thus completing the cycle. This cycle or motion of an elec-

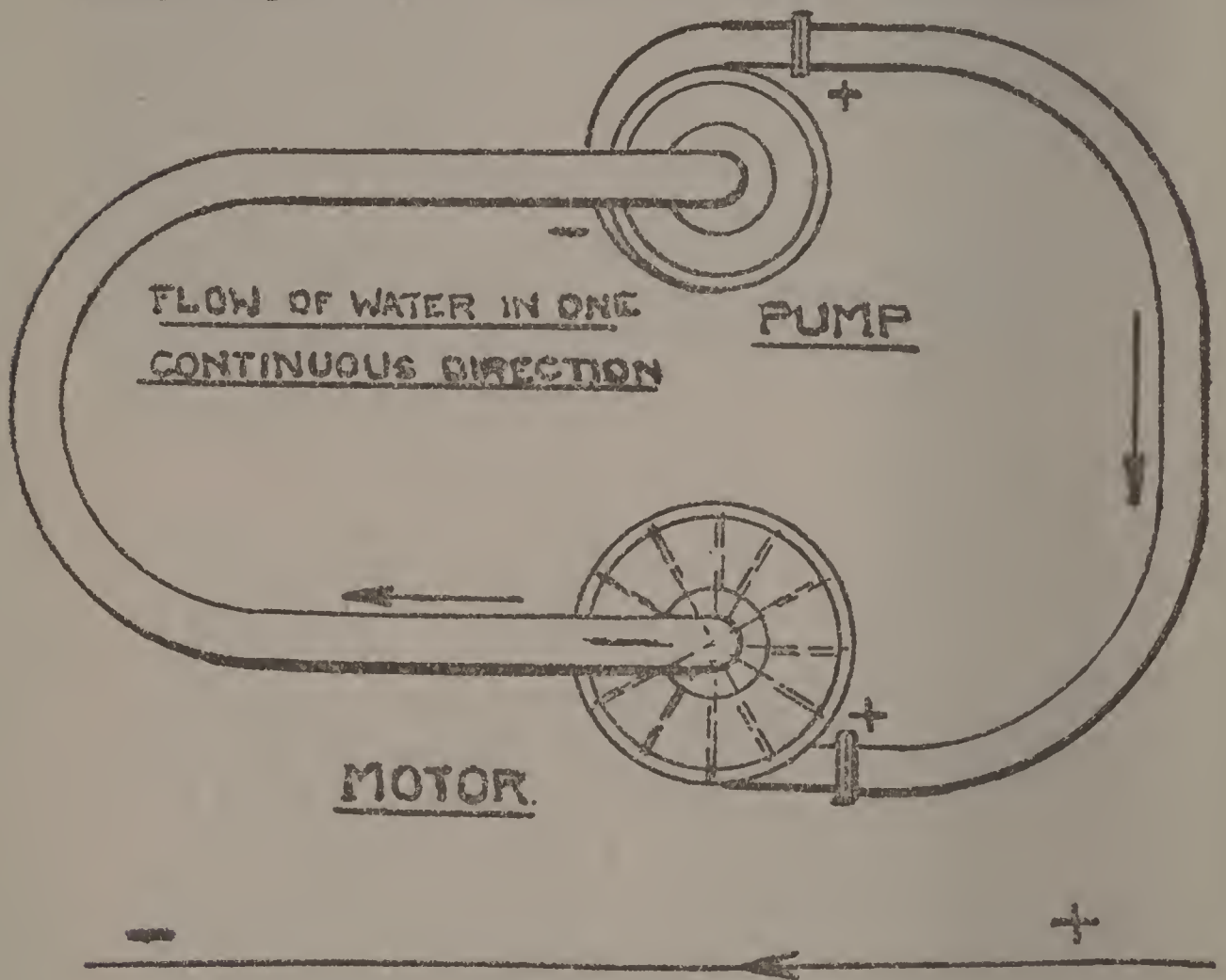

Fig. 6—Direct Flow of Water Compared to Direct Flow of Electricity.

trical wave can be indicated by a curve such as is shown in Fig. 7. In this book, as well as in most other Radio and Electrical books, these curves are used to designate different types of radio and electrical waves and their frequencies, and it is therefore best to have a thorough understanding of just what they mean. Now, in the

alternating current, the occurrence of the loops in the wave train is so rapid that it is not noticeable when used for lighting up a bulb. Although the current changes back and forth from positive to negative and at times there is a zero point, this does not cause a flickering of the

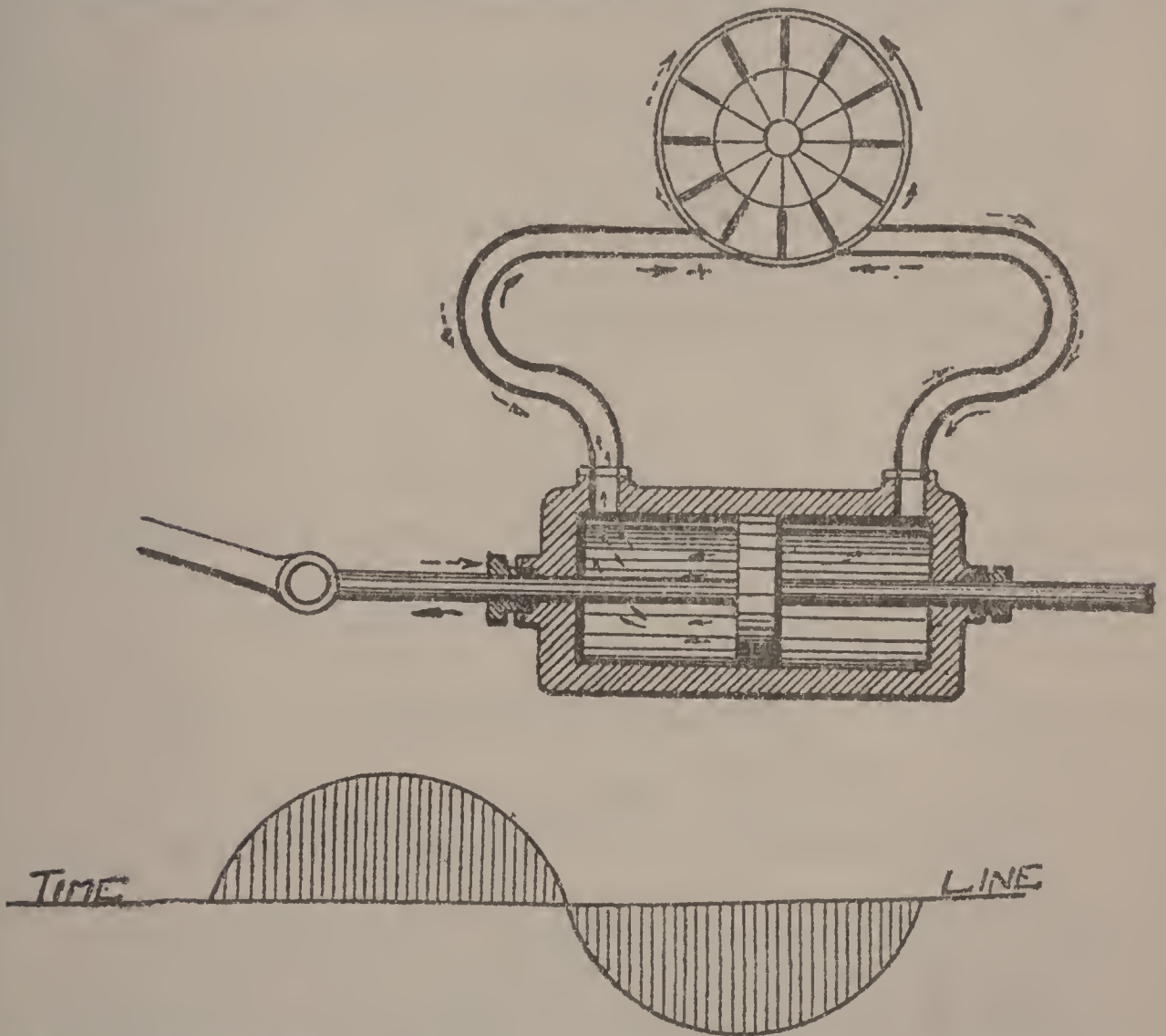

Fig. 7—Alternating Flow of Water Compared to Alternating Current of Electricity.

light because this change occurs so quickly that the filament of the light does not have a chance to become cool between cycles or changes.

Alternating current motors are so constructed that the armature, or rotor, does not reverse with the current but

travels in one general direction. This is the reason that, outside of the universal type motors the same motor will not work on both alternating and direct current. The ordinary alternating electricity used for lighting purposes has sixty (60) complete cycles in a second, and in radio work it sometimes changes as rapidly as five million times a second.

To many persons one of the most confusing questions is the difference between the frequency of waves in cycles or kilocycles, and their length in meters. Just recently the United States Government has made a change in the

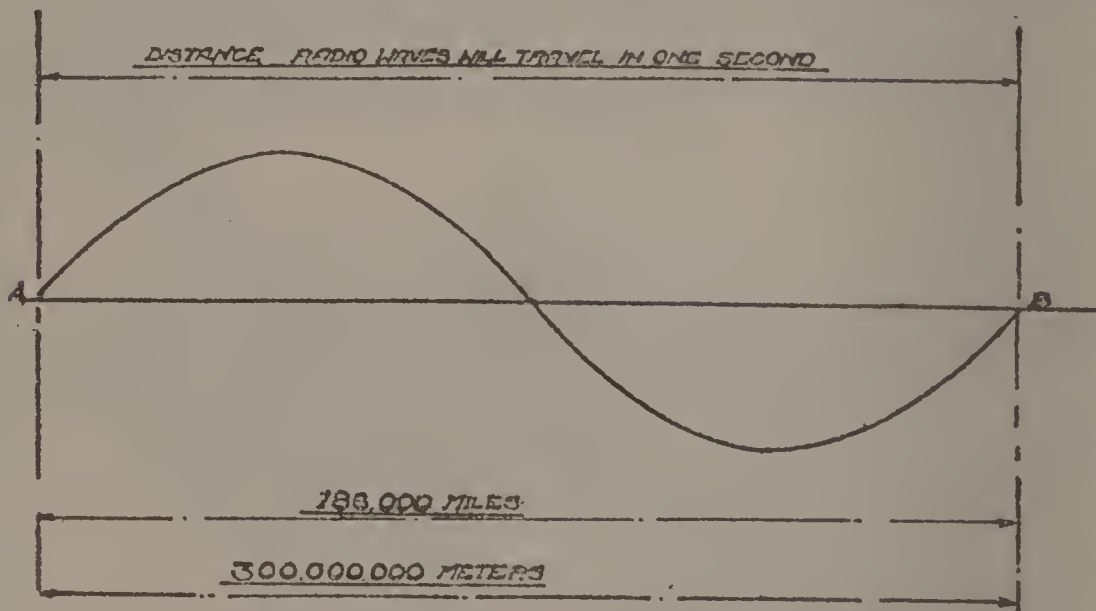

Fig. 8—Radio Wave with Frequency of One Cycle per Second.

way it designates radio stations. It used to be that a station was assigned a certain wave length, where now the station is rated in the number of kilocycles. Referring to Figs. 8, 9, and 10, the difference between the lines "A" and "B" is 186,000 miles, or, when spoken of in the metric system, approximately 300,000,000 meters. Now the distance between "A" and "B", which is the distance that electricity travels in one second, will always remain the same, whereas, the distances between the waves will change in comparison to the number of these that are

sent out per second. In Fig. 8 we send out one wave per second, which would have a wave length of 300,000,000 meters. In Fig. 9 ten of these are sent out per second and they each have a wave length of 30,000,000 meters. In

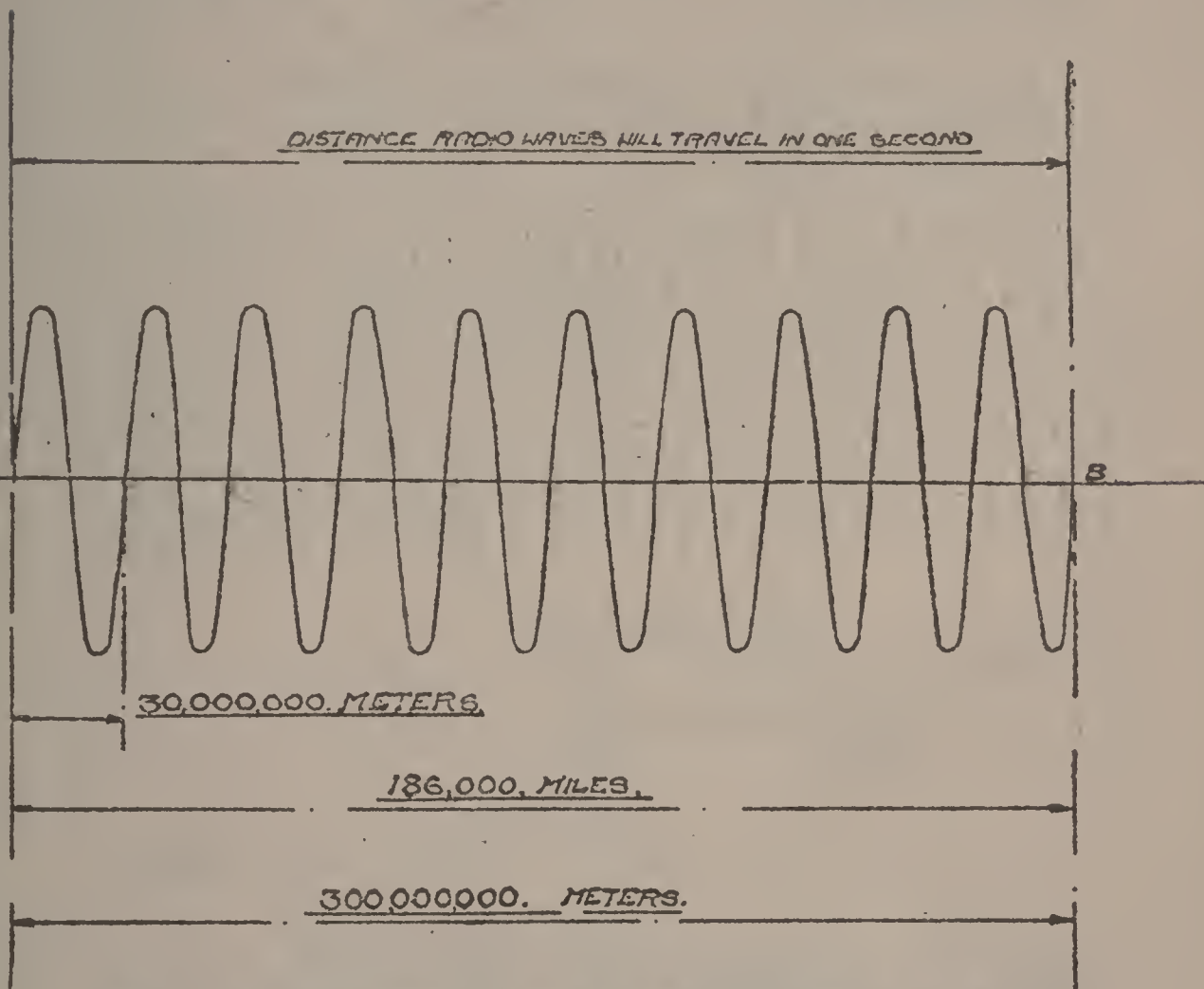

Fig. 9—Radio Wave with Frequency of Ten Cycles per Second.

Fig. 10 thirty of these are sent out per second and they each have a wave length of 10,000,000 meters. The frequency of this wave would be thirty cycles per second. For amateur and broadcast transmission such a great number of these is used per second that instead of designating them in the number of cycles per second, they speak of them as the number of kilocycles per second. (A kilocycle is 1,000 cycles.) From the foregoing it will

be easily understood that the more of these changes, or cycles, that are sent out per second, the shorter will be the length of the wave. To get the length of any wave in meters, divide the constant 299,820 by the number of kilocycles given.

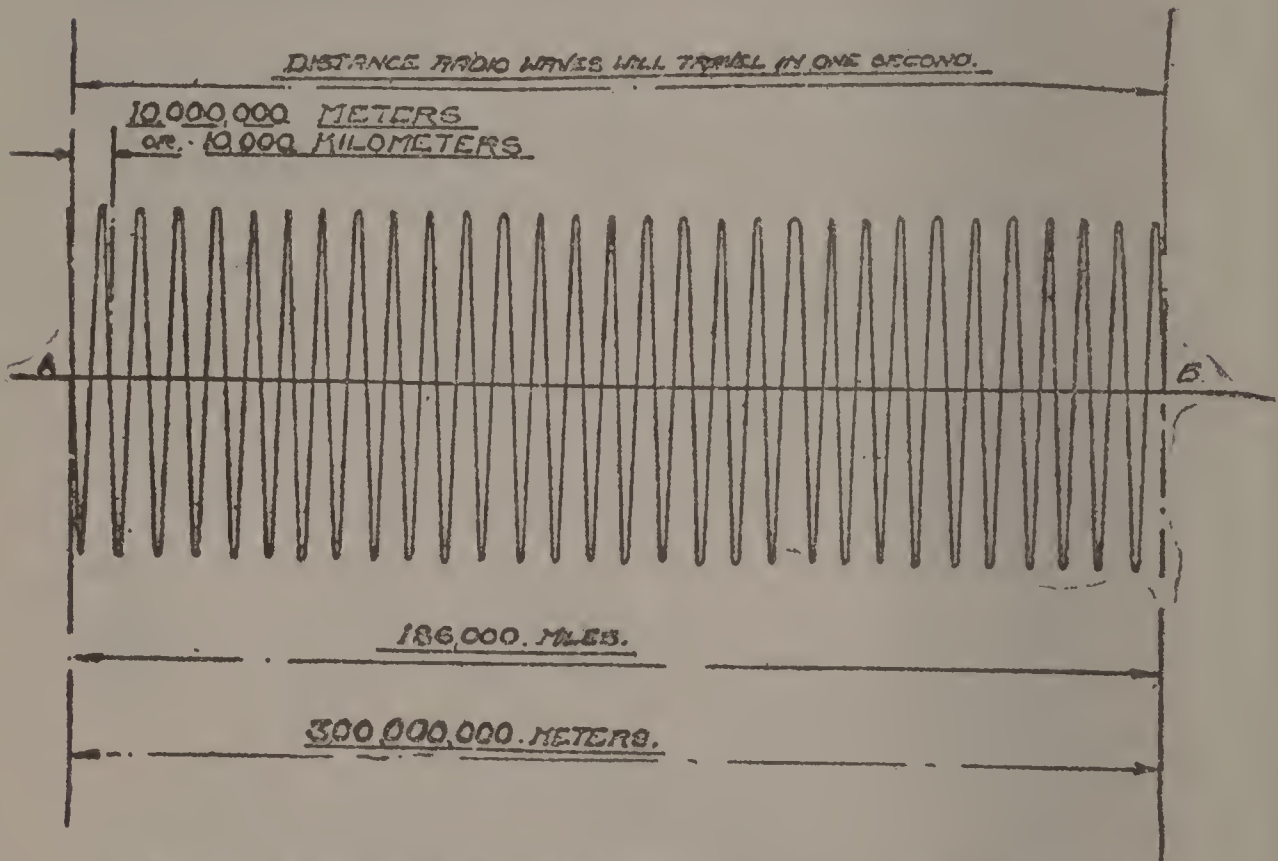

Fig. 10—Radio Wave with Frequency of Thirty Cycles per Second.

Another comparison that can be used would be to think of an imaginary train. This train is traveling at the speed of 186,000 miles per second. The cars that are in this train will be compared to frequency, or cycles, and the length of the cars can be compared to the wave length. Now if it is desired to know the frequency, count the number of cars in 186 000 miles. Then to obtain the wave length, measure the length of one car. The wave length or frequency of a transmitter has nothing to do with the distance that the stations can be heard. The reason for this will be explained later.

6. **SOUND WAVES:** Sound waves have a major part in Radio Telephony, therefore an explanation of some of the characteristics of sound will be given. There are sound waves, which regardless of the much discussed subject, do not have to have the presence of an ear as evidence of sound. Sound waves have frequency and wave length just the same as a radio wave, but the length of the wave and the distance that it will travel through the air depends upon the temperature and other variables, where this does not hold true with radio waves.

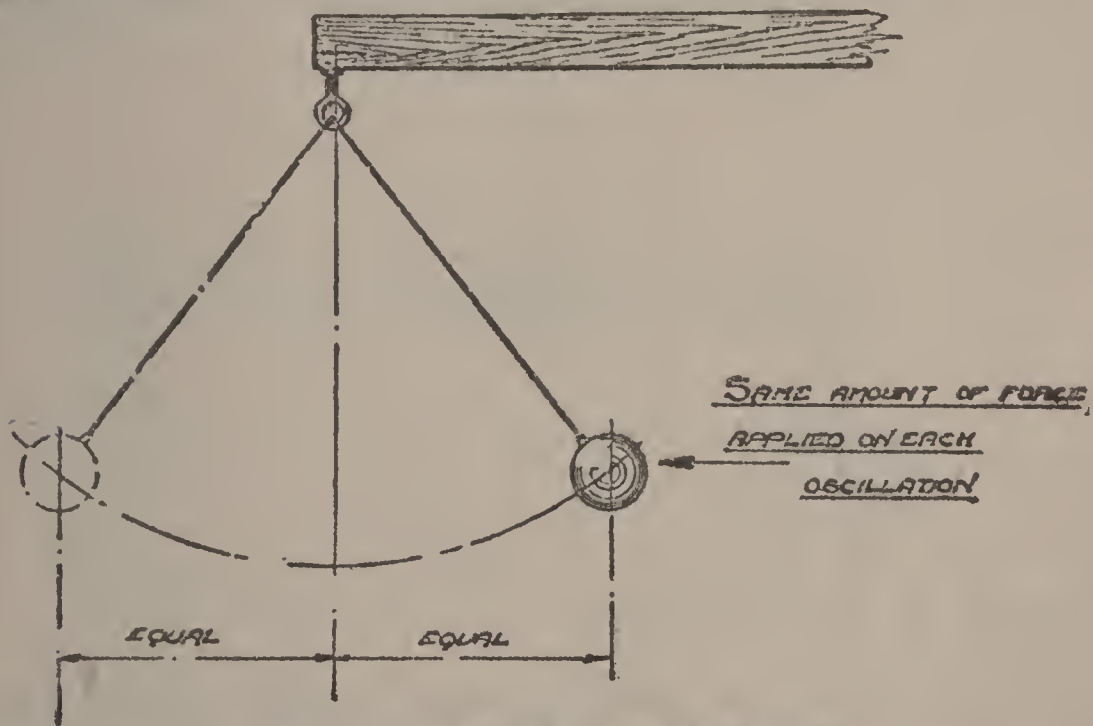

Fig. 11—Undamped Waves Explained.

Anyone in the back of a hall listening to a speech or sermon delivered by a speaker, the speaker being close to a microphone which is connected to a broadcasting station, will hear the voice of the speaker a fraction of a second after any person who is listening to the same speaker over the radio, although the radio listener may be over 1,000 miles distant. As radio waves travel at the rate of 186,000 miles per second and a sound wave, at ordinary temperature, travels only 1,100 feet per second, it will be seen that there is quite a difference.

There are audible and inaudible sound waves the same as we have a high frequency and low frequency in radio waves. Also with sound waves; they will travel through certain solids better than through the air. This same holds true with an electrical wave, only an electrical wave follows a wire at the same speed as it travels through the Ether, where a sound wave travels faster through a solid conductor than it does through space. Sound waves are affected by the wind, whereas radio waves are not. In sound waves there exists that which is called Harmonics, which causes a reflection of the voice of a friend to be recognized. In radio exists also Harmonics of a radio station.

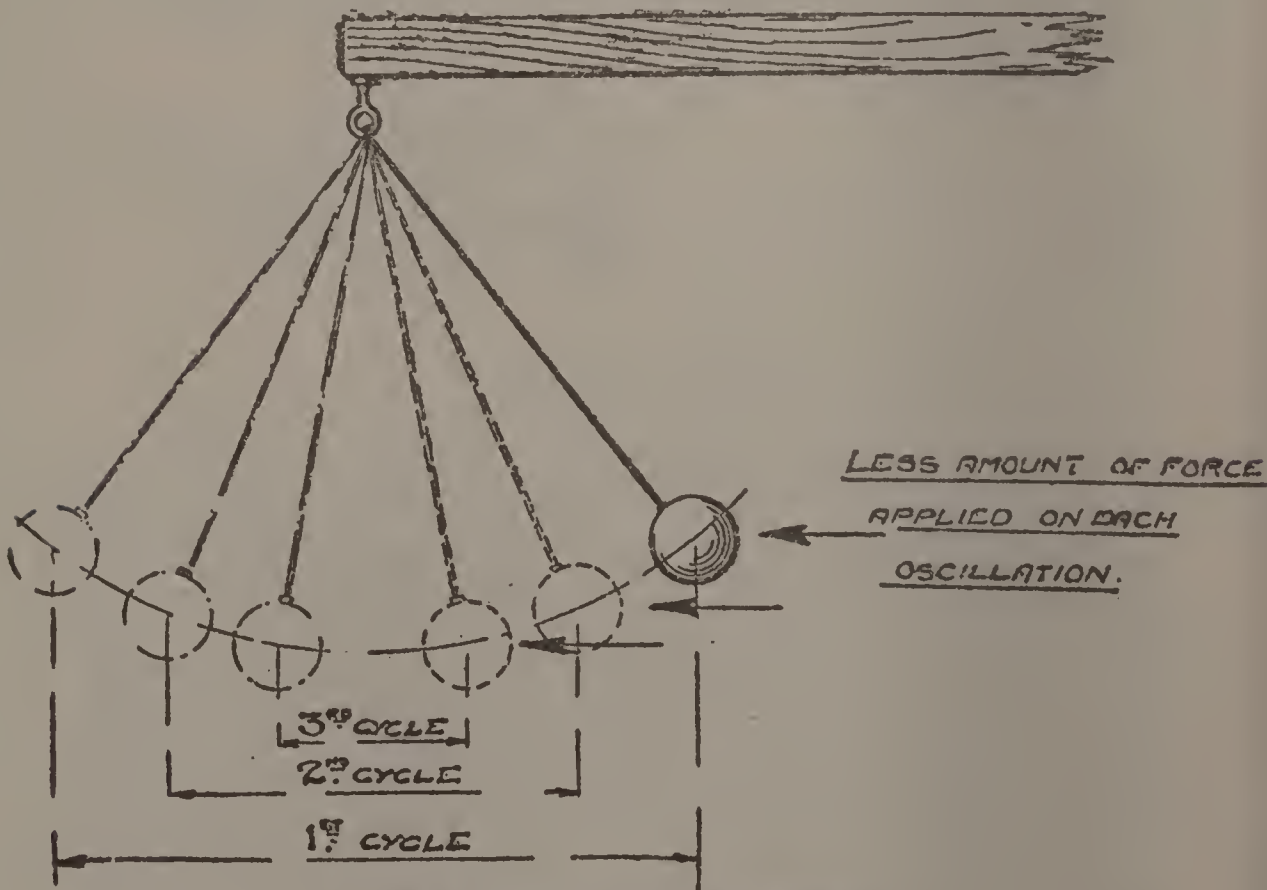

Fig. 12—Damped Waves Explained.

7. **HARMONICS:** These are over-tones or under-tones which give the reflection to the human voice and give quality or timbre to a musical sound. The Harmonics are an exact multiple of the fundamental frequency of the sound wave. In radio there exists also a harmonic frequency, which is also an exact multiple of the transmitted wave. These harmonics are undesirable in radio transmission and cannot be wholly done away with, but are kept down to a minimum. This is the reason one sometimes hears a station on an altogether different wave length or frequency from that being transmitted, as well as being able to hear it on the basic frequency.

8. **DAMPED WAVES:** In radio communication there is also used what is known as a damped wave. These can best be explained by referring to Figs. 11 and 12. Here a ball suspended on a string is being moved back and forth. Now if each time this ball swings back and forth, we applied the same force to the ball, it would swing in the same cycle as shown in Fig. 11, but if there is applied a lesser amount of power each time and finally stopped, the amount of swing would gradually decrease and then completely die out. As shown in Fig. 12, the damped wave has a lesser amount of power behind each of the oscillations and in time the oscillations gradually die out where the continuous wave or un-damped wave keeps its momentum by having an even amount of force behind it on each oscillation. In damped waves there is a series of wave trains, as shown in Fig. 13. Comparison may be made of a damped wave from a spark station and an undamped wave from a C. W. or continuous wave station, to the difference between noise and music. According to the teachings of Physics, music has a continuous wave, where anything rated as noise is made up of waves which have a difference in frequency or vibration. The noise which we hear after a thunder-clap, for instance, is very irregular while the music which we receive from a

piano has a regular vibration to it. This might be carried a little farther, saying that there is as much difference between a spark and a C. W. station as there is between noise and music. All stations sending out dots and dashes are not using damped waves, but they can be distinguished. Many Ships and Government stations

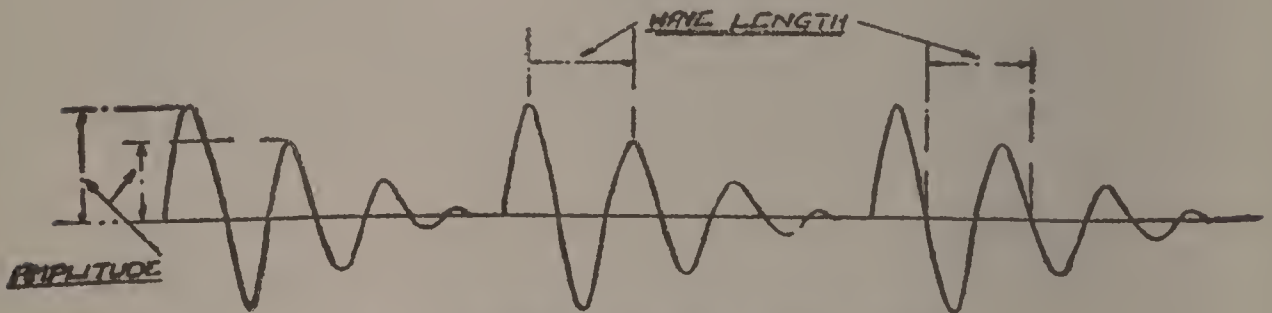

Fig. 13—Series of Damped Wave Trains.

are using spark. Most of these, sooner or later, will be changed over. The disagreeable features of the spark station will eliminate it in time, but until that time there will always be noises in the air. When using a receiving set one sometimes hears irregular waves which are caused by a street car going by the house, an arc light flickering in the vicinity and many other electrical disturbances which are sending out a non-continuous wave. It is nearly impossible to tune out or eliminate these waves, so when they are heard the blame should not be laid to the amateur who is thought to have a spark set. Now if the amplitude or height of a damped wave cannot be controlled, it cannot be used to transmit music and voice or be made into what is called a modulated wave. Hence it cannot be used for a radio telephone, but only in wireless telegraphy. As this book deals mostly with radio telephony, the theory of damped waves will be omitted and further explanations of C. W. will be considered.

9. TRANSMITTING STATIONS: In transmitting stations that are used for radio telephony there is what is known as the oscillator. This is the generator of the radio frequency wave and this wave is used to transmit sound. In Chapter Three where an explanation of audion bulbs is given, space will be devoted to an explanation of how the bulb works as an oscillator. In radio code work there is also used a mechanical oscillator, but as an oscillator of this type is not used for the transmission of sound, no explanation of this will be given.

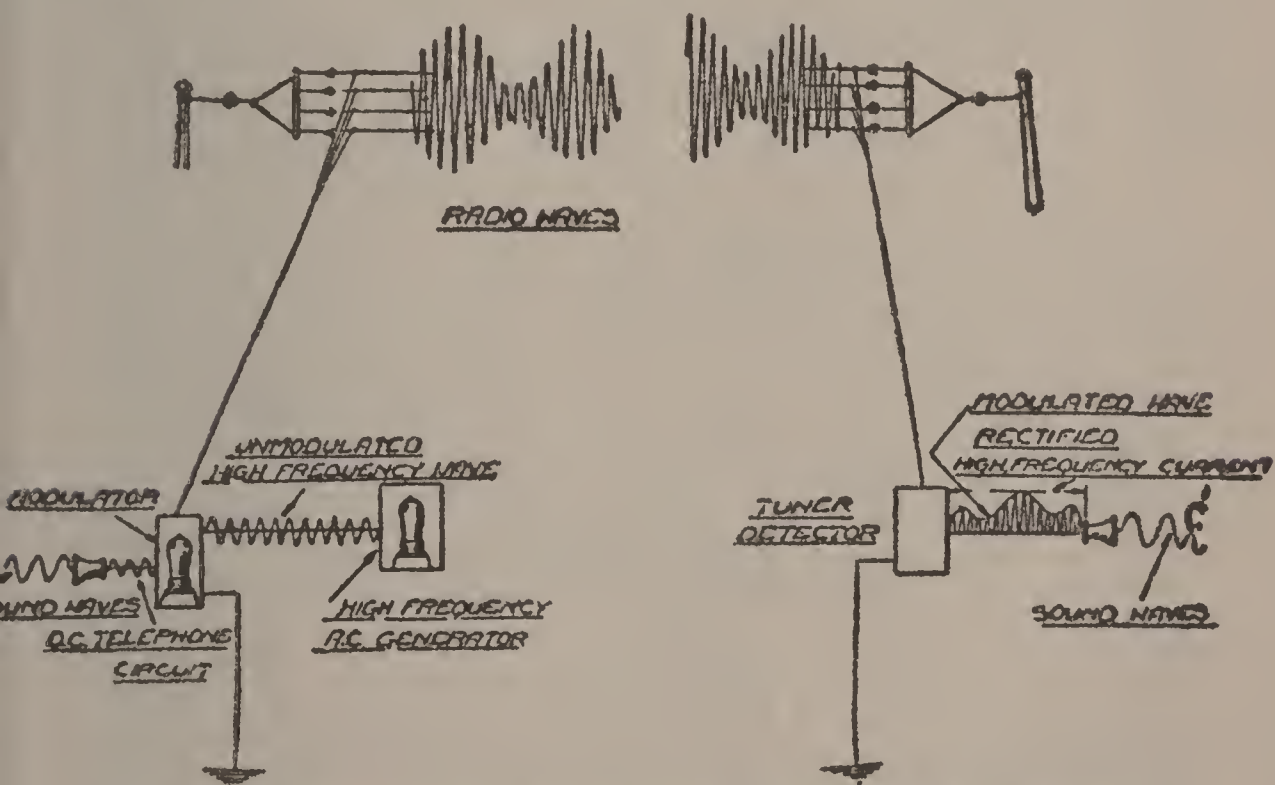

Fig. 14—Transmission and Reception of Continuous Radio Waves.

By referring to Fig. 14 it will be noted that there is at the start, a sound wave impressed on a microphone. This is similar to an ordinary land line telephone. This sets up a pulsating or undulatory direct current. Then it, in turn, goes to the modulator where it molds or changes the amplitude of the radio frequency wave and this wave

is transferred to the aerial where it is in turn radiated in all directions. As this wave travels away from the transmitting station, it becomes weaker and weaker until it is so faint that the receiving instruments are not delicate enough to be affected by it. With the higher powered stations there is sufficient power whereby it may be received over a distance of many thousands of miles. There seems to be great confusion in the mind of a beginner in radio on what the range of any given broadcasting station is. Many times he is confused by thinking that the wave lengths in meters tell the range of a station. It is quite true that with the longer wave lengths it is easier to transmit great distances, but this is because it is possible with an apparatus which generates a long wave to put more power behind this wave. So the distance that a station can be heard depends on many things besides the length of the waves. One often hears the Radio Man speak of having a transmitting station which gives him so many amperes of radiation, or of a station which is of 5, 10, or 500 watts. To make this understandable one needs only to think of the average electric light using an alternating current. It is known that the brighter or stronger this light is, the greater the distance it will radiate its beams; also the rated voltage of the light makes no difference upon its brightness. The alternating current of electricity used in the average home is 60 cycles and 110 volts and will work equally well on the 5-watt lamp or on a 100-watt lamp; thus the same holds true in the use of radio. Within certain limits, a 5-watt station and a 500-watt station will work equally well on a 400-meter wave length, but of course the 500-watt station will carry farther, everything else being equal. Many times other things are not equal.

Referring again to the distance which the light from an electric bulb would carry. A large electric light could be put in the center of a number of buildings or in a grove of trees and its rays would not carry as far as it would if

it were in the clear; so oftentimes we hear of a small station with small power getting out much farther than one of the larger stations. Much depends on how the station is kept up, how well the antenna is insulated and a good many other things, just the same as light waves will not radiate well from a bulb which is enclosed in a dirty glass shade. An operator of a broadcasting station cannot always tell how good his station is working and how far it is reaching. That is one of the reasons that it is desirable to hear from the person who picks up broadcasting at a great distance away from his station. By having this information a check can be made upon the broadcasting station and thereby maintain it at its maximum efficiency. This is one of the reasons why we should always co-operate with station operators when they ask for cards from listeners-in.

If the reader wishes to go more fully into the subject of the transmitting station, there are many good books upon the subject. The remainder of the space will be devoted to the explanation of how these radio waves are picked up and in fact how the different Receiving Sets work. These are the sets which the listener-in will operate and the better they are understood, the more proficient he will become in operating them.

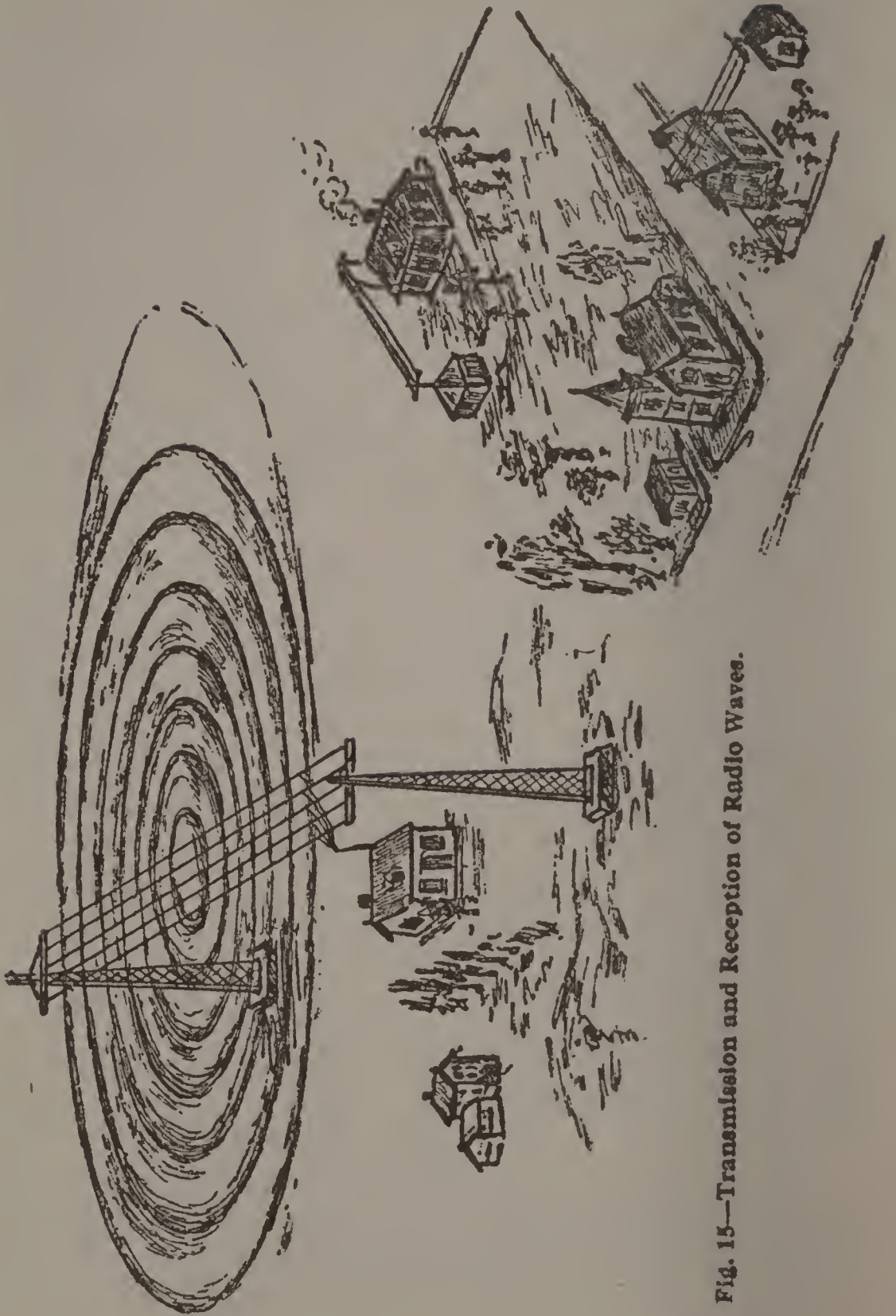

Fig. 15—Transmission and Reception of Radio Waves.

CHAPTER II

TRANSMITTING AND RECEIVING AERIALS

10. **USE OF THE AERIAL:** In the past chapter it was shown how the modulated radio wave traveled out in all directions from the broadcasting station and how these waves affected the receiving circuit. It was then shown how these waves were rectified into a pulsating direct current passing through the telephone receivers of a set and there being changed into a sound wave which was audible to the human ear.

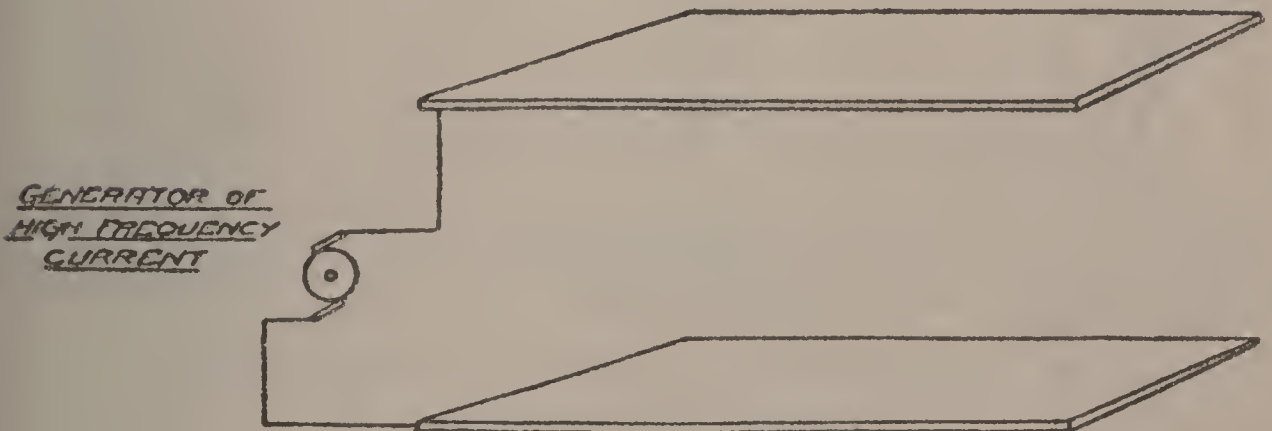

Fig. 16—Large Metal Plates Could be Used as Antenna.

When transmitting radio signals, the aerial and ground act as a large condenser which is charged and discharged. Sometimes instead of using the ground as one side of the condenser, a counterpoise is used. The counterpoise consists of a number of wires placed between the aerial and ground.

To understand this, think of the ideal antenna. This would consist of two large plates of metal placed some

distance apart, forming in this manner a gigantic condenser, being similar to any two plates of an ordinary small condenser.

Fig. 16 is a diagram of an aerial such as we would have by using two metal plates.

In order that the plates may have the merits of a good aerial they would have to be very large; so they are impractical and in place of them different types of wire

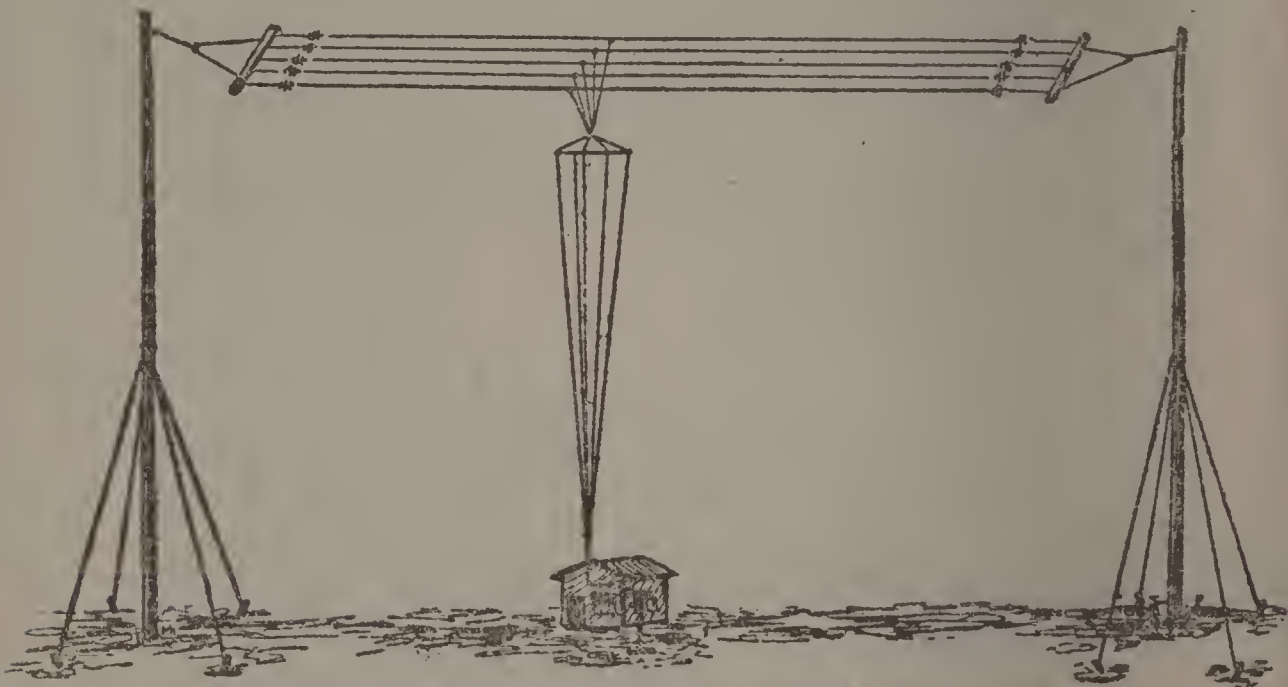

Fig. 17—Antenna Using Ground as One Side of Condenser.

aerials are used which are less expensive, easier to install, and give good results.

Fig. 17 shows a transmitting aerial of the flat top type, using the ground as the lower plate of the condenser and in Fig. 18 the same type of flat top is shown having a wire counterpoise instead of the ground to form one side of the condenser.

Now as the station is transmitting, the aerial condenser becomes charged and discharged and this sets up a wave in the Ether which travels out in all directions. To receive these radio waves properly, another condenser or aerial,

similar to the one used for transmitting, will be necessary, but as we do not have to handle the large amount of current which is necessary in a transmitting aerial, it can be of a much simpler design. The receiving aerial may be one of many different types.

Ordinarily, one wire well insulated, which is kept away from all trees and buildings and is anywhere from 50 feet to 100 feet long and from 20 feet to 50 feet from the ground, gives good results for broadcast reception with most any type of set.

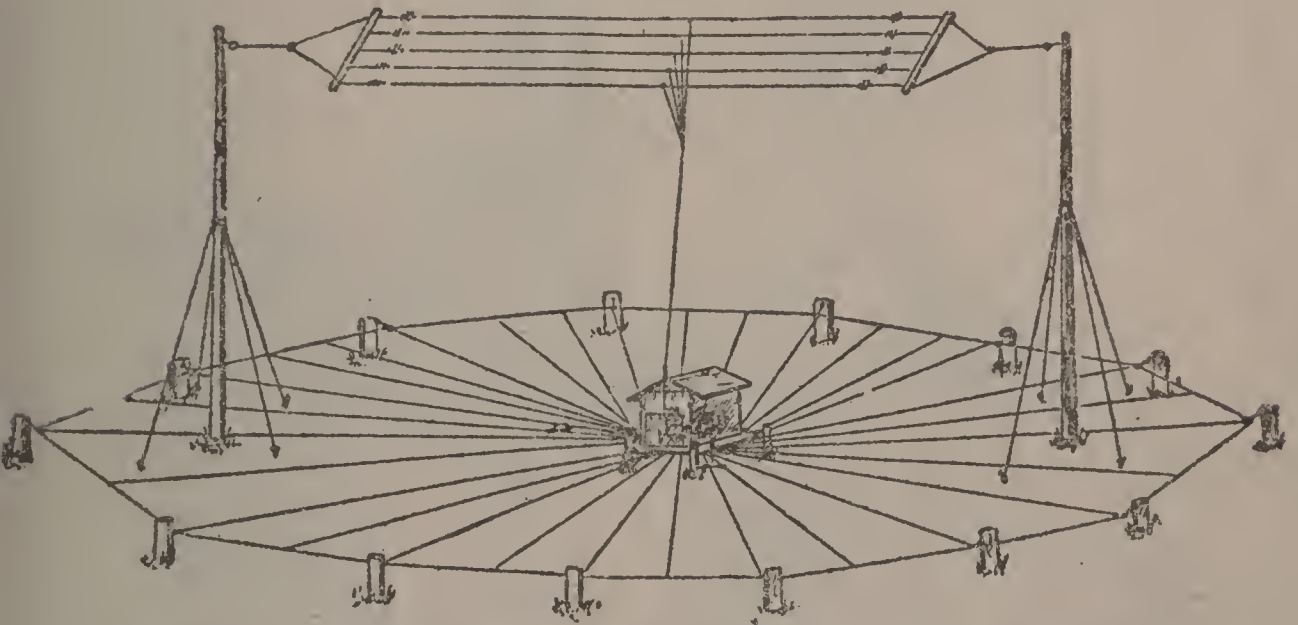

Fig. 18—Antenna Using Counterpoise as One Side of Condenser.

With the better type of sets which use one or more stages of radio frequency amplification, long distance reception can generally be had when using short or inside aerials. It must be remembered, however, that when using a short or inefficient aerial, the same signal strength will not be present in the aerial circuit and this must be made up by having a well designed and well built receiving set.

Fig. 19 shows a poorly constructed aerial, having a house, trees, and other obstructions close to the aerial wire and so cutting down its efficiency. It would have been much better to have placed this aerial in some other direction so that there would not be a decrease in the capacity effect by having objects of this kind between aerial and ground.

11. LOOP AERIALS: In using a loop for reception, a somewhat different method is used and it can be com-



Fig. 19—Inefficient Aerial having Trees, Buildings, etc. in Condenser Field.

pared more to that which is known as the inductance method of reception rather than the condenser method of reception.

In using any type of inductively coupled set, we set up oscillations in the secondary coil which in turn go to the

detector, so with a loop or coil aerial the E.M.F. is set up in the loop or coil and goes to the first bulb. This type of aerial has a much less chance to pick up a strong incoming wave so that the signal must generally be strengthened before it can be detected in order for it to be audible. For this reason, radio frequency amplification is generally used in connection with a loop especially to receive distant stations.

Further information regarding loop antennae is given in Chapter 5.

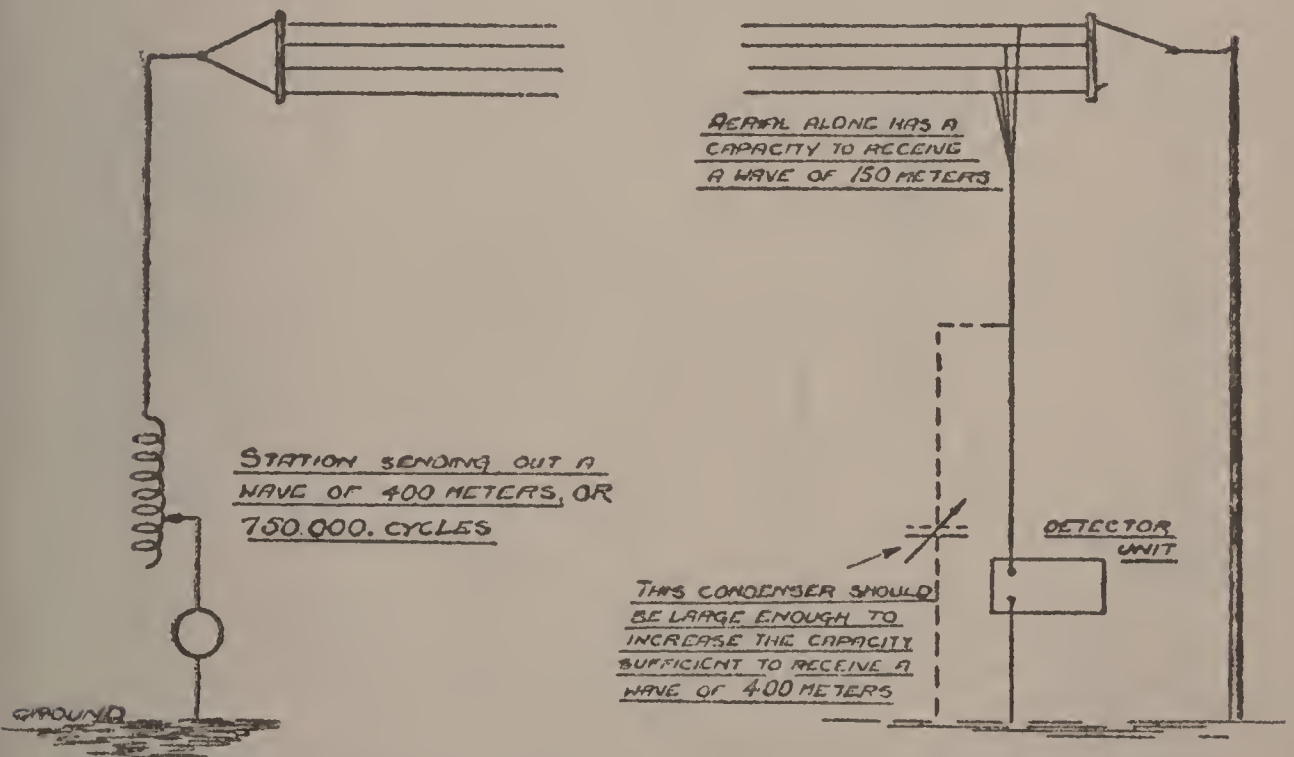

Fig. 20—Tuning the Antenna by Using Tapped Coil and Variable Condenser.

With very sensitive sets the wire in the set is sometimes sufficient to pick up a signal, or sometimes the ground or aerial is used alone. When this happens, the same effect is present as with the loop.

12. TUNING THE ANTENNA: When it is wished to tune a radio receiving set to resonance with the sending

station it is necessary to use some type of tuning apparatus. This can be accomplished either by capacity tuning or by changing the inductance of the coils. Before these different methods are applied to the tuning of a receiving set, a short explanation of the different ways of doing this

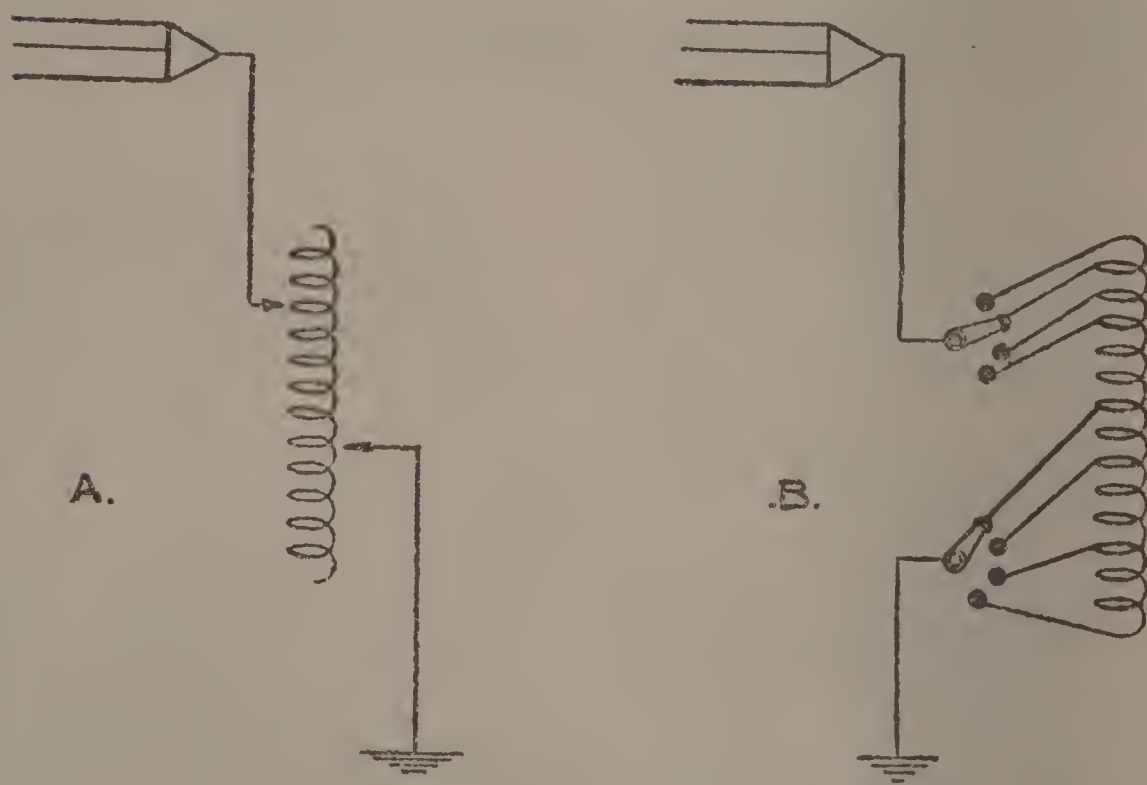

Fig. 21—Method of Using Tapped Coil between Aerial and Ground.

will be given. In Fig. 20 is shown a sending station which has an aerial condenser combined with the set that sends out a wave of 400 meters or 750 kilocycles. In the receiving aerial condenser, there is a natural capacity which will receive a wave of say 150 meters in length or 2000 kilocycles. The difference to be made up in the receiving set by some method of tuning would be 250 meters. One method of doing this would be to shunt a variable condenser between the aerial and ground. This is shown by

the dotted lines placed between the aerial and ground in Fig. 20. The second method that could be used would be to make up for the lack of wire in the aerial and ground lead by placing some kind of coil, with a number of turns of insulated wire wound on same, between the aerial and ground. These coils are generally made up so that the number of turns can be varied.

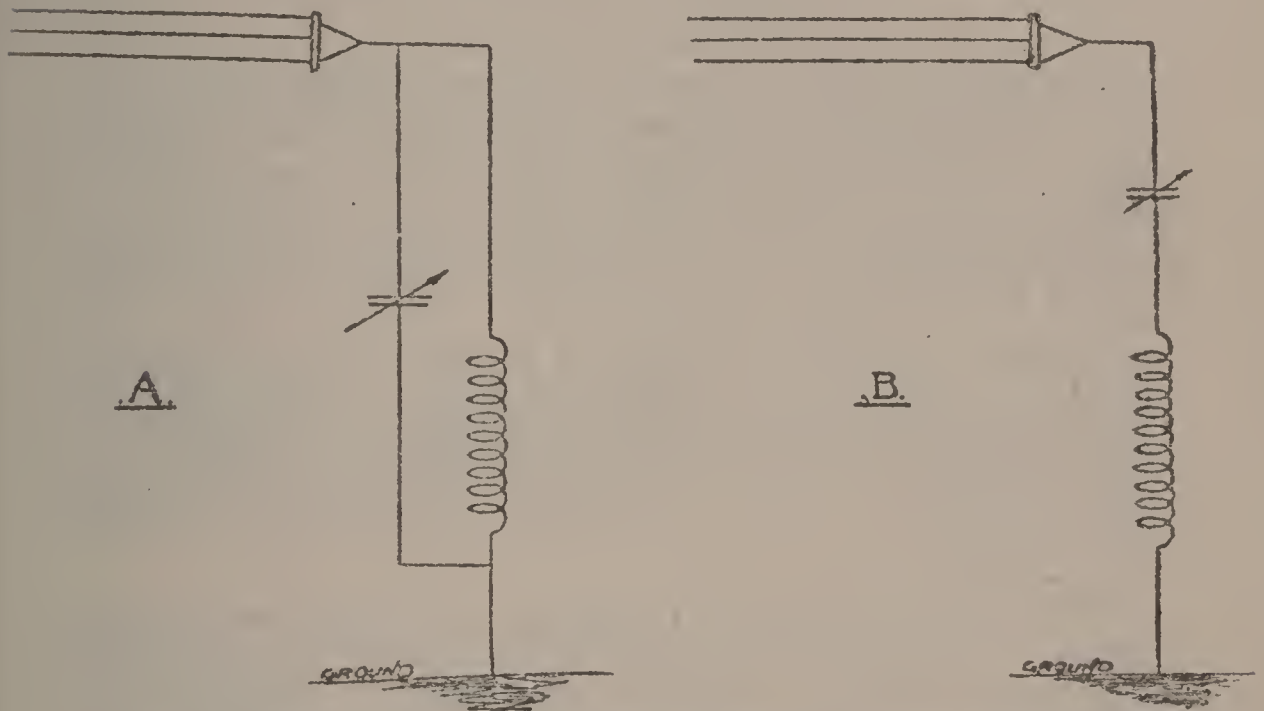

Fig. 22—Method of Using Variable Condensers to Tune Fixed Coils.

The two different methods are shown in Fig. 21. At "A" there is an illustration of a two slide tuning coil with an aerial fastened to one slider rod and the ground to the other. At "B" there is a tapped coil such as is used on a vario-coupler.

It can readily be seen that with either of these methods of adjustment and with a coil sufficiently large so that enough turns may be put into the circuit, the aerial can be tuned in resonance with transmitting stations sending out waves of different lengths.

Oftentimes a combination of condenser and inductance is used. In Fig. 22 at "A" the variable condenser is shunted across the coil and at "B" it is in series with the coil. A good thing to remember is that shunting a coil with the condenser raises the natural wave length of the tuning device and putting it in series with either the aerial or ground, lowers the natural wave length of the tuning devices.

Often coils used for tuning purposes have no way of varying the number of turns. The most common of these are the spider web and honeycomb coils. When these are used, a condenser is generally shunted across or connected in series with the coil. With this type of coil, dead end losses are eliminated, due to having all of the wire in the circuit at all times.

Another method of tuning is by having two separate windings connected in series. Changing the positions of these windings will then change the inductance of the tuning device. A variometer in the aerial circuit employs this method.

When a receiving set uses both a primary and secondary coil for tuning, the secondary circuit must also be tuned by the use of a tapped inductance, a variable condenser, or by the introduction of a variometer in the secondary circuit. With many of the newer types of radio frequency amplifying sets, the aerial or primary circuit is not tuned. A sufficient number of turns is wound on a coil and this is closely coupled to a secondary tuning coil. Oscillations will then be set up in this secondary coil if same is brought in resonance with the radio wave which it is desired to hear.

CHAPTER III

THE OPERATION AND ACTION OF CRYSTAL DETECTORS AND AUDION BULBS

13. RECTIFICATION OF RADIO FREQUENCY WAVES: In the past chapter was shown how the modulated radio waves travel out in all directions from the broadcasting station. In Fig. 14 was shown, how the aerial of the transmitting station sent out waves and how these waves affected the receiving circuit. It is then rectified into a pulsating direct current passing through the telephone of the receiving set and there being changed into a sound wave audible to the human ear. Fig. 15 also shows this wave action.

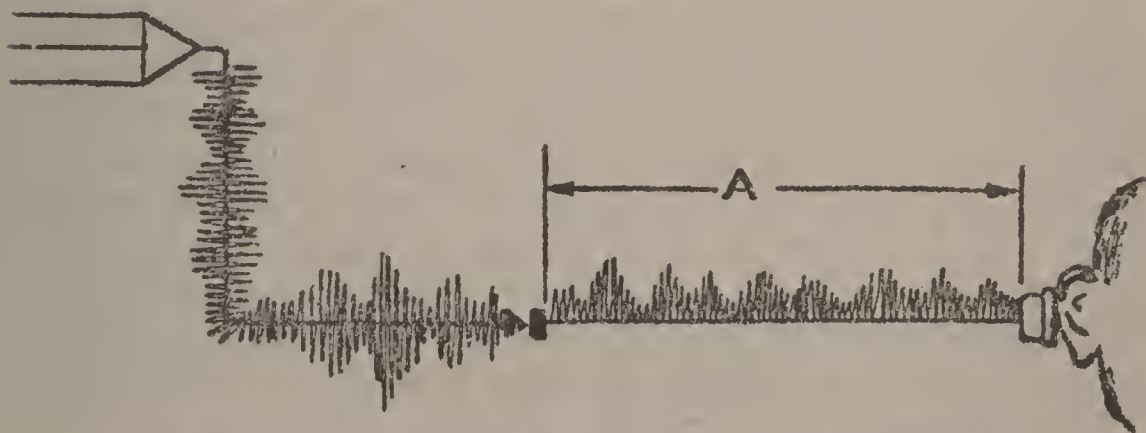

Fig. 23—Crystal Detector Rectification of Radio Waves.

There are many different types of receivers and in all of these, two main methods are used for rectification. The first to be described will be the crystal detector and the second the audion bulb.

14. **CRYSTAL DETECTOR RECTIFIER:** In Fig. 23 is shown a common crystal detector circuit. The properties of the crystal or mineral that is used are such that it will pass a positive current of electricity better than it will a negative current. In Galena this ratio is ten to one (10-1). That is, it will pass a positive charge of electricity ten times easier than it will a negative charge so that the negative charge is intercepted and will not pass the detector to any considerable extent. This is the reason that only one half of the cycle is present in the circuit beyond the crystal detector and this wave can be shown as in Fig. 23 at "A." This pulsating direct current is then passed on to the telephone which will not vibrate to the numerous pulsations of the radio frequency wave and consequently we hear only the sound caused by the curve of the modulated wave. This is the same curve that would apply to the modulated radio frequency wave which was set up at the broadcasting station. This modulated wave actuates the diaphragms of the telephone receiver and causes a sound audible to the human ear, similar to the sound given at the microphone of the broadcasting station.

Since the telephone receivers will not respond to the pulsation of the high frequency wave, most radio receiving sets have a by-pass condenser placed across the phone terminals to enable these high frequency waves to pass around the high resistance of the coils in the receivers. There is, however, a small capacity effect between the two wires which run parallel in the cord connecting the receiver or loud speaker to the set and this capacity is sometimes great enough so that a by-pass condenser is unnecessary.

15. **THE AUDION BULB:** The second method used for the rectification of radio waves is with an audion bulb or vacuum tube. These are sometimes also called thermionic valves. A whole volume could be devoted to a most complete explanation of this wonderful invention but as space does not permit, a short understandable

outline of the tubes as used for broadcasting transmission and reception will be all that is given in this book. To thoroughly understand the action of an audion bulb one must have a slight understanding of the electron theory.

16. **THE ELECTRON THEORY:** Heretofore it has been stated that volumes could be written about the audion bulb. The same holds true for the electron theory and in fact, Prof. Millikan (who has claimed to have isolated and weighed the electron) has written a volume dealing with practically nothing but this subject.* The electron is the smallest particle of matter to have been thus isolated and weighed and although it would take many millions of these to make a particle of matter large enough to be seen, the basis of Prof. Millikan's mathematical calculations seems to be sound and his theories are generally accepted as being true.

An electron is a negative charge of electricity which, except in an extremely cold temperature, is in constant motion. As the temperature rises, these electrons become more active until they reach such a high boiling point that they are thrown out into space. This is the reason that an electron discharge is present around the heated filament of an ordinary electric light bulb as well as in the audion bulb which is used for radio work. When a body has too many of these electrons, it is said to be negatively charged and when it is lacking in electrons it is thought of as having a positive charge. The electrons are a negatively charged body and will always be attracted by any other body which is lacking in electrons.

Certain substances offer an easier path for the flow of electrons than others. This is the reason for wires of a high resistance and wires of low resistance. When the construction of a wire is such that the resistance to the flow of electrons through the wire is not great, it can be said that the wire is of low resistance. If the substance

*The Electron, its Isolation and Measurement—The University of Chicago Press.

of the wire is such that it hinders the flow of electrons through the wire, it is known as having a high resistance. The reason that some substances have this high resistance is because the composition of the atoms (the atom is composed of both positive and negative charges of electricity) is so dense and closely packed as to make it difficult for the negative electrons to flow and if a great many electrons are forced through them they will heat up in passing an electric current. This varies greatly with the different substances. With glass, porcelain and other high di-

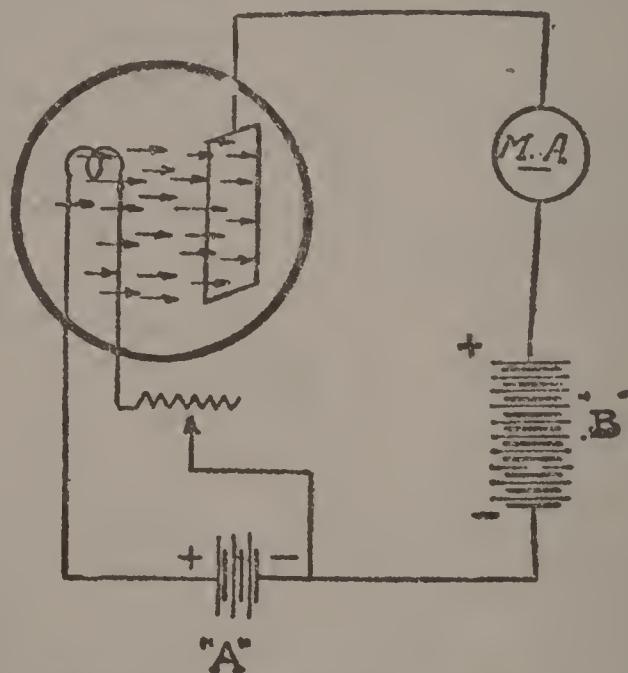

Fig. 24—Electron Flow between Filament and Plate.

electric composition, the resistance to the flow of the electrons is so high that they are used for insulation between electrically charged bodies. Much more could be said about the electrons but for the purpose of this book, suffice it to know that electrons are emitted from the heated filament of an electric bulb and that these electrons will be attracted by any body which is positively charged or lacking in electrons and that these electrons will travel through a partial state of vacuum better than through air of ordinary density.

17. **TWO ELEMENT BULB:** Consider now the action of this electron flow between the filament and plate of a two-element bulb. Fig. 24 shows a drawing of a two-element bulb connected to an "A" and "B" battery and using a milliammeter in the plate circuit. When the filament of the tube is heated by the "A" battery, electrons

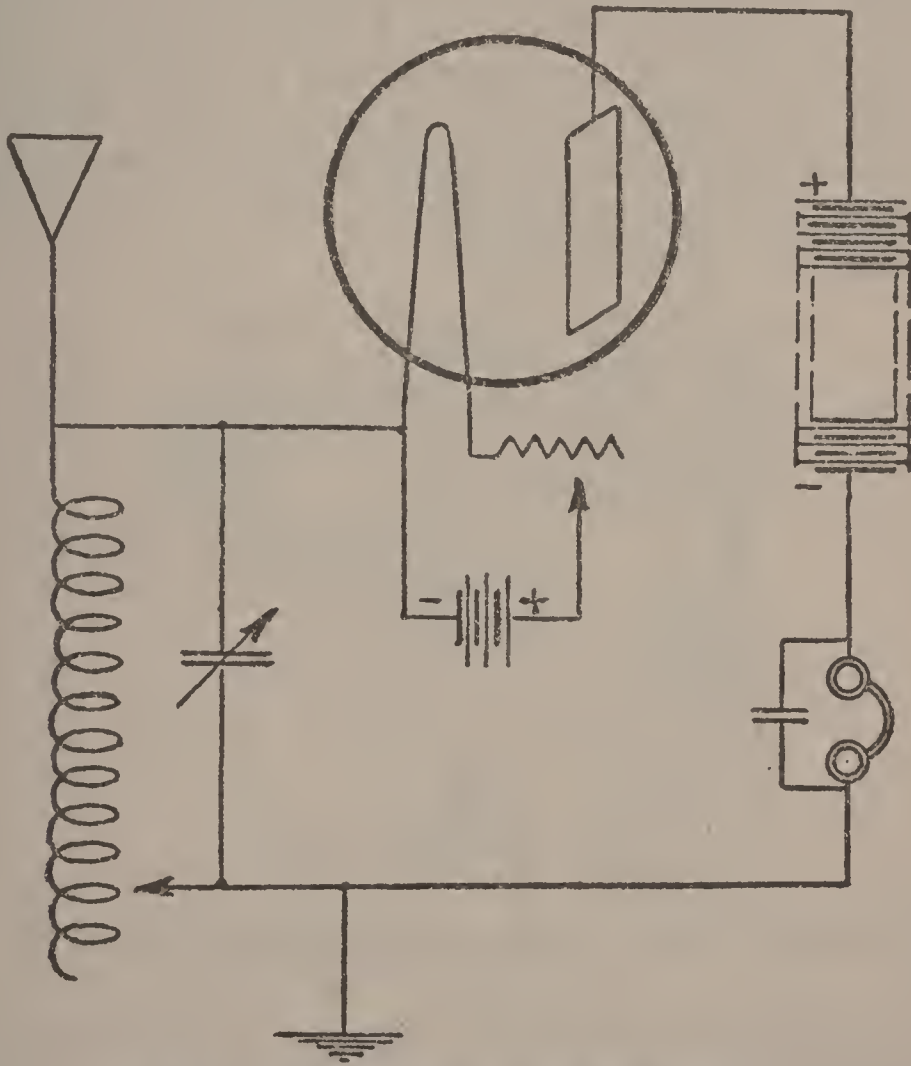

Fig. 25—Circuit Using Two Element Bulb.

are present around this filament. These electrons will be attracted by anything which is positively charged. The plate or second element in the tube can then be connected to the positive side of a "B" battery and this will put a positive potential or charge on the plate in the tube. This

positively charged plate will then attract the negative electrons which are being emitted from the heated filament. This electron flow can be controlled by changing the temperature of the filament with the rheostat, which is in series with the "A" battery. By inserting a milliammeter in the plate circuit, the current present can be measured. The two-element tube can be used as a rectifier of alternating current and is so used in some transmitting stations. It can also be used as a rectifier of the high frequency radio waves and was used in this manner in radio work before the introduction of the three-element tube such as used today. Fig. 25 shows the hook-up using the two-element tube.

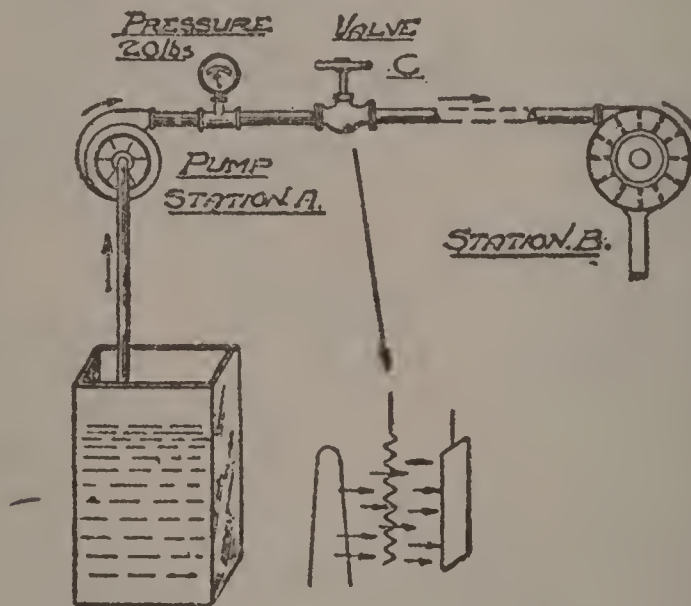

Fig. 26—Water Analogy Showing Use of Grid.

18. **THREE ELEMENT BULB:** Consider next the operation of the third element which is added to an audion bulb. It has been shown that there was an electron flow between the heated filament and the plate. The two-element bulb was invented by Fleming and has been in use since 1904. In 1907 the three-element bulb was invented by Dr. Lee DeForest. This perfection of the Fleming valve has been one of the outstanding steps in radio

advancement and it is due strictly to the field opened up by this invention, that it is now possible to transmit sound by radio. All of the wonderful features of broadcasting today owe their existence to this perfection of the Fleming valve. To explain the sensitiveness of an audion bulb using the three elements, a water analogy is made use of.

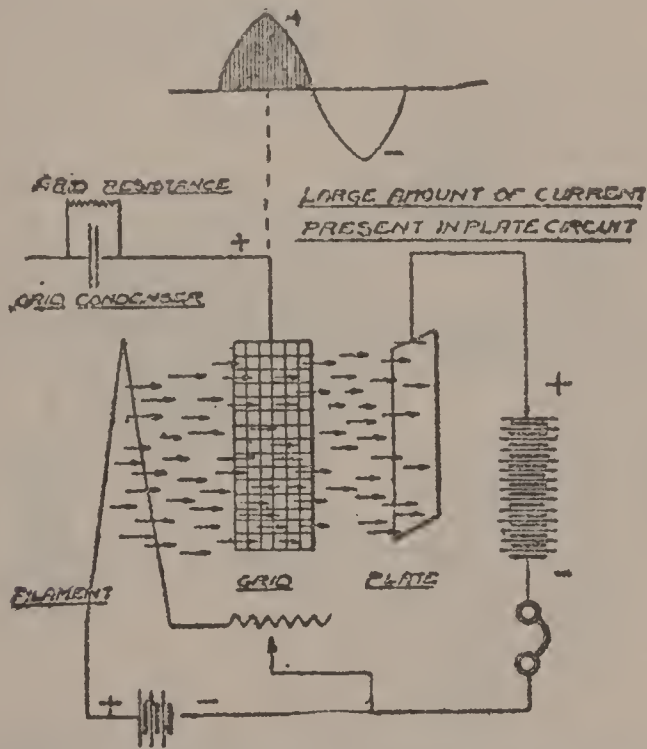

Fig. 27—Action of three element bulb when grid is positive.

In Fig. 2, Chapter I, was shown how water flowing through a pipe could be used to explain the resistance that was set up in a wire when passing an electric current through same. A similar type of drawing can be used to show the action and use of the grid in a vacuum tube, how this grid can control the electron flow between the

filament and the plate, and now it will take but a very weak signal to actuate this control. In Fig. 26 is shown a water pipe filled with water and a water pump which keeps a 20-pound pressure on a part of the pipe. Inserted in this pipe is also a valve which will control the flow of water between stations "A" and "B". As one knows, it will take very little power to either open or close the valve at "C" and that this small amount of power will control the greater power which is being used to force the water

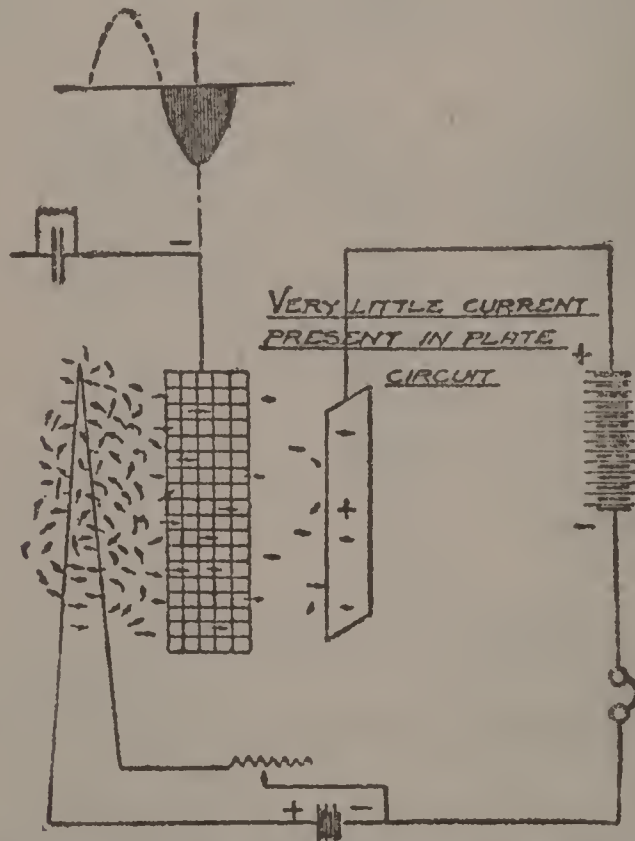

Fig. 28—Action of Three Element Bulb when Grid is Negative.

through the pipe. The same holds true with an audion bulb. The electron flow or power used to actuate the telephone receivers is furnished by the batteries. The "A" battery heats up the filament of the bulb and starts

the electron flow between the filament and plate while the grid acts as a valve to either retard or help this electron flow. In the three-element tube the grid lies between the filament and plate and is generally made of some fine

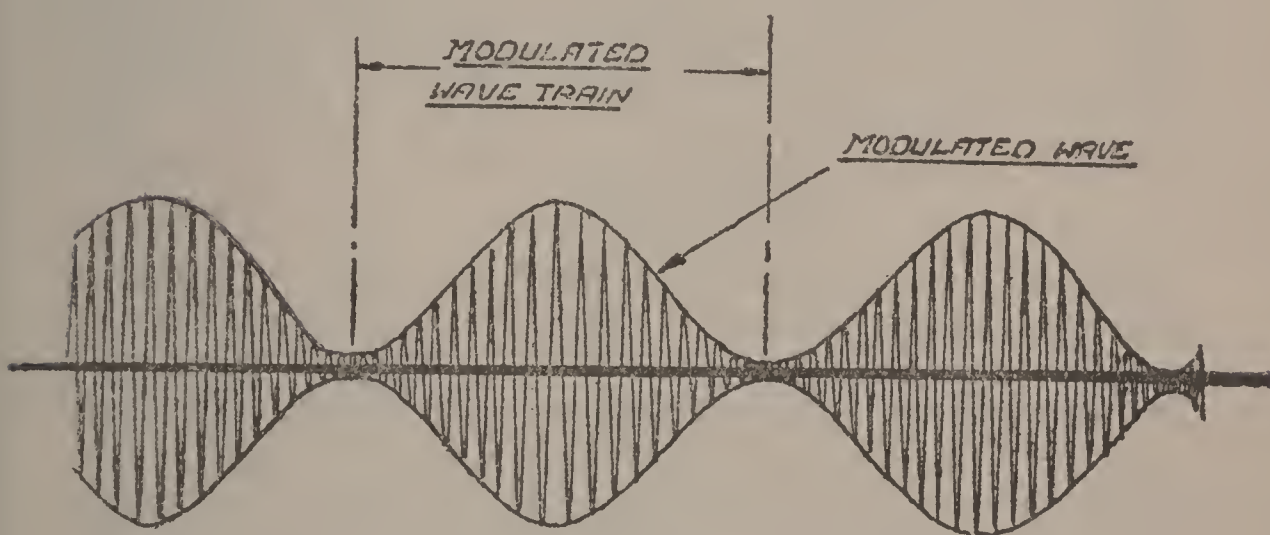

Fig. 29—Modulated Radio Wave Train.

wire mesh or screen which will facilitate the flow of electrons between filament and plate. The incoming wave is an alternating current; first positive, then negative. Sometimes it is strong and sometimes it is weak. When it is strong it is said to have a high amplitude and when it is weak it is said to have a low amplitude. When the incoming wave is positive, the grid will also be positively charged and will help the flow of electrons from the filament to the plate. When the incoming wave is negative, the grid will be negative and this will retard the flow of electrons between filament and plate. Fig. 27 shows the

action of the bulb when the incoming wave is positive and Fig. 28 shows the action when the incoming wave is negative.

This increase or decrease of the flow of electrons is the cause for the variations of the pulsating direct current, present in the telephone circuit. The grid changes in polarity or goes from positive to negative, many thousands of times per second. The diaphragms of the receivers will not vibrate fast enough to register these pulsations. There is also present what is called a modulated wave which is a line drawn at the height of the amplitude of the radio frequency wave. This wave is shown in Fig. 29 and is the one which will affect the telephone receiver.

19. GRID CONDENSER AND LEAK: The beginner in radio hears much about the different types of grid condensers and leaks. There are many varieties of variable grid leaks on the market and where one is not furnished with a grid condenser, an additional piece of cardboard or other substance may be put across the terminals of the condenser while a pencil mark or mark made with India ink makes a suitable leak and can be easily varied. The following explanation tells why the leak must be varied for different kinds and types of tubes.

The grid condenser is always connected in series with a tuning apparatus so that with the variations of the alternating current wave, the condenser becomes charged and discharged and likewise puts a positive and negative potential on the grid of the tube. Various detector tubes have different characteristics but with most of them, by using a grid condenser and leak, better reception is obtainable.

Fig. 30 represents a drawing of a well modulated continuous wave. The upper half of the wave is positive and the lower half negative. According to the previous explanation of the audion bulb, the filament throws off the negative charges of electricity which are attracted by the

positively charged plate. Now as the grid becomes positively and negatively charged, it helps or retards the flow of the electrons.

When the incoming oscillations are positive, the grid is positive and consequently will pick up some of these negatively charged electrons the same as the plate, but when the incoming oscillations change to negative, it will not be able to get rid of all of the electrons which it has collected, so the grid still holds some of these electrons and each time the frequency changes it will add to the number of electrons on the grid. If there was no let-up in the

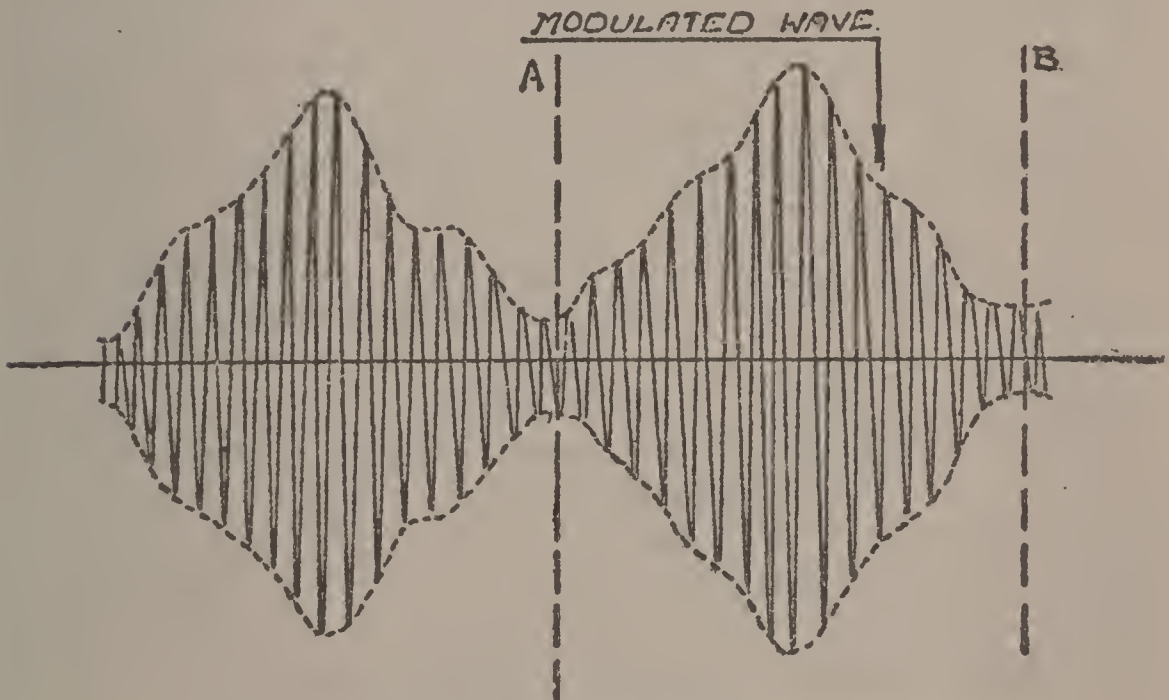

Fig. 30—Modulated Wave.

storing up of this charge on the grid, they would soon become so numerous that they would hinder or stop the flow between the filament and the plate, so in most types of radio transmitting stations there is a means of breaking these continuous oscillations so that the grid will have a chance to become discharged.

Referring again to Fig. 30, there is a well modulated wave and at the point "A" it is near a zero point and from there to point "B" there is that which is known as a modulated wave train. Now at these two points "A" and "B" the grid will have a chance to become discharged by having the negative charge of electrons leak off through the grid condenser and back into the "A" battery circuit. If a tube were used in which there was a perfect vacuum, it could only happen in one way, but in all commercial tubes there is some gas left in the tube and part of this charge leaks off through these gases and through the walls of the tube. The rest of the charge leaks back through the grid condenser. To be sure that this happens before the next wave train starts, a large resistance of from one to five megohms (a megohm is 1,000,000 ohms) is put across the condenser, which helps to relieve the grid of this charge. (This is a very important thing for the operator of a receiving set to remember.)

As stated, some of this charge on the grid leaks off through the gases in the tubes and that which does not, must leak through the grid condenser and grid leak. All tubes are not alike and even two tubes of the same make may not have the air pumped out to the same state of vacuum, so that oftentimes to get the best results the grid leak must be varied to operate right with the particular bulb in use. Too much of a grid leak is as bad as not enough. For this reason it is always advisable to have a variable grid leak or some method of changing this leak.

20. **AUDIO FREQUENCY AMPLIFICATION:** It has been explained how the audion bulb acts as a rectifier and amplifier of the incoming alternating current radio frequency wave. So a similar type of bulb will act as an amplifier of the rectified wave after it leaves the detector. In fact, the audion bulb will work as an amplifier of any sound carrying electrical wave. It is so used by telephone companies on their long distance lines.

They are also used in connection with speech amplifiers at many large gatherings. When used as an amplifier of audio frequency current in a receiving set the primary of the transformer is connected where the phones would be used if it was not wished to use more than one bulb. This transformer changes the voltage of the pulsating direct current. It also forms a means of coupling the two bulbs together without impressing the "B" battery voltage which was in the plate circuit of the previous bulb. The two coils of the transformer will not pass this low voltage current but as the coils of the transformers are always closely coupled they will pass the sound carry-

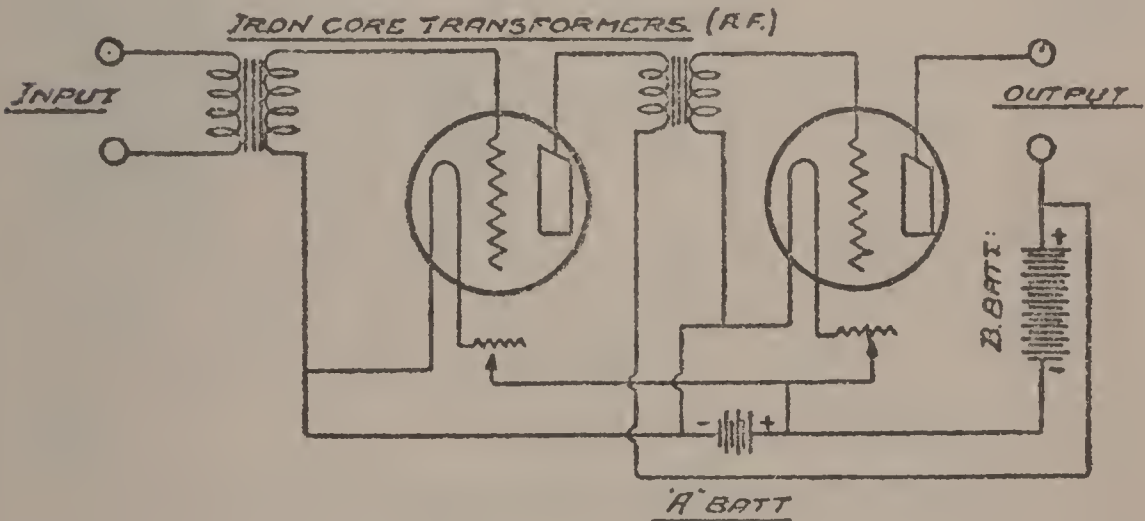

Fig. 31—Circuit Showing Transformer Coupled Audio-Frequency Amplifier.

ing electrical waves which it is wished to amplify. The principle of this amplification can be very easily understood if the original explanation of the audion bulb is at all clear. A sound carrying wave is impressed on the grid of the amplifier bulb in the same manner that the carrier wave from the broadcasting station is impressed on the

grid of the detector bulb. This audio frequency wave which is present in the plate circuit of the detector bulb is then amplified many times by the electron flow across the tube of the second bulb. Since this tube does not have to be used for the rectification of this wave, a tube of a higher state of vacuum and higher voltage can be used. Hence, a greater amplifying effect is present than could be had from the detector tube.

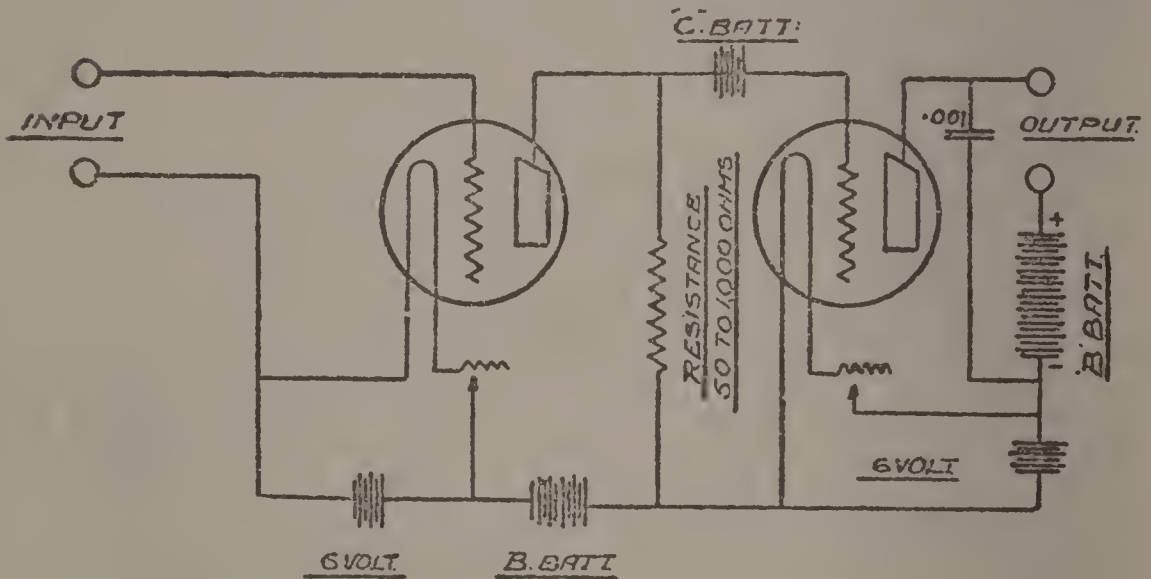

Fig. 32—Circuit Showing Resistance Coupled Audio-Frequency Amplifier.

There are several ways of coupling tubes together in order to get this amplifying effect. Fig. 31 shows the hook-up generally used when using an iron core transformer. Fig. 32 shows the hook-up using a "C" battery and high resistance in place of a transformer. This type of hook-up is not in general use. A "C" battery is sometimes used in the grid circuit of the amplifier bulbs when

using a hook-up similar to the one shown in Fig. 31. Further explanation of this is given in the chapter devoted to the different parts used in making up a radio set.

21. AUDION BULB USED FOR AMPLIFICATION OF RADIO FREQUENCY WAVES: When using an audion bulb as an amplifier of the radio frequency waves, very weak signals can be strengthened and then be passed on to either a crystal detector or an audion bulb detector and changed into a rectified audio frequency current. When using a bulb in this manner it is not desired to have

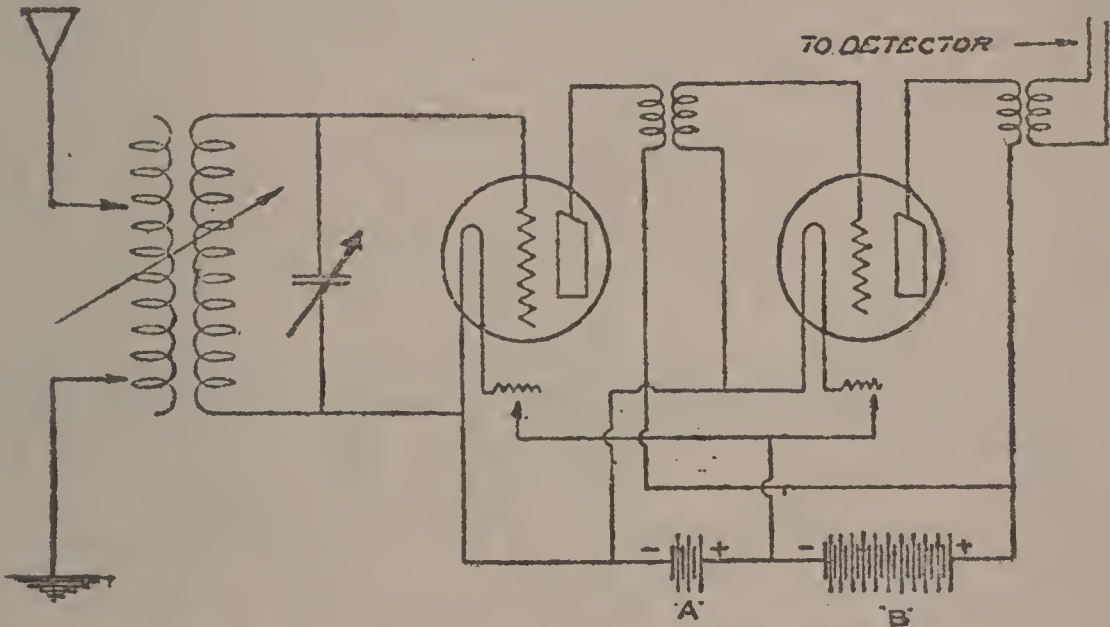

Fig. 33—Circuit Showing Transformer Coupled Radio Frequency Amplifier.

the radio frequency bulb act as a rectifier of the incoming alternating current wave. This is done by keeping the grid voltage of a value that will not change the similarity of the operations in the plate circuit. In this manner the strength of the signal in each added stage of audio frequency amplification will be strengthened but will not in any way change its form. Fig. 33 shows a schematic drawing of two stages of radio frequency amplification and Fig. 33A shows the amplifying effect of each one of these

stages although the proportion of amplification would be much greater than is shown in this drawing. The drawing is given merely to show the effect of the radio frequency bulb.

Now if radio frequency bulbs will act as an amplifier of the incoming weak wave, loop aeri-als can be used. Also, much greater distances can generally be had as any weak wave which is present in the aerial circuit can be brought up to sufficient strength so that it can be rectified by using a crystal detector or a detector bulb. For the same reason that a transformer was necessary in the coupling of one or more stages of audio frequency amplification to the detector, it is necessary to use some method of connecting radio frequency bulbs. This is generally done by using an air core transformer rather than one with an iron core but there are on the market several types of radio frequency transformers which have a very light iron core. When one or more stages of radio frequency amplification are used, it is called cascade amplification. Quite often, instead of using a transformer coupling between the different stages, resistances or condensers are used. These are used more extensively in foreign countries than they are in the United States. They are very efficient on the higher wave lengths but do not give the best of results on anything below one thousand meters.

21-A. AUDION BULB USED AS A GENERATOR OF HIGH FREQUENCY CURRENTS: A better understanding can be had of an audion bulb as a generator of high frequency currents after reading paragraph 23 which takes up the theory of regeneration and paragraph 24 which tells of re-radiation of regenerative sets.

In some transmitting stations, audion bulbs are used to generate high frequency currents. These currents are used for the transmission of radio signals. Any regenerative circuit such as shown in the next chapter, can be

made to generate spontaneous oscillations. This is brought about in the following manner: every change in the grid voltage causes a greater change in the plate current. In order to make the tube oscillate it is then only necessary to have some method of coupling the plate circuit to the grid so that the greater current in the plate circuit will supply a small amount of power to the grid and make possible a surplus power which is available for use in an external circuit.

This surplus power can be sent into an antenna in the form of continuous or undamped oscillations at a frequency it is desired to use.

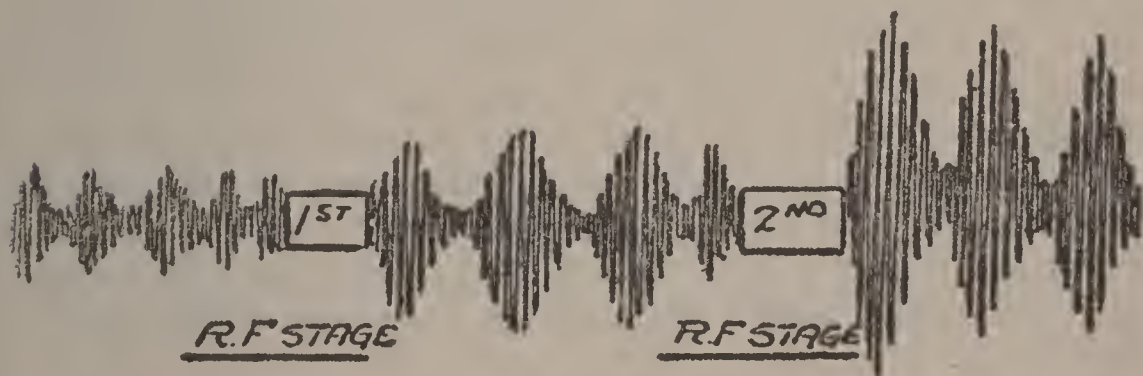

Fig. 33A—Effect of Radio Frequency Amplification.

CHAPTER IV

RECEIVING SETS

22. **FACTS ABOUT RECEIVING SETS:** This chapter will be devoted to an explanation of the theory of the most commonly used types of radio sets. There are so many different types and kinds of receiving sets and hook-ups on the market that it is confusing to the beginner in radio to know which one of these will be best for him to buy or build.

The author has been asked hundreds of times which is the best set to build or buy and what the price of buying or building a good radio receiving set would be. The question has always been hard to answer as much depends upon the amount of money which the purchaser wishes to spend, just how much he expects to receive from the set and the condition under which the set must operate. Ordinarily a simple type of set will give better results when used in rural districts where there is not a great deal of congestion of electric wires, telephone wires, street car lines, large buildings, motors, etc. than it does in the city where this congestion does exist.

The beginner who wishes to construct his own set should start out with one of the simple hook-ups and after he has become familiar and has learned to use and get the most out of his set, he will want more "miles per hour" or greater distance, "more riding comfort" or less interference and the desire to always want something better, will stimulate his interest in radio the same as it did and does in the automobile.

Many writers tell us to buy only high priced merchandise. This is not a rule which is always necessary to follow. Experience has shown that the beginner in radio could generally get as much actual satisfaction out of the

cheaper apparatus or out of the parts that he constructs himself, than he could from buying the best that could be had with the expectation of wonderful results.

Many people started by driving one of the cheaper makes of car, and it would have been a mistake to have started in driving a high priced car. To begin with, if they ran it into the first telegraph pole they came to, it didn't cost them so much and in the second place when anything went wrong (which always did sooner or later) they could fix it themselves or get some one who knew how to fix it.

The same applies to radio apparatus. The man who wound his vario-coupler on an oatmeal can used a wood block for a rotor, baling wire to fasten it together, got more of a thrill out of hearing a station two hundred miles distant than a man who spent four or five hundred dollars for a set and heard stations across the continent.

This is not an excuse for the manufacturer who turned out junk and oftentimes charged as much for it as is charged for good merchandise. Also, it should be unnecessary to pay a dollar and a half or two dollars for some simple little item that should sell for twenty-five cents or can be made by the experimenter with five cents worth of material.

Many times the advanced radio man calls the simple types of receiving sets "Simple sets for simple people." The same might be said of the Ford car, but to use the old advertised slogan "Go out on the street and watch them go by." Quite true of the simple types of sets, you cannot tune out interference the same as could be done with a more expensive receiver, but it is also true that if you do not know how to operate a selective type of set, results obtained will be unsatisfactory.

The drawing and explanation given will not give construction details. Directions in building different types of radio sets are given in another book written by the

same author.* The diagrams and explanations here, are merely for the purpose of giving an idea of the theory and principle of different sets.

23. **THEORY OF REGENERATION:** Before taking up different types of receiving sets individually the theory of regeneration will be explained. The regenerative principle will apply to several different sets which are explained later in the chapter. The regenerative idea

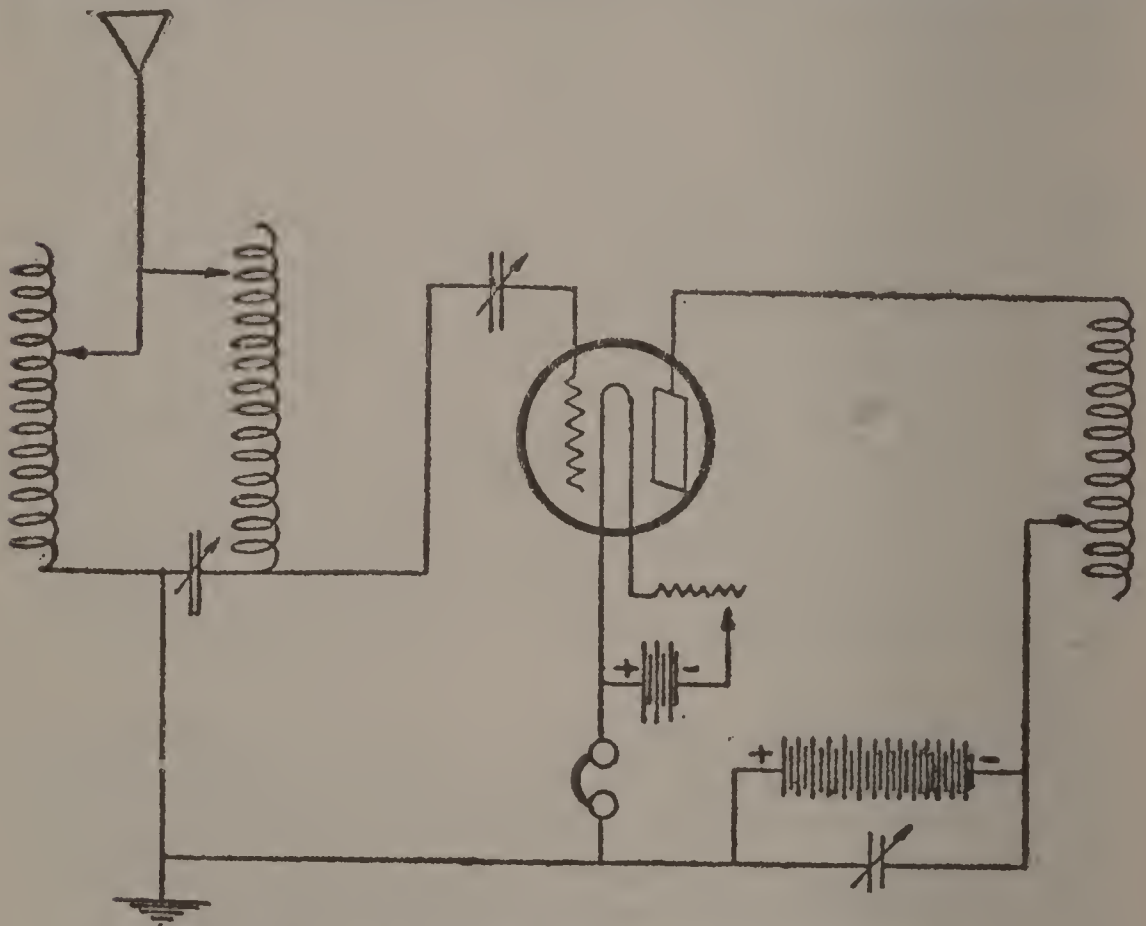

Fig. 34—Original Armstrong Regenerative Circuit.

originated with Armstrong a number of years ago and was perfected by him while a student at Columbia University. A patent was applied for and entered in the Patent Office in 1913. This patent was allowed and will not

* "Radio Construction for the Amateur."

expire until 1930. The patent is now controlled by the Westinghouse Electric & Mfg. Company. Many suits have been started to break the patent but Armstrong's title has always been upheld and he has always been declared the true inventor.

Tuned plate amplification and feed back amplification are generally classified under two different headings: Altho the effect of these or results obtained are practically the same. The operation of this method of regeneration is somewhat as follows; the incoming radio frequency oscillations are repeated in the plate circuit and if coil is inserted in this circuit and can be tuned, it either assists or opposes the flow of current in the plate circuit, according to whether this current decreases or increases. There is a certain internal or self capacity effect between the filament and plate of the audion bulb. The tuning of the plate circuit would have the effect of changing the space or capacity effect between the filament and plate according to whether or not the current was being helped or opposed.

Where the single circuit regenerative and three circuit regenerative sets are dealt with separately the difference between tuned plate and feed back amplification will be explained.

24. RE-RADIATION OF REGENERATIVE SETS

A great deal is said and printed about the re-radiation of regenerative receivers. Interference caused by re-radiation is especially noticeable in the cities and towns where there are a number of regenerative receiving sets located within a short distance of each other. Much of the fading and the noise which are thought to be static are caused by the operator of a receiving set who is keeping the bulb in his regenerative receiver in an oscillating condition, thus causing interference.

There are numerous receiving sets which use some system of radio frequency amplification. These do not

cause a great deal of interference and, for the person who is constantly changing or experimenting with different hook-ups, we see no good reason why he should not use a set of this type.

To the users of regenerative sets who have spent a great deal of money installing their receivers and who do not wish to spend the time or money to build or buy additional equipment, the following are general rules and instructions which, if closely adhered to, will keep a regenerative receiver from interfering with reception by their neighbors.

A regenerative receiver does not re-radiate except when the detector bulb is in an oscillating condition. When the bulb is oscillating, reception is not clear and before it can be cleared up, the bulb must be brought down below the oscillating point. This can be done in numerous ways with the different types of receivers. With the ordinary three circuit receiver, if the bulb is tuned down low and the tickler adjustment loosely coupled, the set will not re-radiate. One reason that the operator turns his bulbs on full is to enable him to hear the carrier wave from the different stations which he is trying to pick up. With almost any type of receiving set this is unnecessary and if the operator will get the bulb set at the proper point, get the coupling of his tickler coil at the proper place, and then tune with the balance of his tuning controls, he will find that he can pick up distant stations without causing interference with other receiving sets.

As there are many different types of regenerative receivers it is difficult to give detailed instructions on just how to keep all of them from oscillating; but, one thing to remember is that when your set is squealing or howling, this same sound is heard in all receiving sets which are in operation in your immediate vicinity.

Drivers of automobiles are oftentimes told that "Courtesy will prevent accidents." Courtesy in the air will also prevent interference with your neighbor and when op-

erating a set a good thing to remember is "To do unto others as you would have others do unto you."

25. **SINGLE COIL CRYSTAL SET:** One of the simplest types of receiving sets is the single coil crystal set. Explanation of the operation of a crystal detector was explained in the last chapter. It was shown how the crystal works as a rectifier of the incoming alternating current wave. In previous chapters it was also shown how some type of tuning device must be provided to make up for lack of wire in the aerial and ground leads.

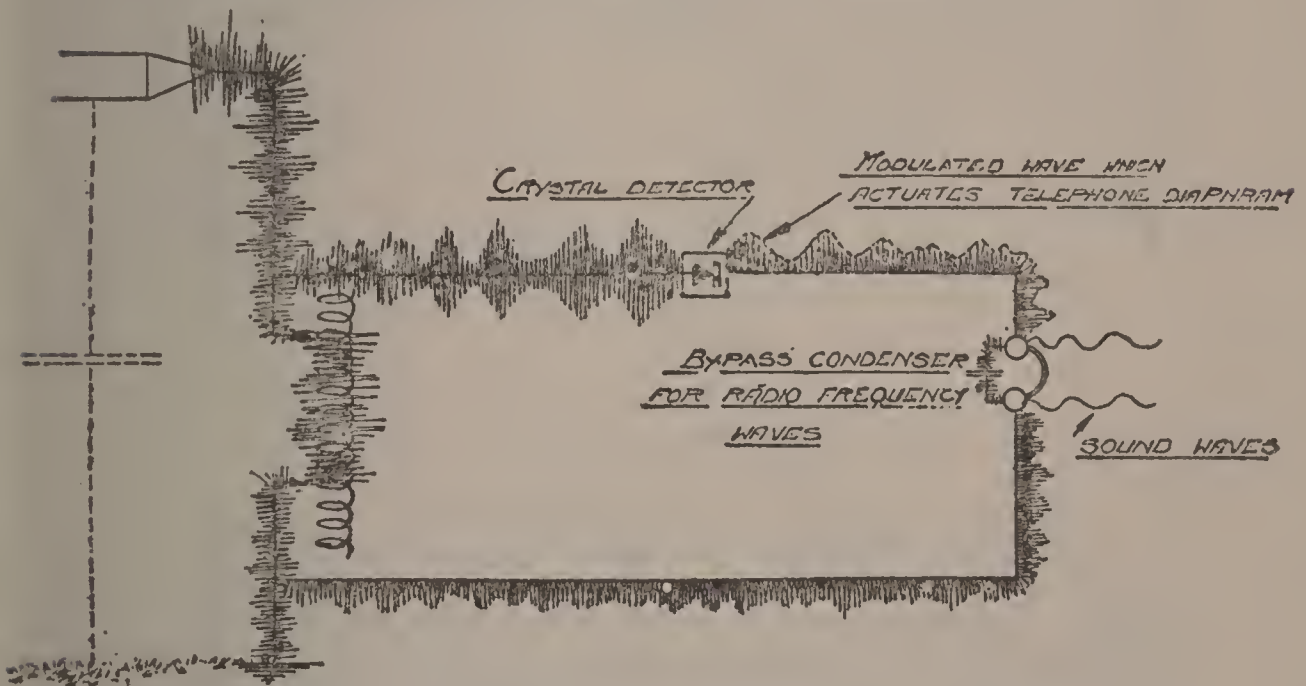

Fig. 35—Theoretical Operation of Crystal Detector Circuit.

With crystal detector sets all sorts of tuning devices are found. The simplest and most commonly used types are the two slide tuner and a single coil of insulated wire which is tapped, and can be varied by using a switch arm and contact points connected to the various taps. In Fig. 35 is shown how a radio wave travels theoretically and how the aerial and ground, acting as a condenser, picks up this wave. The coil tunes the set to the proper frequency, the crystal detector turns the alternating wave

into a direct current pulsating wave, and the modulated wave, which is made up by changing the amplitude of the carrier wave, actuates the telephone receiver, which in turn produces a sound audible to the human ear. In Fig. 36 is shown a schematic drawing of this same type of crystal detector set. If the beginner is at all confused in reading schematic drawings, it will be best for him to study this simple type of drawing and compare it to the drawing in Fig. 35. In the next chapter symbols are also shown in connection with pictures of various radio parts used in making up receiving sets, and reference can also be made to these.

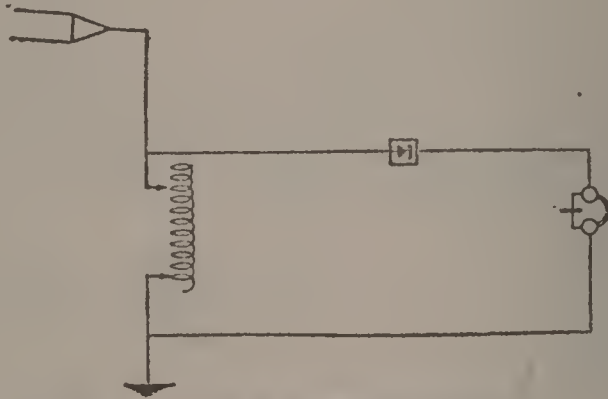

Fig. 36—Crystal Detector Circuit.

26. TWO COIL CRYSTAL SET: The two coil crystal set is similar in operation to the single coil crystal set explained in the previous paragraph. The difference is that a second winding is introduced. The primary or first winding is placed between the aerial and ground, and when tuned in resonance with the incoming wave and the secondary winding is tuned in a like manner, oscillations will be present in the secondary winding the same as though only one coil were used. The advantage to be had with a two circuit crystal set is sharpness of tuning or selectivity.

Some method is generally provided for tuning both coils. When using a loose coupler for a two circuit crystal set, the primary or outside coil is generally tuned by the

use of a slider connected to the aerial or ground lead and the secondary or inside coil is tuned by being tapped or by being shunted by a variable condenser.

When using spider web or honeycomb coils, variable condensers are generally shunted across or put in series with either one of the two coils. In Fig. 37 two drawings are shown. The one set at "A" is a drawing that would be used for two ^{coil} crystal set using a loose coupler and the one at "B" would be used in building a set using honeycomb or spider web coils.

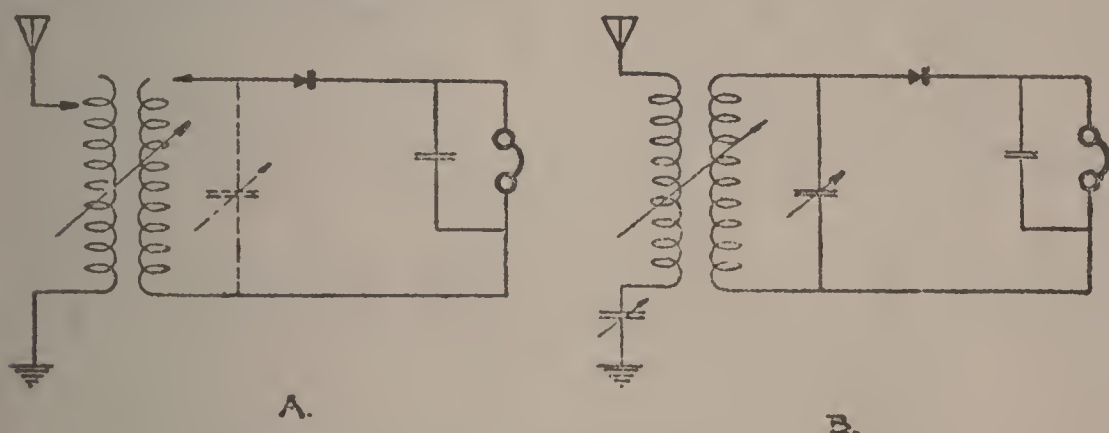

Fig. 37—Two Coil Crystal Detector Circuits.

In all crystal detector sets there are only three major units; the tuning device, the crystal detector and the phones. The coil tunes the set to the wave, the crystal detector changes the alternating current wave to a direct current pulsating wave and the modulated wave which is made by changing the amplitude of the carrier wave actuates the receivers, thus producing sound.

27. SINGLE CIRCUIT NON-REGENERATIVE SET: The single circuit non-regenerative set works similar to the crystal detector set only that instead of using a crystal detector to rectify the electric current oscillations, an audion bulb is used. Compare the drawing in Fig. 38 to the Crystal drawing in Fig. 36 and it can be seen that they are the same except that in Fig. 38 an audion bulb is included in place of the crystal. This type of set is not in

general use because by using different methods of feed back amplification the efficiency of the set can be increased without much additional expense. The audion bulb is, however, a much better detector and a set using a bulb as a detector will have a greater range than one using a crystal.

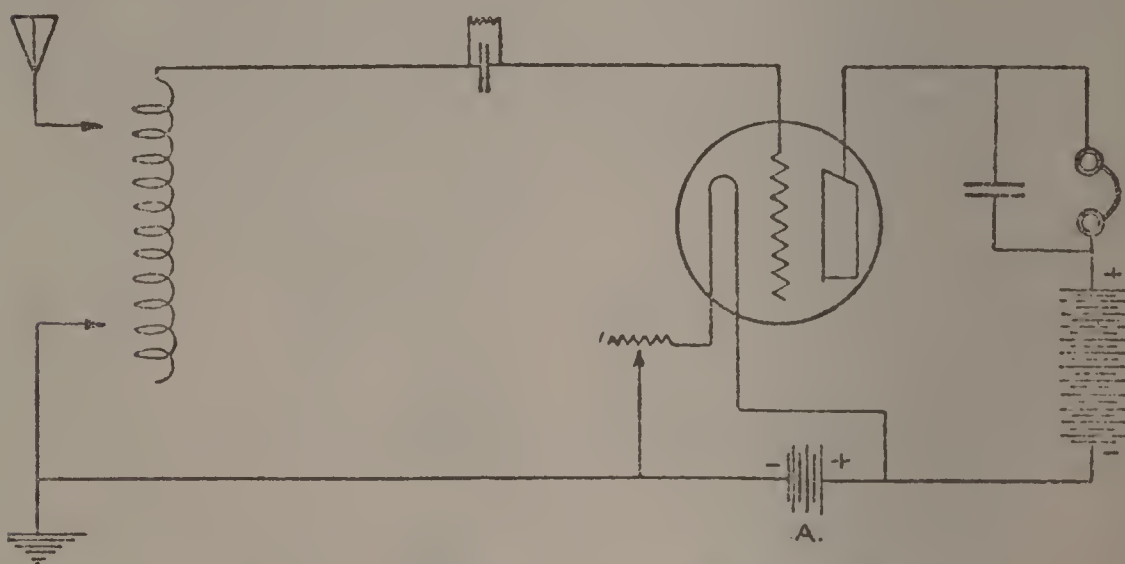

Fig. 38—Single Circuit Non-regenerative Hook-up.

28. **TWO CIRCUIT NON-REGENERATIVE SET:** The two circuit non-regenerative set uses two coils for tuning the set in resonance to the incoming wave. The first or primary coil is composed of the wire between the aerial and ground and the second or secondary coil is placed close to the primary and when tuned in resonance with the primary an E.M.F. or electromotive force will be set up in this coil similar to the one present in the primary. The two circuit receiver can be made from many different types of apparatus. When a loose coupler is used, the outside coil or primary is tuned by either using a slider rod with a slider to vary the number of turns or by being tapped and the inductance changed by using a switch lever. Additional tuning may be had by placing a variable condenser in series or shunted across the coil. The secondary of the loose coupler is the tube which slides

in or out of the primary and must also be provided with a system of tuning.

Another tuning device used for a two-circuit is a Vario-coupler, where the outside coil is the primary and the rotor is the secondary. As the rotor is a fixed inductance it is generally shunted by a condenser so that it can be tuned.

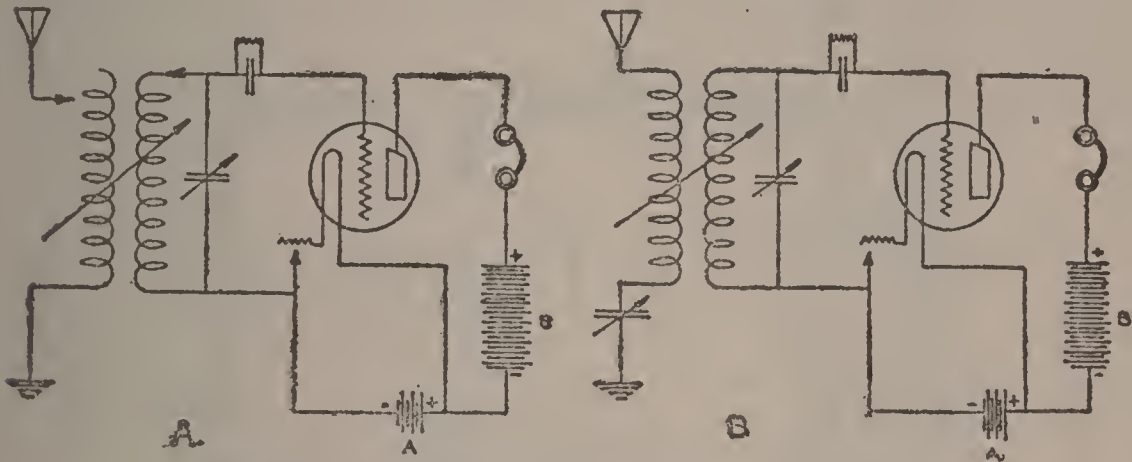

Fig. 39—Two Coil Non-regenerative Circuits.

Other coils that can be used are honeycomb or spider web coils. As these are not generally tapped, condensers must be used for tuning. Fig. 39 shows two drawings. "A" uses either a loose or vario-coupler and "B" either honeycomb or spider web coil.

The two circuit non-regenerative set has very few advantages over the single circuit non-regenerative type and today it is not used. It is very sensitive but does not have a great range especially when compared with any of the regenerative types of receivers. An explanation was given so as to make it easier to explain different regenerative sets.

In order to familiarize the reader with the different symbols used in schematic drawings, explanation of a few symbols used will be given. The arrow which is shown attached to the aerial wire and close to the coil means that there should be some method of varying the number of turns of wire on the coil. The long arrow across the

two coils means that the two coils should have some method of varying the relationship between each other. The arrow across the condenser means that the capacity should be capable of being changed by moving the plates of the condenser closer together or farther apart.

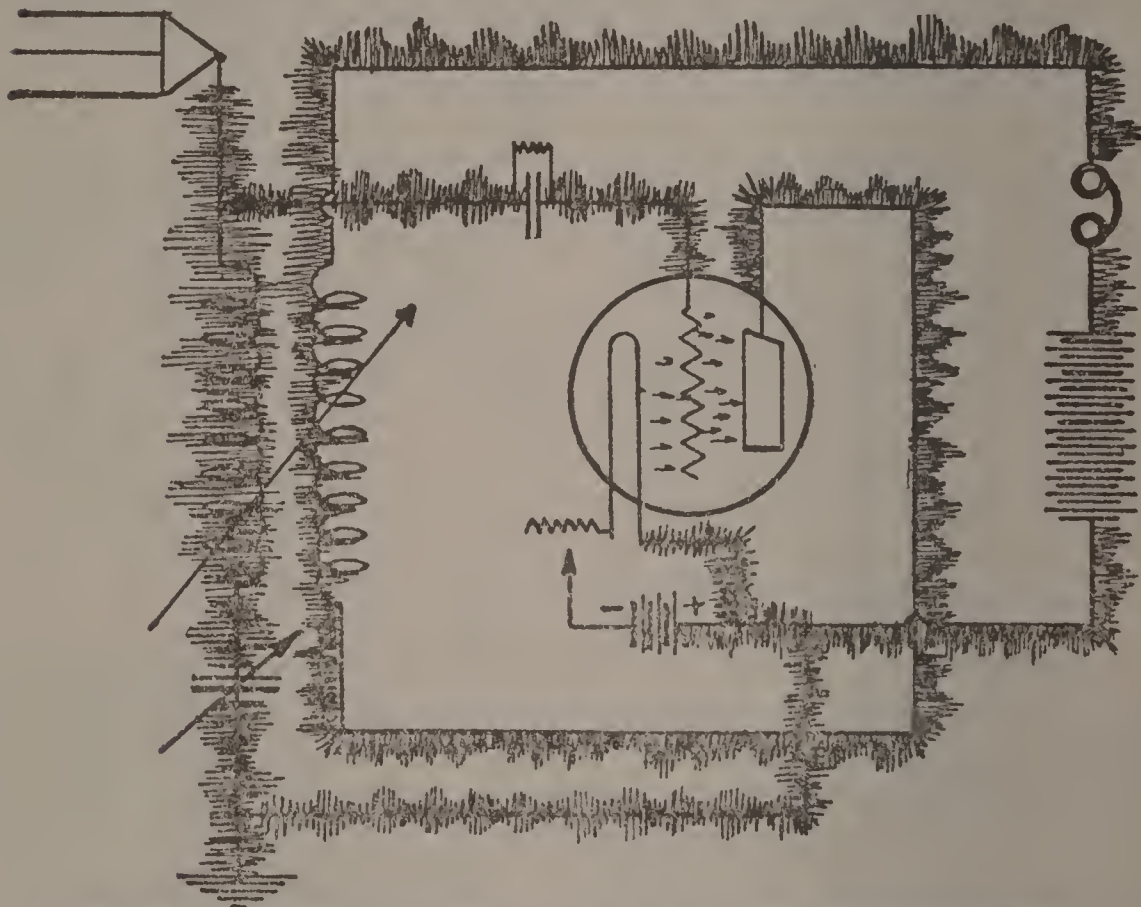

Fig. 40—Theoretical Operation of Single Circuit Regenerative Set.

29. SINGLE CIRCUIT REGENERATIVE SET: There are probably more single circuit regenerative sets in use today than any other one particular type of set. The method of wiring these and the apparatus used varies greatly, but the general principle of the operation of all of them is the same. This set consists of some type of tuning device fastened between the aerial and ground and the regenerative action is had by inserting a separate variable inductance in the plate circuit or by using another coil placed in close relation to the tuning unit for the feed

back effect. The set is very efficient for use with just one bulb but is not at all selective and a great deal of agitation has been started to do away with it due to its being one of the worst offenders or re-radiators in existence.

This set will not re-radiate and interfere with the reception by other people unless the bulb is in an oscillating condition. If the tickler coil is kept quite a distance away from the tuning coil or loosely coupled, and the detector bulb is turned down fairly low, good reception can be had without the set sending out oscillations over the receiving antenna.

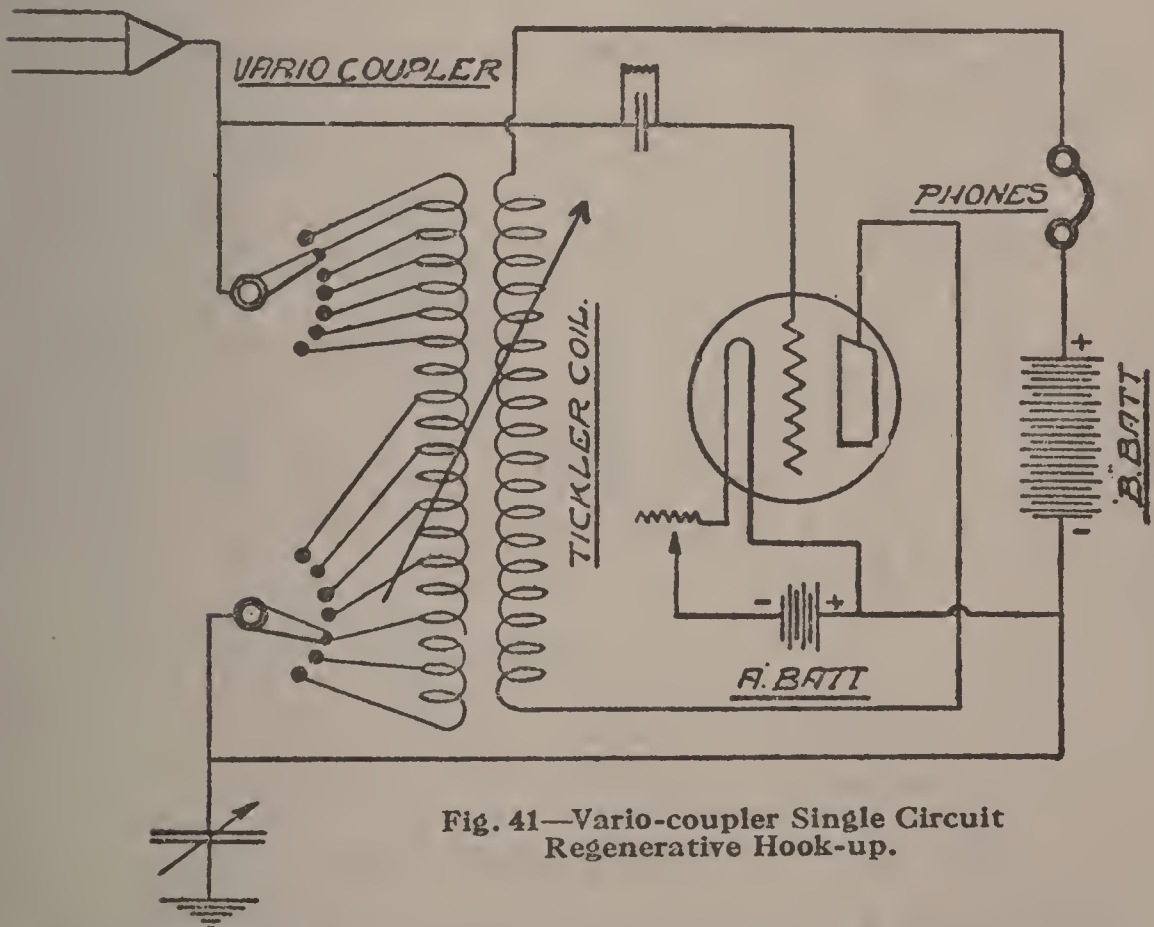

Fig. 41—Vario-coupler Single Circuit Regenerative Hook-up.

Many types of tuning units are used for building up single circuit receivers. The most common is the vario coupler, where the outside of the coil is used as the tuning coil and the rotor as the tickler, which is connected in the plate circuit.

Three figures are given in connection with single circuit regenerative set. The first of these, Fig. 40 gives the theoretical idea of the feed back action. Fig. 41 gives the drawing of a single circuit regenerative set such as would be used with a vario-coupler and Fig. 42 shows the same hook-up only that instead of using vario-coupler, two spider web or honeycomb coils are used.

Sometimes single circuit regenerative sets are built which have a direct wire running from the plate circuit to the aerial. This is known as the ultra audion circuit.

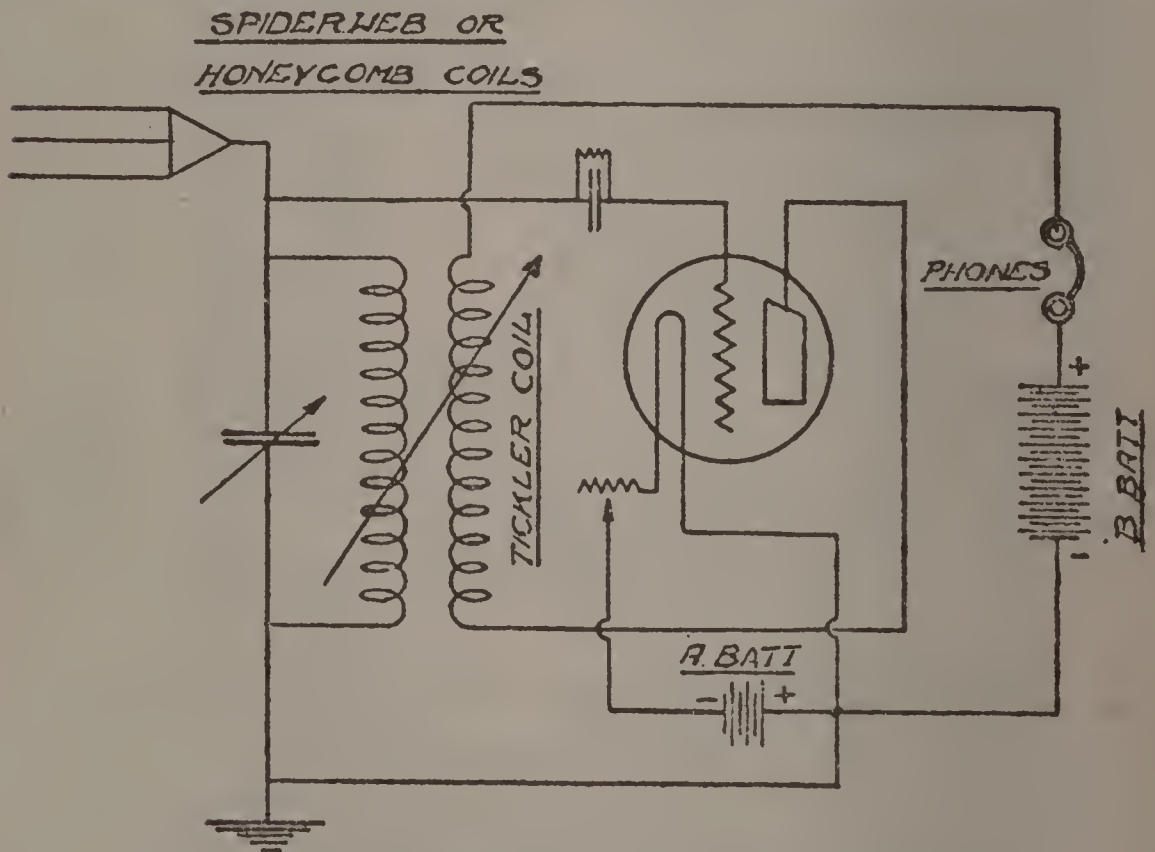

Fig. 42—Two Coil Single Circuit Regenerative Hook-up.

30. THREE CIRCUIT REGENERATIVE SET: The term three circuit regenerative receiver is generally applied to a receiving set which consists of primary circuit, secondary circuit and tuned plate circuit. Primary and secondary windings can be of various types. The

outside winding of a vario-coupler is sometimes used and is generally tapped and tuned by varying the number of turns between the aerial and ground. Oftentimes a variable condenser is also placed in the aerial or ground lead to give a finer tuning arrangement. The rotor of the vario-coupler is used as the secondary and is generally tuned by shunting with a variable condenser or by using a variometer in series with the windings of the rotor and the grid. Sometimes both a variometer and a variable condenser are used. In the third or plate circuit some type of variable inductance such as a variometer is introduced.

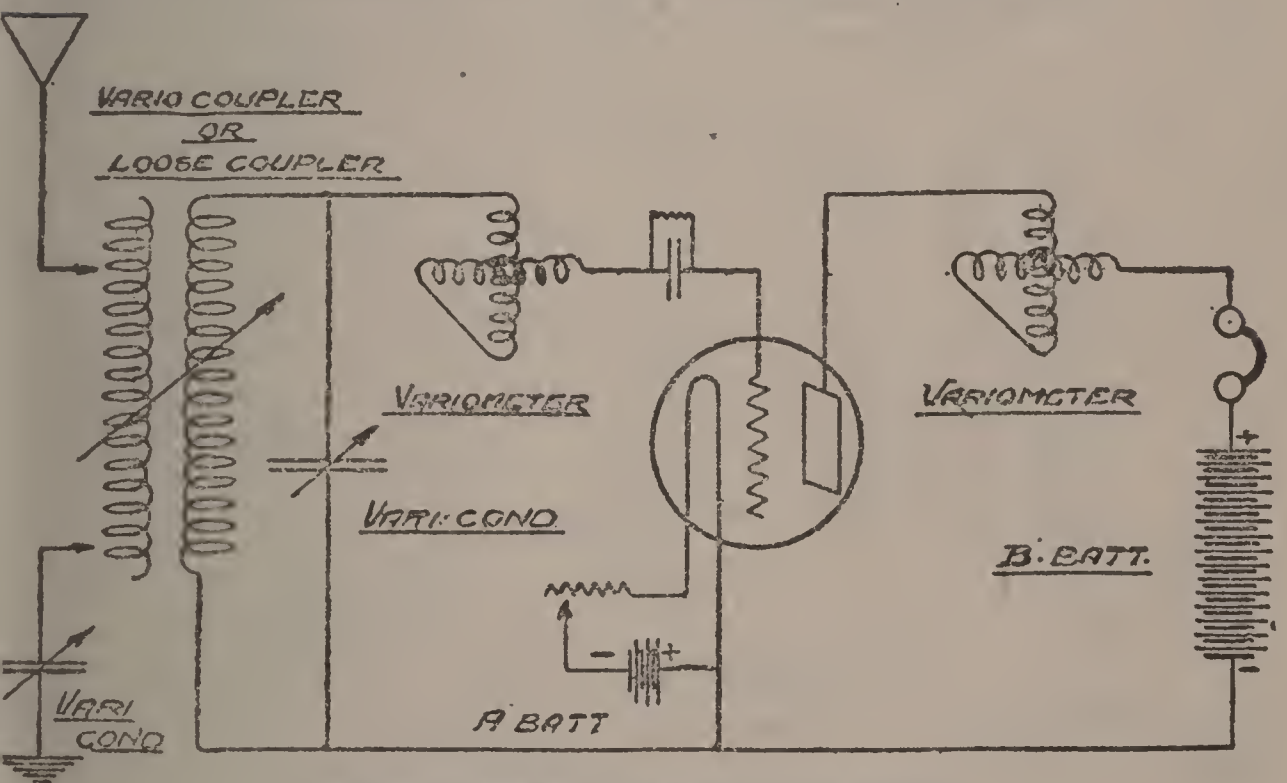

Fig. 43—Standard Three Circuit Receiver.

Another type of three circuit receiver which is often built is one using three honeycomb or three spider web coils in place of the vario coupler and variometer. One of the coils is placed between the aerial and ground and is tuned by shunting or placing a variable condenser in series with it, the second coil is used as the secondary and is tuned by shunting a variable condenser across the coil.

A third coil is used as a tickler and the regenerative action is controlled by some method of coupling or varying the coil in its relation to the secondary coil.

Three circuit receivers do not re-radiate as easily as the single circuit regenerative sets but they will re-radiate to some extent. The only way this could be entirely eliminated would be to put one or more stages of radio frequency amplification in front of the detector bulb. Several articles have been written regarding the feasibility of

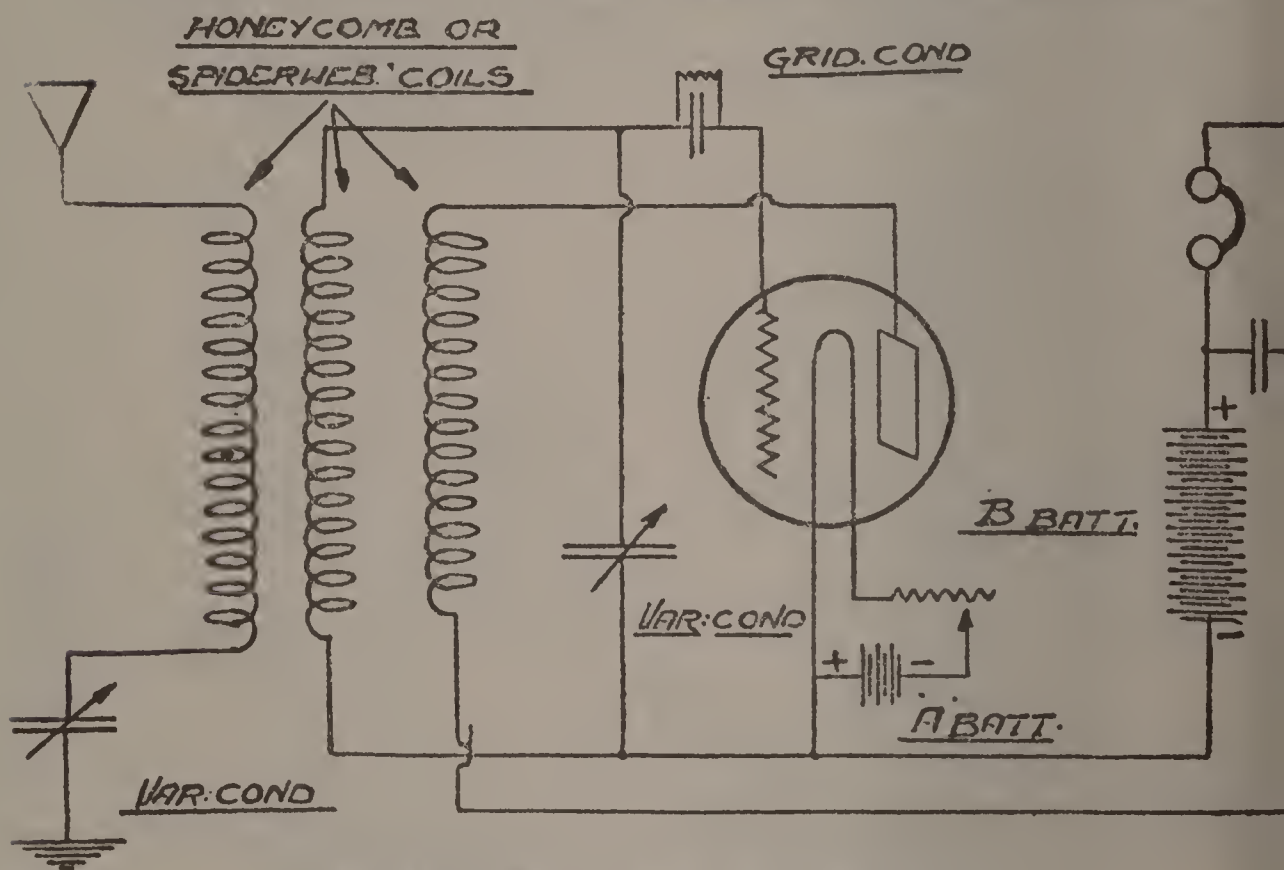

Fig. 44—Three Coil Regenerative Receiver.

using radio frequency amplification with regenerative sets. In certain cases manufacturers have successfully made sets using this method, but for the ordinary amateur it is thought best to stick either to straight regeneration or to a tuned radio frequency set of the Neutrodyne type.

Two drawings are given of the three circuit receiver—the first, Fig. 43 gives the hook-up when using a vario-

coupling obtained between the circuits and the ease with which they may be controlled by the use of the tuning controls. Fig. 45 shows the old standard hook-up using tapped coils, but recent perfections have been made in the circuit whereby taps are eliminated and all tuning done by variable condensers.

32. NEUTRODYNE SETS: One of the most popular types of radio frequency sets being built and sold at the present time is the Neutrodyne on which U. S. Patent No. 1,450,080 has been issued. There have been many arguments regarding the efficiency of two stages of radio frequency amplification and detector as compared to a single circuit single tube regenerative set. Much can be said in favor of radio frequency amplification if it is properly controlled.

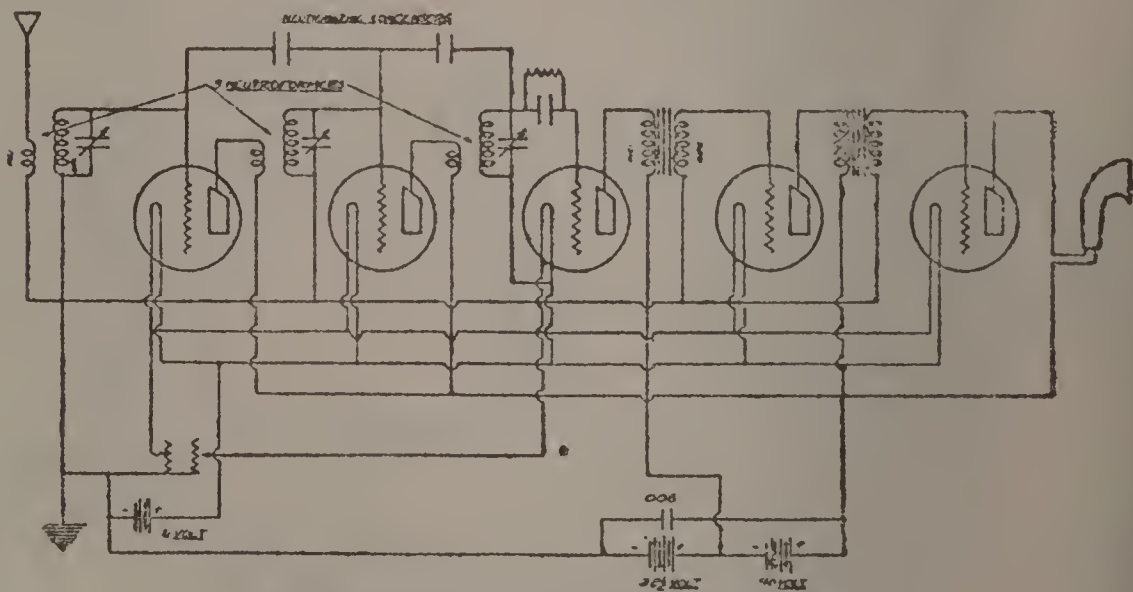
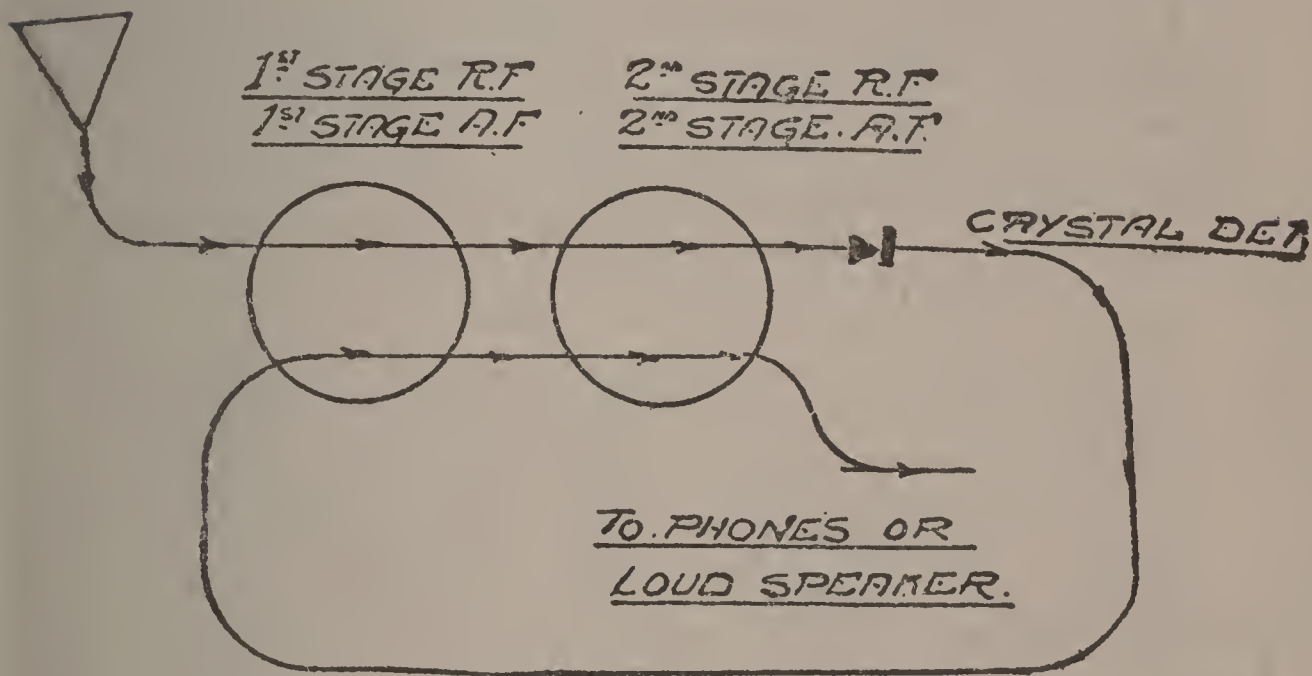

Fig. 46—Five Bulb Neutrodyne Receiver.

Both tuned and untuned radio frequency amplifiers have been used for a number of years. Until just recently however, trouble was generally experienced in keeping the radio frequency bulbs from oscillating. Radio frequency amplification could be controlled better when receiving long waves than it could when receiving short

waves which are used in broadcast work. With the Neutrodyne Prof. Hazeltine devised a scheme for preventing oscillation of the radio frequency bulbs by the introduction of two small capacity condensers placed between the grids of the bulbs, and by the use of specially designed radio frequency transformers.



47—Drawing Showing Reflex Action of Bulbs.

The Neutrodyne consists of the following units—a tuning unit, which is generally the same as the two radio frequency transformers—the first stages of radio frequency amplification and the second stage of radio frequency amplification. The primaries of the tuning unit and transformers is untuned but the secondaries are tuned by shunting them with variable condensers of sufficient capacity to tune the coil over the desired band of wave lengths.

There is this disadvantage in radio frequency amplification—more tubes are used and as all of them will have

to be working in a proper manner before reception is at all clear, this somewhat complicates the operation of the set. The fact that all of the units must be in synchronism before the station is heard makes the set extremely selective and if a set of this type is properly constructed and operated, stations which are operating on almost the same wave length can be separated. Stations which are allotted the same frequency or wave length can be separated due to their not adhering strictly to their assigned frequency thus giving a variation of several meters which will allow the operator with a good set to tune either one of them in. Fig. 46 shows a schematic drawing of the five bulb Neutrodyne using two stages of radio frequency amplification, detector and two stages of audio frequency amplification.

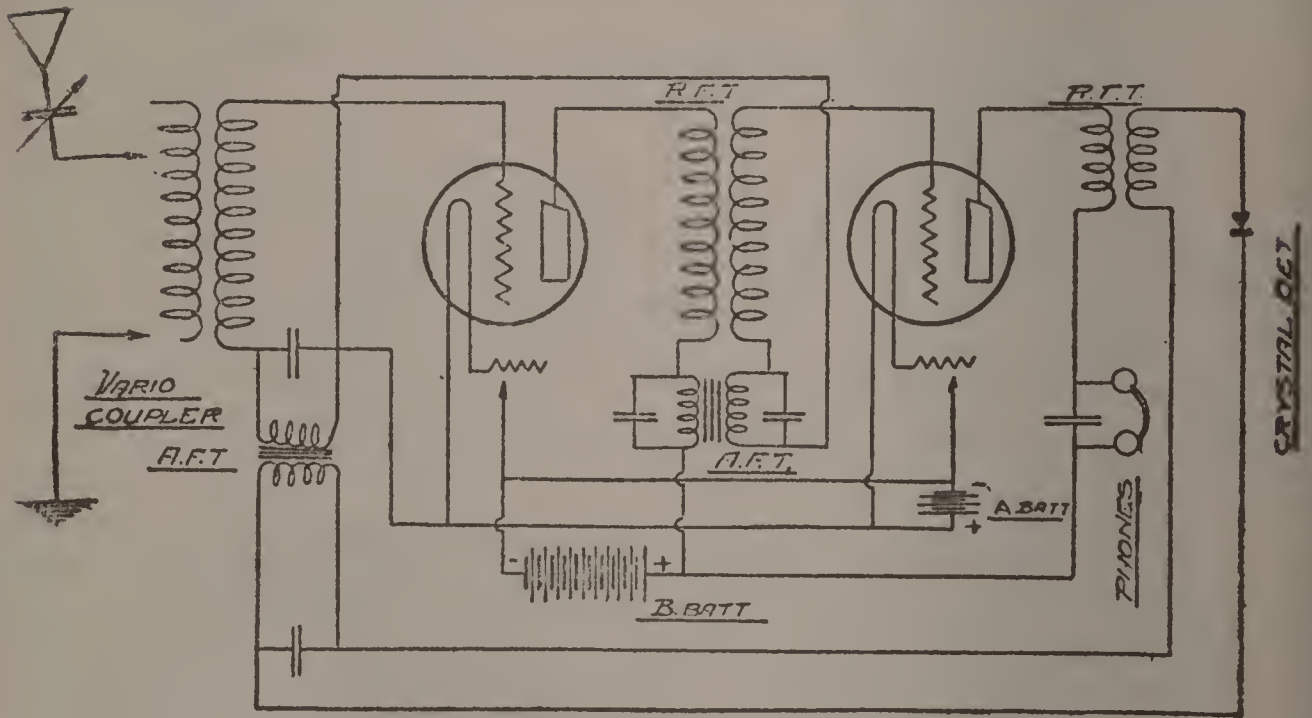

Fig. 48—Two bulb Reflex Circuit.

33. REFLEX CIRCUITS: A short understandable explanation of the complete reflex action is very hard to give due to the fact that the theory of the circuit is extremely complicated. A short understandable explana-

tion will be given however, and it is believed will give the reader a fair understanding of the principles underlying the circuit.

The reflex circuit has become very popular due to its having a duplex action which will give considerable distance and good volume when using only a small number of tubes. In reflex circuits the amplifier bulbs are used for both radio and audio frequency amplification. Sometimes a crystal detector is used for rectification and sometimes an audio detector bulb is used for this purpose. Recently the two element peanut bulb has been incorporated in this circuit as a detector.

In all of the circuits when using one, two or three bulbs, the action is somewhat as that shown in Fig. 47. The incoming radio frequency wave is impressed upon the first bulb or the first stage of radio frequency amplification and then goes to the next stage of radio frequency amplification and then to the detector where it is rectified and passed back through the bulbs again for audio frequency amplification. Not more than three bulbs are generally used because the bulb in the last stage would become overloaded due to its having to carry the maximum amplified current from both audio and radio frequency circuits.

There are many ways of getting the Reflex Action and in some of these the first bulb is used for radio frequency amplification only while the second bulb furnishes the second stage of radio frequency amplification and one set of audio frequency amplification.

Fig. 48 is the drawing of a two bulb reflex set.

34. AUDIO FREQUENCY AMPLIFIERS: Oftentimes audio frequency amplifiers are built and sold in separate units. This type of amplifying unit can be used to amplify any type of sound carrying electrical wave and they also can be used with any type of radio receiving set.

The theory of audio frequency amplification was explained in the last chapter. Audio amplification can be accomplished by using either resistance or by the use of transformers. The type most commonly used is that using transformers for the coupling of the bulbs. These units do not generally consist of more than two stages, as the signals become distorted due to having tube noises, and to the fact that all outside interference is also amplified along with the signal which is desired to be heard.

Audio frequency amplifiers have been the same for many years and the connections which are being used today are the same as was used from the start. Transformers and other materials have changed but the hook-up has not.

35. SUPER-HETERODYNE. The super heterodyne receiver is perhaps the highest type of receiver in general use today. While extreme care must be given to the design and construction of this set and the apparatus used to build it, the actual operation is comparatively simple.

The super-heterodyne was conceived by Major Armstrong soon after the introduction of his regenerative set. It comprises a method of changing the incoming radio frequency wave to one of lower frequency or longer wave length which can be very efficiently amplified by the use of different stages of radio frequency amplification—processes as follows—By the addition of another wave to the incoming radio frequency wave, a beat note of higher or lower frequency may be obtained. By so controlling the added wave, we can obtain a resultant which can be very efficiently amplified.

In Figs. 49A and B schematic drawings of the Super-Heterodyne are given. A two circuit tuner is used with a detector connected in the usual way. The local oscillator is inductively coupled to the secondary of the tuner. This

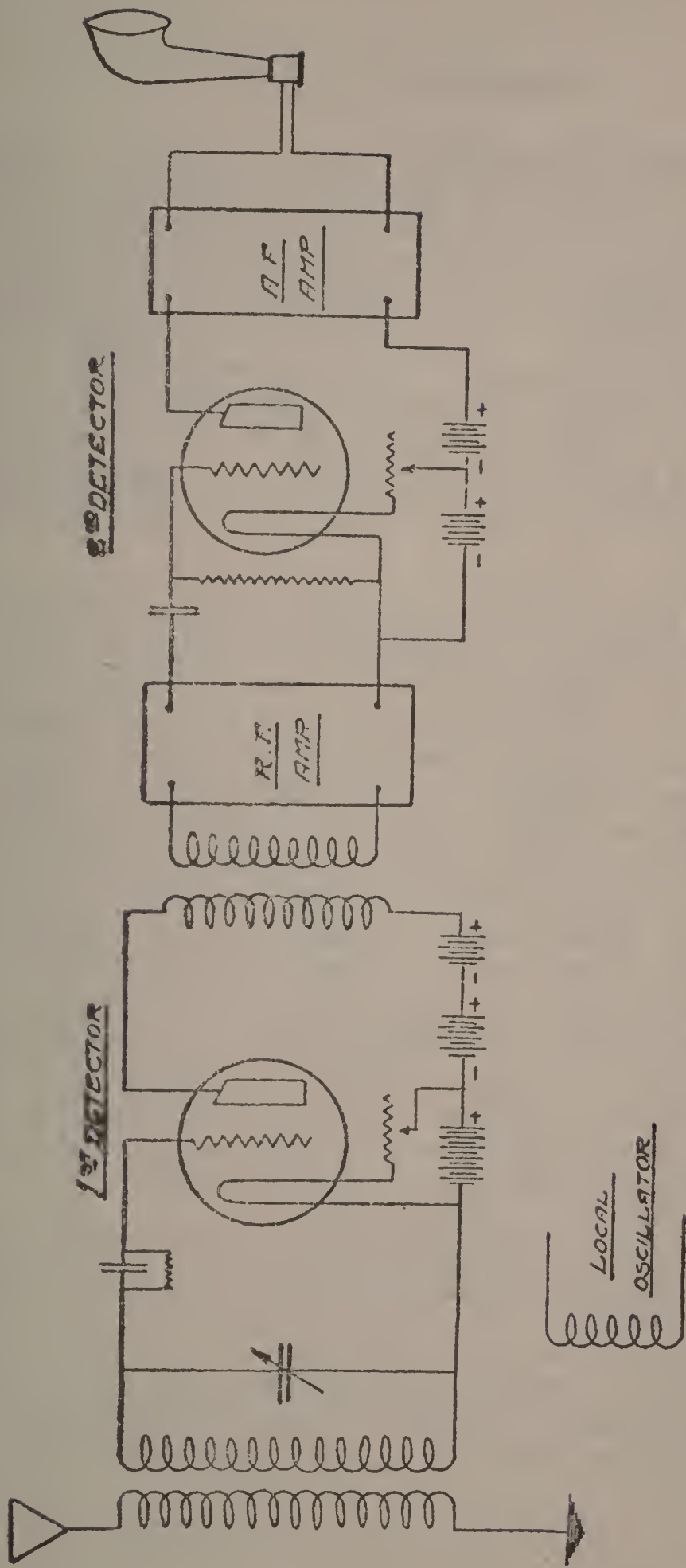

Fig. 49A

Condensed Drawing of Super-Heterodyne.

Note: Radio frequency amplifier unit generally consists of three bulbs and audio frequency unit of two.

local oscillator generates the interfering wave. The radio frequency amplifier is the conventional type excepting that it is designed to amplify at a high wave length. The second detector is necessary because the frequency at which the signal is amplified is still at a higher frequency than can be heard. In practice the R. F. amplifier usually consists of three stages. Two stages of audio are also usually employed. To increase the range of the set, increase the number of stages of R. F. However, eight is about the limit for practical operation. Hard tubes are used for both amplifiers and oscillators but soft tubes for detectors.

36. THE ACMEDYNE CIRCUIT is one of the latest types of tuned radio frequency sets. Recently the name of this set has been changed to "Telemonic". This change was made at the request of the Acme Transformer Company because of the similarity between this name and the name which is given to their transformers. The Acmedyne set is similar in operation to the Neutrodyne set explained in Par. 32 excepting that instead of using fixed inductances tuned by variable condensers for radio frequency transformers, a type of vario-transformers is used. The coils of these transformers are wound in the shape of a figure "D" and consist of a number of these windings wound on cardboard forms. This makes one of the most efficient types of variable transformers it is possible to build. The losses are very low because they do not use variable condensers or have a great deal of metal or dielectric in the electro-magnetic field.

The set was developed by Lester L. Jones and complete units are being made by the Amsco Products Company, Inc. who use the trade name "Melco Supreme" and by other well known radio manufacturers. Parts to build the set are also available so that the fan who wishes to build his own set can do so. The set is neutralized by the use of compensating condensers mounted so that they

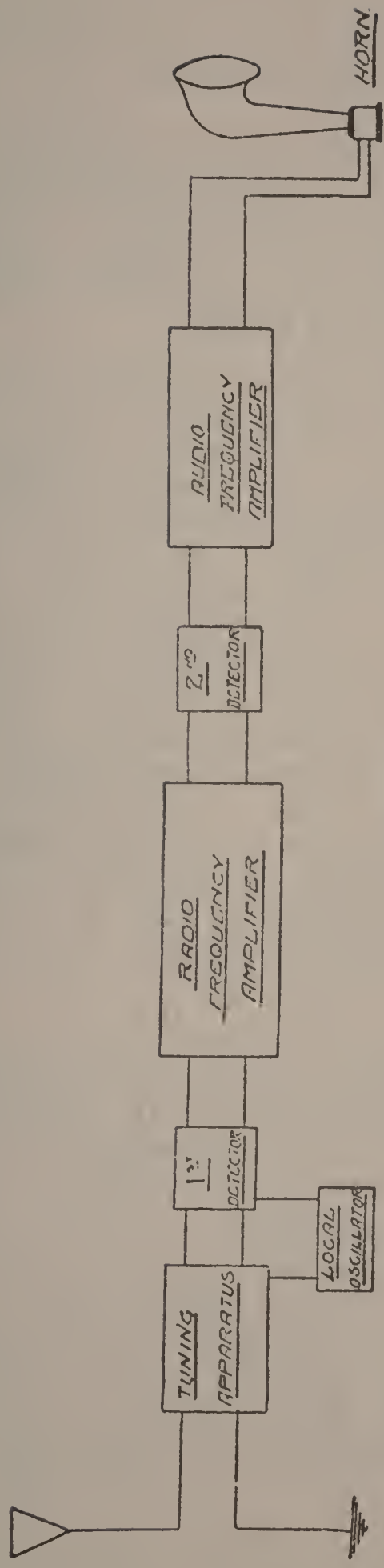

Fig. 49B
Super-Heterodyne Lay-out.

can be readily adjusted for any tubes which might be used. Similar to the Neutrodyne set, all of the controls must be set at the proper place and the vario-transformers and variometers must be working in synchronism before the set will operate successfully. Because of this, it makes a very selective receiver.

Fig. 50 shows a schematic drawing of the set and also the outline of the windings for the vario-transformers. By studying this diagram, it will be noted that the set consists of three major tuning units. The first, a variometer which is constructed similar to the vario-transformers and the second and third; the vario transformers which are used in the radio frequency circuit. As the set gives a strong signal when only using two stages of radio frequency amplification and detector, one stage of audio frequency amplification is only used. For ordinary purposes this is found to give sufficient volume but when this set is used in halls or in the open, some type of power amplifier is generally added. One of the features of the ready built set is the use of a high resistance of 100 ohms to connect the "A" and "B" batteries together. In so doing it is nearly impossible to burn out the filaments of the tubes due to accidental crossing of some "B" battery wires with the filament leads.

The set will work satisfactorily when using an outdoor or indoor aerial, loop or lighting plug. The set can also be calibrated, or the readings for the various stations can be logged and then be referred to when it is desired to pick up the same stations on different occasions.

37. INVERSE DUPLEX: The inverse duplex circuit has been developed in this country by David Grimes of New York City and was adapted from the French circuit developed by an eminent French engineer, Latour. This set is similar to the reflex inasmuch as the bulbs are used for both radio and audio frequency amplifications. The system of passing the current through is somewhat

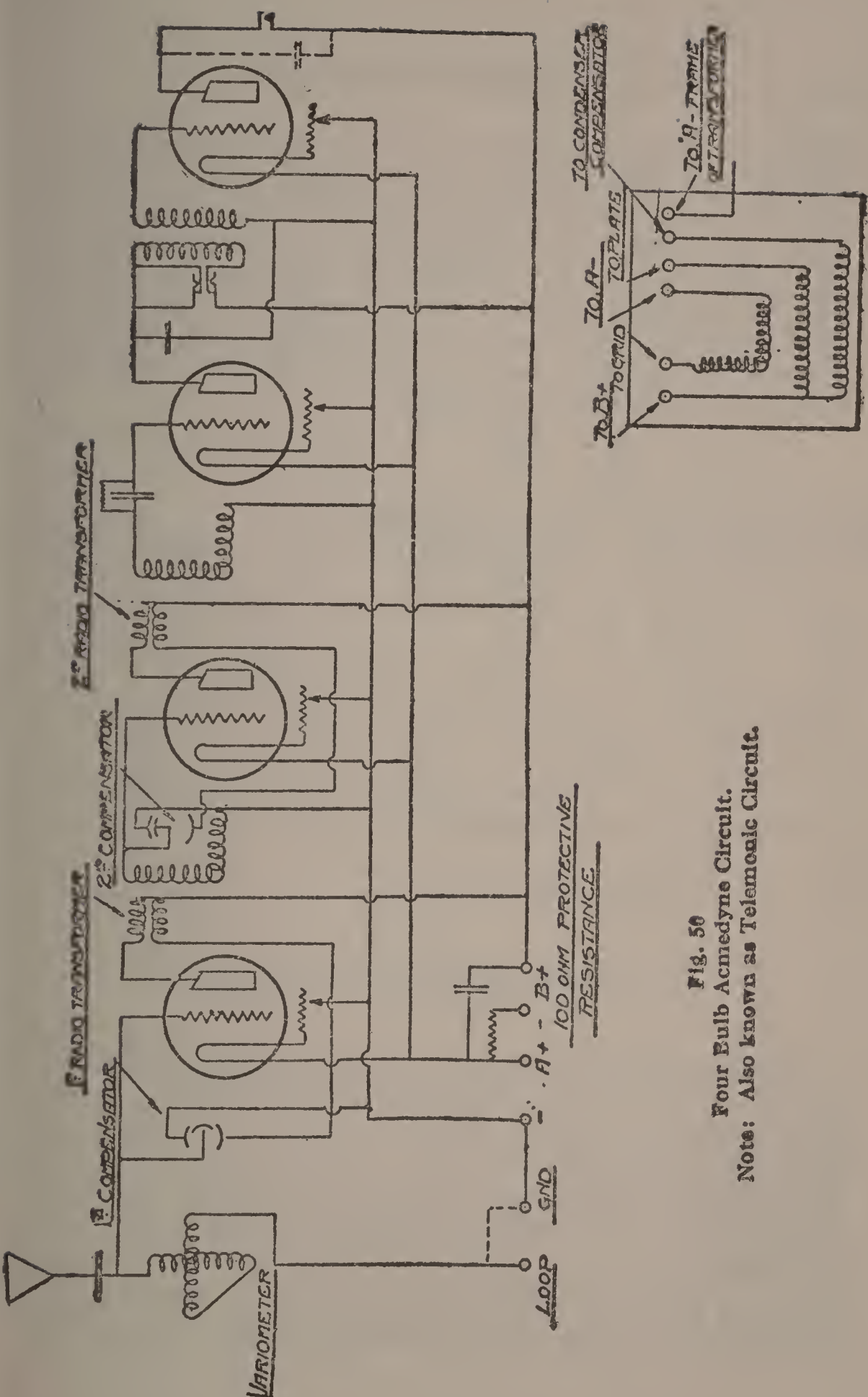

Fig. 50
 Four Eulb Acmedyne Circuit.
 Note: Also known as Telemonic Circuit.

different. As stated in the past paragraphs one of the disadvantages of the reflex circuit was that the last stage would become overloaded due to its having to carry the maximum load. With the inverse duplex set this disagreeable feature is overcome by passing the current through the first stages of radio frequency amplification, then using the last stage of radio frequency amplification for the first stage of audio frequency amplification, etc. Fig. 51 will explain this action.

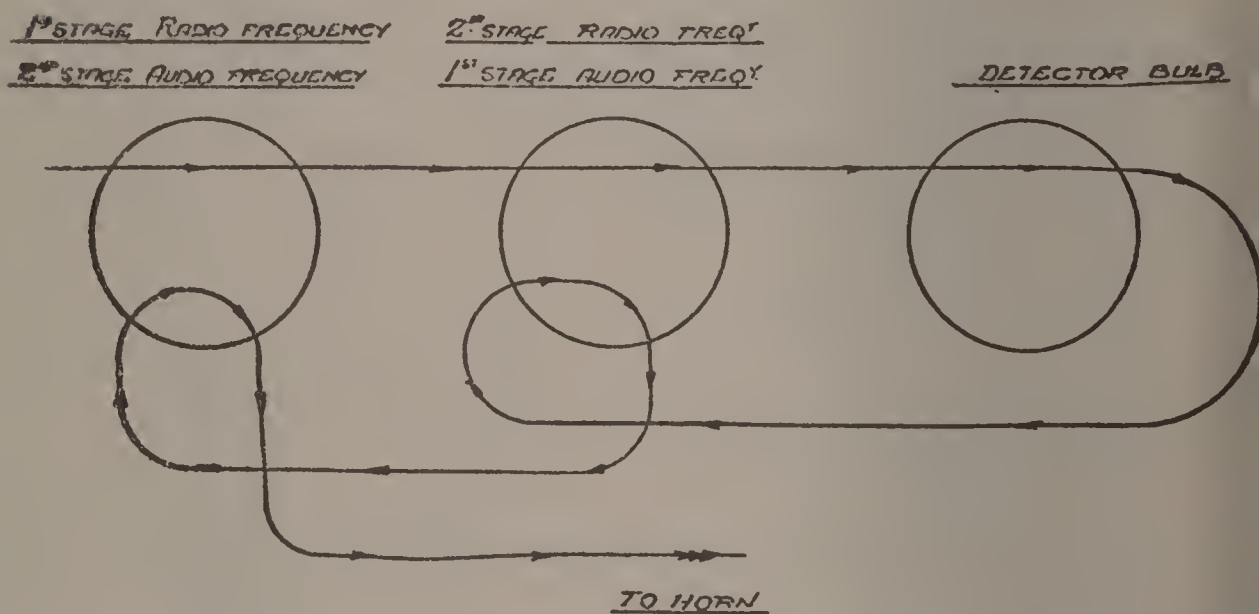

Fig. 51

Drawing Showing Inverse Duplex Action of Bulbs.

The hook-up is being used very much for the construction of portable sets. Tubes of the peanut type can be used and since a good volume and great distance can be had when using only three bulbs, the set will work very well for the experimenter who wishes to build a set in a compact form. If used in connection with a loop only one tuning control is necessary, being the variable condenser which is shunted across the loop. Recently experimental work has been conducted using tuned radio

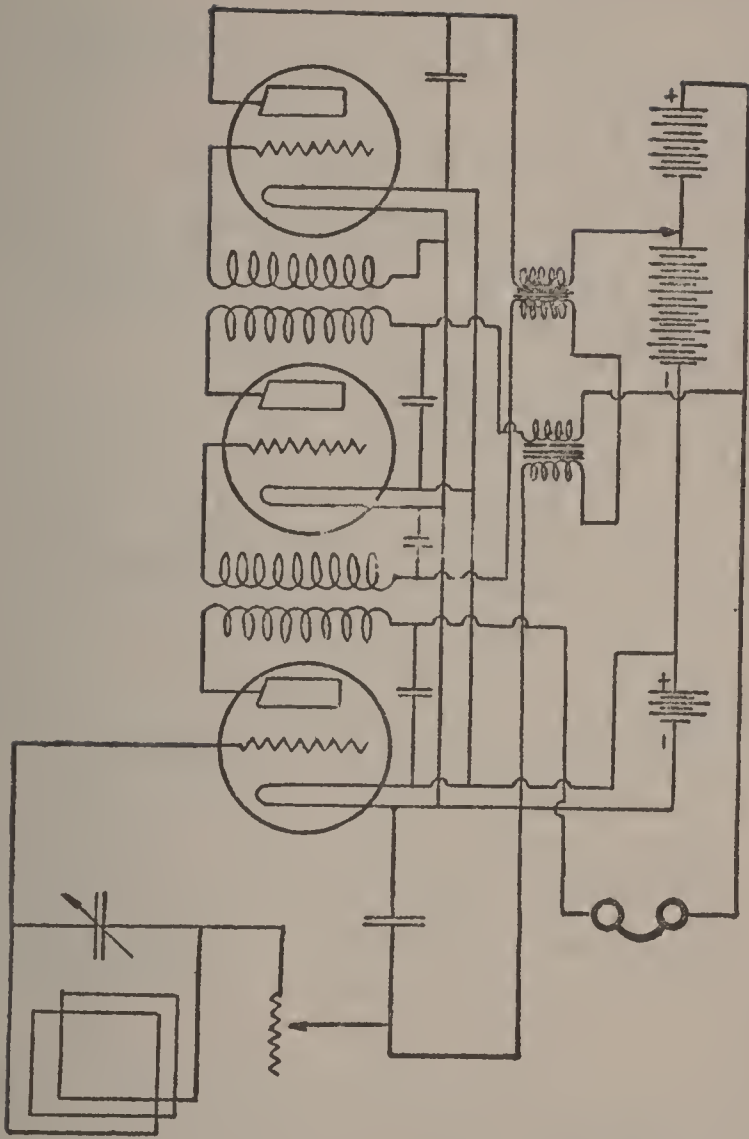

Fig. 52
Three Bulb Grimes Inverse Duplex Circuit.

frequency transformers in connection with an aerial. A set of this type gives extreme selectivity and great distance, only it is very hard to operate and Vernier control is necessary for tuning.

Fig. 52 gives a schematic drawing of a three bulb Grimes Inverse Duplex.

38. RADIO FREQUENCY AMPLIFIERS (TRANSFORMER COUPLED): Radio frequency amplifying units such as shown in Fig. 53 have been used by the Army and Navy of this and foreign countries for a number of years. Sometimes as many as ten or more stages of radio frequency amplification were used, and for use on the higher wave lengths extremely high efficiency could be had when using only a loop for an aerial. As previously explained, the straight transformer coupled radio frequency set does not lend itself well to use on the broadcast wave lengths. This is caused by two reasons—first the radio frequency transformers are designed to give a maximum efficiency on just one basic frequency and as broadcasting stations use quite a range of frequencies it would be very hard to make one of these transformers which would give maximum efficiency over the whole band of wave lengths. The theory of radio frequency amplification when using either tuned or untuned transformers was explained in the past chapters so no more will be said regarding this.

Fig. 53 is that of a seven tube set using four stages of radio frequency amplification—detector and two stages of audio frequency amplification.

39. RADIO FREQUENCY AMPLIFIERS (TUNED) The type of tuned radio frequency amplifier has been explained previously. Both the Neutrodyne and Acmedyne circuits use this principle. One of the old time tuned radio frequency amplifying units is shown merely to give the reader an idea of the different steps through

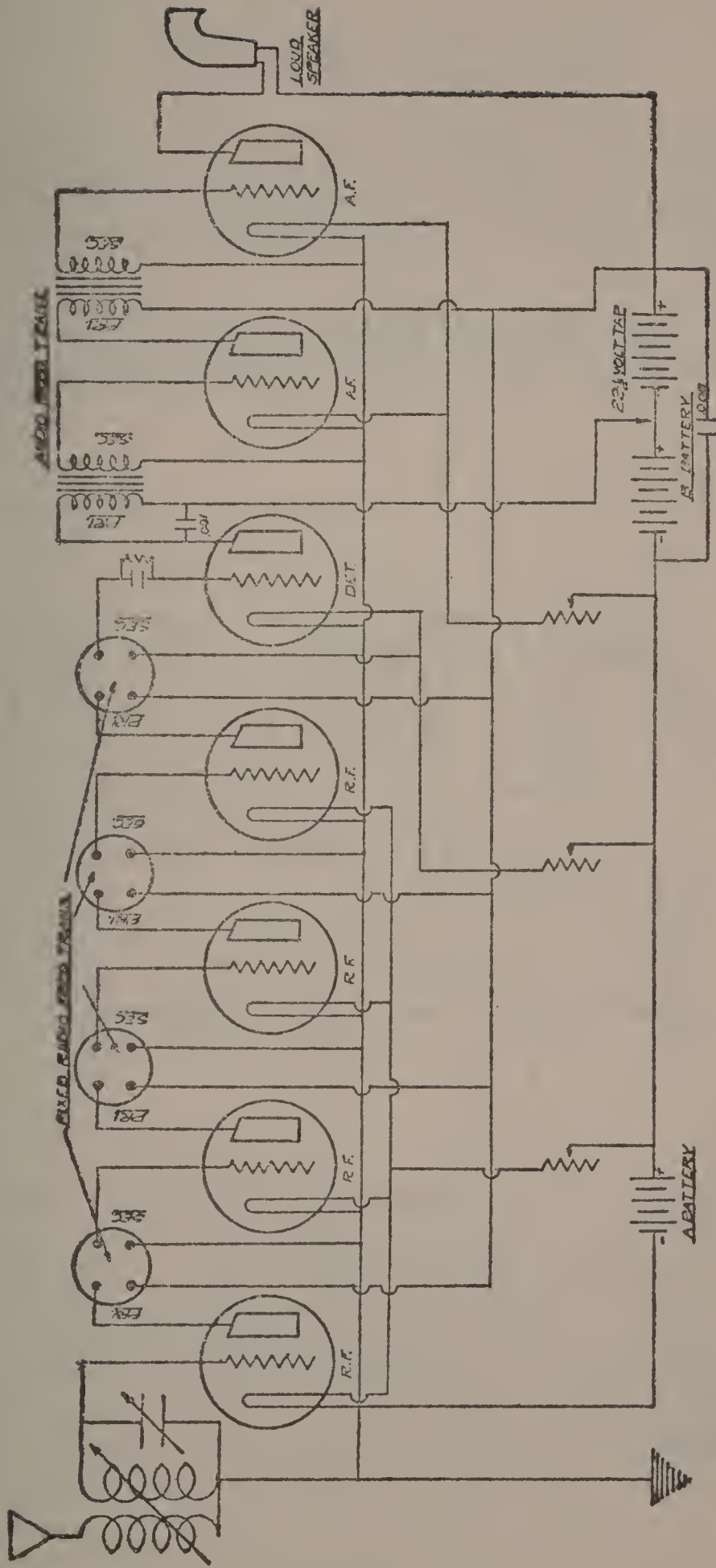

Fig. 53
 Un-tuned Transformer Coupled Radio and Audio Frequency Circuit.

which development has been made. The set shown in Fig. 54 is that of a five bulb tuned radio frequency amplifier using transformers such as was used for this purpose before the introduction of the Neutrodyne and Acmedyne sets.

40. POWER AMPLIFIERS: When wishing to get a great deal of volume such as would be necessary in a

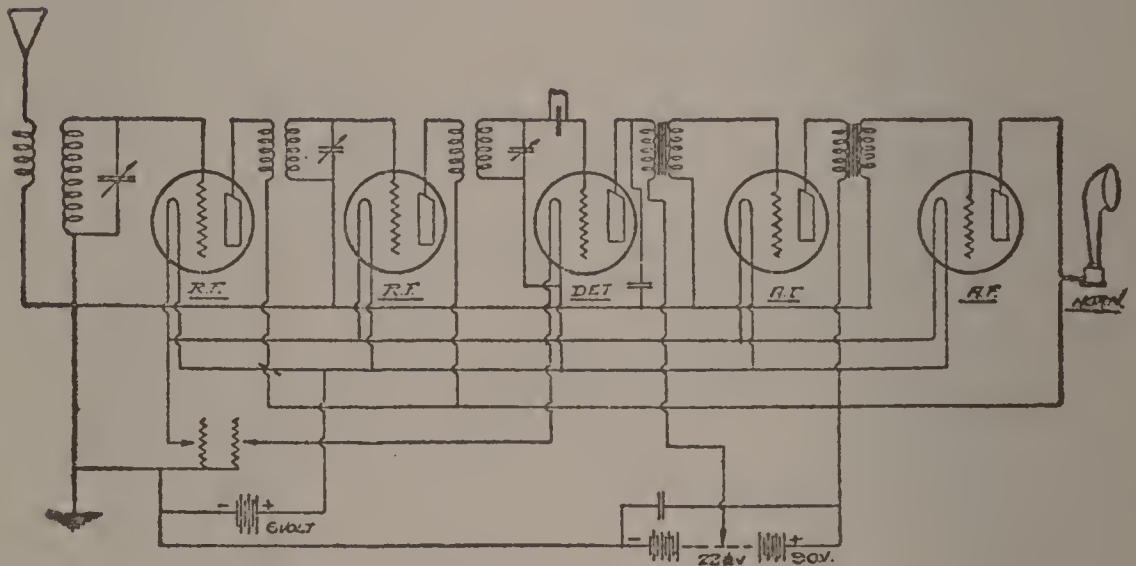

Fig. 54—Tuned Radio Frequency Five Bulb Circuit.

large hall or when used in connection with large gatherings outdoors, radio sets are built which incorporate one or more stages of power amplification. This is no more or less than audio frequency amplification, only that instead of using the common type of audio frequency amplifying bulbs, special bulbs are used in connection with specially designed transformers to give clarity without distortion.

If more than two stages of straight audio frequency amplification were used the last bulb and transformer generally would become so overloaded as to make the signals very distorted. Several types of push pull transformers have been developed for power amplification. These transformers help to keep down the distortion due to having a balanced circuit which uses two bulbs in place of one.

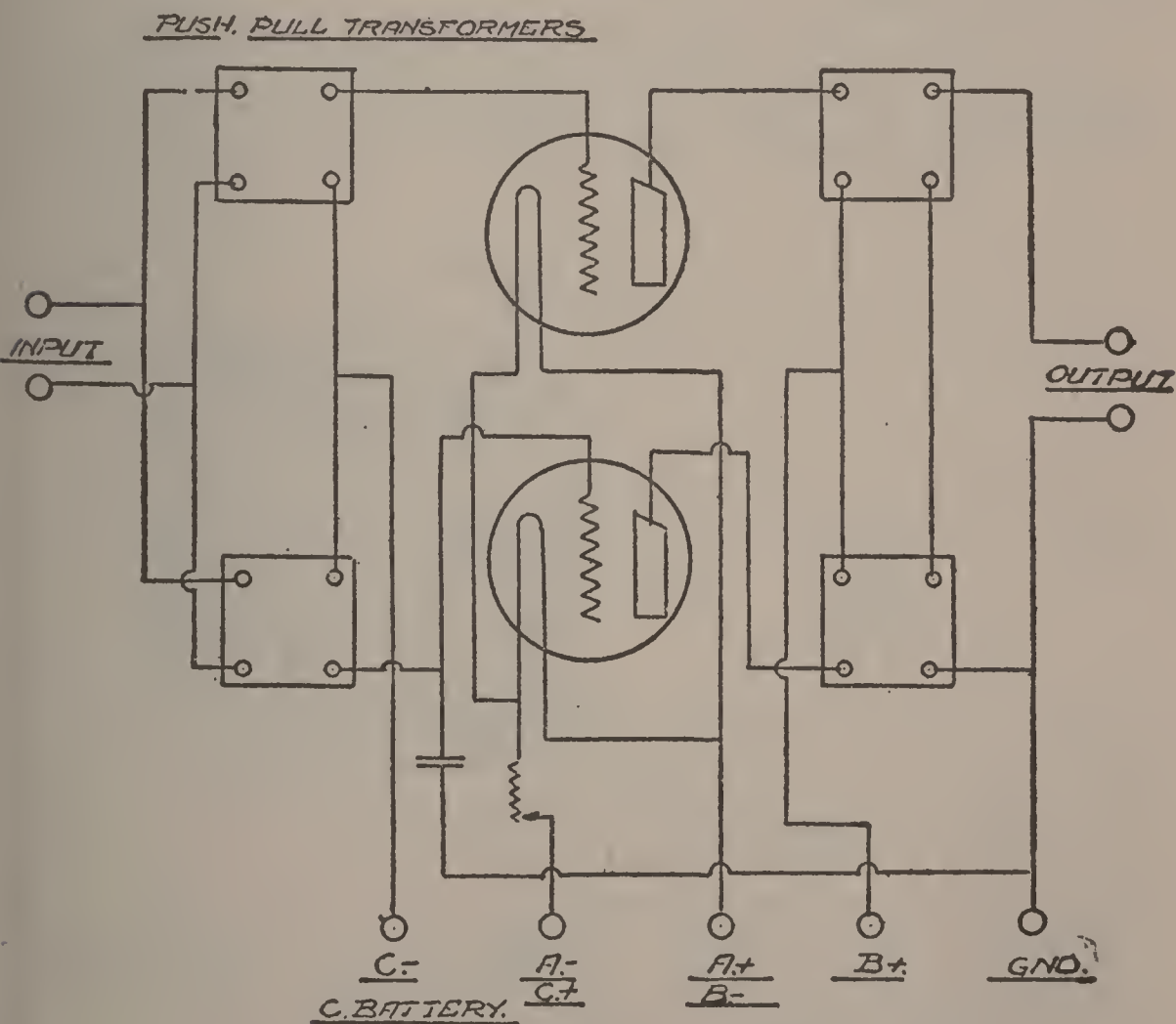

Fig. 55—Two Bulb Push-pull Amplifying Unit.

Fig. 55 shows a hook-up for a one stage power amplification using push pull transformers.

CHAPTER V

USE OF PARTS IN RECEIVING SETS

41. "A" BATTERY: The "A" battery is the one used to light the filament of the audion bulb. The letter "A" has no other significance than that of a definition of the battery.

Certain types of bulbs use a considerable amount of current, in which case it is necessary to have an "A" battery which is similar to the batteries used for starting and

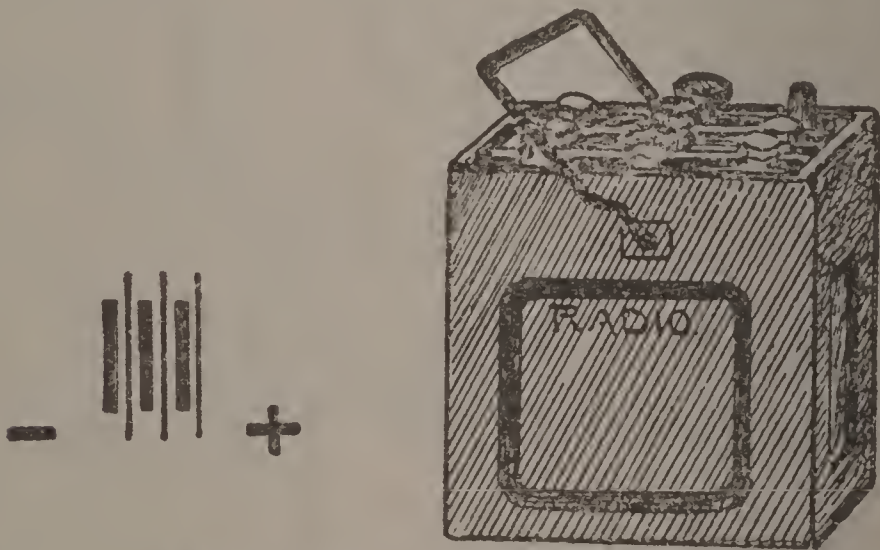

Fig. 56—Radio "A" Storage Battery.

lighting an automobile. Other bulbs use such a small amount of current that it is possible to run them economically with a battery of the dry cell type.

Wet batteries are rated in ampere hours. For instance, the most commonly used in radio work is the 80 ampere

hour battery. This means that it is possible to draw one ampere from this battery for 80 hours of intermittent service, without recharging it. As explained under bulbs, the type 200 or 300 uses from one to one and a quarter amperes so that a battery of the 80 ampere hour type will run a bulb of this kind from 60 to 70 hours. This, of course, is if the battery is fully charged to begin with and the bulb is only used a few hours every day. There are other types of 6 volt bulbs which use only one quarter of an ampere and of course the battery will run these for some time. Nearly all types of wet batteries have a voltage of two volts per cell and if the battery has three cells it has six volts, and if six cells, it has twelve volts. Sometimes automobile batteries are of the twelve volt type, so care must be taken with these to use only three cells with a six volt bulb. The construction of the radio and automobile battery is practically the same so that an automobile battery can be used for radio work. If buying a battery for radio use only, however, it is advisable to have one made specially for this purpose, as an automobile battery is built for a heavier load for short periods of time where a radio battery is built for a small load over a longer time.

"A" batteries of the dry cell type can be used on all bulbs using a quarter ampere or less. The average dry cell has a rated voltage of one and a half volts and .25 amperes for 100 hours. When the bulbs used require more than one and a half volts, it is necessary to connect two or more cells in series.

42. AERIAL INSULATOR: The importance of a well insulated aerial has been explained previously. The efficiency of an aerial is only as good as the insulation used to support same. Much more care must be taken

with the insulation of a transmitting aerial than is necessary with a receiving antenna.

With a receiving antenna, all that is necessary is to use good insulators of the type shown. At times, common 2-wire cleats, such as are used for common house wiring, will do although a porcelain insulator that is glazed is much more efficient in wet weather than one of the unglazed type.

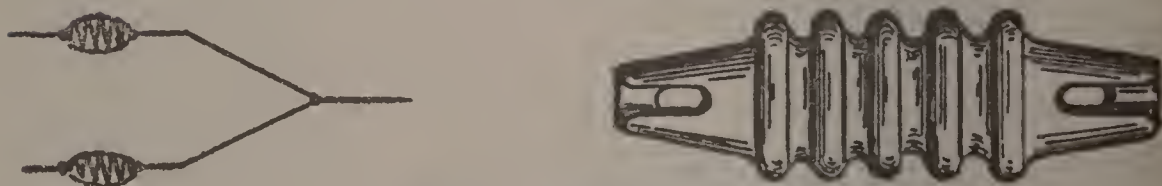

Fig. 57—Aerial Insulator.

43. **AERIAL WIRE:** Many new and novel kinds of wire have been placed on the market for use in receiving aerials. Tests have shown that these were superior only from a sales angle. The buyer was made to believe that because of some fancy twist or turn in the way the small wires were stranded and in the way they were fastened together, that it was superior as a carrier of high frequency current. Tests made by some of the more experienced engineers of the country have proven that these claims were not always based upon facts. It may be said that for all ordinary purposes the solid No. 14 B & S gauge

bare copper wire will give as good results as many of the high priced kinds. Steel wire which is given a copper plating is also satisfactory and also has the added advantage of being much stronger. It has also been brought out that enameling of the wire keeps it from corroding and consequently keeps down skin resistance. This enameled wire is to be had both stranded and solid.

43A. "B" BATTERIES: "B" Batteries, as well as "A" batteries, are of two kinds; wet and dry; but as the plate current required for each vacuum tube is very small the most commonly used type is a number of dry cells

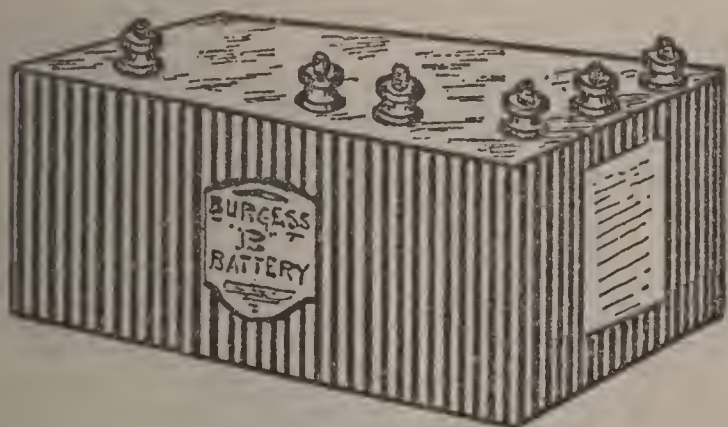

Fig. 58
Dry "B" Battery.



hooked up in series. These can be purchased in block form from $4\frac{1}{2}$ to 113 volts and of various capacities. There is not much to be said of this kind of a dry cell battery excepting that some makes have a much longer life than others and that batteries will become deteriorated or

discharged whether used or not. A good battery should have a shelf life of at least six months. Under ordinary use they should last the same length of time. Poor "B" batteries cause noises and sometimes frying sounds heard in the receivers is being caused by defective "B" batteries. These noises are oftentimes mistaken for static.

It is best to discard dry "B" batteries when they test 70 percent of normal.

44. "B" BATTERIES—CHARGEABLE: Chargeable "B" batteries have the advantage of being very quiet and can also be kept up to efficiency by having them

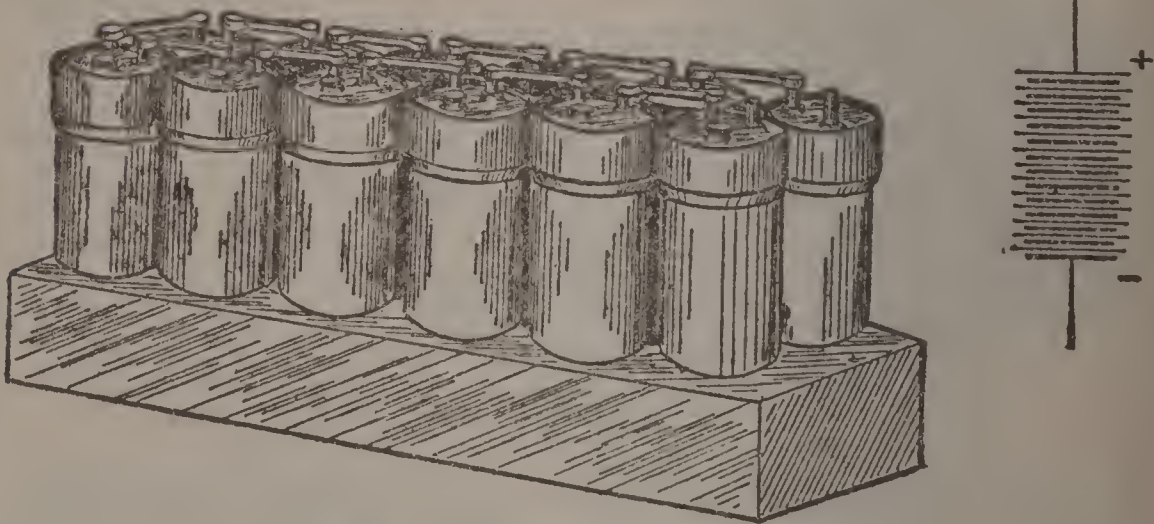

Fig. 59—Storage "B" Battery.

charged from time to time. It is always advisable to have a voltmeter to test batteries occasionally as this is the best way to tell whether or not they are giving efficient service.

The wet or chargeable batteries are sold singularly or in units of twelve cells or twenty-four volts.

45. **BATTERY CHARGERS:** Numerous manufacturers are making battery chargers which can be used in the home for charging both radio and automobile batteries. If the electric current used for lighting purposes is D. C. or direct current, a battery charger is not necessary as a few lamps in series with a 110 volt line is all that is necessary to charge an ordinary radio or automobile battery. When the current used is A. C. or

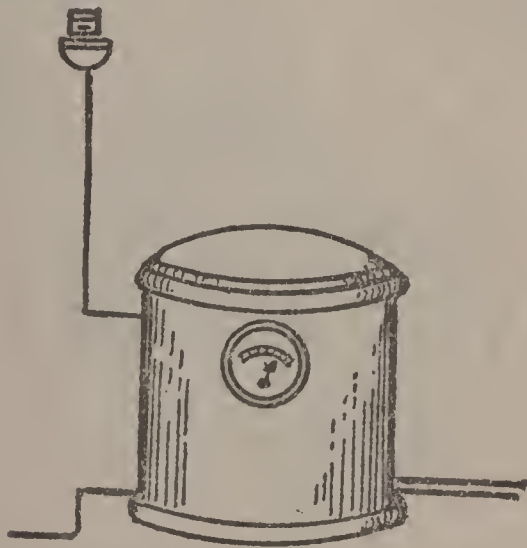

Fig. 60—Storage "A" and "B" Battery Charger.

alternating current, it is necessary to have some sort of mechanical, chemical or vacuum tube rectifier. Mechanical types generally have a much higher charging rate but are very noisy. Chemical chargers are the cheapest kind but ordinarily have a low charging rate and are very disagreeable to have around. The vacuum tube type has many superior advantages although for daily work they are quite expensive. A battery charger which is constructed so that the "B" batteries can also be charged is to be recommended.

46. **BEZELS:** Bezels, which are sometimes used in radio panels, serve two purposes; first, as a ventilator for the cabinet, allowing the heat generated by the bulbs to escape; second, to enable the operator to see if the tubes in the set are burning. Bezels of this type are more necessary with the old time bulbs drawing a heavy current and consequently generating more heat than with the newer type of bulb which uses very little current and so does not



Fig. 61—Ventilator or Bezel.

require the ventilation because very little heat is generated. The later bulbs also light up very little and consequently the operator cannot see whether they are lit or not, even when using a bezel, so the use of the bezel is not as universal or as necessary as it used to be.

Cutting the holes in the panel for these bezels offers quite a difficult job, but special tools can be had for this purpose, or this can be done with an ordinary extension wood bit.

47. **"C" BATTERIES:** "C" Batteries are sometimes used with a detector instead of the common grid condenser and grid leak. This practice has practically ceased



Fig. 62—"C" battery.

and now the only place they are considerably used is in connection with amplifying bulbs. "C" batteries are also called bias batteries or grid bias batteries.

48. **CHOKER COILS:** Choke Coils are used in transmitting sets. There are many kinds and their main requirements is that they have a sufficient number of turns to choke out the passage of radio frequency current and still allow the audio frequency current to pass.

49. **CONDENSERS—FIXED:** Fixed condensers are used in many places in a receiving set. Nearly all hook-ups require a grid condenser and in some instances it is advisable to use one across the phone terminals. Fixed condensers are made by using some type of metal such as tin foil or thin brass separated with mica or paper. The capacity of a condenser is determined by the plate area and by the thickness and strength of the dielectric used. They are rated in farads but as the farad is too

large a unit for practical purposes, the use of microfarads and micromicrofarads is common. A microfarad is one millionth of the farad and the micromicrofarad is one

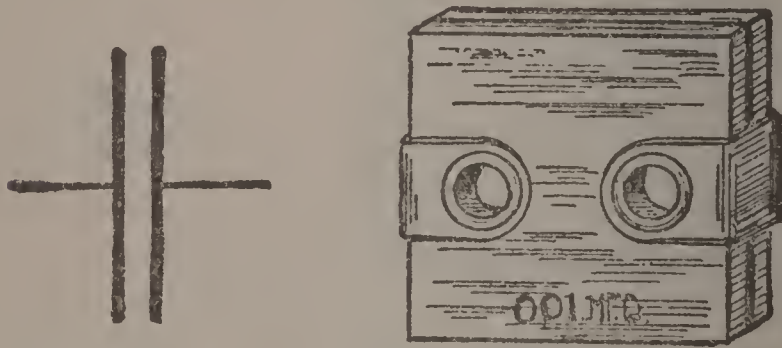

Fig. 63—Fixed Condenser.

millionth of the microfarad. A fixed condenser of .001 MFD capacity would be one one-thousandth of a microfarad.

50. **CONDENSERS—VARIABLE:** Variable condensers operate in the same manner as the fixed condensers except that they have some means provided of varying the capacity. They nearly all use air as a dielectric, although mica and other materials are sometimes used to keep the plates of the condenser from touching. The closer the plates are together, the greater the capacity per square inch of the plate area.

The material used to insulate one set of plates from the others has a great deal to do with the efficiency of the condenser. If this material is poor, the electrostatic current

will creep across the dielectric insulation instead of going through the dielectric between the plates. The variable condenser which has a very small amount of insulation to

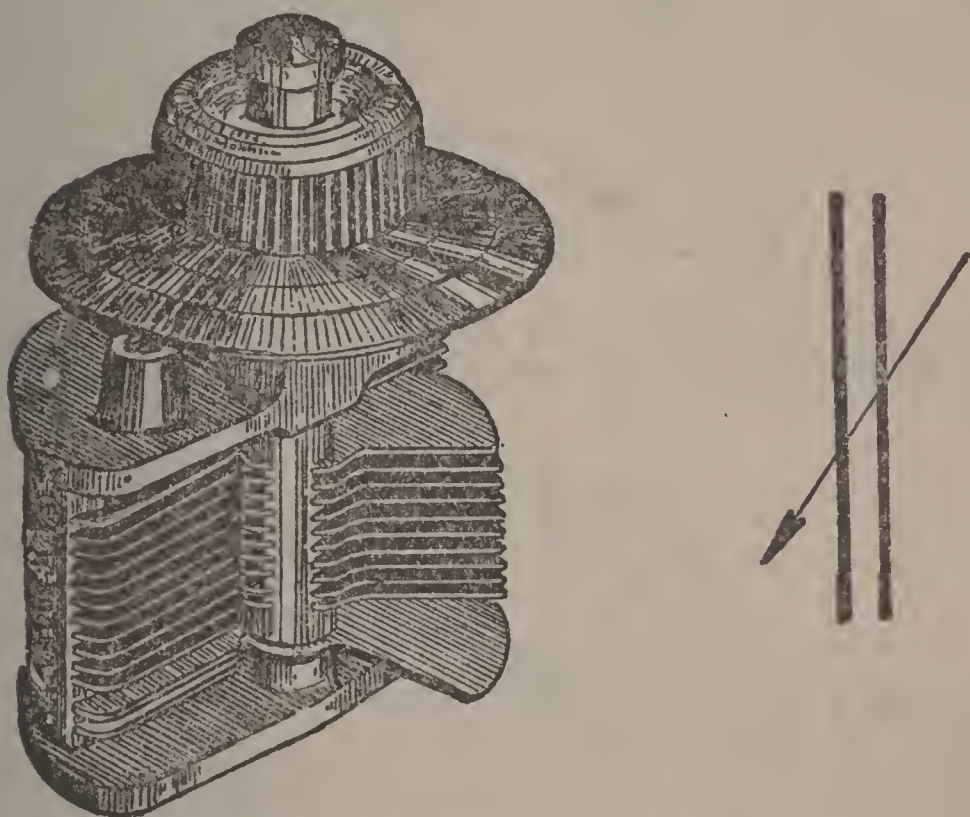

Fig. 64—Variable Condenser.

hold two sets of plates together will have a higher efficiency than one which uses a great deal of insulating material in the electrical field.

51. CRYSTAL DETECTOR: The use of the crystal detector has been explained previously; the following are the different kinds of minerals used for this purpose. The most commonly used are galena and silicon

and the others are iron-pyrites, carborundum, zincite and ferron. Holders for these minerals are of many different types and the only requirements is that the contact is made the proper way.

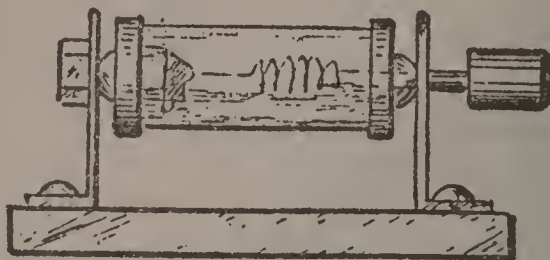

Fig. 65—Crystal Detector. Adjustable.

52. **DIALS:** The only object of the dial is to act as a kind of knob to turn the shafts of the various parts of the

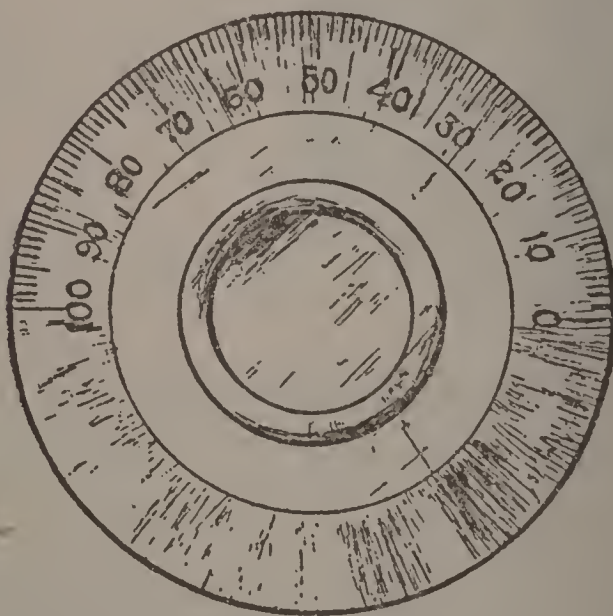

Fig. 66—Dial.

set, such as the vario-coupler, variometer, variable condenser, etc. They are nearly always calibrated so that the operator can get a reading of the position of the apparatus.

Some of the better types are also geared to give a vernier adjustment. Dials also insulate the operator's hand from the metal shafts of these parts so that the better kinds are made of some good dielectric material.

53. **GRID CONDENSERS:** The use of the grid condenser has been explained previously. These are nearly always of small capacity from .00025 to .0005. These are also sold in one unit complete with grid leak. It is better if some method can be had of changing or varying the resistance of the grid leak.

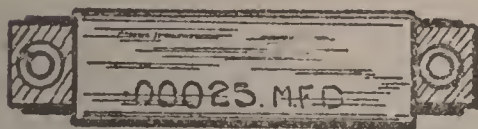

Fig. 67—Grid condenser.

Grid Leaks can be purchased as a separate unit with a fixed resistance or with some method of varying their resistance. When the resistance is fixed and they are put up in cartridge form, mountings can be had whereby they can be changed easily. Many times operators use a common piece of cardboard and a pencil mark. If care is taken to get this mark around the terminals so that it makes a good contact, it will work as well as any and can be varied by making the mark lighter or heavier. India ink also makes a good leak and is oftentimes used across a piece of cardboard in place of a pencil mark.

54. **GRID LEAKS:** The use of the grid leak in connection with the grid condenser has been explained thoroughly in Chapter 2. Grid leaks of many kinds can be

had. Quite often a fixed leak of the cartridge type is furnished with the grid condenser and clips are fastened

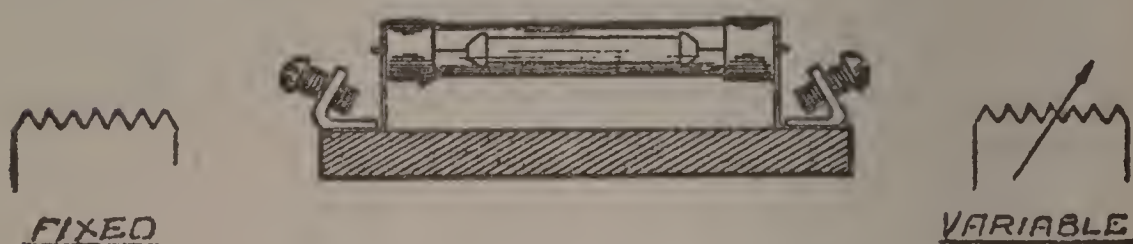

Fig. 68—Grid Leak.

on the condenser in which this cartridge leak can be mounted and very easily changed.

55. **GROUND CLAMPS:** Ground clamps are used to make a good connection between the ground wire and water pipe or the pipe going into the ground. Just wrapping the wire around the pipe will not make a good connection and it is very difficult to solder a wire to a water pipe, but the pipe can be cleaned, the ground clamp fastened securely in place, and the wire soldered to the clamp.

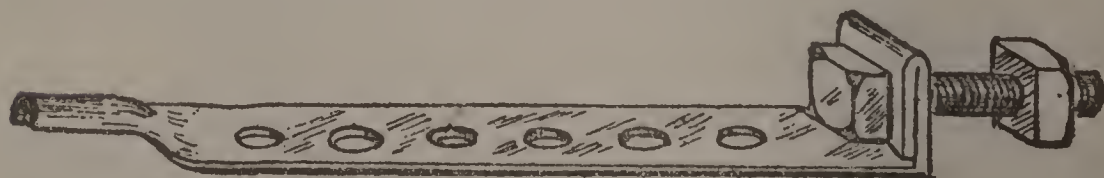

Fig. 69—Ground Clamp.

56. **HONEYCOMB COILS:** The word honeycomb coils is generally applied to all coils of similar make although it should be used only in connection with the coils made by one company. Coils of this type make very good inductances and a great many turns of wire can be wound in a small space. Sometimes these are tapped but most generally they have only the two ends which can be connected to the circuit. They are mounted in many different ways: sometimes on the front of the panel and sometimes on the back. Mounting plugs and brackets

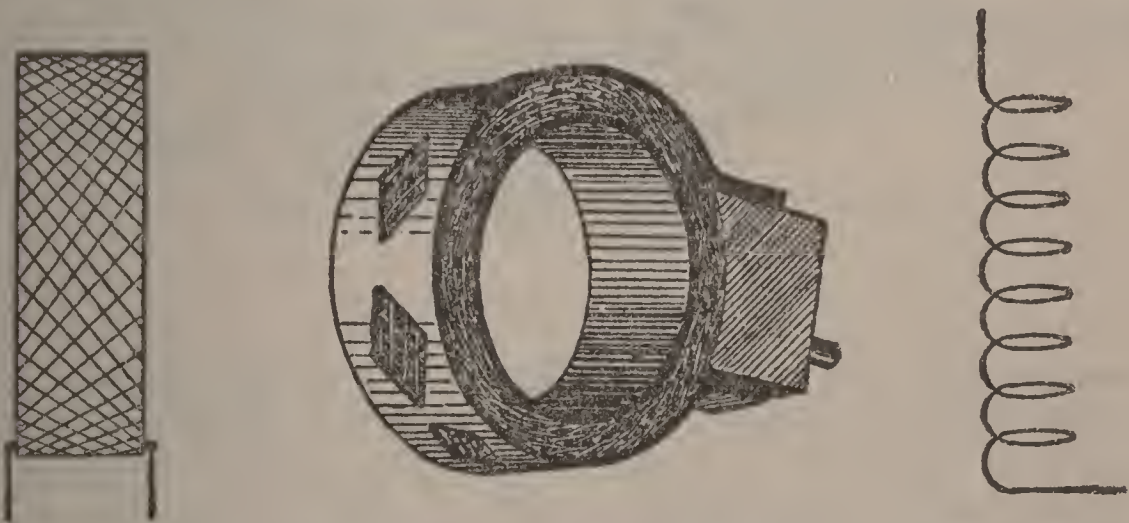

Fig. 70—Honeycomb or Duolateral Coil.

can be had which have the proper contacts whereby the coils can be changed quickly. When this type of coil is used to receive both long and short waves, changing of these coils is often necessary. The only method of tuning an inductance coil which is not tapped is with a variable condenser shunted across or in series with the coil.

Often, coils of the honeycomb type are used for loading the primary circuit in order to receive stations transmitting very long waves. The efficiency of these as inductance coils is very good.

57. **HYDROMETER:** By having a hydrometer the operator of a receiving set can determine the conditions of his wet "A" or "B" batteries. When a storage battery becomes charged, the active materials of the plates forms acid which goes into solution with the water in the jar and we have what is known as a high specific gravity. This

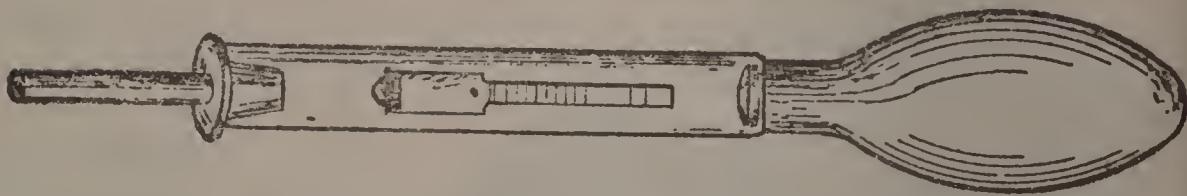

Fig. 71—Hydrometer or Storage Battery Tester.

can be measured with a hydrometer. As the battery is used, the acid is lost in reaction with the plates and the acid in the water is lessened and then there is what is known as a low specific gravity. Most batteries are charged when the hydrometer reads 1250 and discharged when it reads below 1050. The hydrometer tells the condition of the battery much better than a voltmeter, as the specific gravity changes in a greater proportion than does the electromotive force upon charge and discharge.

58. **INDUCTANCE SWITCHES:** Inductance switches, such as shown in Fig. 72 are often times used in place of contact points and switch arms. These are generally arranged so that they do not require more than one to three holes in the panel, thus saving considerable work

for the builder of a set. Inductance switches of this type should always have a pointer or other indicating device for registering the position of the contact. If this is available, direct readings can be taken of the position of the

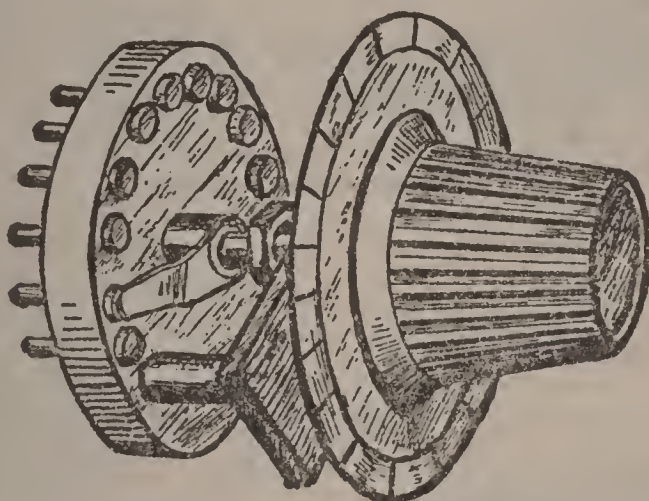

Fig. 72—Inductance Switch.

contact arm and reference can be made to this reading when it is wished to pick up the same station on two different occasions.

59. **JACKS:** Jacks are used merely to make it easy to change from one stage of amplification to another. There are also filament control jacks constructed so that when the telephone plug is inserted in the jack, the filament of the bulb in that particular stage of amplification will light and when the plug is removed, the light will go out.

When more than one jack is used, they should be of the two circuit type, the same as shown, except that in the

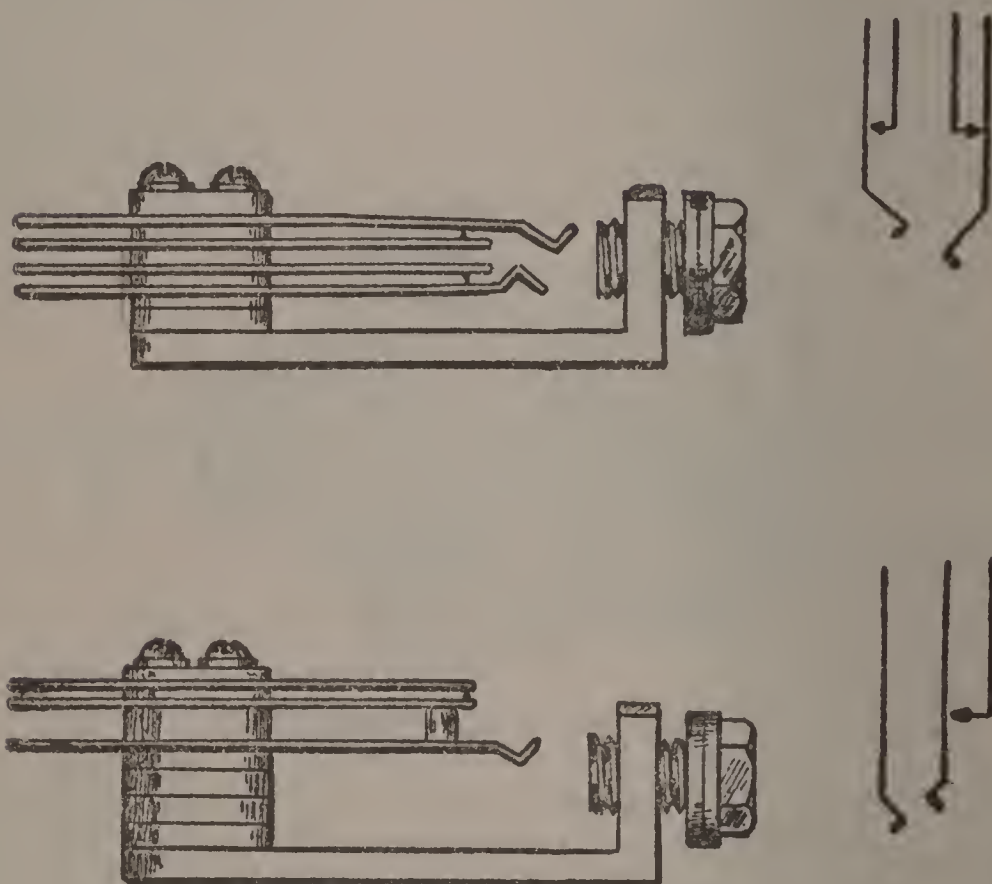

Fig. 73—Jacks.

last stage a single circuit jack can be used. The two-circuit jack is so made that when the plug is removed, connection is made to the next stage.

60. LOOSE COUPLERS: Loose couplers were one of the first pieces of apparatus used for tuning, in radio circuits. They are also oftentimes called transformers. All of the old timers, at some time used a loose coupler and they always proved very efficient for use over a wide

band of wave lengths. They are now being discarded in favor of the more compact forms of inductances such as the honeycomb coil, spider web coil, vario-coupler, and variometer. There are still a few in use, however, and it will be found that they can be adapted to many circuits using either a crystal detector or audion bulb.

61. LOOP ANTENNAE: Loop or coil antennae are becoming more and more popular as advancement is made in building efficient radio frequency amplifying units. They have the advantage of being compact, portable, and have what is known as directional qualities.

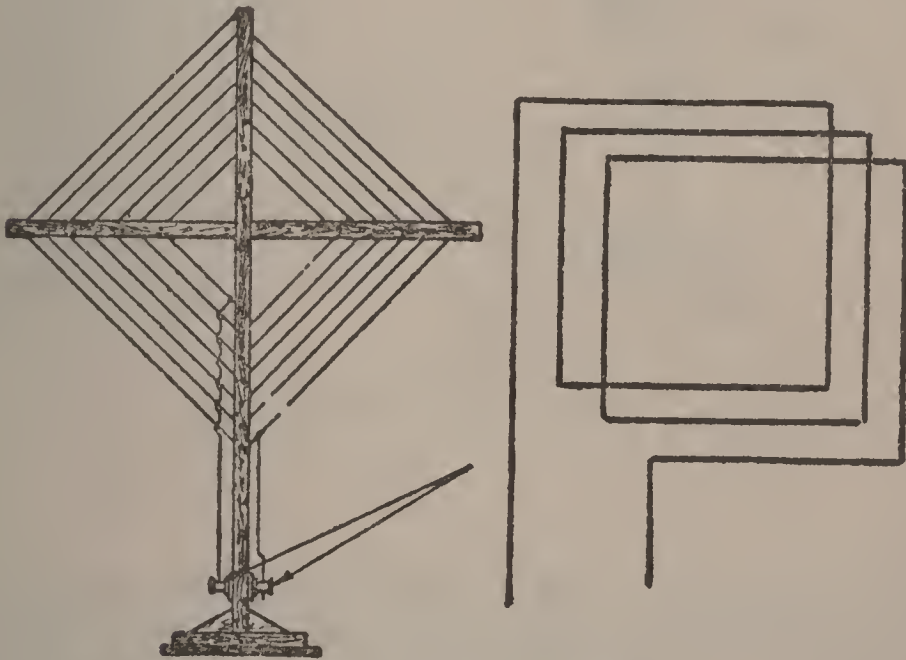

Fig. 74—Loop Antenna.

This means that they will become excited when pointed directly at the station sending out the radio wave. The loop is generally shunted by a large condenser and this is generally the only tuning adjustment, although taps are sometimes taken off and then the number of turns in use can be varied.

62. **LOUD SPEAKING UNITS:** Loud speaking units are in general use today and as the radio industry advances they will become more and more common. Most radio receiving sets are used to receive programs from

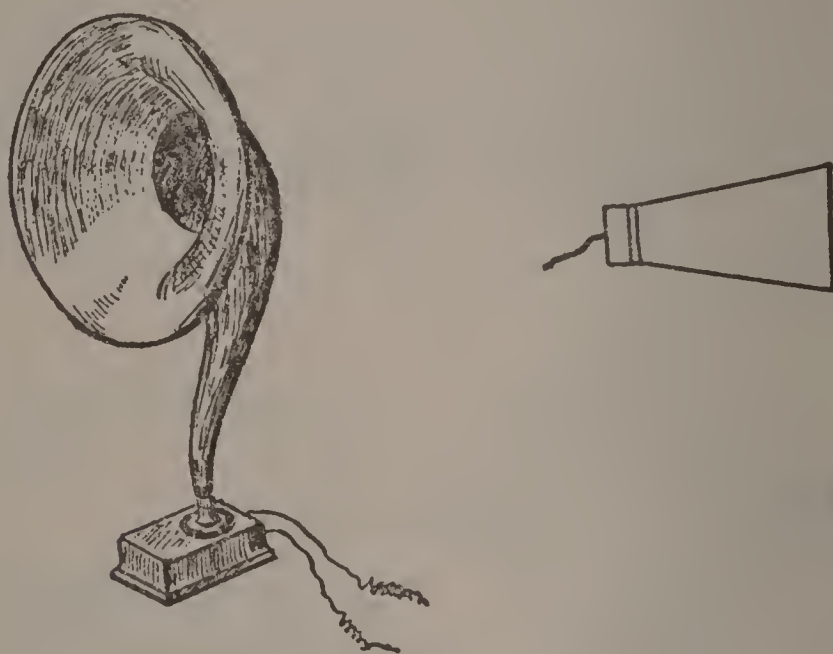

Fig. 75—Loud Speaker or Radio Horn.

broadcasting stations and when listening to these it is much more pleasant to be able to hear without the use of head phones. There has been a big advancement in the manufacture of this type of apparatus and some of the later models give very good reproductions.

The first of these put on the market were a great deal like the first phonographs and the noise which they made was anything but musical. They are still far from being perfect but with the strides that are being made, indications are that soon they will be equal in accoustical qualities to the better types of phonographs.

Some kinds of loud speakers use what is known as field excitation, meaning that they must be connected to the "A" battery. This strengthens the signal and gives it a much greater volume. Many types are used in connection with power amplification. Power amplification consists of one or more bulbs used with a special kind of transformer which gives a stronger signal without distortion.

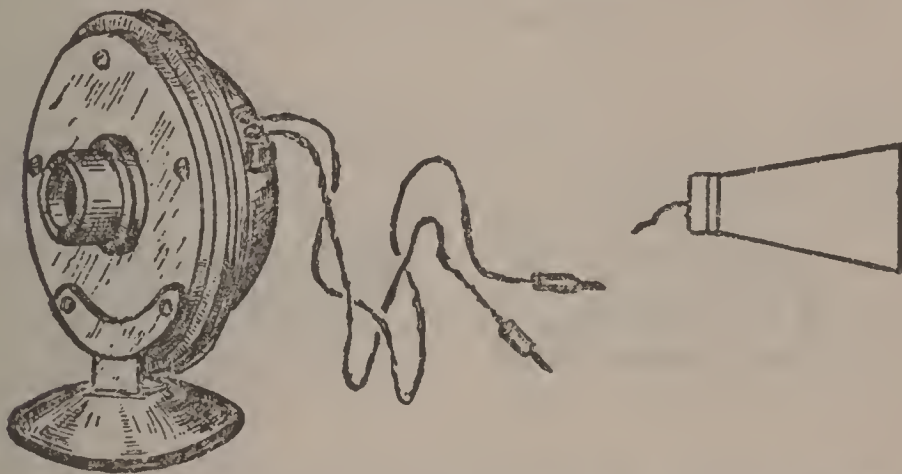

Fig. 76—Phonograph Loud Speaking Attachment.

There are many horns on the market which can be used with head phones. These are not as satisfactory as a specially built loud speaking unit as the phones were not designed to stand the stronger current which is present after one or more stages of audio frequency amplification have been used.

Another popular type of loud speaking unit used is the one which can be fastened to a phonograph. These units were made to take a strong current and most of them have a method of adjusting the diaphragm so that the tone will be very clear.

63. **PANEL MARKERS:** Panel markers come in many different types. Binding posts are sometimes furnished with tops which have the markings on them where they can readily be seen. One disadvantage of the majority of these is that these tops can be taken off and care must be used not to reverse them in putting them back. There are many other types of metal markers which can be fastened under the metal binding posts.

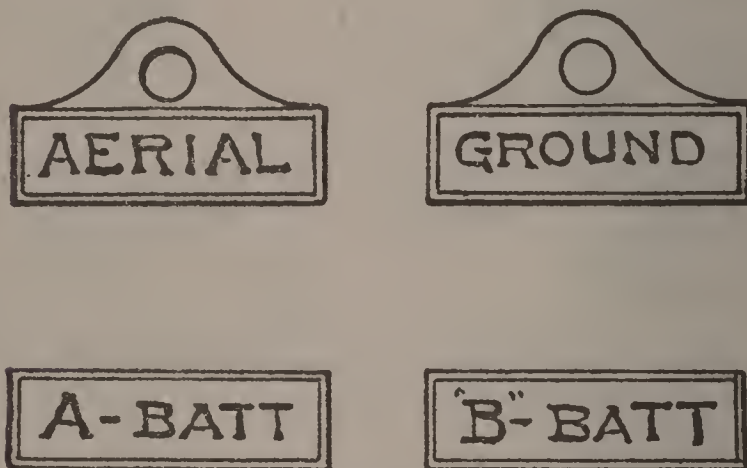

Fig. 77—Panel Markers.

Other panel markers in use are the transfers which are easy to put on and some of the later types brought out have the appearance of the engraved panel. A nice job of engraving is generally the best but this is a considerable bother and for ordinary use the panel markers will answer the purpose.

64. **PLUGS:** Phone plugs, similar to those used in radio work, have been in use by the telephone companies in their switchboards for years. A few changes have been made in these, however, to adapt them for radio use. The plug which is used by the operator of a receiving set should be of the proper kind to fit the jacks which are in

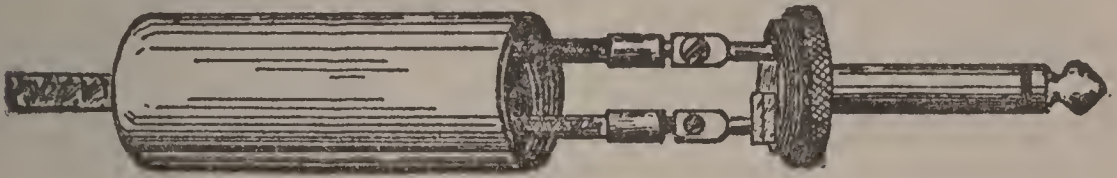
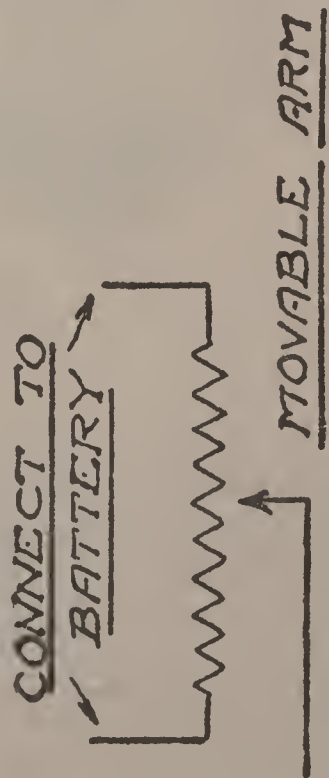
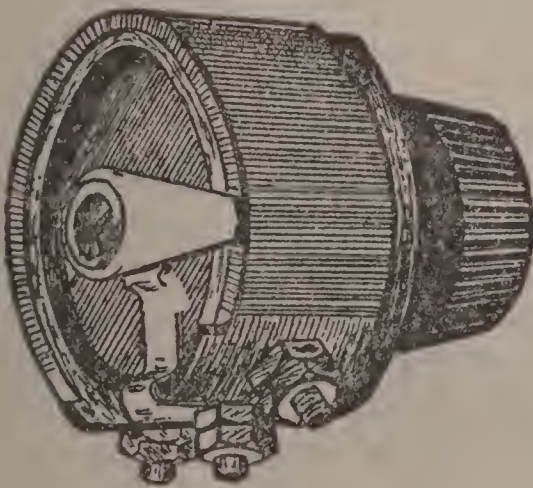

Fig. 78—Phone Plug.

the set. Often times interrupted service is caused by using a plug which is not making a good contact in the jack. Several types of phone plugs are made which will accommodate one or more pairs of receivers.

65. **POTENTIOMETER:** There are not so many potentiometers used now as have been used in the past.

Fig. 79—"A"
Battery Potentiometer.



Several years ago, "B" battery potentiometers were in general use, but experience teaches us that these run down the "B" battery and the use of them was finally discontinued. "A" battery potentiometers are quite often used at the present time in radio frequency sets. These are generally of quite high resistance, 200 ohms or over, and when shunted directly across the "A" battery do not pass a sufficient amount of current to run down the "A" battery to any considerable extent. If leaving the set stand for any great time, however, the "A" battery should be disconnected, either by inserting a battery switch between the potentiometer and the battery or by disconnecting one of the wires fastened to the terminals of the battery.

66. RESISTANCE UNITS: Various hook-ups have different places for installing resistance units. These units are built from 20 to 30 ohms up into 400 or 500 ohms



Fig. 80—Resistance Unit.

of resistance and are merely a type of resistance wire wound in compact form in order to obtain the proper values and allow them to go into the small amount of space which is available in the receiving set. Quite often 20 or 30 ohm resistances are mounted upon the common 6 ohm rheostat in order to give added control for bulbs of the 201A and 199 type.

67. RHEOSTATS: There are many and various types of filament rheostats and they range in size from four to forty ohms. The rheostat is inserted between the battery and the filament of the tube in order to control the voltage applied to the tube. By thus having this variation, the heat of the bulb can be controlled, which in turn controls the flow of electrons between the filament and plate. This adjustment is sometimes so critical that a vernier of some type should be used. A vernier adjustment is generally no more or less than a single stand of

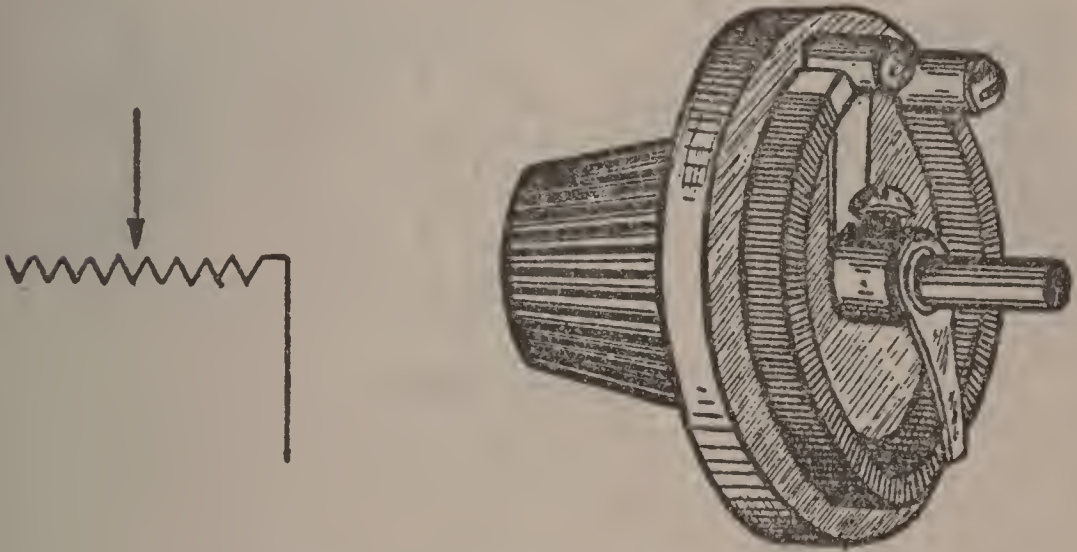

Fig. 81—Filament Rheostat.

resistance wire which is controlled by a separate knob. The size of rheostats to use for different types of bulbs is shown in the latter part of this chapter where the individual bulbs and their uses are considered. Sometimes rheostats should be installed in the negative lead and sometimes in the positive lead. The instructions which come with most of the audion bulbs and different hook-ups, show the proper place to install the rheostats.

68. **SOCKETS:** There are hundreds of different types of sockets on the market. Some of these are very efficient and others are the cause of much trouble and annoyance in receiving sets. The socket holds the heart of the receiving set, the bulb, and if for any reason this is not held rigidly, and good connections are not made with all the contact points on the bottom of the bulb, trouble will be experienced. Also, if the binding posts on the

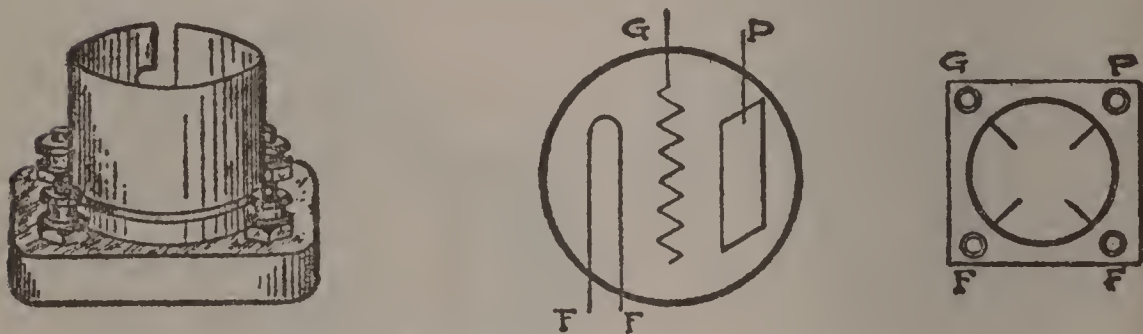

Fig. 82—Tube Socket.

socket are not securely fastened to the springs making contact with the bulb, a radio set will oftentimes be noisy.

When purchasing a socket a good thing to watch is that the outside of the shell fits the bulb snugly but not closely enough to make the changing of the bulb difficult. Also see that the springs are made of material which will keep a good tension on the prongs of the socket. These springs should also be clean, free from corrosion, and uniform. A little attention or tightening up of sockets in a radio set will oftentimes do away with troublesome noises that are thought to be outside interference.

69. **SOCKET BRACKETS:** Socket brackets such as are pictured, afford a very convenient method of mounting the socket and transformer to the panel. Many

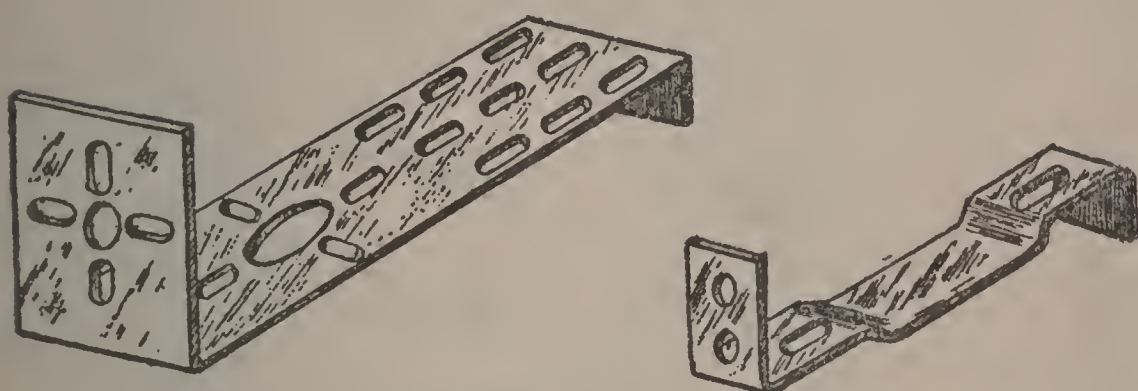

Fig. 83—Socket and Transformer Brackets.

times a sub-base which is made of wood or some other panel material, is used to mount the sockets, but these are generally more or less of a bother and if socket brackets similar to those shown in the drawing are used, the sub-base is unnecessary.

70. **SOLDERING LUGS:** Since the introduction of heavy bus-bar wire, soldering lugs have come into general use. The ordinary terminals on radio apparatus and the

screws used in binding posts are not heavy enough to make a good connection with the heavy bus-bar wire, so soldering lugs, similar to those shown in the drawing, are fastened to the terminals and the bus-bar wire soldered to them.

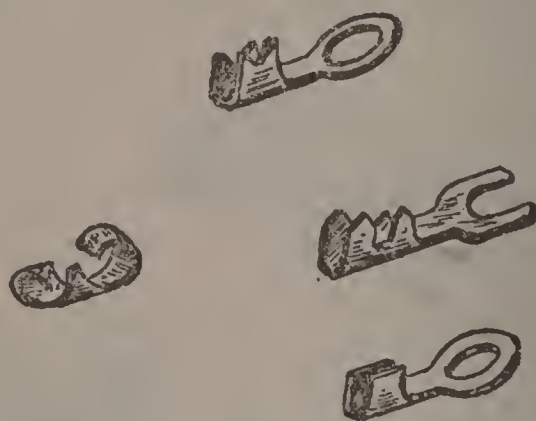

Fig. 84—Soldering Lugs.

71. SPIDER WEB COILS: Spider web coils are a type of inductance which is used for many purposes. Sometimes they are tapped and then the number of turns on the coil can be varied but generally they are tuned by the use of variable condensers and also by couplings or changing their relations to each other.

These coils are made in various types. Sometimes a form is used to wind the wire and at other times the wire is wound on a form and some type of adhesive paint is applied which will hold the wire together when the form is removed. Other spider web coils are wound on a form and then held together by the use of string. These coils are generally of high efficiency and wonderful results can

be obtained by the use of them for tuning purposes. They can also be used as radio frequency transformers.

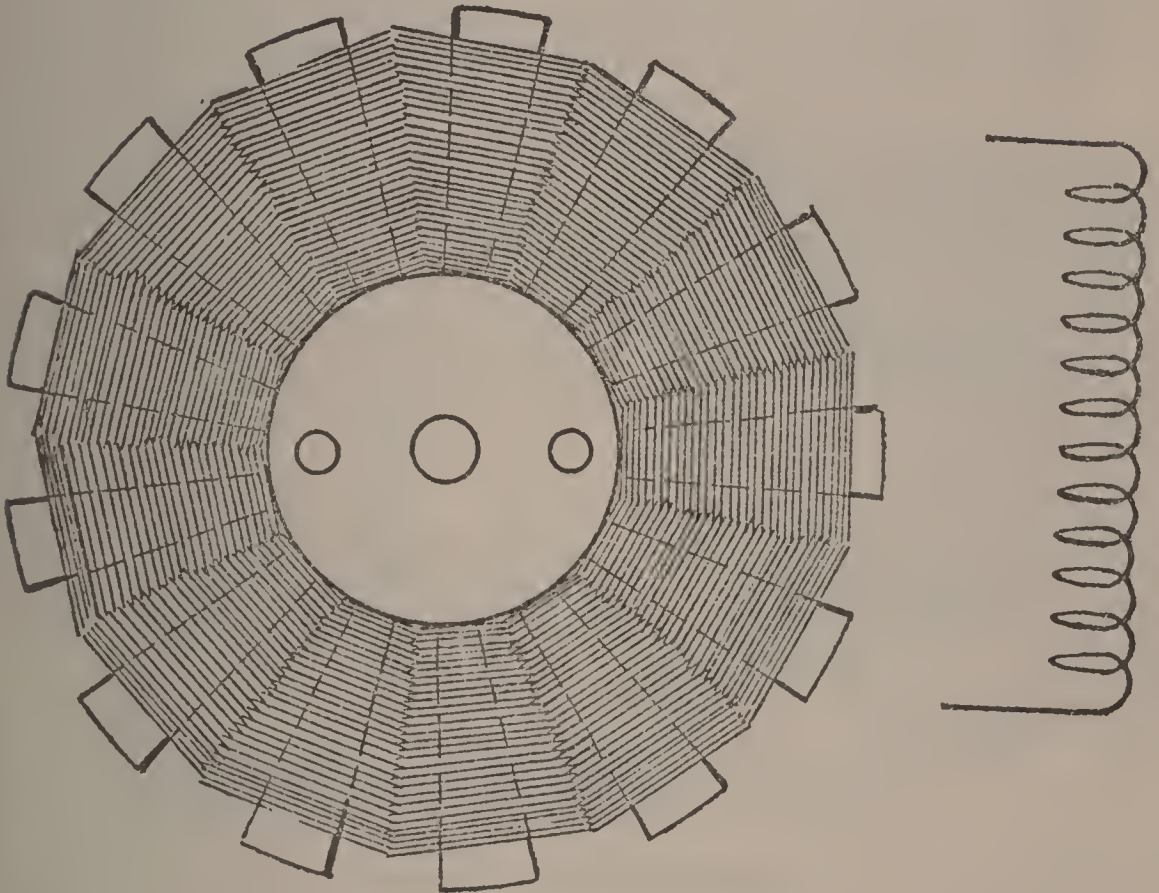

Fig. 85—Spiderweb Coil.

72. TRANSFORMERS — AUDIO FREQUENCY:
As explained before, audio frequency transformers are used to raise the voltage of the rectified audio frequency wave which is taken from the plate circuit of the detector bulb. The transformer also acts as a coupling between the two bulbs to keep the "B" battery plate voltage from being impressed directly upon the grid. The same type of transformer can be used to hook one or more stage of audio frequency amplification together.

Many questions are asked regarding the proper ratio of audio frequency transformers. It used to be thought that the higher ratio transformers were the best but recently the lower ratio transformers, viz., three to one

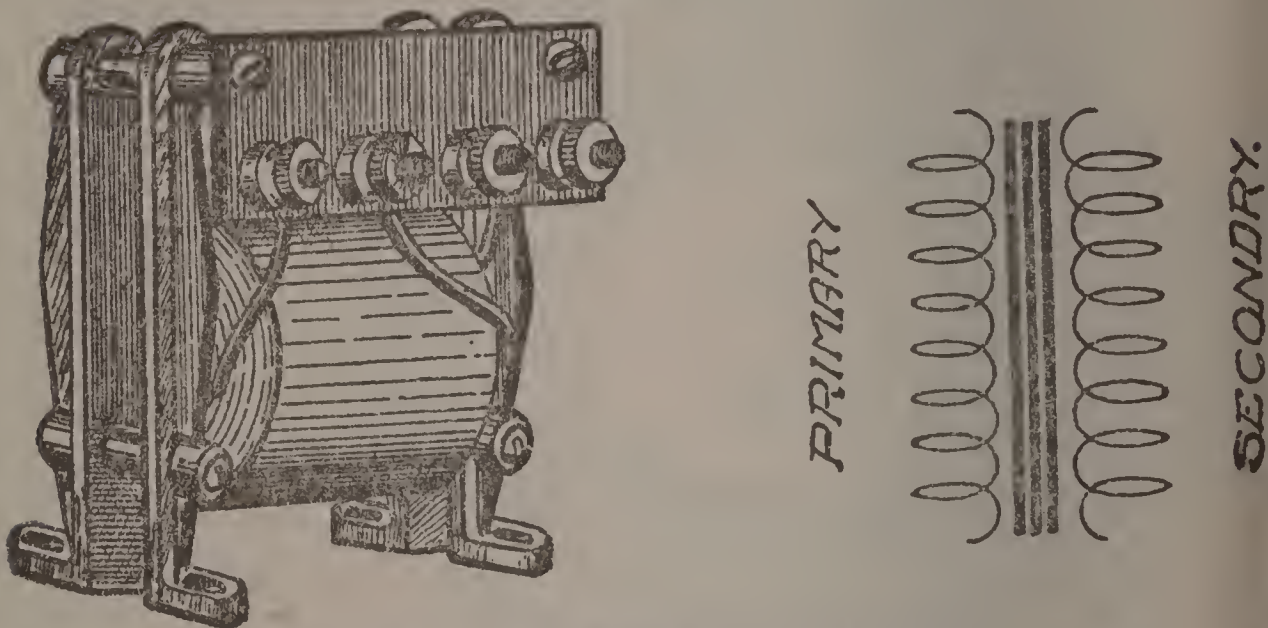

Fig. 86—Audio Frequency Transformer.

(3-1) four to one (4-1) and five to one (5-1), seem to be the most popular types. Regardless of the change in voltage which a transformer will make, it will not increase the power which is impressed on the grid of the amplifier tube so that for ordinary use a transformer of the lower ratio will give as strong a signal and many times a much clearer signal, than can be had from a transformer of a higher ratio. Transformer ratio is the comparison between the number of turns of the primary and the secondary windings. For instance, in a ten to one (10-1) ratio transformer having a windings of 11,000 turns, there will be one thousand turns on the primary and ten thousand

turns on the secondary. A three to one (3-1) ratio transformer would have two thousand seven hundred fifty turns on the primary and eight thousand two hundred fifty turns on the secondary.

73. TRANSFORMERS — RADIO FREQUENCY: The use of radio frequency transformers was explained in Chapter 3. There are many different types of these manufactured and the efficiency generally depends upon having the proper hook-up for the transformer being used. Also there are many different types of air core transformers which can be made very easily by the person who wishes to build a radio frequency set. Some of the later types of tuned radio frequency sets use transformers

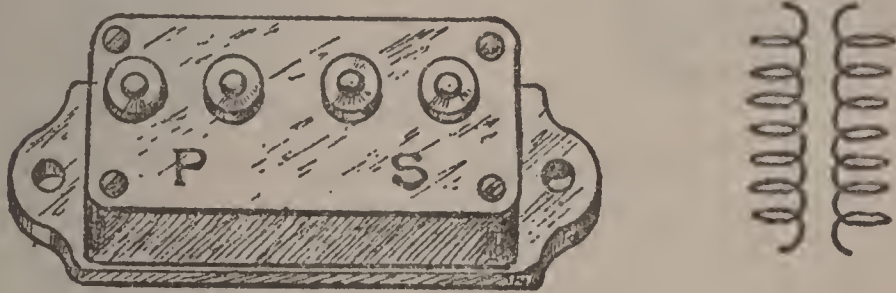

Fig. 87—Radio Frequency Transformer.

which consist of no more or less than two inductance coils wound on paper or composition tubes and which are tuned by the use of a variable condenser. Two spider web or two honeycomb coils are also used for coupling the radio frequency bulbs together and at times there are two windings wound on the same form. One winding is used as the primary and the other as the secondary of the transformer. In any of these types of transformers the values must be right in order to give efficient results, over the desired wave length band.

74. **VARIO-COUPPLERS:** Vario-couplers are used for tuning the aerial circuit in resonance with the incoming radio wave. It has been explained how some method of tuning must be had in order to get the receiving set in resonance with the wave which is wished to be picked up. Vario-couplers are generally tapped and the number of

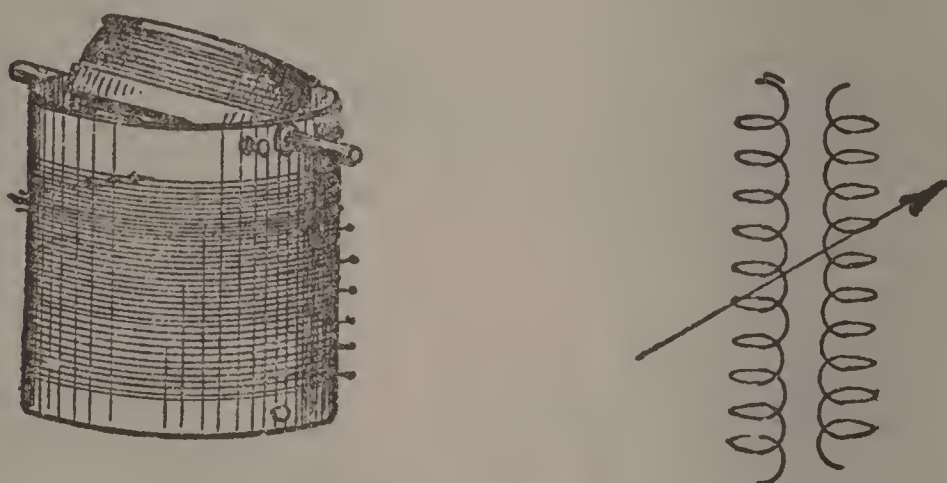

Fig. 88—Vario-Coupler.

turns of wire can be varied as well as the coupling or the distance or position between the rotor and the tapped coil can be varied. When using a vario-coupler in a two or three circuit receiver, the rotor is generally tuned by shunting a variable condenser of proper capacity across this.

75. **VARIOMETERS:** Variometers consist of an inductance device which is made up of stator windings and windings on the rotor. When this is used as a tuning device or as a variable inductance in the plate circuits to cause regeneration, the rotor is wired in series with the stator windings and electric fields set up around these separate windings will either buck or help each other so

that a variable amount of inductance can be had by turning the rotor of the variometer into different positions.

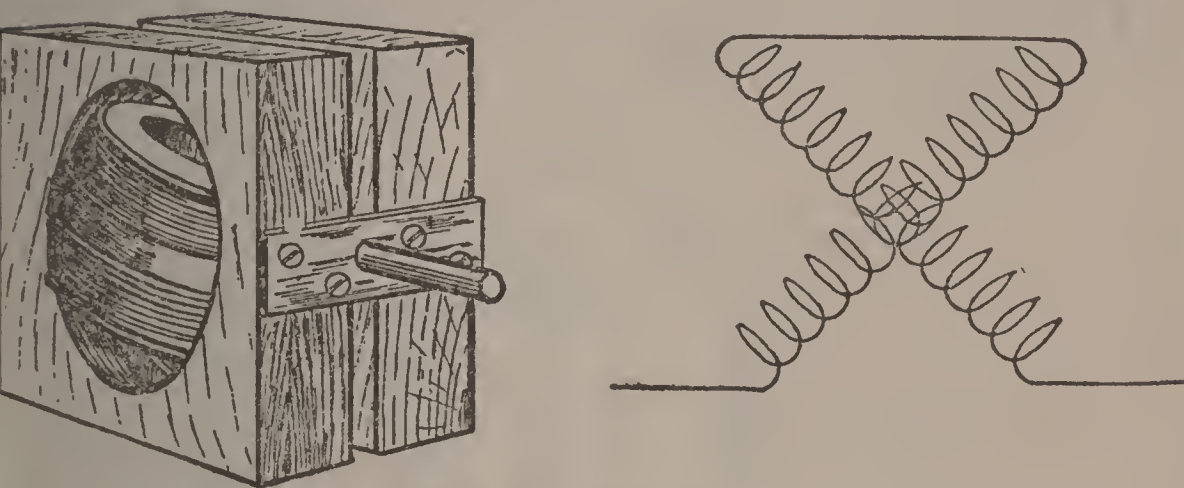

Fig. 89—Variometer.

Some of the later types of hook-ups use a split variometer which makes a two circuit tuning device of it. When used in this way the two windings are not connected in any way.

76. BULBS USED IN RECEIVING SETS: The balance of this chapter will be taken up with the explanation of several different types of vacuum tubes and their different characteristics as given by the manufacturers. There are so many different types of bulbs made that it is confusing to the amateur to know which one of them will fit his particular needs. The recommendations which are given need not be followed but are based on experiments which have been made from time to time on broadcast

reception. Different operators will have their likes and dislikes and so some of these recommendations will be probably disagreed with.

Since the original DeForest patent has expired, a great number of new bulbs have been placed on the market, but these have not been out long enough for proper tests to have been made; therefore, A DISCUSSION OF THESE WILL BE OMITTED.

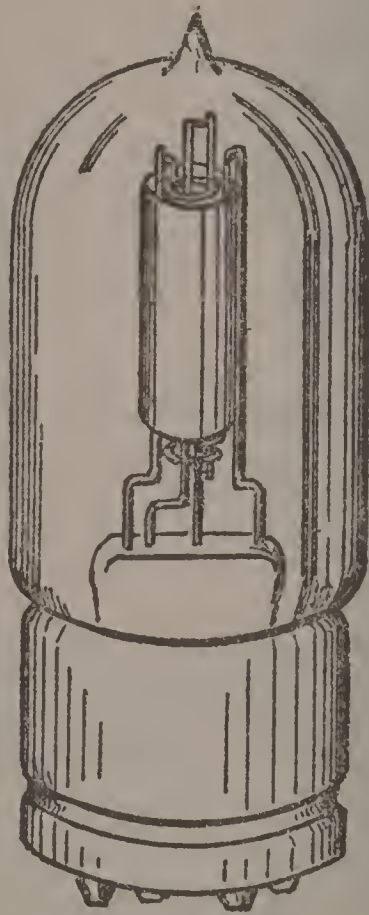

Fig. 90—U. V. 199 or C 299 Audion Bulb.

77. RADIOTRON UV 199 and CUNNINGHAM C 299: The Radiotron UV 199 is distributed by the Radio Corporation of America and the C 299 is distributed by E. T. Cunningham, Inc.

These bulbs are the smallest of the later types of tubes and works very well for use as a detector or amplifier and can be used with dry cells as an "A" battery. Anyone who wants a portable radio or audio-frequency amplifier and detector will find that this type of bulb will work as well as any. When using this tube as an amplifier with a high plate voltage a grid bias battery should be used. This grid bias battery should be hooked in the grid return, as is shown in Fig. 91. The grid bias battery should also be of different voltage for the different plate voltage. The table below gives this, as well as other of their electrical characteristics.

Filament Battery Voltage	4.5 Volts
Filament Terminal Voltage	3 Volts
Filament Current	.06 Amperes
Plate Voltage:	
Detector	40 to 45 Volts
Amplifier	45 to 90 Volts
Grid Bias Battery:	
Plate Voltage	45 to 67.5 Volts—use 1.5 to 3.0 Volts
Plate Voltage	67.5 to 90 Volts—use 3.0 to 4.5 Volts
Rheostat Used	
3 Dry Cells (4.5 Volts)	30 ohms
6 Volt Storage Battery	60 ohms
Grid Condenser	.00025 MFD
Grid Leak	2 to 5 Megohms

As this tube is much smaller than a standard base, a special socket or adapter must be used. This tube will stand a much higher filament voltage than it is rated at. When this voltage is applied, however, electron emission will cease and the bulb can be brought back to normal by lighting the filament with the plate battery disconnected.

78. RADIOTRON UV 201 and CUNNINGHAM C 301: These tubes have been superseded by the UV 201A and the C 301A.

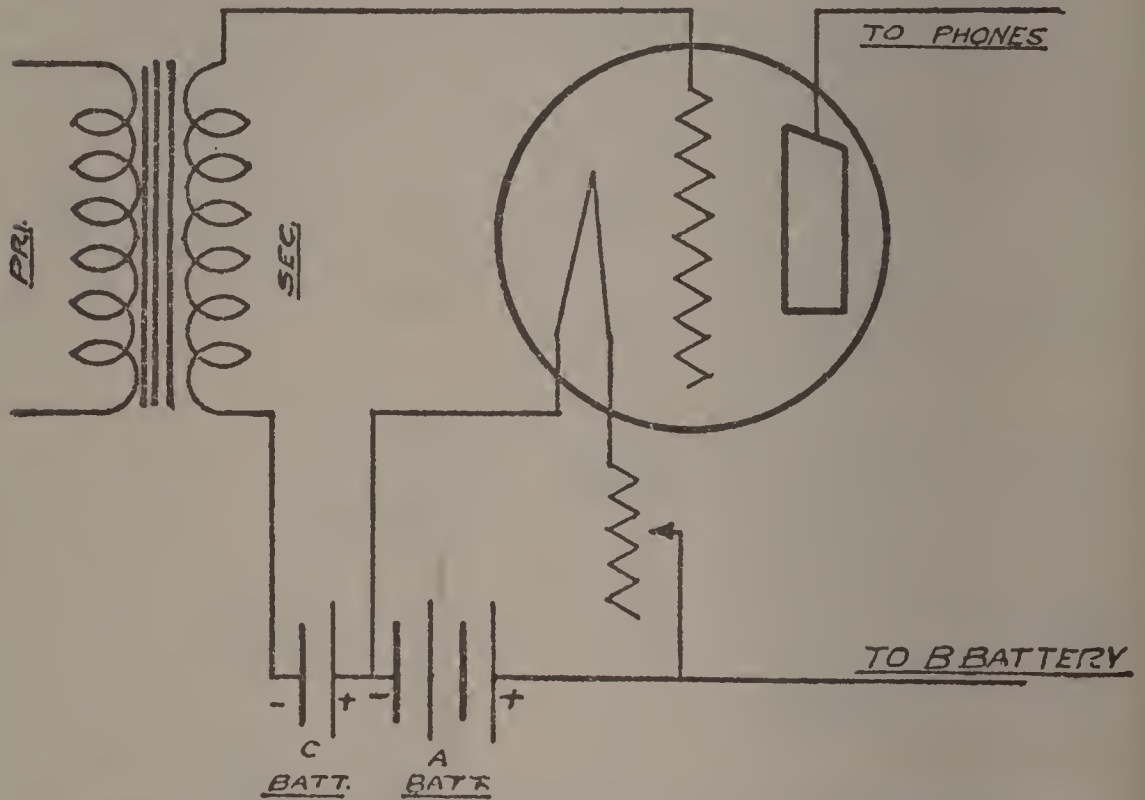

Fig. 91—Hook-up Showing Proper Place for “C” or Grid Bias Battery.

79. RADIOTRON UV 201A and CUNNINGHAM C 301A: These are two of the later type of tubes using a

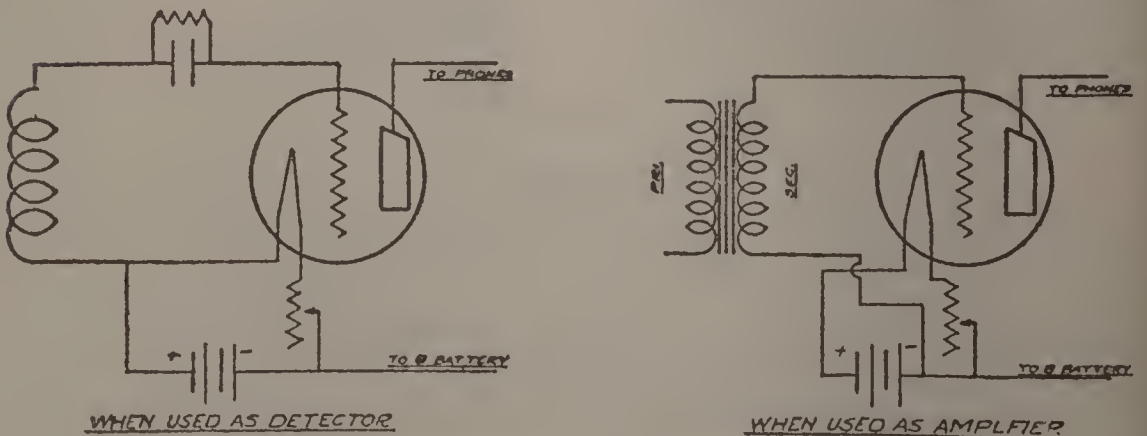

Fig. 92—Hook-up Showing Proper Connections for Grid Return.

new tungsten filament and are much more economical in operation, as they only use .25 of an ampere of current whereas the old 201 and 301 used 1.0 ampere. These tubes also have a very high vacuum and are the best that can be had for either radio or audio frequency amplification. They can also be used as a detector but are not nearly so good as a detector bulb of the 200 and 300 type.

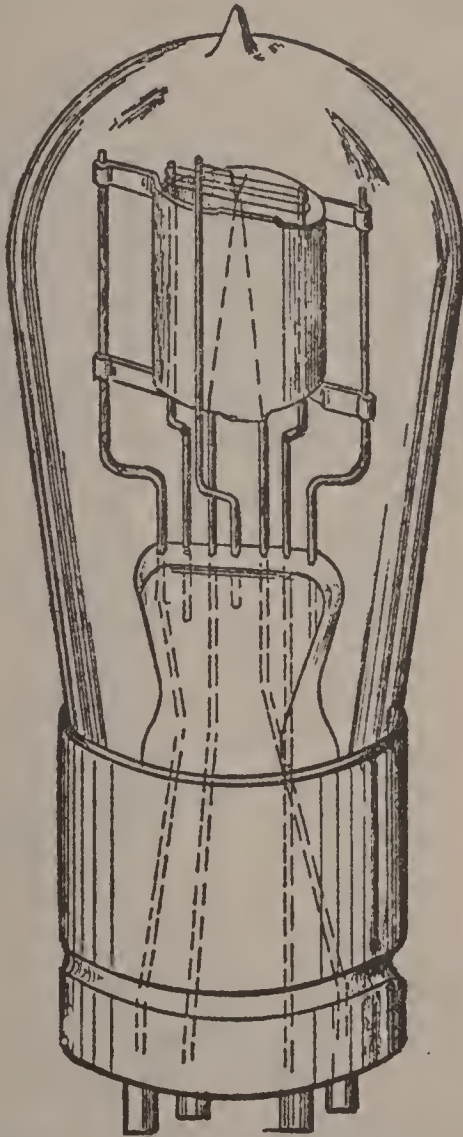

Fig. 93—U V 200 or C 300 Audion Bulb.

The filament of this bulb is very rugged in construction and will sometimes stand a very high voltage. Once, by

accident, 45 volts were connected across the filament for a short period and the tubes did not burn out. This is, however, not an experiment which would be advisable for anyone to make.

If excessive voltage is applied to the filament, electron emission will cease and can be brought back to normal by lighting up the filament as rated voltage for one-half hour with the plate battery disconnected.

When this bulb is used as a detector the grid return should be connected to the positive side of the "A" battery and when used as an amplifier the grid return should be connected to the negative side of the "A" battery. The drawing in Fig. 92 shows how this is done. When used either as a detector or as an amplifier, the rheostat should be in the negative "A" battery lead. Sometimes a grid bias battery is used and the voltage of this battery should vary according to the plate voltage, as shown in the table for the UV 199 and C 299.

Filament Battery	6-volt Storage Battery or 4 Dry Cells
Plate Voltage	
Detector	40 Volts
Amplifier	40 to 100 Volts
Grid Condenser	.00025 MFD
Grid Leak	2 to 5 Megohms
Socket Needed	Standard Navy Base

These tubes should be operated at the least possible voltage and with a six volt storage battery, the rheostat should be between 10-30 ohms resistance.

80. RADIOTRON WD 11 OR C 11: The WD 11 is similar to the WD 12 with the exception, however, that the WD 12 will fit the standard navy socket whereas the WD 11 must have a special socket or adapter.

81. RADIOTRON WD 12 OR C12: This bulb is sometimes called a peanut tube, although it is not in any sense the shape of a peanut. The elements used in this tube were small and so were the elements used in the old time peanut tube so that is probably the reason it is erroneously called a peanut tube. The WD 11 and WD 12

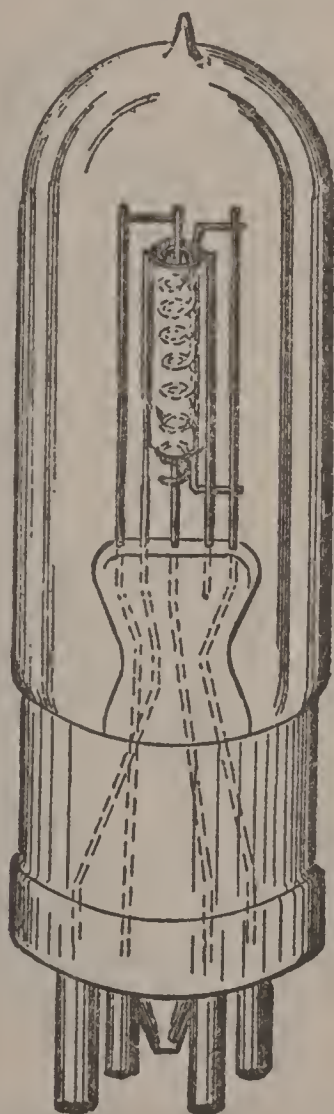

Fig. 94—W D 11 or C 11 Audion Bulb.

have many advantages as a detector bulb; chief of which is that they use very little current and low voltage, and can be worked with a single dry cell. They can also be

used as amplifier bulbs but it has been found that they are not nearly as good for this purpose as the bulb of the 201A type. For use with a single bulb detector set, results are very satisfactory and oftentimes when it is impossible

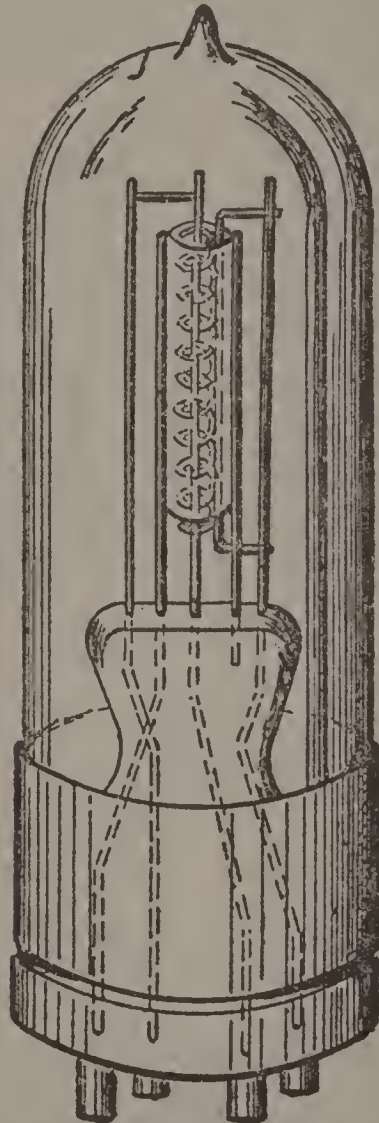

Fig. 95—W D 12 or C 12 Audion Bulb.

or impracticable to have a storage battery, there is a great advantage in using a bulb of the dry cell type. They are also much cheaper as the cost of the storage battery is eliminated.

Filament Battery	1 Dry Cell or 1 2-Volt Cell of a Storage Battery
Filament Terminal Voltage	1.1 Volts
Filament Current	.2 Amperes
Grid Bias Battery	Plate Voltage
1½ Volt Bias Battery	Over 50 Volts
3 Volt Bias Battery	Over 100 Volts
Plate Voltage	
Detector	20 to 22.5 Volts
Amplifier	22.5 to 45 Volts
Rheostat Used	
	6 Ohm with Vernier for Detector
	6 Ohm without Vernier for Amplifier
Grid Condenser	.00025 MFD
Grid Leak	2 Megohms
Socket	
WD 12	Standard Navy Socket
WD 11	As stated previously

For use as a detector the grid return should be connected to the positive side of the "A" battery and for use as an amplifier the negative side of the "A" battery.

When using a dry cell as an "A" battery, the center post of the battery is positive and the outside post is negative. Care must be taken not to get the voltage higher than two volts on the filament. Connections are the same as those shown in the drawings of the UV 199 in Fig. 92.

82. NORTHERN ELECTRIC 215-A BULB: The Northern Electric type of 215-A Vacuum tube is one of the smallest tubes in use and will give good results both as detector and amplifier. They are very economical in operation and are well adapted to portable sets due to

the fact that they require low filament current and can be operated on a single dry cell. This is a Canadian tube, it being distributed by the Northern Electric Company of Canada. However it can be purchased in the United States.



Fig. 96—Northern Electric Type 215A Audion Bulb.

Filament Battery	1 dry cell, 1.5 Volts
Filament Terminal Voltage	0.8 to 1.1 Volts
Filament Current	0.25 Ampere
Plate Voltage—	
Detector	17-22 Volts
Amplifier	17-45 Volts
Plate Current	0.7 Milliampere
“C” Battery	1.5 Volts at 45 Volts
Socket	Special

83. WESTERN ELECTRIC 216-A BULB: The Western Electric 216-A tube is similar in appearance to the VT-2 altho the electrical characteristics are

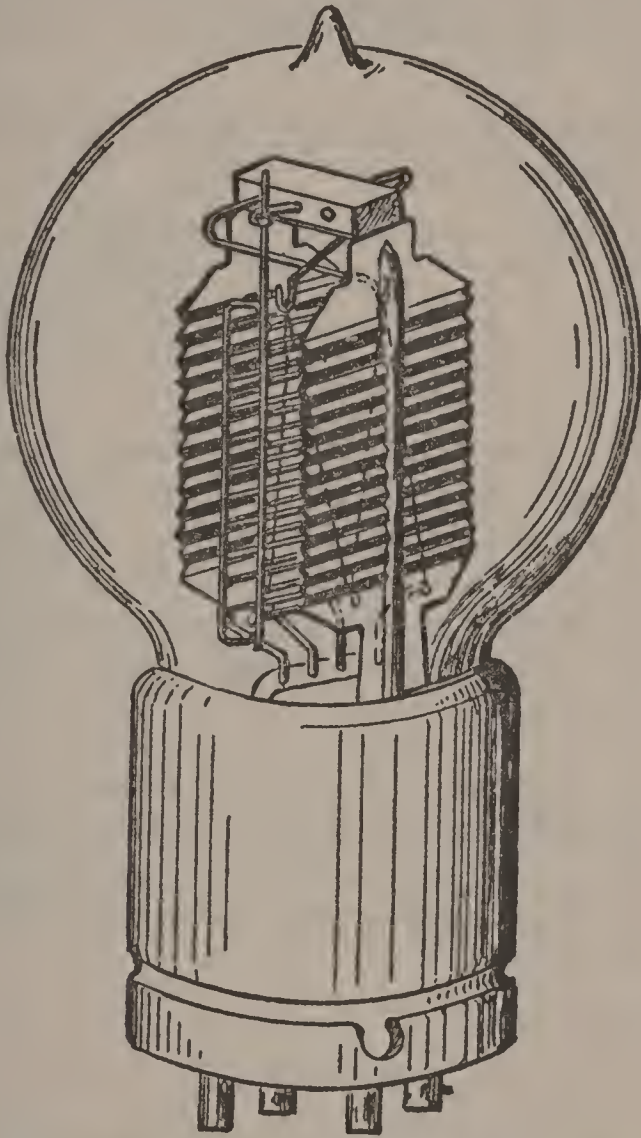

Fig. 97—Western Electric Type 216-A Audion Bulb.

entirely different, This bulb is being used extensively in power amplifiers but may be used successfully in any ordinary audio frequency amplifying unit. It is not nearly as economical on operation as a tube of the UV 201-A type, due to the fact that it uses more current for both filament and plate.

The advantages of the 216-A lie in that it will stand a heavier load without giving a distorted signal, and that due to the low filament temperature, long life is assured as the tube is operated under normal conditions. The filament should never burn brighter than a dull red.

Filament Battery	6 Volt Storage Battery
Filament Terminal Voltage	6 Volts
Filament Current	1.0 Ampere
Plate Voltage	100-130 Volts
Plate Current	7 to 9 Milliampere
Socket	Standard 4 prong Navy

Other tubes which are coming into general use and seem to have merits are the "Sodion", manufactured by the Connecticut Telephone & Telegraph Company and The Meiers. The Meiers was one of the old timers but was temporarily withdrawn from the market, but is now manufactured in Canada and can again be purchased in the United States.

Another tube having a general sale is the DeForest, made by the DeForest Telephone & Telegraph Company, but due to lack of cooperation on the part of the manufacturers, details and characteristics will have to be omitted.

CHAPTER VI

HISTORY OF RADIO ADVANCEMENT

It may interest many radio fans to read a summary of the important events in radio. The first experiments which have any bearing on the radio industry were conducted in 1827 and at various times since, new discoveries have been made which make possible radio telephony as we have it today.

A history of the important events in radio has been compiled by the Bureau of Navigation, U. S. Government, and was published by the Department of Commerce in their "Radio Service Bulletin." As many radio enthusiasts probably did not get a chance to see this Bulletin, it is here being reprinted. This will make a ready reference for anyone who wished to check up on the dates of the important events of Radio History.

1827 Savary found that a steel needle could be magnetized by the discharge from a Leyden jar.

1831 Farady discovered electromagnetic induction between two entirely separate circuits.

1837 The first patent for an electric telegraph was taken out by Cooke and Wheatstone (London) and by Morse (United States).

1838 Steinheil discovered the use of the earth return.

1840 Henry first produced high frequency electric oscillations and pointed out that the discharge of a condenser is oscillatory.

1842 Morse made wireless experiments by electric conduction through water.

1843 Lindsay suggested that if it were possible to provide stations not more than 20 miles apart all the way across the Atlantic there would be no need of laying a cable.

1845 Lindsay made experiments in transmitting messages across the River Tay by means of electricity or magnetism without submerging wires, using the water as a conductor.

1849 Wilkins revived the same suggestions for wireless telegraphy.

Dr. O'Shaughnessy succeeded in passing intelligible signals without metallic conduction across a river 4,200 feet wide.

1862 Heyworth patented a method of conveying electric signals without the intervention of any continuous artificial conductor.

1867 Maxwell read a paper before the Royal Society in which he laid down the theory of electromagnetism, which he developed more fully in 1873 in his great treatise on electricity and magnetism. He predicted the existence of the electric waves that are now used in wireless telegraphy.

1870 Von Bezold discovered that oscillations set up by a condenser discharge in a conductor gave rise to interference phenomena.

1872 Highton made various experiments across the River Thames with Morse's method.

1879 Hughes discovered the phenomena on which depend the action of coherer. The coherer was later used practically by Marconi.

1880 Trowbridge found that signaling might be carried on over considerable distances by electric conduction through the earth or water between places not metallically connected.

1882 Bell's experiments with Trowbridge method on the Potomac River resulted in the detection of signals at a distance of $1\frac{1}{2}$ miles.

Professor Dolbear was awarded a United States patent in March 1882, for wireless apparatus in connection with which he made the statement that "electrical communication, using this apparatus, might be established between points certainly more than one-half mile apart, but how much farther I can not say." It appeared that Professor Dolbear made an approach to the method that was, subsequently in the hands of Marconi, to be crowned with success.

1883 Fitzgerald suggested a method of producing electromagnetic waves in space by the discharge of a conductor.

1885 Edison, assisted by Gilliland, Phelps and Smith worked out a system of communication between railway stations and moving trains by means of induction and without the use of conducting wires. Edison took out only one patent on long-distance telegraphy without wires. The application was filed May 23, 1885, at the time he was working on induction telegraphy, but the patent (No. 465971) was not issued until December 20, 1891. In 1903 it was purchased from him by the Marconi Wireless Telegraph Company.

Preece made experiments at Newcastle-on-Tyne which showed that in two completely insulated circuits of square form, each side being 440 yards, placed a quarter of a mile apart, telephonic speech was conveyed from one to the other by induction.

1886 Dolbear patented a plan for establishing wireless communication by means of two insulated elevated plates, but there is not evidence that the method proposed by him, did or could, effect the transmission of signals between stations separated by any distance.

1887 Hertz showed that electromagnetic waves are in complete accordance with the waves of light and heat, and founded the theory upon which all modern radio signaling devices are based.

Heaviside established communication by telephonic speech between the surface of the earth and the subterranean galleries of the Broomhill Collieries, 350 feet deep, by laying above and below ground two complete metallic circuits, each about $2\frac{1}{4}$ miles in length, and parallel to each other.

1889 Thompson suggested that electric waves were particularly suitable for the transmission of signals through fogs and material objects.

1891 Trowbridge suggested that by means of magnetic induction between two separate and completely insulated circuits communication could be effected between distances.

1892 Preece adopted a method which united both conduction and induction as the means of affecting one circuit by the current in another. In this way he established communication between points on the Bristol Channel and at Lochness in Scotland.

Stevenson of the Northern Lighthouse Board, Edinburgh, advocated the use of an inductive system for communication between the mainland and isolated lighthouses.

Branly devised an appliance for detecting electromagnetic waves, which was known as a coherer.

1894 Rathenau experimented with a conductive system of wireless telegraphy and signalled through 3 miles of water.

1895 Smith established communication by conduction with the lighthouse on the Fastnet.

Marconi's investigations led him to the conclusion that Hertzian waves could be used for telegraphing without wires.

1896 Marconi lodged his application for the first British patent for wireless telegraphy. He conducted experiments in communication over a distance of $1\frac{3}{4}$ miles successfully.

The first demonstration of directional wireless using reflectors was given in England. Experiments were conducted to determine the relative speed of propagation of light waves and the electric vibrations which actuated a receiver at a distance of $1\frac{1}{2}$ miles between reflectors.

1897 March 1: Marconi demonstrated communication being established over a distance of 4 miles.

March 17: Balloons were first used for the suspension of wireless aerials.

July 10-18: Marconi maintained communication between the shore and a ship at sea at distances up to 10 miles.

September and October: Apparatus was erected at Bath, England, and signals received from Salisbury, 34 miles distant.

November 1: First Marconi station erected at the Needles, Alum Bay, Isle of Wight. Experiments were conducted covering a range of $14\frac{1}{2}$ miles.

December 6: Signals transmitted from shore to a ship at sea, 18 miles distant.

December 7: First floating wireless station was completed.

1898 June 3: The first paid radiogram was transmitted from the Needles (Isle of Wight) station.

July 20-22: Events of the Kingstown regatta in Dublin reported by wireless for Dublin newspaper from steamer Flying Huntress.

1899 April 22: The first French gunboat was fitted with wireless telegraph apparatus at Boulogne.

July: During the naval manoeuvres three British warships equipped with Marconi apparatus interchanged messages at distances up to 74 nautical miles (about 85 land miles).

The international yacht races which took place in September and October were reported by wireless telegraphy for the New York Herald. At the conclusion of the races series of trials were made between the United States cruiser New York and the battleship Massachusetts, signals being exchanged between the vessels at distance up to 36 miles. On the return journey from America Marconi fitted the steamship St. Paul with his apparatus, and on November 15 established communication with the Needles station when 36 miles away. Reports of the progress of the war in South Africa were telegraphed to the vessel and published in a leaflet entitled "The Transatlantic Times," printed on board.

1900 February 18: The first German commercial wireless station was opened on Borkum Island.

February 28: The first German liner fitted with wireless apparatus communicated with Borkum Island over a range of 60 miles.

November 2: The first wireless land station in Belgium was finished at Lapanne.

Between 1900 and 1905 Dr. De Forest was granted numerous patents in the United States and other countries for inventions connected with wireless telegraphy.

1901 January 1: The Bark Medora was reported by wireless as waterlogged on Ratel Bank. Assistance was immediately sent.

January 19: The Princesse Clementine ran ashore, and news of the accident was telegraphed to Ostend by wireless.

February 11: Communication was established between Niton Station, Isle of Wight, and the Lizard station, a distance of 196 miles.

March 1: A public wireless telegraph service was inaugurated between the five principal islands of the Hawaiian group, viz, Oahu, Kauai, Molaki, Maui, and Hawaii.

October 15: The first fan aerials were erected for experiments between Poldhu and Newfoundland.

December 12: The letter "S" was received by Marconi from Poldhu, England, at St. Johns, Newfoundland, a distance of 1,800 miles.

Prof. R. A. Fessenden applied for United States patent on September 28 for "Improvements in apparatus for the wireless transmission of electromagnetic wave, said improvements relating more especially to the transmission and reproduction of words or other audible signals." It appears that in connection with this apparatus there was contemplated the use of an alternating-current generator having a frequency of 50,000 cycles per second. Professor Fessenden was granted a number of United States patents between 1899 and 1905 covering devices used in connection with radiotelegraphy.

1901-1904 During this period Dr. John Stone was granted more than 70 United States patents covering radiotelegraphy.

1901-1905 More than 40 United States patents were granted to Harry Shoemaker covering certain apparatus used for radio communication.

1902 February: Steamship Philadelphia, American Line, received messages a distance of 1,551½ statute miles and received Morse signals up to a distance of 2,099 statute miles from Poldhu station, Cornwall, England.

June 25: The first moving wire magnetic detector actuated by clockwork was installed on the Italian cruiser Carlo Alberto.

July 14-16: Marconi received messages from Poldhu on the Italian cruiser Carlo Alberto, lying at Cape Skagen, a distance of 800 miles; and at Kronstadt, 1,600 miles.

December: On the 17th the first wireless message was transmitted across the Atlantic. On the 18th wireless messages were dispatched from Cape Breton station to King Edward VII.

1903 January 19: President Roosevelt sent a trans-Atlantic radiogram to King Edward via Cape Cod and Poldhu stations.

March 30: First transoceanic radiogram was published in the London Times.

August 4: First International Radiotelegraphic Conference was held at Berlin.

Poulsen patented the improved arc oscillation generator, using a hydrocarbon atmosphere and a magnetic field.

1904 January 20: The first press message was transmitted across the Atlantic.

August 15: The wireless telegraph act of Great Britain was passed.

November 16: Dr. J. Ambrose Fleming took out his original patent No. 24850 for thermionic valves.

1905 In October of this year erection of Clifden, Ireland, high-power radio station was commenced.

1906 Doctor De Forest was granted a patent on January 18 for a vacuum rectifier, commercially known as the audion.

Second International Radiotelegraphic Convention was held at Berlin, and a convention was signed by a majority of the principal countries of the world.

Dunwoody discovered the rectifying properties of carborundum crystals and Pickard discovered the similar properties of silicon crystals. These discoveries formed the basis of the widely used crystal detectors.

1907 October 17: Trans-Atlantic stations at Clifden and Glace Bay were opened for limited public service.

1908 February 3: Trans-Atlantic radio stations were opened to the general public for the transmission of messages between the United Kingdom and the principal towns in Canada.

In carrying out his invention Professor Fessenden constructed a high-frequency alternator with an output of 2.5 kilowatts at 225 volts and with a frequency of 70,000 cycles per second. Later Professor Fessenden reported successful wireless telephonic communication between his station located at Brant Rock, Mass., and Washington, D. C., a distance of about 600 miles.

1909 The steamship Republic, after colliding with the steamship Florida off the coast of the United States on January 23, succeeded in calling assistance by wireless, with the result that all her passengers and crew were saved before the vessel sank.

1910 The steamship *Principessa Mafalds* received messages from Clifden at a distance of 4,000 miles by day and 6,735 miles by night. On April 23 the Marconi Trans-Atlantic (Europe-America) service was opened.

June 24: Act approved by the United States Government requiring radio equipment and operators on certain passenger-carrying vessels.

1911 July 1. Radio service organized in Department of Commerce and Labor to enforce the act of June 24, 1910.

1912 F. A. Kolster, of the Bureau of Standards, invented and developed the Kolster decremeter, which is used to make direct measurements of wave length and logarithmic decrement. This instrument has been used by the radio service of the Department of Commerce since it was invented.

Early in the year the American Marconi Co. absorbed the United Wireless Co., of the United States.

In February the Marconi Co. procured the patents of Bellini and Tosi, including those for the wireless direction finder.

On February 9, the Australian Commonwealth station was opened.

On April 15, the steamship *Titanic*, on her maiden voyage, struck an iceberg and sank, but, owing to the prompt wireless call for assistance, the lives of more than 700 of her passengers were saved.

The International Radiotelegraphic Conference opened in London on June 4 and approved important regulations to have uniformity of practice in wireless telegraph services. On July 5 the International Radiotelegraphic Convention was signed at London.

July 23: Act approved by the United States Government extending act of June 24, 1910, to cover cargo vessels and requiring auxiliary source of power, efficient communication between the radio room and the bridge, and two or more skilled radio operators in charge of the apparatus on certain passenger-carrying vessels.

August 13: Act approved by the United Government licensing radio operators and transmitting stations.

1913 F. A. Kolster submitted to the Government a paper pointing out the advantages of certain applications of radio signaling for use at lighthouses, light-ships, and life-saving stations, especially in time of fog.

During this year the Governments of France and the United States experimented between the Eiffel Tower station and Washington by wireless to procure data for comparing the velocity of electro-magnetic waves with that of light.

In June, a wireless telegraph bill was presented to the Ottawa Parliament and passed under the title "Radio-telegraph Act of Canada."

On October 11, the *Volturno* was burned in mid-Atlantic, and in response to the wireless appeal 10 vessels came to the rescue, 521 lives being saved.

On November 24, the first practical trials with wireless apparatus on trains were made on a train belonging to the Delaware, Lackawanna & Western Railroad.

The station at Macquerie Island was the means of keeping Doctor Maason the Australian explorer, in touch with the outer world. Radio dispatches were published in a small journal which was established, called the *Adelle Blizzard*.

November 12: Safety at Sea Conference held in London. At this conference the use of radio received appropriate consideration.

November 24: The first practical trials with wireless apparatus on trains were made, messages having been received and transmitted on board trains.

1914 Experiments in wireless telephony were carried out between several vessels lying at anchor five-eighths of a mile apart, ordinary receivers being used with success. The wireless telephone experiments were continued between two warships on the high seas, and the reception was consistently good over a distance of $18\frac{1}{2}$ miles. Successful wireless telephone communications were effected later, using only very limited energy between vessels on the high seas 44 miles apart. These experiments were repeated where land intervened between the communicating vessels, and in this case again excellent results were obtained. On this day radiotelephonic communication was constantly maintained for 12 hours.

On April 15, at Godalming, a memorial was unveiled to the memory of Jack Philips, chief radio operator of the ill-fated Titanic, who died at his post when the vessel foundered in mid-Atlantic on the 15th of April, 1912.

A new departure in the application of radiotelegraphy to the safety of life at sea was the equipment of the motor lifeboats of the steamship Aquitania with radio apparatus.

High powered transoceanic stations were completed at Carnarvon, Wales, Belmar, Honolulu, and San Francisco during the autumn of 1914. The Honolulu-San Francisco stations were opened to public service September 24. The Tuckerton-Eilvese and Sayville-Nauen stations were in operation about this time.

Most of these stations made use of the latest developments in the art, using undamped and long waves as produced by the Poulsen arc and the radio frequency alternator.

On October 6, E. H. Armstrong was issued a patent covering the regenerative circuit also known as the feedback and the self-heterodyne circuit.

1915 During this year F. A. Kolster, of the Bureau of Standards, developed a radiocompass said to be more effective than that which was being used.

On February 20, the Panama-Pacific Exposition at San Francisco was officially opened by President Wilson at Washington, through the medium of wireless telegraphy.

On May 12, in Battery Park, New York City, the mayor unveiled the monument in memory of wireless operators who had lost their lives at the post of duty.

On July 27 wireless communication between the United States and Japan was effected. Two terminal stations were located at San Francisco and Funabashi, near Tokio, and the messages were relayed through Honolulu.

On July 28, the American Telephone & Telegraph Co., working in conjunction with the Western Electric Co., succeeded in telephoning the wireless across the American continent from Arlington to Hawaii, a distance of nearly 5,000 miles.

On October 26, the wireless telephone experiments were continued, communication being effected across the Atlantic from Arlington to the Eiffel Tower, Paris.

During this year ship service was greatly improved through the installation of new equipment, embodying features of great practical value, by various operating companies. Efficient emergency radio transmitters came into wider use, owing considerably to the efforts of the radio service of the Department of Commerce and its refusal to pass inefficient equipment. Such installations considered as essential are safeguards to shippers and the seagoing public.

1916 During the course of a severe blizzard in the United States during February wireless telegraphy was extensively used for train dispatching, as the telegraph wires were down.

The determination of the difference in longitude between Paris and Washington with the aid of radio which had been in progress since October, 1913, was completed during May, the result, expressed in terms of times, being 5 hours 17 minutes 35.67 seconds, and has a probable accuracy of the order of 0.01 second.

The initiation of the newly established trans-Pacific wireless service between the United States and Japan was celebrated on November 5, by an interchange of messages between the Mikado and President Wilson.

1917 June 2, marked the "coming of age" of wireless telegraph in England, that is, that 21 years had elapsed since the registration of patent 12039 in 1896.

1918 The trend of progress toward continuous-wave communication as distinct from that by damped waves was very marked during this year, a particular impetus being given by the continued development of the electron tube as an efficient receiver and generator of undamped oscillations. Steady improvement was also evident in the arc form of generator which was installed in many new high-power stations.

Wireless telephony also progressed to a marked extent, particularly in the direction of reliability and increase of range, due mainly to the development of valve generator and receivers.

In the equipment of aircraft with wireless great progress was made, both in radiotelegraphy and radiotelephony.

At the end of the year a high-power station, erected by the United States Government, was opened at Croix d'Hins, near Bordeaux.

In the Argentine the erection of a station destined for direct communication with the North American continent was commenced in the vicinity of Buenos Aires.

The extension in the application of wireless telegraphy to merchant vessels continued, and at the close of the year some 2,500 to 3,000 vessels of the British Merchant Marine carried installations.

On July 31 the United States Government took over all wireless land stations in the United States, with the exception of certain high-power stations, which remained under the control of commercial companies.

On September 22 messages transmitted from Carnarvon were received in Sydney, 12,000 miles away. Cable confirmations of these messages were sent forward at the same time but were received some hours later than the corresponding radio-telegrams.

In April a high-power station was opened at Stavanger, Norway, for the use of the Norwegian Government. The station communicates with the United States.

1919 The successful transatlantic flights of Alcock and Brown, of the American NC4, and of the British dirigible R34, during the summer of the year focused attention upon the application of radio for aviation purposes and its great value for aerial navigation.

On June 30, 1919, there were 2,312 ship stations of the United States, having increased from 1,478 on June 30, 1918. At this time new ship stations were increasing at the rate of 100 a month. This increase was due to the great number of vessels built during the war period.

The temporary war measures relative to the installation of wireless telegraph apparatus on all merchant vessels of 1,600 tons or over under the British flag was made permanent by a bill passed by the British Parliament.

In February a Spanish decree was issued to the effect that all sailing vessels of 500 tons or over and carrying 50 or more passengers must be equipped with wireless apparatus.

During the year the Radio Corporation took over the radio interests of the American Marconi Company.

The war-time ban on private and experimental wireless stations was removed.

1920 The steady development of continuous-wave wireless work was continued during the year and some further progress made in the commercial application of tube apparatus.

On January 14, a law was passed in Greece making the carrying of wireless apparatus obligatory on all Greek merchant ships of 1,600 tons gross and over, or having 50 or more persons aboard, including crew.

On January 25, a new high-power station was opened at Monte Grande, Argentine, call letters LPZ.

Amateur radio work in this and other countries progressed steadily during the year with the gradual removal of wartime restrictions.

Bordeaux, France, high-power station opened.

1921 Experiments were carried out in France with successful results in the application of Baudot and similar high-speed telegraph apparatus to radio work.

The Noble Prize for physics was awarded this year to Prof. Edouard Branly for his researches in radio.

The progress made in amateur and experimental wireless is exemplified by the attempts made in February and December of this year to effect communication on short wave lengths between the wireless amateurs of the United States and Great Britain. The first attempt was unsuccessful, but during the second test signals from many American amateur stations were heard both by British radio amateurs and by the representative of the American Radio Relay League who was sent over for the tests. The signals were also heard in Holland.

The American Radio Relay League held its first annual convention in Chicago, August 30—September 3, at which many thousands of amateurs of the United States were present.

The first licenses for broadcasting stations were issued in September of this year.

New York radio central station opened on Long Island.

1922 During this year broadcasting stations increased rapidly in keeping with the great interest taken in the art.

On June 7 E. H. Armstrong read a paper before the Institute of Radio Engineers on some recent developments by him of regenerative circuits. Professor Armstrong was granted a patent for the super-regenerative circuit.

Experiments in radiotelephoning from ship to shore were conducted during this year. In tests from the steamship American it was proved possible to communicate with land telephone stations more than 400 miles distant from the ship.

1923 On March 2, L. A. Hezeltine, of Stevens Institute of Technology, presented a paper before the Radio Club of America on tuned radiofrequency amplification with neutralization of capacity coupling. Professor Hezeltine was granted a patent for the nonradiating neutrodyne receiver.

Great progress was made during the year in the development of vacuum tubes.

Short wave lengths were used to greater advantage than heretofore.

The McMillan expedition to the polar regions had radio for their only means of direct communication. Using low power and short wave lengths their vessel, Bow-

doin, communicated with several stations in the United States while they were frozen in thousands of miles away. Broadcasting concerts from United States Stations were heard during the long dark nights of the arctic zone.

During the year foreign countries became interested in radiotelephone broadcasting.

Broadcasting in United States heard in England, and vice versa.

1924 In January radio was used in the region of the Great Lakes during a blizzard for dispatching trains.

An expedition from the United States, under the leadership of Hamilton Rice, which will explore the Amazon and Orinoco Rivers in Brazil and Venezuela in the interest of geographical science in general, will have radio as their only means of communication.

On February 5, a radio program broadcast in the United States from Pittsburgh station of Westinghouse Electric & Manufacturing Company was received and rebroadcast in England for the benefit of English stations.

On February 23 a concert broadcast by the same station and relayed from London was heard clearly in Calcutta, India.

Roger Babson, economist, estimates that during this year the American people will spend approximately \$350,000,000 for radio equipment. Sales of radio equipment are running nearly twice as large as all kinds of sporting goods.

A wireless lighthouse has been set up on an island in the Firth of Forth, Scotland. Wireless waves are concentrated by reflectors into a beam which can be sent 100 miles, giving ships their position in a fog.

APPENDIX "A"

APPENDIX "A"











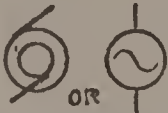

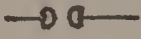

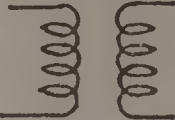
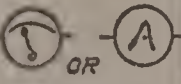

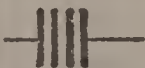

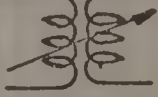











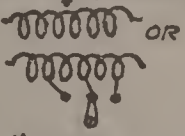



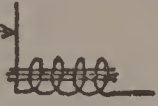

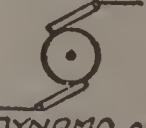
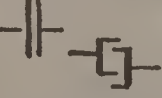

USEFUL TABLES AND CHARTS

THE student in his study of radio will probably find many symbols and abbreviations with which he is not familiar. If he will acquaint himself with those shown in this appendix, he will then be able to better understand the drawings shown in this book and other drawings of a similar nature which are found in most radio books and magazines. Tables are also given which can be used in working out radio problems.

TABLE OF ABBREVIATIONS

C. , Centigrade	m.m. or m/m , millimeter(s)
cu. ft. , cubic foot (feet)	o. d. , outside diameter
F. , Fahrenheit	oz. , ounce(s)
ft. , foot (feet)	sq. ft. , square foot (feet)
f. o. b. , free on board (cars)	sq. in. , square inch(es)
gr. yd. , gross yard(s)	sq. yd. , square yards()
in. , inch(es)	sp. gr. , specific gravity
lb. , pound	' foot (feet)
lbs. , pounds	" inch(es)
	= plus or minus

SYMBOLS USED IN RADIO DIAGRAMS

				
ALTERNATOR	VARIABLE CONDENSER	SPARK GAP	TELEPHONE RECEIVER	COUPLED COILS
				
AMMETER	CONNECTION	QUENCHED GAP	TELEPHONE MICROPHONE	VARIABLE COUPLING
				
AERIAL	NO CONNECTION	GROUND	IRON CORE TRANSFORMER	VARIABLE CONDENSER.
				
ARC	COIL	KEY	TWO COIL IRON CORE TRANSFORMER	VOLTMETER
				
BATTERY	VARIABLE INDUCTANCE	RESISTANCE	CHOKE COIL	VARIOMETER
				
BUZZER	DETECTOR CRYSTAL	VARIABLE RESISTANCE	VACUUM TUBE	DYNAMO OR MOTOR
				
FIXED CONDENSER	GALVANOMETER	SWITCH	VACUUM TUBE	LOOP AERIAL
				
SWITCH. SPST.	SWITCH. SPDT.	SWITCH. DPST.	SWITCH. D.P.D.T.	REVERSING.

COPPER WIRE TABLE

This Table will help determine the Resistance, Length, Weight and Area of Different Sizes of Copper Wire.

A.W.G	Diameter	Area	Weight	Length	RESISTANCE	
B.&S. Gauge	Inches	Circular Mils	Pounds per 1000 Feet	Feet per Pound	Ohms per 1000 Feet	Ohms per Pound
0000	0.4600	211,600.	640.5	1.561	.04901	.00007652
000	0.4096	167,800.	507.9	1.969	.06180	.0001217
00	0.3648	133,100.	402.8	2.483	.07793	.0001935
0	0.3249	105,500.	319.5	3.130	.09827	.0002076
1	0.2893	83,690.	253.3	3.943	.1239	.0004891
2	0.2576	66,370.	200.9	4.978	.1563	.0007778
3	0.2294	52,630.	159.3	6.276	.1970	.001237
4	0.2043	41,740.	126.4	7.911	.2485	.001966
5	0.1819	33,100.	100.2	9.980	.3133	.003127
6	0.1620	26,250.	79.46	12.58	.3951	.004972
7	0.1443	20,820.	63.02	15.87	.4982	.007905
8	0.1285	16,510.	49.98	20.01	.6282	.01257
9	0.1144	13,090.	39.63	25.23	.7921	.01999
10	0.1019	10,380.	31.43	31.82	.9989	.03178
11	0.09074	8,234.	24.92	40.13	1.260	.05053
12	0.08081	6,530.	19.77	50.58	1.588	.08035
13	0.07196	5,178.	15.68	63.77	2.003	.1278
14	0.06408	4,107.	12.43	80.45	2.525	.2032
15	0.05707	3,257.	9.858	101.4	3.184	.3230
16	0.05082	2,583.	7.818	127.9	4.016	.5136
17	0.04526	2,048.	6.200	161.3	5.064	.8167
18	0.04030	1,624.	4.917	203.4	6.385	1.299
19	0.03589	1,288.	3.899	256.5	8.051	2.065
20	0.03196	1,022.	3.092	323.4	10.15	3.283
21	0.02846	810.1	2.452	407.8	12.80	5.221
22	0.02535	642.4	1.945	514.1	16.14	8.301
23	0.02257	509.5	1.542	648.5	20.36	13.20
24	0.02010	404.0	1.223	817.7	25.67	20.99
25	0.01790	320.4	0.9699	1031.	32.37	33.37
26	0.01594	254.1	0.7692	1300.	40.81	53.06
27	0.01420	201.5	0.6100	1639.	51.47	84.37
28	0.01264	159.8	0.4837	2067.	64.90	134.2
29	0.01126	126.7	0.3836	2606.	81.83	213.3
30	0.01003	100.5	0.3042	3287.	103.2	329.2
31	0.008928	79.70	0.2413	4144.	130.1	539.3
32	0.007950	63.21	0.1913	5227.	164.1	857.6
33	0.007080	50.13	0.1517	6591.	206.9	1364.
34	0.006305	39.75	0.1203	8312.	260.9	2168.
35	0.005615	31.52	0.09542	10480.	329.0	3448.

A.W.G.	Diameter	Area	Weight	Length	RESISTANCE	
B. & S. Gauge	Inches	Circular Mils	Pounds per 1000 Feet	Feet per Pound	Ohms per 1000 Feet	Ohms per Pound
36	0.005000	25.00	0.07568	13213.	414.8	5482.
37	0.004453	19.83	0.0601	16664.	523.1	8717.
38	0.003965	15.72	0.04759	21012.	659.6	13860.
39	0.003531	12.47	0.03774	26497.	831.8	22040.
40	0.003145	9.888	0.02990	33411.	1049.	35040.
(41)*	0.00275	7.5625	0.02289	43,700.	1370.	59,900.
(42)*	0.00250	6.2500	0.01892	52,800.	1660.	87,700.
(43)*	0.00225	5.0625	0.01532	65,300.	2050.	133,700.
(44)*	0.00200	4.0000	0.01211	82,600.	2600.	214,000.
(45)*	0.00175	3.0625	0.00927	107,900.	3390.	365,200.
(46)*	0.00150	2.2500	0.00681	146,800.	4610.	676,800.

*B. & S. Gauge numbers for the sizes smaller than No. 40 are often used, but are not yet fully recognized. It is best to specify these sizes by their diameters.

COMMON RADIO ABBREVIATIONS

<i>ANT.</i>	<i>ANTENNA OR AERIAL</i>
<i>GND.</i>	<i>GROUND</i>
<i>TEL</i>	<i>TELEPHONE</i>
<i>AMP.</i>	<i>AMPLIFIER.</i>
<i>DET</i>	<i>DETECTOR</i>
<i>BATT</i>	<i>BATTERY.</i>
<i>M.F.D.</i>	<i>MICROFARAD.</i>
<i>POT</i>	<i>POTENTIOMETER</i>
<i>A.-F.</i>	<i>AUDIO-FREQUENCY.</i>
<i>TRANS</i>	<i>TRANSFORMER.</i>

INTERNATIONAL TELEGRAPHIC CODE

CODE.

A.	● ■	N.	■ ■ ●
B.	■ ■ ● ● ●	O.	■ ■ ■ ■ ■
C.	■ ■ ● ■ ■ ●	P.	● ■ ■ ■ ●
D.	■ ■ ● ●	Q.	■ ■ ■ ● ■ ■
E.	●	R.	● ■ ■ ●
F.	● ● ■ ■ ●	S.	● ● ● ●
G.	■ ■ ■ ●	T.	■ ■
H.	● ● ● ●	U.	● ● ■ ■
I.	● ●	V.	● ● ● ■ ■
J.	● ■ ■ ■ ■ ■	W.	● ■ ■ ■ ■
K.	■ ■ ● ■ ■	X.	■ ■ ● ● ■ ■
L.	● ■ ■ ● ●	Y.	■ ■ ● ■ ■ ■ ■
M.	■ ■ ■ ■	Z.	■ ■ ■ ■ ● ●

NUMBERS

1	● ■ ■ ■ ■ ■ ■ ■	6	■ ■ ● ● ● ●
2	● ● ■ ■ ■ ■ ■	7	■ ■ ■ ■ ● ● ●
3	● ● ● ■ ■ ■ ■	8	■ ■ ■ ■ ■ ● ●
4	● ● ● ● ■ ■	9	■ ■ ■ ■ ■ ■ ■ ●
5	● ● ● ● ●	0	■ ■ ■ ■ ■ ■ ■ ■

.	● ● ● ● ● ●
,	● ■ ■ ● ■ ■ ■ ■
:	■ ■ ■ ■ ■ ● ● ●
;	■ ■ ● ■ ■ ● ■ ■ ●
?	● ● ■ ■ ■ ■ ● ●

TABLE SHOWING THE RELATION OF WAVE LENGTH TO FREQUENCY

(Wave Length in Meters—Frequency in Kilocycles)

W. L.	Freq.	W. L.	Freq.	W. L.	Freq.
10	20980	530	565.7	1050	285.5
20	14980	540	555.2	1060	282.8
30	9994	550	545.1	1070	280.2
40	7496	547.6	547.6	1080	277.6
50	5996	560	535.4	1090	275.1
60	4997	570	526.0	1100	272.6
70	4283	580	516.9	1110	270.1
80	3748	590	508.2	1120	267.7
90	3331	600	499.7	1130	265.3
100	2998	610	491.5	1140	263.0
110	2726	620	483.6	1150	260.7
120	2499	630	475.9	1160	258.5
130	2306	640	468.5	1170	256.3
140	2142	650	461.3	1180	254.1
150	1999	660	454.3	1190	252.0
160	1874	670	447.5	1200	249.9
170	1764	680	440.9	1210	247.8
173.2	1732	690	434.5	1220	245.8
180	1666	700	428.3	1230	243.8
190	1578	710	422.3	1240	241.8
200	1499	720	416.4	1250	239.9
210	1428	730	410.7	1260	238.0
220	1363	740	405.2	1270	236.1
230	1304	750	399.8	1280	234.2
240	1249	760	394.5	1290	232.4
250	1199	770	389.4	1300	230.6
260	1153	780	384.4	1310	228.9
270	1110	790	379.5	1320	227.1
280	1071	800	374.8	1330	225.4
290	1034	810	370.2	1340	223.7
300	999.4	820	365.6	1350	222.1
310	967.2	830	361.2	1360	220.4
320	936.9	840	356.9	1370	218.8
330	908.6	850	352.7	1380	217.3
340	881.8	860	348.6	1390	215.7
350	856.6	870	344.6	1400	214.2
360	832.8	880	340.7	1410	212.6
370	810.3	890	336.9	1420	211.1
380	789.0	900	333.1	1430	209.7
390	768.8	910	329.5	1440	208.2
400	749.6	920	325.9	1450	206.8
410	731.3	930	322.4	1460	205.4
420	713.9	940	319.0	1470	204.0
430	697.3	950	315.6	1480	202.6
440	681.4	960	312.3	1490	201.2
450	666.3	970	309.1	1500	199.9
460	651.8	980	305.9	1510	198.6
470	637.9	990	302.8	1520	197.2
480	624.6	1000	299.8	1530	196.0
490	611.9	1010	296.9	1540	194.7
510	599.6	1020	293.9	1550	193.4
500	587.9	1030	291.1	1560	192.2
520	576.6	1040	288.3	1570	191.0

Table Showing the Relation of Wave Length to Frequency—Continued

W. L.	Freq.	W. L.	Freq.	W. L.	Freq.
1580	189.8	2140	140.1	2710	110.6
1590	188.6	2150	139.5	2720	110.2
1600	187.4	2160	138.8	2730	109.8
1610	186.2	2170	138.1	2740	109.4
1620	185.1	2180	137.5	2750	109.0
1630	183.9	2190	136.9	2760	108.6
1640	182.8	2200	136.3	2770	108.2
1650	181.7	2210	135.7	2780	107.8
1660	180.6	2220	135.1	2790	107.5
1670	179.5	2230	134.4	2800	107.1
1680	178.5	2240	133.8	2810	106.7
1690	177.4	2250	133.3	2820	106.3
1700	176.4	2260	132.7	2830	105.9
1710	175.3	2270	132.1	2840	105.6
1720	174.3	2280	131.5	2850	105.2
1730	173.3	2290	130.9	2860	104.8
1732	173.2	2300	130.4	2870	104.5
1740	172.3	2310	129.8	2880	104.1
1750	171.3	2320	129.2	2890	103.7
1760	170.4	2330	128.7	2900	103.4
1770	169.4	2340	128.1	2910	103.0
1780	168.4	2350	127.6	2920	102.7
1790	167.5	2360	127.0	2930	102.3
1800	166.6	2370	126.5	2940	102.0
1810	165.6	2380	126.0	2950	101.6
1820	164.7	2390	125.4	2960	101.3
1830	163.8	2400	124.9	2970	100.9
1840	162.9	2410	124.4	2980	100.6
1850	162.1	2420	123.9	2990	100.3
1860	161.2	2430	123.4	3000	99.94
1870	160.3	2440	122.9	3020	99.28
1880	159.5	2450	122.4	3040	98.62
1890	158.6	2460	121.9	3060	97.98
1900	157.8	2470	121.4	3080	97.34
1910	157.0	2480	120.9	3100	96.72
1920	156.2	2490	120.4	3120	96.10
1930	155.3	2500	119.9	3140	95.48
1940	154.5	2510	119.5	3160	94.88
1950	153.8	2520	119.0	3180	94.28
1960	153.0	2530	118.5	3200	93.69
1970	152.2	2540	118.0	3220	93.11
1980	151.4	2550	117.6	3240	92.54
1990	150.7	2560	117.1	3260	91.97
2000	149.9	2570	116.7	3280	91.41
2010	149.2	2580	116.2	3300	90.86
2020	148.4	2590	115.8	3320	90.31
2030	147.7	2600	115.3	3340	89.77
2040	147.0	2610	114.9	3360	89.23
2050	146.3	2620	114.4	3380	88.70
2060	145.5	2630	114.0	3400	88.18
2070	144.8	2640	113.6	3420	87.67
2080	144.1	2650	113.1	3440	87.16
2090	143.5	2660	112.7	3460	86.65
2100	142.8	2670	112.3	3480	86.16
2110	142.1	2680	111.9	3500	85.66
2120	141.4	2690	111.5	3520	85.18
2130	140.8	2700	111.0	3540	84.70

Table Showing the Relation of Wave Length to Frequency—Continued

W. L.	Freq.	W. L.	Freq.	W. L.	Freq.
3560	84.22	4720	63.52	7150	41.93
3580	83.75	4740	63.25	7200	41.64
3600	83.28	4760	62.99	7250	41.35
3620	82.82	4780	62.72	7300	41.07
3640	82.37	4800	62.46	7350	40.79
3660	81.92	4820	62.20	7400	40.52
3680	81.47	4840	61.95	7450	40.24
3700	81.03	4860	61.69	7500	39.98
3720	80.60	4880	61.44	7550	39.71
3740	80.17	4900	61.19	7600	39.45
3760	79.74	4920	60.94	7650	39.19
3780	79.32	4940	60.69	7700	38.94
3800	78.90	4960	60.45	7750	38.69
3820	78.49	4980	60.20	7800	38.44
3840	78.08	5000	59.96	7850	38.19
3860	77.67	5050	59.37	7900	37.95
3880	77.27	5100	58.79	7950	37.71
3900	76.88	5150	58.22	8000	37.48
3920	76.49	5200	57.66	8050	37.25
3940	76.10	5250	57.11	8100	37.02
3960	75.71	5300	56.75	8150	36.79
3980	75.33	5350	56.04	8200	36.56
4000	74.96	5400	55.52	8250	36.34
4020	74.58	5450	55.01	8300	36.12
4040	74.21	5476	54.76	8350	35.91
4060	73.85	5500	54.51	8400	35.69
4080	73.49	5550	54.02	8450	35.48
4100	73.13	5600	53.54	8500	35.27
4120	72.77	5650	53.07	8550	35.07
4140	72.42	5700	52.60	8600	34.86
4160	72.07	5750	52.14	8650	34.66
4180	71.73	5800	51.69	8700	34.46
4200	71.39	5850	51.25	8750	34.27
4220	71.05	5900	50.82	8800	34.07
4240	70.71	5950	50.39	8850	33.88
4260	70.38	6000	49.97	8900	33.69
4280	70.05	6050	49.56	8950	33.50
4300	69.73	6100	49.15	9000	33.31
4320	69.40	6150	48.75	9050	33.13
4340	69.08	6200	48.36	9100	32.95
4360	68.77	6250	47.97	9150	32.77
4380	68.45	6300	47.59	9200	32.59
4400	68.14	6350	47.22	9250	32.41
4420	67.83	6400	46.85	9300	32.24
4440	67.53	6450	46.48	9350	32.07
4460	67.22	6500	46.13	9400	31.90
4480	66.91	6550	45.77	9450	31.73
4500	66.63	6600	45.43	9500	31.56
4520	66.33	6650	45.09	9550	31.39
4540	66.04	6700	44.75	9600	31.23
4560	65.75	6750	44.42	9650	31.07
4580	65.46	6800	44.09	9700	30.91
4600	65.18	6850	43.77	9750	30.75
4620	64.90	6900	43.45	9800	30.59
4640	64.62	6950	43.14	9850	30.44
4660	64.34	7000	42.83	9900	30.28
4680	64.06	7050	42.53	9950	30.13
4700	63.79	7100	42.342	10000	29.98

Form 173 a-

DEPARTMENT OF COMMERCE
BUREAU OF NAVIGATION
RADIO SERVICE

INTERNATIONAL RADIOTELEGRAPHIC CONVENTION
LIST OF ABBREVIATIONS TO BE USED IN RADIO COMMUNICATION

ABBREVIATION	QUESTION	ANSWER OR NOTICE
PRB	Do you wish to communicate by means of the International Signal Code?	I wish to communicate by means of the International Signal Code.
QRA	What ship or coast station is that?	This is.....
QRB	What is your distance?	My distance is.....
QRC	What is your true bearing?	My true bearing is.....degrees.
QRD	Where are you bound for?	I am bound for.....
QRP	Where are you bound from?	I am bound from.....
QRQ	What line do you belong to?	I belong to the.....Line.
QRH	What is your wave length in meters?	My wave length is.....meters.
QRJ	How many words have you to send?	I have.....words to send.
QRK	How do you receive me?	I am receiving well.
QRL	Are you receiving badly? Shall I send 20% for adjustment?	I am receiving badly. Please send 20% for adjustment.
QRW	Are you being interfered with?	I am being interfered with.
QRN	Are the atmospherics strong?	Atmospherics are very strong.
QRO	Shall I increase power?	Increase power.
QRP	Shall I decrease power?	Decrease power.
QRQ	Shall I send faster?	Send faster.
QRS	Shall I send slower?	Send slower.
QRT	Shall I stop sending?	Stop sending.
QRU	Have you anything for me?	I have nothing for you.
QRV	Are you ready?	I am ready. All right now.
QBW	Are you busy?	I am busy (or: I am busy with.....). Please do not interfere.
QRX	Shall I stand by?	Stand by. I will call you when required.
QRY	When will be my turn?	Your turn will be No.
QRZ	Are my signals weak?	Your signals are weak.
QSA	Are my signals strong?	Your signals are strong.
QSB	Is my tone bad?	The tone is bad.
	Is my spark bad?	The spark is bad.
QSC	Is my spacing bad?	Your spacing is bad.
QSD	What is your time?	My time is.....
QSF	Is transmission to be in alternate order or in series?	Transmission will be in alternate order.
QSQ	Transmission will be in series of 5 messages.
QSH	Transmission will be in series of 10 messages.
QSI	What rate shall I collect for?	Collect.....
QSK	Is the last radiogram canceled?	The last radiogram is canceled.
QSL	Did you get my receipt?	Please acknowledge.
QSM	What is your true course?	My true course is.....degrees.
QSN	Are you in communication with land?	I am not in communication with land.
QSO	Are you in communication with any ship or station (or: with.....)?	I am in communication with..... (through.....).
QSP	Shall I inform.....that you are calling him?	Inform.....that I am calling him.
QSQ	Is.....calling me?	You are being called by.....
QSR	Will you forward the radiogram?	I will forward the radiogram.
QST	Have you received the general call?	General call to all stations.
QSU	Please call me when you have finished (or: at.....o'clock)?	Will call when I have finished.
QSV	Is public correspondence being handled?	Public correspondence is being handled. Please do not interfere.
QSW	Shall I increase my spark frequency?	Increase your spark frequency.
QSX	Shall I decrease my spark frequency?	Decrease your spark frequency.
QSY	Shall I send on a wave length of.....meters?	Let us change to the wave length of.....meters.
QSZ	Send each word twice. I have difficulty in receiving you.
QTA	Repeat the last radiogram.
QTE	What is my true bearing?	Your true bearing is.....degrees from.....
QTF	What is my position?	Your position is....latitude....longitude.

APPENDIX "B"

APPENDIX "B"

THE AMATEUR RADIO OPERATOR AND THE A.R.R.L.

As stated in the preface, this book was written primarily for the class of people known as "B.C.L's" or Broad-Cast Listeners.

It is believed that too often the B.C.L. is ready to criticize the amateur radio operator. It is also believed that if a better understanding were had between these two classes of radio fans, each would be more considerate of the rights of the other. To help make this possible, the author has included in this appendix, a few facts which he hopes, will enable the reader, who is a broadcast listener, to better understand the aims and aspirations of the amateur radio operator.

These operators are, with a few exceptions, all members of the A.R.R.L. or American Radio Relay League. The aims of this organization can be understood best by quoting from the By-Laws of the League. This quotation appears in every issue of their official organ, QST.

"The American Radio Relay League, Inc. is a national non-commercial association of radio amateurs, bonded for the more effective relaying of friendly messages between their stations, for legislative protection, for orderly operating, and for the practical improvement of short-wave two way radio telegraphic communication. It is an

incorporated association without capital stock, chartered under the laws of Connecticut. Its affairs are governed by a Board of Directors, elected every two years by the general membership. The officers are elected or appointed by the Directors. The League is non-commercial and no one commercially engaged in the manufacture, sale, or rental of radio apparatus is eligible to membership on the Board."

Much of the advancement of the radio industry today is due to the fact that thousands of transmitting amateurs, scattered all over the United States, have spent and are still spending their time and energy in the development of the radio art. Many of the well known radio engineers of today were at one time transmitting amateurs.

Many rules and regulations have been voluntarily accepted by them, curbing their rights, in favor of the man who wishes to listen to a broadcast program. Of course, the organization, as with all organizations, has its outlaws, but it, as a whole should not be condemned because of the few who will not observe "silent periods."

It should be realized that the transmitting amateur is easily outnumbered by one hundred to one, and because of this, the higher grade amateur realizes that he must not infringe too greatly upon the rights of the broadcast listener. The broadcast listener oftentimes says he does not see the use of transmitting the seemingly unimportant messages back and forth and the amateur operator does not understand the broadcast listener, who is a "DX" hound, and does not particularly care for the quality of the program he is receiving, as long as it is a good distance away.

In this respect, one type of amateur is doing it for the same reason as the other. Both trying to get the most

efficient operation out of their apparatus. This desire calls for constructive experimental work from both parties and so is worth while.

Much can still be done by the transmitting amateur to eliminate interference to the B.C.L. The complete elimination of the spark transmitter and adoption of C. W. will do much to lessen interference. Other improvements which can be made are the total elimination of key click, more careful tuning of the transmitters to the allotted wave length and complete observation of quiet hours.

The broadcast listener can do his part by buying or building more efficient receiving equipment, whereby he will not be interfered with by the operator who is handling his station properly. When the B.C.L. is interfered with on the higher wave lengths, he can rest assured that it is not amateur interference, but is undoubtedly ship or commercial traffic of importance.

APPENDIX "C"

APPENDIX "C"

LOCATING TROUBLE

It is assumed that most of the readers of this book, either have radio sets at the present time or intend buying one in the future. This appendix will be devoted to the explanation of some of the most common ways of locating the source of trouble when a radio receiving set does not operate successfully. It is believed that with these helps most any one will be able to find the most common causes of unsuccessful operation.

IF THE SET FAILS TO OPERATE AT ALL

See if the aerial and ground are connected to their proper places. Phone or loud speaker may be disconnected.

"A" and "B" batteries may be disconnected.

Leads from "B" battery may be reversed. Trace out and see that the positive side of the "B" battery is connected to the plate terminal of the audion bulb.

One of the tubes in the set may be burned out or the elements of the tube may be touching each other.

Check the set over and see if there are any loose connections.

A phone condenser may be shorted.

A transformer may be shorted or burned out.

One of the jacks in the set may be open. This oftentimes happens. To find out if it is causing the trouble press down on the leaves of the different jacks and see if a signal can be received.

Tubes may not be making contact in their sockets. Try pressing down on different tubes to see if this brings in signals.

Phone plug may not be making proper contact in jack due to its not being pushed in far enough.

Dead "B" batteries. These should be tested with a volt meter.

Variable condenser secondary coils may be shorted.

IF NOISES ARE HEARD IN THE SET BUT NO SIGNALS CAN BE RECEIVED

Look for poor connection to aerial and ground.

Look for poor connection to "A" battery making filament current unsteady.

Set may be in an oscillating condition due to the tickler coil being too closely coupled.

Grid wire or return lead from grid to "A" battery may be open. This generally causes a very pronounced A-C hum or whistle.

Variable condenser may be shorted. (Keep variable condensers free from dust between plates.)

"B" battery voltage on the detector may be too high. Try changing Detector "B" battery voltage.

Jacks may be open.

Noises may be due to power leaks, x-ray machines, motors, arc lights, flickering, etc. To see if this is causing trouble, disconnect aerial and ground to see if noises disappear.

Lighting Arrestor may be shorted.

WEAK SIGNALS

Exhausted "A" or "B" battery.

"A" battery terminals reversed.

Poor bulbs.

Poor socket contacts.

Inefficient transformers.

Amplifier "B" battery voltage too low.

Detector "B" battery voltage too high or too low.

Poor phones or loud talker.

Poor grid condenser.

Grid leak not of proper value. Try changing to different sizes.

Phones or loud speaker leads may be reversed. Try changing around and see which gives best signals.

Set may not tune to wave length which it is desired to hear. Try adding loading coils.

Tickler coil connections may be reversed.

Phone condenser omitted.

Shellac or paraffin on coils. Use high dielectric varnish only.

Signals may be fading. Noticed especially in the summer time and on distant stations. Nothing can be done to rectify this trouble except that sometimes where the fading comes at long intervals variations may be followed by changing the tuning.

Poor aerial or ground. Fastened ground to water pipe or to pipe driven into moist earth.

Inefficient parts used in set.

Leads to primary of audio frequency transformer may be reversed.

Set untuned. Some radio frequency sets are very hard to tune, so do not become discouraged until sure you know how to operate.

NOISES PRESENT WITH SIGNALS

Static, especially in summer. Not much can be done to overcome static, except that shorter aeriols or a loop may be used. Sets using radio frequency amplification do not amplify static to any great extent.

Power leak caused by defective transformer or poor insulator of high tension line. If sure this is causing trouble, notify local power company.

Battery charger operating close by.

Arc light flickering.

Passing street cars.

Noises caused by improperly operated nearby regenerative sets.

One broadcasting station heterodyning another.

If noises are caused by any of the reasons above, they should practically disappear when antenna and ground are disconnected.

Noisy or nearly exhausted "B" battery.

Excessive regeneration.

Amplifier tubes turned up too high.

Corroded connections caused by using acid flux in soldered joints.

If using reflex set crystal may not be making contact.

Radio or audio frequency transformers too close together. Spread apart and place at right angles to each other.

Noises are caused by vibration of UV 199 type Bulb. Use sponge rubber cushioned socket.

Leaking or broken down condensers.

Noise can be heard if set has a loose connection, especially when set into vibration.

Pencil marks or acid making low resistance path between terminals.

CAUSES OF DISTORTED SIGNALS

Defective bulbs.

Defective transformers.

Excessive regeneration. Loosened coupling of tickler and turned down detector bulb.

Excessive "B" battery voltage.

Overloading phones or loud speaker.

INDEX

	Page
ABBREVIATIONS	
Code Telegraphic.....	161
International.....	161
Radio.....	160
Units.....	157
ACMEDYNE CIRCUIT.....	84
AERIAL	
Capacity.....	37
Insulators.....	96
Location of.....	39
Loop.....	40-111
Metal Plates used as.....	37
Natural wave length of.....	42
Poorly constructed.....	40
Receiving.....	40
Transmitting.....	38
Tuning.....	41-42-43
Wire.....	96
ALTERNATING CURRENT	
Compared with direct current.....	25
Wave form.....	25
Amateur Wireless Operator.....	169
A. R. R. L. American Radio Relay League.....	169
AMMETER	
Use of.....	20
AMPERE	
Explanation of.....	19
AMPERE HOUR	
Capacity of battery.....	95
AMPLIFICATION	
Theory of Audio Frequency.....	56
Theory of Radio Frequency.....	59
Regenerative.....	64

	Page
AMPLIFIER	
Audio.....	81
Power.....	92
Radio.....	90
Tube.....	128
AMPLITUDE	
Change in modulated wave.....	23
Of damped wave.....	22
Of undamped wave.....	21
ANTENNA	
See aerial	
APPARATUS	
Receiving.....	94
Symbols for.....	158
ATOM	
Composition of.....	48
AUDIO FREQUENCY	
Amplifier.....	81
Transformers.....	121
AUDION BULB	
Amplifier.....	56
Detector or Rectifier.....	49
Three Element.....	50
Two Element.....	49
UV 199 or C 299.....	126
UV 201 or C 300.....	128
UV 201 A or C 301 A.....	128
WD 11 or C 11.....	130
WD 12 or C 12.....	131
Northern Electric 215-A.....	133
Western Electric 216-A.....	135
BATTERIES	
"A" Dry.....	95
"A" Storage.....	94
"B" Dry.....	97
"B" Storage.....	98
"C" Use of.....	101
BATTERY	
Charger.....	99
BROWN AND SHARP	
Wire Gauge.....	159
BULB	
See Audion Bulb	

	Page
BY PASS	
Condenser	46
"C" BATTERY	
See batteries	
CAPACITY	
Antenna	37-39
Of Batteries	94
Of Condensers	101
Unit of Measurement	101
CARRIER WAVE	
See modulated wave	
CASCADE AMPLIFICATION	
See audio and radio frequency Amplification	
CHOKER COILS	
Where used	101
CIRCUITS	
Use of	62
Acmedyne	87
Amplifier Audio	81-57
Amplifier Radio	90-59
Armstrong original regenerative	64
Crystal Detector	67
Inverse Duplex	86
Neutrodyne	78
Reflex	80
Reinartz	77
Single Non-Regenerative	70
Single Regenerative	72
Super Heterodyne	82
Three circuit Regenerative	75
Two Circuit Non-Regenerative	70
CLOSE COUPLING	78
CODE	
International Telegraphic	165
COIL ANTENNA	
See Loop	
CONDENSER	
Antenna	41
By-pass	46-101
Fixed	101
Grid	54-105
Phone, same as by-pass	
Shunt	43
Tuning by means of	43
Variable	102

	Page
CONDUCTORS	
Good and poor.....	48
CONTINENTAL	
Wireless Code.....	165
CONTINUOUS WAVES	
See undamped waves	
COPPER CLAD WIRE.....	96
COPPER WIRE TABLES.....	159
COUNTERPOISE.....	39
COUPLING	
Of tuning coils.....	44
CRYSTAL DETECTOR	
Circuits.....	67-68
Rectification of.....	45
Reflex Circuits.....	80
Types of.....	103
CURRENT	
In aerial.....	33-34
Alternating.....	25
Direct.....	24
Measuring instruments.....	20
Pulsating direct.....	33
Thru vacuum tubes.....	51
Unit of measuring.....	19-20
60 Cycle.....	34
CYCLE	
See frequency	
DAMPED WAVES.....	31
DETECTOR	
Audion Bulb.....	50
Crystal.....	46
DIELECTRIC MATERIALS.....	47
DIRECT CURRENT.....	24
DISTORTION OF SIGNALS.....	Appendix "C"
ELECTRIC CURRENT	See current
ELECTRICAL PRESSURE OR VOLTAGE.....	19-20
ELECTRON	
Flow.....	48
Theory.....	47
Tube, see vacuum tube	
ELECTROLYTE IN STORAGE BATTERIES.....	108
E. M. F. or ELECTROMOTIVE FORCE.....	20

	Page
FILAMENT	
Current, regulation.....	50-117
In vacuum tube.....	49-50
Rheostat.....	117
FIXED CONDENSERS See condensers	
FLEMING VALVE	
See audion bulb, two element	
FREQUENCY	
Of radio waves.....	26-28
Of Audio waves.....	57-58-30
GALANA AS DETECTOR.....	46
GAUGE	
See wire gauge	
GRID	
Battery see "C" battery	
Characteristics in vacuum tube.....	50
Condenser.....	54-105
Current.....	54
Leak.....	54-105
GROUND	
Clamp.....	106
Use of.....	38-39
Good Ground for Radio.....	106
HONEYCOMB COIL.....	107
HOOK-UPS See Circuits	
HYDROMETER.....	108
INDUCTANCE.....	71-40
INSULATION.....	47
INSULATORS, AERIAL.....	96
INTERFERENCE.....	32-65
INTERNATIONAL Telegraphic Code.....	165
LEAK GRID.....	54-105
LOOPS.....	111
LOOSE COUPLERS.....	110
LOOSE COUPLER CIRCUITS.....	71-69
LOUD SPEAKERS.....	112
METER Unit of measurement.....	26
MICROFARAD.....	101
MODULATED WAVE.....	53
MODULATING ACTION.....	33
NEGATIVELY CHARGED BODIES.....	47

	Page
OHMS LAW.....	19
OPERATOR, LICENSED AMATEUR.....	Appendix "B"
OSCILLATIONS	
Damped.....	31
Undamped.....	29
OSCILLATING CURRENTS.....	30
PANCAKE COIL See Spiderweb Coil	
PHONE CONDENSER.....	101
PLATE	
In audion bulb.....	49
Circuit tuned.....	75
Milliammeter.....	48
Voltage of audion bulbs.....	126-136
POTENTIOMETER.....	115
POWER	
Amplifier.....	92
Tube.....	135
PRIMARY CIRCUIT TUNING	
RADIO	
Frequency Amplification.....	59
Telephone—how made possible.....	51
Waves.....	21-22
Wave-train.....	22
RECEIVING SETS See Chapter V	
REGENERATION	
How obtained.....	64
Theory of.....	64
REGENERATIVE SETS.....	72-78
RE-RADIATION OF RECEIVING SET.....	65
RESISTANCE	
In wire.....	47-159
Units.....	116
RHEOSTAT	
Filament.....	117
SATURATION POINT OF BULB.....	55
SECONDARY CIRCUIT.....	44-76
SOLDERED CONNECTIONS	
Care in making.....	Appendix "C"
SPARK TRANSMITTING SETS.....	32
SPEED OF RADIO WAVE.....	26
SPEED OF SOUND WAVE.....	29

	Page
SOUND WAVES.....	29
STATIC.....	Appendix "C"
STORAGE BATTERY.....	94
SUPER HETERODYNE.....	82
TAPPED COILS.....	42
TESTING FOR TROUBLE IN RECEIVING SET.....	Appendix "C"
THERMONIC VALUE	See audion bulb
TRANSFORMERS	
Audio.....	121
Radio.....	123
Why used.....	57
TRANSMITTING STATIONS.....	32
TROUBLE FINDING.....	Appendix "C"
TUNED PLATE.....	75
TUNING	
Antenna.....	41
Primary.....	41
Radio Frequency Transformers.....	90
Secondary.....	69-71-76
UNDAMPED WAVES.....	29
VACUUM TUBES	See audion bulbs
VARIABLE CONDENSERS.....	102
VARIABLE RESISTANCE.....	115-117-116
VARIO COUPLER.....	124
VARIOMETER.....	124
VOLT.....	20
VOLTAGE DROP IN D. C. CURRENT.....	20
WATER ANALOGY.....	19-20-50
WAVES	
Amplitude of.....	21
Carrier.....	33
Damped.....	31
Length, how measured.....	21
Light.....	22
Modulated Sound.....	29
Train.....	22-53
Undamped.....	29
WEIGHT OF ELECTRON.....	47
WIRE	
Antenna.....	96
Gauge.....	159
ZERO BEAT RECEPTION.....	94
ZINITE MINERAL.....	103

PART II

A RADIO DICTIONARY OF RADIO TERMS AND WORDS

Radio Dictionary

Absorption Modulation—Process of varying the amplitude of a high frequency alternating current in accordance with a desired wave form by a systematic absorption of energy from the circuit in a part of the circuit which serves as an appropriate variable resistance.

Acceptor—A combination of capacity and inductance attuned to the frequency of a desired signal, and connected in series with the aerial.

Aerial Wire—See Antenna.

Air Condenser—One having air as the dielectric, with the support made of a minimum of solid dielectric.

Alternating Current Characteristic—The relation indicated by a graph using the impressed E. M. F. as abscissas and the resultant current as ordinates for alternating E. M. F. and current. (See Alternating Current).

Alternating Current, Damped—See Damped Alternating Current.

Alternating Current, Forced—See Forced Alternating Current.

Alternating Current, Free—See Free Alternating Current.

Alternating Current, Undamped—See Undamped Alternating Current.

Alexanderson Alternator—An alternator of the inductive type which directly generates currents of sufficiently high frequency to be used in Radio Telegraphy.

Alternating Current—A current that periodically reverses its direction.

Alternation—One half cycle or the rise and fall of a current in one direction.

Alternator—A generator for producing alternating currents.

Amateur Call Letters—Certain combinations of letters that are assigned to amateur radio stations for purposes of identification.

- Amateur Publications**—Books and magazines that are published for the use of Amateur Radio Operators
- Amateur Station License**—The permit issued by the government to amateur radio operators owning transmitting sets.
- American Wire Gauge**—The arbitrary series of numbers assigned to wires to indicate their sizes.
- Ammeter**—An instrument for measuring electric current intensity in a circuit in Amperes.
- Ampere**—The standard electrical unit of current. This is the current flowing in a circuit of one ohm resistance under a pressure of one volt.
- Ampere-Hour**—Unit for expressing the quantity of electricity passing in a circuit. This is a current of one ampere flowing for one hour.
- Amplification Factor**—The ratio between the plate voltage and grid voltage for constant plate current.
- Amplifier**—A device or arrangement to augment or strengthen feeble oscillations (either of audio or radio frequency).
- Amplitude**—The measure of the maximum deviation of an electric wave from its zero point.
- Antenna**—A conductor designed for absorbing or radiating the energy of radio waves.
- Antenna Resistance**—The opposition offered to the electric current by the electrical properties of the antenna. See Radiation Resistance.
- Antenna, Effective Resistance of**—The quotient of the power given to the antenna by the square of the antenna current.
- Arc Converter**—An electric arc used for the conversion of direct to alternating or pulsating current.
- Arc**—The completion of an electric circuit through a gas or vapor, the conductivity of which is due to the ionization of that gas or vapor. Used as a source of undamped oscillation.
- Armature Core**—The iron mass which supports the armature winding.
- Armature Winding**—The conductors in which an electric current is induced by the action of the electromagnetic field in an electric machine.
- Atom**—The particle or particles that go to make up molecules. The smallest particle of matter that can enter into combination.

Atmospheric Absorption—The part of the total loss of energy by atmospheric conductivity, reflection and refraction.

Attenuation—The decrease, with distance from the source, of the magnitude of amplitude, of any electric or magnetic wave.

Andibility—The ratio of the current producing a signal in the receivers to the current producing a barely audible signal.

Audion—See Electron Tube.

Autodyne Reception—See Self-Heterodyne.

Audio Frequency—A frequency capable of producing sound in the human ear. Considered to be below ten thousand cycles per second.

B

"B" Battery—A battery used as the source of current in the plate circuit of a vacuum tube.

Bakelite—A high grade and efficient insulating material of the phenolic group.

Band, Wave Length—The "side waves" due to the varying amplitude and frequencies of the modulating wave.

Beat Frequency—The frequency of recurrence of maxima of addition or minima of opposition of two superposed periodic phenomena of the same kind but of different frequencies.

Beat Reception—The resultant audible frequency when two sources of unequal undamped electrical oscillations of constant amplitude act simultaneously in the same circuit.

Biasing Potential—The potential impressed on the grid of a vacuum tube to cause it to operate at the most desirable part of its characteristic curve.

Broadcast—Organized one way transmission of news, music or other matter interesting to the public. See Radiocast.

Buzzer—An electromagnetic device with a vibrating member opening and closing its own circuit.

Buzzer Modulation—A process for varying the output power of a continuous wave generator at the tonal frequency of the buzzer used.

By-Pass Condenser—A fixed capacity offering a high impedance to currents of low frequency but lower impedance to radio frequency currents.

C

- "C" Battery**—A source of low potential used in the grid circuit of a vacuum tube to cause operation to take place at a particular point on the characteristic curve.
- Cadmium Cell**—A source of E. M. F. of constant and standard value. A cell using cadmium as the negative electrode.
- Cage Antenna**—One having conductors arranged cylindrically.
- Call Letters**—Certain combinations of letters assigned to radio stations by the government. The group of letters assigned the U. S. by the International Radiotelegraph Convention are all three and four letter combinations beginning with N and all beginning with W and all combinations of KDA to KZZ inclusive.
- Capacity**—The measure of the amount of electrical energy a condenser can store up, the unit being the farad.
- Capacitance**—See Capacity.
- Capacitive Coupling**—The coupling of one circuit to another whereby the energy transfer is by means of condenser action.
- Capacity Resistance**—The opposition offered to an alternating current by a condenser.
- Carrier Wave**—The principal radio frequency wave providing the means for carrying the modulated or audio frequency wave.
- Carborundum**—A synthetic crystalline material (silicon carbide) used as a detector.
- Carbon Rheostat**—A rheostat using carbon as the resistance material.
- Cascade Amplification**—The method of successively using two or more vacuum tubes for amplification.
- Centimeter**—Metric measure of length. (One Hundredth of a meter).
- Central Station, Radio**—Combined multiplex transmitting station and multiplex receiving station simultaneously operating several radio channels.
- Chemical Rectifier**—A chemical device for changing alternating current to pulsating direct, usually used for storage battery charging.
- Circular Mil**—The square of the diameter of a wire in mils. The measure of sectional area of a wire.

- Coil Antenna**—One consisting of one or more complete turns of wire. (See Loop Antenna).
- Condenser Antenna**—An antenna consisting of two capacity areas.
- Coupling Coefficient**—The ratio of the mutual impedance component of two circuits to the square root of the product of the total impedance components of the same kind in the two circuits.
- Choke Coil**—A coil so wound as to offer a choking or self inductance effect to an alternating current.
- Chopper**—A device for rapidly opening and closing a circuit.
- Circuit**—A path through which an electric current may be established.
- Circuit breaker**—A special type of switch arranged to open a circuit when overloaded without injury to itself.
- Close Coupling**—The condition in which two coils are placed in close magnetic proximity to each other, thus establishing mutual induction.
- Closed Core**—A core in which the magnetic path of iron is unbroken.
- Coated Filament**—The coating of oxide on a vacuum tube filament for greater electron emission and longer life.
- Code**—The system of dots and dashes used to represent the letters of the alphabet, numerals, and other symbols.
- Collector Ring**—Metallic rings in contact with brushes for completing the circuit to a rotating member.
- Commutator**—A device used on a dynamo to reverse the connection periodically in order to cause the current to flow in one direction, i. e., to produce direct current.
- Condenser**—A device for storing up electrical energy and consisting of two conducting surfaces or electrodes separated by an insulating medium called a dielectric.
- Conductance**—The reciprocal of resistance; i. e., a measure of the ease with which an electric current will flow through a circuit.
- Conducting Materials**—Those substances which offer relatively little resistance to the passage of an electric current.
- Conductivity**—The measure of the current carrying power of a substance. The reciprocal of specific resistance.
- Conductor**—A substance which offers a relatively small opposition to the passage of an electric current.
- Continuous Waves**—A series of waves or cycles of current all of which have a constant or unvarying amplitude.
- Counter Electromotive Force**—An E. M. F. that opposes the E. M. F. causing it.

- Coulomb**—The quantity of electricity transferred by a current of one ampere in one second.
- Counterpoise**—A system of electrical conductors used to complete the antenna capacity effect in place of the usual ground connection.
- Coupler**—A device for the transfer of the energy of radio oscillations from one circuit to another.
- Crystal Detector**—A form of detector making use of the contact between a metal point and any one of certain metallic crystals, or using two crystals for the detector action.
- Current**—A flow of electricity manifesting its presence by the magnetic or heating effects it produces. The unit of current is the Ampere and is the rate of flow in a circuit of one ohm resistance under a potential of one volt.
- Curve, Sine**—A curve in which the ordinate varies in length according to the sine of the angle of its progression. A curve representing graphically the alternating current.
- Curve Resonance**—The graphical representation of the changes of current in a circuit.
- Cycle**—One complete set of one positive and one negative alternation of current.

D

- Damped Wave**—A wave consisting of a series of oscillations or cycles of current of gradually decreasing amplitude.
- Damping**—The decreasing of the amplitude of oscillations caused by resistance in the circuit.
- Damping Factor**—The product of the logarithmic decrement and the frequency of a logarithmically damped alternating current.
- Decrement**—A number indicating or bearing a relation to the rate of decrease of amplitude in a wave train.
- Decremeter**—An instrument for measuring the logarithmic decrement of a circuit.
- Detector**—A device which converts or rectifies high frequency oscillations into a pulsating direct current or which translates radio frequency power into a form suitable for the operation of an indicator.

- Detector Coefficient**—A measure of the curvature of the plate current grid-voltage characteristic of a three electrode tube.
- Diaphragm**—The vibrating disc in a receiver which gives an audible sound under the influence of an electric current.
- Dielectric**—An insulating, substance which allows electrostatic induction to act across it, as in the insulating medium between the plates of a condenser.
- Dielectric Absorption**—The penetration of a dielectric by the electric strain during a period of time.
- Dielectric Strength**—The property of a material which resists the passage of an electric current. It is measured in terms of volts required to break down this resistance.
- Dielectric Constant**—The ratio of the capacity of a condenser with a given dielectric to the capacity of the same condenser with air as the dielectric.
- Direct Coupling**—Association of two radio circuits by having a condenser, a resistor, or an inductor common to both circuits.
- Direct Current**—A flow of electricity always in the same direction.
- Directional Antenna**—An antenna which impels electric waves with more energy in one direction than in another.
- Distributed Capacity**—Refers to the capacity in a coil due to the proximity of the turns.
- Down Lead**—See Lead-In.
- Dry Cell**—A type of primary cell in which the electrolyte is in the form of a paste.
- Duplex Reception**—The simultaneous reception of two series of signals by a single receiving station.
- Duplex Signaling**—The simultaneous transmission and reception of signals in both directions between two stations.
- Duplex Transmission**—The simultaneous transmission of two series of signals by a single operating station.
- Dynamo**—An electrical machine which gives a direct current.
- Dynamotor**—A direct current machine having two windings on its armature: one acting as a motor, the other as a generator.
- Dynatron**—A three electrode vacuum tube which depends for its action on the release of electrons from an anode by electron bombardment.

E

- Eddy Current Losses**—Losses in electrical devices using iron, due to the currents set up in it by magnetic action.
- Edison Battery**—A type of storage battery in which the elements are nickel and iron and the electrolyte is potassium hydroxide.
- Edison Effect**—The phenomenon attributed to Edison, that when a filament is incandescent a current will flow between it and another electrode in the tube.
- Electric Filter**—See Filter.
- Electrolyte**—A chemical solution used in batteries and chemical rectifiers.
- Electrolytic Rectifier**—See Chemical Rectifier.
- Electrical Oscillation**—A complete cycle of high frequency current.
- Electromagnetic Lines of Force**—The lines of force existing about an electromagnet and a current carrying conductor.
- Electromagnetic Wave**—The electric wave propagated by an electrostatic and magnetic field intensity. Its velocity is 186,300 miles per second.
- Electromotive Force**—The voltage or electric pressure that causes electricity to flow in a circuit.
- Electron**—The smallest known part of matter and assumed to be a particle or charge of negative electricity.
- Electron Tube**—A device whose operation depends primarily upon the flow of electrons from one element to another.
- Electron Tube Rectifier**—A device for rectifying an alternating current by utilizing the flow of electrons between a hot cathode and a relatively cold anode.
- Electrose**—An insulating material.
- Electrostatic Charge**—An electric charge at rest.
- Electrostatic Coupling**—See Capacitive Coupling.
- E. M. F.**—See Electromotive Force.
- Emission of Electrons**—The freeing of particles or negative charges of electricity from metals whose temperature is raised above red heat.
- Enameled Wire**—Wire which has a covering of enamel for insulating purposes.

Energy, Conservation of—The law states that energy can neither be created nor destroyed.

Equivalent Decrement—One of several quantities used as a measure of the distribution of the radiated power or wave amplitude with respect to frequency.

Ether—The medium which permeates all space and matter and which transmits all electromagnetic waves.

Exciter—A small dynamo used to excite the field coils of a larger and alternating current machine.

Expansion Type Ammeter—A current measuring device which operates by the expansion of a metal by the heating effect of the current.

F

Fading—The variation of the strength of received radio signals over temporary periods.

Fan Antenna—An aerial consisting of a number of wires radiating upwards from a common terminal to points on a supporting wire.

Farad—The practical unit of capacity. A potential difference of one volt which causes a condenser to have a charge of one coulomb.

Feed Back—The coupling of the plate circuit back to the grid circuit of a vacuum tube so that there is induced in the grid circuit a larger voltage than that originally acting.

Feed-Voltage Modulation—The process of varying the amplitude of a radio frequency alternating current in accordance with any desired wave form by introducing additional power into the circuit of the high frequency generator according to the desired wave form variations.

Ferron—Iron pyrite crystals used for detector purposes.

Ferromagnetic Modulation—A system of using the hysterectic energy absorption of iron or the variation of the inductance of iron core coils to vary the amplitude of a radio frequency current in accordance with a desired form.

Fibre—An insulating material.

Field—The name given to that part of an electrical system in which an electromagnetic field effect is established.

- Field Rheostat**—A variable resistance used in the field circuit of a generator or motor to control the field current and consequently the strength of the electromagnetic field.
- Filament**—An electrically heated wire in an evacuated glass bulb forming one element of a vacuum tube.
- Filament Supply**—A source of low potential used to send a current through a filament to heat it.
- Filter**—A combination of inductance and capacity arranged so as to eliminate undesirable signals from a receiving circuit.
- Fire Underwriters**—The rules for the safe installation of electrical material as set down by the National Board of Fire Underwriters.
- Fixed Condensers**—One whose plates are stationary and whose capacity cannot be changed.
- Flat Top Antenna**—An aerial consisting of parallel horizontal wires supported between masts. The "T" type and the inverted "L" type belong in this class.
- Fleming Valve**—A two element electron or vacuum tube.
- Flow of Electrons**—The basis for the "Edison Effect." The passage of electricity from a heated filament to a plate in a vacuum tube where the flow consists of negative charges of electricity or electrons.
- Flux**—The electromagnetic lines of force produced by a current in a wire or coil.
- Forced Alternating Current**—One having a frequency and wave form which are equal to the frequency and wave form of the impressed electromotive force.
- Form Factor**—The ratio of the effective to the average value of an alternating electromotive force or current.
- Free Oscillations**—The alternate flow of electricity around a circuit first in one direction and then in the other when no outside source of E. M. F. is acting in the circuit.
- Frequency**—The number of complete cycles of current occurring in one second.
- Frequency Changer**—A device which delivers alternating current at a frequency different from the frequency of the supply current.
- Frequency Transformer**—See Frequency Changer.
- Frictional Electricity**—Static electricity produced by friction.
- Full Wave Rectifier**—A rectifier to rectify and render available all successive half cycles of an alternating current.

Fundamental—The wave length corresponding to the lowest frequency of free alternating current.

Fundamental of an Antenna—The lowest frequency of free alternating current in an unloaded antenna.

Fuse—An element of a circuit designed to melt or fuse at a predetermined value of current and used to protect the circuit from the destroying effects of excessive current.

G

Galena—A natural crystalline structure of lead sulphide used as a detector.

Galvanometer—A delicate instrument used for measuring minute currents.

Gap—An open space in a circuit through which a condenser discharges for producing electric oscillations.

Gaseous Conductors—The gases which, when ionized by an electric field, permit the passage of an electric current.

Gauge Wire—The method of specifying the size of wire. The two important American gauges are the American Wire Gauge (Brown and Sharpe) and the Steel Wire Gauge.

Gauss—The unit of magnetic field intensity measured by the force per unit pole or in terms of the lines of force per square centimeter.

Geometrical Capacity—The ratio of the free charge of a condenser to the voltage across its terminals.

General Call—The letter CQ in the international code and used as a general inquiry call.

German Silver—An alloy consisting of nickel, copper, and zinc and used as a resistance material.

Goldschmidt Alternator—A generator of high frequency currents for radio transmission.

Government Radio Publications—Publications on radio subjects by the Bureau of Standards and Signal Corps and sold by the superintendent of Documents, Government Printing Office, Washington, D. C.

Gram—Metric unit of weight, equivalent to 15.432 grains.

Gram Calorie—The amount of heat required to raise the temperature of one gram of water one degree Centigrade.

- Gravity Cell**—A closed circuit cell used where a continuous flow of current is desired. This type consists of copper and zinc electrodes with copper sulphate and zinc sulphate electrolyte.
- Grid**—That element in a vacuum tube having the appearance of a grid and which controls the flow of electrons away from the filament.
- Grid Battery**—The battery which is sometimes connected in the grid circuit of a three element electron tube to control the plate current.
- Grid Condenser**—The condenser connected so as to give its charge to the grid in an electron tube.
- Grid Leak**—The high resistance sometimes connected from the grid to the filament of a three electrode tube, with a condenser, to maintain the potential of the grid at a certain average negative value.
- Grid Voltage**—See Grid Battery.
- Ground**—An electrical connection with earth.
- Ground Lead**—The conductor leading to the ground.
- Group Frequency**—Often termed "spark frequency." The number of trains of damped waves per second.
- Guy Wire**—A wire used to support a radio mast.

H

- Hard Rubber**—An insulating material having a dielectric constant of from two to four.
- Hard Tubes**—Vacuum tubes having a high vacuum. Usually of the amplifier type.
- Harmonics**—A frequency which is an exact multiple of a fundamental.
- Harp Antenna**—See Fan Antenna.
- Heat**—Electromagnetic waves of a frequency between that of light waves and radio waves. A form of energy.
- Heat Losses**—Loss of energy due to the heating effect of an electric current.
- Henry**—The inductance in a circuit in which the electromotive force induced is one volt when the inducing current varies at the rate of one ampere per second.
- Hertzian Wave**—A name sometimes given to electromagnetic waves.
- Heterodyne Action**—See Beat Reception.

- High Frequency Alternator**—An alternating current generator designed to produce current at a high frequency.
- High Voltage**—Potential of a high value.
- Honeycomb Inductance Coil**—A type of coil in which the turns do not lie adjacent to each other but is lattice-like in appearance.
- Horsepower**—A unit of power equivalent to 550 foot pounds per second or to 746 watts.
- Horse Shoe Magnet**—A magnet which has the shape of a horse shoe.
- Hot Wire Ammeter**—See Expansion Type Ammeter.
- Hydrogen**—A gaseous element having a density of .00008952289 gram per centimeter at 0° c. and pressure of one atmosphere.
- Hydrometer**—An instrument for determining the density of liquids.

I

- Ignition Key**—A rod arranged to strike the arc in an arc generator of high frequency currents.
- Impact Excitation**—The method of transferring the electric energy in the primary circuit to its secondary in such a way that the secondary will vibrate at its own period without reaction from the primary. This is brought about by using an aperiodic primary circuit (see Aperiodic Circuit) and by the use of the quenched gap.
- Impedance**—The total opposition of a circuit to the passage of an alternating current.
- Inclined Coil Instrument**—A type of instrument in which an element, or elements, are inclined.
- Inductance**—The property of a circuit which allows it to store up electrical energy in electromagnetic form.
- Induction**—See Inductance.
- Induction Coil**—A coil having a high turn ratio used for raising the voltage. A step-up transformer.
- Inductive Coupling**—The coupling of one circuit to another whereby the energy transfer is by means of induction. (See Capacitive Coupling and Coupler).
- Inductively Coupled Receiver**—A radio receiver in which the energy in the antenna circuit is transferred to the secondary circuit by induction.

- Inductivity**—A term sometimes used to denote the dielectric constant or the specific inductive capacity.
- Inductor Alternator**—A type of generator for producing continuous high frequency currents.
- Input Circuit**—Refers to the grid circuit of an electron tube.
- Inspector, Radio**—The United States is divided into nine radio districts in each of which there is a Radio Inspector who issues licenses and takes charge of other radio matters under direction of the Department of Commerce.
- Insulated Wire**—Wire which has a non-conducting covering.
- Insulating Materials**—Those substances which oppose the passage of an electric current through them.
- Insulation**—The material used for insulation purposes.
- Interference**—The interruption to radio receiving from sources such as other transmitting stations, static, etc.
- Internal Drop**—That part of the E. M. F. generated that is expended in the generator.
- International Ampere**—The current which will deposit 0.001118 gram per sec. of silver from a neutral solution of silver nitrate.
- Interrupter**—A device so arranged as to rapidly make and break a circuit. (See Chopper).
- Interrupted Continuous Wave**—The name applied to a continuous wave which is interrupted, as by a chopper, before it is sent out. It consists of a series of wave trains, each cycle, however, having the same current amplitude. (Abbreviation—I. C. W.).
- Internal Output Resistance**—The resistance to small alternating currents which exists between the plate and the filament in a vacuum tube.
- Invar**—A special alloy used for standard resistance units.
- Ionic Tube**—See Electron Tube.
- Ionization**—The process of breaking up molecules into positively and negatively charged carriers of electricity called ions.
- Ion**—A neutral atom or molecule to which has been added an electron or from which an electron has been taken.

J

- Jamming**—Transmission of waves of high decrement, that is, highly interfering waves.

Joule—The unit of work or energy. The energy expended when a current of one ampere flows through a resistance of one ohm for one second.

Joule's Law—The heat produced in a circuit in joules is proportional to the resistance, to the square of the current and to the time.

K

Key—A special form of switch arranged for rapid operation to form dots and dashes of the telegraph code.

Keying Flicker—The flickering of lights connected to the same circuit from which a radio transformer is operating.

Key Click—Interfering radio frequency waves caused by opening and closing the circuit of a C. W. Transmitter.

Kick Back—The passage of radio frequency currents back into the low frequency side of the circuit with consequent burn out of transformer or other apparatus.

Kilovolt-Ampere—The unit used in rating alternating current generators, being product of kilowatts and amperes.

Kilowatt—One thousand watts.

Kinetic Energy—The energy in a moving body. Stated in the form of a rule: Kinetic Energy is one half the product of the mass of a body by the square of its velocity.

L

"L" Type Antenna—See Inverted "L" Antenna.

Lafayette Station—The arc station of 100 K. W. capacity at Bordeaux, France.

Lagging Current—The phase difference in an inductive alternating current circuit where the current does not reach maximum until after the E. M. F.

Lambda—The Greek letter used as a symbol for wave length.

Laminations—Thin sheets of steel used as the magnetic core in electrical apparatus.

Lattice Wound Coil—See Honeycomb Coil.

Latour Alternator—An alternating current machine giving high frequencies for radio transmission.

Laws, Radio—Regulations under which radio communication is carried on.

Lead-In—The conductor from the antenna to the instruments.

Leading Current—The phase difference in a capacitive alternating current where the current leads the E. M. F.

Lead Storage Battery—A secondary battery in which the plates are of lead and lead peroxide and the electrolyte of dilute sulphuric acid.

Leak, Grid—See Grid Leak.

Leakage Current—The small current which is lost through insulators under certain circumstances.

Left Hand Rule—A rule for indicating the direction of motion due to a force acting on a wire, when a current flows in the wire which is at right angles to a magnetic field. Extend the forefinger of the left hand in the direction of the magnetic field and hold the middle finger at right angles to it in the direction of the current. The extended thumb, held at right angles to both the other directions, indicates the direction of the motion.

Length, Standards—Certain practically unvarying representations of units of length kept for the purpose of comparison in the Bureau of Standards.

Lenz's Law—Whenever an induced current arises, by reason of some change in linkings, the magnetic field about the induced current is in such a direction as to oppose the change.

Leyden Jar—A type of condenser jar having a metallic coating inside and out but not connected. (See Condenser).

License—The law provides that in order to operate a radio transmitting station, both a station license and an operator's license must be secured. (See Inspector, Radio).

Light—A manifestation of electromagnetic waves ordinarily applied to those having a wave length of from .000075 cm. to .000038 cm. for the red ray to the violet ray respectively.

Lightning—The discharge of atmospheric electricity, causing what is commonly called "static" in radio receivers.

Limited Commercial Stations—One of the eight classes of land radio stations for which provision is made in the law.

Line Drop—That part of the E. M. F. which is expended in sending current through the line.

- Lines of Force**—The directional Lines of magnetic or static field which represent the stresses.
- Linkage**—The interlinking of the line of magnetic flux with the wire turns.
- Liter**—A metric measure of volume equivalent to 2.113 American pints.
- Litz Wire**—See Litzendraht.
- Litzendraht**—A conductor consisting of several insulated wires woven so that they form a single conductor of low resistance to high frequency alternating currents. Commonly known as Litz.
- Load Flicker**—The flickering of electric lights on lines supplying radio transmitting sets, due to the varying load. (See Keying Flicker).
- Loading Coil**—The inductance coil added to radio circuits to increase their wave length.
- Local Action**—The wasting of the zinc in primary batteries due to the action between the zinc and impurities in it.
- Logarithmic Decrement**—The Napierian or natural logarithm of the ratio of two successive current amplitudes in the same direction. It may be considered as a constant of a simple radio circuit, being 3.1416 times the product of the resistance by the square root of the ratio of the capacity to the inductance of the circuit.
- Loop Antenna**—An antenna consisting of one or more complete turns of wire.
- Loose Coupling**—The interlinking of only a small part of the flux set up by one coil with another coil.
- Loud Speaker**—An assembly of devices by means of which received sounds are made audible without the use of telephone receivers held to the ears.

M

- Magnetism**—The manifestations of the force in nature which is seen in the magnet.
- Magnetic Amplifier**—A variable impedance connected in shunt with the external circuit of the Alexanderson Alternator for control of signalling.
- Magnetizing Current**—The current which flows in the primary winding of a transformer when the secondary has "no load" or an "open circuit."

- Magneto**—A small alternating current generator using permanent field magnets.
- Magnet, Electro**—A magnet formed by passing an electric current through a selenoid or a coil of wire.
- Manganise Dioxide**—An oxygen giving substance used to prevent polarization in sal ammoniac batteries, such as dry cells.
- Manganin**—An alloy used as a resistance in laboratory units.
- Mass of Electron**—The electron represents the smallest known component of matter, its weight being about one two-thousandth that of the hydrogen atom.
- Mass Resistivity**—The resistivity of a mass of a substance rather than of its volume.
- Masts**—Supporting towers for radio antenna.
- Mechanical Rectifier**—A device for rectifying alternating current by mechanical means.
- Megohm**—A resistance of 1,000,000 ohms.
- Meter**—The metric unit of length, equivalent to 39.37 inches. An instrument for measuring quantities of length.
- Meter-Amperes**—A factor in indicating the radiating strength of radio transmitting stations.
- Metric System**—A system of weights and measures originating in France.
- Mho**—The unit of conductivity or the reciprocal of resistivity. (See Conductivity).
- Mica**—An insulating material having a dielectric constant of four to eight and a dielectric strength of from 700 to 1500 volts per mil.
- Microfarad**—The one millionth part of the farad which is the practical unit of capacity.
- Microhenry**—A millionth of a Henry, the practical unit of inductance.
- Microhm**—A millionth of an ohm.
- Micro-microfarad**—A millionth of a microfarad.
- Microphone**—A device by means of which sound vibrations cause corresponding variations of an electric current.
- Mil**—A unit of length used in measuring the diameter of wires. It is equal to one thousandth of an inch. (See Circular Mil).
- Milliammeter**—An instrument for measuring small currents.
- Millihenry**—One thousandth of a Henry.
- Millimeter**—A metric measure of length, one tenth of a centimeter and equivalent to .03937 inch.

- Millivoltmeter**—An instrument for measuring small differences in potential.
- Modulated waves**—Alternating current waves which have their amplitude varied periodically.
- Modulating Action**—The action where a radio frequency wave is modulated by an audio frequency wave.
- Modulation**—The act of varying the amplitude of radio frequency oscillations by the action of the audio frequency changes established by the transmitter.
- Absorption method** where the radio frequency output of an electron tube is absorbed to an extent which varies from instant to instant by the use of a second tube.
- Modulation Frequency Ratio**—The ratio of modulation frequency to wave frequency.
- Modulator**—The device used for the purpose of modulating the alternating current wave.
- Molybdenite**—A mineral used in a crystal detector.
- Moorehead Tube**—A type of electron tube made by the Moorehead Laboratories.
- Morse Code**—A system of dots and dashes for signalling and used by the land telegraph companies.
- Motion, Wave**—Wave motion is the phenomena of the progression of a shape or condition. It is the oscillation to and fro of the parts, or particles, of the medium about their respective equilibrium positions.
- Motor**—An electrical machine for converting electrical energy into mechanical energy.
- Motor-Generator**—A motor and generator connected so as to deliver electrical energy of the desired kind.
- Multiple Tuned Antenna**—One with connections through inductances to ground at more than one point and so determined that the total reactances in parallel are equal to those necessary to give the antenna the desired natural frequency.
- Multiplex Telegraphy**—The transmission of several messages over the same wire without one interfering with another.
- Multipolar Machine**—An electric machine having several pairs of field poles.
- Mutual Inductance**—The term applied to designate the inductance produced by a current change in one of two independent circuits which react upon each other.

N

National Electrical Code—See Fire Underwriters.

Natural Frequency—The frequency of the oscillations that take place in a circuit of inductance, capacity, and resistance.

Natural Magnet—The black oxide of iron found in the earth called magnetite and having strong magnetic properties.

Natural Period—The period of the free oscillatory discharge of a condenser thru an inductance.

Negative Electricity—Supposedly those charges of electricity which are called electrons.

Non-Conductors—Those substances which do not ordinarily conduct electricity.

Non-Synchronous Gap—A rotating spark gap which runs without regard to the generator speed.

O

Ohm—The practical unit of resistance. The resistance that will allow one ampere of current to pass under the pressure due to an electromotive force of one volt.

Ohm's Law—The relation between the current, electromotive force and resistance:

Amperes = Volts divided by Ohms.

Volts = Product of Amperes and Ohms.

Ohms = volts divided by Amperes.

Oil Cooled Transformer—One in which the windings are immersed in oil for the purpose of dissipating the heat loss.

Open-Core Transformer—A transformer having the path of the magnetic flux partly through air.

Operators License—See License.

Ordinate Axis of—One of the elements by which a point is referred to a system of rectilinear axes.

- Oscillator, Hertzian**—An apparatus for generating electromagnetic waves.
- Oscillator, Tube**—The electron tube made to generate high frequency currents by proper adjustment of the electrical constants.
- Oscillion**—A type of electron tube made by the DeForest Telephone and Telegraph Company.
- Oscillations**—Alternating currents of high frequency.
- Oscillation Transformer**—An open type of transformer primarily used for transferring oscillating energy from one circuit to another.
- Oscillatory Circuit**—A circuit of capacity and inductance in which oscillations occur.
- Overmodulation**—The distortion of speech caused by too great variation of the amplitude, of the modulating audio frequency.
- Oxide Coatings**—The coatings of the filaments of some electron tubes by the oxides of barium, calcium, or thorium to cause greater electron emission.

P

- Pancake Oscillation Transformer**—A type of transformer having flat spiral windings.
- Panel**—A sheet of insulating material on which electrical apparatus is mounted.
- Paper, Dielectric Constant of**—Dry paper has a dielectric constant of 1.5 to 3.
- Paraffine**—A crude oil derivative having good insulating qualities and a dielectric constant of 2 to 3.
- Parallel Connection**—A connection in which the current divides, only a part of the total current passing through each device.
- Parallel Connection of Resistance**—An arrangement whereby a number of conductors connect the same two points. From this the total resistance is; the sum of the reciprocals of the separate resistance in parallel is equal to the reciprocal of the resultant resistance.
- Parallel Connection of Condensers**—An arrangement whereby a number of capacities connect the same two points. Since the capacity is proportional to the plate area and parallel connection simply increases the area, the total capacity is equal to the sum of the separate capacities. C-C—C—S, etc.

- Parallel Resonance**—A condition existing when a circuit of lumped capacity and lumped inductance are connected in parallel to a source of alternating E. M. F. and so adjusted that the current supplied by the source is a minimum.
- Peak**—The point or points of maximum amplitude on a resonance curve.
- Peanut Audion**—A name given to the smaller sizes of electron tubes.
- Perikon Detector**—A type of crystal detector using bornite and zincite in contact.
- Period**—The time required for one cycle.
- Permeability-Magnetic**—The ratio of the induction to the magnetizing force in a substance.
- Permanent Contact Crystal Detector**—A detector which does not require adjustment.
- Phase**—An aspect or appearance occurring at the same definite part of each succeeding cycle.
- Phase Difference**—The difference in position in the cycle usually expressed as an angle.
- Phenolic Insulating Materials**—A type of insulating materials, one of which is bakelite.
- Phosphor-Bronze**—An alloy of high tensile strength and often used as antenna wire.
- Plate**—The plate-like electrode in a vacuum tube which collects the electrons emitted by the filament.
- Plate Battery**—The source of E. M. F. connected in the plate circuit to give the plate element its positive charge.
- Plate Circuit**—That part of the vacuum tube circuit including all the devices connected directly in the circuit between the filament and the plate elements.
- Plate Current**—The current passing between the plate and heated cathode or filament, in an electron tube.
- Plate Resistance**—See Internal Output Resistance.
- Plate Modulation**—Modulation by variation of the input plate power.
- Plate Voltage**—The potential given the plate of the electron tube by the plate voltage supply.
- Pliotron**—A type of electron tube designated for transmitting purposes.
- Polarization**—The formation of a film of hydrogen gas on the positive plate of certain primary cells which tends to reduce the current flow.
- Poles, Battery**—The terminals of batteries to which the external circuit is connected.

Poles, Magnetic—The points at which magnetic lines of force appear to enter.

Positive Electricity—The condition of the atom which has lost some of its electrons.

Potentiometer—An arrangement for securing any desired voltage by utilizing the voltage drop across a portion of a current carrying resistance.

Power Factor—The ratio of the true watts to the apparent watts or voltamperes of an alternating current circuit. The cosine of the angle of lead or lag of the current with reference to the E. M. F.

Power Factor Indicator—An instrument to indicate the power factor of a circuit.

Primary Cell—A type of cell whose voltage is directly due to the chemical decomposition of matter.

Primary Coil—The coil of a transformer that is electrically connected to the source of energy.

Pulsating Current—A periodic current the average value of which is not zero. A pulsating current is the sum of an alternating and a direct current.

Q

Quadrature—Expressing a phase difference of 90 degrees (90°).

Quarter Phase—Also two phase. The combination of two alternating current circuits differing in phase by 90° or a quarter of a cycle.

Quenched Gap—A gap so arranged that the spark is quenched quickly by a cooling effect. A method used to give impulse excitation.

R

Radiation—The emission of energy from a source—as of electromagnetic waves from an antenna.

Radiation Efficiency—Of an antenna at a given wave length is the ratio of power radiated to the total power delivered to the antenna.

- Radiation Resistance**—A fictitious term applying to the power output of an antenna, which is considered as being a resistance loss. It represents the real useful output of the antenna.
- Radio Communication**—The science of transmitting and recording knowledge by means of radio.
- Radio Compass**—The name applied to a type of receiving apparatus used for taking direction bearings.
- Radiocast**—See Broadcast.
- Radio Frequency**—Currents considered as having a frequency of 10,000 cycles or more.
- Radio Frequency Amplifier**—An amplifier in which the signals are amplified before reaching the detector.
- Radiogoniometer**—The direction finder.
- Radiogram**—A telegram sent by radio.
- Radiophone (Verb)**—To transmit speech by radio.
- Radiotelephony**—The science of transmitting speech by means of radio.
- Radio Waves**—The electromagnetic waves produced by an oscillatory discharge and which move at right angles to the line of propagating with the speed of light.
- Radiotron**—The trade name given electron tubes used for receiving purposes, distributed by the Radio Corporation of America.
- Ratio of Transformation**—The ratio of the induced E. M. F. of the secondary to the E. M. F. impressed on the primary.
- Reactance**—The opposition offered to the flow of an alternating current which is due to the presence of inductance or capacity or both, in the circuit.
- Reactance Coil**—See Choke Coil.
- Reactance Factor**—The ratio existing between the reaction of a circuit and its ohmic resistance.
- Reactive Drop**—The drop in potential caused by reactance as distinguished from that caused by ohmic resistance.
- Reactive Factor**—The ratio of the wattless volt-amperes to the total volt-amperes.
- Reactor**—See Choke Coil.
- Receiver, Telephone**—A device by means of which the variations in the electric current reproduce the corresponding sounds.
- Receiving Apparatus**—All the associated apparatus used for receiving and rectifying radio waves.
- Reception, Beat**—See Beat Reception.

- Reciprocal**—Unity divided by quantity. Multiplying by the reciprocal of a number is equivalent to dividing by the number.
- Rectifier**—Any device for converting alternating current into direct or pulsating current.
- Regenerative Circuit**—An electron tube circuit in which additional amplification is produced by feeding back some of the energy of the plate circuit into the grid circuit.
- Re-ignition**—Starting the arc by the oscillating current in the direction opposite to the steady current after it has been extinguished by the oscillatory current.
- Rejector**—A supplementary closed resonant circuit, consisting of a low resistance inductance and a condenser and tuned to the frequency of the desired signal, connected as a loop in shunt across the receiving primary circuit and acting to provide a low impedance bypass for all frequencies except that of the desired signal. (Sometimes called a "shunt trap.")
- Relay**—A device actuated by an electric current to open or close another circuit.
- Remote Control**—Controlling a radio station from a distant point.
- Repulsion Motor**—An alternating current motor deriving its power from the mutual repulsion between armature and field.
- Resistance**—The opposition to the passage of an electric current by any substance or material. The unit is the ohm.
- Resistivity**—The measure of the resistance of a material to the flow of electricity.
- Resistance Coupling**—The coupling between two circuits when they have a resistance in common.
- Resistance, Effective**—As applied to high frequencies, it is the power lost in heating or otherwise dissipated, divided by the square of the effective current.
- Resistance, Radiation**—See Radiation Resistance.
- Resistance, Internal Input of Electron Tube**—The ratio of voltage change to current change, the grid voltage being constant.
- Resistances, Series Connection**—An arrangement of conductors whereby the total resistance is equal to the sum of the resistance.
- Resistance, Parallel Connection**—See Parallel Connection of resistances.
- Resonance**—The condition that exists when the effects of the capacity and inductance of a circuit are balanced.
- Resonance Curve**—A curve which shows the change of current in a circuit, when changes are made which cause the resonance condition to be somewhat departed from.

Resonance Frequency—The frequency which makes the capacitive and inductive reactances equal.

Rheostat—A resistance device, usually variable.

Right Hand Rule—A rule for indicating the direction of magnetic effect. Grasp the wire with the right hand and with the thumb extended along the wire in the direction of current. The curved finger tips will indicate the direction of the magnetic effect.

Ring Winding—A name given to type of armature winding.

R. M. S.—Abbreviation of root-mean-square.

Root-Mean-Square Value—The square root of the mean square of an alternating current or electromotive force. Also called effective value or virtual value. The root mean square value of sine wave is .707 times the maximum value.

Rotary Converter—See Synchronous Converter.

Rotary Gap—A revolving spark gap.

Rotary Phase Converter—A machine which converts an alternating current to a different number of phases without change of frequency.

Rotating Magnetic Field—A magnetic field created by polyphase current circulating in properly distributed windings which steadily and periodically advance the polarity of the different parts of the magnetic field.

Rotor—The rotating part of a motor, generator or other electrical machine.

S

Sal Ammoniac—A compound (ammonia chloride) used in solution as the electrolyte in certain primary batteries.

Saturation, Electron Tube—The condition existing when the space charge caused by the large number of negative electrons in the tube fully counteracts the influence of the positive charges on grid and plate.

Scale—A series of dimensions arranged to give numerical readings of the setting of the device to which it is connected.

Scott Connection—A method of connecting transformers to change from three to two phase or the reverse.

Secondary Battery—A class of chemical electric generator which can be recharged. Storage batteries fall in this class.

Secondary Coil—The coil in which electromotive forces are induced.

Secondary Emission—Electron emission in which the exciting agency is bombardment of the emitting material by the electrons.

Self-Inductance—The property of an electrical circuit which tends to prevent any change in the current established in the conductor.

Self-Heterodyne—A system for receiving continuous wave signals by the production of audio frequency beats, through the use of a device which is both a radio frequency generator and a detector of the audio frequency beat currents produced.

Sending Station—One equipped with apparatus for producing and radiating radio messages.

Separate Heterodyne—The securing of beat notes by use of a separate source of oscillations.

Series Condenser, Antenna—When a condenser is connected in series with an antenna the condition of series condensers exists and the wave length of the antenna circuit is reduced.

Series Connection—A connection of electrical apparatus or circuits in which all of the current passes through each of the devices in succession, or one after the other.

Series Connection of Condensers—An arrangement of capacities wherein the same charge is given to each condenser and the total voltage is subdivided among the condensers in direct ratio to their capacities.

Series Motor—An electric motor in which the armature and field windings are connected in series.

Series Resistance—See Resistance, Series Connection.

Series Resonance—When a single lumped capacity and a single lumped inductance are connected in series between terminals to which an alternating E. M. F. is applied and the inductance or capacity or frequency is varied, the condition of series resonance exists when the current is maximum.

Shape Factor—A numerical quantity in formulae for the calculation of the inductance of coils.

Sharp Tuning—Refers to the generation of a fundamental of a pure wave, in which practically no harmonics are present. This is desirable to allow freedom from interference.

Sharpness of Resonance—A quantity expressing the fractional changes of current in a simple series circuit for a given fractional change in either capacitive or inductive reactance at resonance.

- Sharp Wave**—A “pure wave” or one which has energy at or near only one wave length—as indicated by a “sharp” resonance curve.
- Shellac**—A material used for insulating and binding purposes, having a dielectric constant of from 3 to 3.7.
- Shell Transformer**—A transformer having the primary and secondary coils within the iron shell which constitutes the magnetic circuit.
- Shunt Circuit**—An arrangement of apparatus or circuits in which the total current is subdivided.
- Shunt Winding**—The arrangement of windings of motors or generators where they are connected in shunt.
- Side Frequency**—The frequency of the side waves.
- Side Waves**—See Band, Wave Length.
- Silicon**—One of the metallic elements used for detecting purposes.
- Silicon Steel**—Steel containing a small amount of silicon and highly desirable for its magnetic properties.
- Silver Chloride Cell**—A type of dry cell in which the depolarizer is silver chloride and in which the positive electrode is silver and the negative zinc.
- Simple Alternating Current**—A sine wave.
- Sine Curve**—See Curve Sine.
- Single Layer Coil**—A coil having all turns side by side and in only one layer.
- Single Phase**—An alternating current system in which only two wires are necessary and making use of only one E. M. F.
- Single Phase Alternator**—A generator of single phase electromotive forces.
- Sinusoidal**—Having characteristics that can be represented by a sine curve.
- Skin Effect**—The tendency of an alternating current to pass through the outer portion rather than through the center of a conductor.
- Slip of Induction Motor**—The difference in the number of revolutions made by a revolving field and the rotor of the motor.
- Solder**—An alloy of lead and tin having a low melting point.
- Soft Tube**—A vacuum tube having a lesser degree of vacuum than that of the hard tube.
- Solenoid**—A coil consisting of a number of turns in cylindrical form.
- Sound Waves**—The waves given off by a vibrating body which are transmitted by an elastic material medium and which can be perceived by the ear.
- Spark**—An arc of very short duration.

- Spark Frequency**—The number of sparks that occur per second.
- Spark Gap**—Terminals or electrodes designed to permit spark discharges to take place across a gap.
- Specific Gravity**—The weight of a material in proportion to the weight of an equal volume of water.
- Specific Inductive Capacity**—The direct measure of the ability of a substance to store up electrical energy when used as a dielectric material in a condenser.
- Spider Web Coil**—A special type of stagger wound or open weave flat inductance coil which has low distributed capacity and high efficiency.
- Spiral Oscillation Transformer**—See Pancake Oscillation Transformer.
- Split Phase**—A difference in phase resulting usually from an unequal distribution of reactance in different branches of a divided single phase circuit.
- Stagger-Wound Inductance Coil**—A type of inductance coil which has its layers staggered with reference to each other—as in the duo-lateral coil, or its turns staggered—as in the spider web coil.
- Standards, Bureau of**—A Bureau of the government established for the purpose of scientific investigation.
- Standard Cell**—A type of cell which has a steady or standard E. M. F. (See Cadmium Cell).
- Star Connector**—The connection of the three windings of a three-phase system in the form of a star. Also called "Y" connection.
- Star Delta Connection**—The designation of the connection of the primary windings of a bank of transformers in star and the secondary windings in delta.
- Static**—Conduction or charging current in the antenna system resulting from physical contact between the antenna and charged bodies or masses of gas.
- Static Electricity**—Defined as electricity at rest, in contradistinction to current electricity. (See Frictional Electricity.)
- Station License**—A permit to operate a transmitting station granted by the government.
- Stator**—That part of an electrical machine or device which remains fixed.
- Step-Down Transformer**—A transformer wound to give a lower voltage on the secondary side than that impressed on the primary.
- Storage Cell**—A type of cell in which the chemical changes of discharge may be reversed by application of an electric current to charge it.

- Strays**—Disturbances in radio reception due to electromagnetic fields other than those caused by radio transmitting stations, caused by sparking commutators, sparks on trolley lines, controllers, ignition systems, etc.
- Sulphation**—The formation of lead sulphate on the plates of the lead acid cell. It results in harm to the cell and is particularly harmful if the cell is left in an uncharged condition.
- Super Heterodyne**—A type of radio receiver operating on the heterodyne or beat principle.
- Surface Leakage**—The loss of current due to a conducting film on insulators.
- Susceptance**—The reciprocal of reactance. The unit is the mho.
- Synchronizer**—An instrument used for indicating the phase relation of two alternating current machines.
- Synchronous**—Simultaneous. Occurring at the same time.
- Synchronous Alternator**—An alternating current generator operating or capable of being operated in synchronism with another generator.
- Synchronous Converter**—A rotating machine having a field excited by direct current and an armature connected to a commutator and a set of collector rings, used to convert direct to alternating or the reverse.
- Synchronous Motor**—A machine constructed similar to a separately excited alternator but operated as a motor.

T

- Telegraph Key**—A type of switch for making and breaking a circuit at will for the purpose of transmitting dots and dashes.
- Telephone Receiver**—A device for producing sound impulses from electric current variations or vice versa.
- Telephone Transmitter**—Refers strictly to a device for converting sound pulsations into electric current variations.
- Tesla Coil**—A special type of step-up transformer used primarily to produce very high voltages.
- Thermal Ammeters**—Current measuring instruments that operate due to the heating effect of an electric current.
- Thermo Couple**—A junction of two different metals which develop an E. M. F. when heated. Used with ammeters to measure small currents.

- Thermoelectricity**—The electrical energy which is transformed from heat energy in the thermo couple.
- Three-Electrode Tube**—A combination of a heated cathode, a relatively cold anode, and a third electrode for controlling the current flowing between the other two; the whole enclosed in an evacuated bulb. Various called, audion, pliotron, radiotron, oscillion, audiotron, aerotron, electron tube, vacuum tube, etc.
- Three Phase**—Having three electromotive forces with a phase displacement of 120° between them.
- Tickler**—The coil in the plate circuit used to feed some of the energy back into the grid circuit. (See Feed Back).
- Tikker**—A device for rapidly and somewhat irregularly making and breaking the circuit of a receiver for reception of undamped waves.
- Time Constant**—Refers to the rate of building up the charge in a condenser. The larger the capacity and resistance, the longer the time required. The product CR is called the time constant.
- Time Signals**—Signals transmitted each day for indication of correct time by certain radio stations.
- Tone Modulation**—The chopper, buzzer and sine-wave modulation system are referred to as "tone modulation."
- Torque**—The amount of force which tends to produce rotation of the armature of a motor or other source of power. The unit is the pounds-foot or pounds-inch.
- Train Frequency**—The number of groups or trains of waves per second.
- Trains, Wave**—Groups of alternating current waves of both the continuous and discontinuous type.
- Transformer**—A device for transferring energy from one circuit to another.
- Transmission, Radio**—The propagation of electromagnetic waves from a transmitting station.
- Transmitter**—See Telephone Transmitter.
- Transmitting Antenna**—An arrangement of conductors connected to a generator of high frequency currents for the radiation of radio waves.
- Transmitting Circuit**—The arrangement of and connections to pieces of apparatus used in the generation of currents of high frequency for radio transmission.
- Tube, Electron**—See Three Electrode Tube.
- Tuned Circuit**—A circuit having its value of capacity and inductance such that the period of vibration corresponds to a desired value.
- Tungar Rectifier**—A device for changing alternating to direct current, working in the electron flow principle.

Two Electrode Electron Tube—A vacuum tube having a hot cathode and a relatively cold anode, or one with filament and plate only.

Two Phase Alternator—A machine for generating two phase alternating electromotive forces.

“T” Type Antenna—A flat top antenna in which the lead-in is taken from the center of the horizontal portion.

U

Umbrella Type Antenna—An antenna the conductors of which form elements of a core with the apex at the top, to which the lead-in is connected.

Undamped Alternating Current—A current passing through successive equal cycles of time whose average value is zero.

Undamped Waves, Radio—Waves representing a true alternating current. Those of constant amplitude and called continuous waves. (See Continuous Waves).

Underground Antenna—An antenna consisting of an insulated wire and placed a short distance under the surface of the ground.

V

Vacuum Tube—See Electron Tube.

Variable Condenser—One whose electrical capacity may be changed or varied.

Variable Inductor—A name sometimes applied to a variometer.

Variation, Wave Length for Modulation—The variation of wave length to produce modulation by using a voice controlled variable condenser.

Vario-Coupler—An arrangement of two or more coils so that the movement of the coils will vary the coupling.

Variometer—A variable inductance controlled by altering the relative position of two coils.

Vector—A quantity having both direction and magnitude.

Velocity—The distance traveled by a wave in one second. For the electromagnetic wave it is 186,300 miles per second.

- Vernier Condenser**—A condenser having small capacity changes.
- Voice Modulation**—The variation of amplitude of an alternating current wave by means of the voice.
- Volt**—The unit of electromotive force. The electrical pressure required to send a current of one ampere through a resistance of one ohm.
- Voltage Amplification**—The ratio of the voltage change produced in the output apparatus in the plate circuit to the change in the voltage impressed on the grid.
- Voltmeter**—A device for measuring the difference of potential in volts.
- Voltage Drop in Generator or Battery**—See Internal Drop.
- Vulcanized Fibre**—An insulating material having a dielectric constant of from 5 to 8.
- "V" Type Antenna**—Two sets of horizontal wires supported by three masts so that the horizontal portions form an angle.

W

- Water Pipe Ground**—A water pipe to which connection is made for the ground.
- Water Rheostat**—A rheostat which uses the resistance properties of water or some salt in solution.
- Watt**—The unit of electrical power and representing the product of current and electromotive force.
- Wave Antenna**—A horizontal antenna the physical length of which is approximately equal to the length of signaling waves to be received, and which is used so as to be directional.
- Wave Changer**—A transmitting device for rapidly changing the radiated wave length.
- Waves, Continuous**—See Continuous Waves.
- Wave, Damped**—See Damped Wave.
- Wave Distortion**—Divergence from a sine wave.
- Wavemeter**—A radio instrument for measuring frequency.
- Wave, Sine**—See Sine Wave.
- Wave Train**—See Trains, Wave.
- Wave, Undamped**—See Undamped Wave.
- Weston Cell**—See Cadmium Cell and Standard Cell.
- Wheatstone Bridge**—An instrument for measuring resistances.

Wired Radio—The guidance of electromagnetic waves of high frequency by conductors.

Wire Telephony—The transmission of speech over wires.

Wood's Metal—An alloy having a low melting point used for mounting crystals for detector purposes.

X

"X"s—A term sometimes used to designate static, strays, atmospherics, etc.

X-ray—The radiation produced outside the cathode ray tube which has the ability to penetrate materials of considerable thickness. Also called **Roentgen Rays**.

Y

"Y" Connection—Same as Star Connection.

Yoke, Dynamo—The frame from which the poles project radially inward.

Z

Zero Beat Reception—Also called "homodyne" reception. A method of reception using a radio frequency current of the proper magnitude and phase relation so that the voltage impressed on the detector will be of the same nature as that of the wave.

Zincite—A mineral (natural red oxide of zinc) used as a detector material.

Zinc Spark Gap—A spark gap having zinc as the electrode.



LIBRARY OF CONGRESS



0 040 055 125 A