

中華兒童教育社叢書
家庭幼稚園小學新教材

我的工作簿

下冊

陳鶴琴
屠哲梅編纂
丁光燮

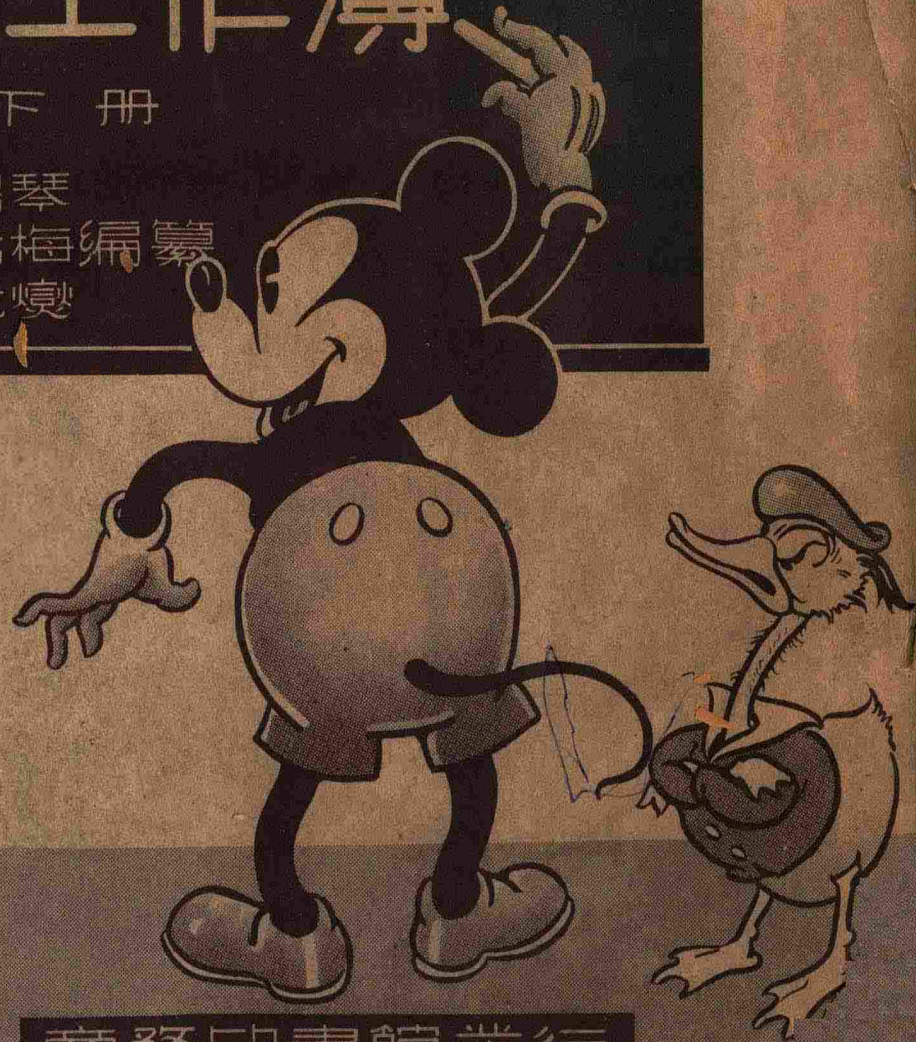
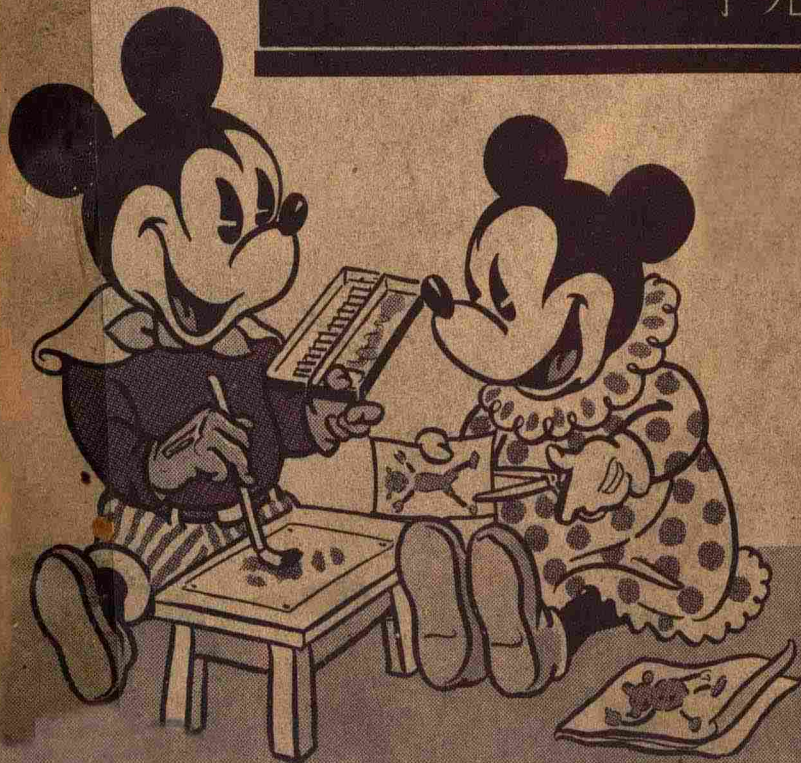

商務印書館發行

中華兒童教育叢書
家庭幼稚園小學新教材

我 的 工 作 簿

下 冊

陳鶴琴 屠哲梅 丁光燮編纂

商 務 印 書 館 發 行

中華民國二十七年七月初版
中華民國三十六年五月四版

(3211.2B)

中華兒童教育社叢書
家庭幼稚園小學新教材
我的工作簿二冊

下冊 定價國幣捌元

印刷地點外另加運費

編纂者

屠陳

哲鶴

梅琴

發行人

朱

上海河南中路

經

農

印刷所

商務

印刷書

館廠

發行所

商務各

地印書

館

版權所有翻印必究

我的工作簿下冊目錄

花 木

方形花	111, 112	玉蘭花	125
十字形花	102, 111, 118, 139	菊花	126
圓形花	112, 113, 115	水仙花	126, 131, 132
分瓣花	113	梅花	127
半圓形花	114	百合花	127, 136
蒲公英	116	荷花	129
玫瑰花	117	向日葵	130
燕子花	118, 119, 137	野菊花	134
鬱金香	119, 120, 128, 133, 138	柏樹	140—142
薔薇	121	樹	143—144
蜀葵	121	法國梧桐葉	145
桃花	122	桑葉	146
油菜花	122	梧桐葉	146
十來紅	123	楓葉	146
甘菊	123, 135	牽牛花葉	146
牽牛花	124	掌狀葉	147
雞冠花	124	葉邊	148
罌粟	125	葉人	149

果 子 菜 蔬

橘子	150, 153	紅菱	153
一盤果子	151	梨	153
葡萄	152	石榴	153
香蕉	152	桃子	153
柿子	152	荸薺	153

蘋果	153, 155	果子人	156
枇杷	154	藕	154
櫻桃	154	青菜	157
蓮蓬	154	蘿蔔	157
杏子	154	蕪菁	157
西瓜	154	菜蔬人	158, 159

玩 具 用 具

麻雀(面具)	160	蝴蝶籃	180, 181
雞(面具)	161	果籃	190
米老鼠(面具)	162	盒	191—194
貓(面具)	163	杯	195, 196
狗(面具)	164	汽球	197
豬(面具)	165	燭與燭盤	198
熊(面具)	165	燈罩	199
羊(面具)	166	燈籠	200, 201
馬(面具)	167	搖馬	202
牛(面具)	168	搖椅	203
兔(面具)	169	搖牀	204, 205
猴(面具)	170	牀	206
虎(面具)	171	桌	206
獅(面具)	172	房子	207
象(面具)	173	中華民國黨旗	208
老人(面具)	174	中華民國國旗	208
花籃	175—177, 182, 183—189	英國旗	209
一籃紅蛋	178	美國旗	209
兔籃	179	法國旗	210
貓頭鷹籃	180	印度旗	211

蘇聯國旗..... 212 |

交 通

帆船..... 213	火車..... 216
輪船..... 214	飛機..... 217
汽車..... 215, 216	

風 景

太陽..... 218	雪人..... 220
月亮..... 219	

十字形花

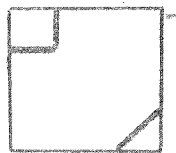
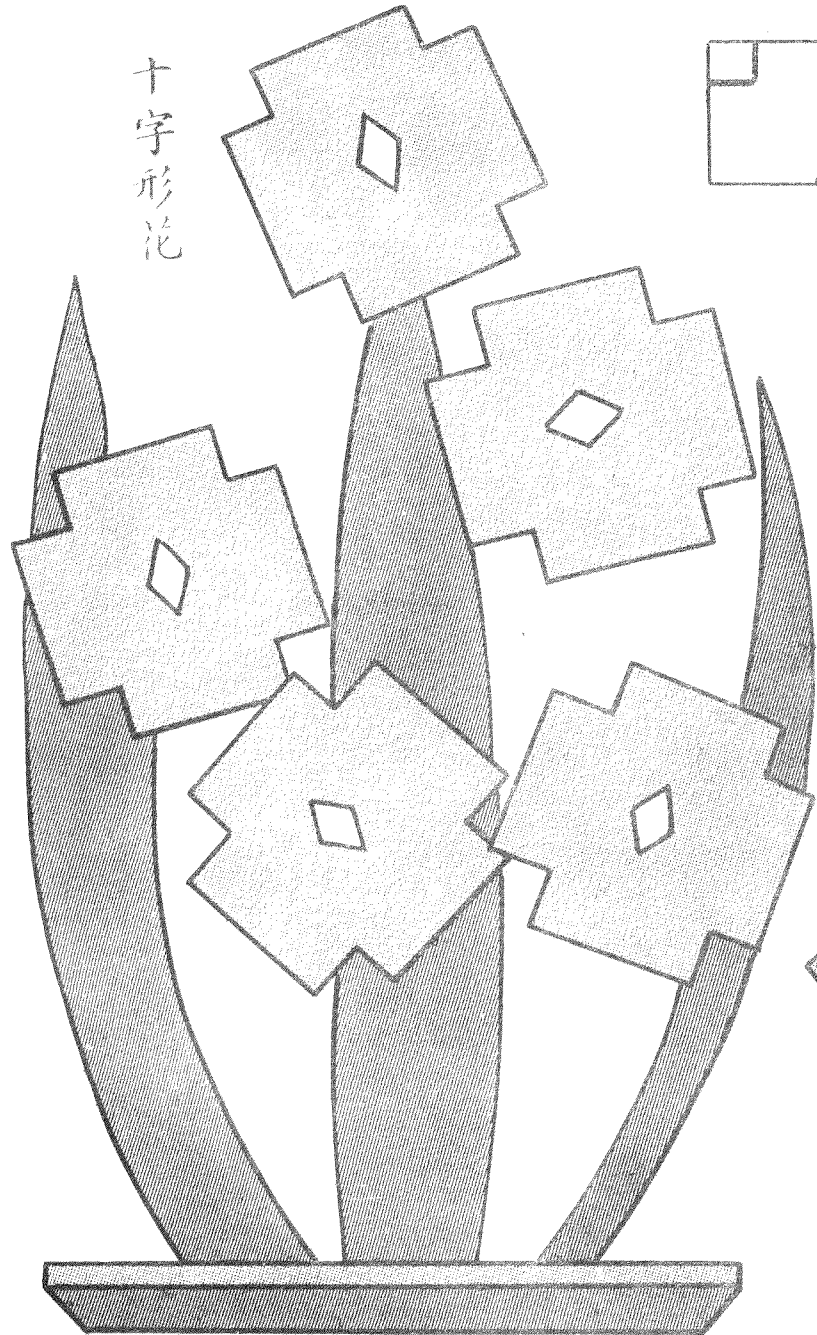

方形花
花莖用綠
色蠟筆畫

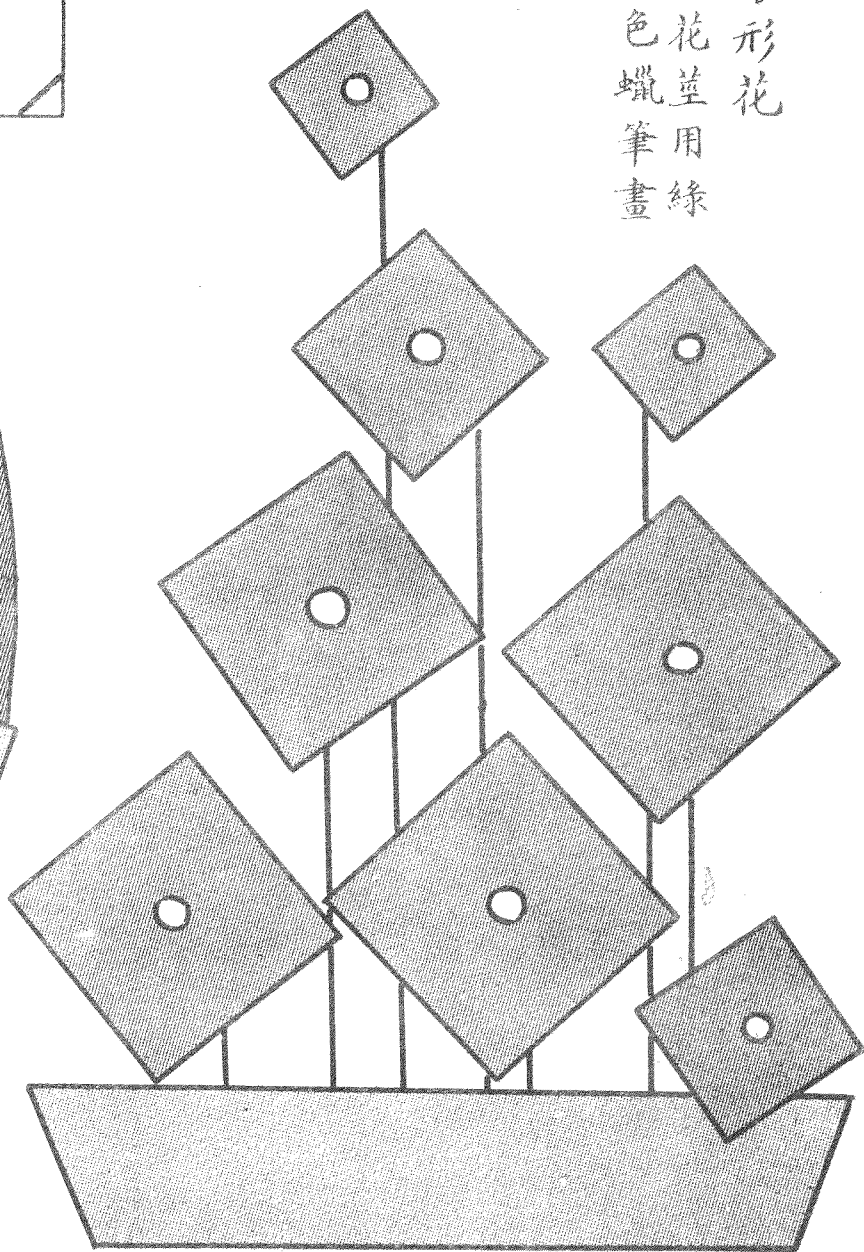

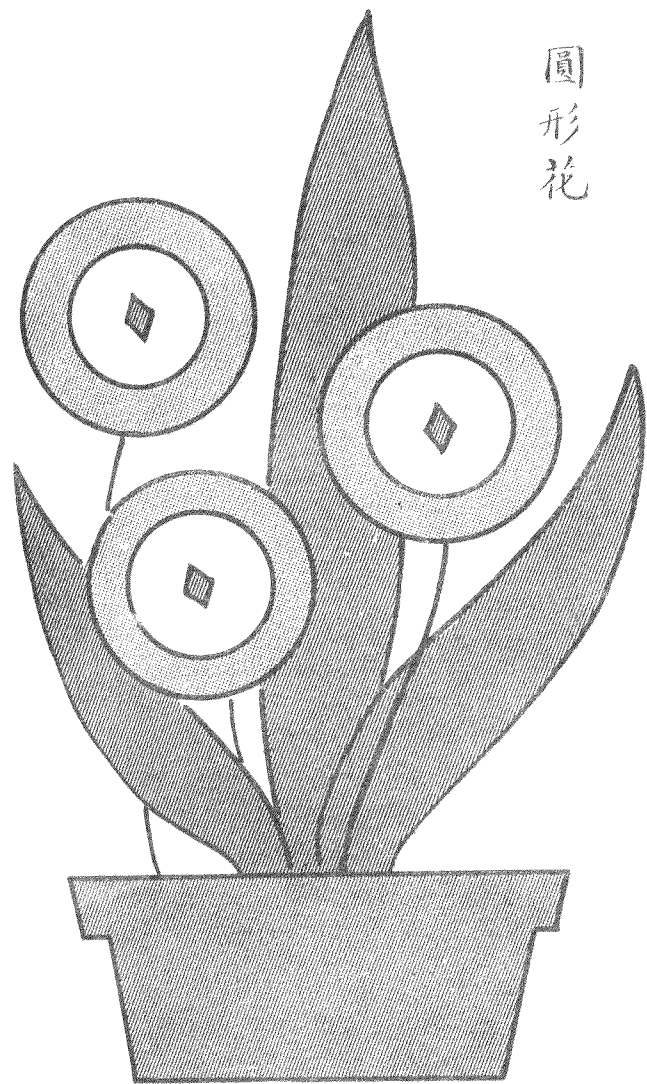

圓
形
花

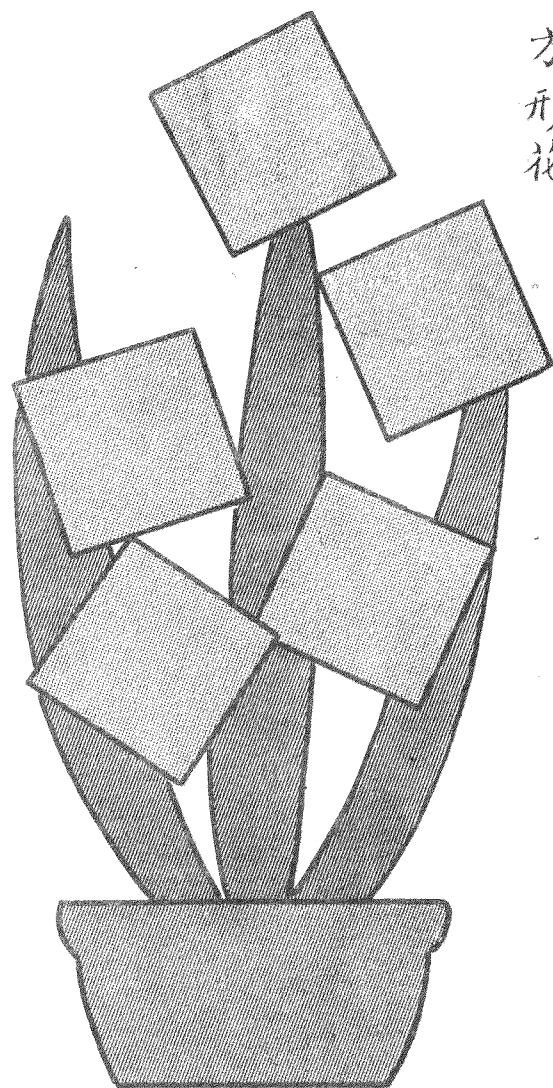

方
形
花

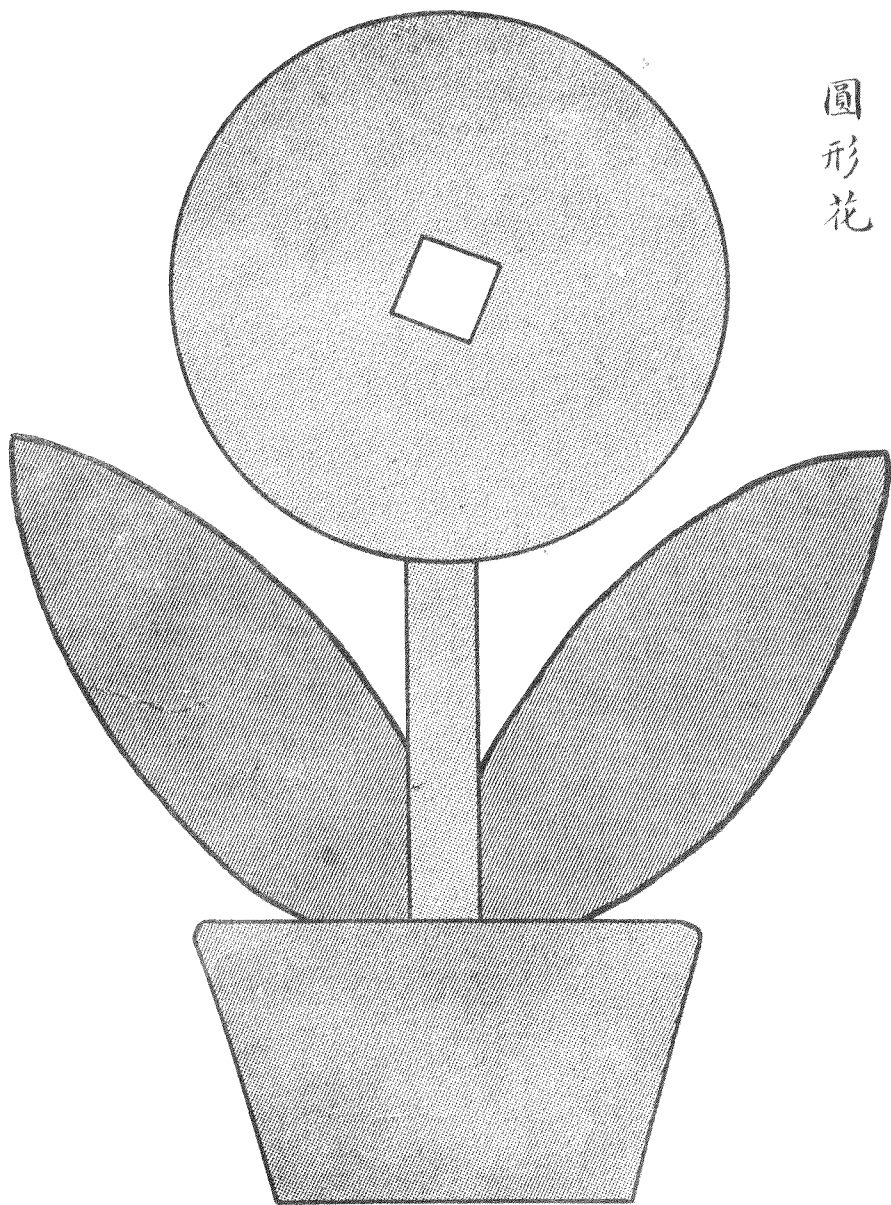

圓形花

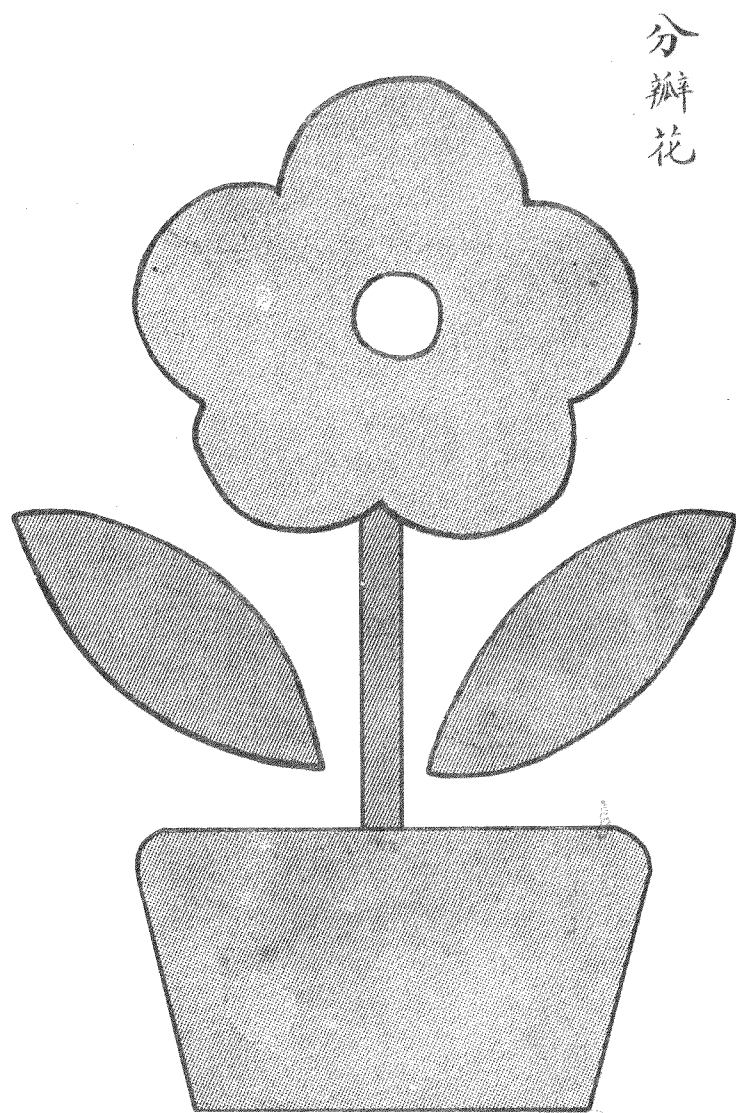

分瓣花

半圓形花
花莖用綠色蠟筆畫



圓形花
花莖和葉
用綠色蠟
筆畫

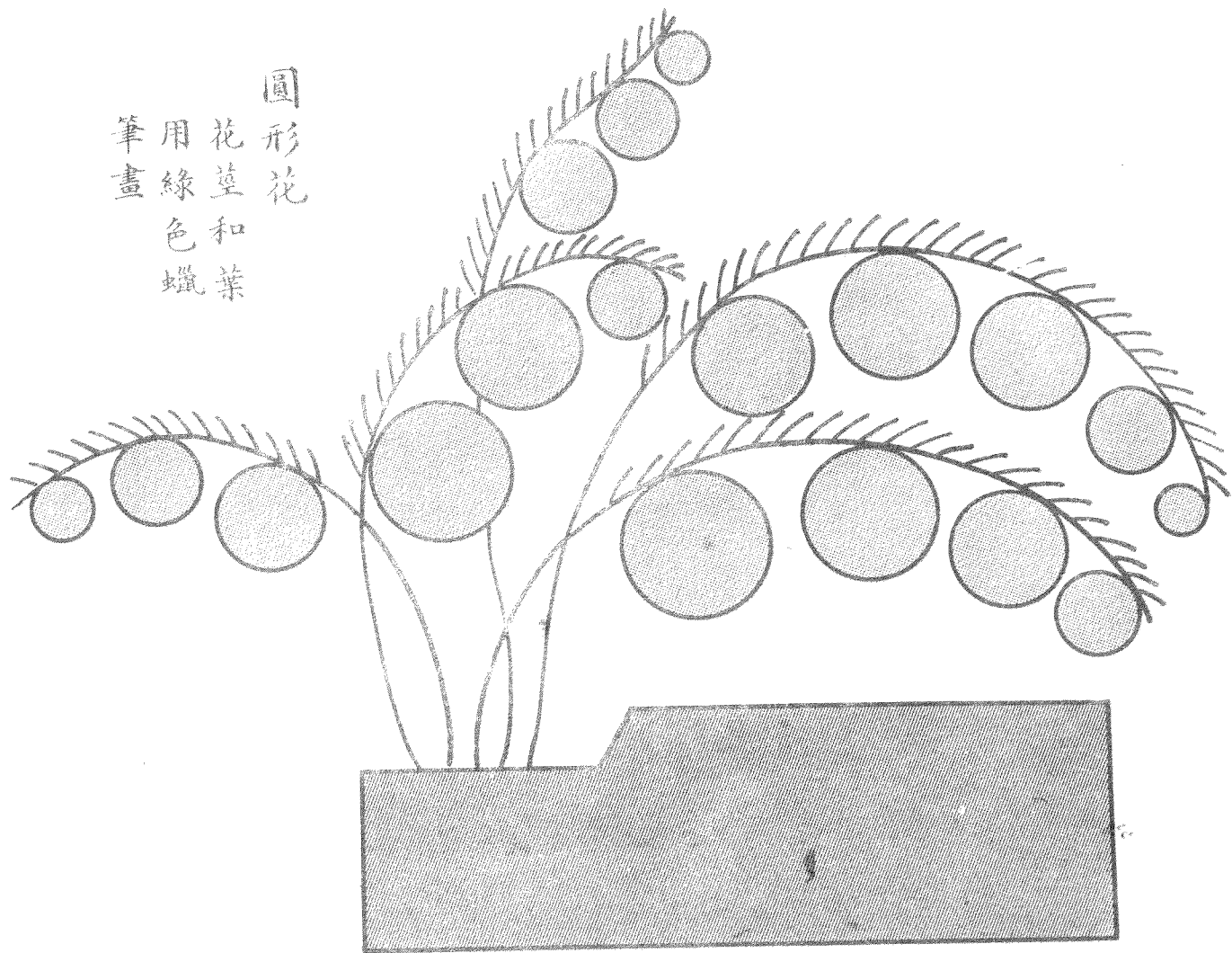

蒲公英

花黄色
蕊棕色
葉綠色
莖淡綠色

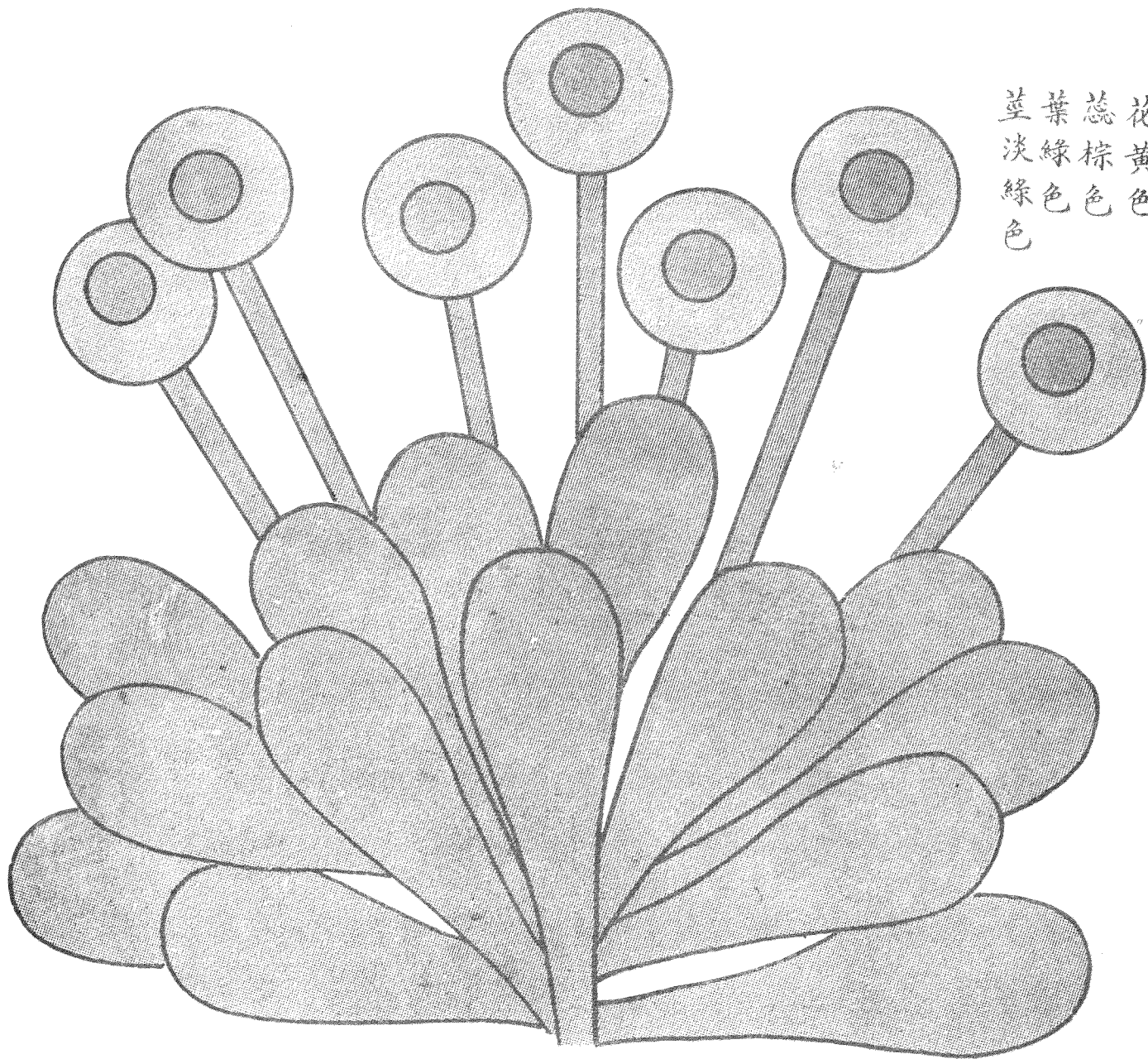

玫瑰花

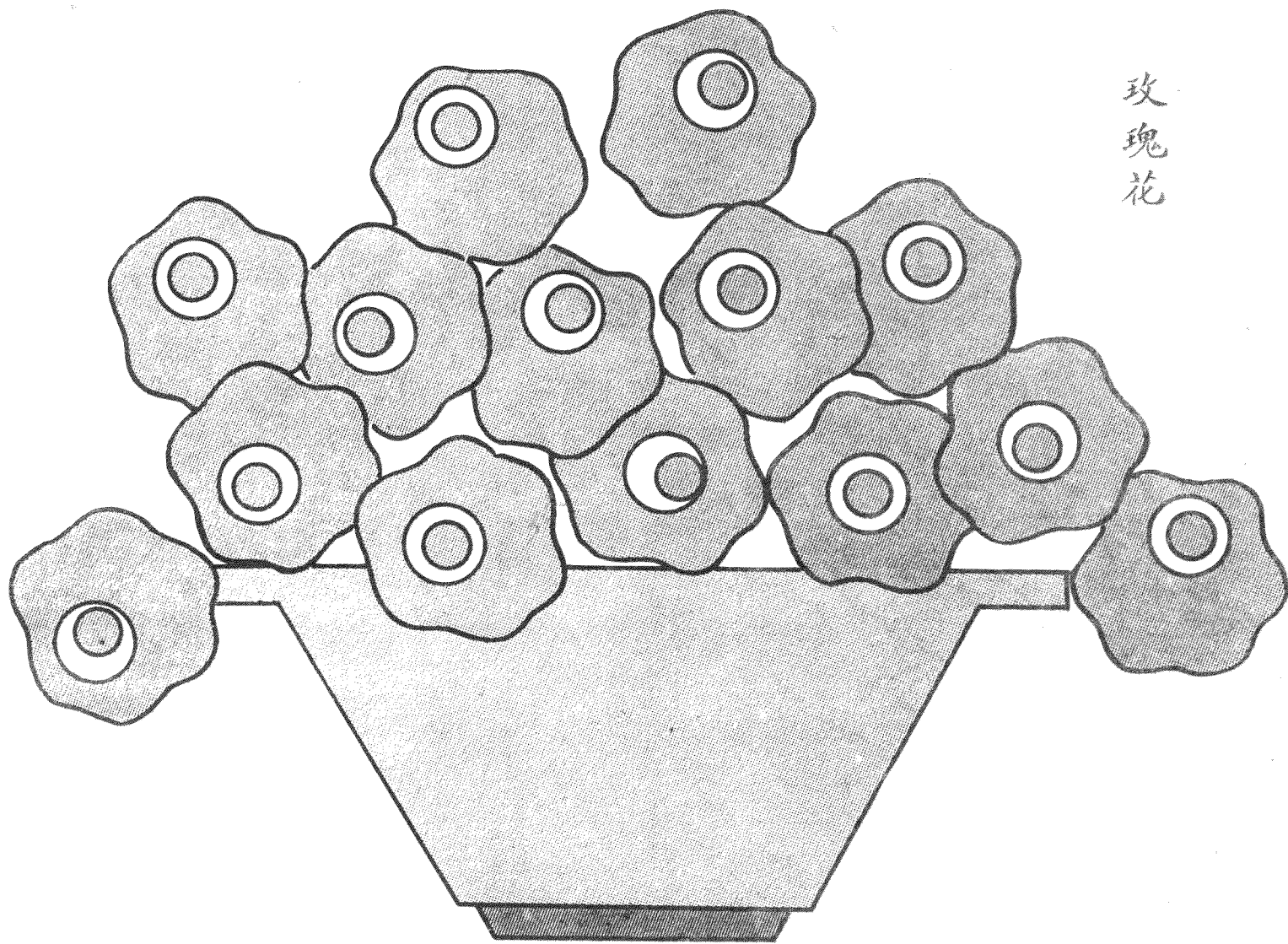

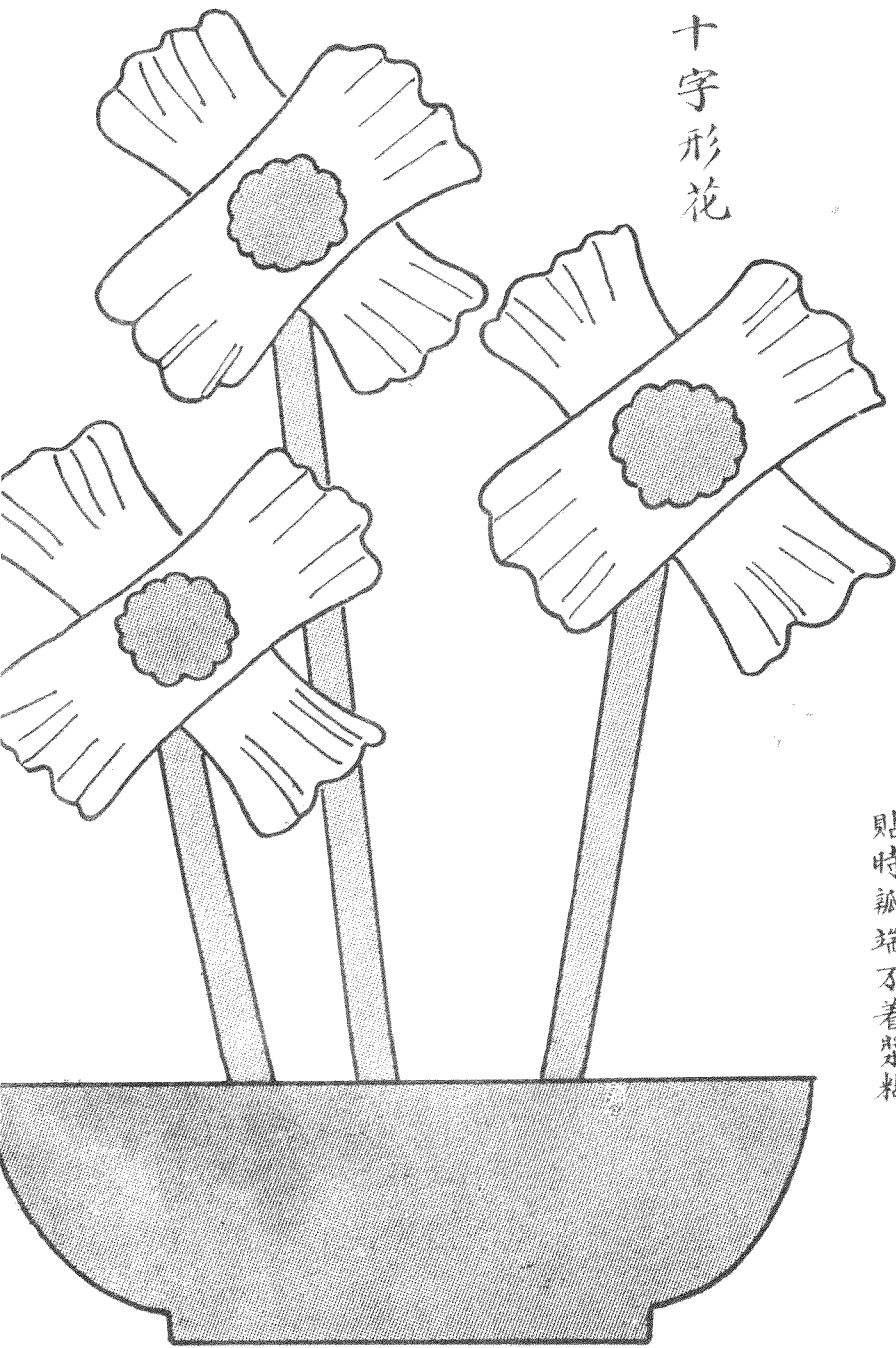

十字形花

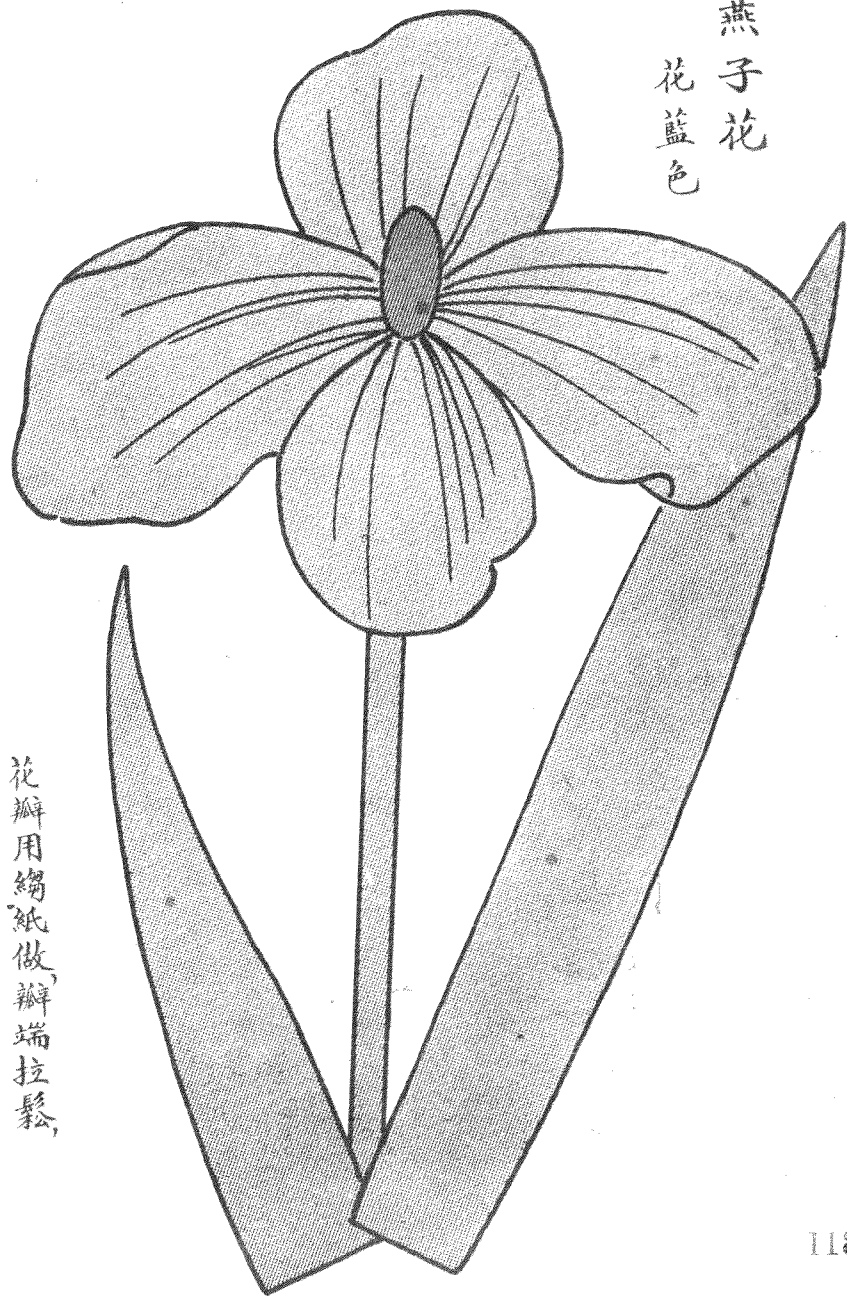

燕子花
花藍色

花瓣用絹紙做，瓣端拉鬆，
貼時瓣端不着漿糊。

燕子花
花藍色

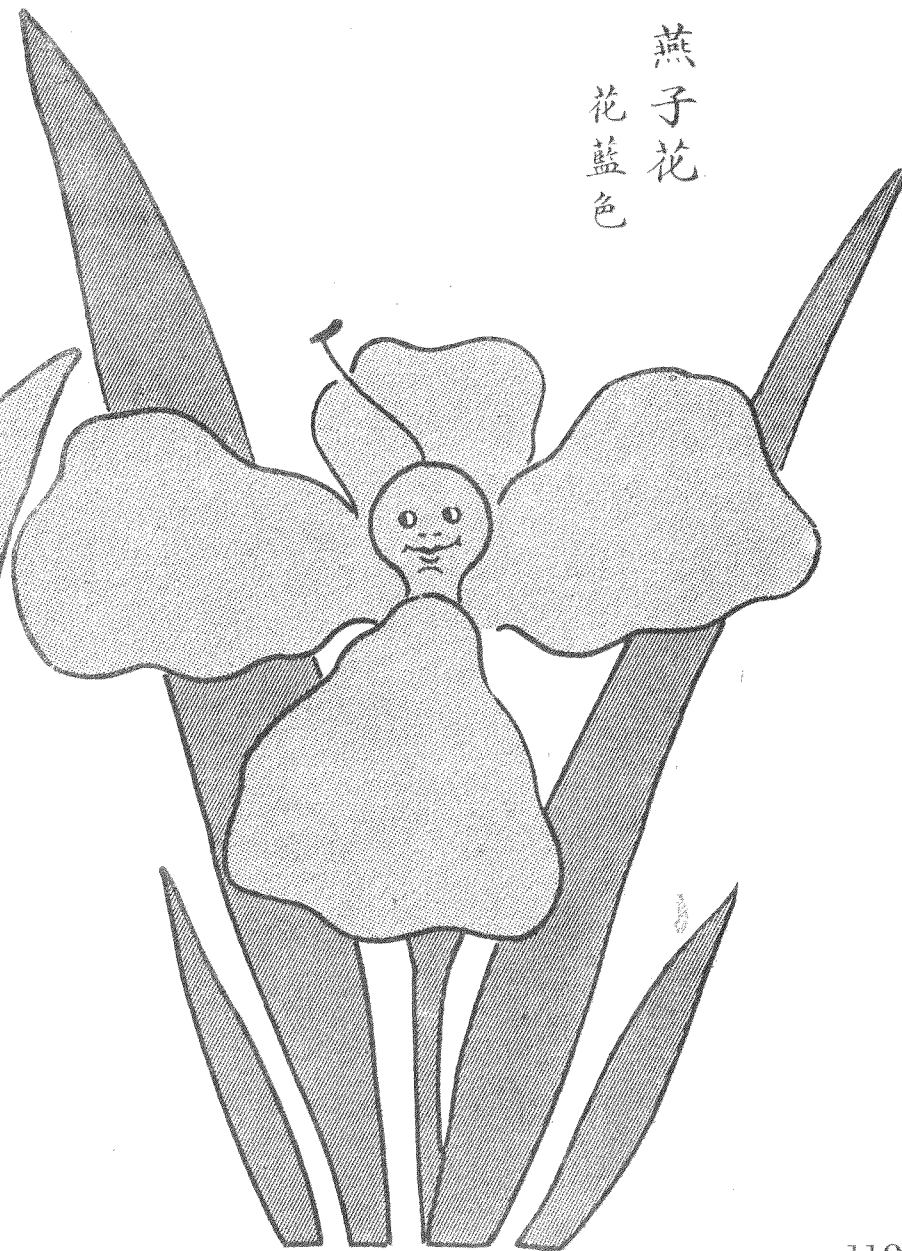

鬱金香
花分黃、白、
紅三色

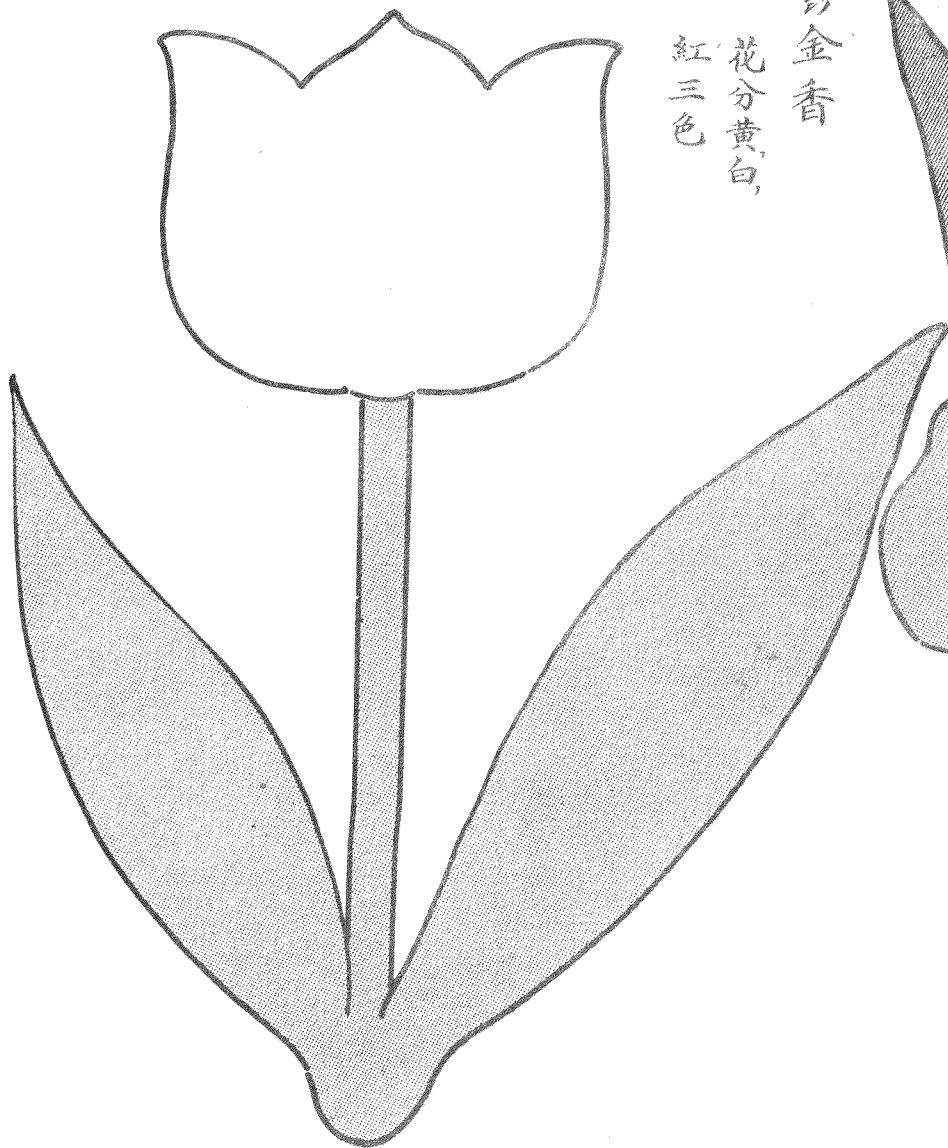

鬱金香

花分黃、白、
紅三色

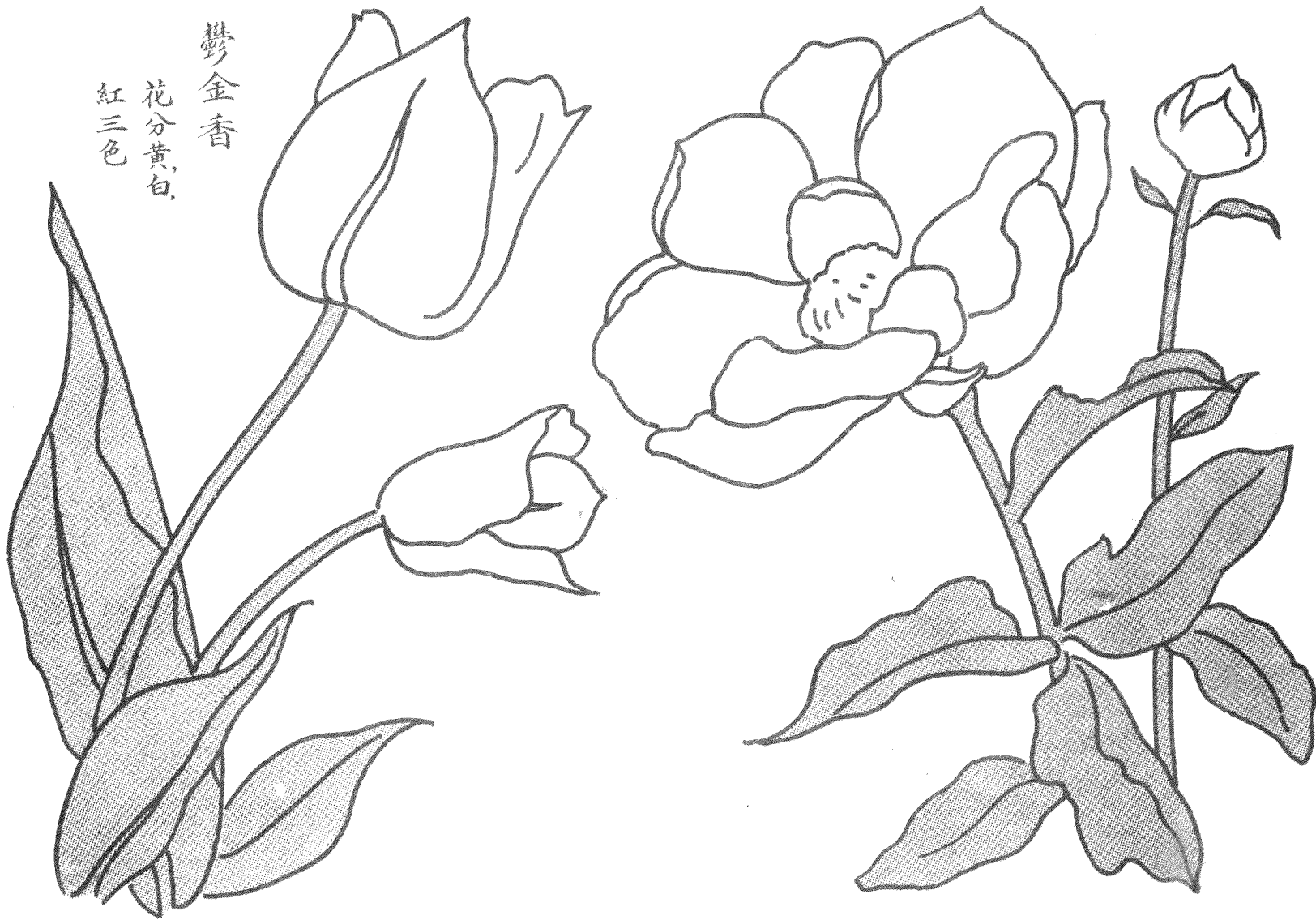

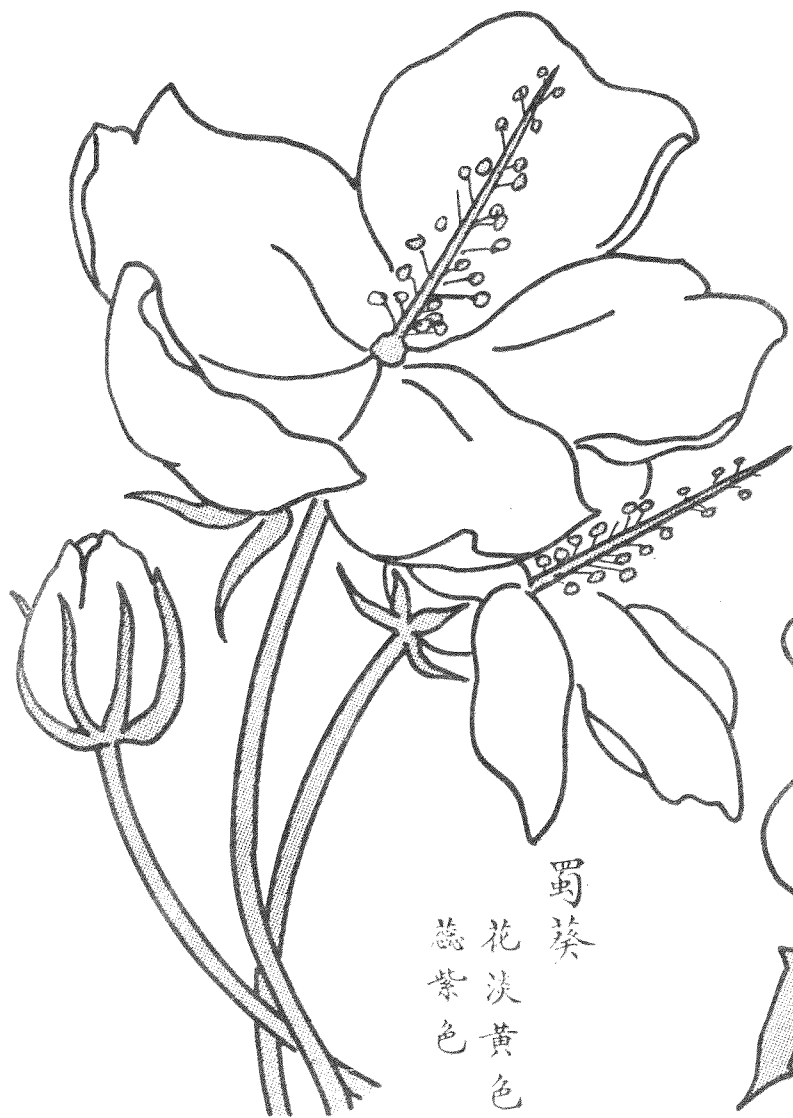

蜀葵
花淡黄色
蕊紫色



蔷薇
花红色
或白色



油菜花
花黄色



桃花
花淡红色



甘菊
花白色
或黄色



十來紅
花大紅色



雞冠花

花深紅色
或黃色

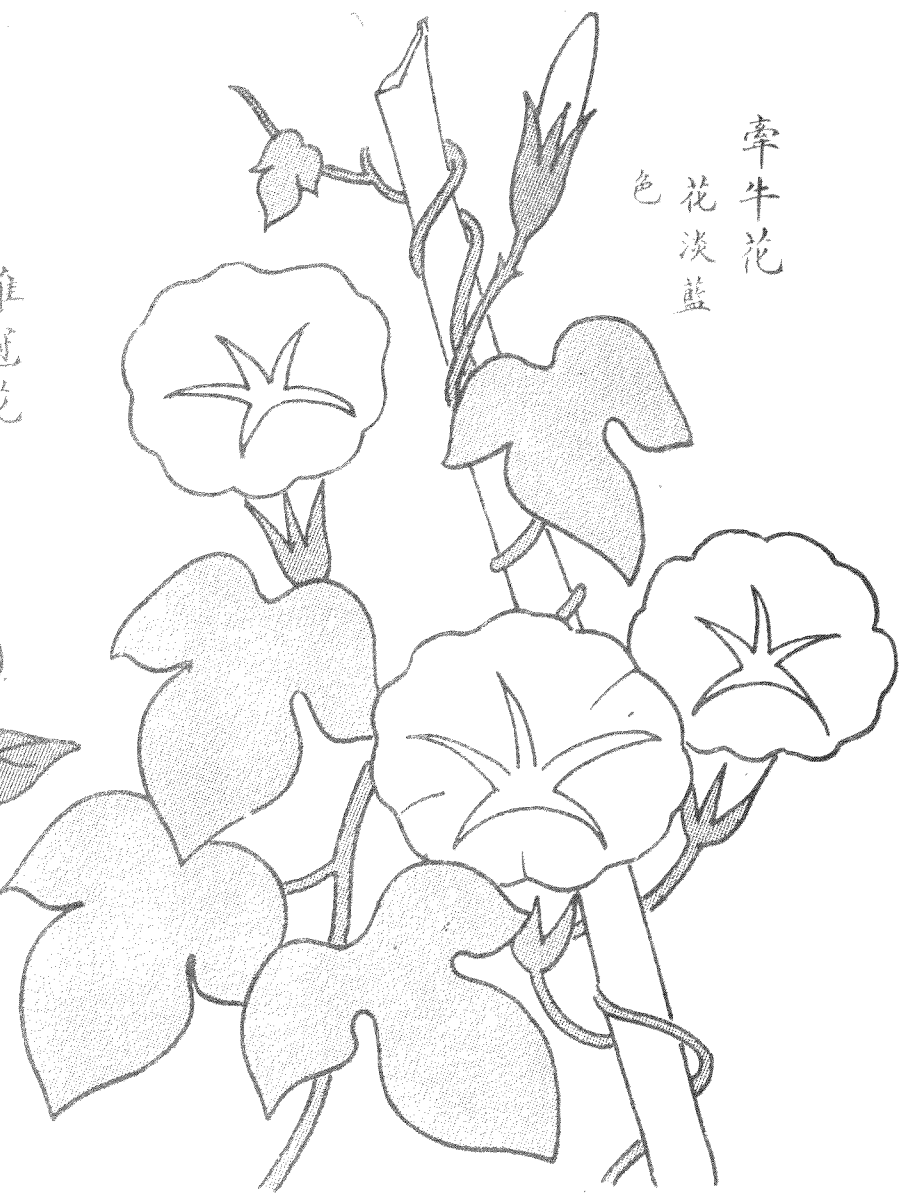

牽牛花

花淡藍色

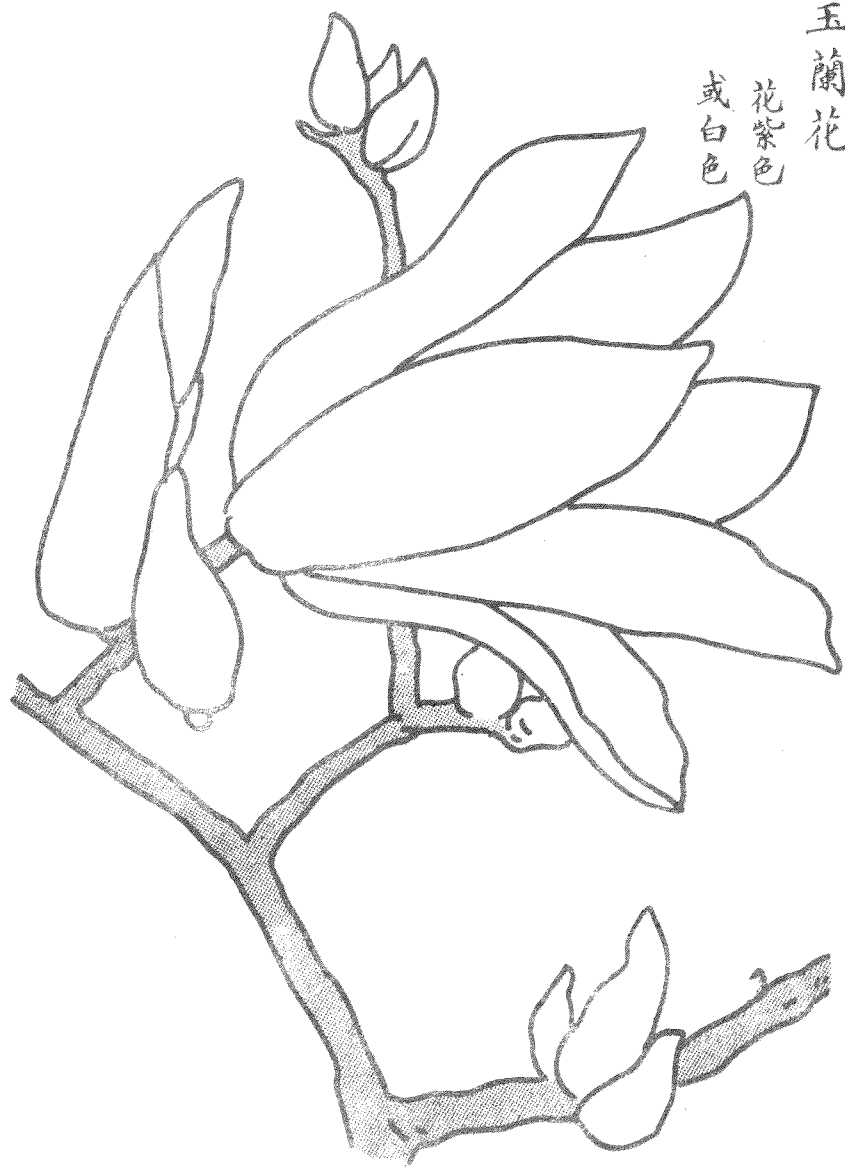

玉蘭花
花紫色
或白色

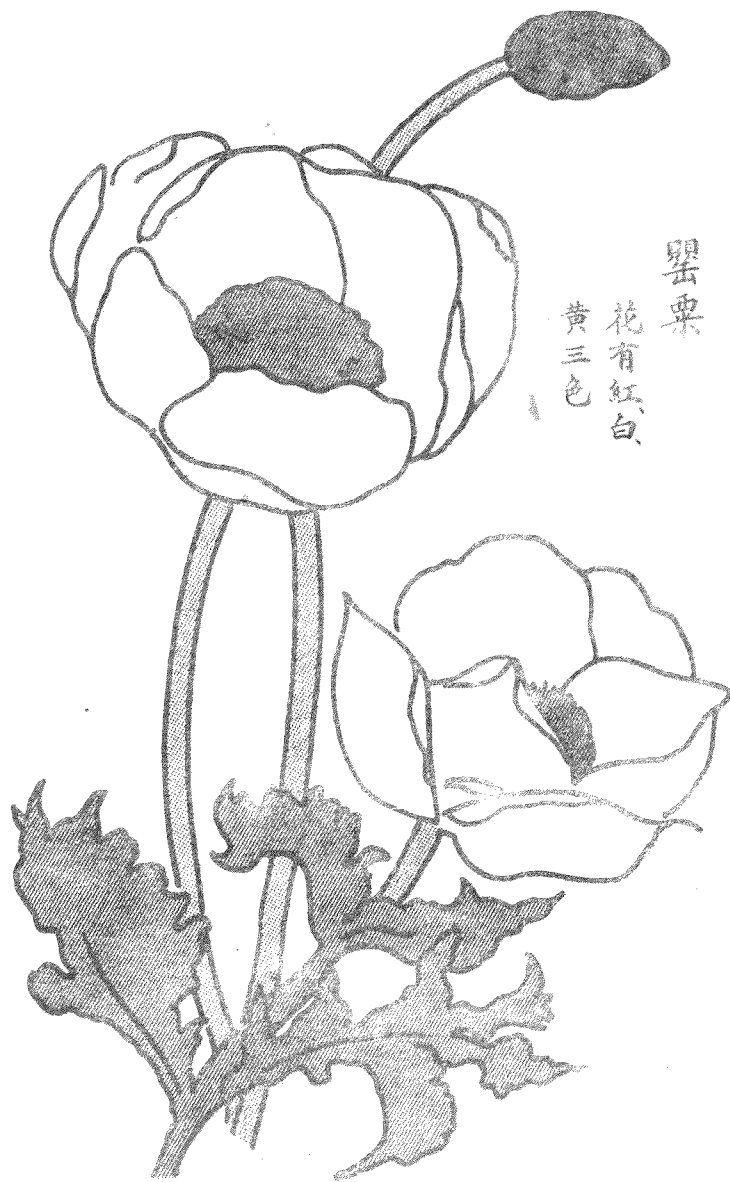

罌粟
花有紅、白、
黃三色

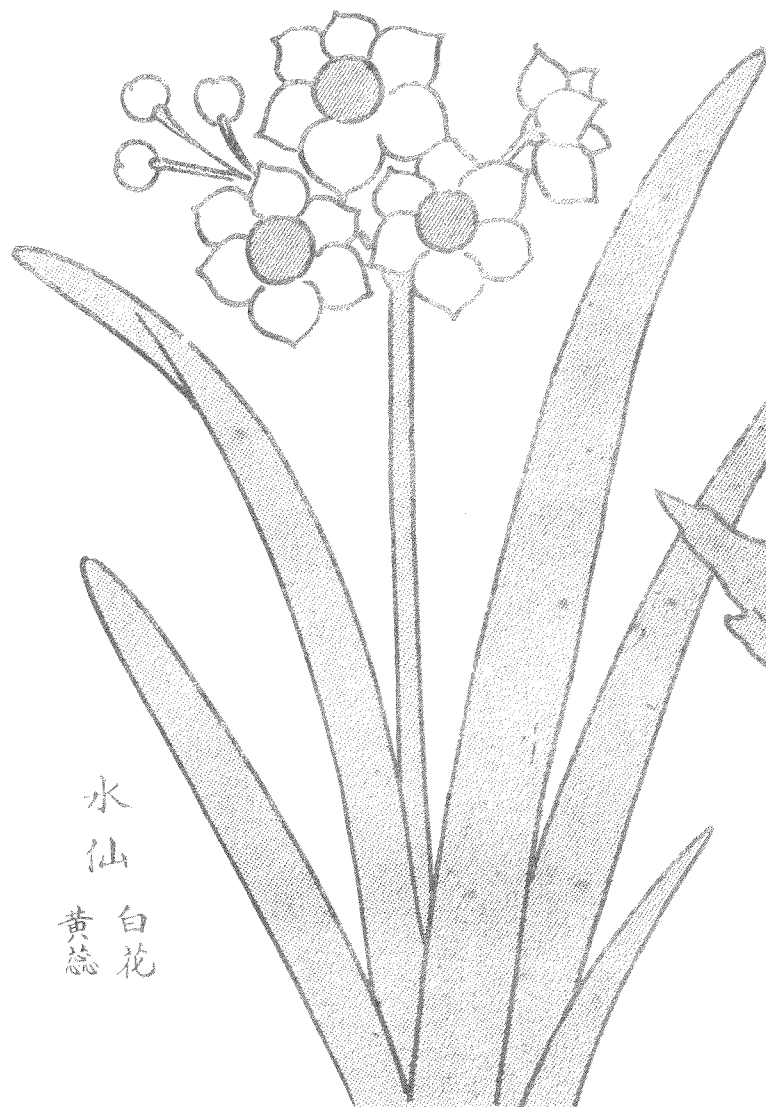

水仙
白花
黃蕊



菊花
花的顏色和
種類很多



百合花
白花黃蕊

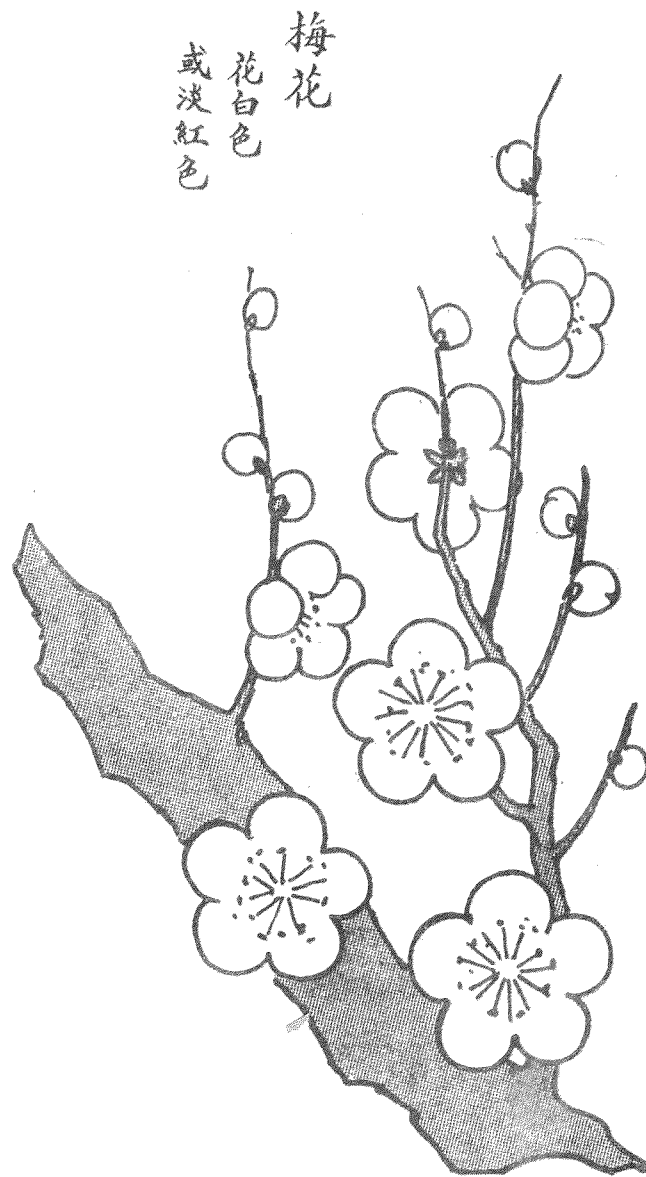

梅花
花白色
或淡紅色

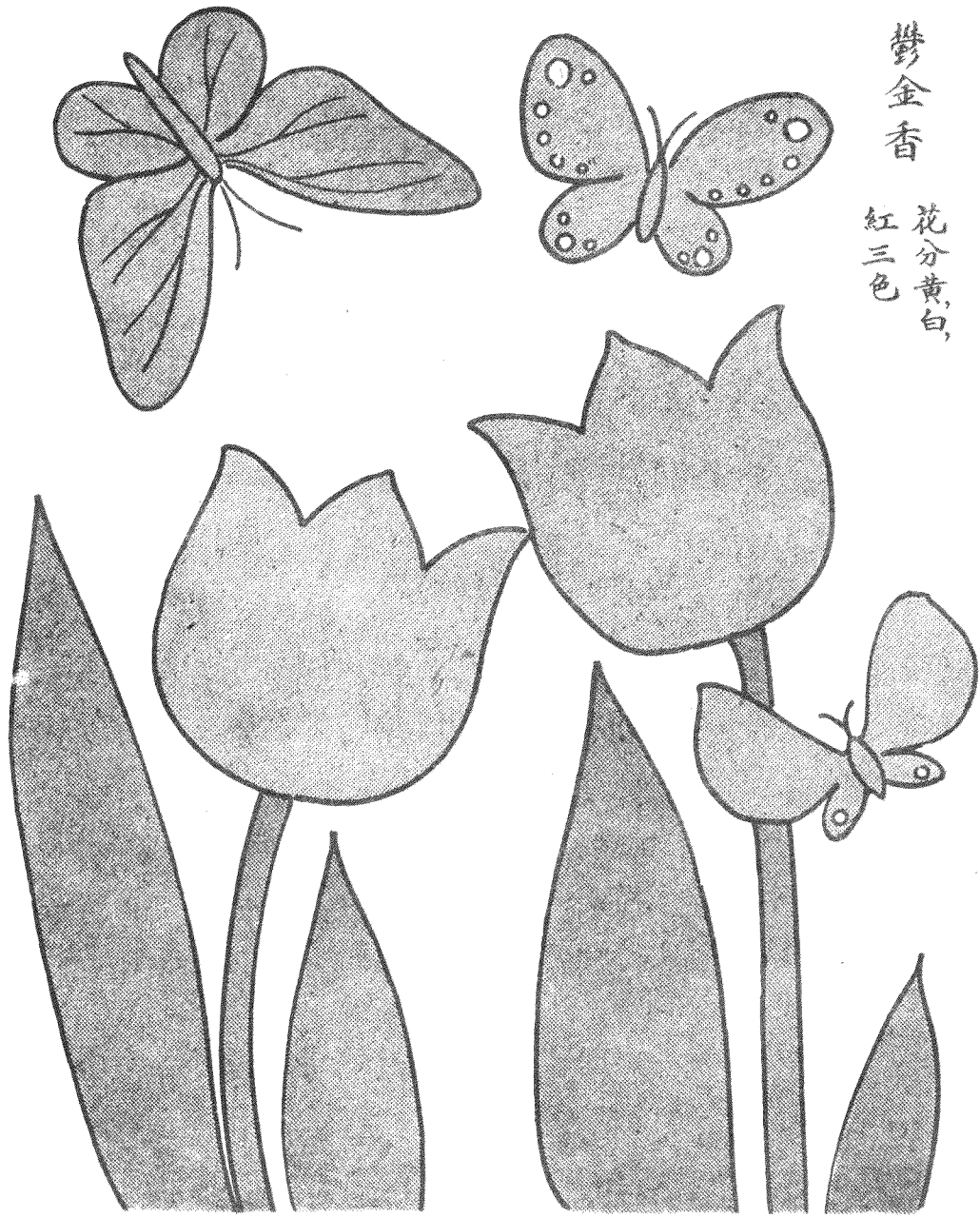

鬱金香

花分黃、白、
紅三色

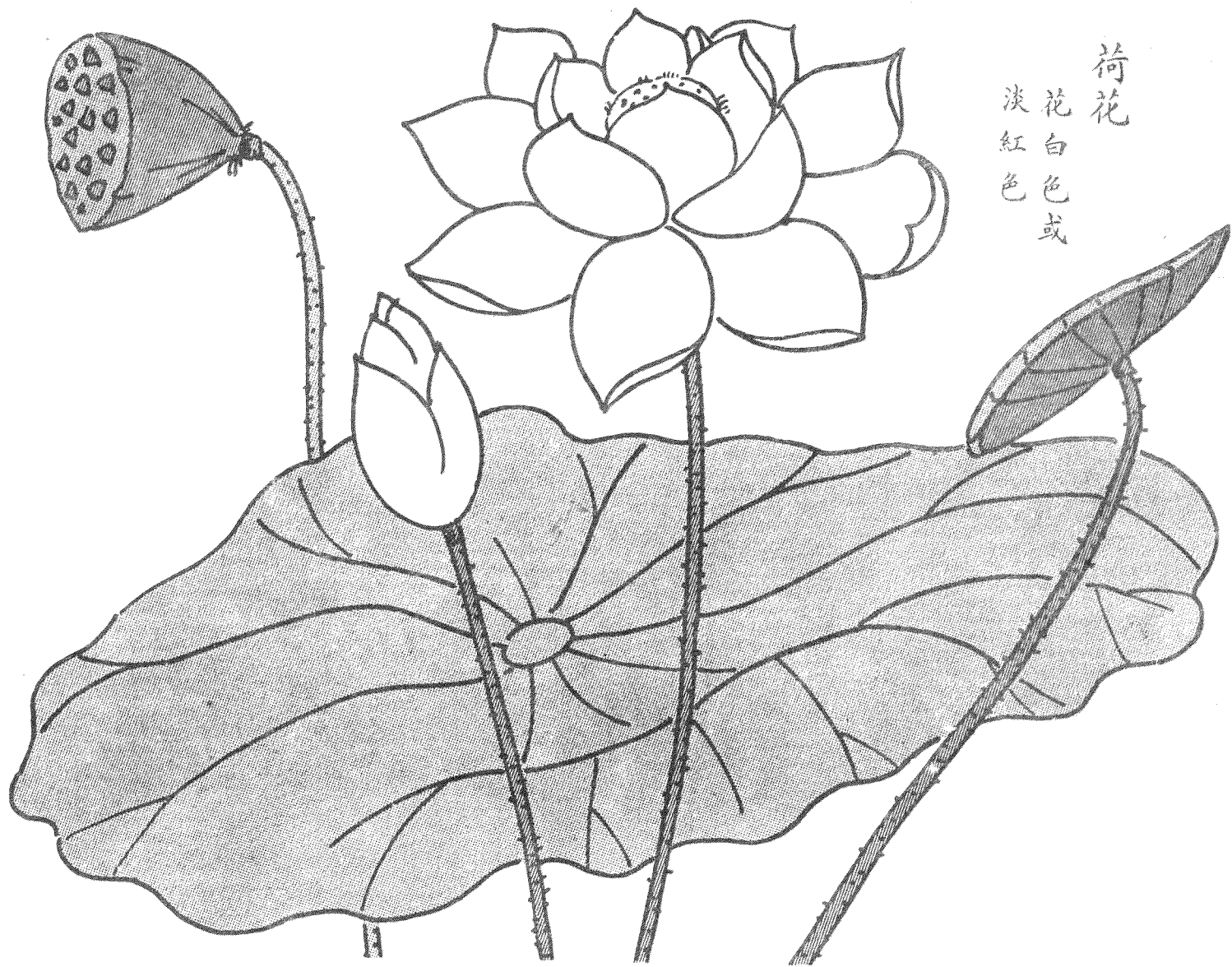

荷花

花白色或
淡紅色

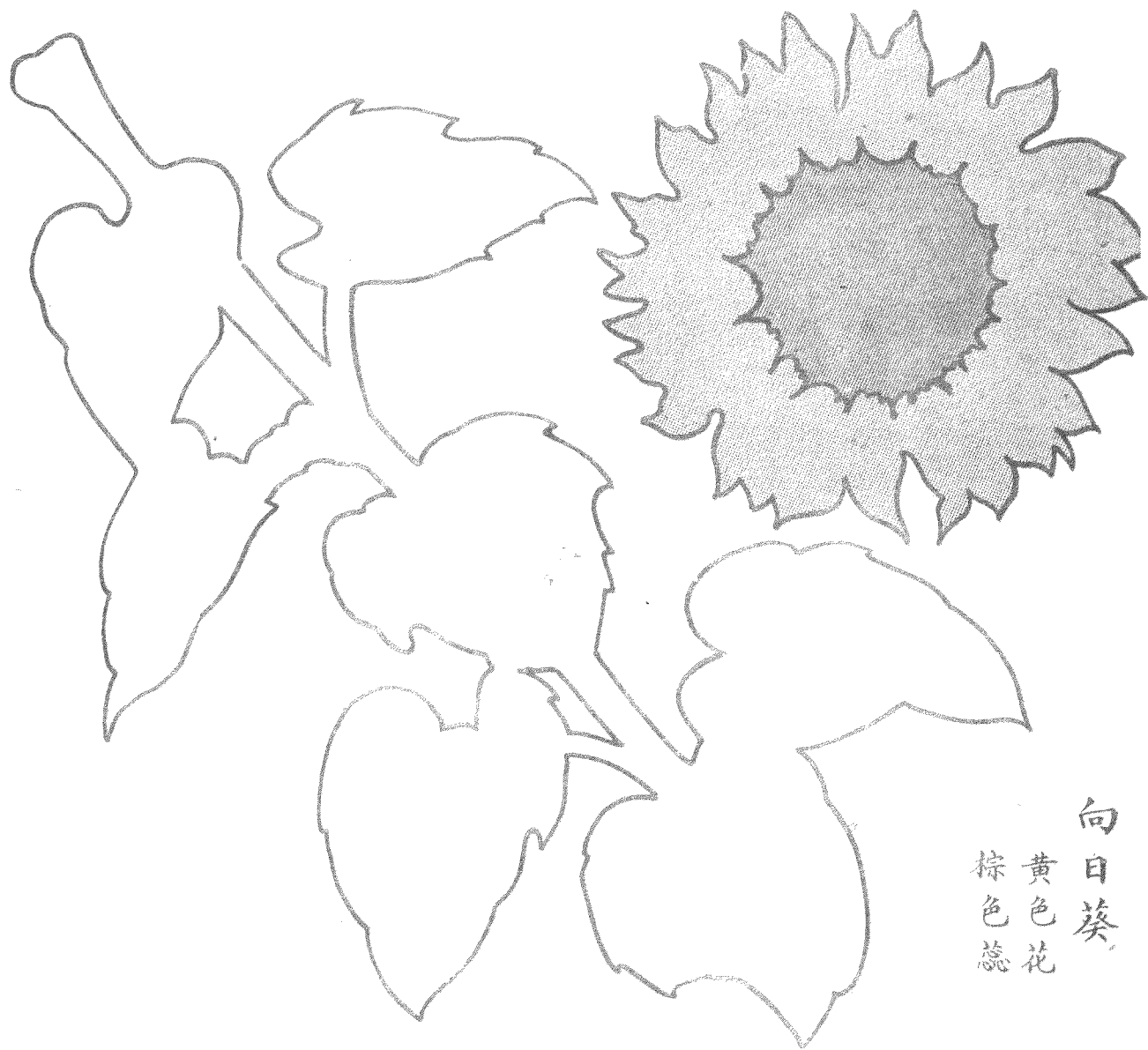

向日葵

黄色花
棕色蕊

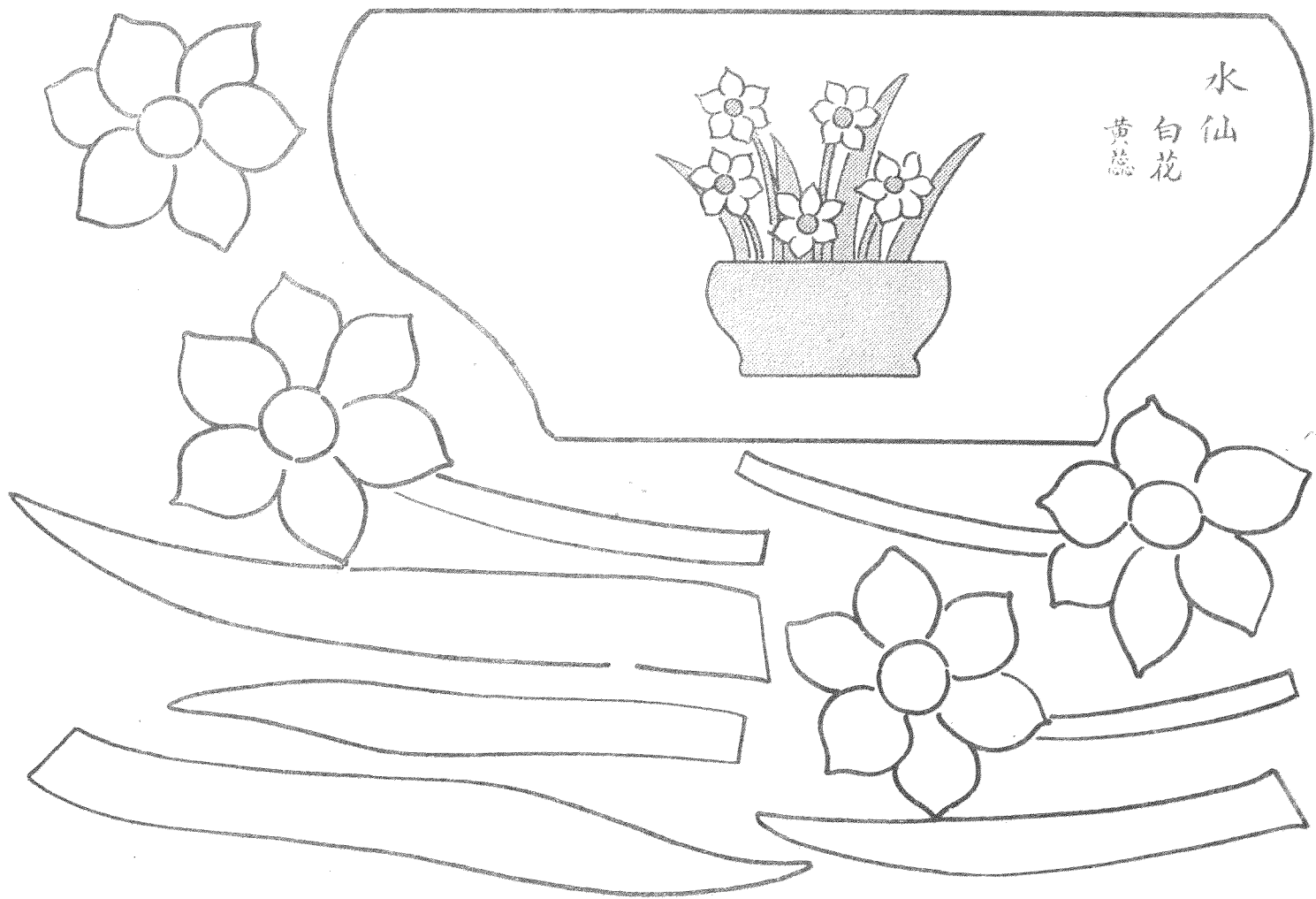

水仙
白花
黄蕊

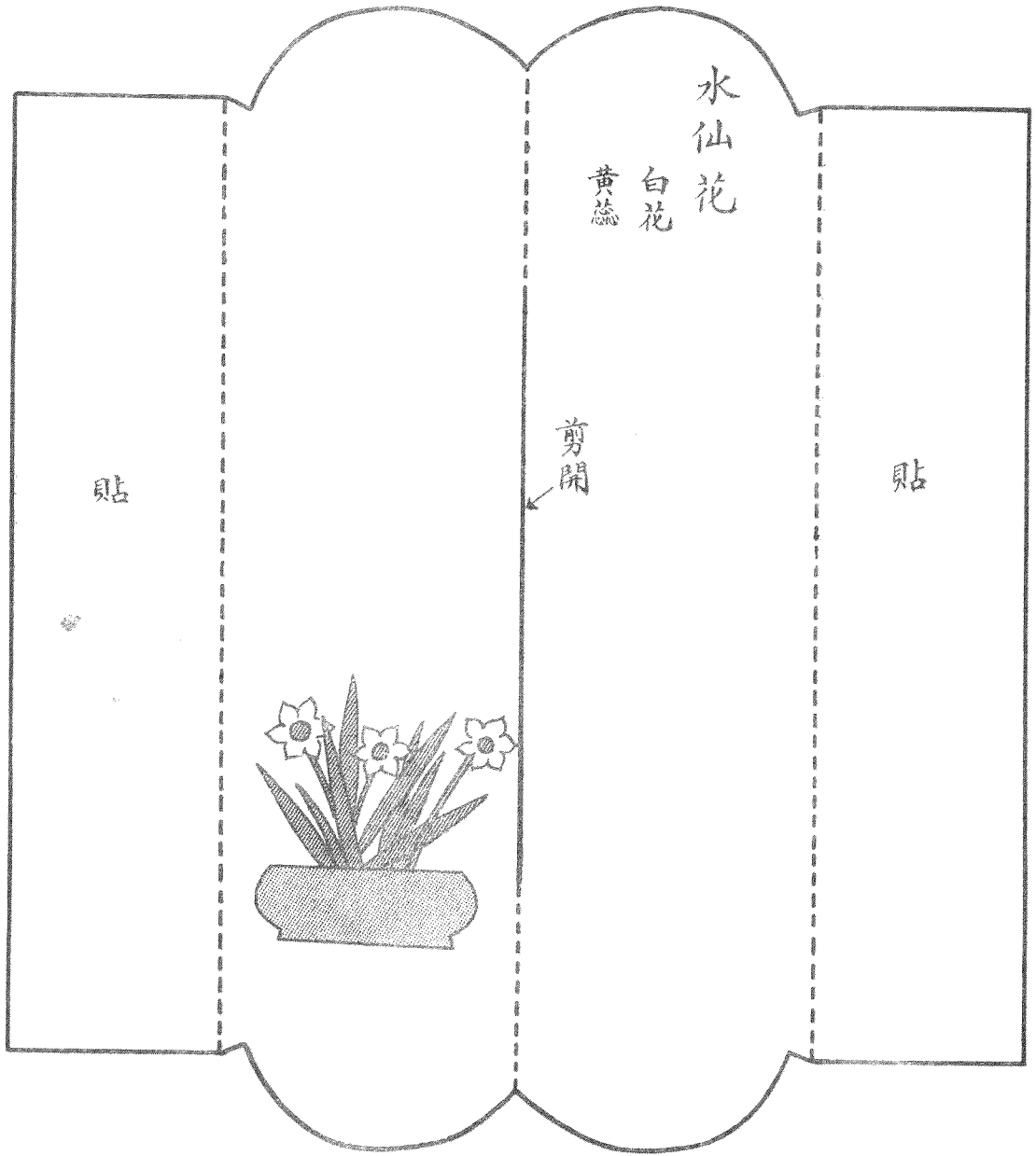
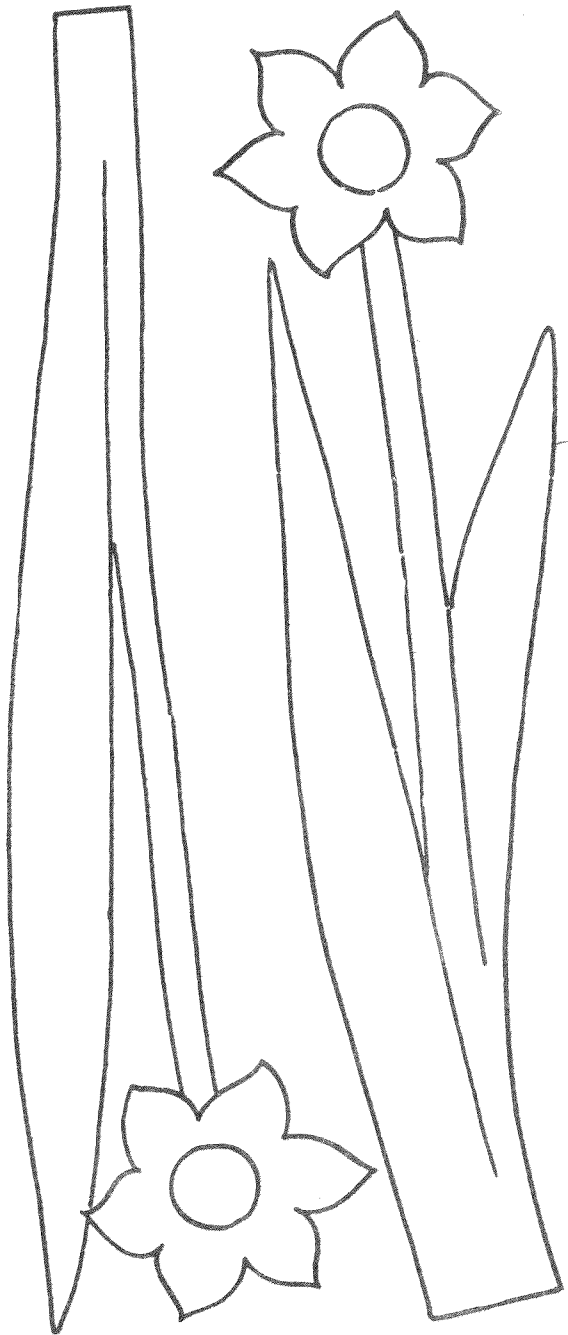

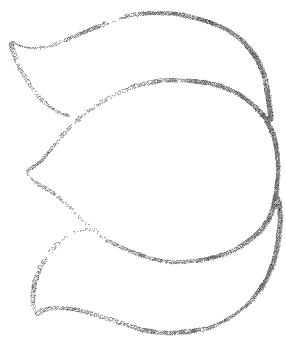
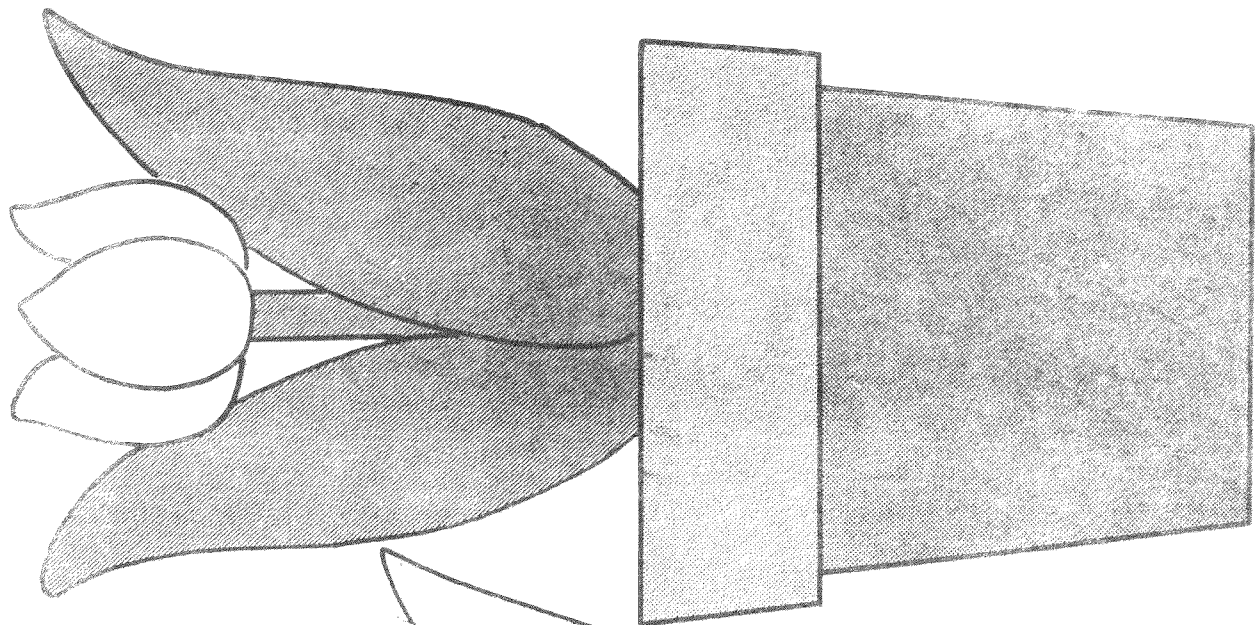

鬱金香

花有黃白紅

三色

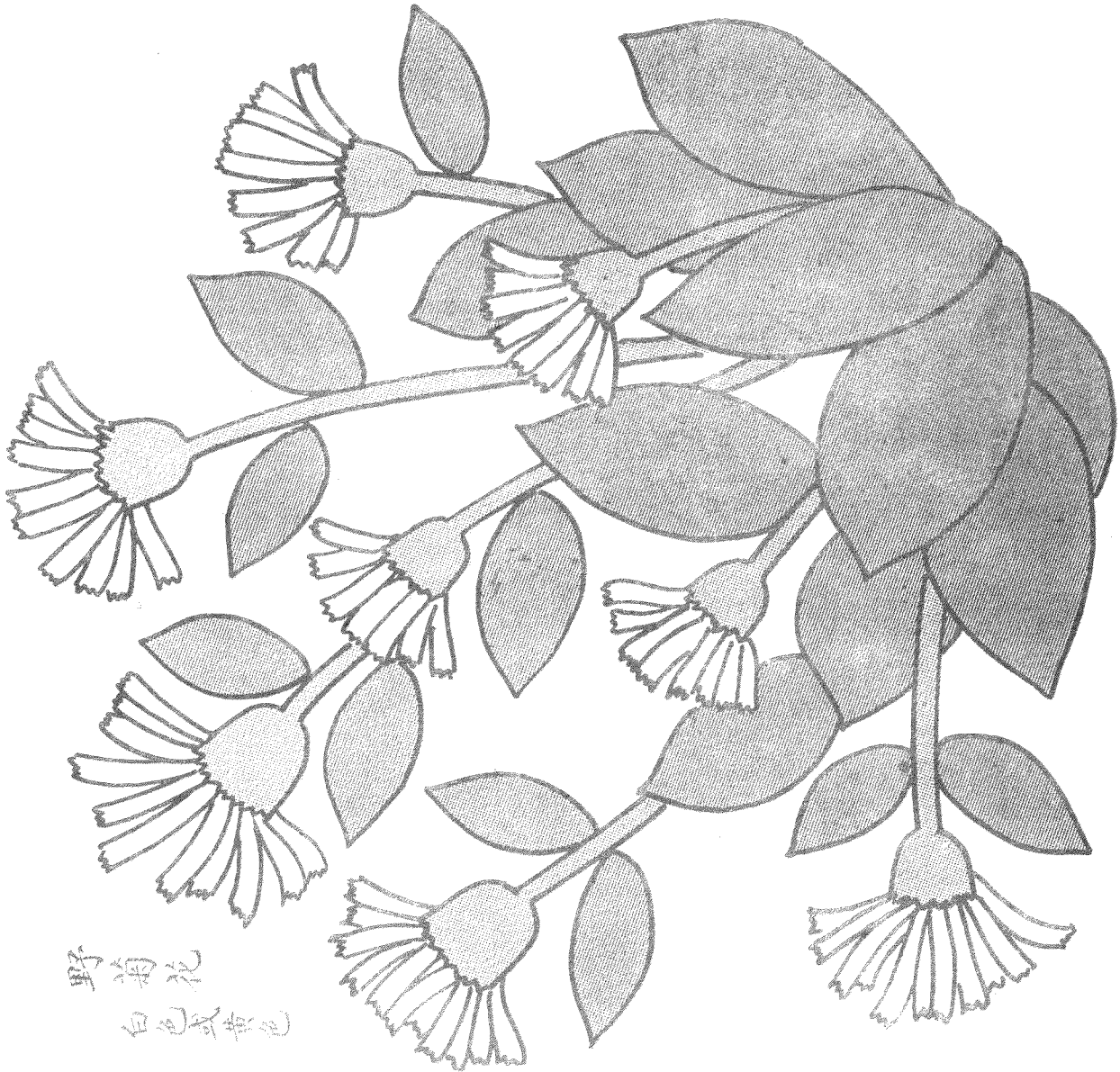

野菊花
白色或黄色

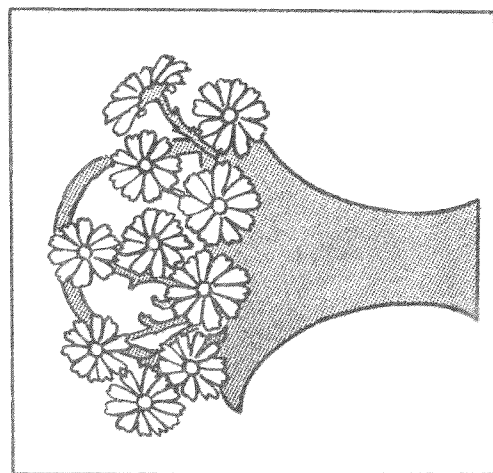
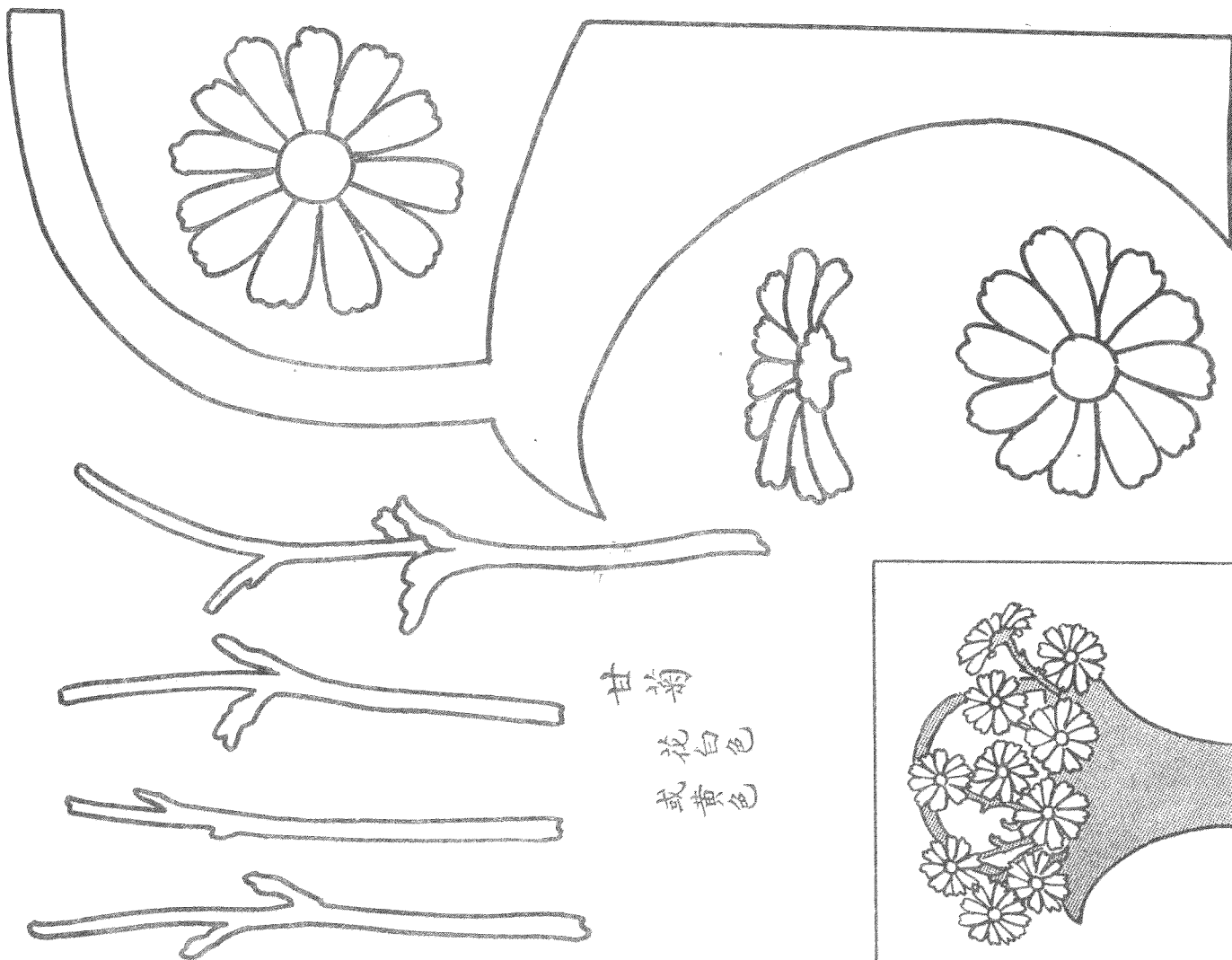

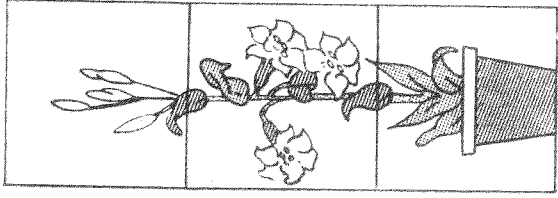

百合花
白花
黄蕊

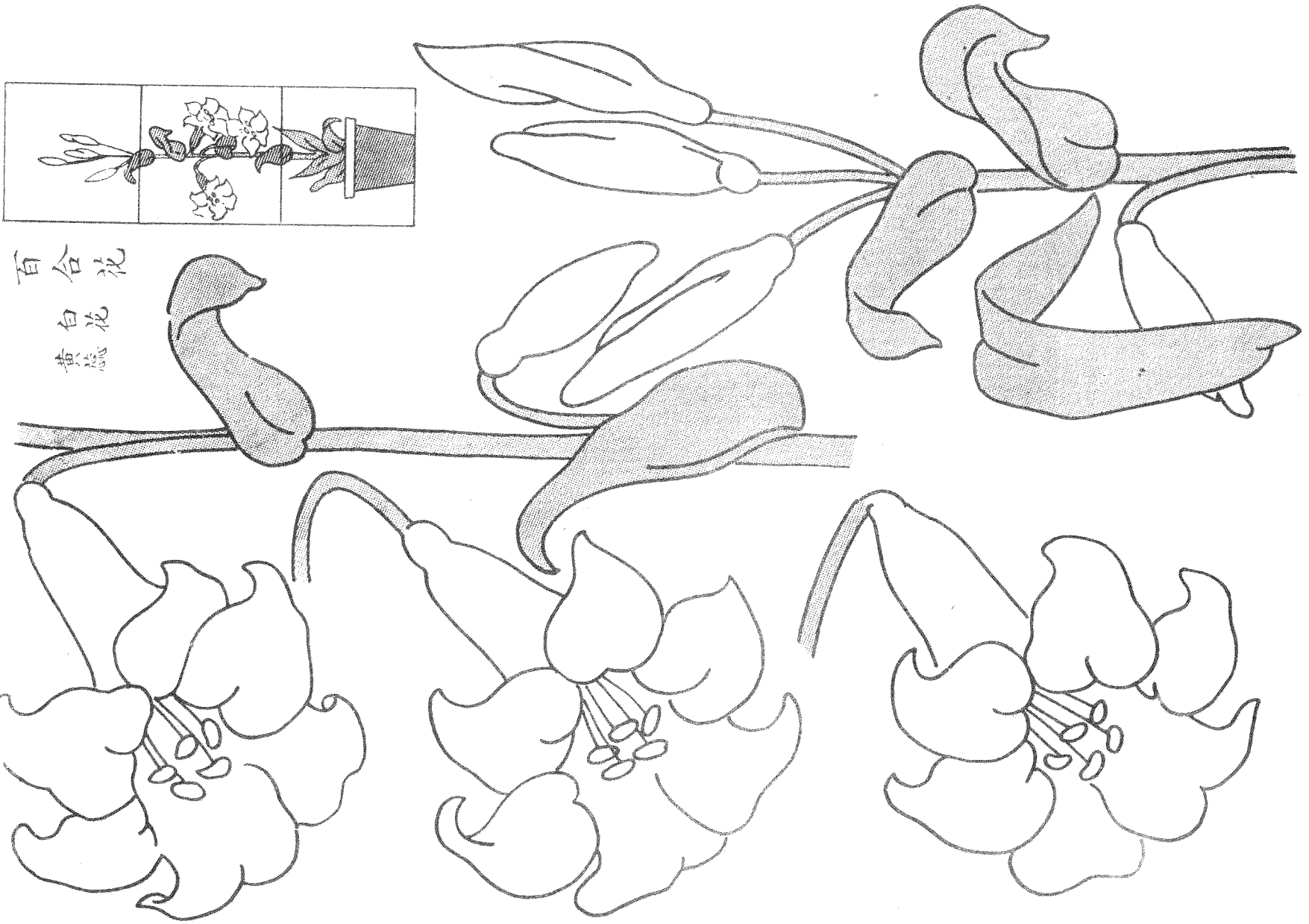

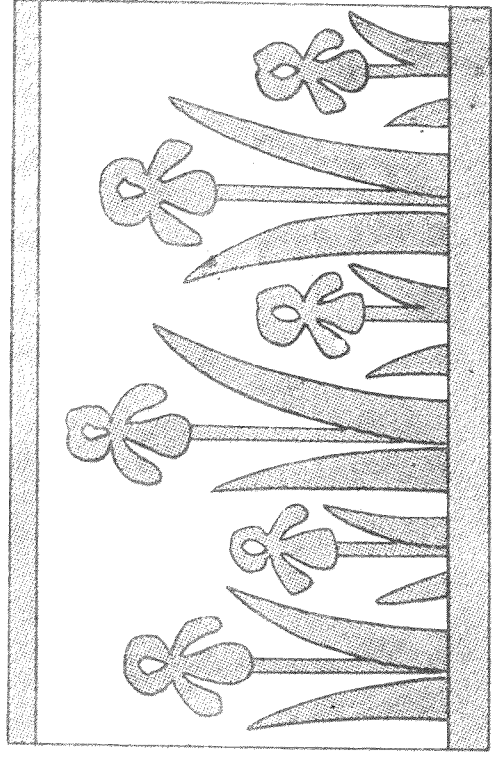

燕子花

花藍色

照圖連續排列可
佈置教室牆壁

摺剪

摺剪

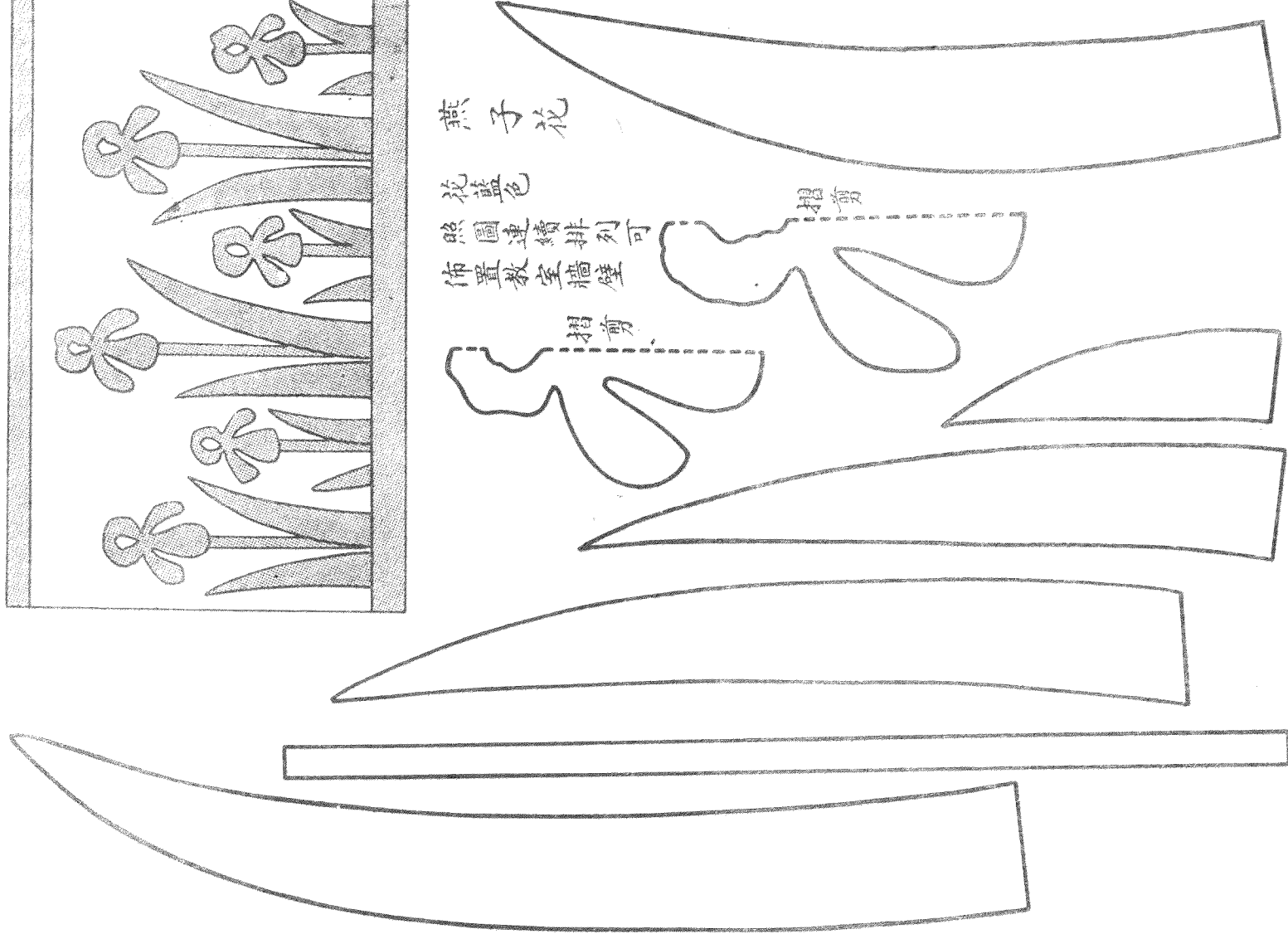

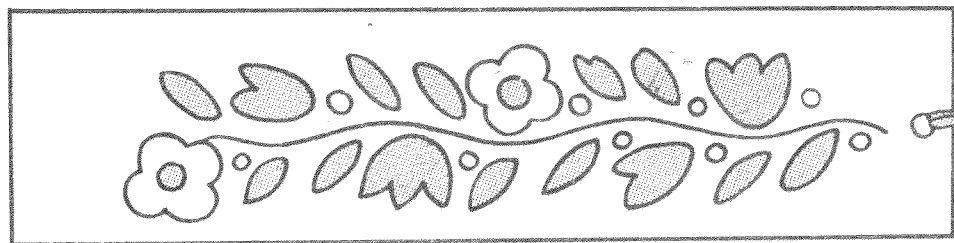
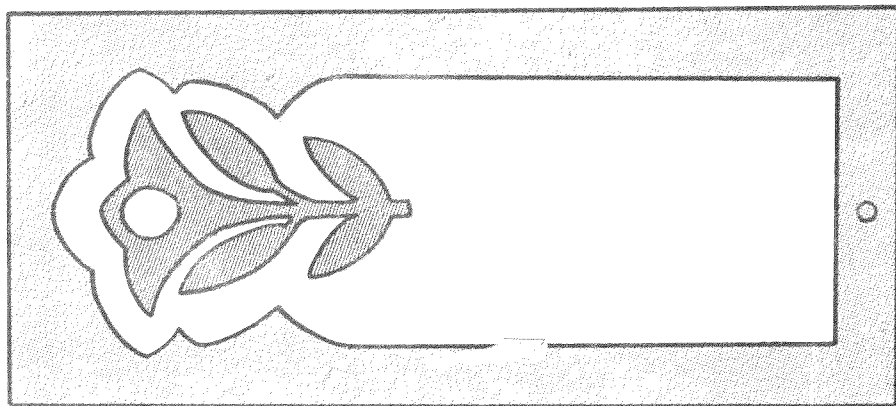
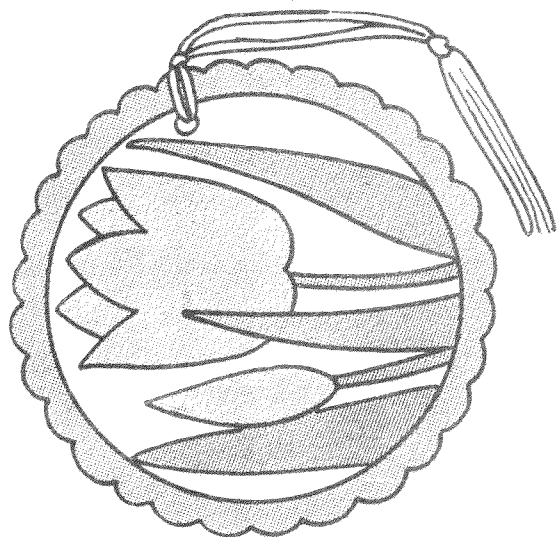

書籤

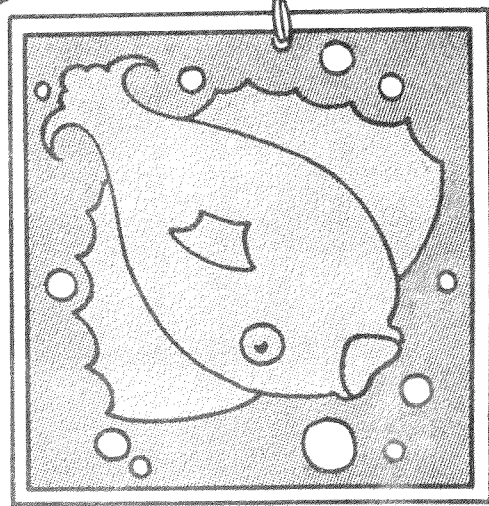
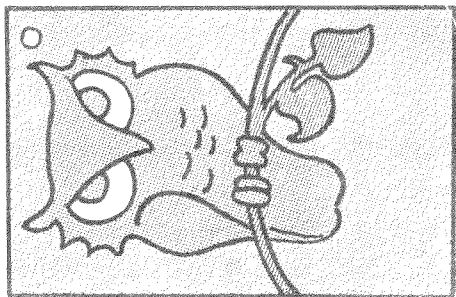
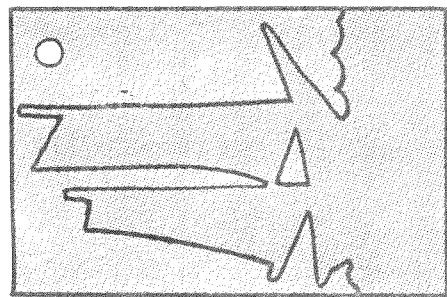

圖案

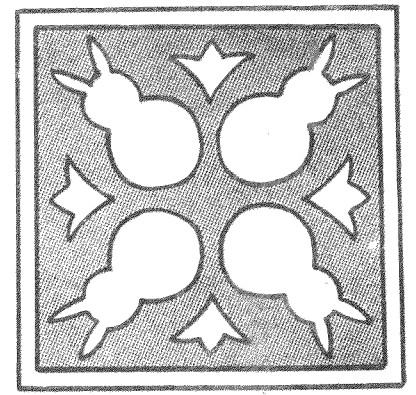
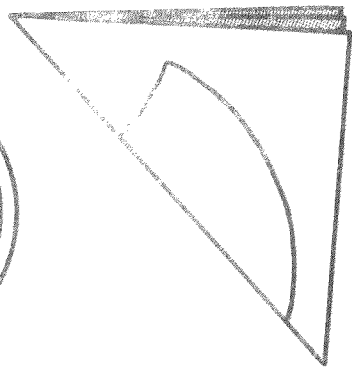
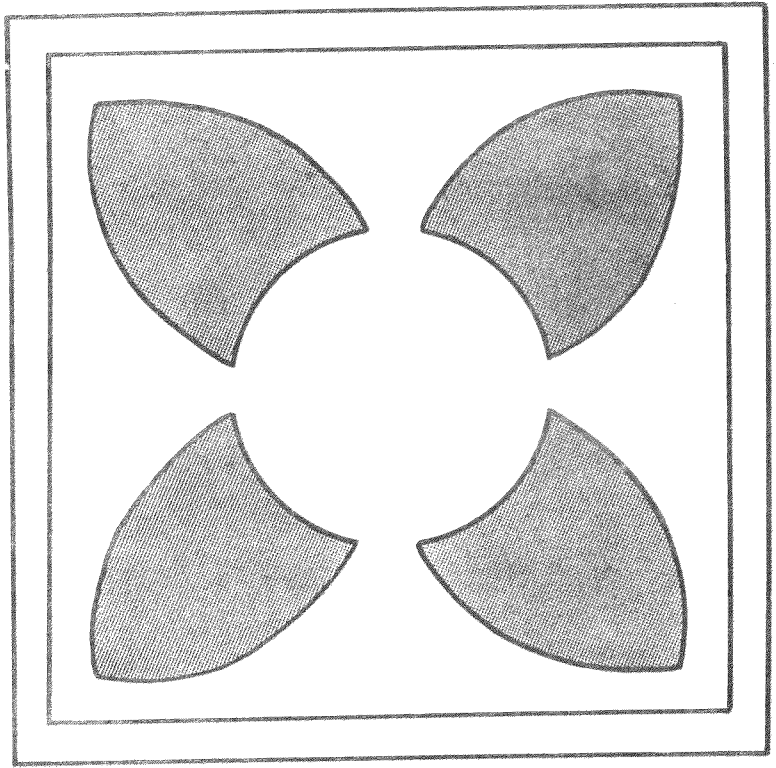
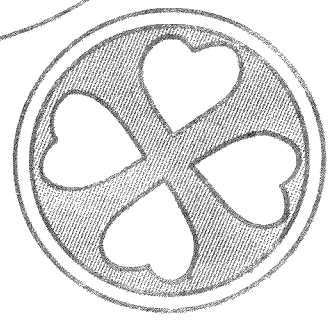
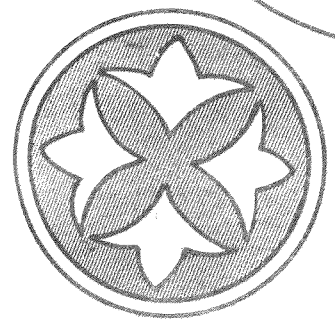
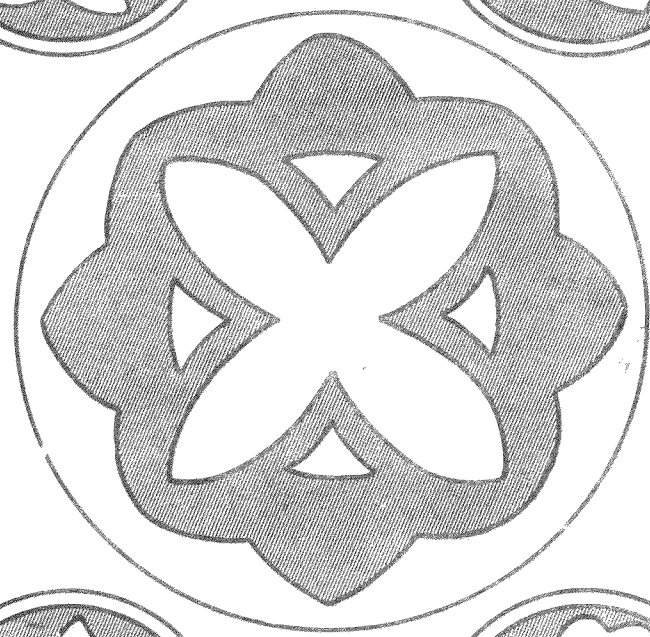
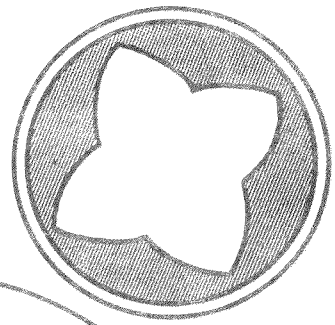
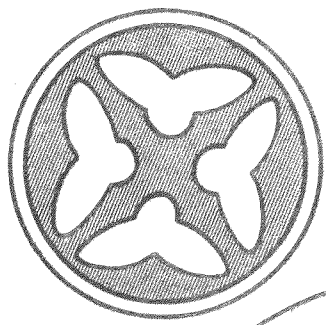

柏樹

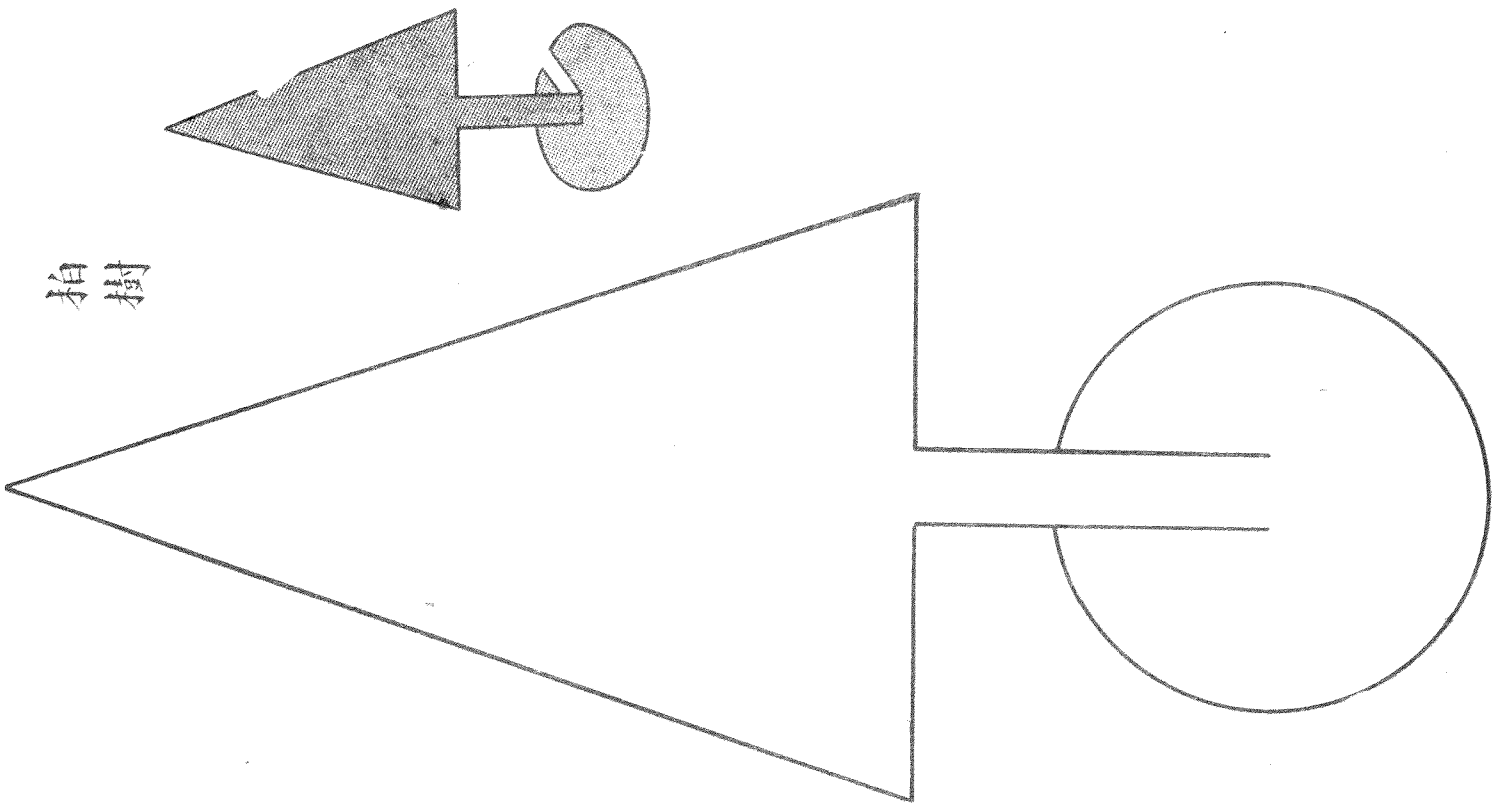

柏樹

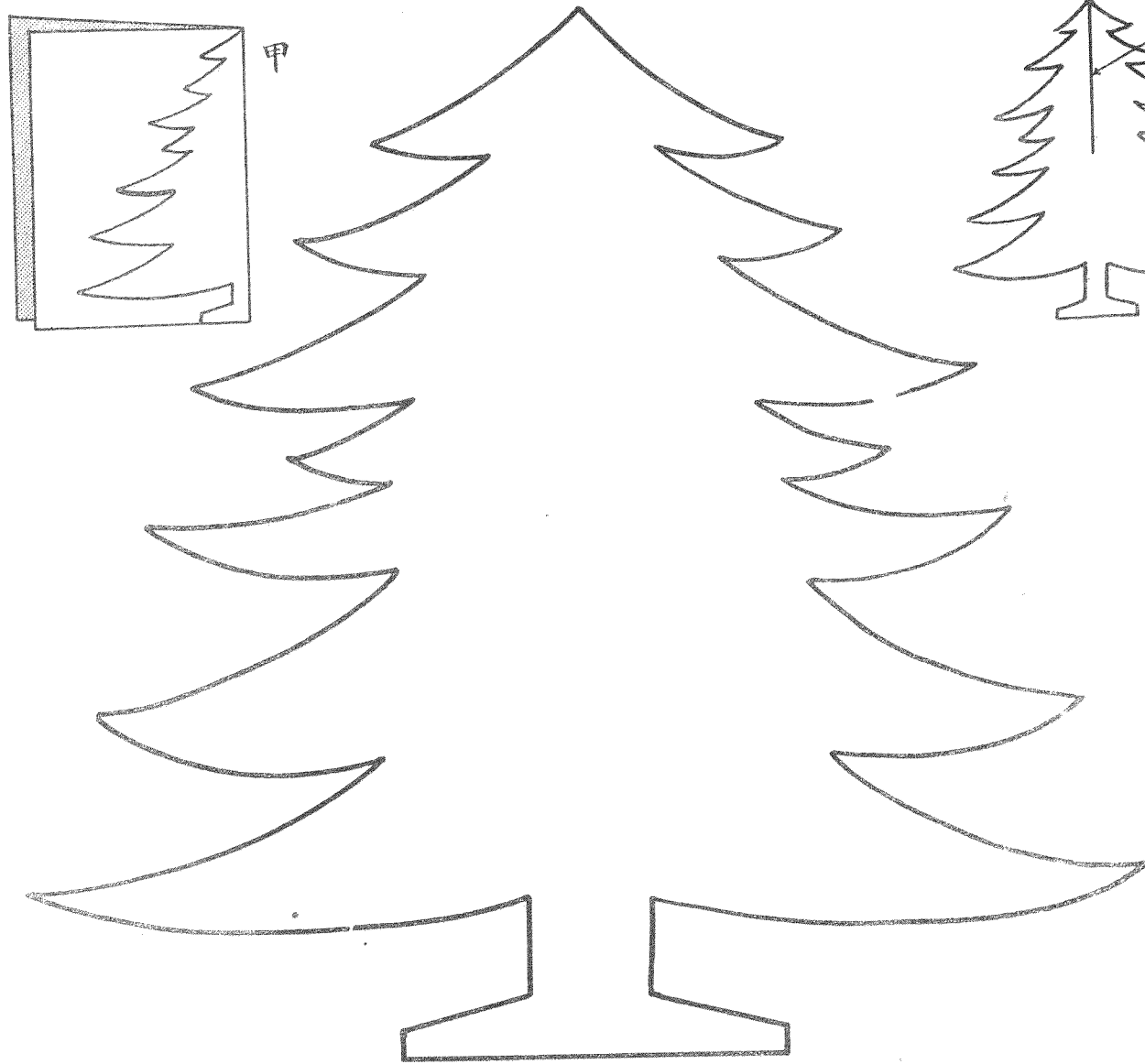

甲

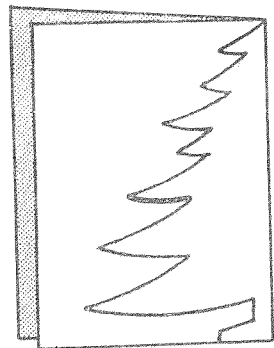

剪開
乙



丙

剪開

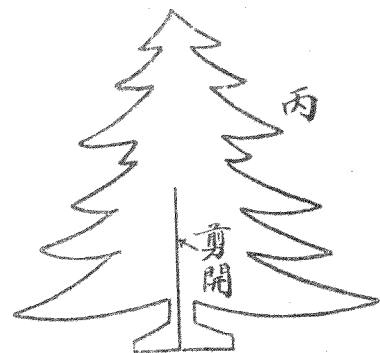

丁

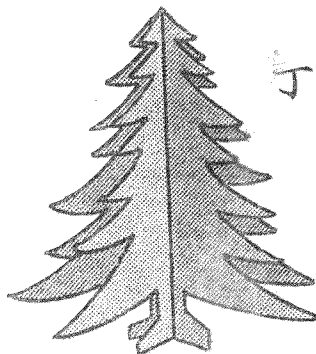

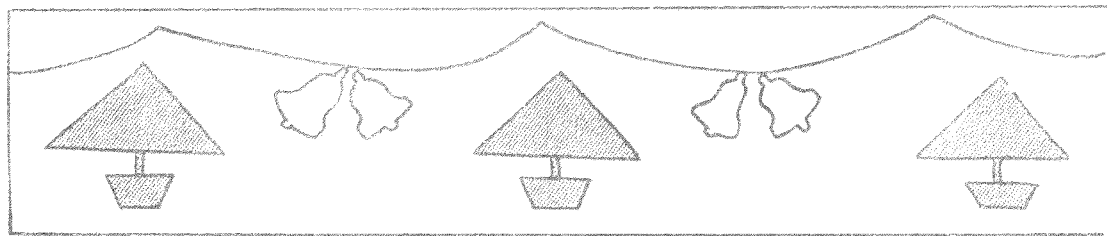
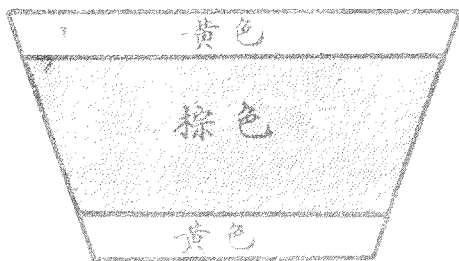
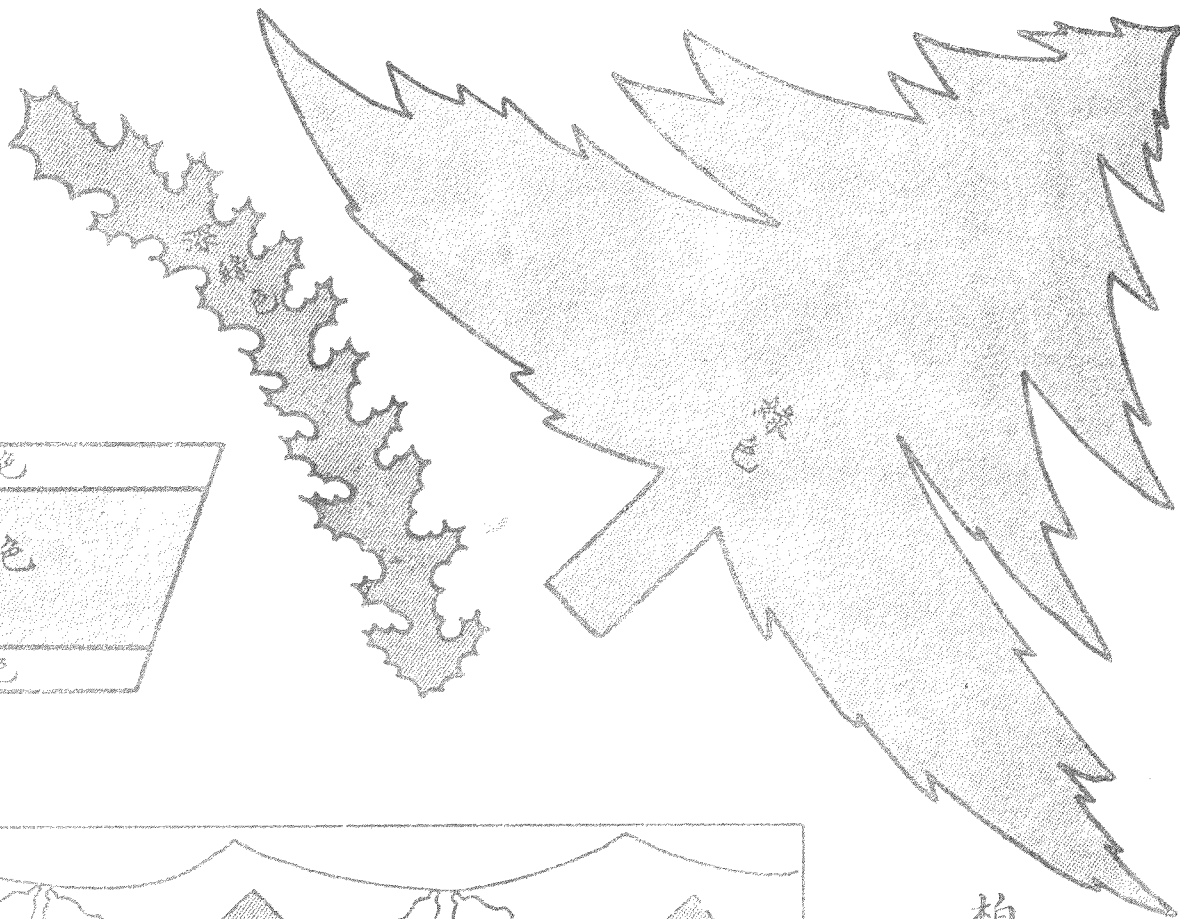
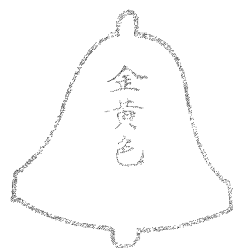

柏树



樹

天 淡藍色
 地 綠色
 樹枝 棕色
 葉草 深綠色
 花 紅色
 鳥 黑色

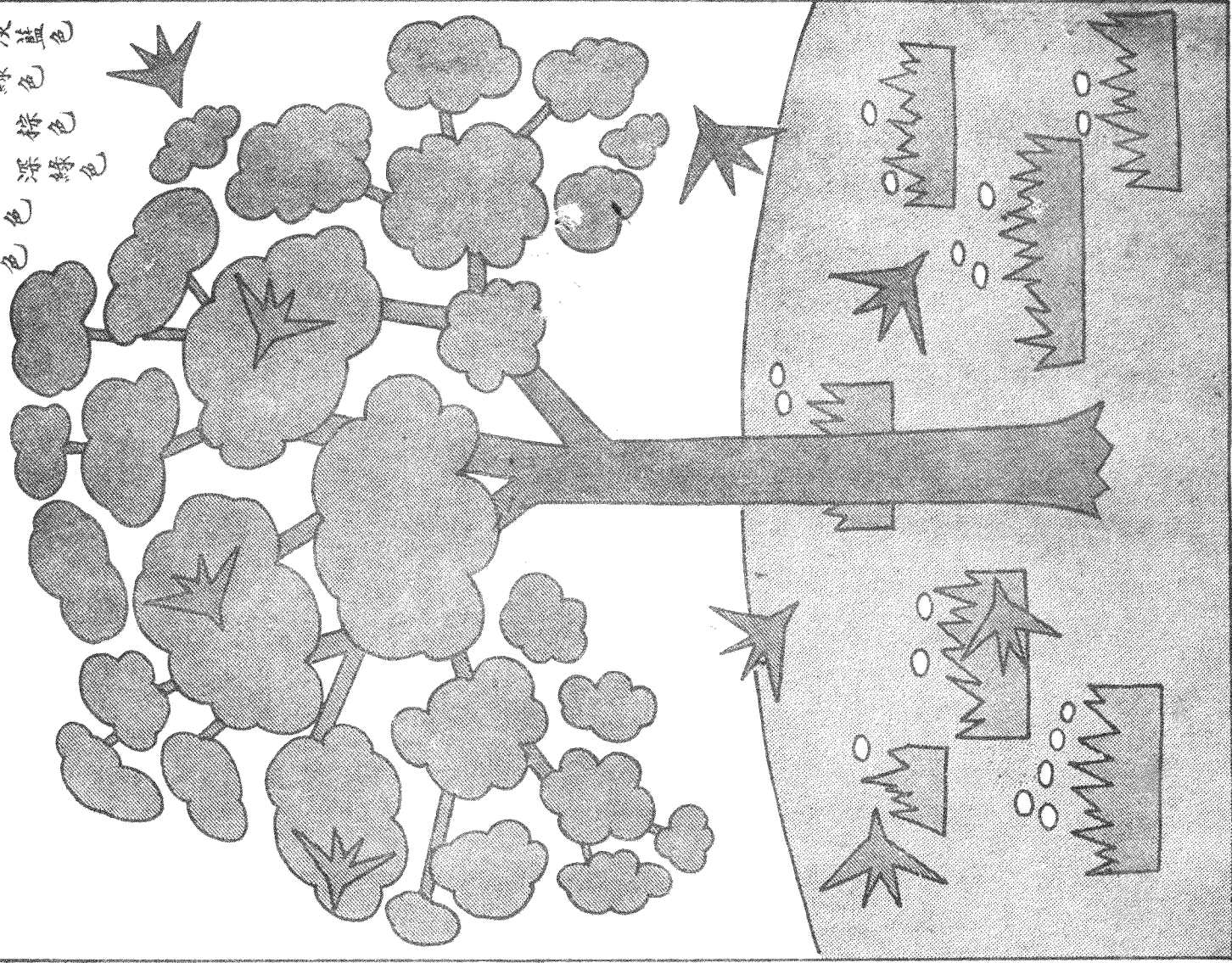

法國梧桐葉

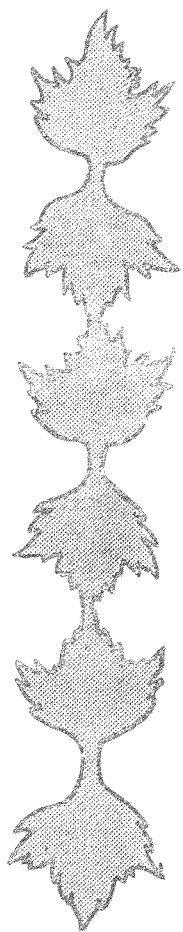
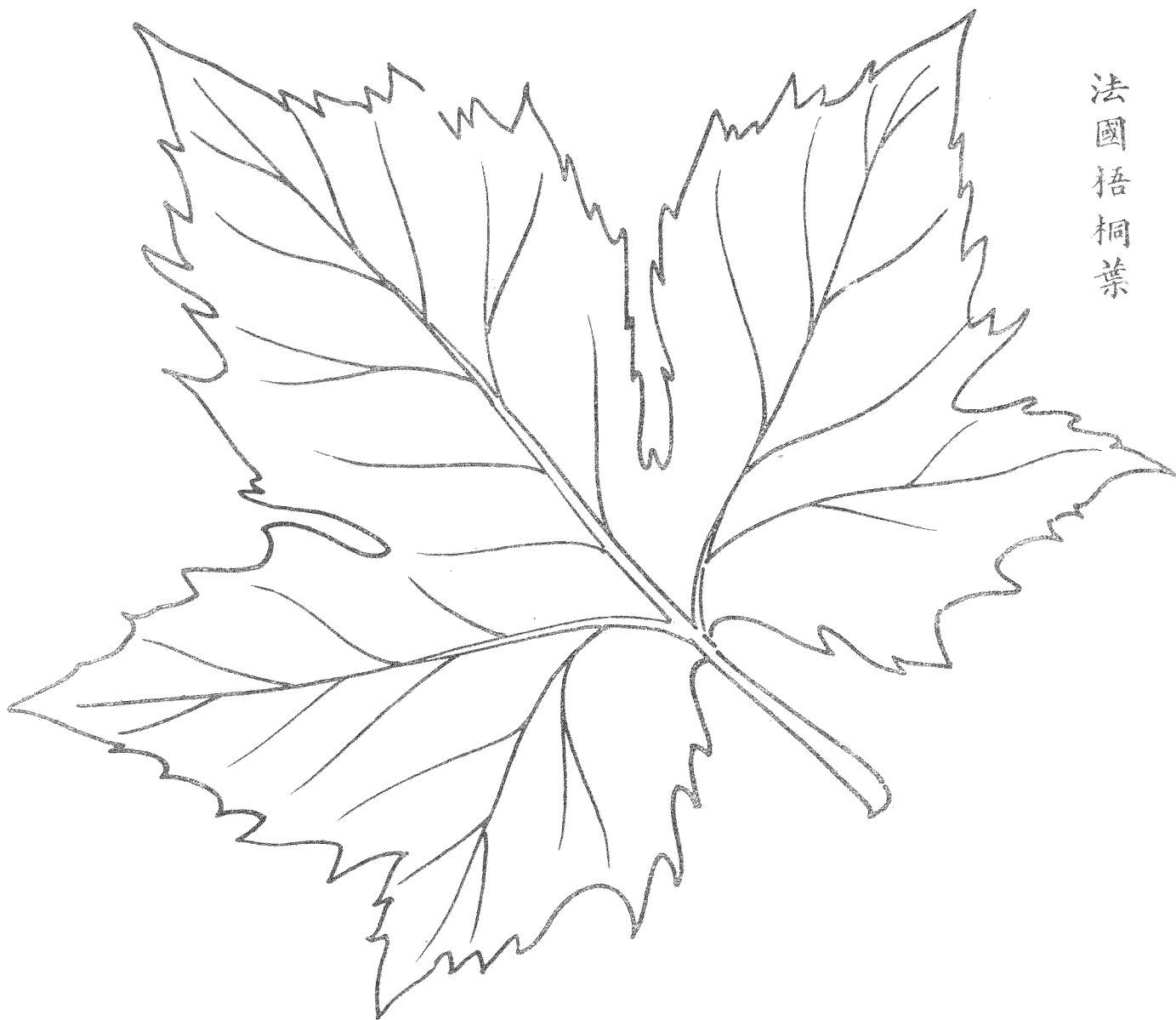

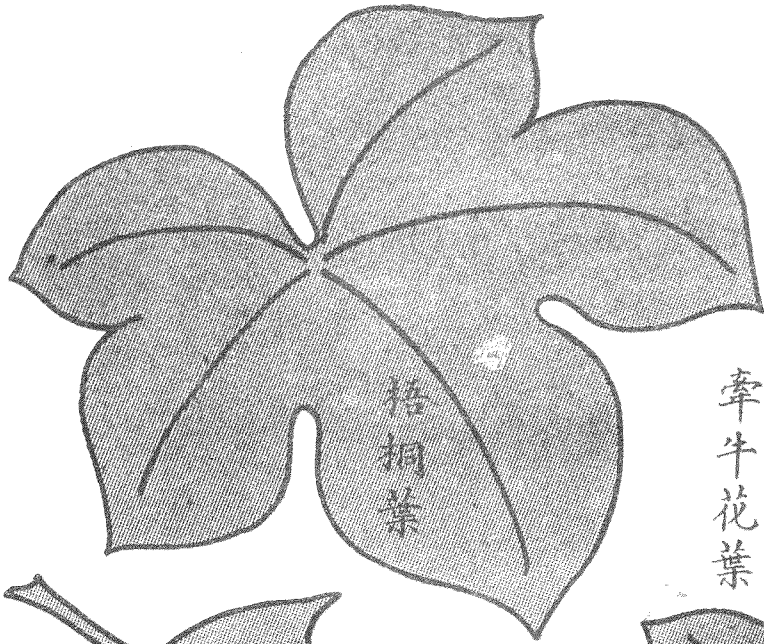

梧桐葉

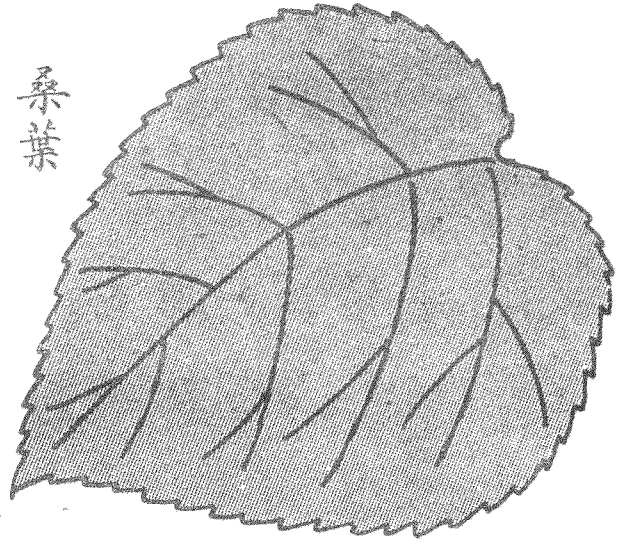

桑葉

牽牛花葉



法國梧桐葉

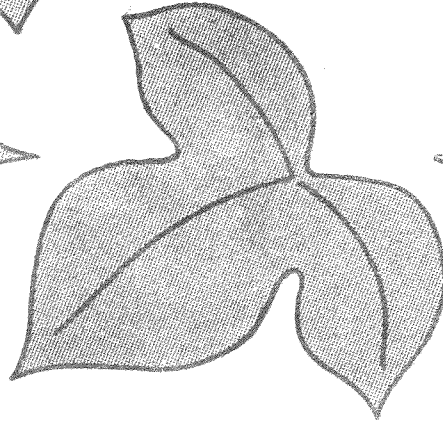

楓葉
秋天變鮮艷的紅色

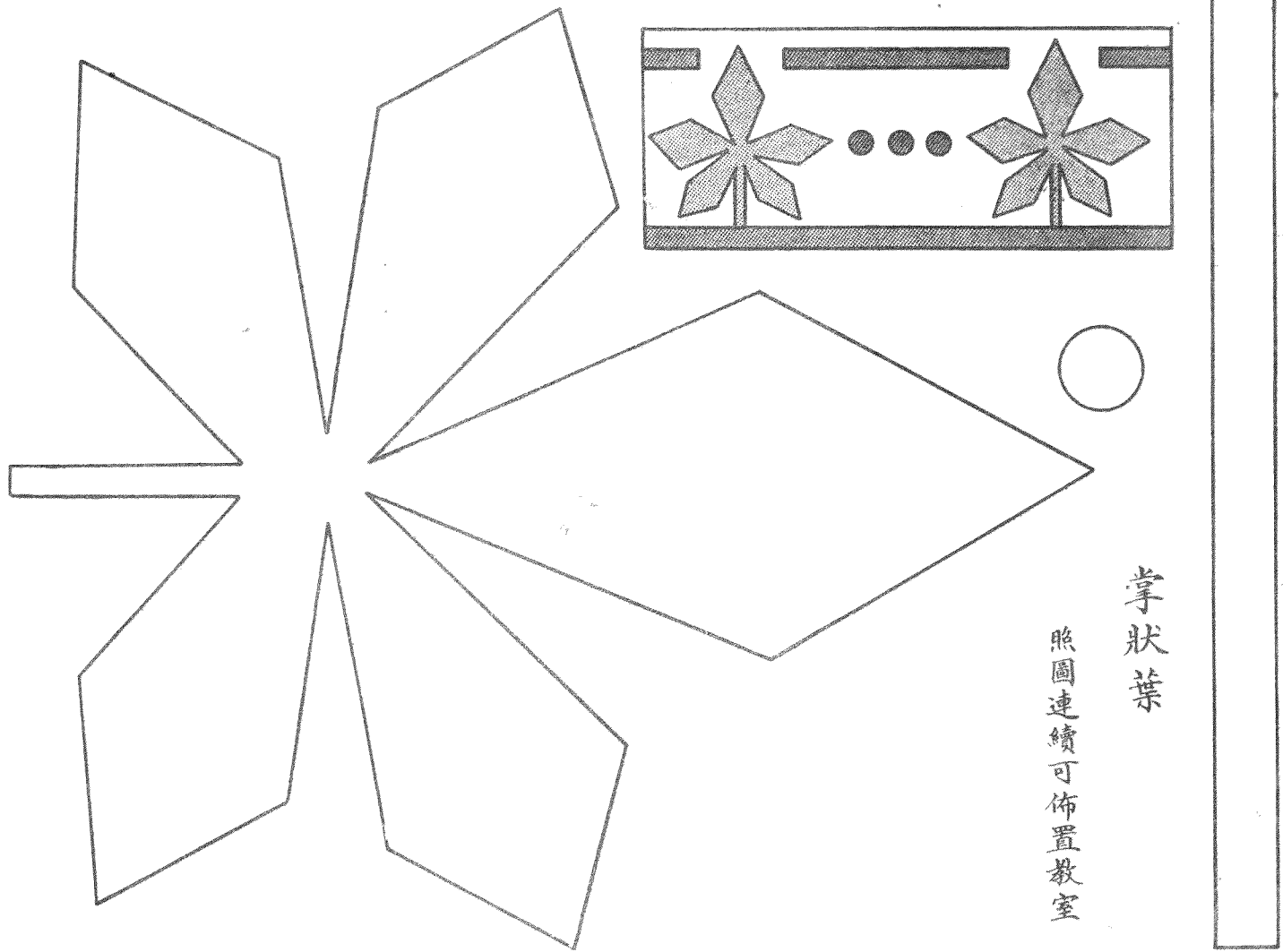

掌狀葉

照圖連續可佈置教室

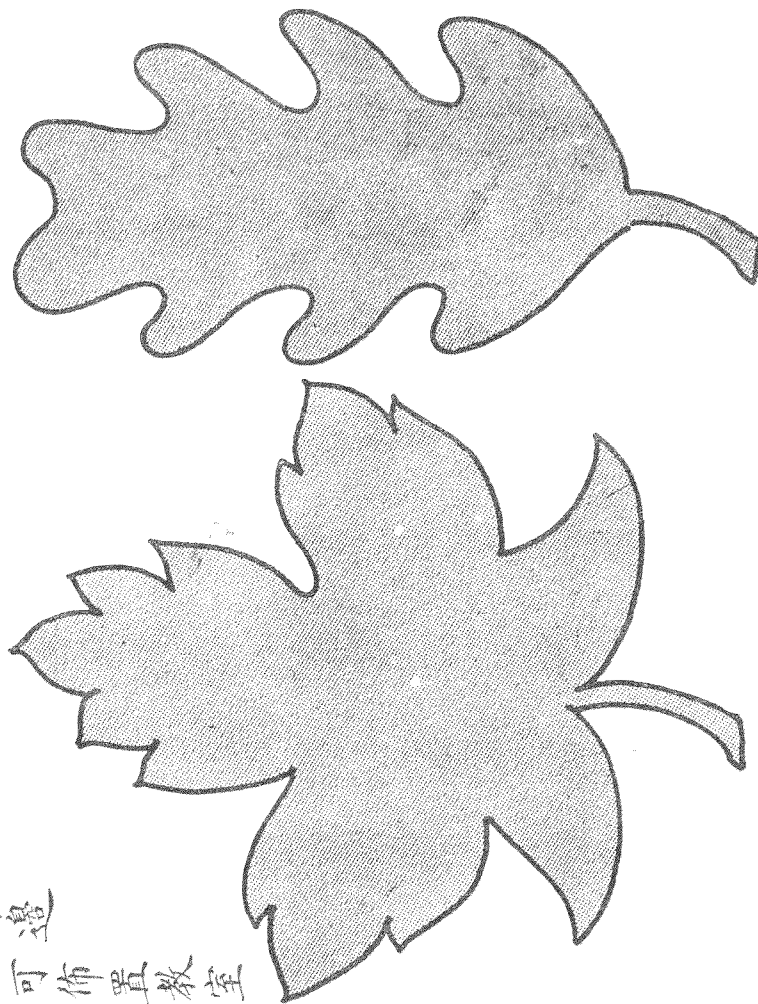

葉邊

可佈置教室

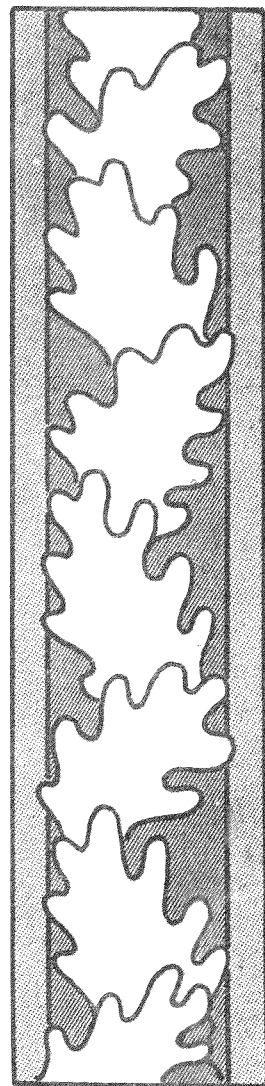

樹葉人

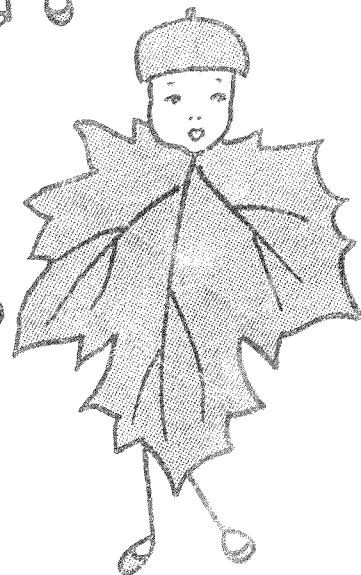
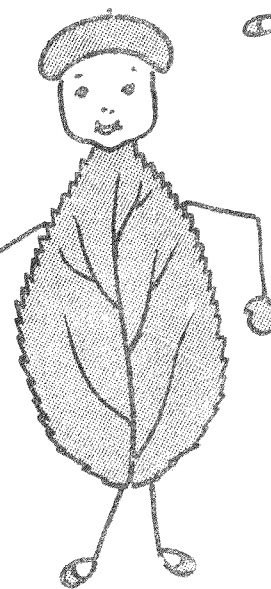

橘子

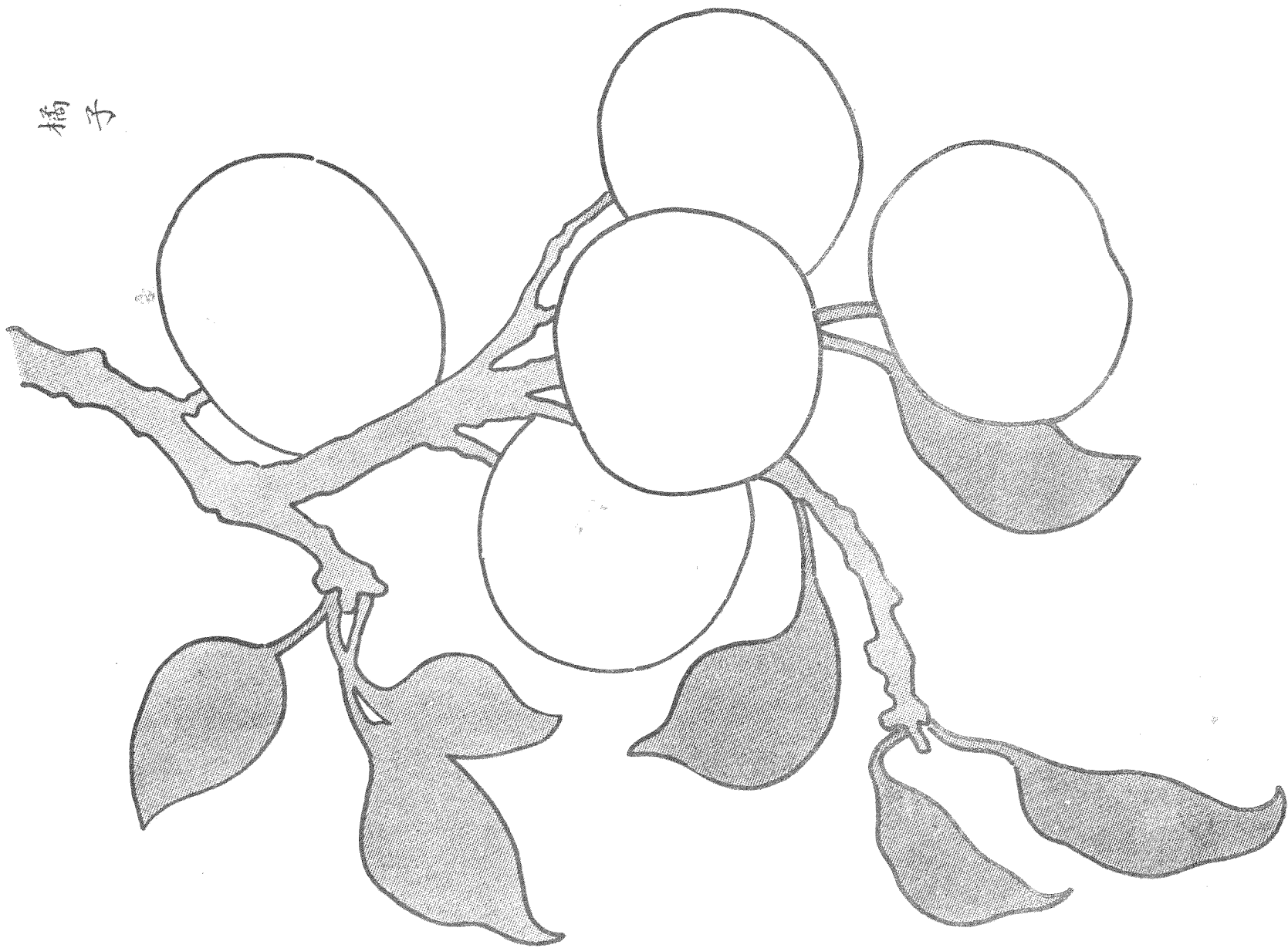

時竹

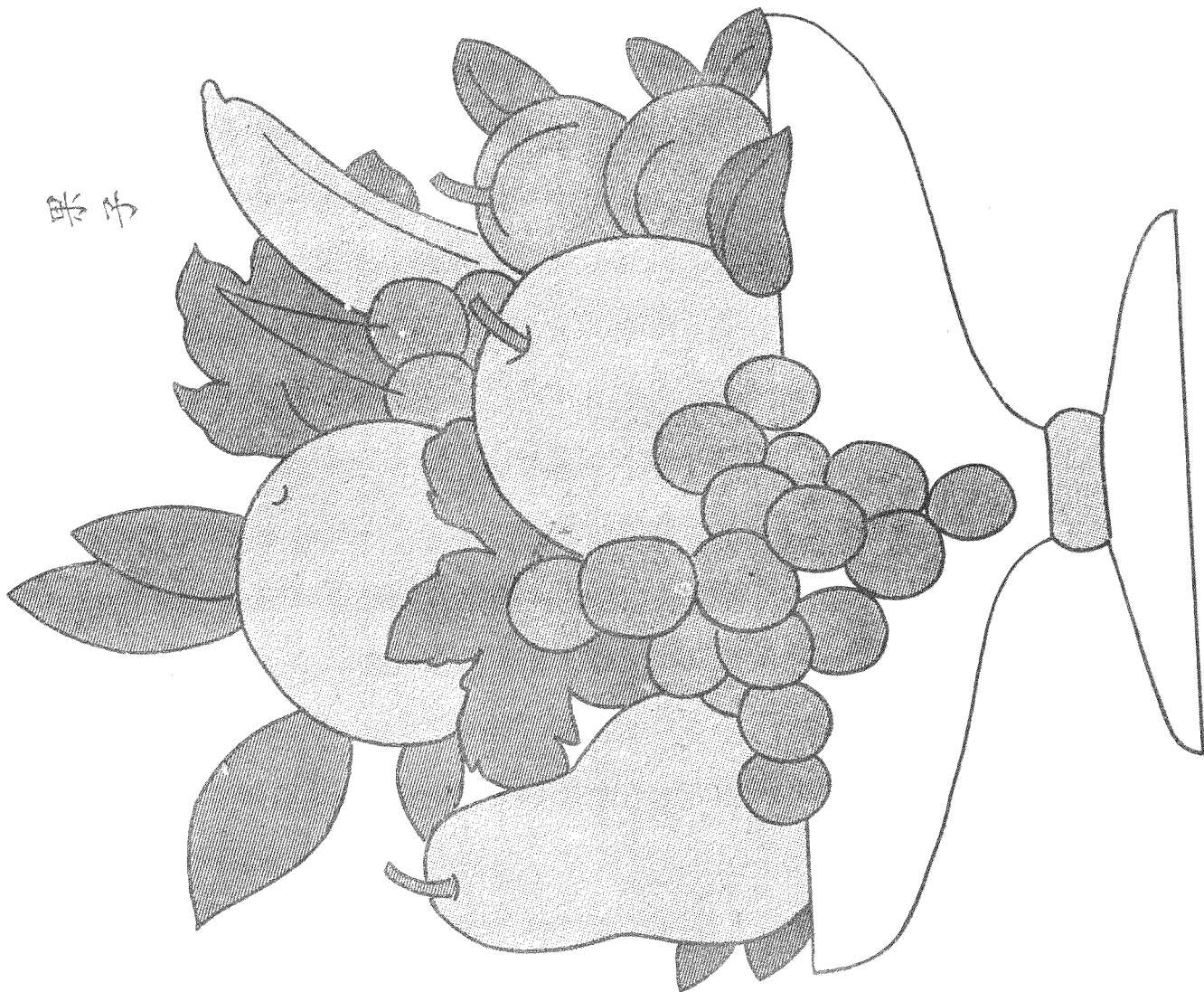



葡萄
紫色
或綠色

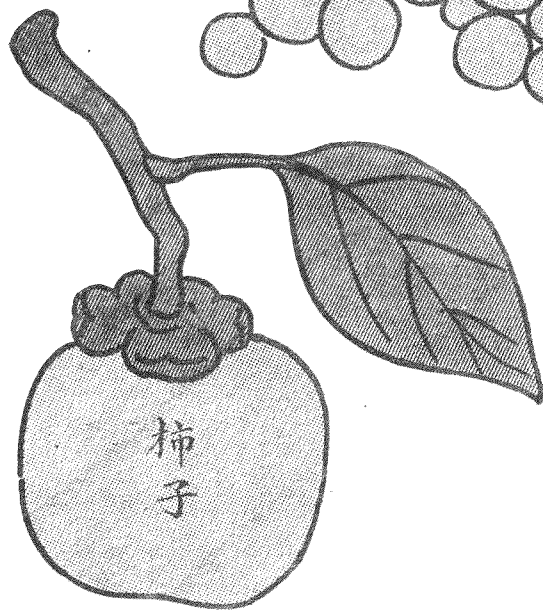

柿子



香蕉

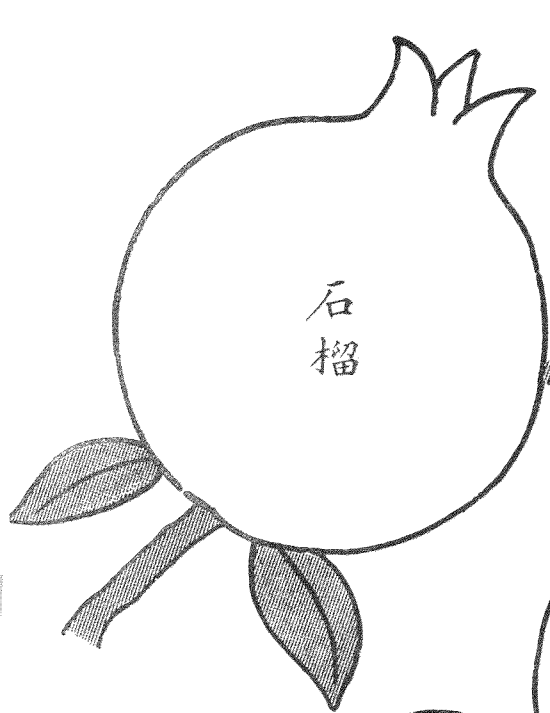

石榴



梨



紅菱



桃子

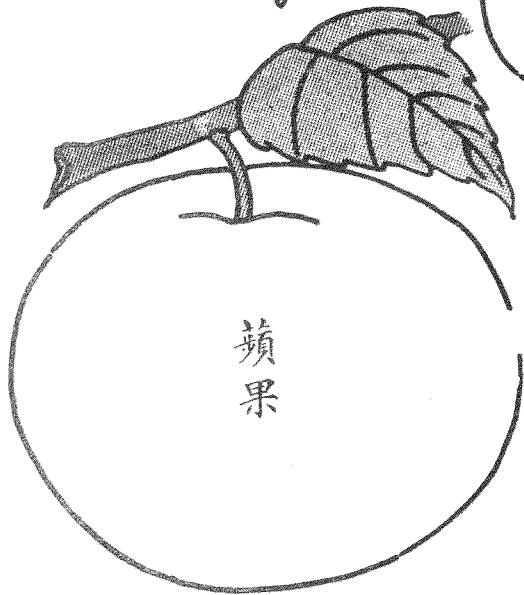

蘋果

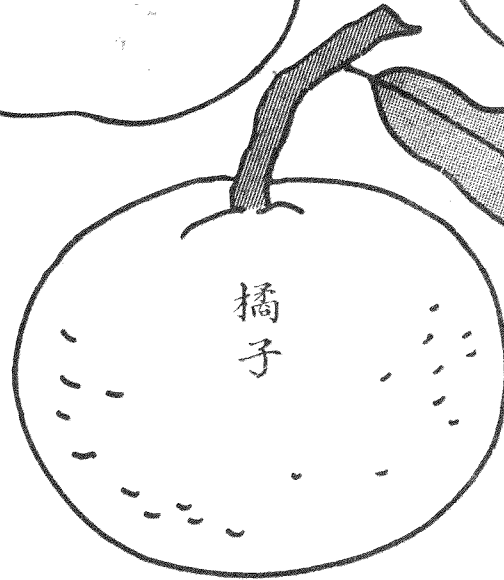

橘子

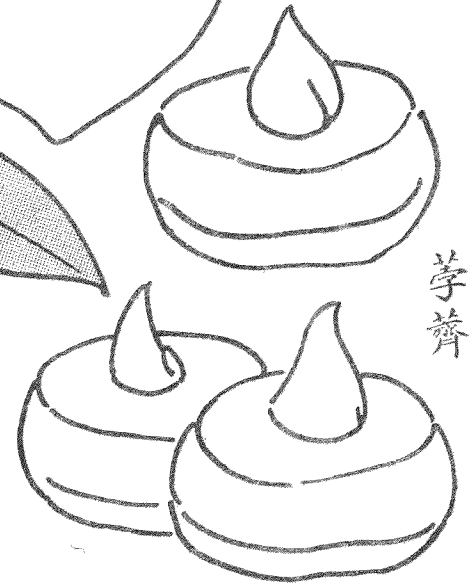

荸薺

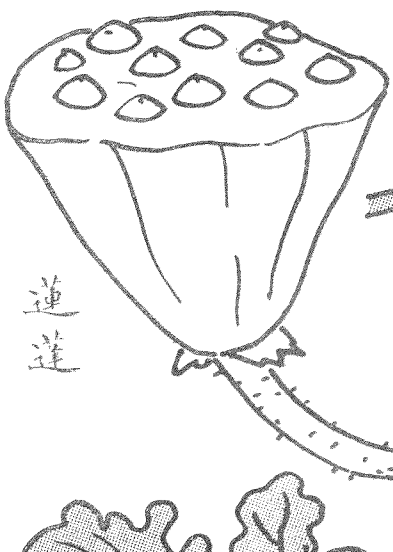

莲蓬

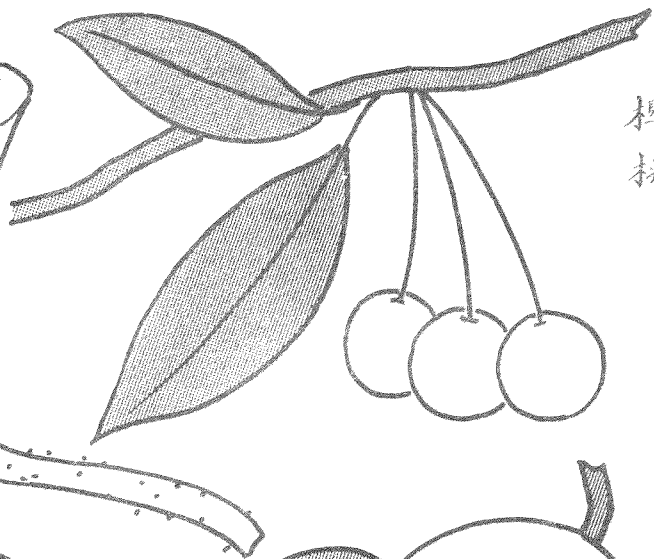

樱桃

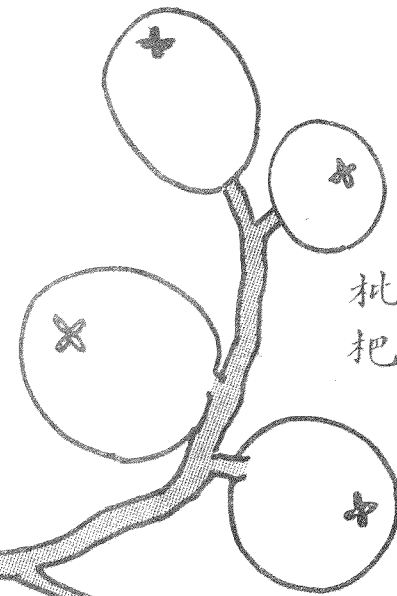
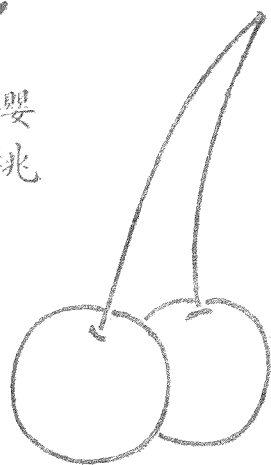

枇杷



西瓜



杏子

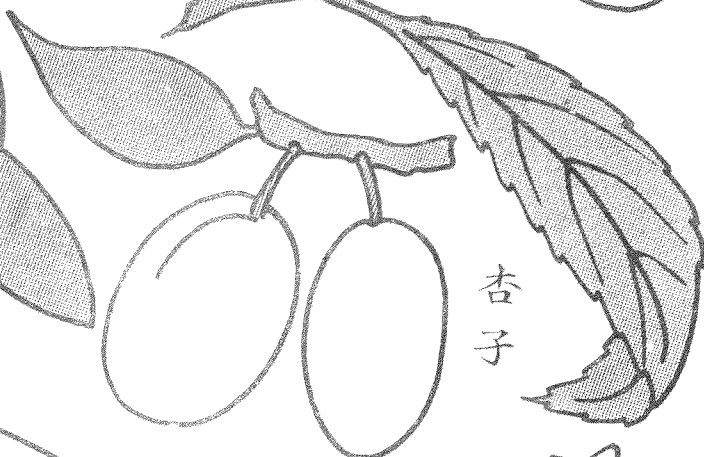

杏子

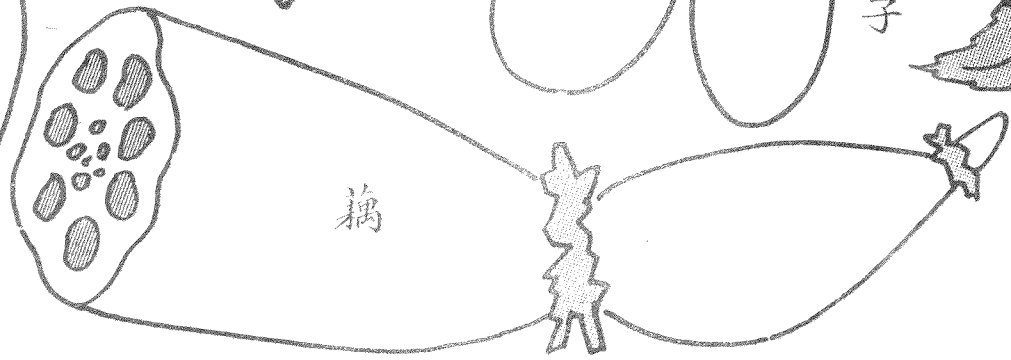

藕



蘋果圖案

果子人

香蕉

櫻桃

胡桃

橘子

蘋果

梨

葡萄

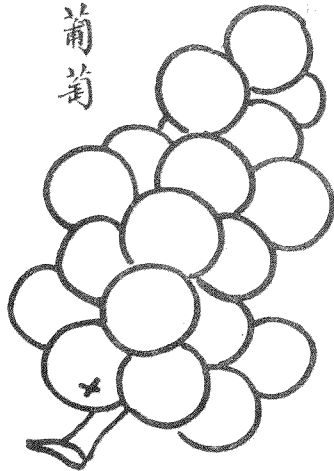
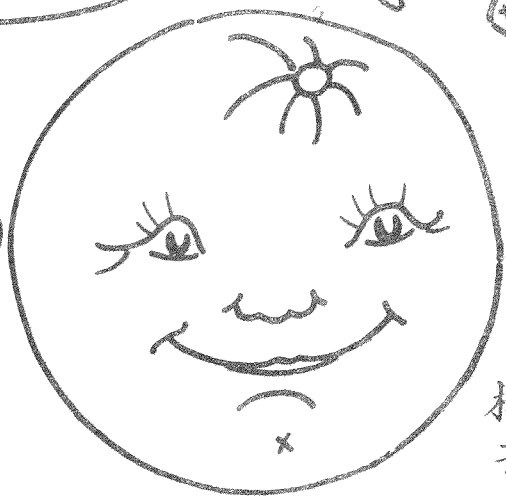
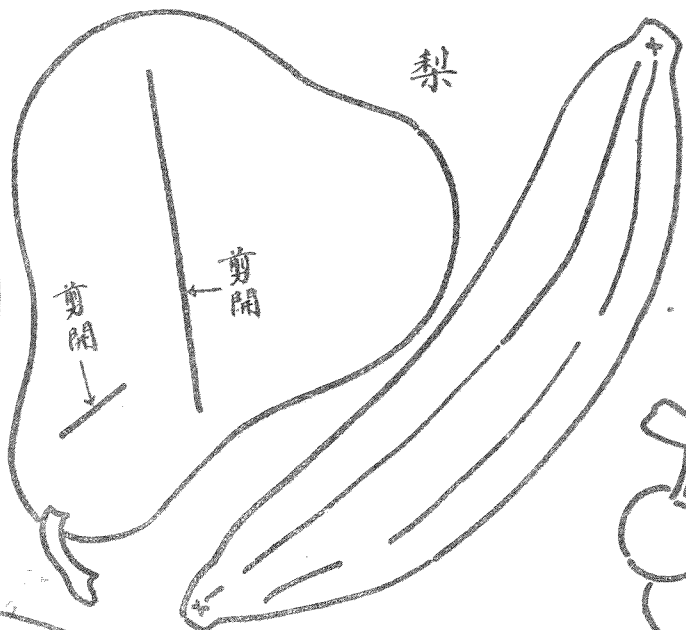
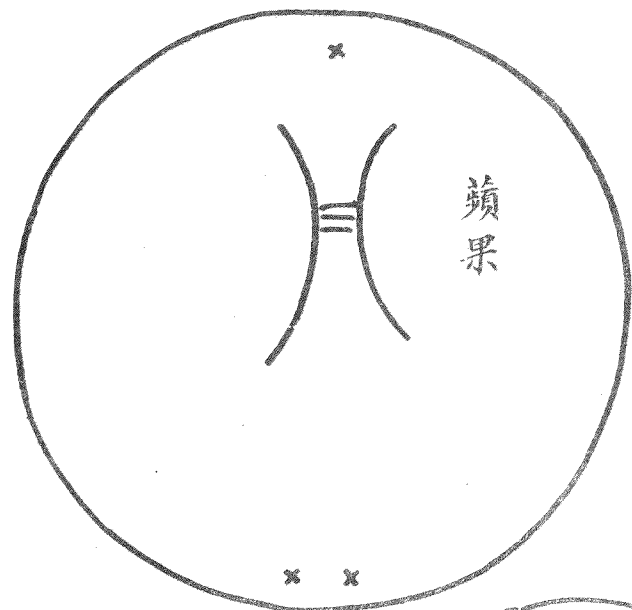

菜蔬



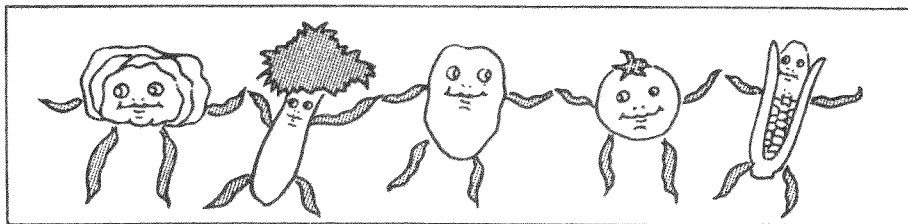

菜蔬人



番茄

山薯

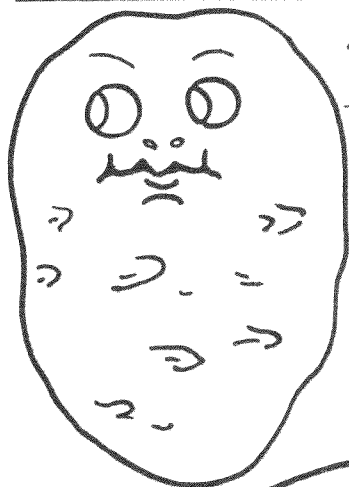

卷心菜

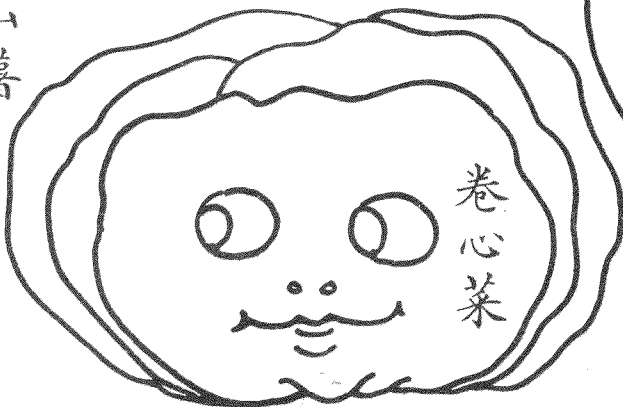

刀豆



玉蜀黍

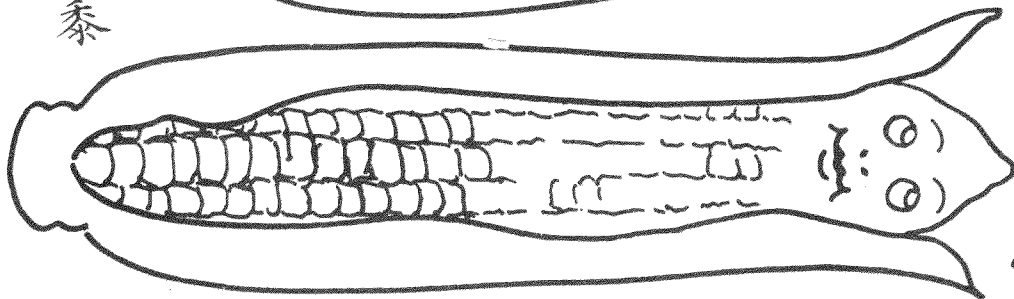

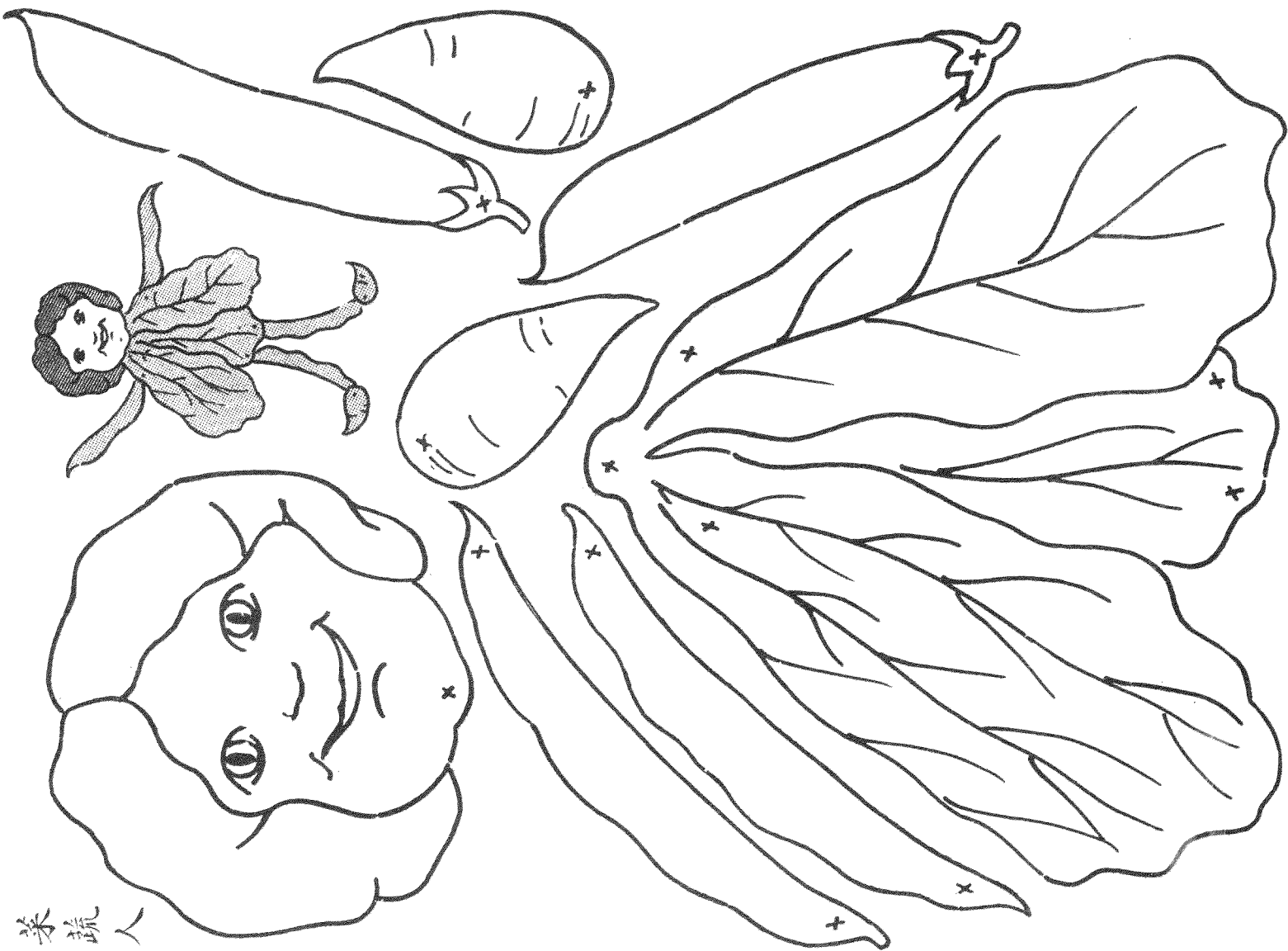

菜蔬人

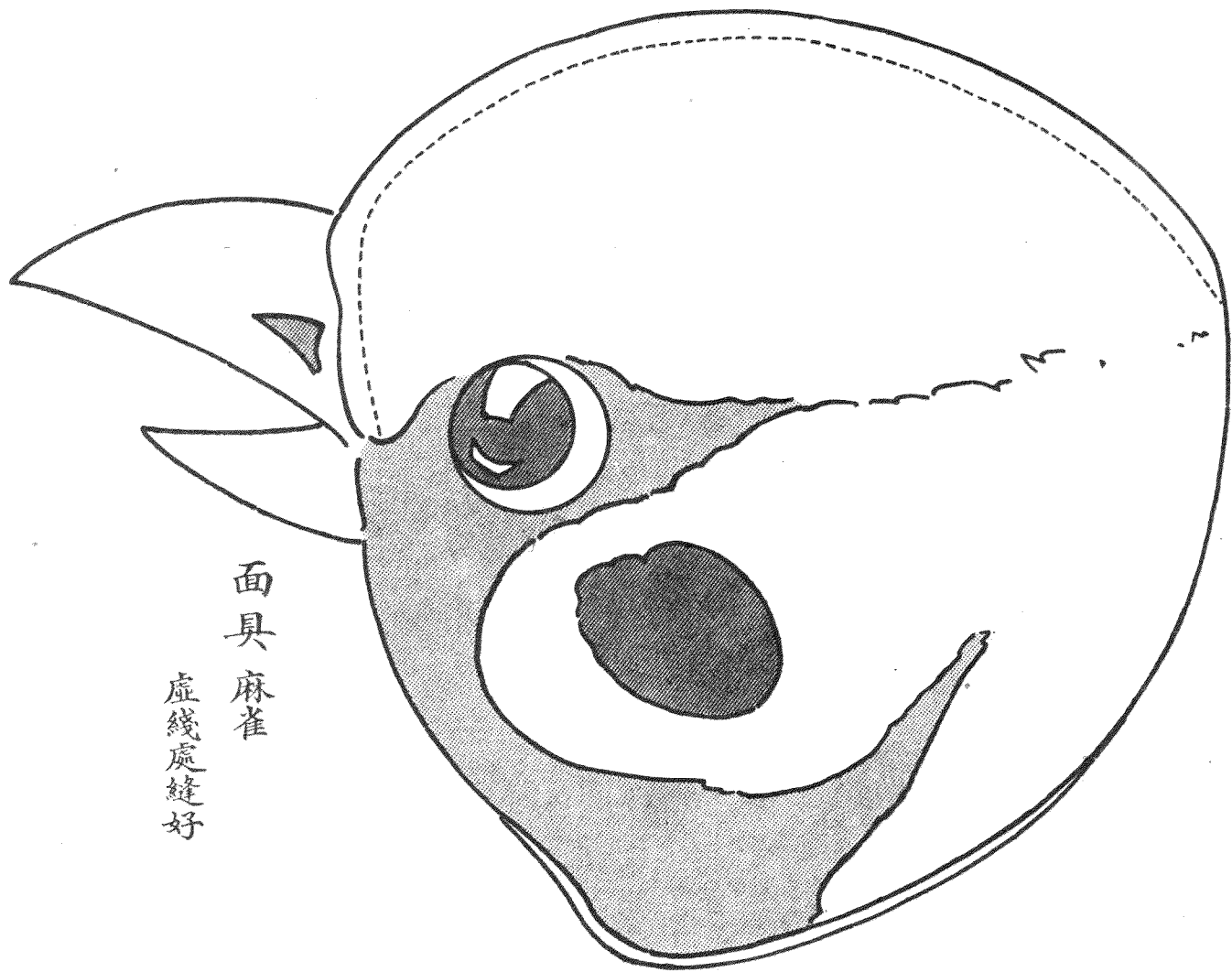

面具 麻雀

虛綫處縫好



面具 雞
虛線處縫好

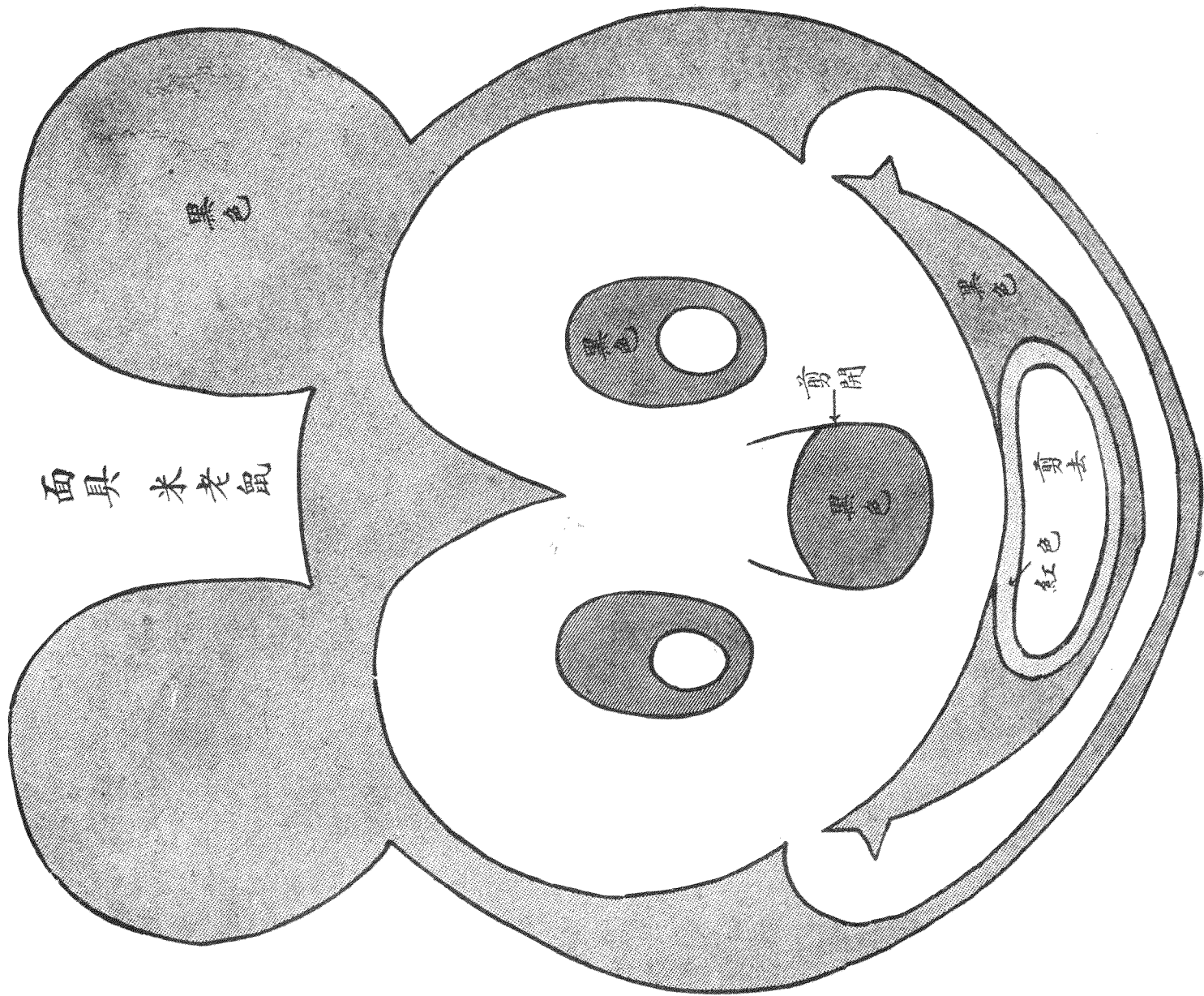

面具 米老鼠

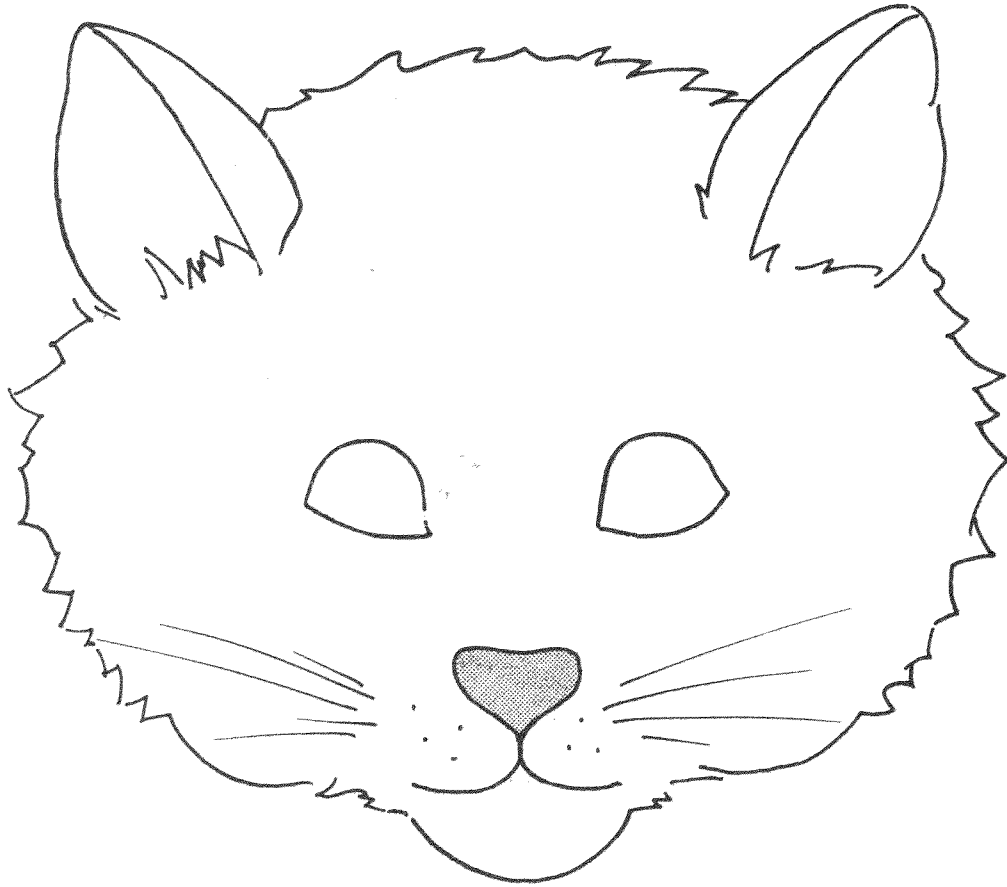

面具
貓

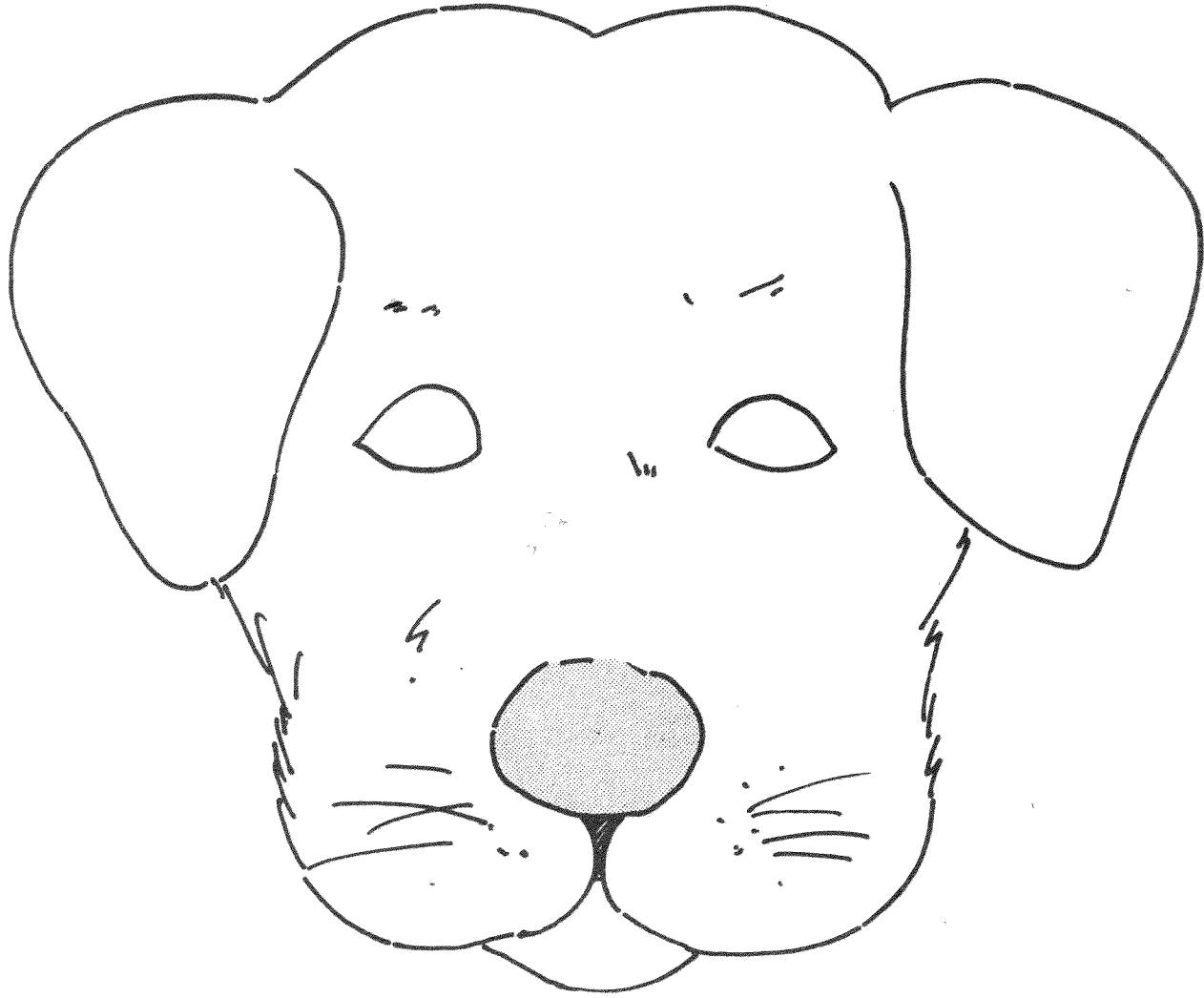

面具
狗

面具 猪熊

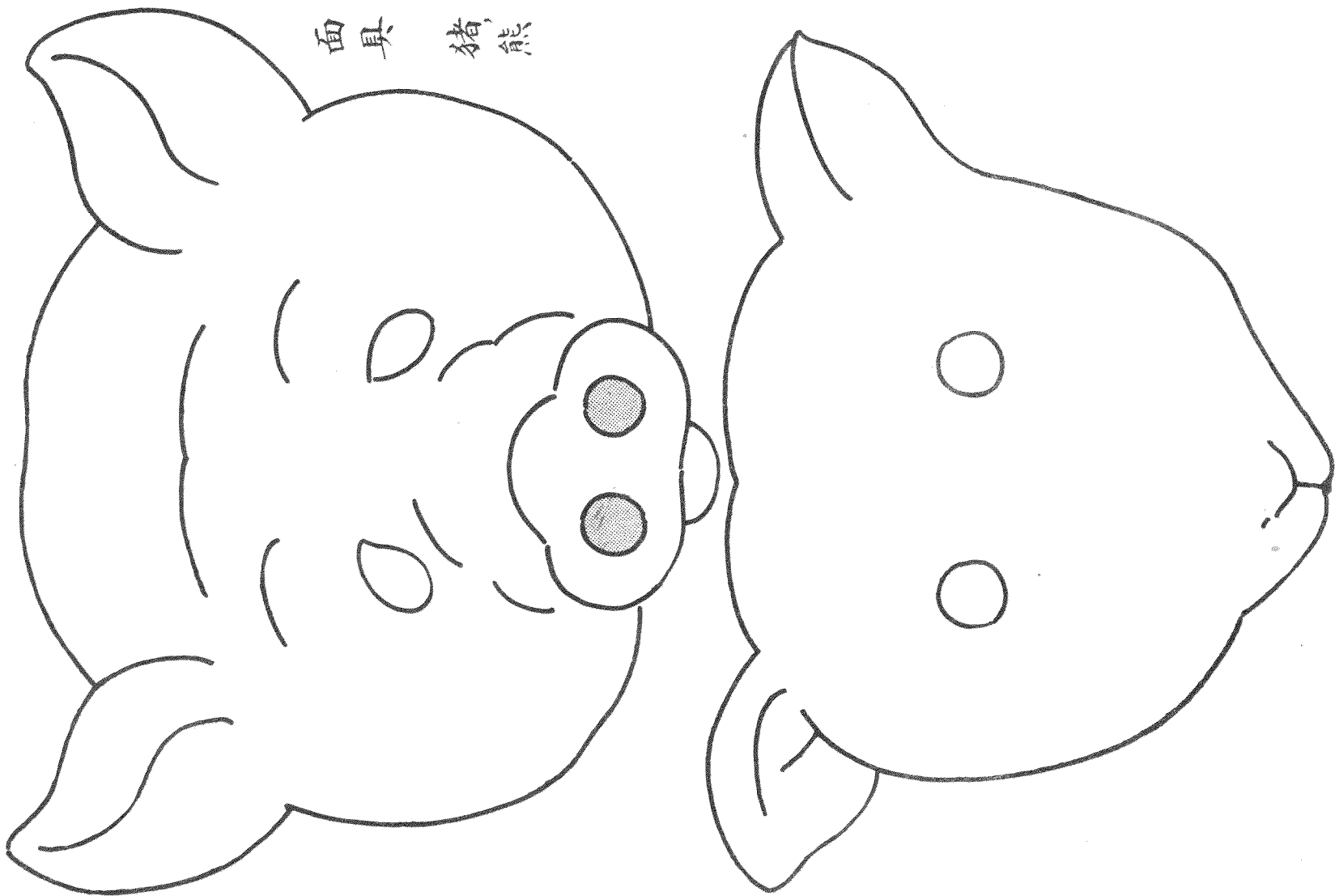

羊 面具

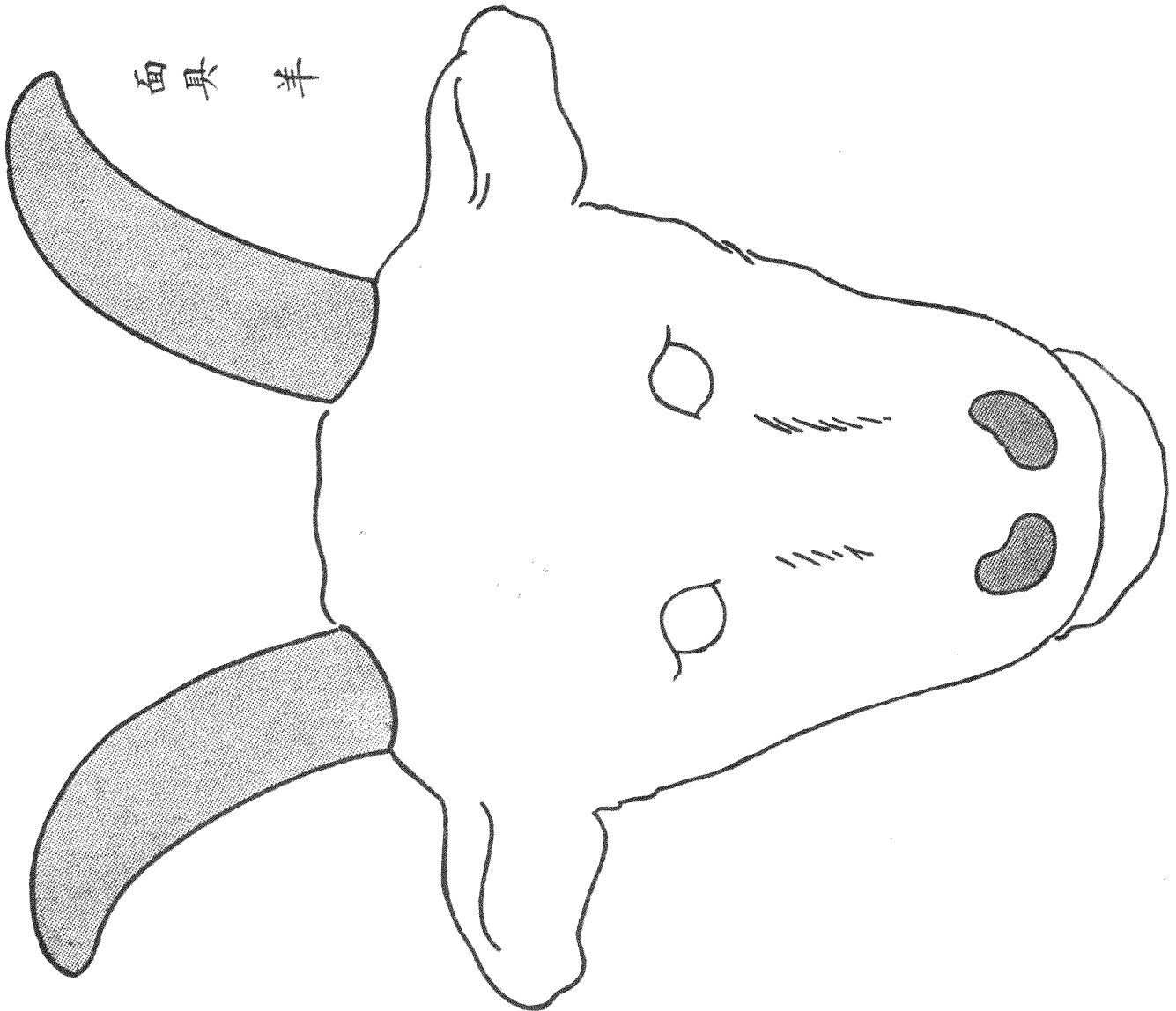

馬 面具

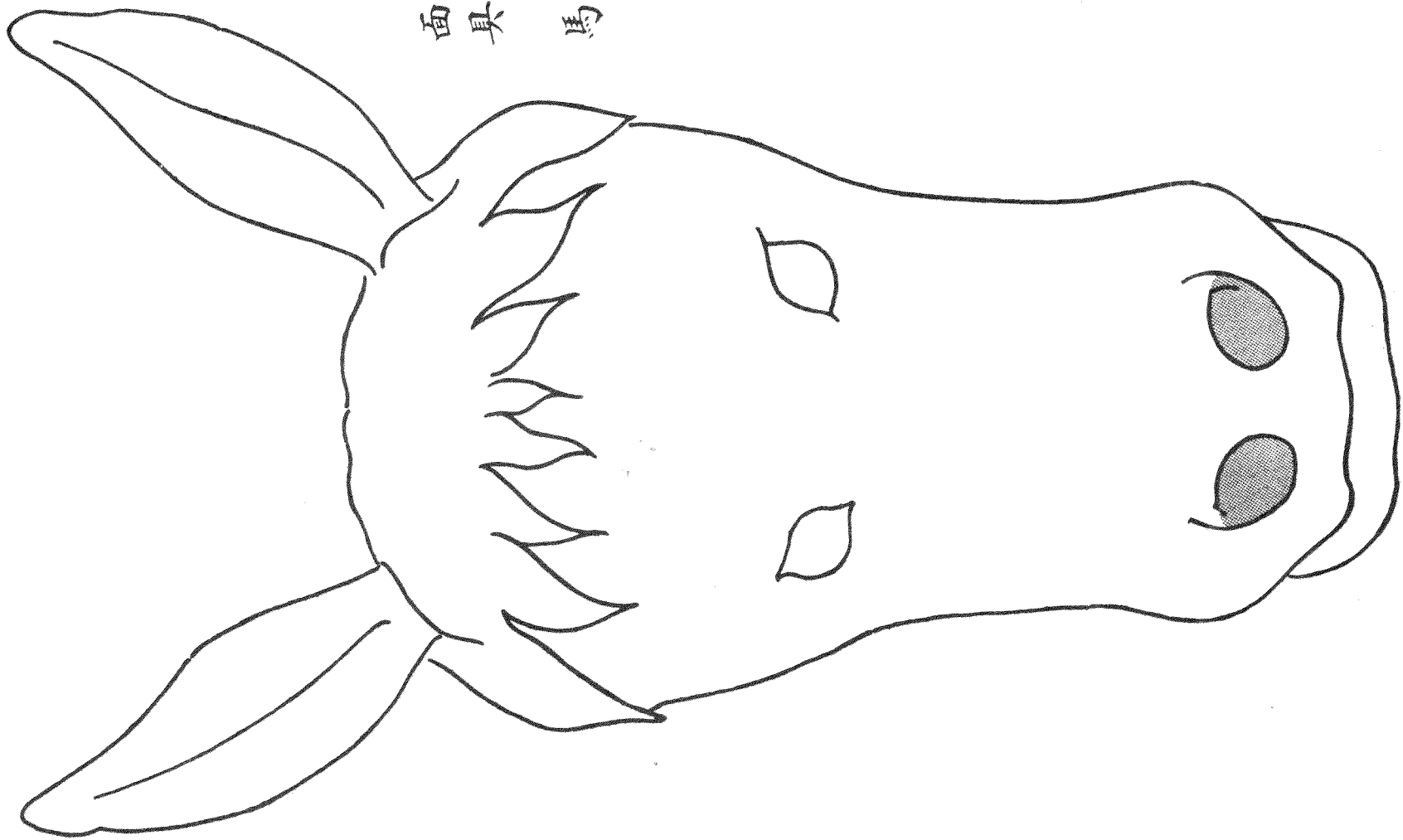

面具 牛

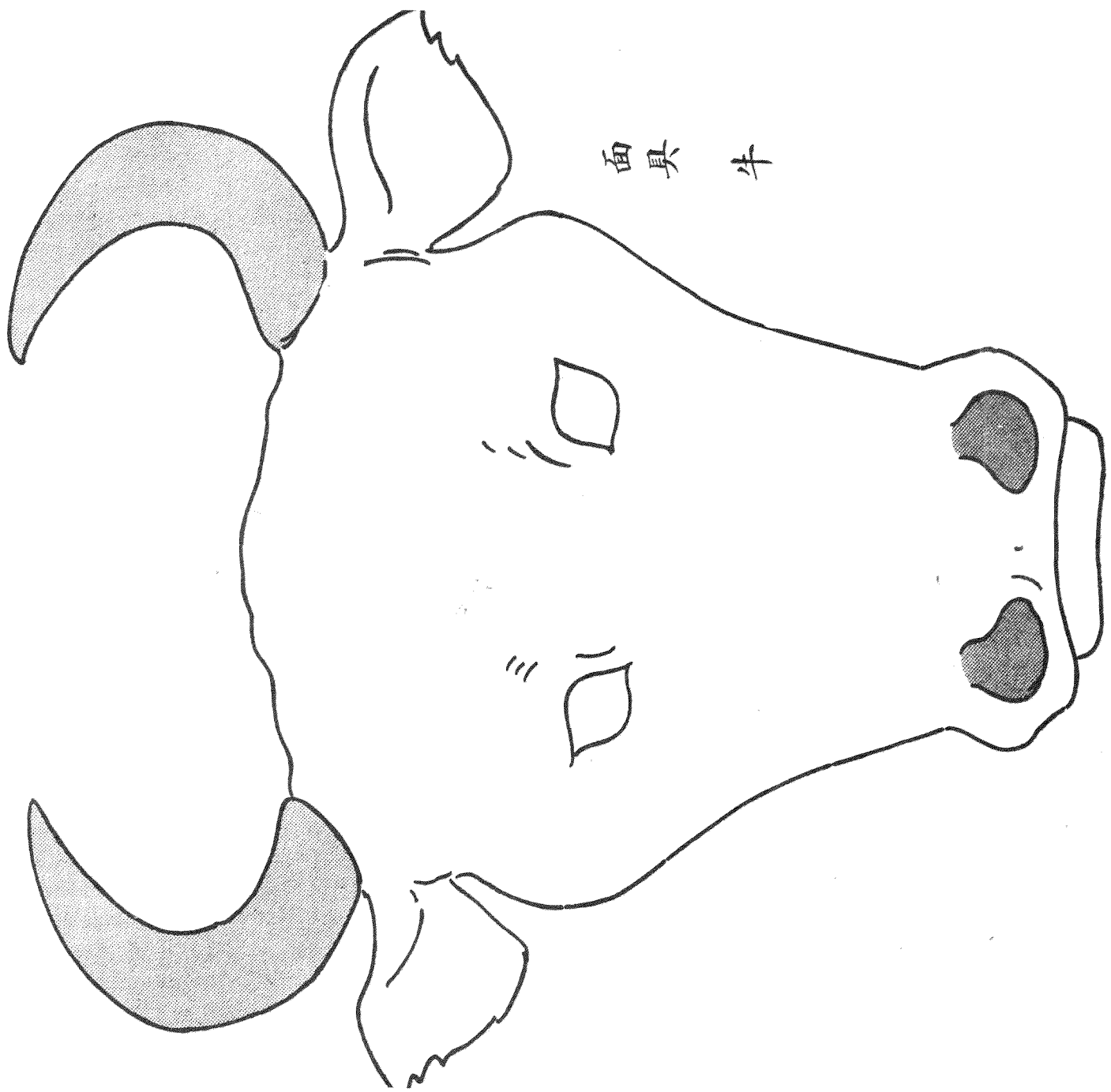

面具 兔

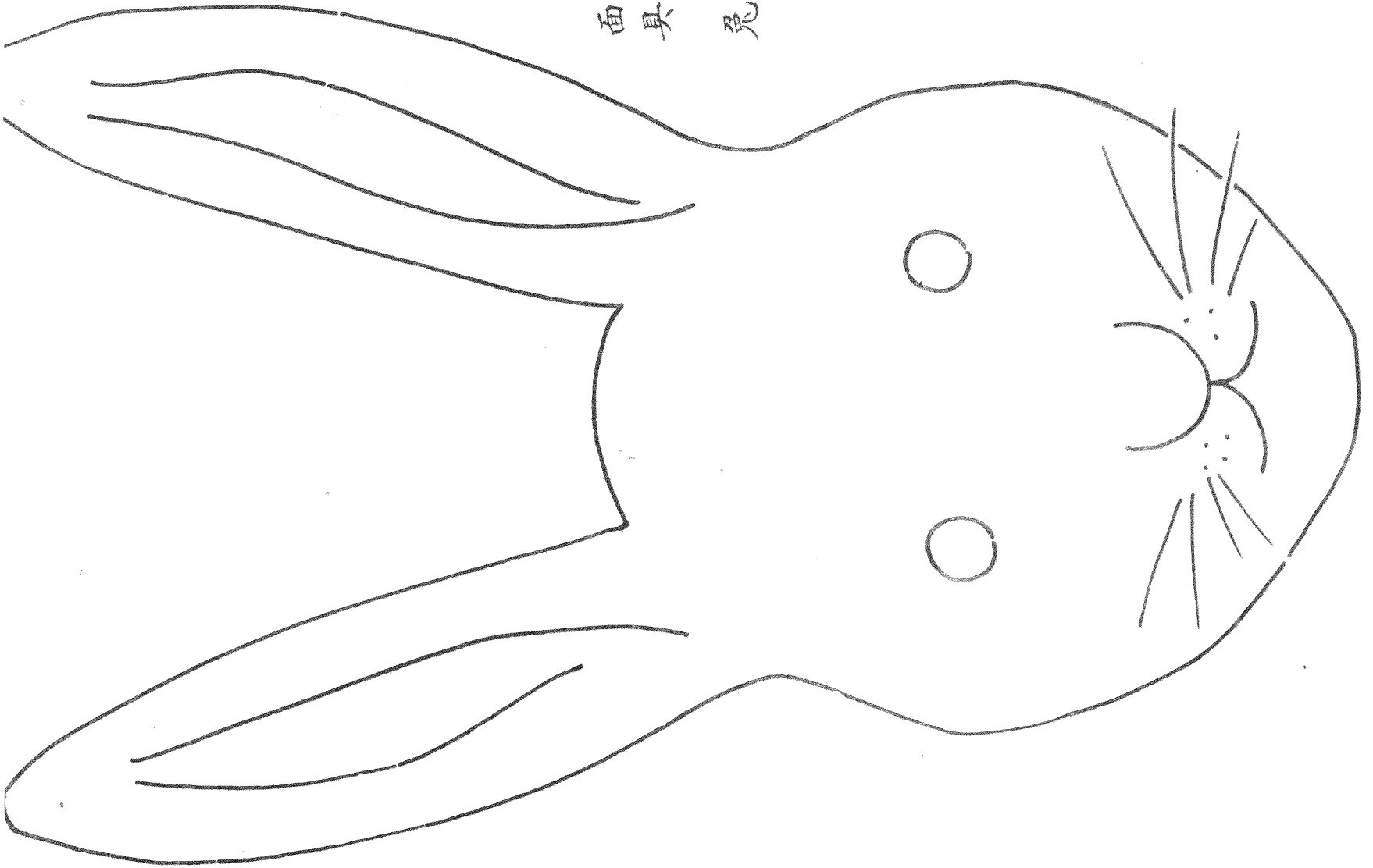

面具 猴





面具
虎

獅 面 具

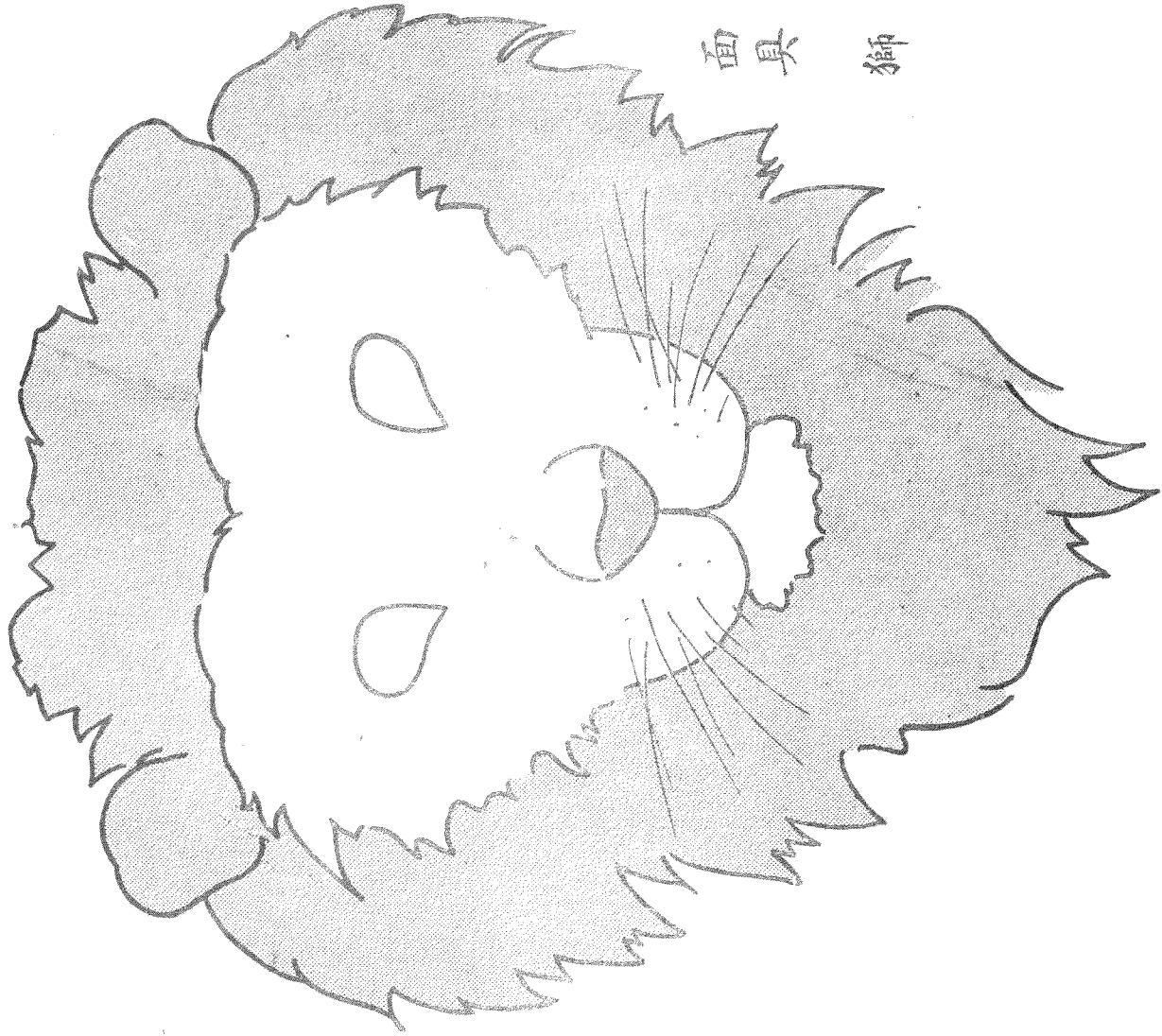

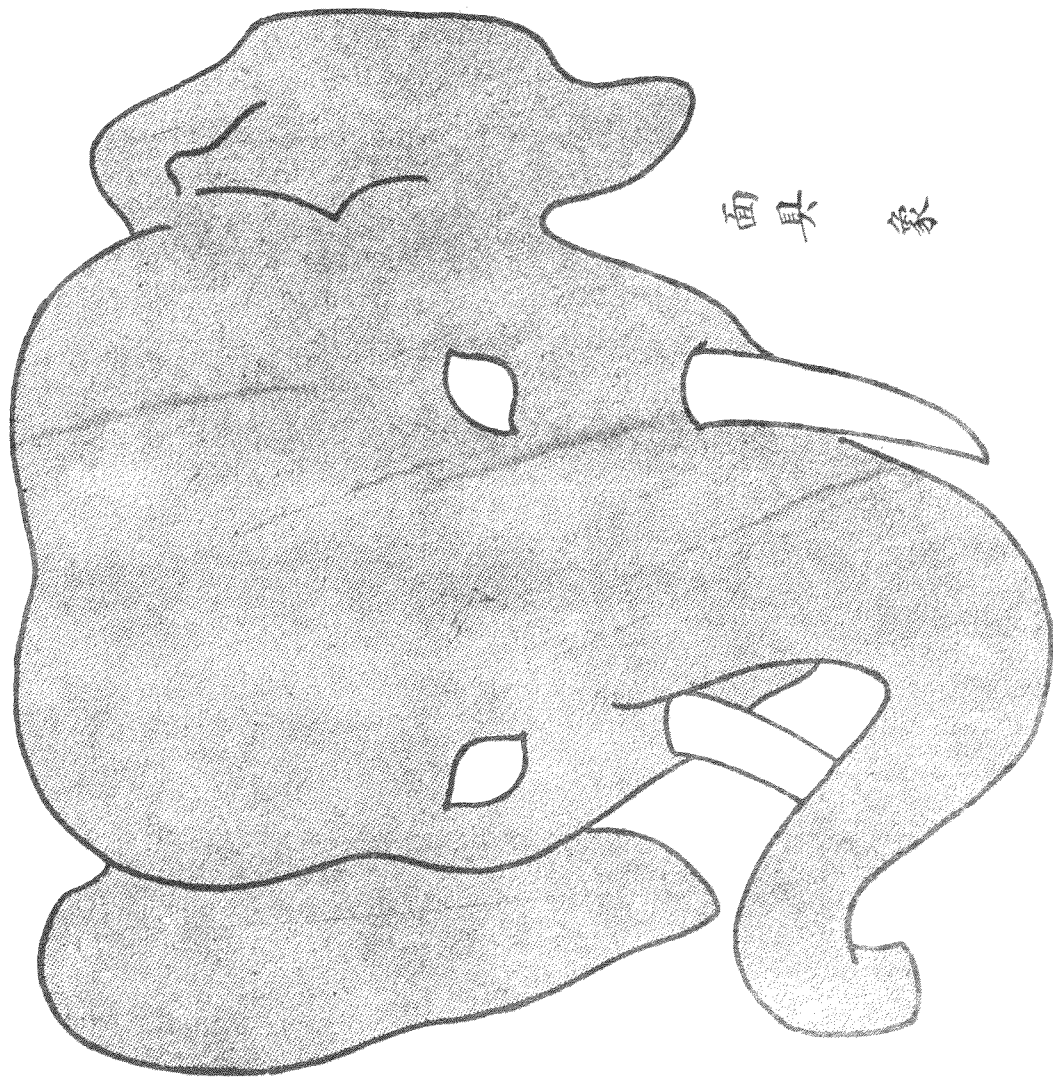

面具

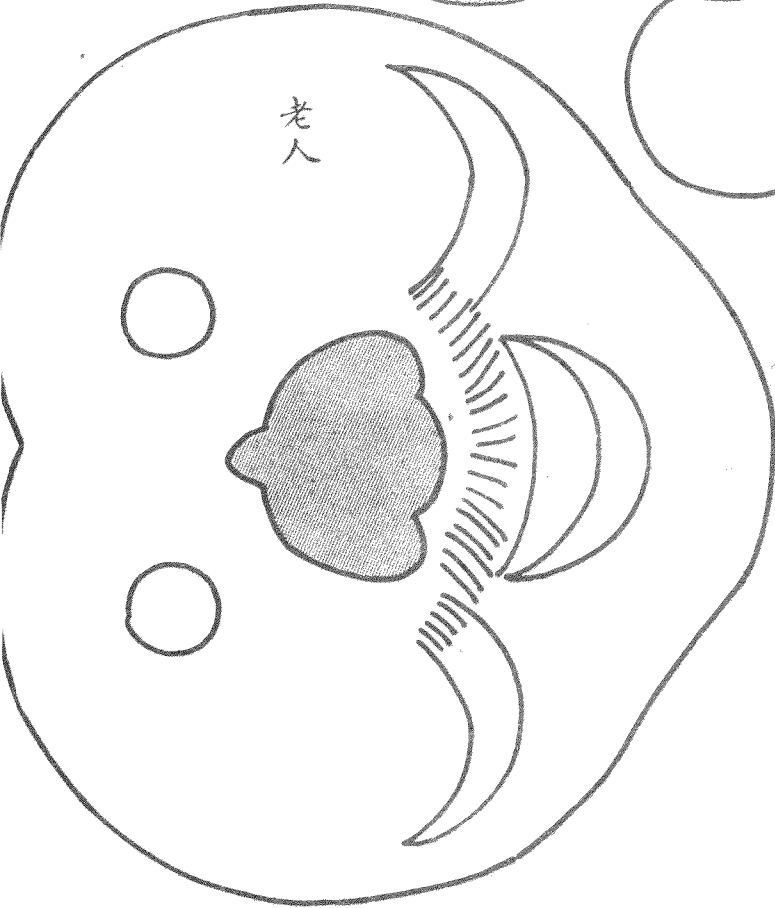
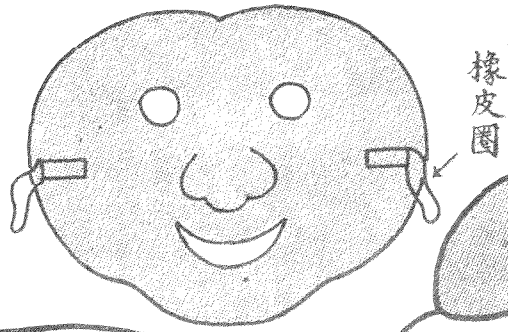

花籃

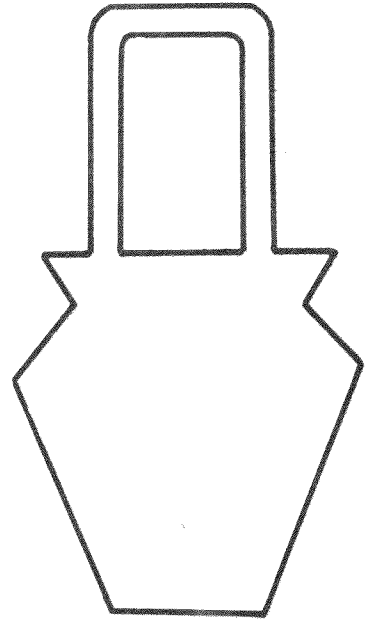
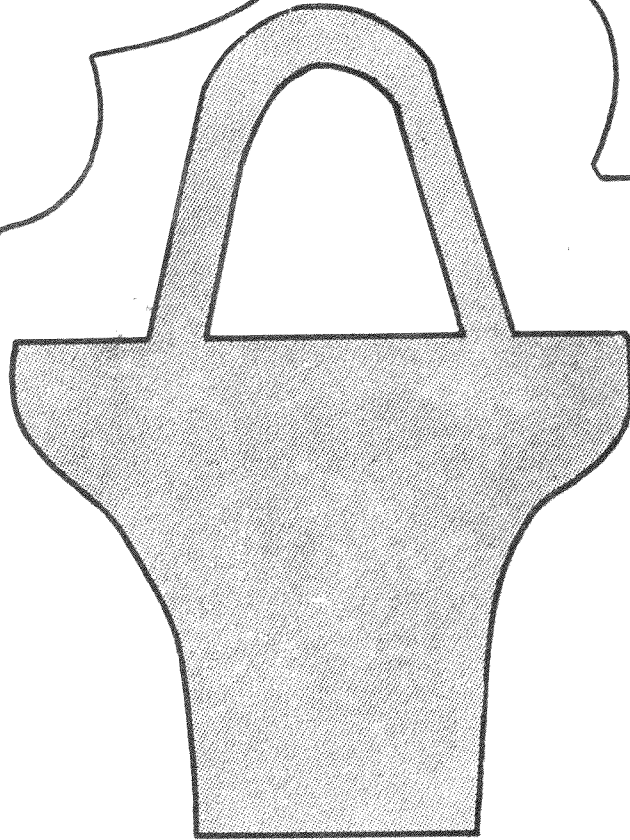
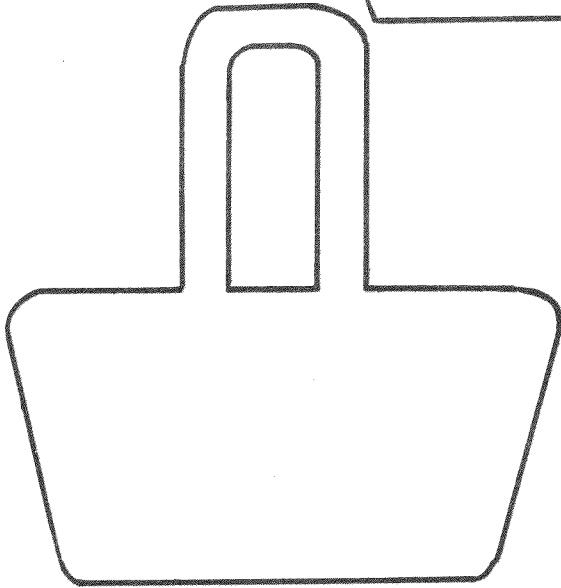
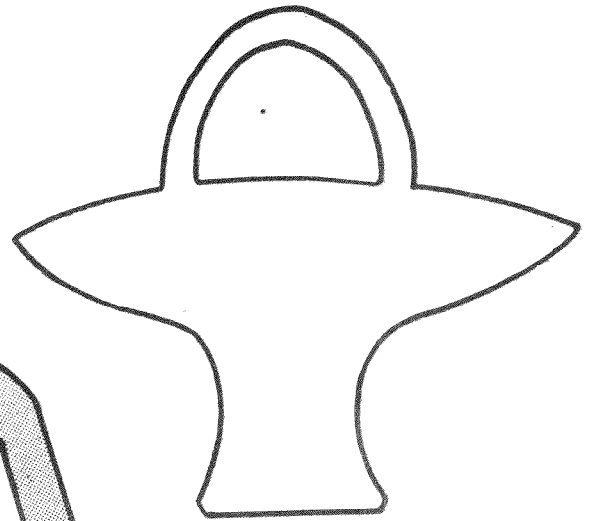
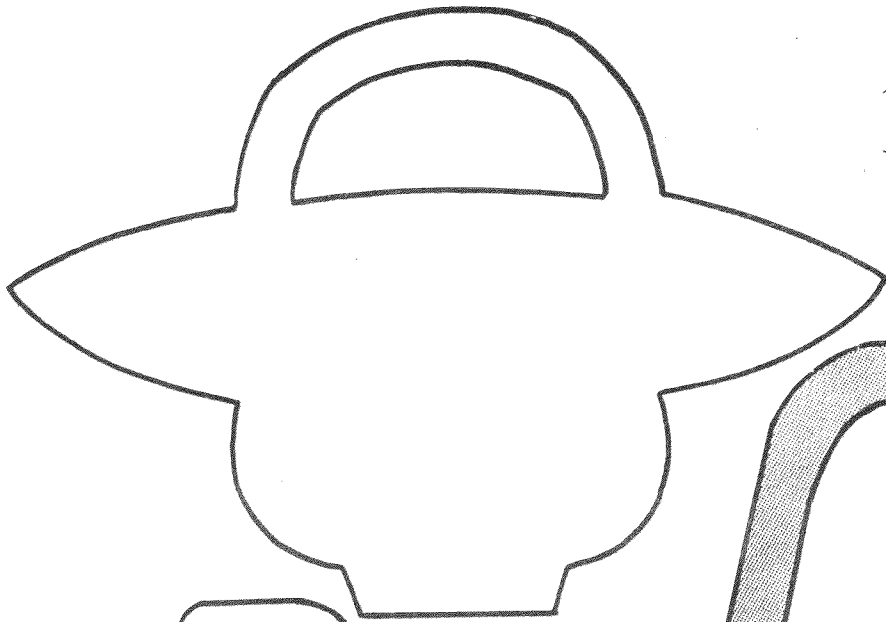

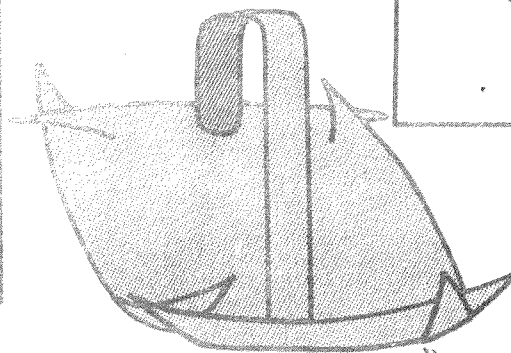
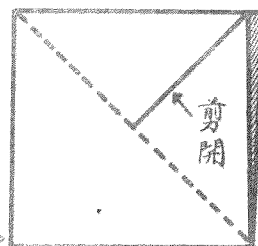
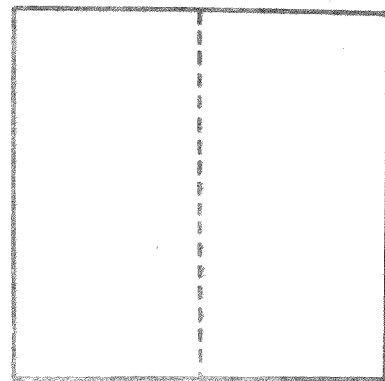
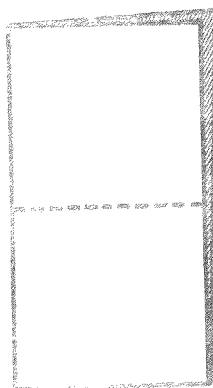
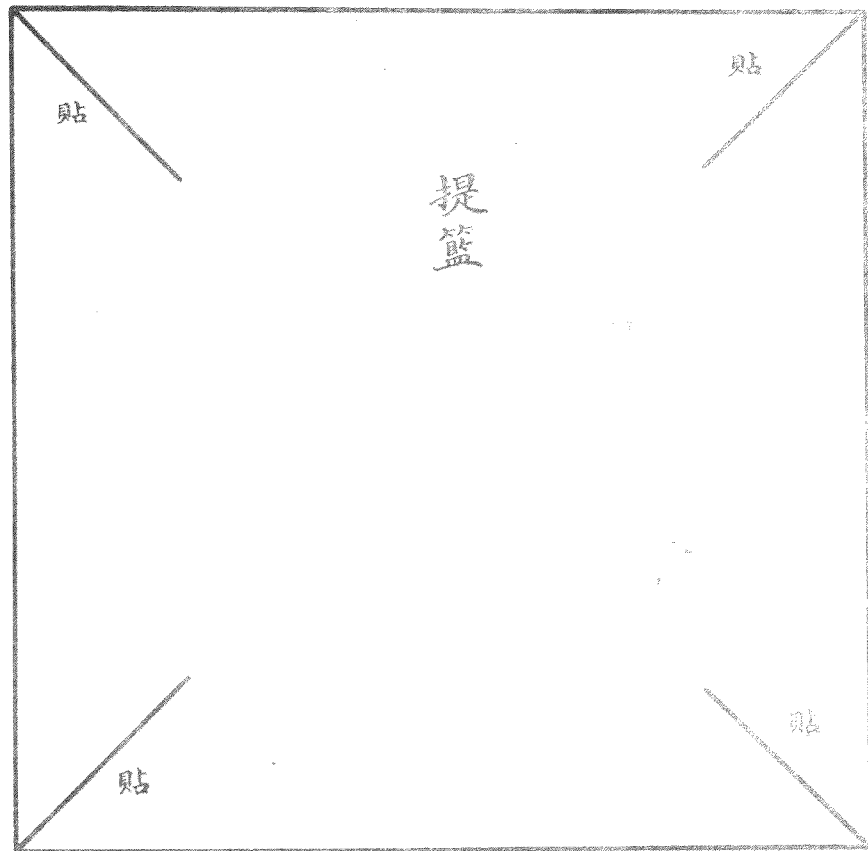

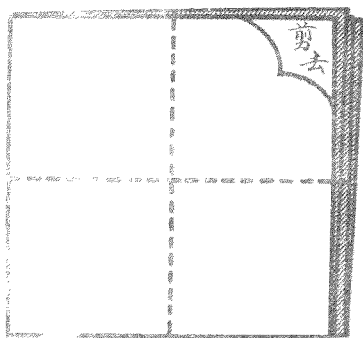

提籃

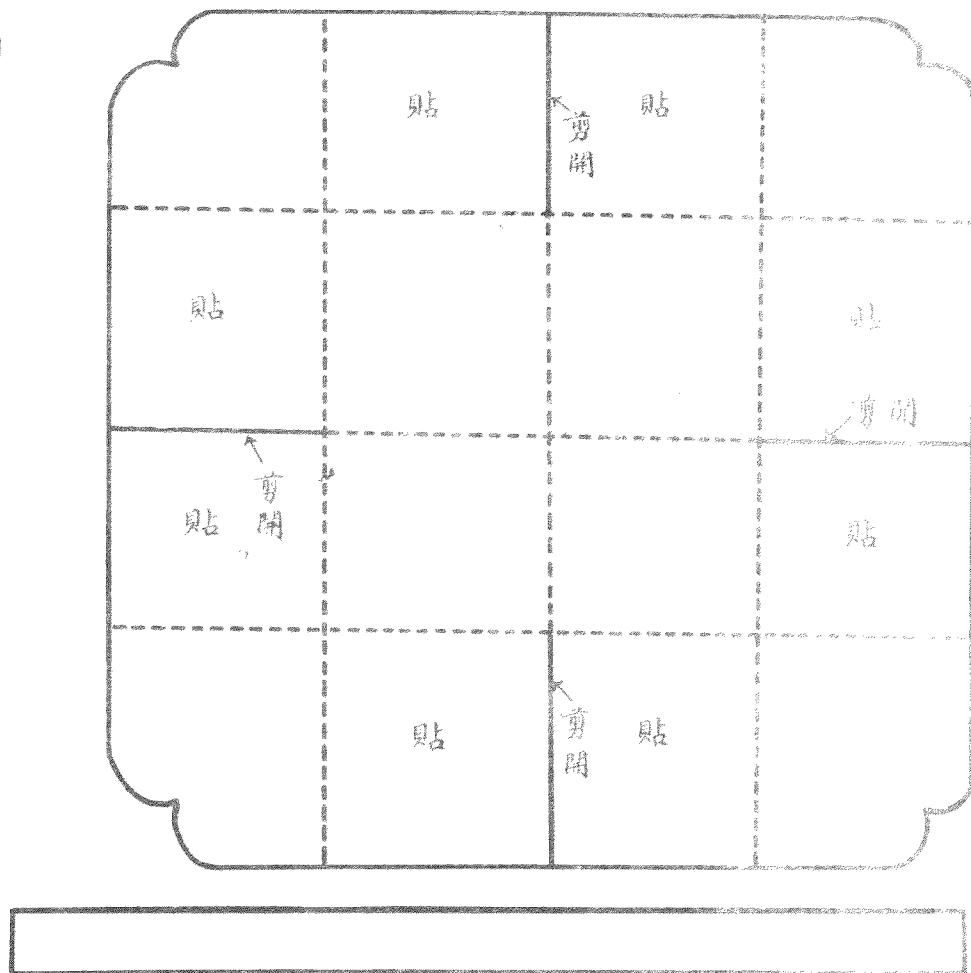
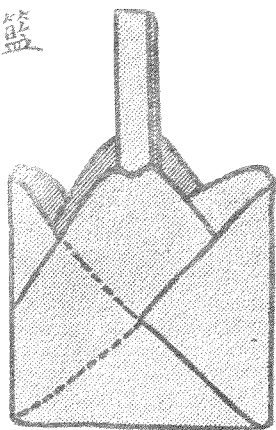

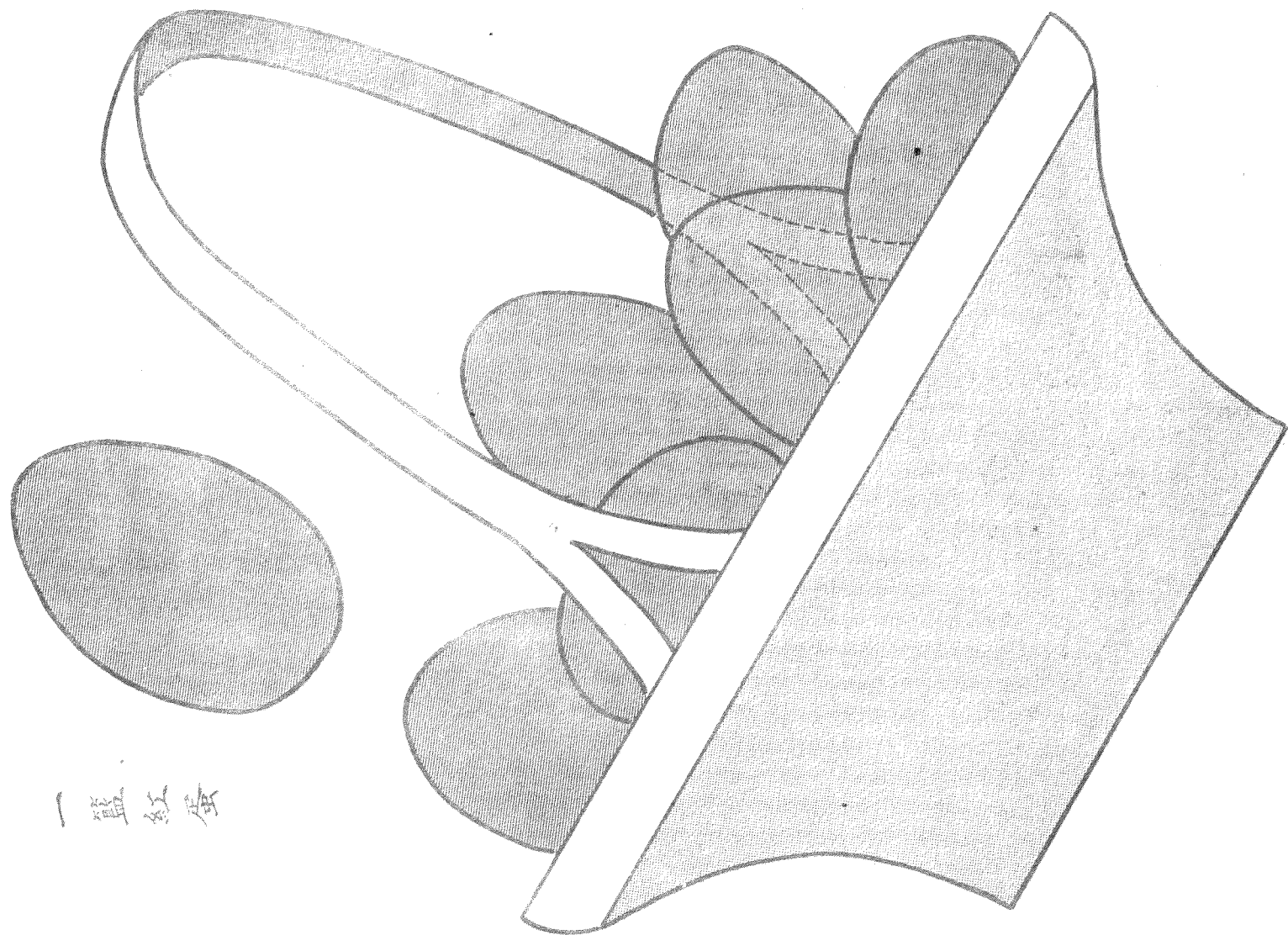

一籃紅蛋

貼

兔籃

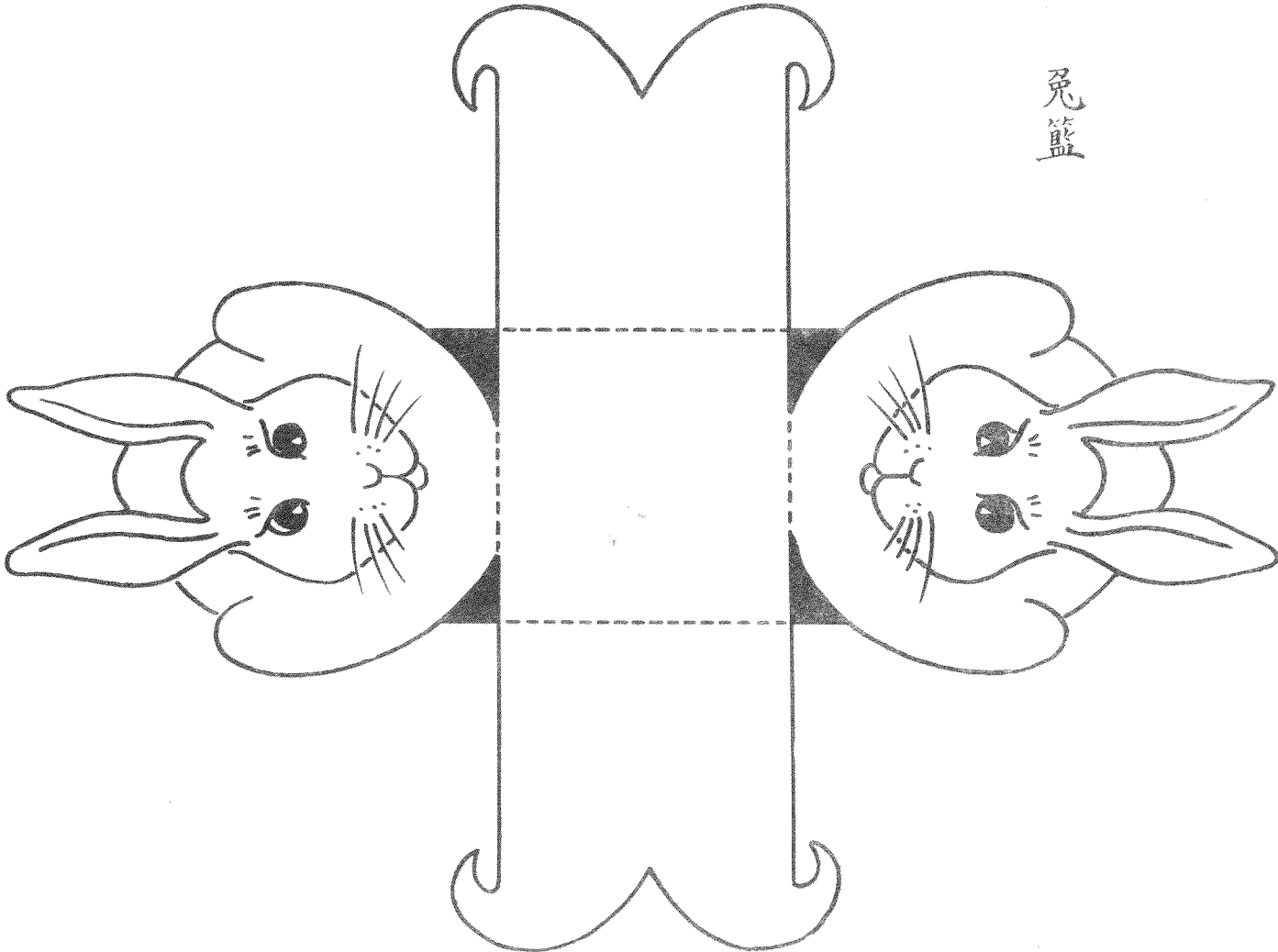

貼

蝴蝶籃

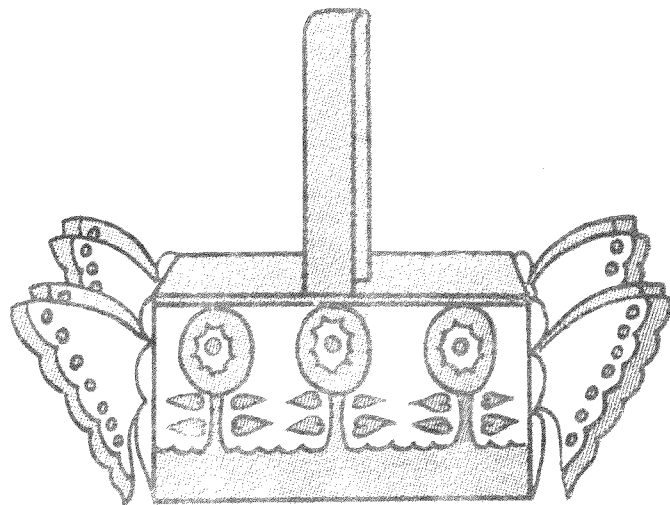
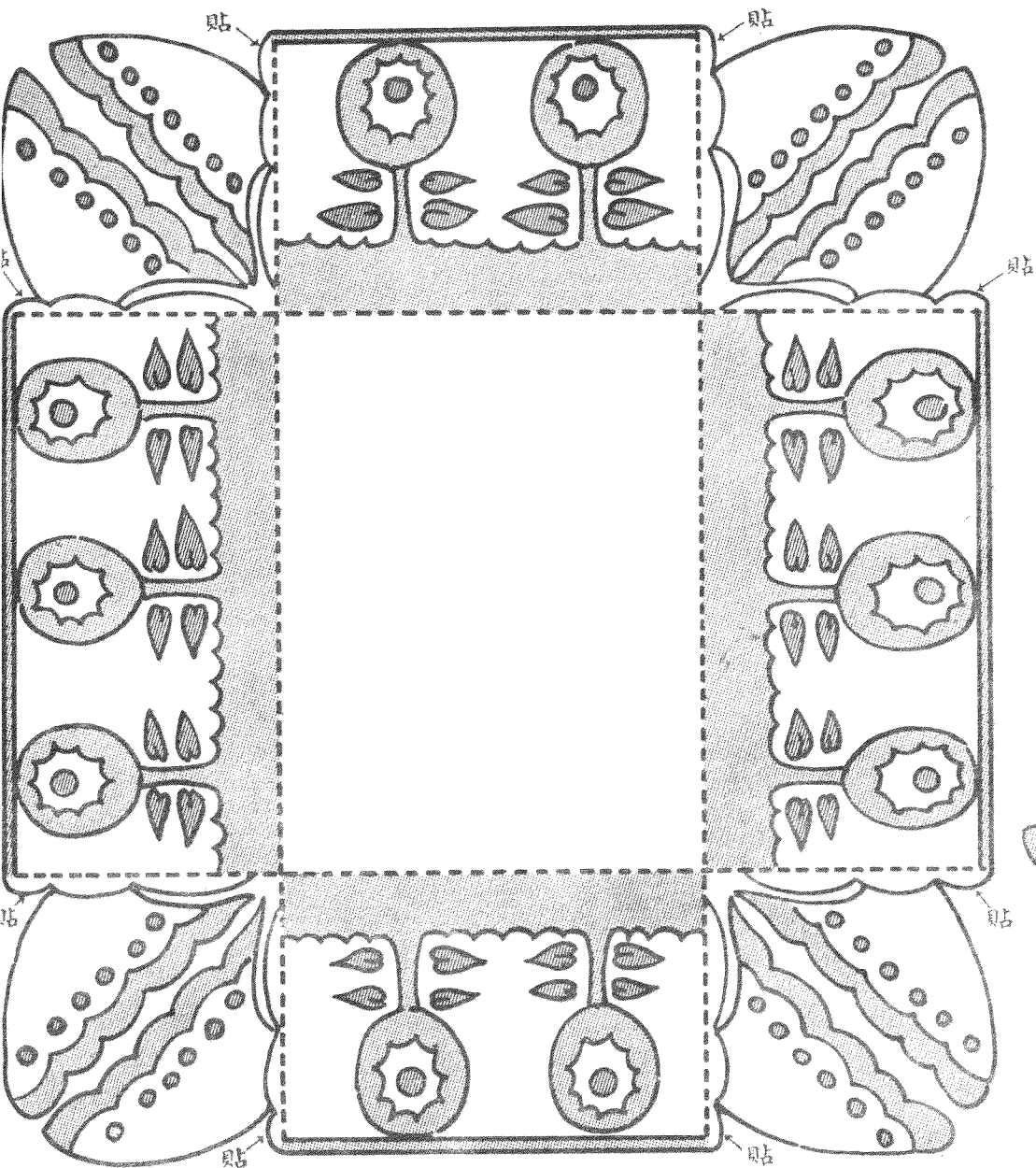

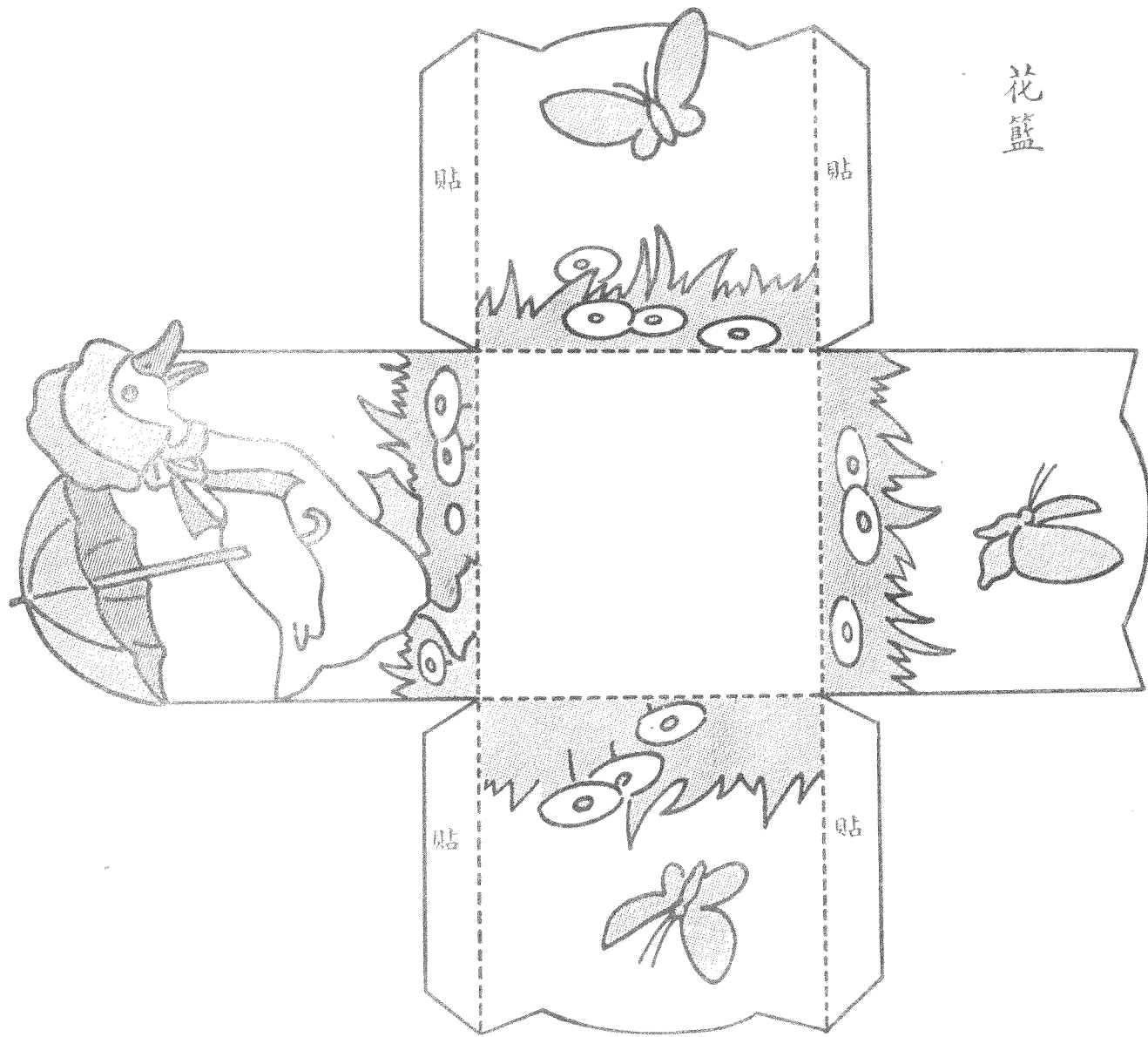

花
籃

鬱金香花籃

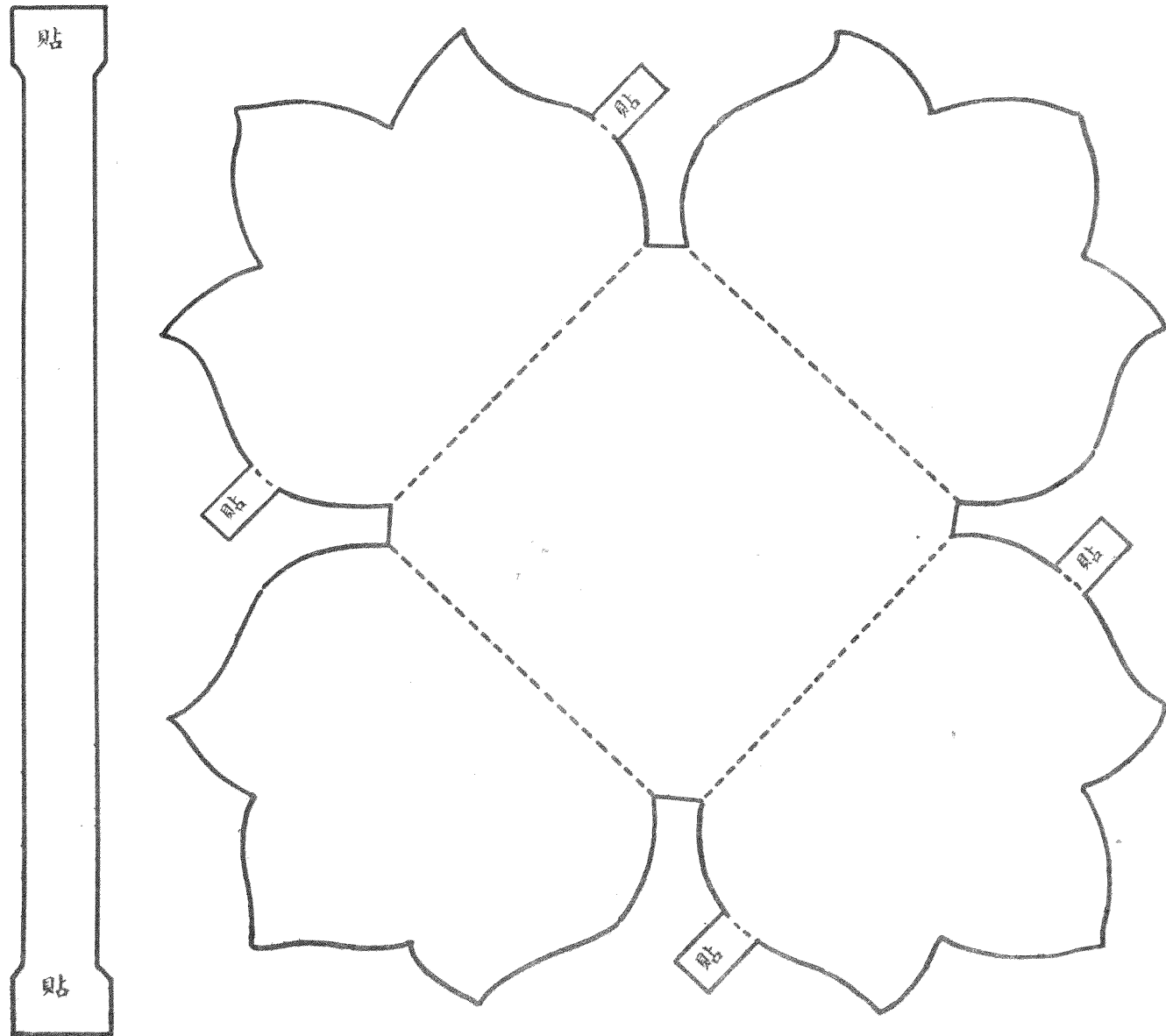

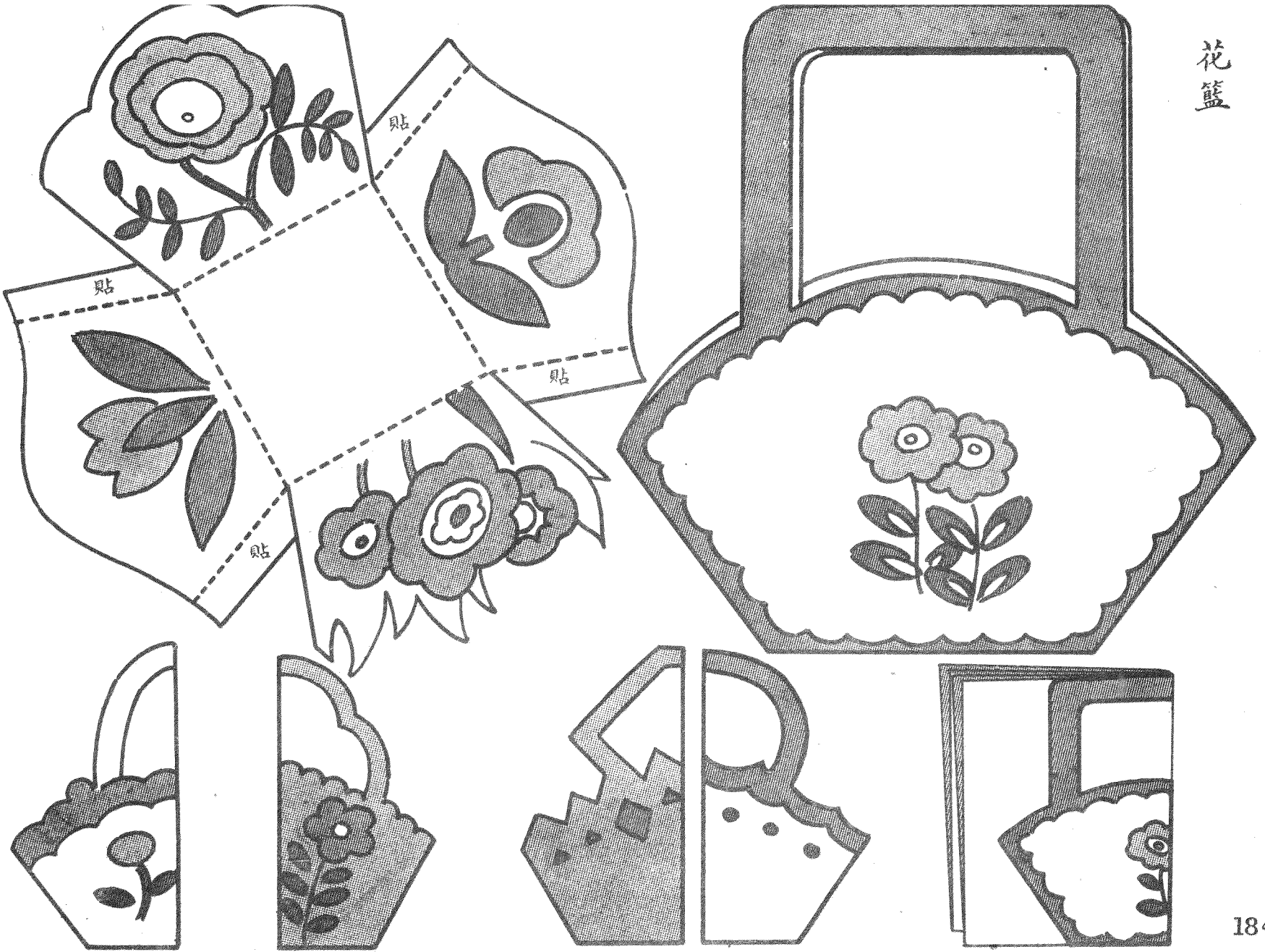

花籃

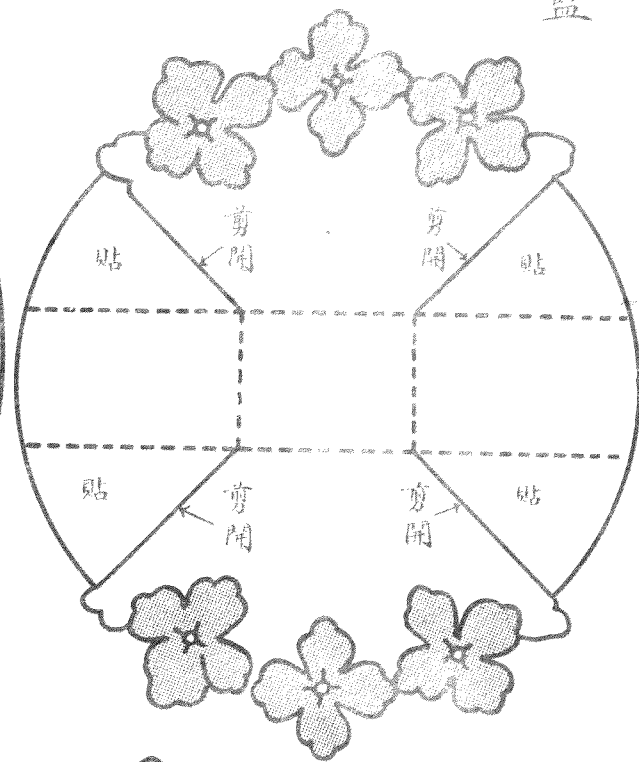
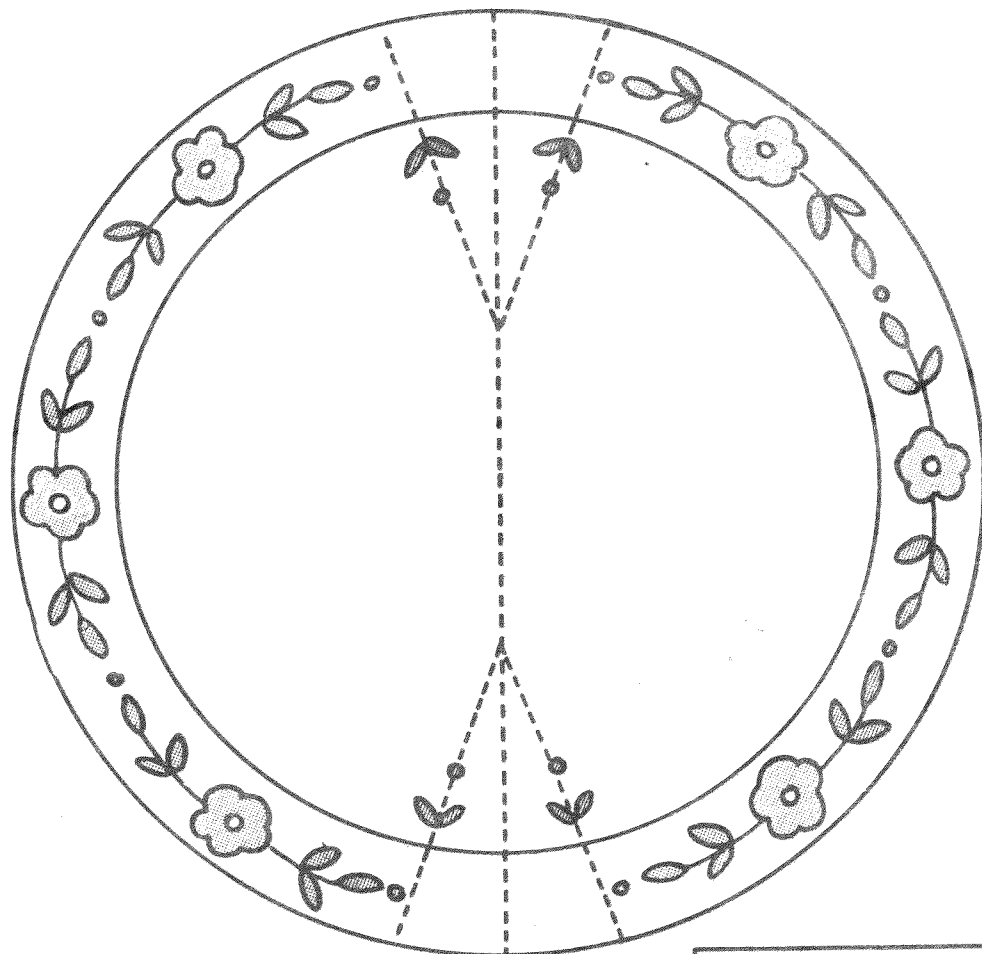

花籃

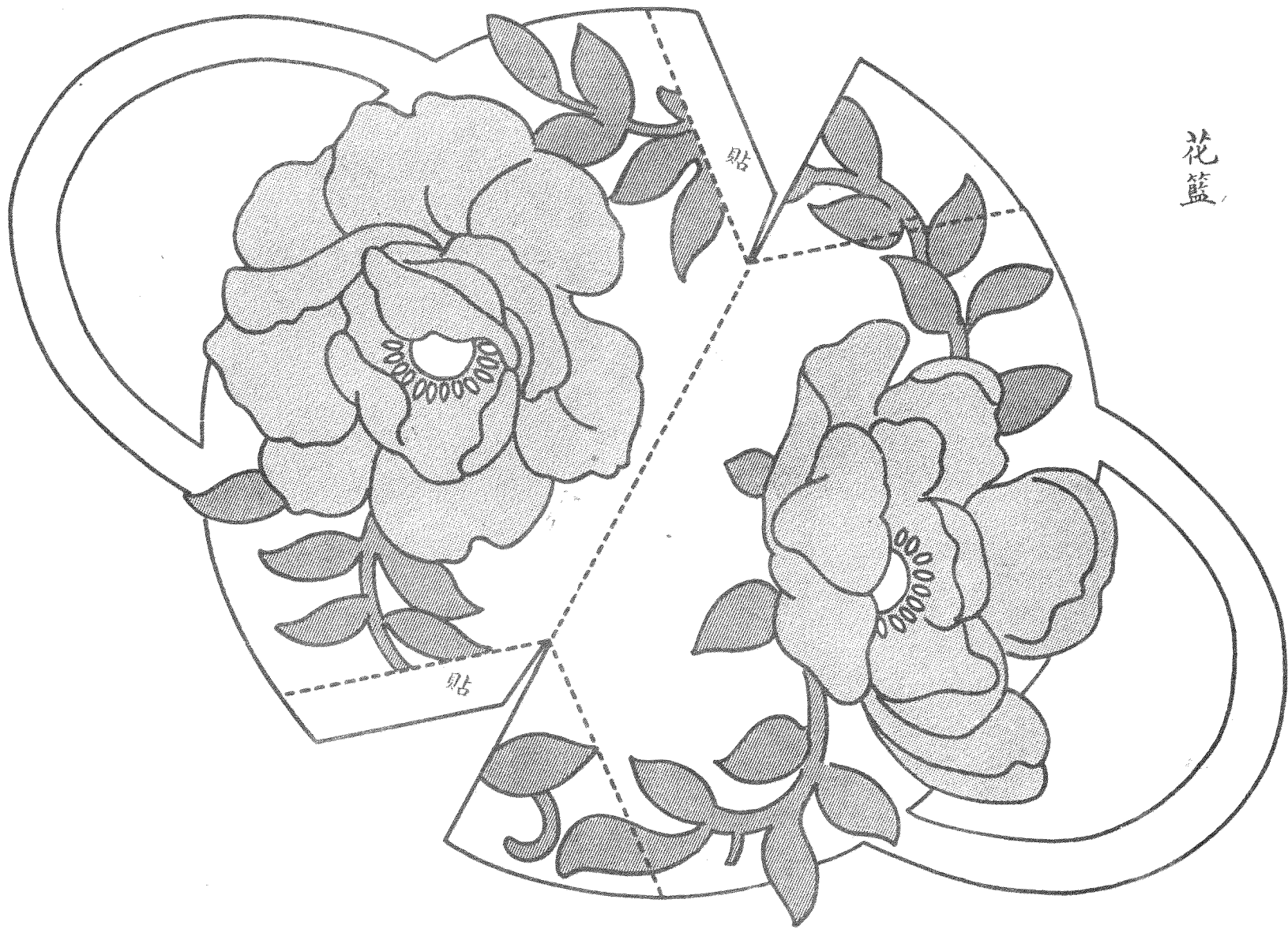

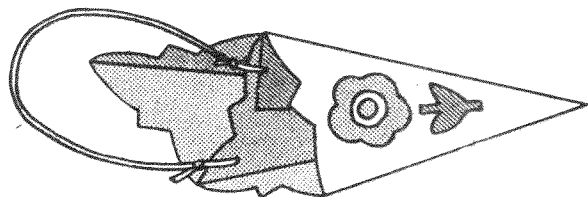
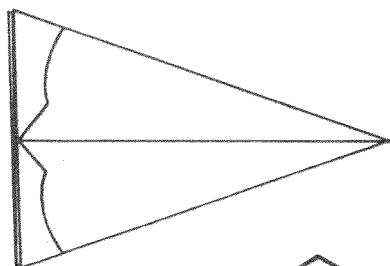
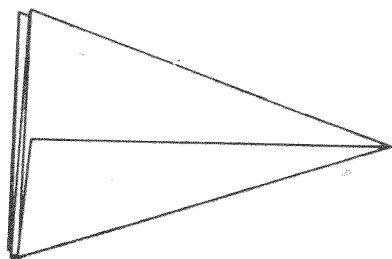

花籃

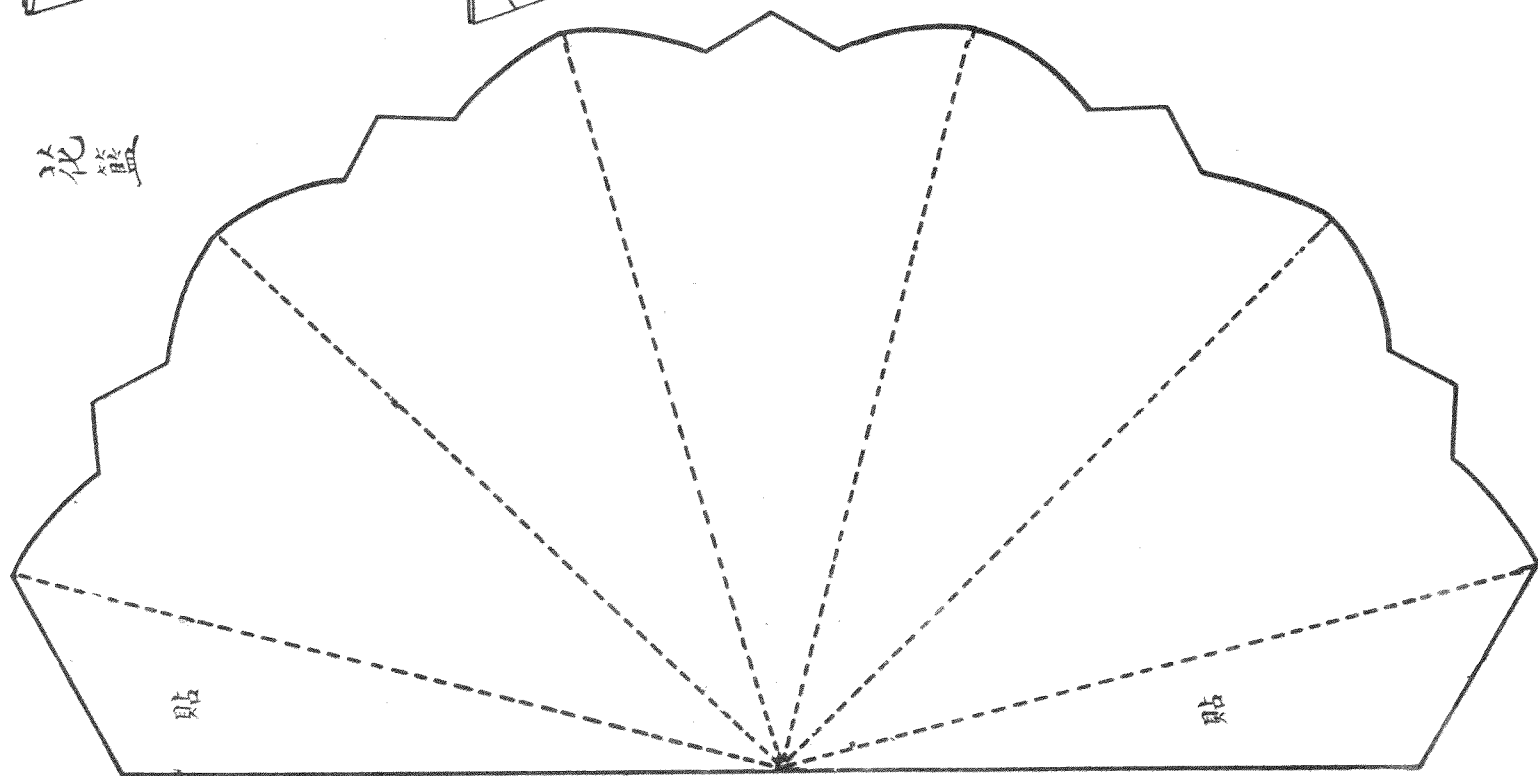

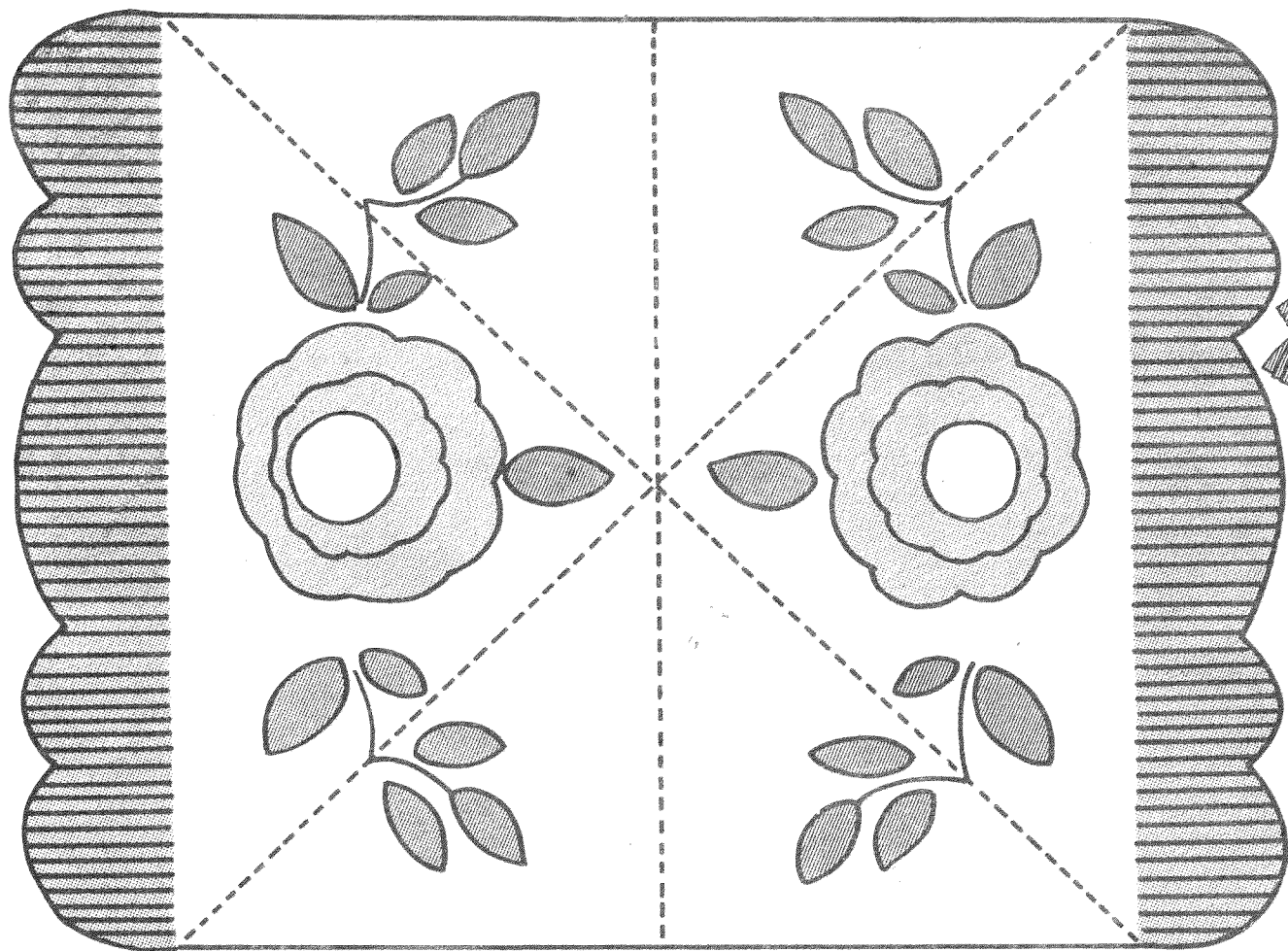

花
籃

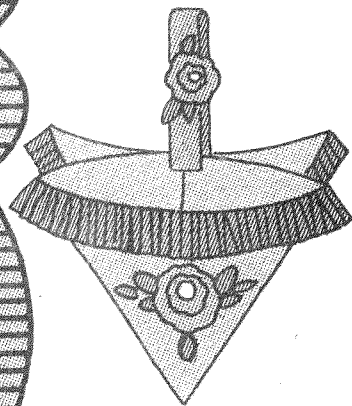

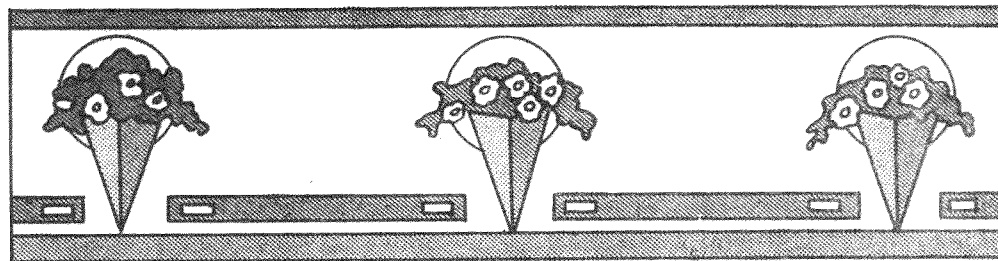
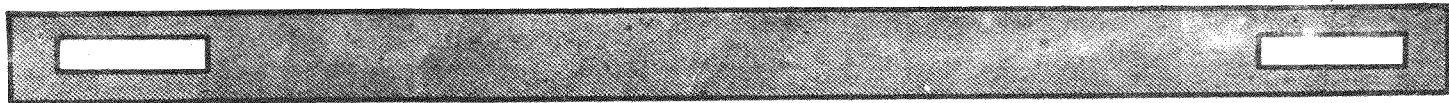
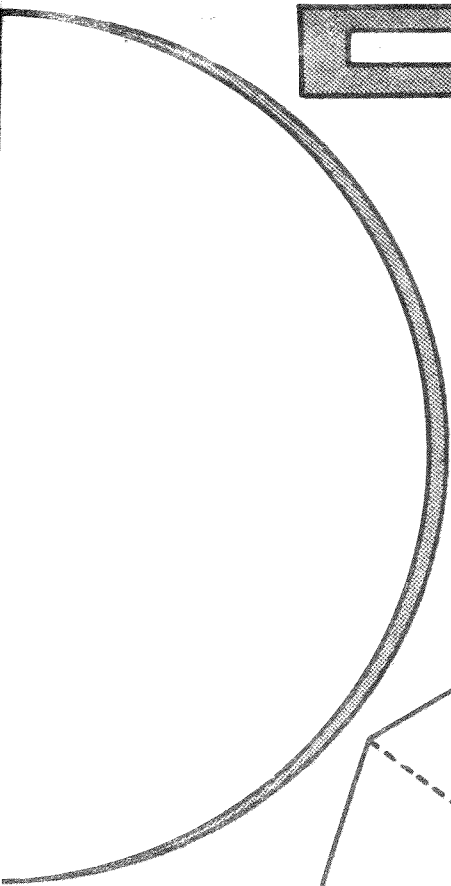

壁上花籃

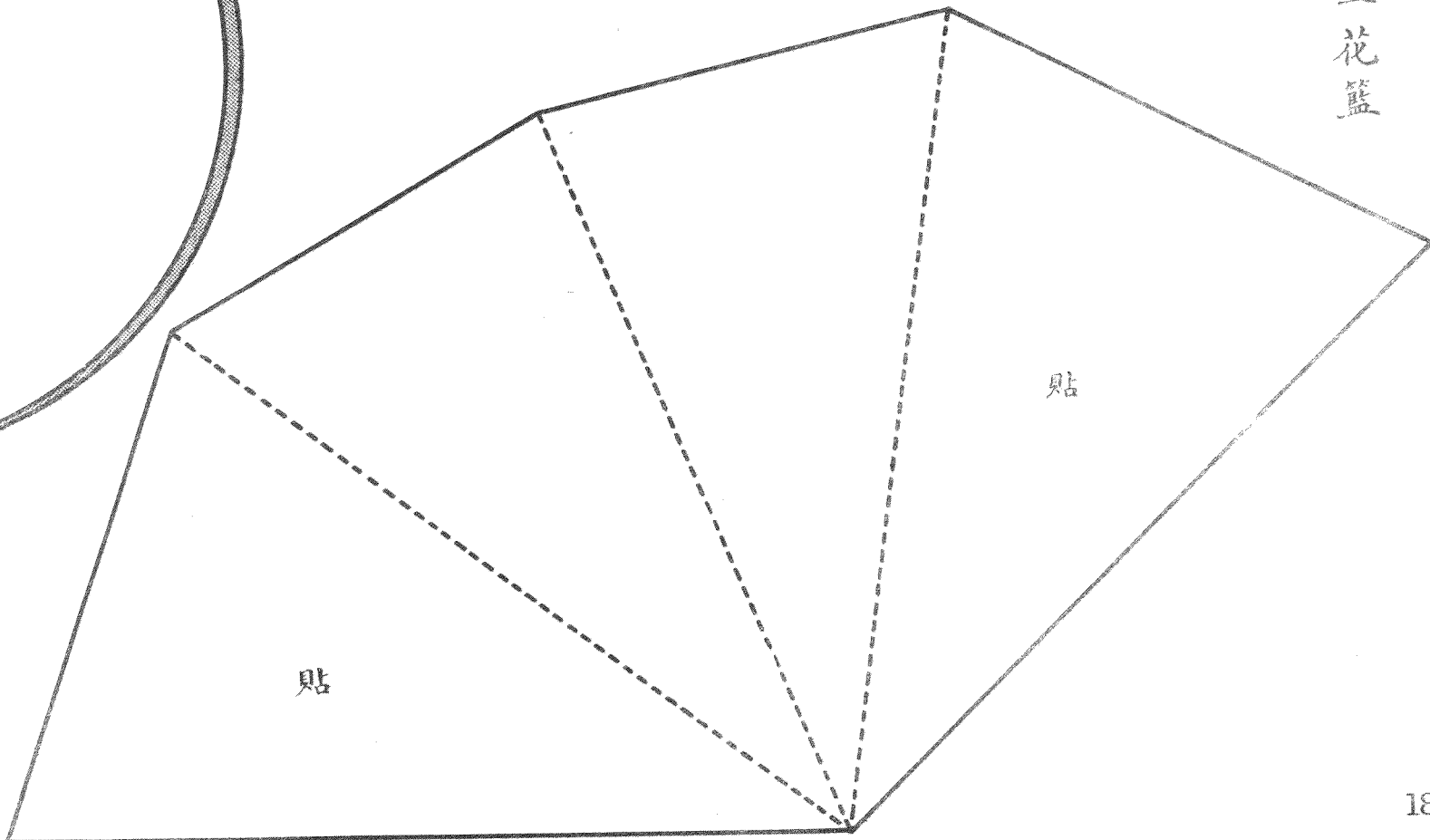

貼

貼

貼
貼

果籃

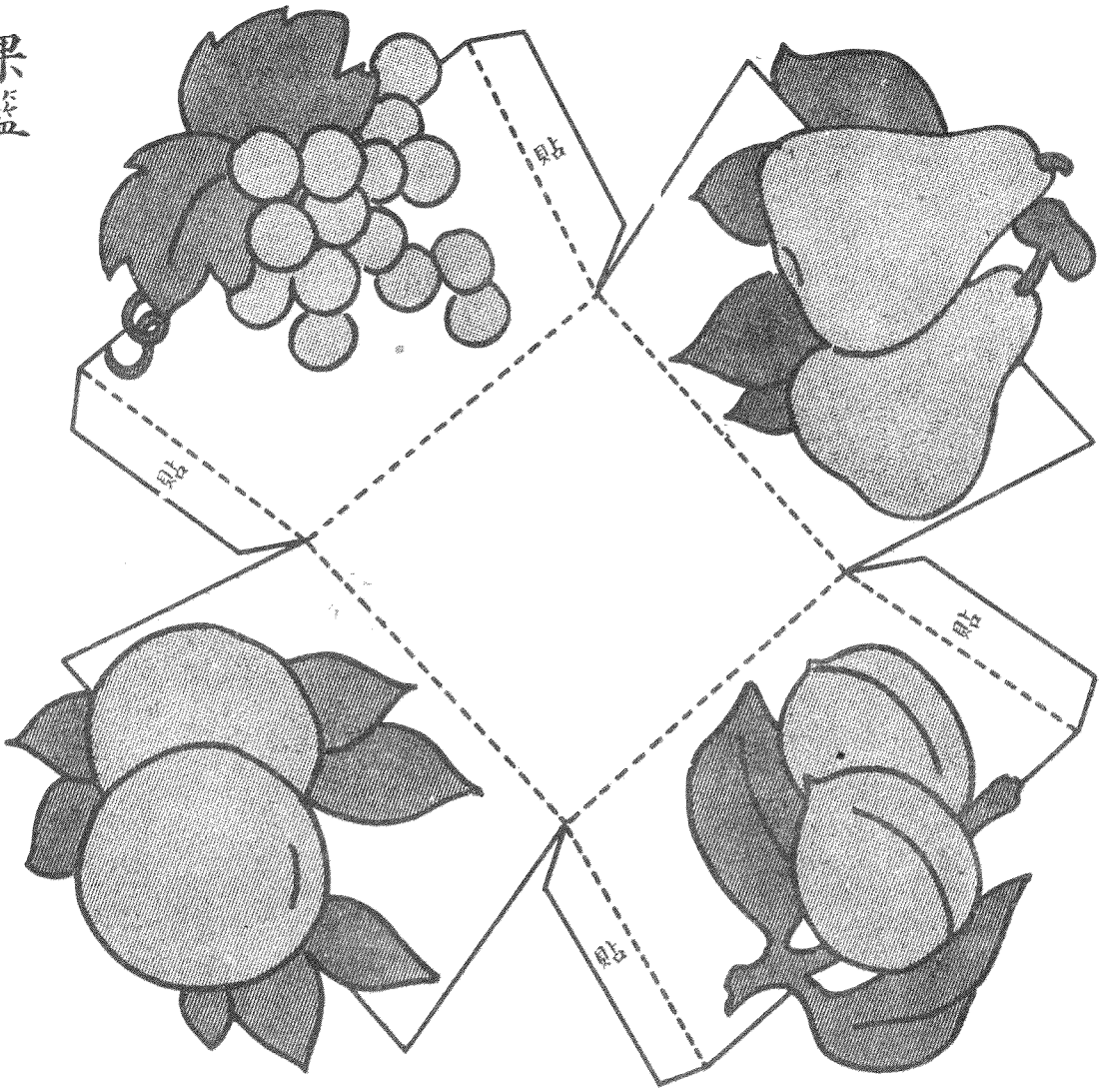

盒

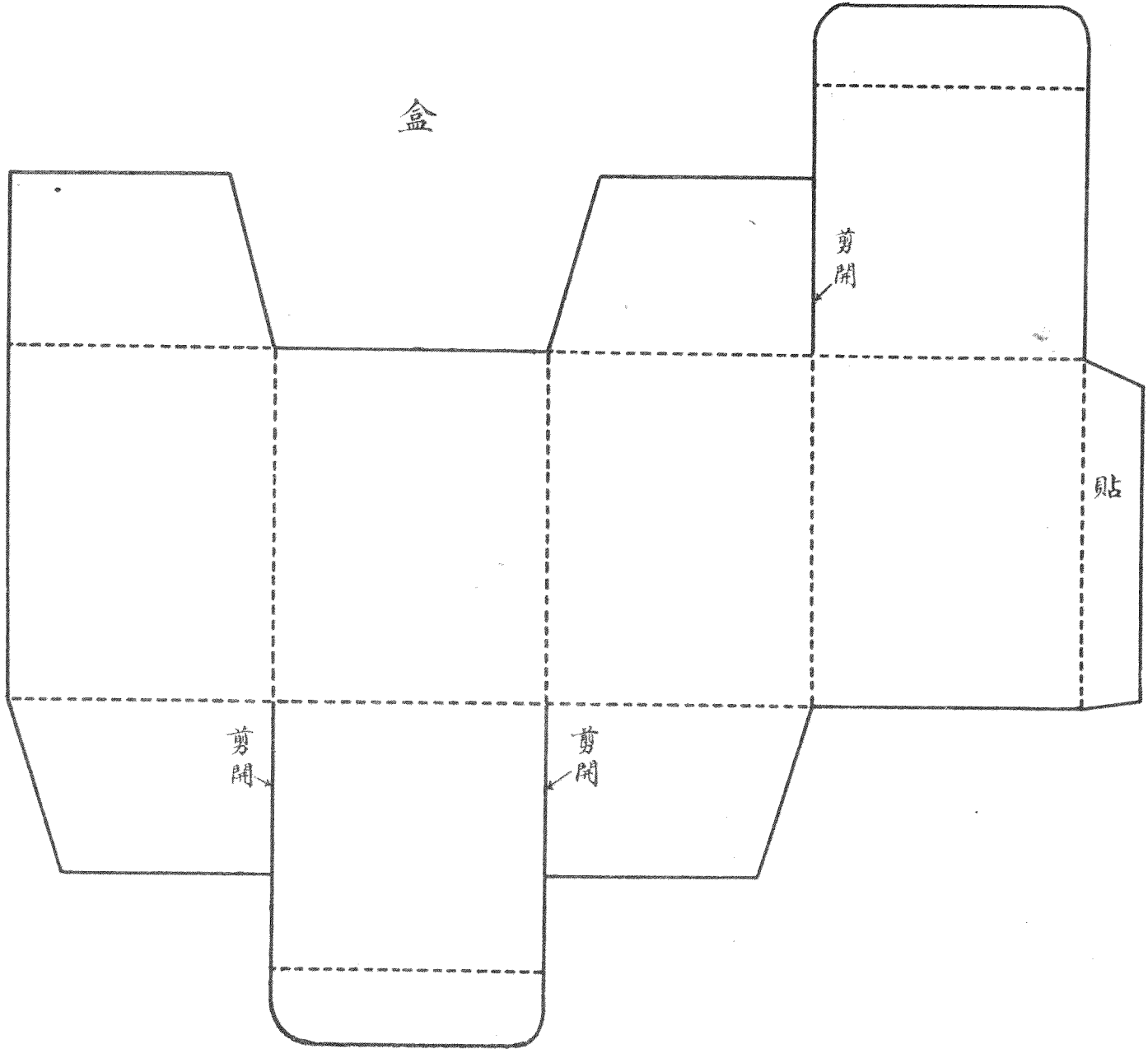

盒

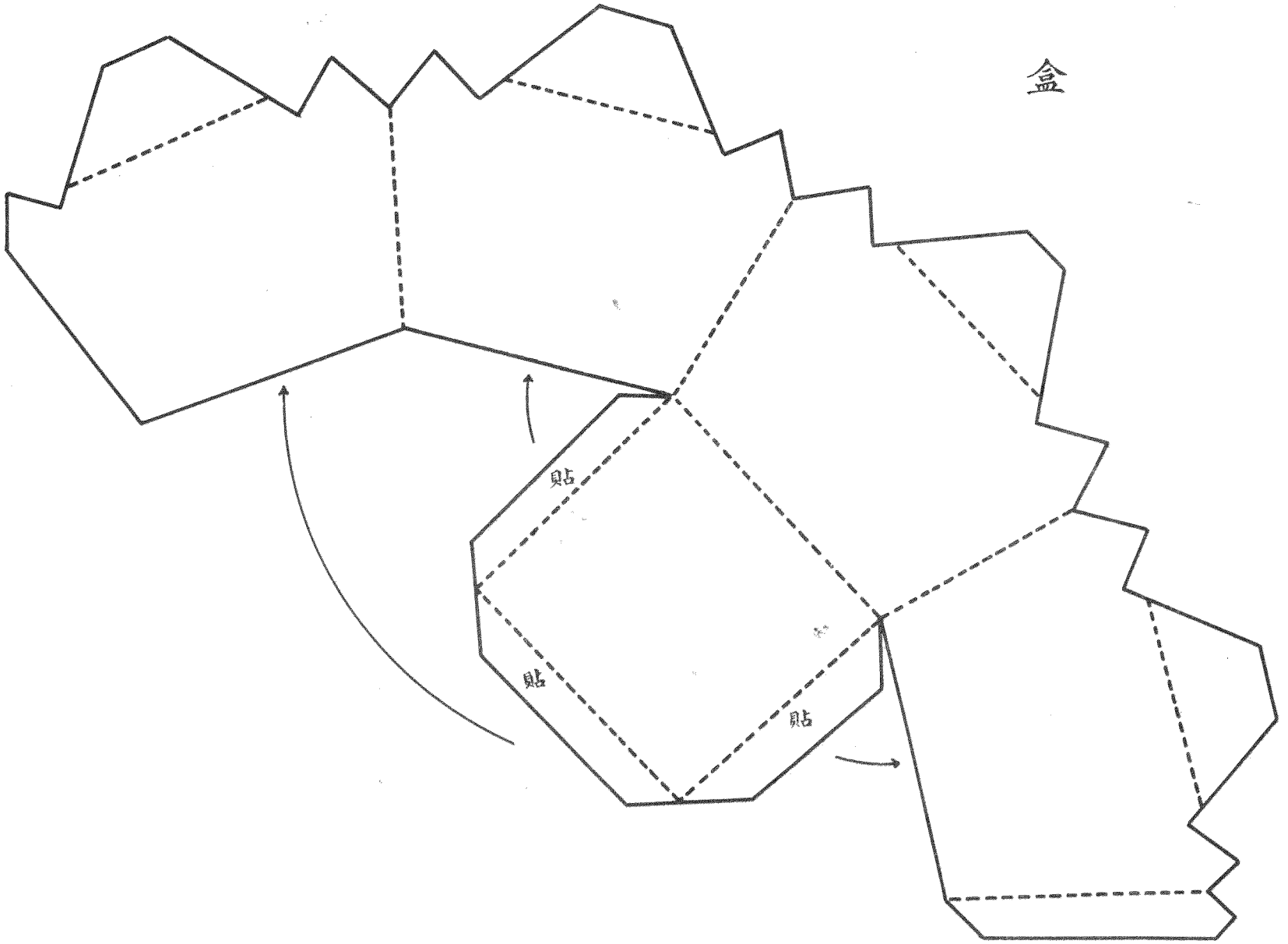

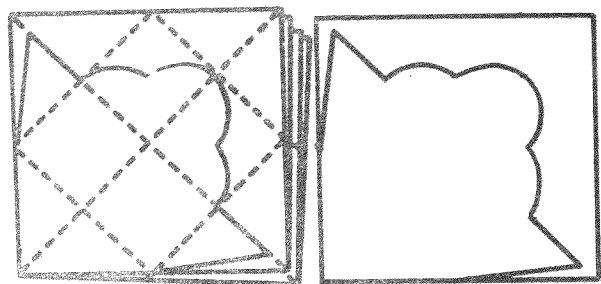

盒

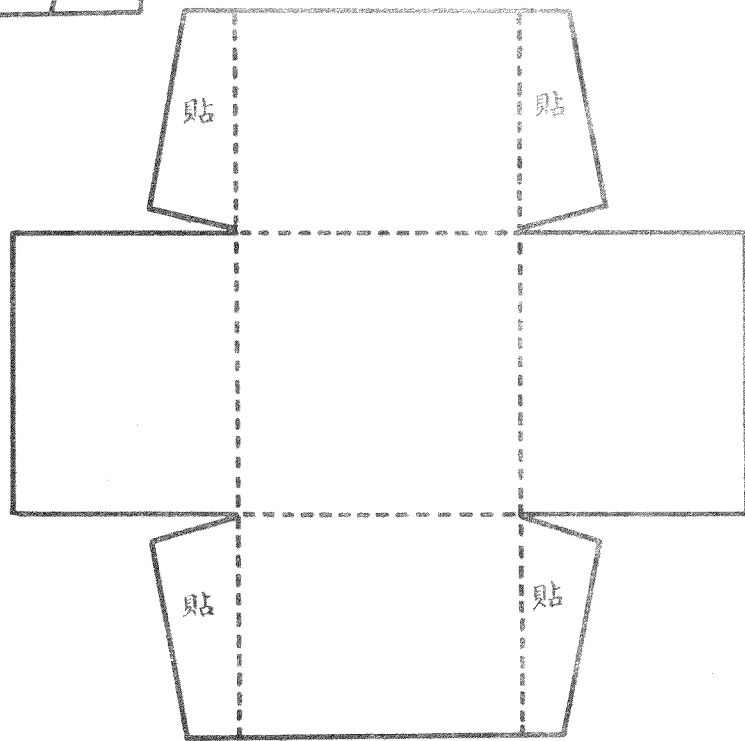
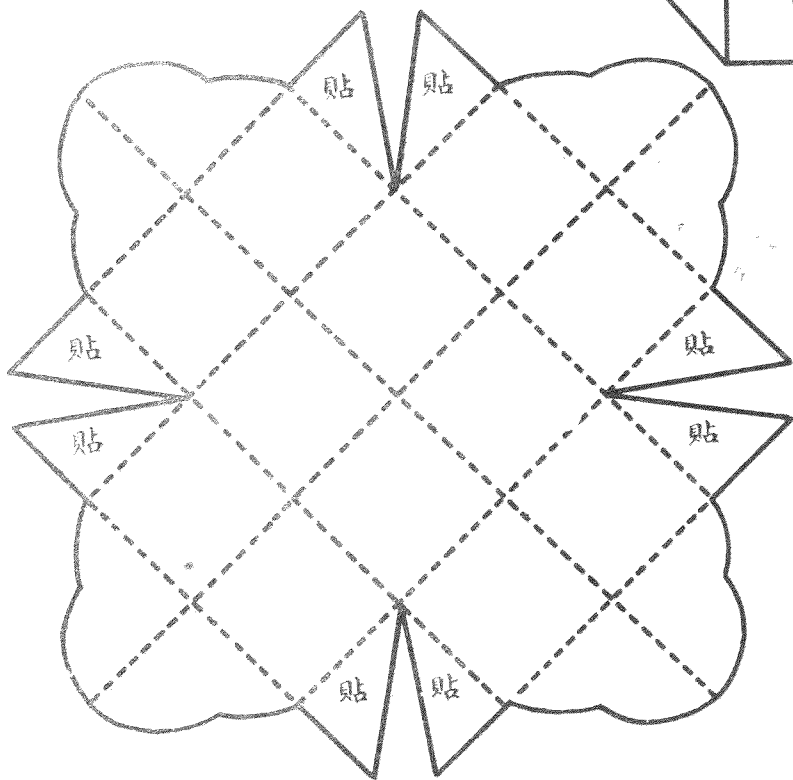
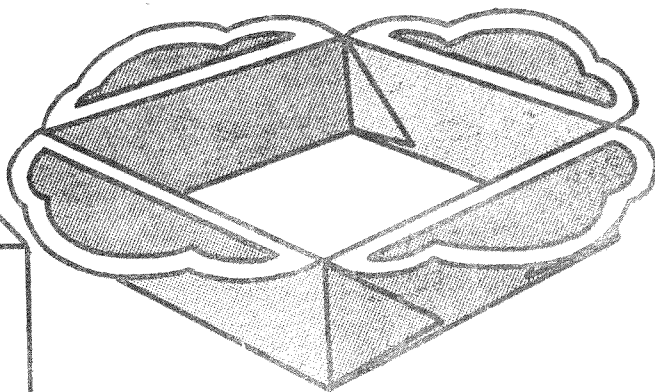
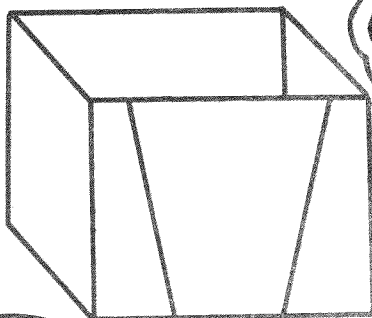

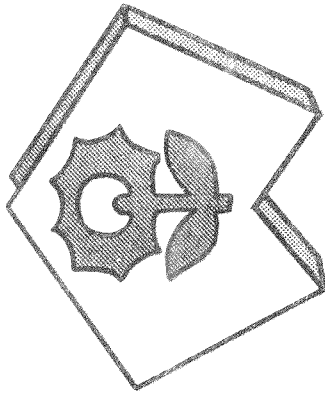
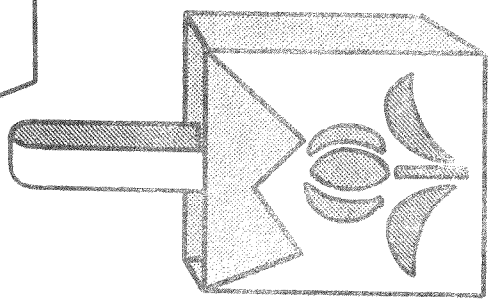
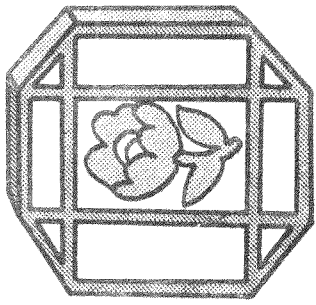
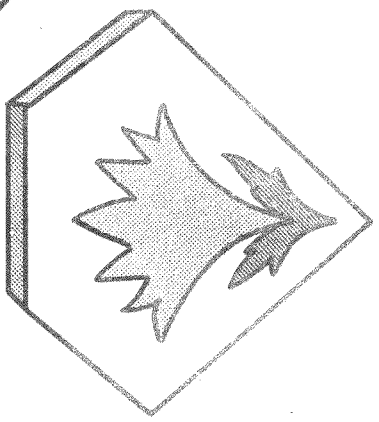
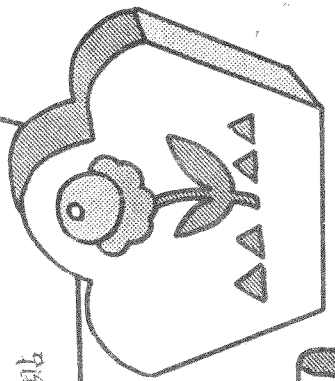
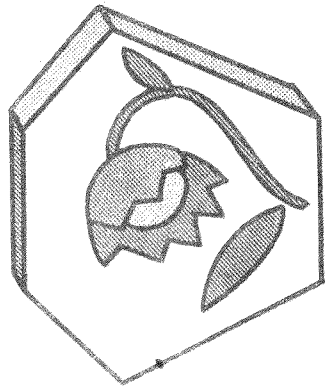
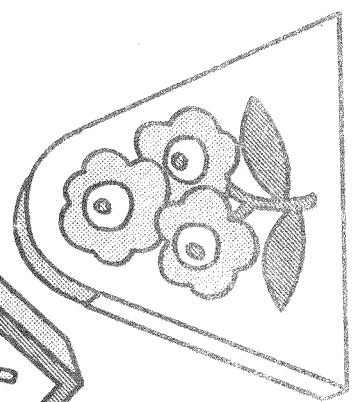
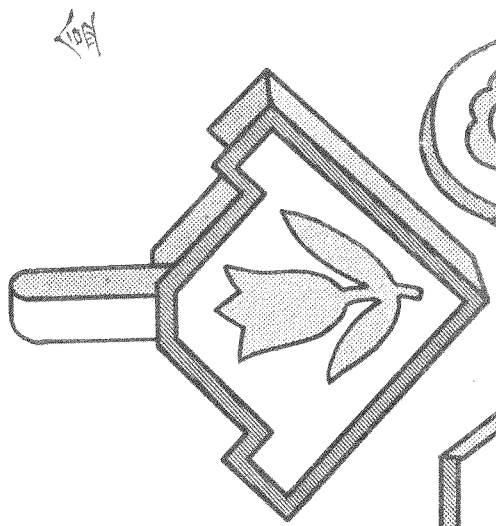
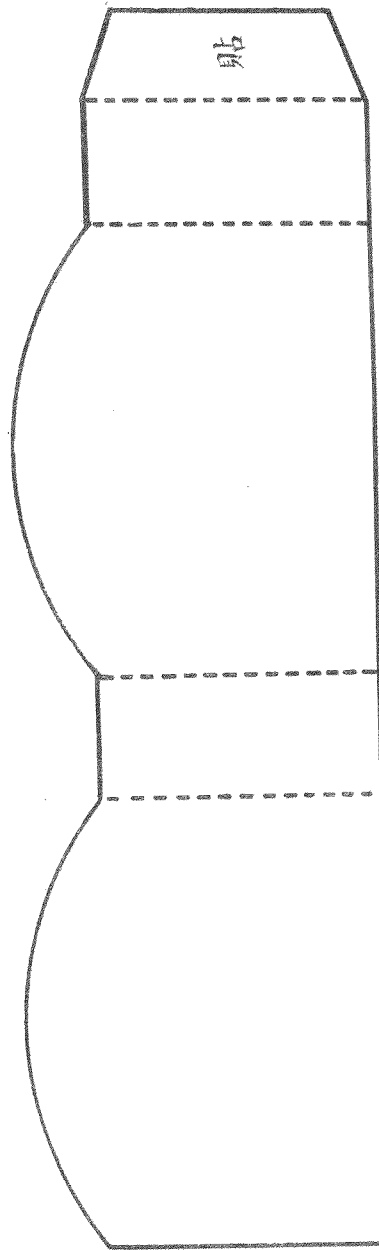

杯

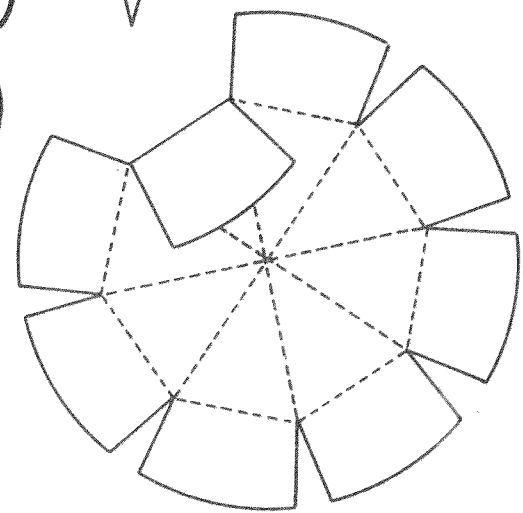
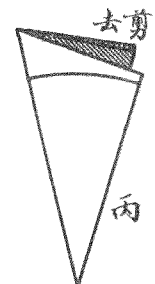
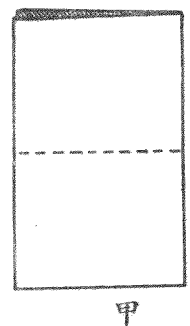
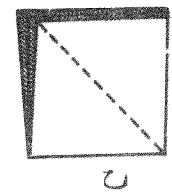
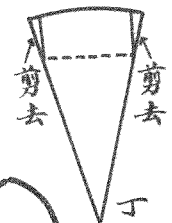
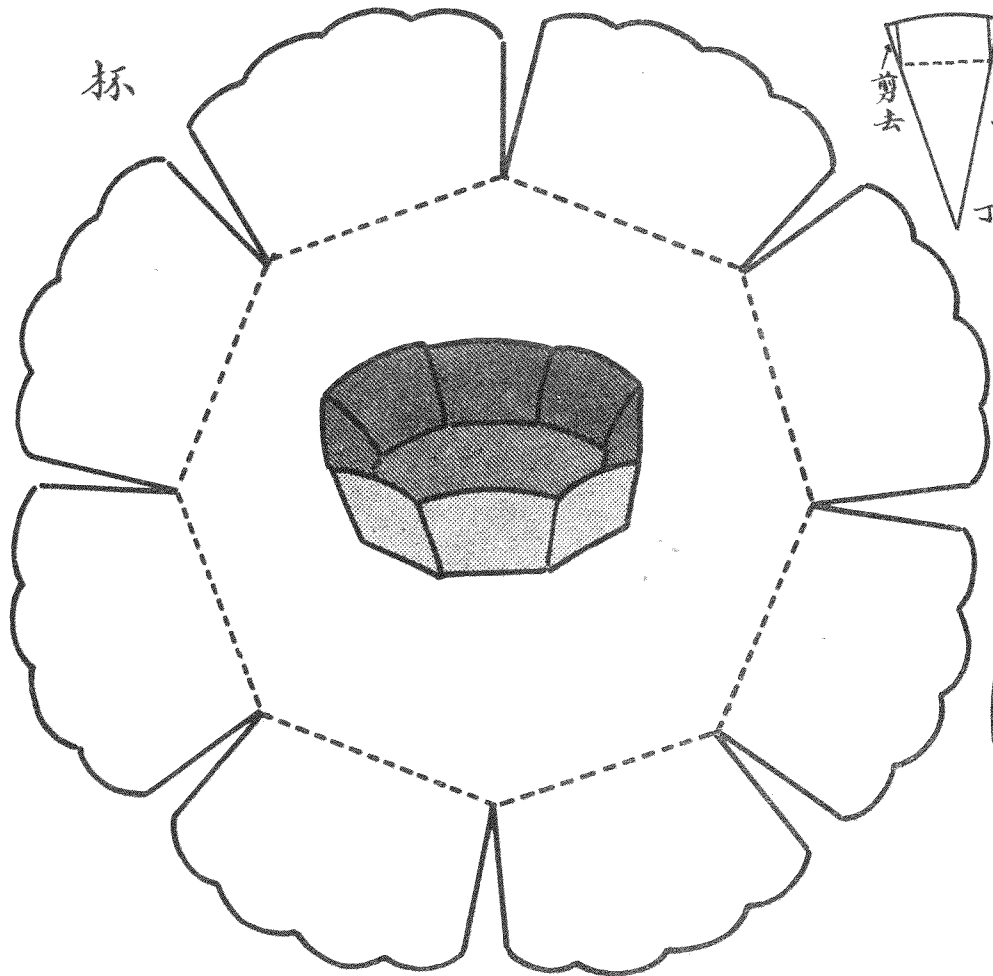

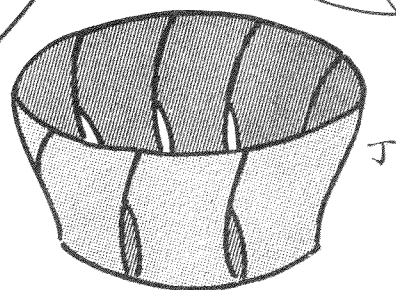
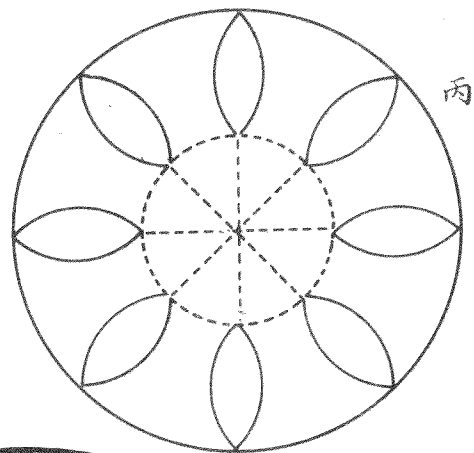
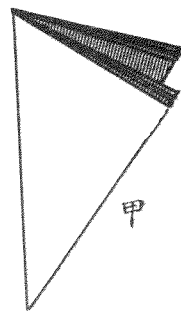
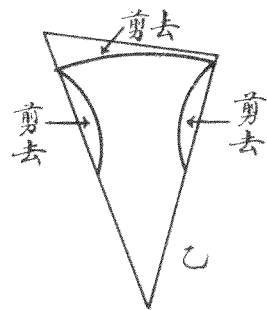
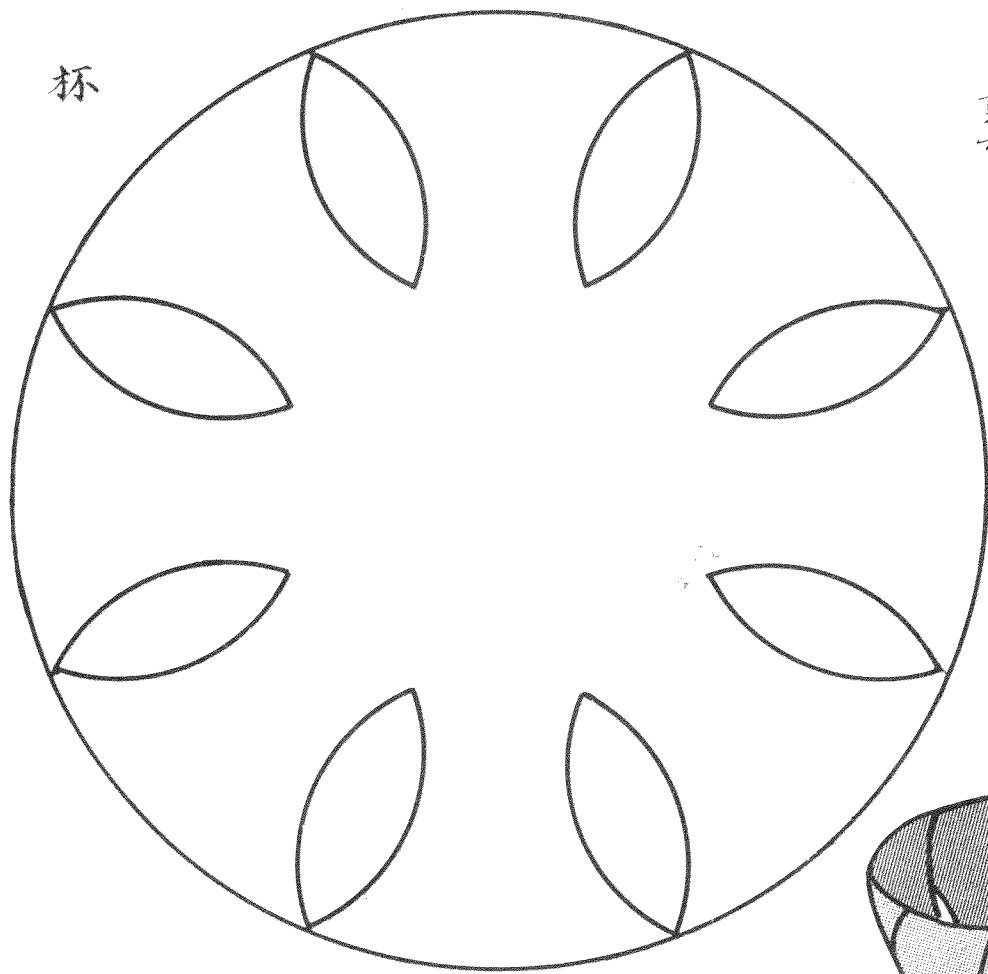

汽球

着色或剪贴

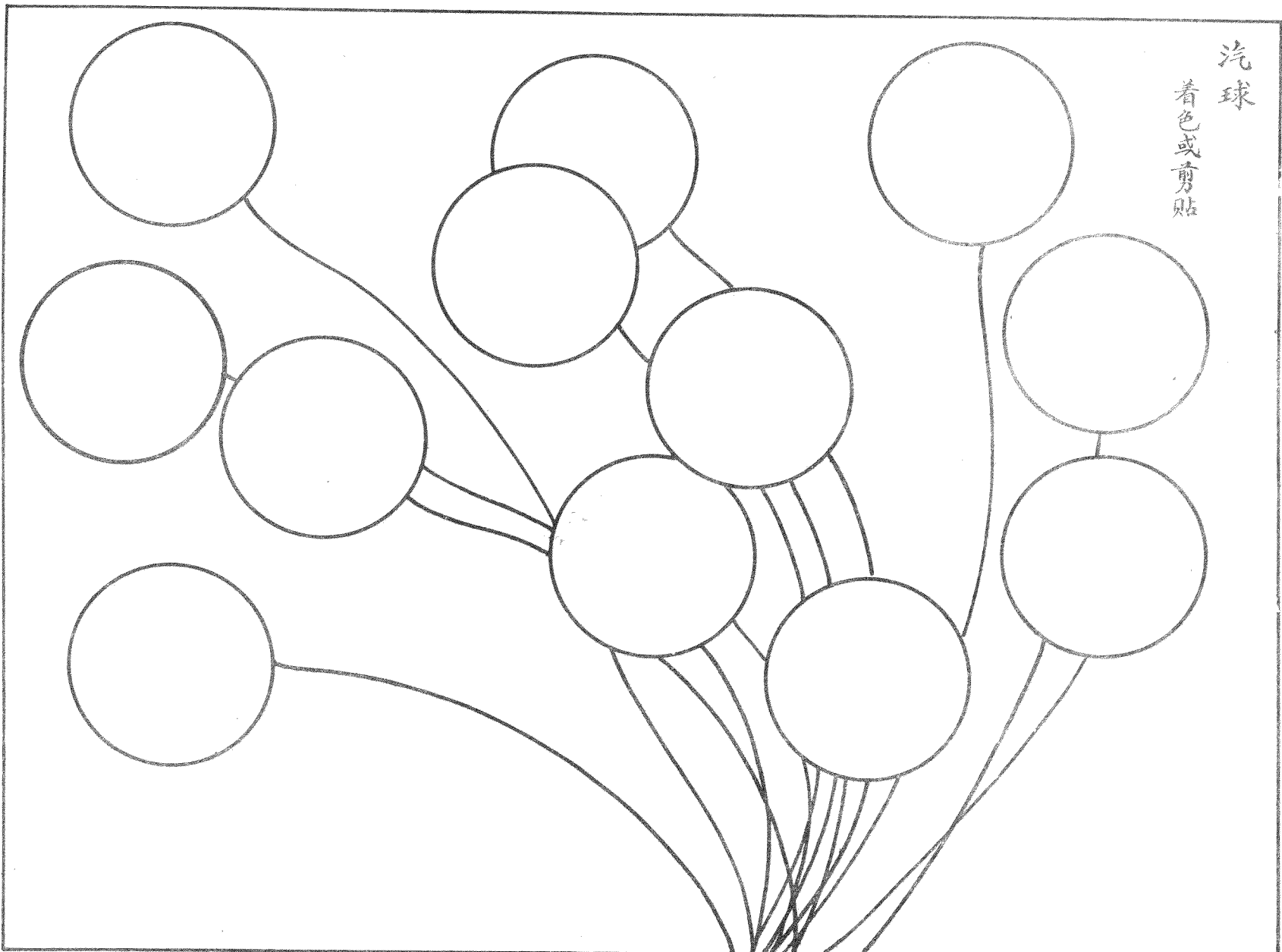

燭與燭盤

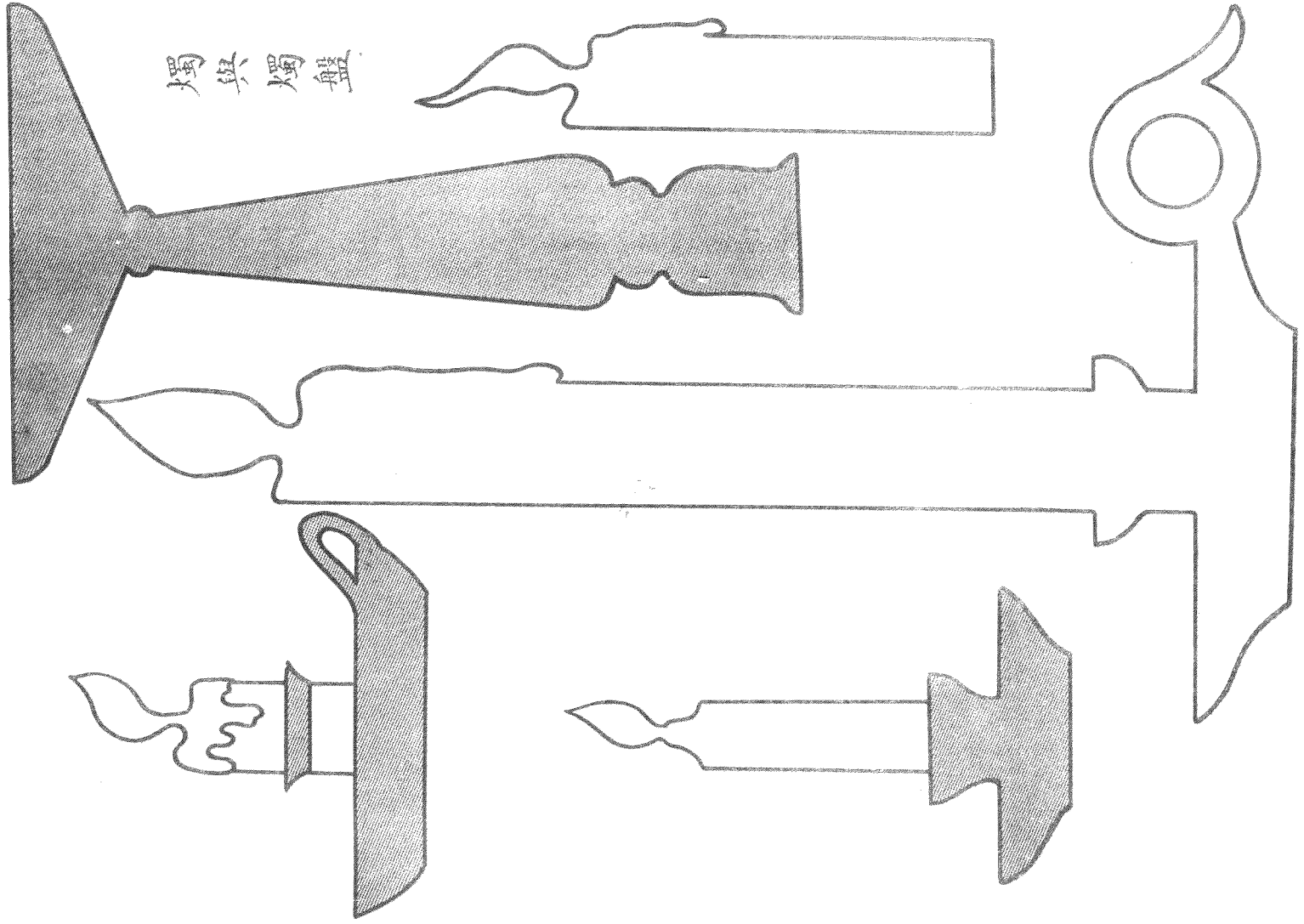

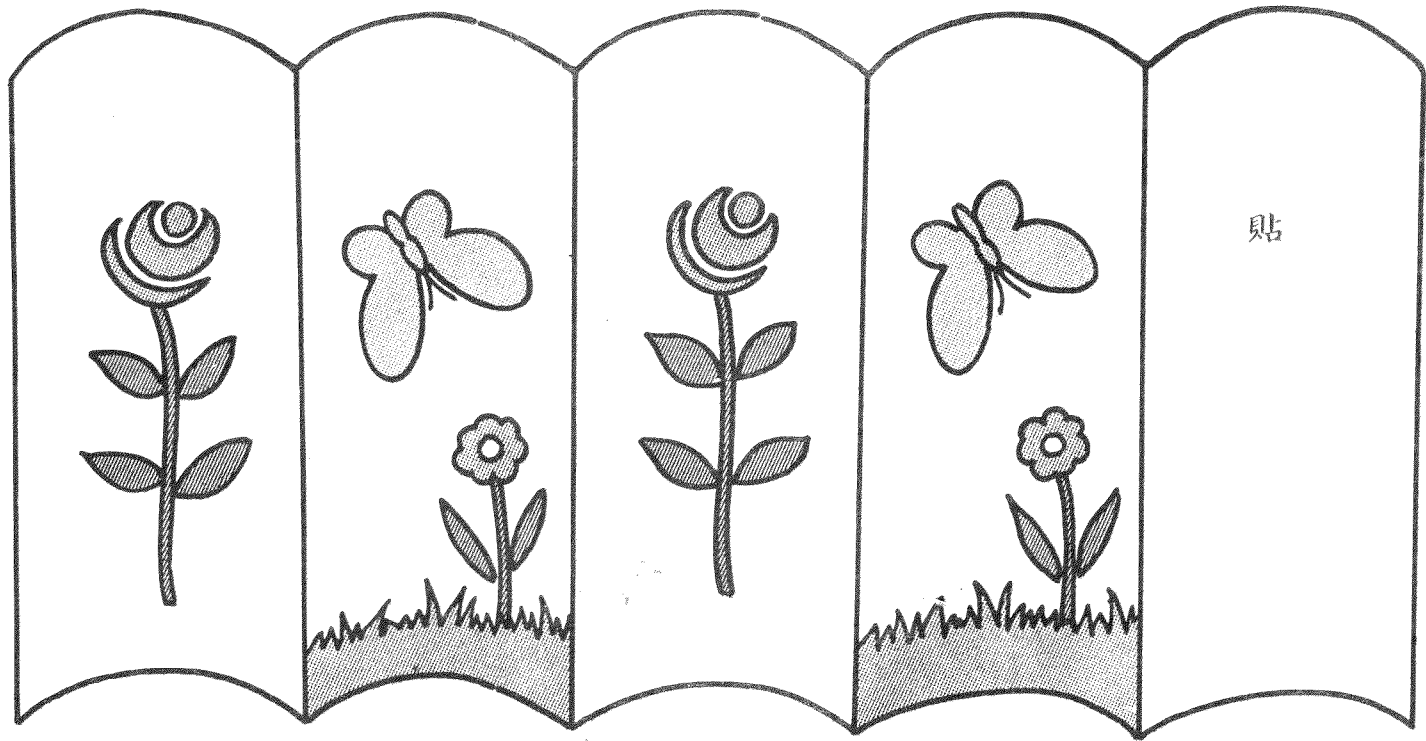

貼 貼

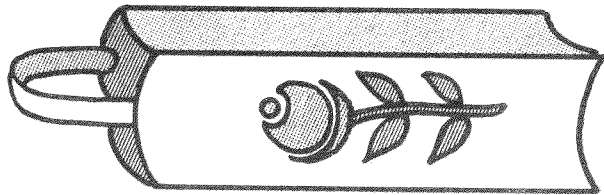

燈
罩

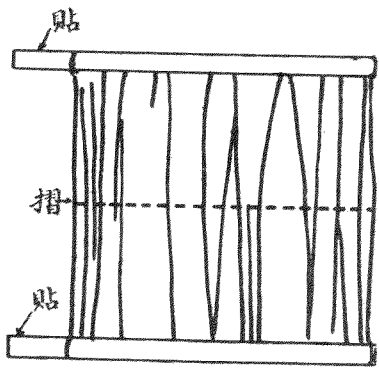

燈籠

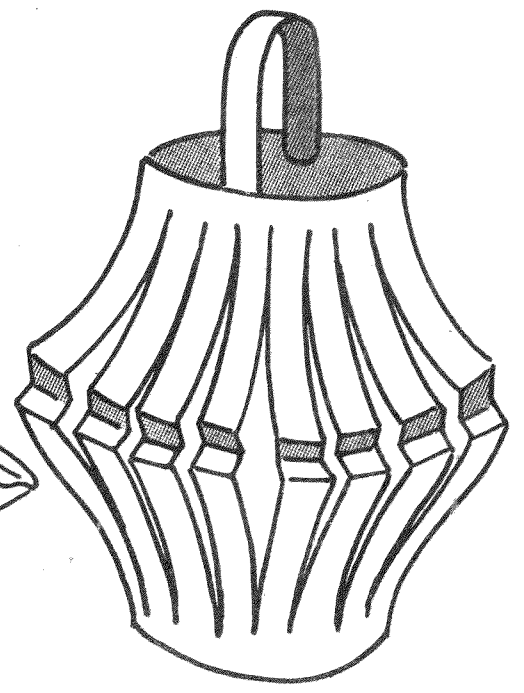
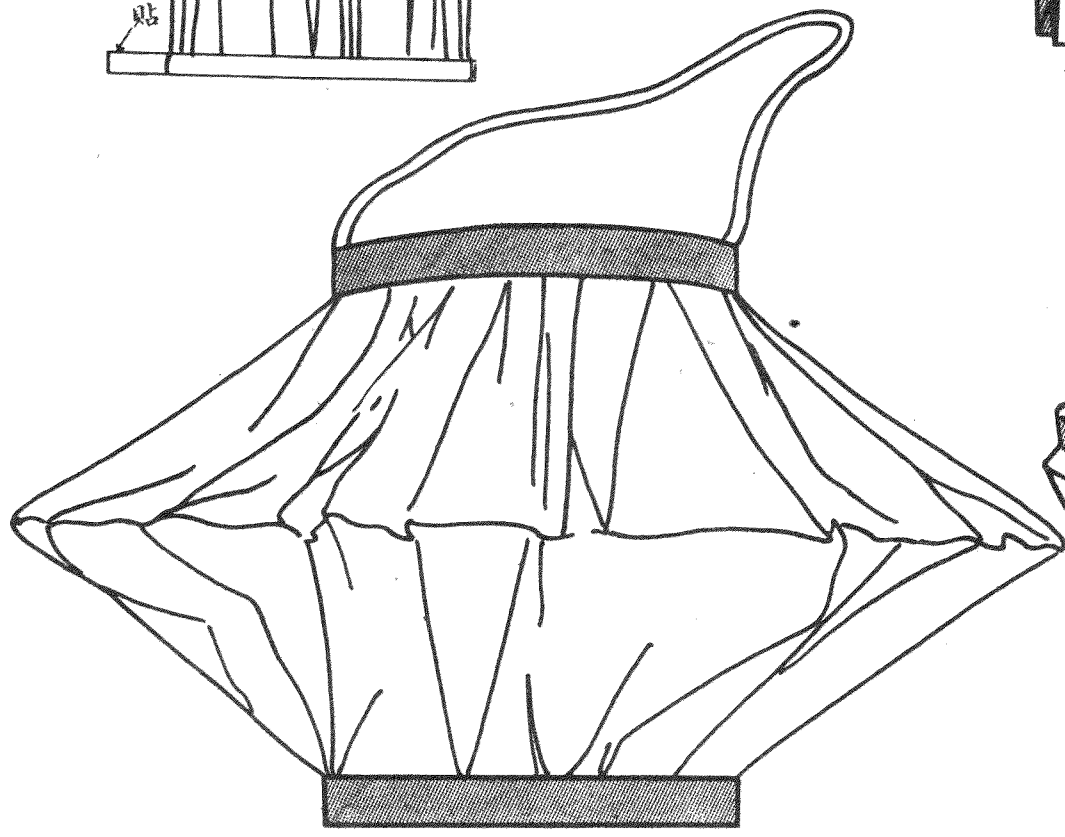
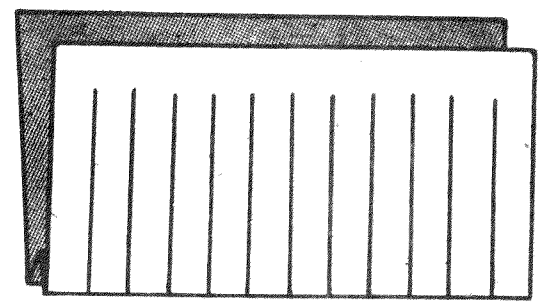

燈籠

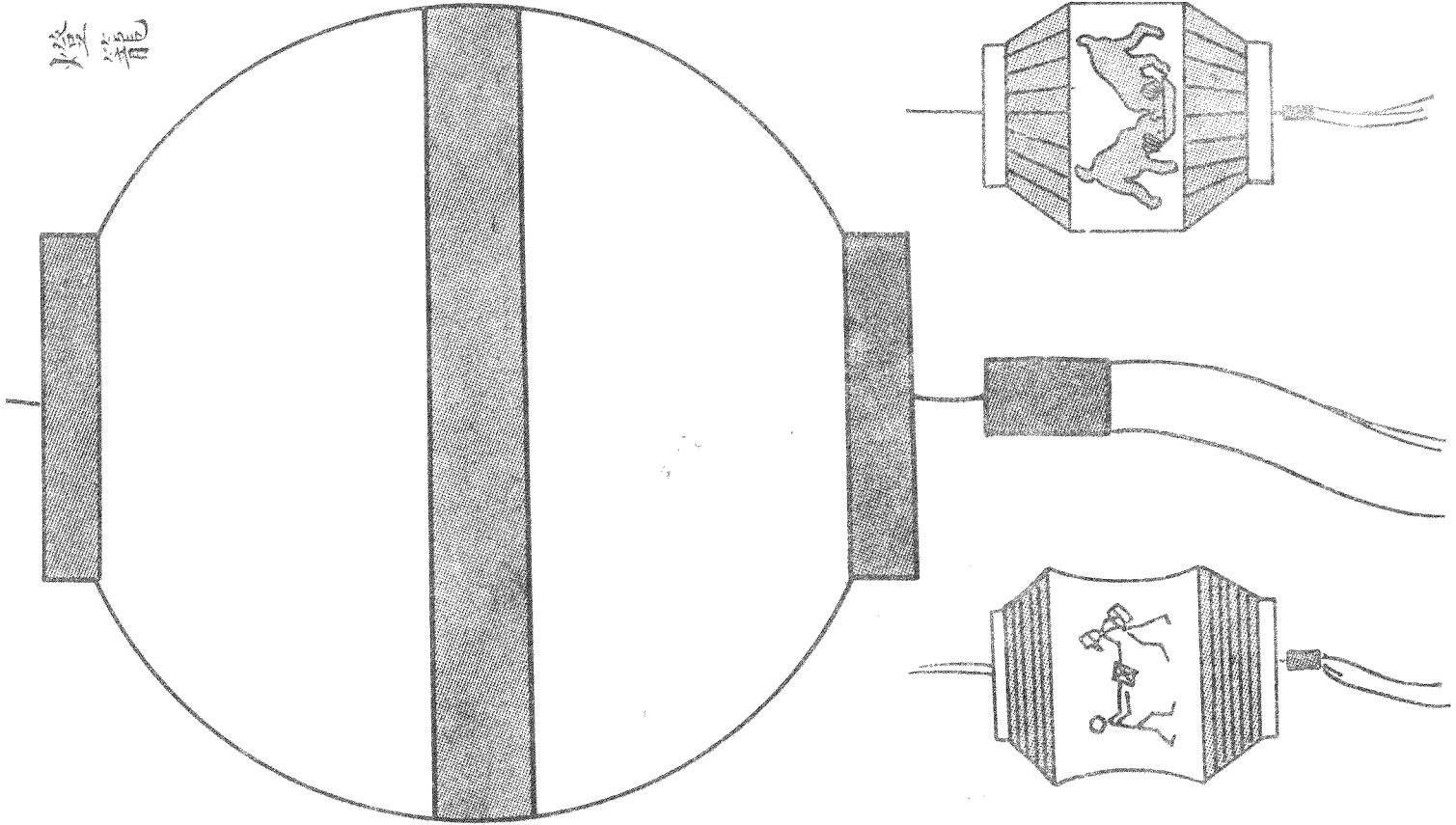

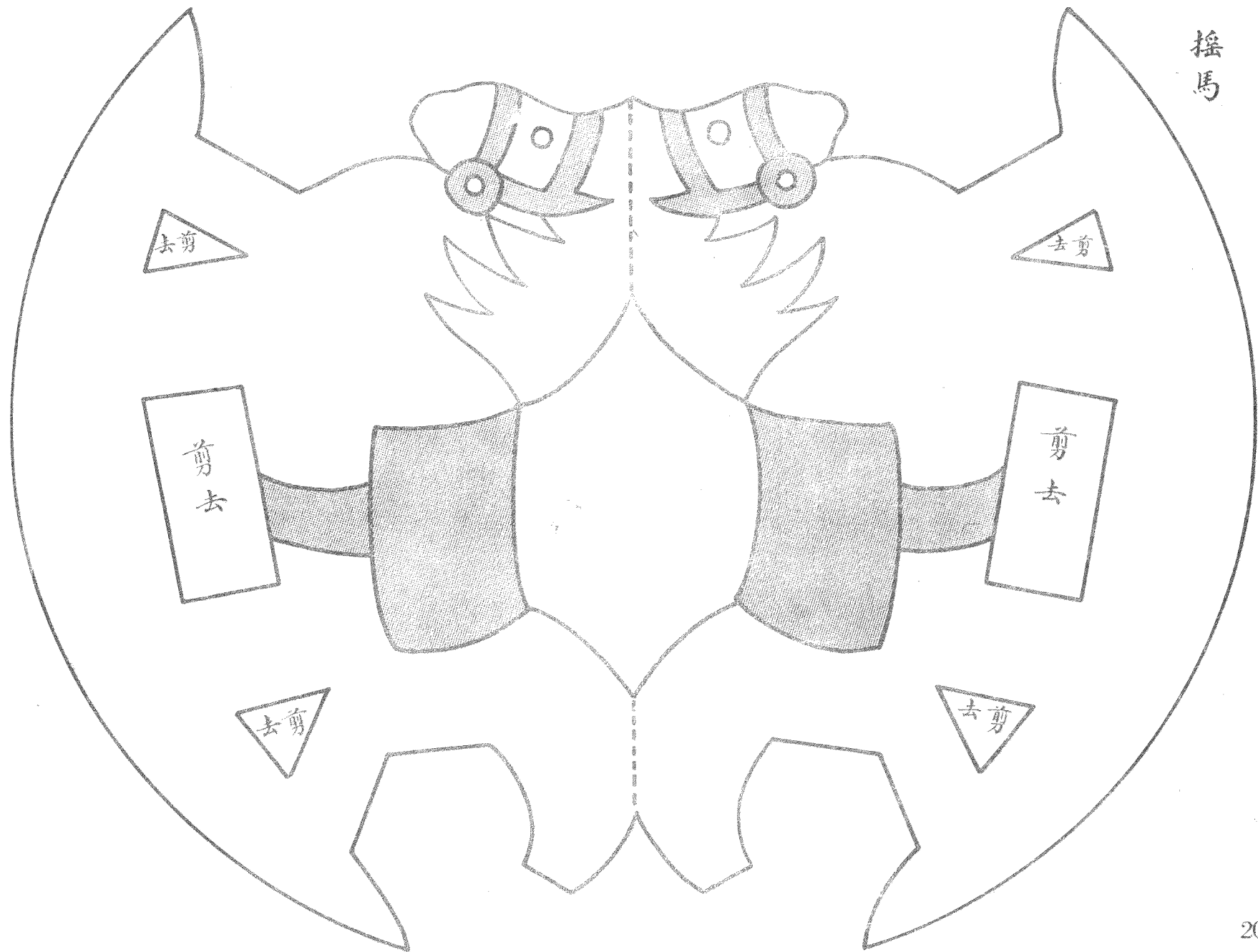

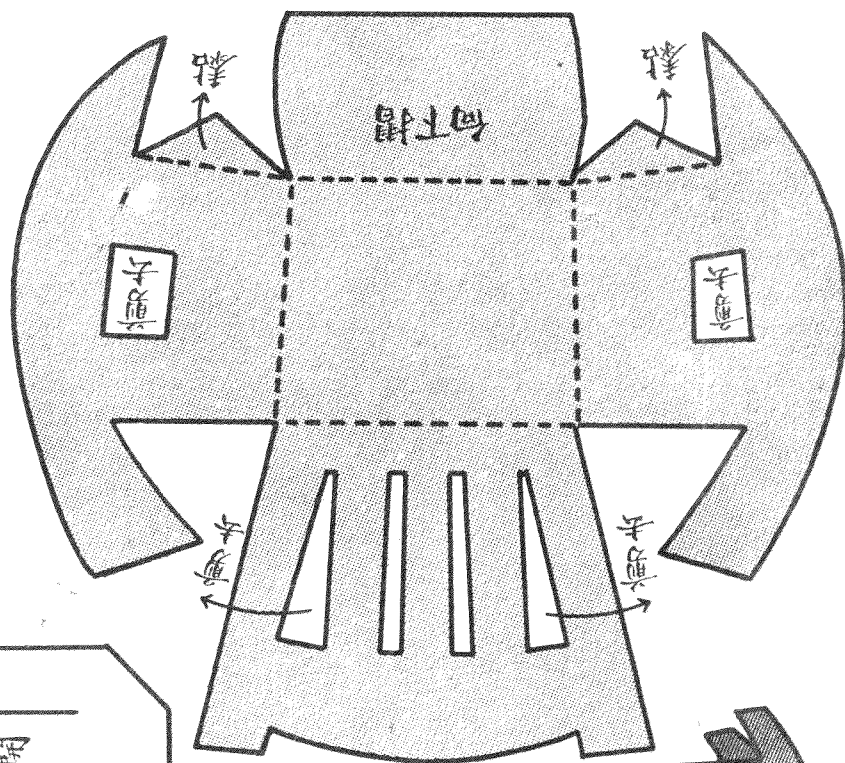
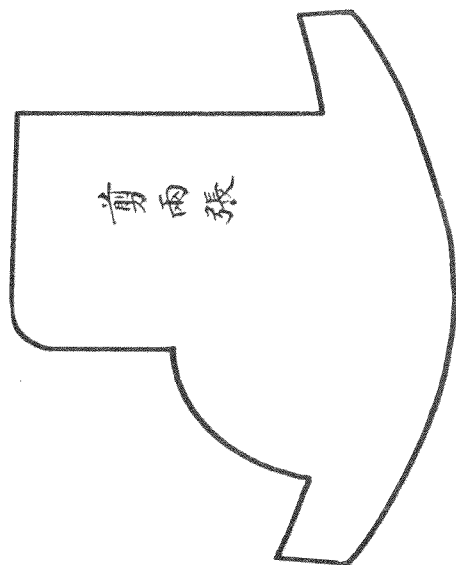
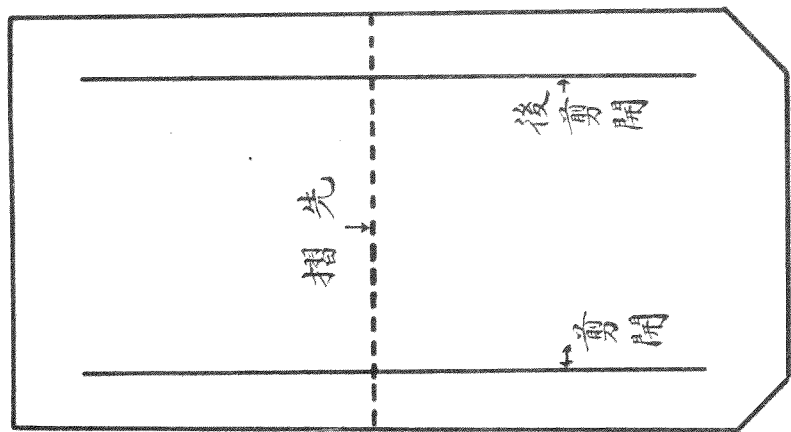

搖椅

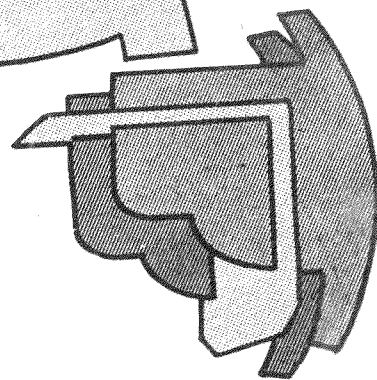

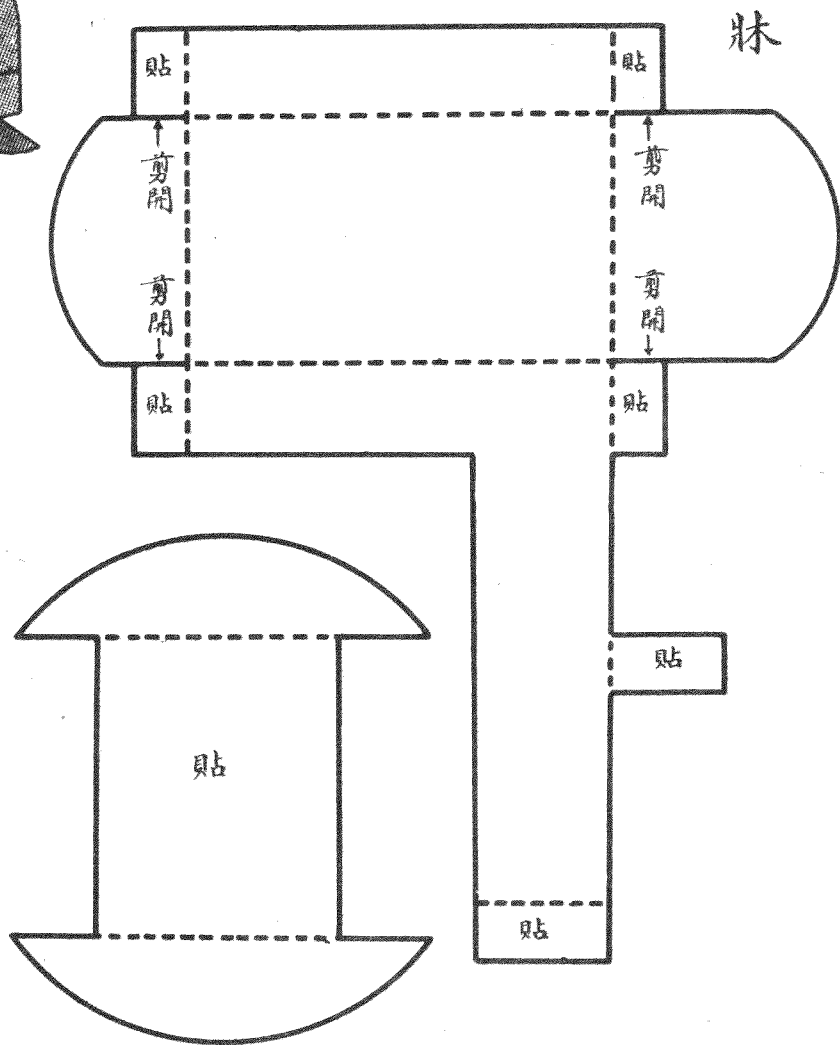
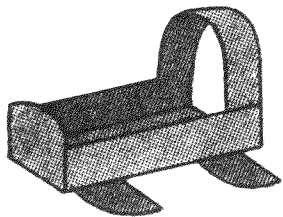
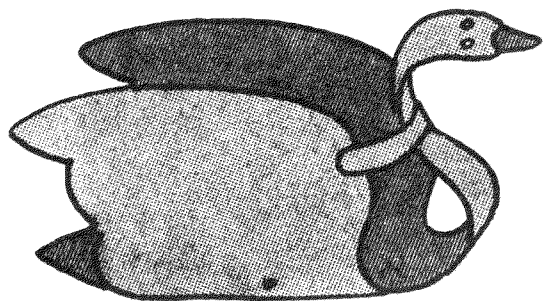
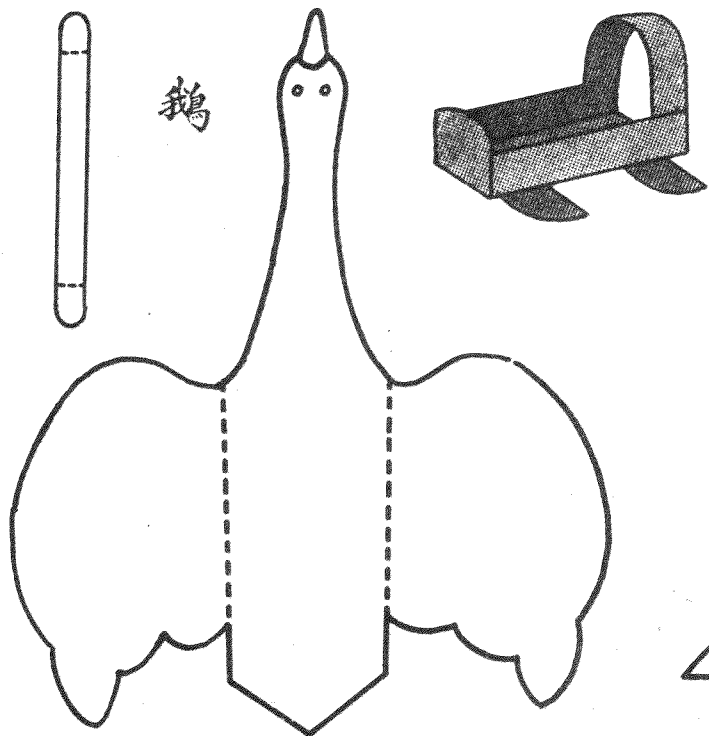

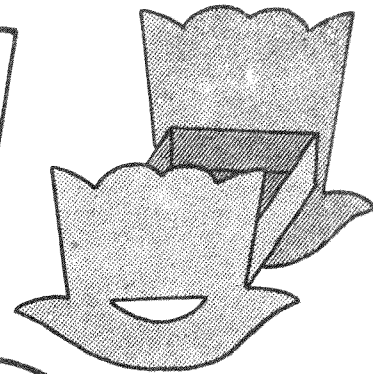
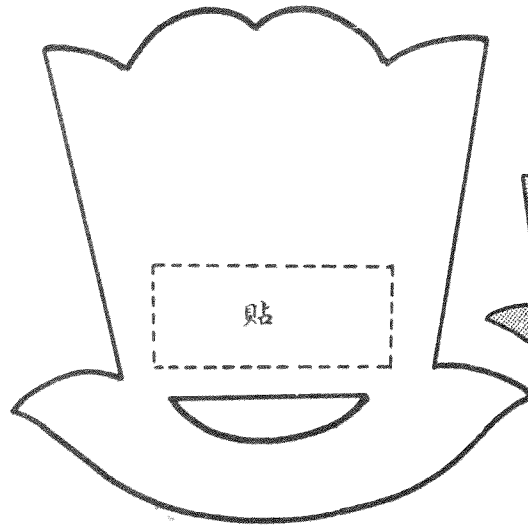
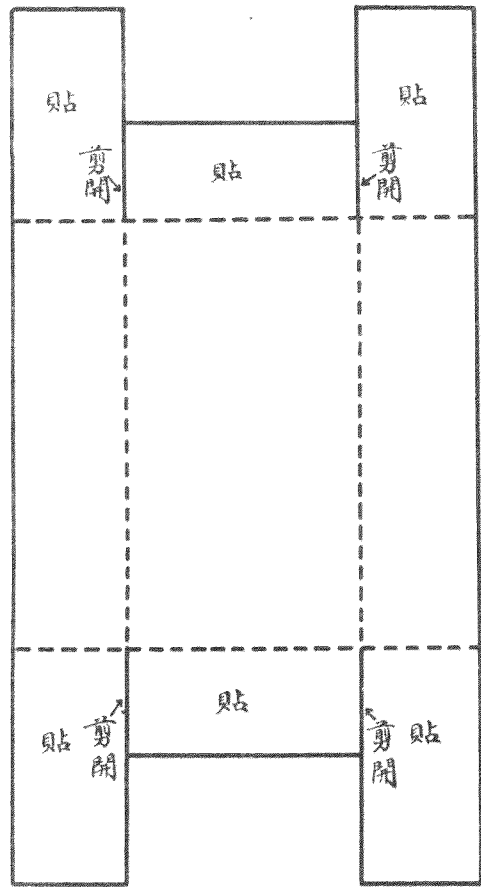

搖牀

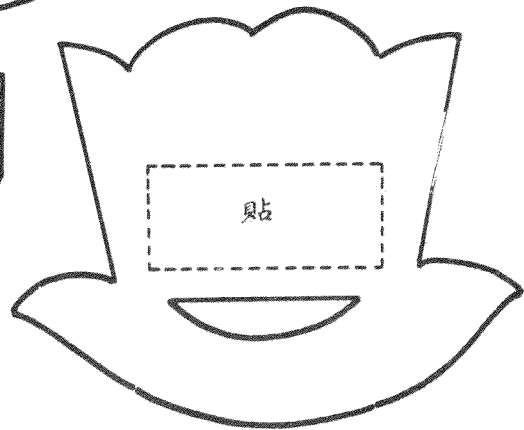
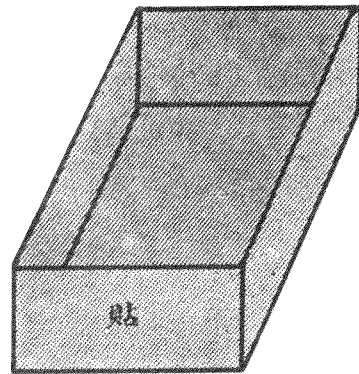

在大圓形紙的上面，剪兩條縫，把長紙條插入縫裡，長紙的兩端貼在小圓形紙上，就成一只圓桌了。

圓桌

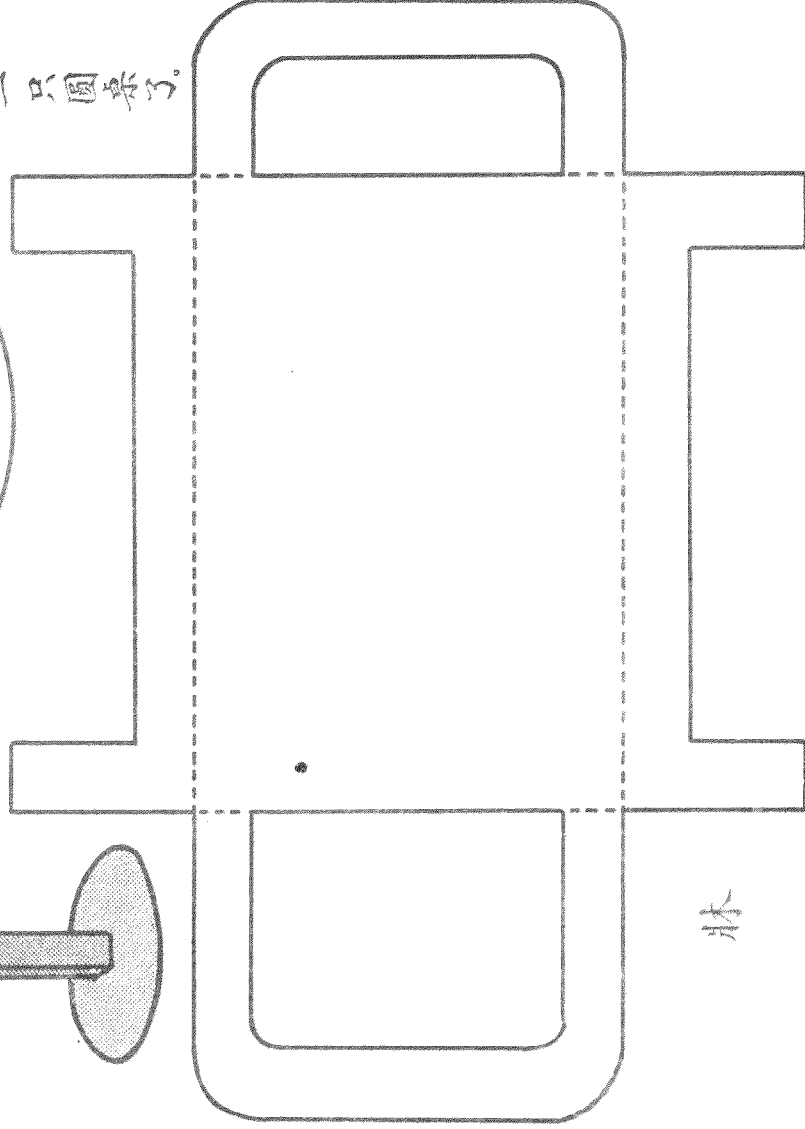
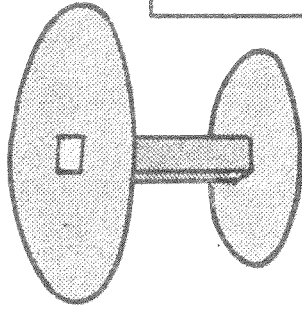
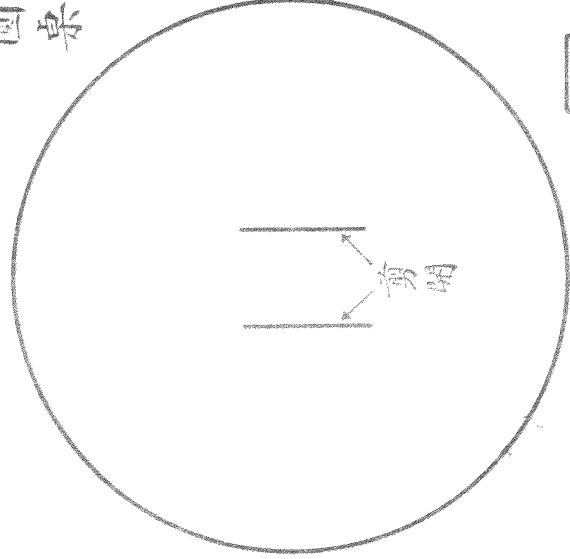
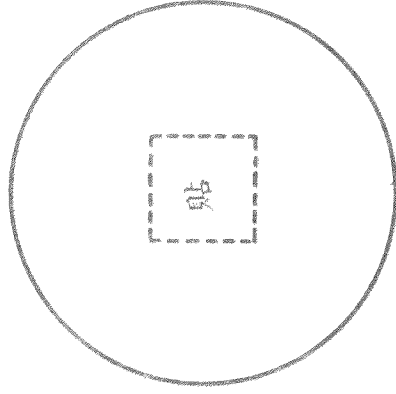

牀

房子

用一張長方形紙，把長的一邊摺成五格，
闊的一邊摺成四格，照圖畫窗門，剪貼起
來就成一座房子了。

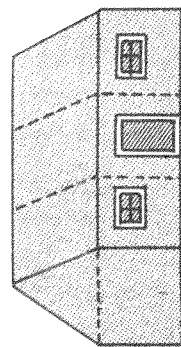
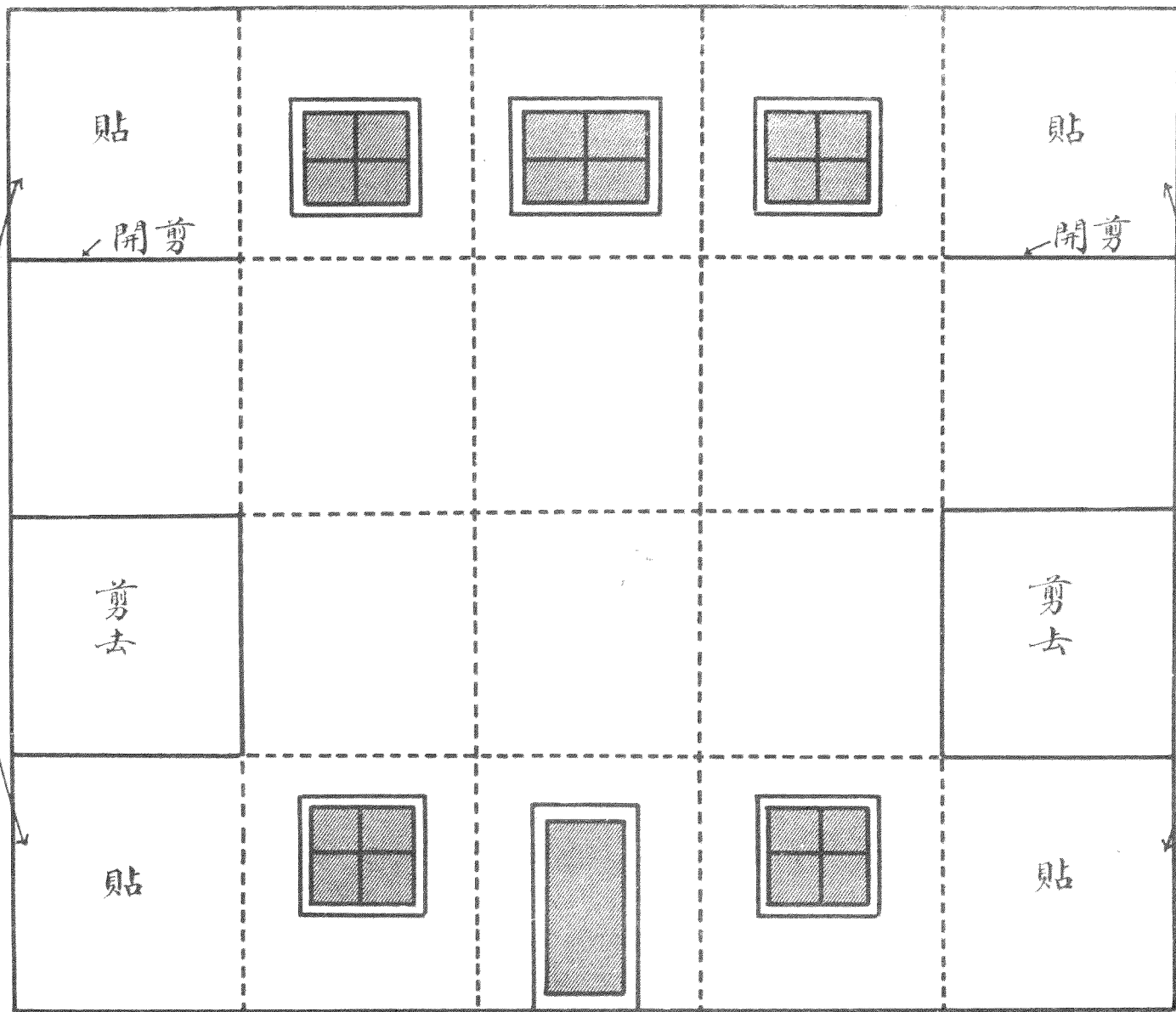

中華民國黨旗

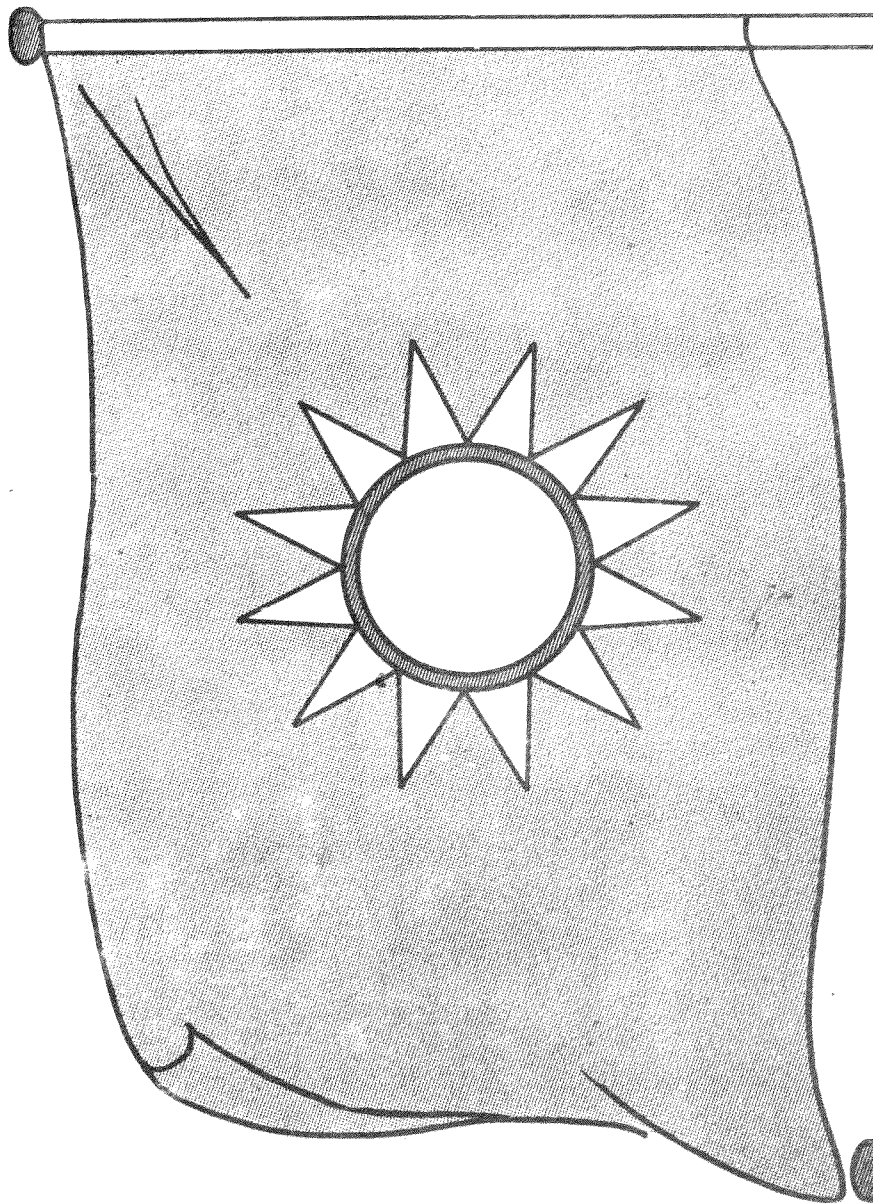

中華民國國旗

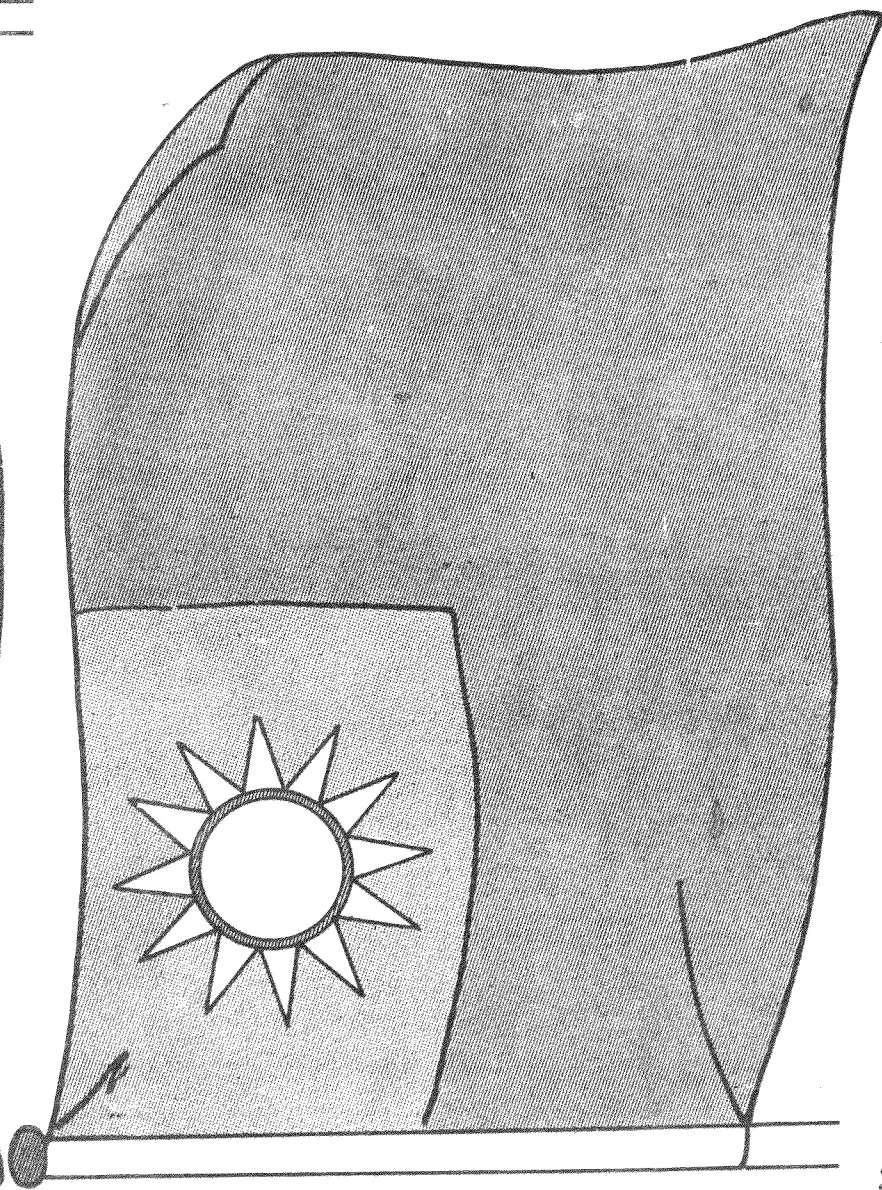

英國旗

白色

常青色

紅色

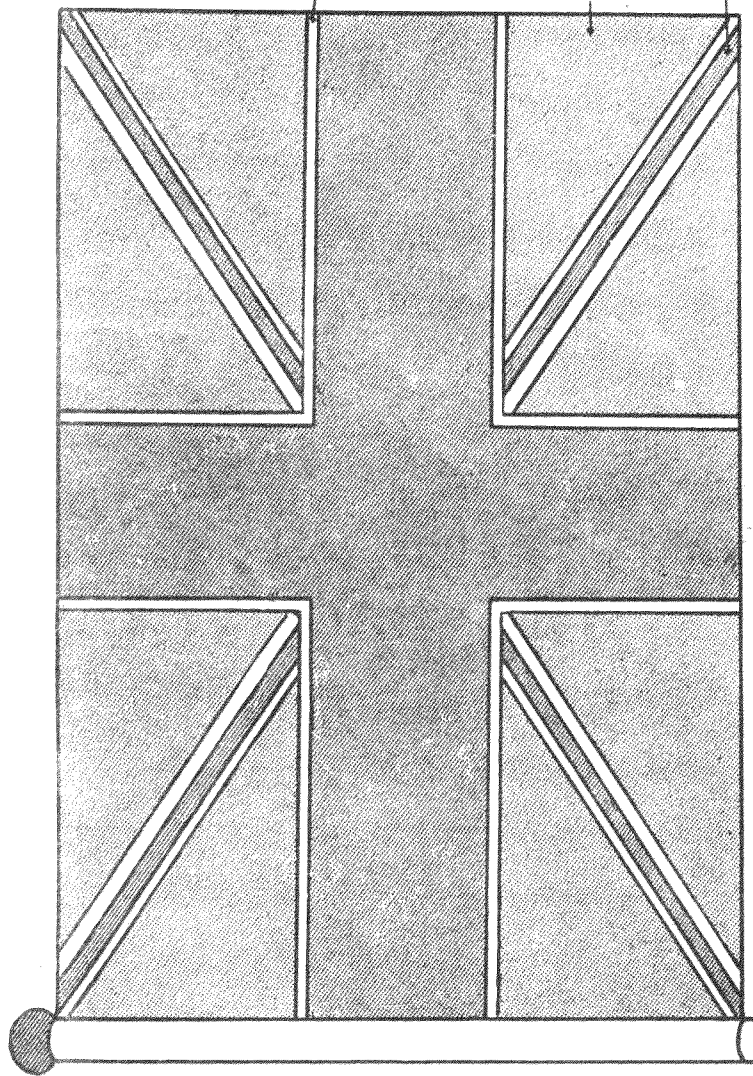

美國旗

七條紅色

六條白色

白星藍地

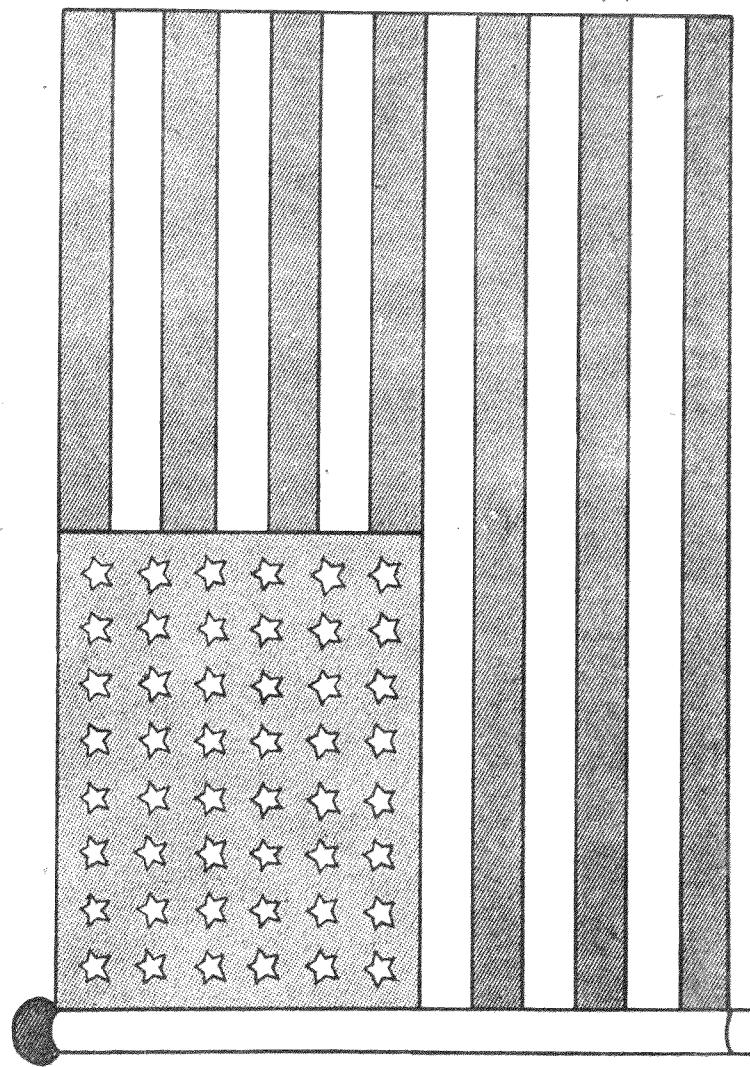

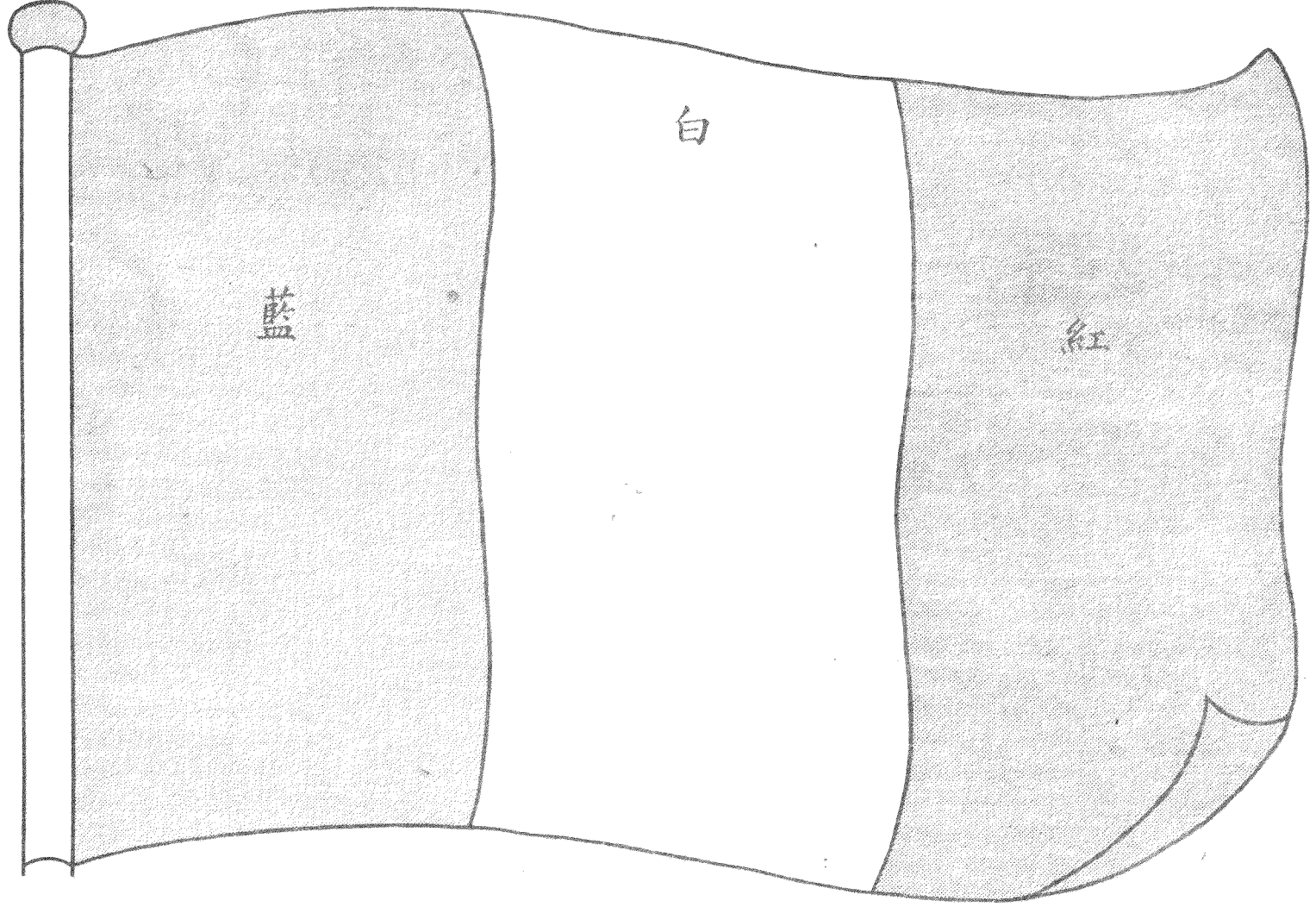

法國旗

印度旗

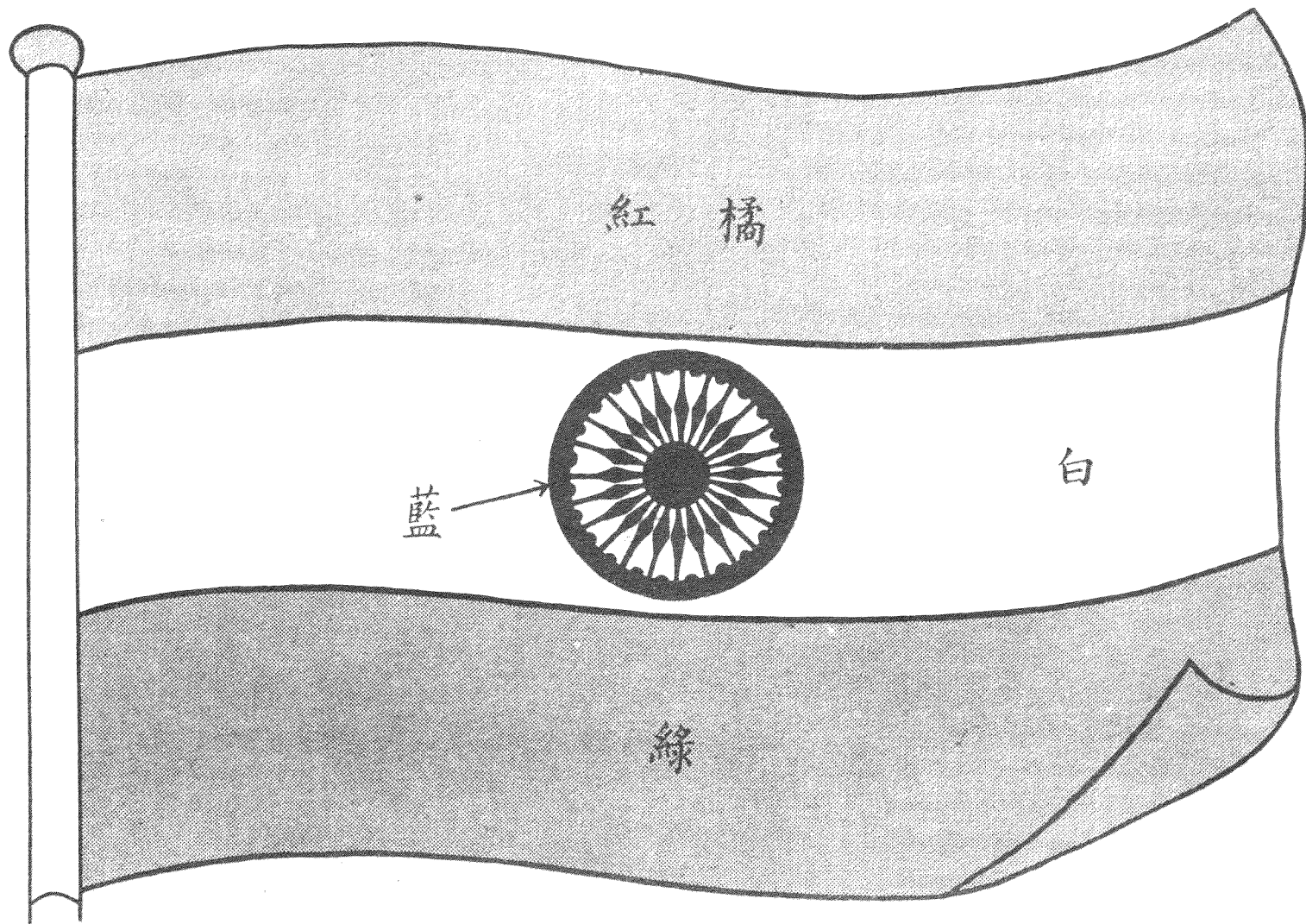

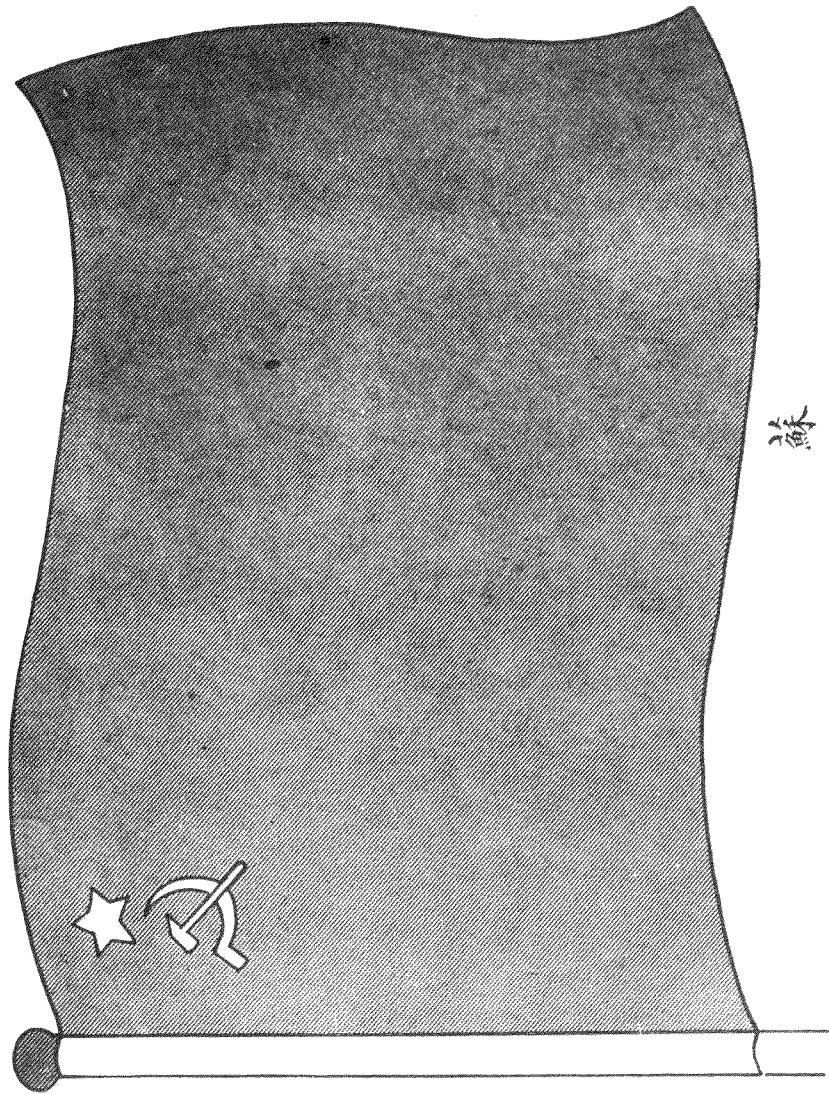

蘇聯國旗
旗紅色
星、鐮、錘黃色

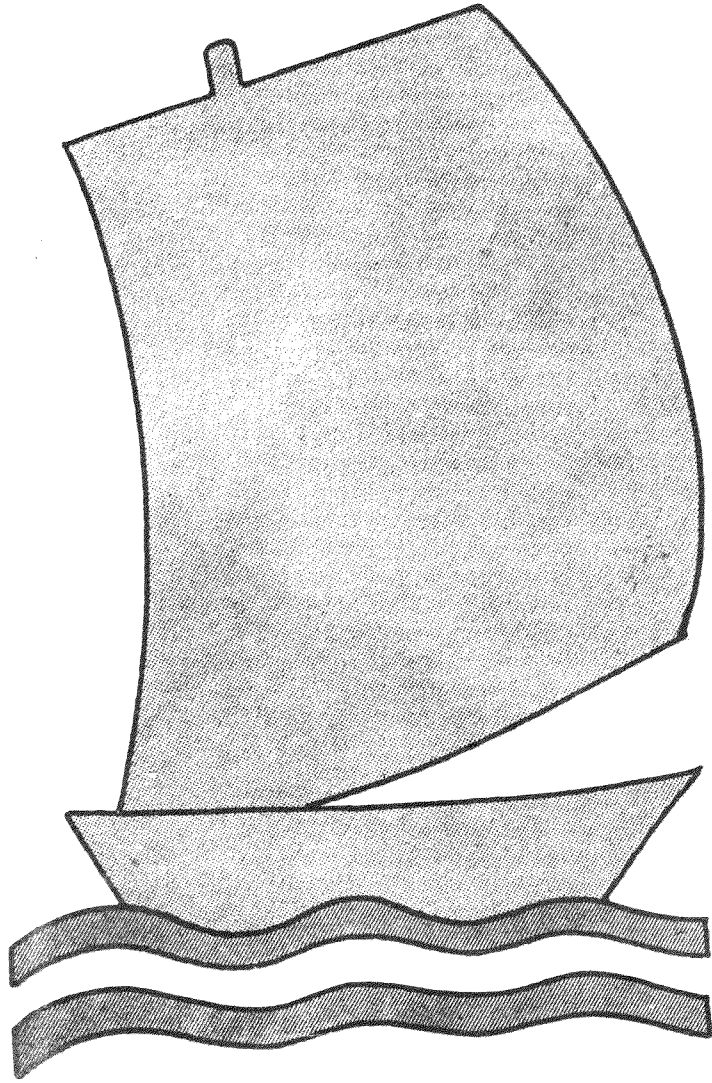

帆船

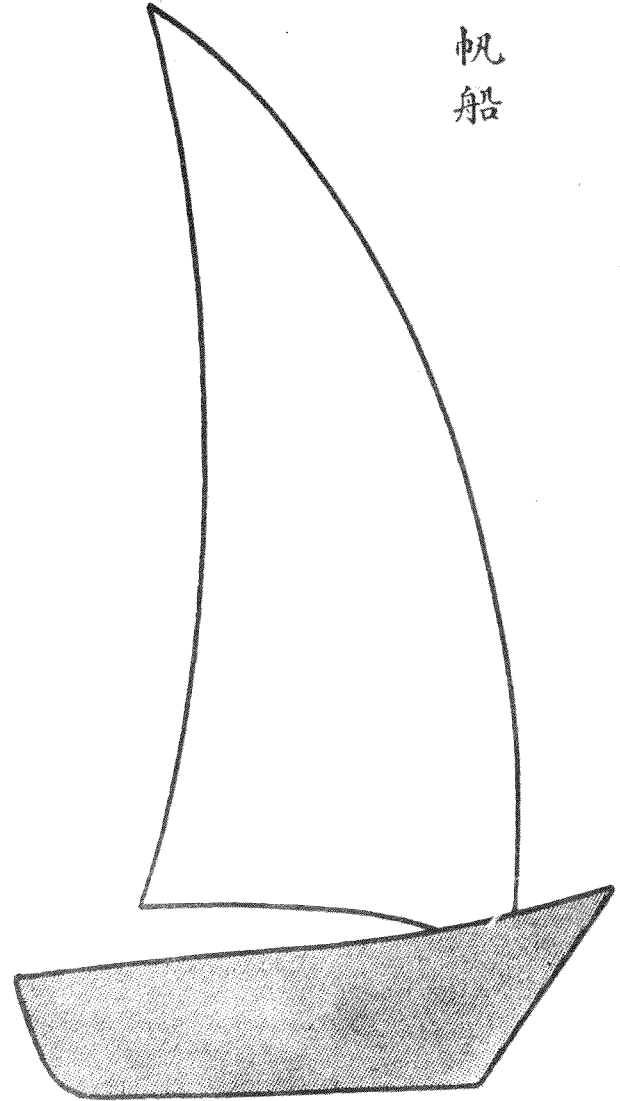

輪
船

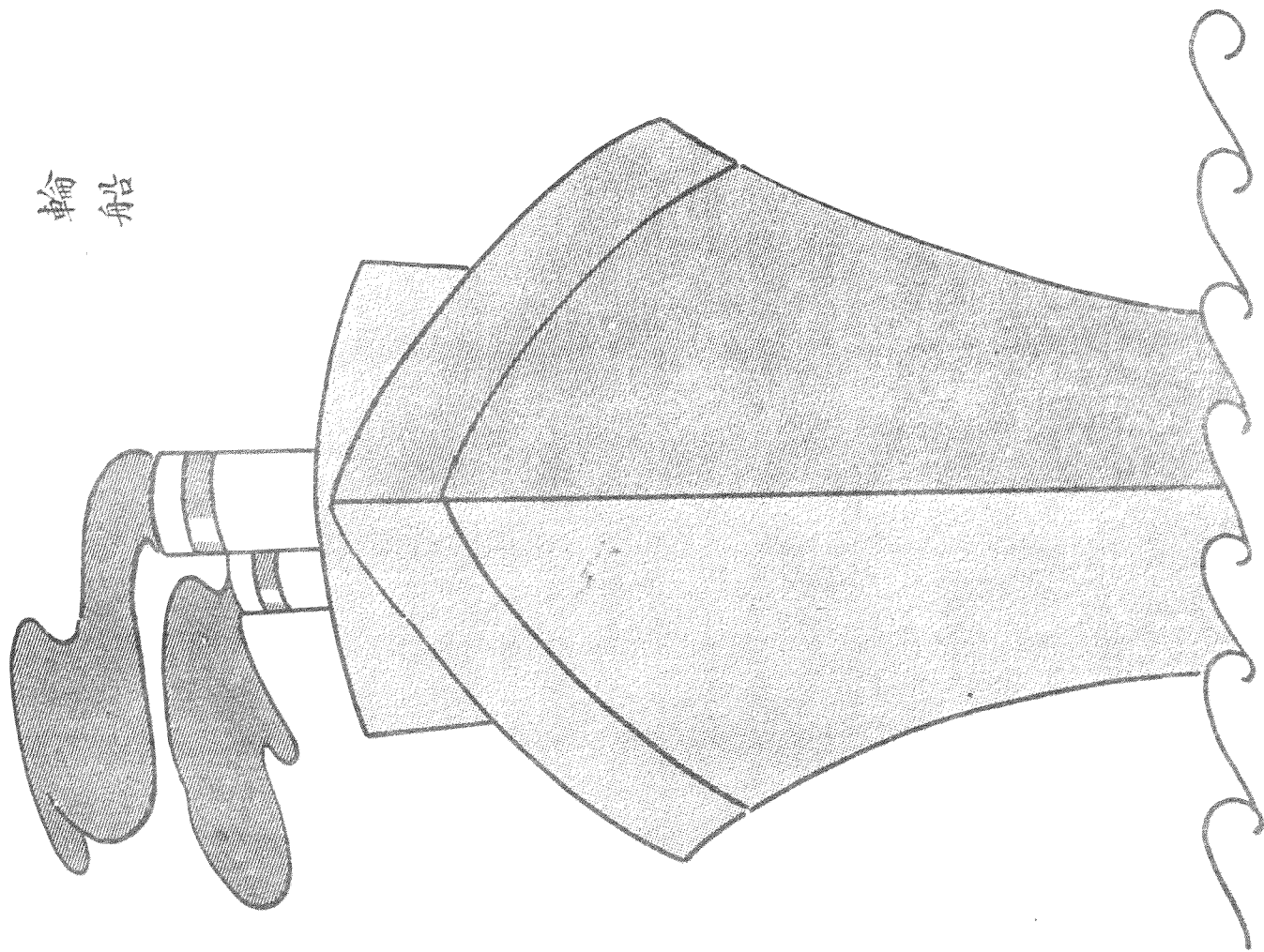

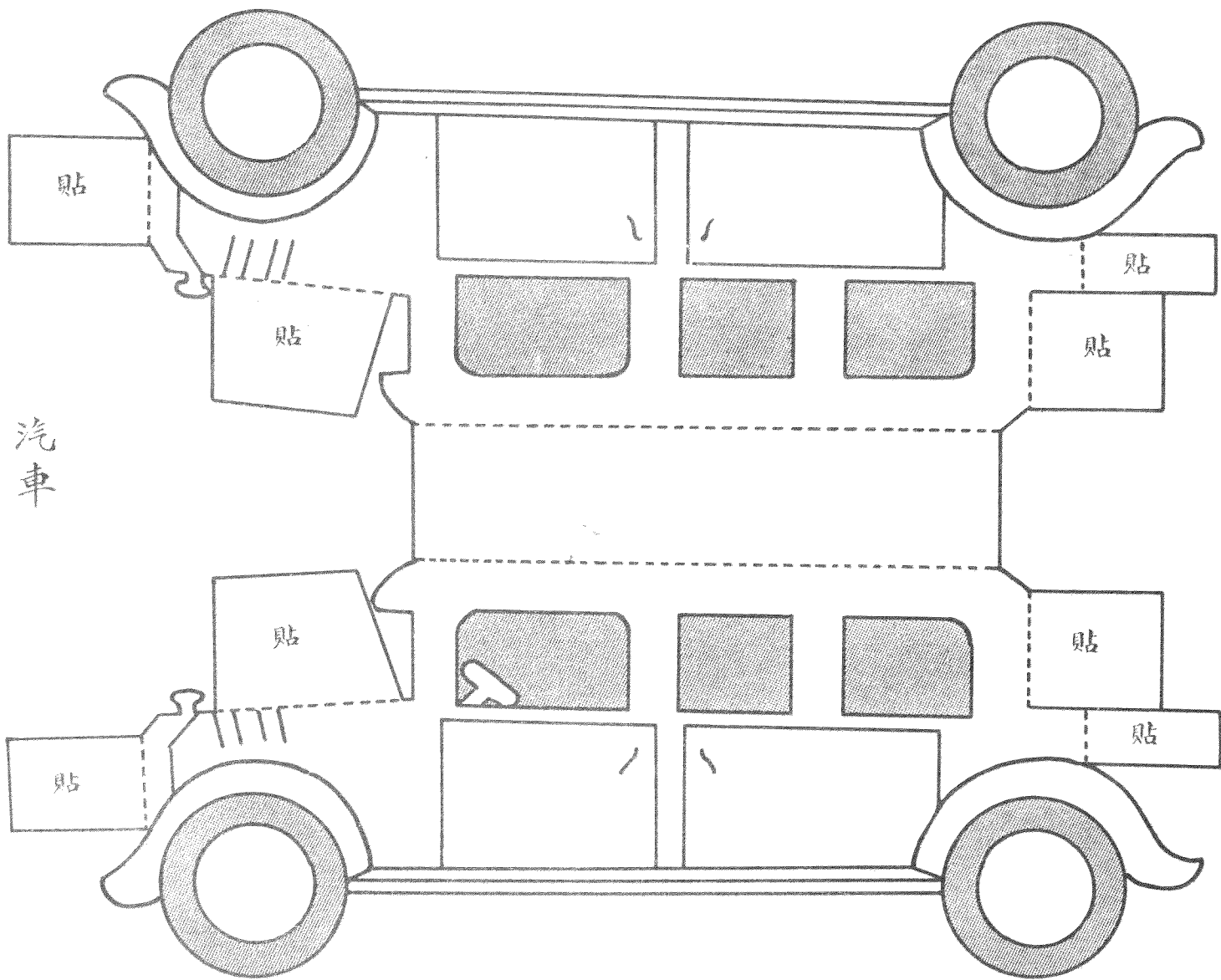

汽車

汽車

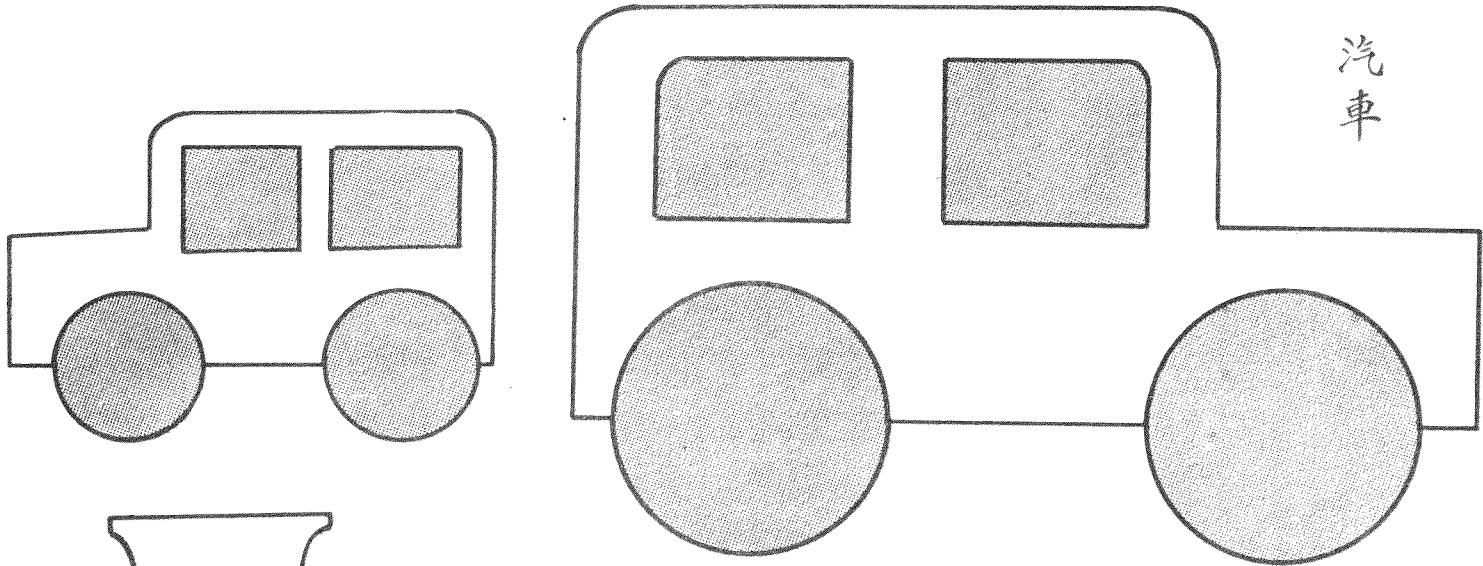

火車

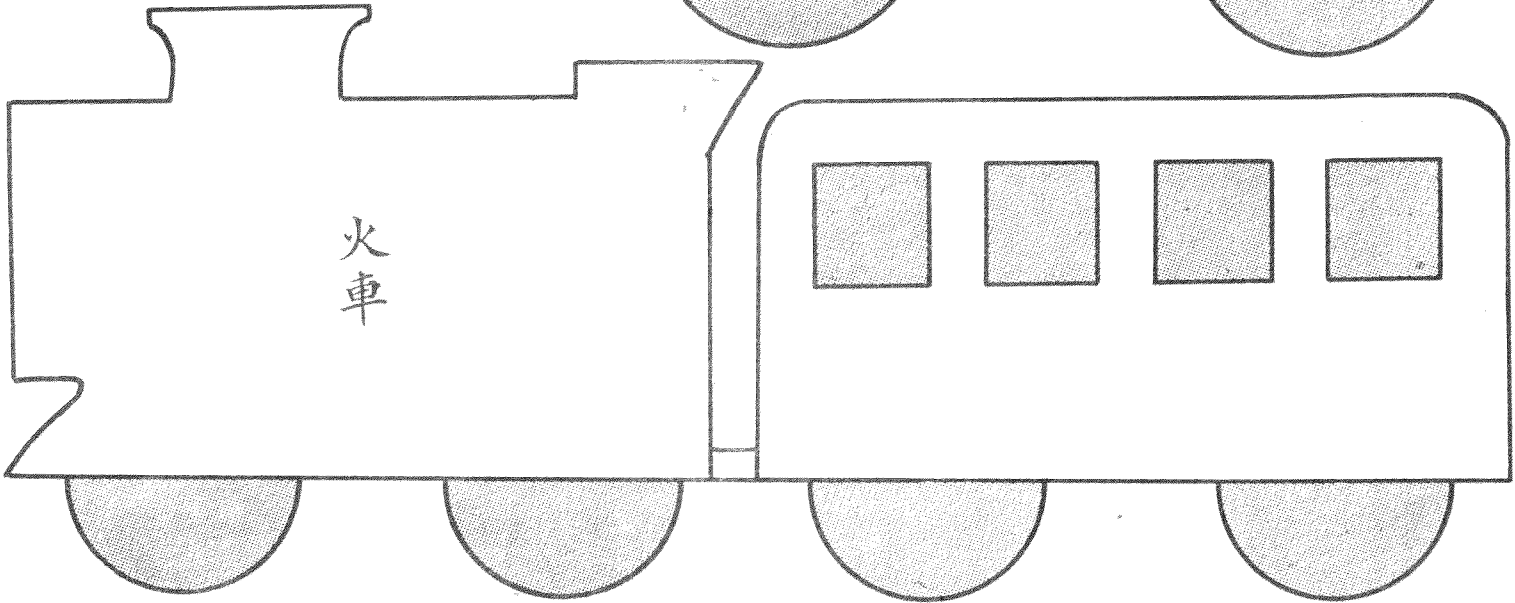

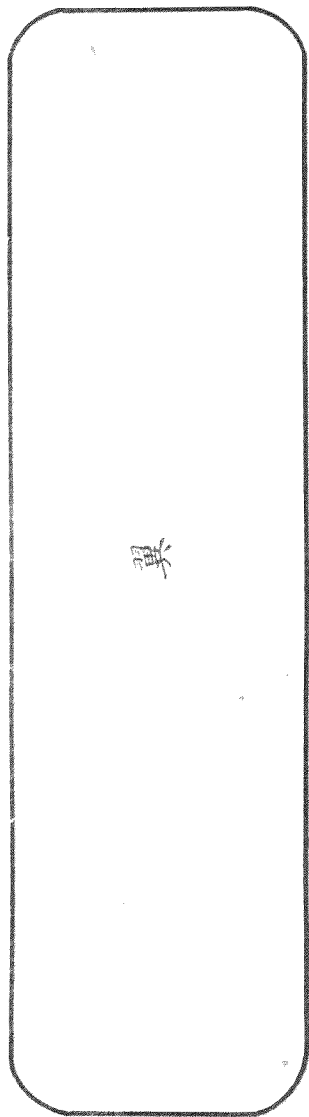

飛機

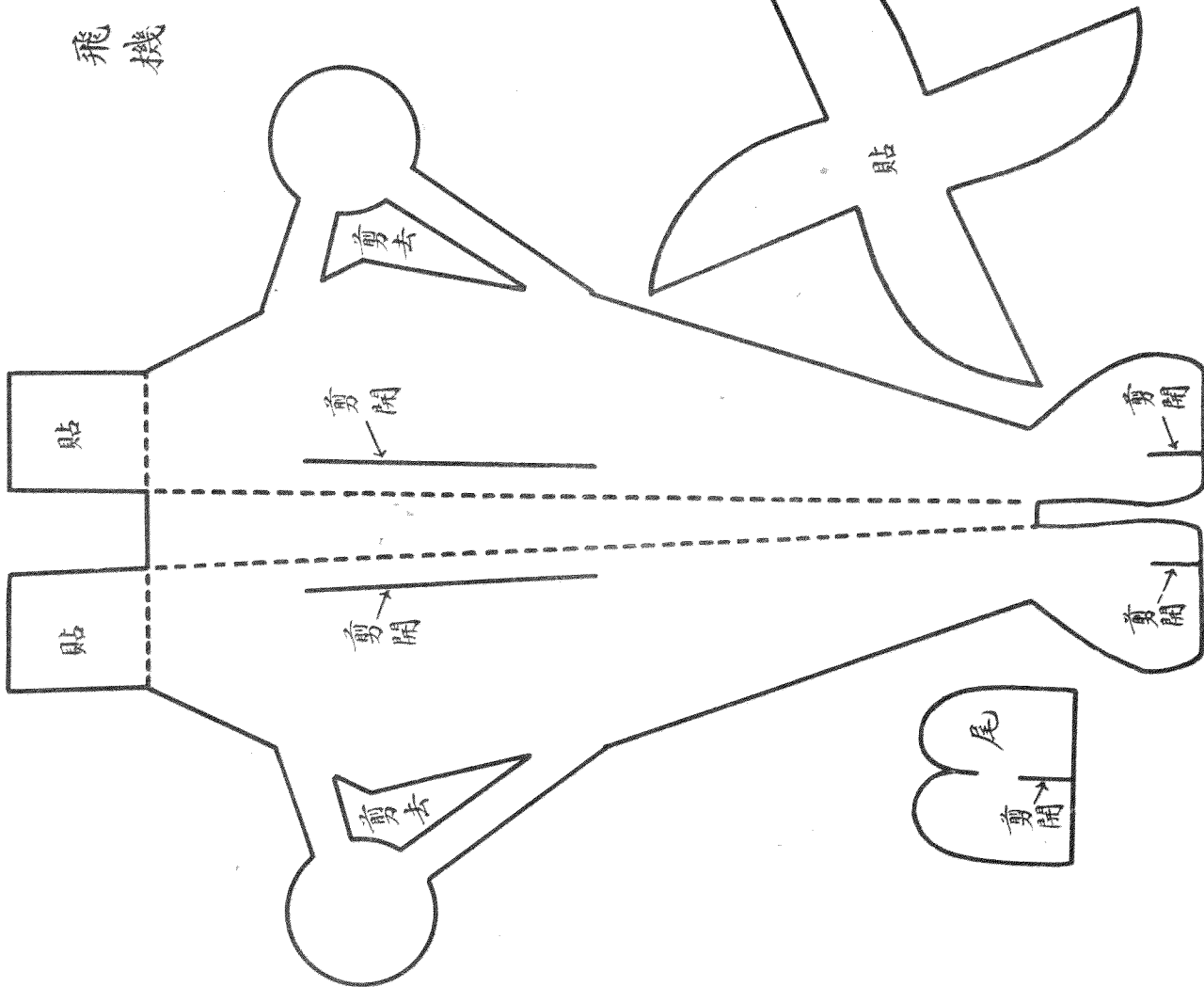

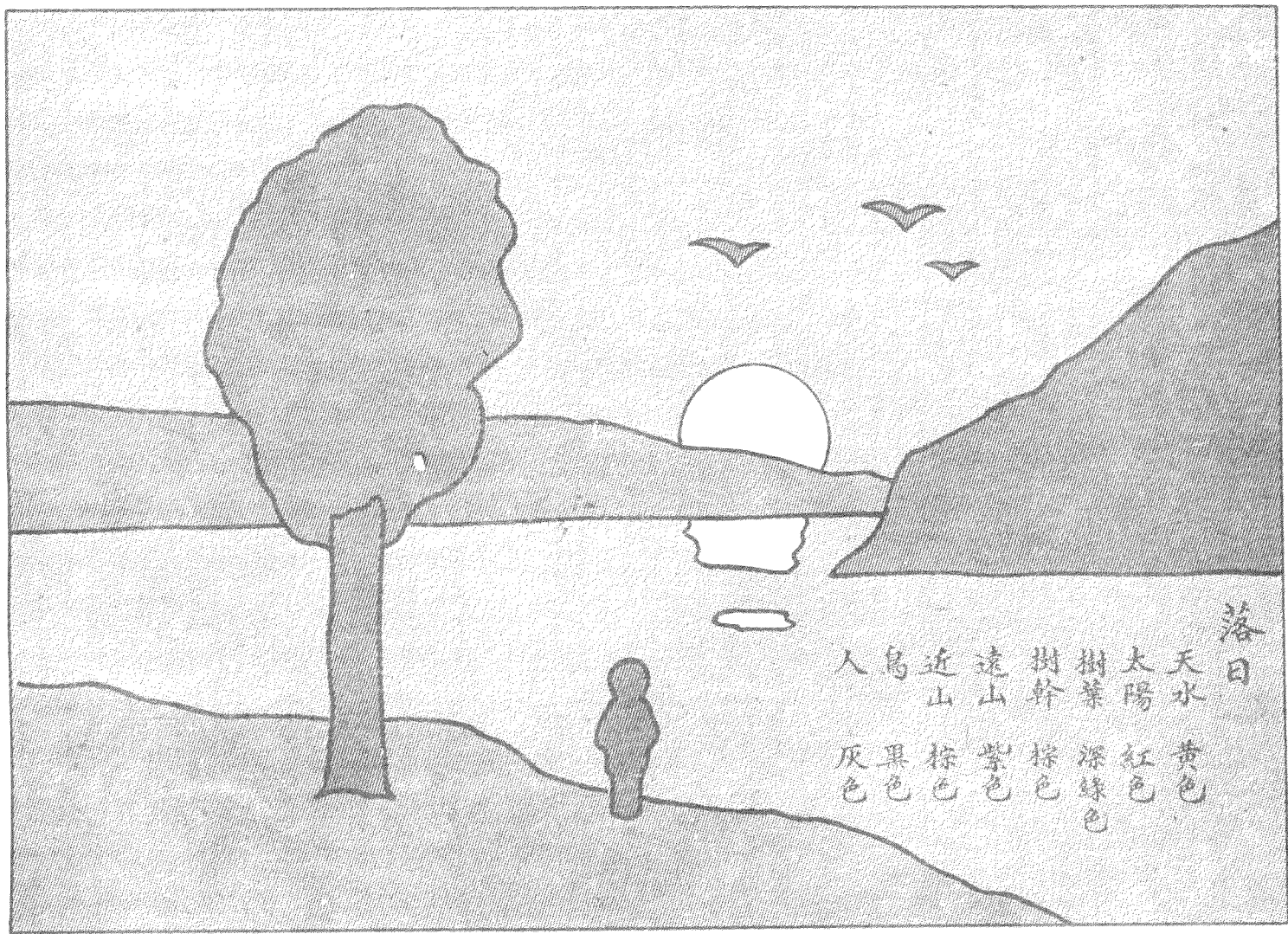

落日

人	鳥	近山	遠山	樹幹	樹葉	太陽	天水
灰色	異色	棕色	紫色	棕色	深綠色	紅色	黃色

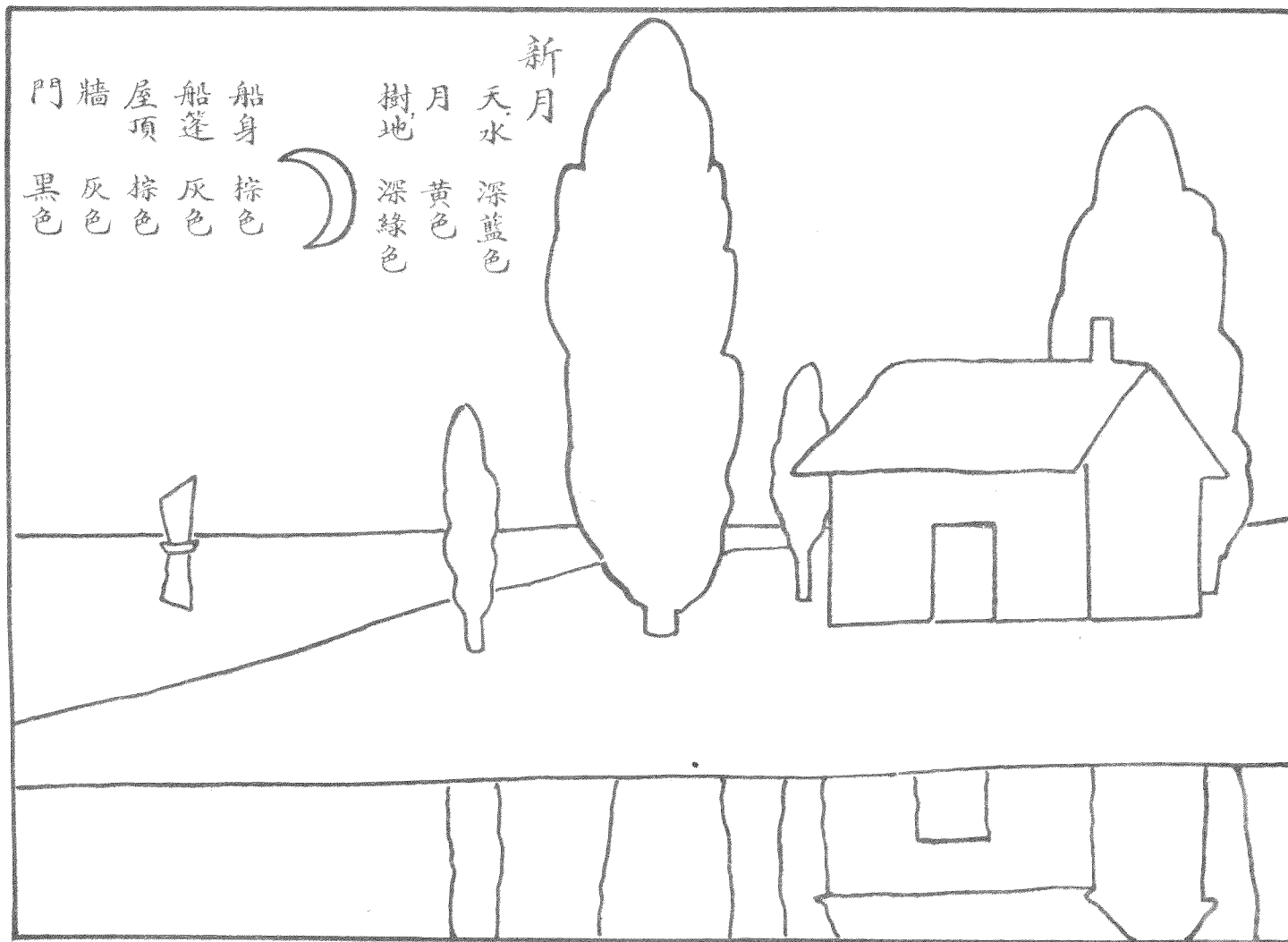

雪人

