





22500487577









40TH CONGRESS, }  
2d Session. }

HOUSE OF REPRESENTATIVES.

{ Ex. Doc.  
{ No. 96.

---

ANNUAL REPORT

OF THE

COMMISSIONER OF PATENTS

FOR

THE YEAR 1867.

---

**VOLUME IV.**

---

WASHINGTON:  
GOVERNMENT PRINTING OFFICE.  
1868.

IN THE SENATE OF THE UNITED STATES,

January 29, 1868.

*Resolved*, That 4,000 additional copies of the letters from the Commissioner of Patents, transmitting Annual Report of that office, be printed for the use of the Senate.

---

IN THE HOUSE OF REPRESENTATIVES,

June 5, 1868.

On motion of Mr. LAFLIN, from the Committee on Printing,

*Resolved*, That there be printed 15,000 extra copies of the Report of the Commissioner of Patents, 10,000 for the use of the House, and 5,000 for the Commissioner.

WELLCOME INSTITUTE LIBRARY	
Coll.	WelMOmec
Coll.	
No.	



---

ILLUSTRATIONS.

---

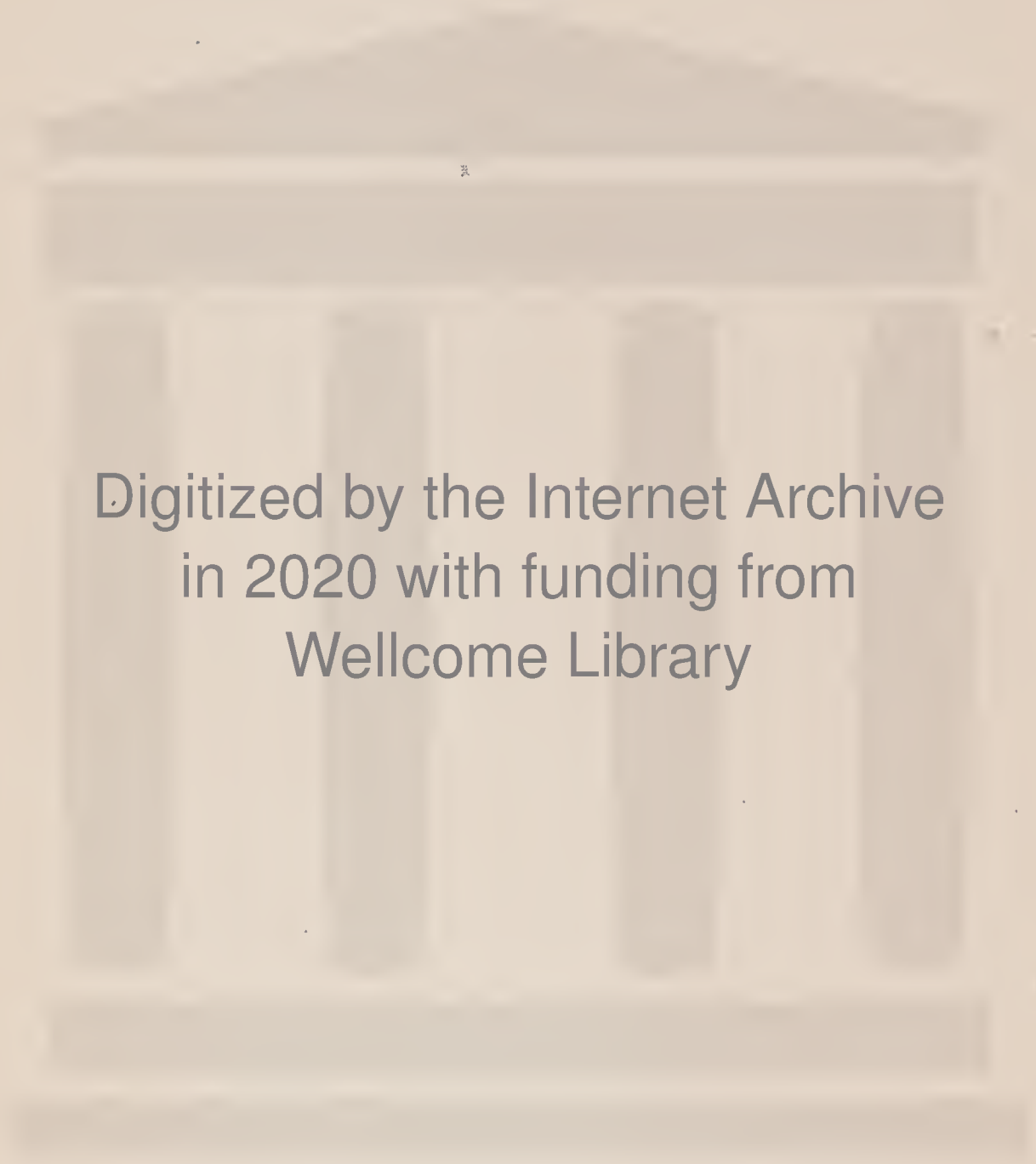

Digitized by the Internet Archive  
in 2020 with funding from  
Wellcome Library

<https://archive.org/details/s607id13664460>



66750—Stubbs & Davis—Evaporating Pan.

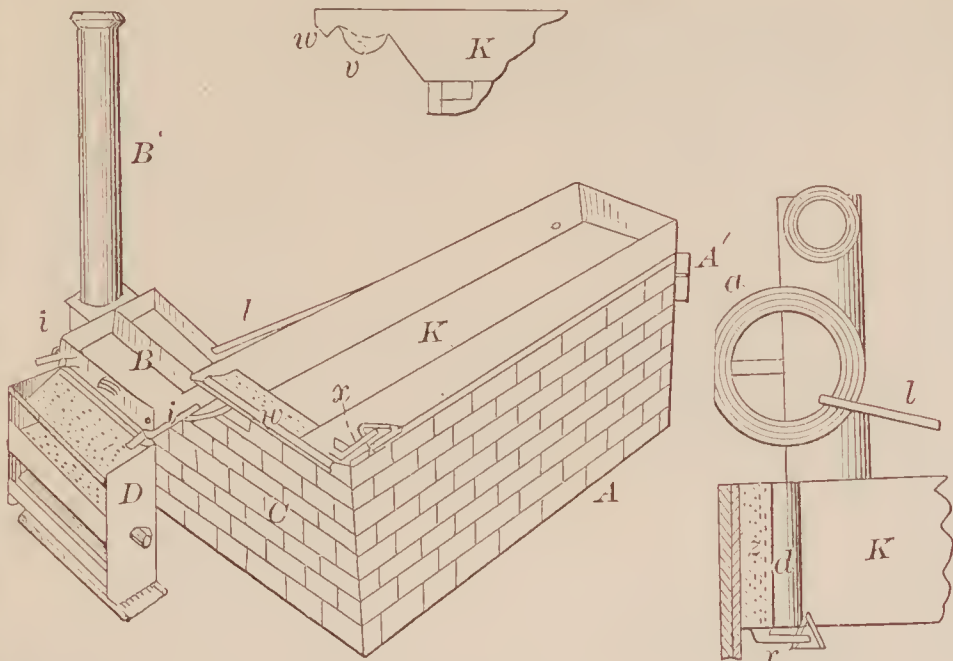

66752—C. C. Taintor—Petroleum Lamp Heater.

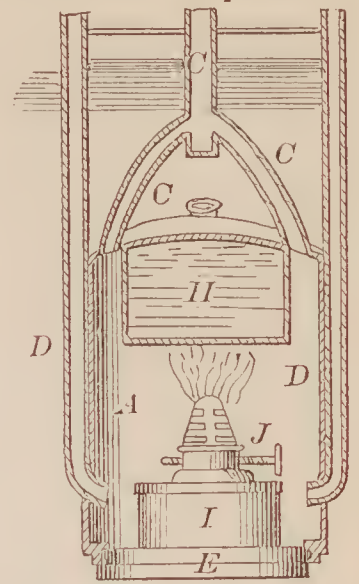

66751—E. L. Sturtevant—Magazine Fire Arm.

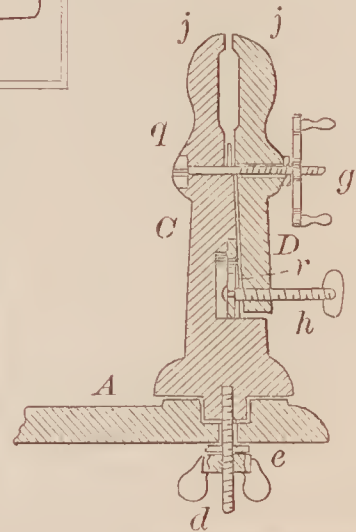
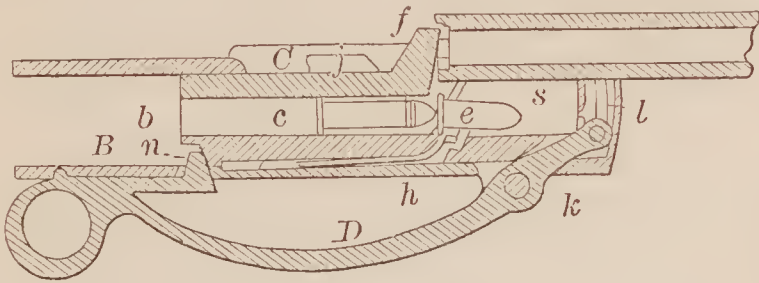

66754—E. F. Van Etten—Clamp for Filing Saws.

66753—Van Auken & Graham—Milk Strainer.

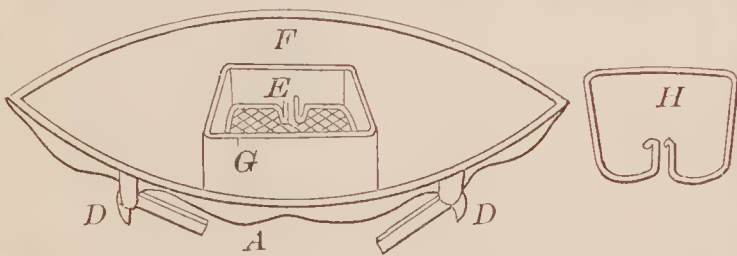

66756—W. Weaver—Rock Drill.

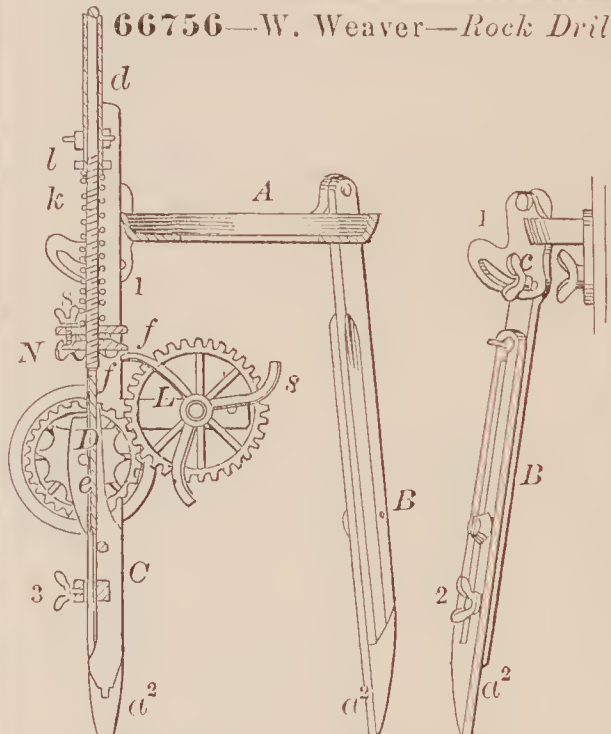

66757—J. H. Webster—Steam Globe Valve.

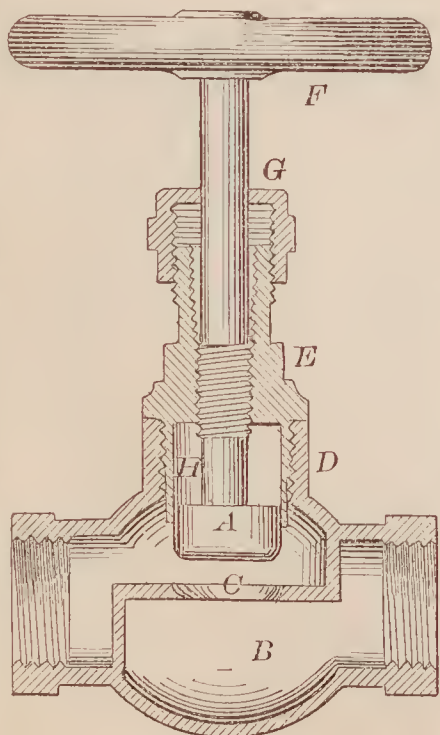

66755—A. Wallach—Watch Chain Hook.

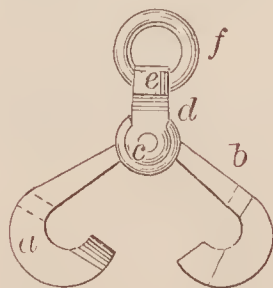

66758—J. H. Webster—Metallic Packing for Piston Rods.

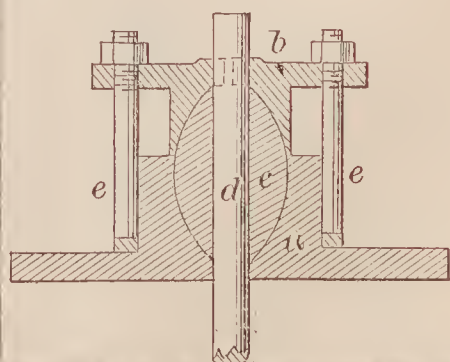





66766—S. W. Young—Wood Screw.



66767—H. Zellner—Breaking and Cleaning Hemp.

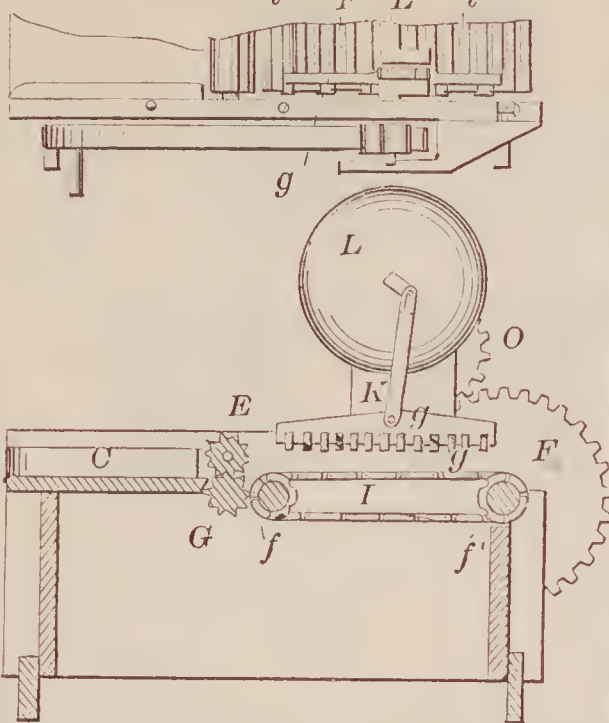

66769—C. Adams—Soap Dish.

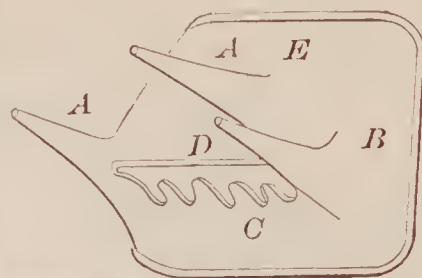

66770—W. Adamson—Match Lighter.



66771—B. J. Aurand—Harness Shaft Loop.

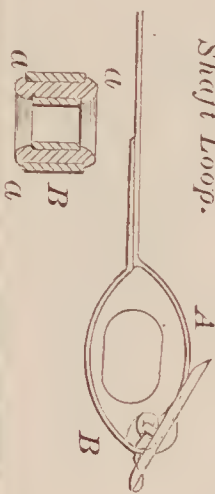

66772—J. Auten—Thill Coupling.

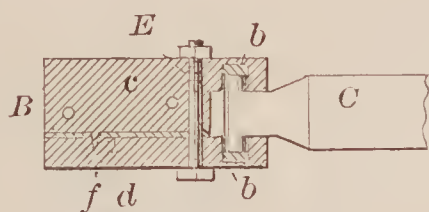

66775—J. G. Bailey—Washing Machine.

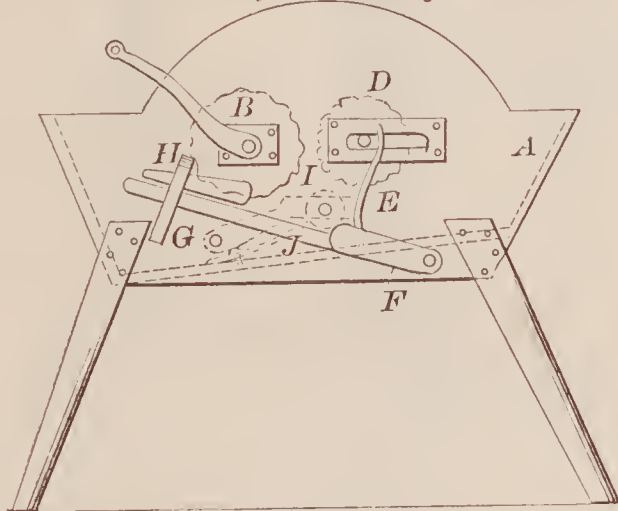

66768—H. Zellner—Seed Sower and Roller.

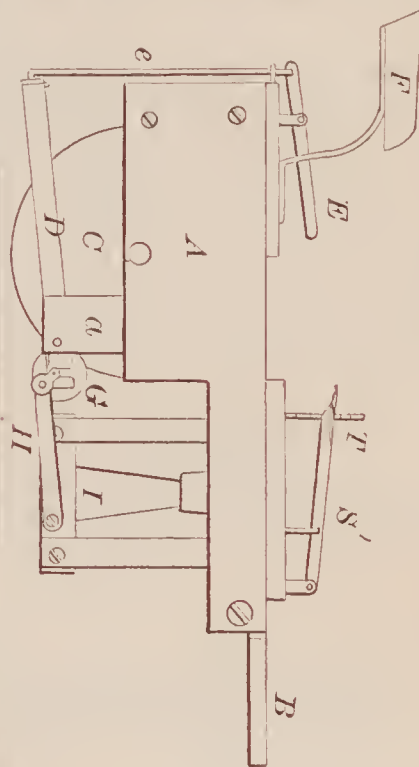

66774—B. F. Avery—Plow.

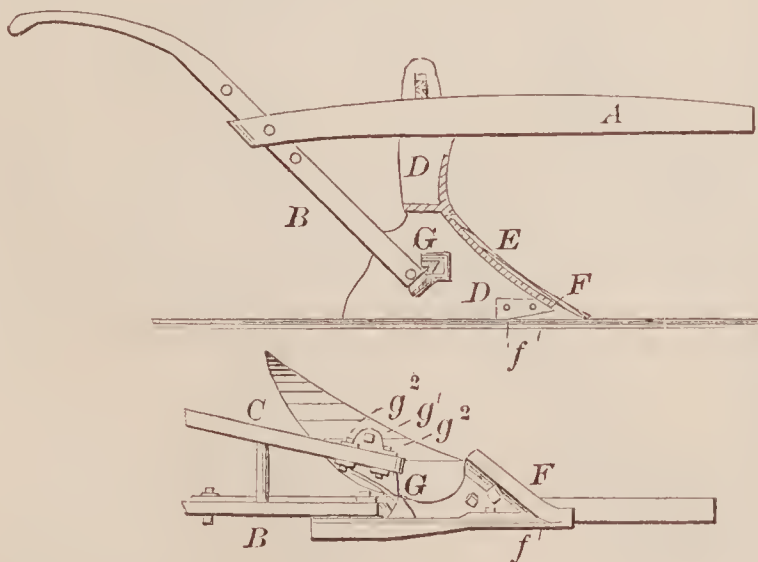

66776—J. W. Baker—Printers' Galleys.

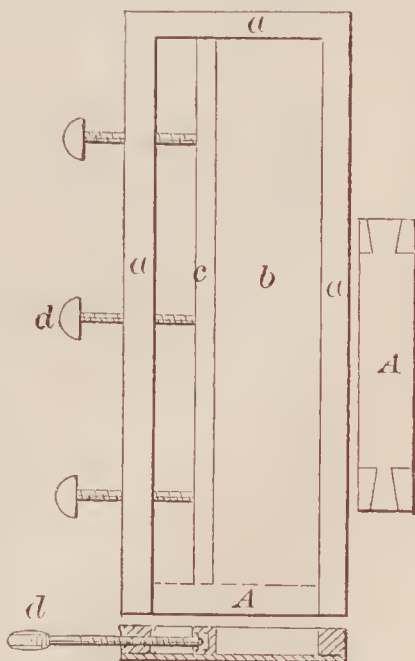

66777—Barker & Gilbert—For Carburetting Air and Gas

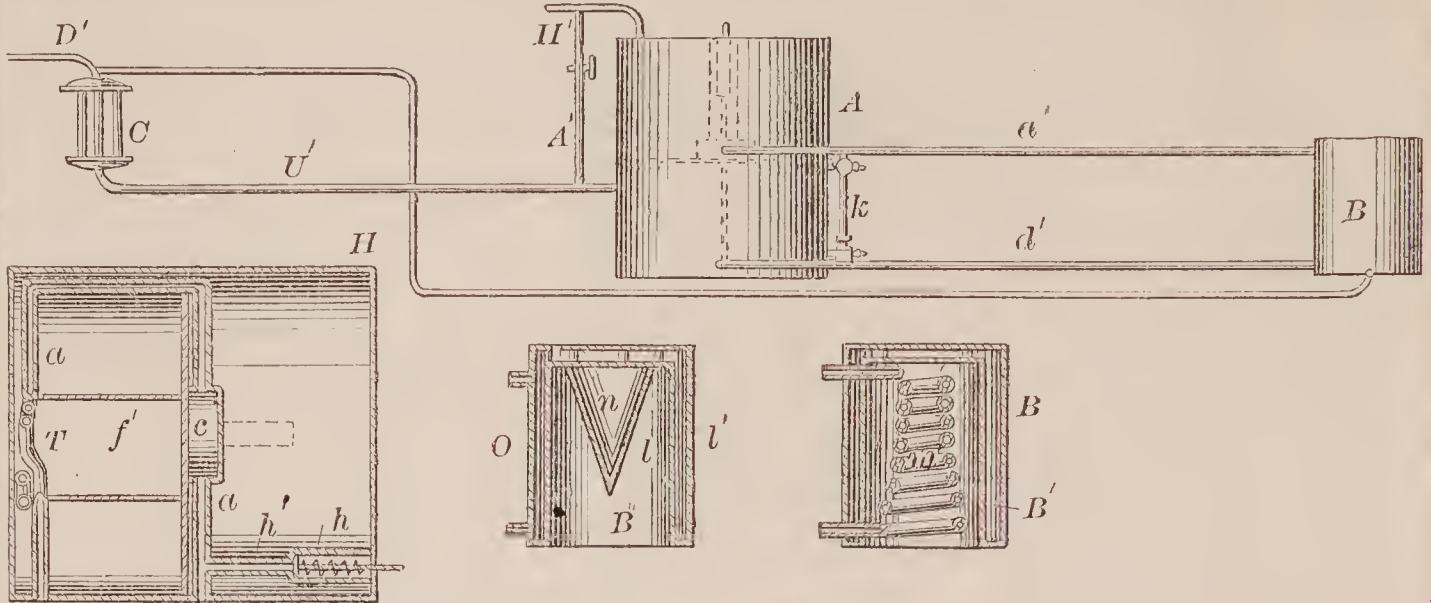

66778—U. N. Beardsley—Gate.

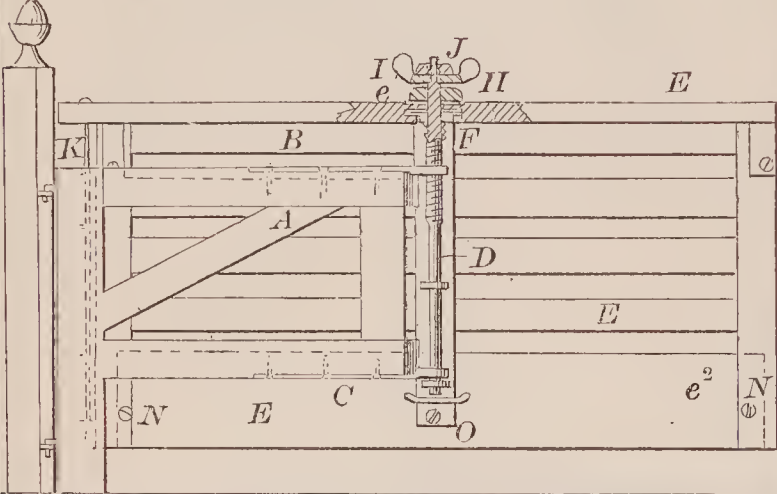

66780—W. J. Berne—Attaching Calks to Horse Shoes.

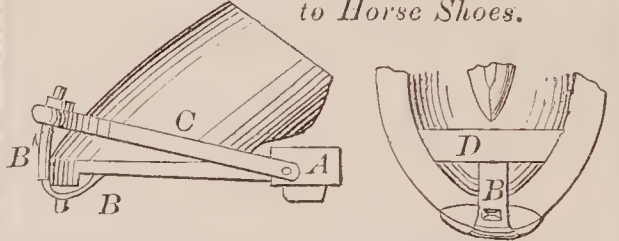

66779—W. Bellamy—Ice Pitcher.

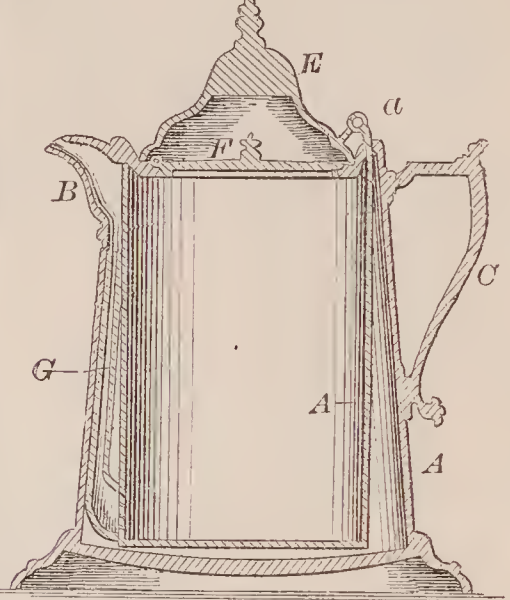

66782—E. G. Blakslee—Joint for Iron Pipes.

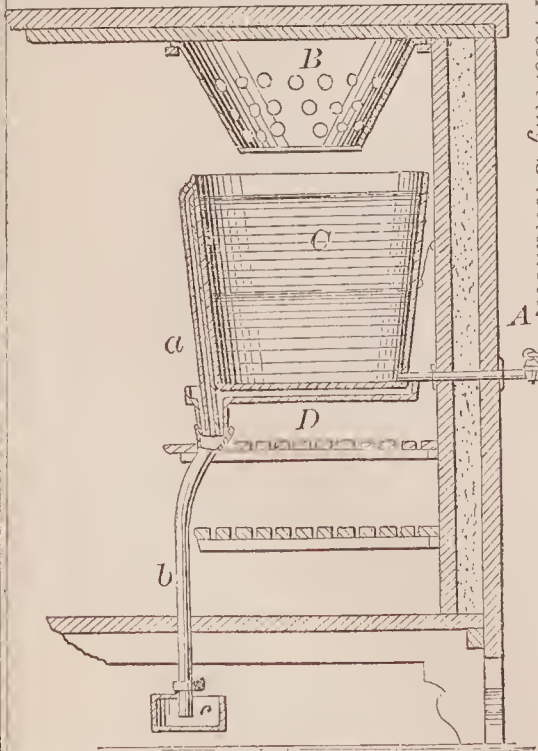
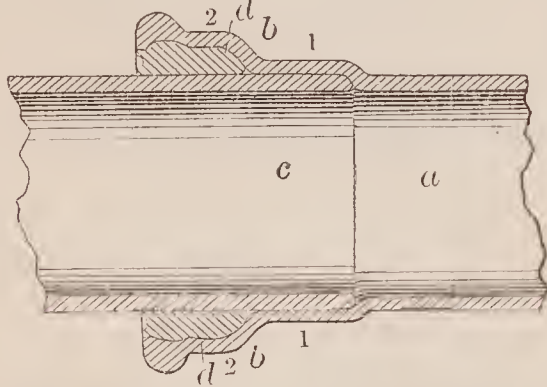

66786—E. D. Brainard—Preserving Substances, Purifying Air for

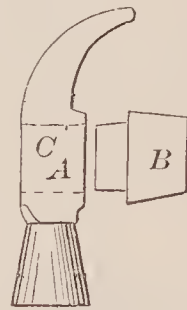

66781—R. Black—Hammer Head.

66784—C. Boynton—Attaching Thills.

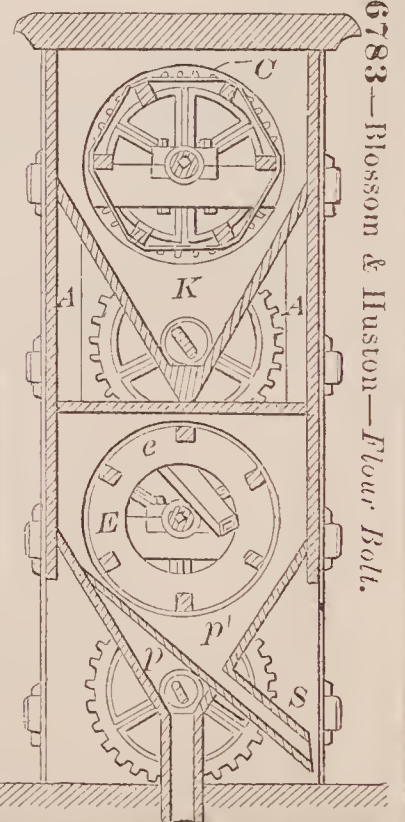
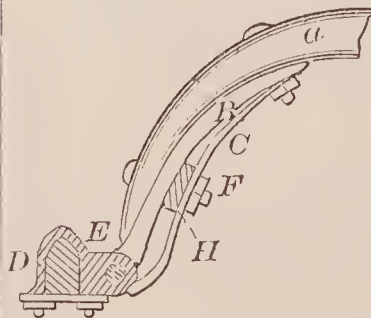

66783—Blossom & Huston—Flour Bolt.



66787—T. E. C. Brinley—*Plow.*

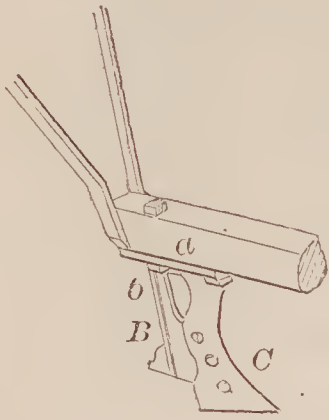

66791—S. P. Campbell—*Tellurian.*

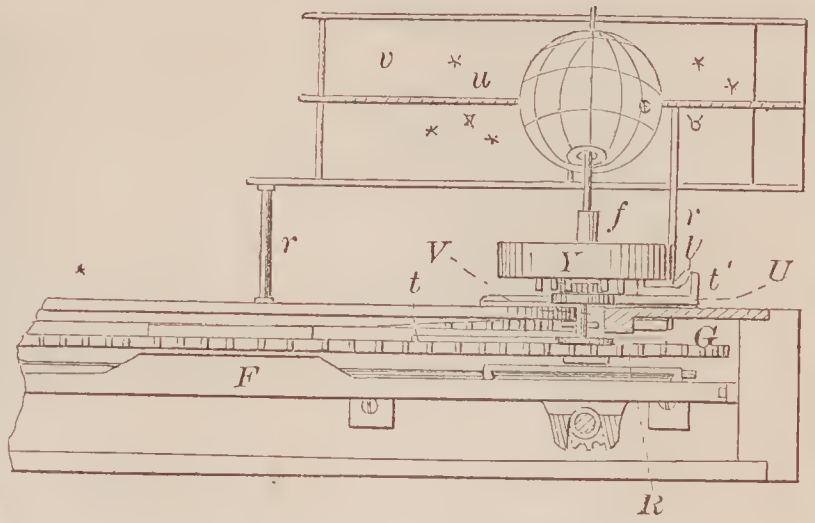

66790—H. H. Bryant—*Scythe.*

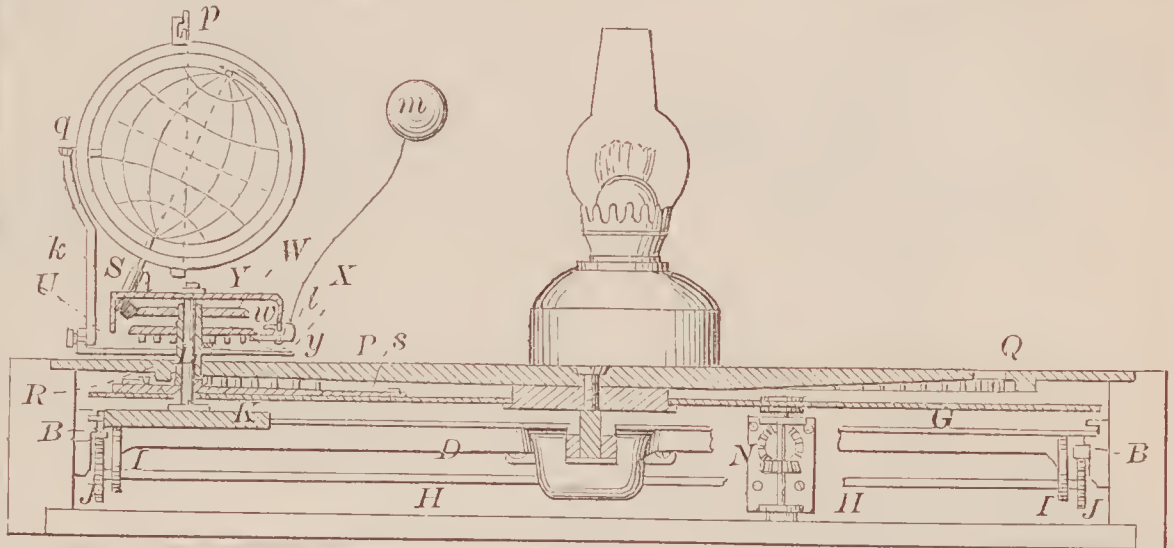
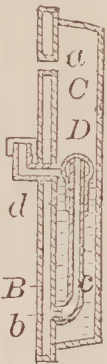

66789—J. D. Brunner—*Attaching Thills.*

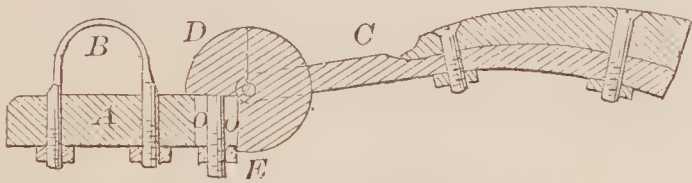

66788—Brooks & McGrady—*Shaving Cup*

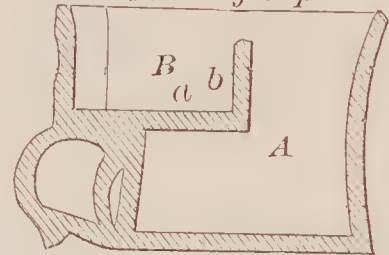

66792—W. L. Camp—*Washing Machine.*

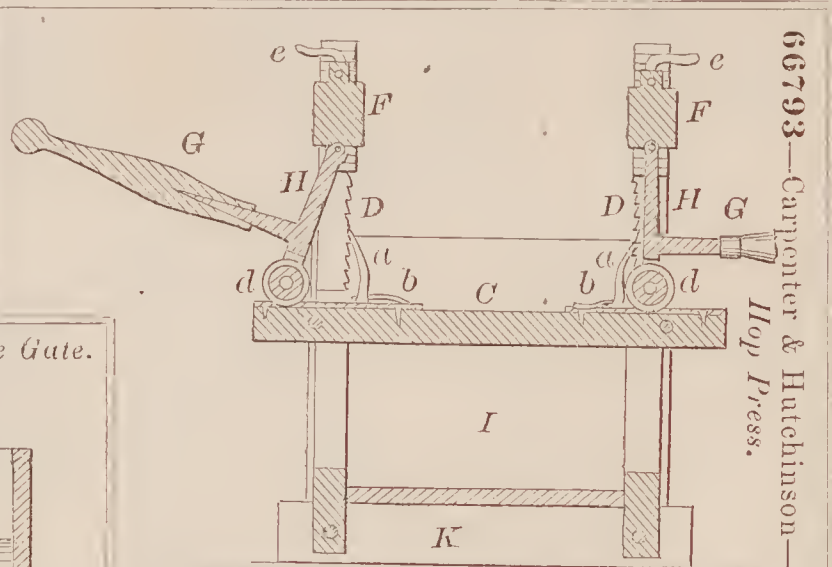
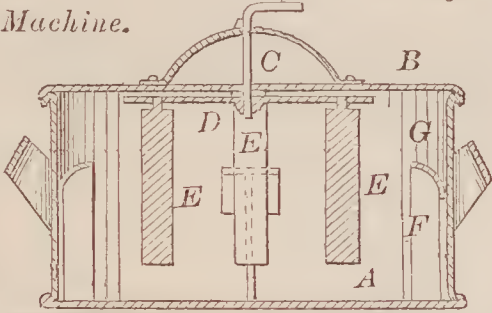

66793—Carpenter & Hutchinson—*Hop Press.*

66795—W. L. Clark—*Flood or Waste Gate.*

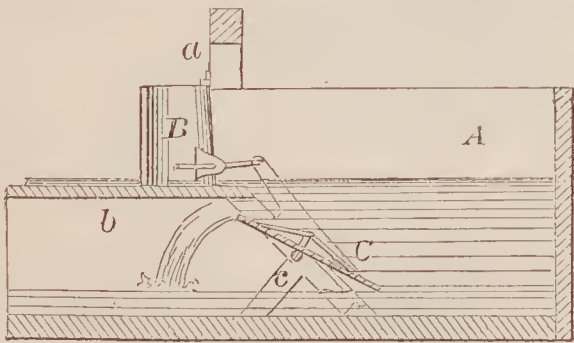

66794—M. L. Changeur—*Corset.*

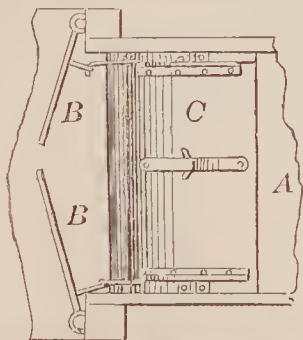
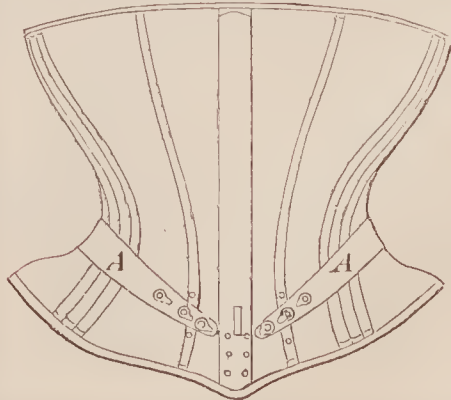

**66796**—A. Clow—*Instrument for Laying out Stair Railings.*

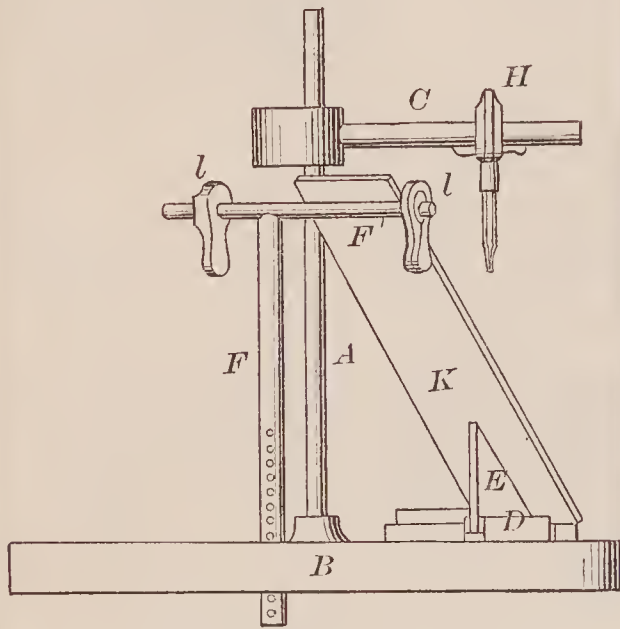
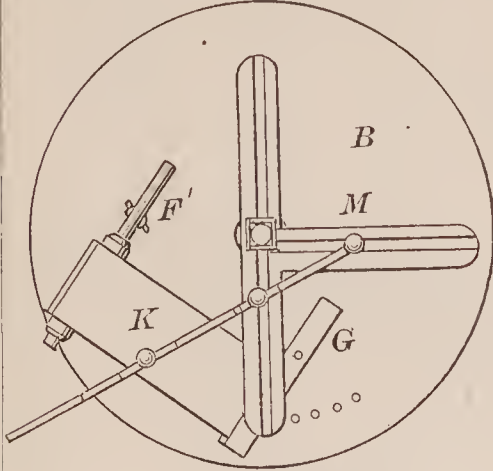

**66797**—W. A. Cobb—*Propeller.*

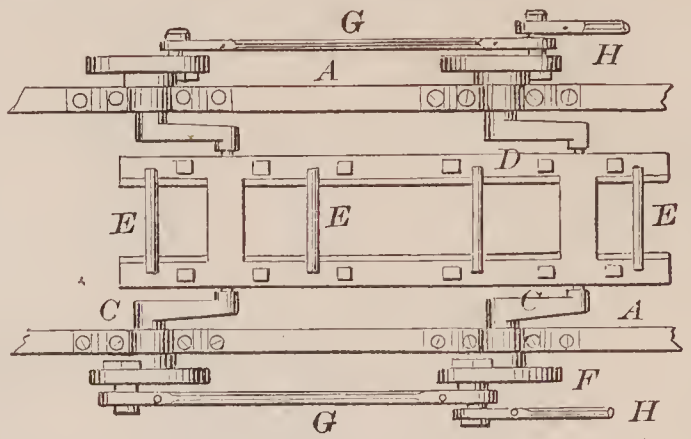

**66799**—G. W. Corey—*Bridge.*

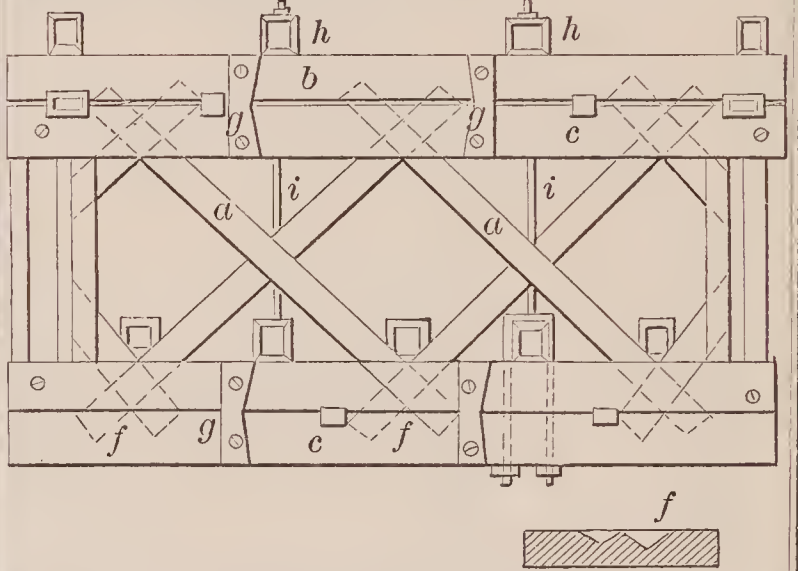

**66801**—S. L. Covell—*Bell Pull and Trip.*

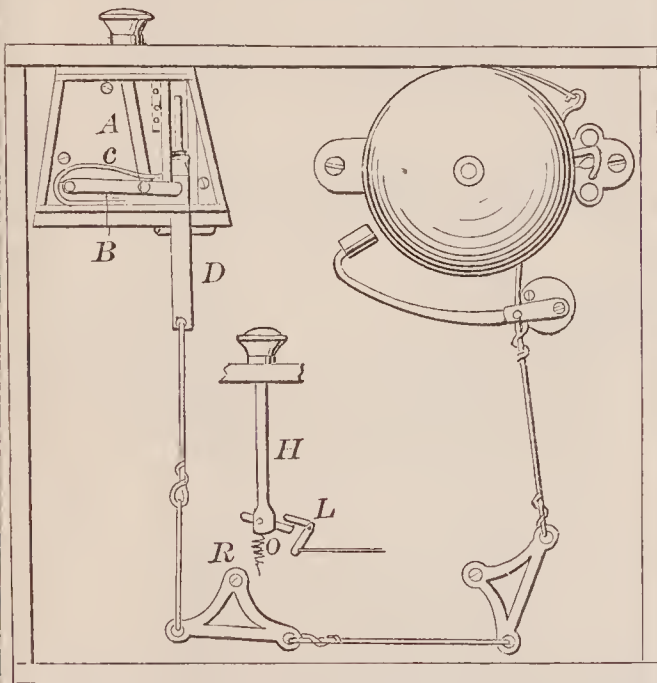

**66798**—C. E. Collins—*Instrument for Watchmakers' Use.*

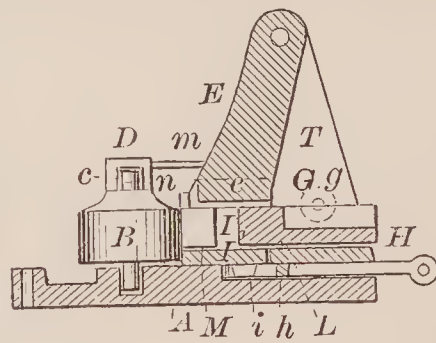
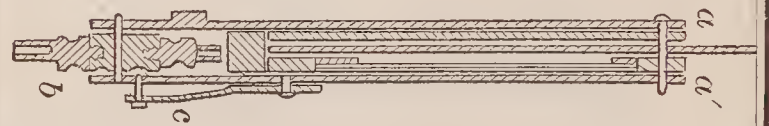
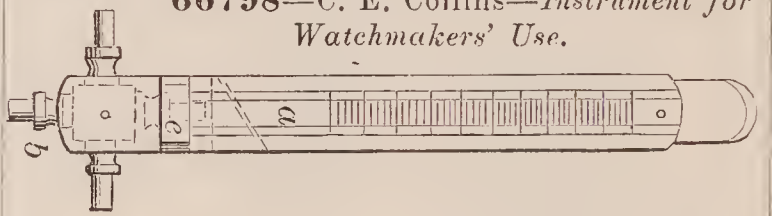

**66800**—F. F. Cornell, Jr.—*Brick Machine.*

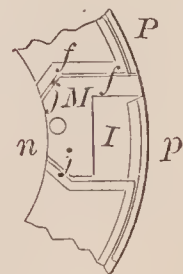

**66802**—M. A. & I. M. Cravath—*Revolving Plow.*

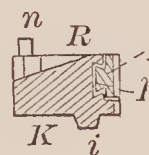
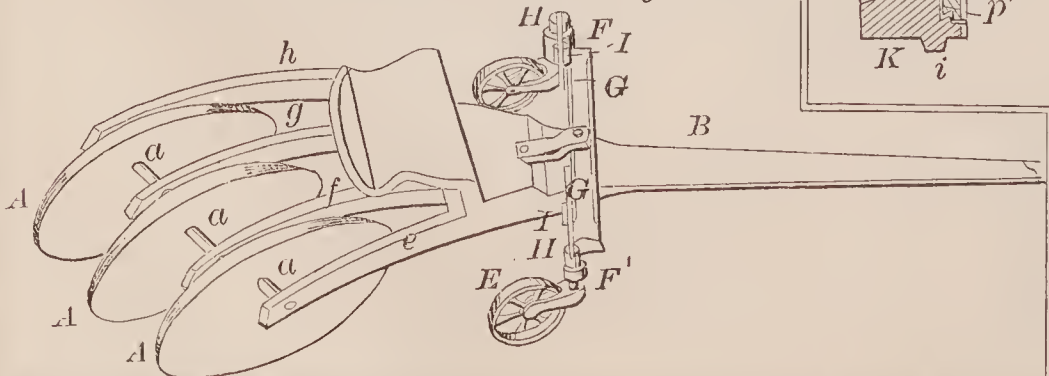



66803—A. B. Culver—*Fanning Mill.*

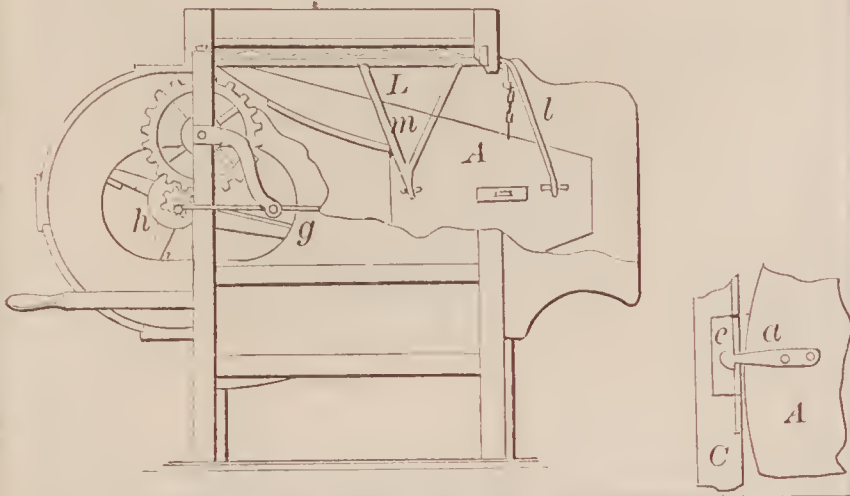

66804—Curtis & Tewksbury—*Hose Coupling.*

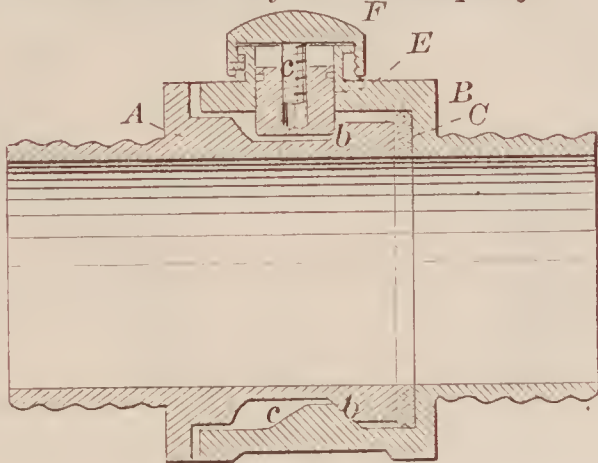

66808—O. A. Dean—*Stitching Horse.*

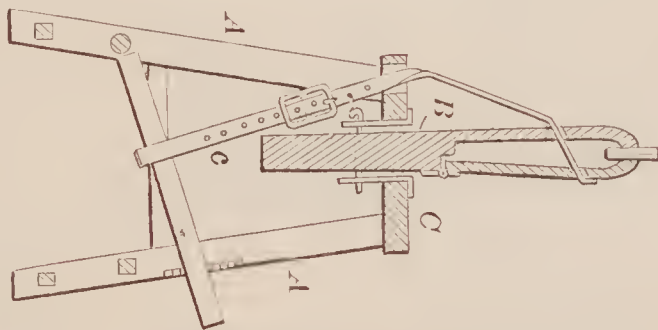

66809—C. P. Devereaux—*Plow Cleaner.*

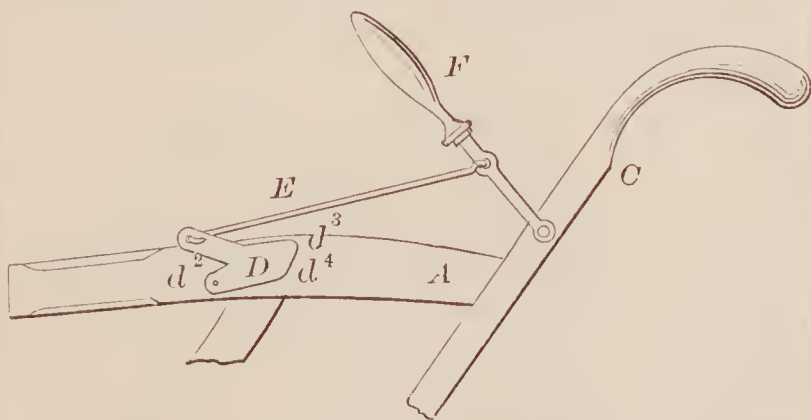

66810—H. C. Dobson—*Banjo.*

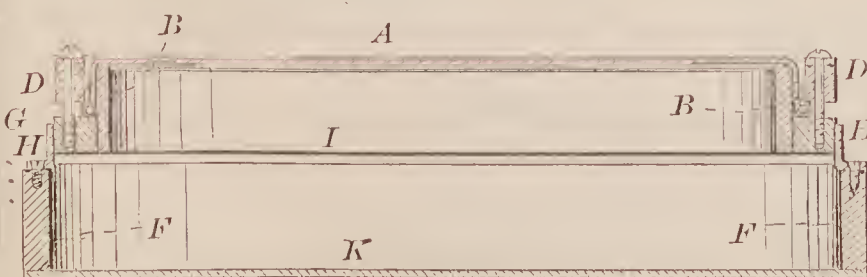

66805—S. Custer—*Mariners' Compass.*

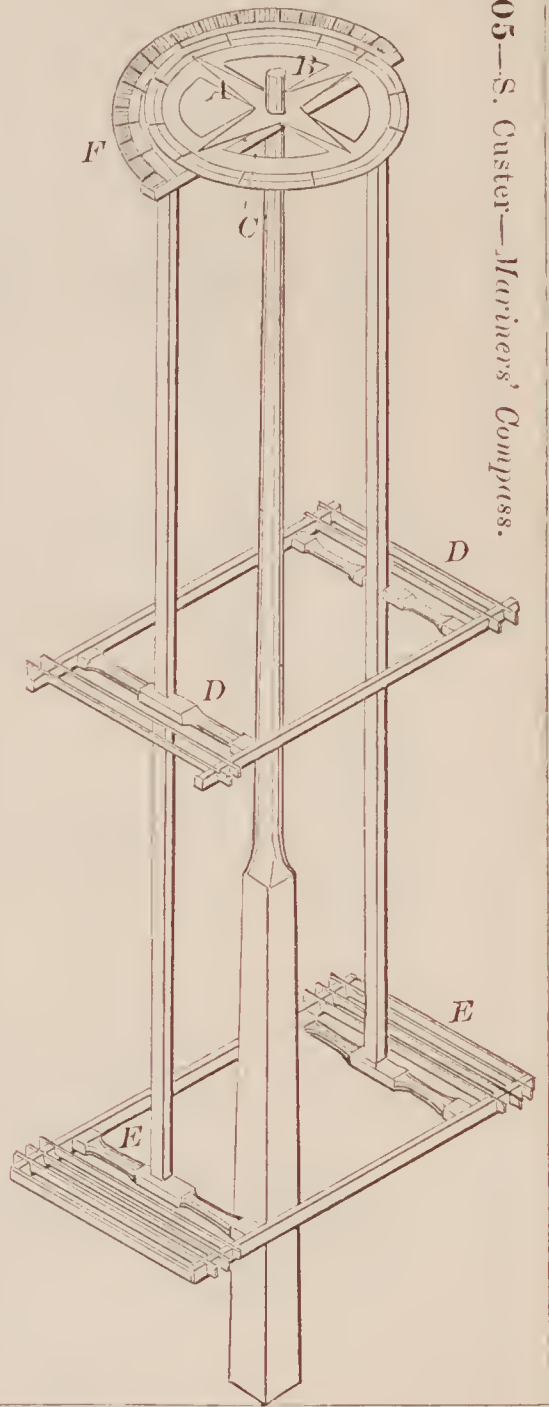

66807—M. Darling—*Fruit Gatherer.*

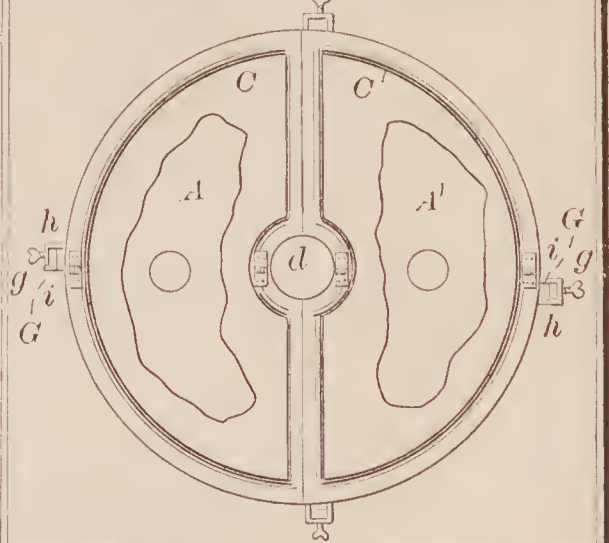

66806—S. Custer—*Magnetizing Compass Needle.*

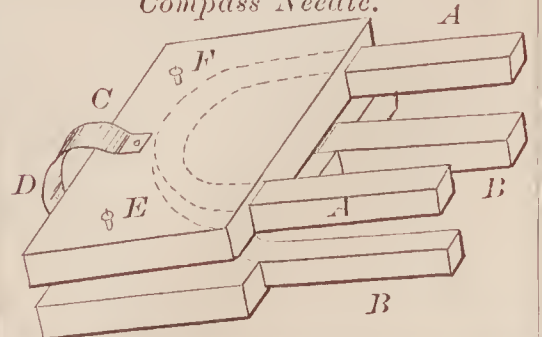

66811—J. G. Dodge—Washing Machine.

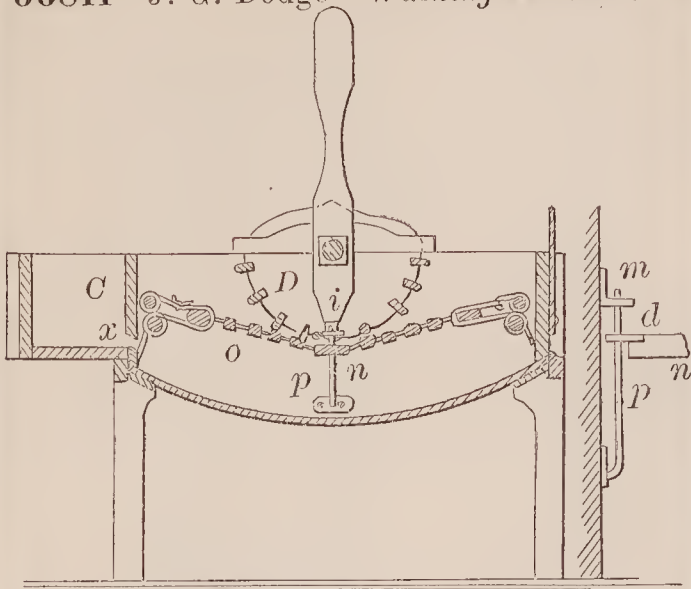

66815—Duncan & Ridgley—Washing Machine.

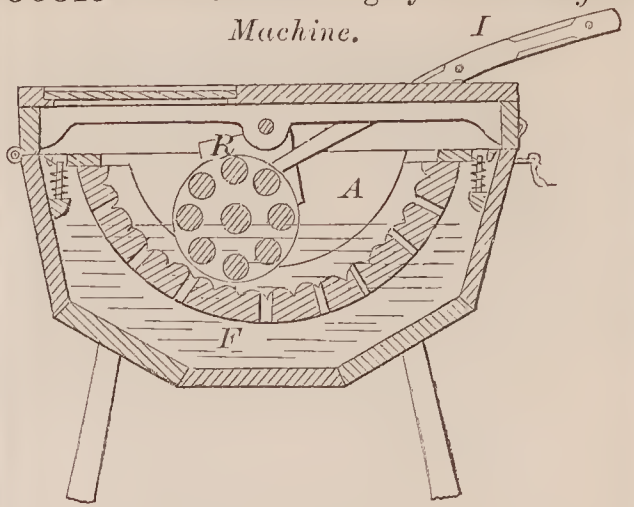

66814—J. L. Drake—Milk Pail and Strainer.

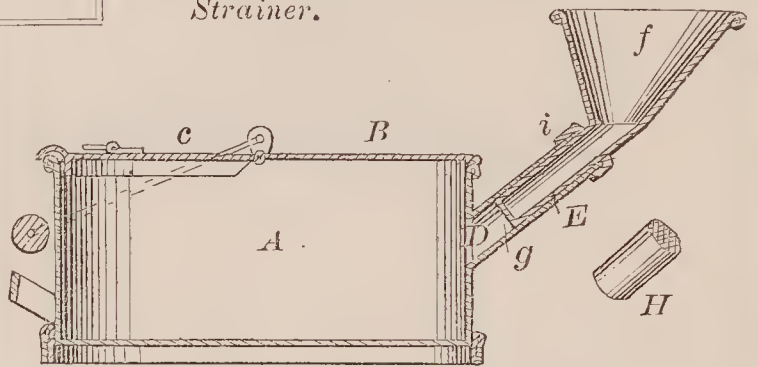

66812—A. J. Doolittle—Scrubbing Brush.

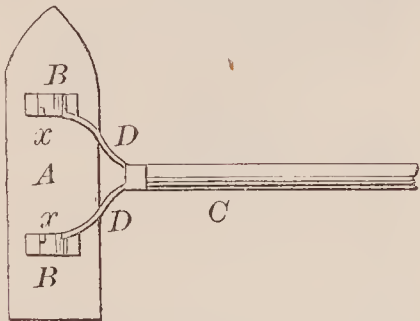

66817—Edwards & Whiting—Attaching Thills to Sleighs.

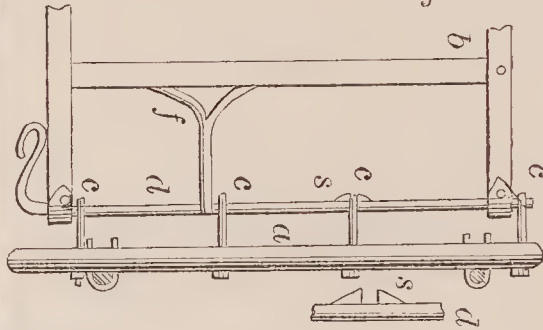

66813—D. Doty—Folding Table.

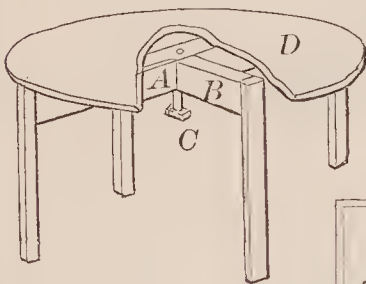

66816—J. C. Eastman—Drill Jar.

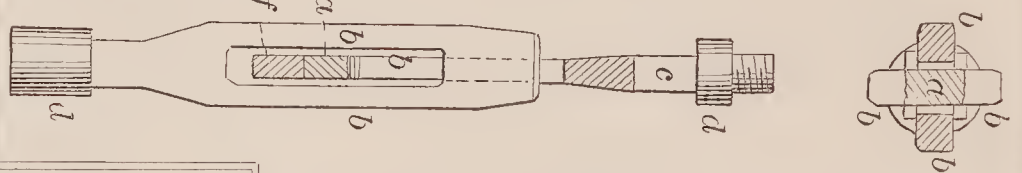

66819—C. H. Field—Rosette Engine.

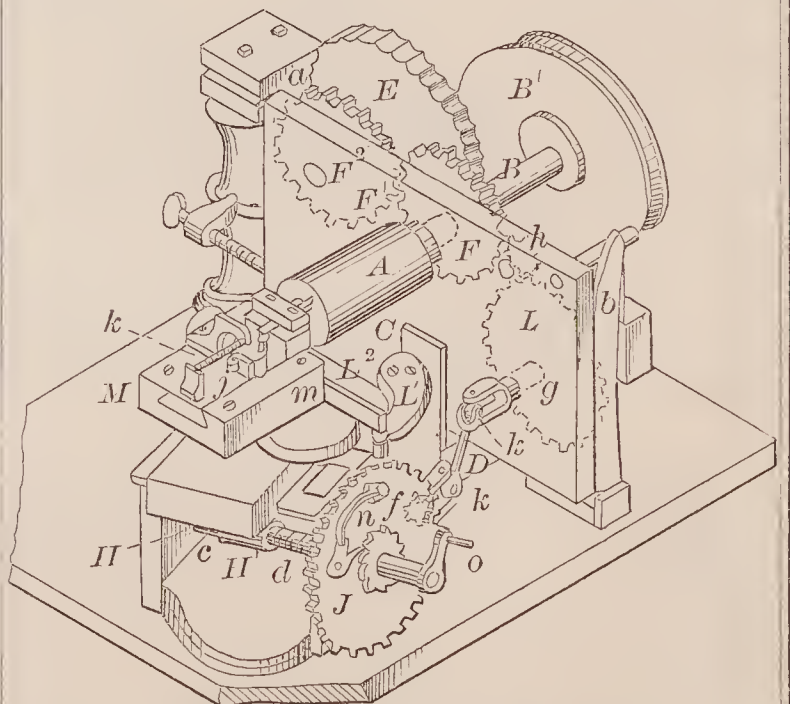

66818—G. S. Faulkner—Cam for Looms.

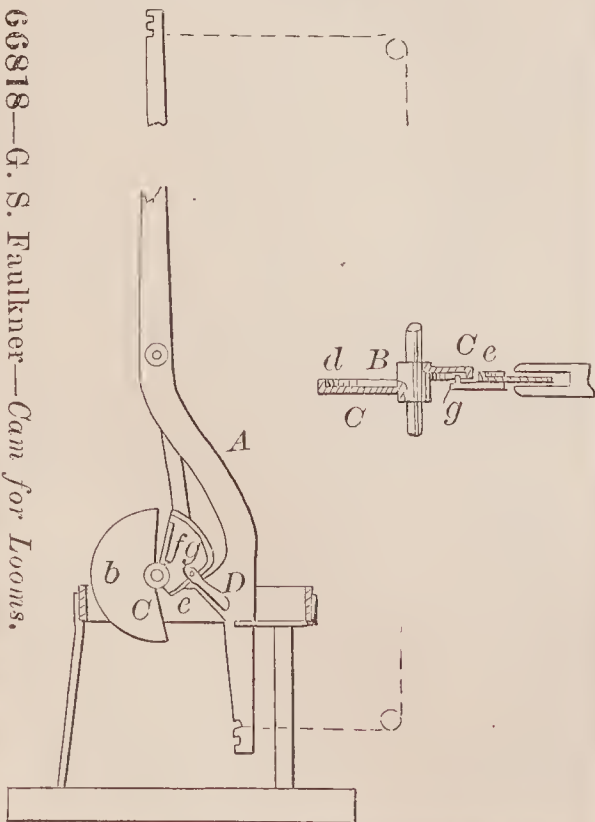



66820—B. Fitts—Pipe Coupling.

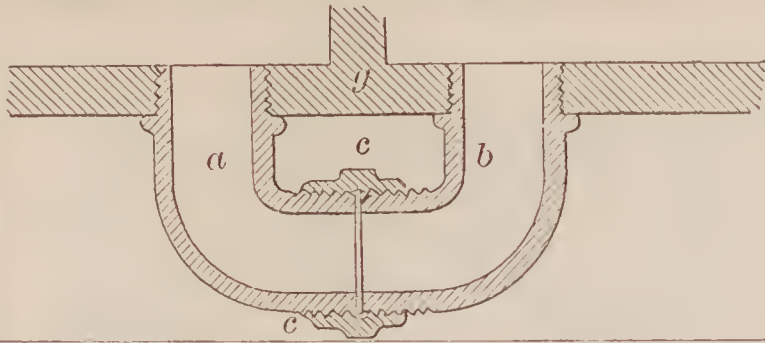

66824—A. Franklin—Wool Packing Table.

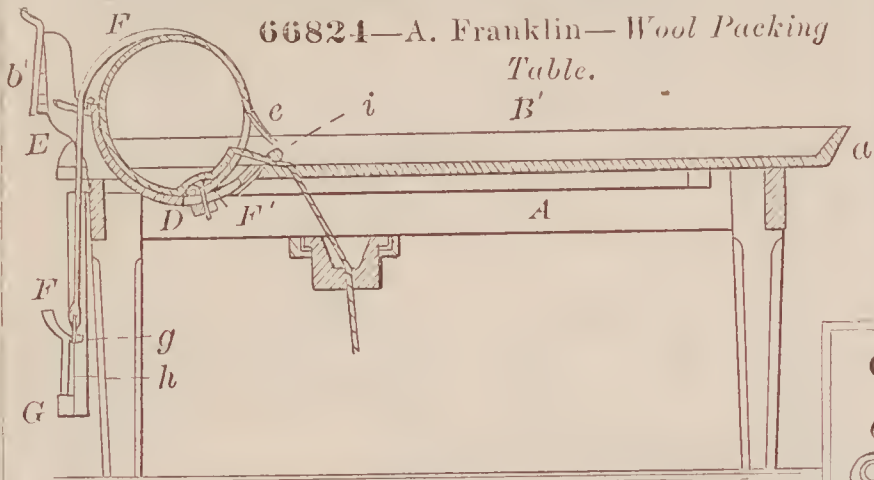

66823—G. W. Fox—Farm Gate.

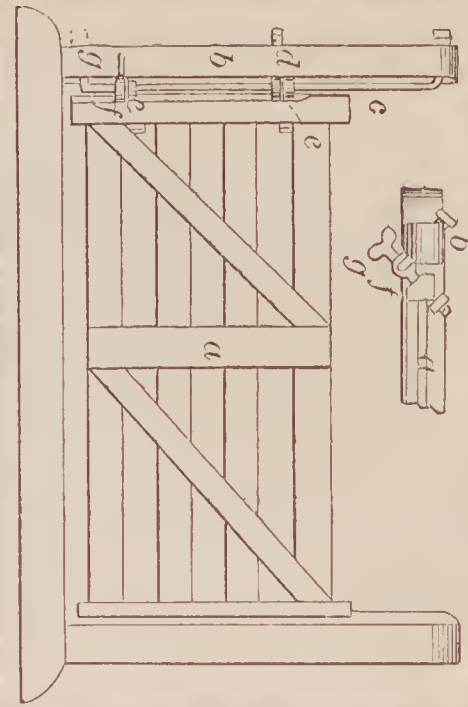

66827—J. F. Gebhart—Harness Motion for Looms.

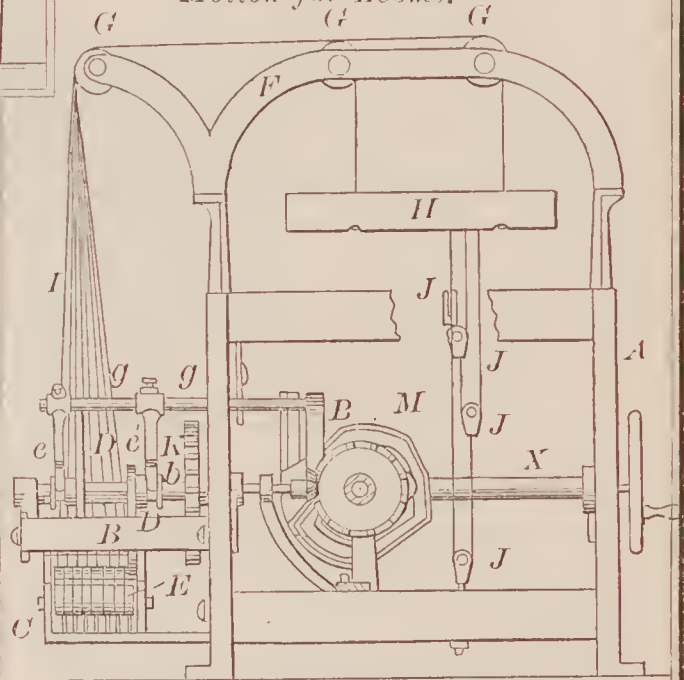

66821—S. Fletcher—Water Wheel.

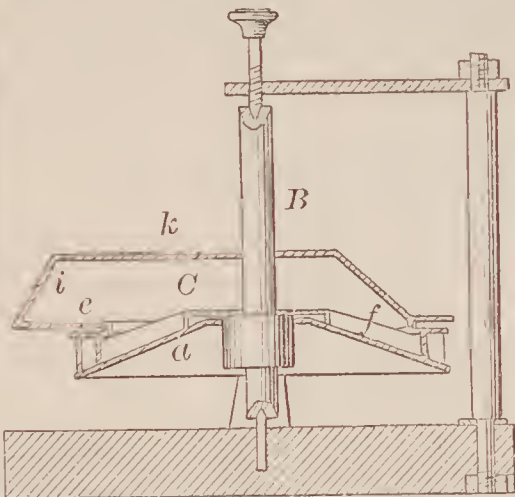

66822—A. Foss—Whitewash Brush.



66828—J. F. Gebhart—Harness Motion for Looms.

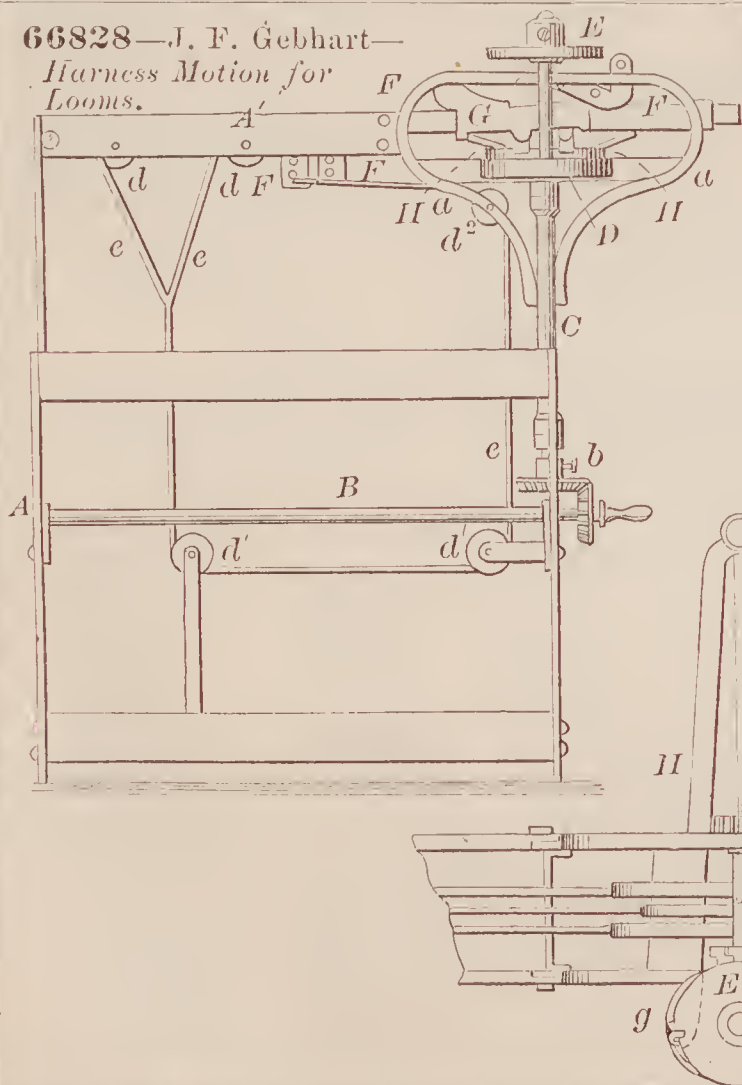

66825—L. H. Franklin—Weighing Scale.

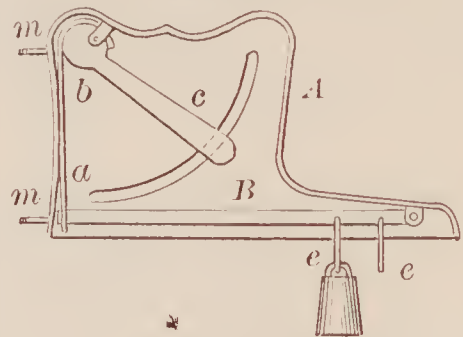

66826—G. L. Gavett—Fence.

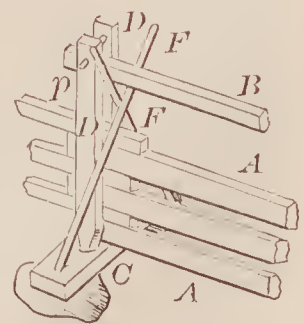

66829—S. Goewey—Farm Gate.

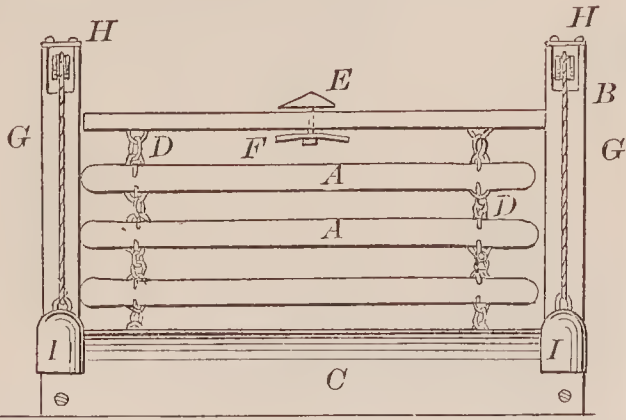

66834—J. J. Harlan—Scrubber and Mop Holder.

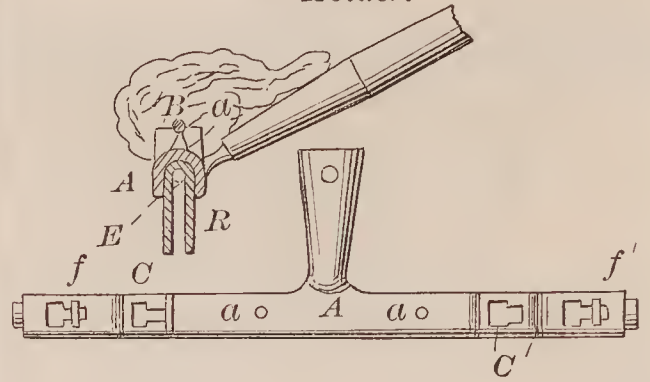

66830—S. J. Gold—For Propelling Vessels.

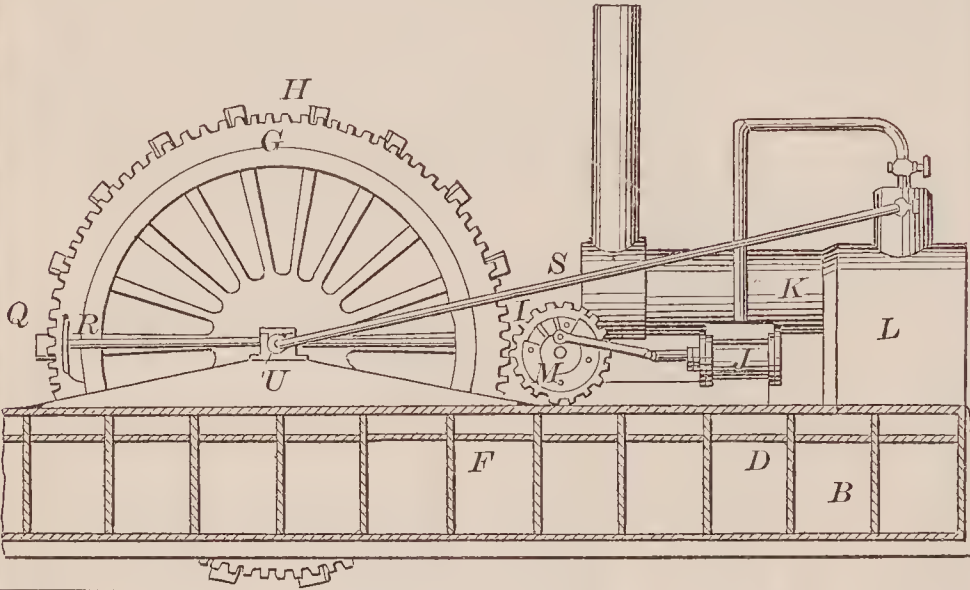

66833—W. S. Haight—For Hopping Beer, Ale, &c.

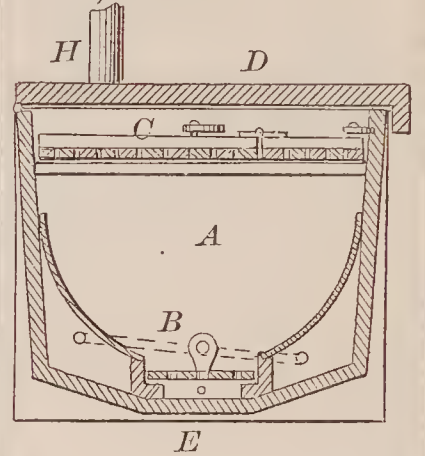

66835—Harrison & Harris—Clothes Wringer.

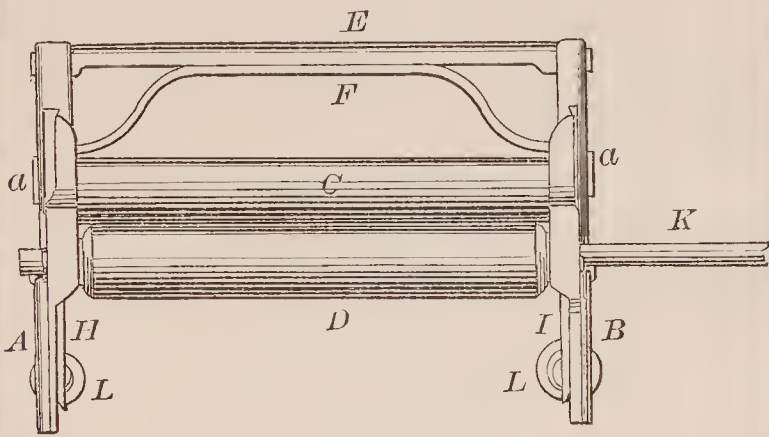

66832—B. Greenside—Gate.

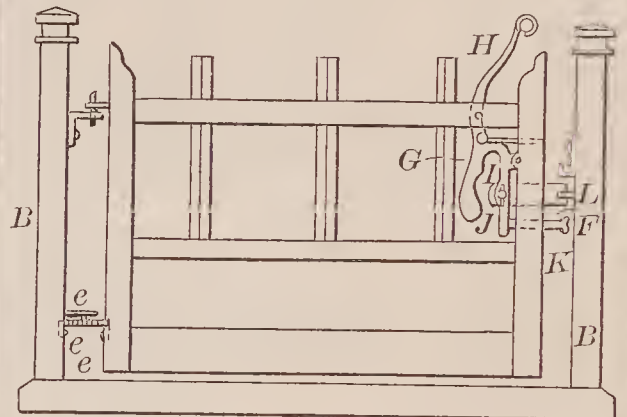

66837—A. Herthal—Knife and Scissors Sharpener.

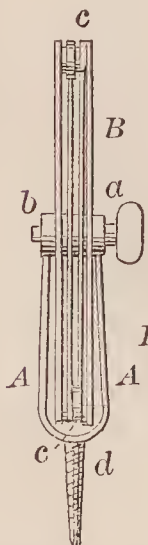

66831—W. Goodman—Washing Machine.

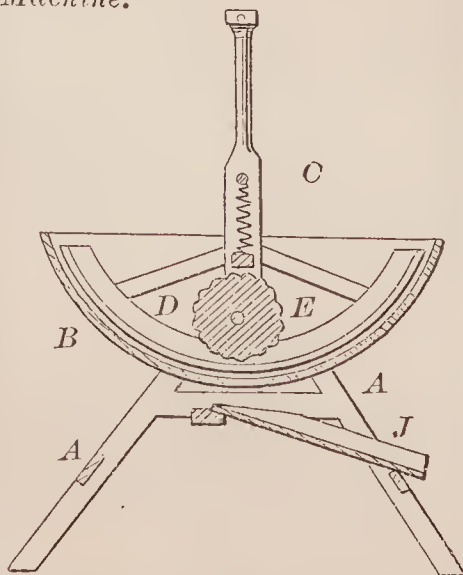

66836—Harrison & Harris—Clothes Wringer.

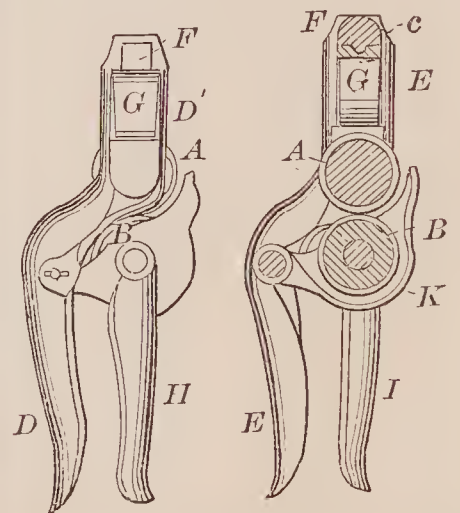



66838—B. Hilbert—For Making Centres for Watch Cases.

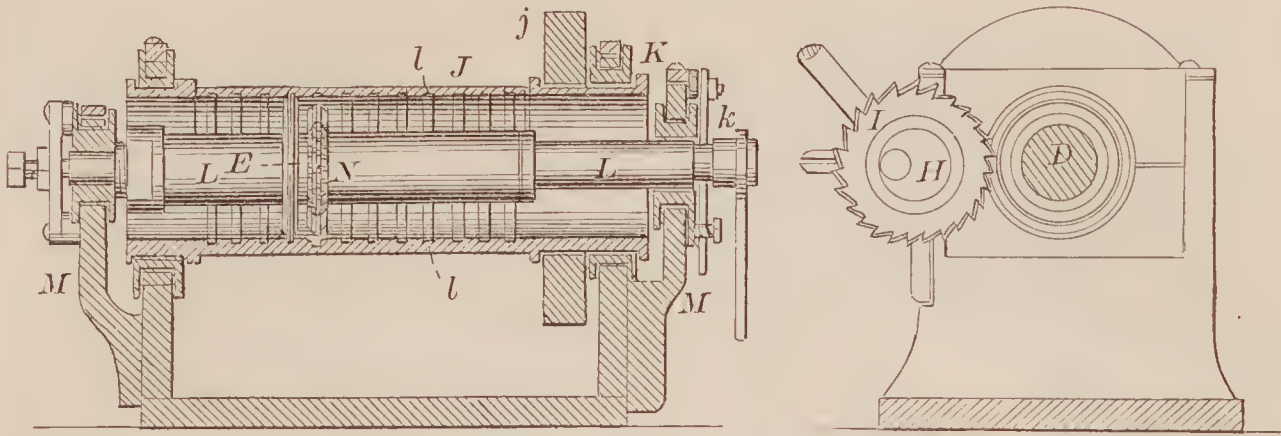

66841—C. G. Howell—For Distilling and Refining Petroleum.

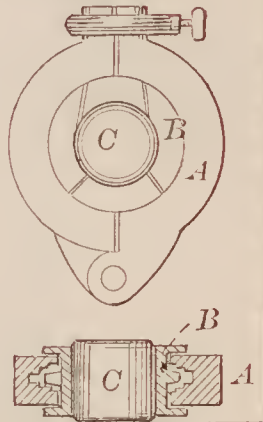
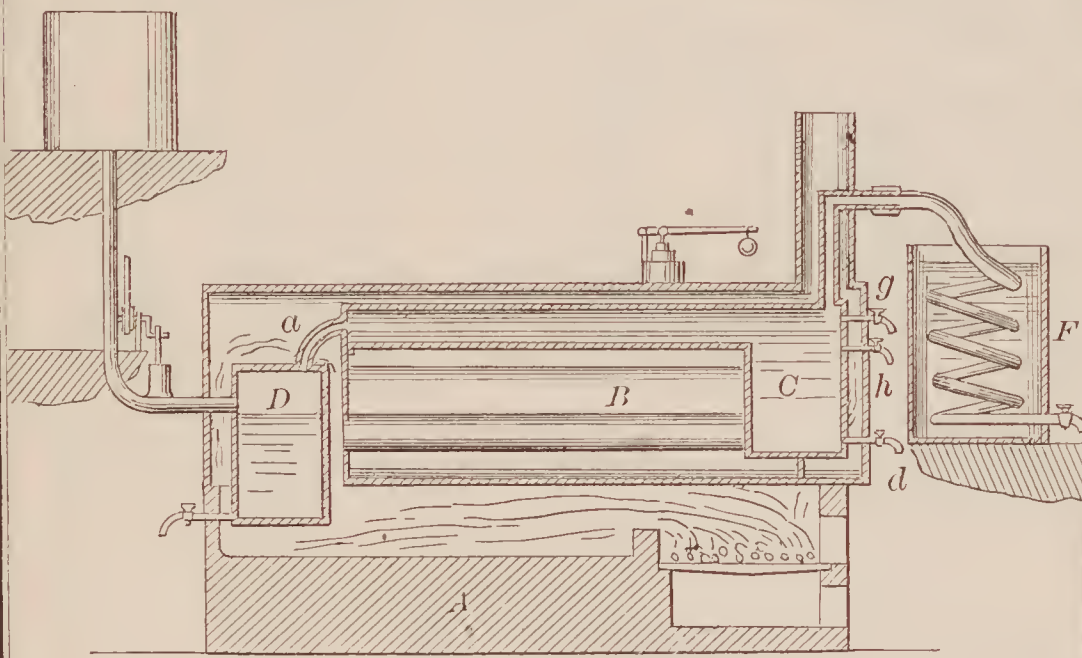

66840—  
B. D. Howe—Preventing  
Horses from Biting and  
Cribbing.

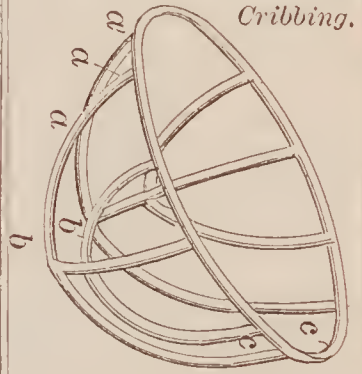

66839—I. Hogeland—Washing and Wringing Machine.

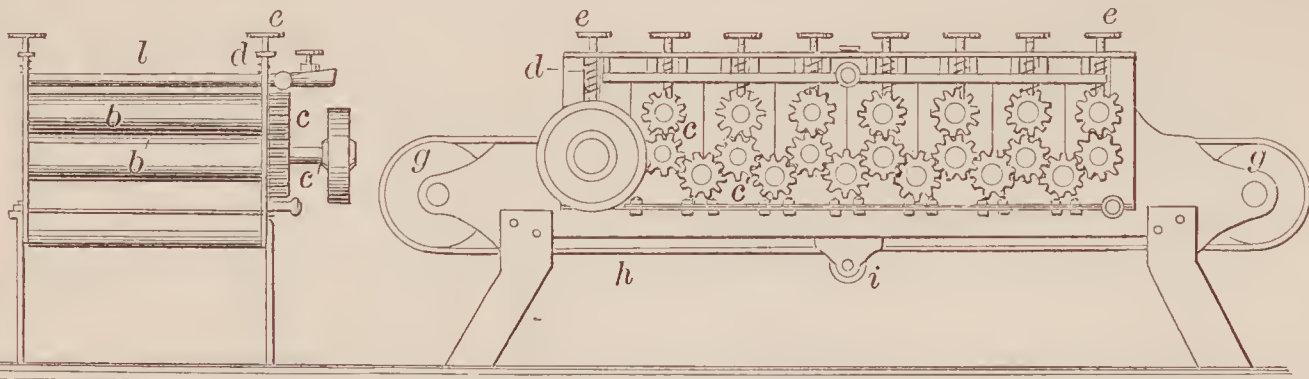

66842—F. M. Hubbard—Dish Holder.

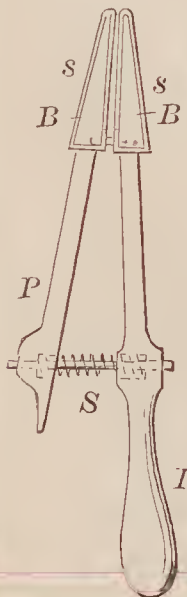

66843—H. Hughes—Door Spring.

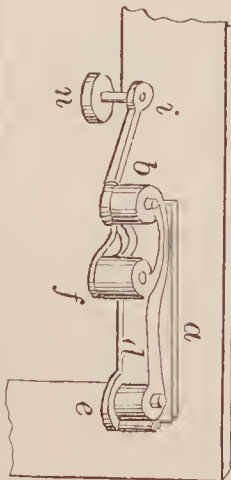

66844—F. W. Huppelsberg—Loom.

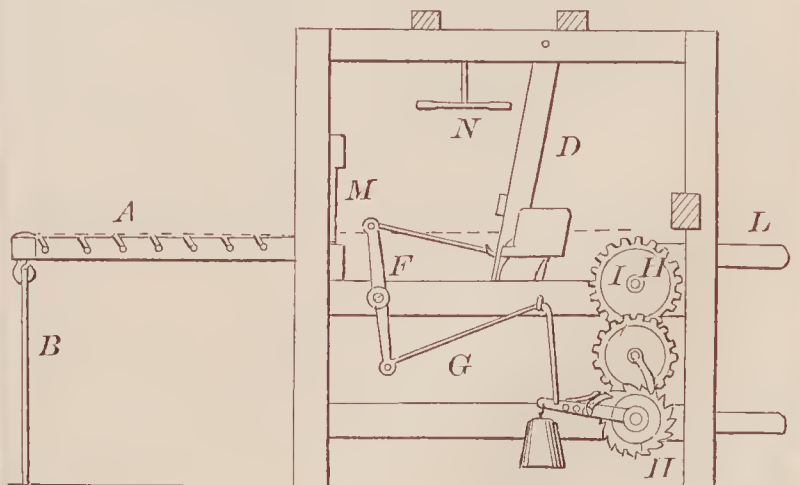

66844—Continued.

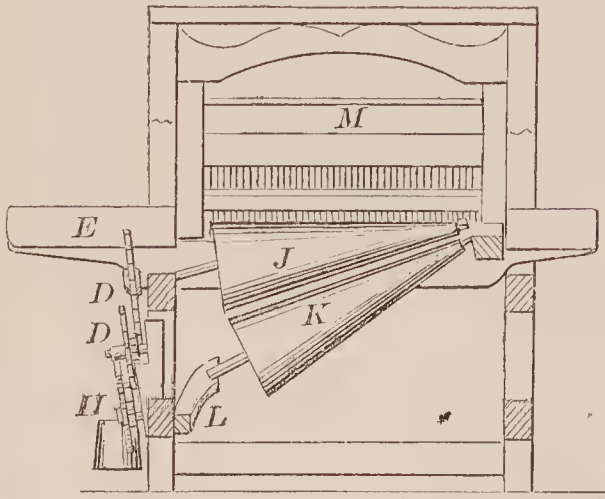

66847—A. S. Jacobs—Oar.

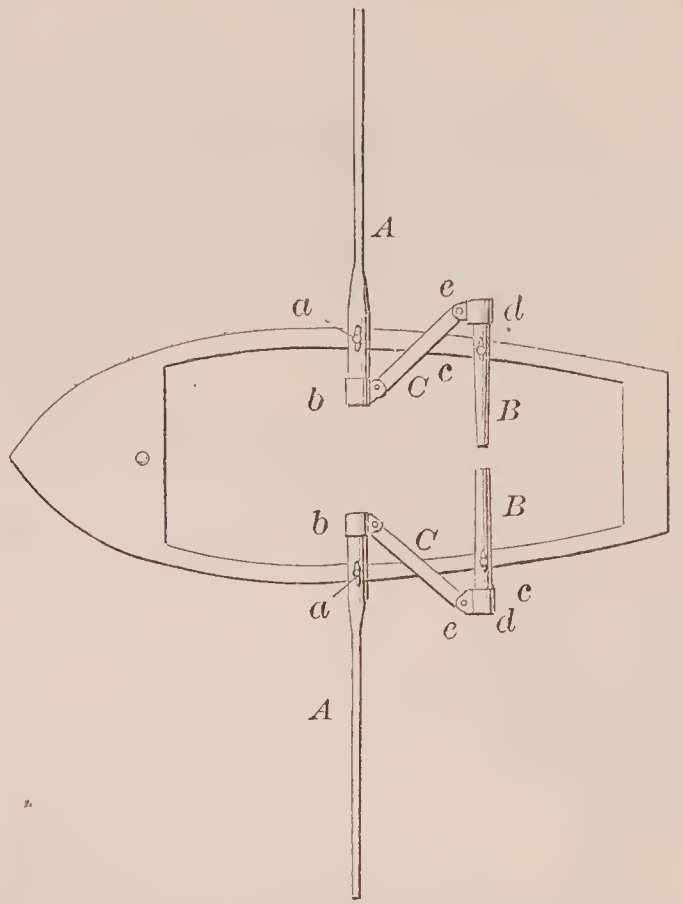

66846—G. W. Hyatt—Hopple.

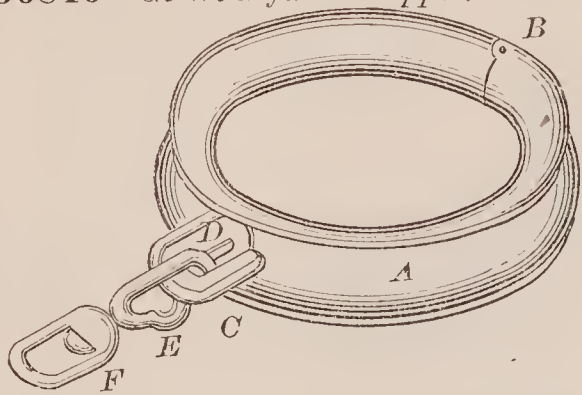

66845—W. W. Huse—For Compressing and Cutting the Filling for Cigars.

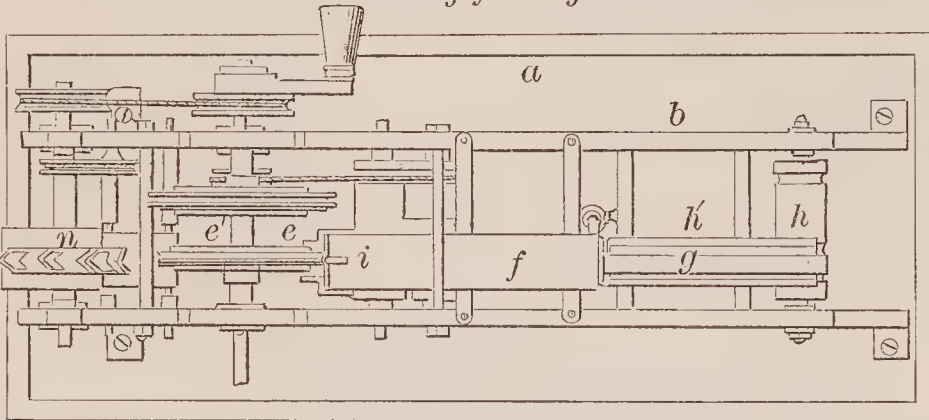

66849—J. Johnson—Bed Bottom Spring.

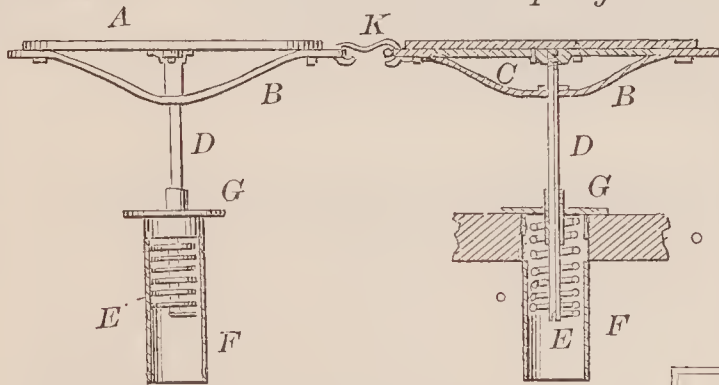

66848—P. Jewell, Jr.—Rubber Coated Rubber Belting.



66850—S. W. Jones—Printing Shears.

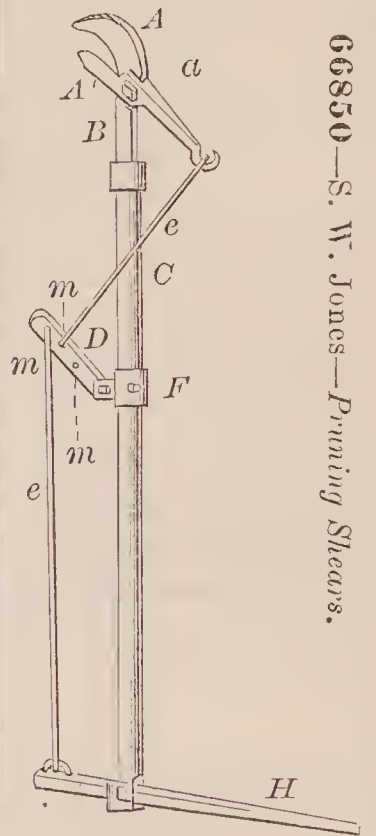

66851—C. Kean—Extension Side for Tables.

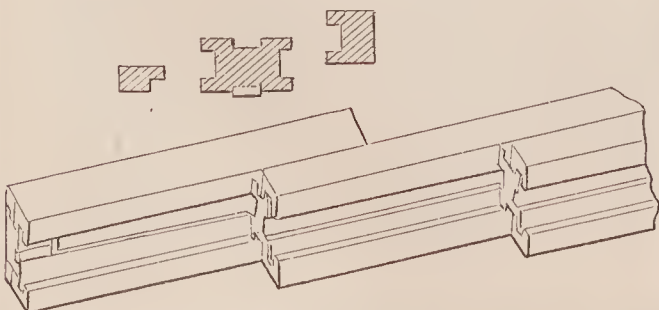

66852—E. Kemper—Gate.

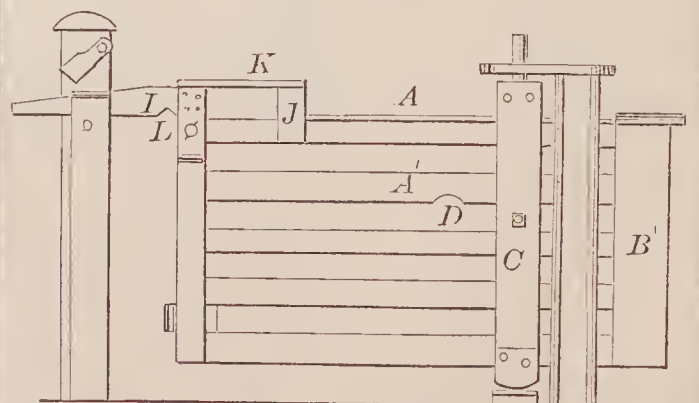



66853—A. Kipp, Jr.—For Grinding Skate Runners.

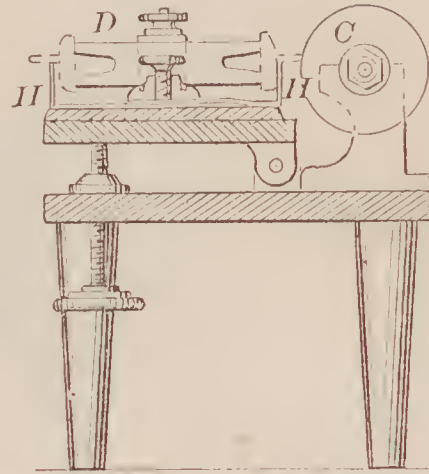
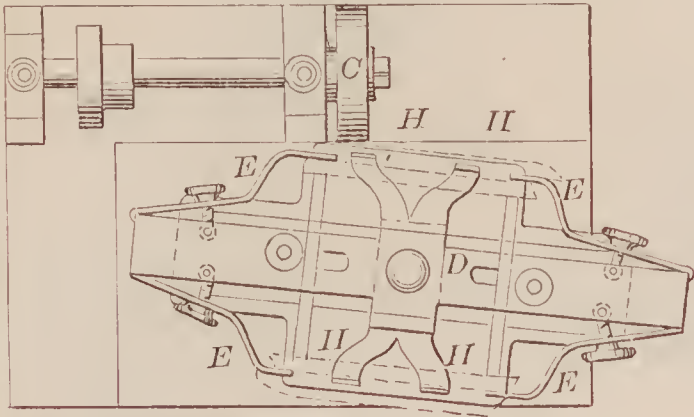

66861—A. Mains—Land Roller and Marker.

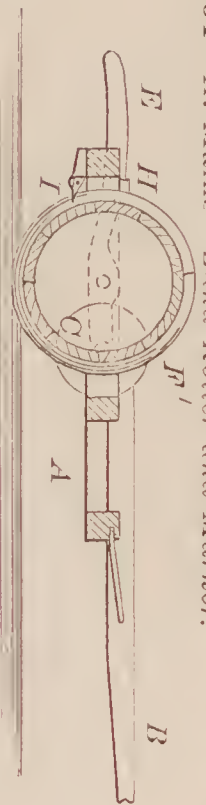

66855—P. Klepper—Egg Beater

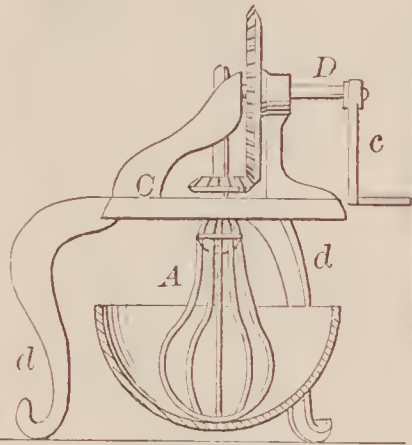

66858—C. L. Lochman—Box for Indelible Ink, &c.

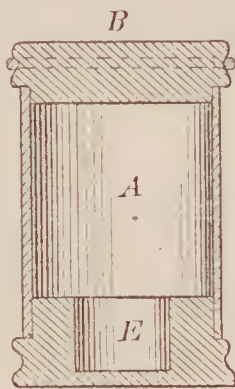

66856—B. I. Lane—Scrubbing Utensil.

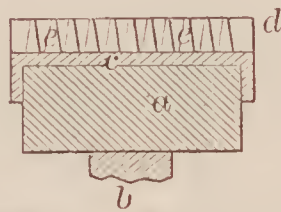

66857—D. Lee—Globe Valve.

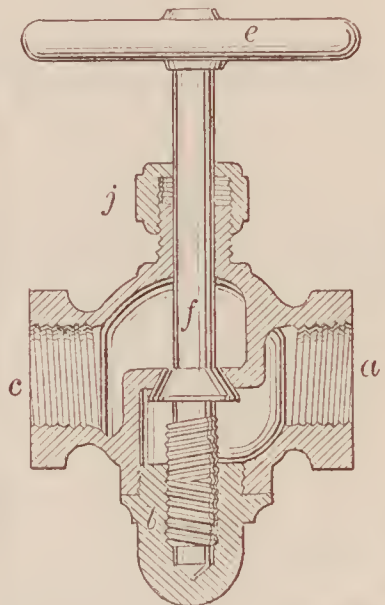

66854—Kissell & Blickensderfer—Corrugated Lightning Rod.



66859—A. W. Lockart—Grain Separator.

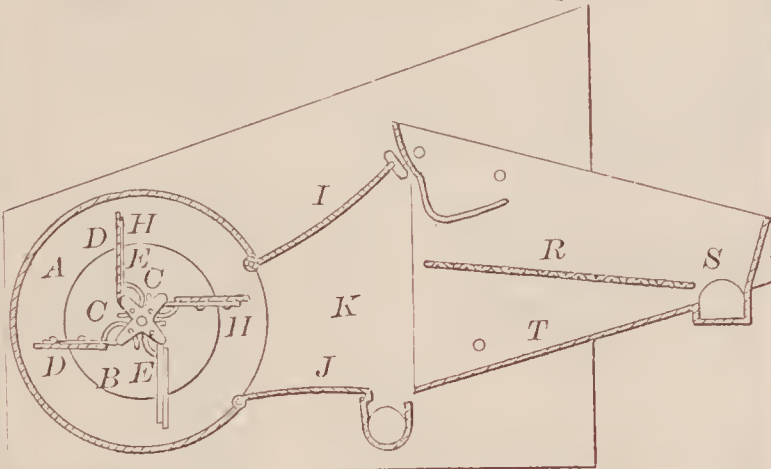

66862—M. S. Marshall—Gas Stove.

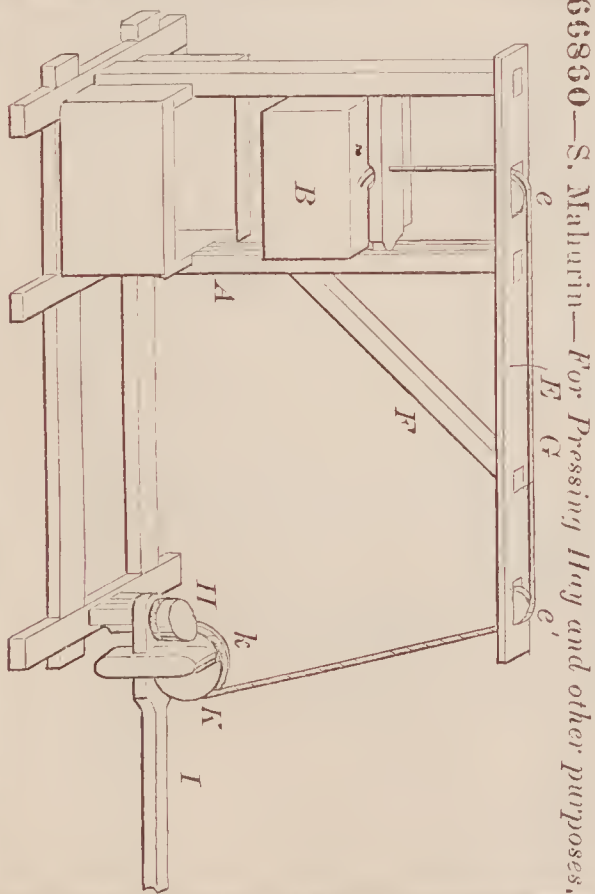
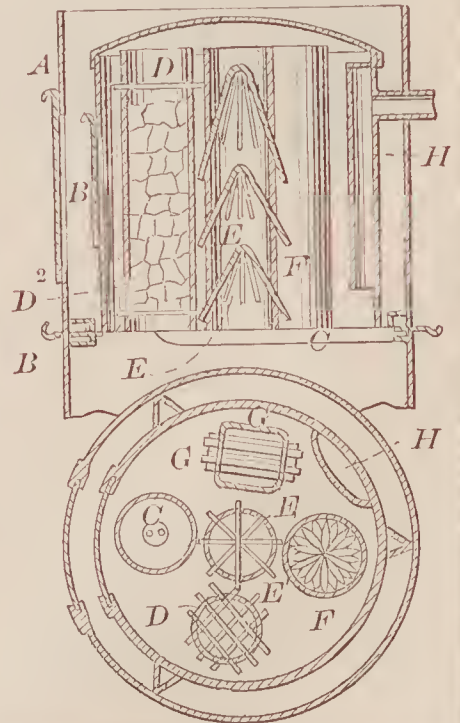
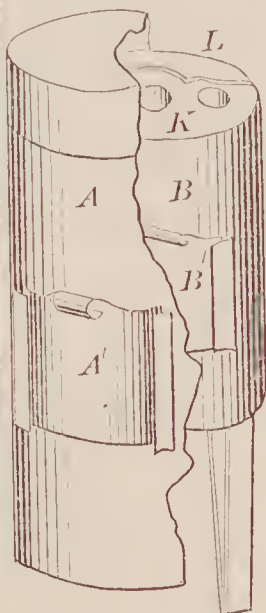

66860—S. Mahurin—For Pressing Hay and other purposes.

66863—Mason & Messenger—*Mop Head.*

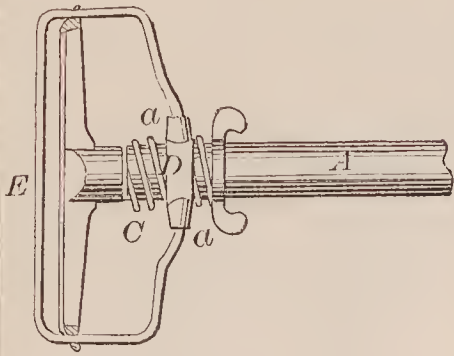

66865—W. H. McPherson—*Horse Rake.*

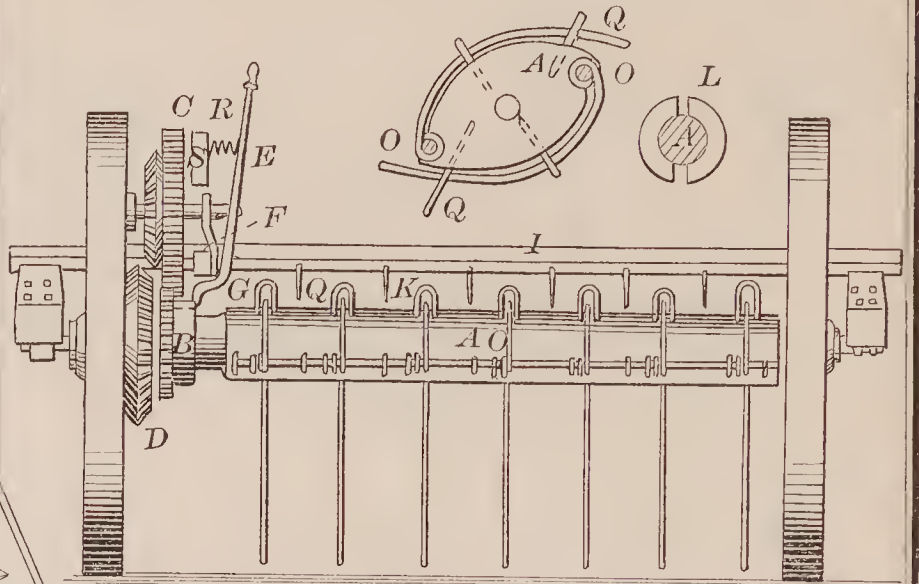

66866—B. B. Monroe—*Wagon Brake.*

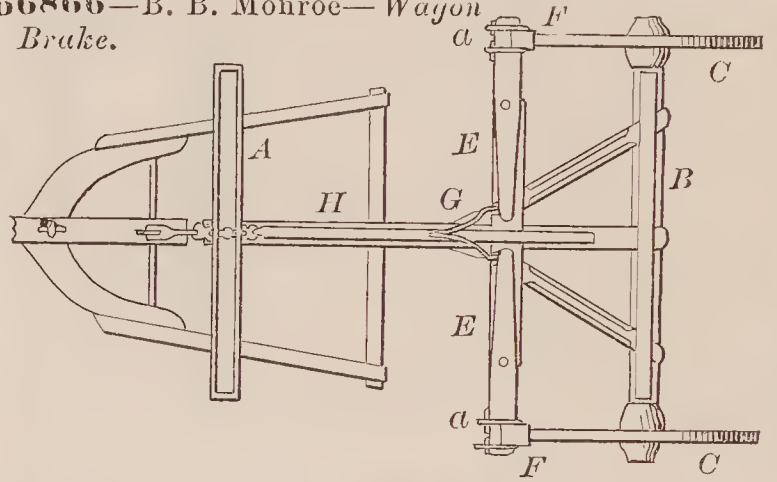

66870—T. Munger—*Gate.*

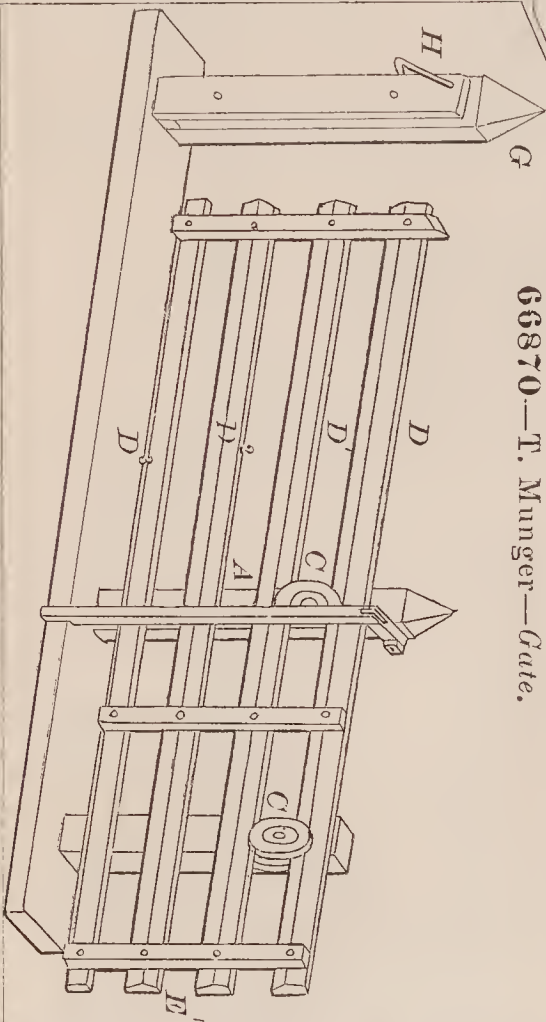

66864—J. W. Maxfield—*For Crimping Boots and Shoes.*

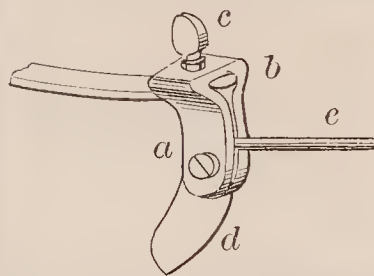

66871—J. Murphy—*Cultivator.*

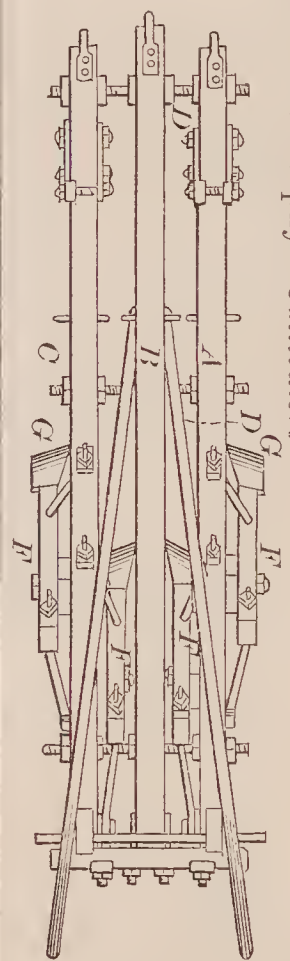

66867—F. Monroe—*Flour Box.*

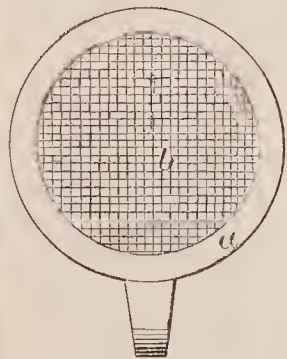

66869—J. E. Morgan—*Harrow.*

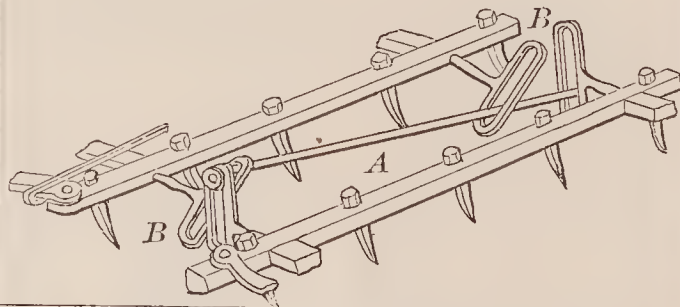

66872—J. W. Neal—*Cockle and Garlic Separator.*

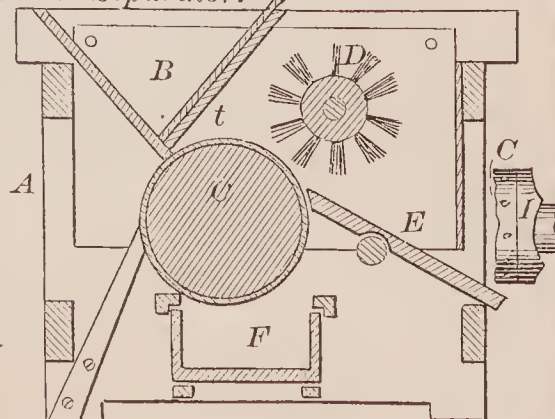

66868—E. Morgan—*Mucilage Stand.*

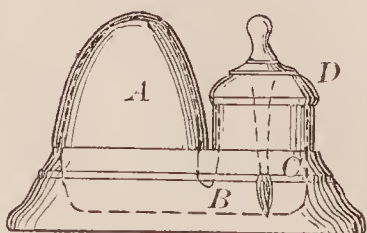



66876—E. B. Olmsted—Packing Apparatus for Envelope Machines.

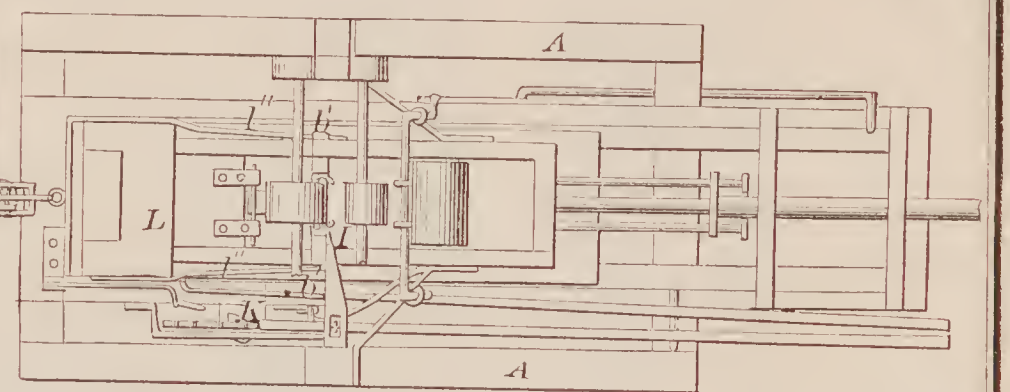
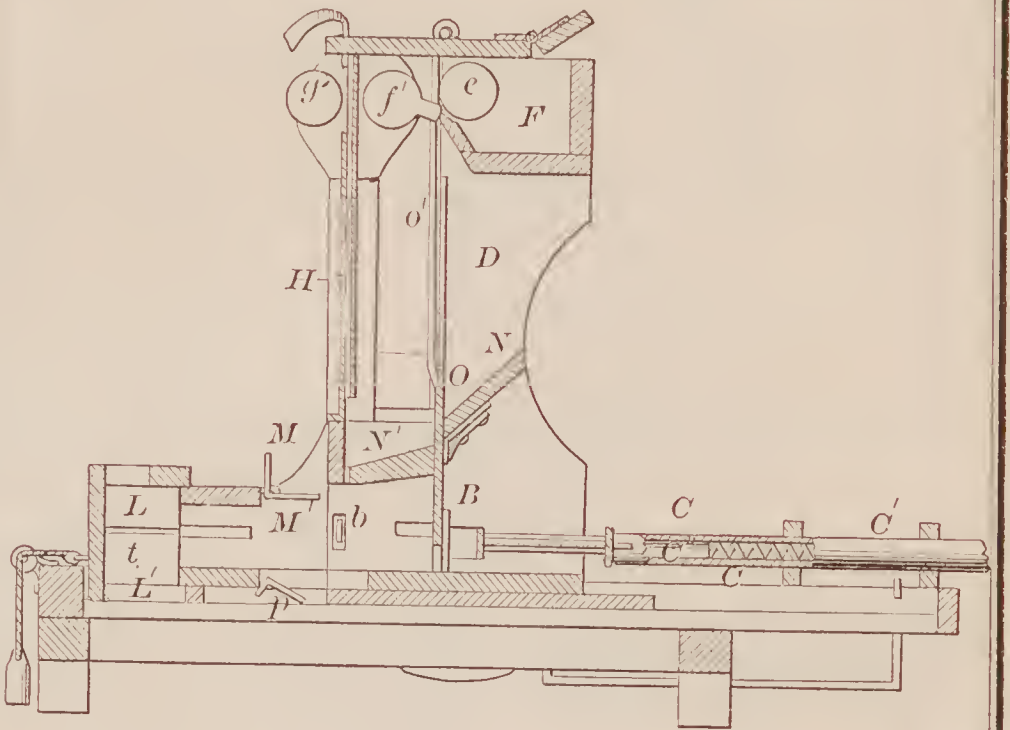
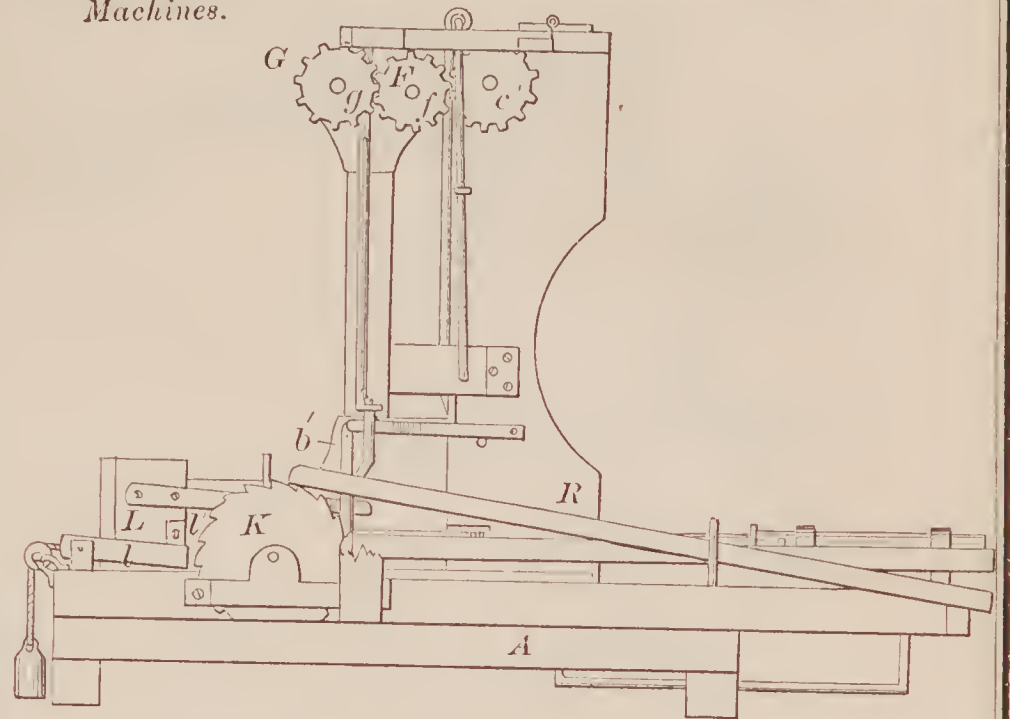

66875—G. H. Ober—For Tenoning Spokes.

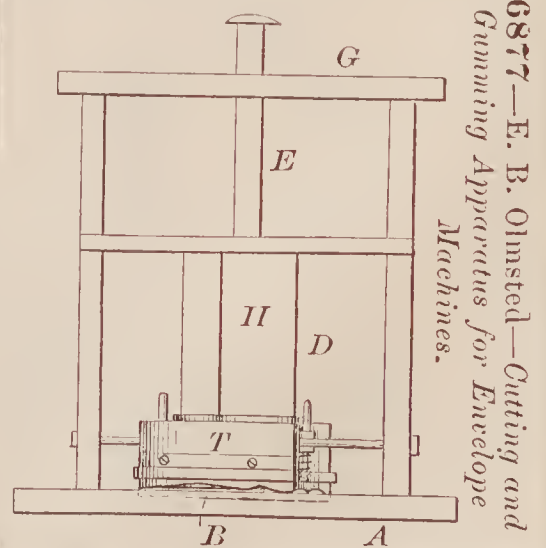
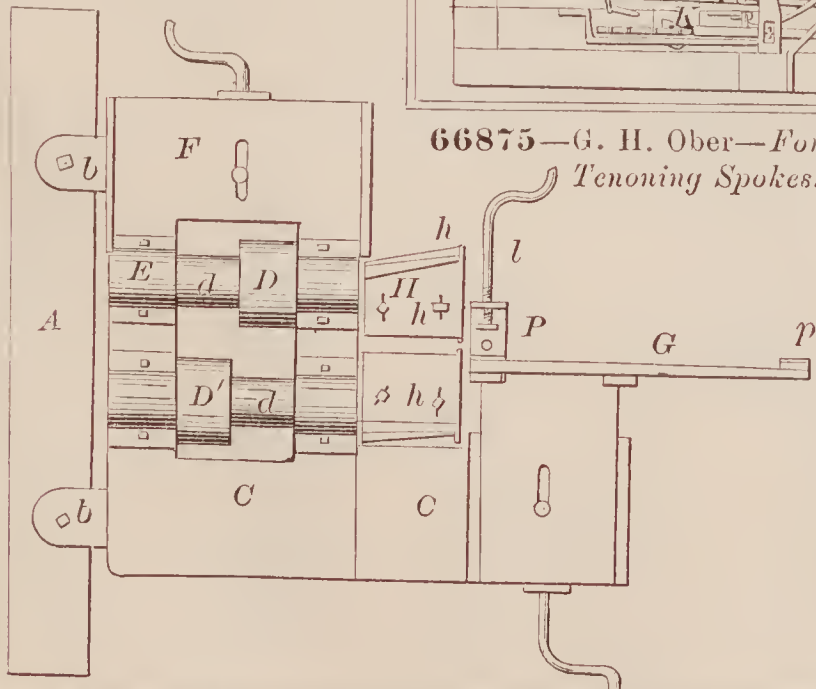

66877—E. B. Olmsted—Cutting and Gunning Apparatus for Envelope Machines.

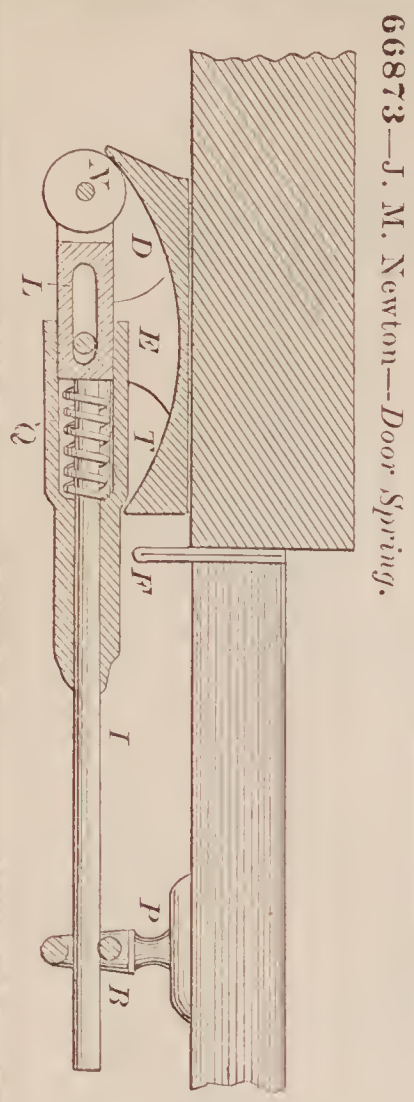

66873—J. M. Newton—Door Spring.

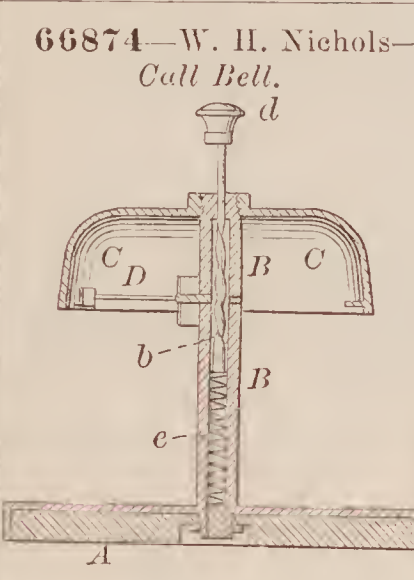

66874—W. H. Nichols—Call Bell.

66877—Continued.

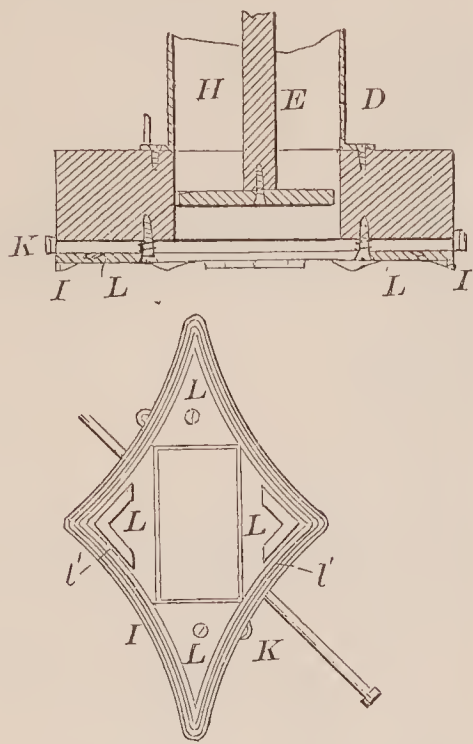

66878—E. B. Olmsted—Folding and Printing Bed for Envelope Machines.

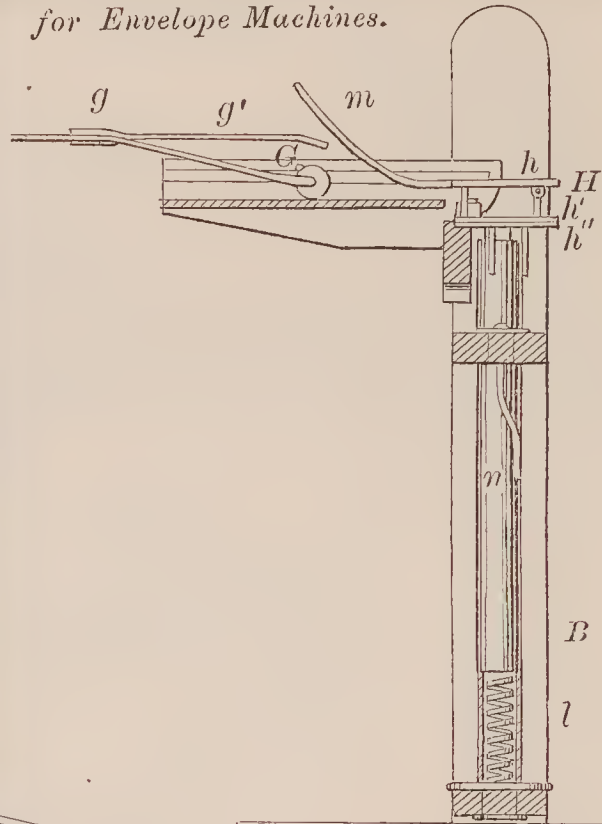

66881—F. B. Parks—Folding Lunch Box.

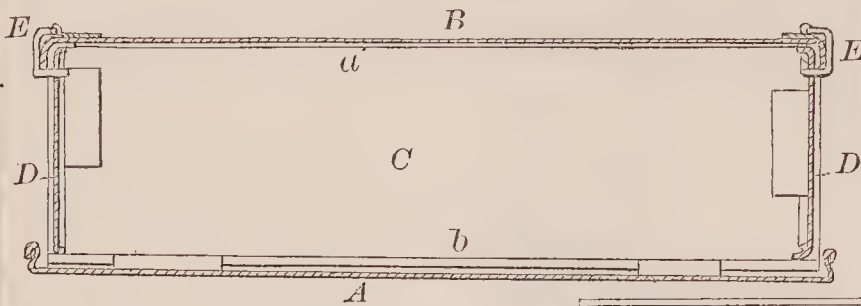

66880—C. W. Packer—Hat Box.

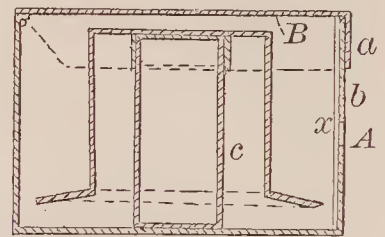

66882—D. H. Peterson—Wagon Box.

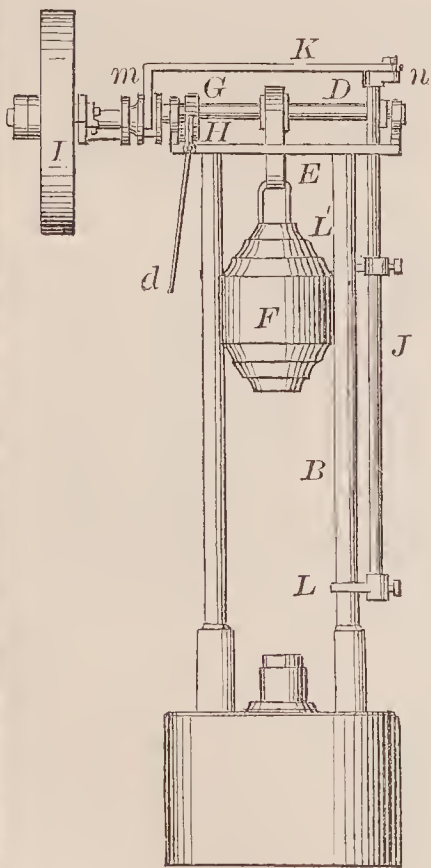
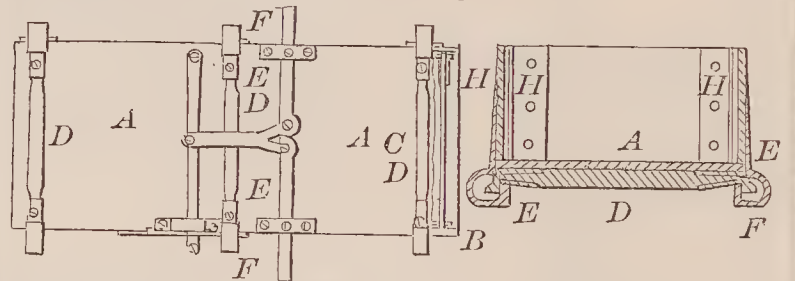

66879—L. H. Olmsted—Drop Hammer.

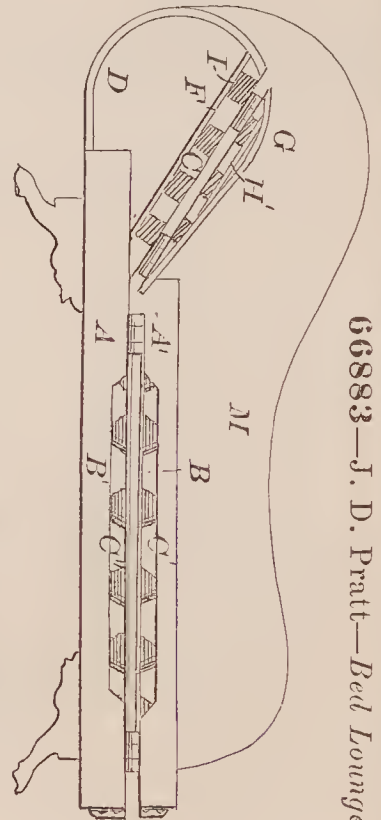
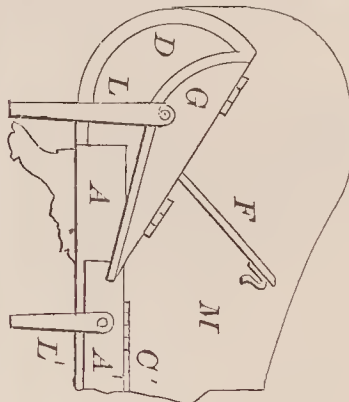

66883—J. D. Pratt—Bed Lounge.

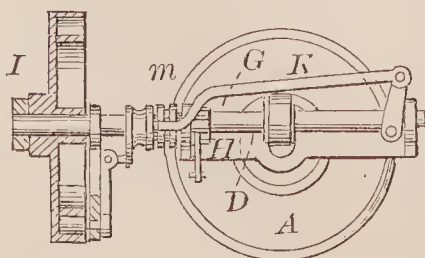



66885—J. Richards—Wood Turning Lathe.

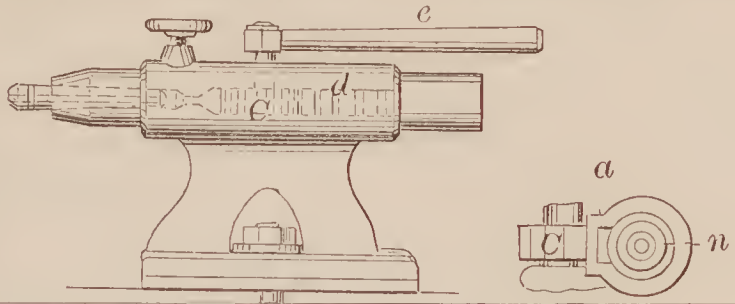

66889—O. L. Robinson—Cherry Stoner.

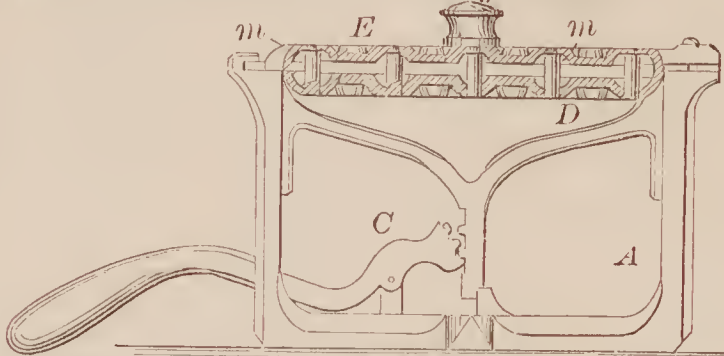

66884—J. C. Rhodes—Drop Press.

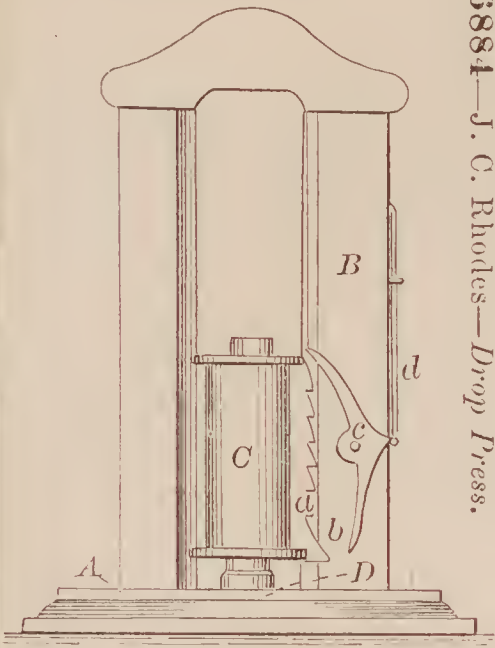

66886—L. V. Richmond—Stop Motion for Warping Machines.

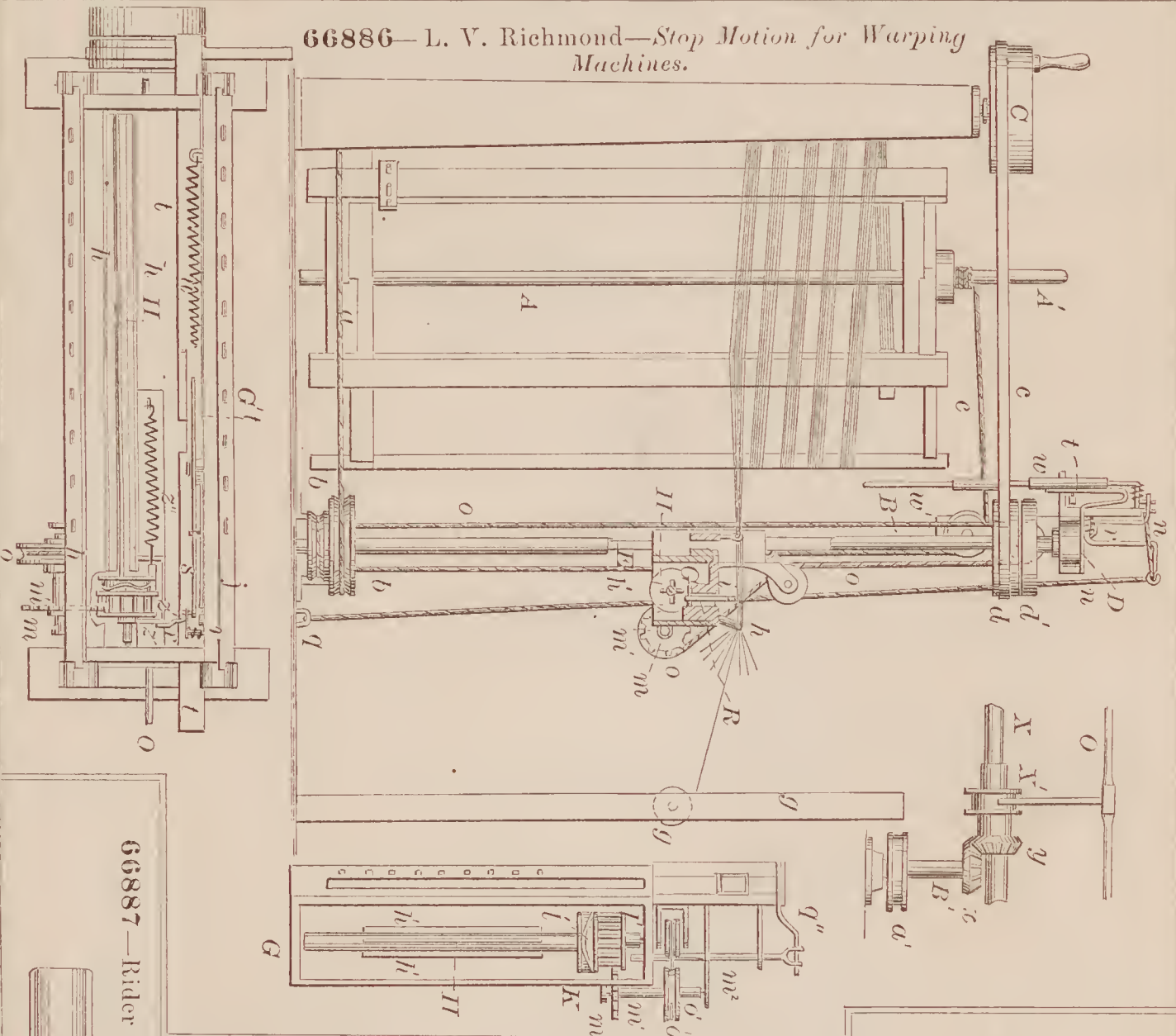

66887—Rider & Perry—Well Tubing.

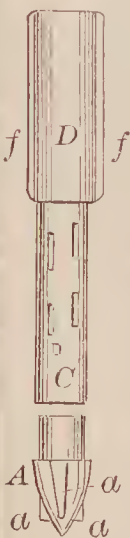

66888—G. Robinson—Piston Packing.

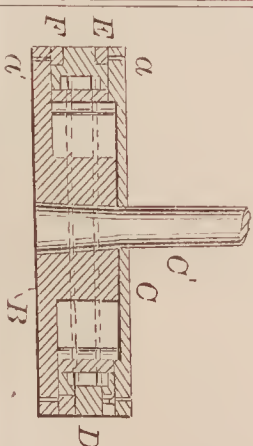

66890—H. Rothfelder—Wrench.

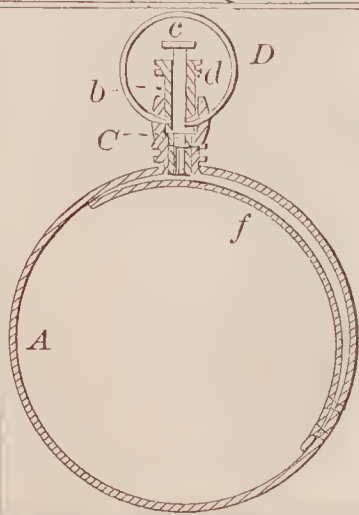

66891—E. W. Rowley, Jr.—Pea Rake.

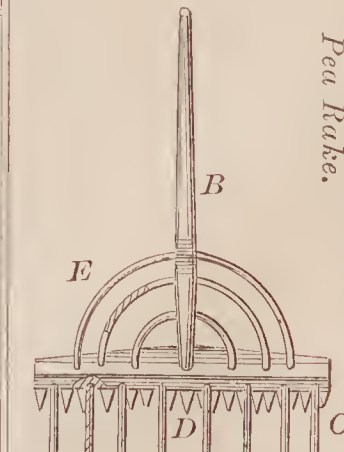

66892—J. S. Rowley—Clip for  
for Clothes Lines.

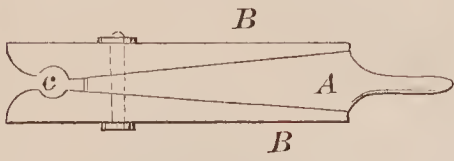

66894—D. P. Sharp—Horse Rake.

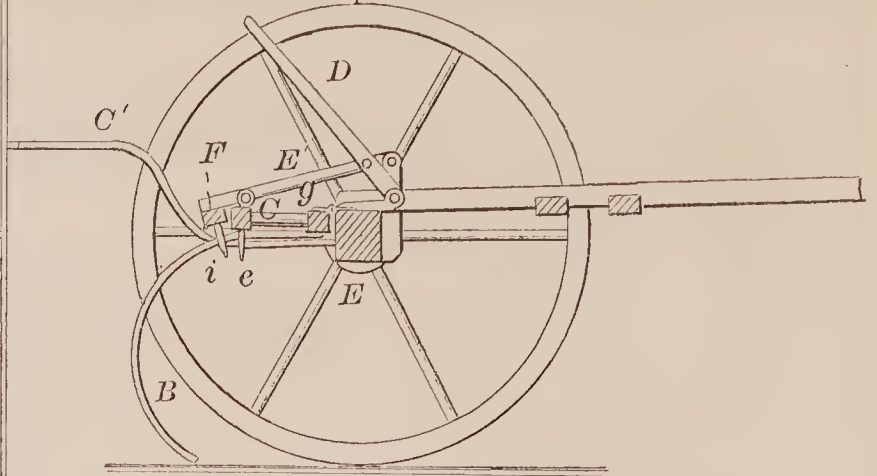

66898—S. A. Simison—Ticket  
Holder.

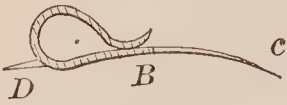

66893—Selden & Liddell—Hinge.

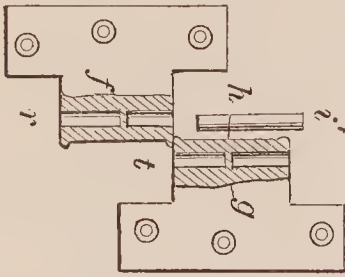

66899—F. Sims—Book Sewing  
Machine.

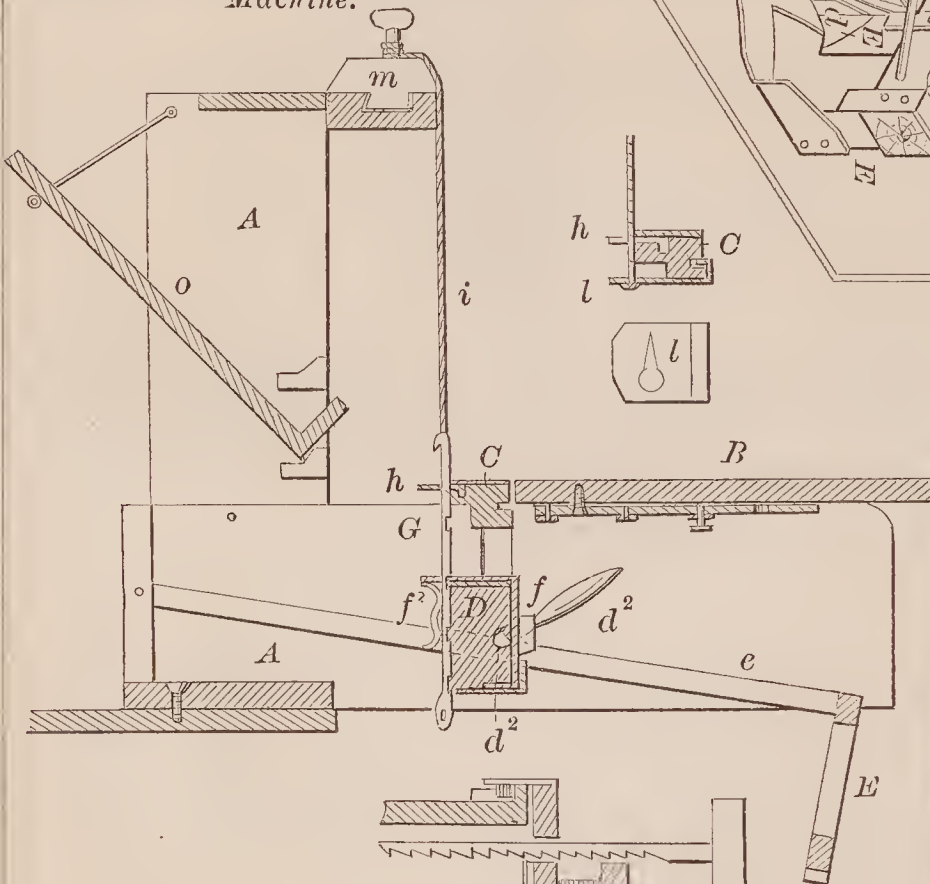

66895—F. M. Shields—Cotton Plow.

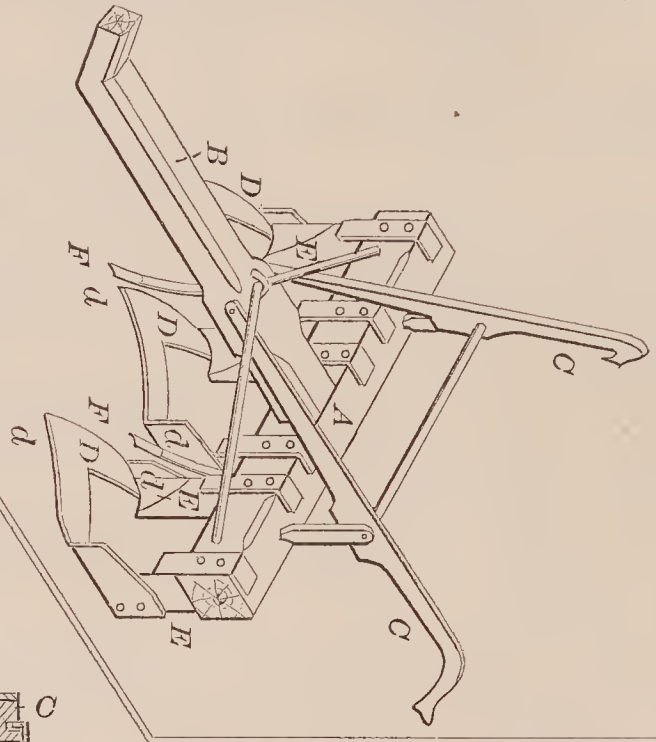

66896—C. Shortau—Wire  
Twisting Machine.

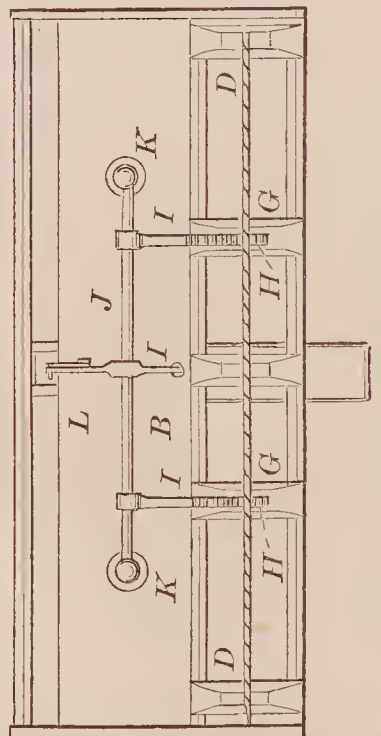
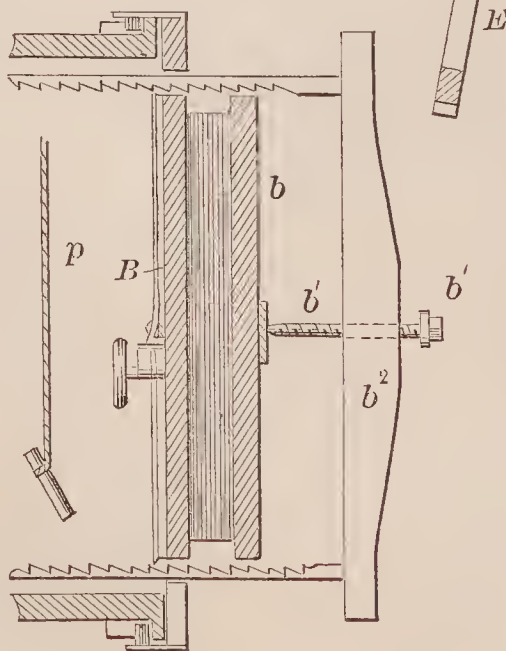
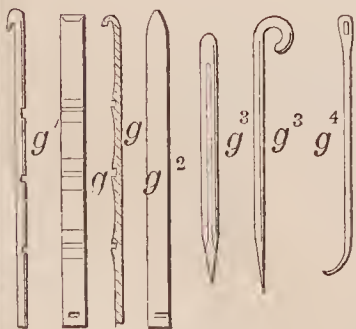
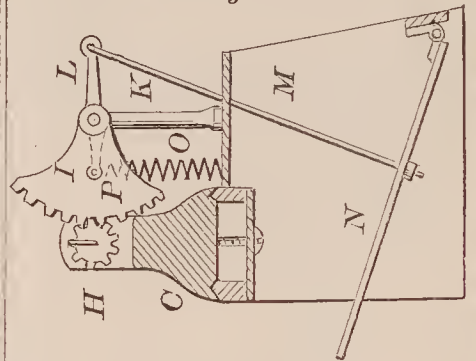



66900—R. W. Smith—*Bridge.*

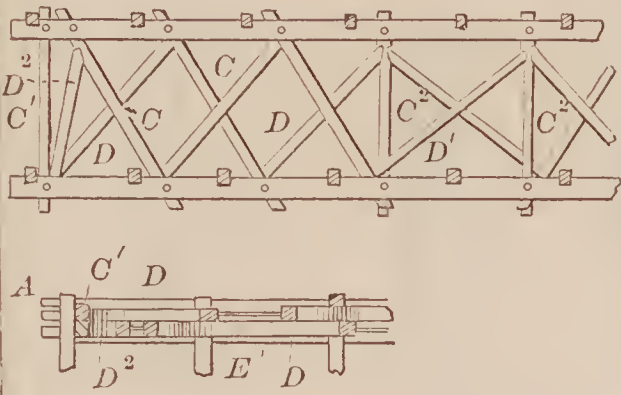

66905—W. F. Stillman—*For Rolling Hoes.*

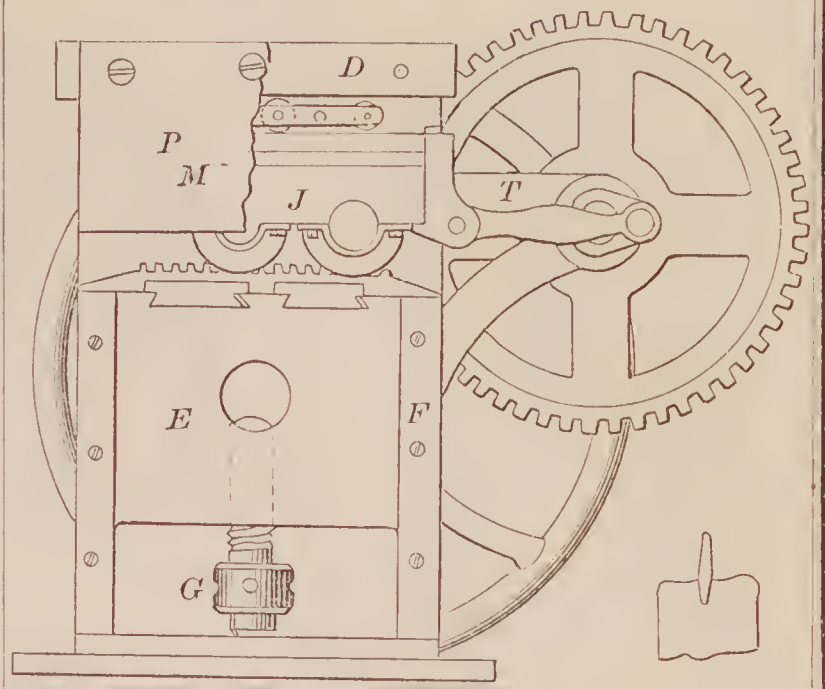

66901—D. D. Stelle—*Planter, Harrow and Cultivator.*

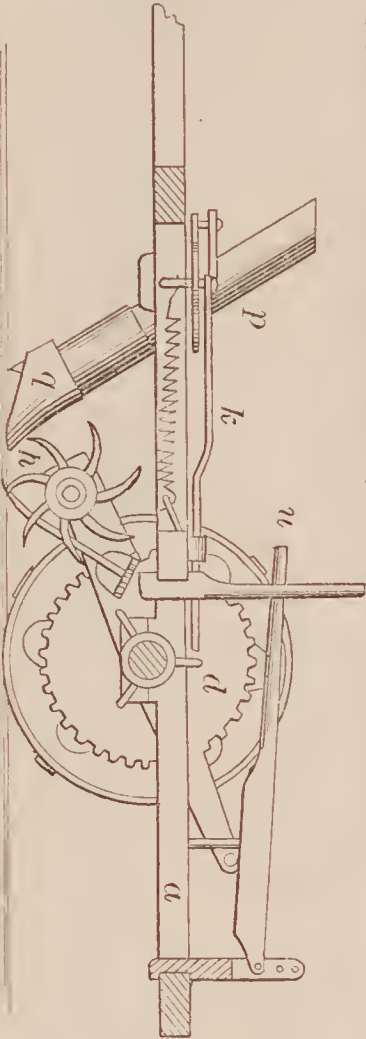

66901—M. H. Spaulding—*Churn.*

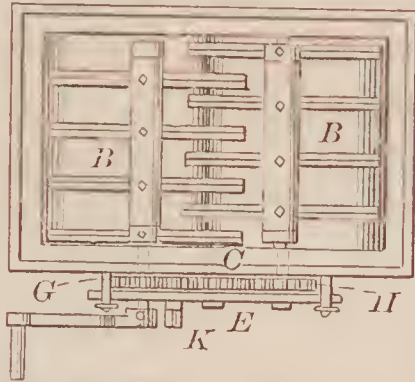

66902—C. F. Spencer—*Lantern.*

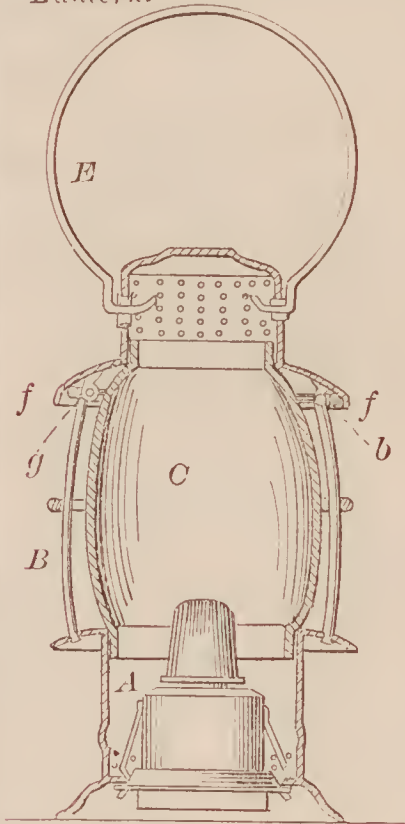

66903—C. E. Stearns—*Stair Rod.*

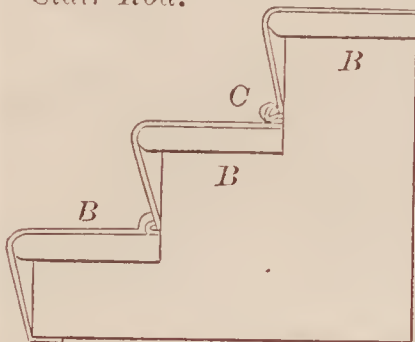

66906—A. St. Louis—*For Making Spikes.*

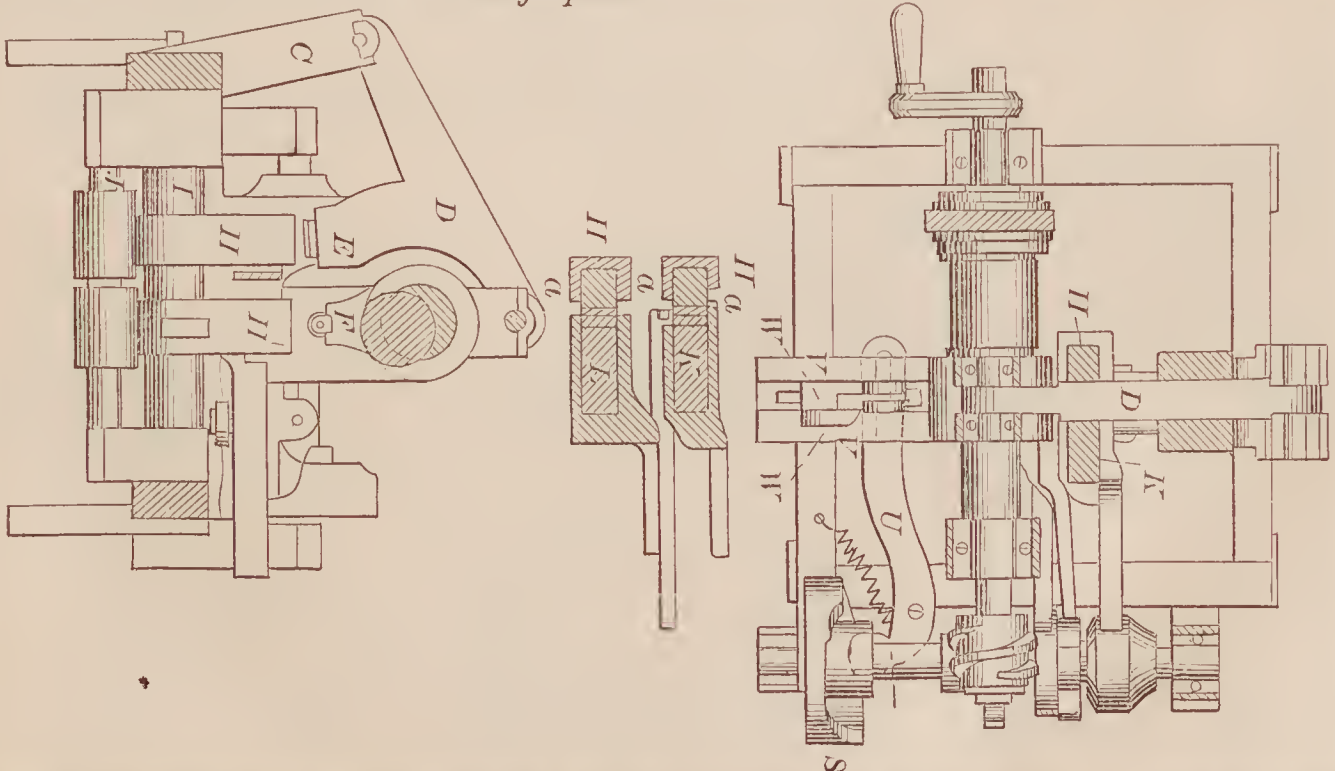

66907—J. H. Stone—Coal Store.

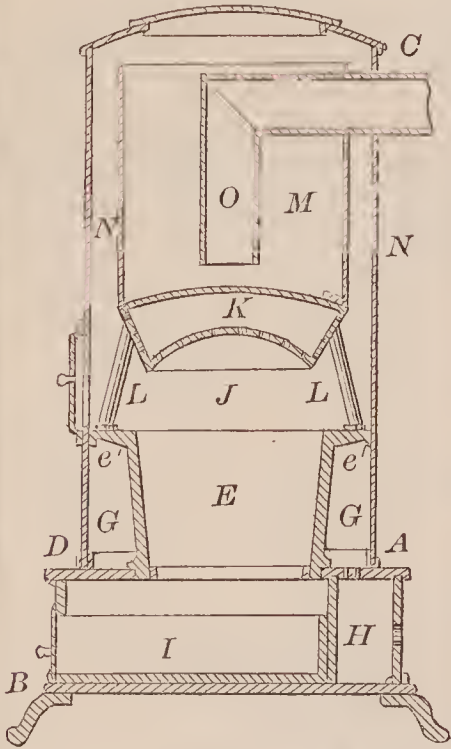

66911—D. C. Teller—Steak Broiler.

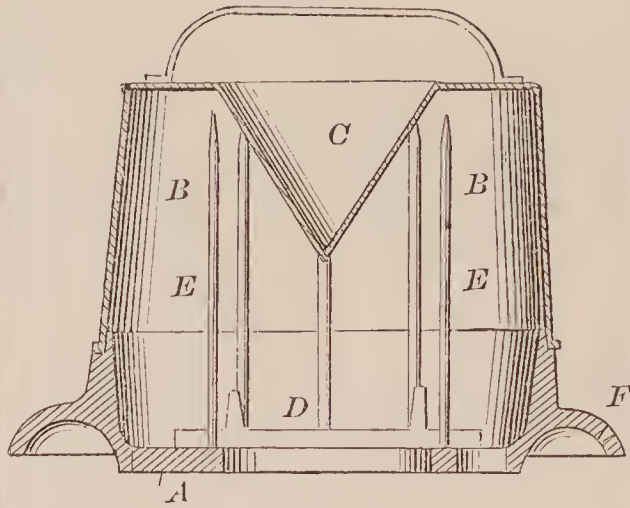

66909—A. L. Taylor—Pastry Roller.

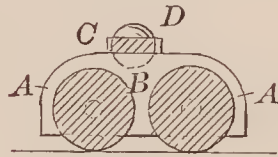

66908—G. O. Sweet—Screw Plate.

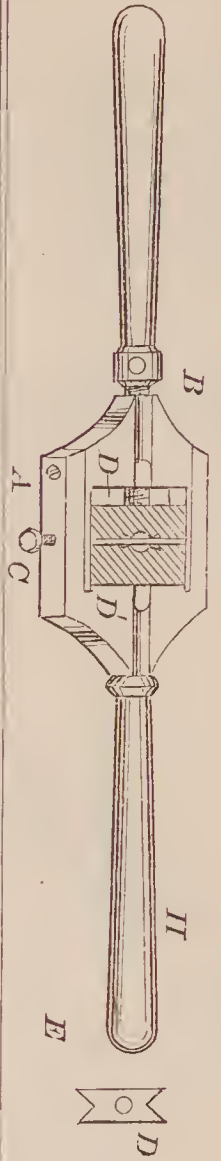

66913—Thrasher & Aiken—Breech-Loading Fire Arm.

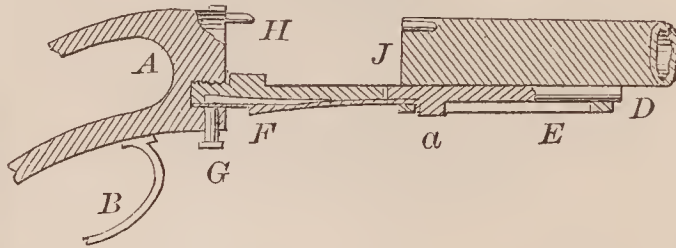

66910—S. J. Taylor—Corn Planter and Cultivator.

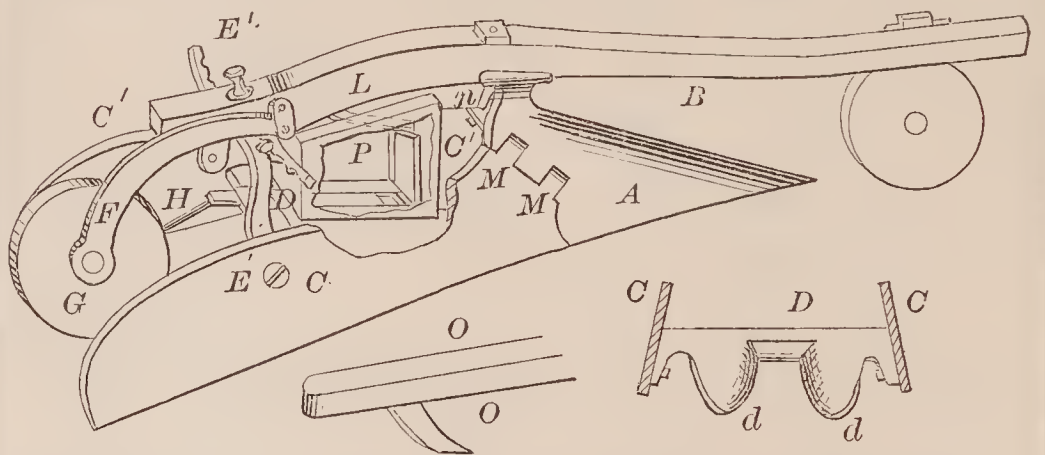

66914—J. E. & W. P. Tynan—Locomotive Truck.

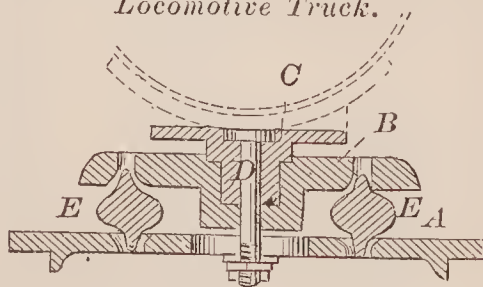

66916—W. H. H. Walker—Meat Chopper.

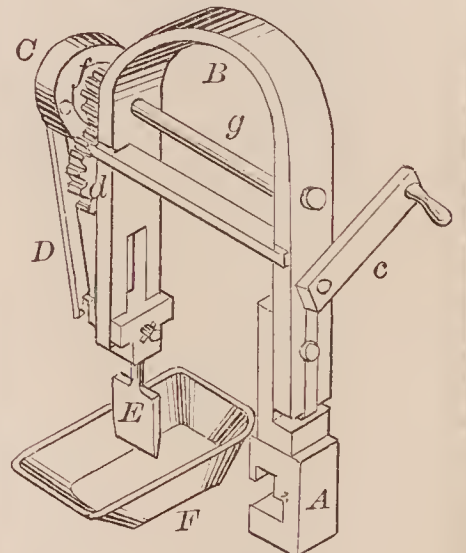

66915—M. Vetter—Window Shade.

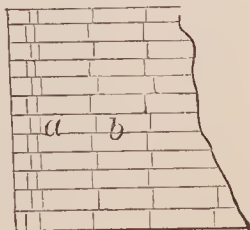

66912—M. L. & R. W. Thornton—Corn and Cotton Seed Planter.

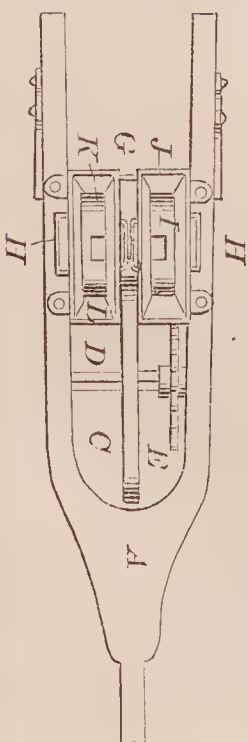
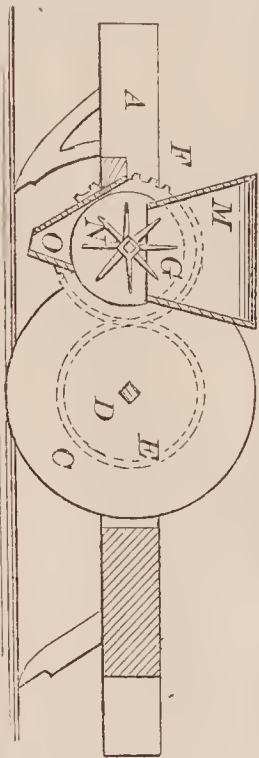



66917—S. Warren—Wagon Brake.

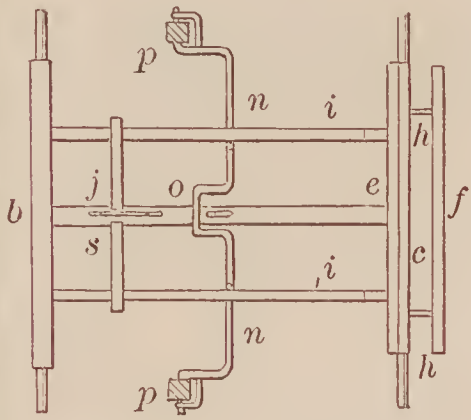

66918—Wheeler & Jerome—Drying Box of Pulp.

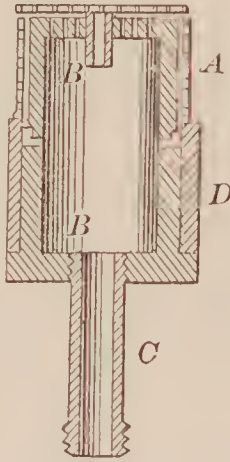

66919—Wheeler & Jerome—Finishing Box of Pulp.

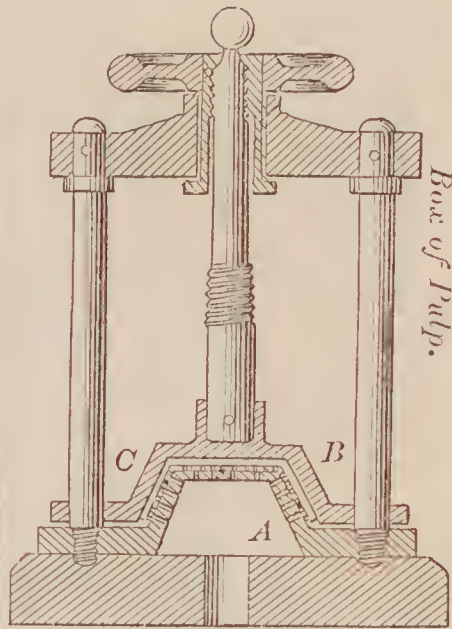

66921—J. Whitehill—Dust Room in Cleaning Cotton.

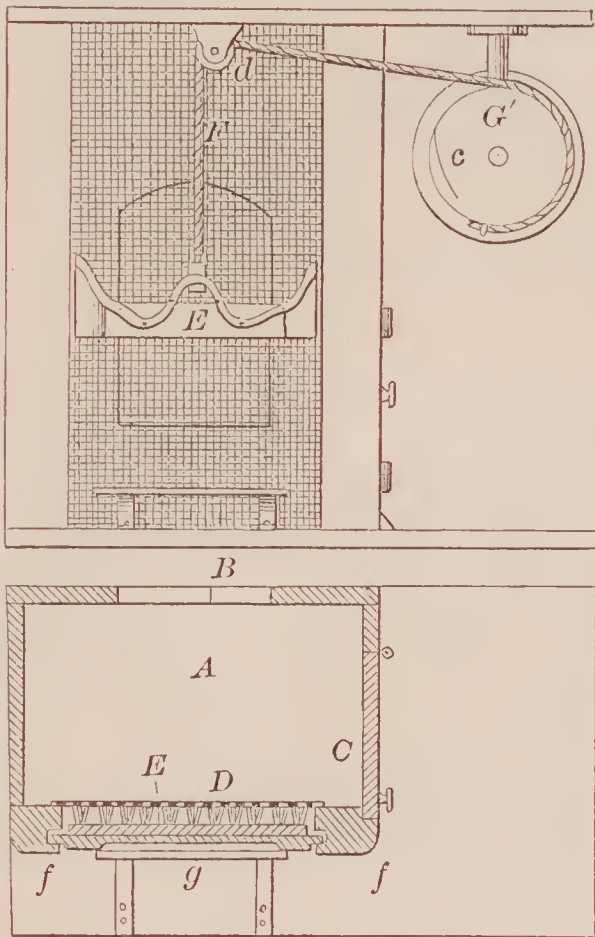

66922—O. J. Whitney—Car Coupling.

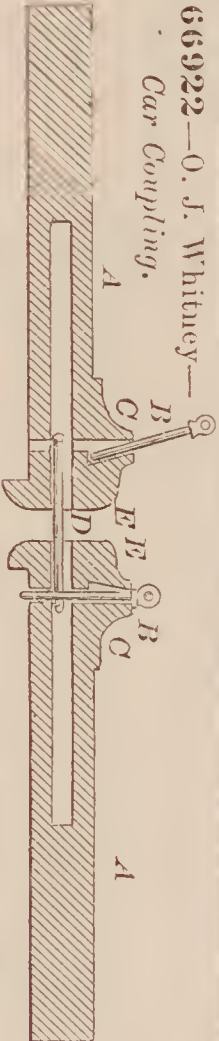

66920—Wheeler & Jerome—Making Blanks for Paper Boxes.

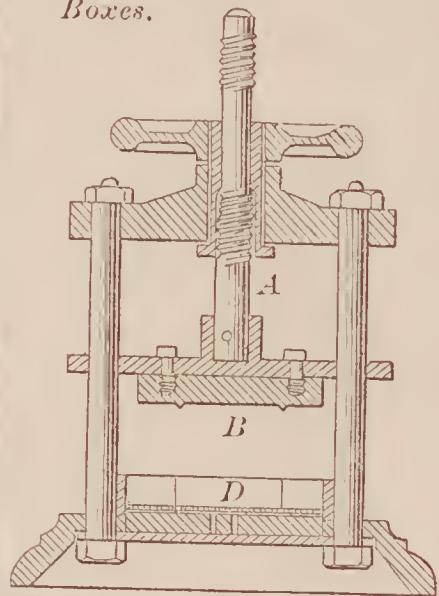

66923—B. Wieland—Corn Planter.

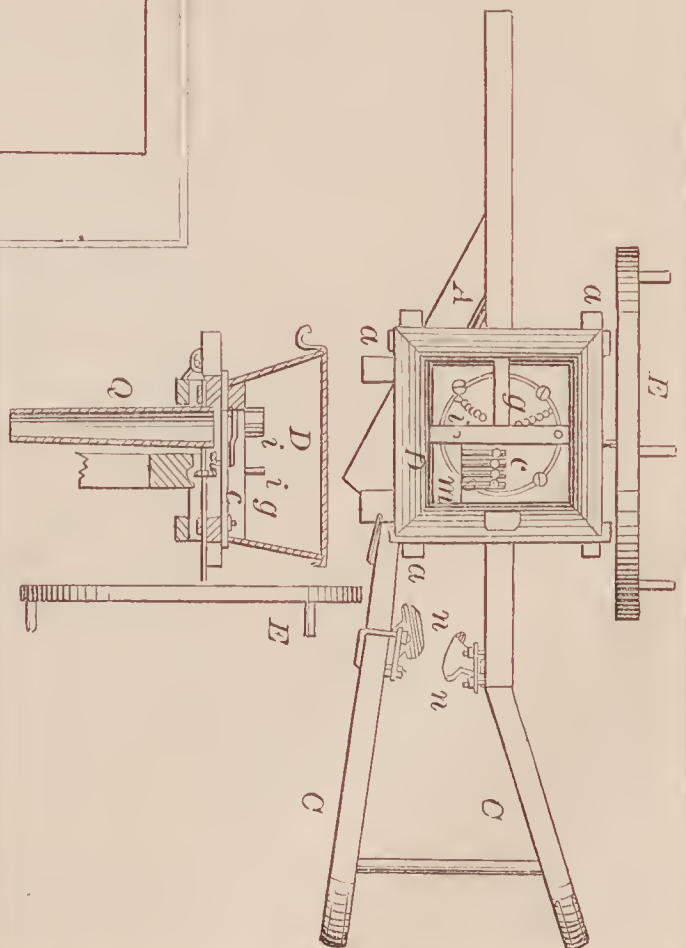

66924—Wilcox & Caldwell—Cotton Seed Planter.

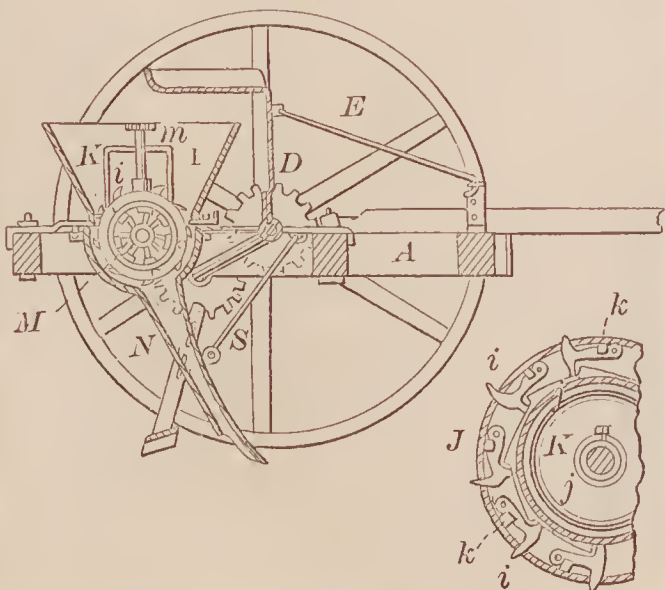

66925—W. R. Wilcox—*Fruit Box.*

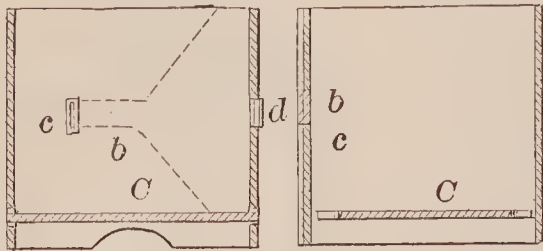

66926—D. L. Winsor—*Snow Plow.*

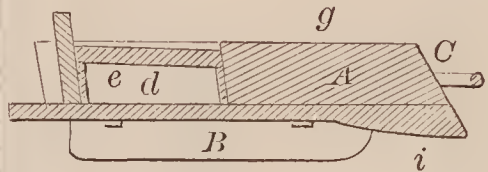

66927—A. Wiswall—*Door Spring and Hinge.*

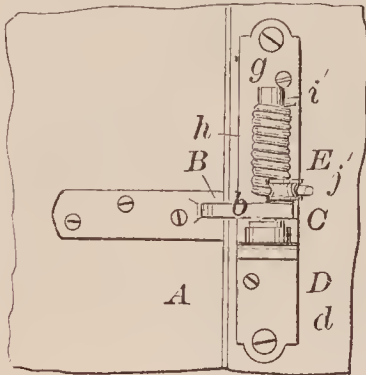

66928—L. Wolf—*Key for Piano Fortes.*

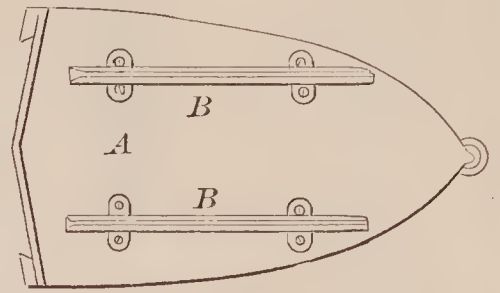

66930—L. M. Woodcock—*Railway Chair.*

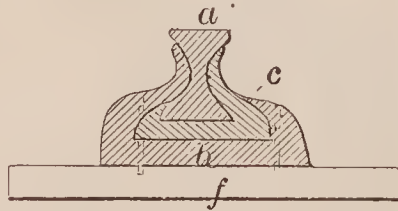

66935—Barney & Berry—*Skate Fastener.*

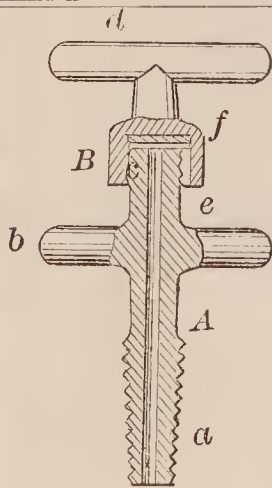
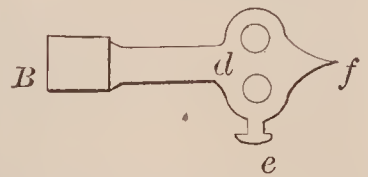

66929—O. N. Wood—*Vent Plug.*

66934—W. M. Ball—*Cultivator.*

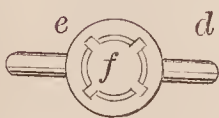
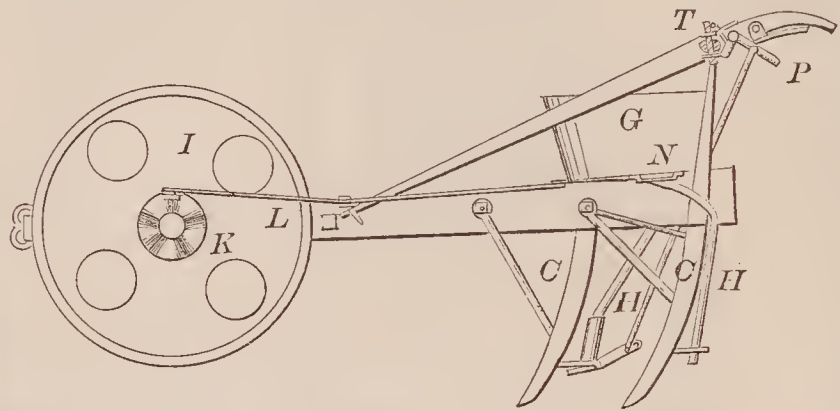

66931—Young & Hoard—*For Threading Screws.*

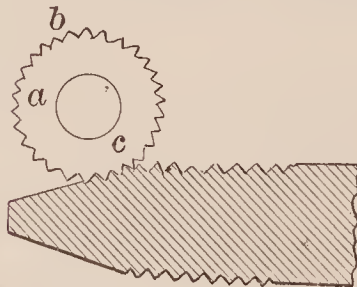

66937—W. W. Pierce—*For Carbureting Gas.*

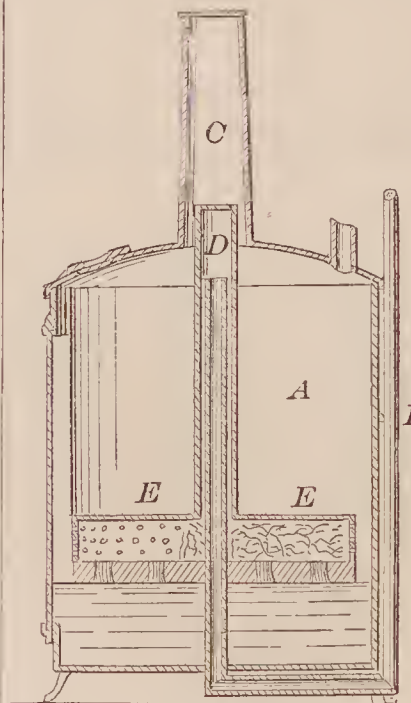

66932—W. Young—*Steam and Water Joint.*

66936—A. Bayley—*Tea and Coffee Pot.*

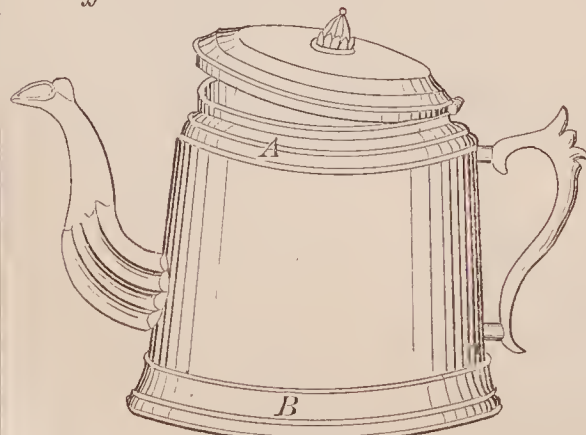



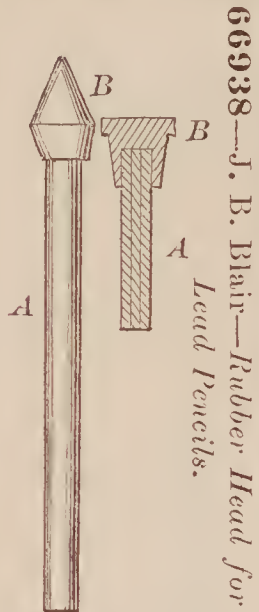

66938—J. B. Blair—Rubber Head for Lead Pencils.



66939—J. D. Bowen—Plow.

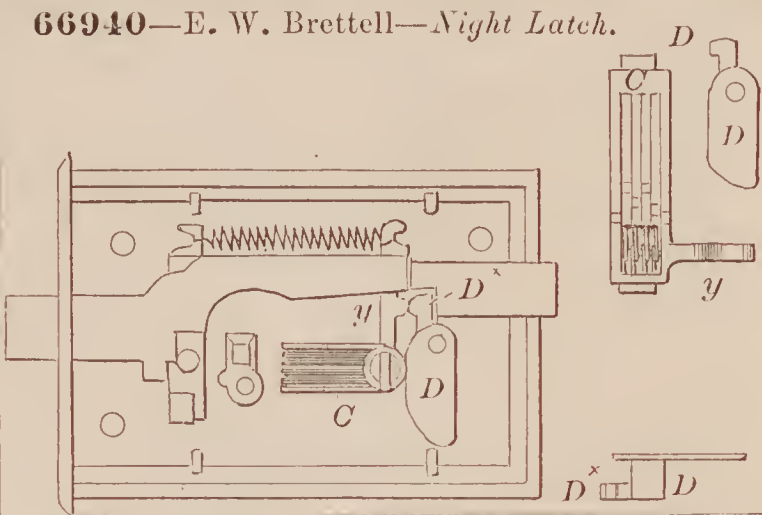

66940—E. W. Brettell—Night Latch.

66941—W. Brower—Pulley Bit for Bridles.

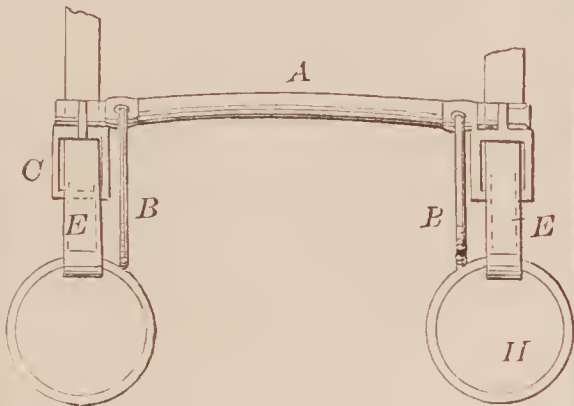

66942—F. Brown—Fog Signal.

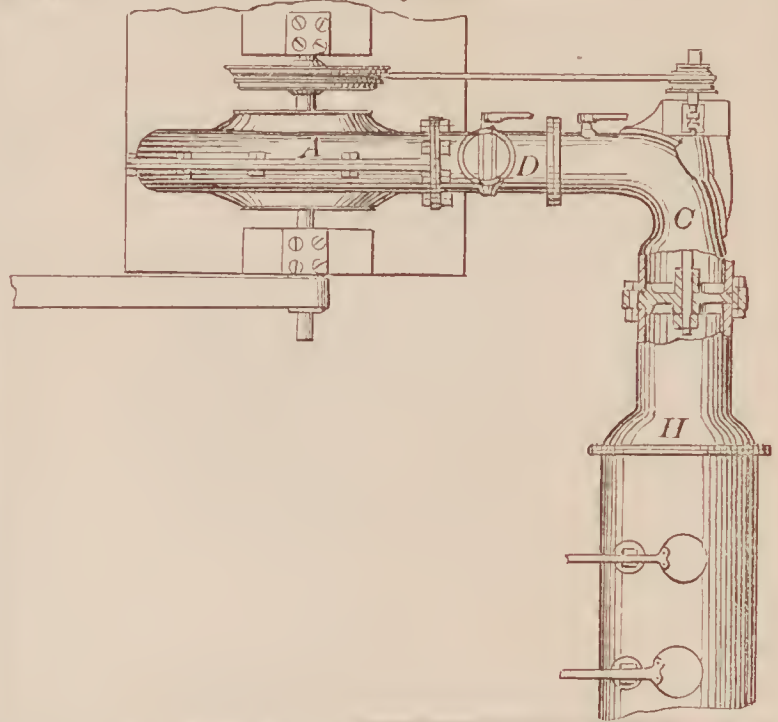

66943—W. G. Brownson—Telegraphic Switch Board.

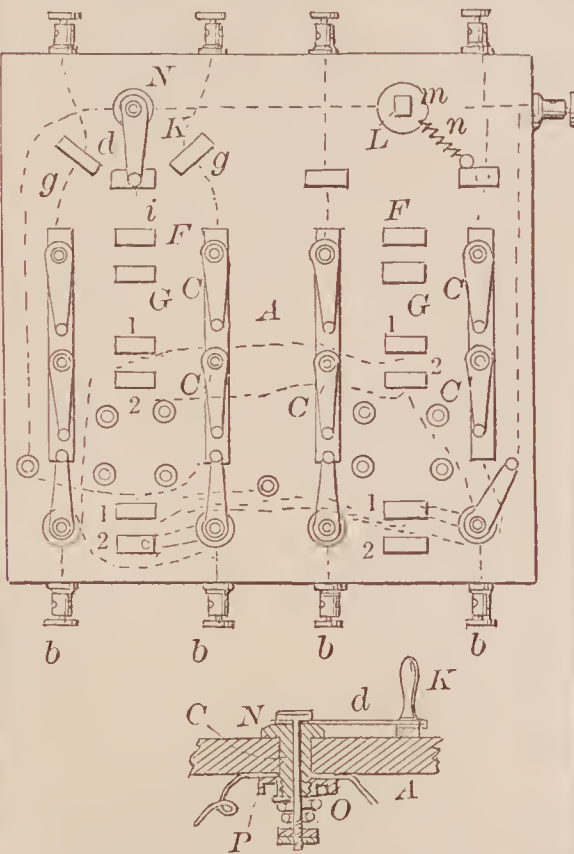

66944—W. G. Brownson—Telegraph Battery Switch Board.

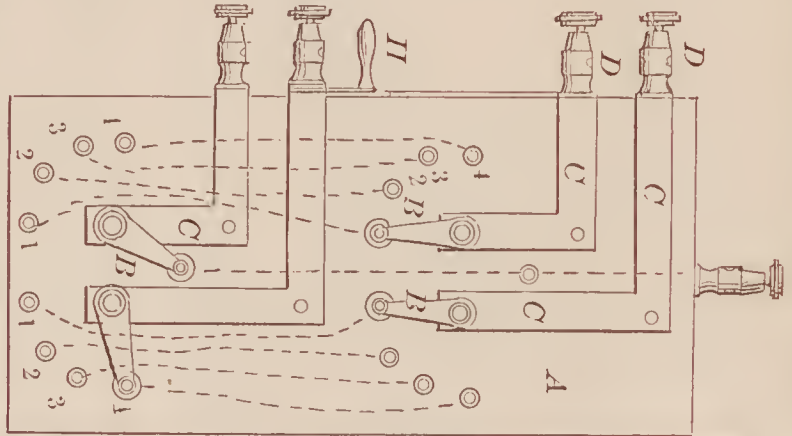

66946—Burt & Miller—Trial Square.

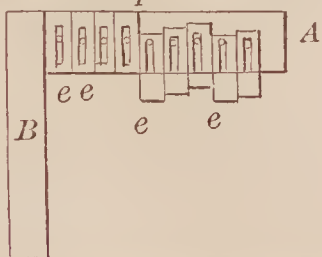

66945—Brownson & Shull—Telegraph Repeating Instrument.

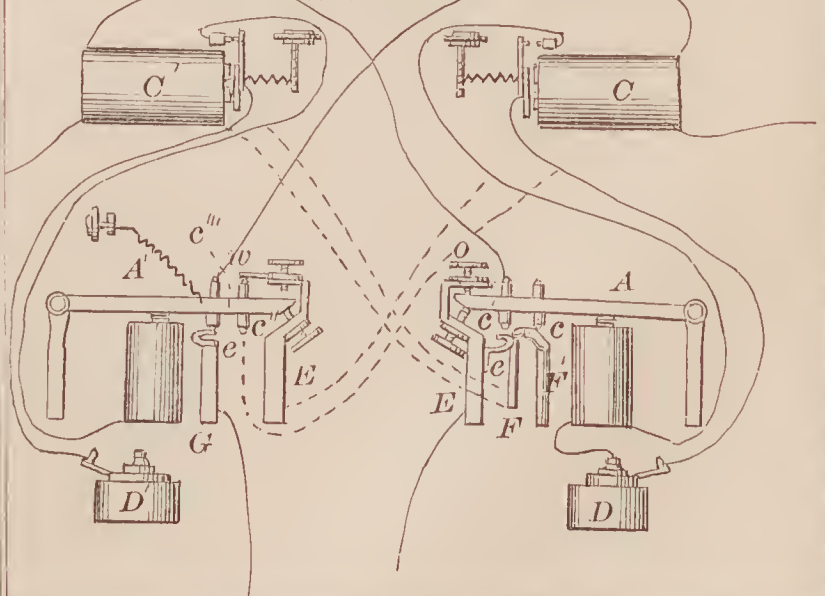

66947—D. G. Canfield—Circular Sawing Machine.

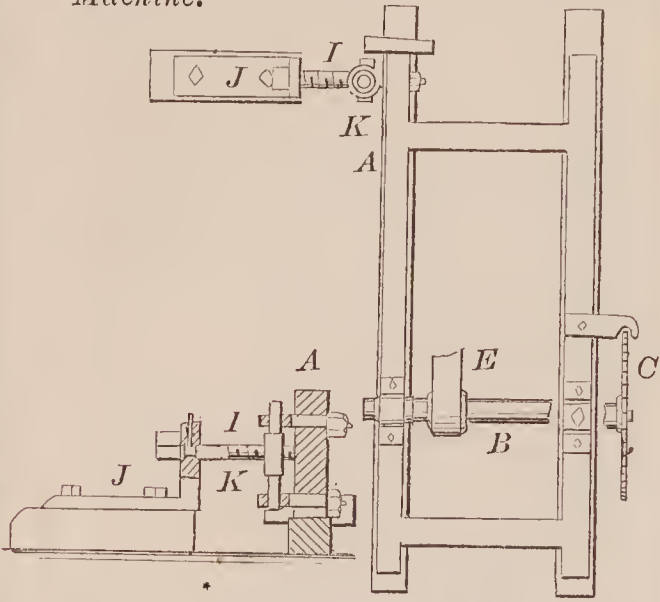

66949—L. M. Cook—Churn.

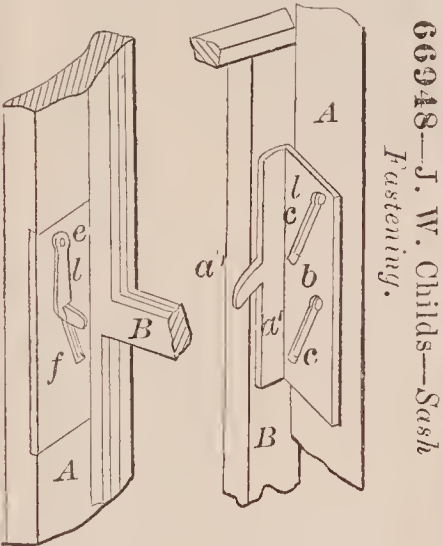
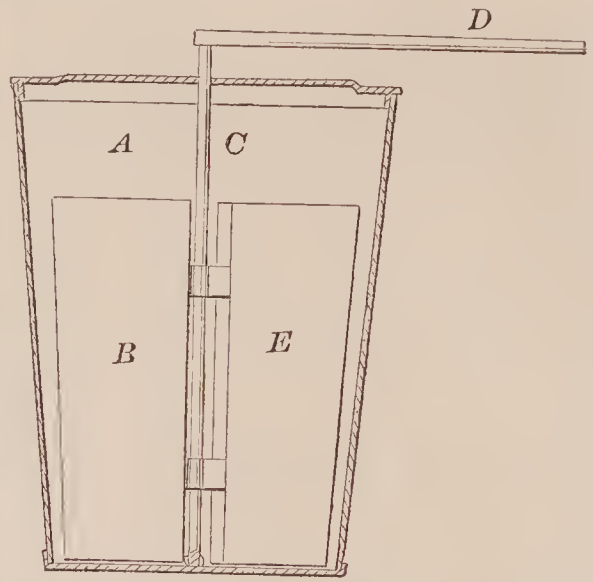

66948—J. W. Childs—Sash Fastening.

66951—G. Custer—Apple Corer and Slicer.

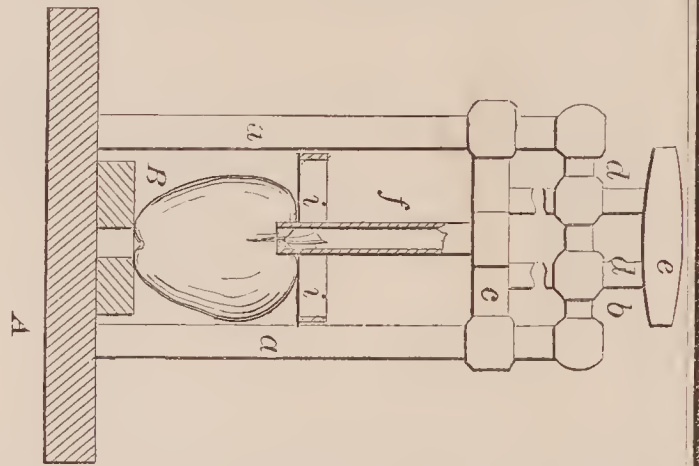
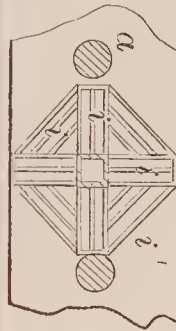

66950—R. T. Coverdale—Gas Apparatus.

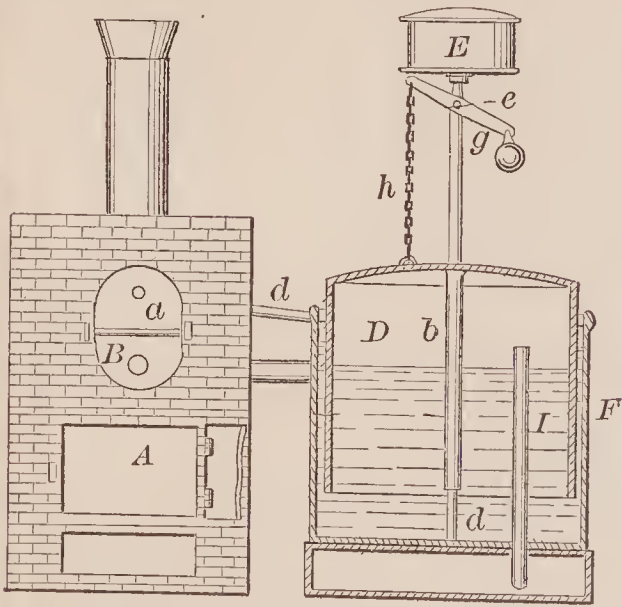

66953—J. H. Deal—Clip and Brace for Carriage Springs.

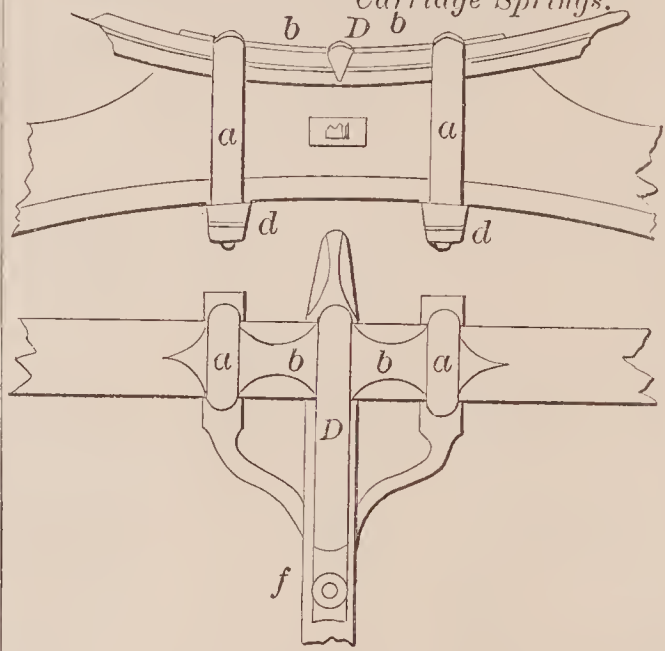

66952—McD. Darrow—For Heating Tires.

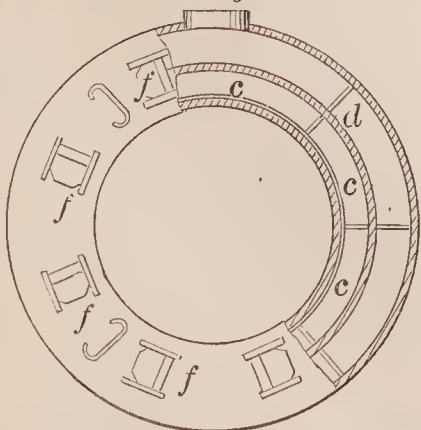

66954—J. H. Deal—Step for Spring Wagons.

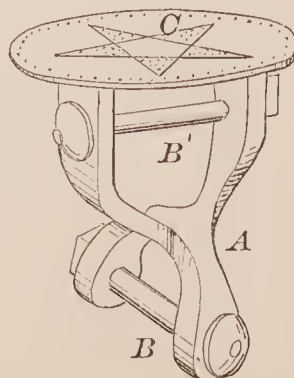

66955—R. E. Deane—Cooking Range.

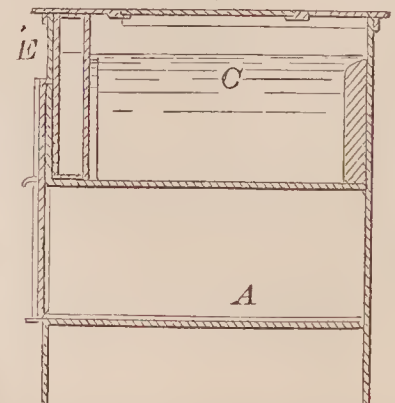



66956—J. Deeble—Fifth Wheel for Carriages.

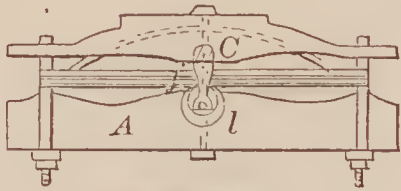

66958—W. C. Evarts—Plow.

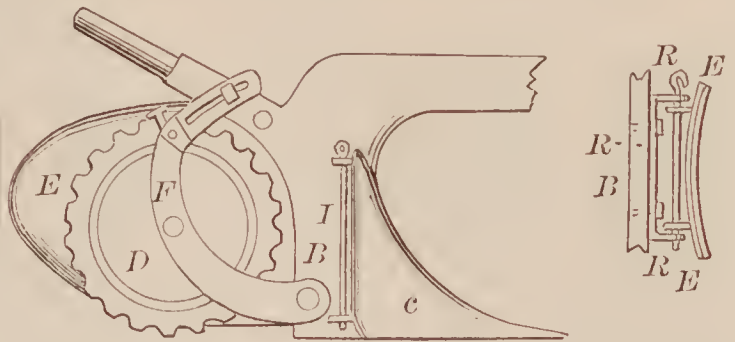

66957—W. C. Durant—Coal Stove.

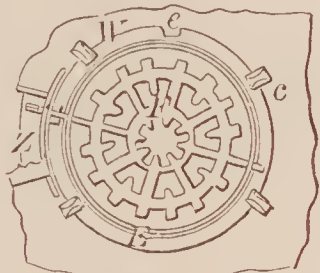
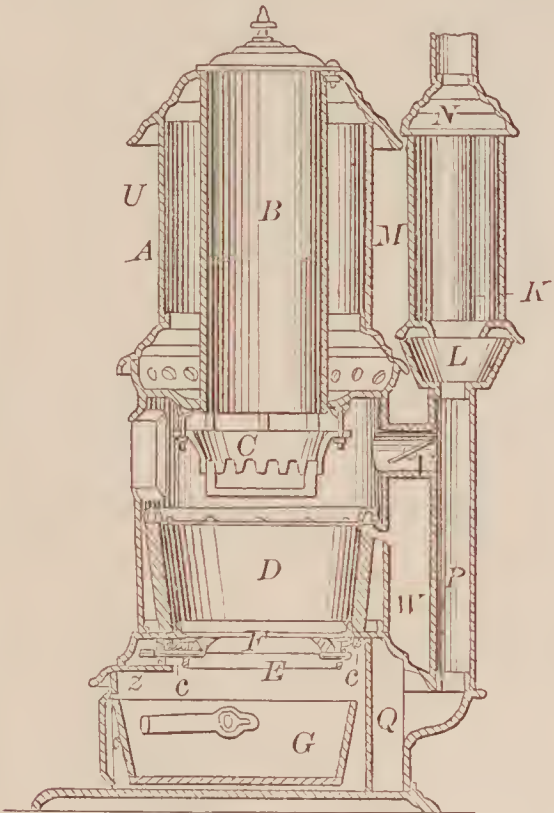

66959—J. B. Gemmill—Corn Planter and Guano Sower.

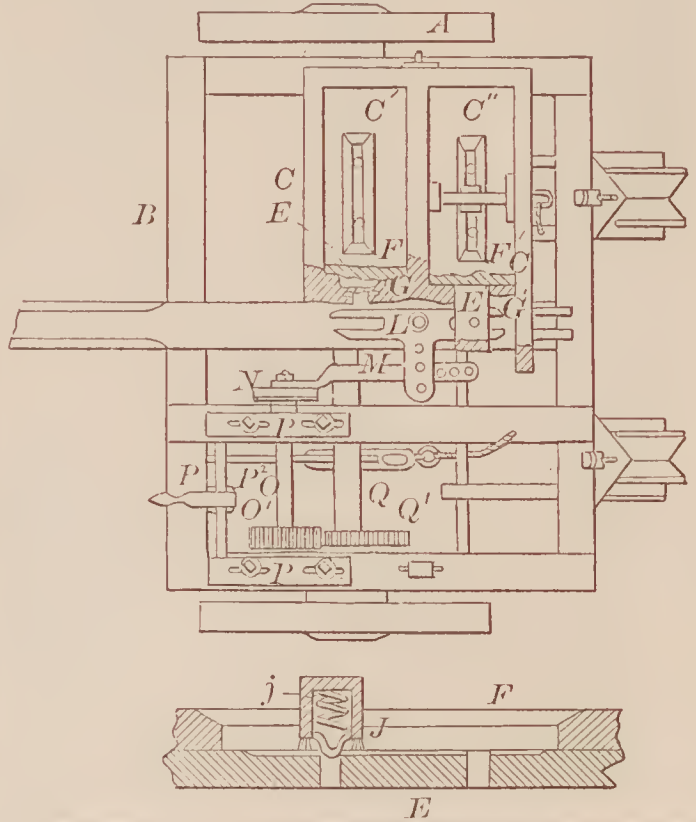

66960—F. Hermann—Cross Head for Sawmills.

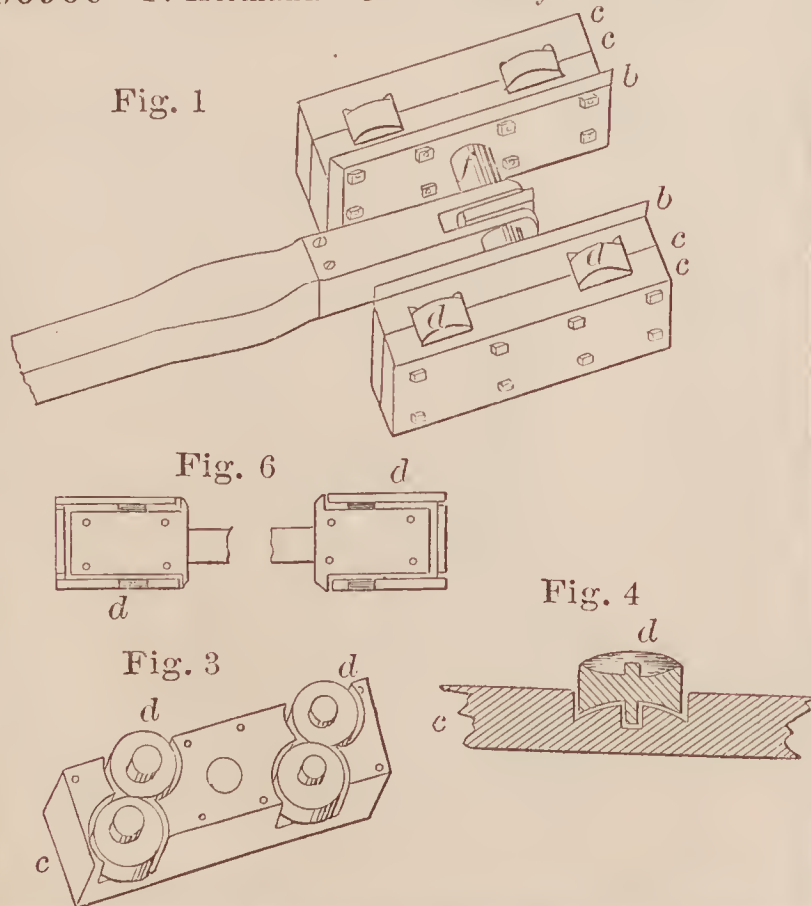

66961—J. Heuermann—Fire Escape.

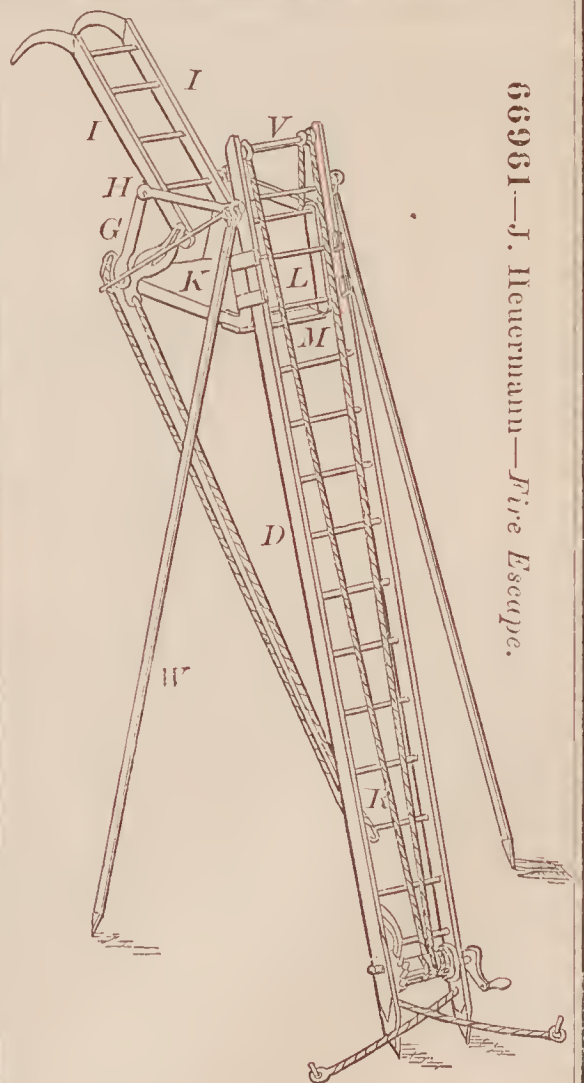

66962—S. C. Hotchkiss—  
*Lime Kiln.*

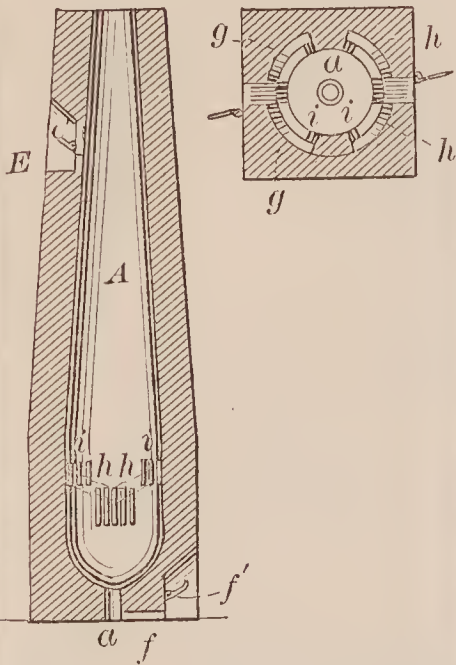

66963—E. F. Howard—*Steering Apparatus.*

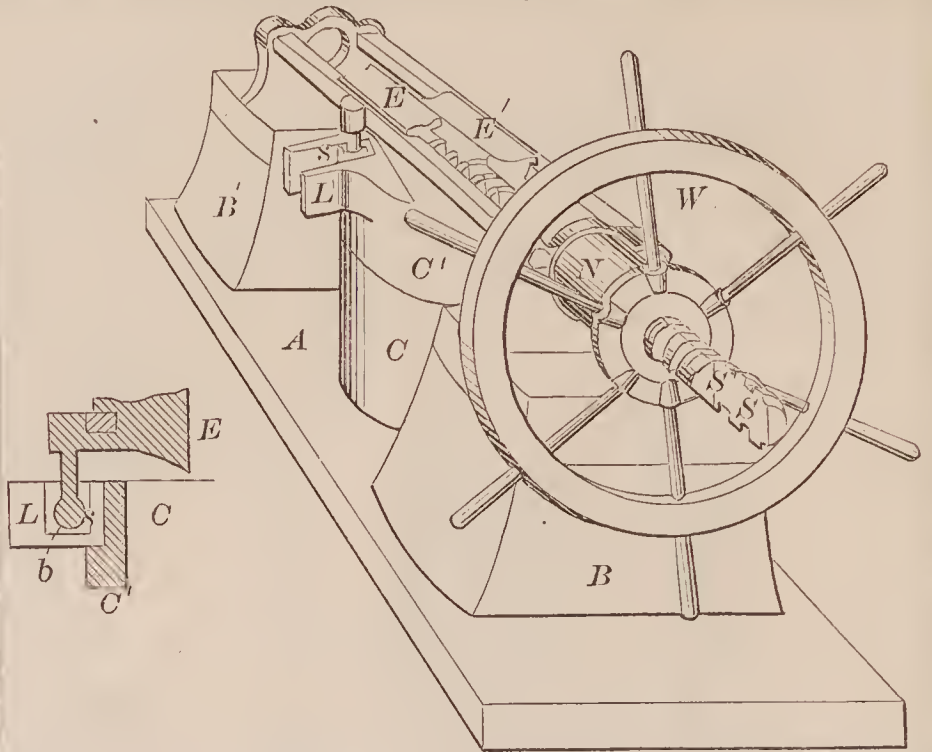

66964—W. S. Hudson—*Piston Packing.*

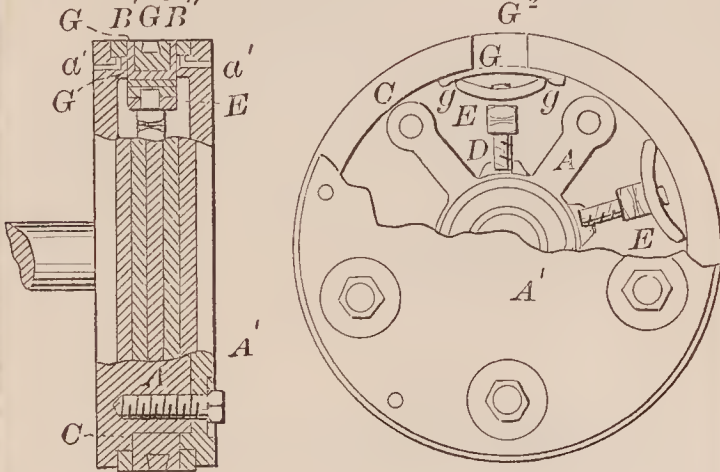

66967—J. M. Jomain—*Metallic Blind.*

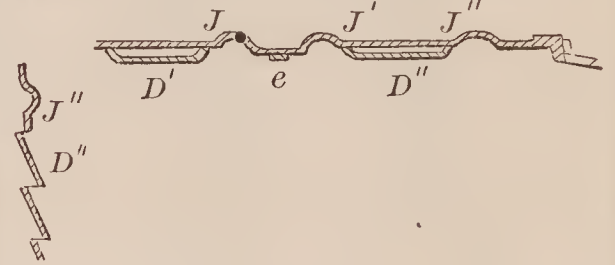

66966—J. V. Jenkins—*For Shearing Sheep.*

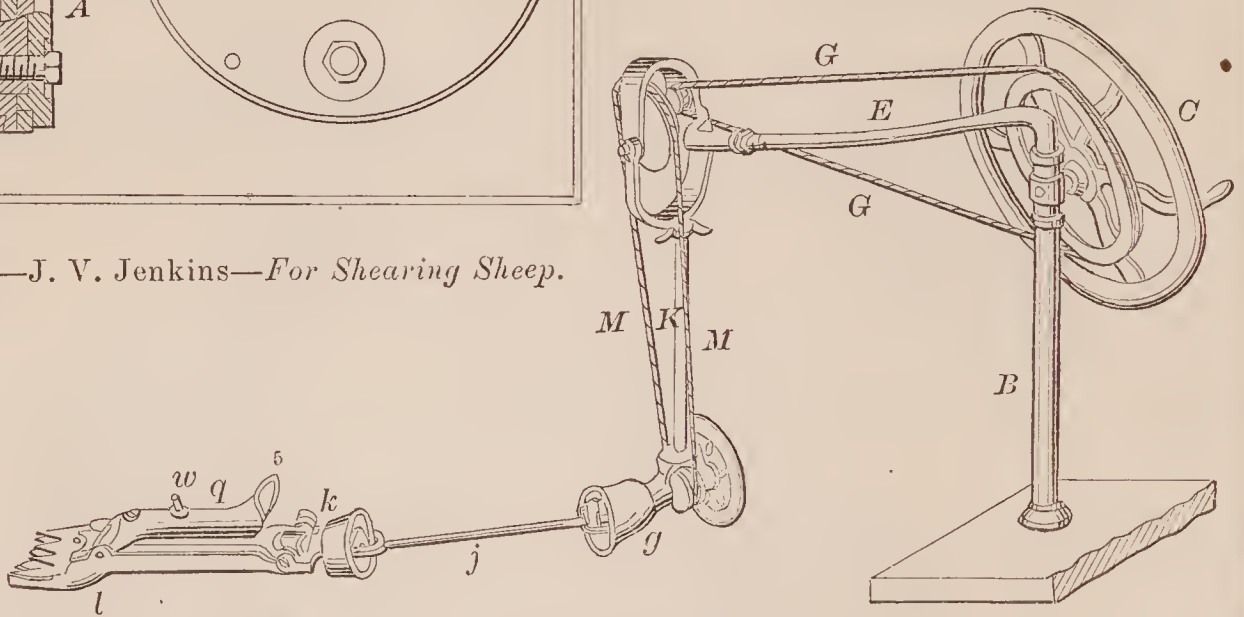

66965—A. Jameson—*Vise.*

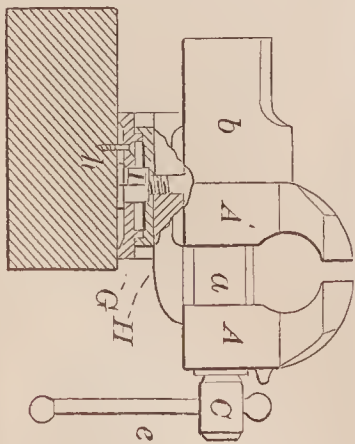

66968—M. H. N. Kendig—*Paper Fastening.*

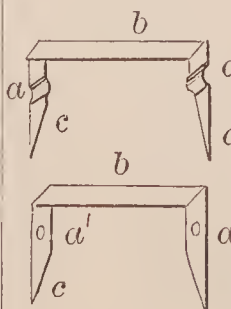

66969—J. H. Keyser—*Coal Stove.*

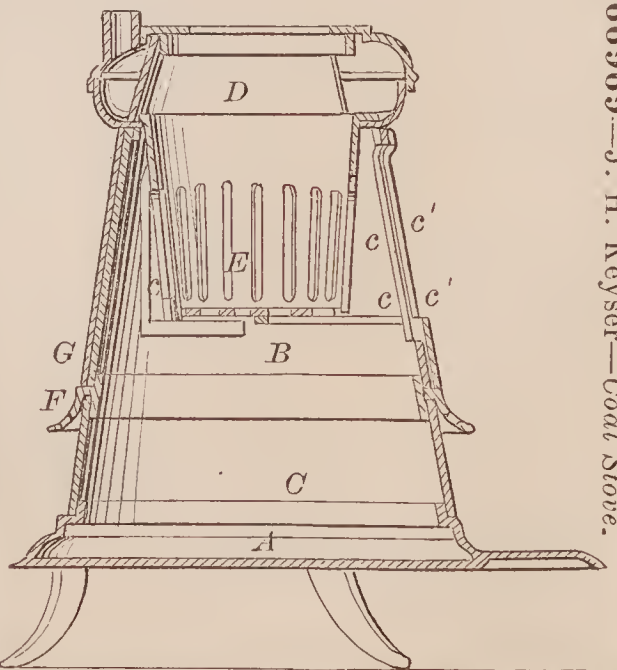



66970—E. B. Lake—  
*Curtain Fixture.*

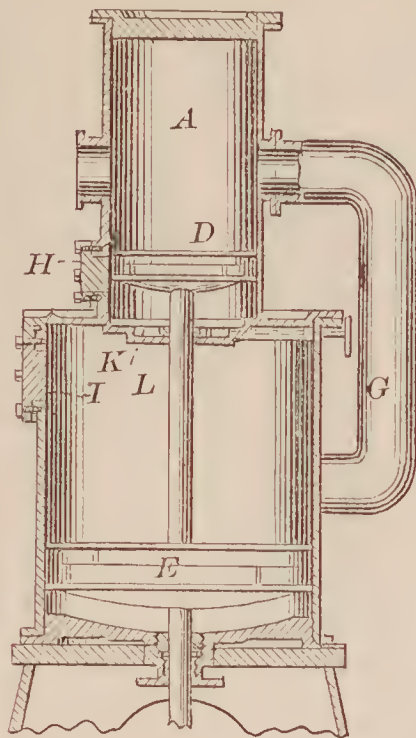
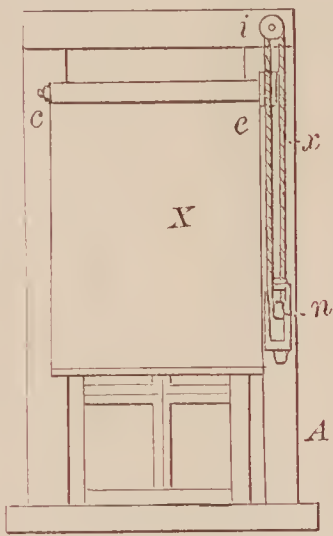

66971—J. L. Lay—*Steam Engine.*

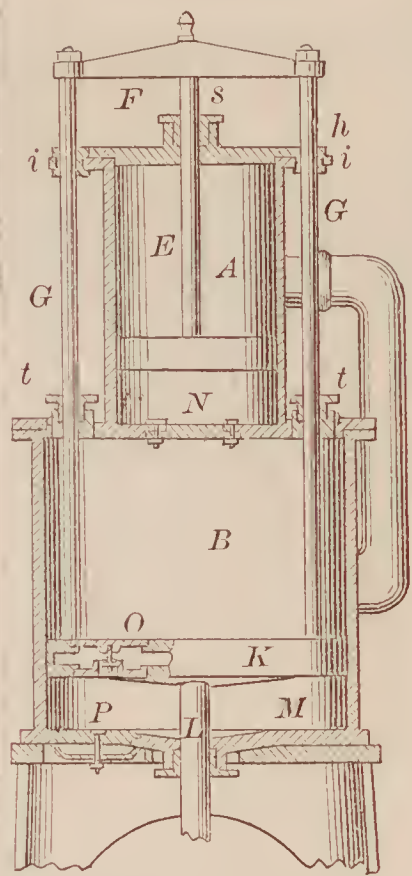

66972—J. L. Lay—*Steam Engine.*

66973—J. L. Lay—*Steam Engine.*

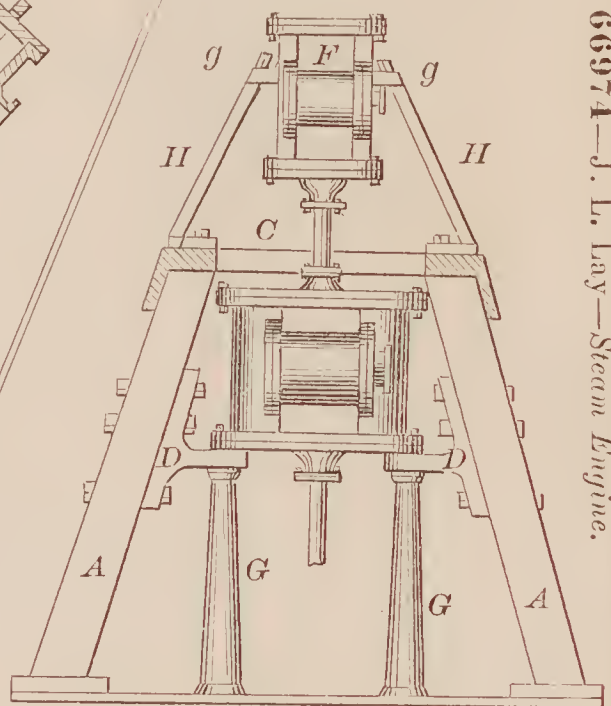
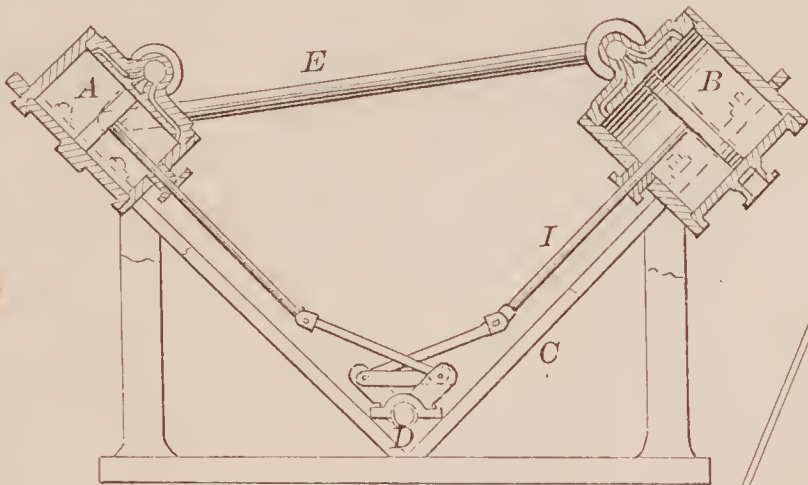

66974—J. L. Lay—*Steam Engine.*

66976—J. L. Lay—*Steam Engine.*

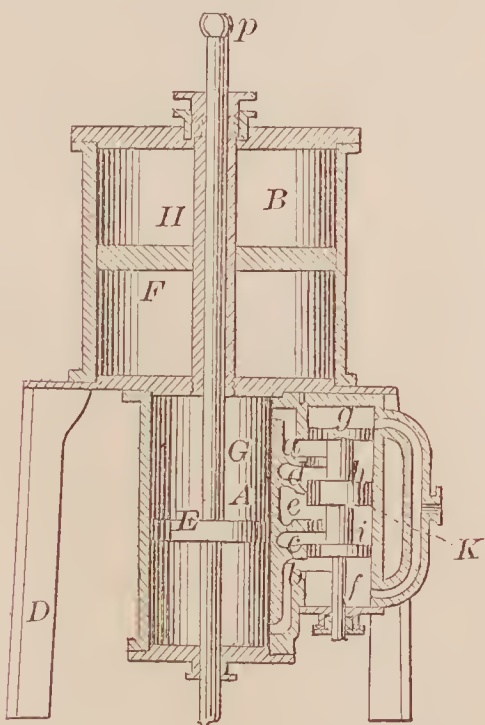

66975—J. L. Lay—*Steam Engine.*

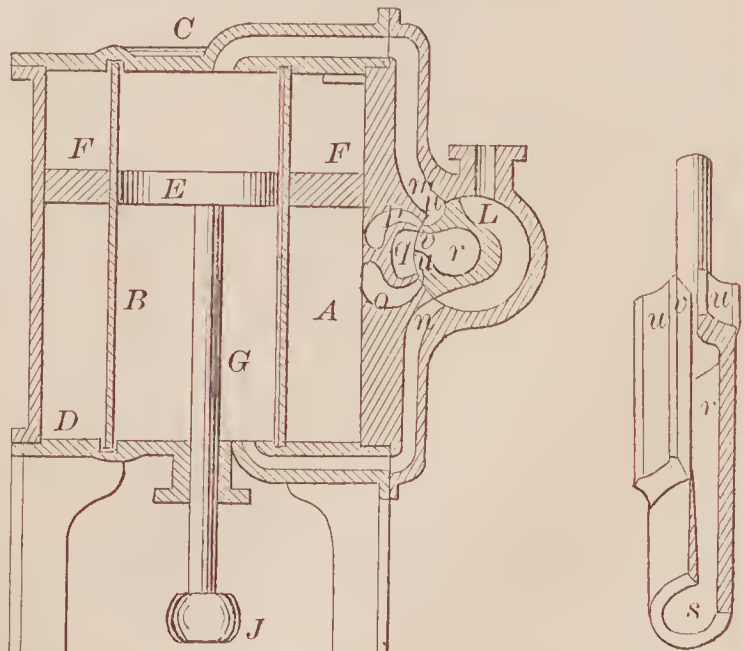



66977—G. W. Leffingwell—*Beehive.*

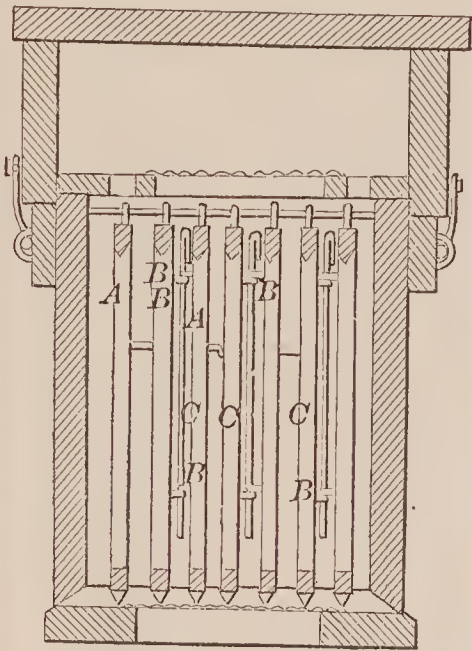

66978—J. Lippincott—*Axe.*

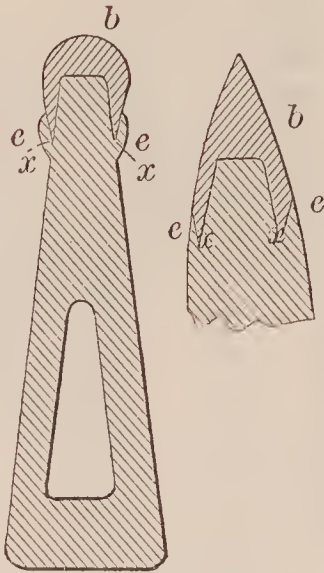

66980—D. J. Martin—*Animal Trap.*

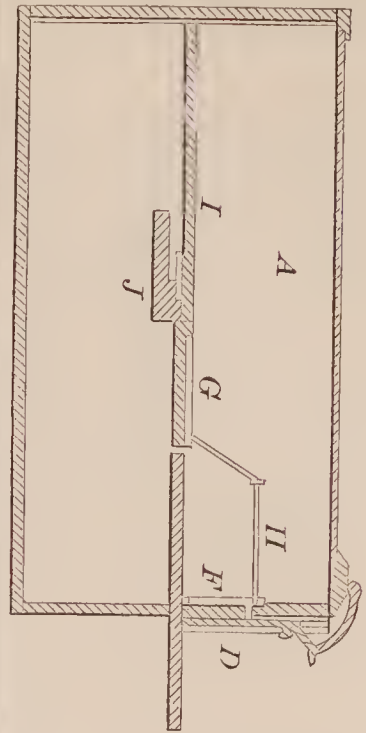

66979—Lotz & Baumann—*Brick Machine.*

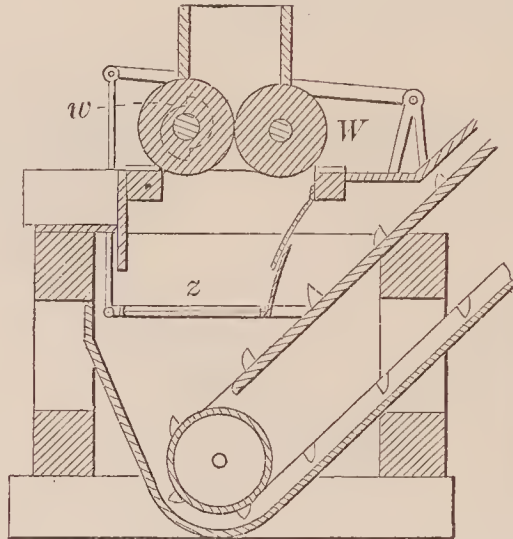
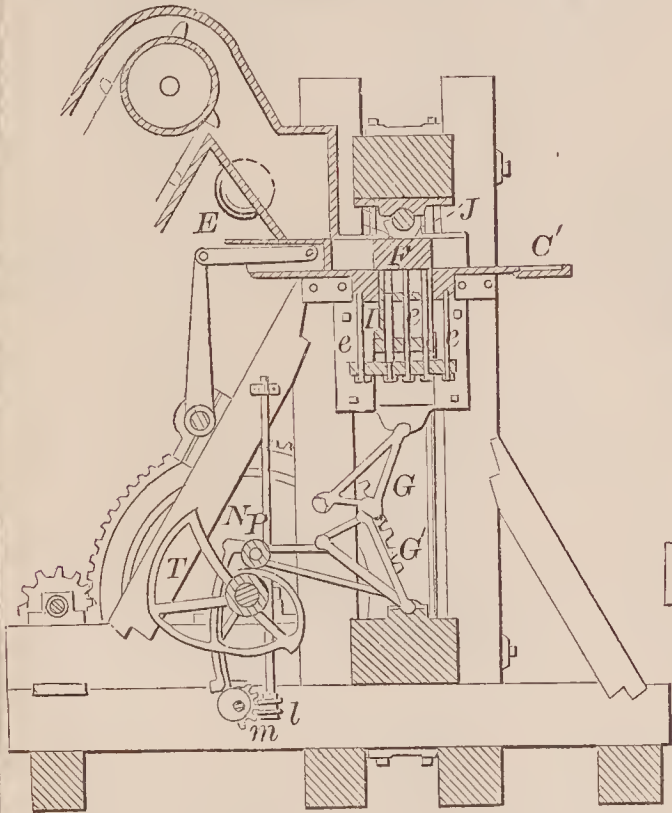

66985—Mitchell & Moriarty—*Moustache Guard.*

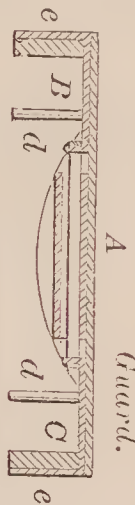

66981—J. Matson—*Carpet Fastener.*

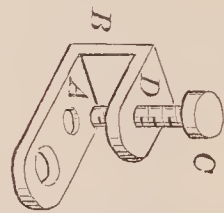

66983—J. Miller—*Harvester Rake.*

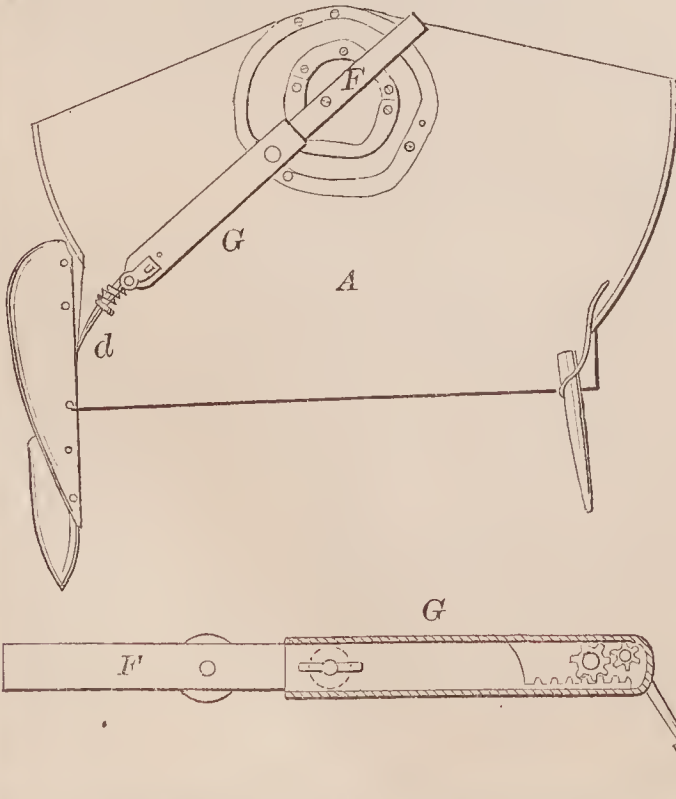

66984—L. H. Miller—*Burglar and Fireproof Safe.*

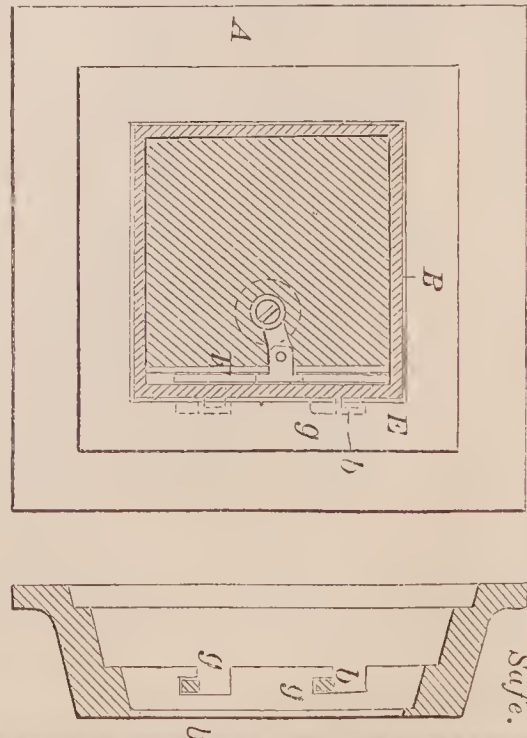

66986—L. J. Newlan—Bolt Cutter.

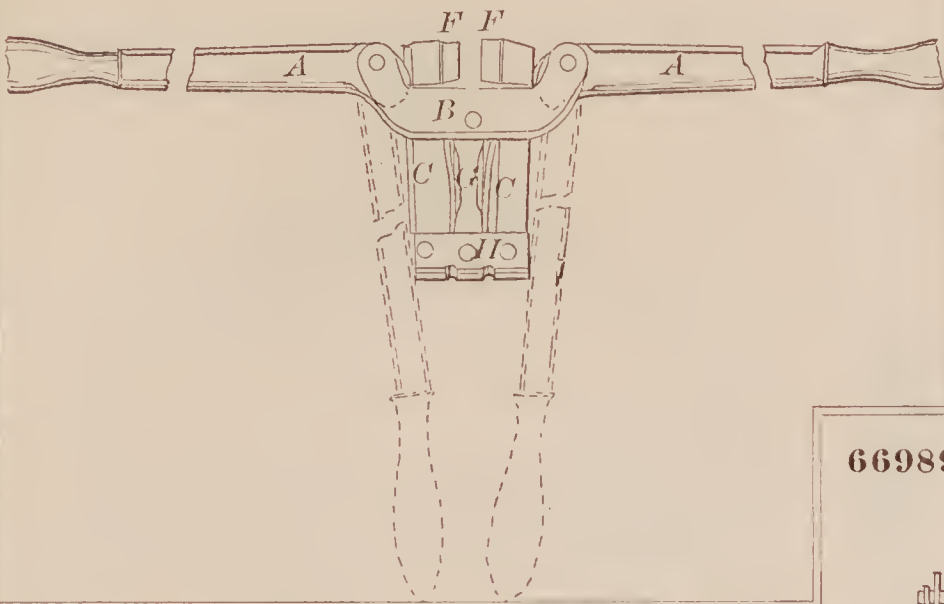

66988—G. H. Ober—Wood Planing Machine.

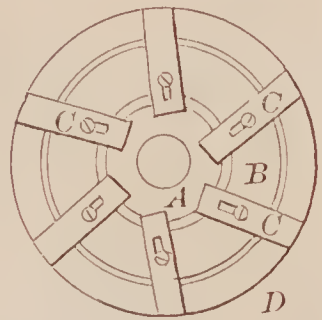

66991—A. Reese—Horse Shoe Machine.

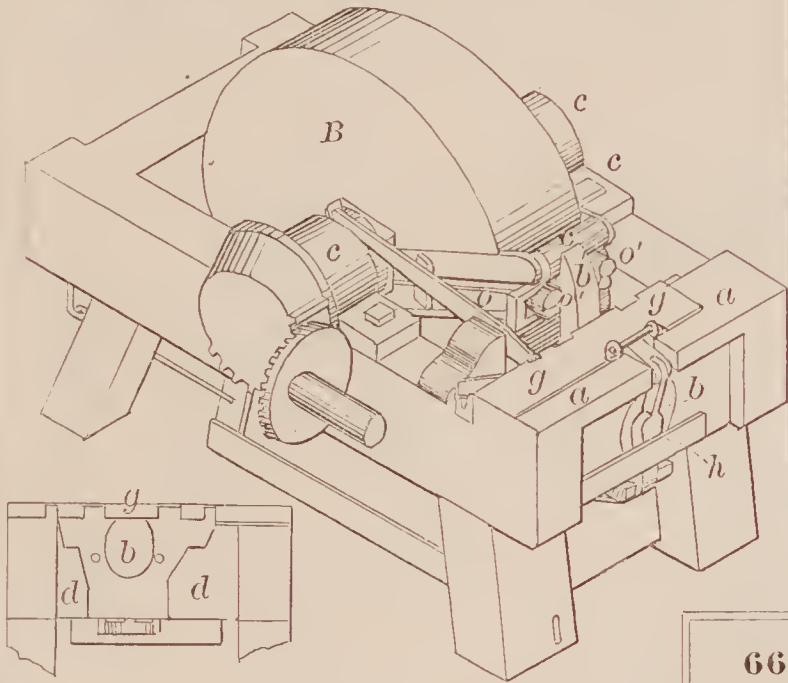

66989—H. Obrecht—Meat Chopper.

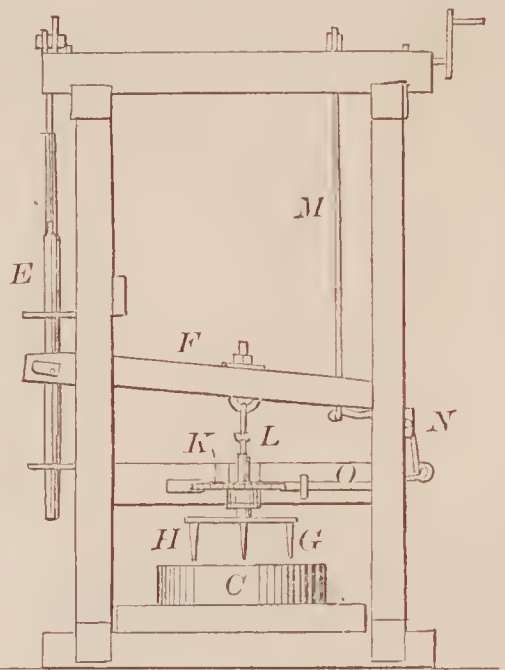

66992—A. P. Rich—For Fitting up Boiler Hole Seats.

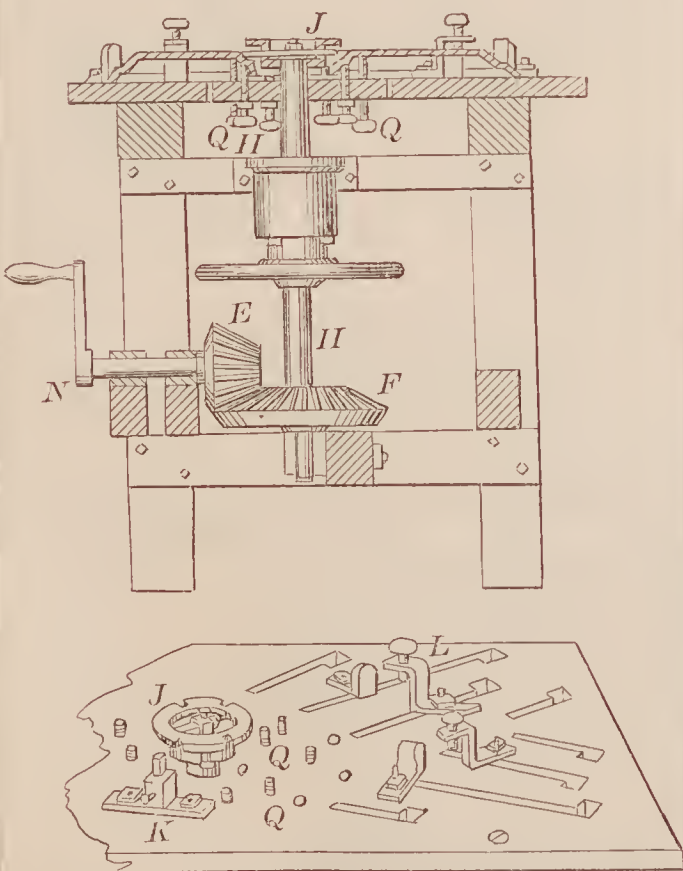

66990—W. L. Overhiser—Hay Elevator.

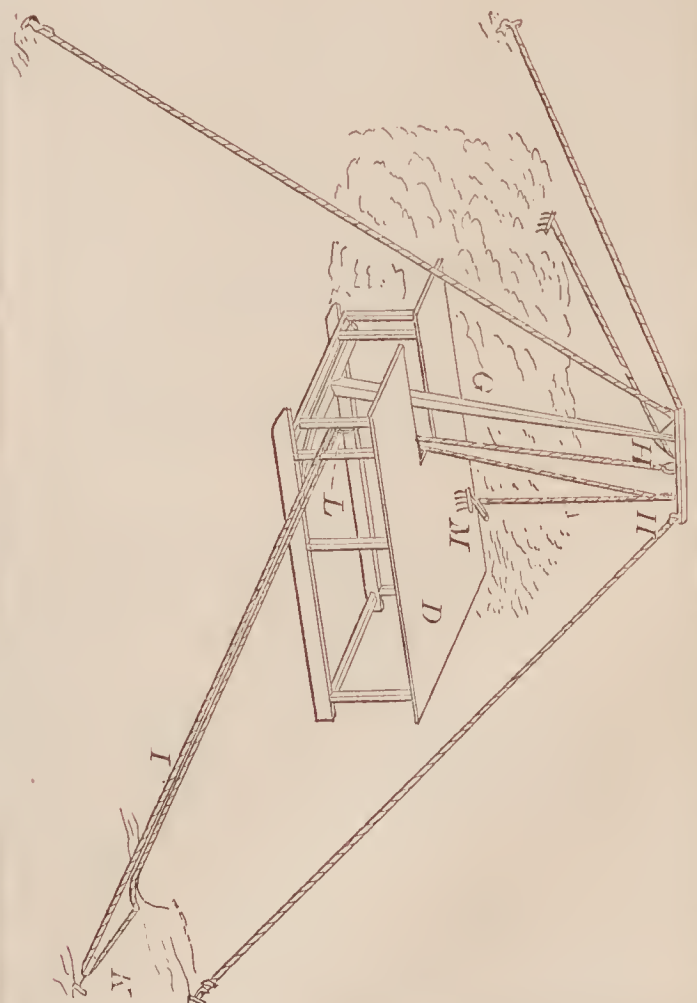



66993—G. A. Riedel—Automatic Boiler Feeder.

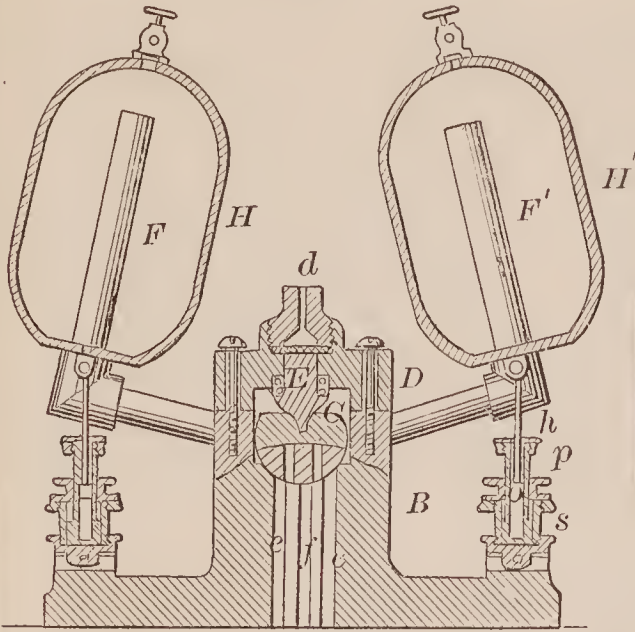

66994—T. E. Sexton—Railroad Rail Coupling.

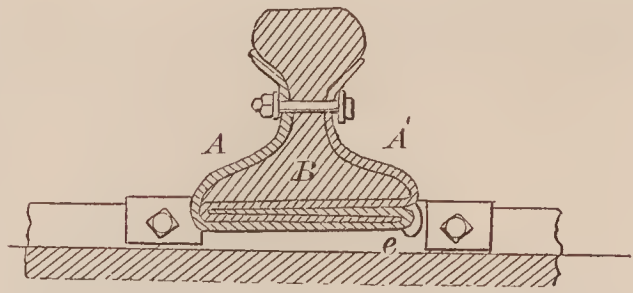

66998—E. R. Stilwell—Feed Water Heater.

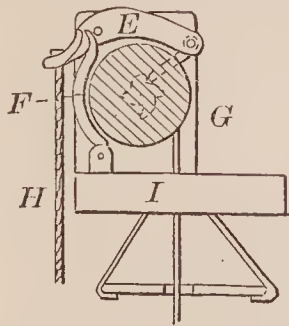
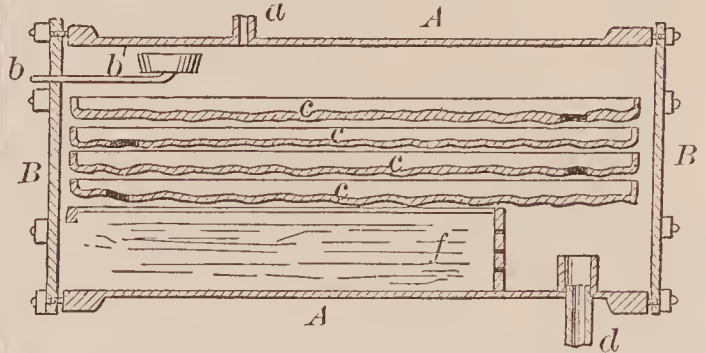

66995—G. F. Smith—Venetian Blind.

66996—O. B. Smith—Loom Picker.

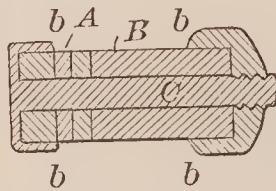

66997—T. B. Smith—For Cutting Veneers.

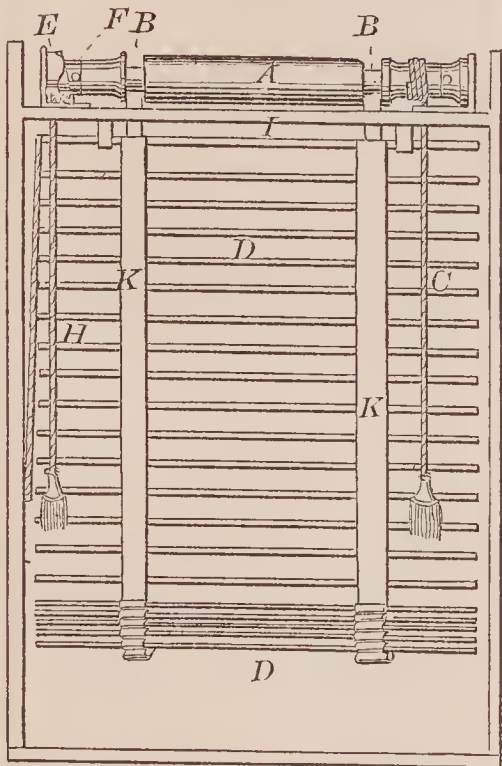
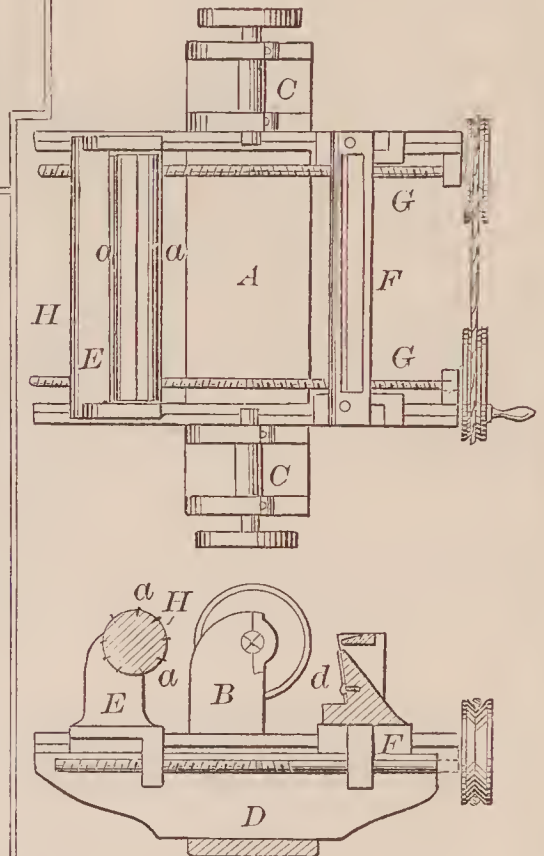

66999—J. Stofer—Toilet Glass.

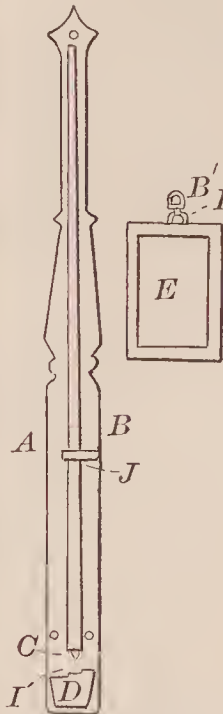

67000—J. B. Tarr—For Making Cast Steel Car Wheels.

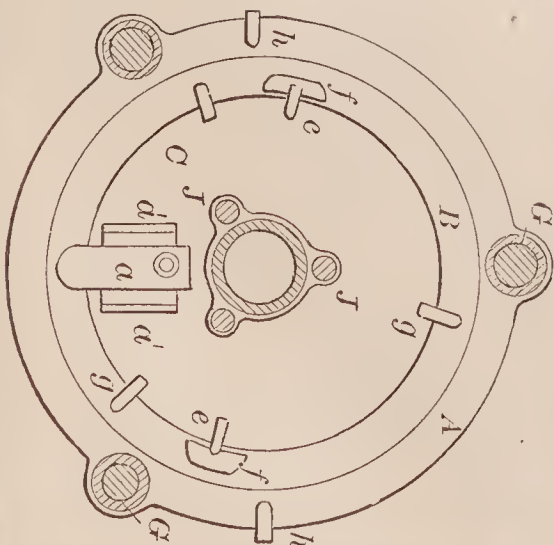
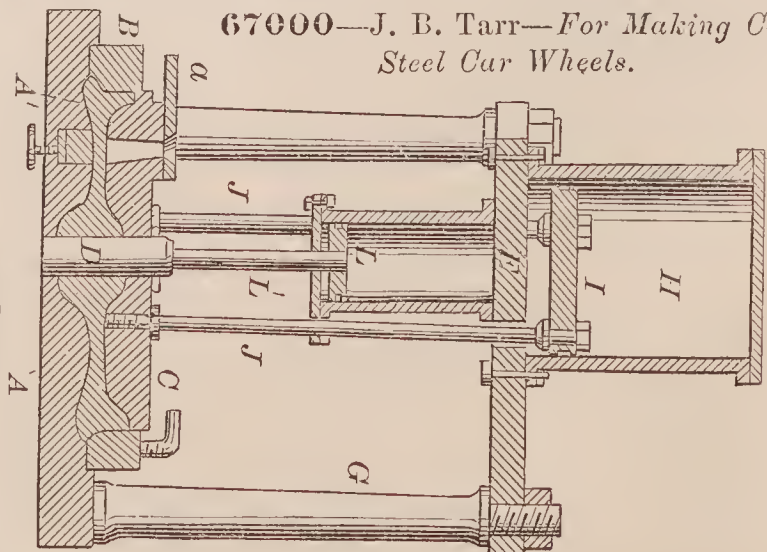





67007—Continued.

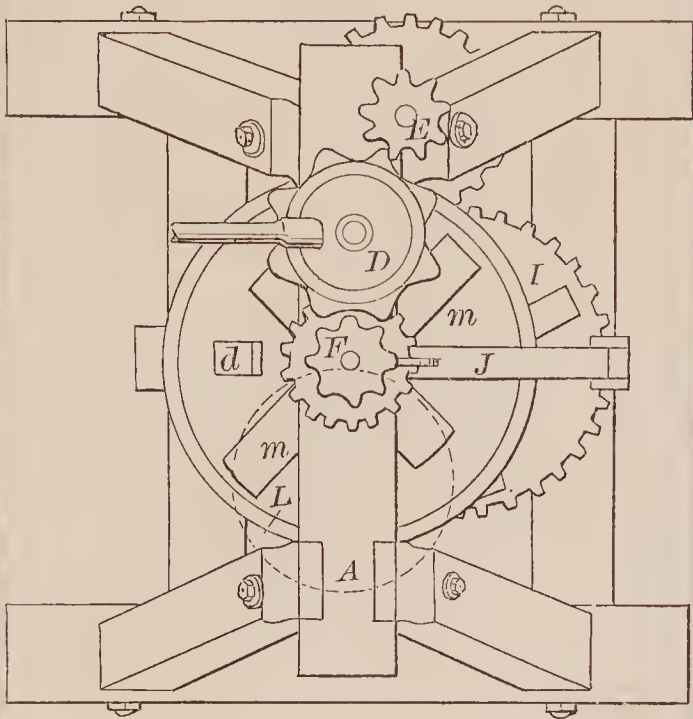

67008—W. & J. Whit—Seeder and Cultivator.

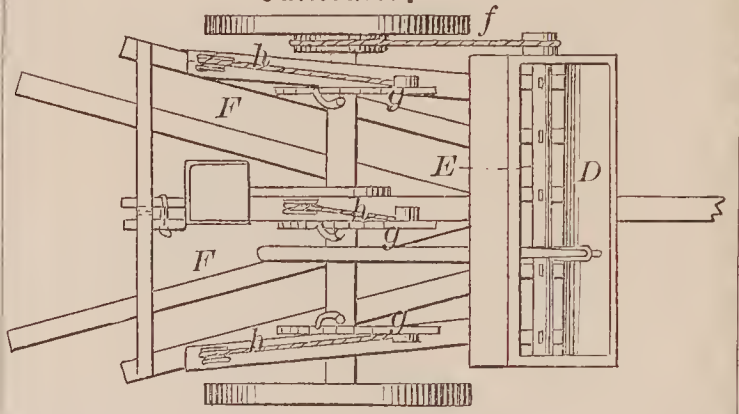

67009—W. & J. Whit—Sulky Harrow and Cultivator.

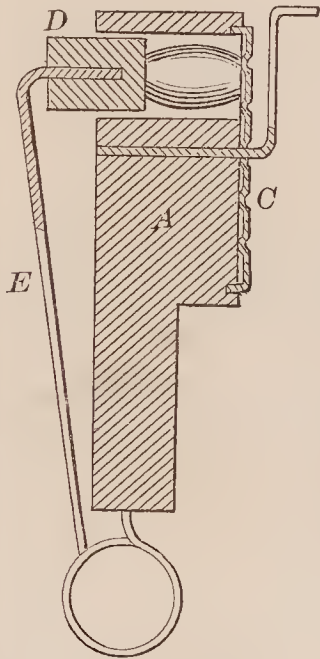
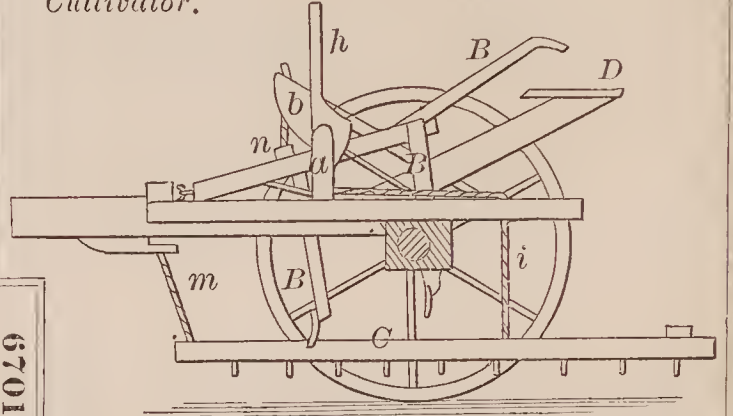

67010—Whitney & Davis—Nutmeg Grater.

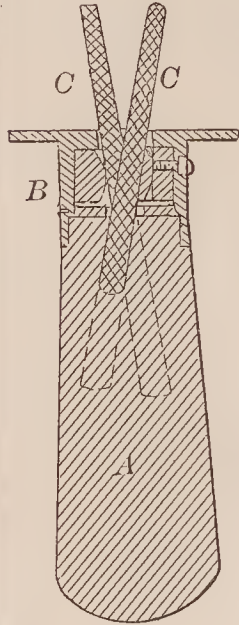

67011—McC. Young—Knife Sharpener.

67013—W. W. Adams—Washing Machine.

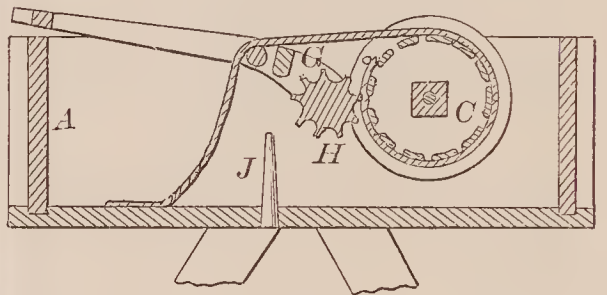

67014—J. A. Ayres—Screwdriver.

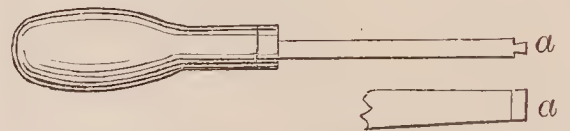

67016—Belmer & Schultz—Dog Muzzle.

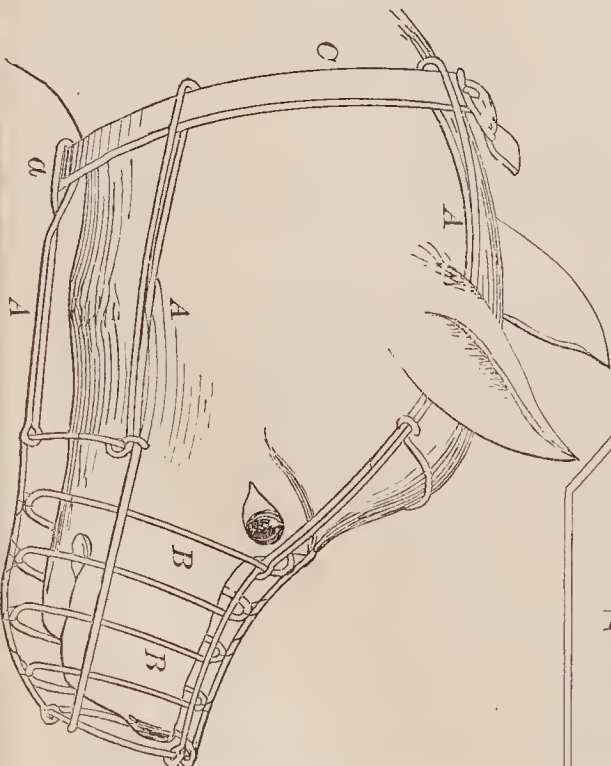

67015—J. R. Baker—Window Blind Fastener.

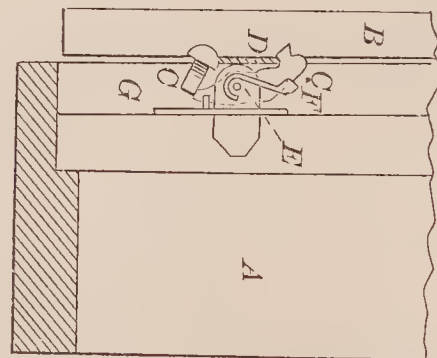

67017—I. Boone—Fence.

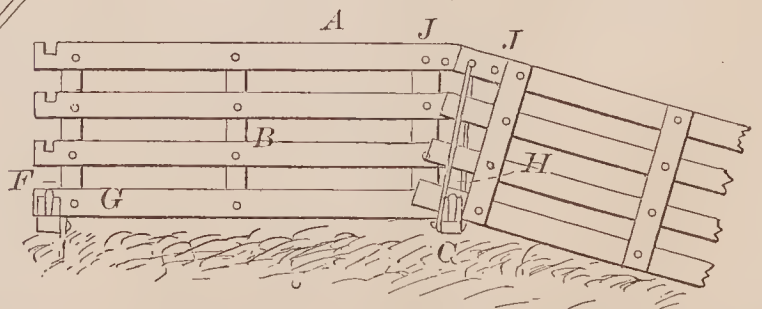

67018—J. Briggs—Globe Valve.

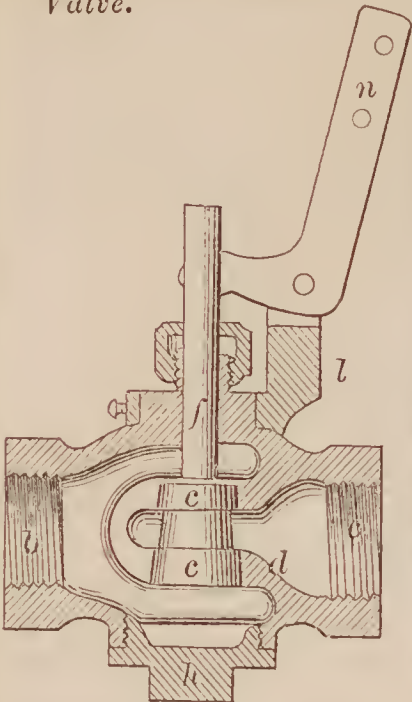

67019—A. Brigham—Dust Pan.

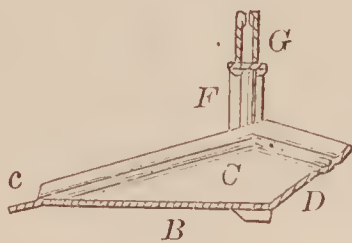

67020—C. B. Bristol—Snap Hook.

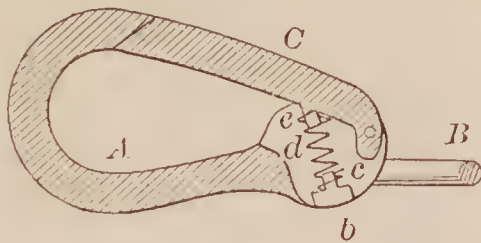

67023—V. Charlet—Stud and Button Fastening.

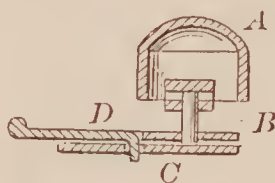

67021—W. E. Brock—Stand for Displaying Clothing.

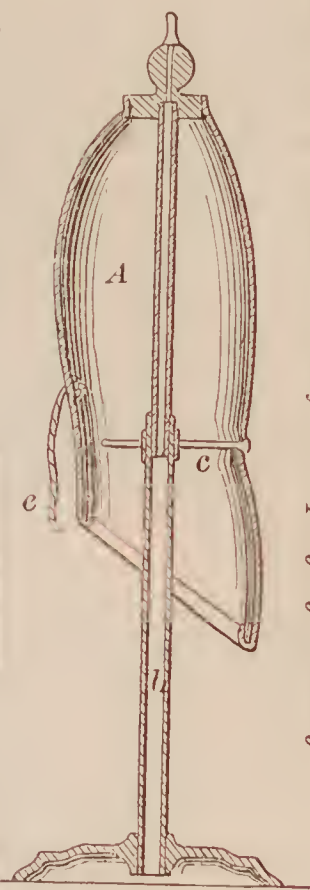

67022—L. Carrier—Pasteboard Box.

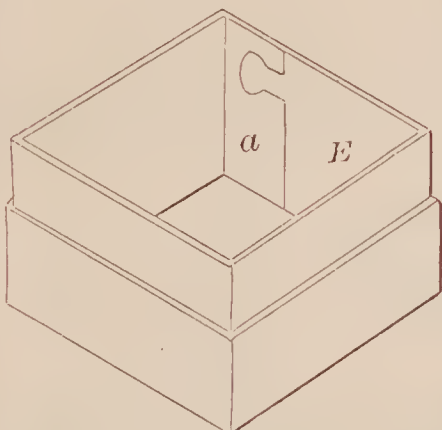
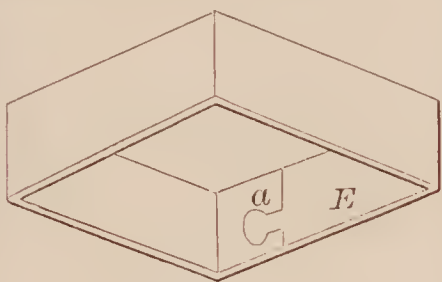

67026—G. F. J. Colburn—Base for Artificial Teeth.



67024—J. B. Clark—Making Solid Blanks for Wagon Shackles.



67027—J. Collett—Steam Engine Lubricator.

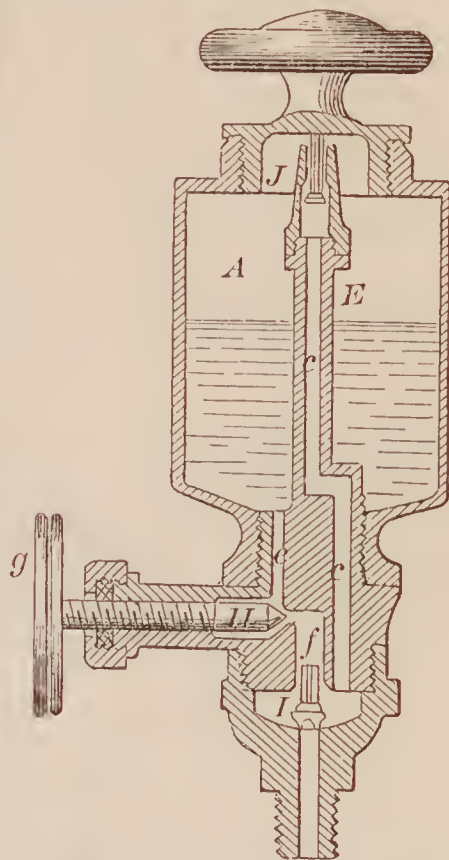

67030—Delavan & Dyson—Door Bell.

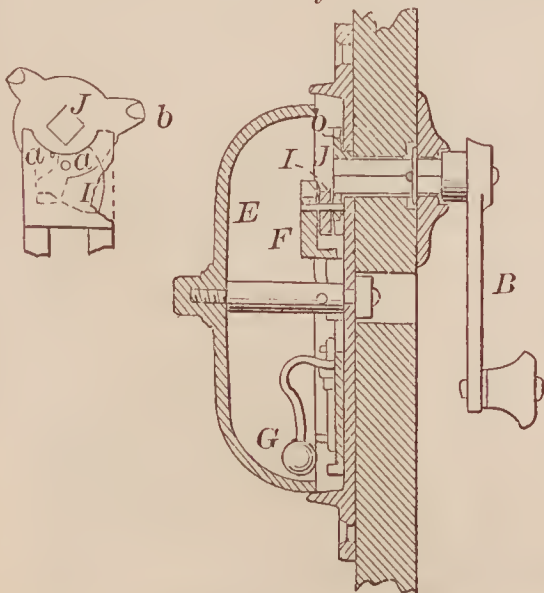

67029—S. Davidson—Tongue for Breastpins.

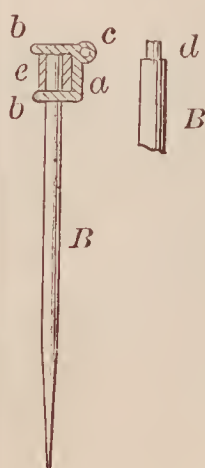

67028—E. F. Conner—Wagon Bed.

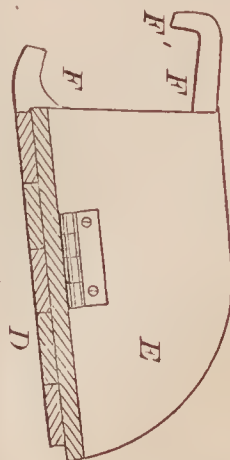



67031—G. A. F. des Corats—Loading and Unloading Vessels.

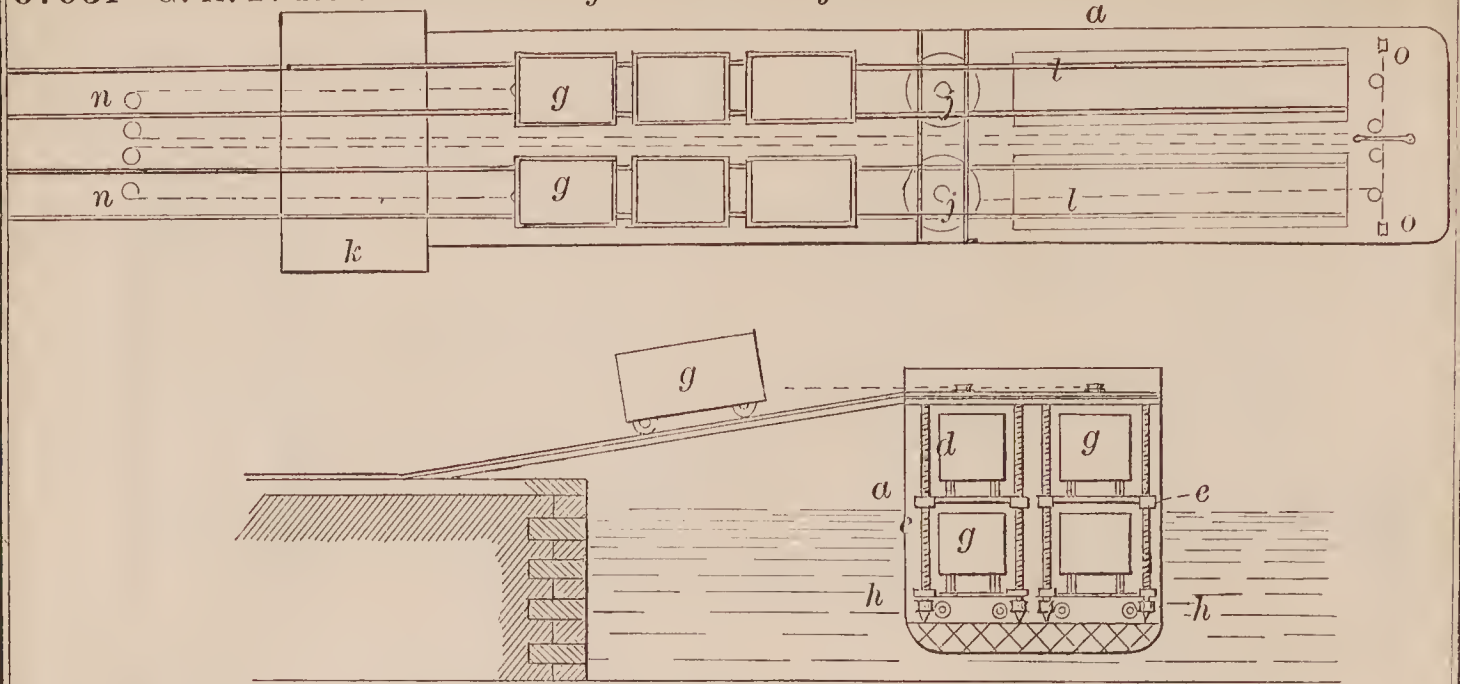

67033—J. Elson—Breech-Loading Fire Arm.

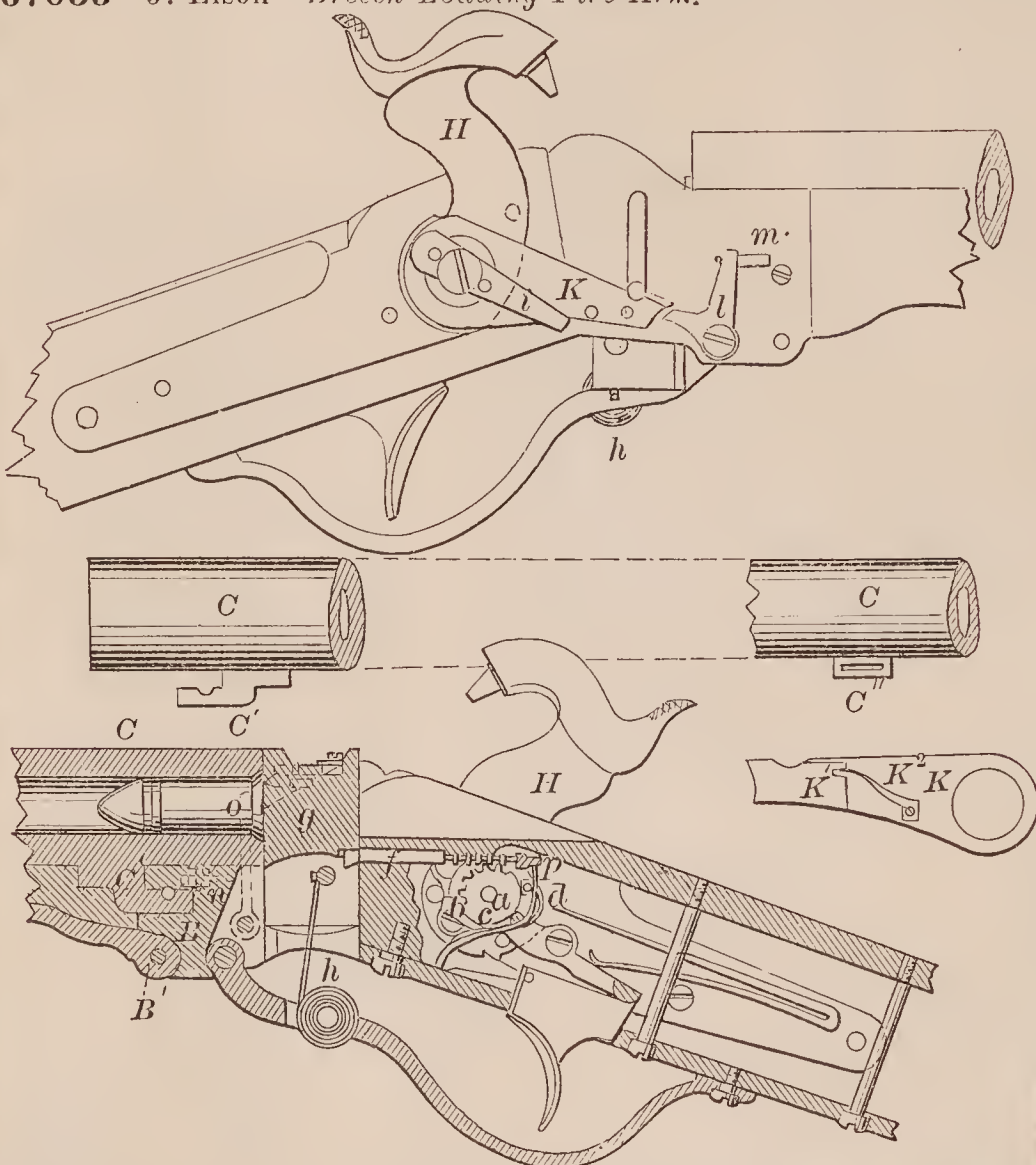

67032—A. M. Dexter—Bread Cutter.

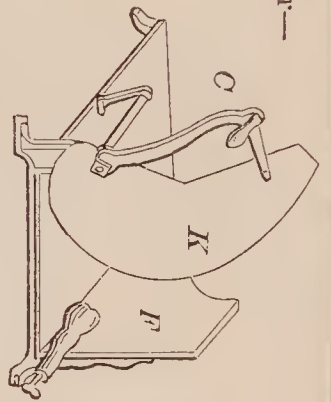

67035—R. Foley—Tunnel.

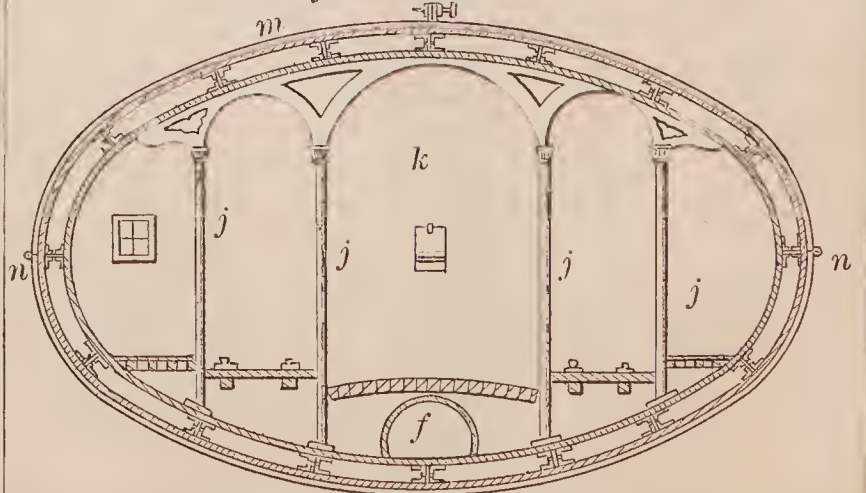

67034—R. Pitts, Jr.—Office Chair.

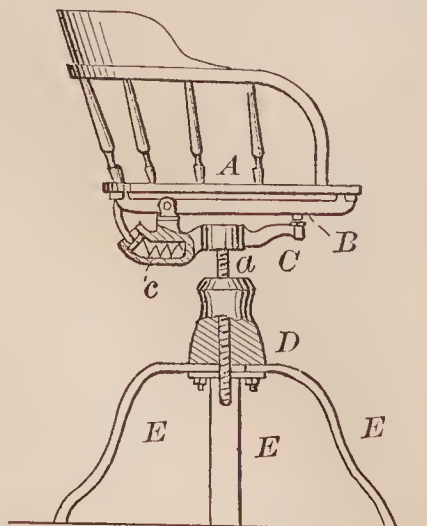

67036—D. Forrest—Car Wheel.

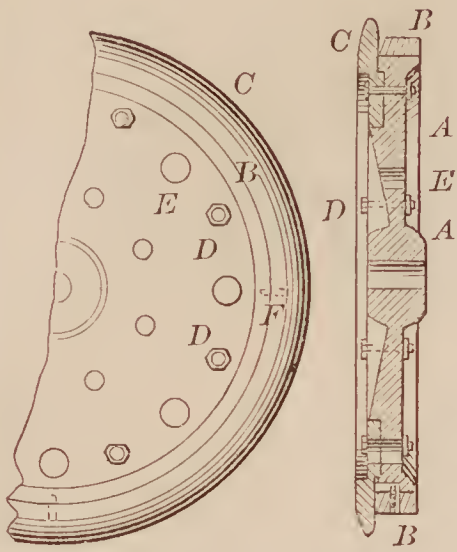

67038—Gifford & Felts—Sawmill.

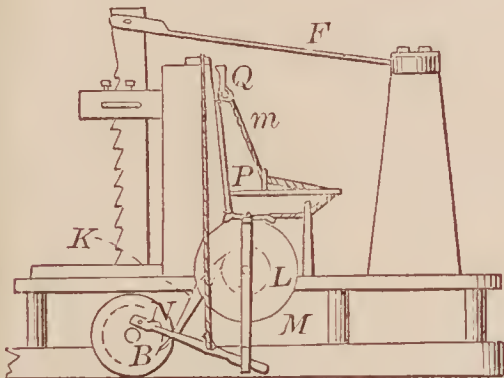
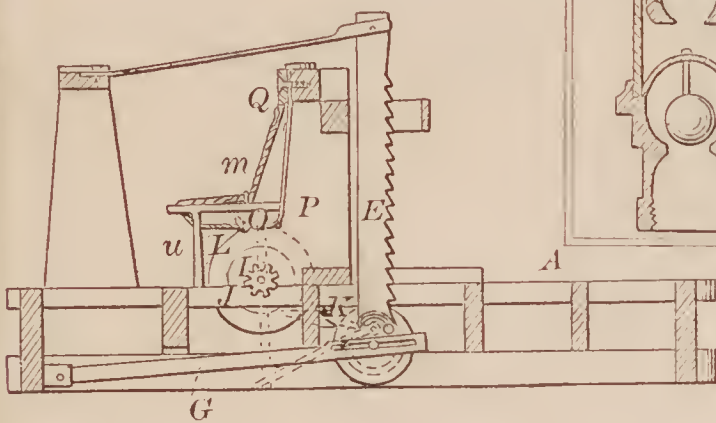

67039—J. Golding—Life Preserving Mattress and Raft.

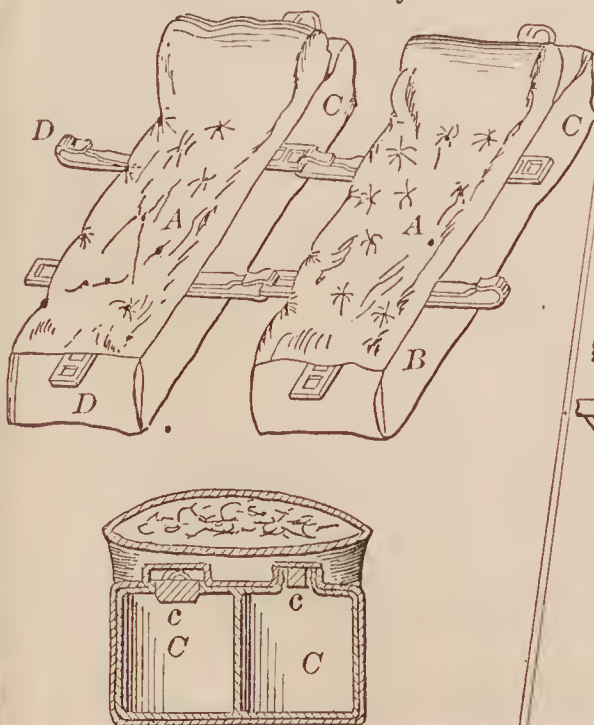

67037—H. Getty—Pump.

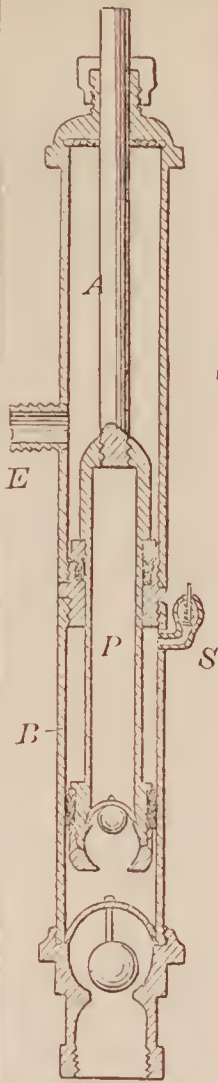

67040—C. G. Grabo—Potato Digger.

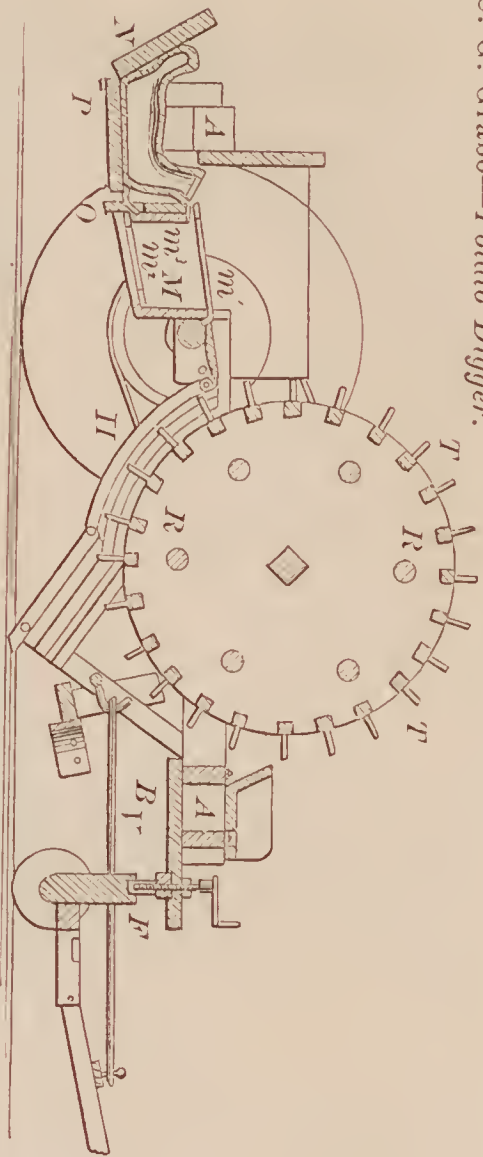

67041—A. B. Graham—Harvester.

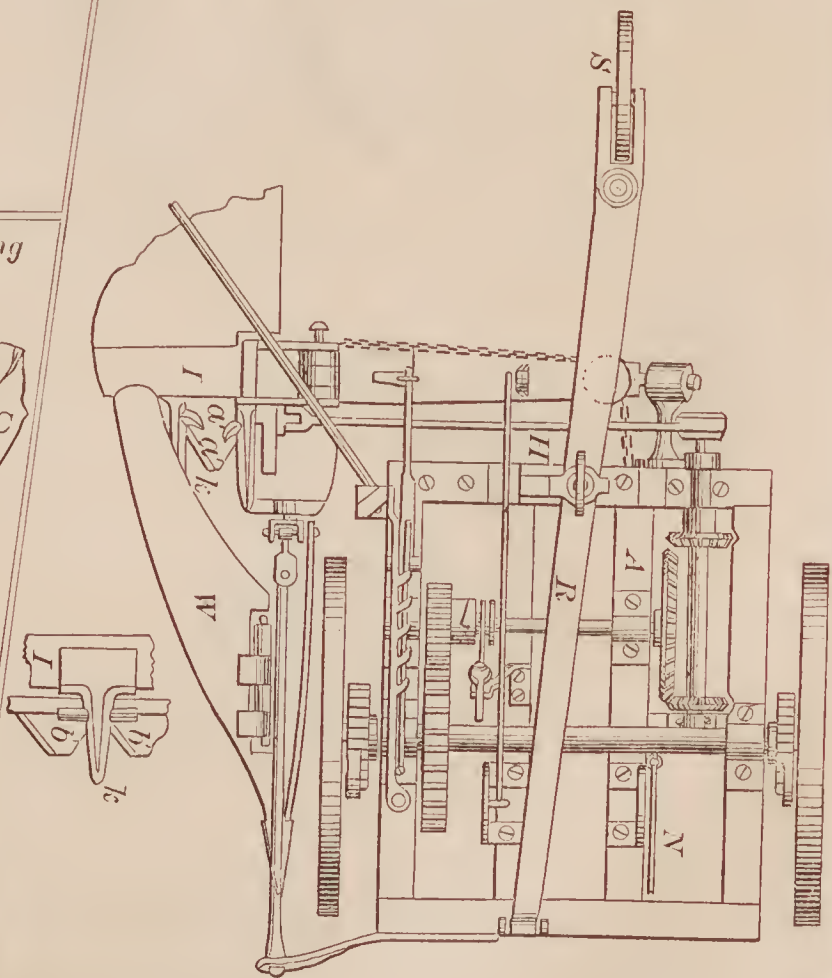



67042—W. M. Greenwood—*Training Hopple.*

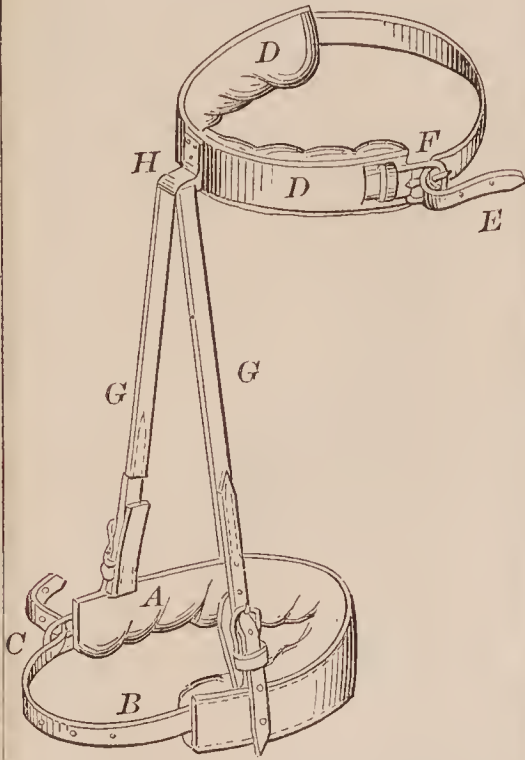

67043—Griswold & Caul—*Cut-off Valve.*

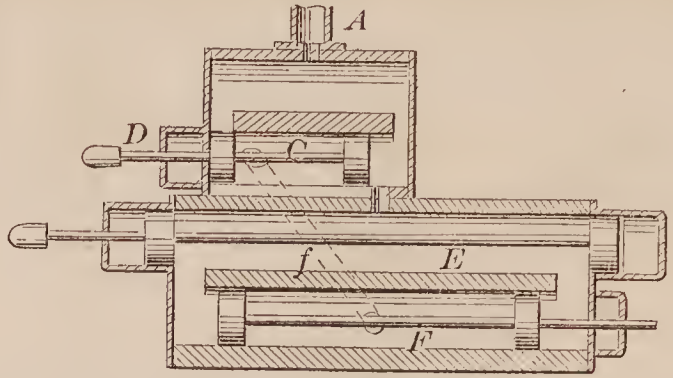

67044—A. W. Hall—*Door Fastening and Knife.*

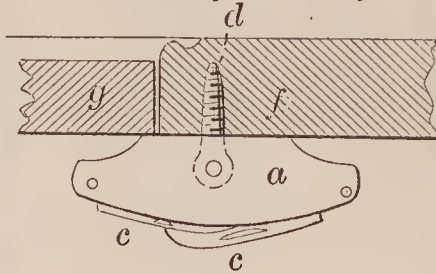

67045—J. L. Hall—*Safe.*

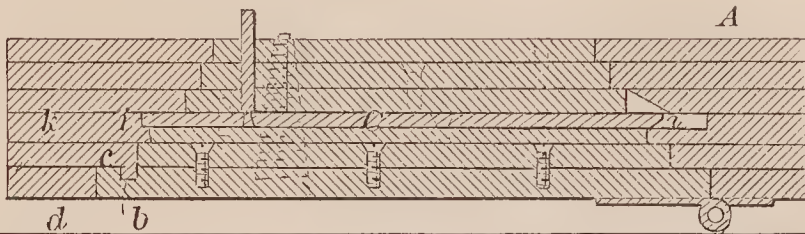

67046—J. L. Hall—*Connecting Door and Casing of Safes.*

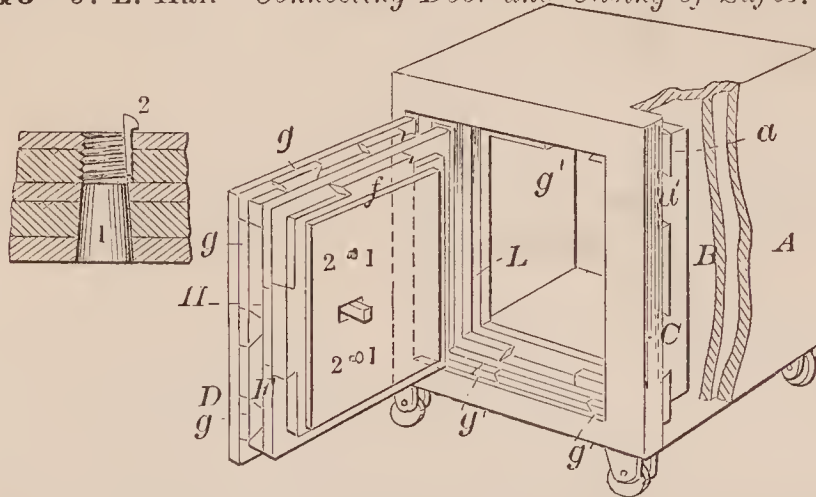

67048—J. R. Harrington—*Carpet Lining.*

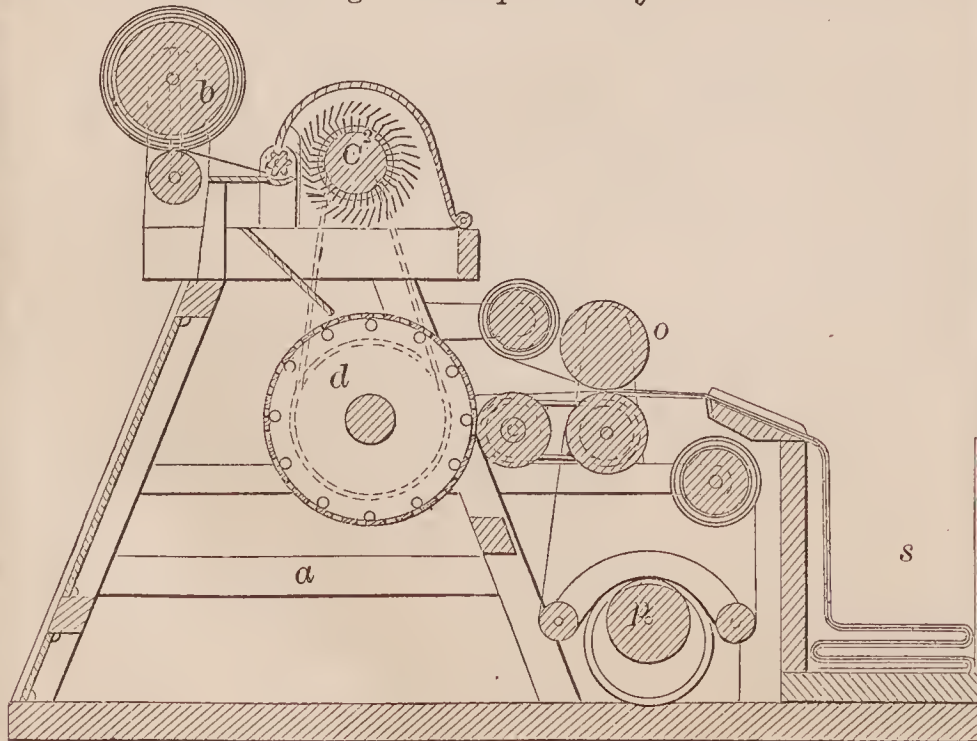

67047—T. C. Hargrave—*Boat Detaching Tackle.*

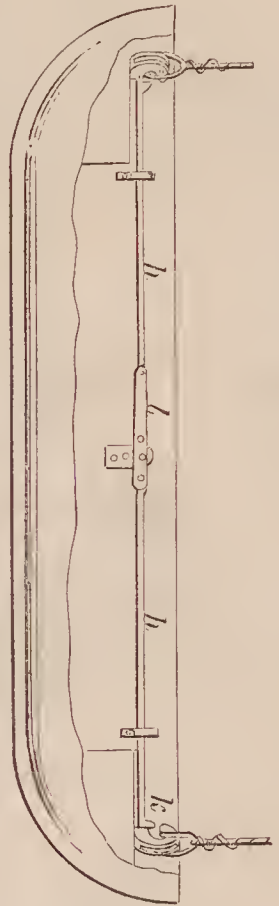

67049—R. S. Harris—*Snow Plow.*

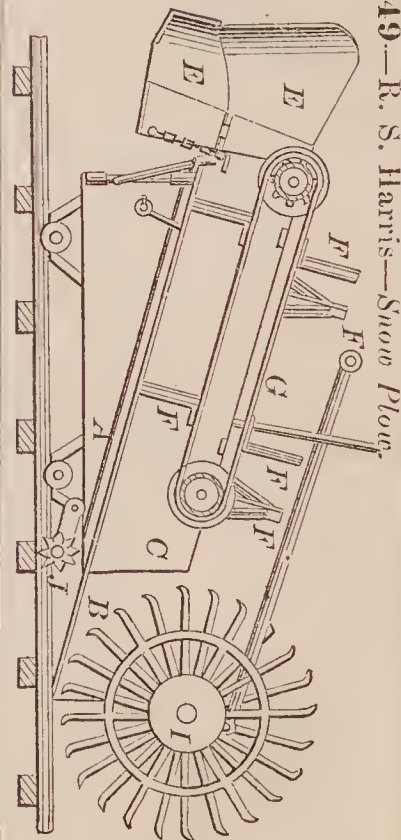

67050—C. B. Hatfield—*Making Paper Boxes.*

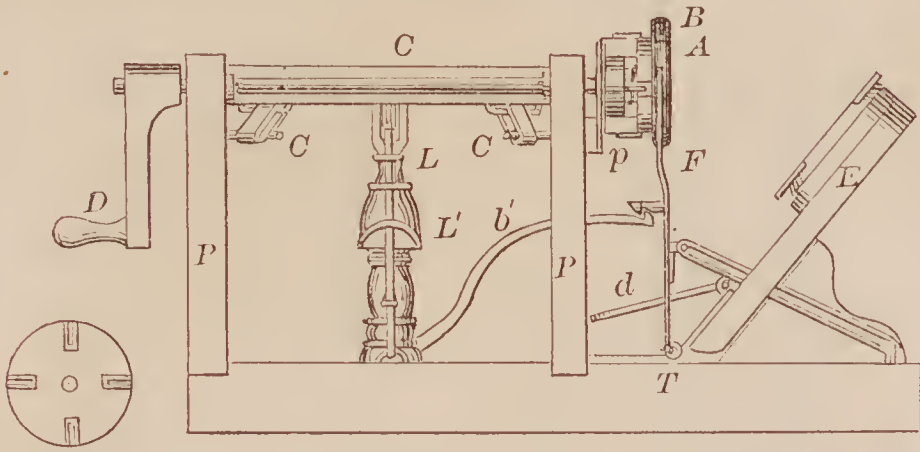

67054—J. B. Hoag—*Horse Rake.*

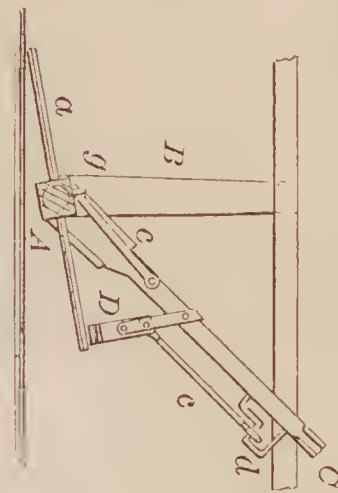

67051—C. B. Hatfield—*Making Paper Boxes.*

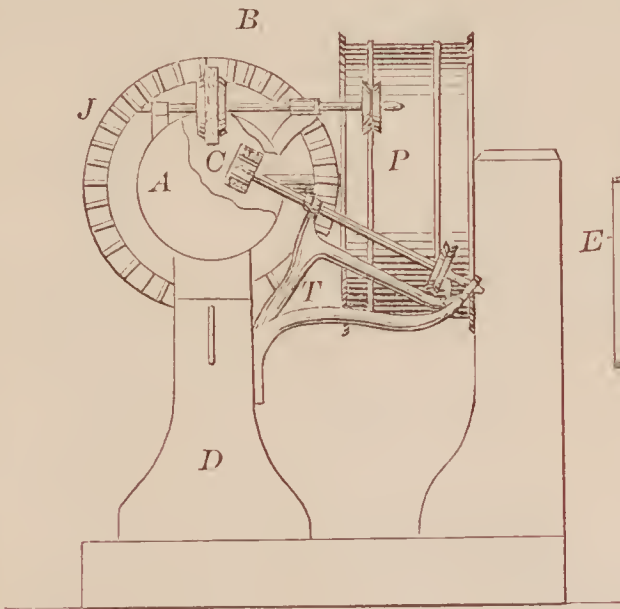

67053—C. F. Hitchings—*Boiler for Heating Buildings.*

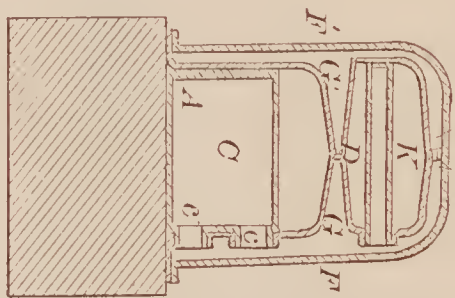
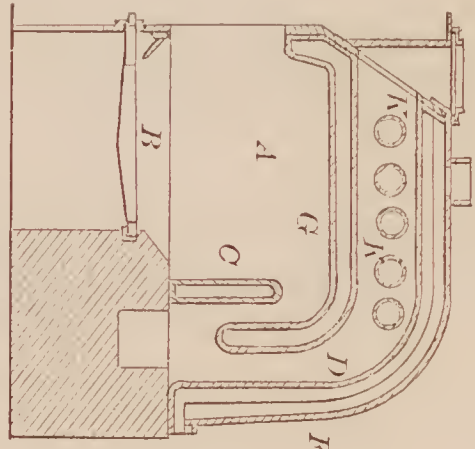

67055—J. Holzman—*Extension Bedstead.*

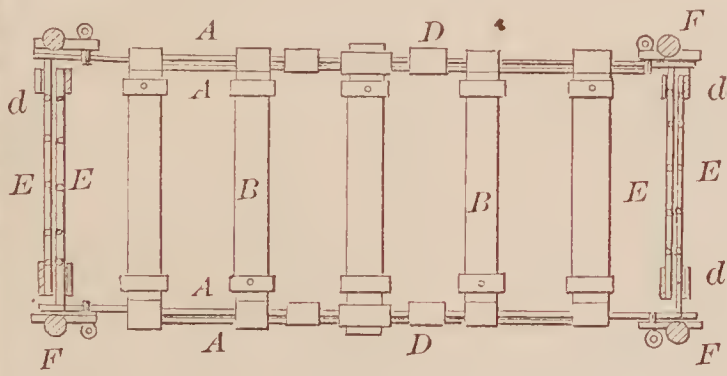

67057—W. Johnson—*For Tethering Animals.*

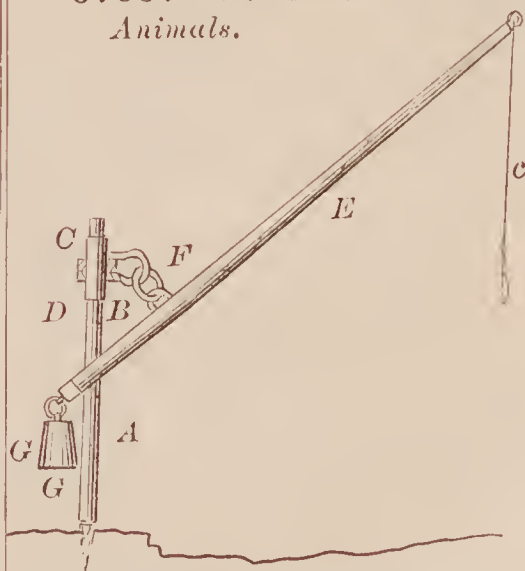

67056—W. H. Humphrey—*Faucet.*

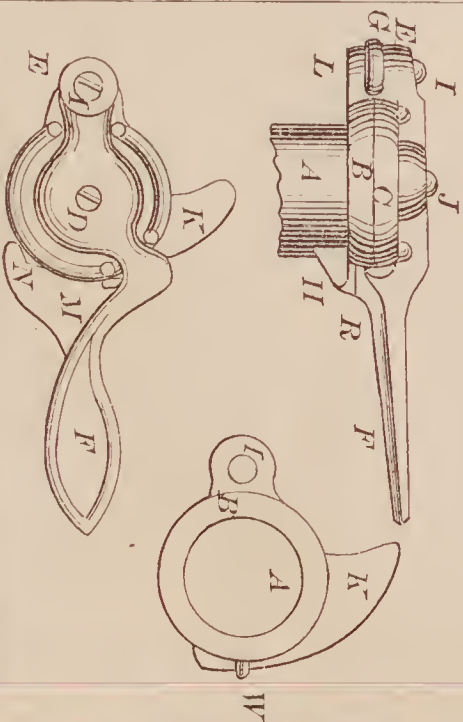

67058—S. Kaufman—*Scouring and Scrubbing Machine.*

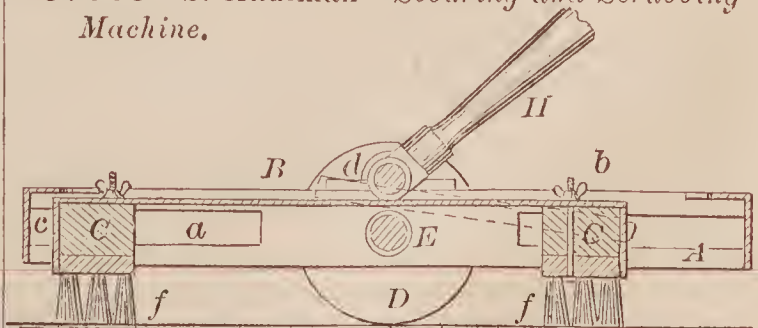



67059—H. Kewley—*Tubing Clamp.*

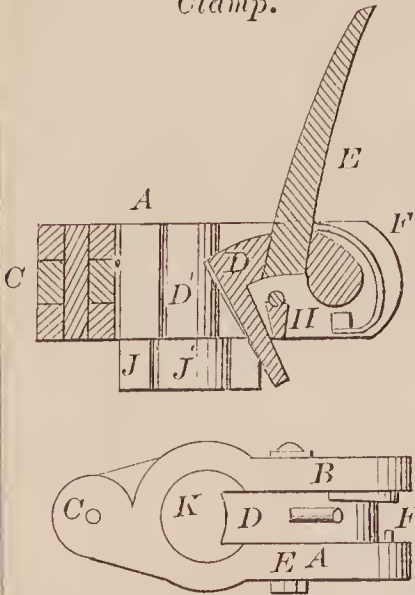

67061—Kohler & Conover—*Pie Plate.*

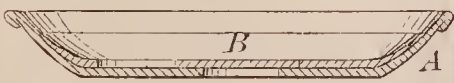

67062—J. F. Little—*Barrel Cresset.*

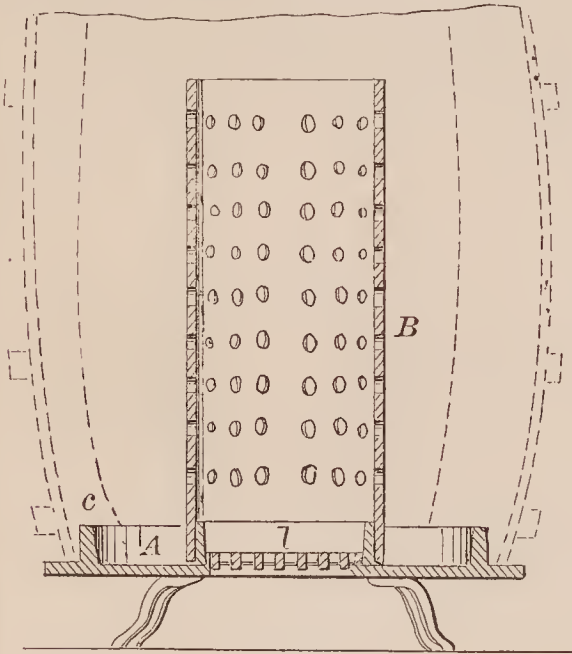

67068—J. D. C. Outwater—*Potato Digger.*

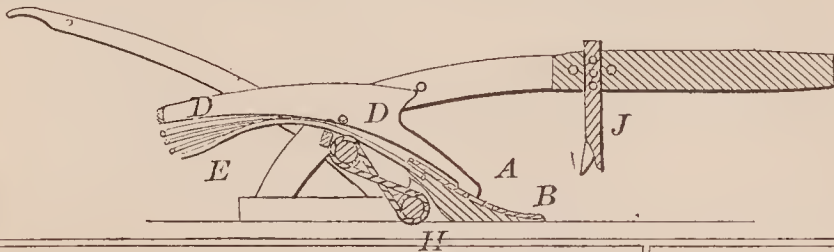

67069—Platt & Gray—*Washing Machine.*

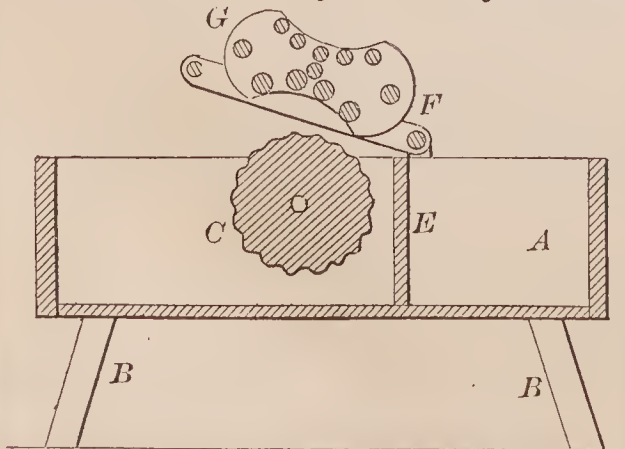

67060—King, Gumber & Shope—*Sash Fastener.*

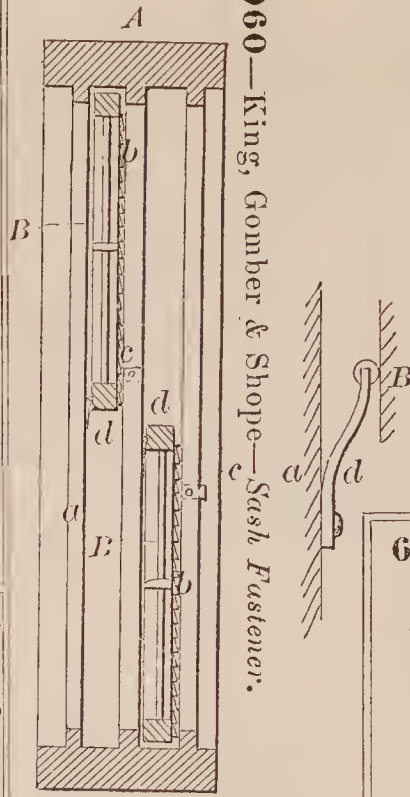

67063—A. A. McMore—*Desk and Table.*

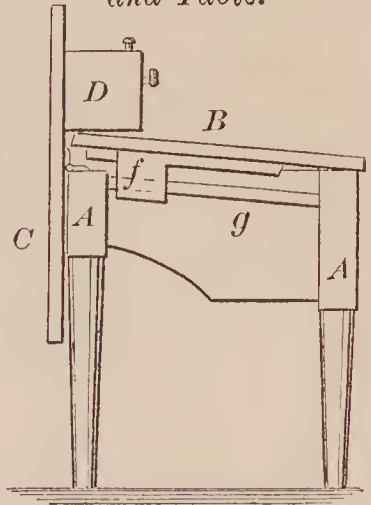

67064—J. P. Morris—*Car Coupling.*

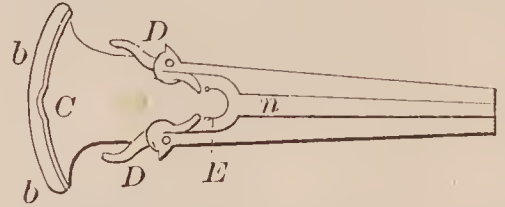

67066—T. W. Murray—*Rudder.*

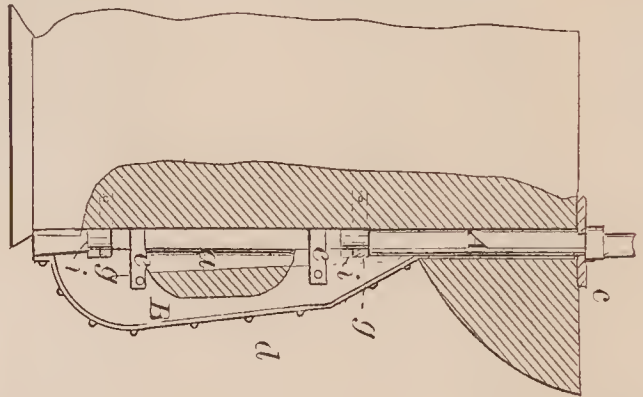

67067—J. H. Orr—*Chamber Pot.*

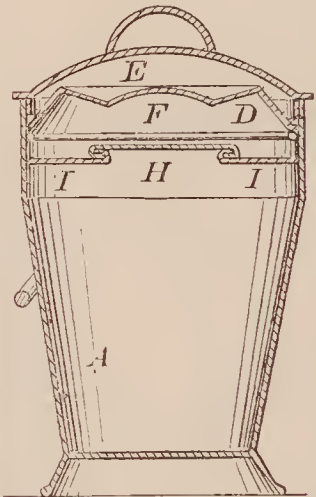

67065—W. H. Morris—*Cartridge Box.*

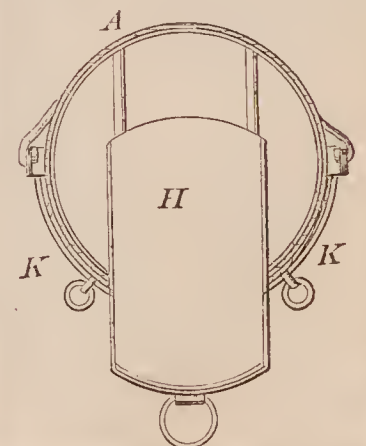
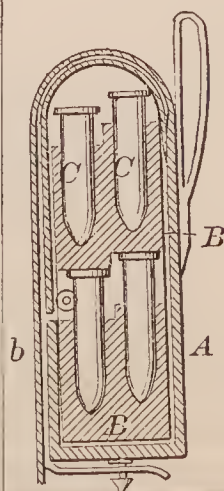





67083—I. P. Tice—Toy Ball Player.

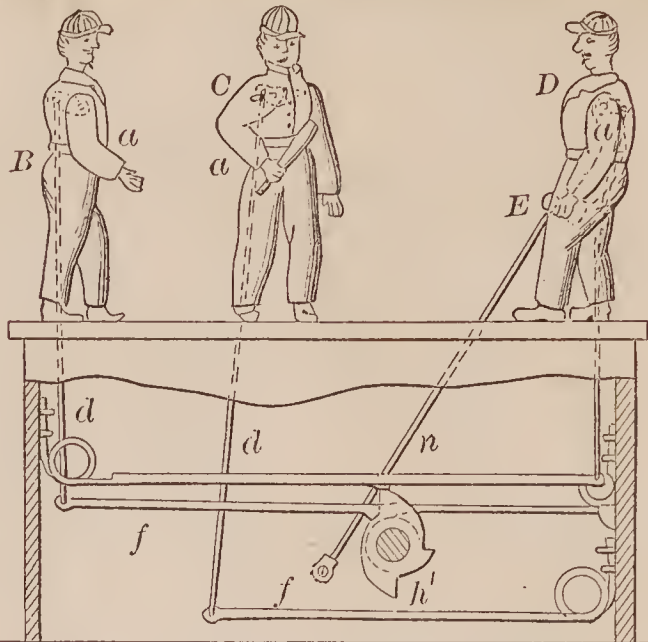

67080—N. Stephens—Tap for Cement Lined Pipe.

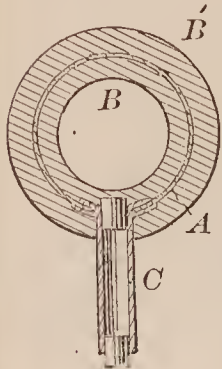

67081—F. A. Sterry—Spindle Step.

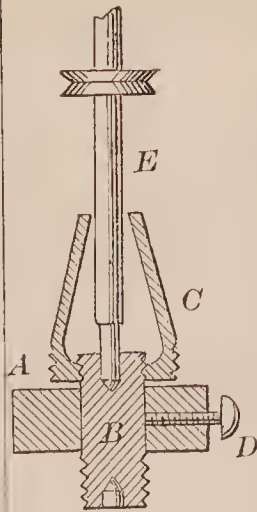

67084—J. Turner—Stone Pipe Shelf.

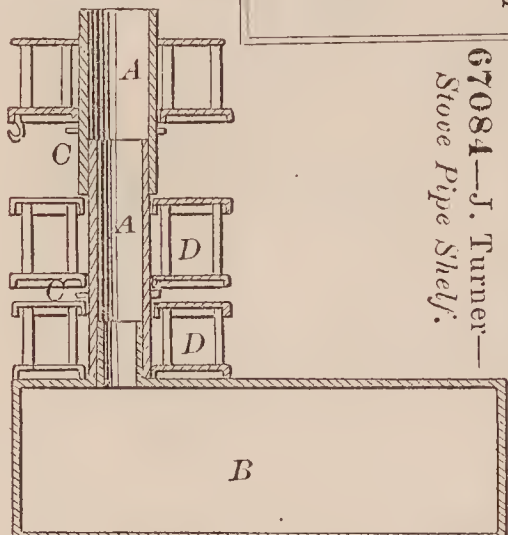

67085—Vogt & Krapf—Churn.

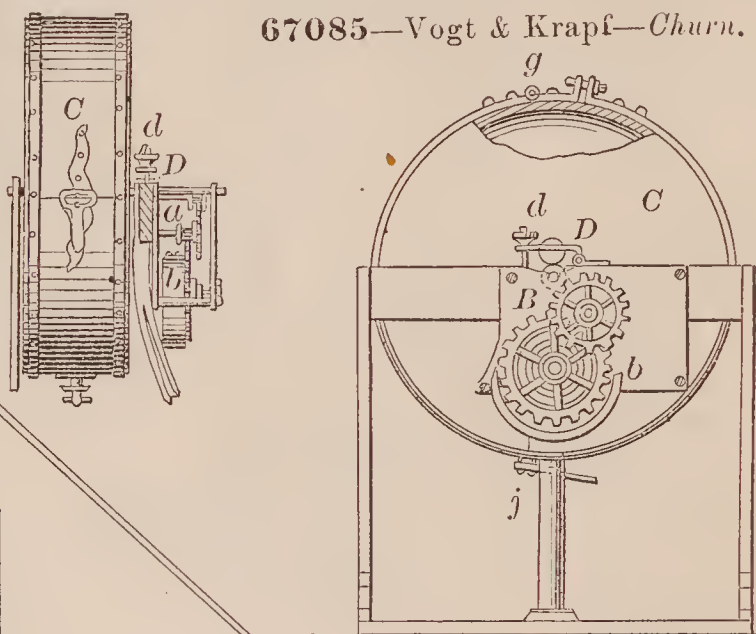

67086—H. Voigt—Curtain Fixture.

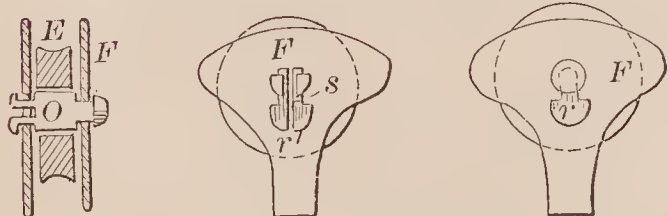
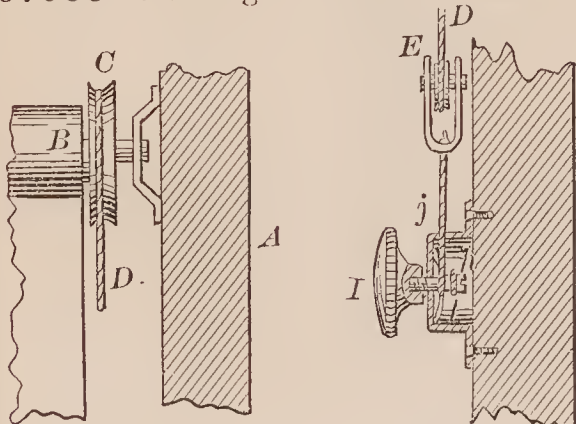

67087—A. P. Von Pornhoff—Manufacture of Bicarbonate of Soda.

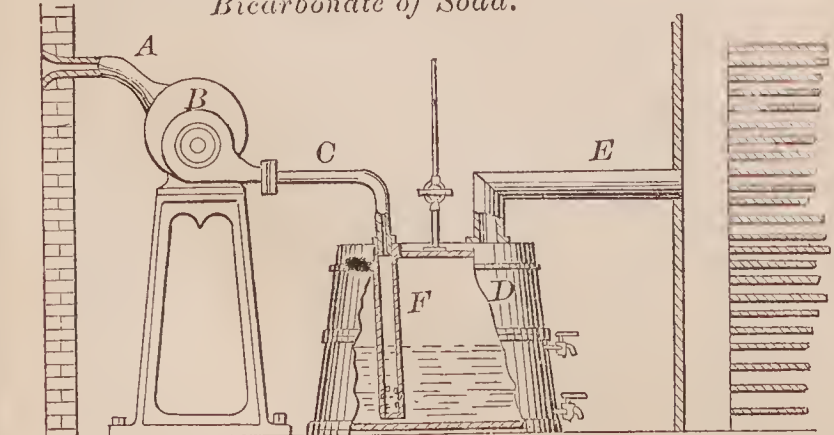

67088—A. W. Ward—For Washing and Drying Dishes.

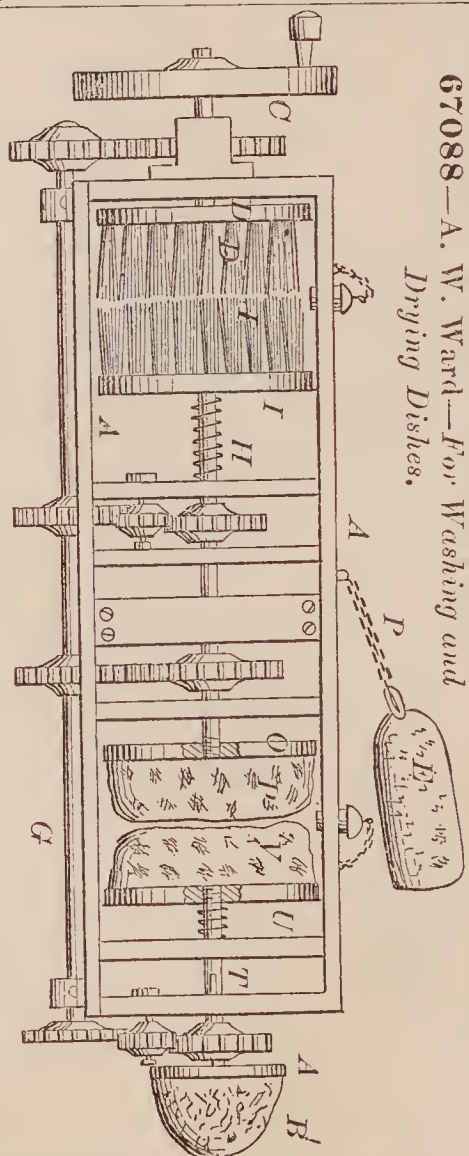

**67089**—Webb & Hermann—*Sealing Padlock.*

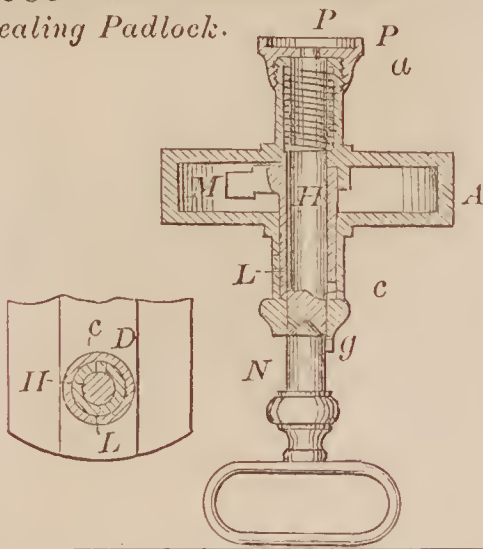

**67093**—J. Wilson—*Cultivator.*

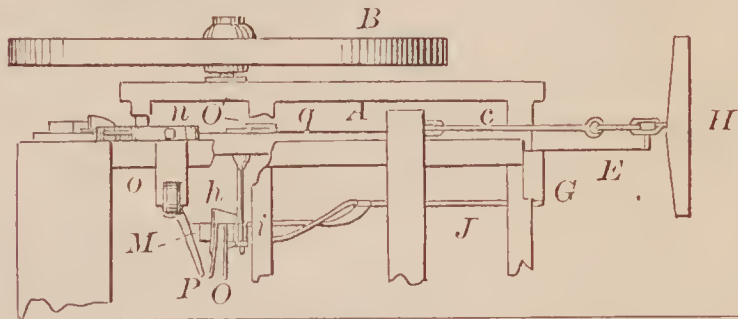
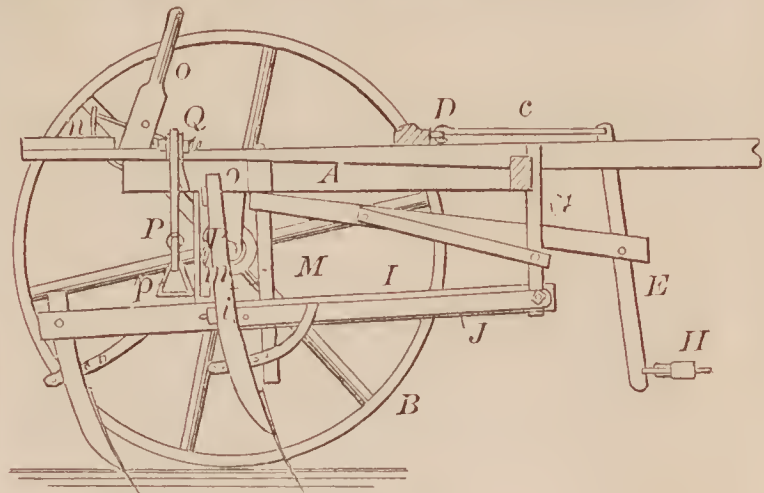

**67092**—J. W. Wilcox—*Document Envelope.*

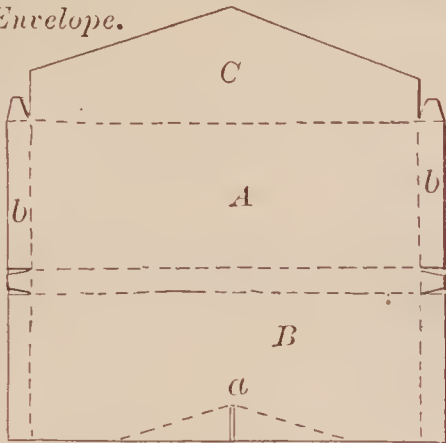

**67096**—E. H. Ashcroft—*Steam Gauge Dial.*

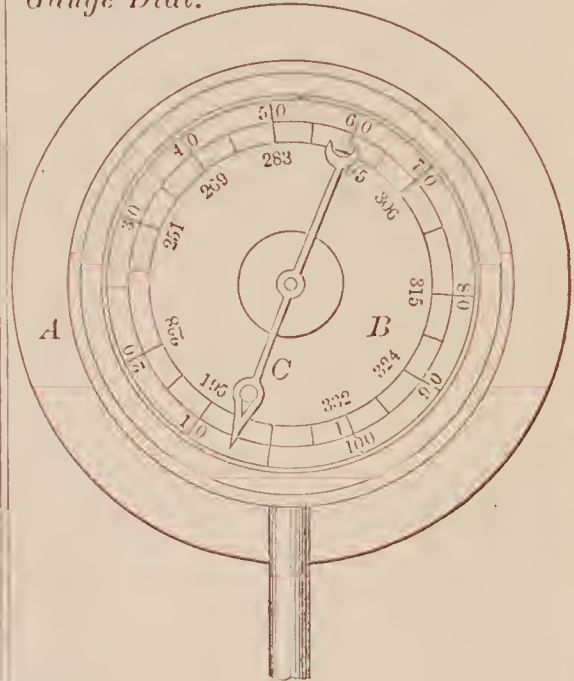

**67094**—E. R. Wolfe—*Gate.*

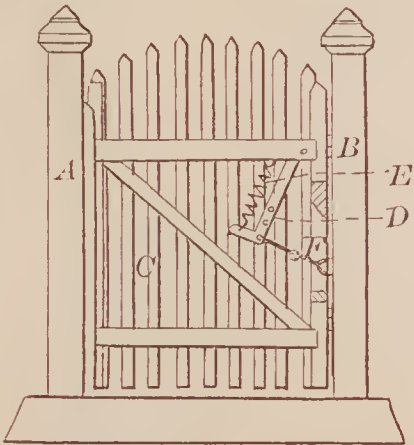

**67091**—H. Whitney—*Paper Yectie.*



**67090**—W. Weddington—*Churn.*

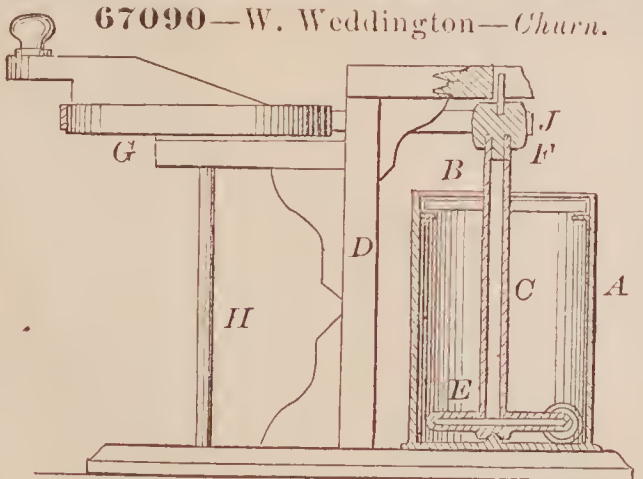

**67095**—R. S. Annall—*Churn.*

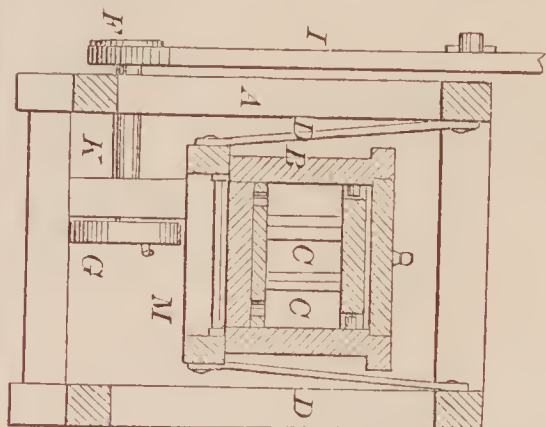

**67097**—R. H. Birt—*Tinners' Folding Machine.*

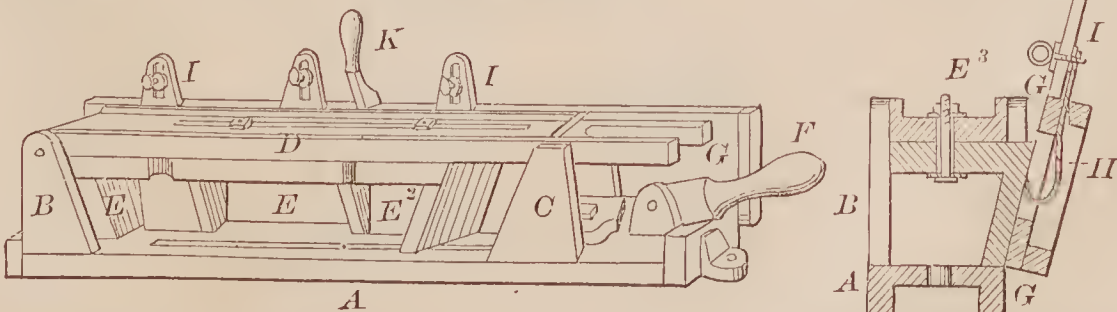



67098—E. B. Bishop—  
*Cotton Tie.*

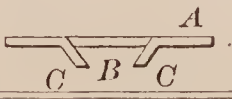

67100—A. W. Brinkerhoff—  
*Clothes Pin.*

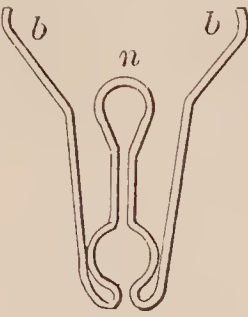

67101—C. L. Browne—*Jumping Hoop.*



67102—L. S. Calkins—*Clothes Dryer.*

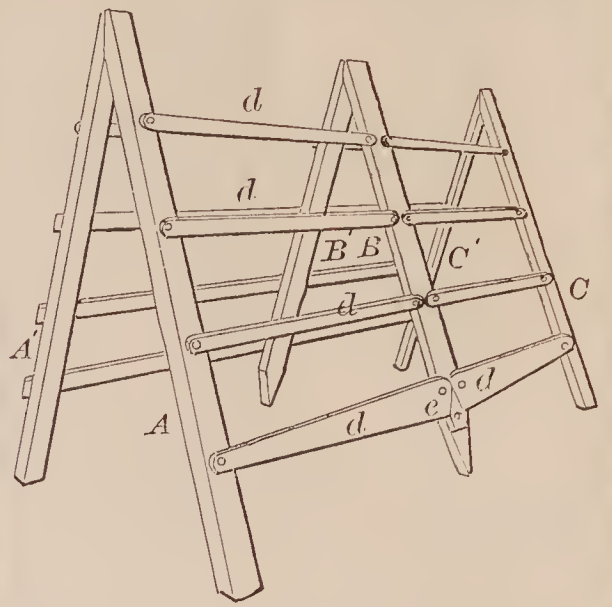

67105—J. E. Cryer—*Churn.*

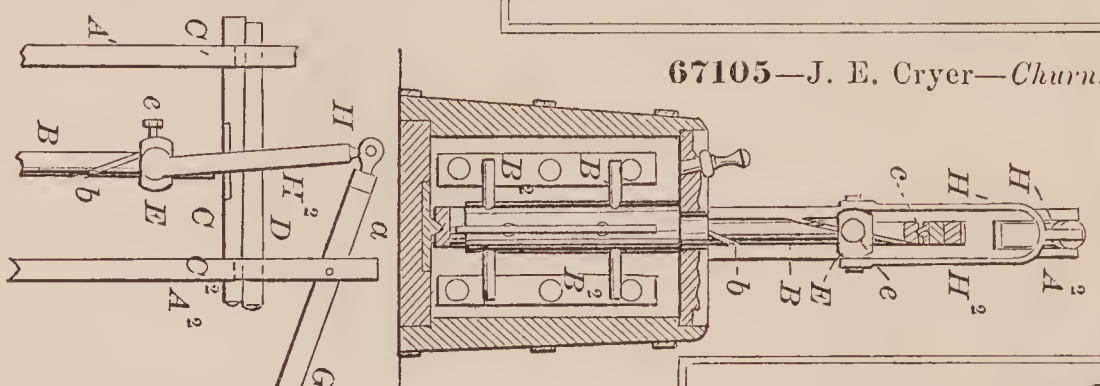

67103—S. J. Clark—*Lifting Jack.*

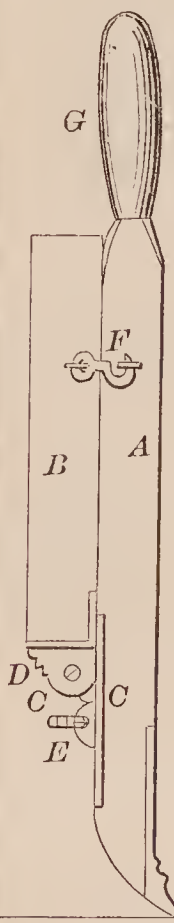

67106—Cummings & Harrington—  
*Threshing Machine.*

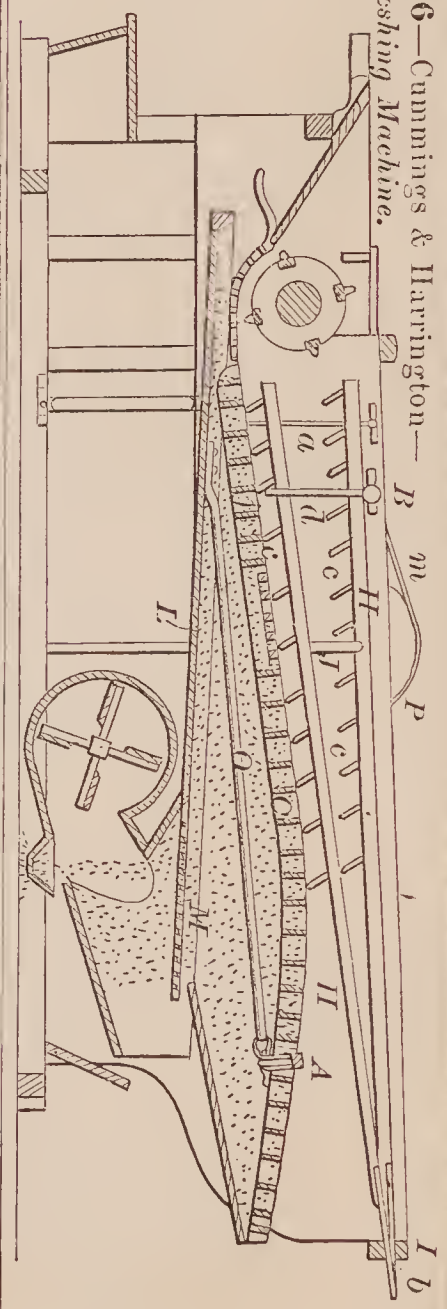

67104—Clark, Hadley & Clifford—  
*Preserving Wood.*

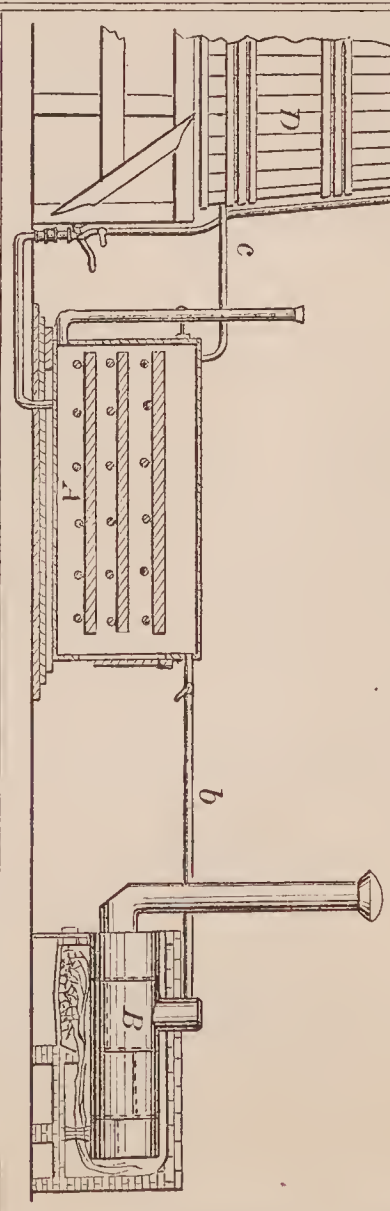

67099—

W. K. Black—*Sever Pipe Machine.*

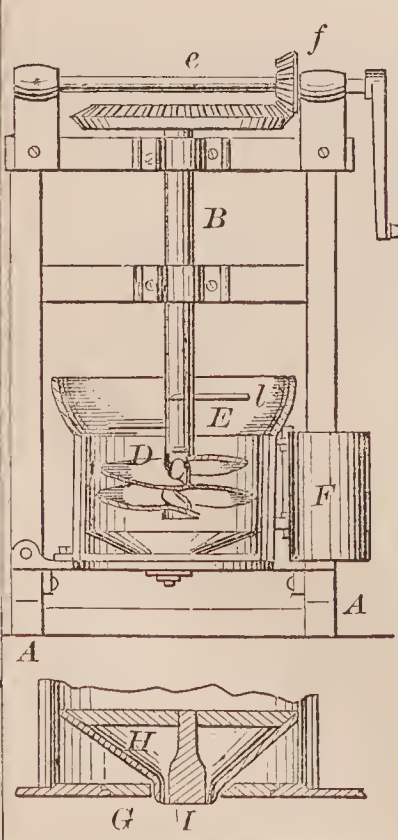

67108—C. Fisher—*Burning Hydro-Carbon Liquids.*

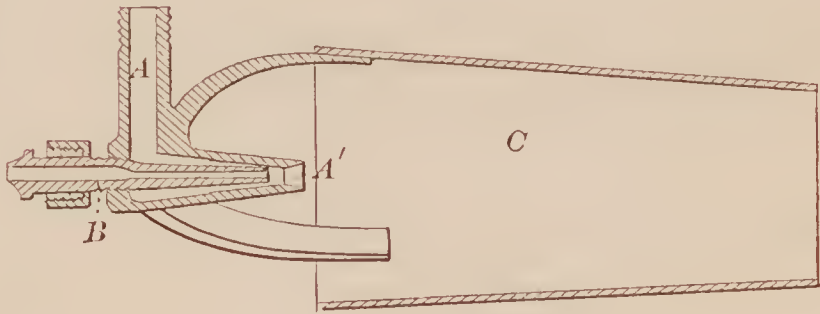
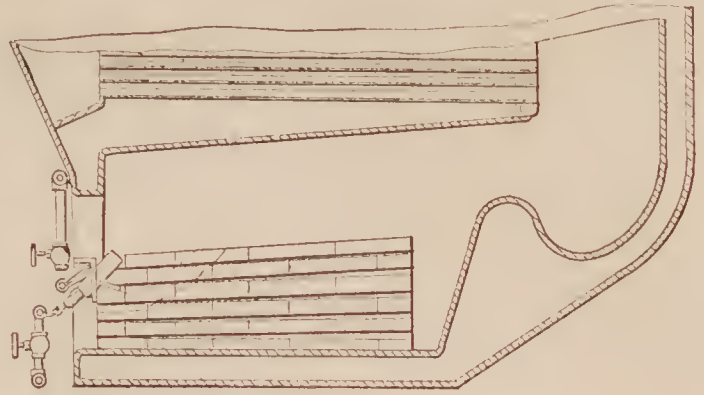

67107—F. J. Dibble—*Folding Seat and Arm.*

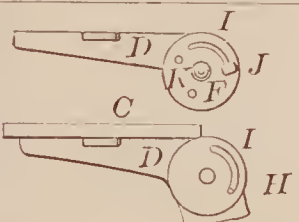
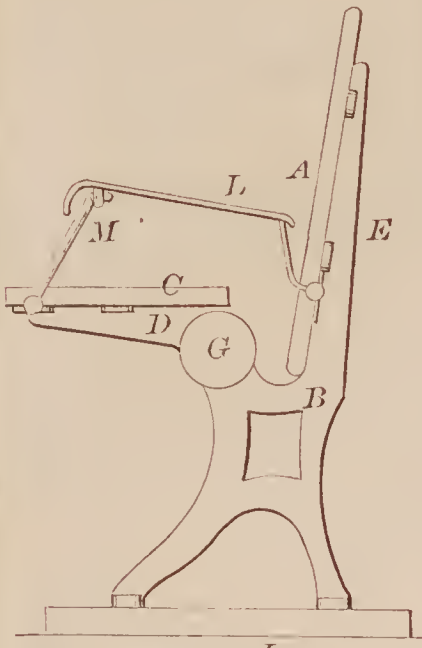

67110—G. Gunderson—*Skate Fastening.*

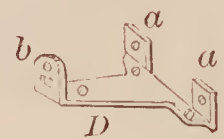
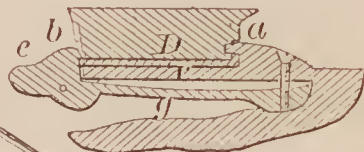
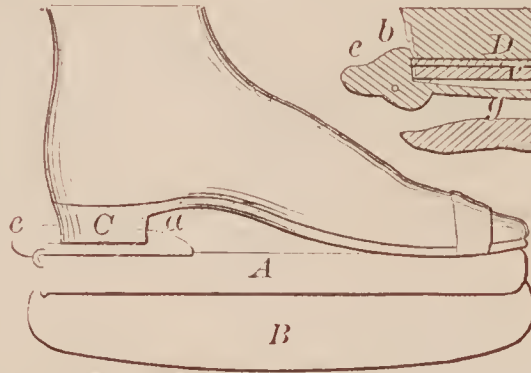

67109—Goodin, Blair & Lyda—*For Manufacturing Sheet Metal Pans.*

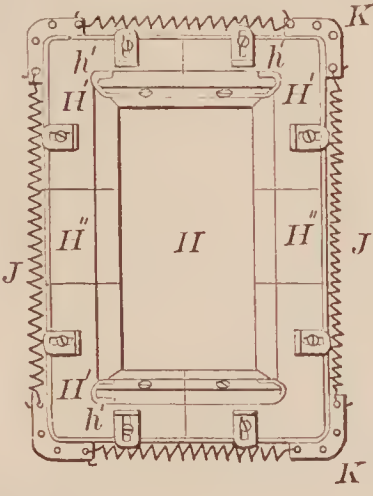

67111—W. E. Haskins—*Envelope.*

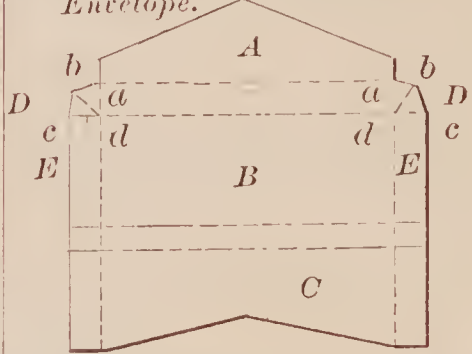

67113—D. S. Hines—*Hydraulic Crane.*

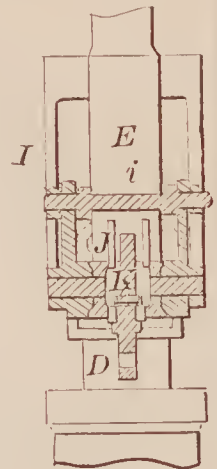
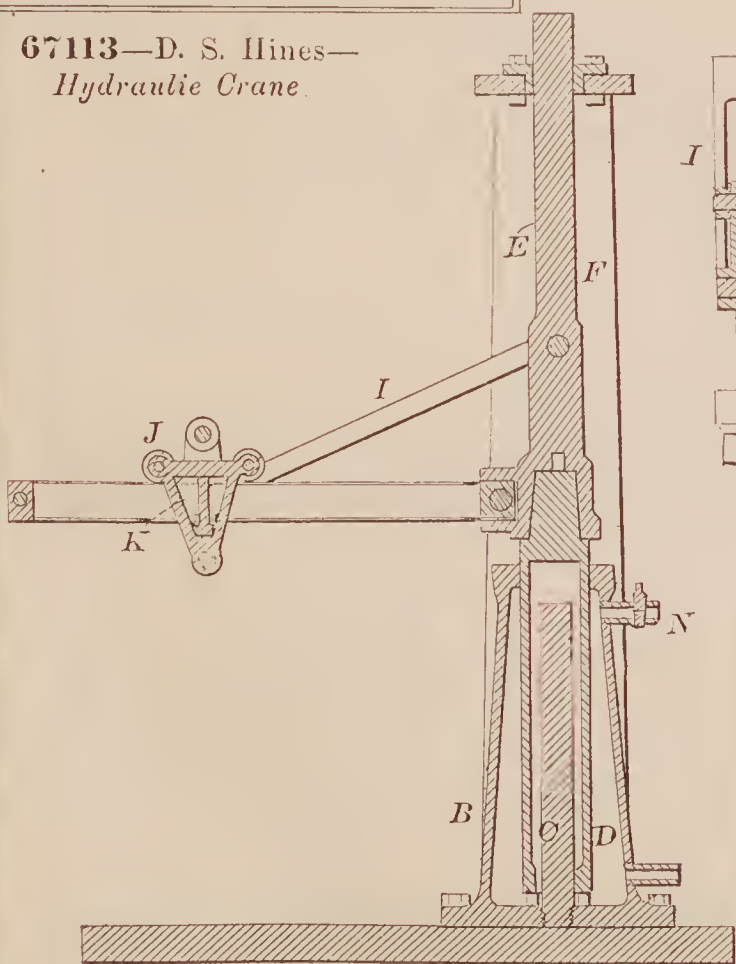

67112—W. P. Heffron—*Boiler Tube Cleaner.*

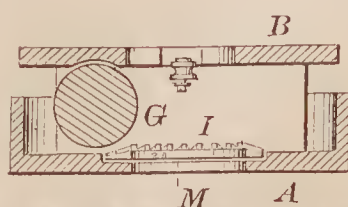
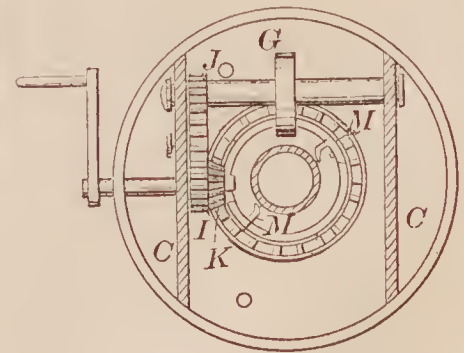



67114—Hodge & Noyes—Automatic Dental Mallet.

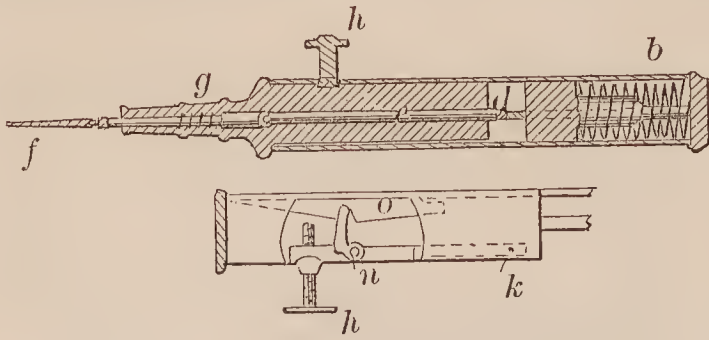

67117—W. D. Hunt—Fence.

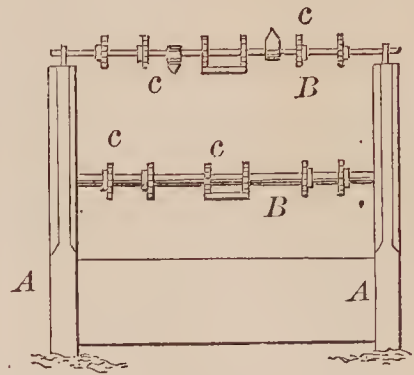

67115—W. W. Hubbard—Corn Planter.

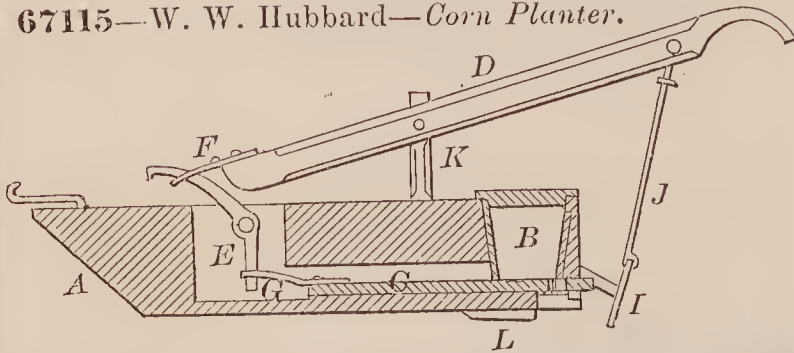

67119—J. Hyde—Folding Chair.

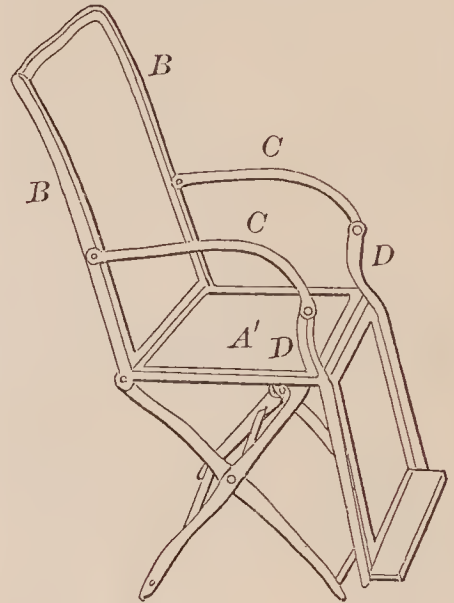

67116—G. Hubert—Compound Lock for Doors.

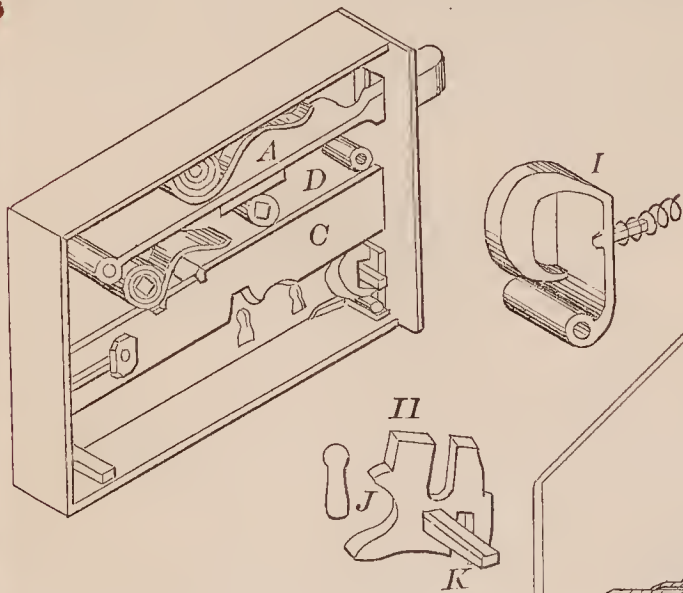

67120—G. Jedamski—Pen Rack.

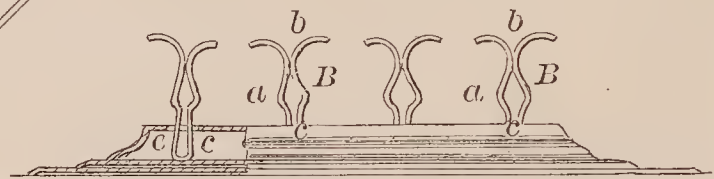

67123—E. Kretchmer—Beehive.

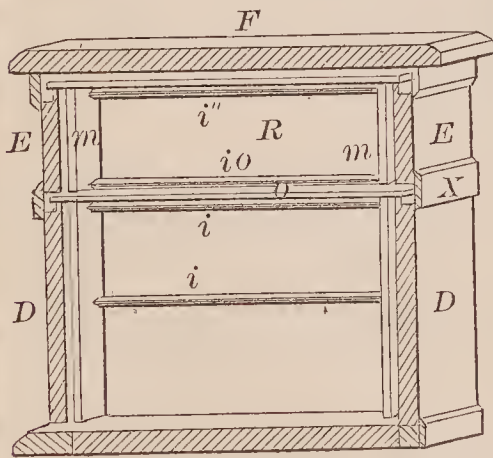

67118—A. B. Hurd—Churn Dasher.

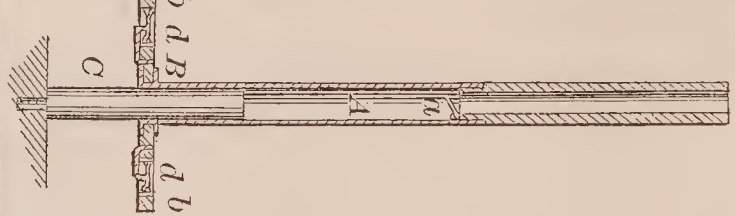

67122—H. M. Keith—Fertilizer and Seed Sower.

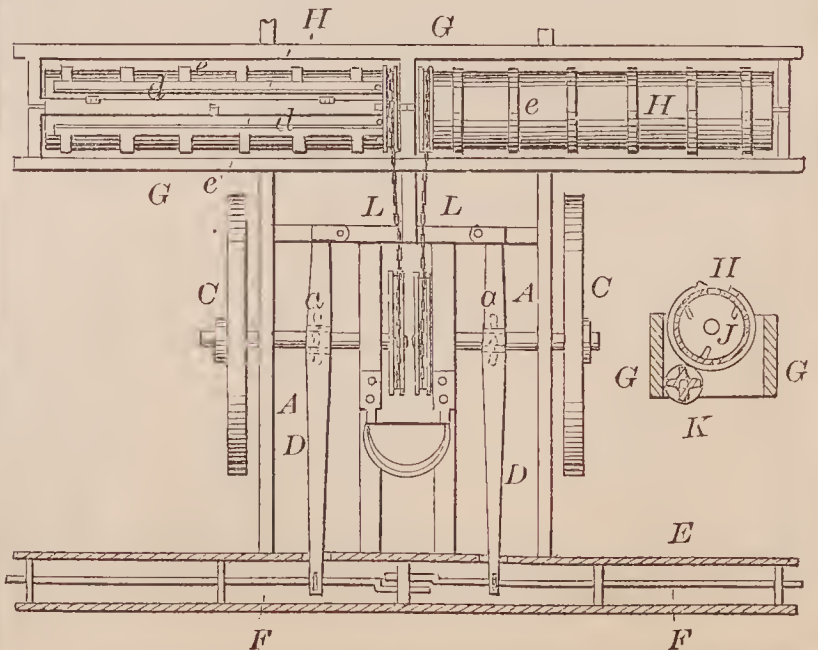

67124—C. F. Kuhnle—Shelf Bracket.

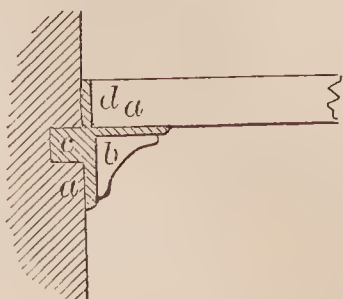

67125—J. Lamb—  
Washing Machine.

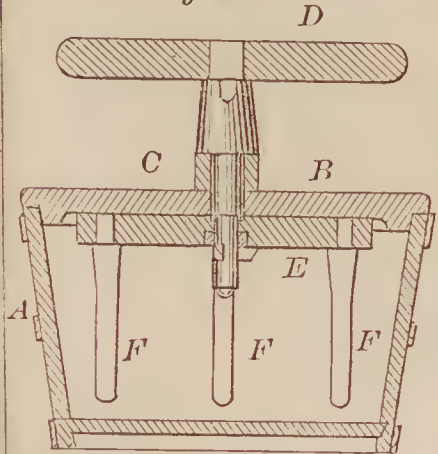

67126—G. Long—Wagon Brake.

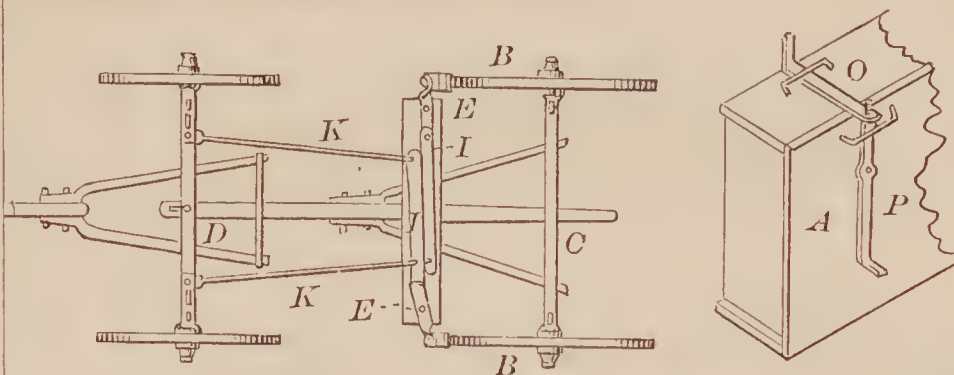

67127—W. L. Lowrey—Manufacture  
of Illuminating Gas.

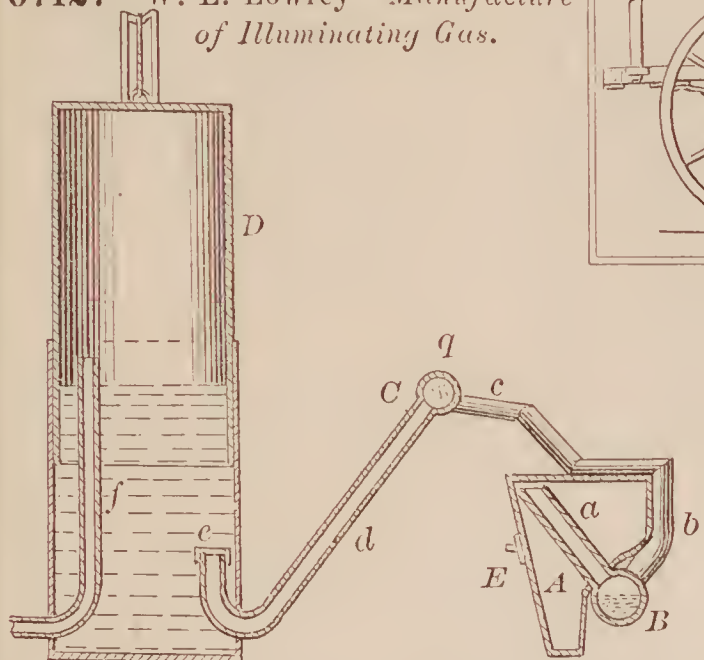

67128—W. Mansfield—Spring Wagon.

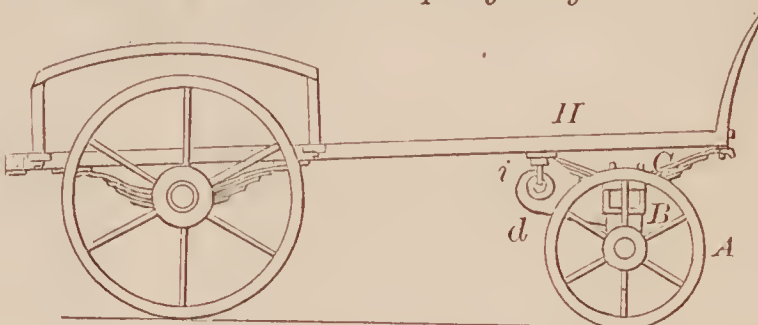

67131—G. Moore—Die for Making Plow  
Braces.

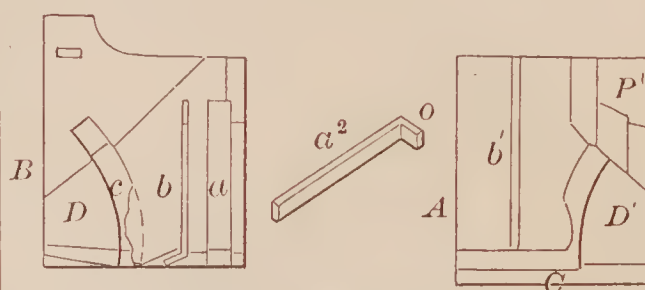

67129—E. J. Merick—  
Dental Plate.

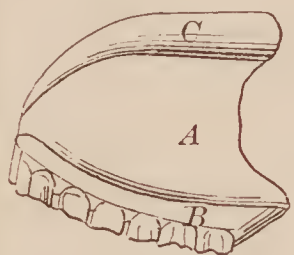

67132—J. Myers—Sleigh Brake.

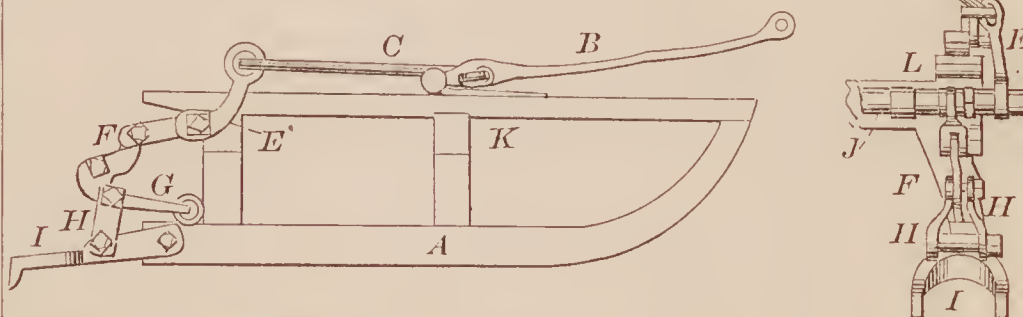

67133—C. W. Packer—Ice Cream Freezer.

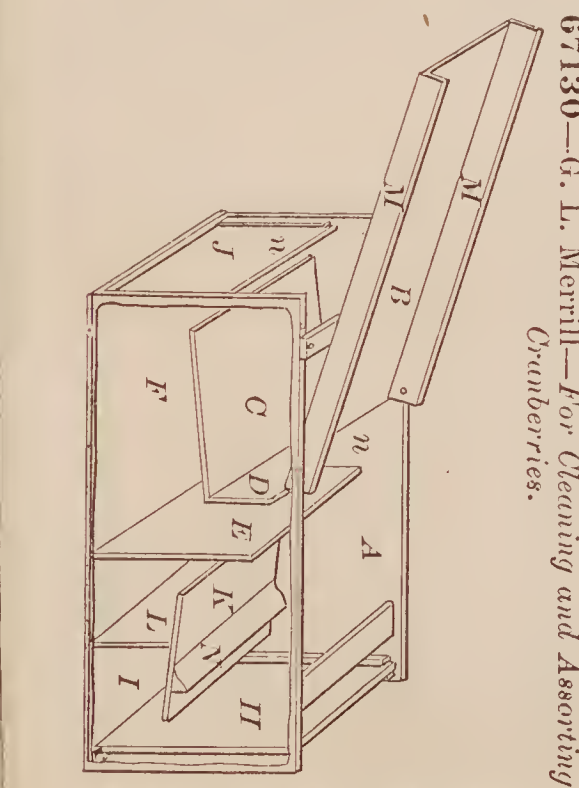
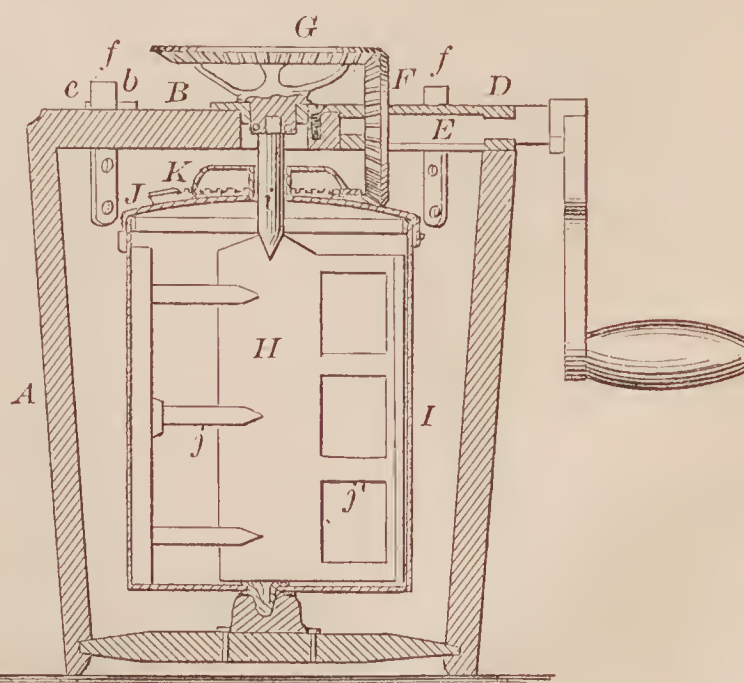

67130—G. L. Merrill—For Cleaning and Assorting  
Crumbeberries.



67134—J. H. Parmelee—Collar.

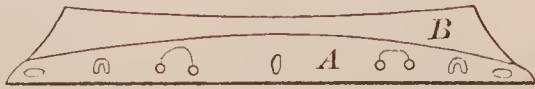

67136—N. Pramer—Grate.

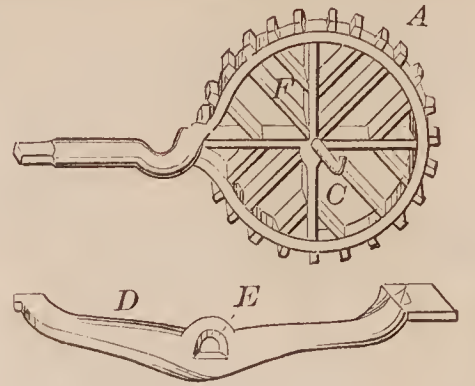

67135—E. Petteys—Gate.

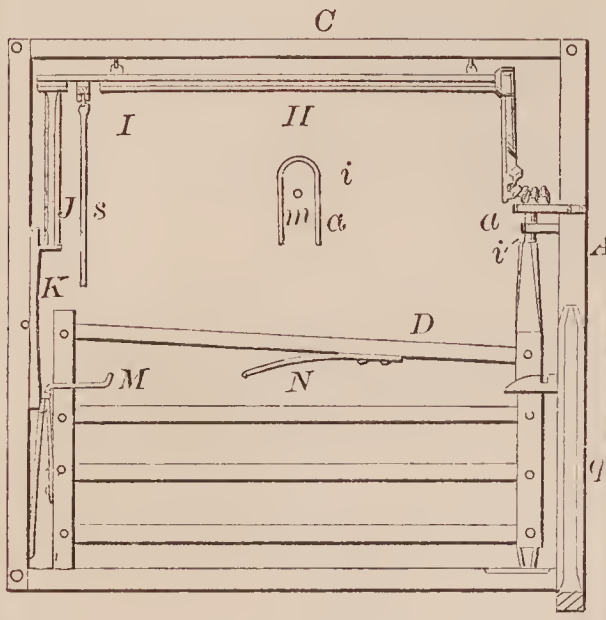

67142—A. L. Smith—Coupling Reach for Bob Sleighs.



67137—T. M. & T. J. Raser—Boat Detaching Tackle.

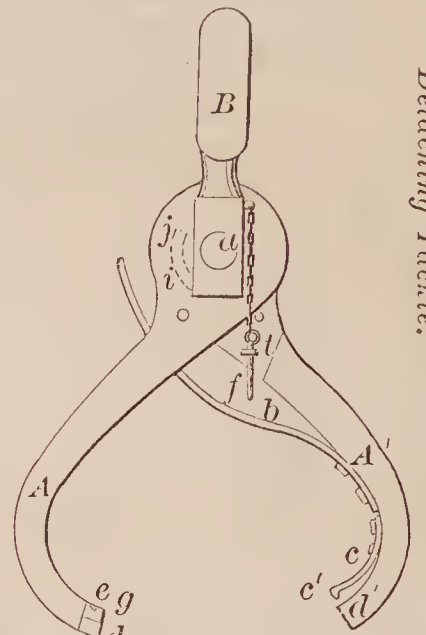

67138—H. Rothfelder—For Winding and Setting Watches.

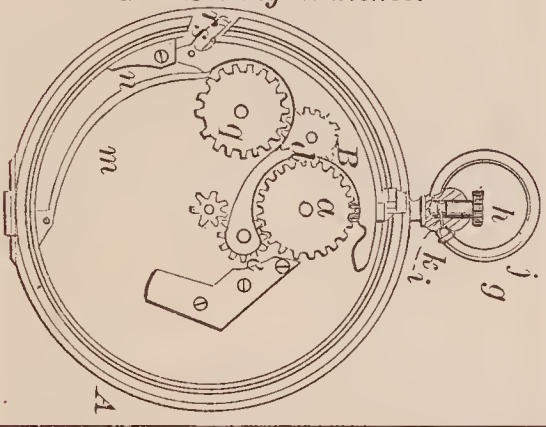

67139—W. F. Seavey—Bit Brace.

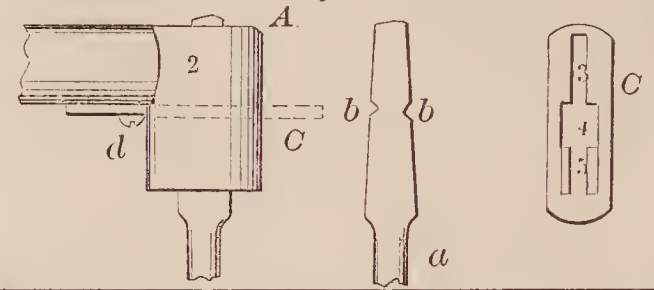

67141—J. Slauder—Broadcast Seeder.

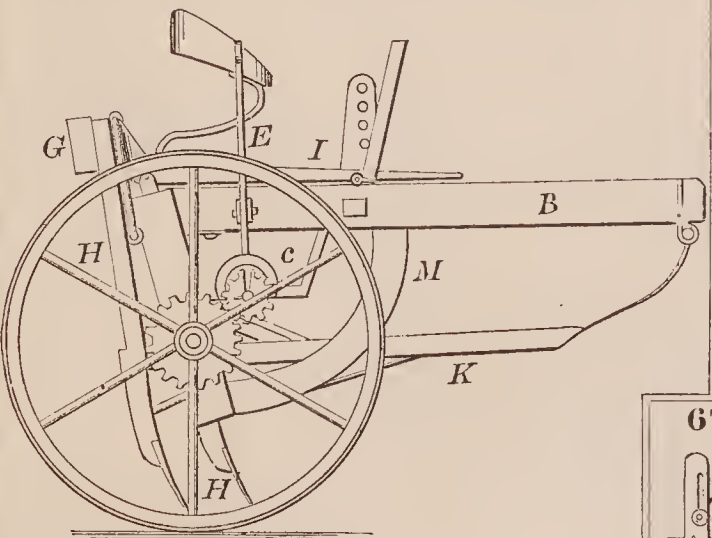

67140—B. Seegmuller—Knob Latch and Lock.

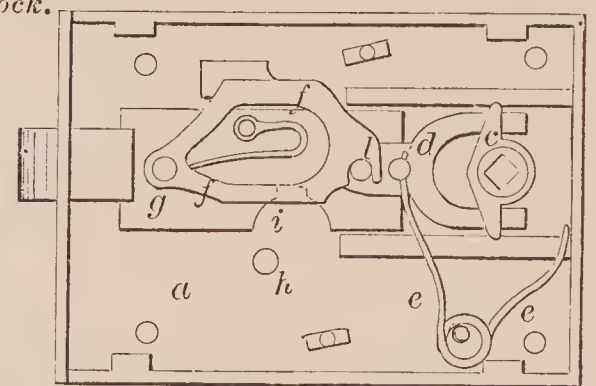

67143—C. S. Snead—Extension Gate.

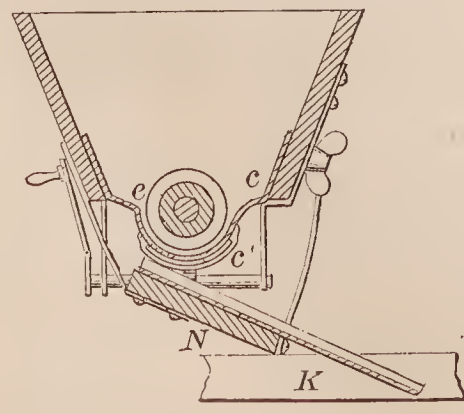
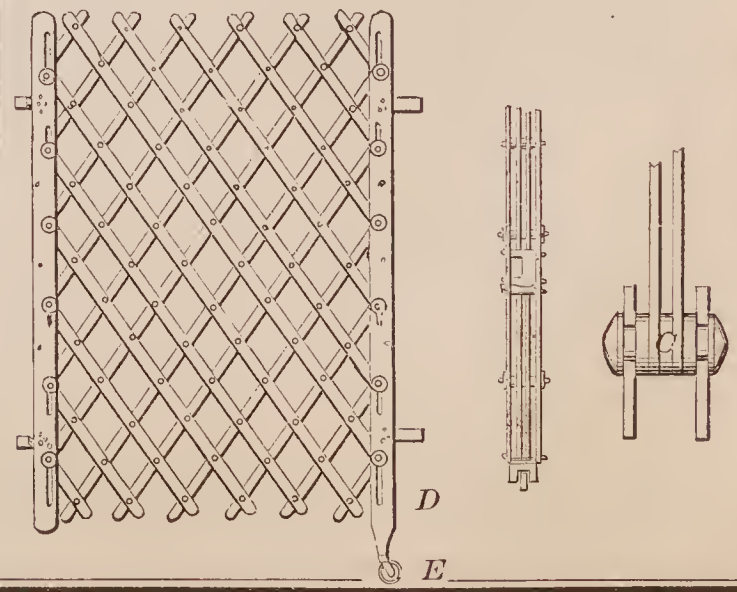

**67144**—H. T. Stanard—*For Applying and Measuring Forces.*

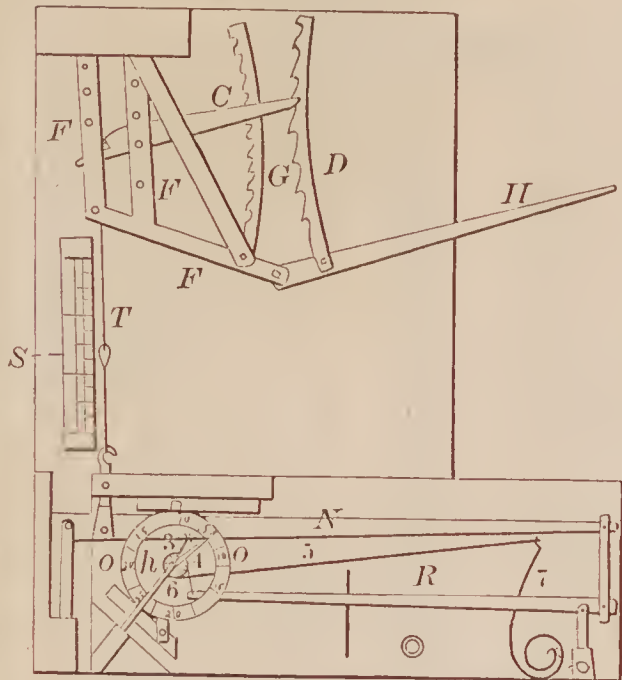

**67146**—T. Stover—*Window Blind Fastening.*

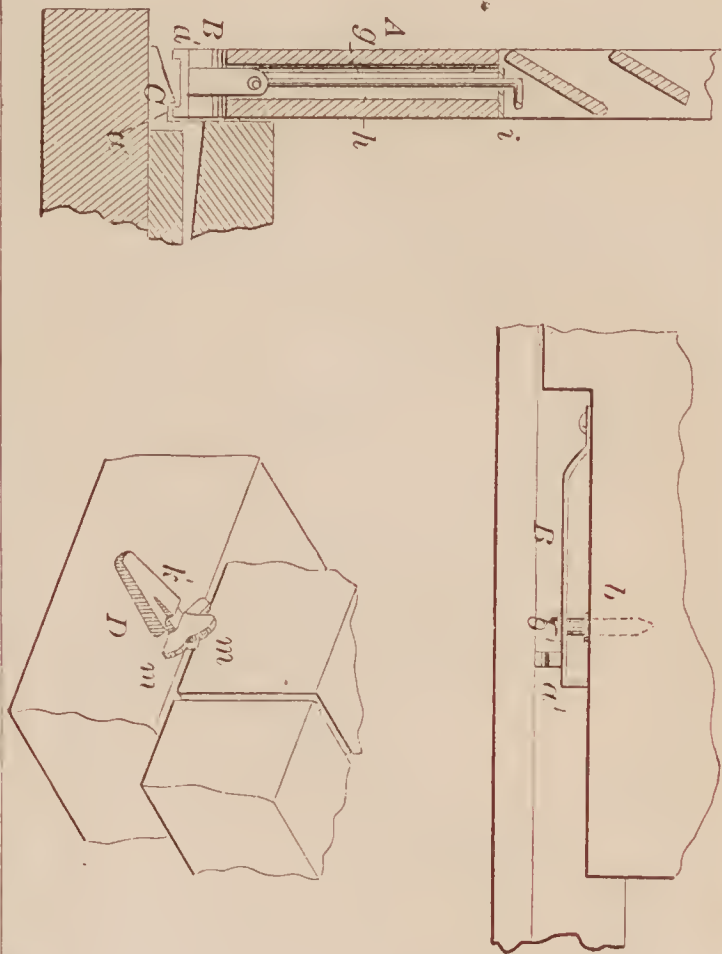

**67147**—E. Stuart—*Cotton Press.*

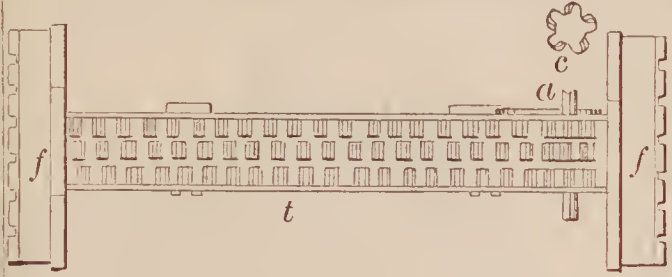

**67149**—R. B. Will—*Washing Machine.*

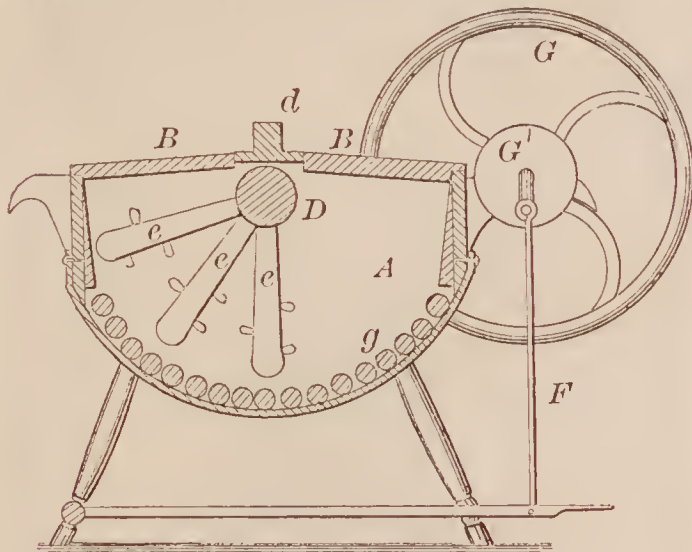

**67150**—G. Wood—*Melodeon.*

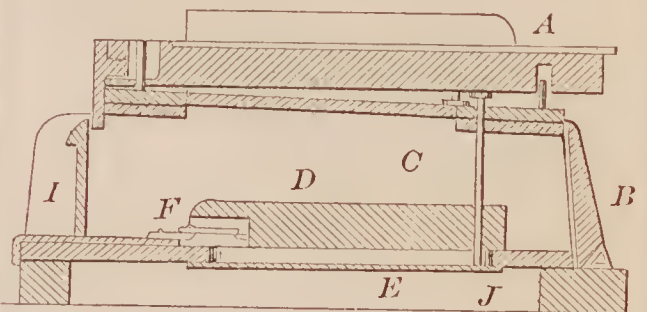

**67152**—H. Zurbrick—*Cultivator and Seed Sower.*

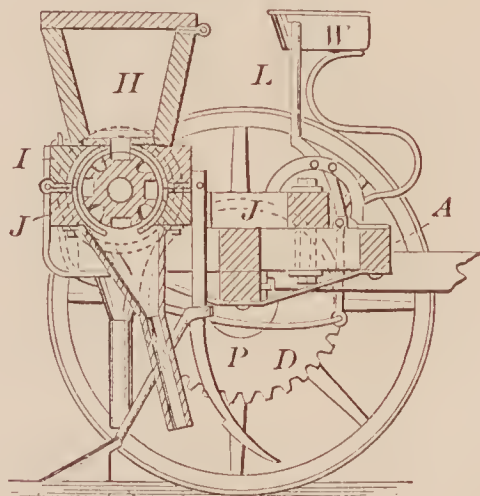

**67148**—J. M. Wilcox—*Potato Digger.*

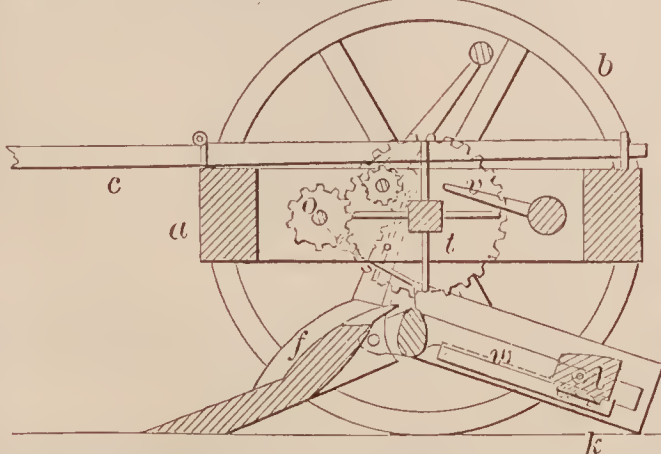

**67151**—D. W. Wright—*Rule for Calculating Time and Measures.*

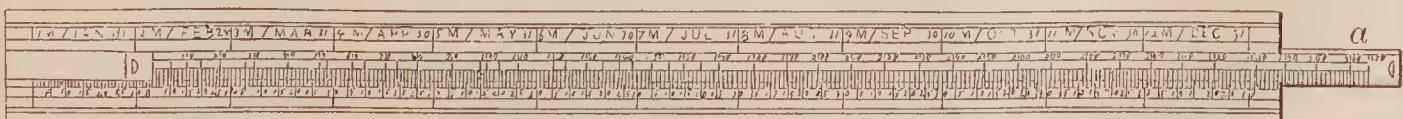



67153—R. Ashe—Baby Jumper and Cradle.

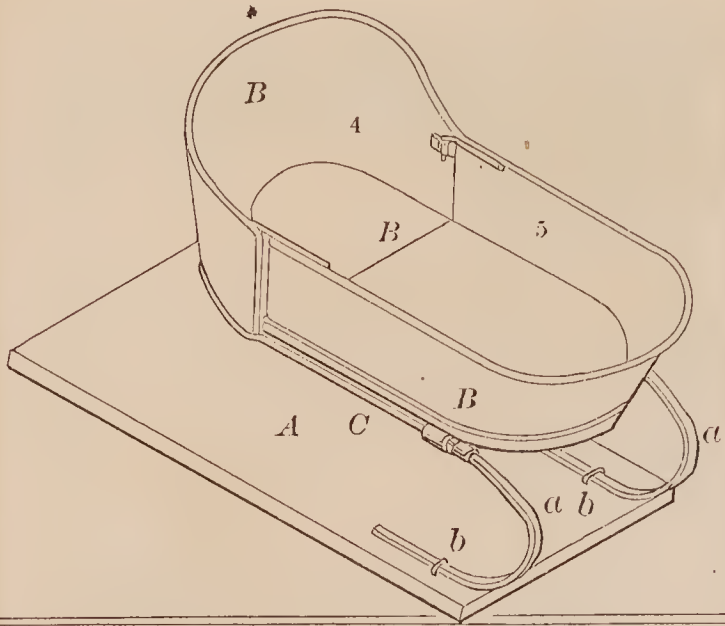

67154—H. H. Bryant—Fireproof Safe.

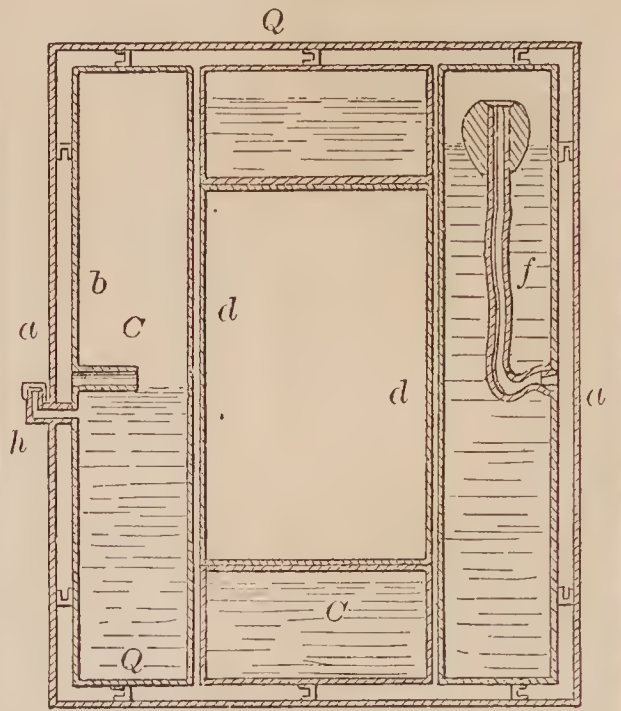

67155—J. N. Ball—Eave Trough Bracket and Cornice.

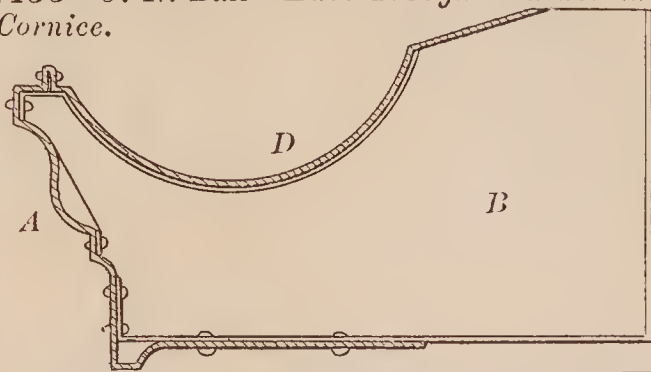

67158—F. A. Brewster—Hoop Skirt.

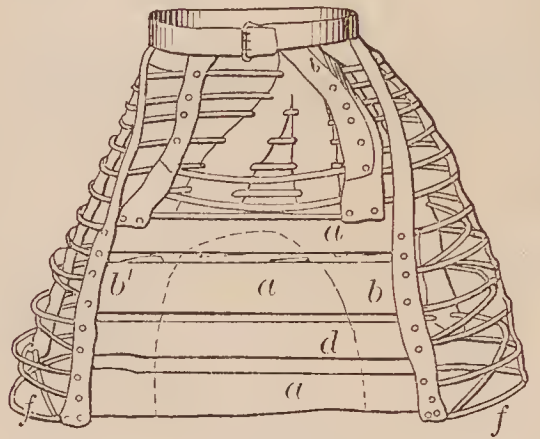

67157—Bess & Hagny—Plane for Cutting Blind Slats.

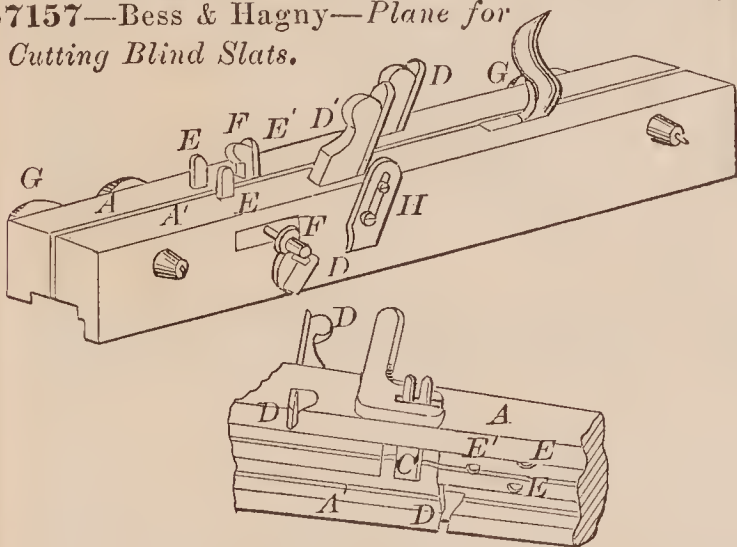

67160—W. G. Brownson—Relay Magnet.

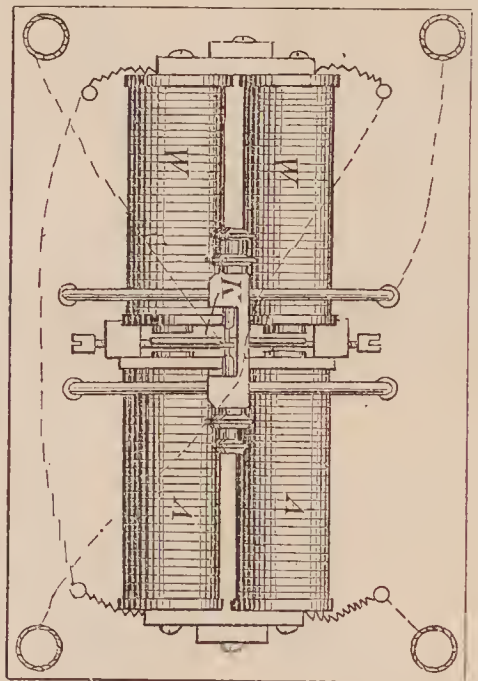

67160—W. G. Brownson—Relay Magnet.

67156—S. A. Barr—Clothes Line Fastening.

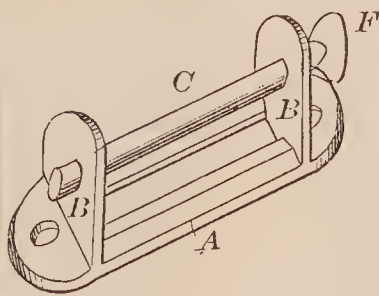

67159—W. Brown—Carpet Stretcher and Tack Driver.

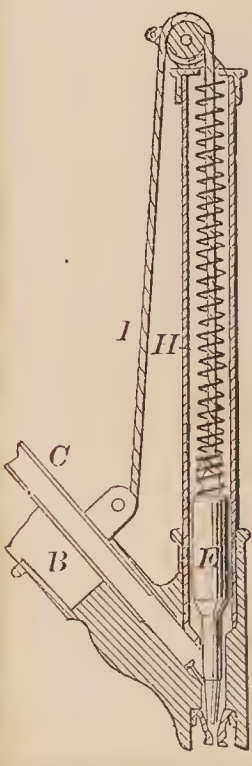

67162—C. O. Buell—Umbrella.

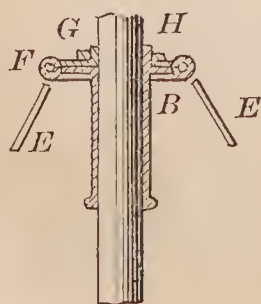

67161—C. Brusio, Jr.—Gas Pipe Joint.

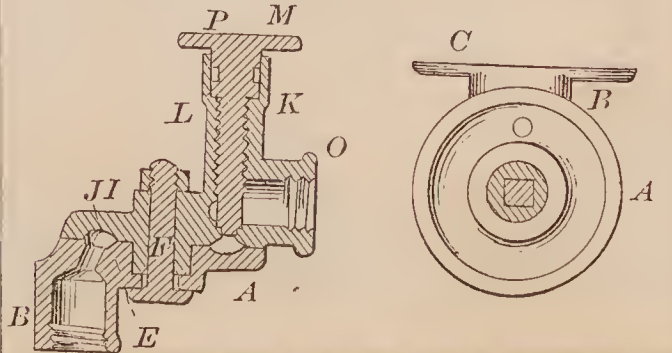

67163—A. G. Buzby—*Portable Writing and Copying Case.*

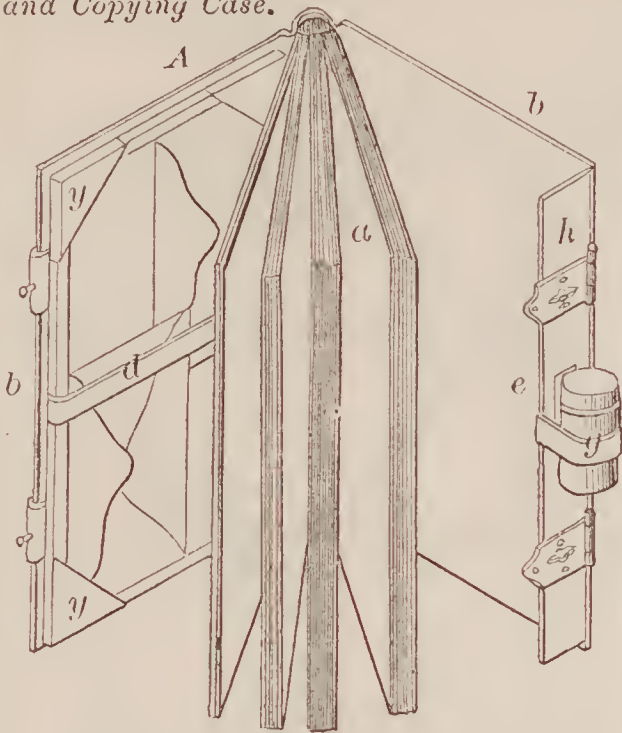

67164—G. W. Carpenter—*Sheep Shears.*

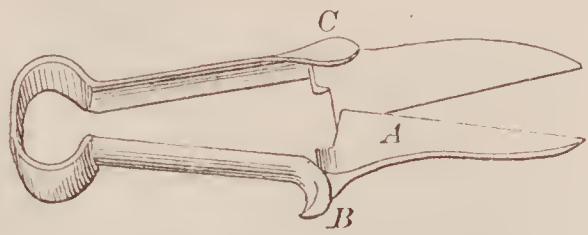

67165—J. R. Chiles—*Car Seat.*

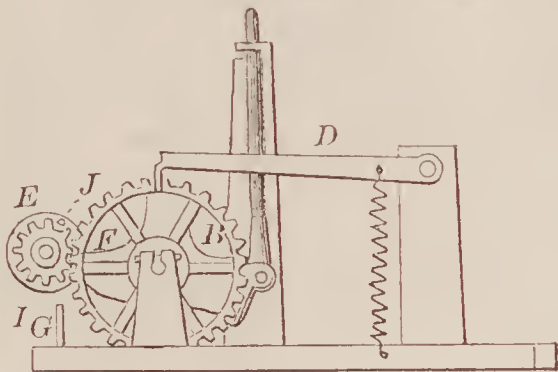
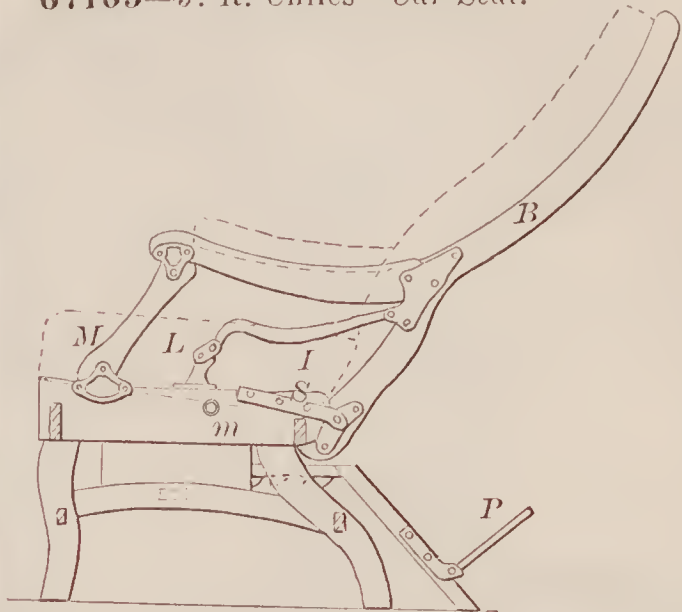

67166—Clinton & Mood—*Calendar Clock.*

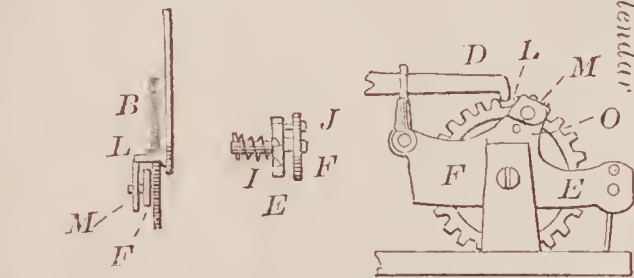

67168—Davis & Smith—*Seeding Machine.*

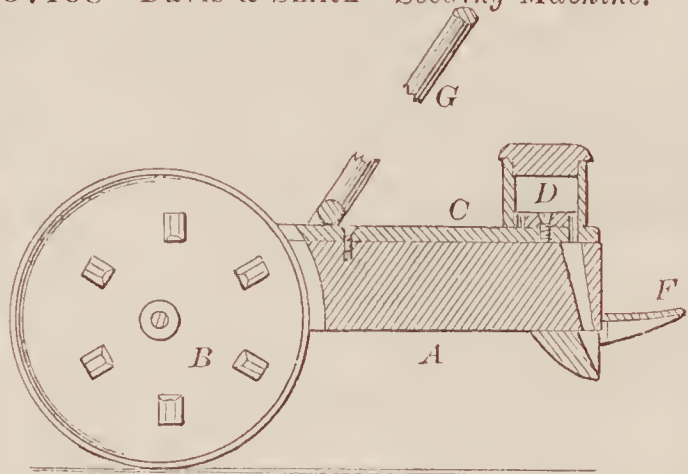

67167—G. N. Cummings—*Eye Glass.*

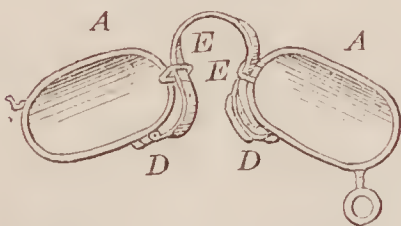

67169—C. F. Dean—*Knife Cleaner.*

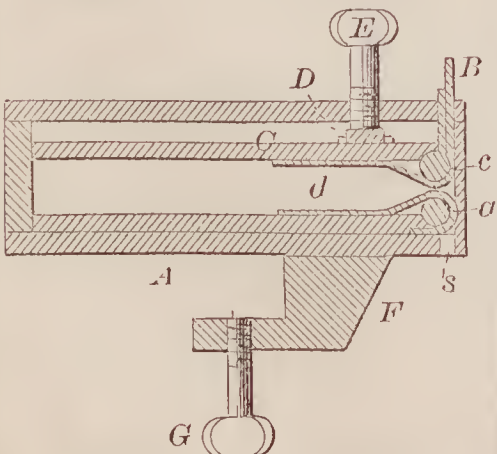

67171—H. Dickinson—*Mould for Casting Ingots.*

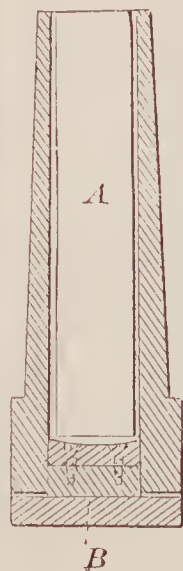

67172—G. Diffenderfer—*Portable Oven for Drying Fruit.*

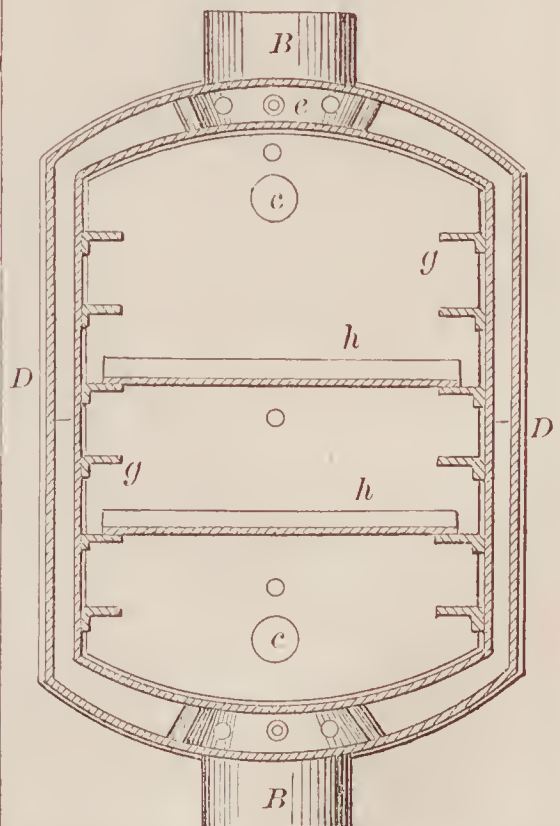



67173—W. A. & C. E. Dryden—Cultivator.

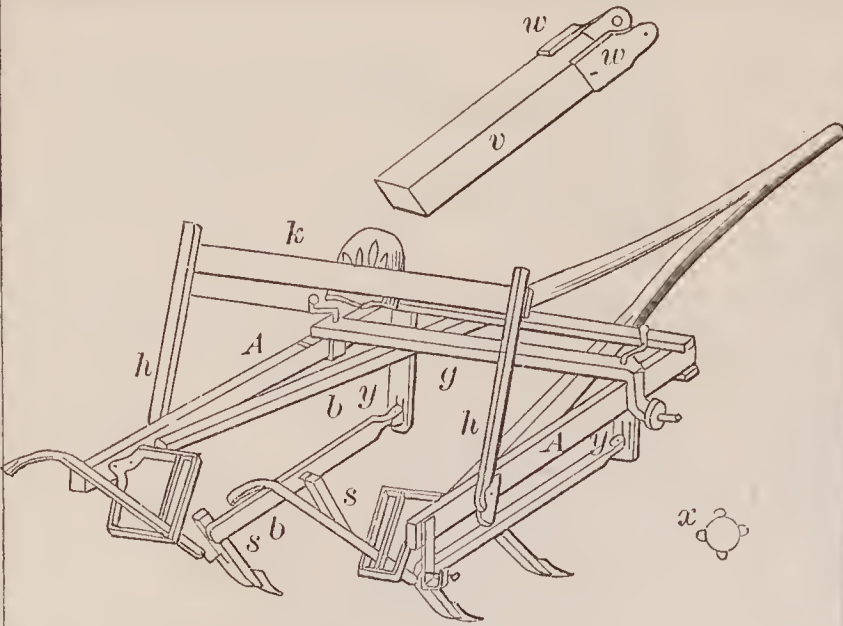

67175—R. Dunbar—Water Wheel.

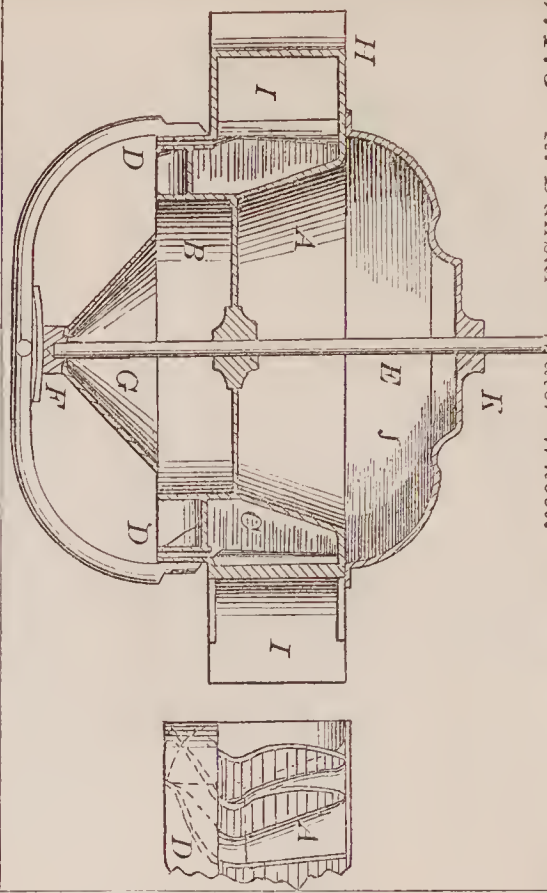

67177—H. V. Edmond—For Exhibiting Hymns

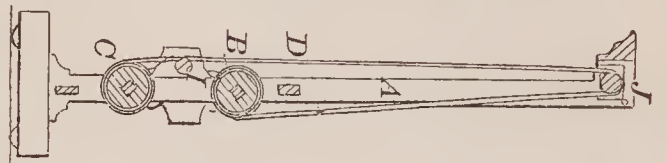

67174—R. Dunbar—Water Wheel.

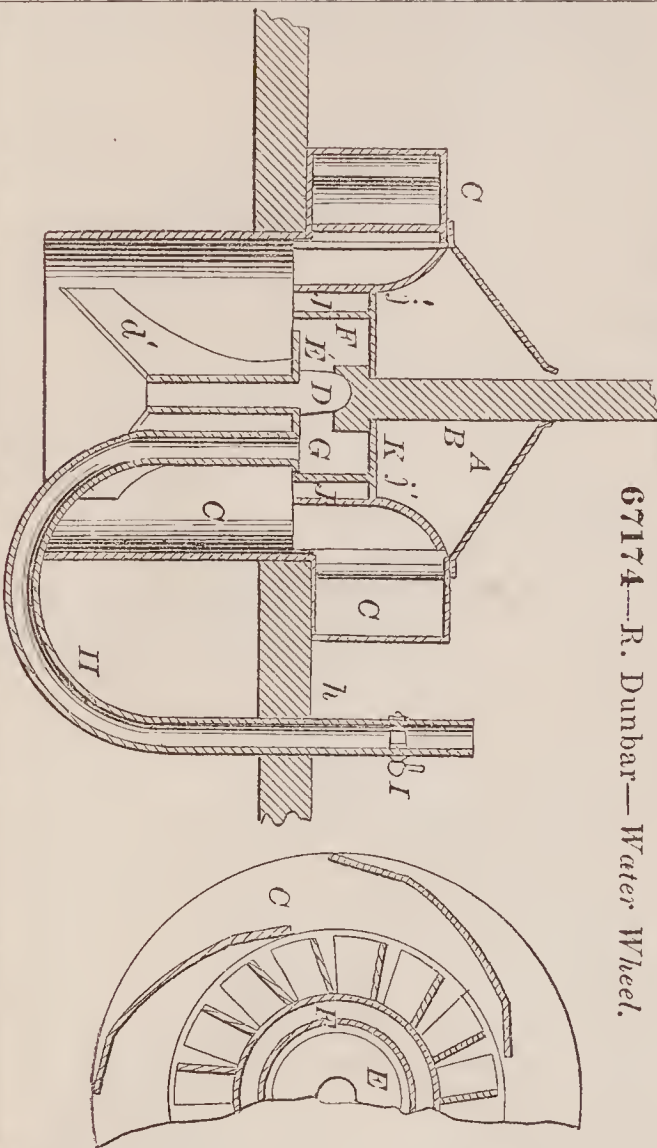

67178—H. L. Eshelman—Harrow.

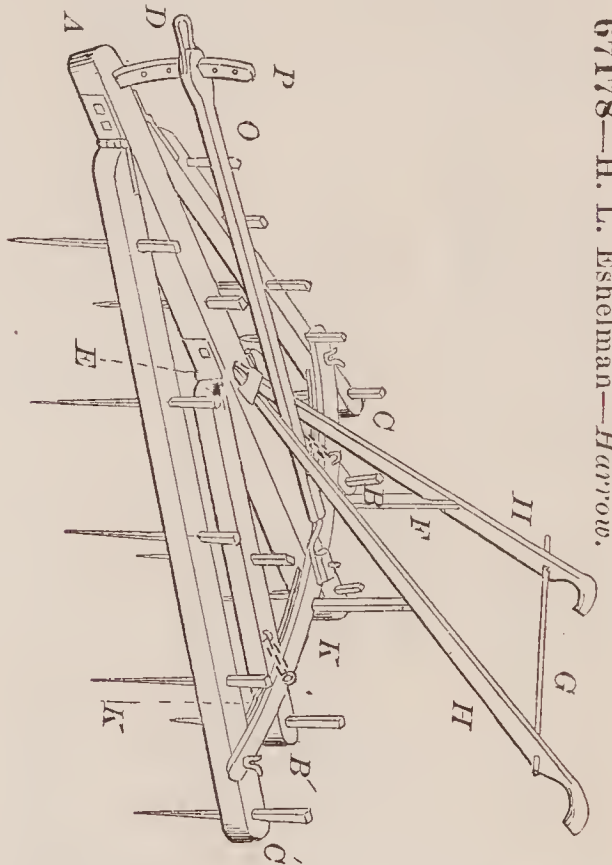

67176—W. A. Duncan—For Raking and Loading Hay.

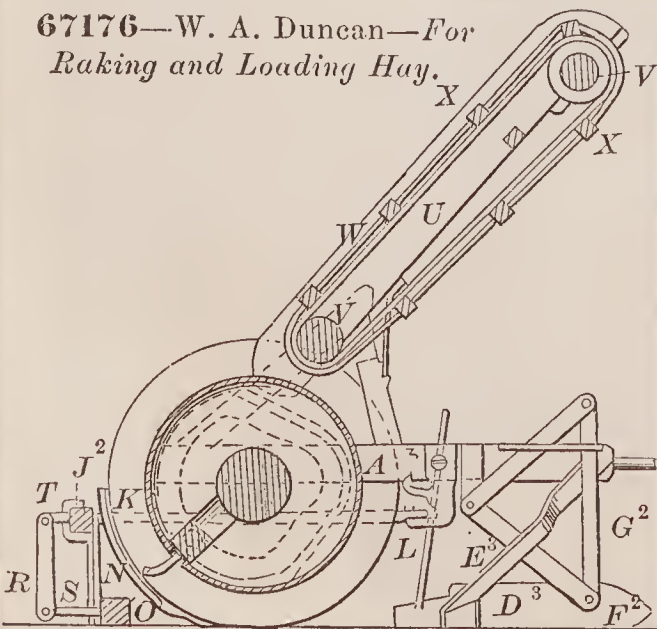

67179—G. A. Fairfield—Thread Controller for Sewing Machines.

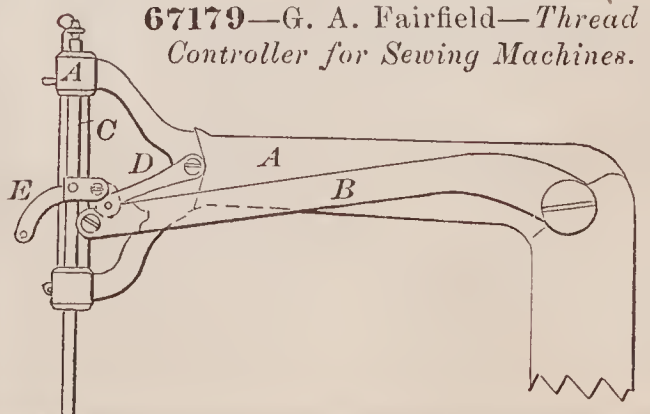



67180—D. P. Farnham—  
*Broom Head.*

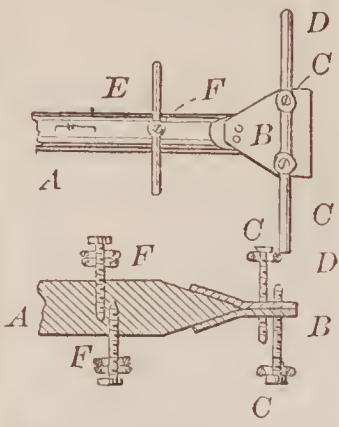

67181—Farrar & Groves—*Mould  
for Casting Metal.*

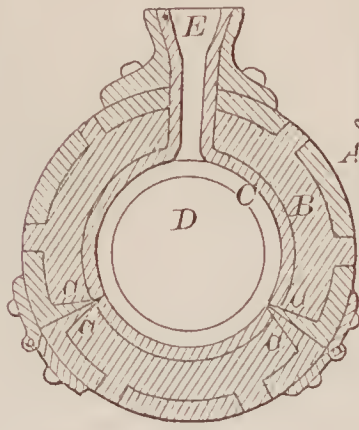

67183—M. T. Fitch—*Ruffling Attachment for  
Sewing Machines.*

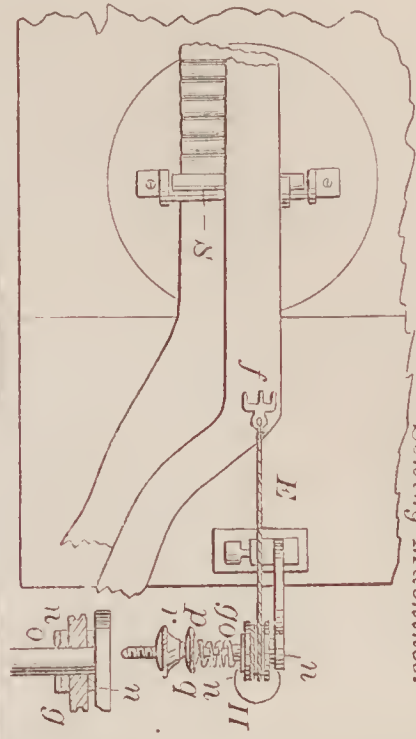

67185—C. Forbes—*Coffee Generator.*

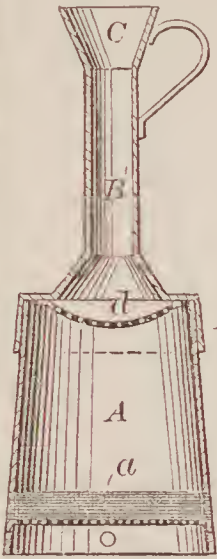

67186—F. Traps—*Spring for Beds  
and Lounges.*

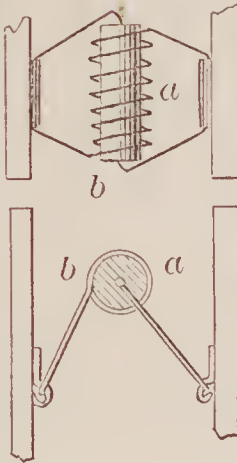

67187—Garland & Morgan—  
*Adjusting Tires to Wheels.*

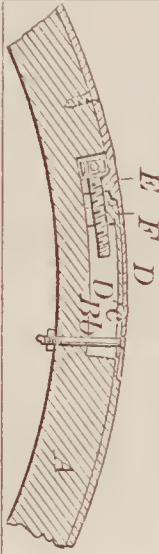

67188—W. Gilman—*Plow Beam.*



67190—D. N. Goff—*For Trimming Percussion  
Caps.*

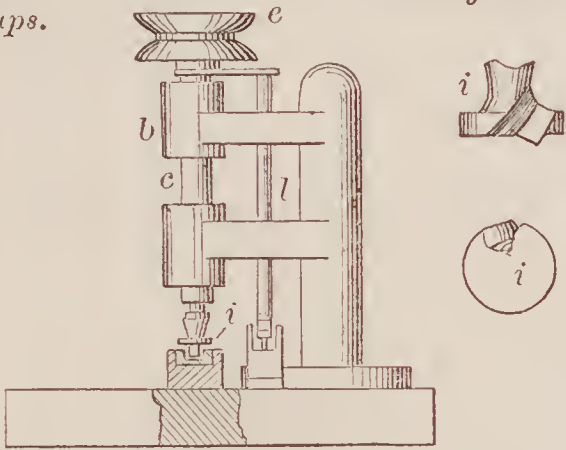

67189—D. N. Goff—*For Lining Percussion  
Caps.*

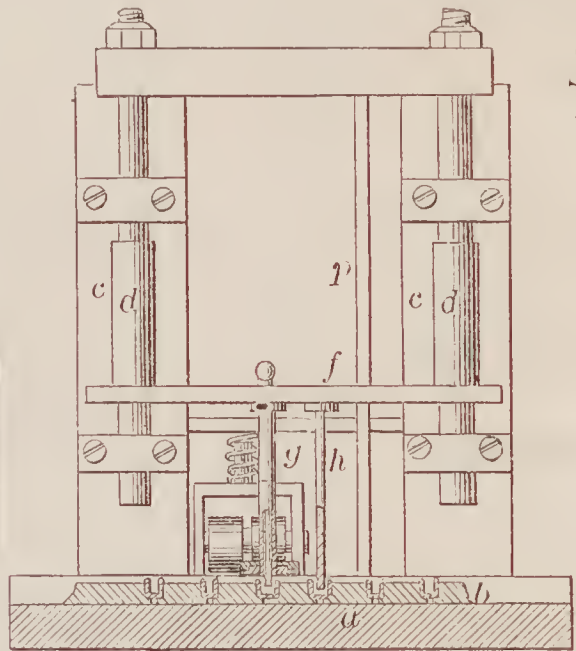

67191—W. S. Gray—*Bread Cutter.*

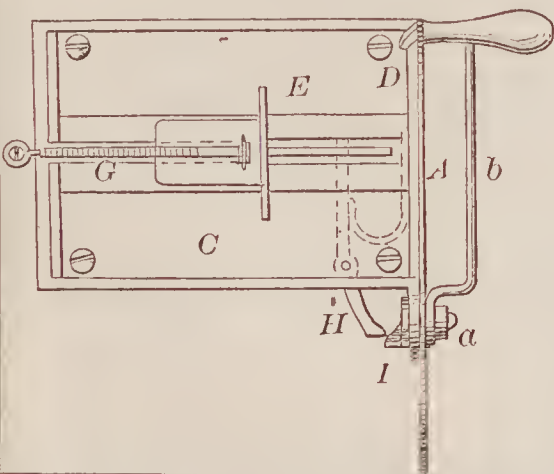

67192—E. L. Hall—  
*Locomotive Head Light.*

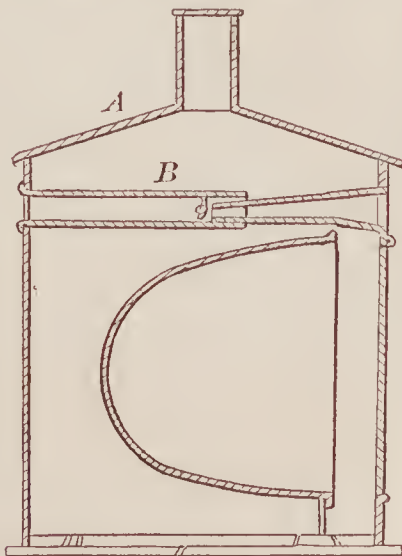

67193—D. B. Hedden—*Step  
Ladder.*

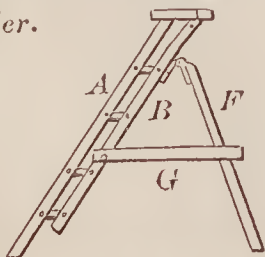

67194—W. H. Menhall—*Tube Hole Cutter.*

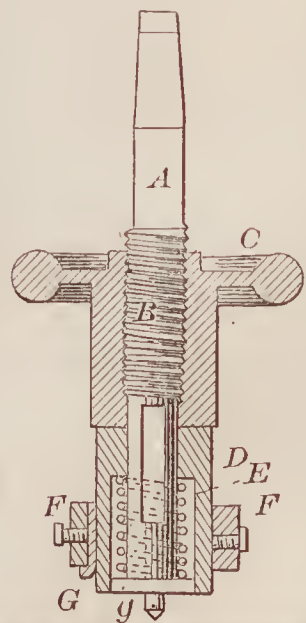



67195—Herrick & Gilbert—For Preparing Floor Oil Cloth.

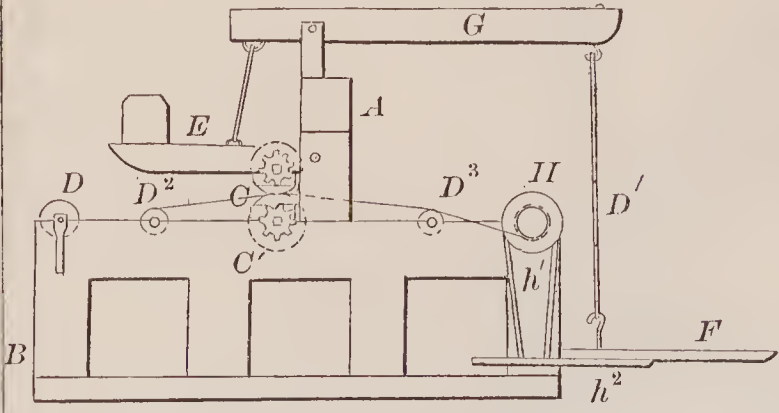

67202—H. & C. Littlefield—Corn Cake Machine.

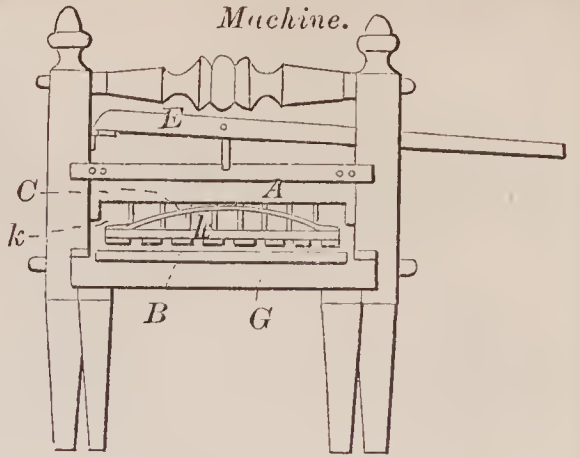

67198—A. Judson—Printing Press.

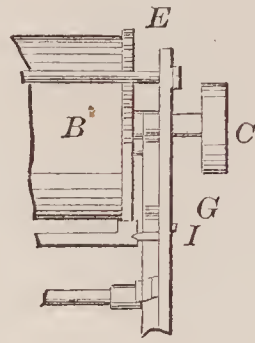
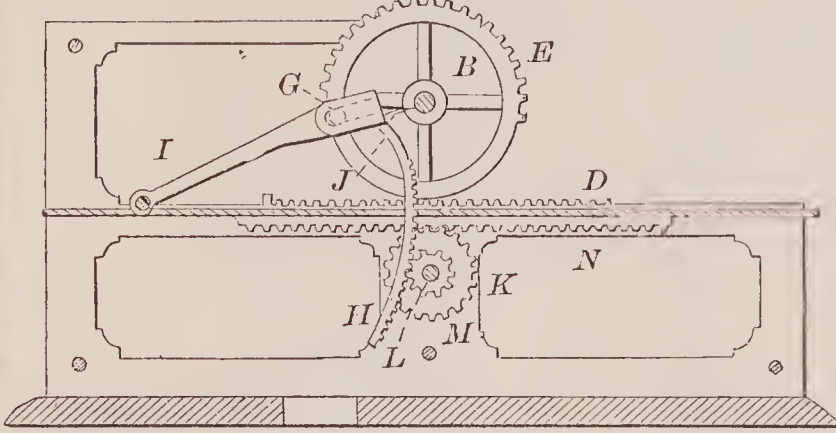

67197—R. J. Jordan—Belt Coupling.

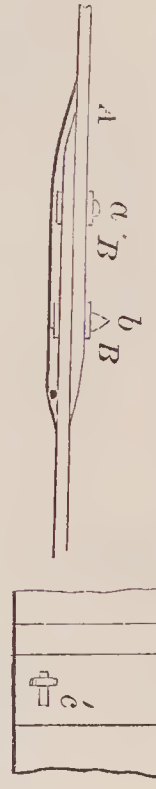

67196—J. L. Howard—Clothes Line Hook.

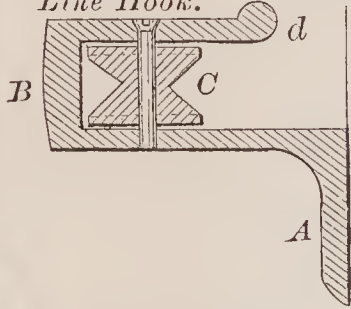

67199—C. S. Kershaw—Suspending Claw for Horse Hay Forks.

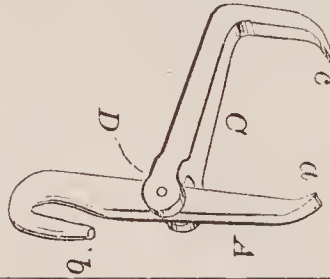

67200—T. K. Knapp—Knife Sharpener.

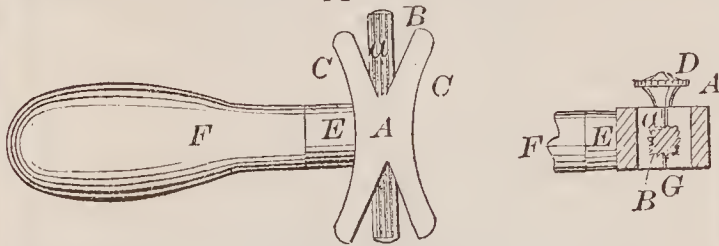

67204—P. C. McManus—Slide Valve.

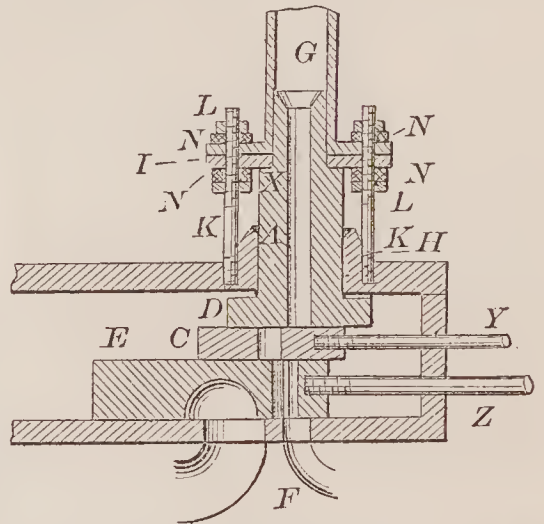

67203—W. C. McGargy—Water Wheel.

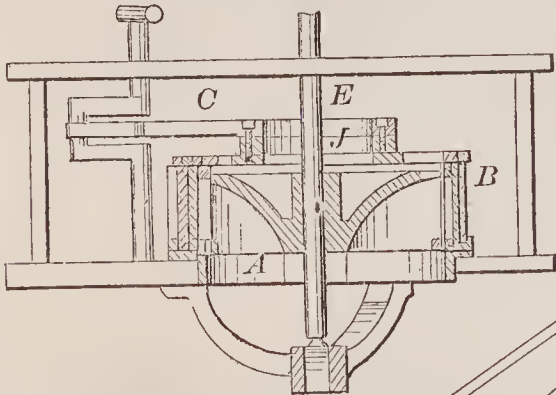

67205—F. McFarnahan—Churn Dasher.

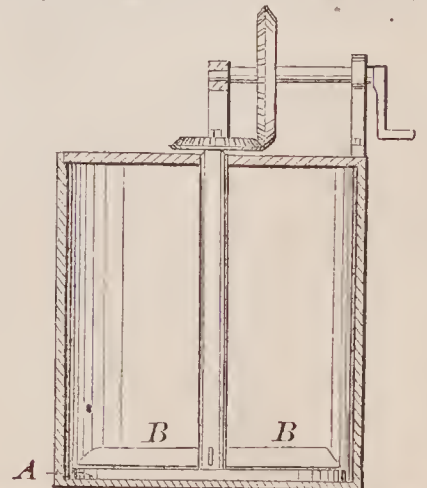

67201—D. Lincoln—Horse Collar.

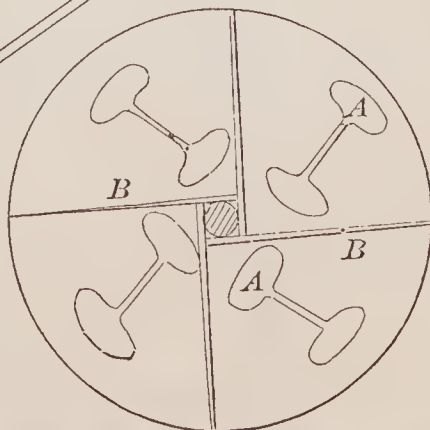
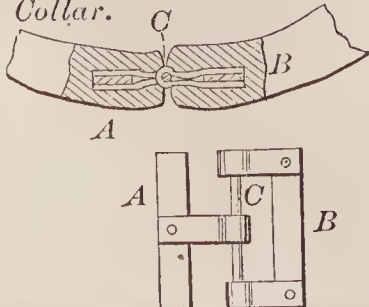

67206—Miller & Chase—Fanning Mill.

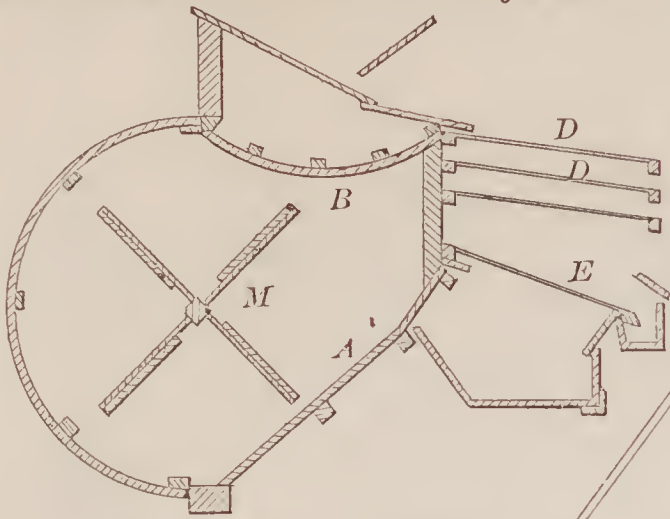

67208—F. B. Morse—Whiffletree Coupler.

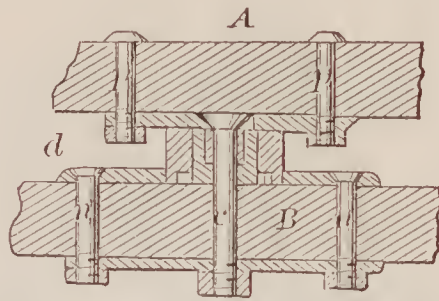

67209—S. O. Blemis—Car Coupling.

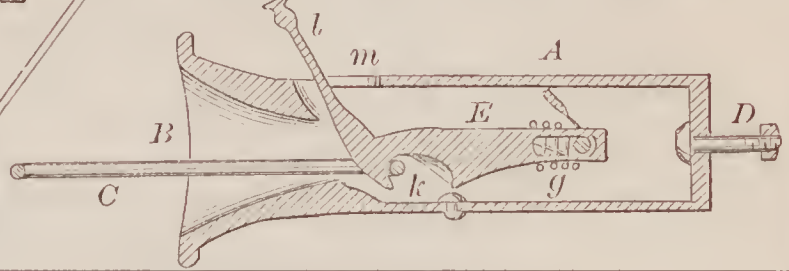

67207—J. O. Minor—Hedge Shears.

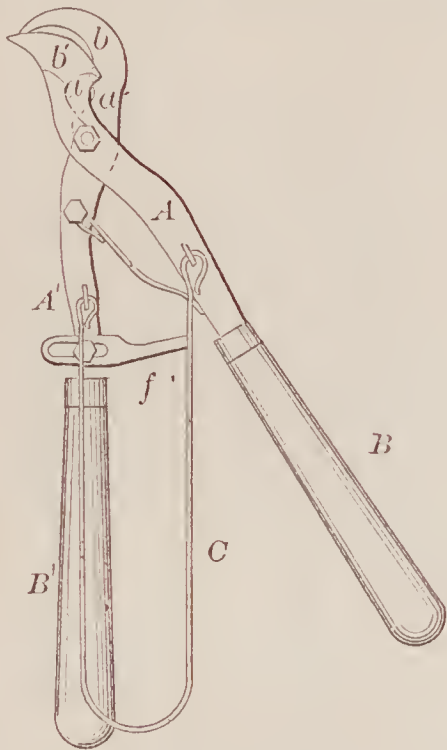

67211—H. Pease—Harvester.

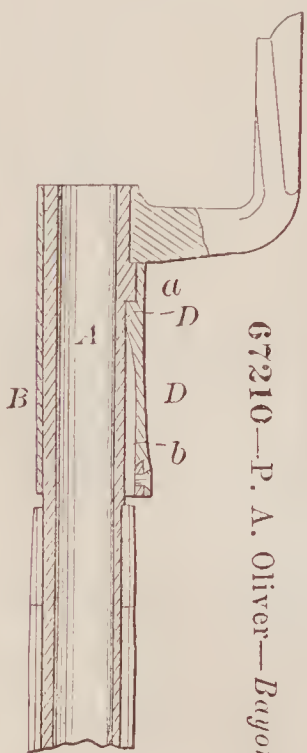
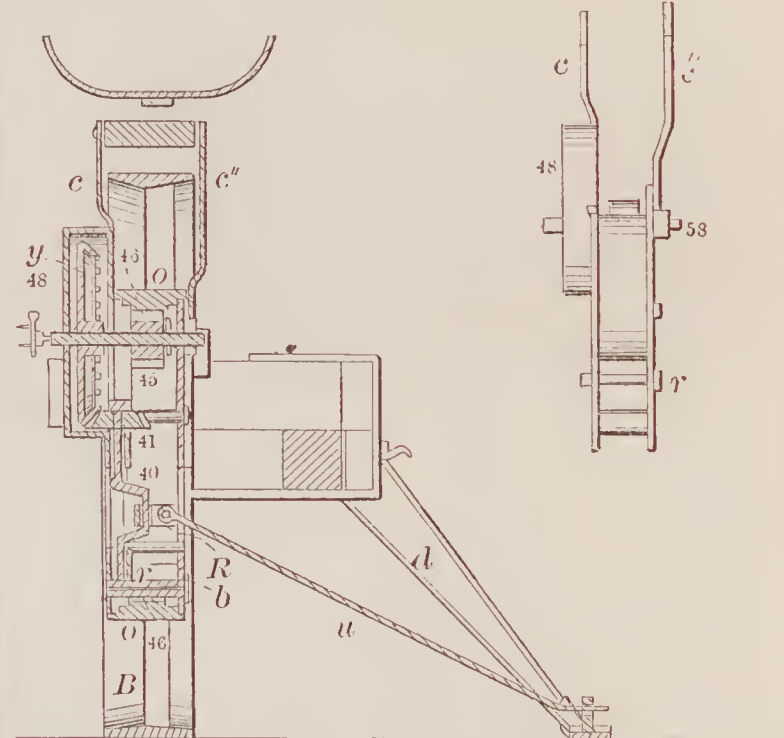
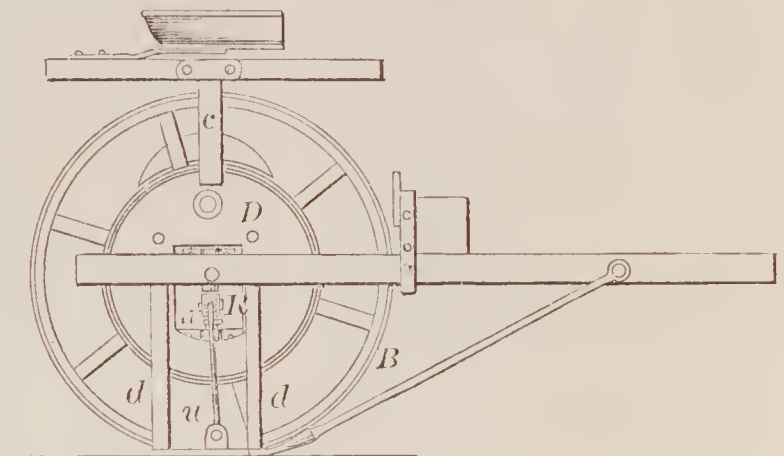

67210—P. A. Oliver—Bayonet Attachment.

67213—N. Petre—Lock Latch.

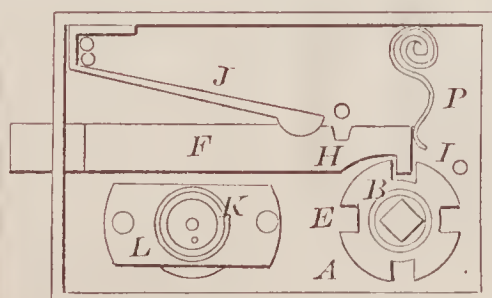

67212—C. Penfield—Door Bell.

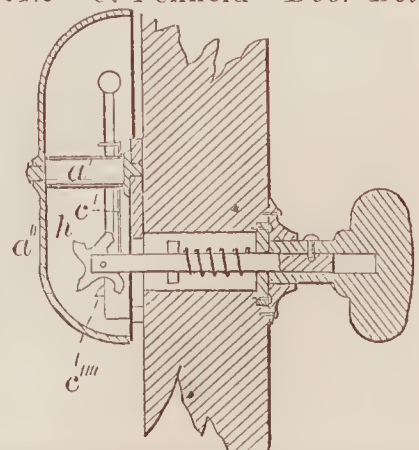



67214—W. H. Pollard—  
*Cut-off Stop Cock.*

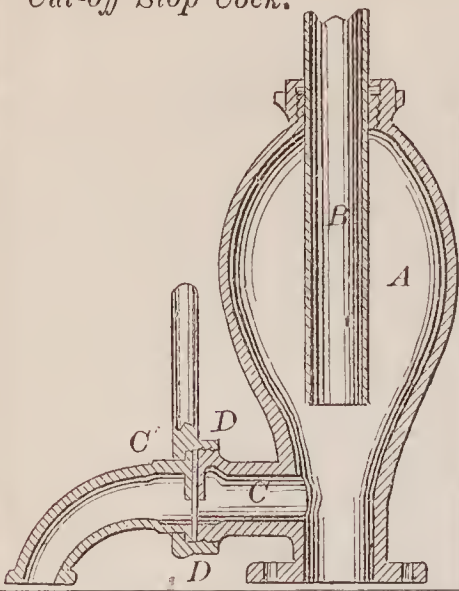

67220—R. S. Sanborn—  
*Fireproof Powder Magazine.*

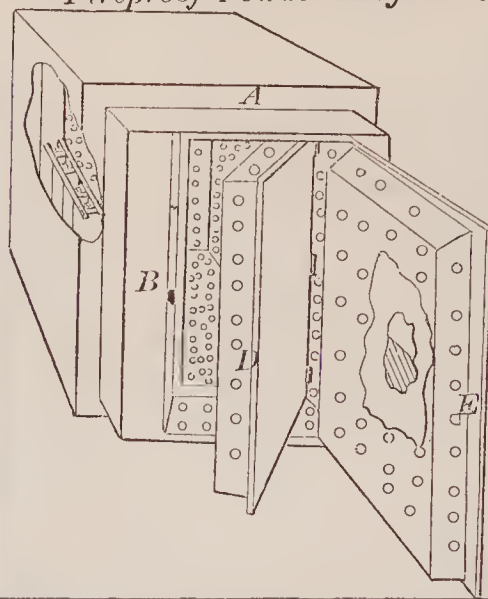

67215—E. Purdy—*For Sealing Fruit Jars.*

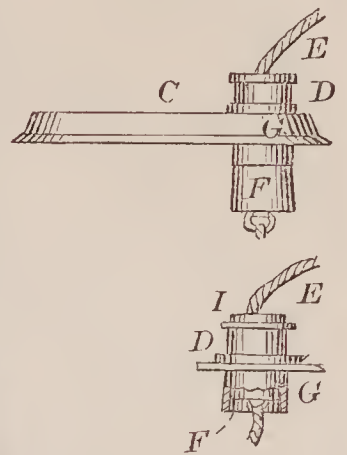

67216—F. Ransom—*Carburetted Apparatus.*

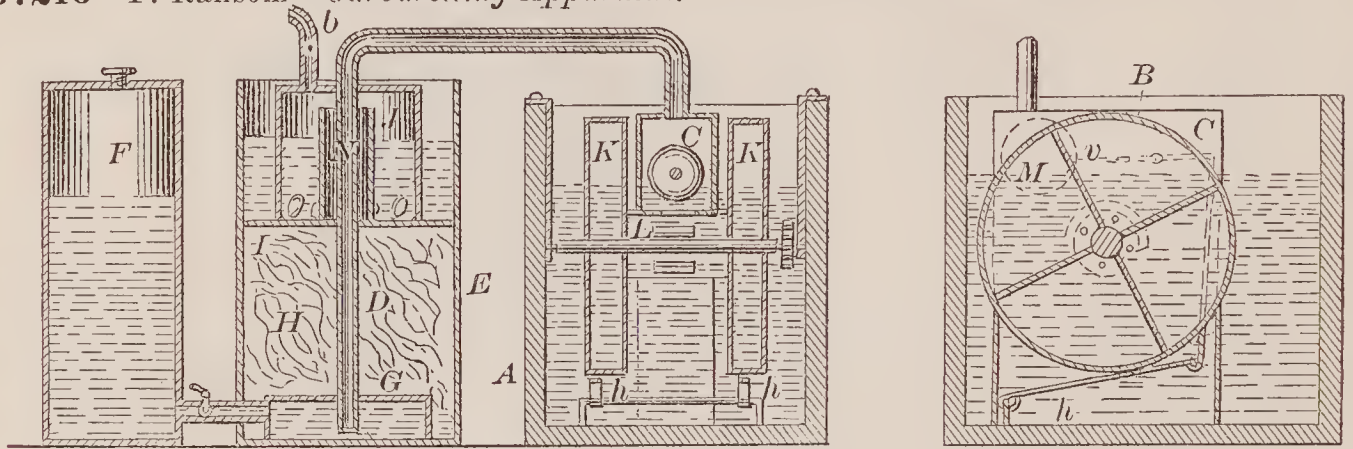

67218—Rosenberry & Worth—*Sifter, Egg Beater and Spice Mixer.*

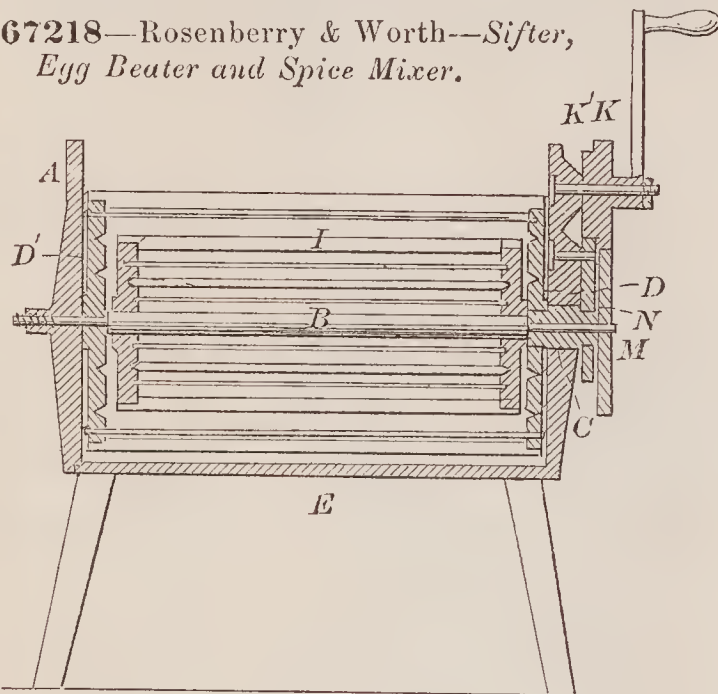

67217—J. T. Rich—*Manufacture of Gas.*

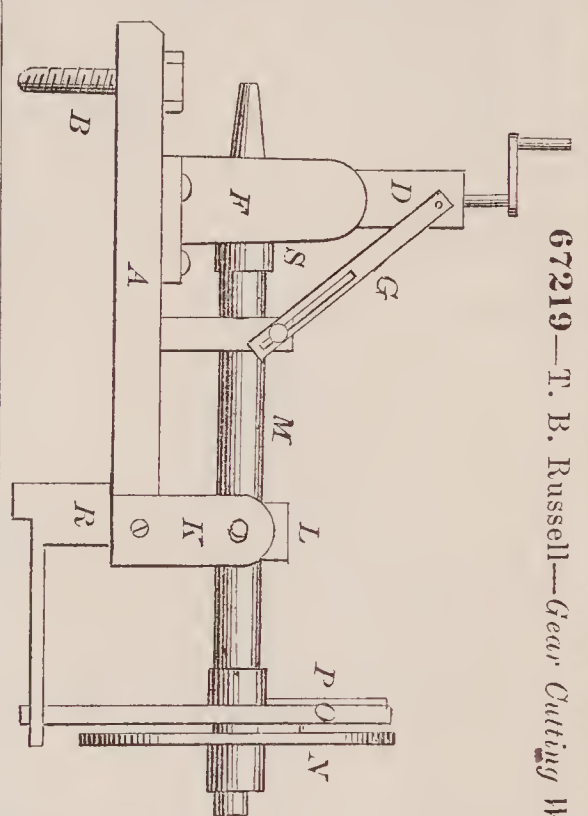
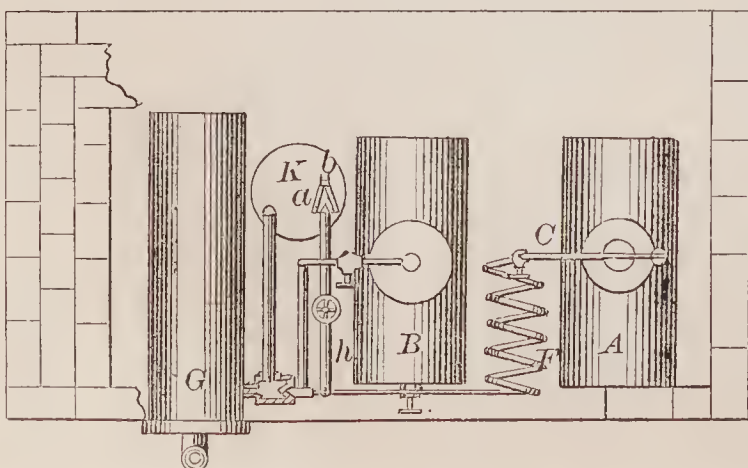

67219—T. B. Russell—*Gear Cutting Wheel.*

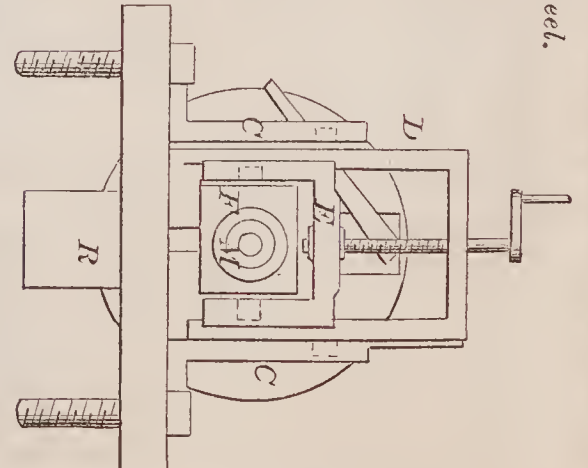

67221—Seymour & Taylor—*Horse Rake and Hay Spreader.*

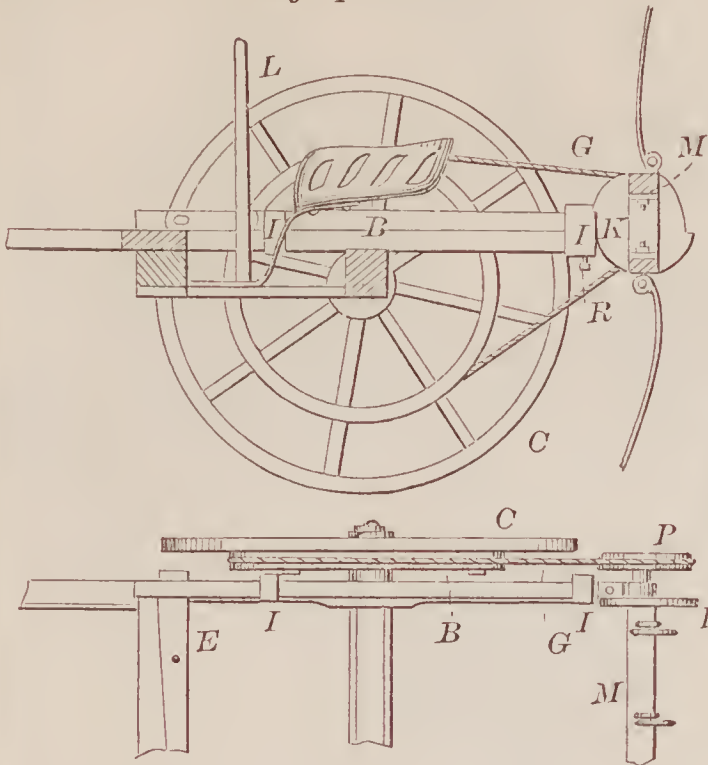

67223—O. F. Stedman—*Watch.*

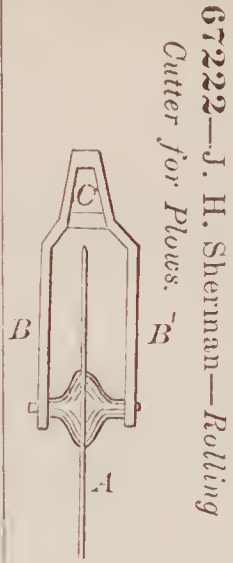
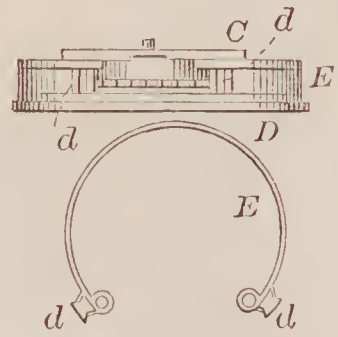

67222—J. H. Sherman—*Rolling Cutter for Plows.*

67225—F. Stone—*Oiler.*

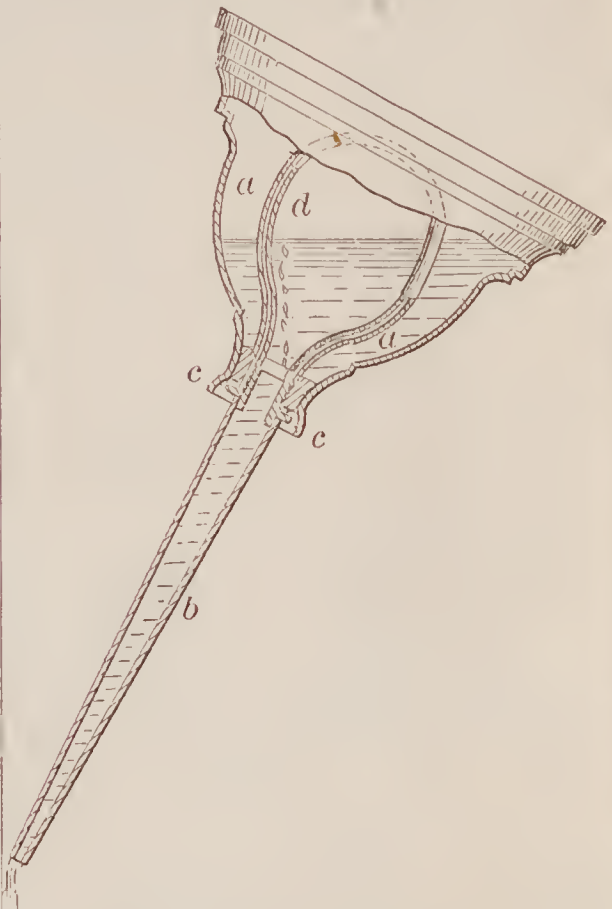

67226—D. Tainter—*Feeding Apparatus for Carding Machines.*

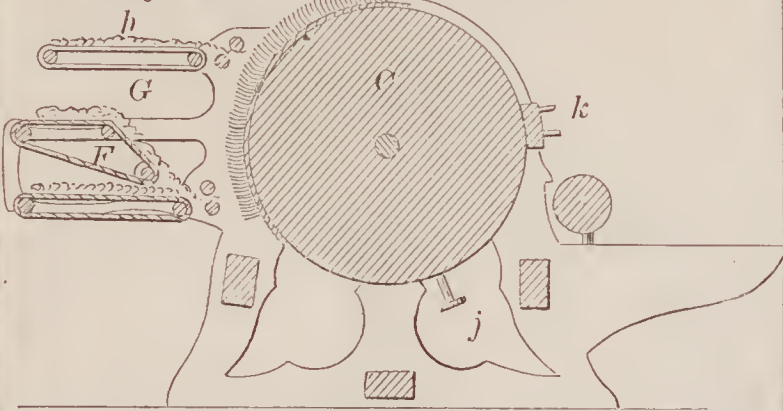

67227—J. B. Tarr—*Cast Steel Car Wheel.*

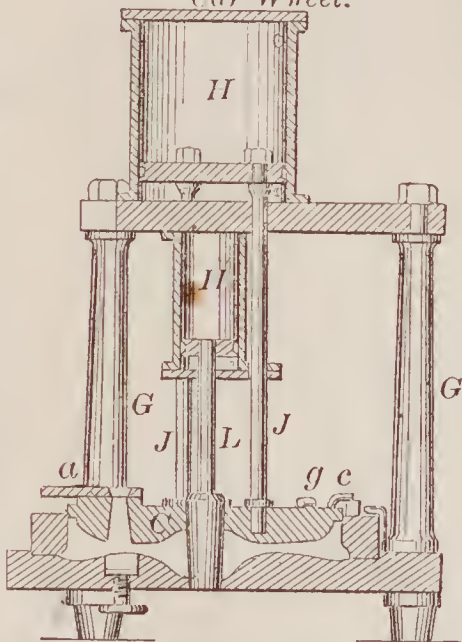

67230—D. R. Torbet—*Cotton Press.*

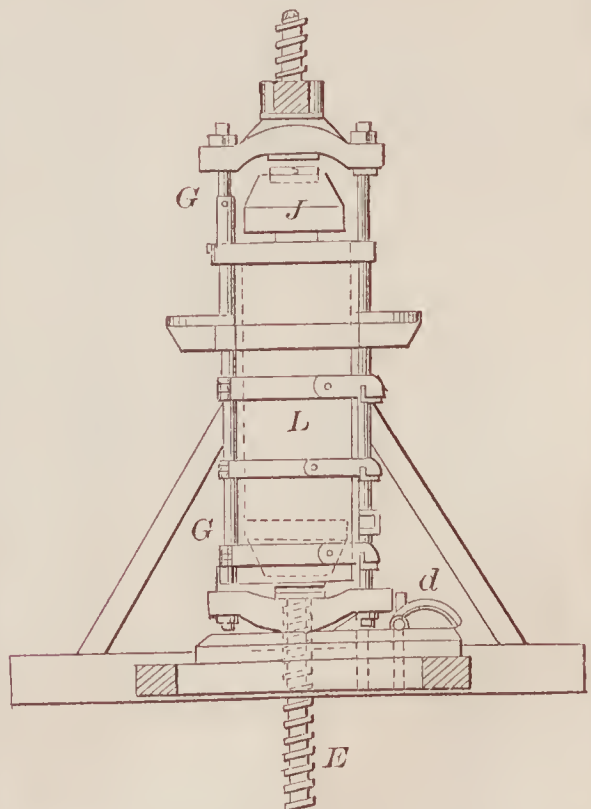

67224—O. F. Stedman—*Watch Case.*

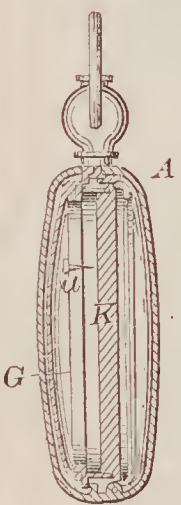

67228—W. Templeton—*Milk Pan.*

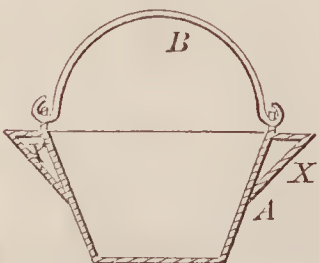

67231—C Ulmer—*Cotton Bale Tie.*

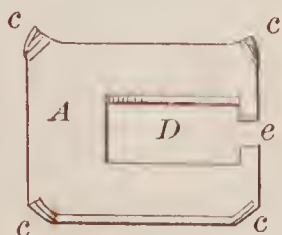



67232—M. Vanderhoven—Dust Pan.

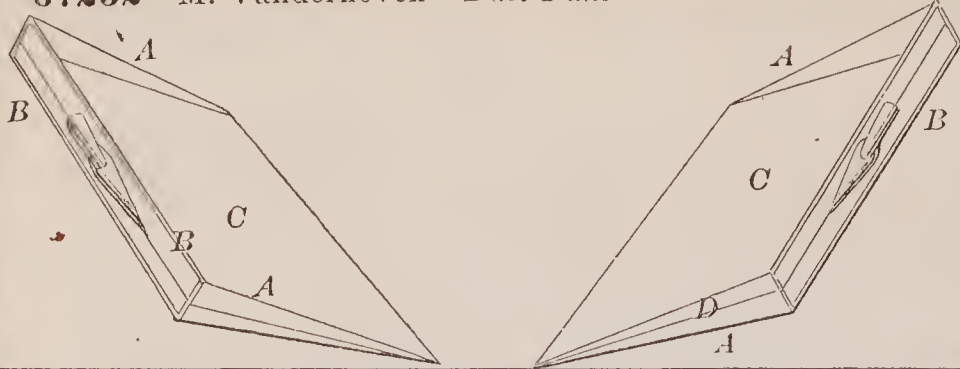

67238—Webster & Prescott—Red Bottom.

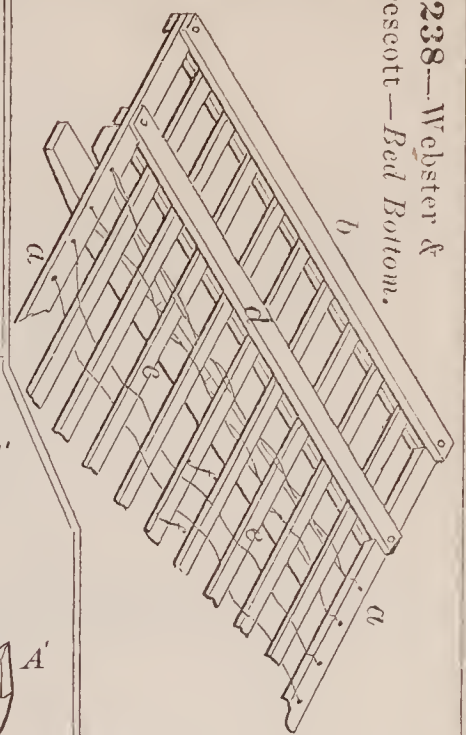

67237—T. Weaver—Whip Socket.

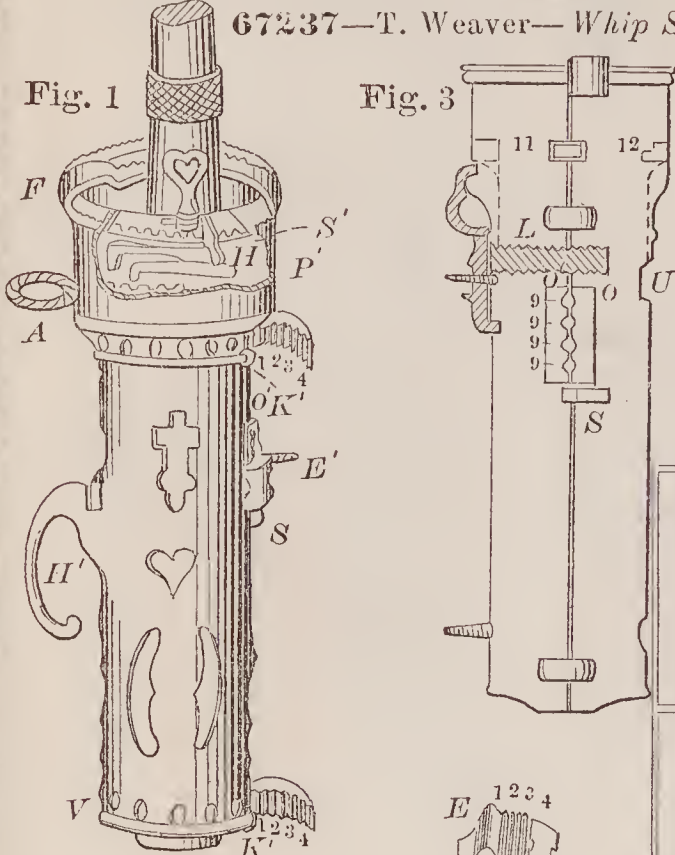

67234—J. D. Van Zandt—Cork Pull.

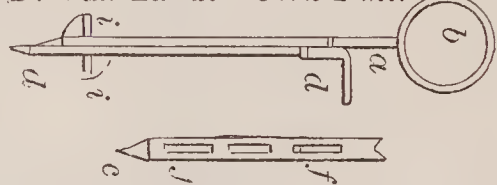

Fig. 4

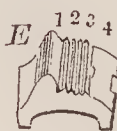
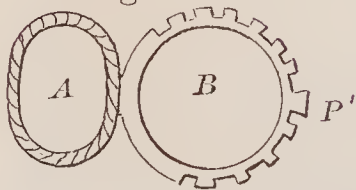
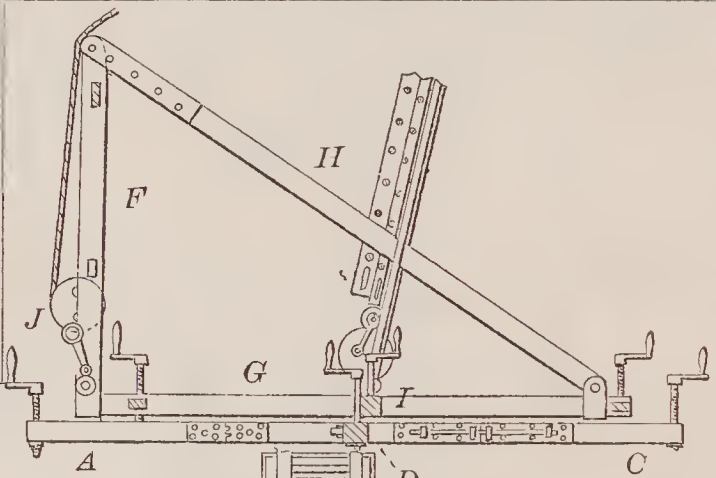
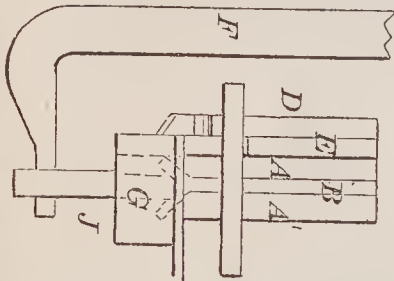

Fig. 5

67239—C. Weidling—Fire Escape.



67236—C. W. Wailey—Die for Forming Cotton Ties.



67235—T. Vogelmann—Step Ladder.

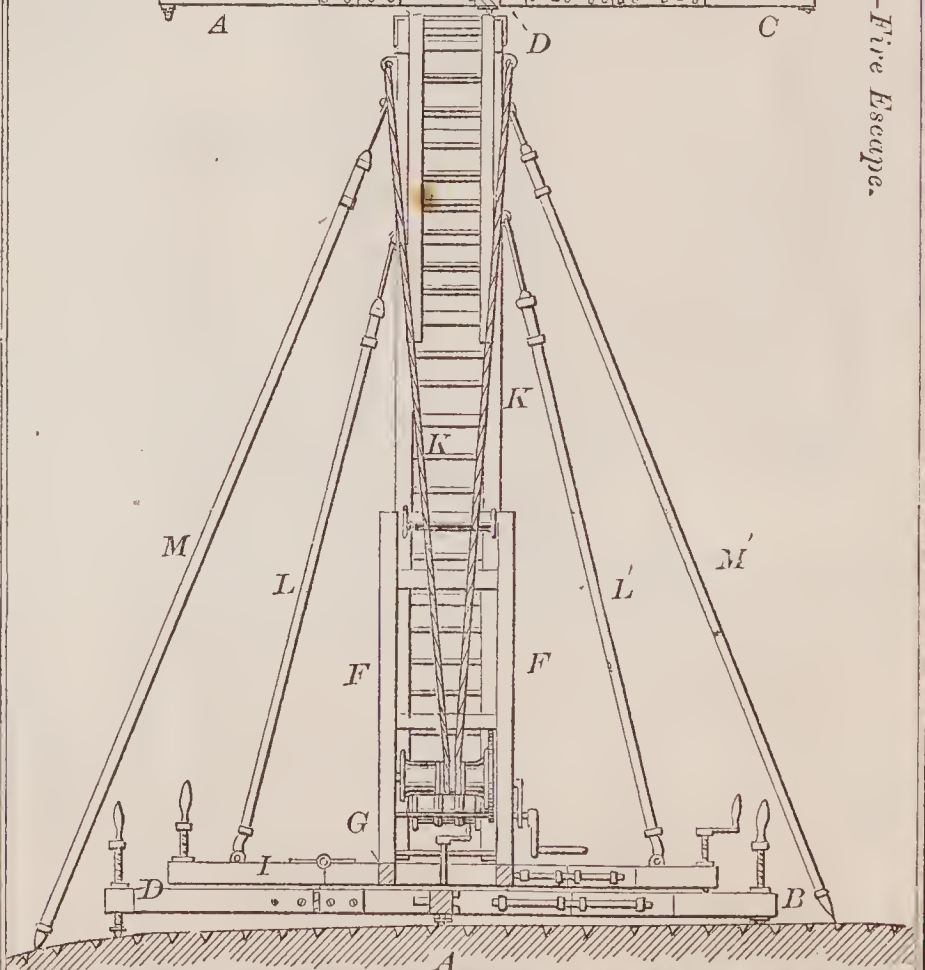
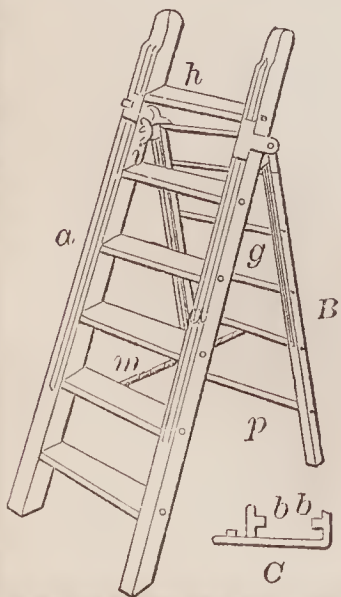

67240—E. Weissenborn—For Polishing Wood. See fig. below.

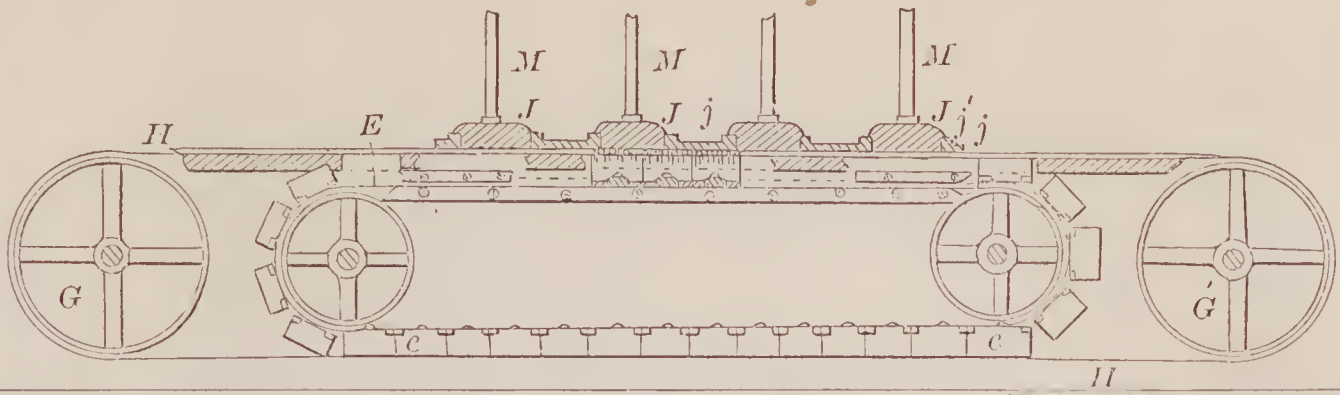

67243—Y. F. Wright—Cotton Press.

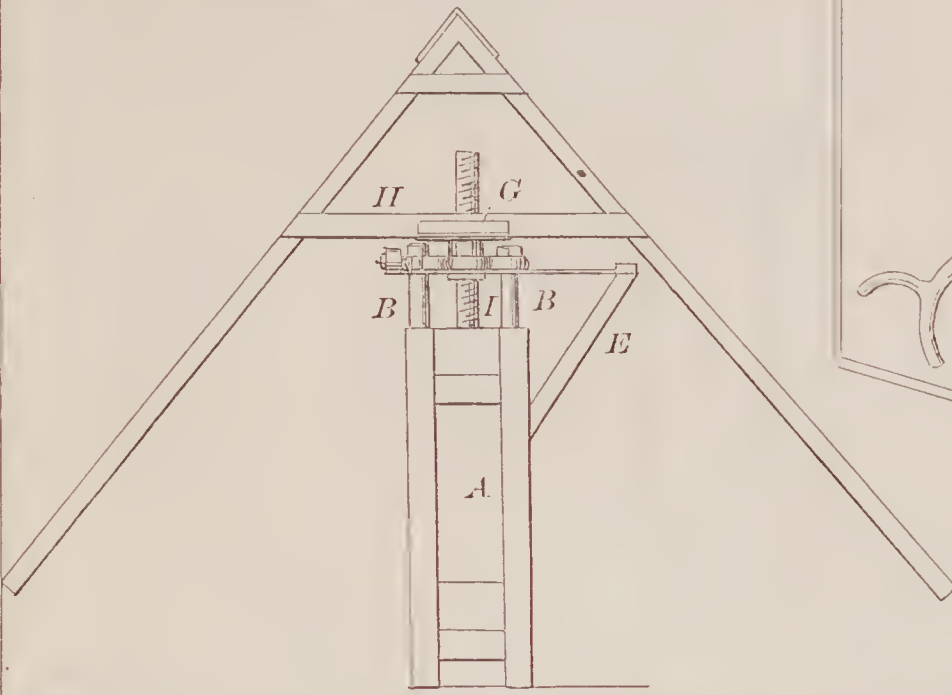

67242—J. A. Whitney—Magazine Fire Arm.

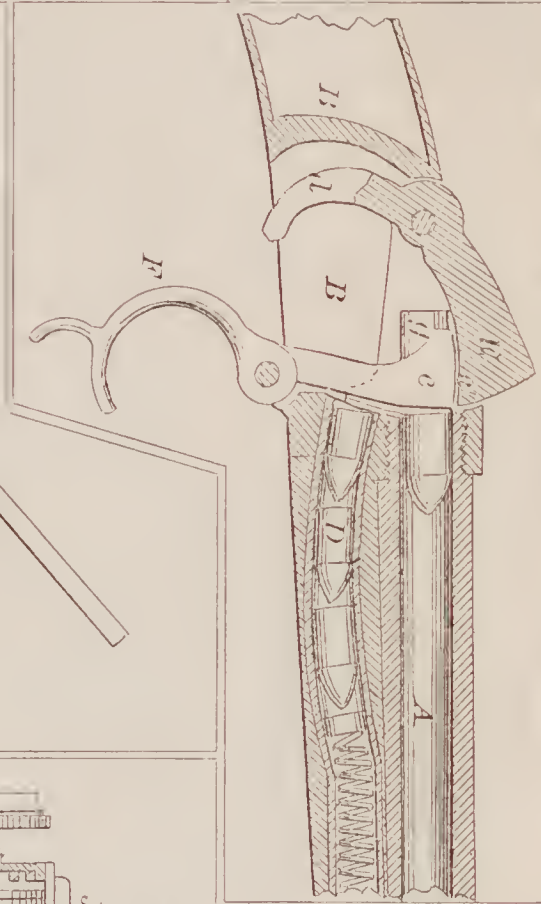

67244—J. Zimmerman—Lamp for Destroying Insects.

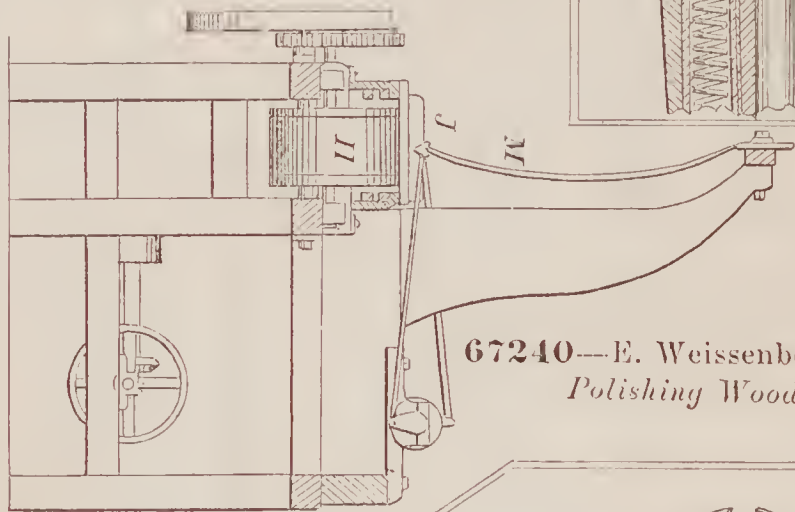
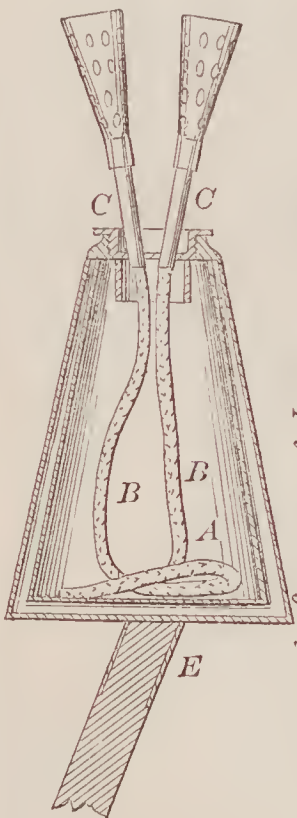

67240—E. Weissenborn—For Polishing Wood.

67245—W. H. Alcorn—Slate Pencil Sharpener and Holder.

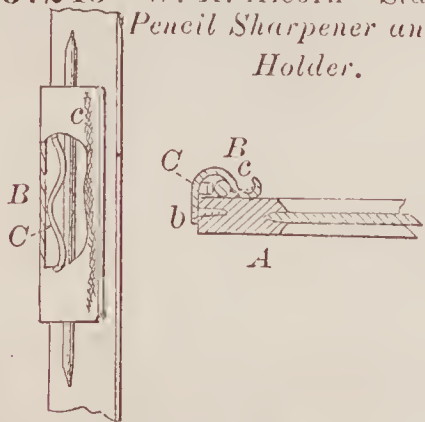

67246—J. E. Alger—Oyster Opener.

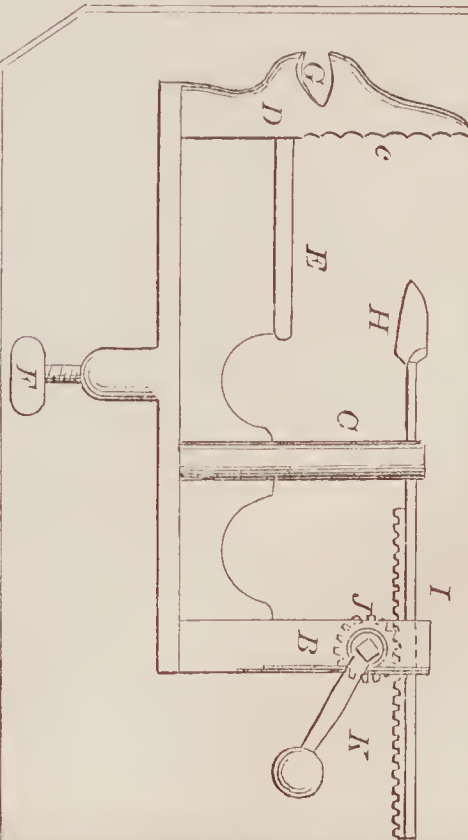

67241—N. F. Weston—Construction of Vessels.

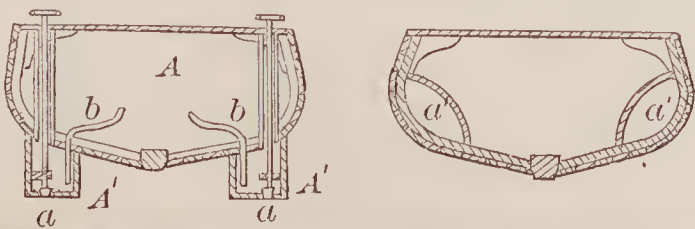



67248—C. L. Andrews—*Washing Machine.*

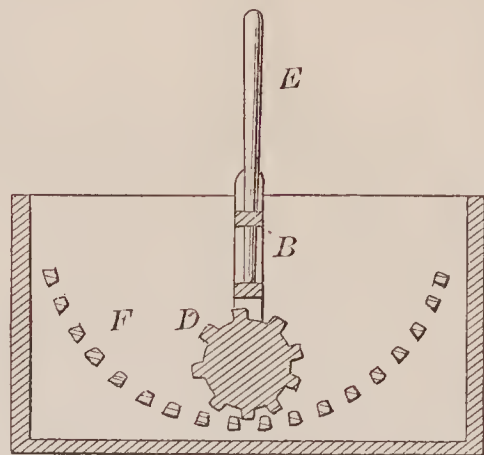
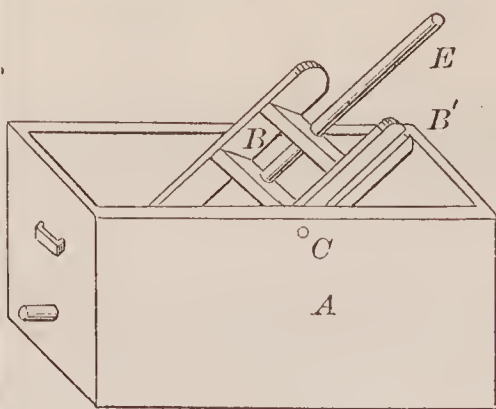

67247—Ames & Horton—*Brush Rack.*

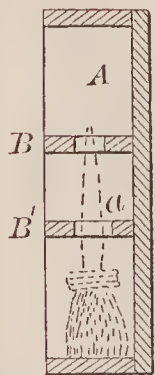

67251—J. F. Beckwith—*Stove Pipe Drum.*

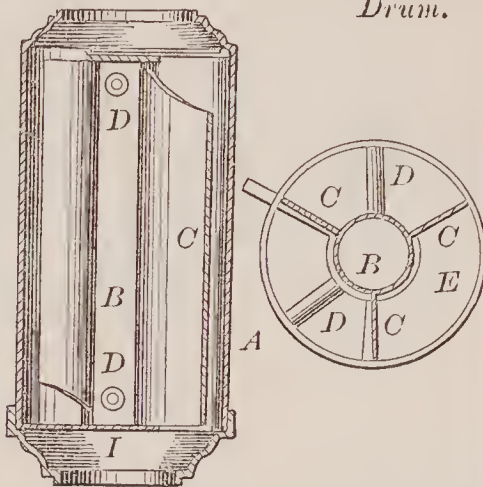

67250—Beal, Sawyer & Webster—*Paper Corset.*



67249—H. A. Barnard—*For Packing Flour.*

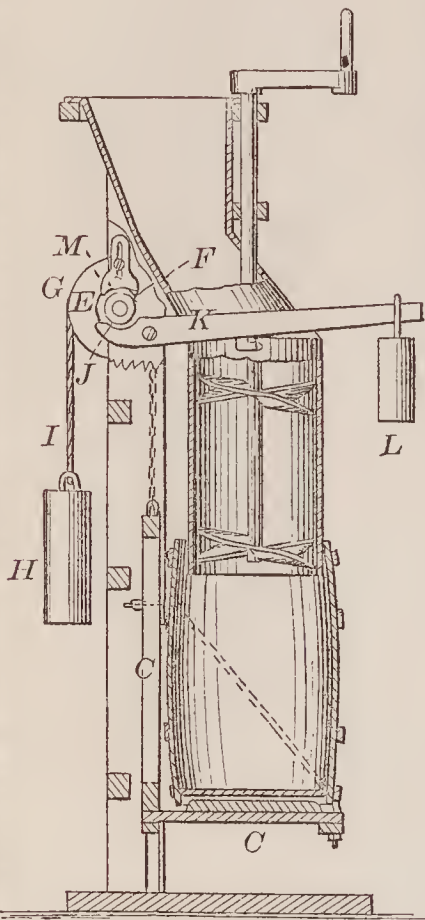

67253—A. S. Blake—*For Lining Percussion Caps.*

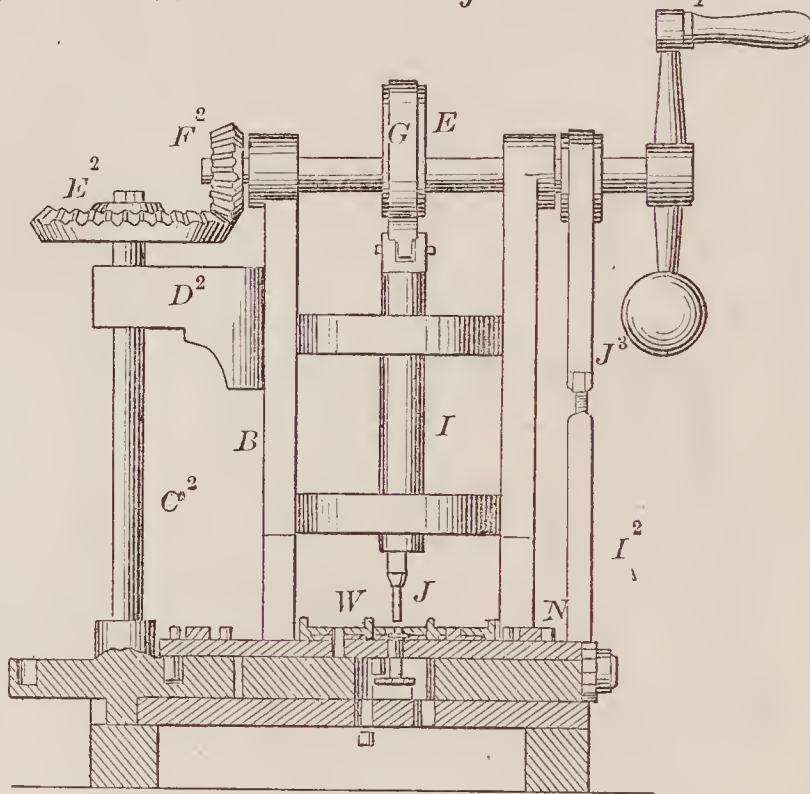

67252—C. Billups—*Corn and Cotton Scraper.*

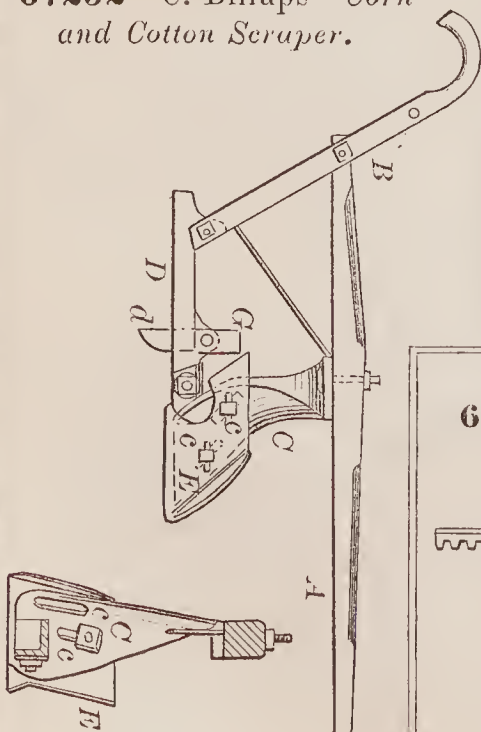

67254—W. Bliesner—*Meat Cutting Machine.*

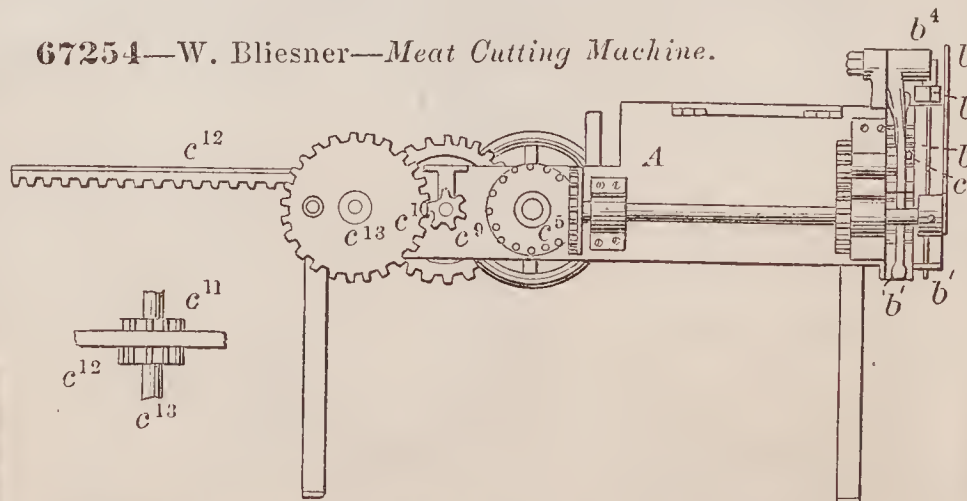



67255—C. T. Boardman—Steam Generator.

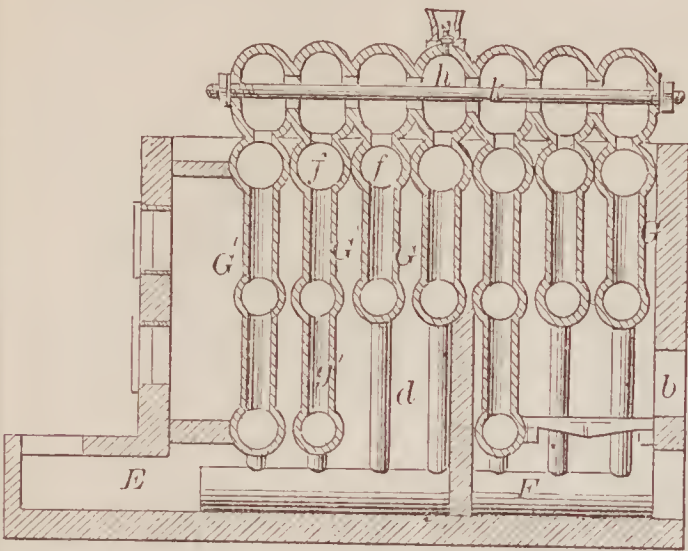

67260—J. J. Bradner—Fanning Mill.

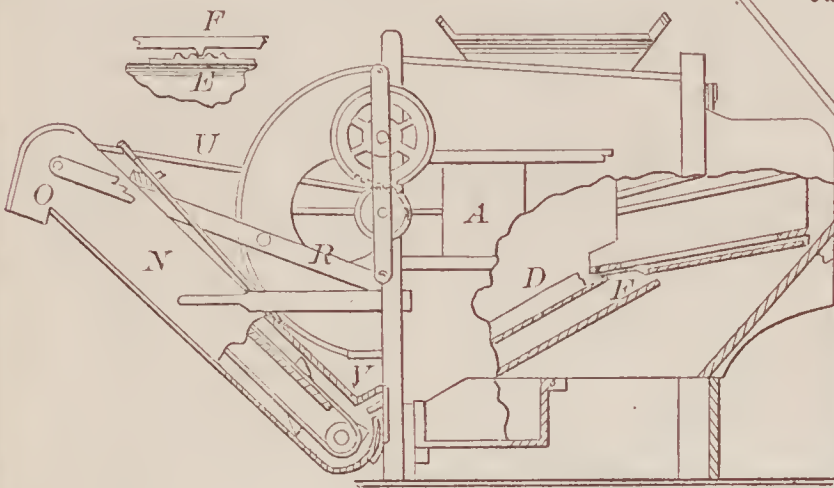

67256—H. Boden—Grain Dryer.

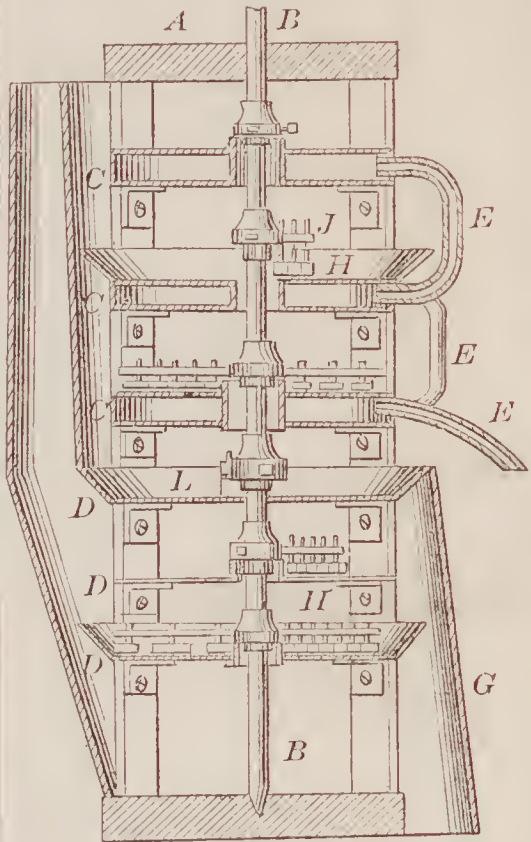

67261—J. D. Burdick—Stream Cutter.

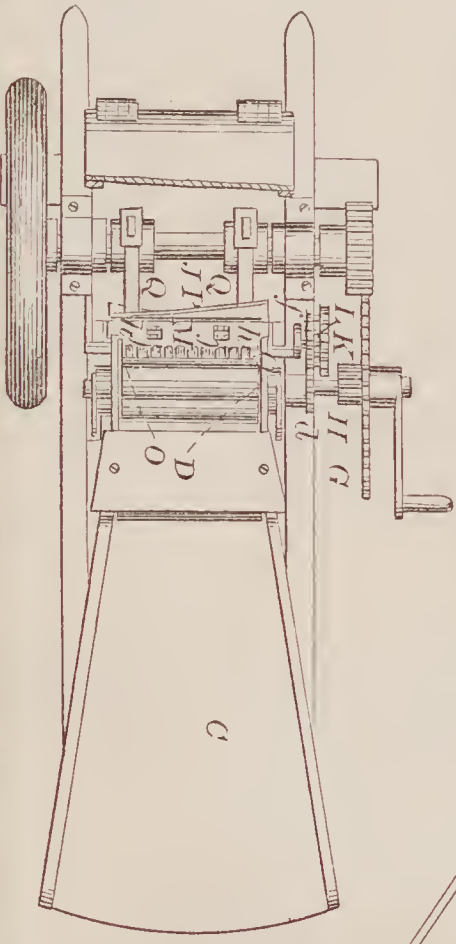

67258—J. C. Bonnell—Sash Support and Fastener.

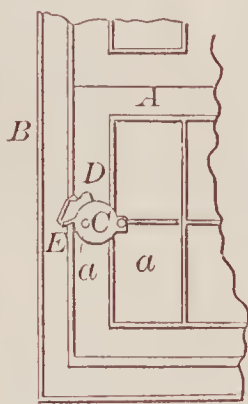

67259—F. B. Bouseatic—Watch.

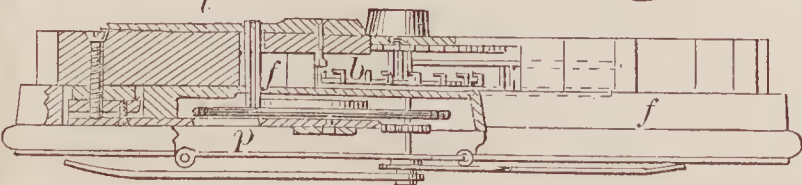

67257—J. C. Bonnell—Suspension Turn Table.

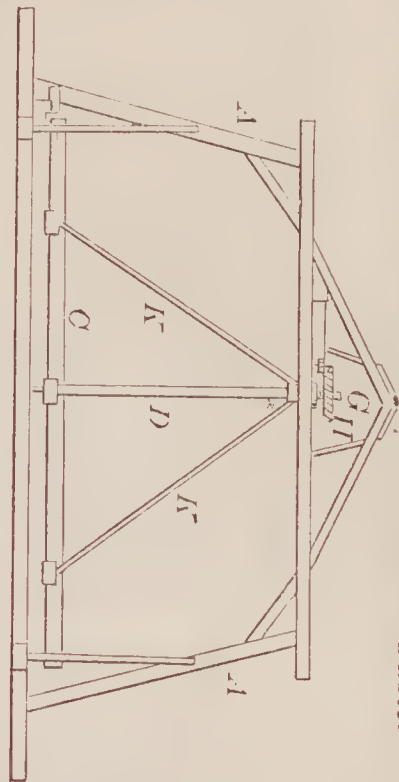

67262—D. H. Buzzee—For Laying Rubber Sheets to be Cut into Threads.

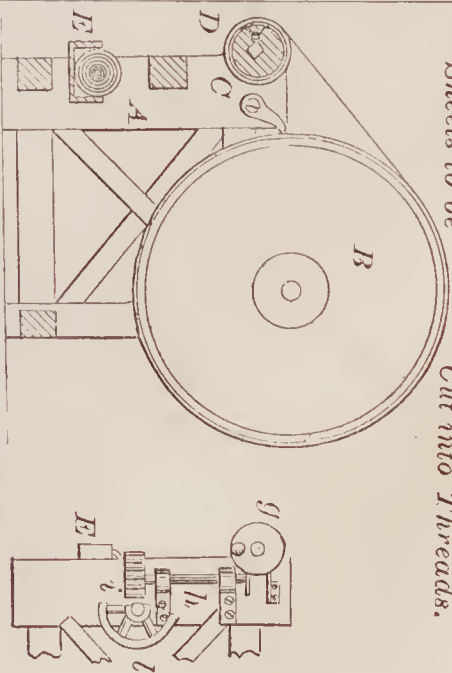



67263—A. C. Carey—*Knitting Machine.*

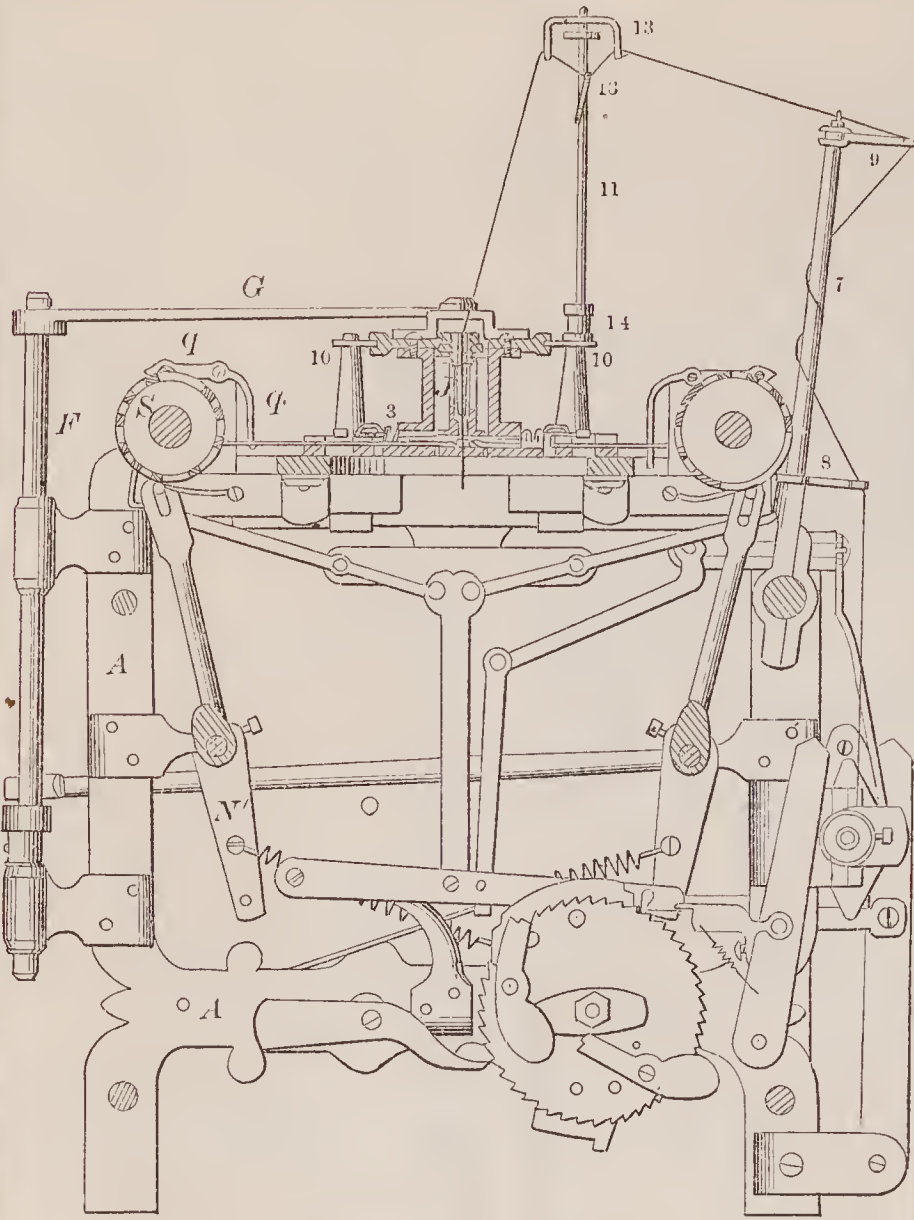

67264—A. C. Carey—*Machine Knitted Stocking.*



67267—V. Charlet—*Button.*

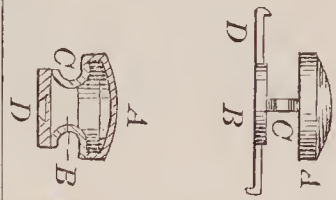

67266—C. J. Chalfant—*Churn.*

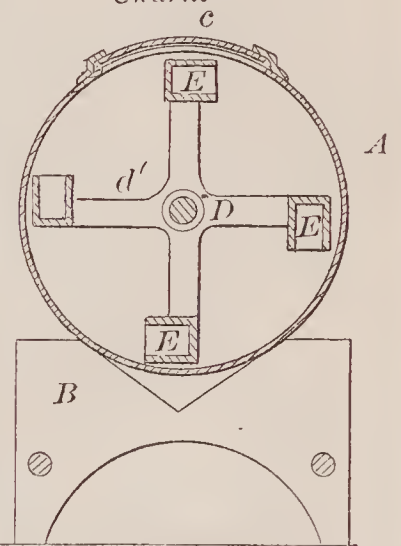

67268—E. Christianson—*Hemp Brake.*

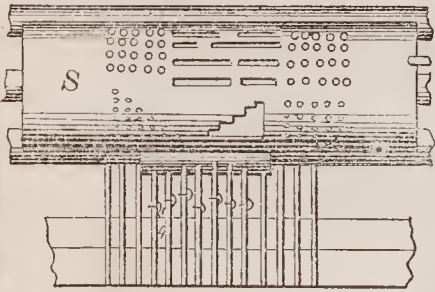
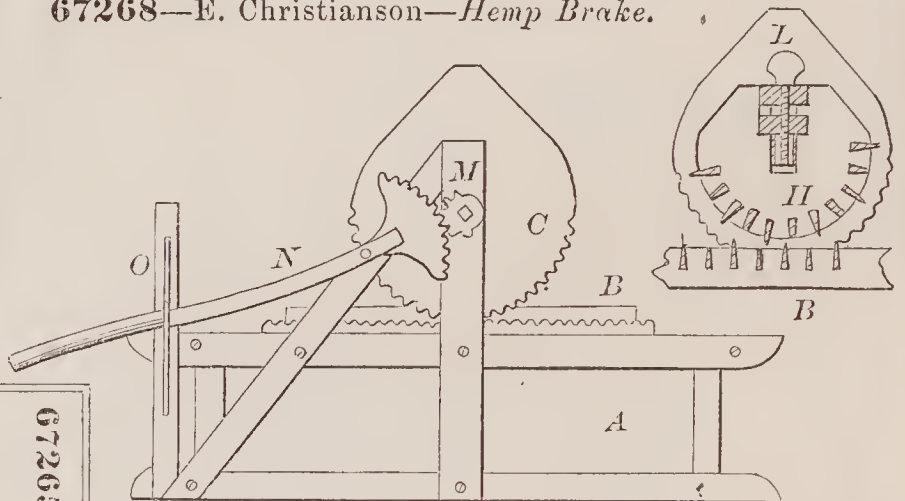

67269—F. J. Coffin—*Slide for Rules, Scales and Tables.*

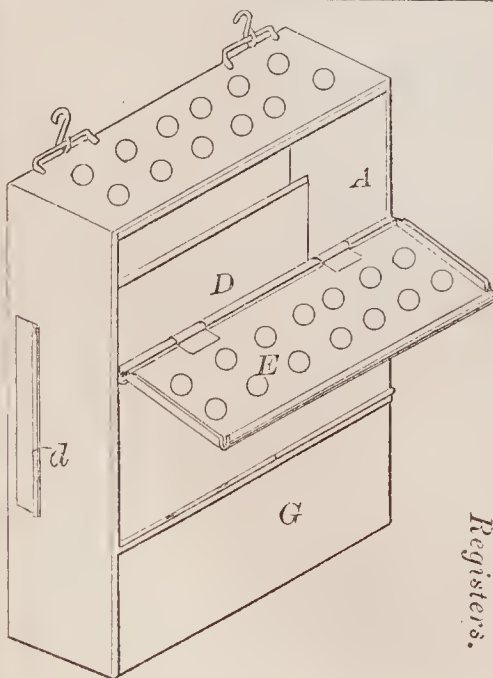
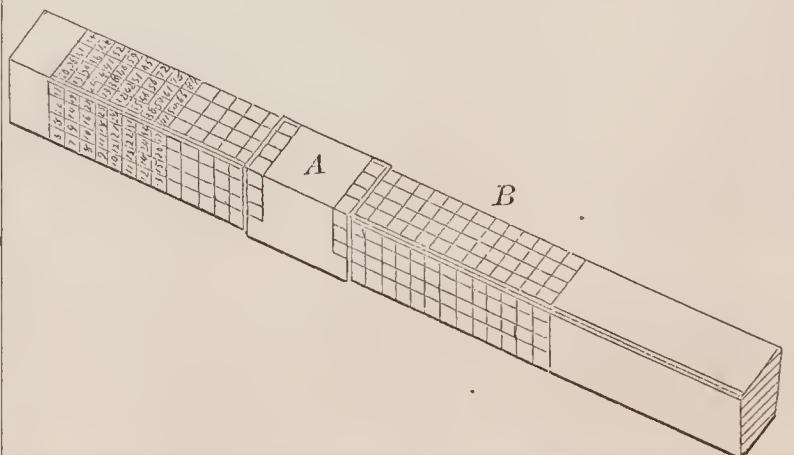

67265—S. H. Canby—*Deflector for Hot Air Registers.*

67270—I. A. Coons—Clothes Dryer.

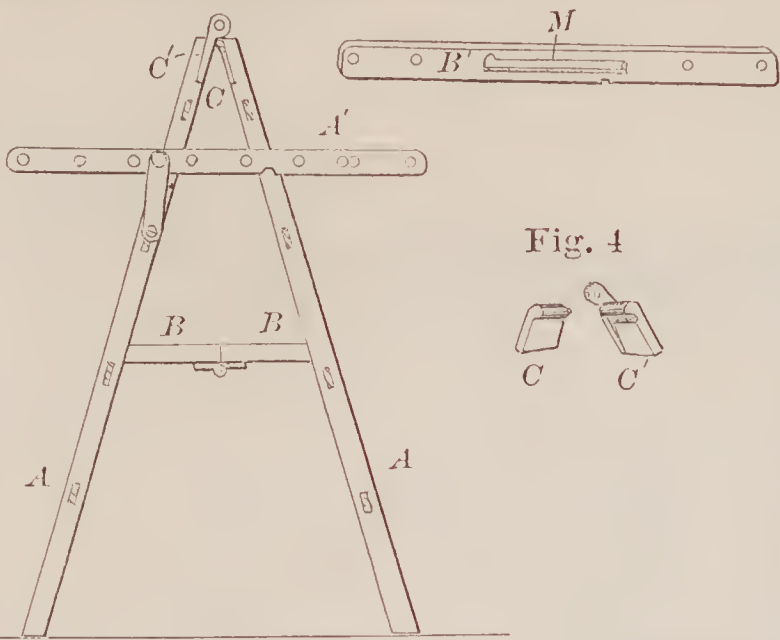

67272—Cox & Hill—Applying Window Shades to Windows.

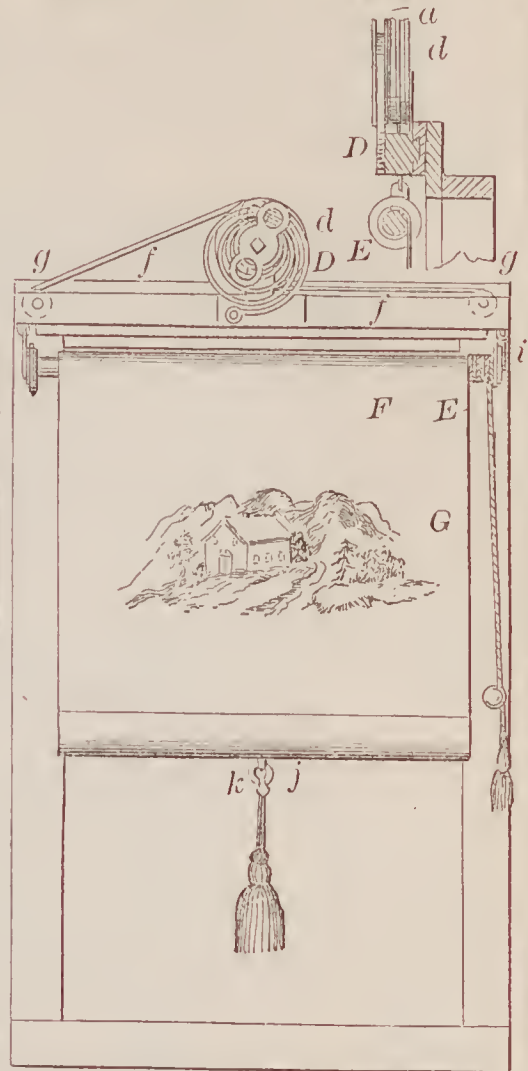

67273—J. C. Cox—Horse Power.

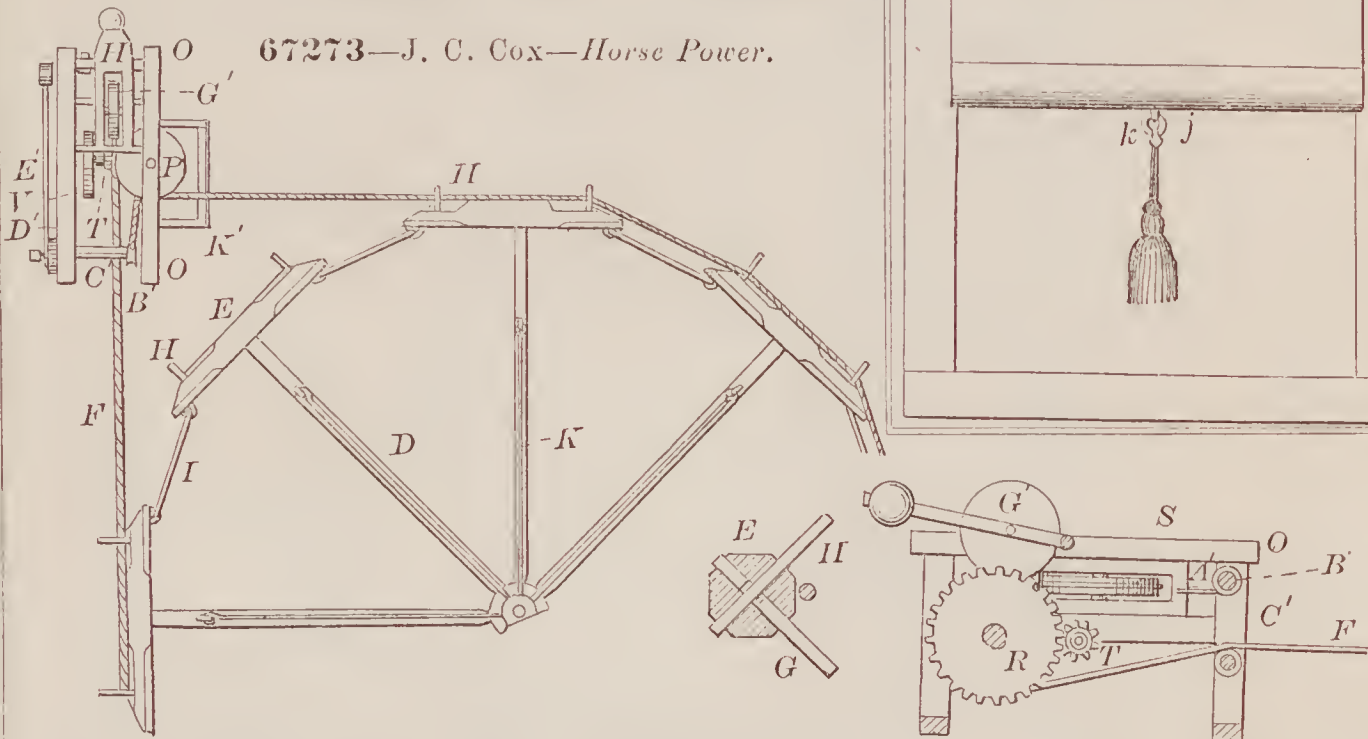

67271—Coville & Keeler—Washing Machine.

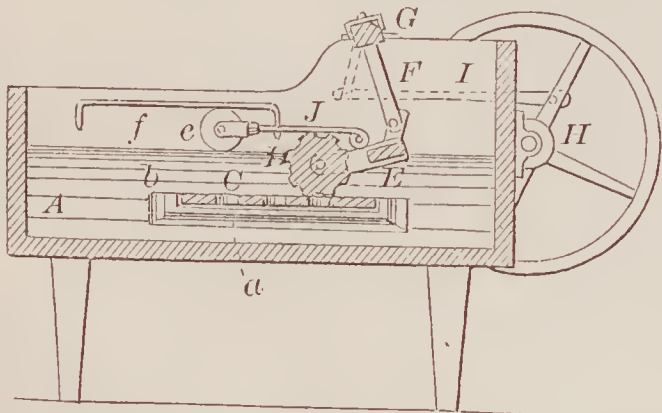

67275—J. C. Delavigne—Saw Mill.

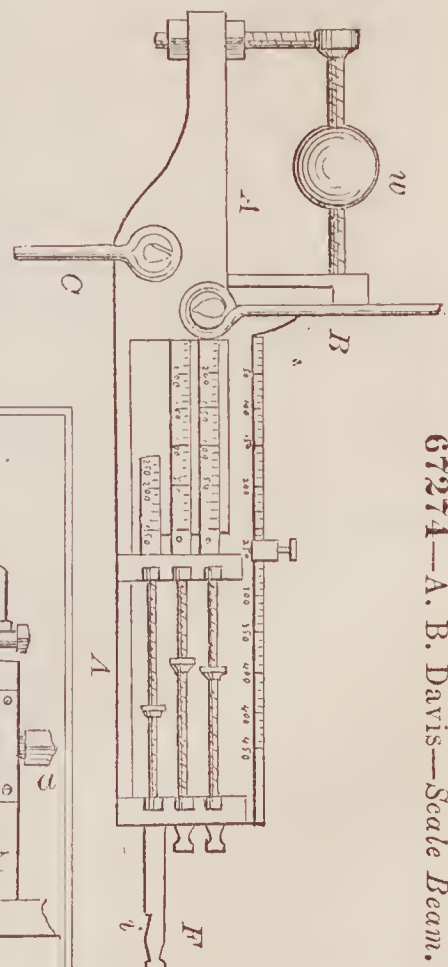
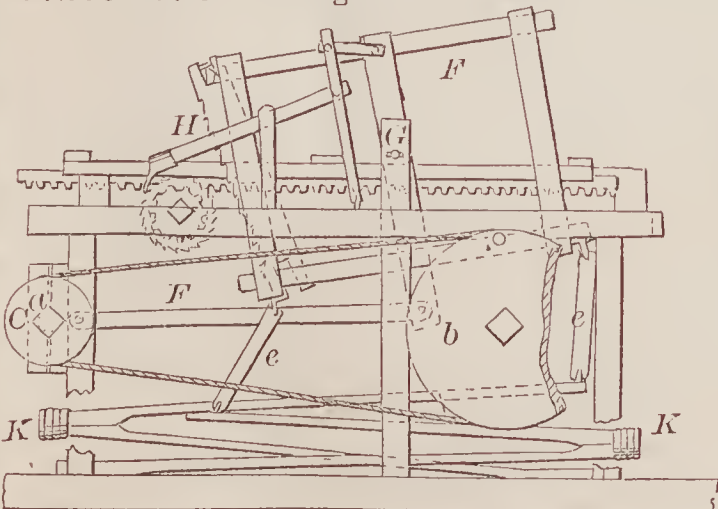

67274—A. B. Davis—Scale Beam.



67276—W. B. Doudes—For Lighting Cigars.



67277—C. W. Duncan—Vapor Burner for Heating.

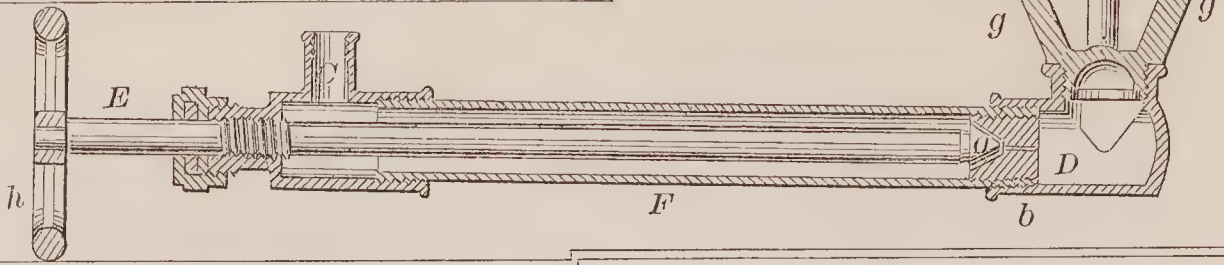

67278—H. Everett—Paint Can.

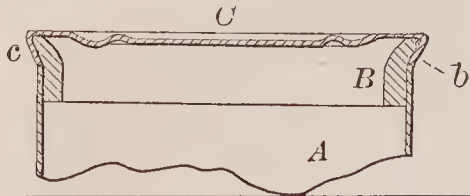

67279—L. Fleckenstine—Fruit Gatherer.

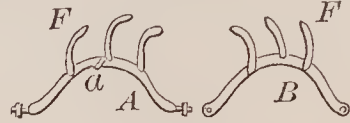

67280—W. Foster—Railway Chair.

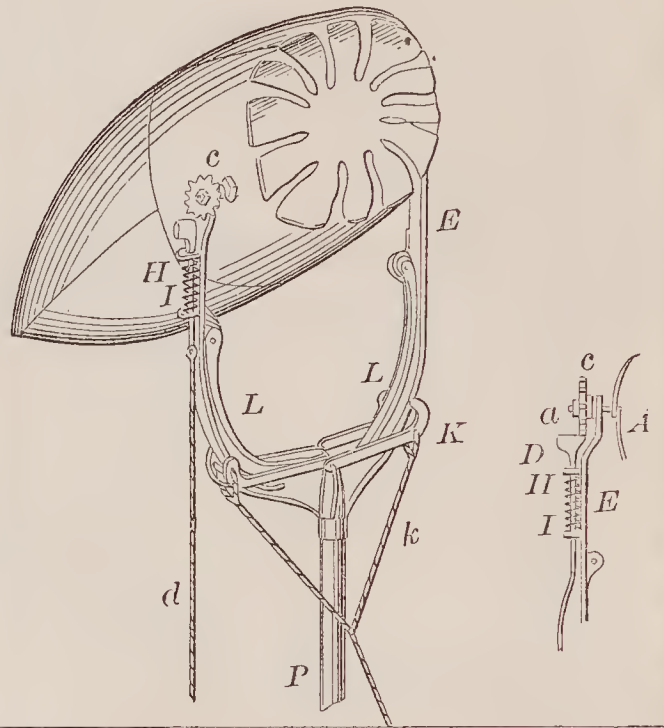
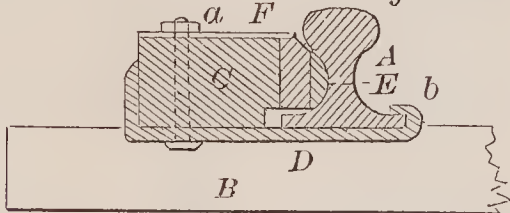

67282—L. F. Frazee—Ship's Davit.

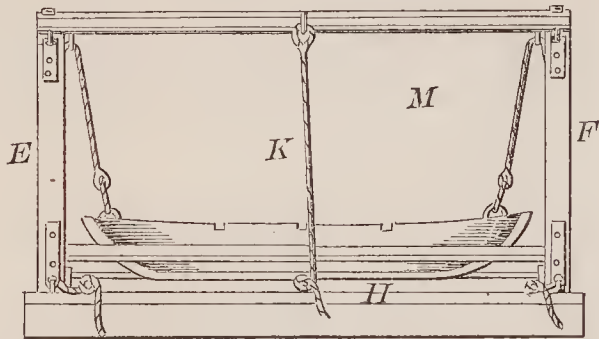

67284—A. J. Fullam—Drilling Apparatus.

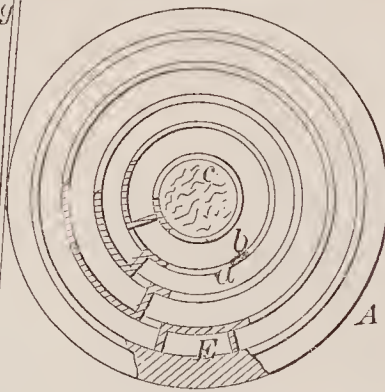
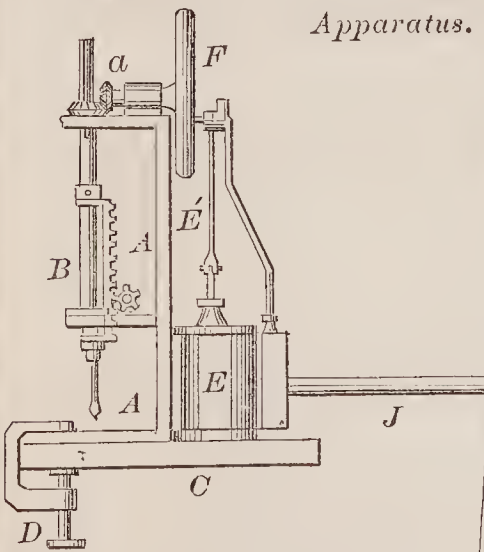

67281—A. Fox—Filter.

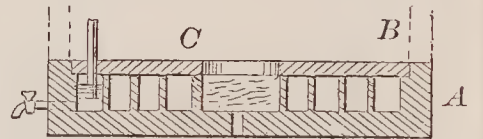

67283—C. H. Frost—Base Burning Stove.

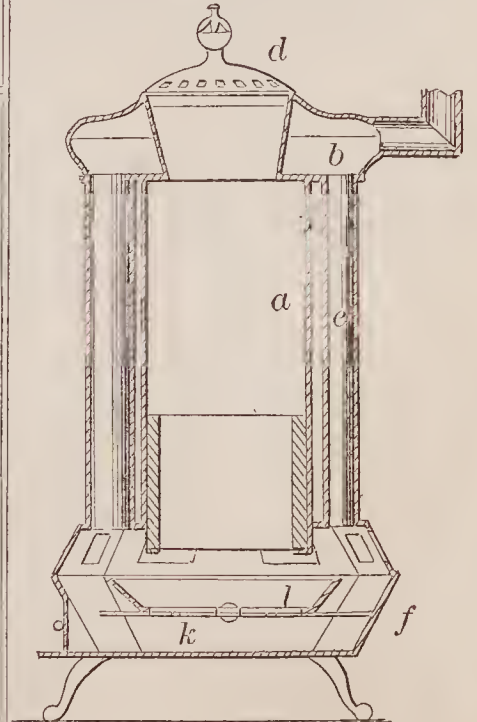

67285—W. Fuzzard—Row Lock

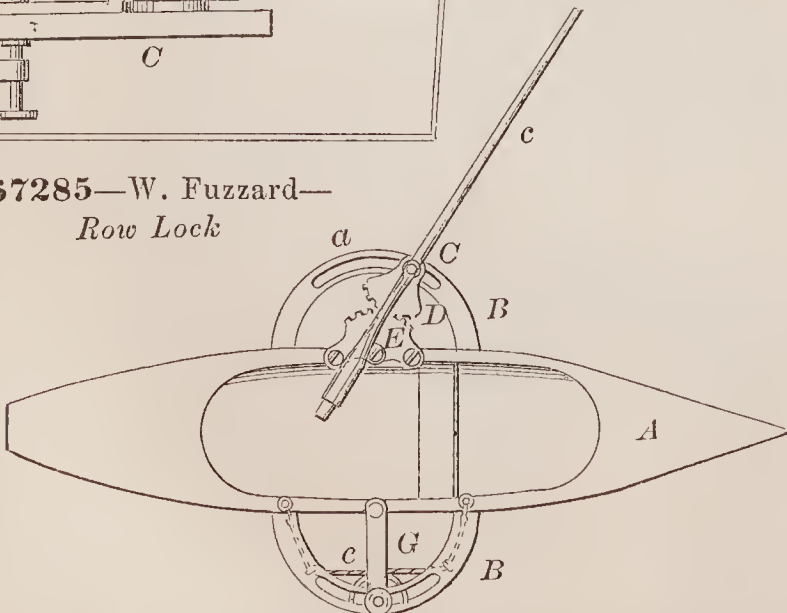

67286—G. R. Gardiner—  
Clamp for Paint Brushes.

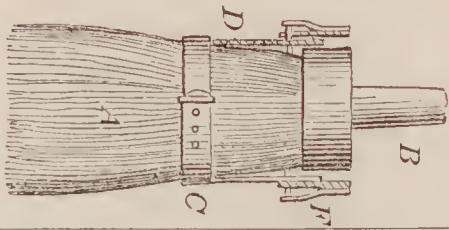

67287—W. N. Gates—*Corn Harvester.*

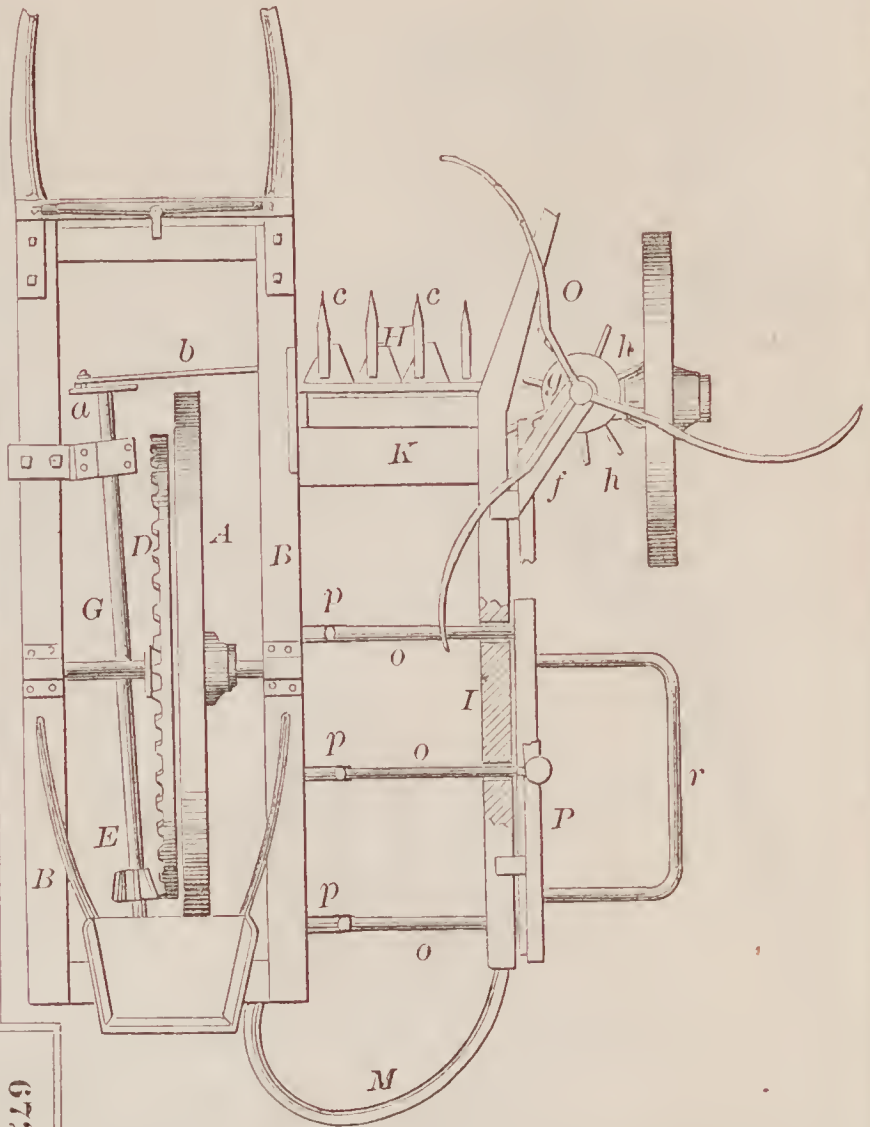

67288—J. B. Gayle—*Lathe for Turning Eccentrics.*

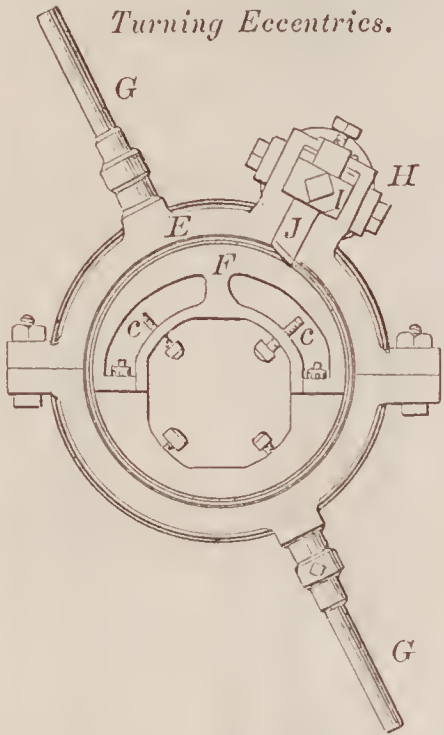

67290—W. Gilfillan—  
Door Spring.

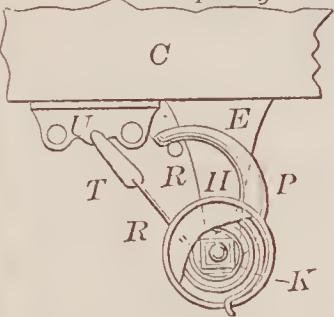

67292—J. H. Gould—  
Bottle Stopper.



67289—C. Gibbon—*Cotton Cultivator.*

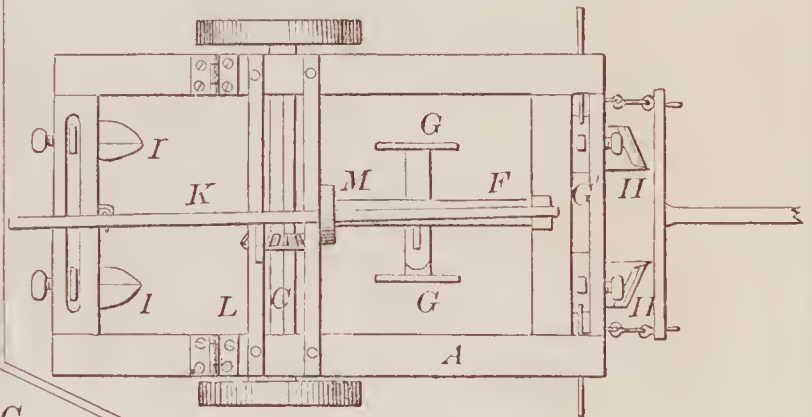

67293—H. Gransden—*Mangle.*

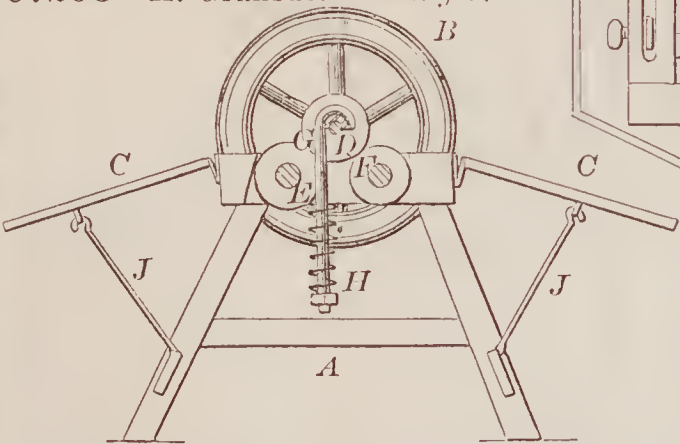

67294—W. Green—*Washing Machine.*

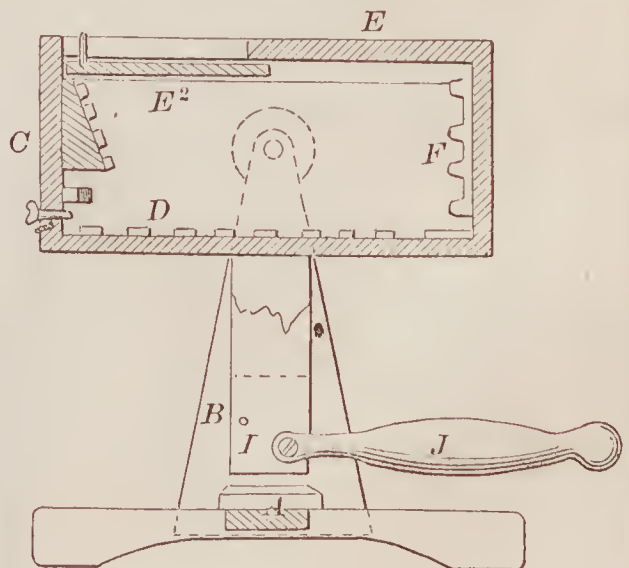

67291—C. B. Gill—*Pump Piston.*

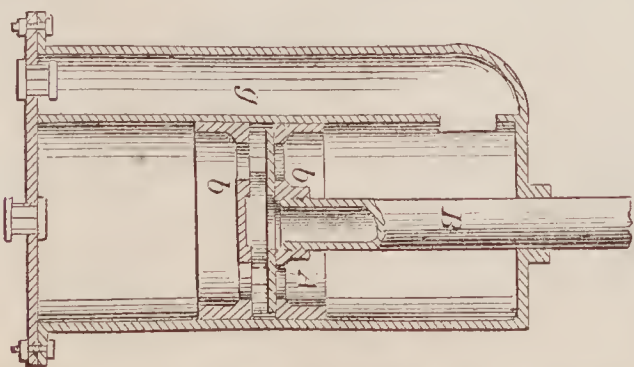



67295—A. M. Griswold—Cultivator.

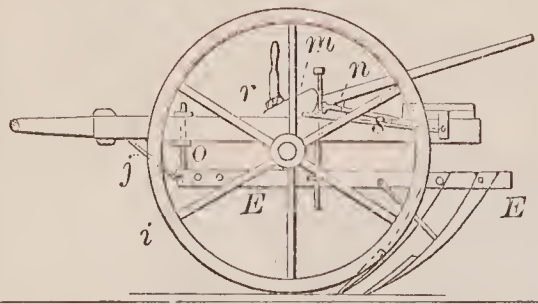

67297—J. F. Hammond—Floor Clamp.

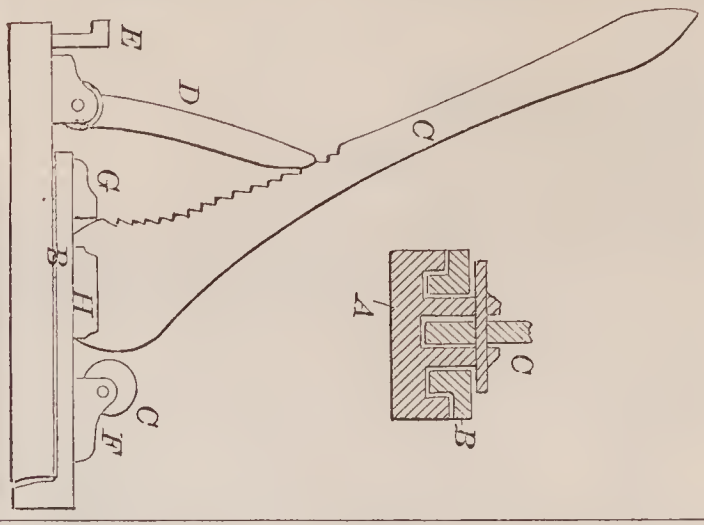

67296—E. W. Gurnee—Fruit Picker.

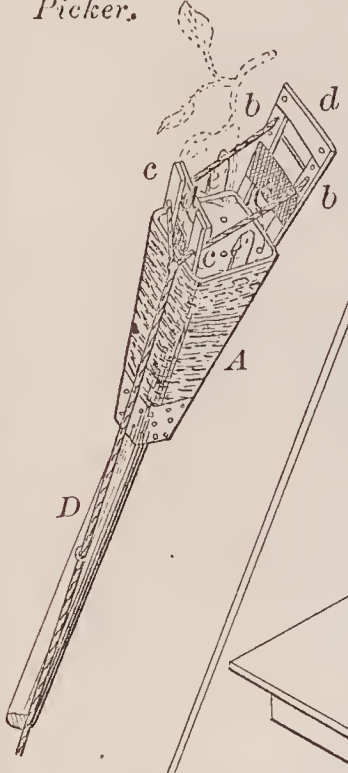

67300—W. F. Hayden—Heating Top Plates of Wax Thread Sewing Machines.

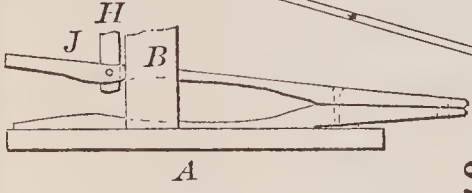
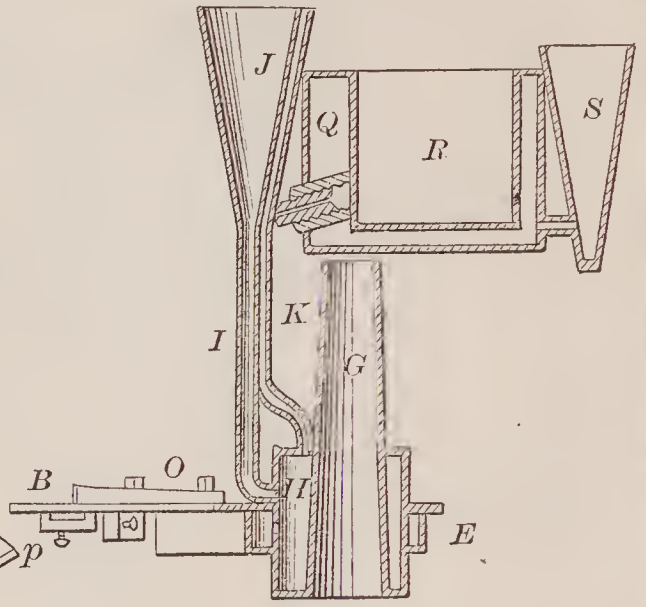
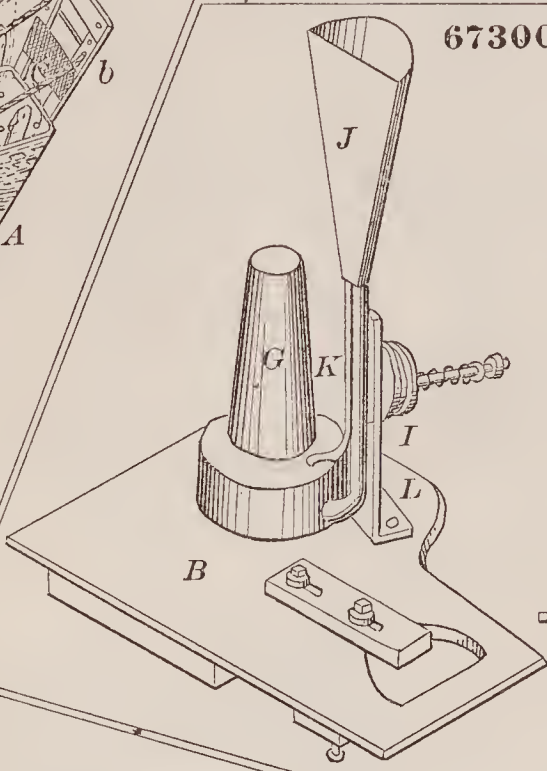

67301—H. N. Hill—Corn Husker.

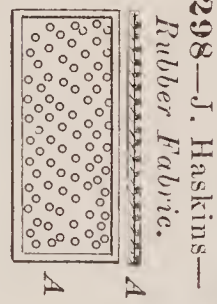
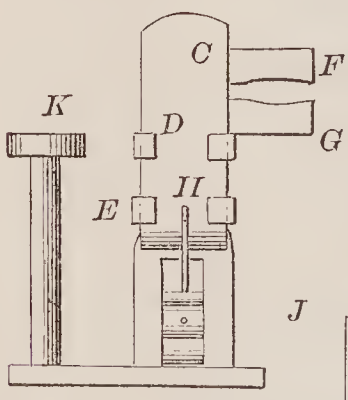

67298—J. Haskins—Rubber Fabric.

67299—J. S. Hawley—Tobacco Pipe.

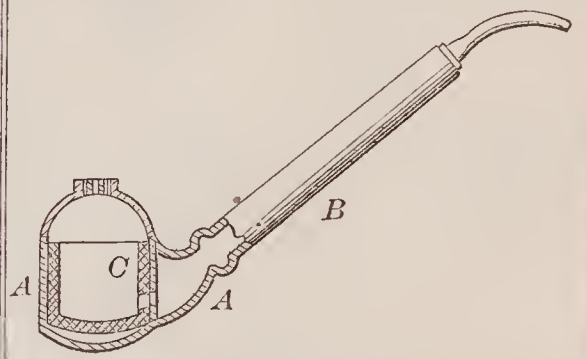

67302—G. H. Hoagland—Slide Valve.

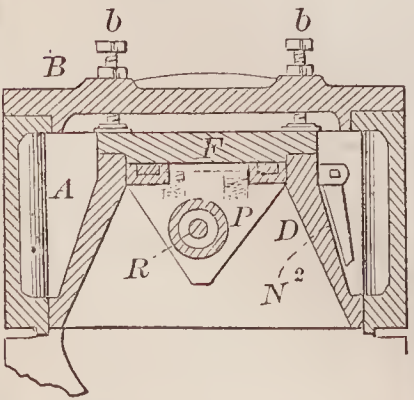

67303—A. Honrath—Cork Receptacle for Bottles.

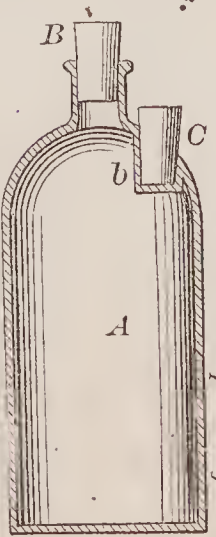

67304—J. Horner—Bedstead.

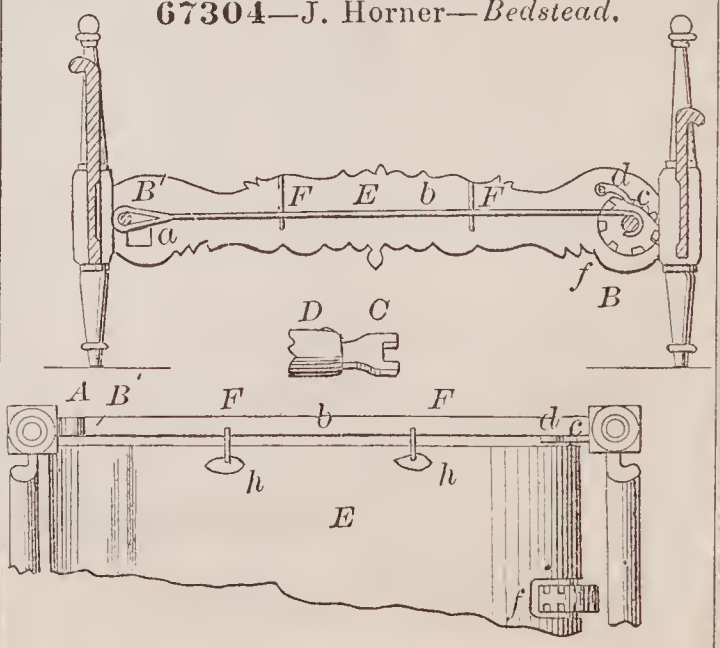

67305—C. Howard—Horse Rake.

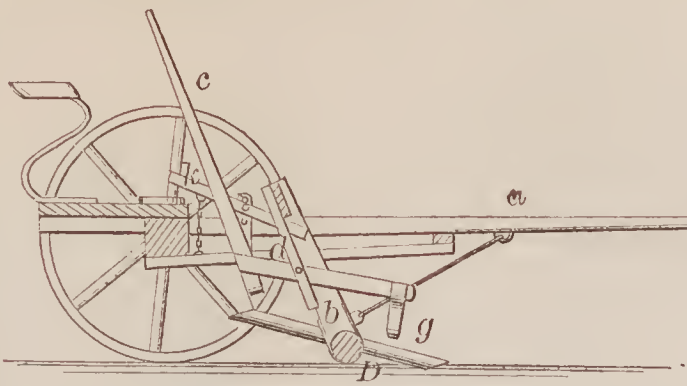

67306—Humphries & Keethler—Wheel Spoking Machine.

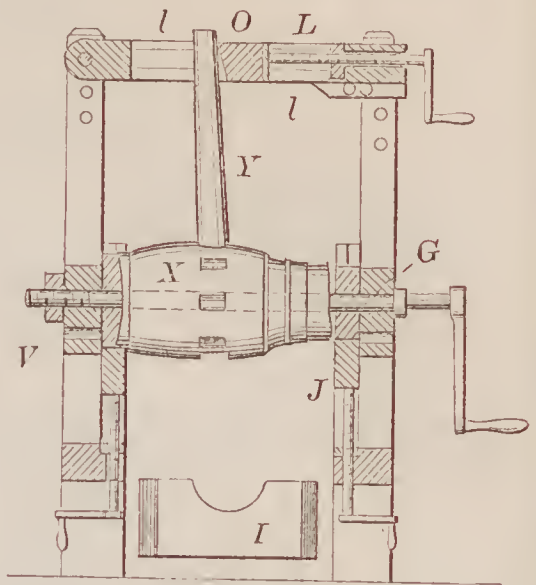

67307—W. S. Huntington—Last Fastening.



67309—J. Ives—For Snuffing Lamps.

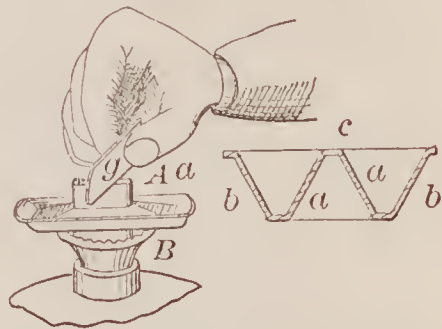

67310—C. P. Jadin—Clothes Post.

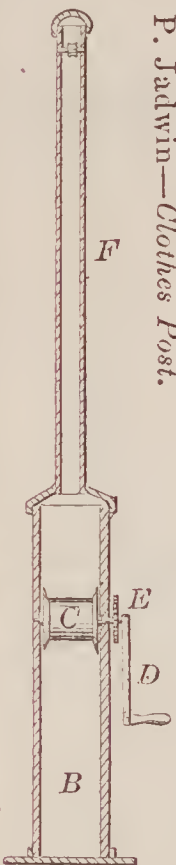

67313—A. E. Johnson—Shoe for Boots and Shoes.

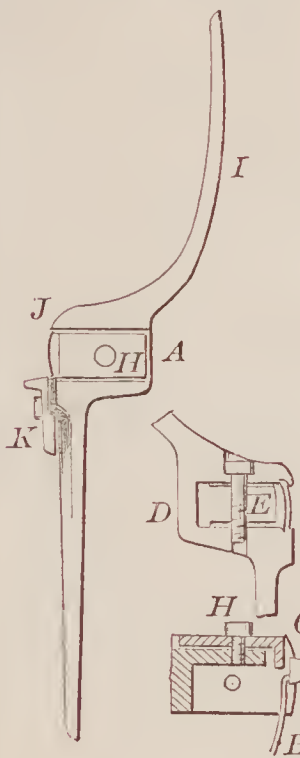

67312—E. Jewett—Manufacturing Veneers.

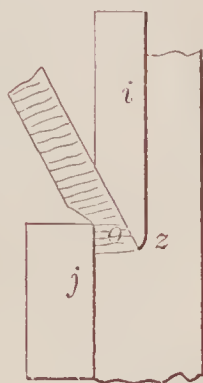

67308—F. W. Huxford—Fence.

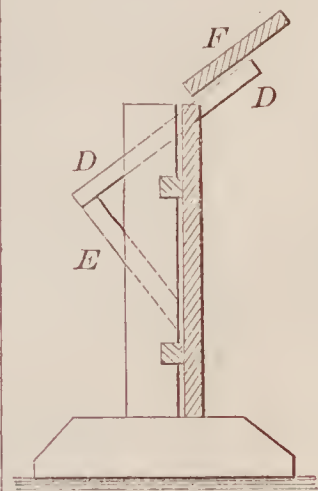

67311—W. R. Jamison—Car Coupling.

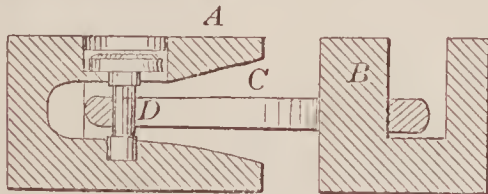

67315—Kenworthy & Silvers—Manual Power Machine.

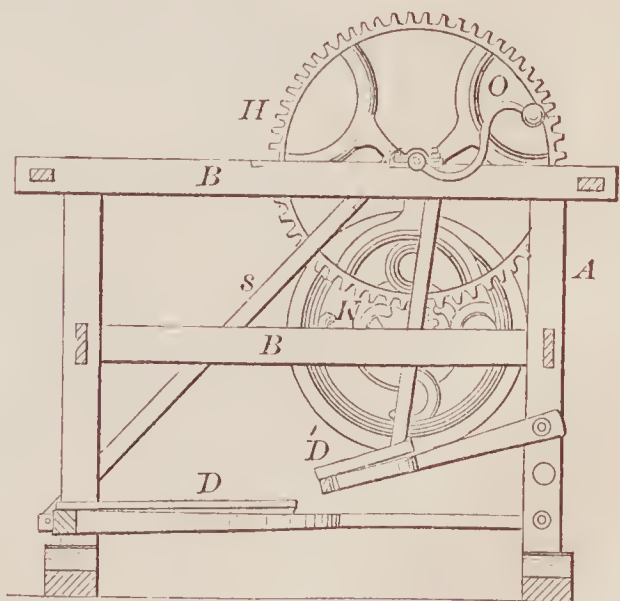

67314—W. Jones—Shoe Stretching Device.

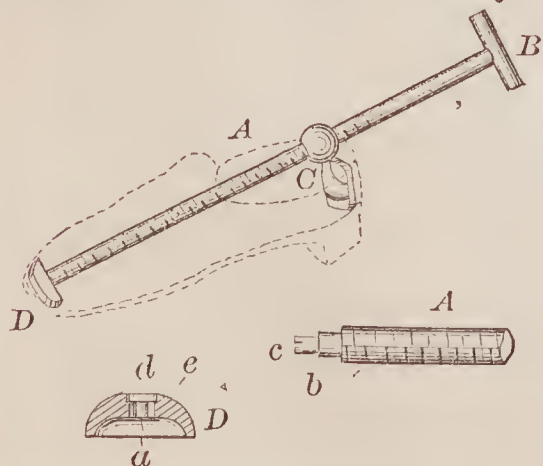



67316—W. Kester—For Making Slate Frames.

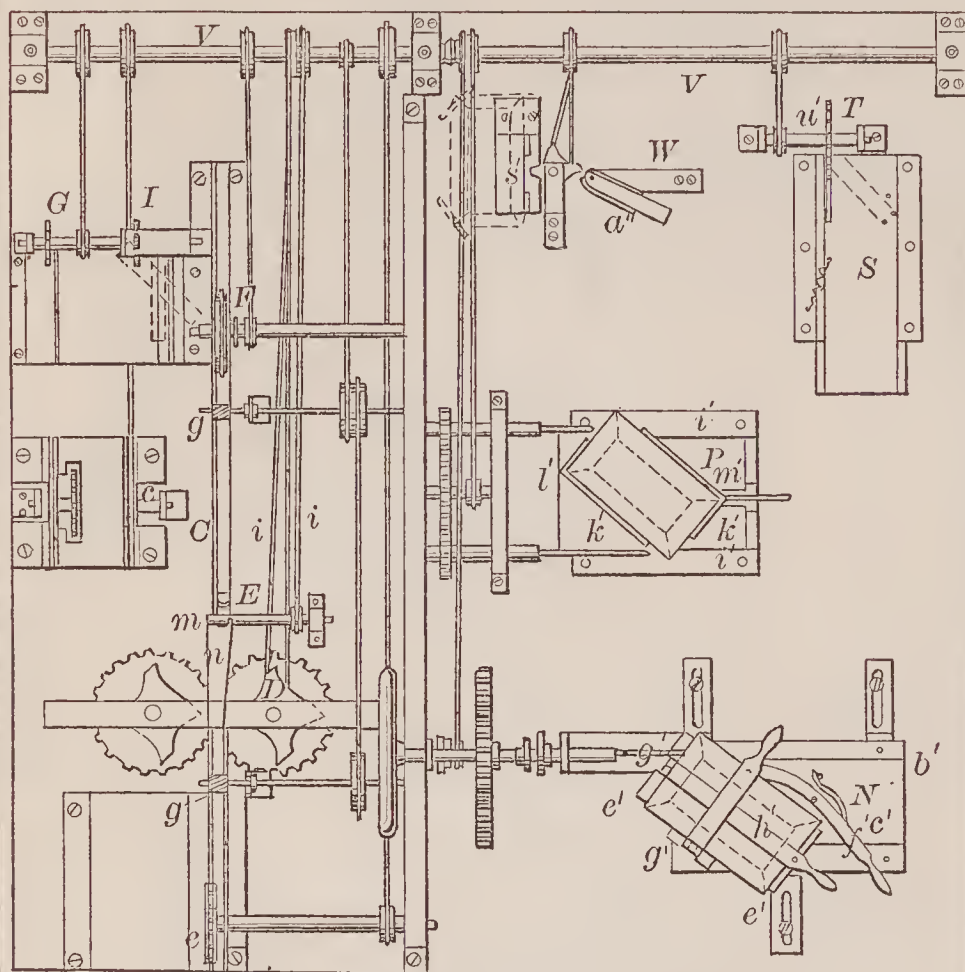
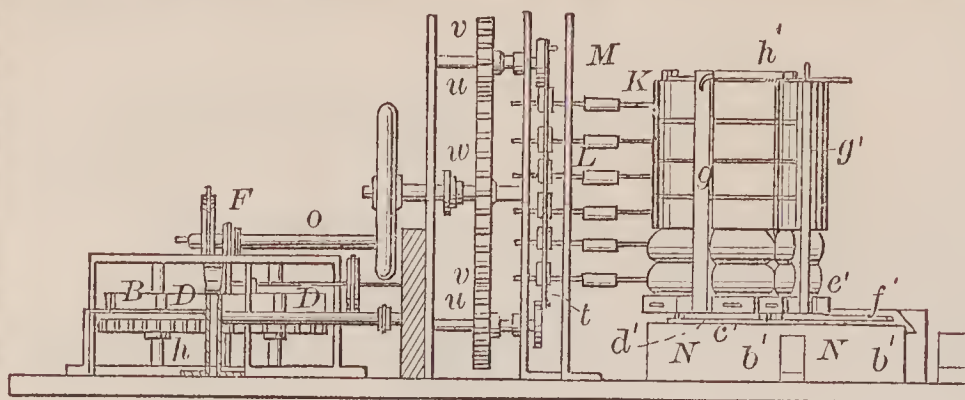

67317—Killin & Yates  
Match Safe.

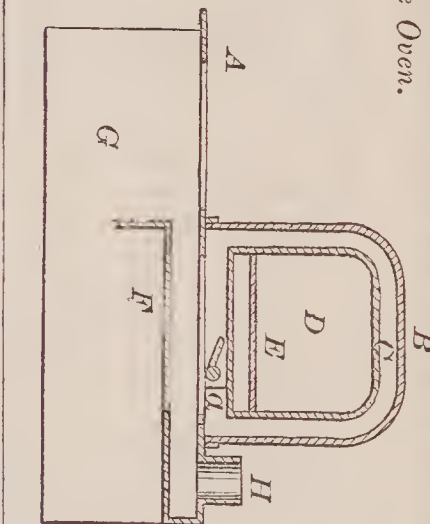
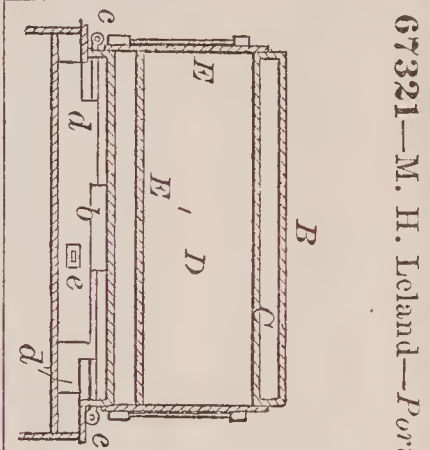
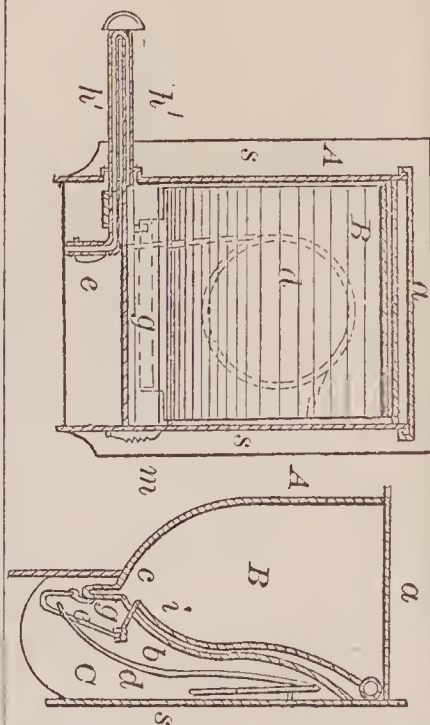

67321—M. H. Ireland—Portable Oven.

67318—P. H. Kimball—Water Elevator.

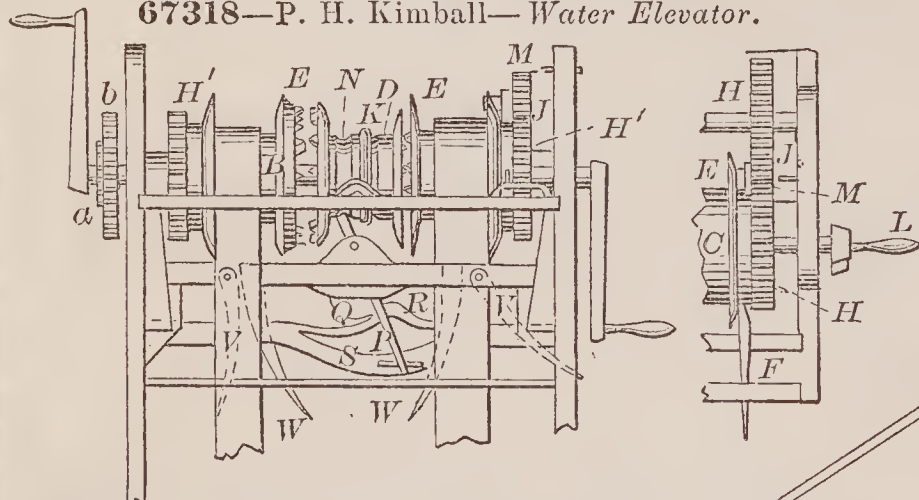

67322—C. H. Littlefield—  
Metallic Loop.

67319—P. H. Kimball—Automatic Molasses  
Gate.

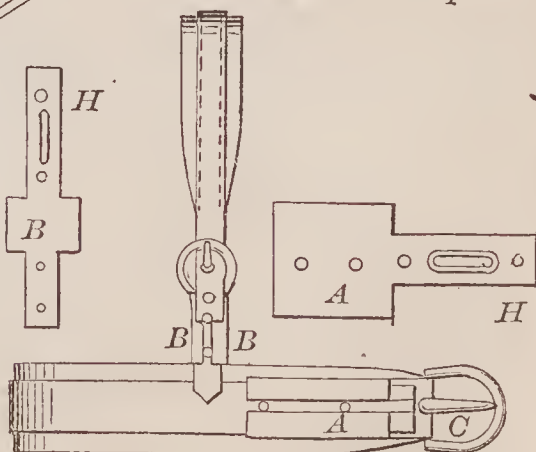
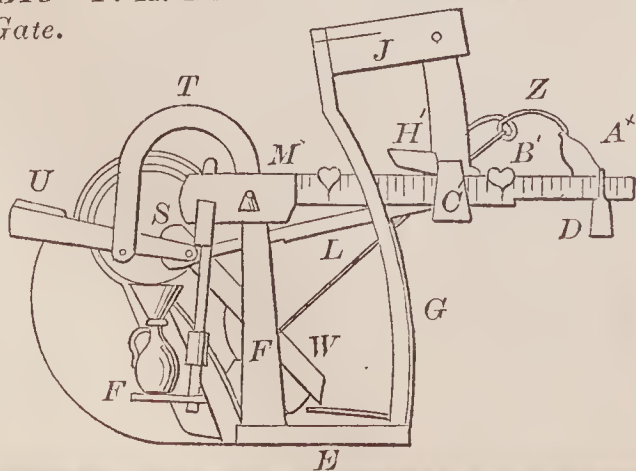



67323—R. C. M. Lovell—Mining and Tunneling Machine.

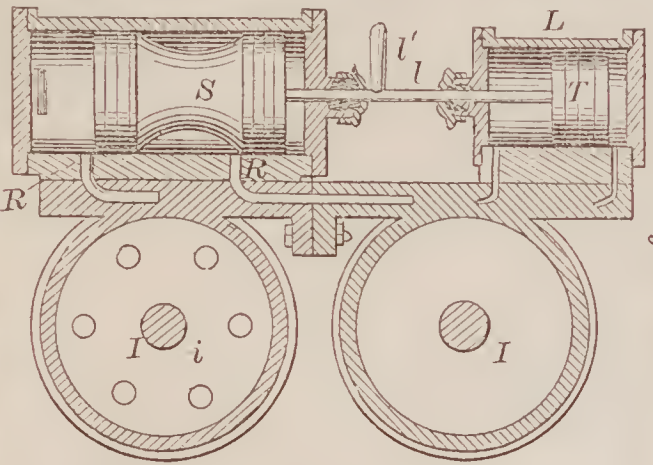
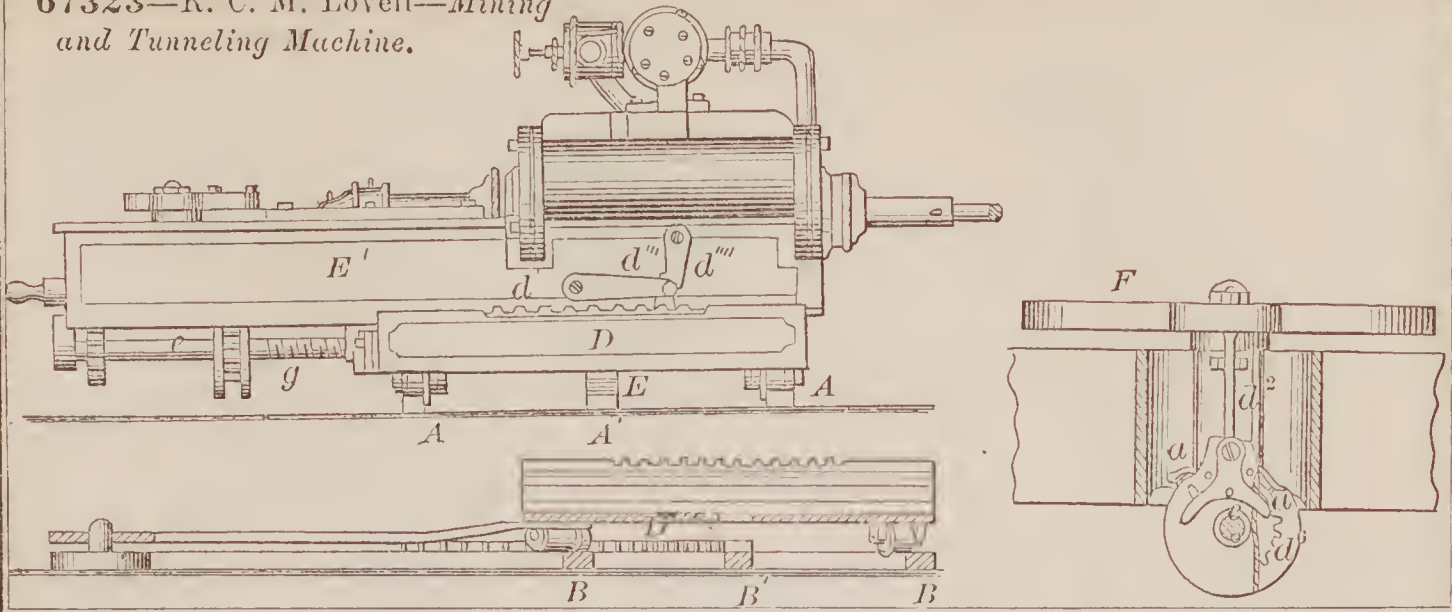

67324—R. C. M. Lovell—Steam Engine Valve.

67326—J. I. Mabbett—Spring Seat.

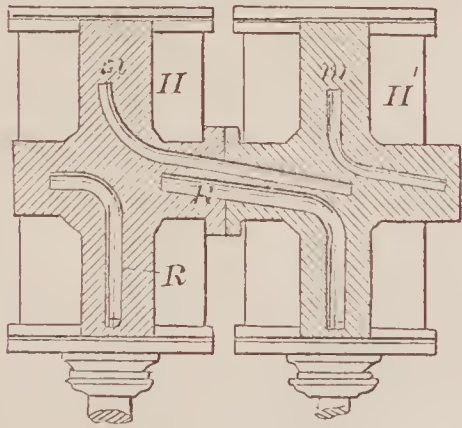
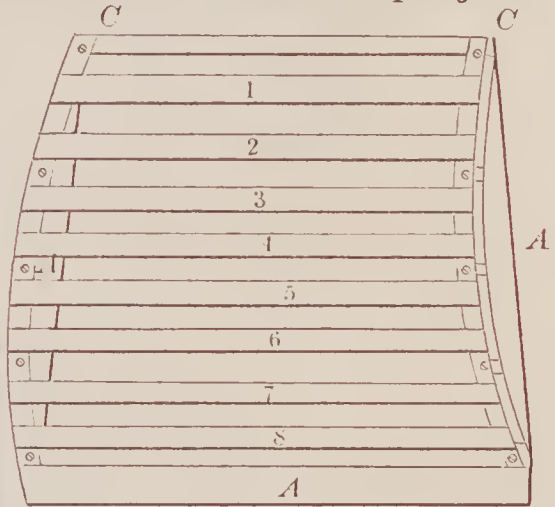

67327—F. McCarthy—Cotton Gin.

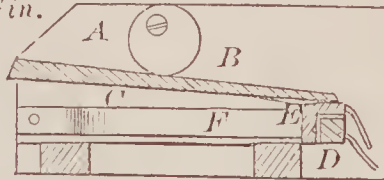

67329—W. J. McLea—Alarm Whistle.

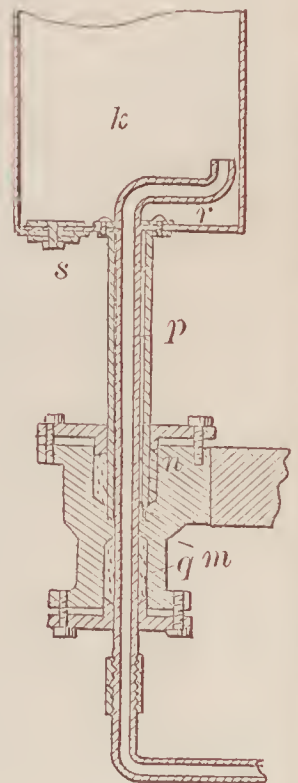
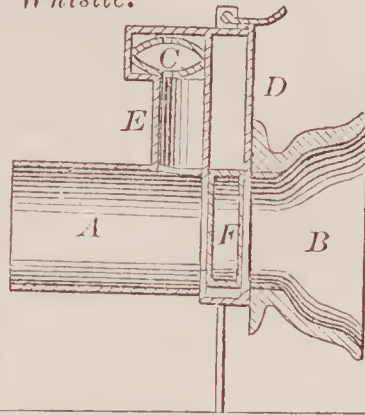

67325—J. Madden—Bread Cutter.

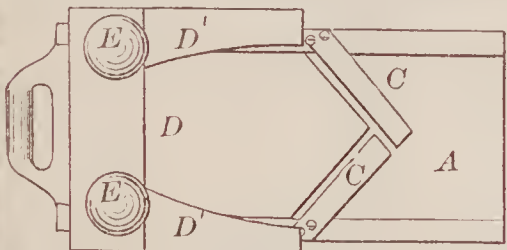

67328—D. McInroy—For Drying Sized Cords, &c.

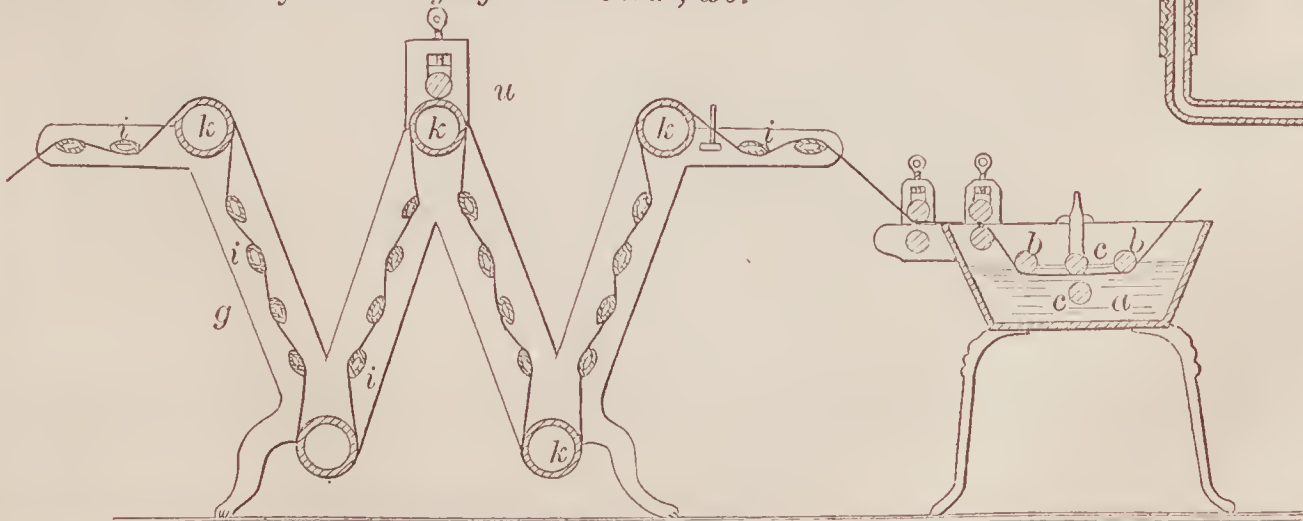



67331—W. M. Messick—Circular Swinging Cradle and Baby Walker.

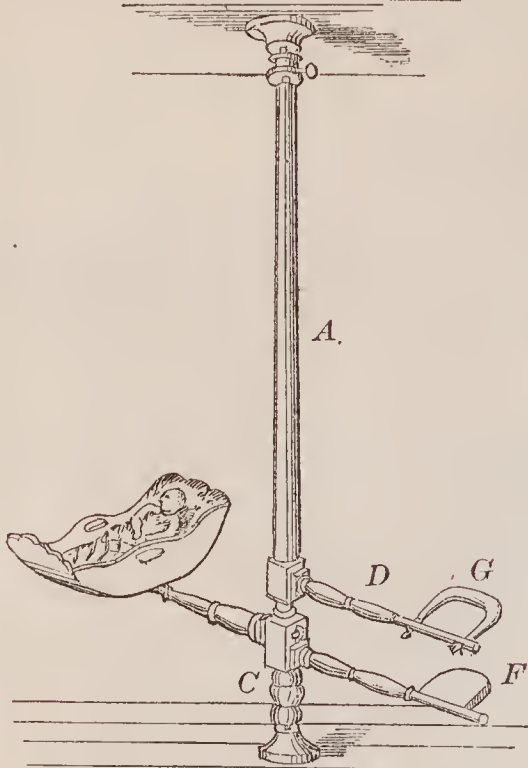

67333—W. Miller—Corset.

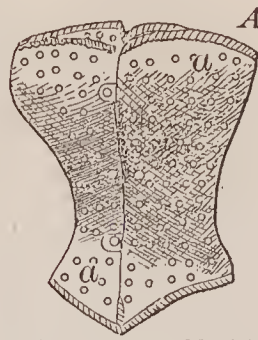

67338—J. Morass—Square.

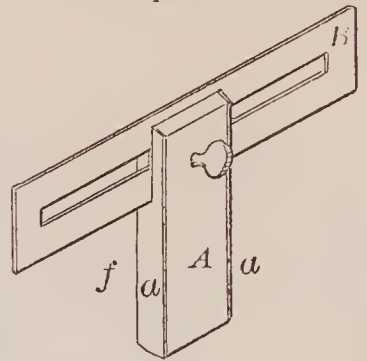

67332—W. A. Middleton—Fence.

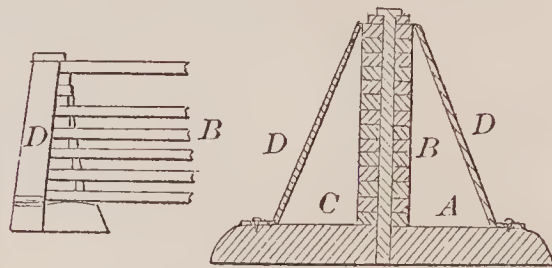

67334—J. F. Milligan—Cotton Bale Tie.



67337—D. G. Morgan—Window Curtain.

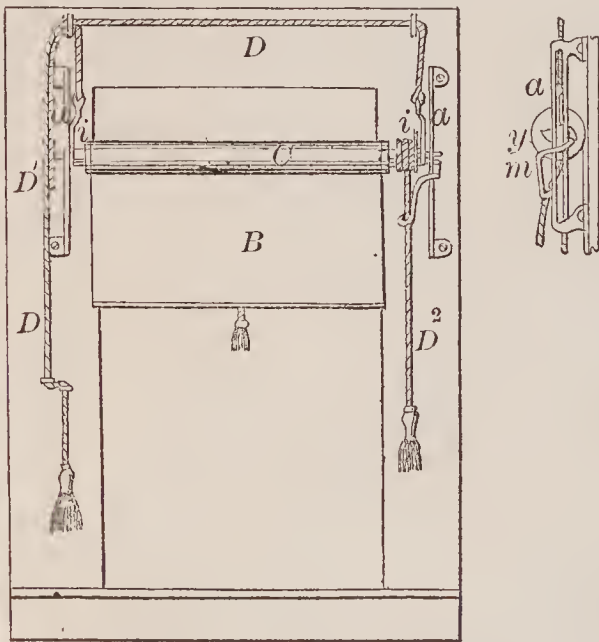

67339—I. Moser—Wardrobe or Closet.

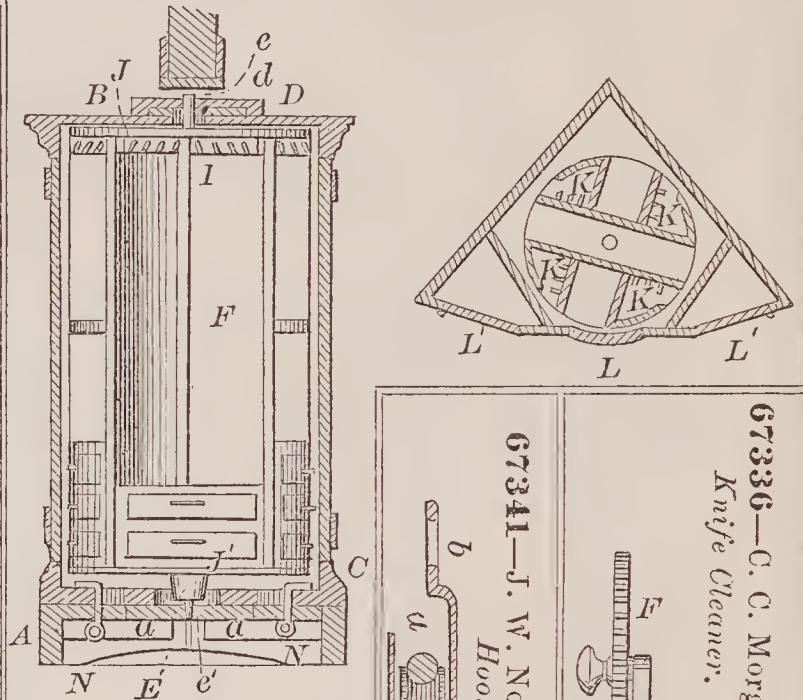

67342—J. A. Olmstead—Boat and Trunk.

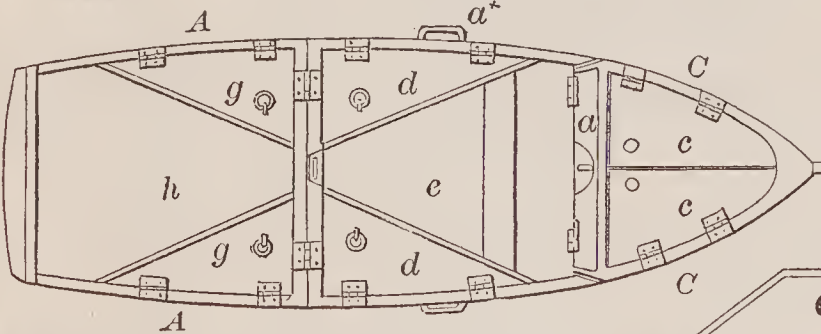

67341—J. W. Norcross—Clothes Line Hook Block. A



67336—C. O. Morgan—Knife Cleaner.

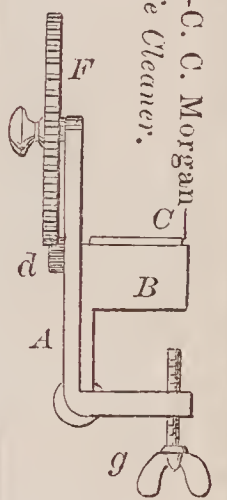

67340—R. Needham—Steam Boiler.

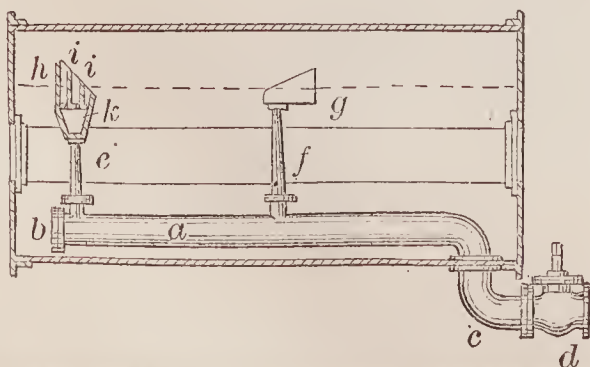

67343—S. Oppenheimer—Buck Saw Frame.

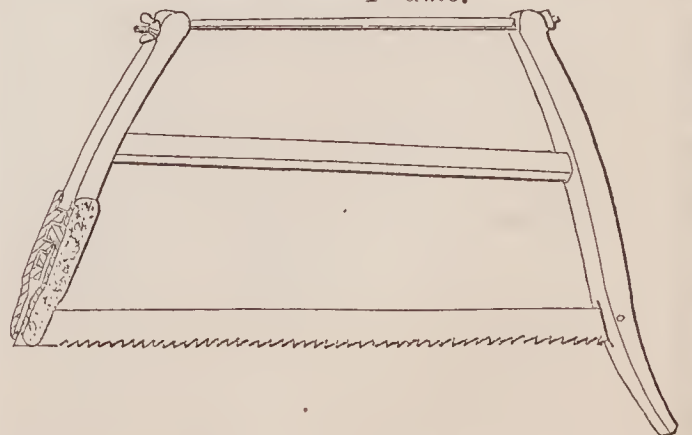





67353—P. W. Robinson—Dough Kneader.

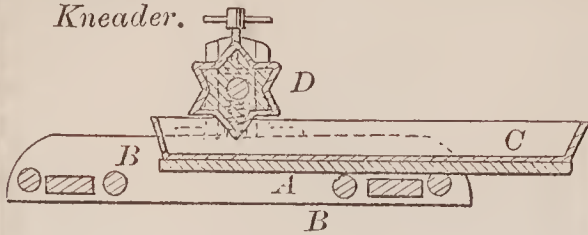

67355—E. M. Scott—For Grinding Reaper Knives.

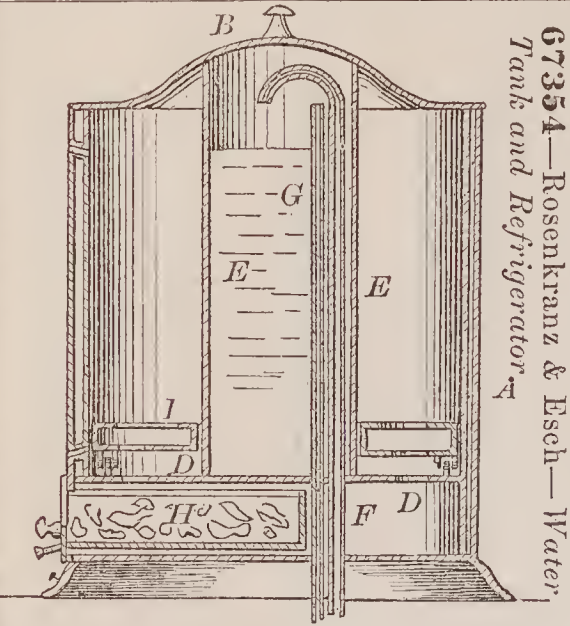
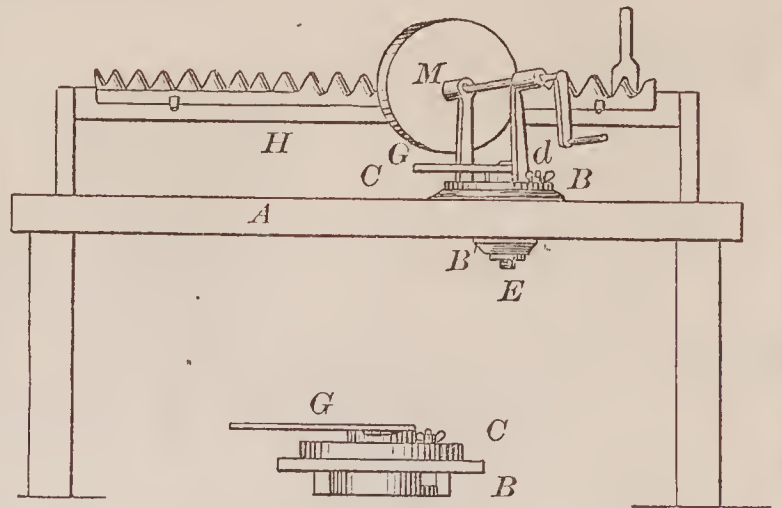

67354—Rosenkranz & Esch—Water Tank and Refrigerator.

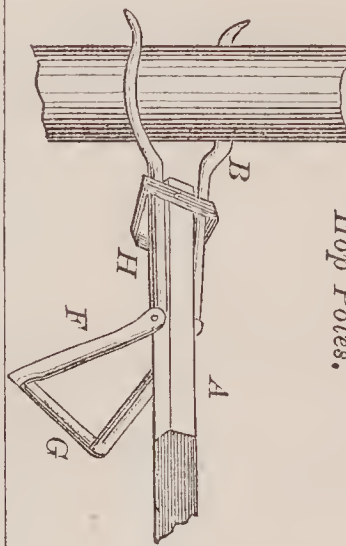

67365—W. Smith—For Pulling Hop Poles.

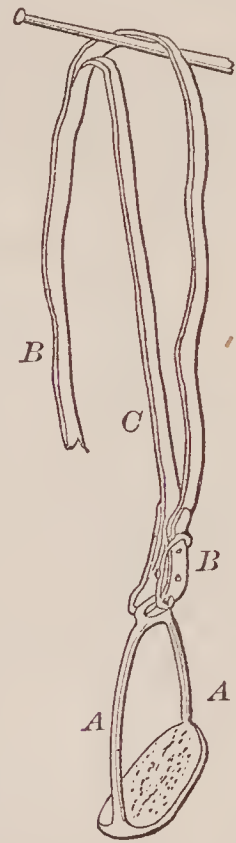

67357—P. Selby—Hanging Stirrups.

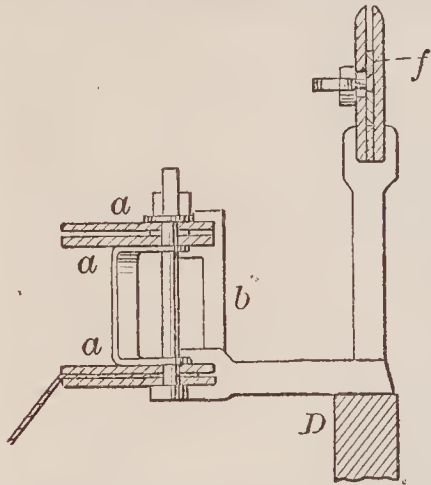

67358—W. Serviss—For Making Sheet Metal Pans.

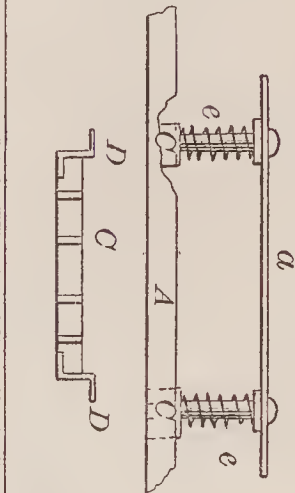

67362—E. Small—Bed Bottom.

67360—L. Shelters—Calipers and Dividers.

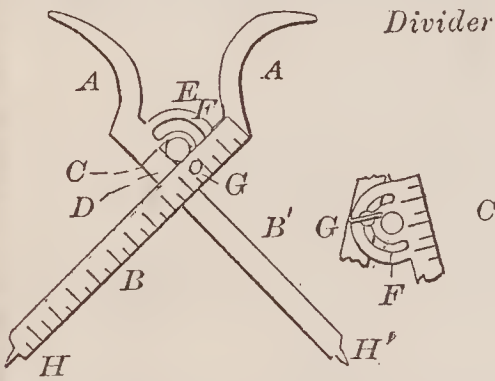

67356—C. E. Searles—Tobacco Pipe.

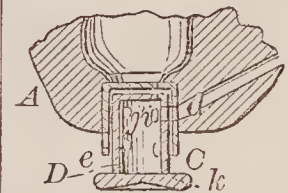

67361—W. P. Slensby—Boiler Cleaner.

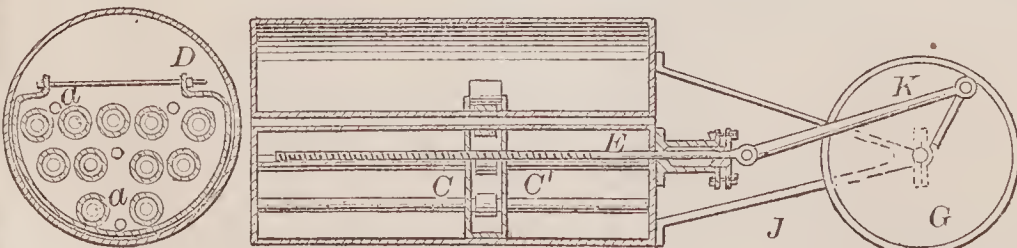

67364—J. Smith—Escape Pipe for Steam Engines

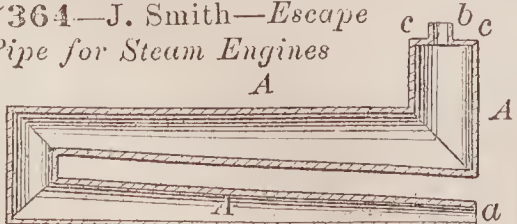

67359—Shapleigh & Colman—Spring Bed.

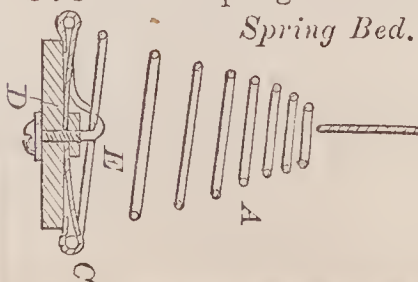

67363—Smith & Lumis—Window Blind.



67366—W. H. Smith—  
Preserving Wooden Piles.

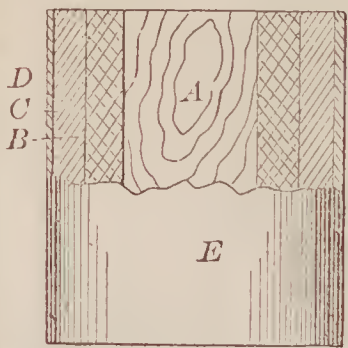

67370—W. X. Stephens—Compound Tool.

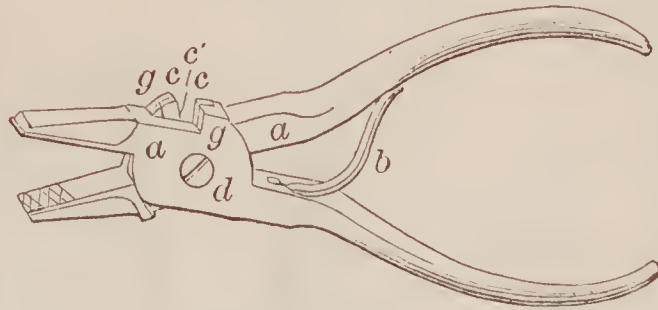

67369—W. R. Stephenson—Saw.

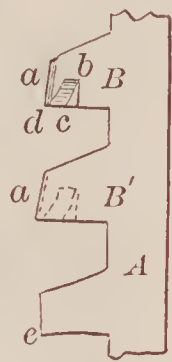

67367—P. H. Snelling—Car Coupling.

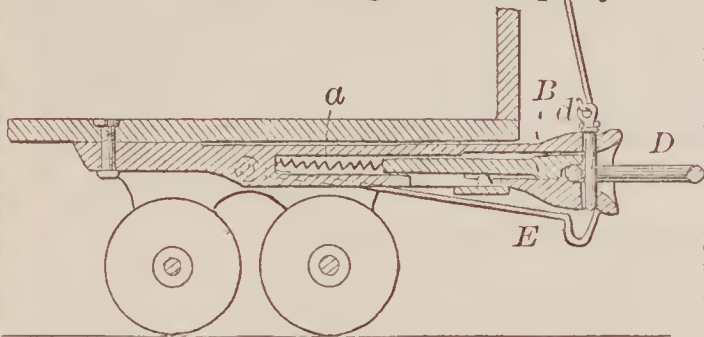

67371—  
W. H. Stichel—  
Prop Block for  
Carriage Tops.

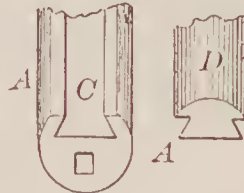

67368—W. S. Shortwell—Draw Head for  
Railroad Cars.

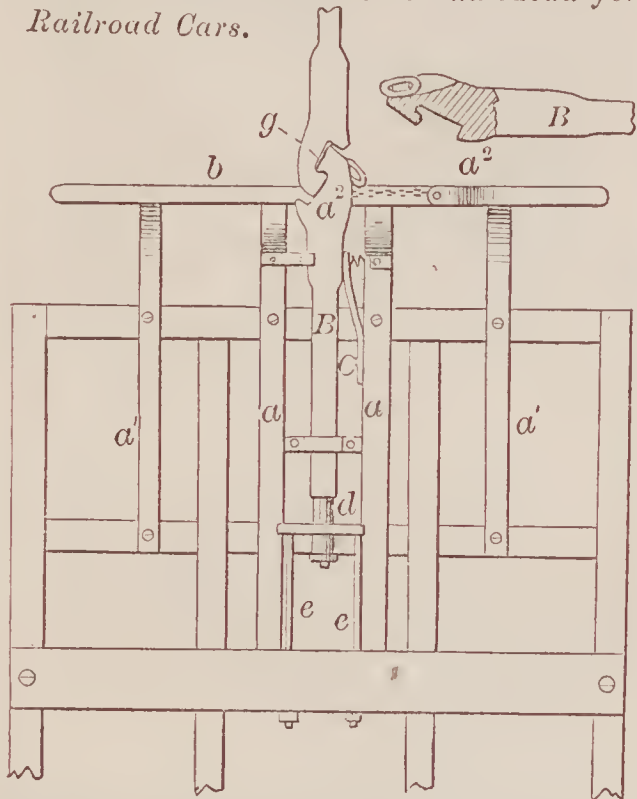

67374—S. A. Sutton—For Cutting Files.

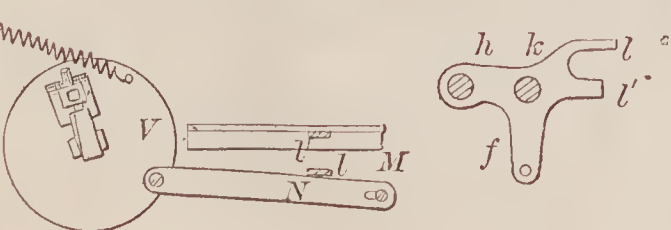
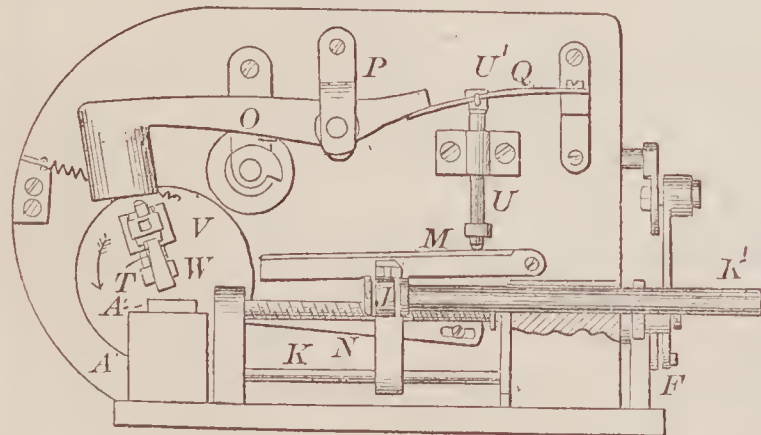

67376—C. E. Toley—Propeller.

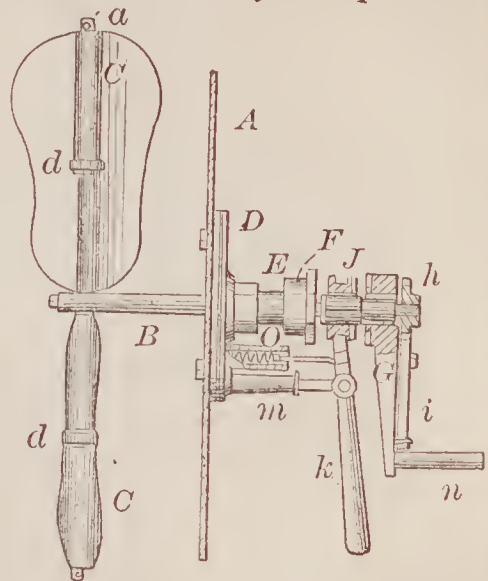

67377—M. Traver—Spittoon for  
Railroad Cars.

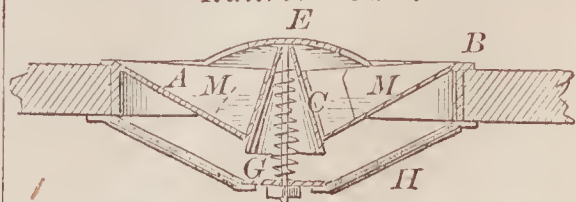



67378—G. Trinks—*Folding Chair.*

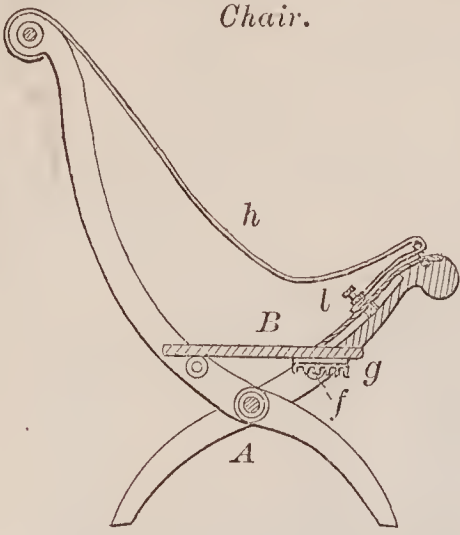

67383—C. Van De Mark—*Cooking Stove.*

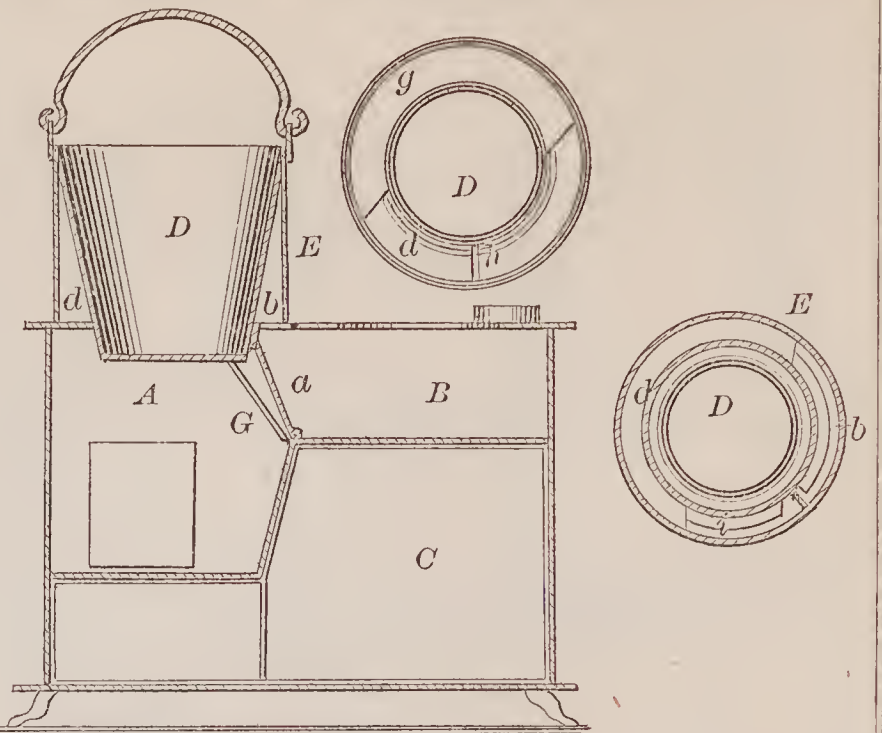

67382—H. Van Ausdall—*For Kindling Fires.*

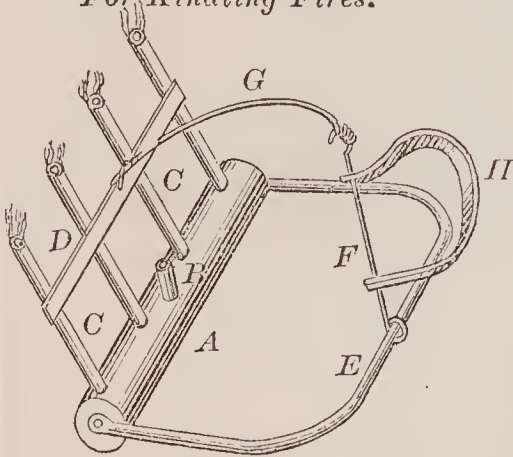

67379—S. G. Tufts—*Harness Hames.*

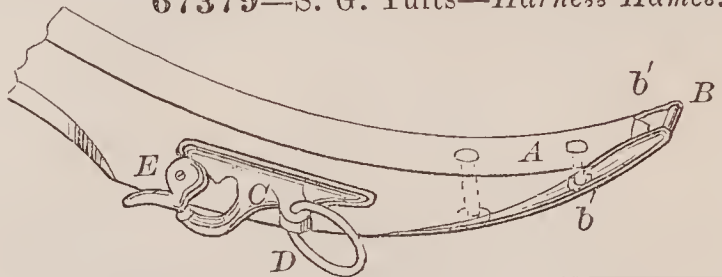

67380—A. Tweedy—*Hedge Trimming Machine.*

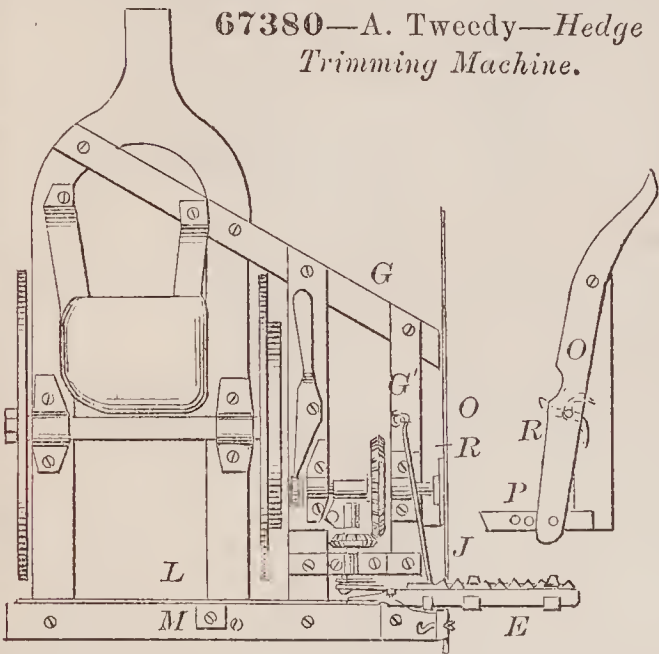

67381—D. Utley, 2d—*Sad Iron Heater.*

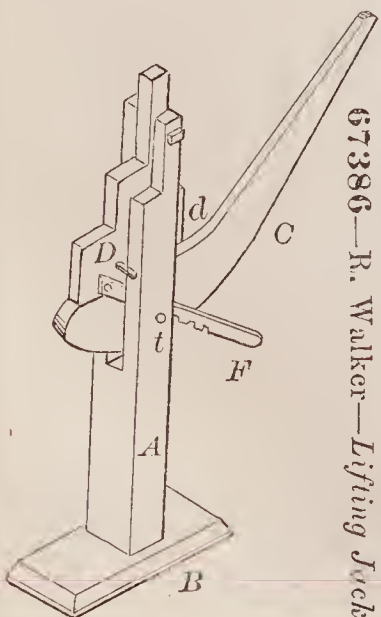
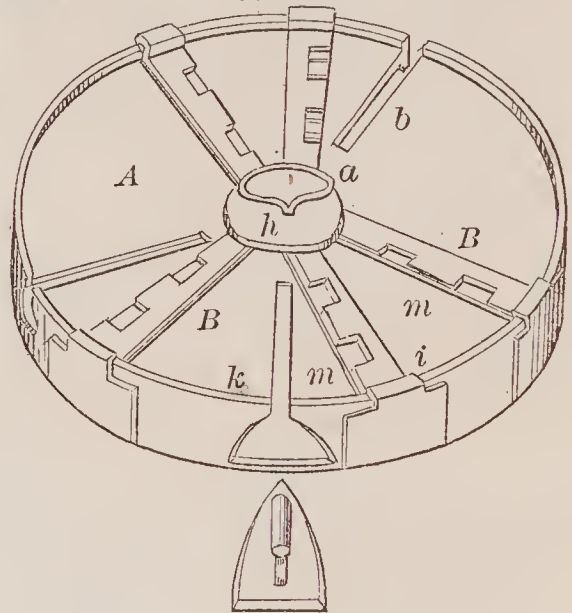

67386—R. Walker—*Lifting Jack.*

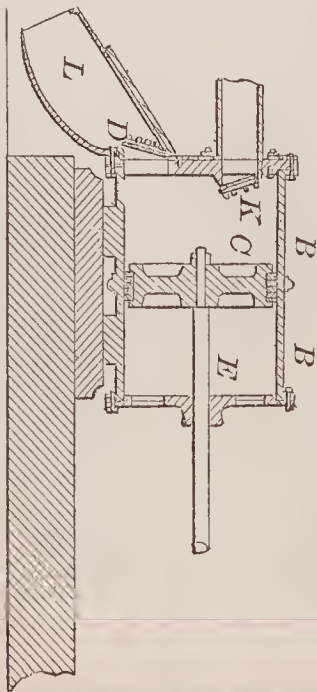

67384—J. L. Vergniais—*Drying Machine.*

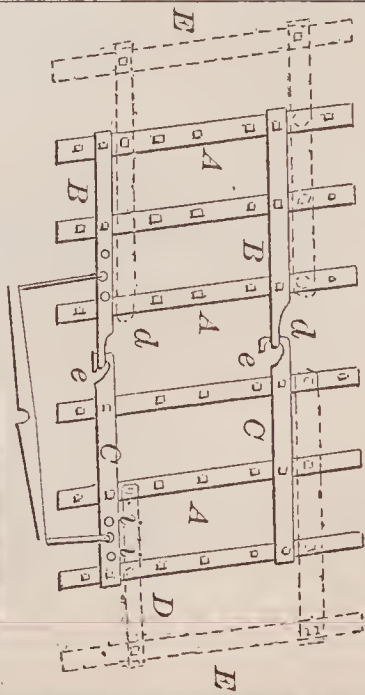

67387—J. Walsh—*Harrow.*



67388—C. E. Wareham—*Mop Wringer.*

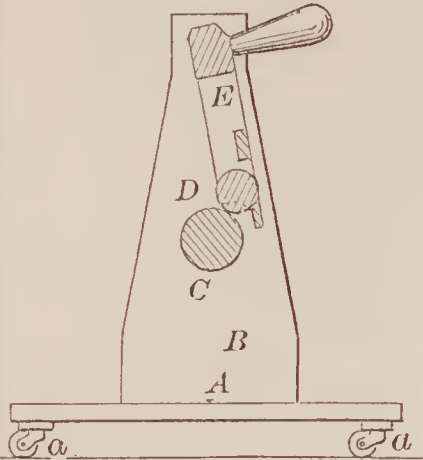

67390—W. Whitworth—*Table Leaf Support.*

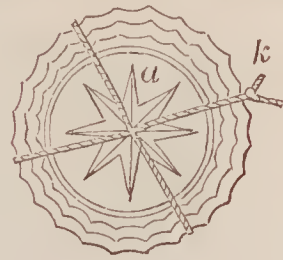
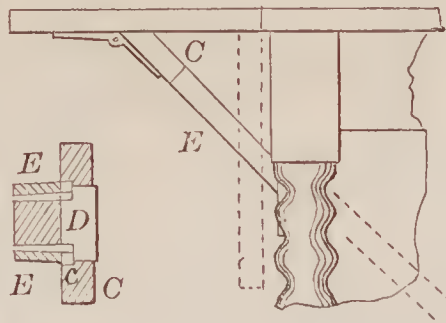

67391—J. Wilcox—*Putting up and Preserving Butter.*

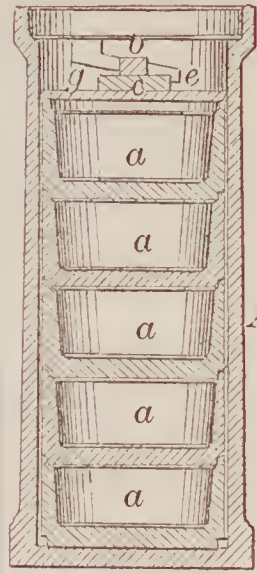

67389—G. Warner—*Grain Binder.*

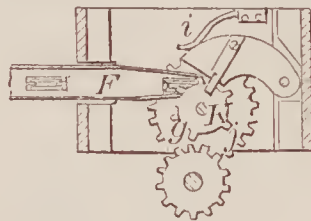
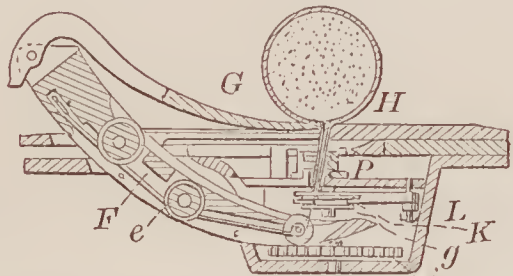
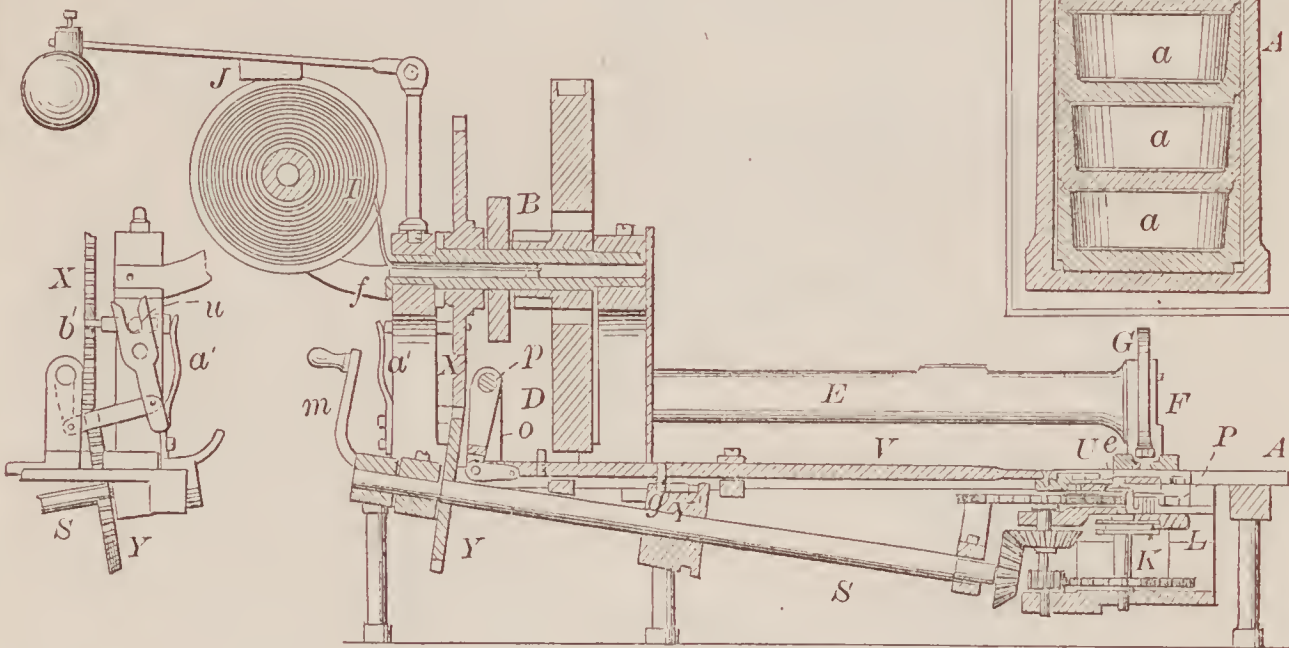

67393—A. M. Wright—*Bag Fastener.*

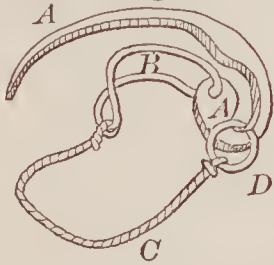

67394—R. J. Clay—*For Barring Wool.*

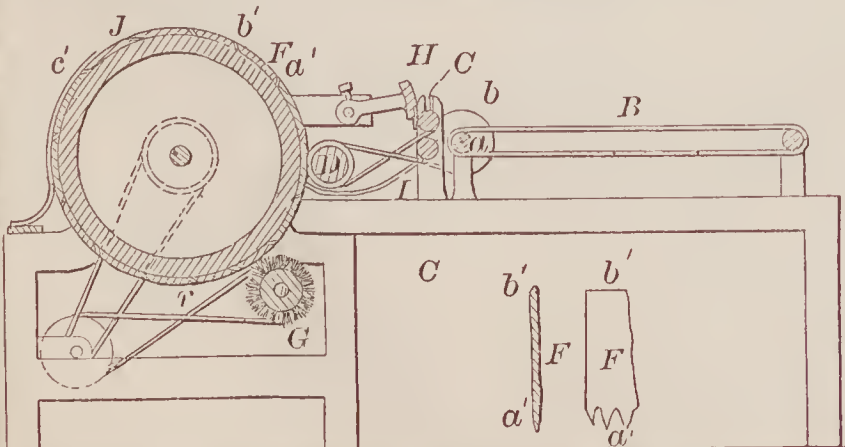

67392—F. R. Wilson—*Valve Gear.*

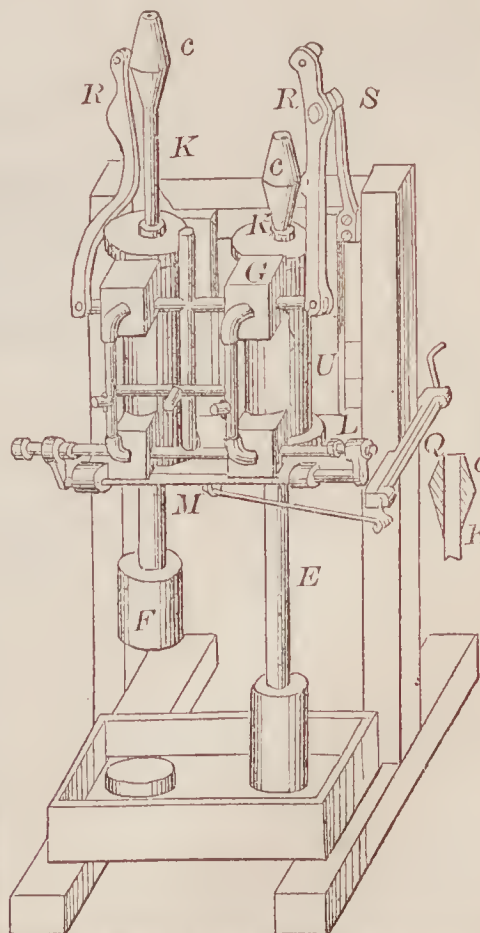



67395—Aldrich & Evans—For Twisting Augers.

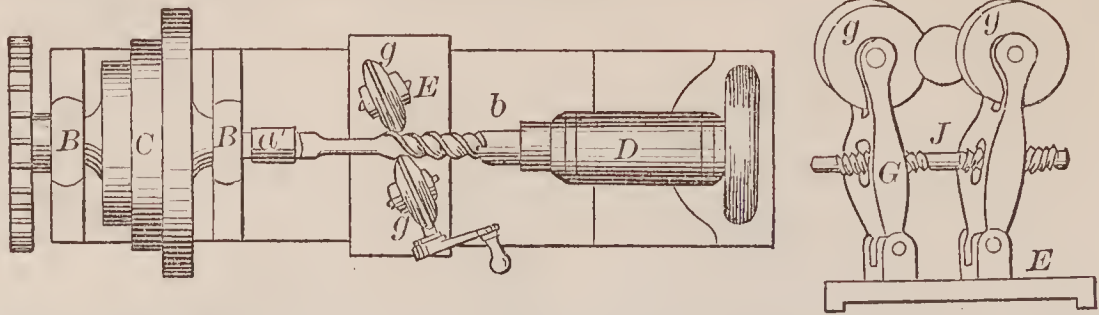

67396—W. Ashton—Screw Plate.

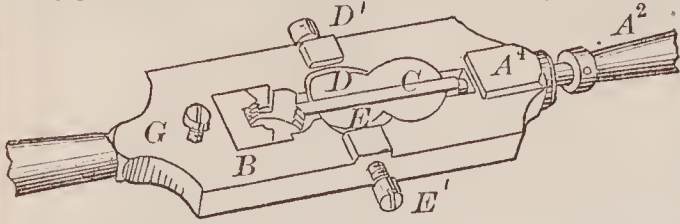

67397—W. K. Bacall—Bedstead.

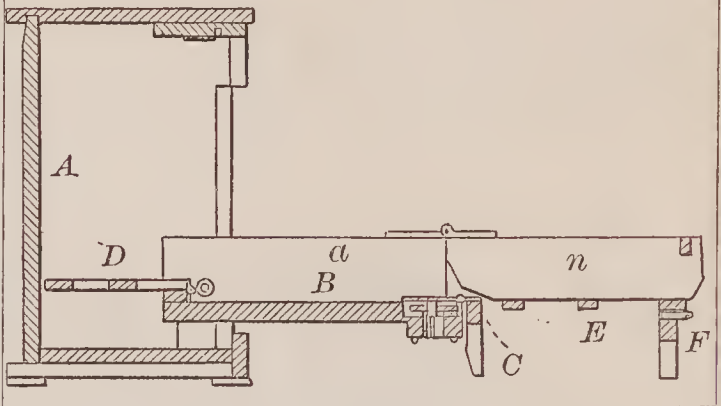

67399—W. W. Ball—Tuyere.

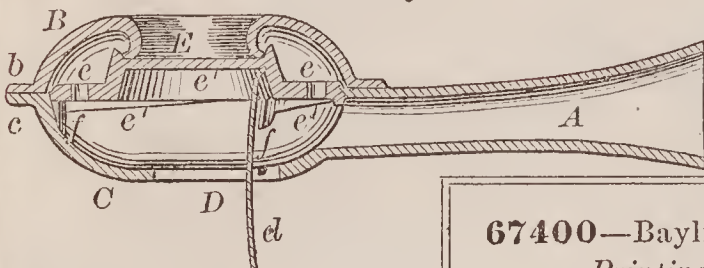

67400—Baylies & Wood—For Printing in Colors.

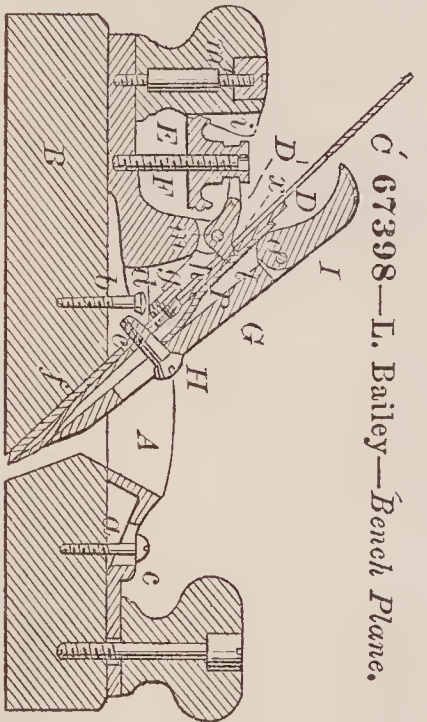
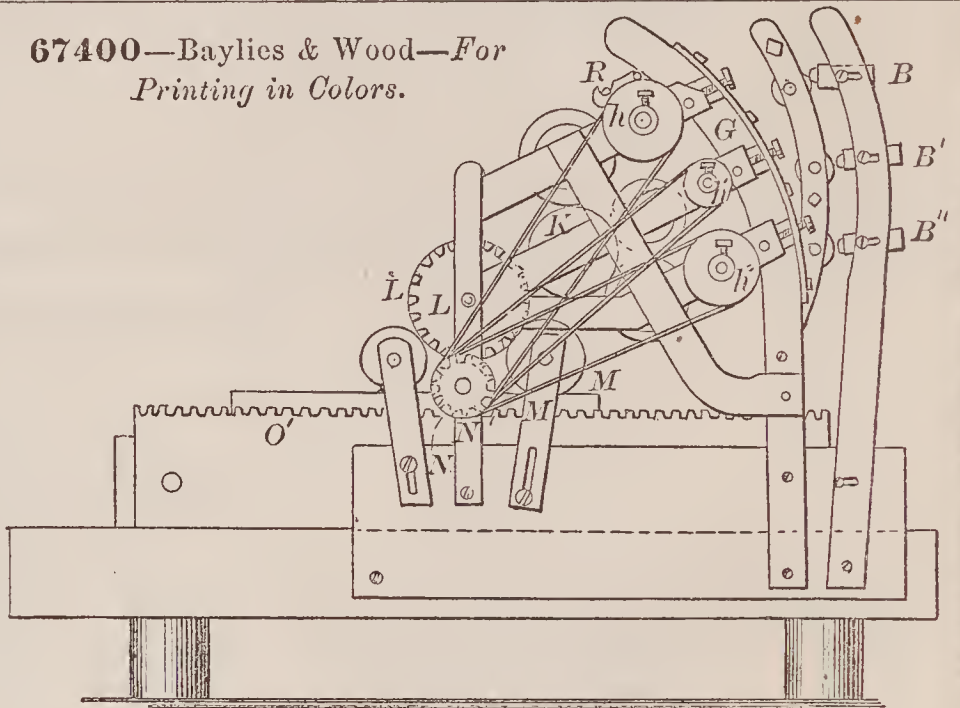

67398—L. Bailey—Bench Plane.

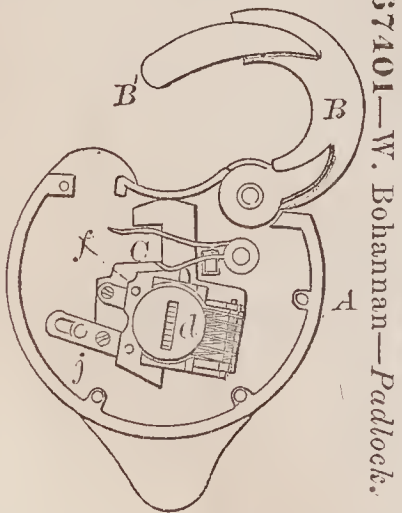

67401—W. Bohannan—Padlock.

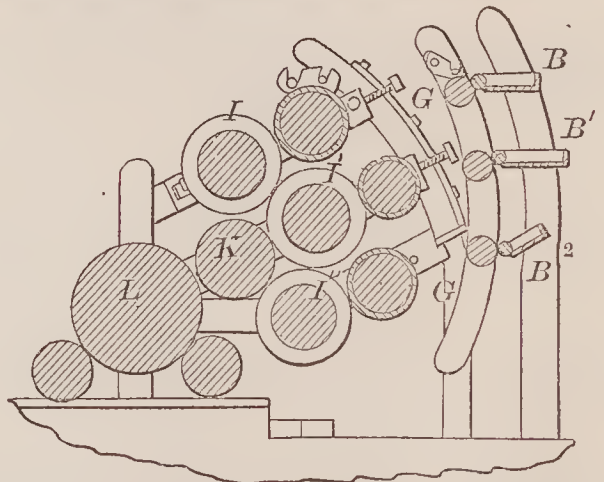
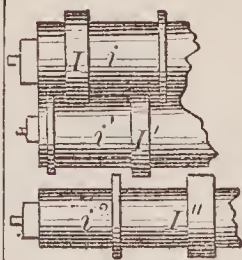

67402—C. F. Bosworth—Plate Lifter.

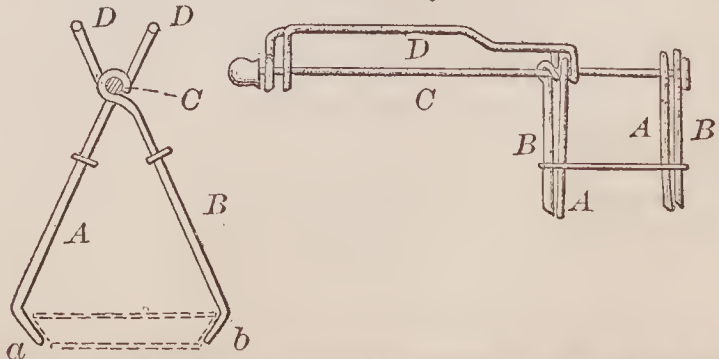



67403—J. R. Bridges—For Making Nuts.

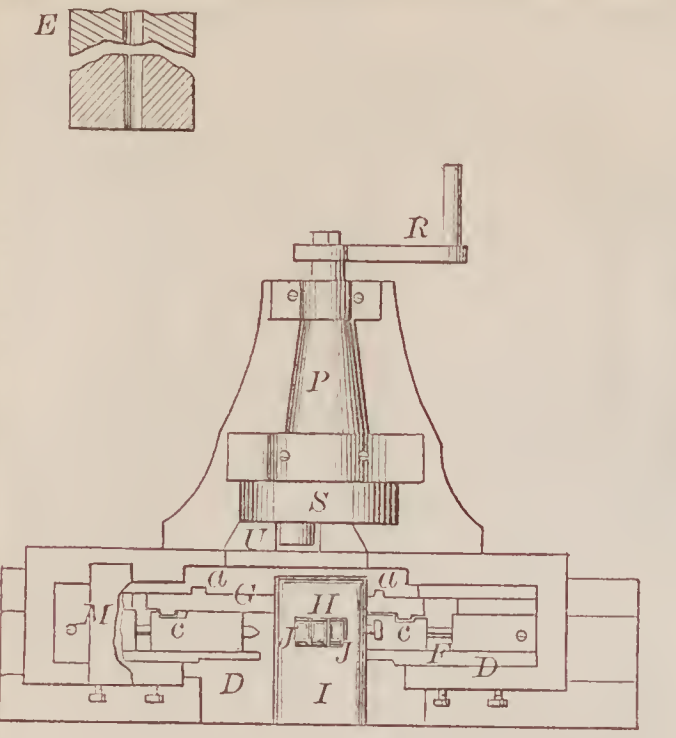

67404—P. Bright—Rolling Mill.

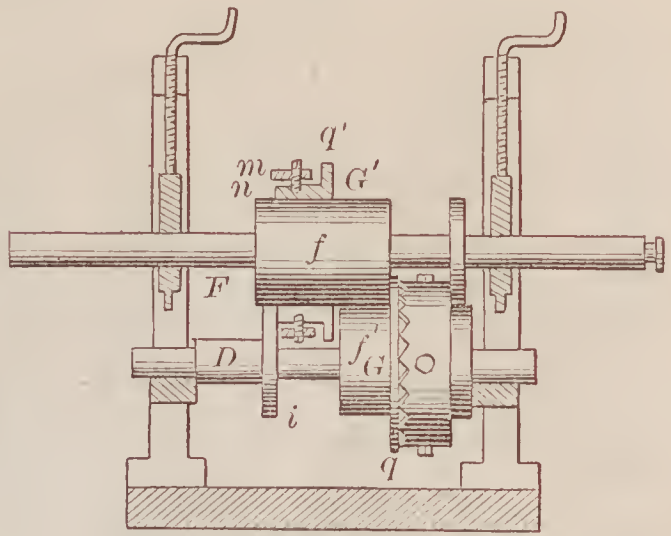

67406—J. P. Brown—Folding Table.

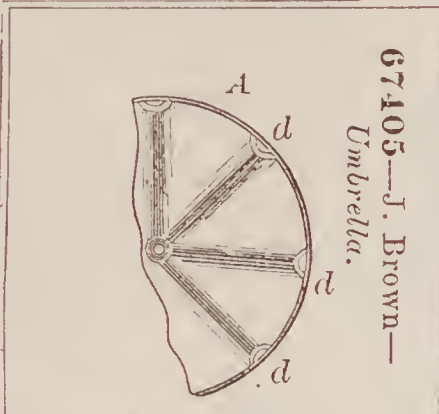
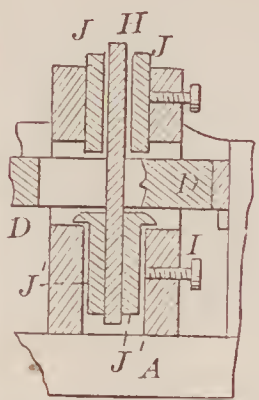
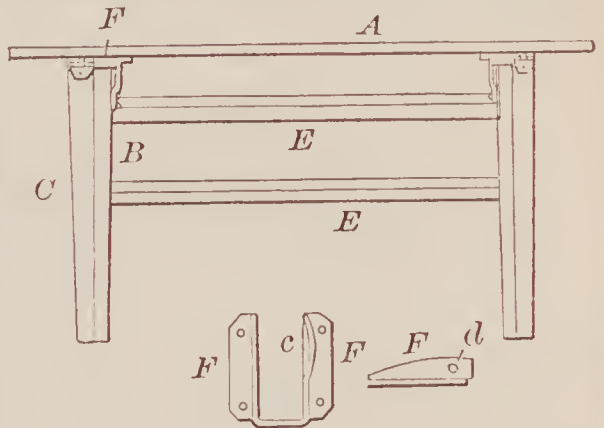

67405—J. Brown—Umbrella.

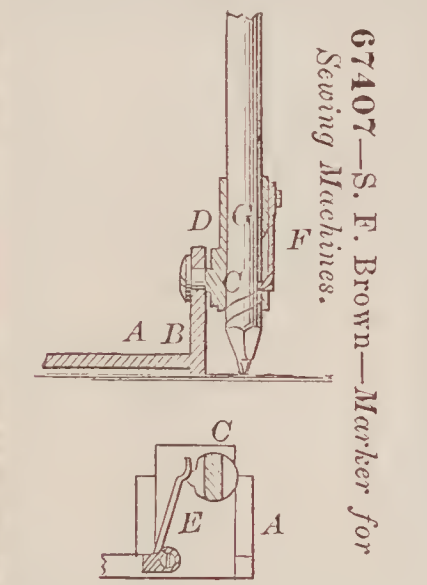

67407—S. F. Brown—Marker for Sewing Machines.

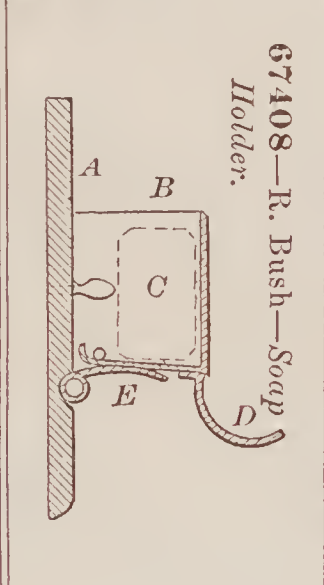

67408—R. Bush—Soap Holder.

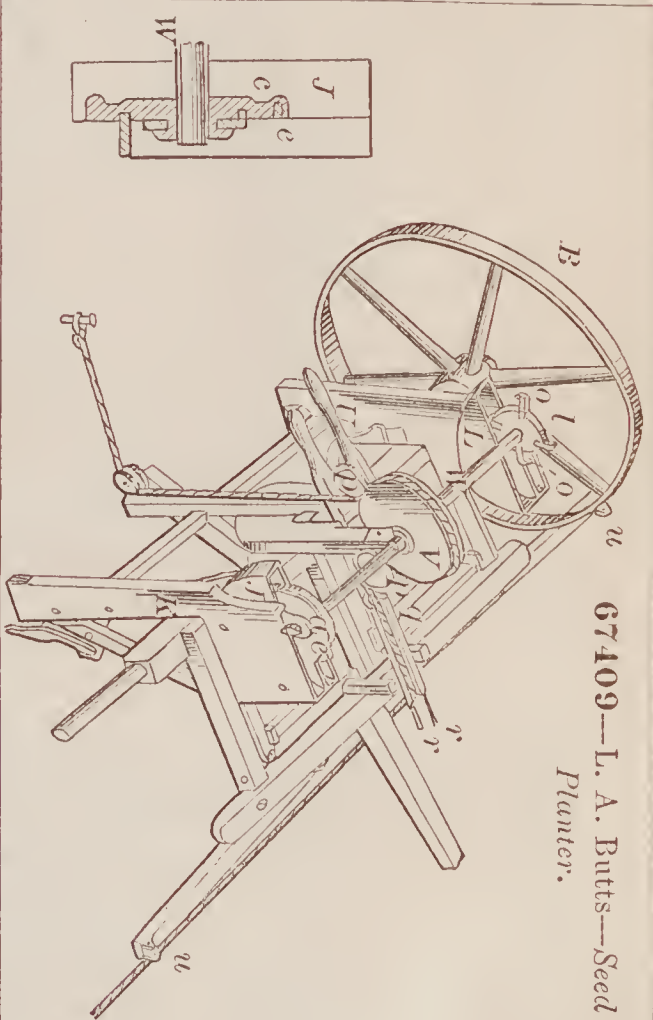

67409—L. A. Butts—Seed Planter.

67410—S. G. Cabell—Telegraphic Instrument.

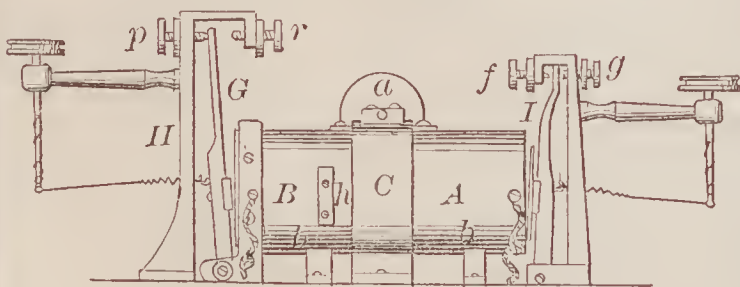

67411—G. Carr—Razor.

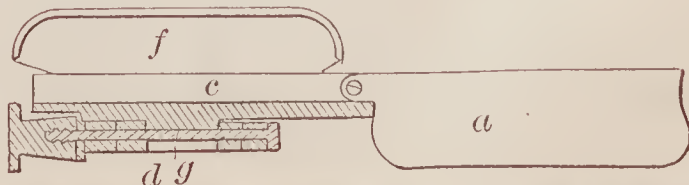
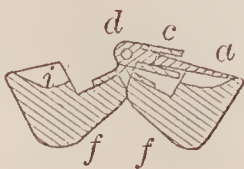



67412—H. Cash—Sash Pulley.

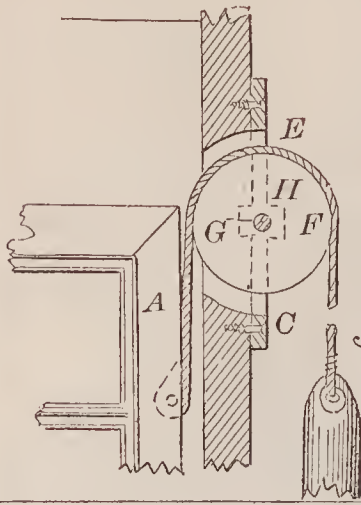

67413—N. L. Chappell—Steam Ejector.

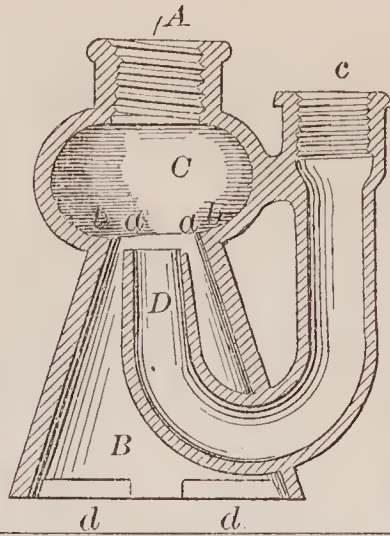

67415—Cox & Potter—Stove Pipe Damper.

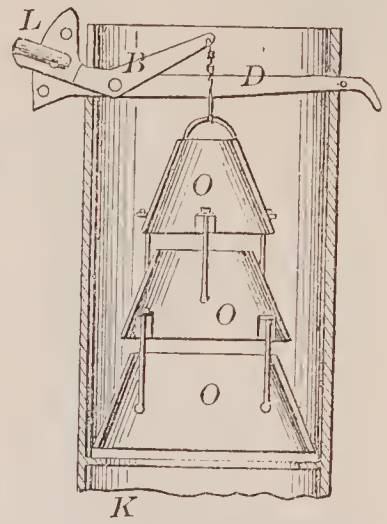

67414—A. W. Cheever—Last.

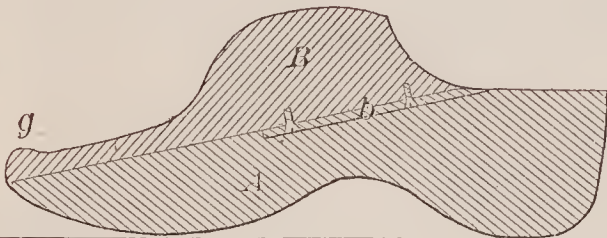

67418—H. M. Curtis—Buggy Top Joint and Fastening.

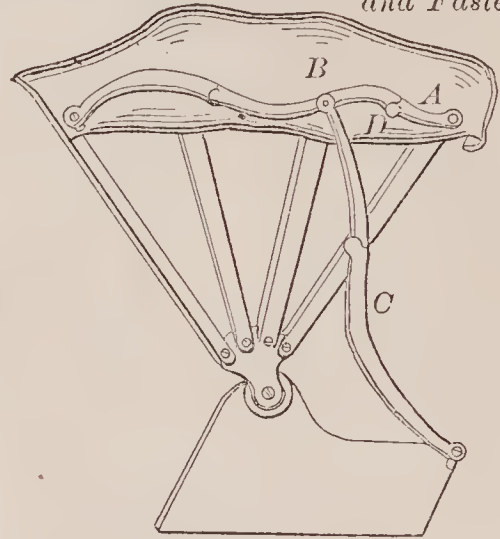

67419—W. A. Devon—For Raising and Lowering Ships' Boats.

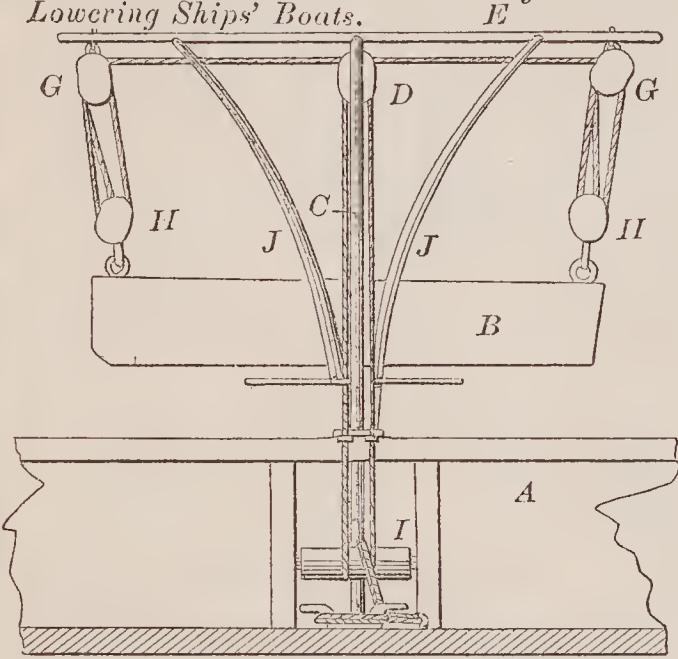

67420—H. Doebele—Bed Bottom.

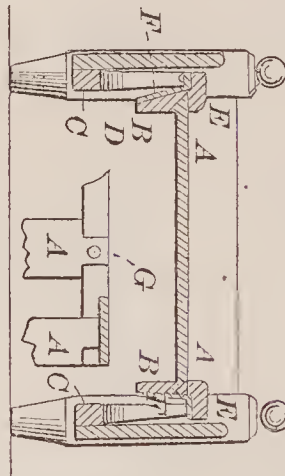

67417—F. A. Cramblitt—Pump Piston.

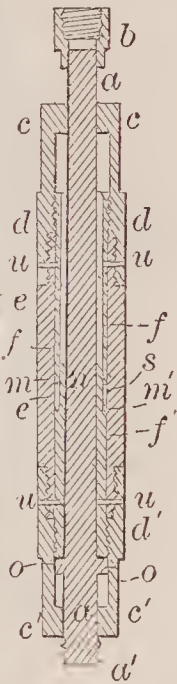

67421—G. Dunham—For Making Nuts.

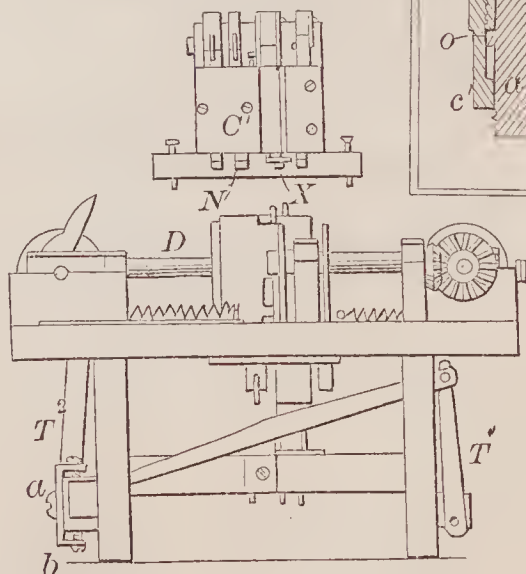
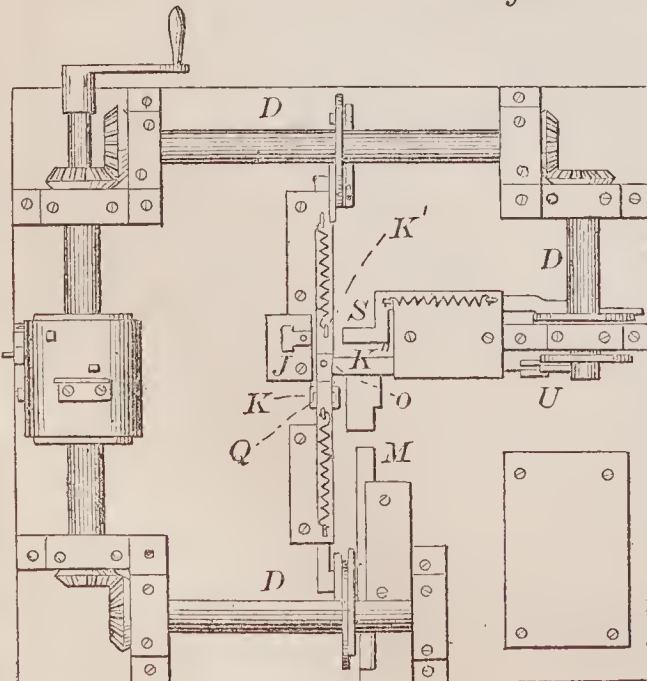



67422—Dyer & Drake—  
Boot and Shoe Heel.

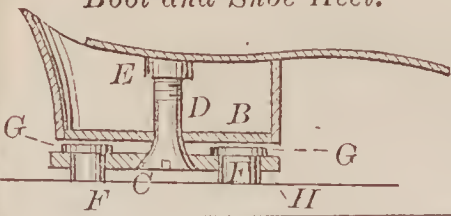

67424—Ely & Cook—  
Cap Primer.

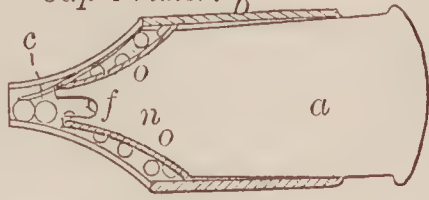

67425—S. B. Everitt—Tea  
Kettle.

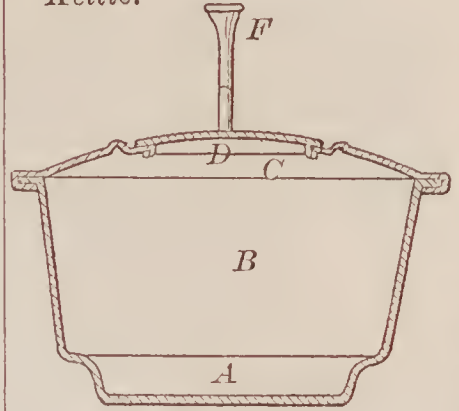

67423—P. T. Elting—Smut Machine.

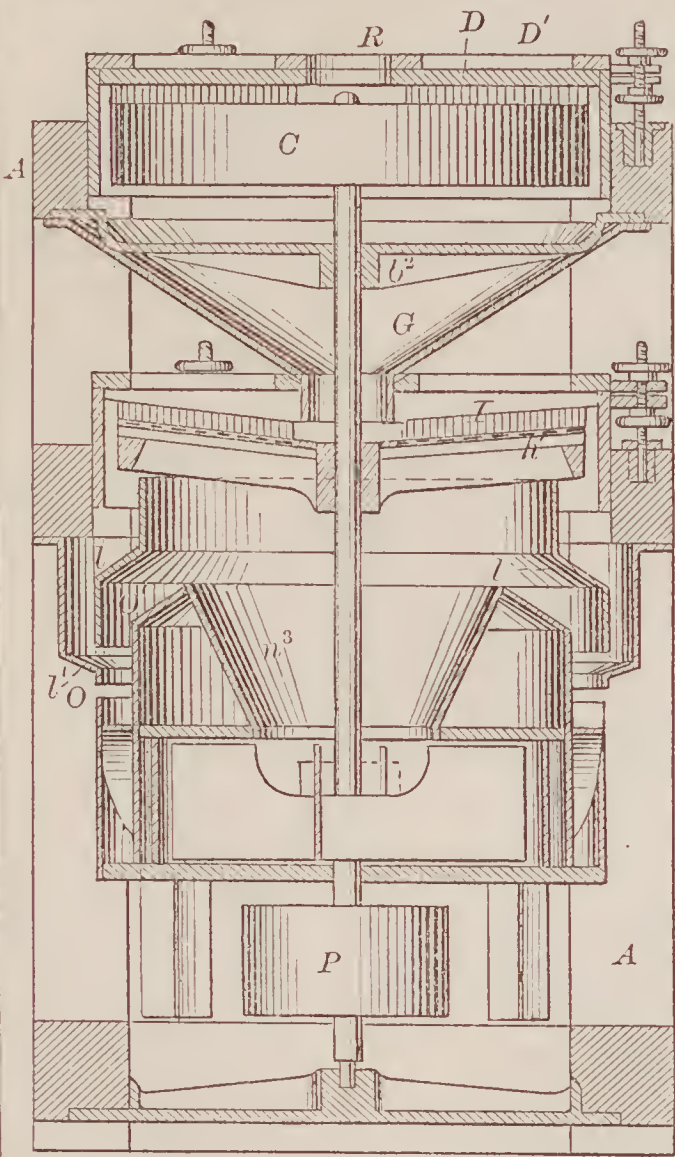

67428—  
G. L. Gerard—  
Buckle.

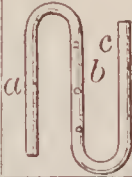

67429—T. E. Harris—  
Punching Apparatus.

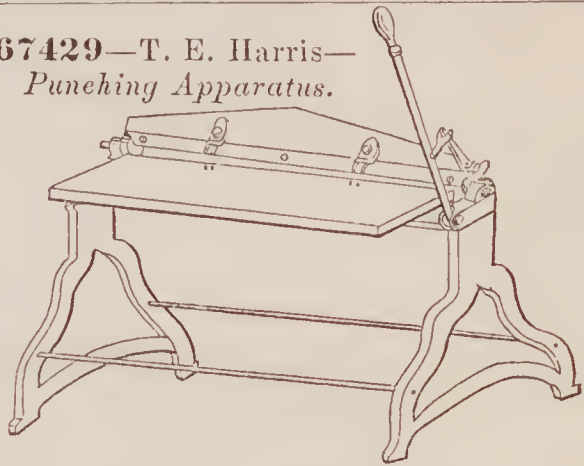

67426—Fletcher & Blanchard—Converting Cast Iron  
into Steel.

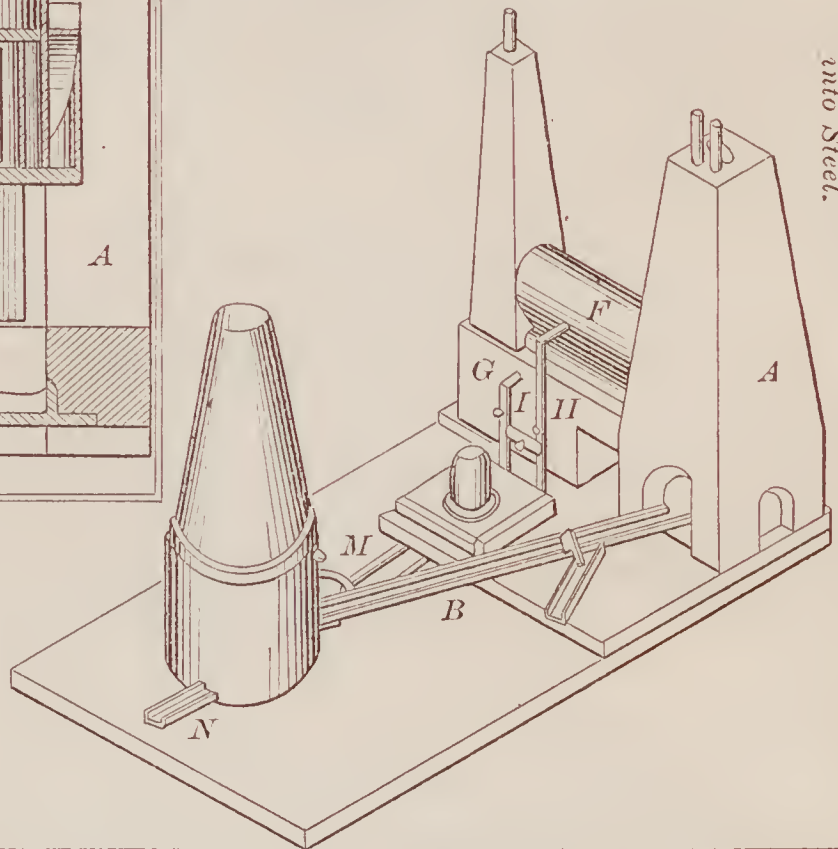

67430—S. L. Heisey—Cultivator.

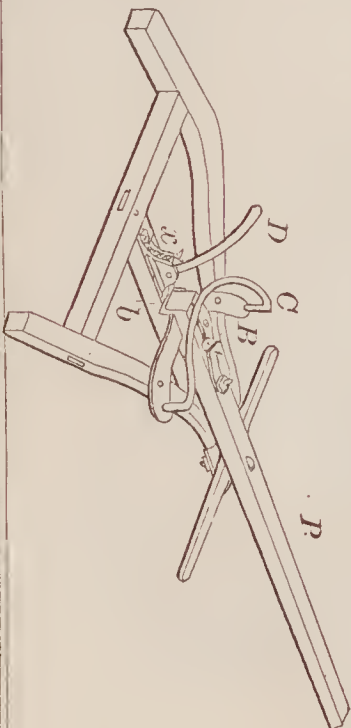

67431—Howell & Oliver—For Stretching Hides.

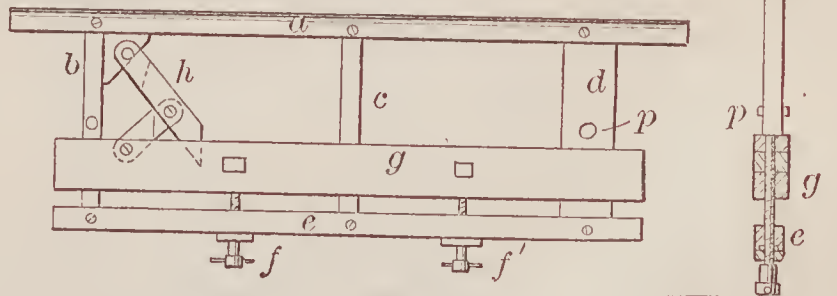

67432—S. W. Huntington—  
Inner Sole for Boots and  
Shoes.



67433—Ingram & Kennedy—  
Lighter for Vessels.





67434—I. Jewett—Knife Cleaner.

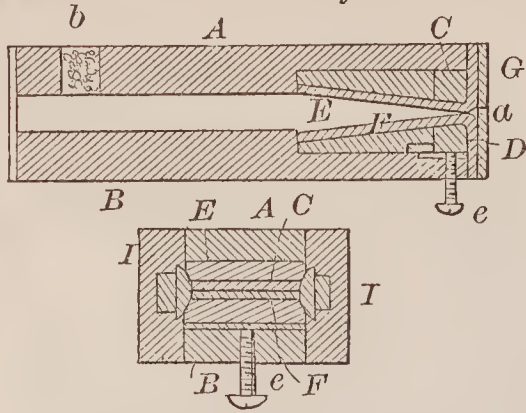

67436—P. Kraher—Bolster for Mattresses.

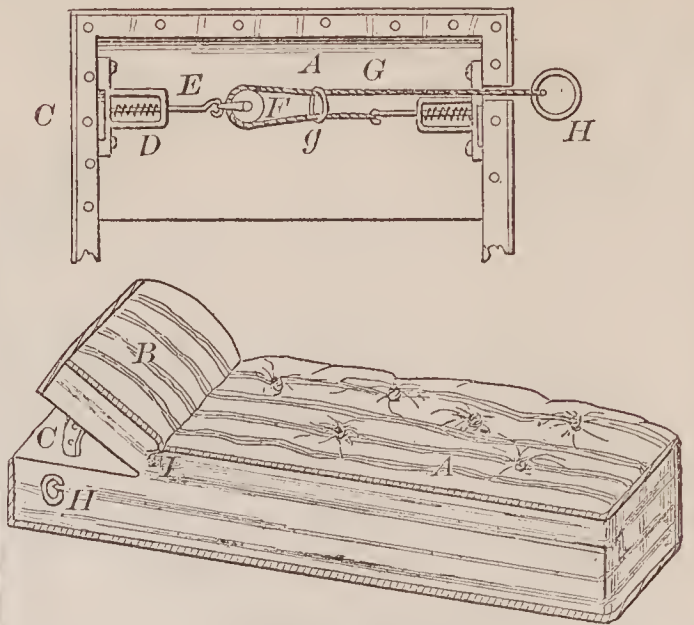

67435—H. H. Johnson—Broiler.

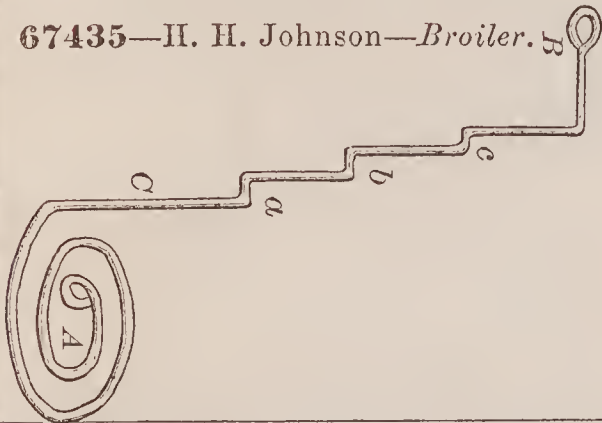

67437—G. A. Keene—Feathering Paddle Wheel.

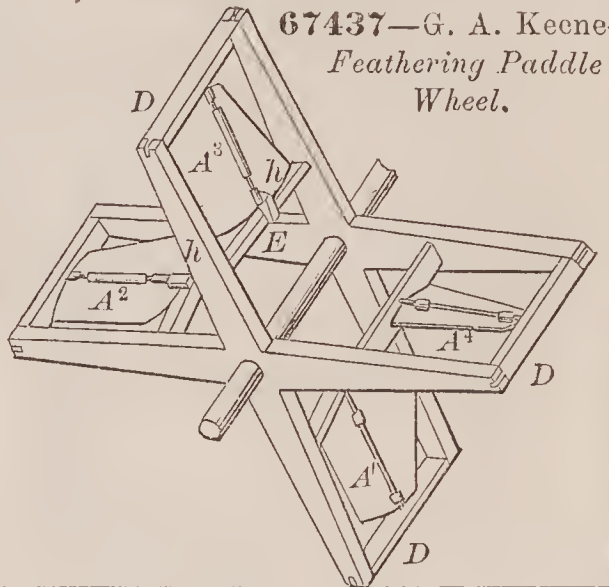

67438—S. Lemon, Jr.—Lubricator.

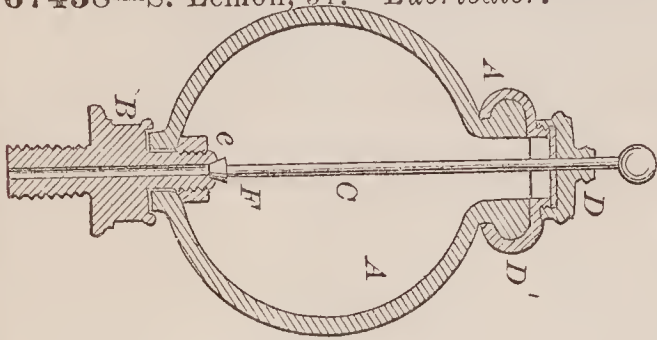

67441—A. Martin—Corn Cultivator.

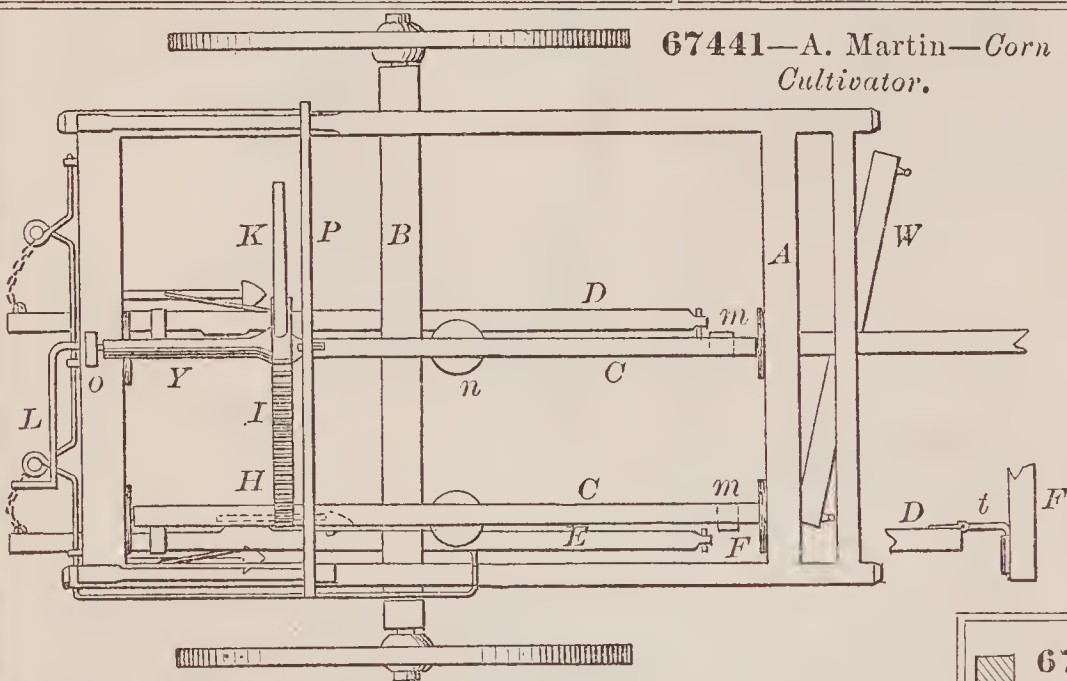

67440—C. Manheim—Securing Rubber Rolls to Shafts.



67442—S. McDonald—Bed Bottom.

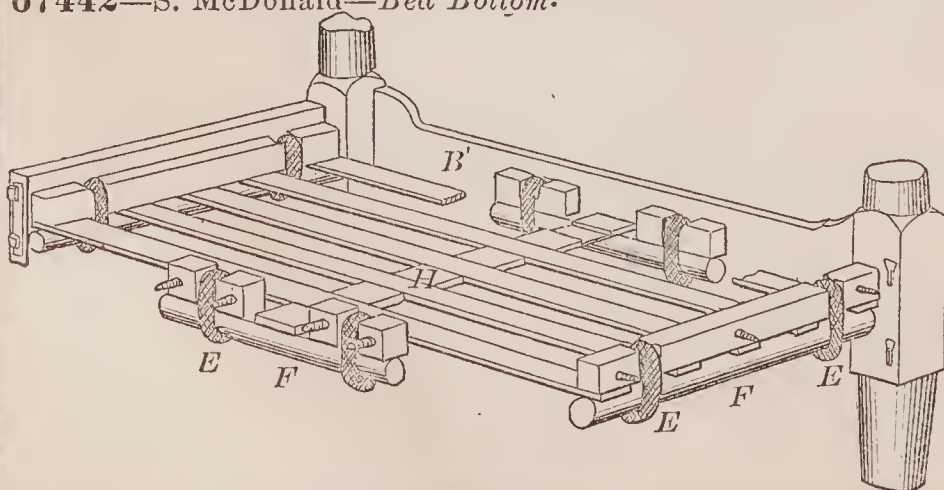

67439—W. O. Leslie—Brick Machine.

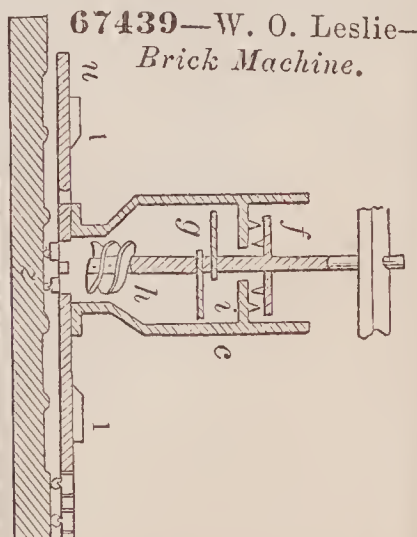



67443—McLaughlin & Jones—Railroad Switch.

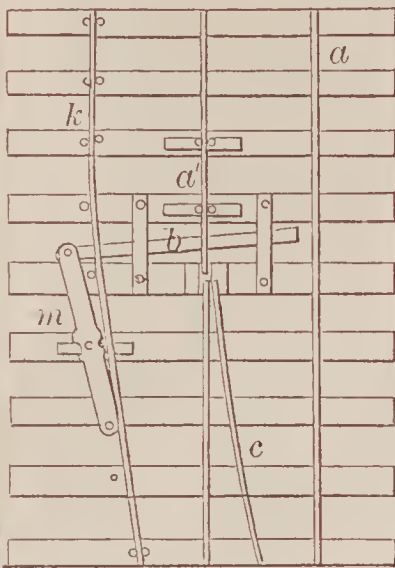

67445—O'Harra & Brown—Furnace for Roasting Ores.

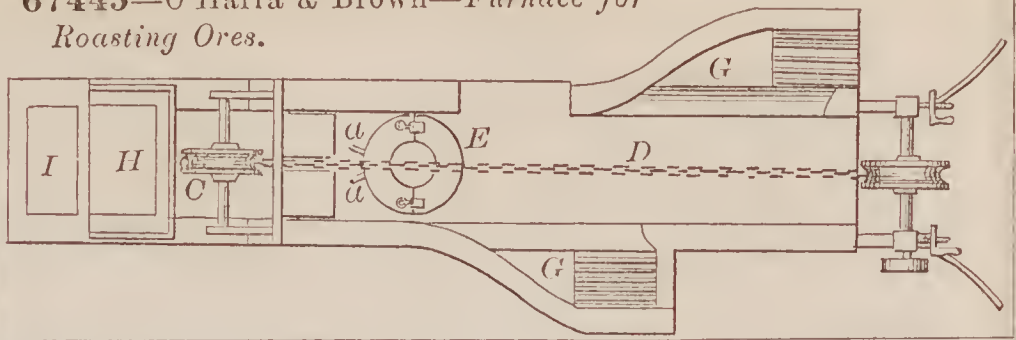

67444—Mitchell & Search—Corn Planter.

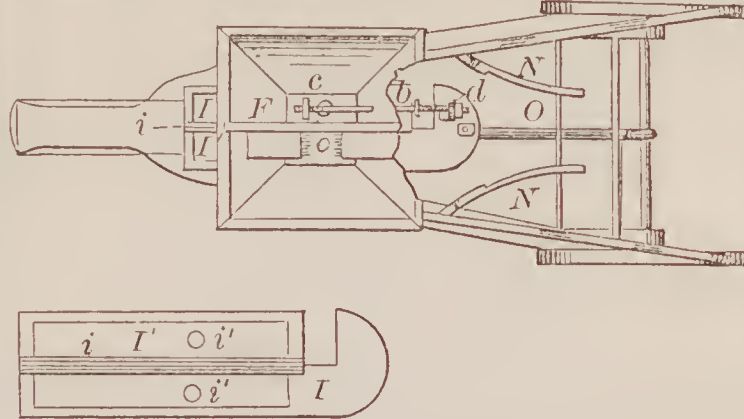

67446—D. Oliver—Fence Post.



67447—A. Paraf—

Manufacture of Ammonia.

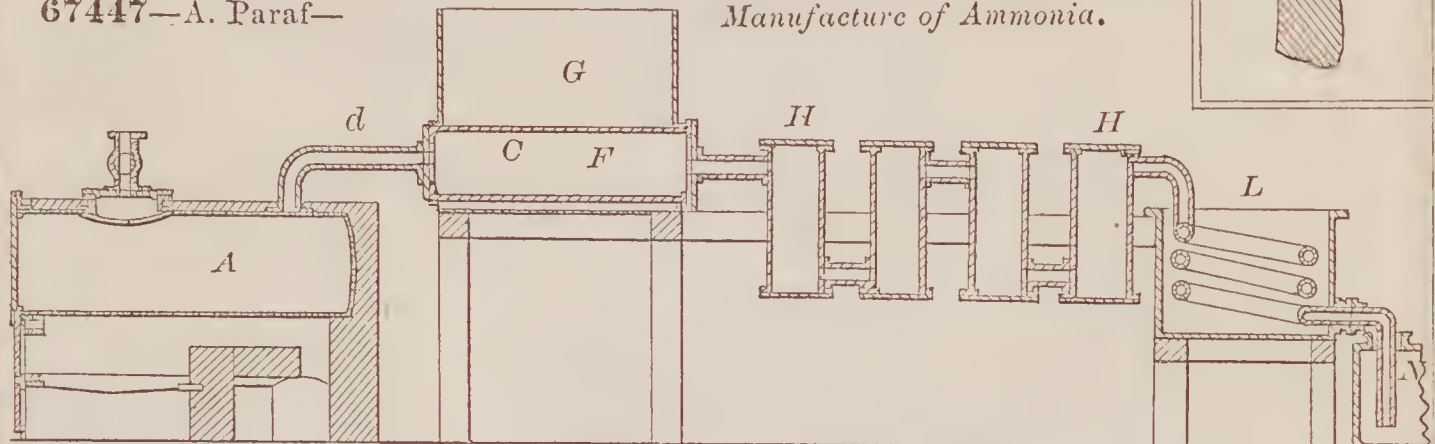

67452—Purdy & Barger—Boiler.

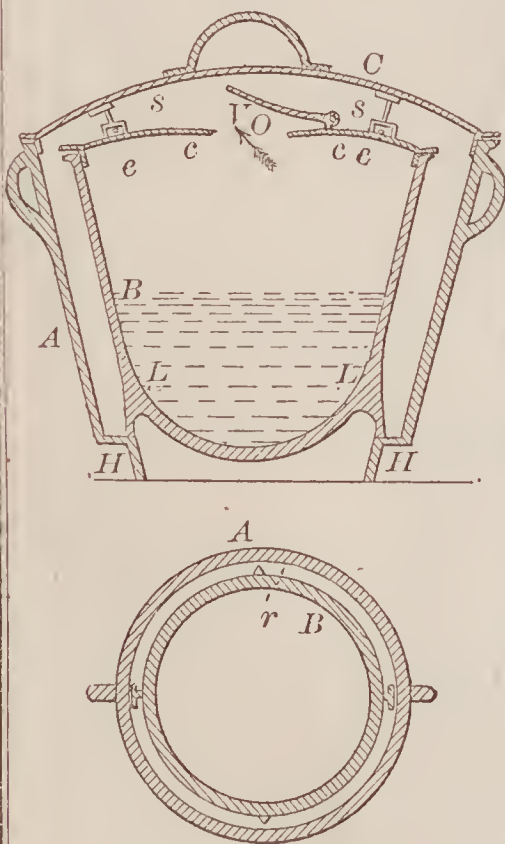

67451—D. R. Pratt—Splicing Railroad Rails.

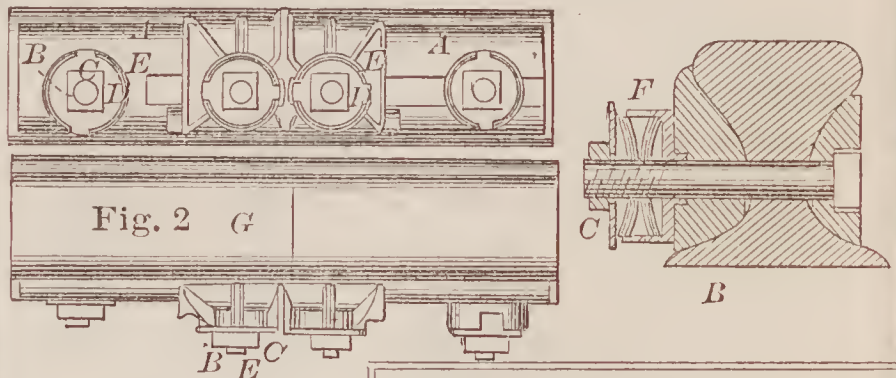

67448—O. B. Payne—Trace Buckle.

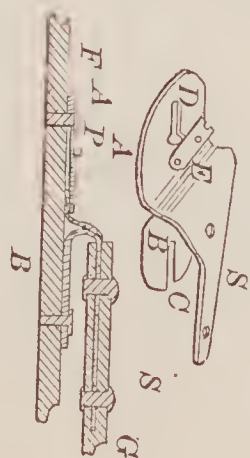

67449—Peabody & Cowles—For Dressing and Renovating Feathers.

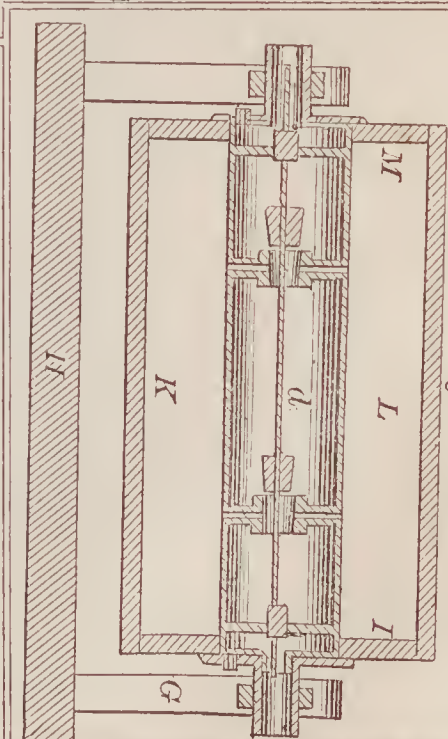



67453—Riggs & Albin—Washing Machine.

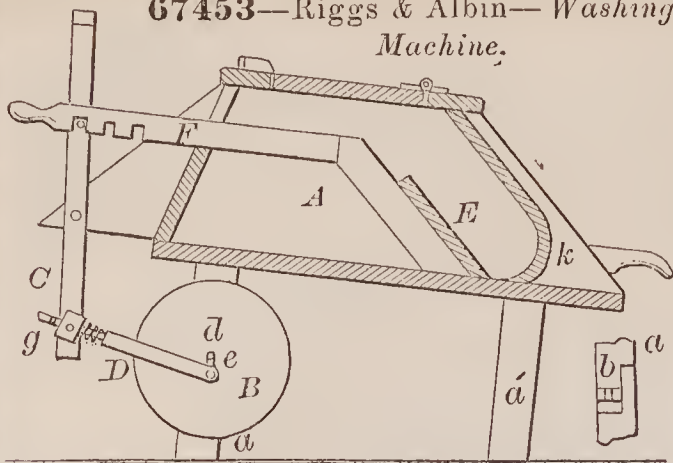

67454—S. E. Robbins—Platform Scales.

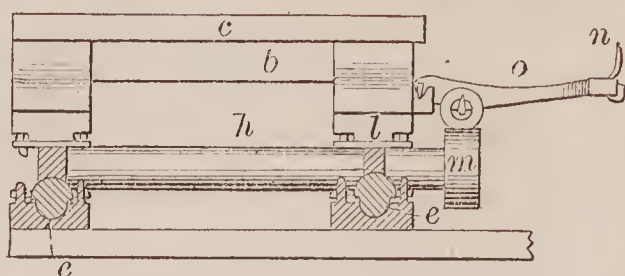

67456—E. Seward—Plow.

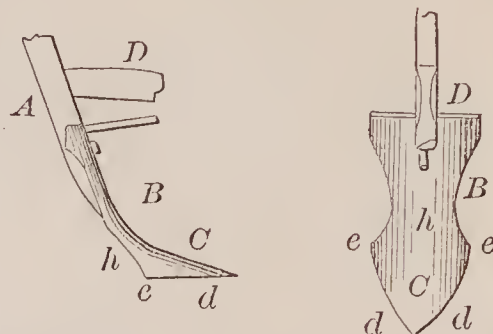

67457—J. Sholl—Furnace.

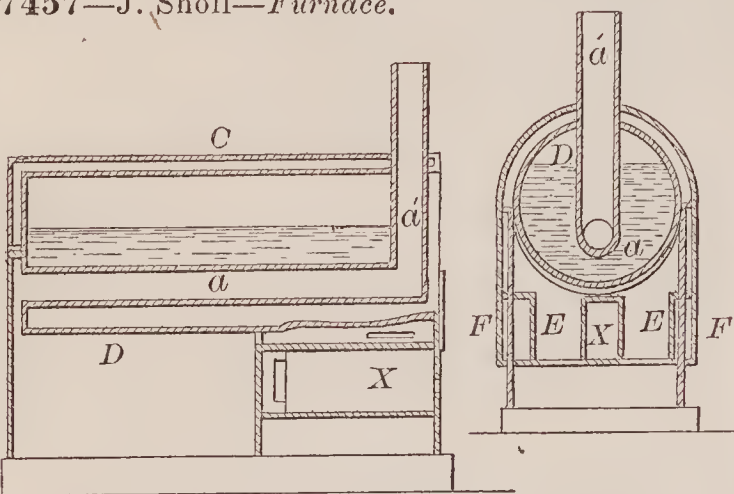

67461—S. Taylor—Dust Brush.

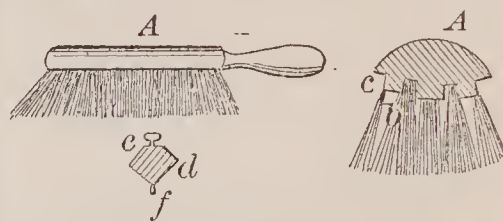

67458—Spooner & Johnson—Carpenter's Plane.

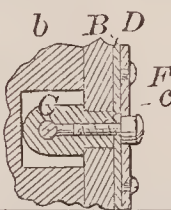
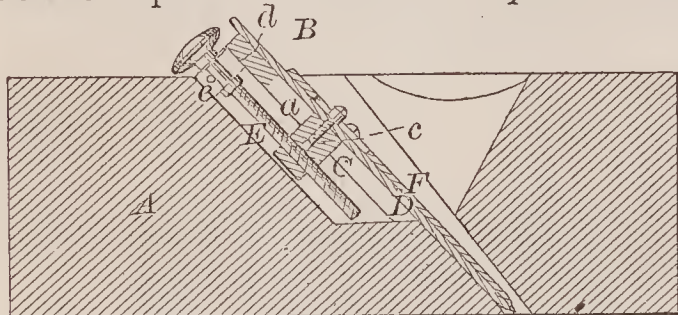

67463—C. E. Thompson—Screw Head Caps.

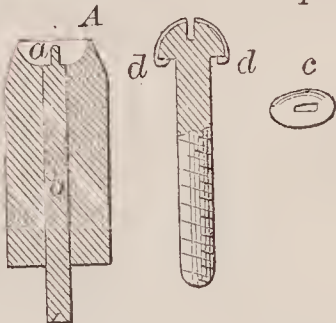

67459—J. D. Starritt—Clothes Line Reel.

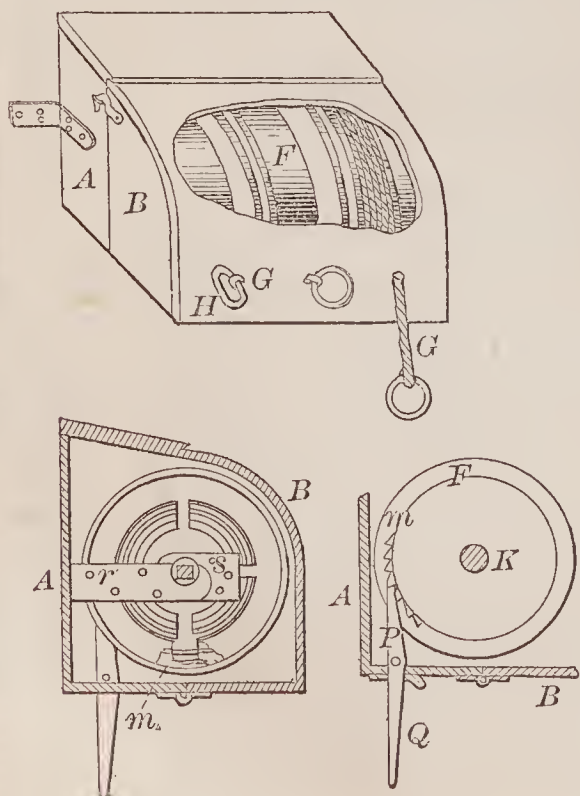

67464—R. S. Torrey—Tool Extractor.

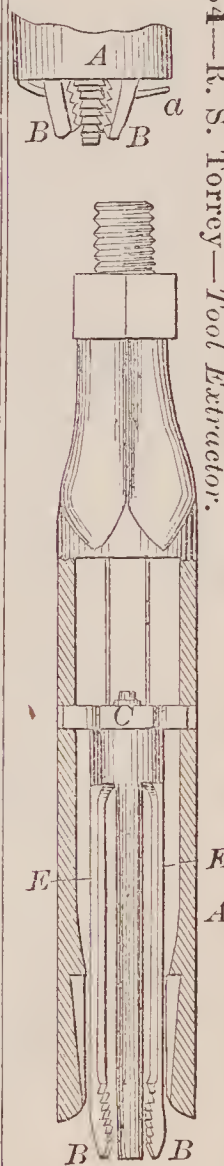

67460—J. Stowell—Safety Lock.

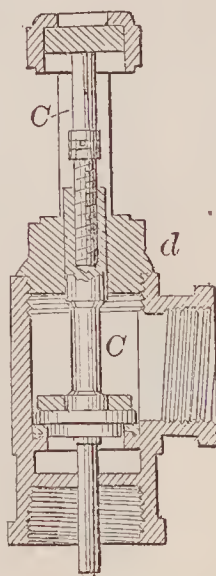

67462—A., A. F. & A. Thoma—For Setting Jewels.

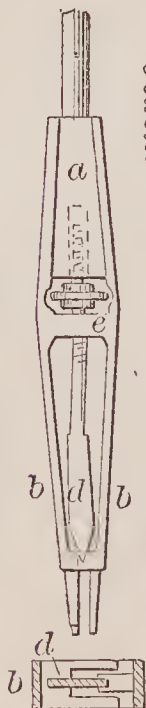



67465—L. A. Tripp—  
Window Shade Fixture.

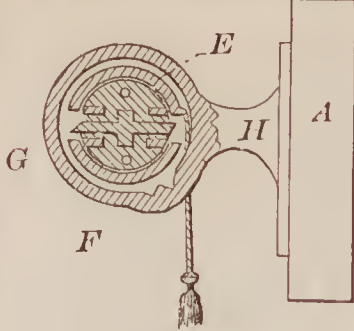

67466—J. E. Van Riper—Harrow.

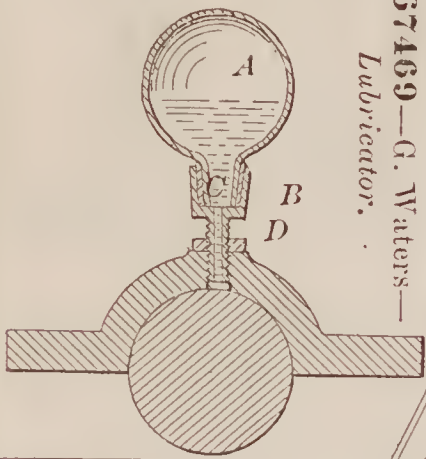
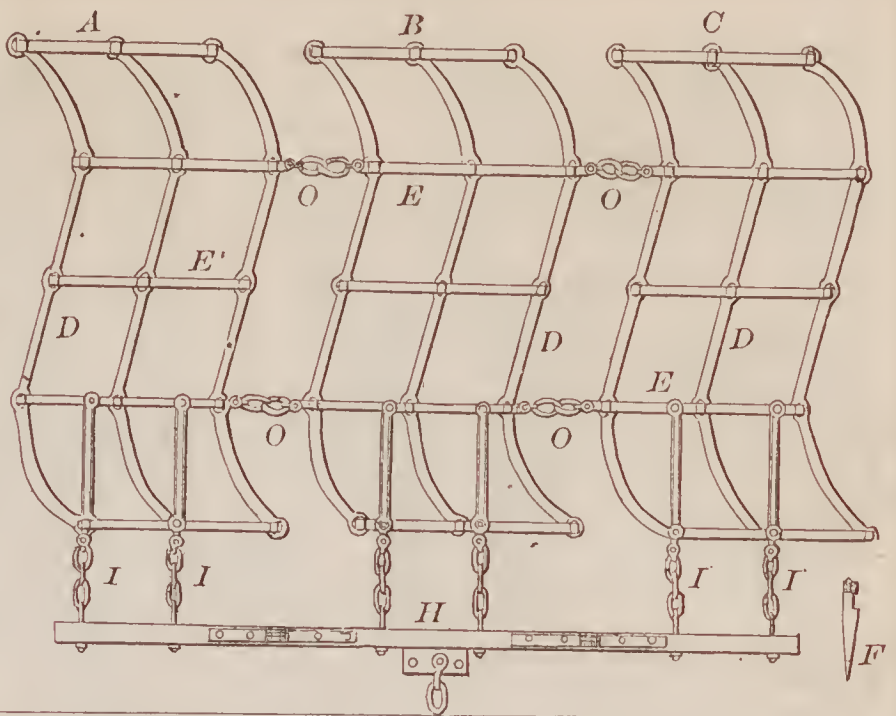

67469—G. Waters—  
Lubricator.

67473—Wicker & Williams—  
Variety Frame Lathe.

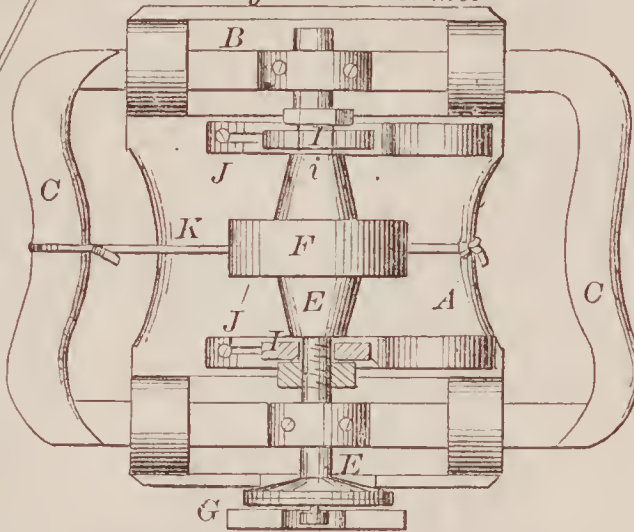

67472—M. V. B. White—  
Sash Fastening.

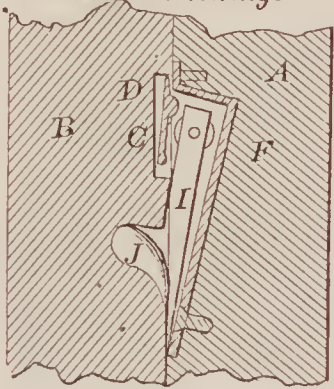

67468—Warner & Palmer—Car Coupling.

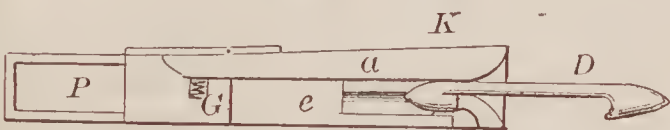

67475—Woods & Tuttle—Printing Press.

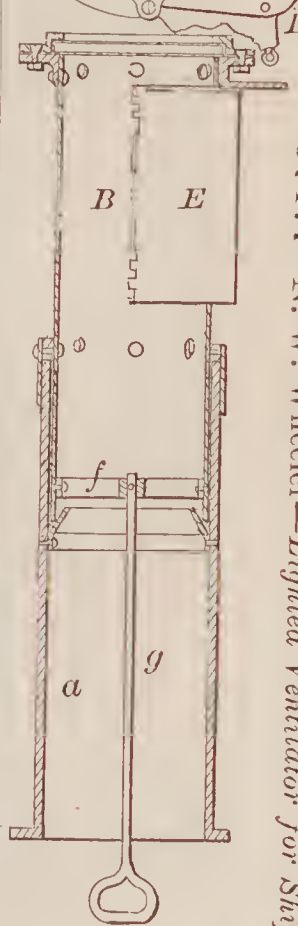
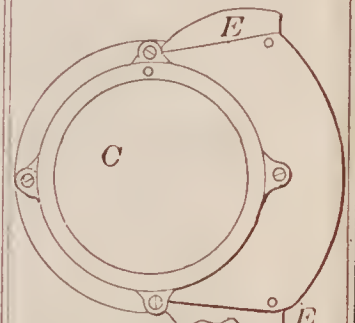
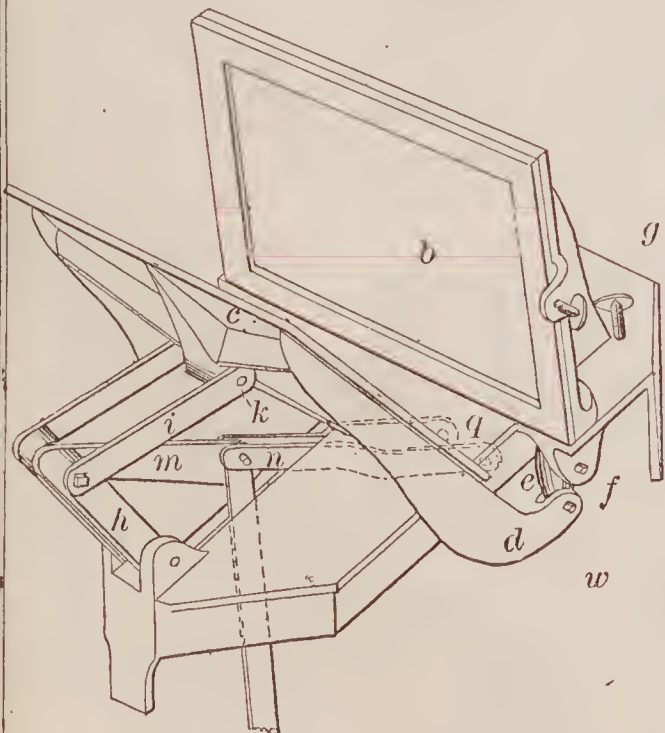

67471—N. W. Wheeler—Lighted Ventilator for Ships.

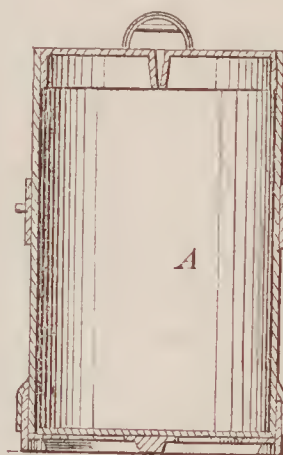

67474—Wiles & Wodd—Milk Can Bottom.

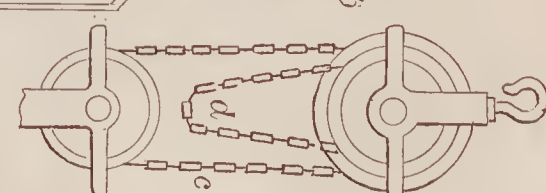
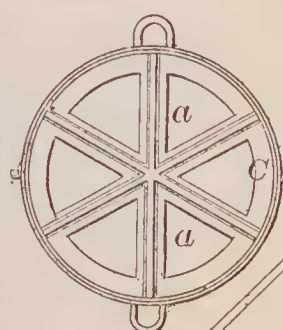

67470—T. A. Weston—Pulley.



67476—E. B. Allen—Piston Packing.

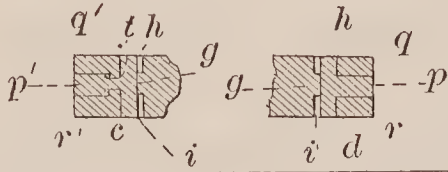

67477—M. Anderson—Chimney Cap.

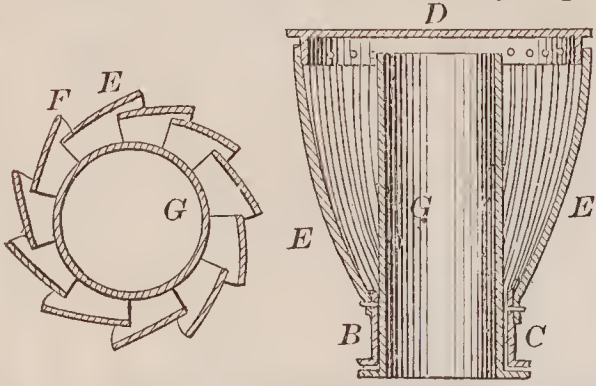

67480—E. C. Atkins—For Grinding Saws.

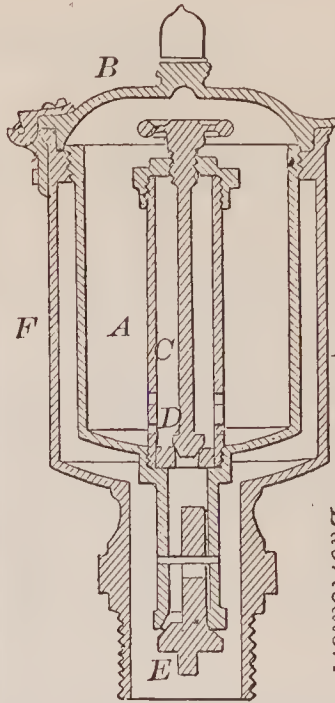
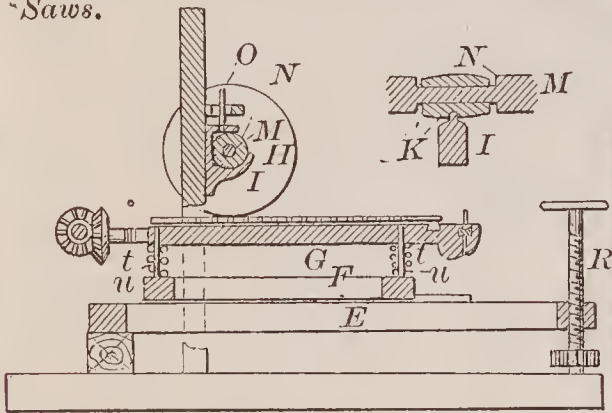

67478—E. H. Ashcroft—Steam Cylinder Lubricator.

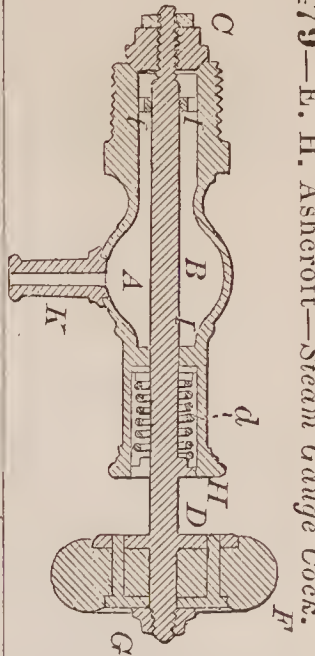

67479—E. H. Ashcroft—Steam Gauge Cock.

67481—W. C. Banks—Cotton Seed Planter.

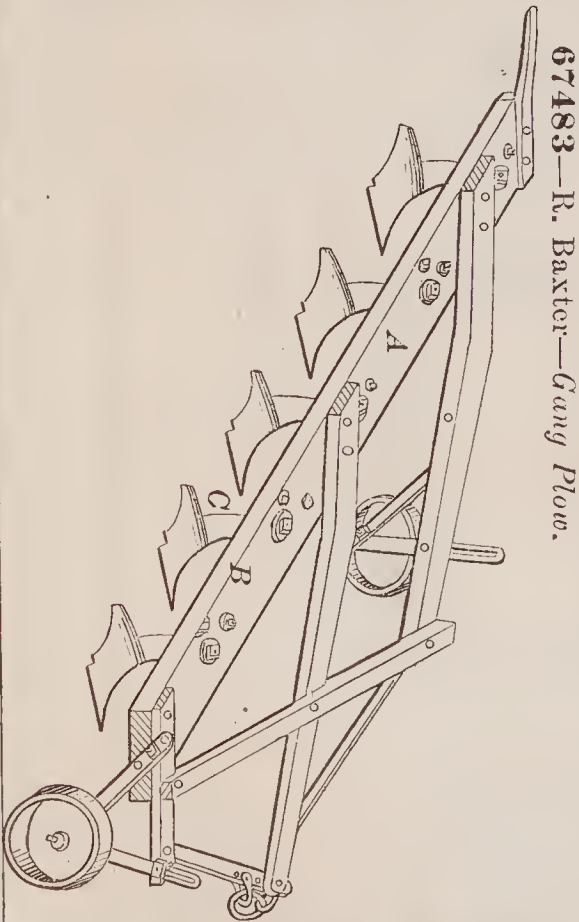
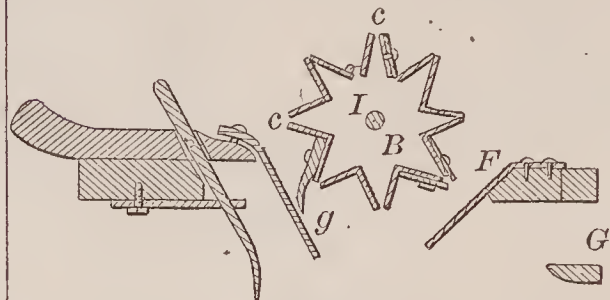
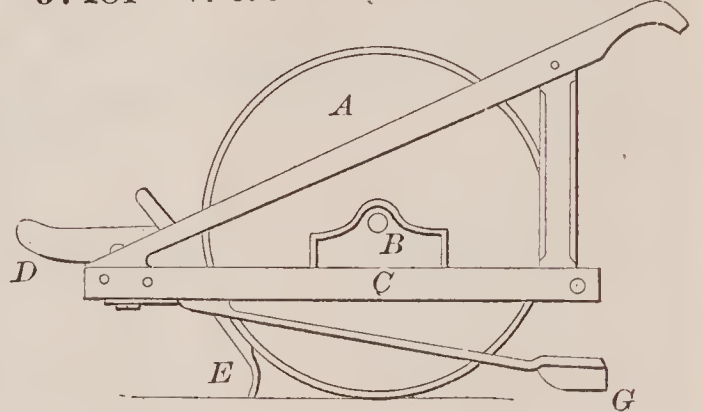

67483—R. Baxter—Gang Plow.

67484—E. Bennett—Thill and Pole Coupling.

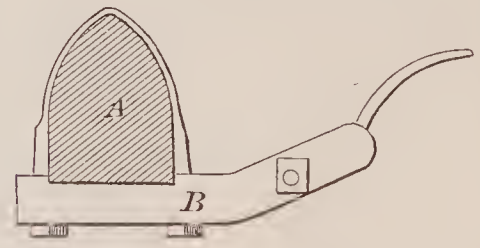

67482—W. G. Barker—Spring Balance.

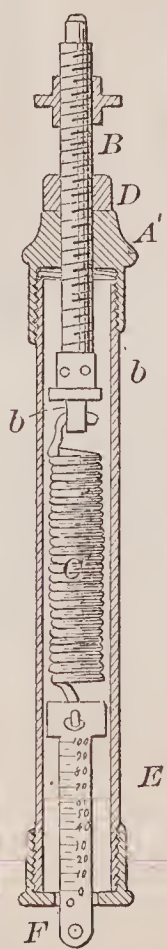

67486—J. Bird—Loop for Bearing Chains.

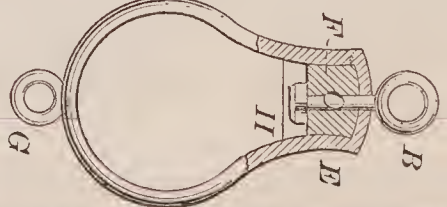

67485—A. Bingham—Chair Seat.

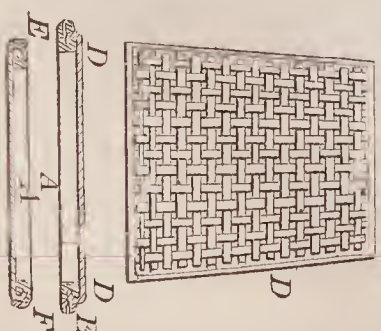



67487—E. Bostock—Adjustable Parallel Ruler.

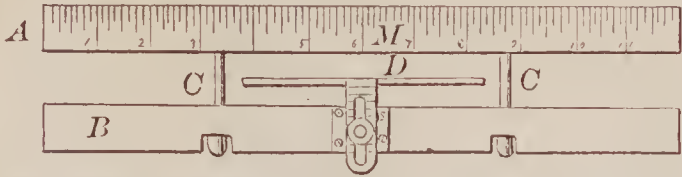

67488—F. G. Botmer—Slate Pencil Sharpener.

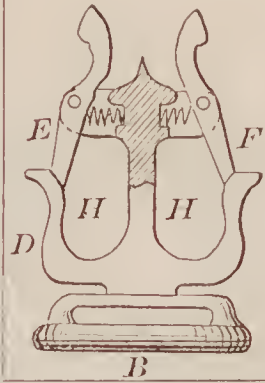

67489—T. J. Bottomley—Troy Holder.

67490—W. F. Brabrook—Harvester.

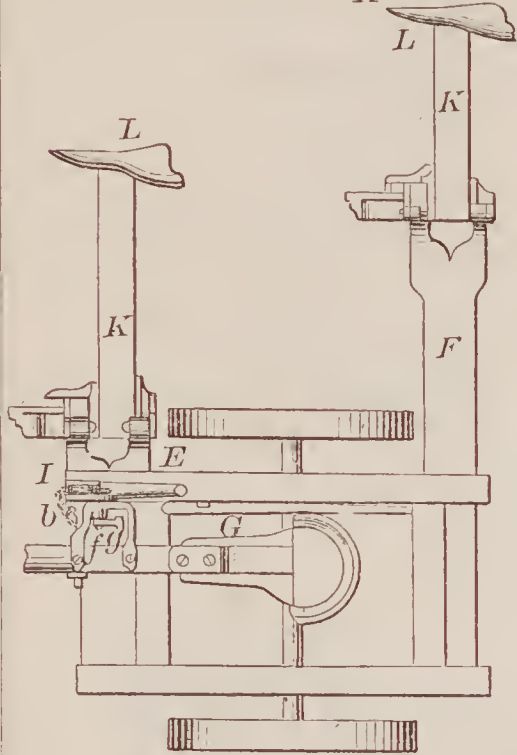
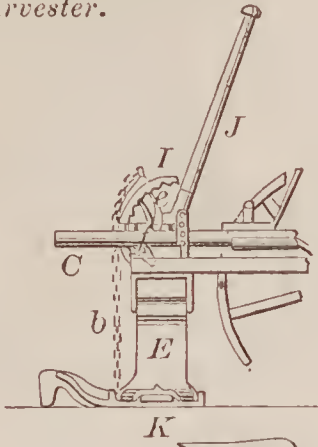

67492—J. Bühner—For the Combustion of Fuel.

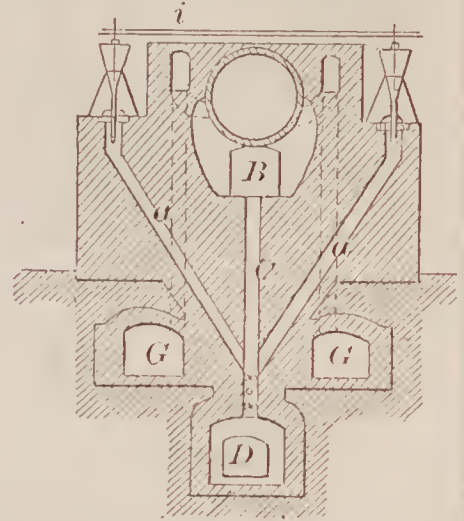
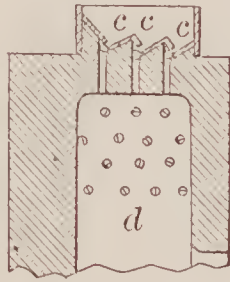

67494—D. Burnett—Elevated Bedstead.

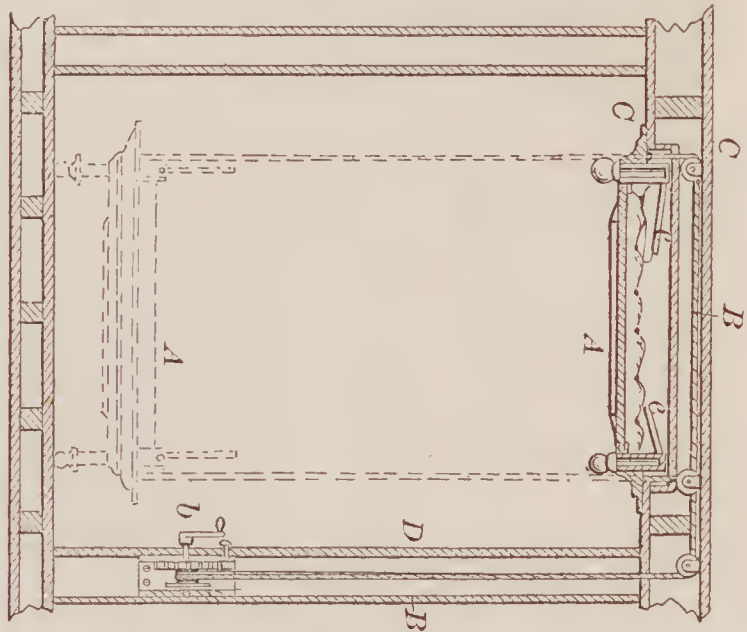

67493—J. L. Burch—Splint.

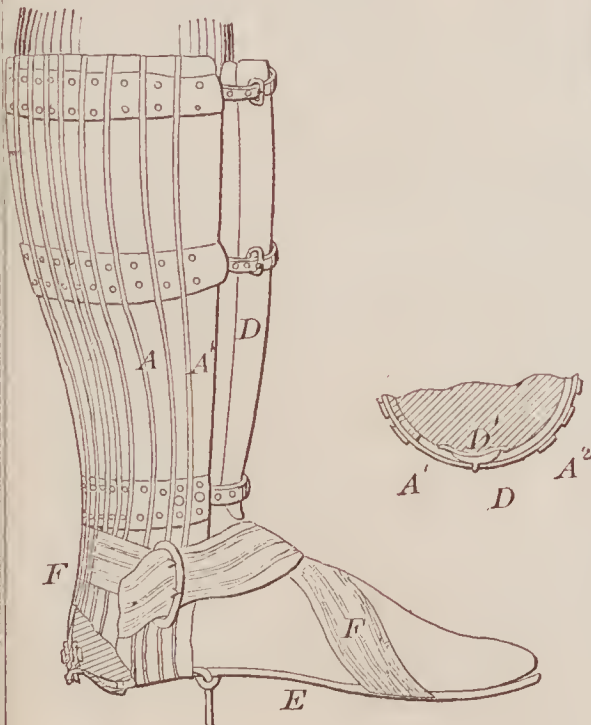

67495—J. D. Carter—For Straightening Sheet Metal.

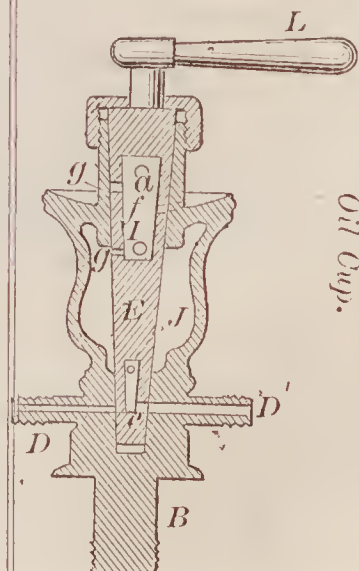
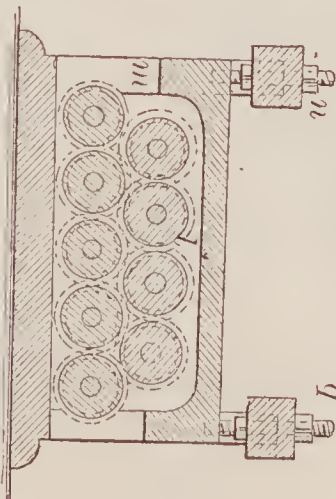

67496—T. Chatterton—Steam Engine Oil Cup.



67497—T. J. Chubb—Furnace for Oxydizing Ores.

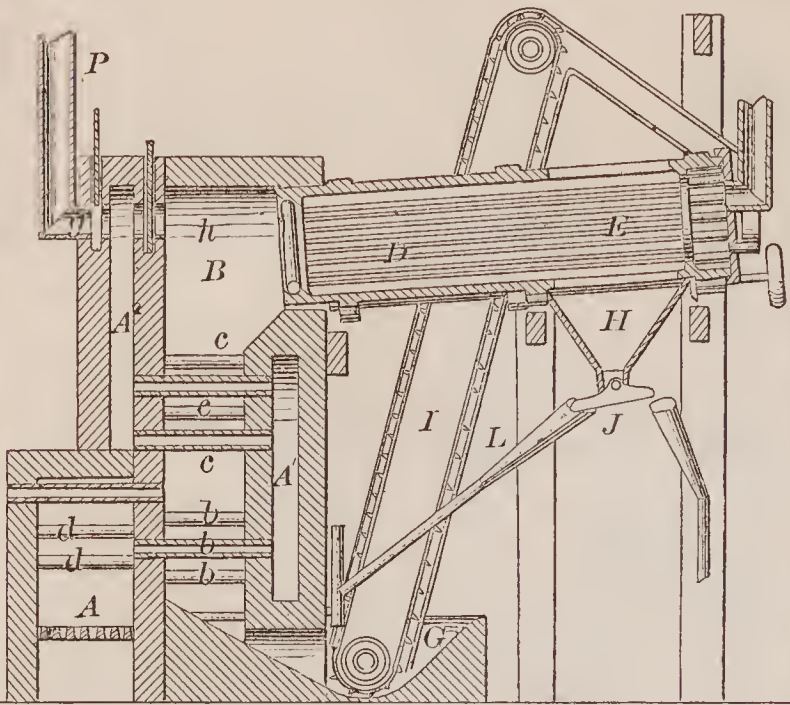

67498—T. J. Chubb—Analgamator.

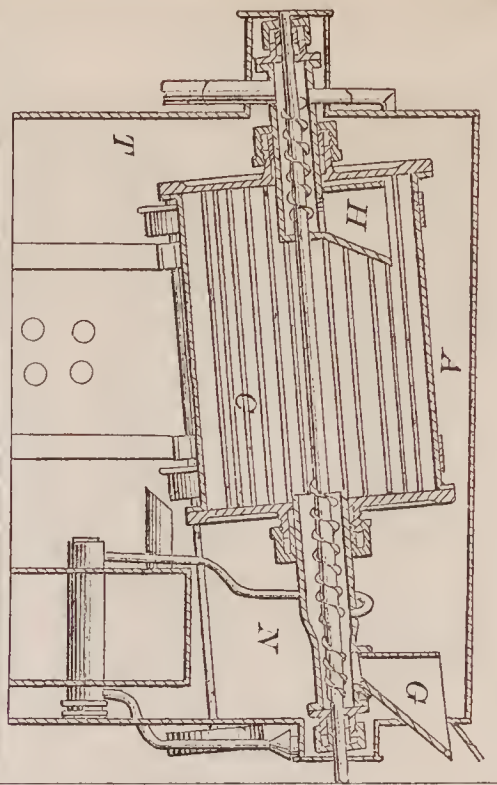

67501—A. T. Covell—Gang Plow.

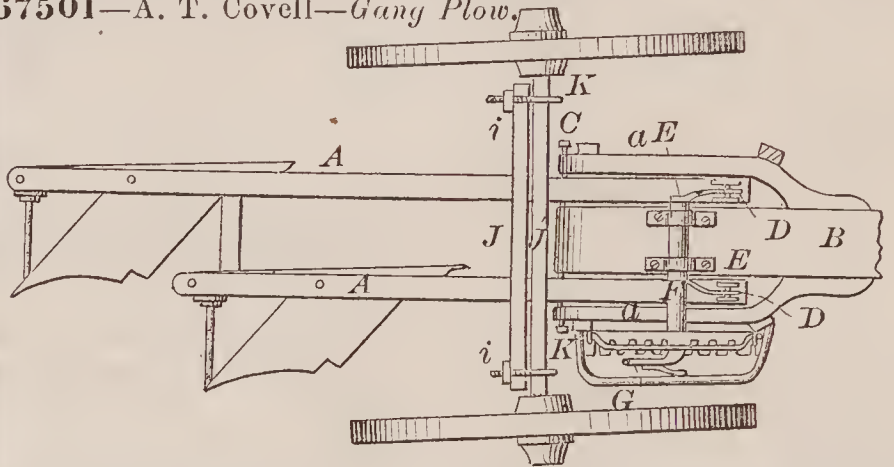

67499—J. B. Coffin—Washing Machine.

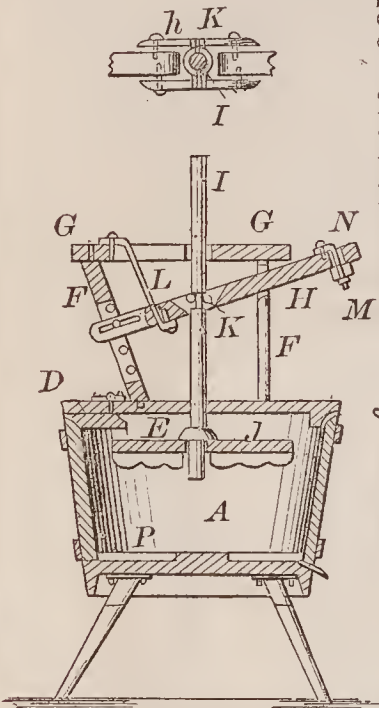

67500—E. G. Cone—Cast Iron Bell.

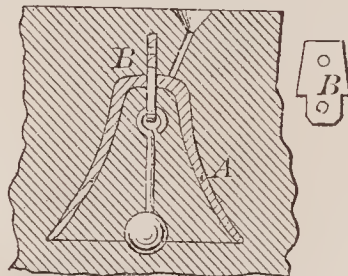

67503—R. T. Crane—Steam Heater.

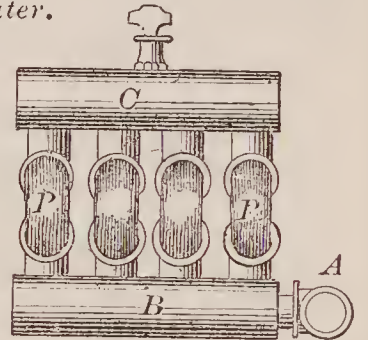

67502—R. T. Crane—Pattern for Casting Steam Pipe Supports.



67505—R. T. Crane—Steam Generator for Heating.

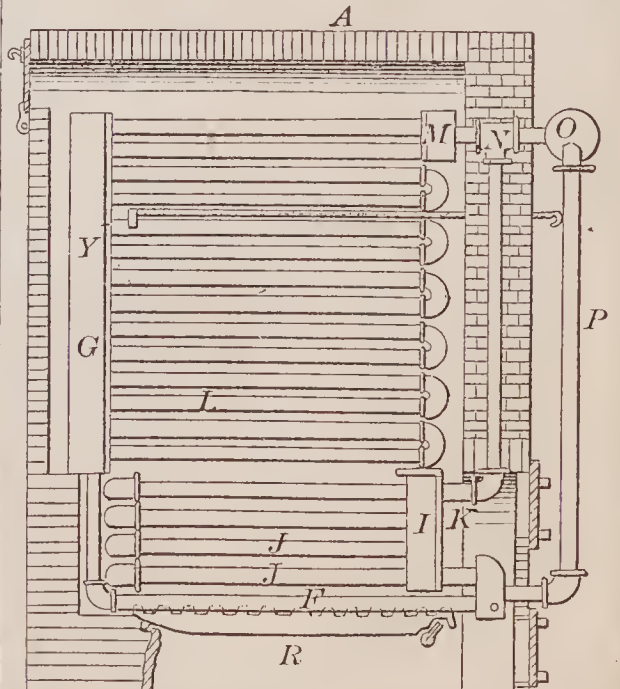

67504—R. T. Crane—Steam Heater.

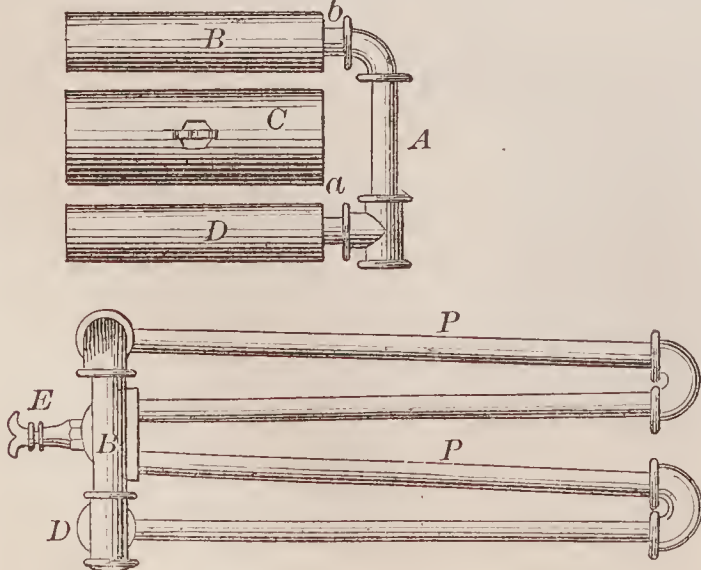



67506—R. T. Crane—Low Water Alarm for Steam Generators.

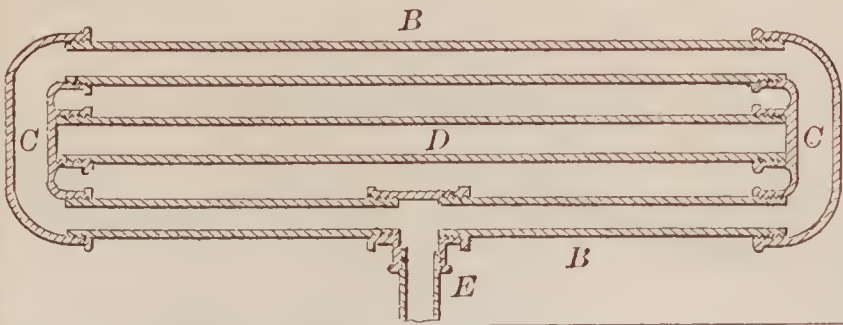

67507—A. J. Cronk—Pad Tree.

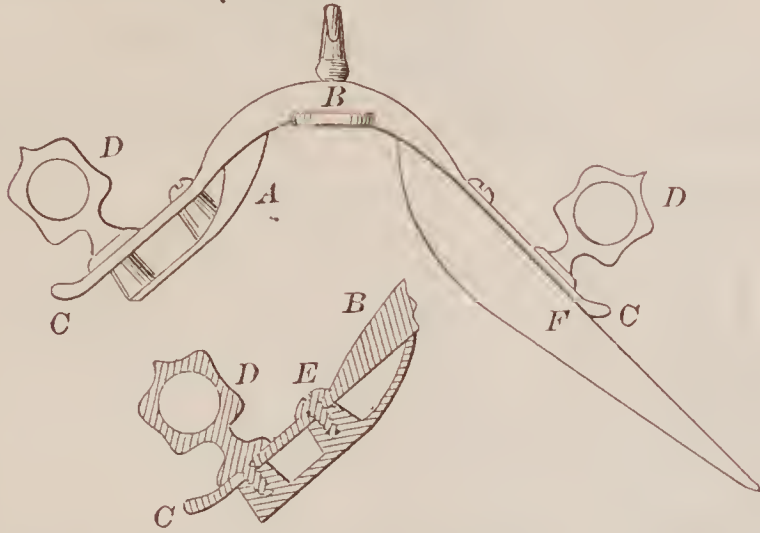

67511—M. V. Cummings—Oscillating Engine.

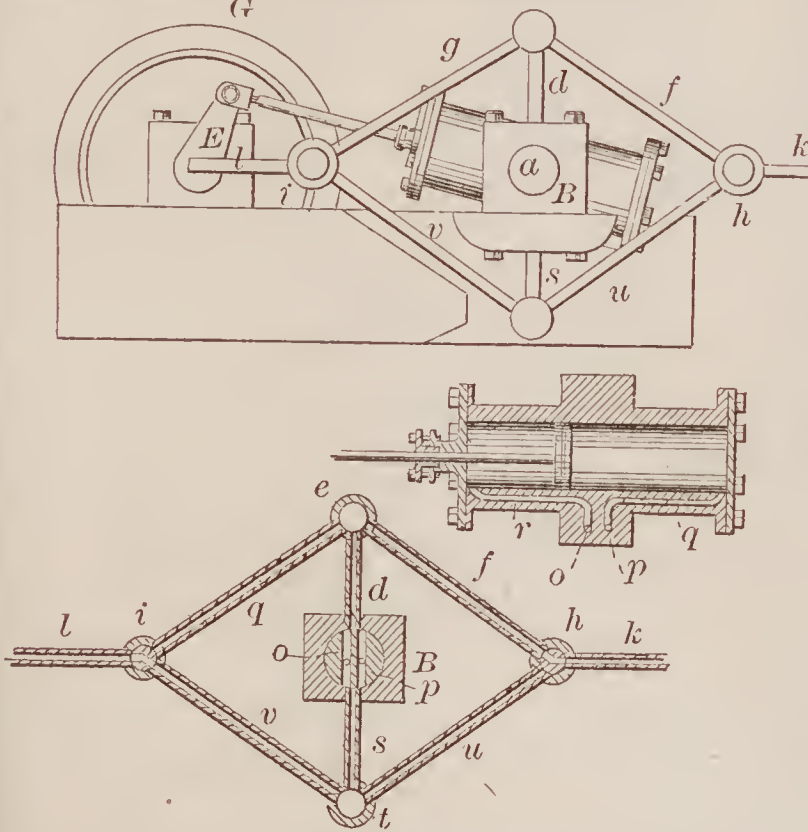

67508—A. J. Cronk—Horse Collar.

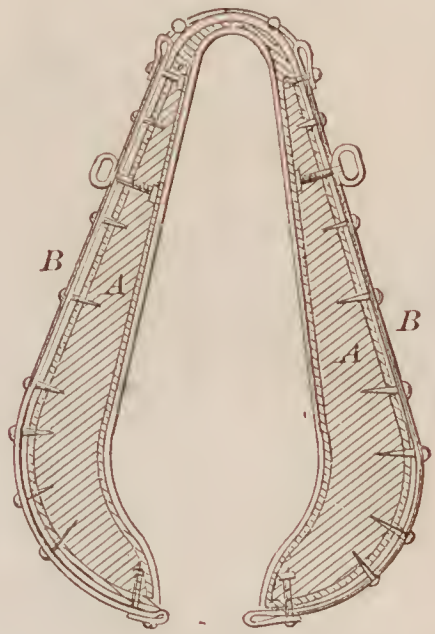

67509—O. Crook—Bridle Bit.

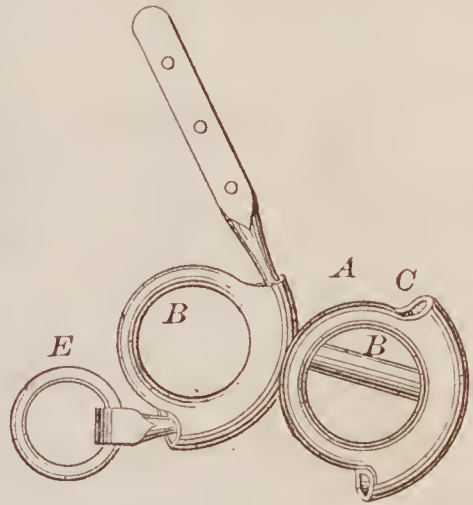

67510—J. E. Cross—Lantern.

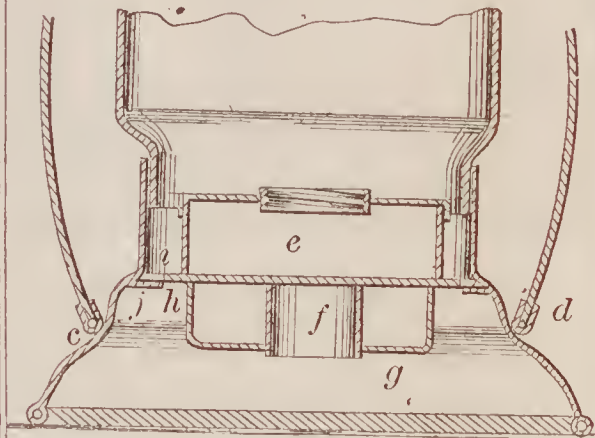

67514—A. Erkenbrecher—Starch Elevator.

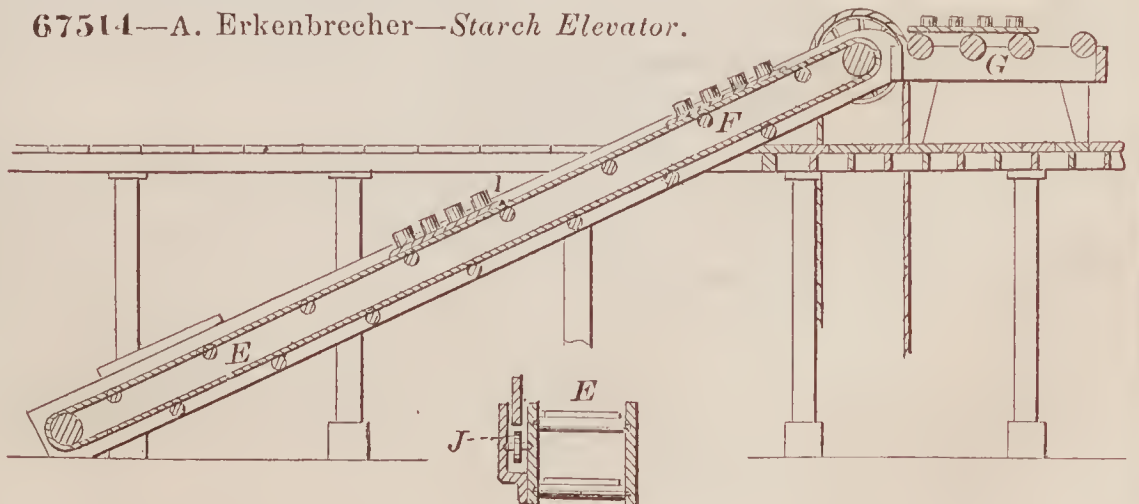

67513—G. Dodge—Plow Wheel.

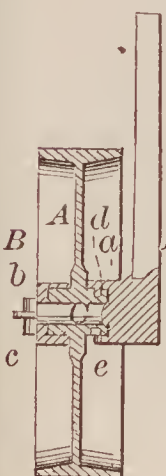



67515—A. Erkenbrecher—*Starch Making Apparatus.*

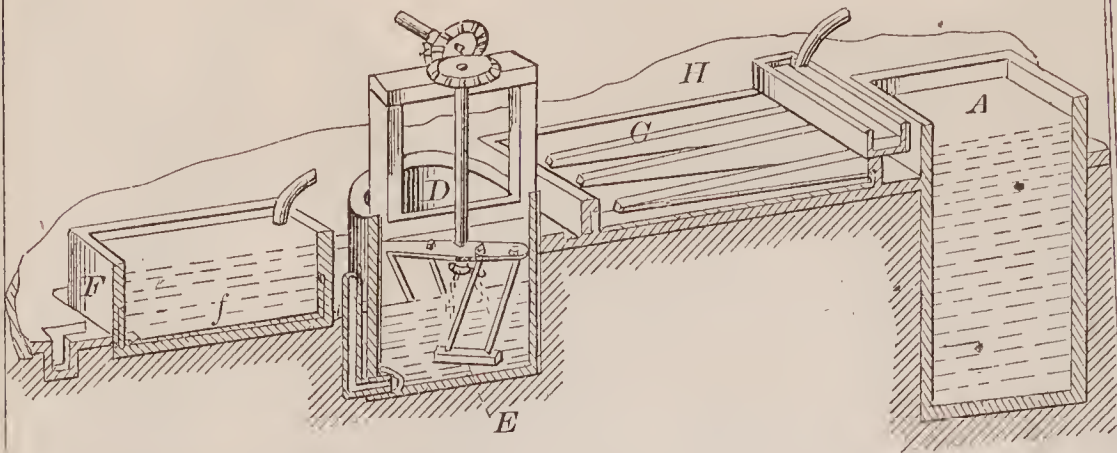

67517—A. B. Fales—*Frying Pan.*

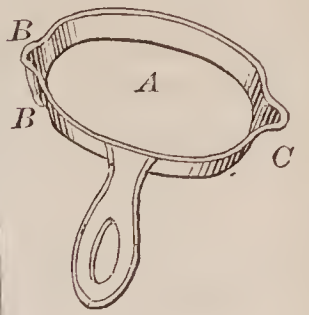

67516—A. Erkenbrecher—*Starch Agitator.*

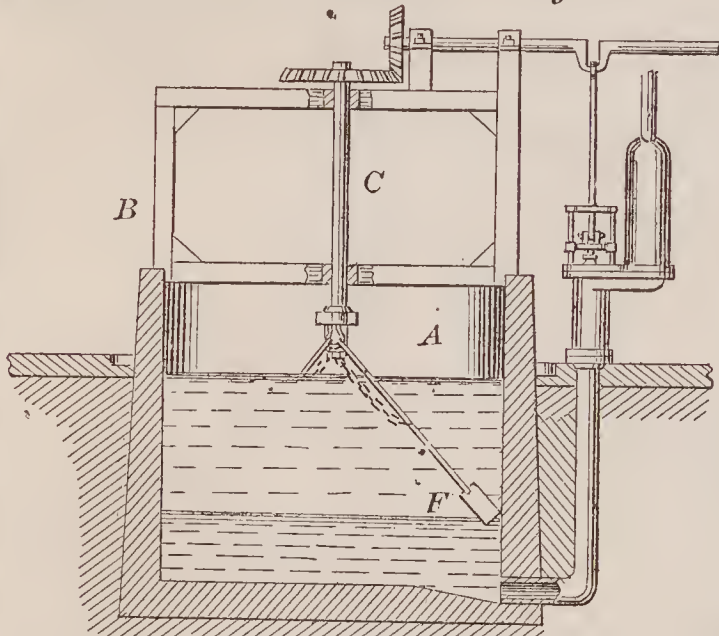

67518—J. B. Farmer—*Latch and Catch.*

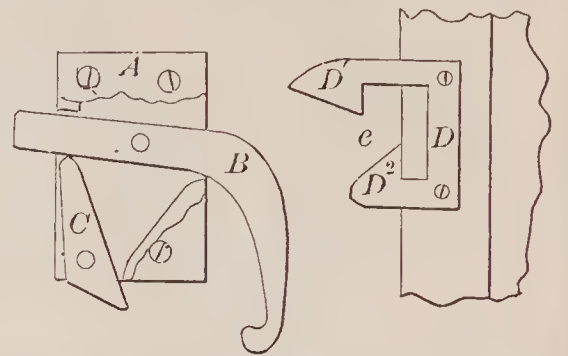

67520—D. Flynn—*For Cutting Key Seats.*

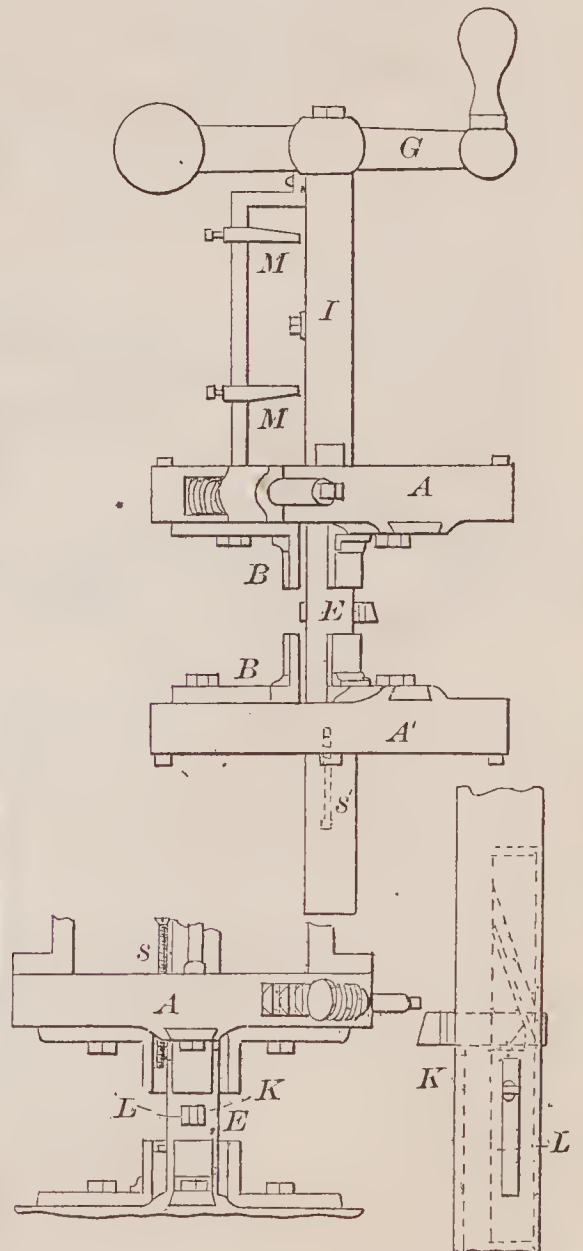

67519—J. Fewkes—*Braiding Machine.*

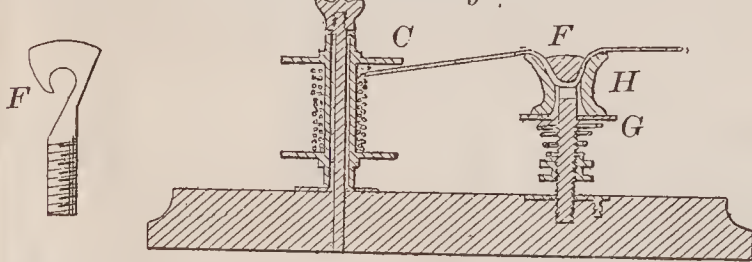

67521—H. A. & A. Follett—*Bed Bottom.*

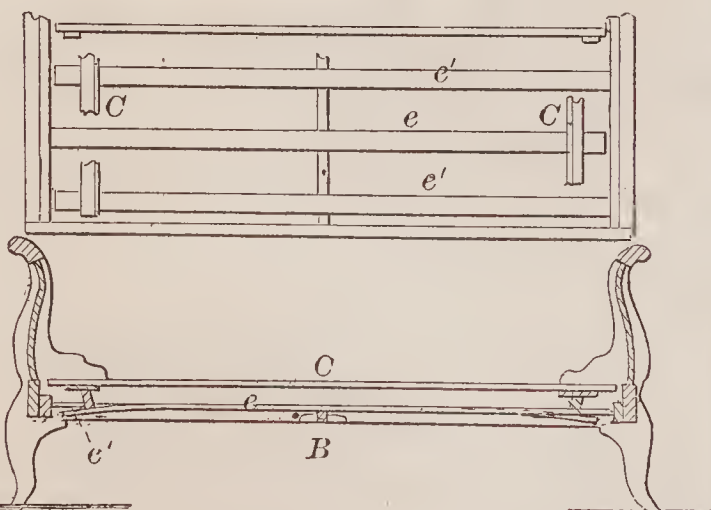

67522—J. Frank—*Cultivator.*

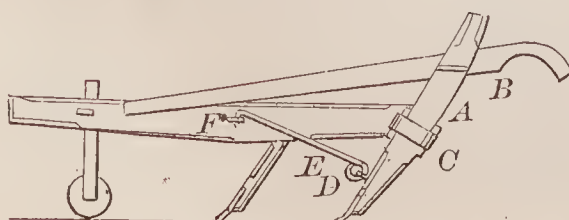

67523—L. W. Frederick—*Horse Rake.*

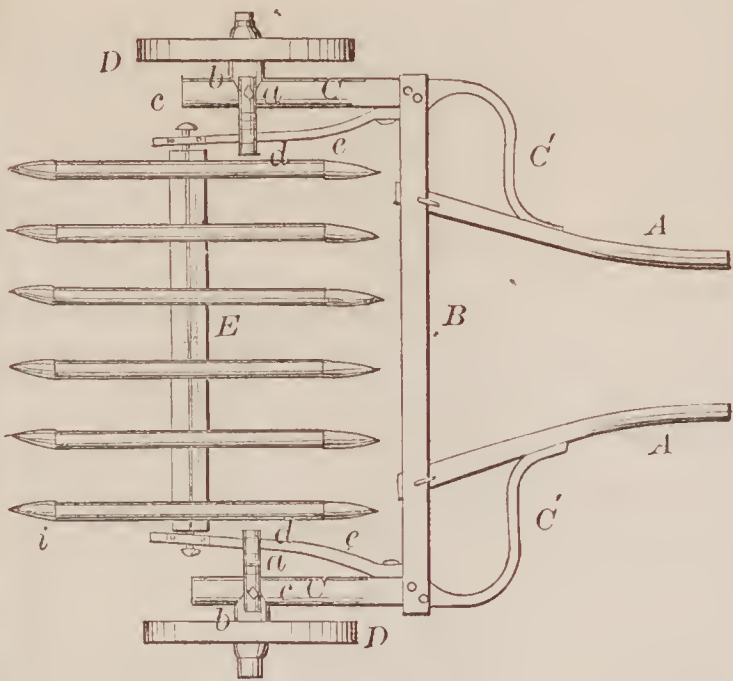

67524—H. E. Frohlich—*Thread Guide for Sewing Machines.*

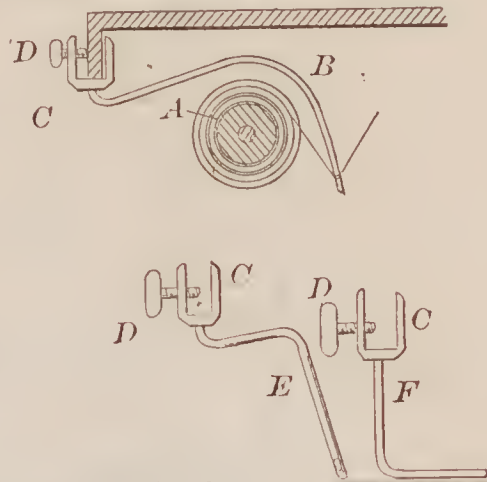

67525—H. S. Frost—*Door Spring.*

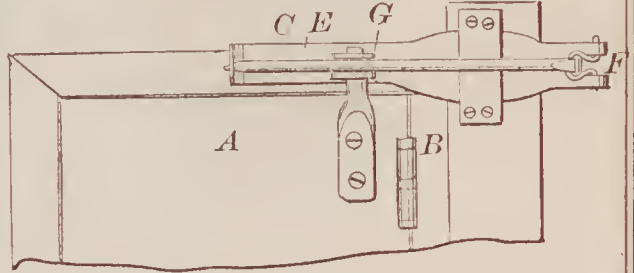

67527—M. Gabriel—*Rotary Steam Engine.*

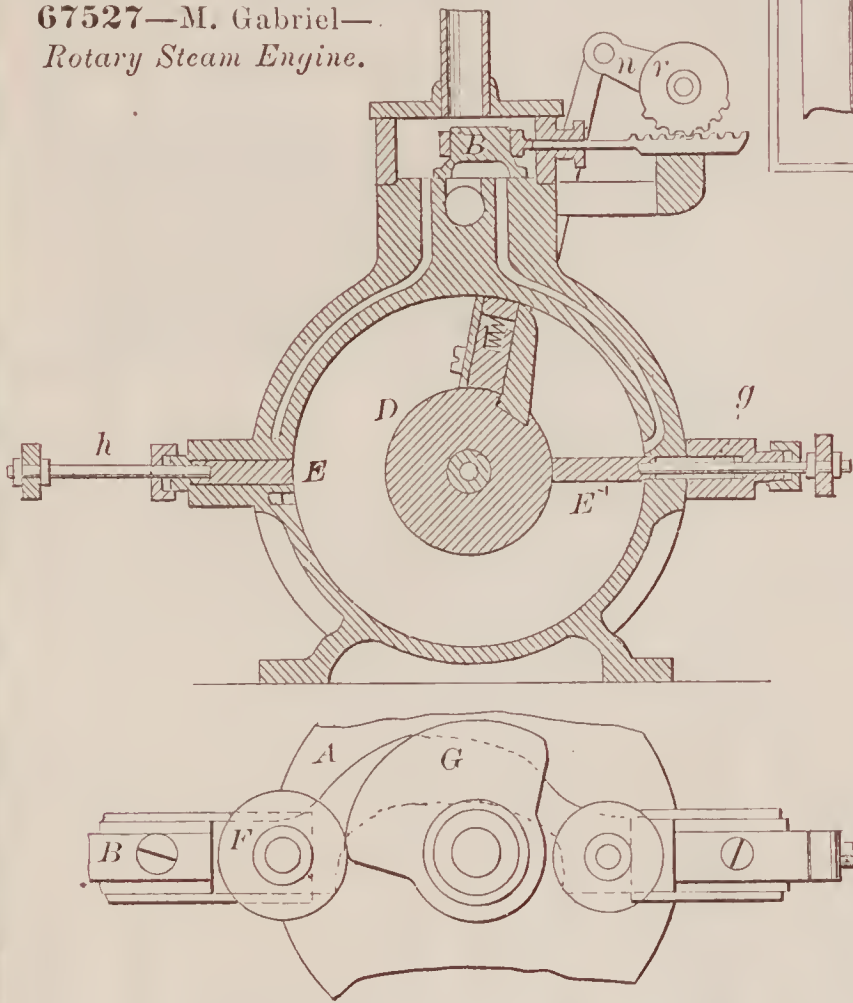

67526—J. Fryling—*Stream Fence.*

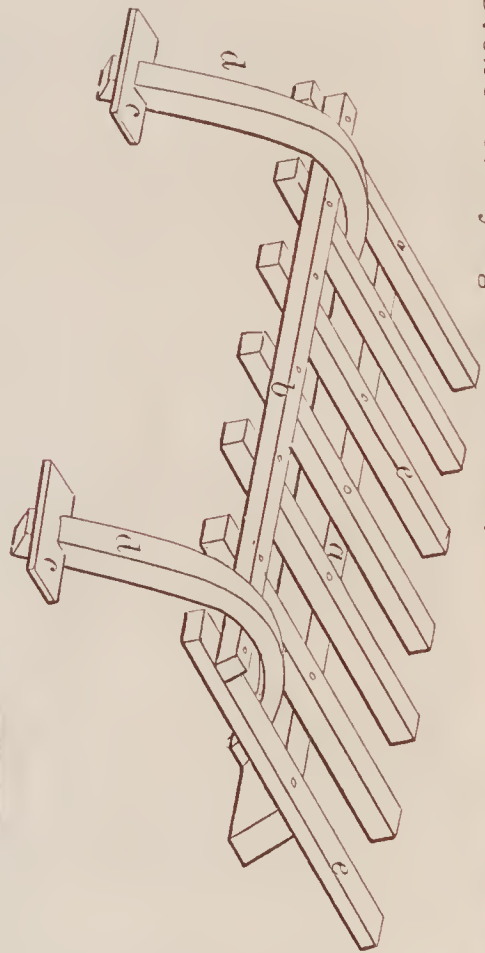

67528—P. Gabriel—*Lead Holder or Pencil.*

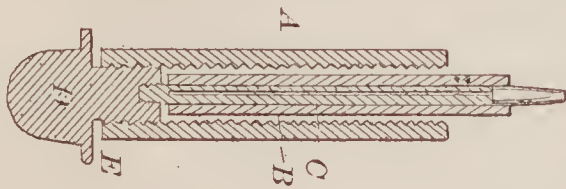

67530—H. Getty—*Tube Cutter.*

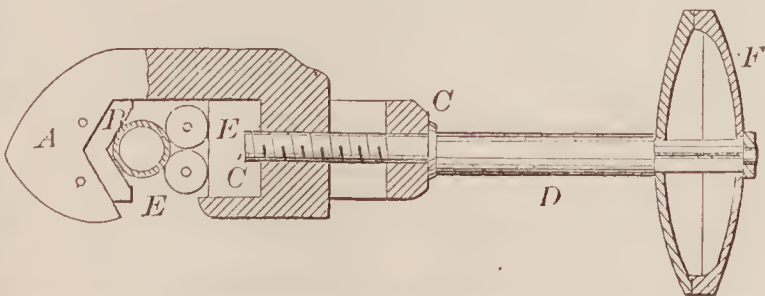

67529—J. Gardiner—*Cocoa Nut Cutter and Grater.*

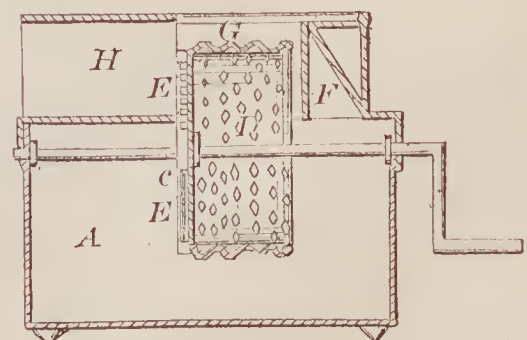



67531—C. Graham—Hydrostatic Press.

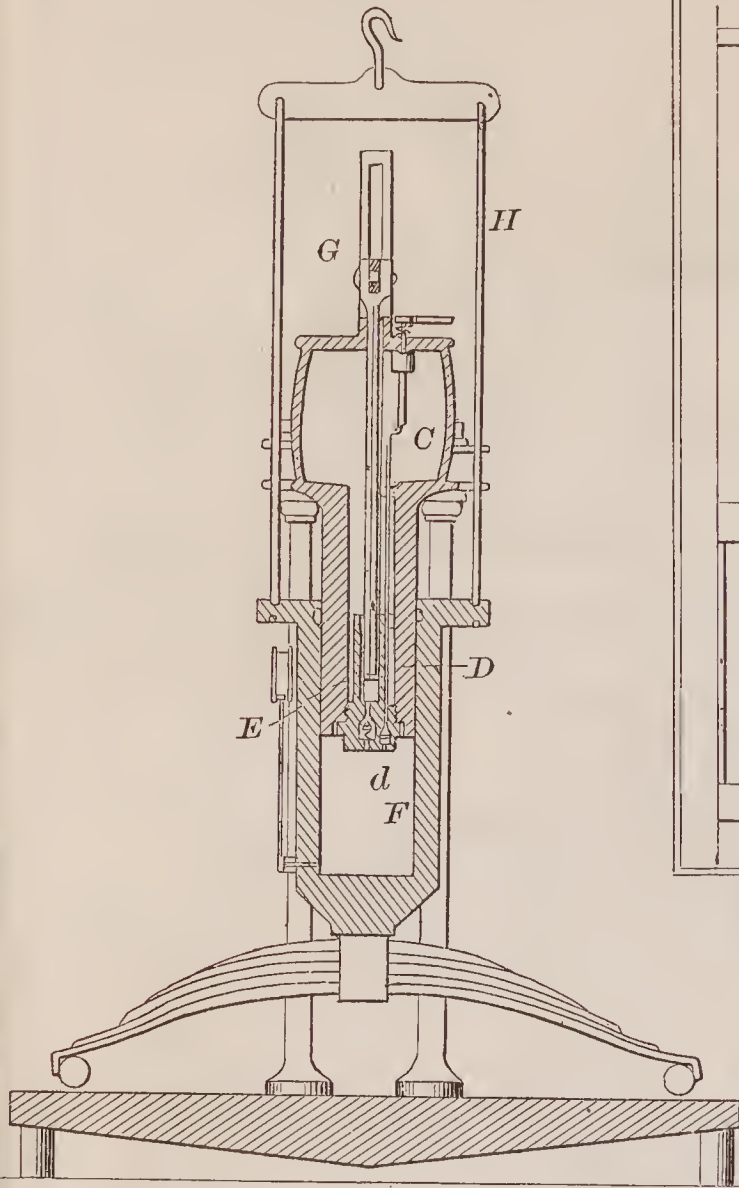

67533—S. Z. Hall—Feeding Attachment for Cotton Gins.

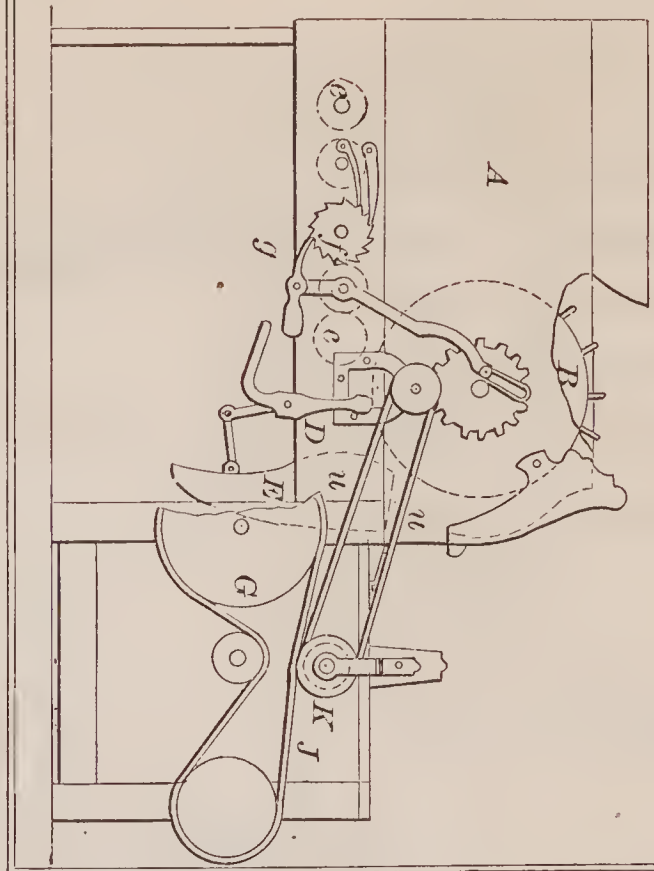

67535—H. J. Hancock—Sewing Machine.

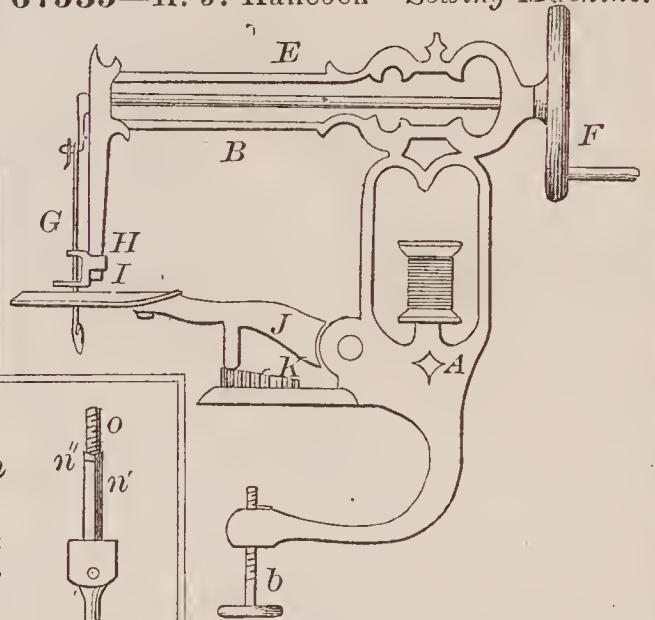

67537—J. Harrison—For Ringing Bells.

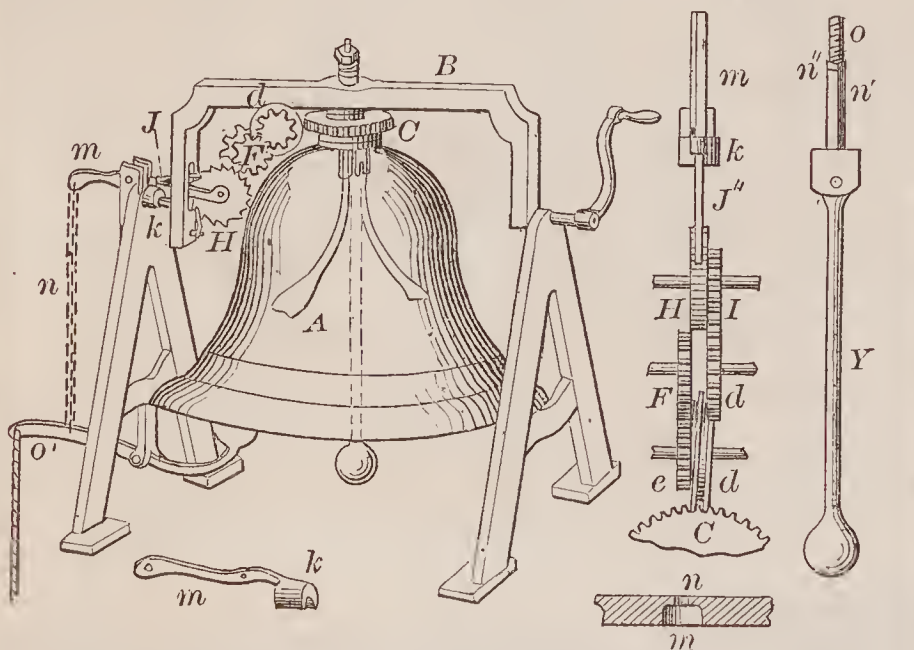

67538—J. G. Harrison—Steam Safety Valve.

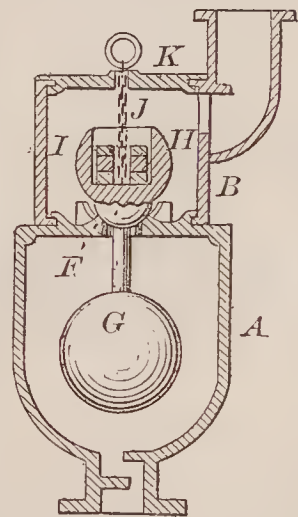

67534—J. F. Hammond—Knife Cleaner.

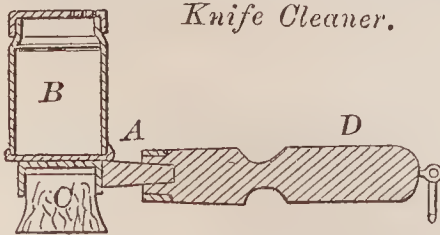

67532—W. A. Griffeth—Mosquito Net Frame.

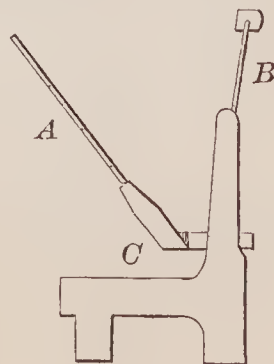

67536—H. A. M. Harris—Needle for Sewing Machines.

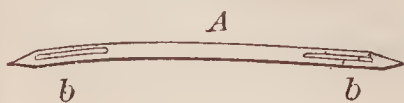

67539—D. B. Hart—Nut and Washer.

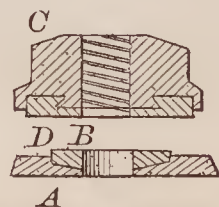

67540—A. Hathaway—Album.

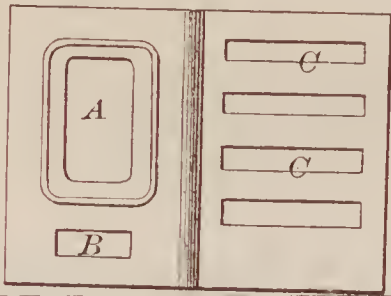

67542—J. C. Henry—Plow.

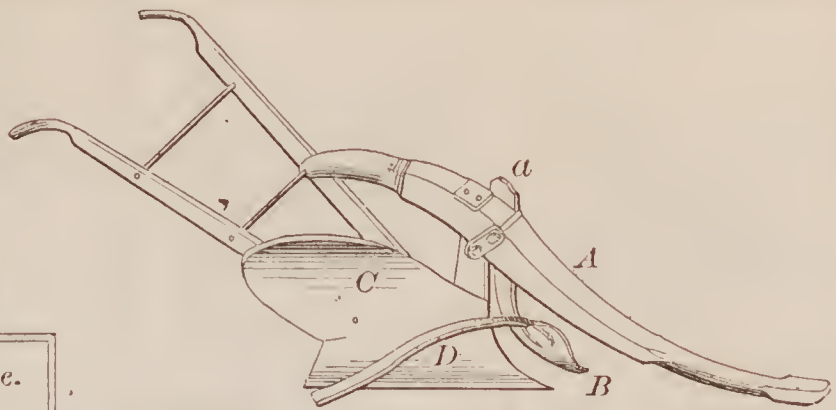

67541—P. Hayden—Brick Machine.

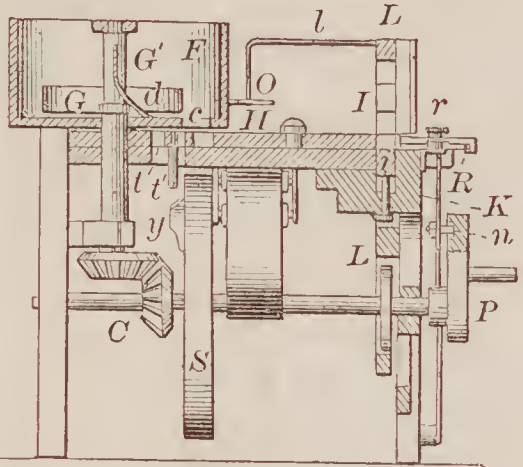
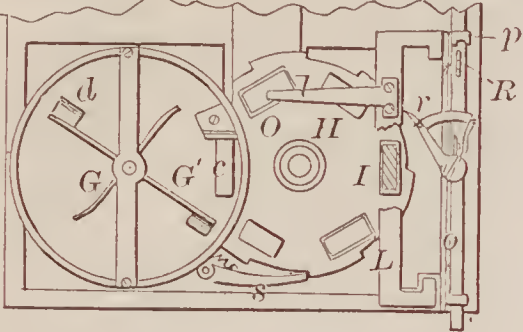

67543—W. Hiler—Straw Carrier.

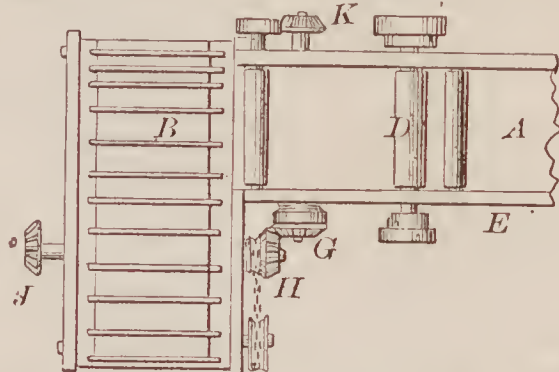

67544—A. C. Hobbs—Sewing Machine.

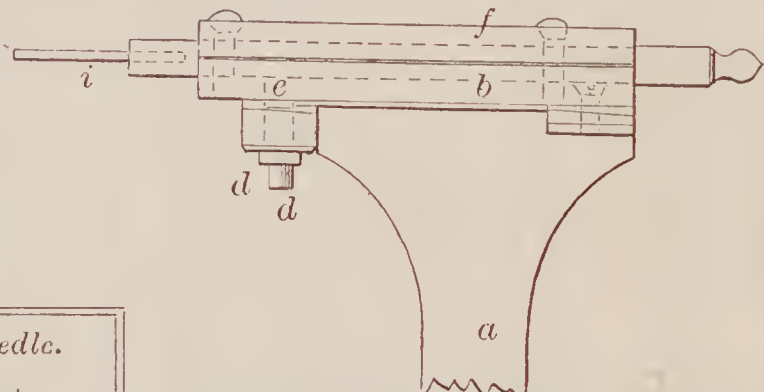

67545—S. Hodgins—Spiral Fissure Needle.

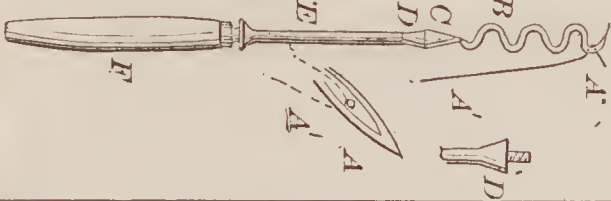

67547—L. Hover—Boat Detaching Tackle.

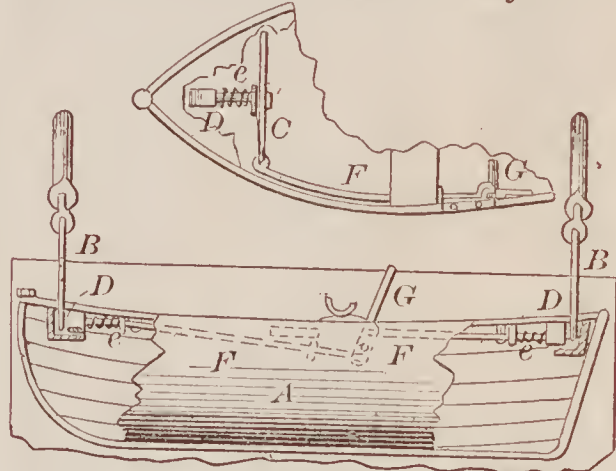

67546—F. Höök—Eor Reefing Top Sails.

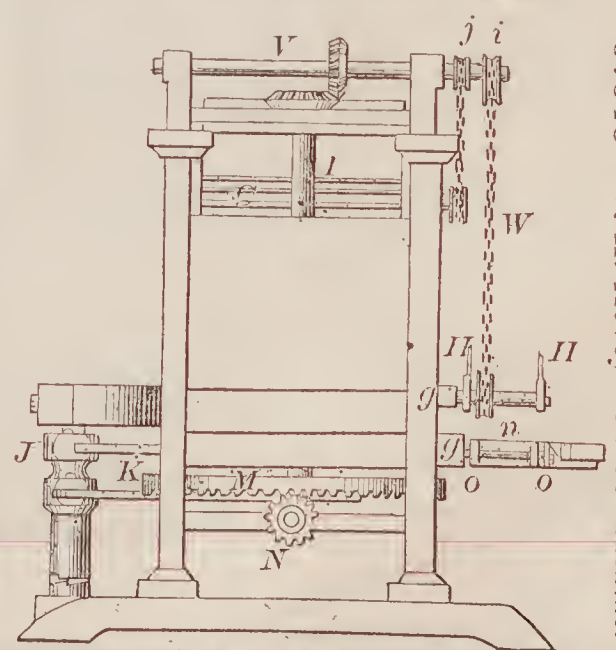
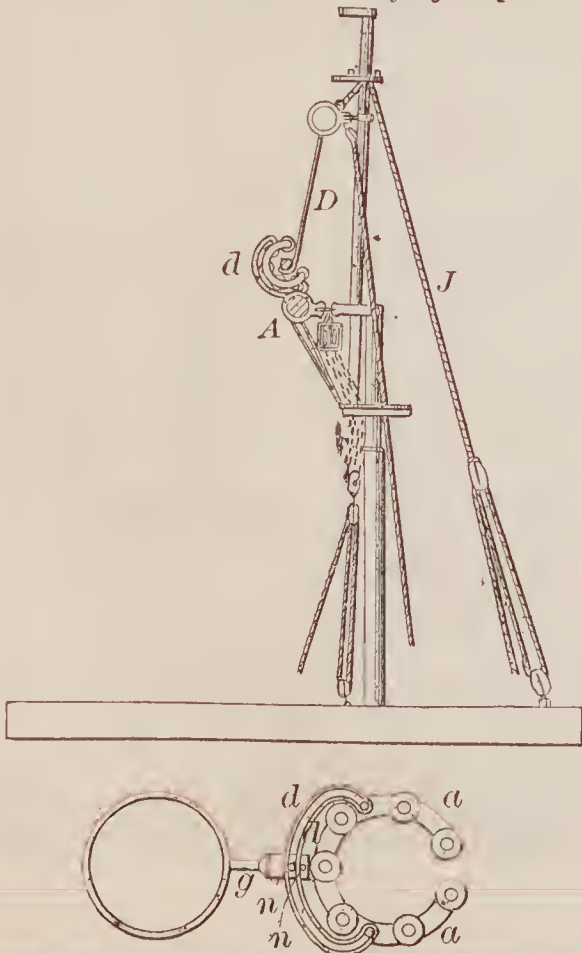

67548—W. H. Hovey—Brick Machine.



67548—Continued.

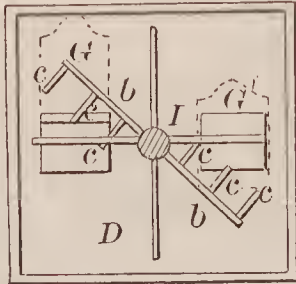
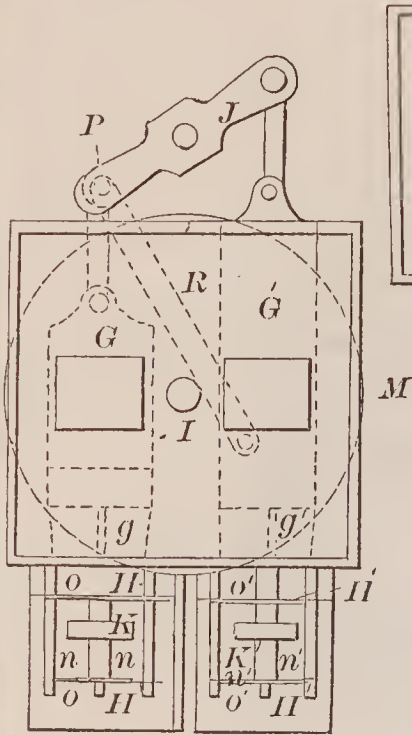

67549—O. D. Hunter—Bolt.

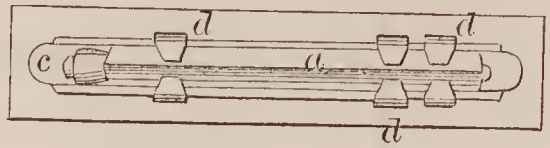

67550—J. Jameson—For Clearing Weeds from Plows.

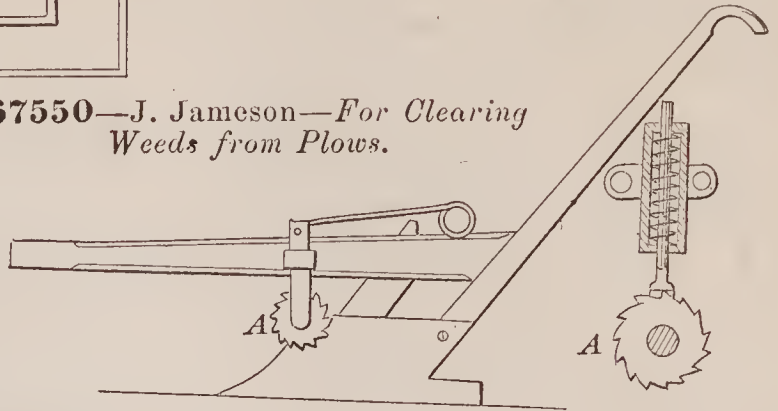

67553—N. Jenkins—For Making Mouldings.

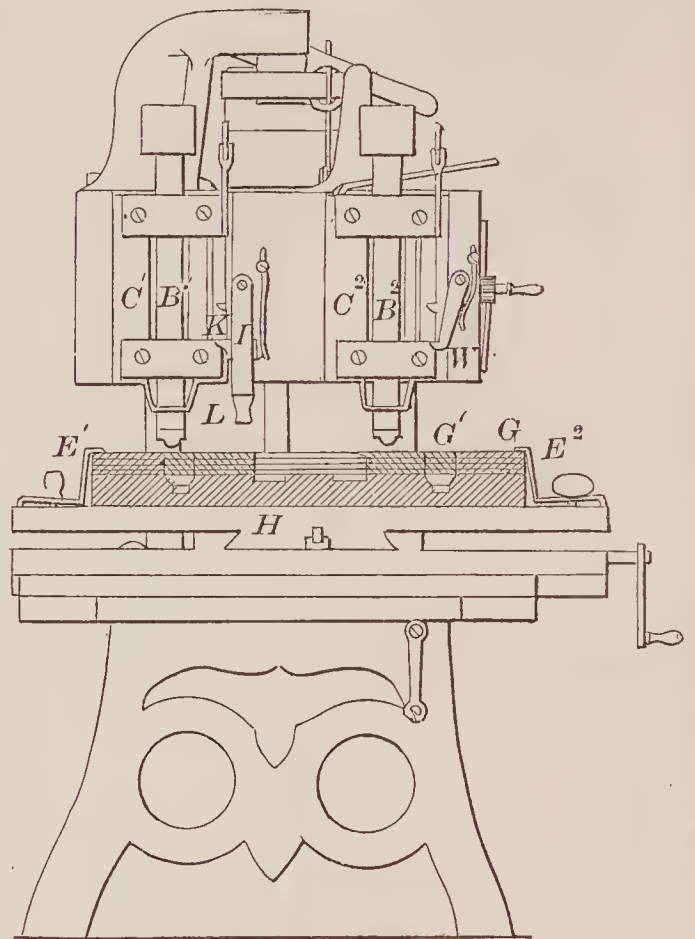

67551—H. & O. Jarecki—Engine Lubricator.

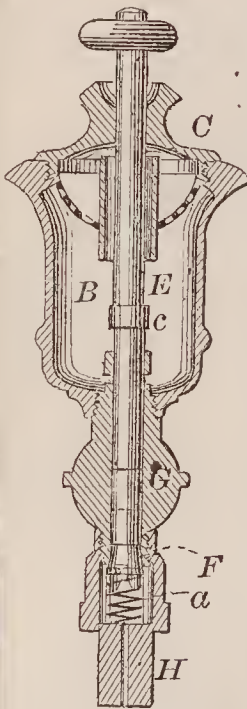

67552—H. Jeffrey—Nail Extractor.

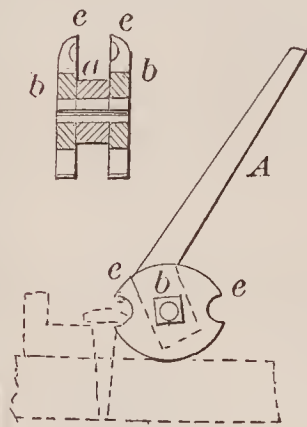

67554—S. C. Jennings—Bed Bottom.

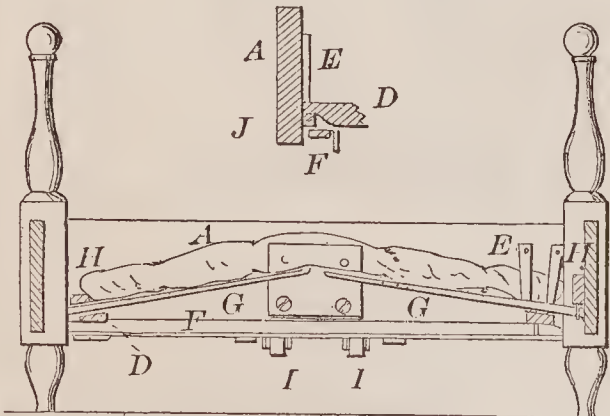

67556—J. E. Jouett—Chair and Couch.

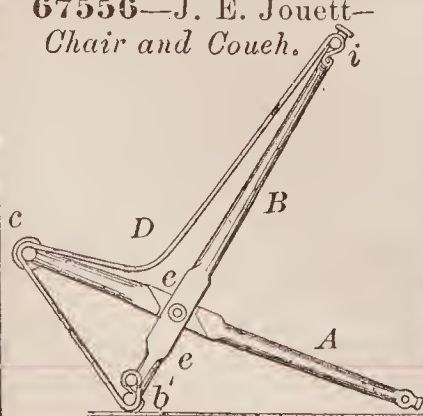

67558—J. H. Knapp—Pencil Case.

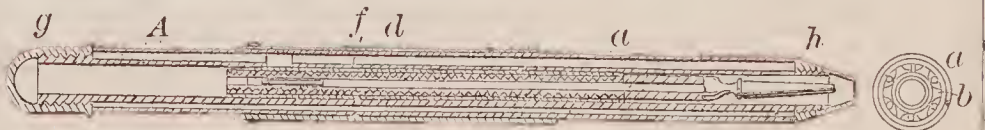

67559—A. J. Loiseau—For Cleaning and Bleaching Fibrous Material.

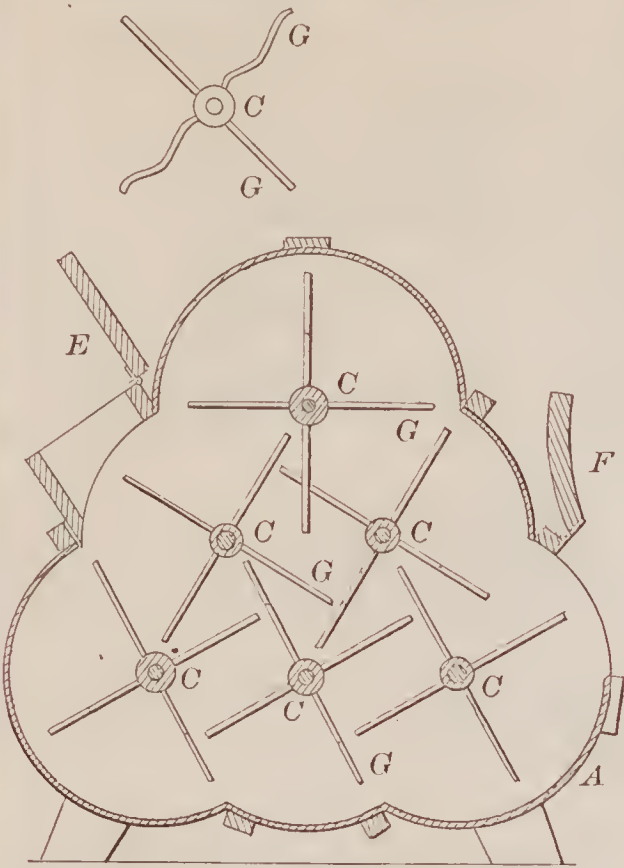

67560—P. Low—Cooking Stove.

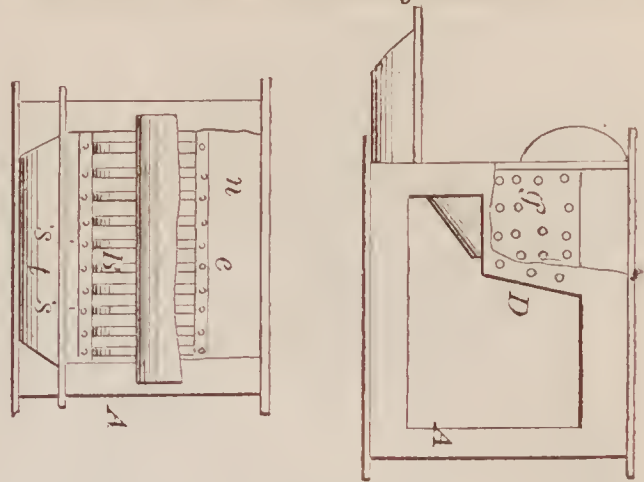

67562—W. A. McReynolds—Table Fan.

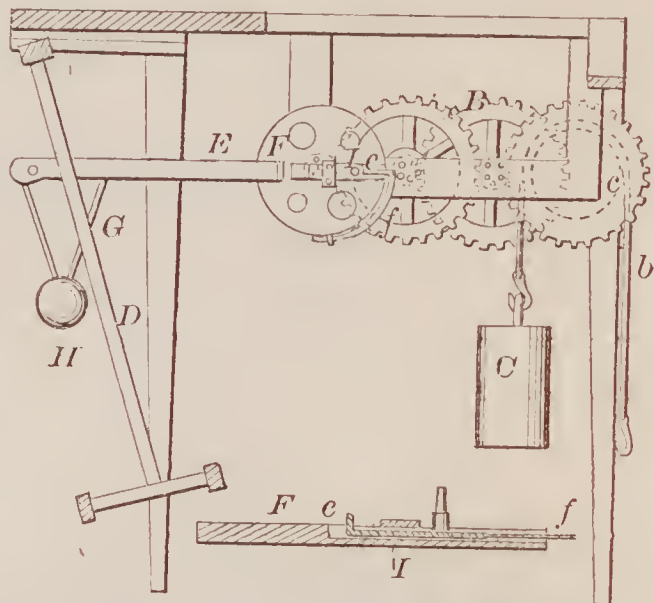

67561—J. McDonald—Brick Machine.

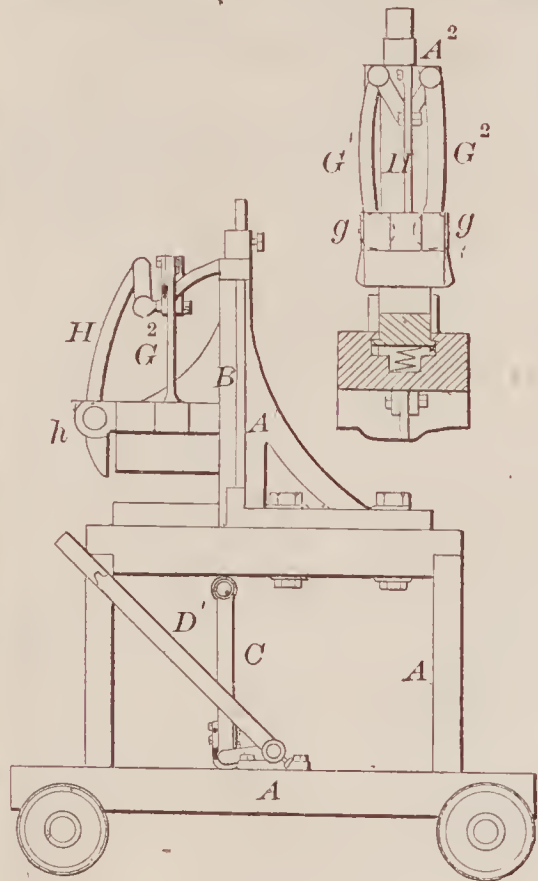

67564—S. Miles—Portable Fence.

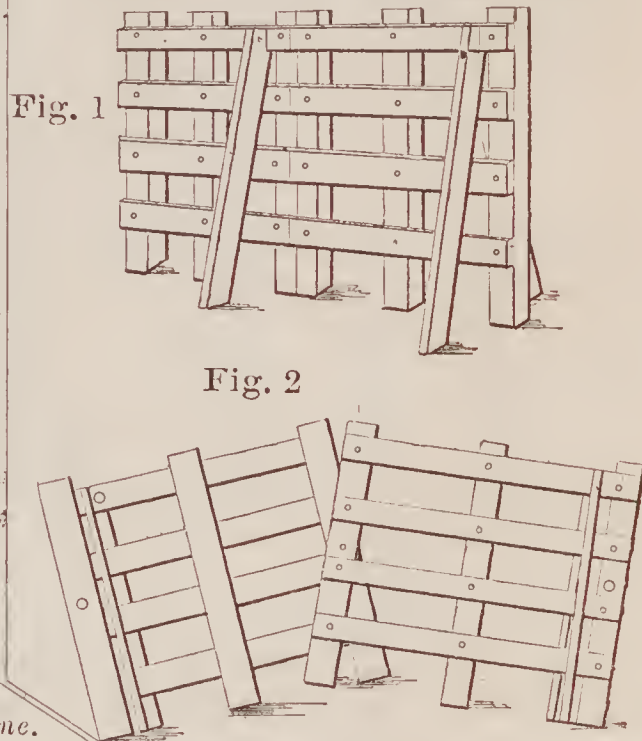

67565—P. H. Munson—Washing Machine.

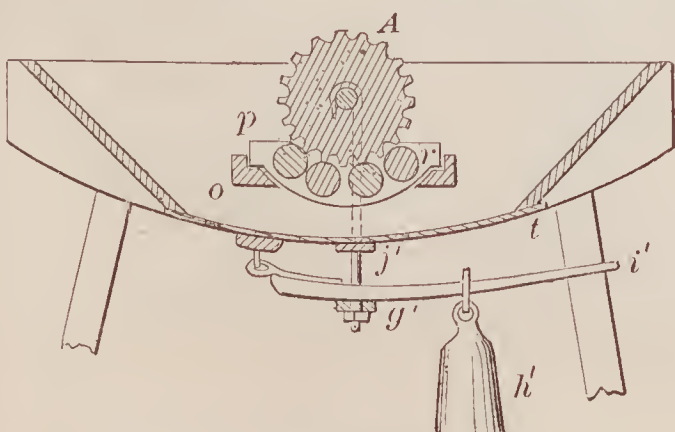

67566—J. M. Myers—Breast Collar and Spreader.

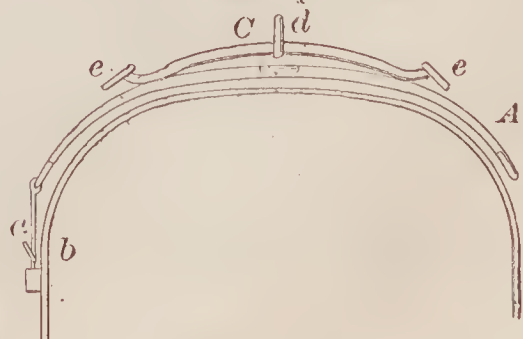



67567—J. J. Newman—*Clothes Dryer.*

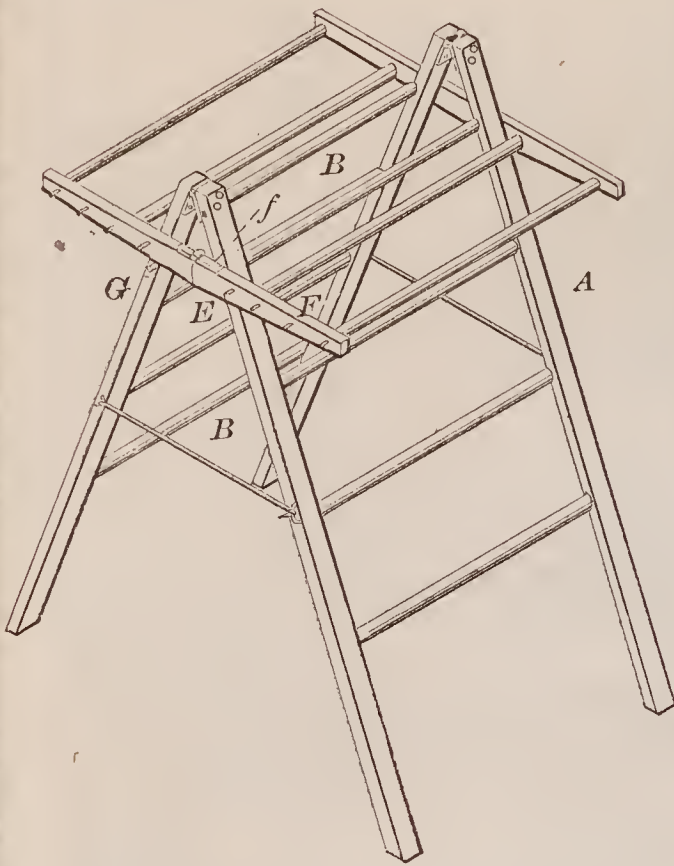

67568—I. C. Nichols—*Beef Steak Preparer.*

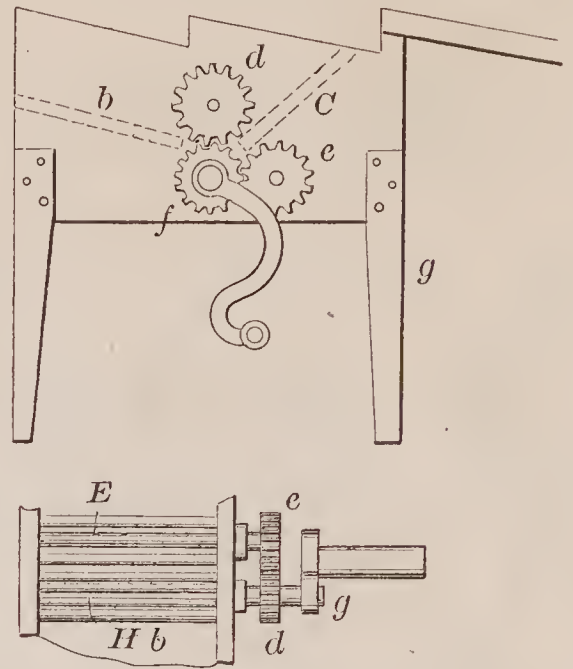

67569—D. P., Nickerson—*Windlass.*

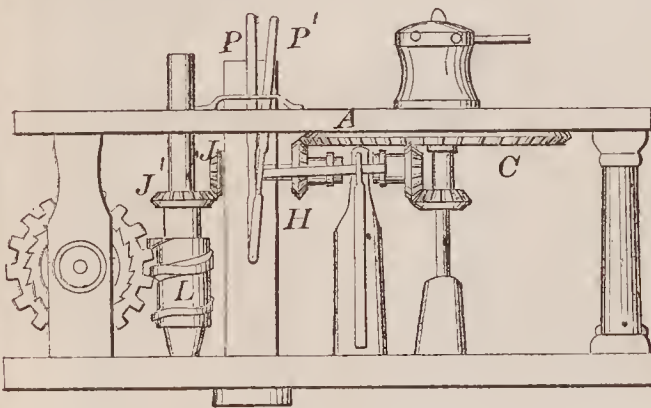

67571—A. B. Nott—*Swing.*

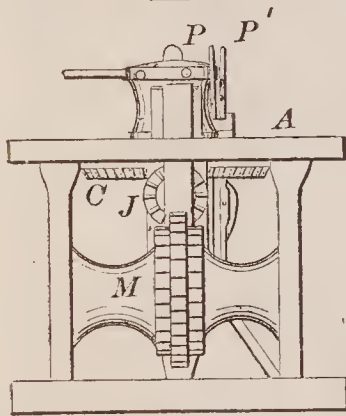
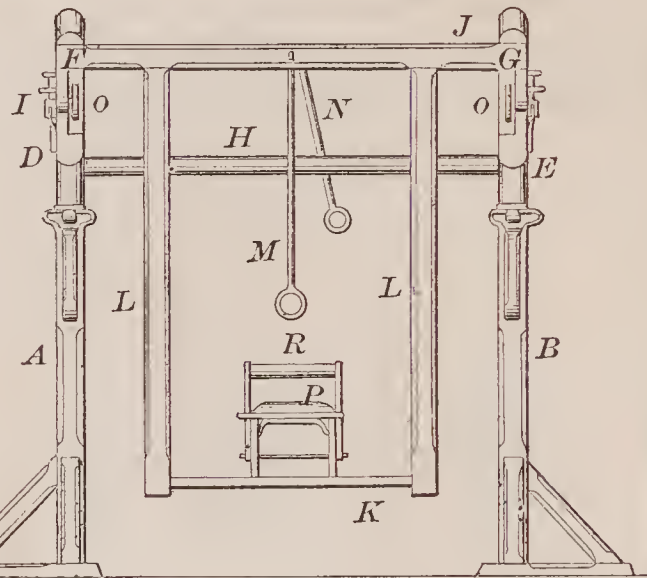

67570—W. A. Niver—*Sleigh Brake.*

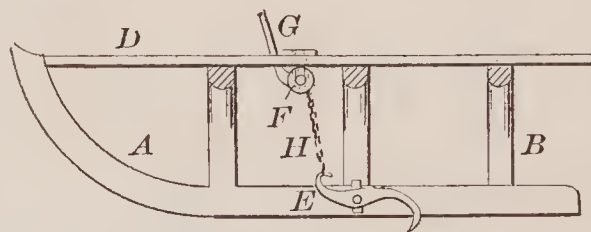

67573—T. G. Packer—*Broom Head.*

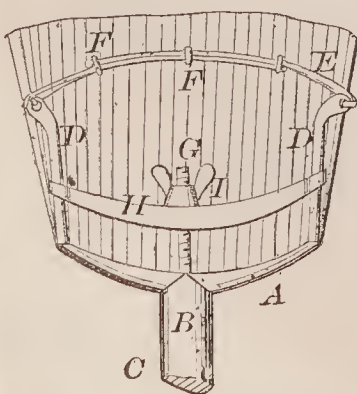

67572—E. H. Olmstead—*Railway Car Seat.*



67574—J. C. Palmer—*Rudder.*



67575—N. Palmiter—Washing Machine.

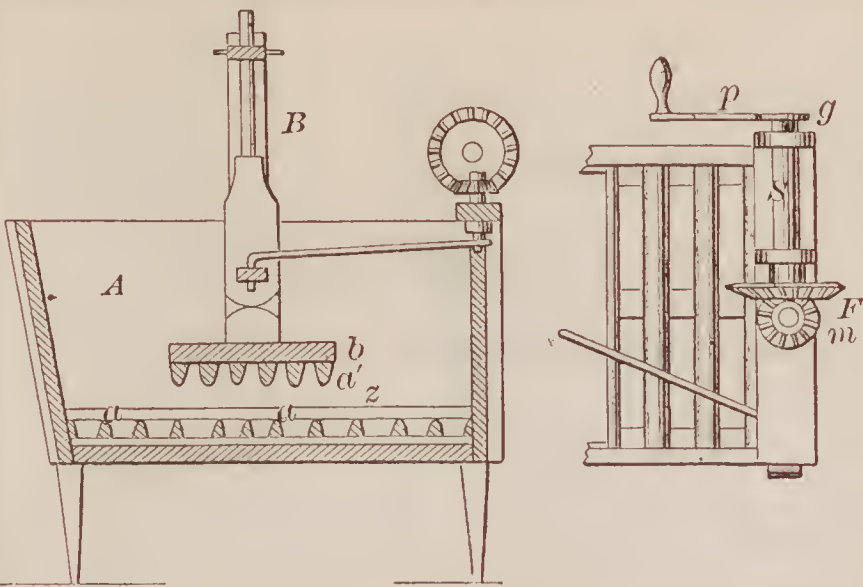

67581—M. S. Prentice—Washing Machine.

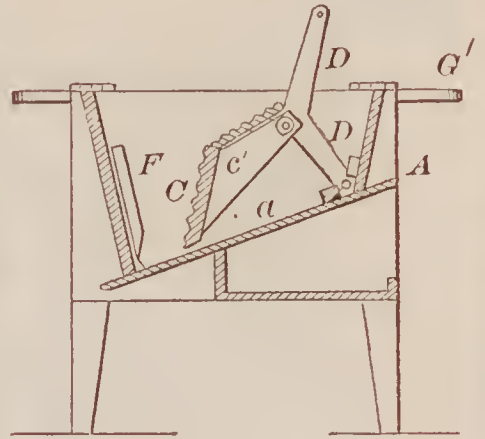

67578—J. Pepper—Door Fastener.

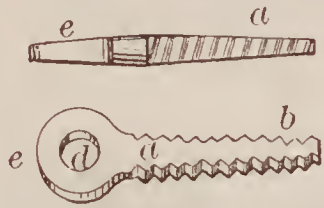

67579—O. P. Pettengill—Sole Finishing Tool.

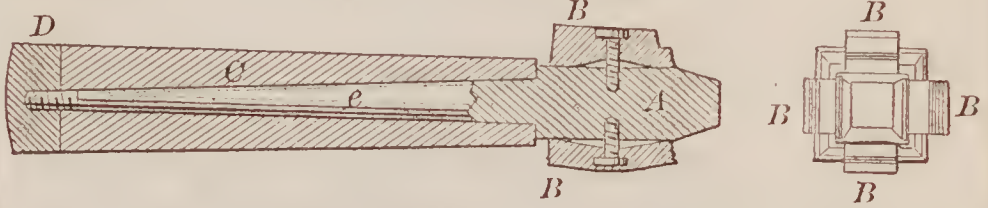

67577—T. G. Pelton—Steam Engine Lubricator.

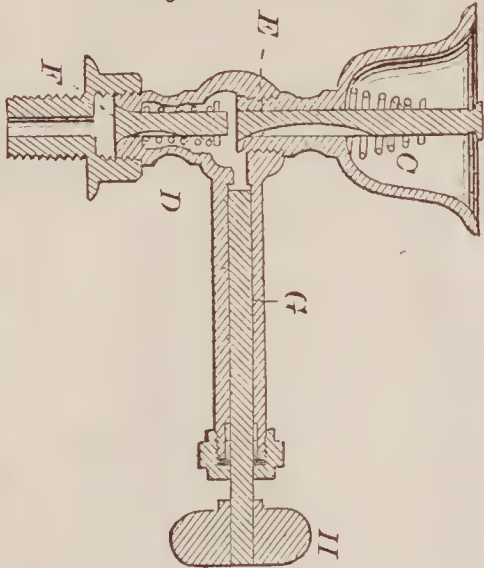

67580—E. W. Poston—Sand Ejector.

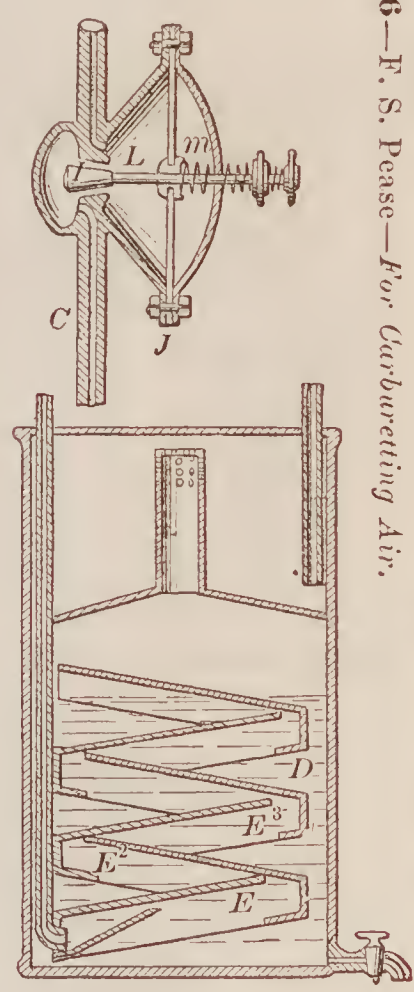
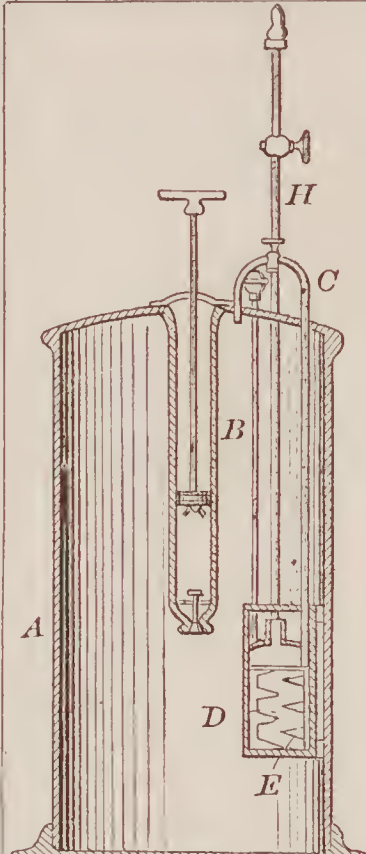
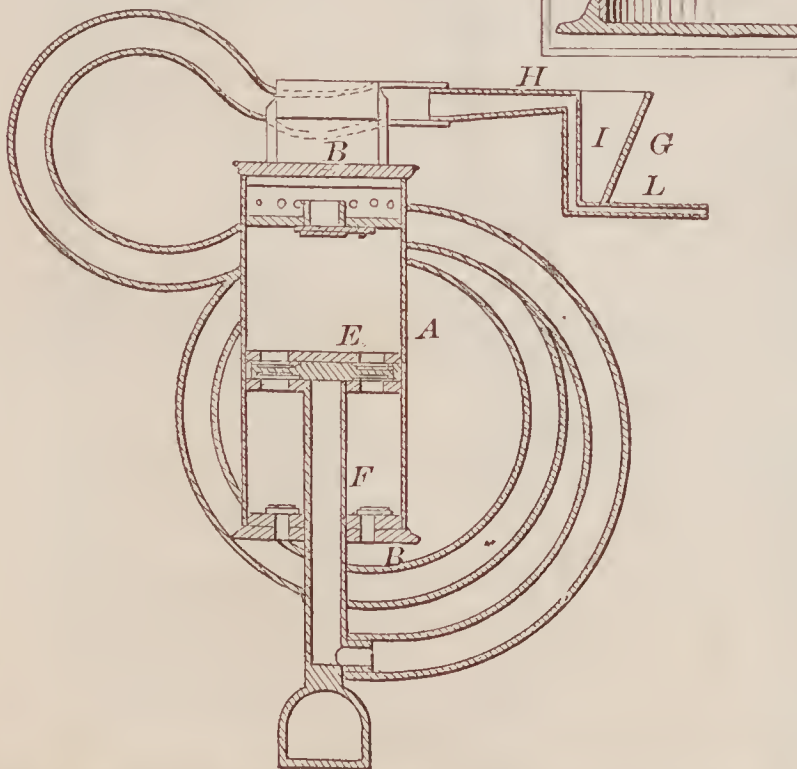

67576—F. S. Pease—For Carbureting Air.

67582—T. K. Reed—Gathering Device for Sewing Machines.

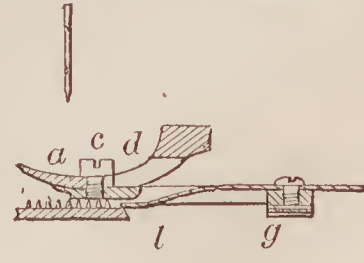



67583—E. Reynolds—*Steam Engine Valve.*

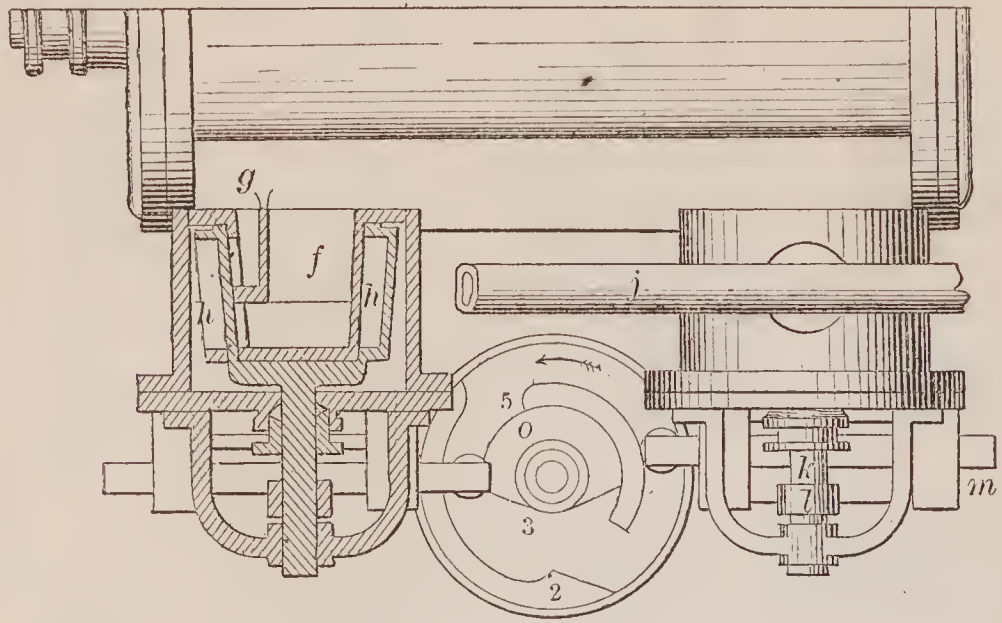

67584—H. C. Reynolds—*For Shaving Axes.*

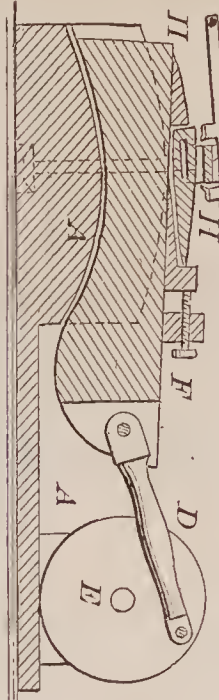

67586—L. Rodney—*Printing Press.*

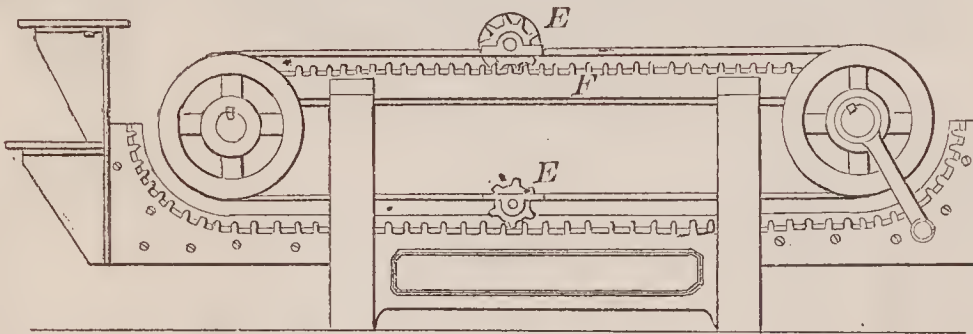

67588—H. Rosenthal—*Paint Brush.*

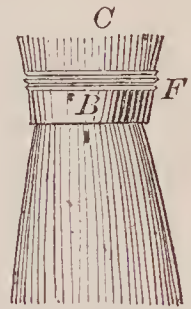

67587—C. E. Roper—*For Cutting Bevel Gears.*

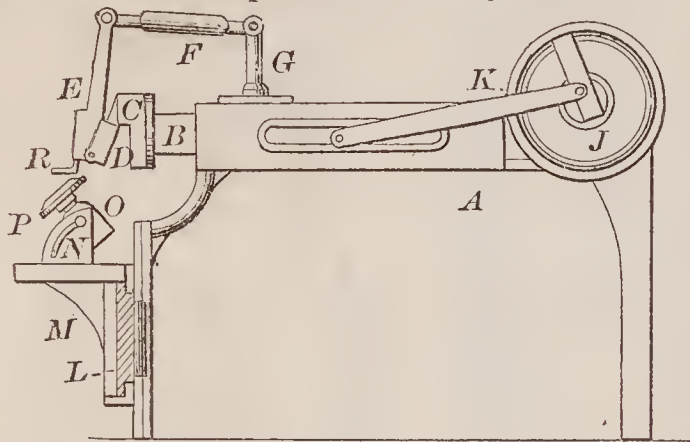

67589—A. Rowe—*Steam Generator.*

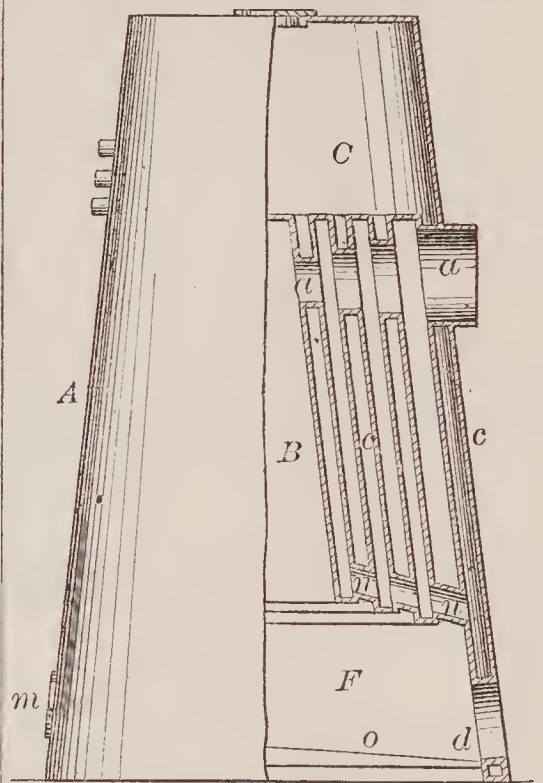

67590—Safford & Masters—*Sewing Machine Guide.*

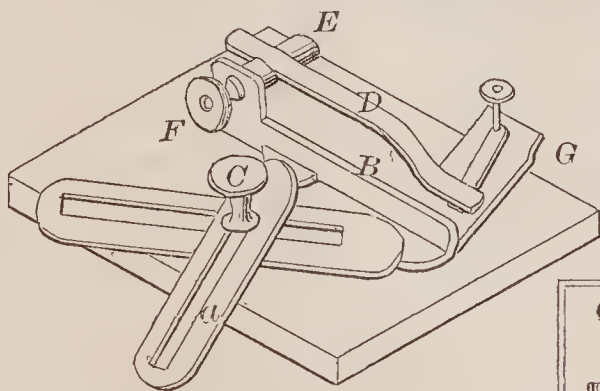

67591—J. A. Sawyer—*Thread Holder and Cutter.*

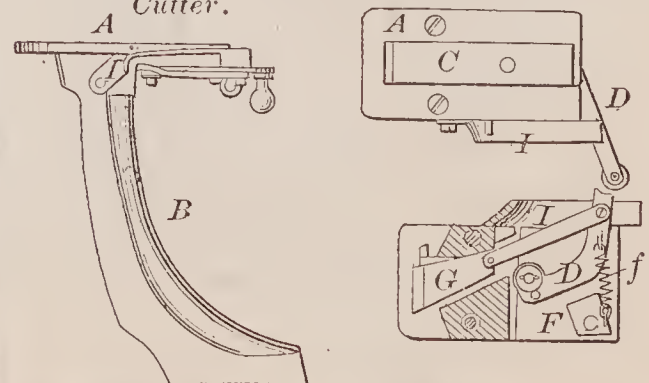

67585—G. W. Robbins—*Bed Bottom.*



67592—R. Schmidt—*Steam Pump.*

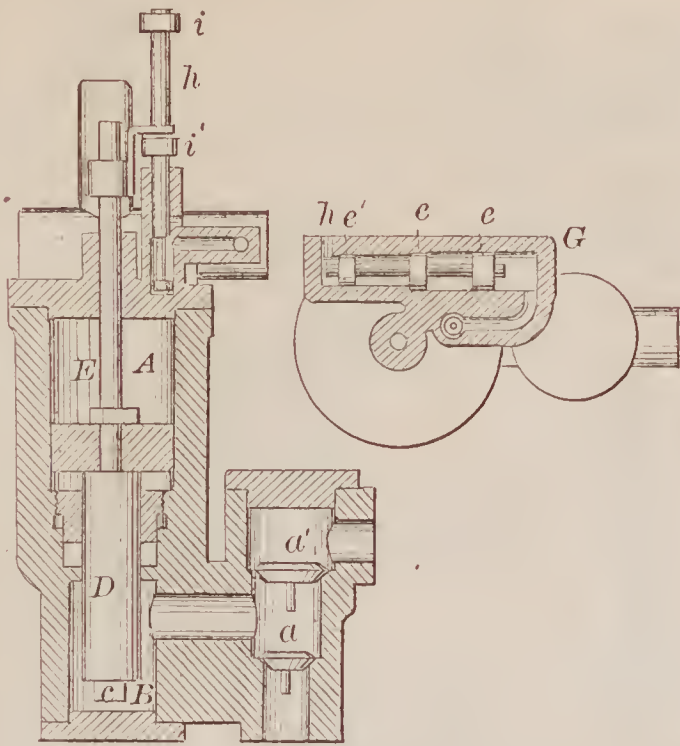

67593—G. B. Scribner—*Stove Lid Lifter.*

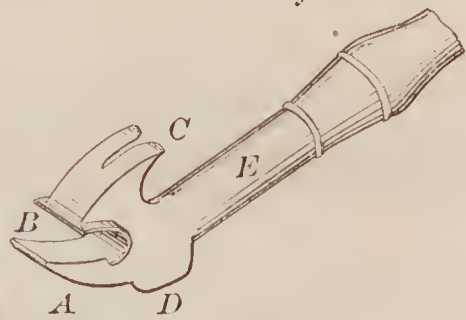

67595—S. F. Seely—*Cultivator and Plow.*

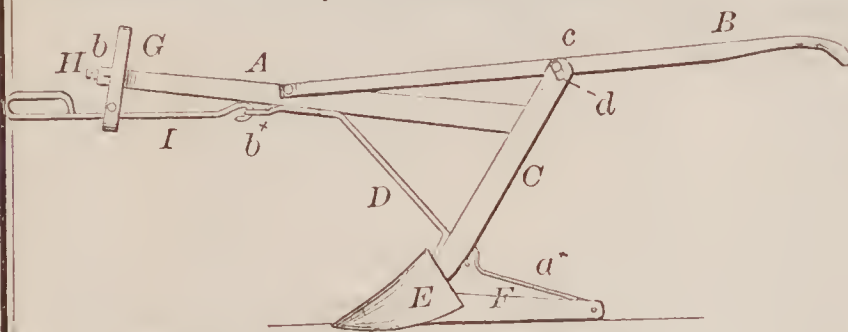

67596—L. M. Severance—*Platform Scales.*

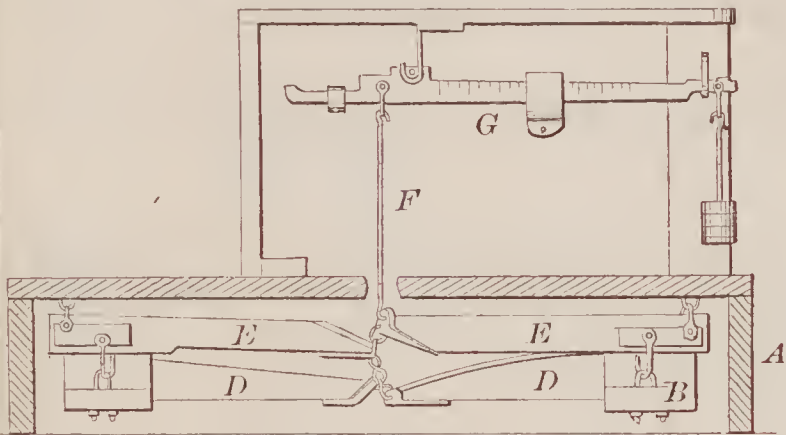

67594—S. H. Scribner—*Churn and Butter Worker.*

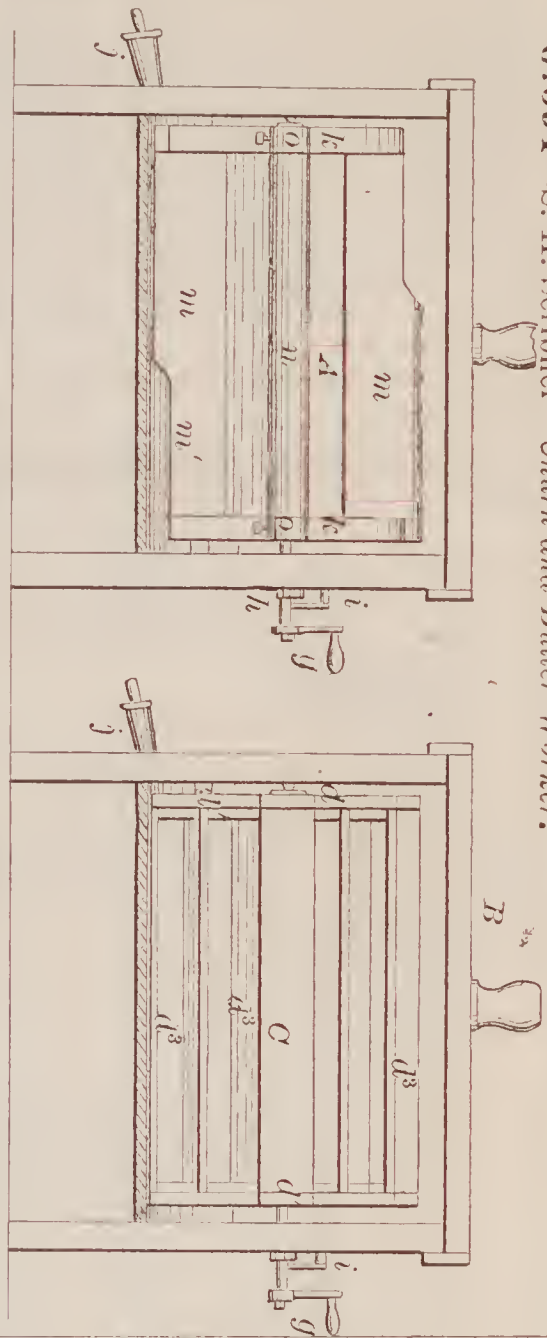

67597—H. Sidle—*Washing Machine.*

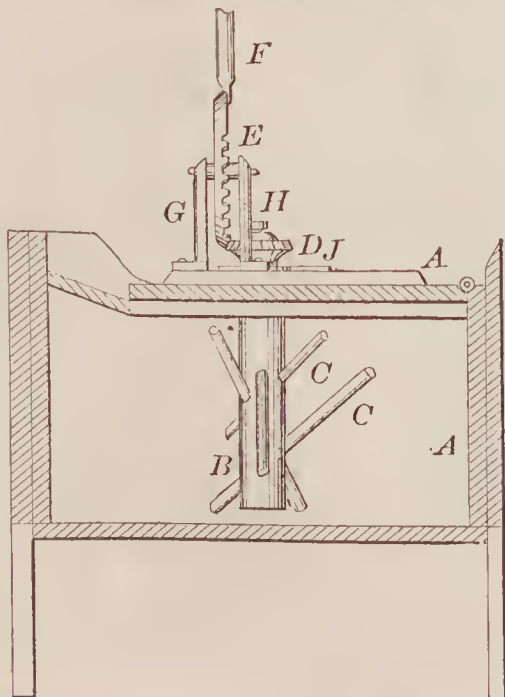

67598—J. T. Siegert—*Heel Measure.*

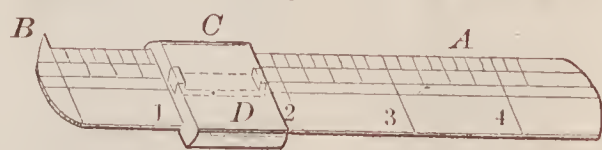

67599—W. H. Skerrett—*Ice Cream Freezer.*

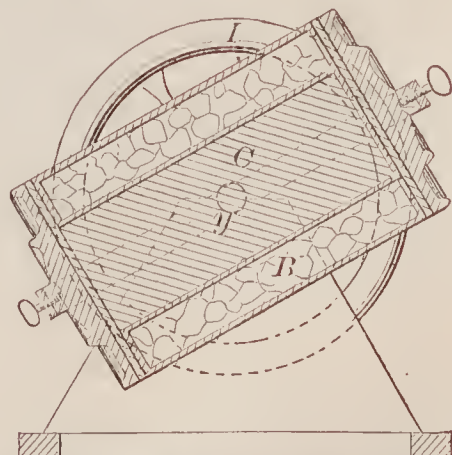



67600—E. Smith—Cherry Stoner.

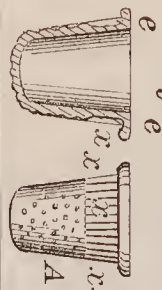
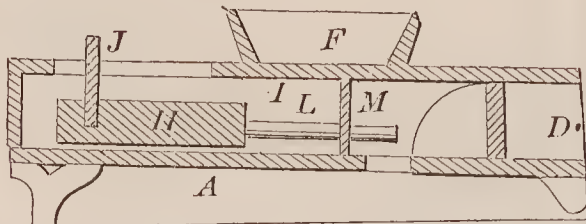

67602—J. Stephen—  
Lady's Thimble.

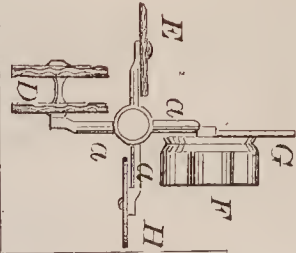

67601—J. Stephen—Pastry Cutter.

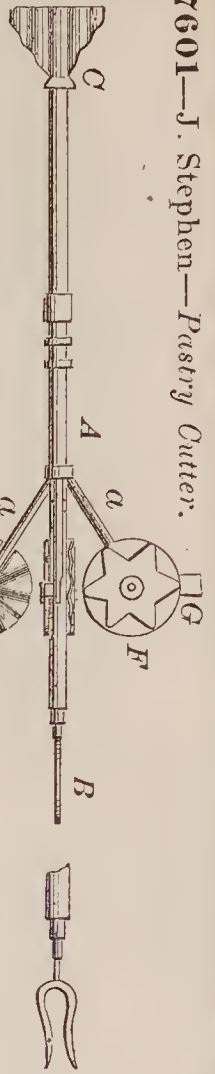

67604—W. Stickney—Bed Bottom.

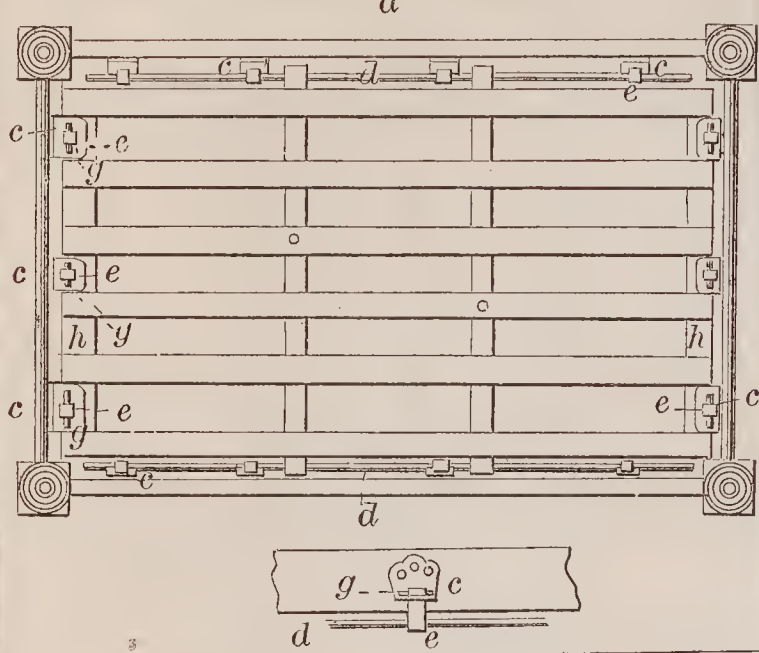

67606—  
S. E. Strickland—  
Sash Fastener.

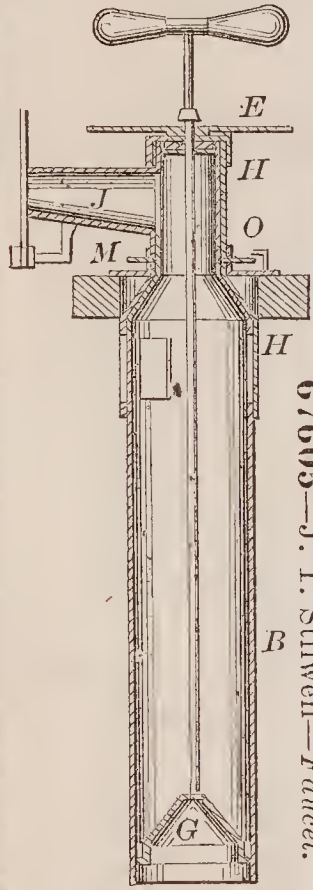
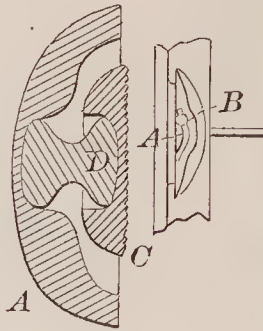

67605—J. T. Silwell—Fancy.

67603—J. Stephen—Pot Hole Lid.

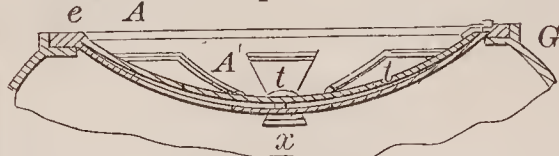

67609—B. C. Taylor—  
Horse Rake.

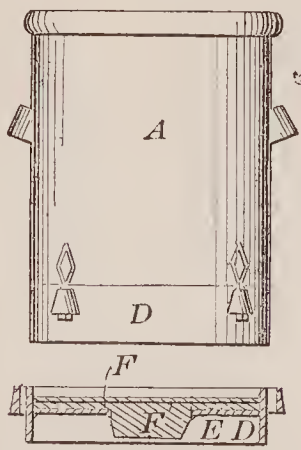
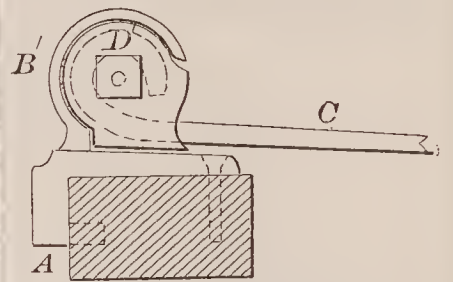

67607—I. A. Sunderland—Dairy Can.

67608—D. M. Swain—Boiler Water  
Gauge.

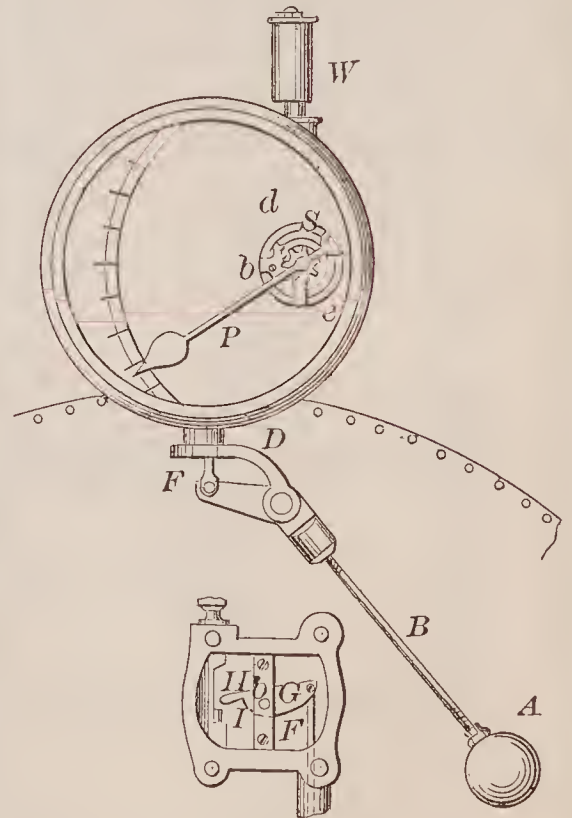

67610—N. Teal—Invalid Bed Attachment.

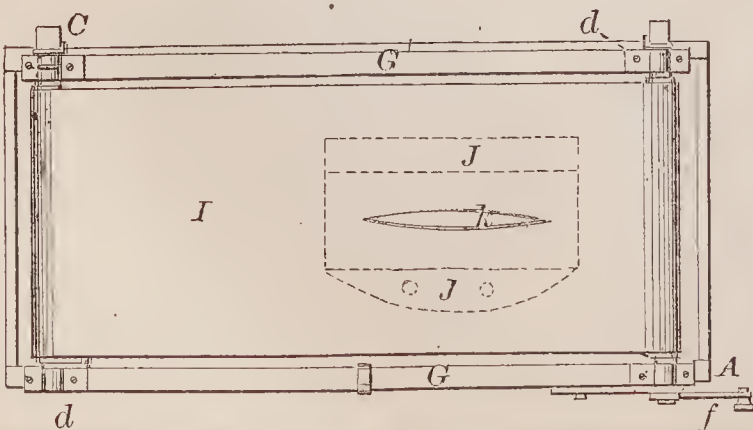

67610—Continued.

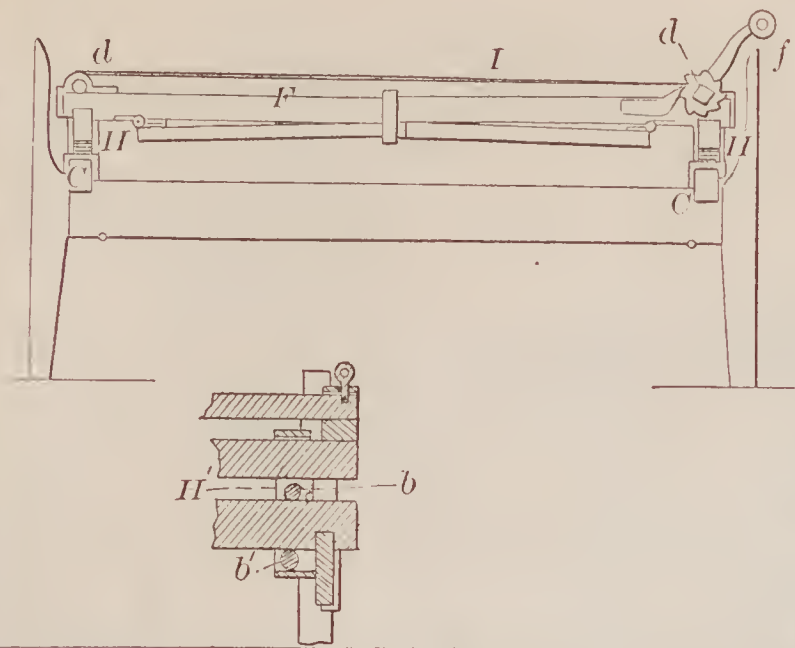

67612—M. L. Treadwell—Mosquito Net.

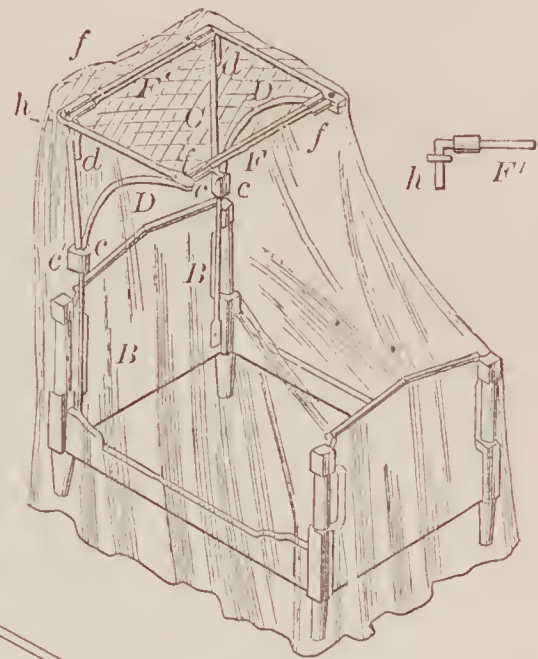

67611—I. P. Tice—Spirit Meter.

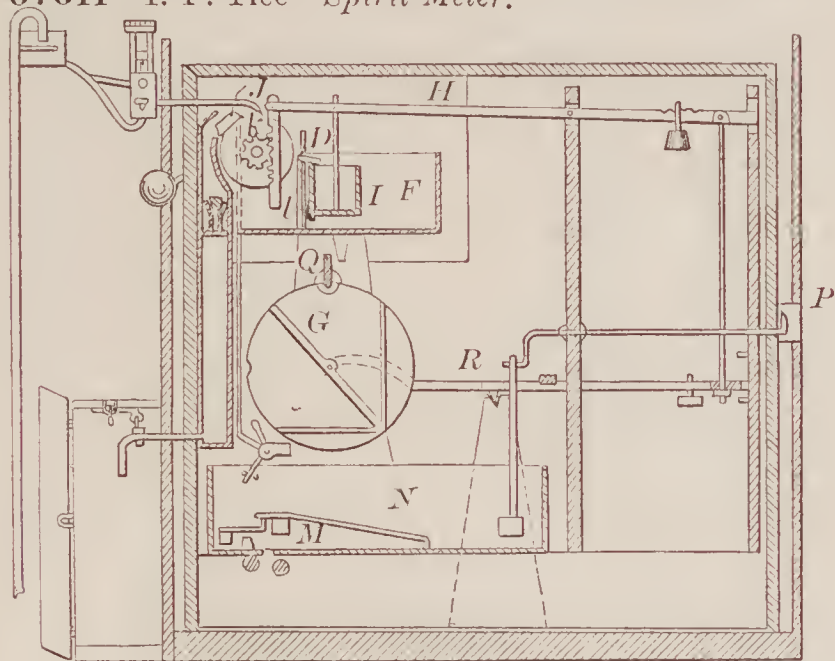

67613—J. Treves—Hose Nozzle.

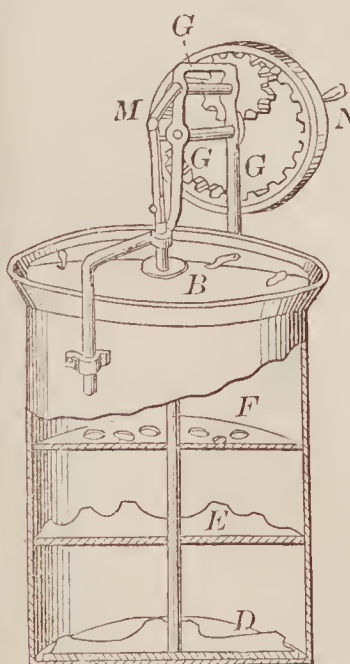
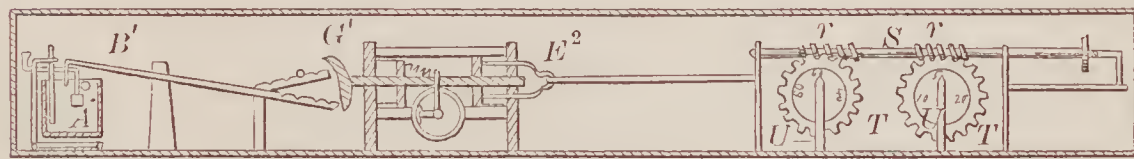
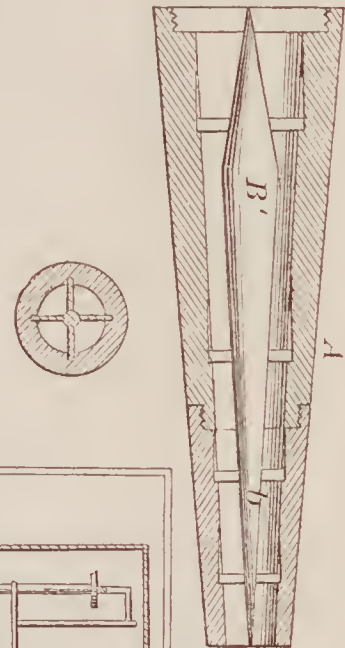

67615—C. A. Van Horn—Churn.

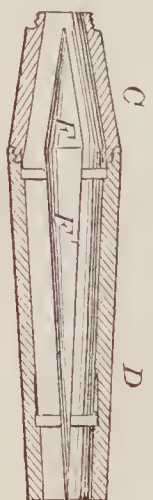

67614—J. Treves—Water Pipe.

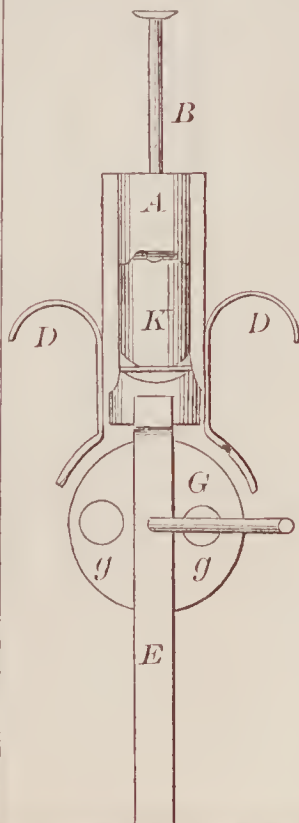

67616—L. Von Frober—Nutmeg Grater.

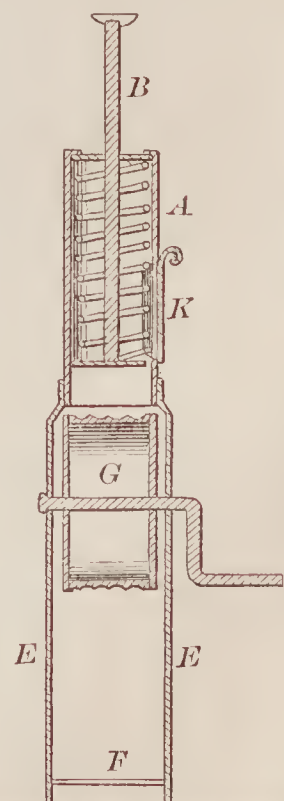



97617—Wallace & Cockerill—  
Churn Dasher.

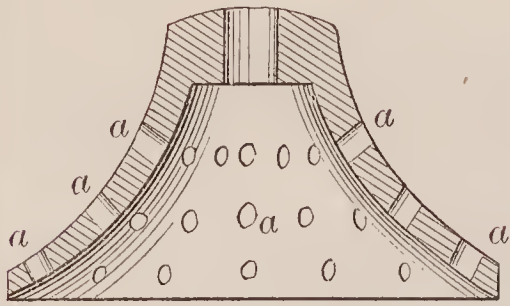

67619—S. Whitaker—*Burglar Alarm.*

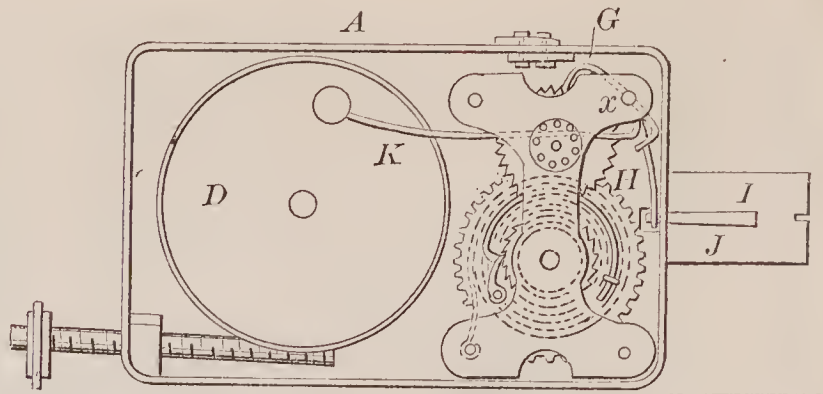

67618—J. Watrous, Jr.—*Coffee Mill.*

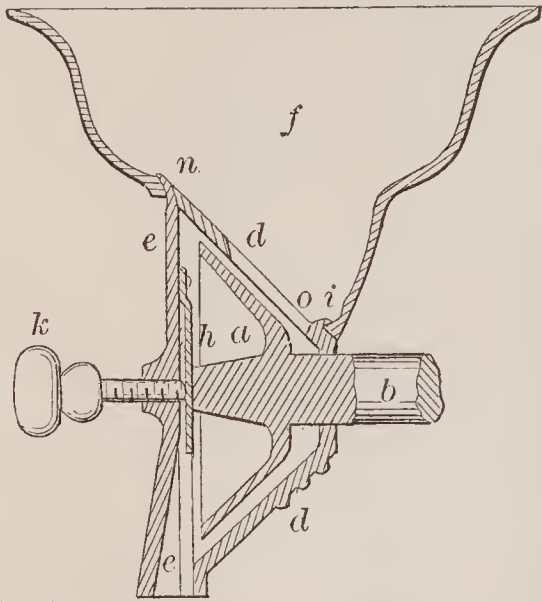

67620—Whitney & Shaw—  
*Hat Hook for Pens.*

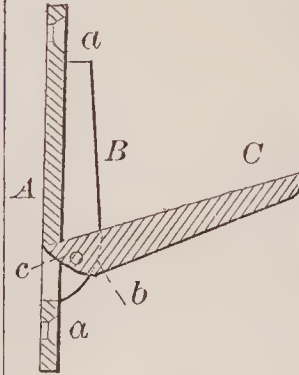

67622—Wirts & Swift—*Lantern and  
Foot Warmer.*

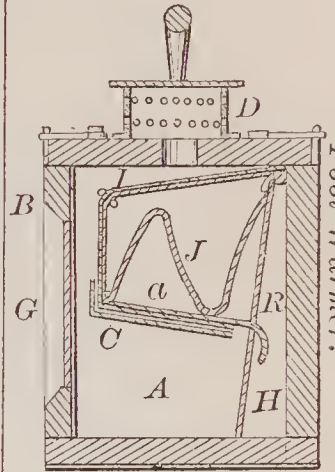

67623—G. E. Woodbury—*Planing Machine.*

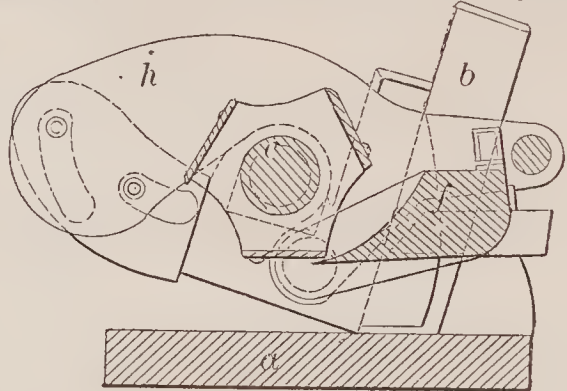

67621—S. L. Wiegand—*Steam Generator.*

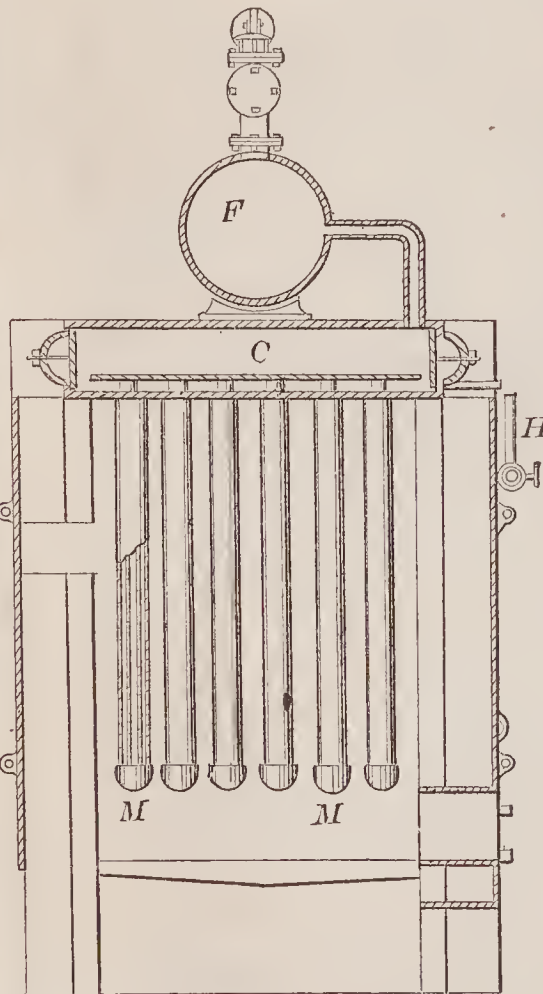

67626—J. Anthony—*Joint Splicer for  
Railroad Rails.*

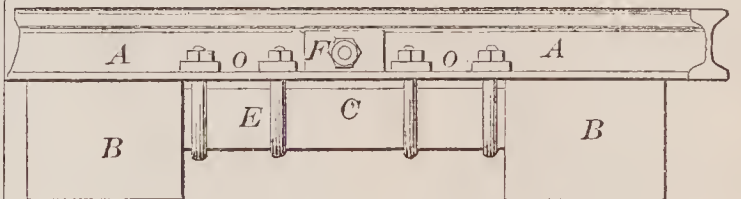

67625—W. E. Andrews—*Spice Box.*

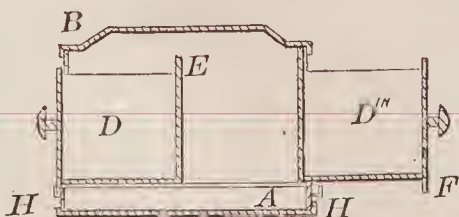

67624—J. E. Wootton—*Rivet.*

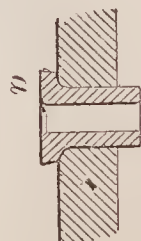
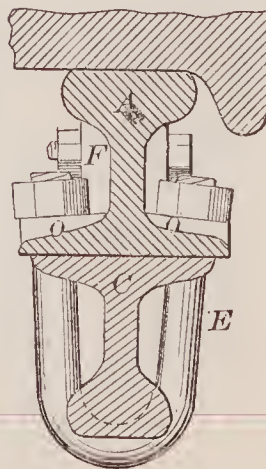

67628—R. Bratton—Wagon Bed.

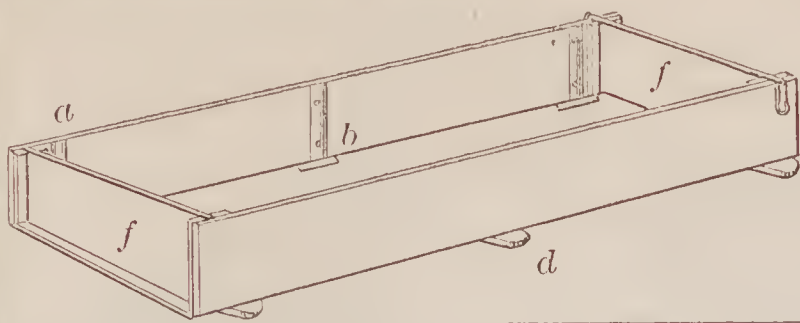

67631—J. H. Burrell, Jr.—Carriage Coupling.



67629—H. H. Bryant—Filling for Safes.

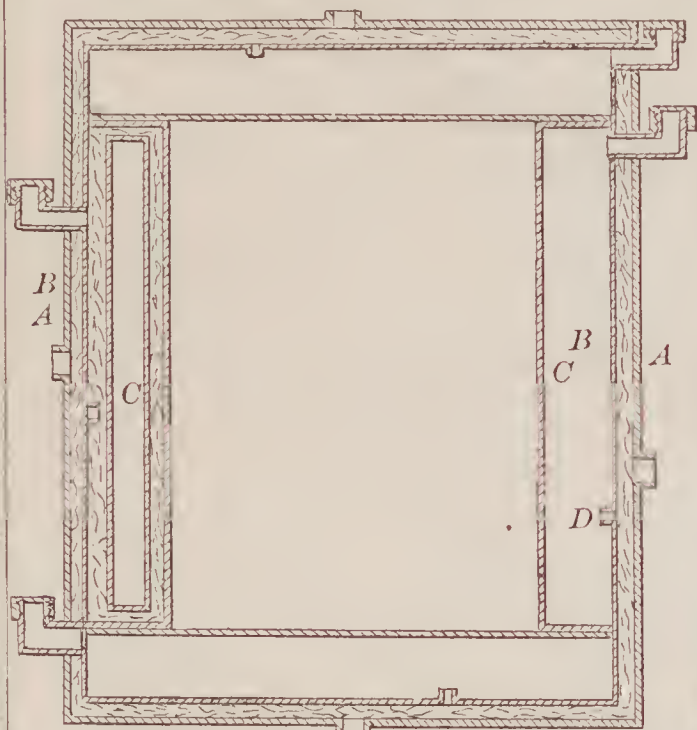

67633—B. F. Carleton—Window Fastening.

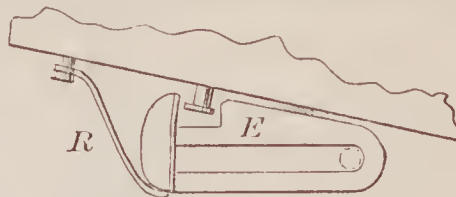

67634—L. Coleman—Harrow.

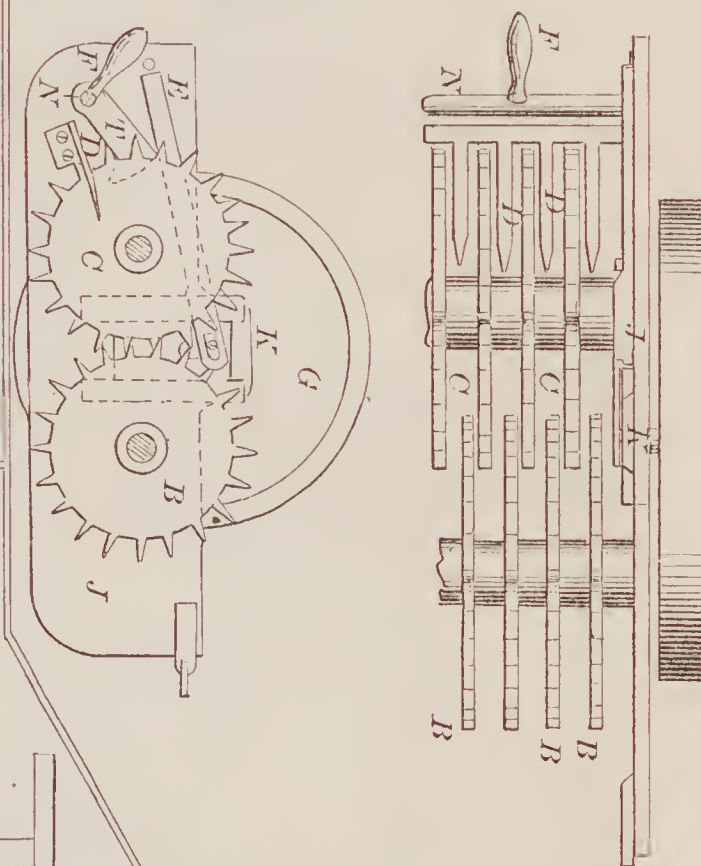

67630—J. E. Burdge—Rest for Lathes.

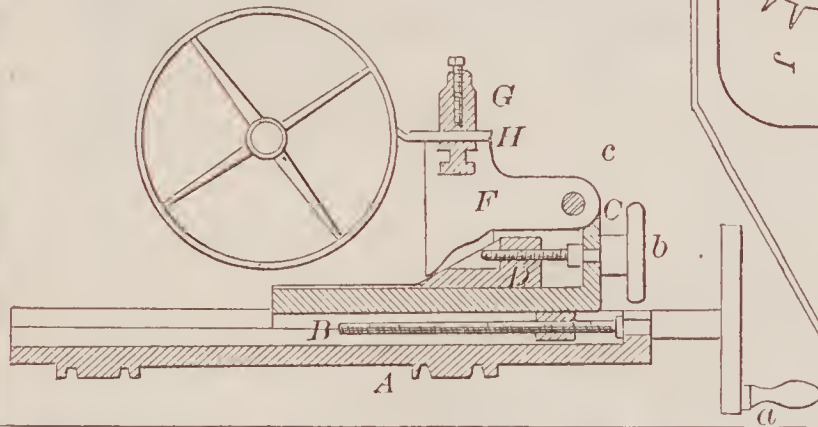

67635—E. H. Craige—Cloth Plate for Sewing Machines.

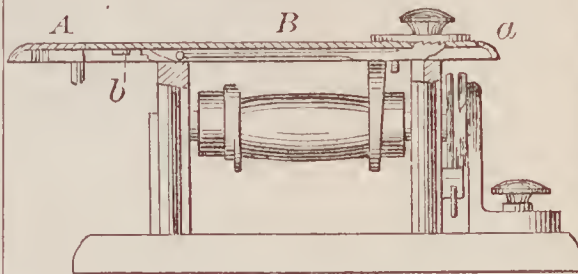

67632—J. K. Caldwell—Brick Car.

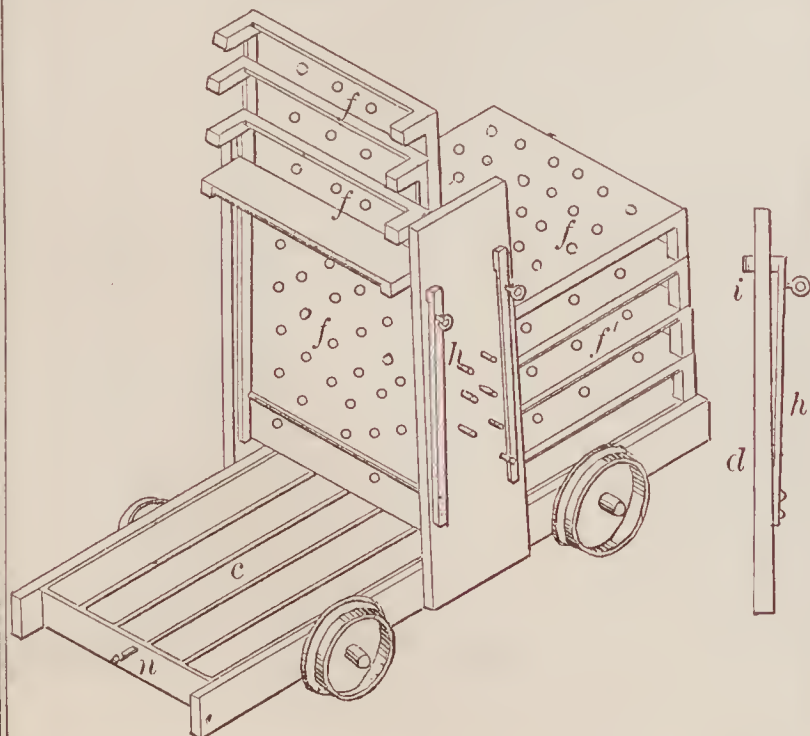

67636—C. Croley—Ladder.

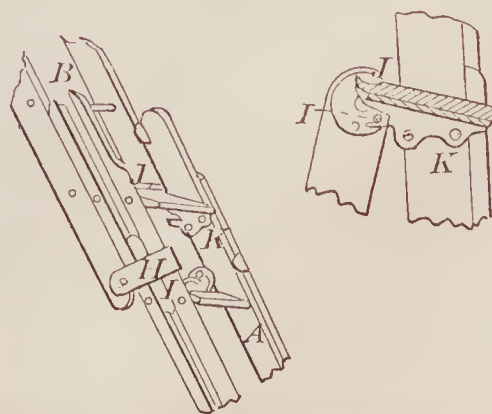



67637—J. M. Dillon—*Steam Generator.*

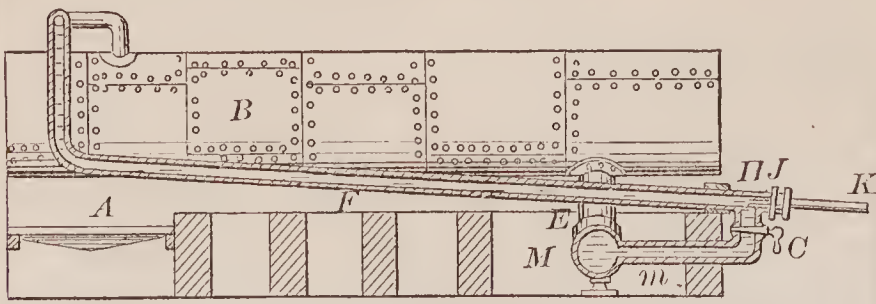

67639—S. H. Downs—*Traveler for the Jib's Boom of Vessels.*

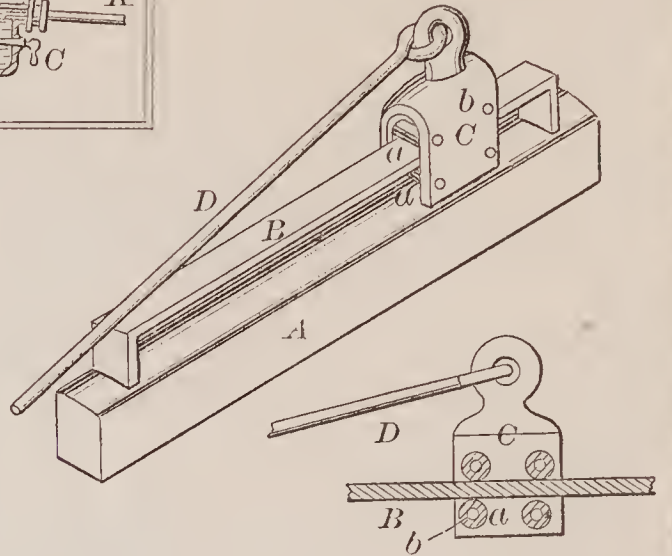

67641—C. E. Felton—*Lock for Prison Doors, &c.*

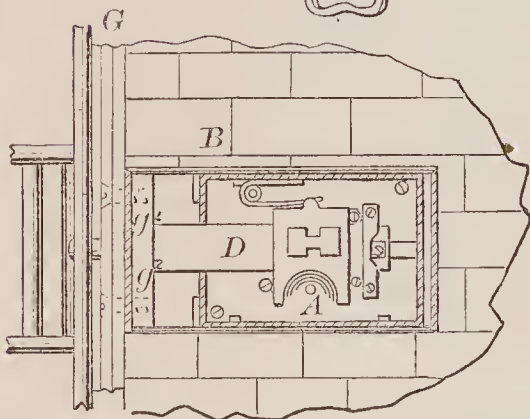
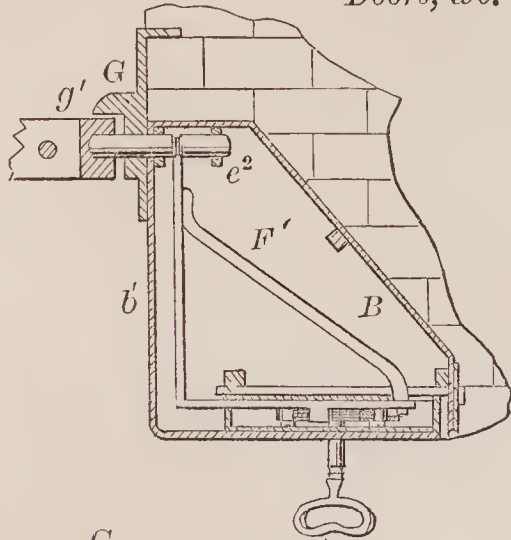

67638—D. H. Dotterer—*Axle Box and Hanger.*

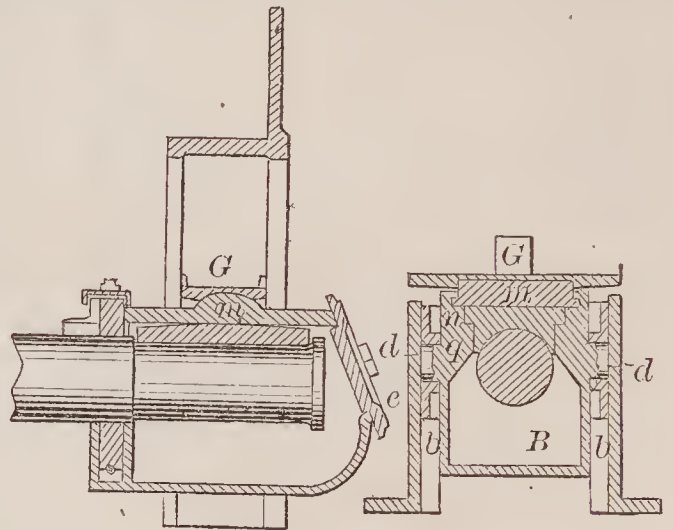

67642—J. B. Francis—*Washing Machine.*

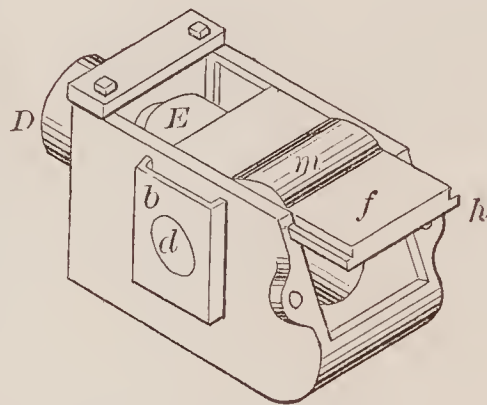
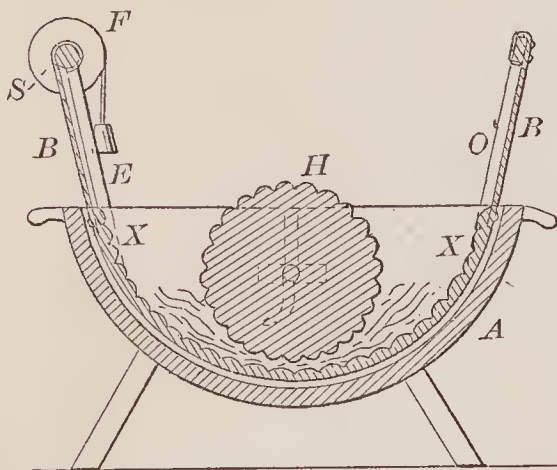

67640—T. G. Estes—*For Striking Gongs or Bells.*

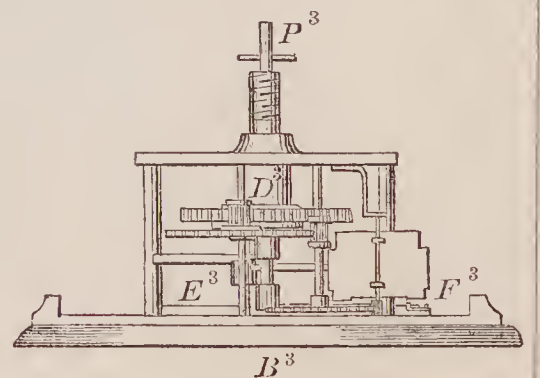
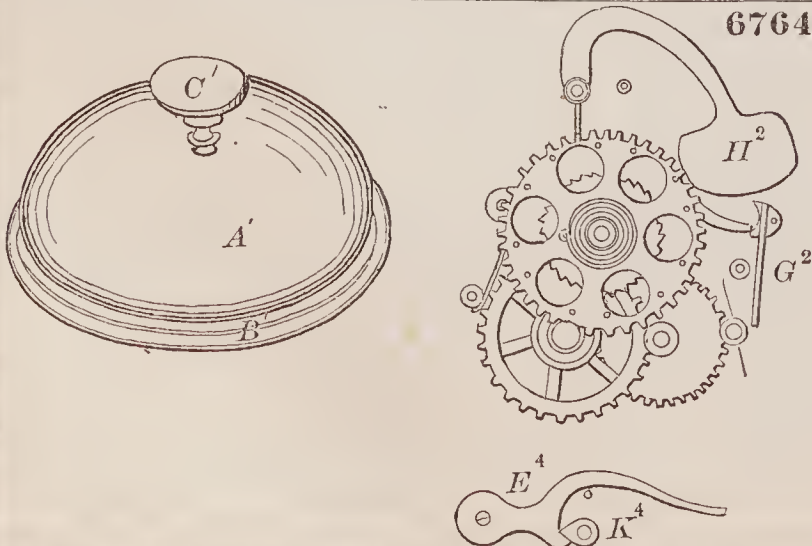

67643—O. S. Garretson—Mop Head.

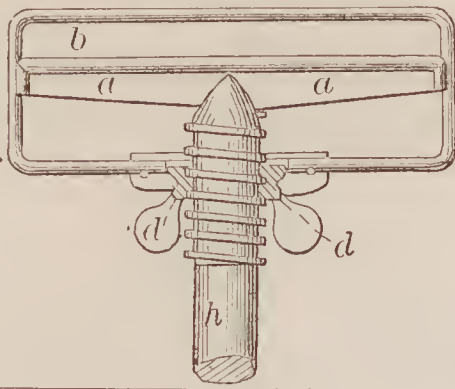

67646—Green & Kay—Reverberatory and Cupola Furnace.

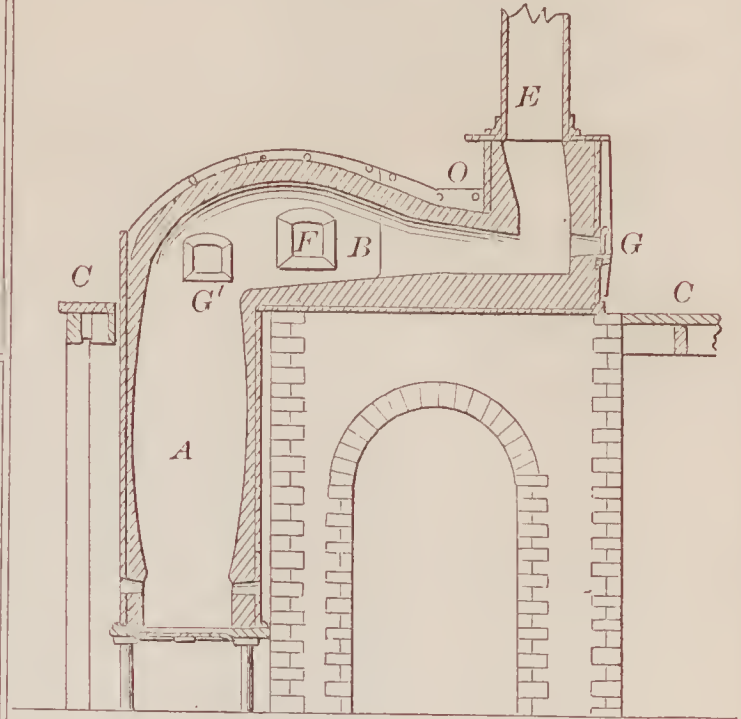

67647—B. Griffin—Bed Bottom.

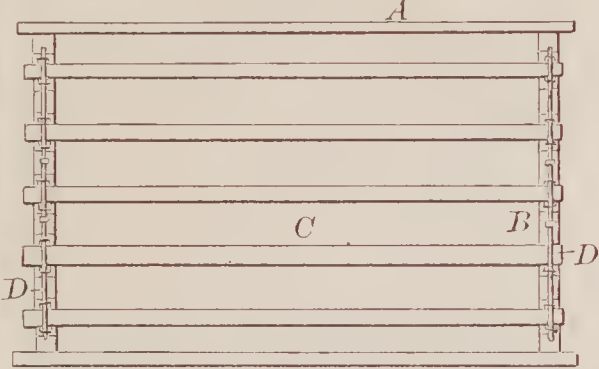

67650—C. H. Helms—Heel Press for Boots.

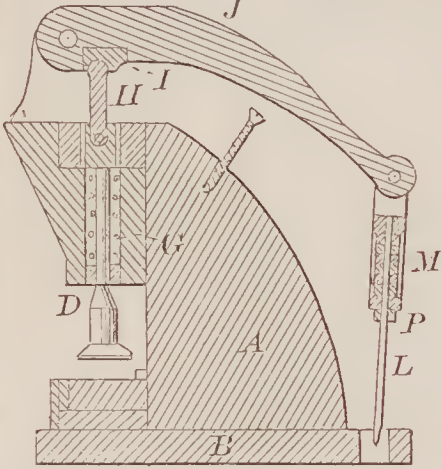

67645—H. Gray—Trunk Roller.

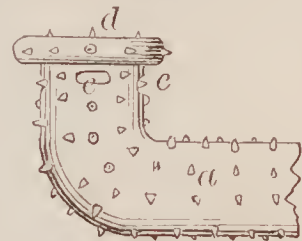
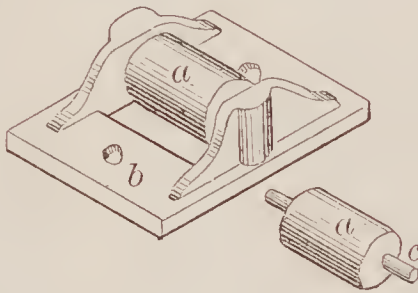

67651—B. H. Hibler—Tugere for Blast Furnaces.

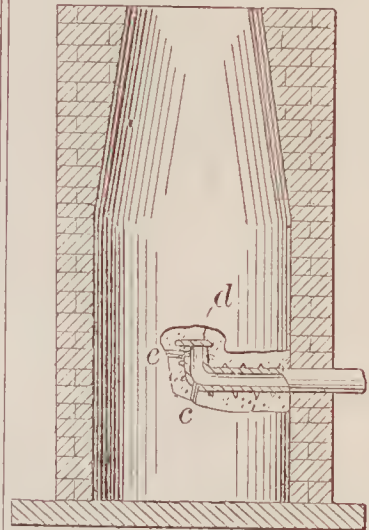

67649—A. H. Hart—Beehive.

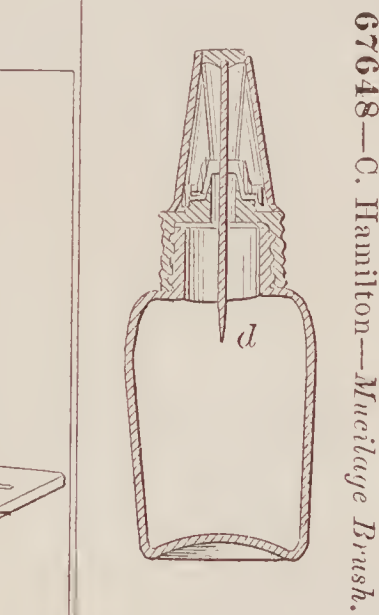
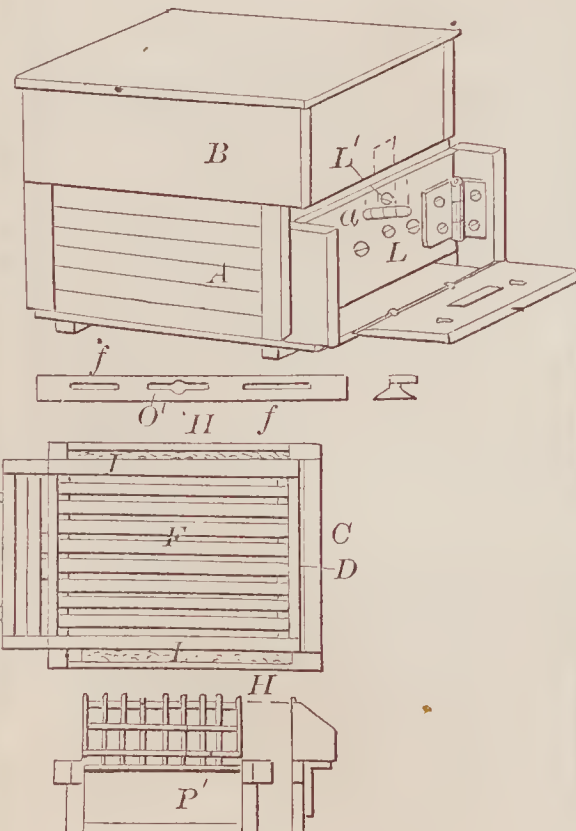

67648—C. Hamilton—Mangle Brush.

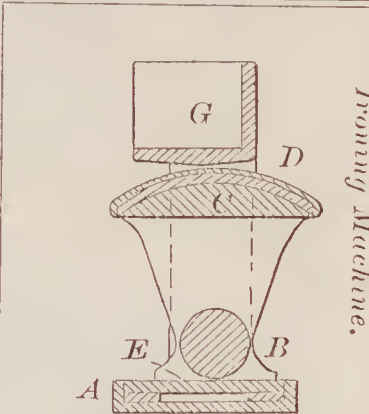

67644—Gilbert & Allen—Ironing Machine.

67652—J. A. & H. A. House—Sewing Machine.

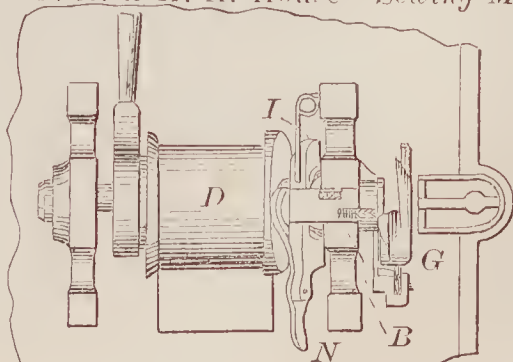







67663—M. Mattson—Cupping Apparatus.

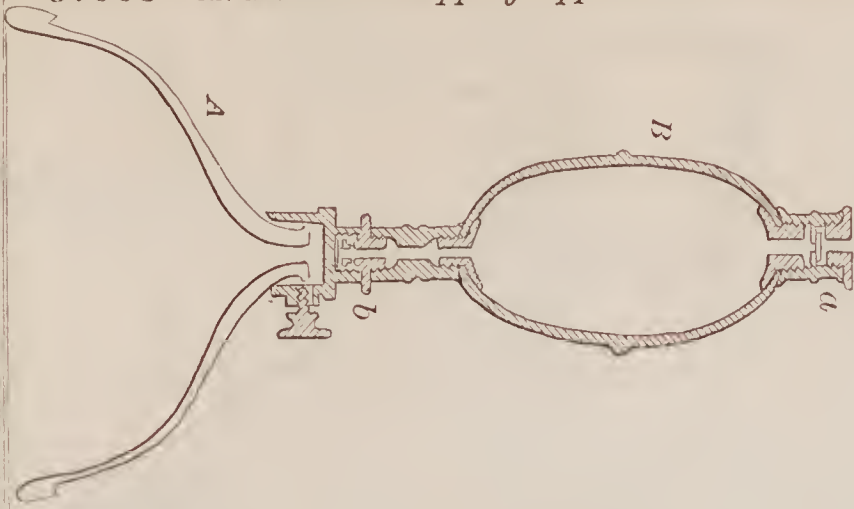

67667—L. Montgomery—Lime Kiln.

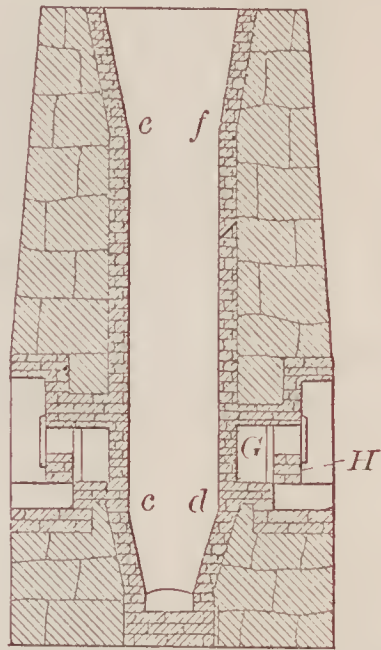
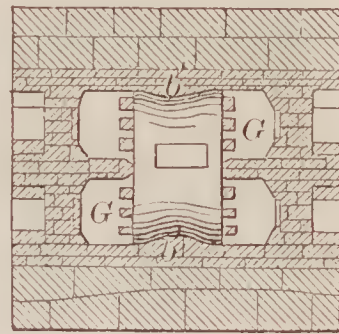

67664—E. McAllister—Windmill for Raising Water.

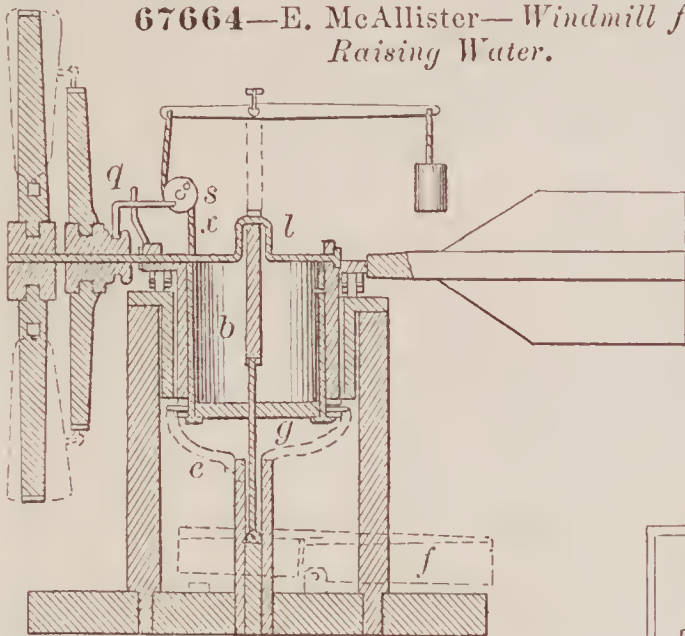

67668—D. B. Neal—For Defecating and Evaporating Sorghum Juice.

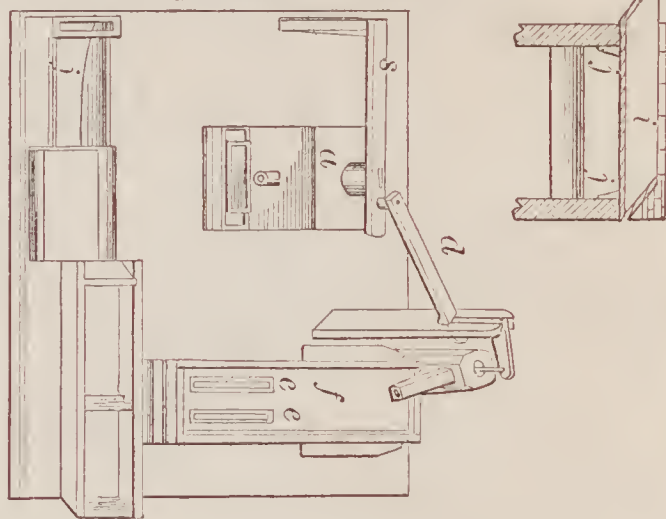

67666—Merrill & Lawrence—Pump.

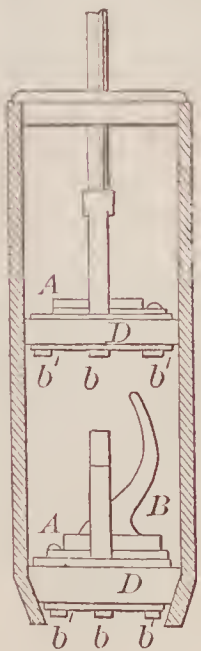

67665—G. W. McGill—Press for Attaching Paper Fasteners.

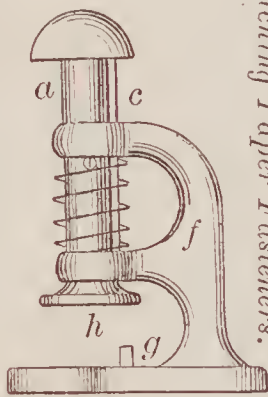

67669—Orr & Wright—For Making Paper Boxes.

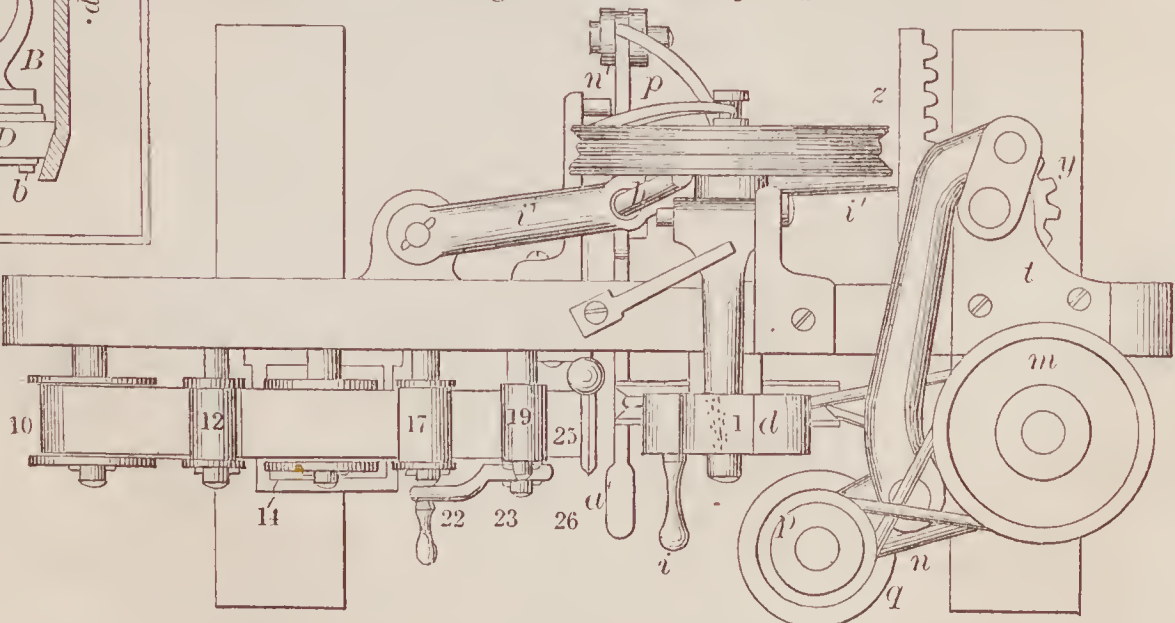



67669—Continued.

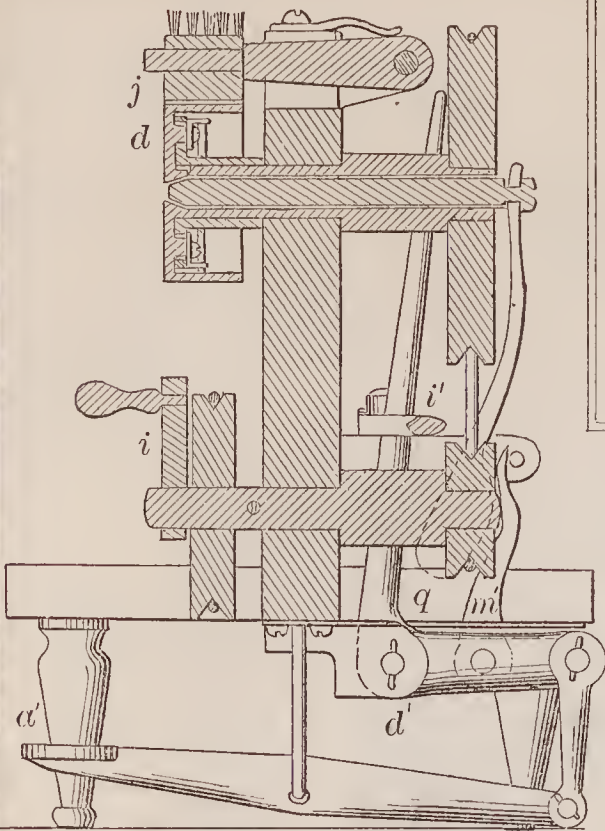

67670—D. E. Paris—Cooking Stove.

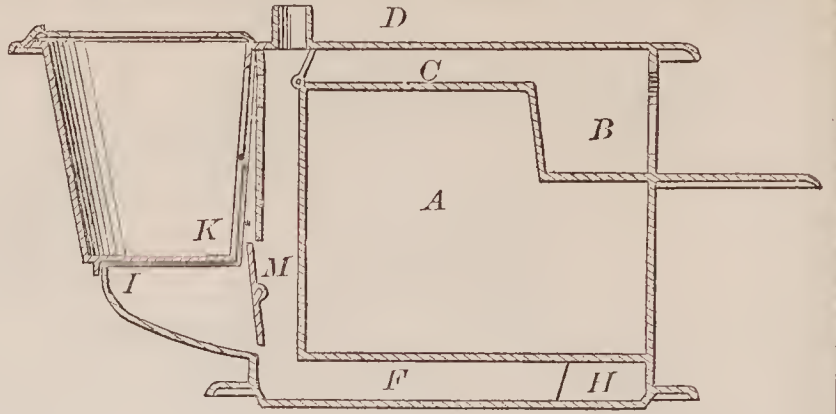

67671—R. Phillips—Carpenters' Plane.

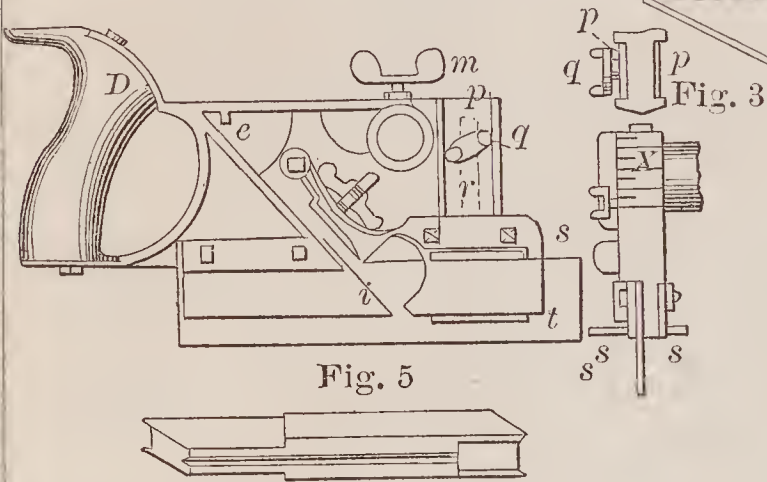

67672—H. E. Pond—Receptacle for Harness.

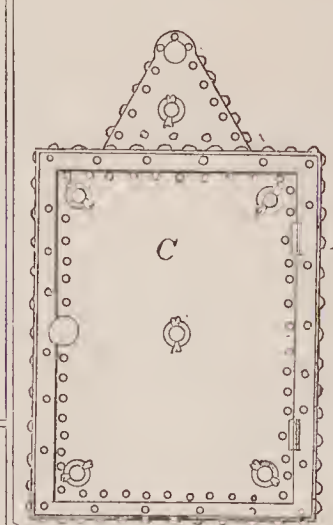

67674—J. Preston—Support for Sewing Machine Operators.

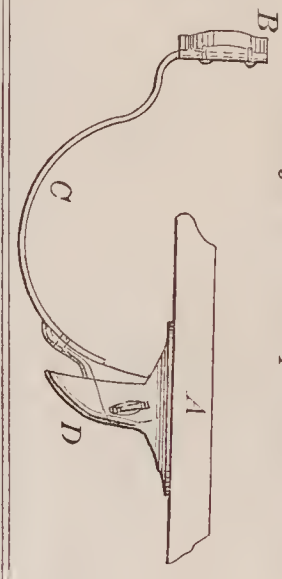

67680—G. Slusser—Beehive.

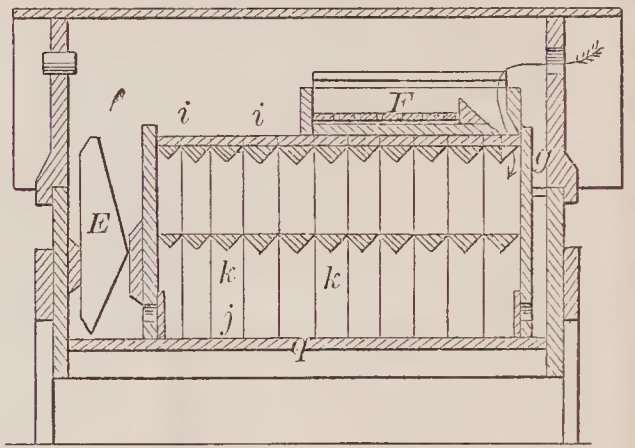

67673—D. Prest—Horse Rake.

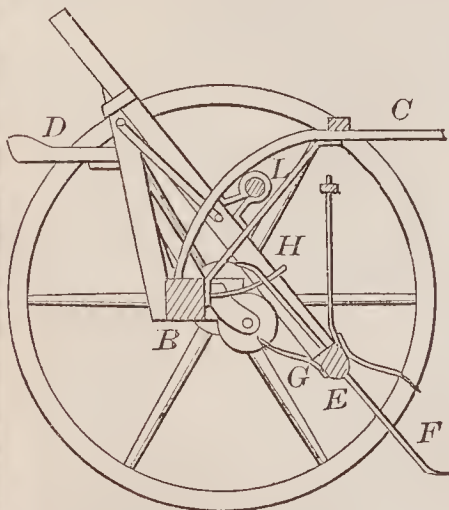

67676—J. Richards—Turning Lathe.

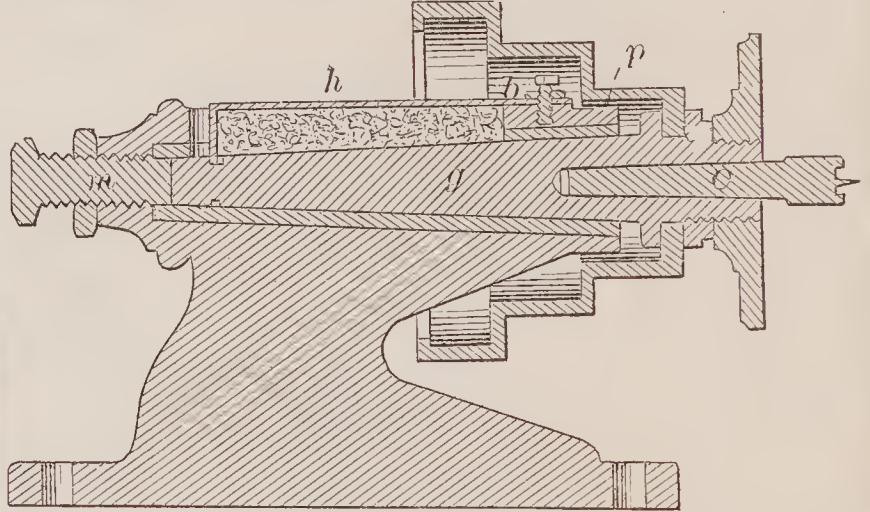

67675—M. Reilly—Trace Supporting Hook.

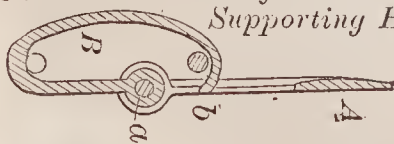

67681—J. H. Snyder—Hame Clasp.

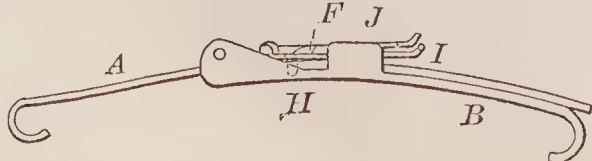

67677—Ridings & Roberts—Car Coupling.

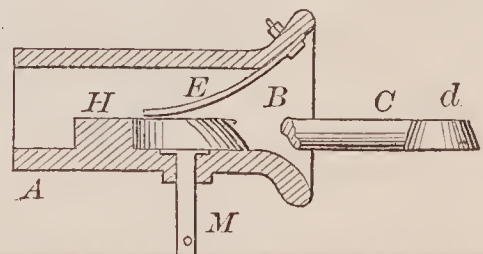



67685—I. C. Tate—Vise.

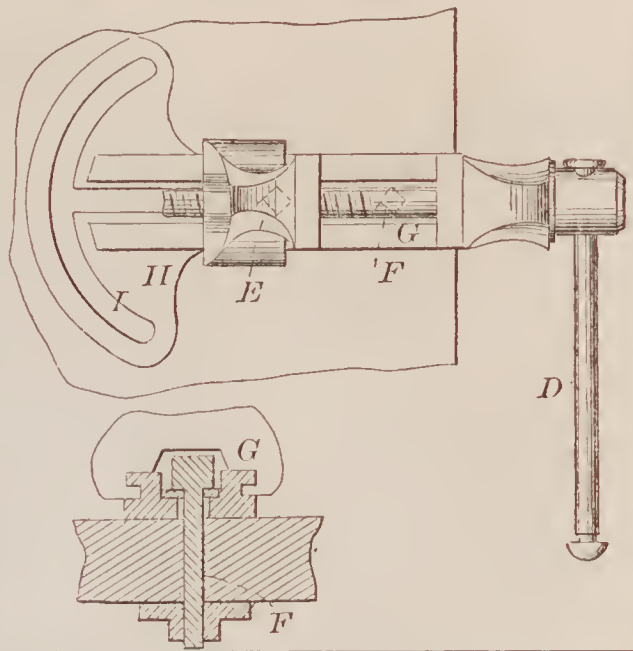

67684—L. Sylvester—Brick Mould Piston.

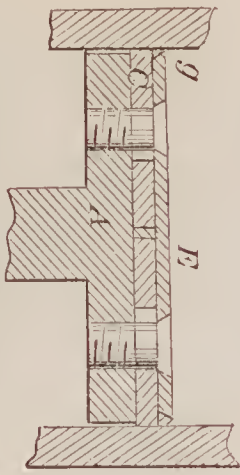

67686—Teale & Brassington—Steering Apparatus.

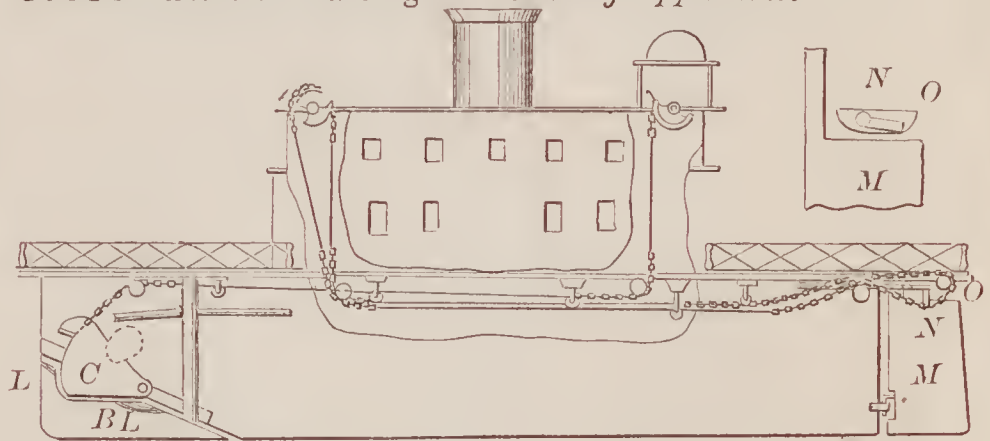

67688—T. J. Turner—Horse Rake.

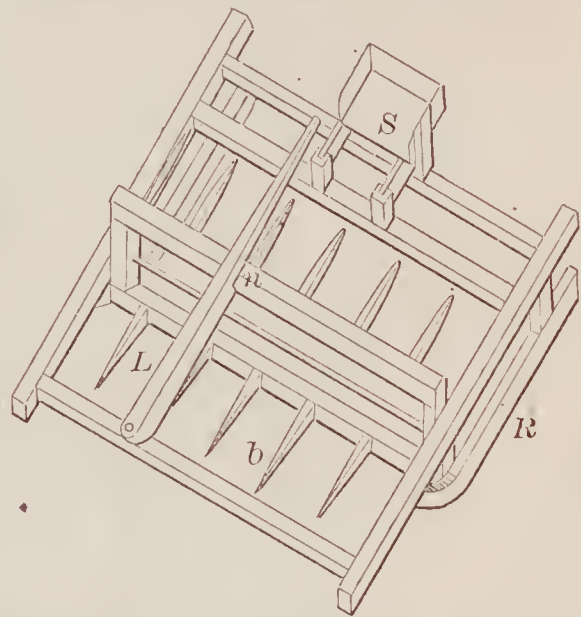

67690—I. P. Warner—Carpet Stretcher.

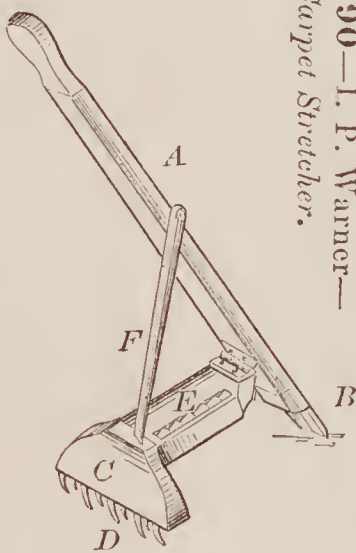

67687—G. A. Townsend—Automatic Damper.

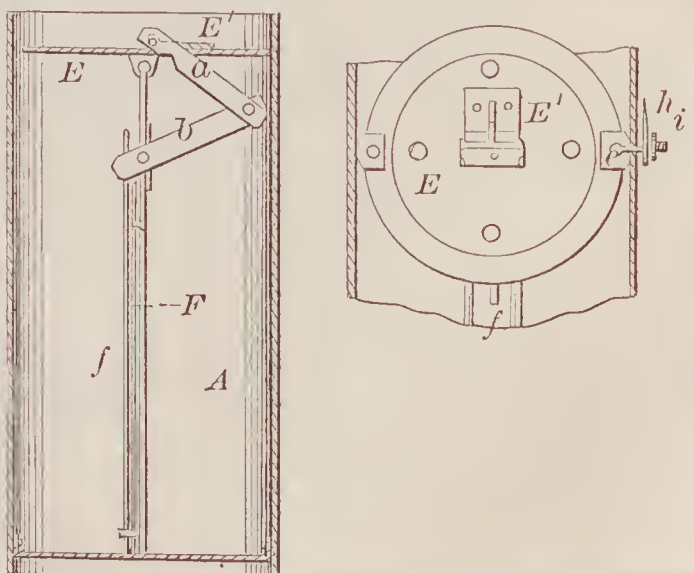

67691—G. M. White—Shirt Stud.



67682—J. W. Strange—Saw Tooth.

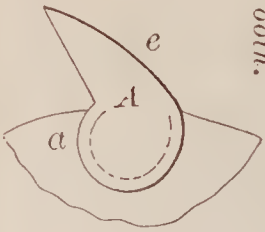

67683—W. A. Sweet—Fagot for Railroad Rails.

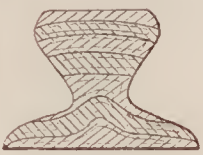
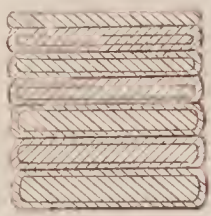

67689—Warne & Pearce—Hitching Device for Horses.



67692—C. V. Woerd—Stem Winding and Setting Watch.

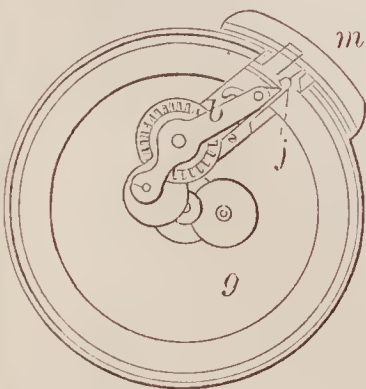



67693—H. Wood—For Treating Matters with Steam.

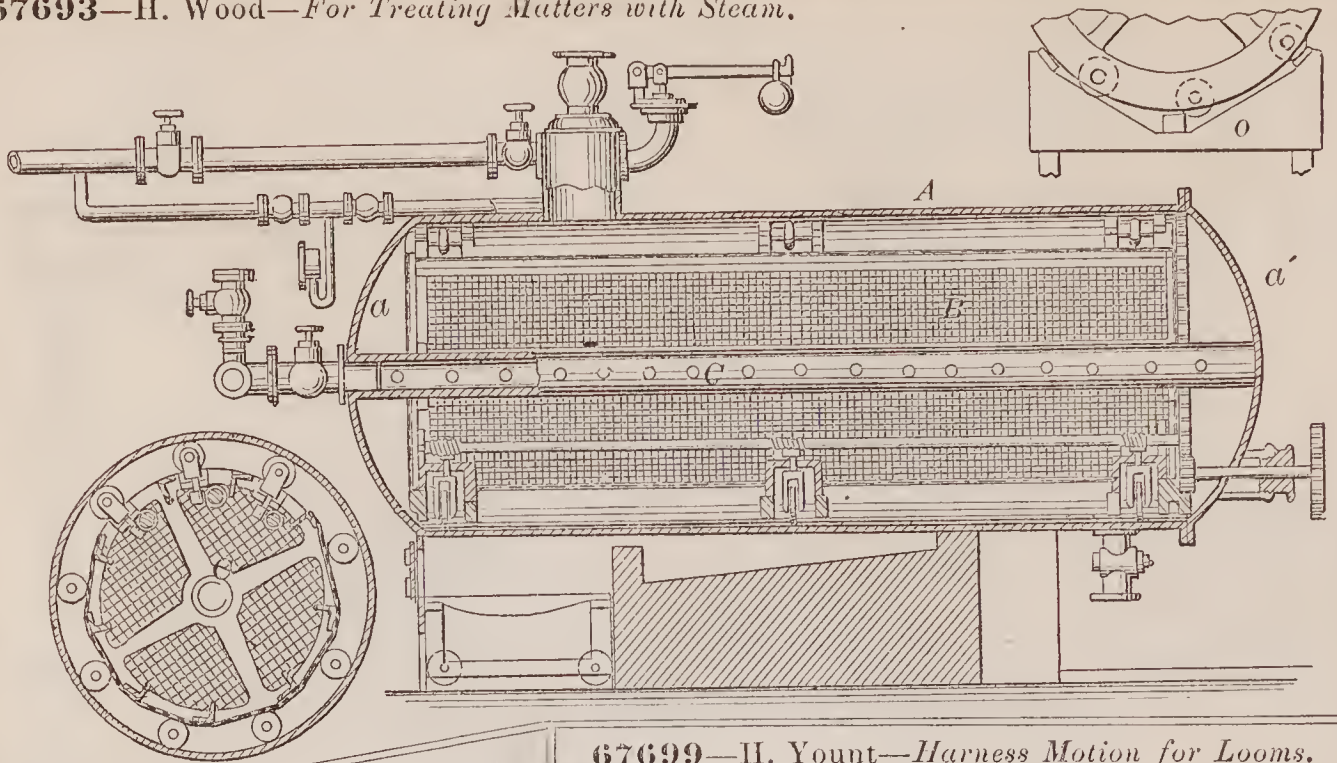

67699—H. Yount—Harness Motion for Looms.

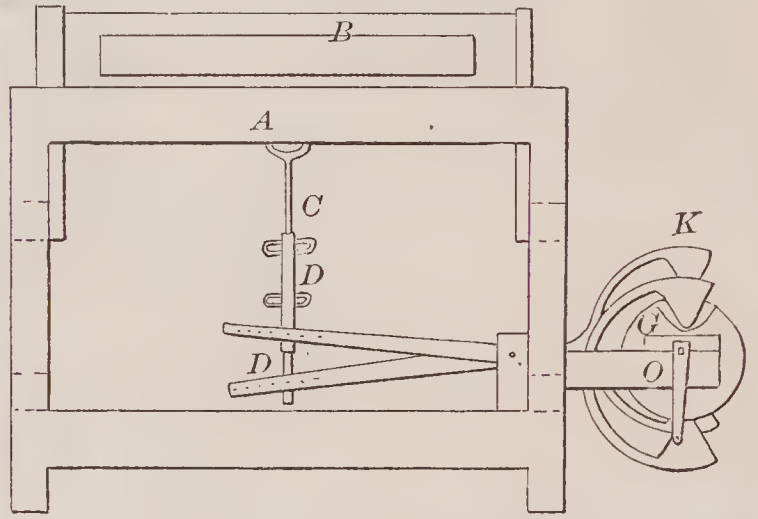

67694—J. S. Wood—Gas Regulator.

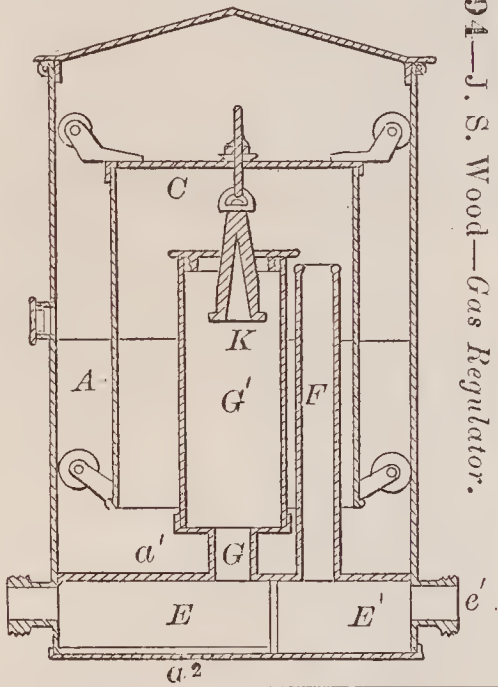

67701—A. H. Allen—Safety Bridge and Gate for Railroad Cars.

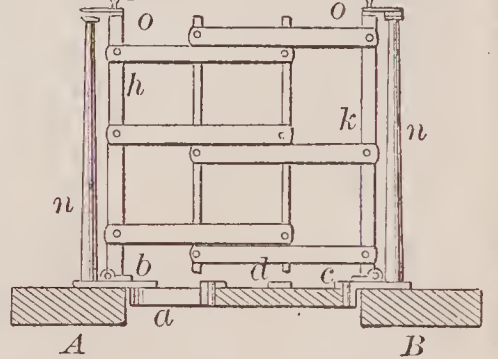

67698—E. Yeoman—Bed Bottom.

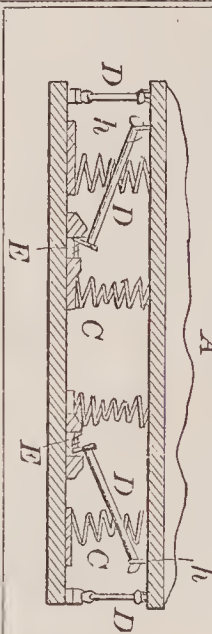

67695—J. R. Woodworth—Tuyere.

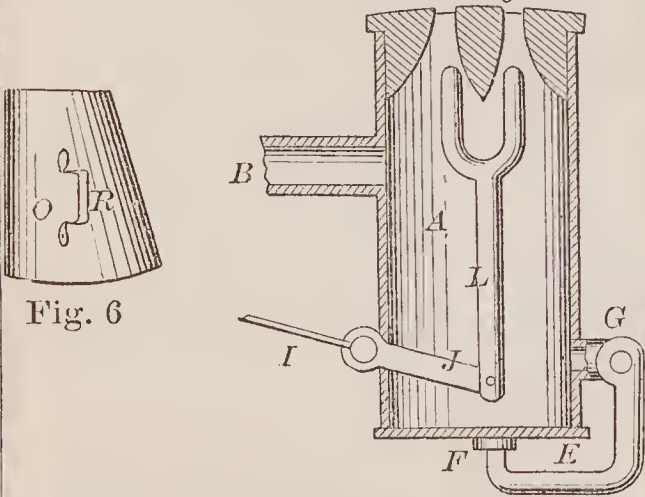

67700—J. Adams—Cotton Cultivator.

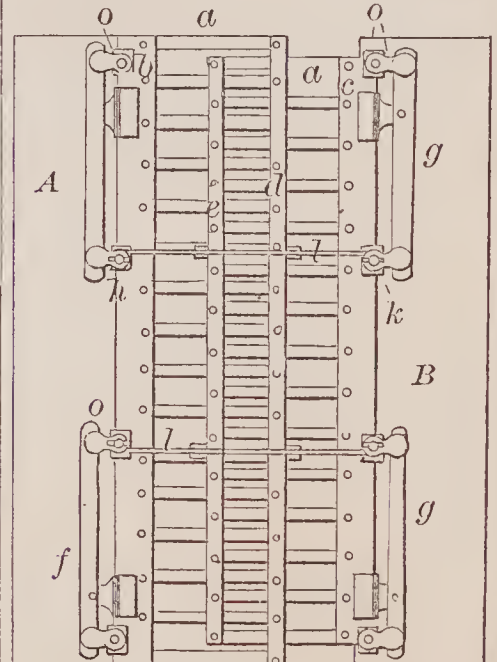
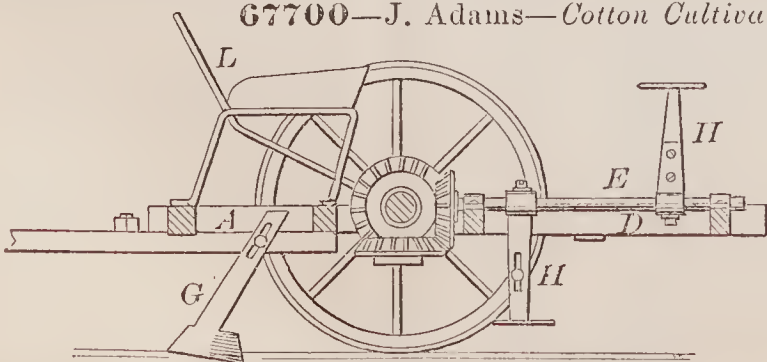



67702—J. O. Alter—Low Water Indicator.

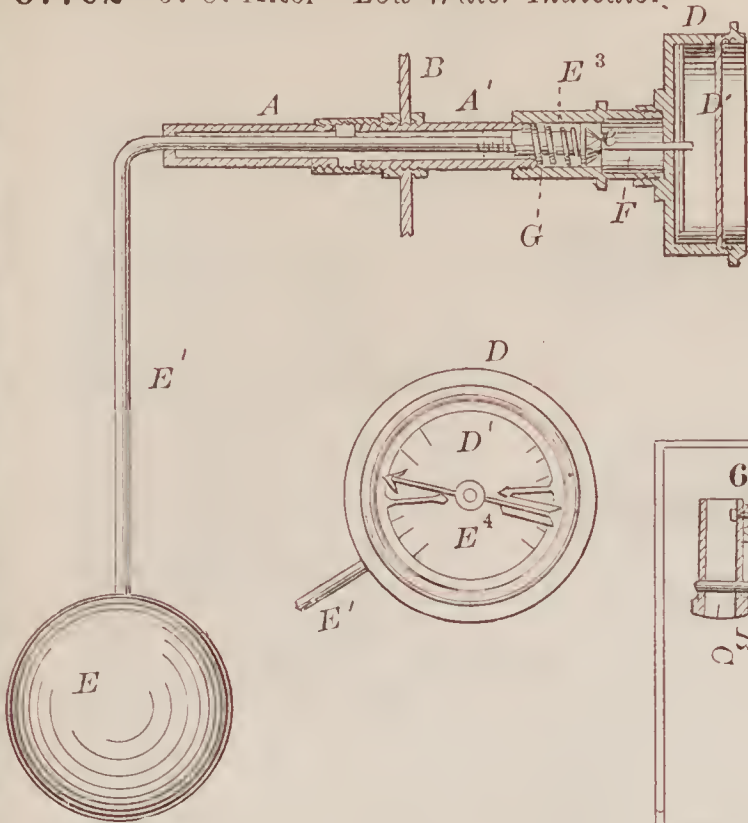

67705—L. B. Ball—Horse Rake.

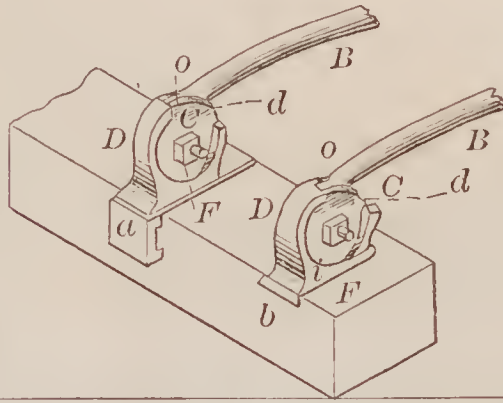

67703—R. S. Arnall—Car Coupling.

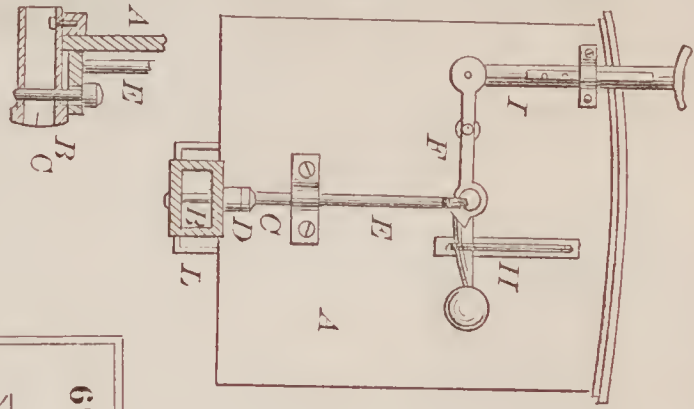

67704—T. Baker—Stop Watch.

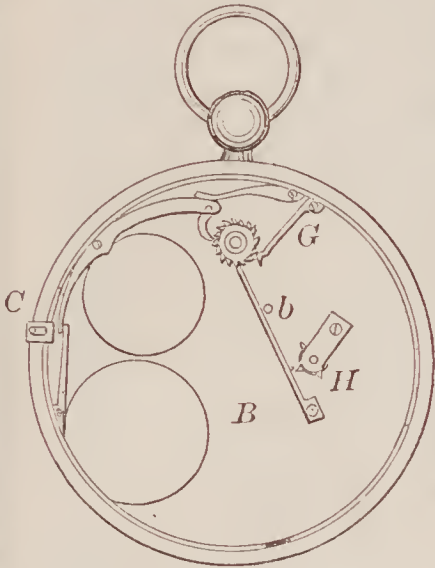

67707—G. N. Beard—Cotton Bale Tie.

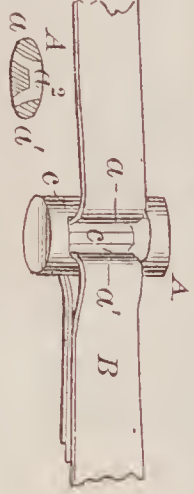

67710—W. W. Berntheisel—Step Ladder.

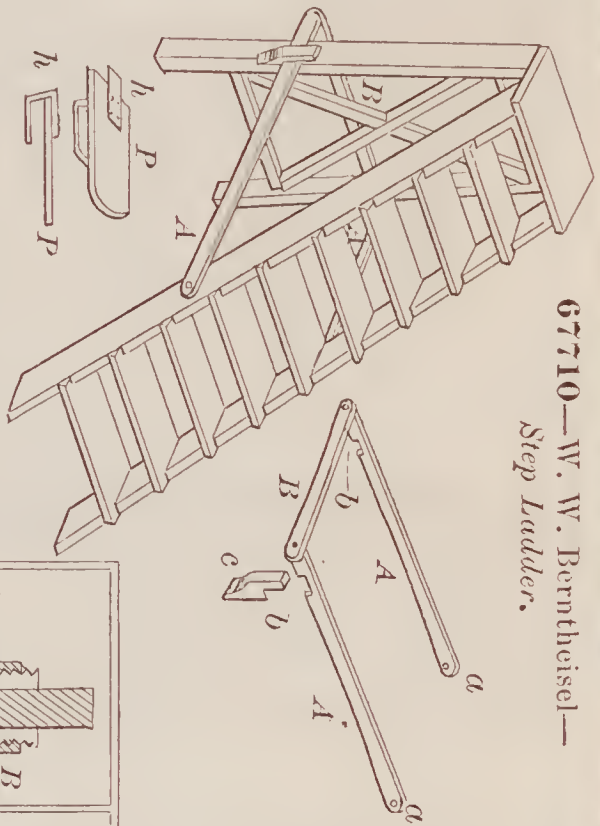

67708—Bechtel, Strahan & Hardy—Reamer.

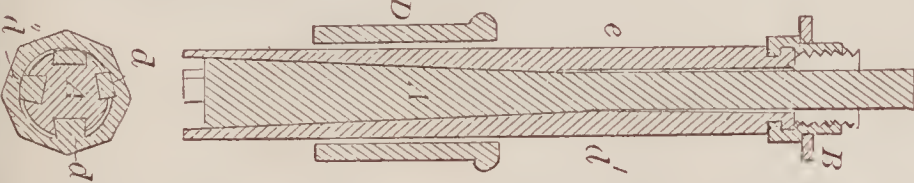

67711—C. C. Blodgett—Horse Hay Fork.

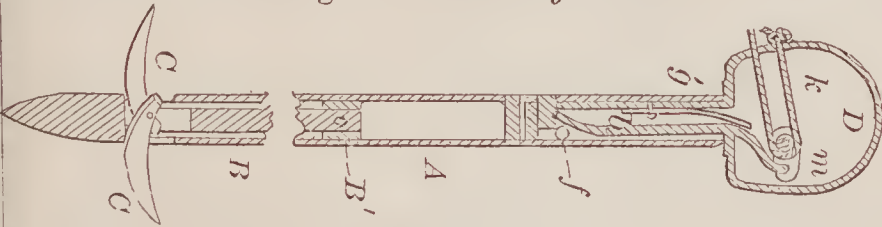

67709—H. Belmer—Animal Trap.

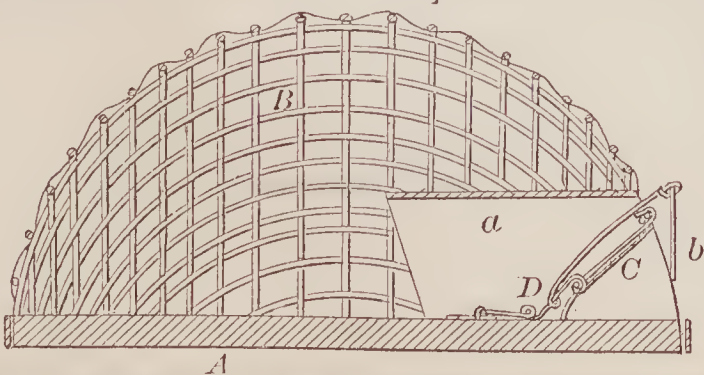

67712—W. Brighton—Meat Safe.

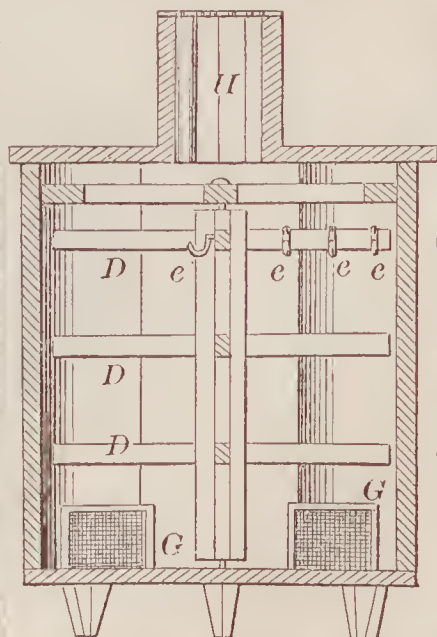



67713—J. Brinkerhoff—*Corn Sheller.*

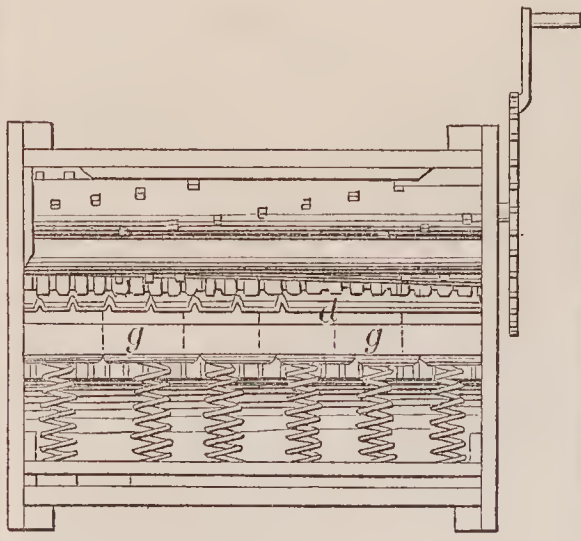

67718—C. Burnham—*Paint Can.*

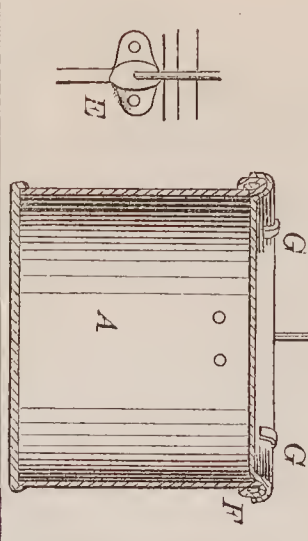

67717—N. C. Burnap—*Mills Cooler.*

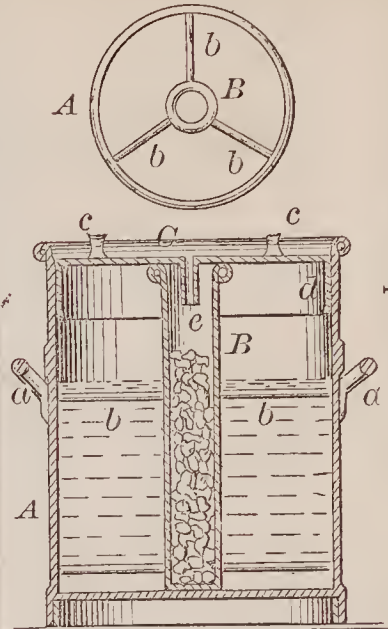

67719—J. T. Burr—*Hydraulic Press.*

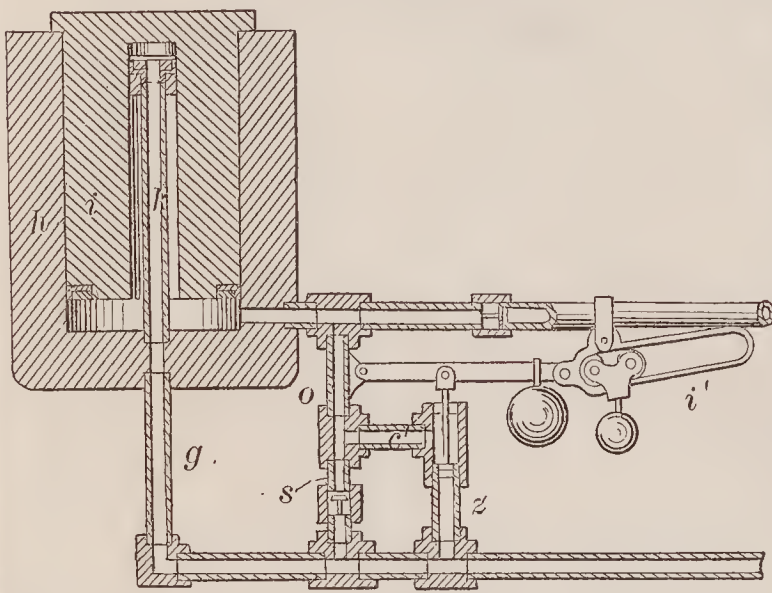

67721—S. E. Chubbuck—*For Moulding Plates of Lead.*

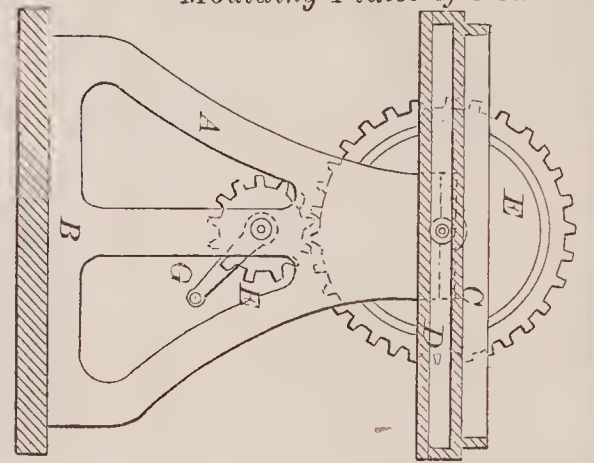

67720—J. S. Charles—*Fountain Pen.*

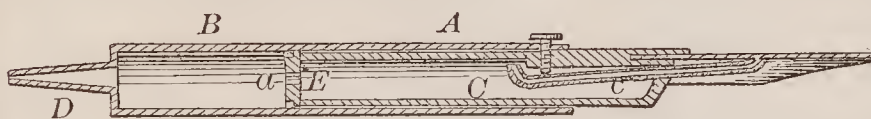

67716—S. Burgess—*Rolling or Winding Paper for Paper Cop Tubes.*

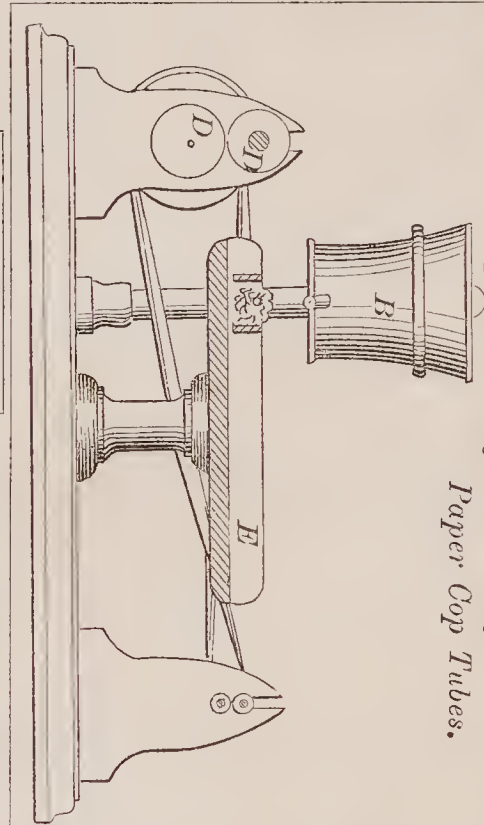

67723—L. Collier—*Farm Gate.*

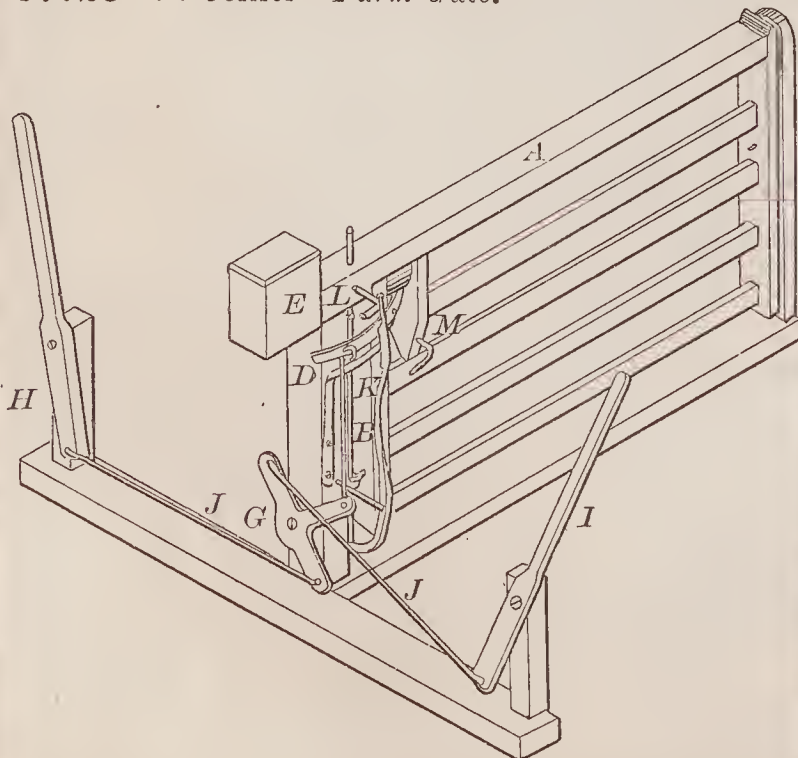

67722—C. B. Clark—*Mop Head.*

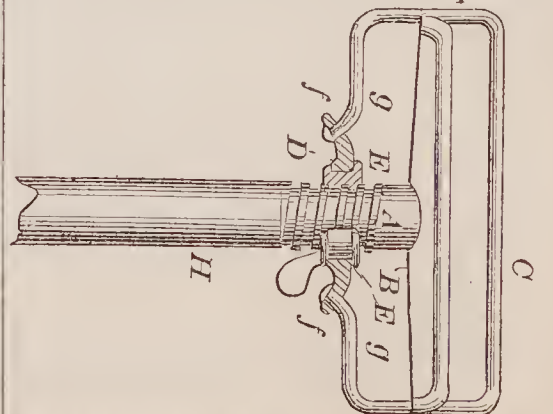



67724—E. B. Cook—*Shingle Machine.*

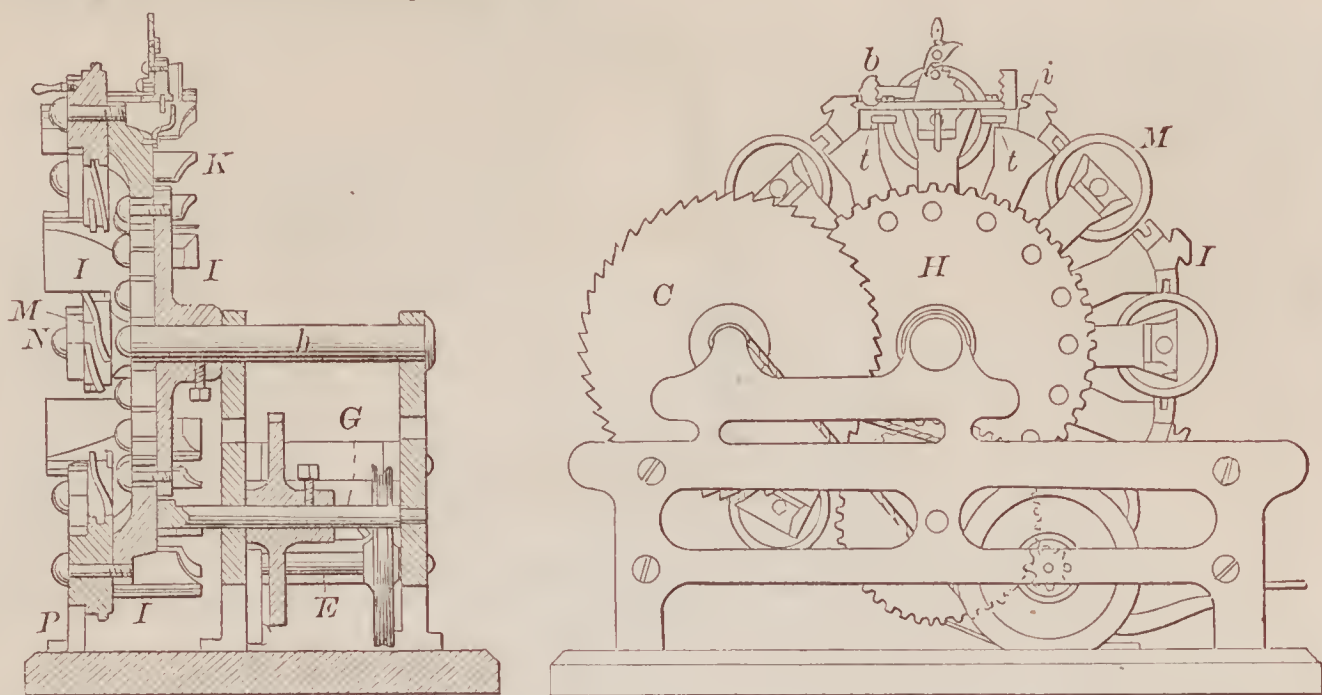

67725—J. Cooper—*Washing Machine.*

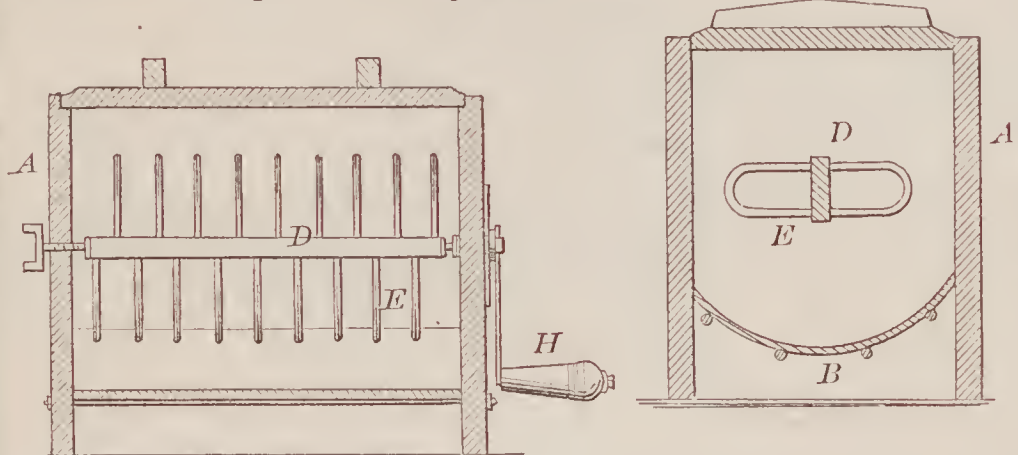

67726—J. S. Costello—*Stencil Brush.*

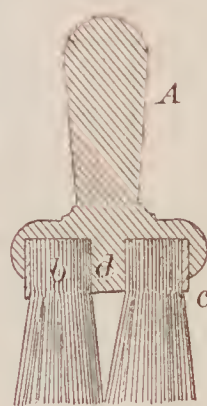

67727—W. Cotton—*Knitting Machine.*

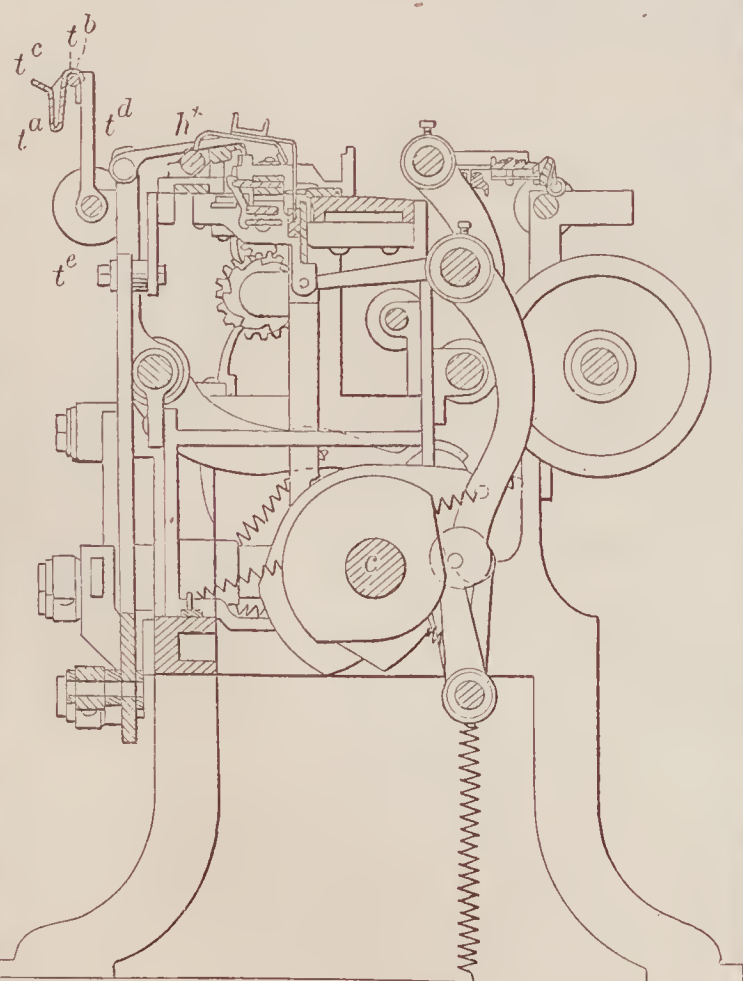

67728—J. W. Crary—*Brick Machine.*

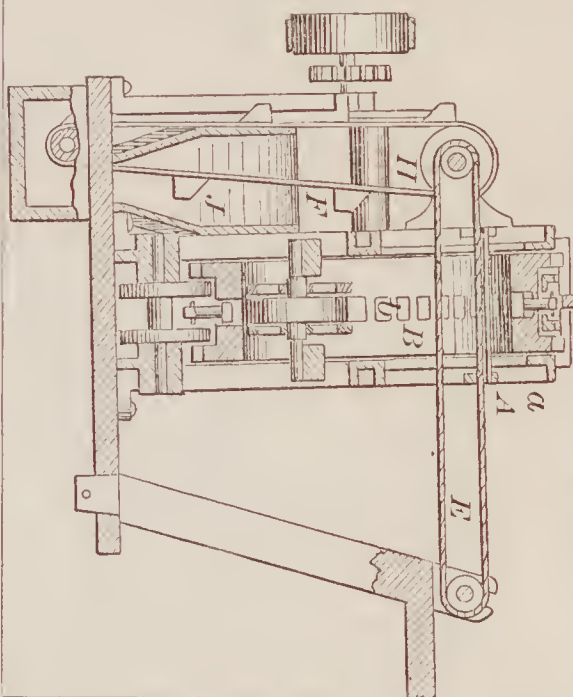

67729—Craw & Randolph—*Mosquito and Fly Net.*

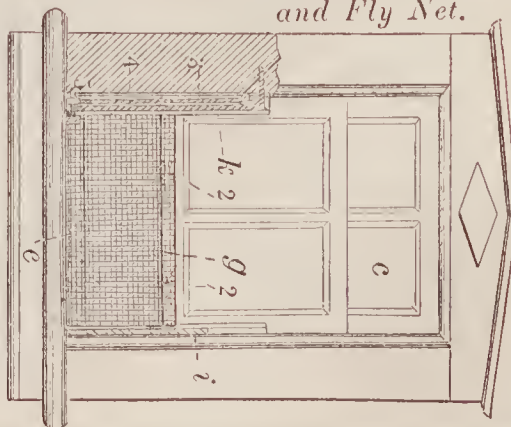



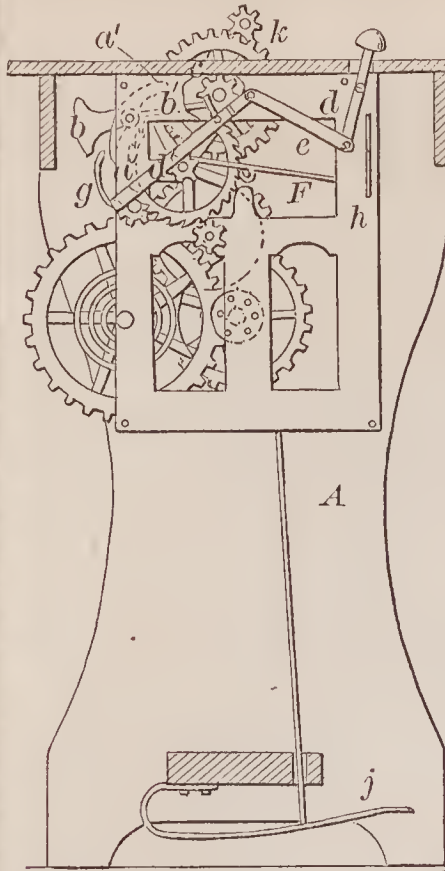

67730—L. Curdts—Applying Power to Machinery.

67732—G. B. Davis—Hot Air Furnace.

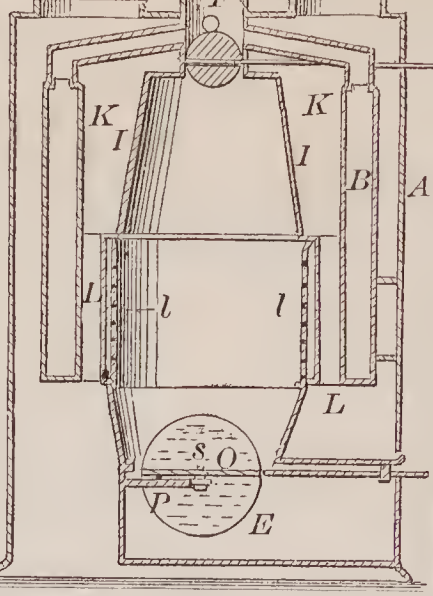

67734—H. Disston—Hardening and Straightening Steel Blades.

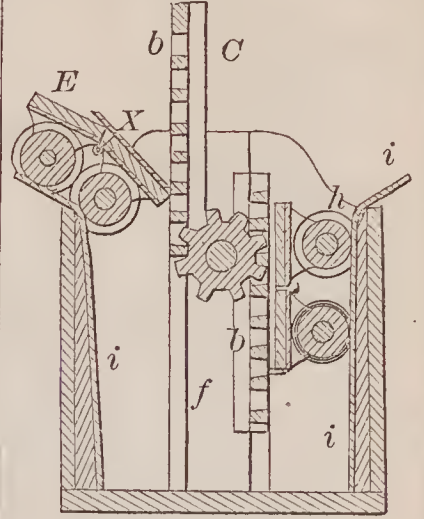

67735—W. A. Donnell—Corn Planter.

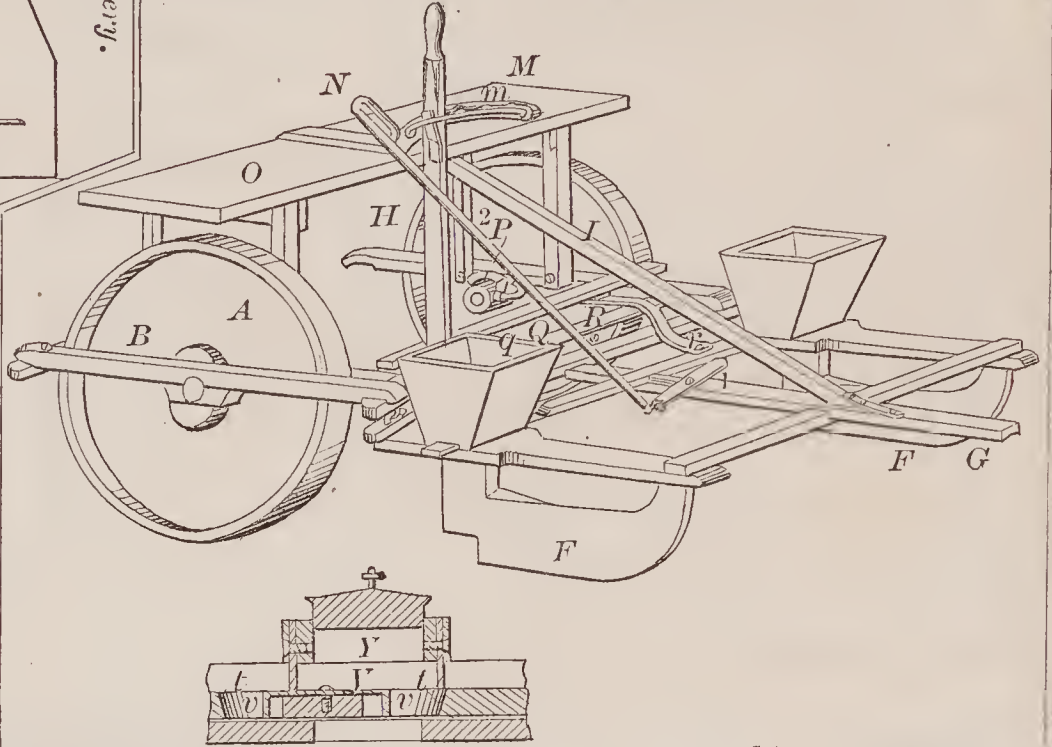

67737—Dunbar & McNaught—Device for Firkins, Barrels, &c.



67731—R. Daily—Washing Machine.

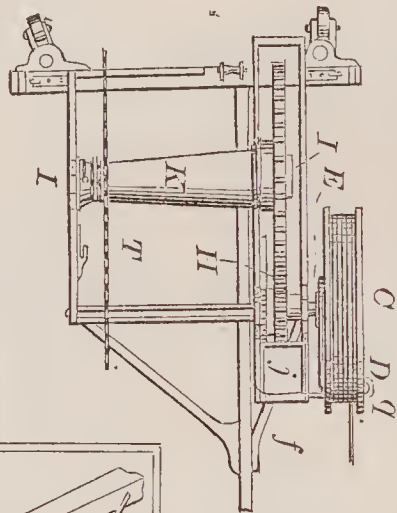
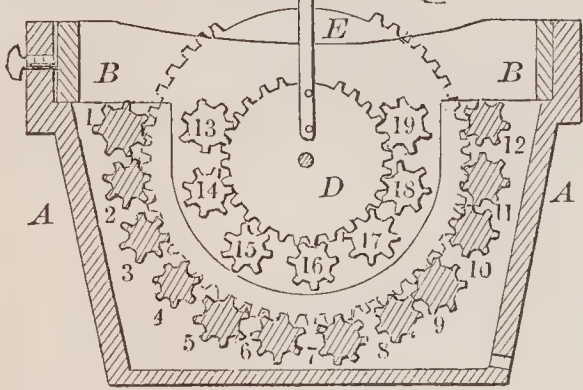

67738—L. R. Dye—Stump Extractor.

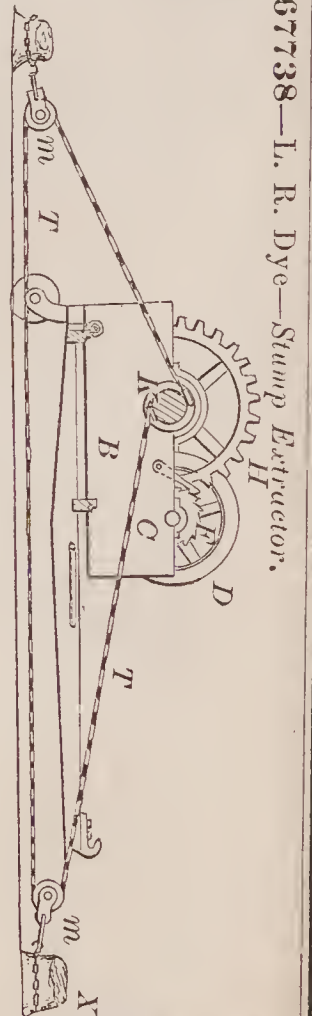

67736—G. D. Dudley—Corn Popper.

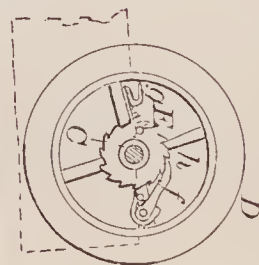
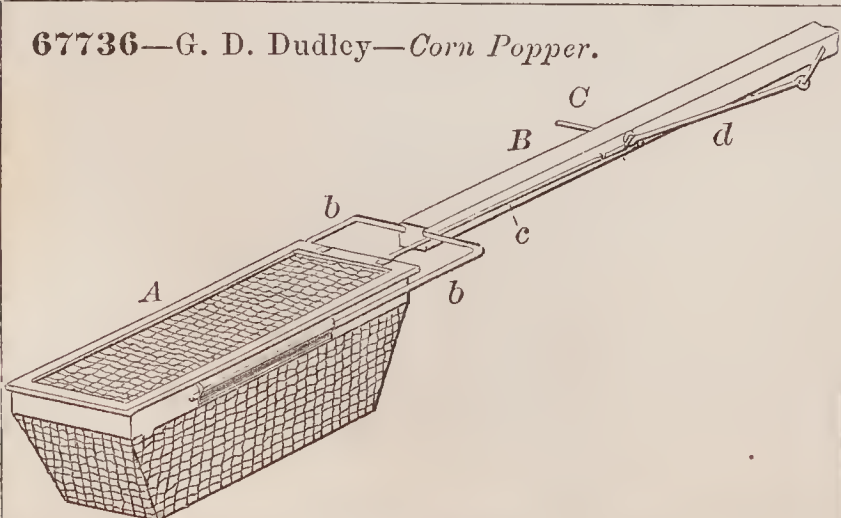

67739—J. A. Elston—Aerial Machine.

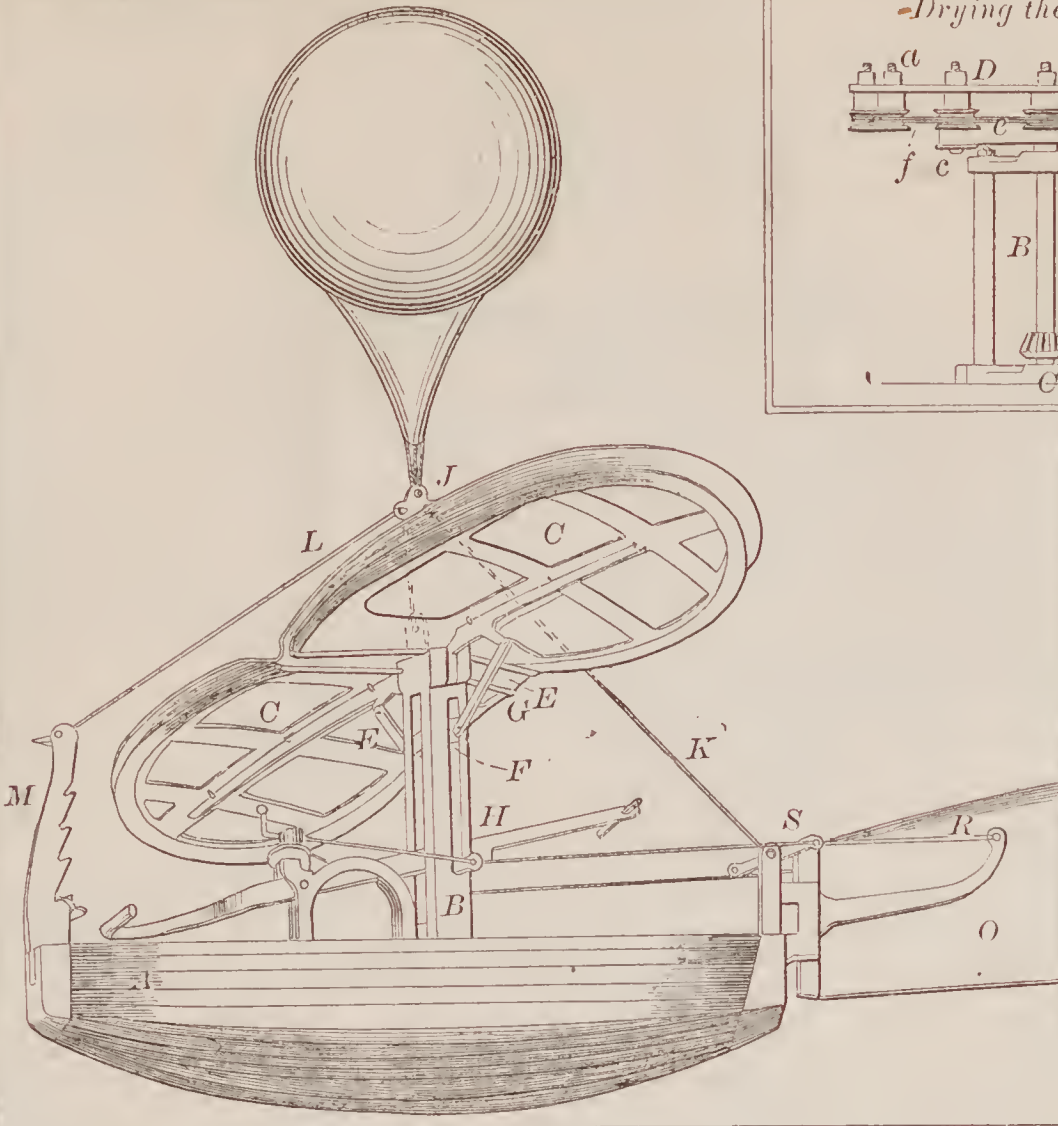

67740—M. Esselen—For Raising and Drying the Naps of Hats.

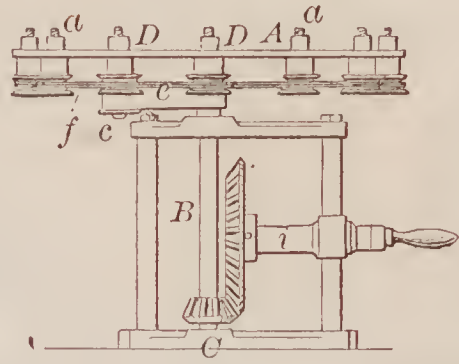

67741—J. Evans, Jr.—For Casting Anchor.



67742—Farquhar & Doan—For Heating and Evaporating.

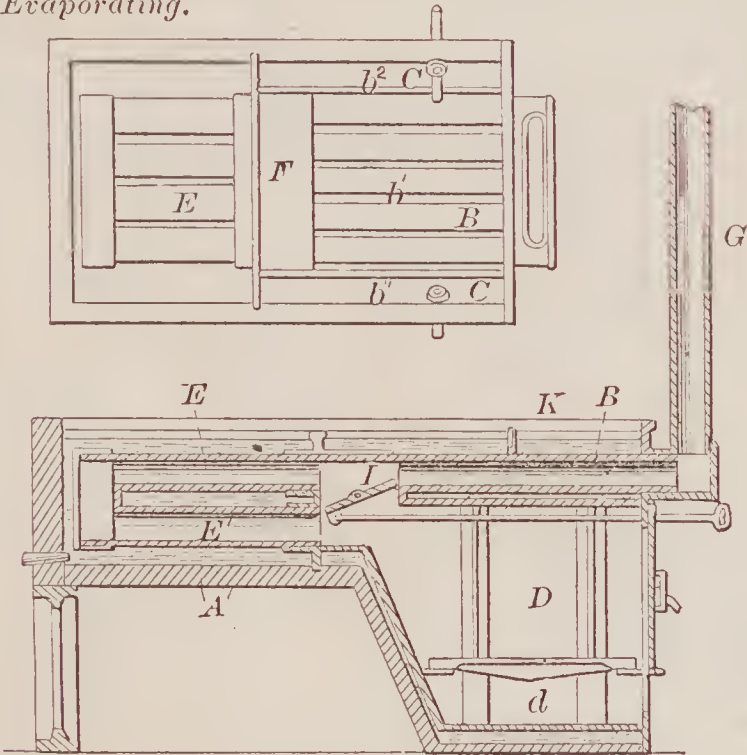

67744—B. G. Fitzhugh—Tethering Stake.

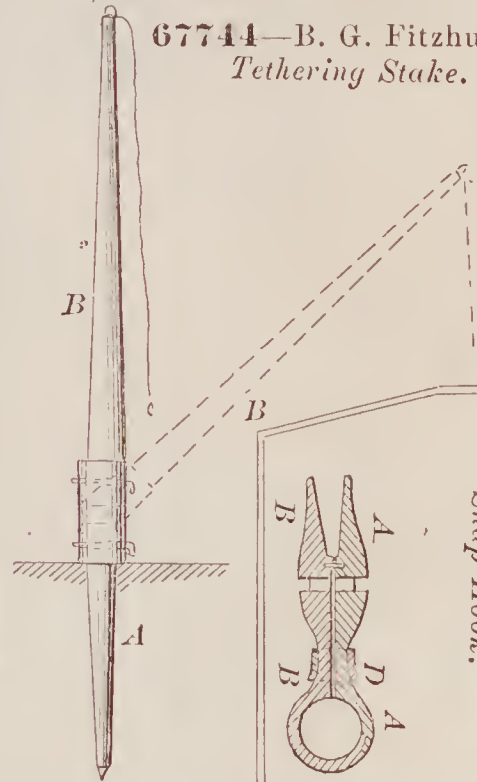

67746—W. S. Furlow—Snap Hook.



67743—E. Faull—Lubricator.

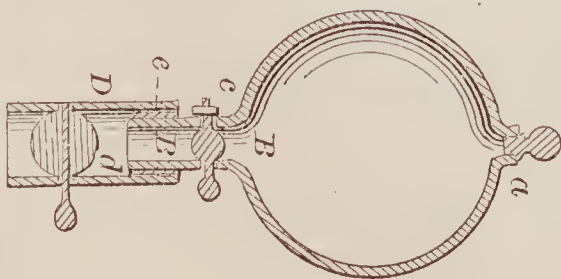

67747—C. Goodrich—Butt Hinge.

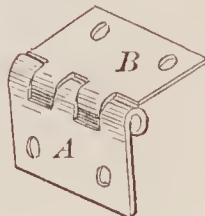

67745—W. H. Forker—Brush.

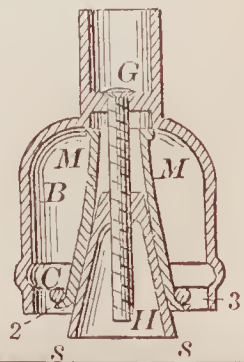



67748—Greene & Forbush—*Railroad Ticket Printing Press.*

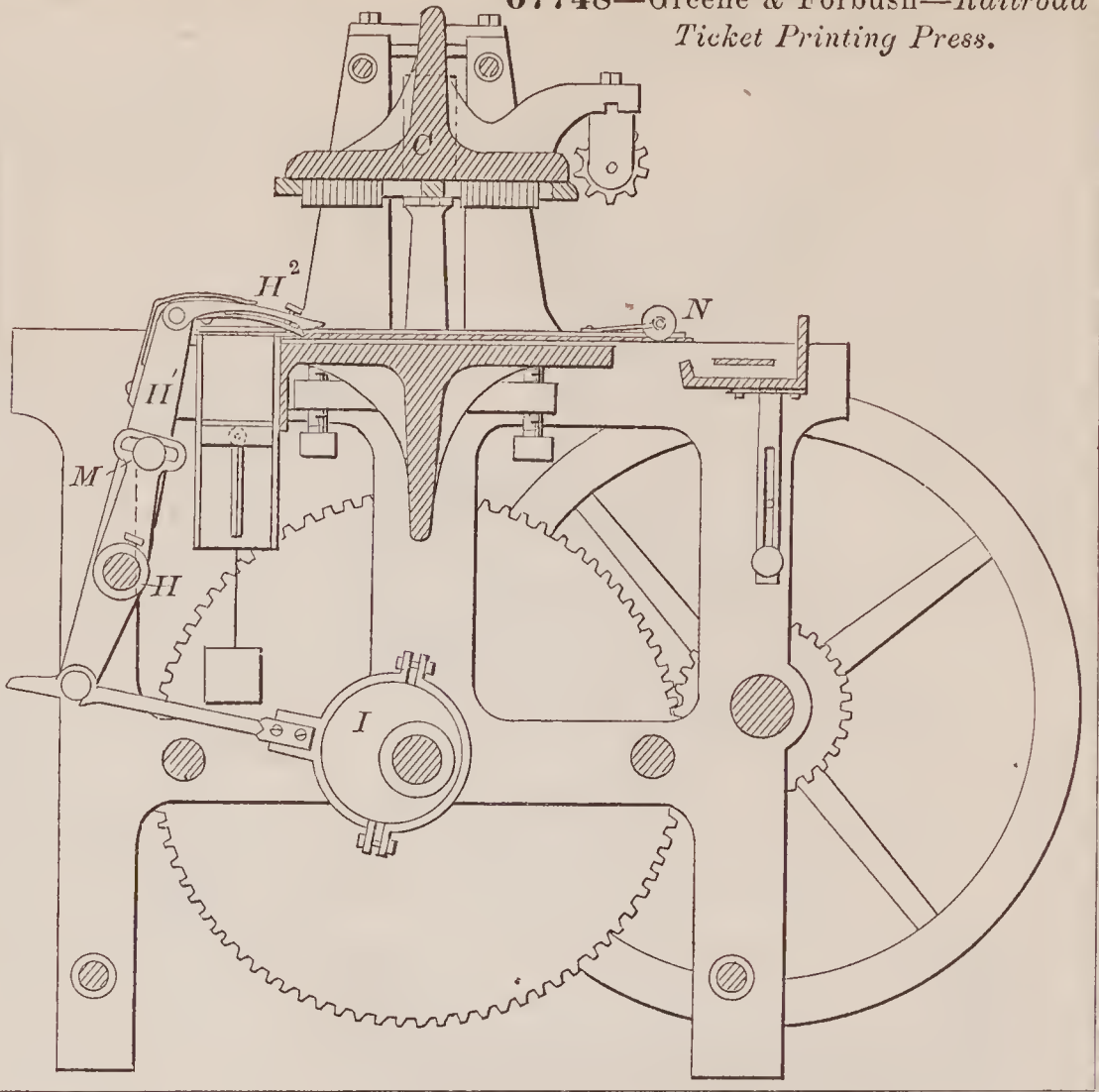

67749—A. D. Griffin—*Packing for Deep Wells.*

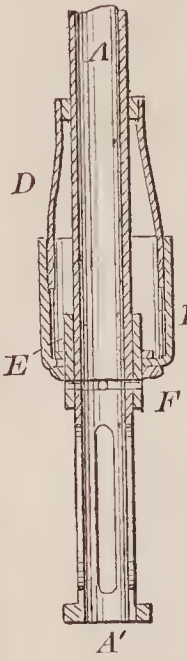

67751—W. D. Grimshaw—*For Manufacturing Chain Cable.*

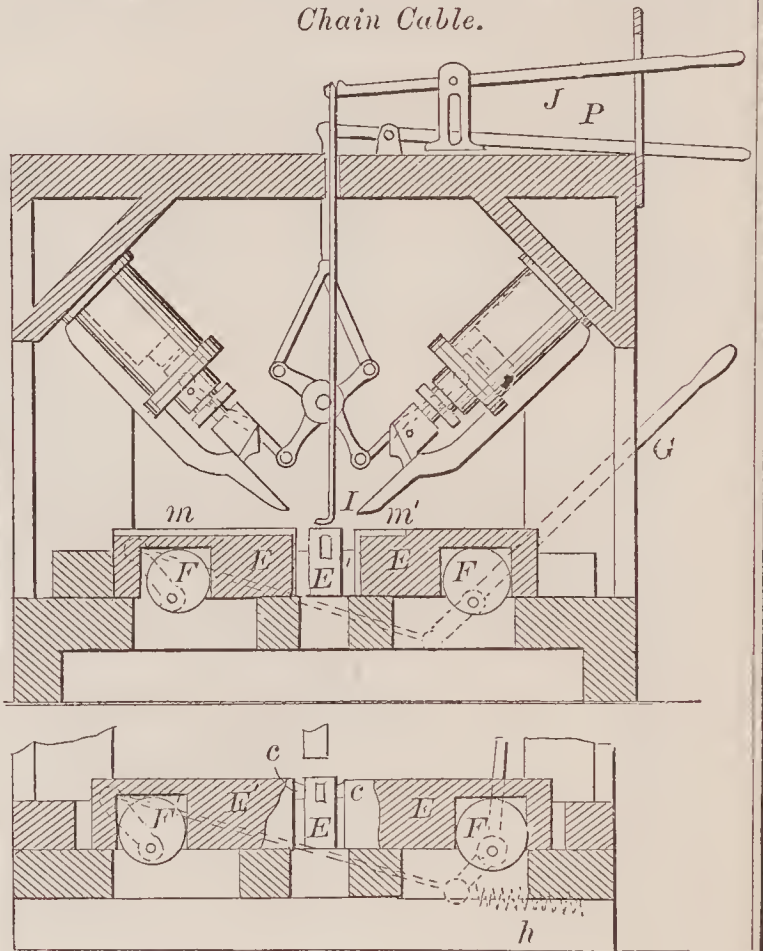

67752—H. W. Hadley—*Sewing Machine.*

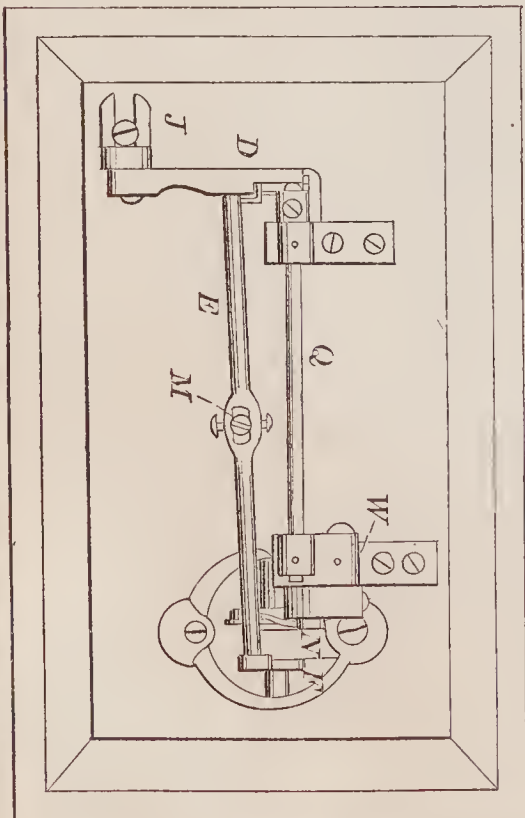

67753—J. R. Haggerty—*Hemmer for Sewing Machines.*

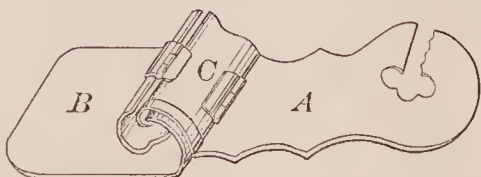

67754—J. Haines—*Fruit Can.*

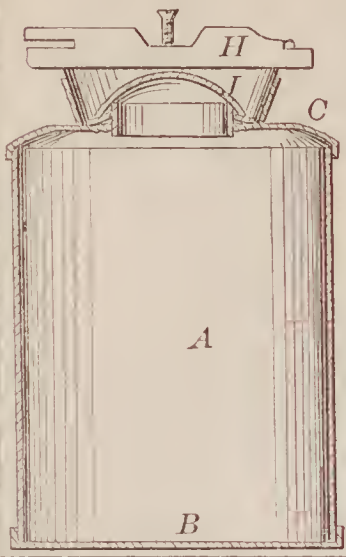

67759—P. J. Hardy—*Folding Chair.*

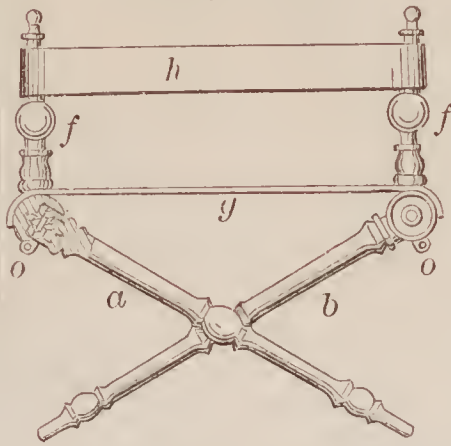

67761—P. A. Hause—*Trace Coupler.*

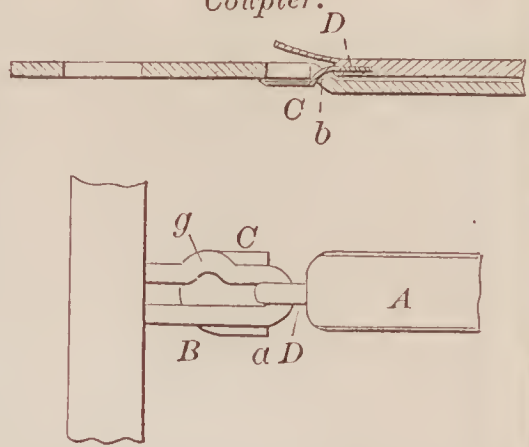

67762—J. Heaton—*Converting Cast Iron into Bar Iron and Steel.*

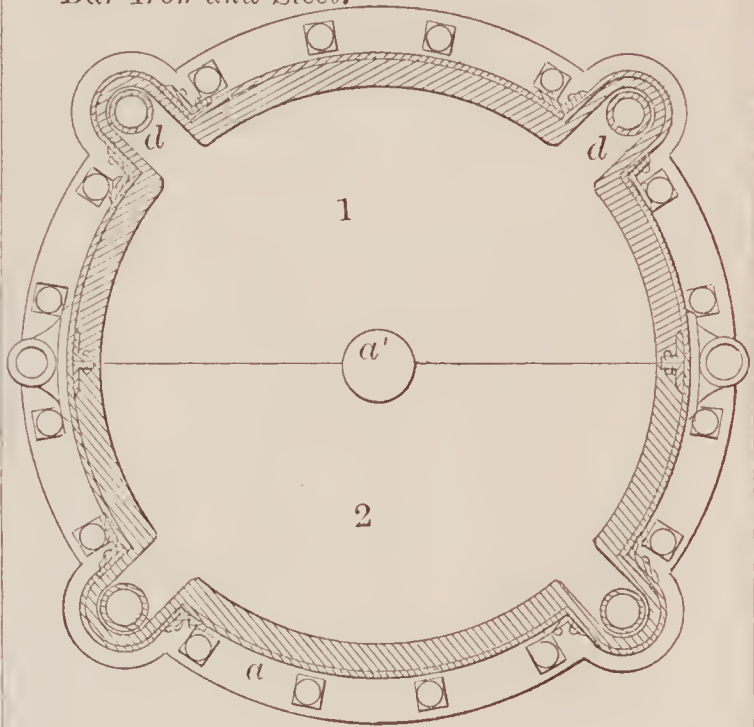

67755—B. M. Hall—*Grinding Machine.*

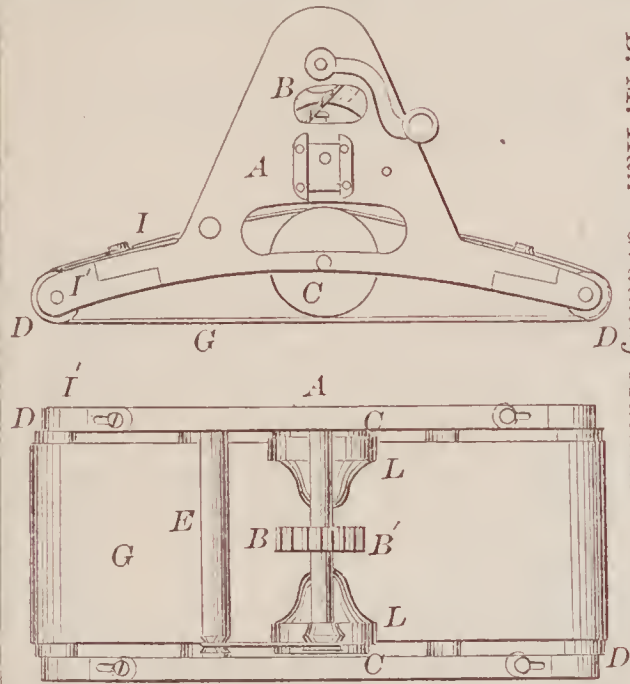

67756—W. E. Hardin—*Plow.*

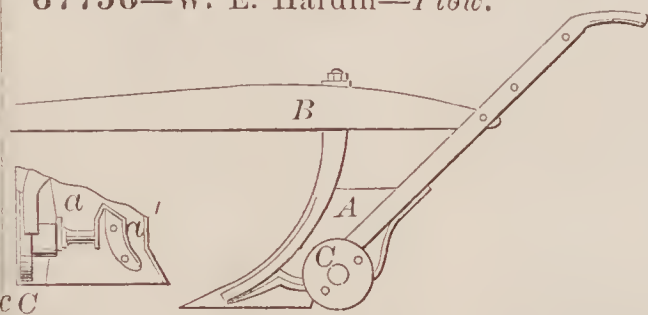

67757—S. L. Hart—*Wood Turning Lathe.*

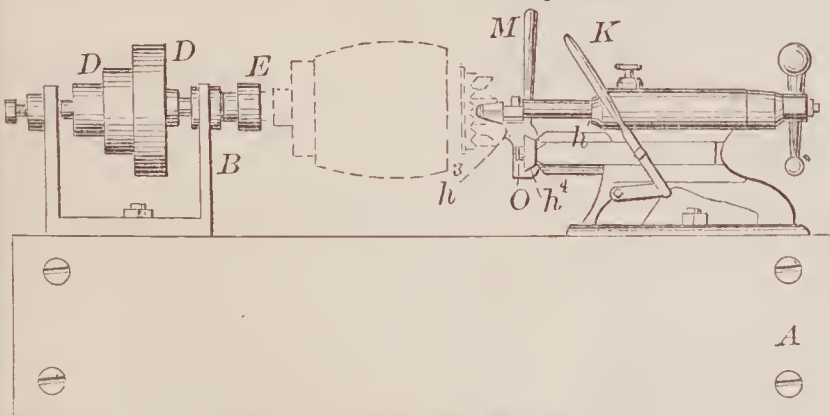

67758—P. J. Hardy—*Chair and Lounge.*

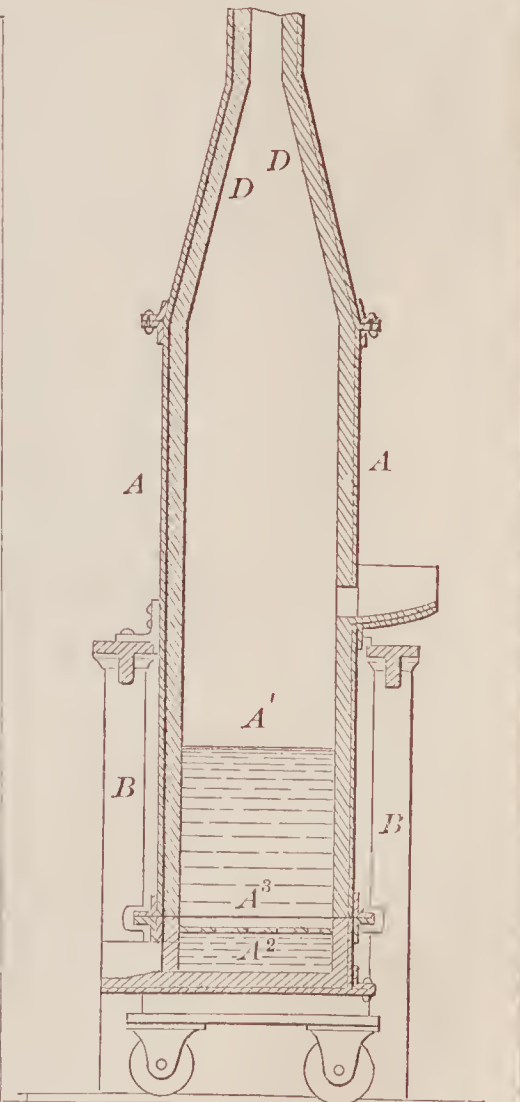
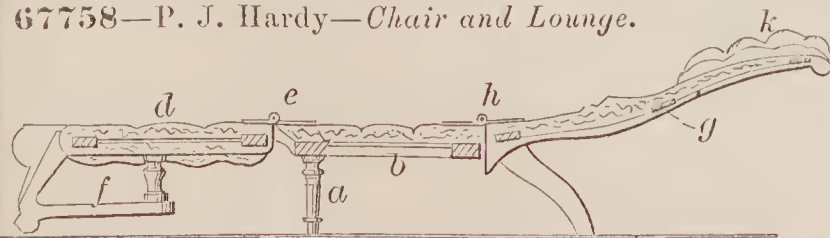



67764—W. S. How—Toilet Stand.

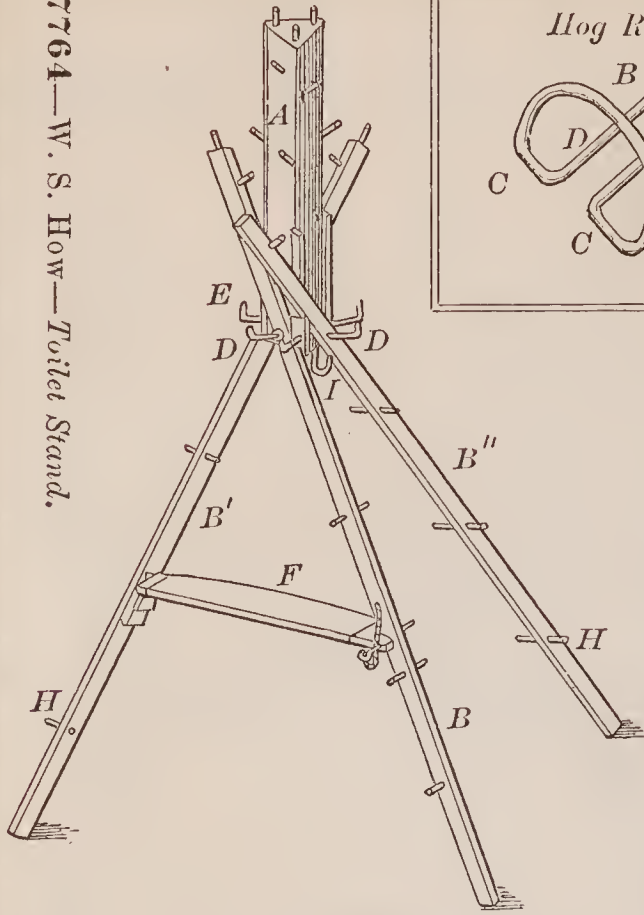

67765—J. J. Hutson—Hog Ring.

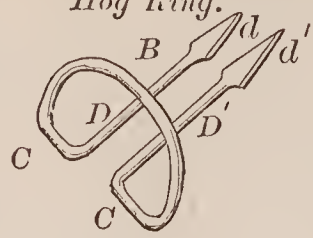

67768—P. Jones—Driving Rein.

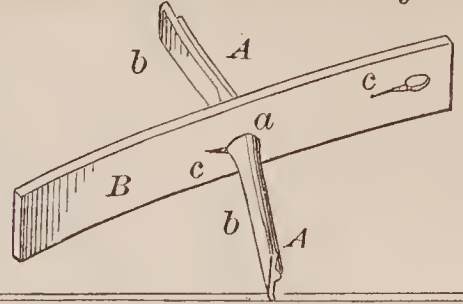

67767—J. H. Jones—Car Coupling.

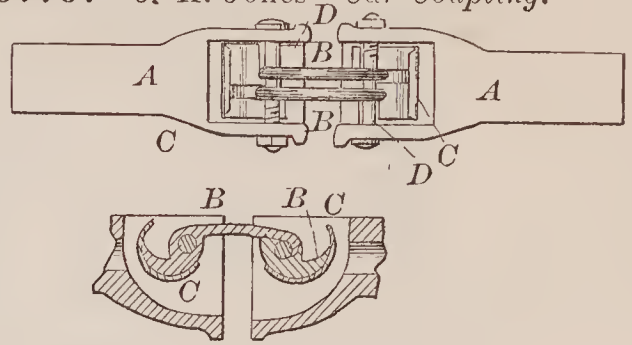

67766—L. L. Jackson—Bedstead Fastening.

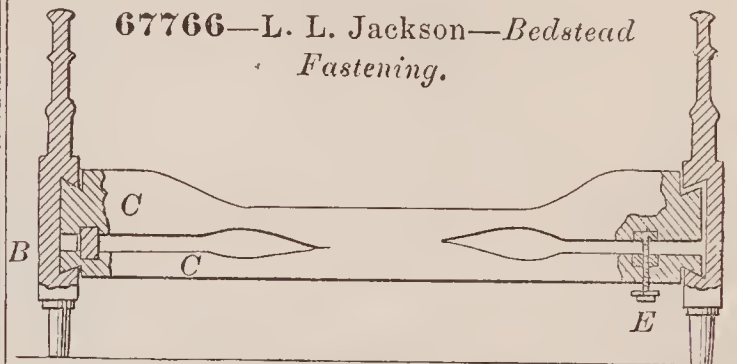

67770—W. G. Kendrick—Railroad Car Heater.

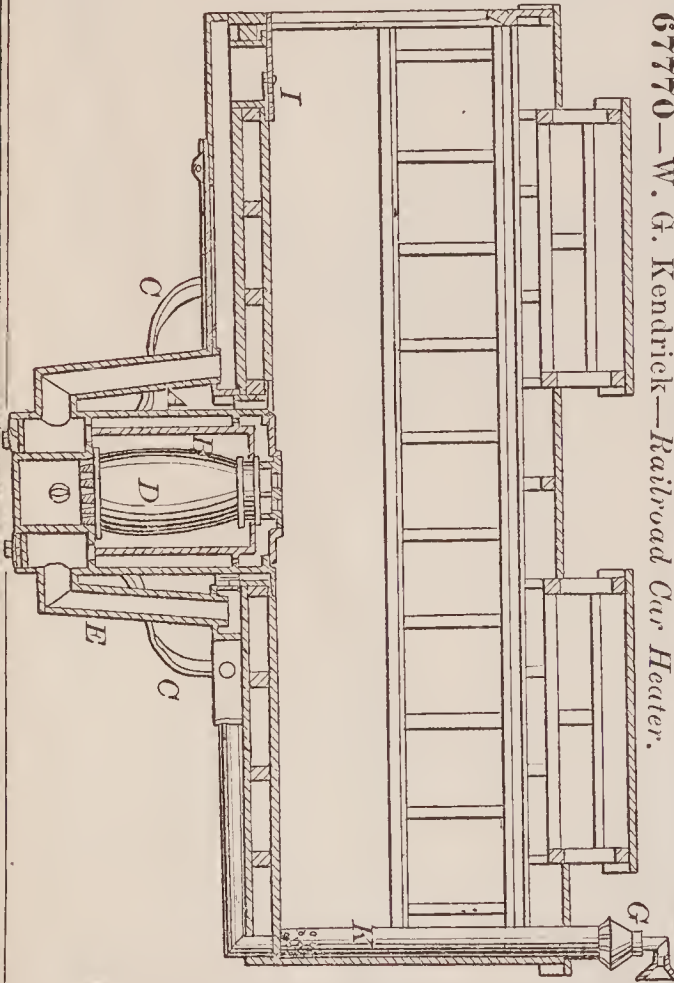

67769—C. Kalbfuss—Warming Apparatus.

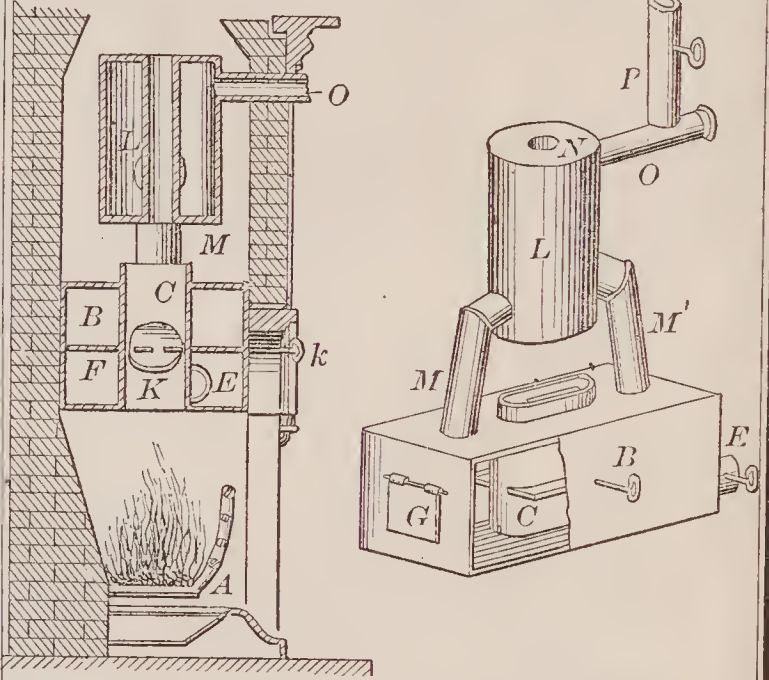

67771—H. Kimmel—Hay Rake and Loader.

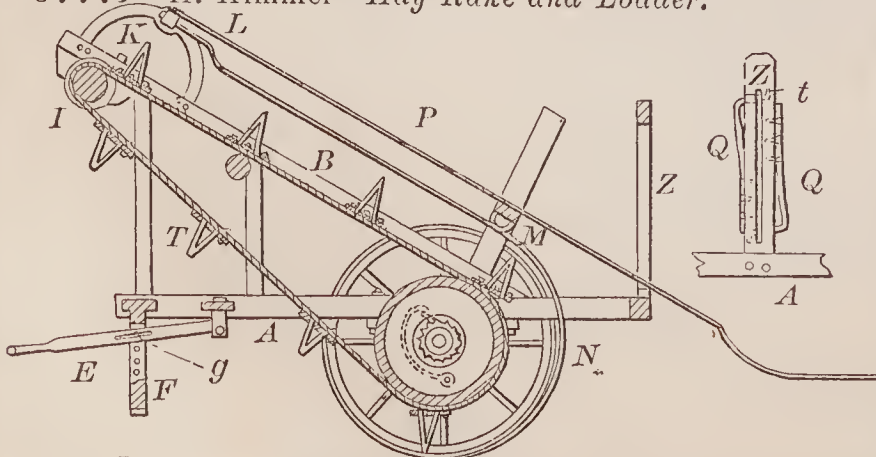

67772—J. D. Kincaid—Plow.

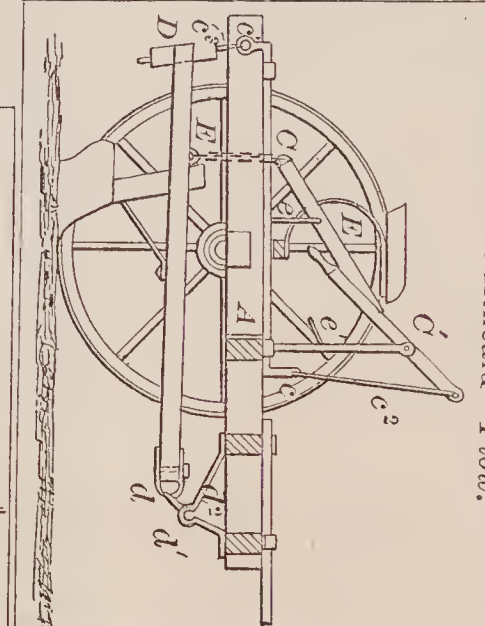

67773—  
J. W. Kokemuller—  
Cotton Gin.

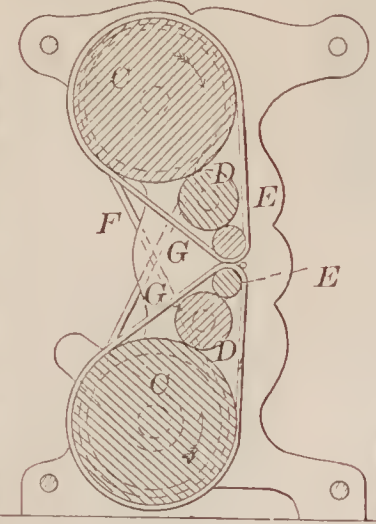

67774—J. M. Krider—Tailors'  
Measuring Instrument.

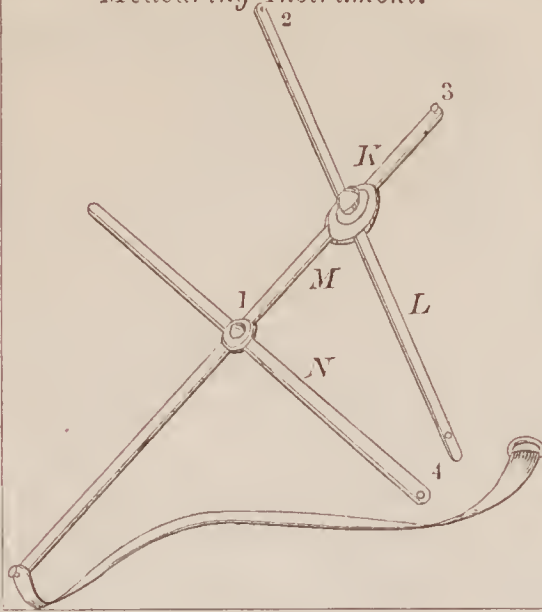

67779—J. A. Marvin—Store Pipe Drum.

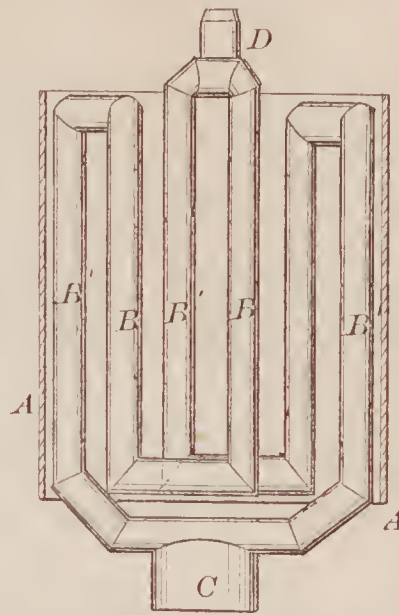

67778—J. B. Luce—Horse Rake.

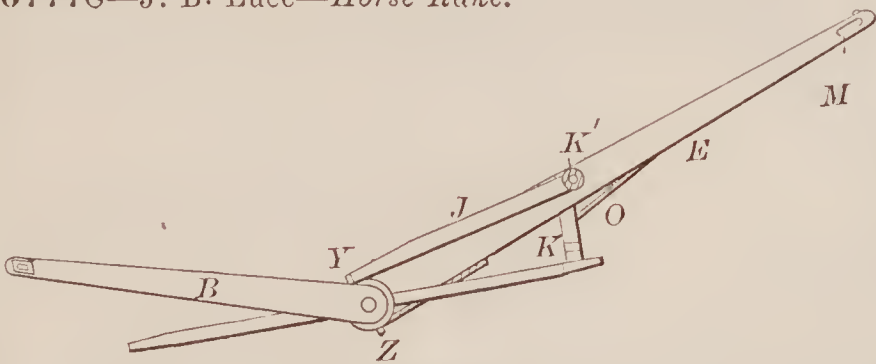

67777—L. Littlejohn—  
Cotton Bale Tie.

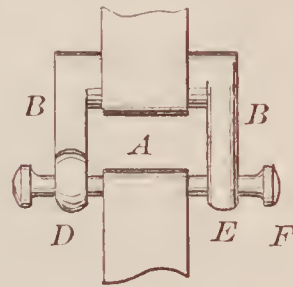

67775—J. D. Leach—Ship's Block and Warping Chock.

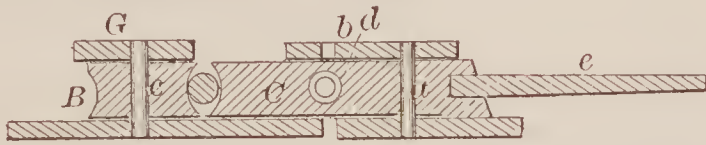

67780—Mason & Downe—Folding  
Chair.

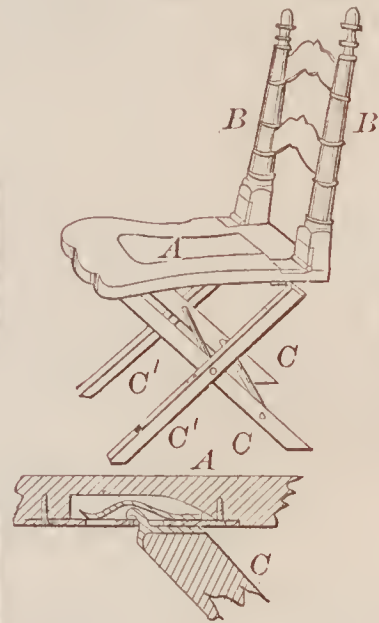

67784—D. McHugh—  
Mosquito Bar.

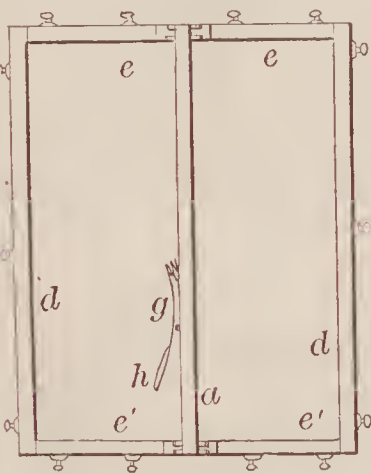

67776—M. Le Page—  
Spring Bed Bottom.

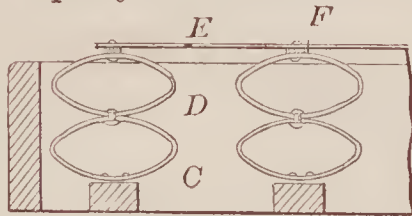

67782—E. P. McCarthy—Wagon Spring.

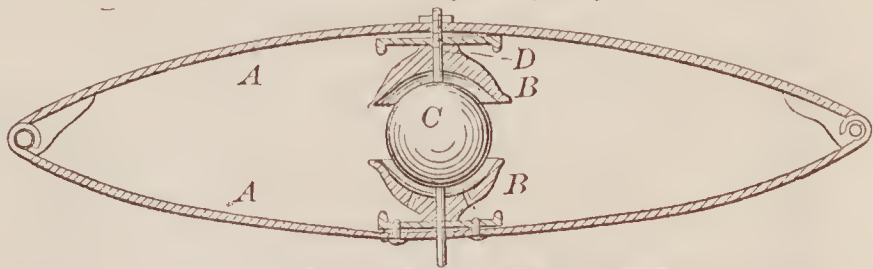

67783—J. McDonald—Brick Dryer.

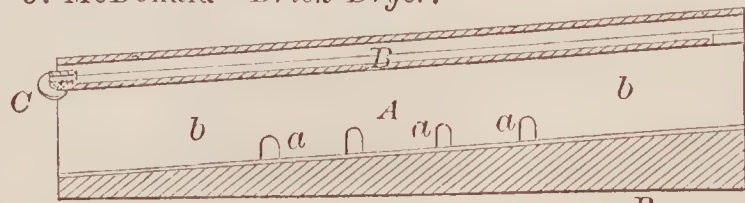

67781—J. Matthews, Jr.—Bottle  
Stopper.

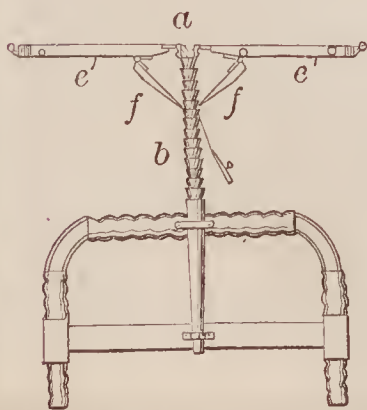
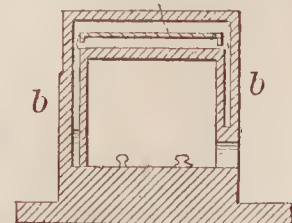
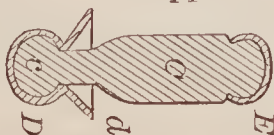



67785—McMillan & Devoe—  
Centre Bit.

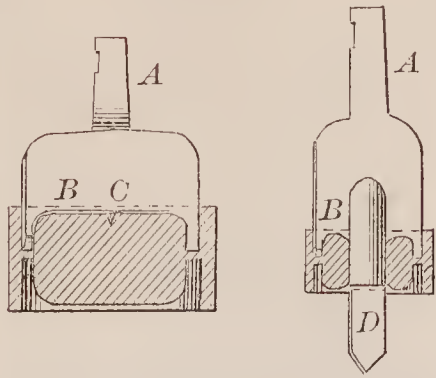

67786—A. Mendenhall—*Calculating Machine.*

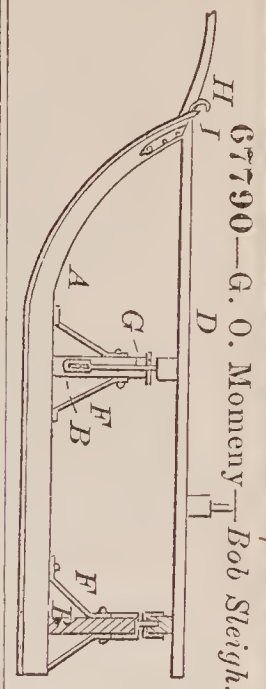
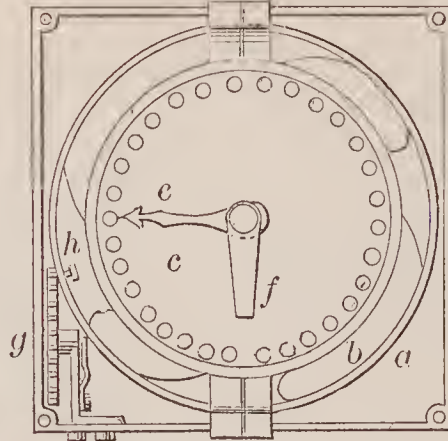
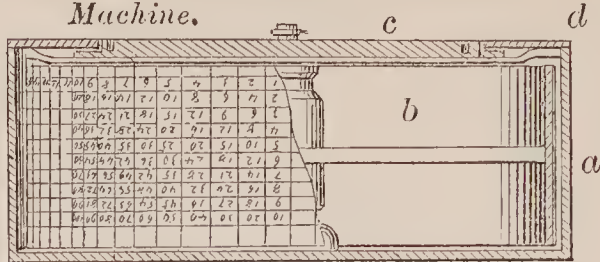

67790—G. O. Momeny—*Bob Sleigh.*

67787—A. S. Miles—  
Brush and Rubber.

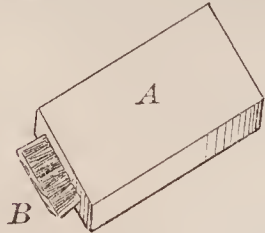

67788—F. Mills—*For Bending Tires.*

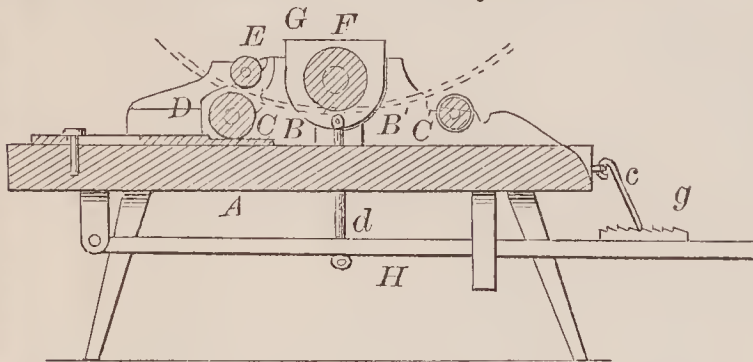

67791—G. R. Moore—*Door for Heating Stoves.*

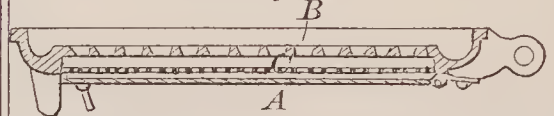

67794—C. Oyster—*Securing Wheels of Vehicles on Axles.*



67792—C. C. Wolfrum—*Breech-Loading Ordnance.*

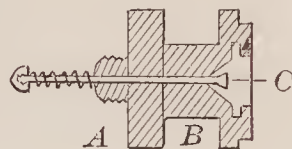
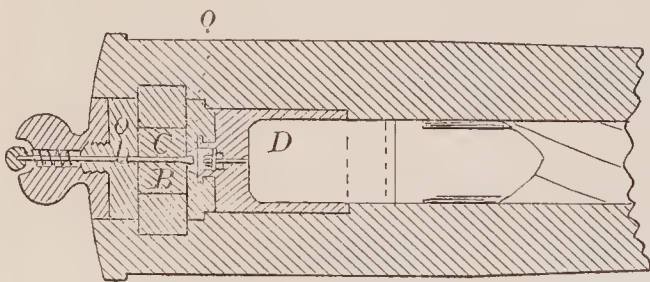

67789—Mitchel & Chapman—*Snap Hook.*



67793—Nobles & Holcomb—*Broom Head.*

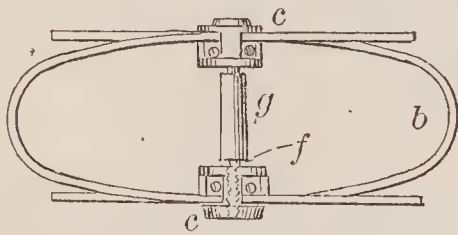
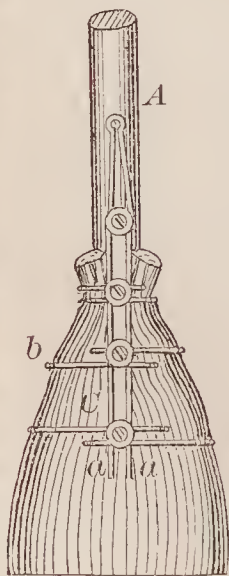

67795—G. H. Palmer—  
*Mortise Knob Latch.*

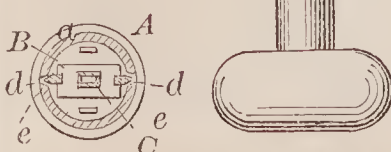
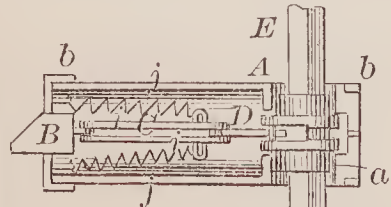

67796—J. C. Pedrick—*For Treating Petroleum.*

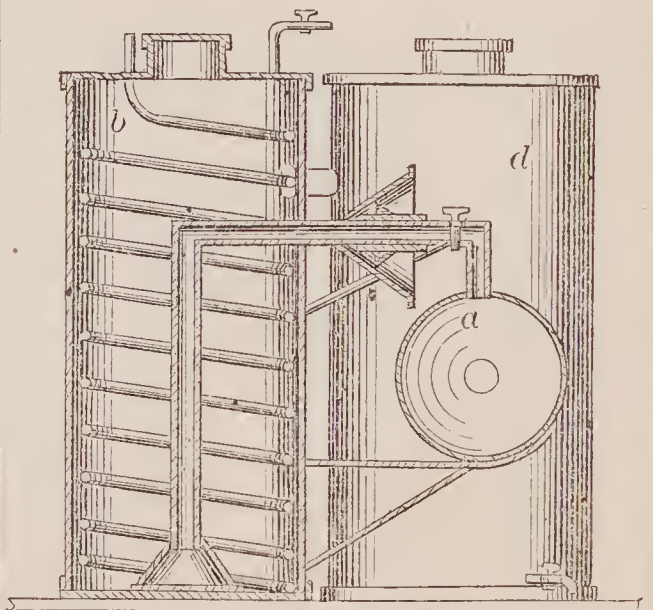

67797—J. F. C. Piekhardt—*Wardrobe Bedstead.*

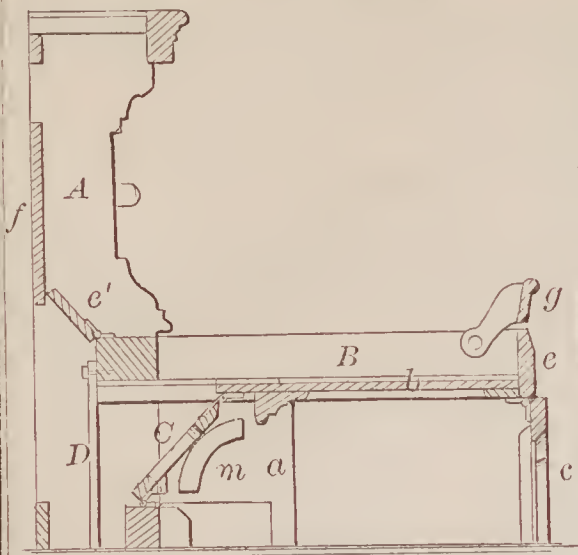

67799—J. W. Post—*Skate.*

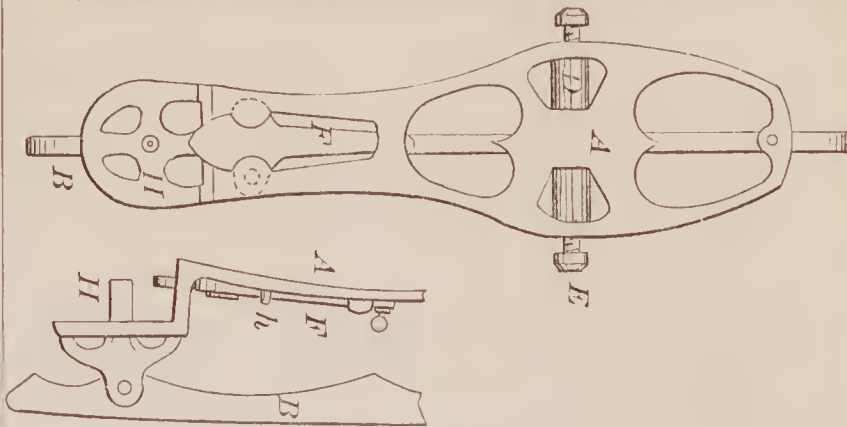

67800—V. Price—*Hanging Swords.*

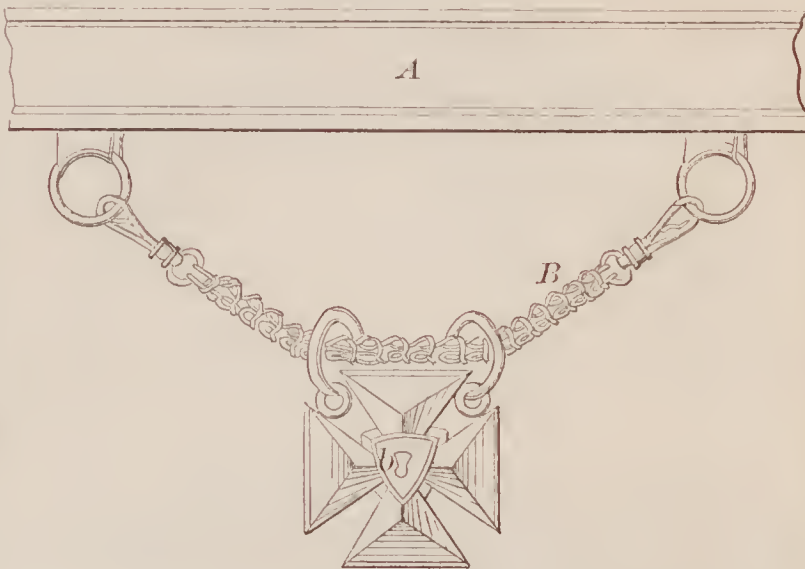

67798—C. H. Post—*Ox Yoke.*

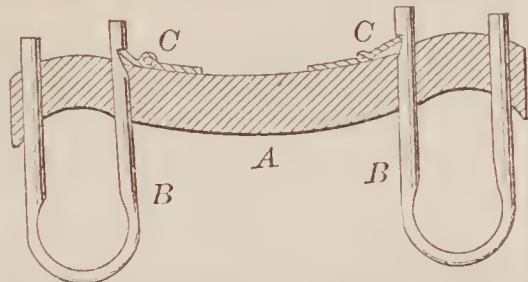

67803—G. Robinson—*Feed Regulator for Sewing Machines.*

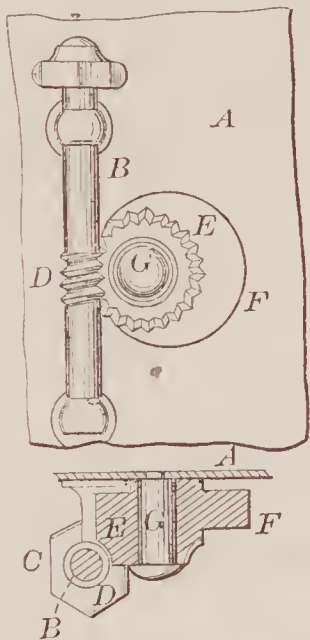

67801—Rawdon & Ethridge—*Washing Machine.*

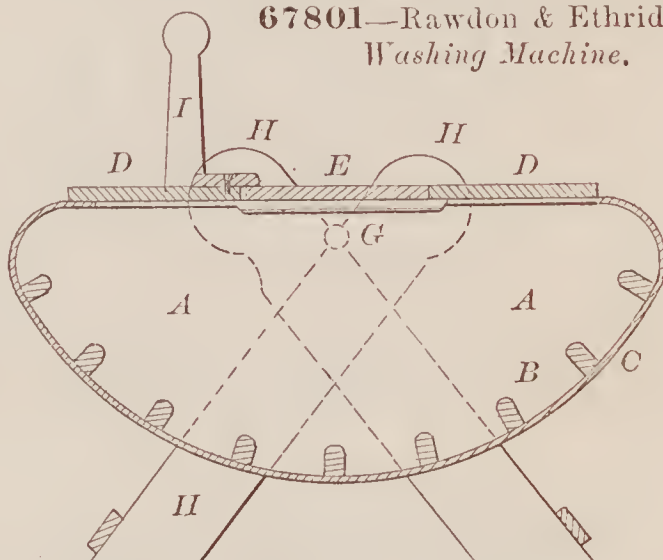

67802—E. Robinson—*Wagon.*

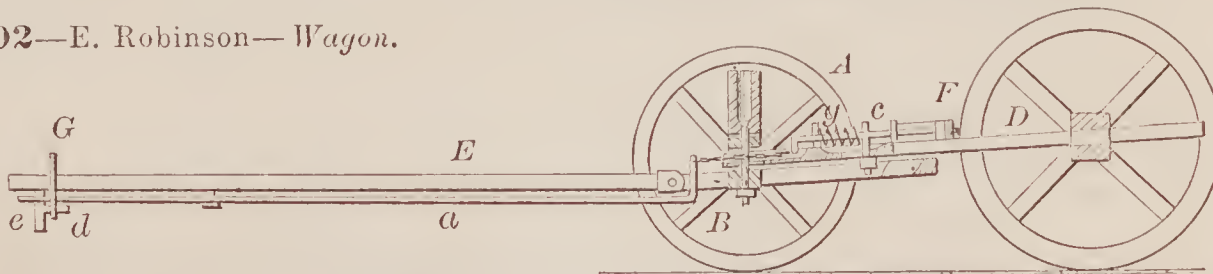

67804—J. Robinson—*Oar Collar.*

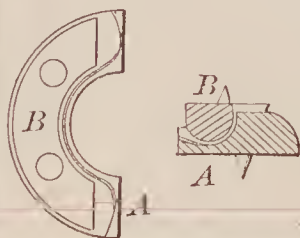

67805—L. Rodenhausen—*Street Sprinkling Cart.*

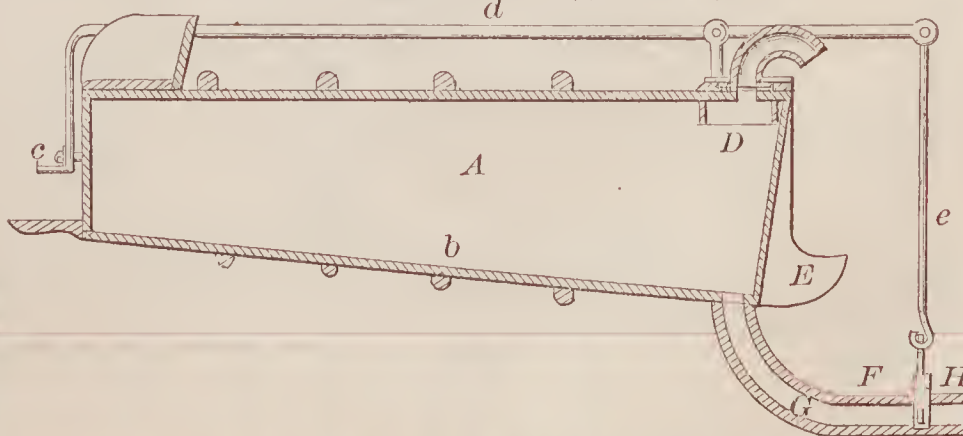





67815—R. B. Stanton—Reversible Feed for Sewing Machines.

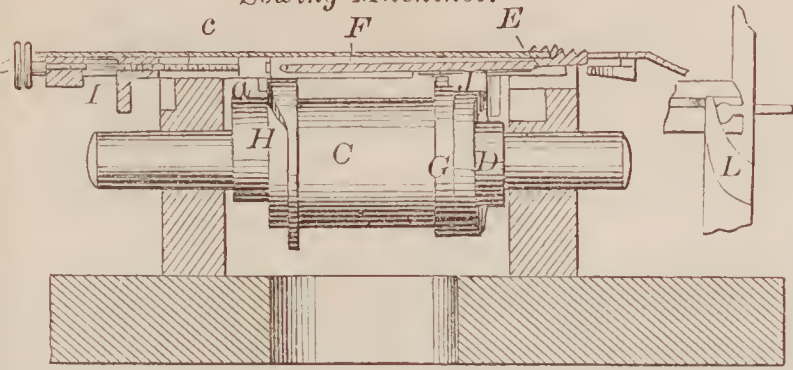

67816—J. Stock—Bureau and Bedstead.

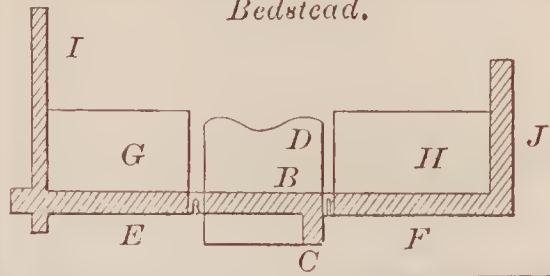

67817—E. E. Stubbs—Cultivator.

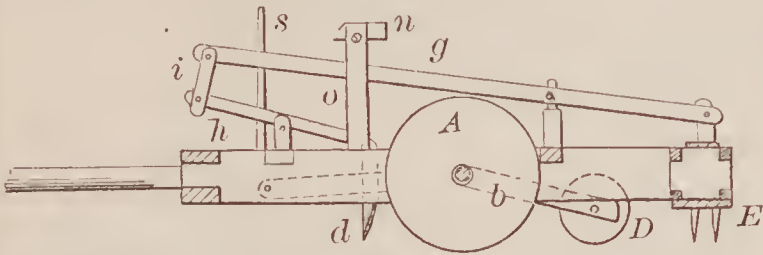

67820—H. Tupper—Window Sash.



67821—R. P. Underwood—Lubricator for Spindles.

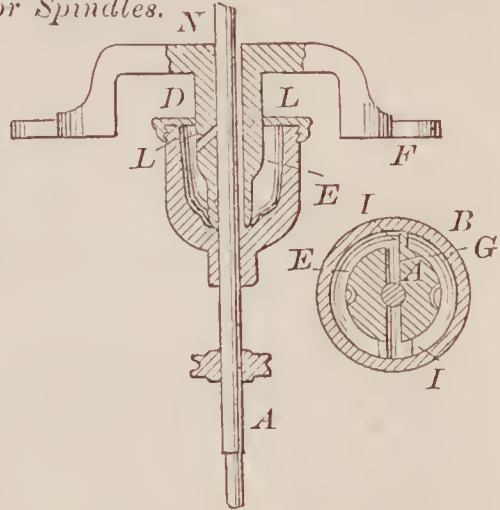

67818—G. C. Taft—Wrench.

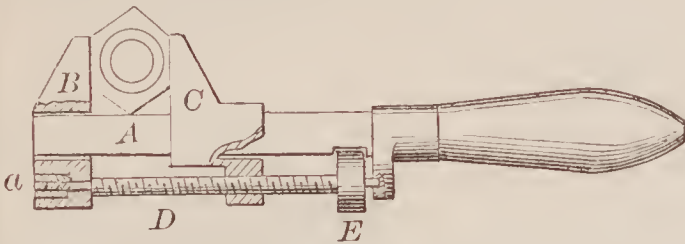

67822—H. H. Vere—Spring Mattress.

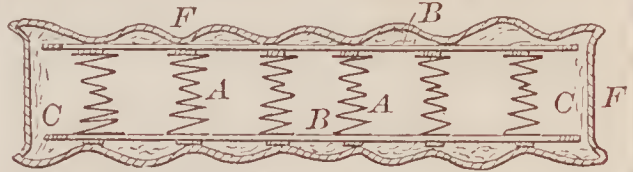

67819—W. A. Thompson—Ox Yoke.

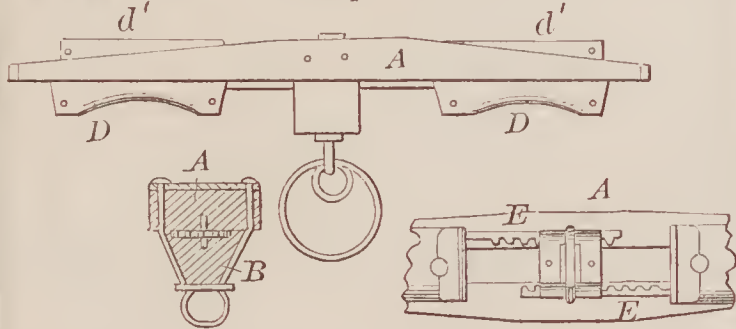

67824—J. G. Walker—Extracting Essences.

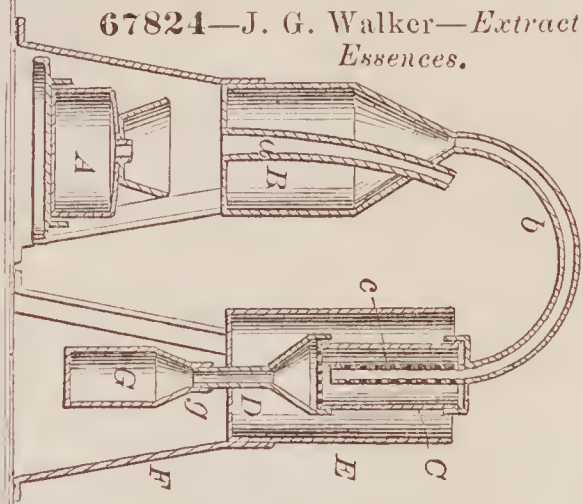

67823—A. Wadsworth—Stem Winding Watch.

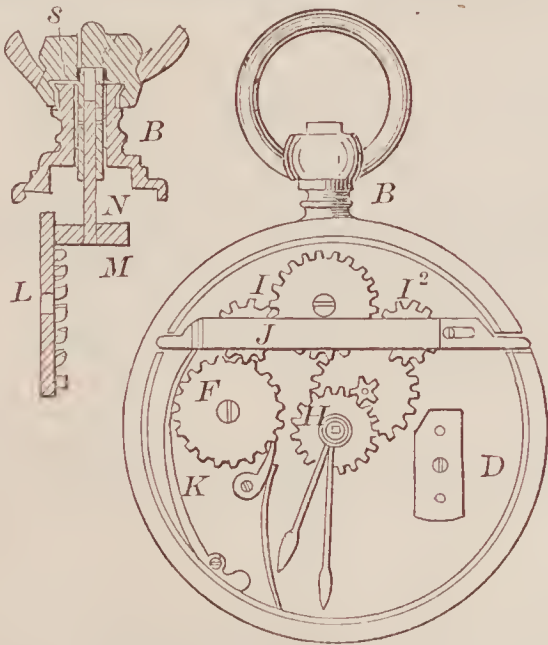

67826—Warner, Peiffer & Lepper—Drilling Machine.

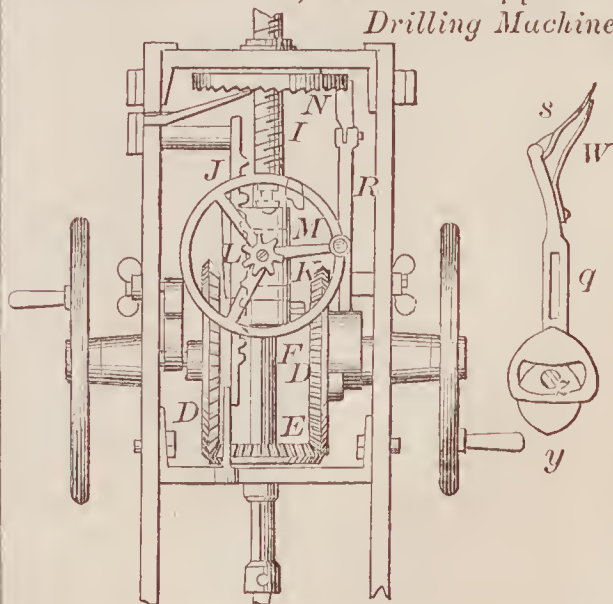

67825—D. Warner—Drill.

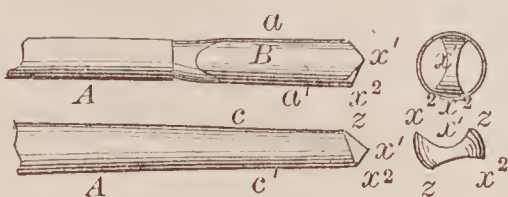



67827—J. P. White—Switch.

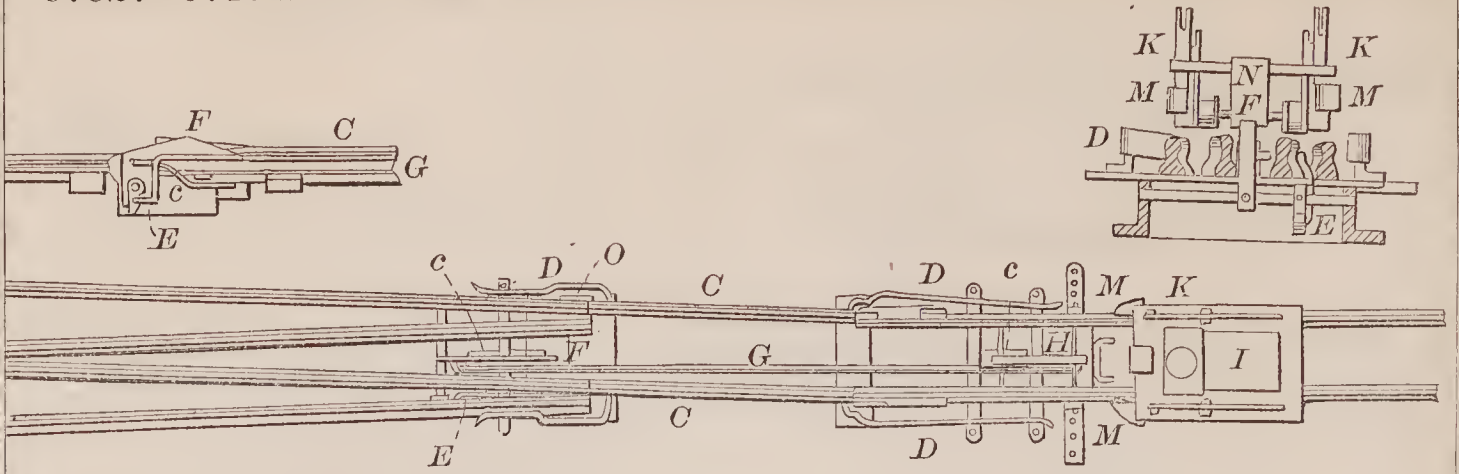

67828—W. N. Whitely—Harvester.

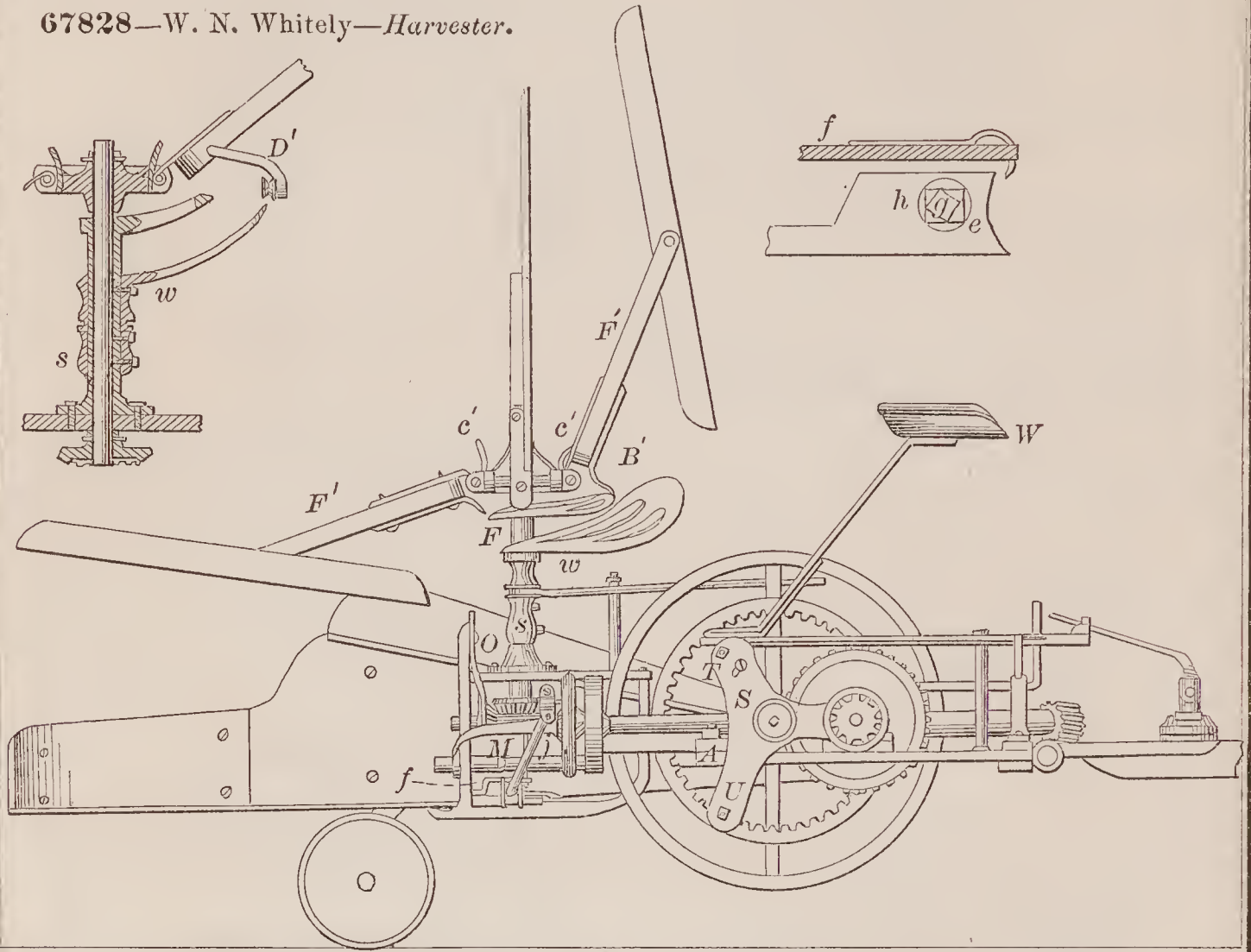

67831—W. B. Williams—Cotton Plow.

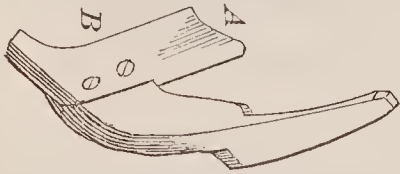

67829—Whitely, Fassler & Kelly—Harvester Cutter.

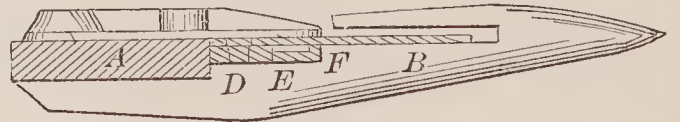

67832—J. M. Winslow—Eye Cup.

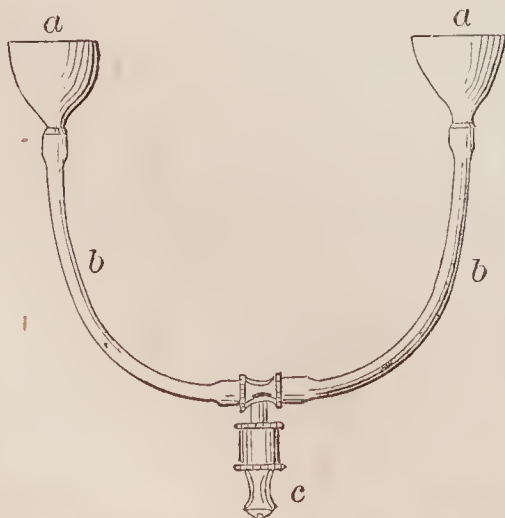

67830—T. E. Wilke—Camera Stand.

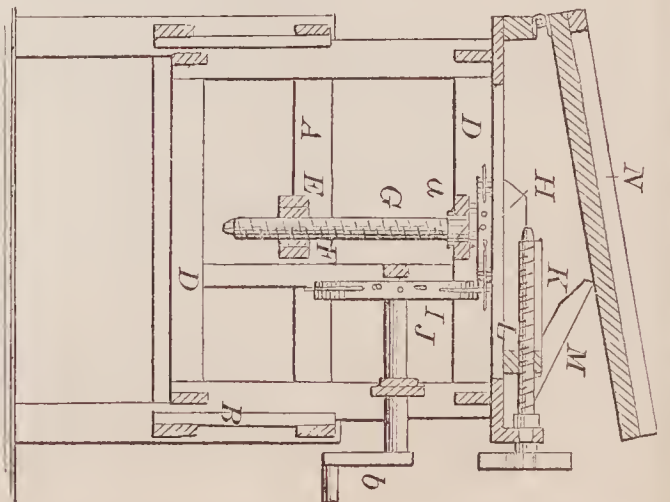

67833—J. F. Zacharias—For Attaching Labels.

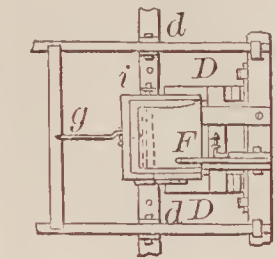
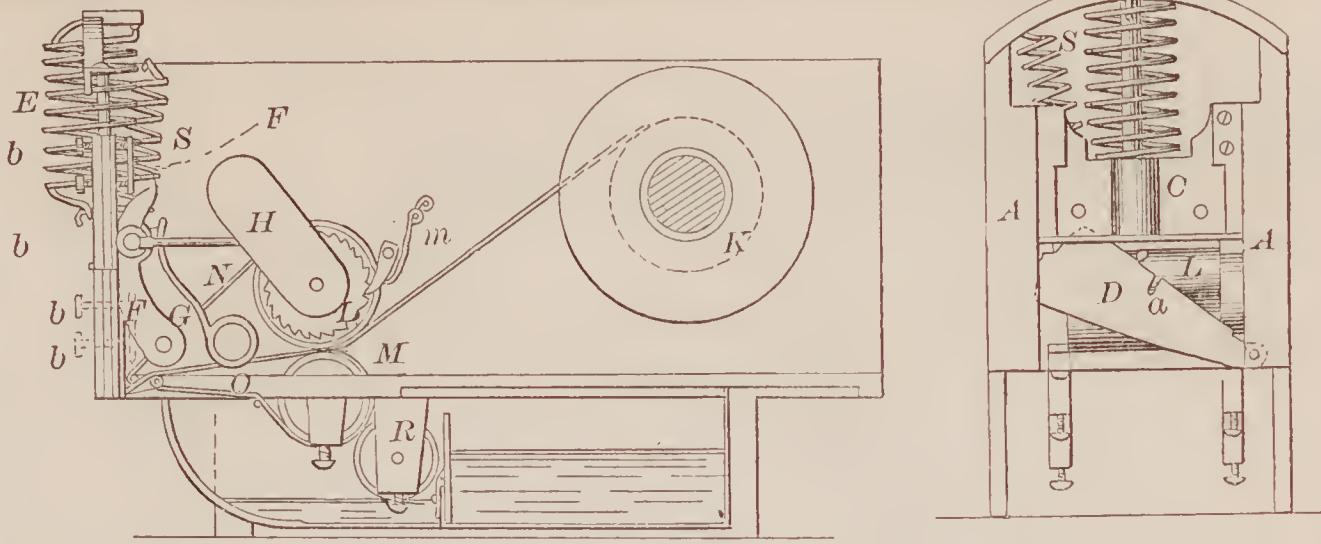

67835—J. N. Fordyce—  
Harrow.

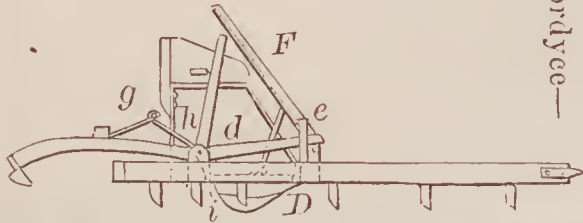

67836—R. H. Alexander—Flour Bolt.

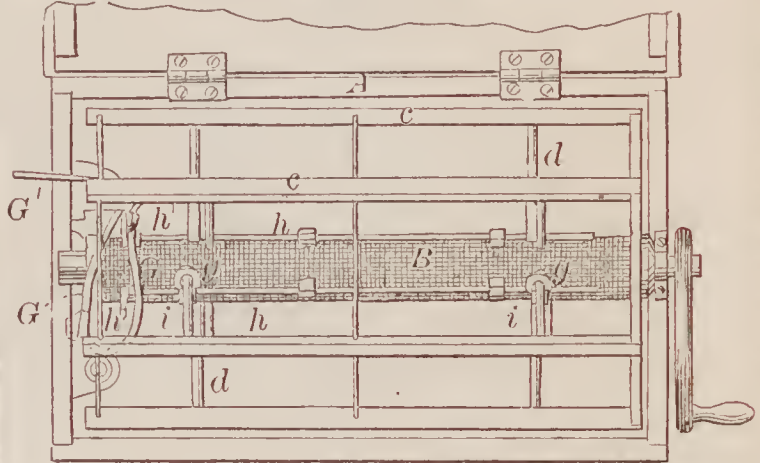

67839—Bartlett & Lewis—White Paint  
Manufacture.

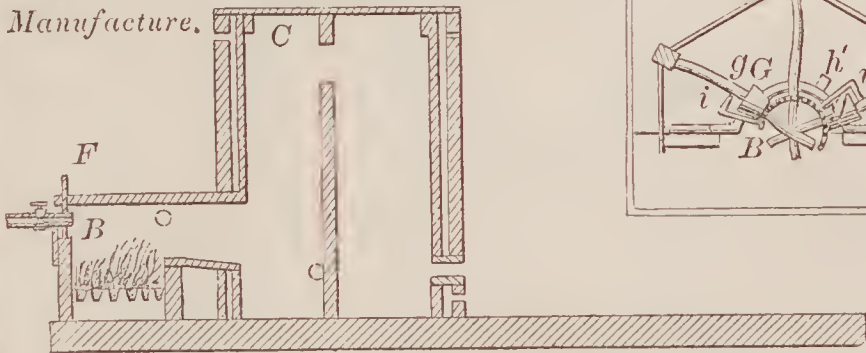

67834—P. J. Steer—Trunk  
Check.

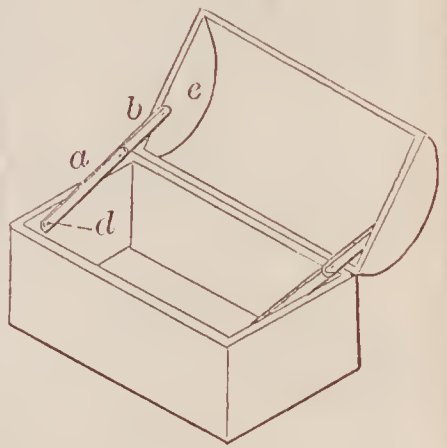

67837—W. D. Andrews—Bridle Rein.

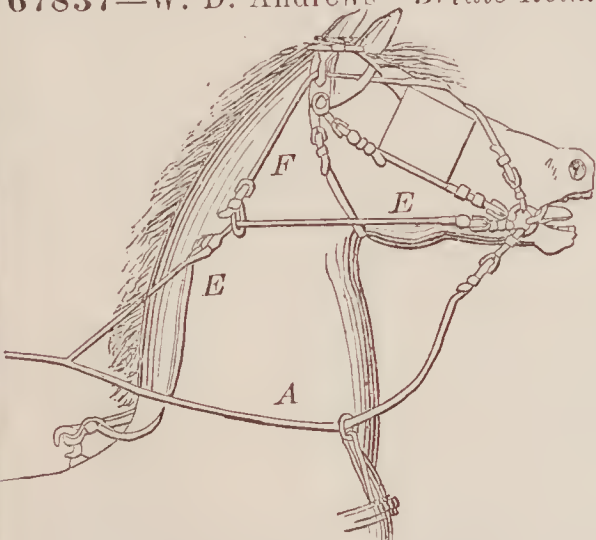

67840—J. H. Beacher—Valve for Gas Generators.

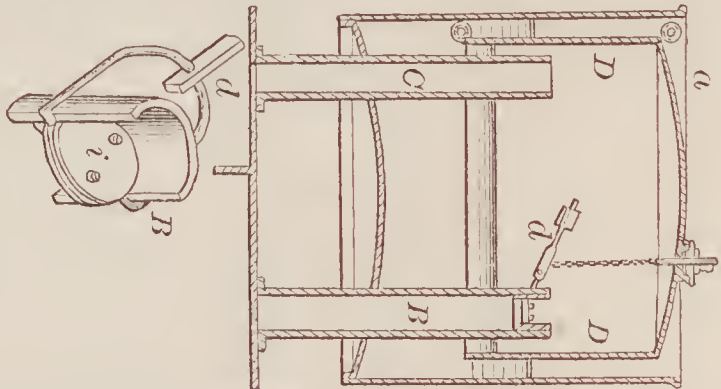

67838—J. Ast—Sleigh Brake.

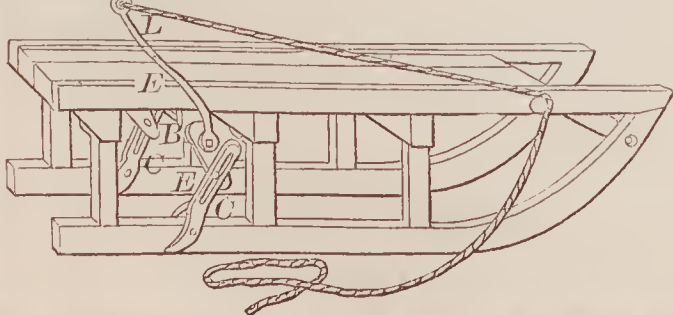

67841—L. Bauhoefer—Muff.





67842—J. B. Beers—Amalgamating Precious Metals.

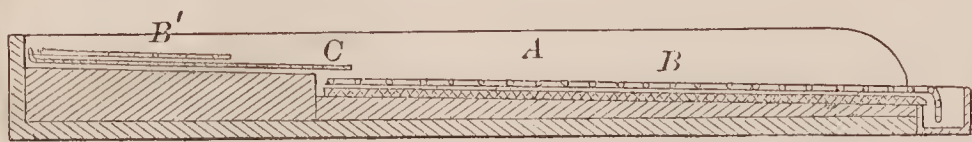

67846—J. M. Cayce—Sporting Life Boat.

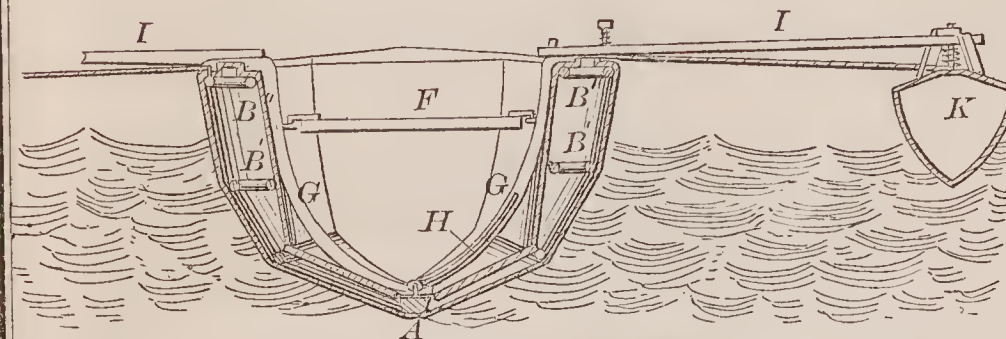
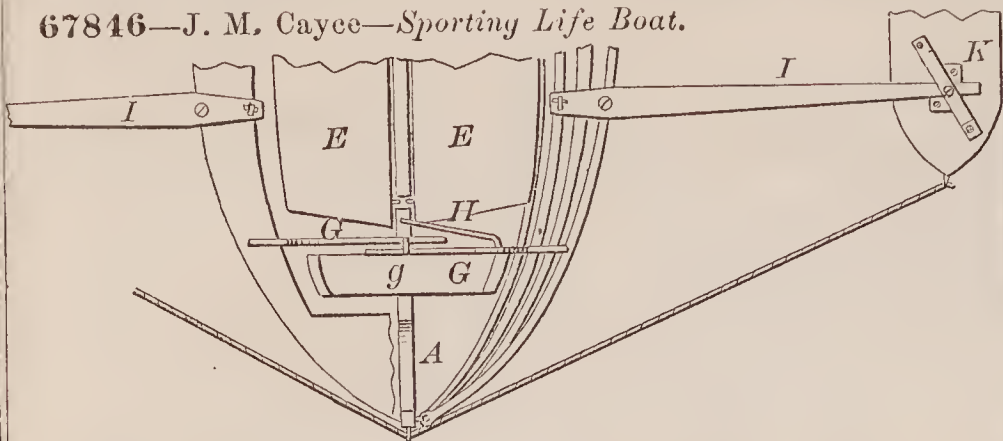

67845—J. M. Cayce—Portable Forge.

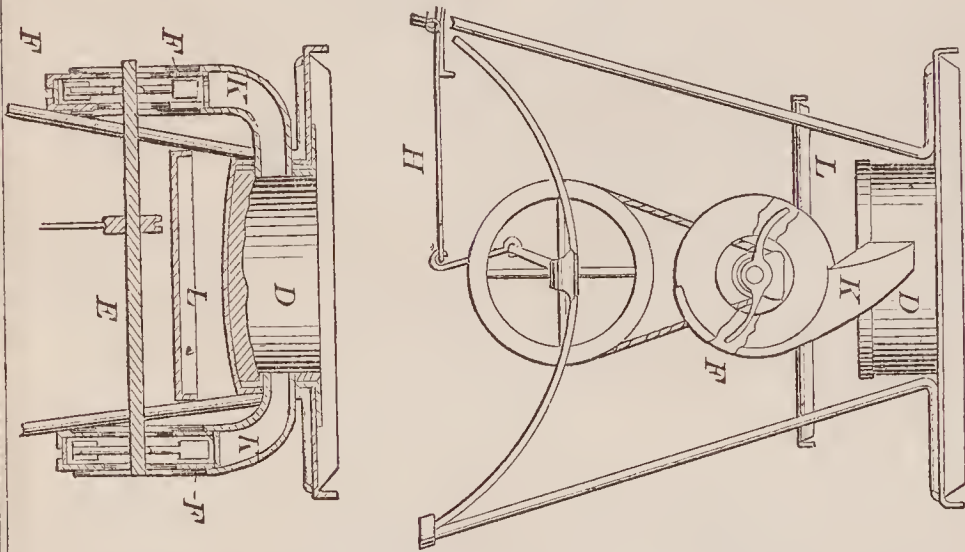

67847—S. B. Cox—Lid for Kettles, Pails, &c.

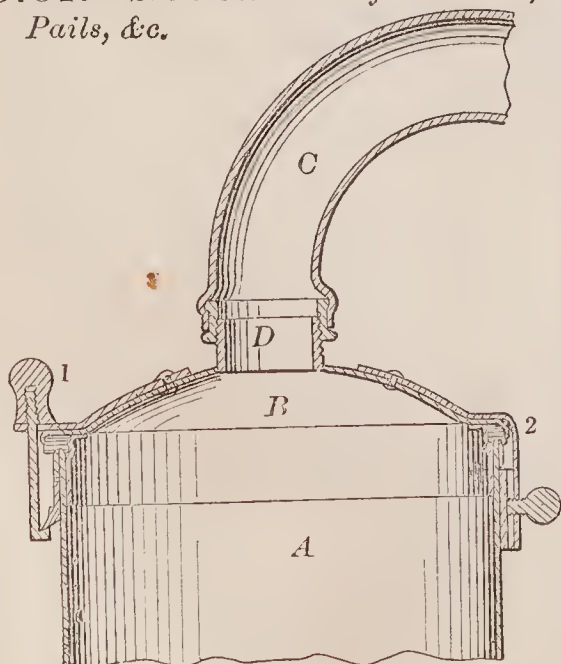

67848—D. Davenport—Corn Candy Cutter.

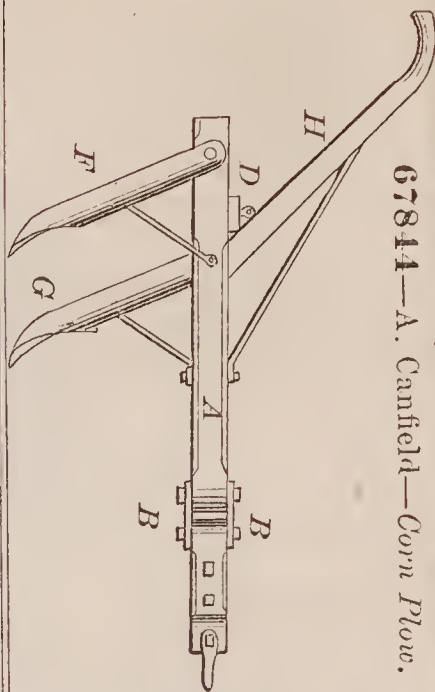
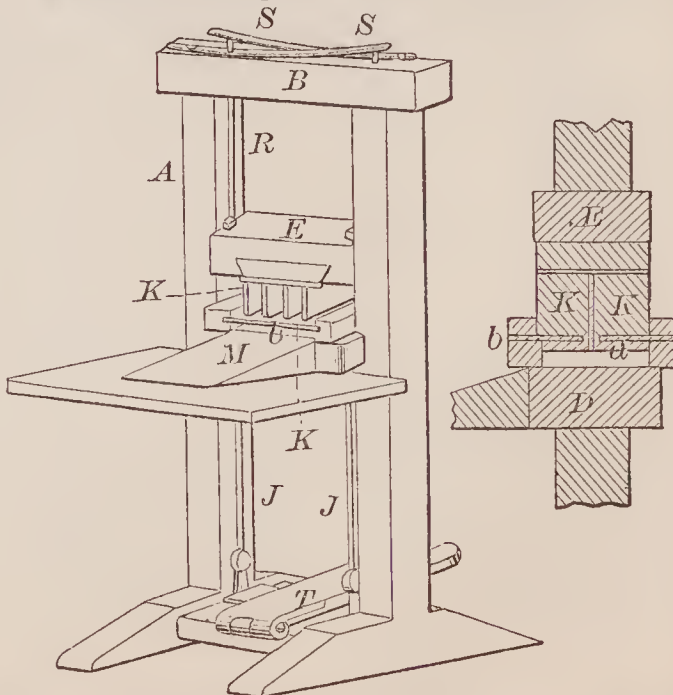

67844—A. Canfield—Corn Plow.

67843—A. Canfield—Corn Plow.

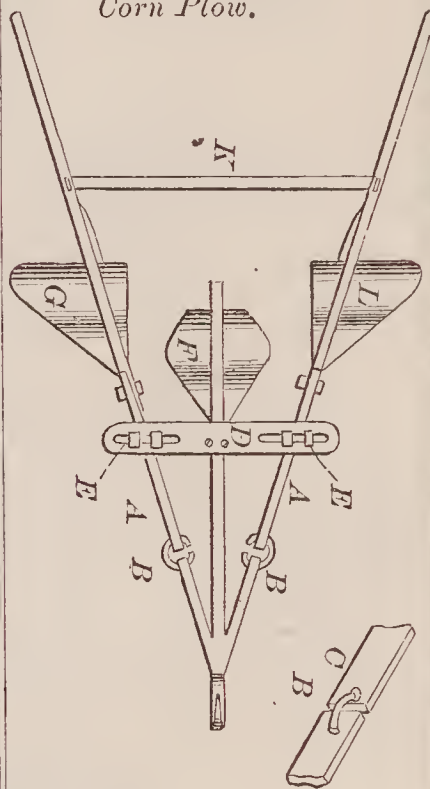

67849—J. Dixon—Tunnel.

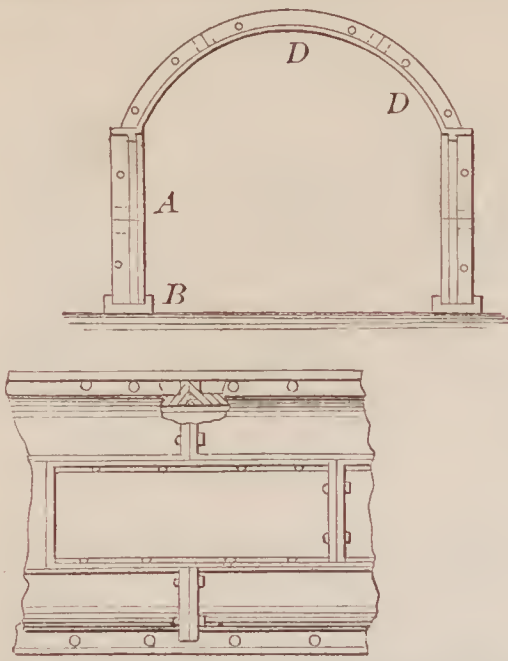

67854—A. F. Doebert—Meat Chopper.

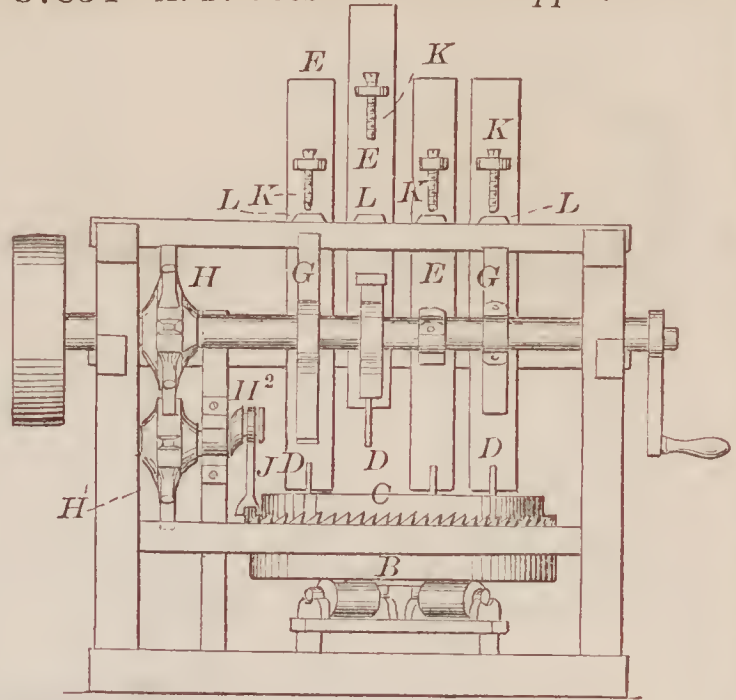

67850—J. A. Dodge—Harvester Rake.

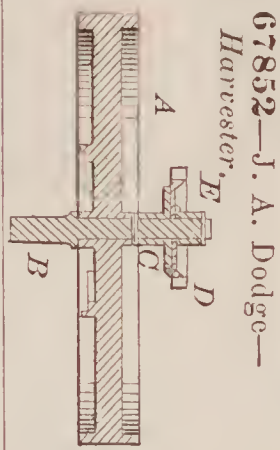
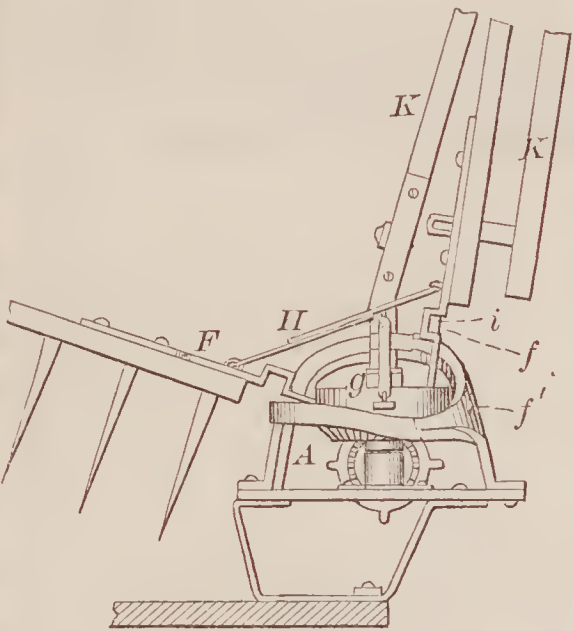

67852—J. A. Dodge—Harvester Rake.

67853—Dodge, Stevenson & Stevenson—Harvester Rake.

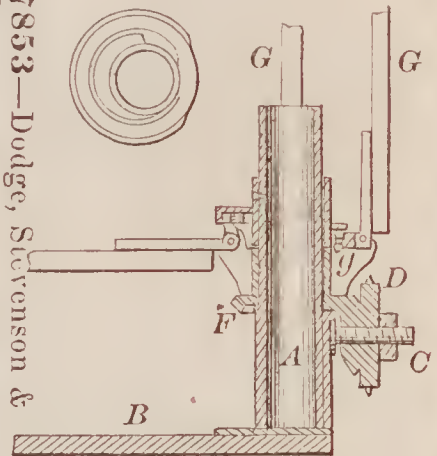

67851—J. A. Dodge—Harvester Rake.

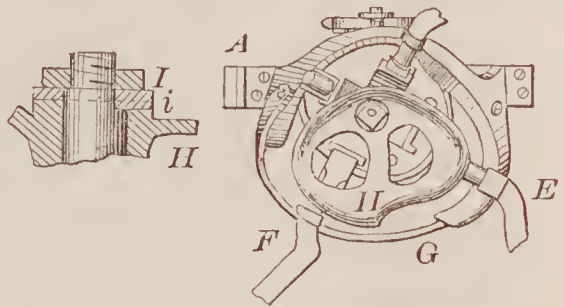

67855—M. M. Donnelly—Moulder's Flask.

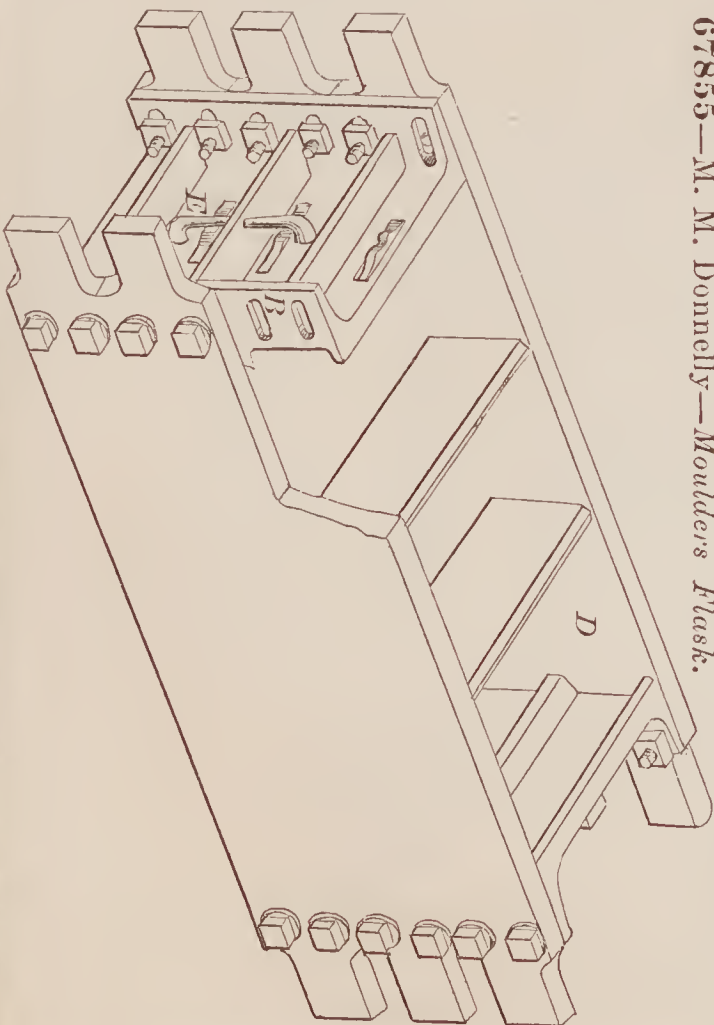

67856—M. M. Donnelly—Moulder's Flask.

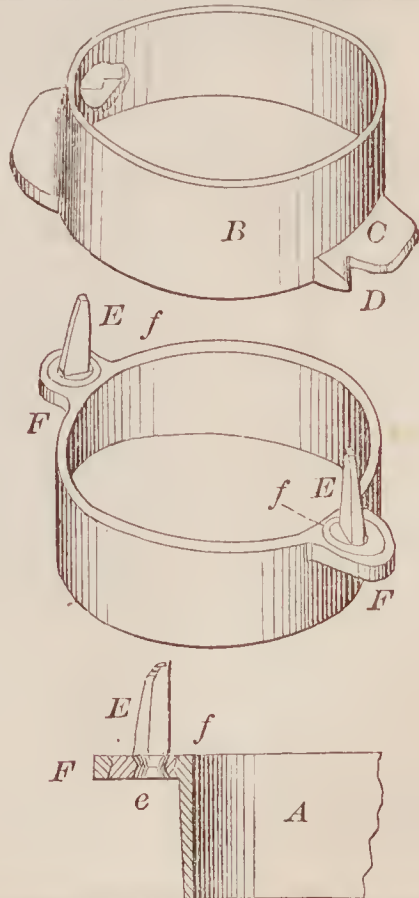



67858—F. Ernst—*Clothes Washer.*

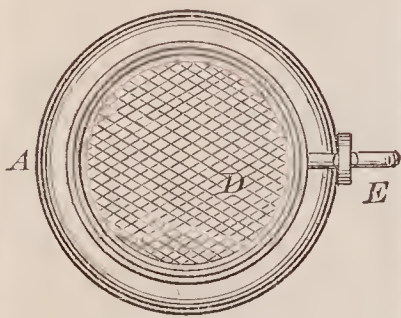
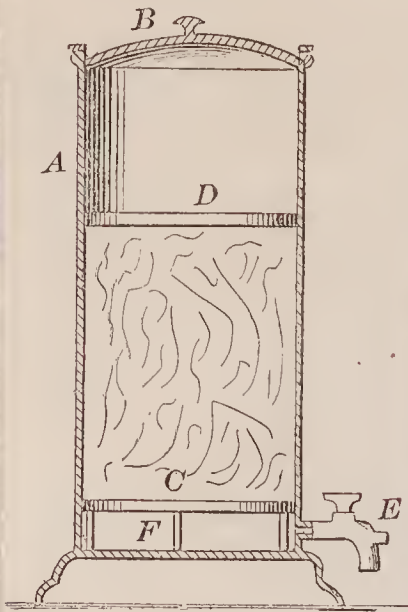

67861—W. R. Ferguson—*Hook and Terrett.*

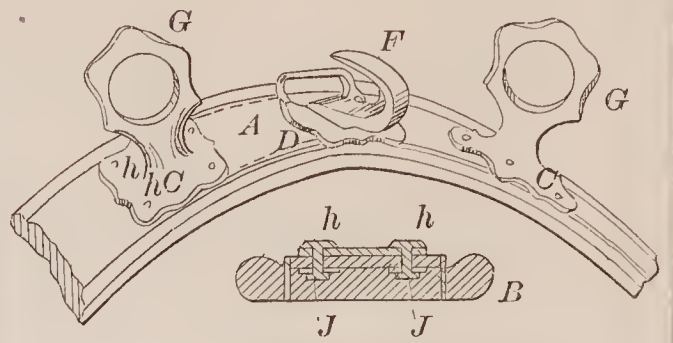

67859—H. Everett—*Metal Can for Putting up Alkali.*



67862—G. B. Field—*Ore Roasting Furnace.*

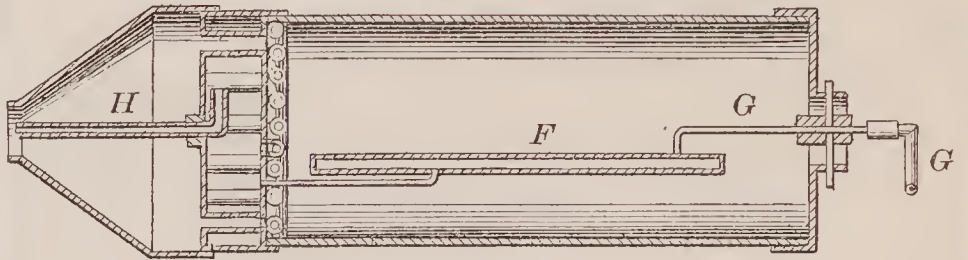

67863—A. Foubert—*For Distilling and Rectifying Spirits.*

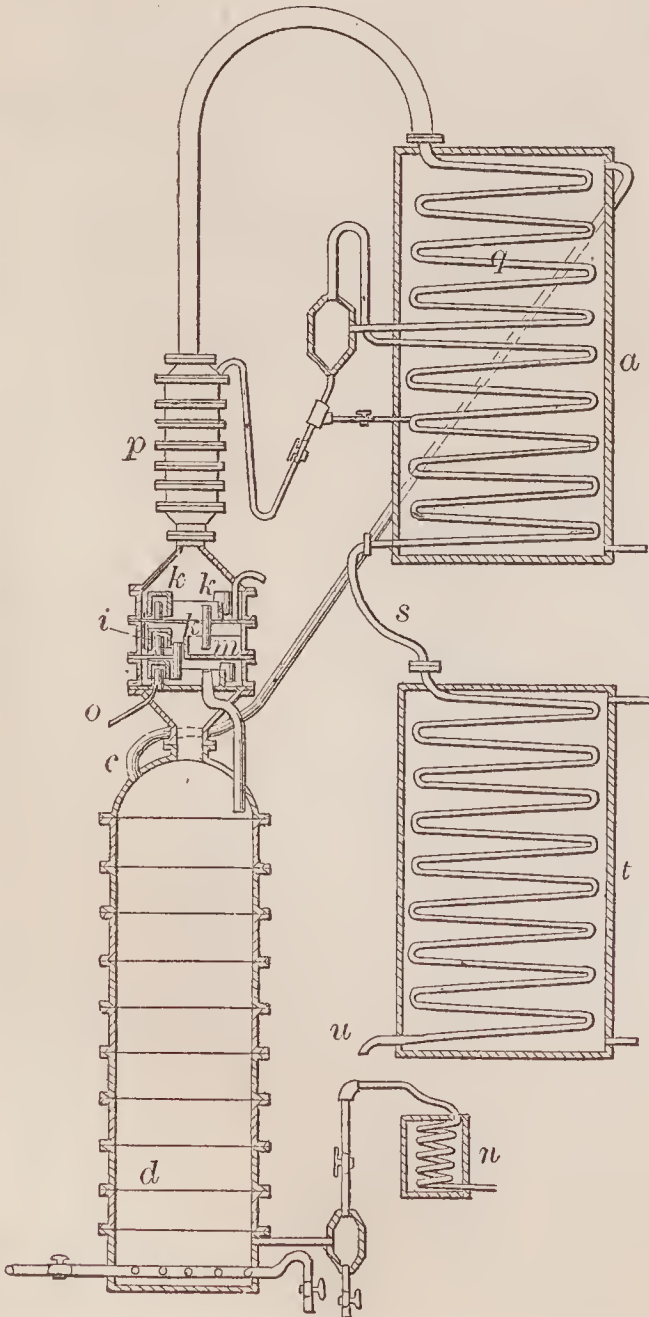

67860—J. B. Ewell—*Seeding Cultivator.*

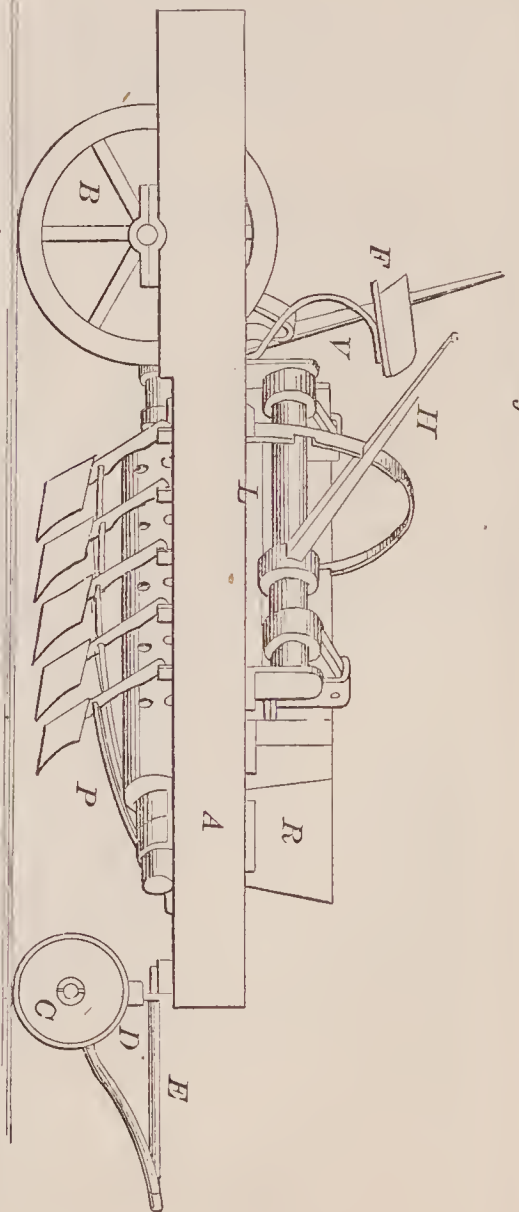

67864—A. Foubert—For Distilling Spirits.

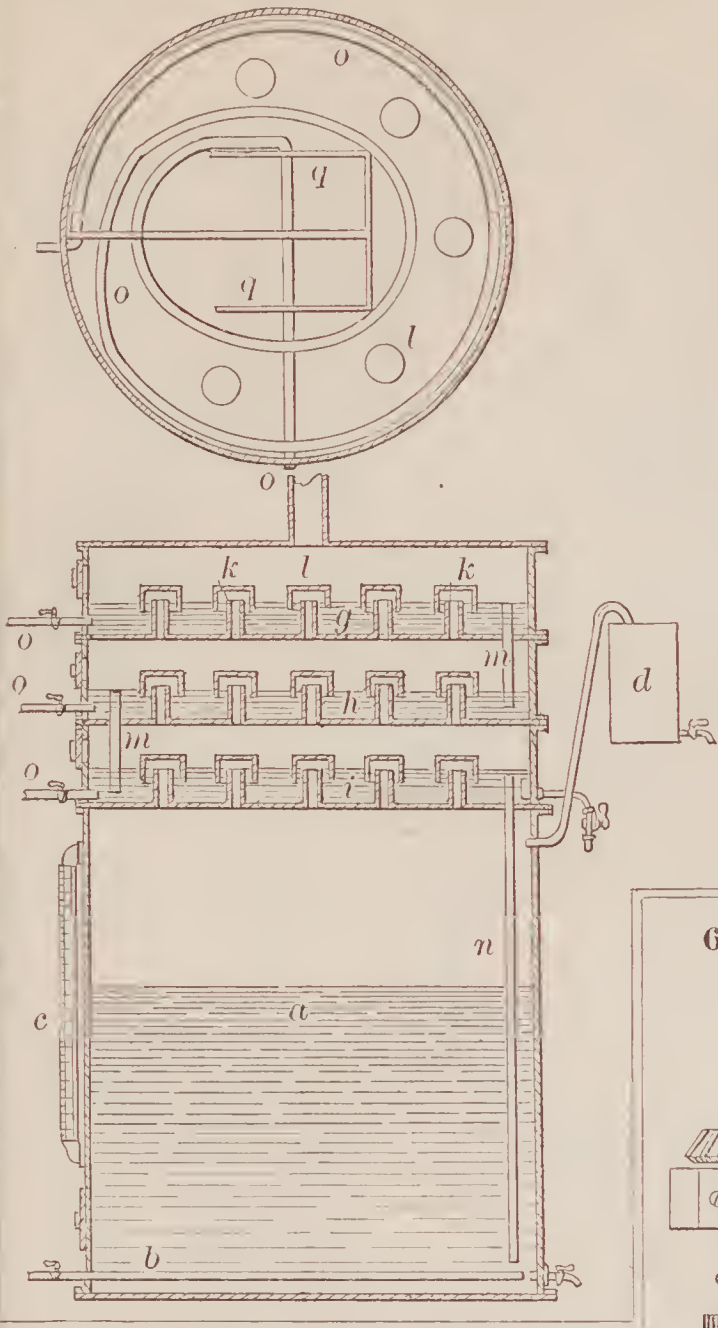

67866—J. French—Boiler Gauge Cock.



67867—F. H. Furniss—Steam Engine Oil Cup.

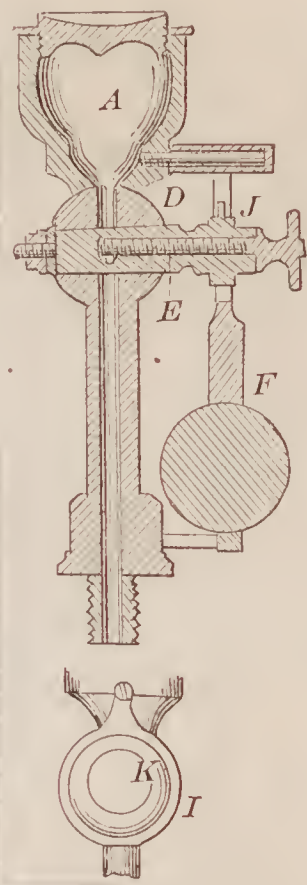

67865—M. Fowler—For Making Buckles.

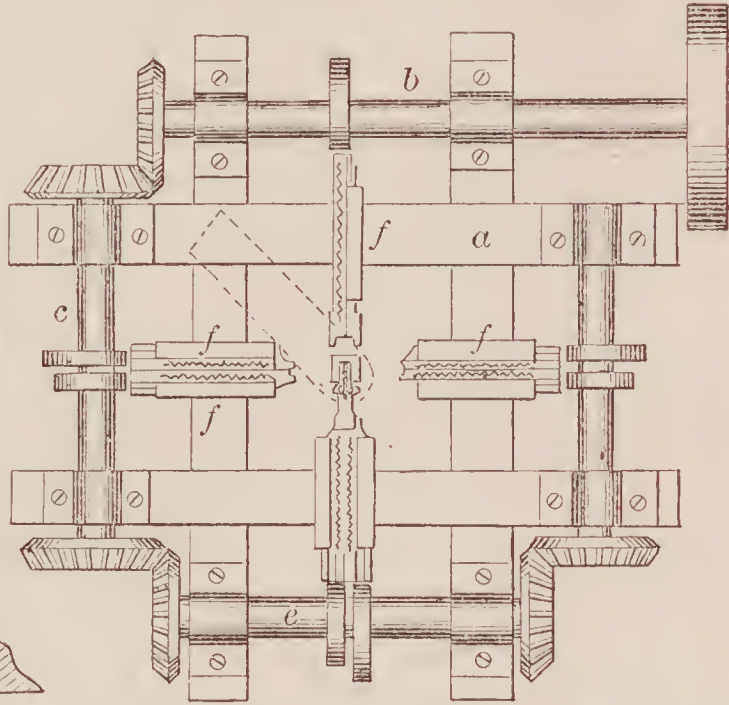

67870—H. C. Goodrich—Tuck Marker for Sewing Machines.

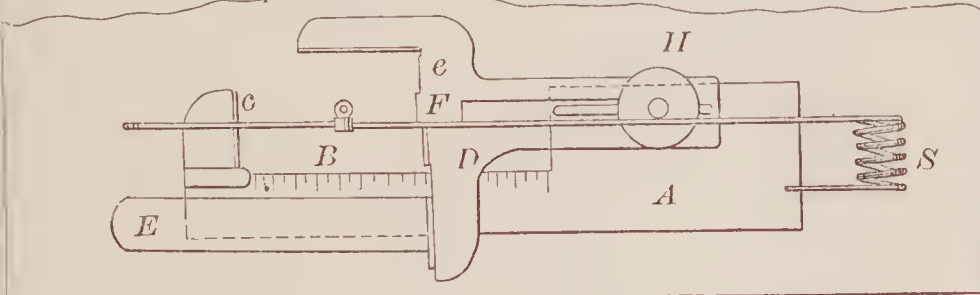

67869—J. Gatley—Cooler for Liquors on Draught.

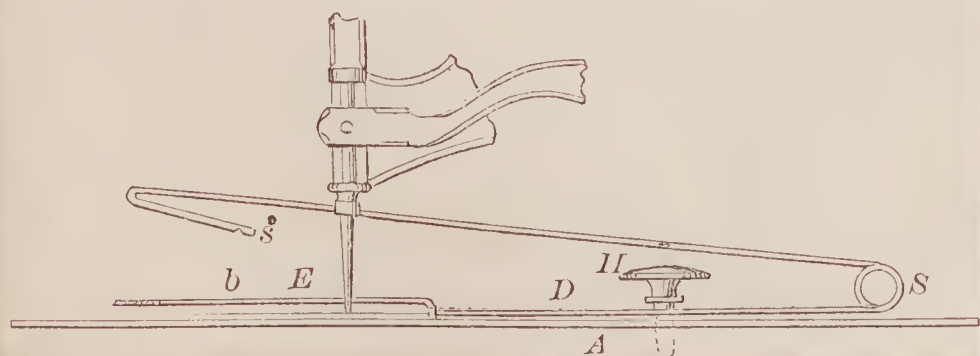
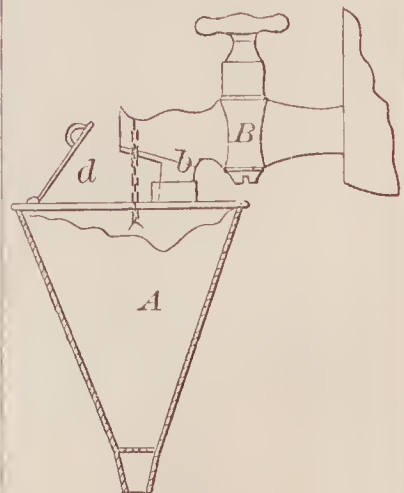



67871—W. P. Goolman—Platform Scale.

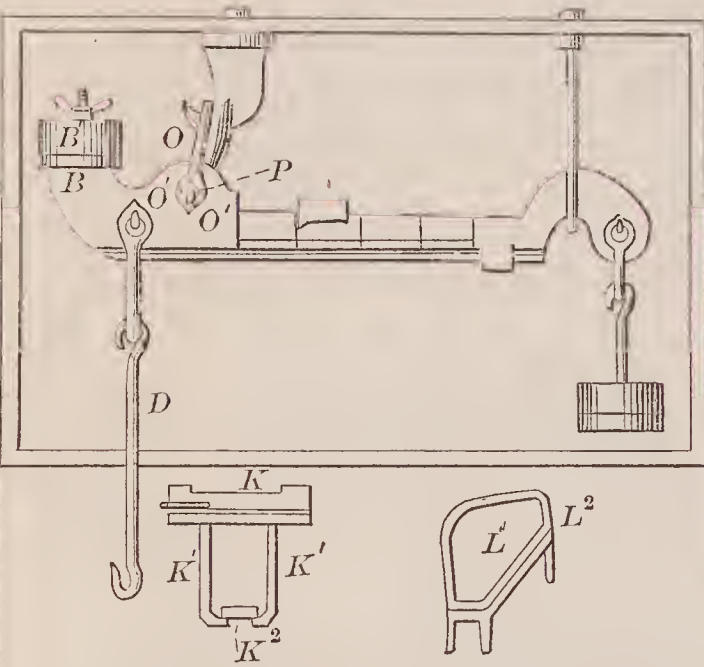
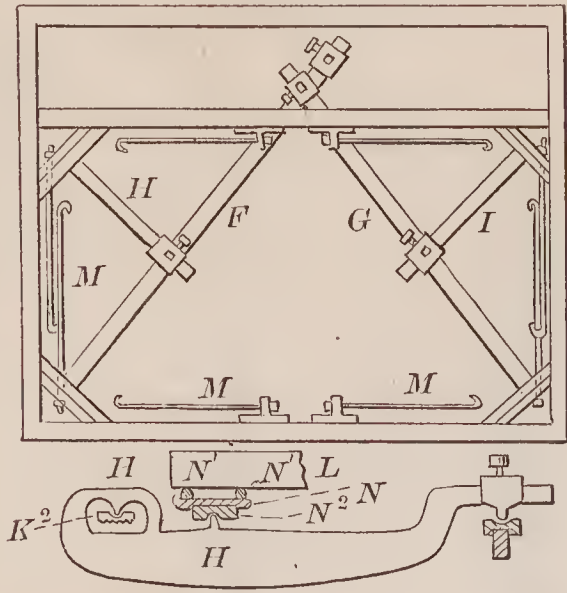

67879—W. G. Hyndman—Brick Machine.

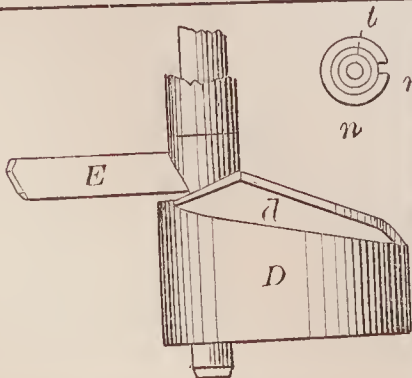
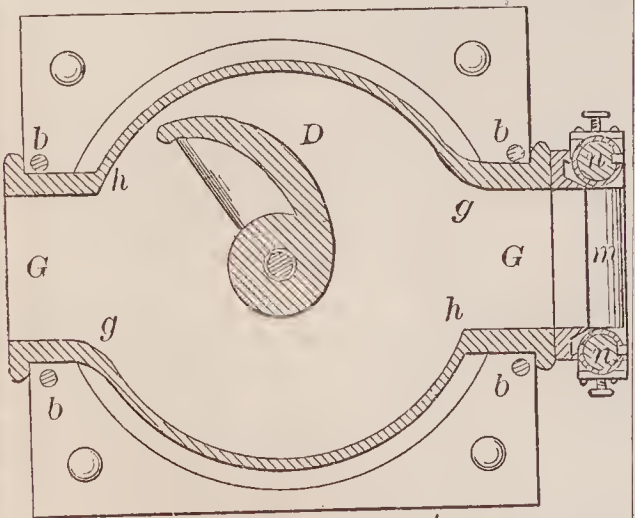

67876—C. F. Herrick—Curtain Fixture.

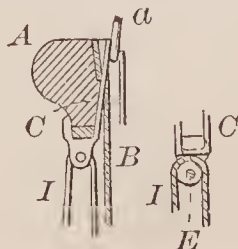

67878—H. A. Hurd—Shaft Coupling.

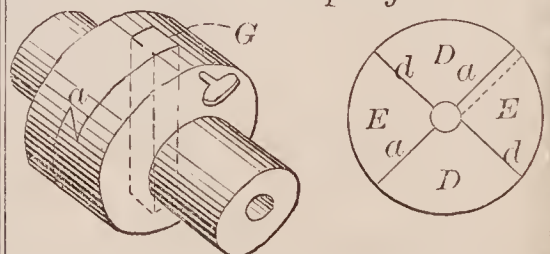

67873—H. M. Guild—Mop Head.

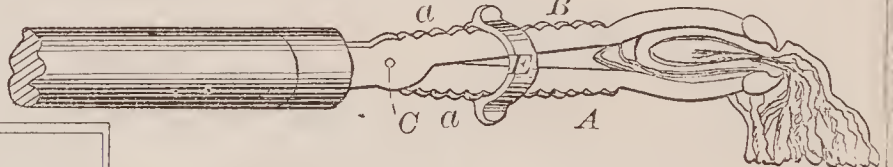

67875—H. M. Hamilton—Miners' Pick.

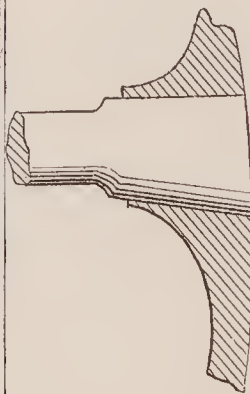

67877—R. Hitchcock—Car Ventilator.

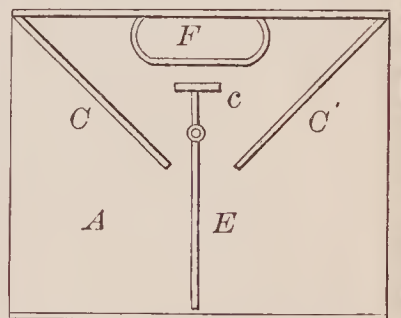

67874—D. Hale—For Attaching Weights to Submarine Armor.

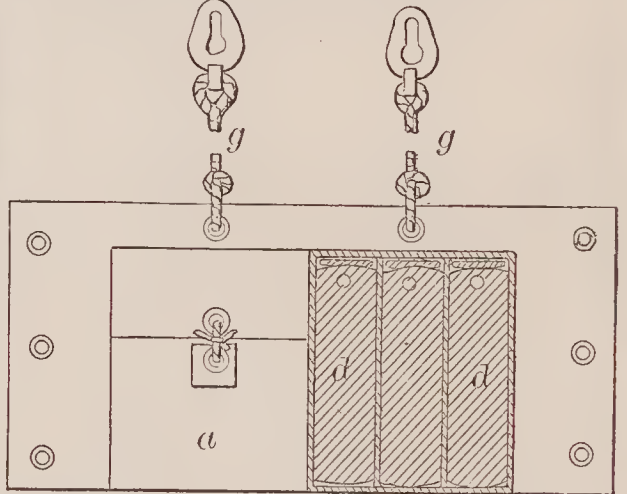

67872—G. B. Griffin—Clothes Line Reel.

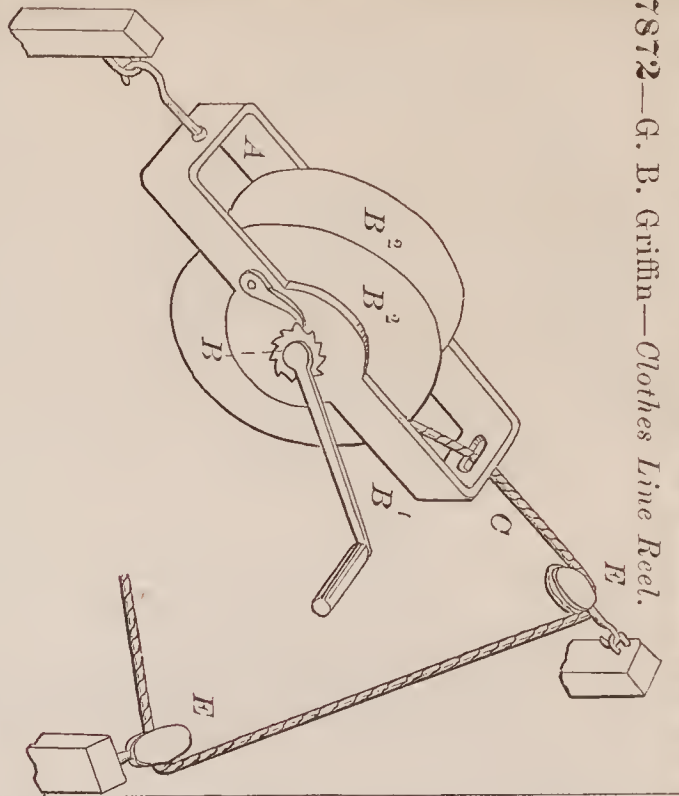

67881—G. F. Kendall—Thread  
Waxer for Sewing Machines.

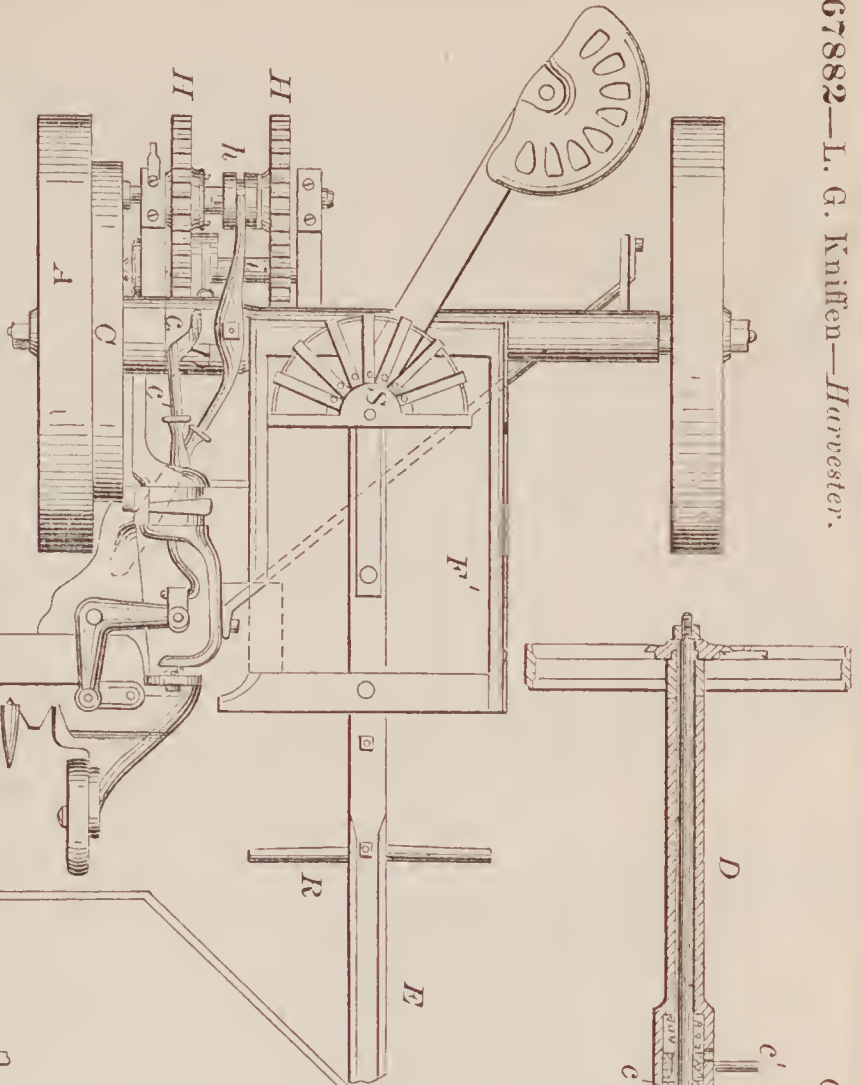
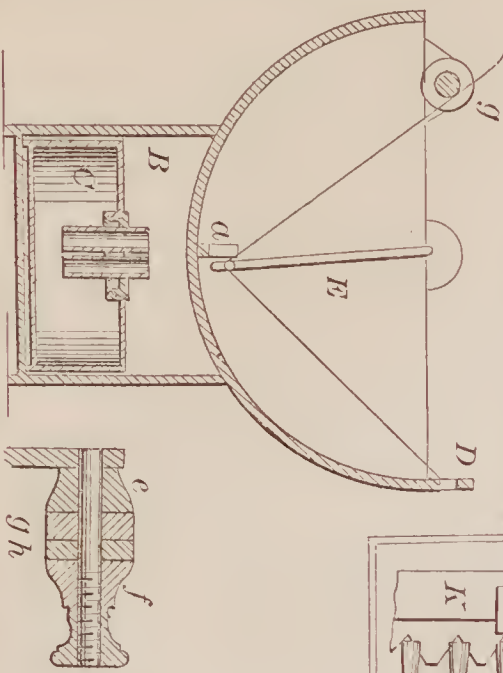

67882—L. G. Kniffen—Harvester.

67884—L. G. Kniffen—Harvester

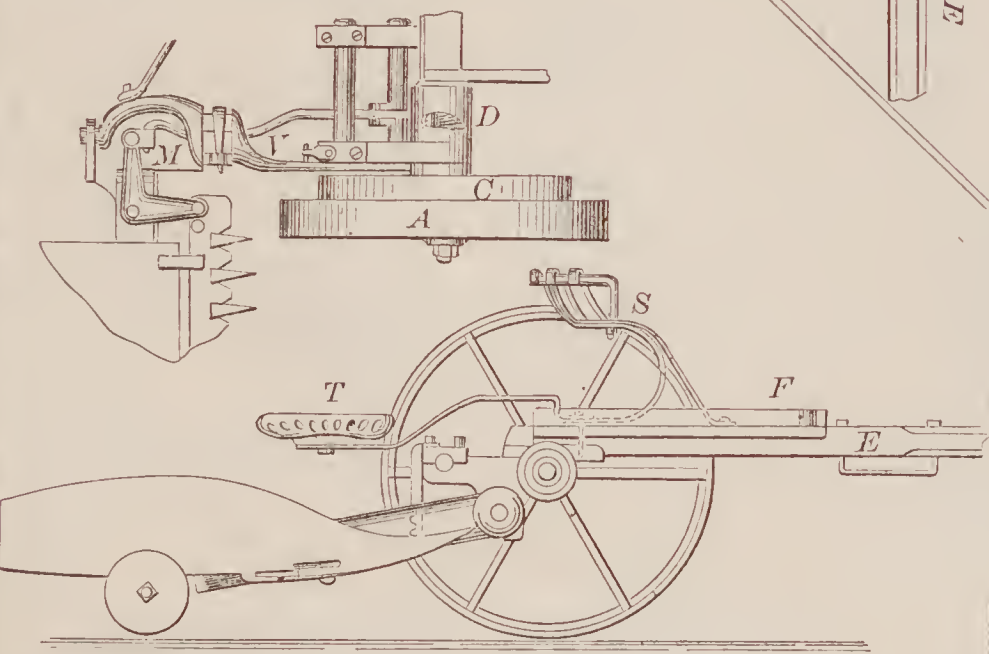

67883—L. G. Kniffen—  
Harvester.

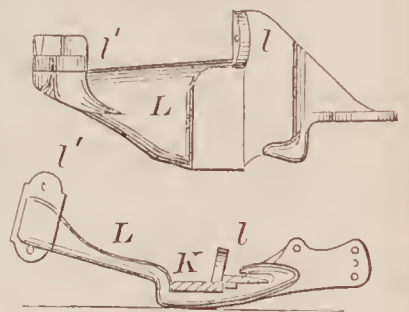

67885—L. G. Kniffen—Harvester.

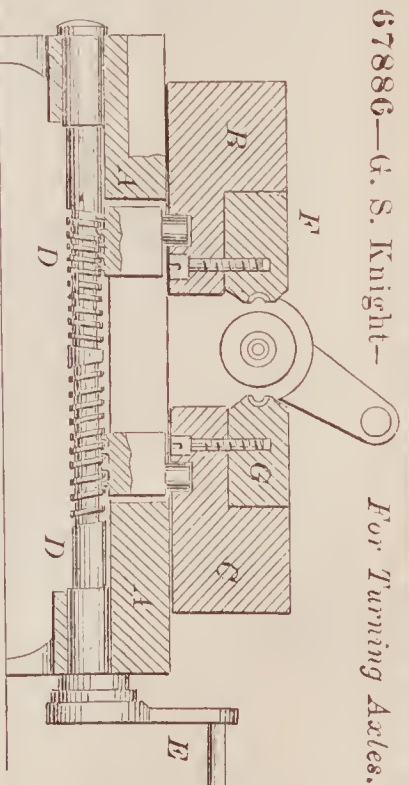
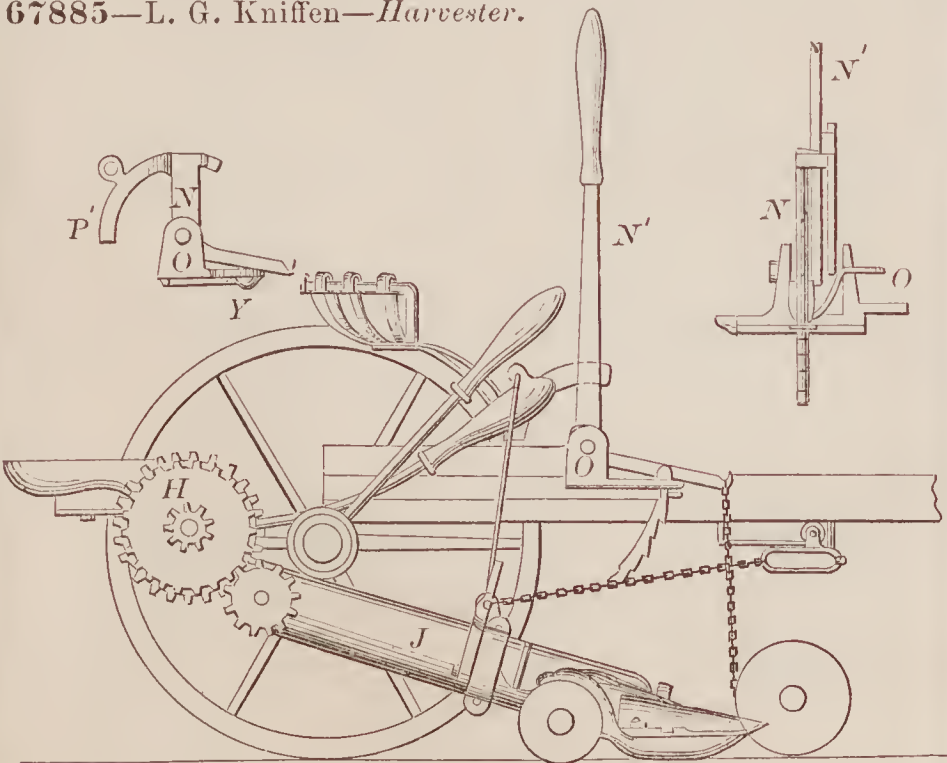

67886—G. S. Knight—  
For Turning Axles.



67887—Kramer & Wise—Cigar Machinery.

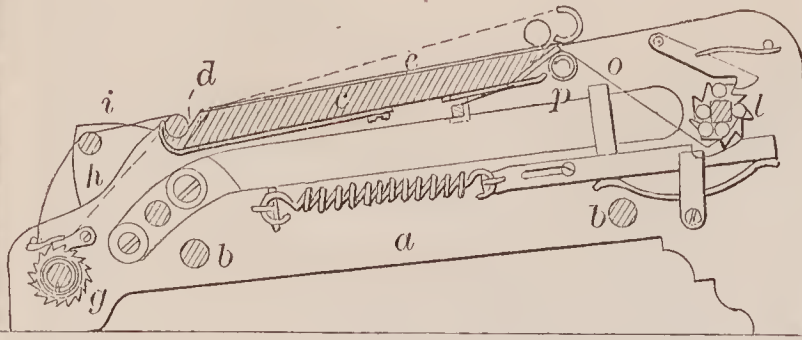

67889—G. W. Lane—Hinge.

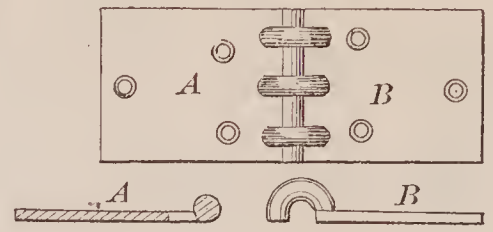

67888—I. Lancaster—Harvester Rake.

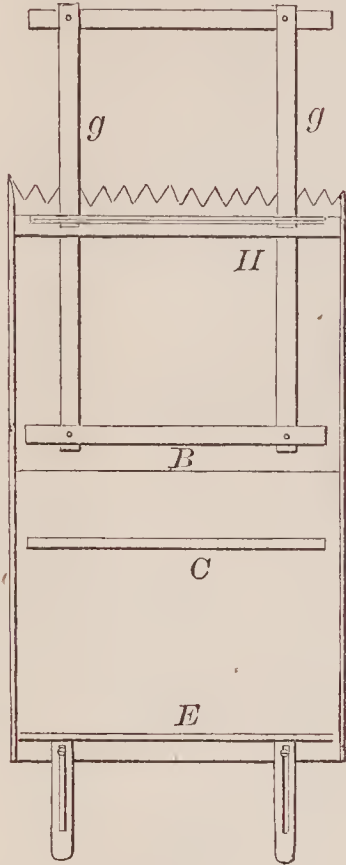

67890—W. E. Levoy—Plow.

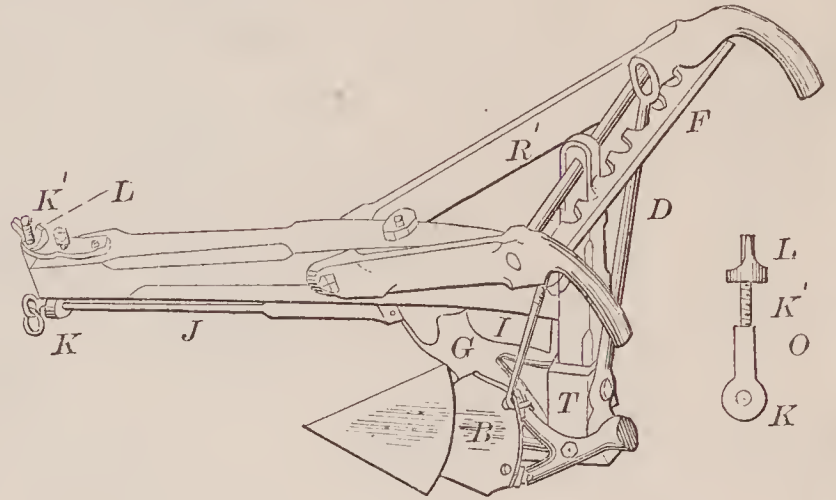

67891—Luther & Marsh—Window Blind Fastening.

Fig. 1

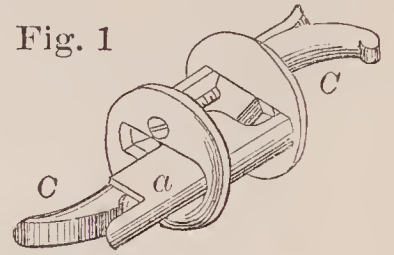

Fig. 3

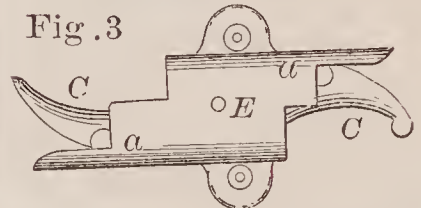
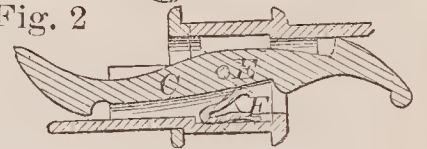
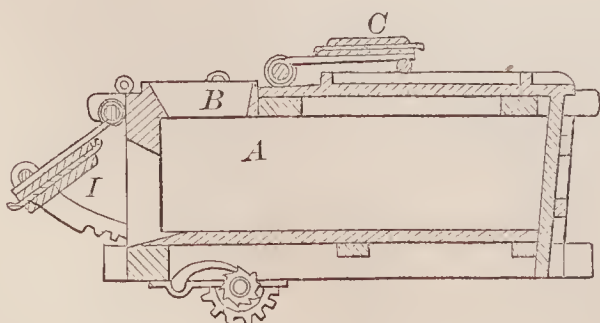

Fig. 2



67892—J. H. Lynch—Night Cart.



67893—H. Mansfield—Animal Trap.

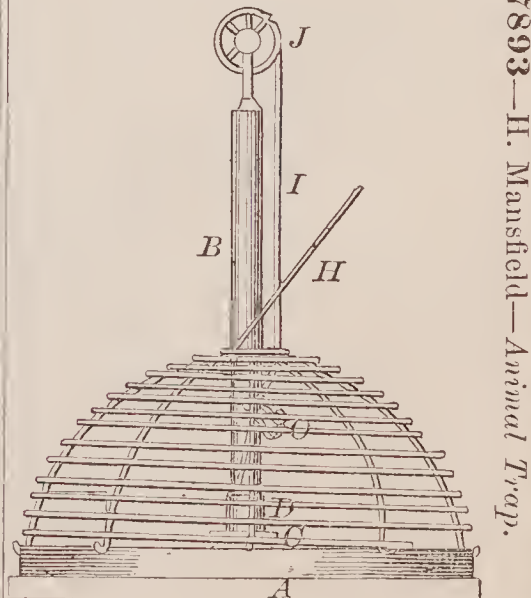





67903—A. Philippi—*Railroad Frog.*



67910—A. J. Roberts—*Manufacture of Horse Shoes.*

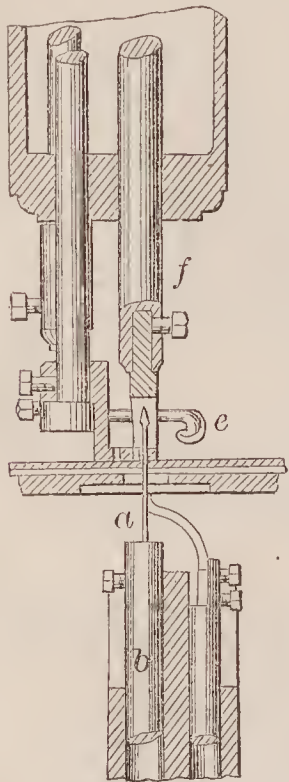
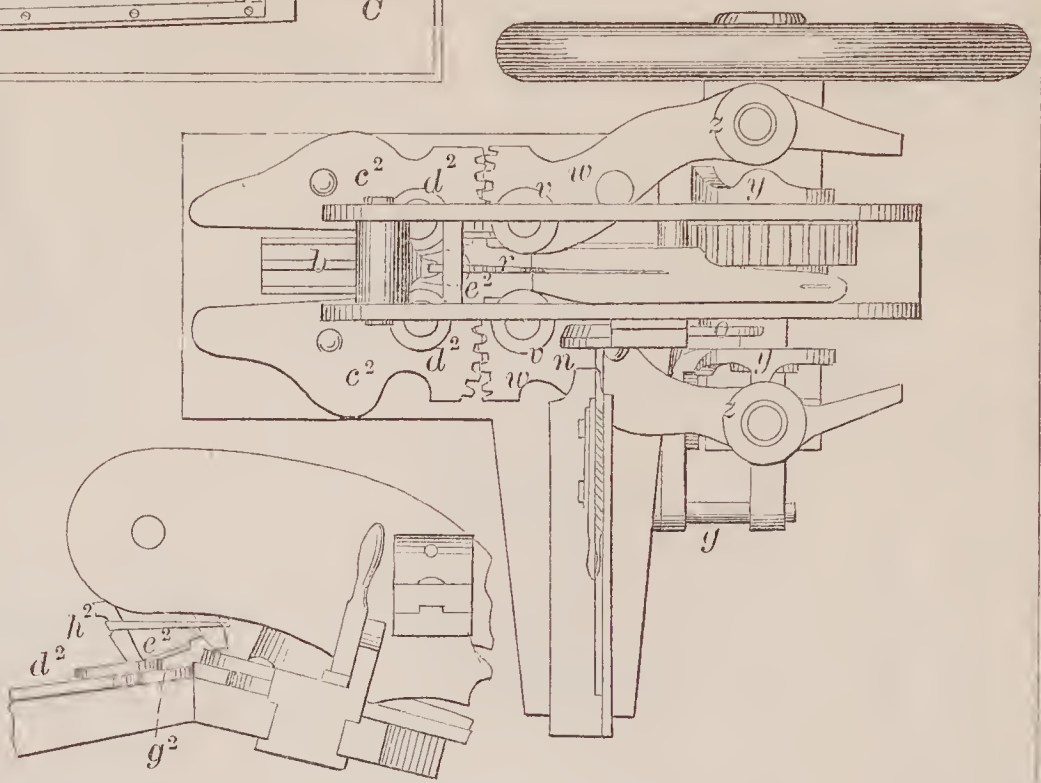

67906—T. K. Reed—*Sewing Machine.*

67907—M. B. Renslow—*For Making Nitrous Oxide, &c.*

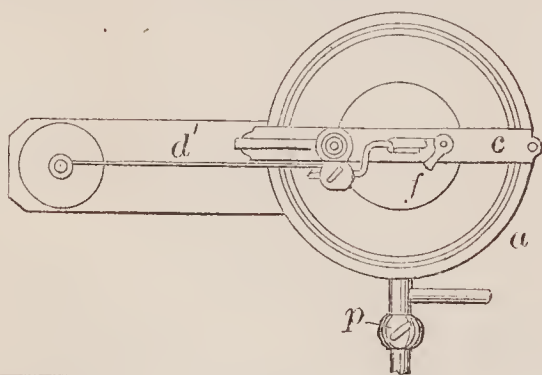
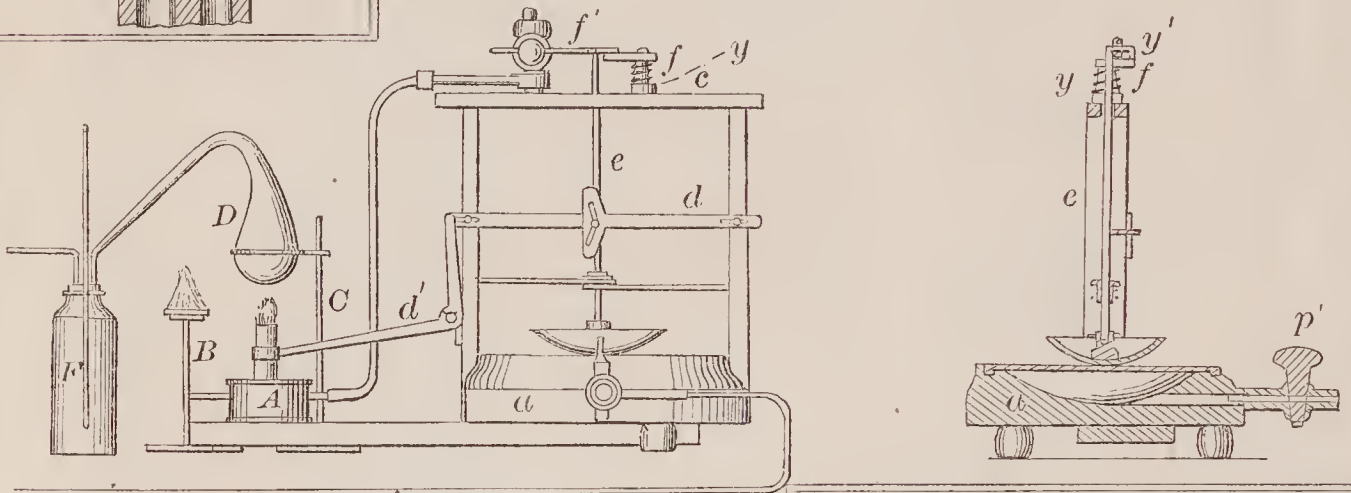

67905—L. Ransom—*Traveling Trunk.*

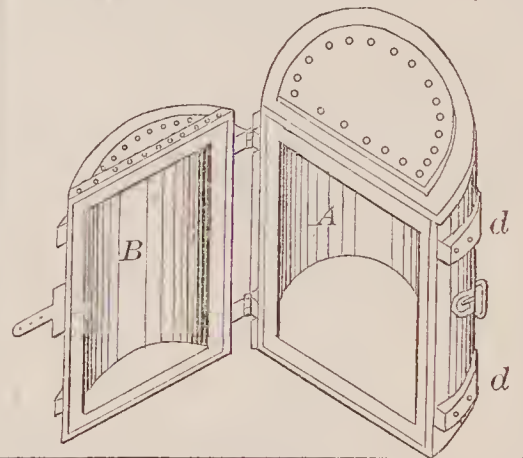

67908—W. W. Reynolds—*Platform Scale.*

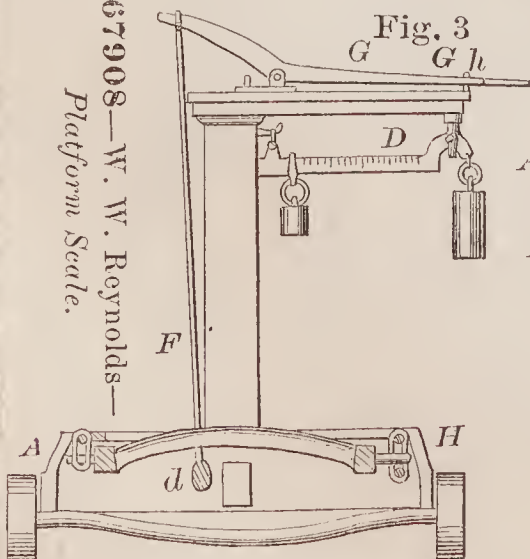
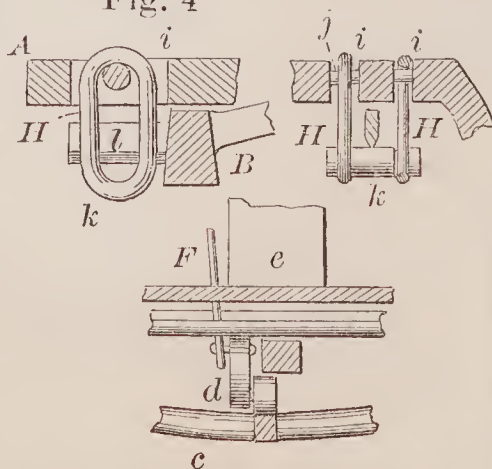
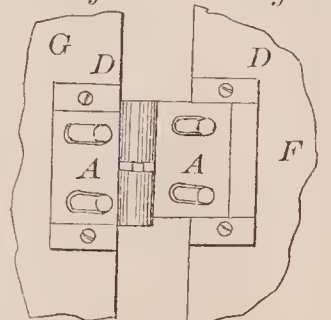

Fig. 4



67904—J. G. Ralph—*Adjustable Hinge.*



67909—J. Richardson—*Manufacture of Vinegar.*

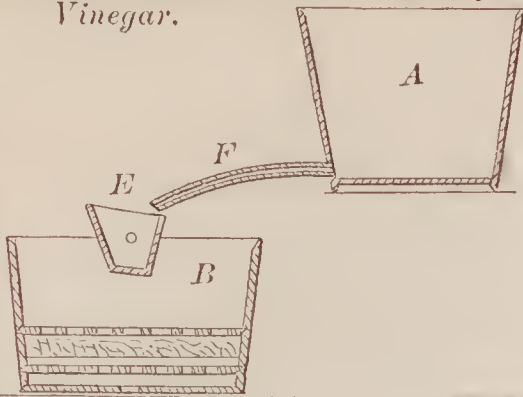

67911—L. Roberts—*Truss.*

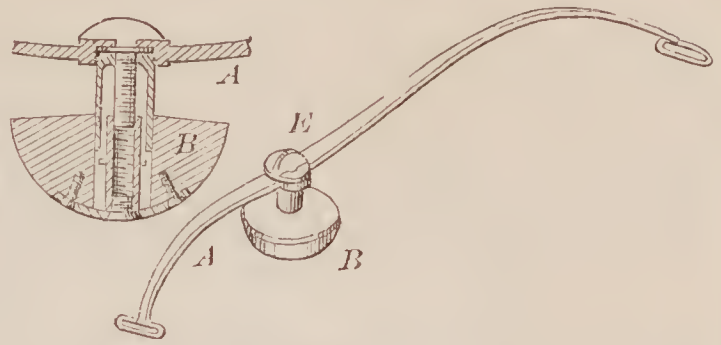

67913—T. J. & R. L. Root—*Trip Hammer.*

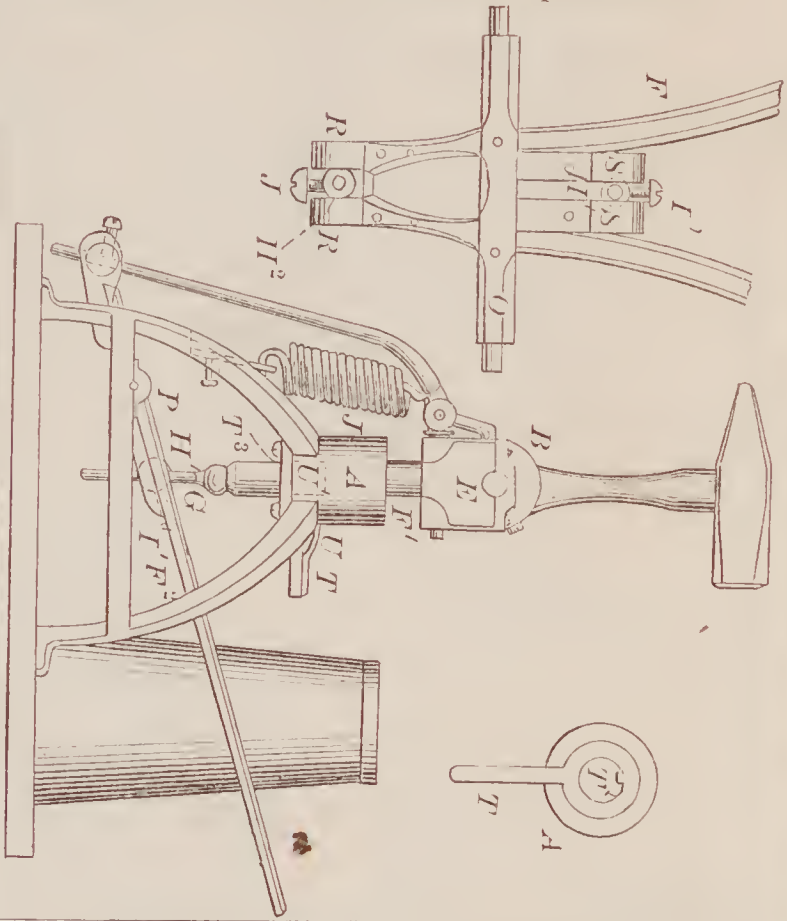

67912—A. Roos—*For Rectifying Spirits.*

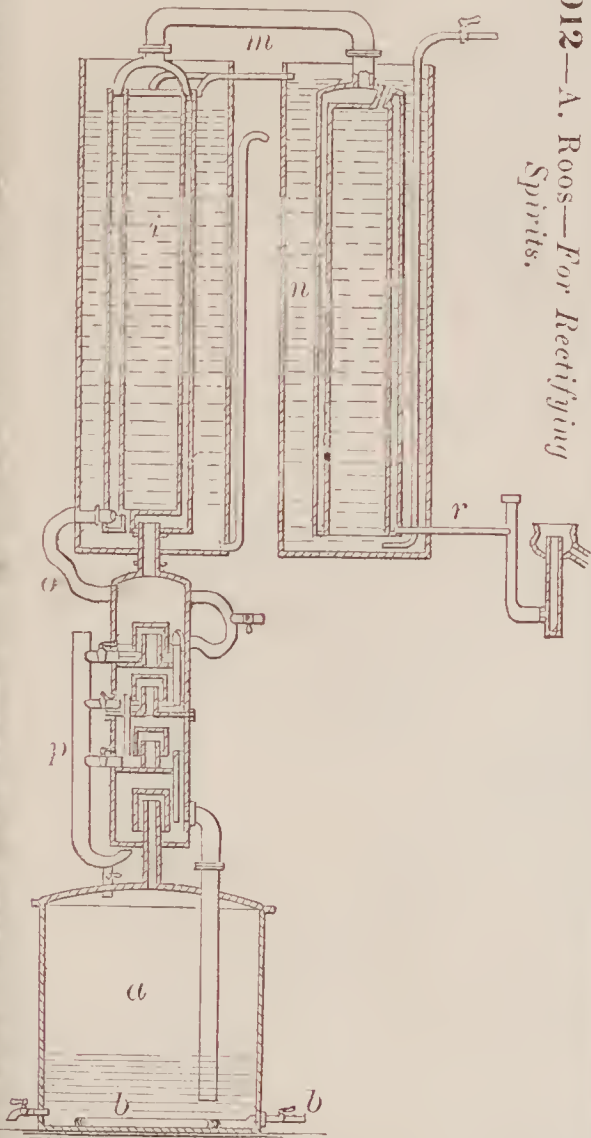

67915—J. W. Sanford—*Gate and Fence.*

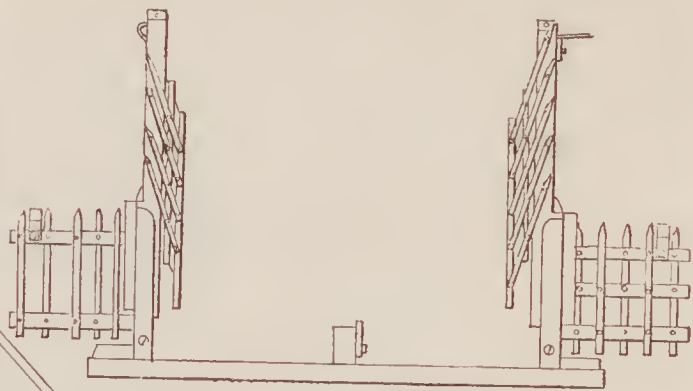

67916—J. W. Sanford—*Broom Head.*

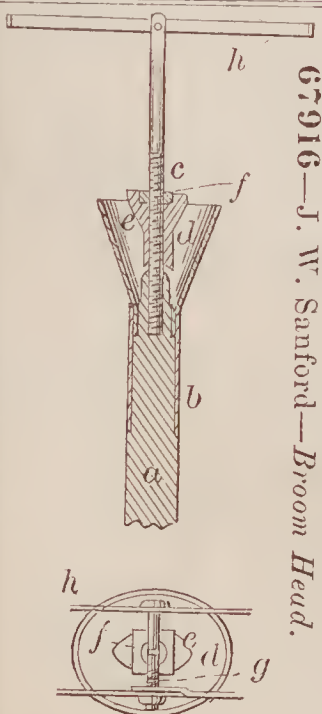

67914—I. S. & H. B. Russell—*Harvester.*

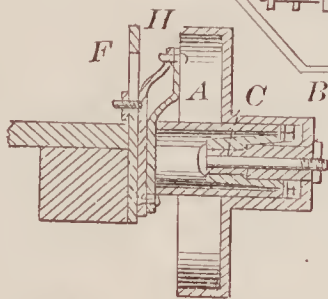

67918—J. B. Shannon—*Speaking Tube.*

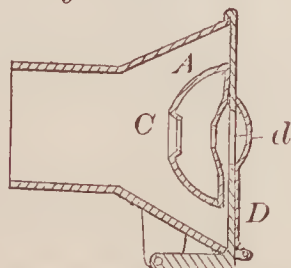

67917—G. W. Sawin—*Horse Hoe.*

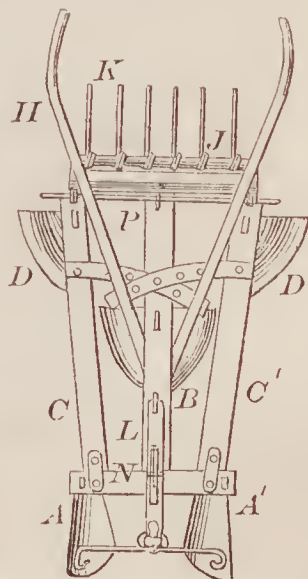



67919—C. G. Smith—*Reflector for Windows.*

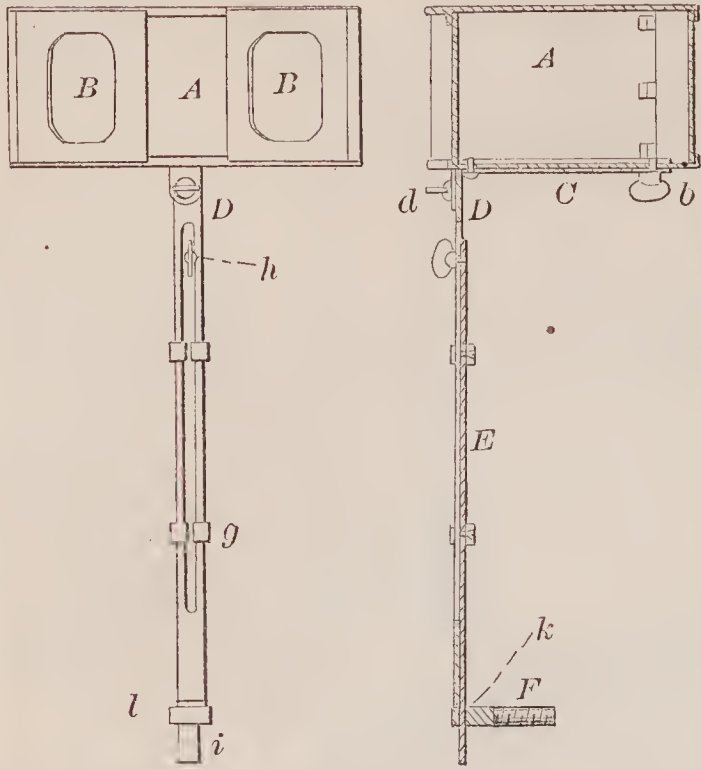

67923—Spofford & Hersey—*Cotton Gin.*

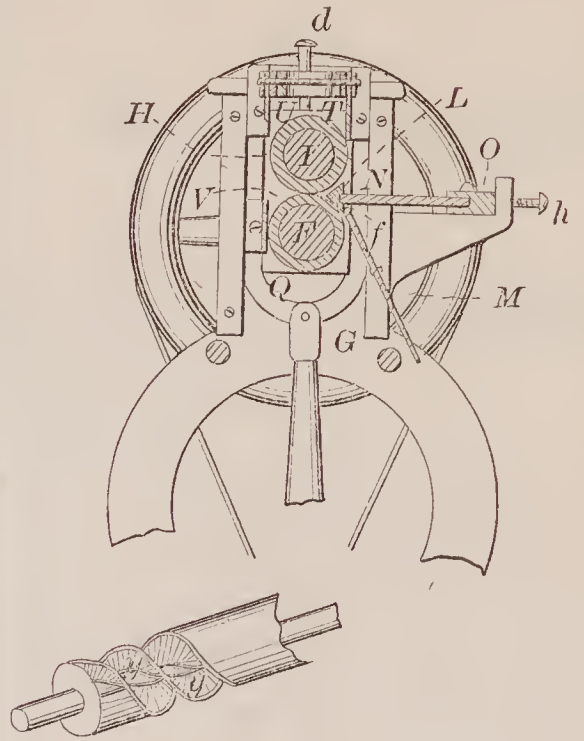

67927—T. J. Sullivan—*Permutation Lock.*

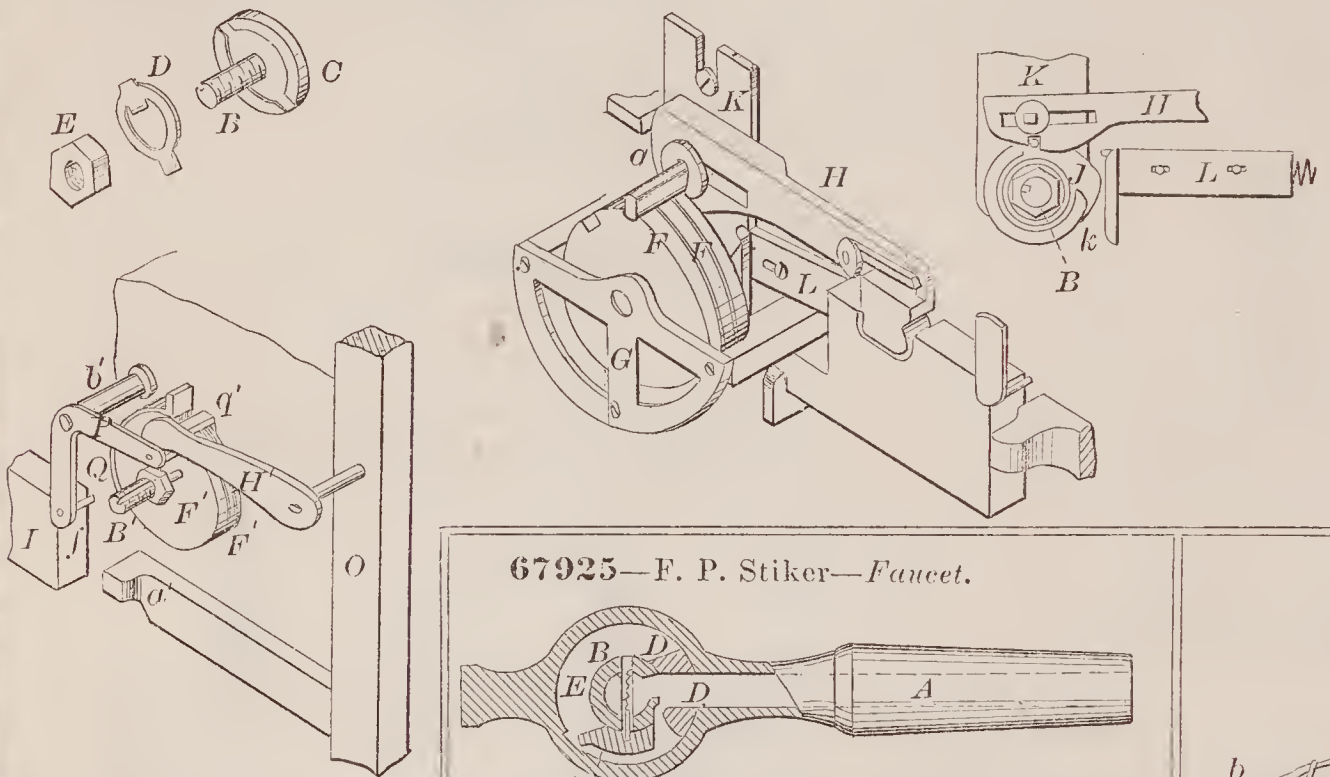

67925—F. P. Stiker—*Faucet.*

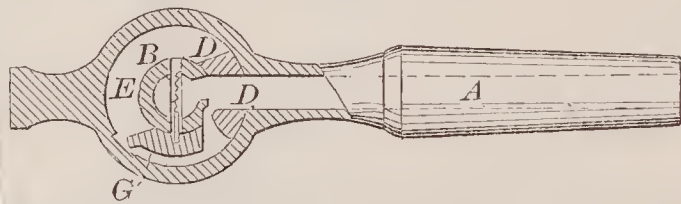

67922—E. Spencer—*Pencil Sharpener.*

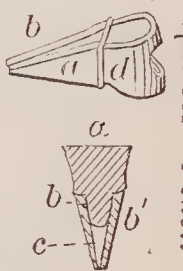

67924—R. T. Sprague—*Liquoring Sugar in Centrifugal Machines.*

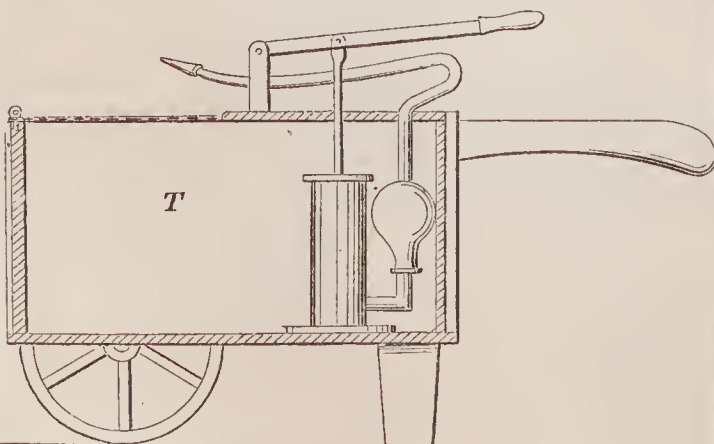

67920—B. F. Sparrow—*Metallic Tip.*

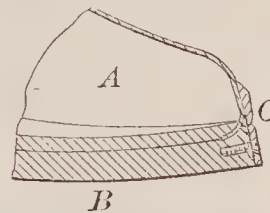

67928—J. D. Summer—*Water Meter.*

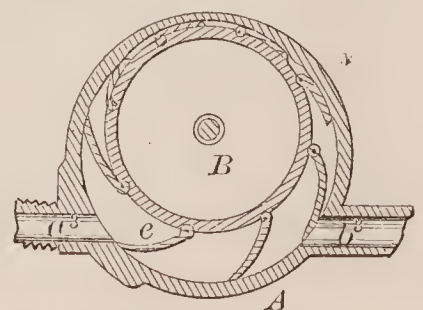

67929—D. M. Swartz—Dumping Platform for Harvesters.

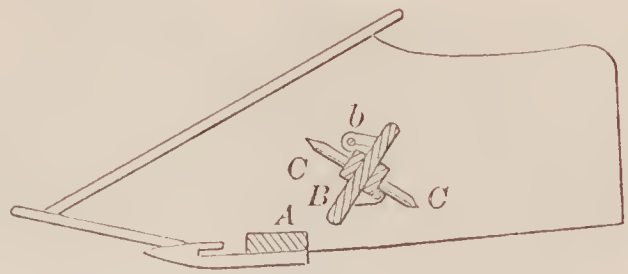
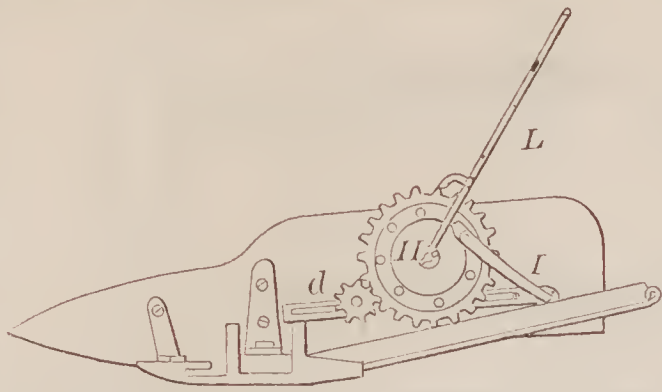

67930—Tucker & Babbitt—Bed Bottom.

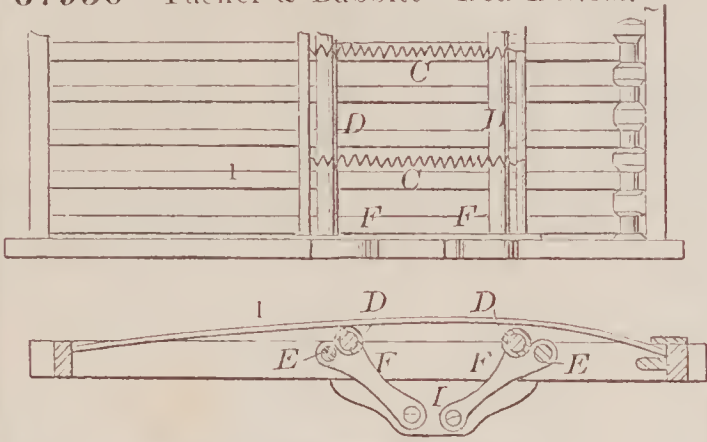

67931—Underwood & Johnson—For Soldering Cans.

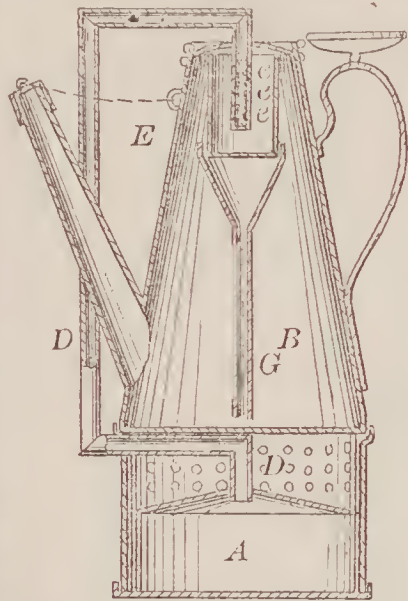
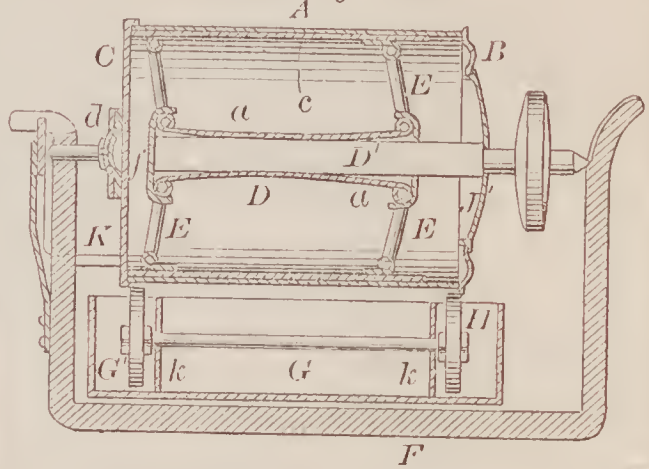

67932—J. C. Walker—Coffee Pot.

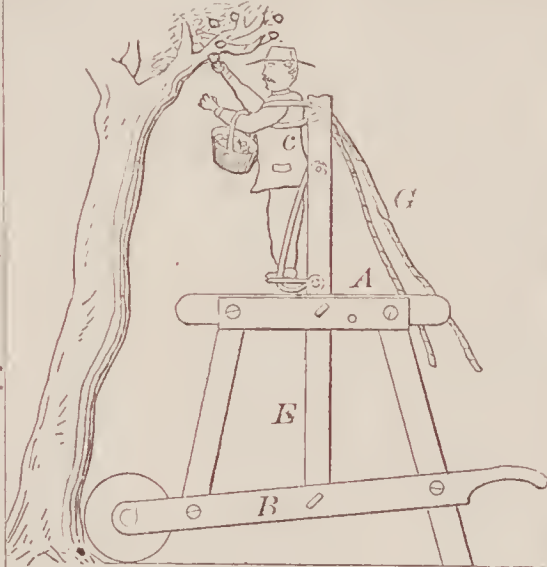

67933—S. S. Whaley—Fruit Ladder.

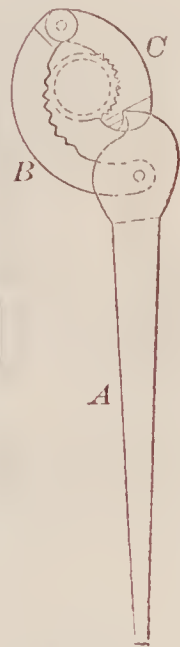

67937—W. C. Abbe—Pipe Wrench.

67935—C. O. Winegar—Steam Generator.

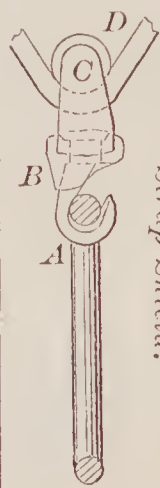
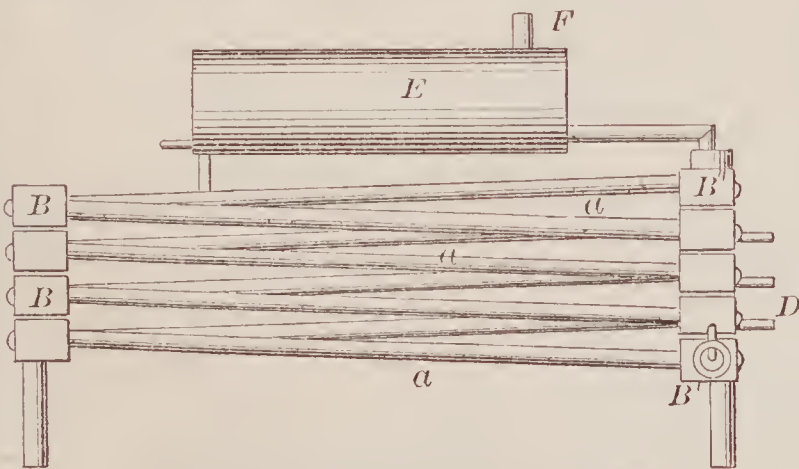

67934—H. F. Willson—Breast Strap Shield.

67936—J. H. Wooster—Steam Engine Governor.

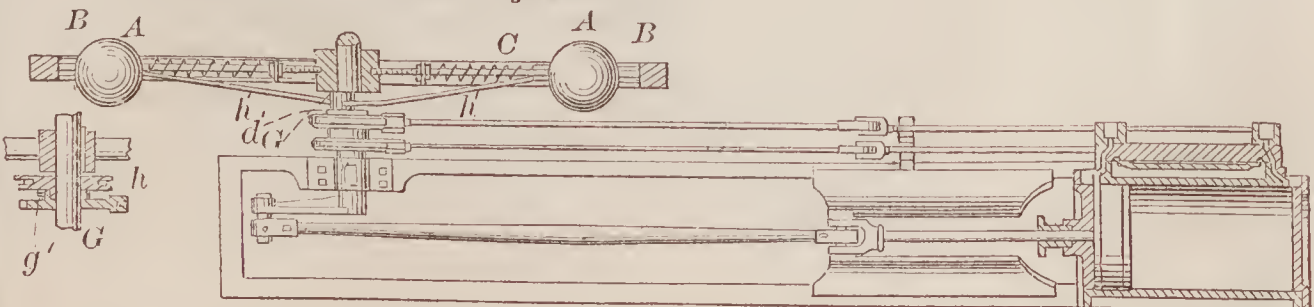



67939—J. Baumeister—Boiler

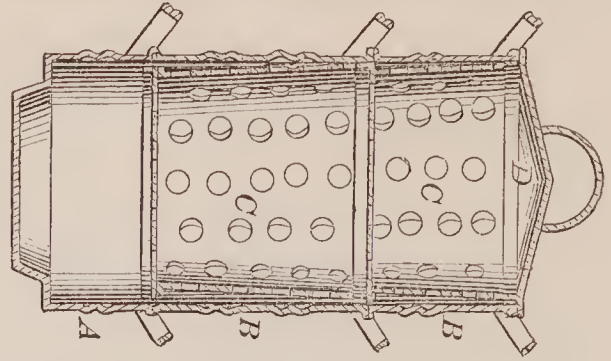

67940—L. Beckelshymer—Harrow.

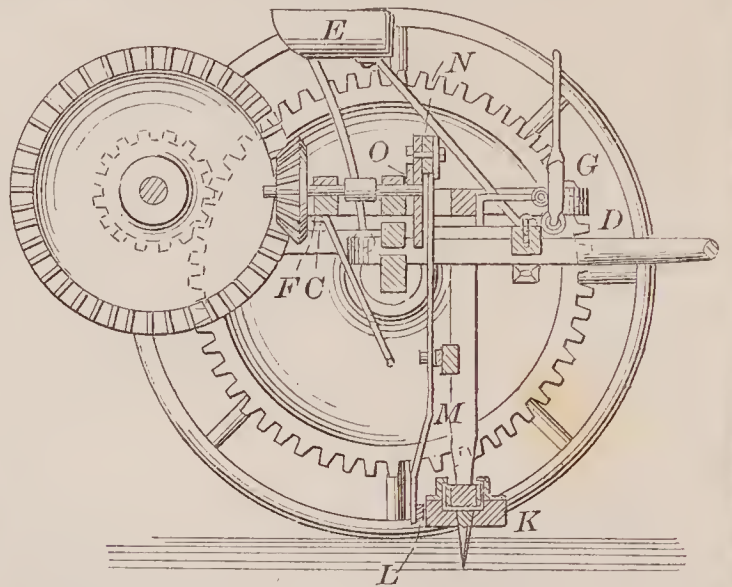

67938—Arndt & Moebius—Lock and Knob Latch.

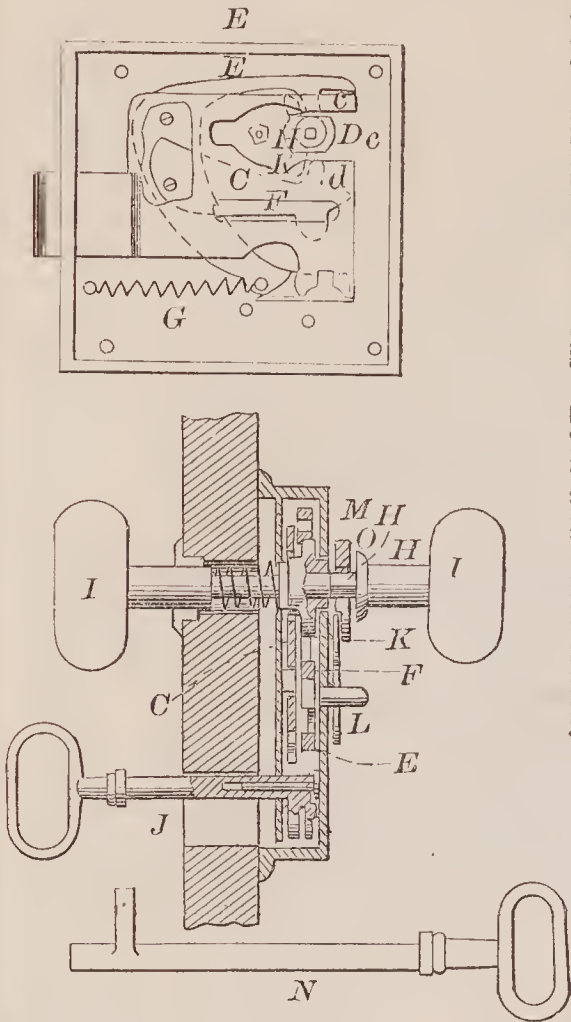

67943—S. Boone—Anchoring Stationary Machinery.

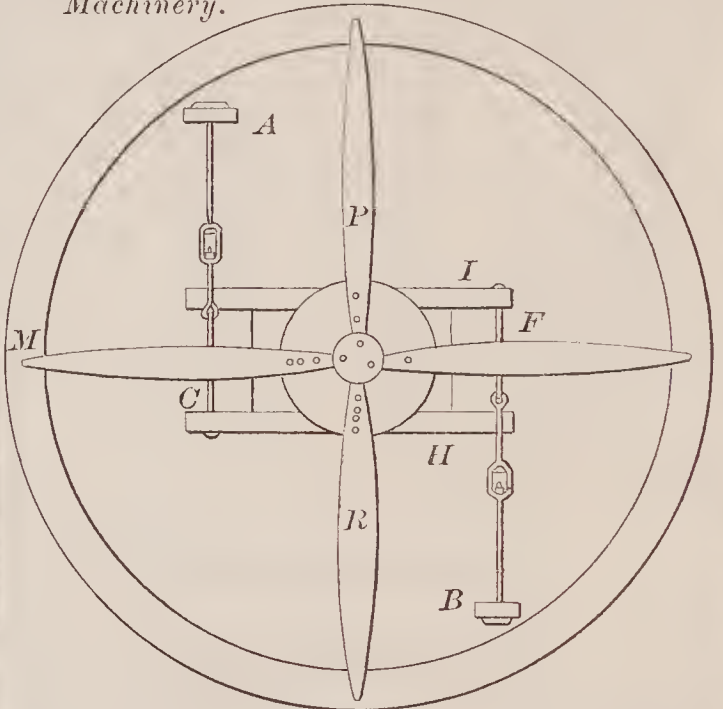

67944—L. H. Bowlus—Fence.

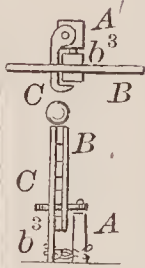

67942—F. S. Bissell—Door for Stores and Furnaces.

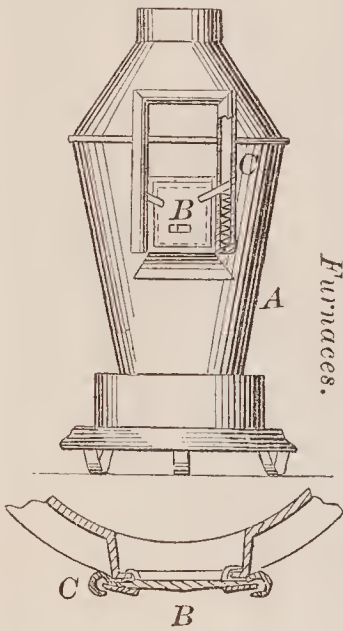

67946—H. Brady—Axle Box.

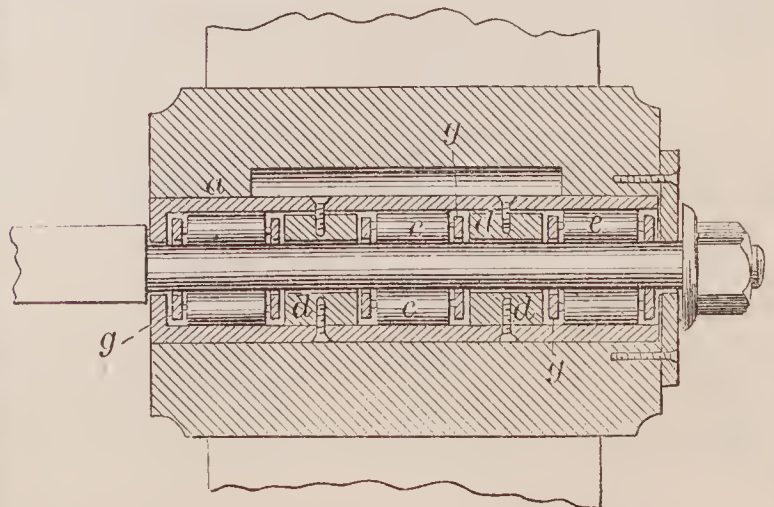

67945—T. S. Bowman—Ventilating Attachment for Stores.

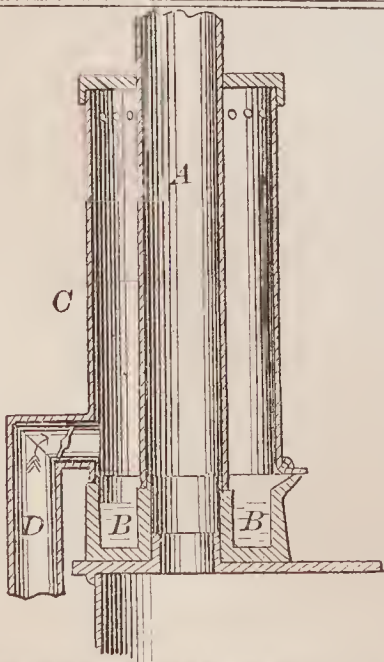



67948—P. Brinkerhoff—*Liquid Measure.*

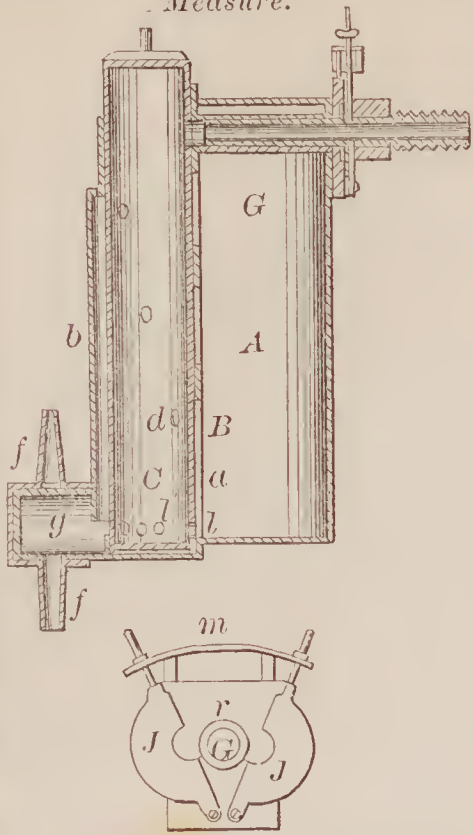

67949—P. F. Brittan—*Corn Cultivator.*

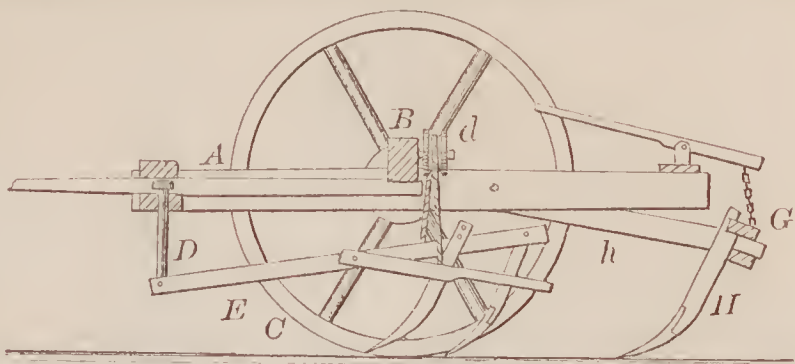

67951—W. Buckley—*Base Ball Table.*

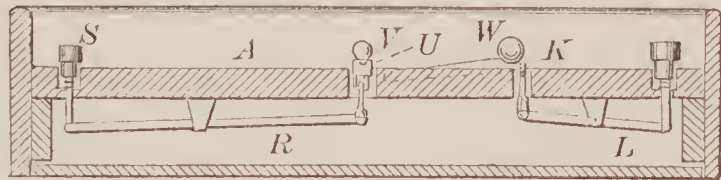

67950—H. Brown—*Clothes Dryer.*

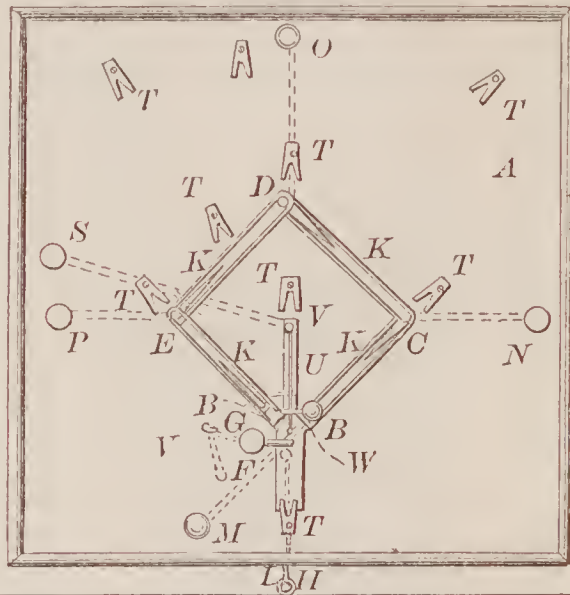
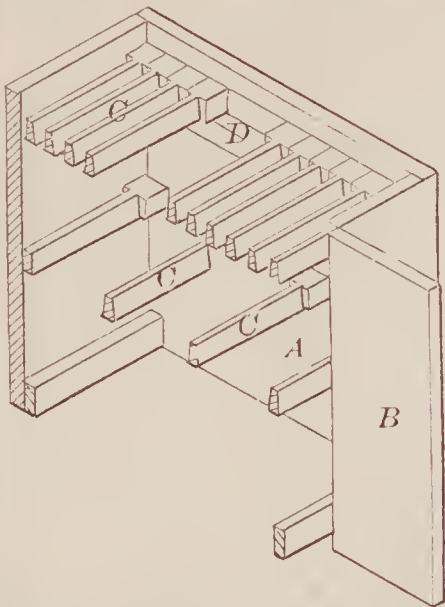

67954—J. B. Cleveland—*For Preparing Plates for Springs.*

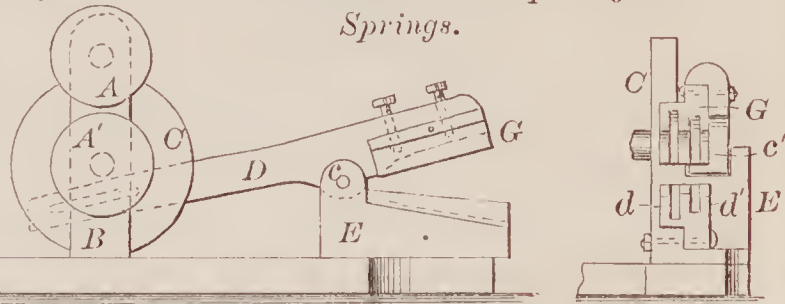

67952—J. Butts—*For Preventing Hogs from Rooting.*

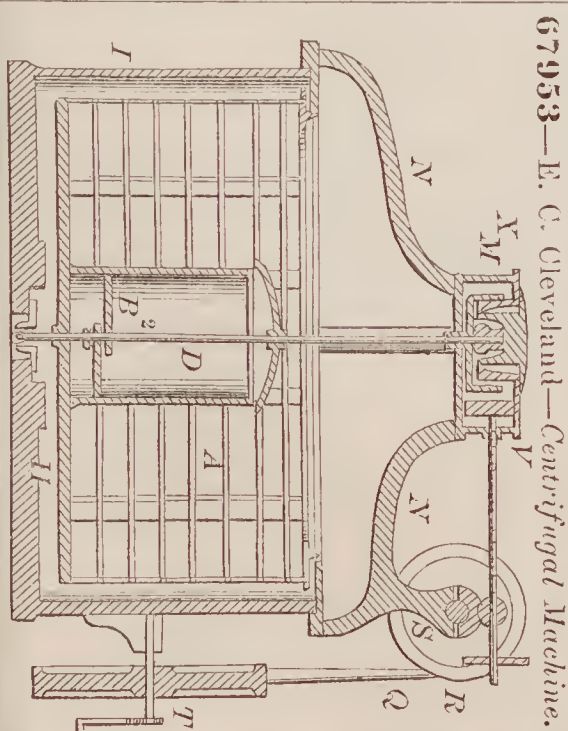

67953—E. C. Cleveland—*Centrifugal Machine.*

67955—Clinton, Prather & Hutchinson—*Corn and Cane Harvester.*

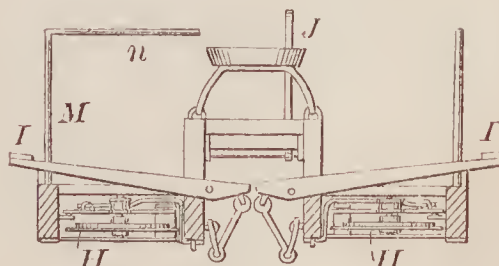
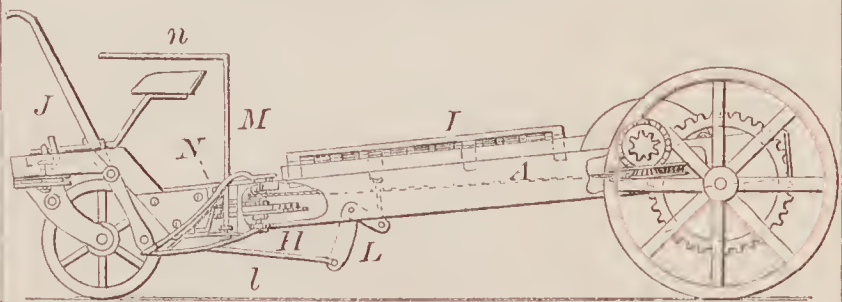



67956—F. J. Coates—Chair.

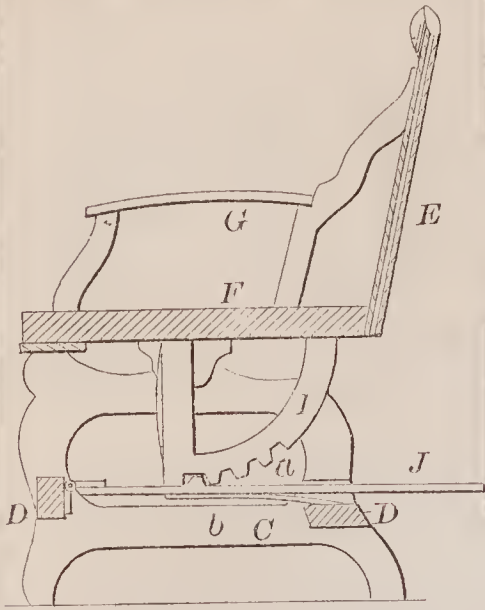

67957—E. R. Cole—Crank Connection.

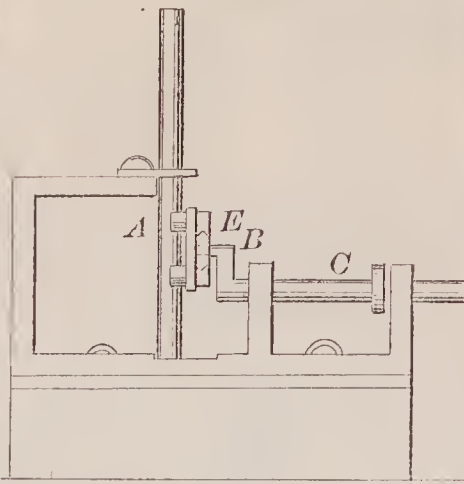

67958—W. T. Cole—Die for Cutting Threads on Tubes.

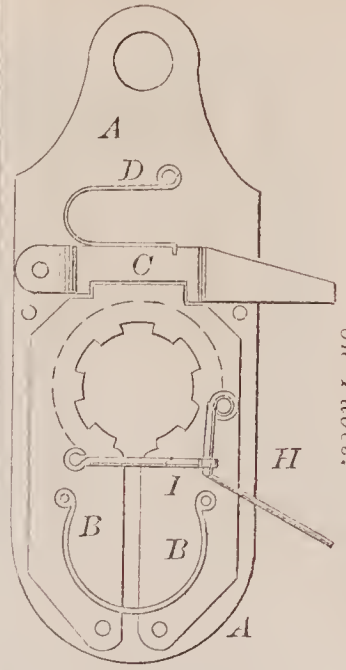

67959—I. N. Connell—Animal Trap.

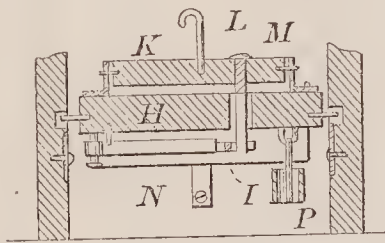
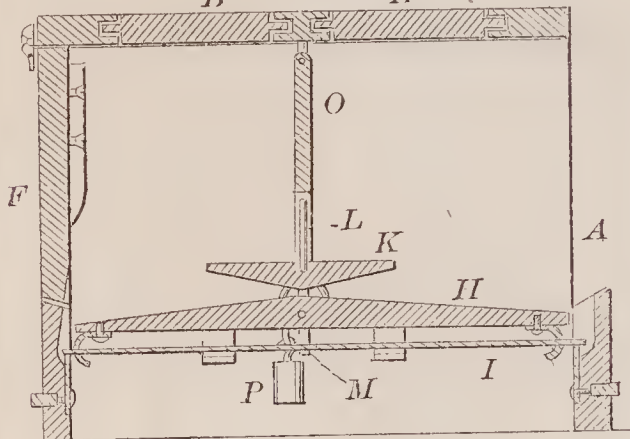

67961—J. G. Cummings—Cotton Press.

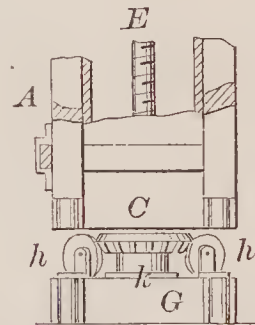
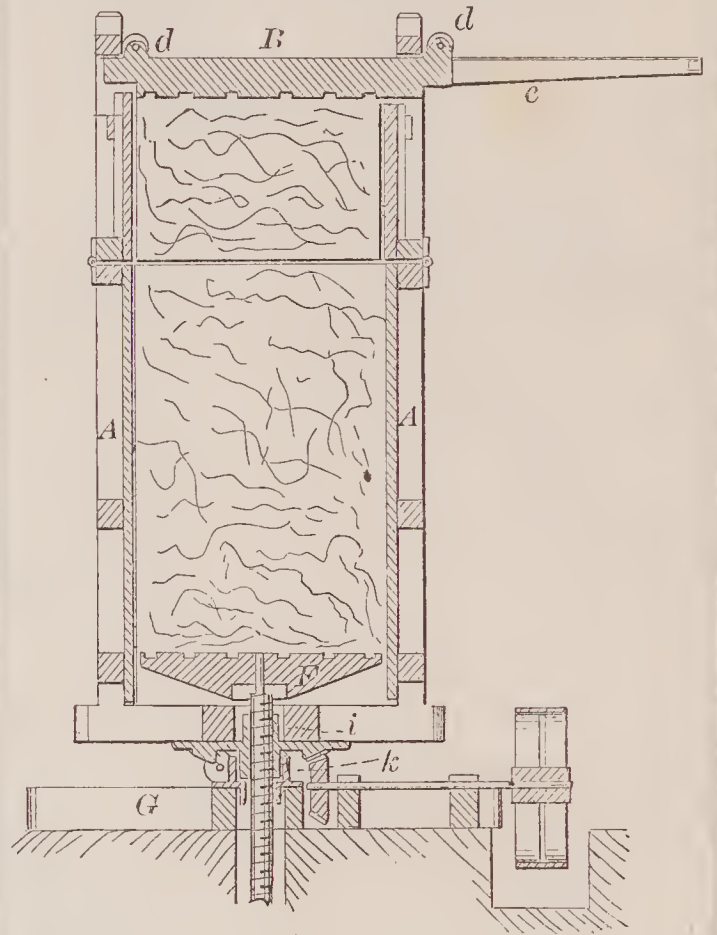

67960—G. Crandell—Churning Machine.

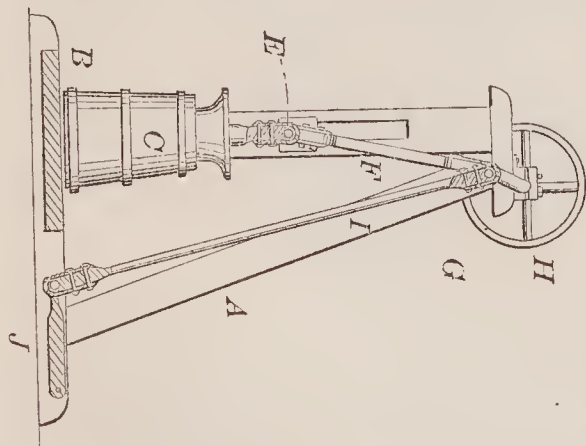

67962—J. Davis—Car Brake.

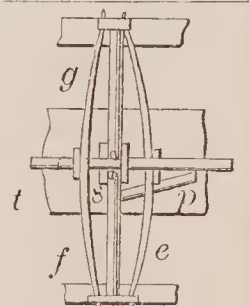
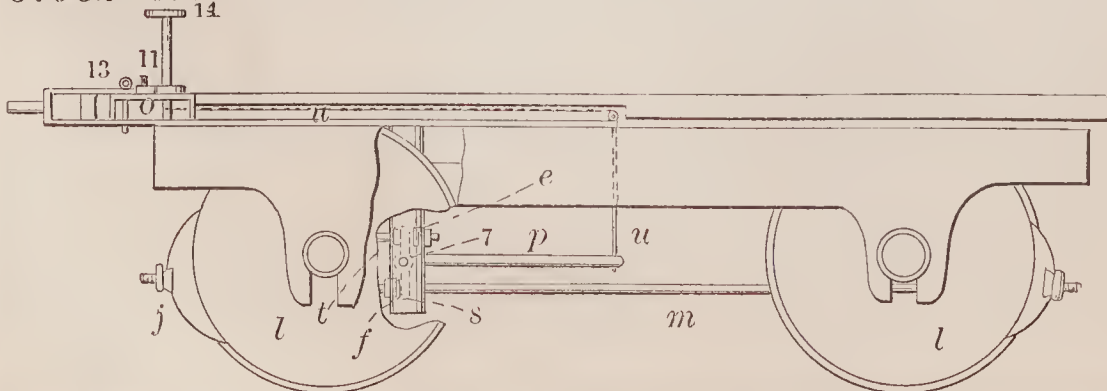

67963—T. R. Drummond—*Slate Cutter.*

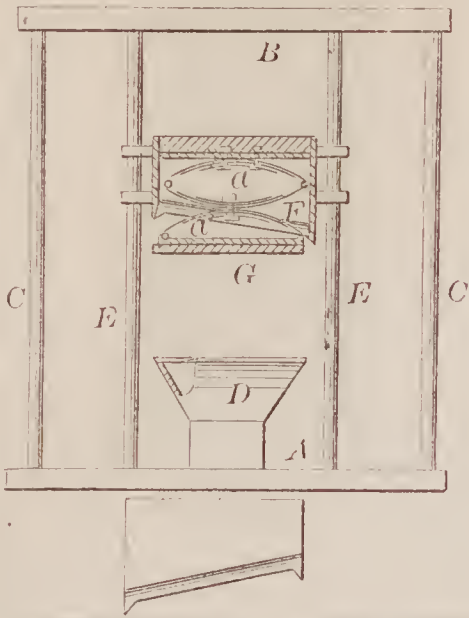

67965—G. Elmes—*Sewing Machine.*

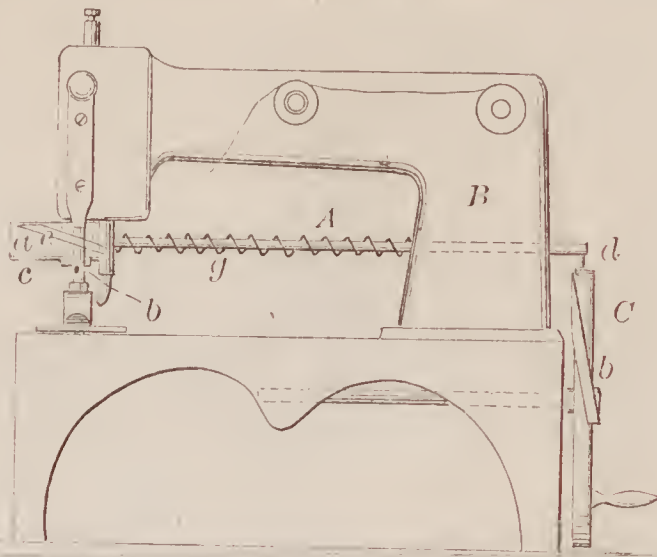

67966—W. M. Elrod—*Oscillating Piston Engine.*

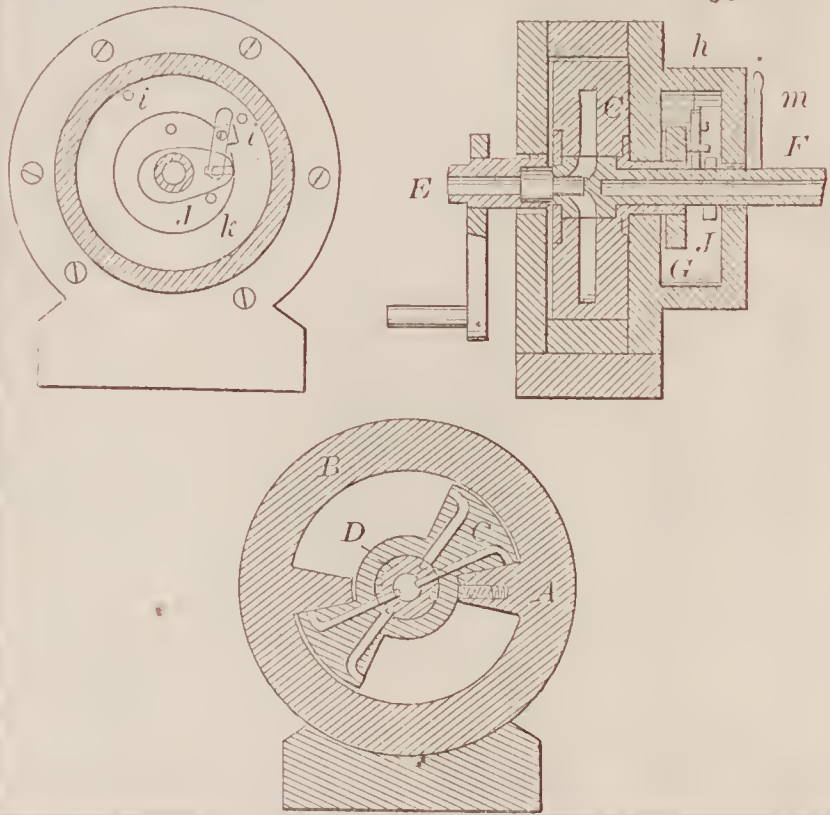

67964—C. L. Eggert—*Churn.*

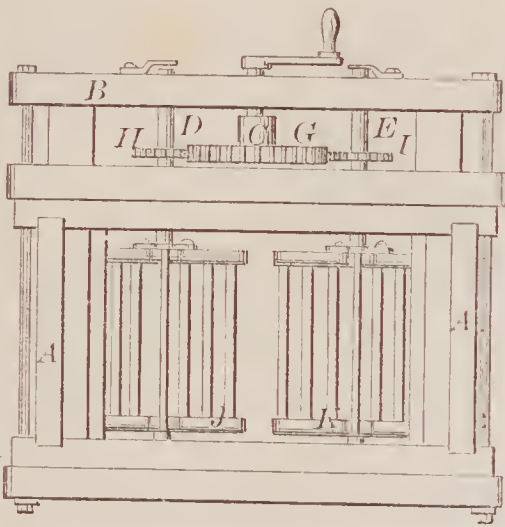

67967—G. W. Fink—*Trace Fastener.*

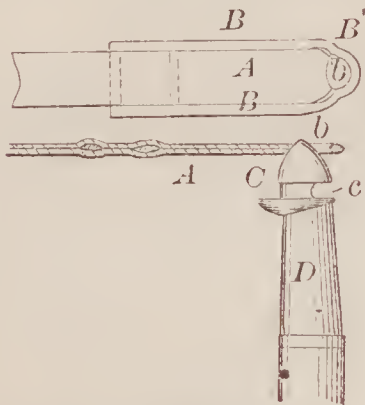

67969—C. & G. Fisher—*For Soldering Eave Troughs.*

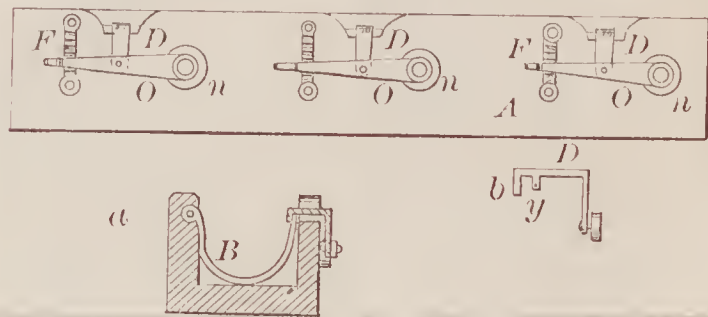

67968—W. Finn—*Carriage Prop.*

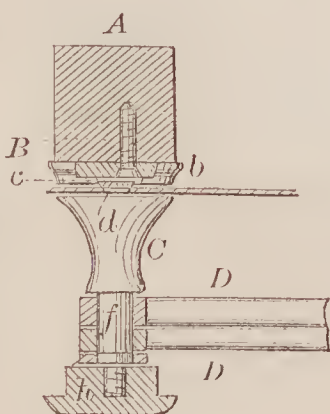

67970—J. Foster—*Fish Flake.*

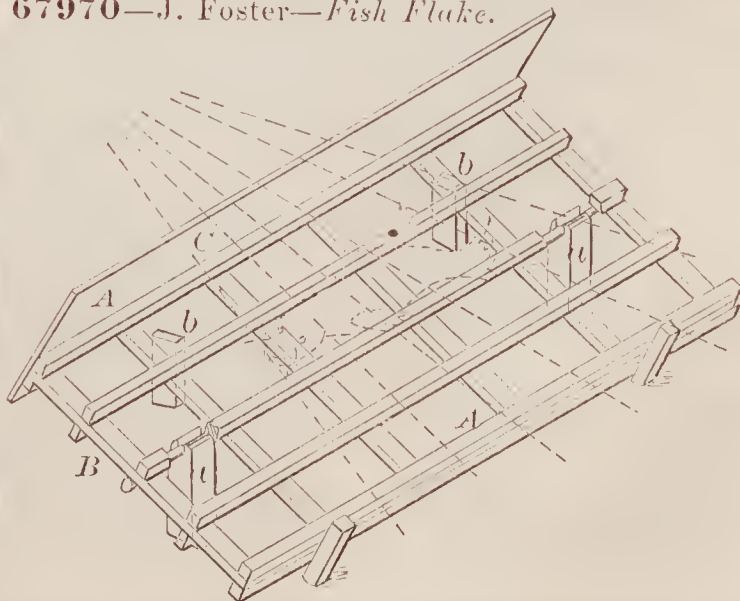



67971—E. J. Fraser—Carburettng Apparatus.

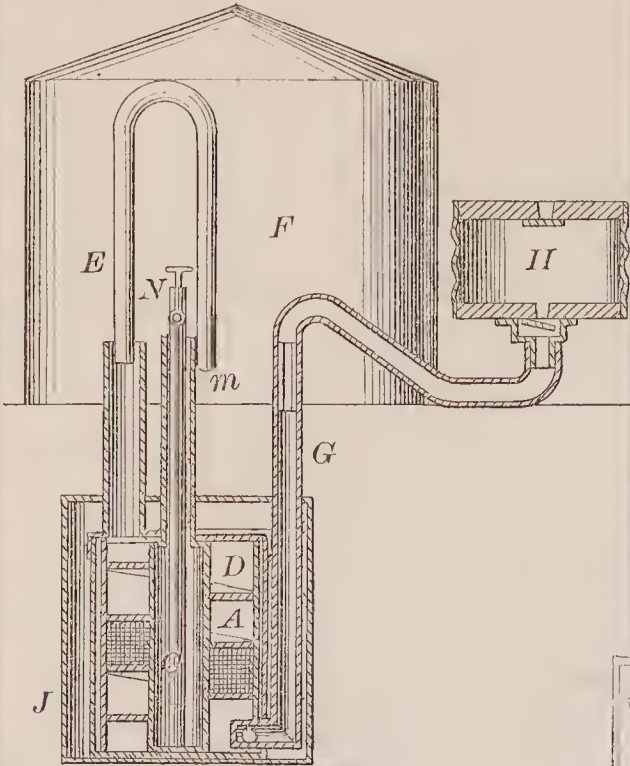

67974—J. H. Godwin—Oiler.

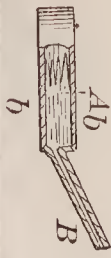

67975 - A. Goodhart—For Cutting and Grinding Corn Fodder.

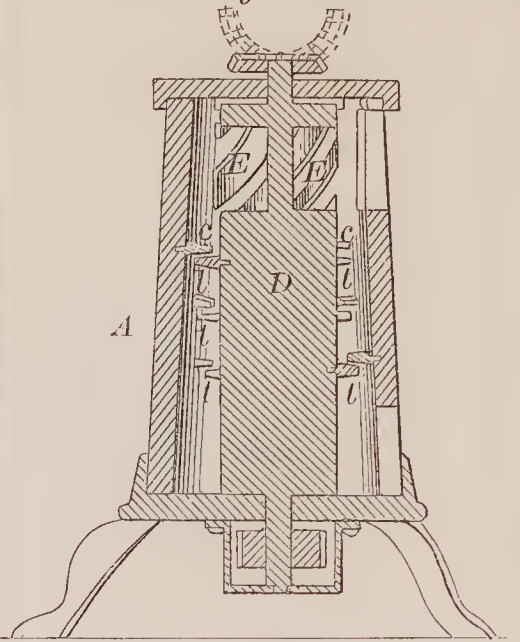

67972—Freeland & Ward—Volute Spring.

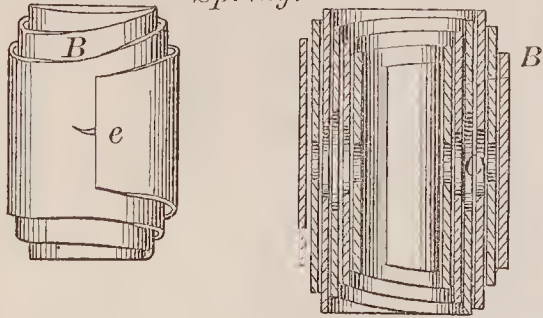

67976—C. W. Grant—Plow.

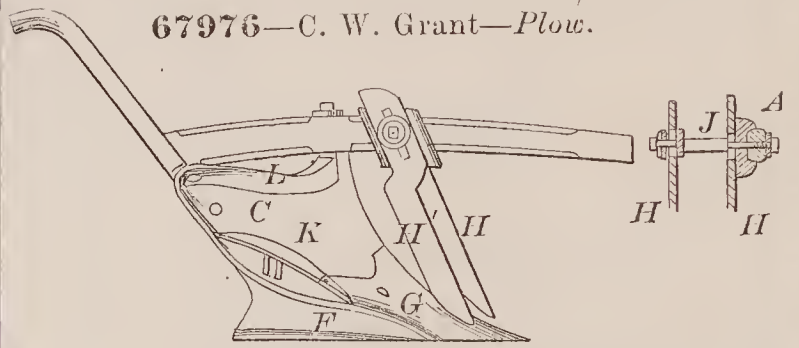

67978—M. Hanford—Rotary Engine.

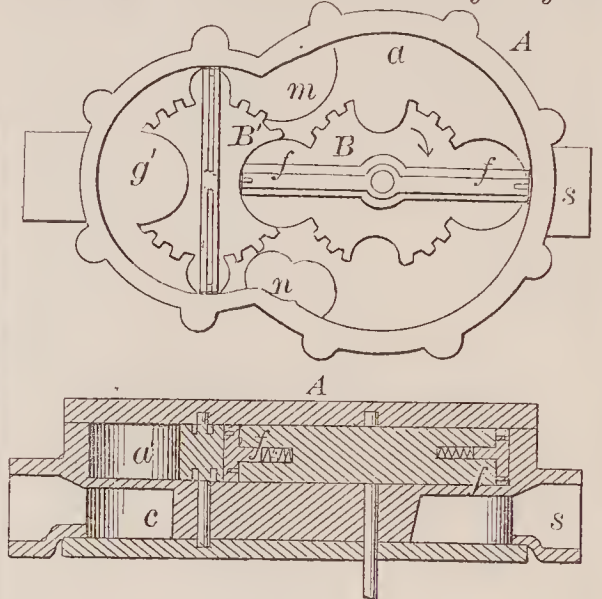

67980—G. W. Havermale—Washing Machine.

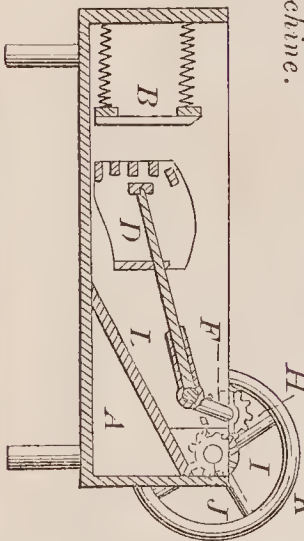

67977—J. Grimes—Top of Cooking Stores.

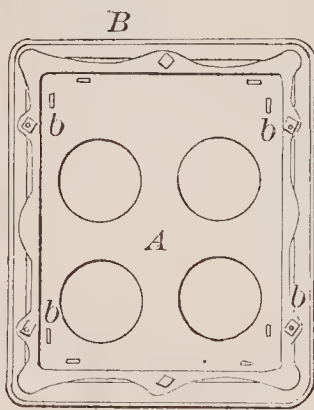

67981—D. H. Houston—Photographic Apparatus.

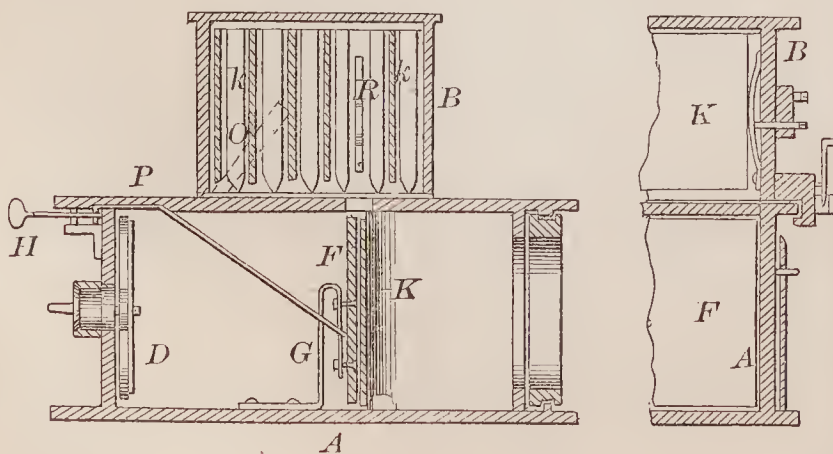

67979—C. C. Hare—Sad Iron.

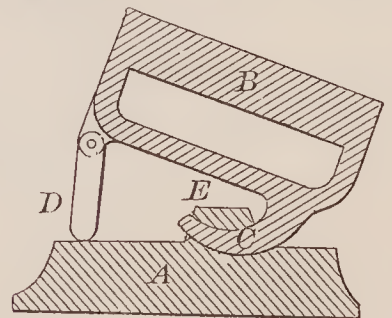

67982—R. H. Hudson—To Prevent Ropes Fouling Ships' Propellers.

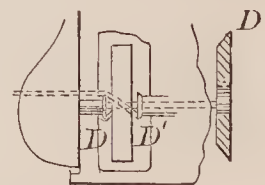



67983—Hurlbut & Snow—Boat Detaching Tackle.

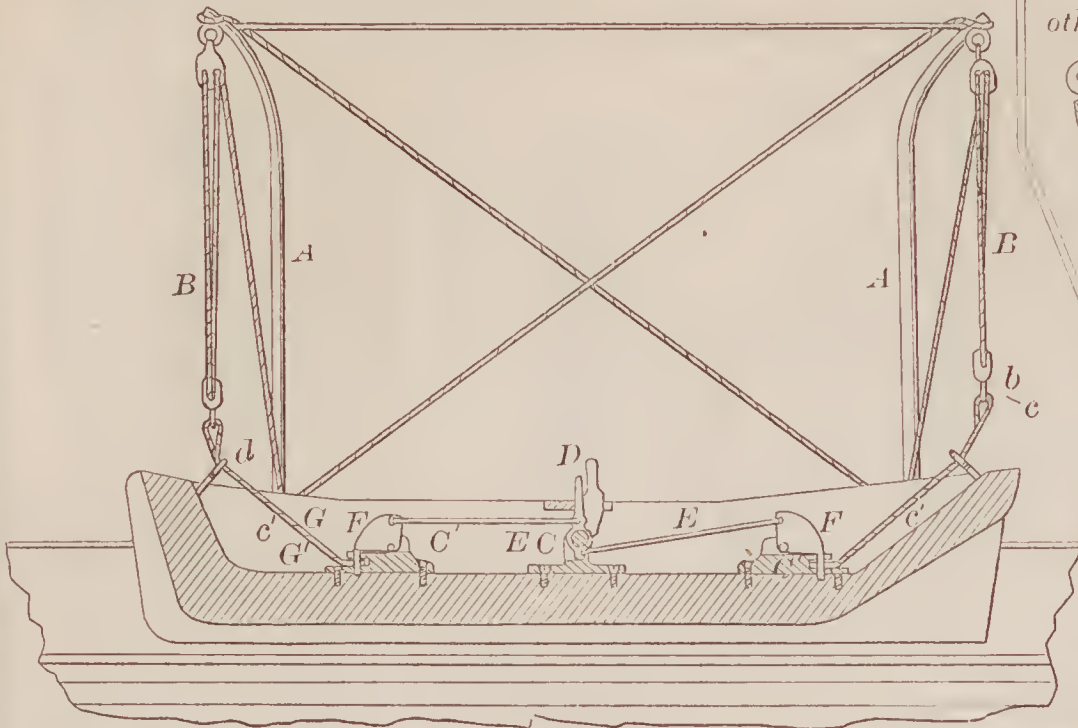

67984—J. W. Jarboe—Manufacturing Pails and other Household Vessels.

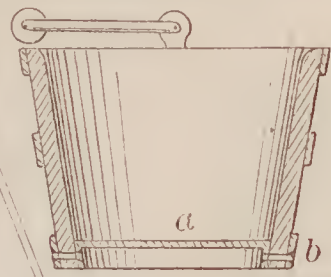

67985—E. Jewell—Watch.

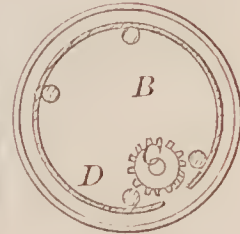

67986—F. B. Johnson—Seeder and Cultivator.

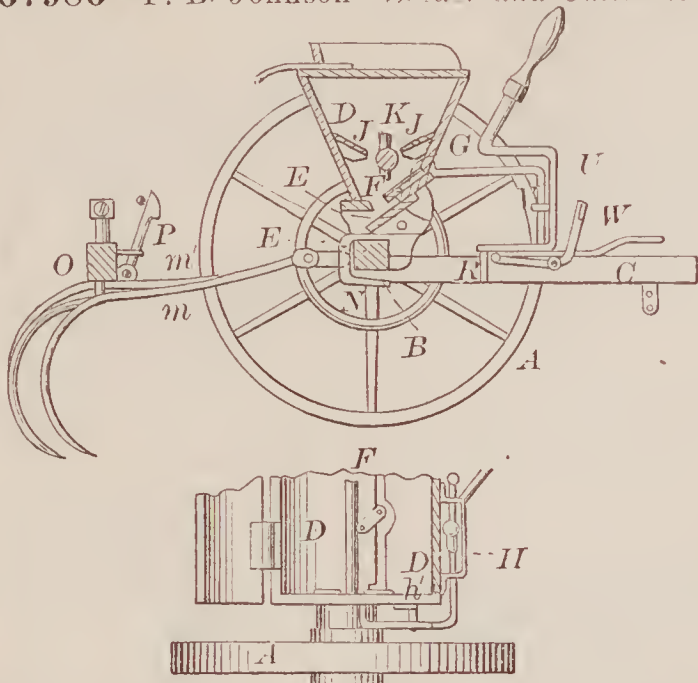

67990—Kranser & Bowman—Washing Machine.

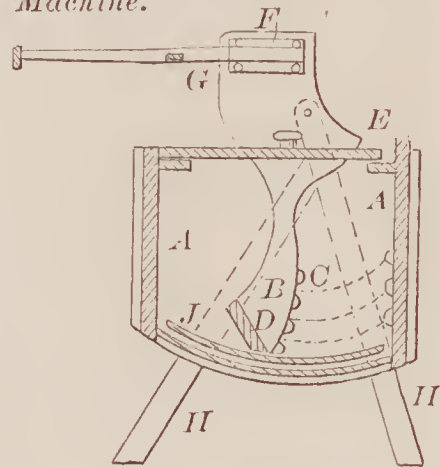

67987—J. S. Kalb—Wrench and Pruning Shears.

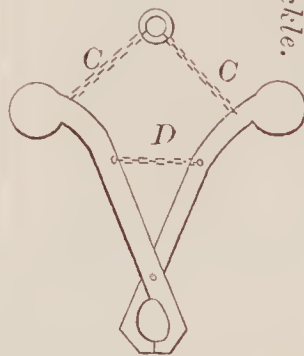
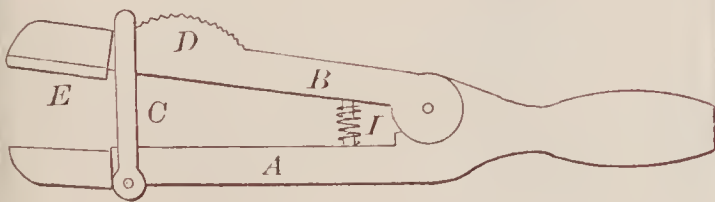

67989—G. H. Kempton—Boat Detaching Tackle.

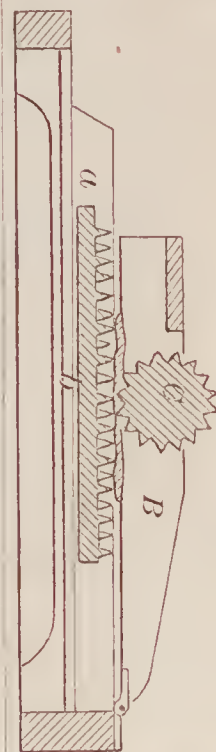

67991—J. Lefebvre—Meat Masher.

67988—E. G. Kelley—Petroleum Still.

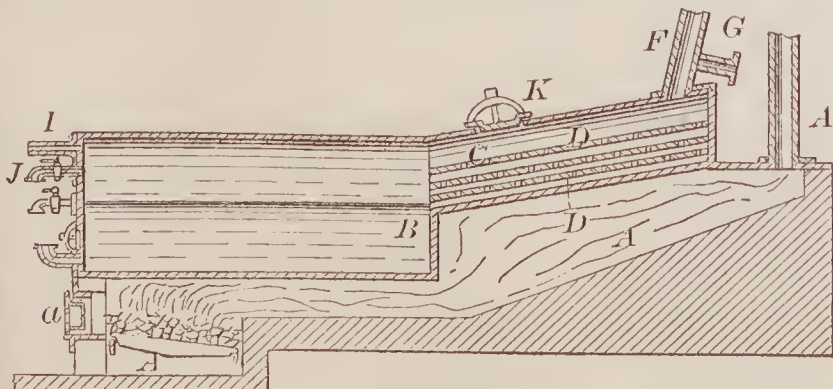

67993—B. T. Loomis—Expanding Dye.

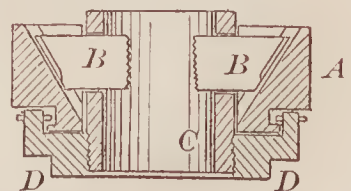



67994—O. W. Ludlow—Water Wheel.

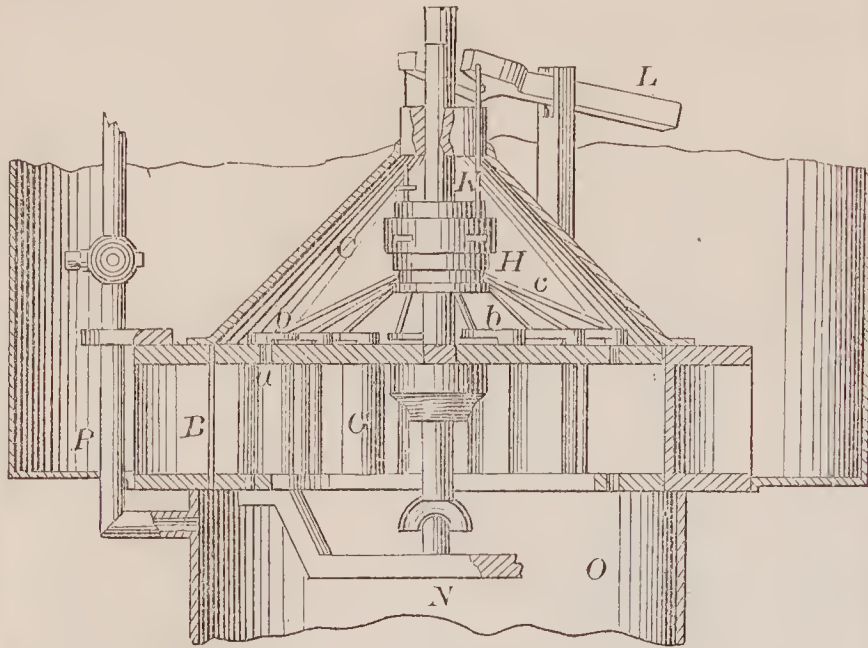

67999—W. W. S. Oberton—Hinge and Blind Supporter.

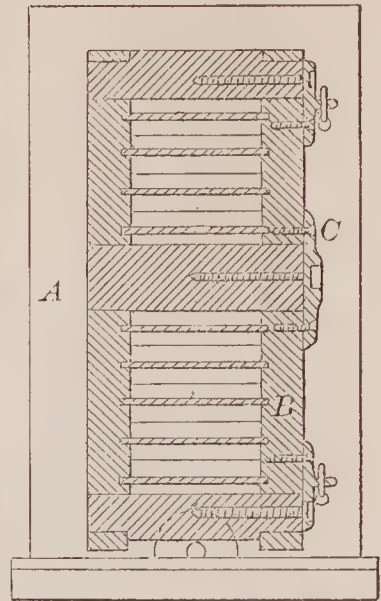

67995—E. Maguire—Coal Chute.

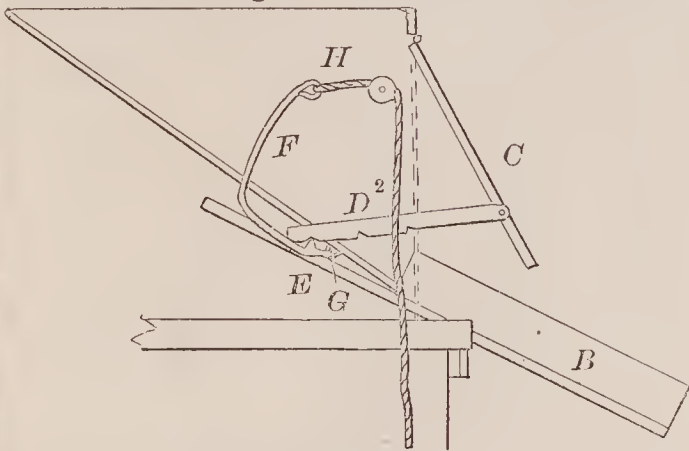

68002—H. A. Potter—Vehicle Wheel.

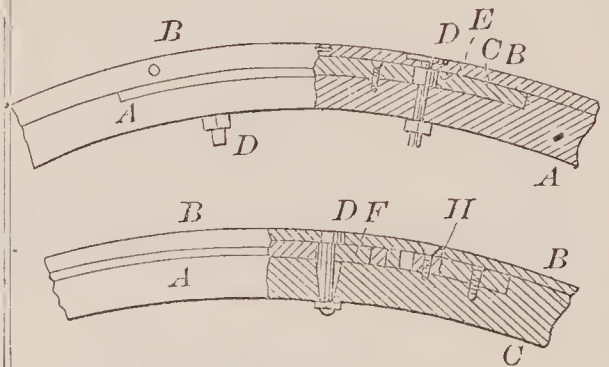

67996—A. Marsh—For Stretching Skins.

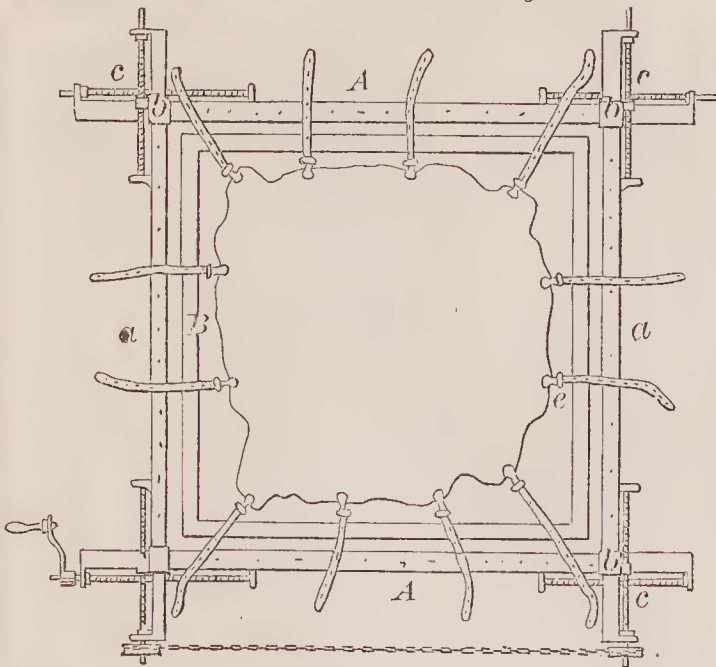

68003—R. B. Prindle—Wagon Jack.

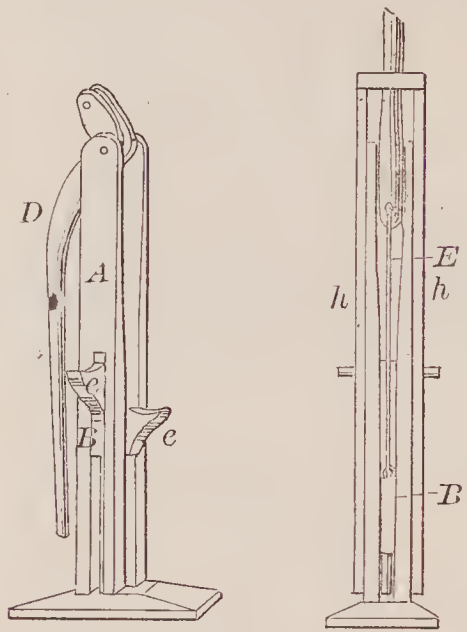

68001—C. Potter, Jr.—Printing Press.

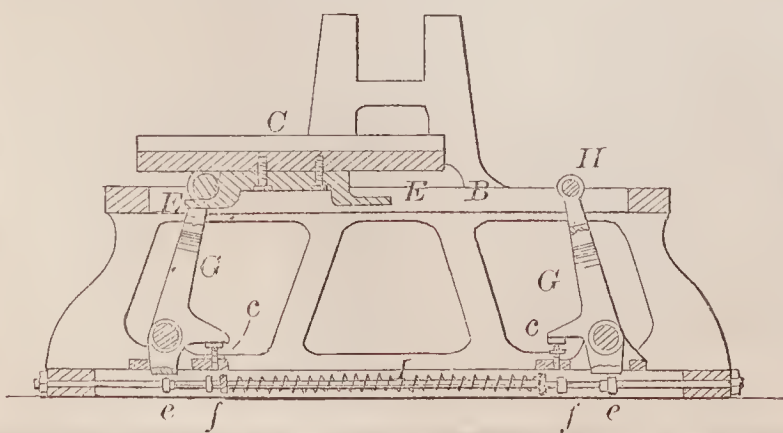

68000—J. W. Pettengill—Churn Dasher.

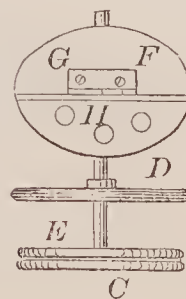

68005—C. & J. G. Rowland—Condensed Leather Peg.

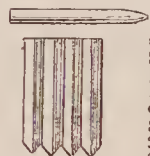

68006—C. & J. G. Rowland—For Making Condensed Leather Pags.

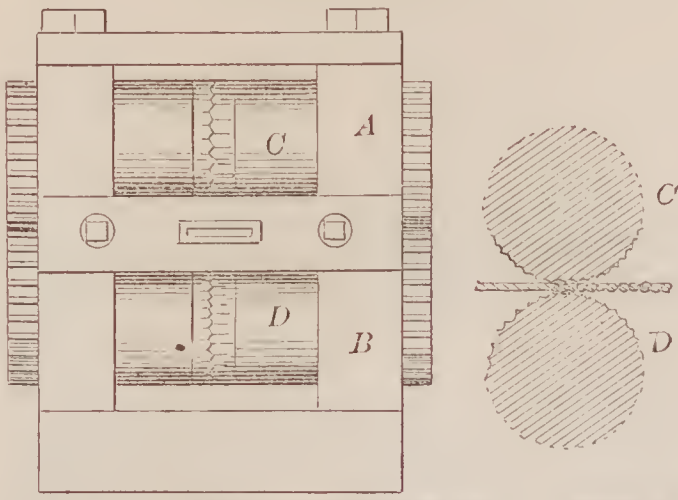

68009—C. Stebbins—Sewing Machine.

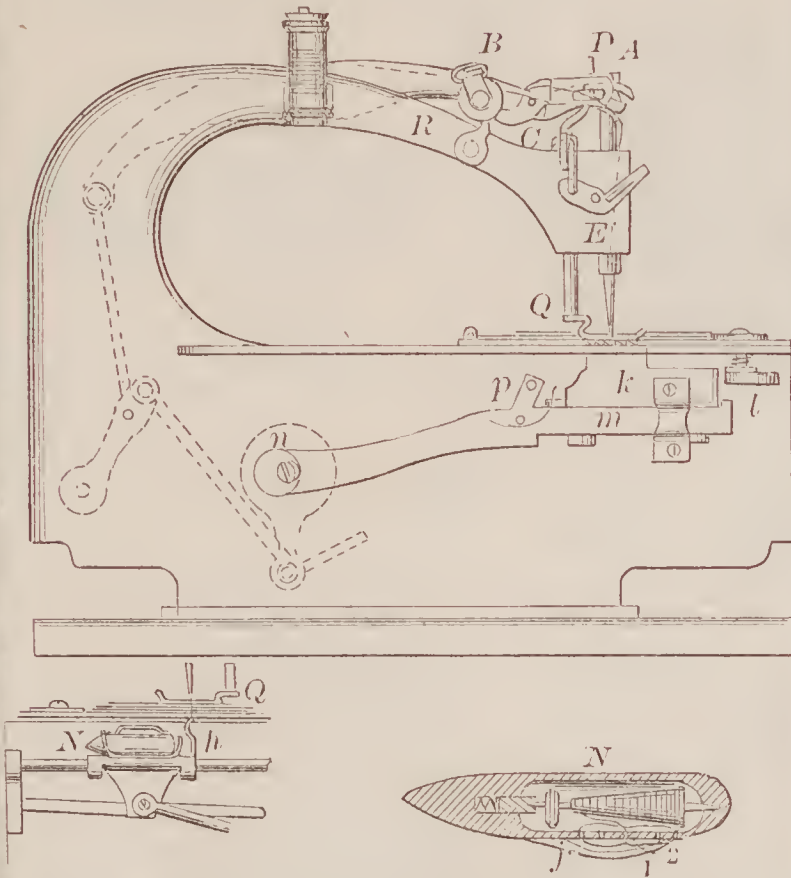

68008—Scott & Morton—Revolving Cylinder Engine.

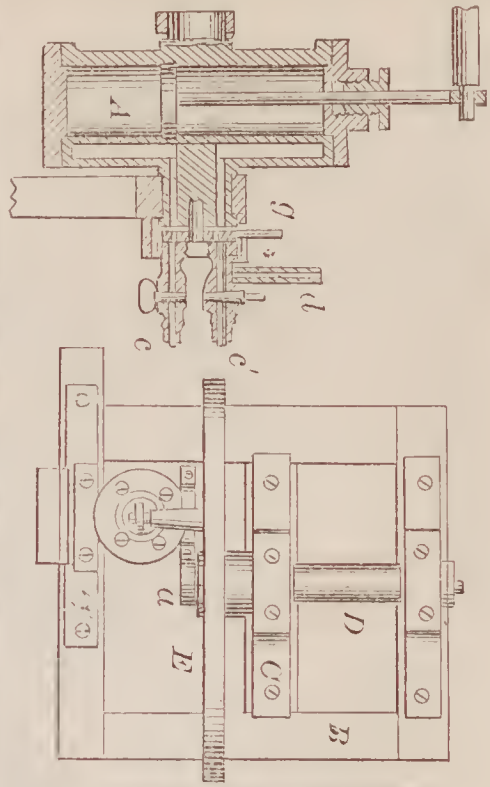

68010—A. Steers—Leaching Tea Bark.

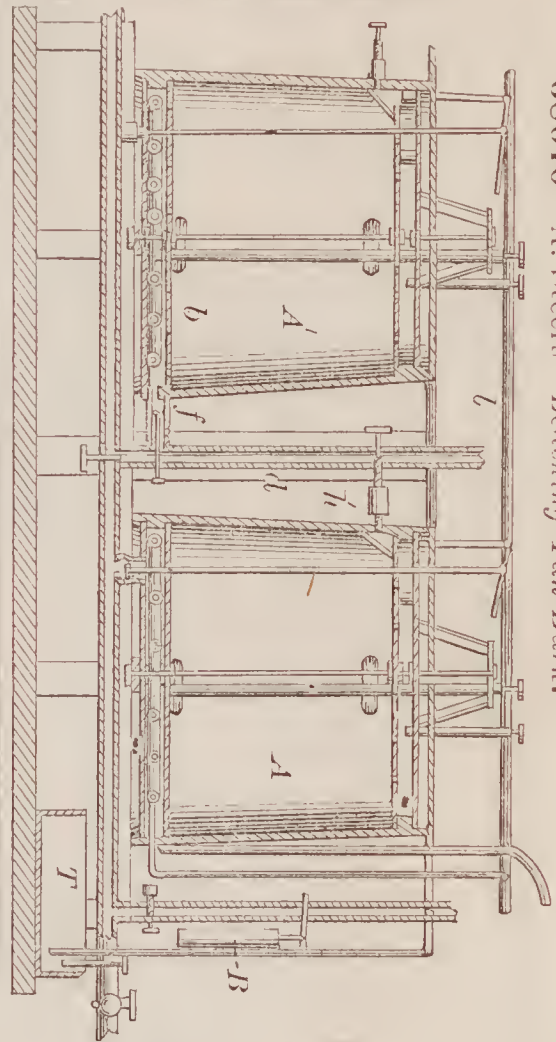

68007—J. Schenker—Windmill.

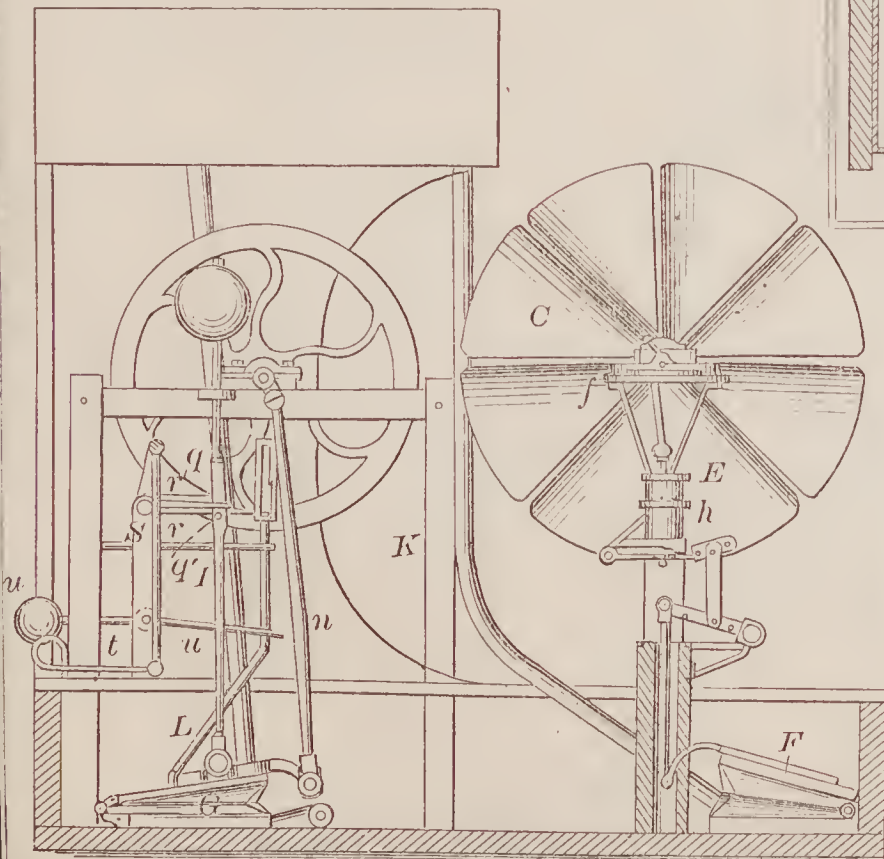

68011—Strong & Dadmun—Fruit Stem Cutter.

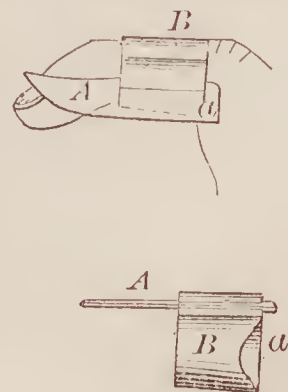



68012—J. Swan—Auger.

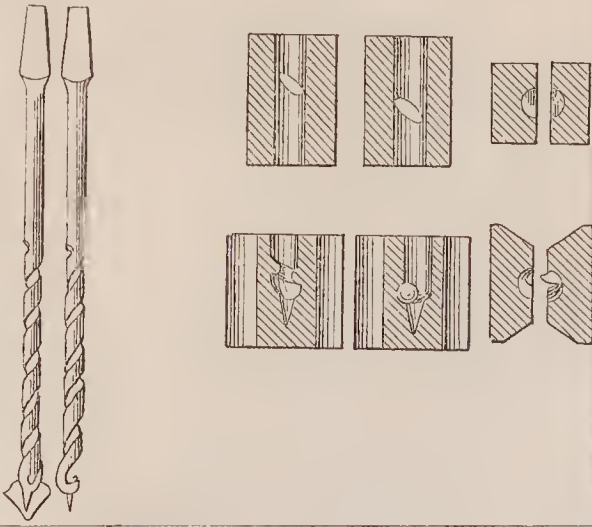

68013—E. Tarrant—Sawing Machine.

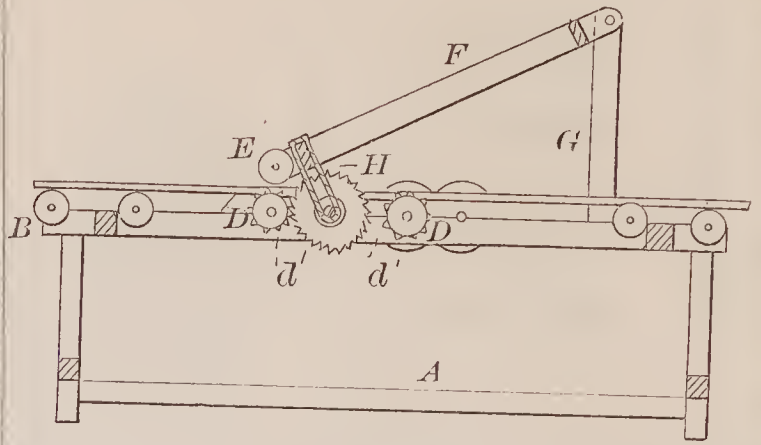

68015—E. Ware—For Propelling Steam Carriages.

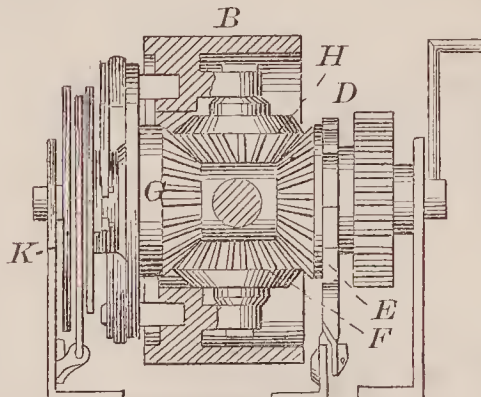
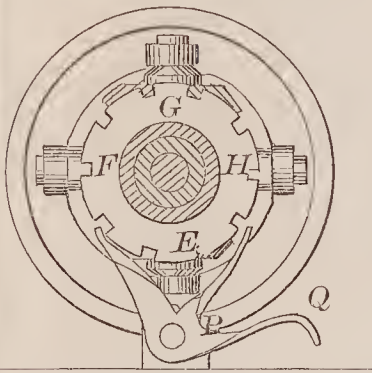

68017—S. B. Welton—Wagon Wheel.

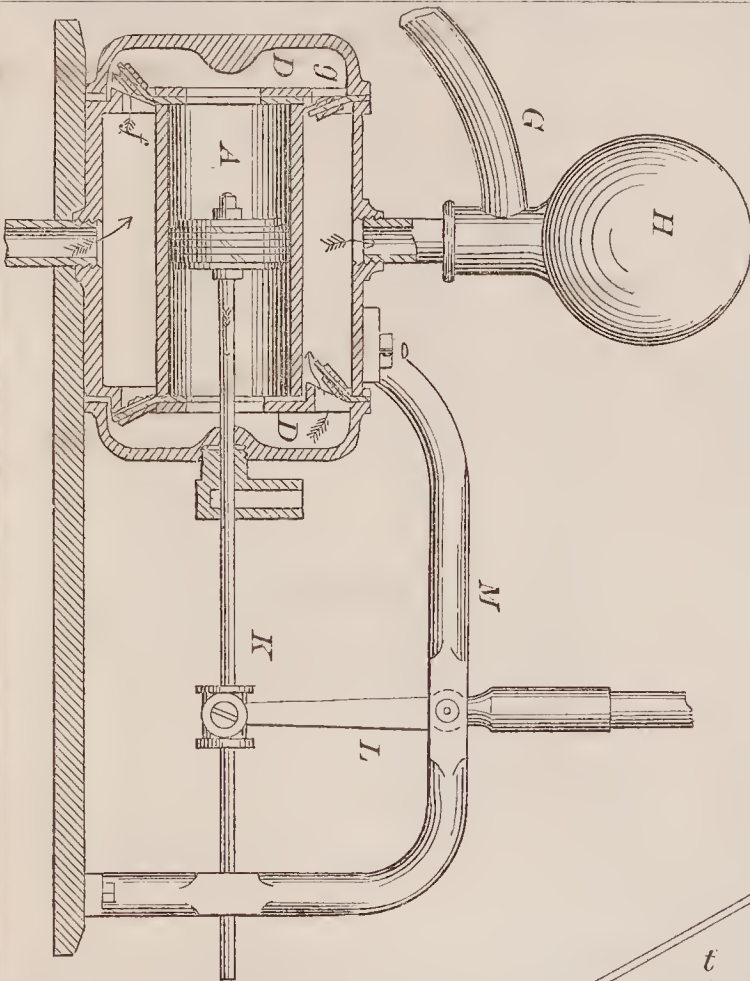
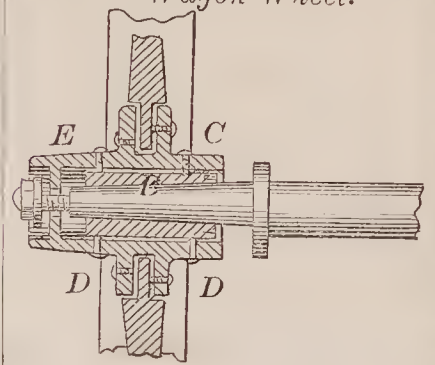

68014—Vernhard & Lucie—Pump.

68018—N. Weston, Jr.—Mosquito and Fly Net.

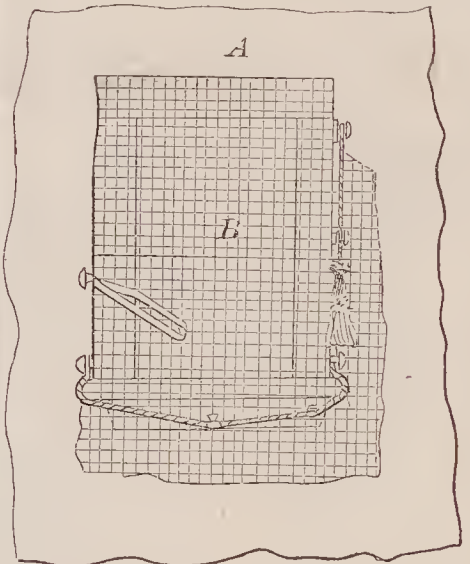

68016—J. Webster—For Preparing Peat for Fuel.

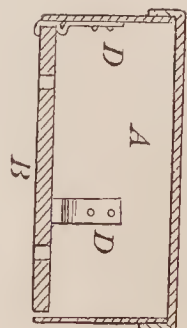
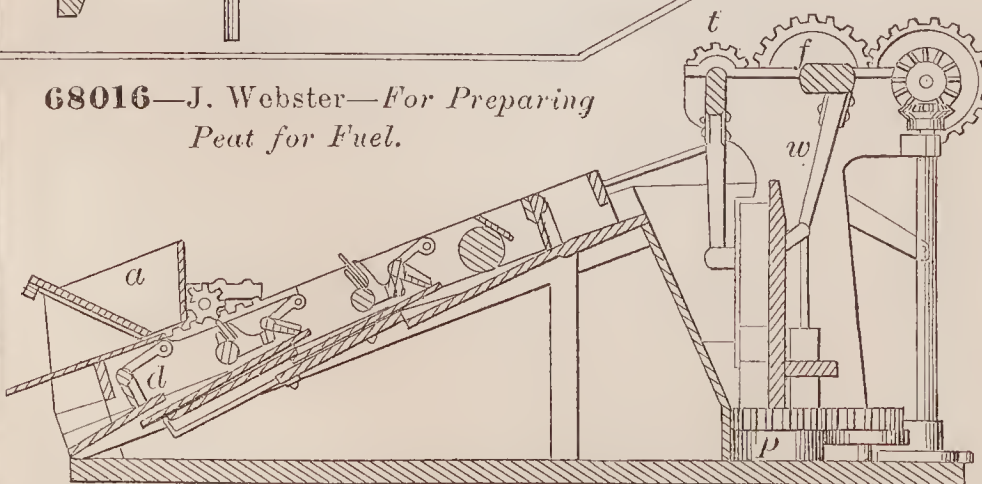

68019—J. White—Fruit Box.



68020—Wilson & Hughes—Wood Turning Lathe.

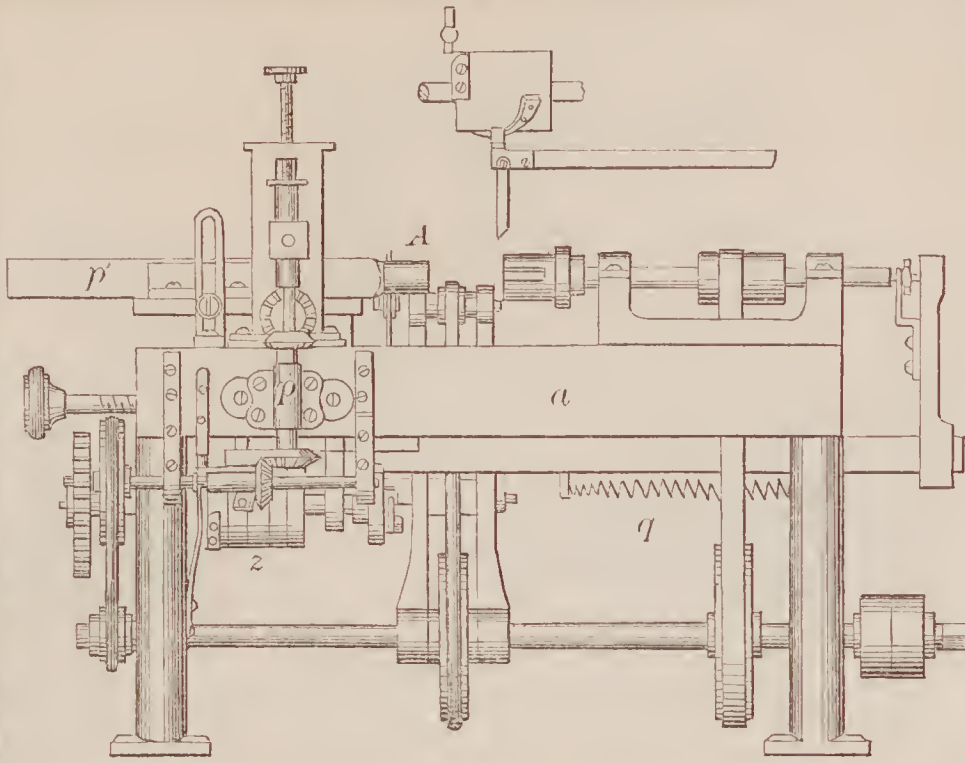

68026—J. Adams—Planter and Cultivator.

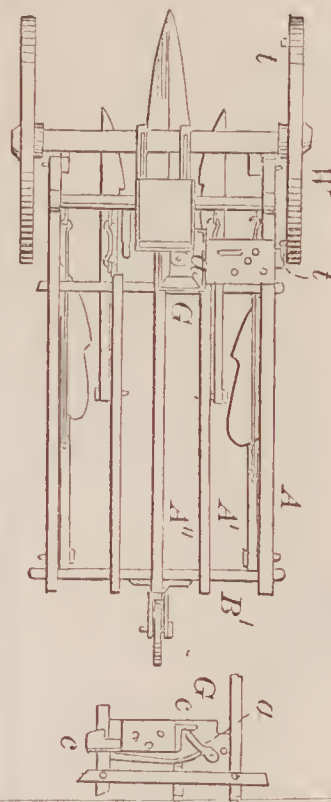

68021—D. Witt—Rocking Chair.

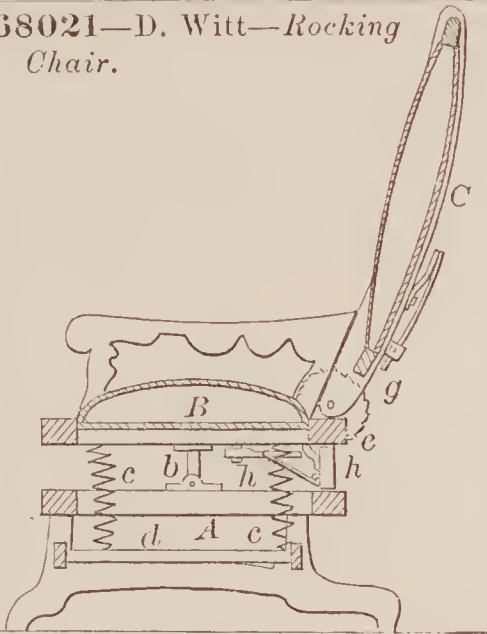

68022—J. B. Wood—Sash Brush.



68023—B. F. Woodside—Bedstead.

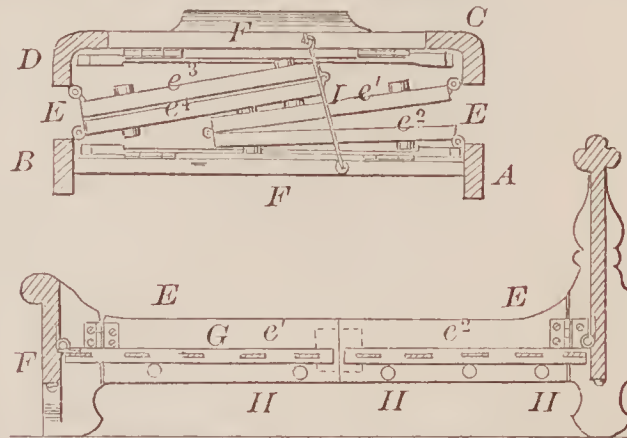

68025—R. W. Young—Liquid Meter.

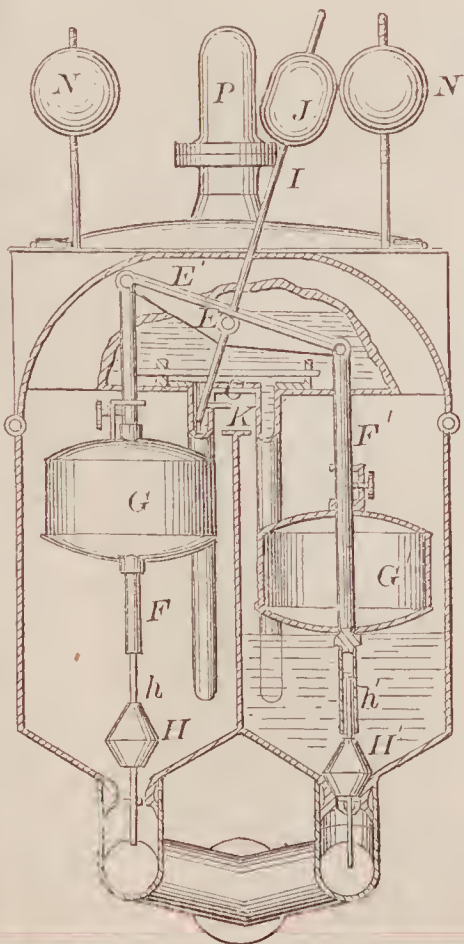

68024—J. H. Yates—Flat Iron Heater.

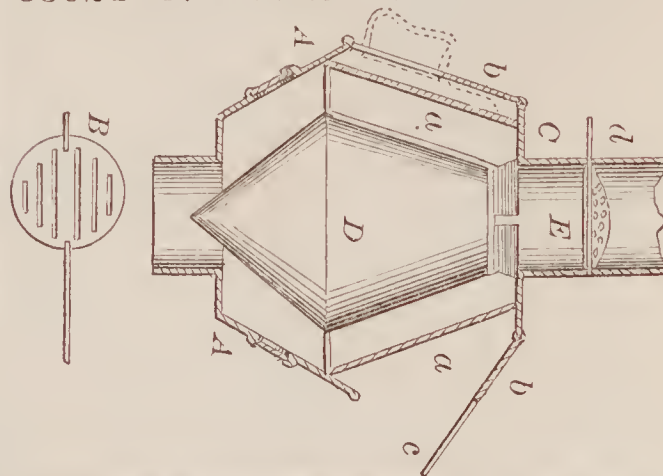

68027—F. Angliard—Fish Hook.

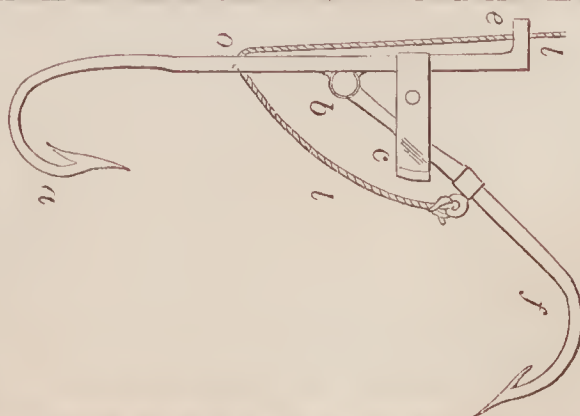



68029—C. J. Ball—*Hinging Covers to Tops of Cooking Stoves.*

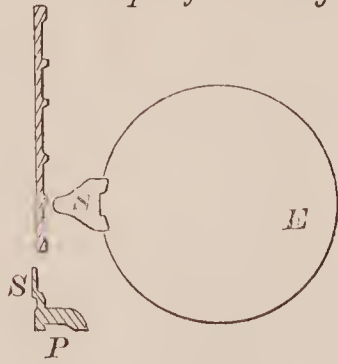

68032—A. C. Belt—*Plow.*

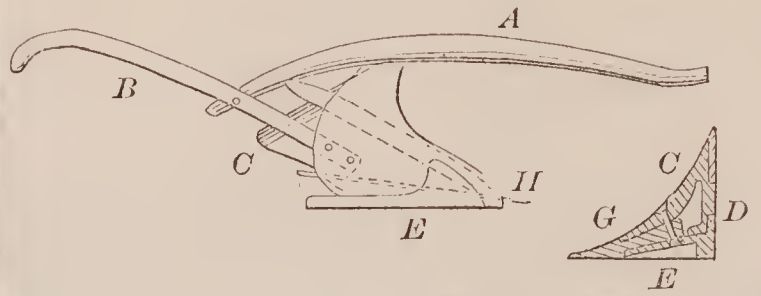

68030—A. T. Barnes—*Fruit Picker.*

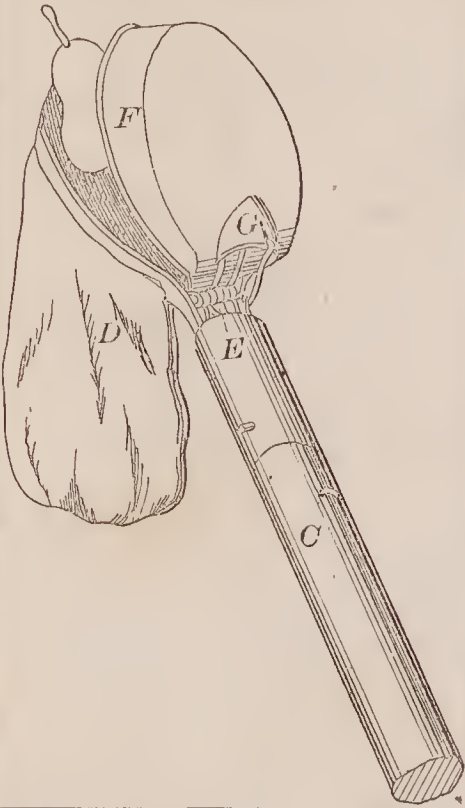

68034—T. Bogan—*Churn.*

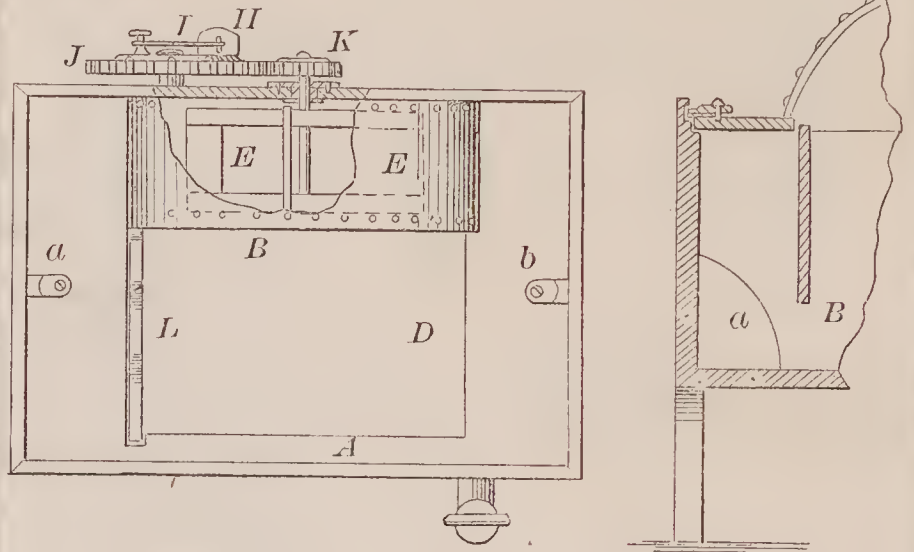

68035—Brackett & Dearborn—*Cotton Gin and Picker.*

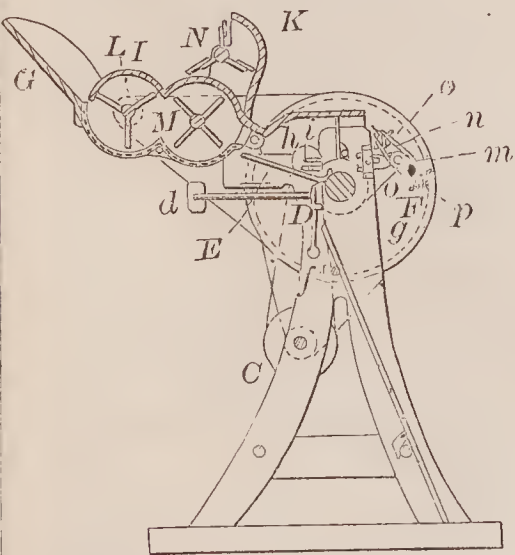

68033—W. E. Bird—*For Making Cores for Pipe Casting.*

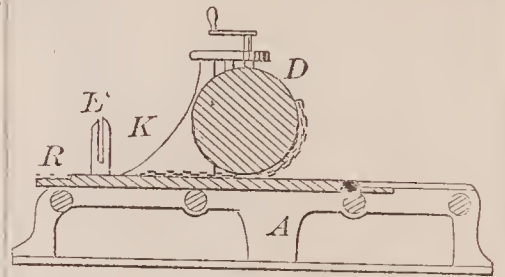

68031—Bartlett & Walman—*For Propelling Steds by Hand.*

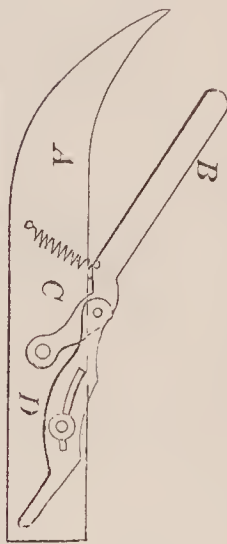

68038—A. P. Brown—*Steam Generator Water Gauge.*

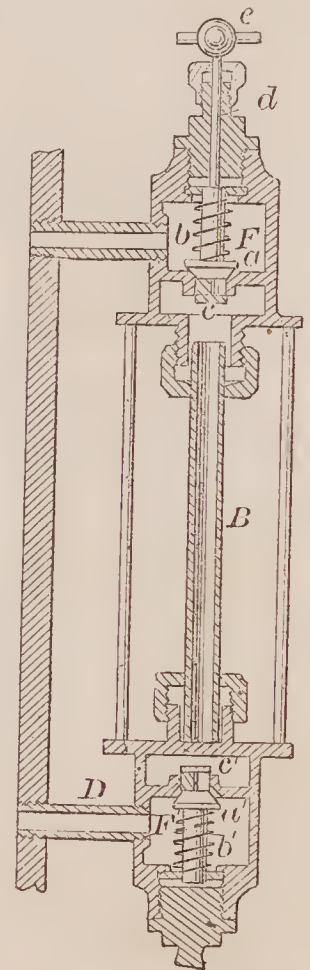

68037—G. E. Bridger—*Egg Beater.*

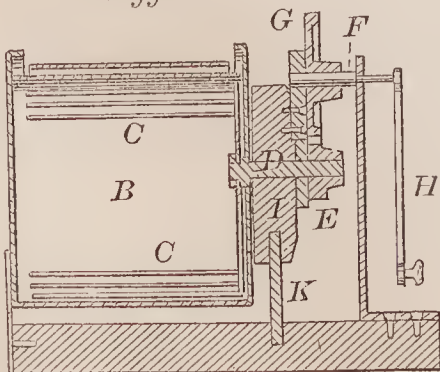

68036—W. Bradley—*Wash Basin.*

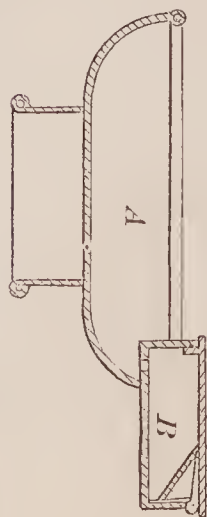

68039—Browne & Hoyt—Water Wheel.

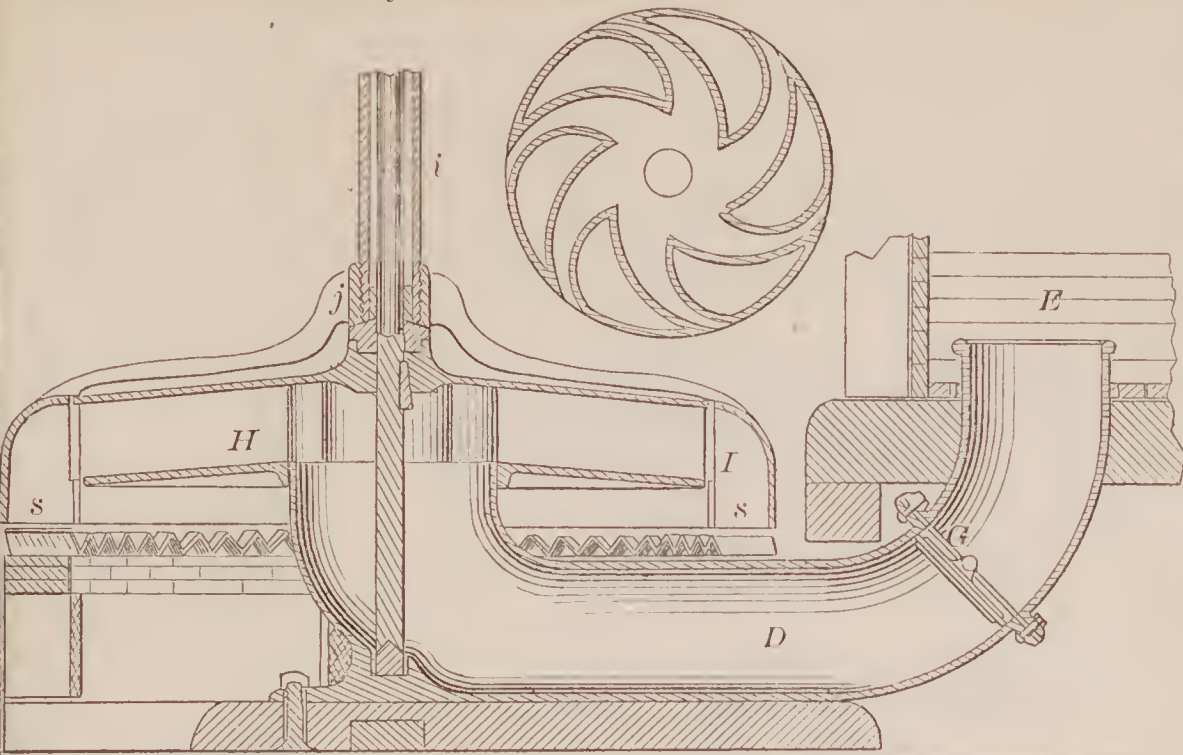

68041—S. G. Cabell—For Preventing Incrustation of Steam Boilers.  
Electrical Apparatus.

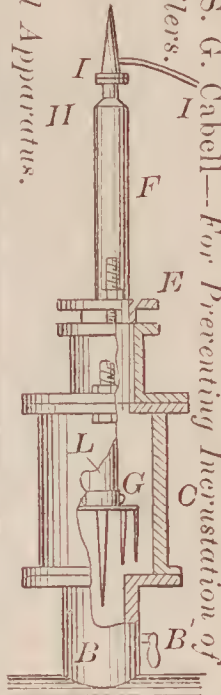

68040—D. W. Bush—For Clinching Nails in Horse Shoeing.

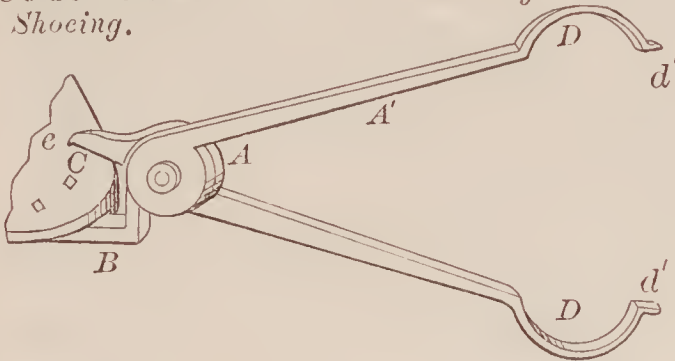

68043—C. L. Carter—Clothes Wringer.

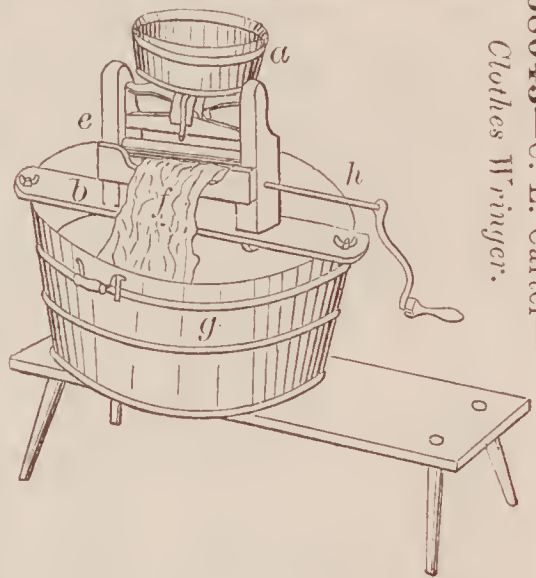

68042—R. A. Cameron—Hemorrhoidian.

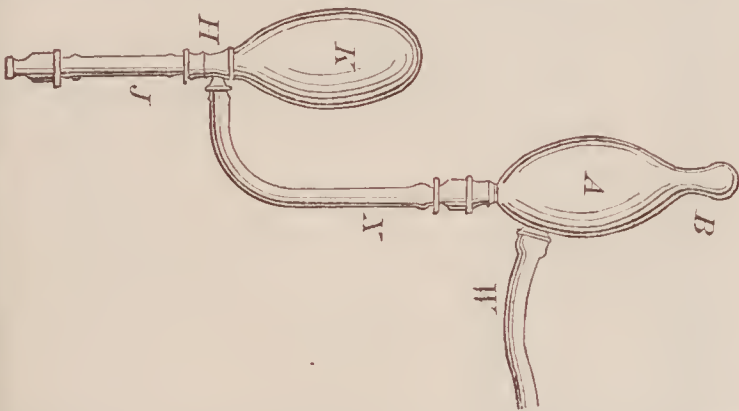

68045—Childs & Copeland—Vapor Burner for Heating.

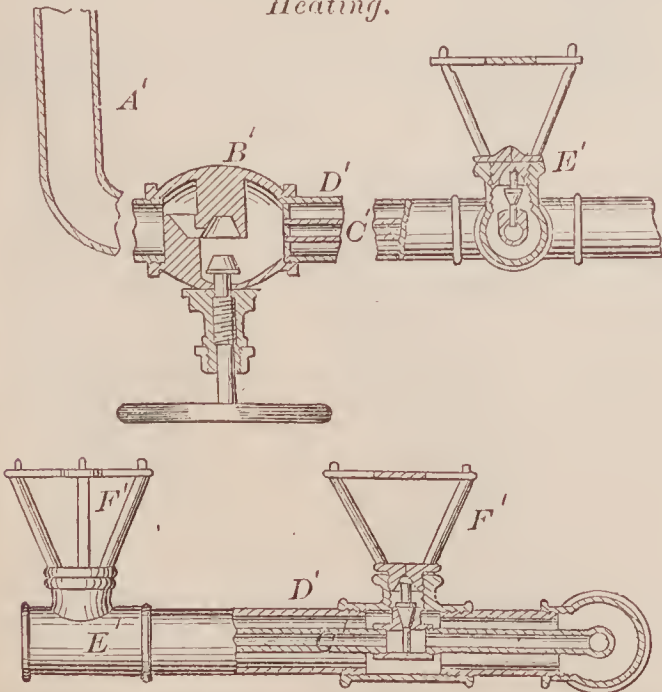

68044—S. Chapman—Kbin for Drying and Preparing Peat.

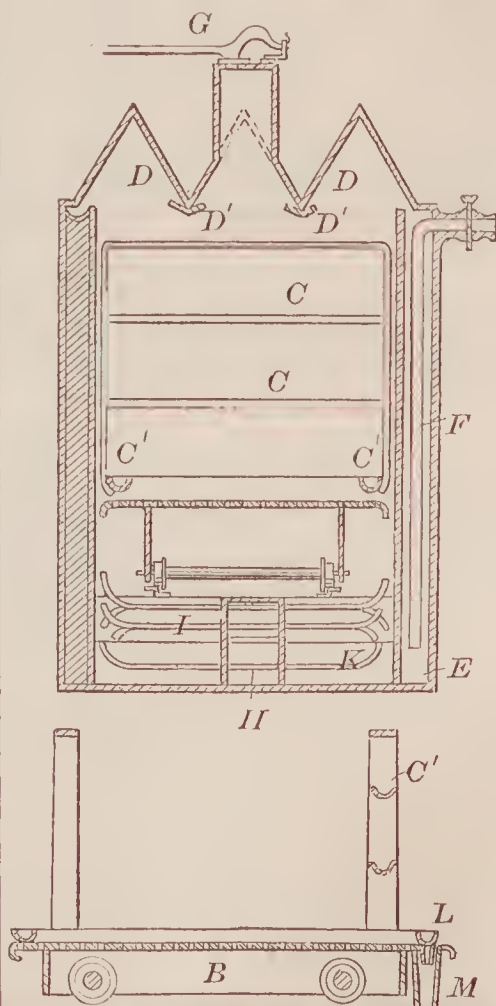



68046—G. C. Clarke—Animal Trap.

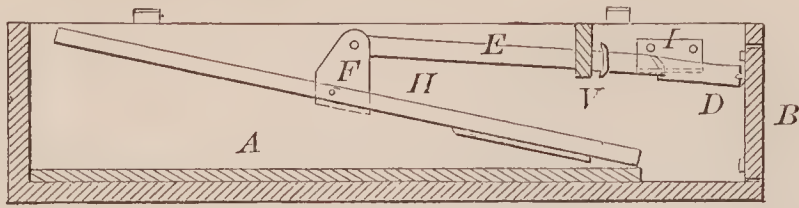

68048—N. F. Connett—Curter Head for Planing Machines.

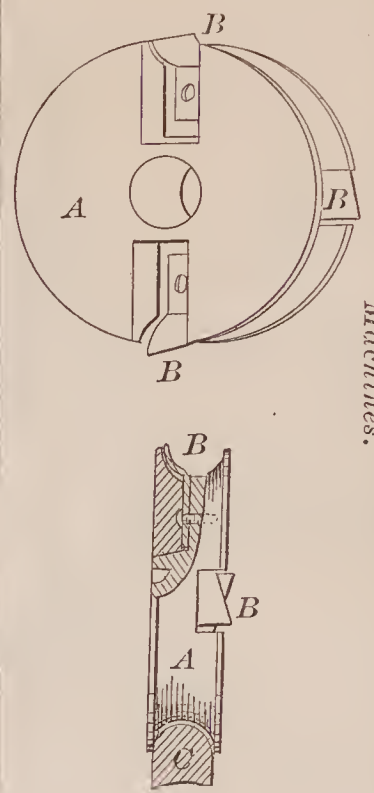

68049—J. J. Cumming—Churn Dasher.

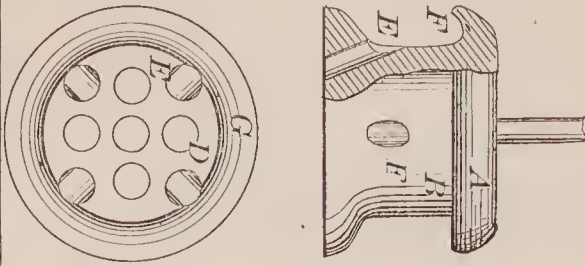

68047—E. M. Conking—Weeding Hoe.

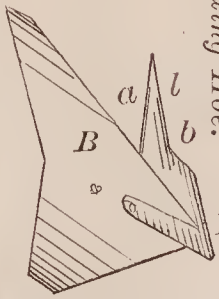

68050—H. V. Davis—Hand Seed Planter.

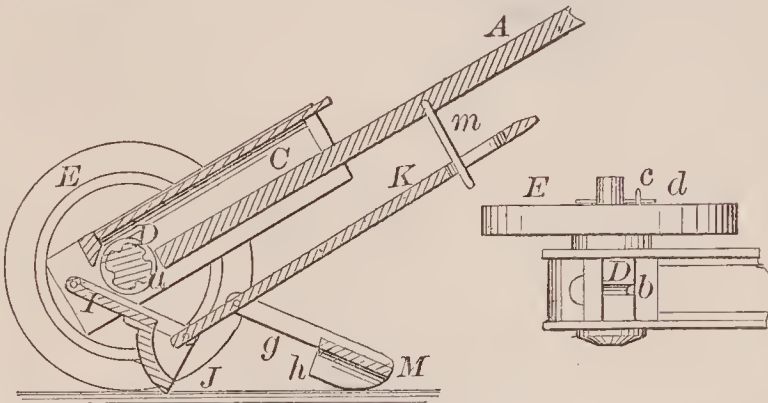

68053—B. K. Dorwart—Shutter Fastening.

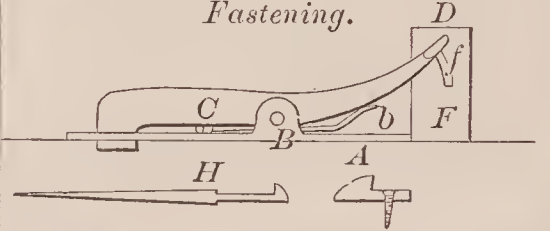

68052—W. Dearborn—Rubber Roller for Cotton Gins.

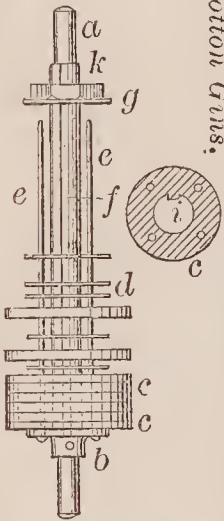

68054—J. H. Doughty—Clothes Dryer.

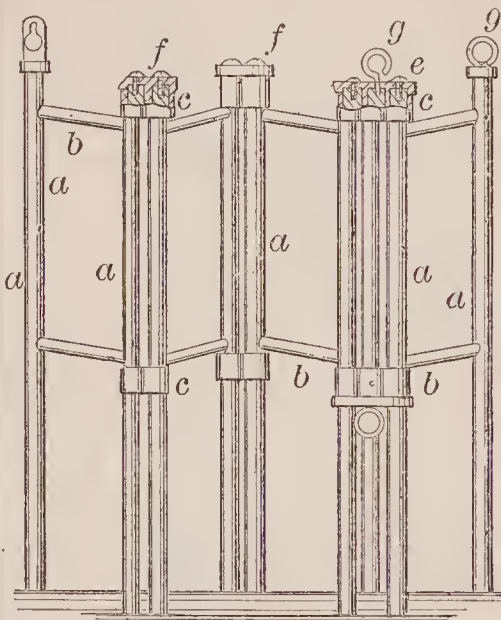

68055—J. B. Dowse—For Exploding by Electricity.

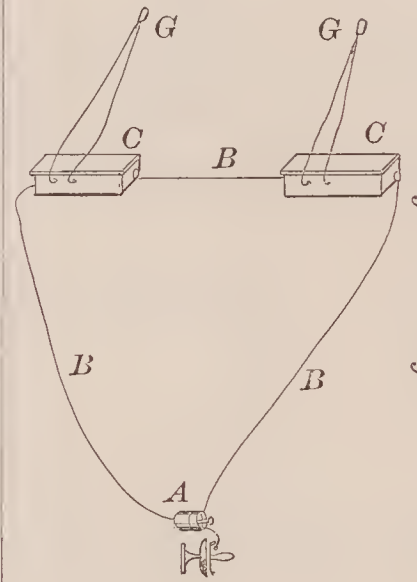

68056—R. N. Ely—Cultivator.

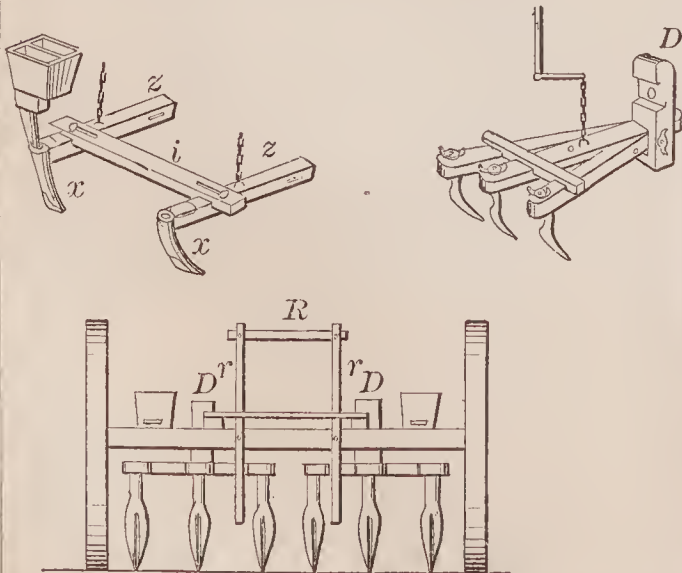

68057—J. G. Edgell—Lubricator for Shafting.

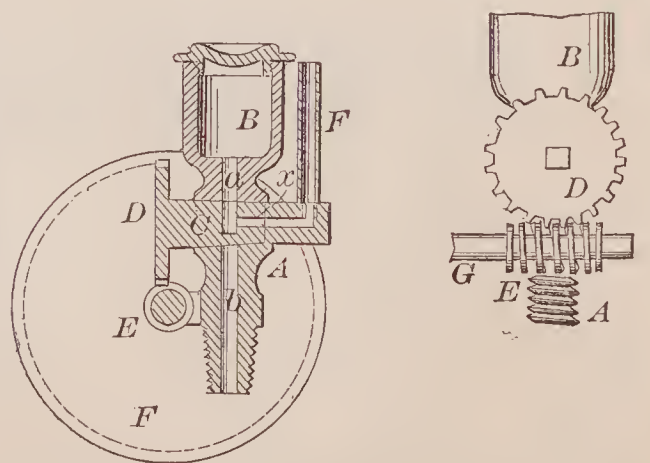

68058—G. B. Field—*Ore Roasting Furnace.*

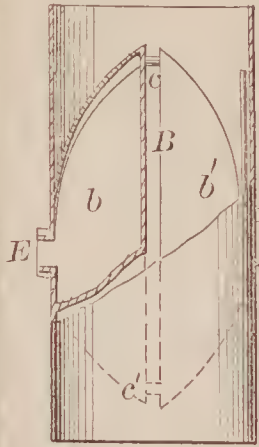

68060—G. W. Fowler—*Churn.*

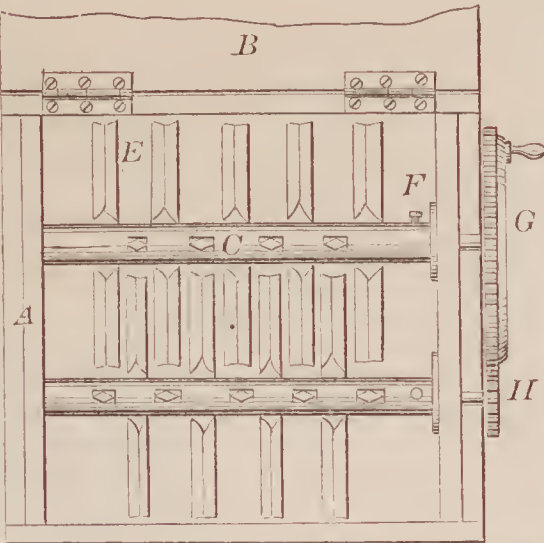

68061—A. M. Freeland—*Belt Shifting Device.*

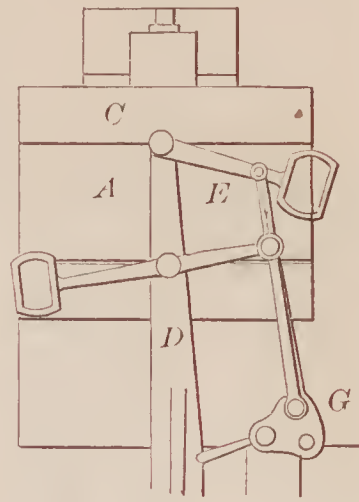

68062—G. B. Garlinghouse—*Baling Press.*

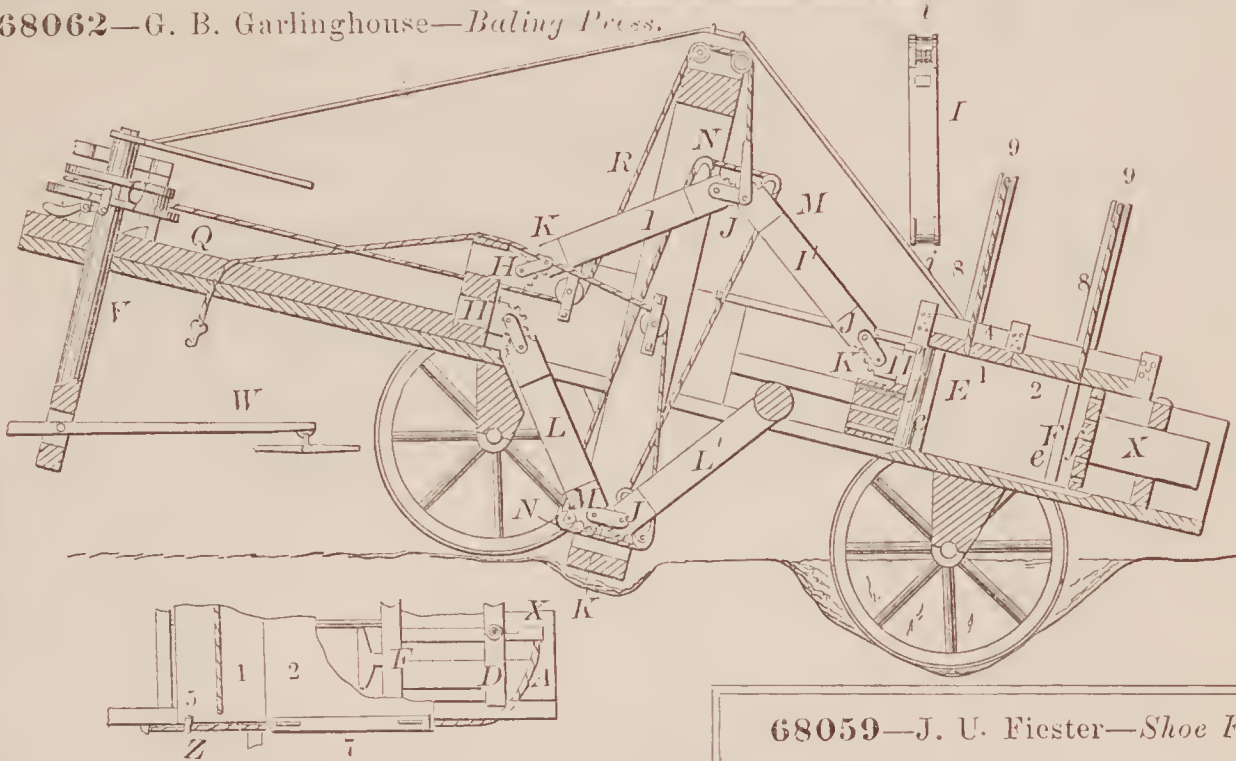

68064—A. W. Gifford—*Milling Tool.*

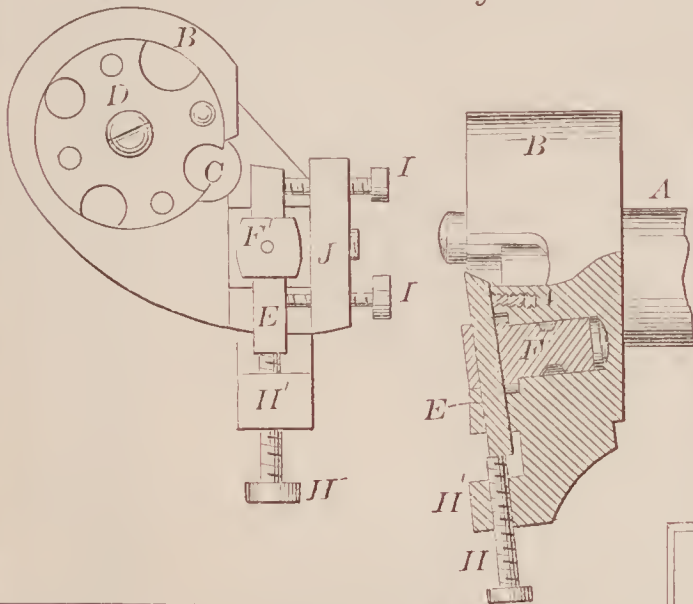

68059—J. U. Fiester—*Shoe Fastener.*



68063—L. Gibbs—*Line Kiln.*

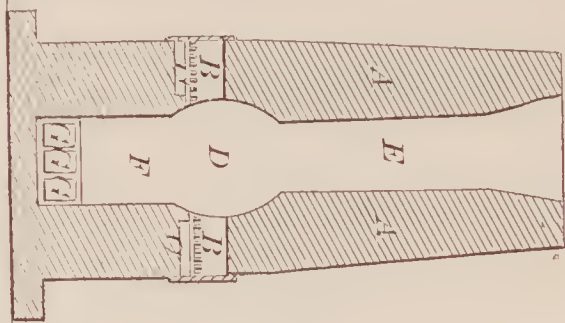

68065—S. I. & G. M. Gillham—*Gang Plow.*

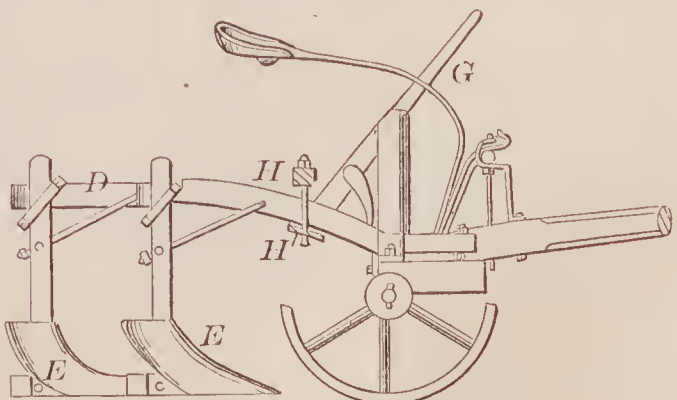

68067—H. Grass—*Churn Dasher.*

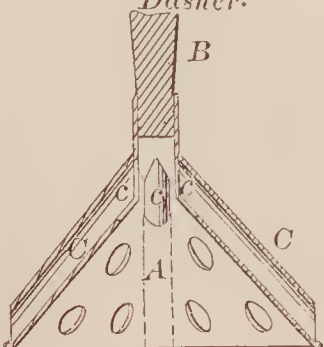

68066—Gilman & Beamish—*Paint Brush.*

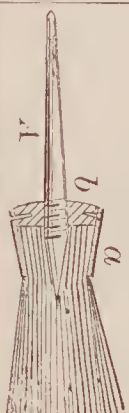



68068—J. C. Haefele—Meat Cutter.

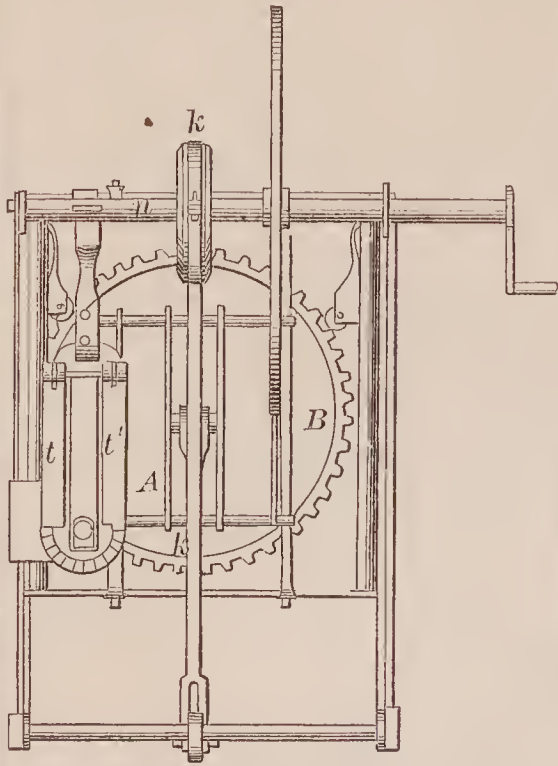

68070—S. Harpster—Corn Planter.

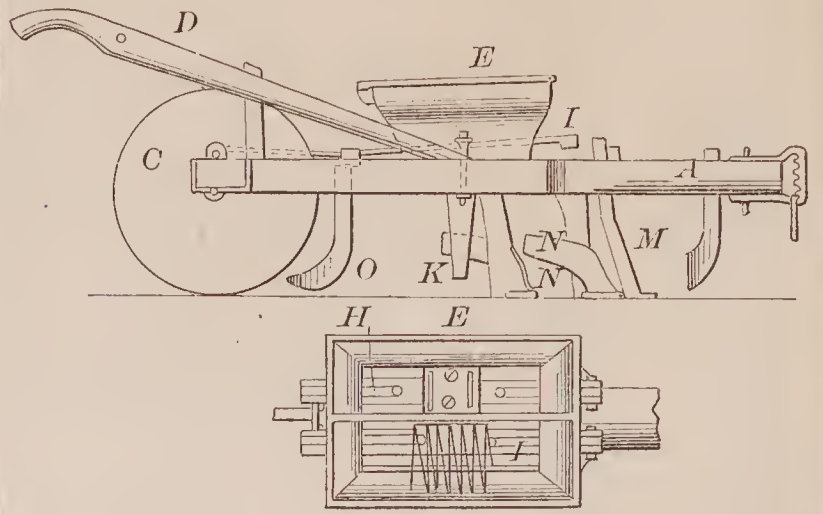

68073—Haynes & Worthington—Medicine Case.

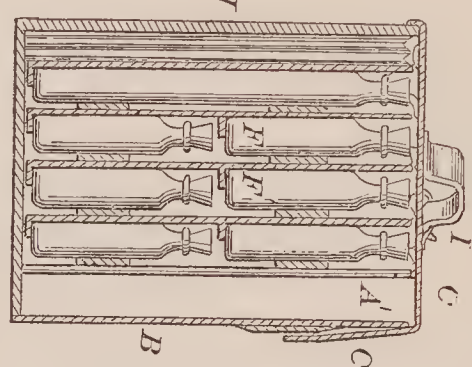

68071—D. F. Hartford—Bow Drill Stock.

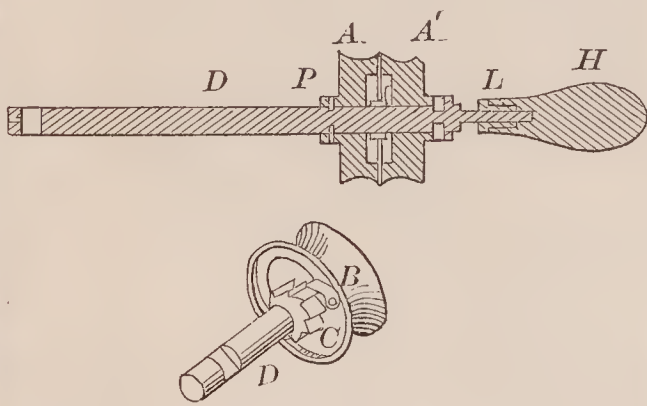

68072—L. W. Harwood—Cooking Stove.

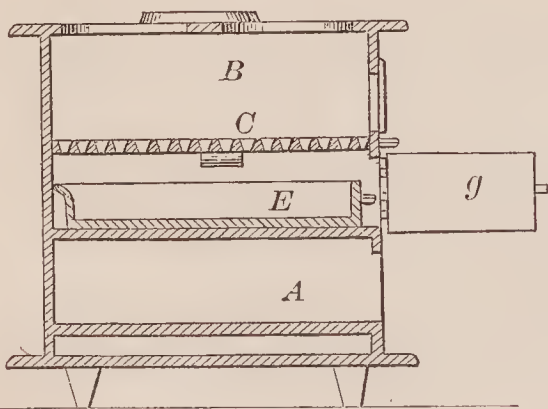

68074—E. Healy—Mechanical Movement for Working Saws, &c.

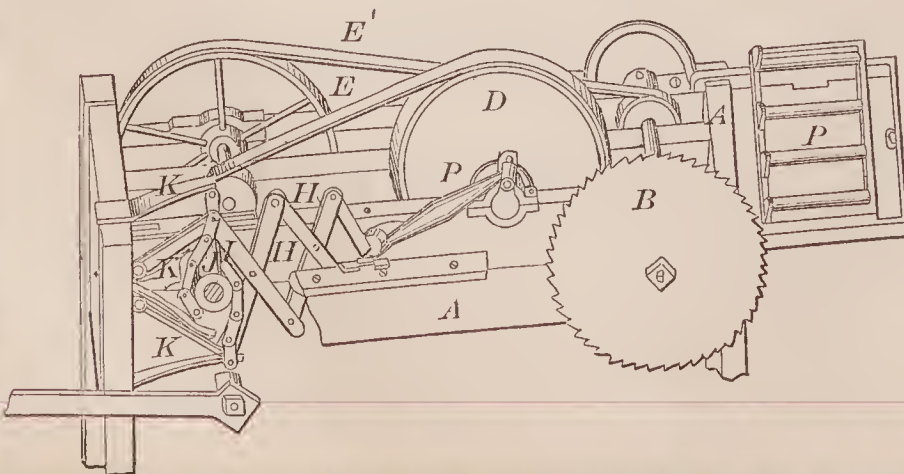

68075—J. D. Heebner—Horse Rake.

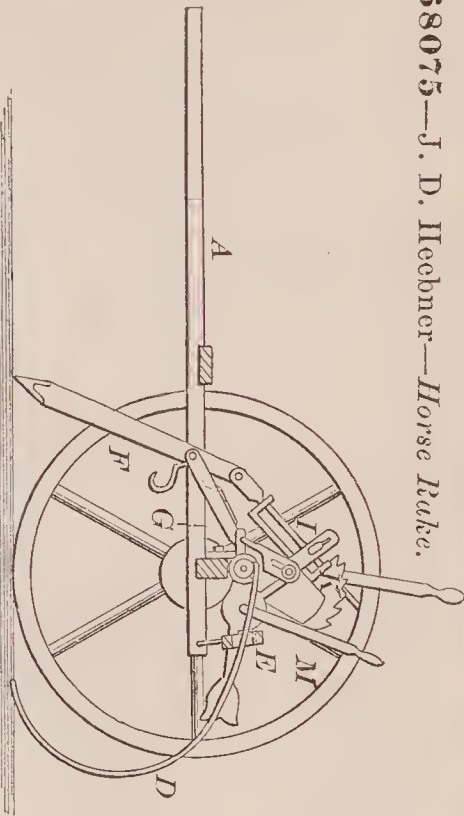

68076—W. P. Hoffman—Window Blind.

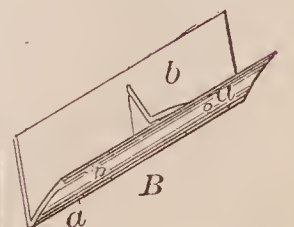
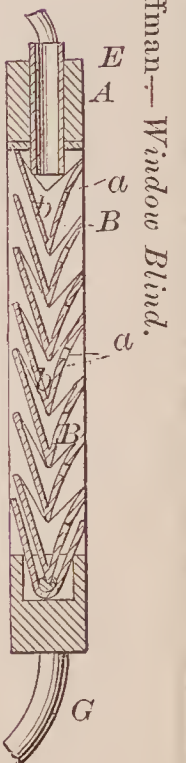

68077—S. Hoke—For Distributing Fertilizers.

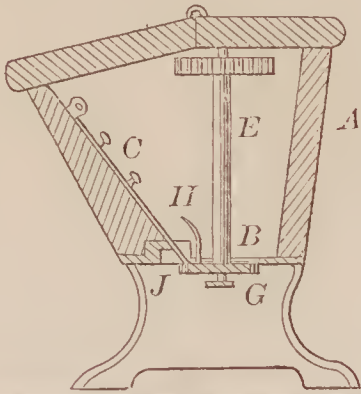

68080—R. S. Hutchinson—Check Valve for Liquid Meters.

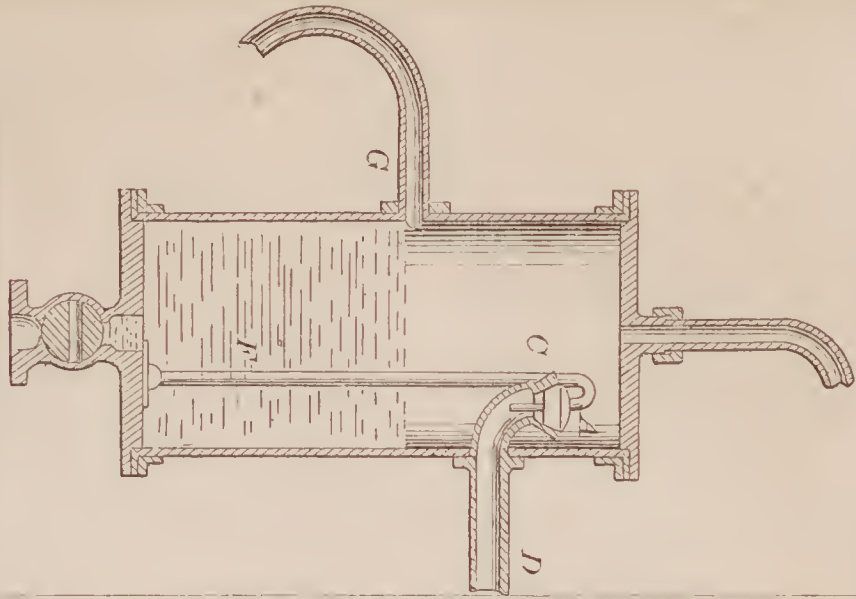

68078—Z. Howe—Bed Bottom.

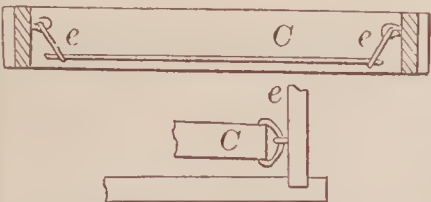

68083—Jameson & Ripley—Lever for Windlasses.

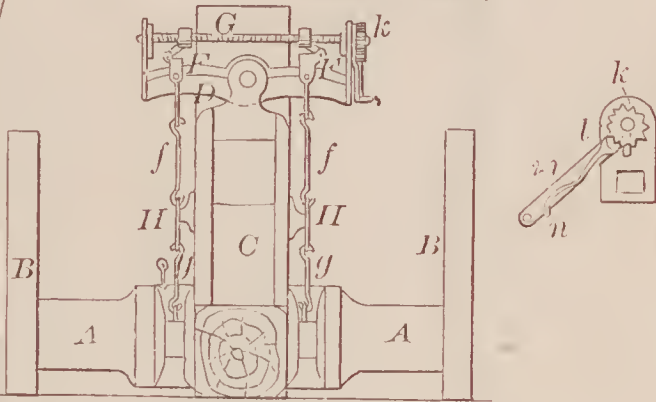

68082—J. P. R. James—Hand Catch.

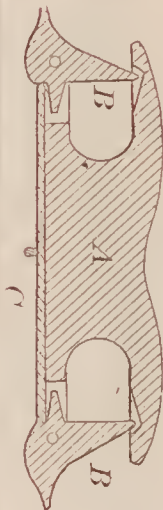

68079—B. F. Hugson—Knife and Fork Cleaner.

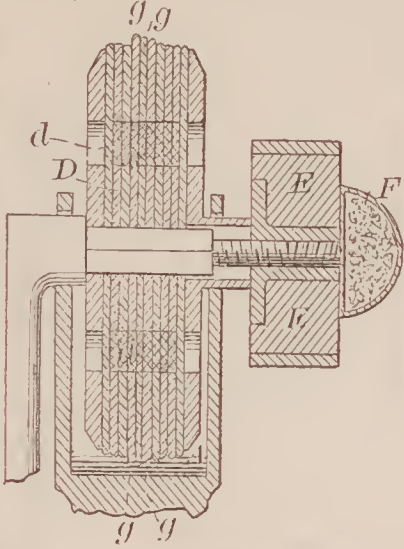

68084—C. Kark—Gate.

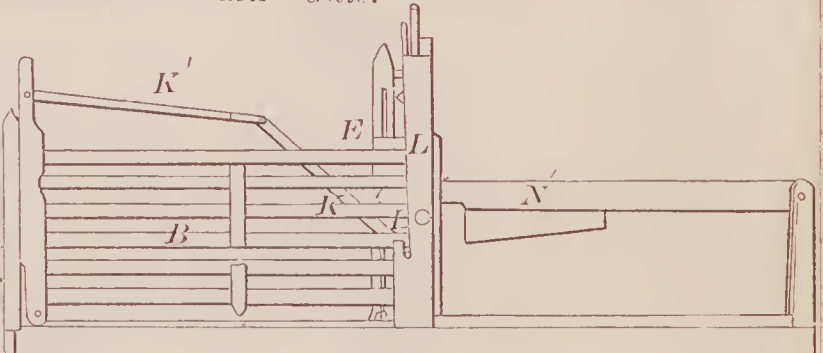

68081—E. S. Hutchinson—Liquid and Spirit Meter.

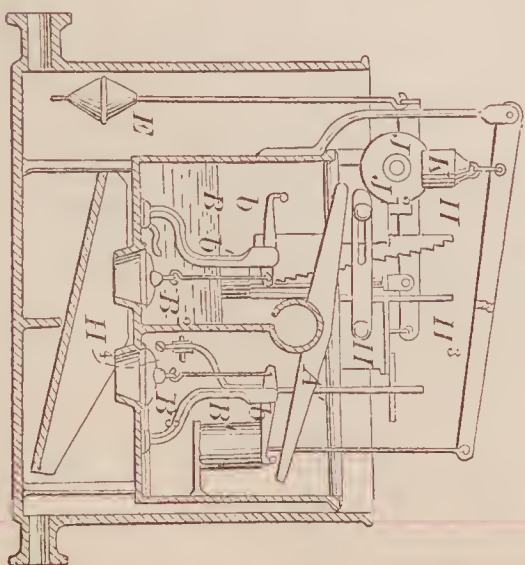
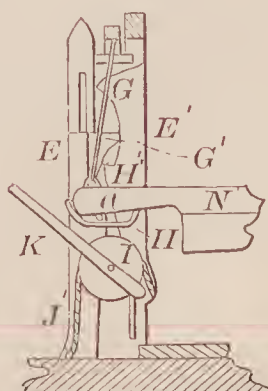
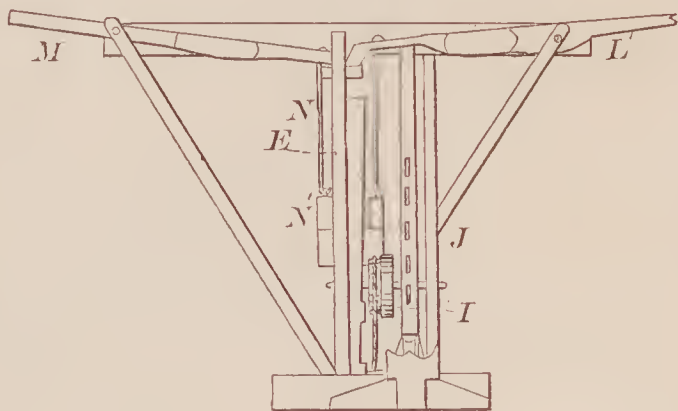
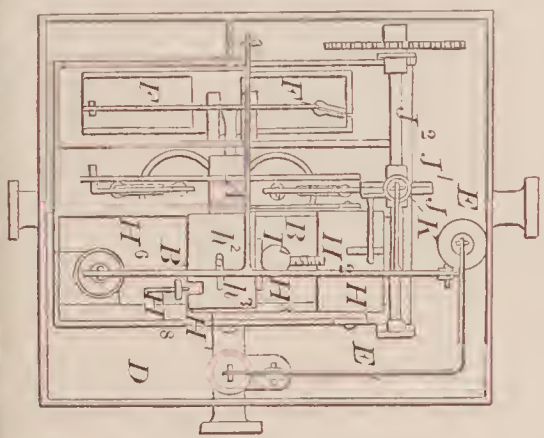



**68085**—S. R. Kenyon—*For Picking and Husking Corn.*

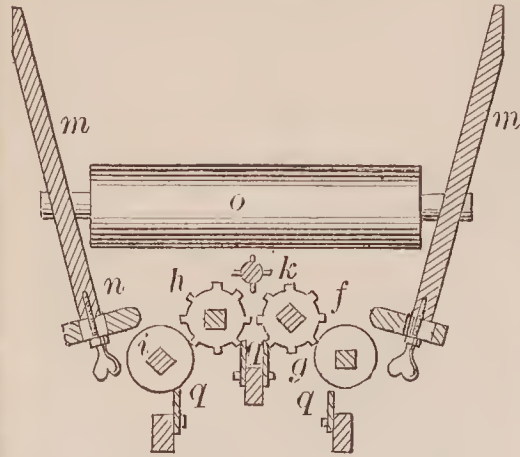

**68091**—L. Larchar—*Corn Planter*

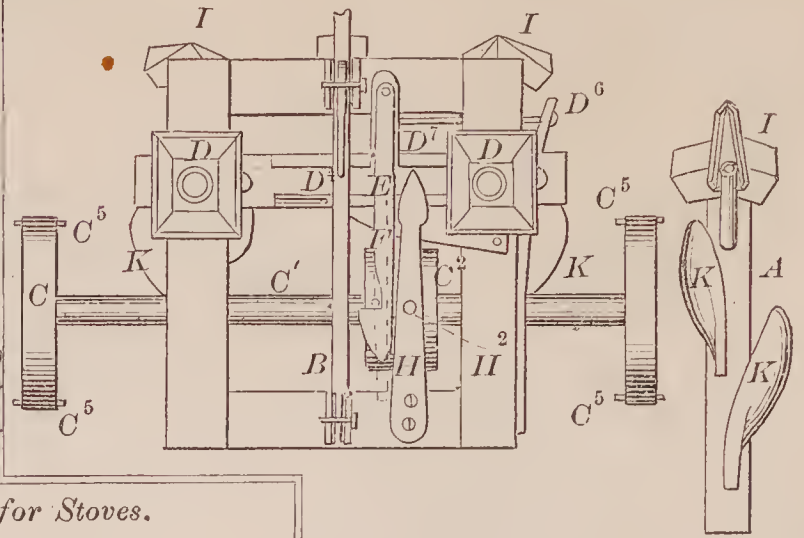

**68086**—J. H. Keyser—*Foot Rest for Stoves.*

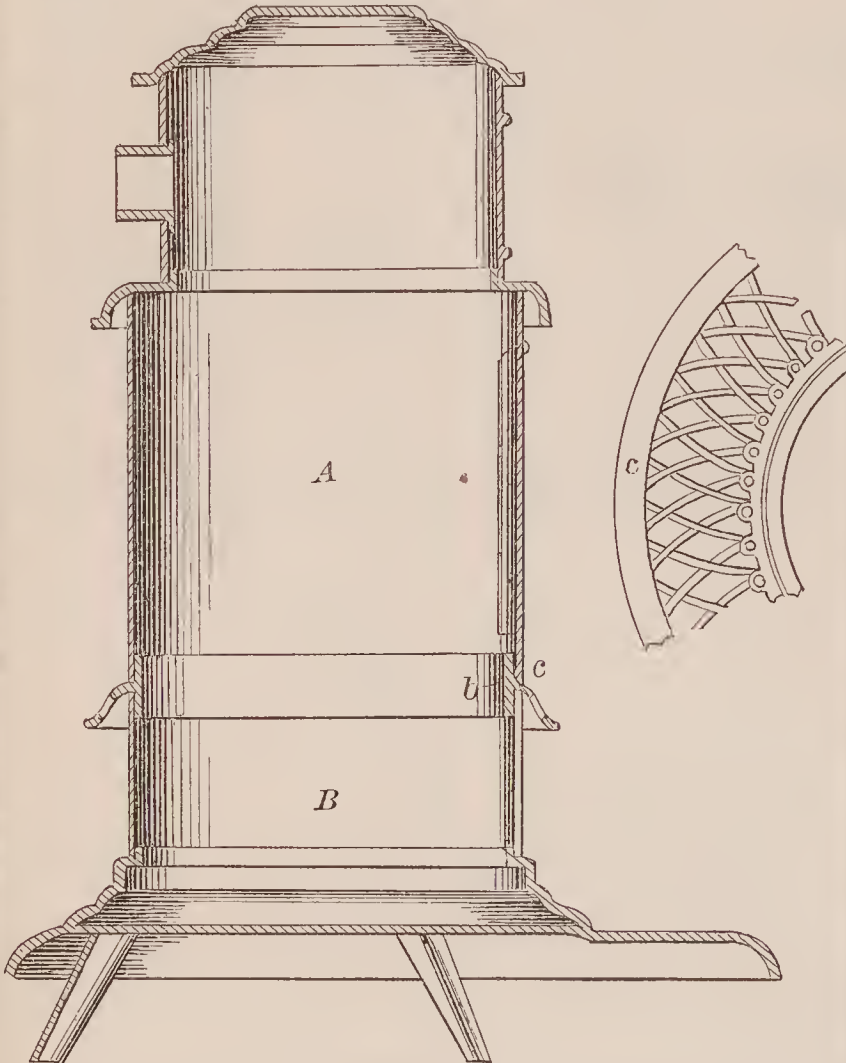

**68088**—T. W. Knox—*Transmitting Plans of Battle Fields by Telegraph.*

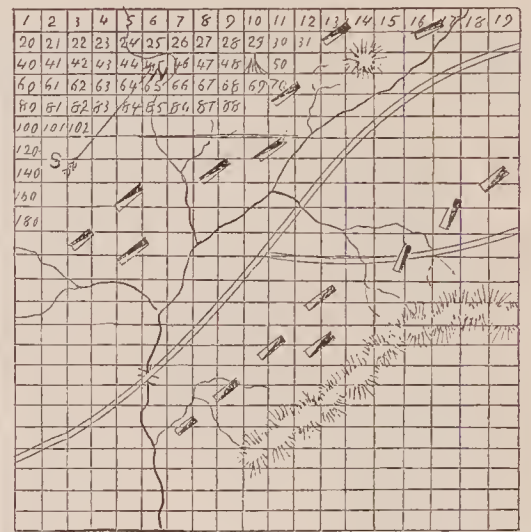

**68089**—P. Koch—*Wooden Pavement.*

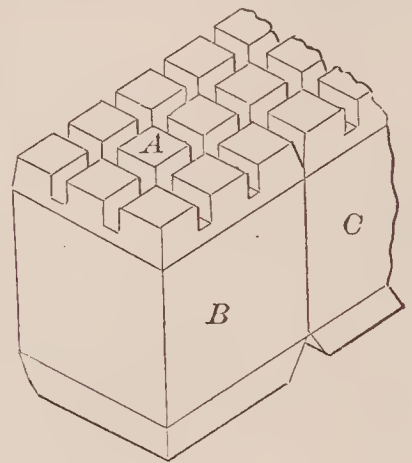

**68090**—C. J. Komar—*Step and Extension Ladder.*

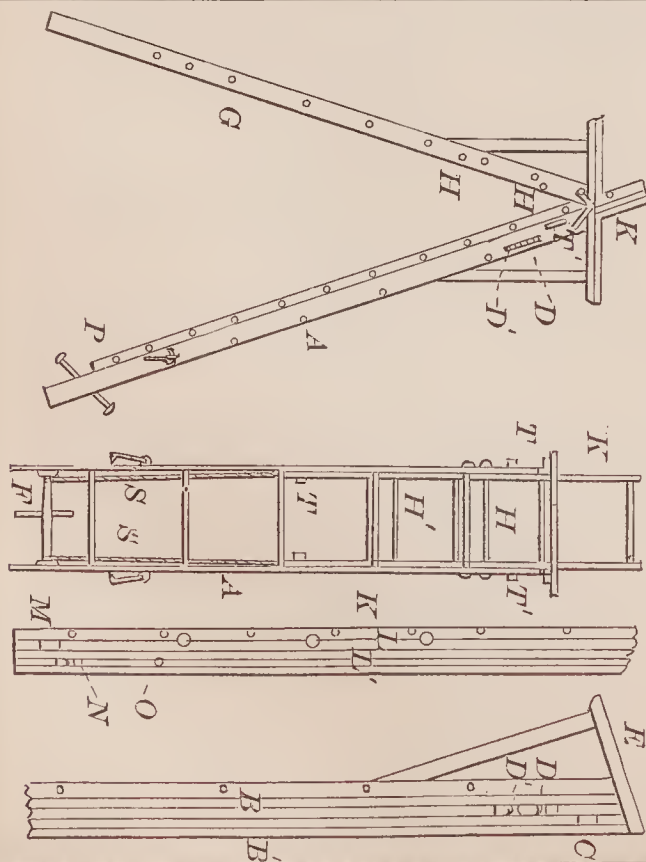

**68087**—E. E. Kilbourn—*Uniting Edges of Hosiery Goods.*

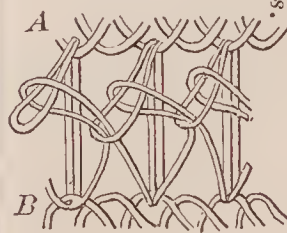

**68092**—T. C. Lippincott—*Cord Rightener.*

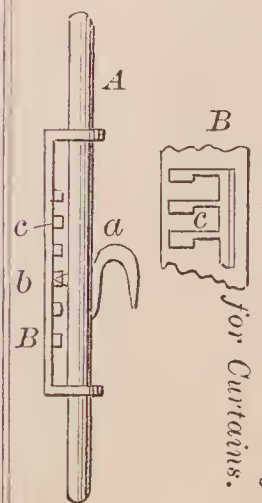

68093—C. L. Lochman—Cork Press.

B

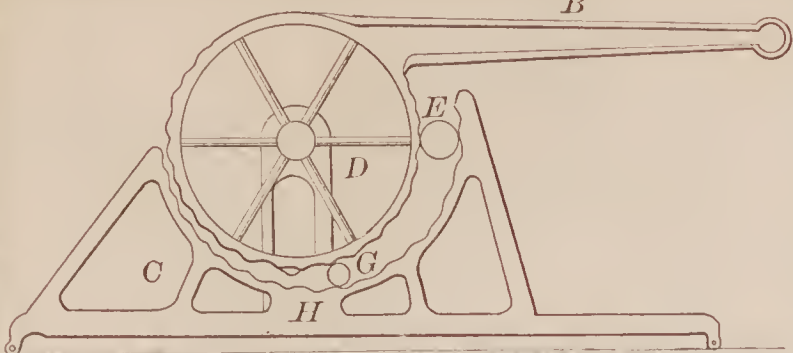

68094—I. Manning—Channeling and Beveling Machine.

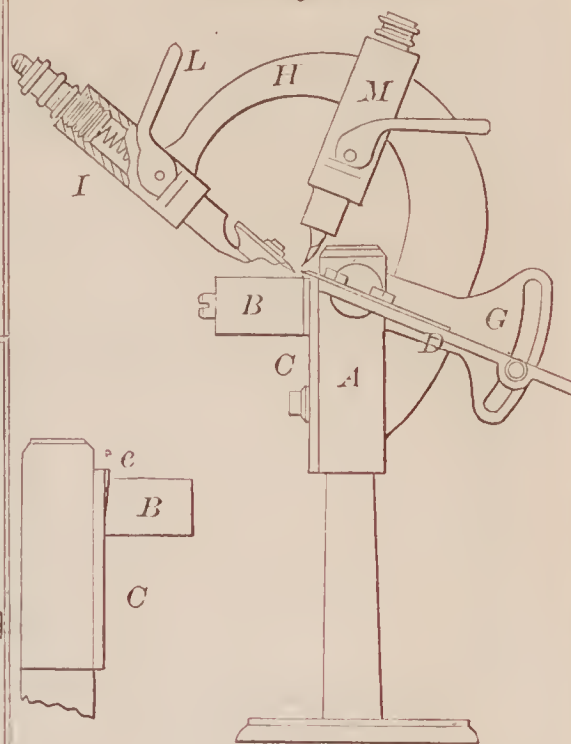

68095—H. W. Matthews—Threshing Machine and Separator.

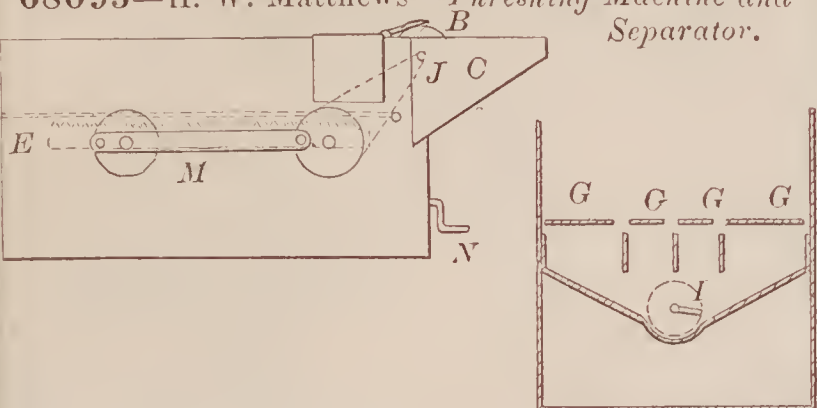

68097—J. McKenzie—Churn.

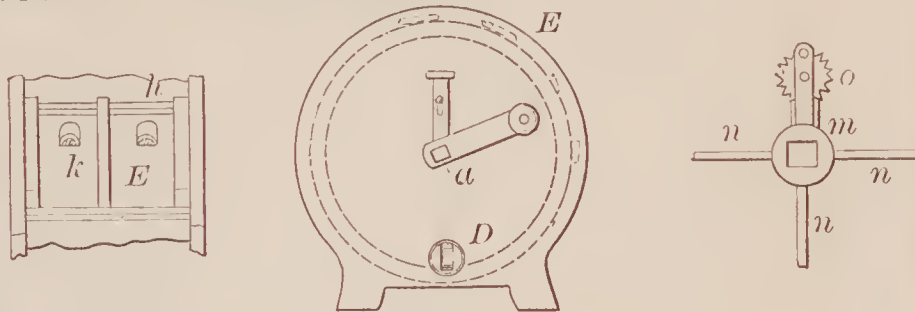

68096—M. Mattson—Toginal Irrigator.

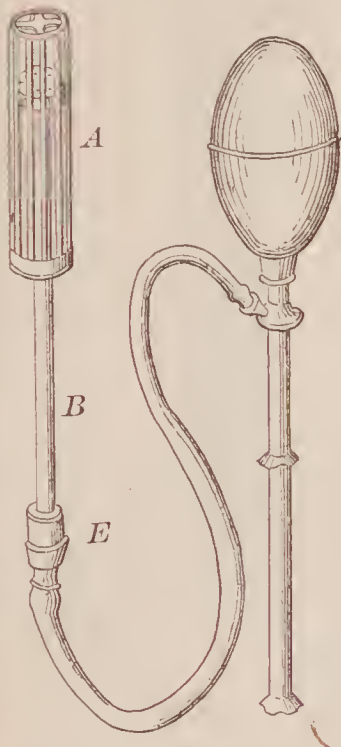

68098—E. D. Merriam—Bed Bottom Spring.

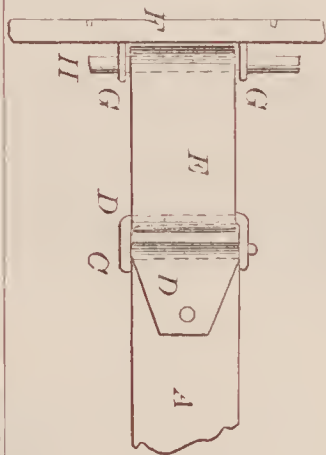

68099—W. H. & G. W. Miller—Cartridge Ejector for Breech-Loading Fire Arms.

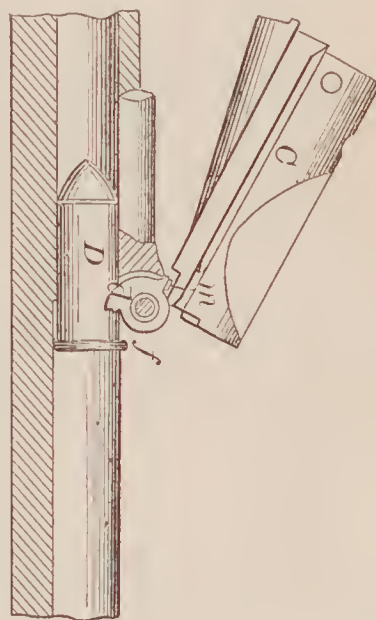

68100—M. B. Mills—Churn.

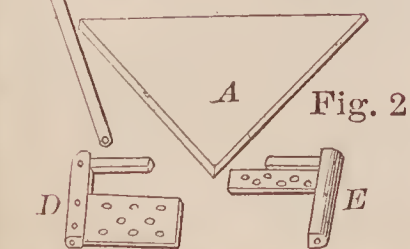
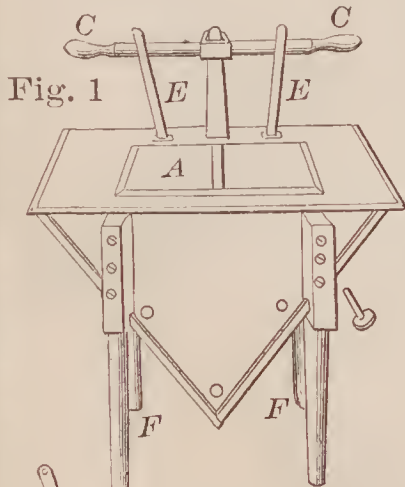

68101—S. Mills—For Grinding Peat.

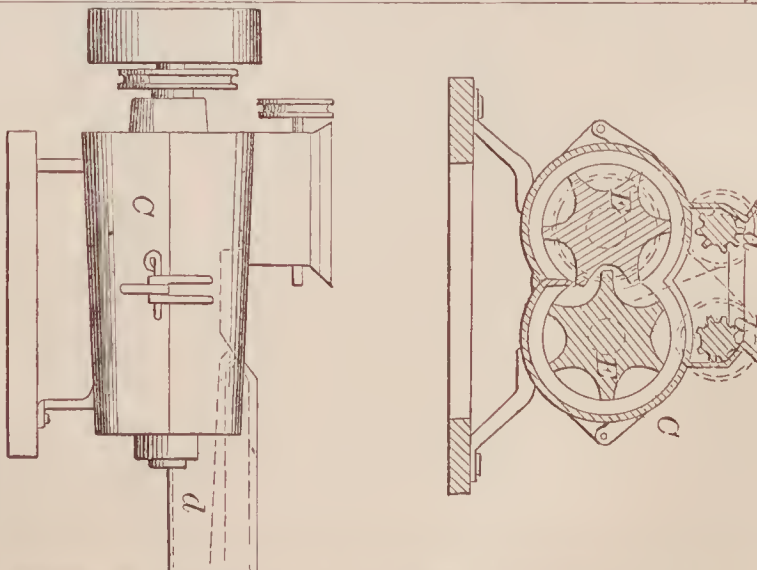



68102—G. Moore—*Plow.*

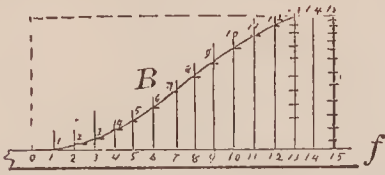

68104—E. Newlon—*Cultivator.*

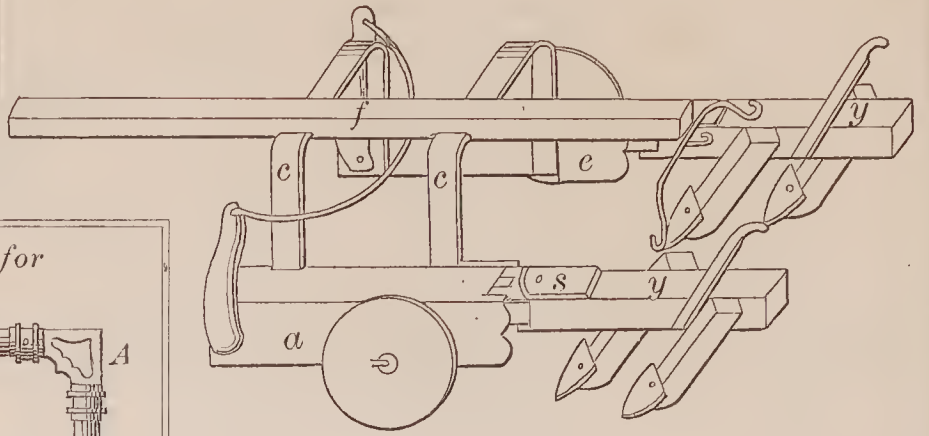

68103—W. H. Nash—*Frame for Window Screens.*

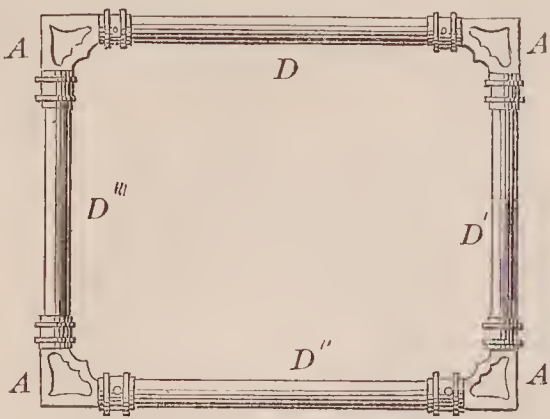

68105—G. W. Noyes—*Car Coupling.*

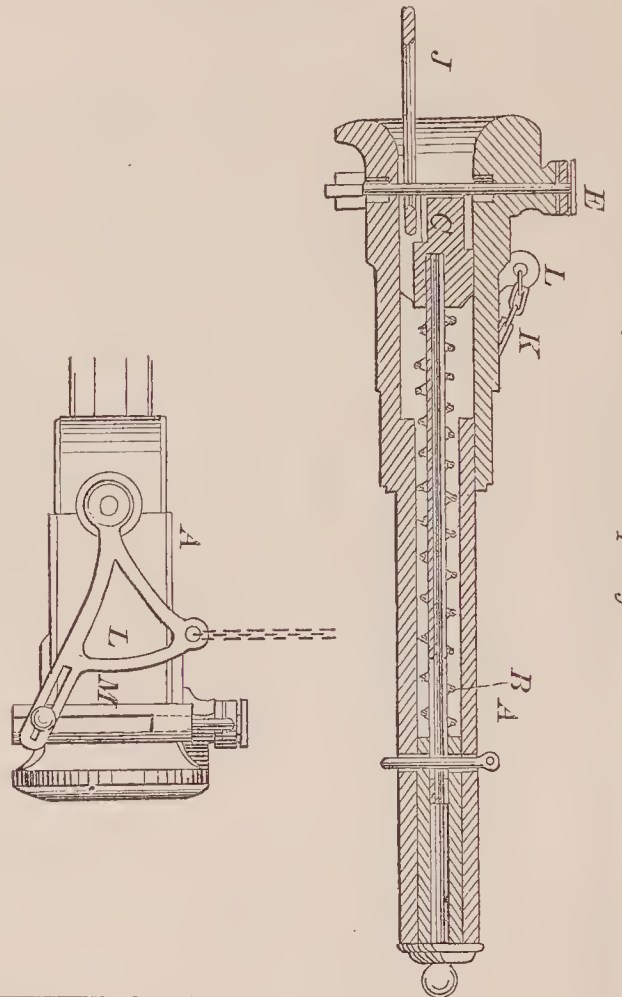

68108—F. J. Plummer—*Clutch Shipper.*

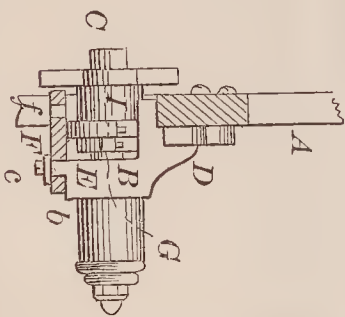
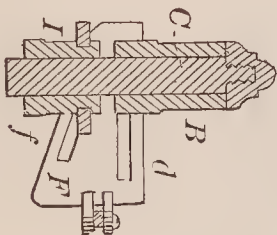
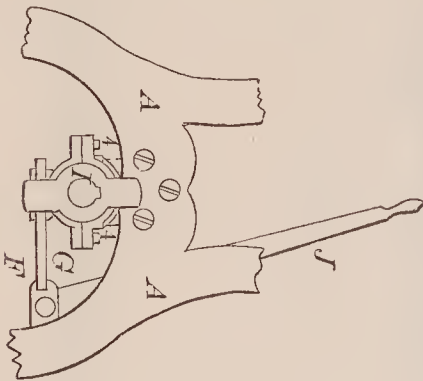

68107—J. Pepper—*Knitting Machine.*

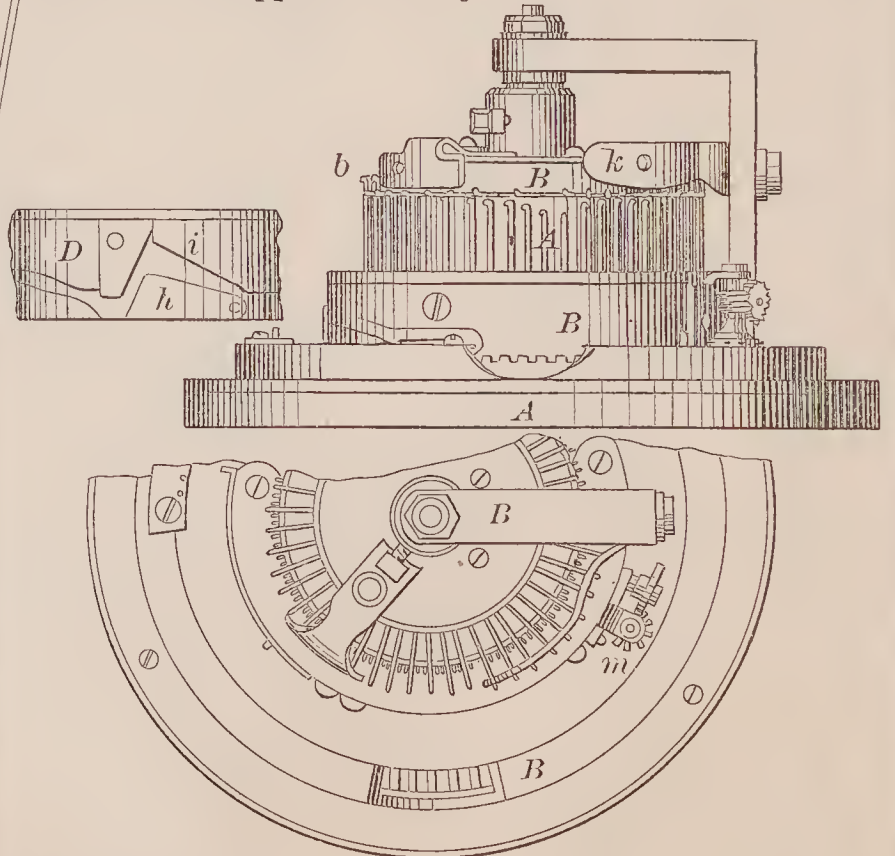

68109—R. W. Porter—*Prawing Knife, Hook and Saw.*

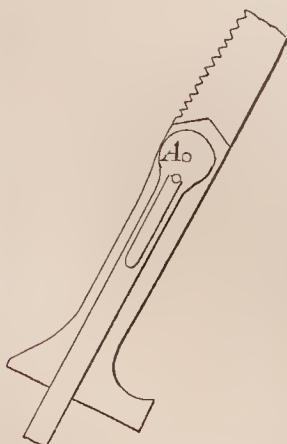

68110—J. Prutzman—For Pulverizing the Earth.

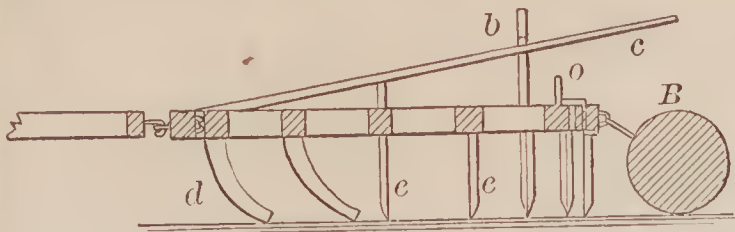

68111—J. C. Ramsey—Feeding Rack for Stock.

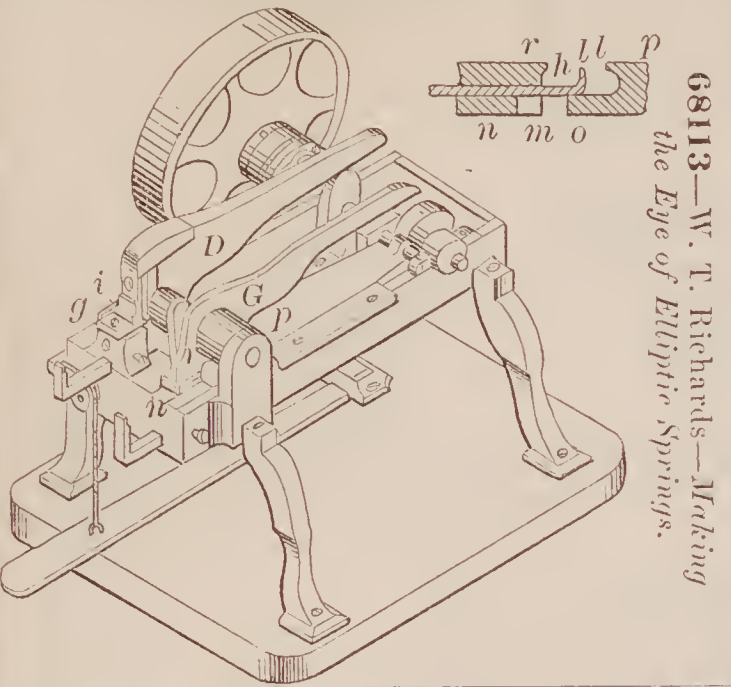
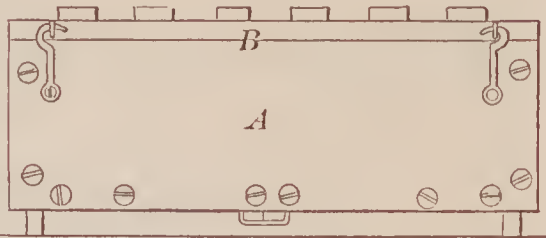

68113—W. T. Richards—Making the Eye of Elliptic Springs.

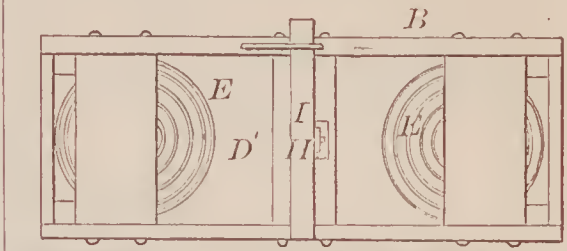

68112—J. H. Rhodes—Adjustable Pipe Joint.

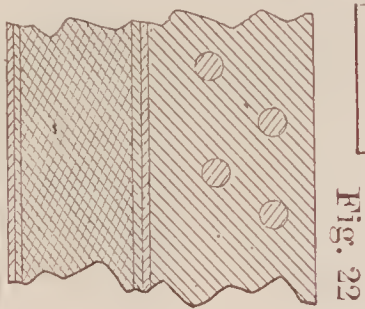
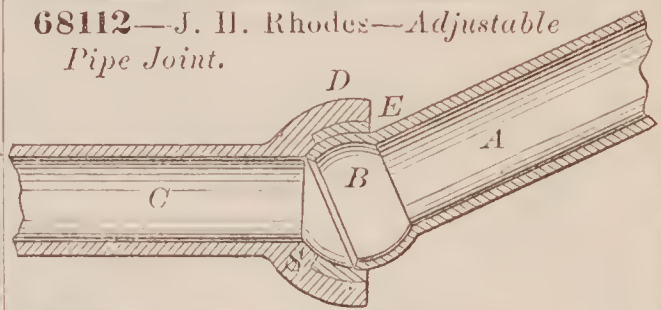

Fig. 22

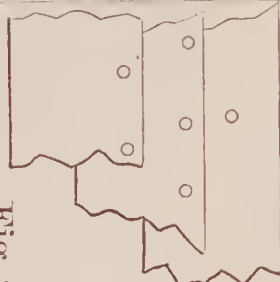
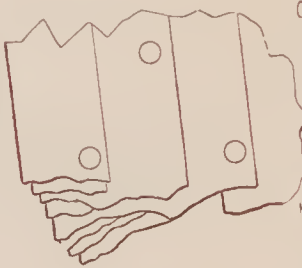

Fig. 21



68116—F. L. Roux—Sheathing of Ships' Bottoms. Fig. 20

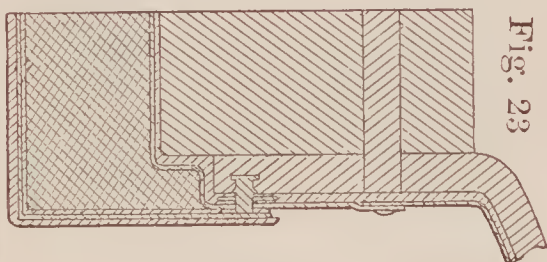

Fig. 23

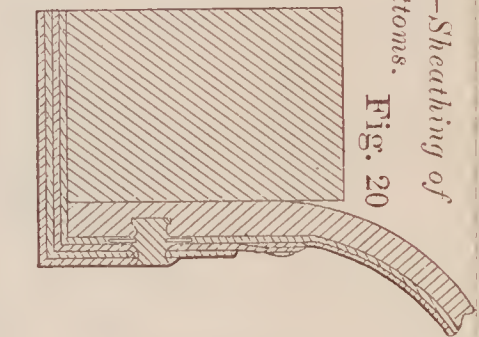
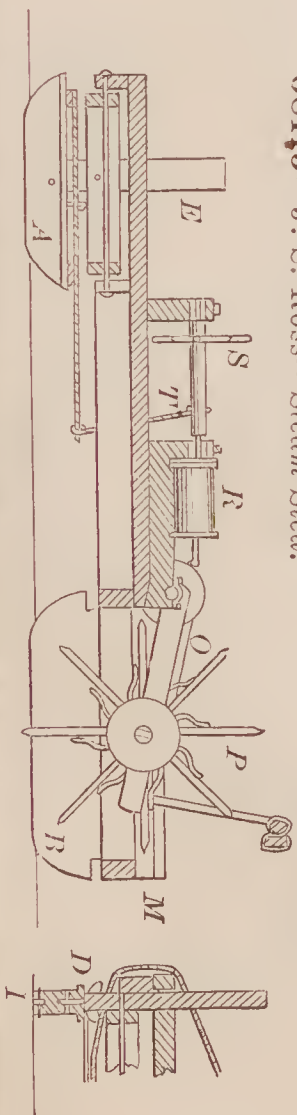
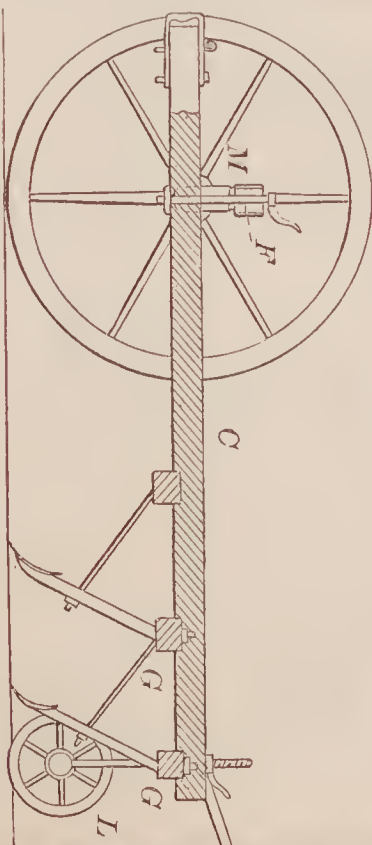

Fig. 24

68115—J. S. Ross—Steam Sled.



68114—Roman & Peterka—Plow and Cultivator.



68117—C. E. Rymer—Press.

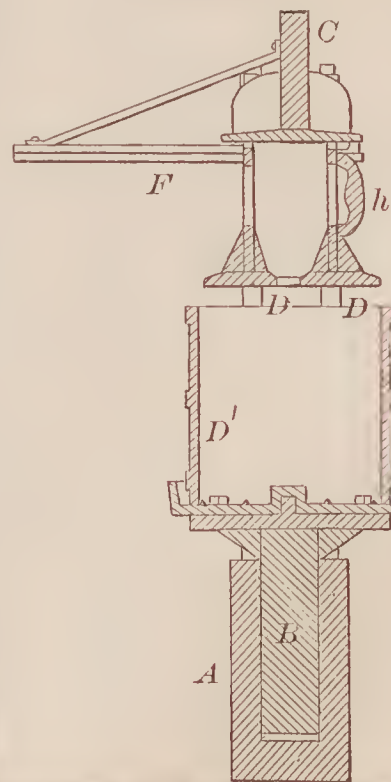



68118—S. C. Salisbury—*Converting Iron and Steel.*

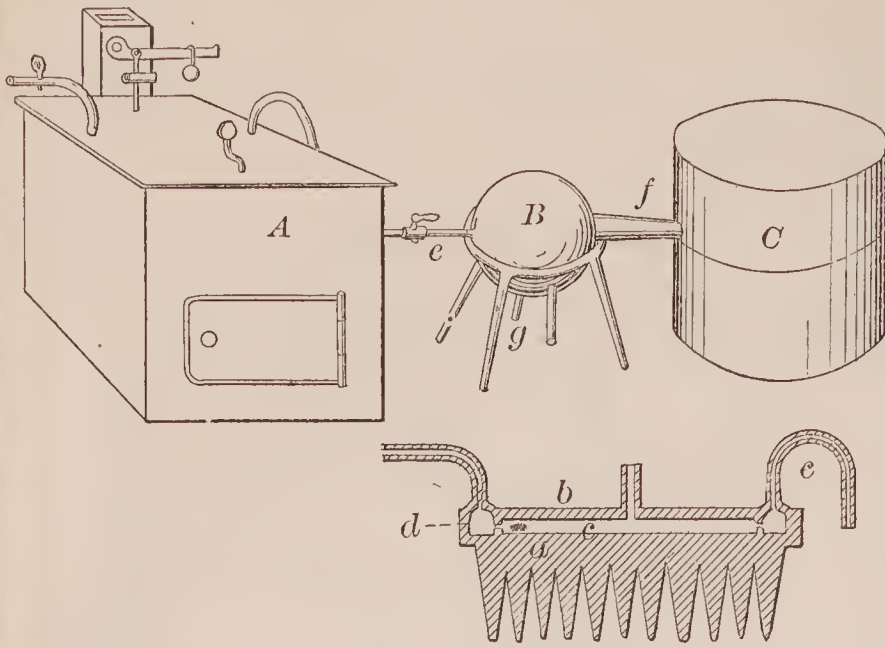

68121—C. E. Schwind—*Carriage Hinge.*

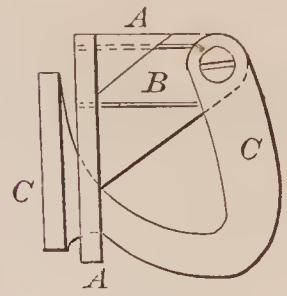

68122—B. Seott—*Railroad Rail Joint.*

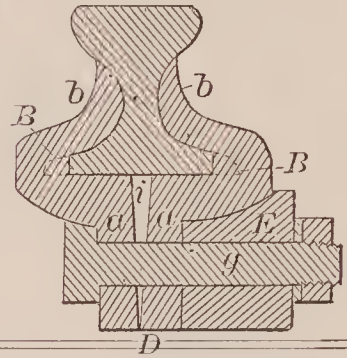

68119—S. C. Salisbury—*For Supplying Gas to Furnaces.*

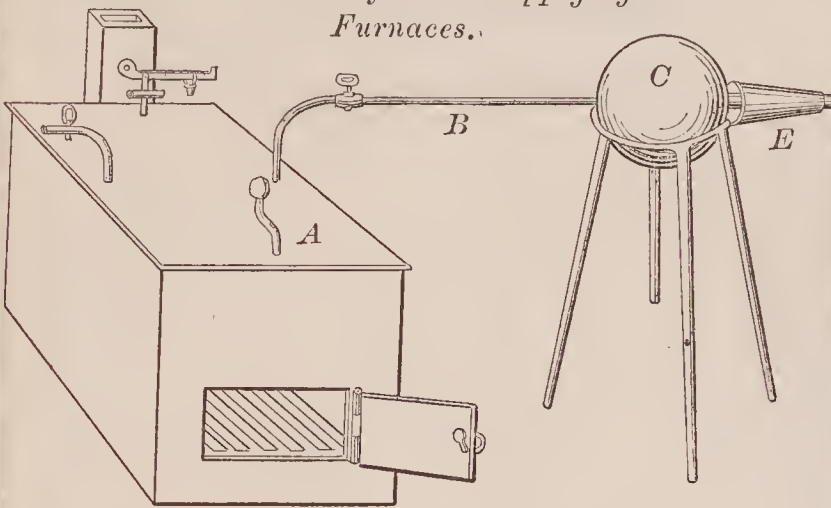

68123—M. & W. Scrannage & Bate—*Swing Nose Basin Faucet.*

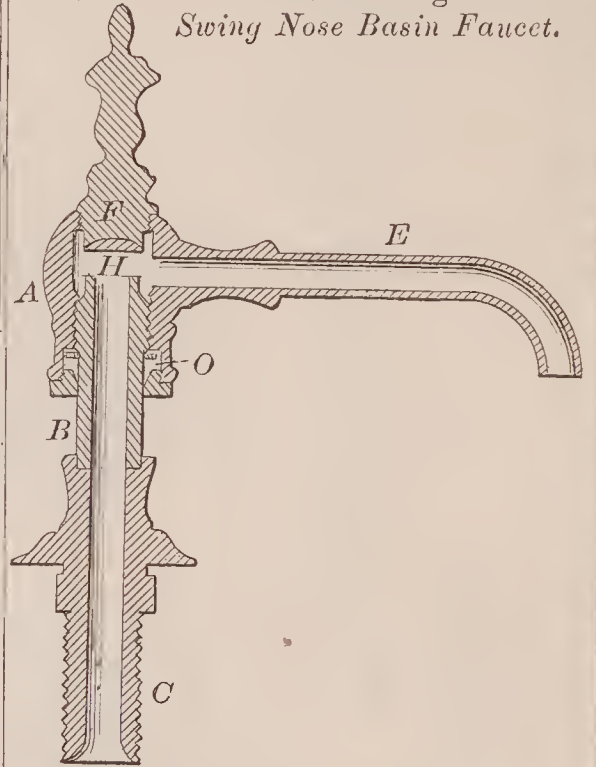

68120—P. H. Schuyler—*Car Coupling.*

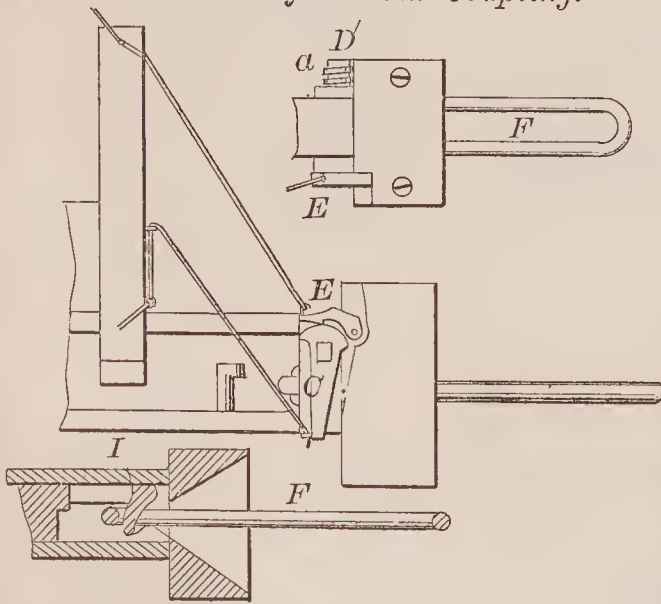

68125—A. B. Smith—*Sorghum Sugar Evaporator.*

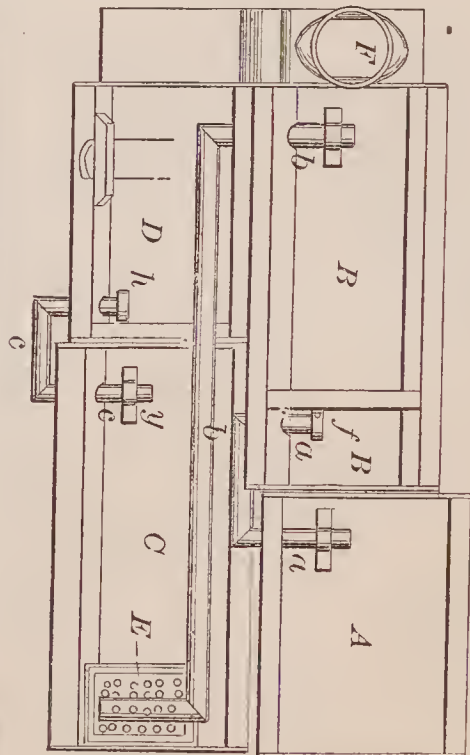

68124—W. A. Sisson—*Wheel Cultivator.*

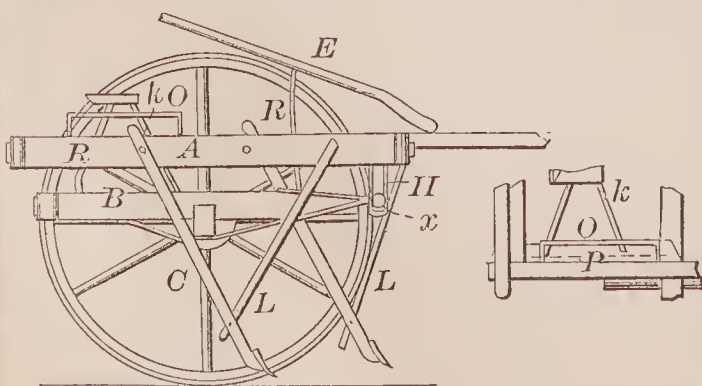

68126—J. Snively—Chimney Top

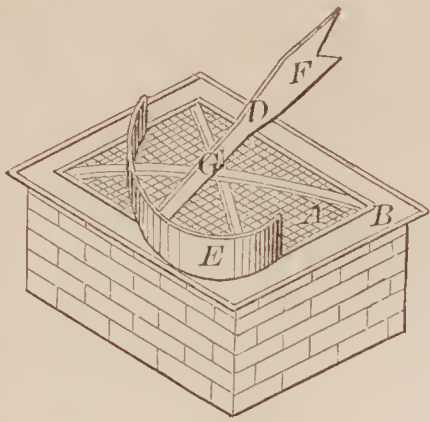

68127—E. Spencer—Water Meter and Force Pump.

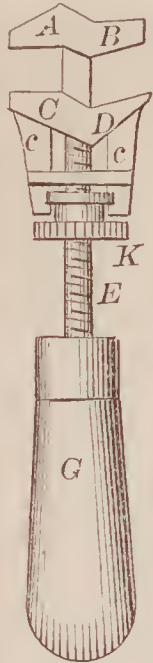
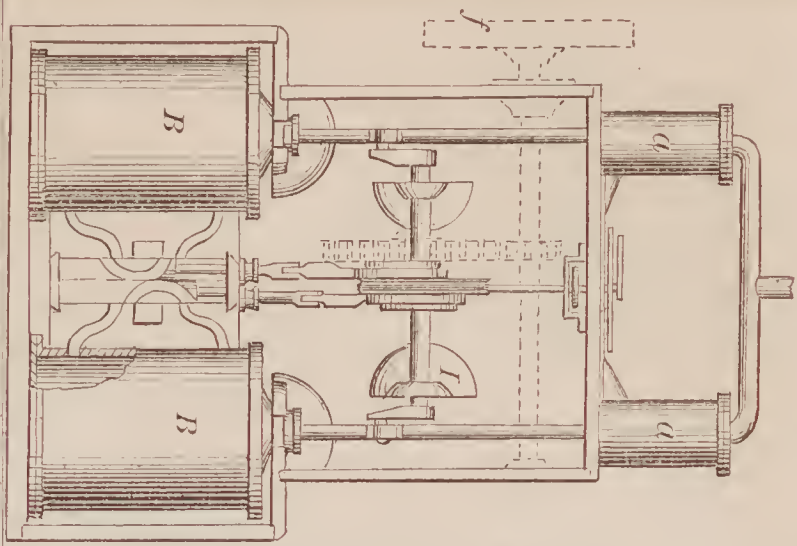

68128—J. A. Talpey—Wrench.

68129—H. K. Taylor—Indicator for Water Closets.

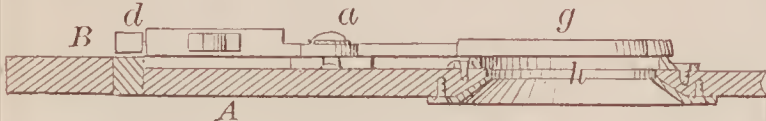

68131—M. G. Tousley—Snout Ring for Swine.

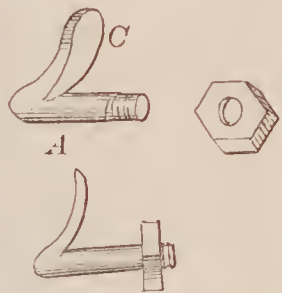

68130—H. T. Tichenor—Axe.

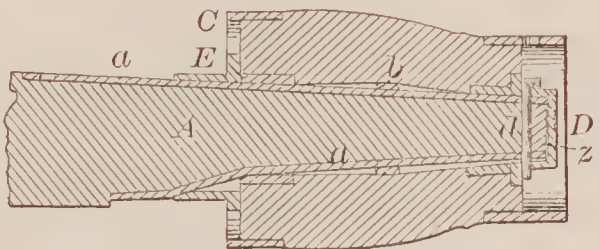

68132—S. W. Tyler—For Pulling Flax.

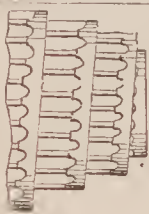
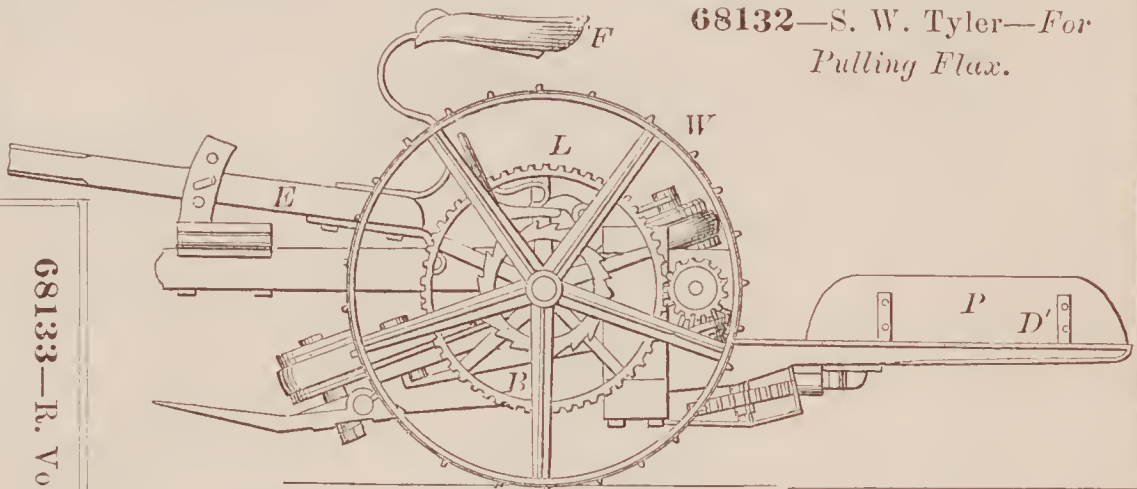

68133—R. Vose—Car Spring.

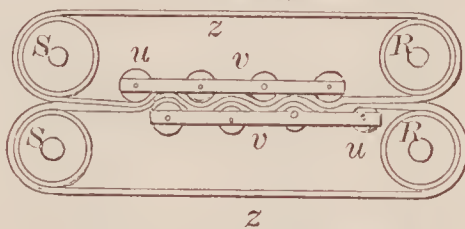

68134—R. Vose—Car Spring.

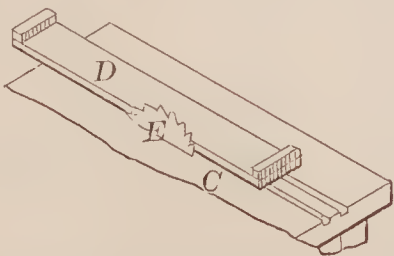
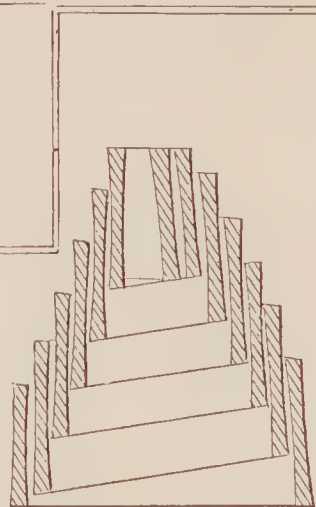

68137—R. V. Whiting—Circular Sawing Machine.

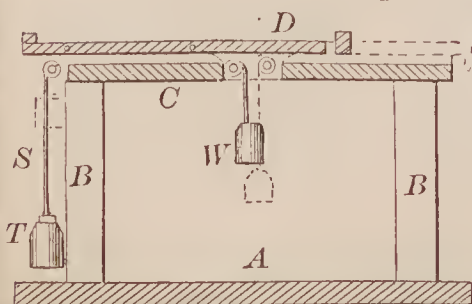

68138—A. H. Whitney—Lock Clasp for Umbrellas.

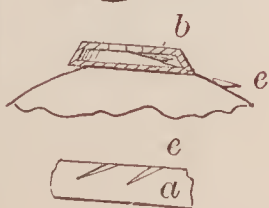

68136—H. Weston—Lamp.

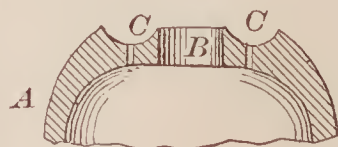



86139—Wilson & Smith—Furnace Grate.

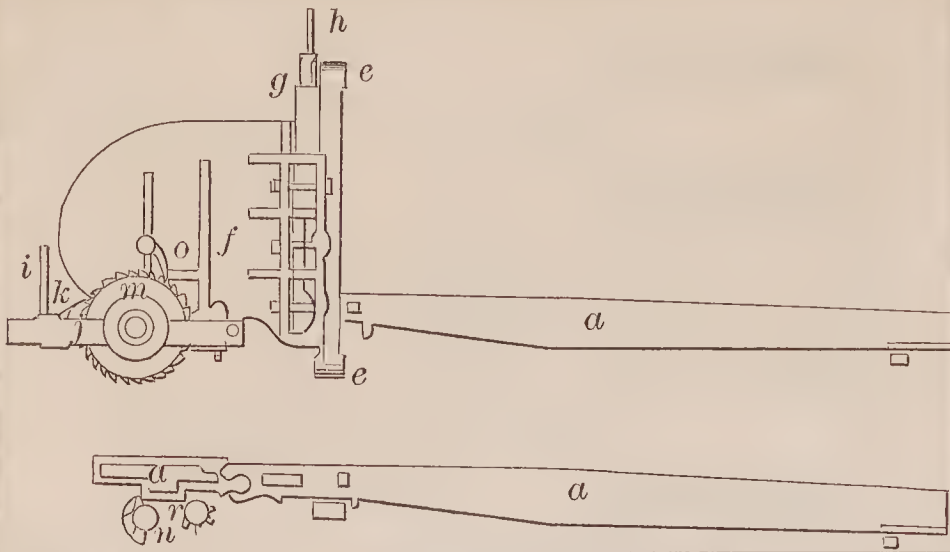

68142—J. B. Alexander—For Attaching Chimneys to Lamps.

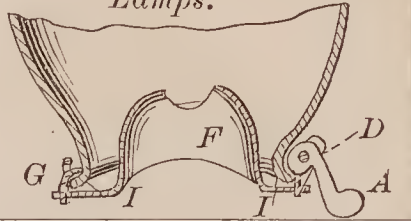

86143—T. F. Allyn—Car Spring.

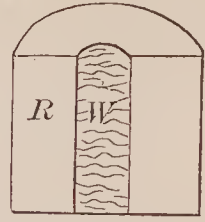

68144—Andrews & Tucker—For Making Match Splints.

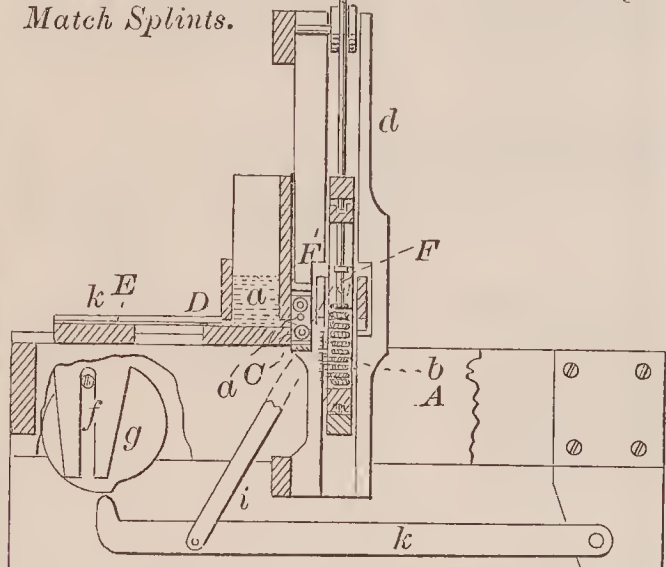

68140—J. Zimmerman—Horse Rake.

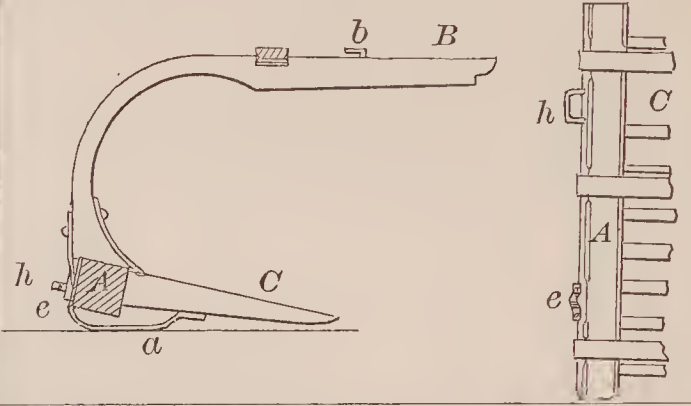

68145—R. C. Archibald—Cider Mill.

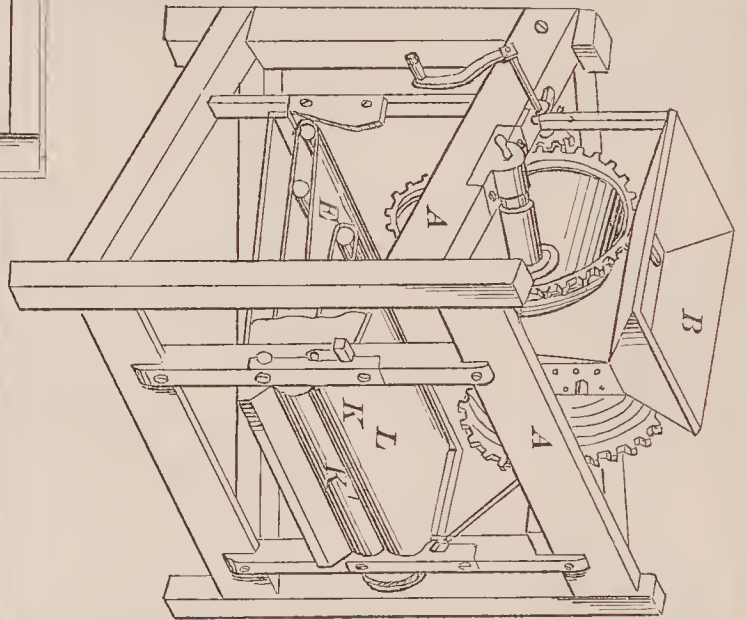

86141—D. L. Adair—Beehive.

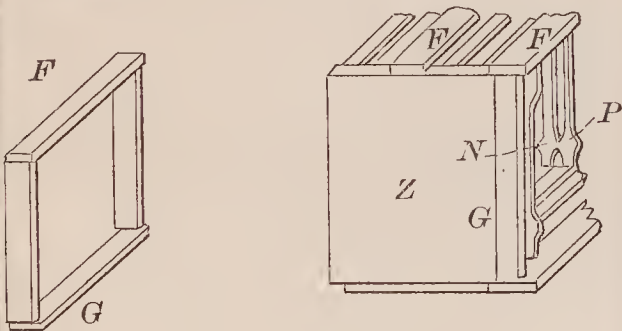

68146—E. F. Bailey—Card Board Dryer.

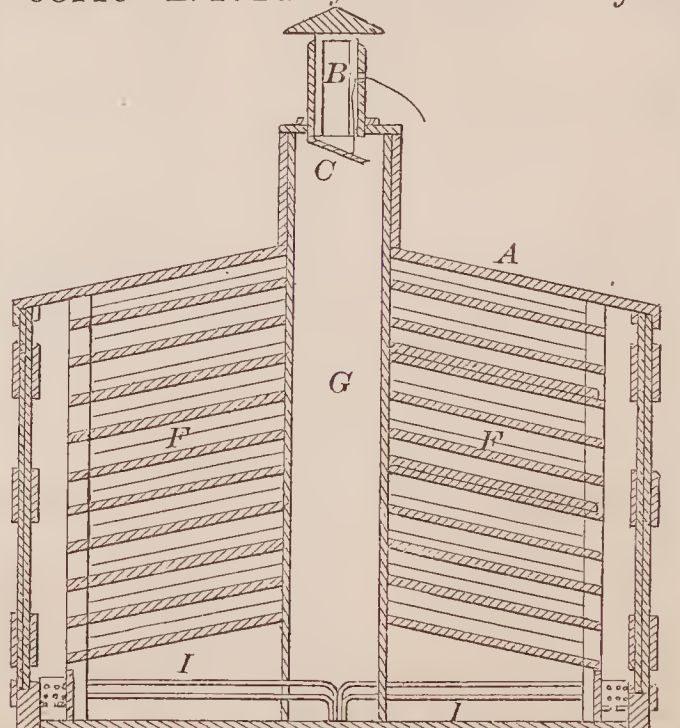
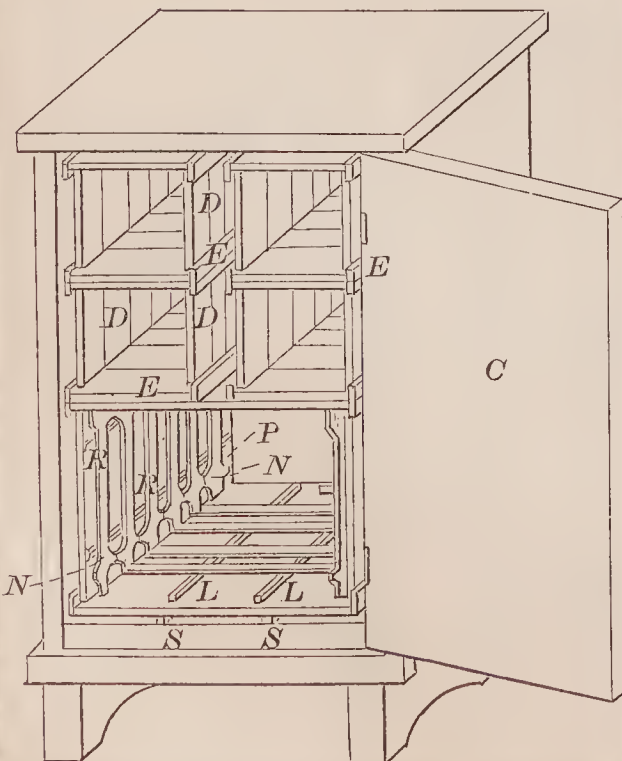

68147—R. J. Baker—Trace Buckle.

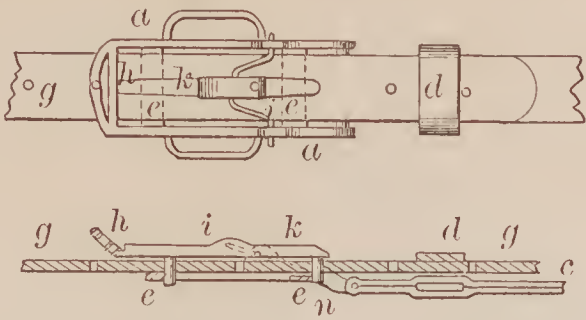

68151—J. S. Beals—Sheep Rack.

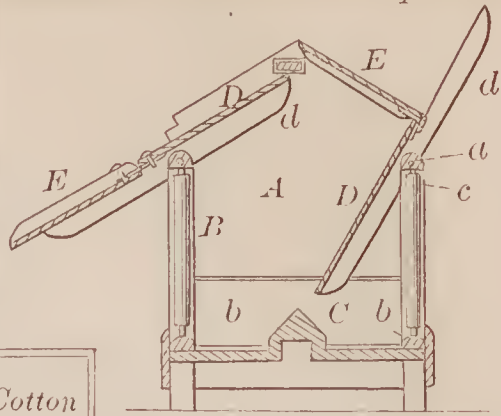

68149—A. Barbarin—Bale Tie.



68148—A. Barbarin—Cotton Bale Tie.



68150—B. F. Barker—Butt Hinge.

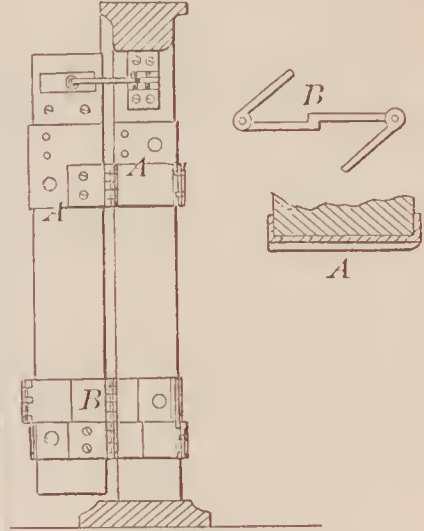

68152—J. S. Beals—Plow.

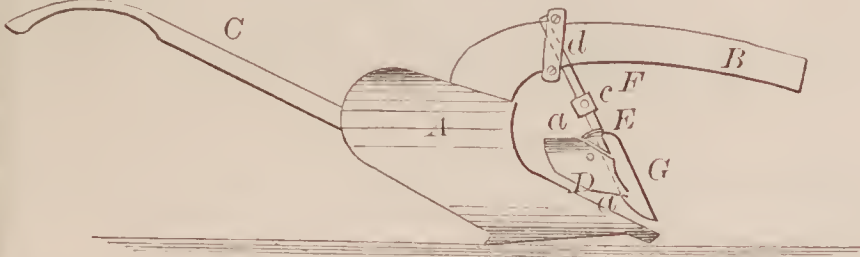

68156—H. H. Beers—Pad Crimp Press.

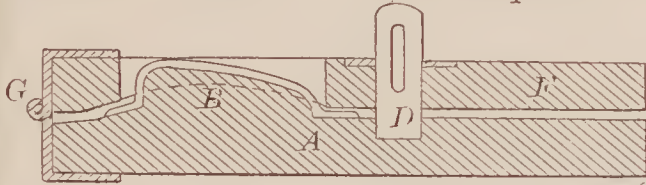

68153—W. F. Beaton—Pen and Eraser.

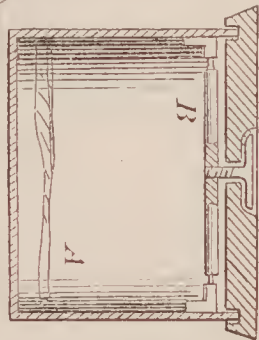
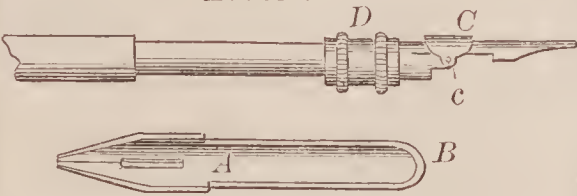

68158—G. W. Bennett—Paint Can.

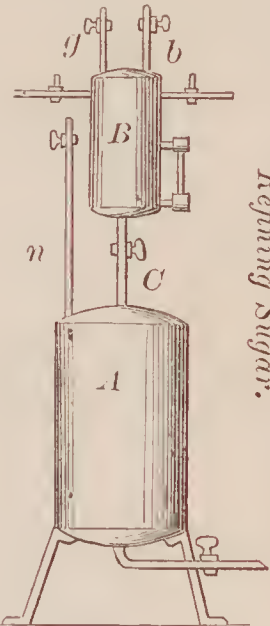

68157—R. W. Bender—Filter for Refining Sugar.

68155—E. Beckwith—Washing Machine.

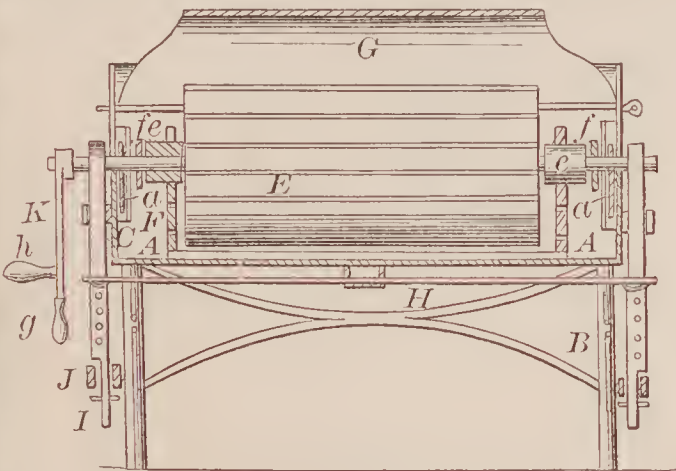

68154—W. F. Beaton—Frame for the Glasses of Carriage Curtains.



68161—H. T. Boutell—Clothes Pin.

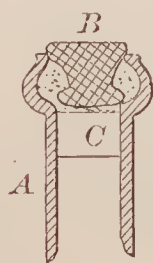
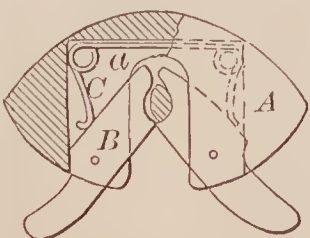

68162—T. S. Bowman—Closing Bottles.

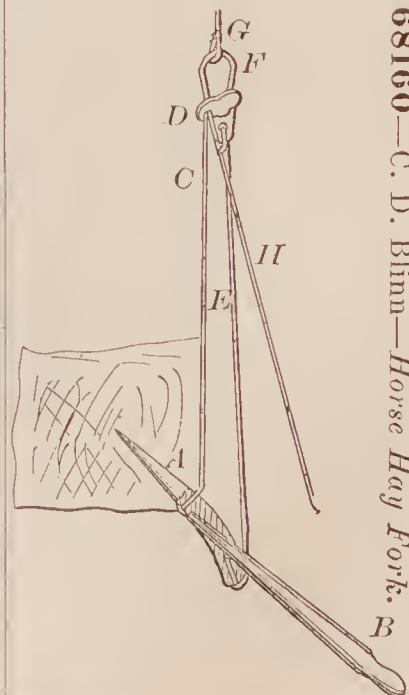

68160—C. D. Blinn—Horse Hay Fork.



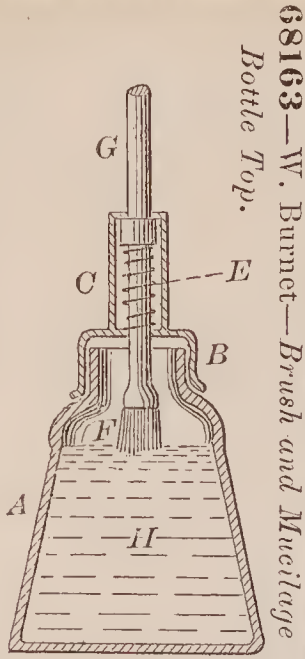

68163—W. Burnet—Brush and Mucilage Bottle Top.

68169—J. Click—Harrow.

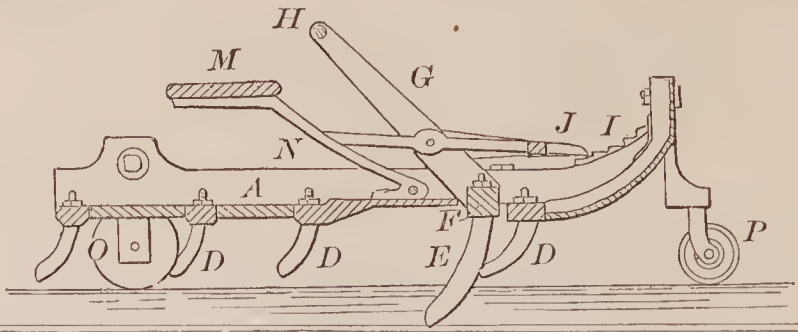

68172—McD. Darrow—Rein Holder.

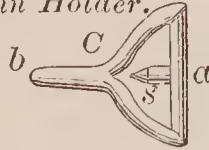

68164—S. Bittenheim—Nursery Lounge.

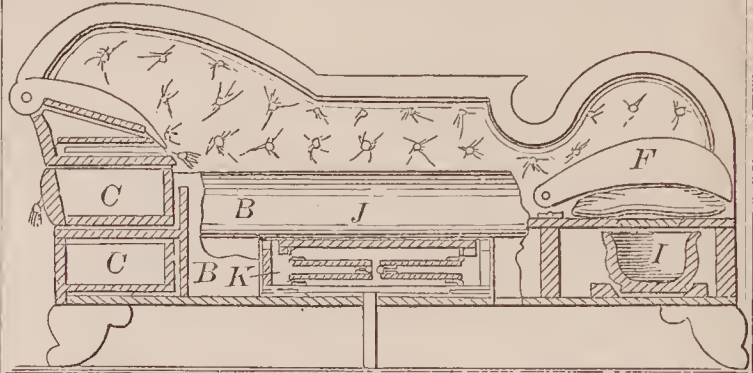

68166—P. Chandler—Portable Fence.

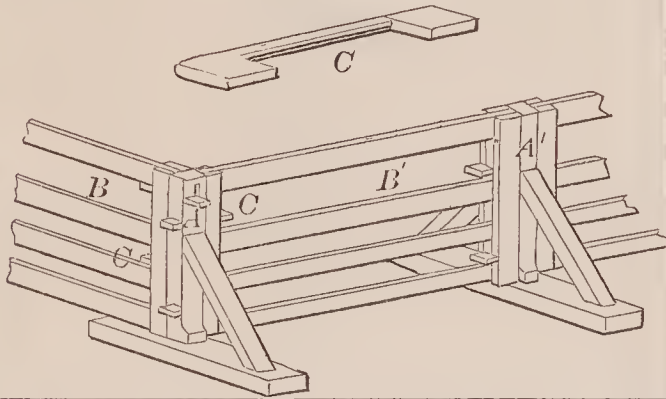

68165—A. Canfield—Corn Cultivator.

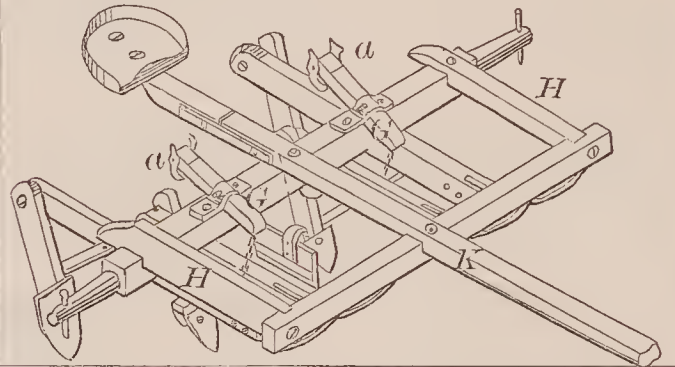

68167—M. D. Cheek—Cotton Bale Tie.

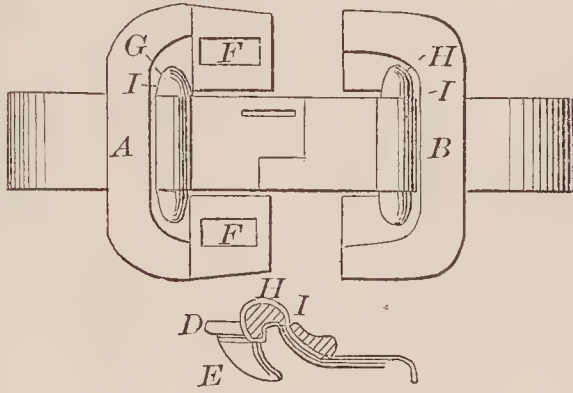

68170—R. B. Coar—Filter Faucet.

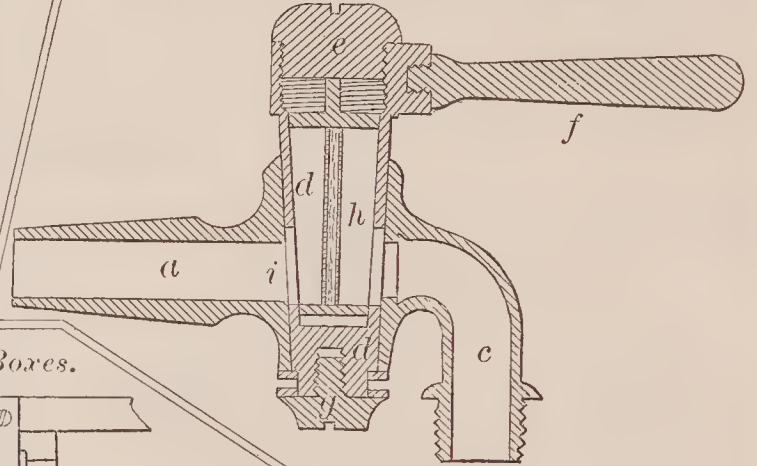

68171—C. Colby—For Cutting Berry Boxes.

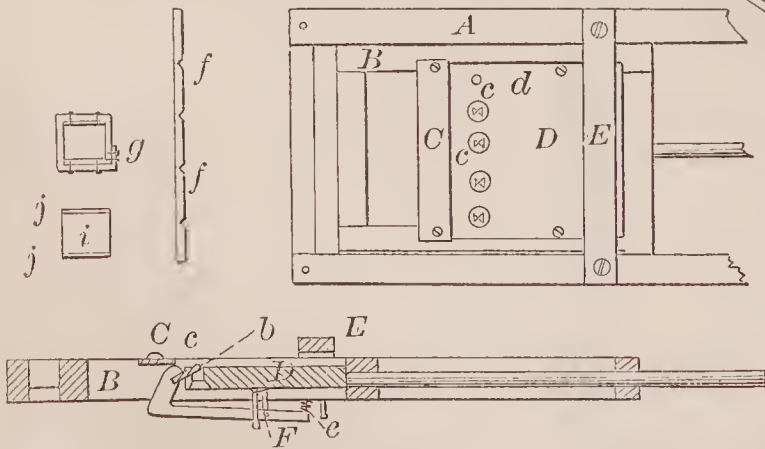

68173—H. V. Davis—Seed Drill.

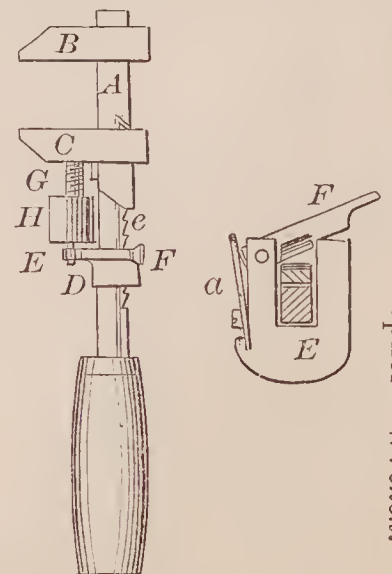
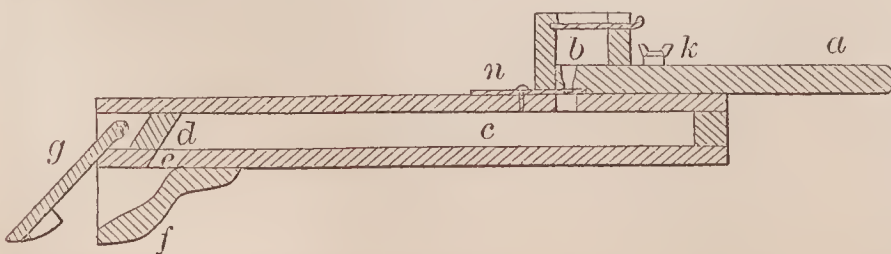

68168—T. D. Christopher—Wrench.

68174—L. De Golia—*Wash Board.*

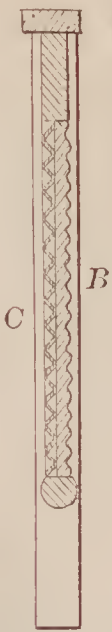

68175—G. B. Field—*Amalgamator.*

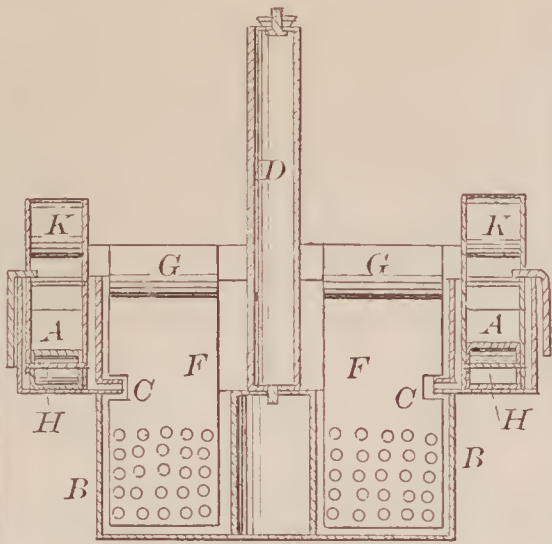

68180—F. Gesswein—*Window Shade.*

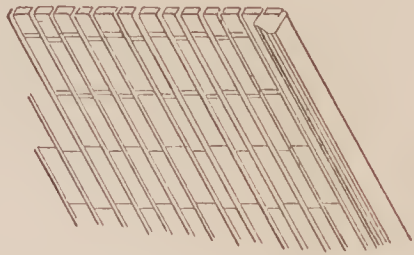

68176—T. G. U. Fisk—*Washing Machine.*

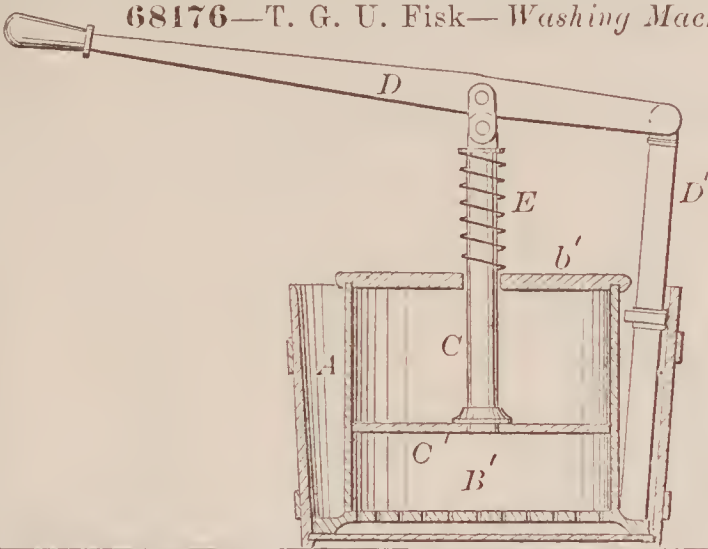

68181—S. Gibbons—*Drying Barrels.*

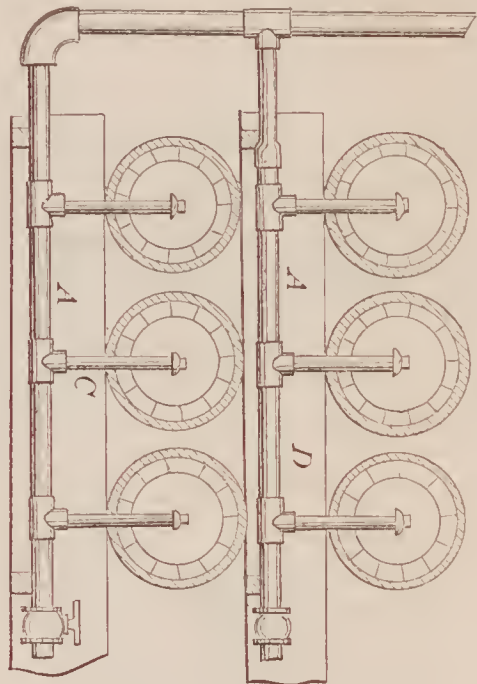

68177—B. Force—*Fence.*

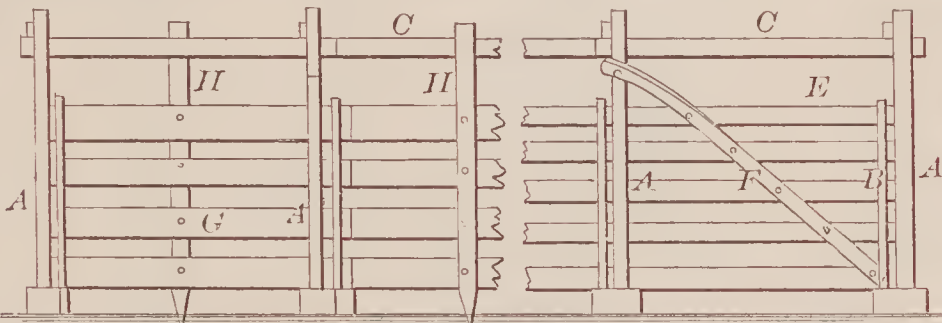

68178—J. Frasn—*Smoothing Iron.*

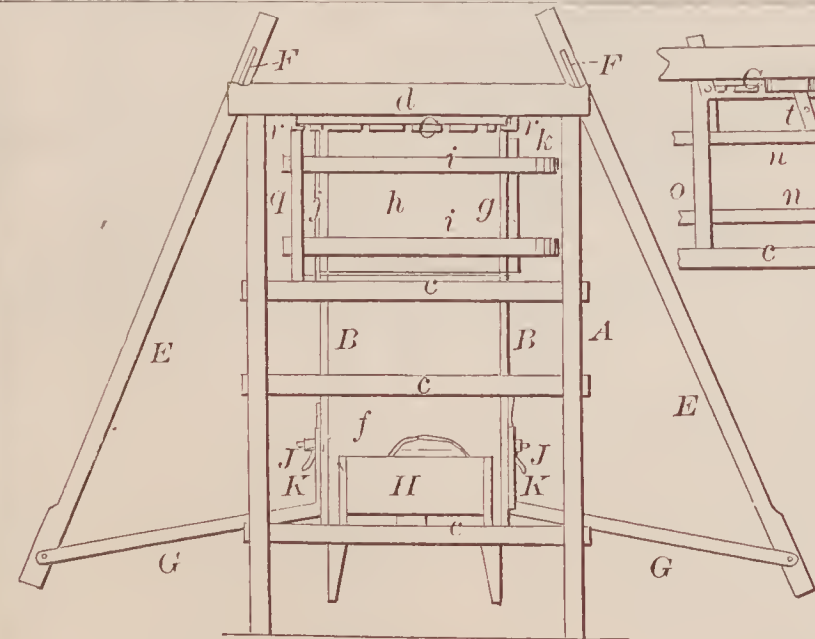
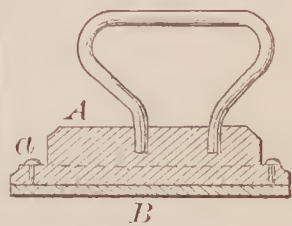

68182—J. H. Godwin—*Baling Press.*

68179—J. M. Freeman—*Riding Attachment for Harrows.*

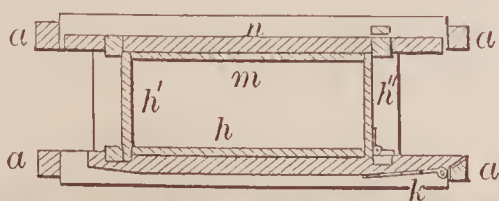



68182—Continued.

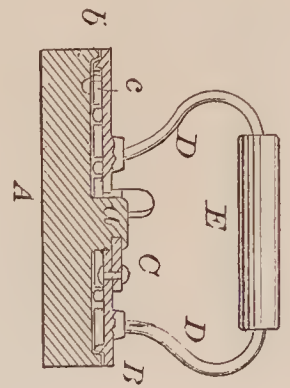
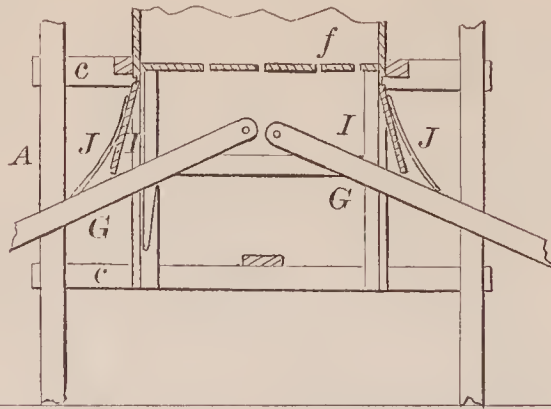
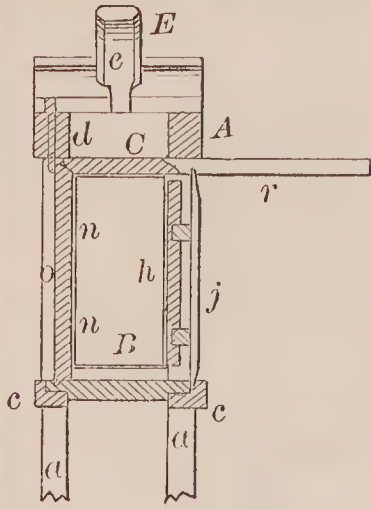

68183—J. Gray—Sadd Iron.

68185—H. G. Hall—Ring for Spinning.



68184—V. Hagmann—Vegetable Cutter.

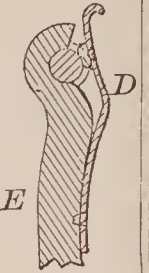
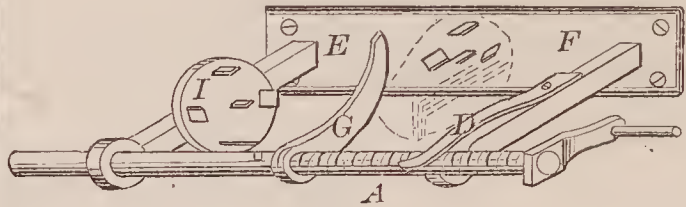

68186—S. G. Hall—Rotary Steam Engine.

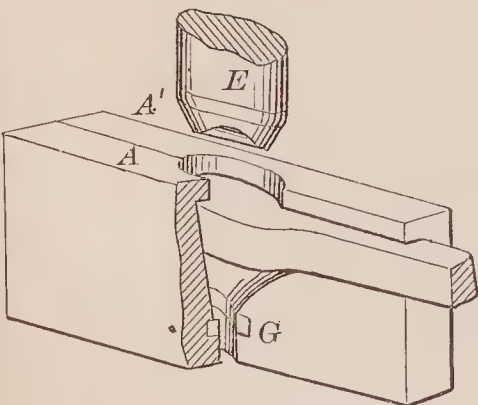
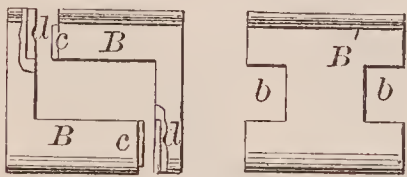
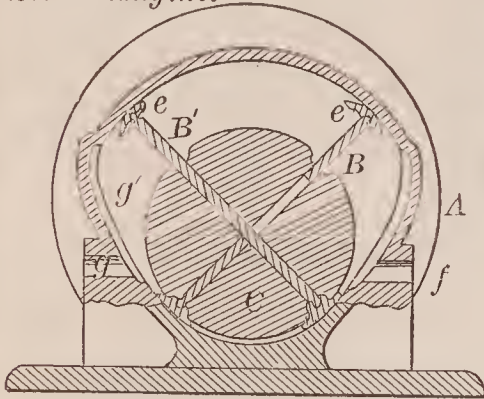

68187—H. M. Hamilton—Die for Forming the Eyes of Picks.

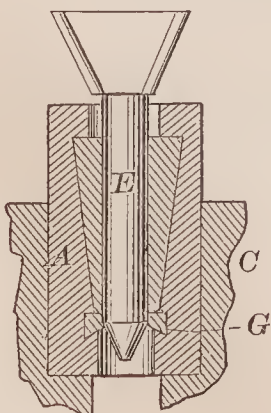

68188—J. R. Hamilton—Fumigator for Destroying Vermin.

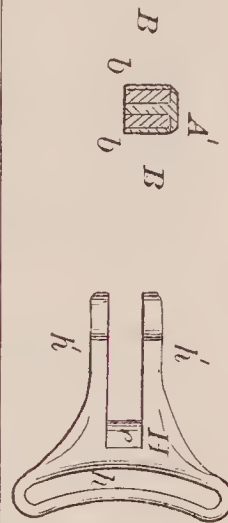
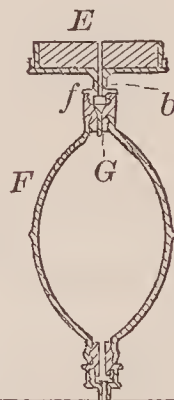
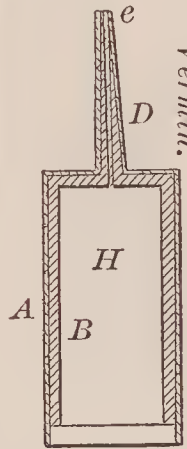

68190—R. Hardenbrook—Grape Plow.

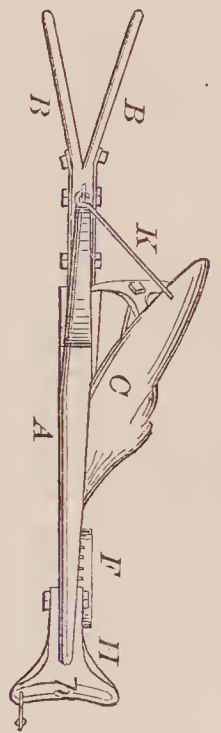

68189—O. Hanks—Curtain Fixture.



68191—J. Harman—Sheep Rack and Mow.

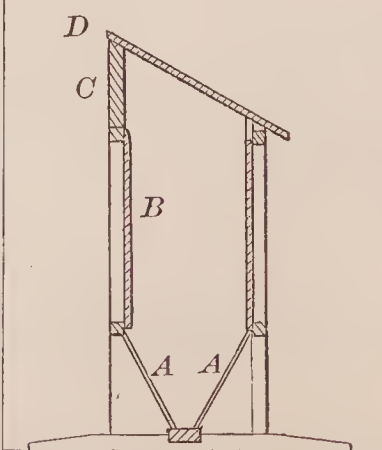

68192—S. Harris—Sash Weight.



68193—W. H. Hawley—Elevating Block.

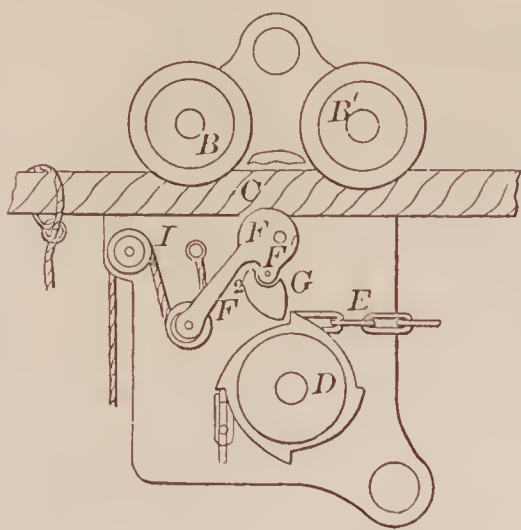

68198—J. C. House—For Agitation of Milk in Cheese Vats.

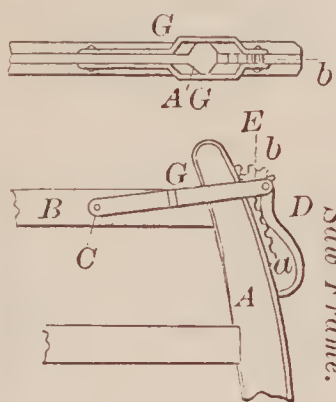
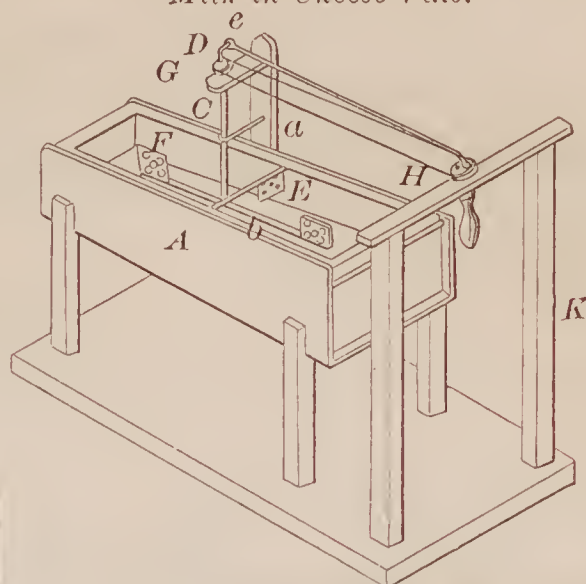

68194—H. M. Hayward—Buck Saw Frame.

68195—Henry & Reist—Horse Hay Fork.

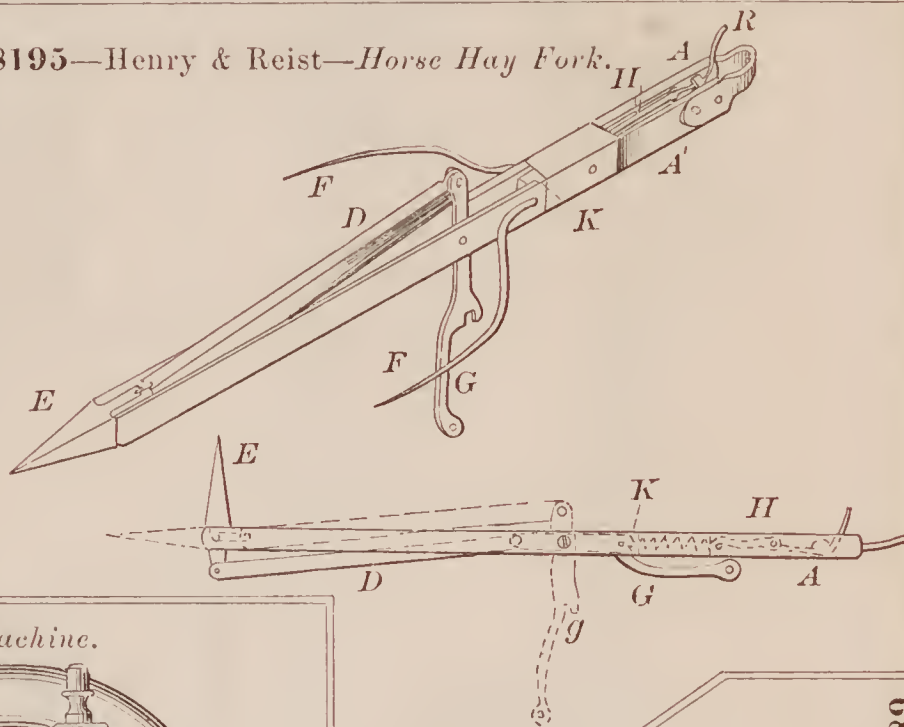

68196—W. S. Hill—Sewing Machine.

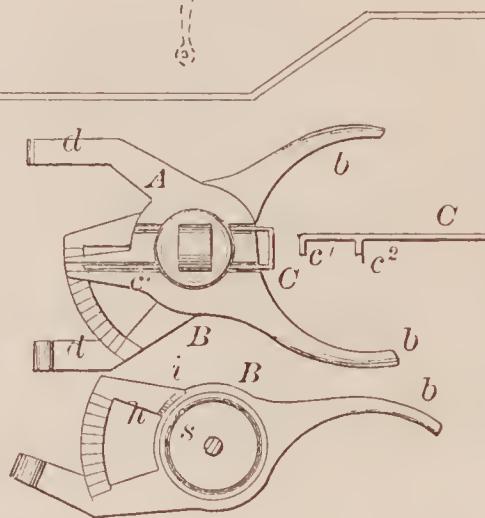
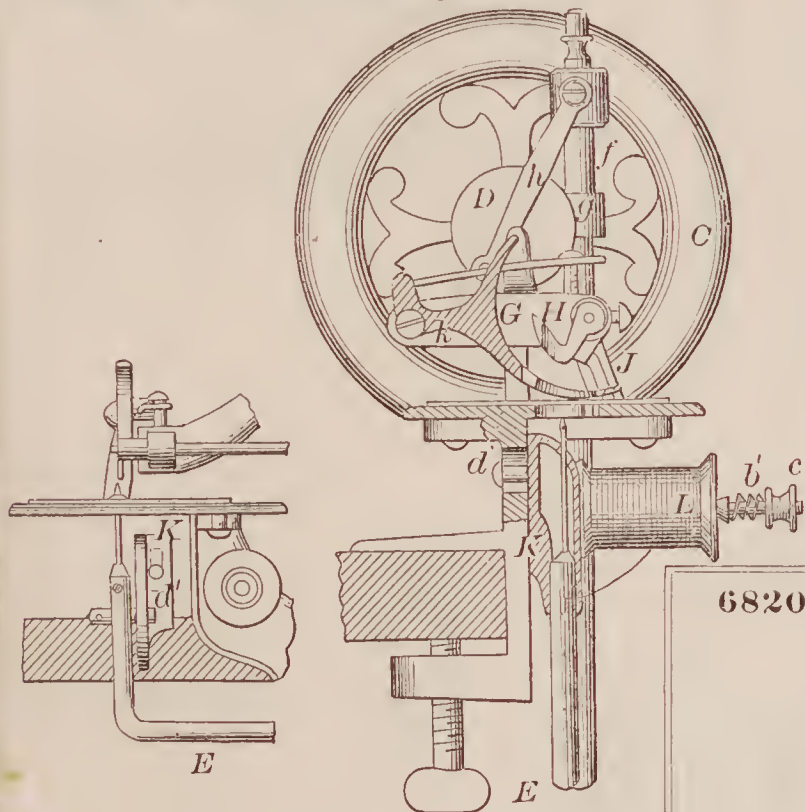

68197—W. L. Hopper—For Catching Animals.

68200—H. Ingraham—Plow Clevis.

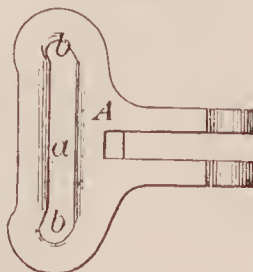

68202—E. A. Jeffery—Griddle.



68201—D. W. Jacoby—Corn Planter and Cultivator.

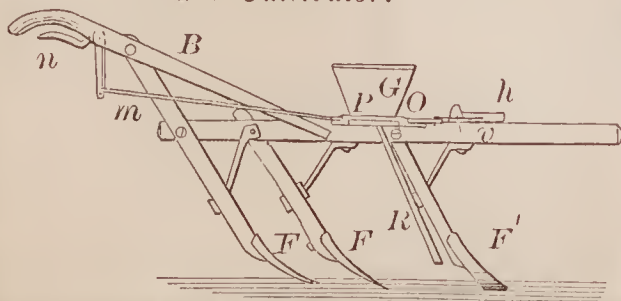

68199—E. Howell—Carriage Curtain Button.

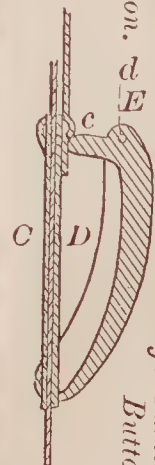



68203—E. Jewett—Veneer Cutter.

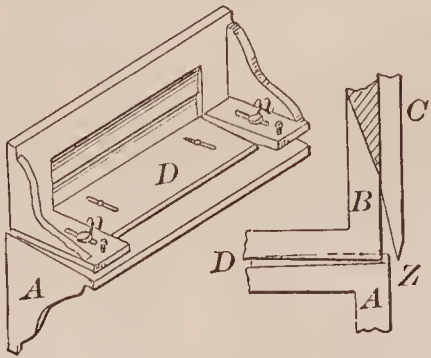

68204—W. B. Johnson—Buckle.

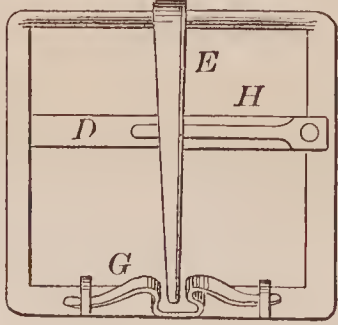

68206—A. Jusberg—Casting Bells.

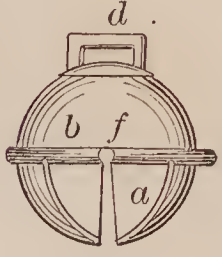

68298—D. L. Gibbs—Mortising Machine.

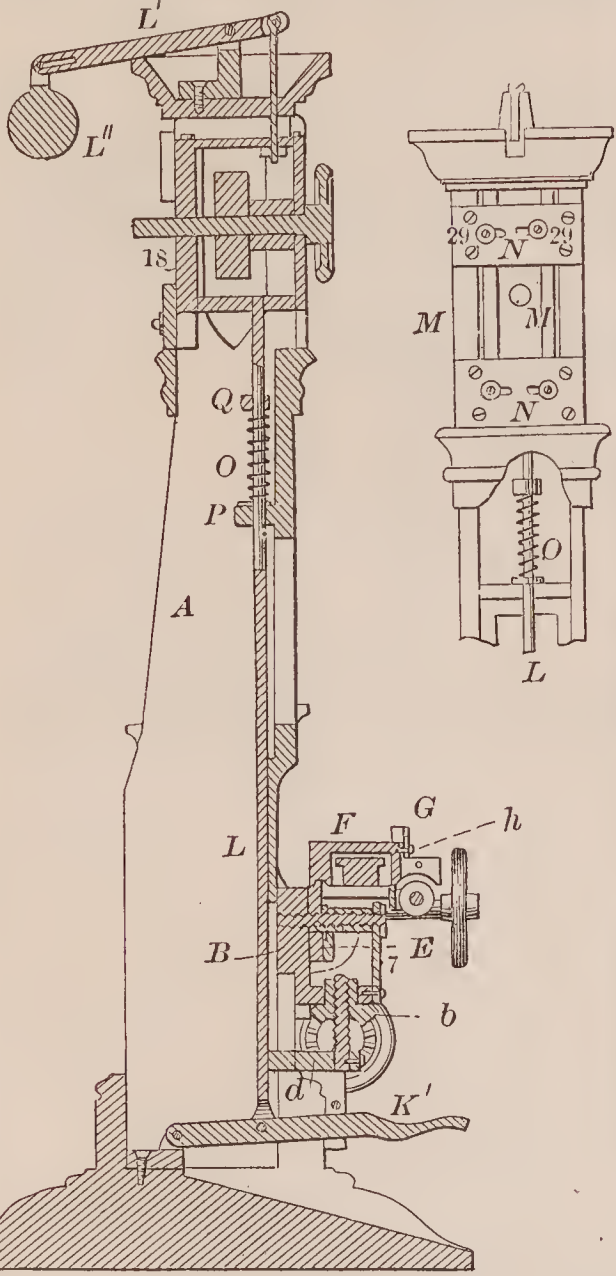

68205—J. Jonson—For Separating Iron from Brass Turnings.

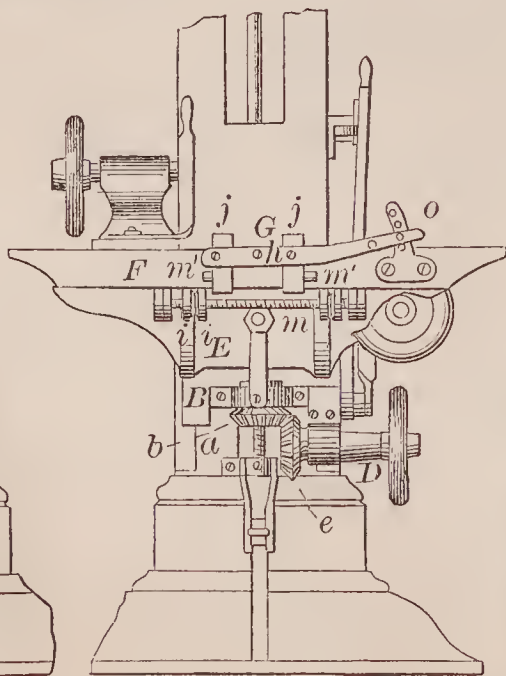
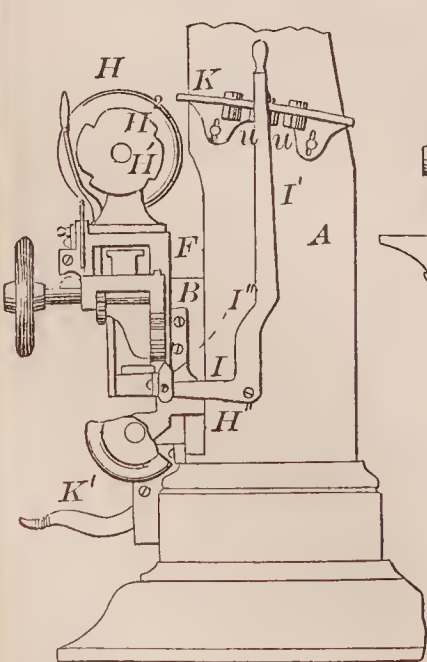
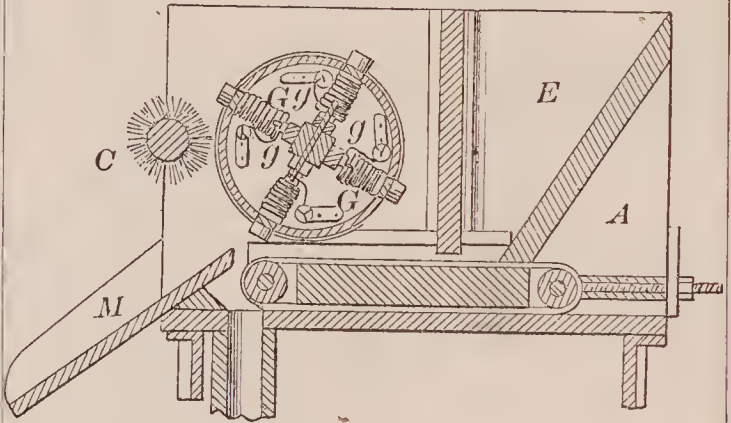
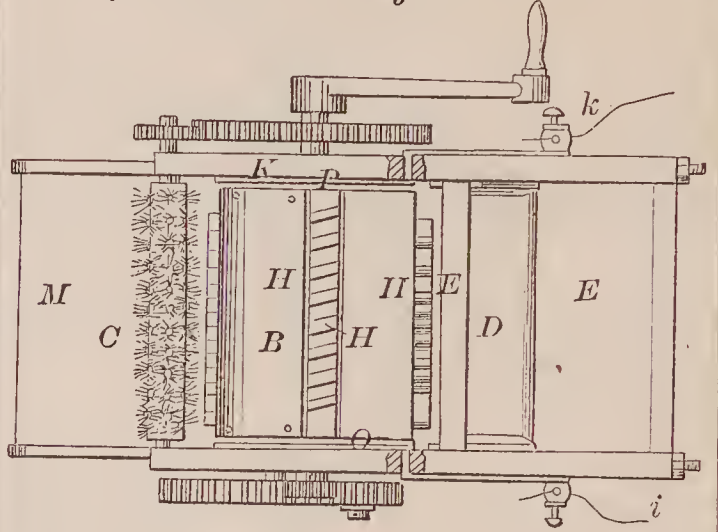

68207—W. J. Keeney—Harvester Pitman.

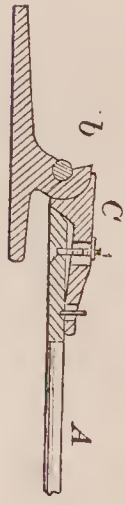

68208—O. P. Kingman—Watch Key.

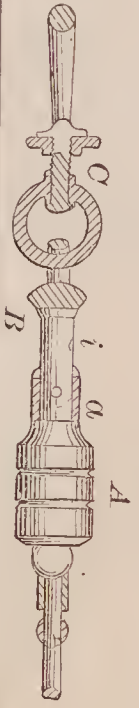

68209—I. Kohn—Broom Head.

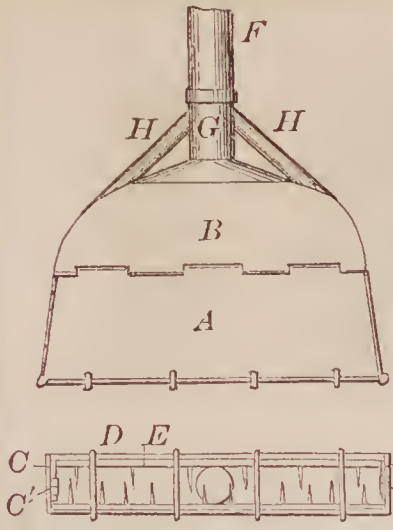

68215—J. Lee—Vise.

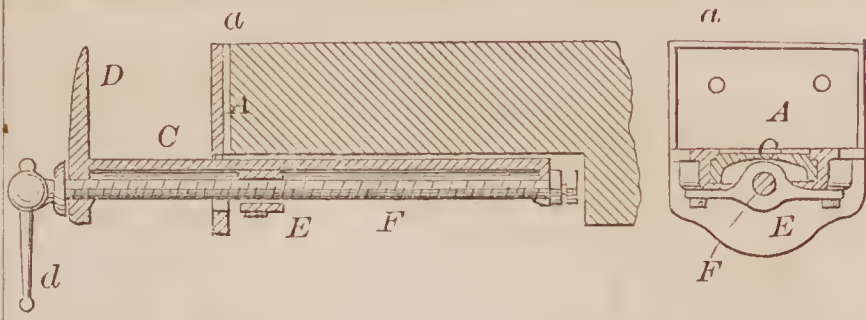

68210—A. Komp—Steam Heating Apparatus.

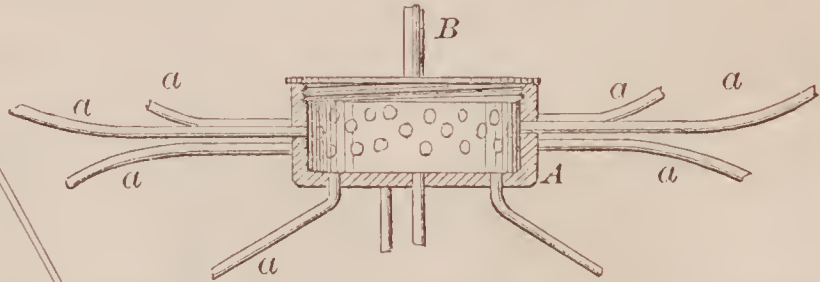

68211—A. F. Kuhlman—Washing Machine.

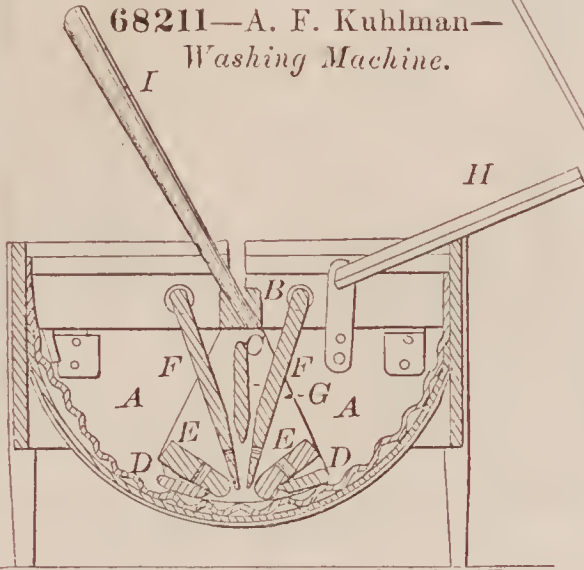

68214—N. H. Leiby—Centrifugal Pump.

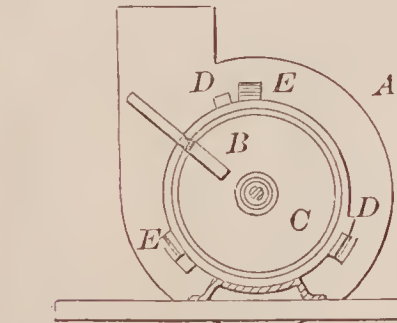
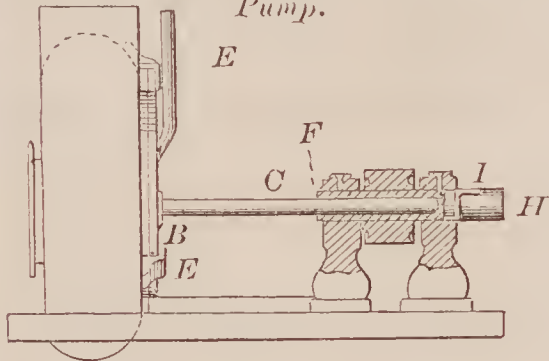

68217—E. C. Lewis—Elliptic Spring.



68212—C. M. Langley—For Driving Printing Presses.

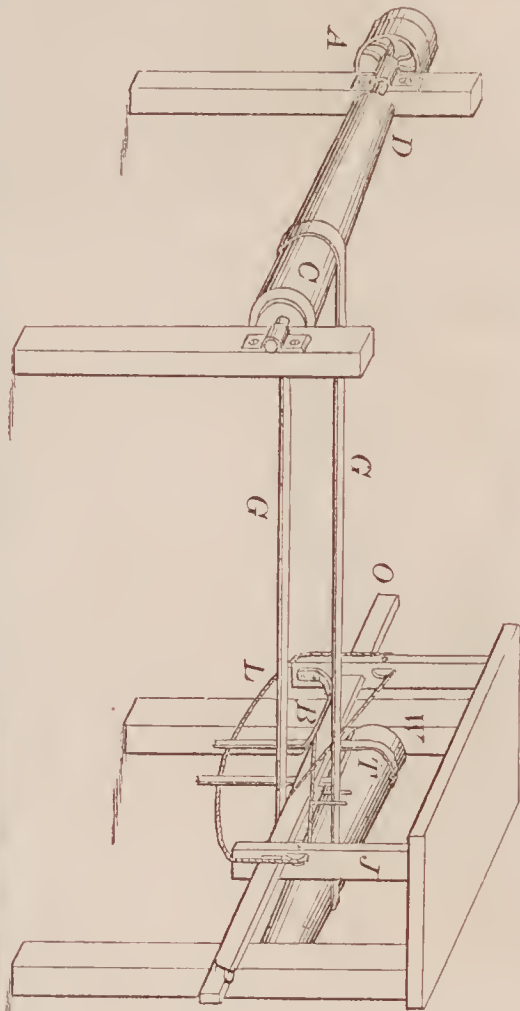

68216—A. Leitner—Portable Crane for Loading Wagons.

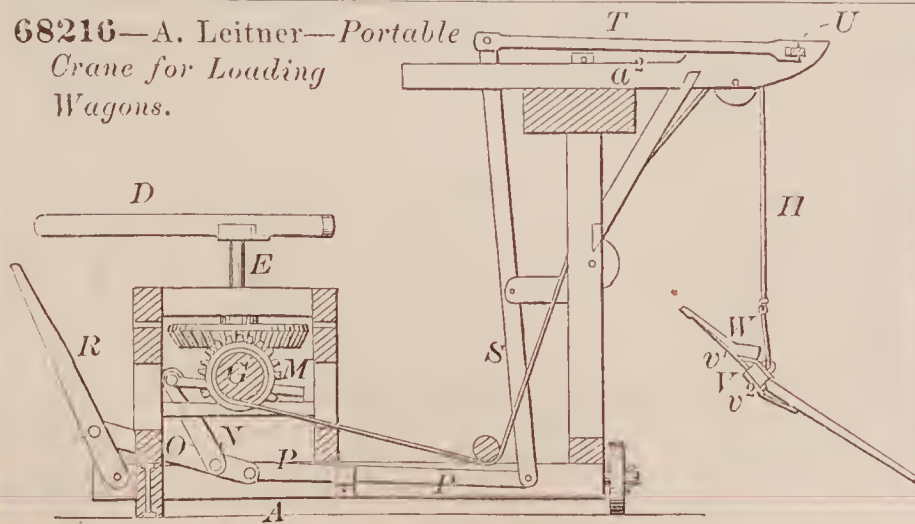

68213—J. A. Lawson—Coal Hod.

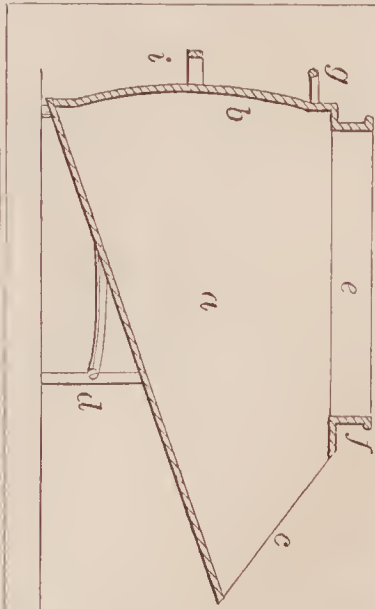



68218—H. Little—For Elevating Ice.

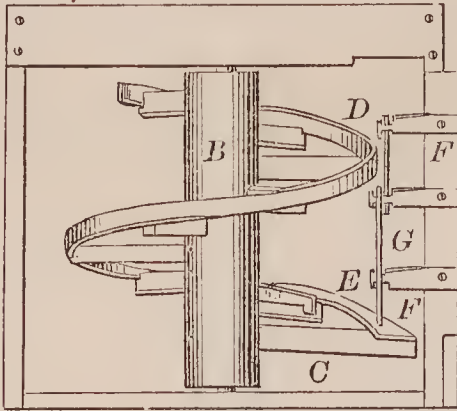

68219—C. L. Lucas—Permutation Lock.

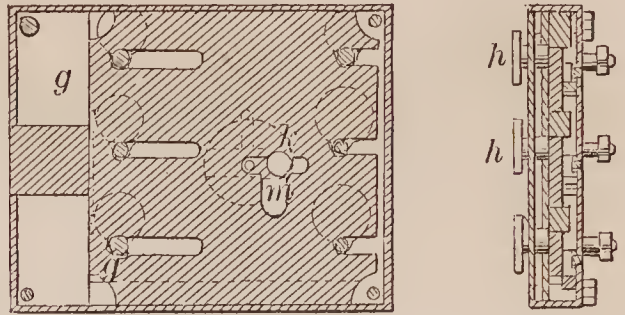

68222—R. G. McKay—For Making Spikes.

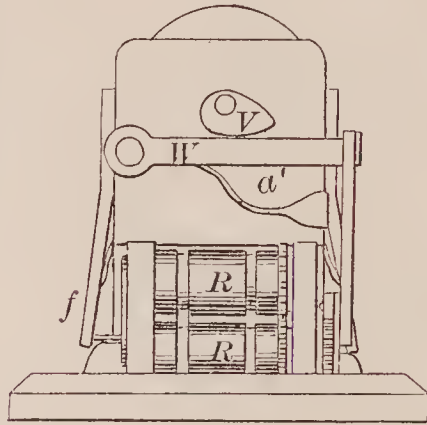
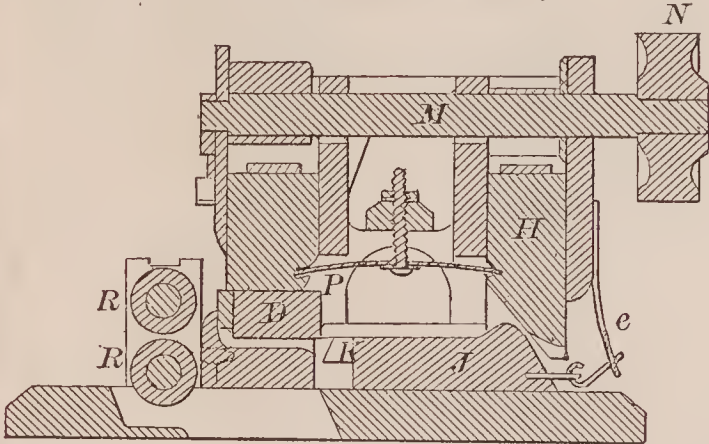

68220—G. B. Markham—Bed  
a  
B Spring  
A  
C

68223—C. Miller—Snap Hook.

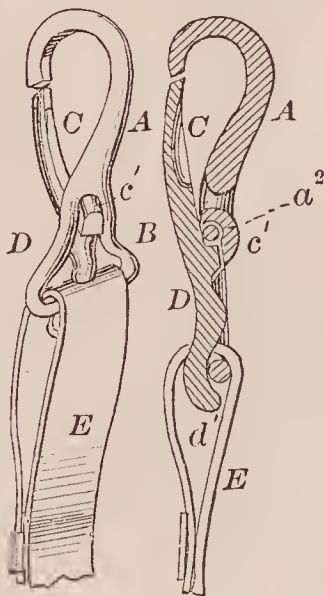

68224—Minor & Ward—For Filling Ruts and Leveling Roads.

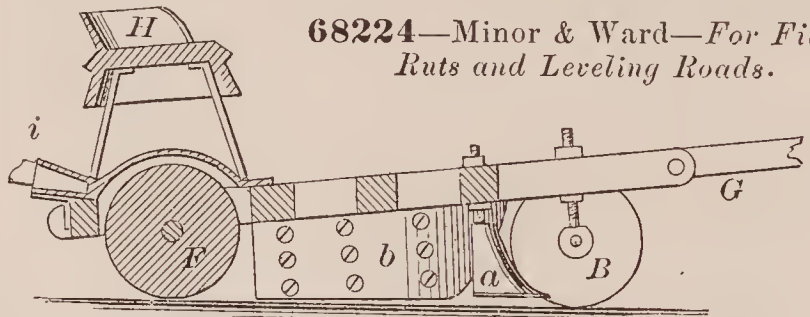

68227—E. Palmer—Grain Rake.

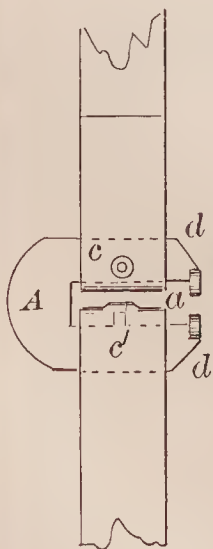
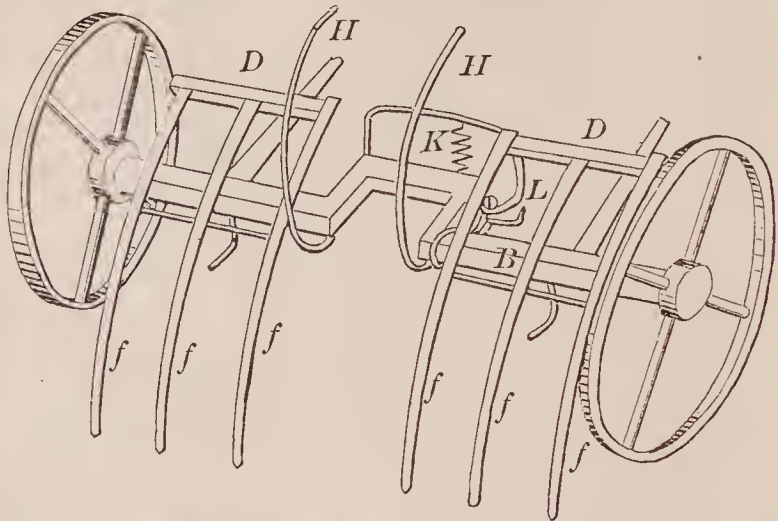

68225—S. J. Mitchell—Cotton Bale Tie.

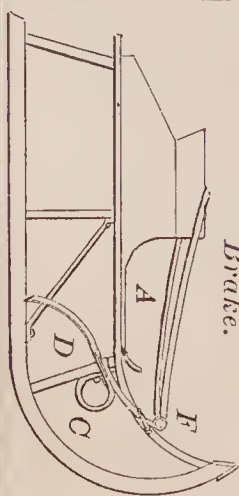

68226—H. F. Morton—Sleigh Brake.

68228—I. H. Palmer—Stump Extractor.

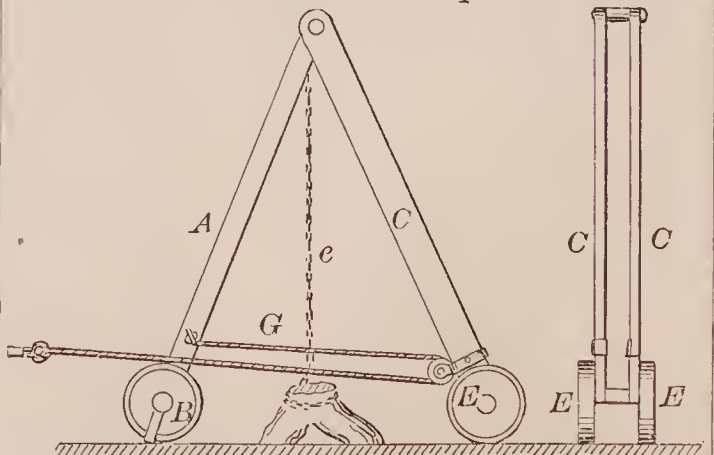

68229—J. C. Palmer—Plate Warmer.

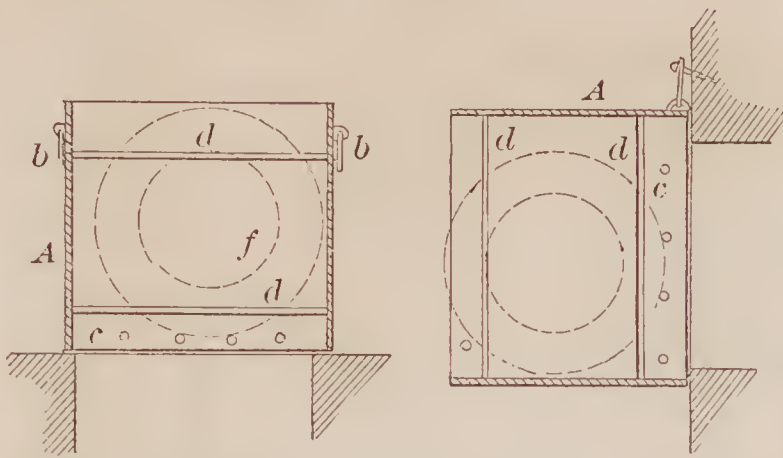

68230—J. N. Parker—Lifting Jack.

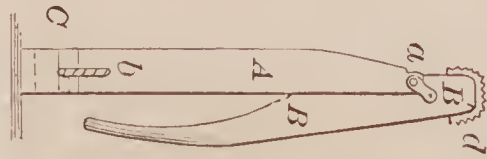

68231—G. H. Peacock—Carbureting Apparatus.

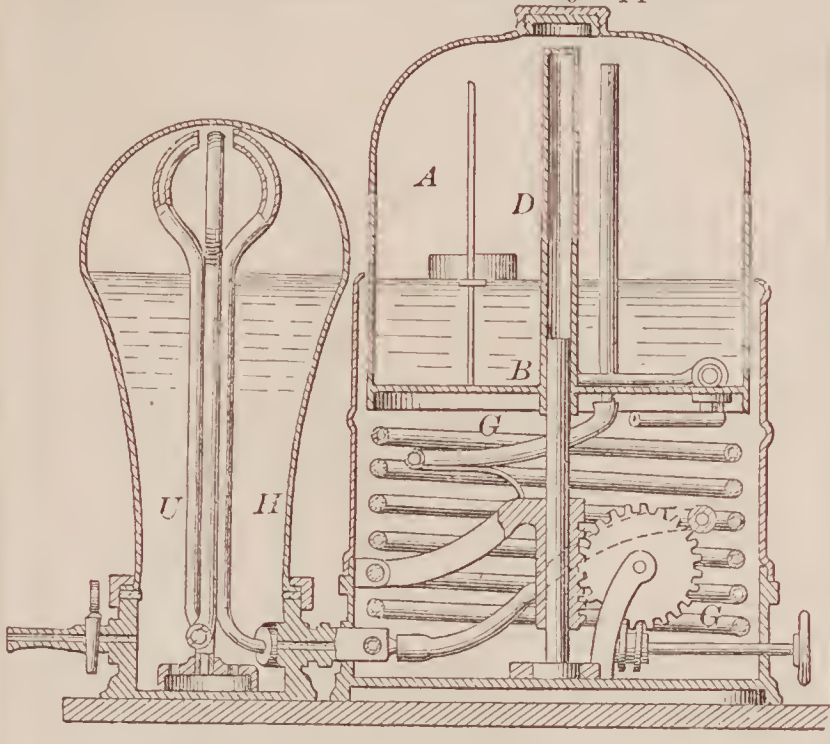

68233—S. I. Potter—Roll for Rolling Railroad Rails.

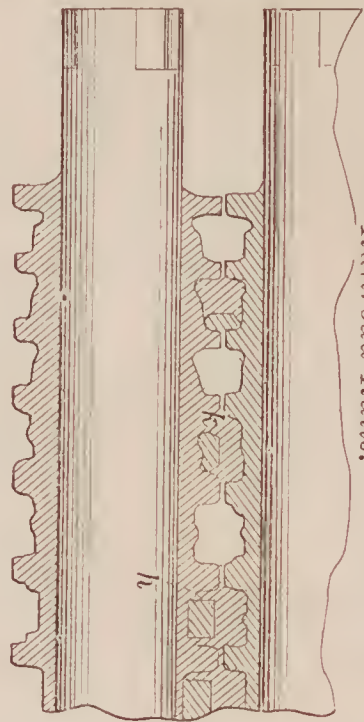

68236—W. P. Read—Paper Binding.

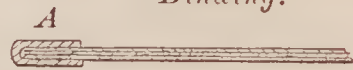

68232—J. Pitcher—Floating Fence.

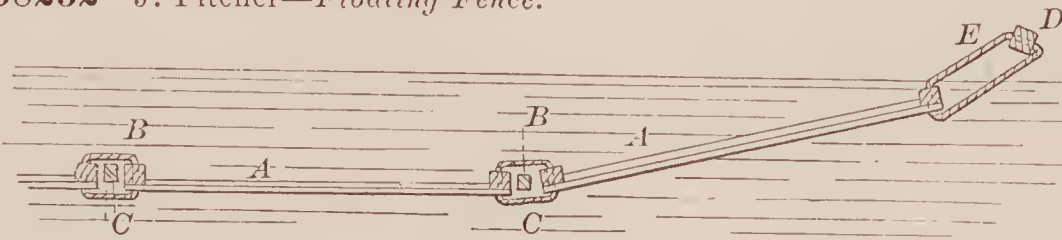

68235—E. Quimm—Water Gauge for Steam Generators.

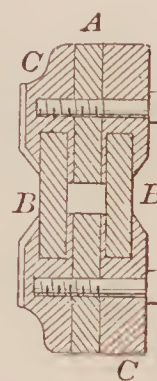

68234—C. T. Provost—Barrel.

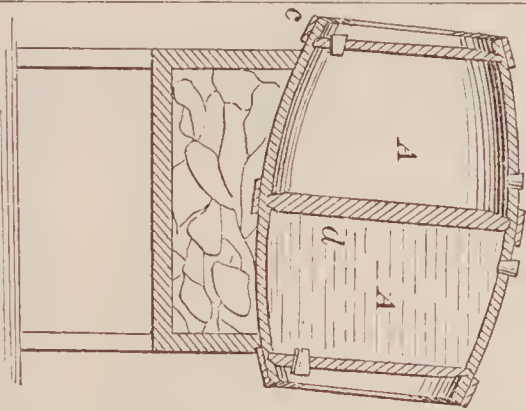

68237—M. Ryerson—Swing Tree.

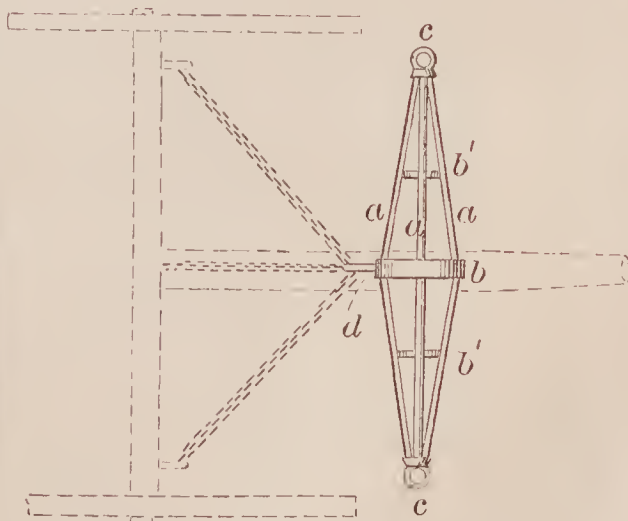

68238—W. S. Ryerson—Hoop Skirt.

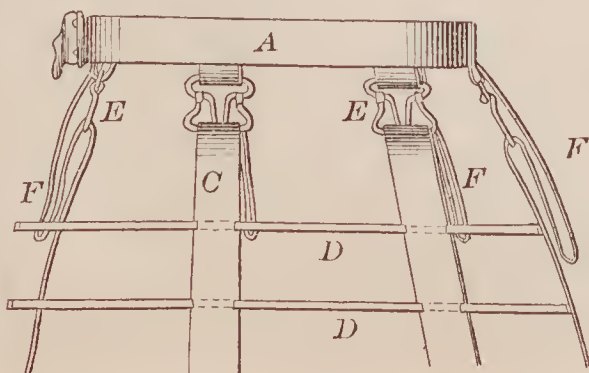



68239—W. Ryner—Steam Drying Apparatus.

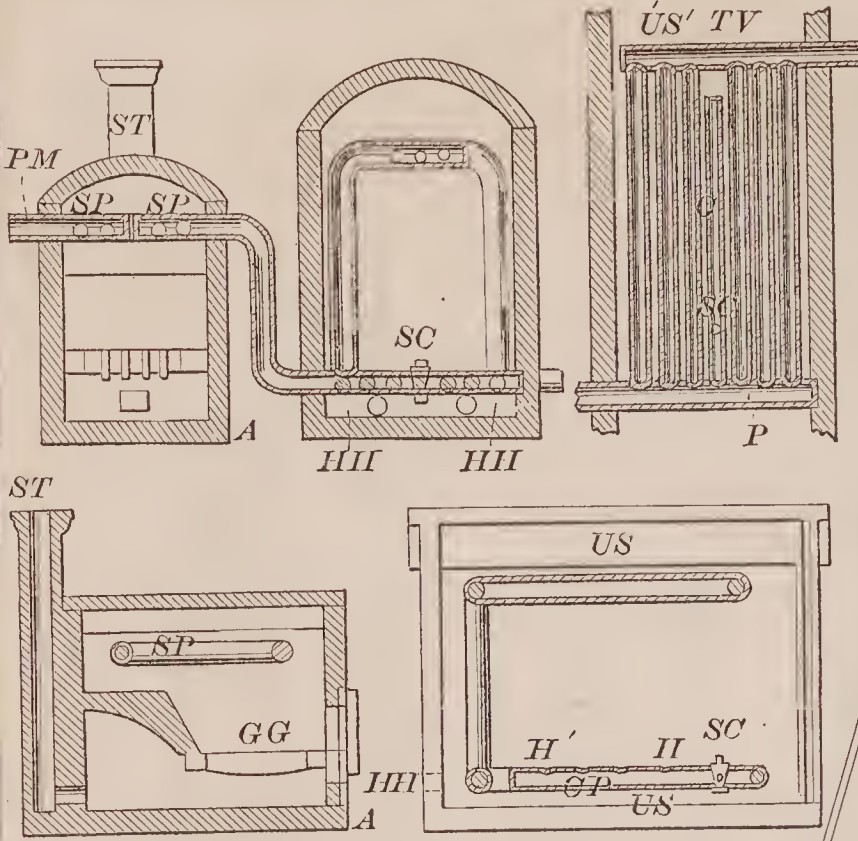

68241—C. H. Sawyer—Jack Screw.

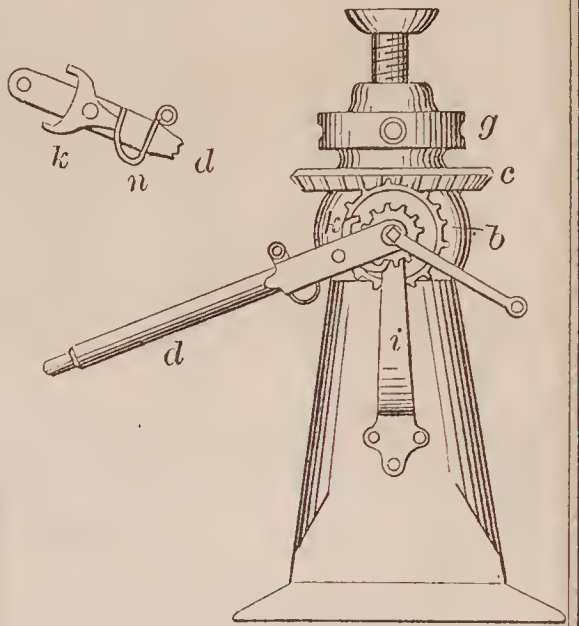

68243—W. Schreck—Straw Cutter.

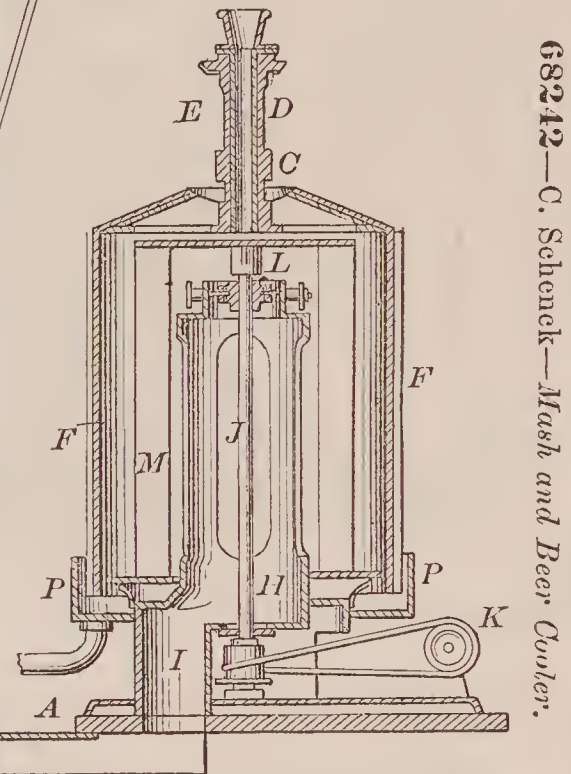
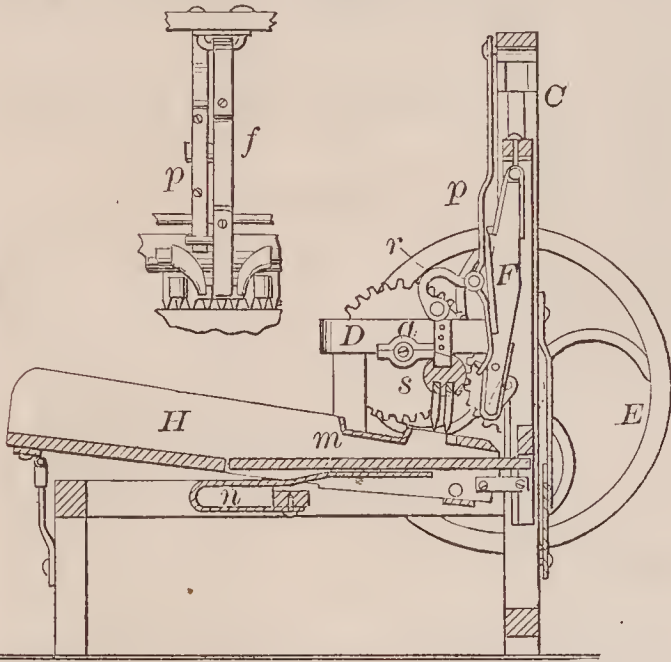

68242—C. Schenck—Mash and Beer Cooler.

68240—A. Saeger—Wool Packer.

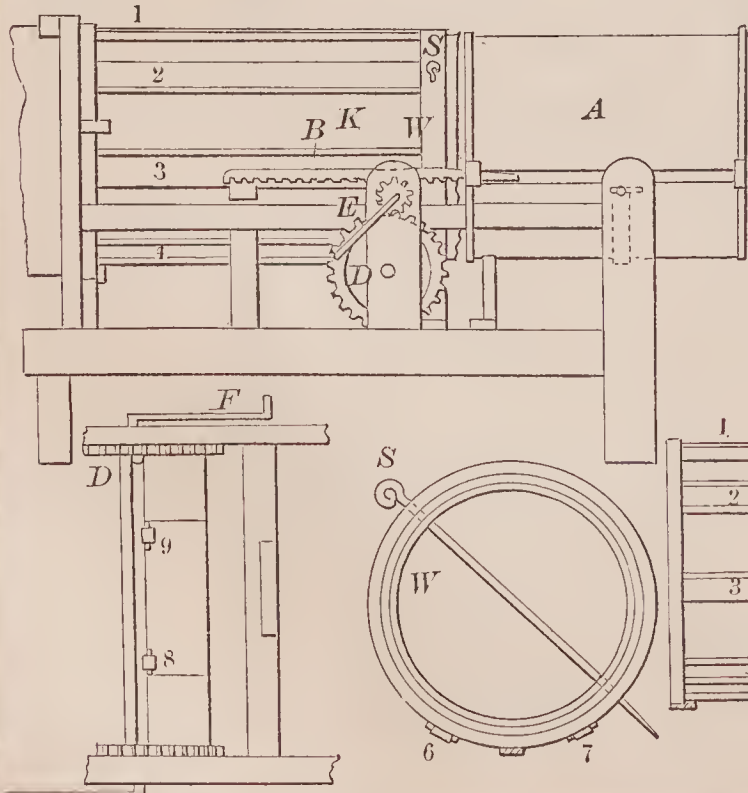
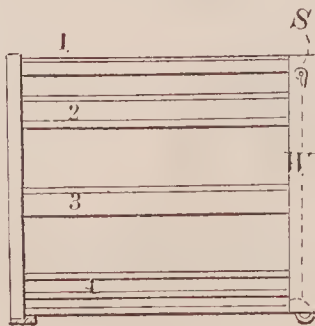
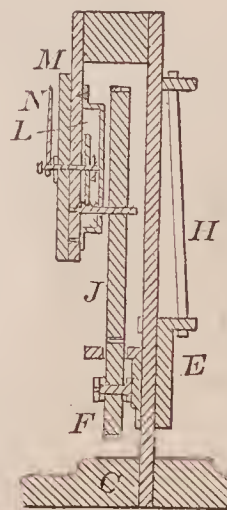
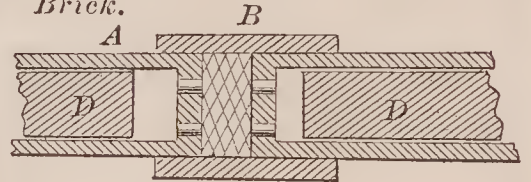

Fig. 5



68244—O. W. Seely—For Pressing Brick.



68245—T. A. Shimm—For Measuring Dry Goods.







68256—H. Stone—Grater.

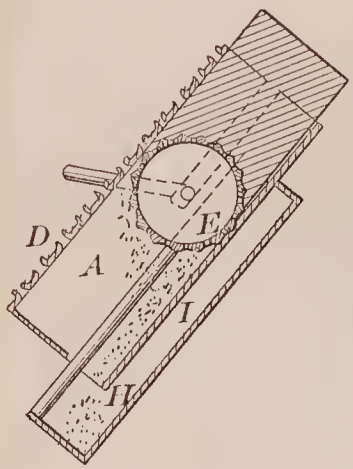

68258—A. B. Sweetland—Refrigerator.

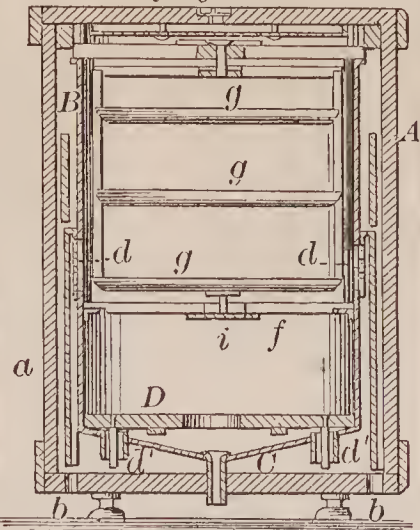

68259—E. Thayer—Dust Brush.

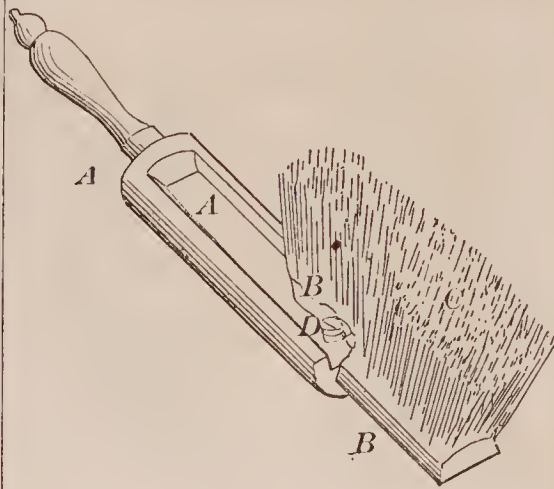

68257—O. Stott—For Distilling and Rectifying Petroleum.

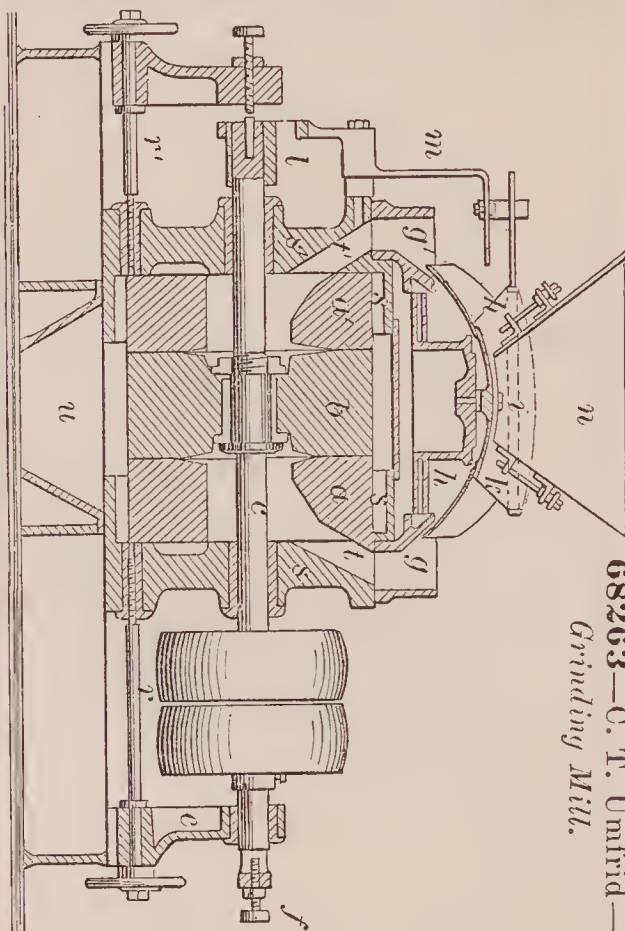
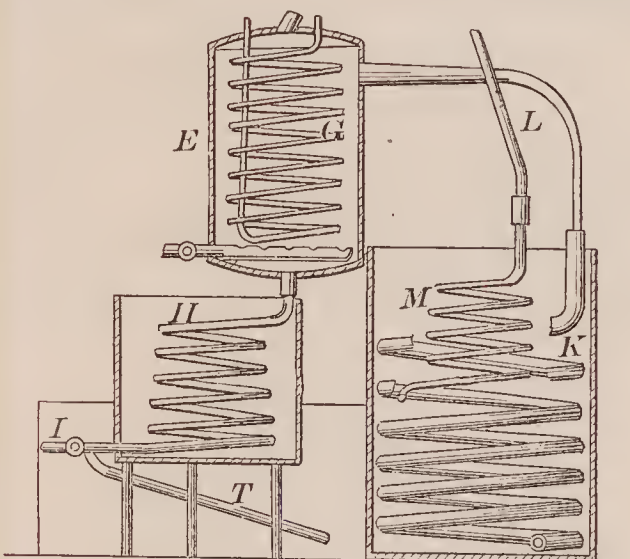

68263—C. T. Unfid—Grinding Mill.

68262—J. C. Tobias—Cotton Seed Planter.

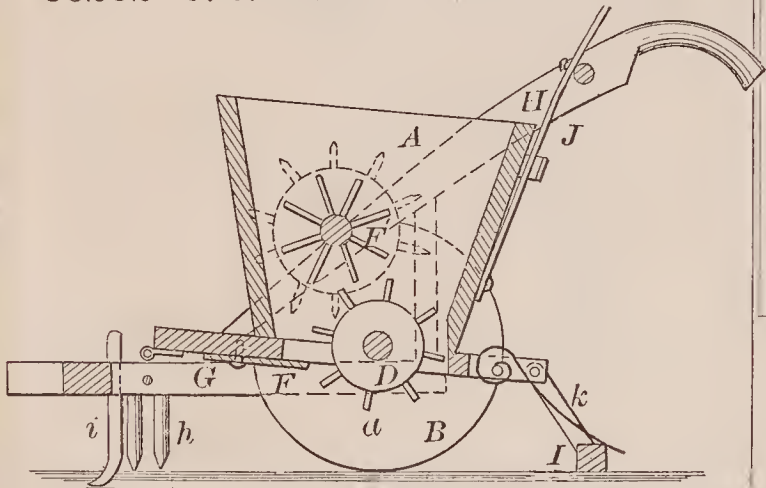

68268—O. H. Weed—Spring Bed Bottom.

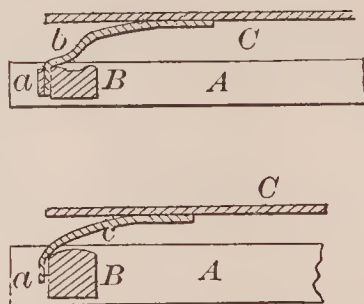

68265—J. C. Walker—Ship Viameter.

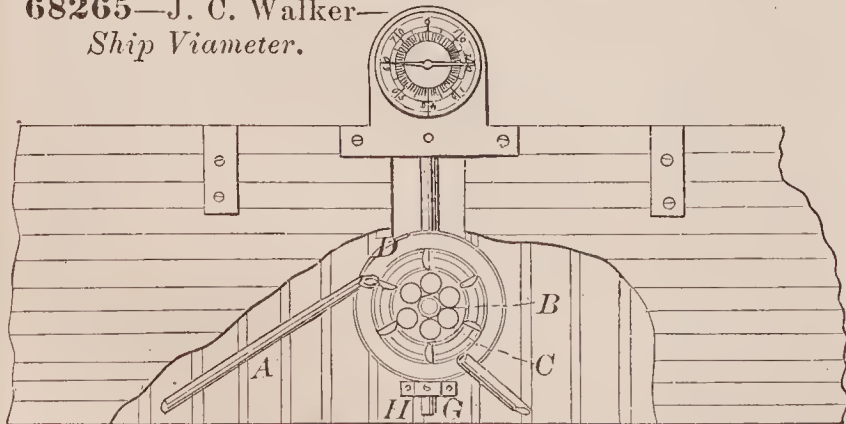

68267—Walters & Shaffer—Pile for Wrought Iron Beams or Girders.

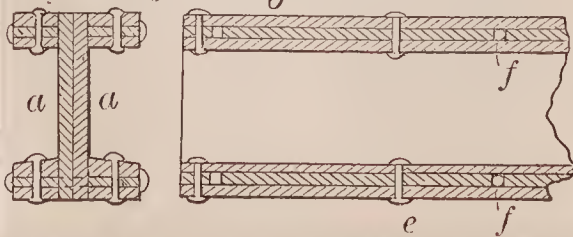

68266—Walters & Shaffer—Pile for Wrought Iron Beams or Girders.

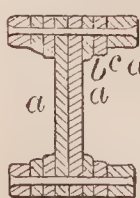

68269—J. De W. Wemple—Refrigerator.

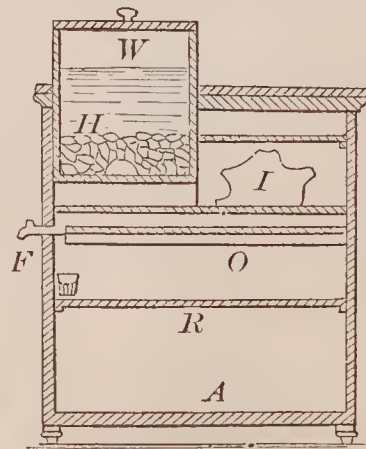

68270—J. Whitney—Washing and Wringing Machine.

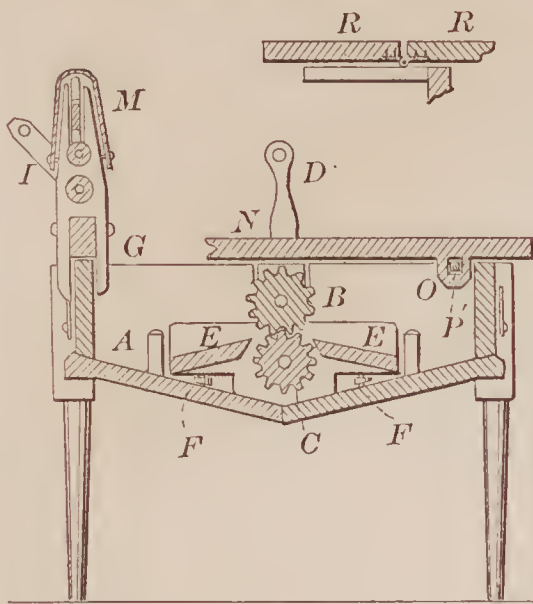

68272—D. Williams—Corn Husker.

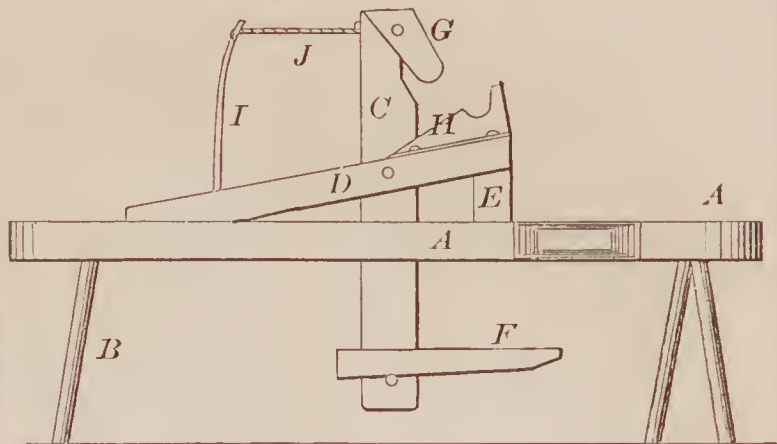

68274—T. H. Wood—Carriage Shaft Coupling.

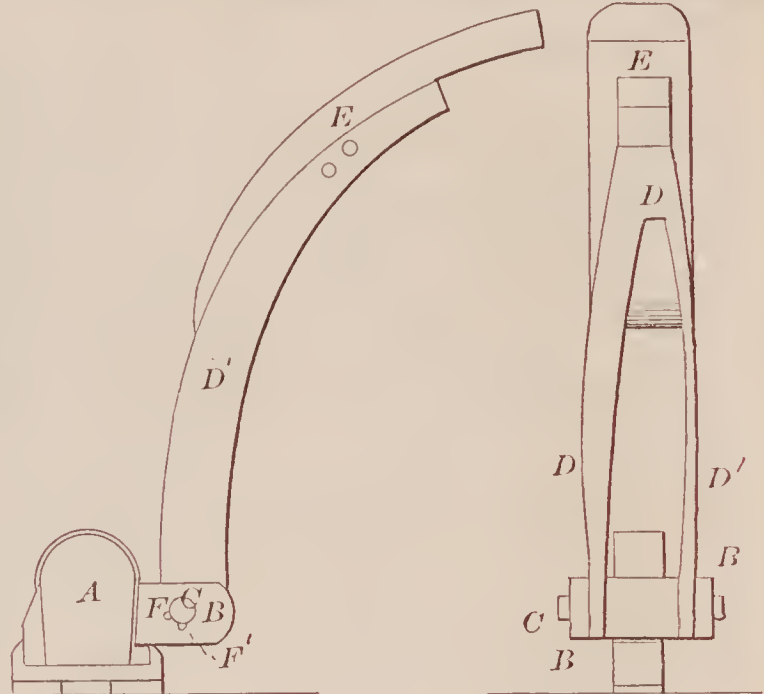

68271—W. W. Wilcox—Strawberry Trellis.

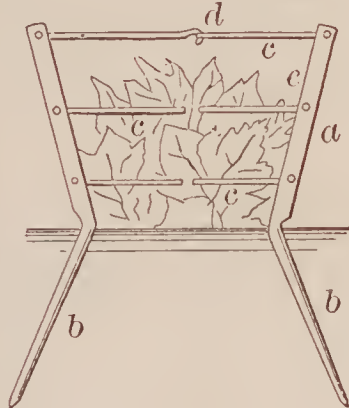

68273—S. C. Wilson—Churn.

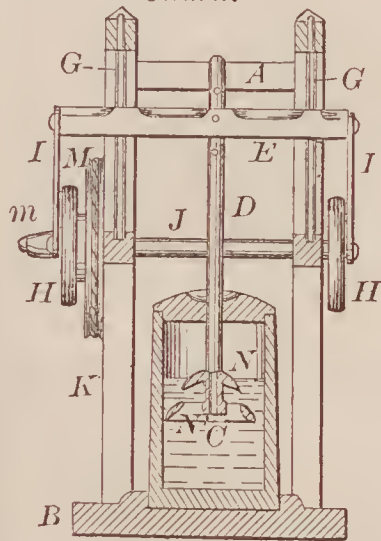

68276—H. Yerty—Milk House.

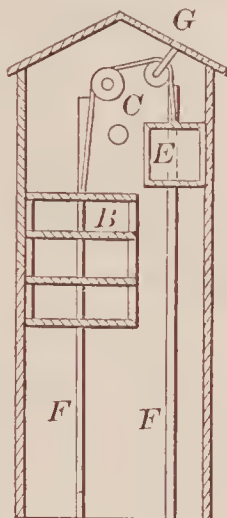

68277—G. C. Avery—Gang Plow.

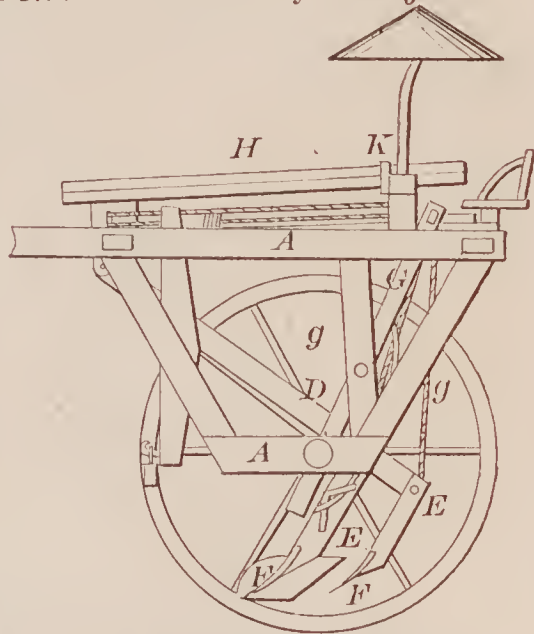

68275—J. Worden—Washing Machine.

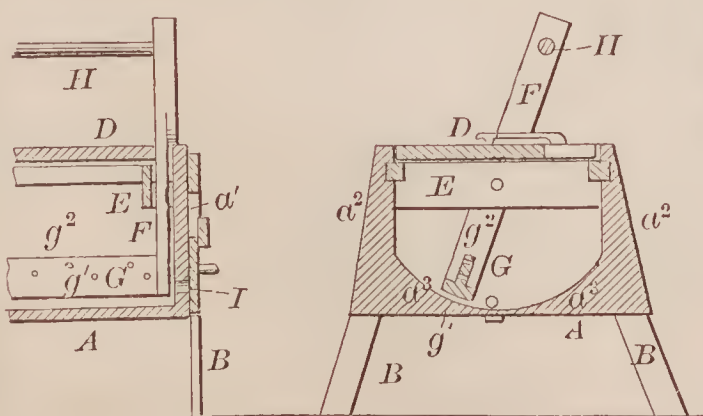

68278—D. W. Bashore—Lamp Shade.

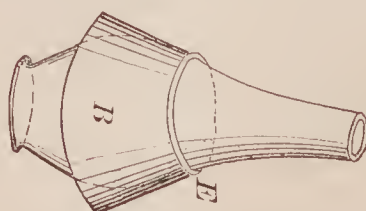



68281—F. W. Brettell—Permutation Lock.

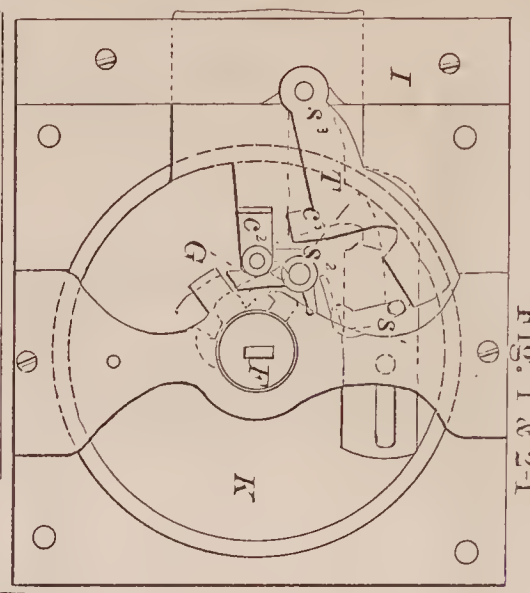

Fig. 1 & 2-I

Fig. 5-II



Fig. 6-II



Fig. 7-D



Fig. 3-I

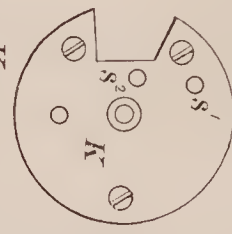

Fig. 2-II

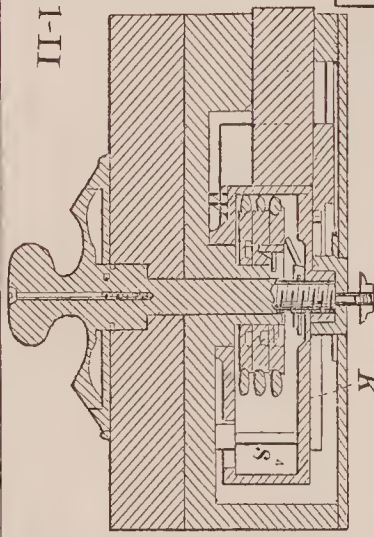
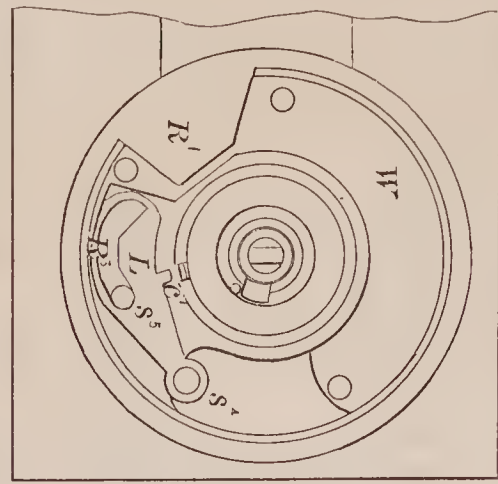
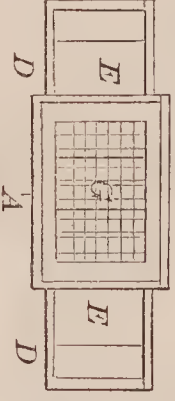

Fig. 1-II



68279—W. A. Remis—Cheese Curd Cutter.



68283—E. W. Bullard—Horse Rake.

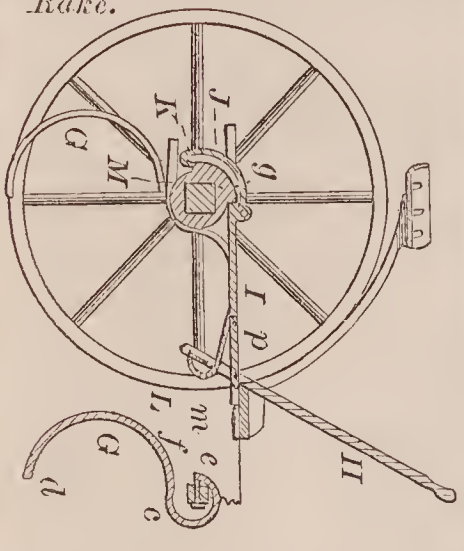

68280—F. Binder—Hedge Trimmer.

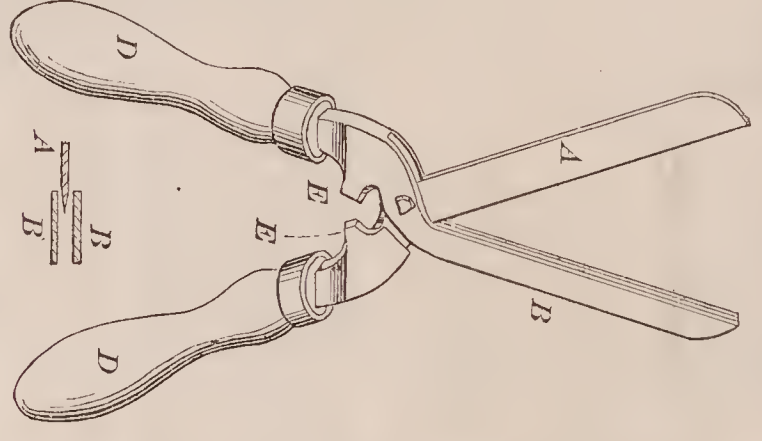

68285—M. S. Burr—Nursing Bottle.

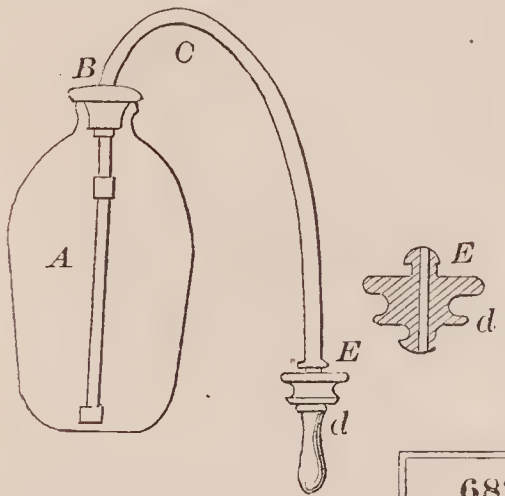

68286—C. M. Carleton—Washing Machine.

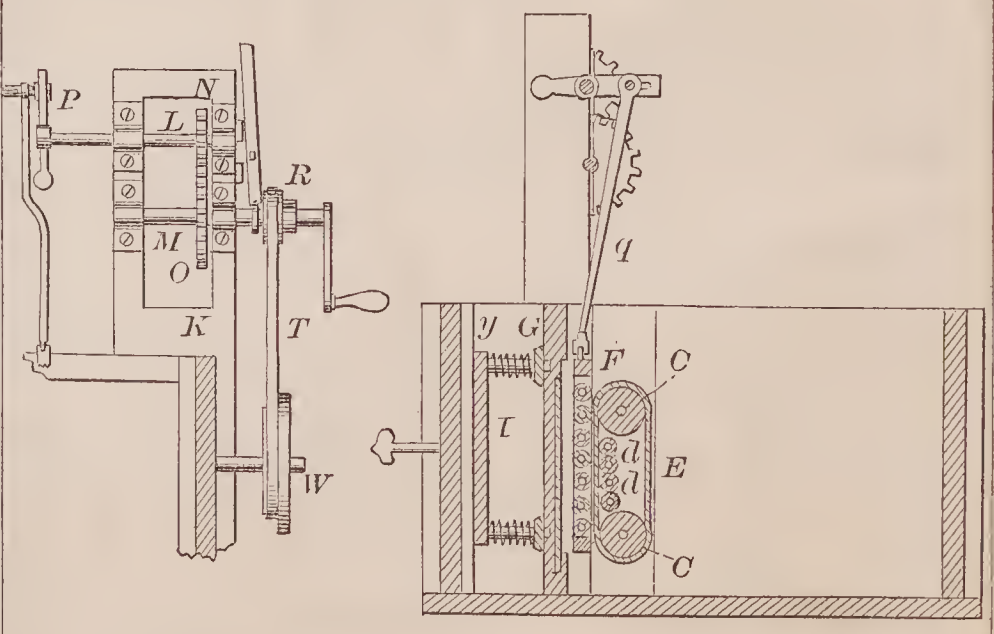

68282—O. Brown—Baling Short Cut Hay, &c.

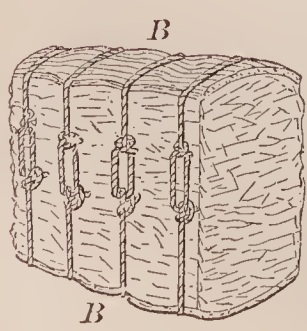







68302—R. S. Jennings—Playing Card Board.

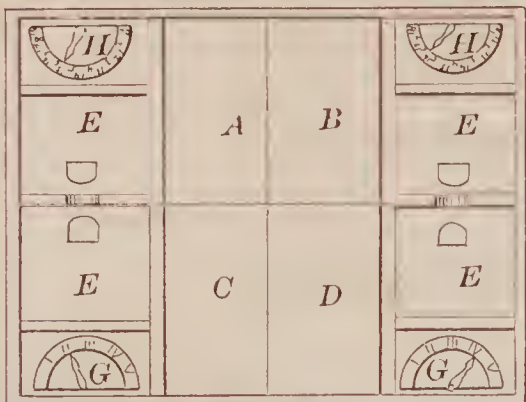

68309—N. S. Noyes—Potato Digger.

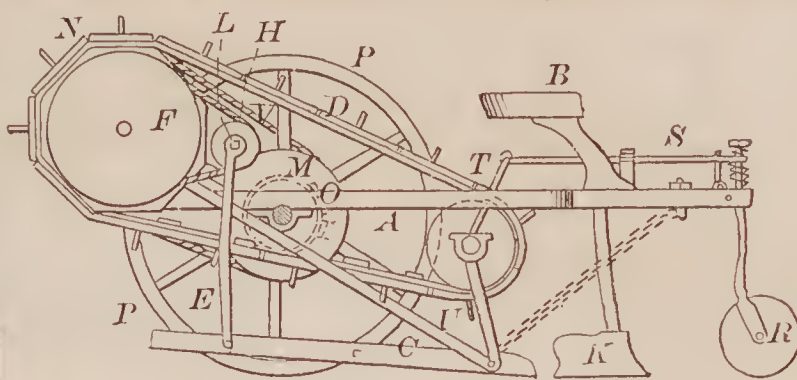

68303—L. J. Knowles—Harness Motion for Looms.

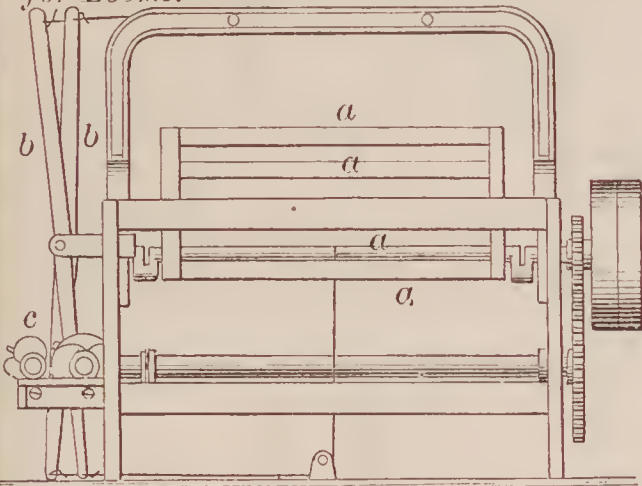

68305—G. Moulton—Bill Holder.

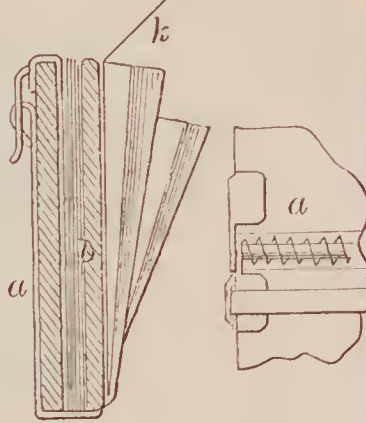

68304—W. Morse—Line Holder.

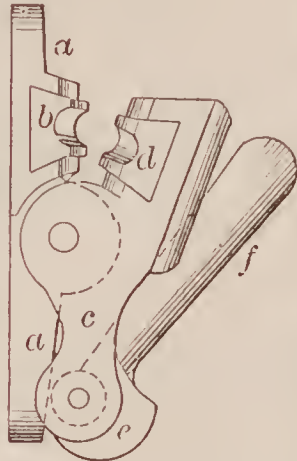

68310—H. E. Paine—Steam Plow.

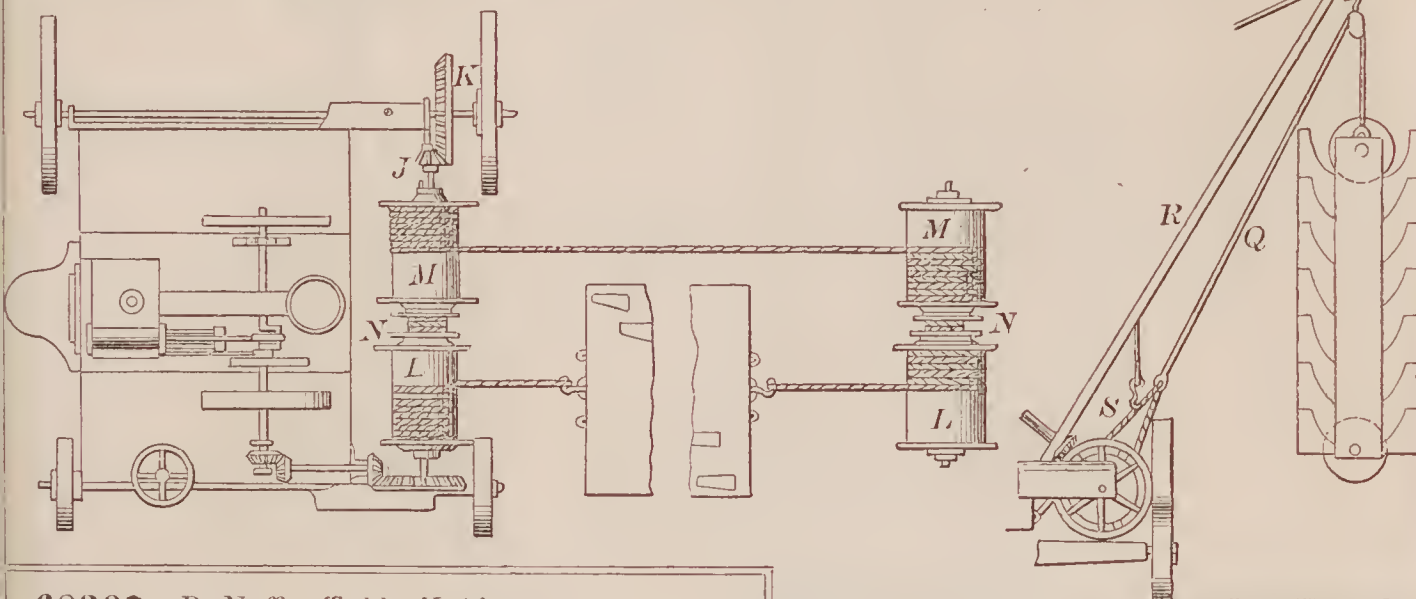

68307—P. Neff—Table Knife.

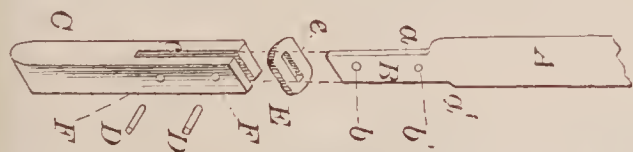

68306—Mason & Wilson—Gate for Railroad Crossings.

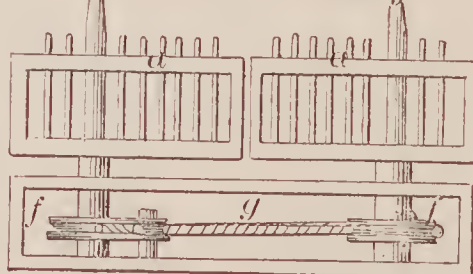

68311—J. Peacock—Barrel Washing Machine.

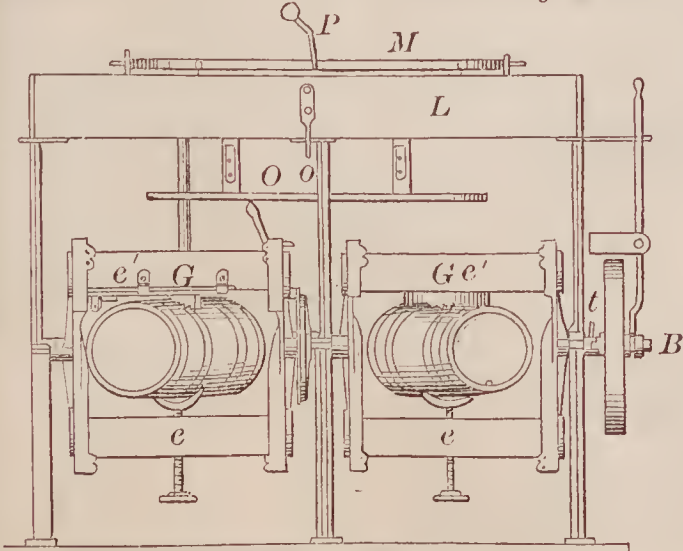

68308—D. Newton—Hitching Post.

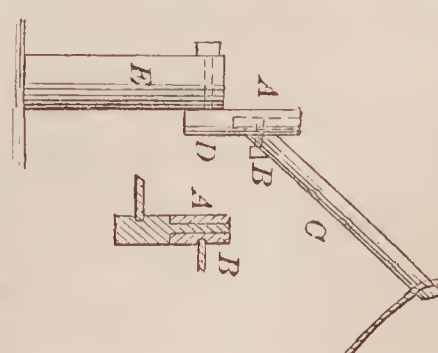



68311—Continued.

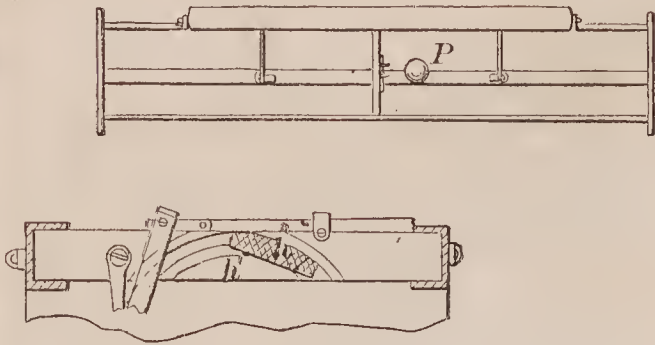

68312—Piper & Marshall—Slide Valve.

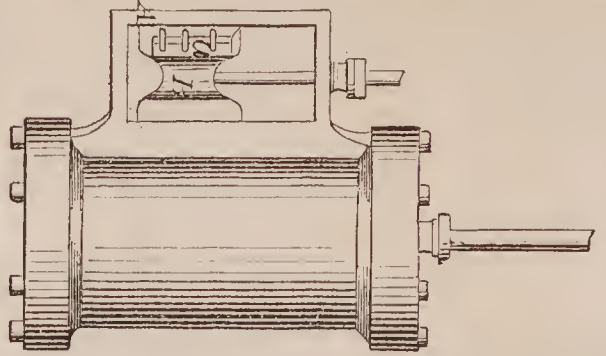

68313—B. C. Rouse—Plow.

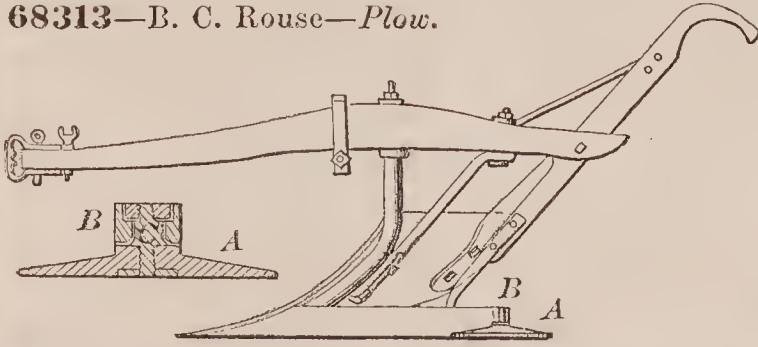

68316—C. L. Sheldon—For Cooling Milk.

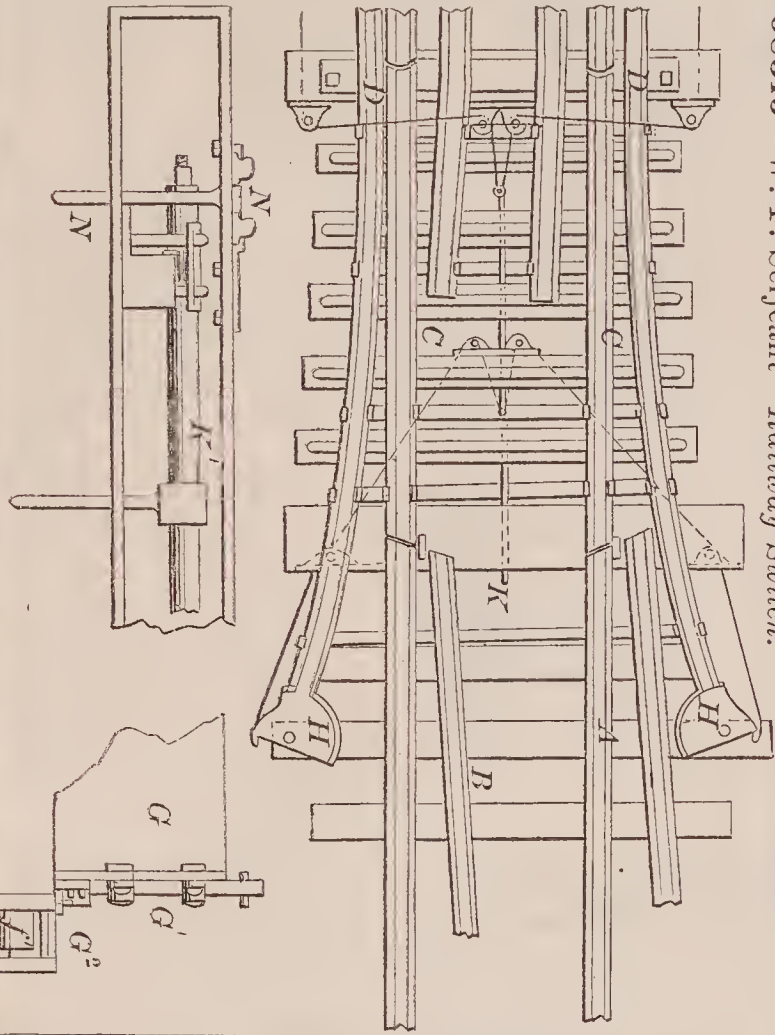
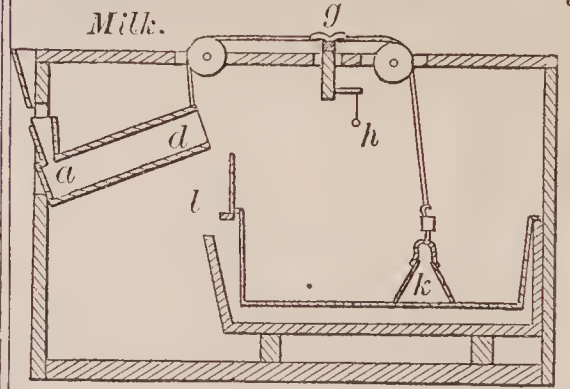

68315—W. F. Serjeant—Railway Switch.

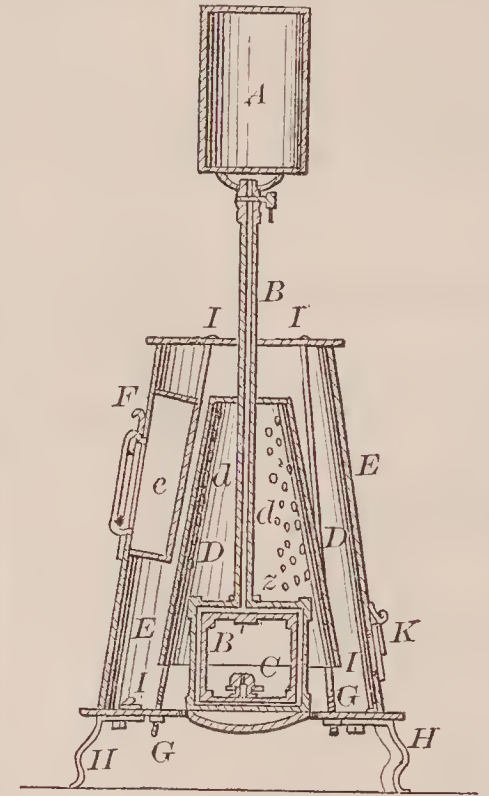

68318—J. D. Spang—Gas Heating Apparatus for Sad Irons.

68317—G. P. Sisson—Clothes Dryer.

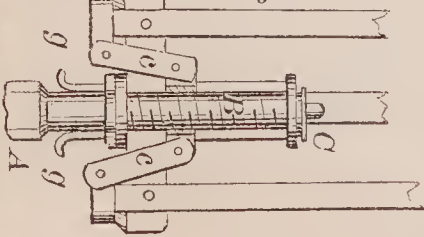

68319—C. F. Spencer—Fruit Jar.

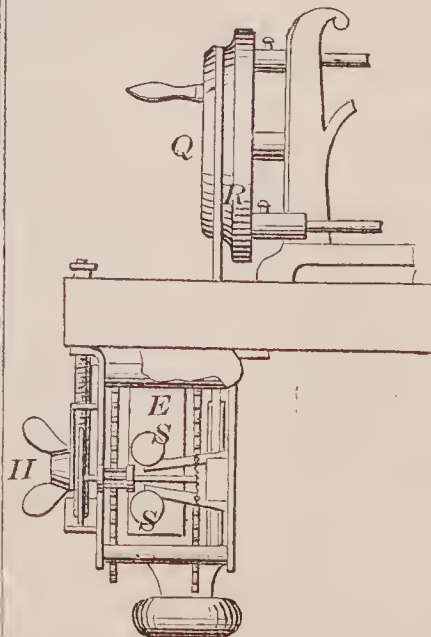
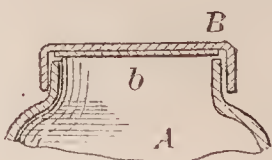

68314—L. W. Sapp—Mechanical Power.

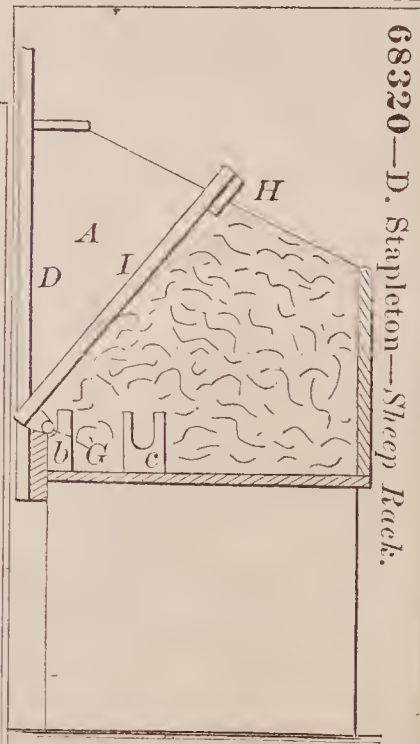

68320—D. Stapleton—Sheep Rack.



68322—G. St. George, Jr.—  
Barrel.

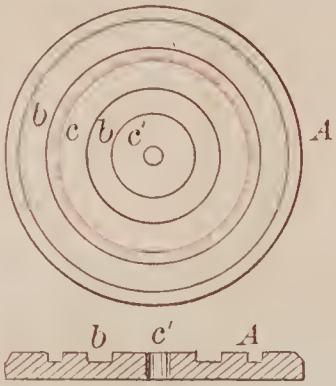

68324—W. B. Tucker—  
Watch Regulator.

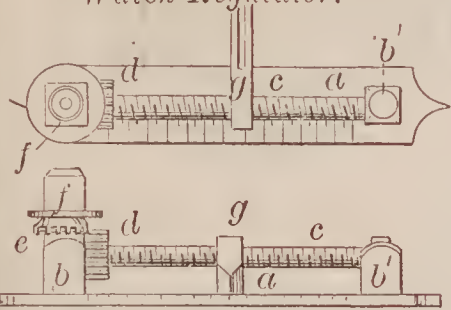

68329—A. J. Combs—*Corn Coverer.*

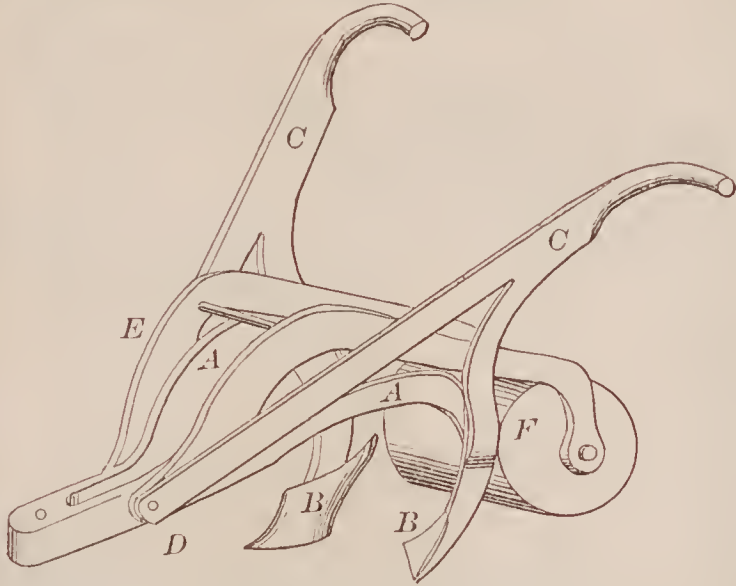

68334—Allen & Brady—*Door Lock.*

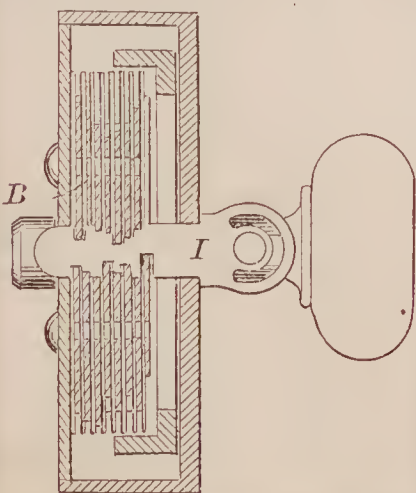
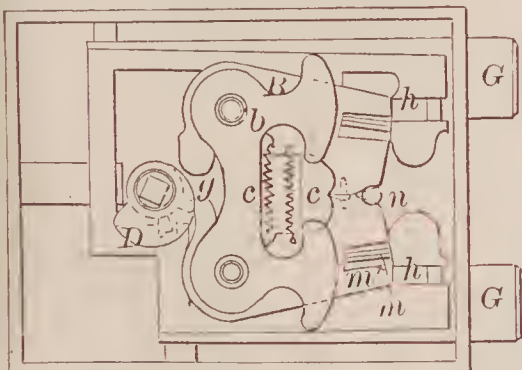

68330—Duchemin & Jeffers—*Boots and Shoes.*

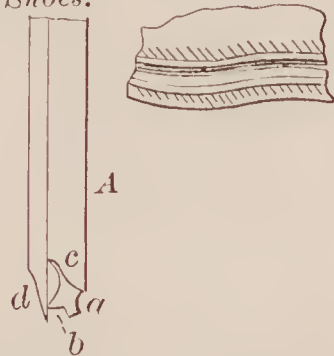

68327—H. S. Wilcox—*Car  
a Platform.*

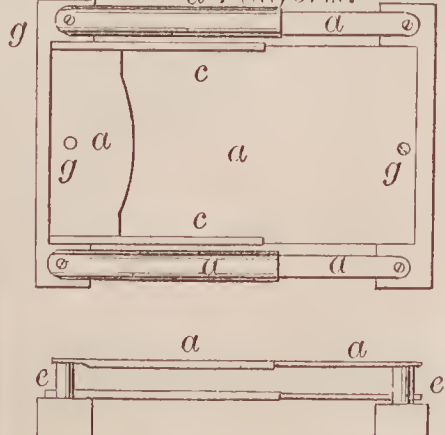

68325—T. Welham—*Water Wheel.*

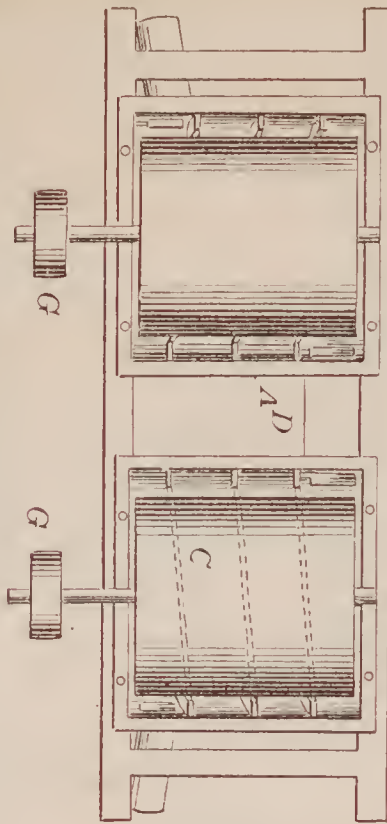

68326—A. J. Whittier—*Mosquito Bar and  
Window Screen.*

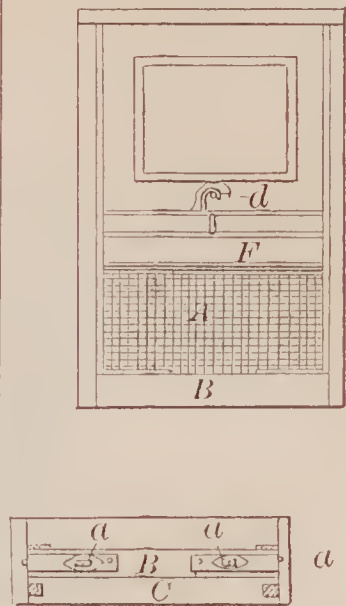

68332—T. Hyatt—*Illuminating Roofs  
and Roof Pavements.*

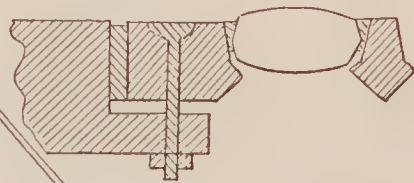
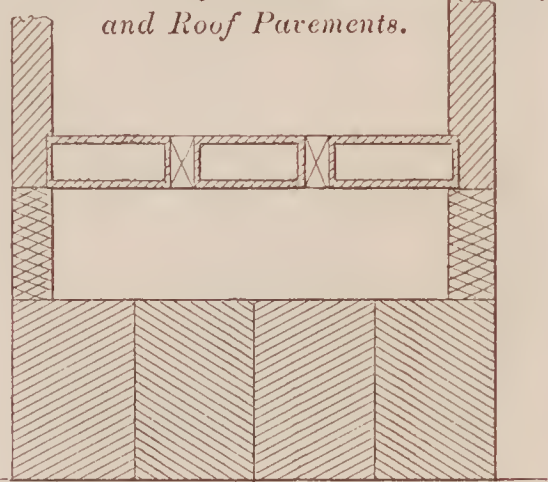

68334—Allen & Brady—*Door Lock.*

68330—Duchemin & Jeffers—*Boots and Shoes.*

68327—H. S. Wilcox—*Car  
a Platform.*

68333—A. W. Washburn—*Vaginal Syringe.*

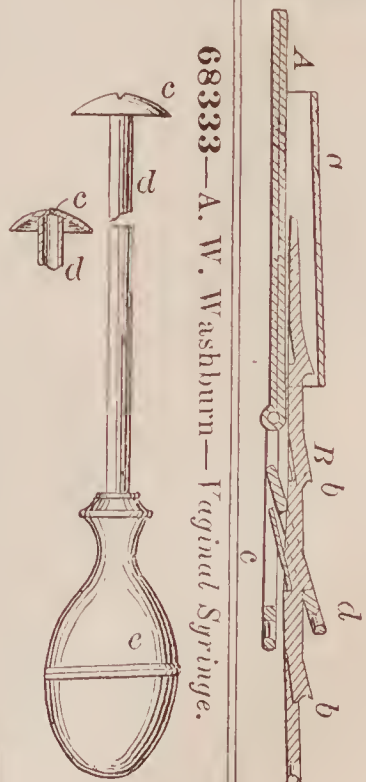

68323—A. Thompson—*Trace Attachment.*

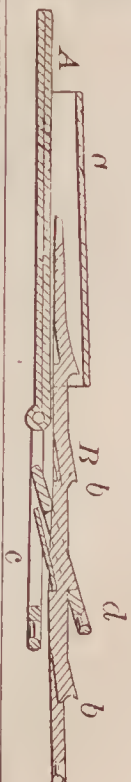



68336—J. Atwood, Jr.—Rig for Sloops and Schooners.

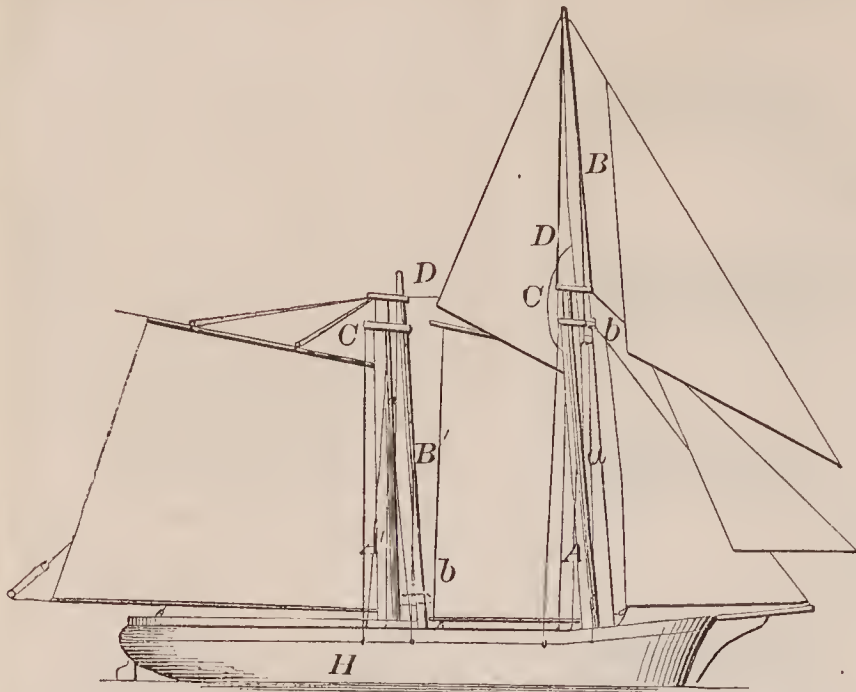

68337—W. Atwood—Rotary Engine.

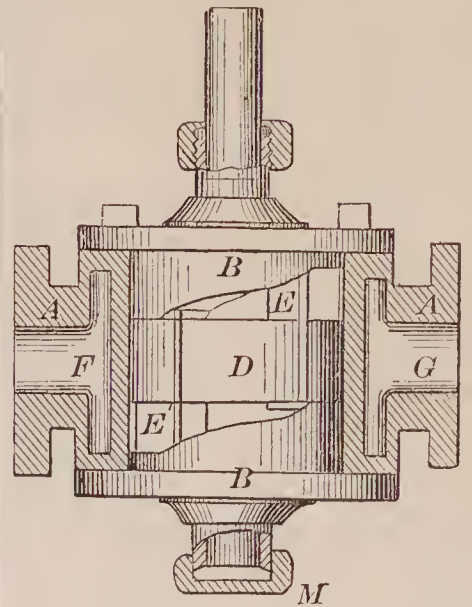

68338—A. G. Batchelder—Lock Key

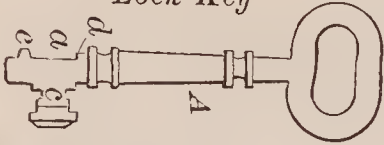

68340—L. H. Beckwith—Bending Machine.

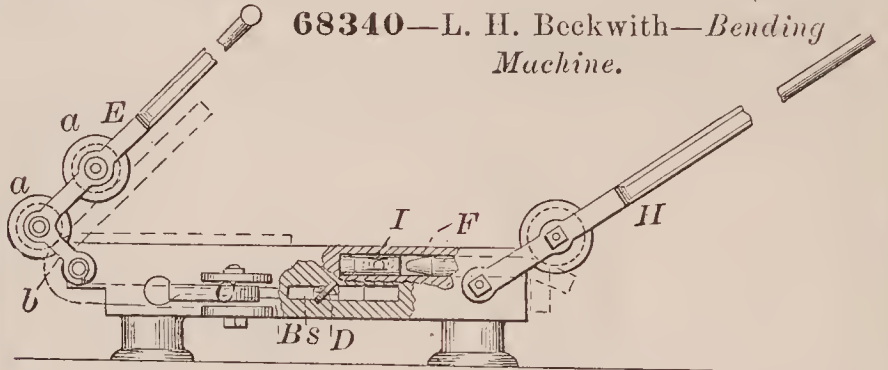

68341—A. Bedford—Strap Attachment.



68339—De W. C. Beamer—Business Card and Pin Cushion.

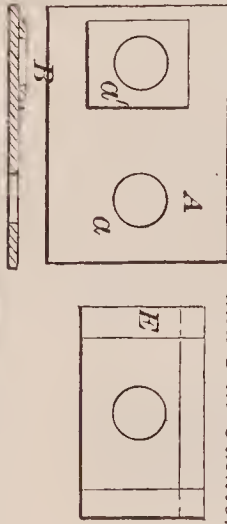

68342—J. Bentz—For Framing Match Splints.

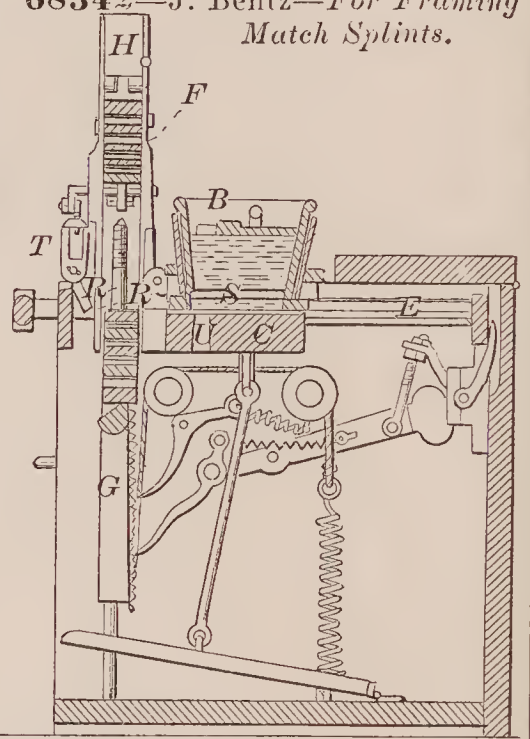

68344—G. H. Bonnaffon—Hose.

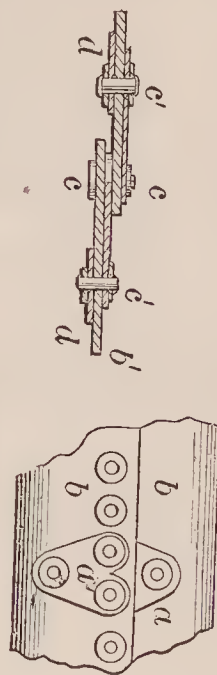

68343—M. Blair—Straw Scatterer.

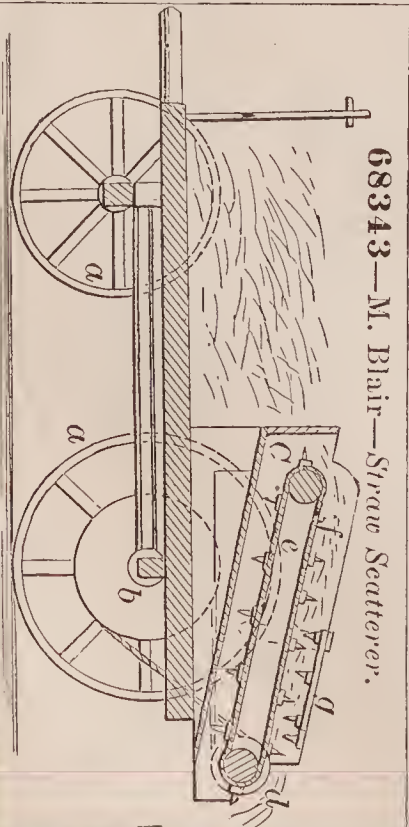

68345—C. Brown—Preparing Short Cut Straw for Feed.

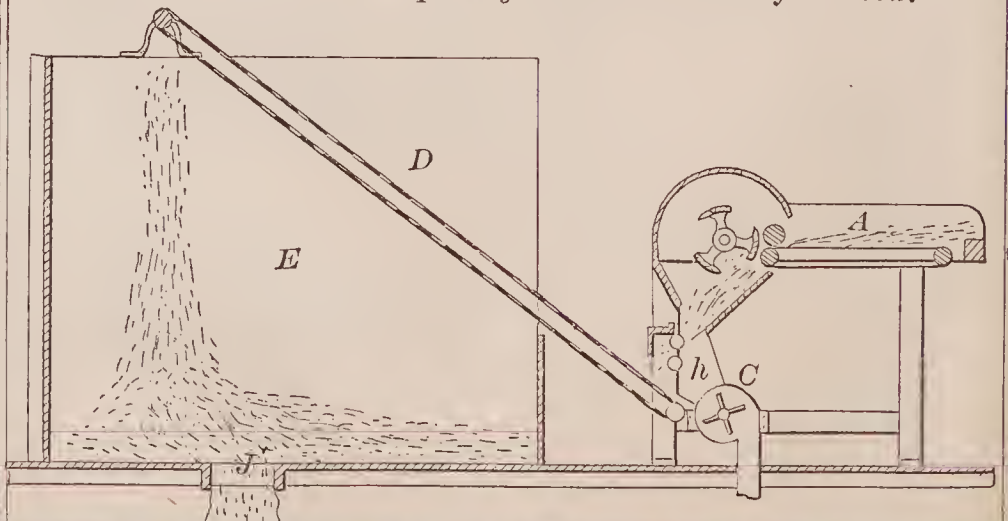



68346—J. D. Brown—For Removing Seed from Broom Corn.

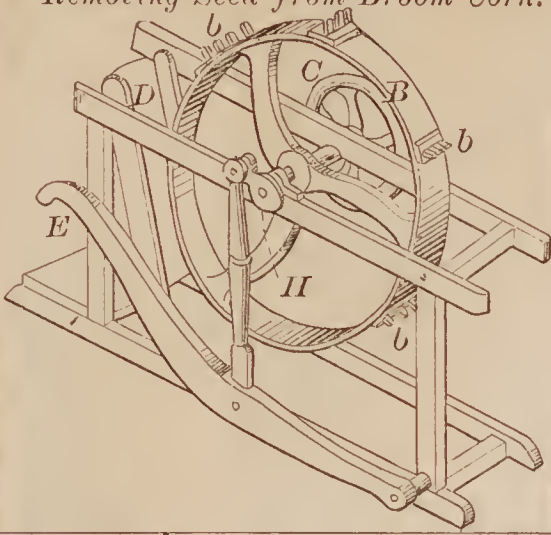

68349—F. C. Buisson—Buoy Safe.

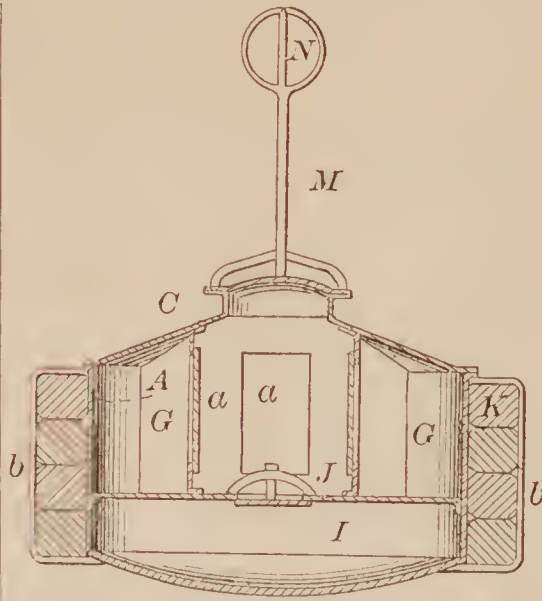

68348—J. R. Buchanan—Hose Coupling

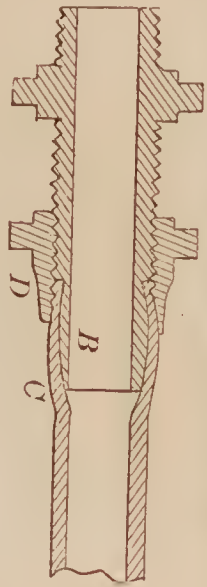

68347—J. A. Brown—Railway Car Seat.

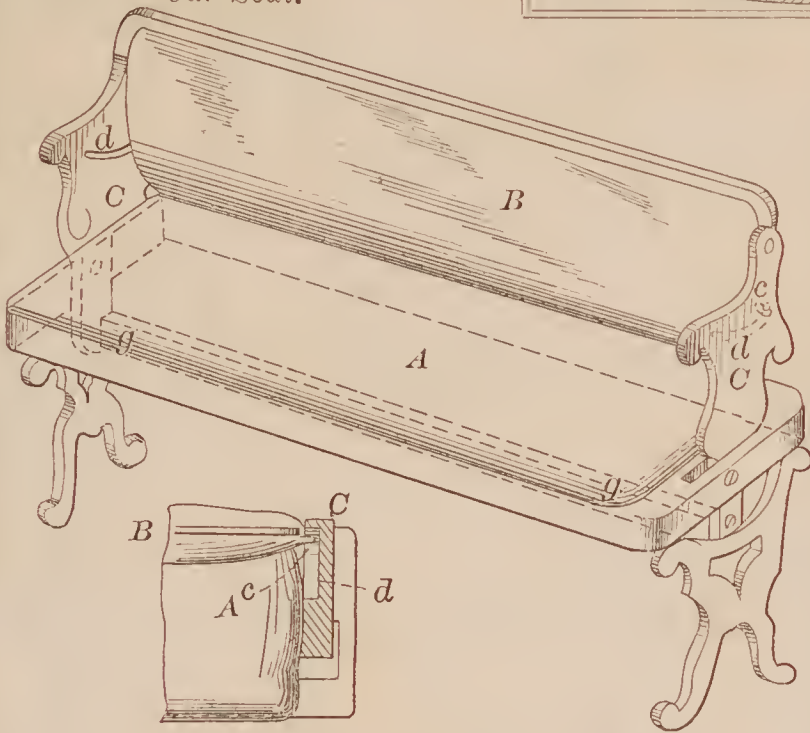

68351—H. W. Butterworth—For Coating Metal Plates with Tin.

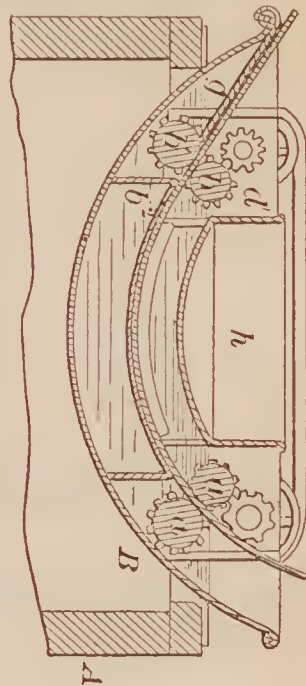

68352—A. Clow—Grain Fork.

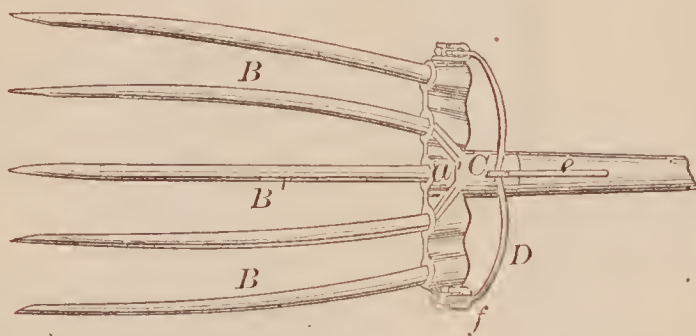

68353—S. Darling—Window Ventilator.

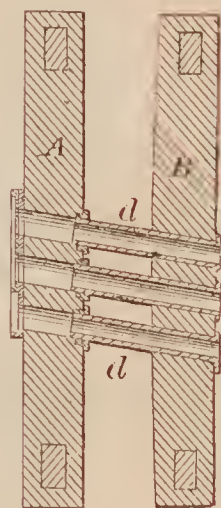

68355—W. H. Earnest—Clothes Dryer and Stand.

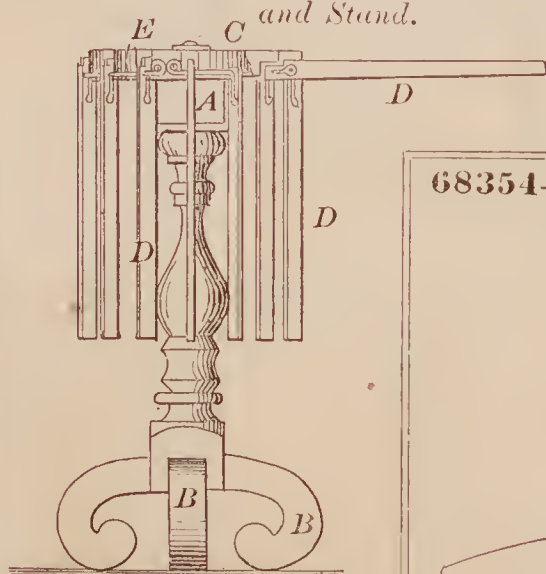

68354—G. H. Dow—Churn Dasher.

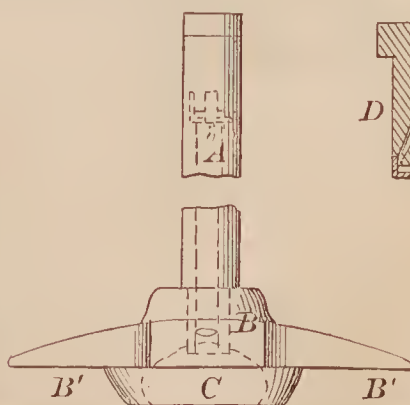

68350—Burr & Wakelee—For Testing Deep Wells.

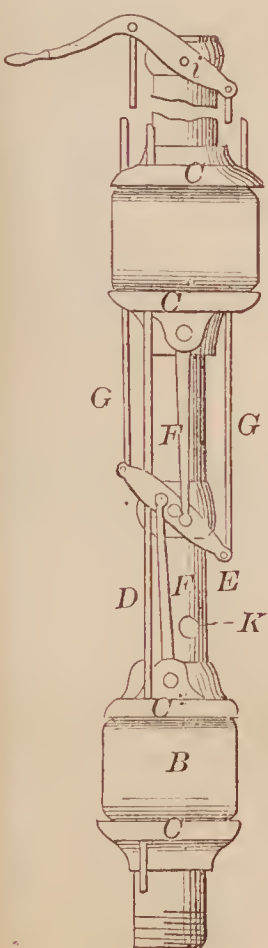



68356—G. E. Evans—For Washing Sugar.

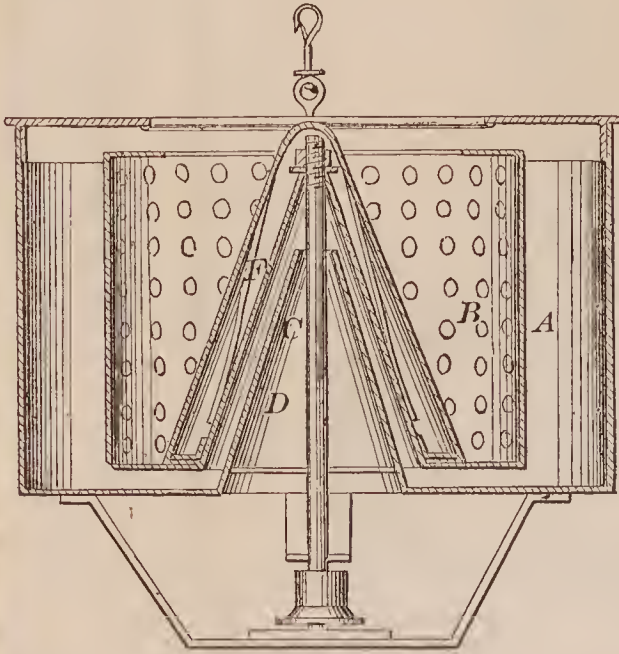

68357—H. E. Fowler—For Separating Tinned and Galvanized Articles.

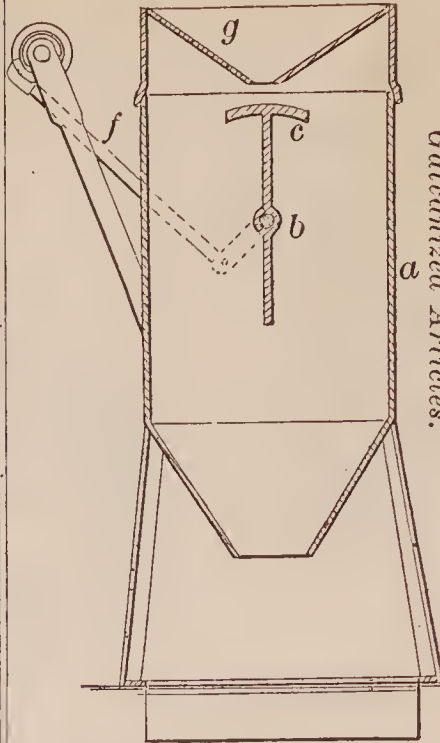

68360—J. Gibson, Jr.—For Holding Whips.

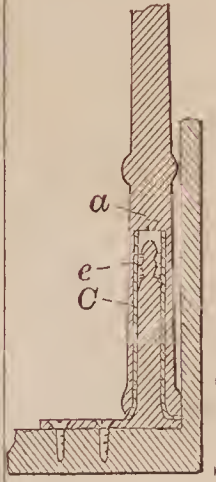

68358—G. H. Gardner—Cow Milker.

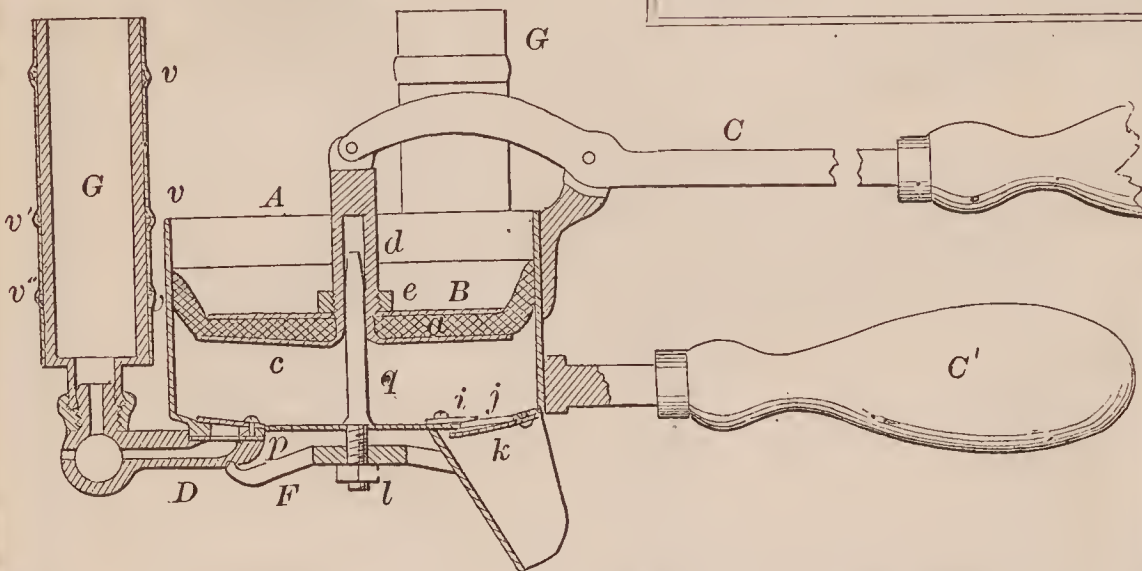

68361—J. F. Goldthwait—Shoe Butoner.



68362—W. D. Grimshaw—Drilling Machine.

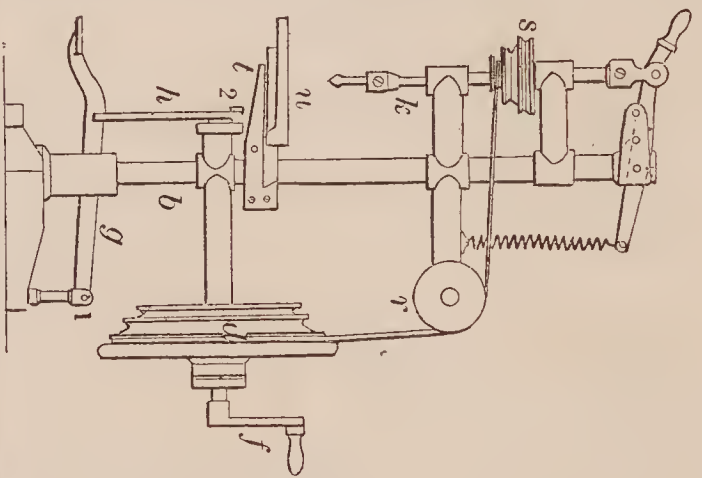

68365—D. C. Hull—For Rolling Rubber into Sheets.

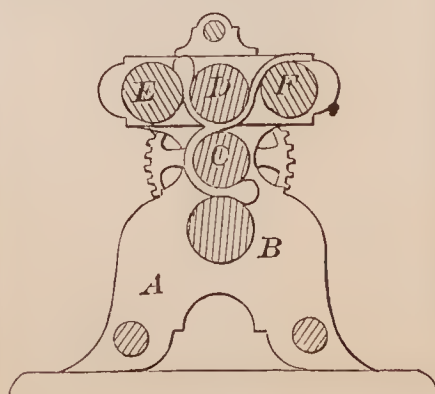

68364—J. Hubbell—Boot Heel.

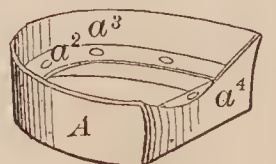

68359—H. A. Gaston—Analyzer.

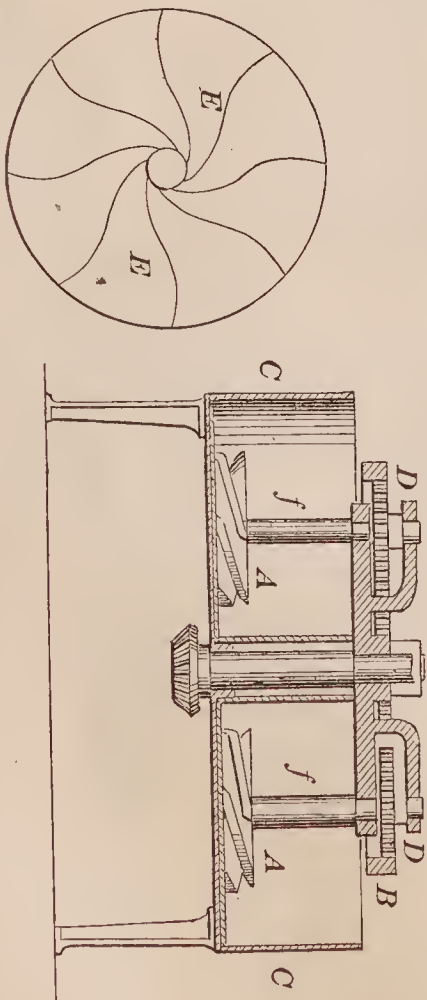

68366—M. C. Hull—Cooking Range.

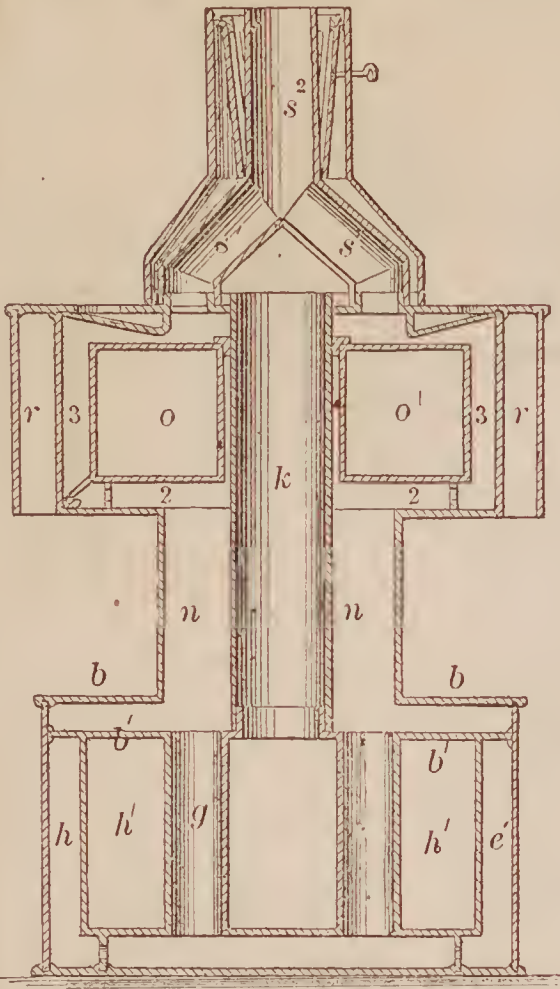

68371—C. C. Lyman—Platform Scale.

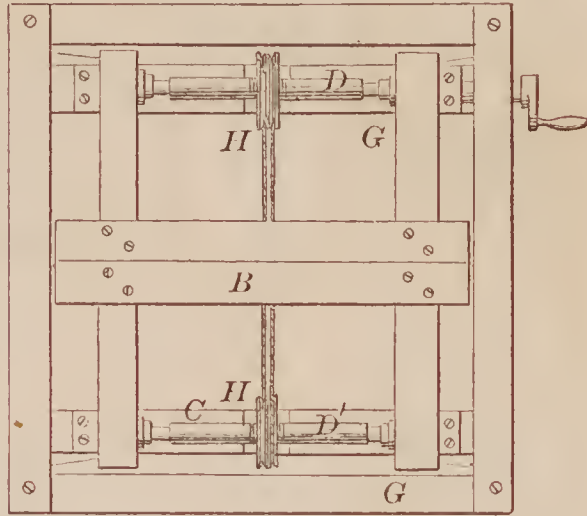

68373—C. F. Martine—Sofa Bedstead.

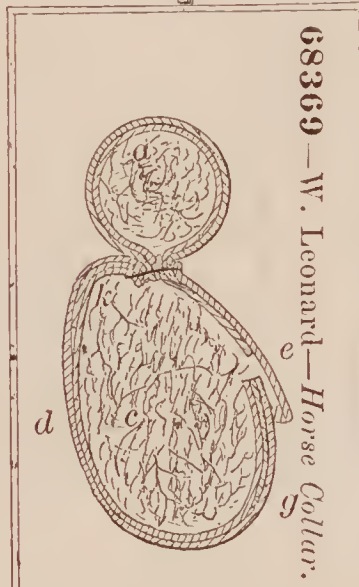
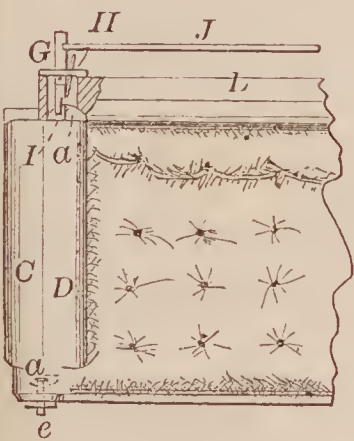
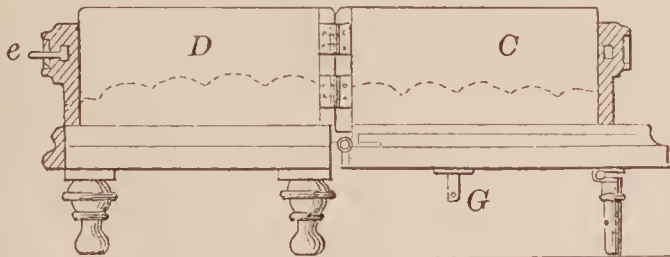

68369—W. Leonard—Horse Collar.

68368—I. W. Lamb—Car Seat and Couch.

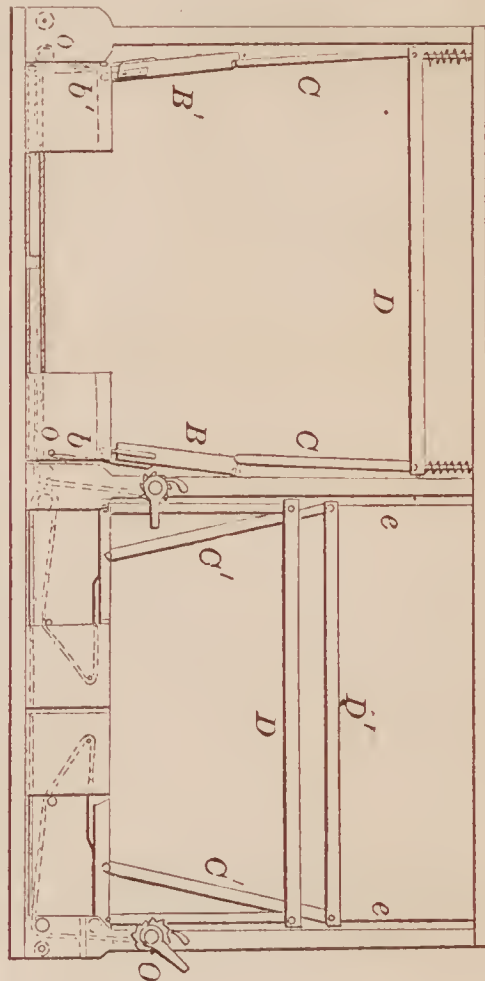

68374—Mason & Brant—For Stirring Starch.

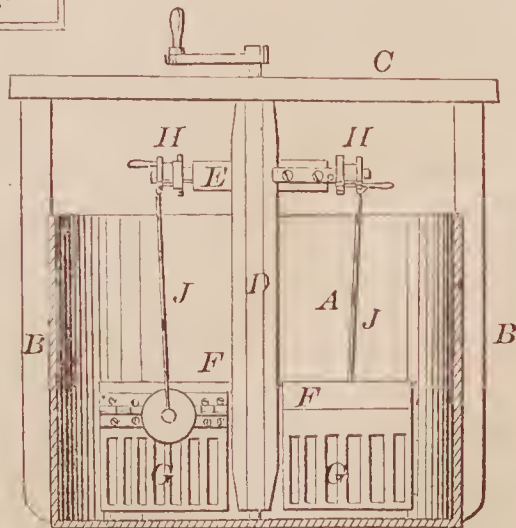

68372—C. H. Mann—Cattle Stanchion.

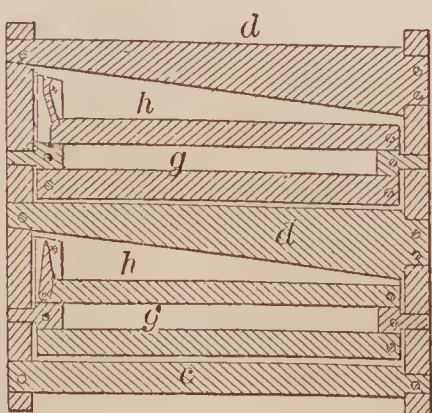



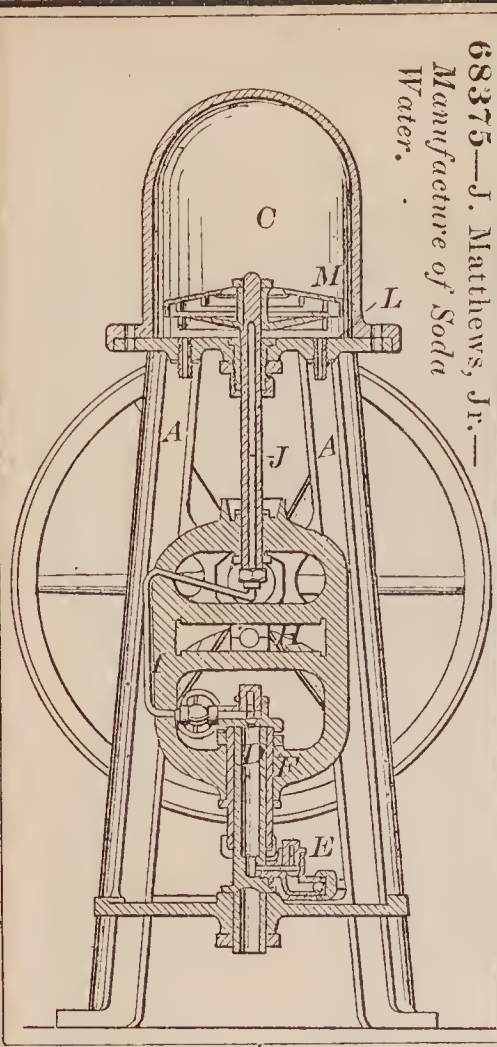

68375—J. Matthews, Jr.—  
Manufacture of Soda  
Water.

68378—L. Merrifield—*Washing  
Machine.*

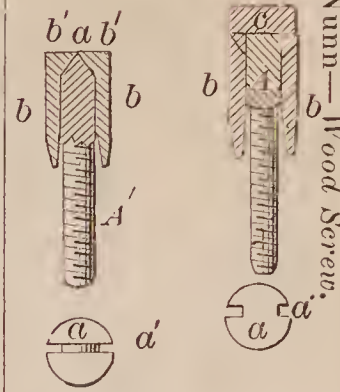
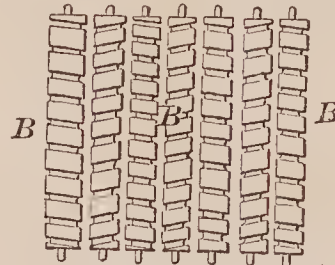
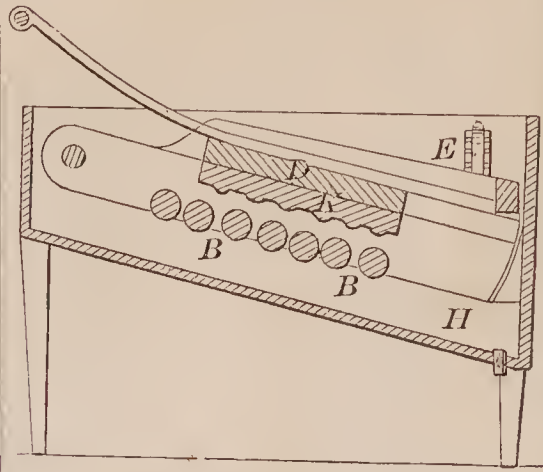

68381—R. J. Nunn—*Wood Screw.*

68380—P. H. Niles—*Hose Coupling.*

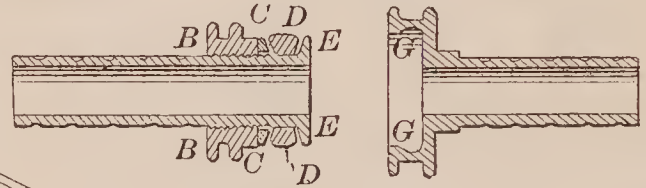

68376—I. H. McOmber—  
*Gate.*

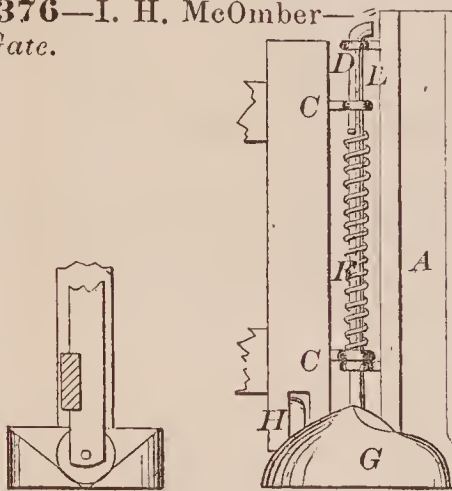

68382—F. Ortlieb—*Condenser.*

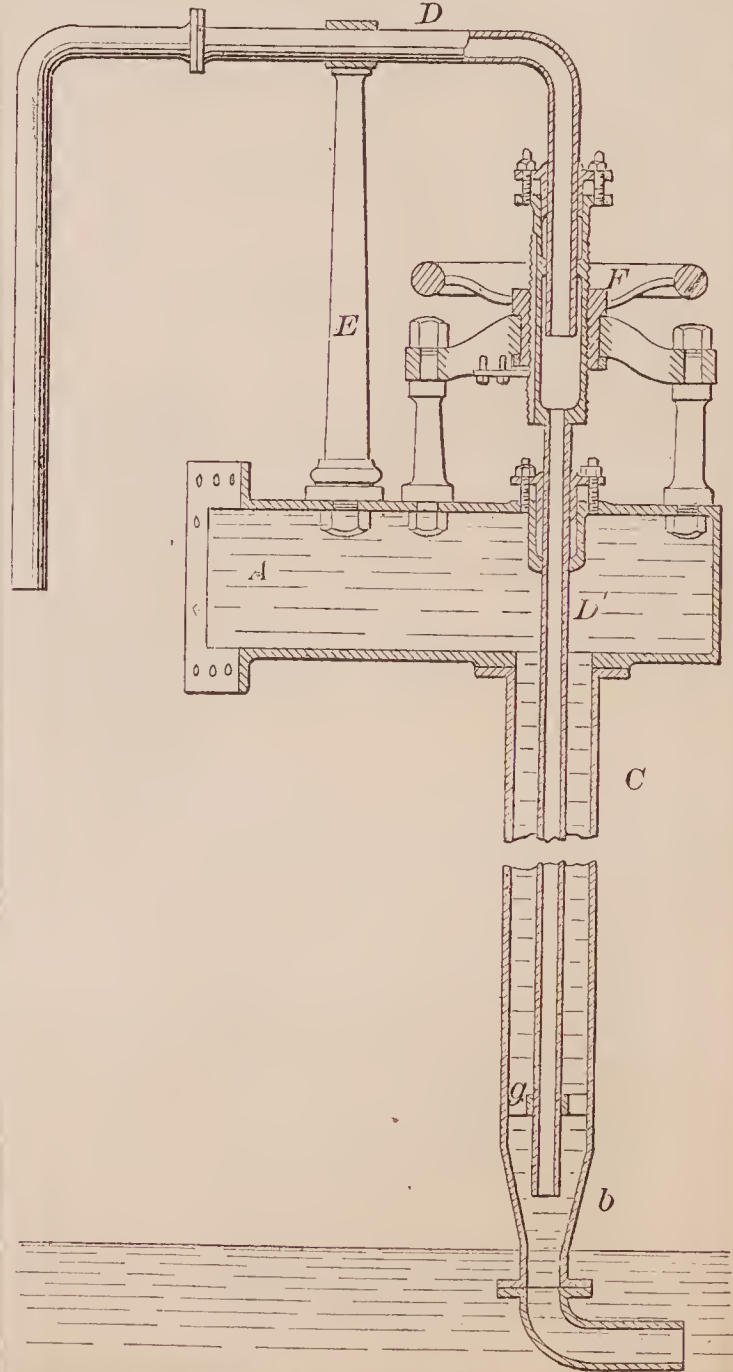

68377—C. H. Merrick—*Steam Engine.*

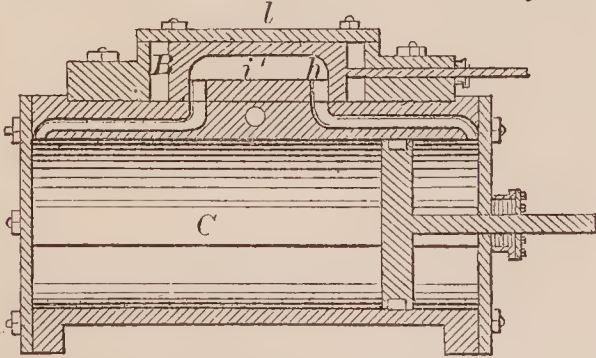

68379—J. Miller—*Curbing.*

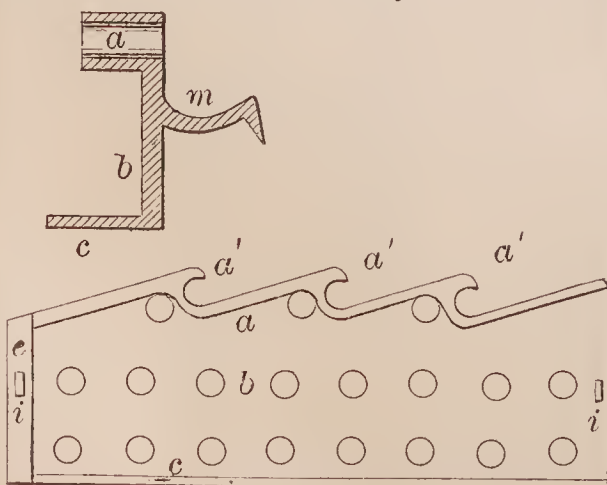

68383—A. Packard—For Securing Linings in Stores.

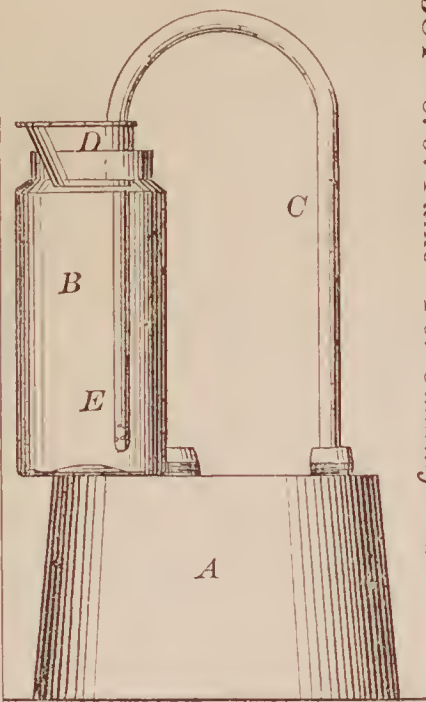

68384—C. J. Paine—For Canning Fruit.

68387—R. Reed—Window Shutter Fastening.

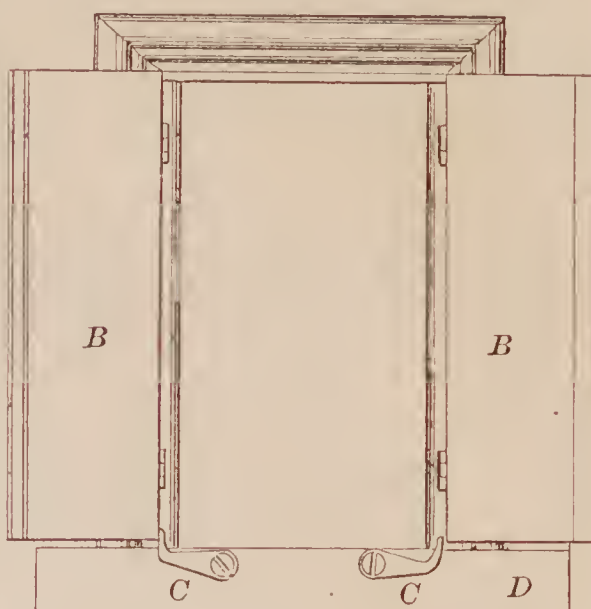

68386—Potter & Crane—Cotton Elevator.

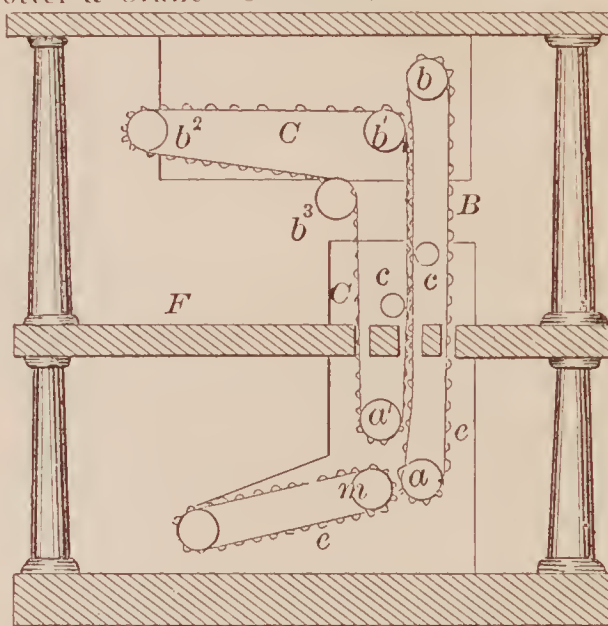
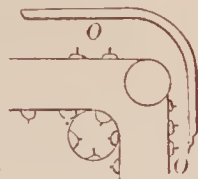

68385—H. & A. Phelps—For Slabbing Soap.

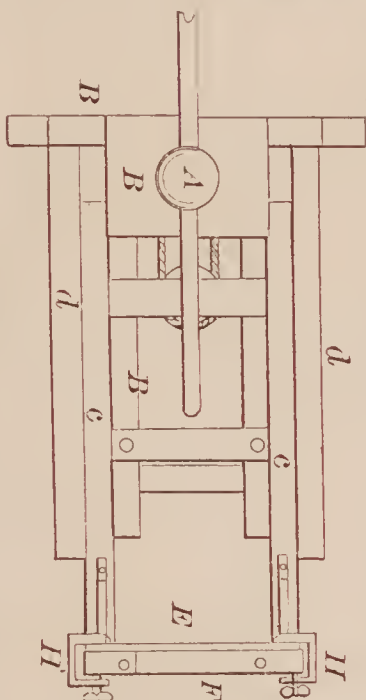

68390—W. J. Sloan—Threshing Machine.

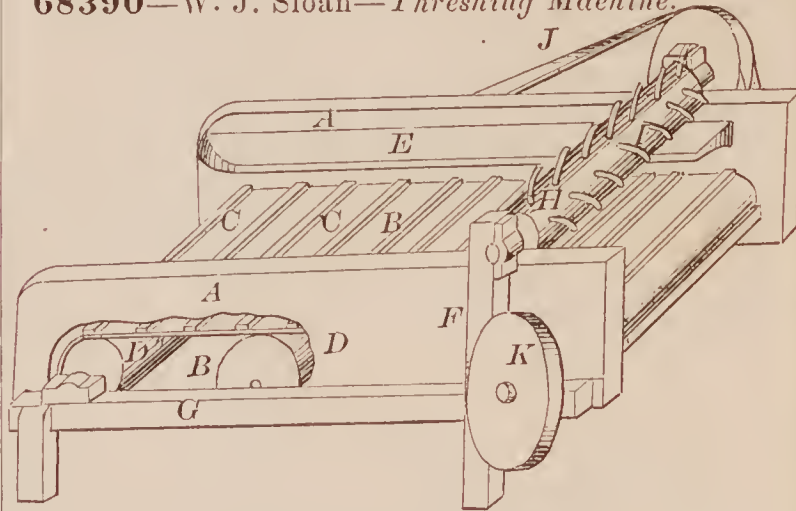

68388—J. H. Rhodes—Pipe Joint.

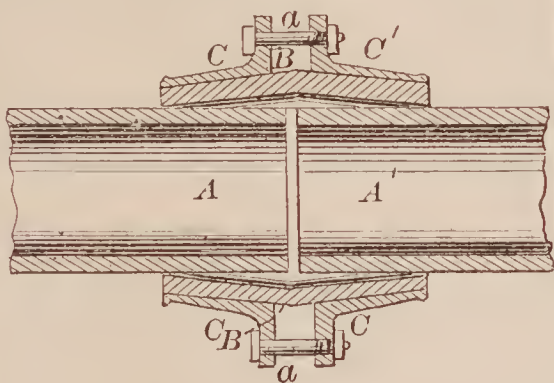

68389—L. Schaefer—Sofa Bedstead.

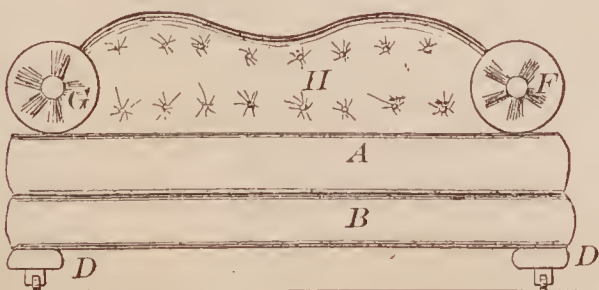

68391—S. Sowle—Staging.

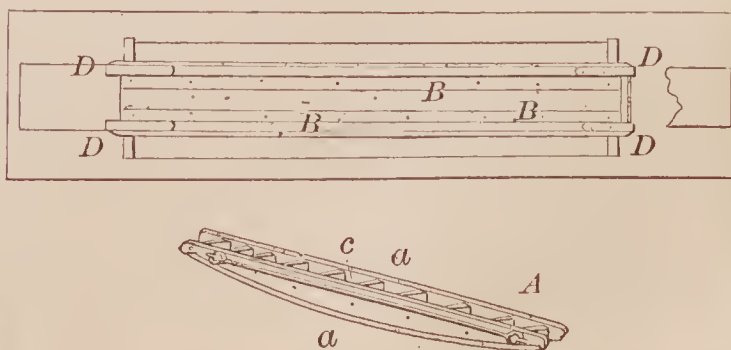



68392—J. P. Stanton—*Potato Plow.*

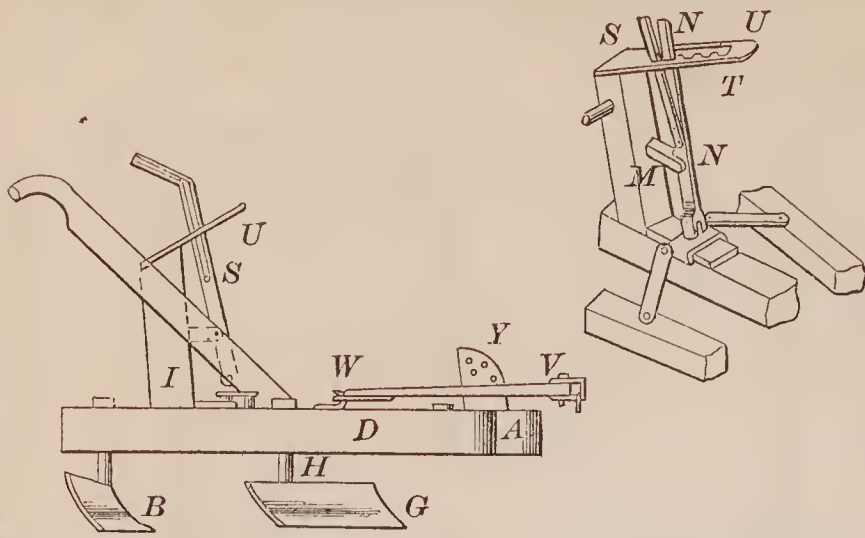

68398—H. G. Tyer—*Overshoe.*

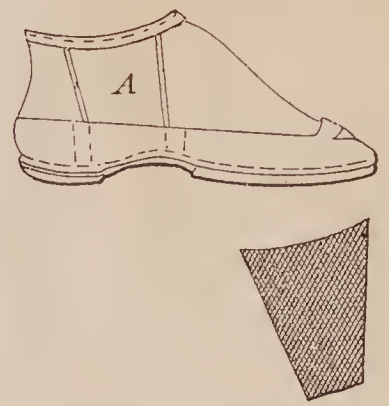

68393—W. H. Startzman—*Cultivator Plow.*

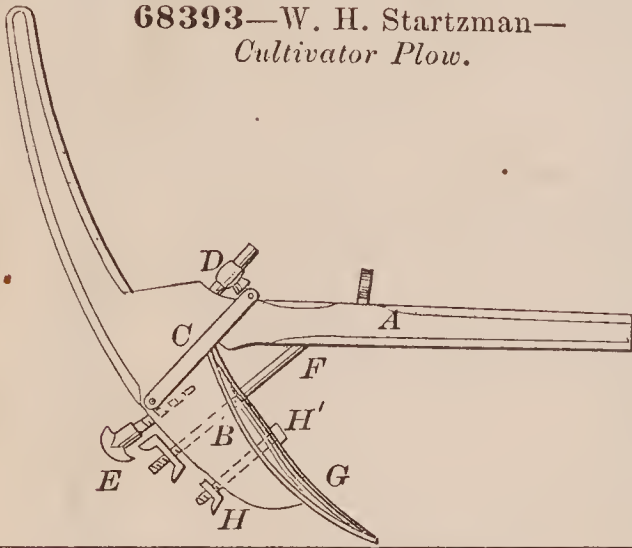

68395—O. B. Sutton—*Carriage Jack.*

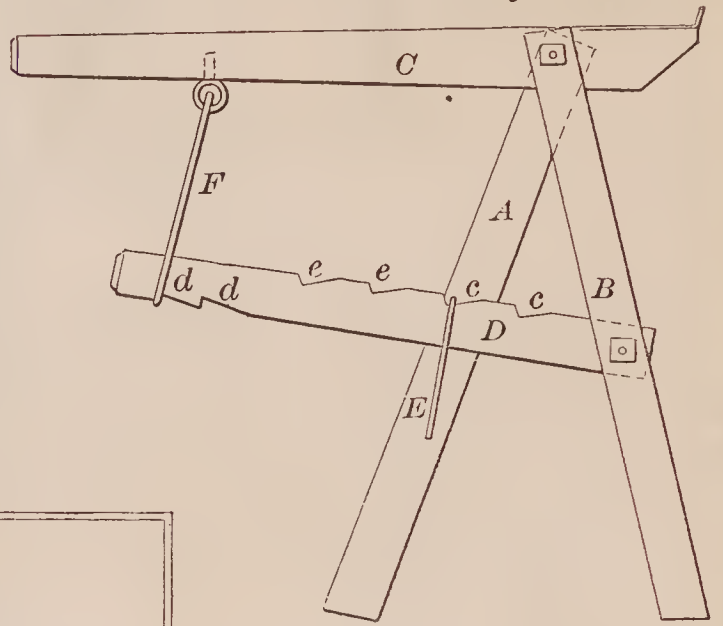

68394—W. B. Stephens—*Mill Pick.*

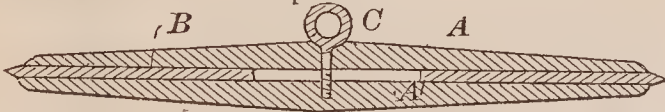

68396—L. Sylvester—*Brick Machine.*

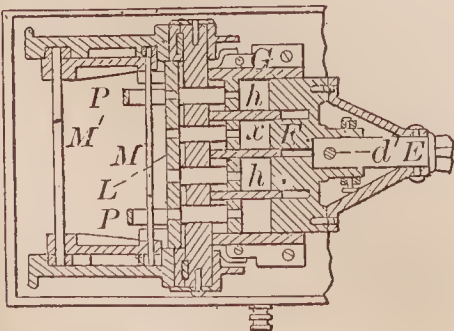
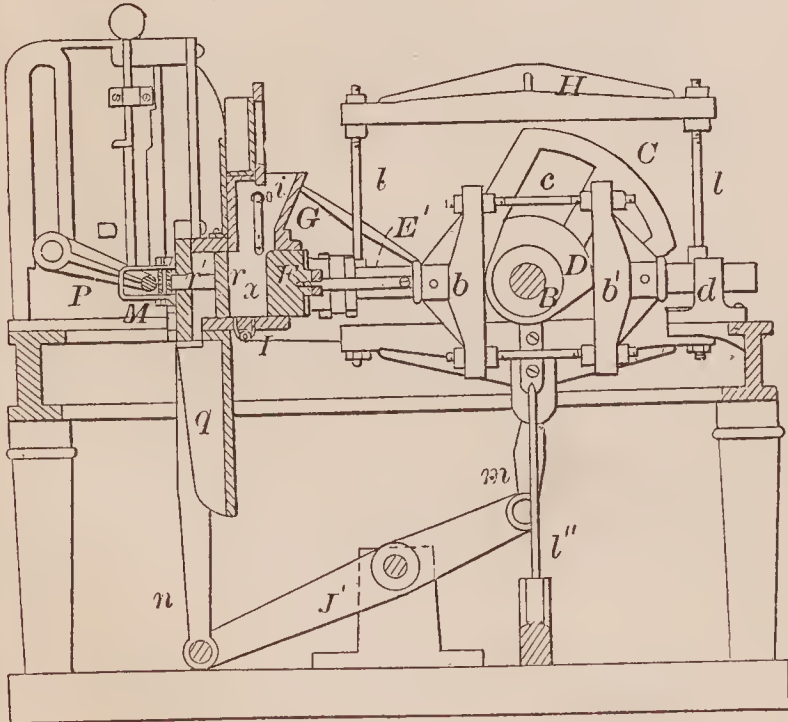

68397—B. F. Taft—*Wheel Hub.*

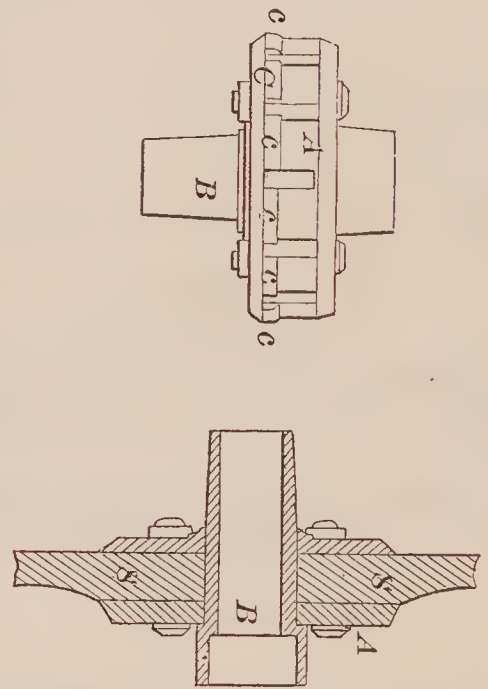

68399—C. Wadsworth—*Grape Gatherer.*

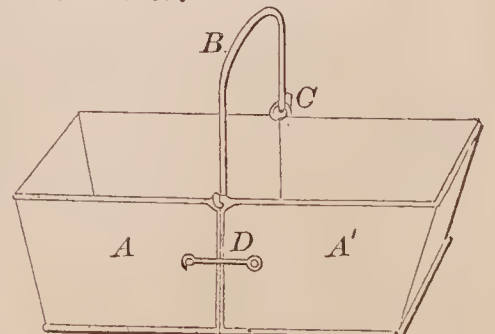

68400—D. N. West—  
Milk Bucket and  
Strainer.

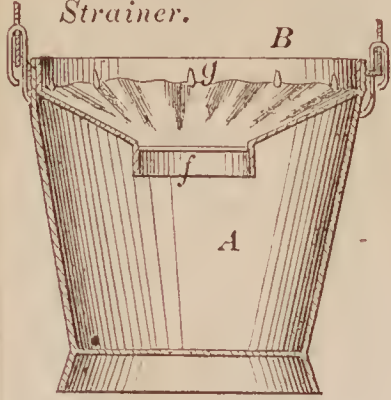

68402—C. B. Whittemore—For Recovering Lost Anchors.

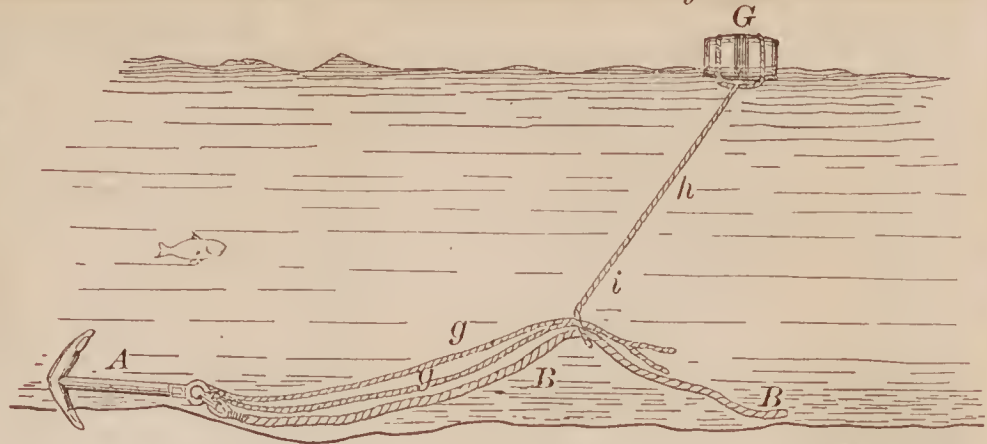

68403—C. Wilson—Earth Pulverizer and Seeder.

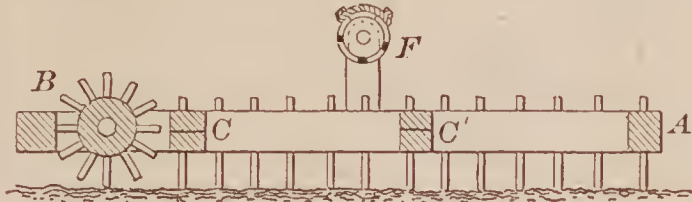

68404—M. W. Woodruff—Wind Wheel.

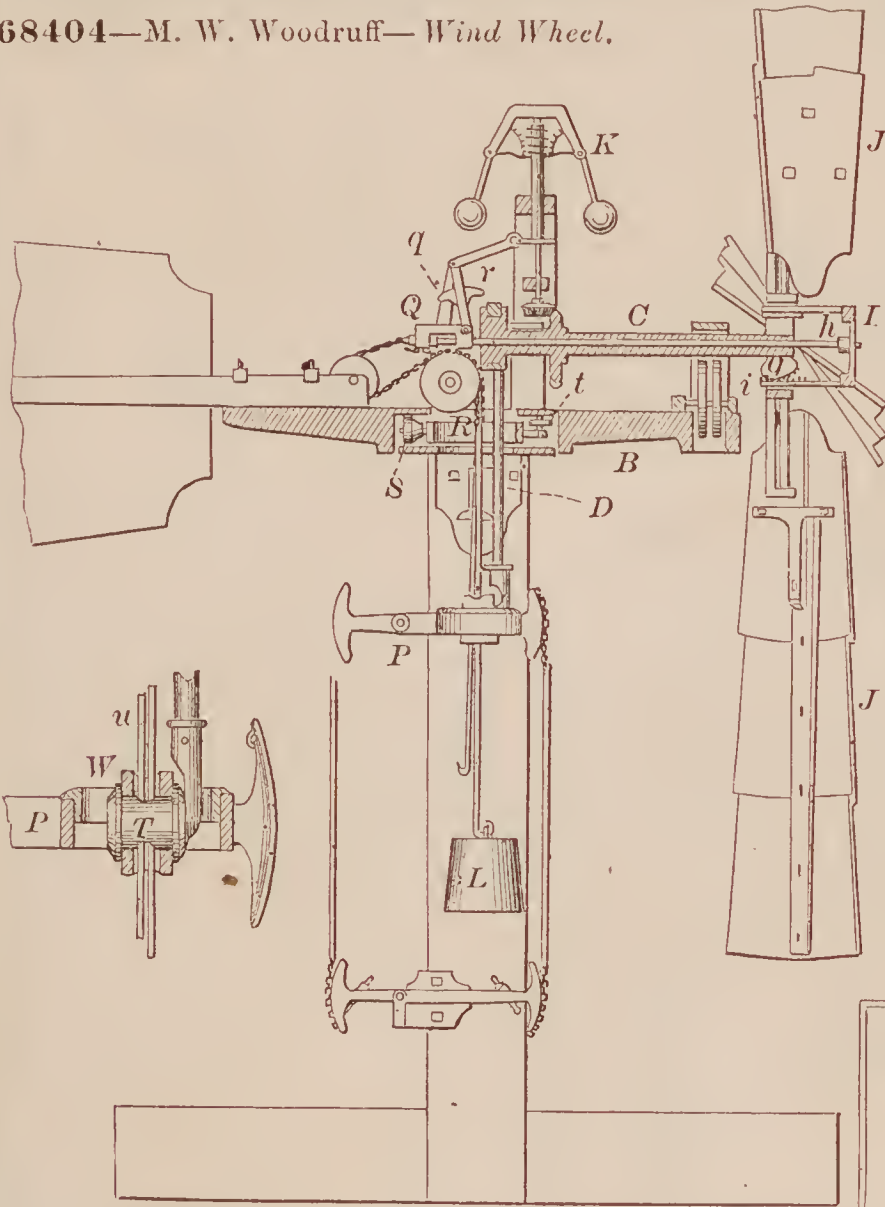

68401—J. F. & O. B. Whitney—Fruit Box.

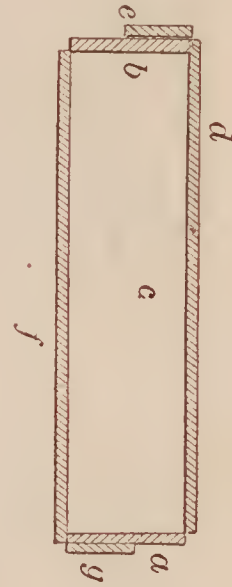

68405—E. Yancy—Horse Hay  
Fork.

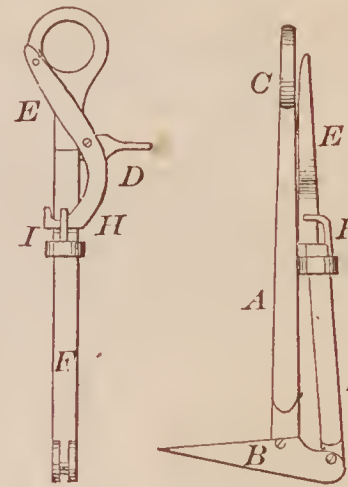

68407—A. Barbarin—Lightning  
Arrester.

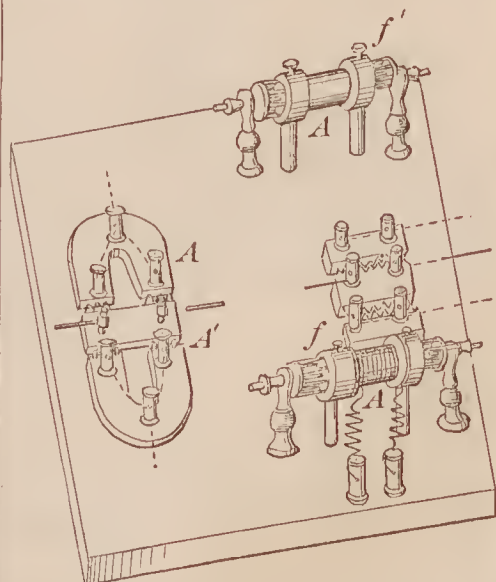

68406—Agrell & Klepzig—Furnace for Roasting Ores.

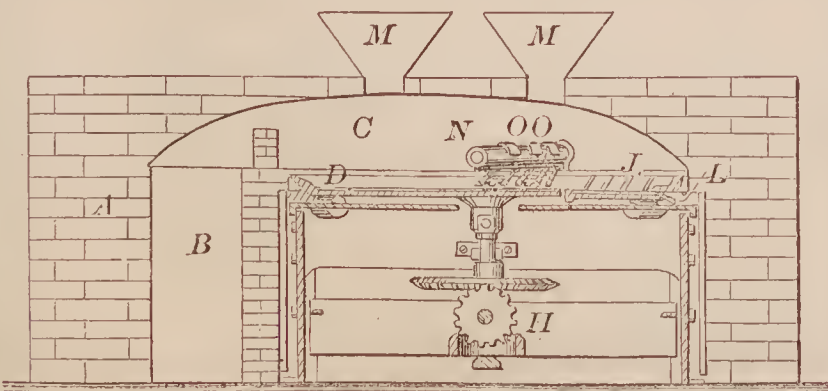



68409—G. Bequet—For Rectifying and Distilling.

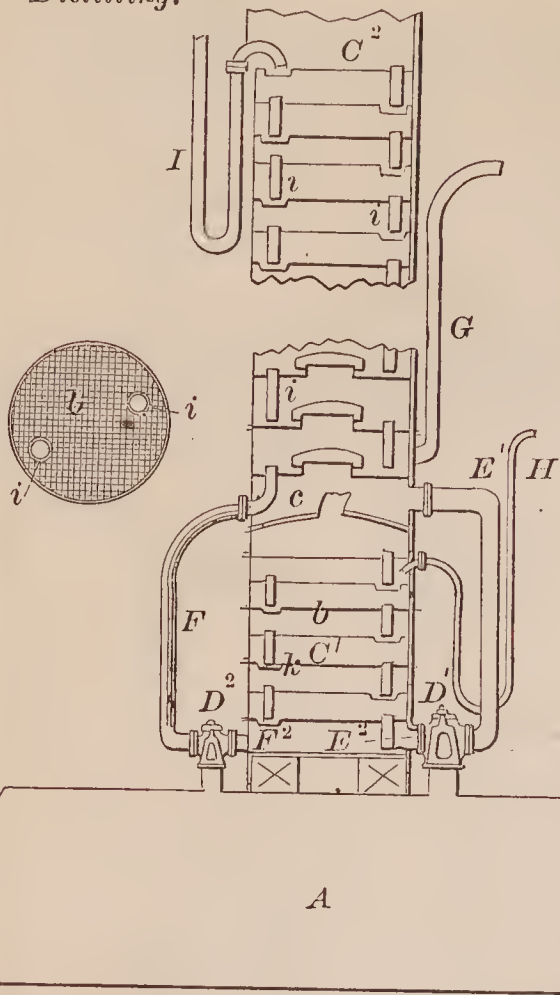

68411—W. H. Butler—For Loosening Earth to be Excavated.

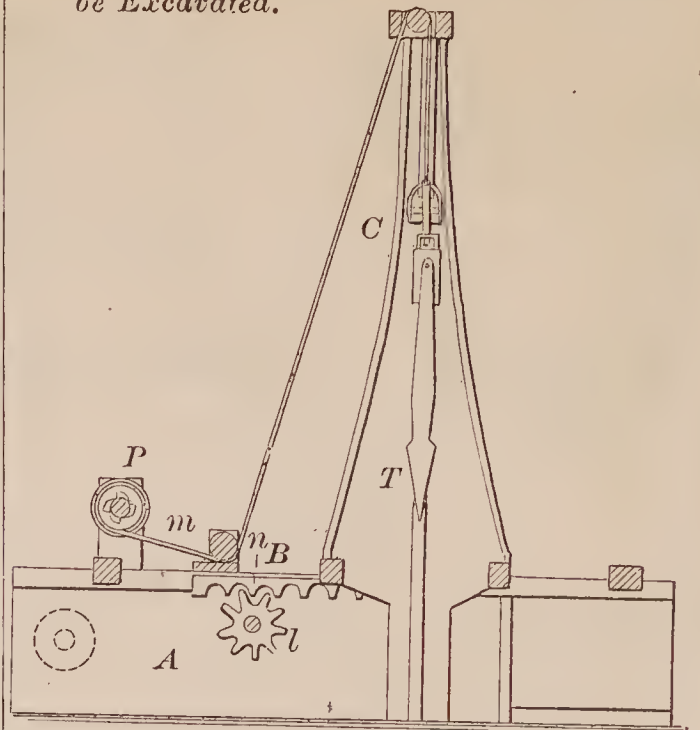

68410—E. T. Bussell—Rotary Plow.

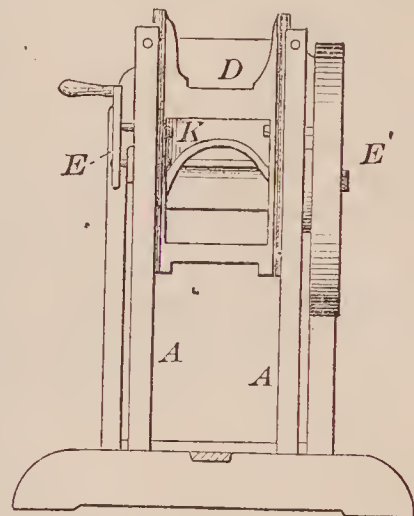
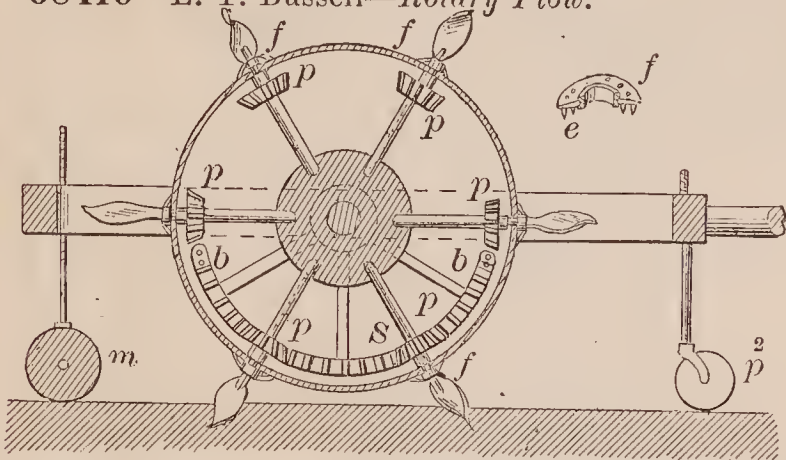

68412—A. P. Chapin—Feed and Straw Cutter.

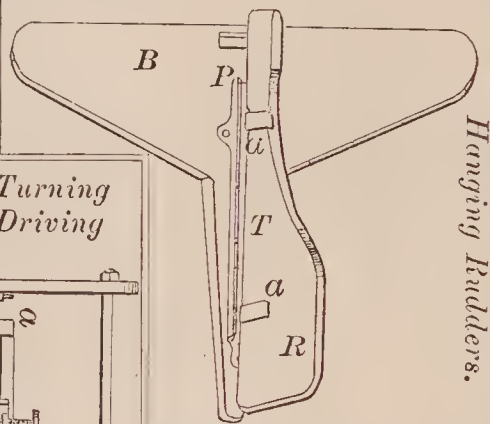

68413—W. A. Clark—For Hanging Rudders.

68415—C. J. Clifford—For Turning Crank Pins on Locomotive Driving Wheels.

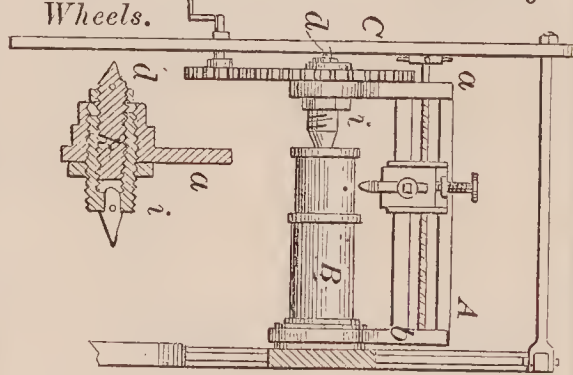

68416—M. H. Collins—Glass Chimney for Lamps.

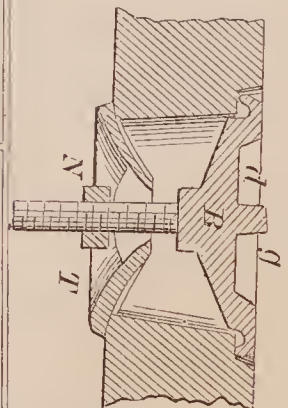
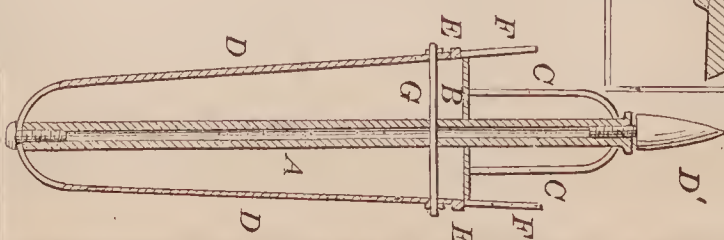

68417—M. C. Cronk—Barrel Bung.

68414—Clement & Foster—For Manufacturing Hoes.

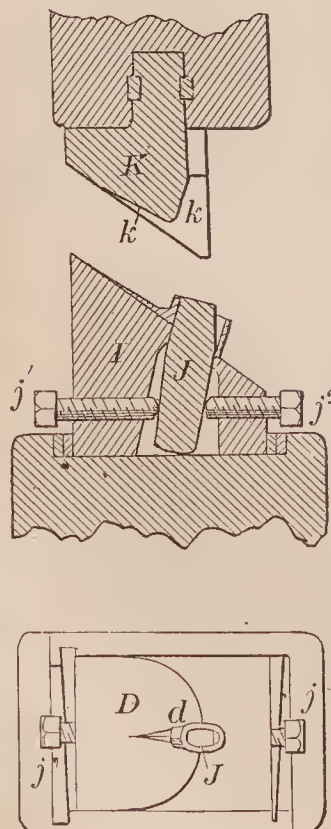

68418—J. Darling—Reservoir Pen Holder.

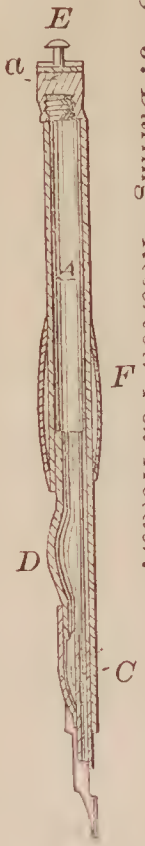

68419—J. W. Dilly—Roller, Stalk Cutter and Marker.

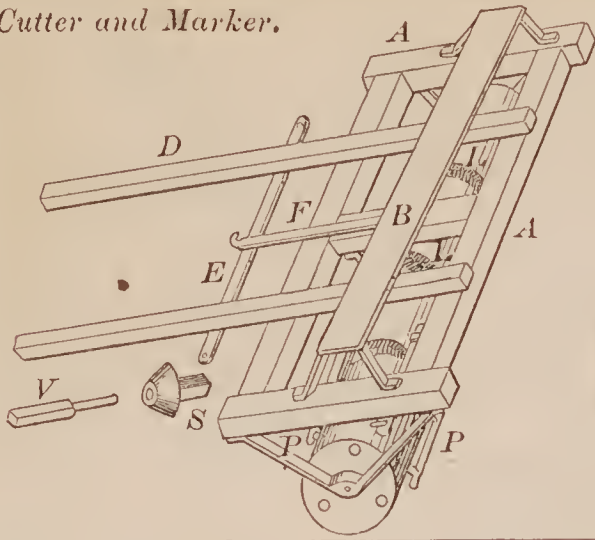

68421—Z. Eastman—Railway.

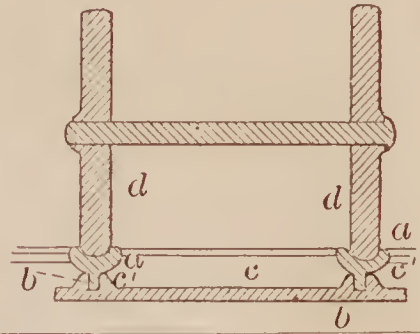

68420—A. Doll—Operating Feed Wheel in Sewing Machines.

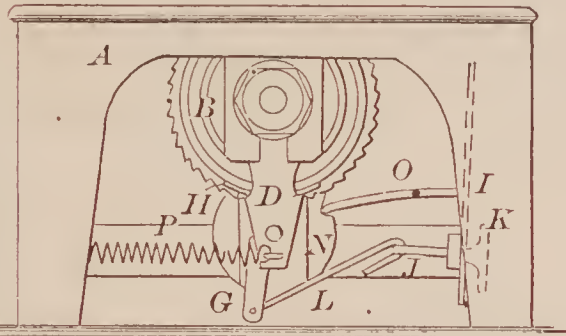

68424—E. R. Ensign—For Marking Holes for Planting.

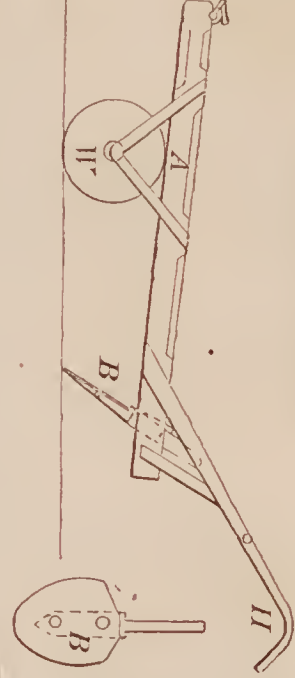

68426—H. B. Everest—For Distilling Petroleum.

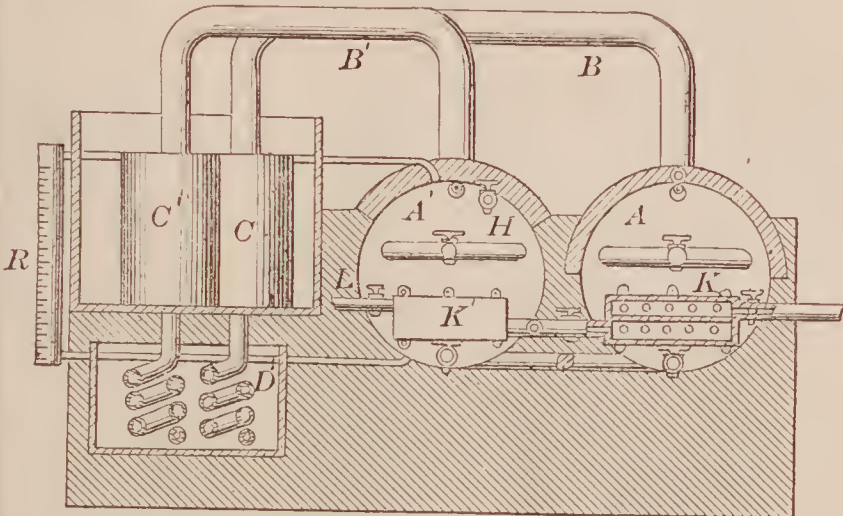

68428—T. St. Clair—Truss Pad.

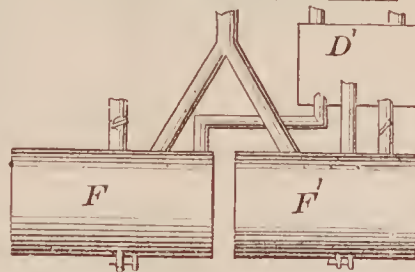
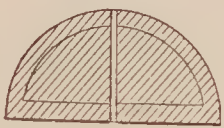

68423—J. W. Ellis—Arc Blank.

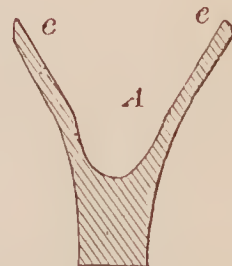
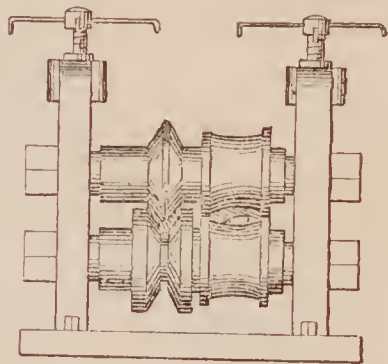

68425—S. V. Essiek—Knitting Machine.

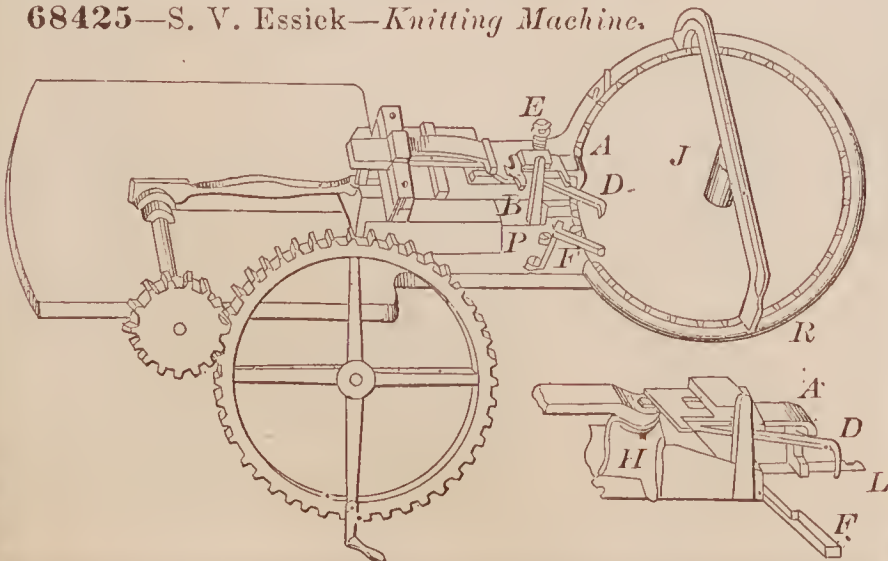

68427—G. Fenton—Sheep Table.

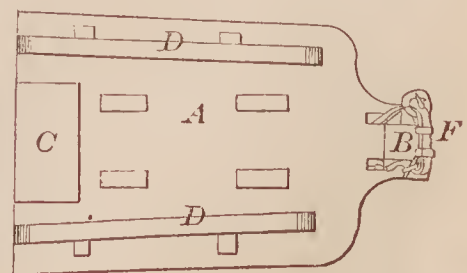



68429—T. Fowler—For Making Sewing Machine Needles.

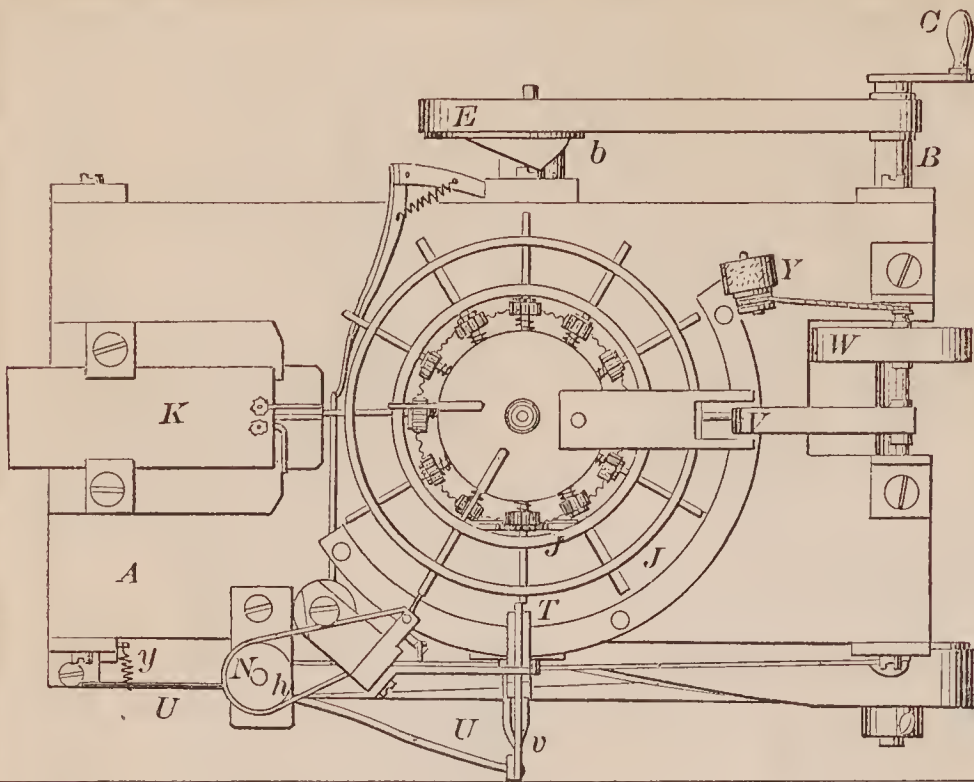

68433—J. G. Goessel—Feed Water Heater.

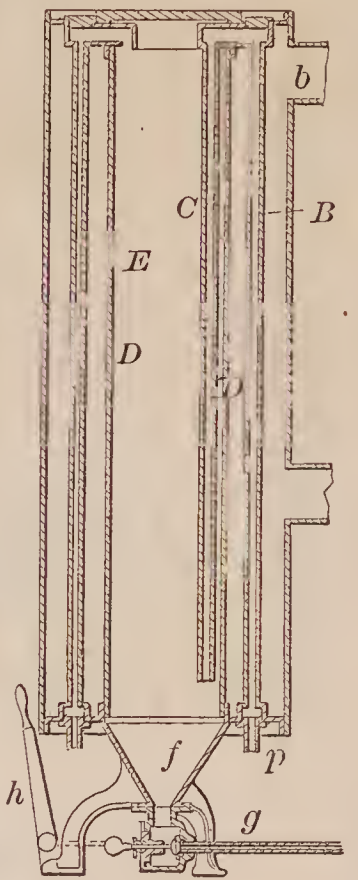

68430—T. Fowler—For Reducing Wires for Needle Blanks.

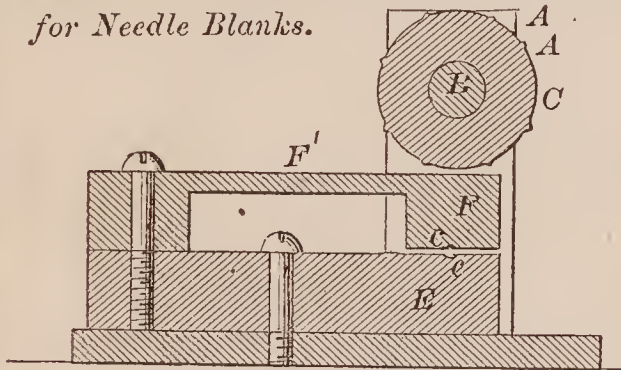

68435—D. M. Graham—Gas Apparatus.

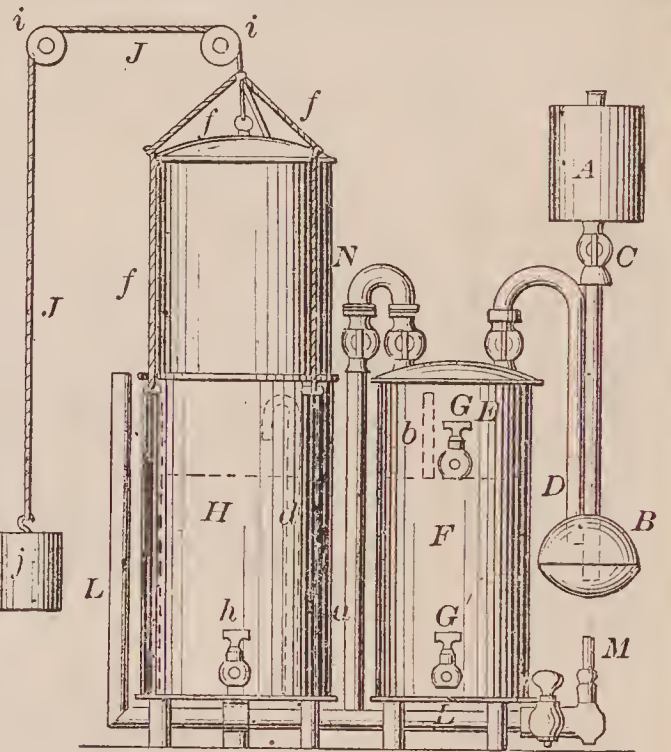

68434—D. H. Gould—Gate Hinge.

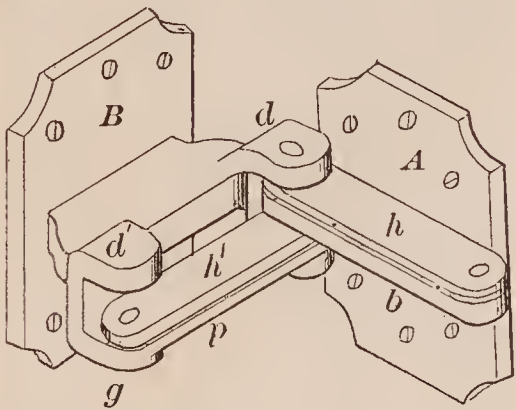

68432—E. W. French—Engine Hose.

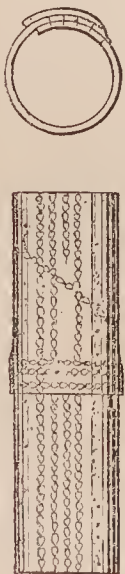

68431—J. N. Freestone—Wrench.

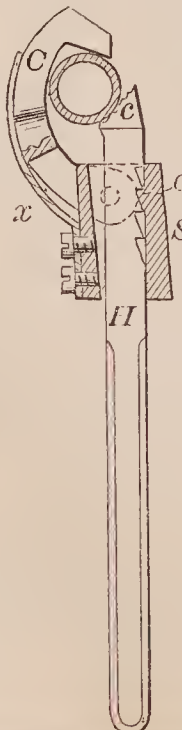

68436—E. Hamburger—Lock for Car Seats.

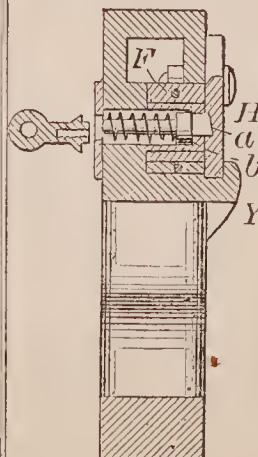

68437—E. Hamburger—Stove Pipe.

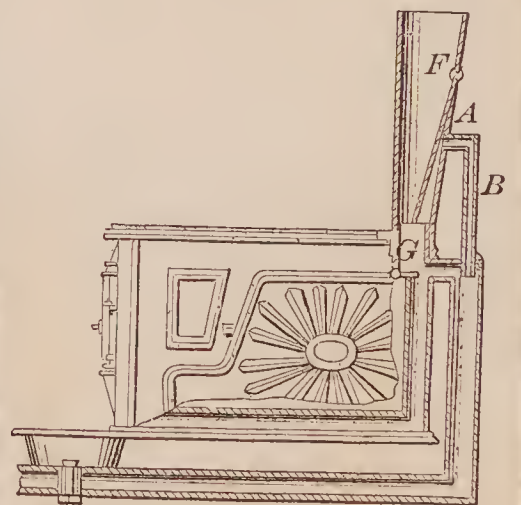



68438—A. Haskell—Swifts.

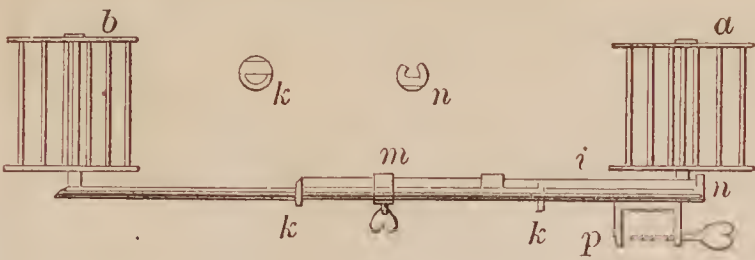

68444—C. Kennedy—Loom Heddle.

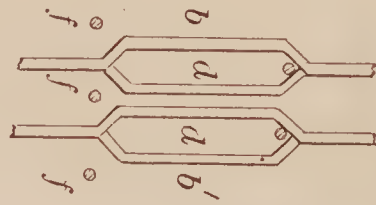

68439—G. H. Henfield—Car Coupling.

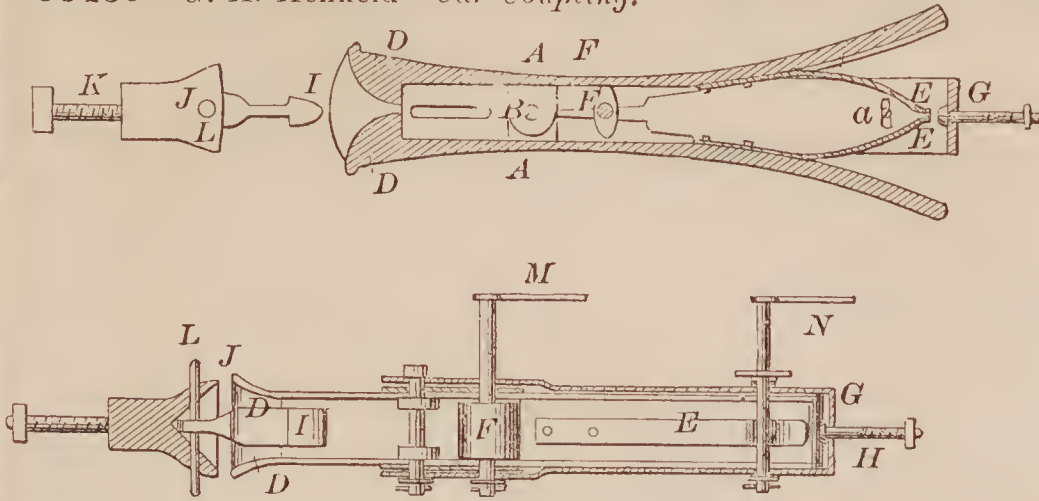

68441—F. W. Hoffmann—For Cutting off the Ends of Cigars.

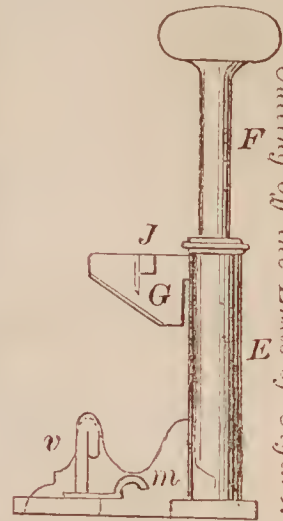

68440—B. F. Hisert—Cultivator Teeth.

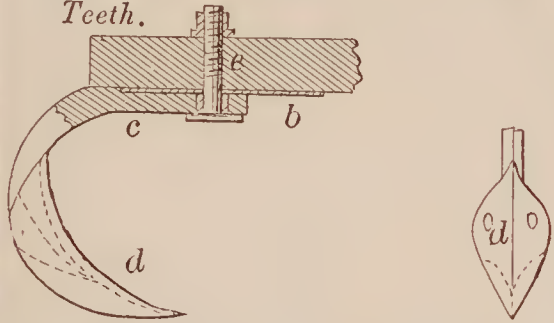

68442—J. Hyde—Bed Spring.



68443—D. W. Jacoby—Corn Planter.

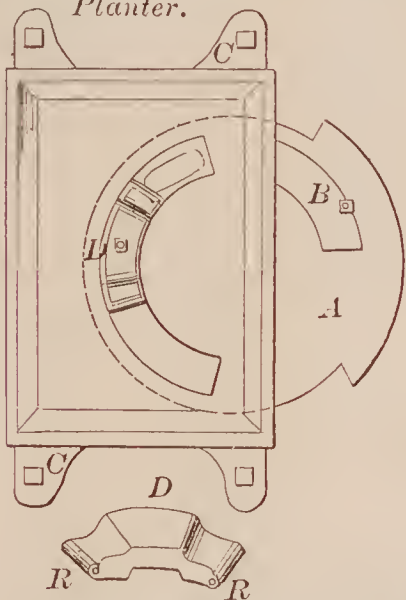

68445—Klein & Wynne—Fountain Pen.

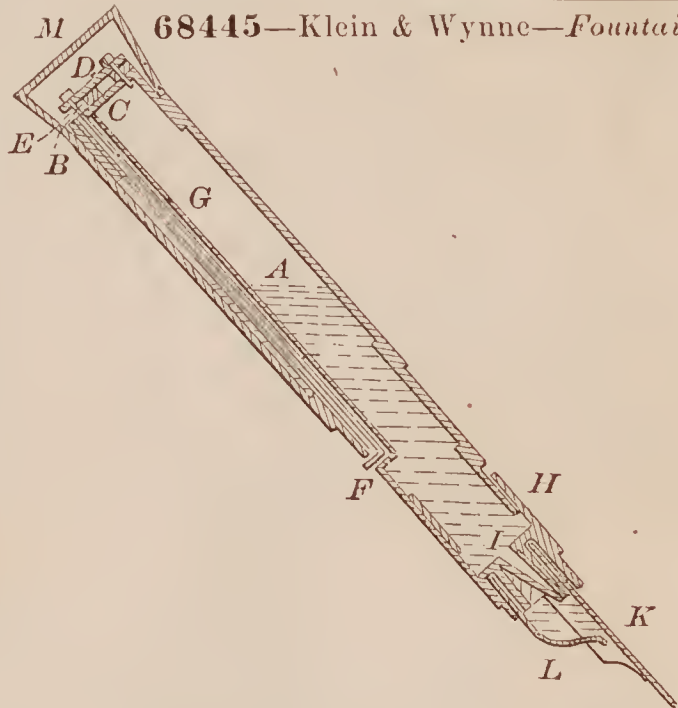

68446—C. Konold—Die for Swaging Mattocks &c.

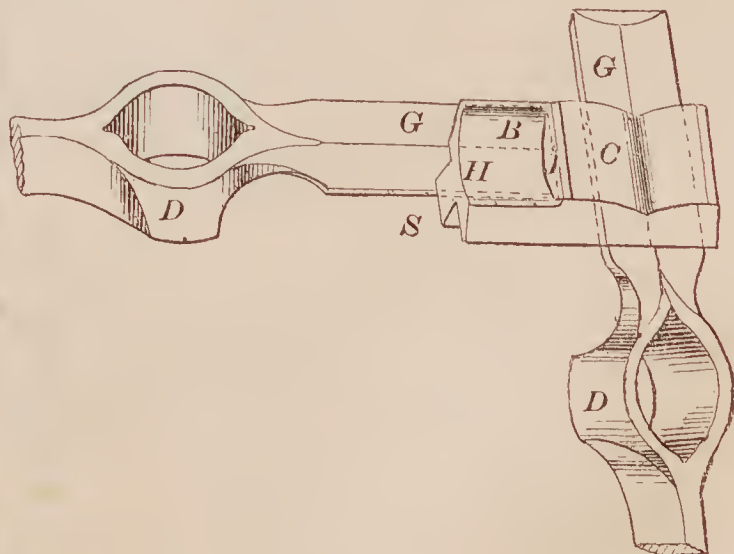

68447—Lord & Hinman—Mop Pail and Wringer.

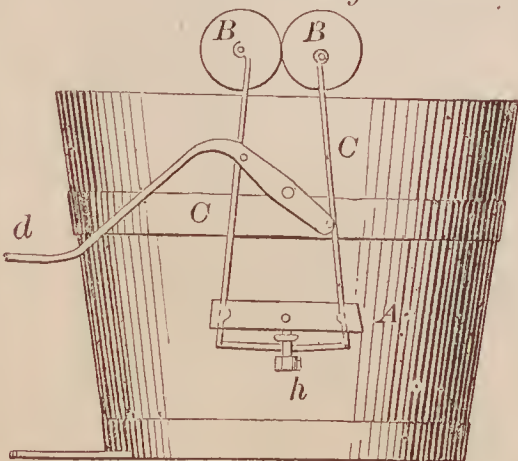



68448—A. Man—Bank Check.

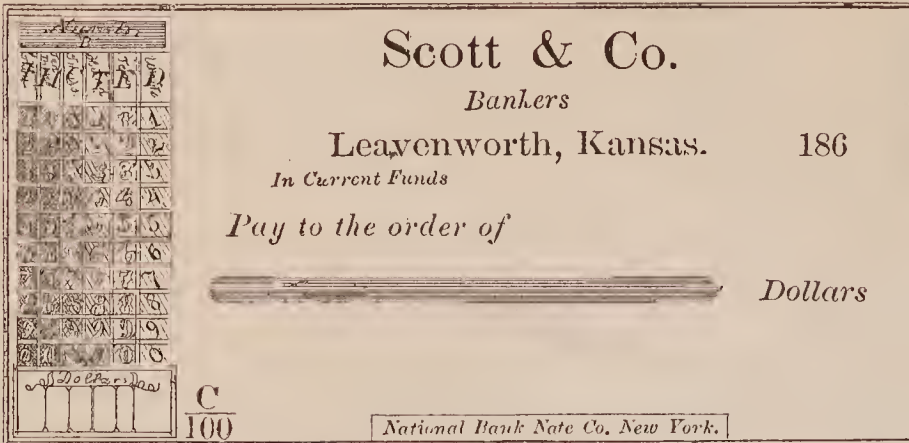

68449—G. D. Matcham—Sheep Chair and Vat.

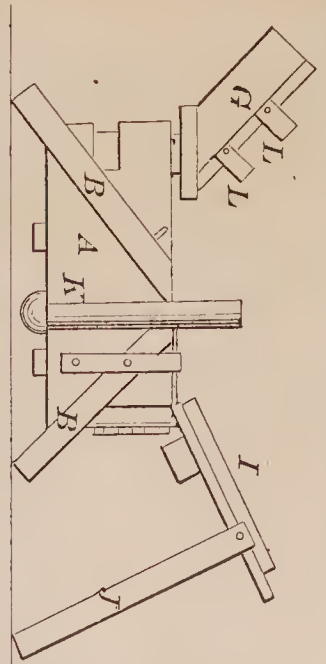

68452—T. W. Murray—Car Brake and Starting Apparatus.

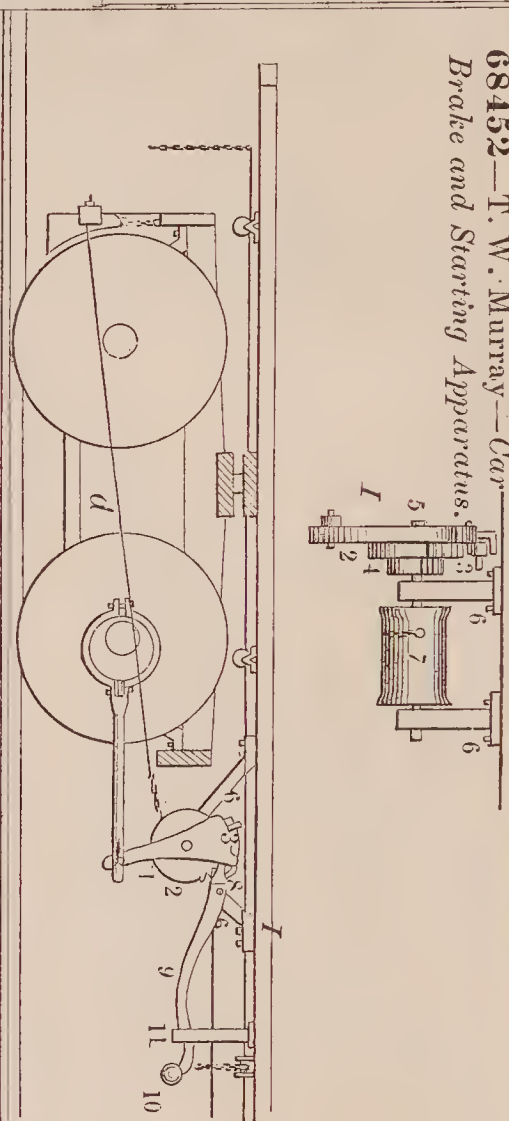

68450—F. H. McArthur—For Cutting and Folding Paper.

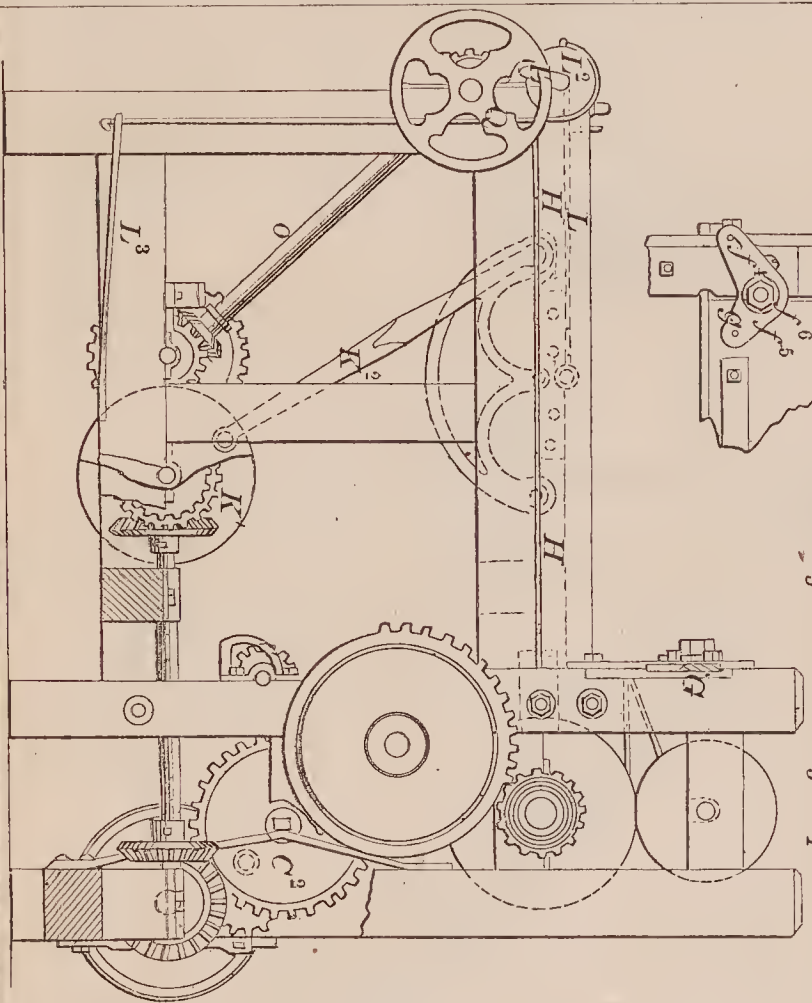

68451—J. P. Moore—Carriage Jack.

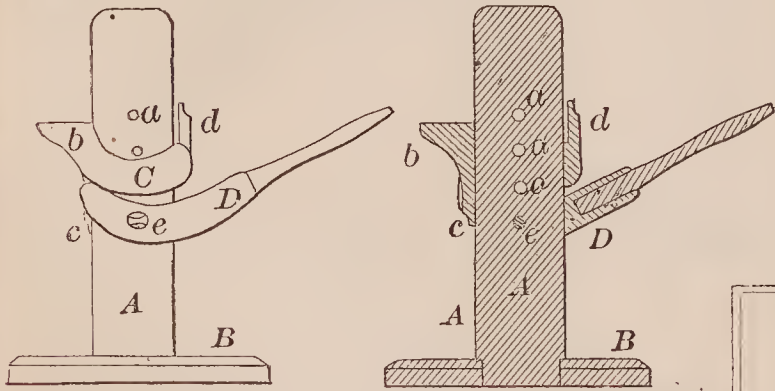

68454—J. Palmer—Die for Making Heads for Elliptic Springs.

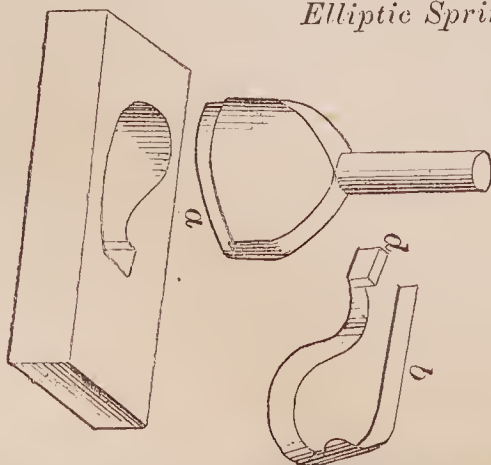

68453—J. L. Nettleton—Tool.

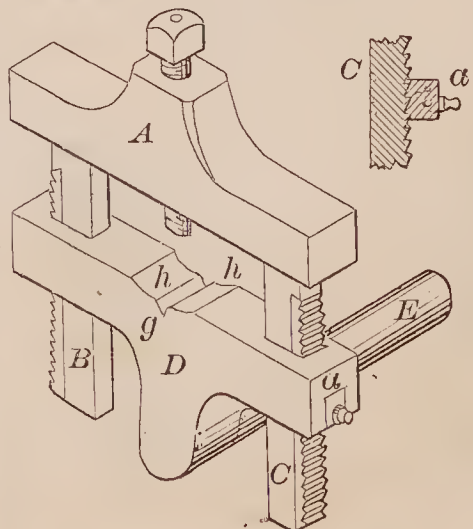

68455—A. M. Plimpton—*Detachable Buggy Top.*

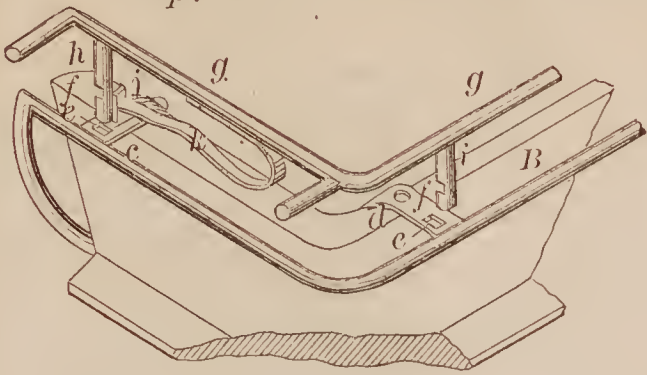

68459—D. Rice—*For Drying Fruit.*

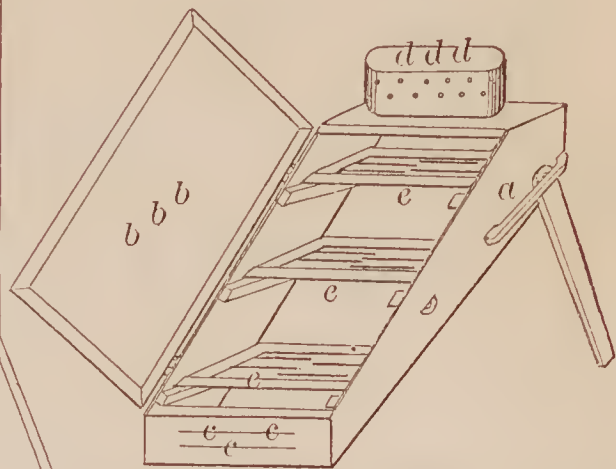

68458—S. A. Rankin—*For Stripping Sorghum.*

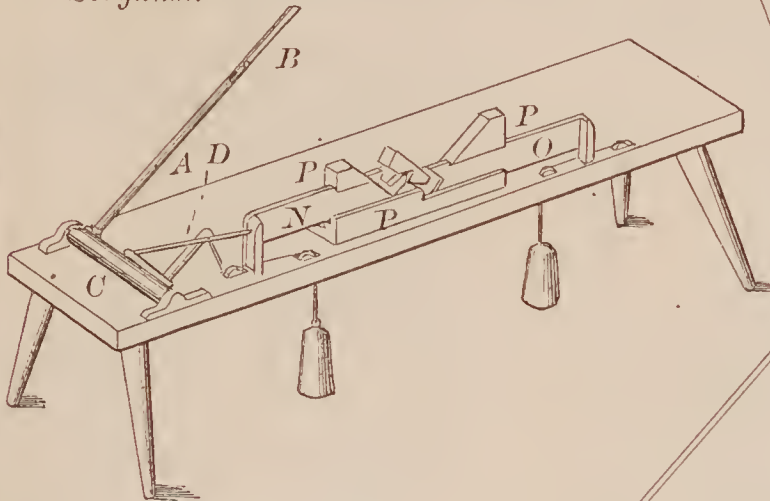

68460—H. Richardson—*Axle Bearing for Wagons.*

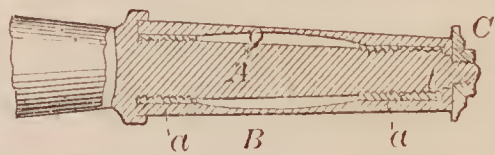

68462—J. S. Schofield—*Hay and Cotton Press.*

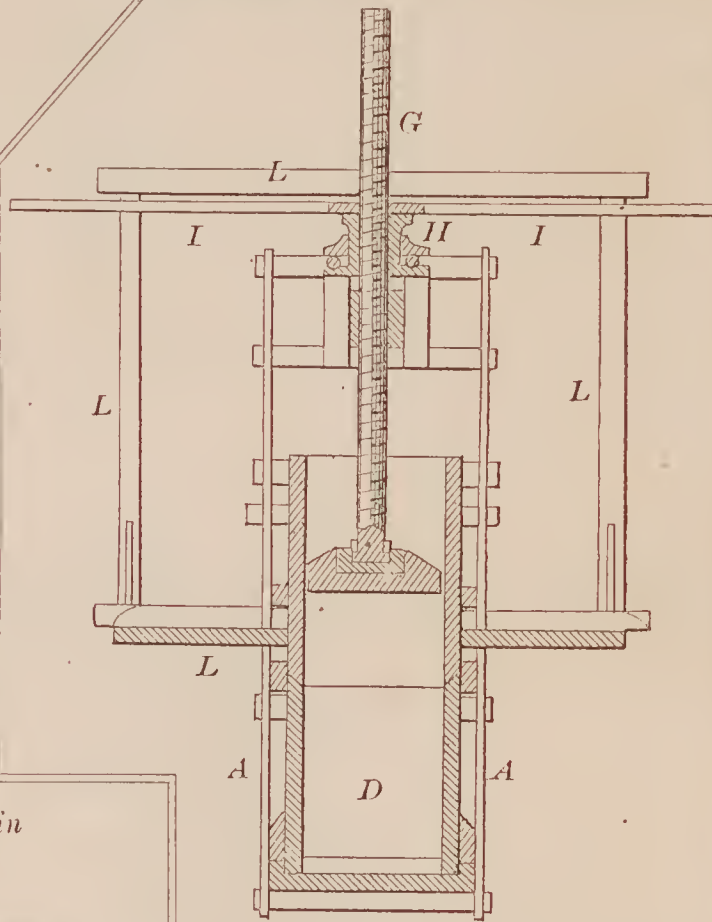

68456—N. Prescott—*For Closing Bottles.*

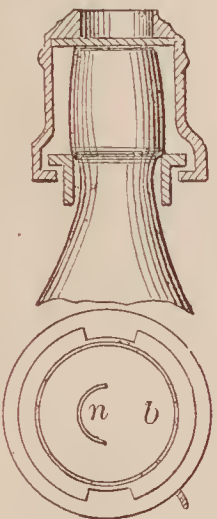

68463—Skillin & Reed—*Nutmeg Grater.*

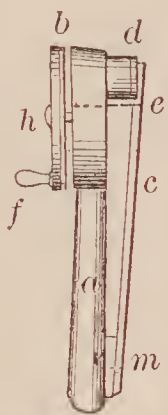

68464—E. Stafford—*Condensing Roller in Carding Machines.*

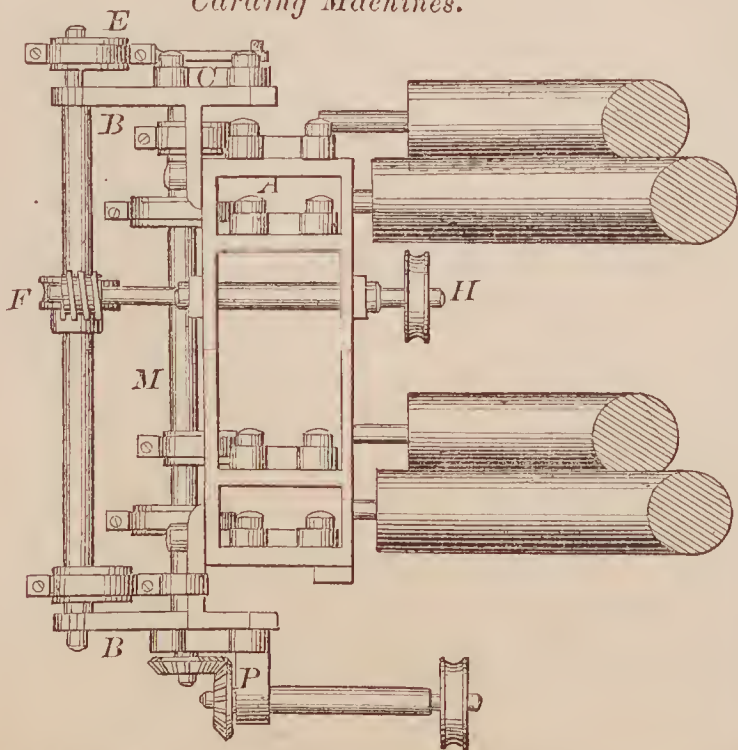

68461—E. P. Russell—*Dumping Reel for Harvesters.*

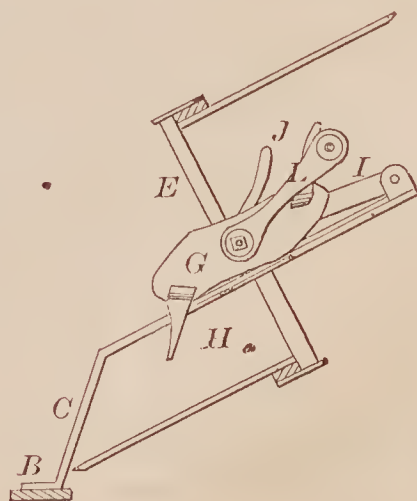



68465—T. G. Stansberry—Belt Tightener.

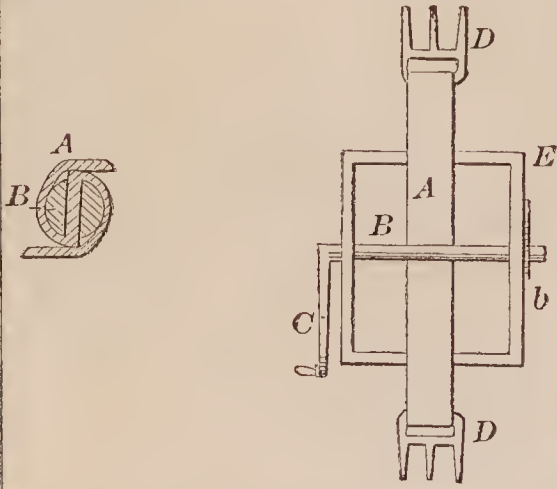

68466—N. A. Swett—Heeling Plate.

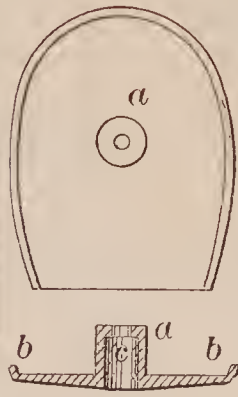

68470—Trageser & Illofsky—For Distilling.

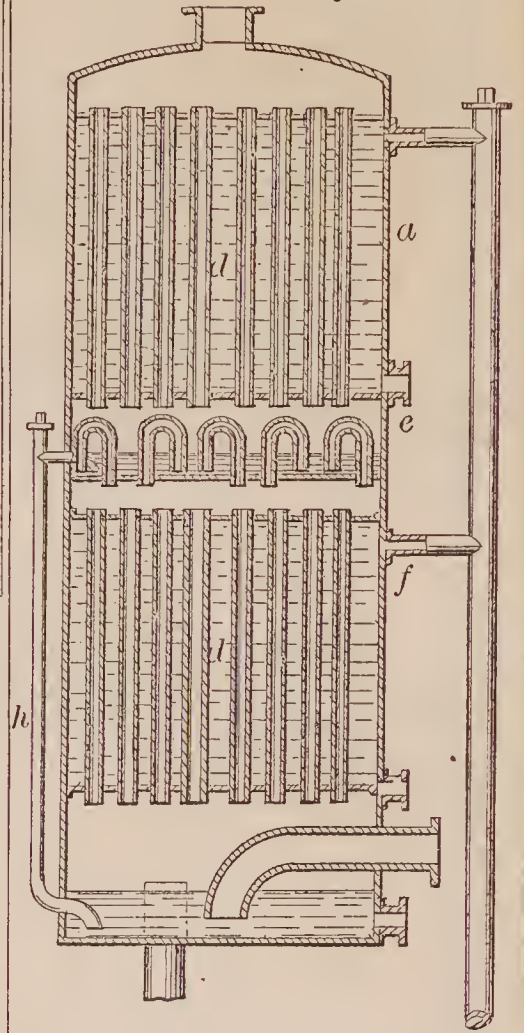

68467—W. Tanner—Theatrical Scenery.

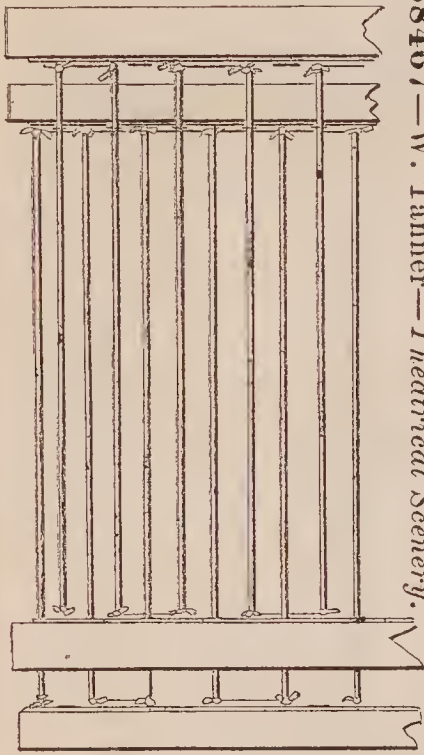

68468—W. McK. Thornton—Buckle.

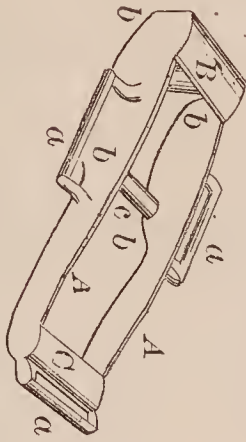

68469—H. H. Tietjens—Cultivator.

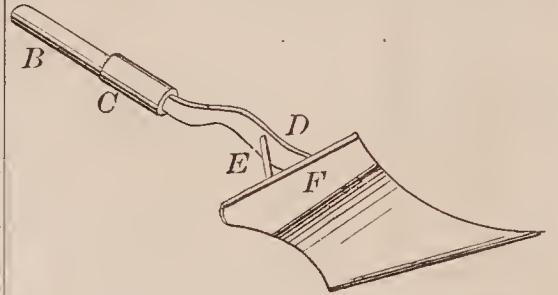

68471—L. T. Verney—Printing Press.

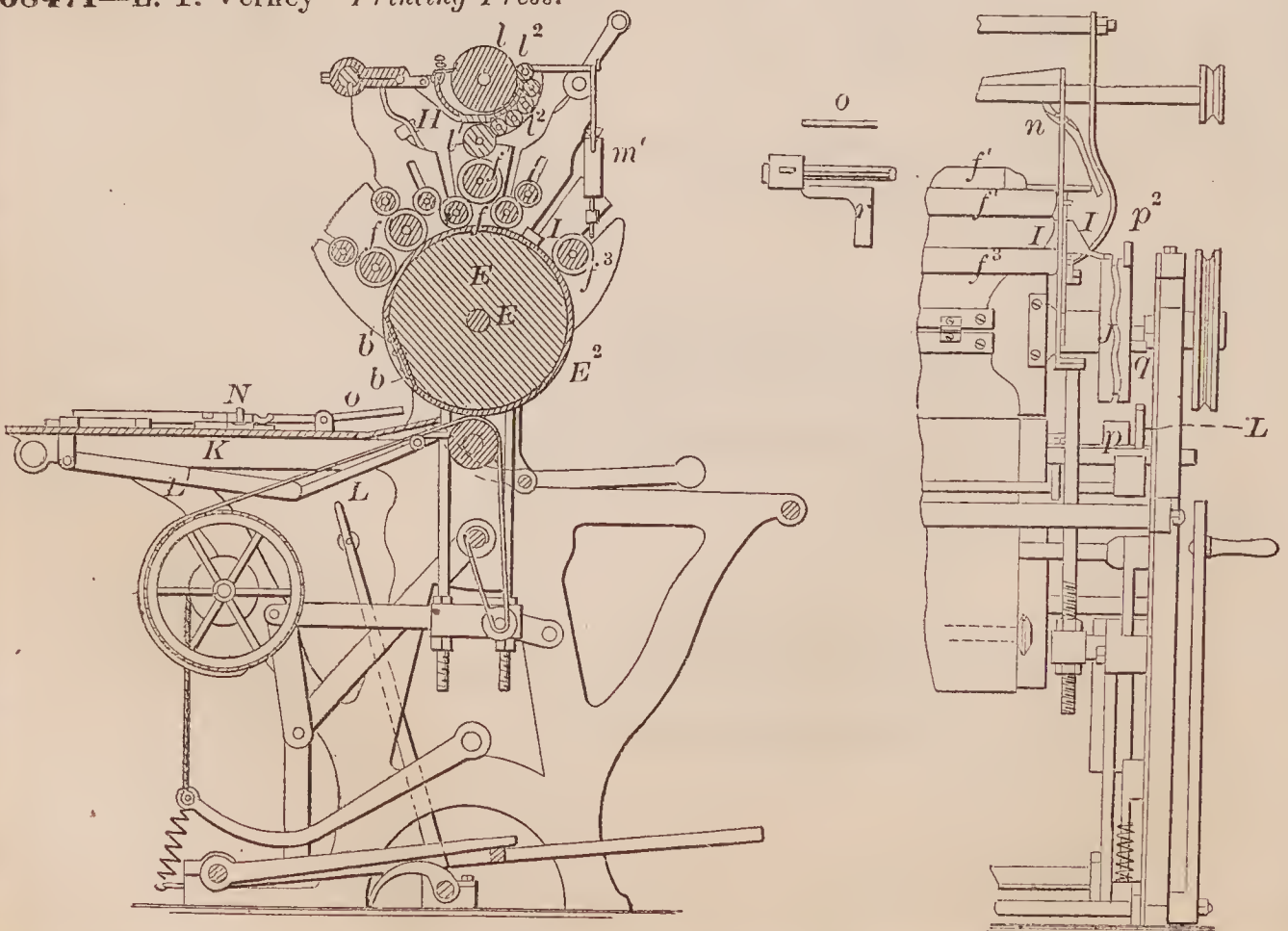



68472—J. C. Walker—Grain Meter.

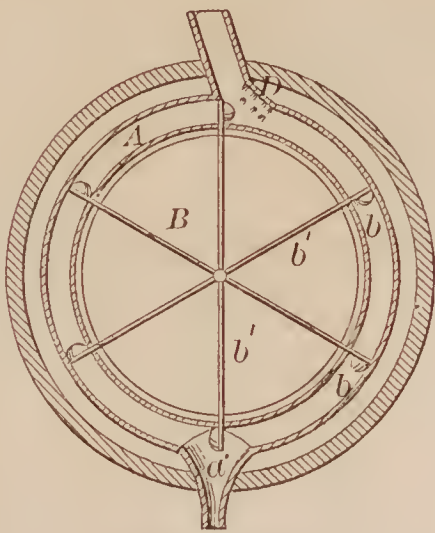

68473—J. V. Weitz—Low Water Detector for Steam Generators.

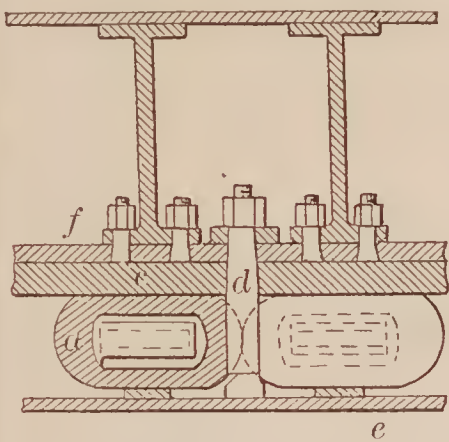
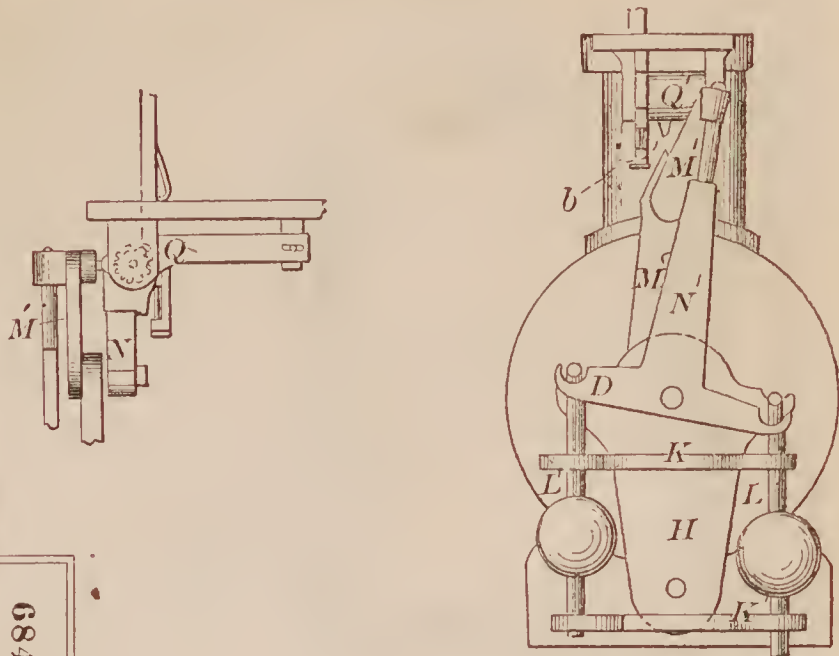

68474—T. Whitby—Armor for Ships of War.

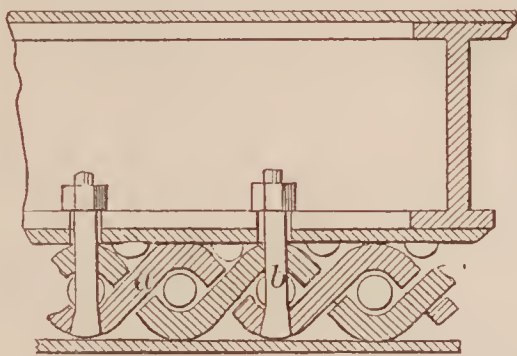
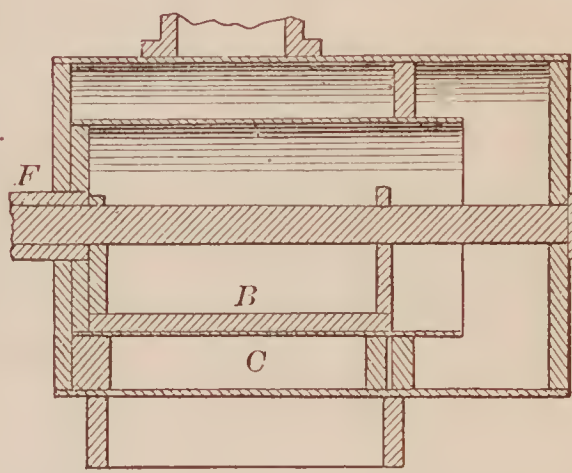

68477—Witt & Sina—Hemp Brake.

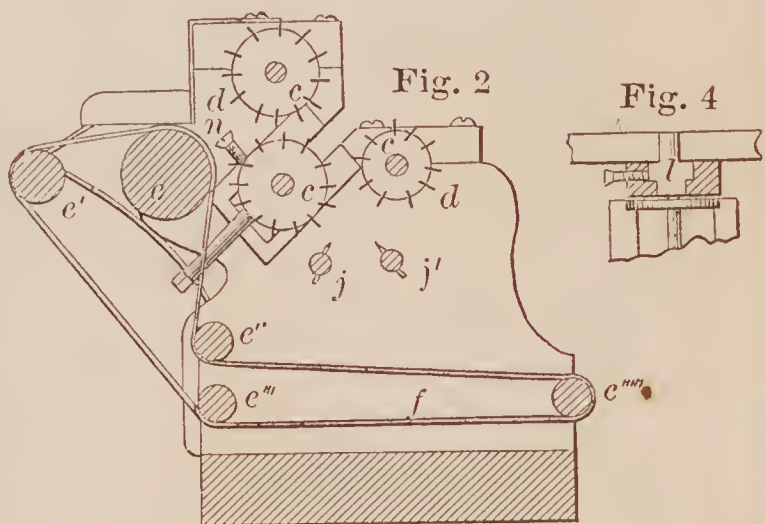
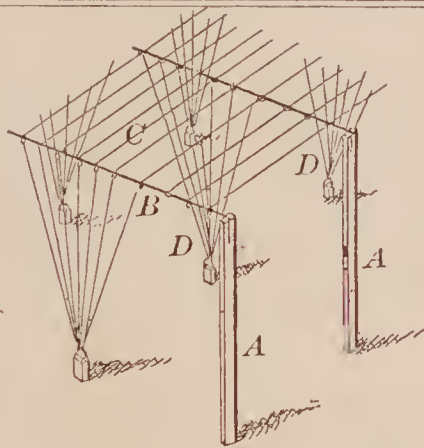

Fig. 2

Fig. 4



68475—L. H. Whitney—Vine Trellis.

Fig. 3

Fig. 6

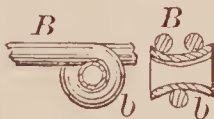

68476—Winterbottom & Lord—Spinning Jack.

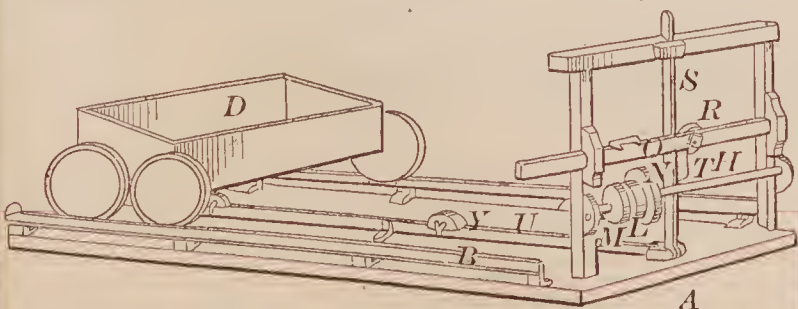

68478—A. F. Allen—Escape Valve Hose Coupling.

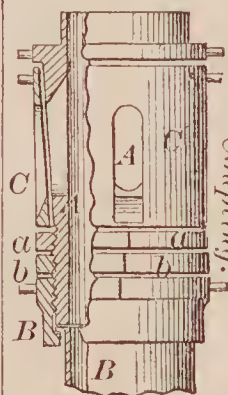

68479—R. L. Allen—Wagon Seat and Spring.

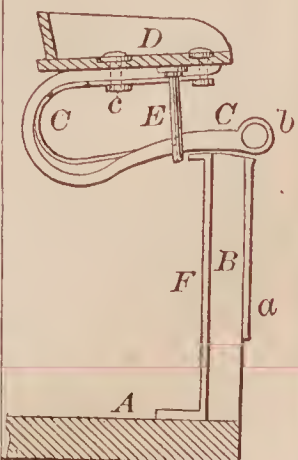



68480—Arkle & Greer—Automatic Measuring Can.

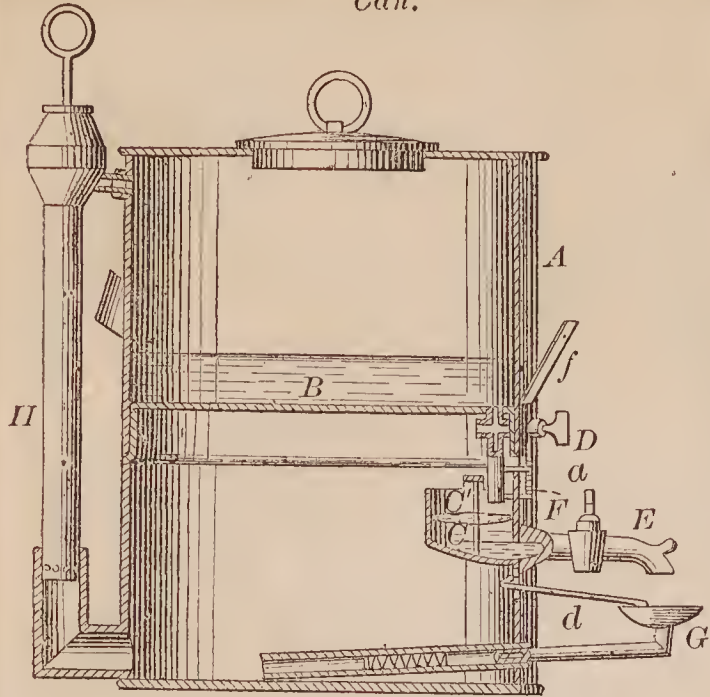

68486—J. Carlisle—Rail for Buggy Seats.

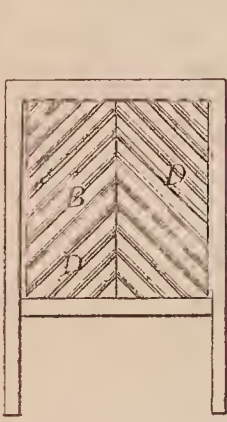
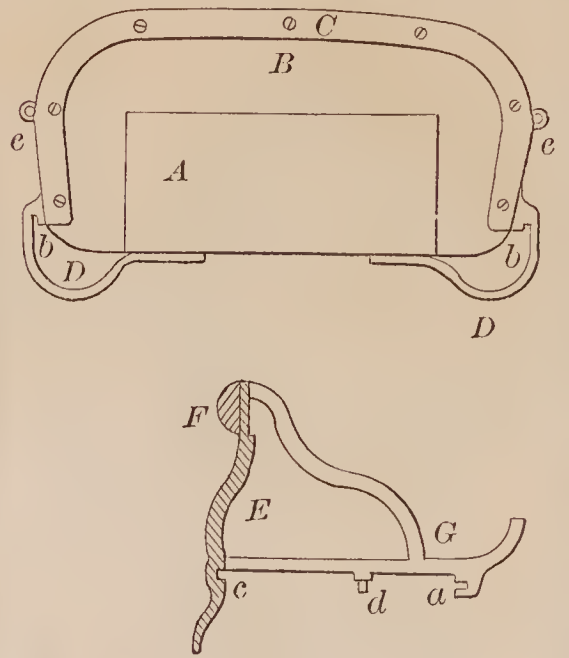

68481—P. Andamim—Wash Board.

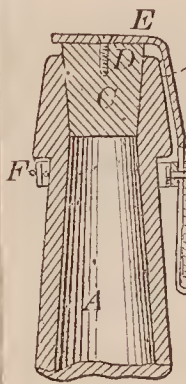

68484—H. S. Carley—Bottle Stopper.

68485—H. S. Carley—Bottle Stopper.

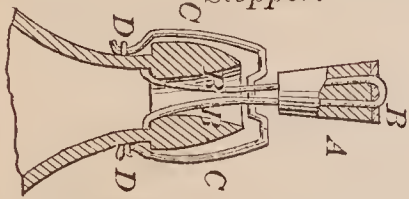

68483—J. & A. Bloom—House Fan.

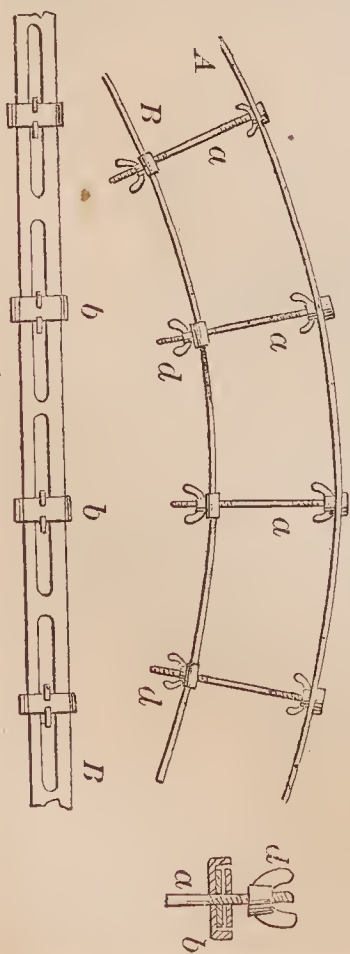
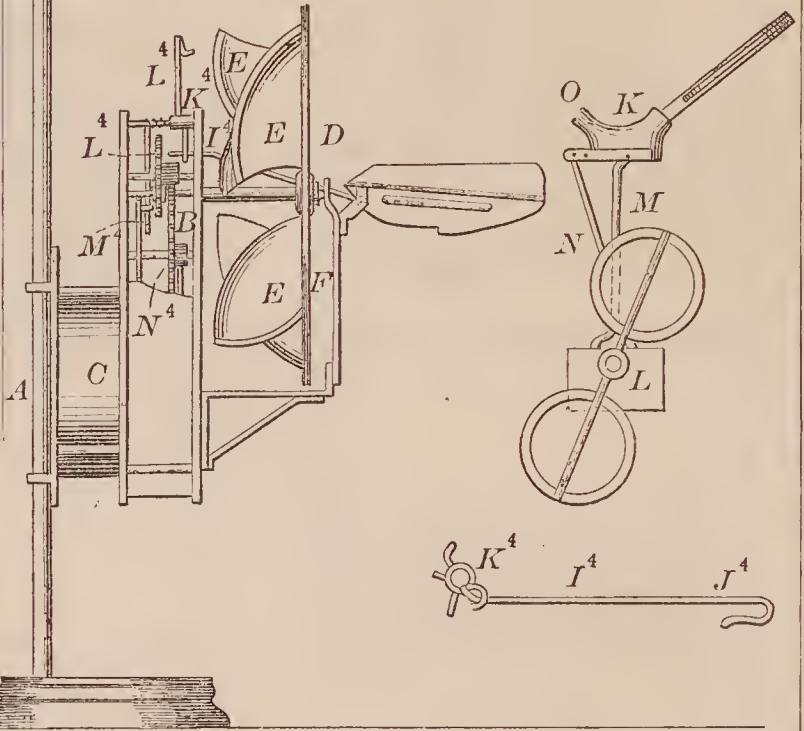

68487—J. J. Cassidy—Adjustable Shipbuilders' Mould.

68482—W. Bicknell—Crank Motion.

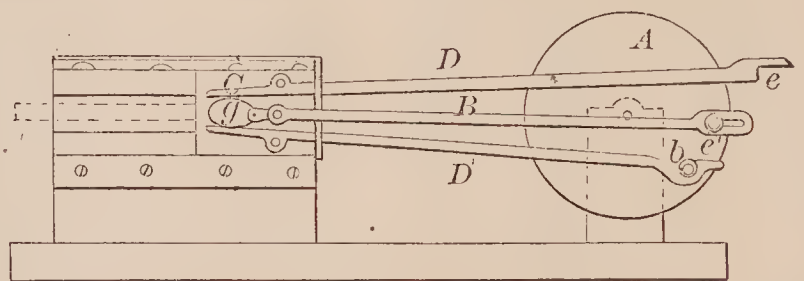

68488—E. S. Chapell—For Boring and Screw Cutting.

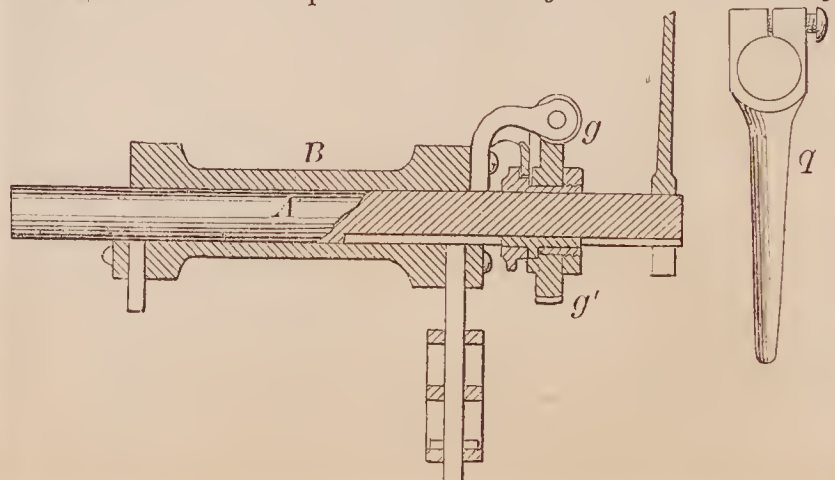

68489—D. W. Colburn—*Plow and Hoe.*

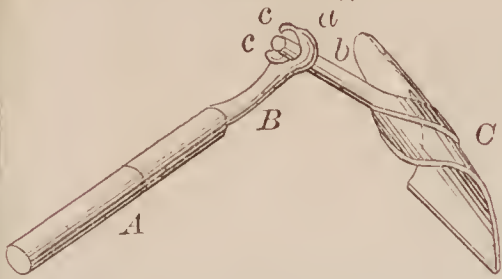

68493—A. Downer—*Wagon Lock.*

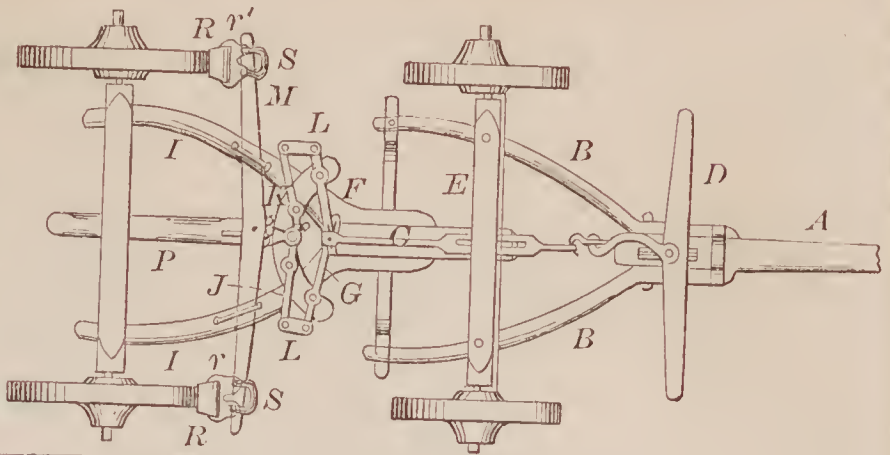

68495—J. Eddy—*Steam Engine Governor.*

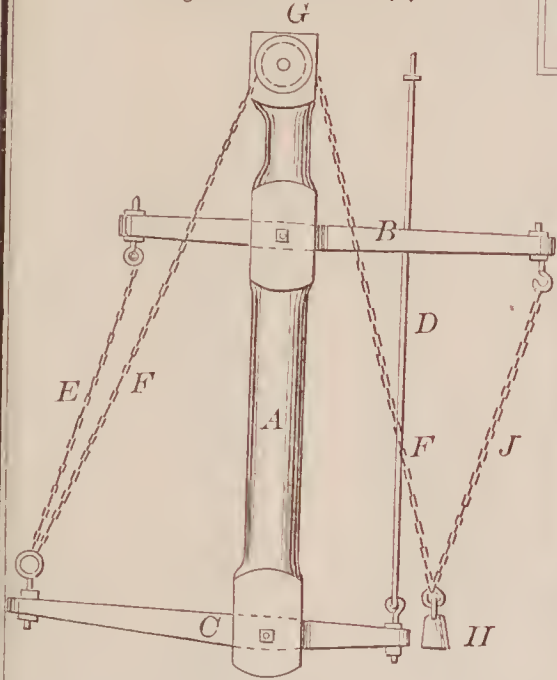

68490—E. P. Crain—*Scale Beam.*

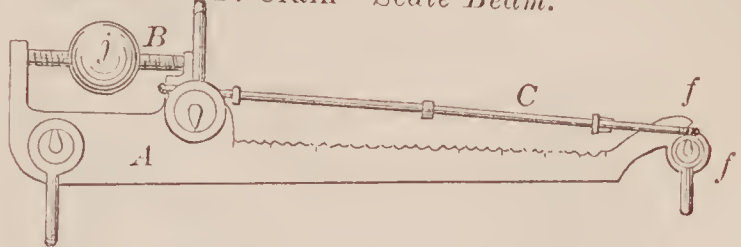

68494—W. L. Drake—*Brick Press.*

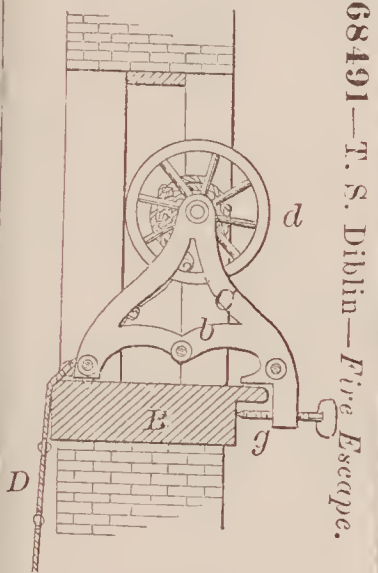
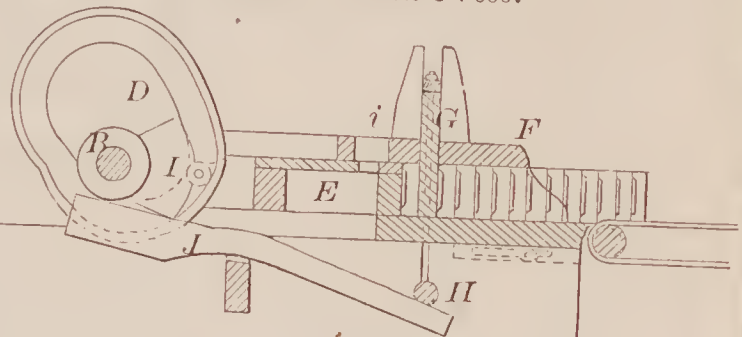

68491—T. S. Dillin—*Fire Escape.*

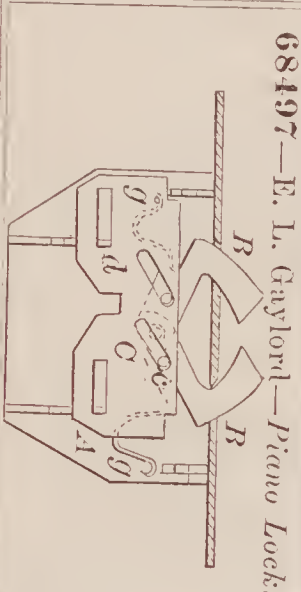

68497—E. L. Gaylord—*Piano Lock.*

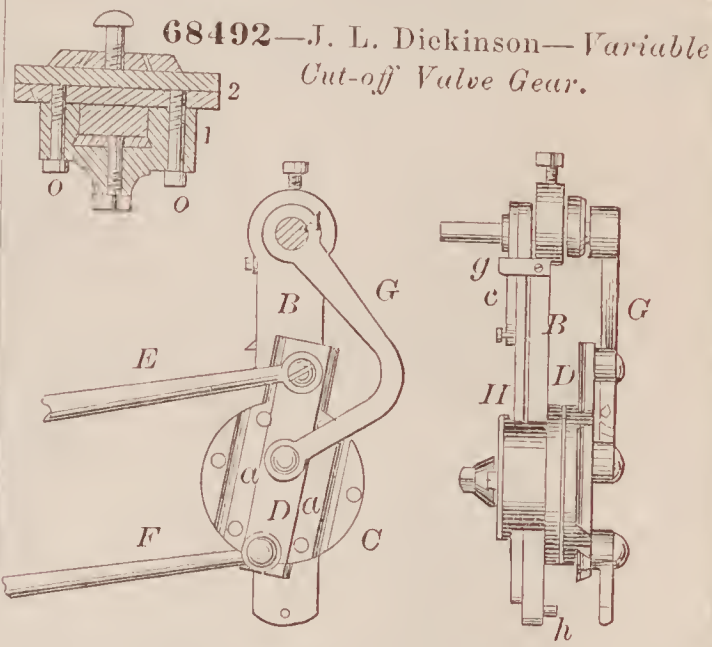

68492—J. L. Dickinson—*Variable Cut-off Valve Gear.*

68496—E. L. Gaylord—*Piano Lock.*

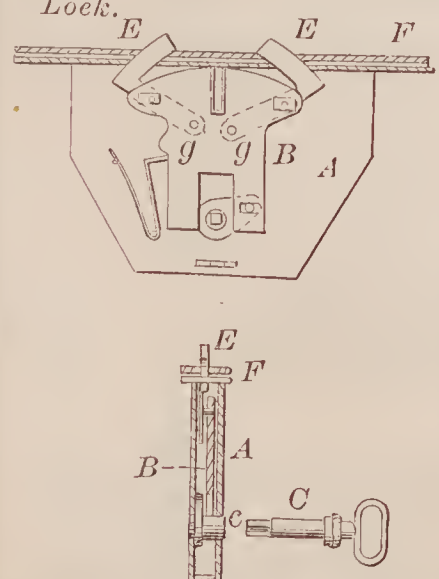

68498—H. Gill—*Screw Plate for Cutting Screws.*

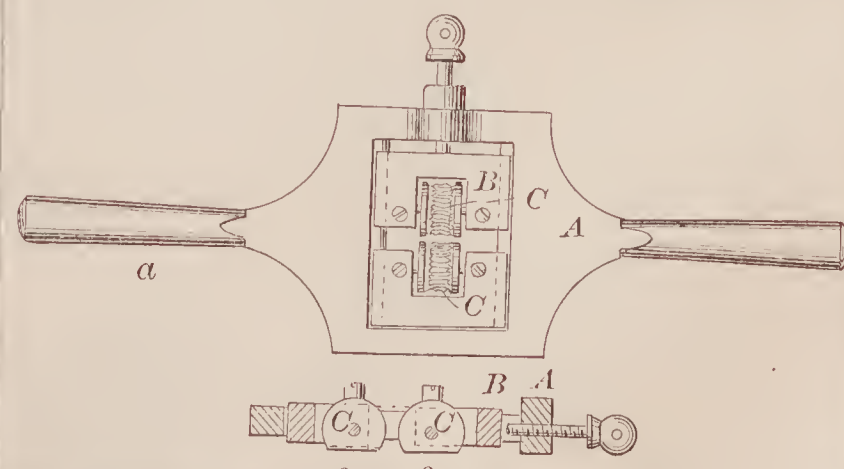



68499—J. S. Grant—*Bed Bottom.*

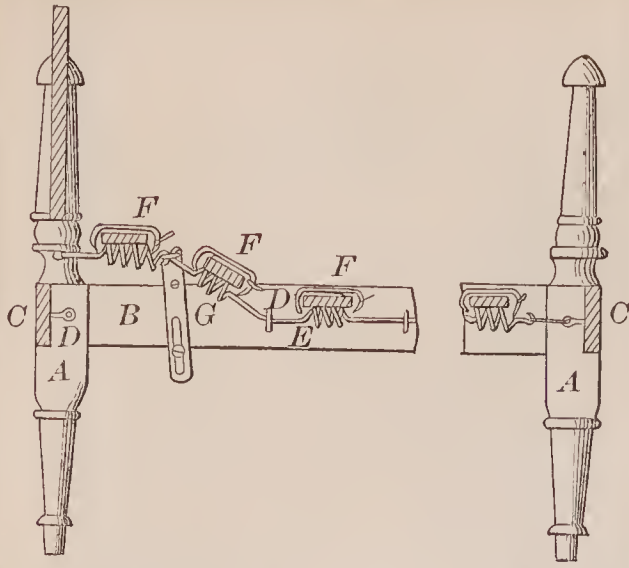

68500—J. S. Grant—*Horse Rake.*

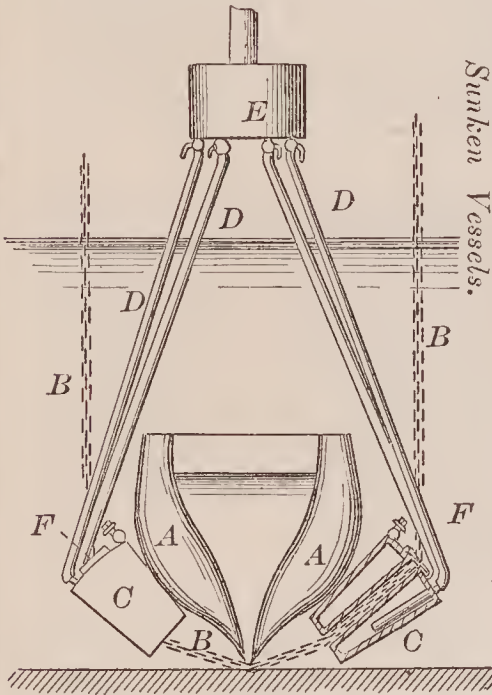
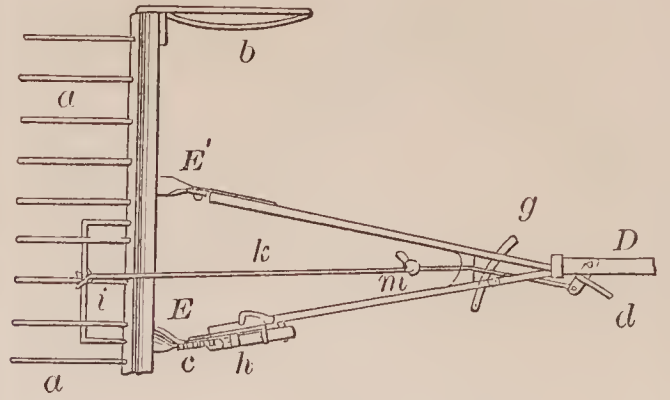

68501—R. W. Hallett—*For Raising Sunken Vessels.*

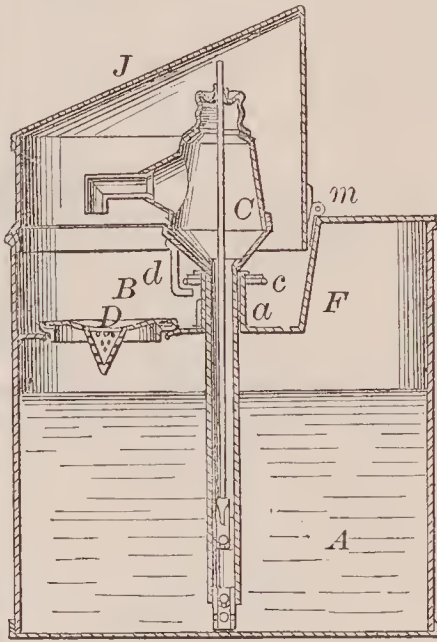

68503—G. Hatch—*Oil Can.*

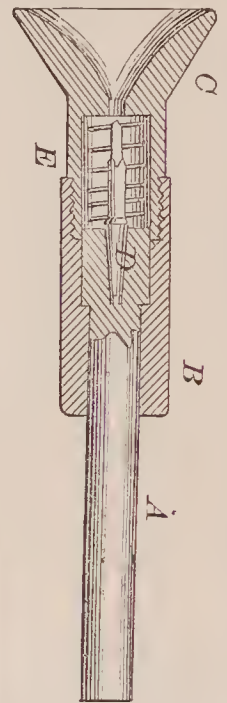

68504—R. Haworth—*Centering Tool.*

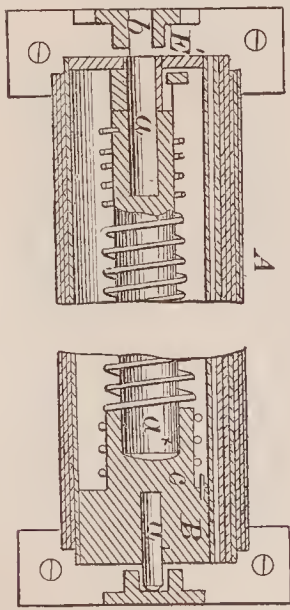

68502—S. Hartshorn—*Shade Fixture.*

68506—C. O. Heyl—*For Extracting Oil from Substances.*

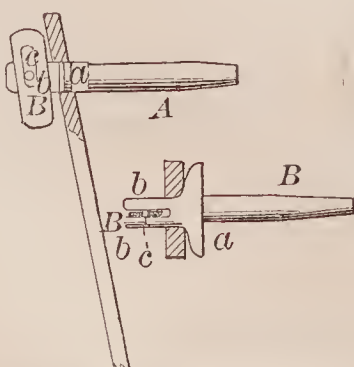
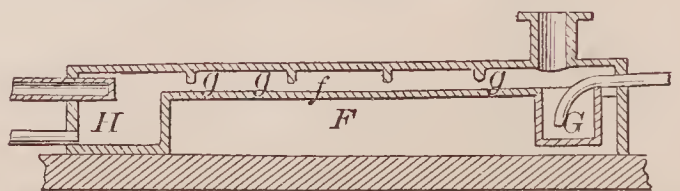
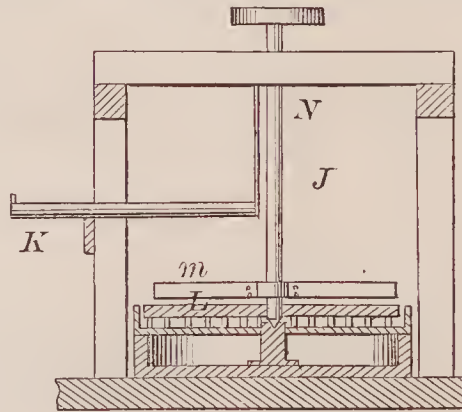
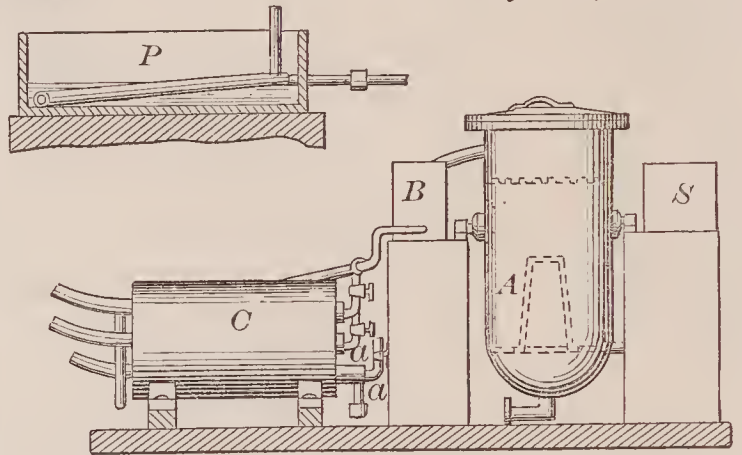

68505—C. Hayden—*Trace Fastener.*



68507—J. D. Hill—*For Gathering and Husking Corn.*

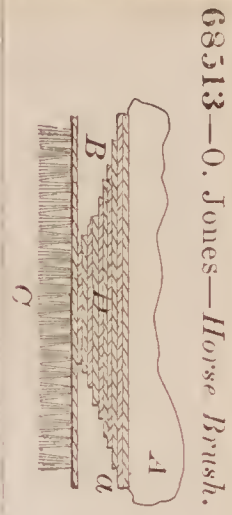
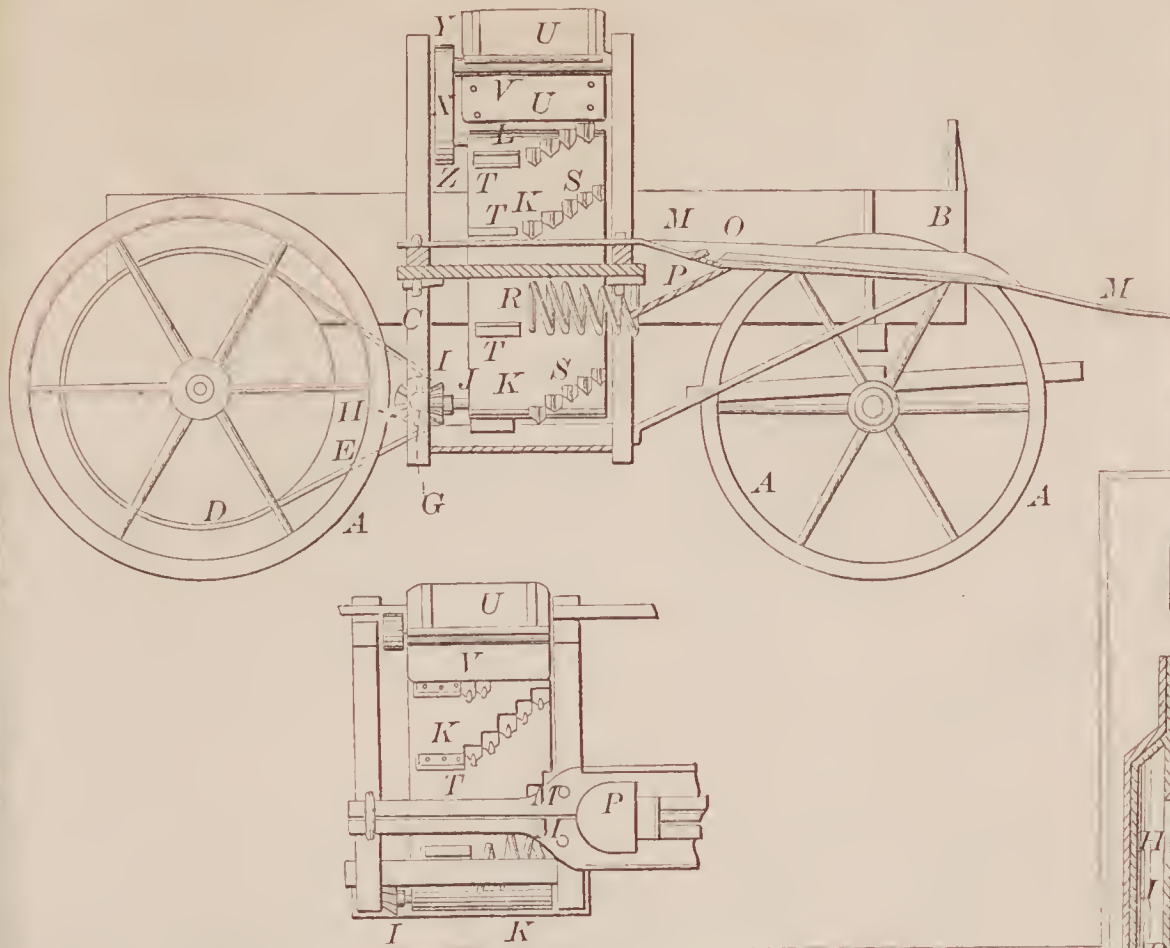

68513—O. Jones—*Horse Brush.*

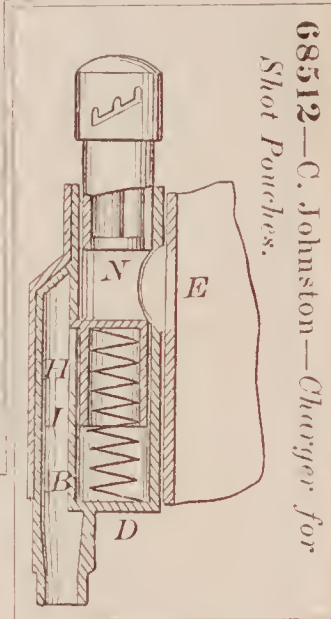

68512—C. Johnston—*Charger for Shot Pouches.*

68509—T. N. Hornsby—*Manufacture of Cannon.*

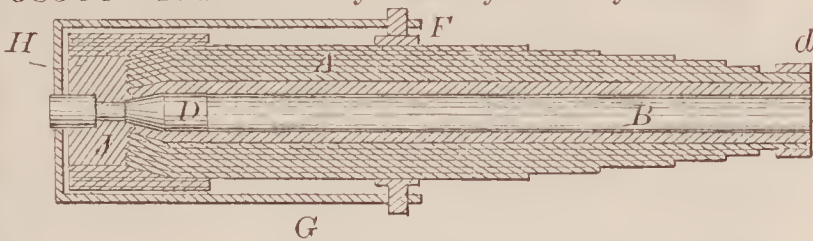

68514—E. C. Kellogg—*Cattle Pump.*

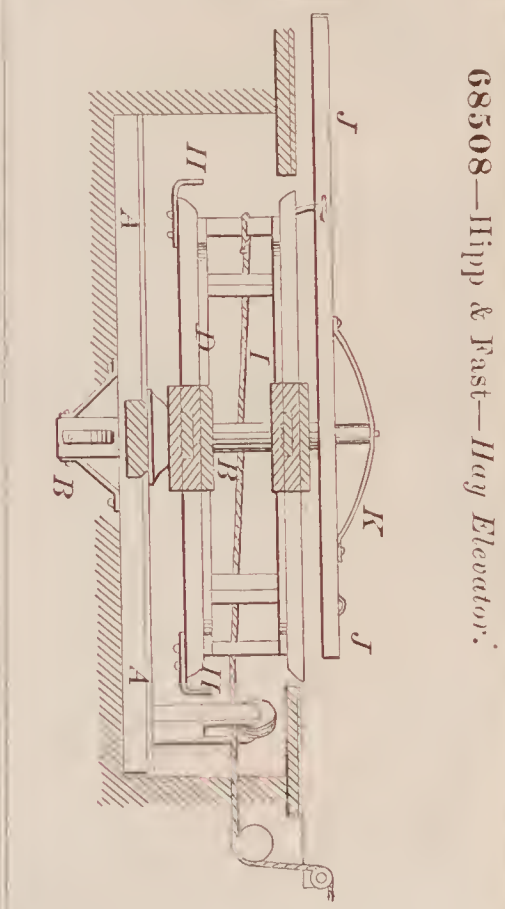
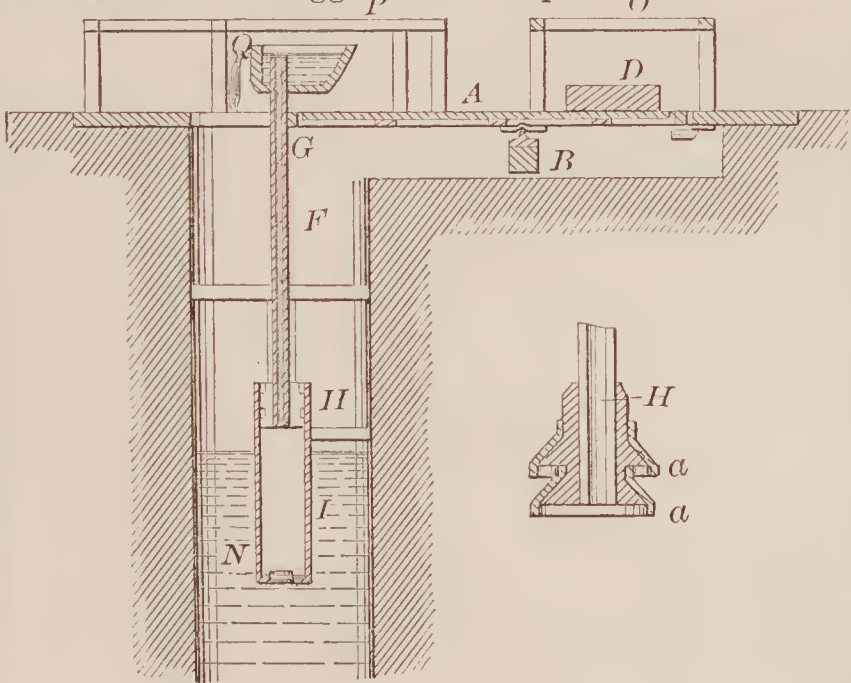

68508—Hipp & East—*Hay Elevator.*

68510—J. P. R. James—*Clothes Pin.*

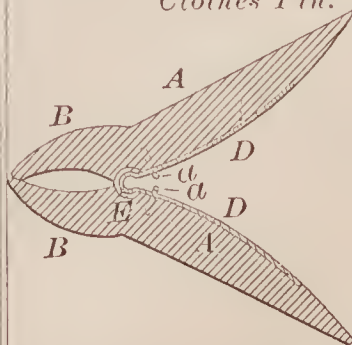

68515—J. Knox—*Thill Coupling.*

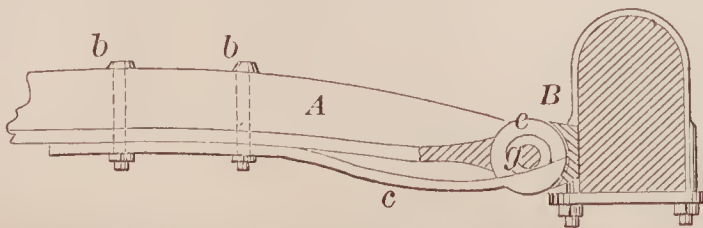



68516—S. B. Lane—For Making Button Rings.

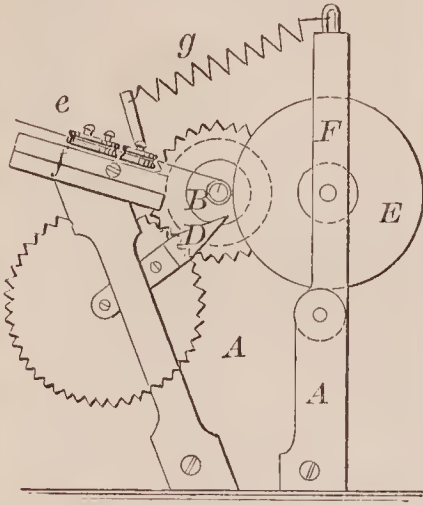

68517—G. C. Lathrop—Sawing Machine.

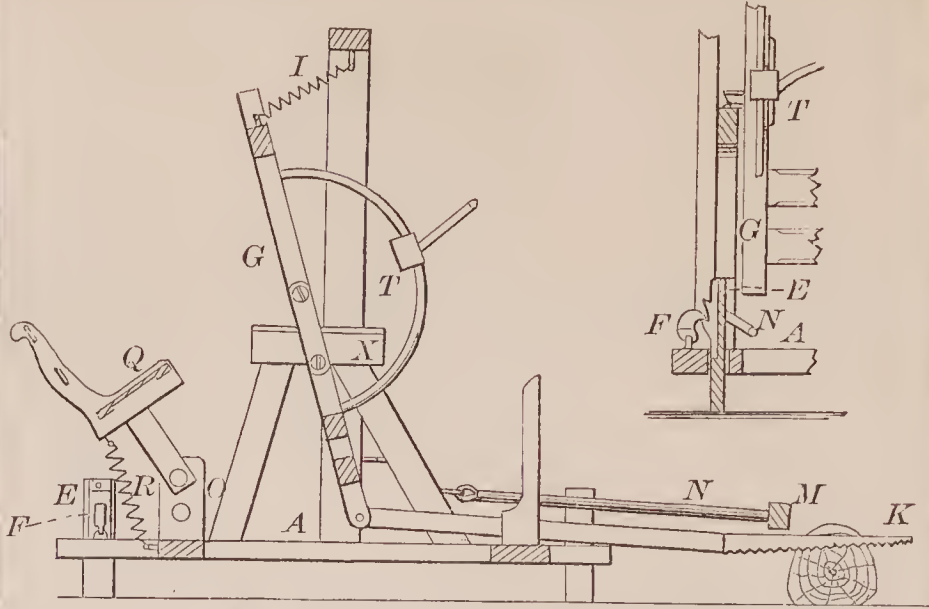

68521—S. B. Manley—Obstetric Supporter.

68519—H. E. Long—Wood Vise.

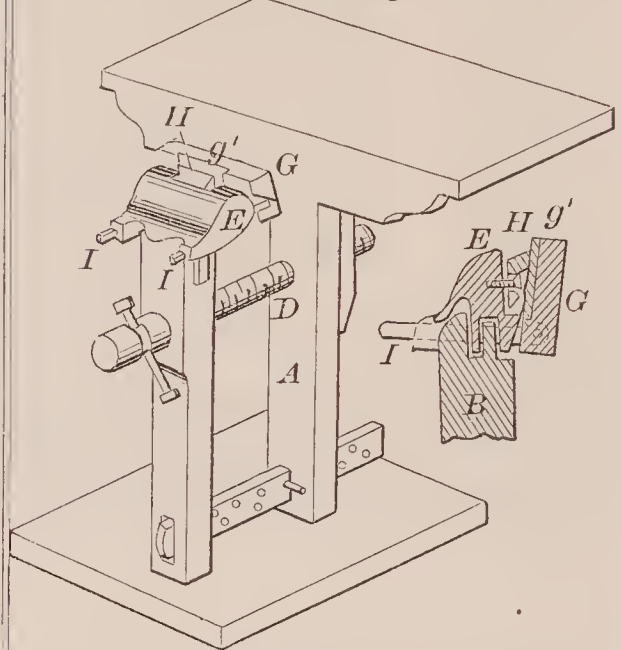

68522—E. Masters—Yard for Ships.

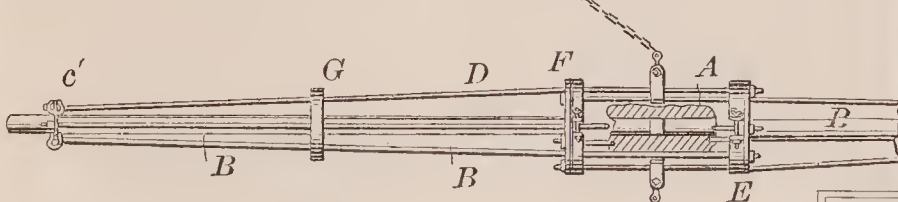

68518—L. B. & G. W. Lee—Fly Net.

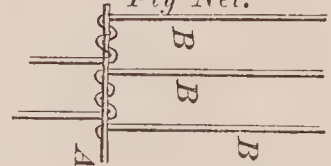

68524—M. J. Mellyn—Adjusting Thills to Carriages.

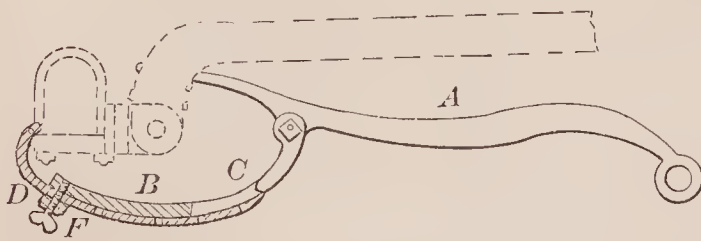

68520—E. F. Mallory—Burglar Alarm.

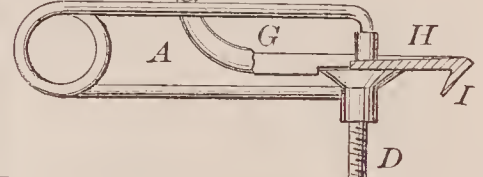

68525—W. A. Moody—N Cultivator.

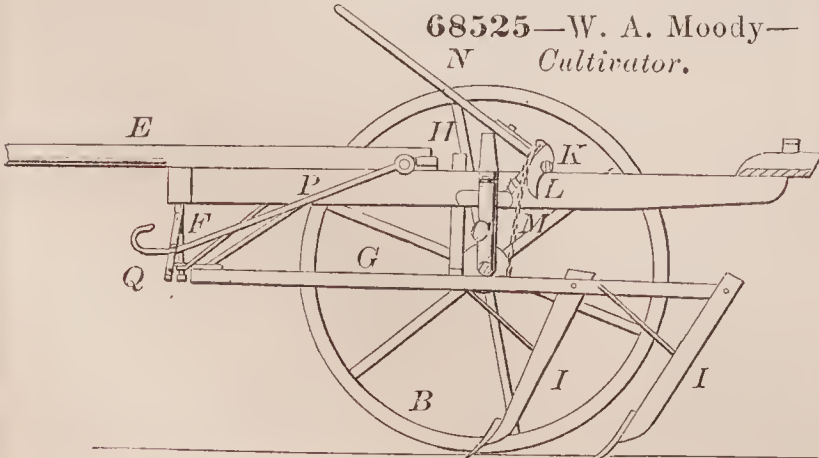

68523—D. C. McNeil—Churn.

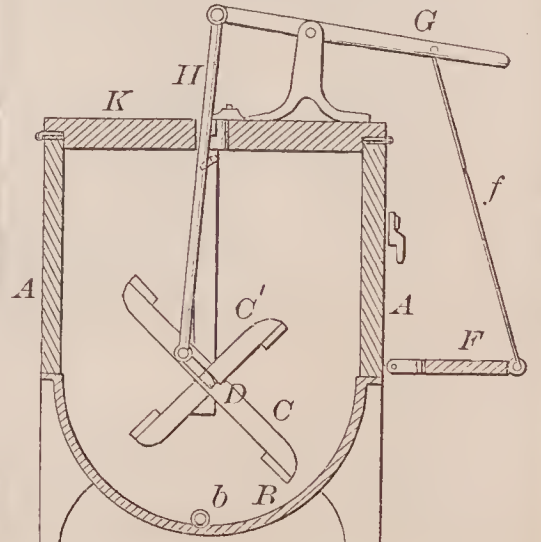

68526—R. M. Morriell—*Clothes Dryer.*

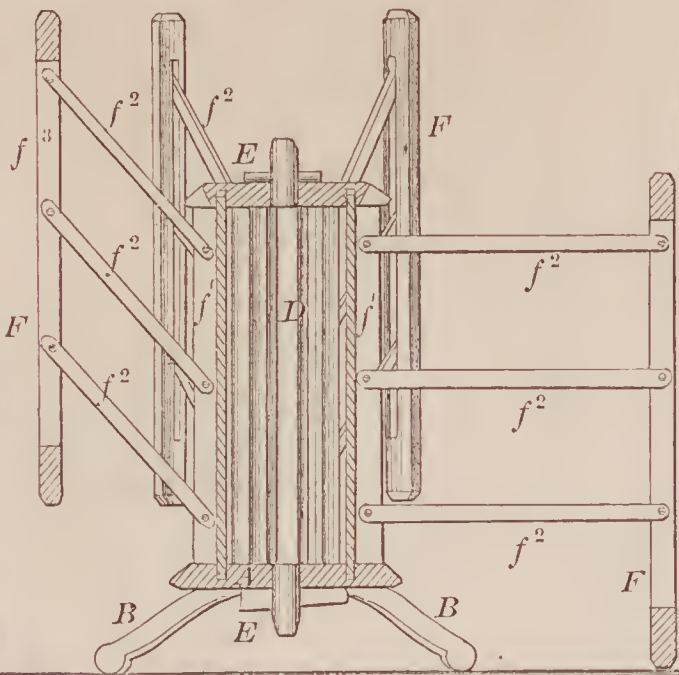

68527—  
W. H. Murphy—  
*Padlock.*

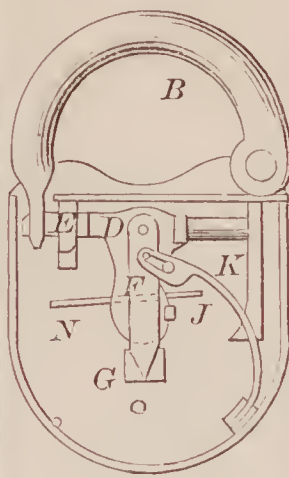

68528—S. W. Perkins—  
*Wire Snap Hook.*

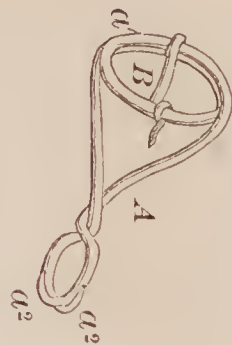

68531—I. Robbins—*Alarm Money Drawer.*

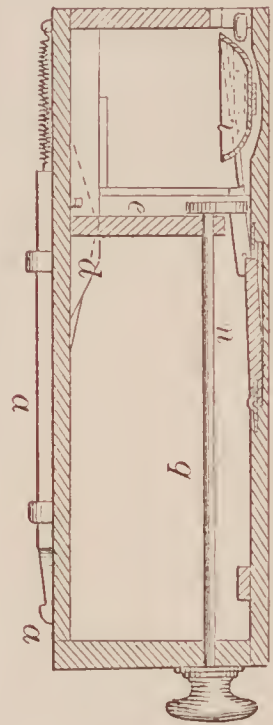

68529—A. Rais—*For Making Butt Hinges.*

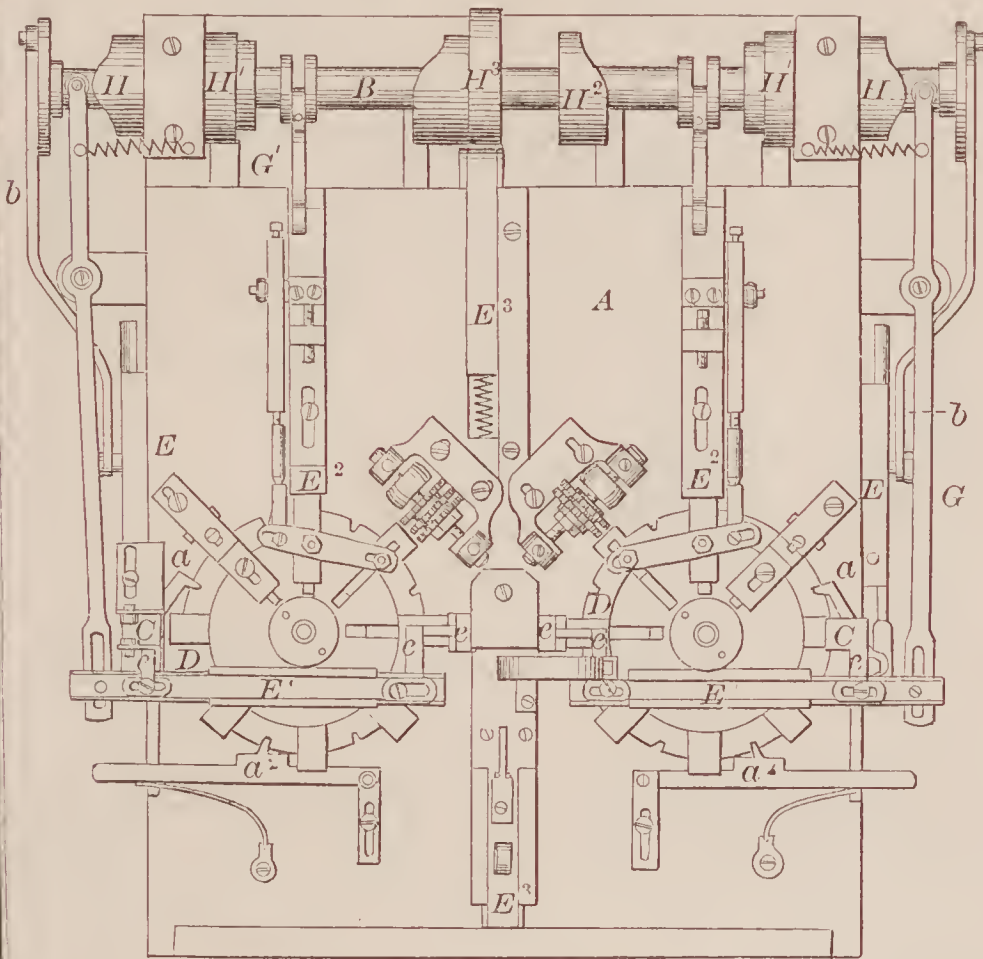

68532—W. S. Rooney—*Melasses  
Cup.*

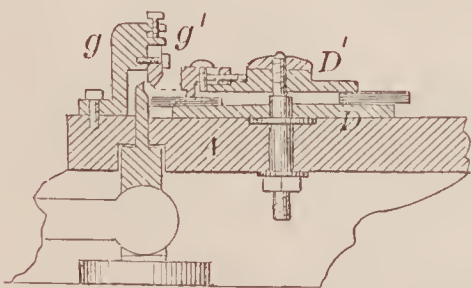
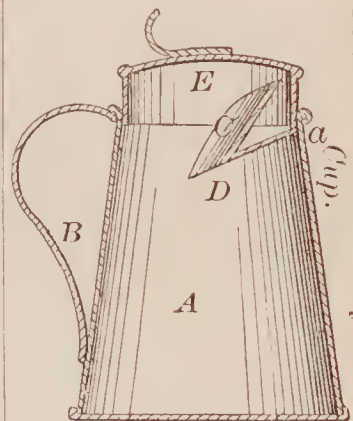

68530—R. Rice—*Fly or Balance Wheel.*

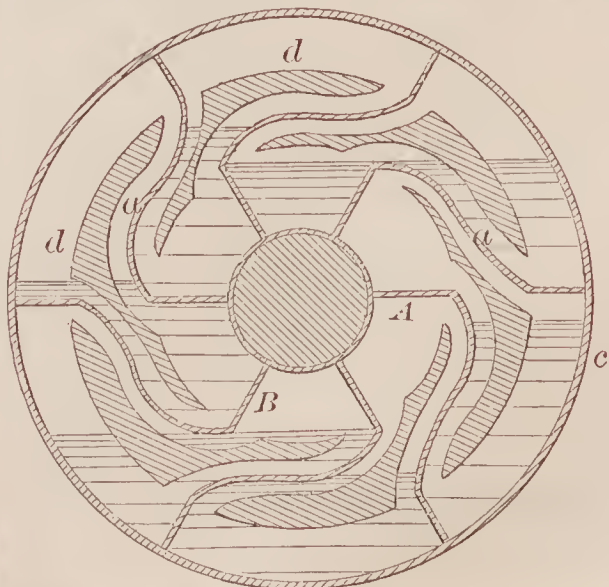

68533—Seger & Smith—*Clamp for Hinges.*

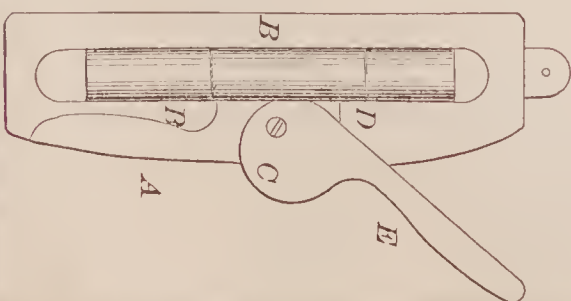



68534—J. Shaaber—Sled.

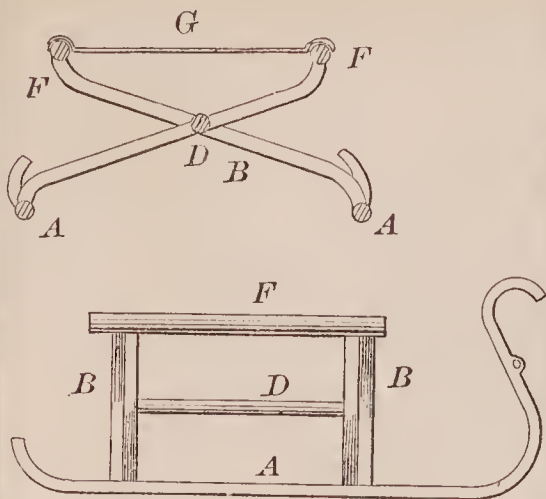

68535—J. L. Short—Trace Fastener.

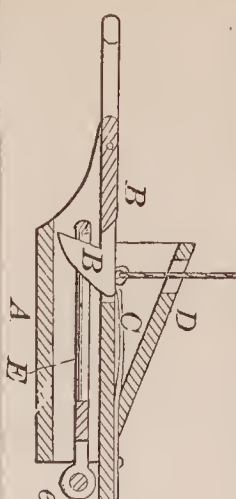

68537—J. M. Smith—Chuck.

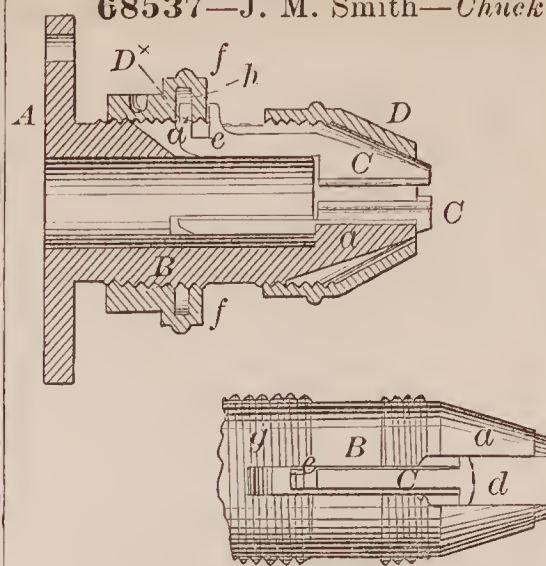

68536—H. M. Smith—Hay Knife.



68538—B. F. Southgate—Diamond Key.

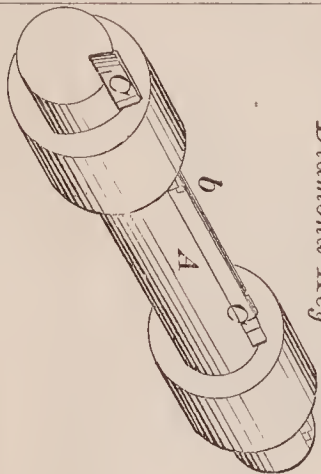

68539—C. N. Taylor—Grinding Mill.

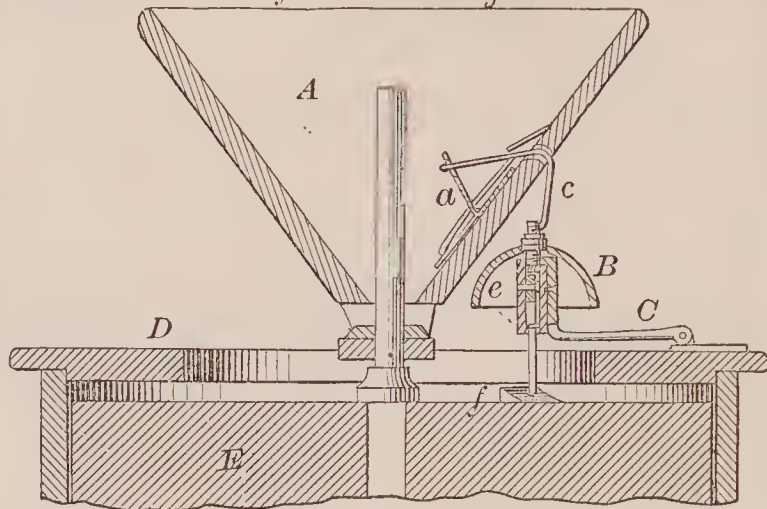

68542—A. Zwiebel—Universal Joint.

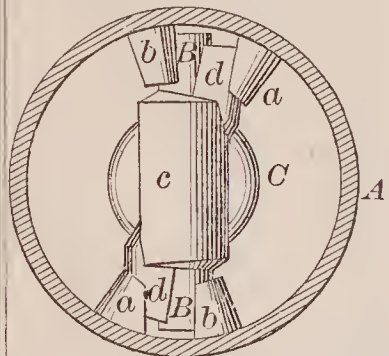

68541—A. B. Woodbury—Spinning Jack.

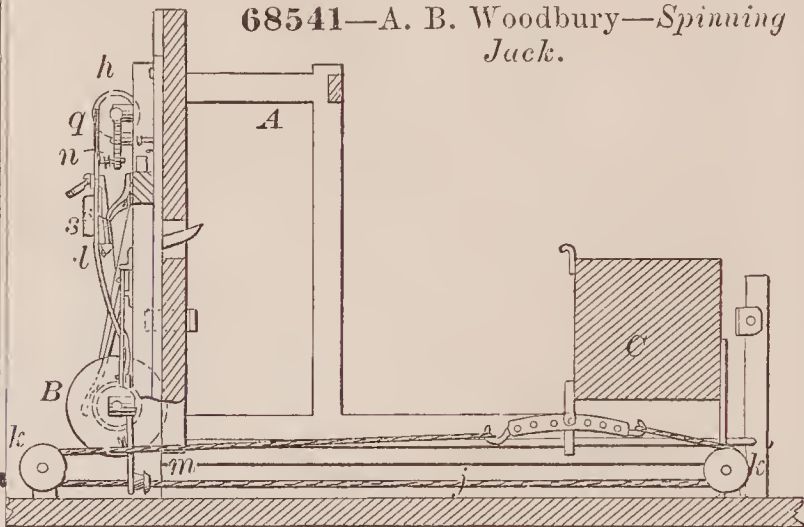

68540—W. Welch—Locking Device.

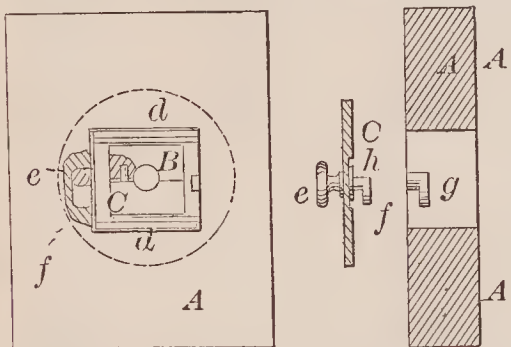

68543—C. R. Abbot—Safety Car Platform.

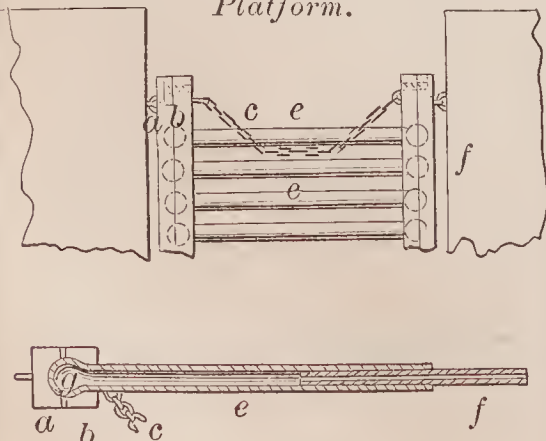

68544—Andrews & Green—Corn Planter.

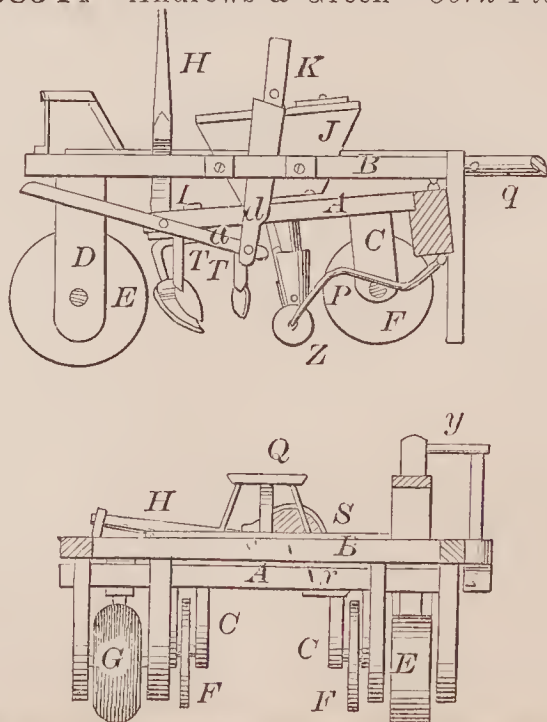

68545—Austin & Schaw—Plow Clevis.

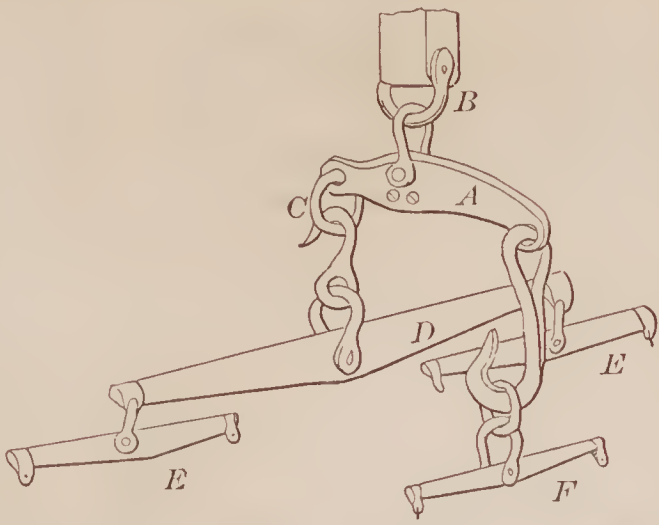

68547—H. A. Bartlett—For Connecting Strips of Metal.

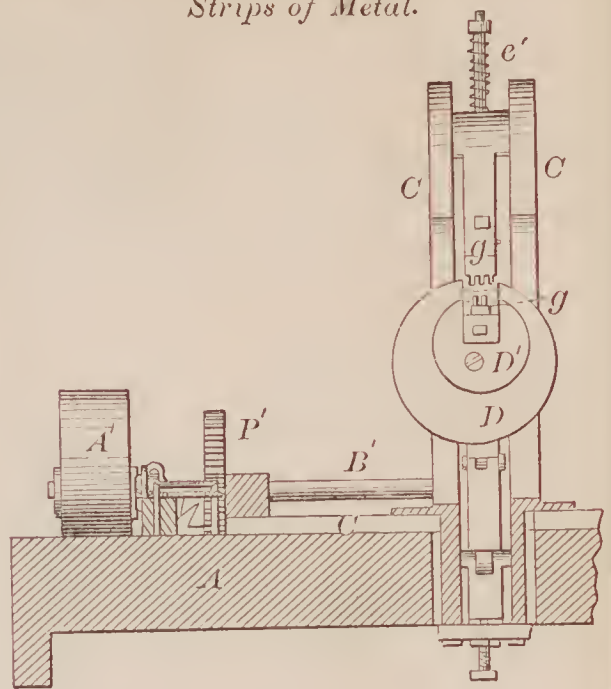

68548—J. B. Beam—For Casting Aluminium.

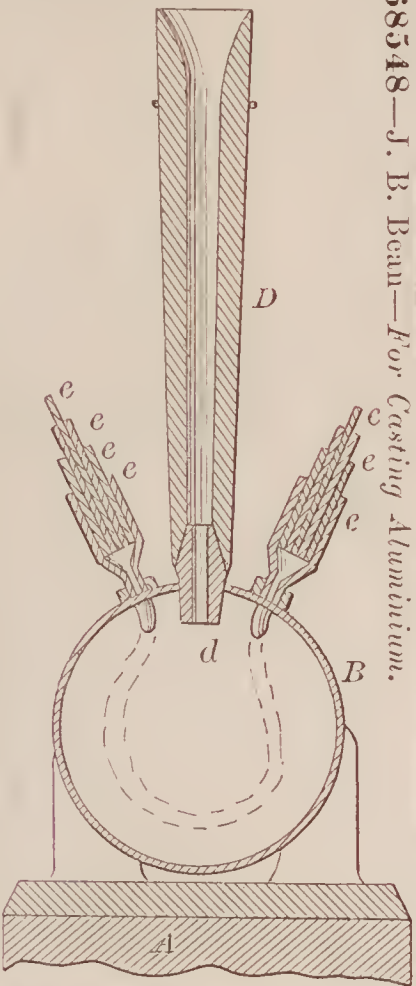

68546—Baker & Harbster—Rotary Measuring Faucet.

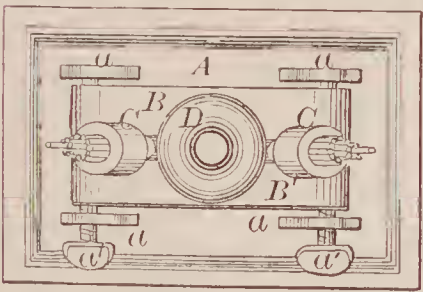
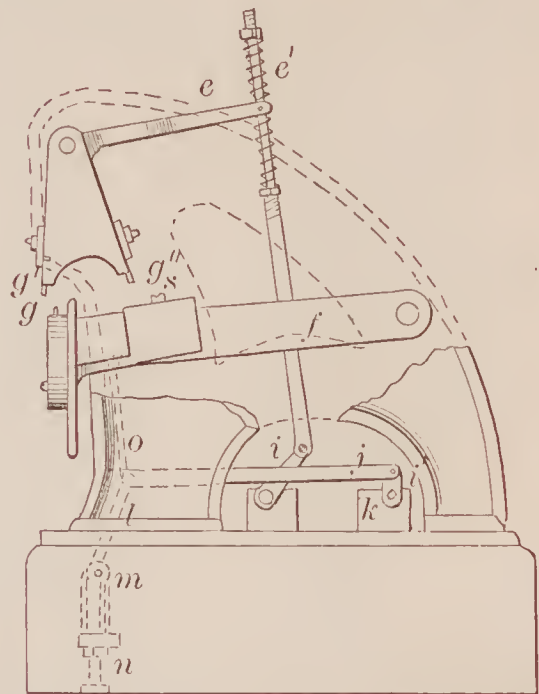
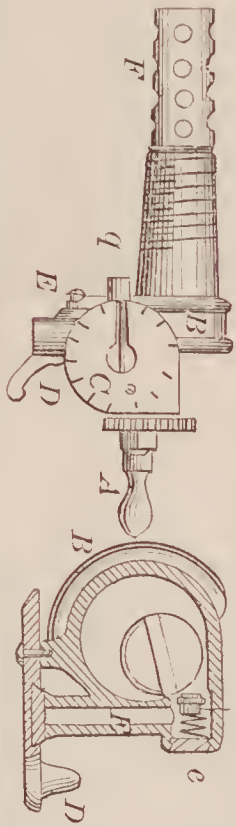

68550—E. L. Bergstresser—Plow.

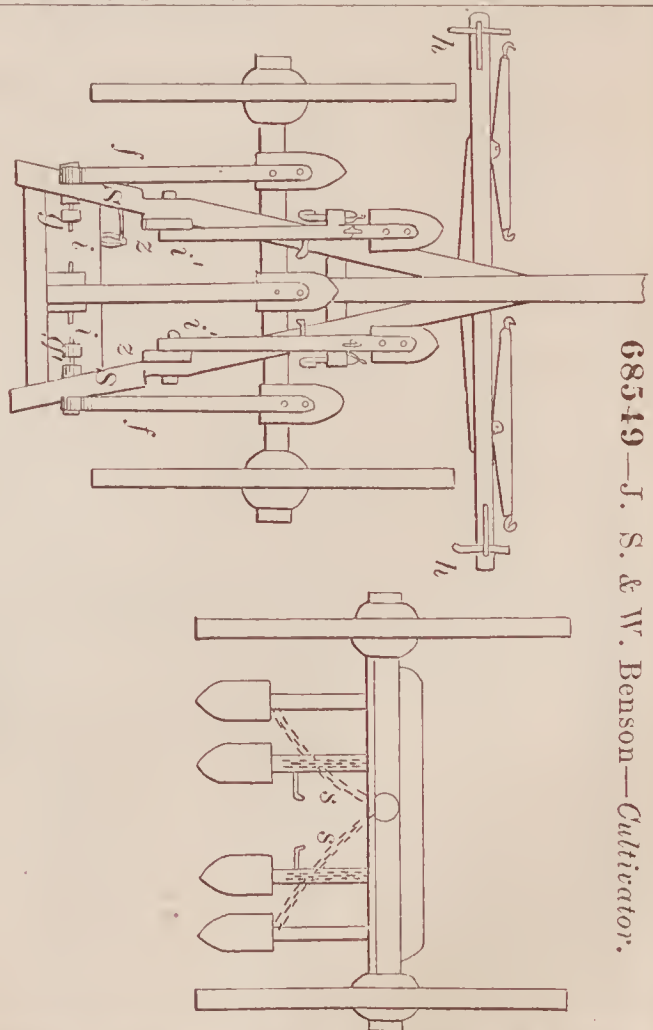
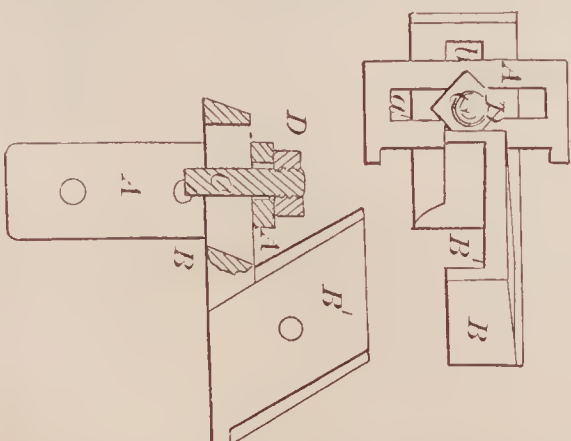

68549—J. S. & W. Benson—Cultivator.



68551—  
B. R. Boynton—  
Bed Bottom.

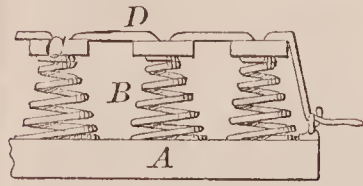
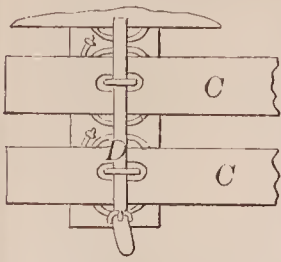

68552—E. T. Briggs—Curtain Fixture.

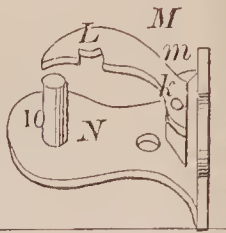
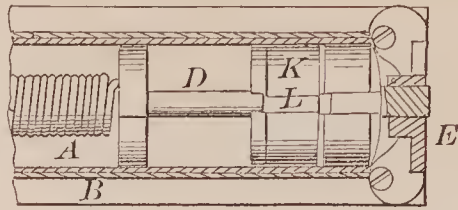
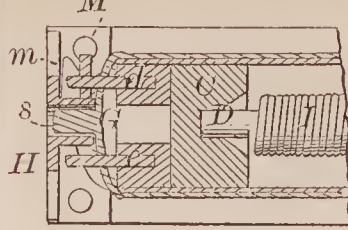

68553—N. Burch—Fence Gate.

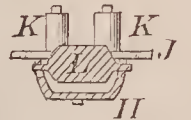
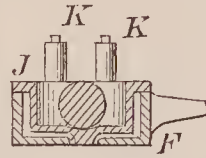
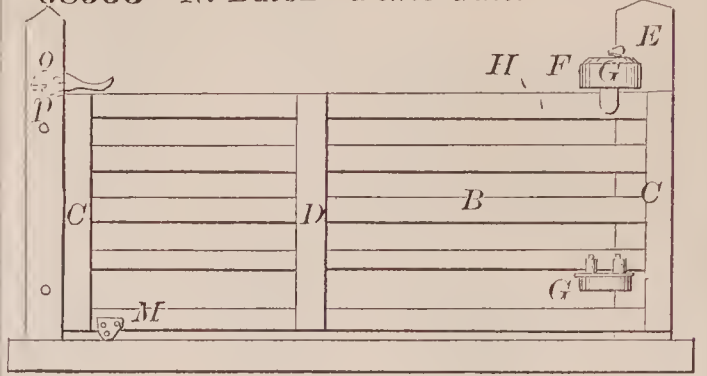

68554—O. C. Burdick—Carriage Bolt.

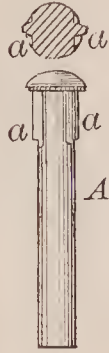

68555—O. C. Burdick—For Heading Bolts.

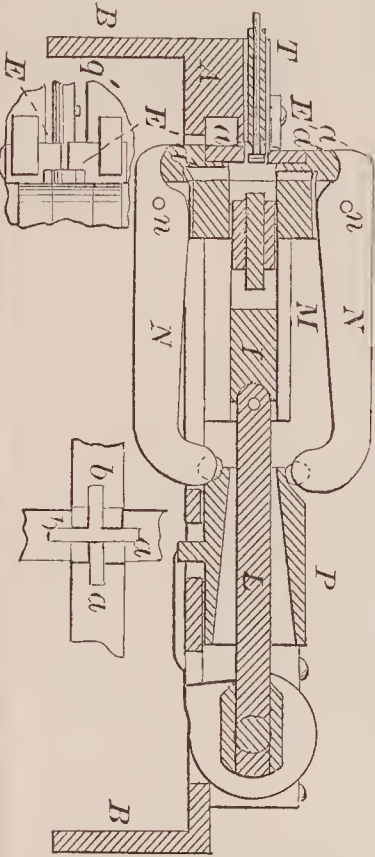

68556—O. C. Burdick—Nut Machine.

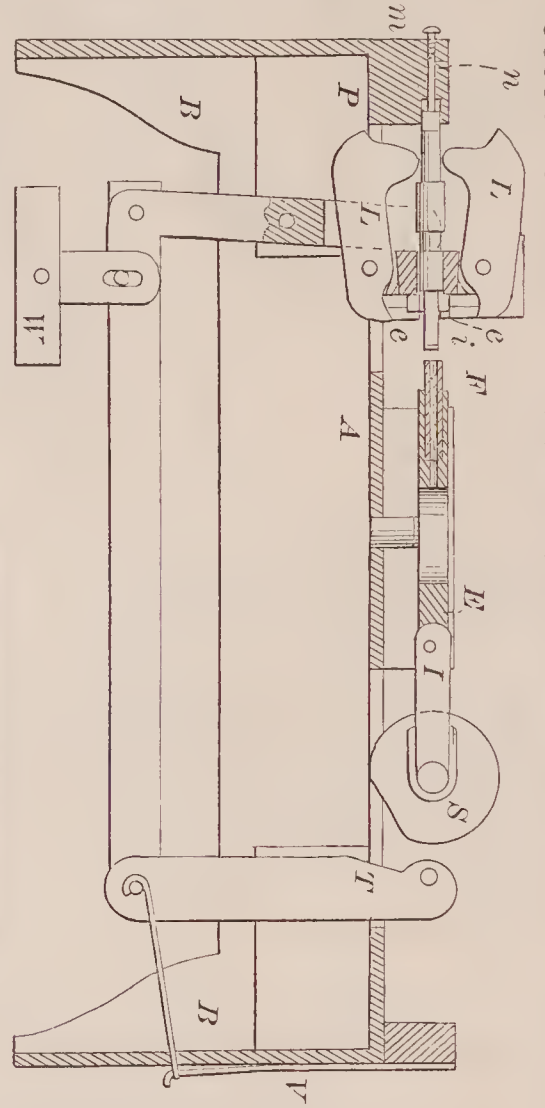
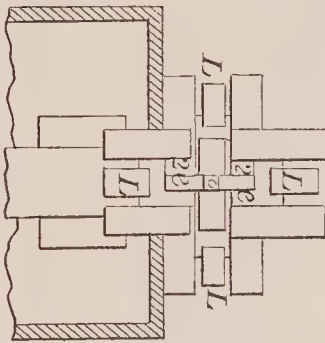

68557—J. A. Burns—Plate Lifter.

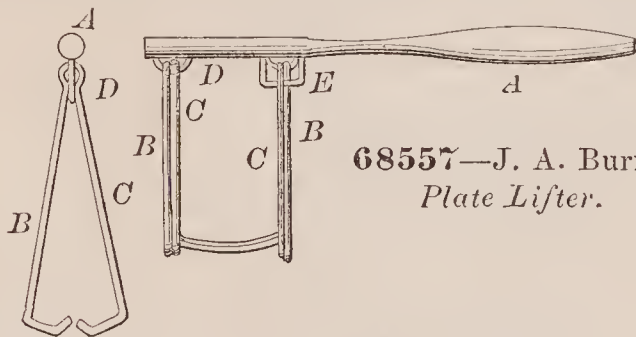

68560—J. E. Finley—Churn.

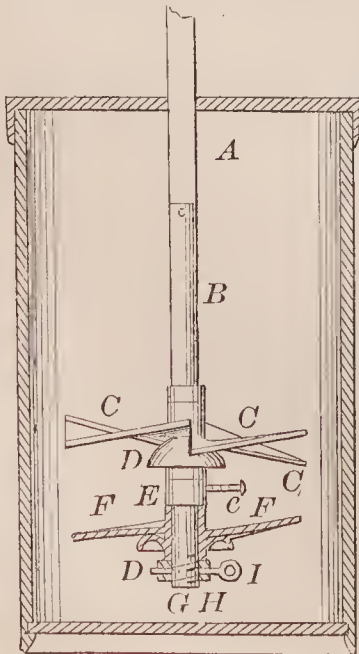

68559—E. Deming—Check Hook.

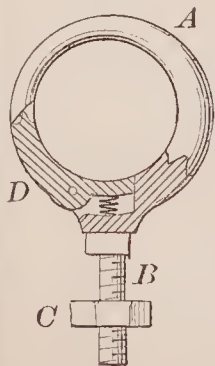

68558—R. Carmichael—Skate.

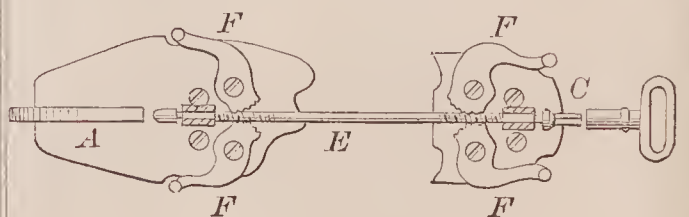

68562—  
R. H. Guilford—  
b Button.



68563—P. Hackett—Seed Sower and Corn Plow.

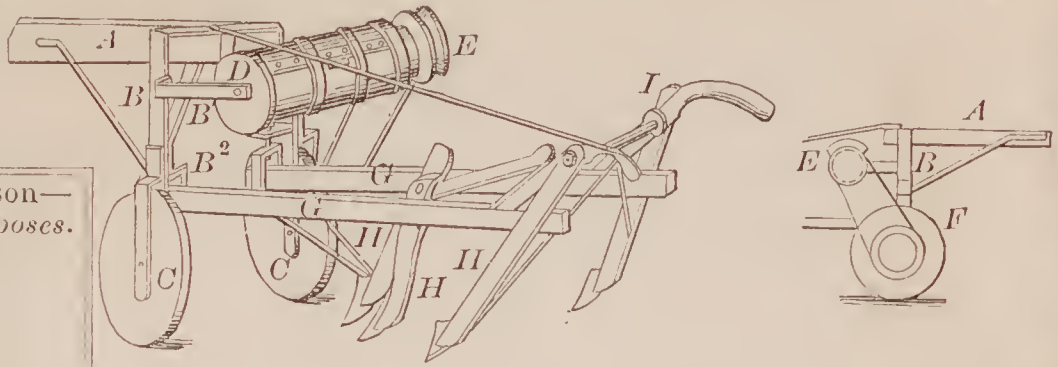

68564—W. H. Henderson—  
Boiler for Culinary Purposes.

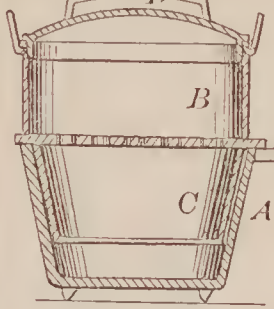

68568—M. McElroy—Hay and Cotton Press.

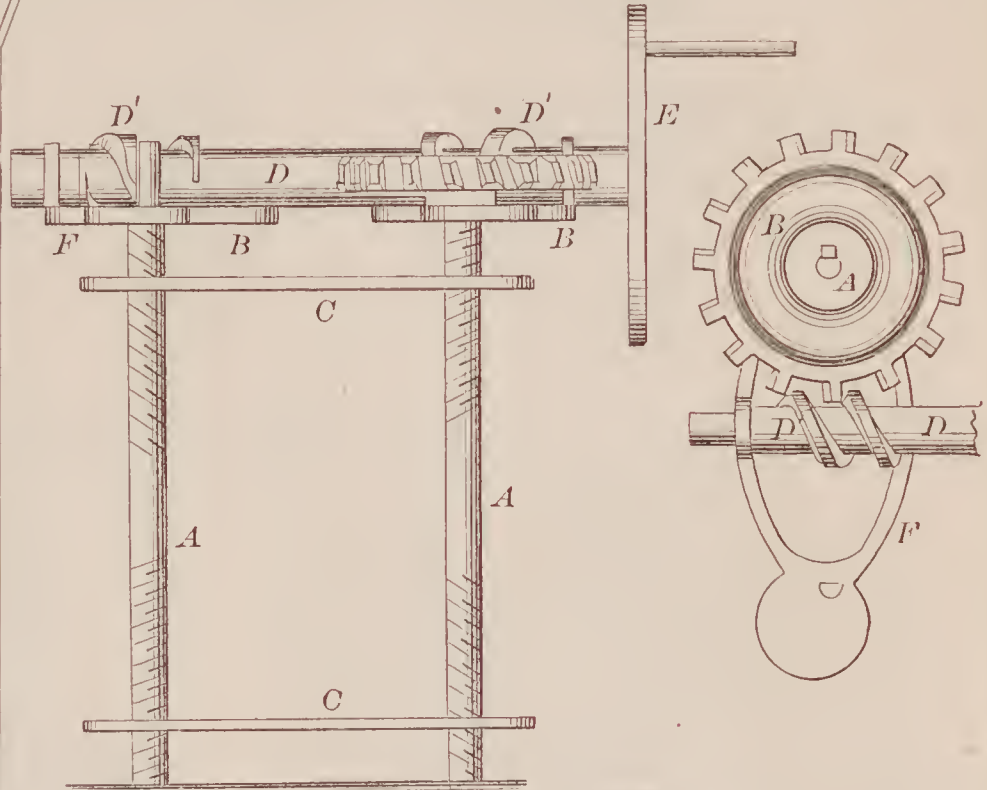

68565—Hendrickson & McLean—Blast Furnace  
for Making Iron.

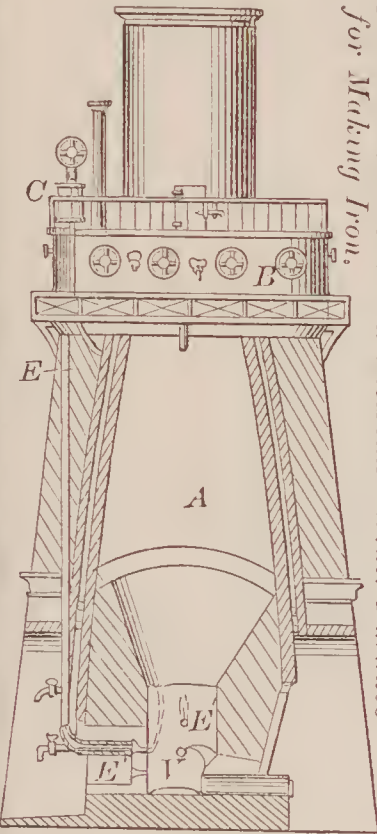

68570—F. B. Morse—  
Whiffletree Iron.



68567—J. Koyl—Nail Clincher.

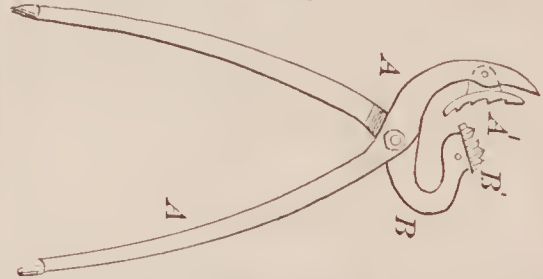

68566—Hendrickson & McLean—For  
Making Iron.

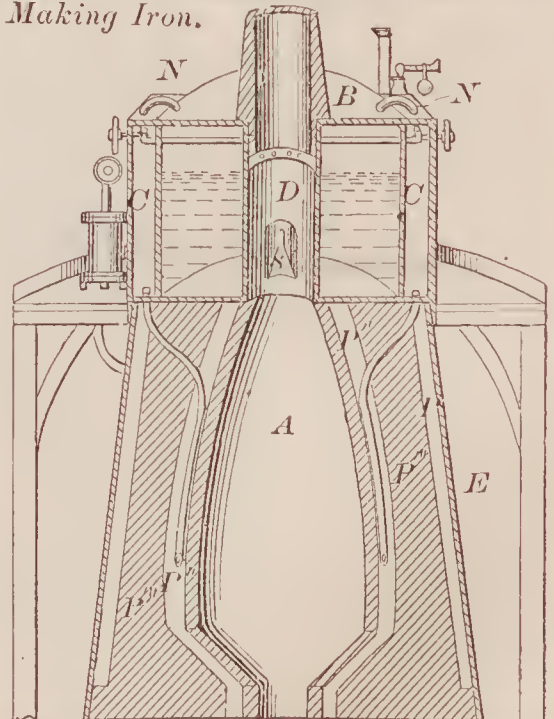

68569—J. D. Miller—Hitching Strap.  
68571—W. B. Pollock—Paper Rolling Machine.

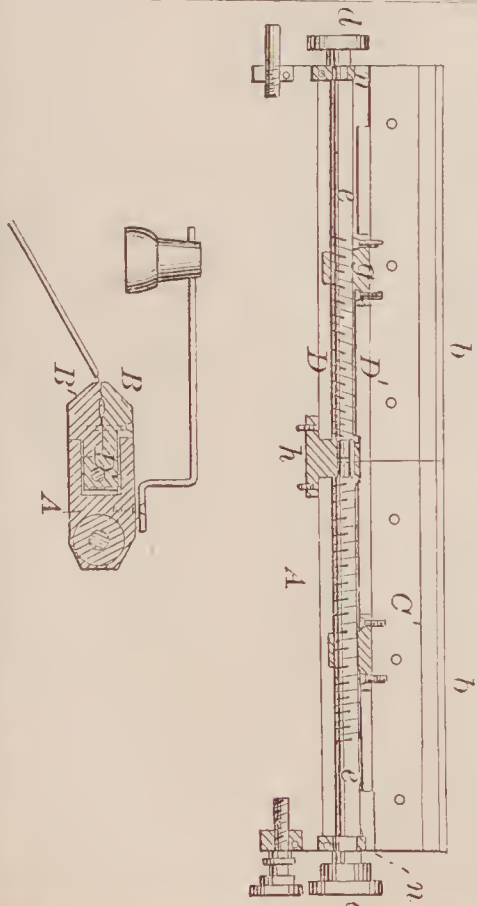



68572—P. C. Porter—*Carriage Jack.*

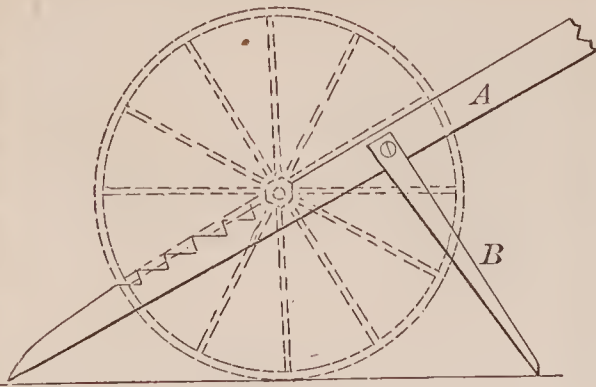

68573—A. Powell—*Washing Machine.*

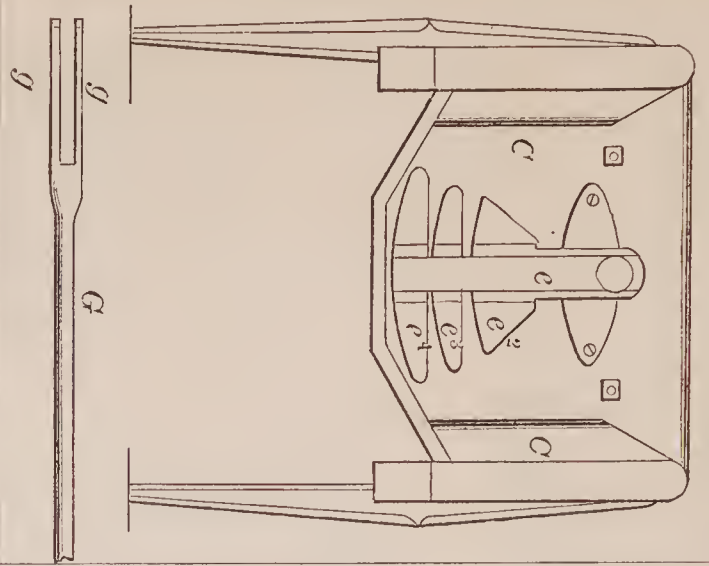

68575—J. R. Richardson—*Hame Fastener.*

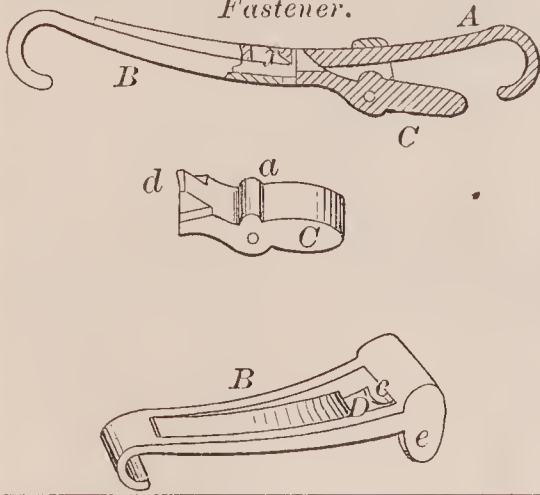

68576—W. Rowell—*Clothes Wringer.*

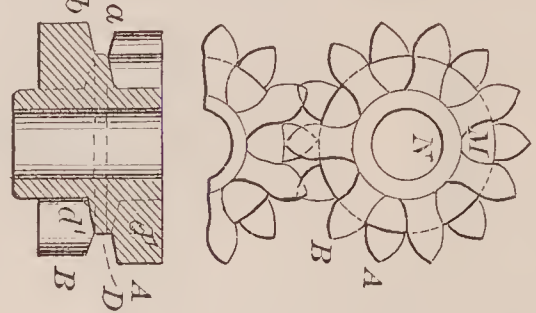

68577—Rudd & Shawk—*Electro-Magnetic Pump.*

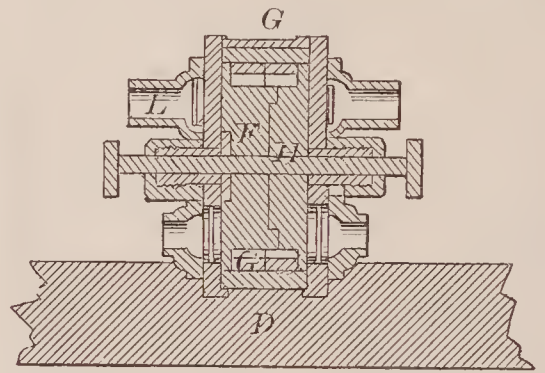
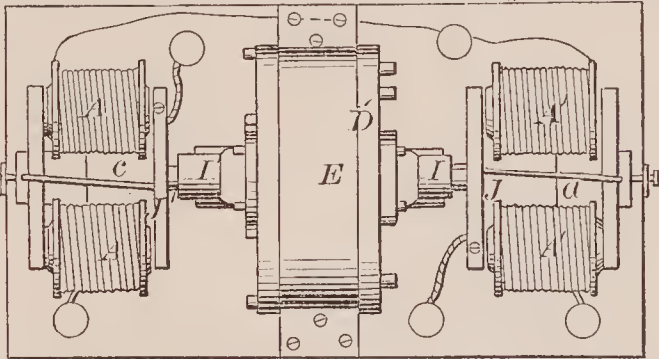

68579—J. L. Smith—*Car Brake.*

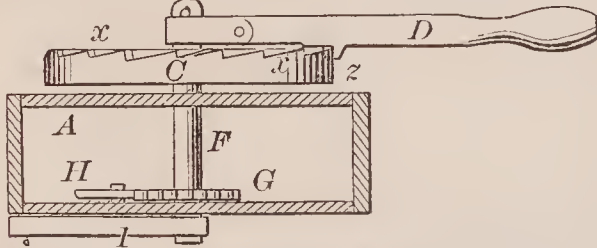

68574—C. C. Reynolds—*Threshing Machine.*

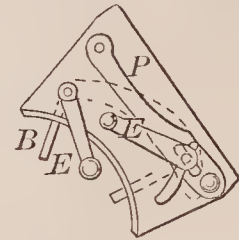

68580—A. M. Southard—*Stone Drilling Machine.*

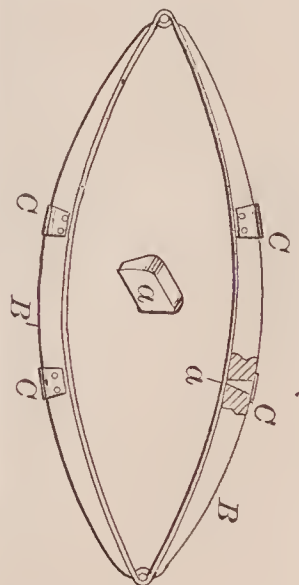
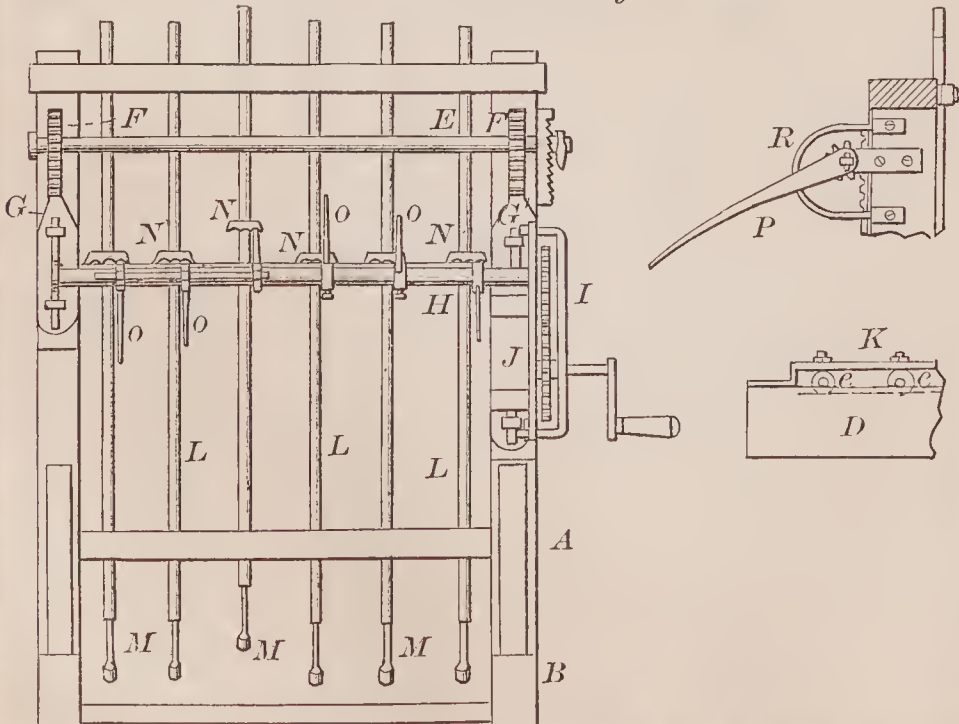

68578—Smith & Judson—*Spring.*

68581—G. L. Squier—*Harvester Pitman.*



68586—C. E. Wilcox—*Billiard Table Cushion.*

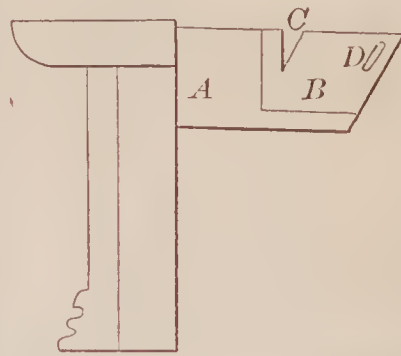

68583—Thompson & Ballard—*Loom.*

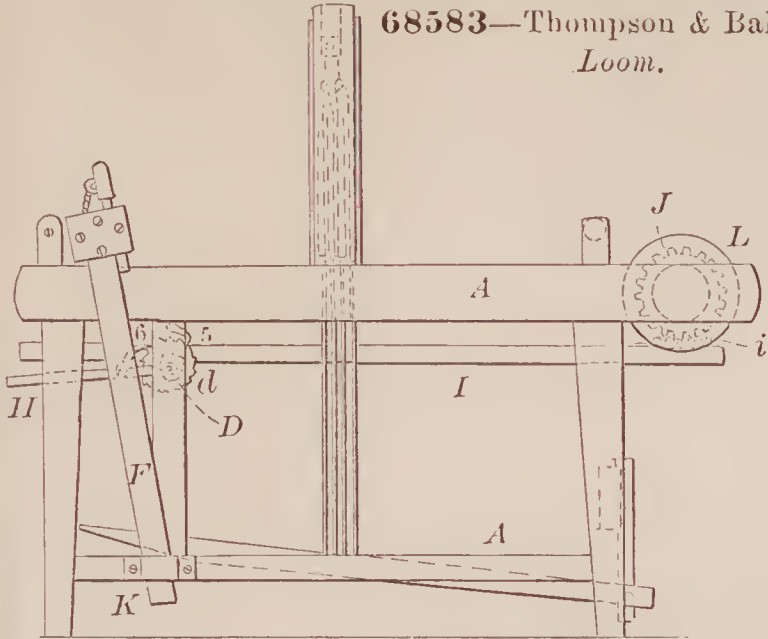

68588—S. Darling—*Inkstand.*

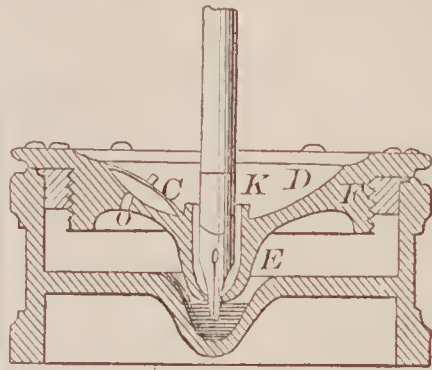

68584—A. Weed—*File.*

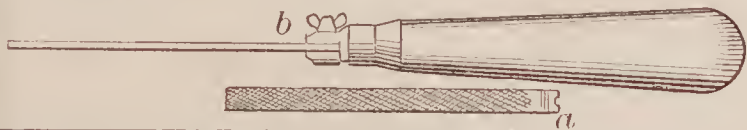

68589—J. Albee—*Hot Air Furnace.*

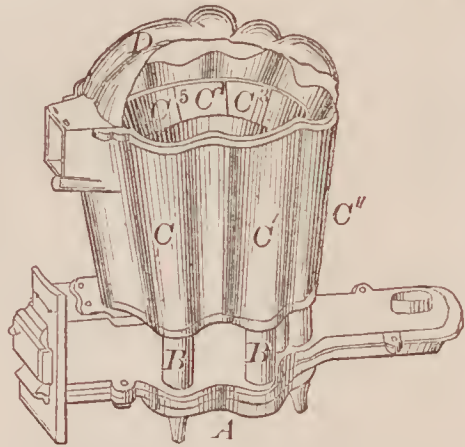

68587—M. Webb—*Hay Raker and Loader.*

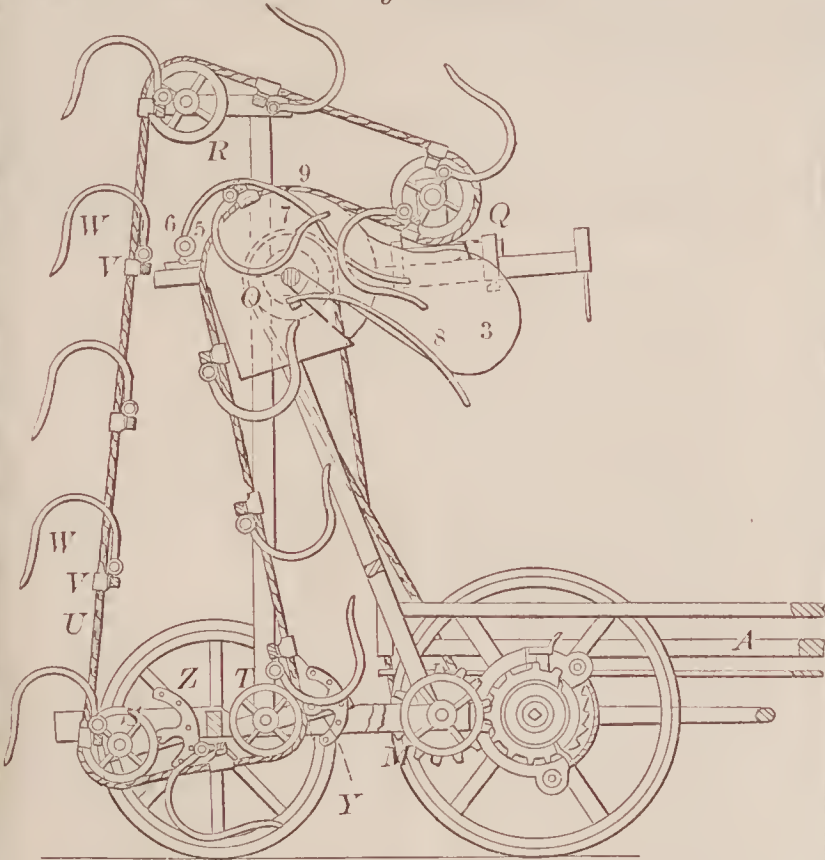

68591—A. D. Atwood—*Sheep Shears.*

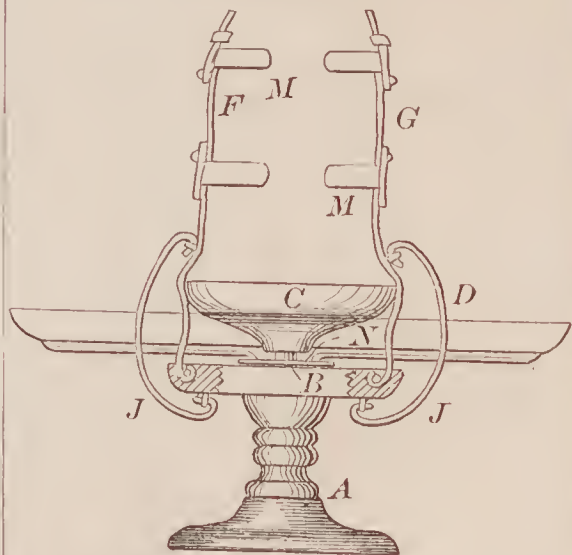

68592—J. A. Ayres—*For Nicking Screws.*

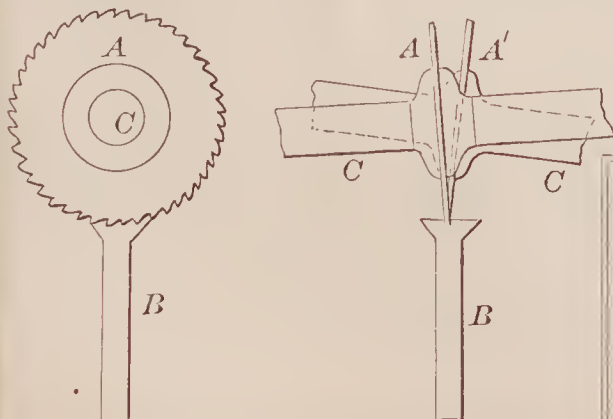

68585—A. Weed—*File Handle.*

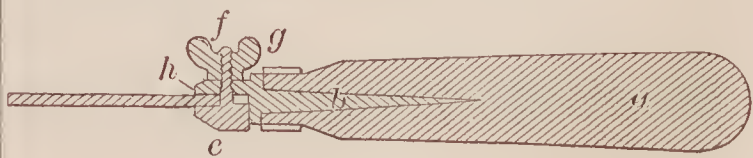



68593—R. T. Barton—For Making Needles.

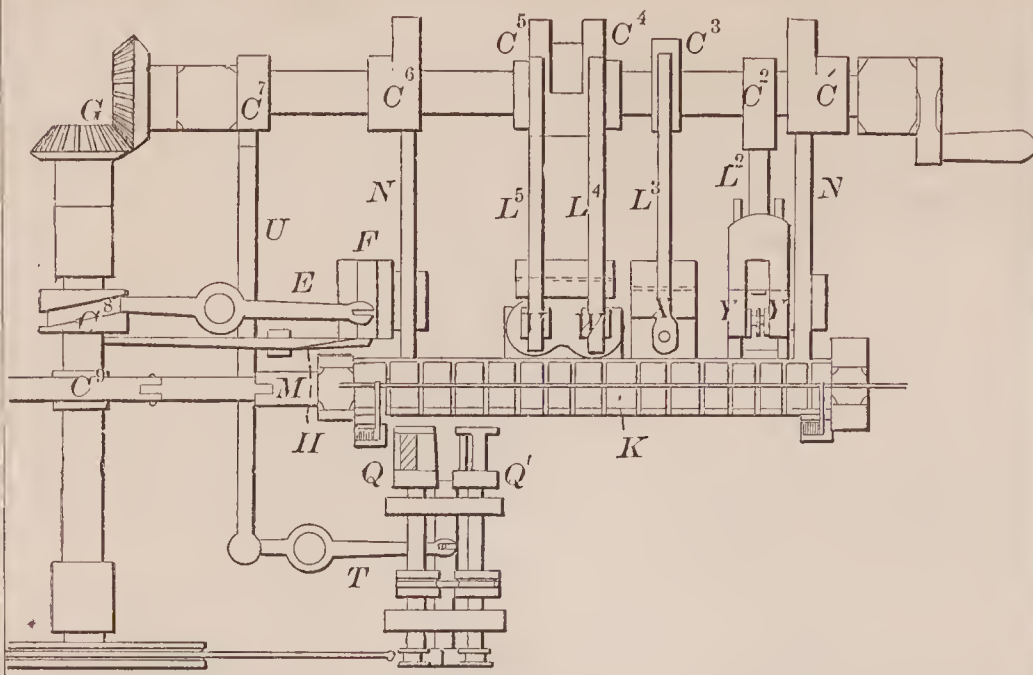

68595—D. Bickford—Knitting Machine.

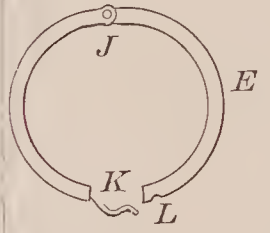
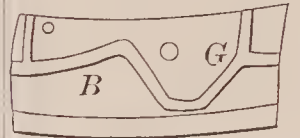
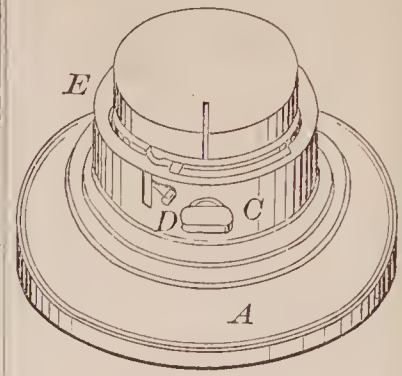

68596—L. F. Blair—Carriage Axle and Hub

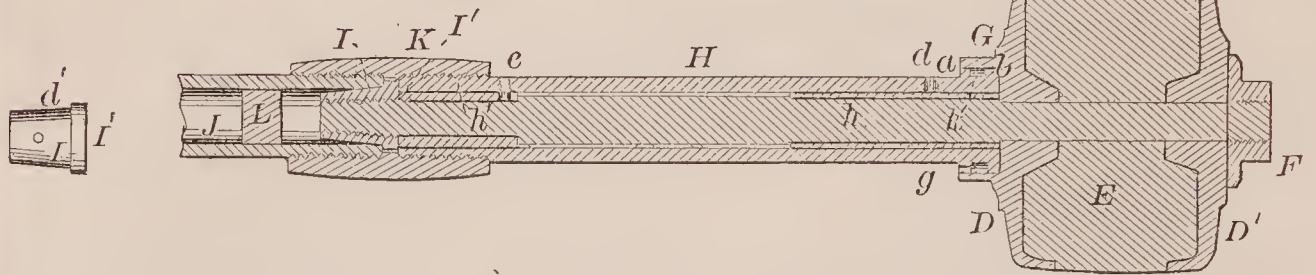
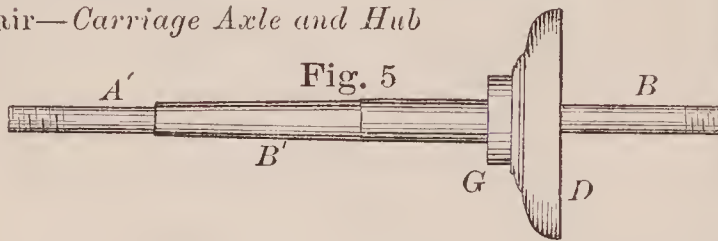
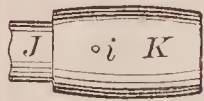

68594—A. Beale—Carriage Wheel.

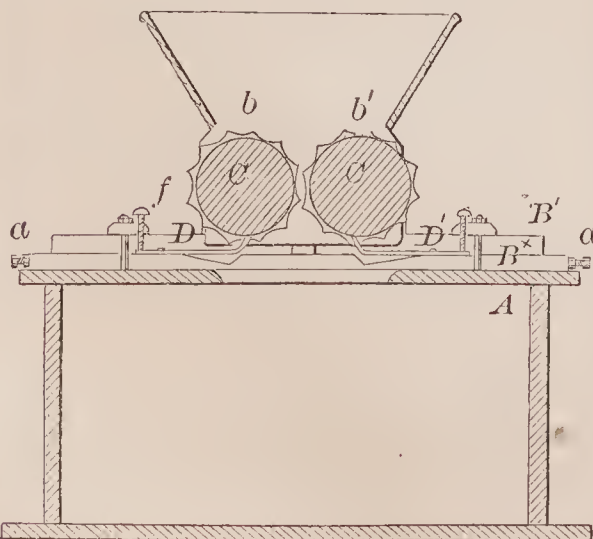
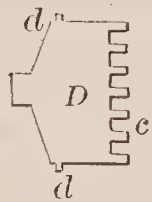
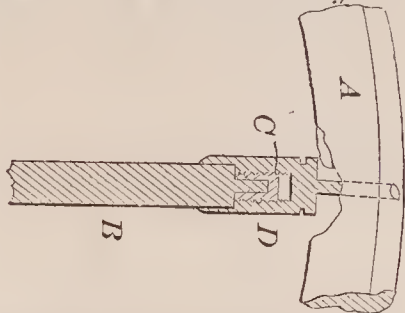

68597—N. H. Borgfeldt—For Breaking Stems of Tobacco.

68598—J. F. Boynton—Steam Generator.

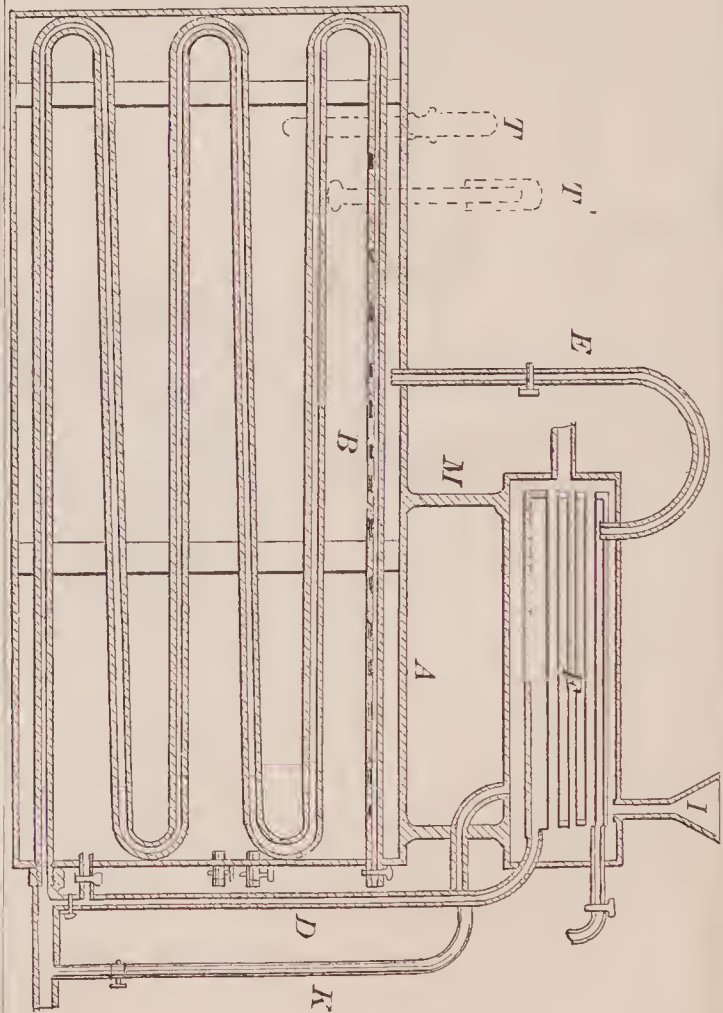





68608—S. B. Cox—Dinner Pail.

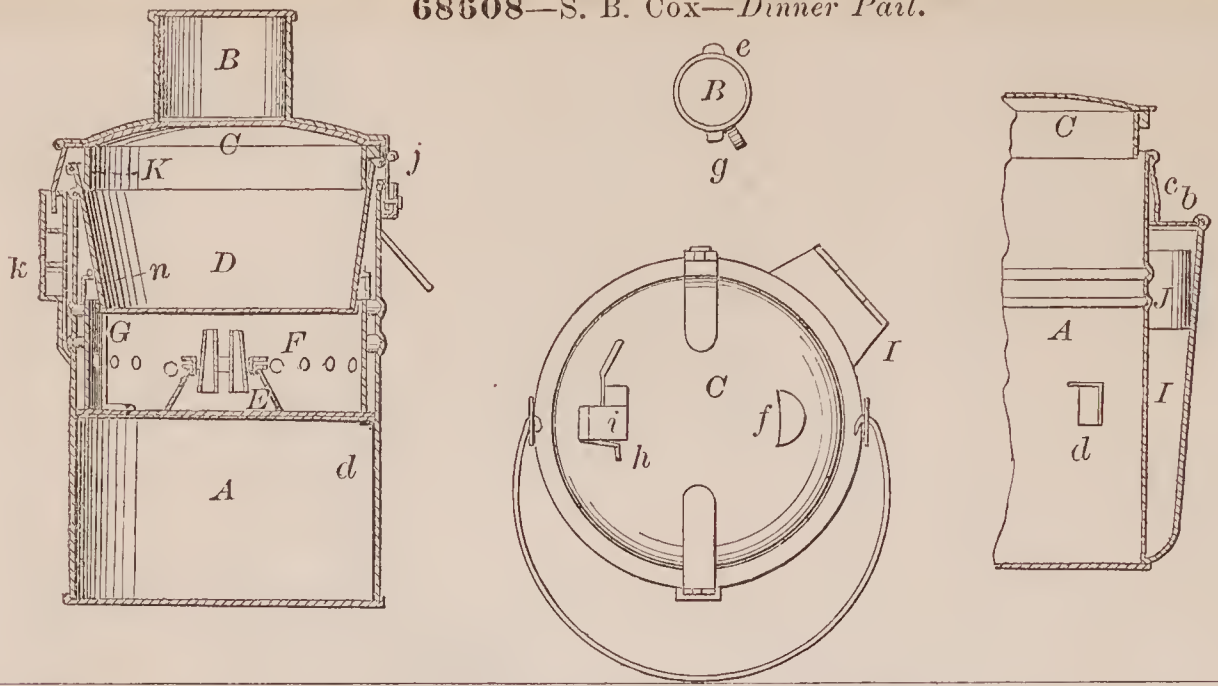

68609—J. M. Crockett—Cartridge for Ordnance, &c

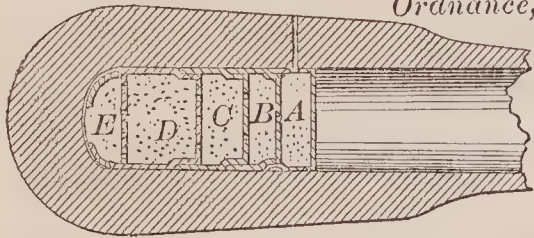

68610—H. L. Currier—Land Roller.

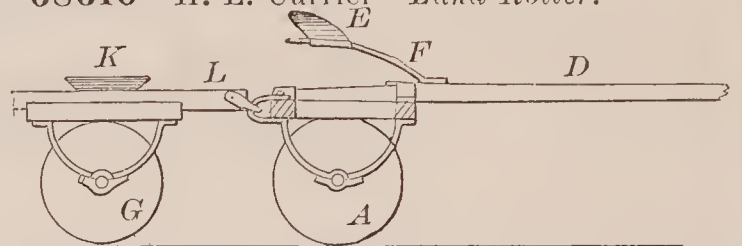

68612—R. H. Cutter—Bed Bottom.

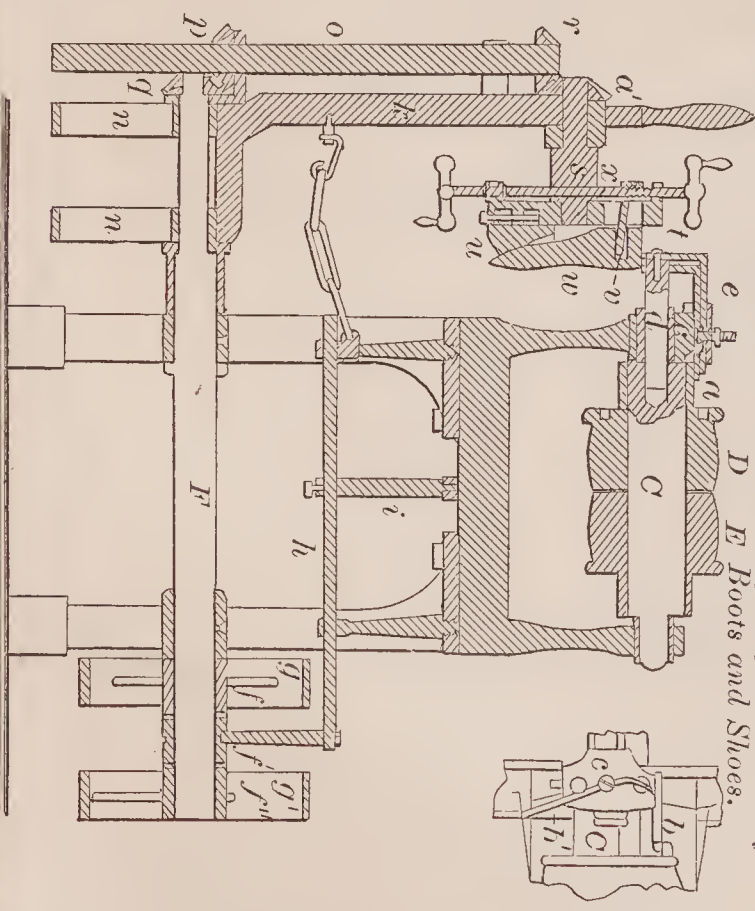
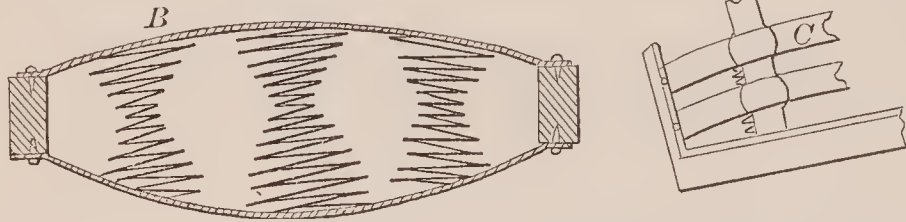

68611—E. B. Cushing—For Burnishing Edges of Soles of Boots and Shoes.

68614—C. H. Eccleston—Atomizing Tube.

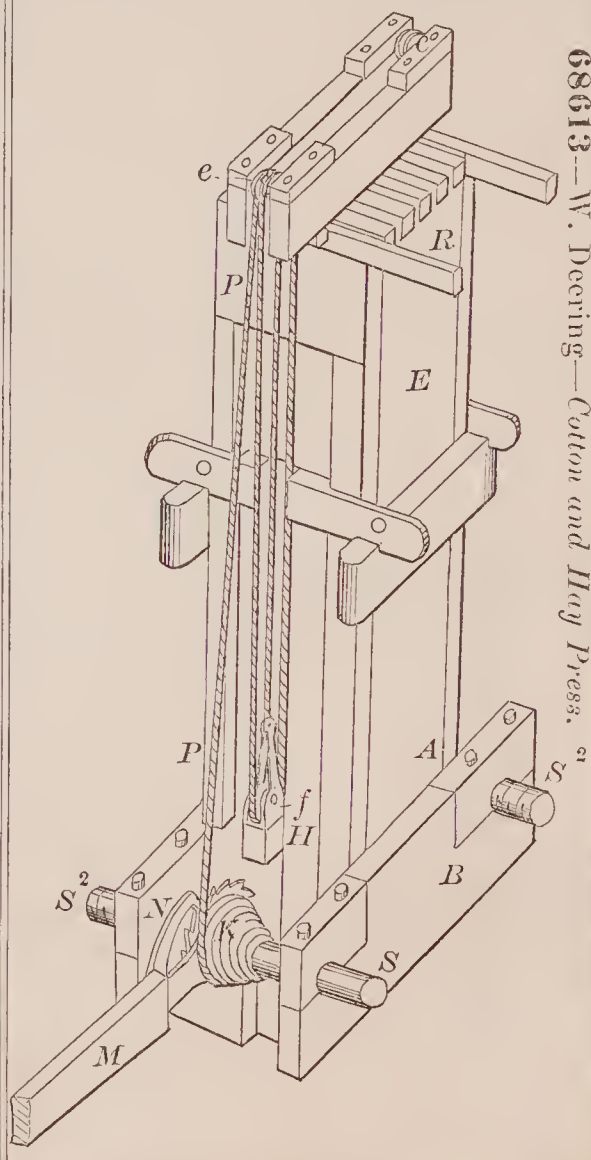
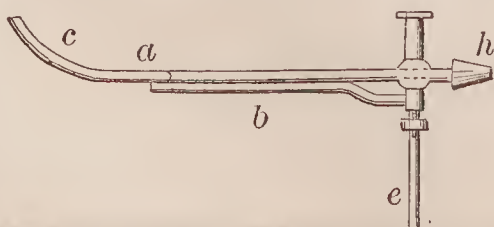

68613—W. Deering—Cotton and Hay Press.

68615—D. L. Emerson—Harvester.

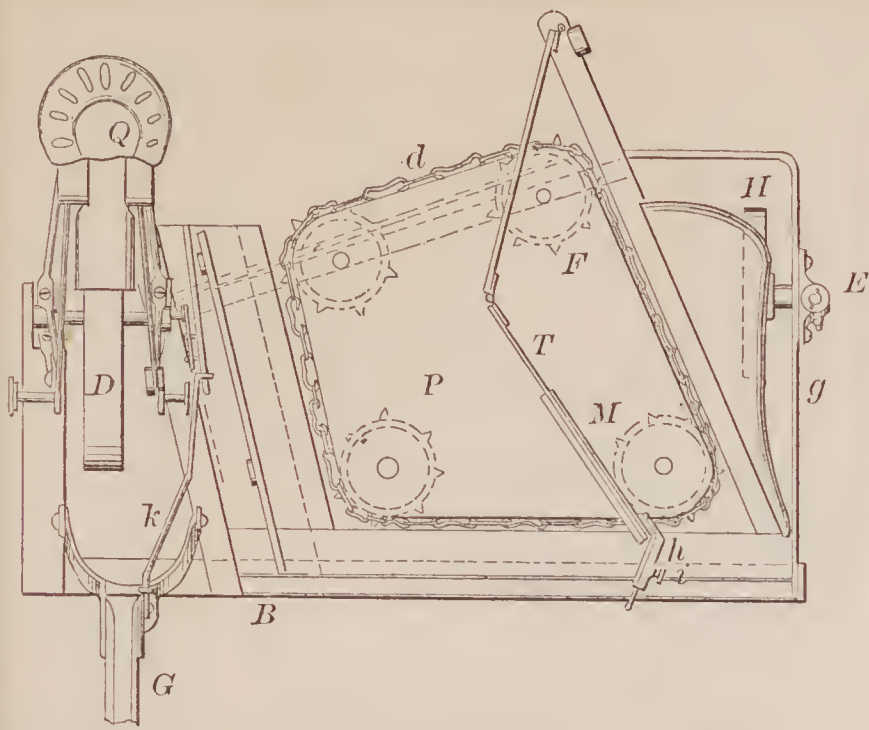

68616—F. M. Everingham—Clothes and Picture Hanger.

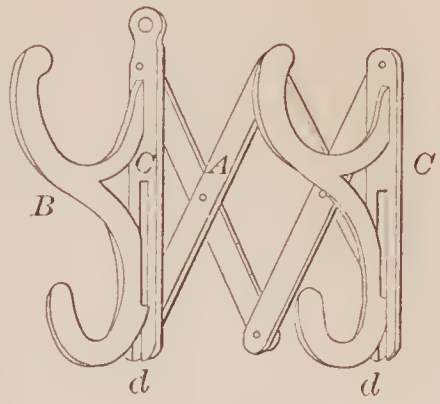

68617—P. J. Flanedy—Ironing Machine.

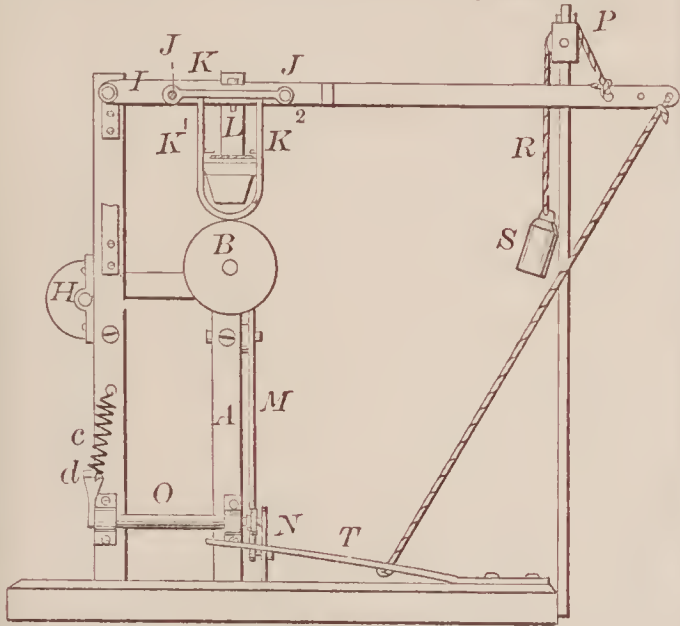

68618—B. S. Fletcher—Rein Holder.

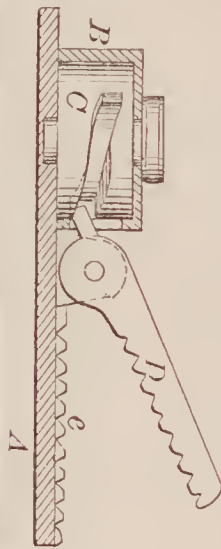

68619—J. Foreman—Railway Car.

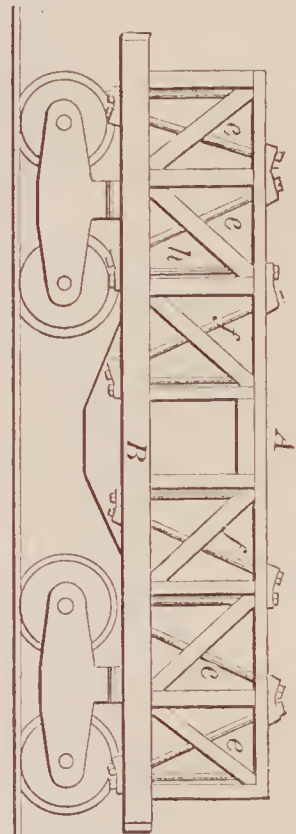

68621—S. C. & E. O. Frink—Wood Bending Machine.

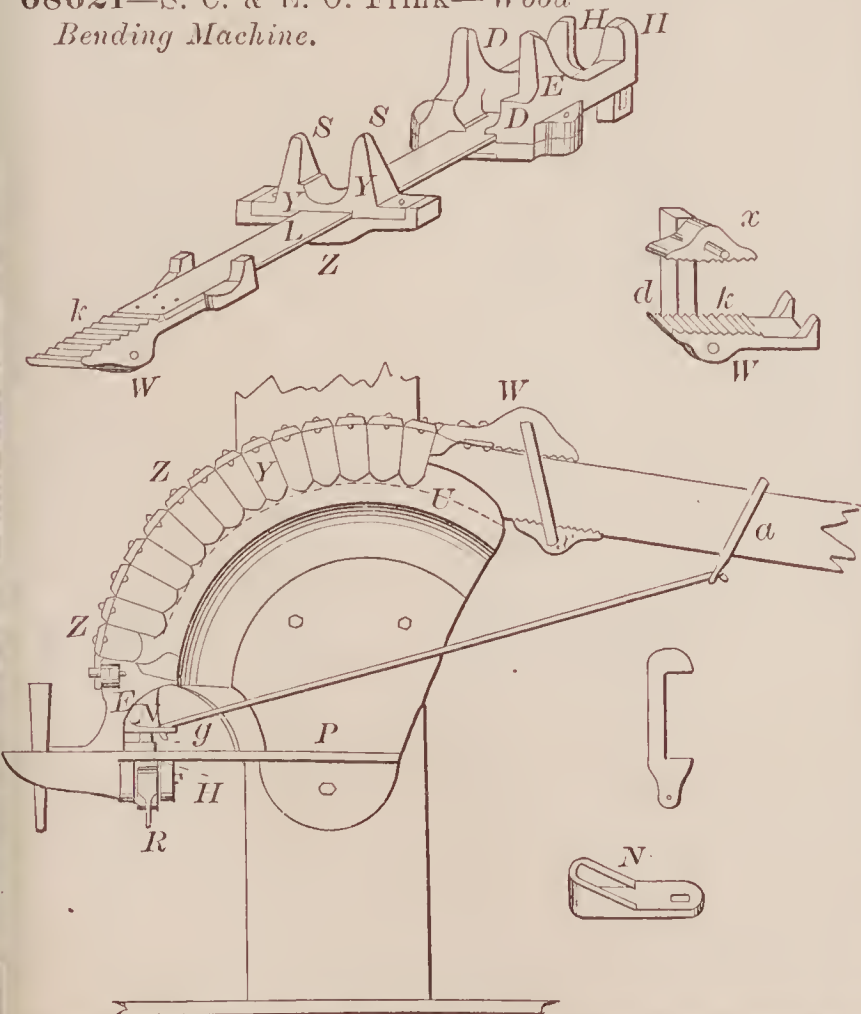

68620—H. C. Freeman—For Transporting Strawberries.

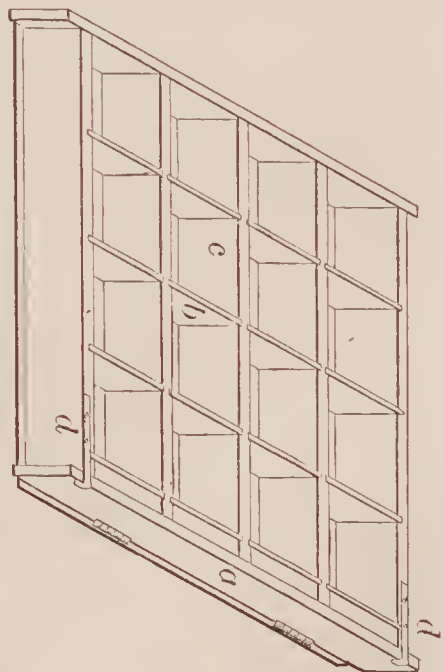



68622—H. R. Gillingham—Door Lock.

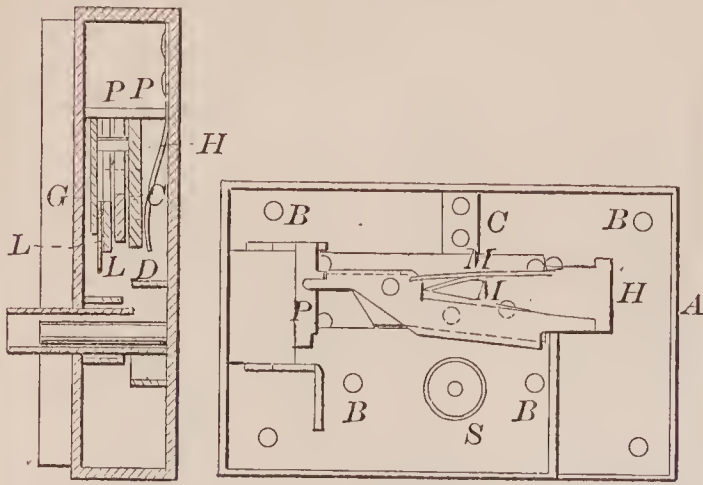

68627—R. Hoffmann—Rocking Chair.

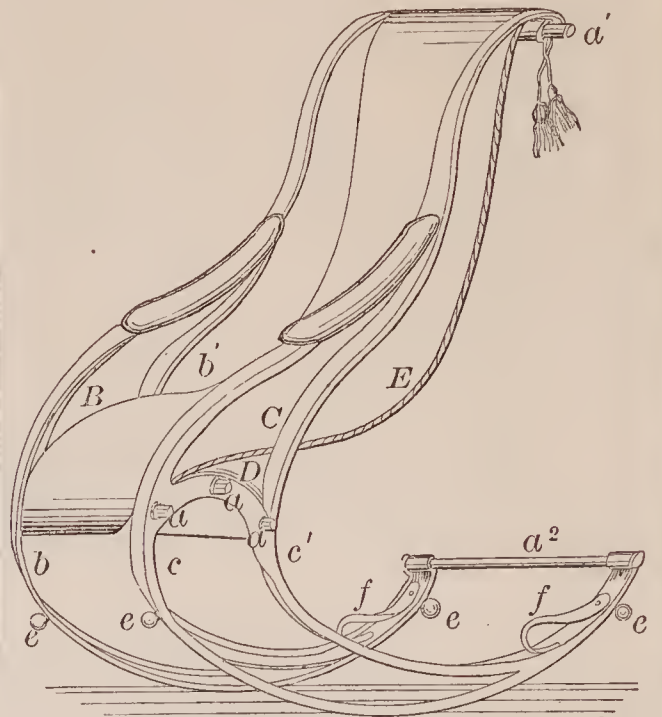

68626—J. Highbarger—Washing Machine.

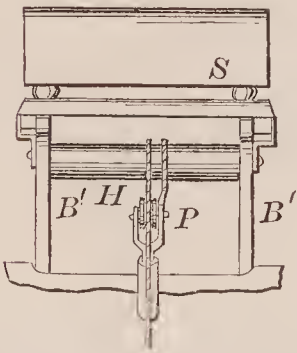
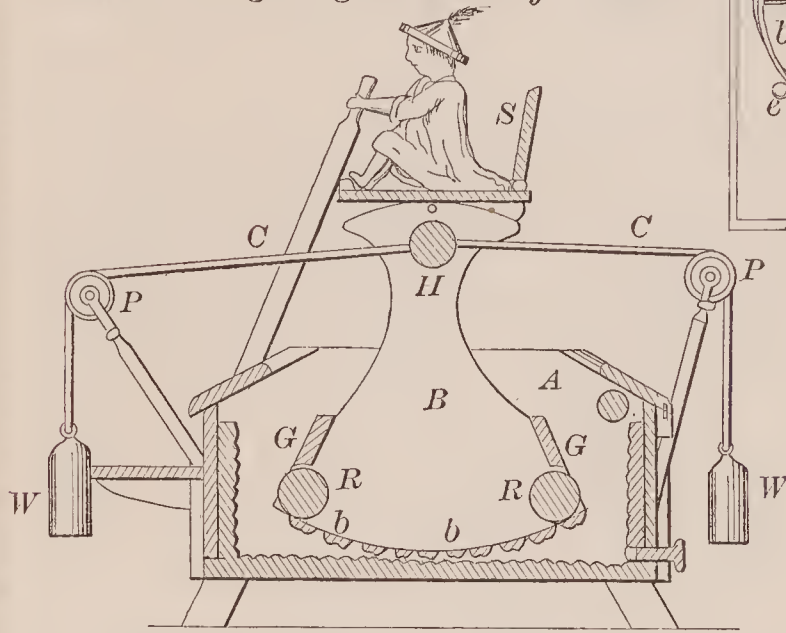

68624—J. Hale—Washer.

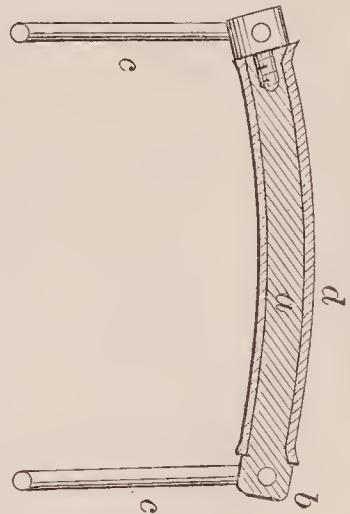
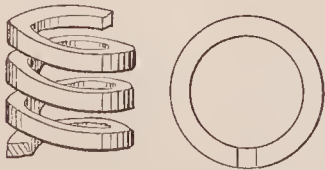

68623—D. Hale—Driving Bit.

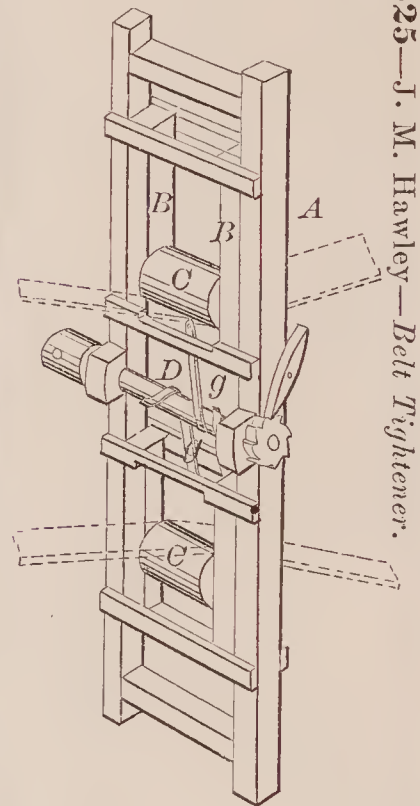

68625—J. M. Hawley—Belt Tightener.

68628—A. Hutchinson—Stove Pipe Thimble.

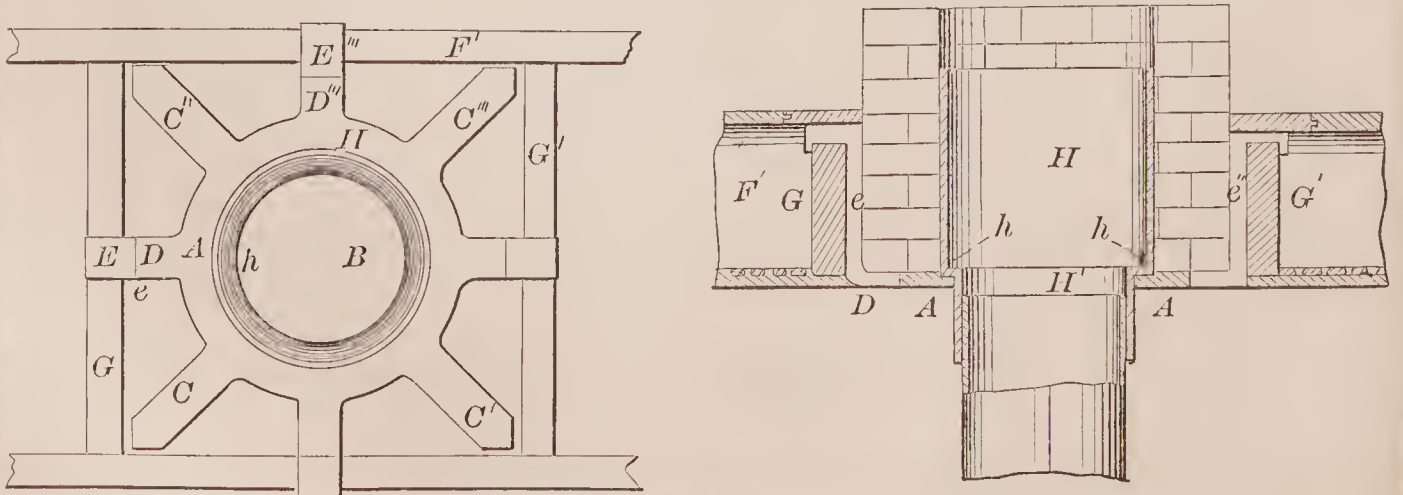

68629—T. Lewis—Syringe.

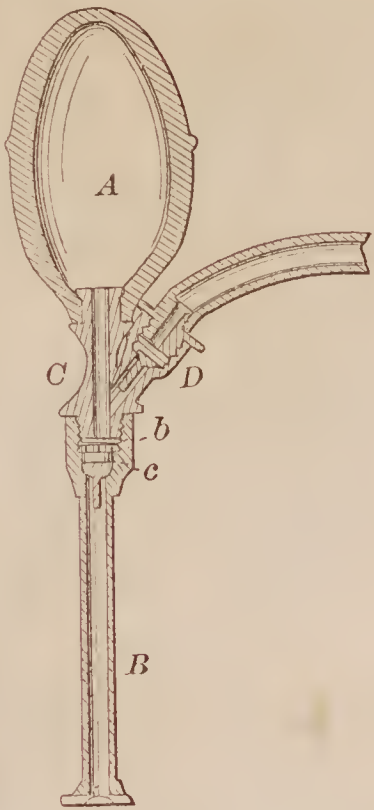

68633—J. Magoun—Mould for Glasses, &c.

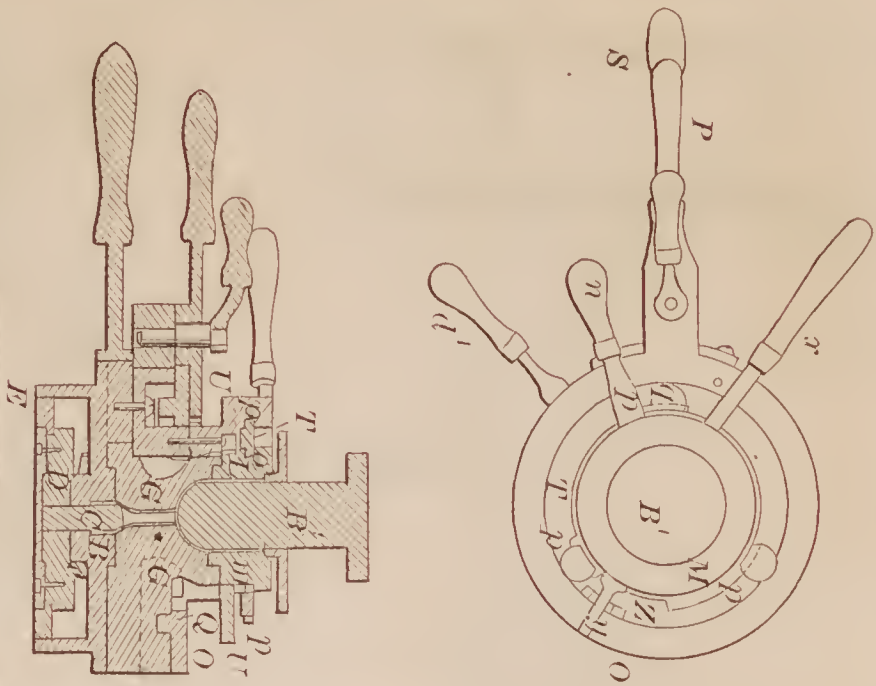

68630—E. J. Leyburn—Cupping Instrument.

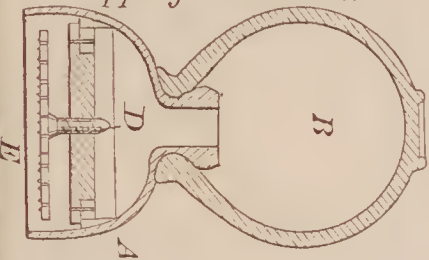

68634—J. M. March—Baggage Label.

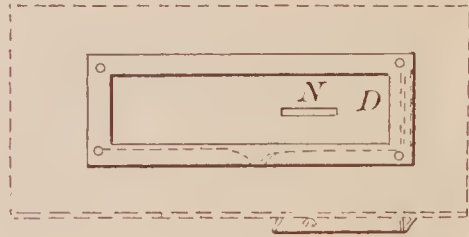
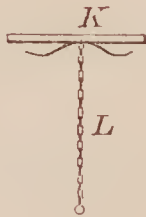

68635—T. March—Plow.

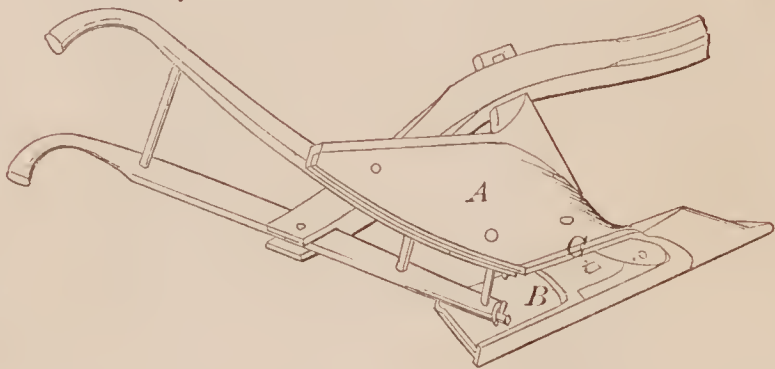

68636—W. C. Marshall—For Operating Window Shutters.

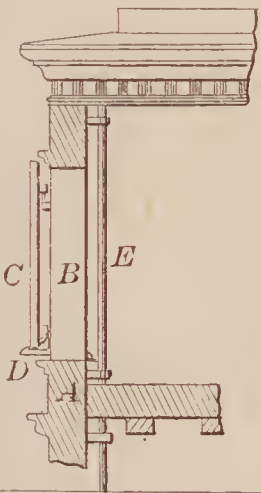

68637—A. H. Mason—Baby Jumper.

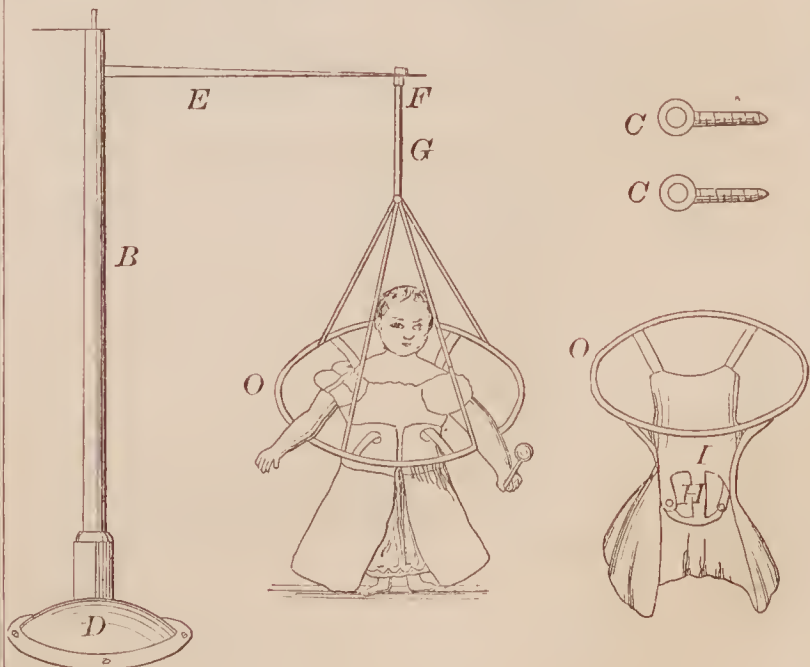

68638—S. McCray—Post Hole Auger.

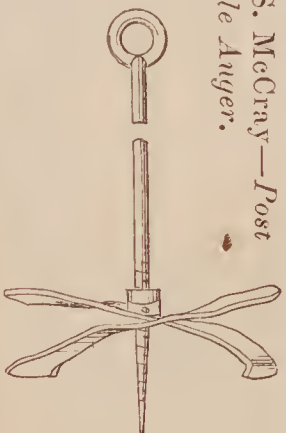

68640—L. Mendel—Safety Attachment for Watch Chains.





68641—C. F. W. Meyer—Leather Hose.

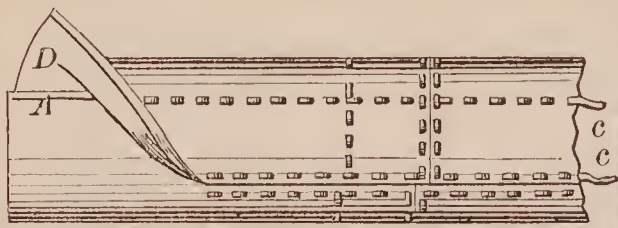

68648—W. H. Parlin—Corn Cultivator.

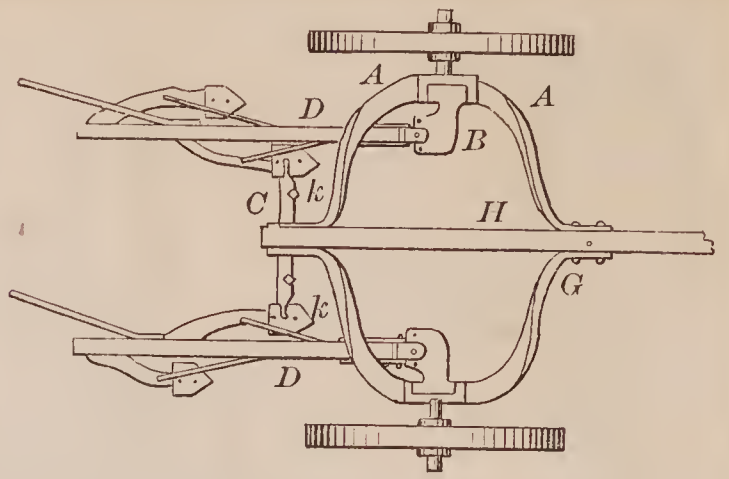

68642—W. K. Miller—Harvester.

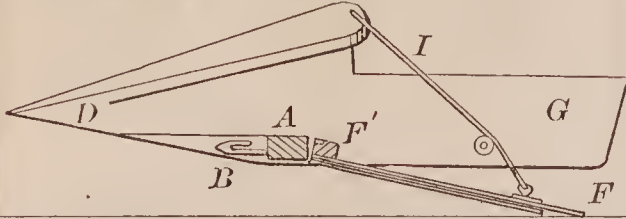

68644—J. A. Morrell—Hinge.

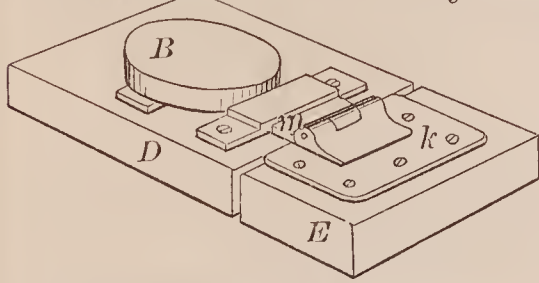

68645—R. B. Nevens—Bed Bottom.

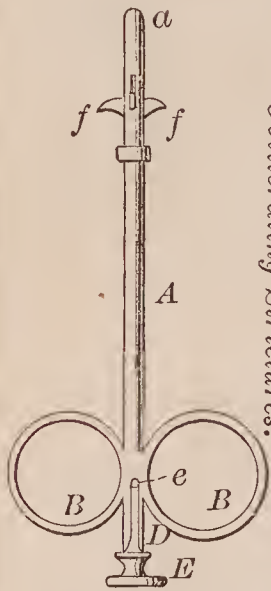
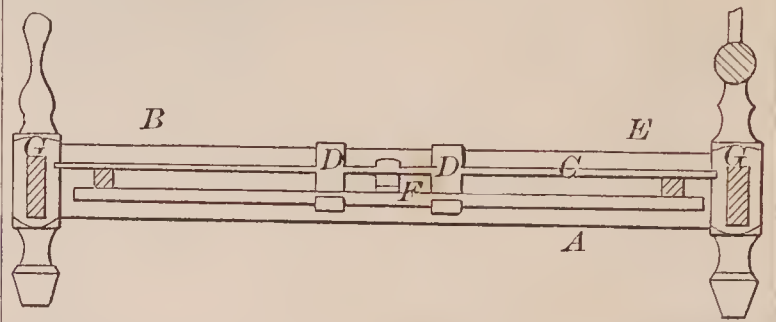

68647—G. N. Palmer—For Obliquating Strictures.

68643—G. Moore—Cultivator.

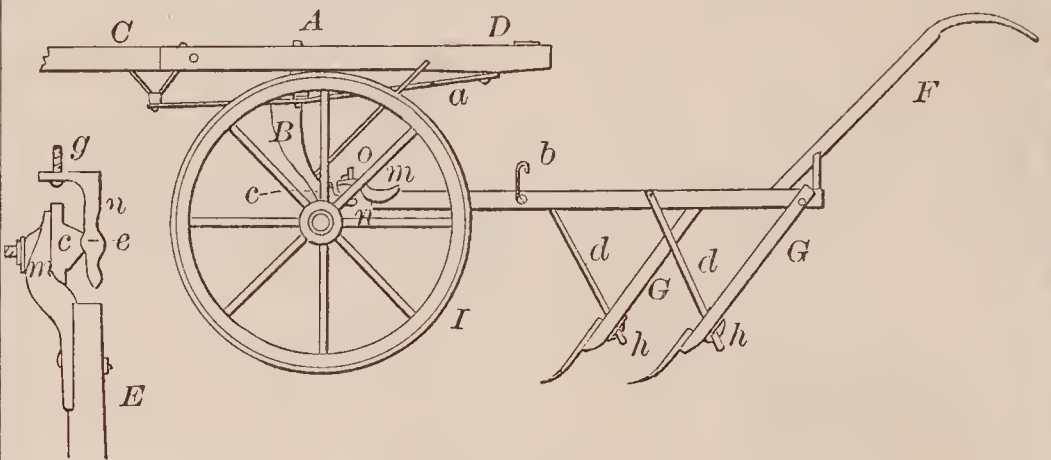

68649—W. S. Payne—Self-Closing Barrel Filling Apparatus.

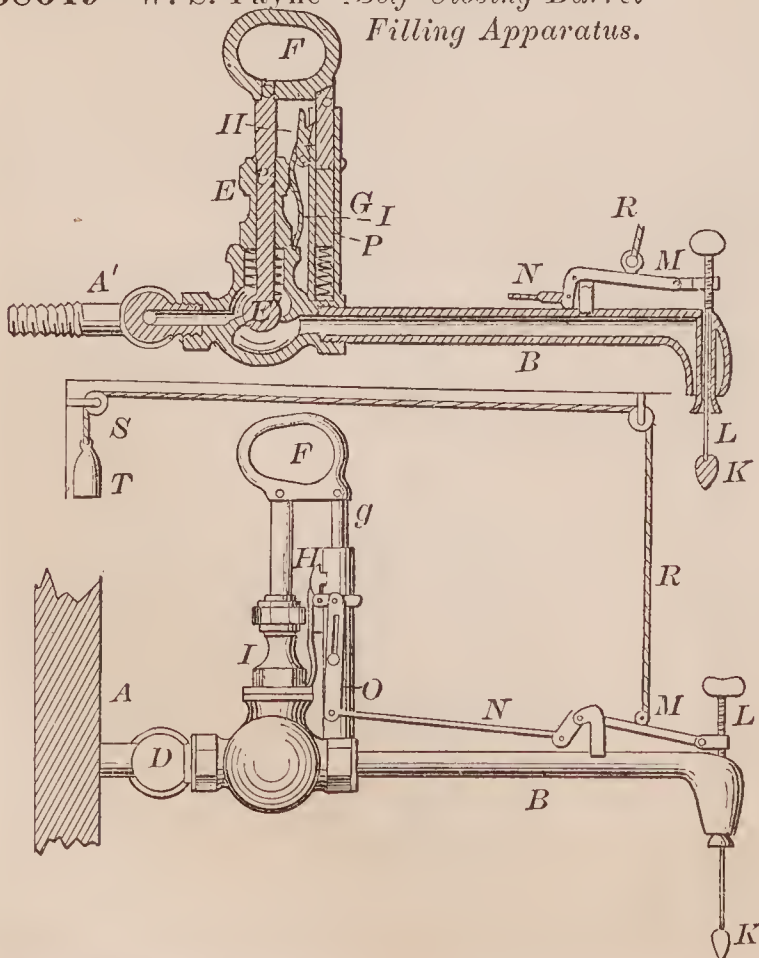

68646—B. F. Paine—Running Gear for Vehicles.

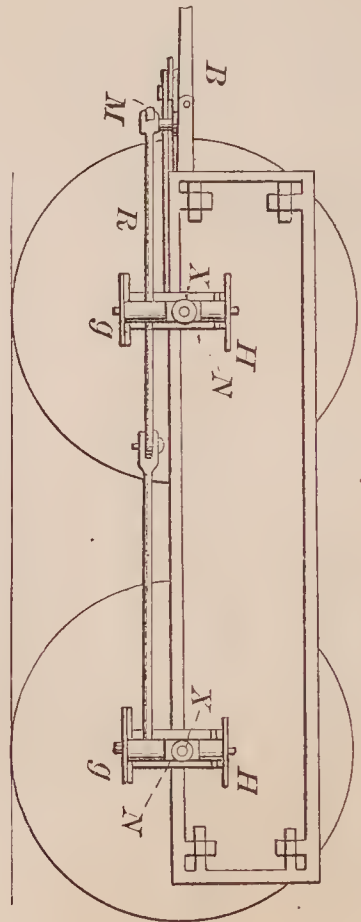

68650—Perkins & Hovey—Hose Coupling.

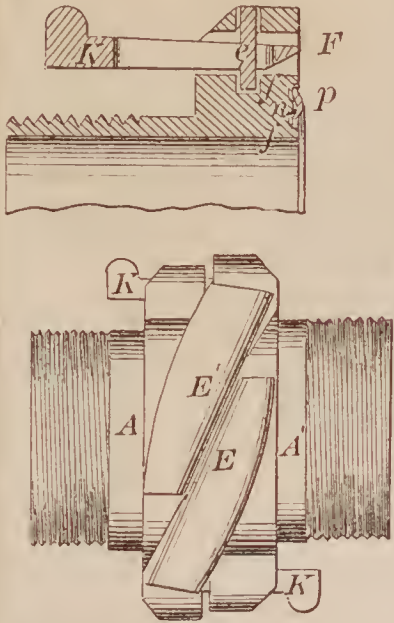

68652—A. J. & A. J. Rice—Boot and Shoe Shank.



68654—J. G. Rominger—Slide Rest for Lathes.

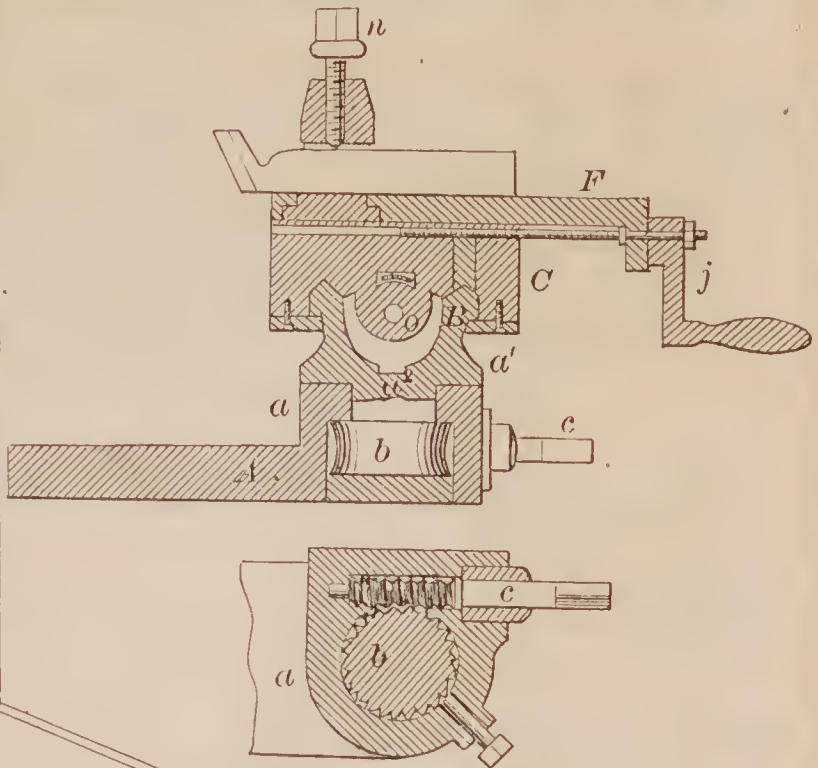

68653—E. Y. Robbins—Fireplace.

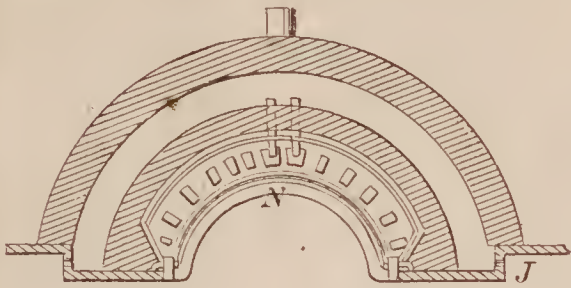

68655—H. D. Rumsey—Churn.

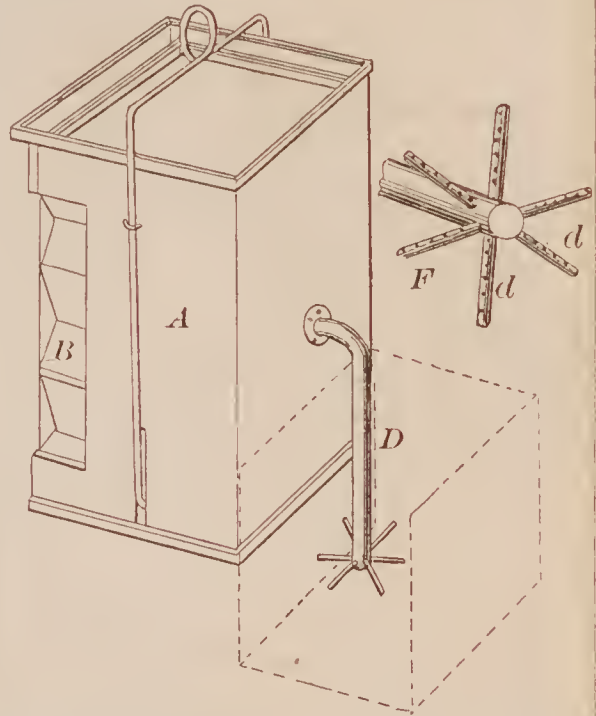

68656—O. Salgee—Hose Coupling.

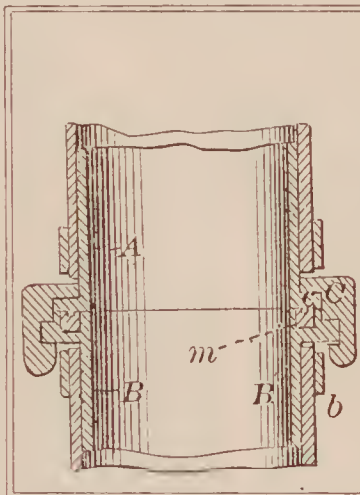

68657—Saylor & Bair—Fire Box for Forges.

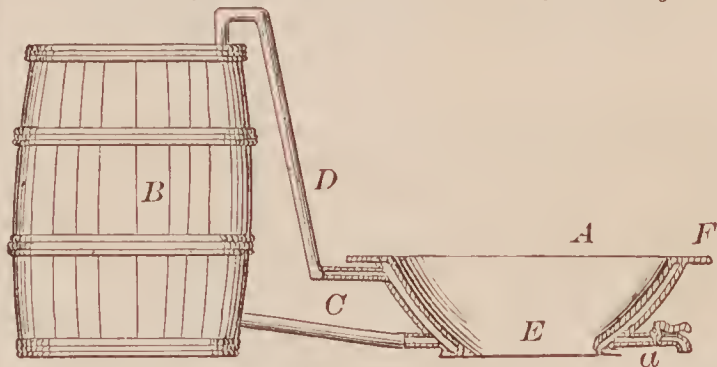

68651—S. S. Rain—Animal Trap.

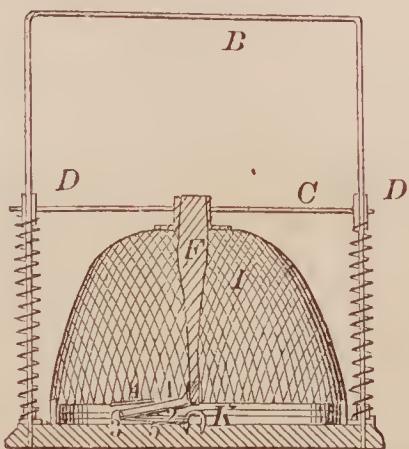

68658—C. Shepard—Gate.

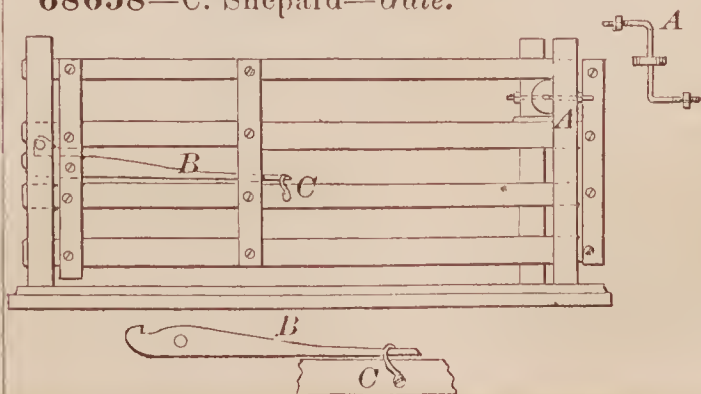





68669—F. Sylvester—Refining Petroleum.

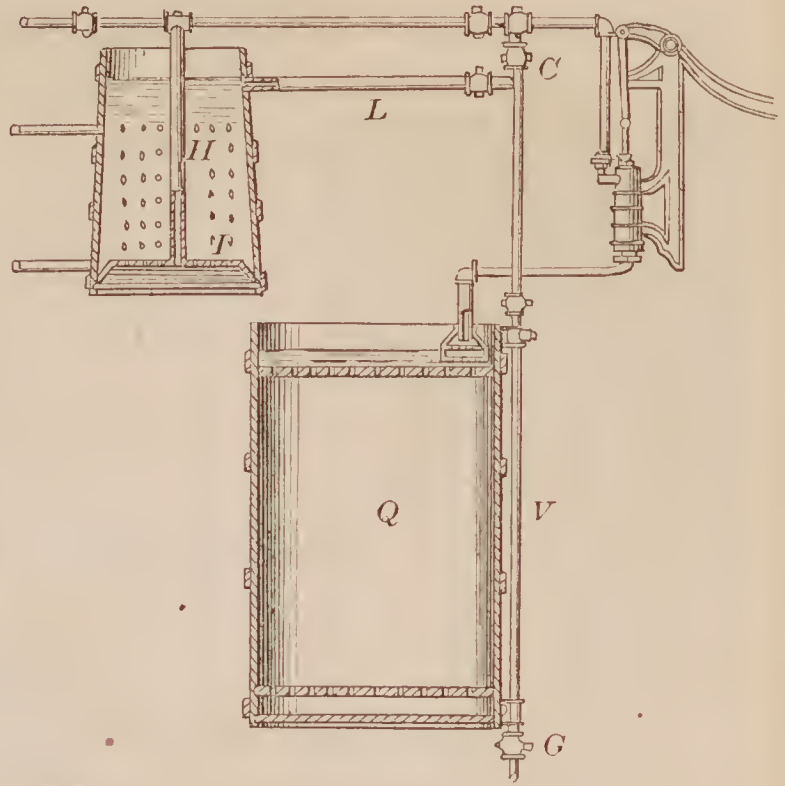

68668—A. Storm—Bed Clothes Clamp.

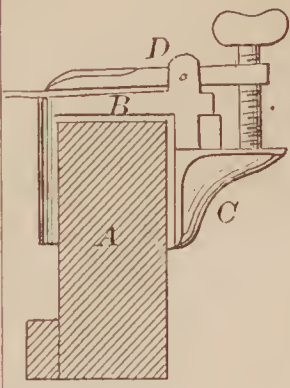

68667—H. T. Sith—Journal Box.



68673—H. J. Wattles—Gang Plow.

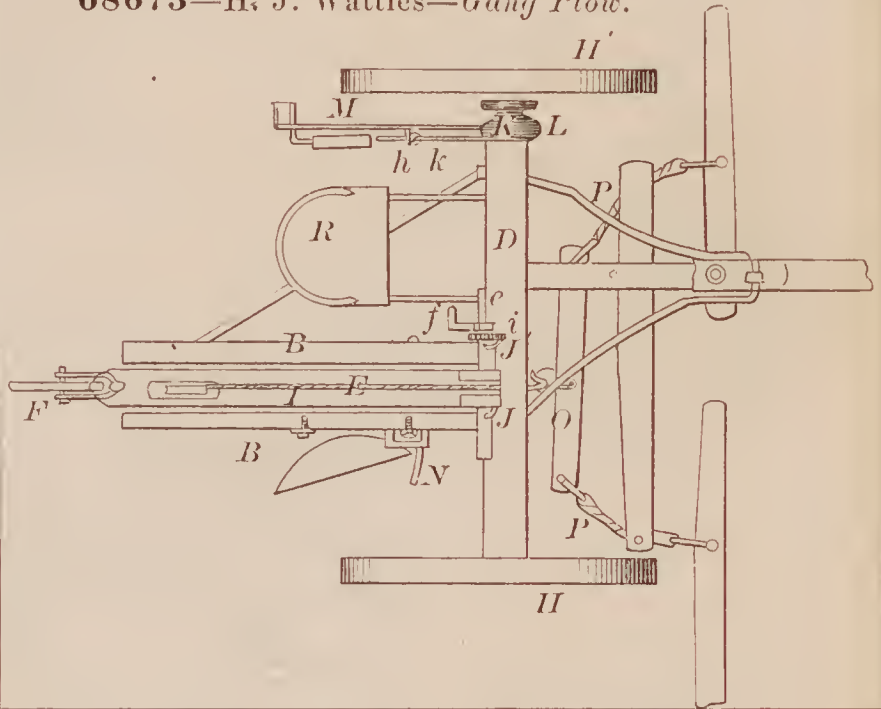

68672—H. Ury—Valve Gear for Steam Engines.

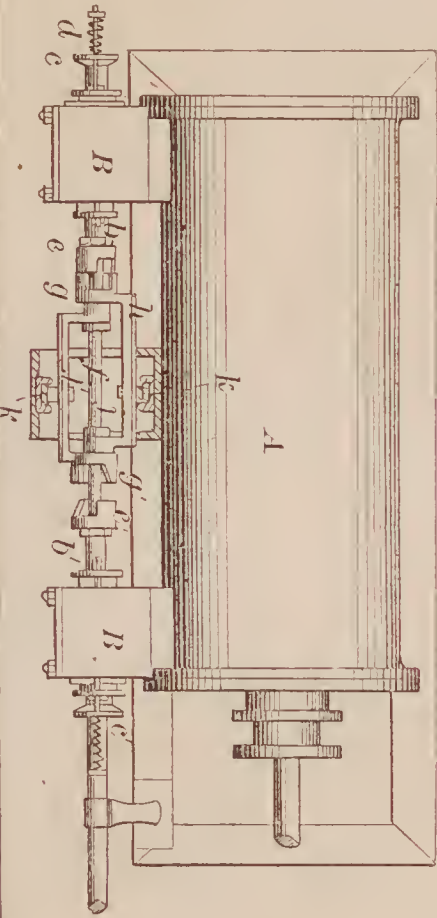

68674—L. H. Wheeler—Wind Wheel.

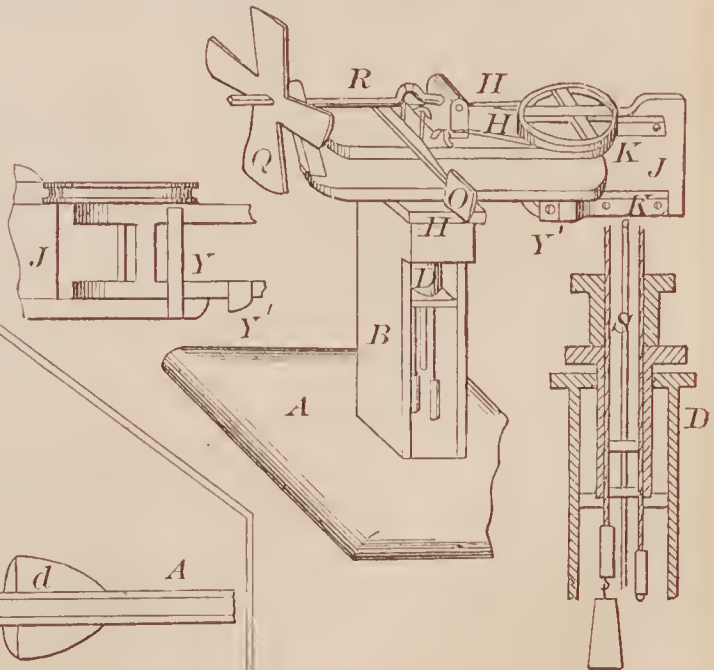

68670—J. R. Thomas—Corn Plow.

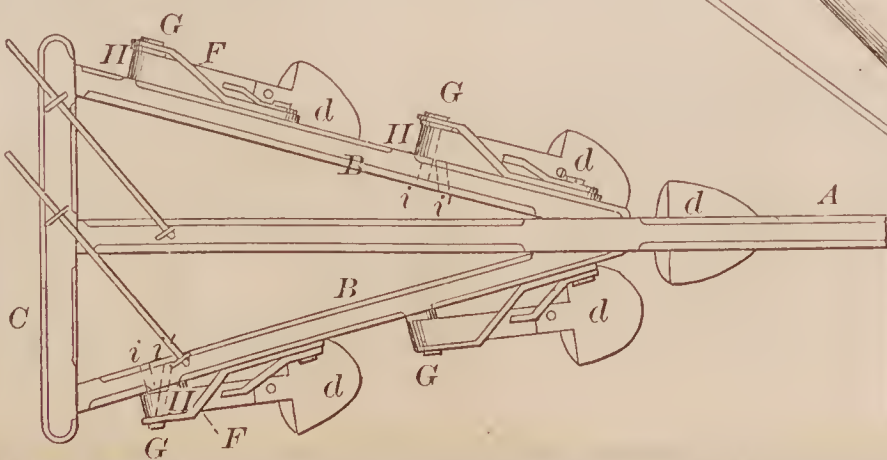



68675—W. H. Wiley—Filter.

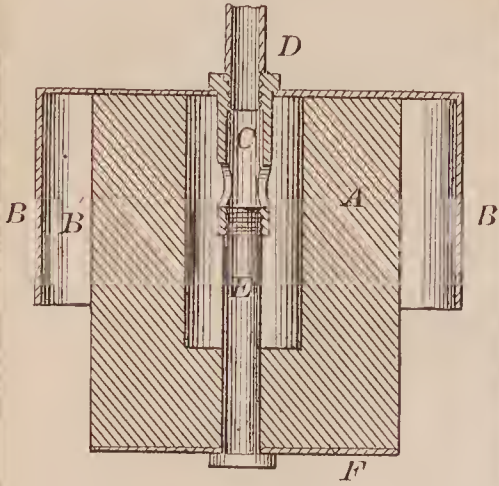

68676—A. T. Williamson—Washing Machine.

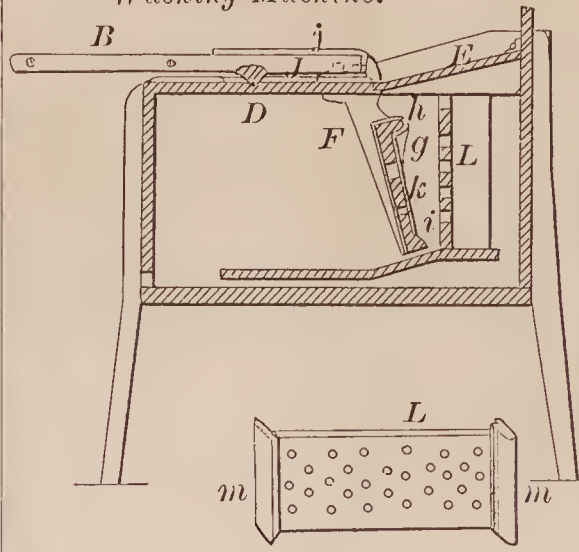

68677—S. R. Wilmot—Hoop Skirt Clasp.

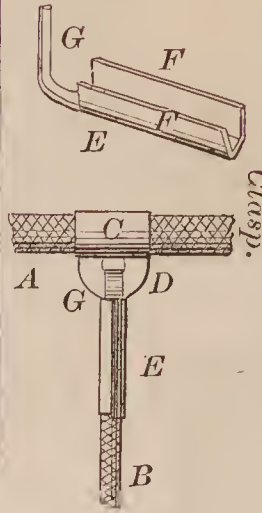

68678—M. Wilson—Corn Cultivator.

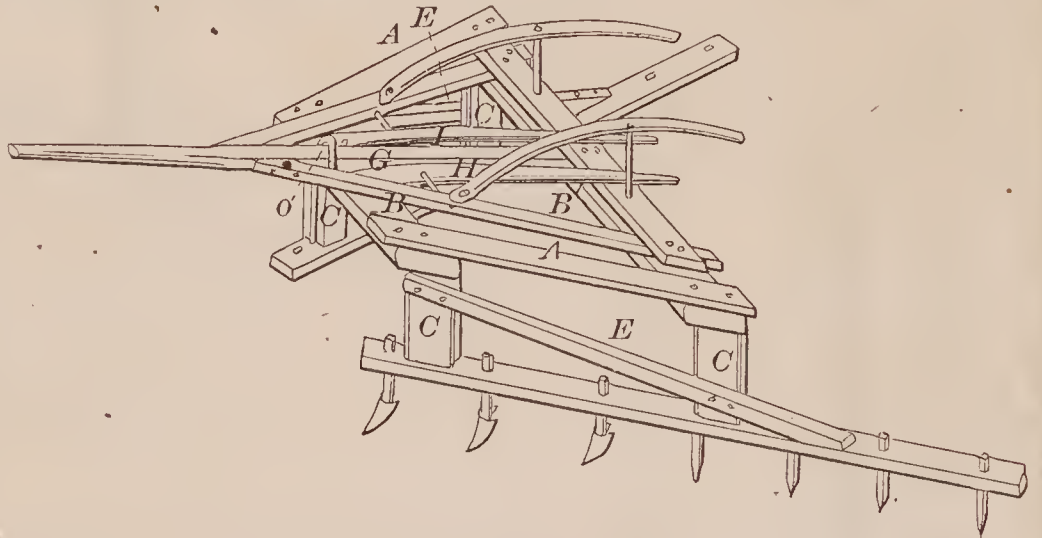

68679—W. B. Young—Cultivator.

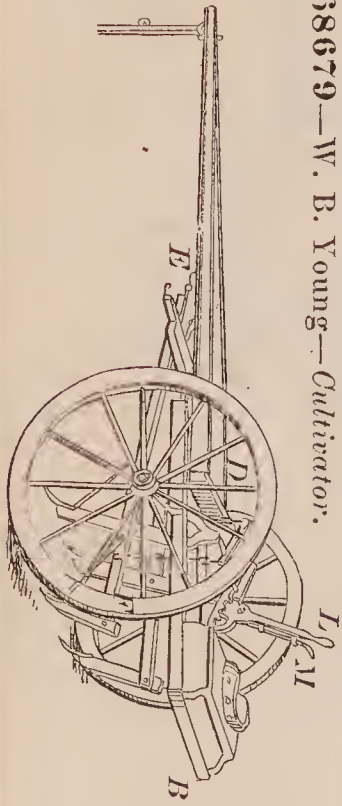

68680—J. Adt—Riveting Machine.

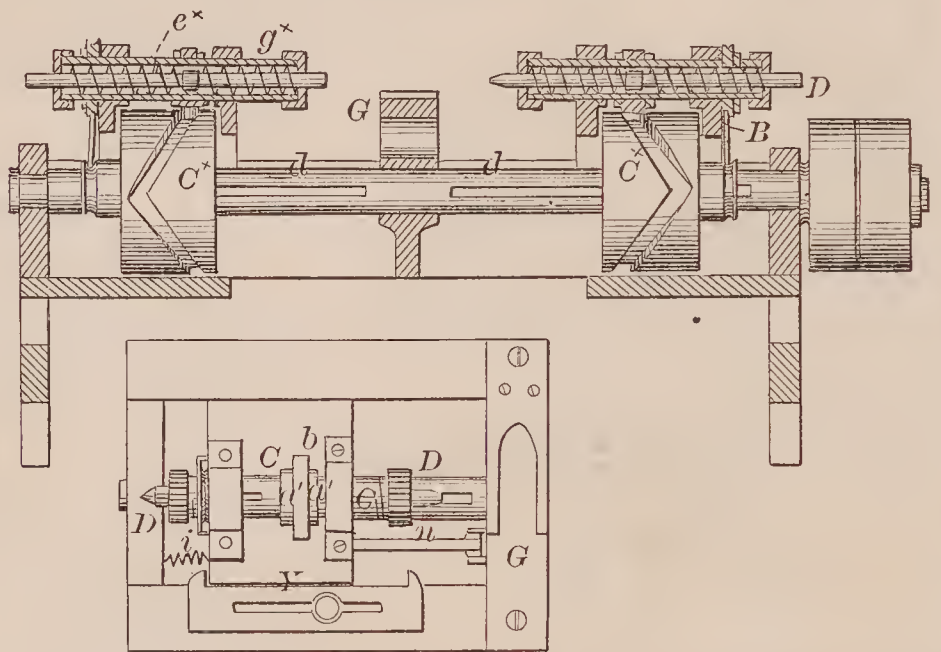

68683—T. H. Arnold—Horse Hay Fork.

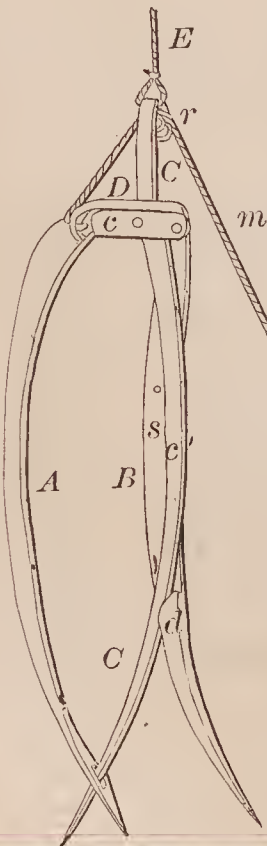

68681—M. Ames—Self-Registering Thermometer.

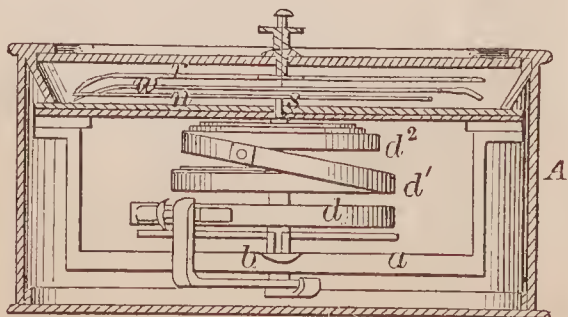

68682—E. B. Armstrong—Cut-off for Water Conductors.

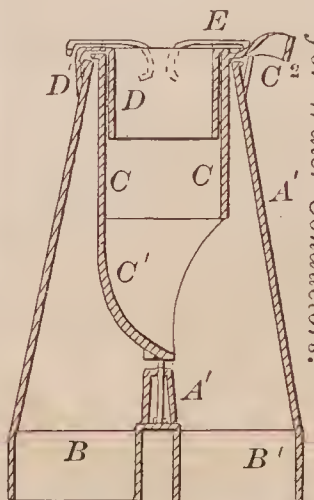



68684—H. Balschmiter—Gate.

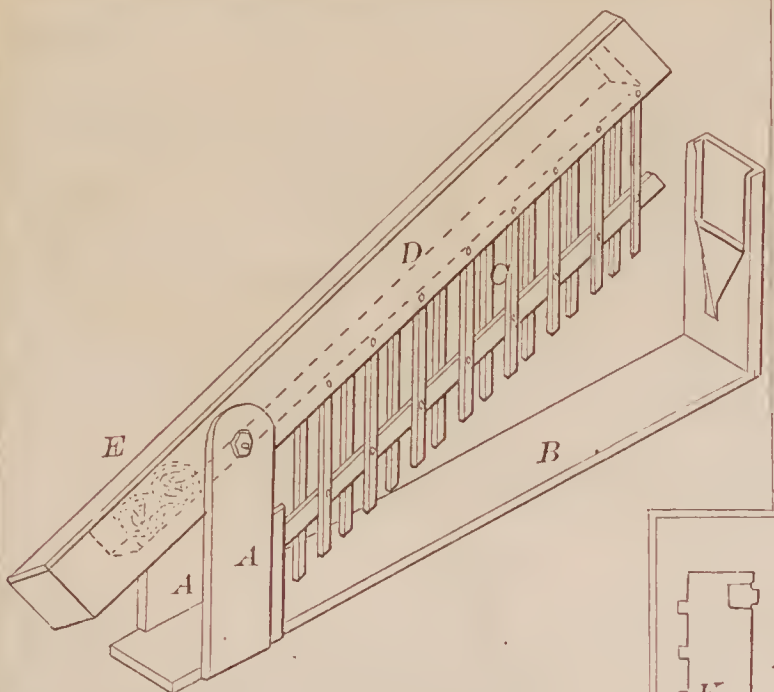

68691—J. Bish—Horse Power.

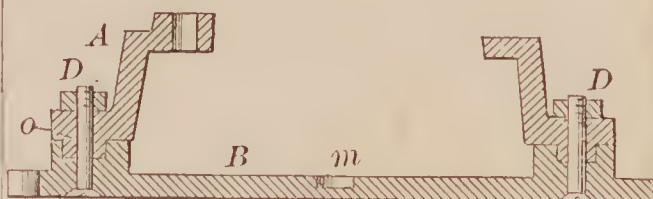

68685—H. Basch—Permutation Trunk Lock.

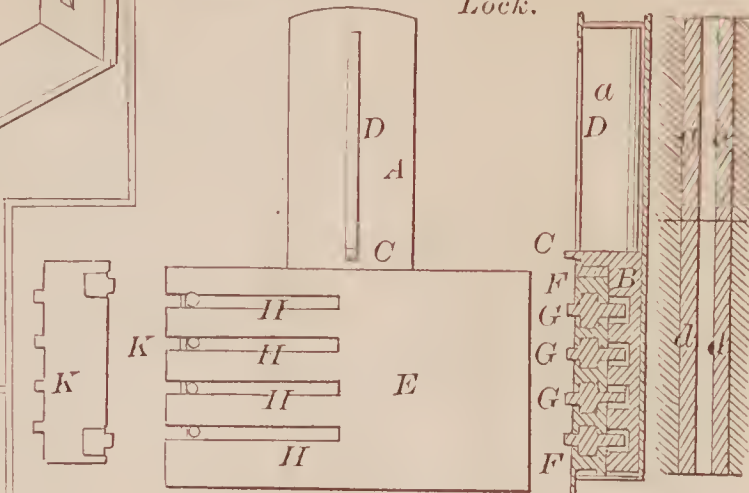

68687—J. Beck—Ticket Punch

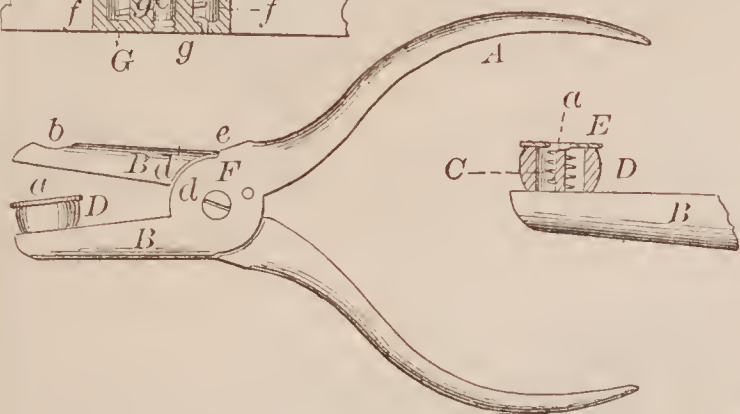
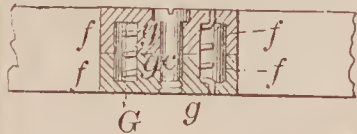

68688—J. A. Belvin, Jr.—Catamential Guard and Supporter.

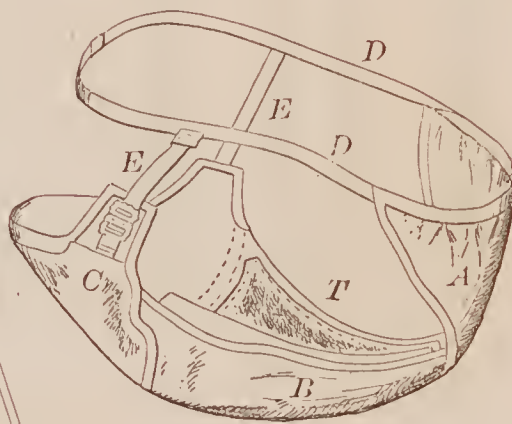

68689—H. Berkstresser—Rotary Plow.

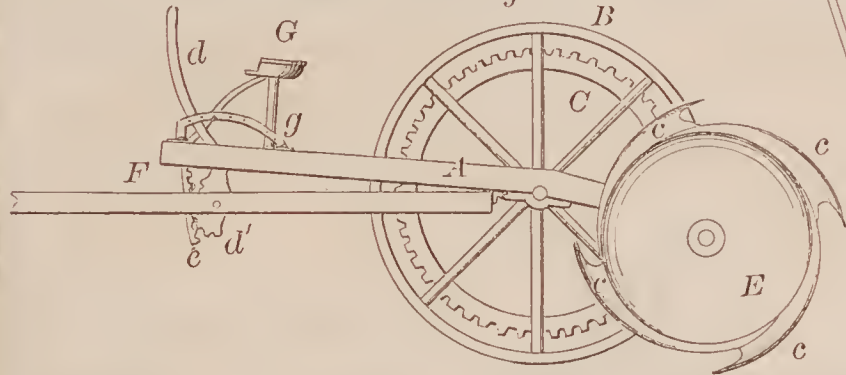

68693—I. W. Boatman—Horse Rake.

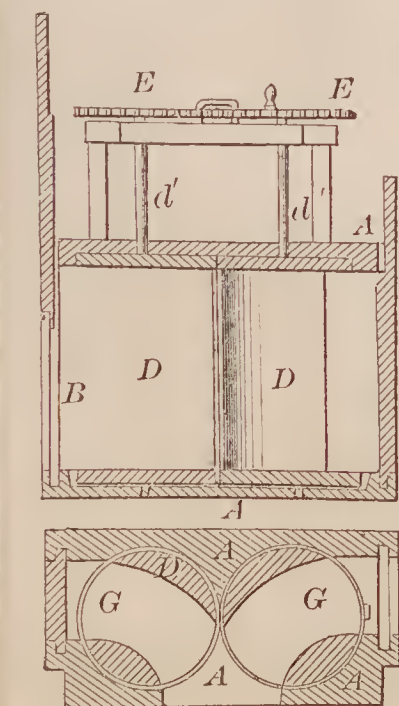
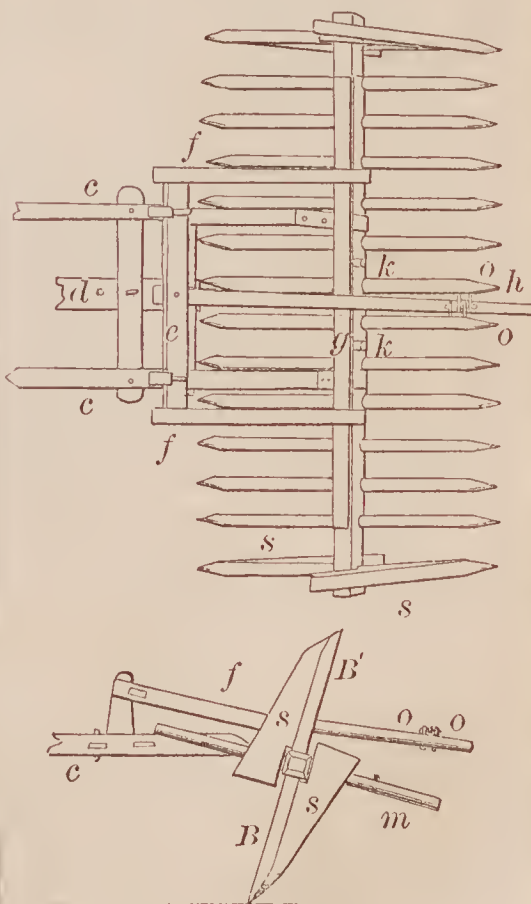

68692—C. D. Blakeslee—Gate for Water Wheels.

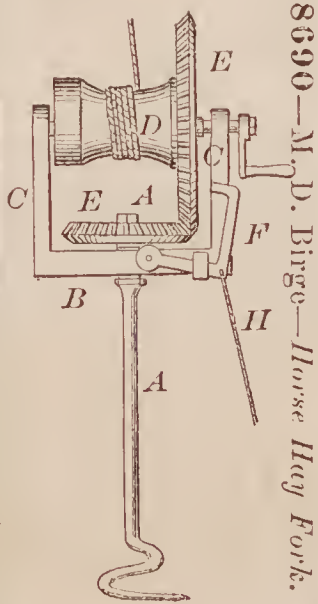

68690—M. D. Birge—Horse Hay Fork.



68694—S. E. Bright—Door for Grain Cars.

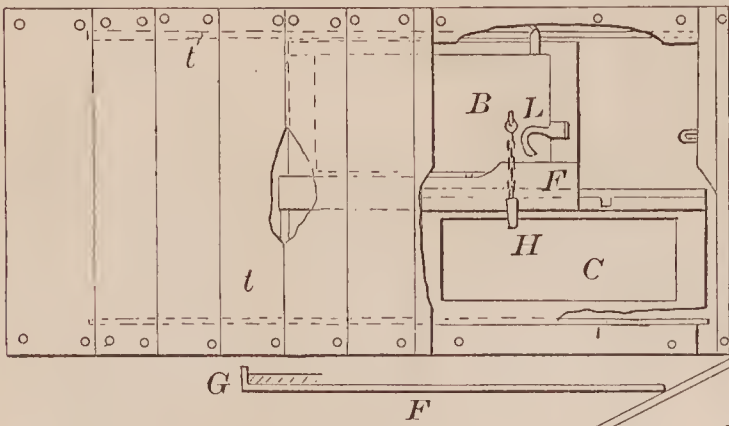

68701—T. B. Comins, Jr.—Car Brake.

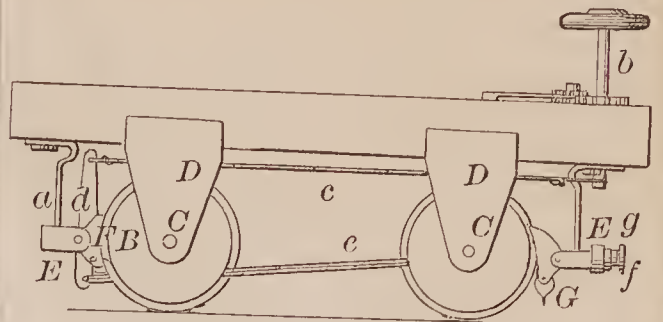

68695—F. H. Brown—For Weaving Baskets.

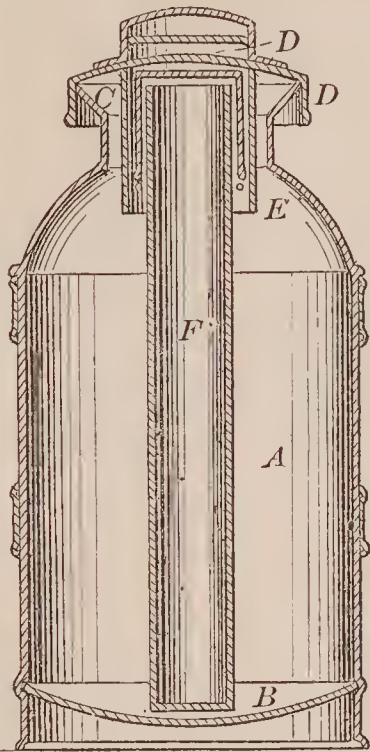
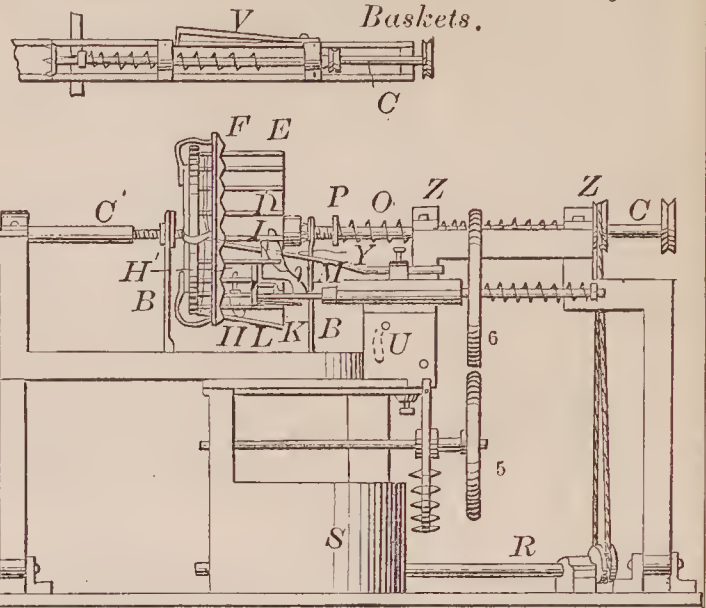

68696—J. Buckley—Milk and Oyster Can.

68697—W. R. Clark—Ditching Plow.

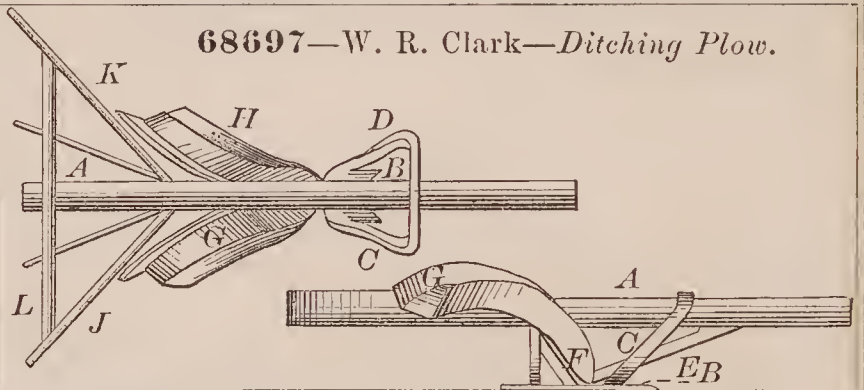

68699—A. B. Coleman—Draught Neck Yoke.

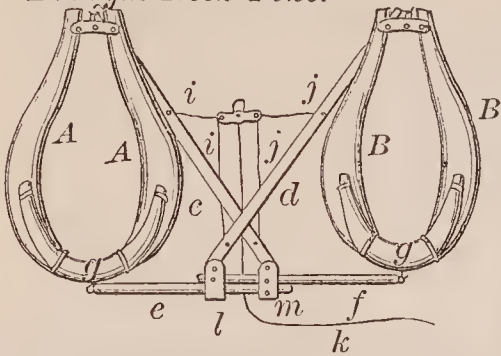

68698—Coester & Lawther—For Grinding Lathe Arbors.

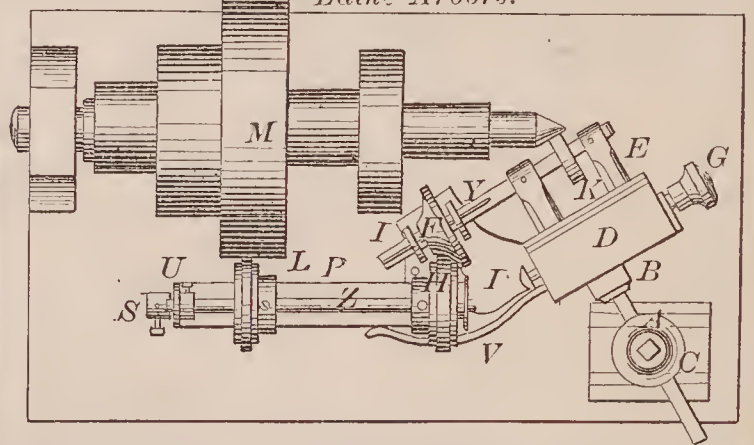

68700—T. B. Comins, Jr.—Car Brake.

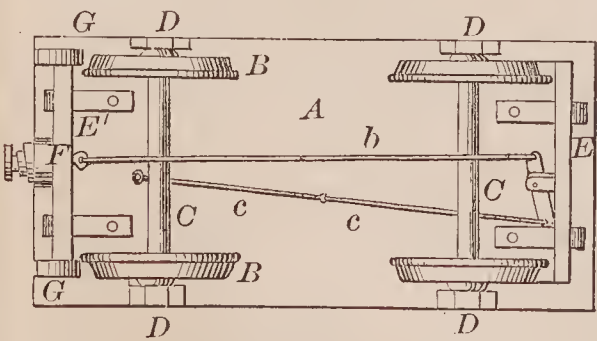

68702—F. Cook—For Vaporizing and Burning Hydro Carbons.

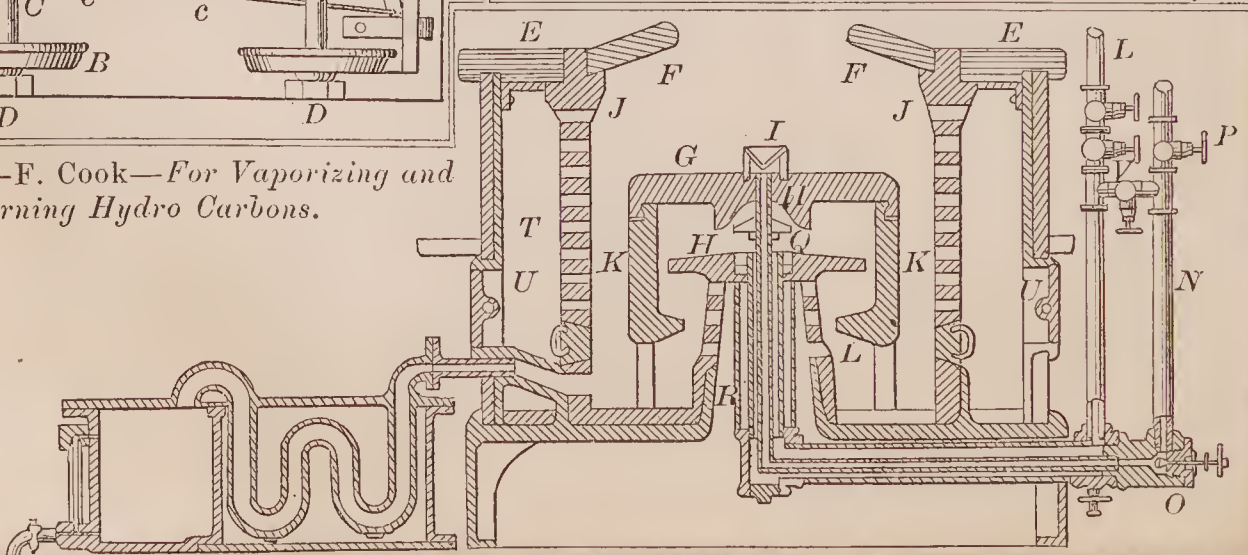



68703—F. Cook—Vaporizing and Burning Hydro Carbons.

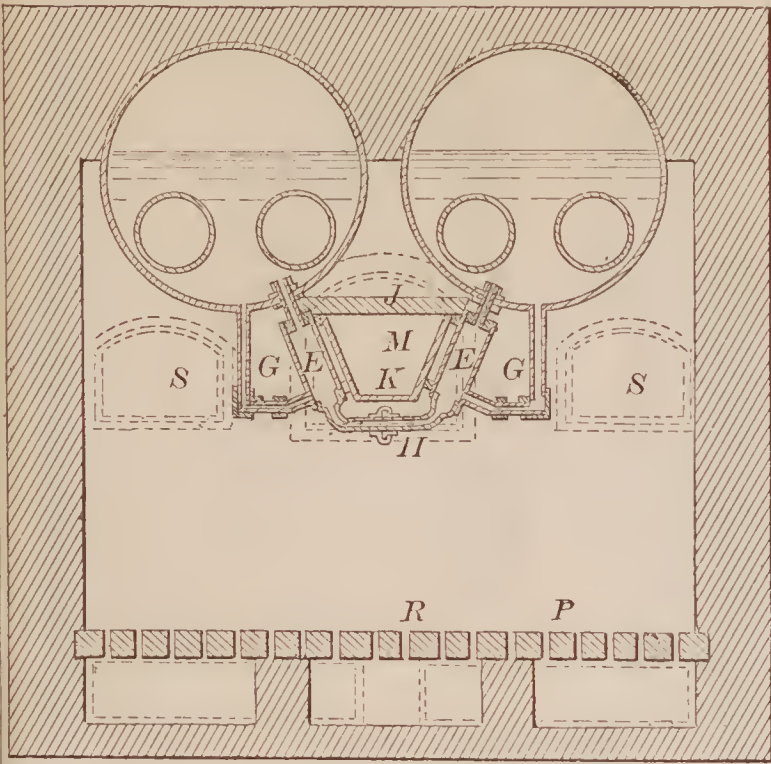

68704—F. Cook—For Burning Petroleum.

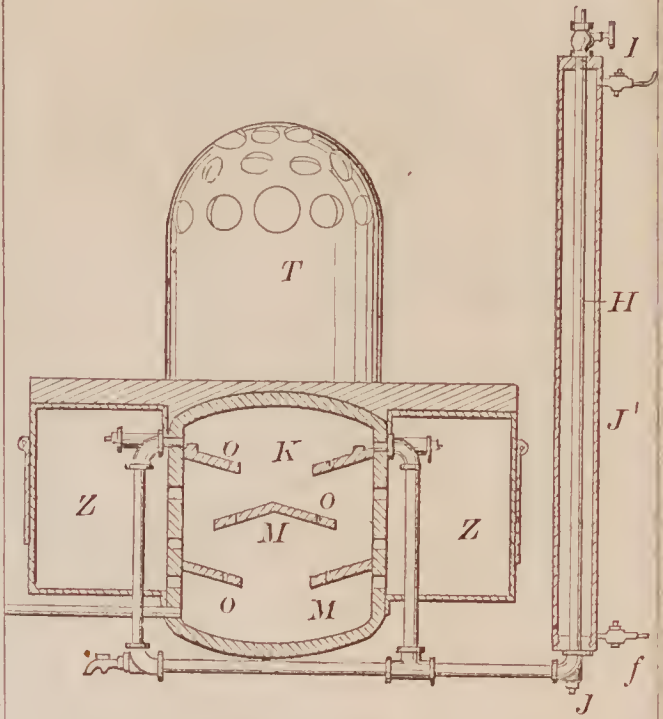

68706—F. Cook—For Burning Petroleum.

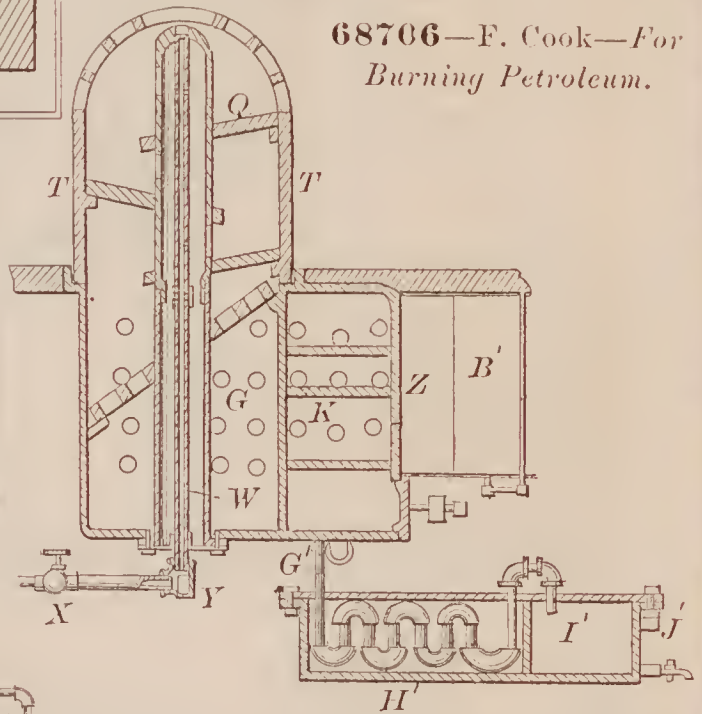

68707—F. Cook—Burning Hydro-Carbon Oil.

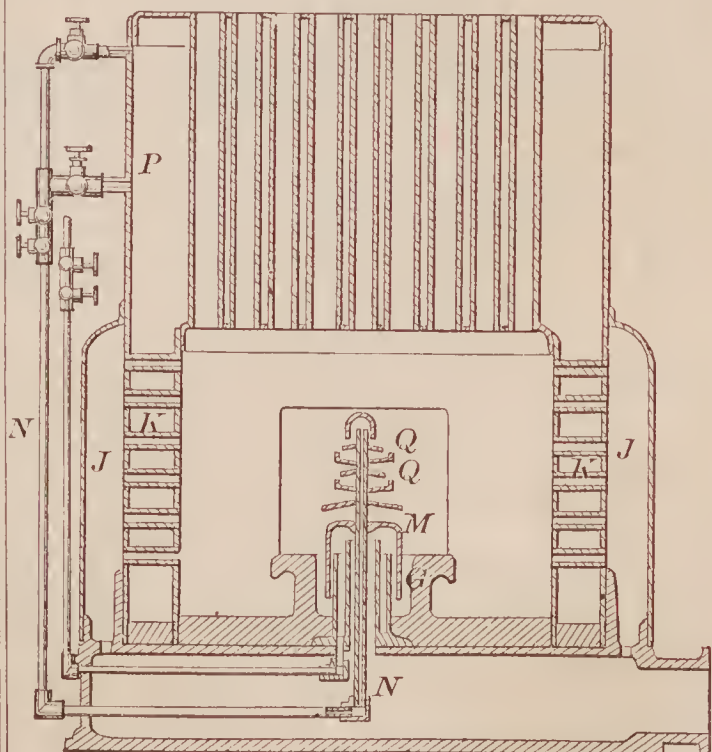

68705—F. Cook—For Using Hydro Carbons as Fuel.

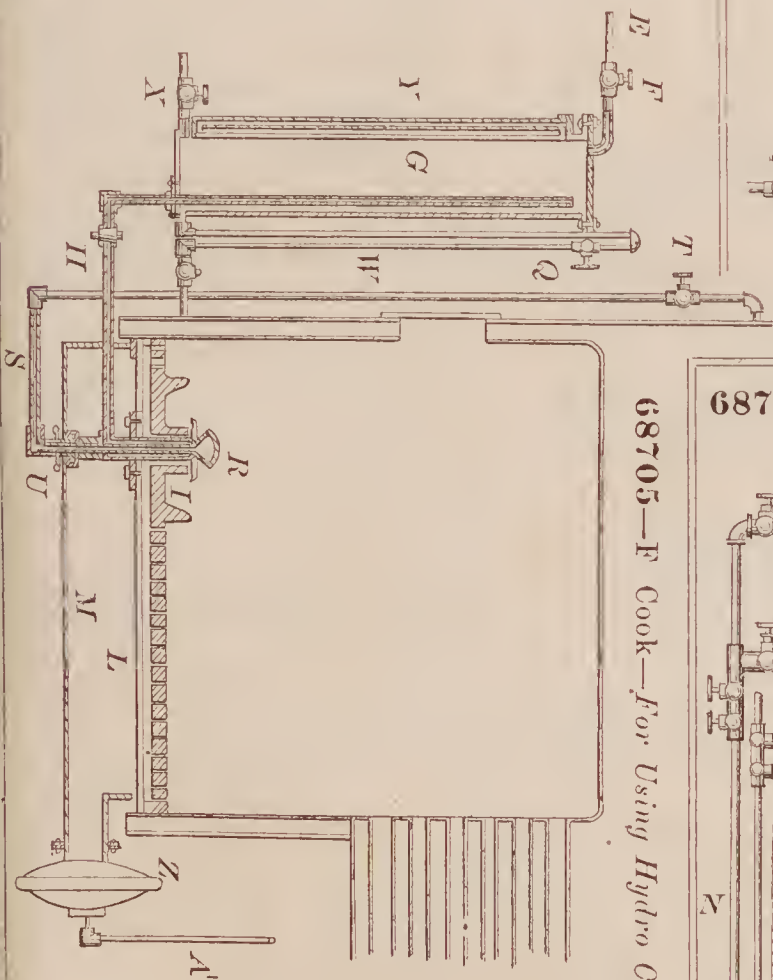



68707—F. Cook—Burning Hydro-Carbon Oil.

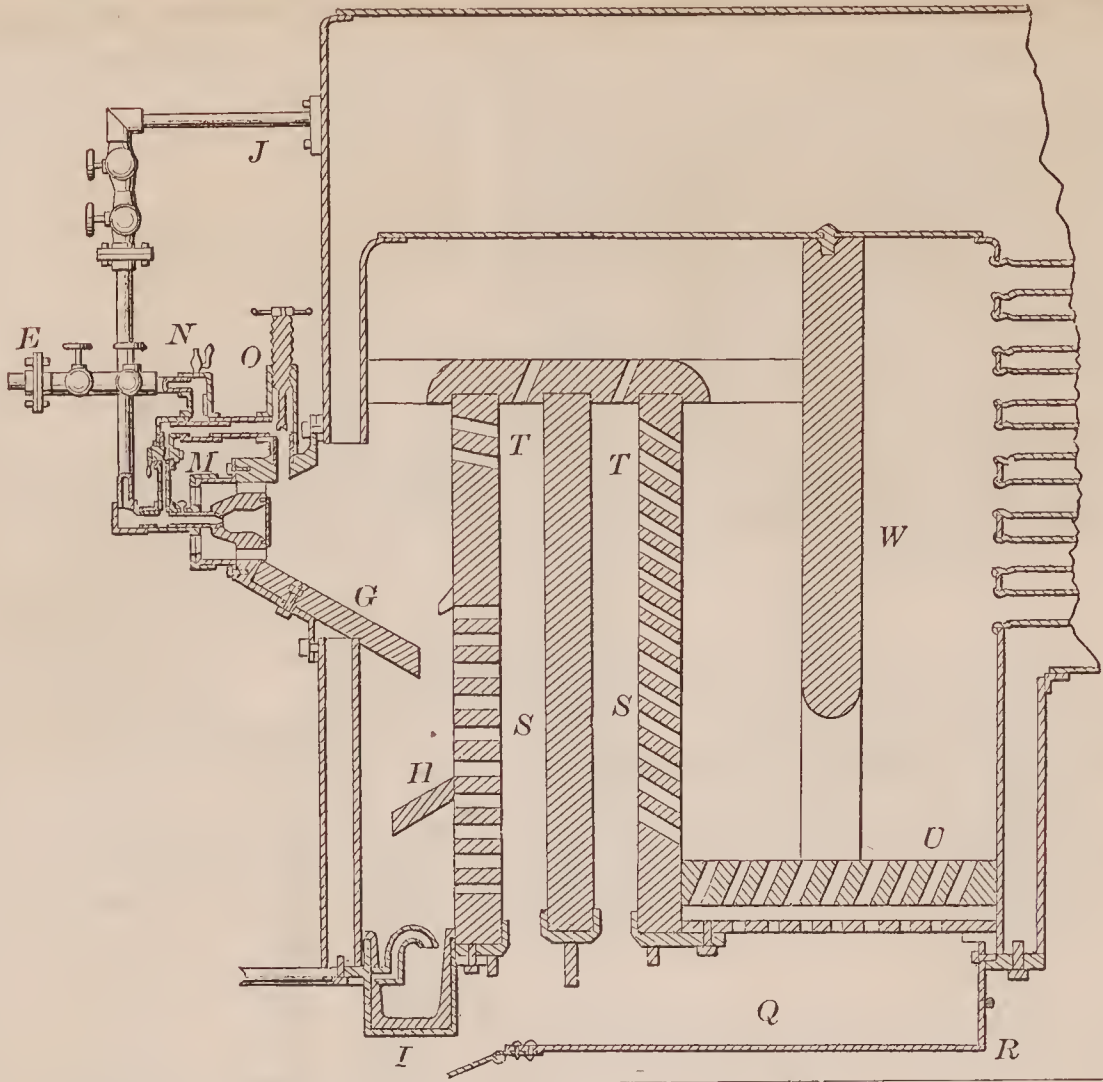

68708—Cook & Bassett—For Vaporizing and Decomposing Hydro-Carbon Liquids.

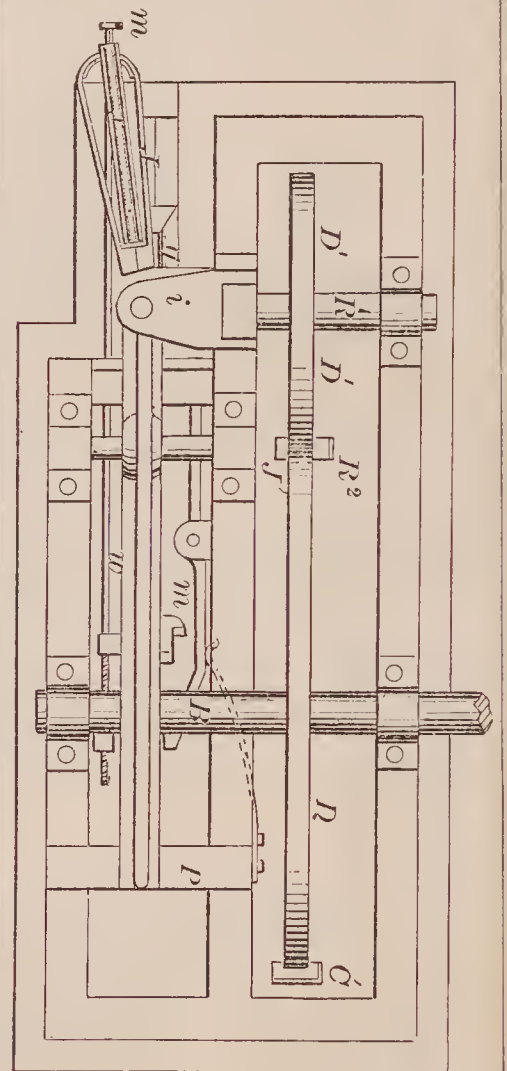
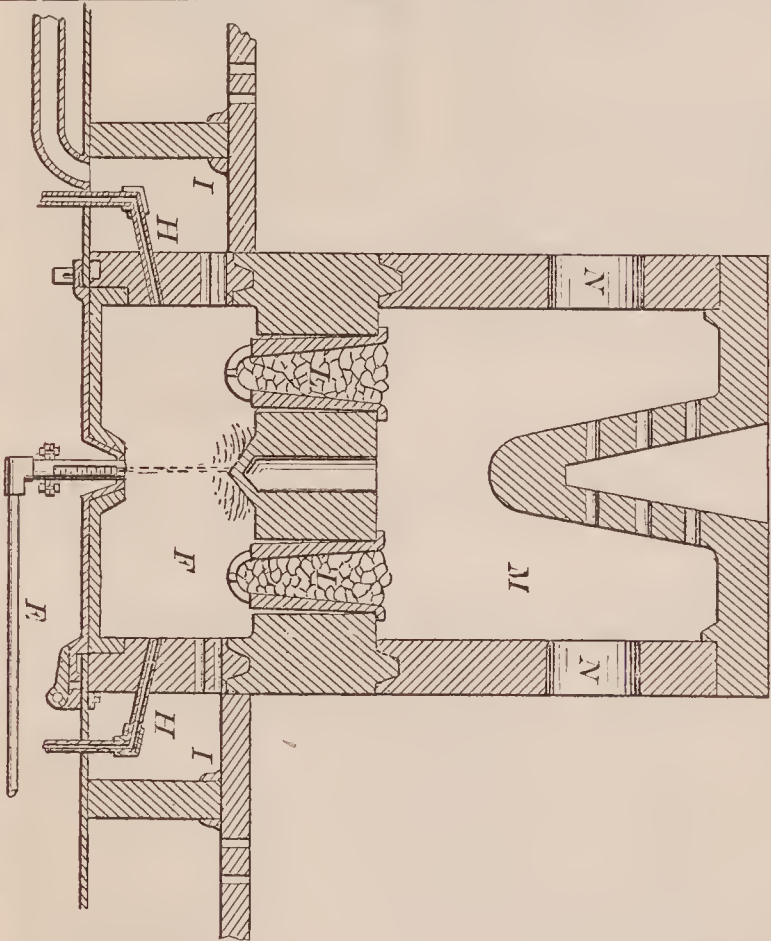

68709—J. Copley, Jr.—For Making Chairs.

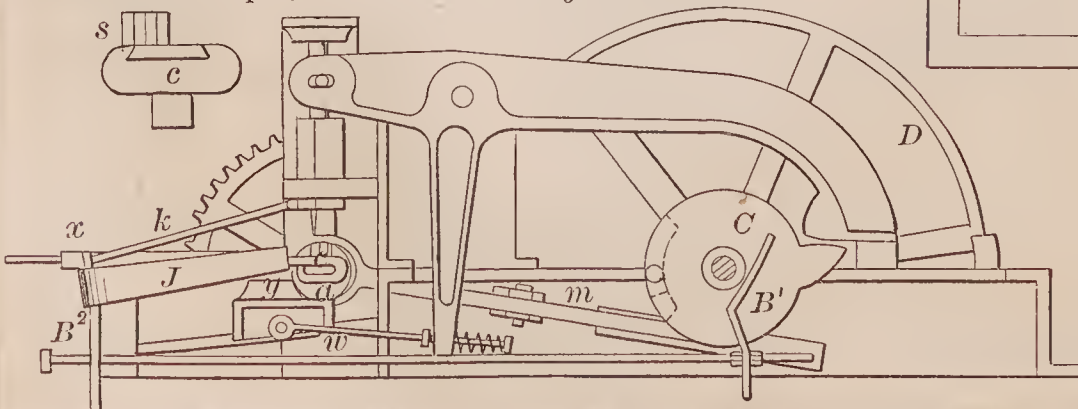

68710—E. Covert—Snare Hook.

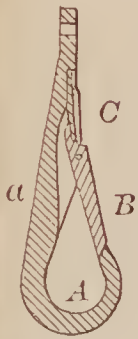

68711—J. W. Crannell—Water Elevator.

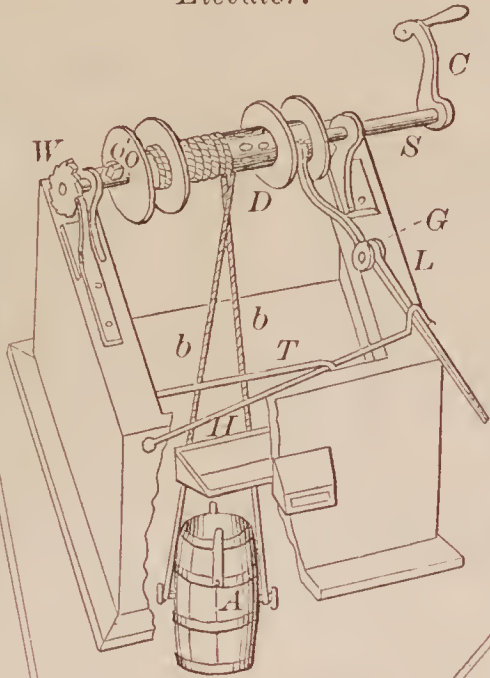

68713—W. Curry—Slide Valve.

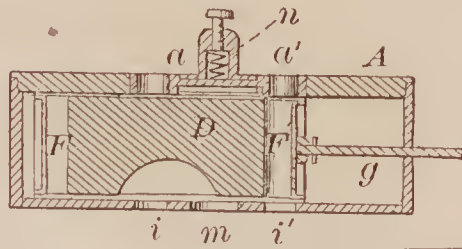

68717—C. Disser—Shifting Rail for Buggy Seats.

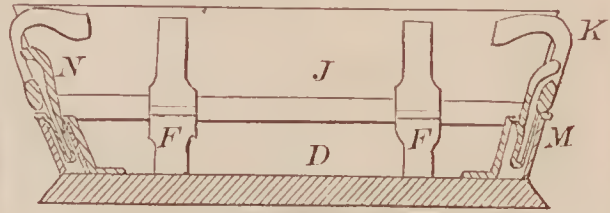

68712—C. Crook—Expansible Hose Nozzle.

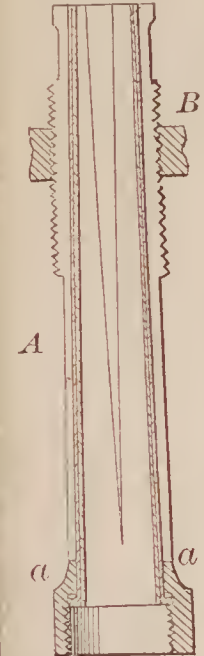

68716—J. Dimelow—Kiln for Burning Clay Pipes.

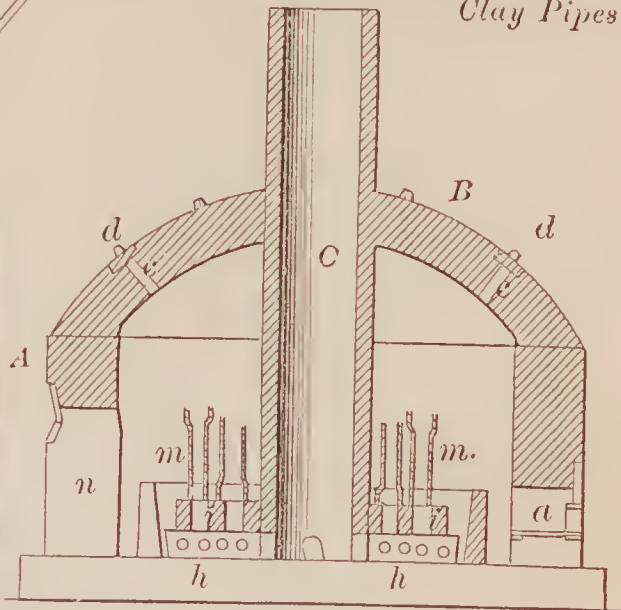

68714—P. W. Dalton—For Handling Hogs.

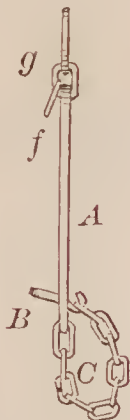

68719—C. W. Doten—Steam Engine Lubricator.

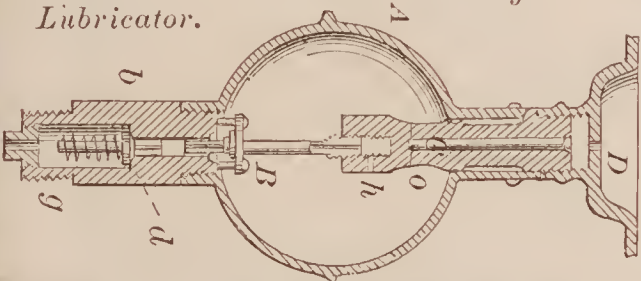

68722—H. T. Field—Fruit Safe.

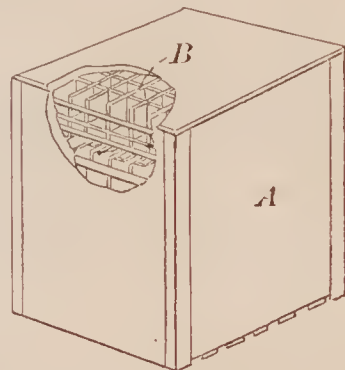

68718—L. Dominy—Riding Attachment for Gang Plows.

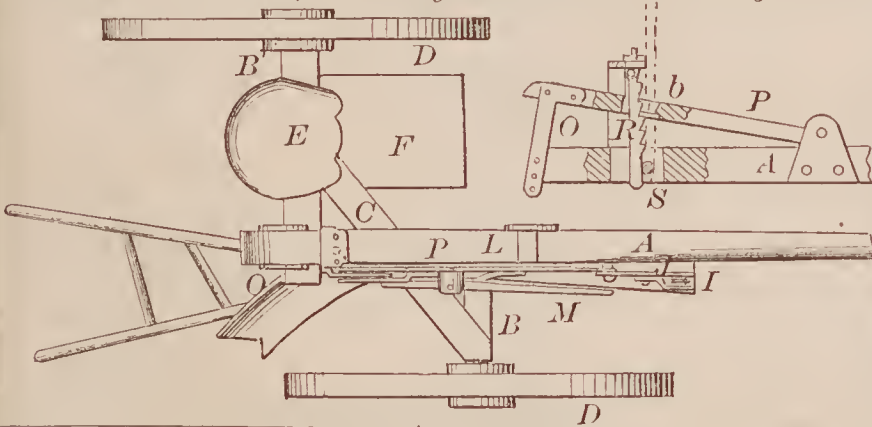

68723—J. B. M. Fifield—Side Board and Refrigerator.

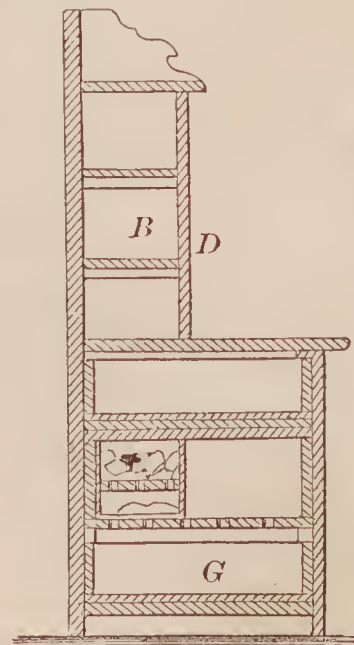

68721—J. Fairelough—Steam Engine.

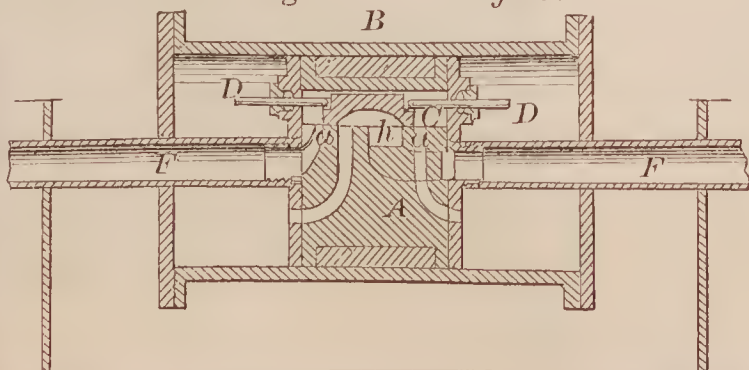



68724—J. R. Fish—*Valve Gear for Steam Engines.*

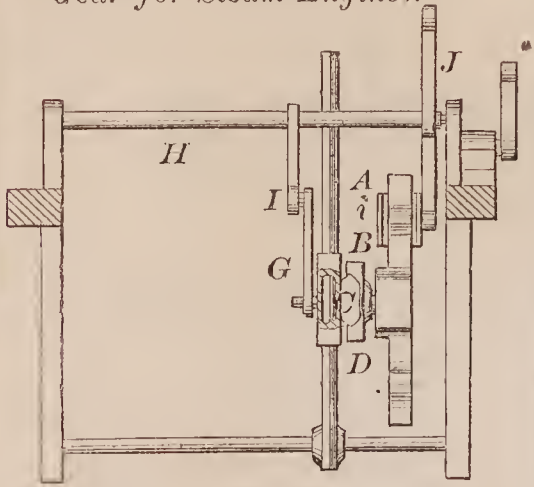

68728—C. E. Gage—*Weighing Scale.*

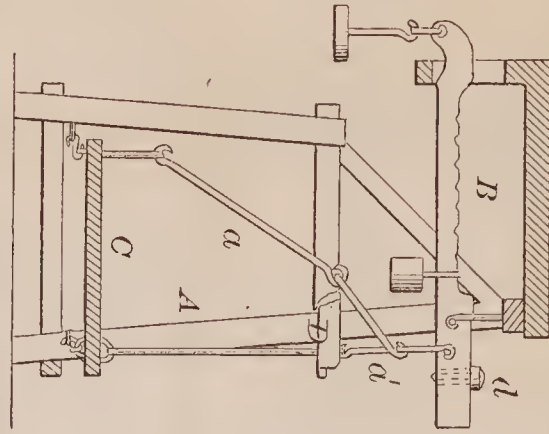

68725—A. J. French—*For Lining Percussion Caps.*

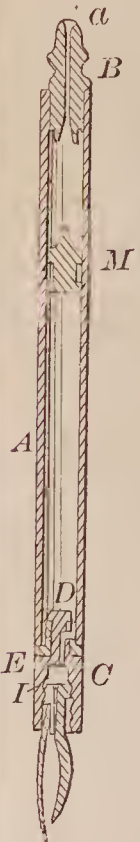
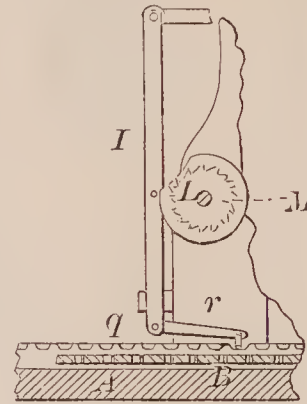
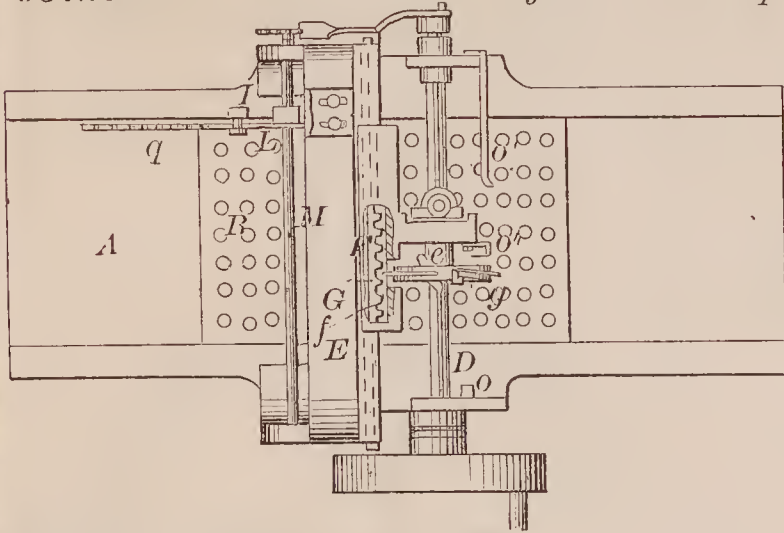

68727—P. Gabriel—*Fountain Pen Holder.*

68726—D. Fuller—*Gate.*

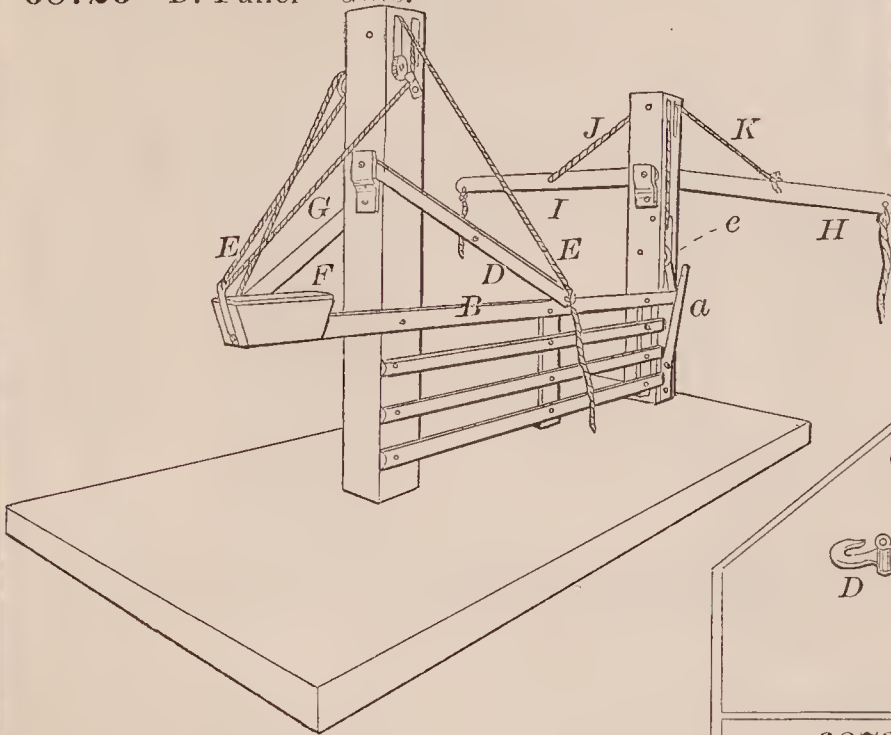

68730—O. L. Gardner—*Mirror Frame.*

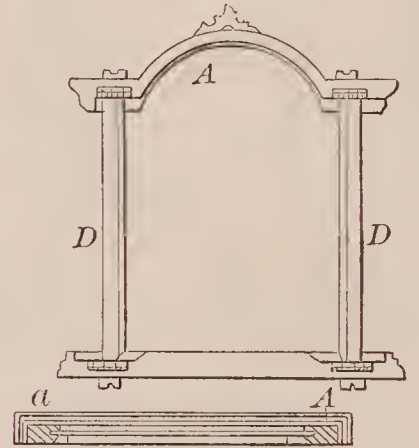

68729—M. Gally—*Evener for Whiffletrees.*

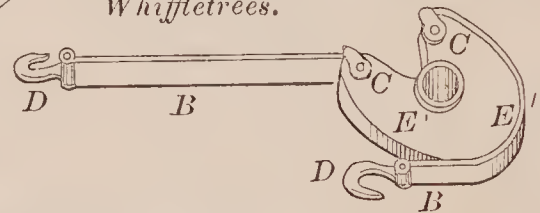

68732—F. A. Gleason—*Clothes Wringer.*

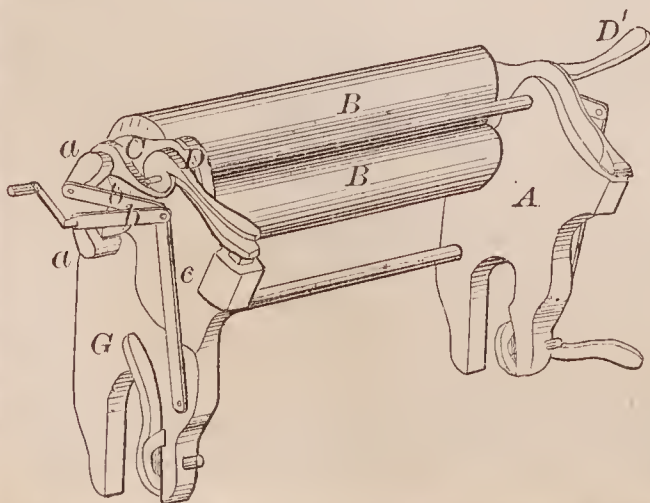

68731—F. Gilman—*Coal Stove.*

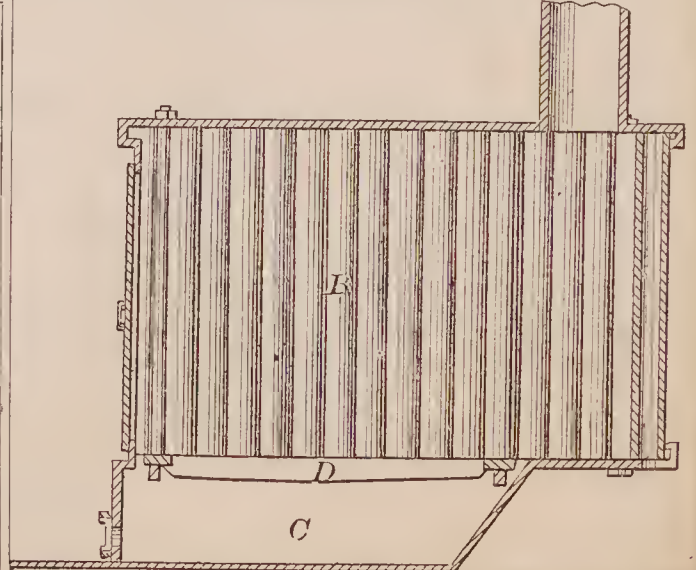

68733—G. L. Grant—*Steam Engine Valve.*

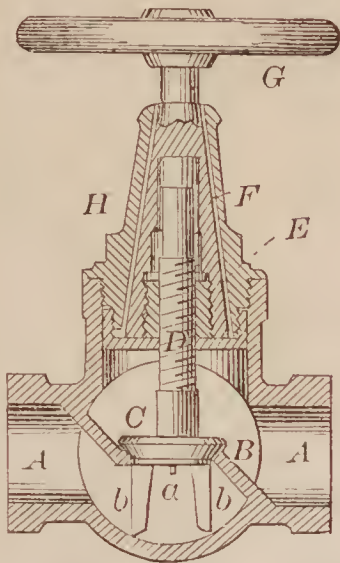

68734—J. Gray—*Ice Cream Freezer.*

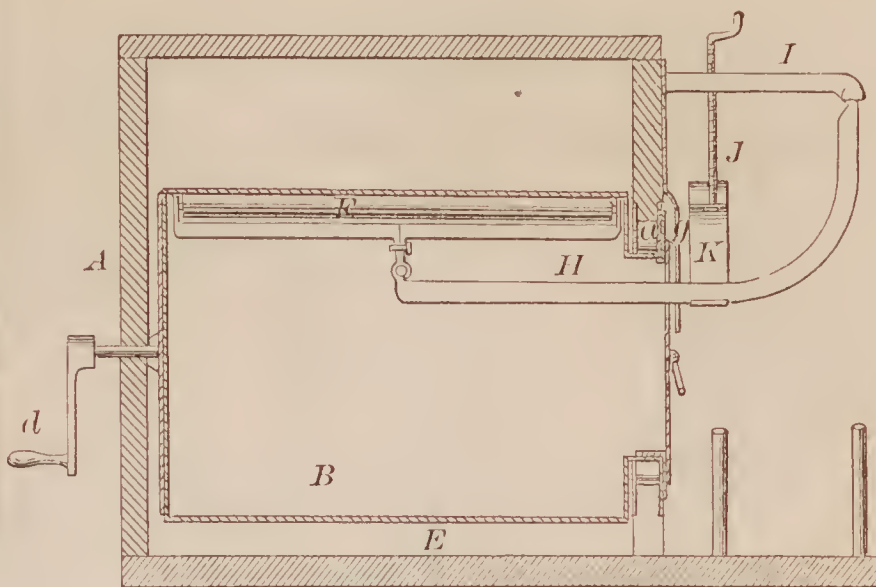

68735—J. Greenhalgh, Jr.—*Clothes Dryer.*

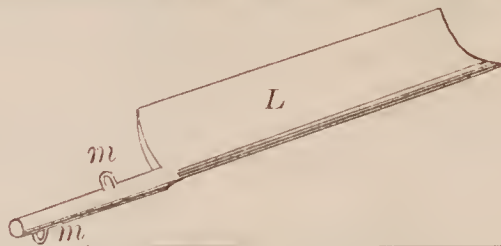
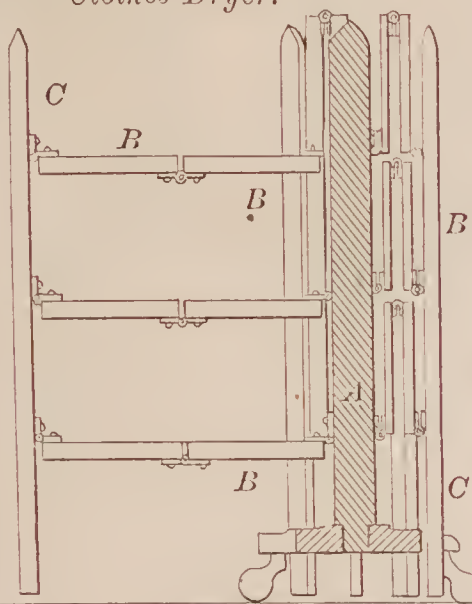

68736—E. F. Gunn—*Breech-Loading Fire Arm.*

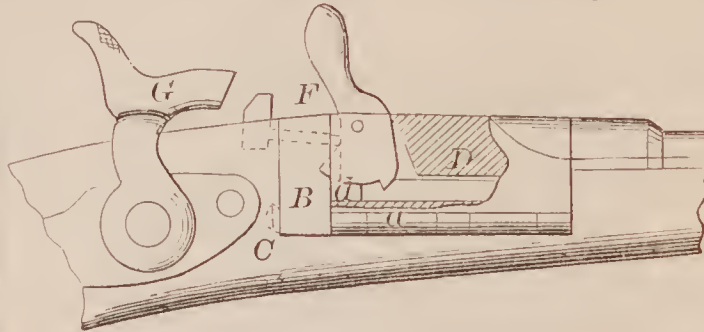

68737—J. Haggerty—*Cock Eye.*

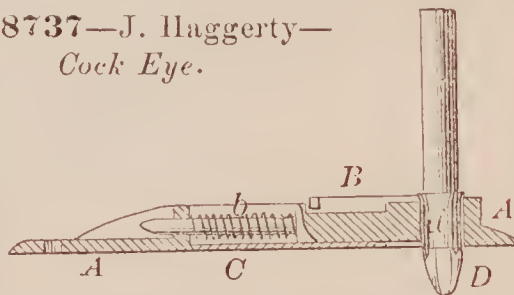

68740—T. B. Harrison—*Power Hammer.*

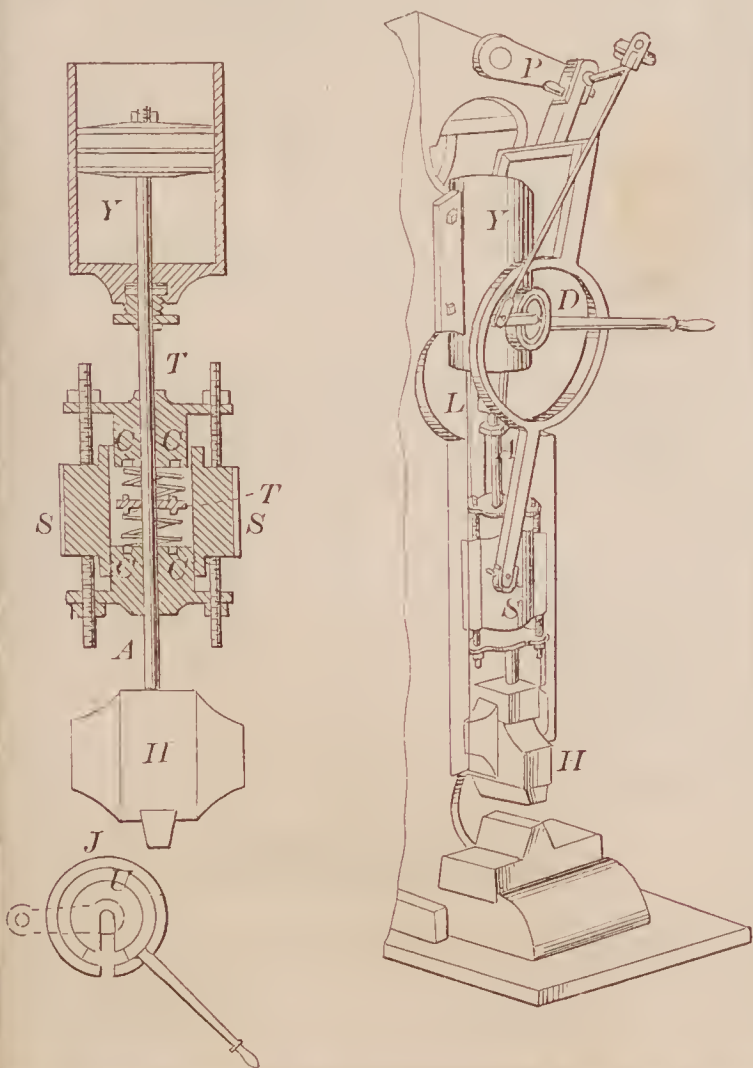

68738—Hailes & Finkle—*Store Pipe Damper.*

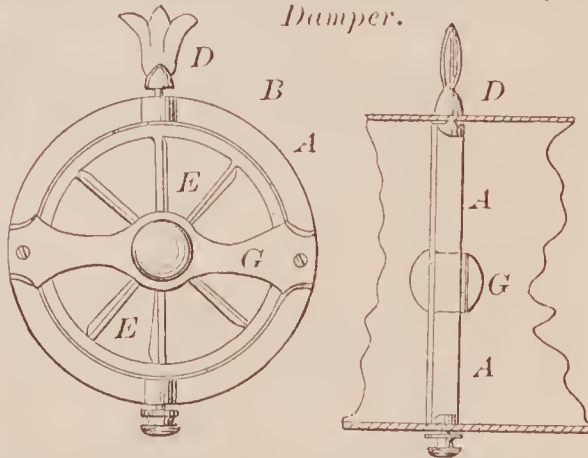

68739—H. Harris—*Mosquito Guard.*

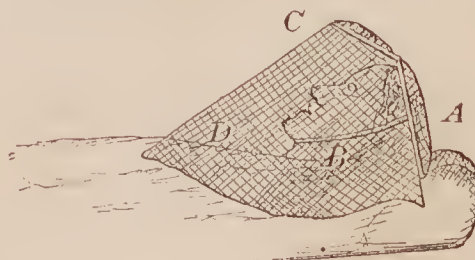



68741—C. Herrschaft—*Feed Regulator for Spinning Machines.*

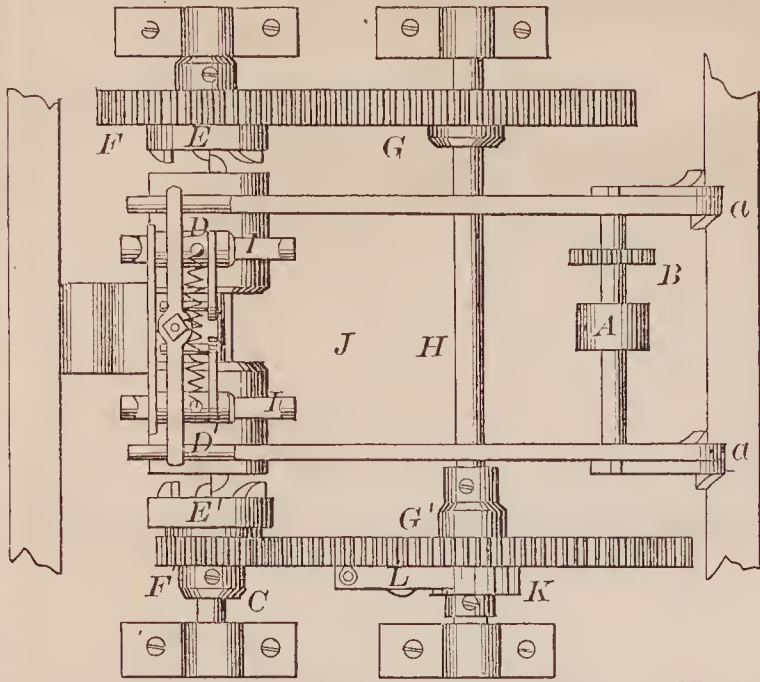

68746—Horton & Hawkins—*Liquid and Fluid Meter.*

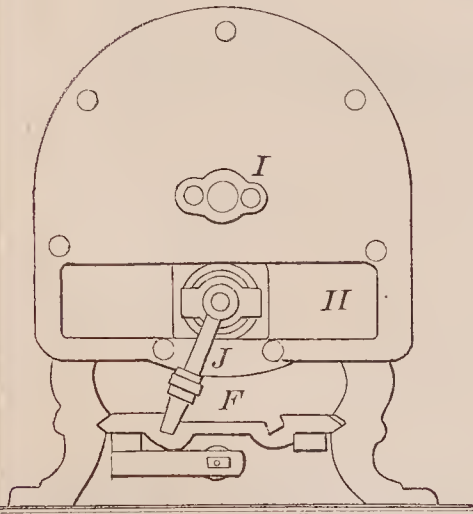
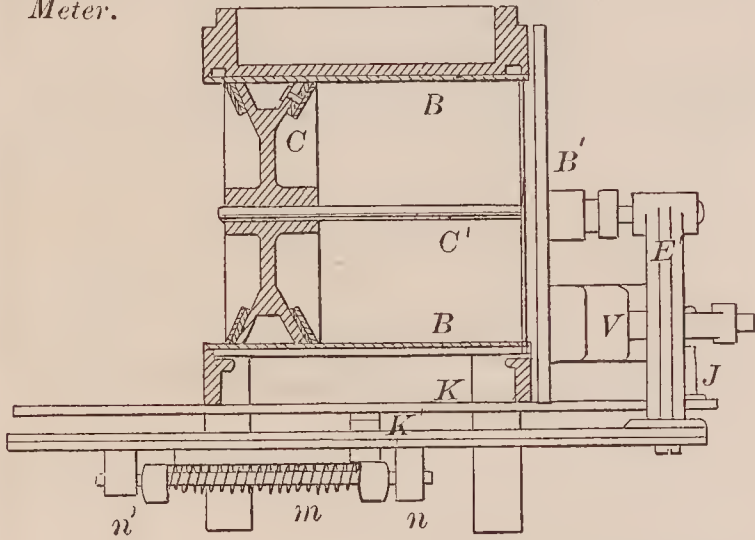

68744—Hoagland & Moser—*Corn Sheller and Fanning Mill.*

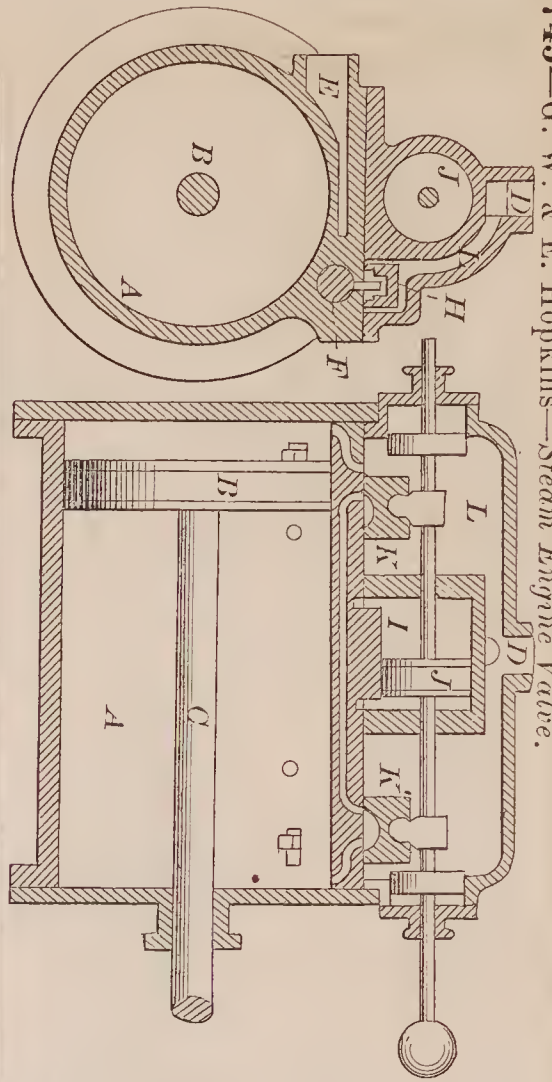
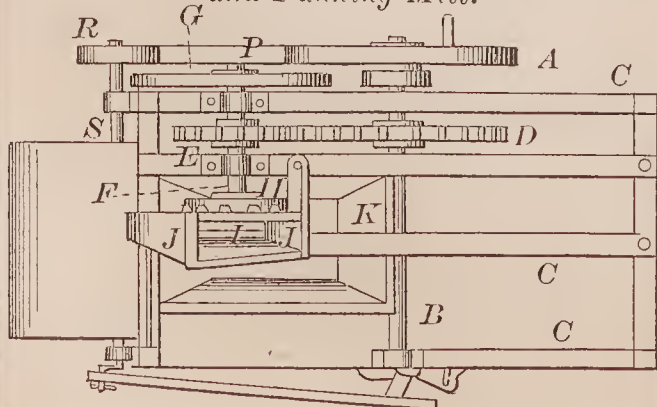

68745—G. W. & E. Hopkins—*Steam Engine Valve.*

68742—G. G. Hickman—*Bolt Washer.*

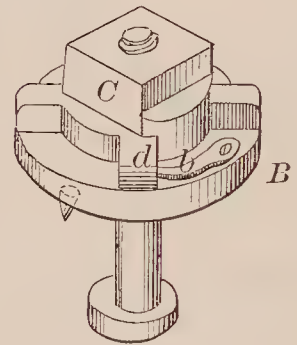

68743—G. Hilgar—*Sheep Shears.*

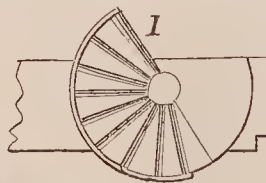
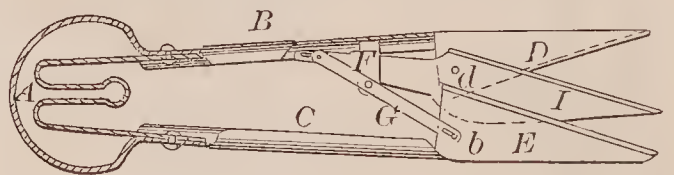

68747—S. W. Hudson—*Steam Engine.*

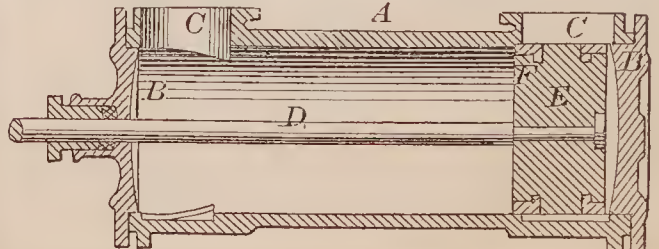

68748—S. W. Hudson—*Steam Engine.*

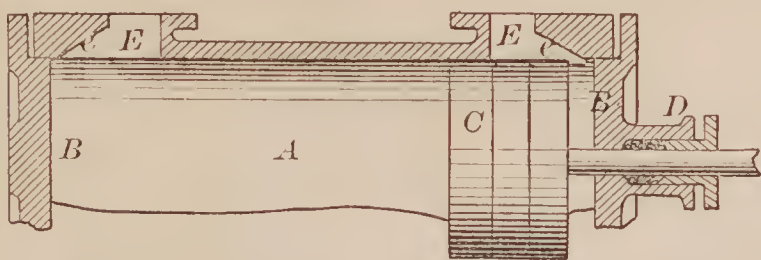

68749—A. Hunt—*Cornstalk Cutter.*

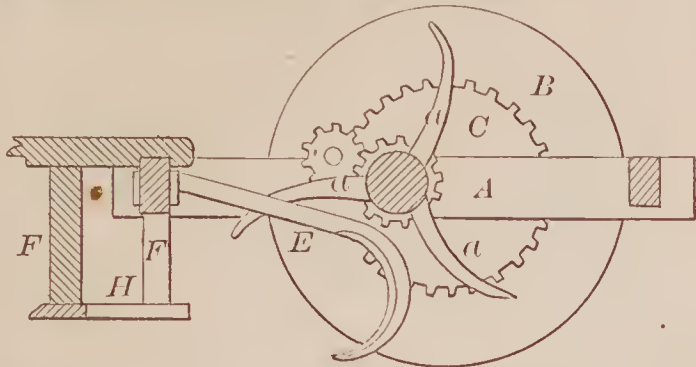

68753—A. H. Knapp—*Water Elevator.*

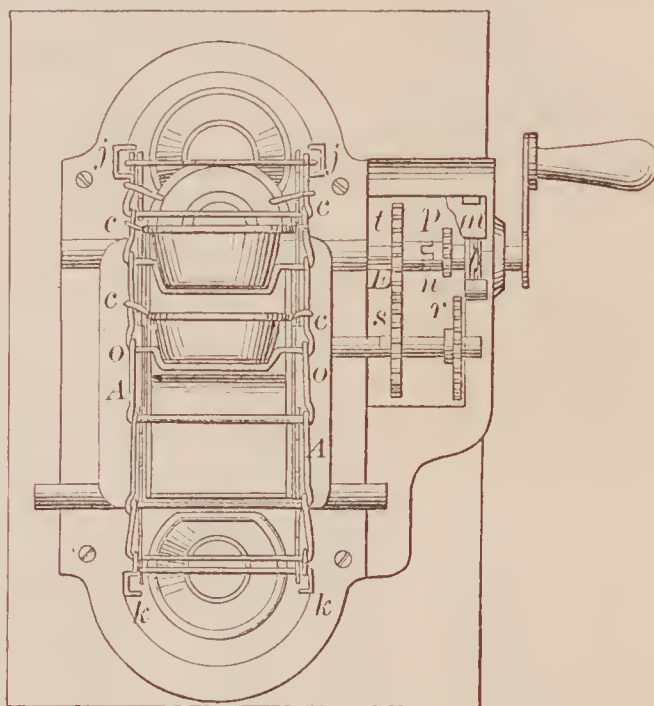
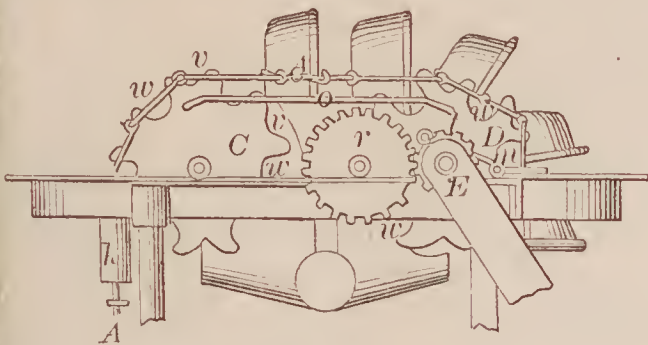

68752—W. Kimble—*Gate Fastening.*

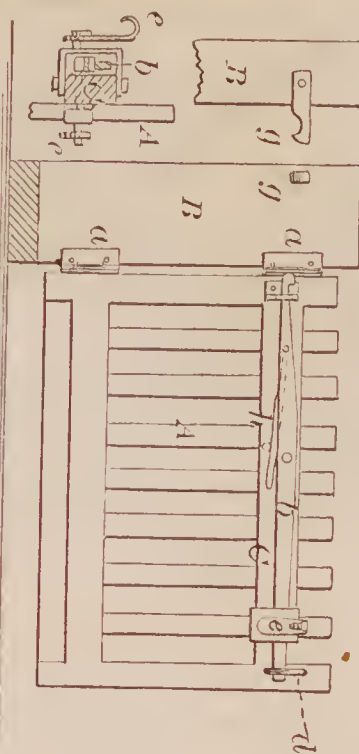

68751—T. B. James—*Window Shade.*

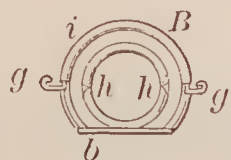
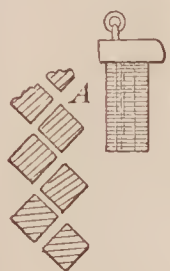

68754—G. H. Knight—*Mechanical Movement.*

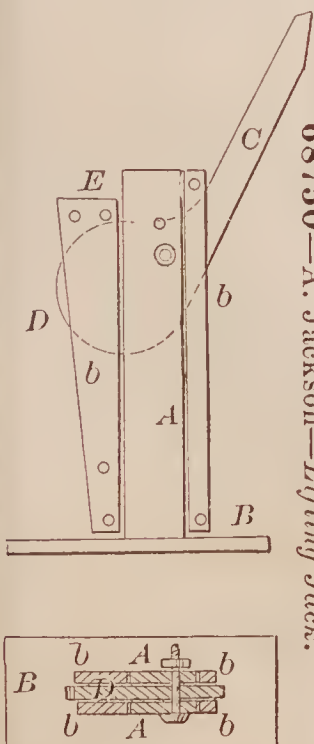
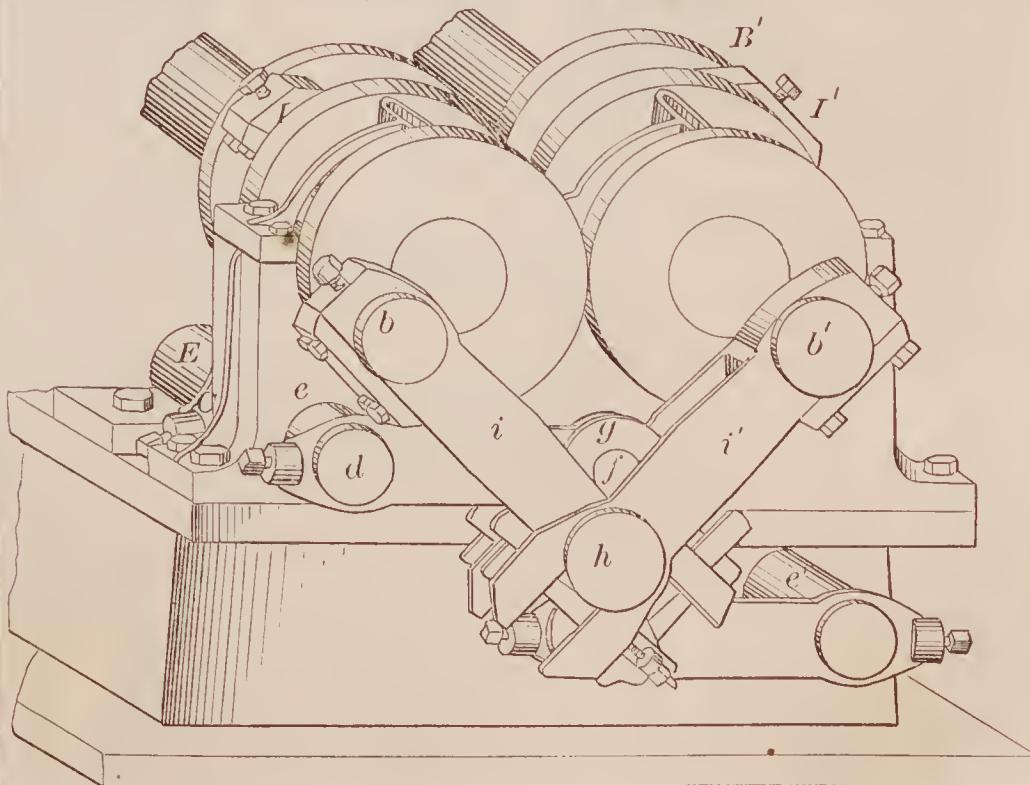

68750—A. Jackson—*Lifting Jack.*



68754—Continued.

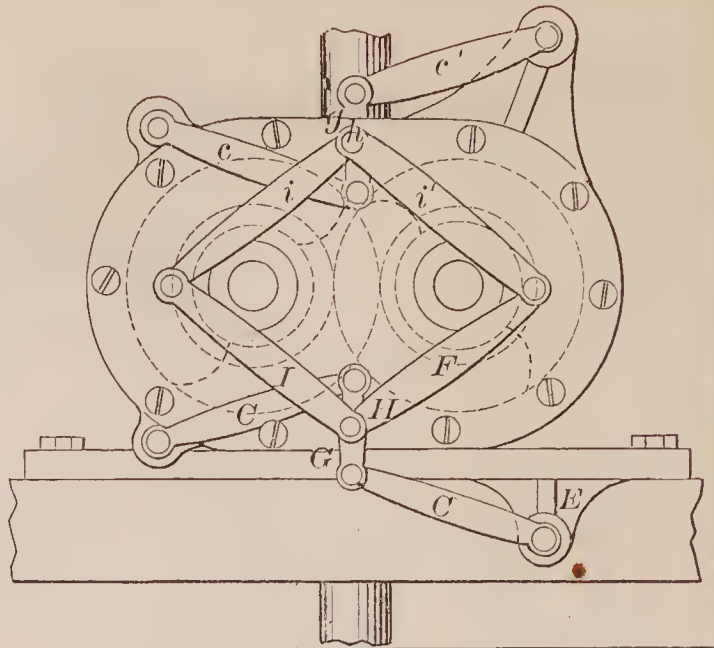
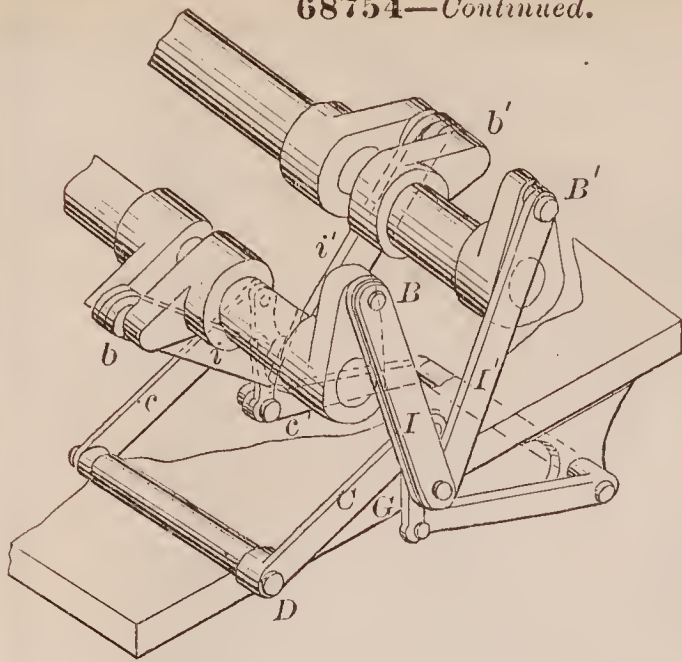

68755—H. Kniphals—*Plow Point.*

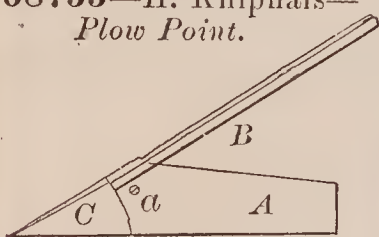

68756—E. T. Lacy—*Trace Buckle.*

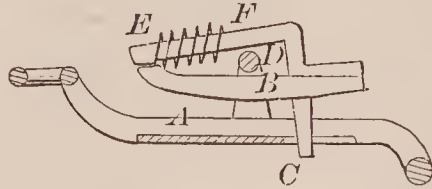

68759—V. Leonard—*Beehive.*

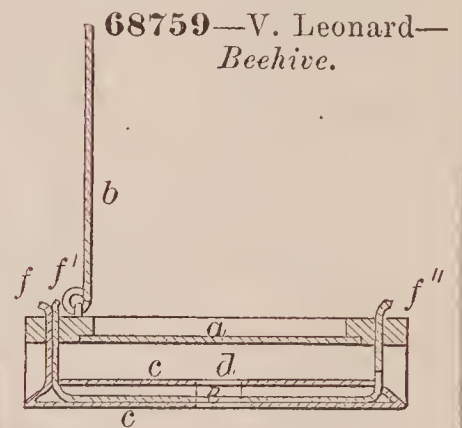

68757—C. C. Lawrence—*Thill Coupling.*

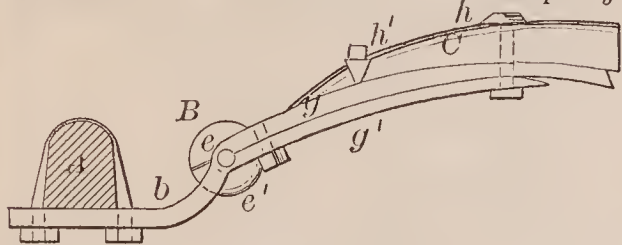

68761—N. M. Lurton—*Grain Measure.*

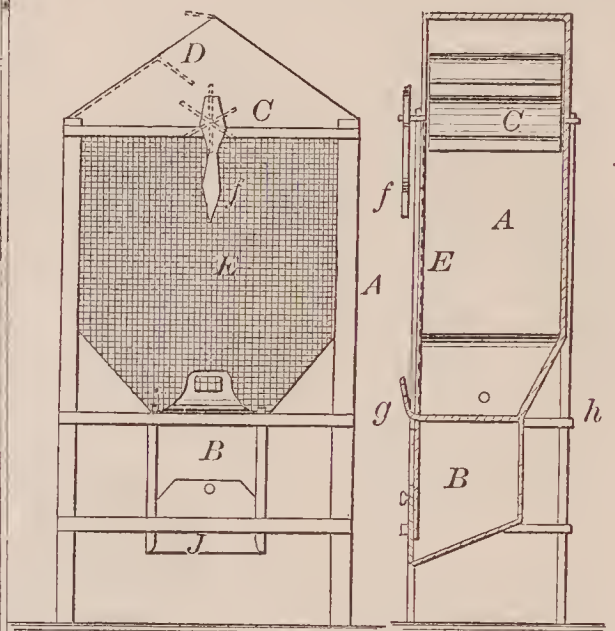

68758—L. Legran—*Artificial Leg.*

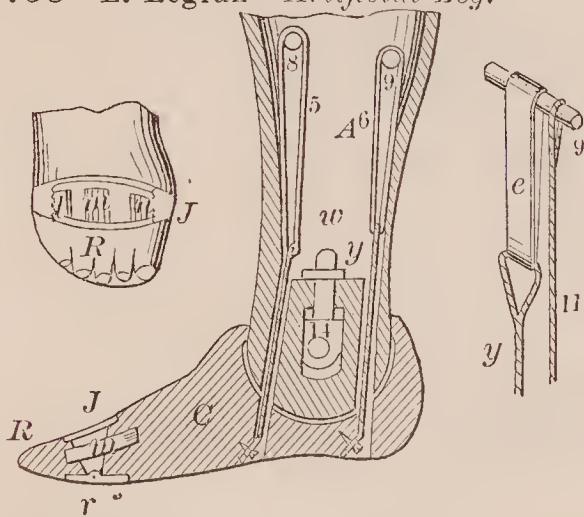

68762—J. P. Luther—*For Rolling Whips.*

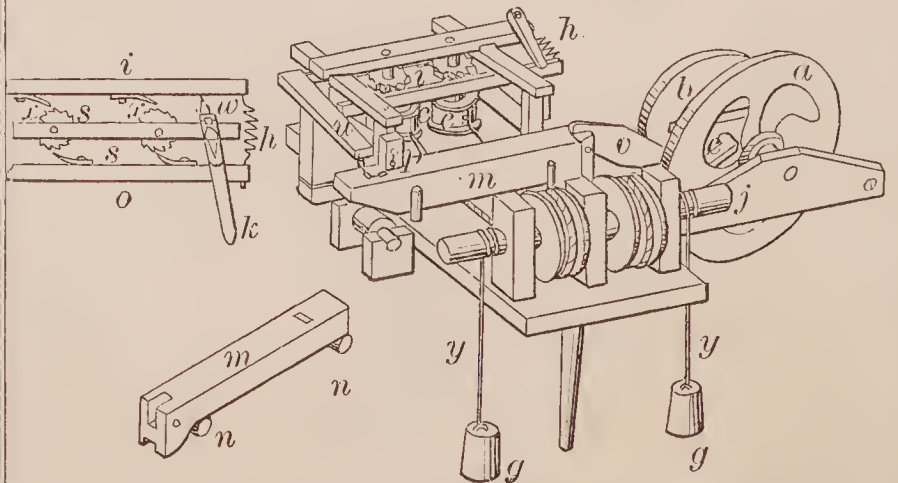

68760—C. E. Lipe—*Corn Dropper.*

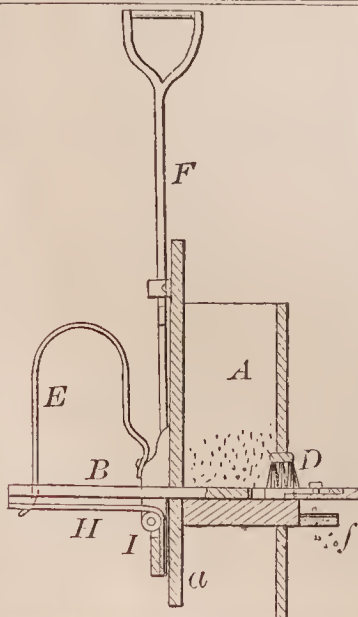

68763—J. C. Lyons—Fog Alarm.

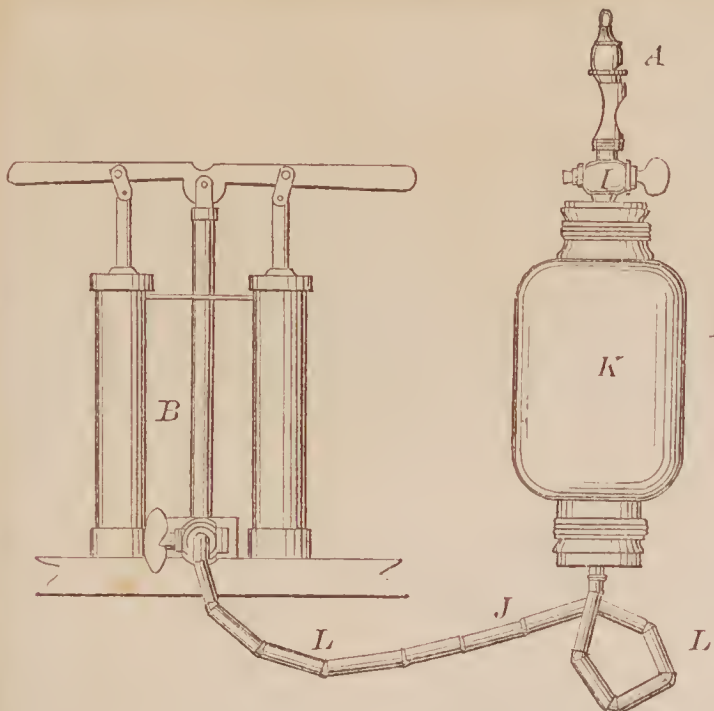

68765—J. Marshall—Eaves Trough Bracket.

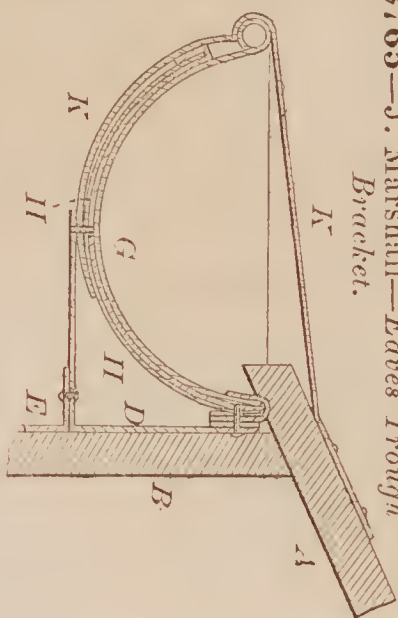

68766—C. Matheny—Wagon Seat, Manger and Tail Board.

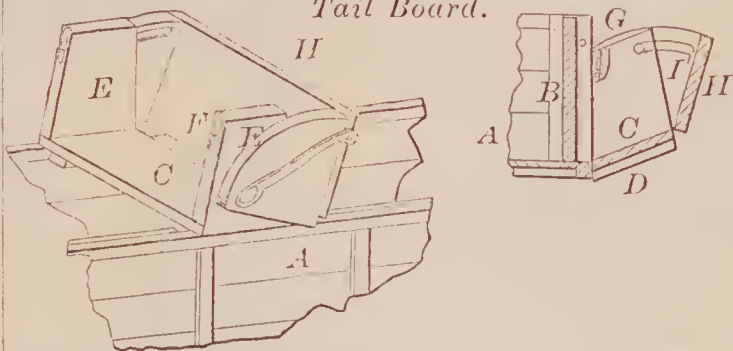

68767—C. Mahan—Hoe.

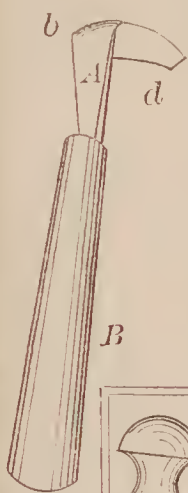

68768—W. S. McKinney—Shaft Coupling.

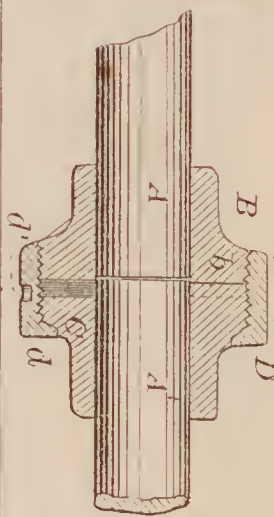

68769—J. F. Melcher—Washing Machine.

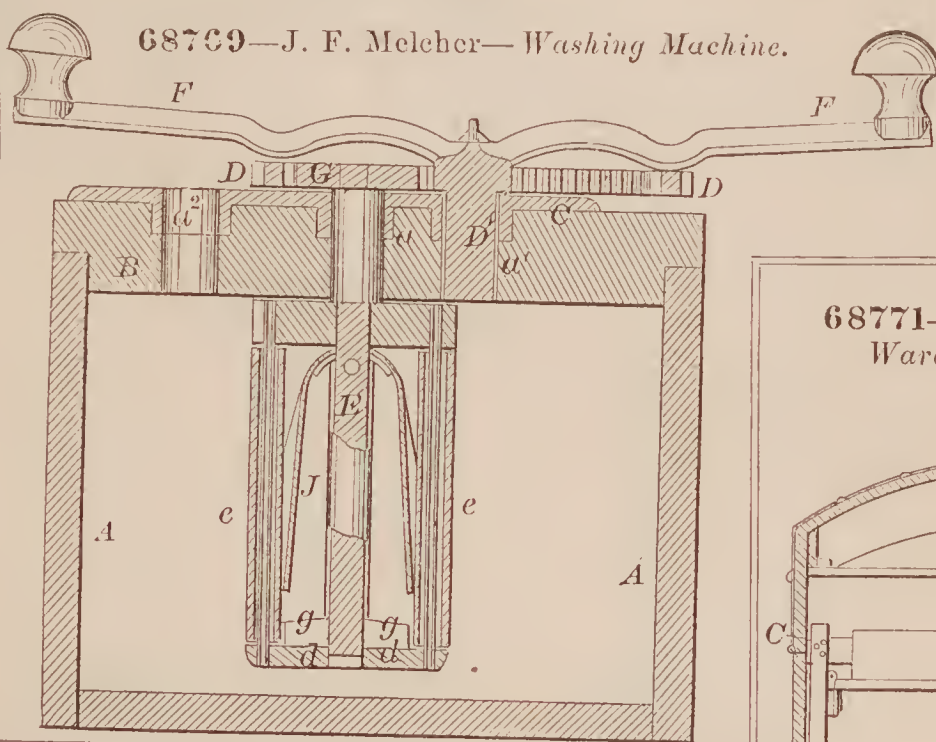

68771—C. Memmert—Wardrobe Trunk.

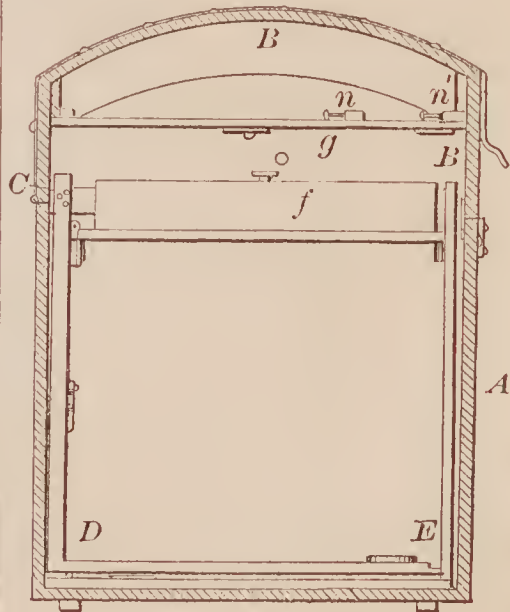

68767—C. B. McKinney—Flood Gate.

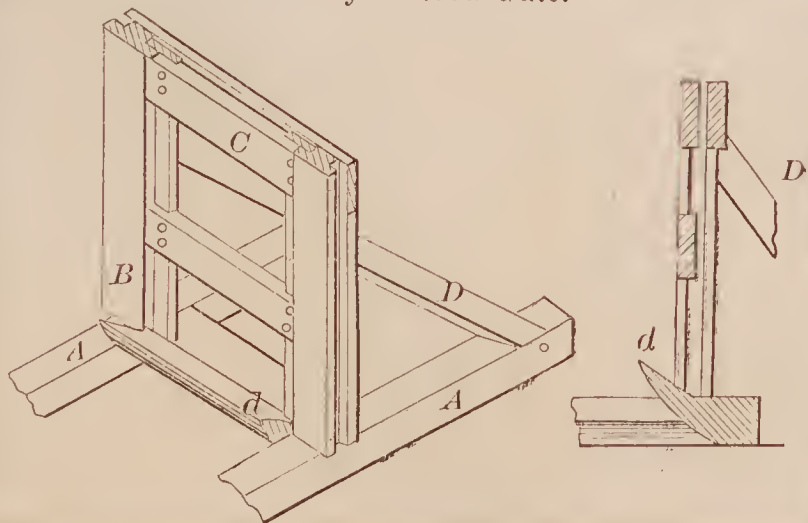



68772—Meredith & Mulligan—*Extension Bed for Farm Wagons.*

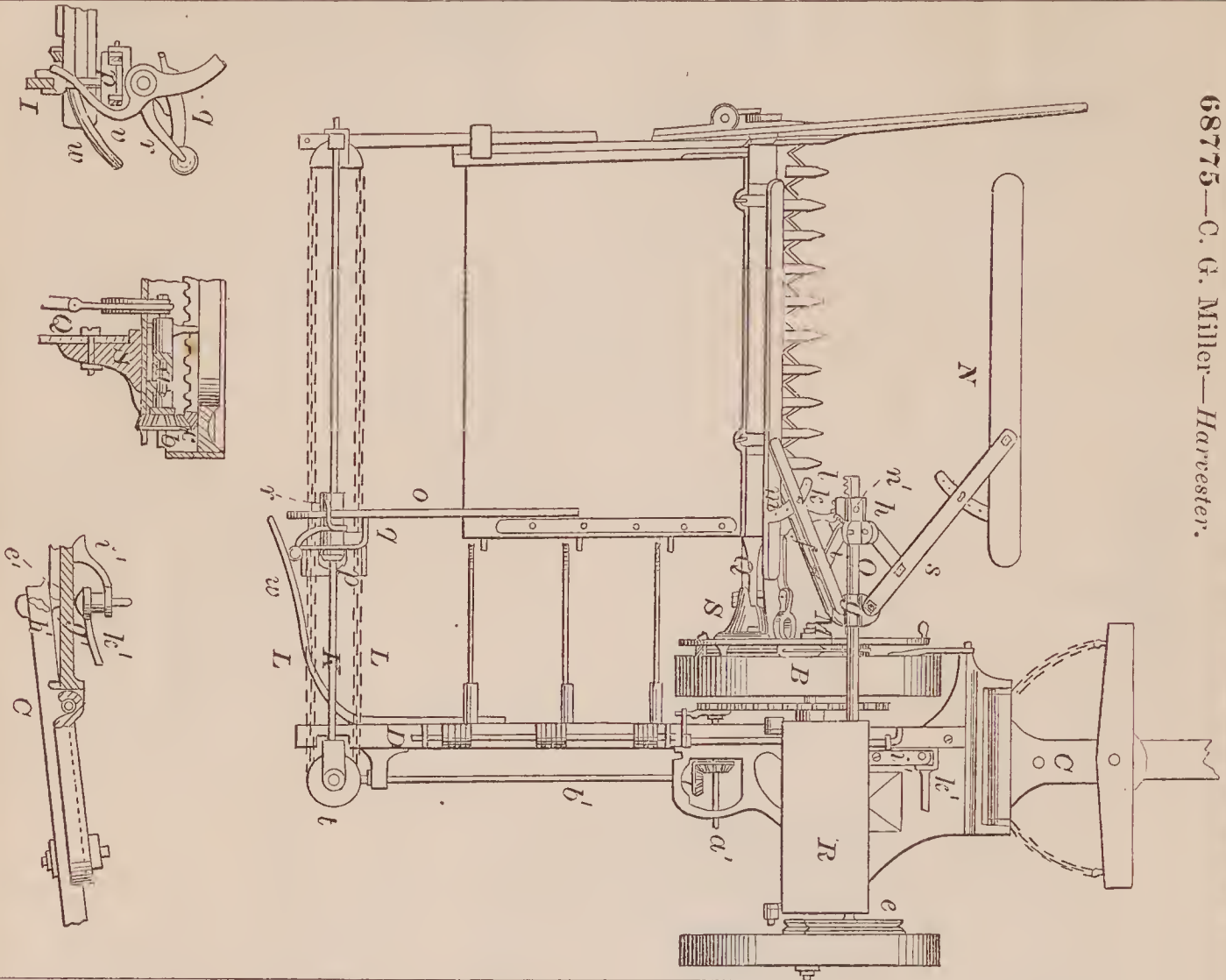
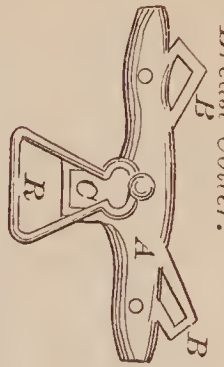
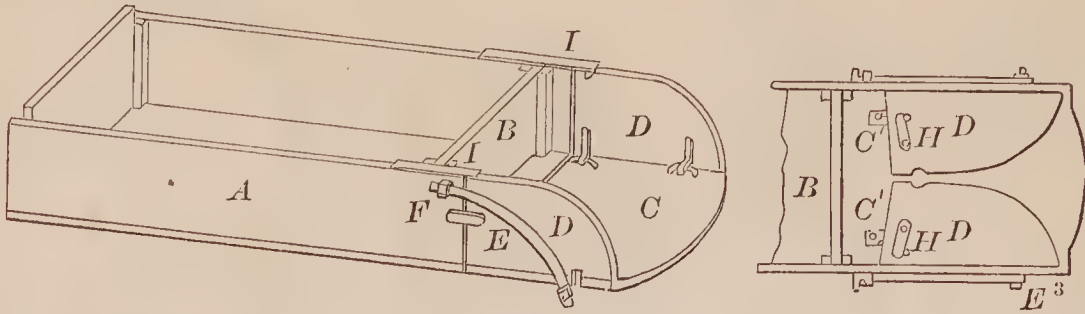

68775—C. G. Miller—*Harvester.*

68773—G. W. Miles—*For Driving Spokes in Wagon Wheels.*

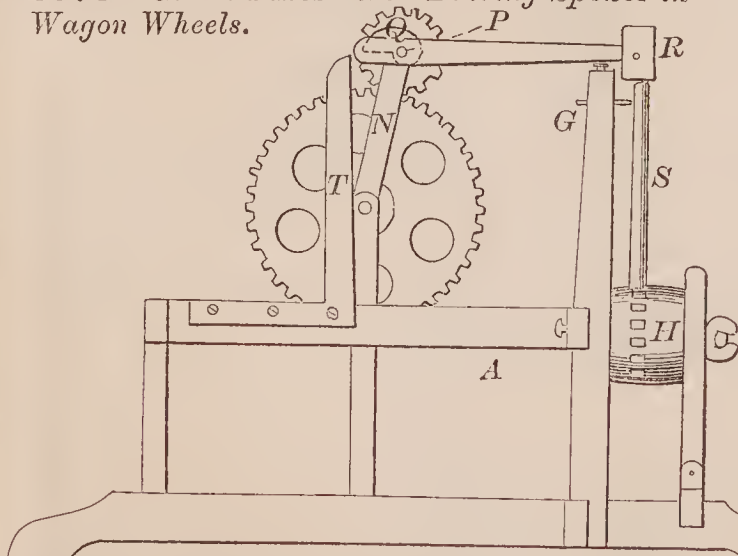

68776—I. Miller—*For Setting Animal Traps.*

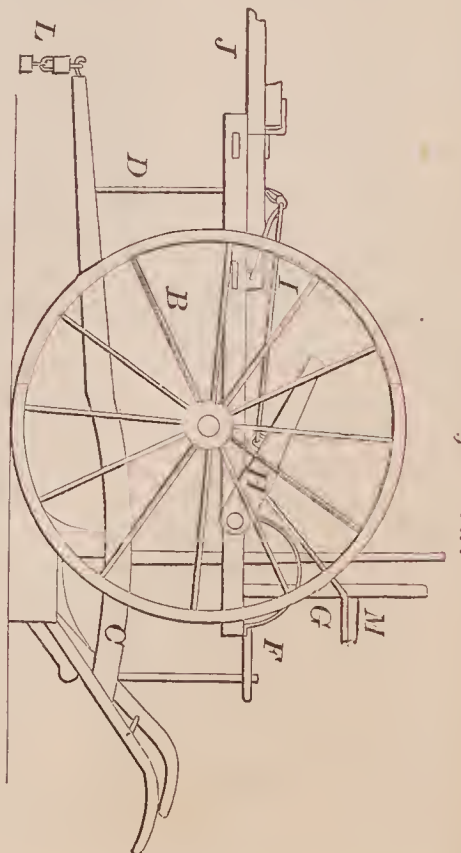
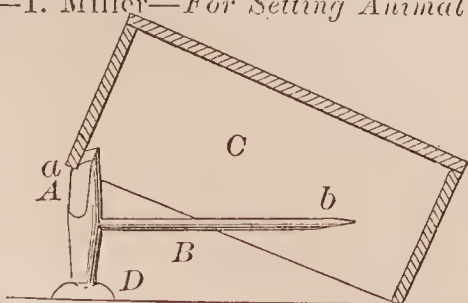

68777—H. Minuse—*Carriage Plow.*

68778—Nevergold & Brosey—*Shaft Coupling.*

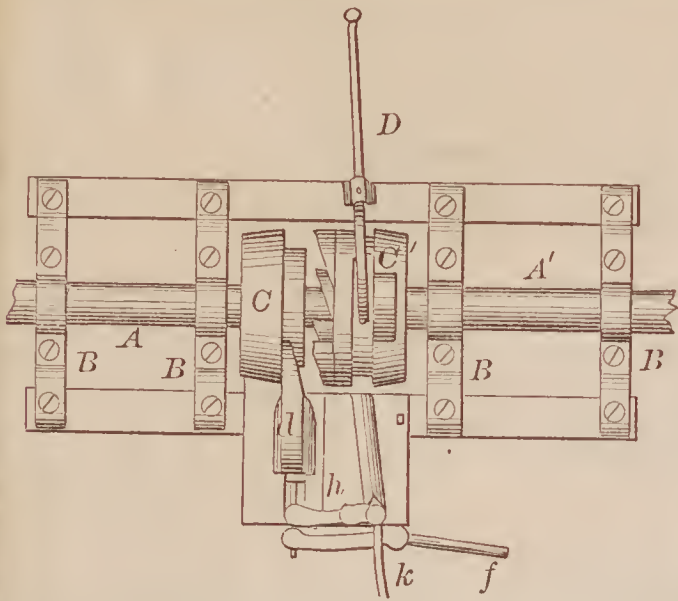

68779—G. W. Nichols—*Insulation of Telegraph Lines.*

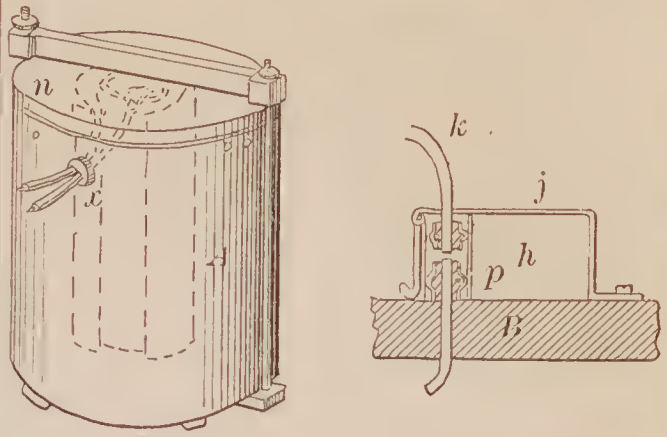

68782—H. Olds—*Slide for Extension Tables.*

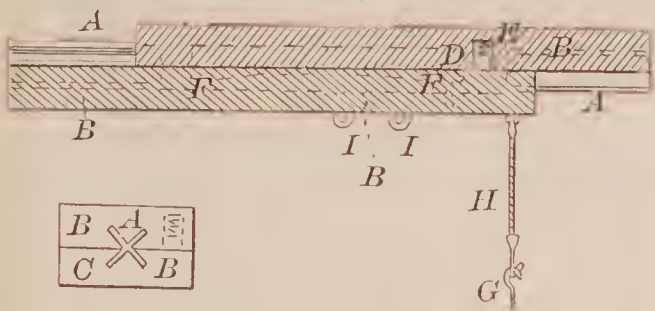

68783—C. R. & N. P. Otis—*Steam Engine Valve.*

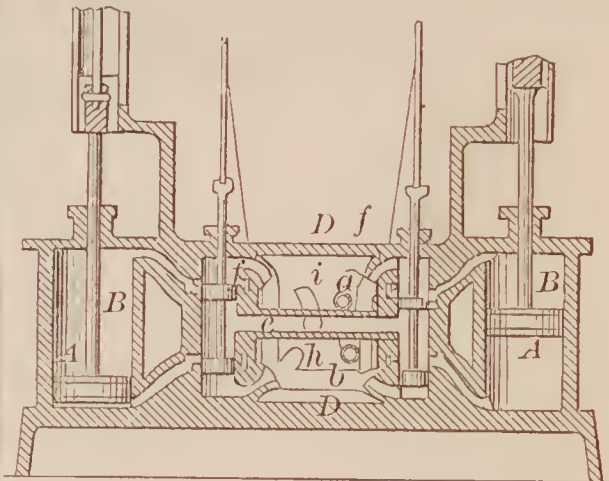

68781—H. S. North—*Snap Hook.*

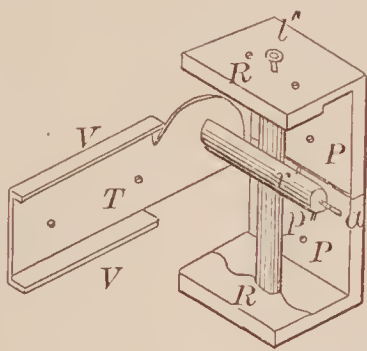
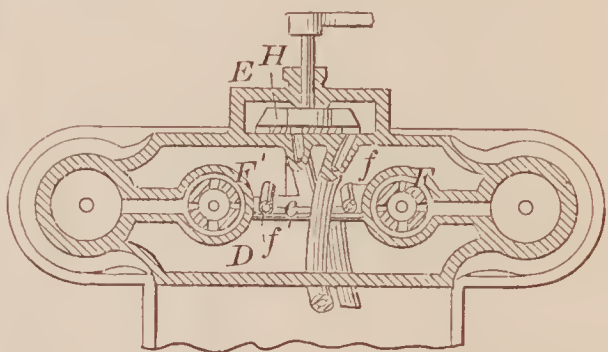
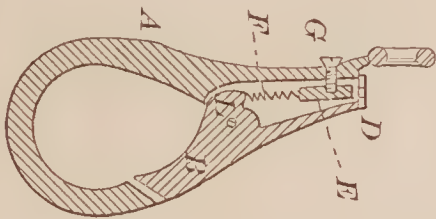

68784—I. A. Palmer—*Cultivator.*

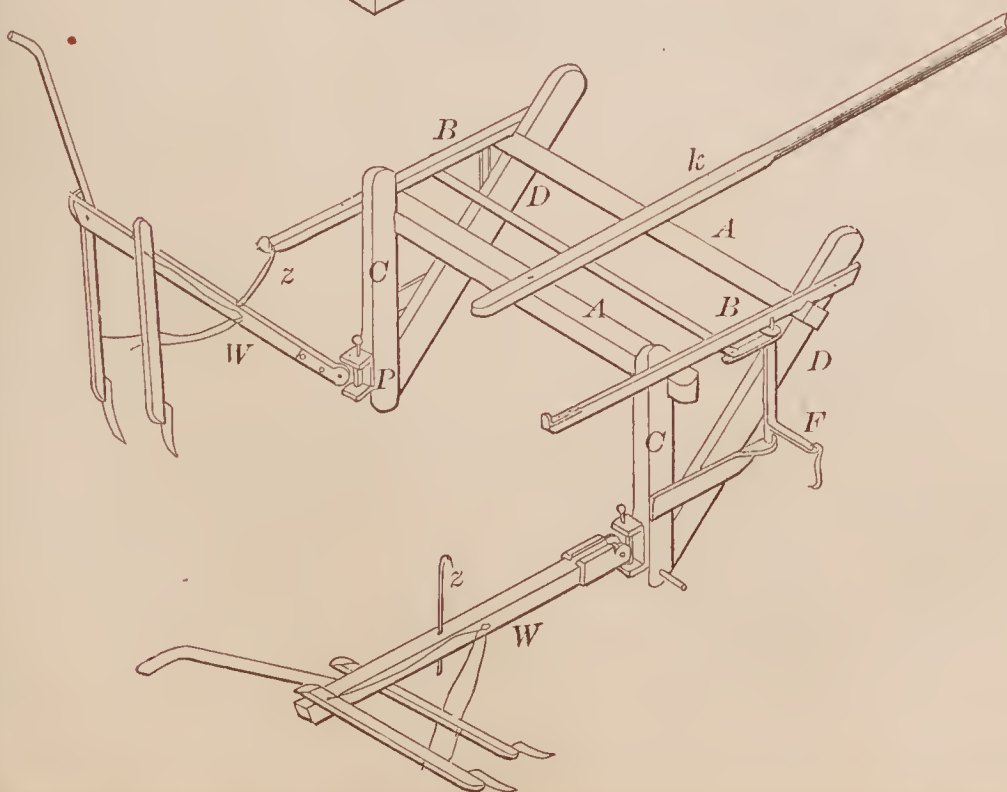

68780—R. Nickson—*Carriage Joint.*

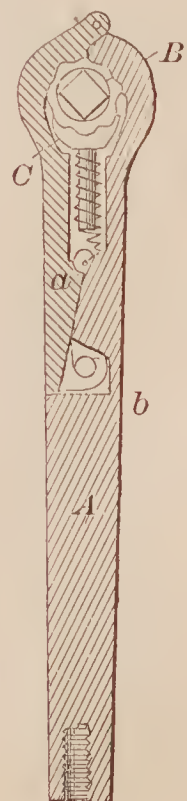



68785—H. Peterson—Cigar Gauge and Butt Cutter.

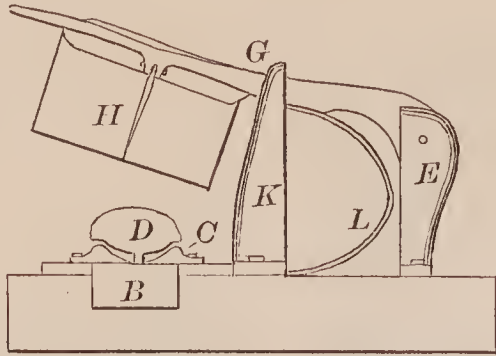

68788—E. L. Pratt—For Aerating Liquids.

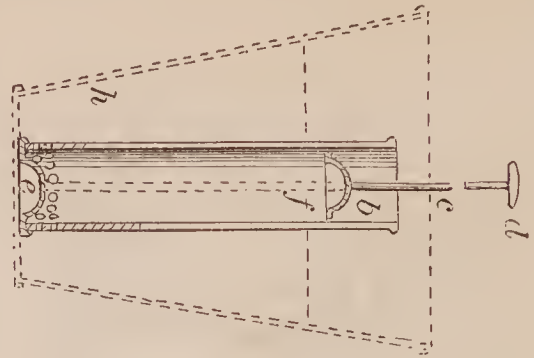

68786—Pidault & Elieze dit Lagieze—Breech-Loading Fire Arm.

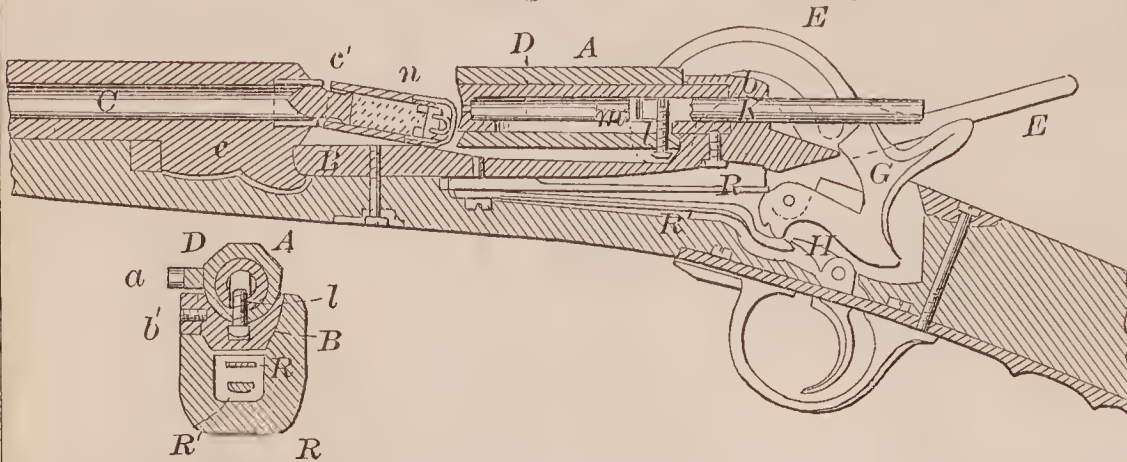

68787—C. T. Poulton—Wrench.

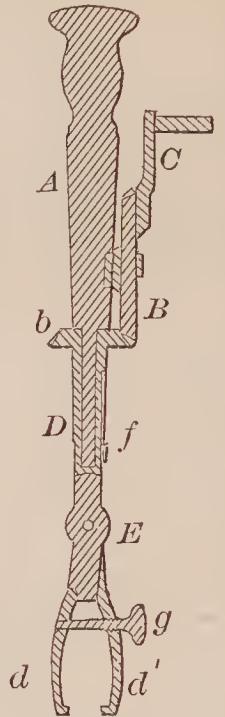

68789—W. F. Quinby—Flying Apparatus.

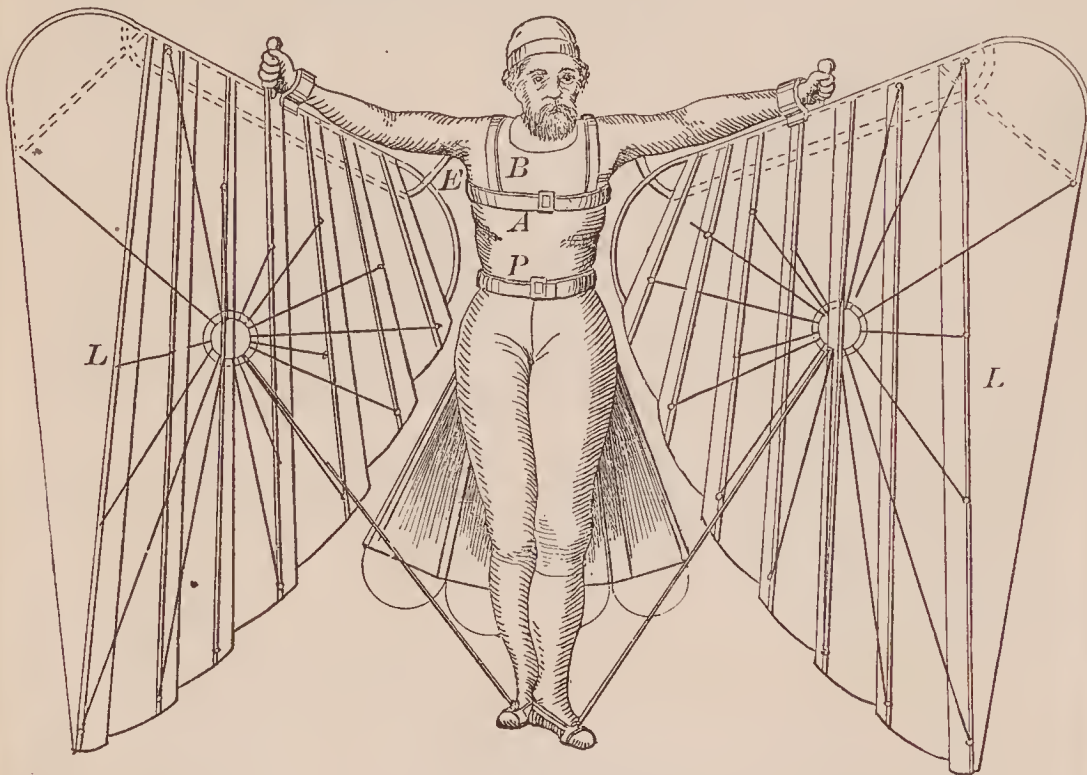

68790—T. D. Read—Fence.

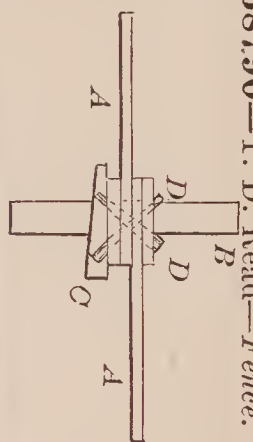

68791—Richards & Doane—Mortising Machine.

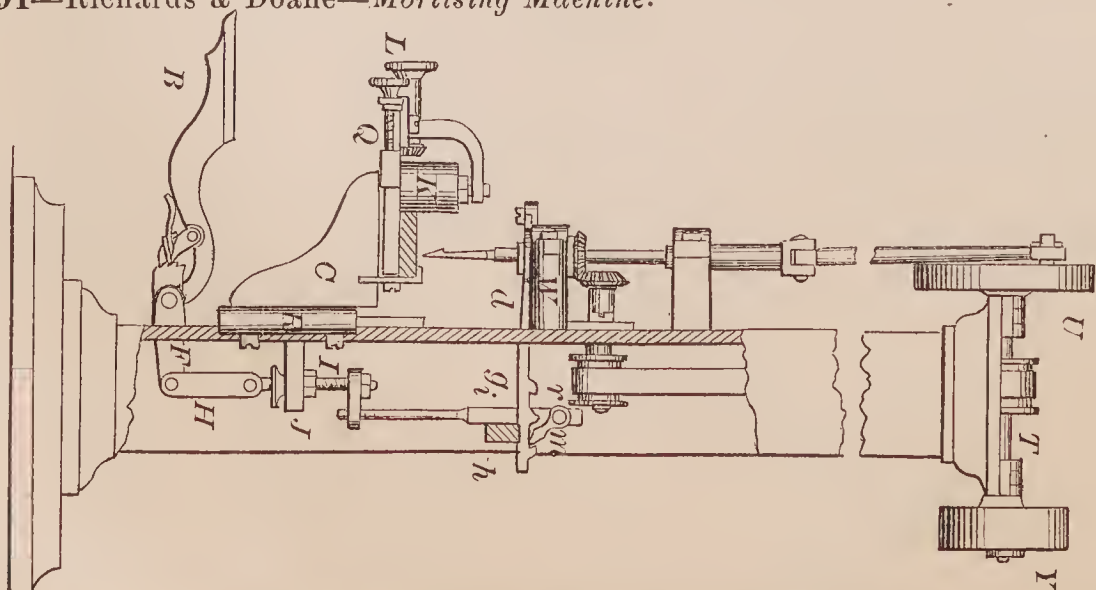

68792—R. D. Rogers—Winch.

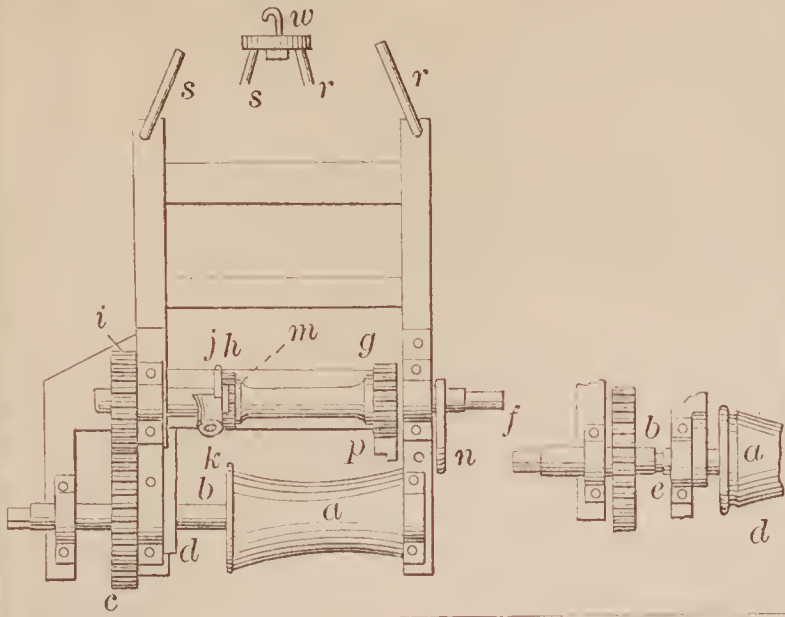

68793—W. F. Rossman—Milk Strainer.

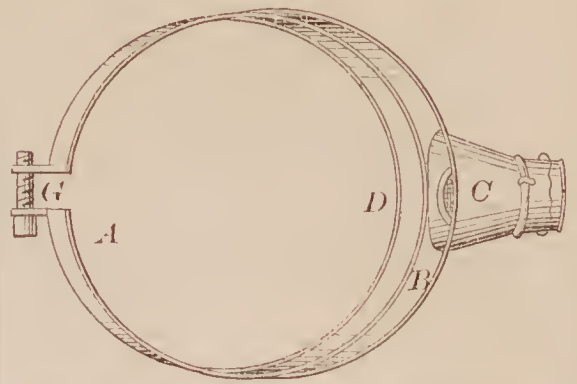

68797—Scott & Claridge—Power Hammer.

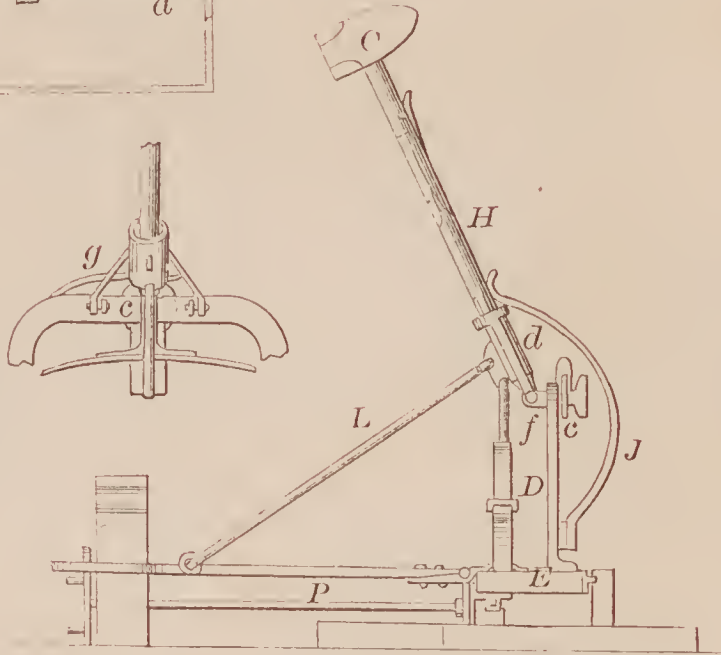

68794—W. Rung—Hoisting Apparatus.

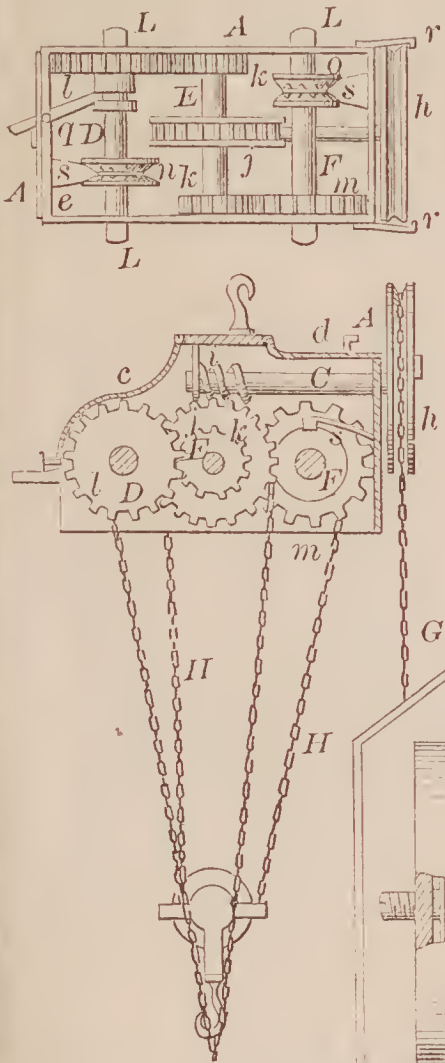

68798—L. W. Shaeffer—Churn.

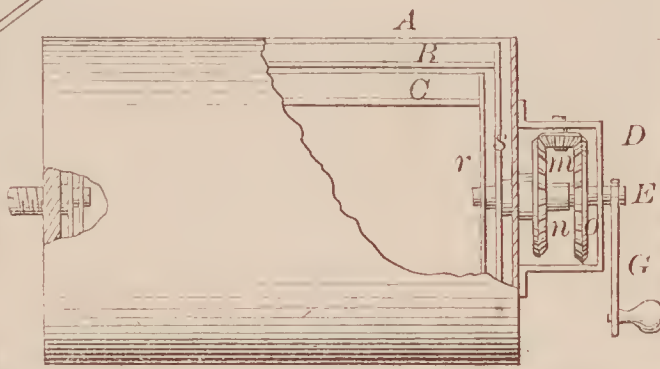

68796—C. Schwaner—Trace Buckle.

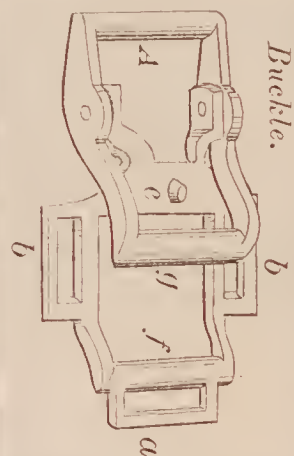

68799—J. Shickel—Mill Gearing.

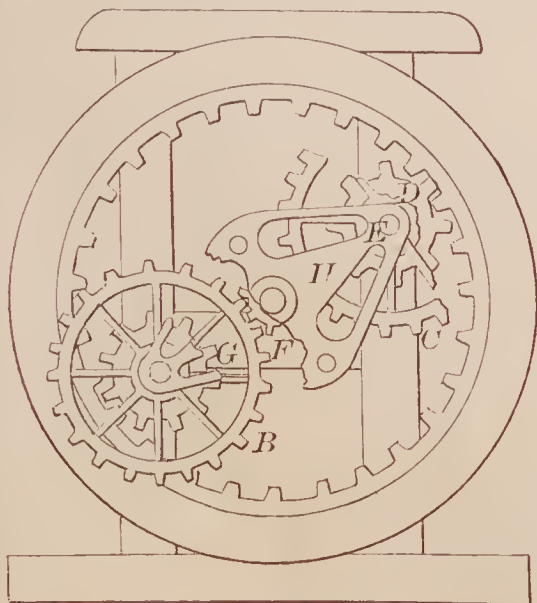

68795—C. Schilling—Harness Motion for Looms.

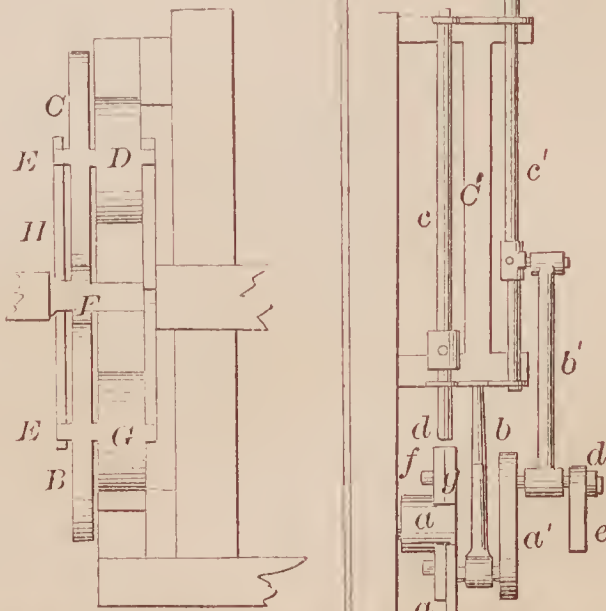



68800—W. H. Shurtleff—Horse Shoe.

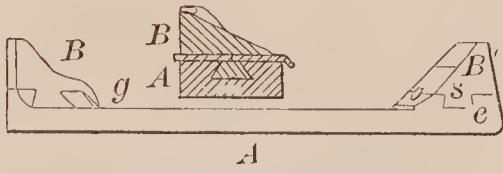

68802—C. A. Staples—Dressing Case and Bath Tub.

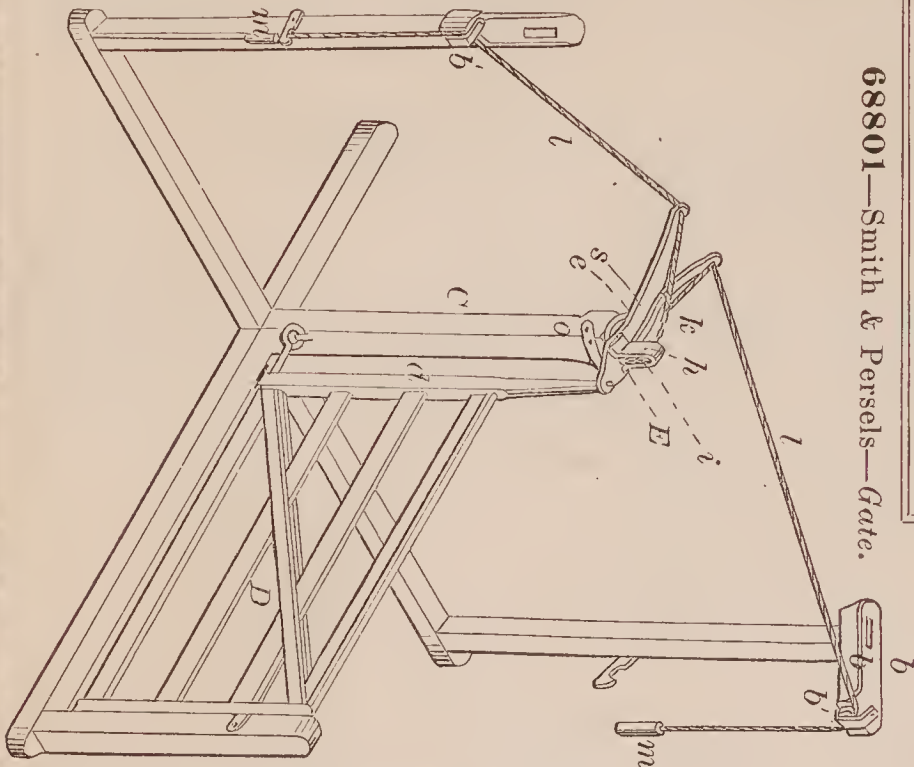
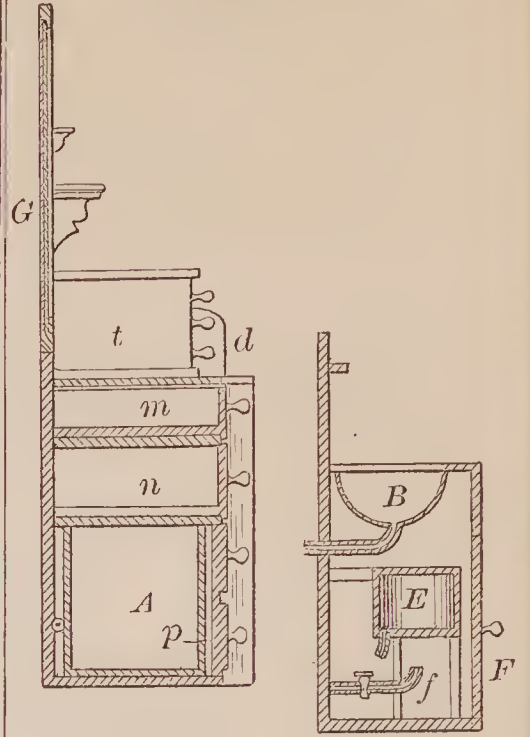

68801—Smith & Persels—Gate.

68805—J. G. Taylor—Churn.

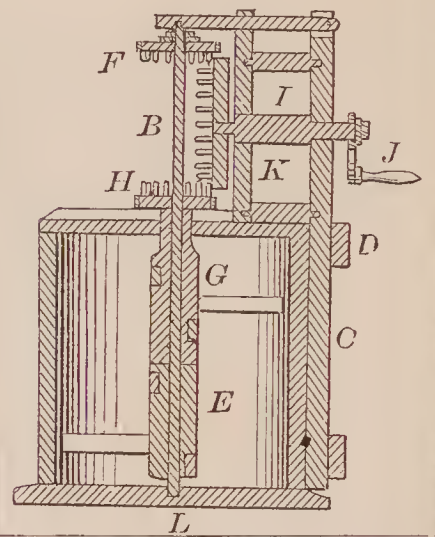

68803—M. Sweet—Cultivator.

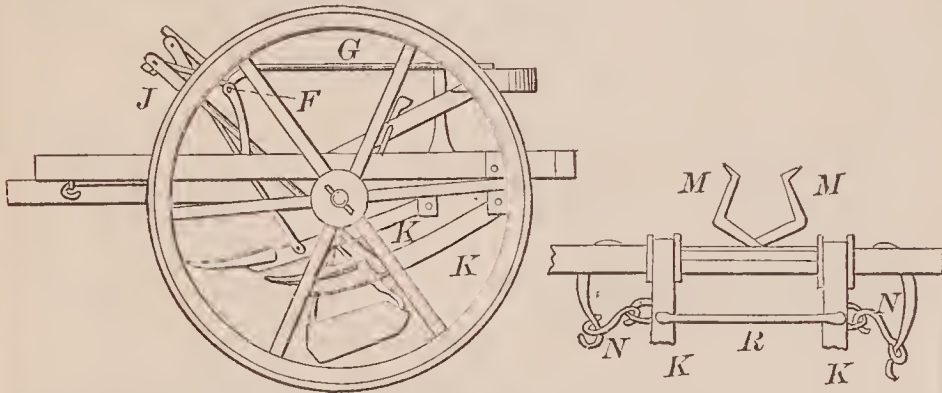

68804—J. M. Swift—Gate.

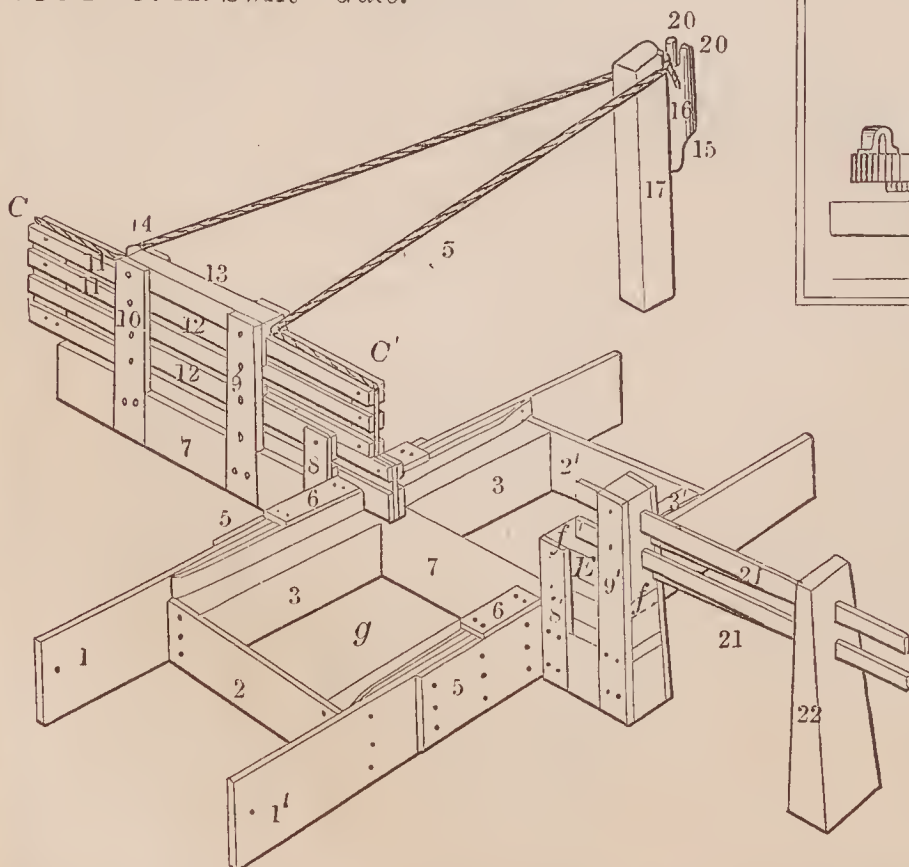

68806—A. D. Tingley—Brake for Horse Power.

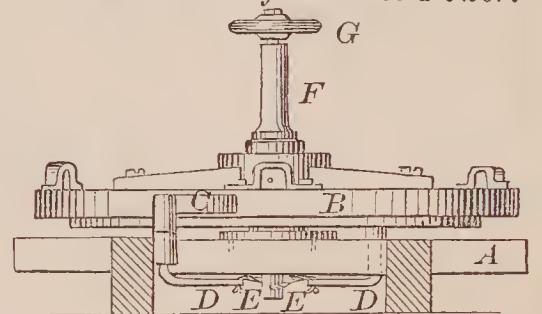

68807—O. S. Trexler—Ventilating Device.

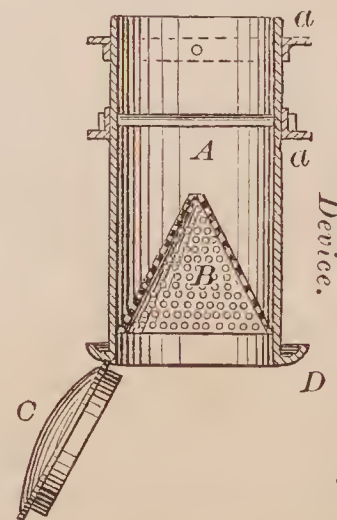

68808—W. C. Tucker—Wagon Hub.

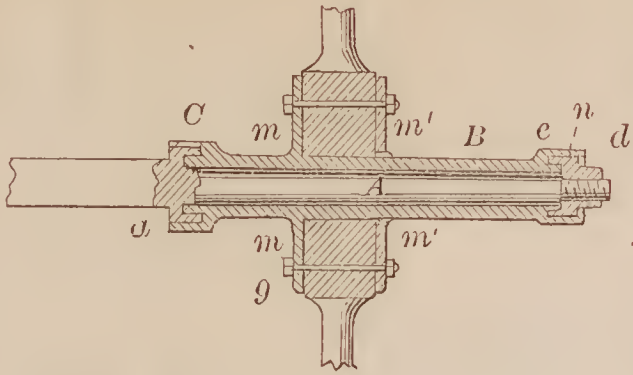

68813—J. B. Walker—Flexible Rammer for Turret Guns.

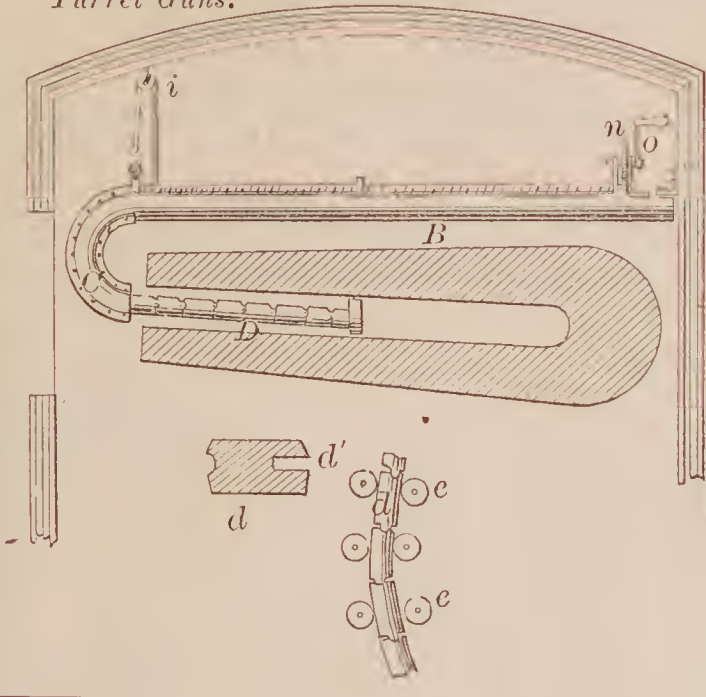

68809—G. L. Turney—Papering Pins.

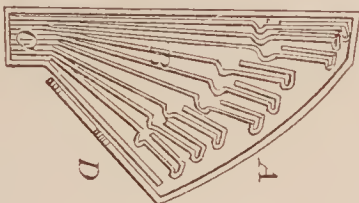

68814—N. B. Wallace—Watch.

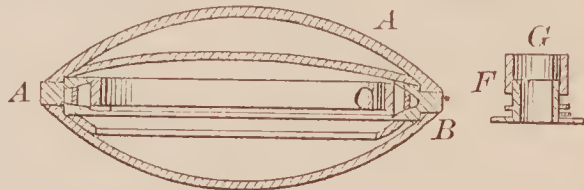

68815—S. Walton—For Cutting Files.

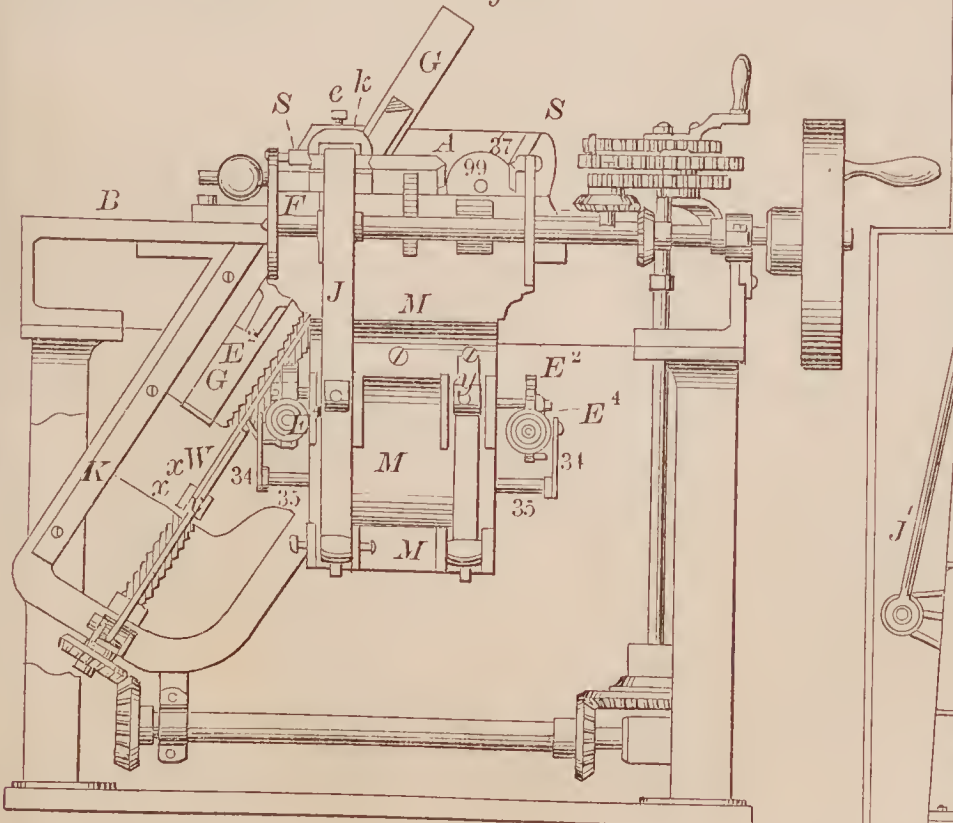

68810—H. Tyler—Pump.

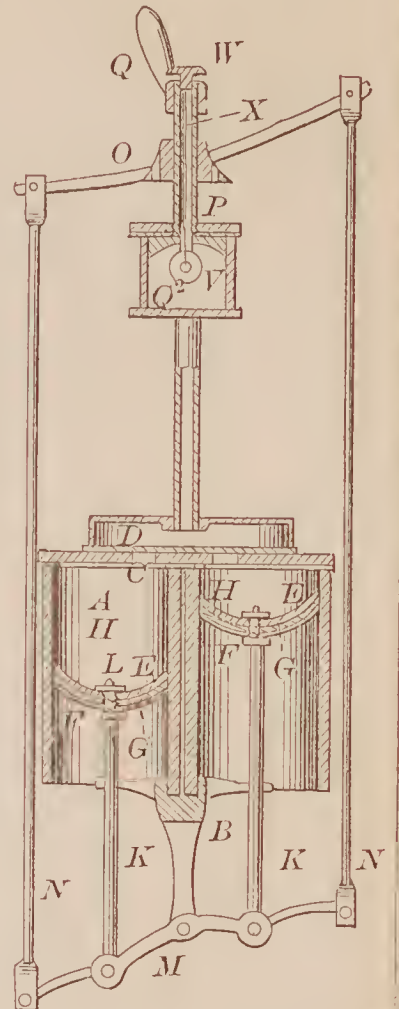
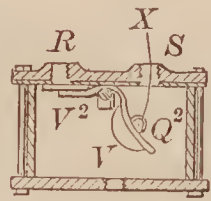

68811—F. Van Doren—Steid and Friction Roller.

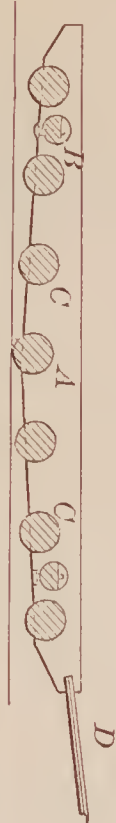

68812—C. P. Wagner—Press.

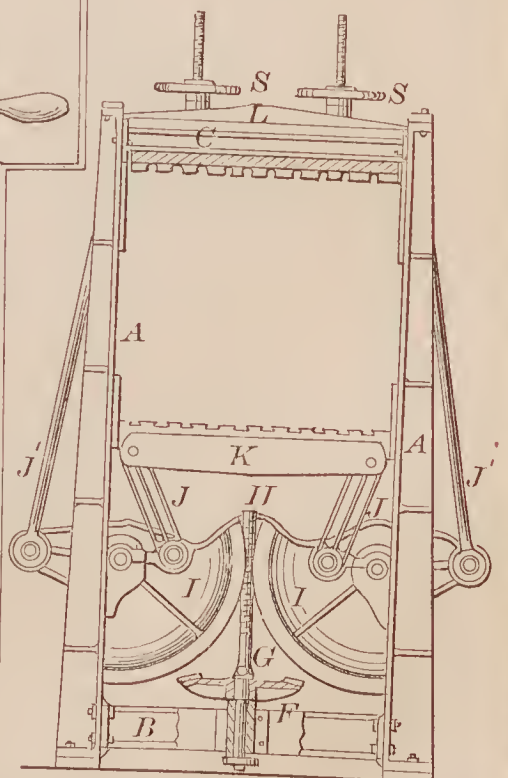



68815—Continued.

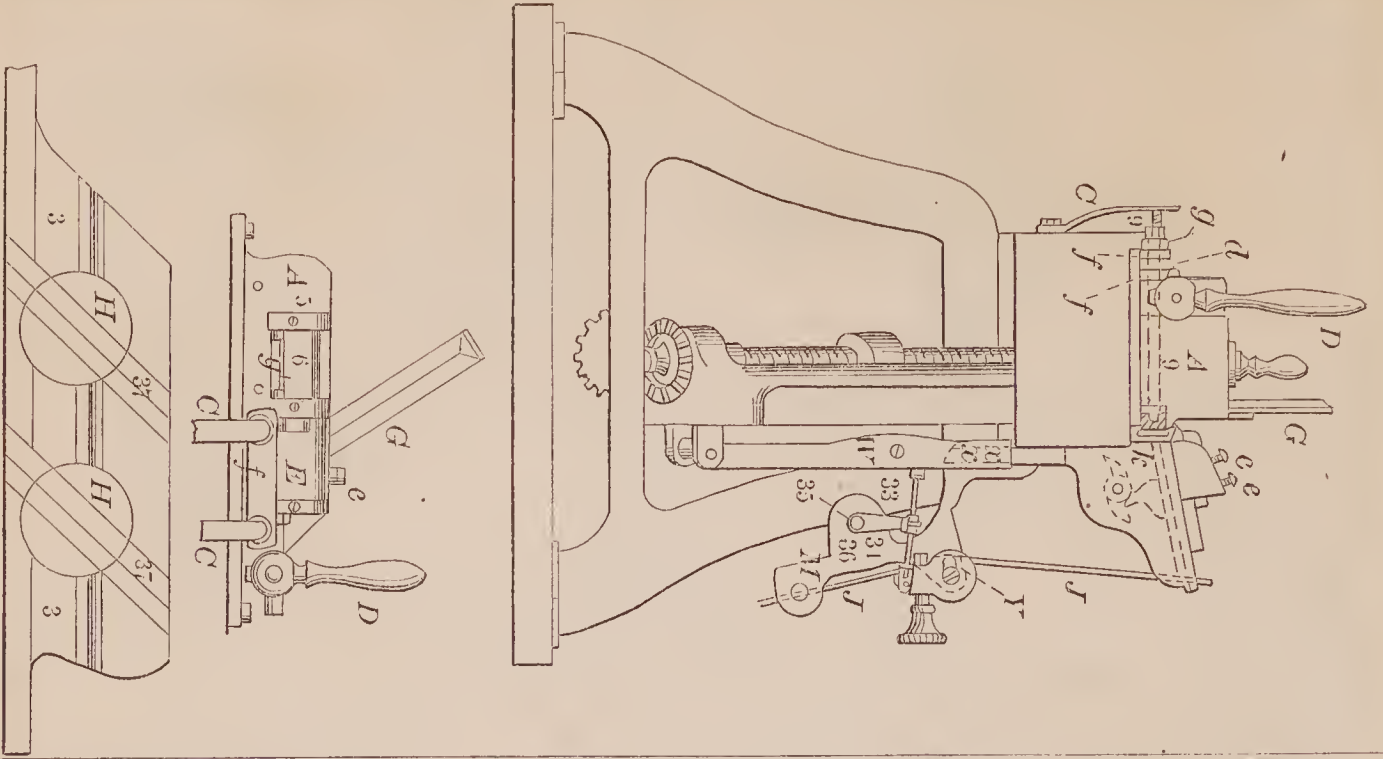

68816—J. H. Weaver—Lock for Money Drawers.

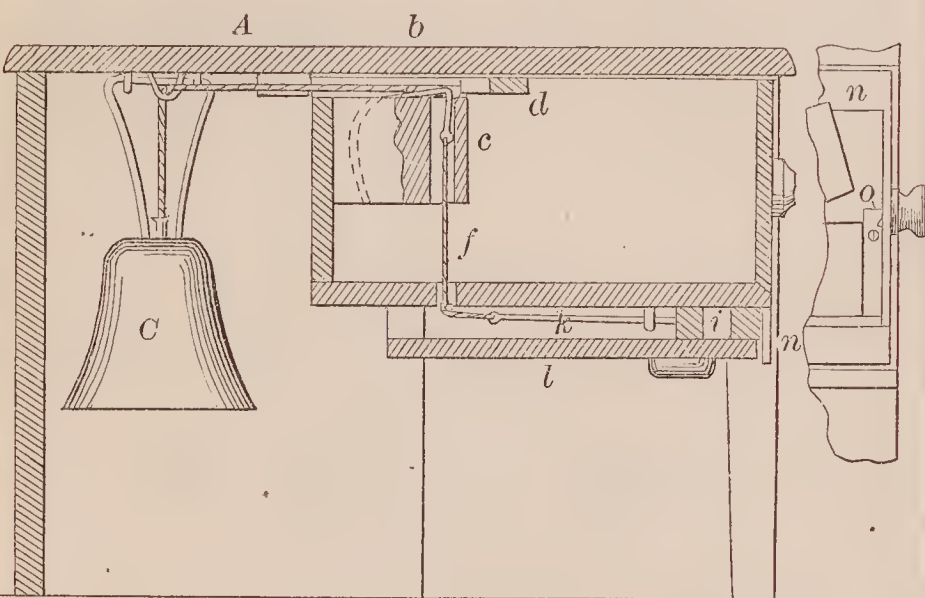

68818—Webster & Ladd—Spring Bed Bottom.

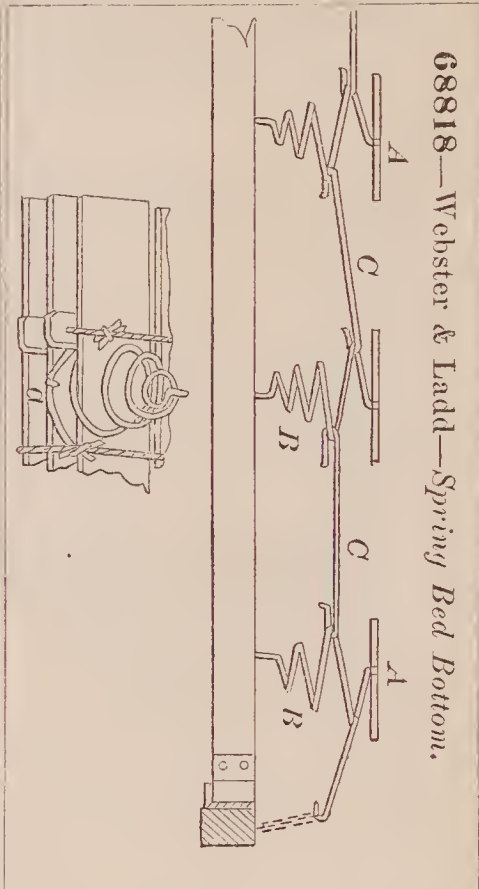

68819—E. Weissenborn—For Making Lead Pencils.

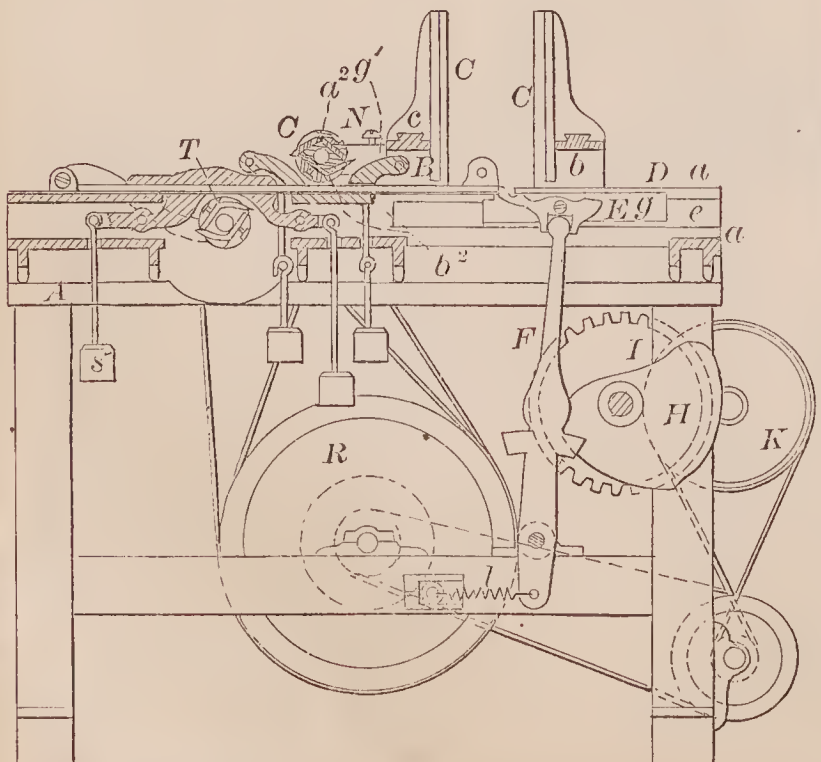

68817—M. D. Webber—Washing Machine.

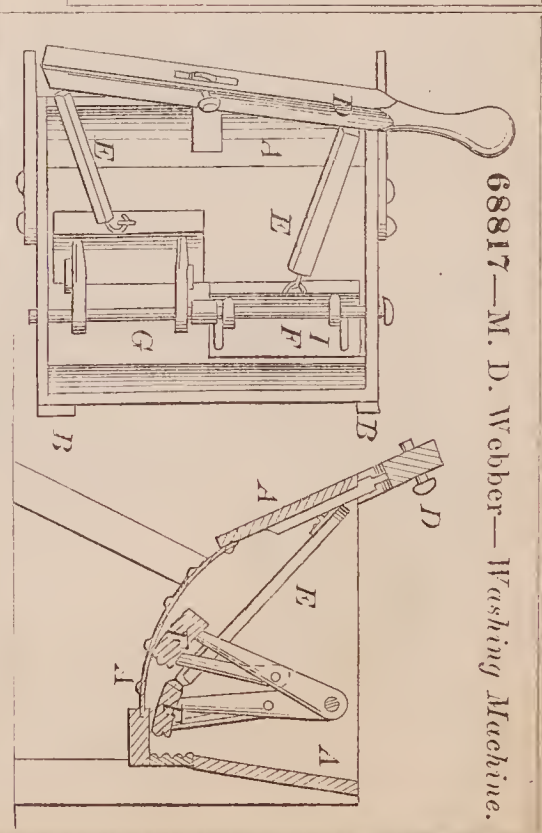

68820—J. F. Welch—Wheel and Axle Connection.

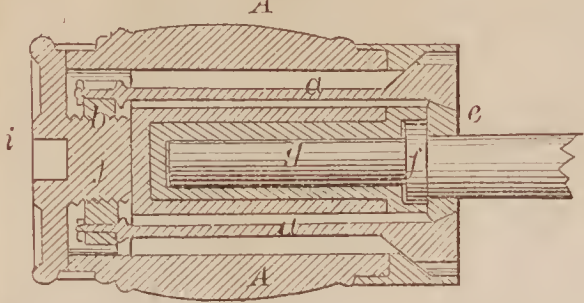

68821—N. Willey—Evaporating Pan.

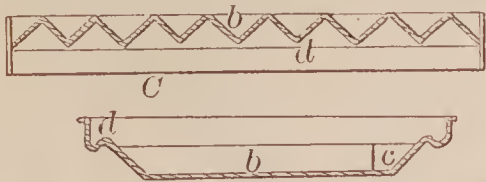

68827—Young & Whipple—Drill.

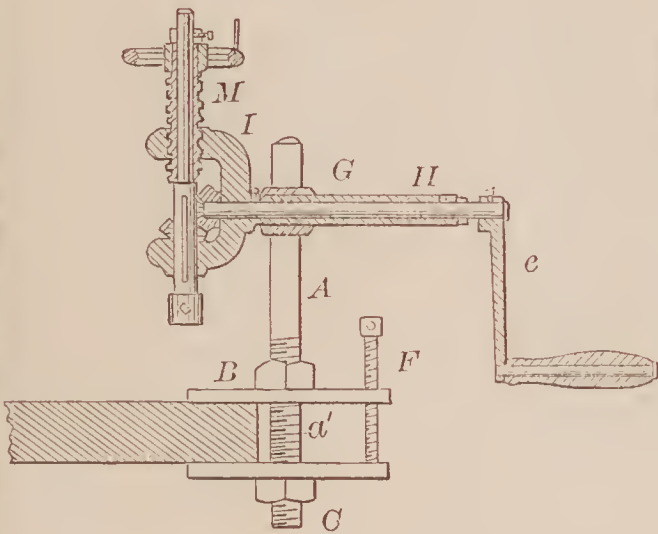
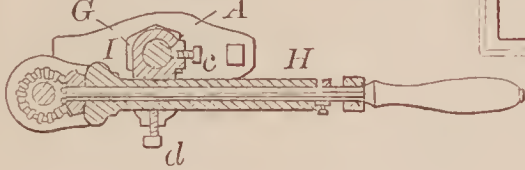

68824—Wrightington & Rider—Horse Shoe Nail Machine.

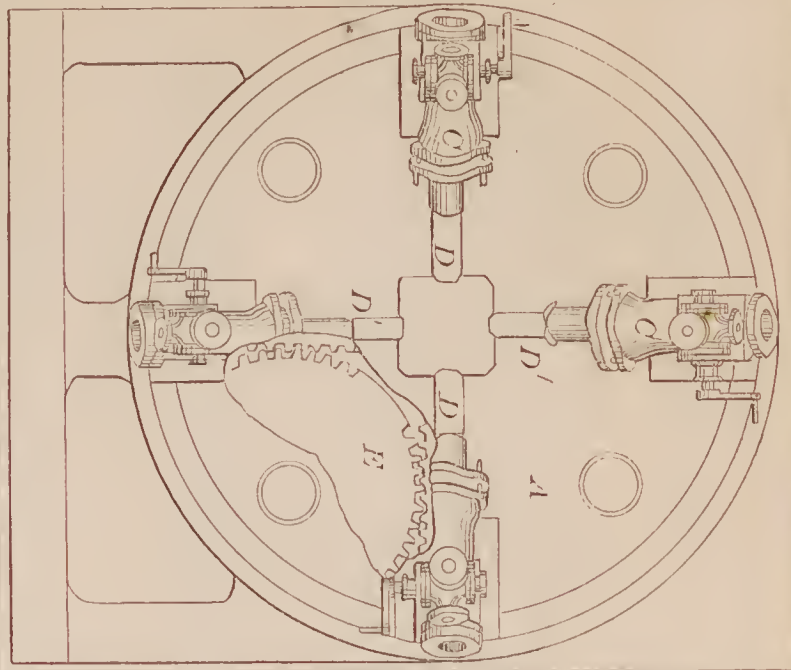

68826—J. Yocom, Jr.—Hanger for Shafting.

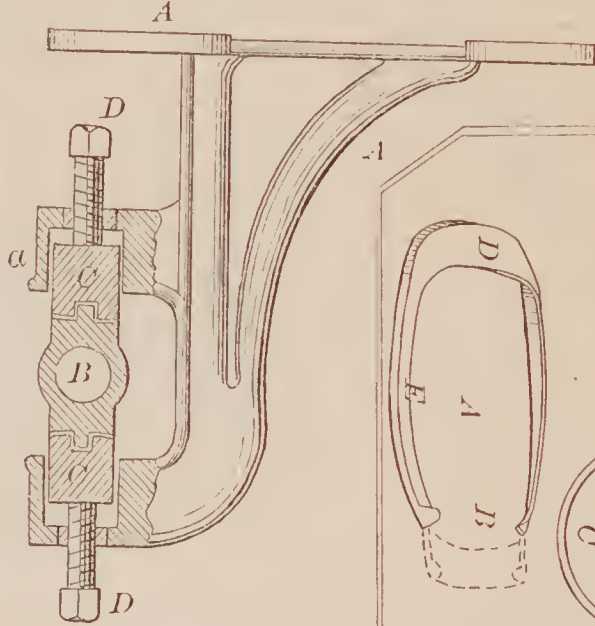

68822—E. W. Woodruff—Over Sole for Boots and Shoes.



68825—B. Yeakel—Threshing Machine.

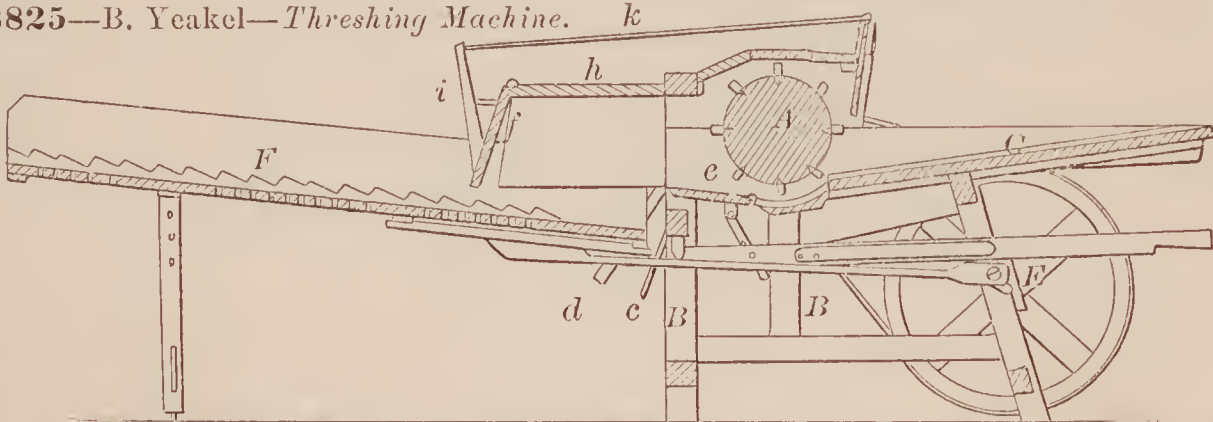

68828—A. Judson—For Sewing Oval Seams.

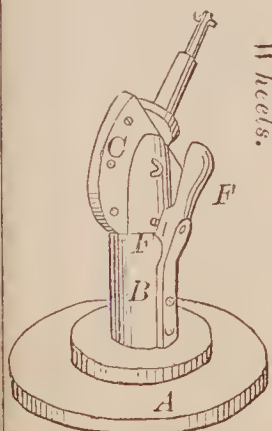
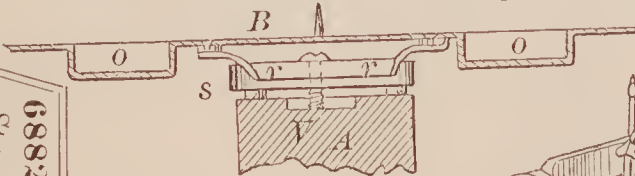

68823—J. N. Woodward—Stand for Supporting Wagon Wheels.

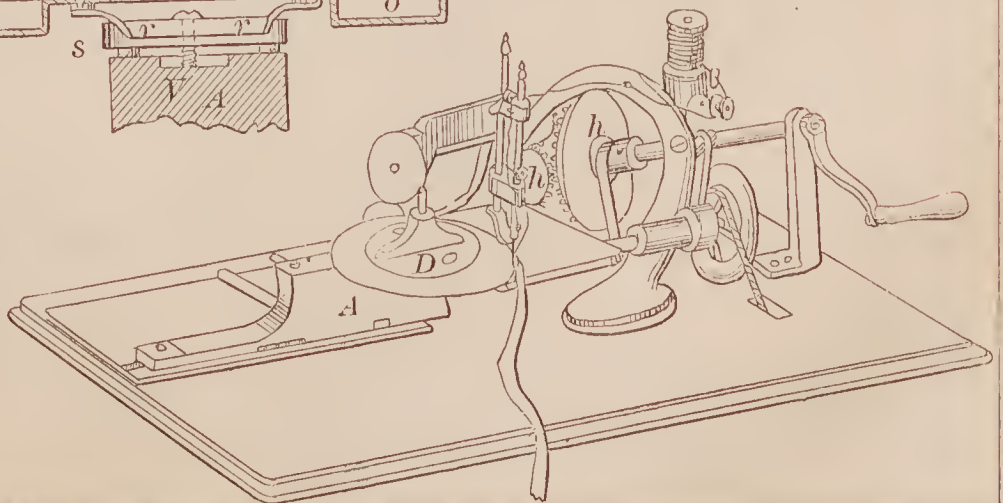



68829—H. Aldridge—*Portable Horse Power*

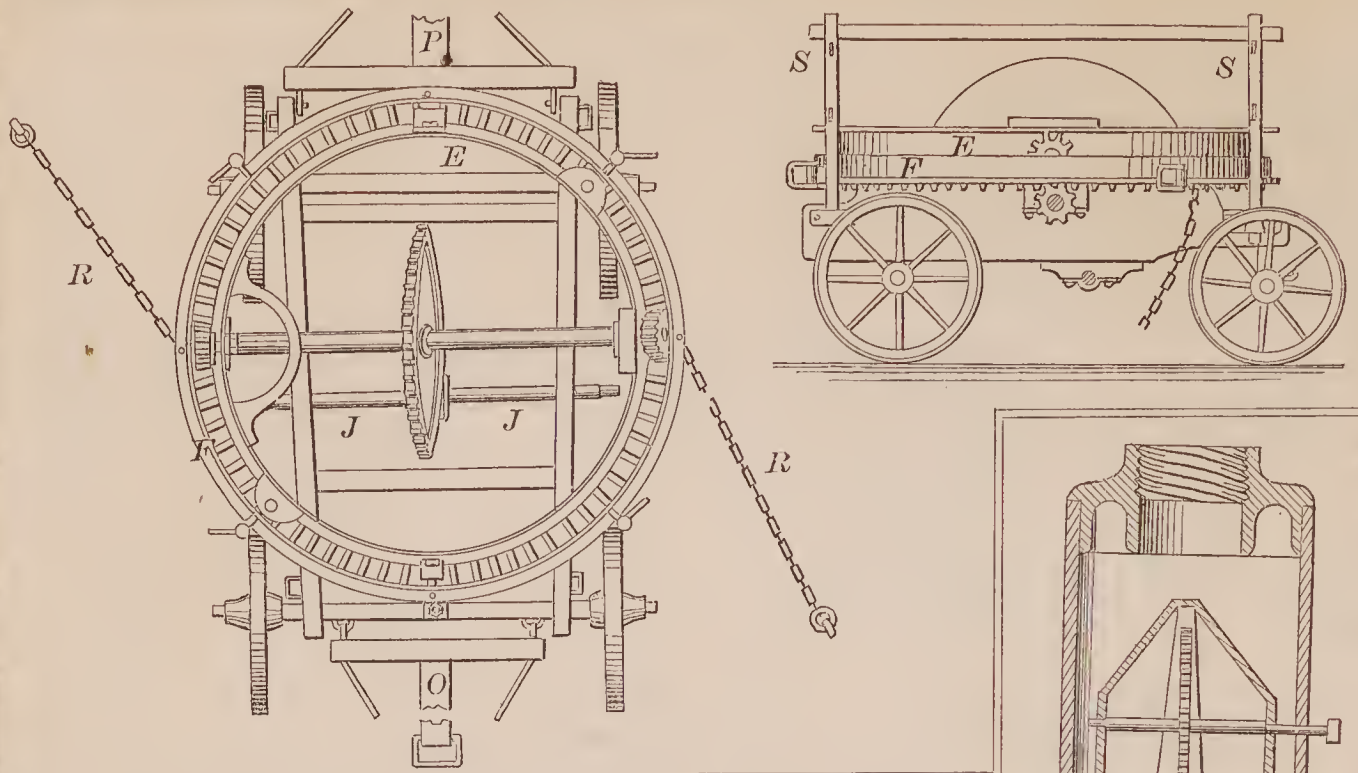

68830—R. H. Atwell—*Liquid Meter.*

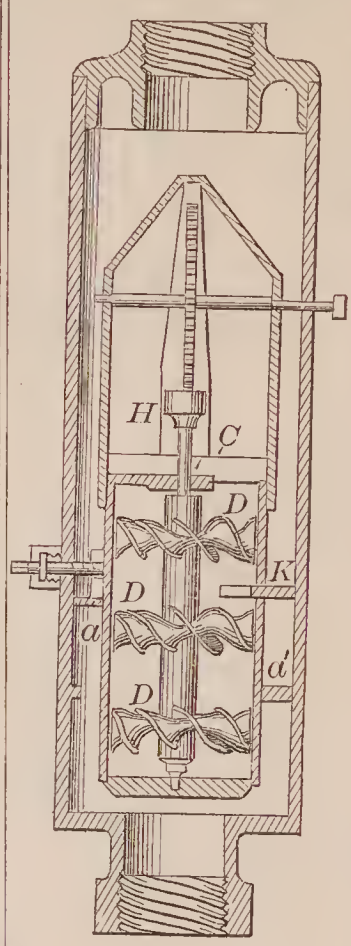

68833—M. Bishop—*Candle Locks.*

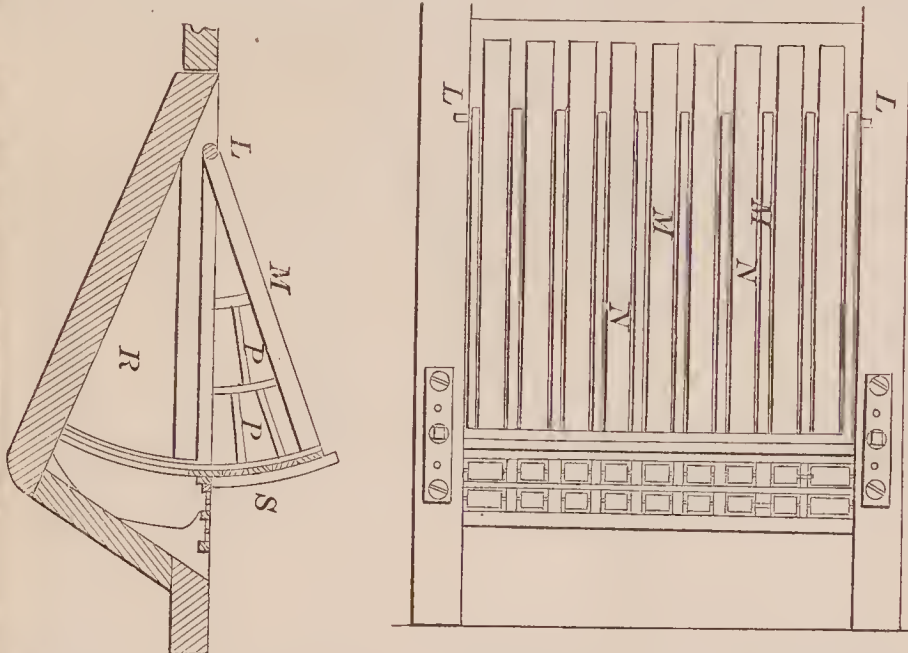

68832—A. E. Bigelow—*For Dressing Weavers' Harness.*

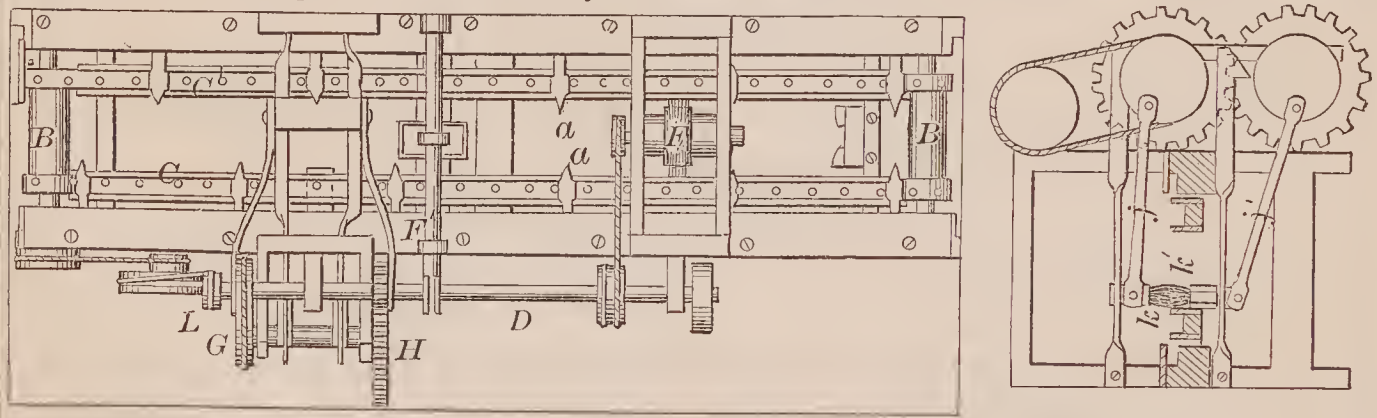

68834—L. H. Boole—*Preserving Eggs.*

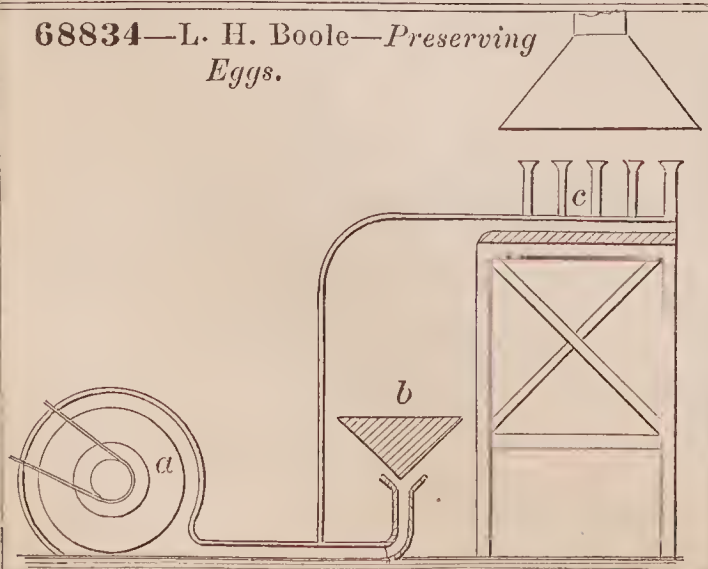

68831—F. A. Balch—*Reel.*

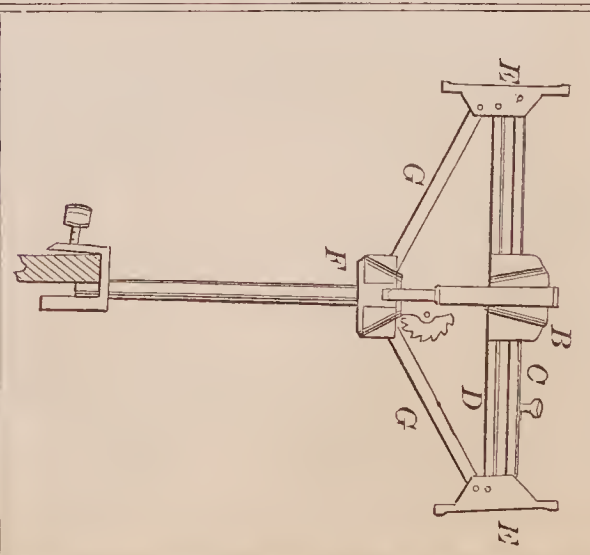

68835—C. F. Bosworth—*Sewing Machine.*

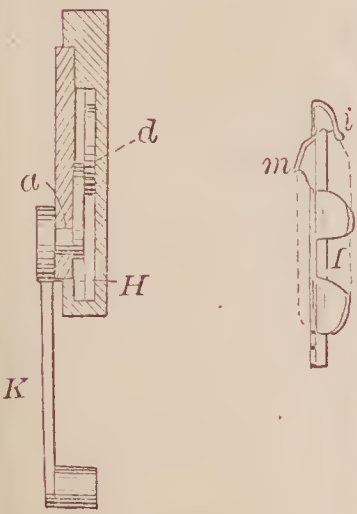
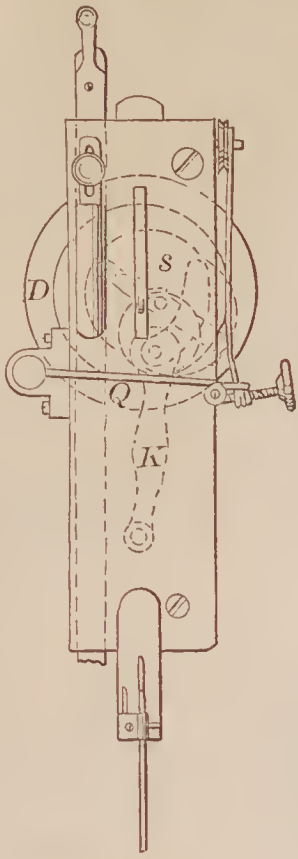

68839—L. B. Bruen—*Sewing Machine.*

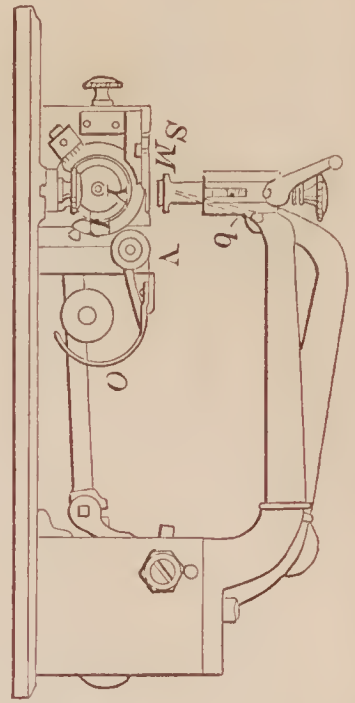
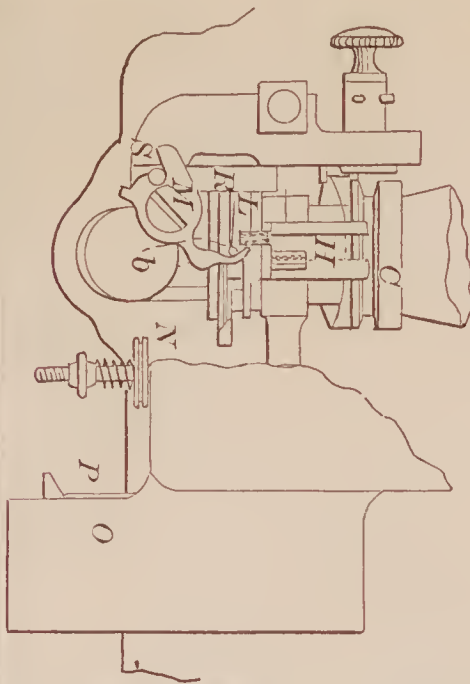

68838—J. M. Brown—*Telegraph Apparatus.*

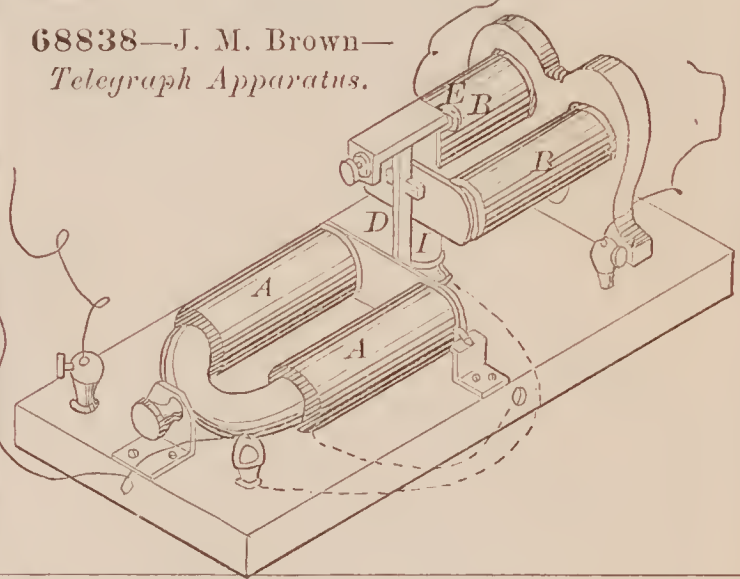

68836—M. D. Boyd—*Ladder.*



68840—J. H. Burgin—*Producing Gas for Fuel.*

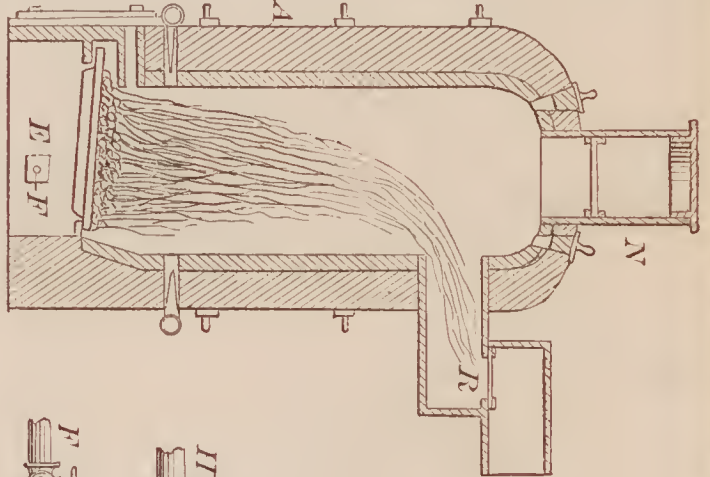

68837—A. C. Brinser—*Lifting Jack.*

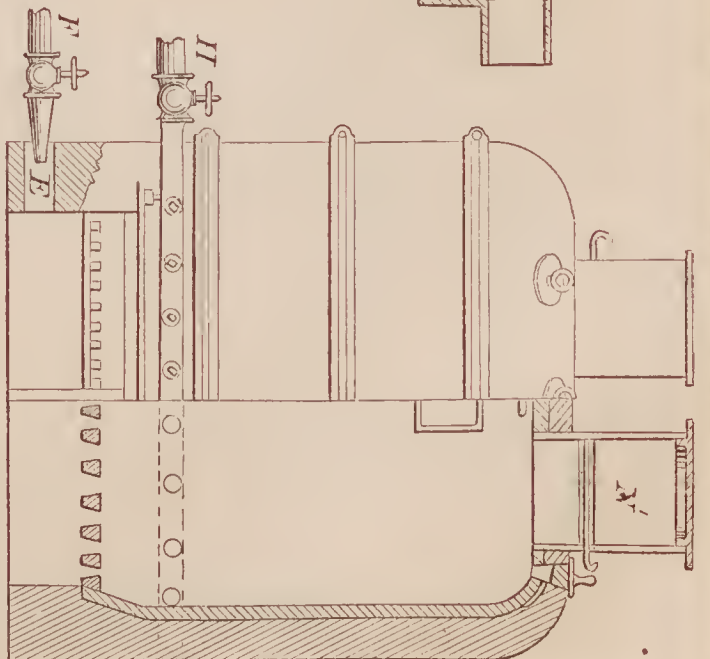
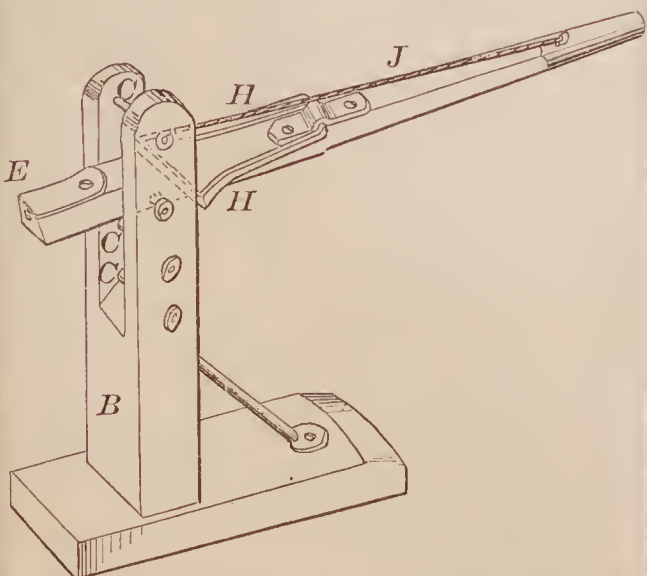



68841—R. & J. L. Cassaday—*Corn Planter.*

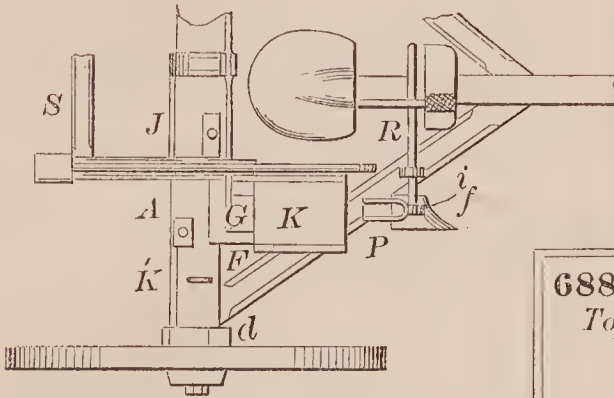
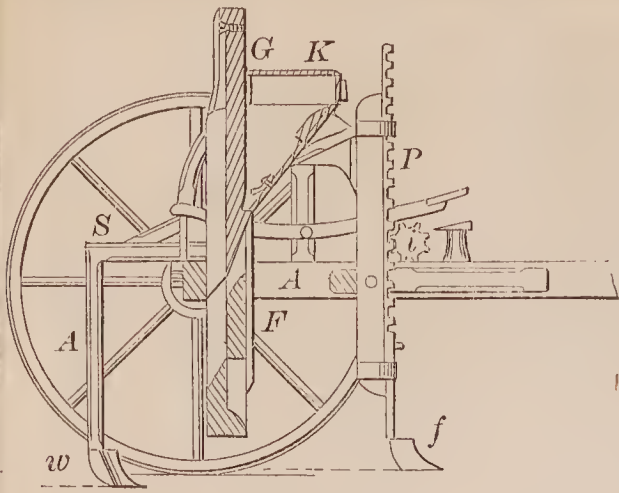

68848—E. Davies, Jr.—*Cultivator.*

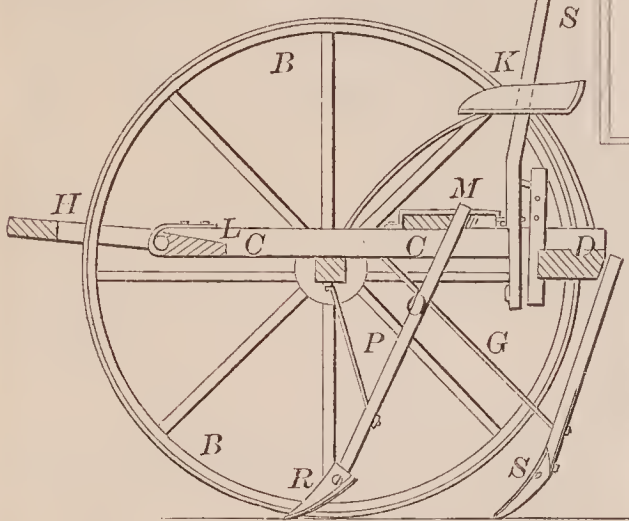

68842—R. H. Champlin—*Truss.*

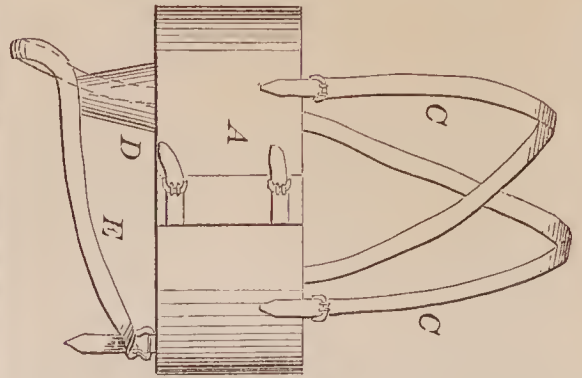

68846—W. H. Cocks—*Harness Buckle.*

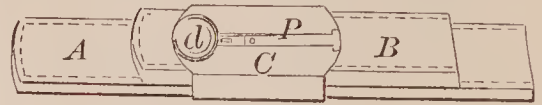

68843—P. G. Clancy—*Shifting Rail for Carriage Tops.*

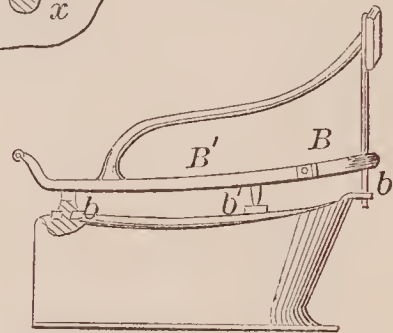
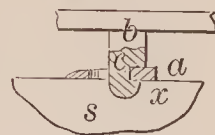
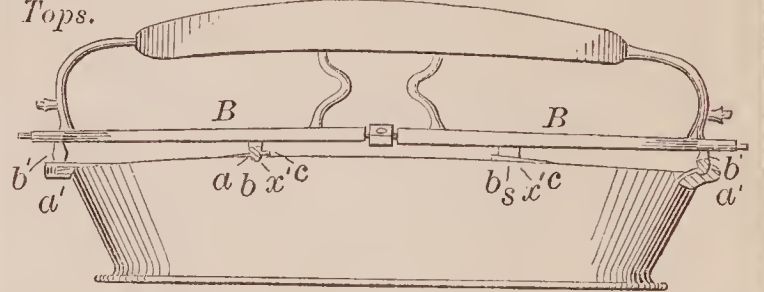

68845—H. H. Clemons—*Railroad Snow Plow.*

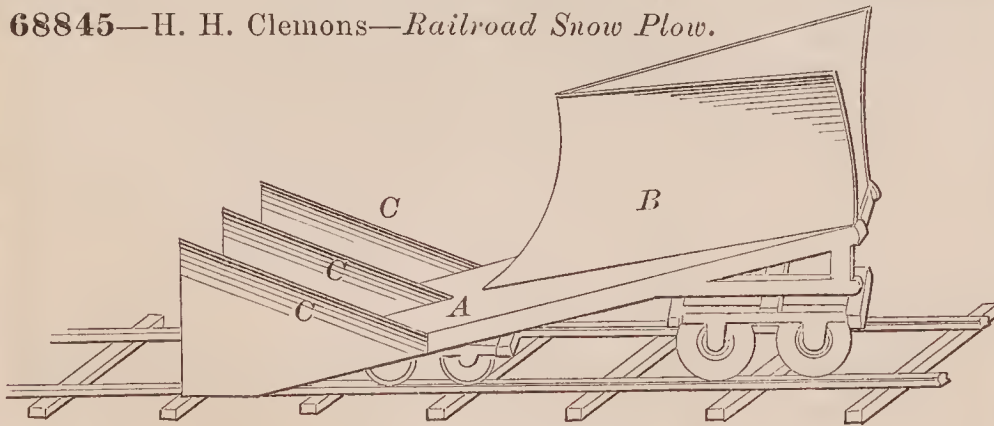

68849—G. M. Davis—*Steam Gauge.*

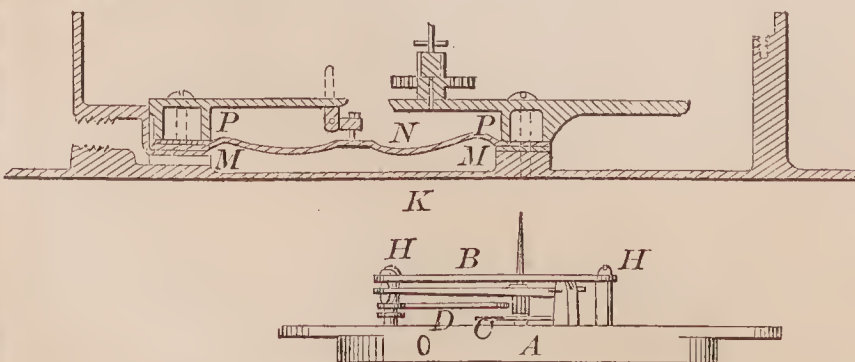

68847—P. K. Curll—*Water Elevator.*

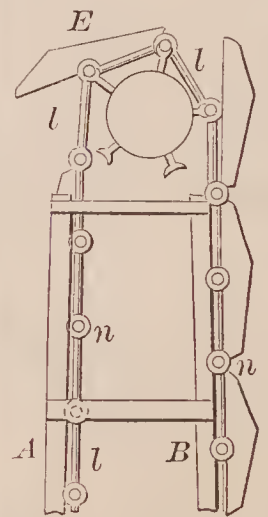

68844—L. C. Clark—*Thill Coupling.*

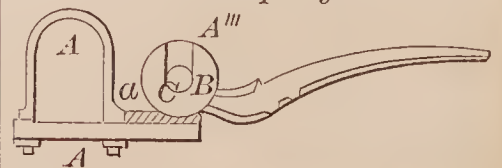

68851—A. Denison—Washing Machine.

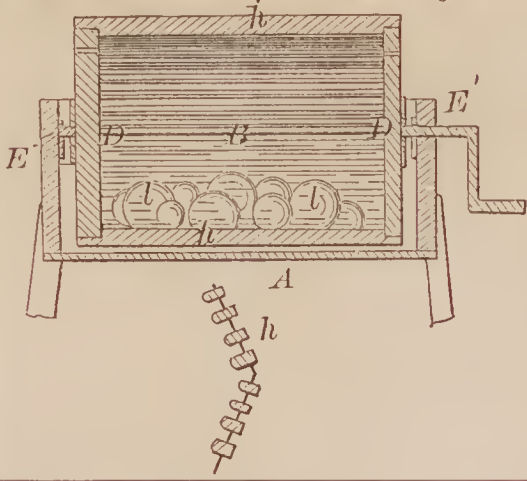

68852—W. E. Derrick—Pump Piston.

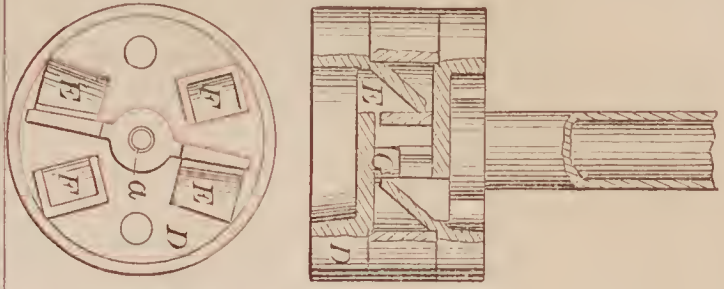

68853—E. N. Dickerson—Steam Engine.

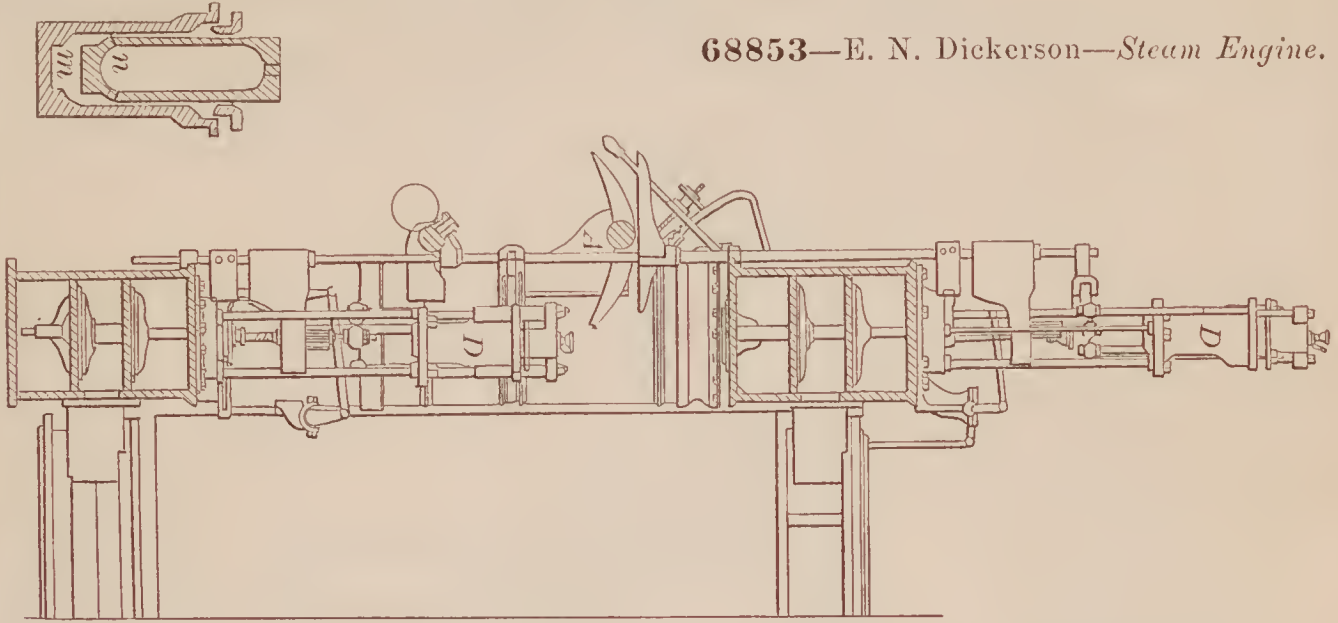

68854—M. A. & J. H. Diedrichs—For Grinding and Polishing Metals.

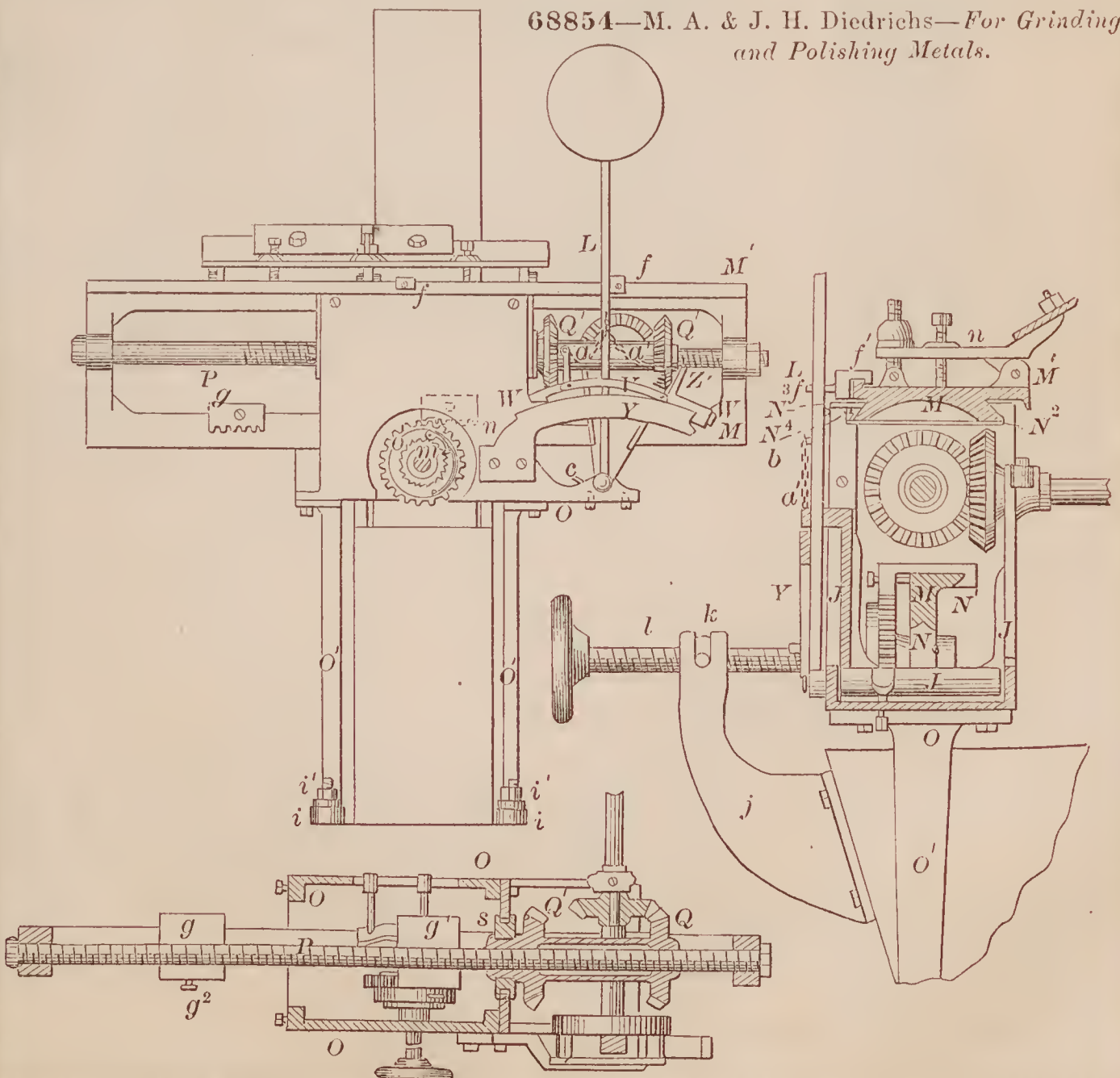



68855—M. A. Dilley—Hay Loader.

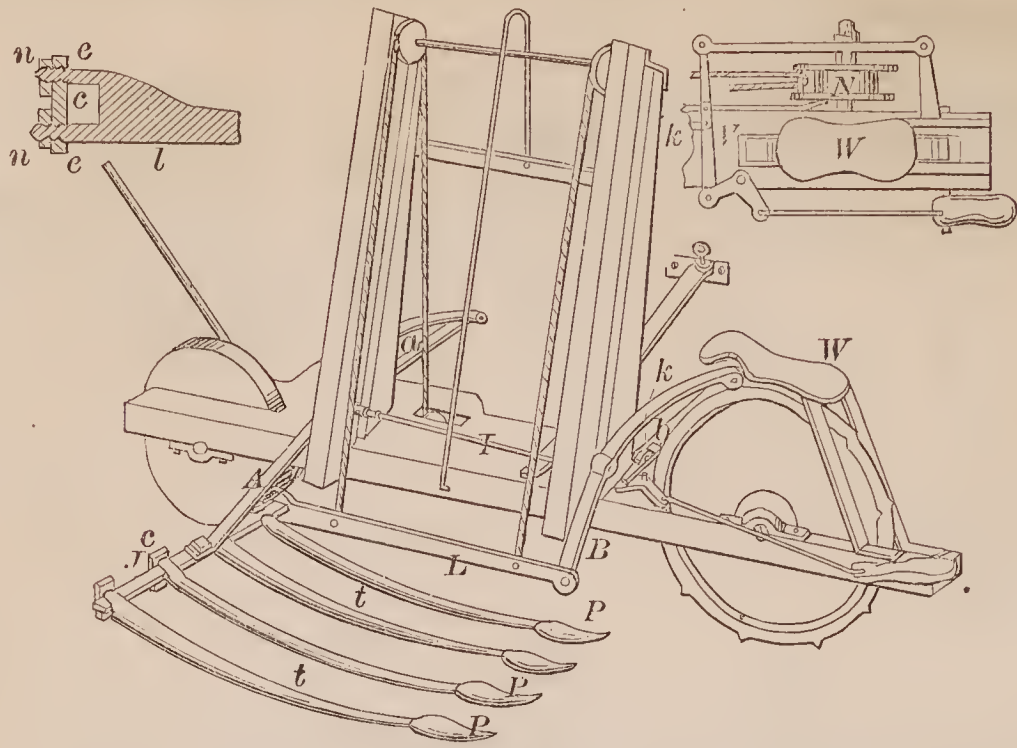

68856—J. B. Dougherty—Barrel Head Machine.

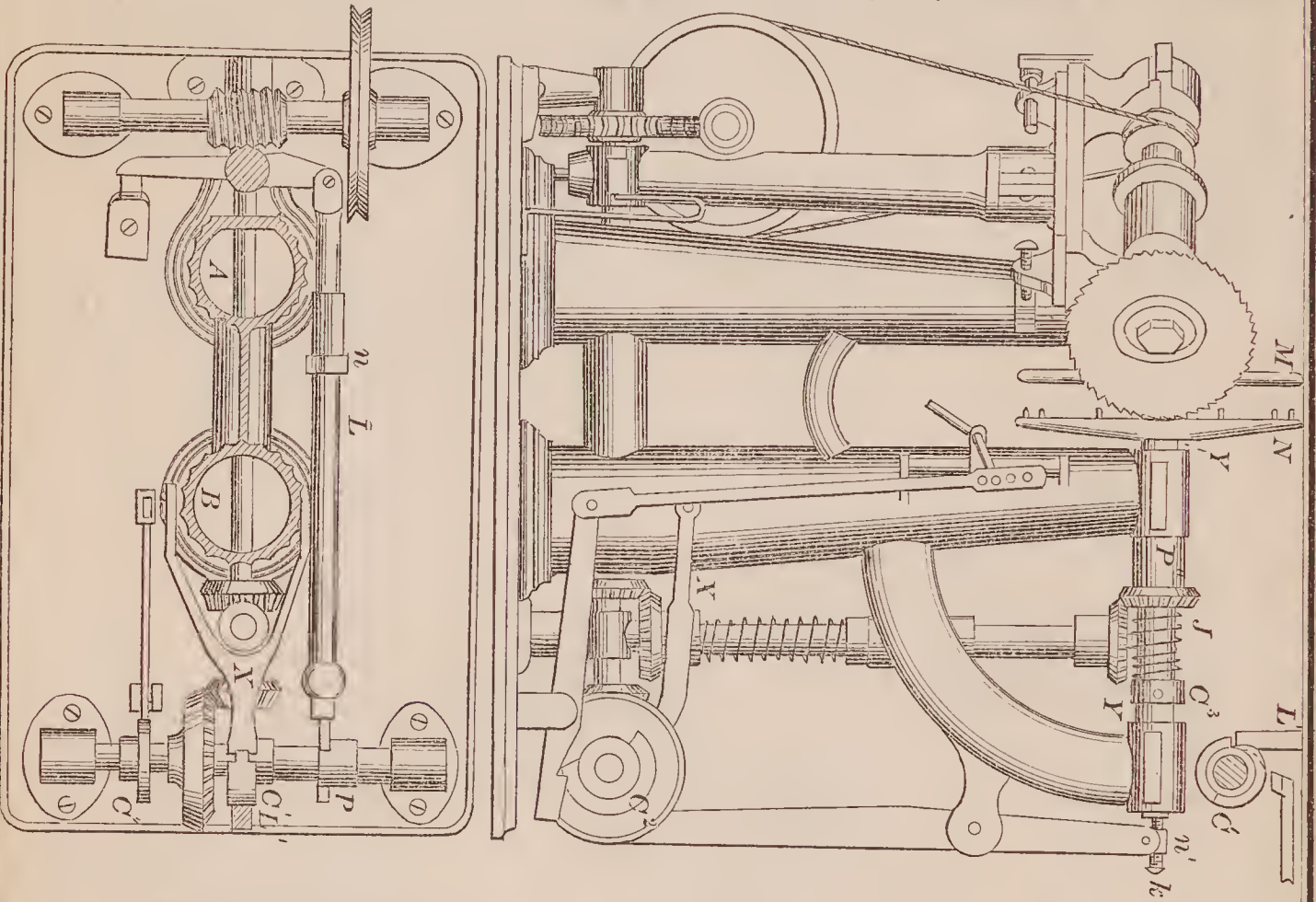

68857—C. A. Eaton—Burglar Alarm.

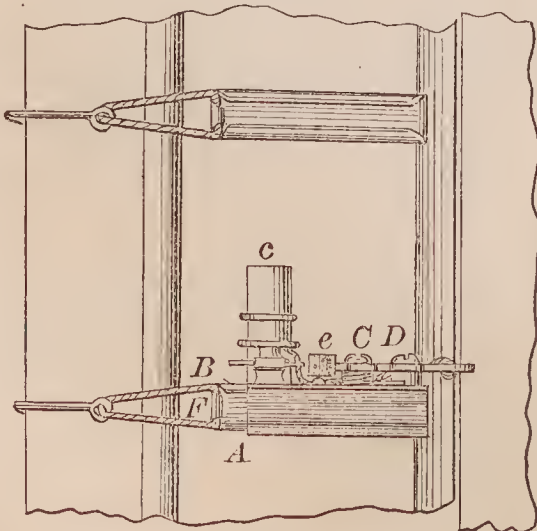

68859—N. T. Edson—Cotton Bale Tie.

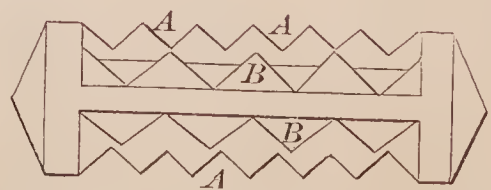



68860—Ellis & Kattell—For Distilling and Refining Oils, &c.

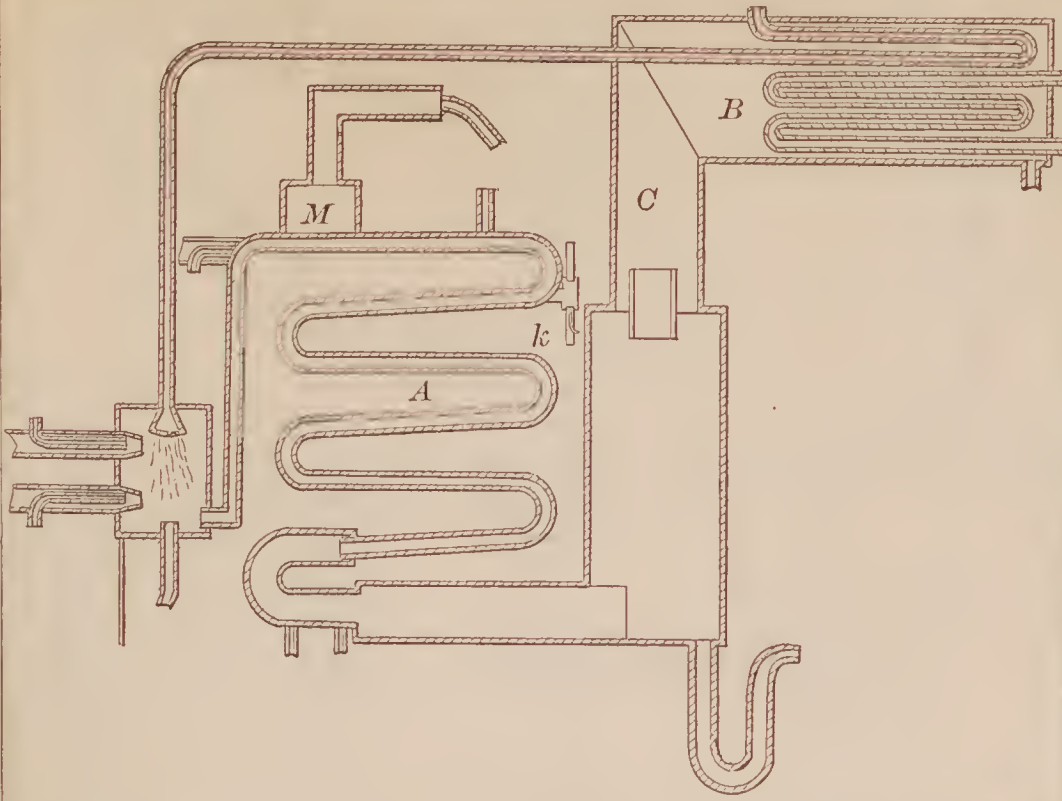

68862—J. Evans—Brick Mould.

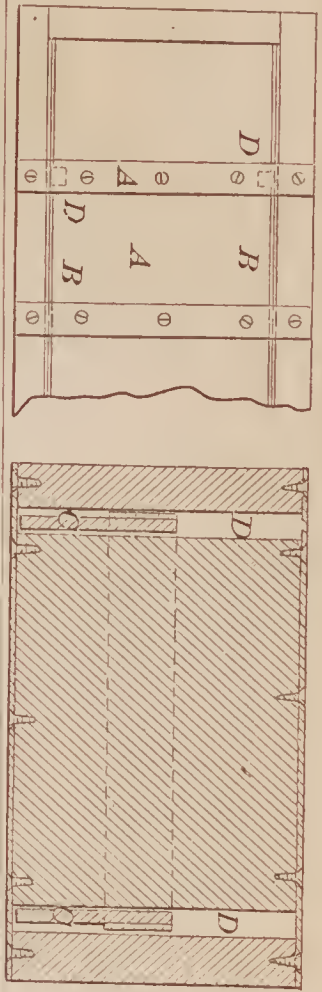

68863—M. Everett—Hydraulic Engine.

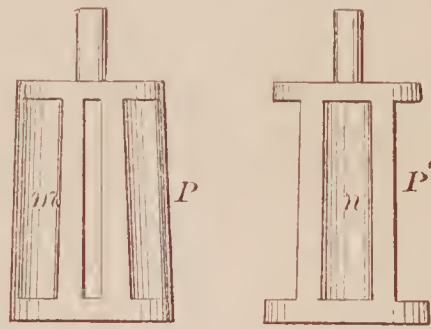
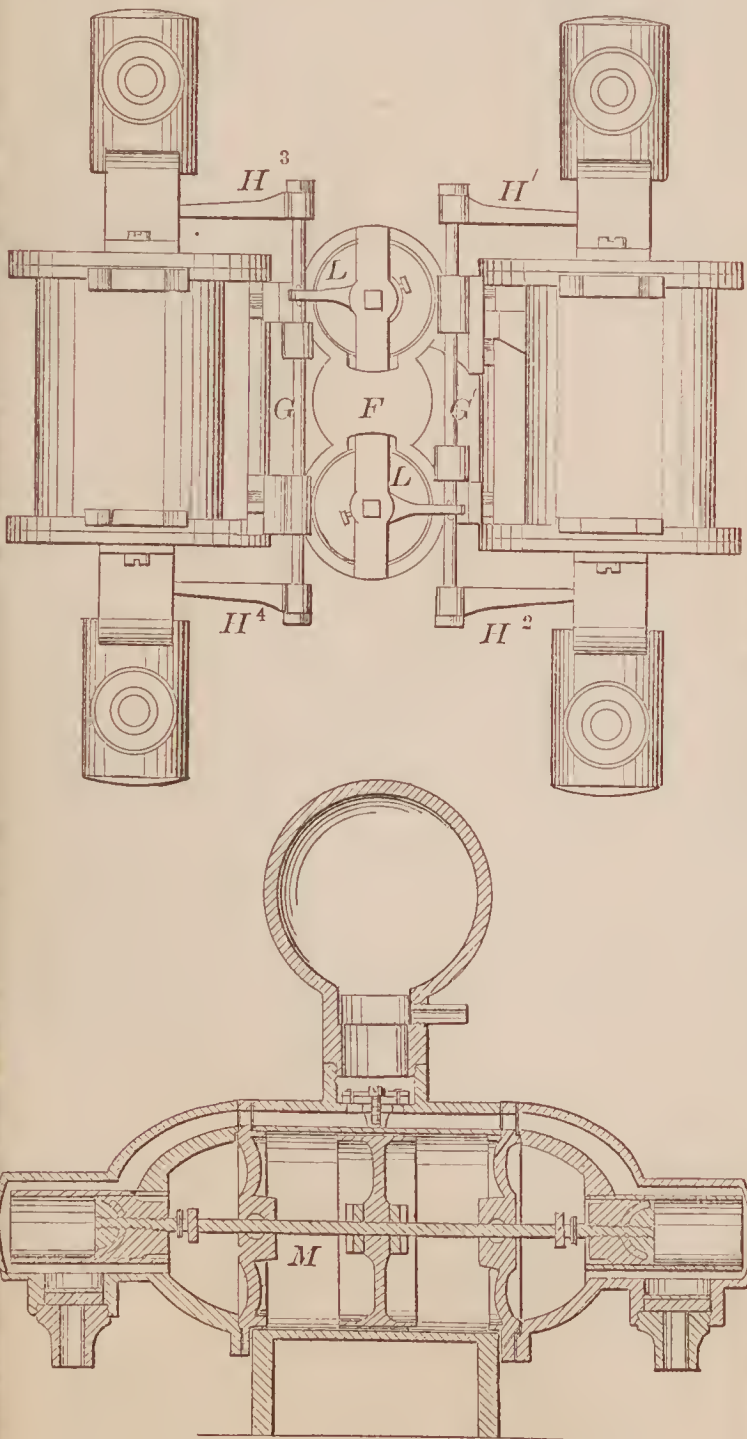

68861—L. C. England—Tannery.

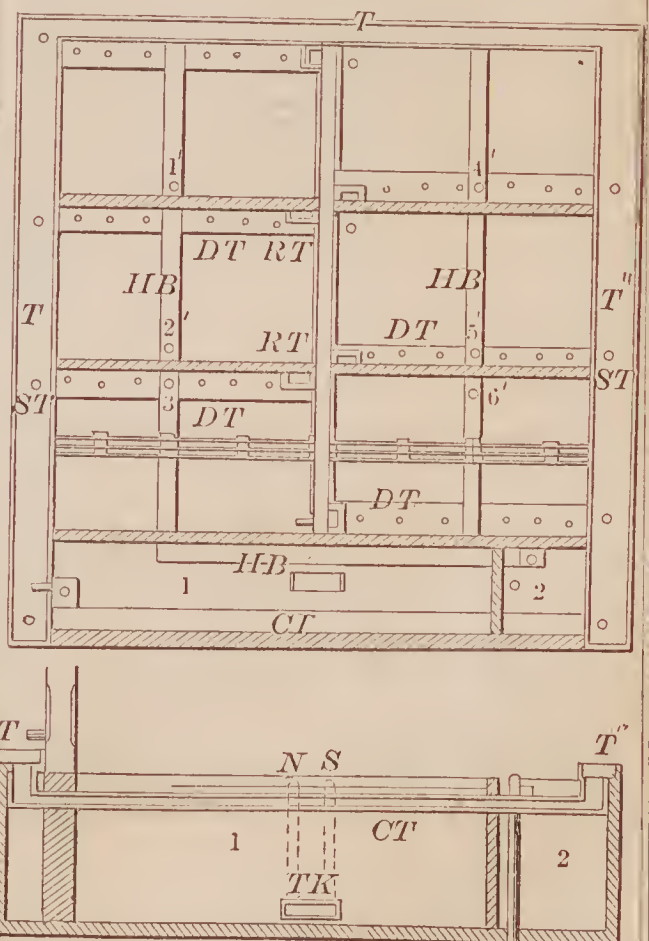



68864—O. Finch—Trace Buckle.

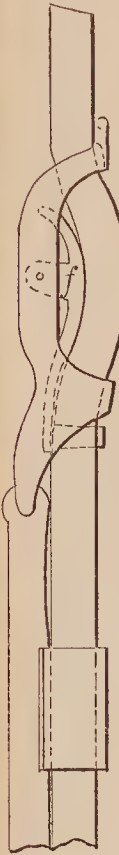

68865—J. Foley—Balancing Mill Stone.

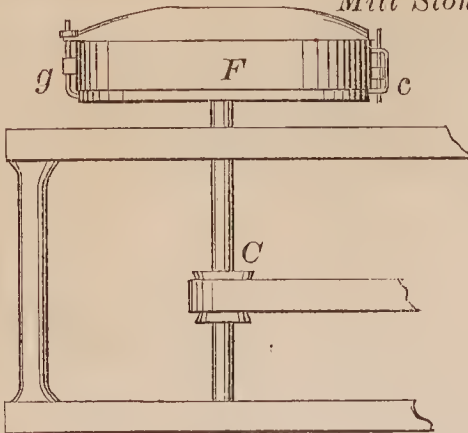

68866—A. J. Foster—Hame Fastener.

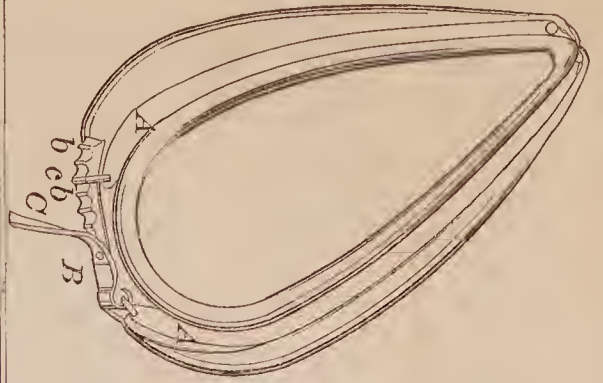

68870—S. Gissinger—Foot Holder for Turning Lathes.

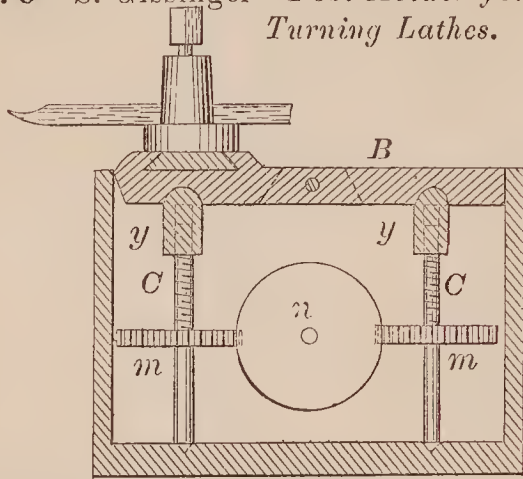

68869—J. Geemen—Malt Kiln.

68872—Hart, Hart & Reesman—Spinning Machine.

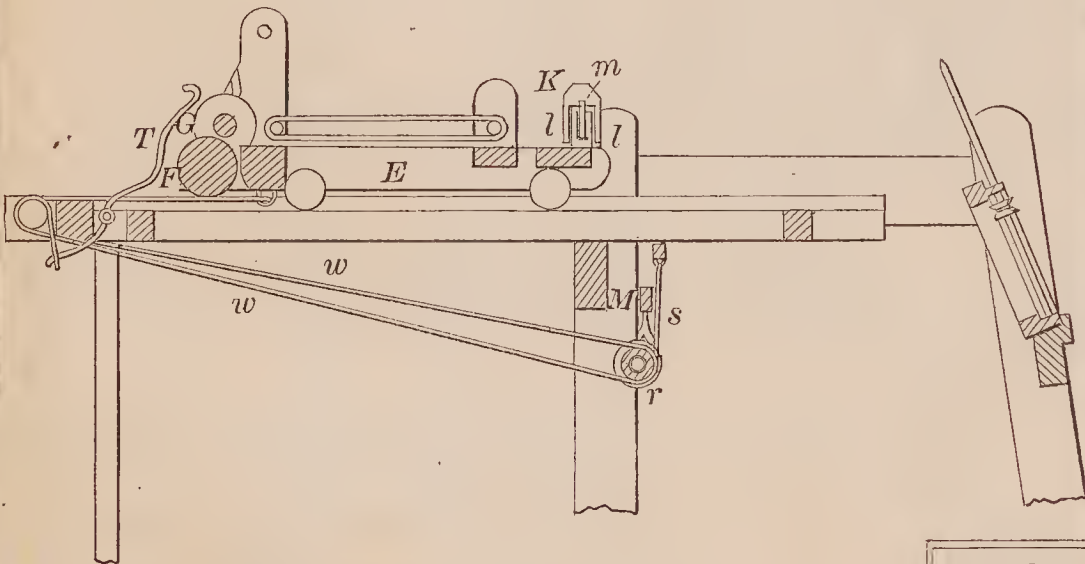
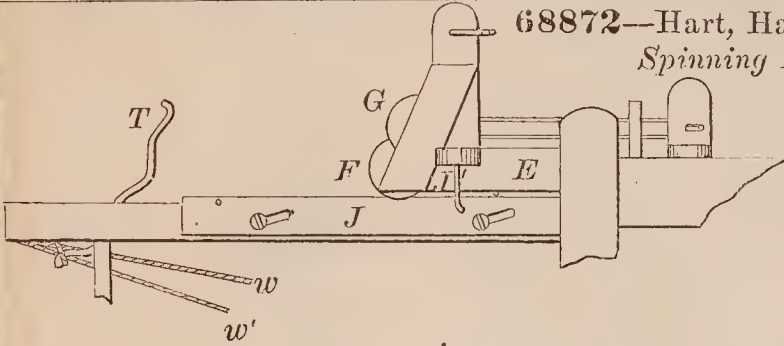

68871—S. Green—For Hatching the Spawn of Fishes.

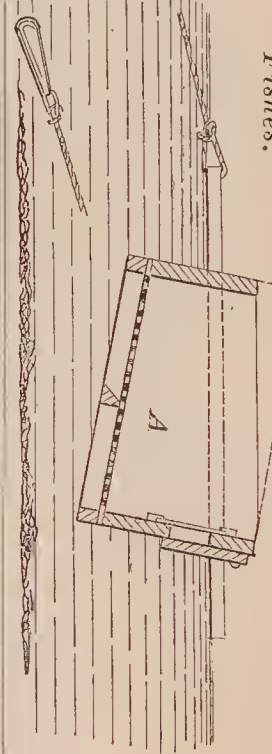

68868—O. S. Garretson—Window Pulley.

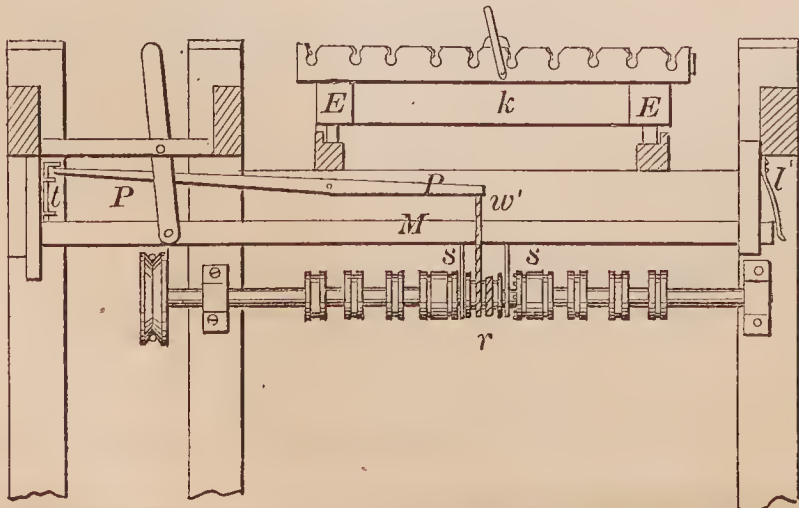
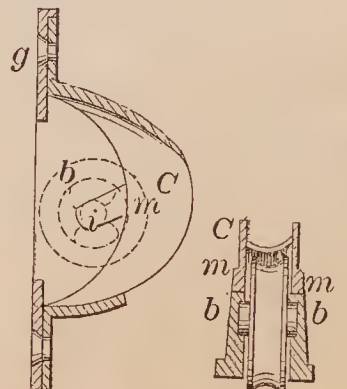

68873—L. Haverstick—*Horse Hay Fork.*

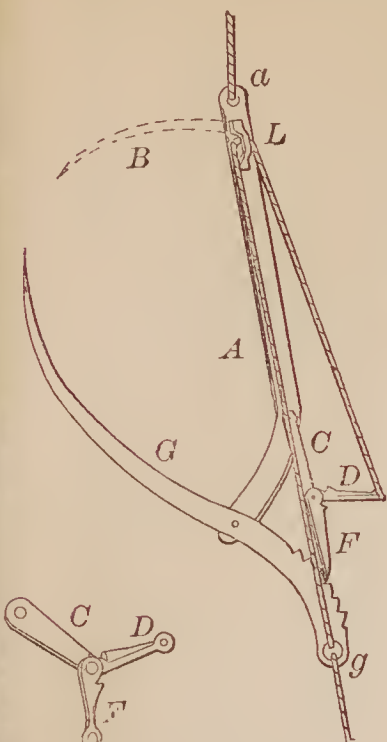

68877—T. G. Höfer—*Vegetable Slicer and Grater.*

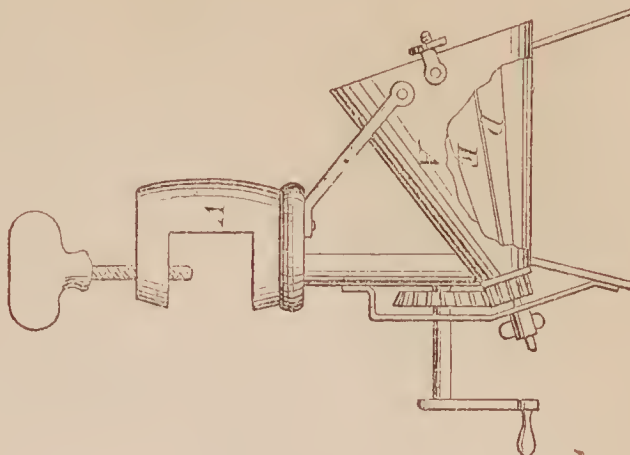
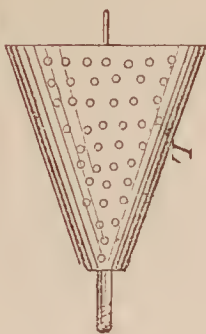
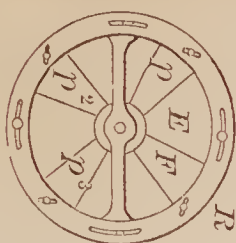

68874—W. H. Hawley—*Elevating Block.*

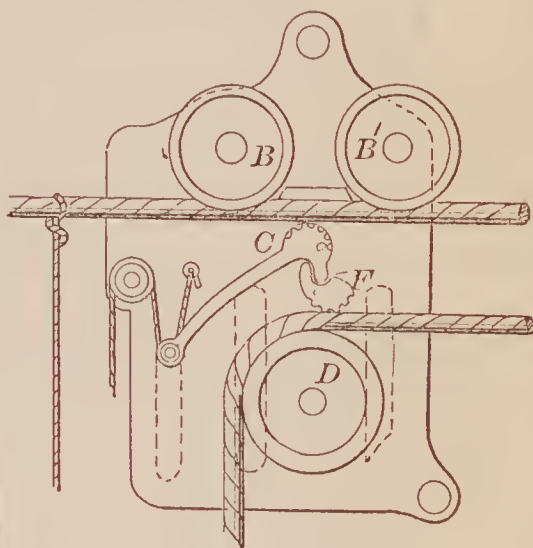

68876—D. B. Herrinton—*Harveying Grindstone.*

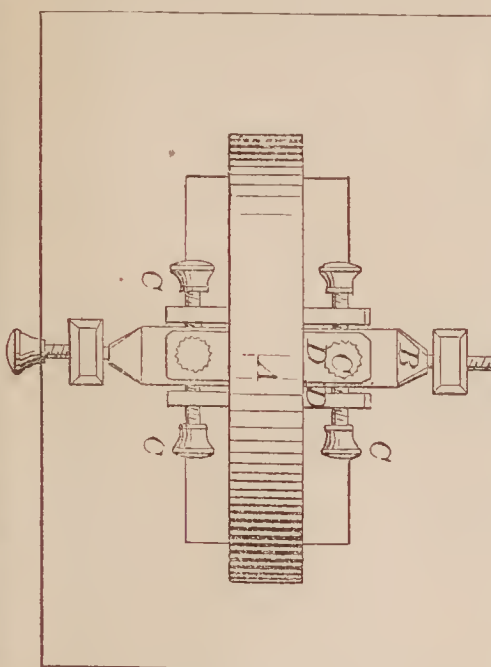

68878—J. A. Howe—*Cant Hook.*



68879—S. W. Hudson—*Steam Engine Slide Valve.*

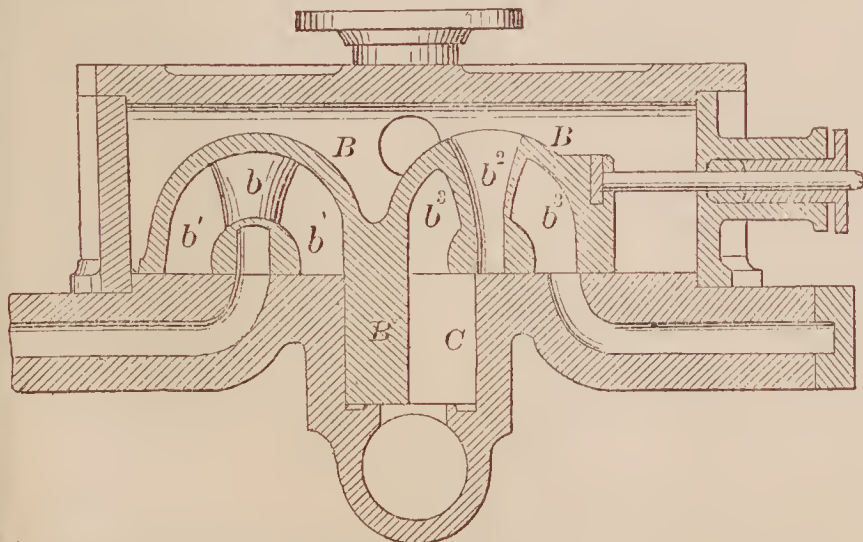

68880—Hunt & Mero—*Carriage Curtain Fastener.*

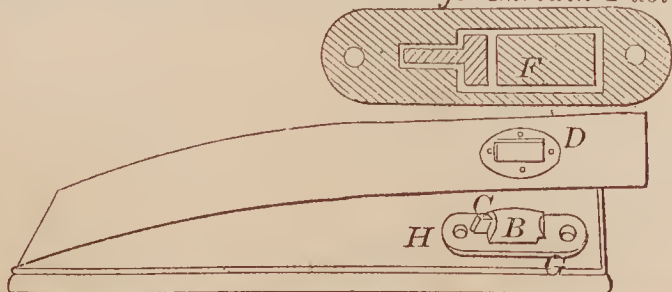

68875—R. Menage—*Car Brake and Starter.*

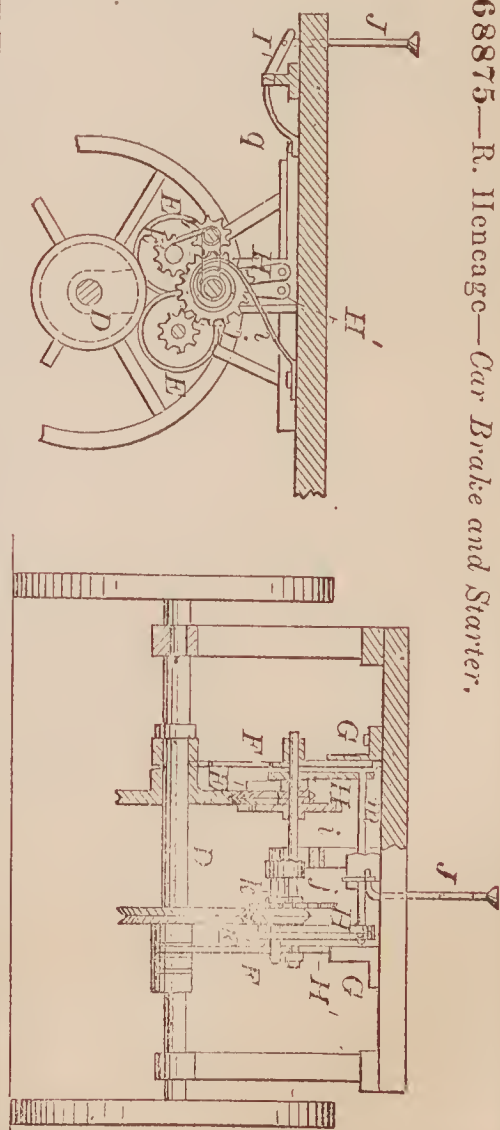



68881—R. Hutchison—  
*Shoe Spike.*

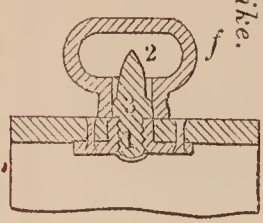

68882—G. W. Ives—  
*Brick Machine.*

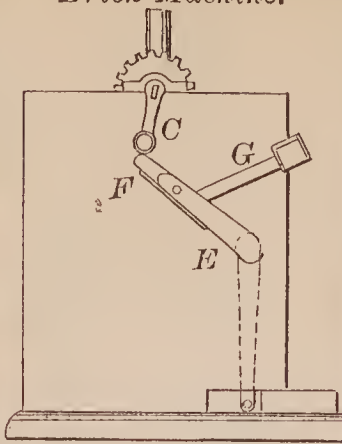

68887—Kinyon & Smith—*Hay Raker and Loader.*

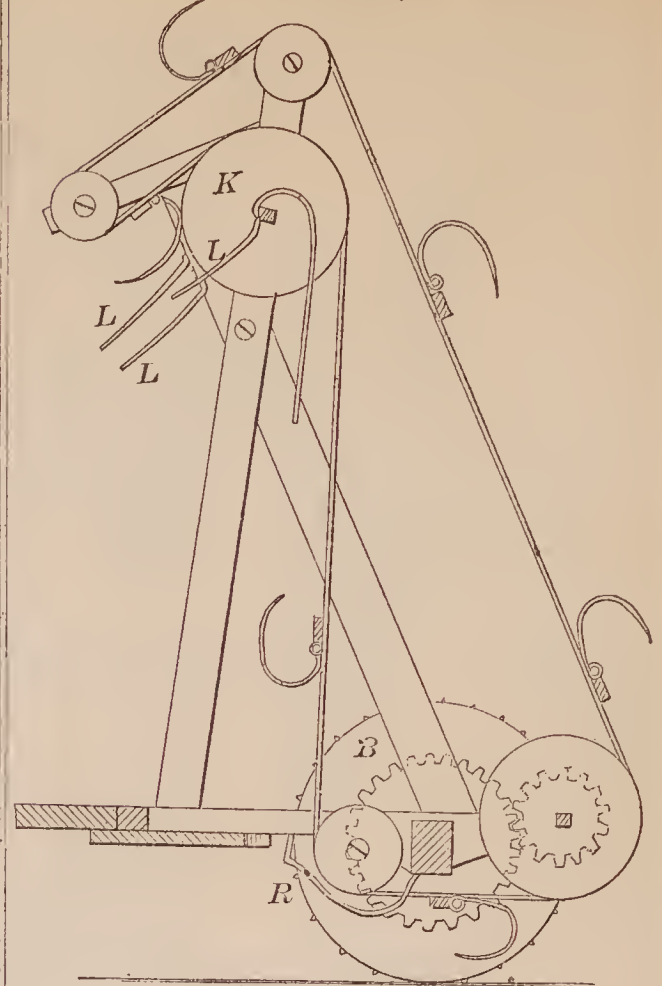

68883—E. Jewett—*Cant Hook.*

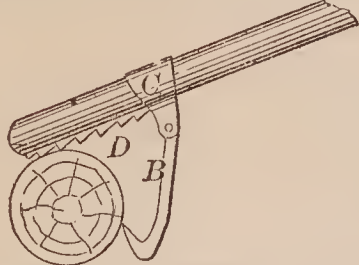

68886—E. King—*Clamping Device.*

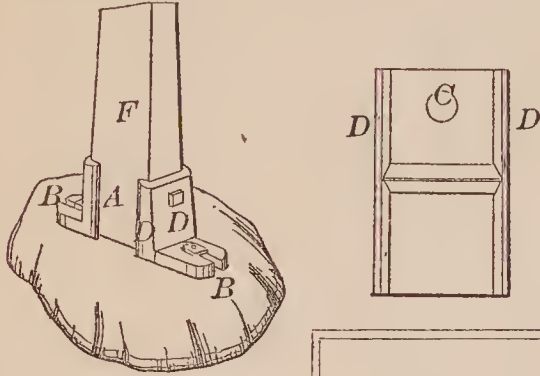

68888—E. G. Lamson—*Operating Drill.*

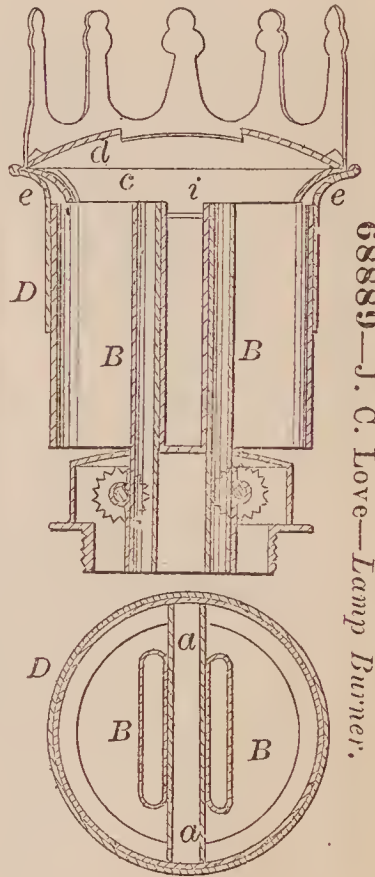
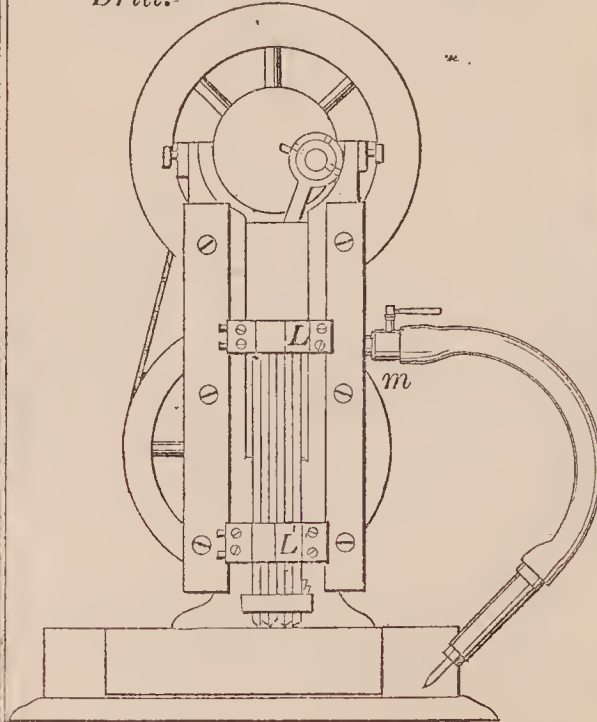

68889—J. C. Love—*Lamp Burner.*

68884—Johnson & Davis—  
*Building.*

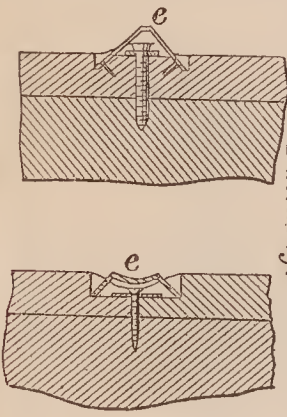

68890—W. Lucas—*Fan.*

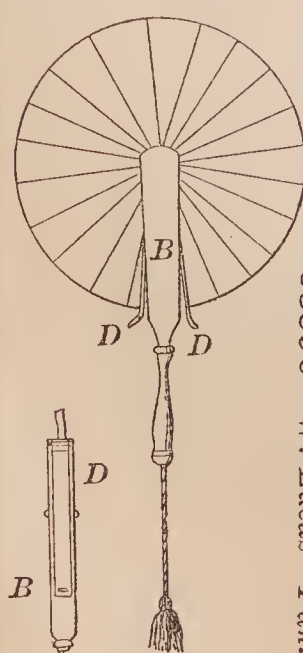

68891—E. L. Marsh—*Lifting Jack.*

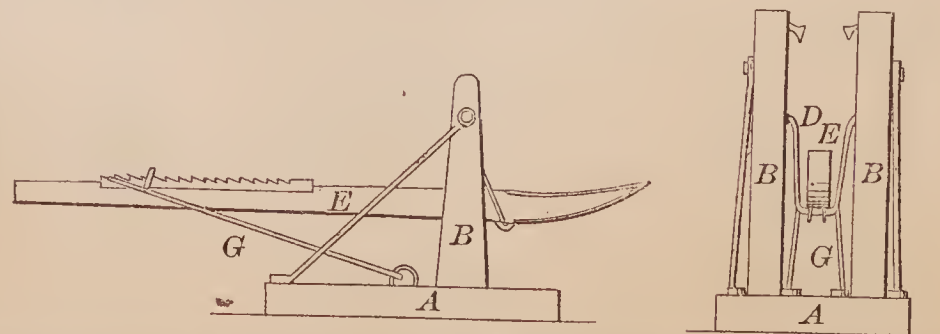

68892—J. Massey—Invalid Bedstead.

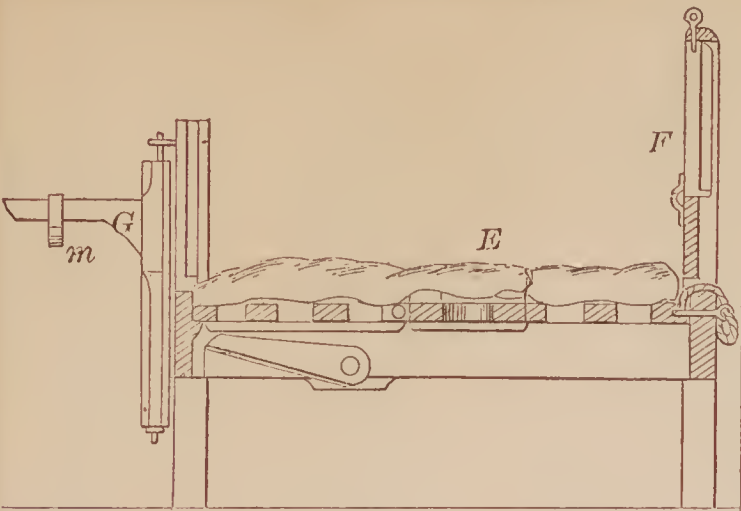

68896—C. D. Page—Brick Press.

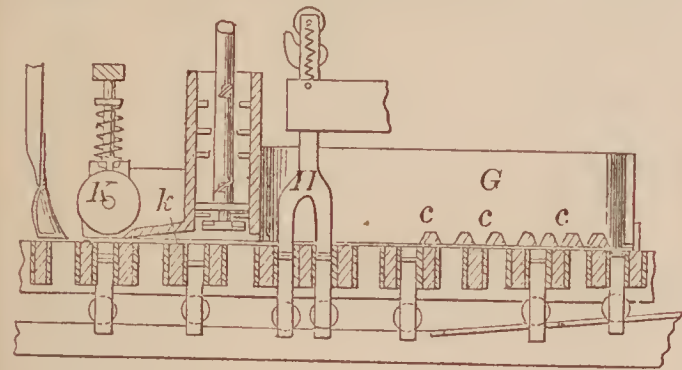

68894—J. M. Moyer—Brick Machine.

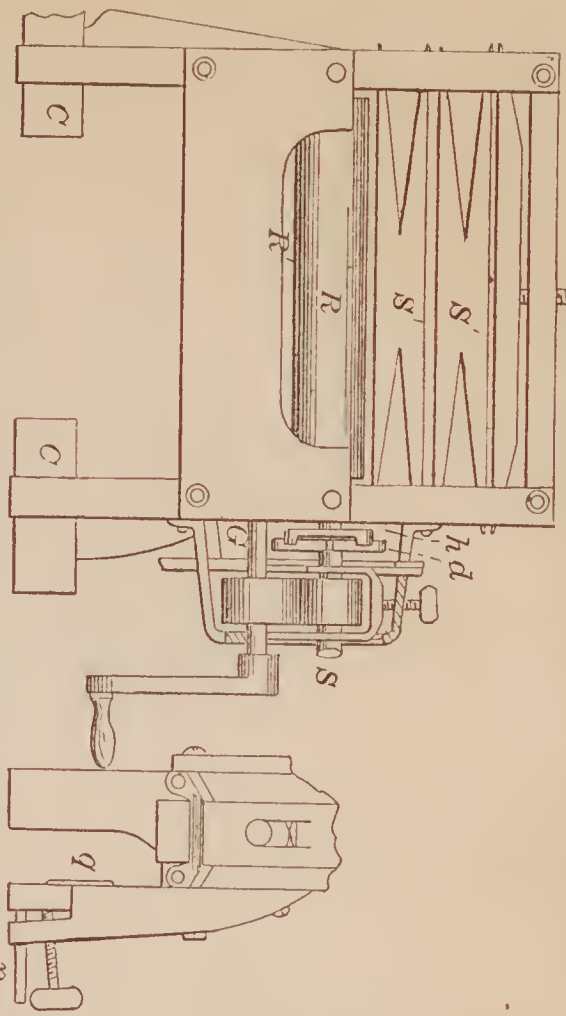
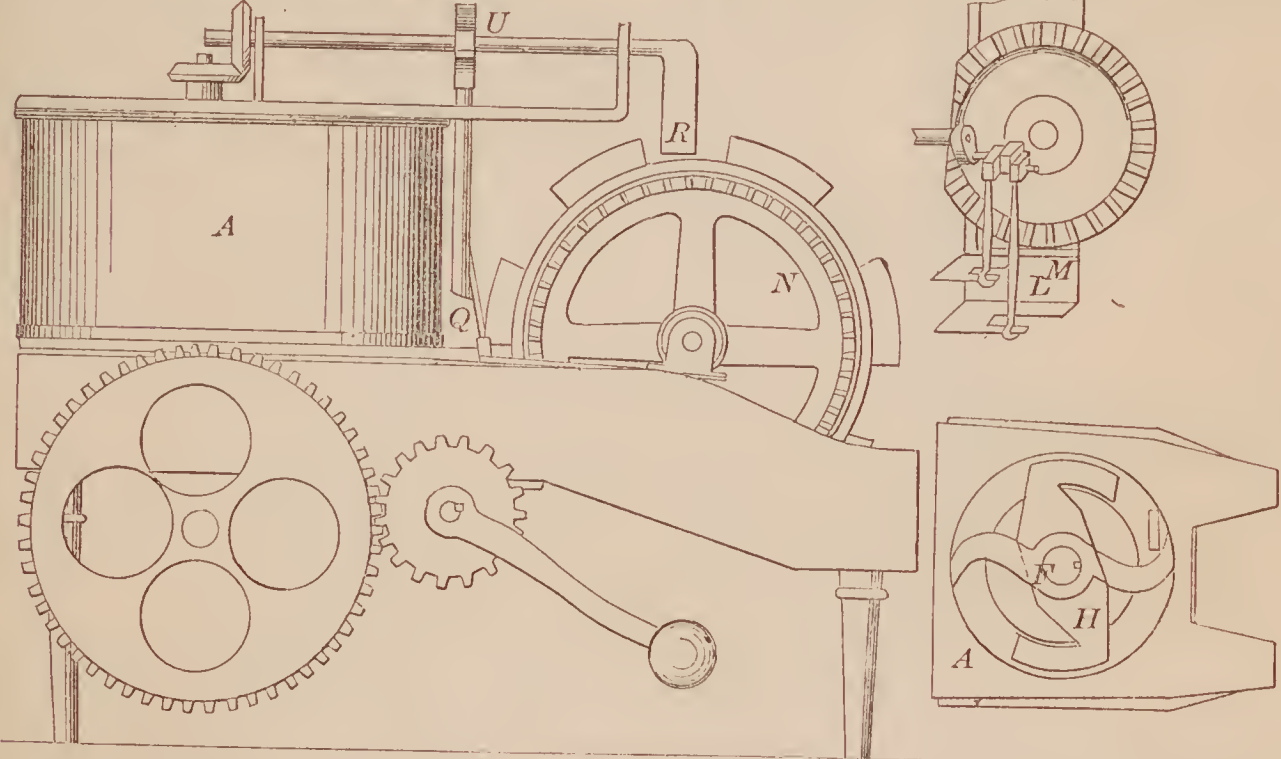

68893—J. M. McMaster—Clothes Wringer.

68898—G. Perkins—Cooking Stove.

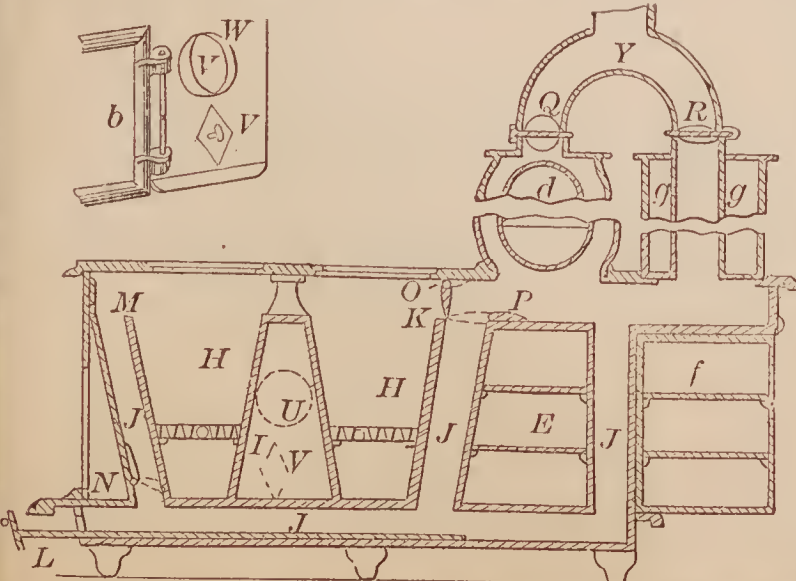

68895—A. Odell—Attaching Thills to Carriages.

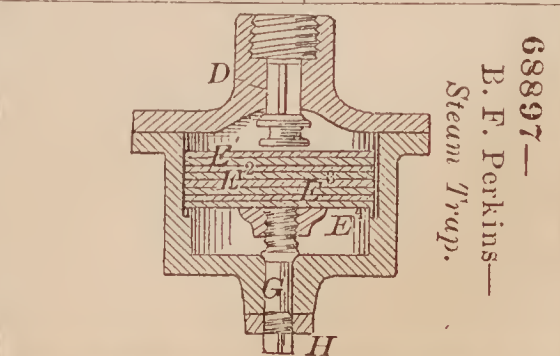
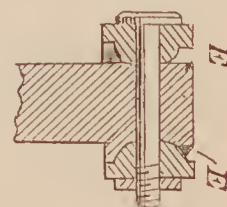

68897—B. F. Perkins—Steam Trap.



68899—W. H. Plumb—Hat.

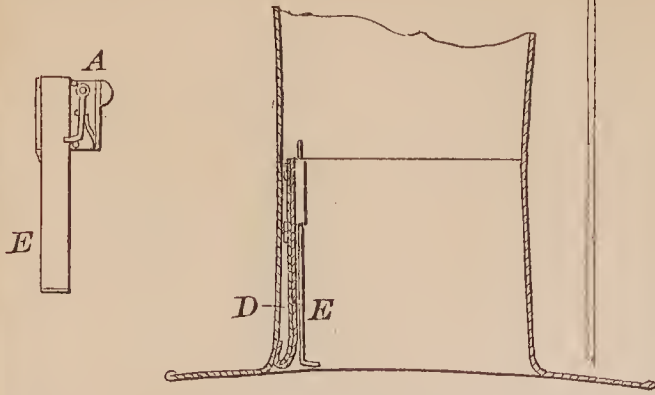

68905—B. Roezl—For Cleaning Hemp, Ramie, &c.

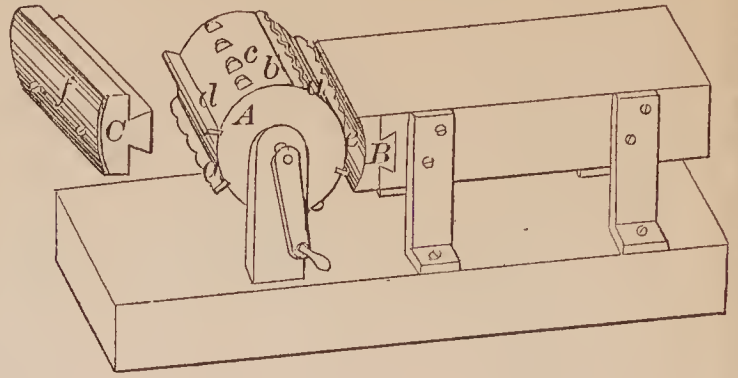

68901—W. Richardson—Plow.

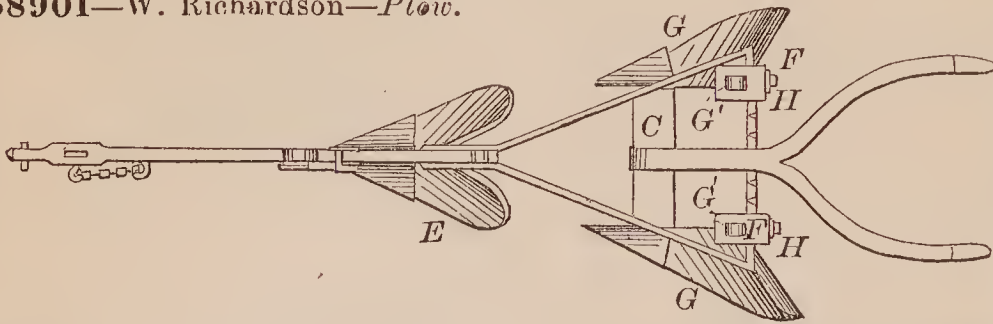

68904—J. Rock—Carriage.

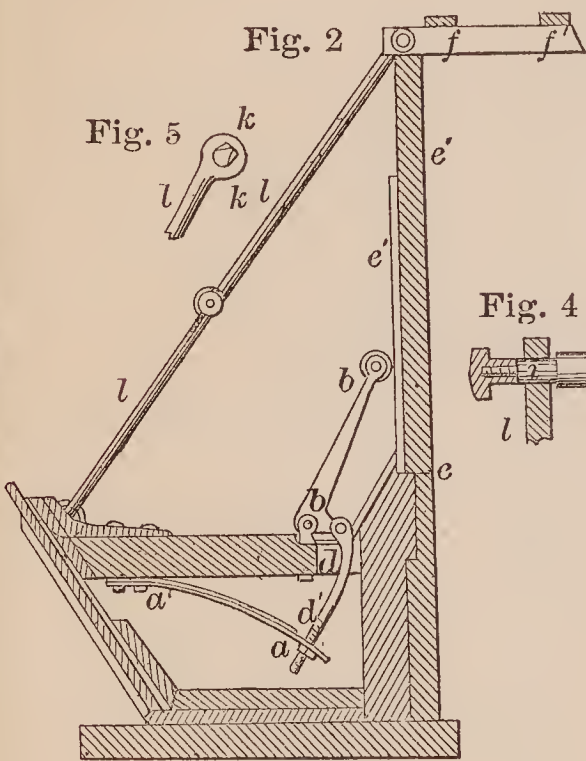

68900—J. & W. W. Porter—Reverse Lever Pitman.

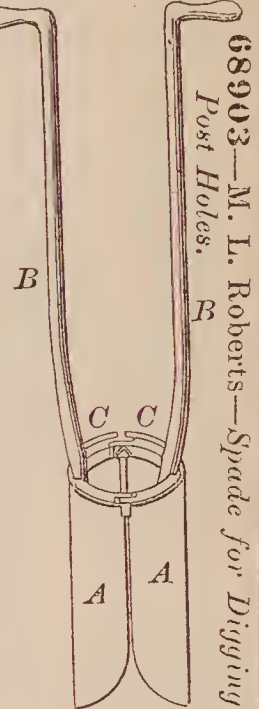
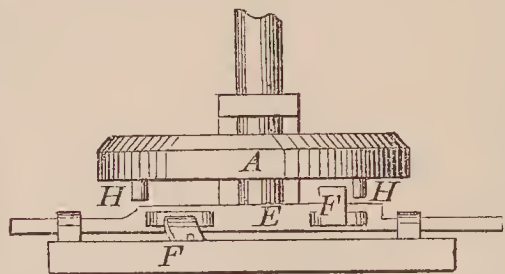

68903—M. L. Roberts—Spade for Digging Post Holes.

Fig. 2

Fig. 5

Fig. 4

68902—J. Robbins—Fence Post Pedestal.

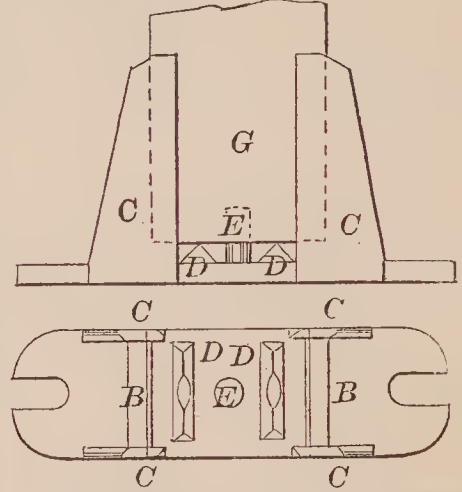

68906—Sargent & Flanders—Animal Tether.

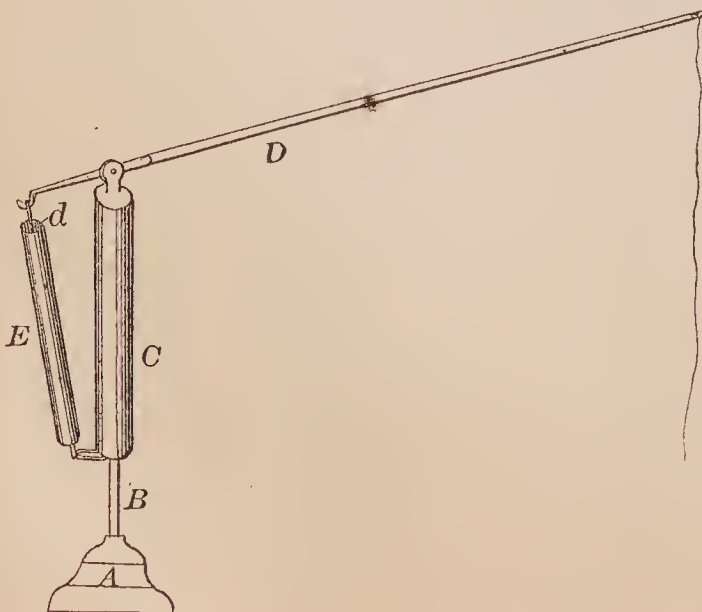

68907—H. C. Sergeant—Brick Machine.

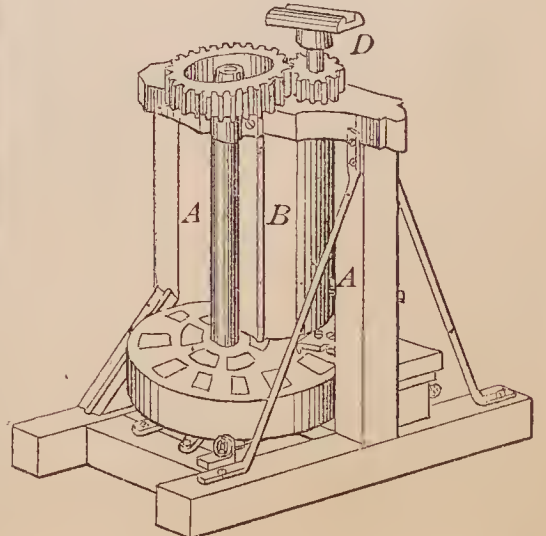

68909—A. B. Sprout—*Derrick.*

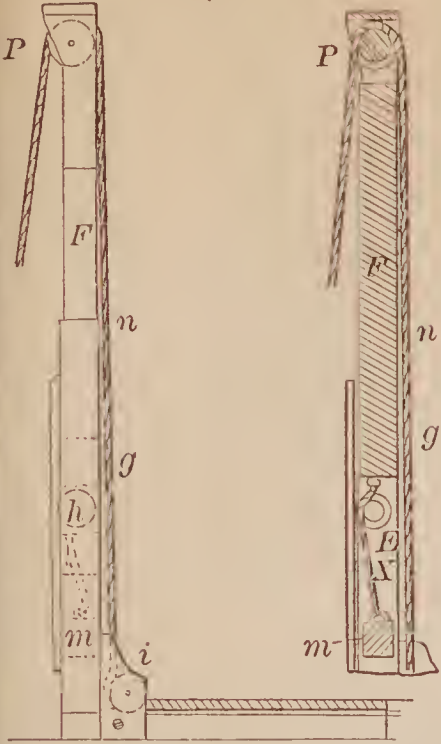

68911—T. B. Stevenson—*For Measuring Lumber.*

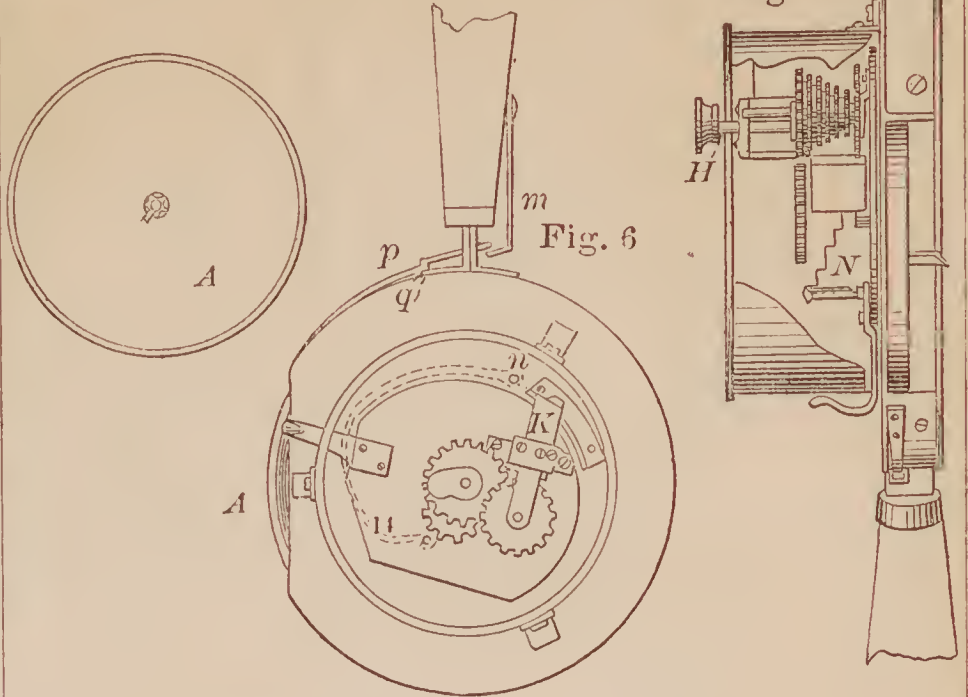

68914—S. Tucker—*Piston Packing.*

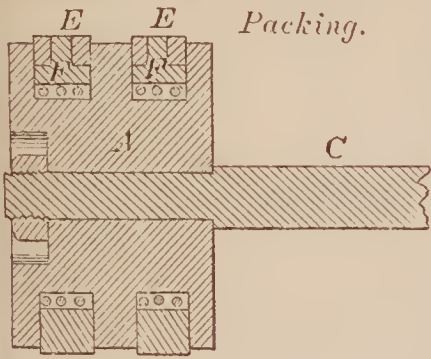
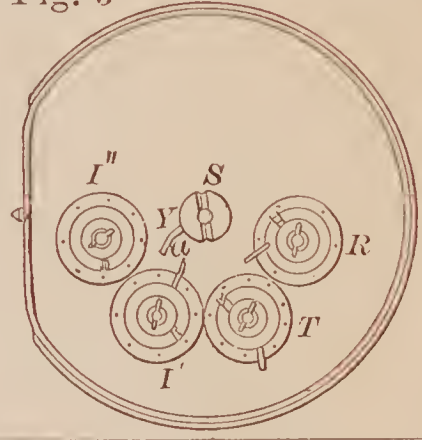
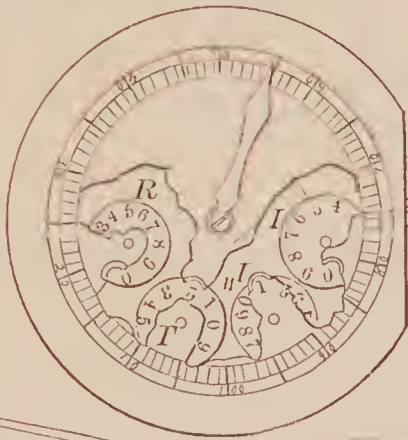
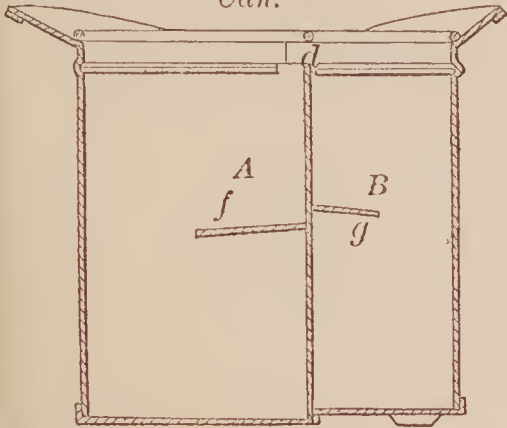

Fig. 2

Fig. 3



68913—D. H. Summer—*Measuring Can.*



68910—E. Stafford—*Cultivator.*

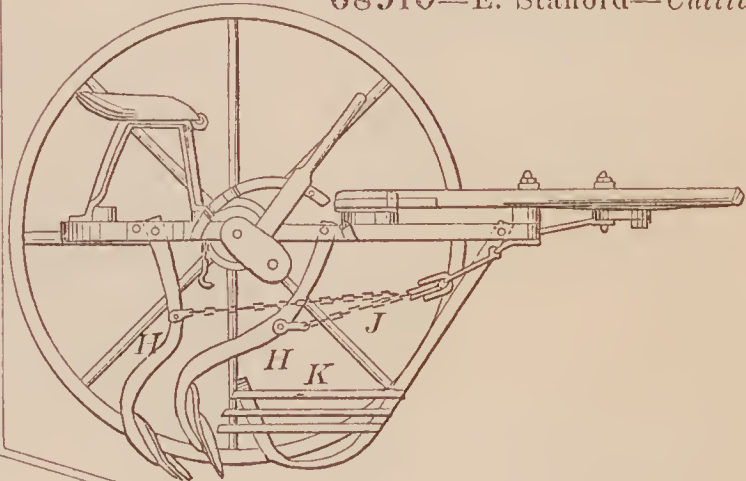

68915—D. H. Turner—*Cooling and Purifying Animal Charcoal.*

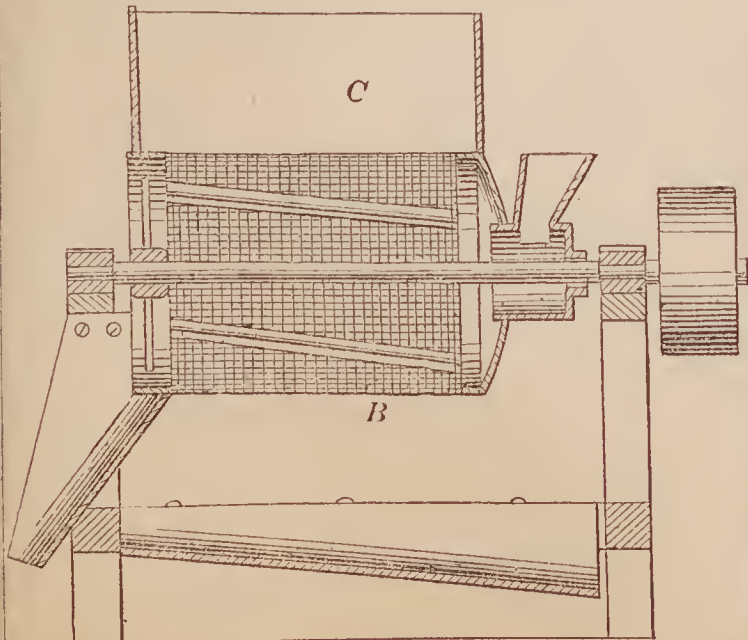

68912—W. Stickney—*Bed Bottom.*

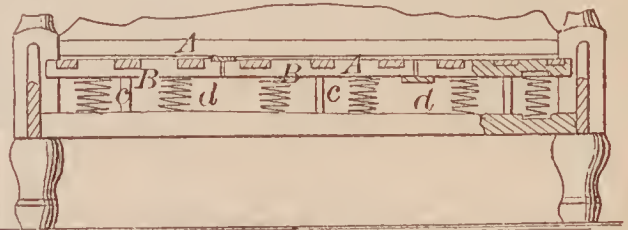

68916—B. Van Deusen—*Spittoon for Railroad Cars.*

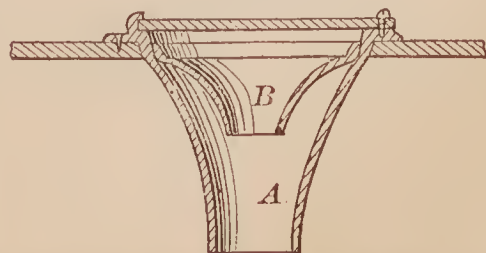



68918—C. Wandel—*Hand Loom.*

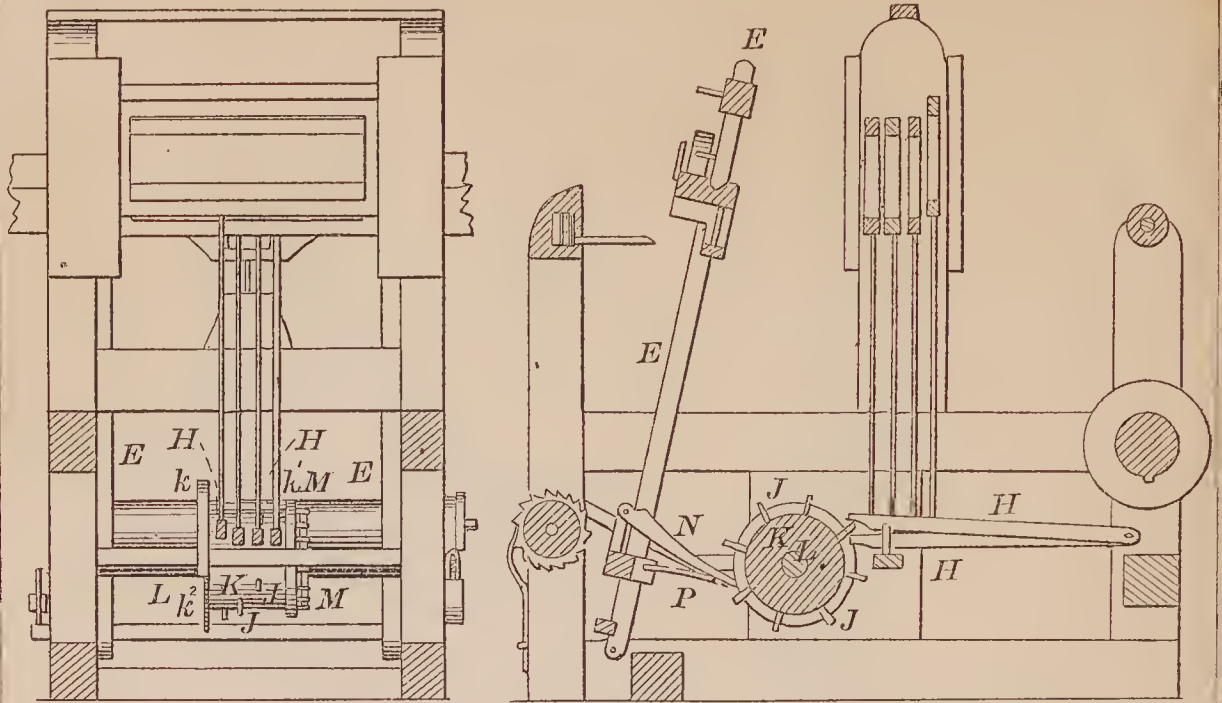

68917—S. Waite—*Driven Pump.*

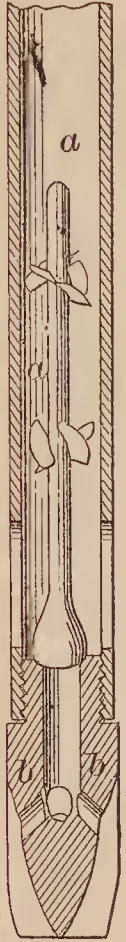

68924—L. Wilkinson—*Carriage Shackle.*

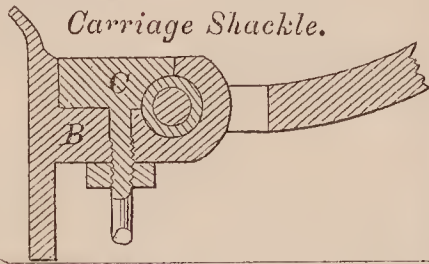

68921—J. W. Wetmore—*Washing Machine.*

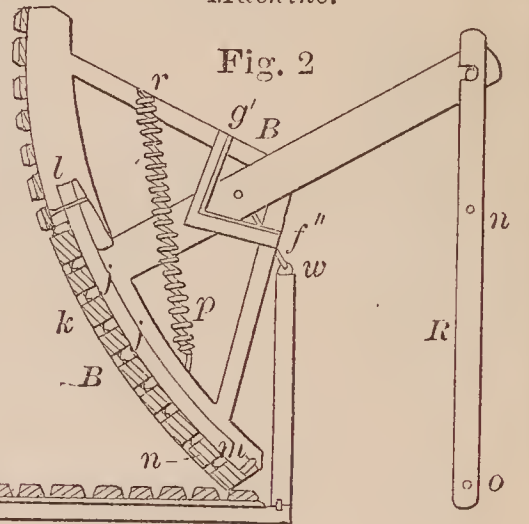

68920—J. Q. Welch—*Rotary Steam Engine.*

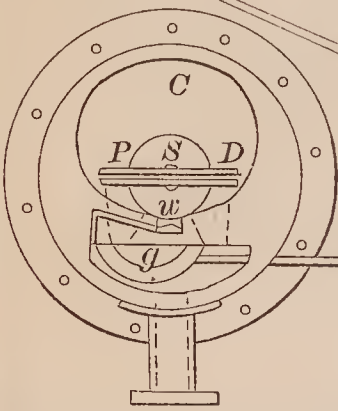
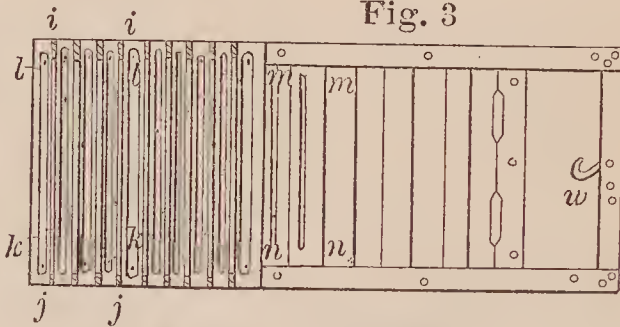
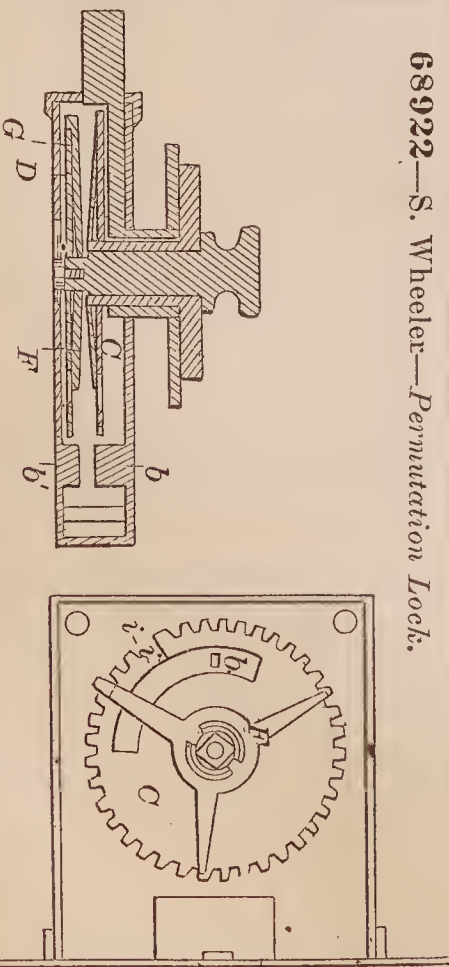

Fig. 3



68922—S. Wheeler—*Permutation Lock.*



68919—W. G. Ward—*For Hitching Horses.*

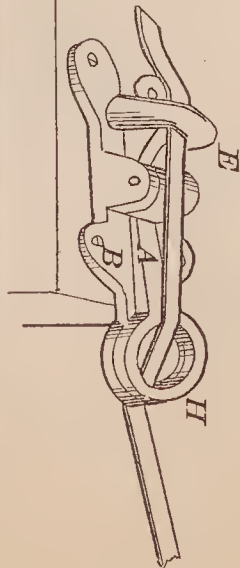

68923—A. J. White—*For Lighting Factories.*

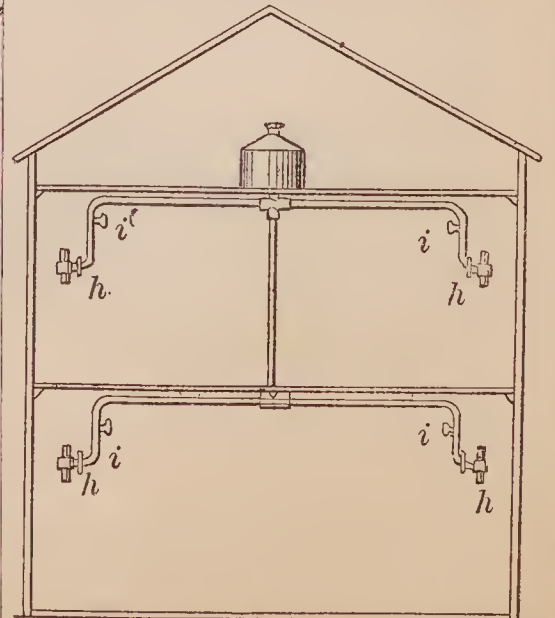

68926—J. F. Wood, 2d—Self-Acting Wagon Brake.

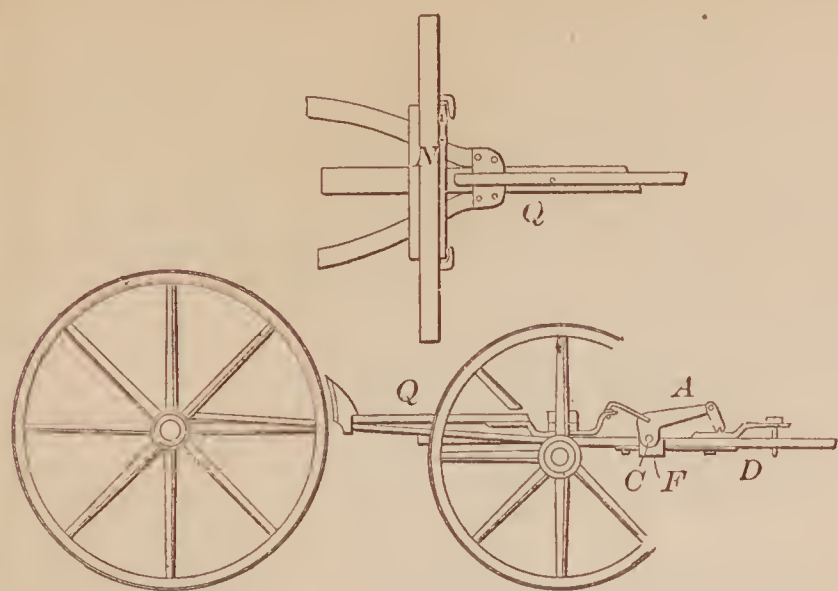

68930—W. Youngblood—Wagon Step.

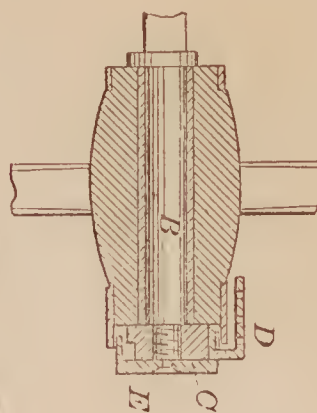

68929—H. Young—File.



68931—J. L. Abbott—Liquid Measure.

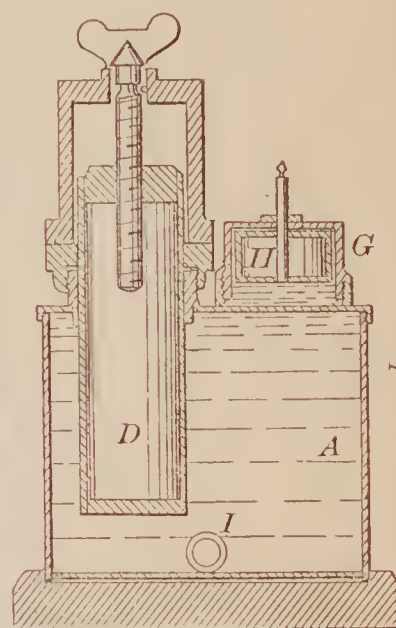

68927—A. Woods—Hammock.

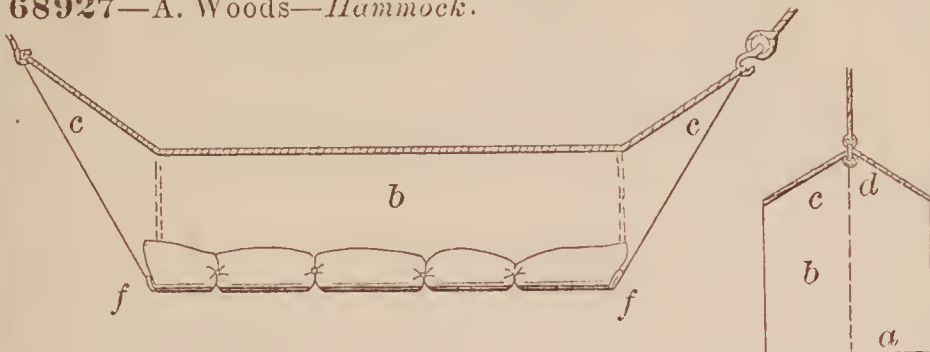

68932—Adams & Parson—Slide Valve.

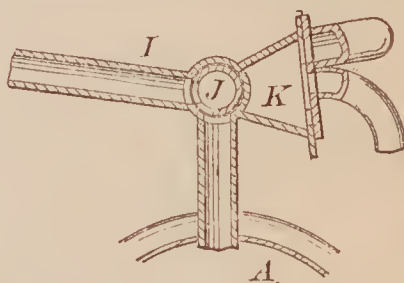
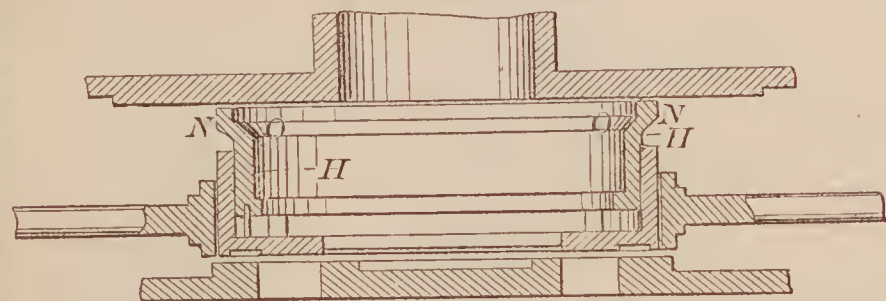

68925—A. Woerber—Carriage Curtain Fastener.



68928—Wyman & Hartshorn—Knitting Machine Register.

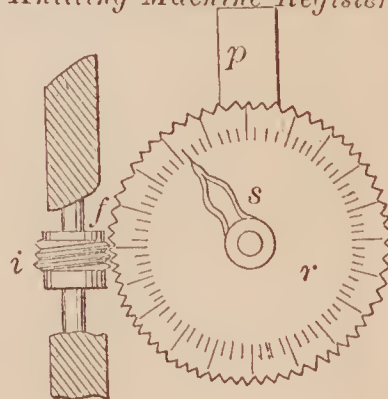

68933—J. K. Andrews—Window Sash Stop.

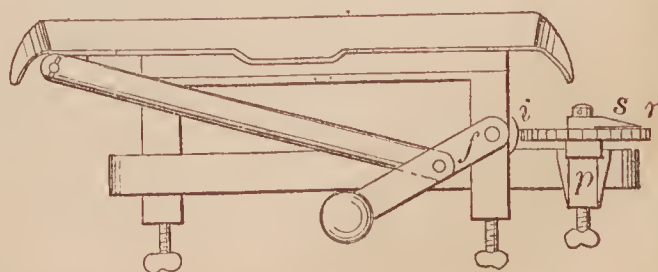
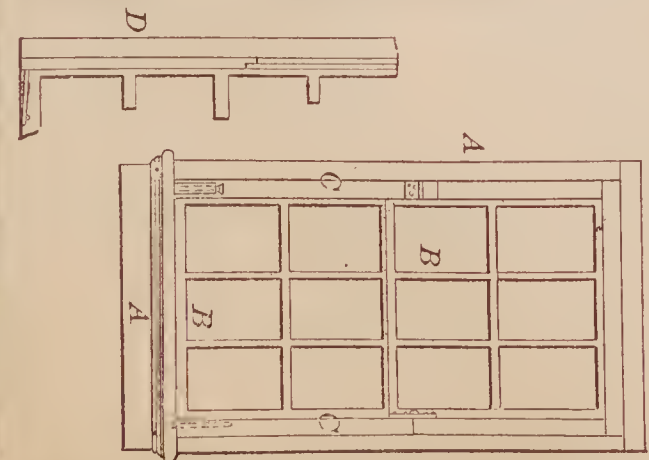







68938—Bancroft & Ward—*Steam Engine.*

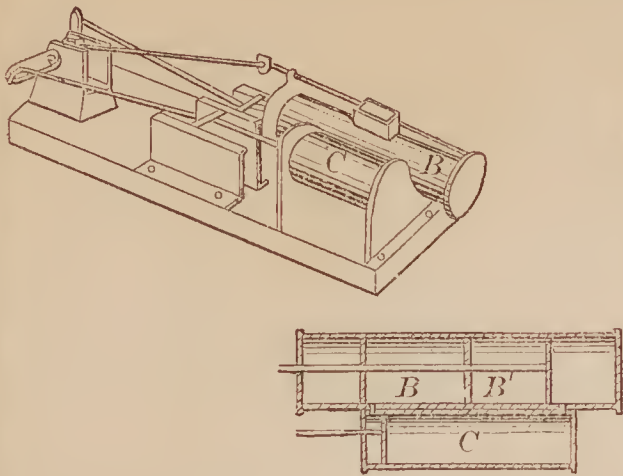

68939—J. Bayliss—*Tuyere for Furnaces.*

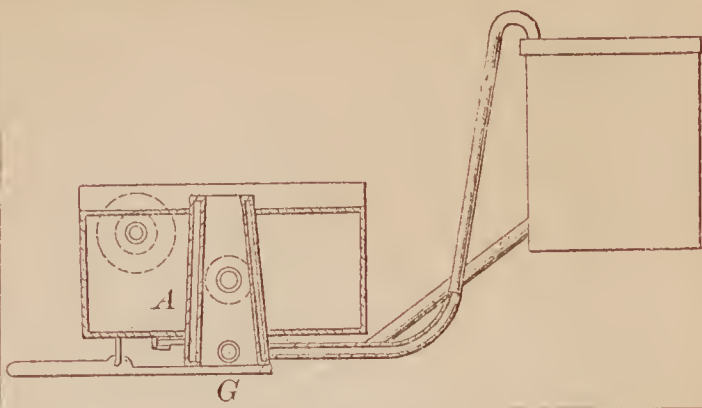

68940—J. F. Boynton—*Fire Extinguisher.*

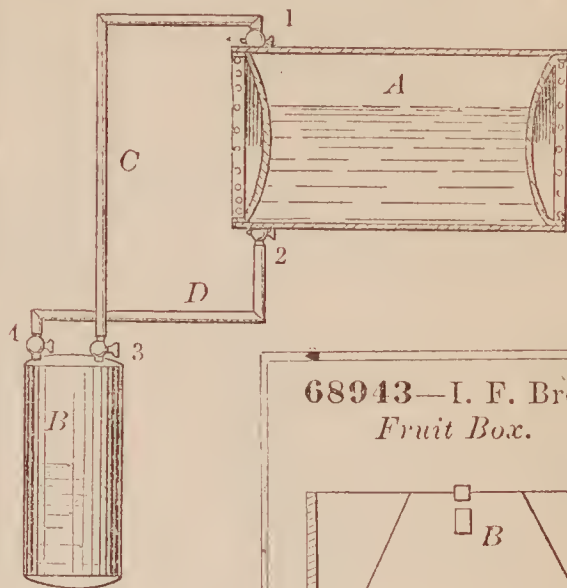

68945—J. D. Bryson—*Water Wheel.*



68943—I. F. Brown—*Fruit Box.*

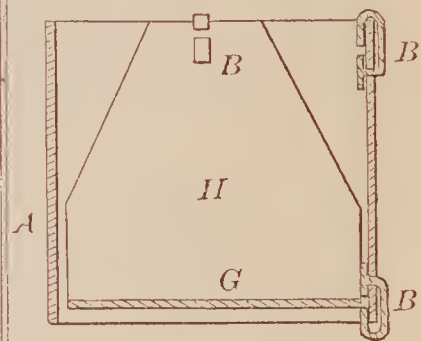

68944—N. H. Bruce—*Foot Warmer.*

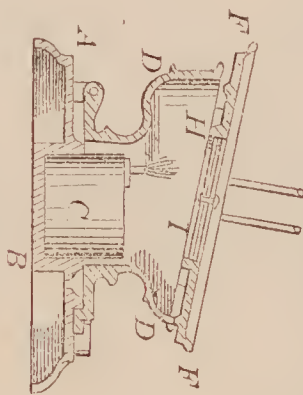

68941—C. H. Brady—*Corn Sheller.*

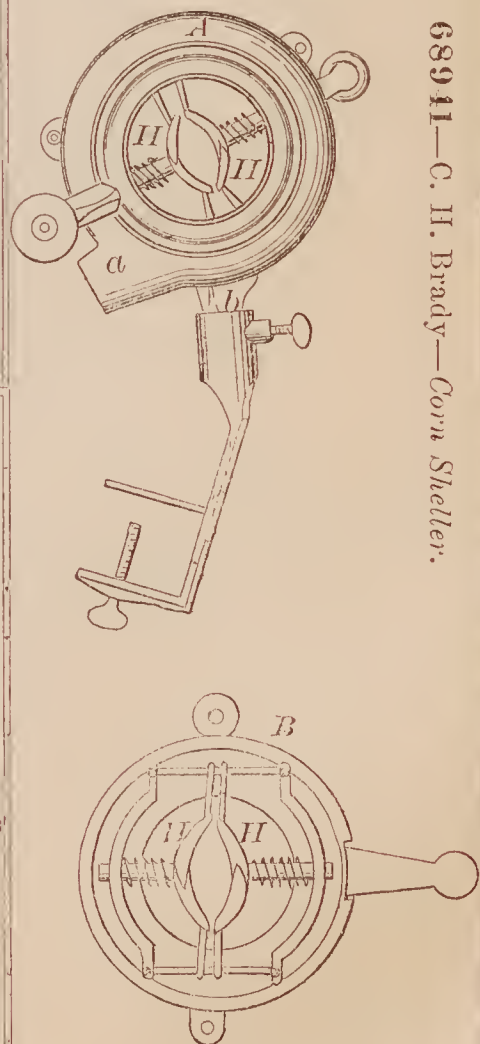

68946—E. Bucklin, Jr.—*File Cutting Machine.*

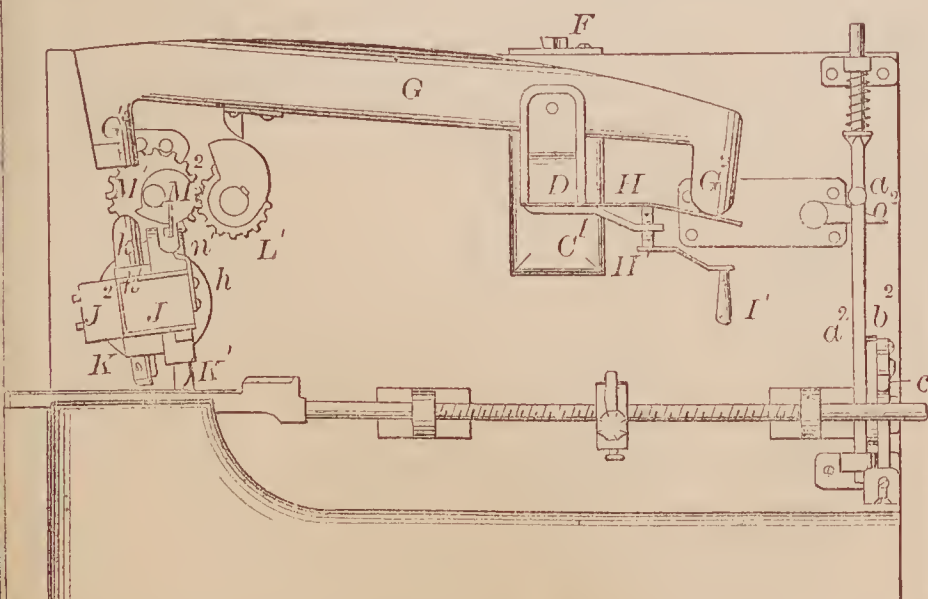







68959—A. W. Cramer—Adjustable Track for Conveying Loads by Gravity only.

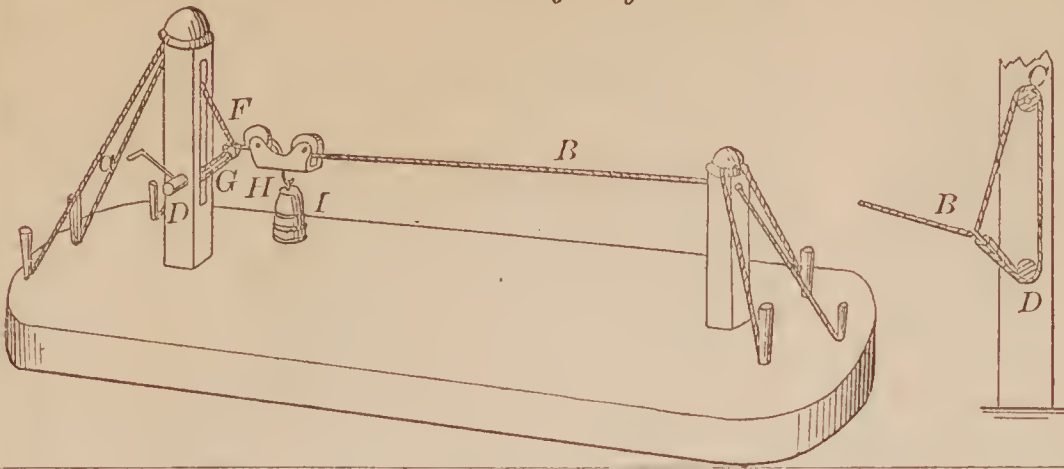

68960—J. F. Cranston—Priming Metallic Cartridges.

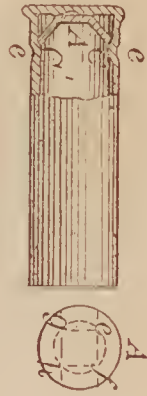

68961—L. L. Davis—Adjustable Spirit Level.

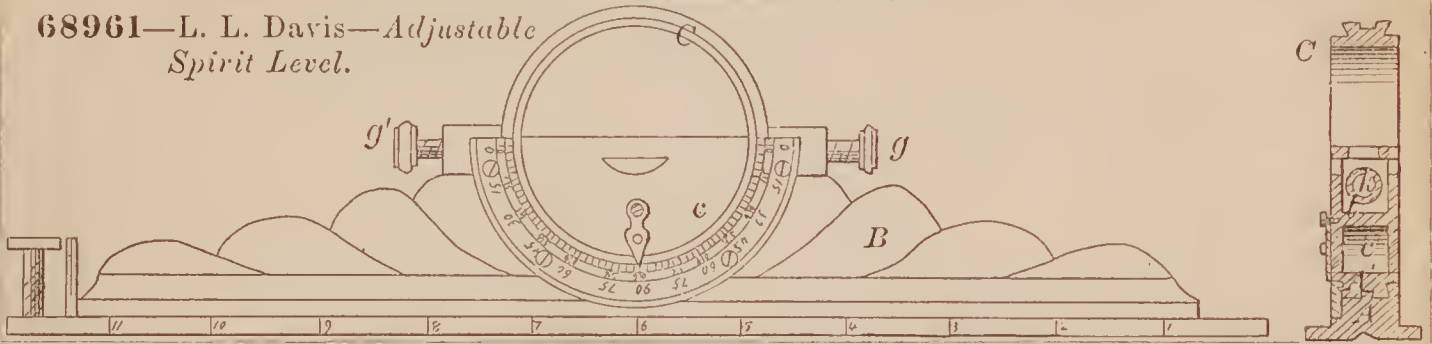

68962—Davis & Wagor—Sheet Metal Pan Former.

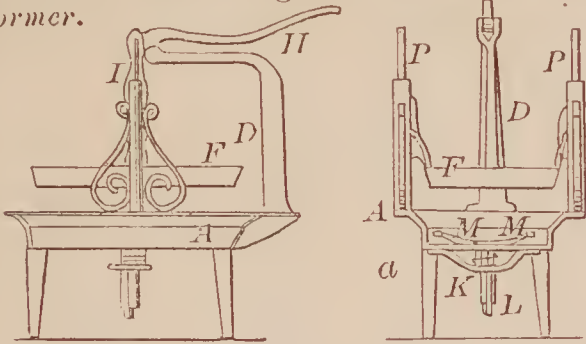

68963—Dawson, Dawson & Hilton—Balancing Mill Stones.

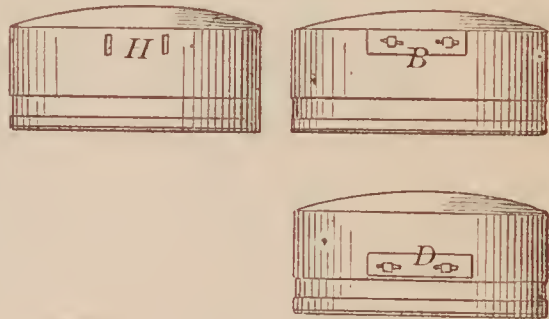

68964—H. O. Demarest—Boiler Feeder.

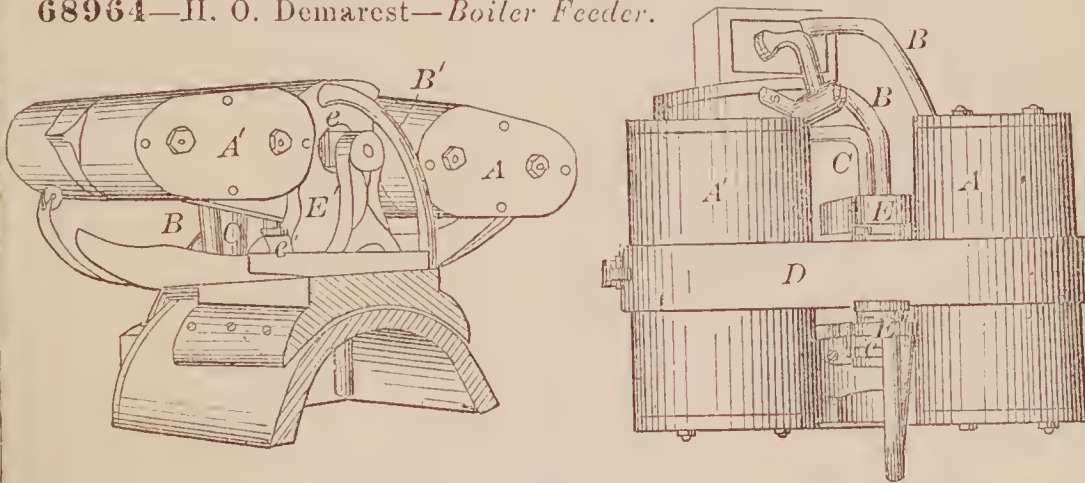

68966—T. De Witt—Carriage Spring.



68965—Denzler & Miller—Manger.

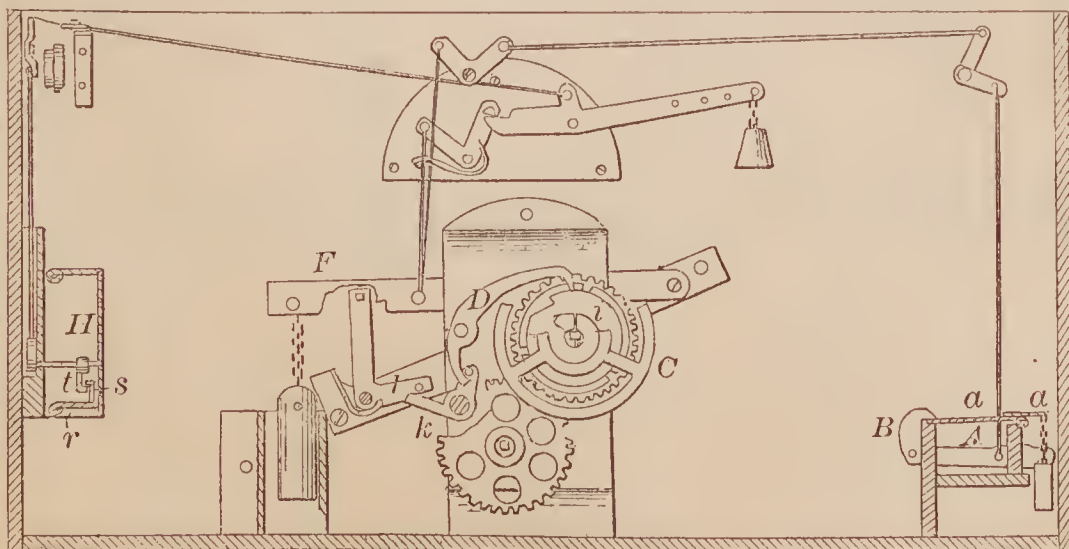

68967—G. H. Dimond—Fastening Blind Slats.

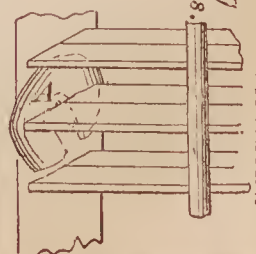



68968—F. H. Duc—Ice Cream Freezer.

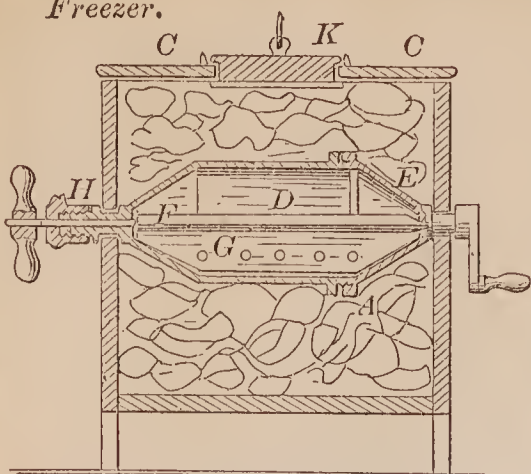

68972—L. B. Gates—For Rounding Lines.

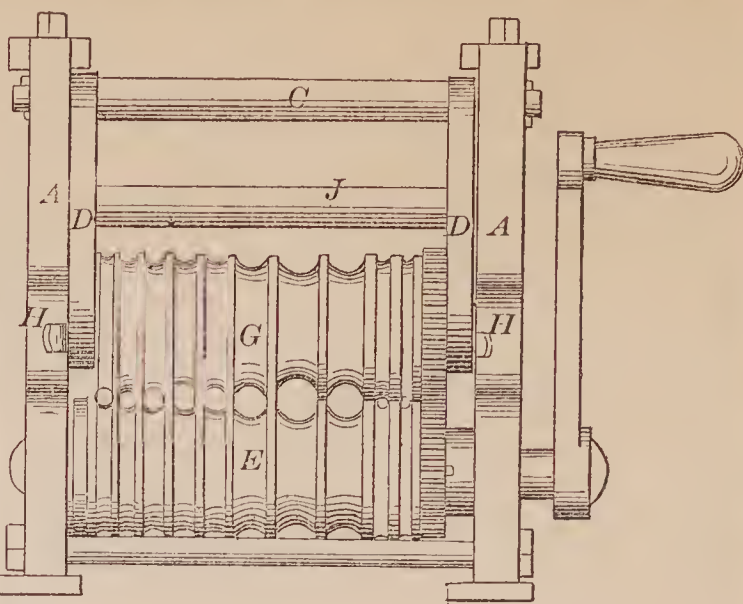

68969—T. A. Dugdale—Hand Loom.

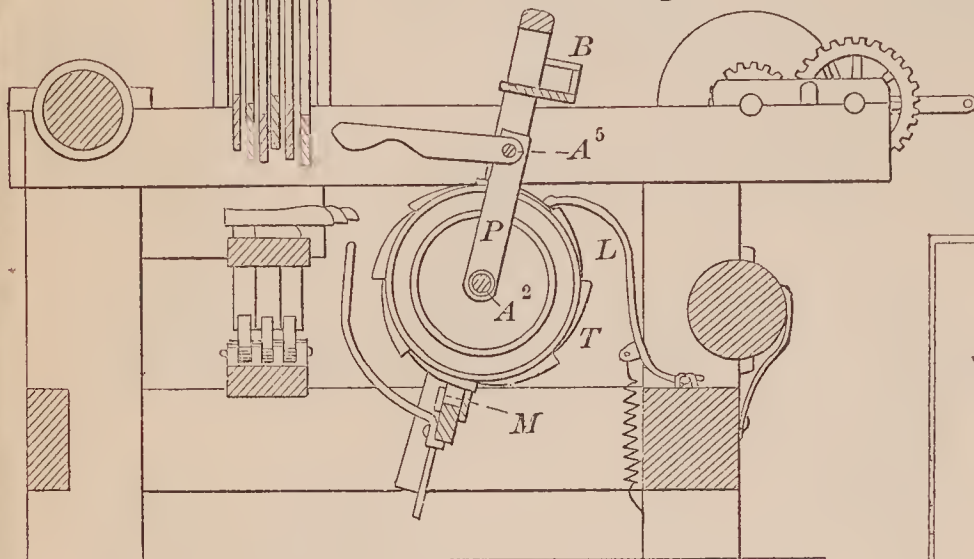

68971—F. B. Fancher—Tile for Bordering.

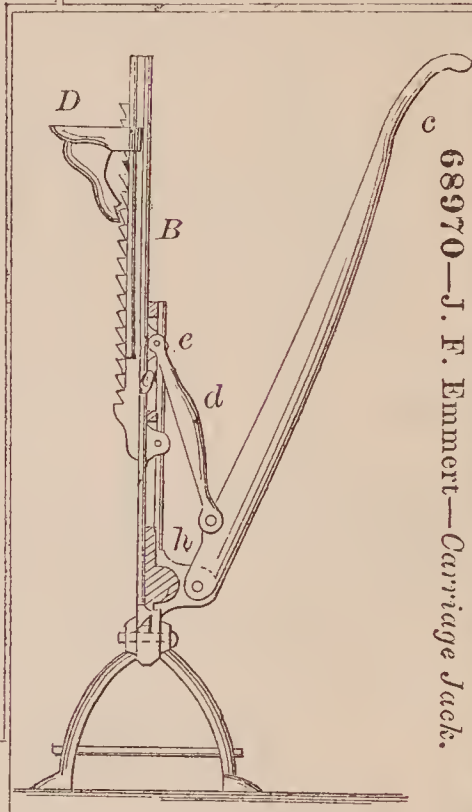
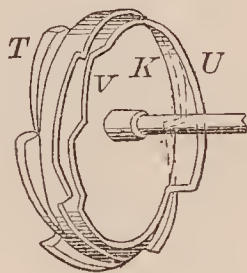
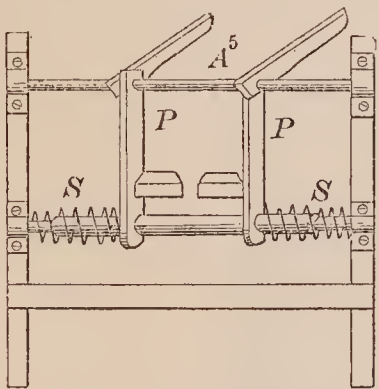
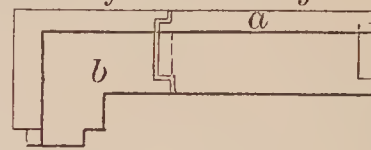

68970—J. F. Emmert—Carriage Jack.

68973—J. Gerdom, Jr.—Chair, Lounge and Step Ladder.

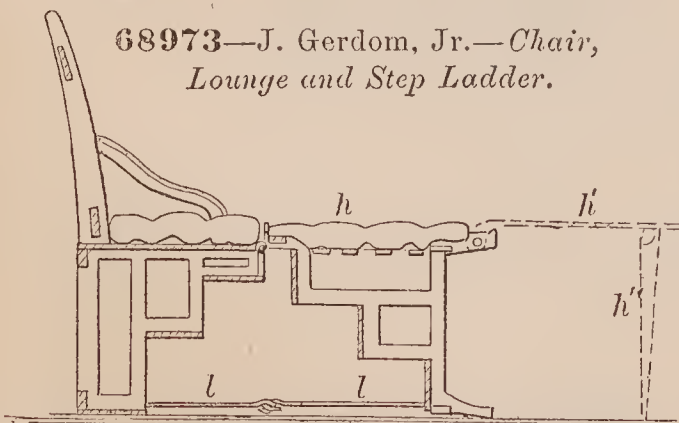

68974—S. Gibbons—For Refining and Distilling Oil.

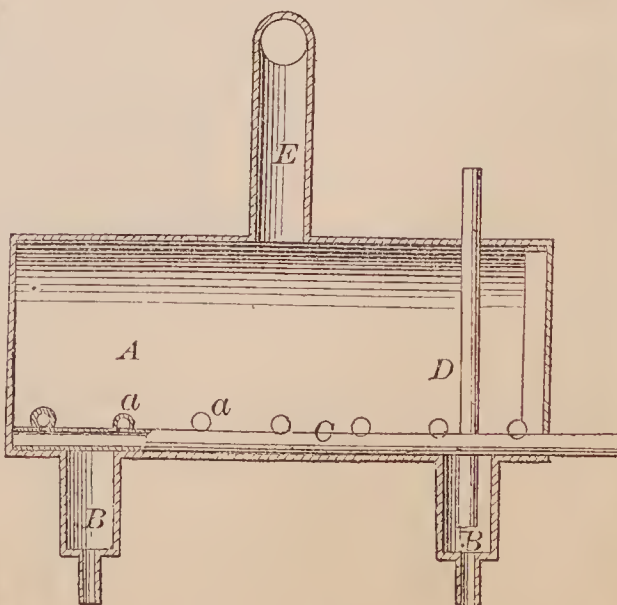

68975—Gifford & Seright—Ditching Machine.

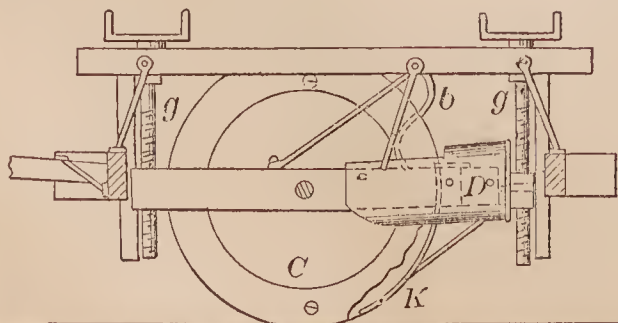

68976—E. C. Goddard—*Portable Field Fence.*

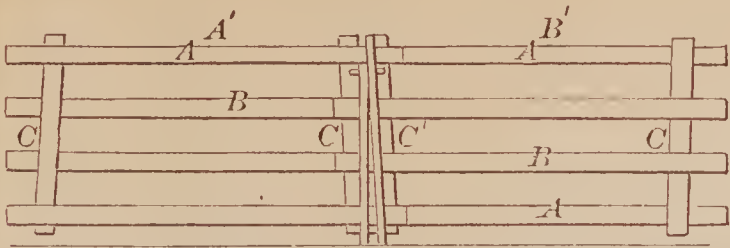

68977—N. W. Godfrey—*Dumping Cart.*

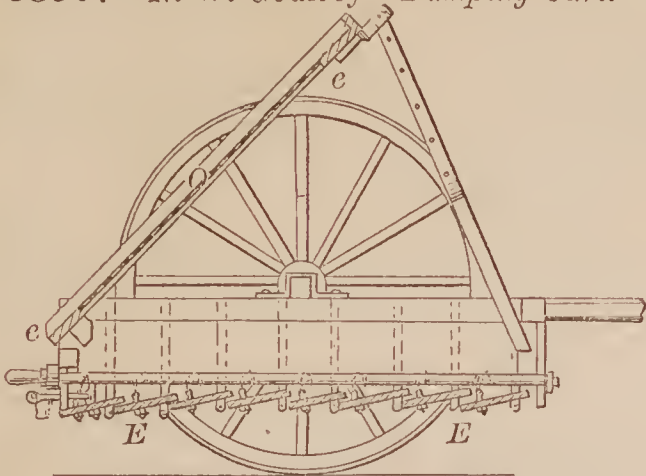

68980—S. P. Graham—*Construction of Carriage Bodies.*

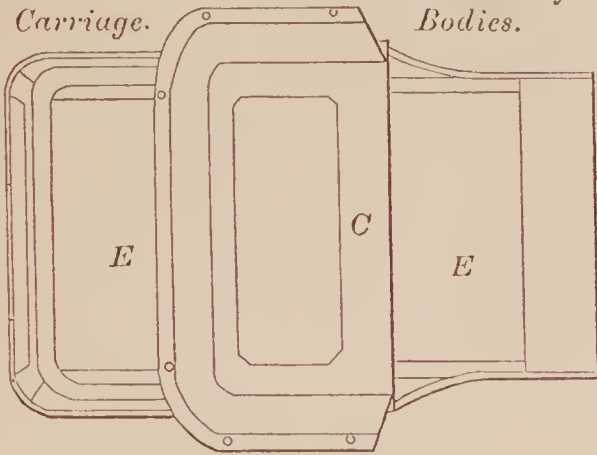

68979—Gordon & Archbald—*Barometric Vacuum Exhauster.*

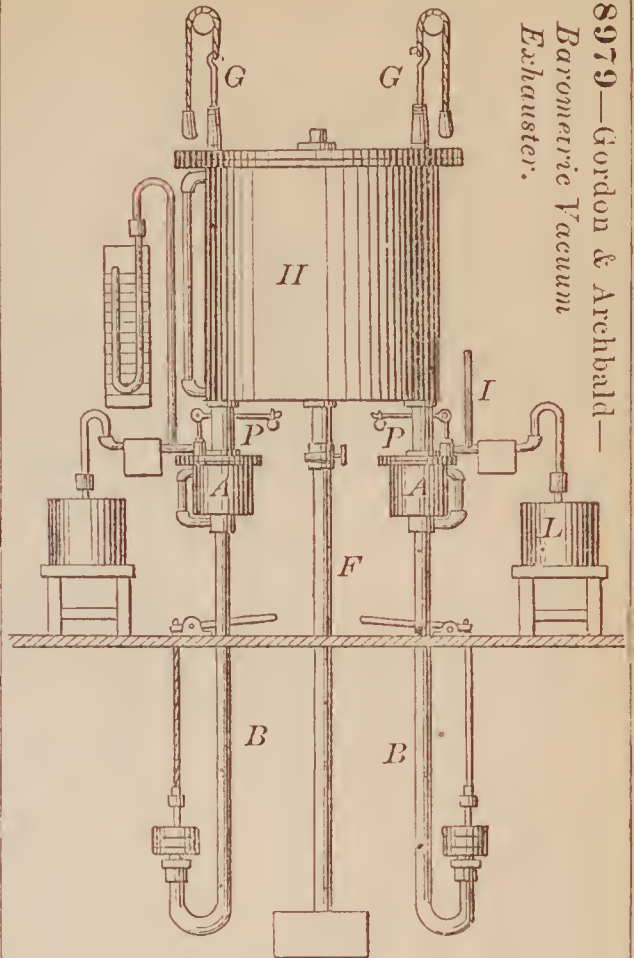

68978—Goodwin & West—*Ore Concentrator.*

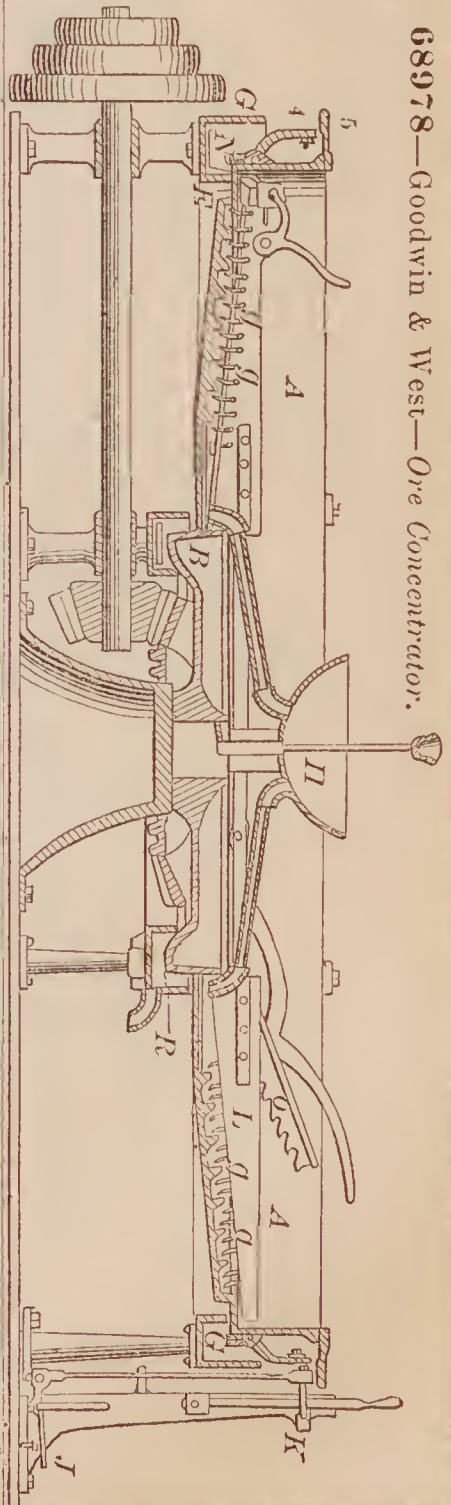

68981—D. Hanna—*Washing Machine.*

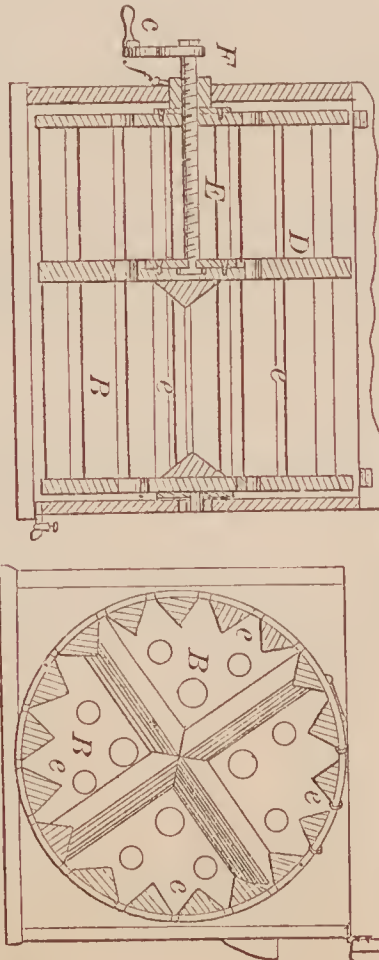

68982—W. R. Harmon—*Shovel Plow.*

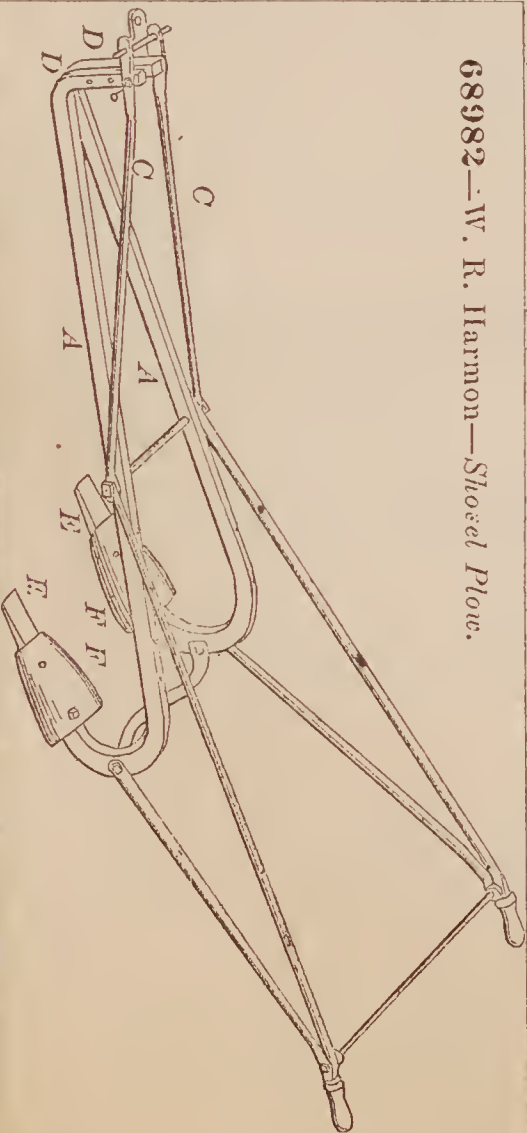



68983—L. D. Harvey—Wagon.

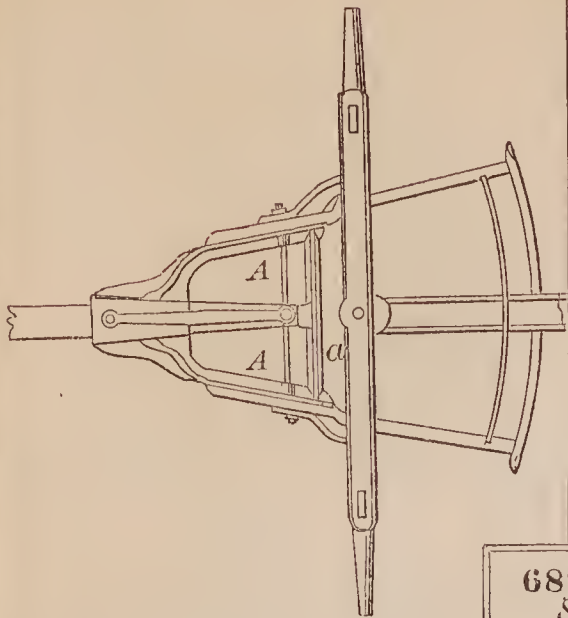

68986—Hotchkiss & Buss—Brick and Tile Machine.

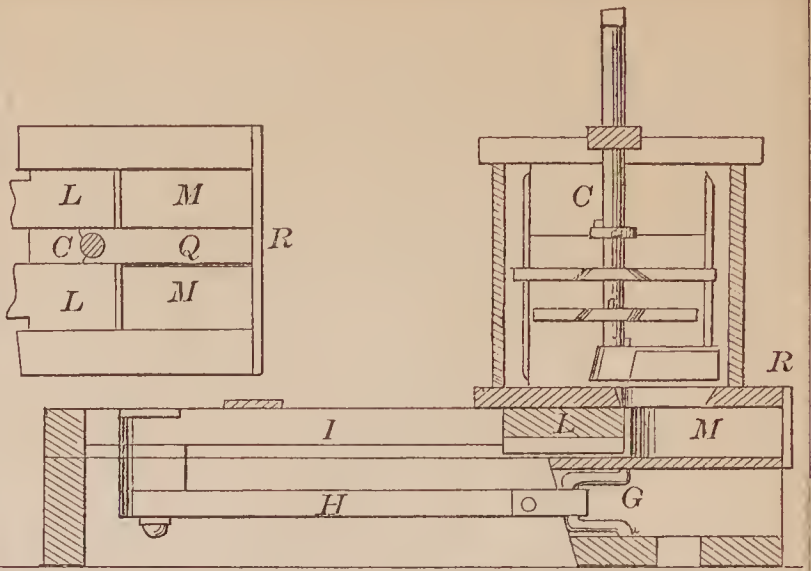

68984—C. Hellen—Egg Cup and Tongs.

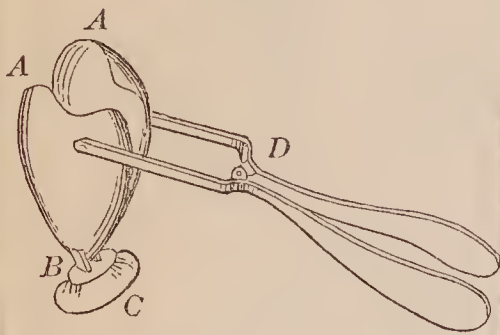

68987—H. Howard—For Heating Water and Generating Steam.

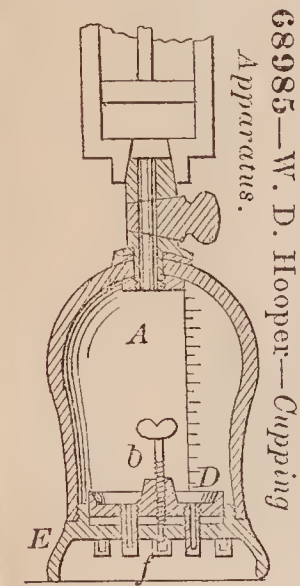
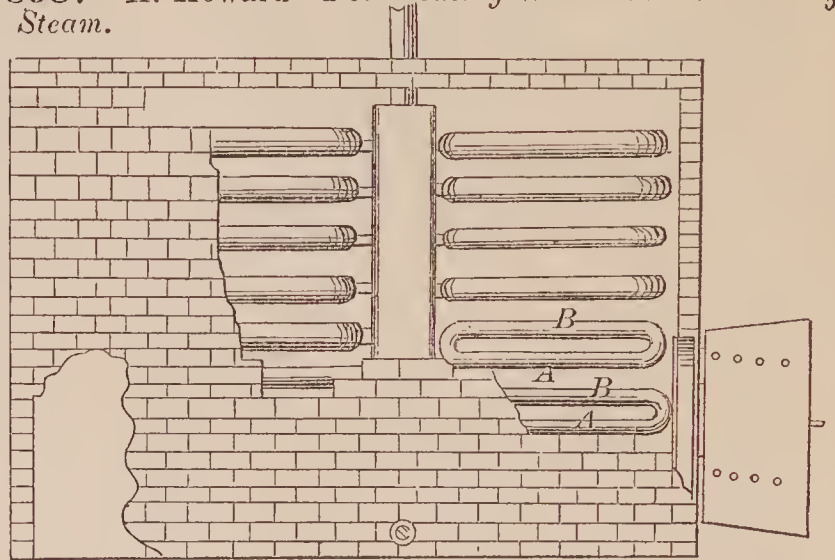

68985—W. D. Hooper—Cupping Apparatus.

68988—T. A. Huffer—Rein Holder.

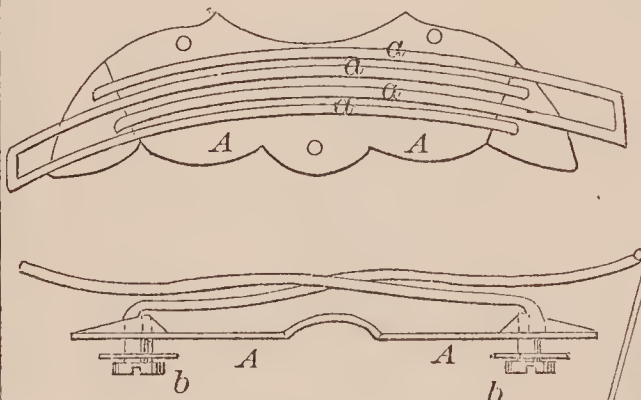

68990—J. H. Jones—Check Hook.

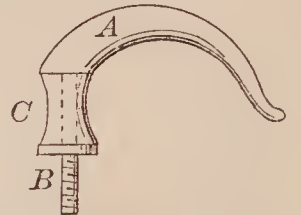

68989—N. Hunt—Engine Piston.

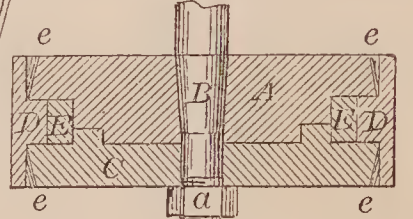

68993—J. Kerns—Hose Coupling.

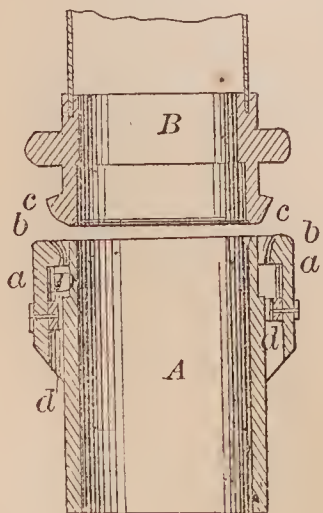

68991—D. Kaufman—Fence.

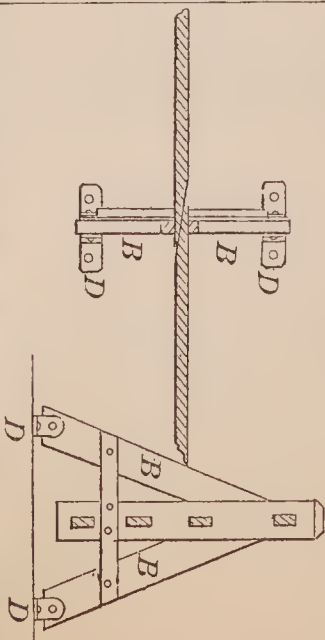

68992—G. B. Keeler—Hoisting Apparatus.

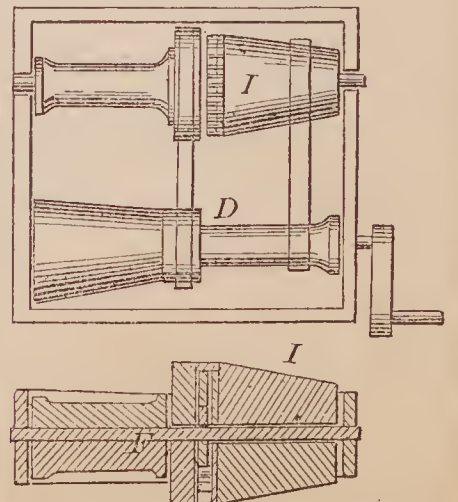

68994—J. C. King—For Operating Valves of Force Pumps.

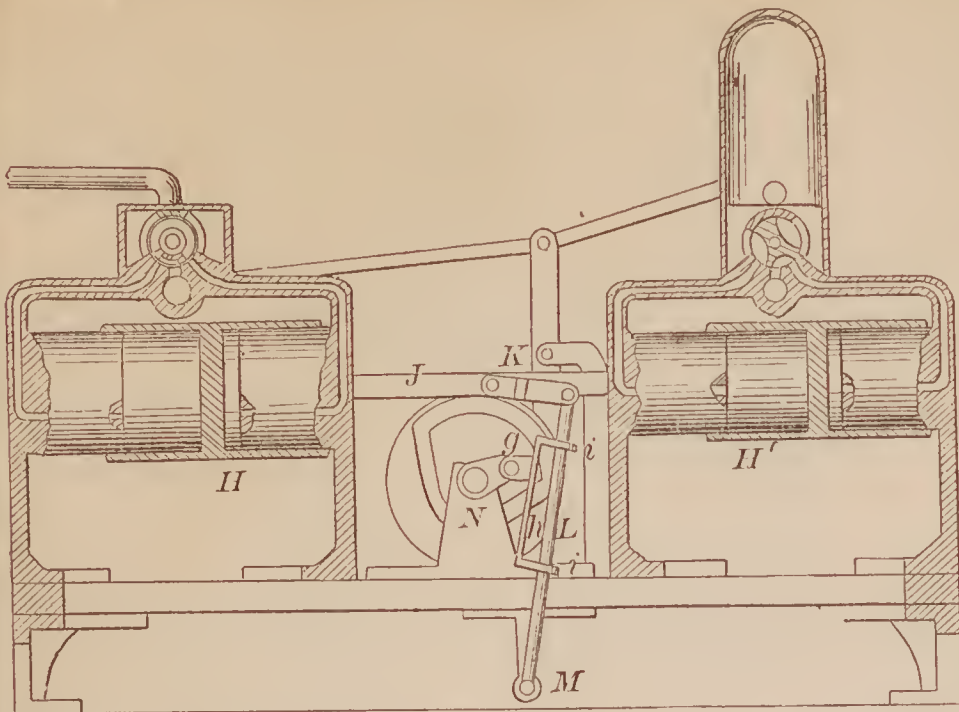

68995—M. Koppe—Injector for Insect Powder.

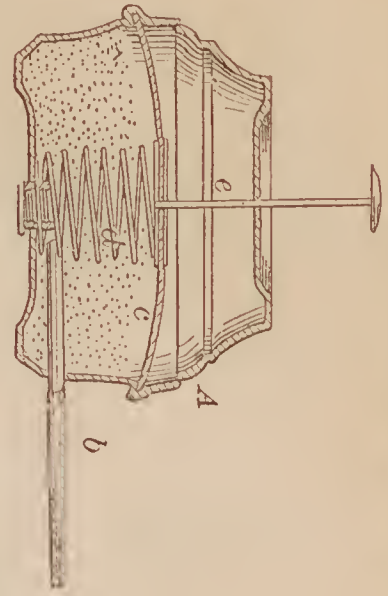

68996—E. Lake—Grain Drill.

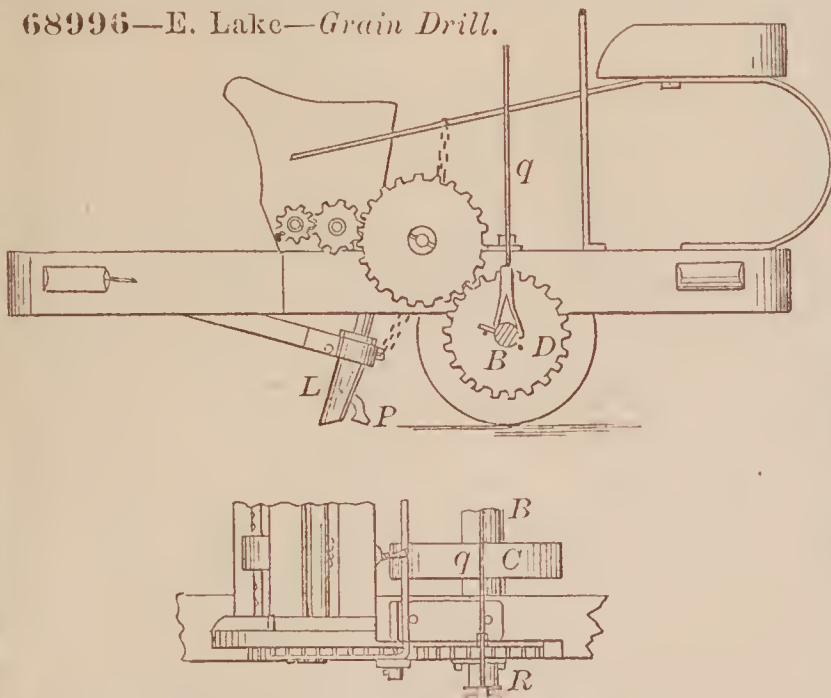

68998—S. S. Lavey—Chuck for Watchmakers' Lathes.

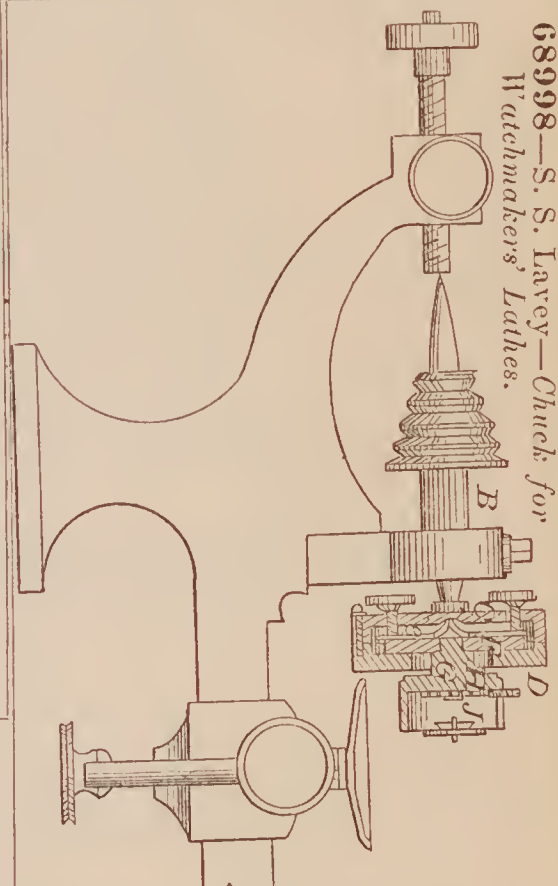

68999—J. W. Lawrence—For Securing Felloc Joints.

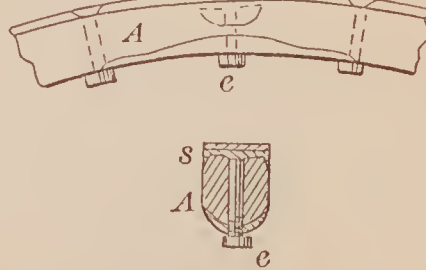

69000—E. T. Ligon—Submarine Plow.

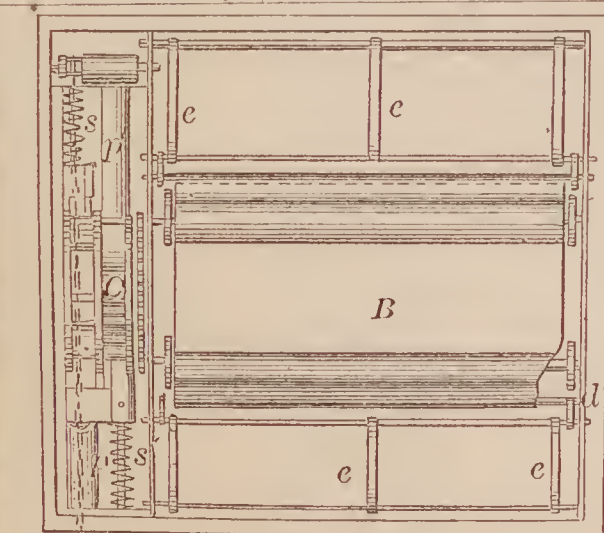
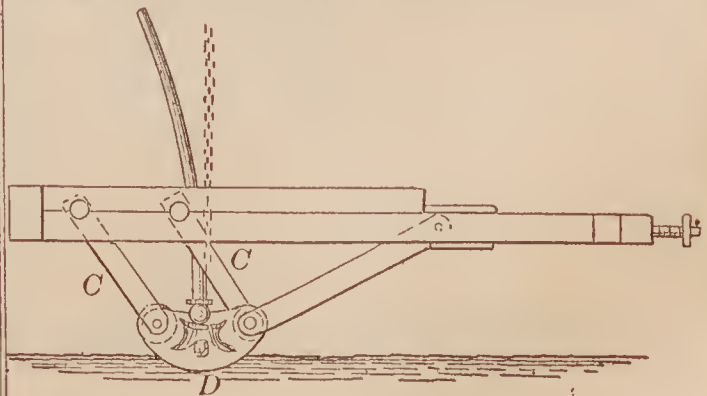

68997—G. T. Lape—Railroad Station Indicator.

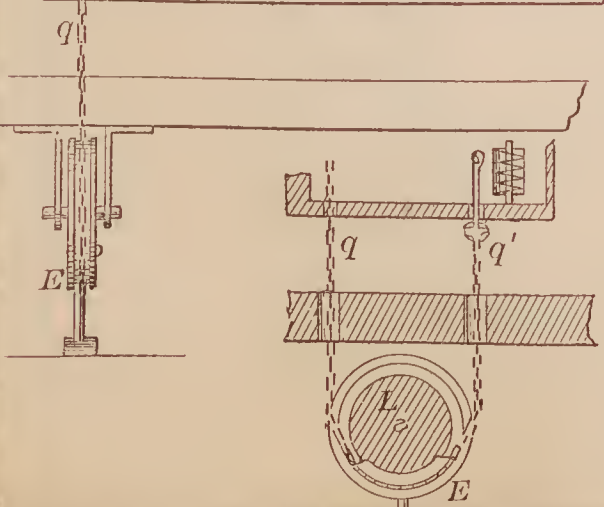





69007—J. Mason—Liquid and Gas Meter.

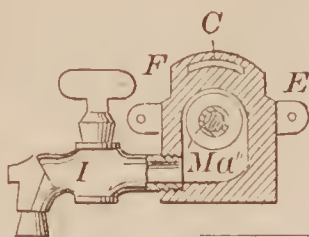
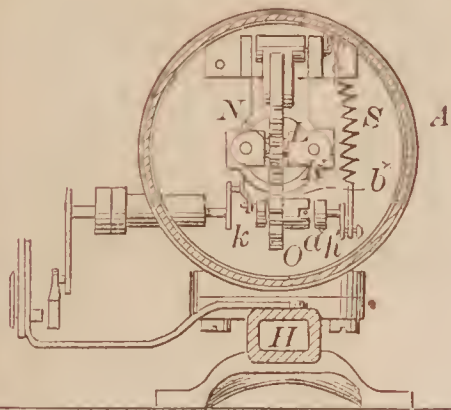
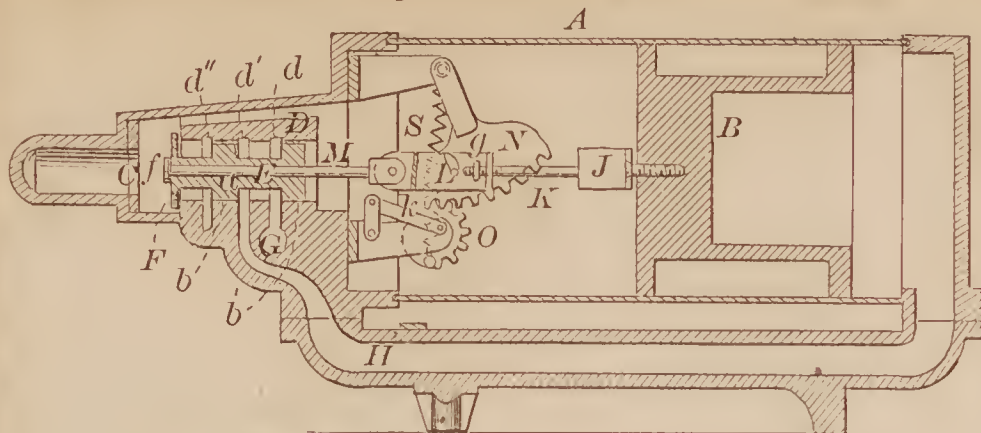

69010—J. H. Miller—Weather Strip for Doors.

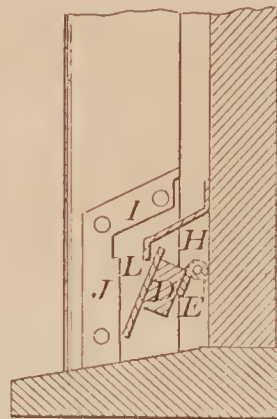

69008—F. McLaughlin—Brush.

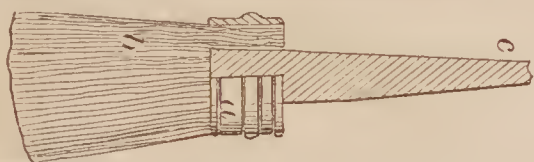

69009—W. S. Mead—Mechanical Movement.

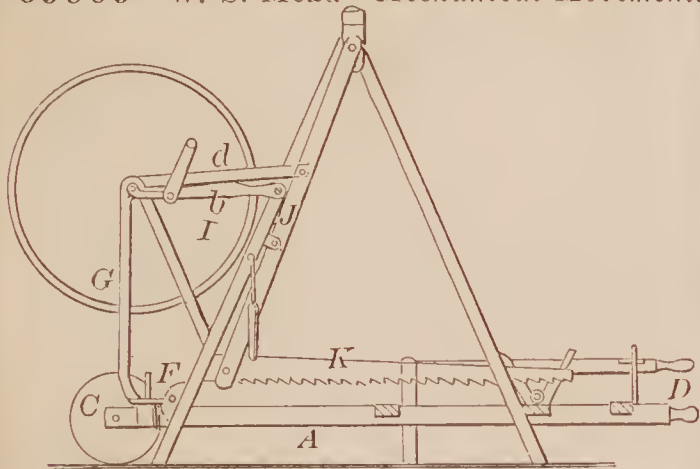

69011—W. H. Miller—Rake and Spade.

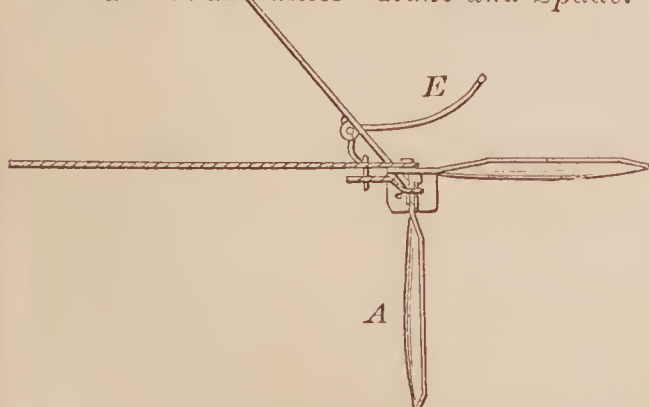

69012—Minor & Ward—Three-Wheeled Vehicle.

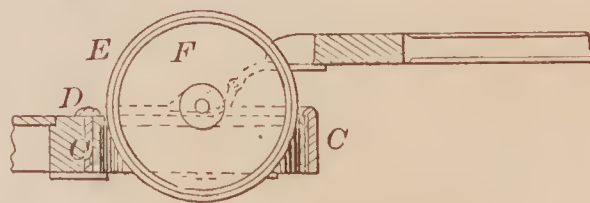
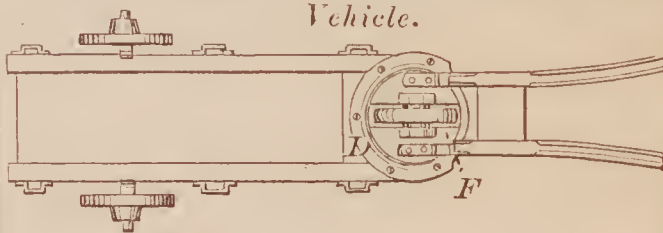

69015—F. W. Neubert—Truss.

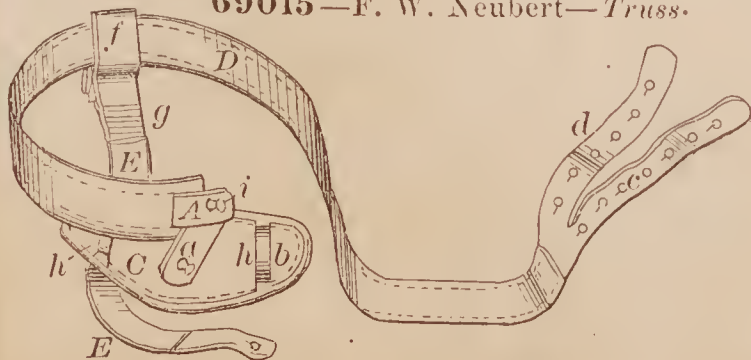

69014—E. J. Moore—Tube Expander.

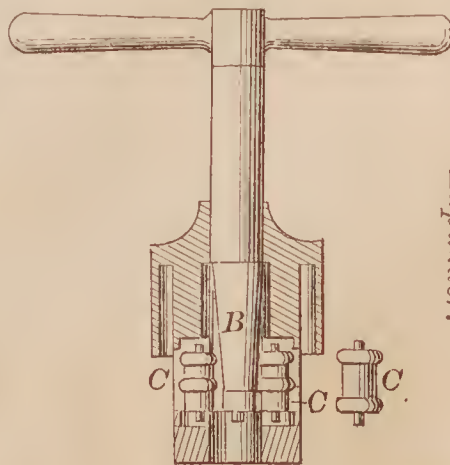



69016—E. M. Noyes—  
Curry Comb.

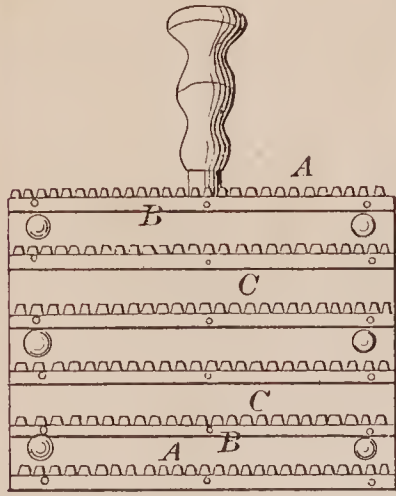

69018—G. M. Peters—*Harvester.*

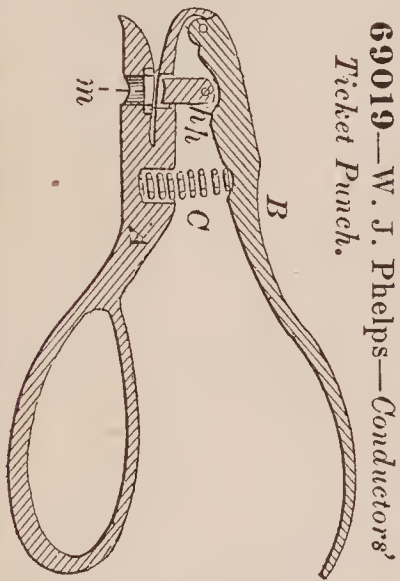
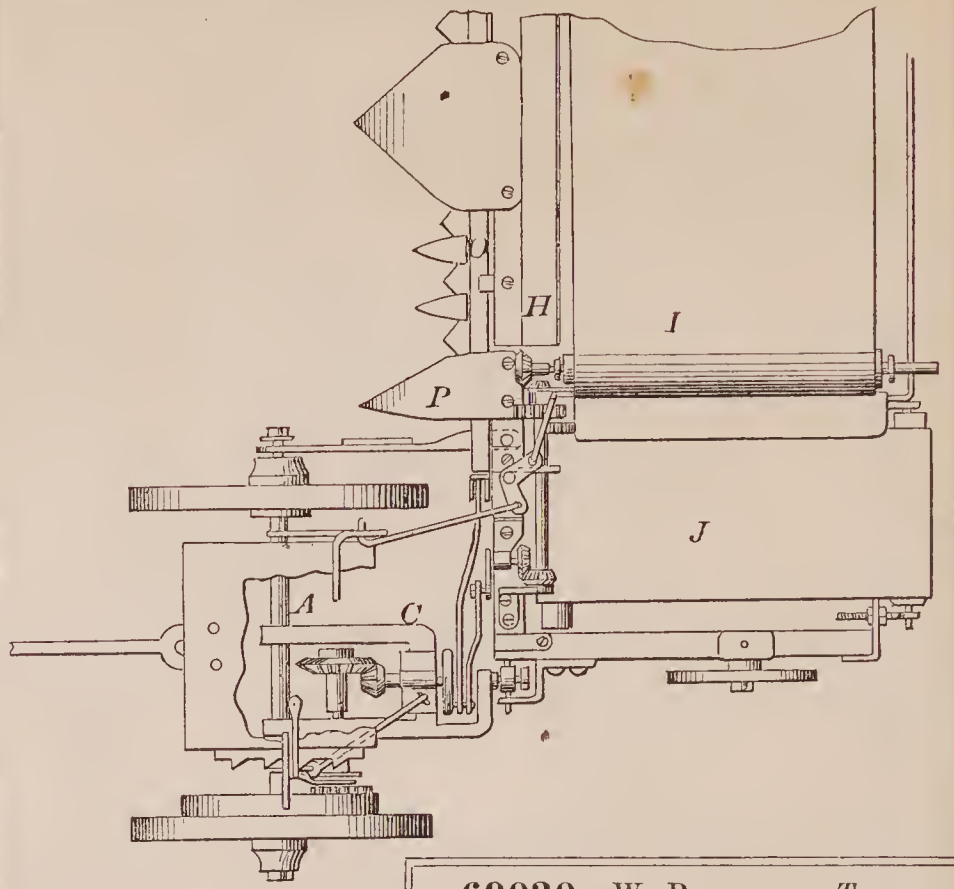

69019—W. J. Phelps—*Conductors' Ticket Punch.*

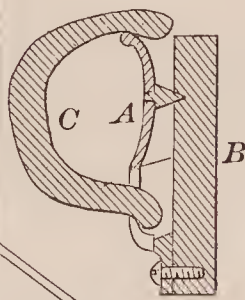

69021—S. S. Putnam—  
*Clothes Hook.*

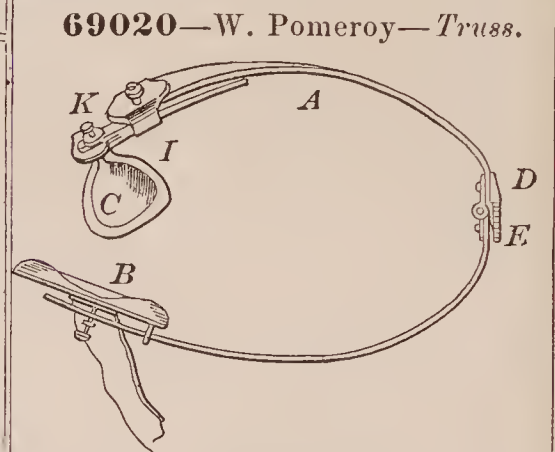

69020—W. Pomeroy—*Truss.*

69022—S. S. Putnam—  
*Stall for Animals.*

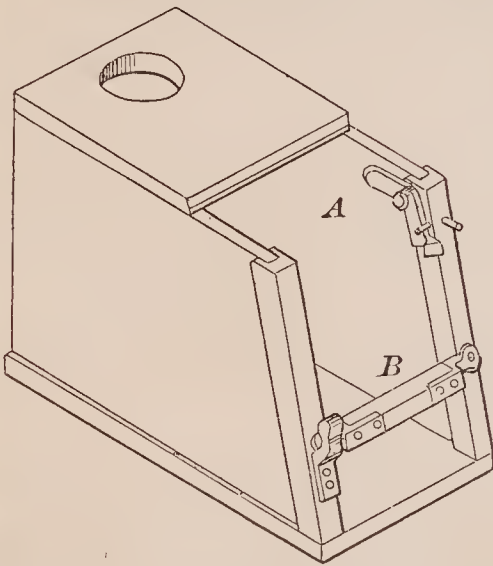

69023—Randall & Williams—*Clothes Dryer.*

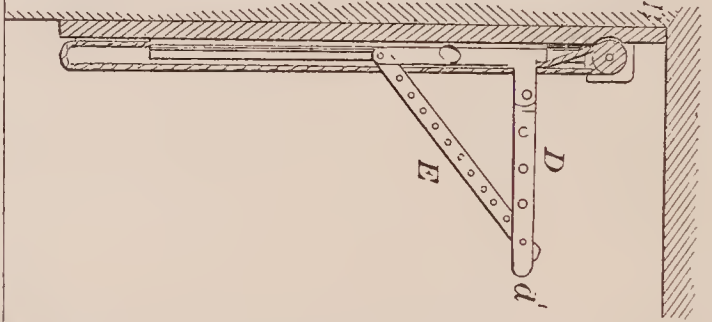

69024—E. Reynolds—*Gate.*

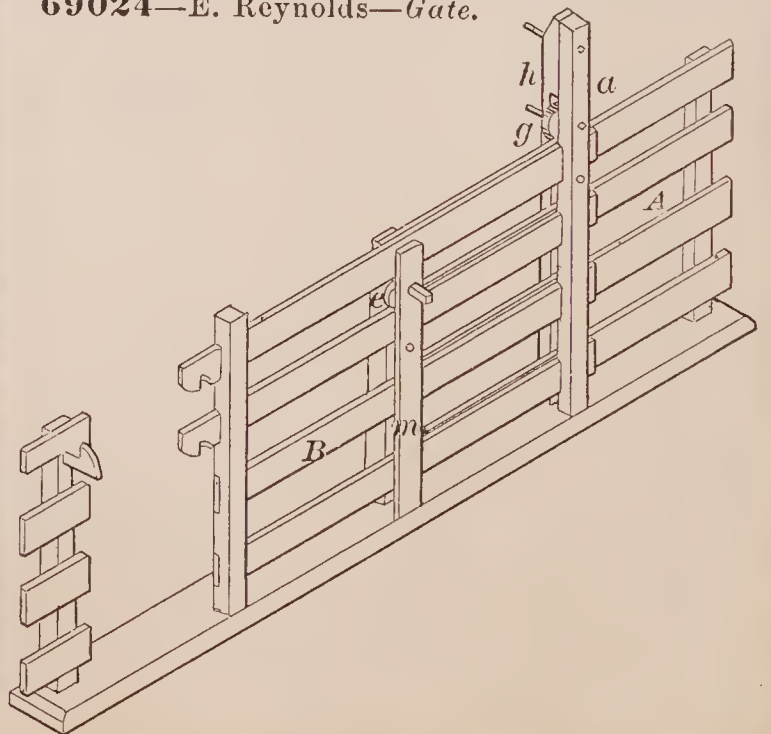

69017—P. Perry—*Coffee Pot.*

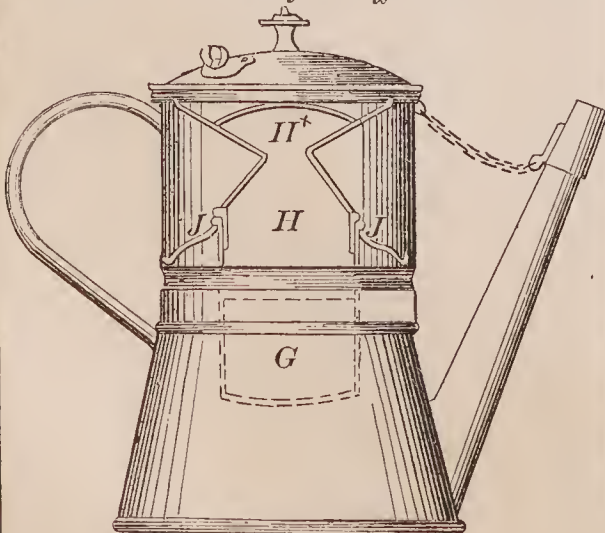

69025—A. H. Richardson—For Smelting Ores of Silver.

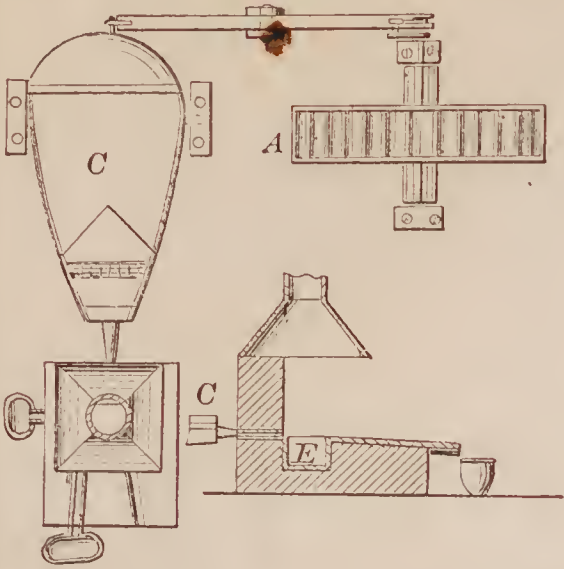

69027—D. C. Robie—Hitching Post.

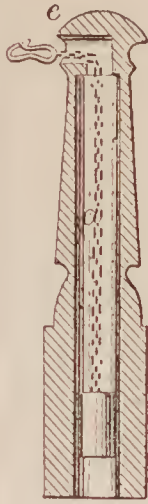

69028—J. L. Rowe—Tyruss.

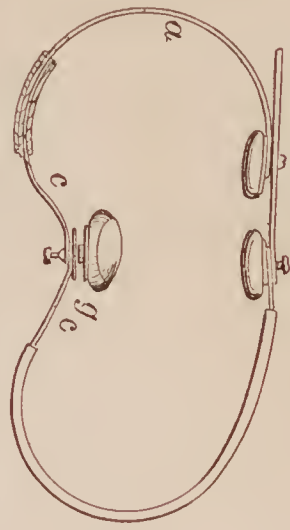

69026—E. Richmond—Rack for Brooms, Billiard Cues, &c.

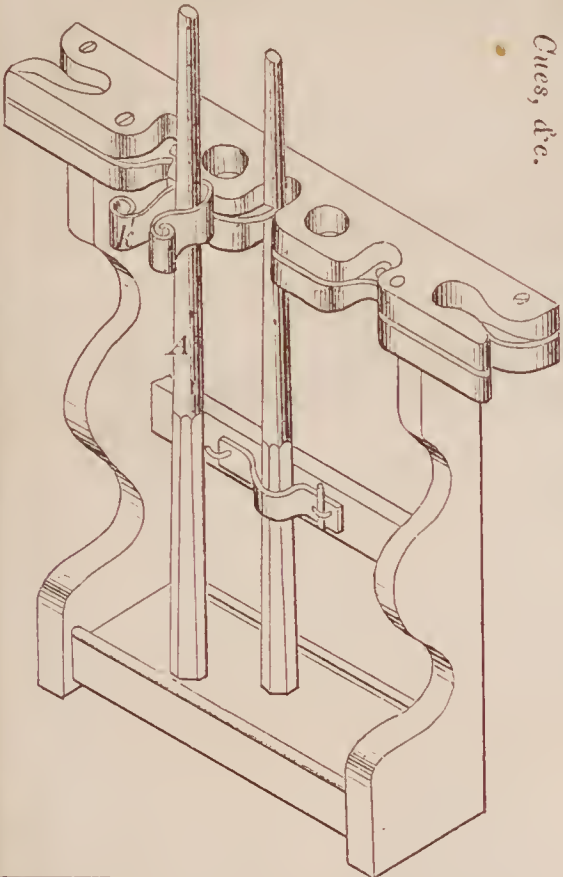

69030—N. S. Ryder—For Washing Ores.

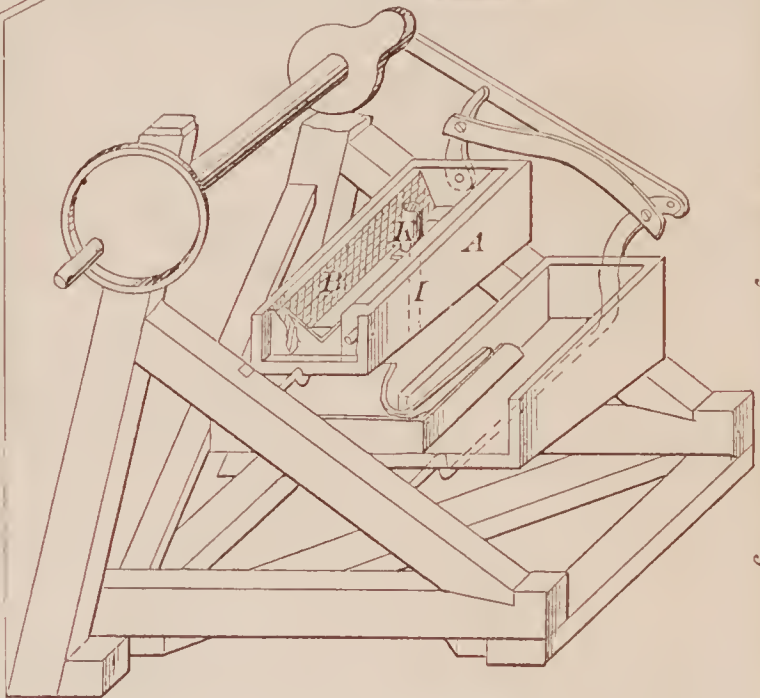

69032—W. Schmitt—Coat and Hat Hook.

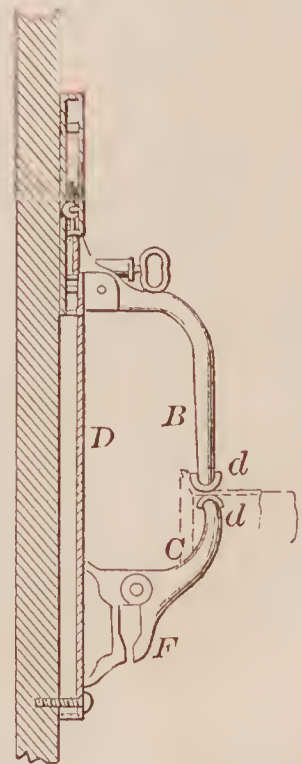

69029—M. V. B. Rowley—Churn.

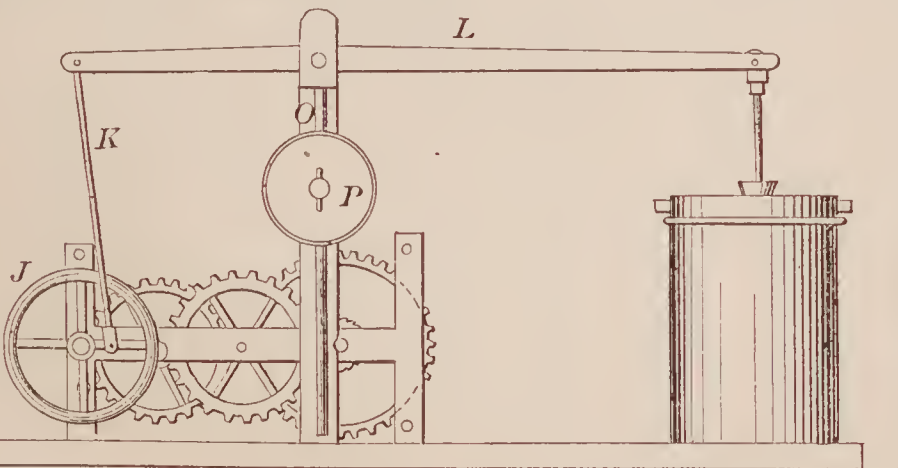

69031—Schindler & Metzger—Punch.

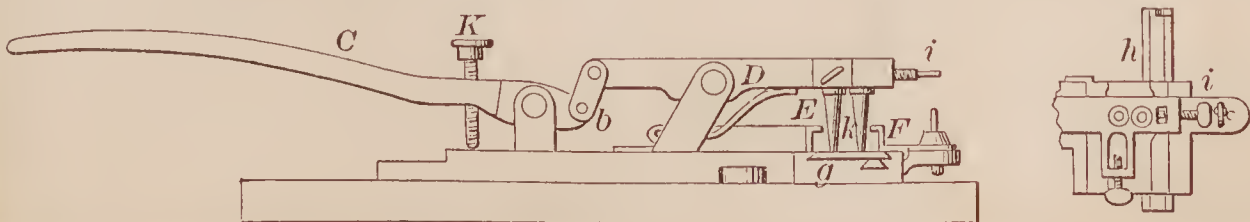



69033—A. H. Sherwood—*Door Bolt.*

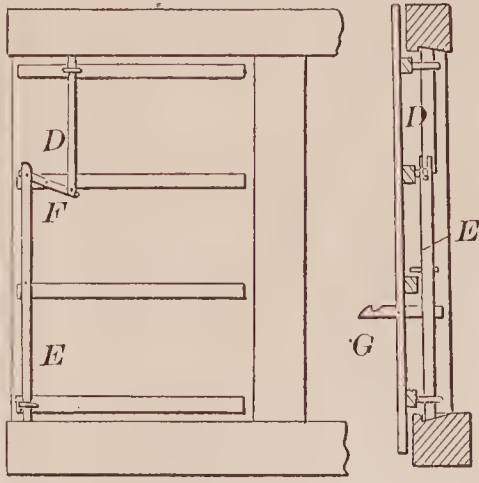

69035—A. P. Smith—*Wagon Brake.*

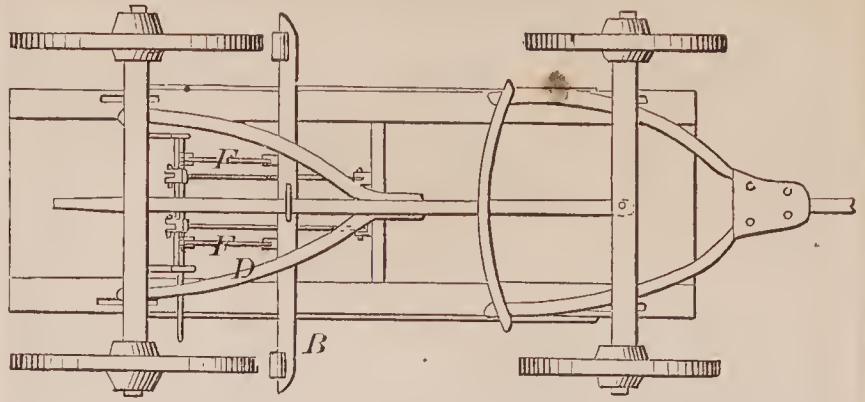

69034—G. W. Slater—*Bow Irons for Vehicles.*

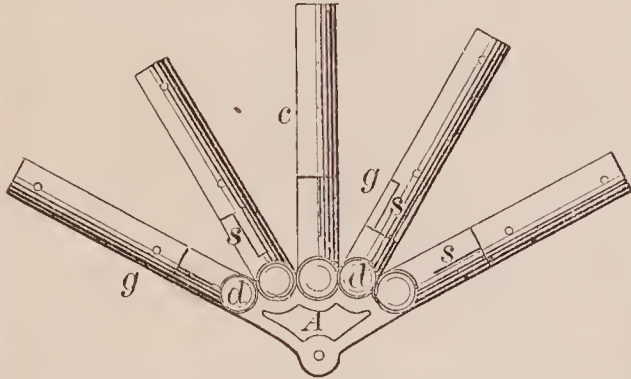

69037—J. F. Spence—*Hydro-Carbon Vapor Machine.*

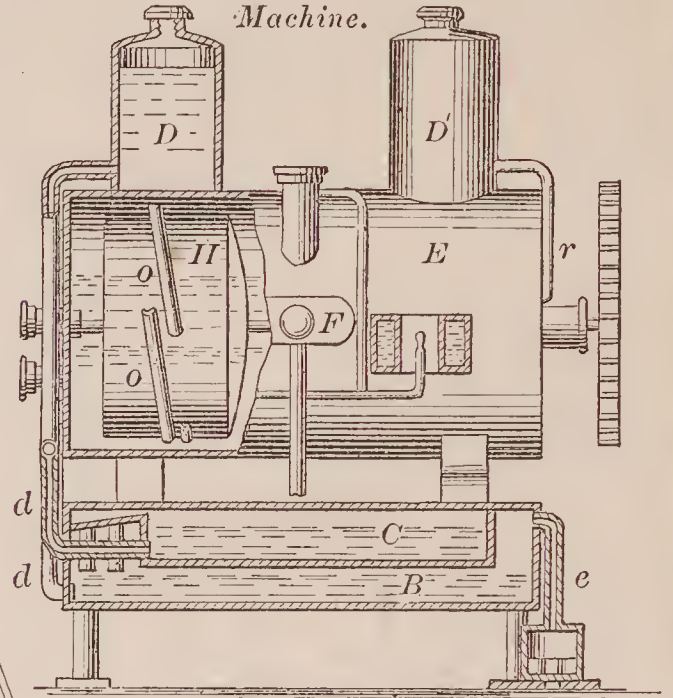

69036—G. W. Snyder—*Horse Rake.*

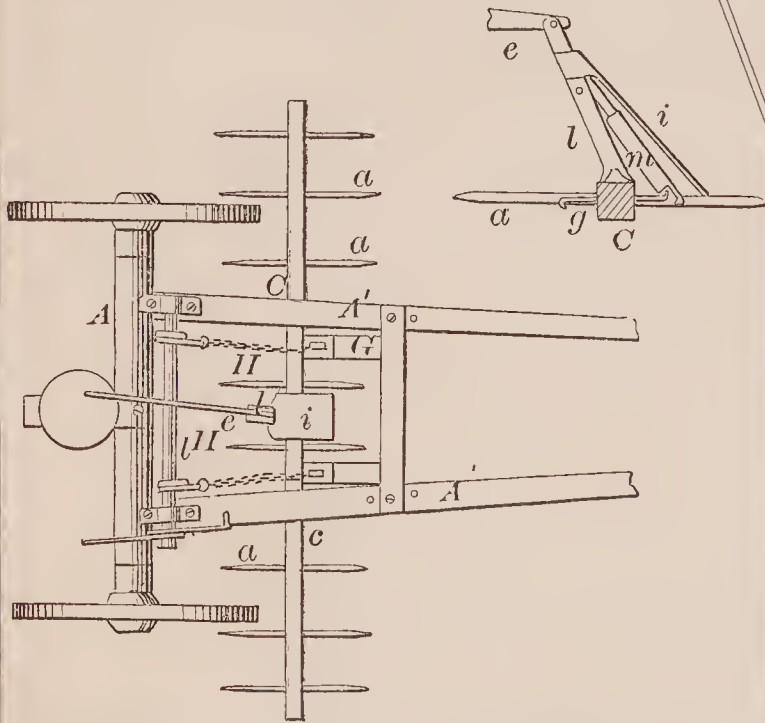

69038—J. C. Spencer—*Odometer.*

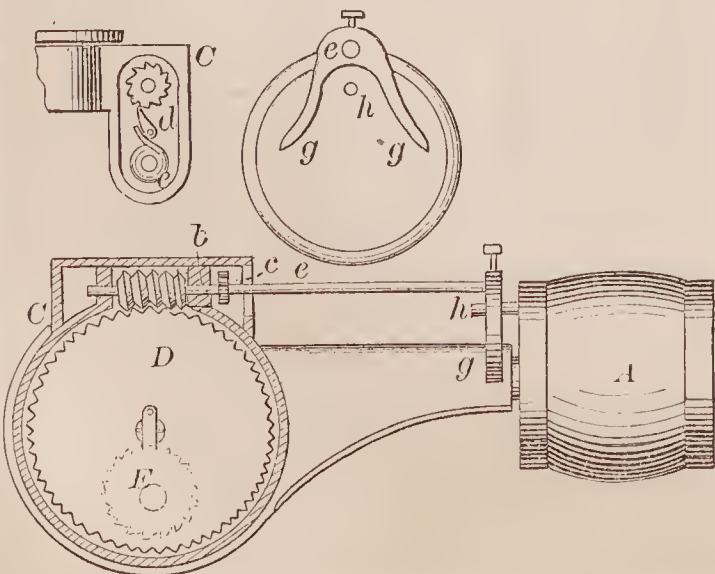

69039—J. B. Stearns—*Fire Alarm Telegraph.*

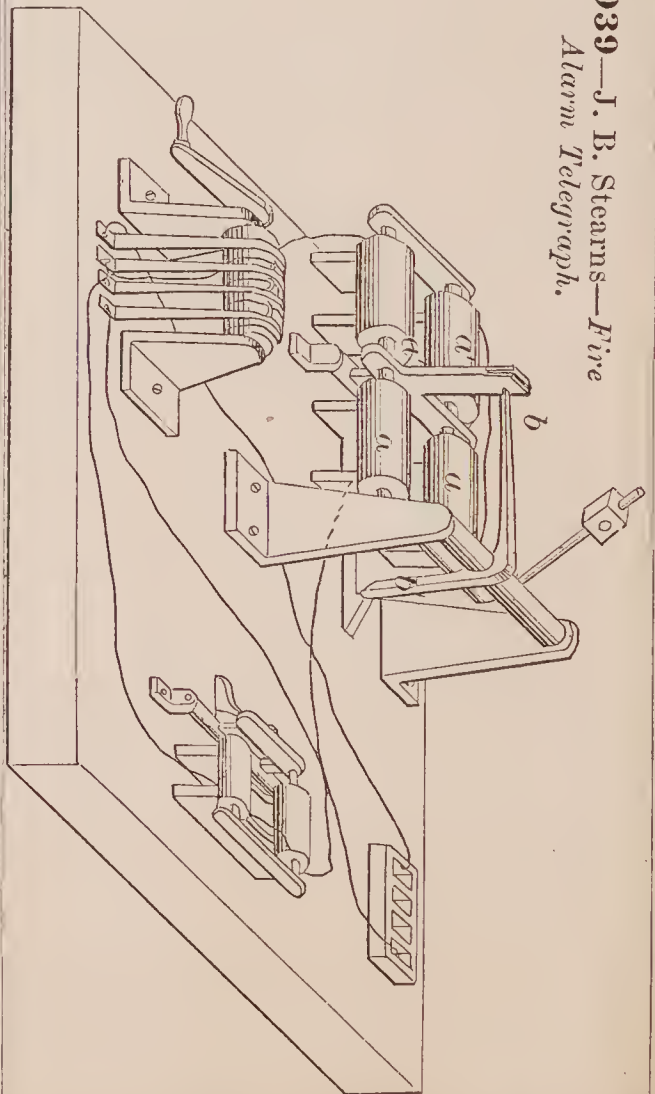

69040—H. C. Stone—Pegging Machine.

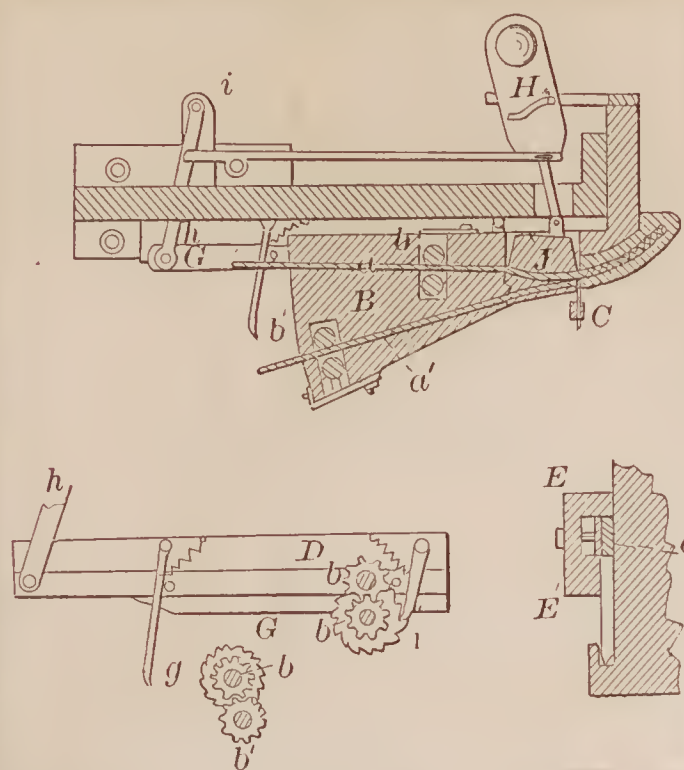

69041—J. M. Stone—Hanger.

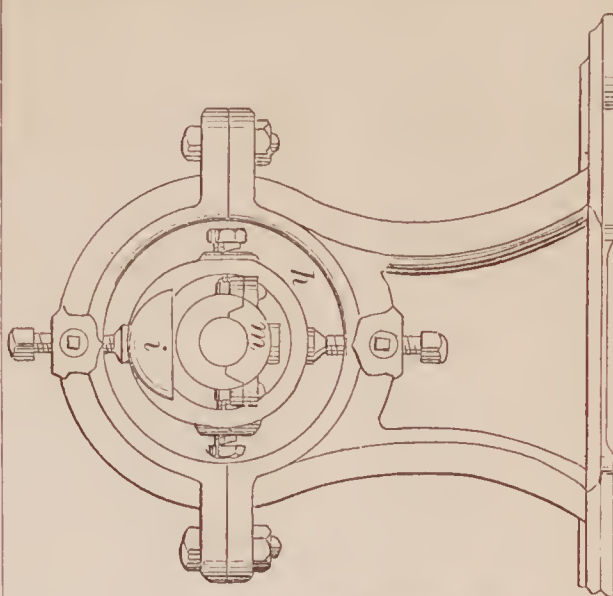

69045—C. M. Terrell—Hay Shocker.

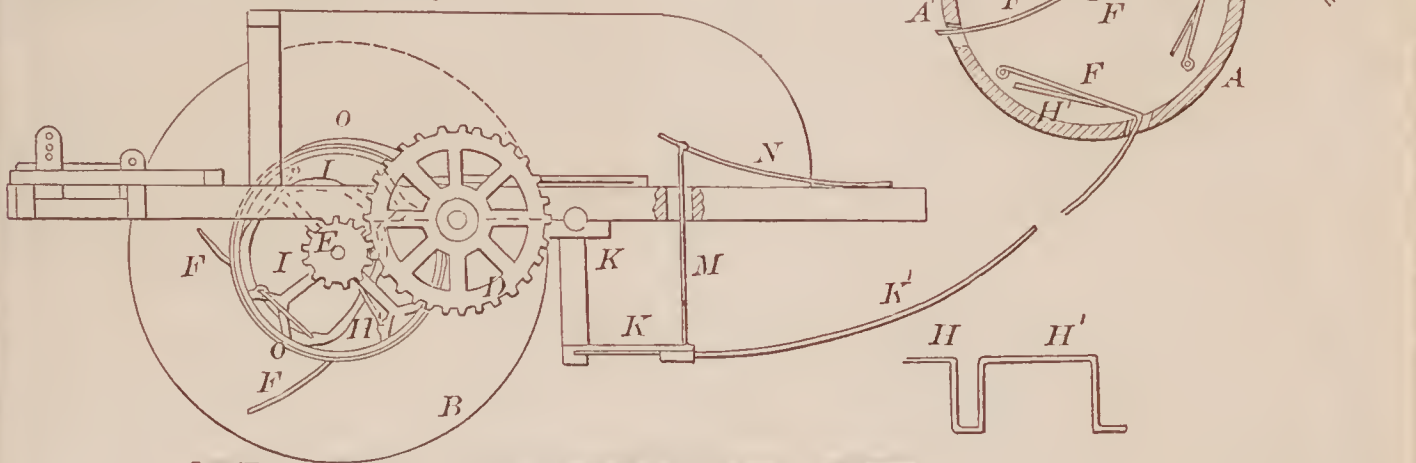

69046—R. Thomas—Window Sash.

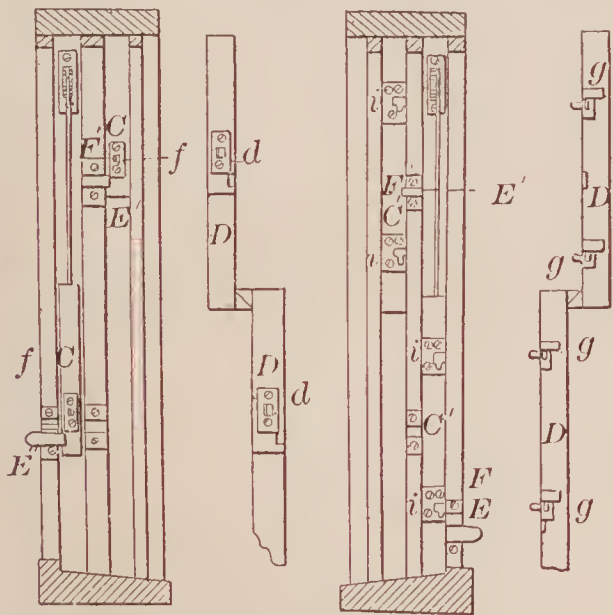

69044—J. W. Taylor—Shaft Coupling.

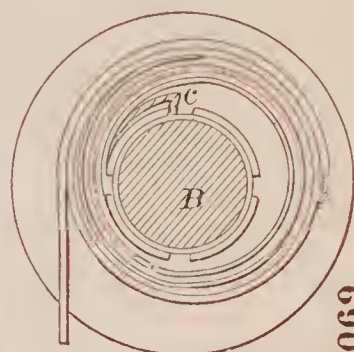

69048—J. B. Thornton—For Hitching Horses



69047—Thompson & Fox—Hand Loom.

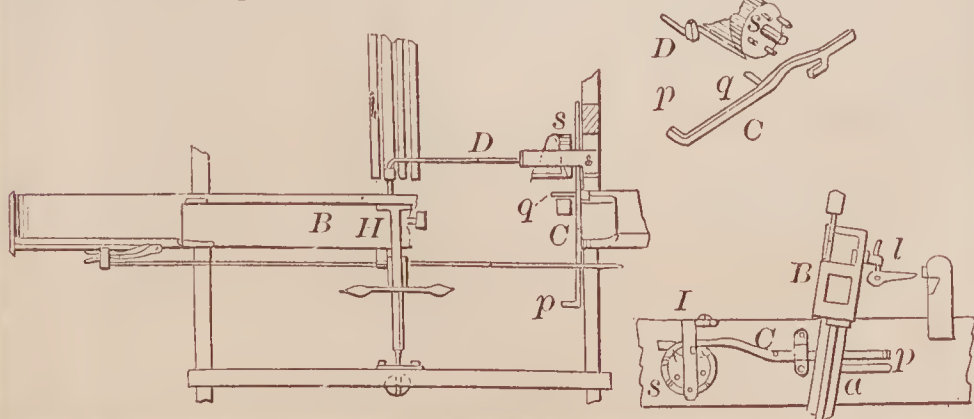



69049—B. F. Turner—*Fruit Ladder.*

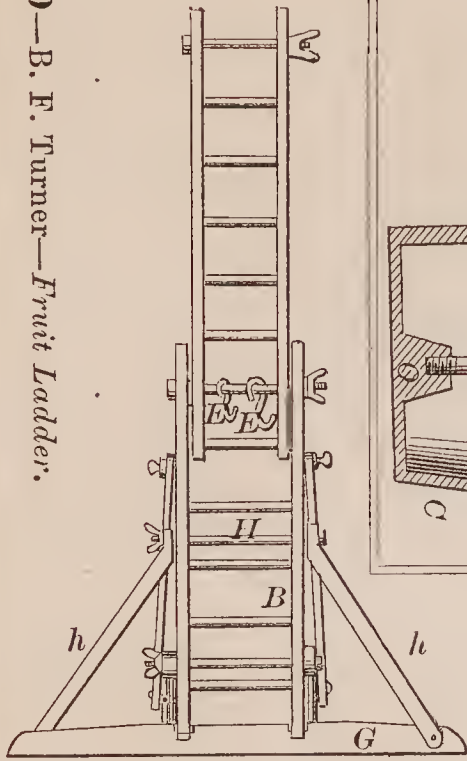

69051—R. Vandervort—*Boot Heel.*

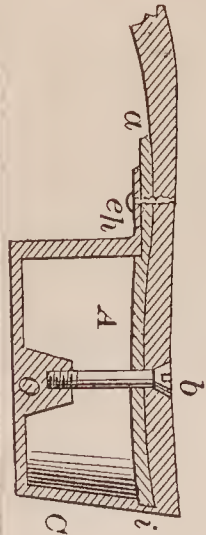

69055—T. Whitmore—*Head Block for Saw Mills.*

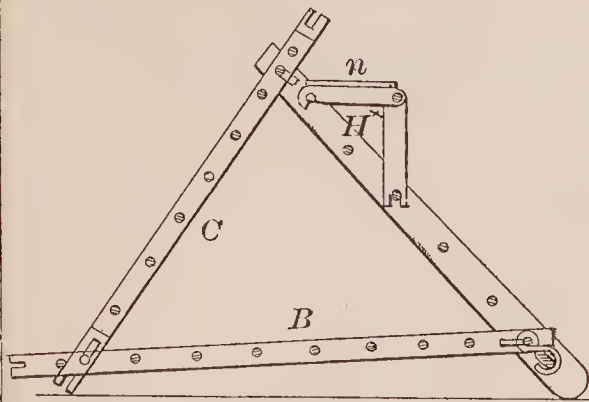
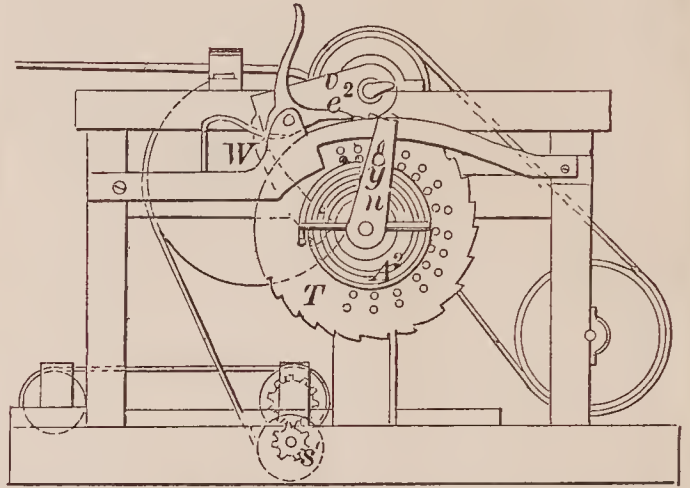
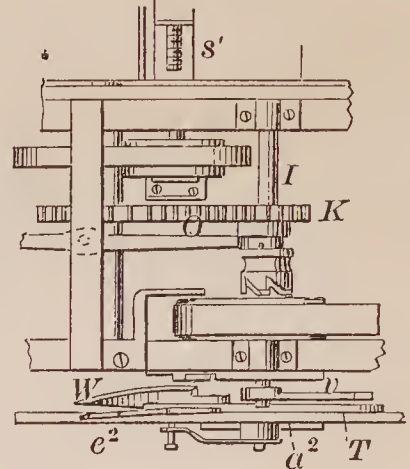

69050—E. W. Vaill—*Folding Chair.*

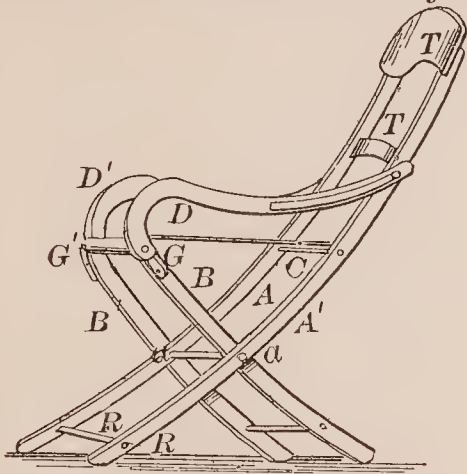

69052—A. K. P. Walker—*Breastpin Fastening.*

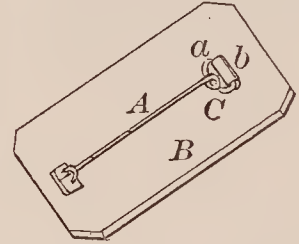

69053—A. Warren—*Regulating Device for Watches.*

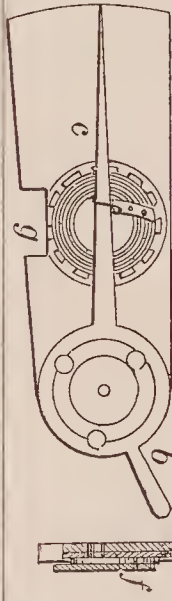

69054—G. Watkins—*For Mixing Liquids.*

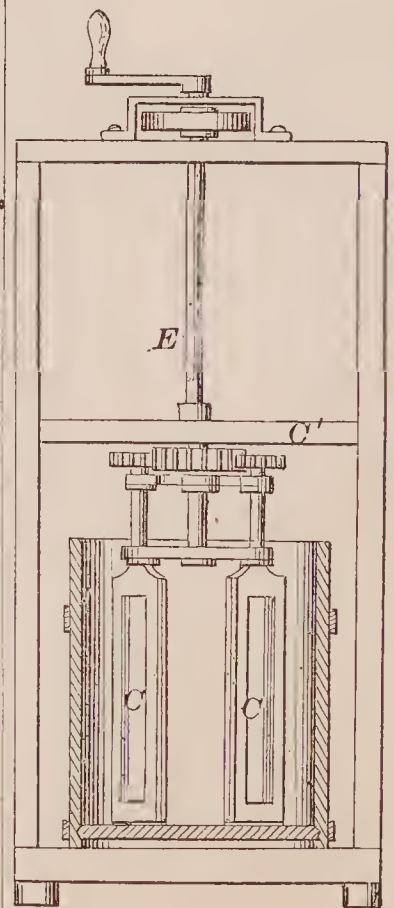

69056—L. R. Wiggin—*Waxing Device for Sewing Machines.*

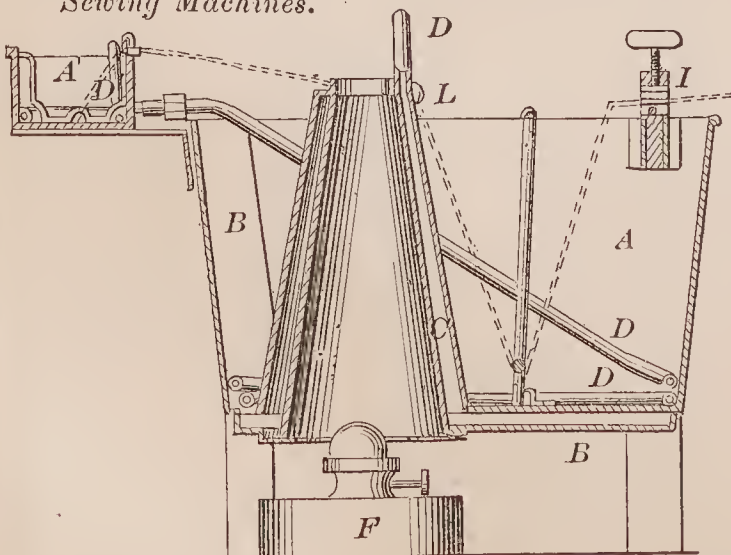

69057—C. A. Wilson—Steam Pressure Gauge.

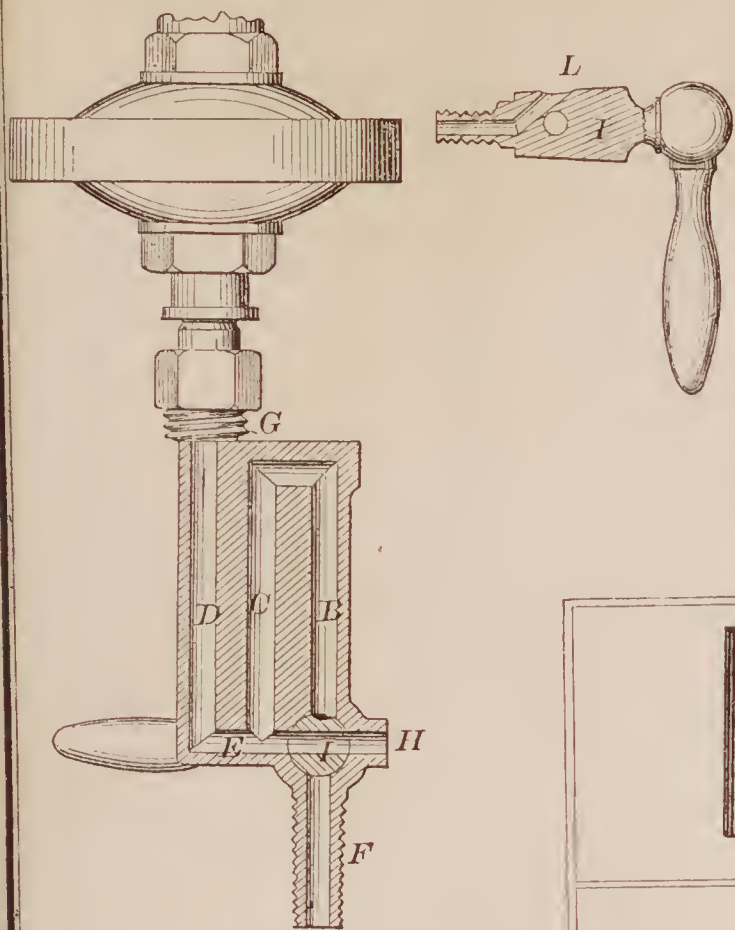

69059—J. W. Woodruff—Washing Machine.

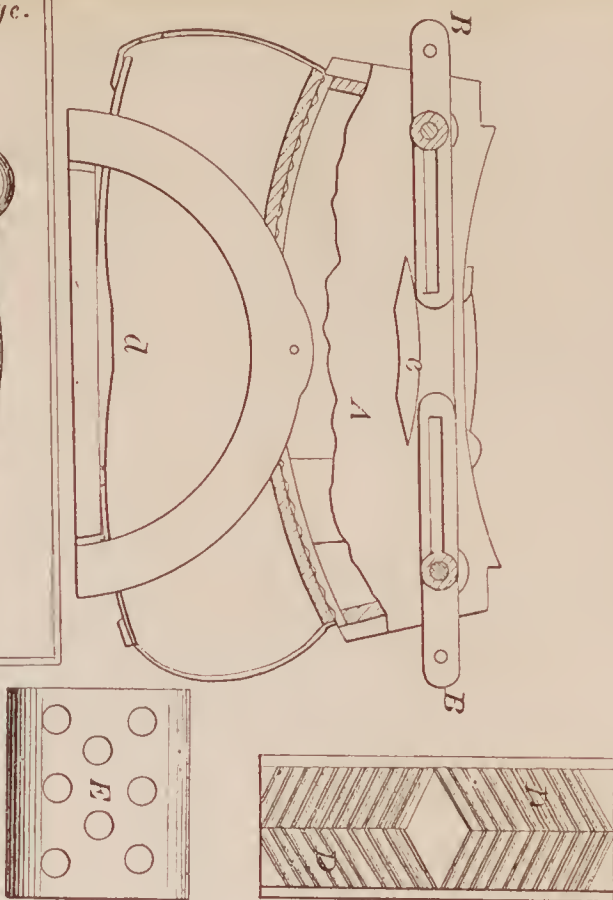

69061—A. Adair—Washing Machine.

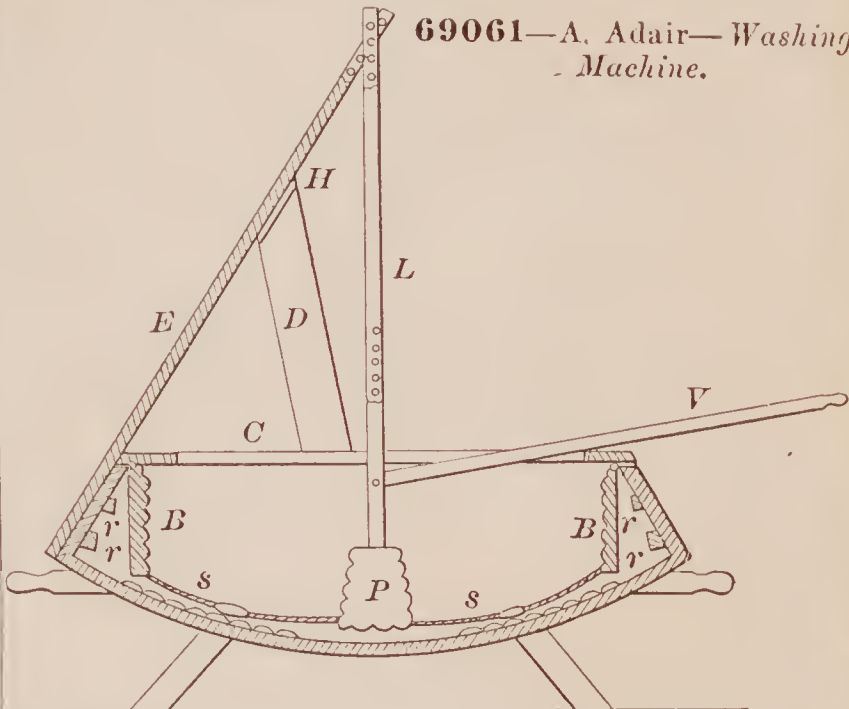

69062—Alexander & Osborn—Book Cover Protector.

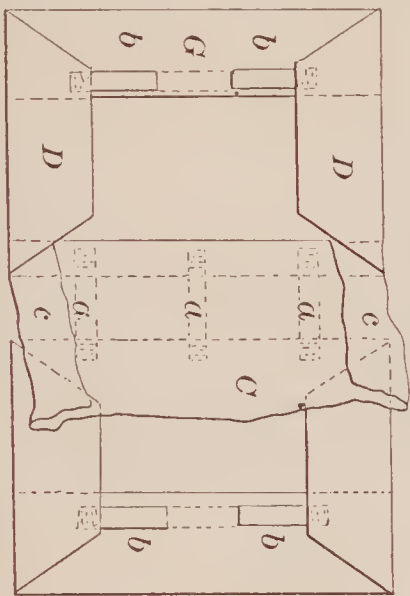

69063—W. Batty—Heating and Puddling Furnace.

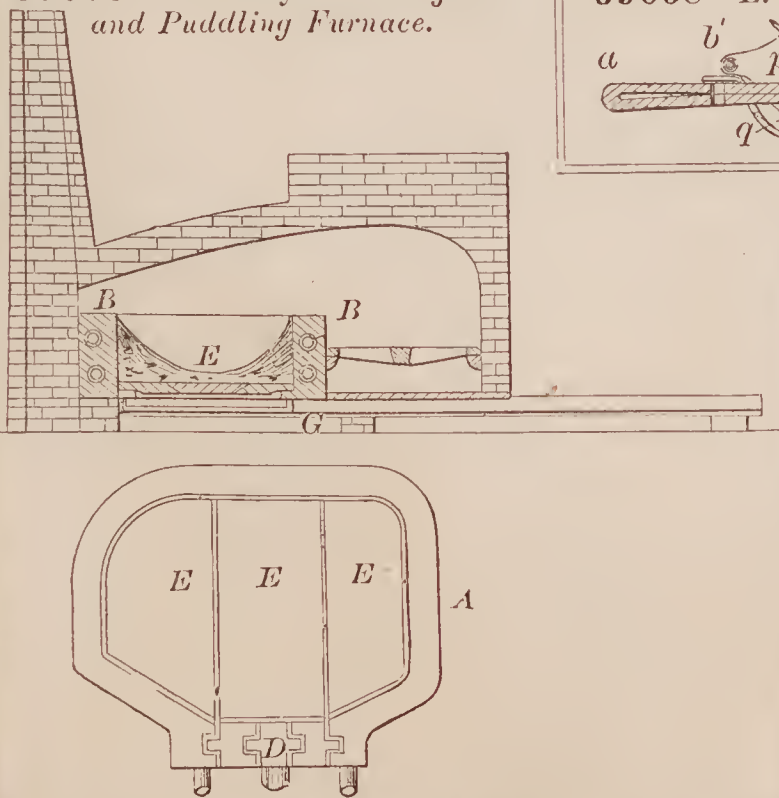

69058—E. B. Winslow—Trace and Pad Buckle.

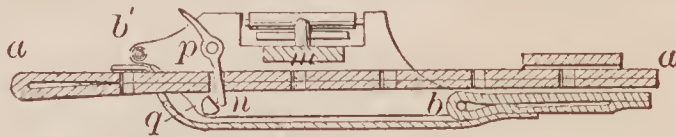

69060—J. N. Woodward—Bending Machine.

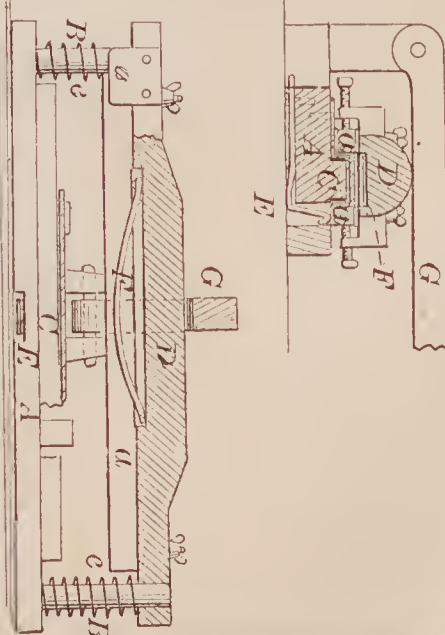



69064—W. D. Baughn—Metal Sleigh Knee.

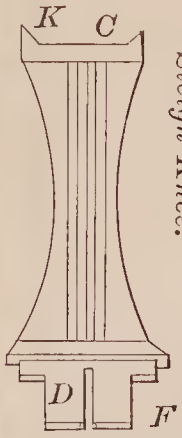

69065—S. & M. Bear—Churn.

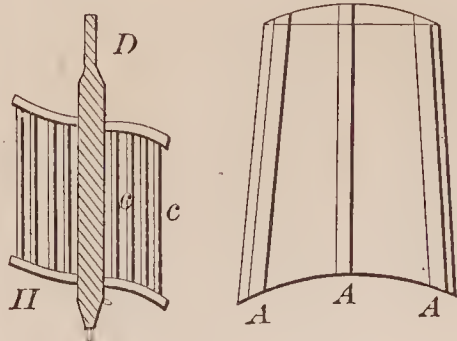

69067—W. Bonner—Extension Nozzle and Ventilating Oil Can.

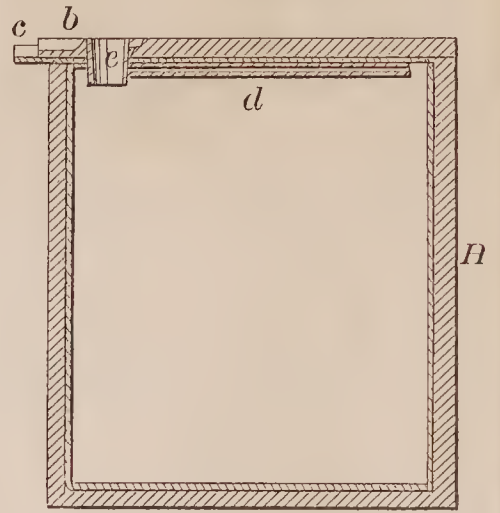

69066—Bliss & Adams—Boot Shank Laster.

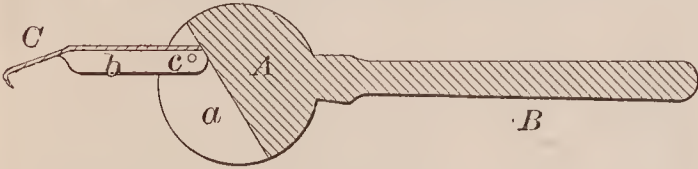

69068—C. Brada—Drawer for Furniture.

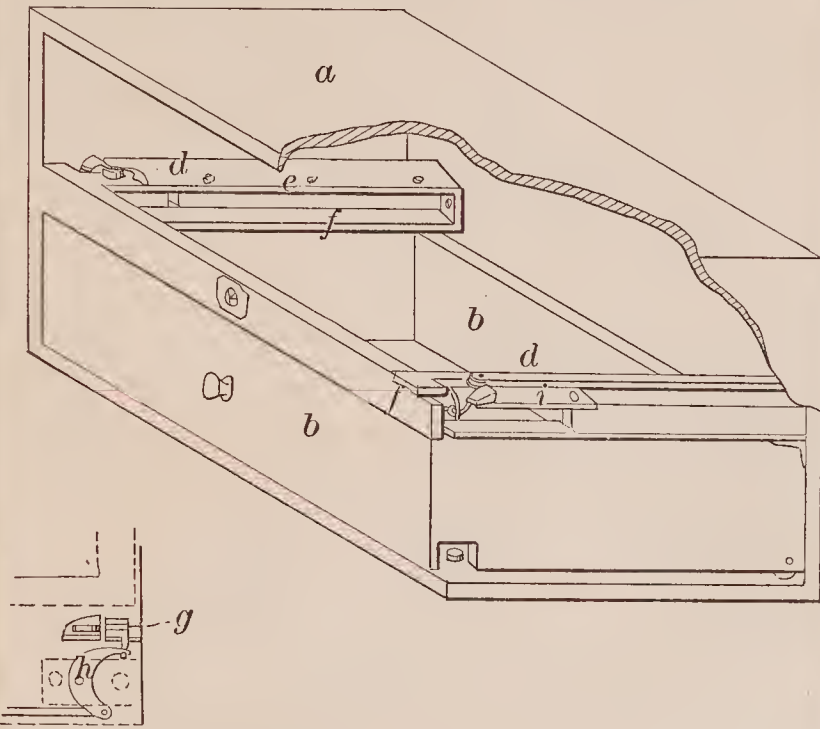

69072—P. L. Butler—Rein Snap.



69071—M. C. Buffington—Corn Plow.

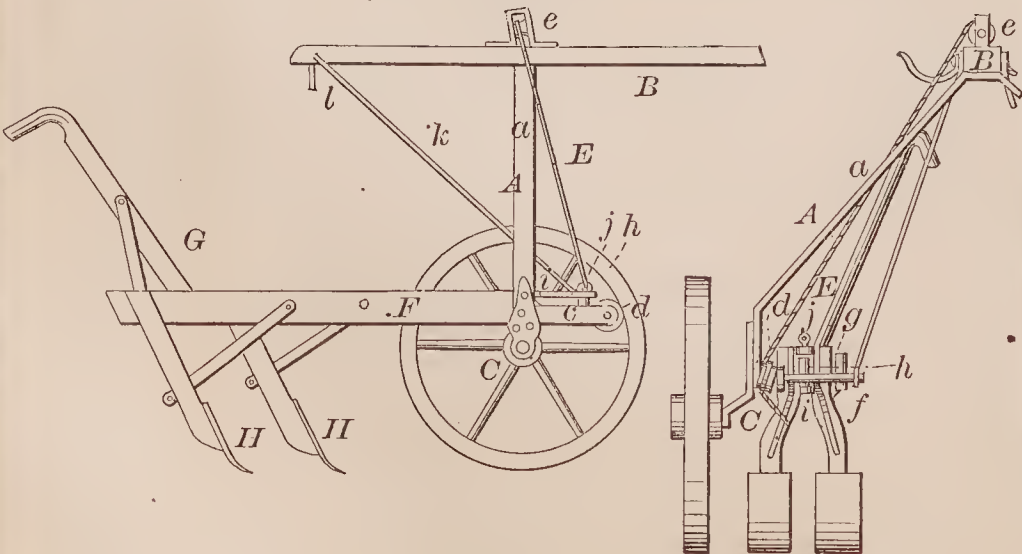

69069—J. M. Brooke—Boat Detaching Tackle.

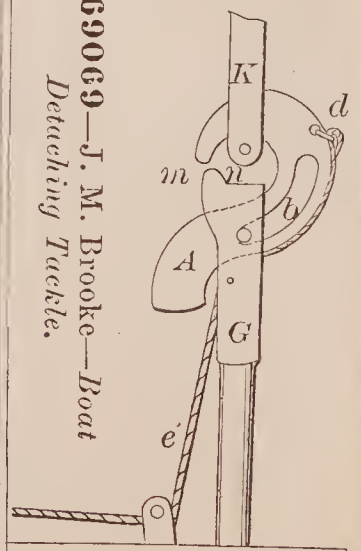

69070—F. R. Brunot—Sluice Gate for Dams or Locks.

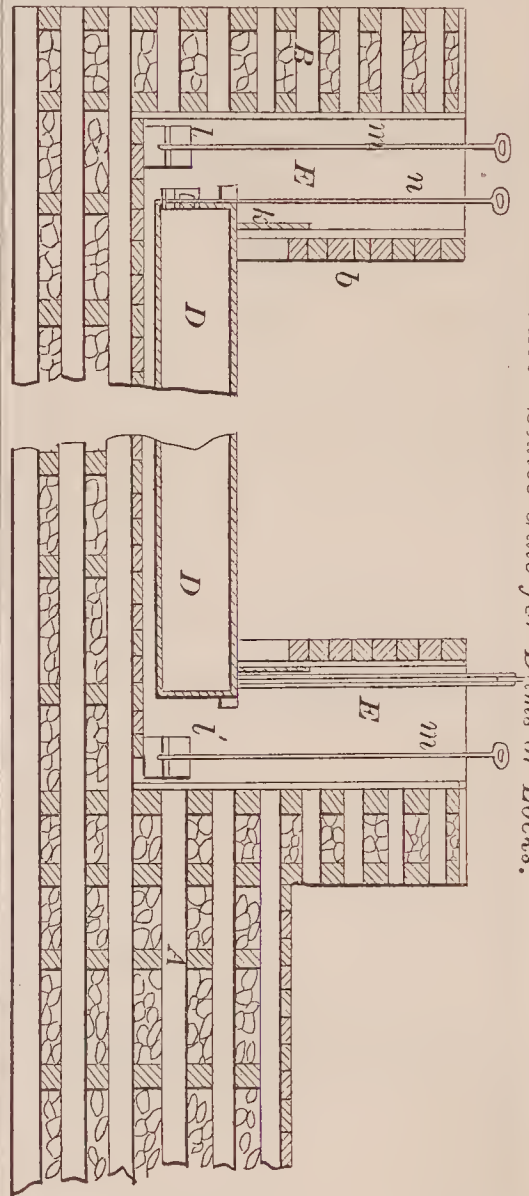

69073—H. Chamberlain—For Chopping Meat.

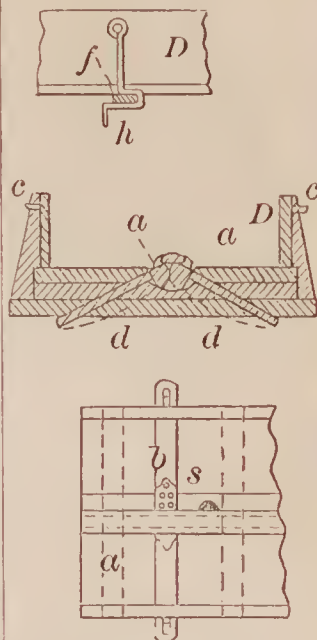
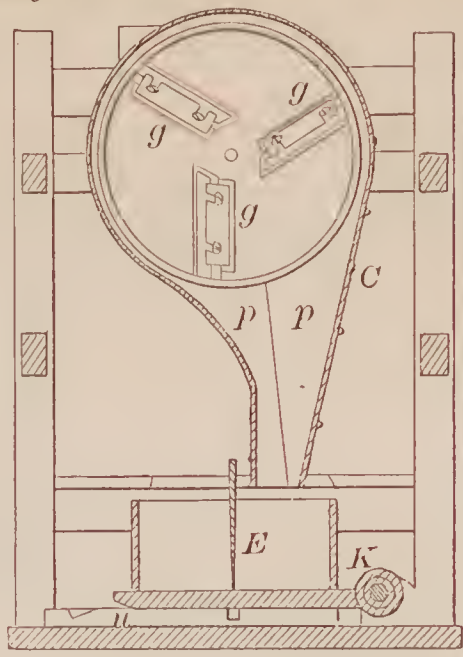
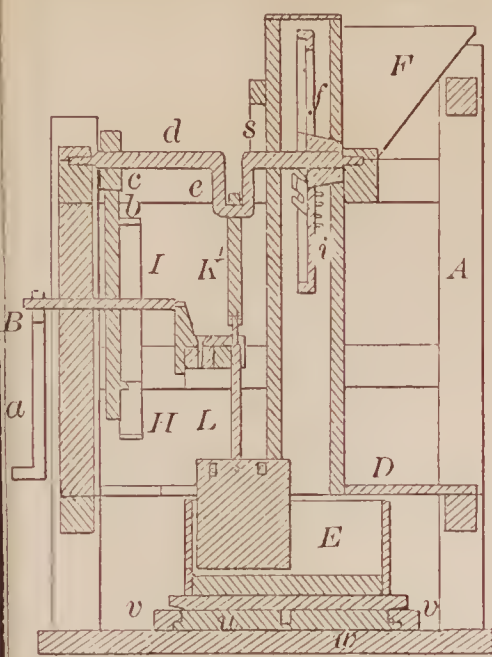

69075—G. R. Clark—Dumping Wagon Bar.

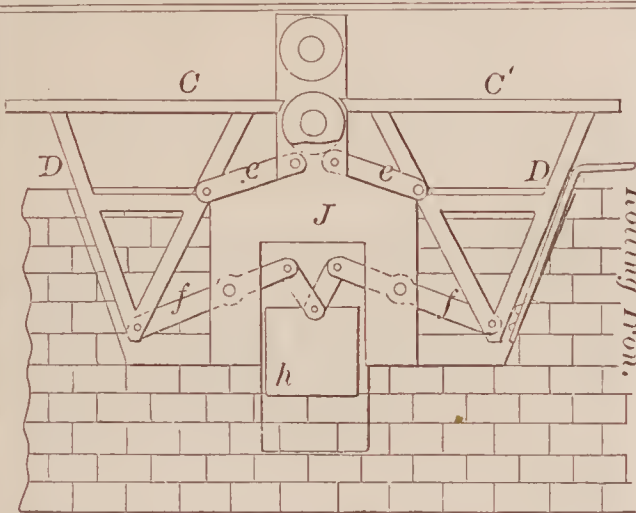

69077—J. Copely, Jr.—For Rolling Iron.

69074—W. B. Chapman—Neck Yoke.

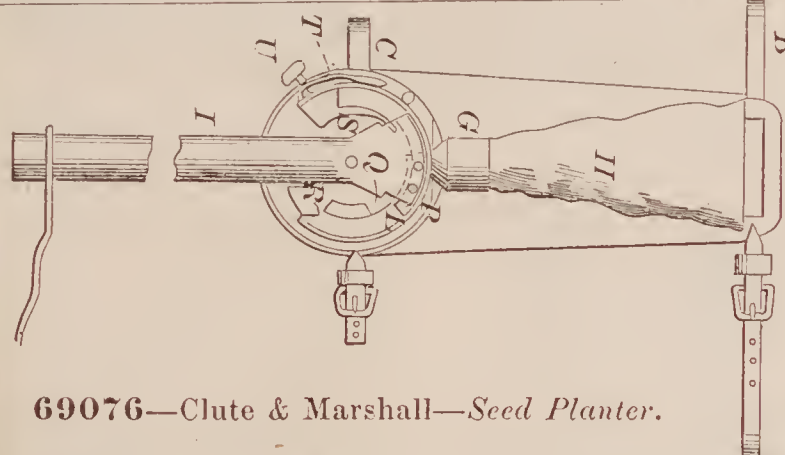
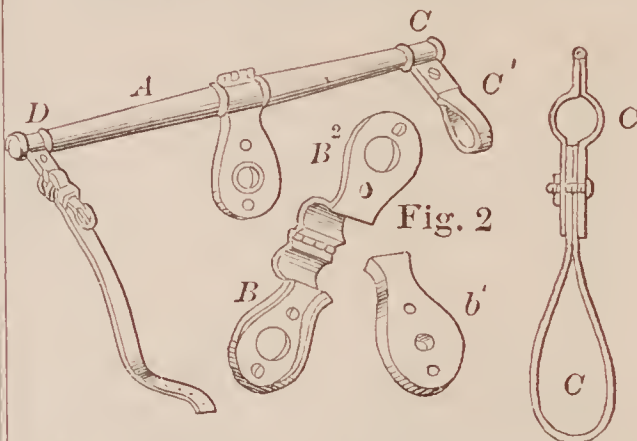

69078—E. M. Crandal—Self-Acting Vent for Cans.

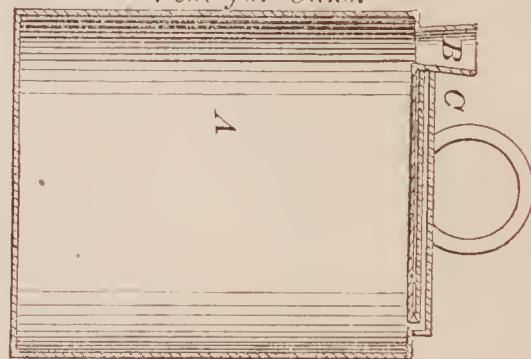

69076—Clute & Marshall—Seed Planter.

69080—T. B. De Forest—Forging Apparatus.

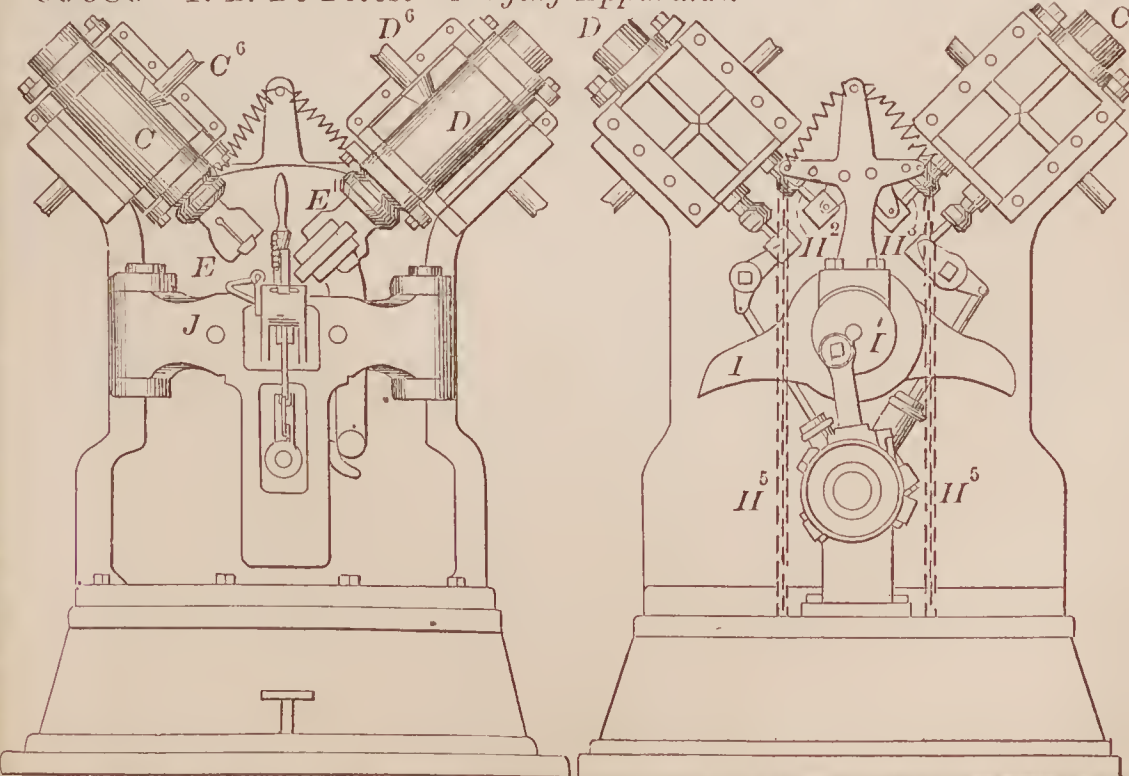

69079—E. S. Dawson—Driving Bit.





69080—Continued.

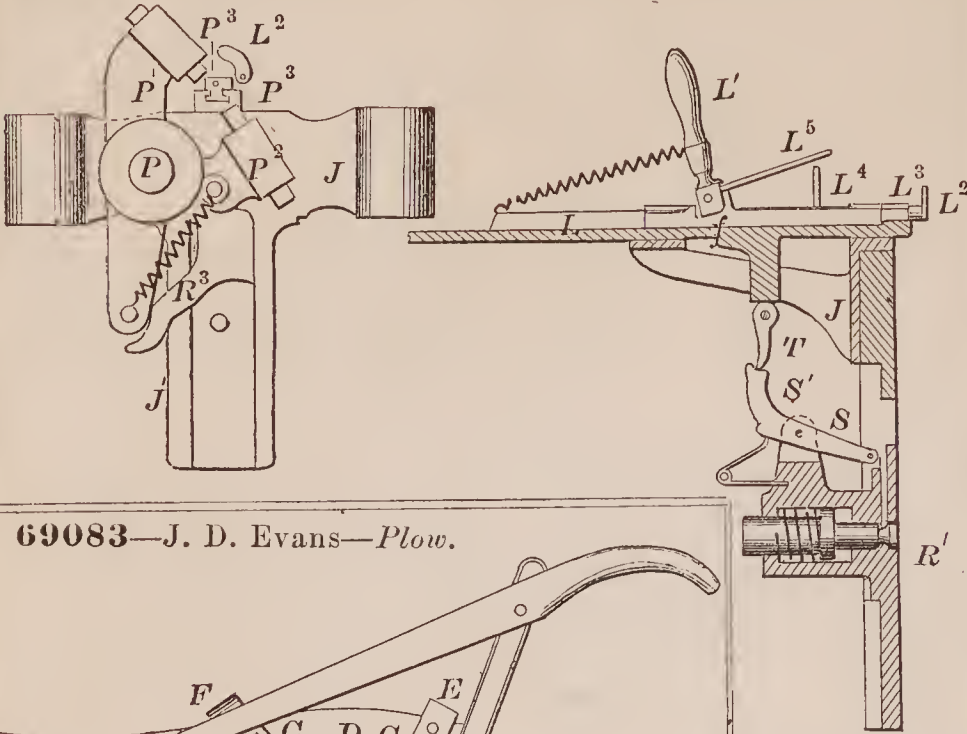

69081—E. F. Dhart—Cultivator.

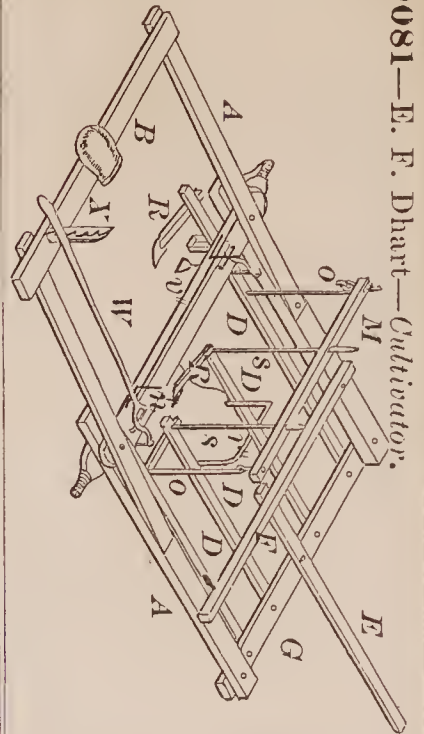

69083—J. D. Evans—Plow.

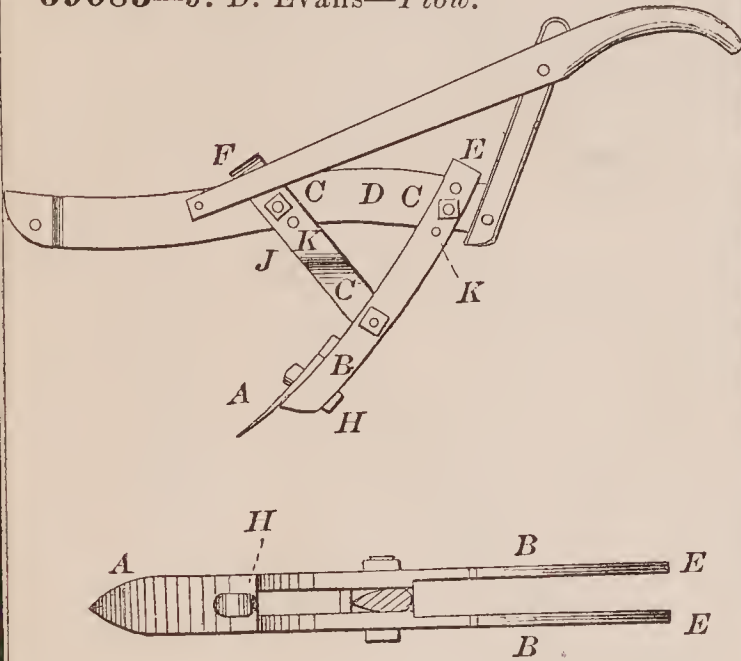

69085—D. Eynon—For Rolling Chairs for Railroads.

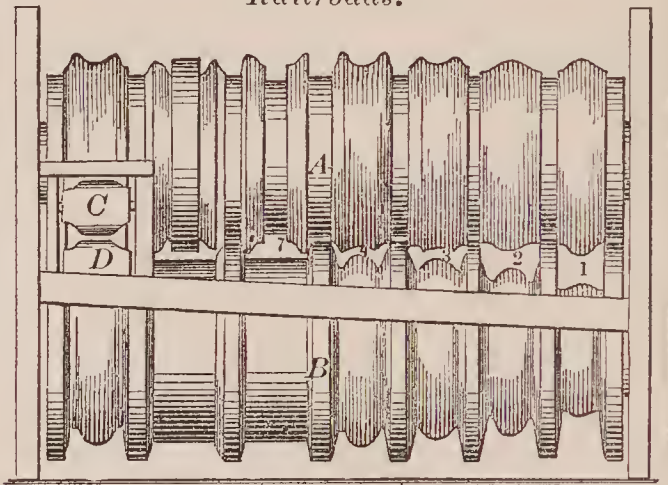

69084—O. Evans—Horse Hay Forks.

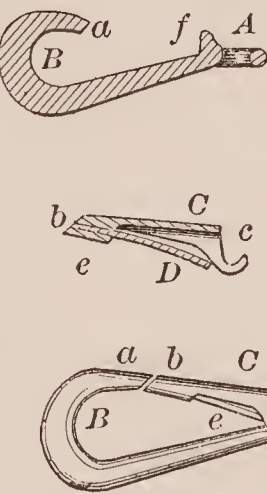
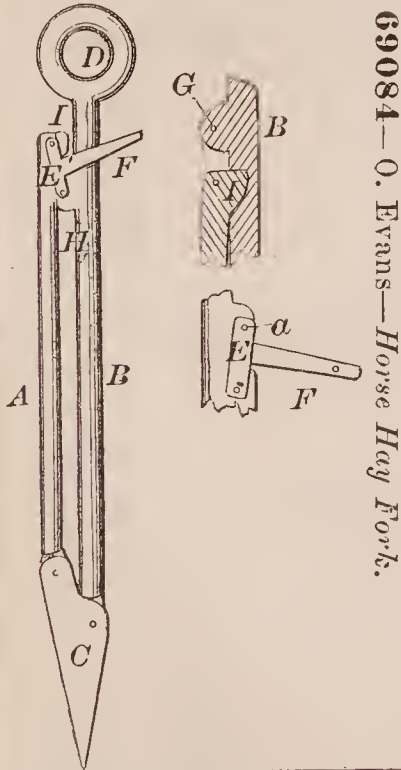

69087—K. Frazer—Snap Hook.

69088—J. W. Gault—Churn.

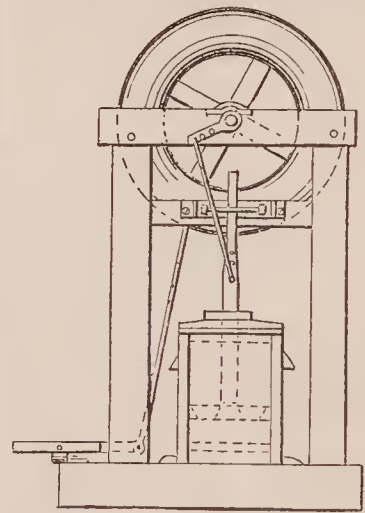

69086—J. B. Fellows—Brace for Boring Bits.

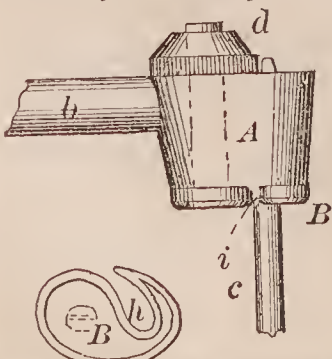

69082—A. B. Ely—Boot and Shoe Tip.



69089—J. Haddleton—Animal Trap.

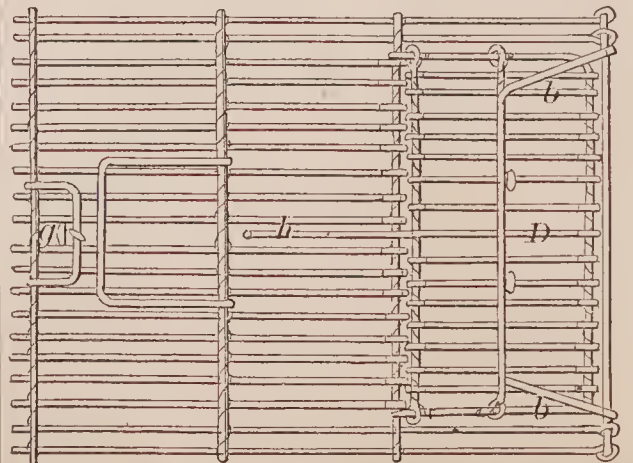

69090—H. M. Hamilton—For Forming the Eyes of Picks.

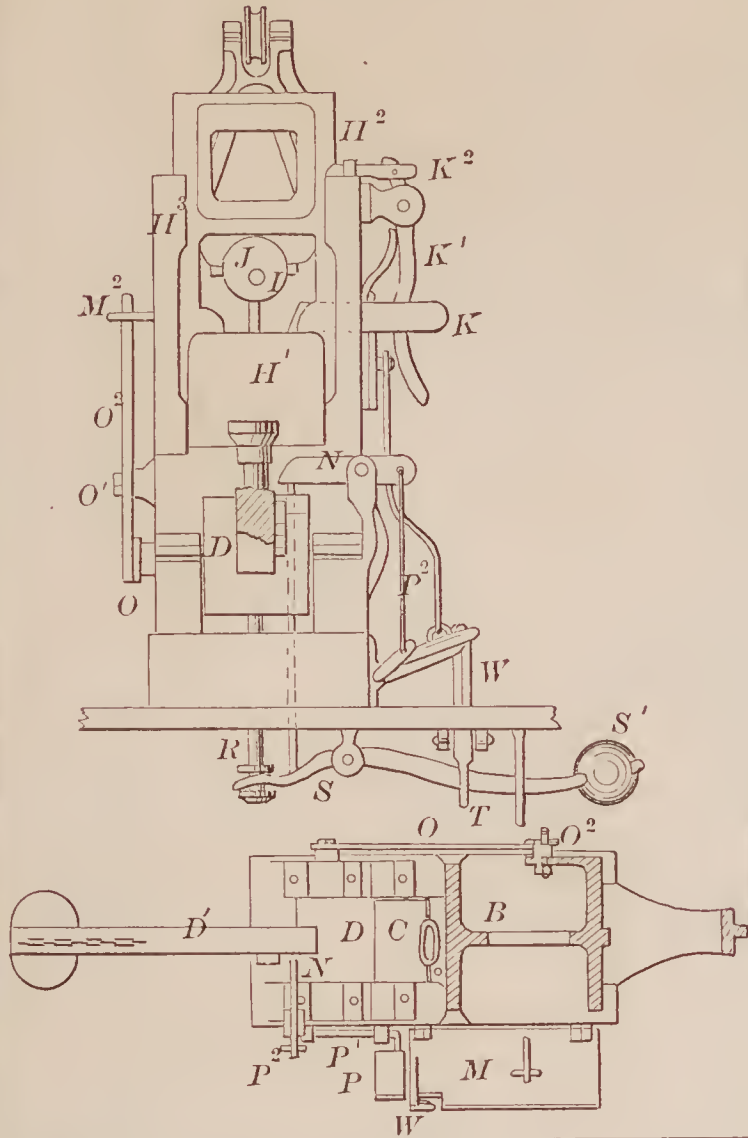

68091—H. L. Hanson—Lamp.

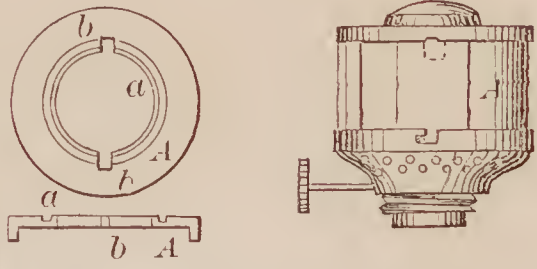

69092—H. A. M. Harris—Pump.

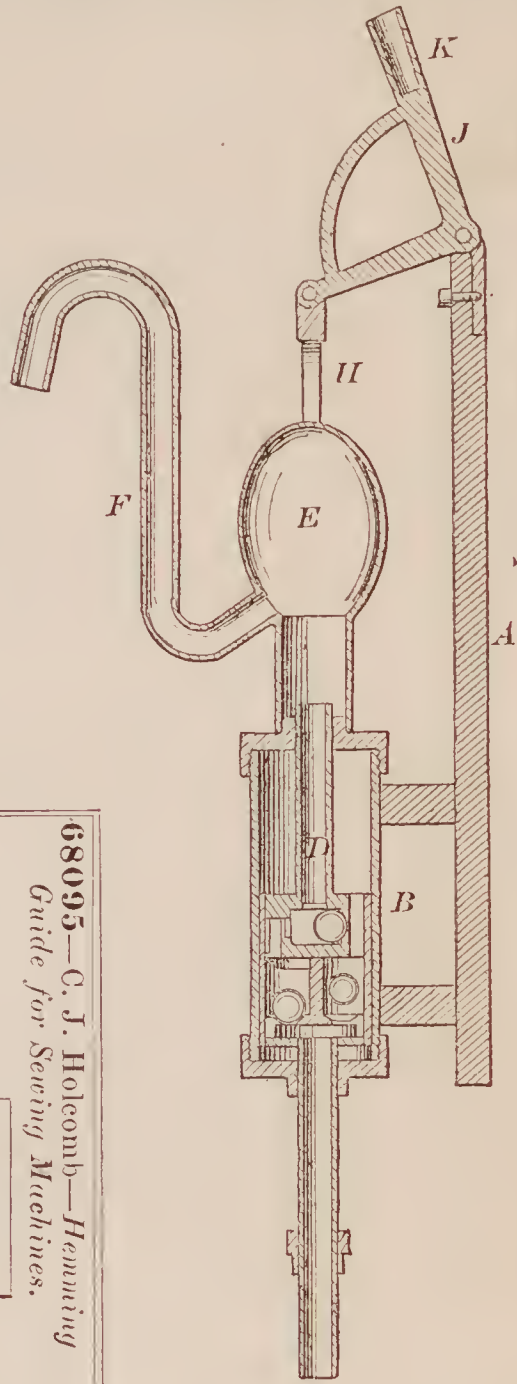

68093—J. Harwood—Rotary Churn.

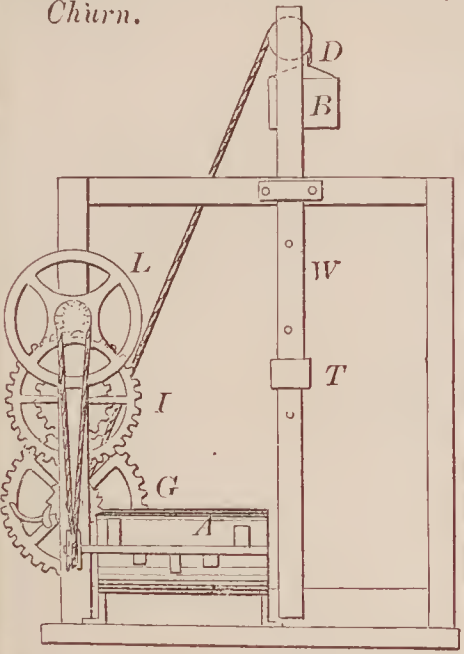

68095—C. J. Holcomb—Hemming Guide for Sewing Machines.

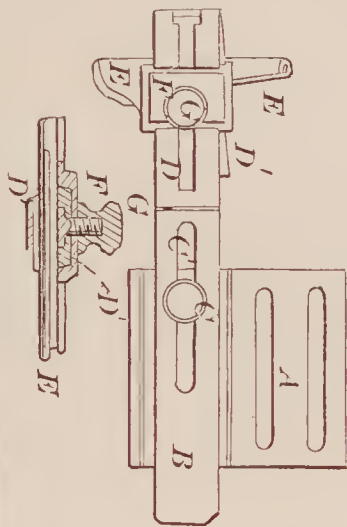

69094—B. Hershey—Wagon Spring.

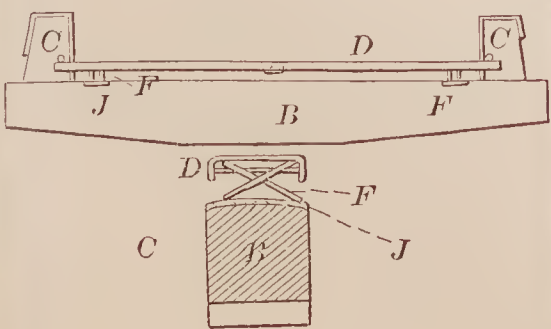

69096—I. L. Husband—Preventing Incrustation of Steam Boilers.

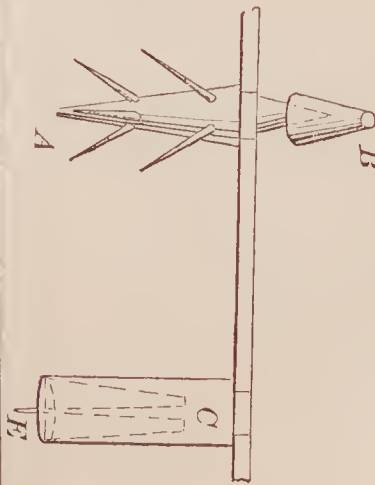

68097—A. Isko—Holder for Whiteash Brushes.

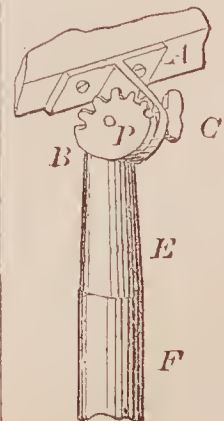



69098—A. Jack—For Dyeing and Embossing Table and Piano Covers.

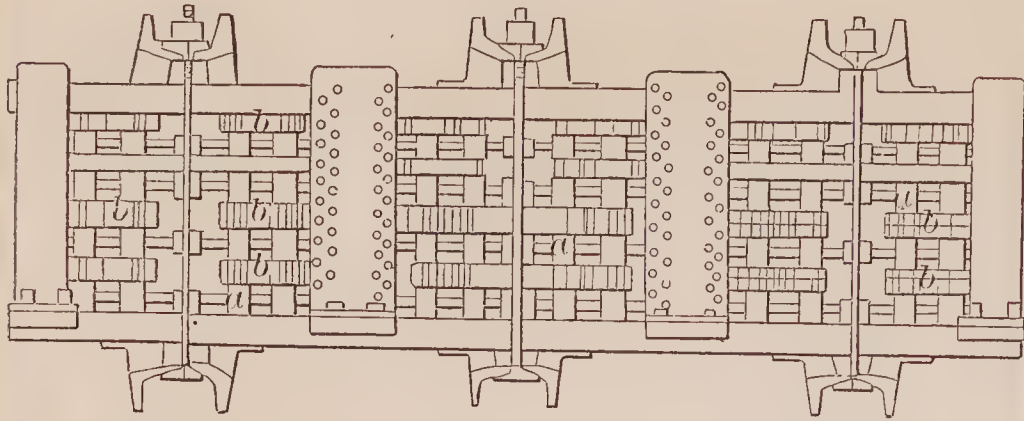

69100—Kellogg & Sweet—Curry Comb.

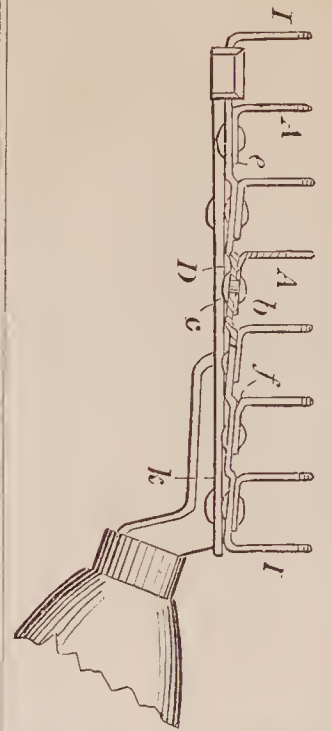

68099—M. R. Jones—Subsoil Plow.

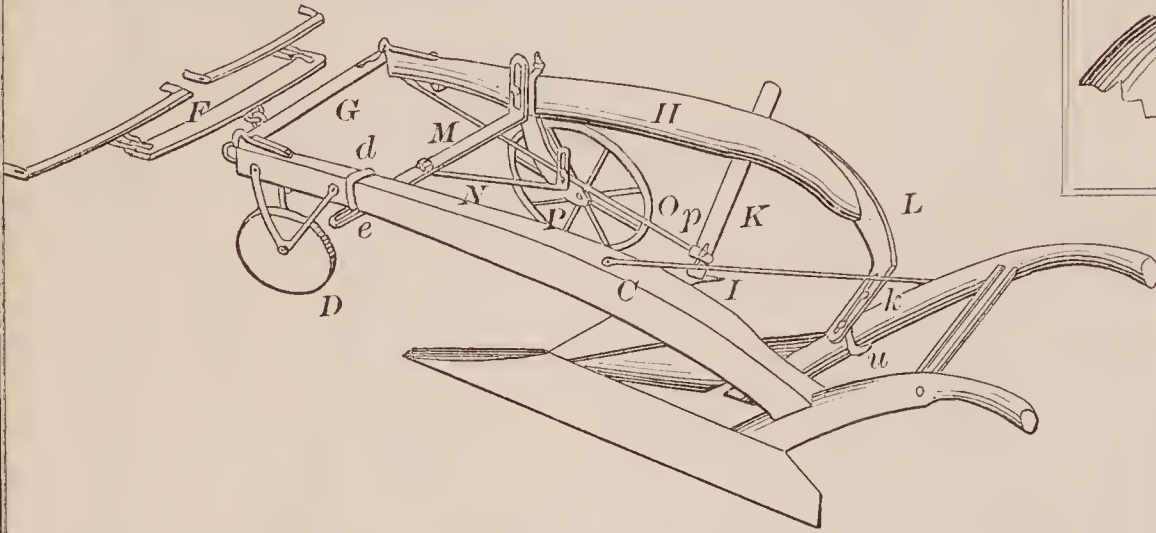

69104—B. Knapp—Knee for Sleighs.

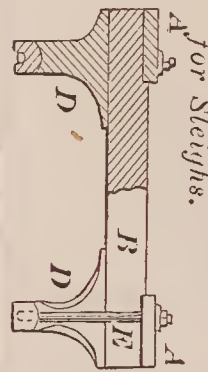

68101—R. Kershaw—For Winding Yarn from Spools.

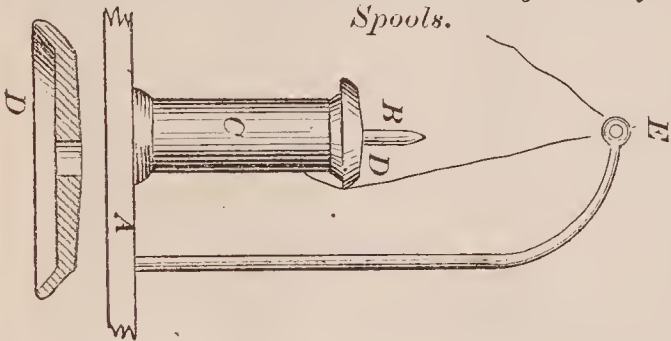

69102—C. P. Kimball—Jump Seat for Carriages.

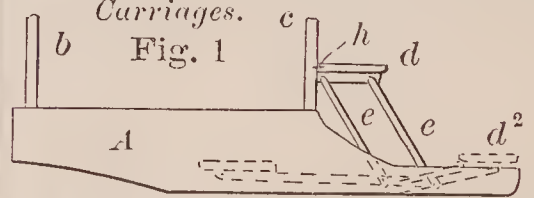

68105—J. W. Larmore—Whiffletree.

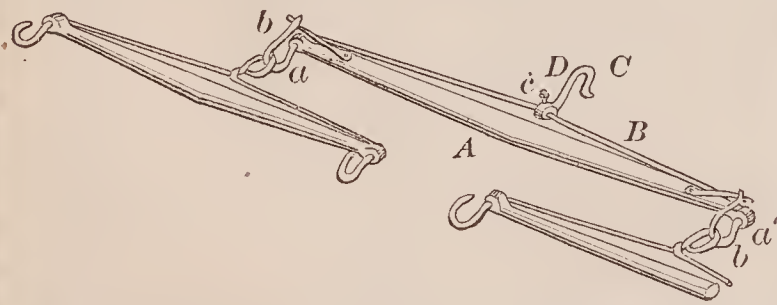

68103—E. M. Kimball—Watch Key.

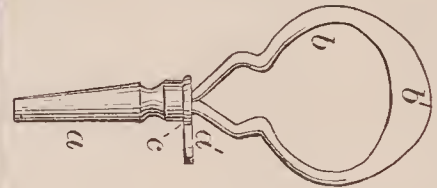

68107—W. Louden—Elevating and Conveying Device.

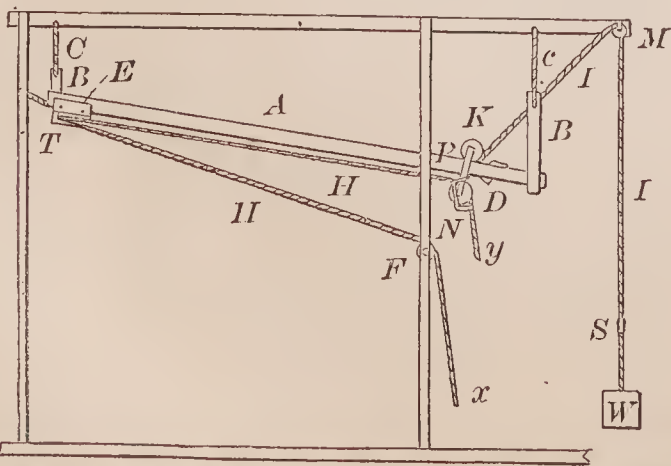

69106—E. W. Lindeman—Safety Bridle.

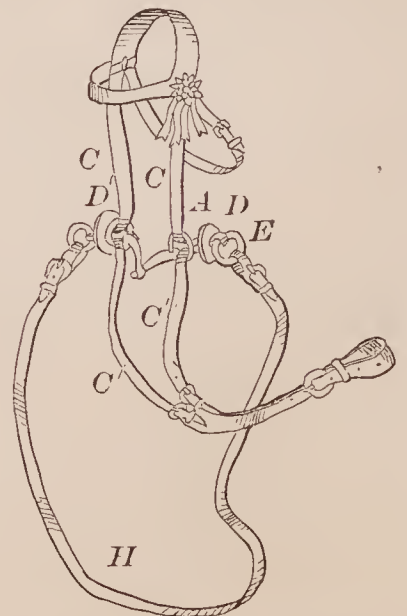

69108—H. Mansfield—Gate.

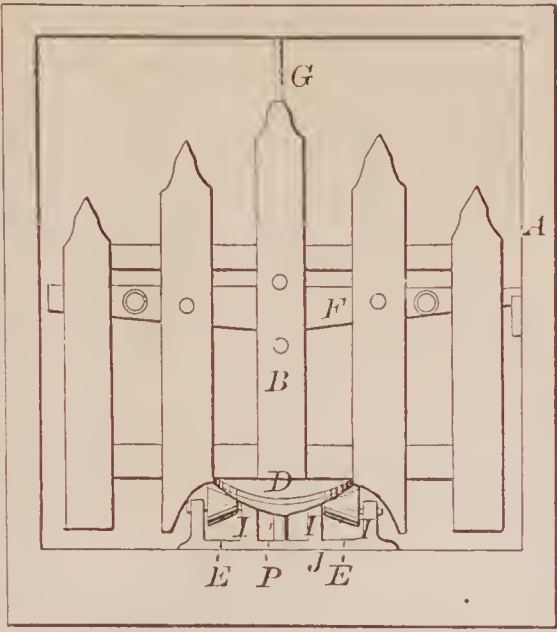

68109—J. Marsh—Corn Plow.

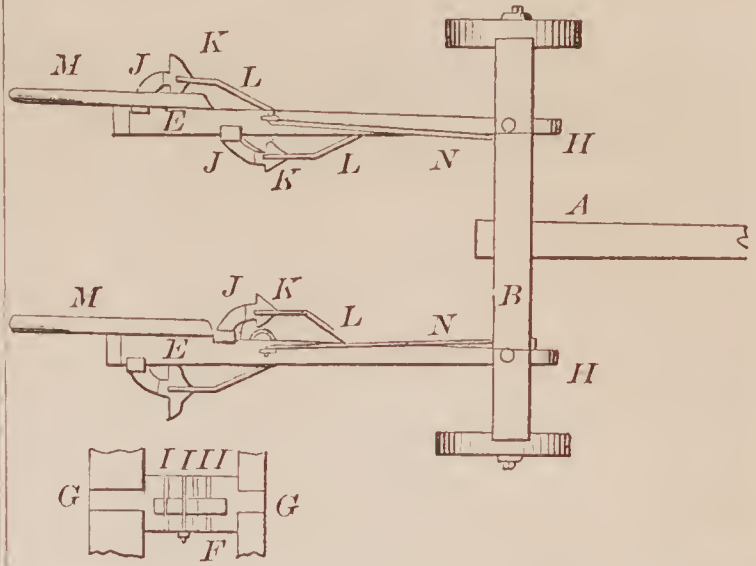

69110—M. Mattson—Syringe.

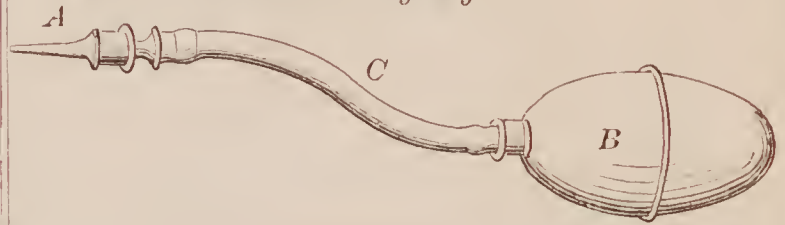

68113—J. F. Milligan—Cotton Bale Tie.

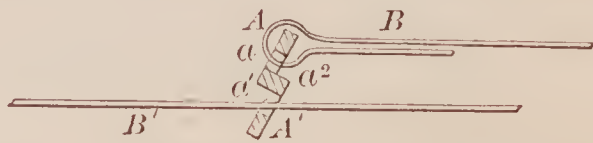

69114—O. C. Monroe—For Renovating and Cleaning Feathers.

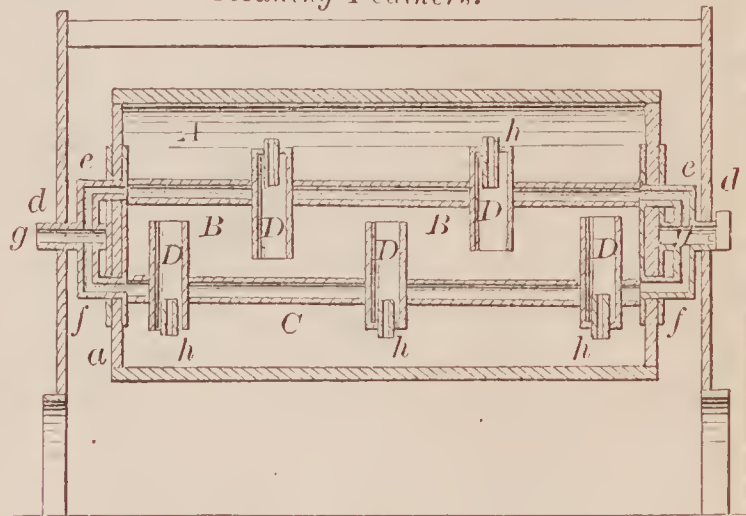

69112—H. J. Miller—Boot Jack and Blacking Brush.

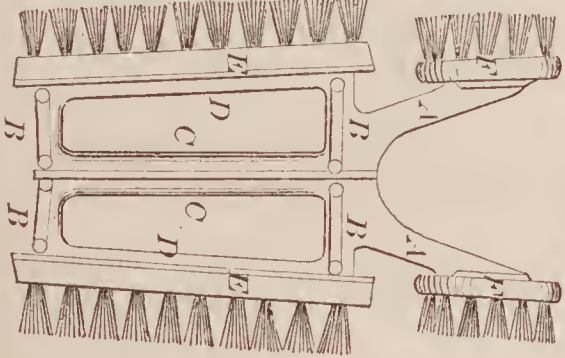

68116—A. M. Nichol—Fence.

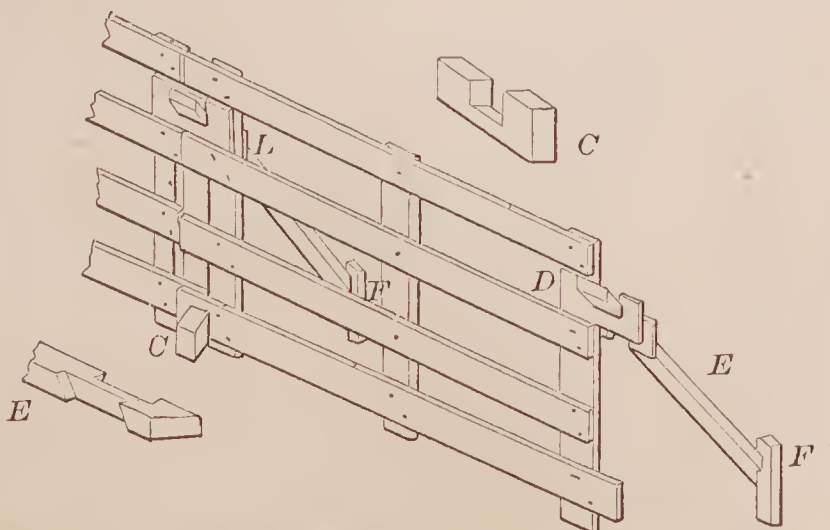

69115—N. Nard—Trunk Lock.

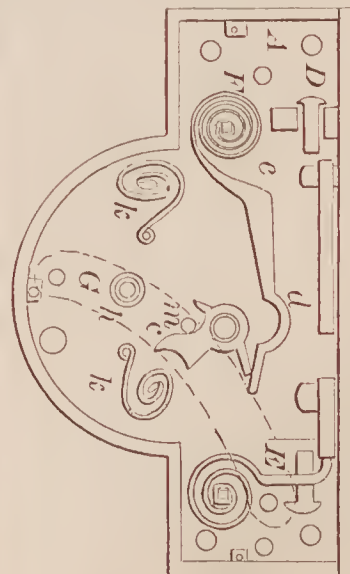



69117—Nichols & Clark—Plow.

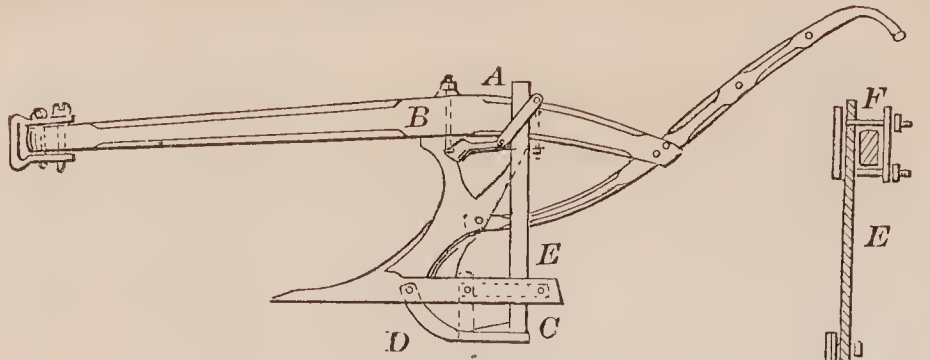

69120—C. J. Paine—Cotton Bale Tie.  
Fig. 2  
Bale Tie.

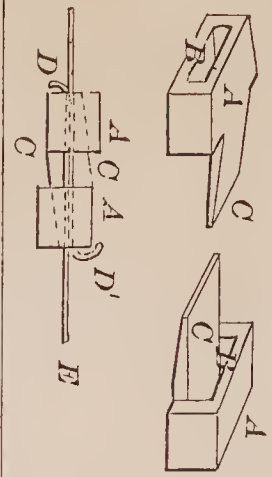

68119—P. Owens—Carriage Top.

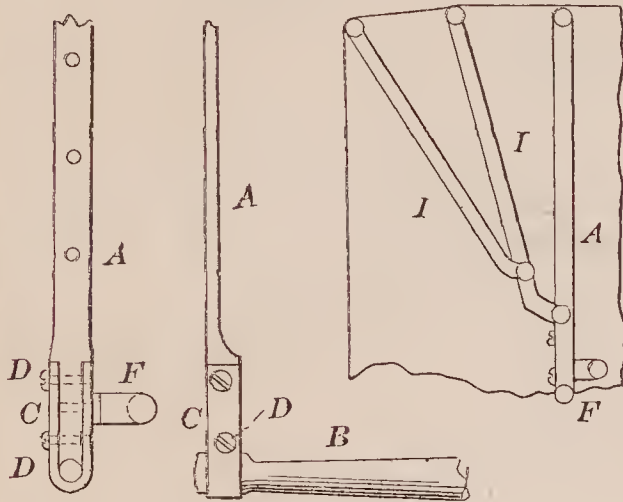

69123—H. C. Payson—Car Coupling.

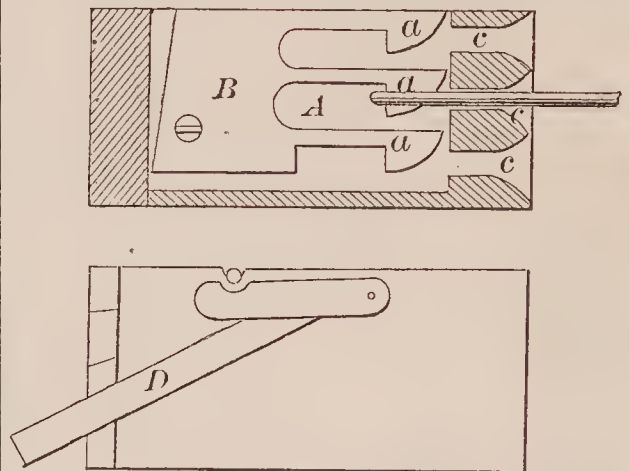

69124—J. Phelps—Faucet.

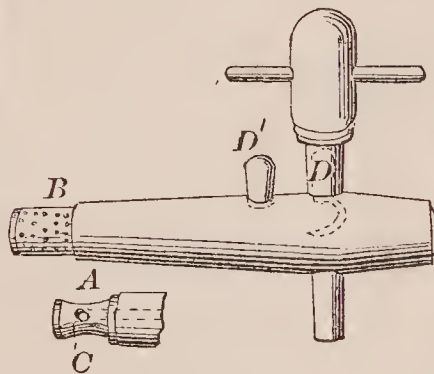

69126—J. T. Price—Pen and Pencil Holder.

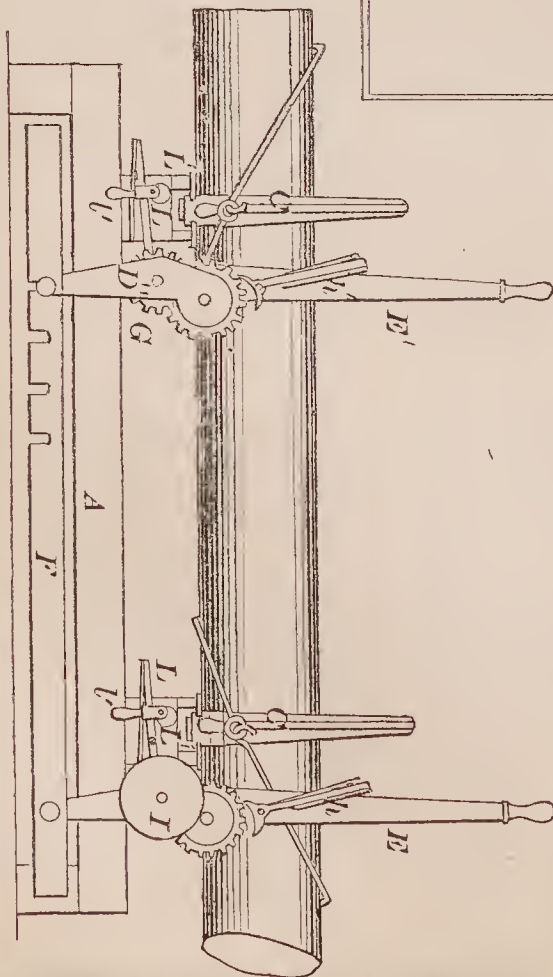
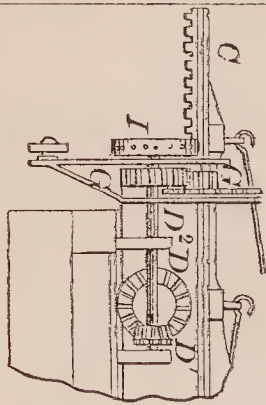
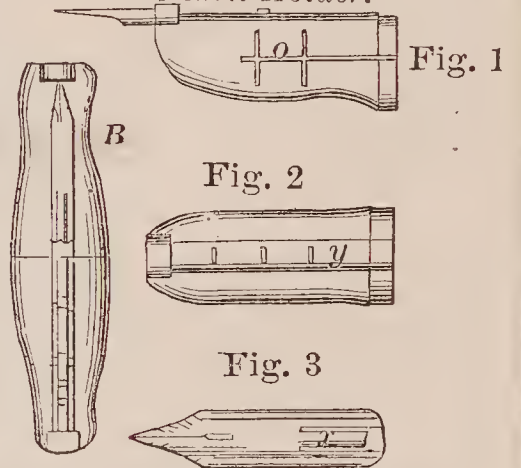

69122—D. Parkhurst—Saw Mill Head Block.

69125—E. J. Post—Vehicle Spring.

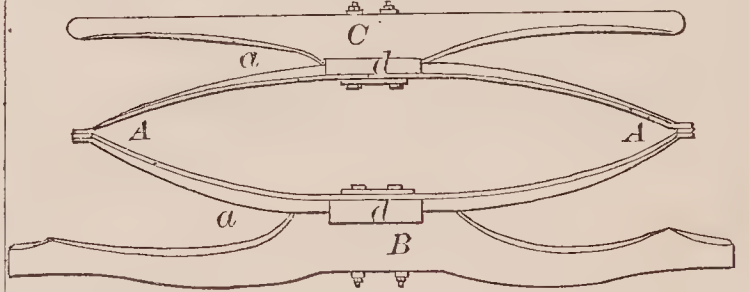

69127—J. Reinsch—Fan Attachment to Children's Carriages.

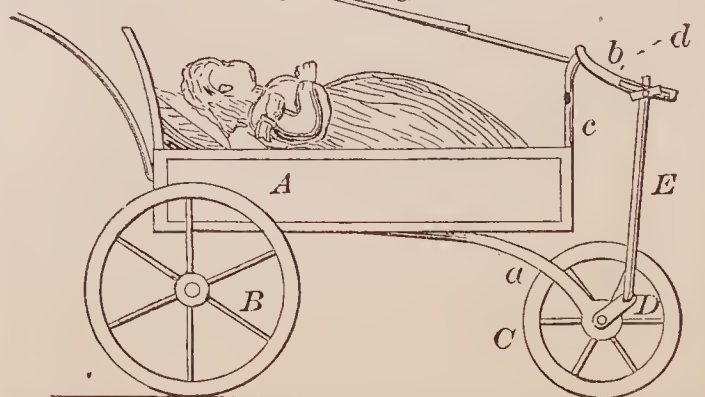





69137—M. E. Stanger—Shovel Plow.

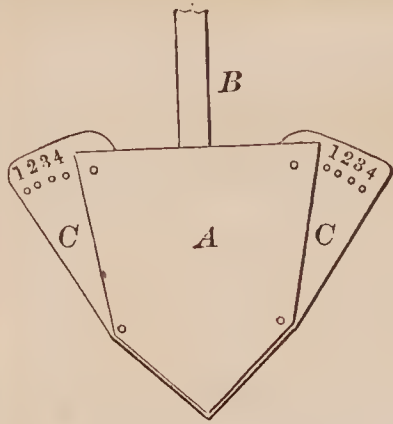

69139—J. S. Stockham—Rock Drill.

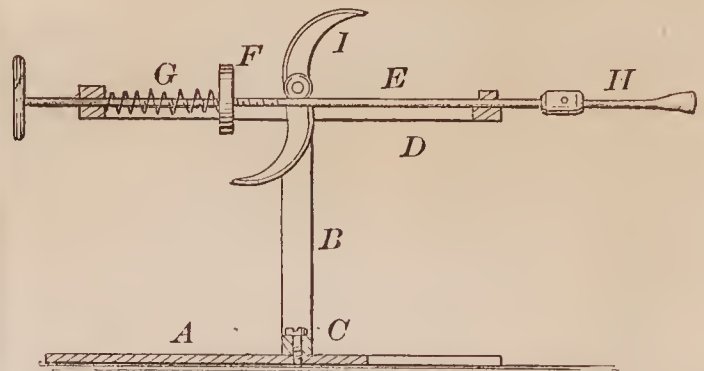

69138—States & Lutts—Farm Gate.

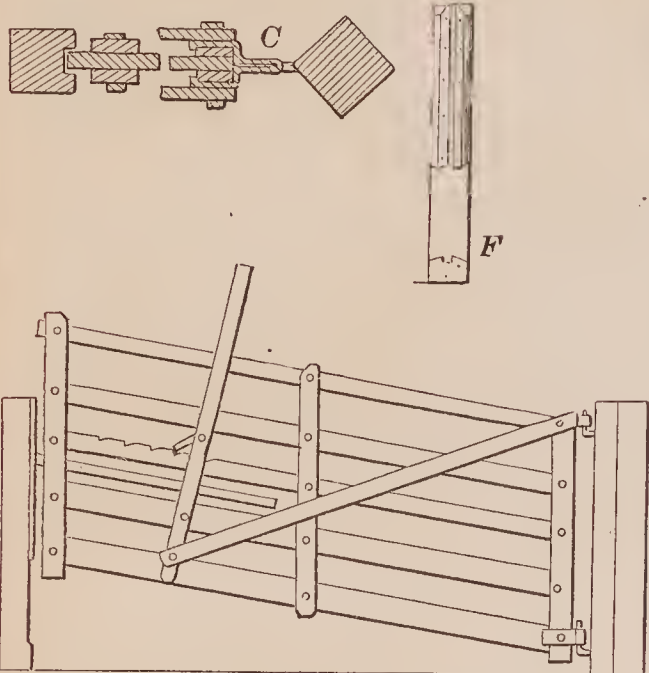

69141—H. Thompson—Washing Machine.

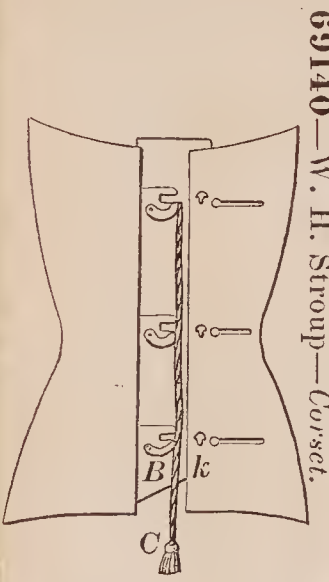
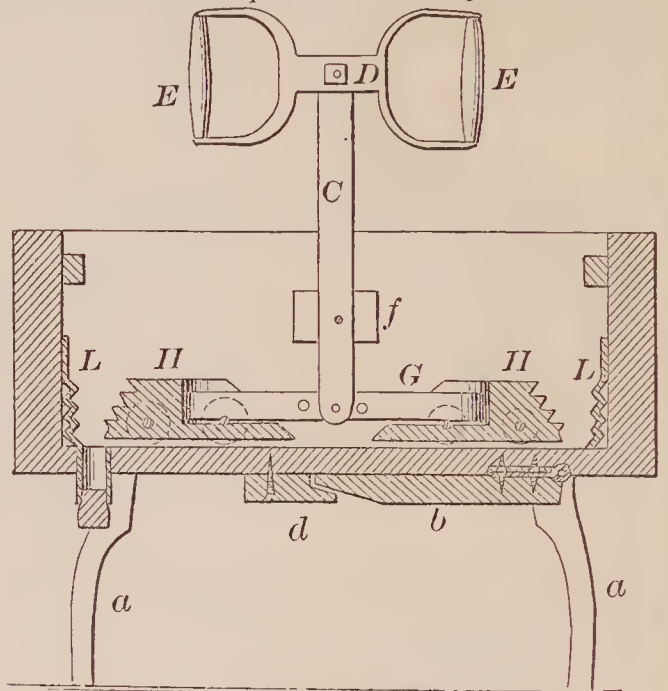

69140—W. H. Stroup—Corset.

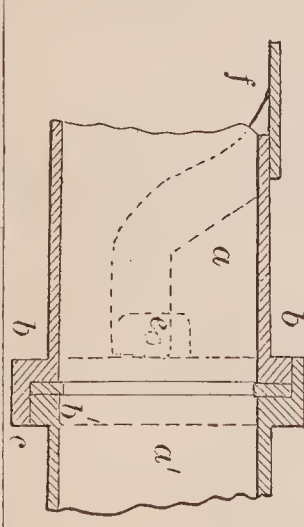

69142—N. Thompson—Pipe Coupling.

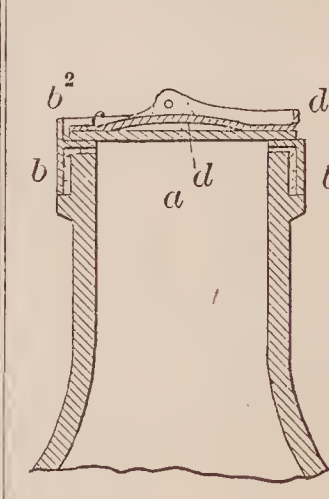

69143—N. Thompson—For Closing the Mouths of Bottles

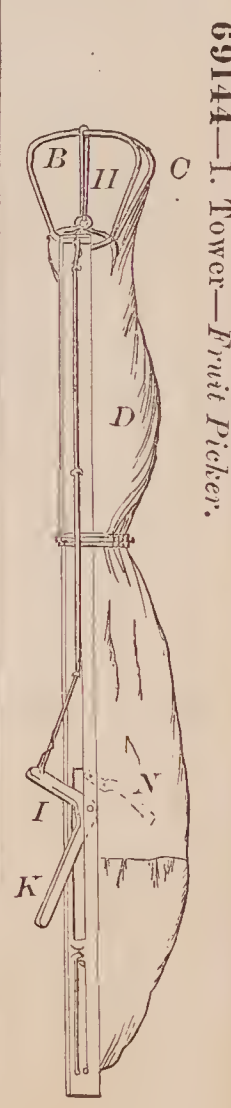

69144—I. Tower—Fruit Picker.

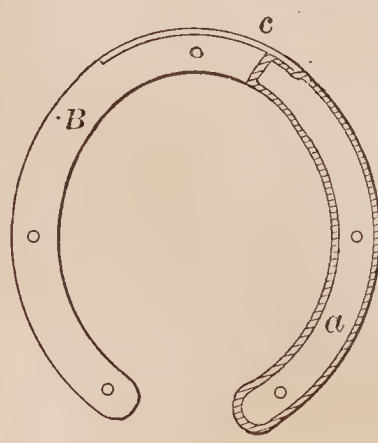

69146—A. S. Wilkenson—Horse Shoe.

69145—E. W. Vaill—Folding Chair.

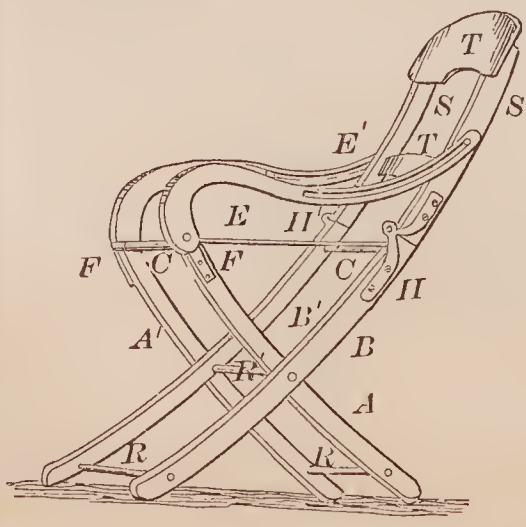

69147—J. B. Wilson—*Axle for Vehicles.*

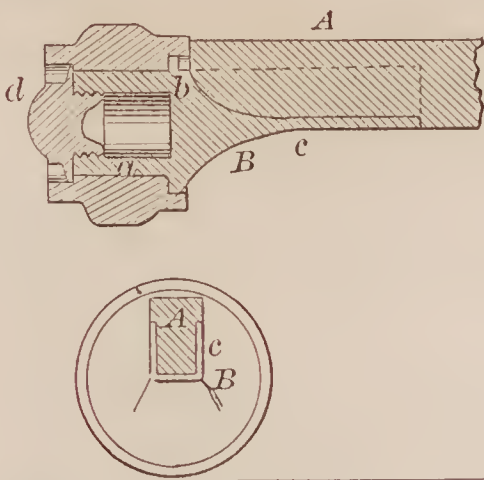

69148—J. Wood—*Ladies' Work Table.*

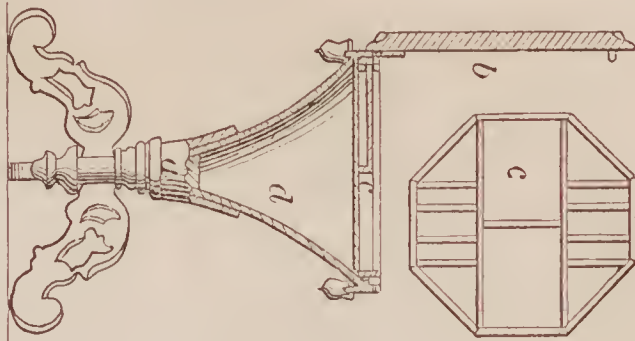

69150—C. Worden—*Nutmeg Grater.*

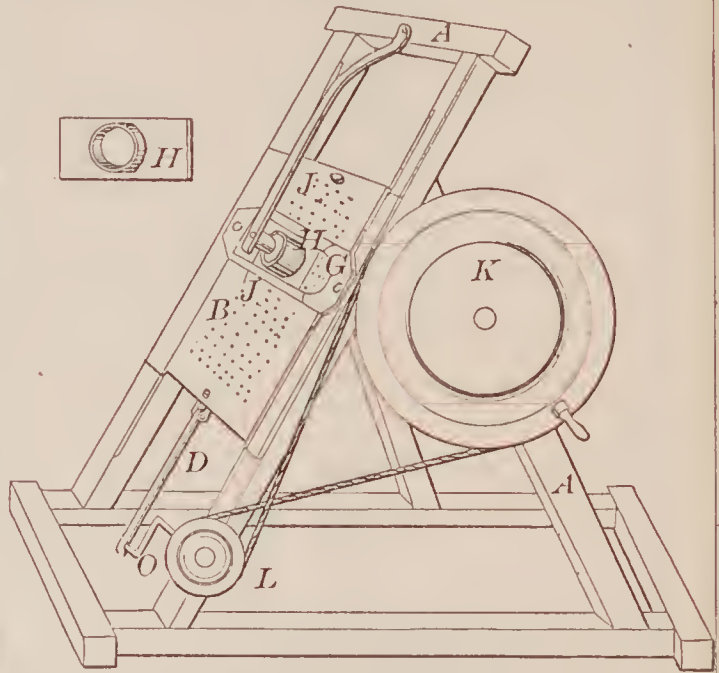

69149—A. B. Woodbury—*Jack Spinning Machine.*

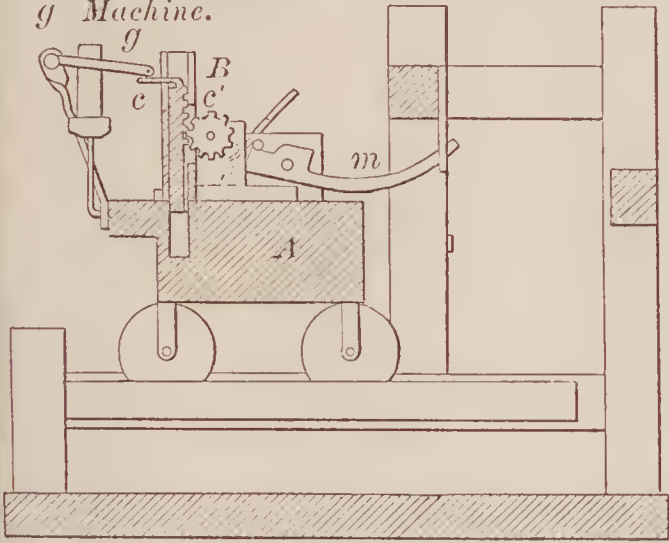

69152—G. W. Young—*Carpet Cleaner.*

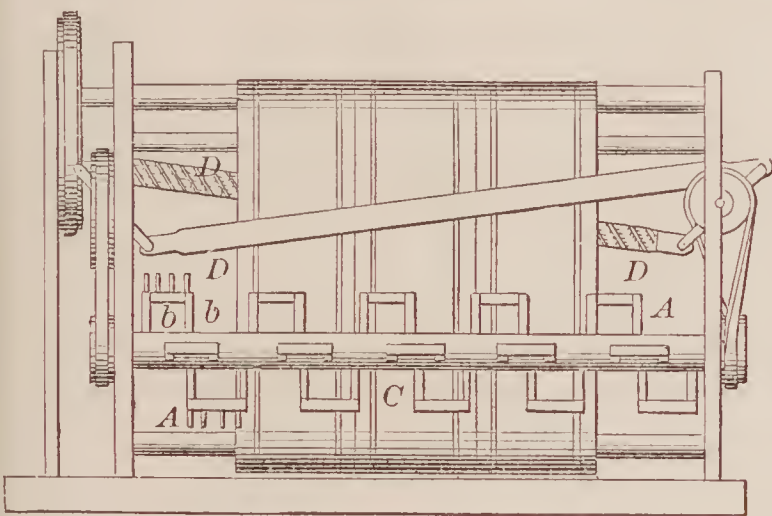

69153—R. Allison—*Steam Engine.*

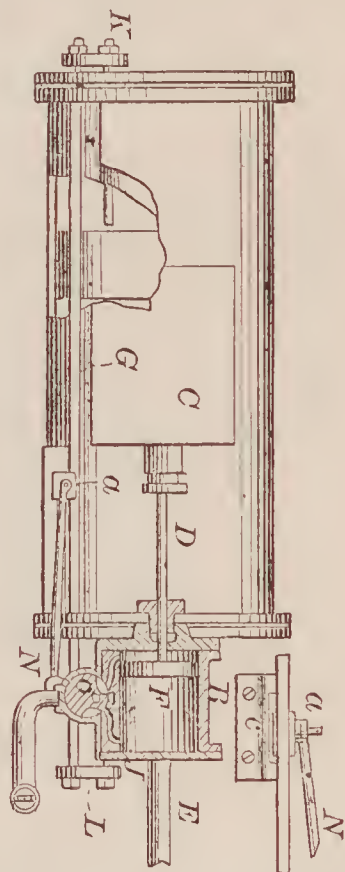

69151—H. Wright—*Jug Top.*

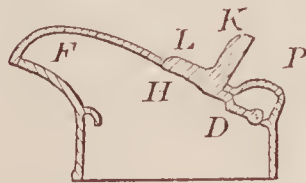

69155—J. W. Baker—*Hydrant.*

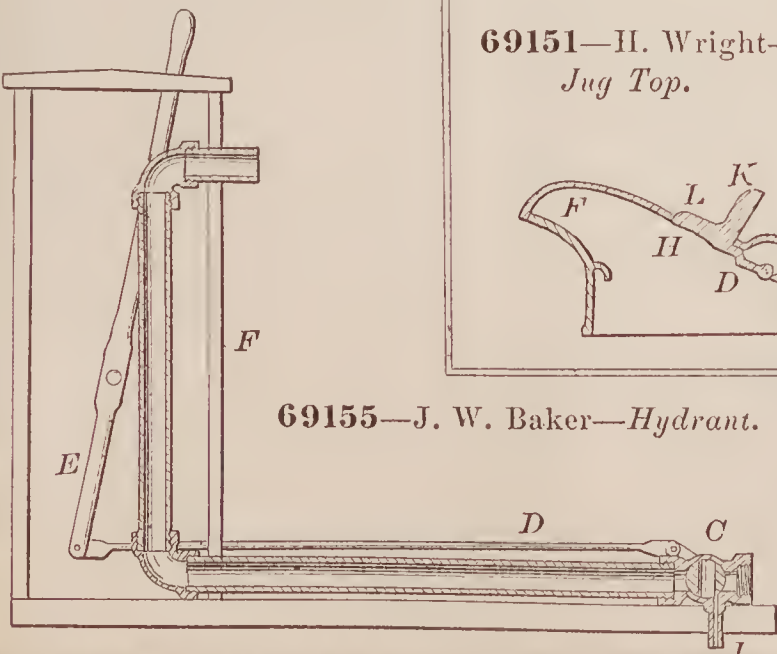

69154—A. D. Armstrong—*Can.*

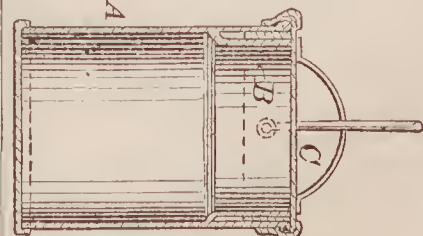



69156—J. W. Baker—Fire Plug.

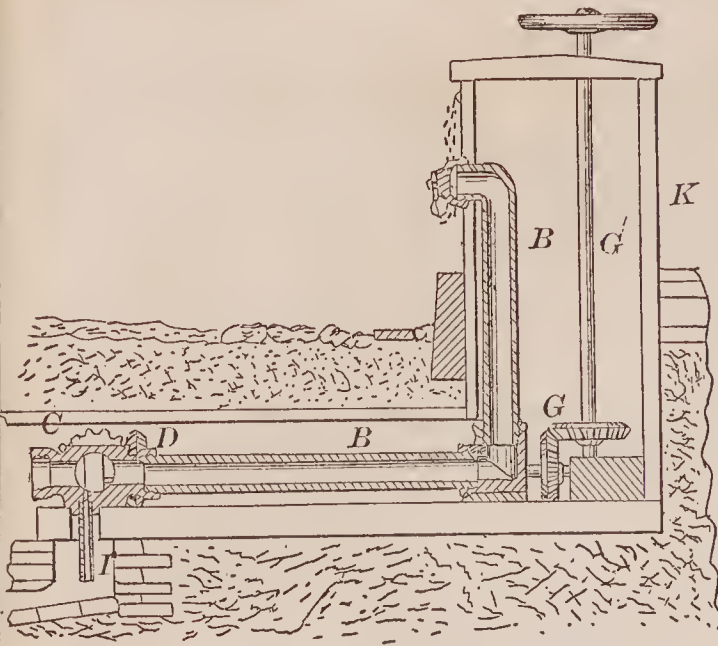

69157—J. Baldwin—Cutlery.

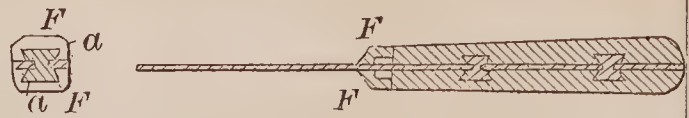

69158—J. Balmer—Spike.

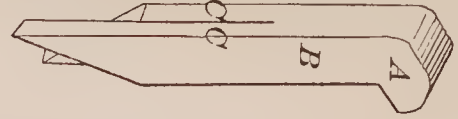

69163—J. F. Barrett—Rubber Boot Heel.

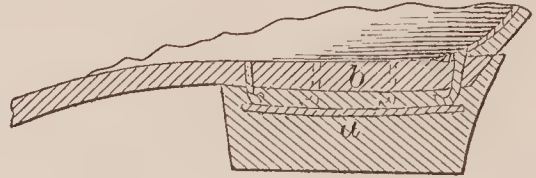

69159—S. Barbour—For Finishing Thread.

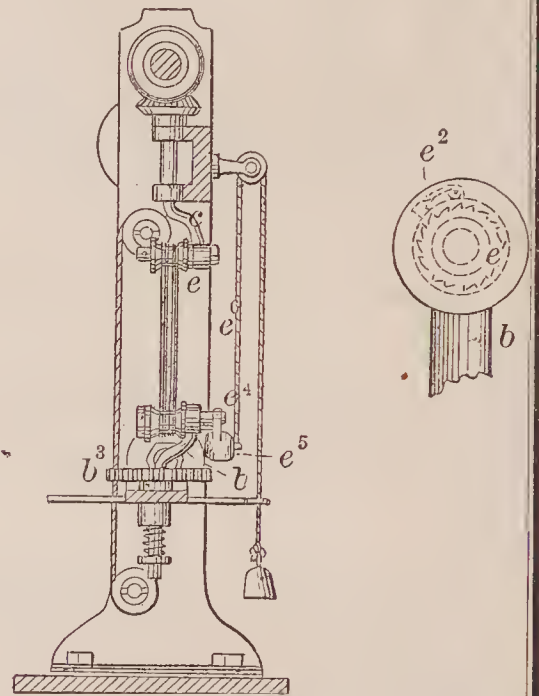
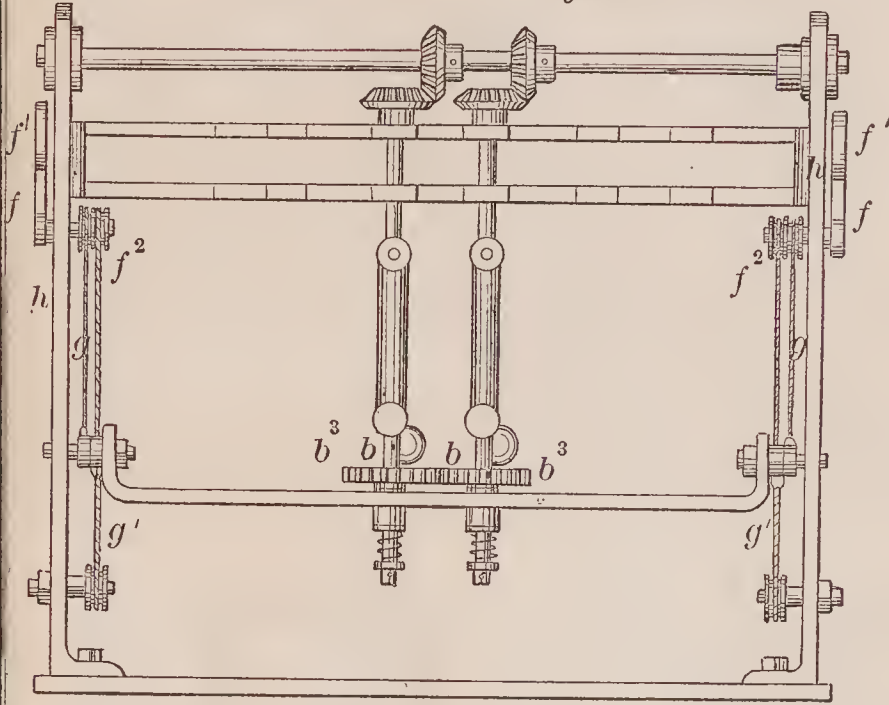

69162—J. H. Barley—Cultivator.

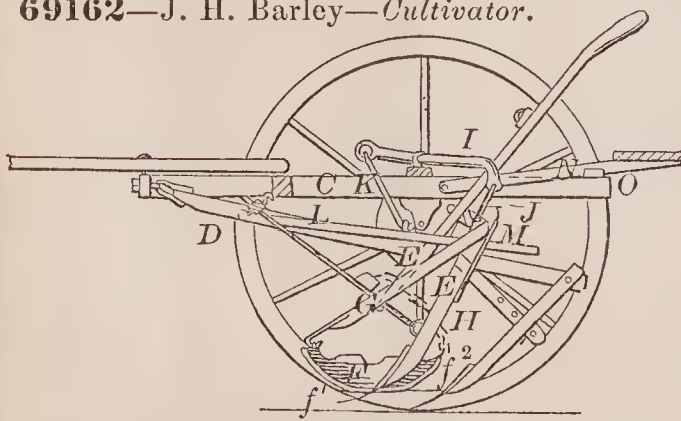

69164—G. Beatty—Sheep Shed and Rack.

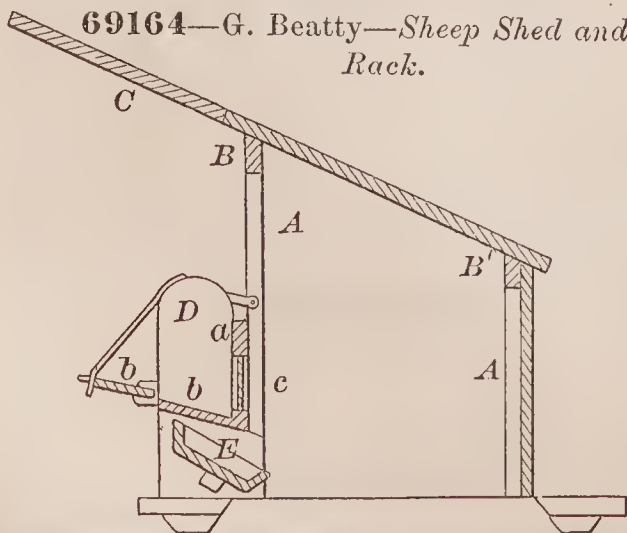

69160—S. Barker—Arle Box.

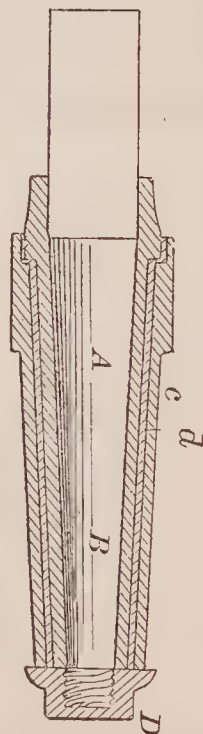

69161—J. H. Barley—Cune Stripper.

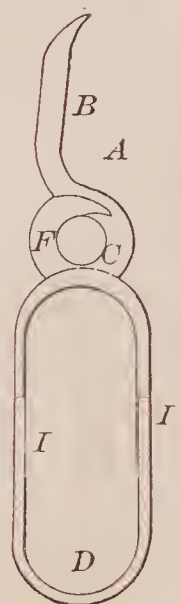

69166—J. Blackadder—  
*Omnibus Fare Box.*

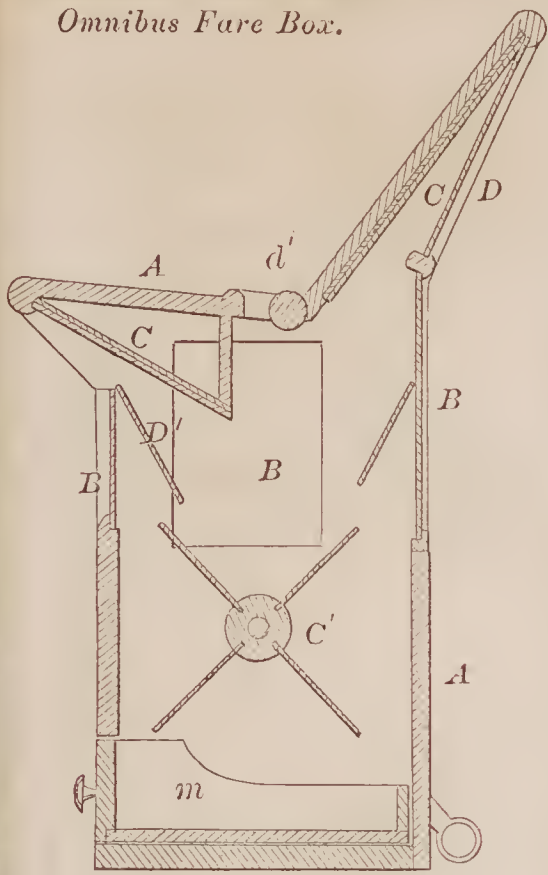

69167—Blackwood & Wilson—*Hand Spinning Machine.*

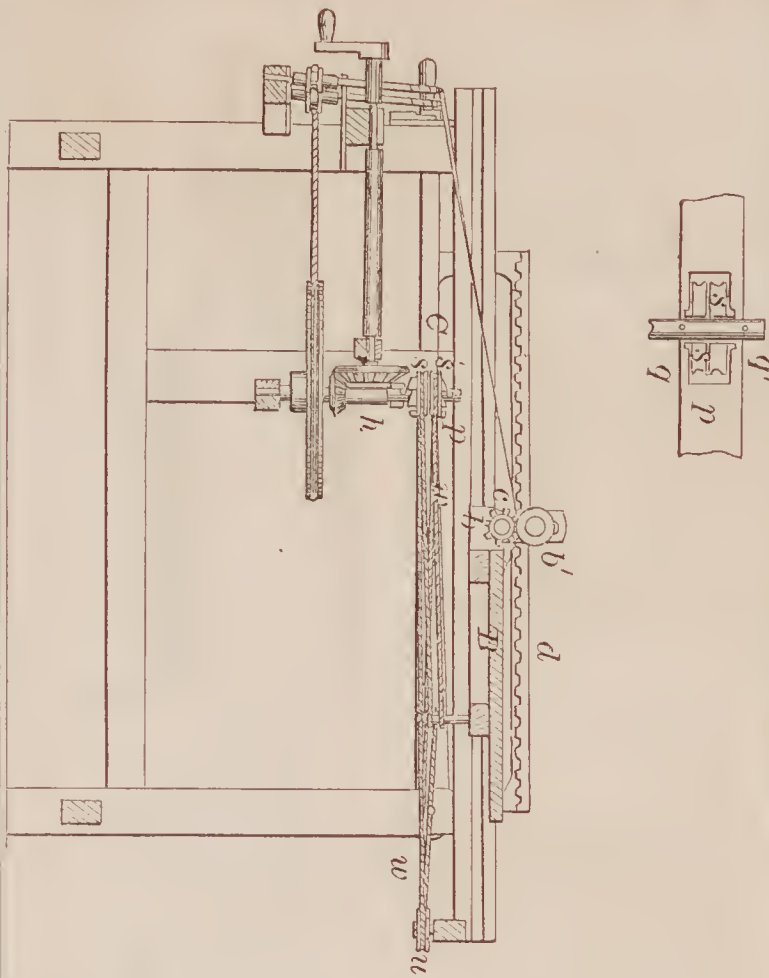

69170—T. Bradley—*Hand Seeder.*

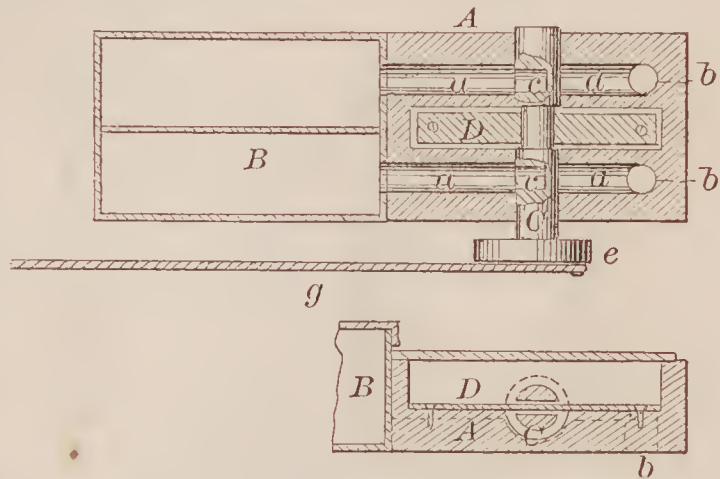

69171—J. Braum—*Dryer for Scoured Clothes.*

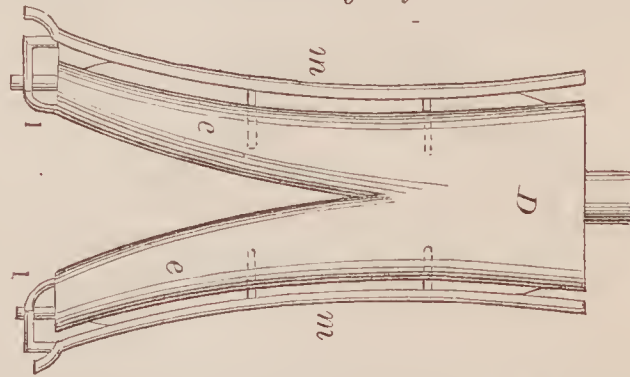

69169—L. W. & R. A. Blood—  
*Water Wheel.*

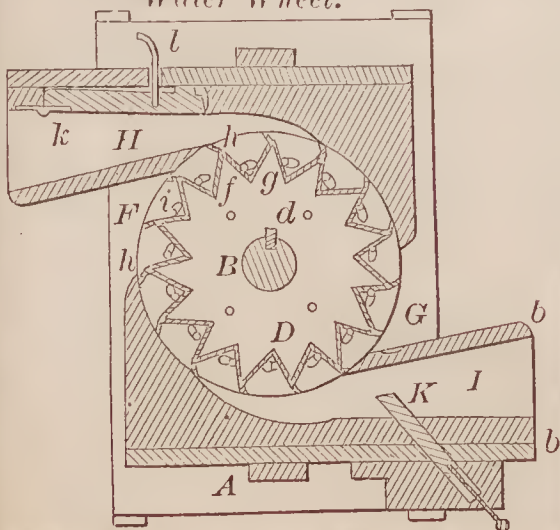

69173—C. Buckley, Jr.—*Nut Fastener.*

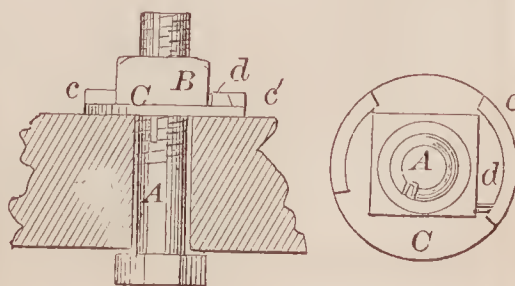

69172—  
J. B. Brown—  
*Hat Block.*

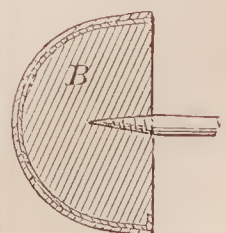

69168—Blomgren & Andersen—*Painters' Scaffold.*

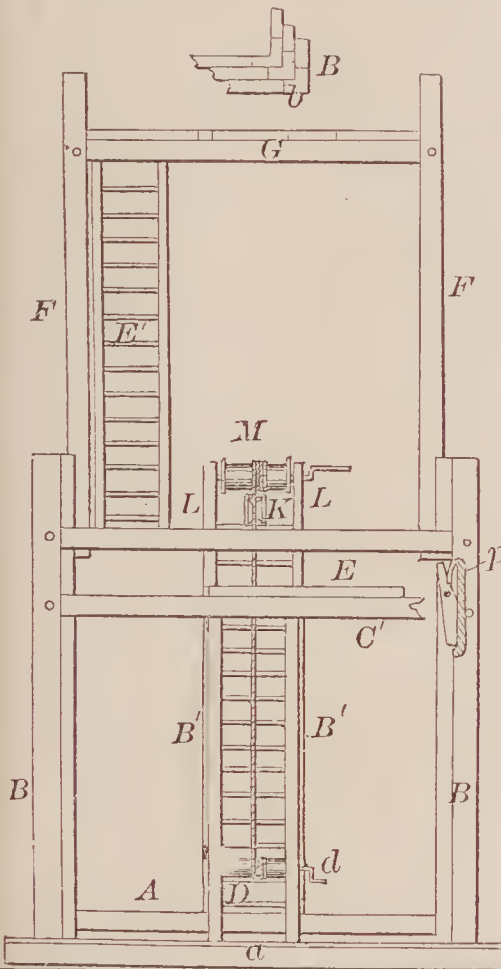



69174—J. Burns—Grinding Mill

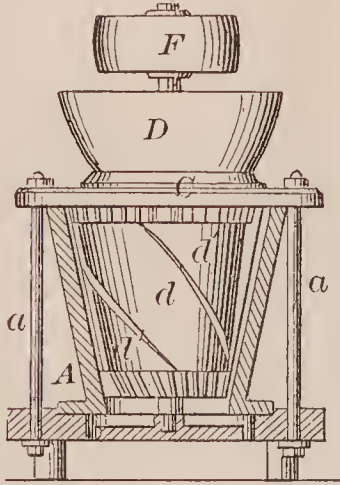

69177—H. S. Carley—Bottle.



69178—S. Chase—For Making Clouded Yarn.

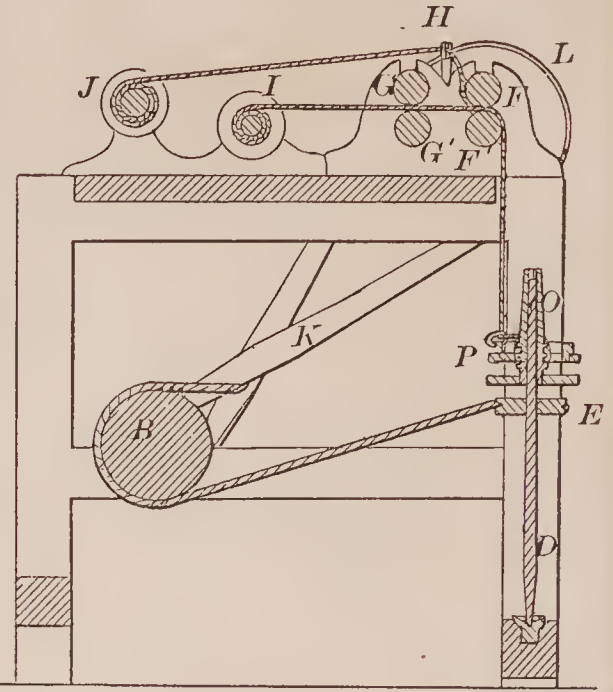

69175—G. R. Burt—Land Roller.

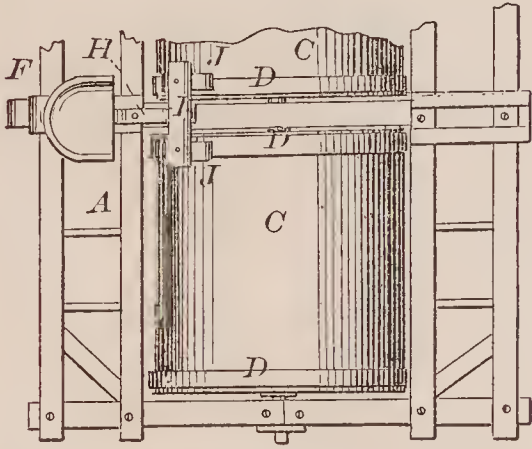
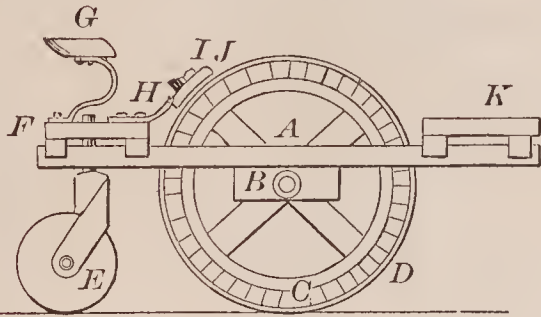

69176—W. Campbell—Window Shade Fixture.

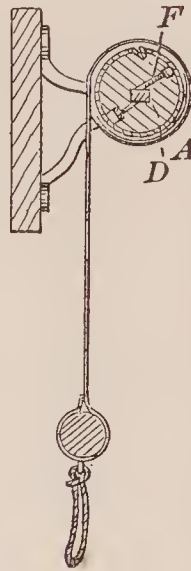

69179—J. C. Clime—For Teaching Music.

Key of C	1	2	3	4	5	6	7	8	9	10	11	12	13	14	15	16	17	18	19	20	21	22	23	24	25	26	27	28	29	30	31	32		
D																																		
E																																		
F																																		
G																																		
A																																		
B																																		
Key of C	1	2	3	4	5	6	7	8	9	10	11	12	13	14	15	16	17	18	19	20	21	22	23	24	25	26	27	28	29	30	31	32		
D																																		
E																																		
F																																		
G																																		
A																																		
B																																		
Key of C	1	2	3	4	5	6	7	8	9	10	11	12	13	14	15	16	17	18	19	20	21	22	23	24	25	26	27	28	29	30	31	32		
D																																		
E																																		
F																																		
G																																		
A																																		
B																																		

69180—P. Cohen—Coat.

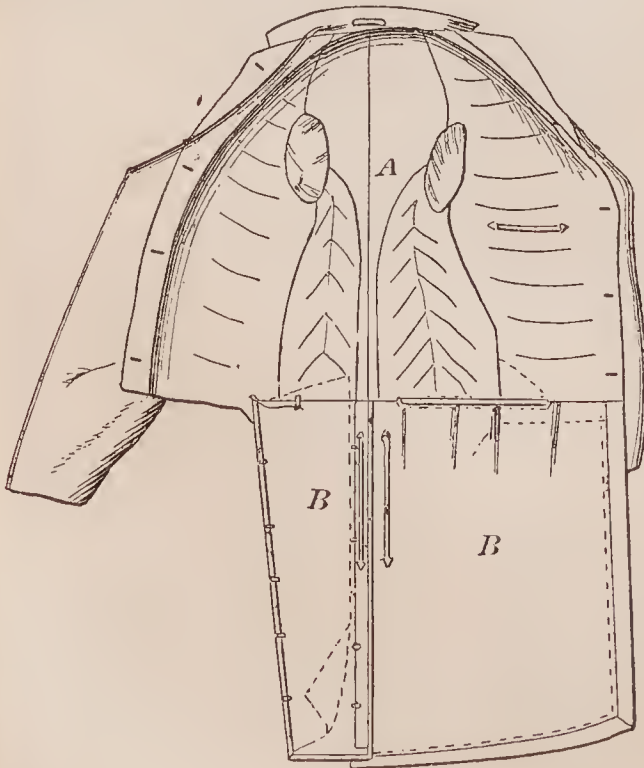

69181—E. Cole—Buckle.

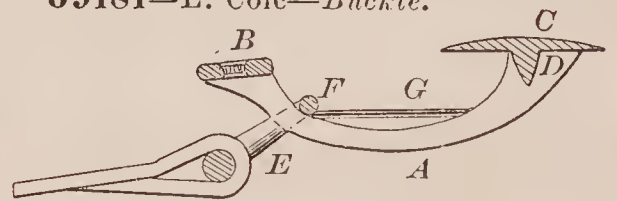

69182—E. Cole—Buckle.

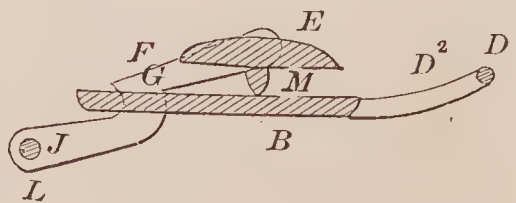

69183—G. M. Cole—*Pump.*

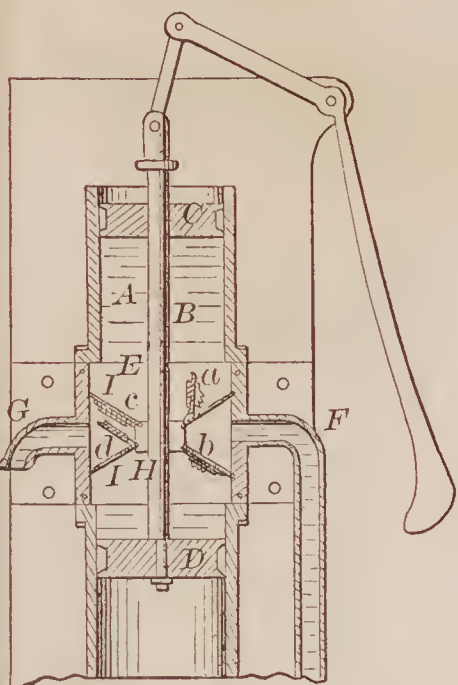

69188—H. Crossman—*Self-Acting Mule.*

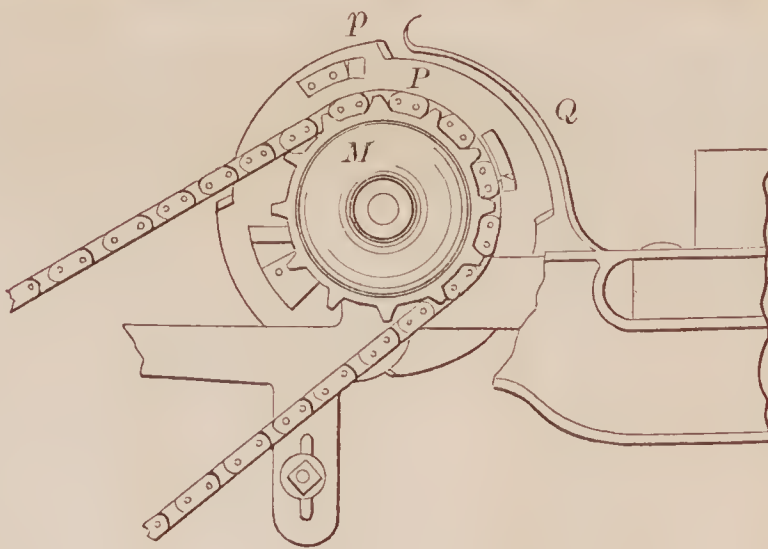

69187—L. D. Copeland—*Hay Raker and Loader.*

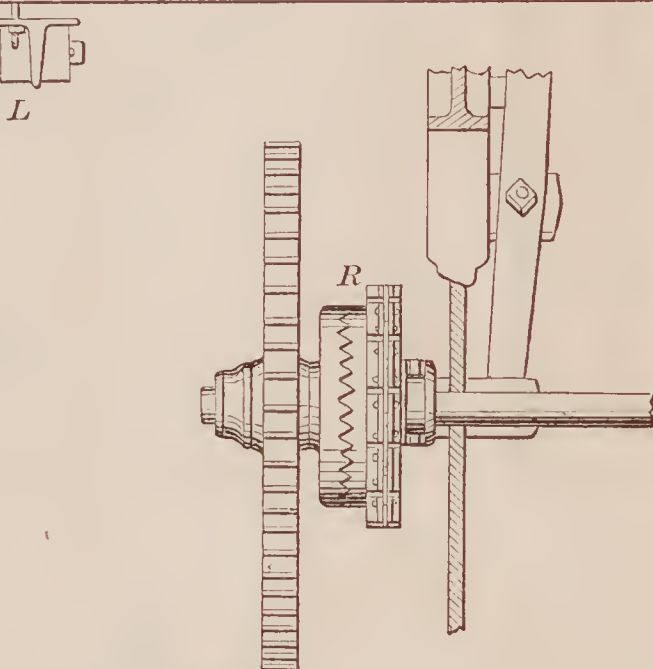
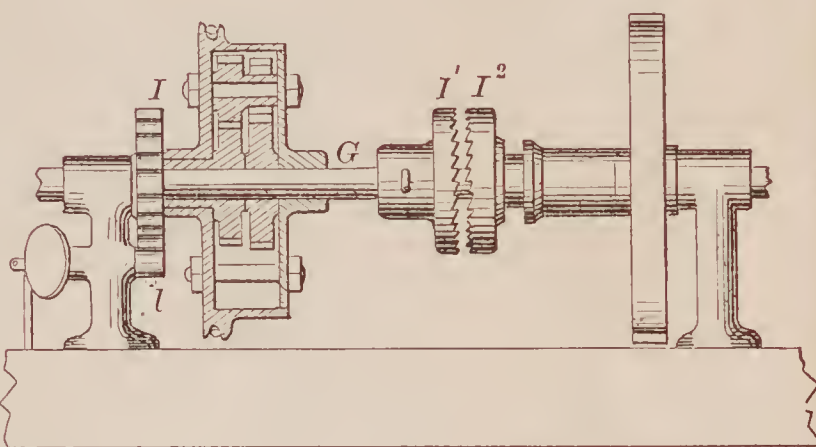
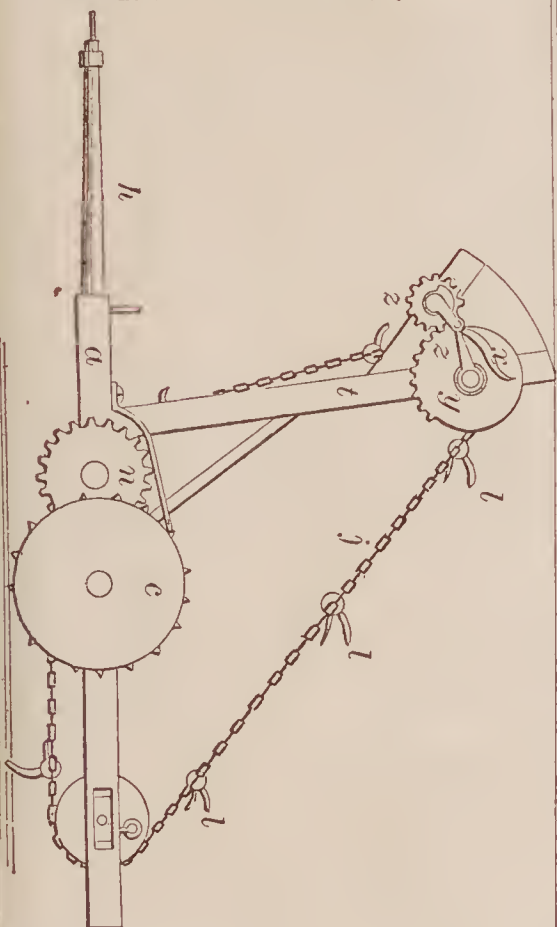

69184—W. T. Cole—*Chuck.*

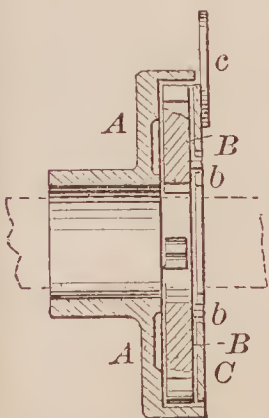

69186—J. W. Connely—*Cultivator.*

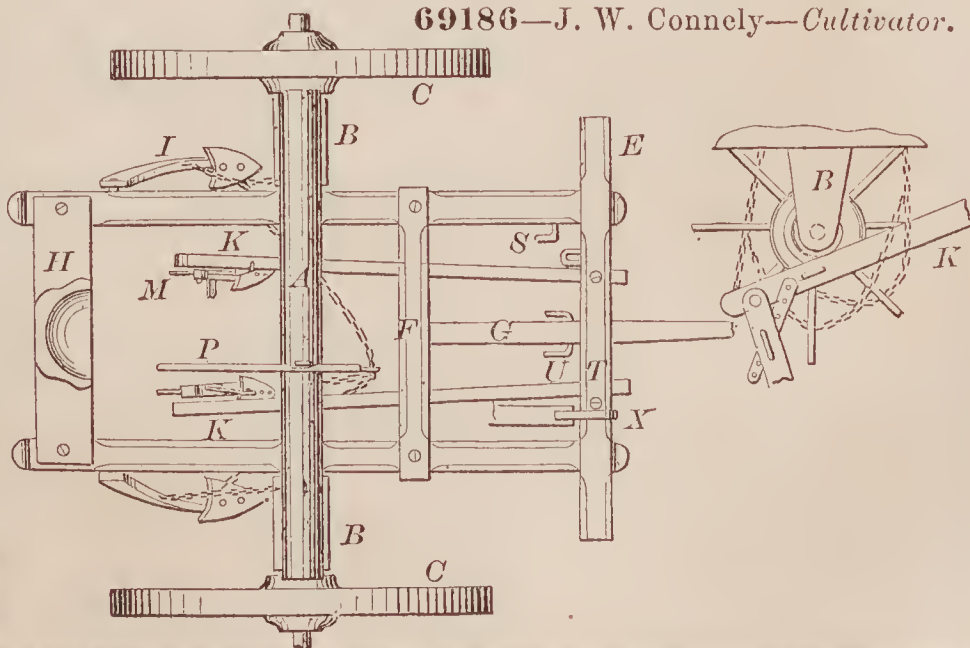







69199—S. Ferris—Horse Blinder.

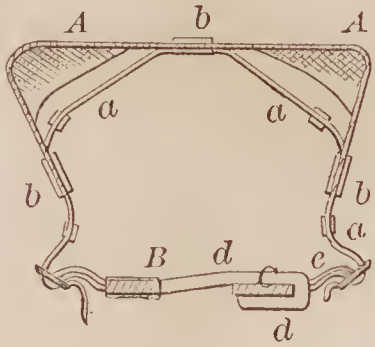

69202—H. C. Freeman—Sawing Machine.

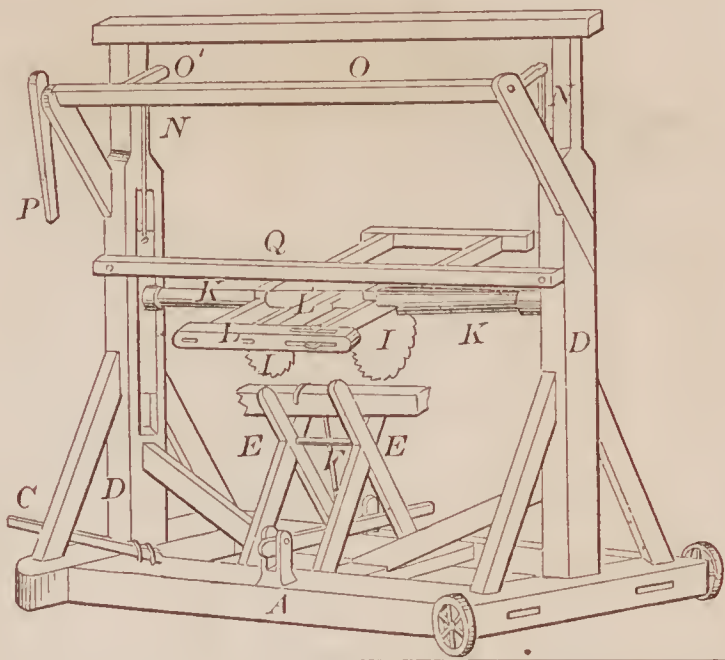

69200—H. W. Fisher—Cooler and Filterer.

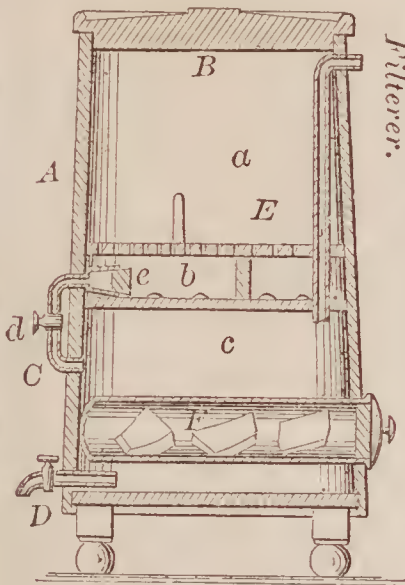

69201—J. Forbes—Attaching Calks to Horse Shoes.

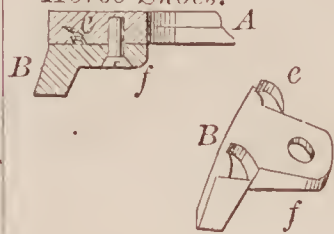

69203—J. Garrison—Cook Stove.

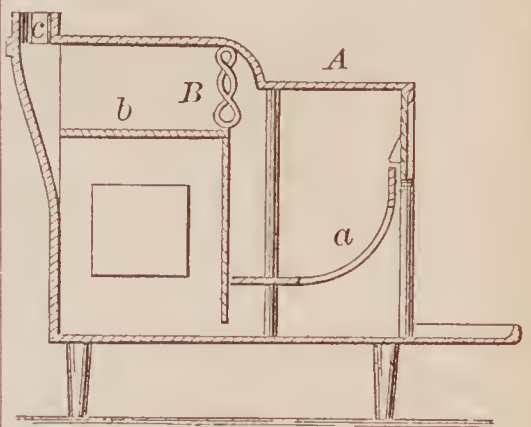

69208—C. P. Hawley—Wagon Spring.

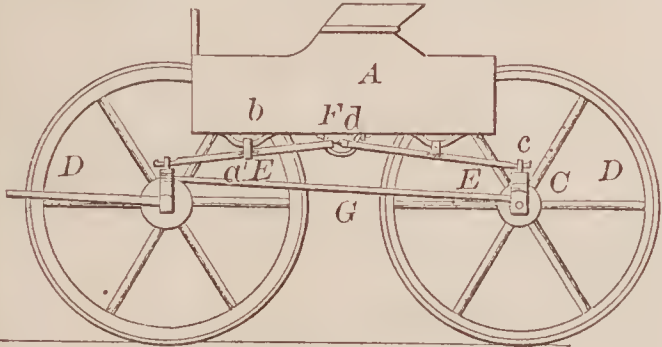

69204—F. Gearing—Market Box.

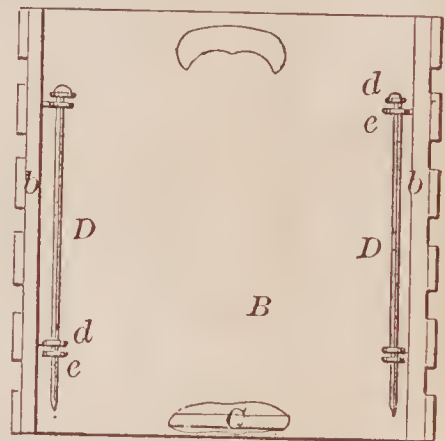

69209—Hazen & Hitchcock—Stump Extractor.

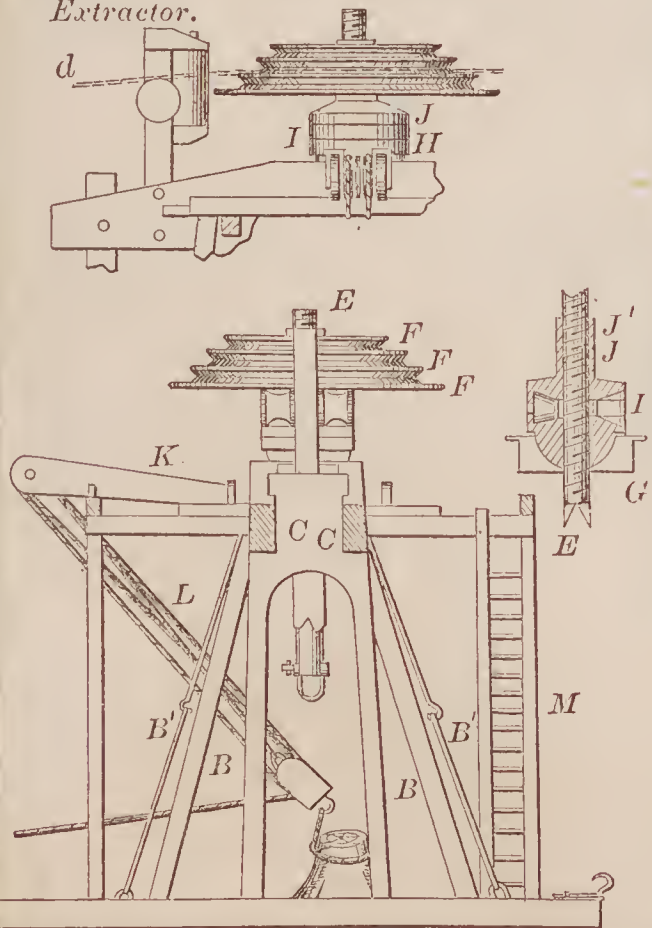

69205—W. Germain—Condensing Tube for Carding Machines.



69207—Harper & Partridge—Seed Dropper.

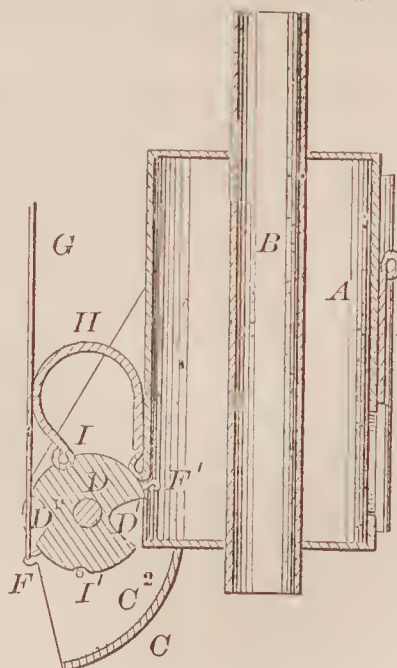



69211—Hoover & Hadley—Spinning Machine.

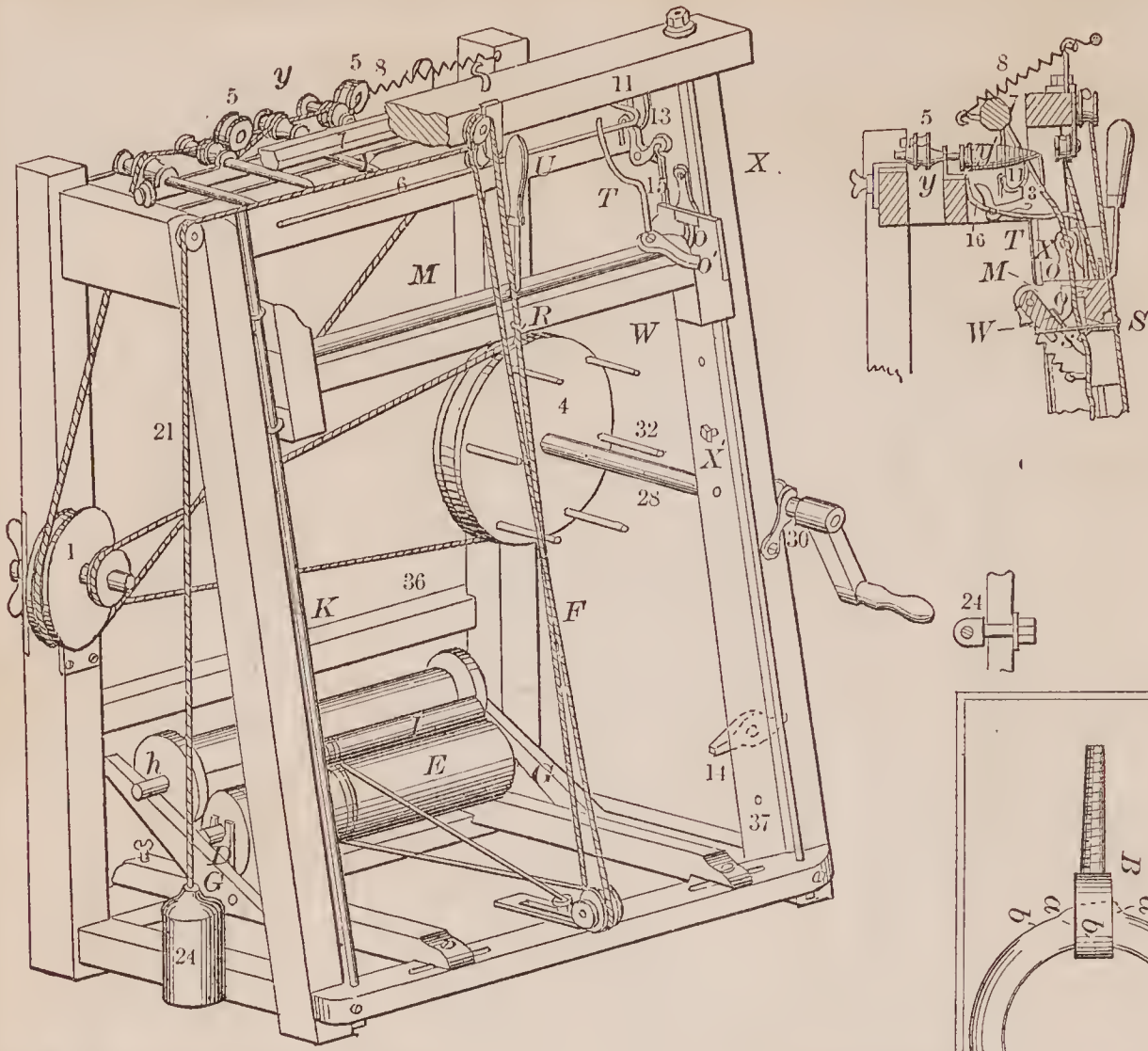

69212—J. P. Howell—Hitching Ring.

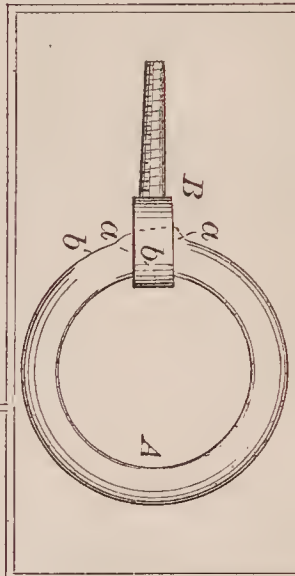

69213—H. W. Howland—Churn.

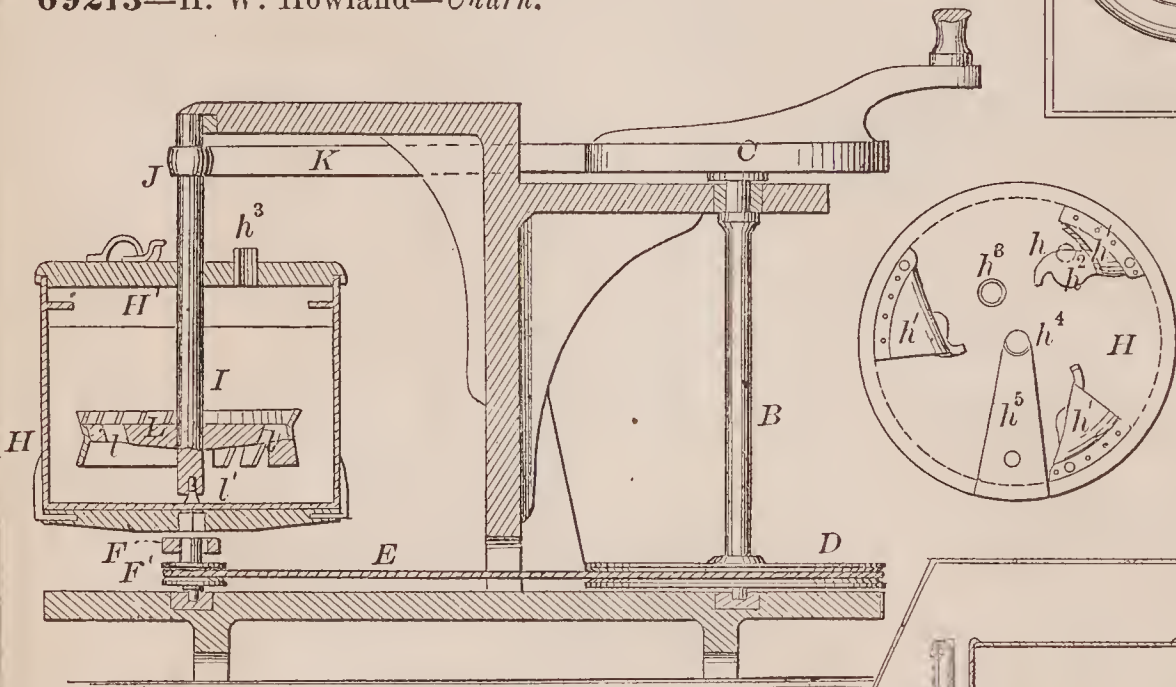

69214—J. C. Hughes—Portable Fence.

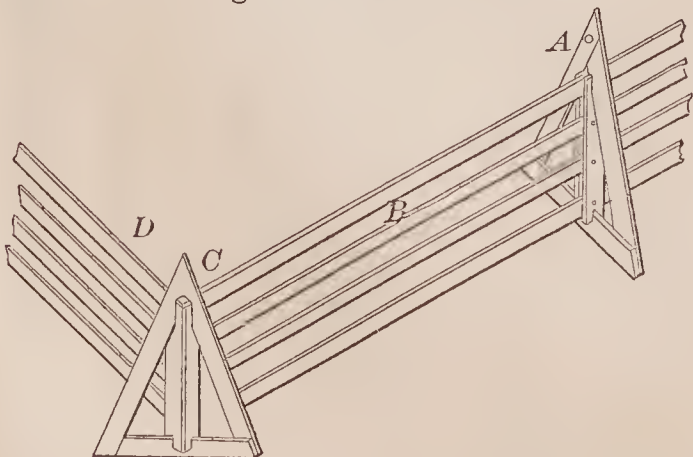

69215—G. G. Hunt—Steam Generator.

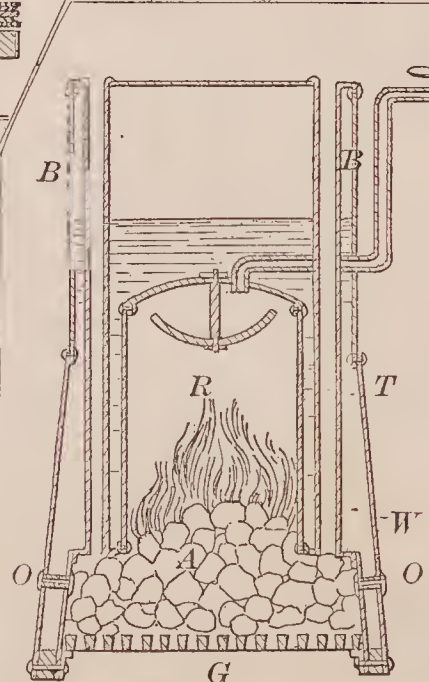

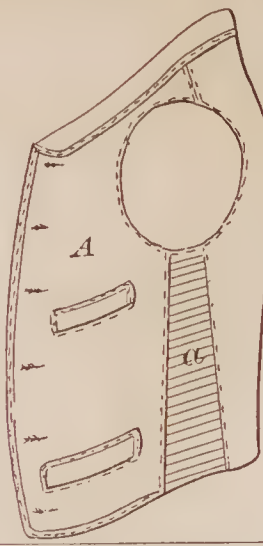

69216—S. W. Huntington—Vest.

69217—J. J. Johnston—Brick Dryer.

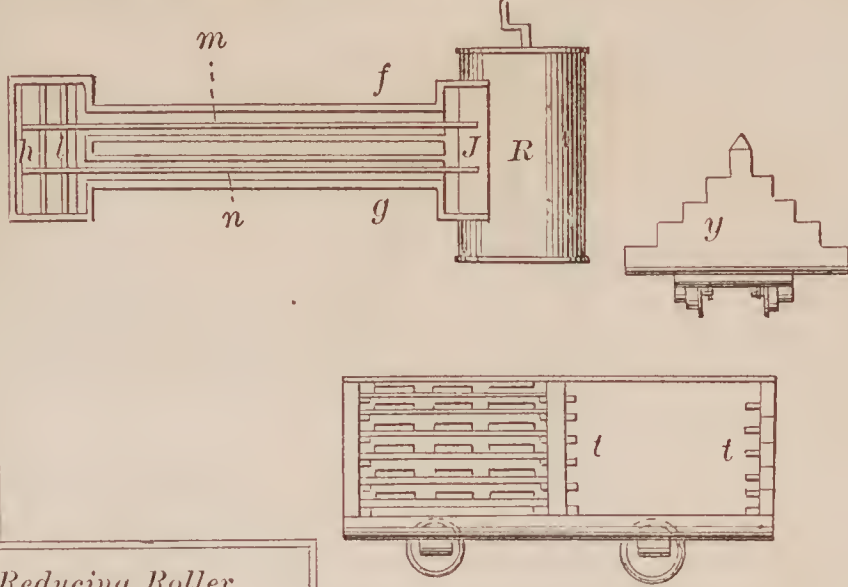

69219—W. C. Joslin—For Reducing Roller Leather to a Uniform Thickness.

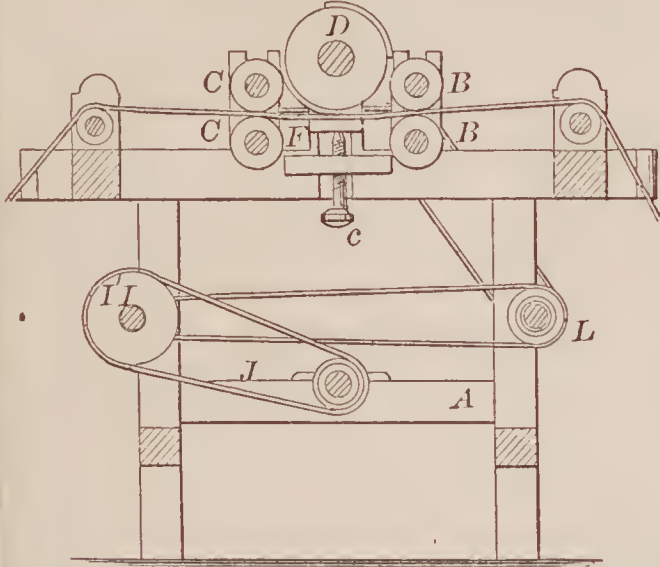

69218—R. J. Jordan—Boiler Water Regulator.

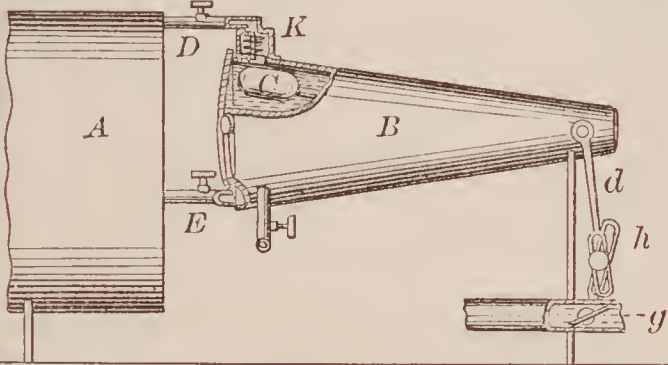

69223—Le G. Kniffen—Refrigerator Car.

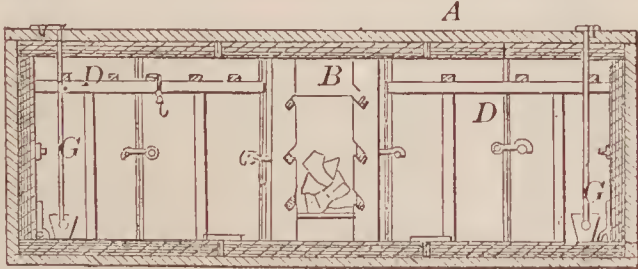

69222—B. V. Kirk—Skirt Elevator.

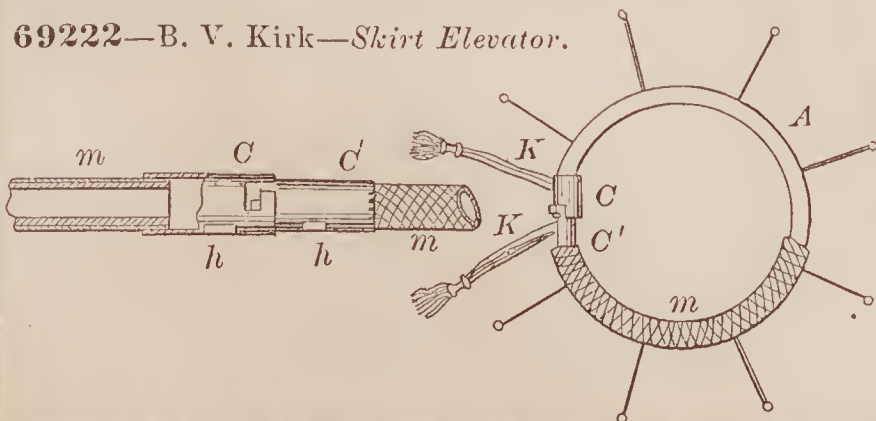

69220—M. Joyce—Boat Lowering and Detaching Apparatus.

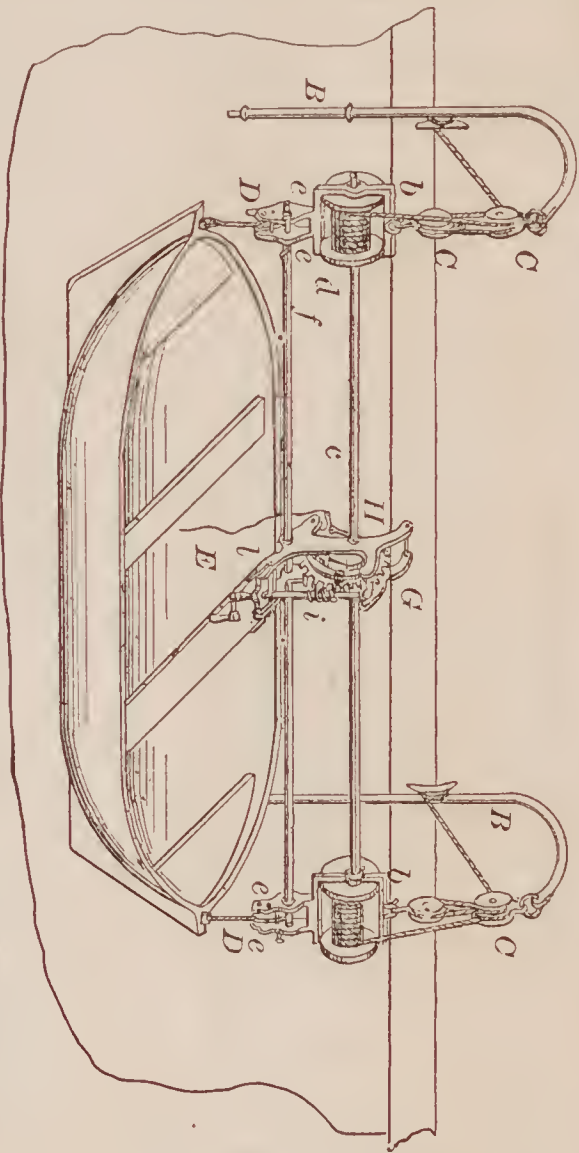

69221—D. Kidder—Spring Fish Hook.

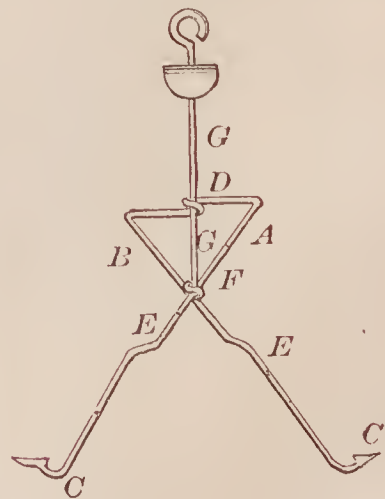



69224—C. Krebs—Adjustable Railing for Vehicles.

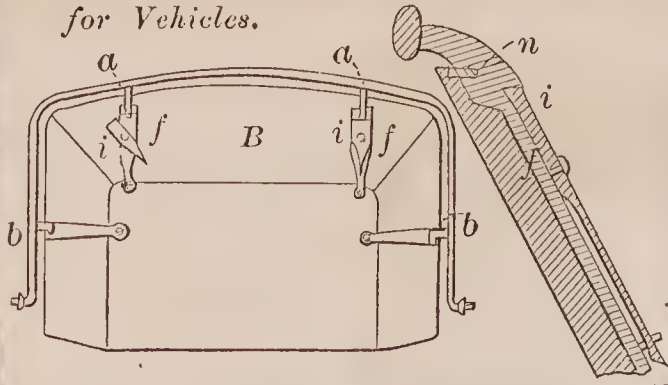

69229—W. Mannheim—For Tapering Leather.

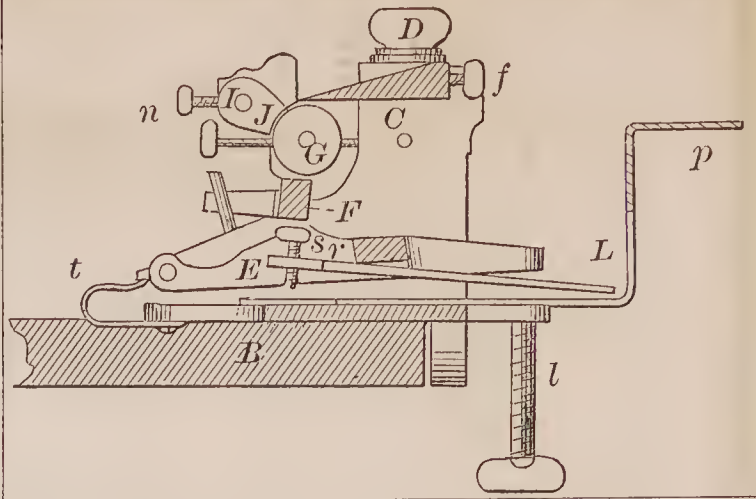

69226—Lamason & Murray—Brake Block and Shoe for Railroads.

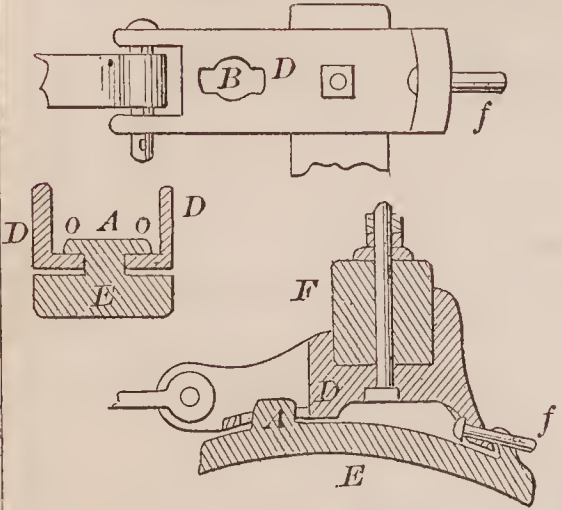

69225—B. P. Lamason—Axle Box.

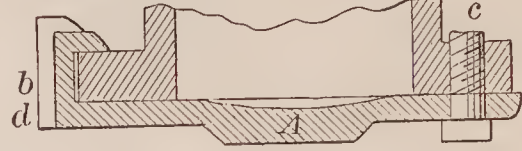

69231—C. K. Marshall—Window Blind.

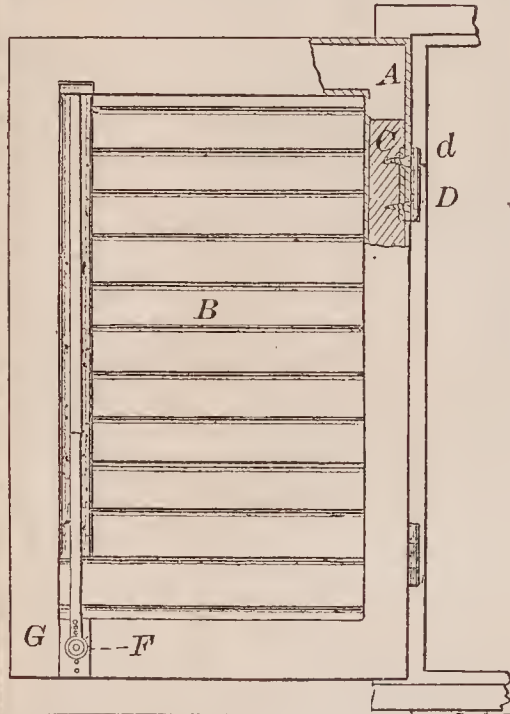

69227—O. Lapham—Wagon Tongue Support.



69228—H. Liebmann—Vegetable Slicer.

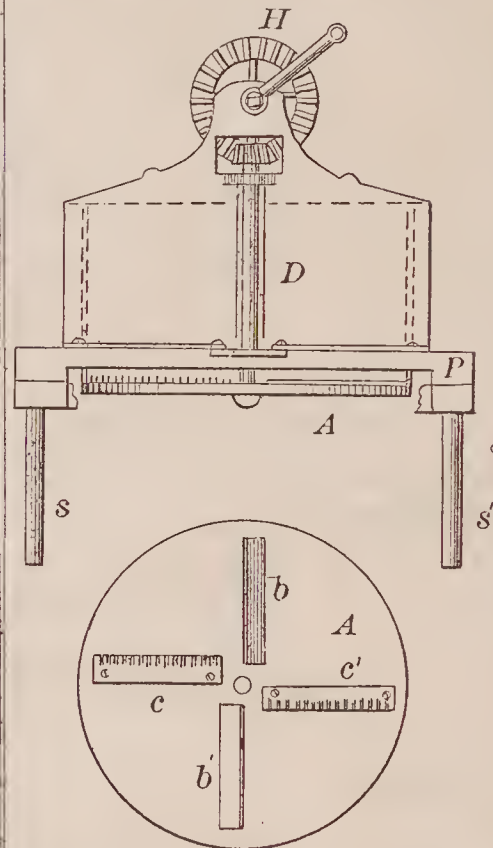

69232—J. McConnell—Steam Engine Valve.

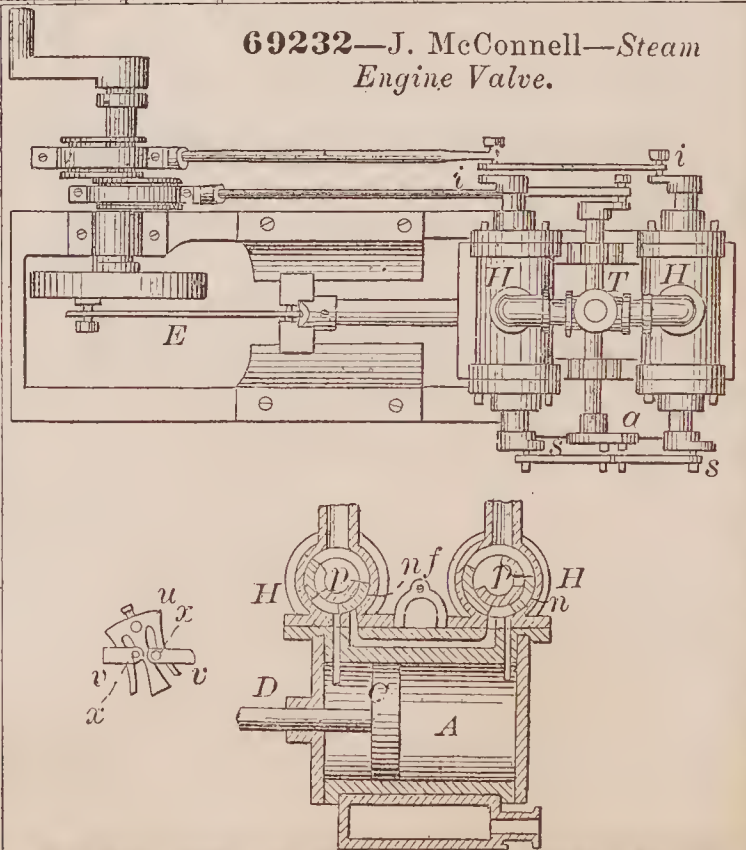

69230—Manville & Judd—For Capping Screw Heads.

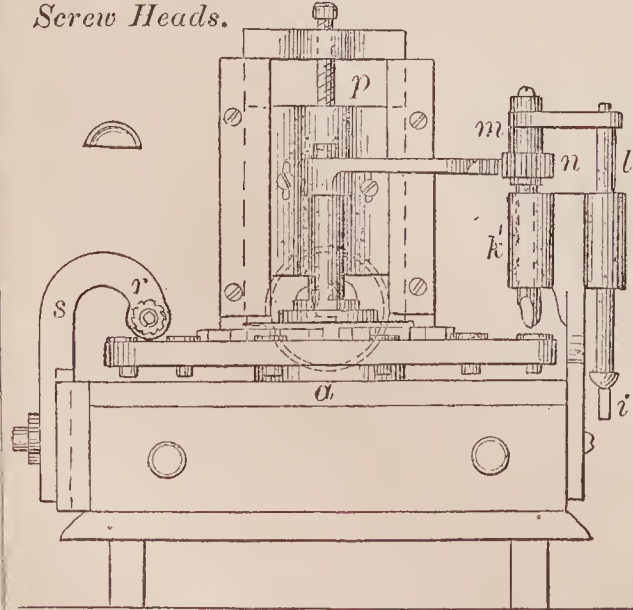



69233—J. R. McGuire—Carriage Circle.

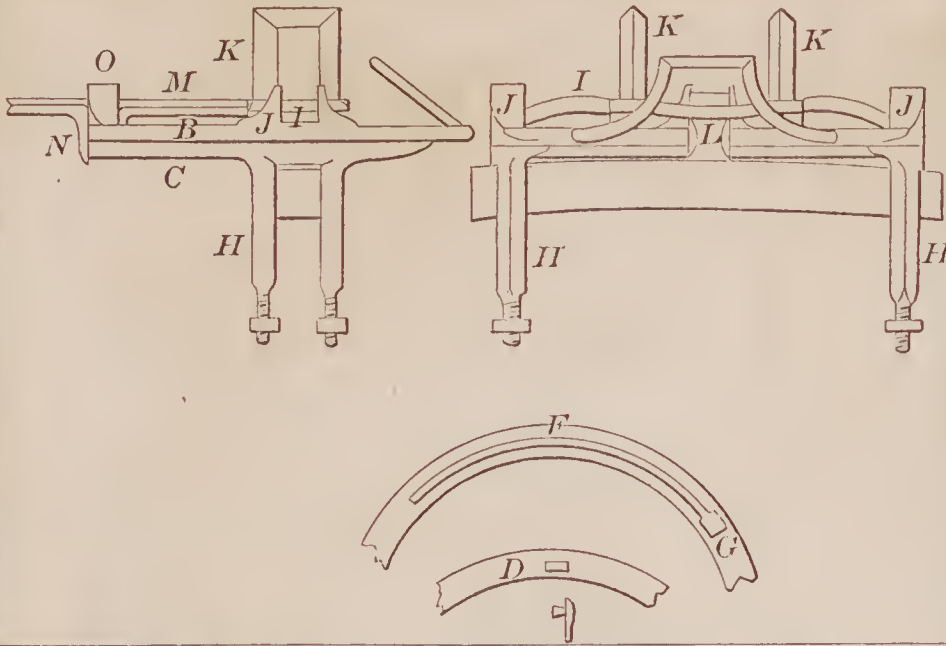

69234—J. W. McKee—Clamp Strap for School Books.

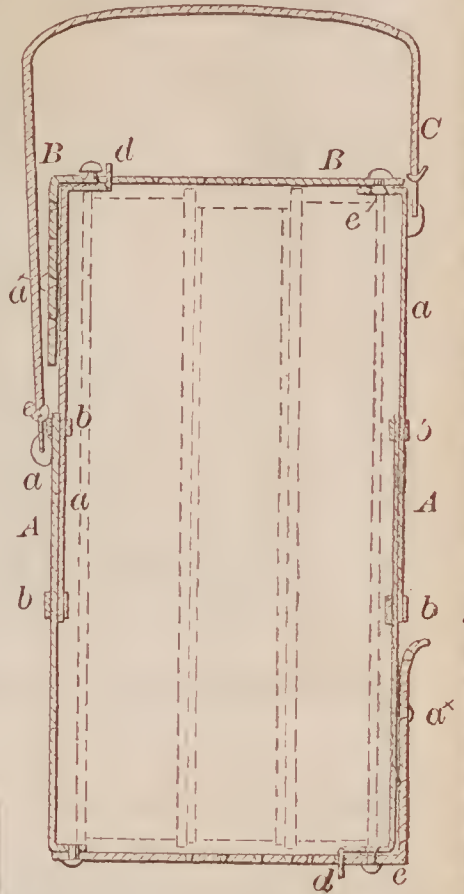

69236—Miller & Mund—Burglar Proof Window and Door Grate.

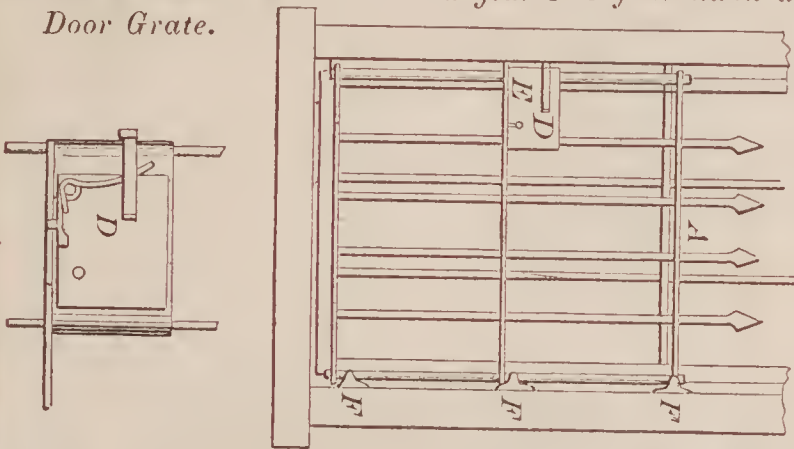

69240—J. N. Paddock—Dish and Vegetable Washer.

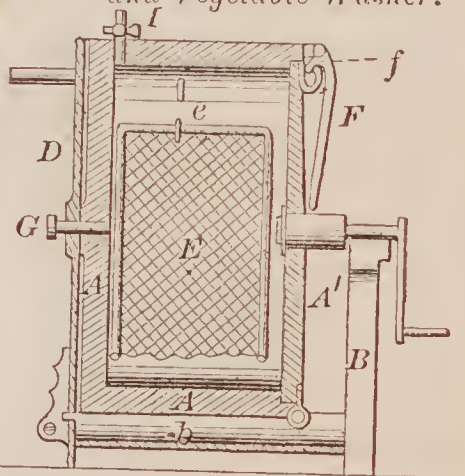

69237—W. W. Miller—Fagot for Beams.

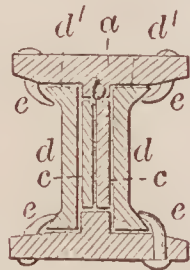

69235—W. A. Messler—Door Holder.

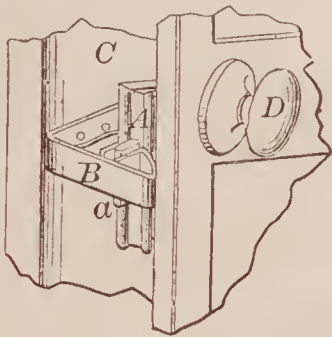

69238—J. D. Nietzsche—Coffin.

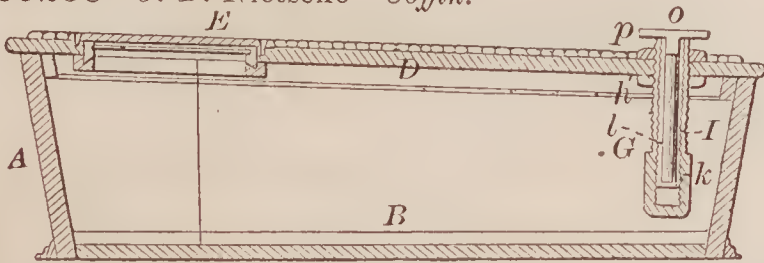

69241—G. Palmer—Joint and Railroad Rail.

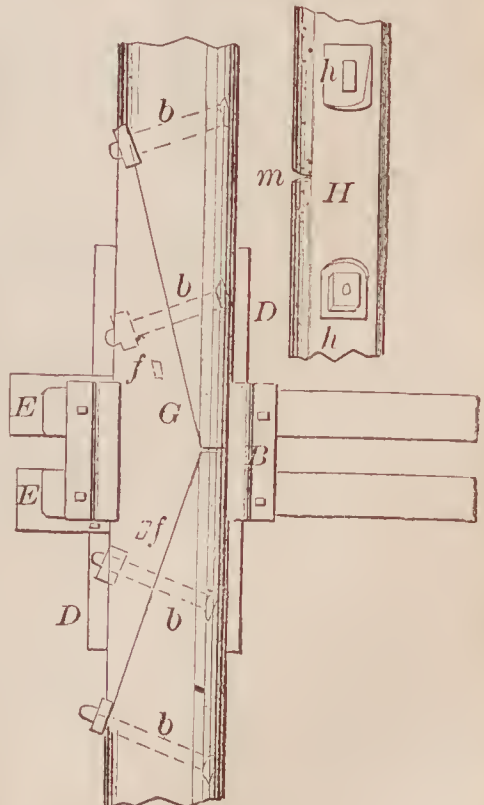

69239—H. W. Ostrom—Harrow Cultivator.

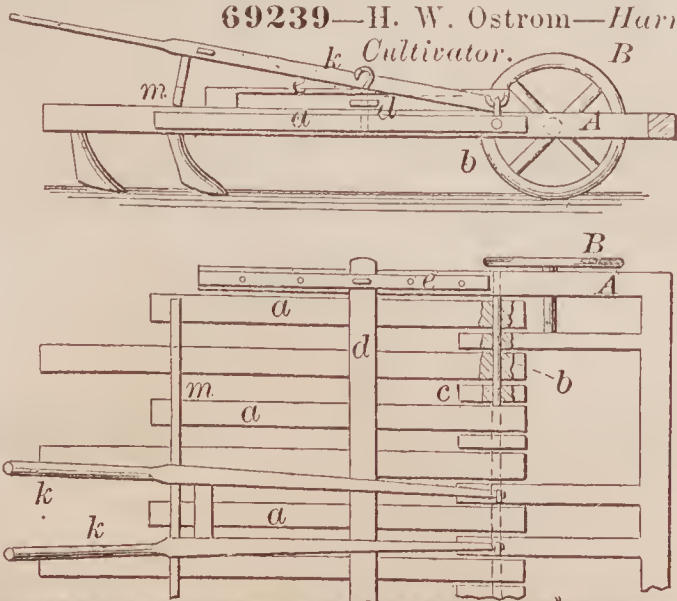



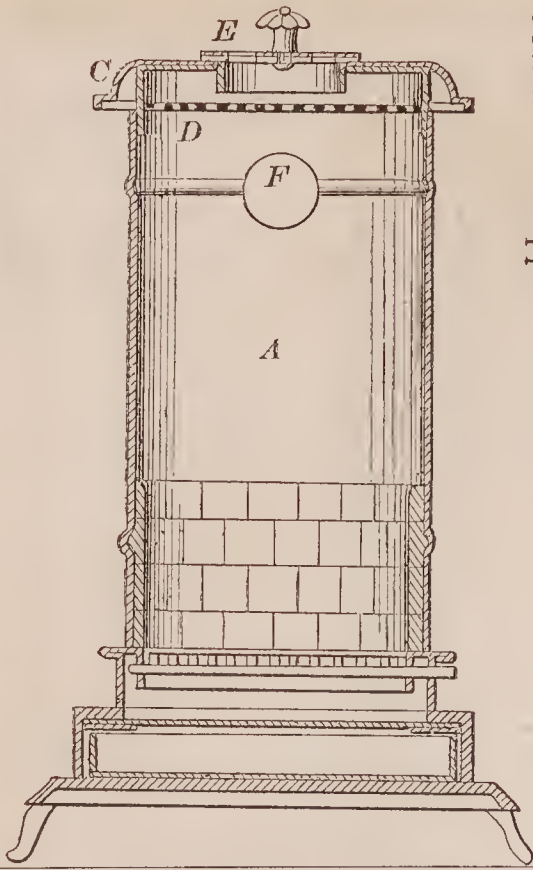

69242—C. Pepper—Coal Stove.

69244—Powers & Stevens—Sugar Cane Mill.

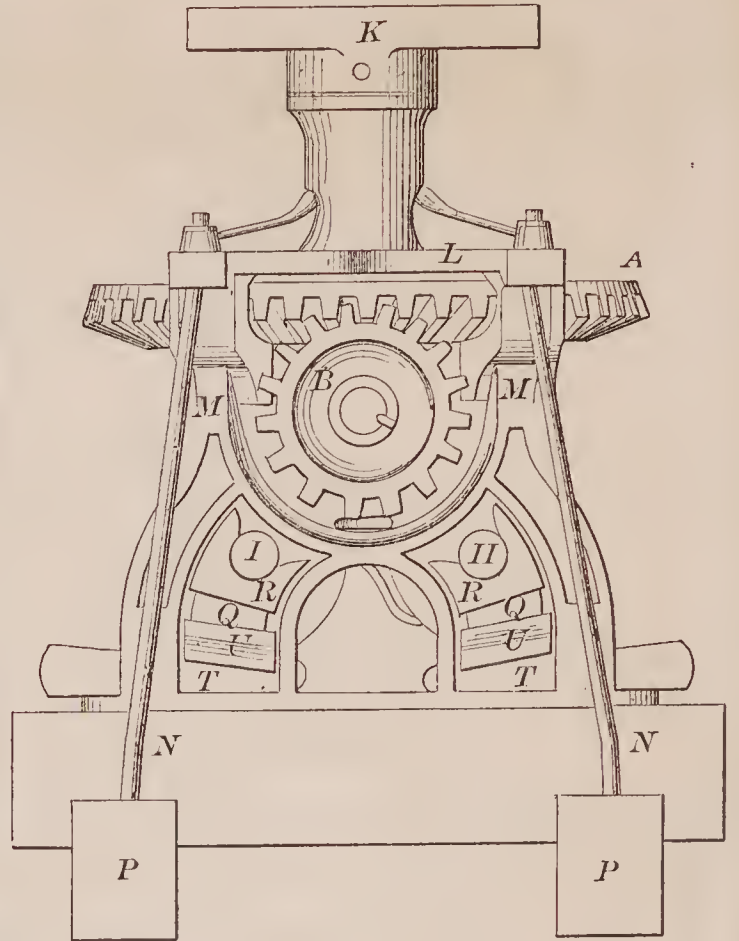

69246—J. H. Quackenbush—Washing Machine.

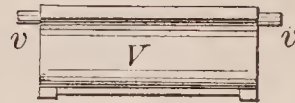
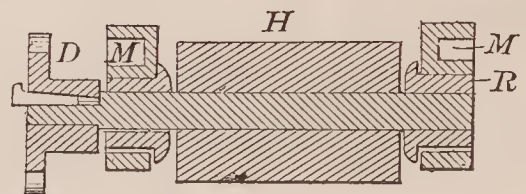
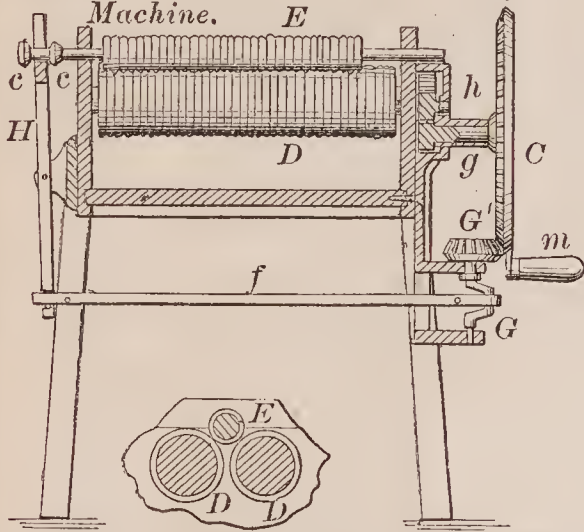

69243—S. Perry—Chain Wheel for Chain Horse Power.

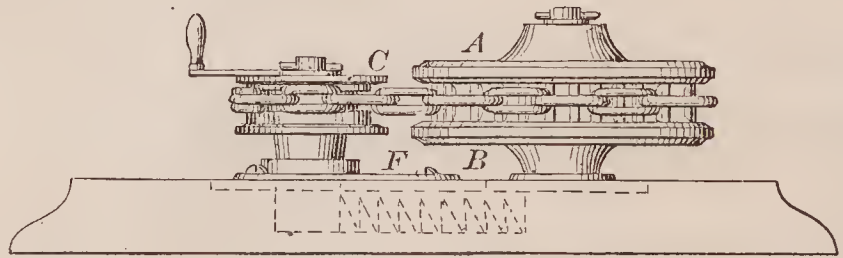
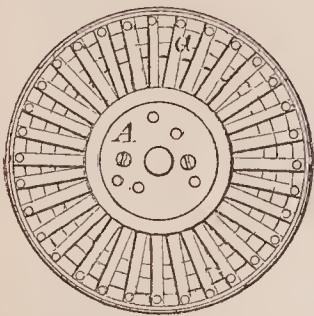

69245—J. A. Preston—Coal Barge.

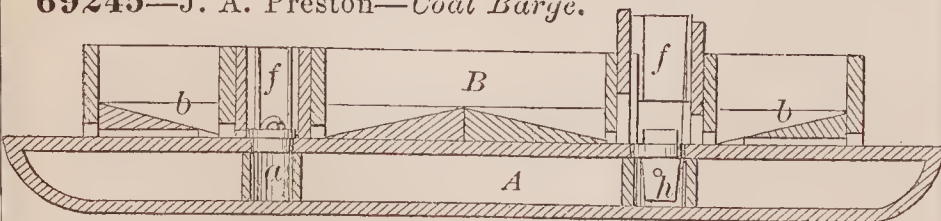

69248—F. Ransom—Churn Dasher.

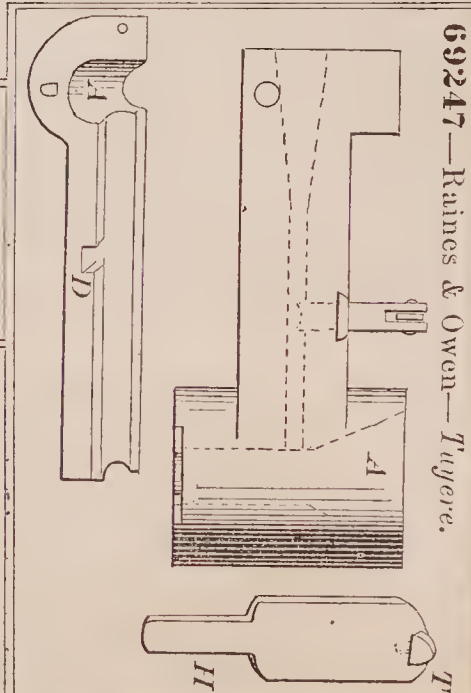
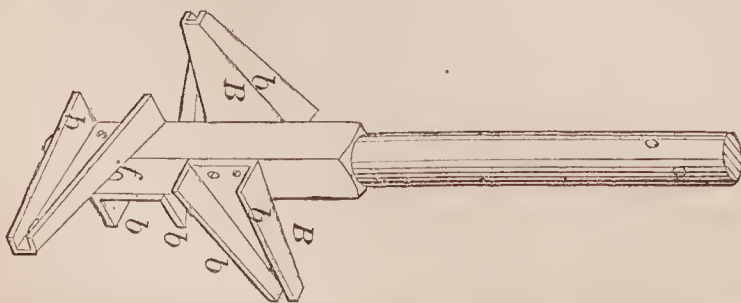

69247—Raines & Owen—Tugger.

69249—I. W. Reid—*Manufacture of Sugar.*

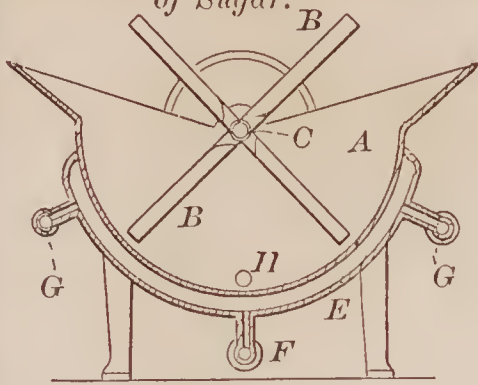

69253—C. Saffray—*For Burning Crude Petroleum.*

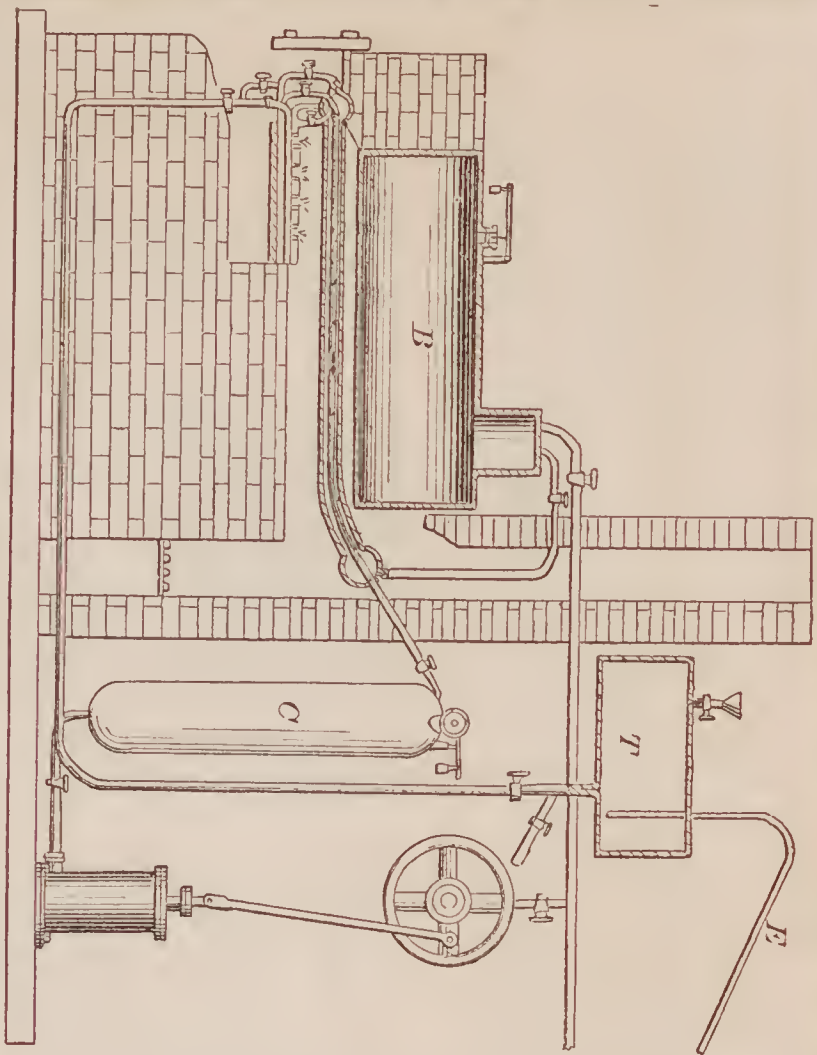

69250—A. J. Reynolds—*Pump.*

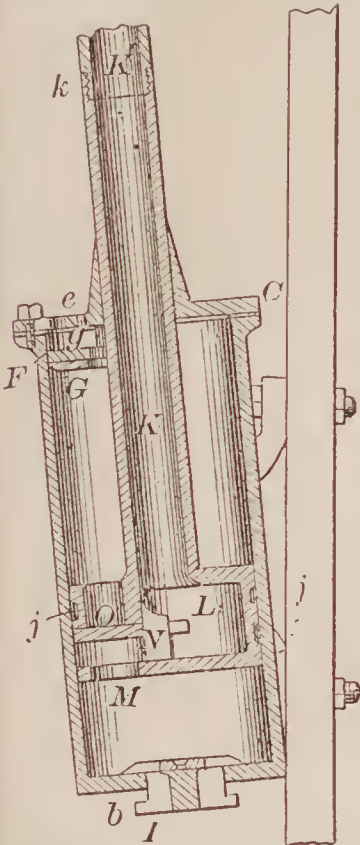

69255—J. Schröder—*Cultivator.*

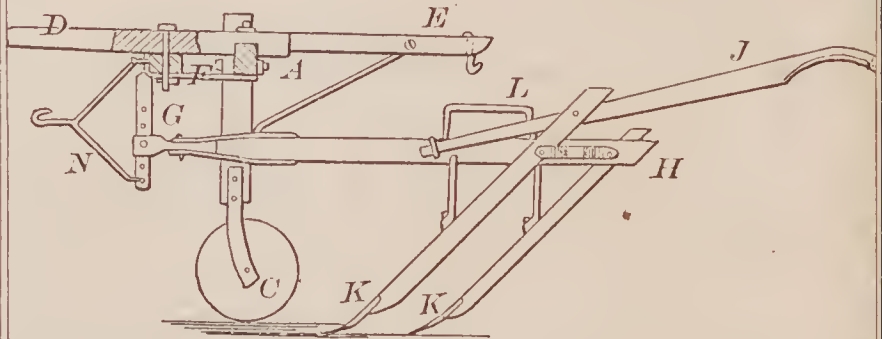

69251—U. Reynolds—*Attaching Yokes to Carriage Poles.*

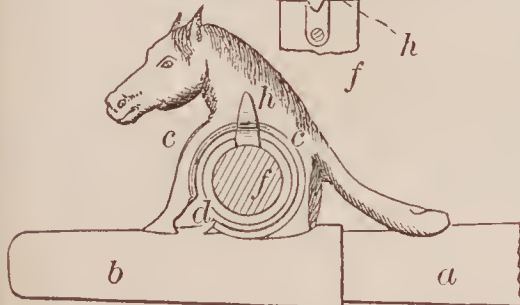
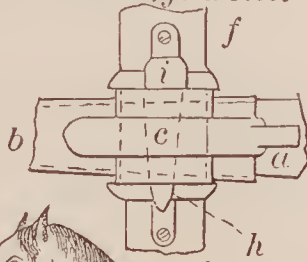

69254—M. Schall—*Candle Holder.*

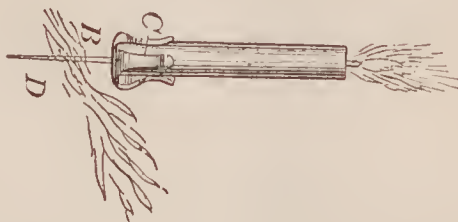

69256—A. Schwebel—*Nut Machine.*

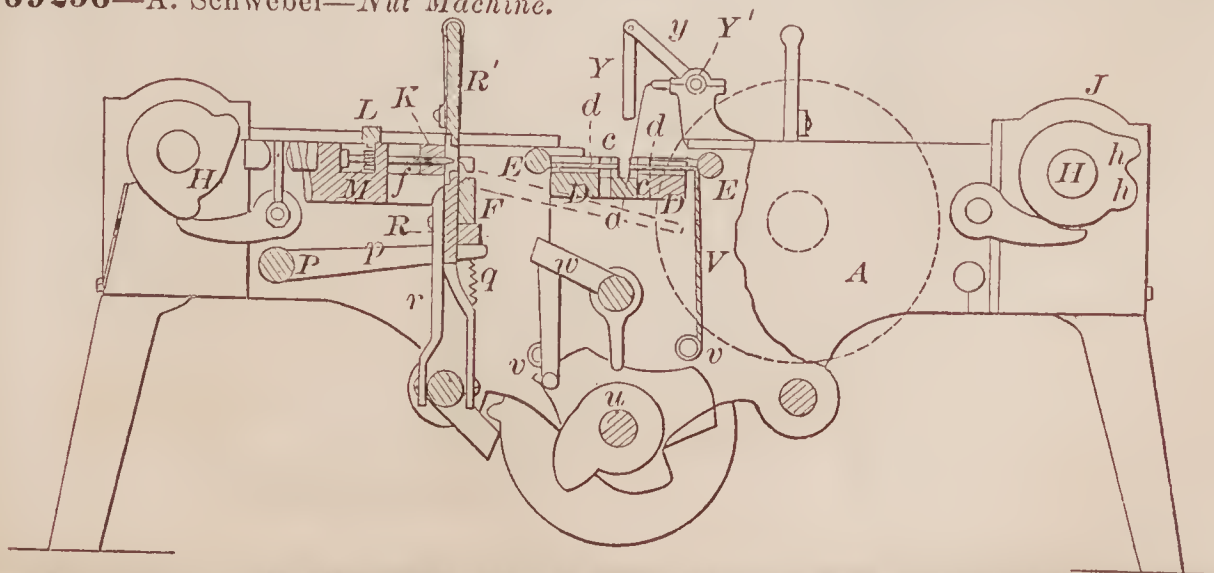



69257—E. U. & W. L. Scoville—Hoisting Apparatus.

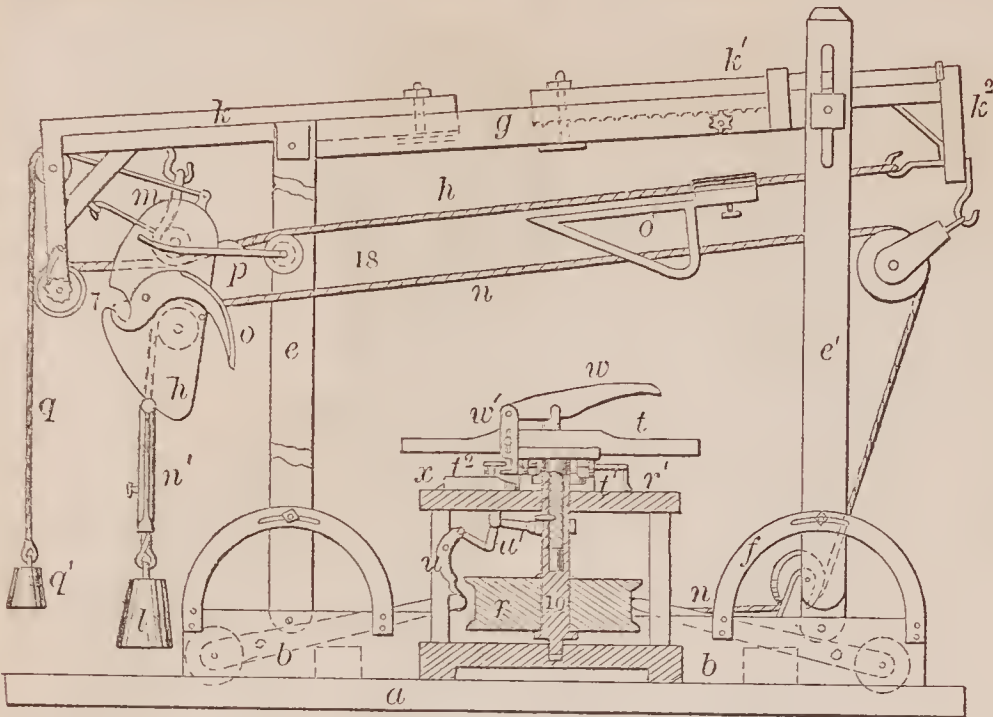

69259—H. Seehausen—Tuning Attachment for Guitars.

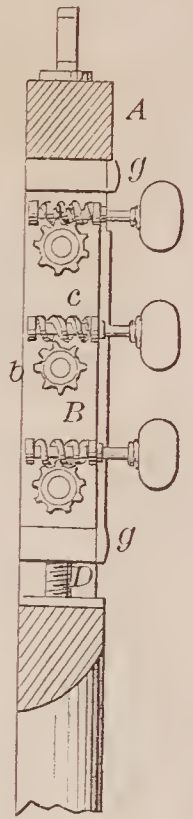

69261—H. F. Seinders—Washing Machine.

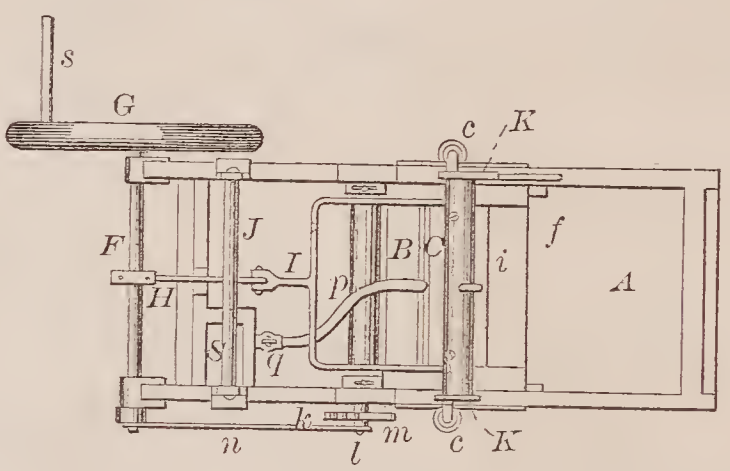
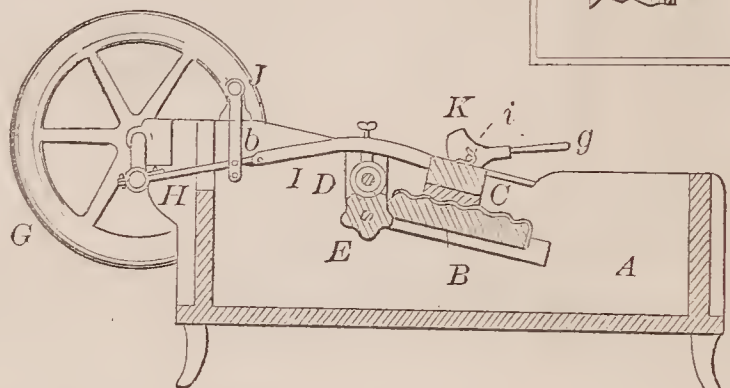

69262—W. S. Shotwell—Car Brake.

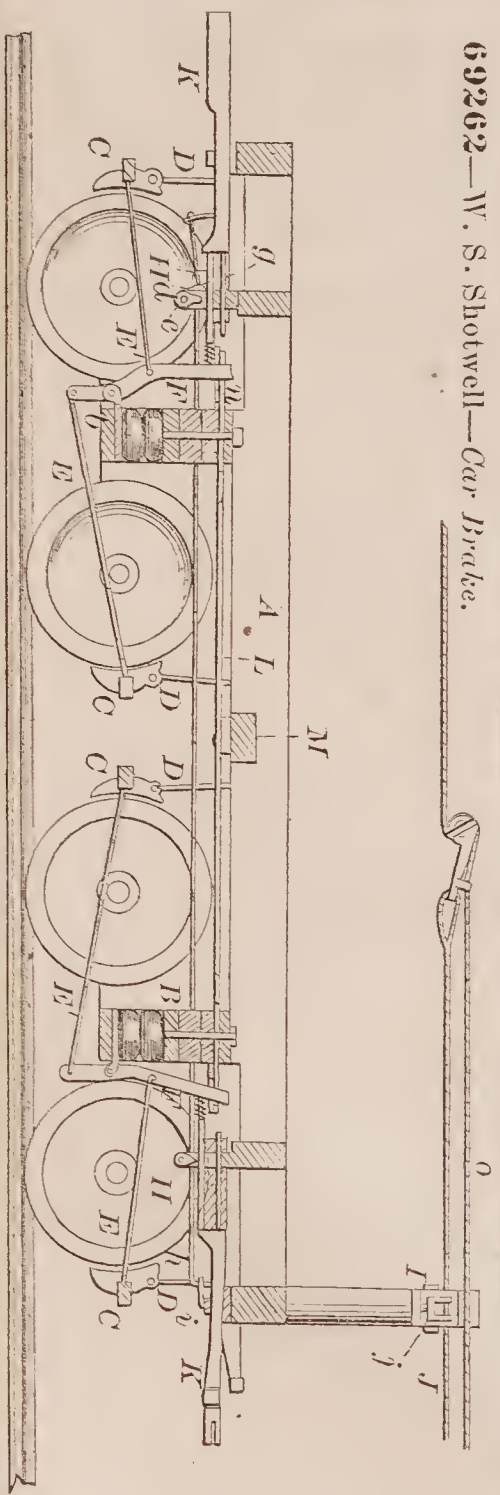

69263—J. B. Slawson—Omnibus Fare Box.

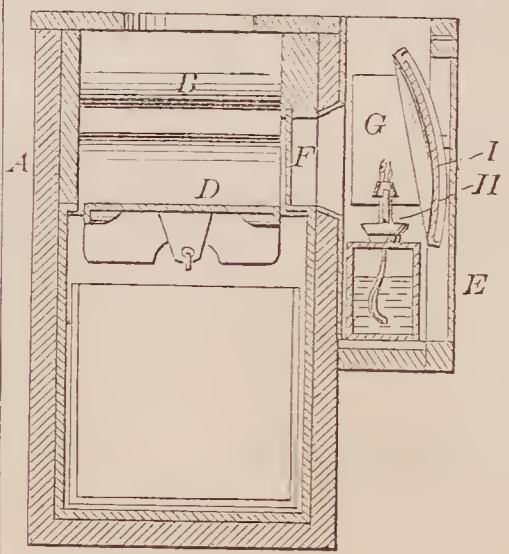

69258—J. Seehrist—Corn Husker.

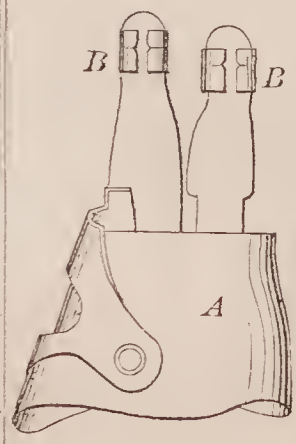

69264—D. A. Smith—*Straw Cutter.*

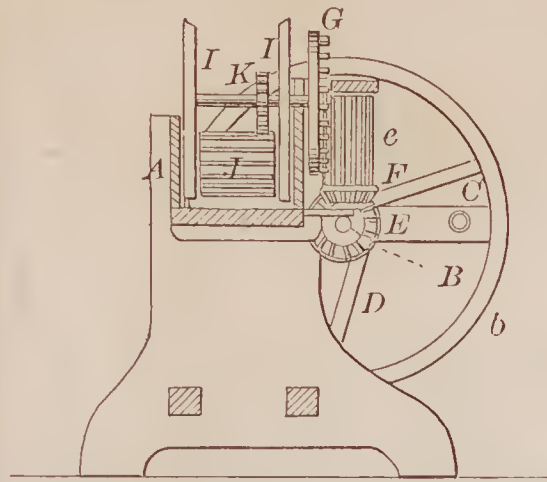

69269—I. Stanbery—*Safety Rein.*

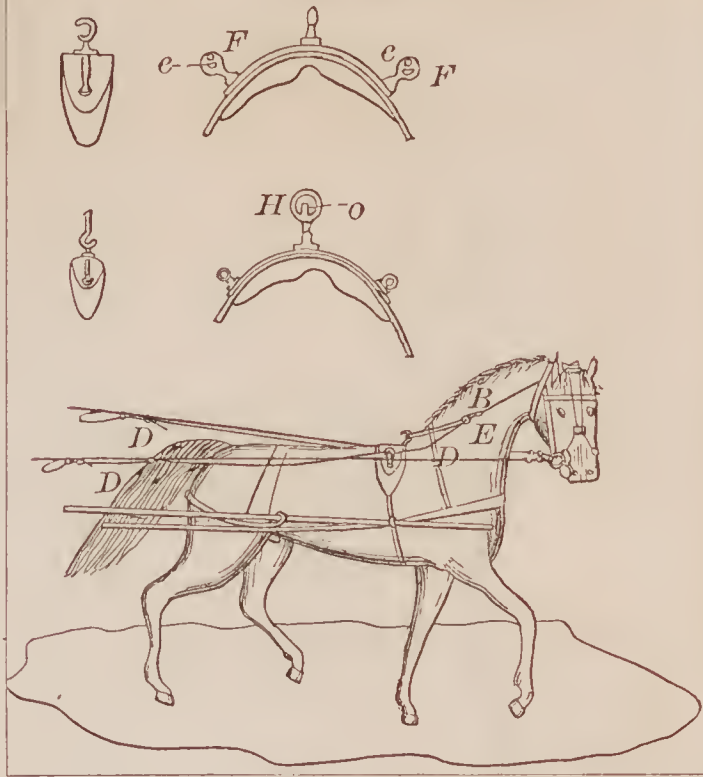

69265—L. S. Smith—*Peg Cutter.*

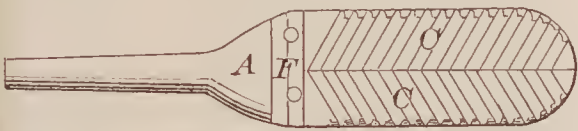

69266—S. H. Smith—*Car Coupling.*

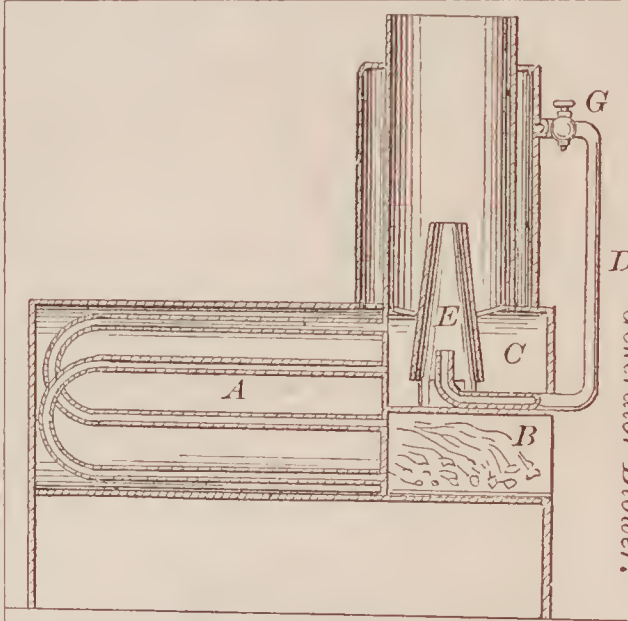
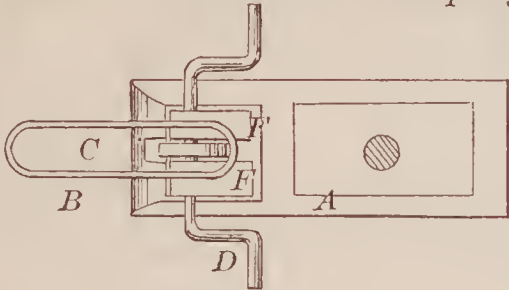

69268—W. H. Squires—*Steam Generator Blower.*

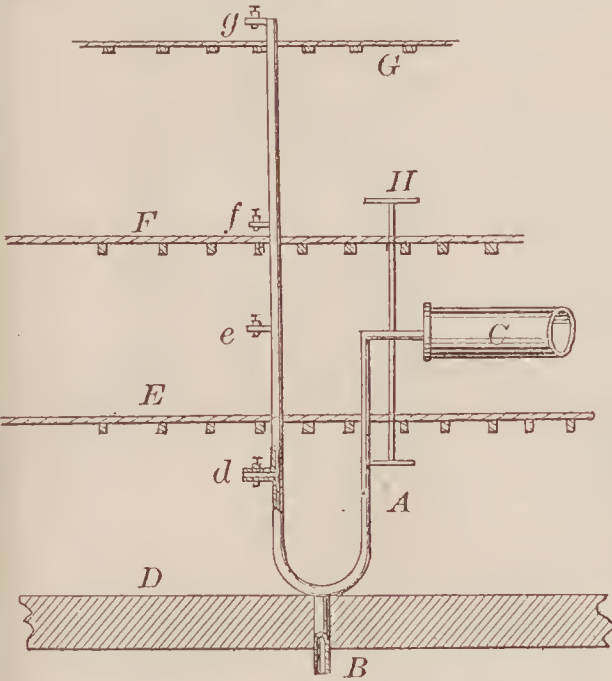

69267—D. Spooner—*For Extinguishing Fire in Steamships.*

69272—J. S. Tibbals—*Lunch Box.*

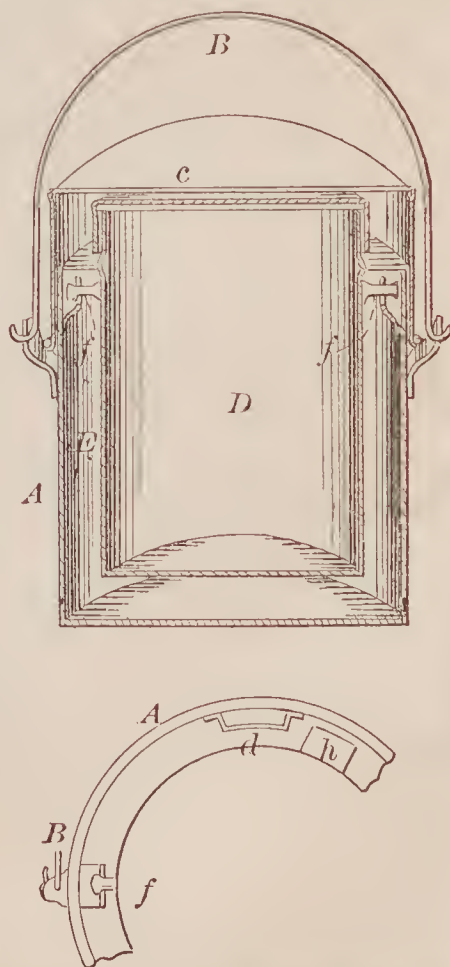

69270—A. E. Thayer—*Third Seat for Carriages.*

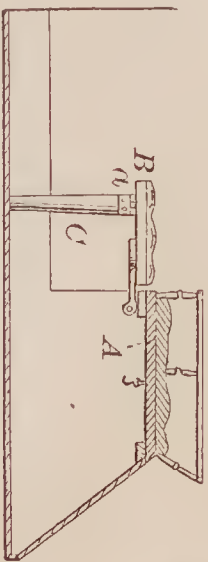

69271—Thompson & Walker—*For Nicking Screw Caps.*

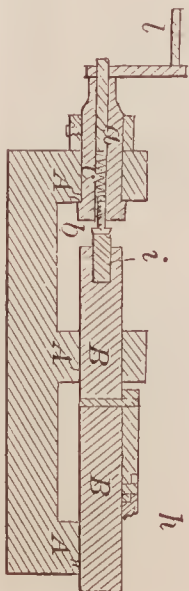



69273—W. H. Townsend—Attaching Horses to Carriages.

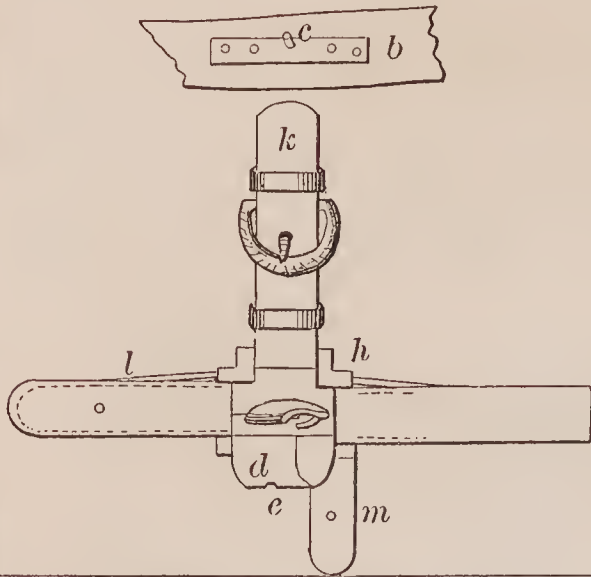

69274—J. W. Truman—Cotton Bale Tie.

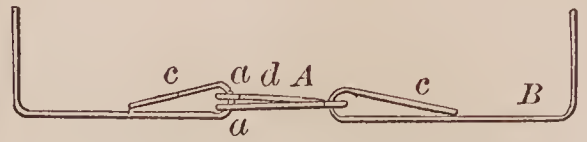

69276—C. S. Twitchell—Folding Chair.

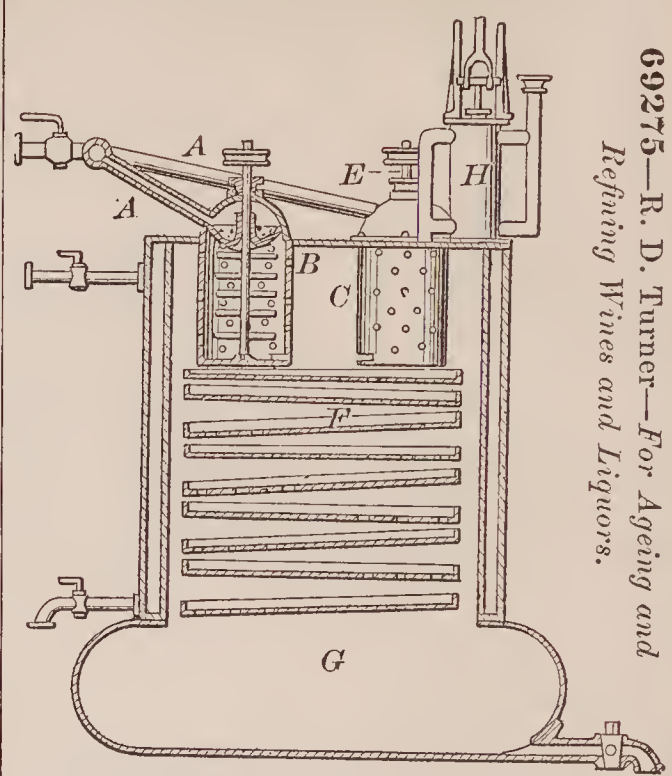
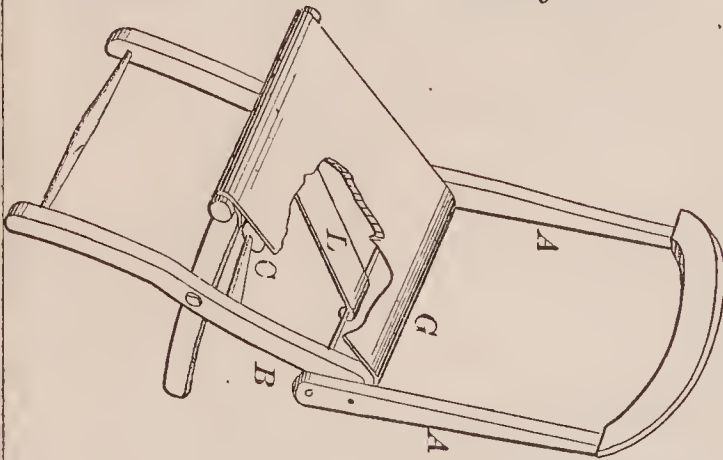

69275—R. D. Turner—For Ageing and Refining Wines and Liquors.

69277—P. W. Vail—For Pouncing Hats.

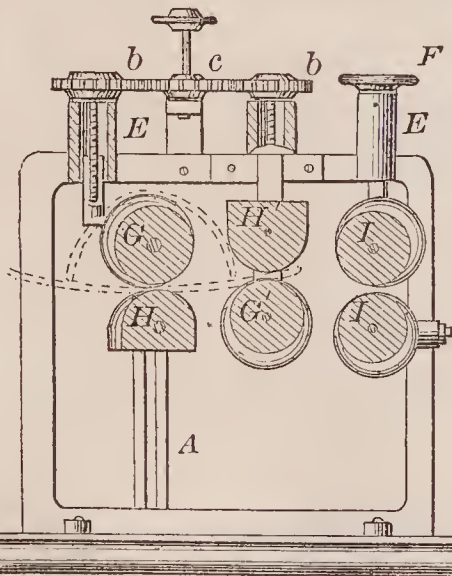

69279—S. Ward—Animal Trap.

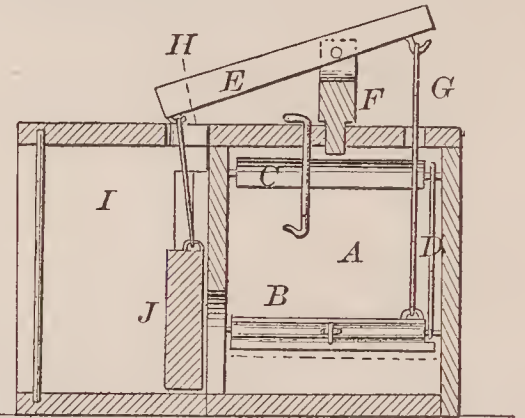

69280—C. P. S. Wardwell—For Making Needles.

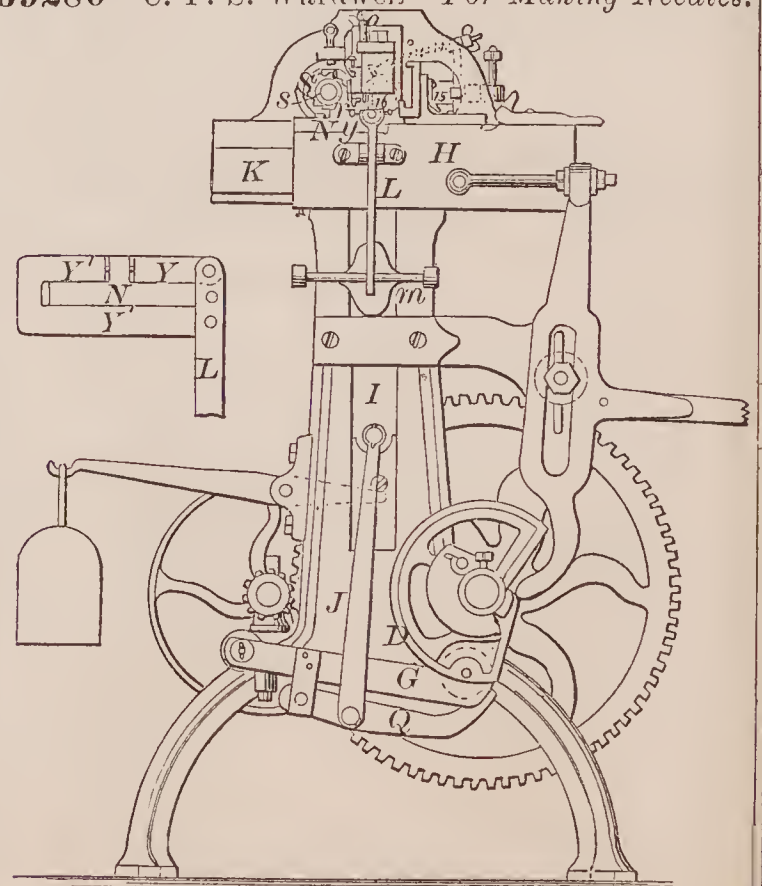

69278—P. A. Vogt—Refrigerator.

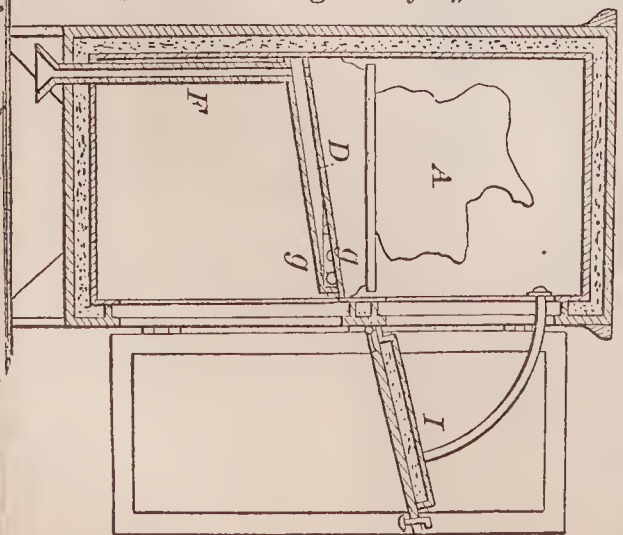

69282—G. J. Wardwell—For Quarrying Stone.

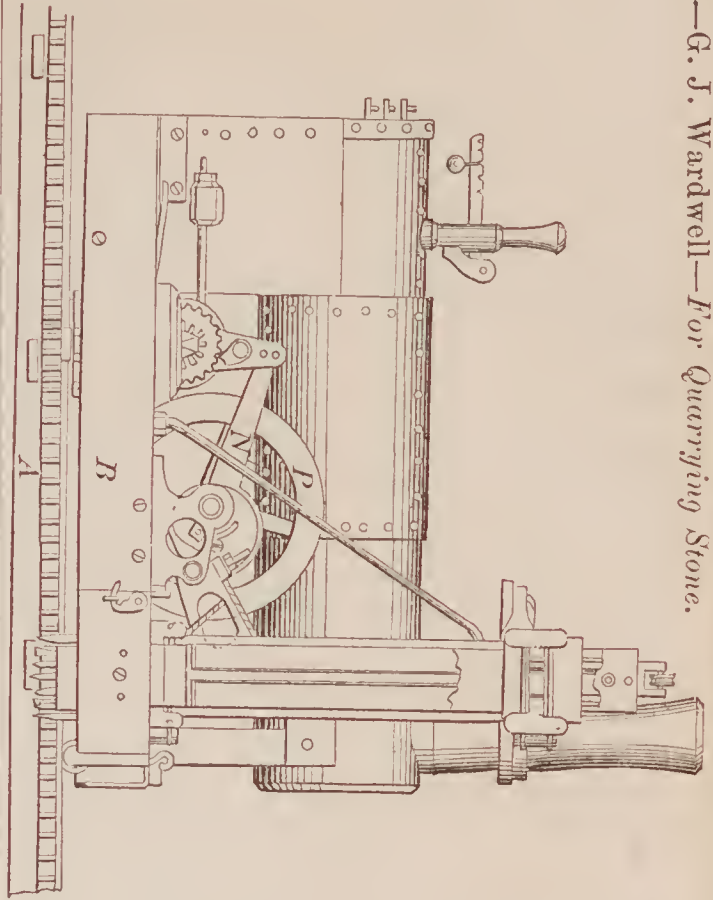

69281—C. P. S. Wardwell—For Making Needles.

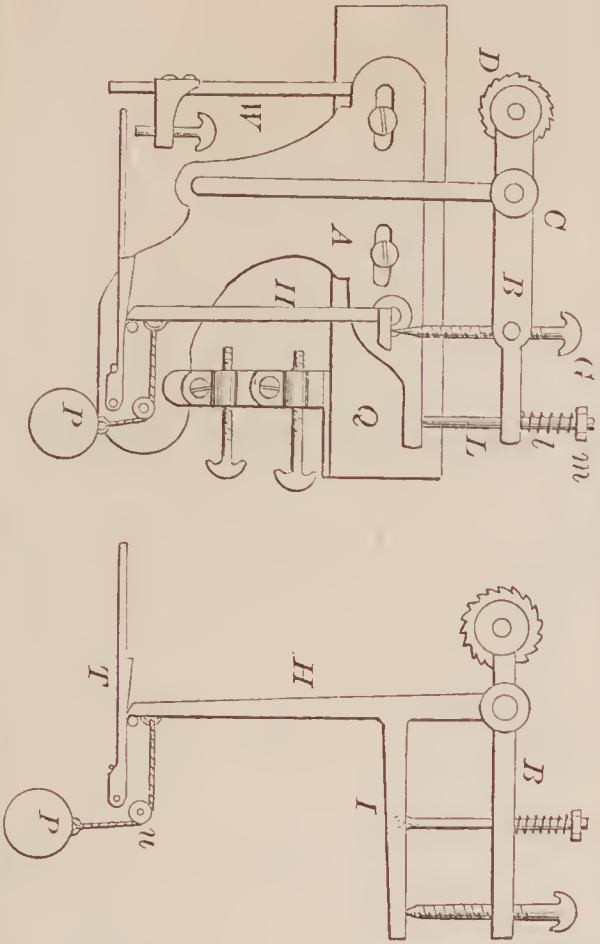

69283—G. J. Wardwell—For Quarrying Stone.

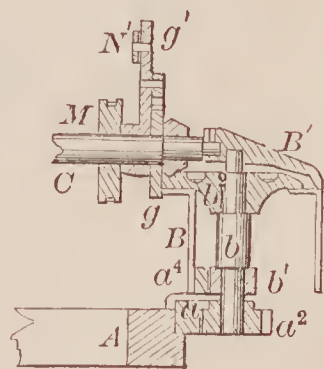
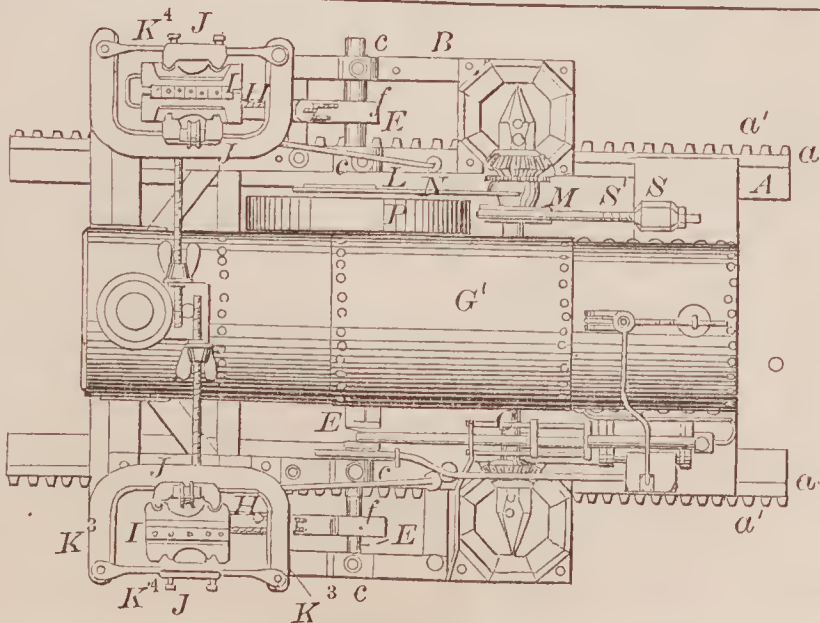
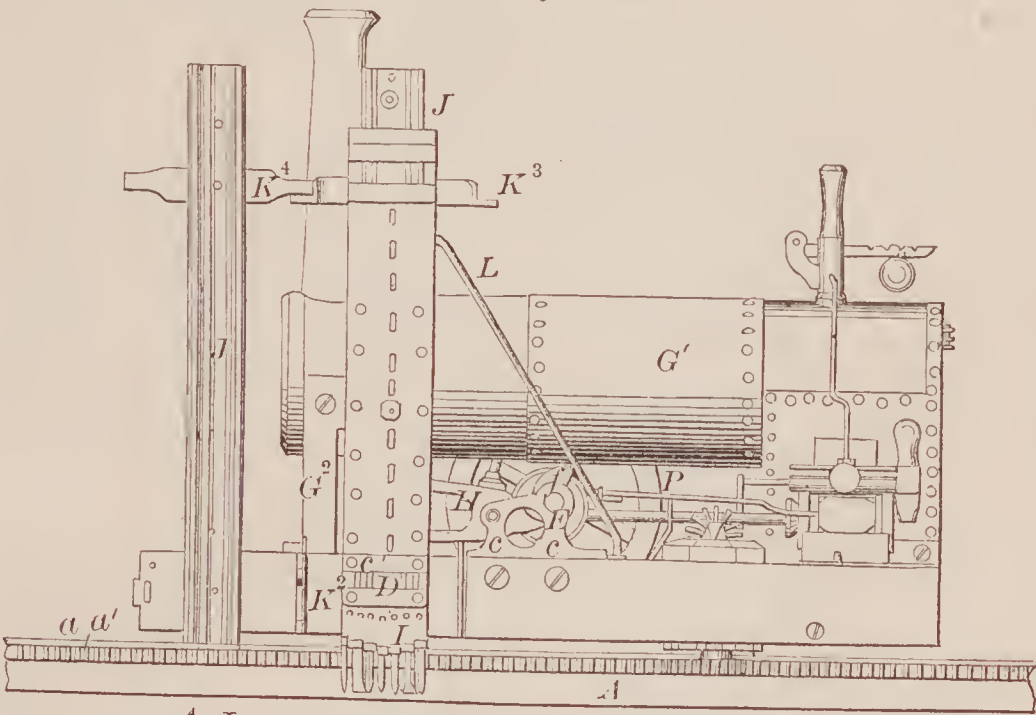



69284—E. J. Warner—Eyeletting Machine for Attaching Buttons to Garments.

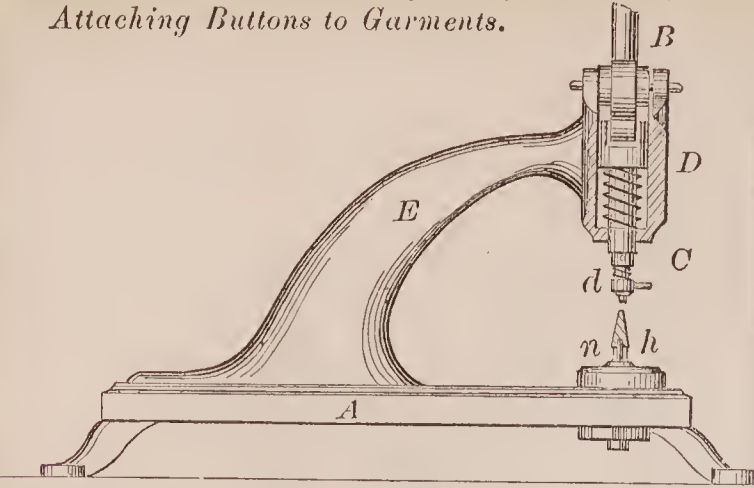

69286—F. J. Weber—For Making Wagon Wheels.

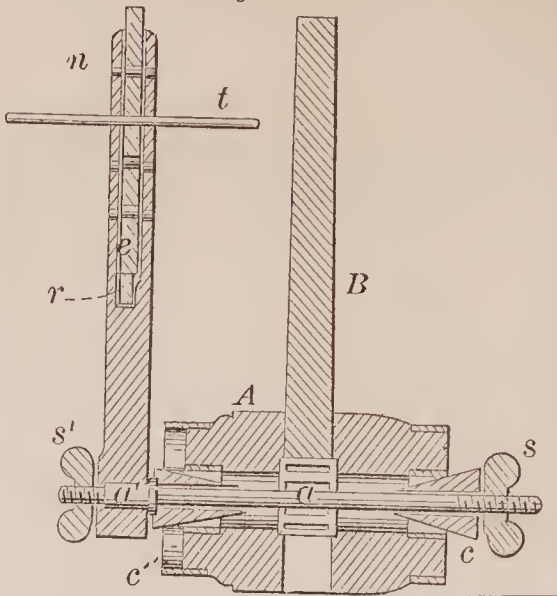

69285—W. C. Watson—Clamp for School Books.

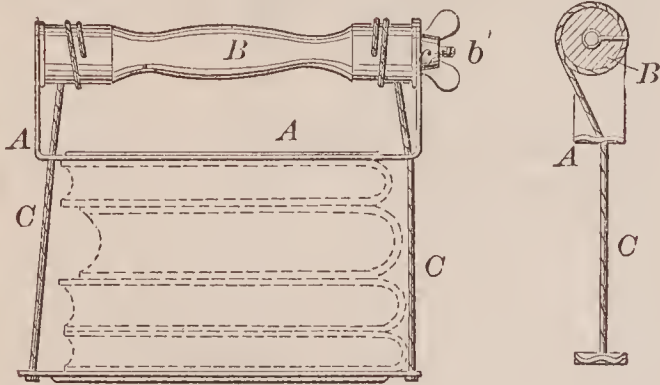

69287—W. S. Weed—Reversible Butt Hinge.

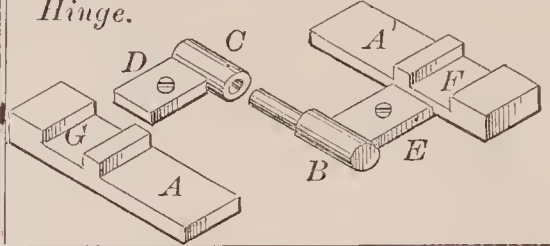

69289—J. P. White—Marker, Hemmer, &c., for Sewing Machines.

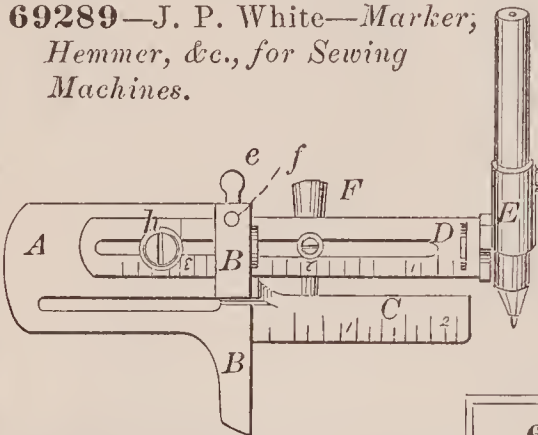

69290—F. R. Willson—Harrow Teeth.

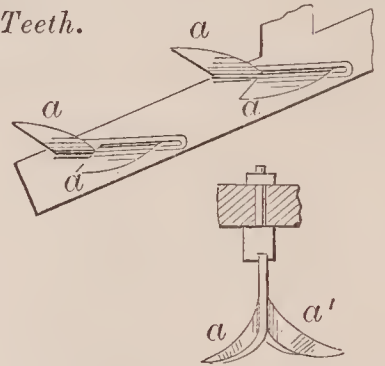

69288—Wells & Hawse—Clothes Pin.

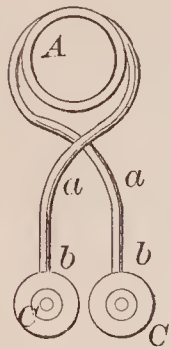

69291—F. Wood—Securing Whip Soekets to Carriages.

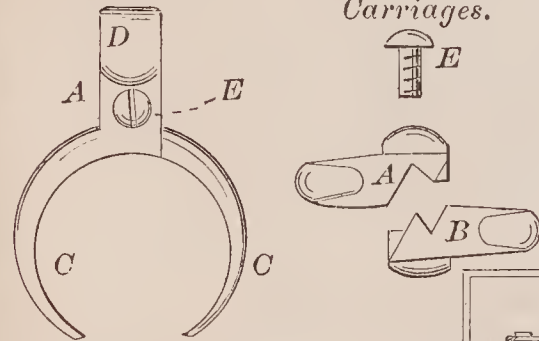

69292—E. Wright—Calipers and Dividers.

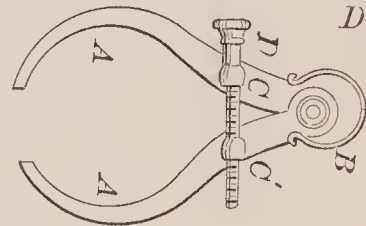

69294—L. D. Wynkoop—Water Wheel.

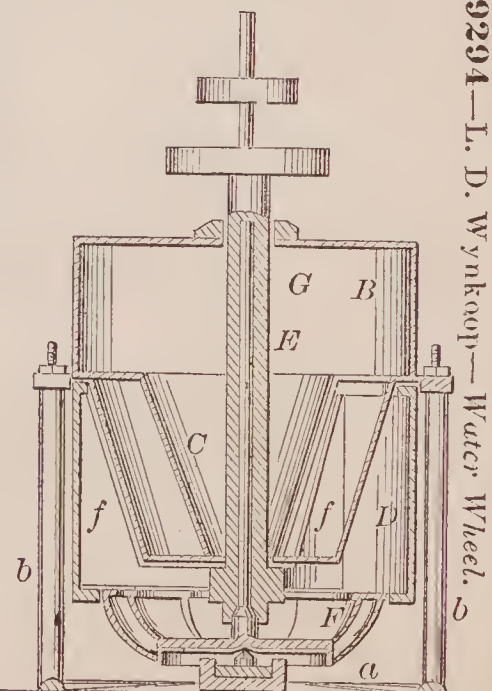

69293—S. J. Wright—Stretchers for Hosiery.

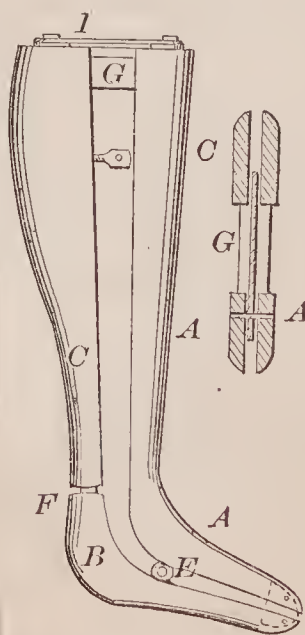

69295—Zeller & Lechner—Bag Fastener.

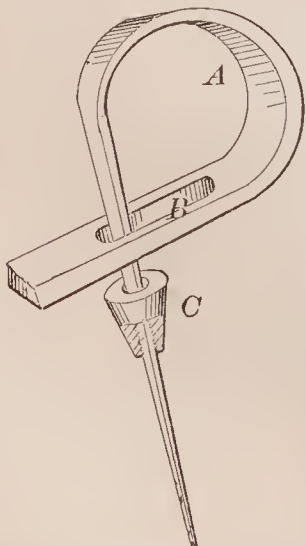

69296—E. L. Bergstresser—*Corn Planter.*

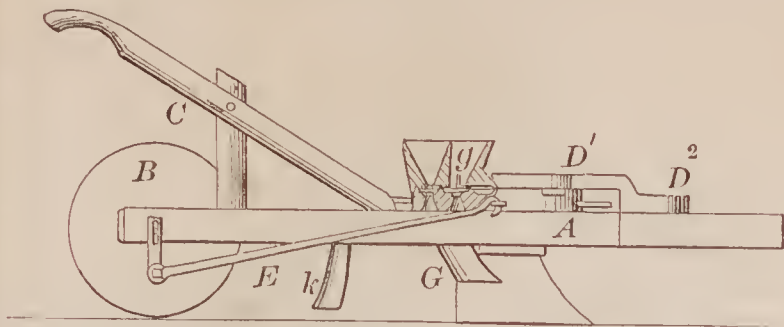

69299—G. W. Adams—*Fence.*

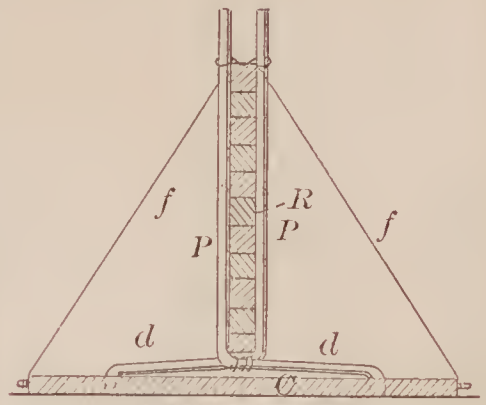

69297—C. W. Stafford—*Pavement.*

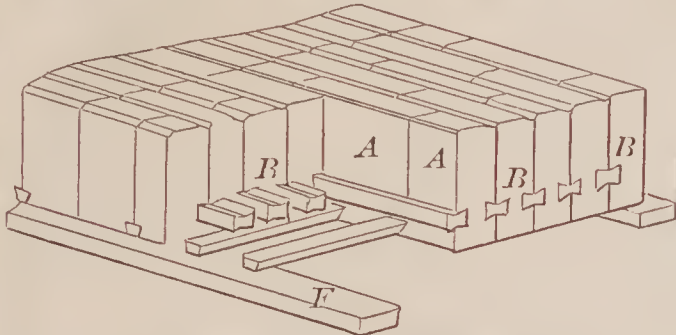

69300—Alexander & Kellogg—*Broom Head.*

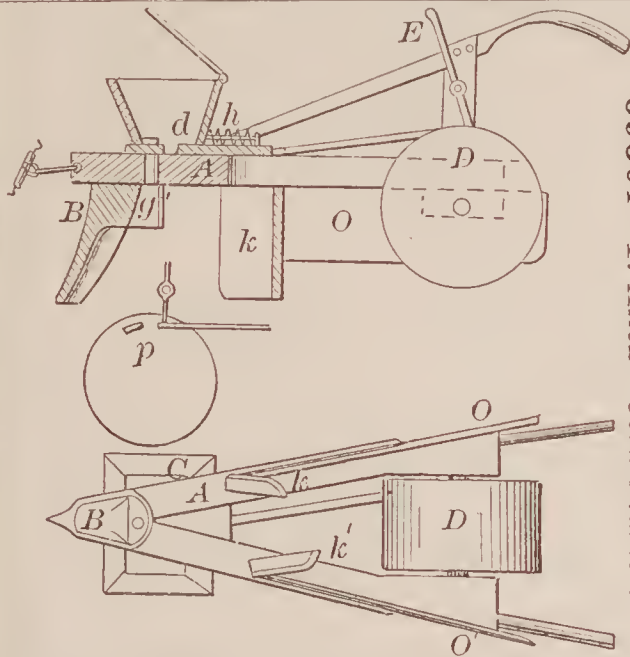
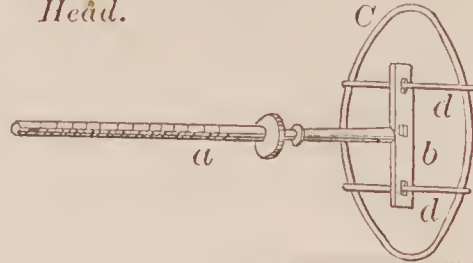

69301—T. Allen—*Corn Planter.*

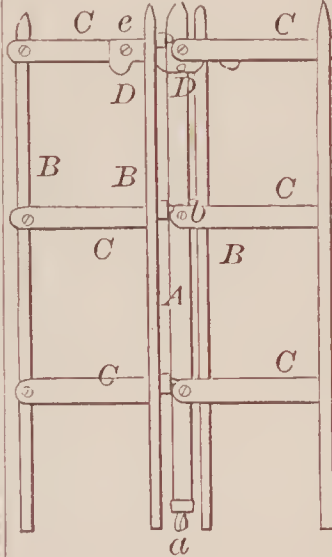

69302—I. B. Arnold—*Clothes Dryer.*

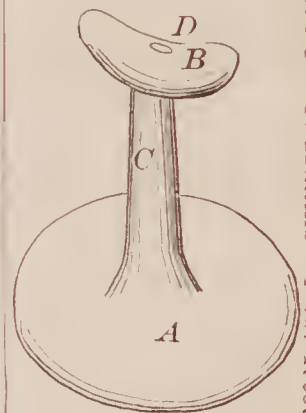

69298—C. Adams—*Foot Rest.*

69303—C. Austin—*For Making Socketed Reed Plates.*

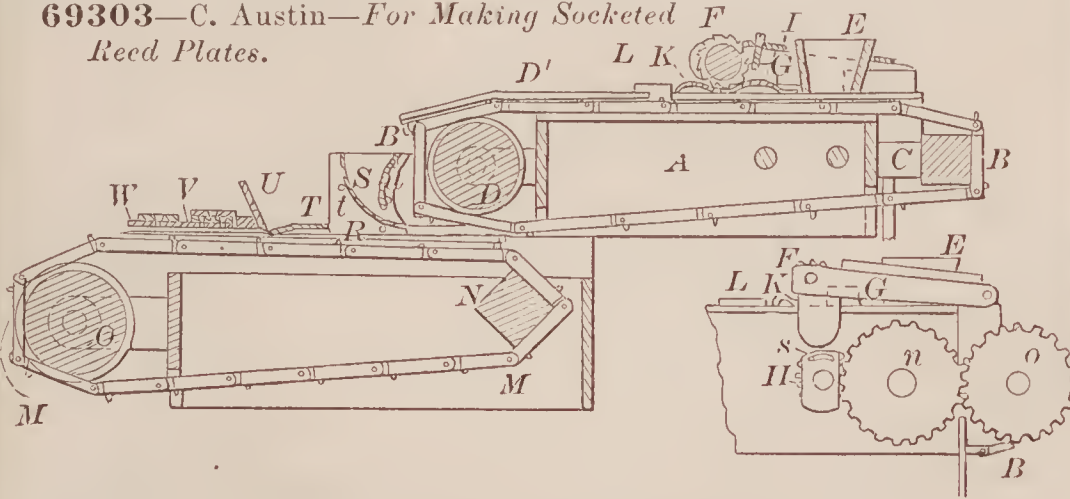

69304—W. R. Bagnall—*Wardrobe Bedstead.*

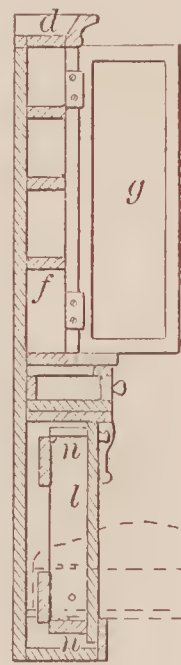

69305—J. P. Barriek—*Carriage Shaft Coupling.*

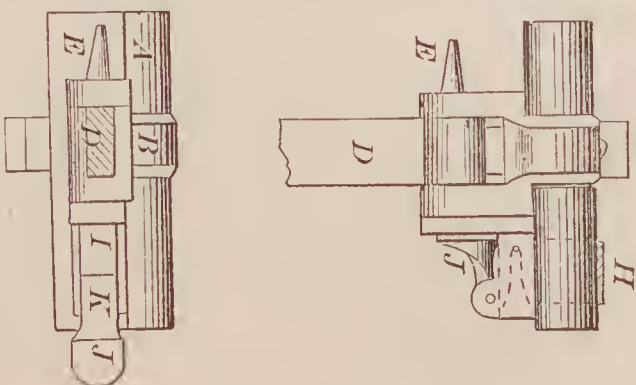

69306—W. P. Bateman—*Carriage Button.*

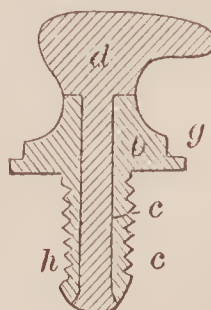



69307—Beswick, Richardson & Brown—For Making Wagon Wheels.

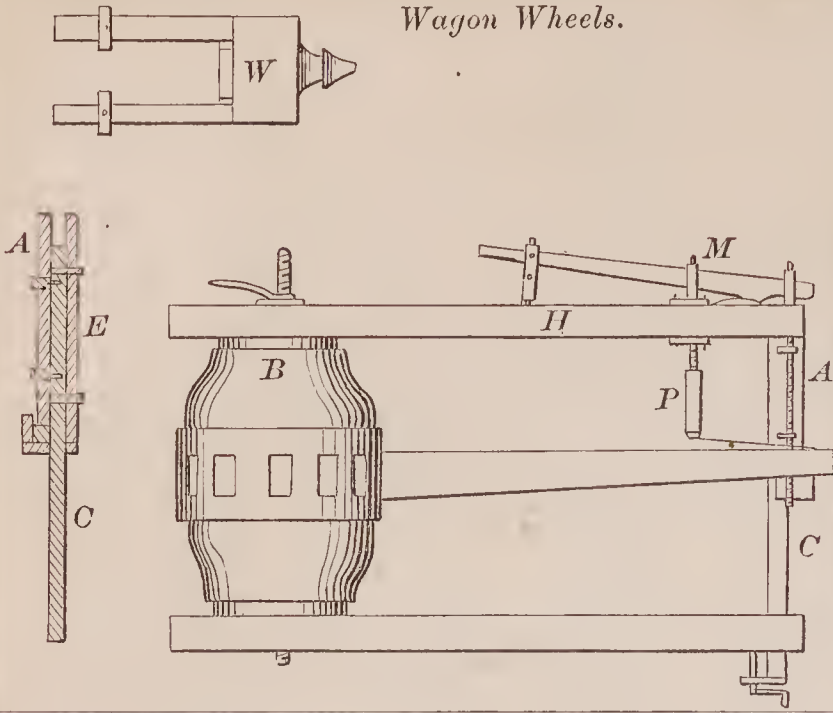

69310—J. C. Brown—Cane Stripper.

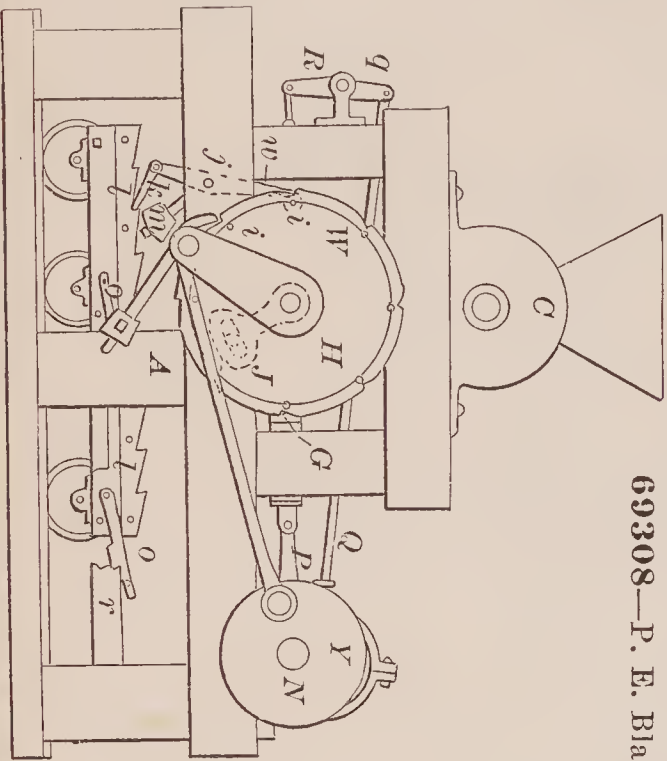
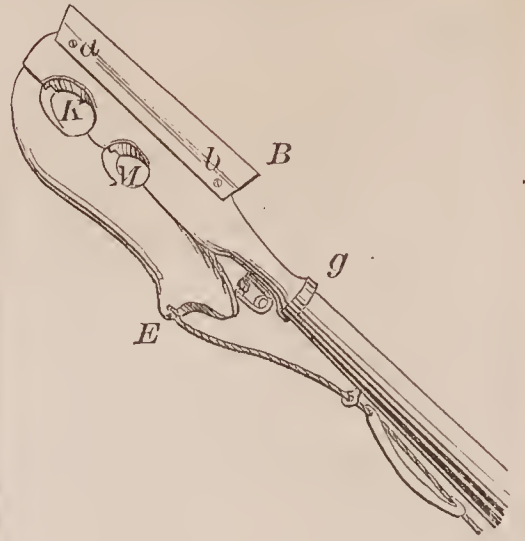

69308—P. E. Bland—Brick Machine.

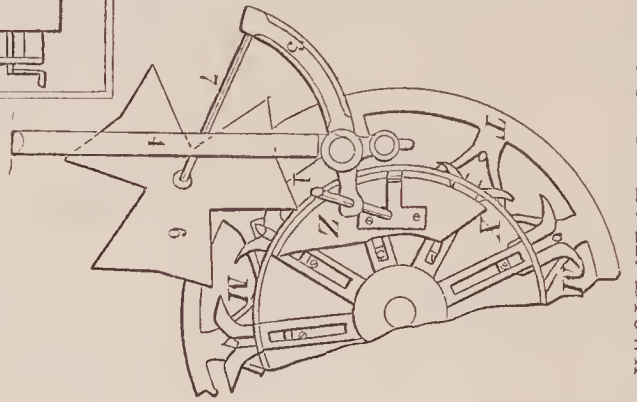
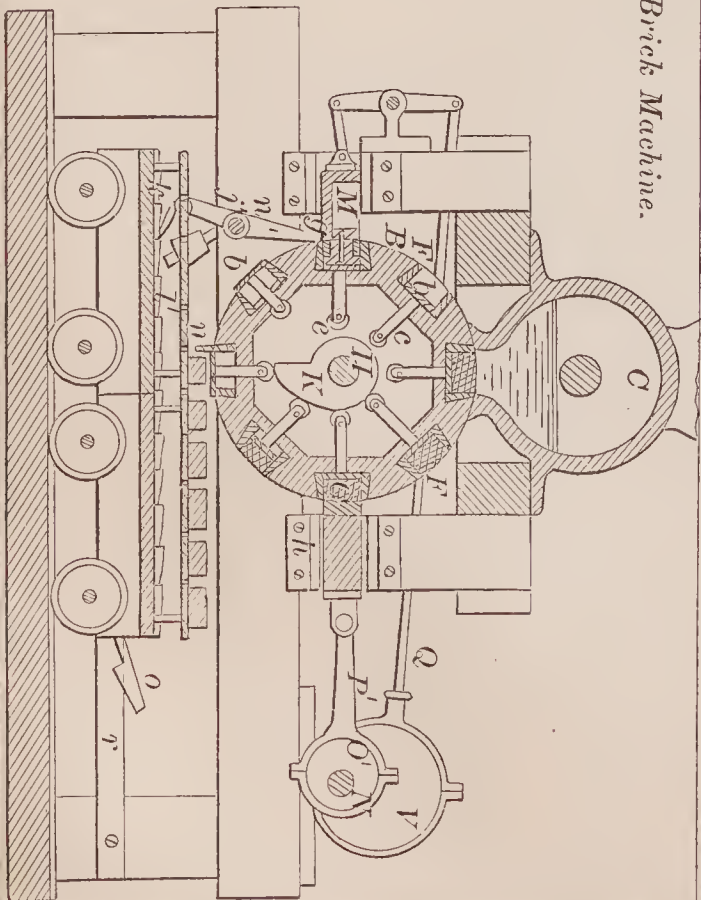

69309—F. H. Brown—For Weaving Baskets.

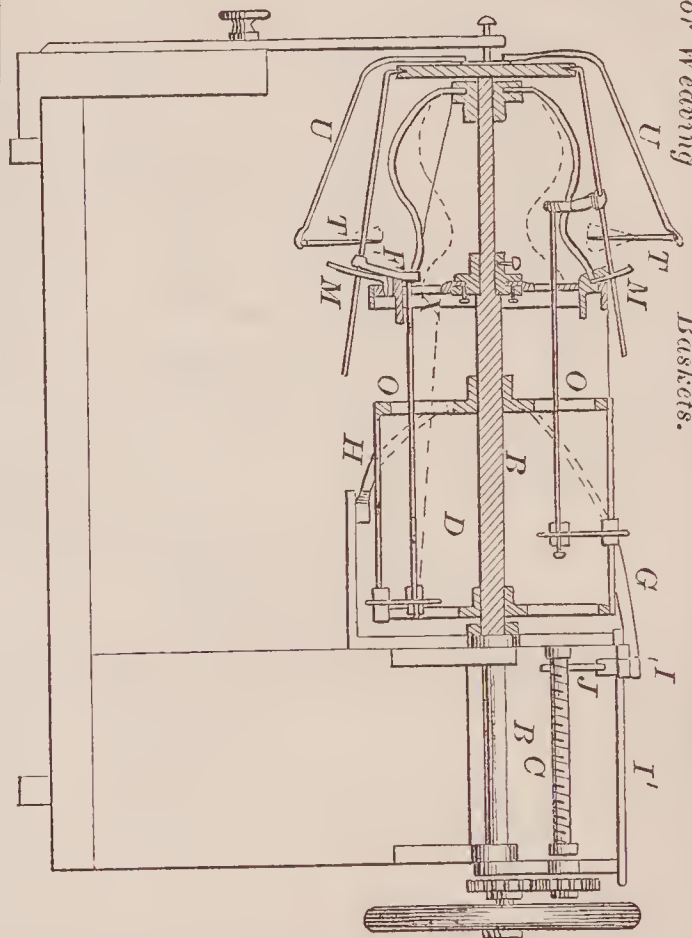

69311—T. W. Brown—Hat and Coat Rack.

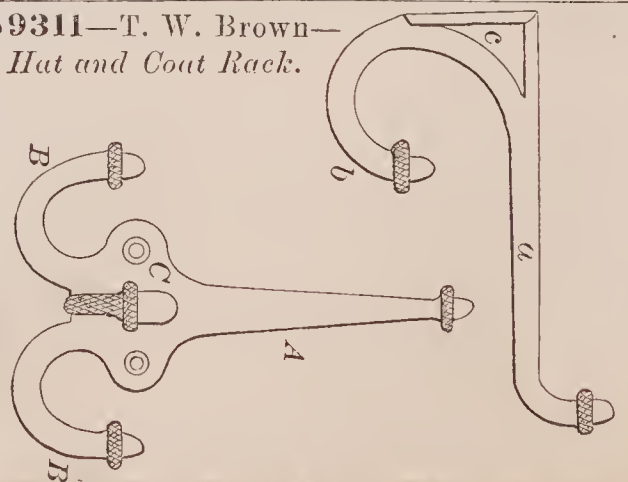

69313—Catchpole & Havens—Wood Bending Machine.

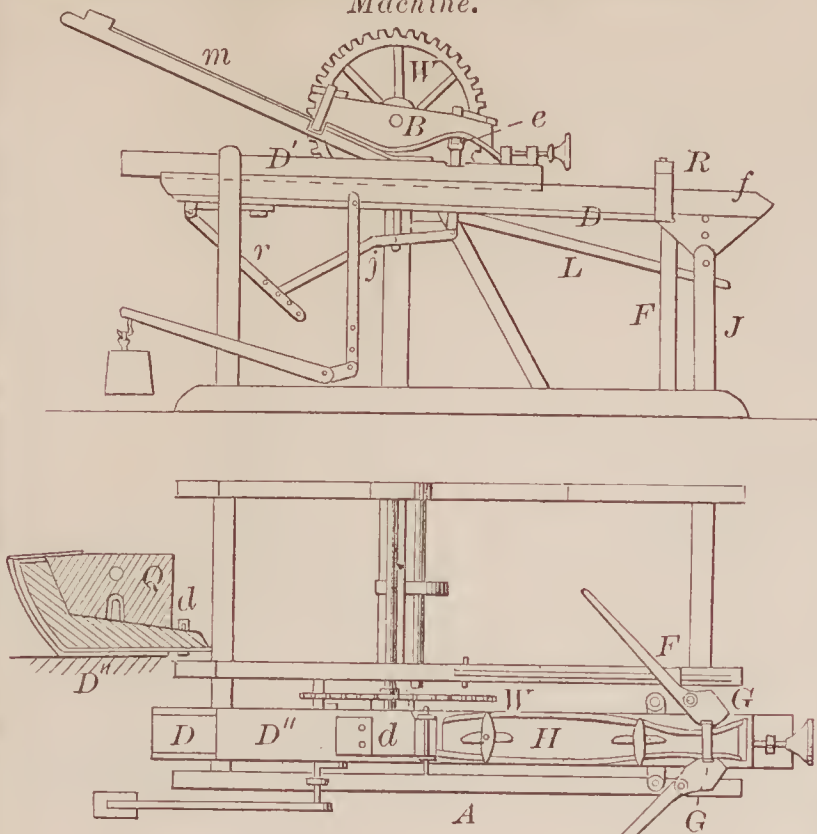

69314—N. A. Gates—Cultivator.

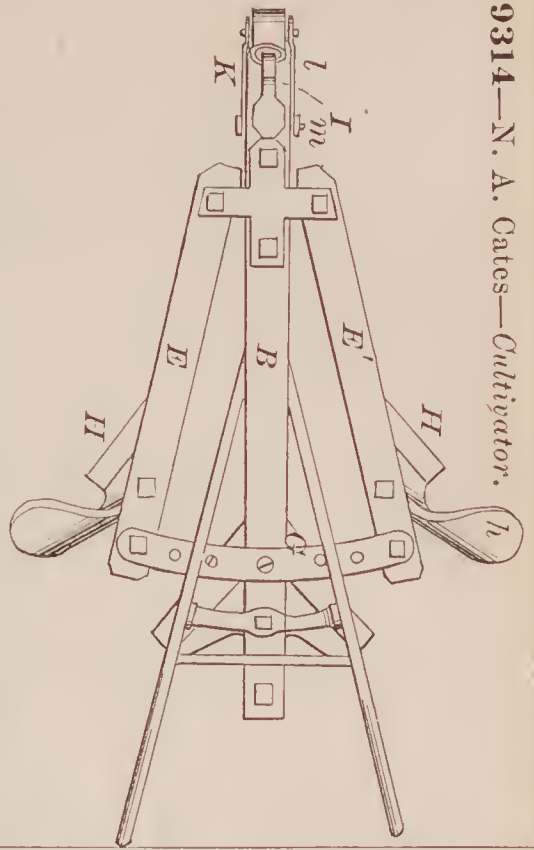

69320—Cottrell & Draper—Loom.

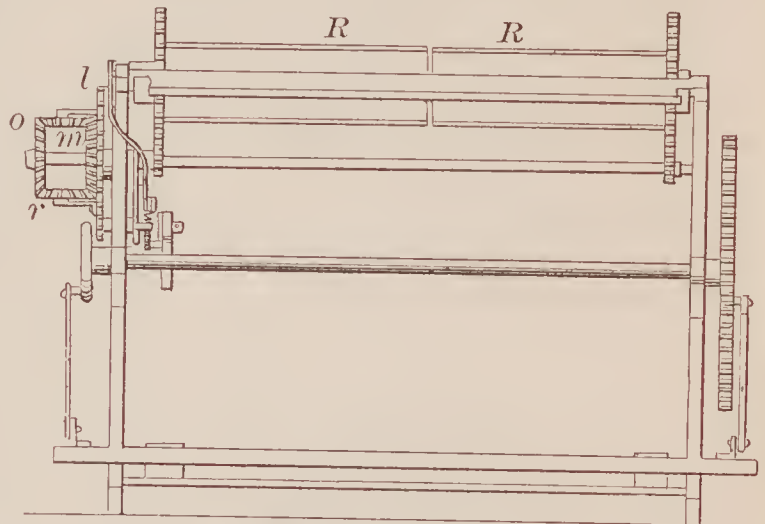

69319—R. Collins—Picker Staff for Looms.

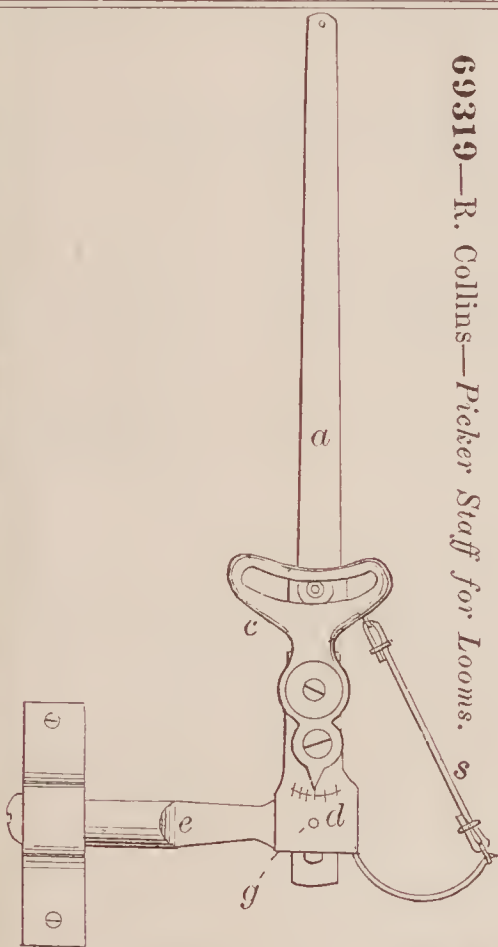

69322—Crossman & Spicer—Harvester Rake.

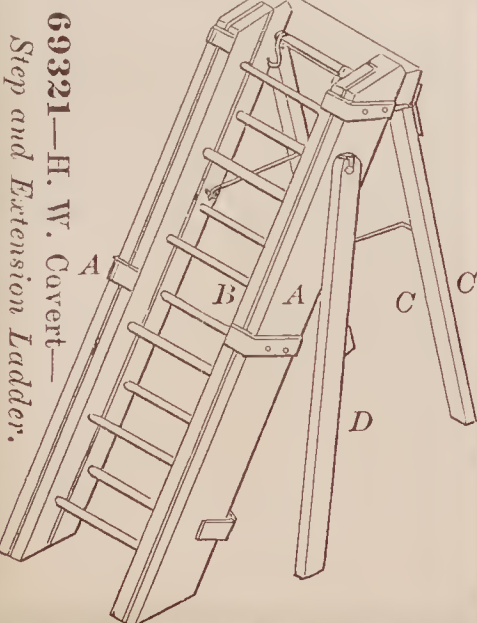
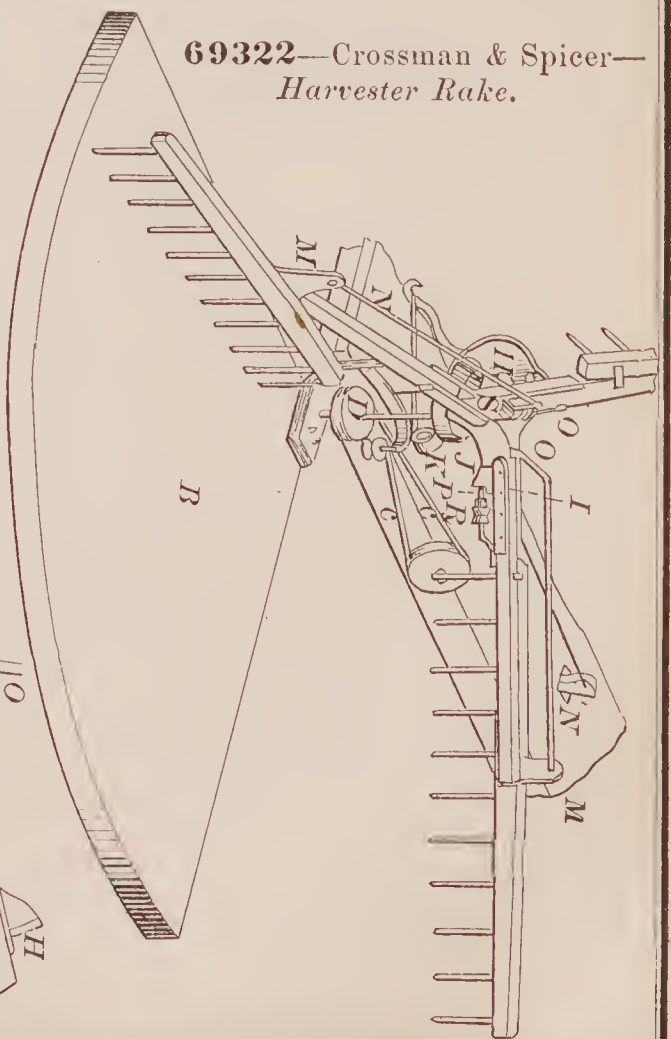

69321—H. W. Covert—Step and Extension Ladder.

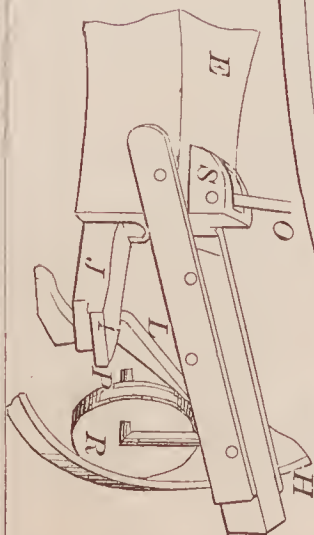



69323—M. S. Curtiss—Coupling Plows to Wheeled Carriages.

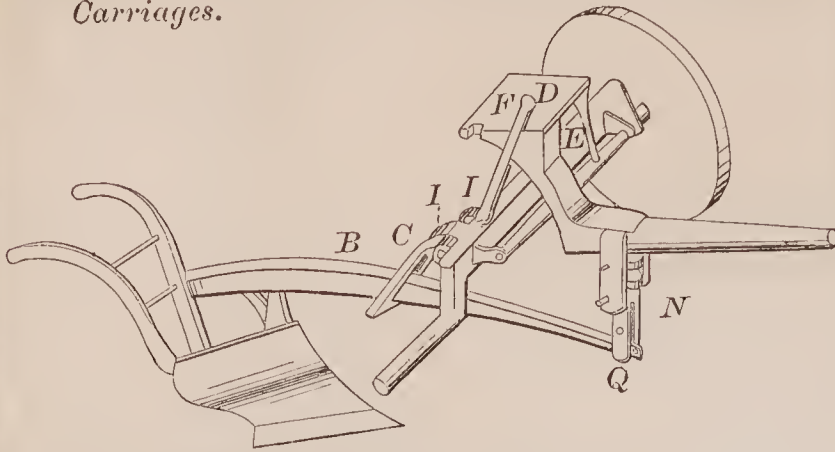

69326—Dixon & Heath—Clutch for Suspending Hay Forks.

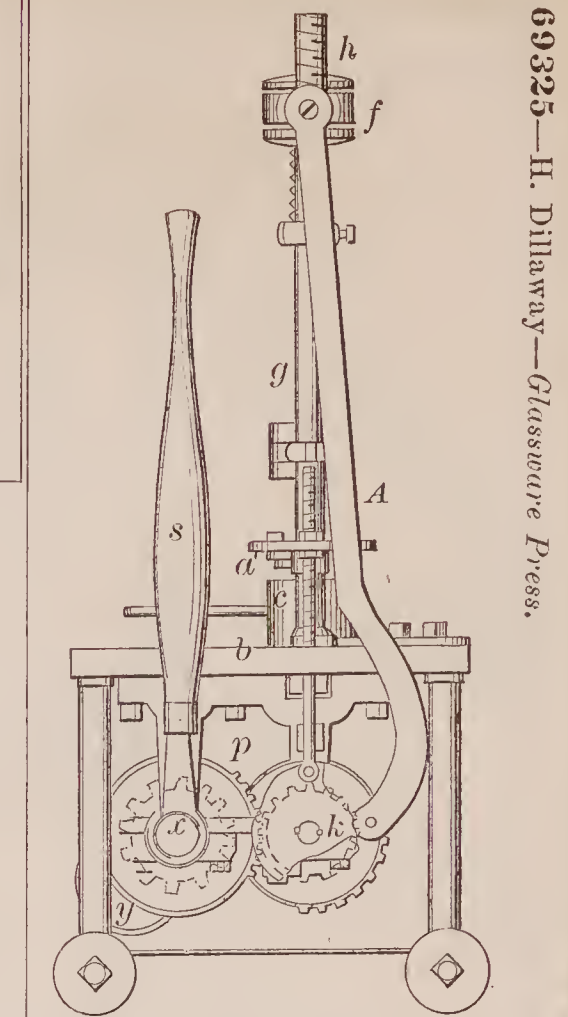
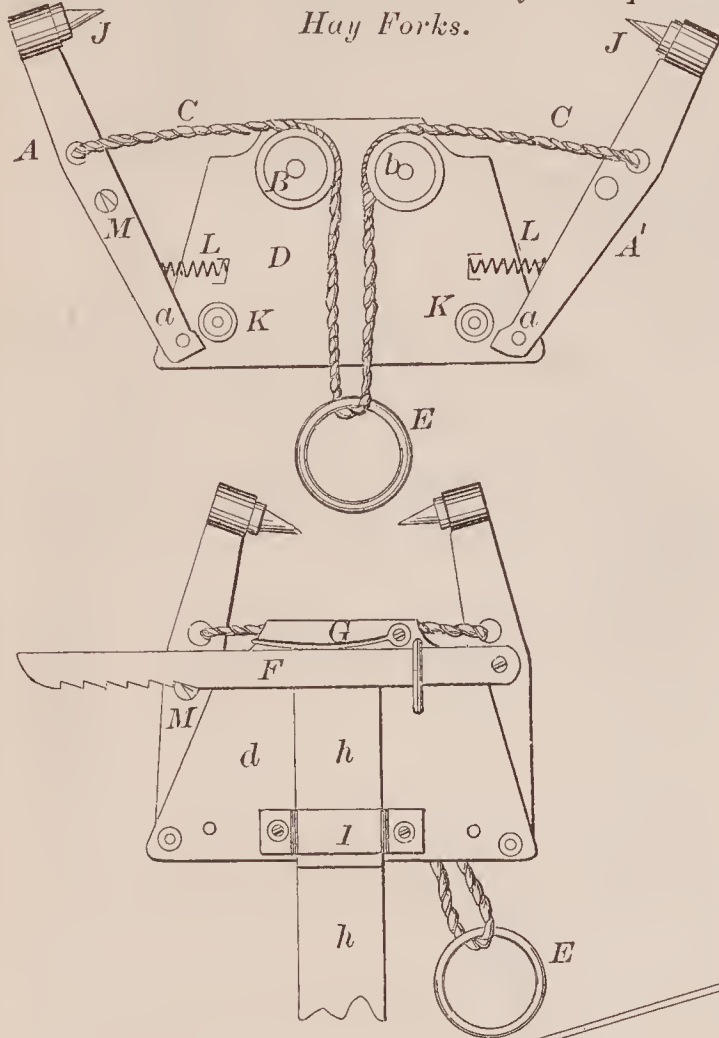

69325—H. Dillaway—Glassware Press.

69324—W. Davis—Churn.

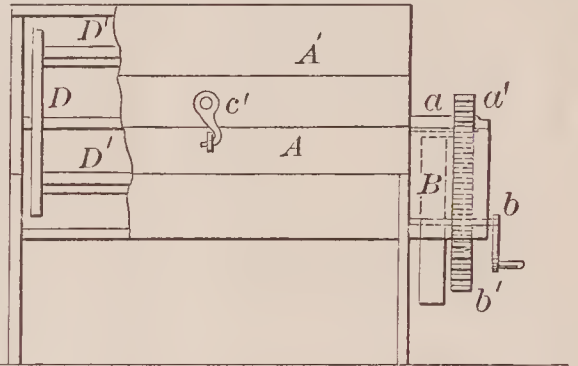

69327—W. Dunn—For Stretching Hides.

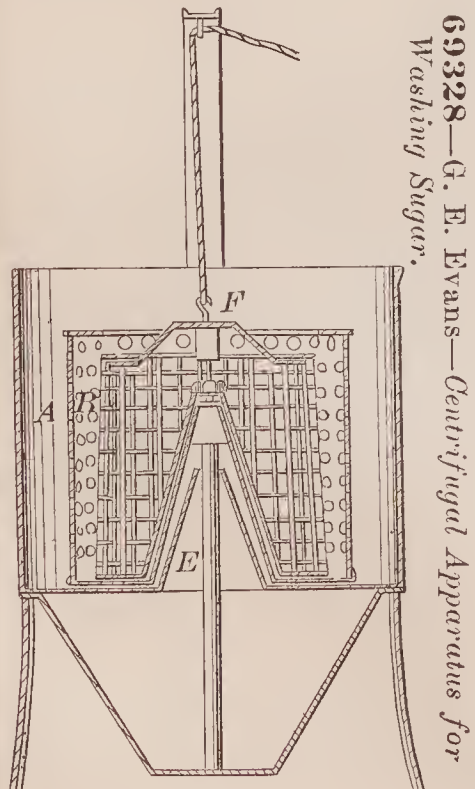
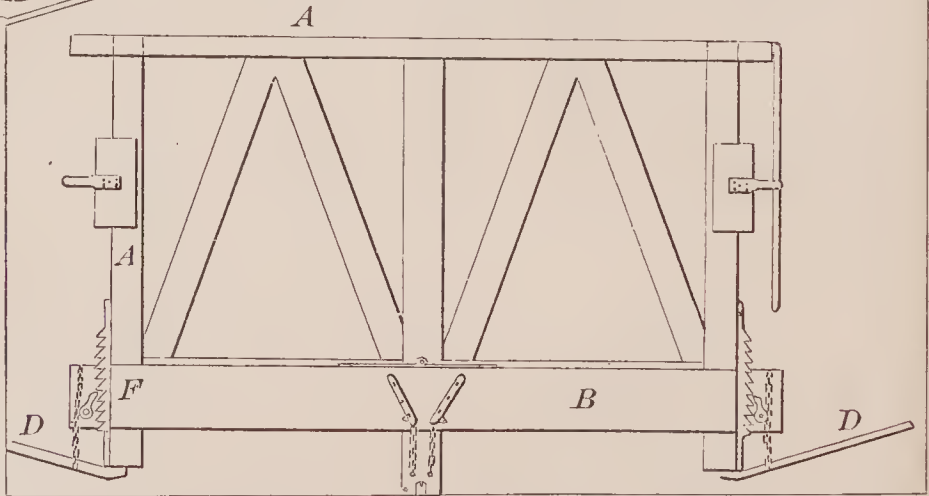

69328—G. E. Evans—Centrifugal Apparatus for Washing Sugar.

69329—C. T. Faber—Lid Support for Pianos, Desks, &c.

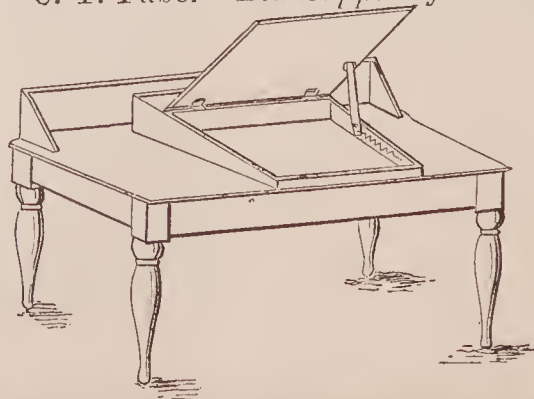

69330—H. B. Fernald—*Railway Truck.*

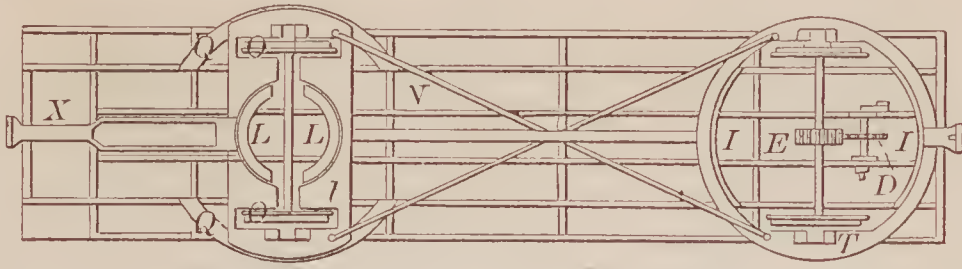

9332—S. Freet—*Horse Rake.*

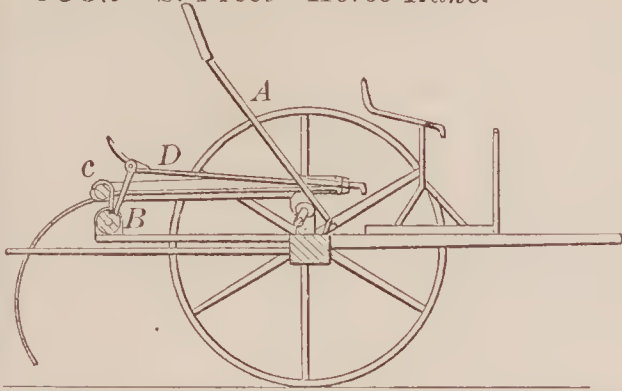

69334—B. Gantner—*Shoemakers' Bench.*

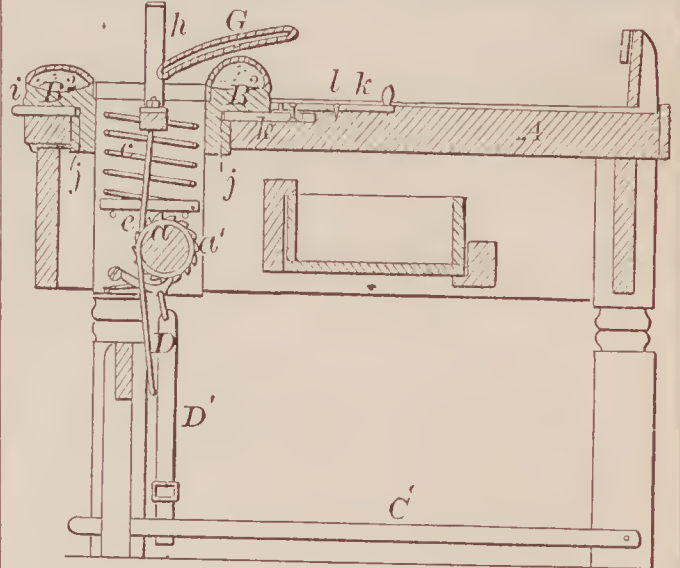

69333—Frisbie & Upson—*For Making Carriage Bolts.*

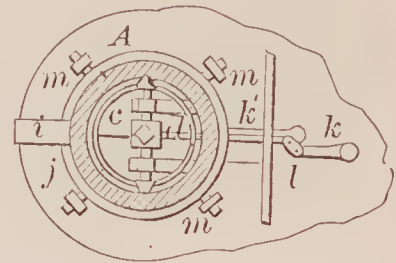
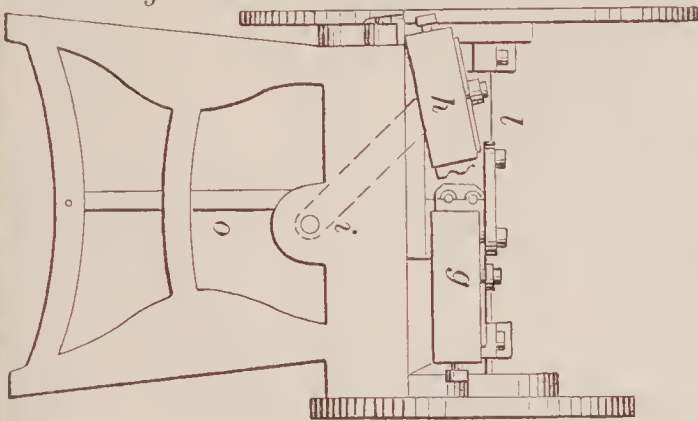

69335—J. Gehr—*Three Wheel Carriage.*

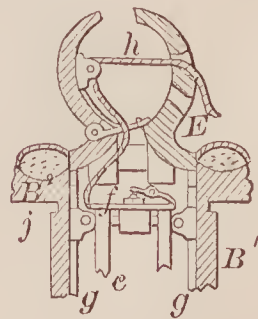
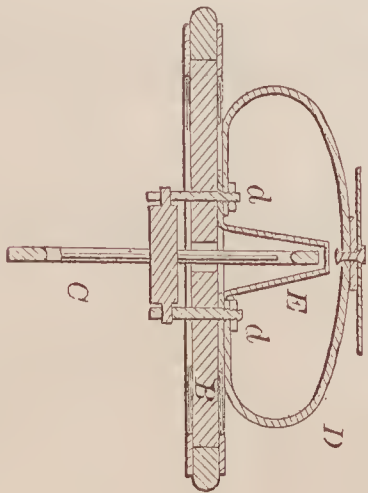
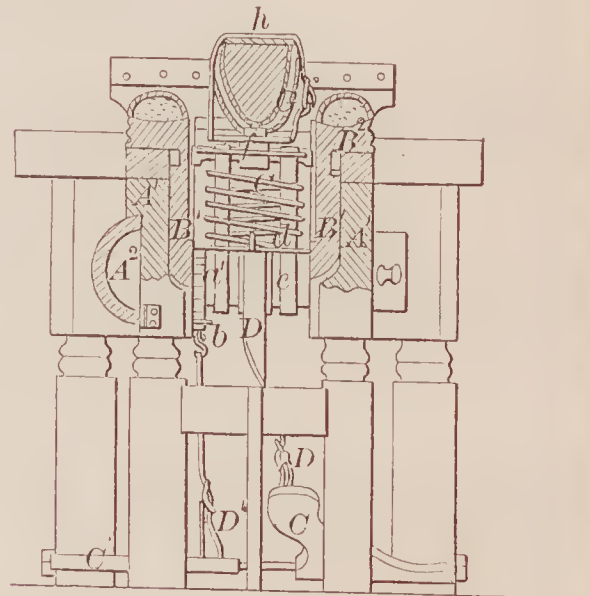
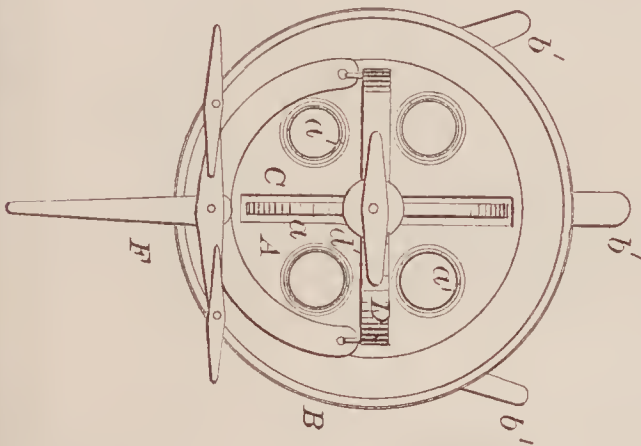



69336—R. J. Gilbert—Gate.

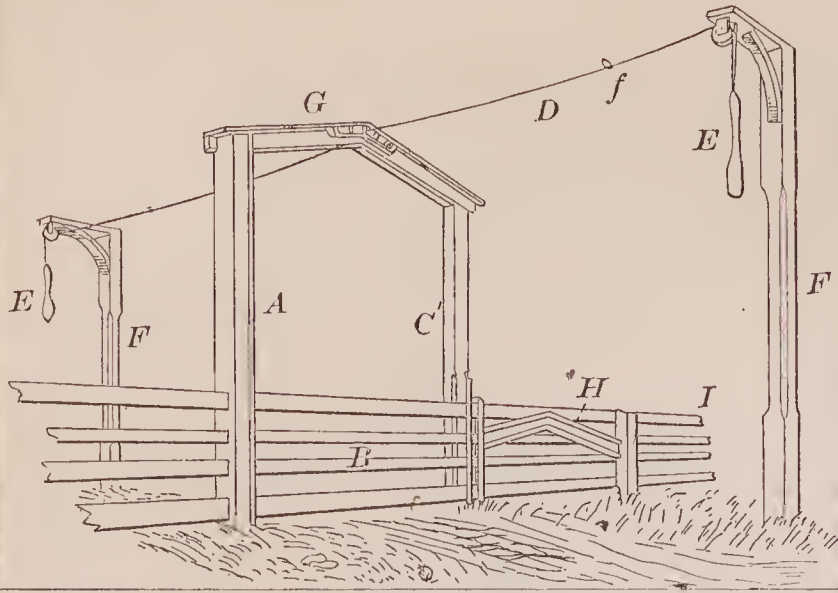

69340—G. W. Hall—Double Rotary Harrow.

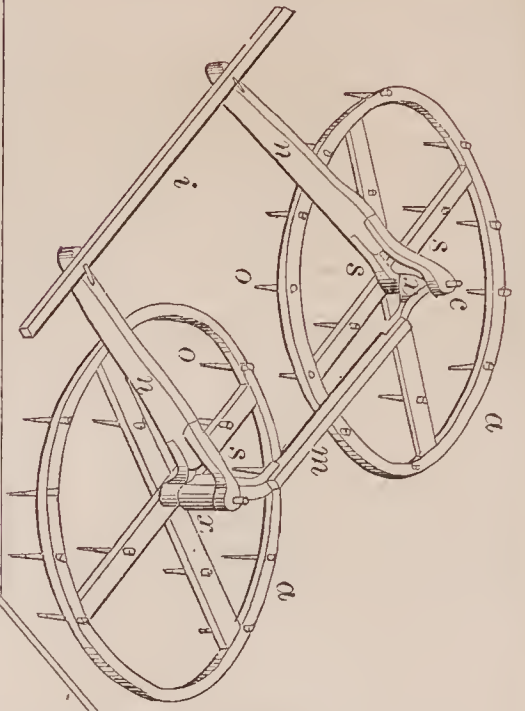

69338—G. B. Gruman—For Cutting Ice.

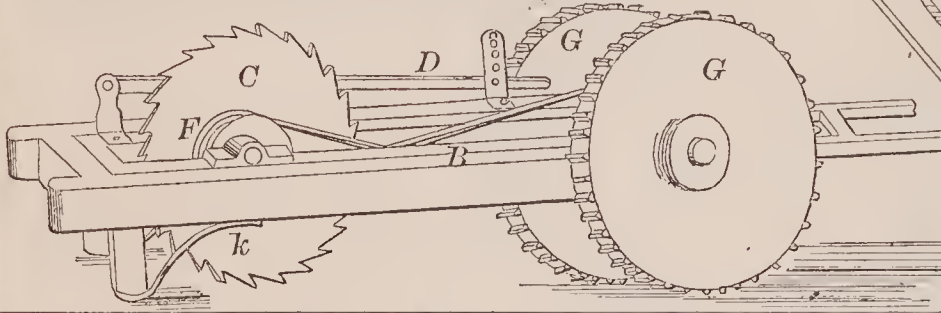

69343—A. E. Horton—Mosquito Frame for Windows.

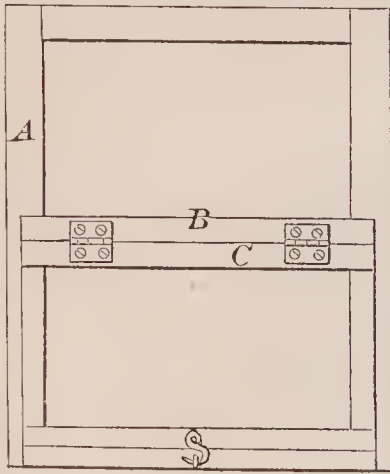

69342—A. Hilts, Jr.—Harvester.

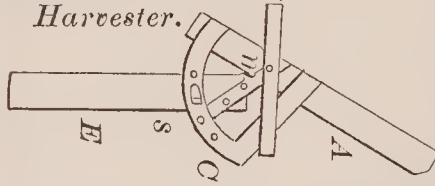

69344—A. Y. Hubbell—Sad Iron.

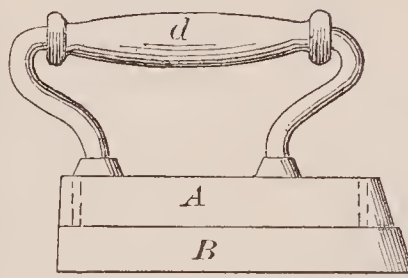

69339—G. W. Hall—Potato Digger and Weeder.

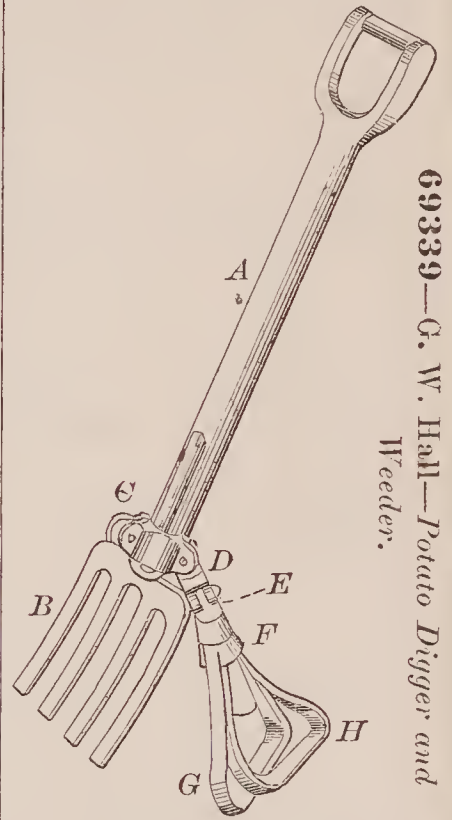

69345—W. Jeffries—Puddling and other Furnaces.

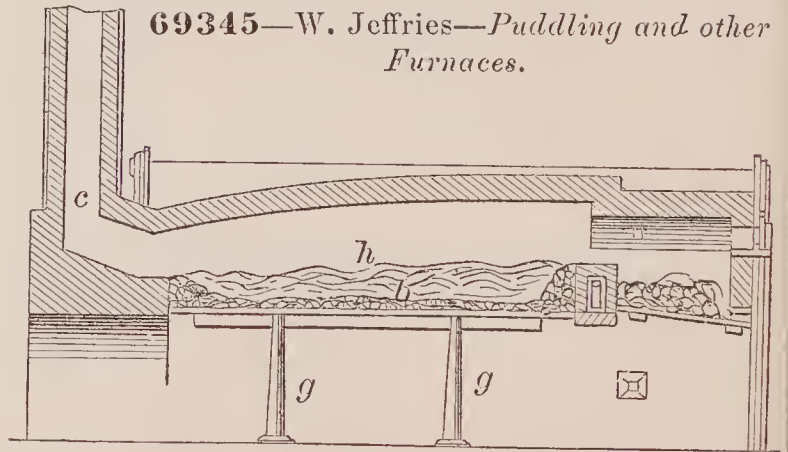

69341—G. G. Hickman—For Preventing Horses from Cribbing.

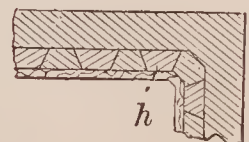
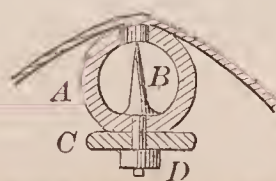

69337—N. J. Glover—Farm Gate.

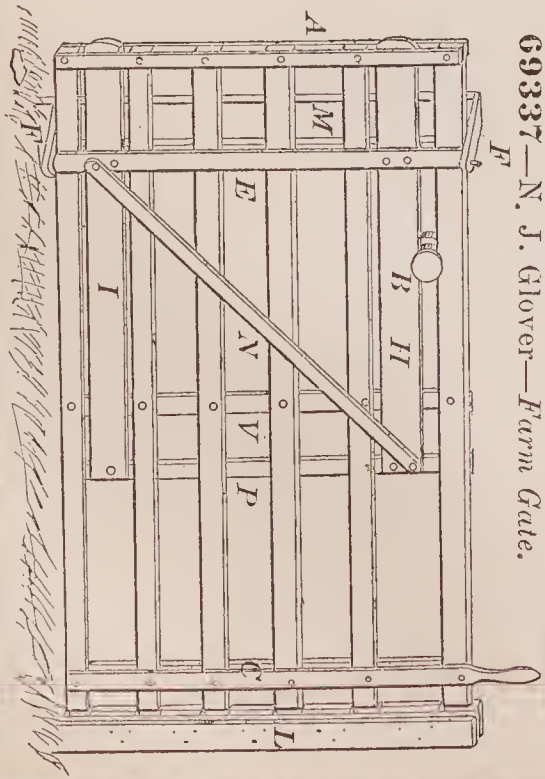

69346—C. Jillson—*Strawberry Ripener*

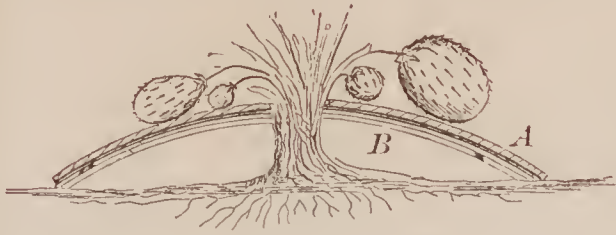

69347—J. J. Johnston—*Sad Iron Heater*

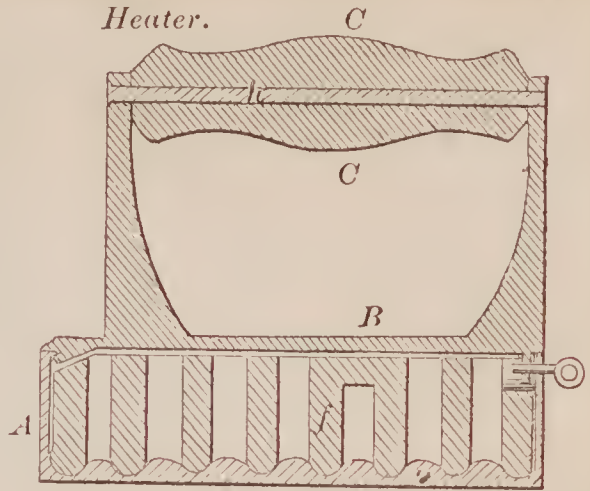

69352—J. Lowe—*Clod Fender*

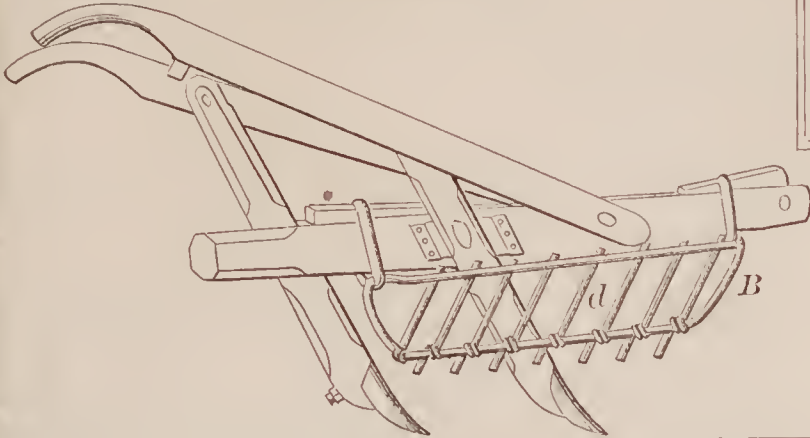

69349—King & Mason—*Clothes Dryer*

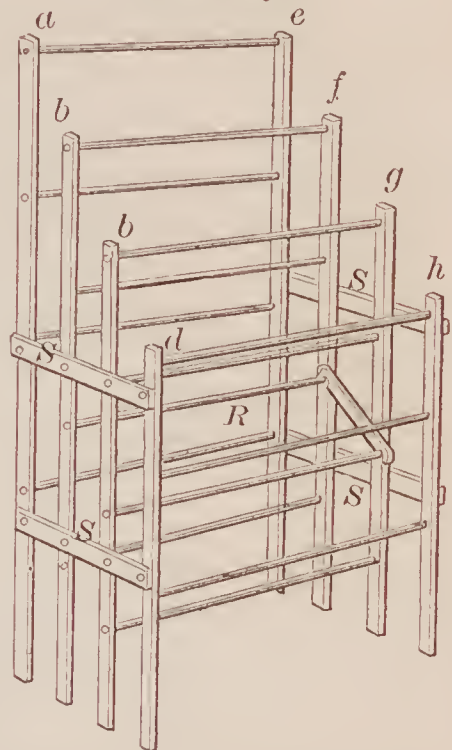

69351—G. H. Lomax—*Poultry Drinking Fountain*

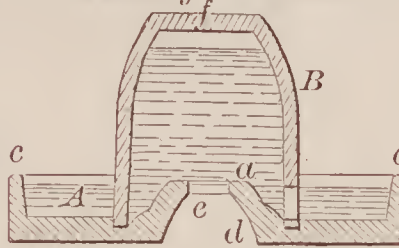

69353—J. M. Mansfield—*Horse Hay Fork*

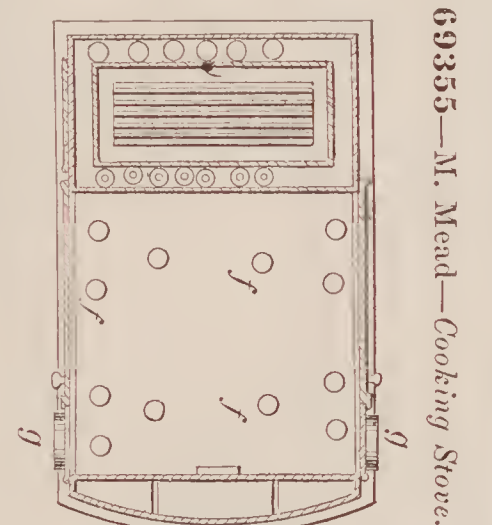
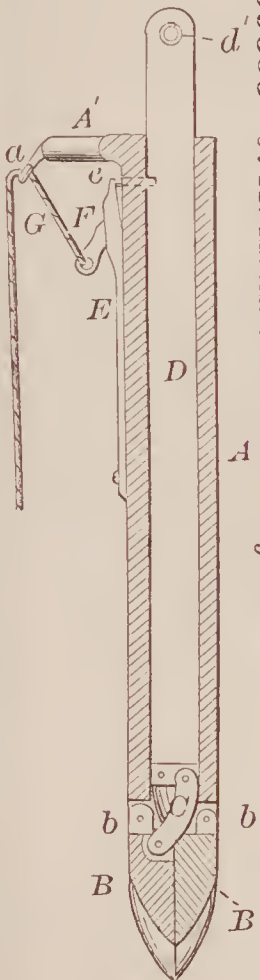

69355—M. Mead—*Cooking Stove*

69350—S. D. Littlefield—*Axle*

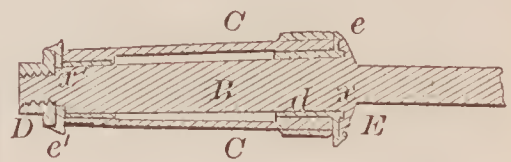

69356—C. K. Mellinger—*Carriage Pole*

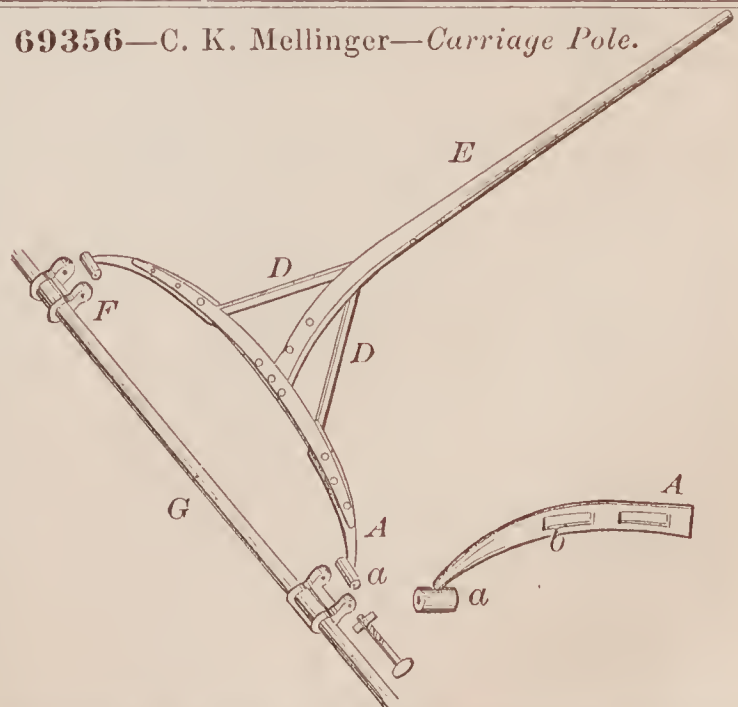

69354—J. McDuffie—*Wagon Spring*

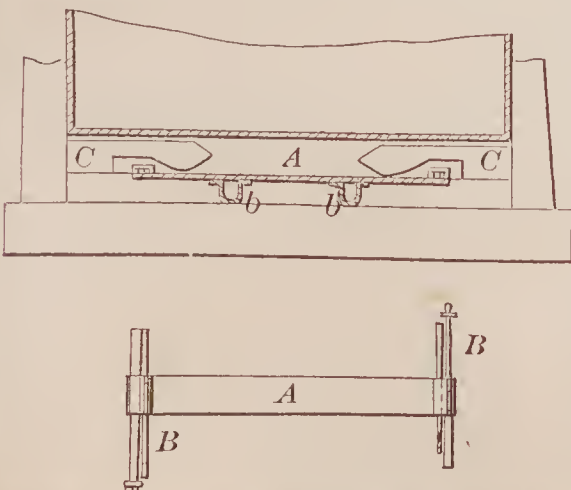



69357—J. H. Moore—*Railroad Car Ventilator.*

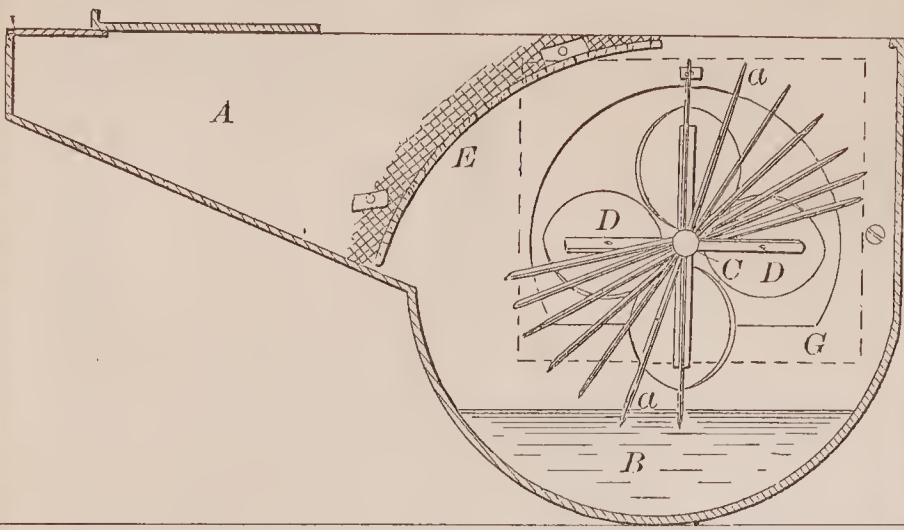

69362—W. Nevins—*Arle.*

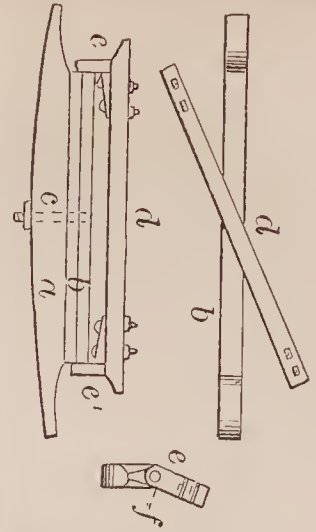

69358—M. & C. H. Morse—  
*For Pressing Hats.*

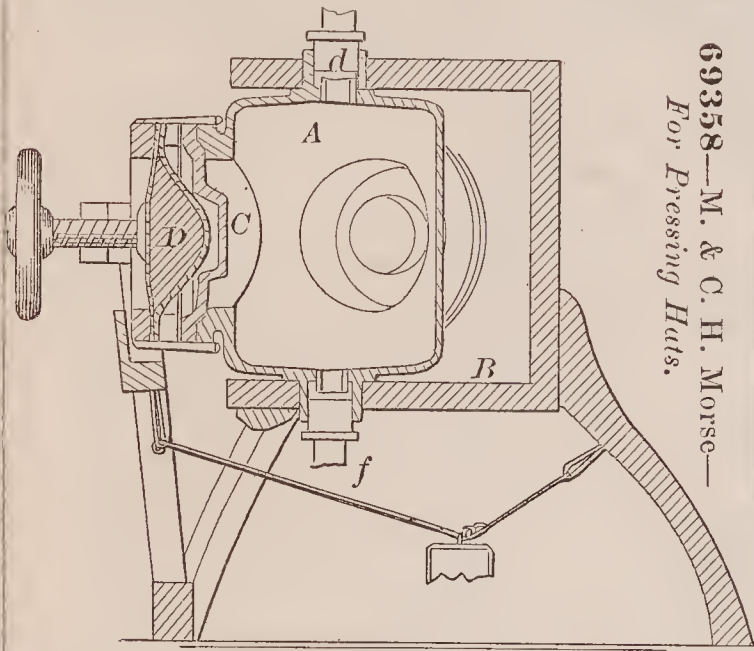

69361—J. H. Murray—*Vise.*

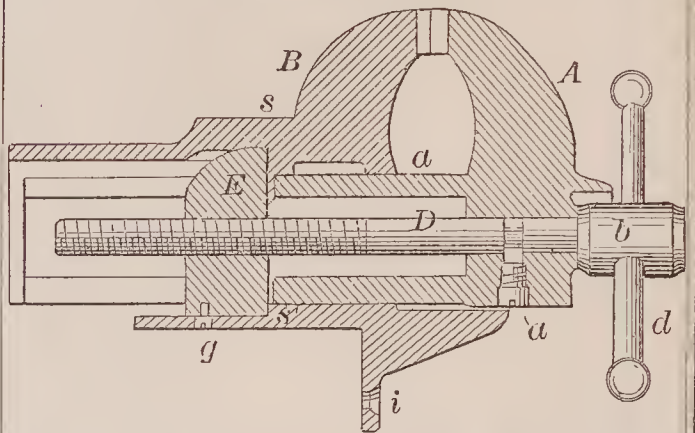

69360—J. Mumma—*Water Wheel.*

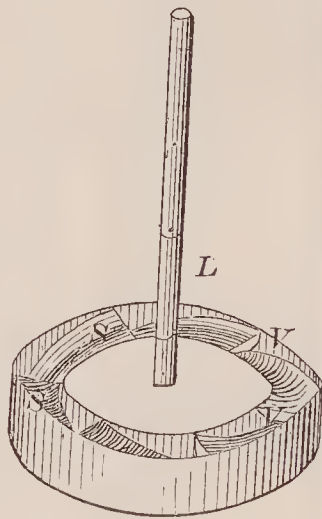
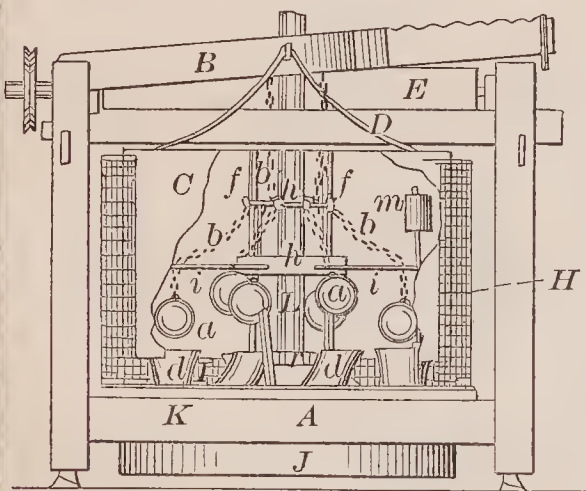

69359—H. W. Mosher—*Out-off for Water Spouts.*

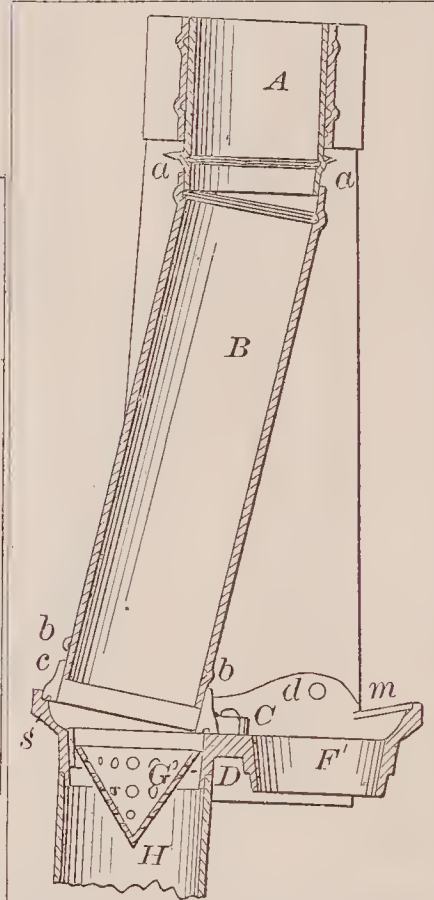

69364—Parker & Vogler—*Carriage Step.*

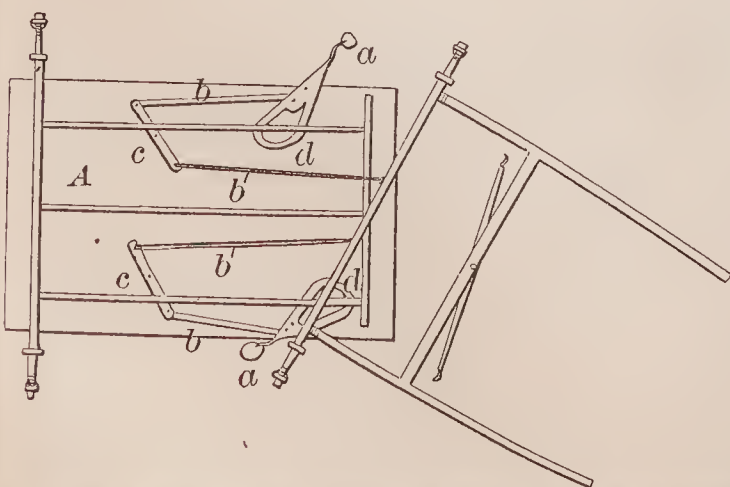

69363—M. A. Ober—*Churn Dasher.*

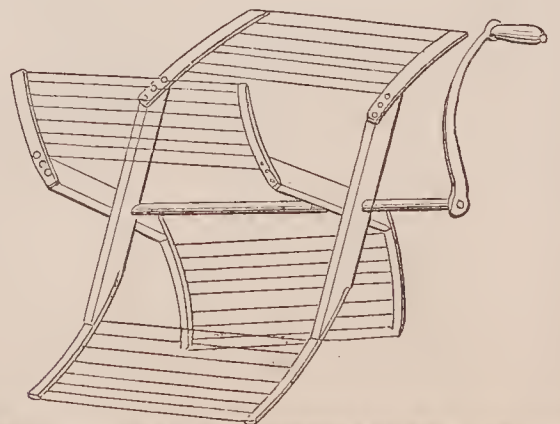

69365—M. Perry—Loose Joint Butt Hinge.

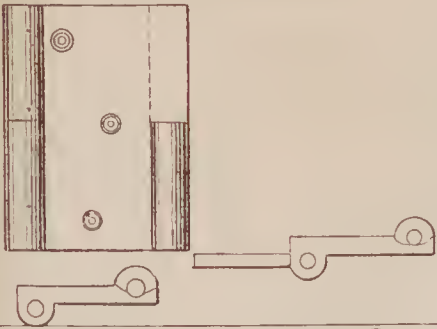

69366—T. Raser—Bed Bottom.

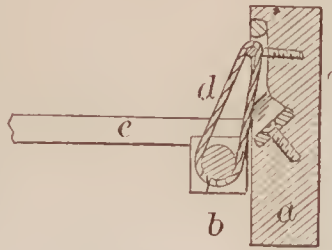

69367—C. H. Reno—For Heating Tires.

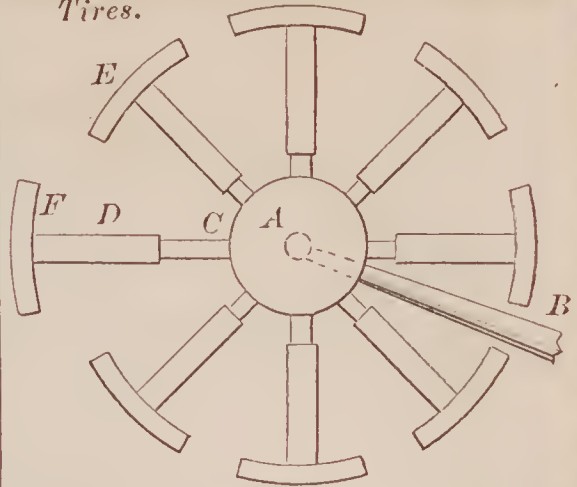

69368—G. W. Sanders—Mop Head.

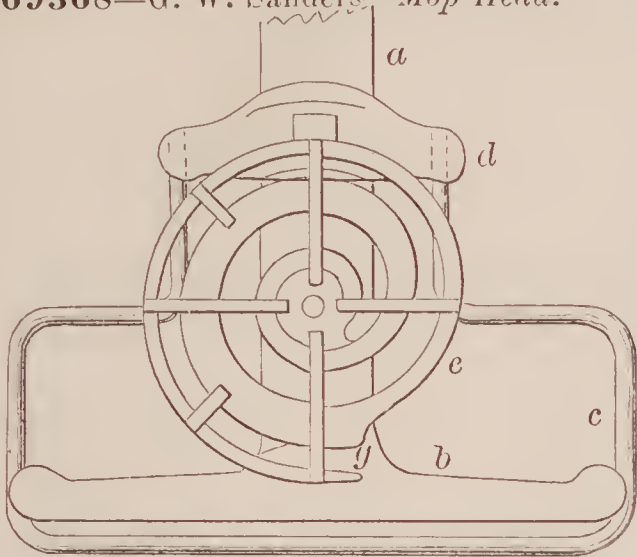

69371—J. Sheldon—Hat Blocking Machine.

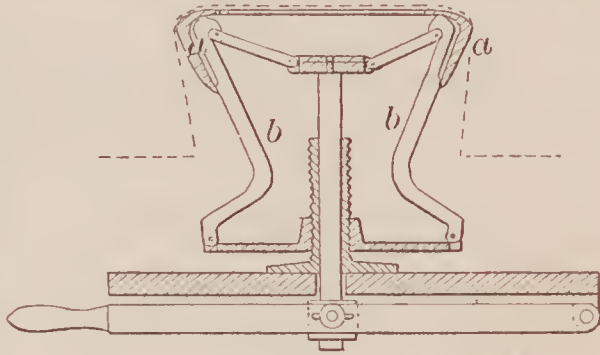

69370—A. M. Sawyer—For Preparing Peat for Fuel.

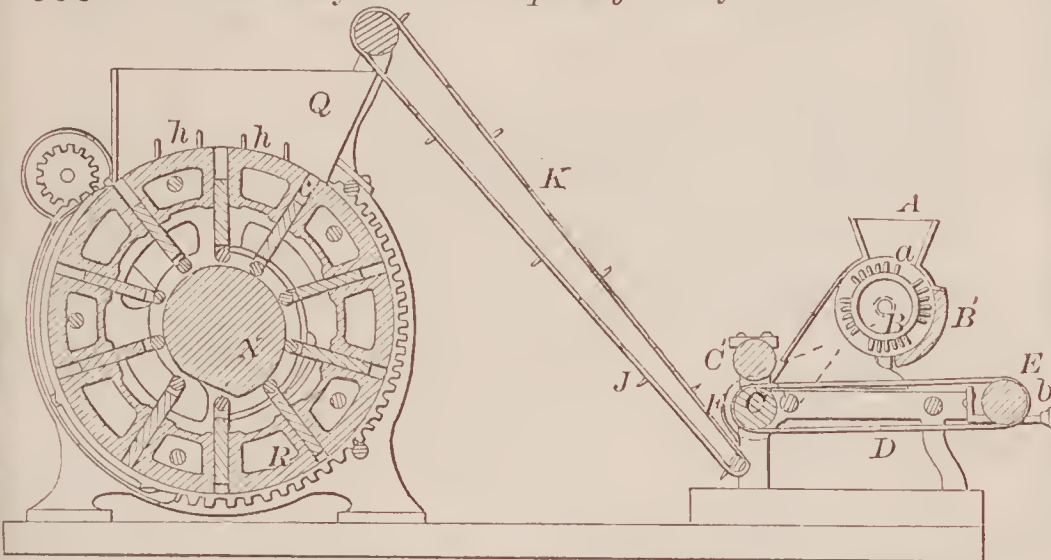

69372—G. P. Sisson—Flask for Casting

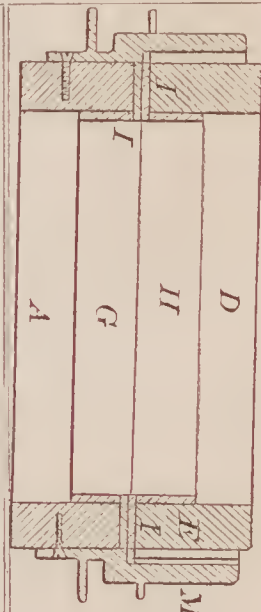

69374—J. S. Thornton—Windmill.



69373—Taylor & Fowler—Journal Box.

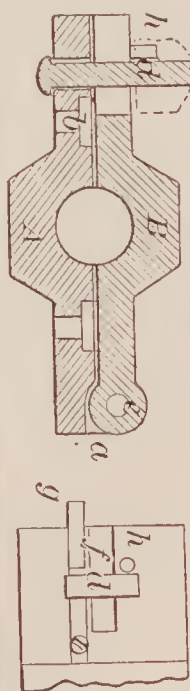

69369—H. & J. M. Saunders—Hitching Device for Whiffletrees.

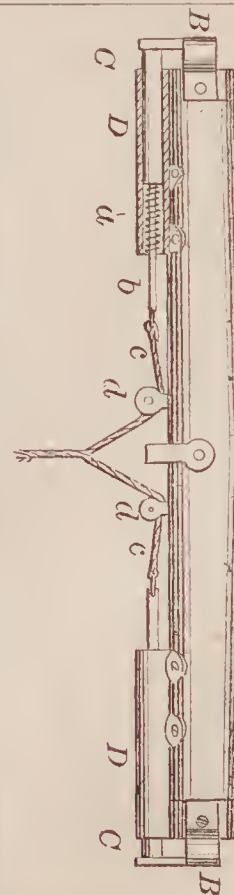



69375—I. V. Voorhis—Hay Derrick.

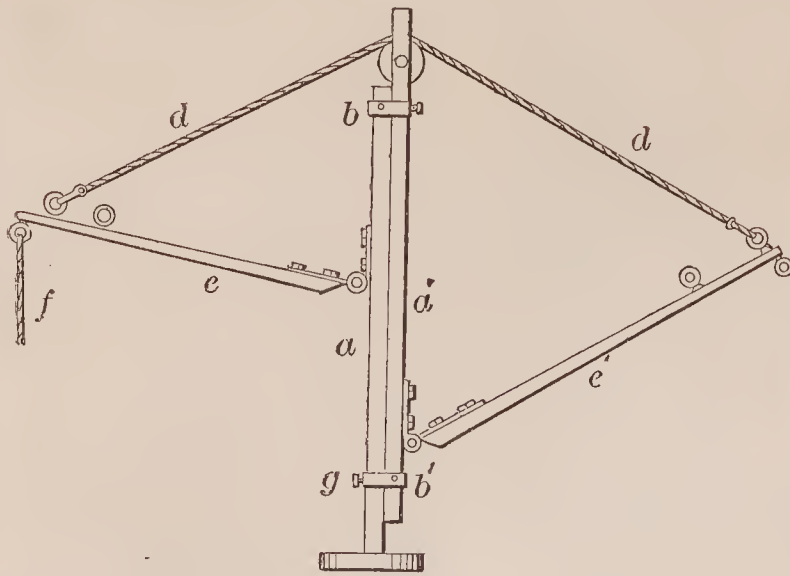

69376—B. F. Walton—Mattress.

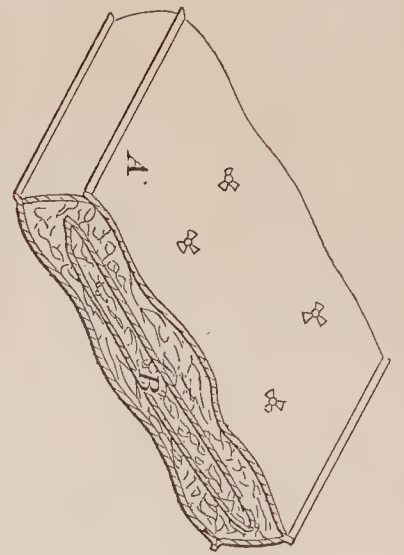

69378—E. H. & D. R. W. Williams—Excavating Machine.

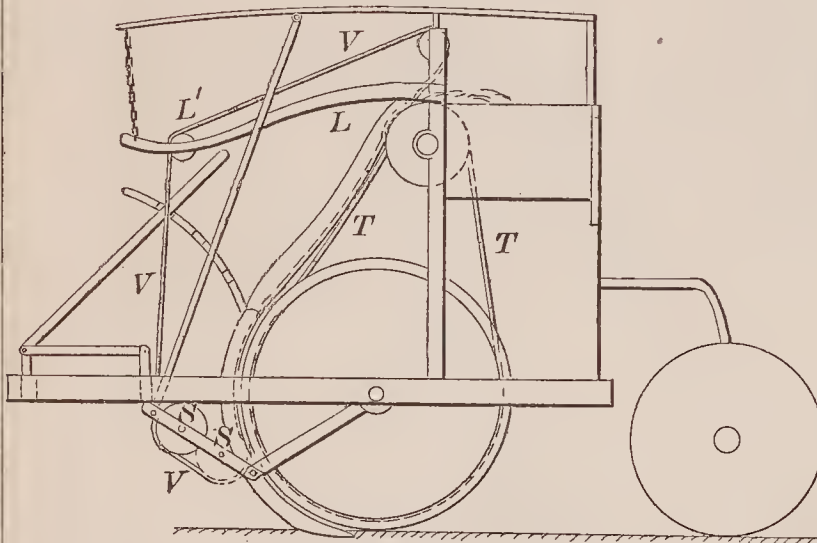

69377—I. P. Wendell—Car Brake Shoe.

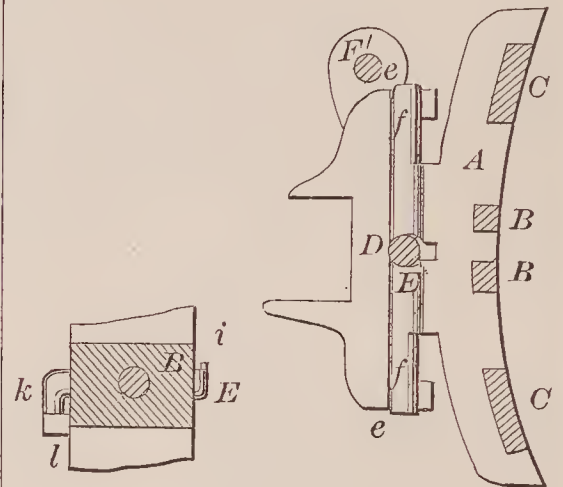

69379—A. H. Wirz—Pill Machine.

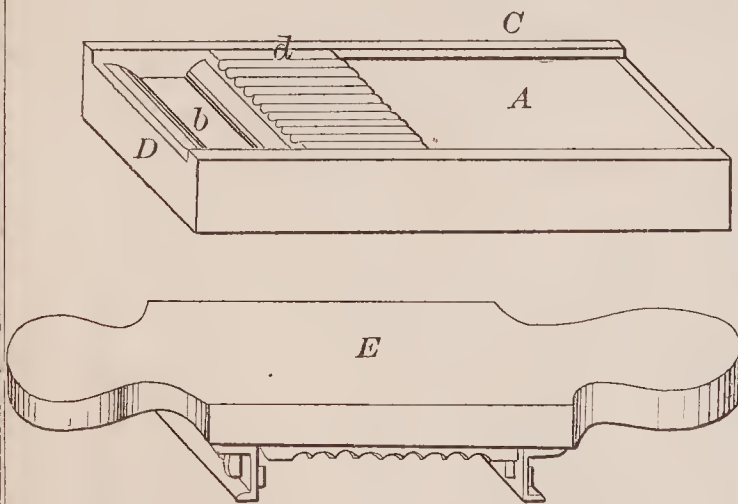

69382—W. C. Abbott—Treadle for Propelling Machinery.

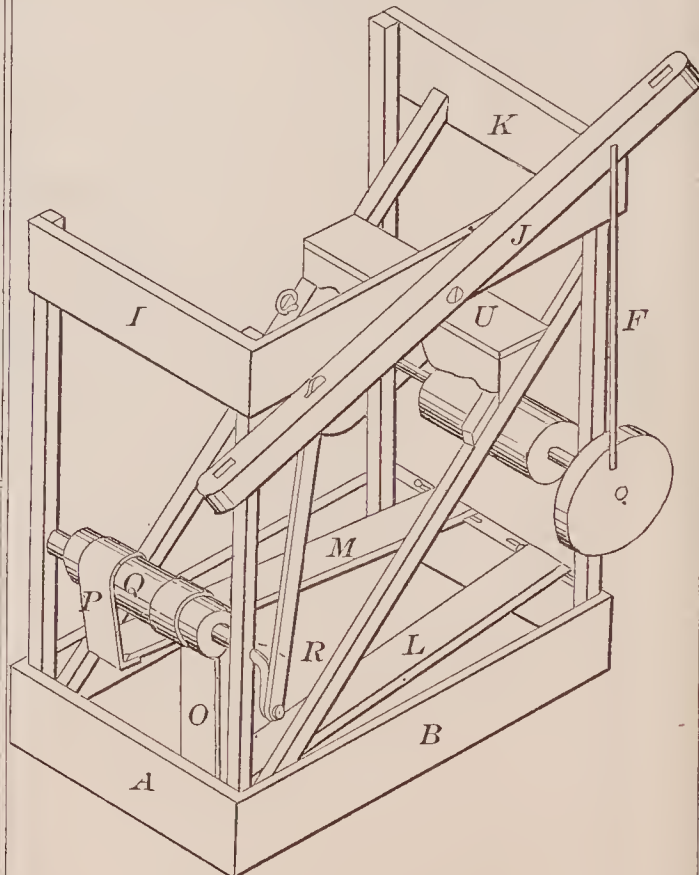

69380—E. Wright—Picker for Looms.

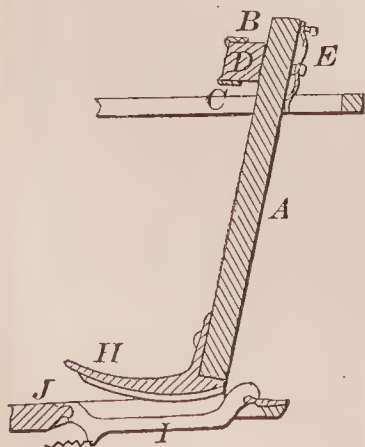

69381—H. L. & E. J. Zahn—Watch Regulator.

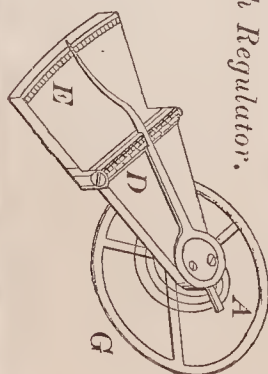

69383—M. L. Andrew—Rotary Engine.

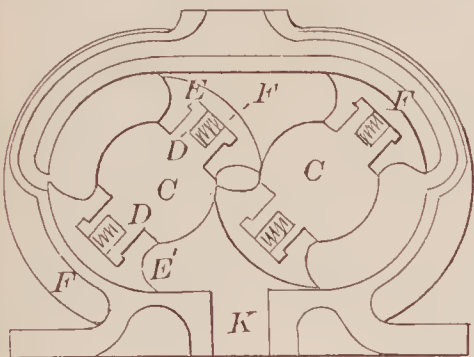
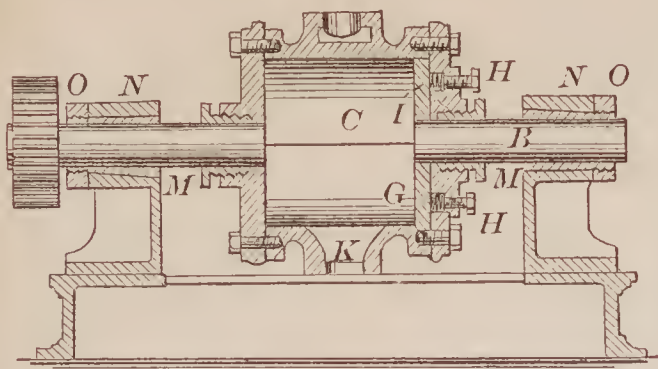

69384—W. D. Andrews—Hoisting Apparatus.

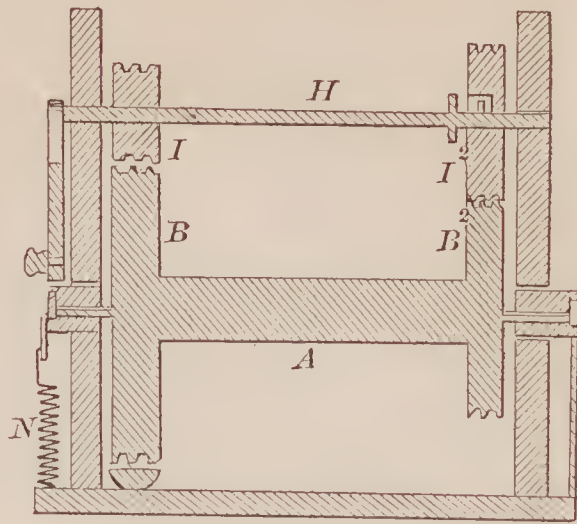

69386—M. Barker—Elliptic Spring Brace.

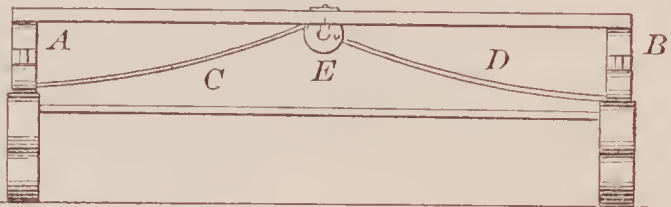

69387—T. Barns—Hand Spinning Machine.

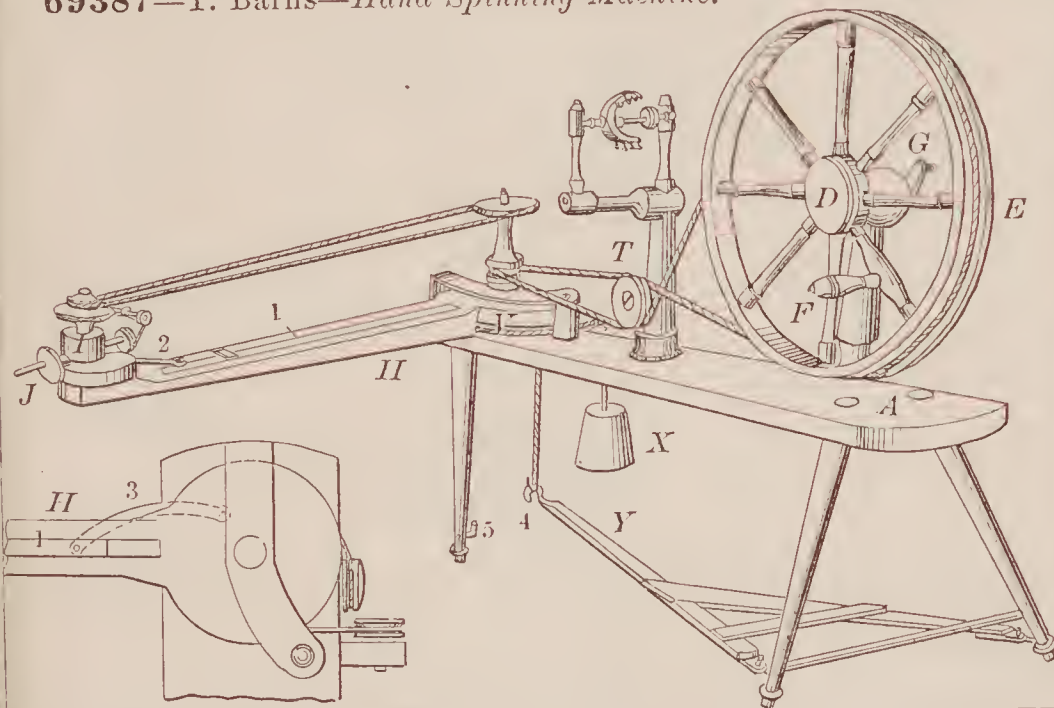

69385—F. Ashley—Letter File.

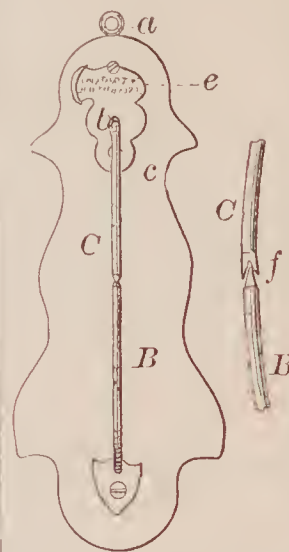

69388—G. C. Barney—Eraser and Letter Opener.

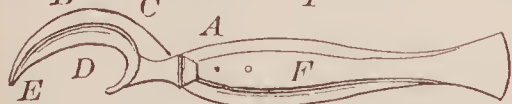

69389—Beardsley, Boyle, Lewis & Clancy—For Recording Votes.

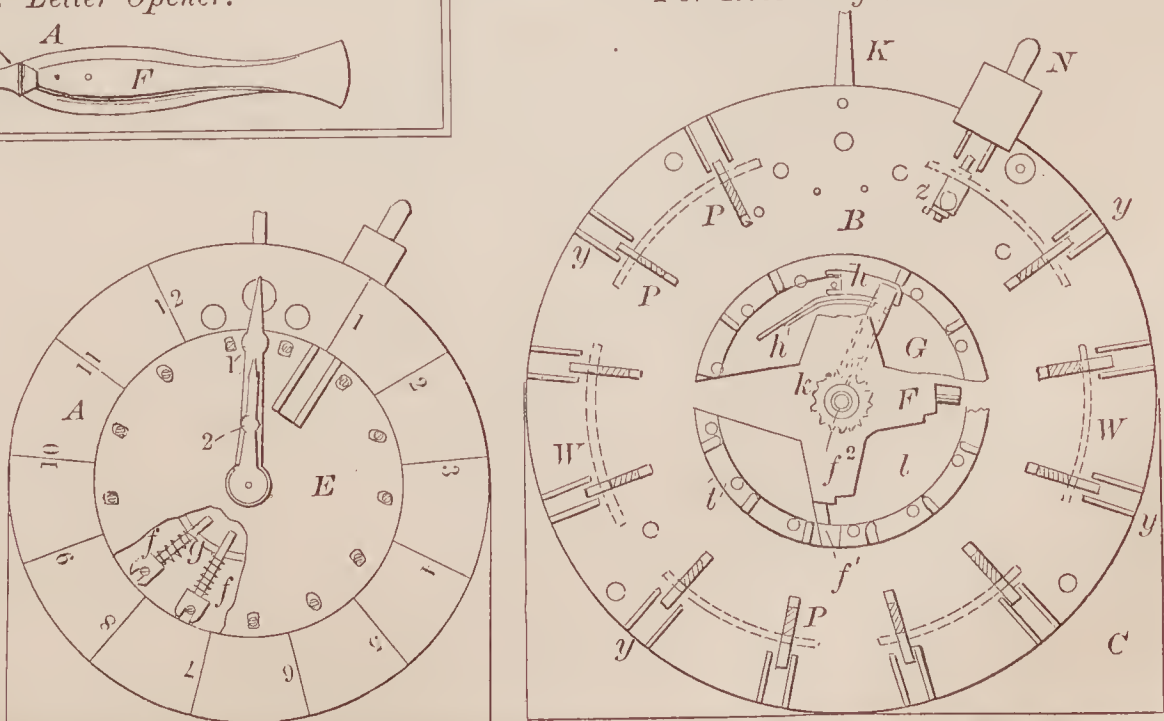



69389—Continued.

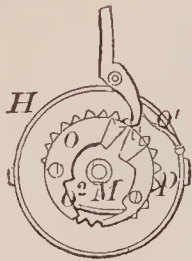
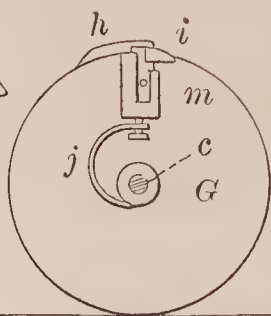
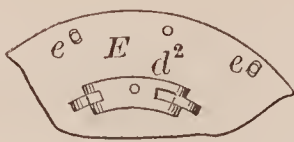
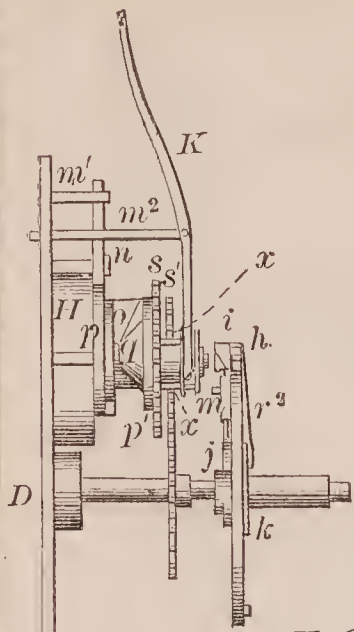

69392—C. W. Blackman—Hen's Nest.

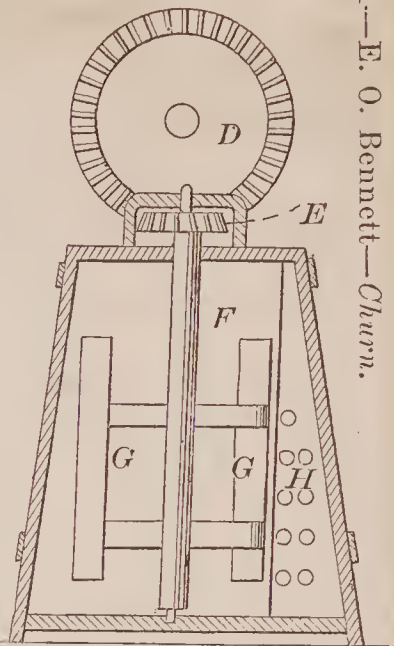
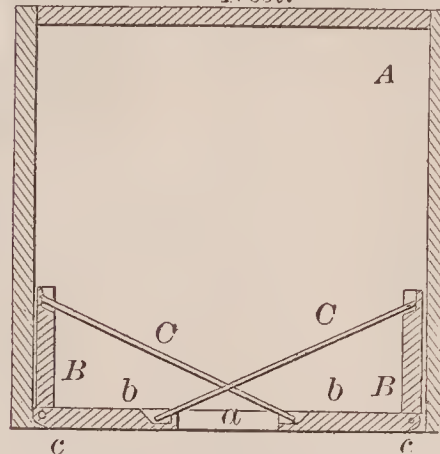

69391—E. O. Bennett—Churn.

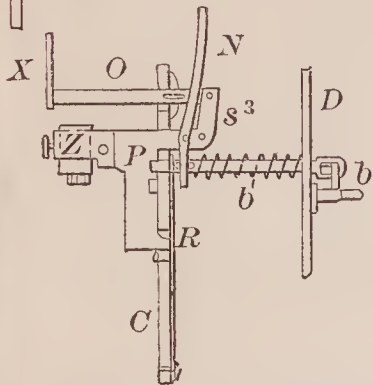

69394—S. S. Bliss—Attaching Thills to Carriages.

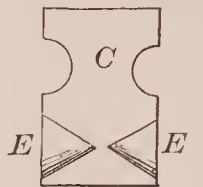
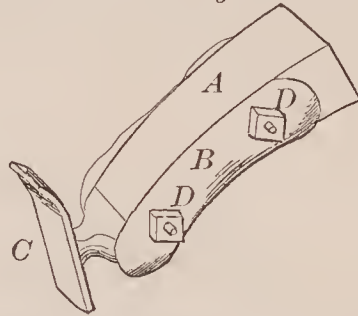
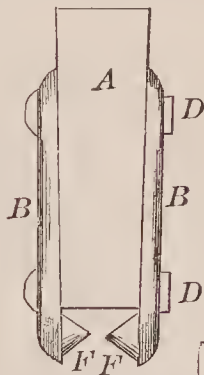

69390—W. F. Bearns—For Filtering and Purifying Spirits.

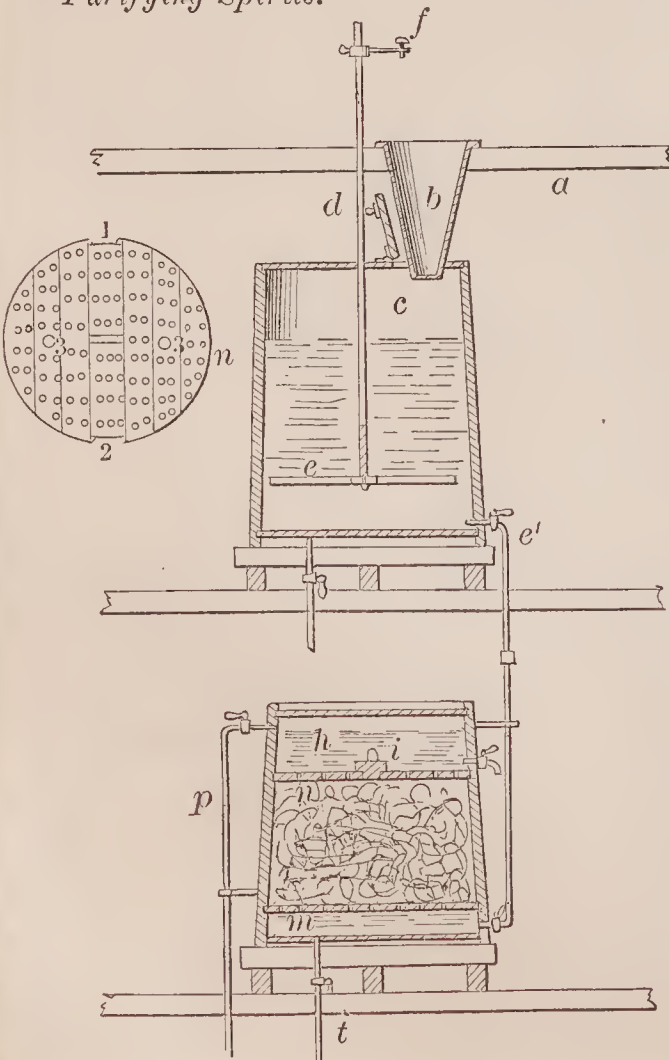

69395—C. K. Bradford—Lasting Awl.

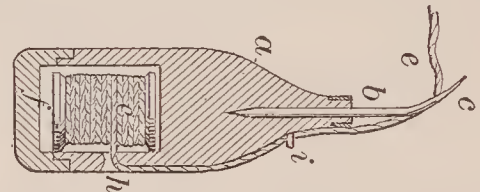

69396—Brayton & Curtis—Respirator.

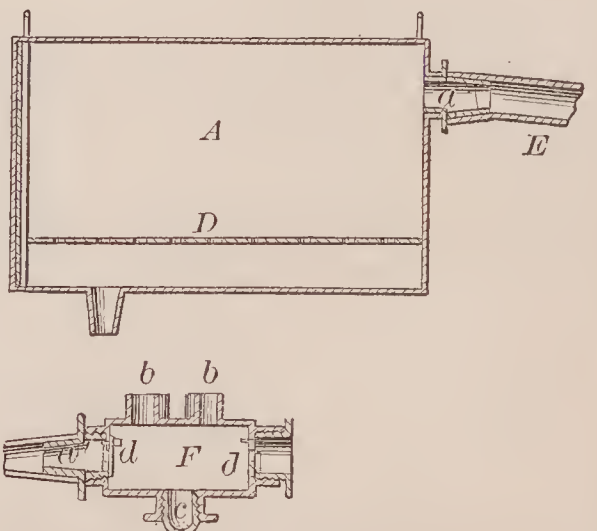

69397—R. F. Briggs—Seat for Carriage Bodies.

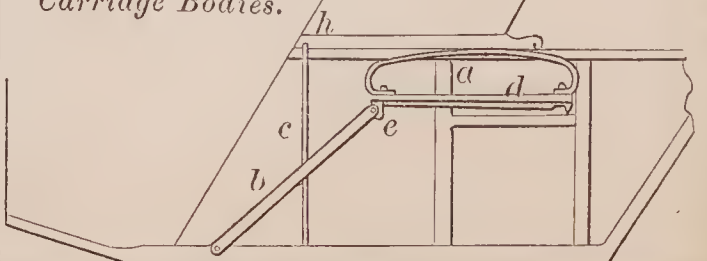

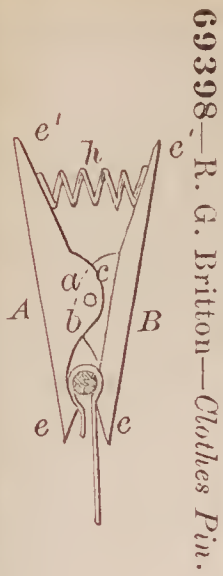

69398—R. G. Britton—Clothes Pin.

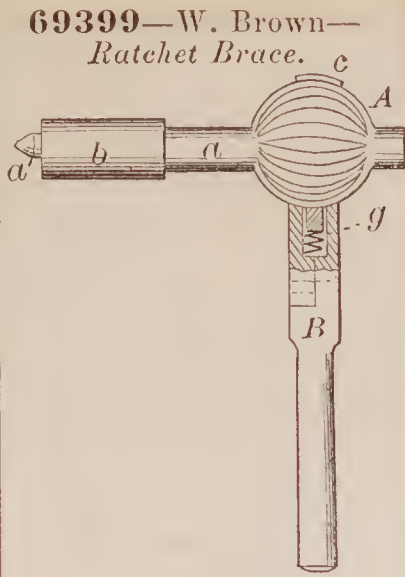

69399—W. Brown—Ratchet Brace.

69402—E. M. Butler—Attaching Thills to Vehicles.

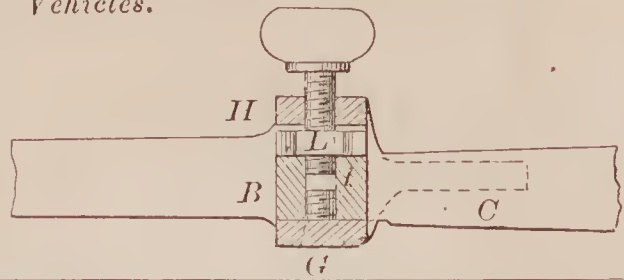

69403—J. G. Buzzell—Carriage Wheel.

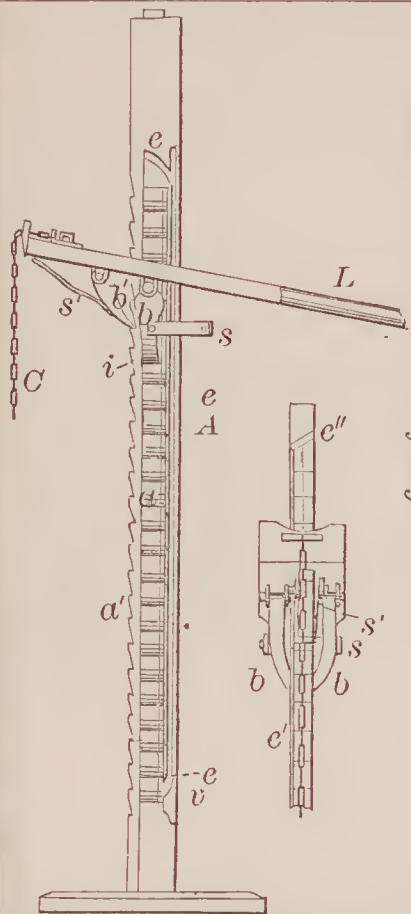
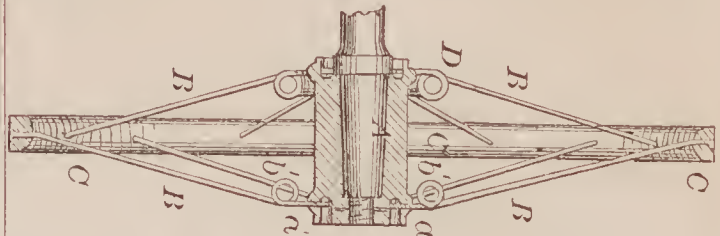

69400—W. Green—Lifting Jack.

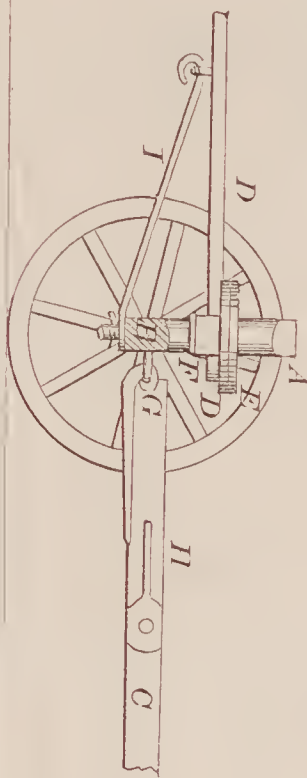

69404—V. M. Chafee—Wagon.

69401—G. Bushnell—Bellows.

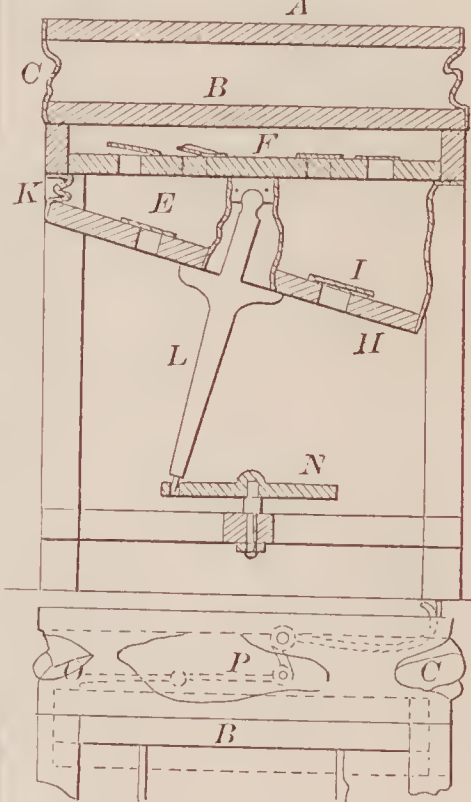

69407—Clark & Little—Coal Elevator and Distributor.

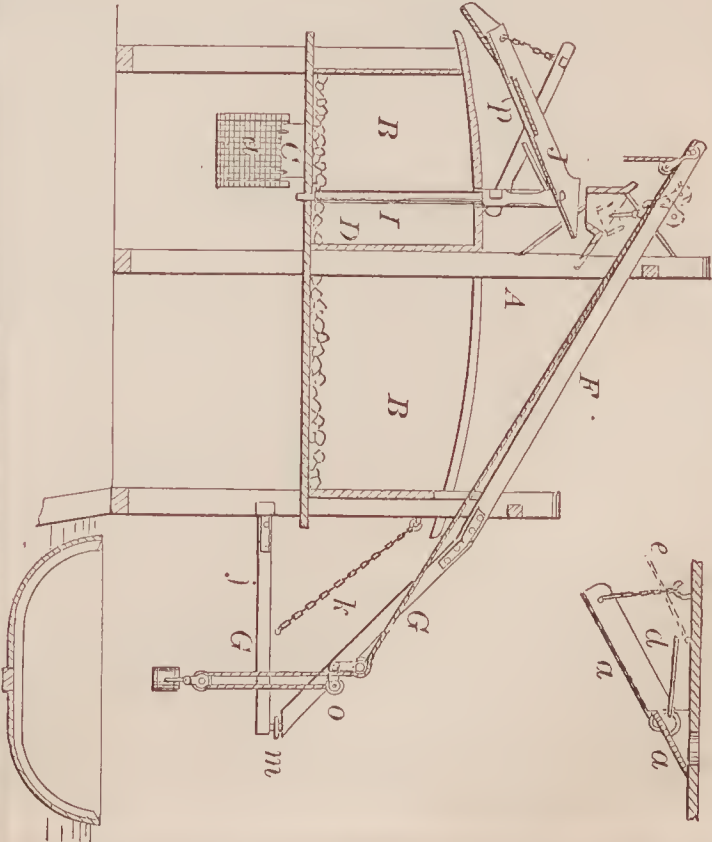

69405—C. H. Chapman—Tag or Label.



69406—G. W. Clark—For Ringing Hogs.

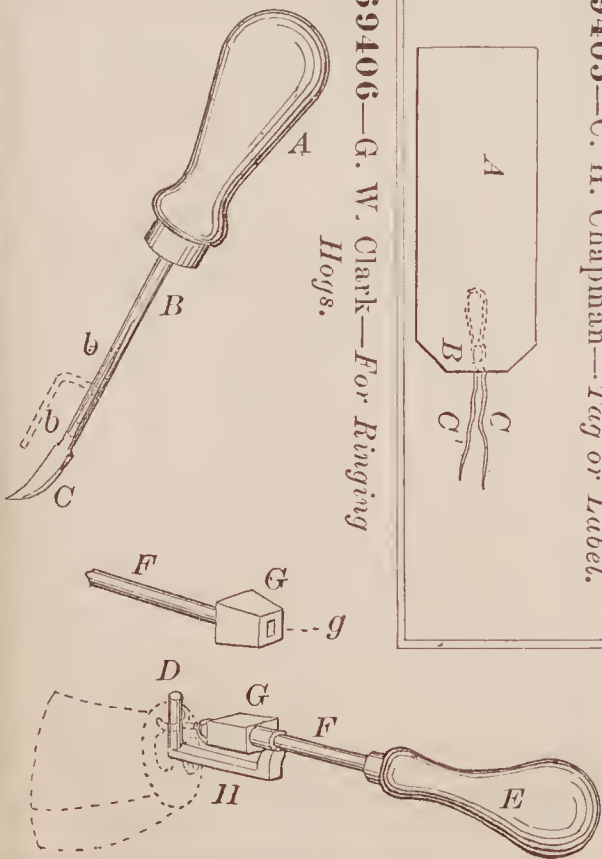



69408—G. P. Clarke—*Terrestrial Globe.*

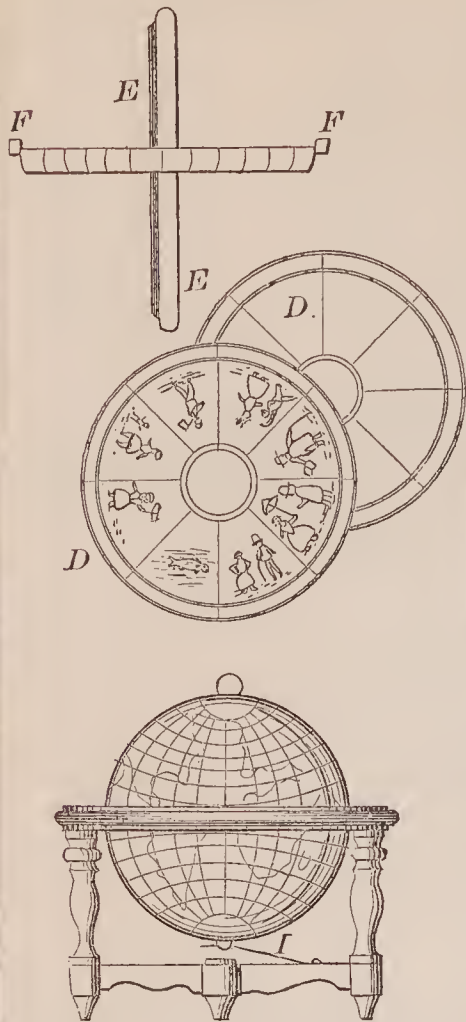

69409—J. P. Cook—*Hand Reaper and Mower.*

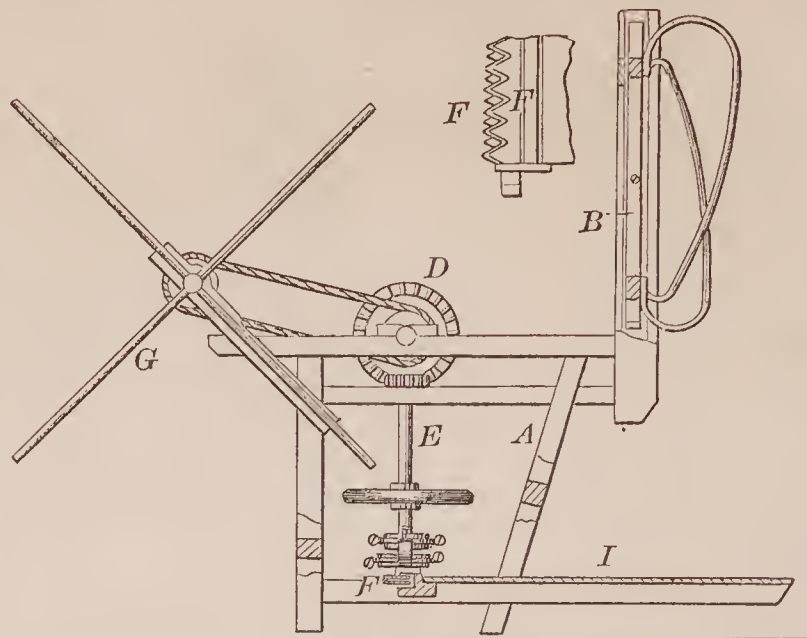

69412—J. C. Covert—*Hold Back.*

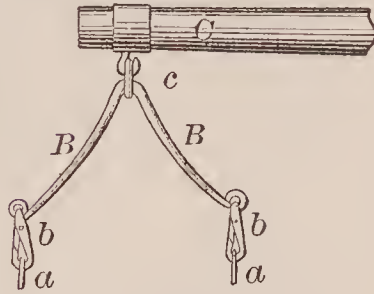

69415—O. Dean—*Mucilage Pot.*

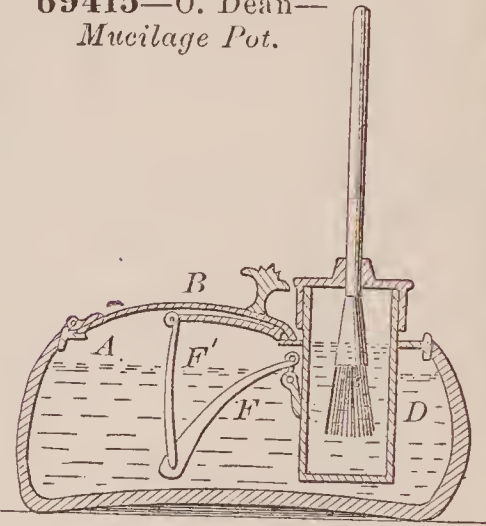

69410—W. Cooper—*Water Wheel.*

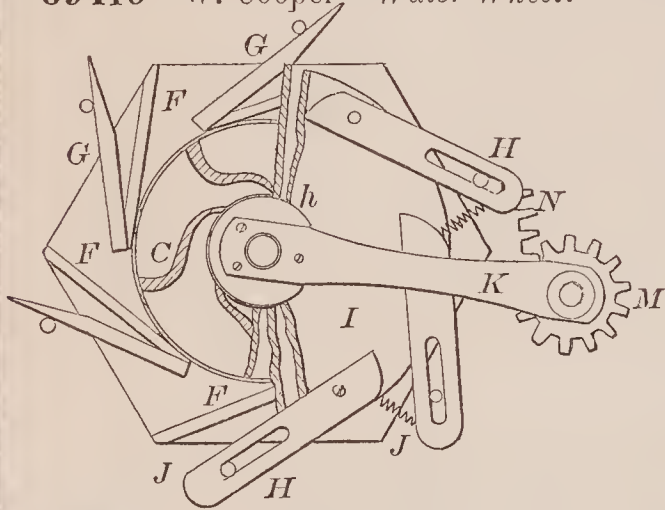

69411—L. R. Cornell—*Steam Superheater.*

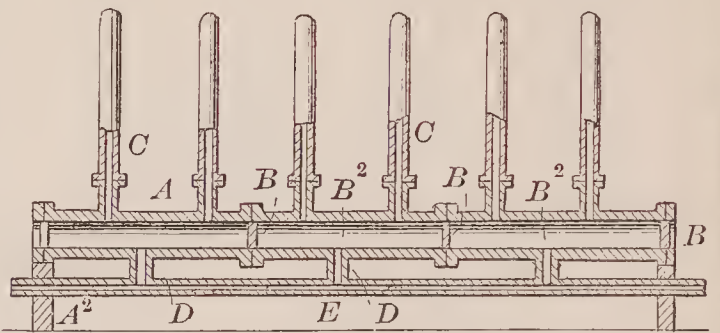

69416—S. B. Driggs—*Dike and Levee to Rivers.*

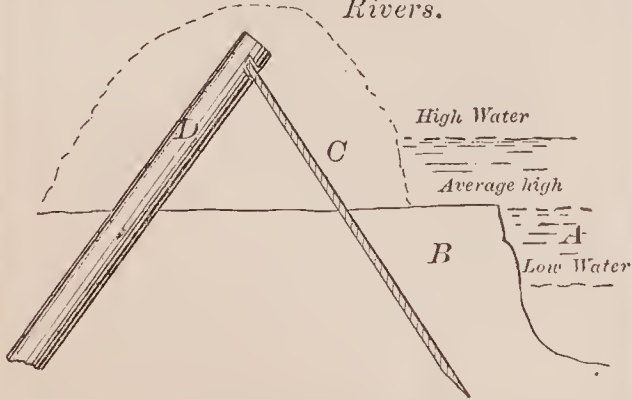

69413—Curran & Baxter—*Metallic Hame Tug.*

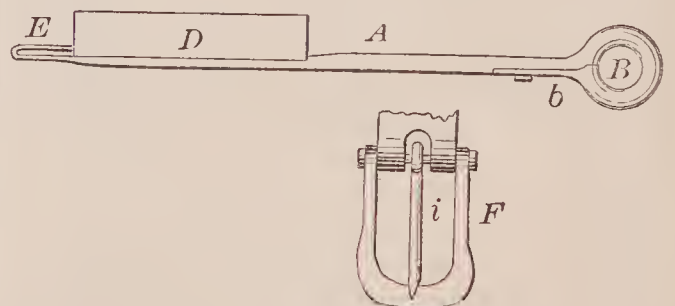

69417—F. Ellershausen—*Manufacture of Cast Steel.*

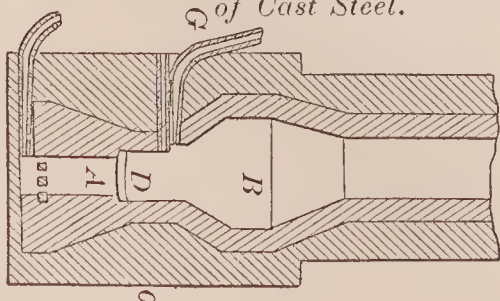

69418—D. F. Elmer—*Index Gauge and Calipers.*

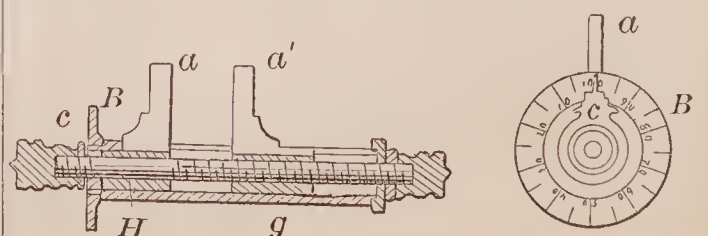

69419—T. B. Estep—Coffin.

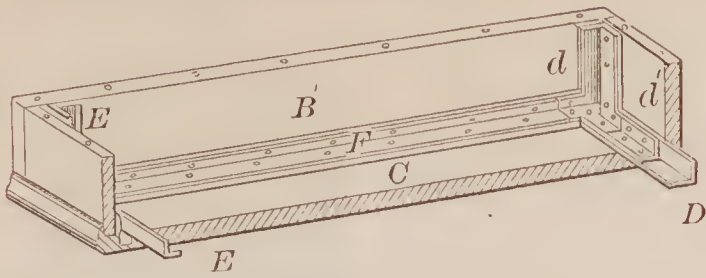

69420—Estep & Hefferman—Coffin.

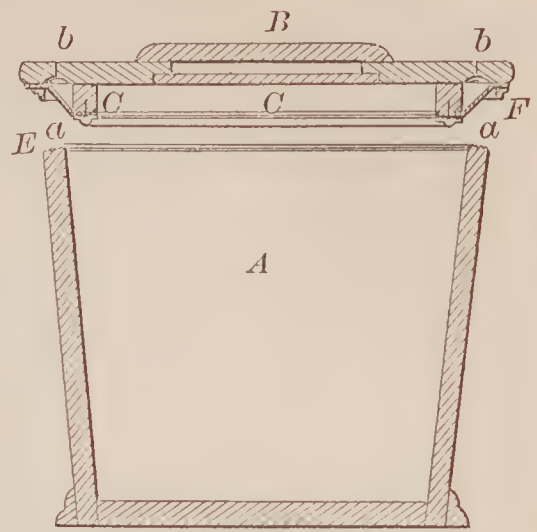

69422—D. K. Fretz—Loom.

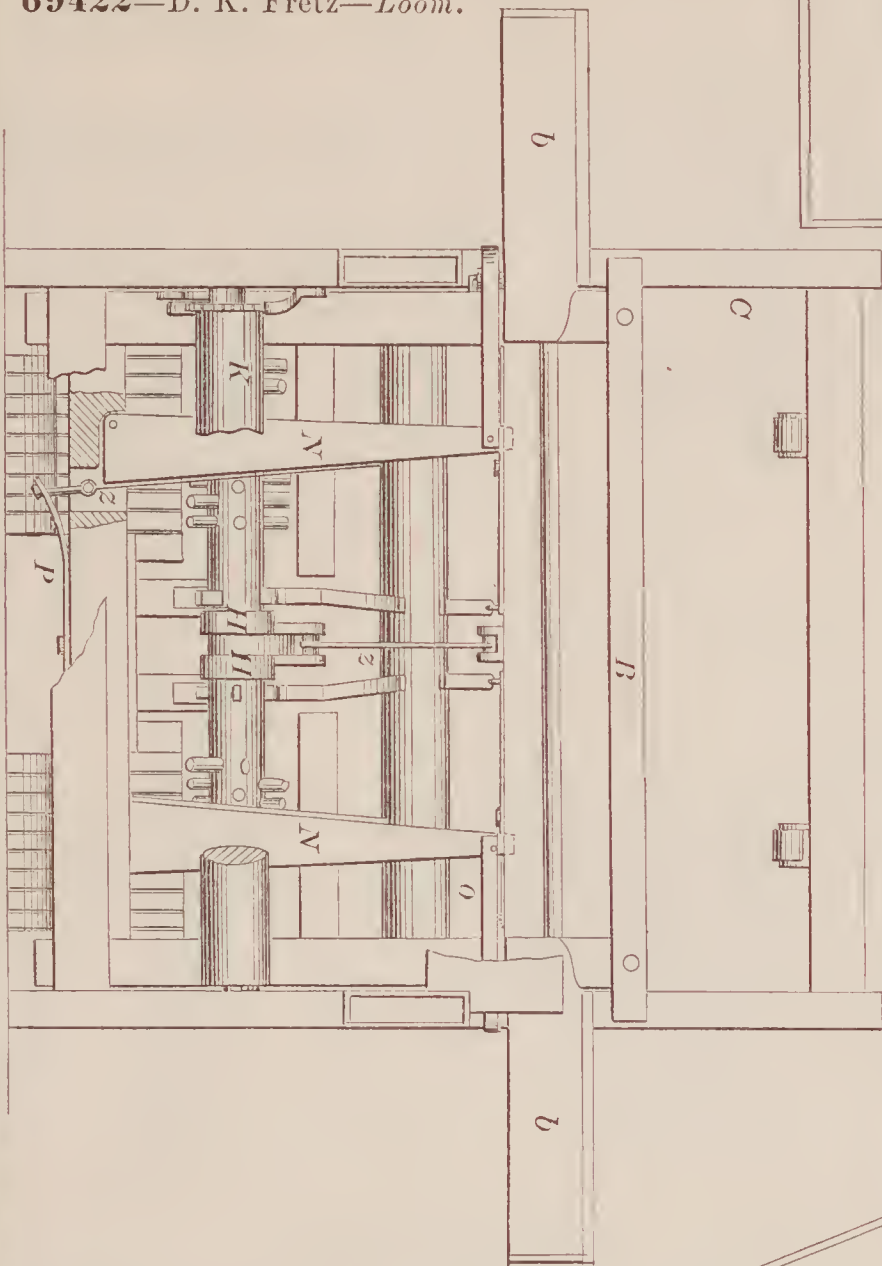

69421—J. W. Evans—For Coiling Springs.

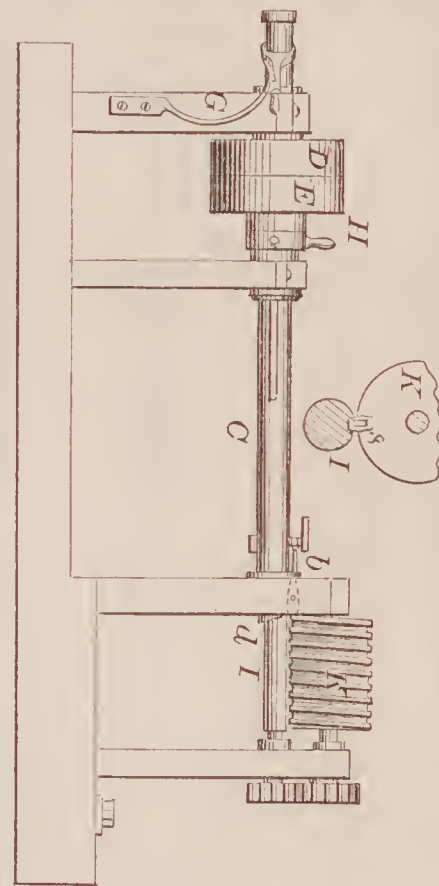

69423—H. Getty—Air Pump.

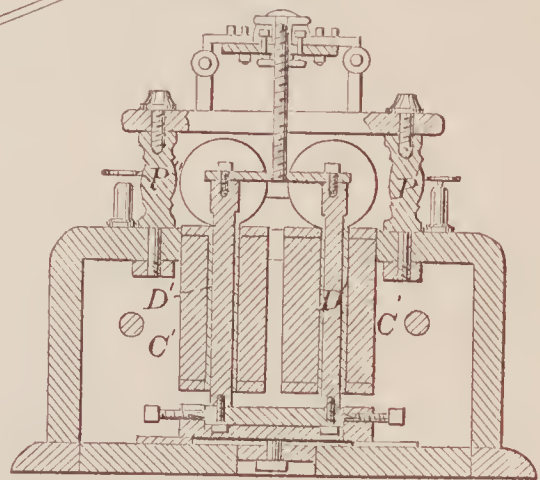
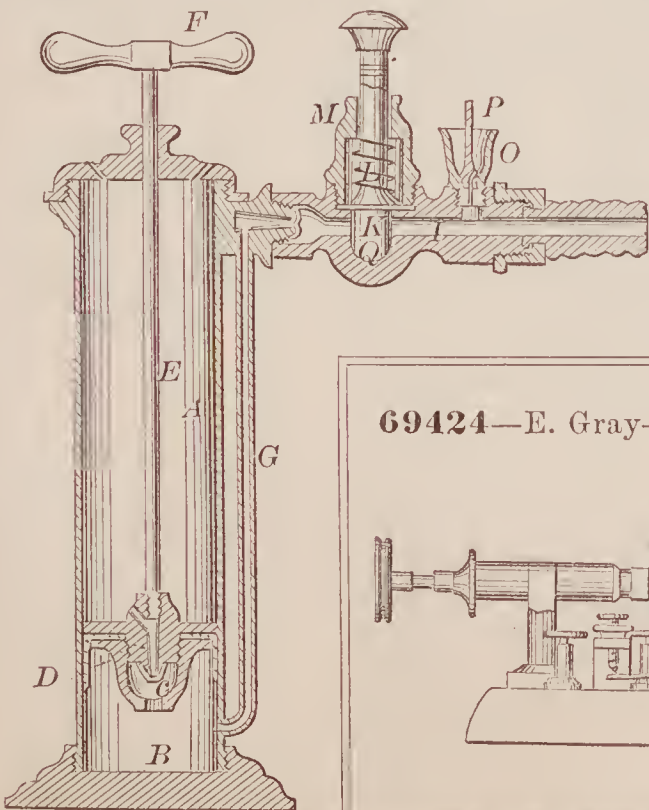

69424—E. Gray—Telegraph Apparatus.

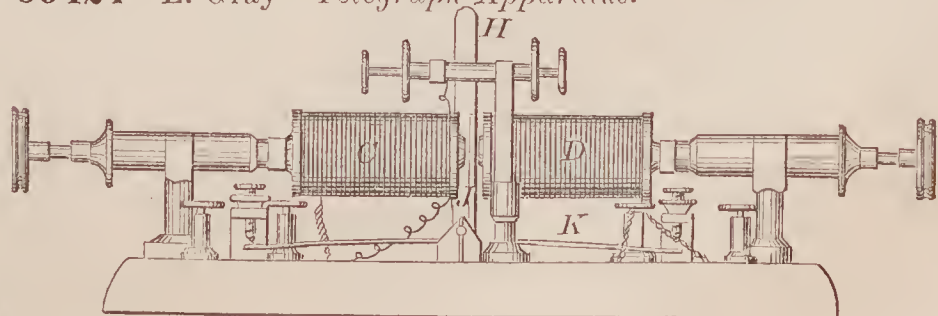



69425—Fisher & Holliday—*Weighing Attachment to Faucets.*

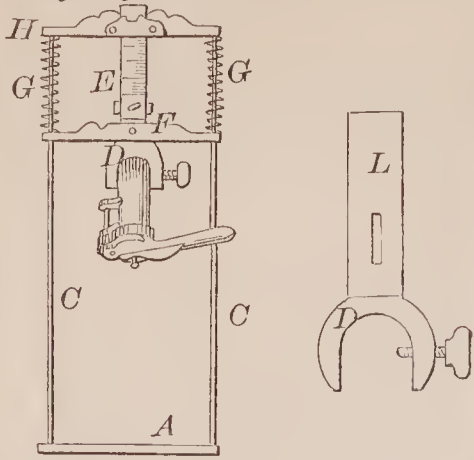

69427—J. A. Harman—*Watch.*

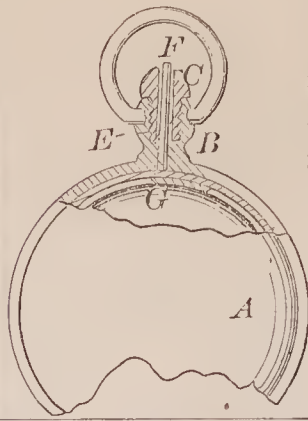

69430—G. Heesen—*Chair Seat.*

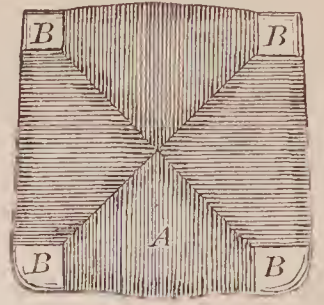

69426—J. Haley—*Glass Ware Press.*

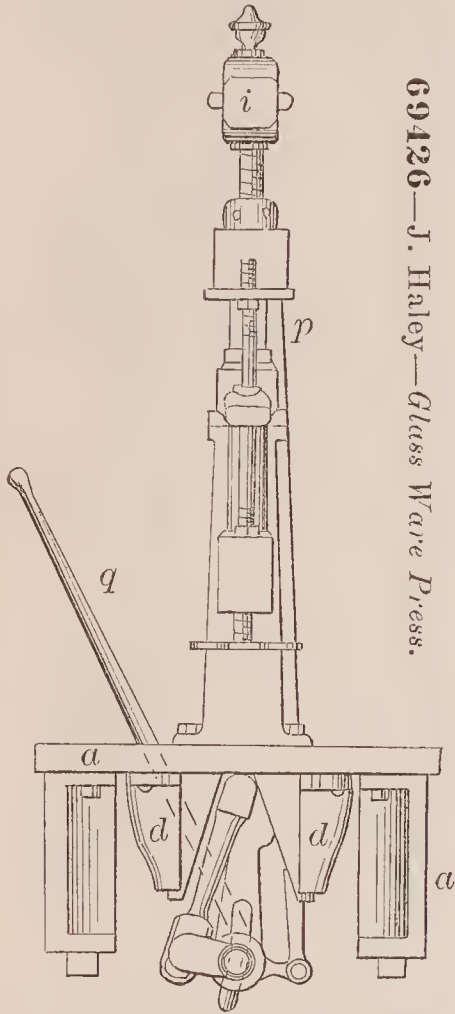

69429—J. G. Haymaker—*Horse Collar.*

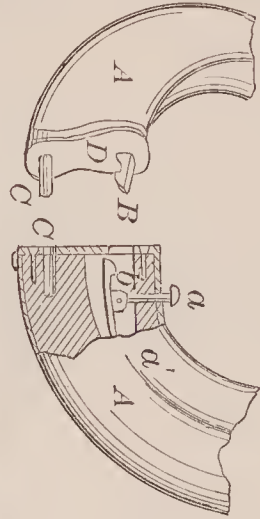

69431—J. H. Hendrick—*Beehive.*

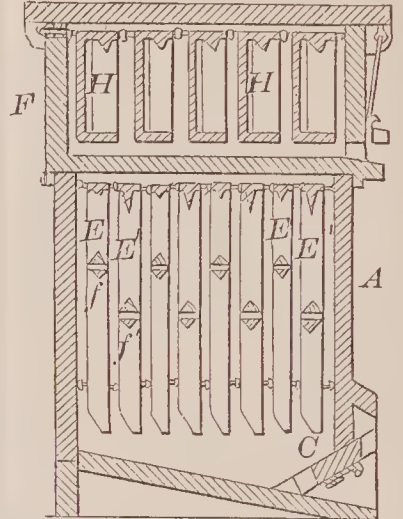

69432—J. W. Henry—*Hay Raker and Loader.*

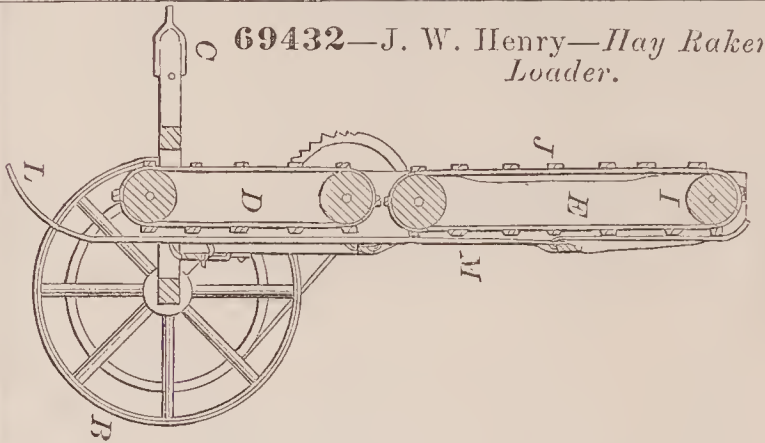

69428—E. Harrison—*Beehive.*

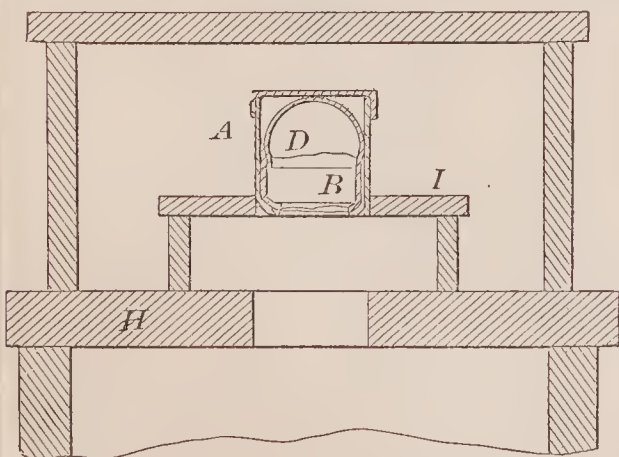

69433—F. Henshaw—*Filter.*

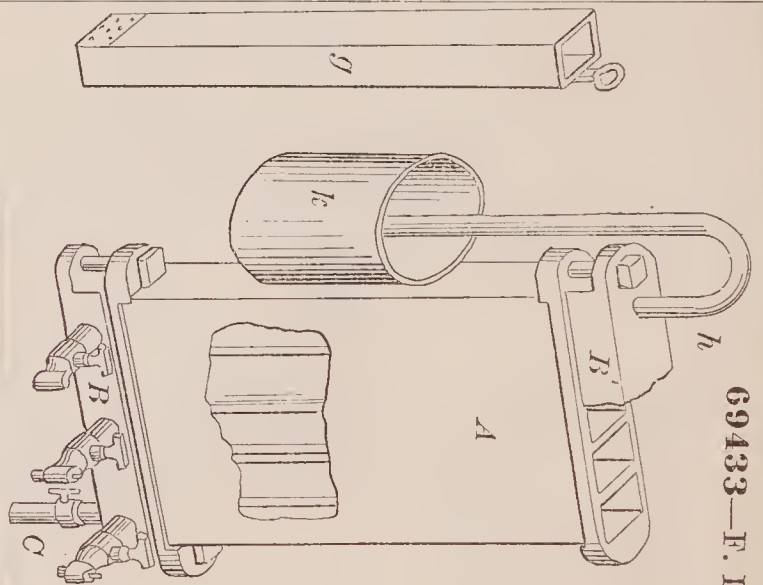

69434—E. Hicks—*Suspension Hook for Horse Hay Forks.*

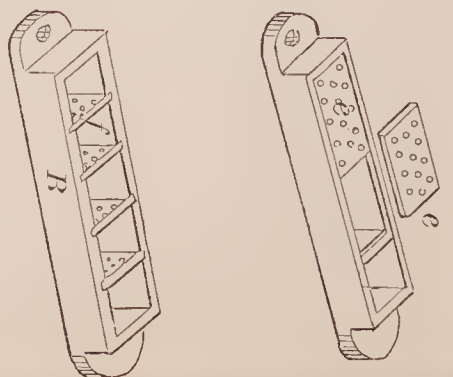
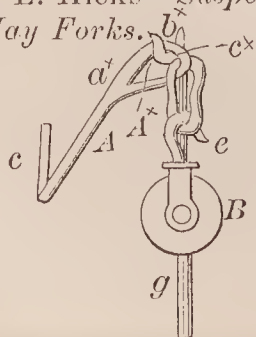

69435—  
G. H. Hoagland—  
*Chair.*

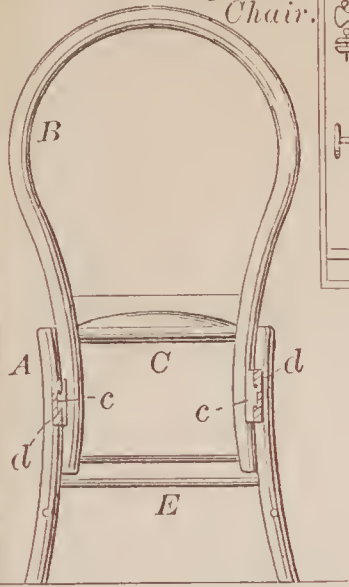

69437—T. & H. Hopper—*Steam Car Brake.*

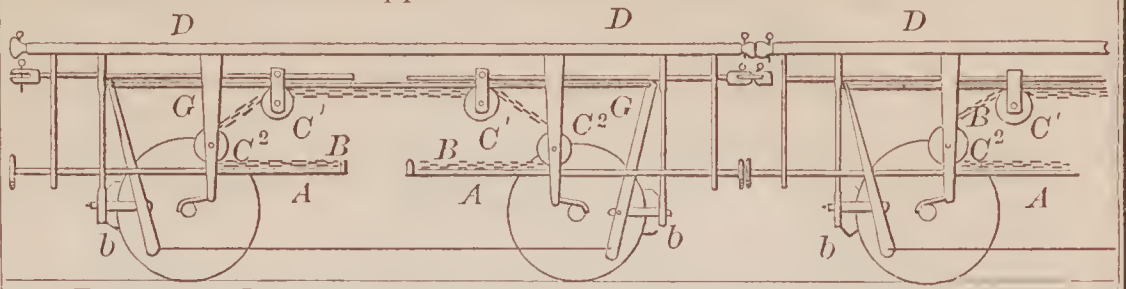

69442—C. M. Jenne—*Cultivator.*

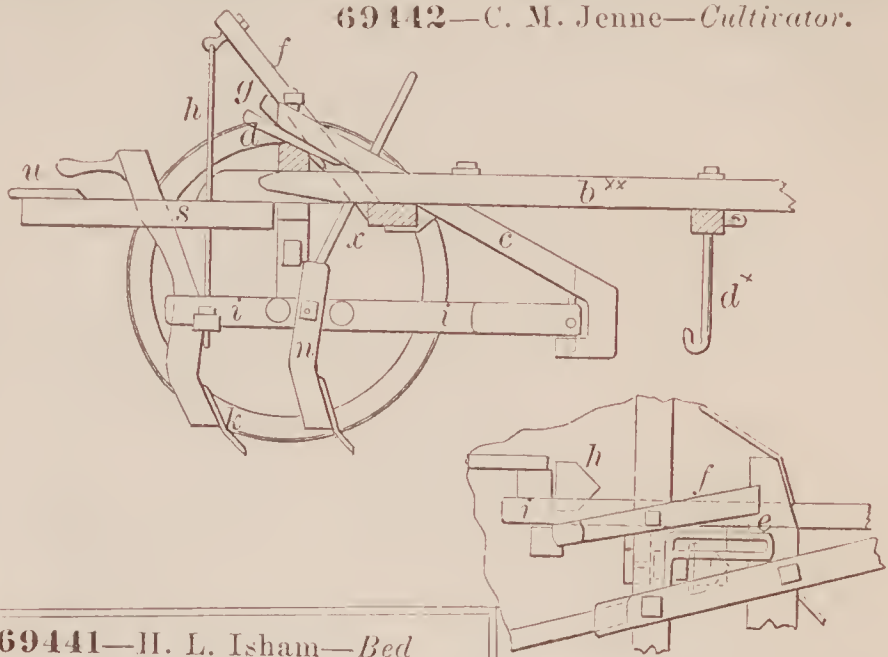

69436—P. Hoffman—*Lamp.*

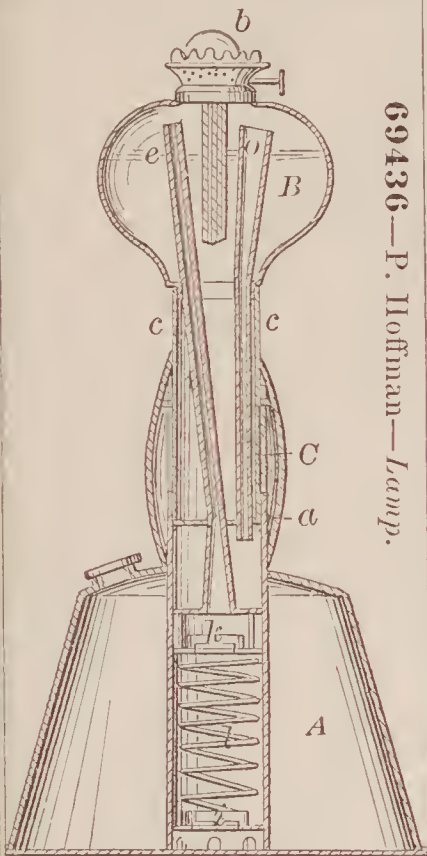

69441—H. L. Isham—*Bed  
Bottom*

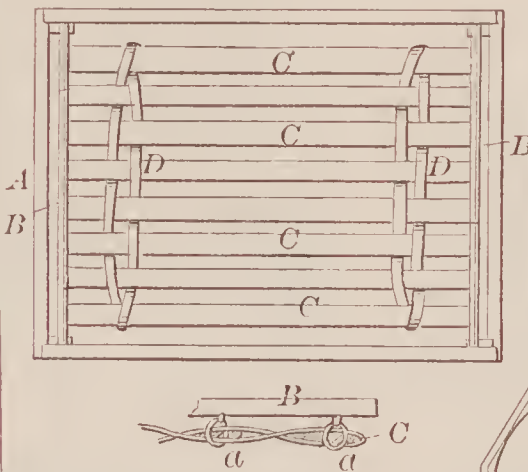

69438—Howe & Washburn—*Gum for Looms.*

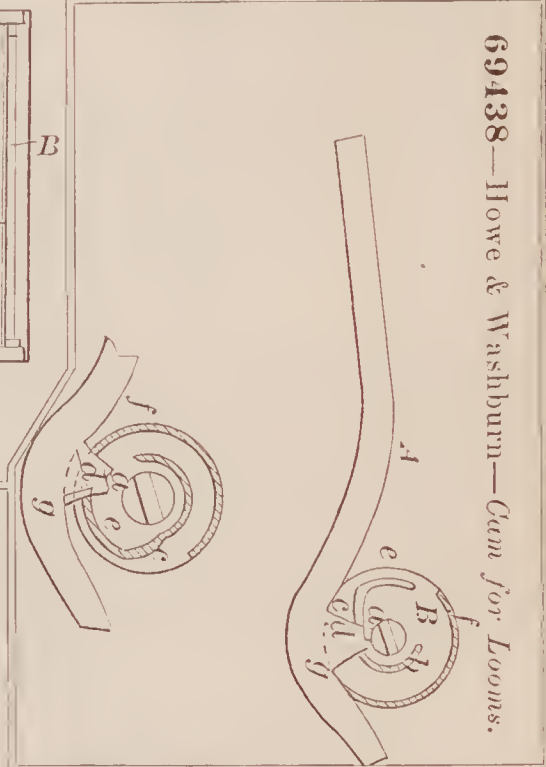

69439—J. P. Howell—*Lamp Chimney Cleaner.*

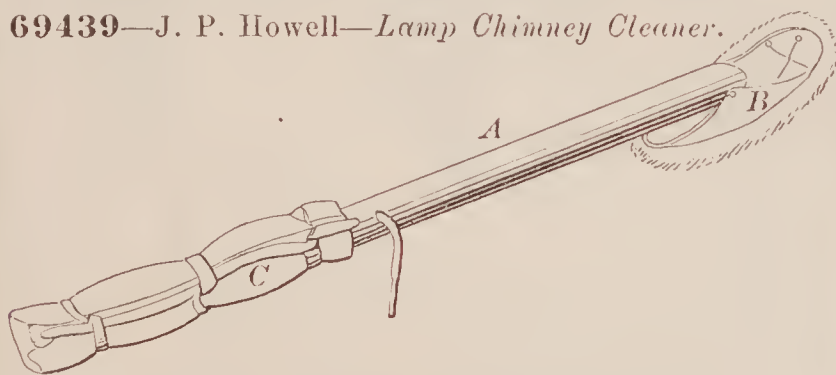

69440—R. Hubbard—*Washing  
Machine.*

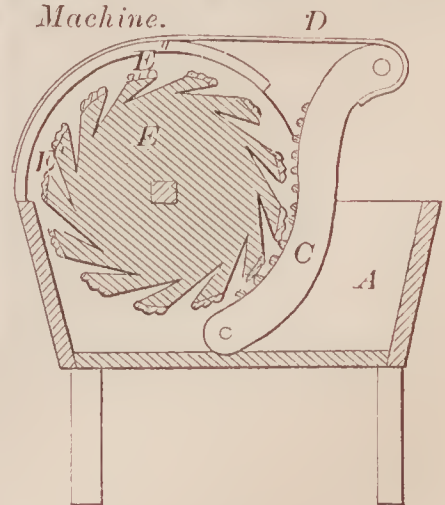

69443—H. J. Johnson—*Gate.*

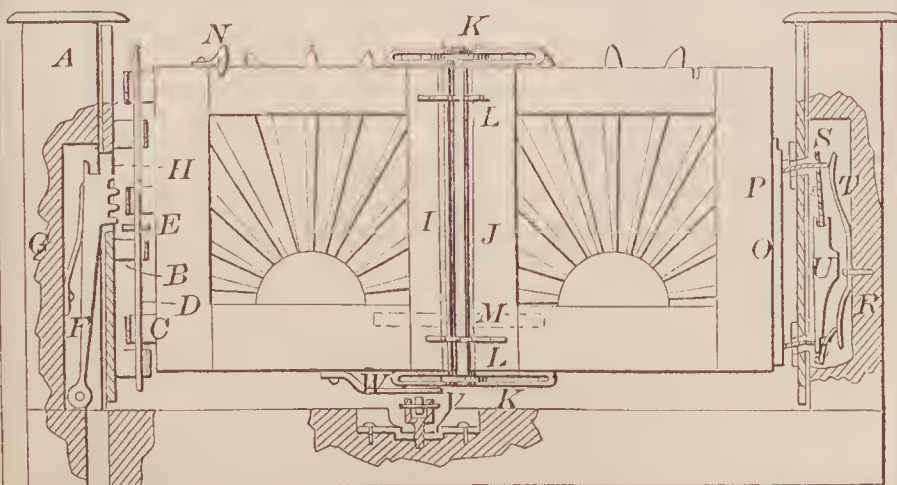





69453—Lloyd & Tetlow—Sewing Needles.



69454—J. Lombard—For Folding Leather.

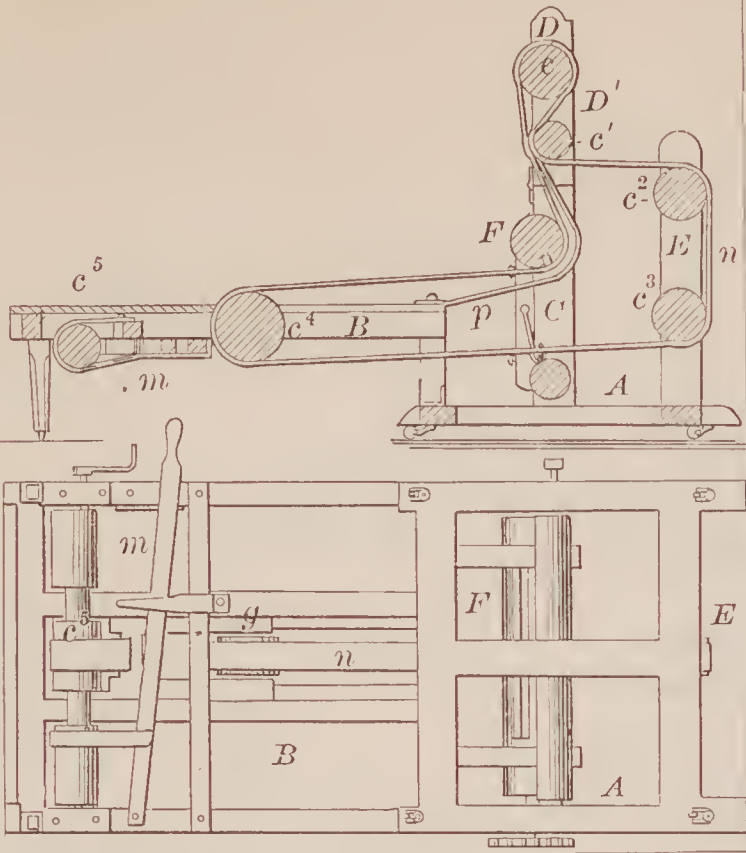

69458—T. B. McConaughy—Governor.

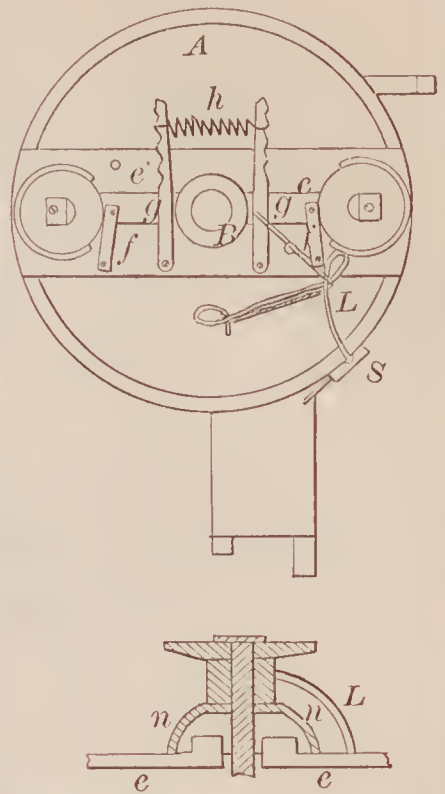

69455—C. Mack—Gate.

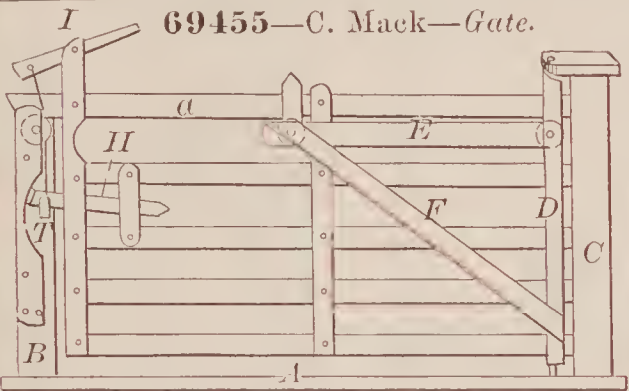

69457—S. H. Mapes—Folding Bedstead.

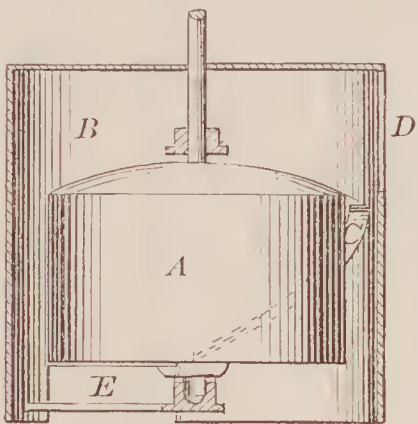
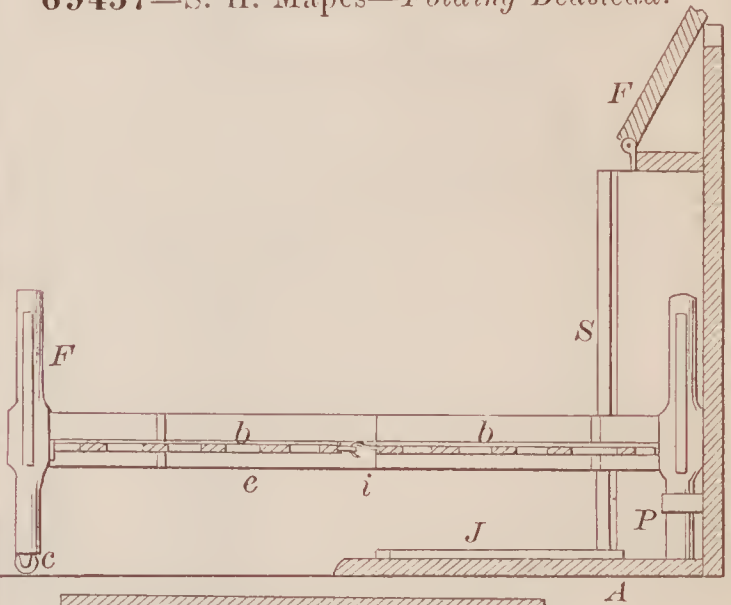

69459—H. McElDowney—For Ventilating Millstones.

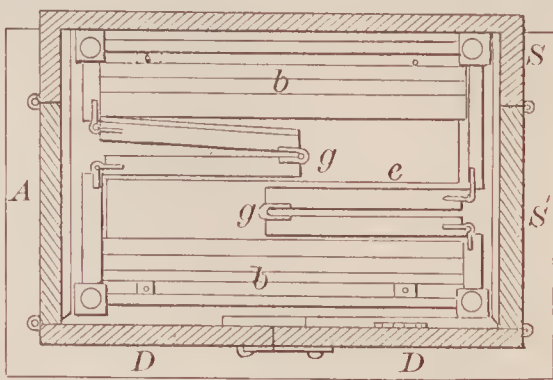

69456—D. D. Mackay—Sash Lock and Stop.

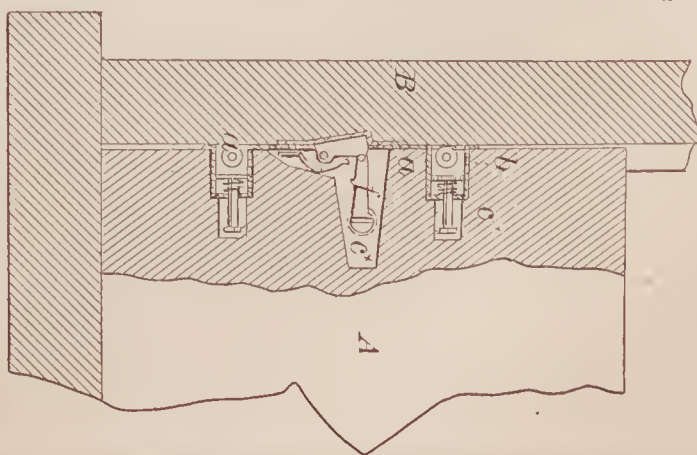

69460—J. McFeely—Window Screen.

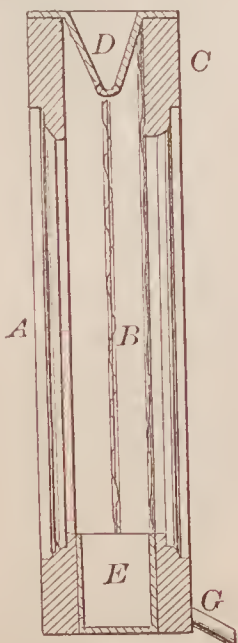



**69461**—J. McNeill—*Tucking Attachment for Sewing Machines.*

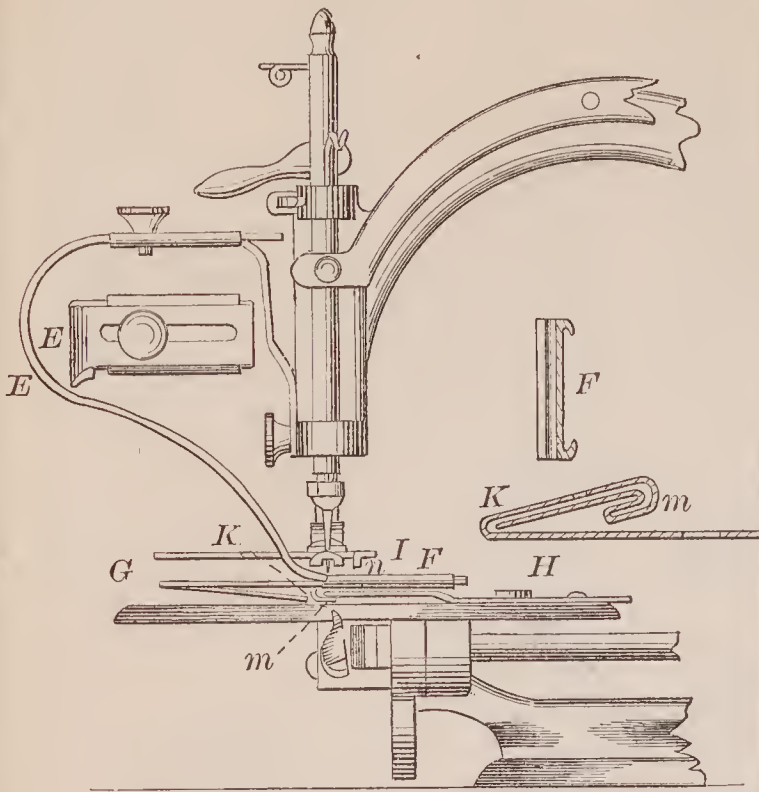

**69462**—M. D. Messler—*Fence*

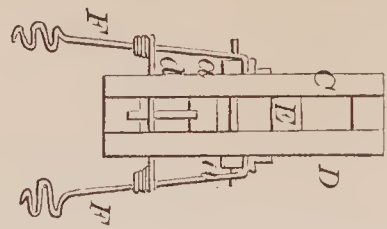

**69463**—T. C. Michener—*Needle Setter for Sewing Machines.*

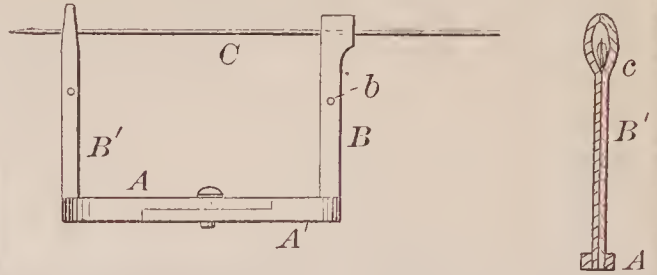

**69465**—E. Miller—*Shifting Step for Vehicles.*

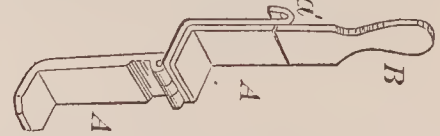

**69466**—L. B. Miller—*For Milling Twist Drills.*

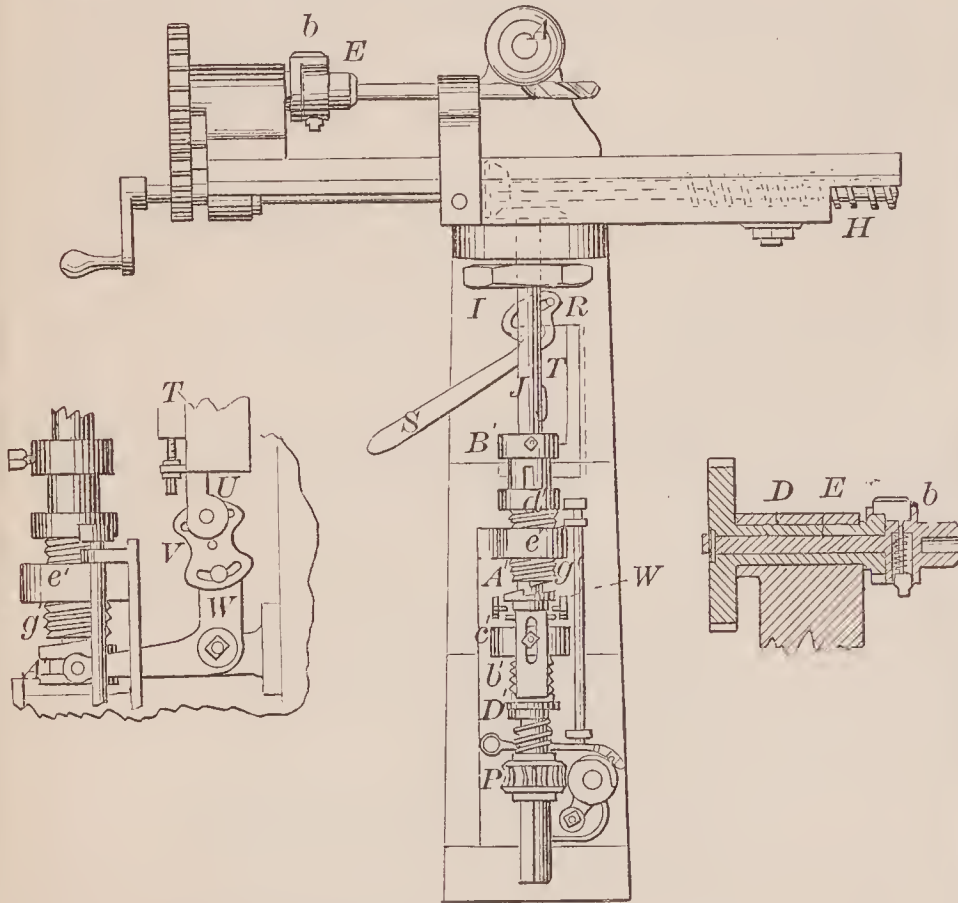

**69464**—Miller & Brestle—*Car Coupling.*

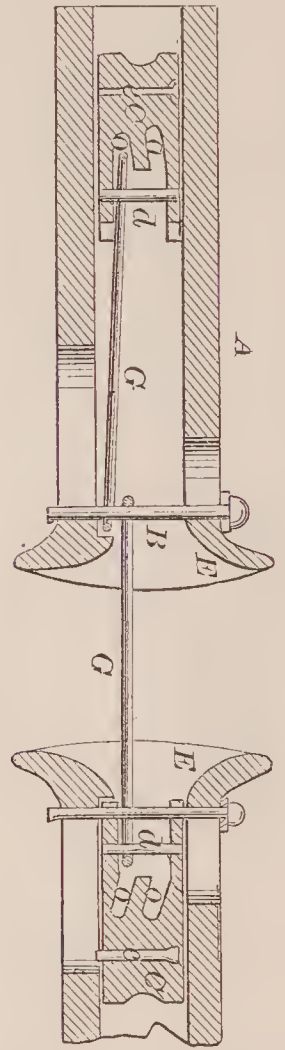

**69468**—J. M. Morse—*Cultivator.*

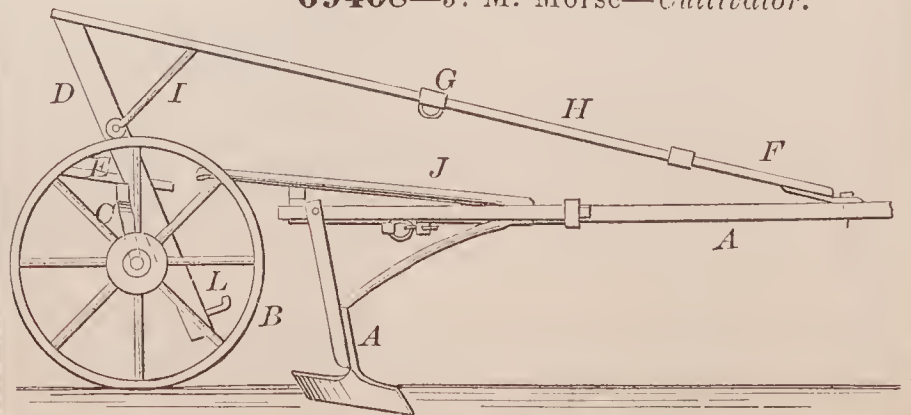

**69467**—W. B. Morrison—*Dough Kneader.*

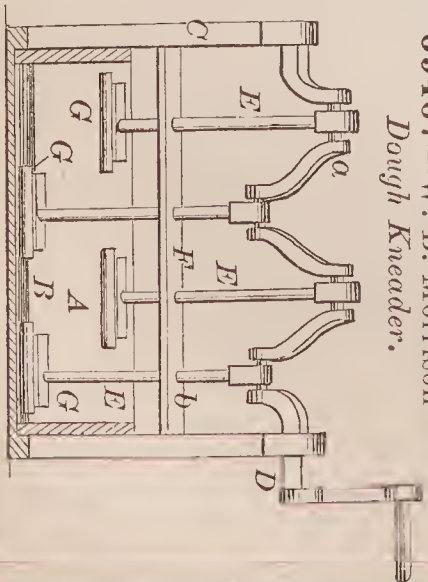

69469—E. M. Naramore—*Thill Coupling.*

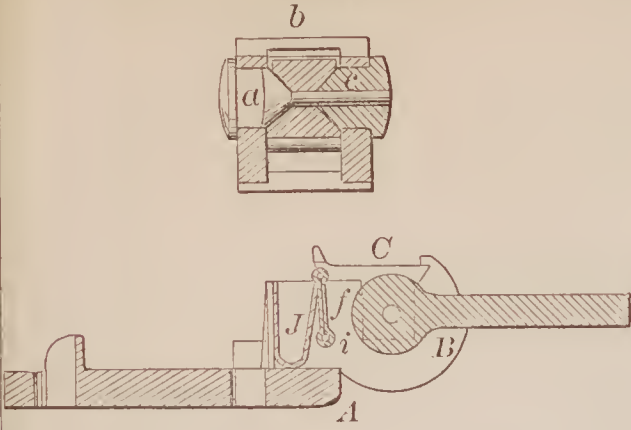

69471—A. J. Nichols—*Warper and Dresser Plate.*

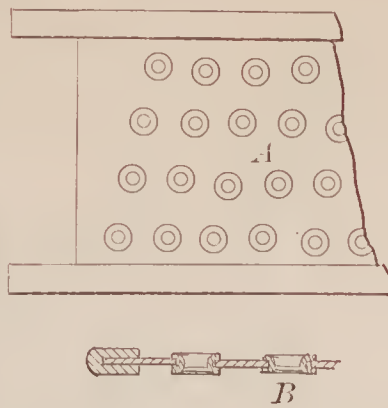

69472—B. W. Nichols—*Picker for Looms.*

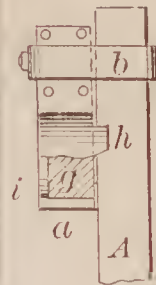

69473—C. C. Parsons—*Pipe and Bolt Cutter.*

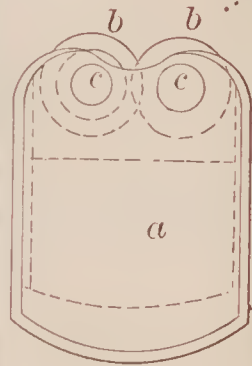

69474—B. D. Pease—*Rein Holder.*

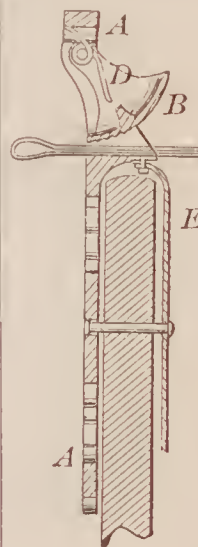

69476—G. M. Peters—*Harvester Rake.*

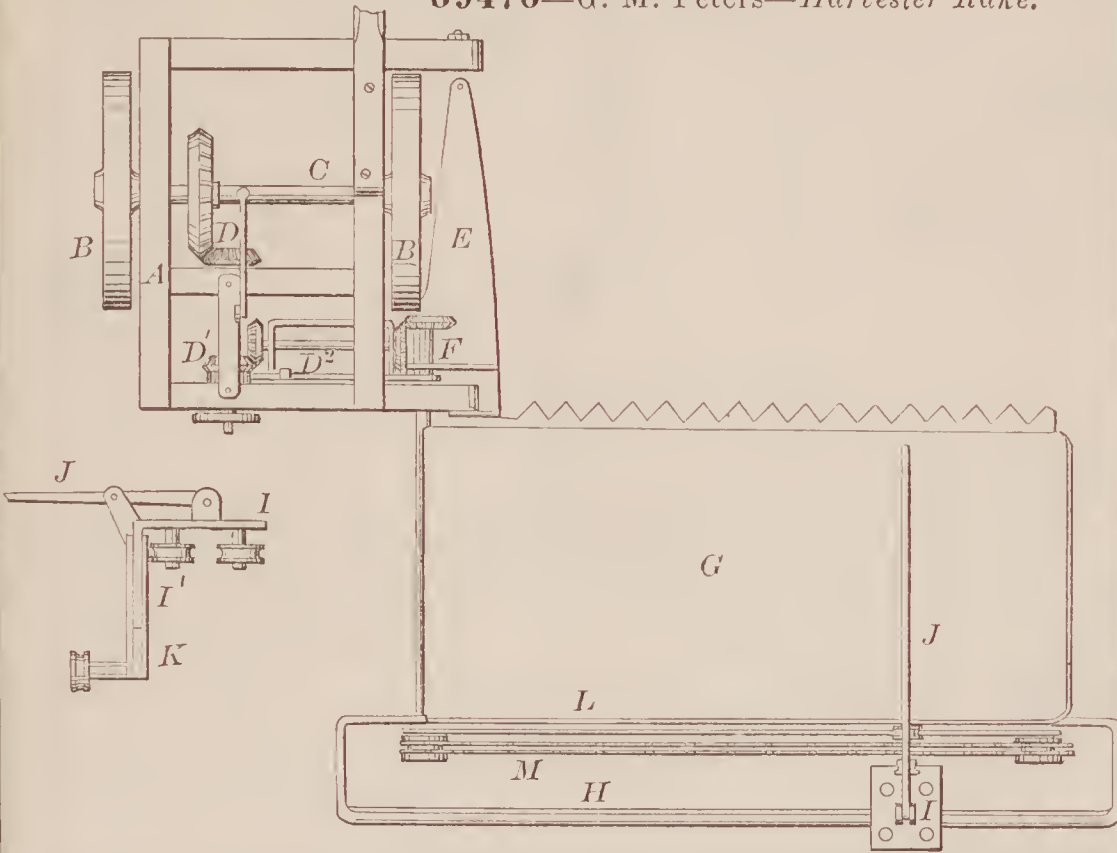

69477—H. J. Phalen—*For Heating Water and Condensing Steam.*

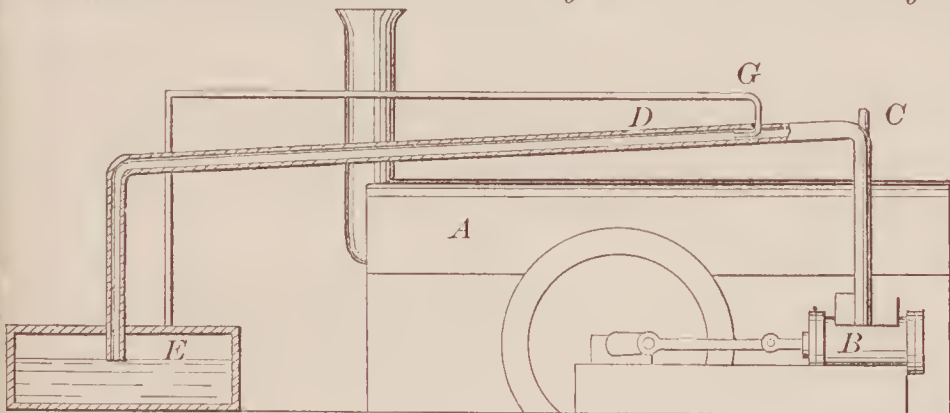

69475—W. C. Peck—*Churn.*

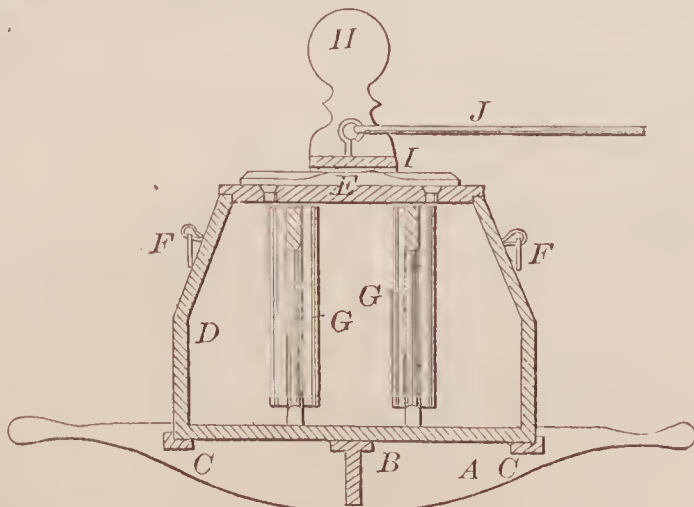

69478—M. Prentiss—*Plow.*

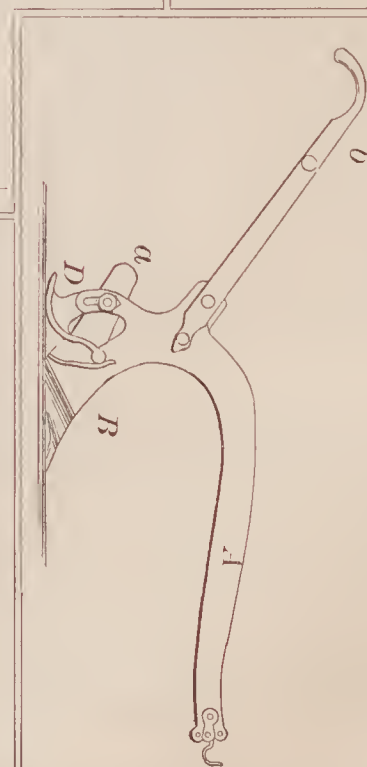



69481—C. H. Remington—*Bullet Machine.*

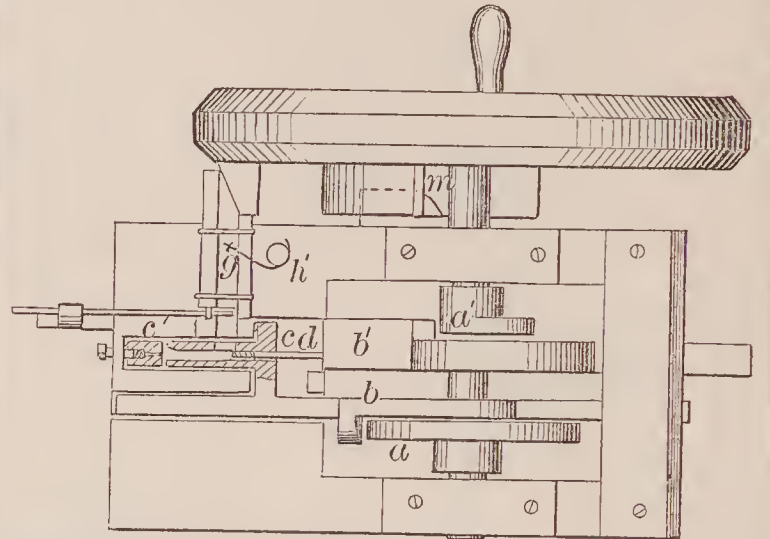
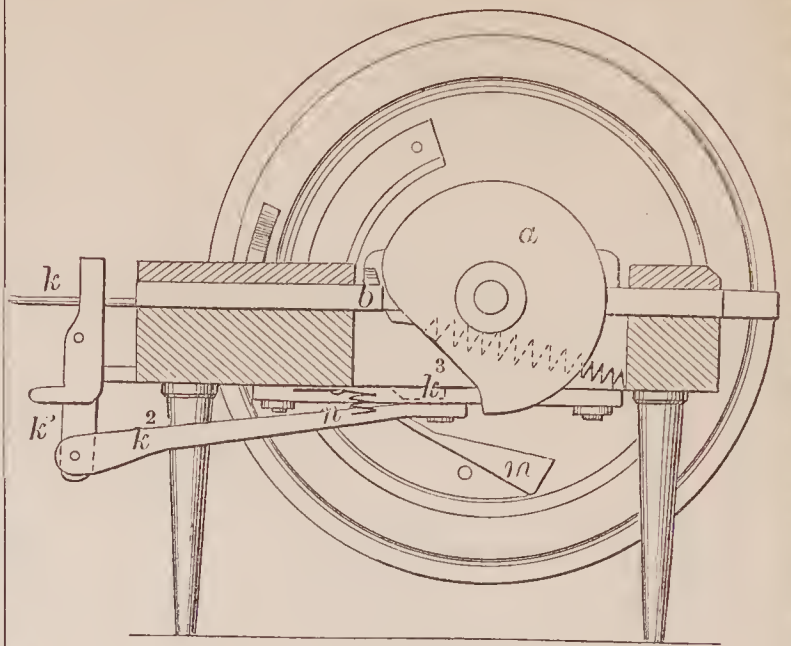

69482—Richardson & Graeme—*Logotrope.*

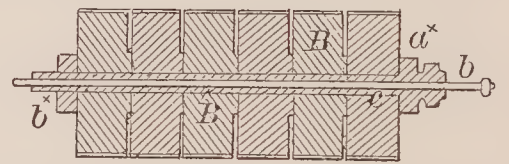
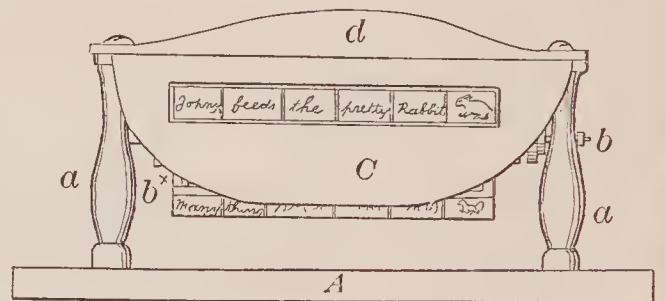

69484—E. Ritson—*Seeding Machine.*

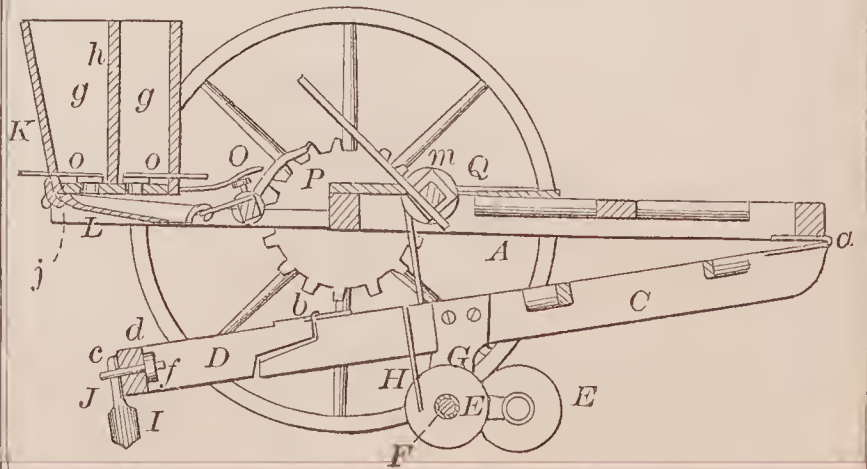

69479—A. J. Purviance—*Horse Hay Fork.*

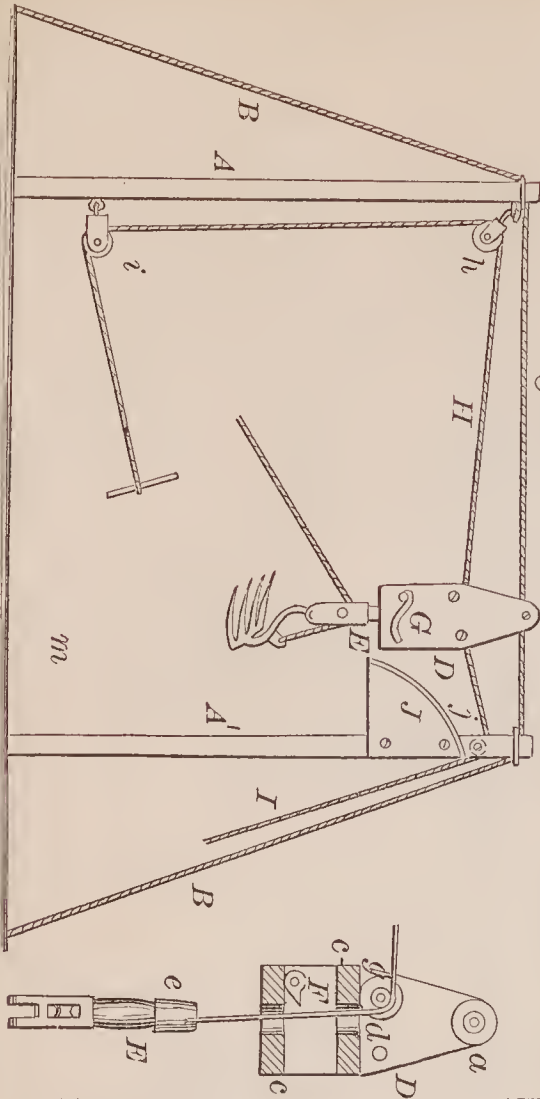

69480—A. Reid—*Potato Baker.*

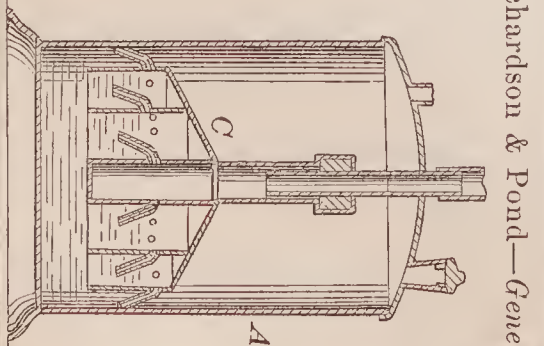
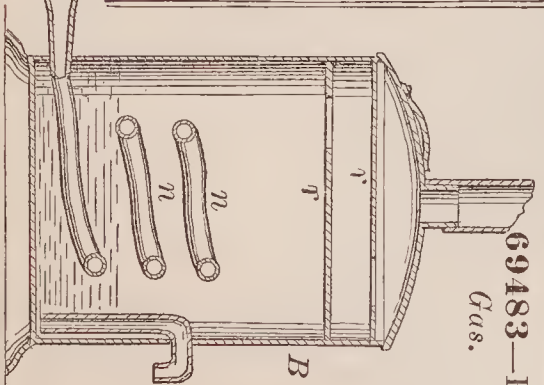
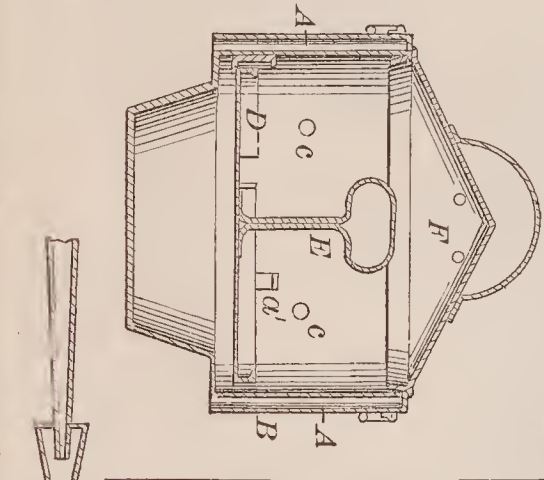

69483—Richardson & Pond—*Generating Gas.*

69492—J. G. Saunders—Centre Board.

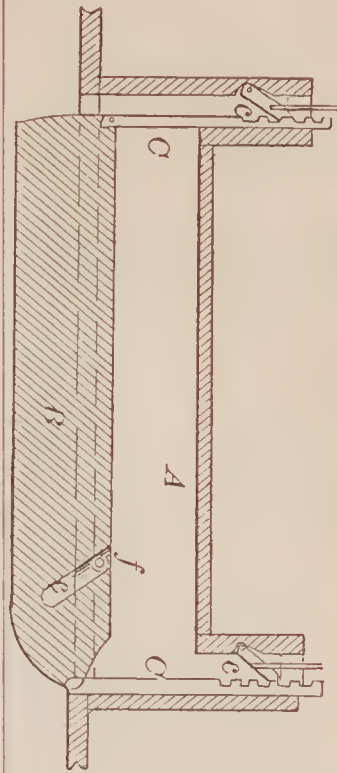

69486—H. Rodes—Corn Planter and Plaster Dropper.

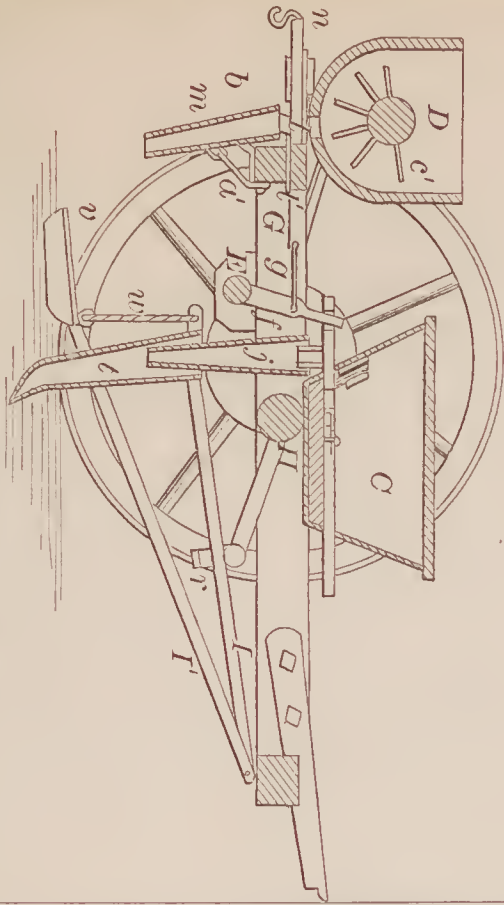

69485—M. Robbins—Oil Can.

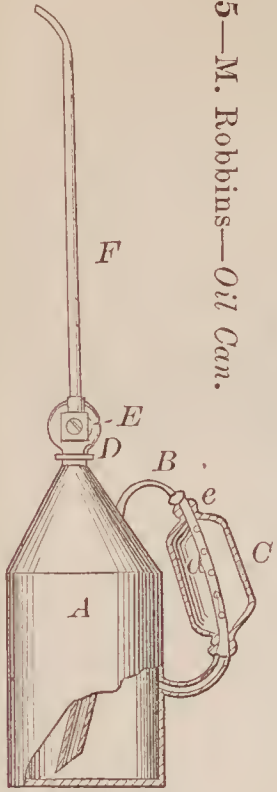

69487—C. Rogers—Horse Rake and Hay Spreader.

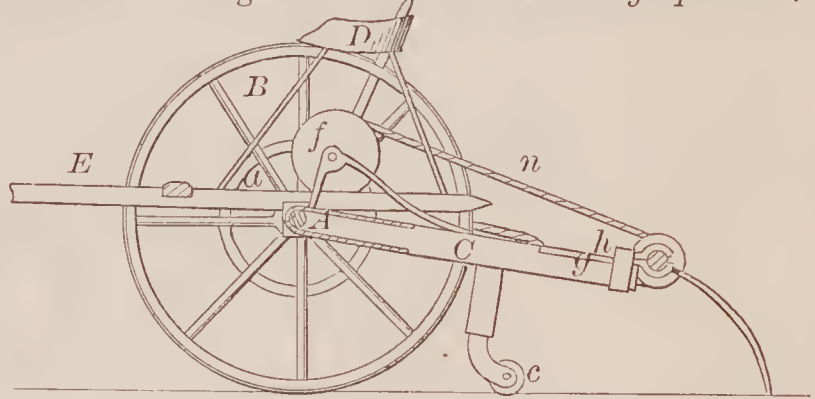

69488—A. V. Ryder—Trunk.

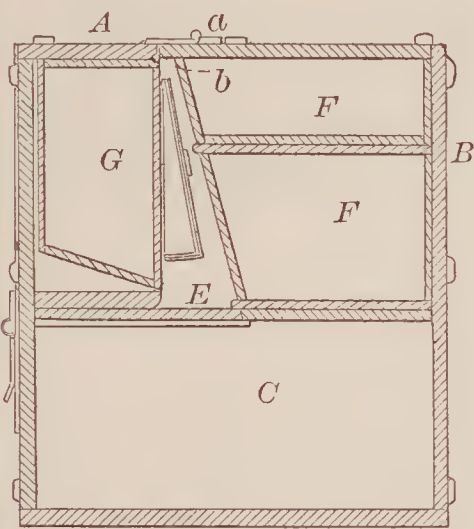

69490—H. Sauerbier—Shoe Knife.

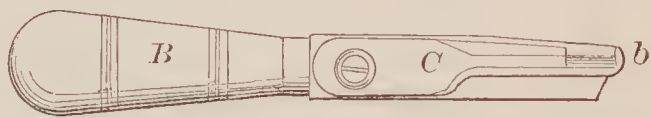

69491—H. Sauerbier—Shoe Knife.



69489—J. Sattison—Grain and Seed Cleaner.

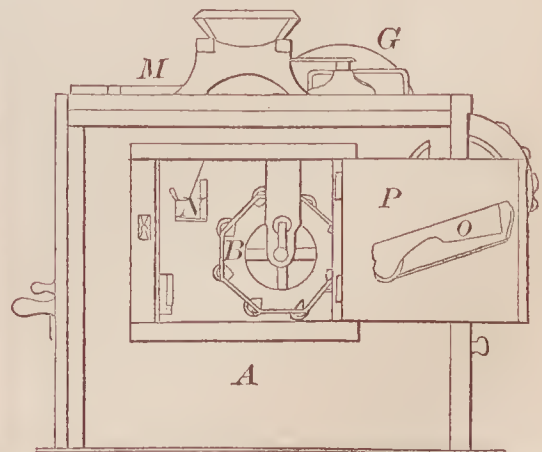

69493—J. Schermerhorn—Washing Machine.

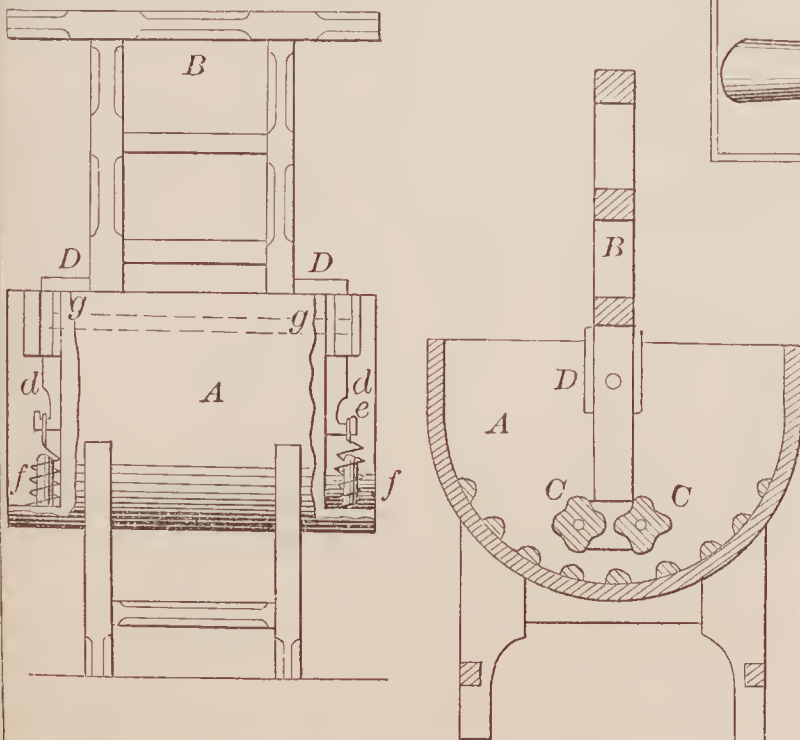



69494—W. Serviss—Gate.

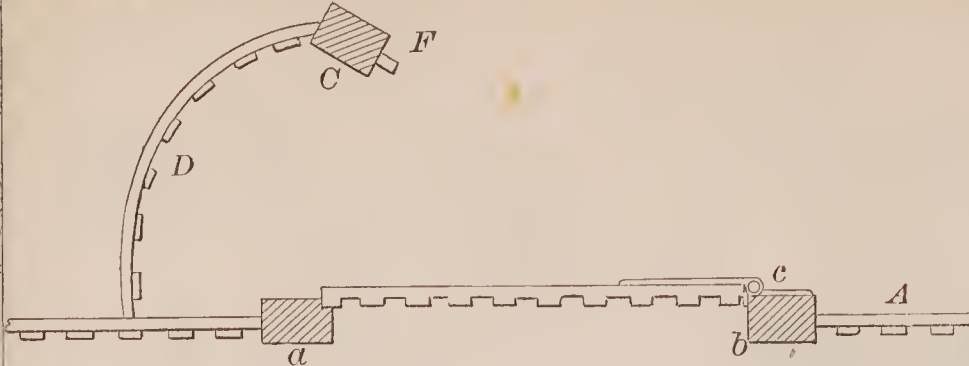

69498—W. H. Sloan—Butter Tryer.

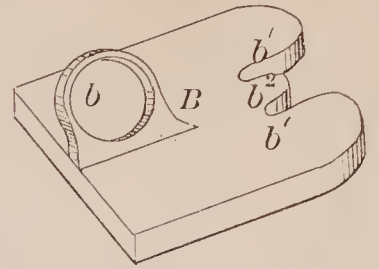

69500—Spofford & Raffington—Toy Pistol.

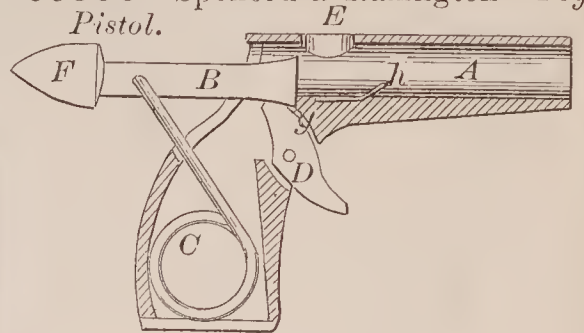

69495—S. Shive—Water Wheel.

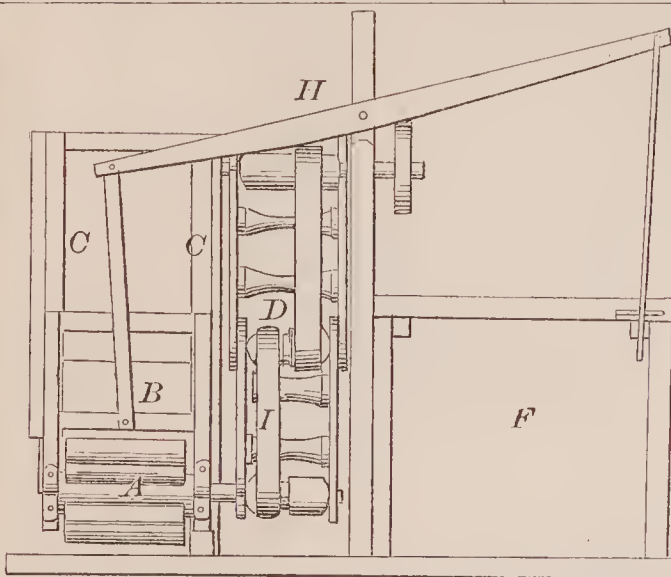

69499—H. D. Snow—Steam Governor.

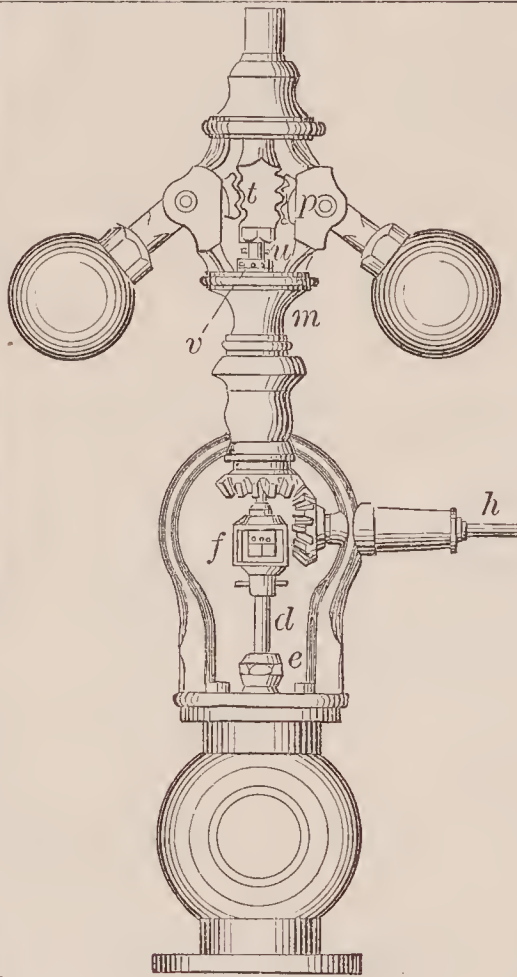

69496—D. Simmons—Railway Switch.

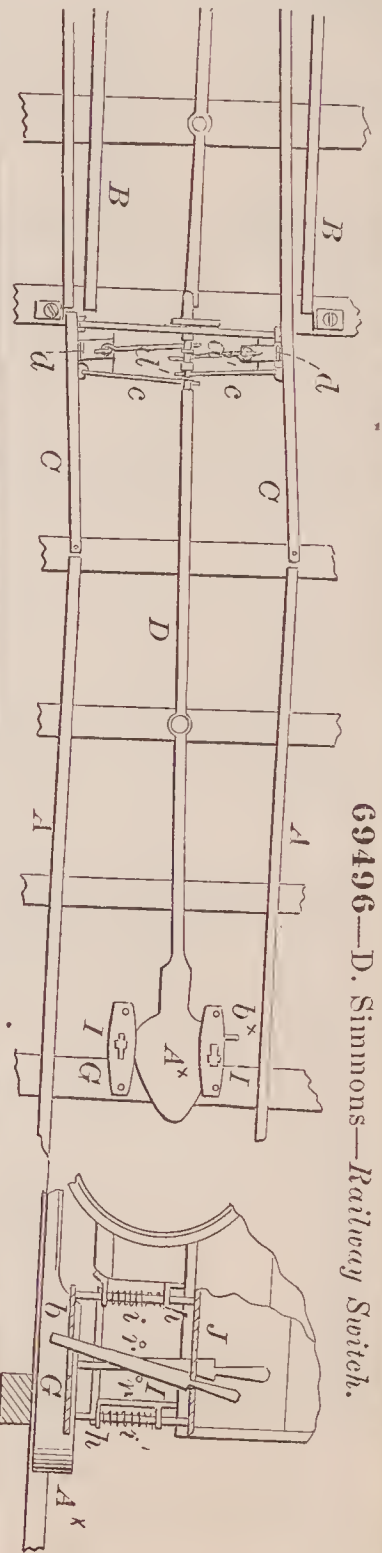

69497—L. F. Skinner—Bob Sleigh.

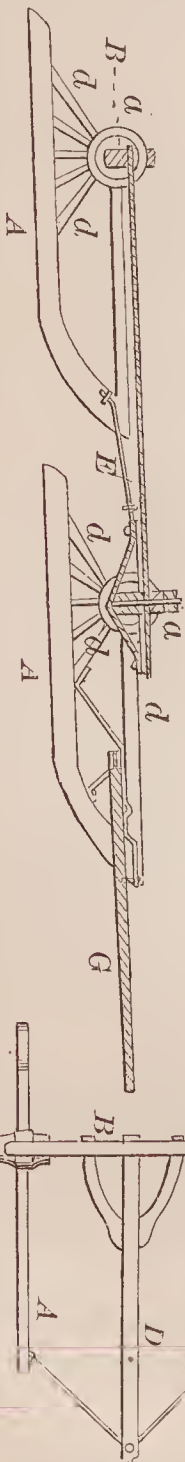

69501—D. I. Stagg—School Desk Attachment.

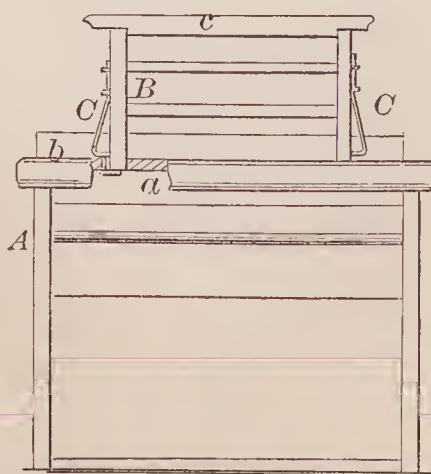

69502—Storrett & Reynolds—Corn Planter and Cultivator.

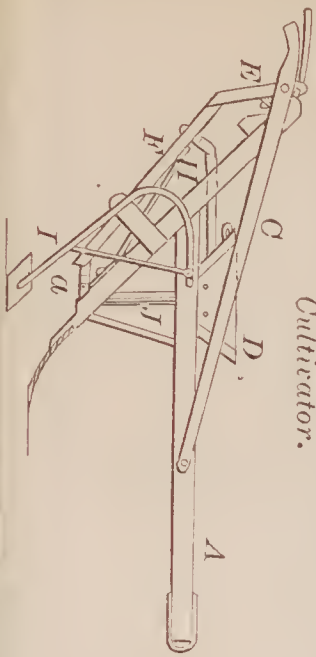

69503—J. H. Stevens—Fire Alarm Telegraph.

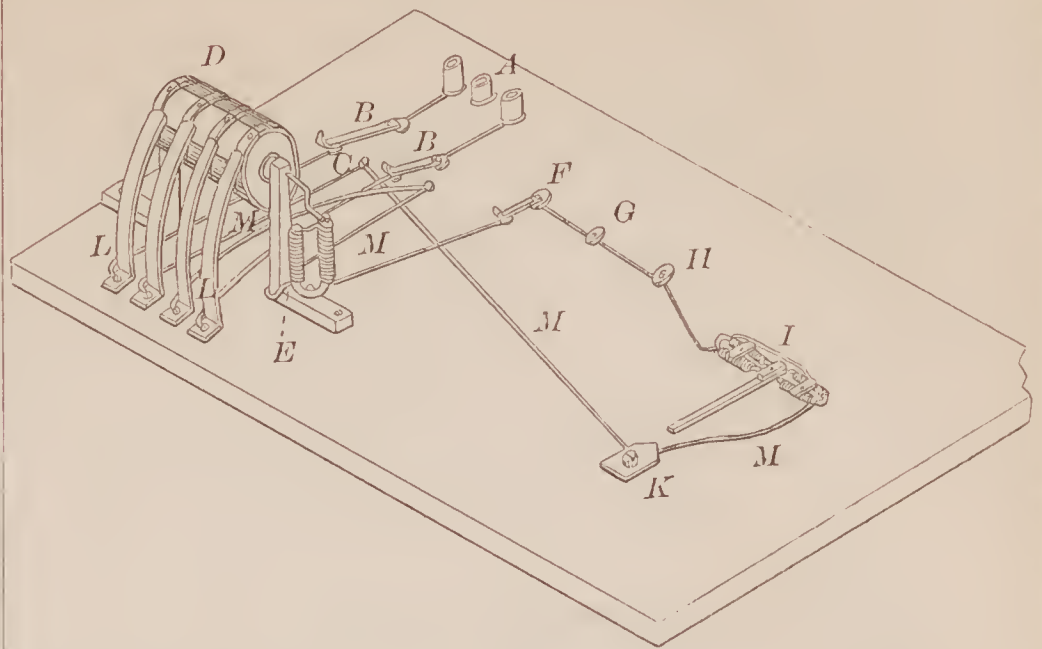

69504—Stevens & Drake—Odometer.

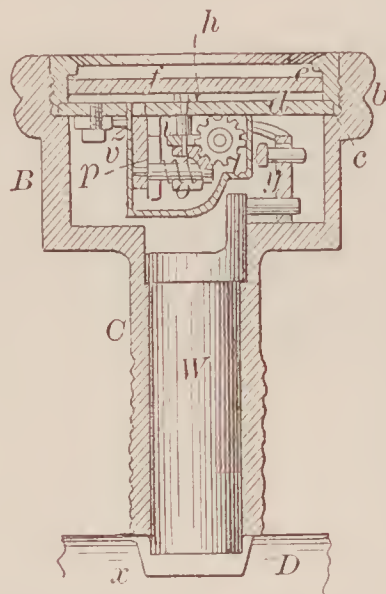
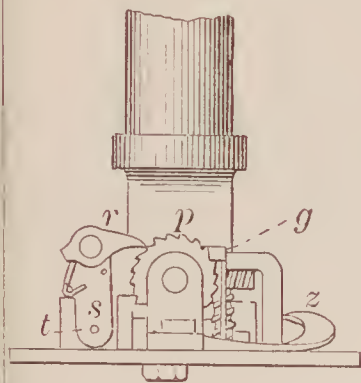

69505—W. Stevens—Furnace.

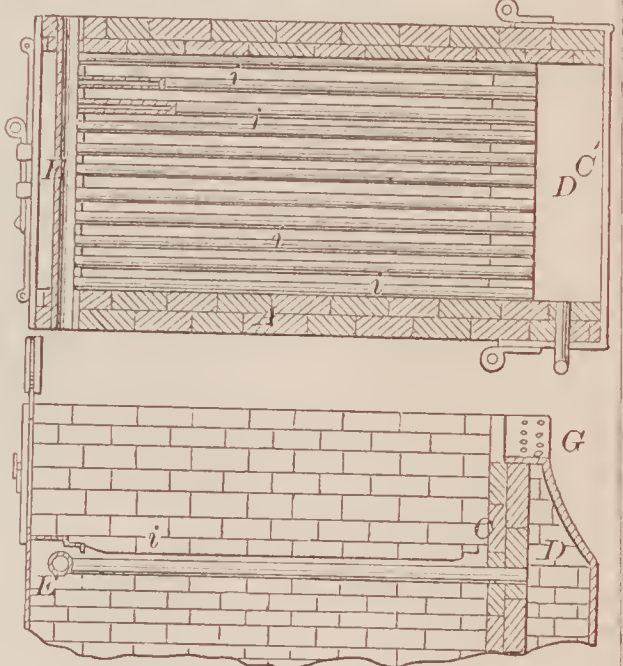

69507—T. B. Stout—Washing Machine.

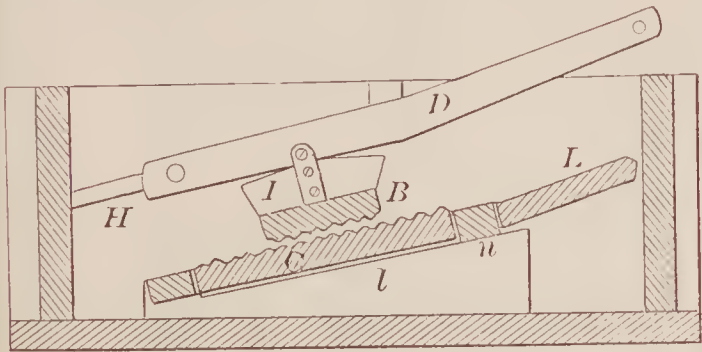

69508—W. H. Stroup—Sleigh Runner.

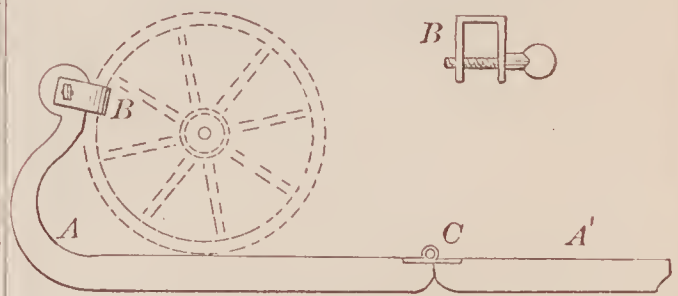

69506—W. Stine—Stove Pipe Joint.

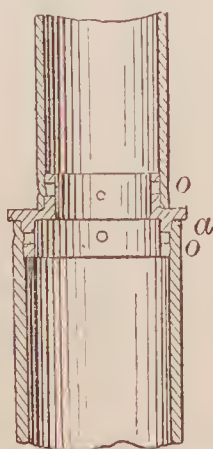

69509—A. Tandy—Gate.

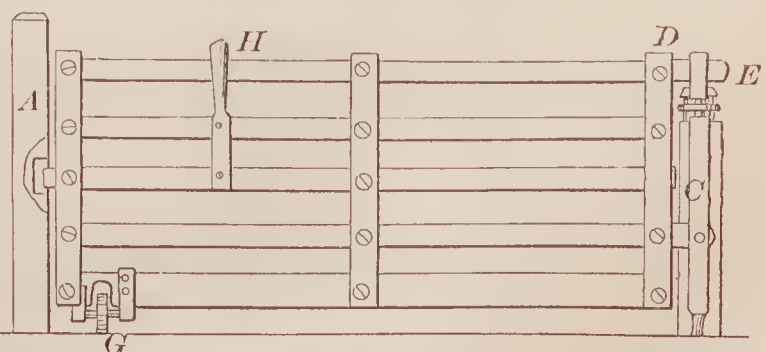



69510—R. F. Tompkins—Wood Mitering Machine.

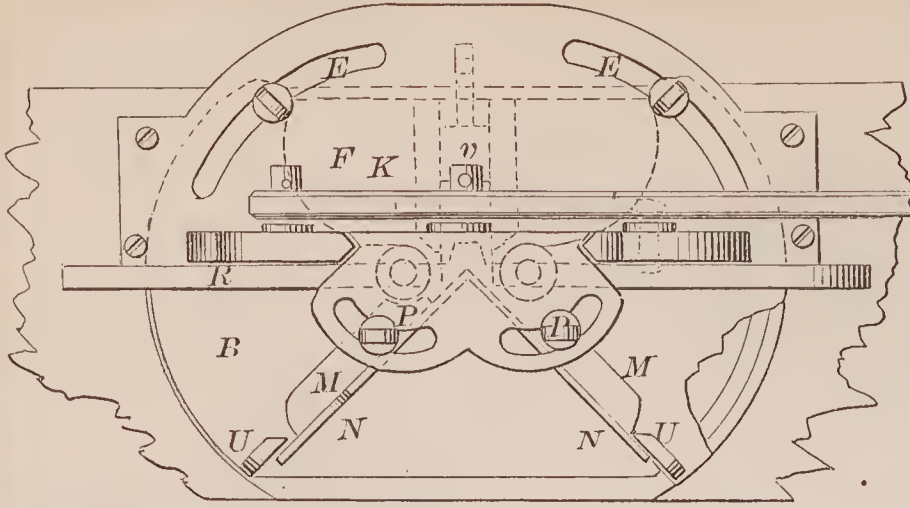

69512—J. Troxel—Mop Head.

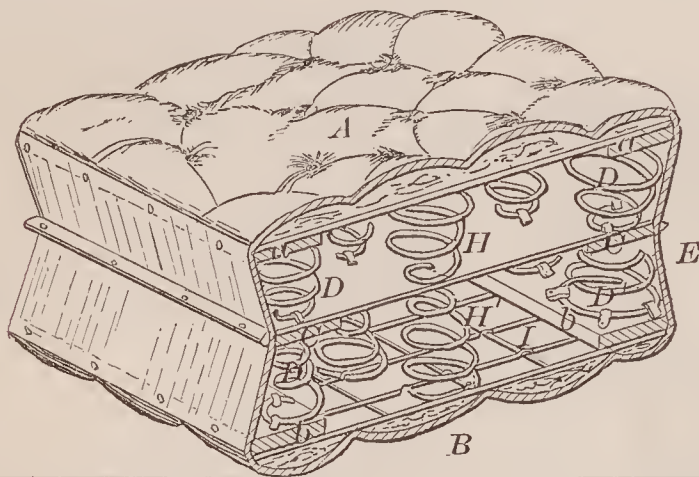
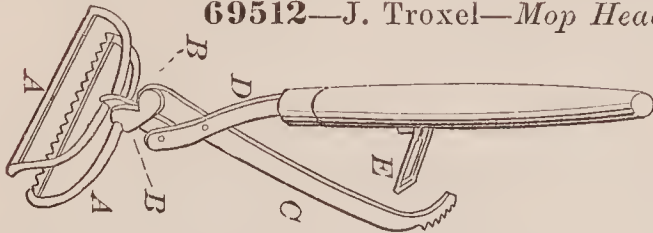

69514—C. Van Dyck—Spring Bed.

69515—A. O. Very—Loom.

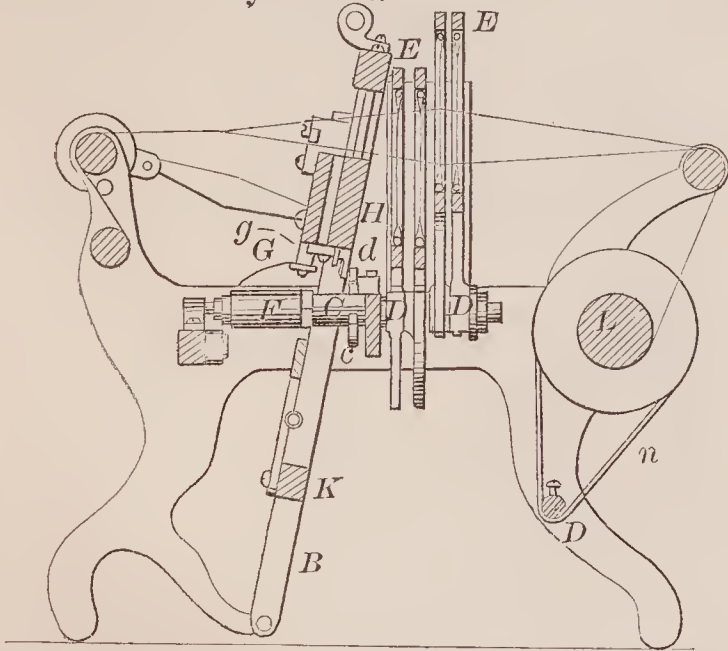

69516—W. B. Walker—Loom.

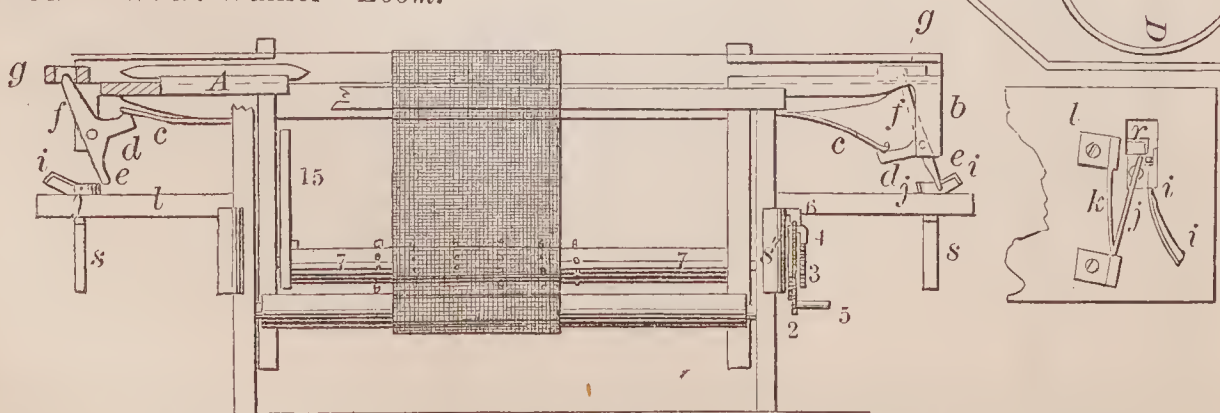

69511—J. Trent—Car Coupling.

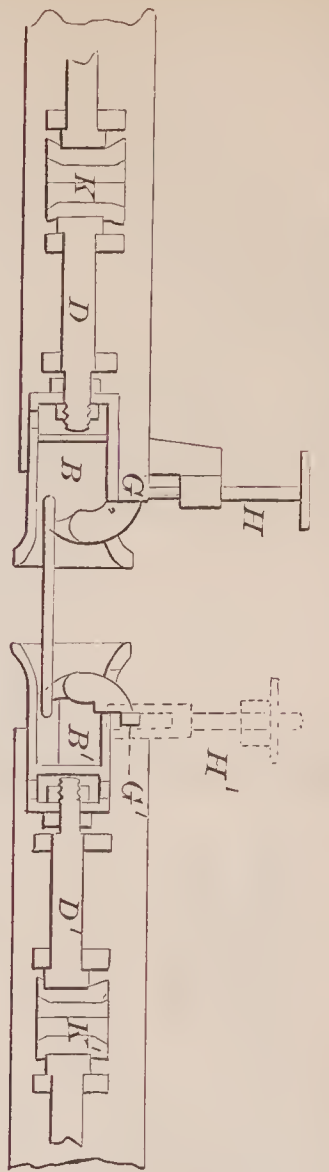

69513—E. Van Doren—Sheep Shears.

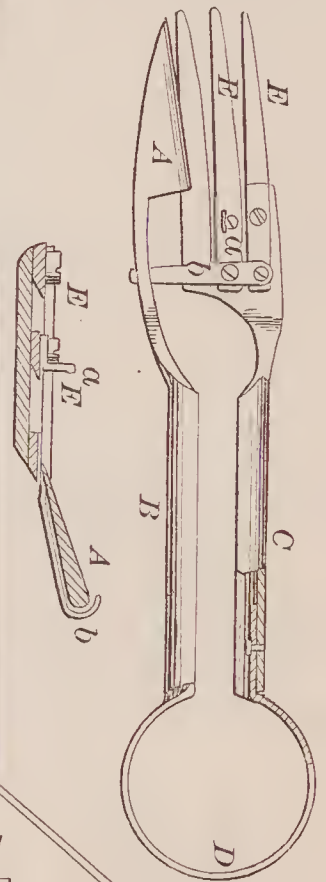

69517—C. G. Waterbury—*Wooden Pavement.*

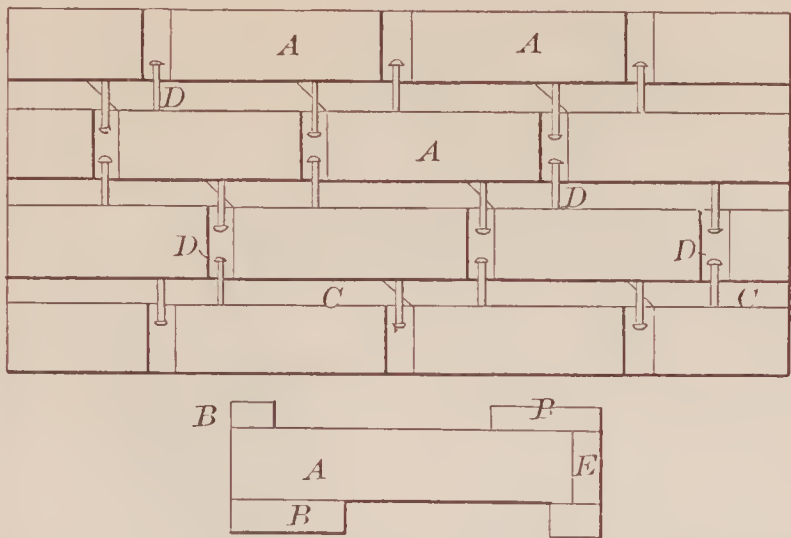

69520—D. C. Westfall—*Horse Collar*

*Fastening.*

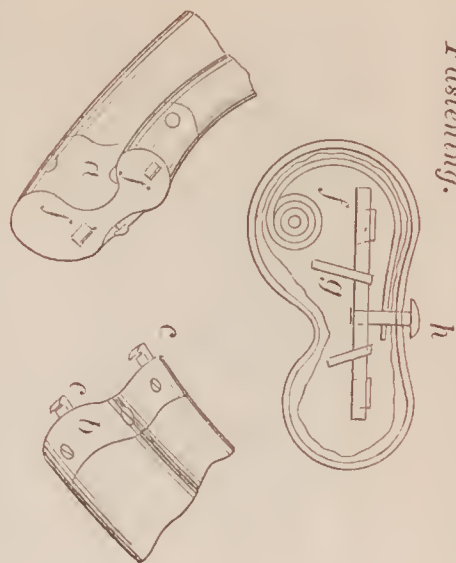

69519—A. Weeks—*Breech-Loading Ordnance.*

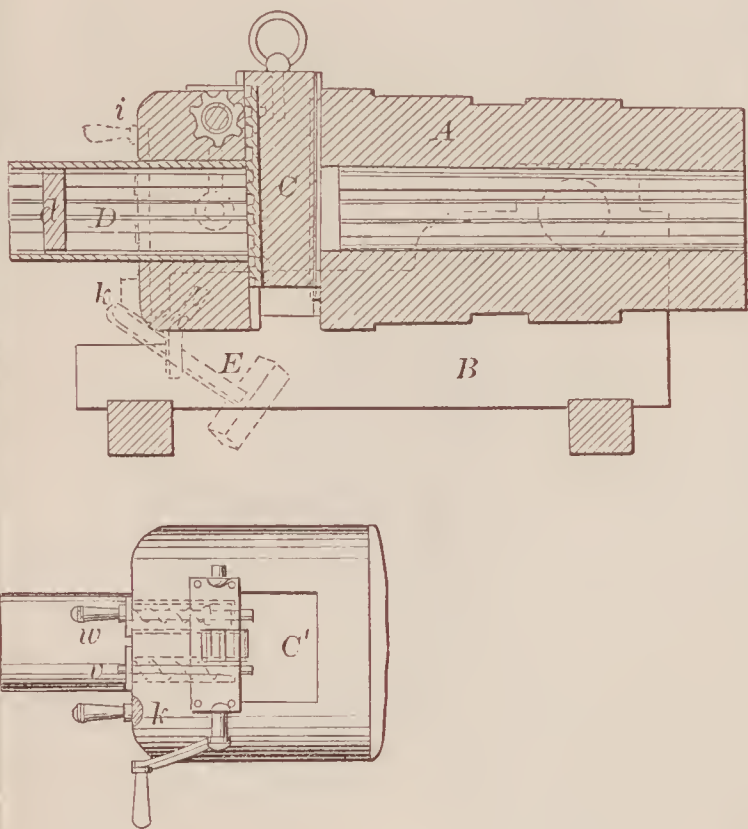

69521—J. A. Whitney—*Spike.*

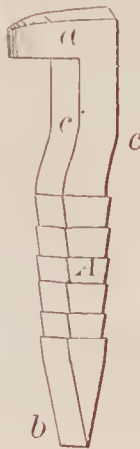

69518—W. H. Waters—*Drop Hammer.*

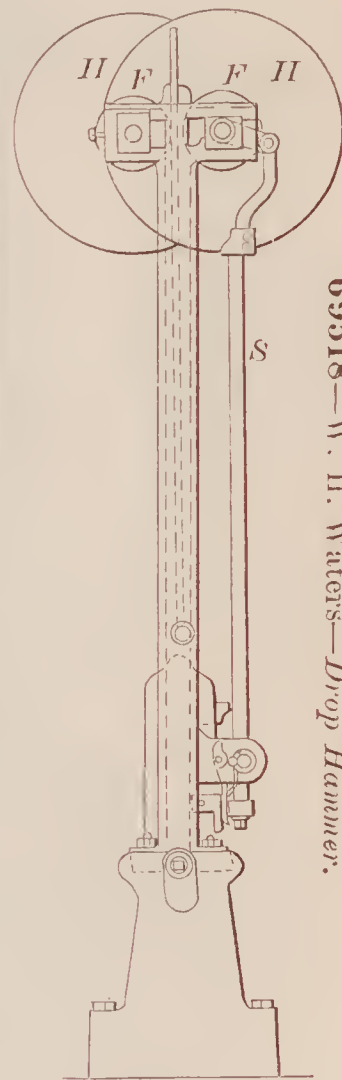

69522—Wichelhaus & Rothe—*Skate.*

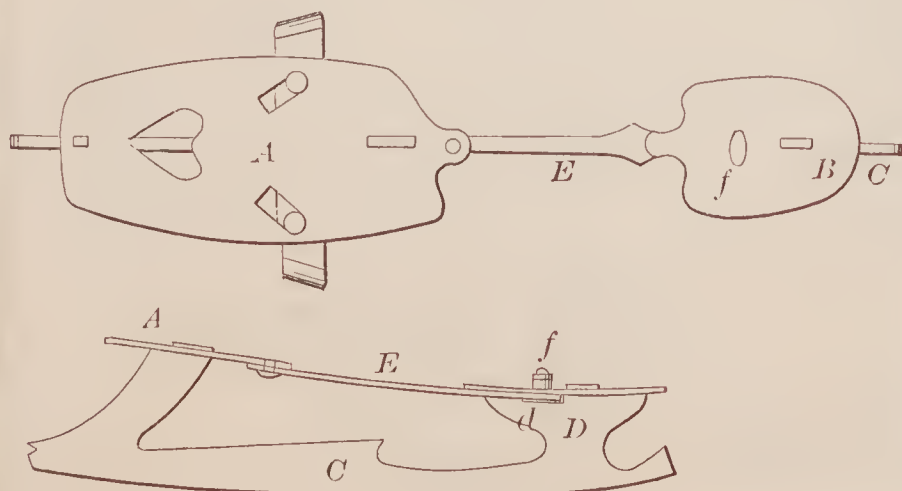

69523—D. C. Wilson—*School Desk and Seat.*

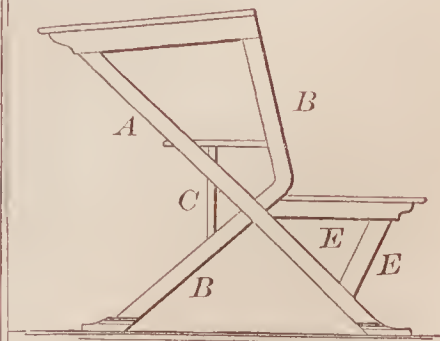





69532—Barber & D. C. & G. W. Van Brunt—  
*Seeding Machine.*

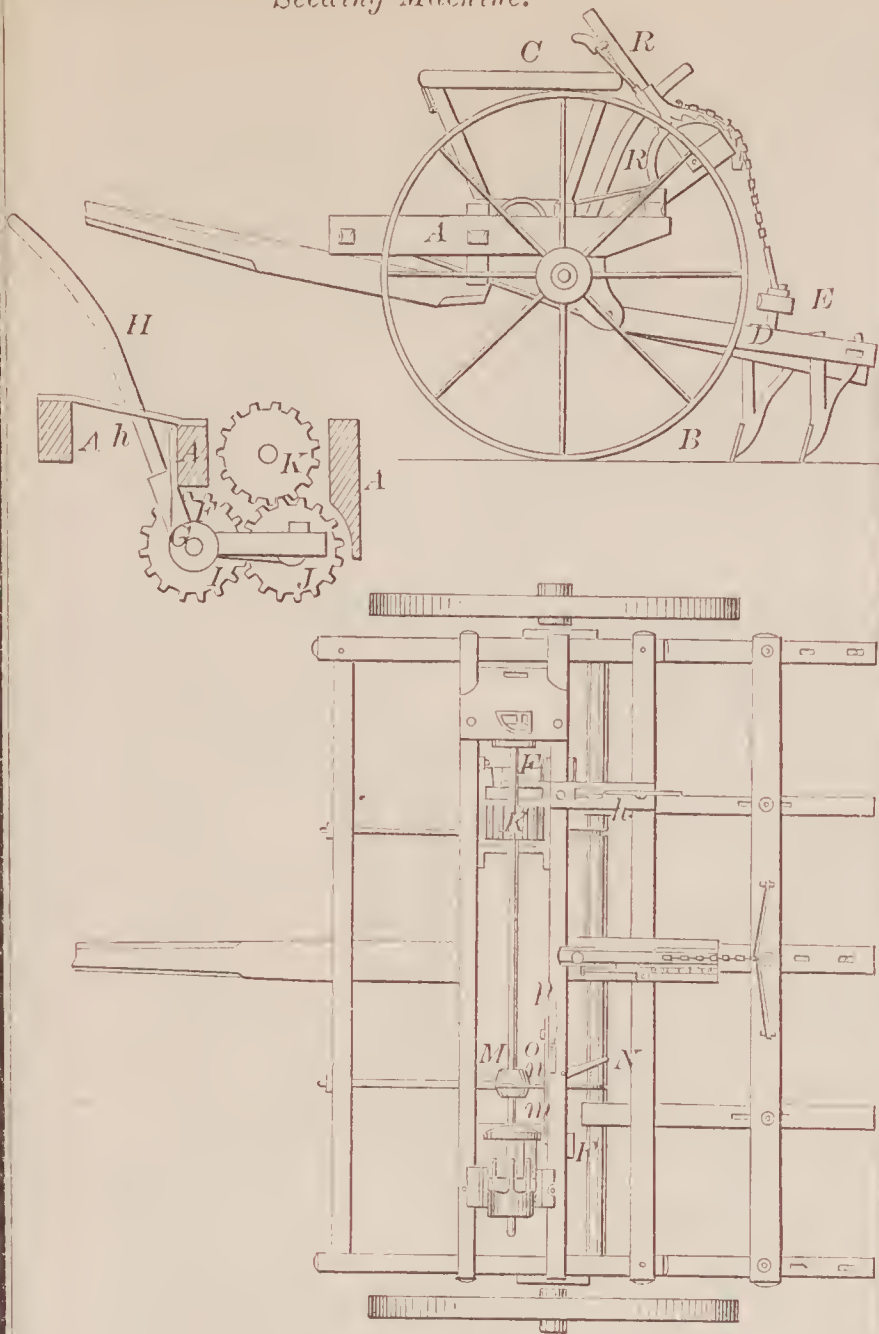

69533—G. W. Bishop—*Drilling Machine.*

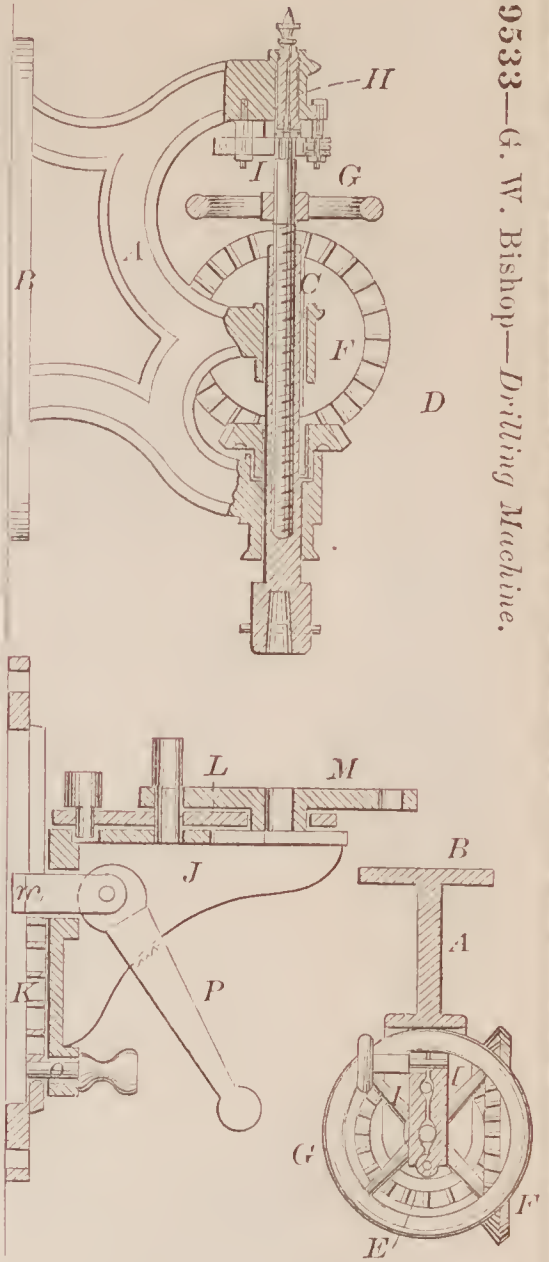

69534—W. Blakey—*Malt Kiln.*

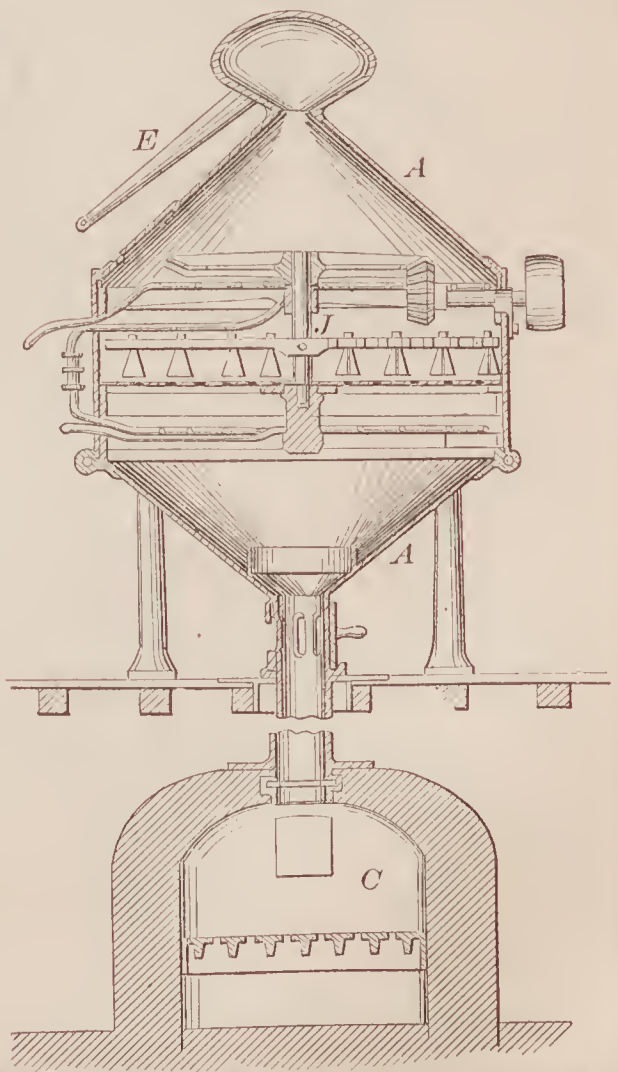

69535—L. F. Brown—*Gate.*

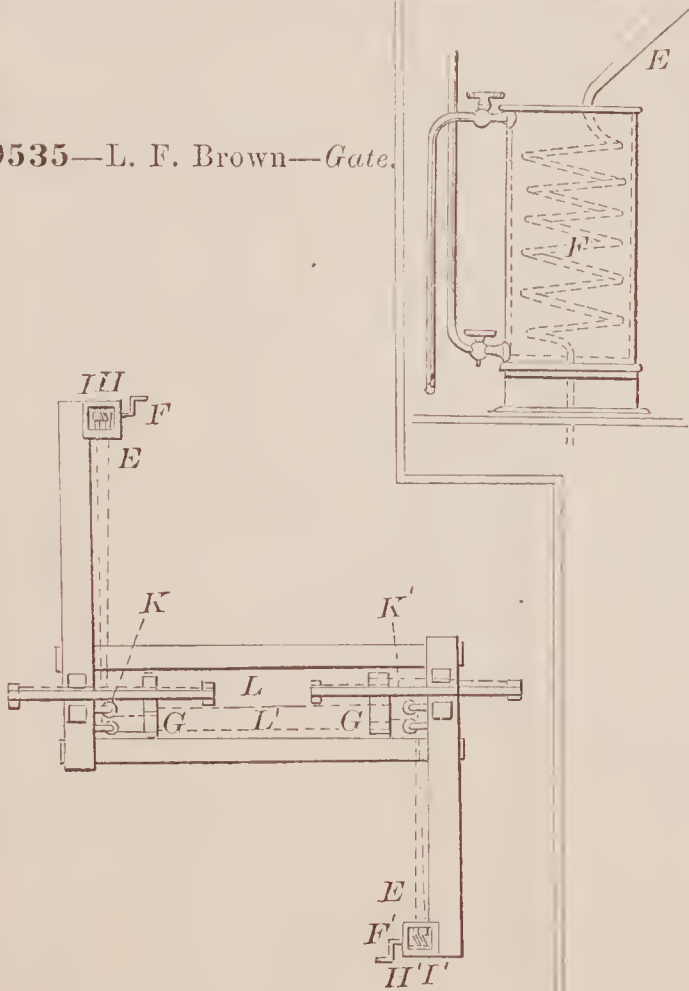



69536—C. H. Buck—Cooking Stove.

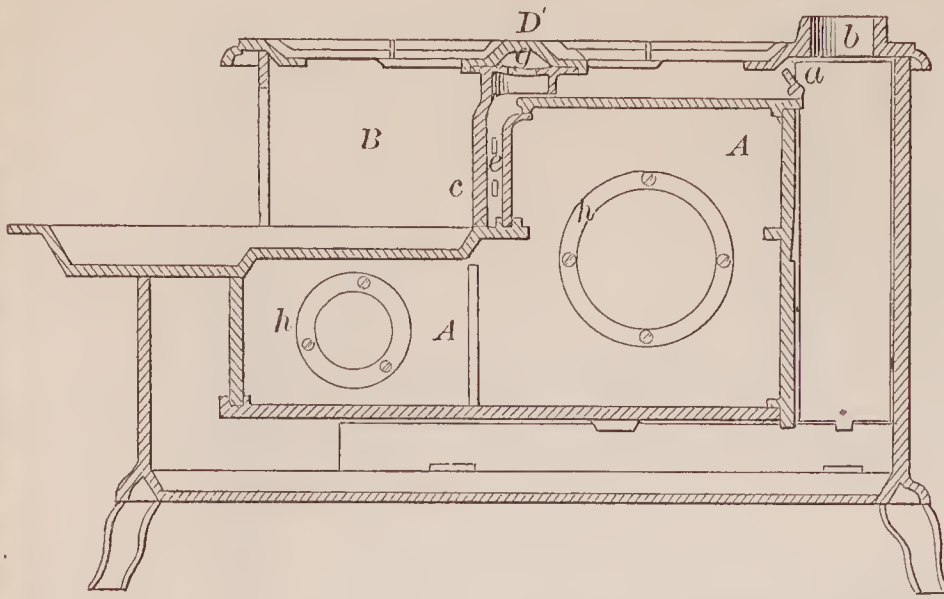

69540—F. P. Canfield—Sash Lock and Support.

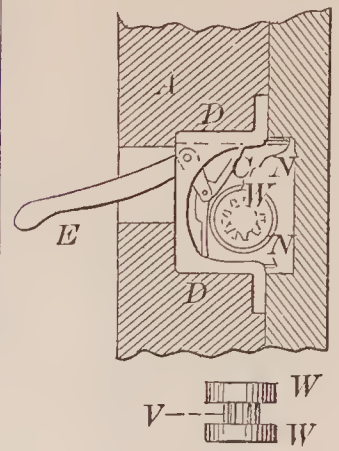

69537—C. H. Buck—Heating Stove.

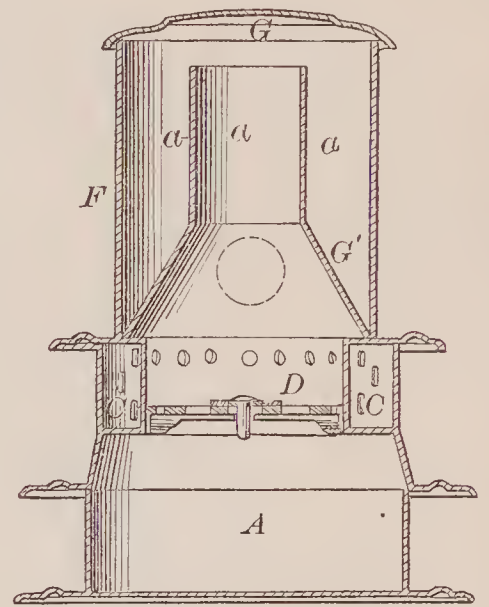

69541—Clark & Delent—For Shearing Sheep.

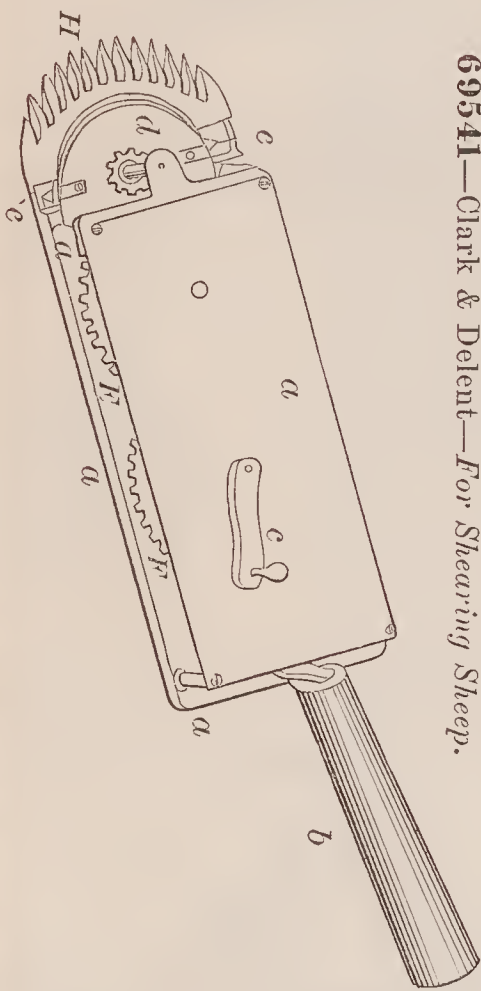

69539—F. Böhle—Paper File.



69538—T. W. Buck—Churn.

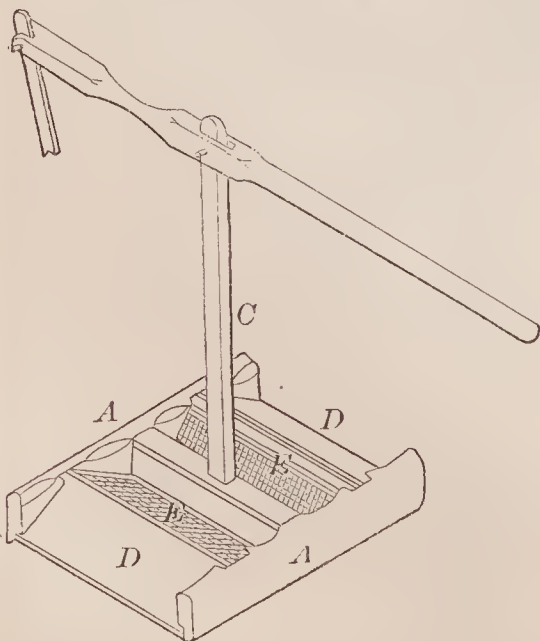

69542—E. B., J. S. & W. S. Clark—Steam Heater.

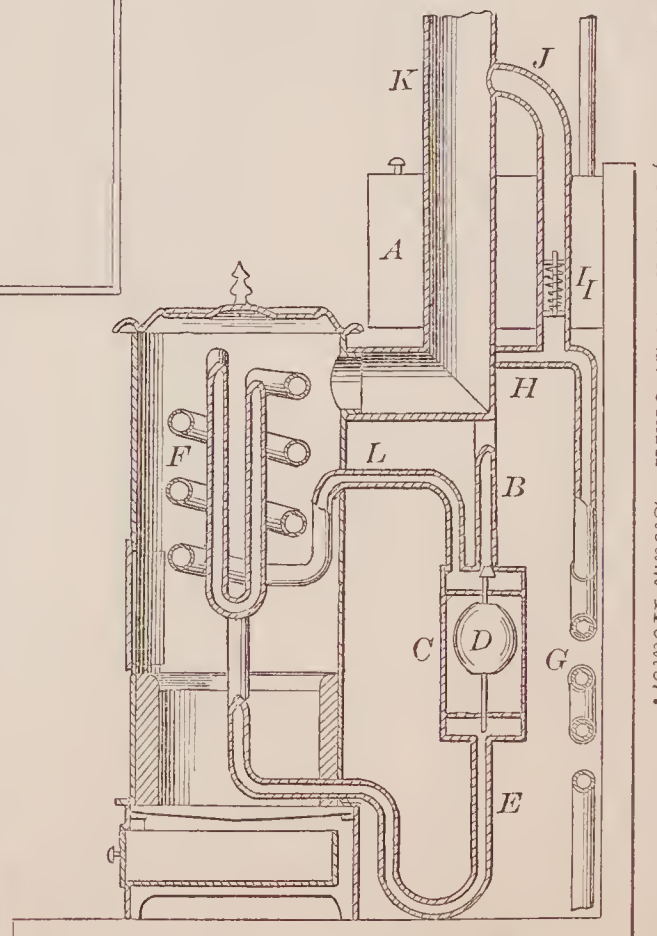







69558—W. H. Foster—*Steering Apparatus.*

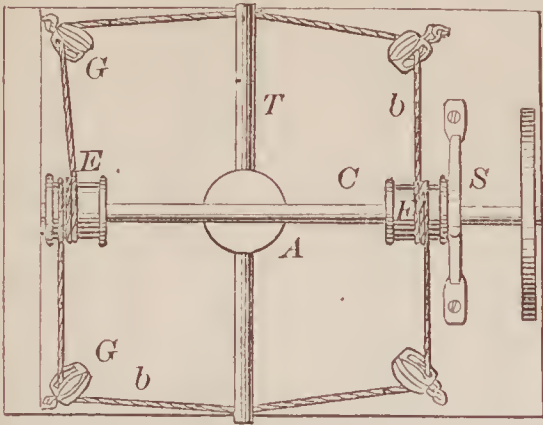

69559—Gale, Ames & Blaisdale—*Carriage.*

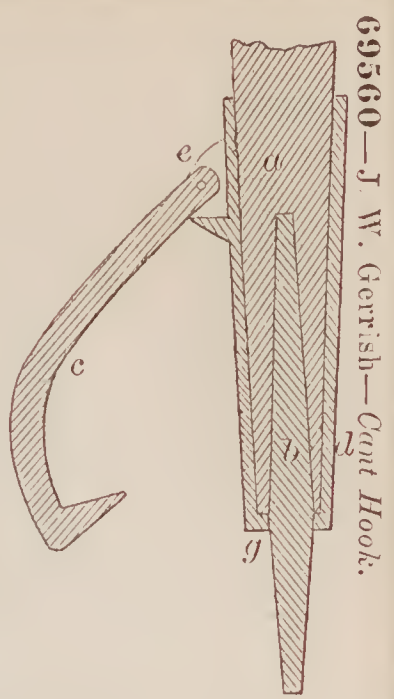
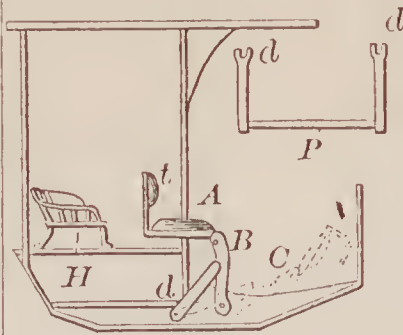

69560—J. W. Gerrish—*Cant Hook.*

69564—F. G. Hesse—*Amalgamator.*

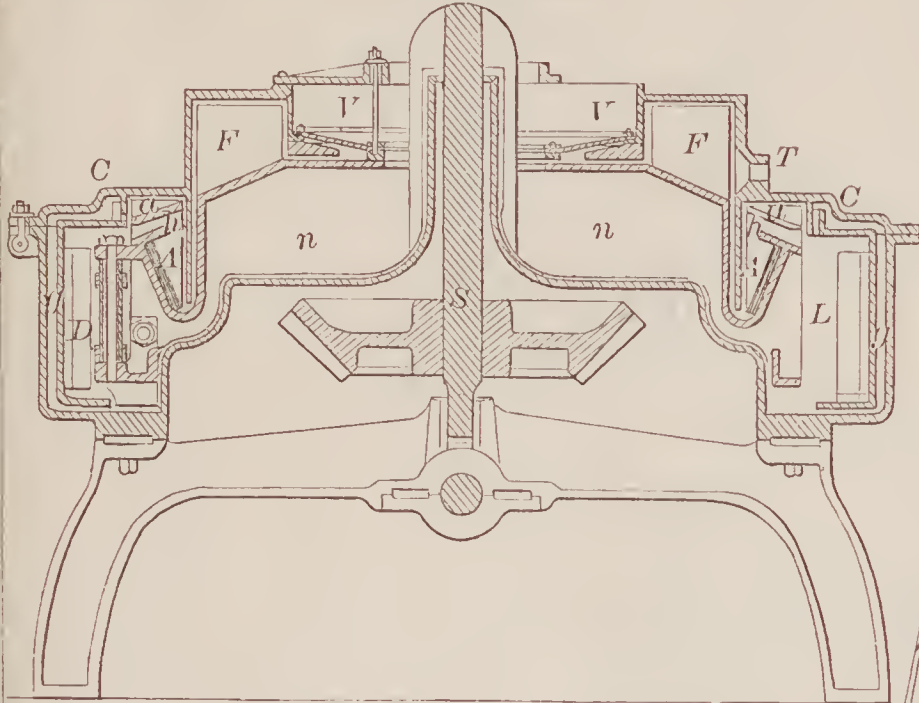

69561—C. K. Giles—*Cuckoo Clock.*

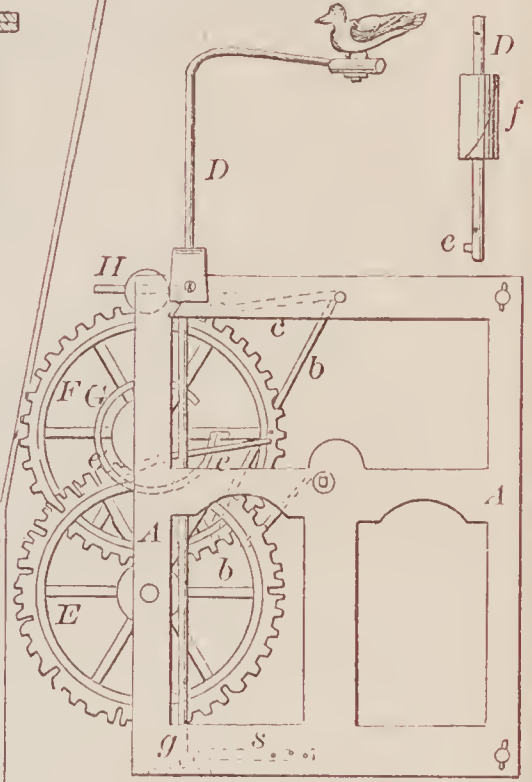

69565—W. Hughes—*Spring Seat for Vehicles.*

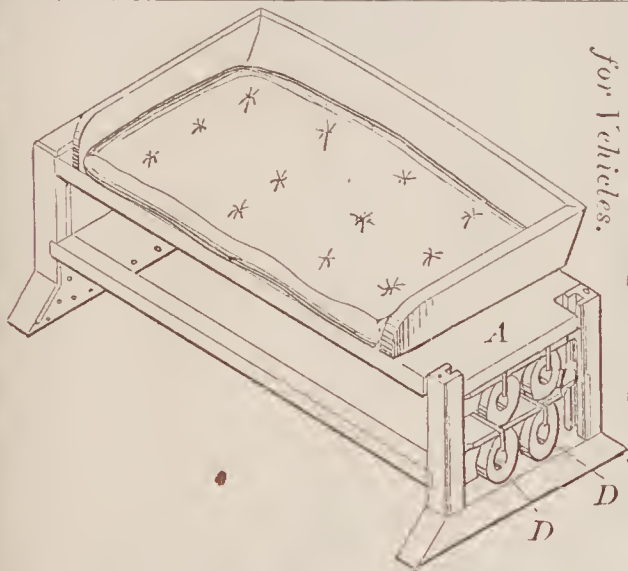

69563—A. Herde—*Extracting Bung from Barrels.*



69562—W. B. Hayden—*Trace Buckle.*

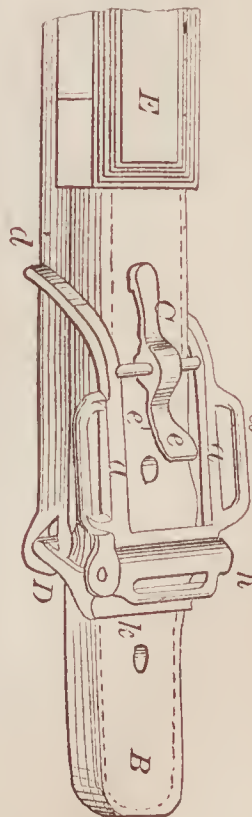

69566—C. B. Littlefield—*Gas Cock.*

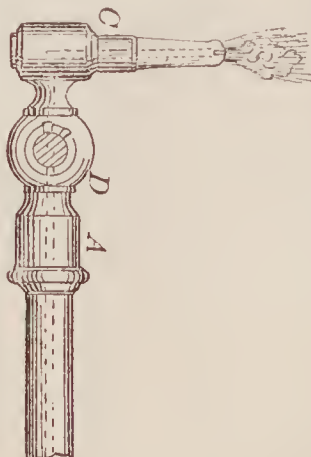

69567—S. Lockwood—*Washing Machine.*

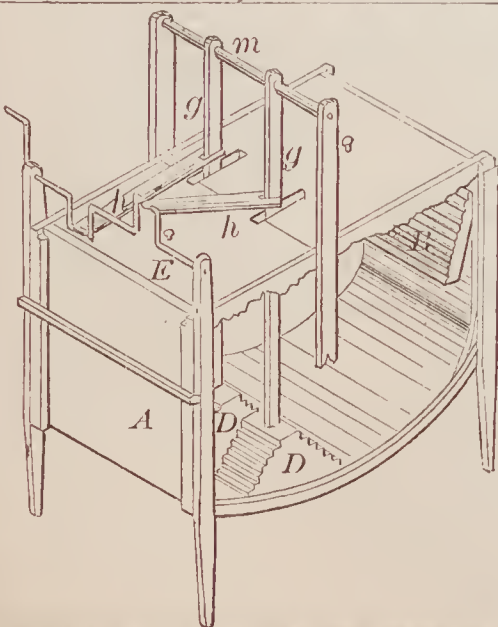



69568—M. F. Magliocco—  
Heating Furnace.

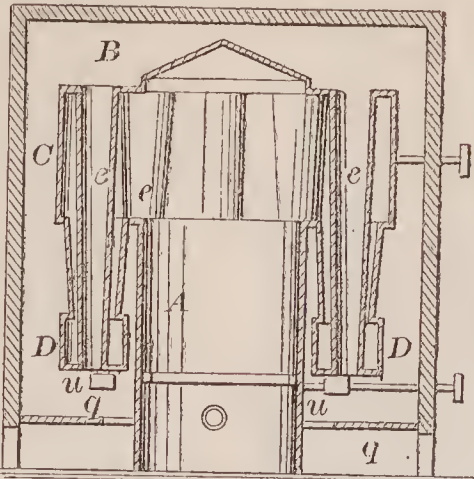

69571—D. E. McSherry—Seed  
Drill Tooth.

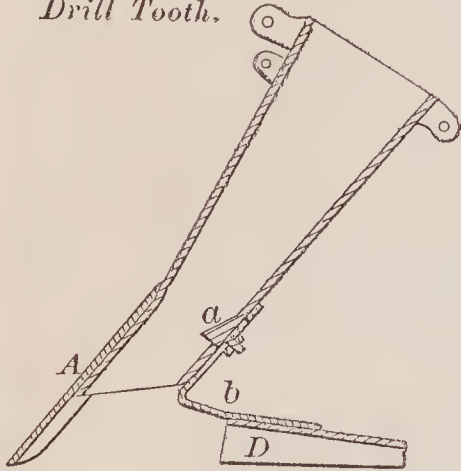

69574—J. Milne—Car Coupling.

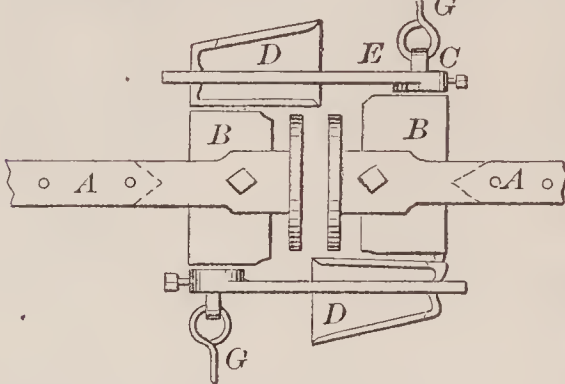

69575—J. Mott—Implement or Wrench.

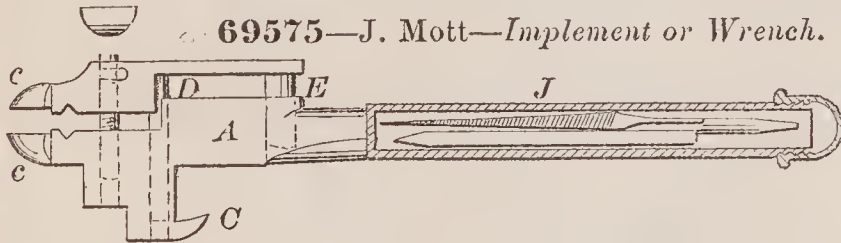

69578—N. Page, Jr.—Pump.

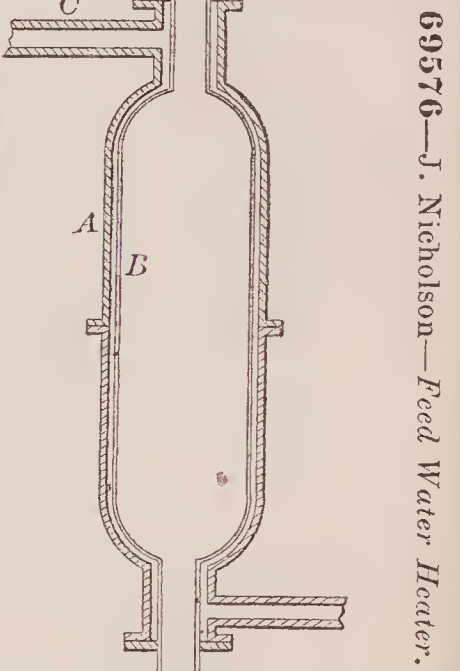
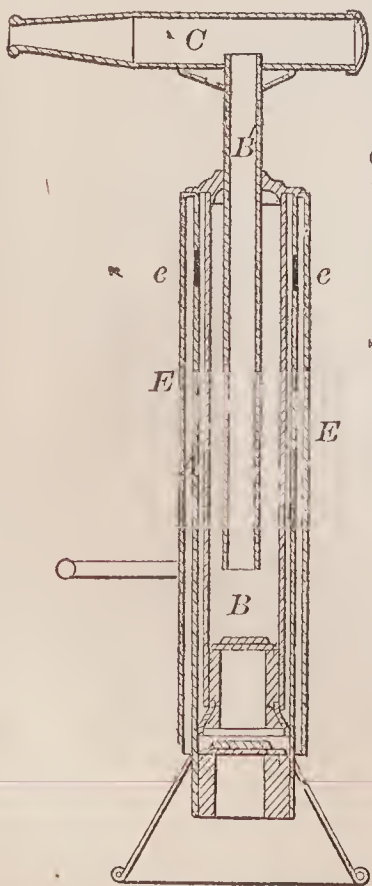

69576—J. Nicholson—Feed Water Heater.

69577—J. O. Connor—Lathe  
Chuck.

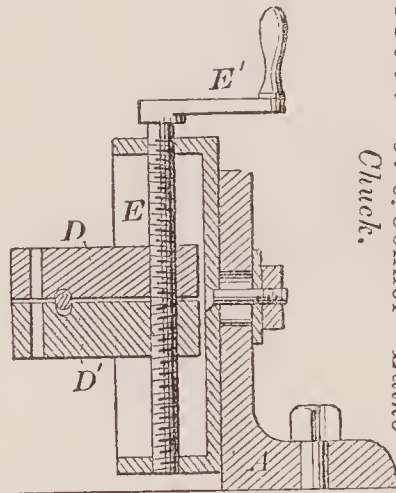

69579—J. Foreman—Reel.

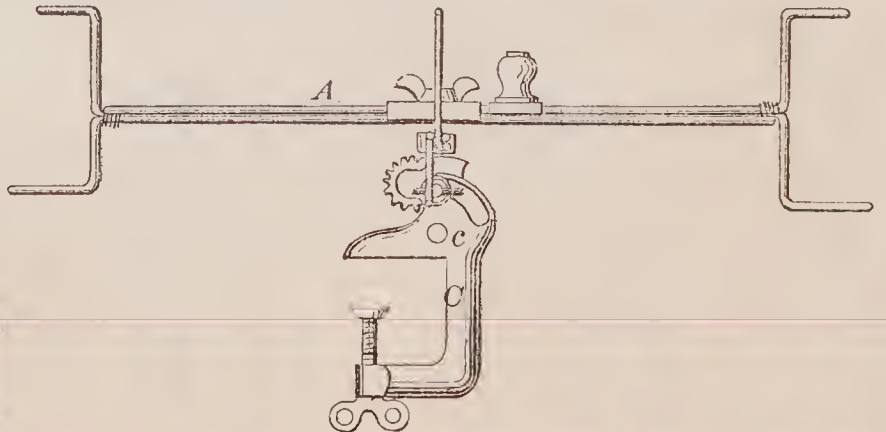

69569—J. Mathius—Beehive.

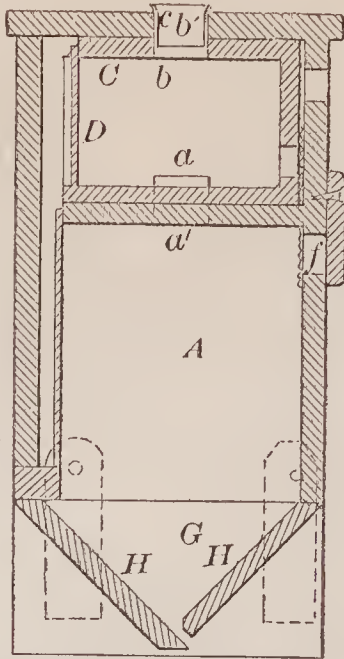

69570—M. Mattson—Coupling for  
Vacuum Cups.



69572—W. T. Mersereau—Curtain  
Fixture.

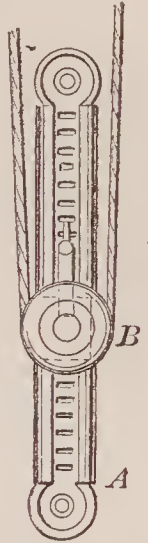

69580—D. Pangle—*Sheep House.*

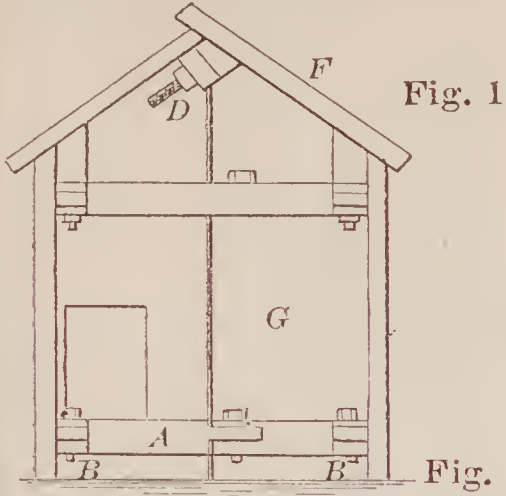

69581—J. D. Patrick—*Ball Alley.*

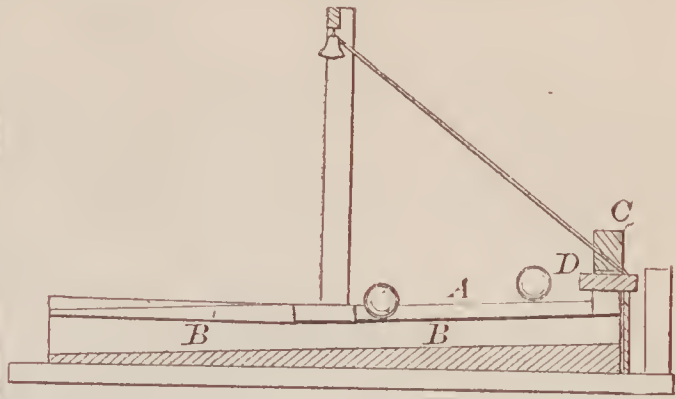

69583—T. S. Phillips—*Animal Trap.*

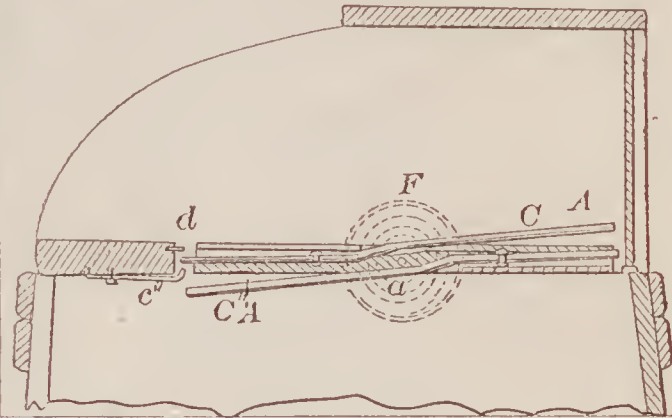

69584—T. & C. Plumleigh—*Converting Circular into Reciprocating Motion.*

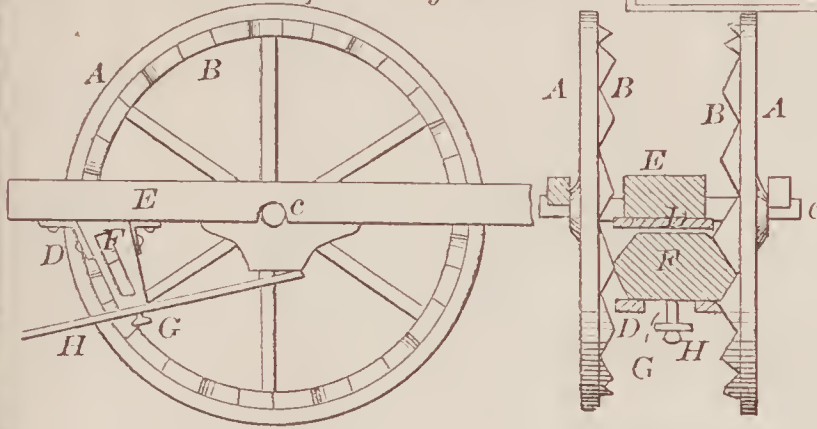

69582—Patton & Miller—*Oil Cup.*

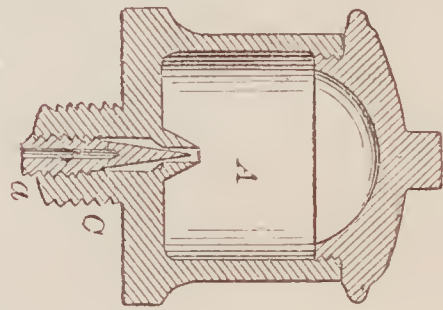

69587—S. S. Putnam—*Clothes Hook.*

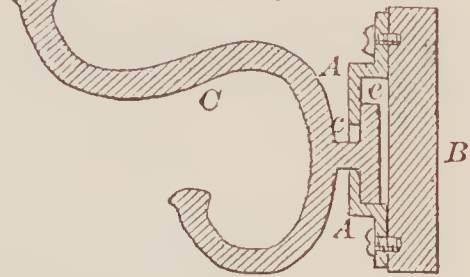

69585—C. H. Pond—*Telegraph Apparatus.*

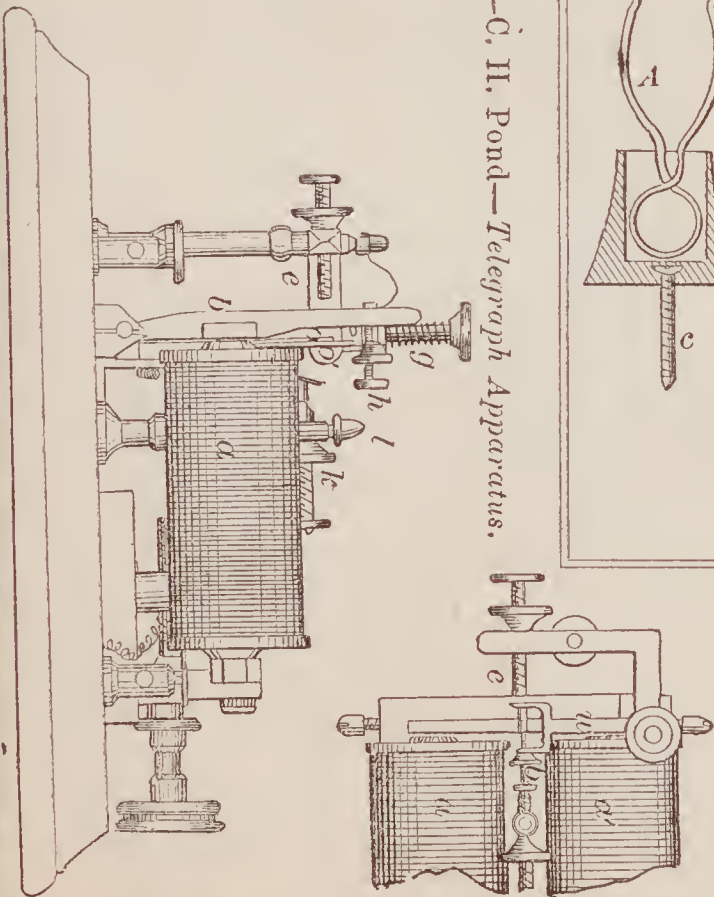

69586—Powell & Morse—*Broom Holder.*

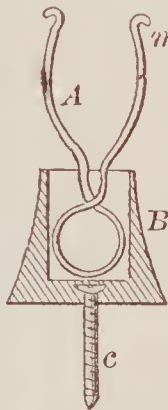

69588—J. G. Reiff—*Carriage Spring.*

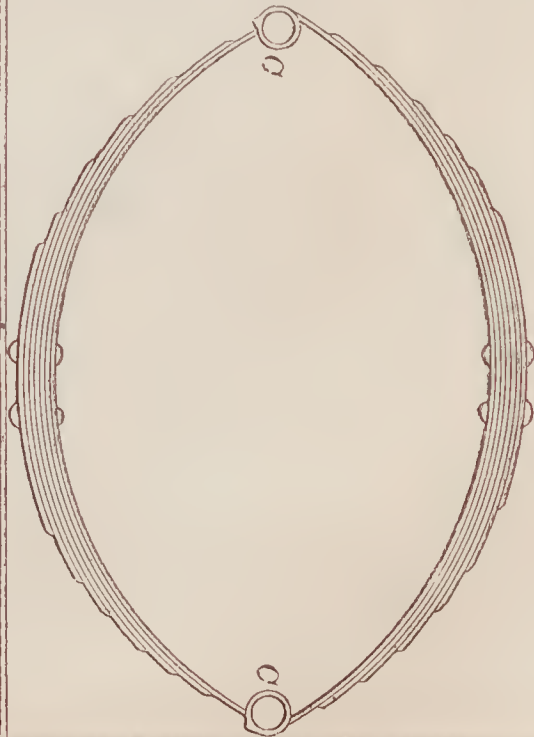





69595—F. J. Underwood—*Pump.*

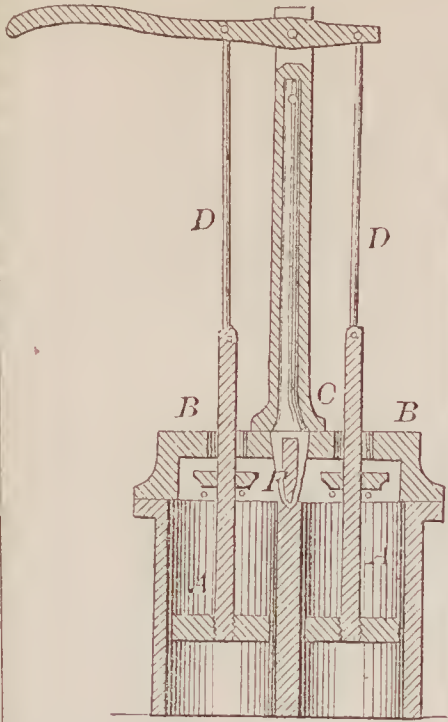

69596—J. H. Van Houten—*Burial Case.*

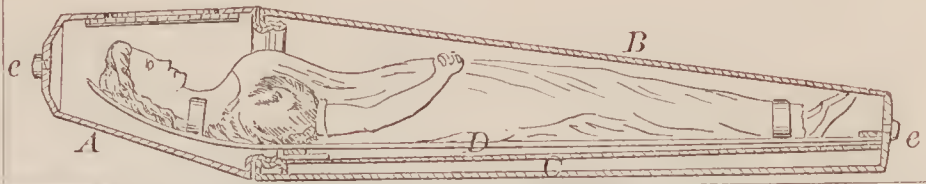

69599—W. Wharton, Jr.—*Railway Switch.*

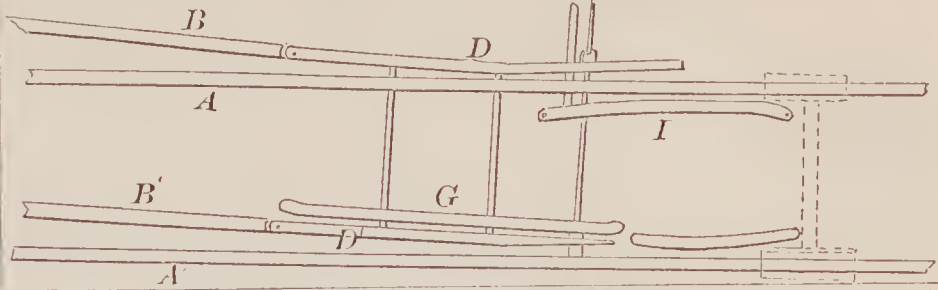

69600—C. W. Williams—*Corn Harvester.*

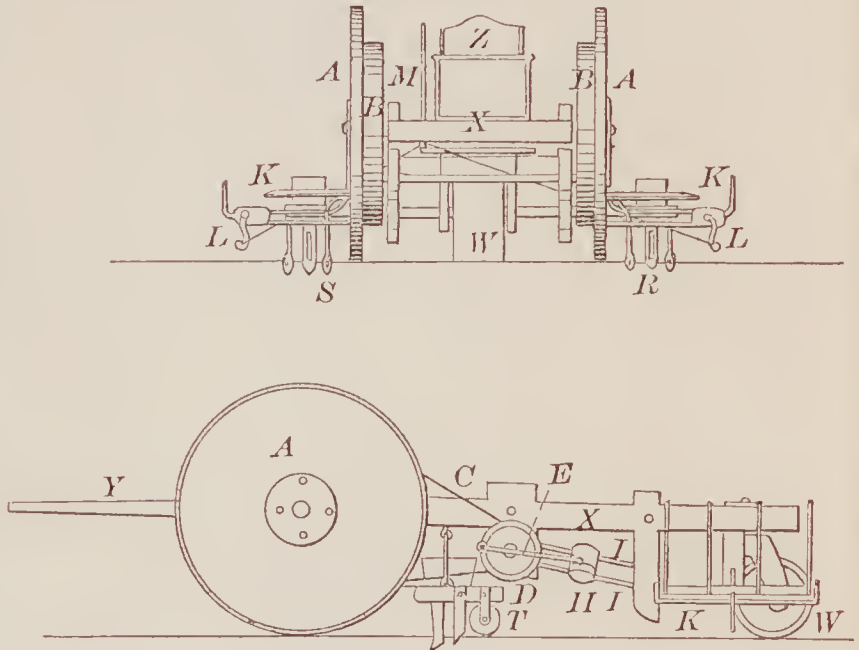

69598—M. Walton—*Churn.*

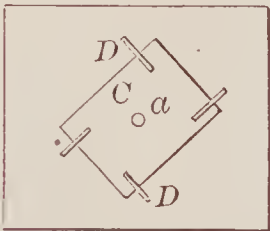
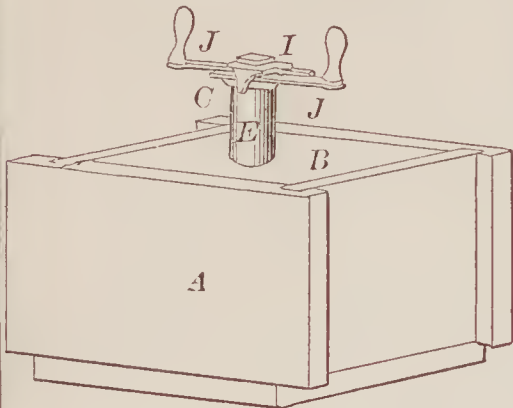

69597—Walters & Shaffer—*For Securing the Bars of Piles or Fagots.*

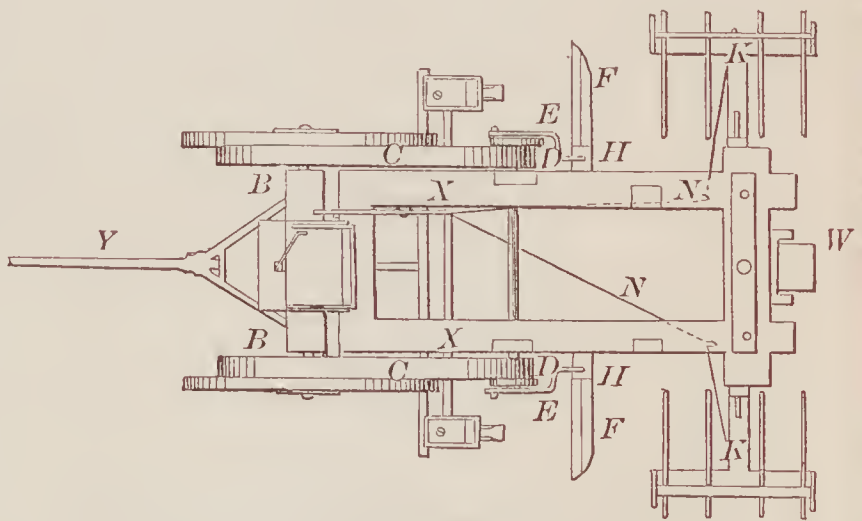
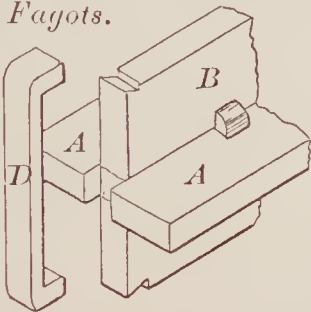

69602—Zimmerman & Baker—*Plumb Level.*

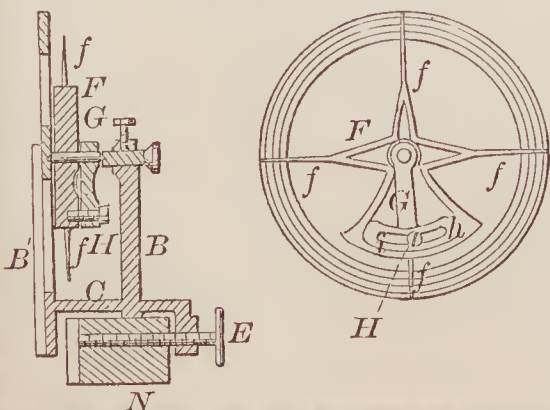

69601—H. Woodward—*Knife Cleaner.*

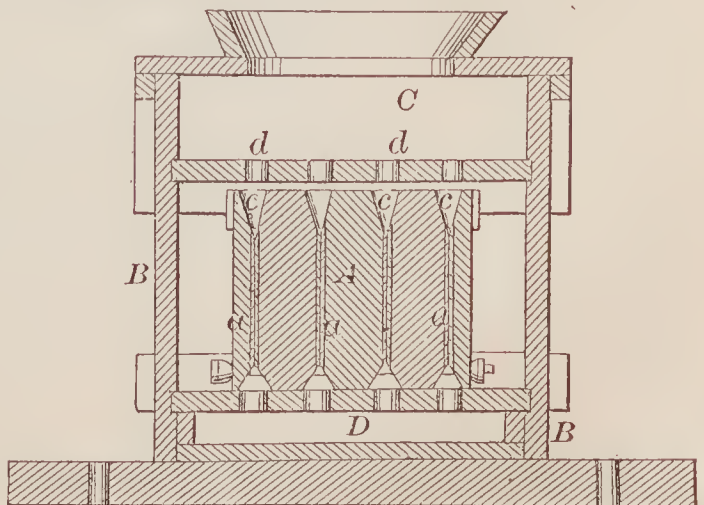



69603—R. Adams—*Blacking Brush.*

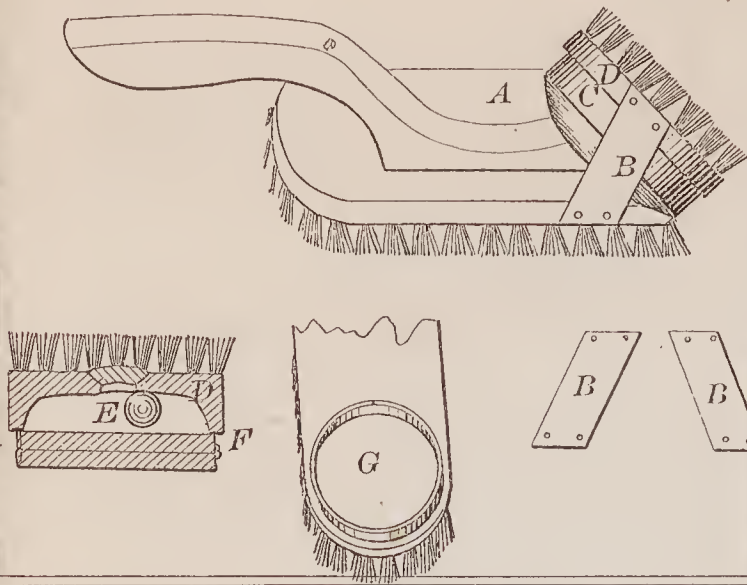

69606—J. Anthony—*Harvester.*

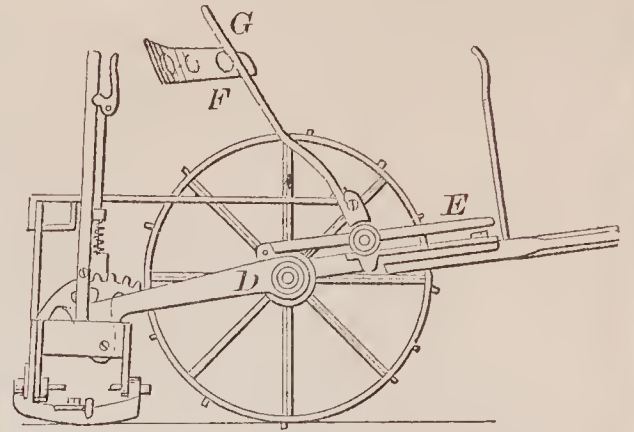

69607—H. Arthur—*For Grating Vegetables.*

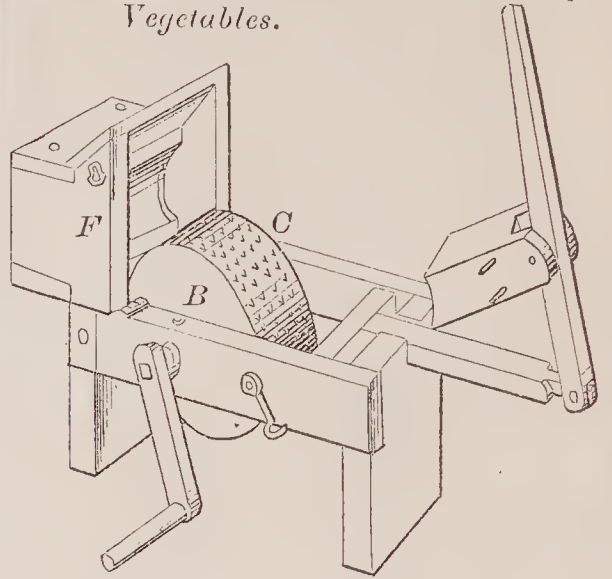

69604—Alley & Williamson—*Wagon Brake.*

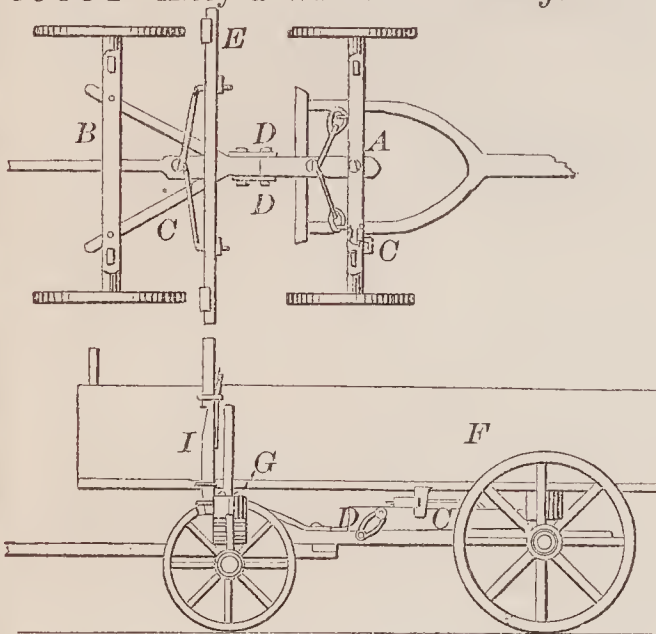

69609—O. Baldwin—*Wash Tub Attachment.*

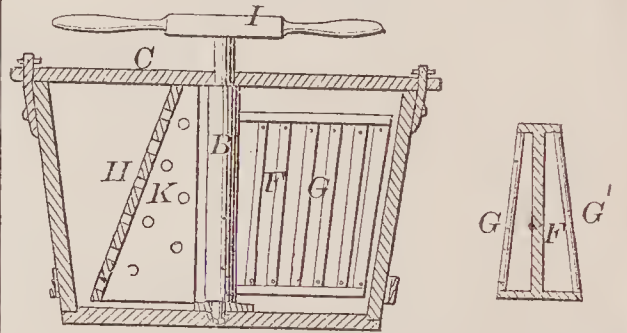

69608—G. W. Balding—*Feeding Rack for Cattle.*

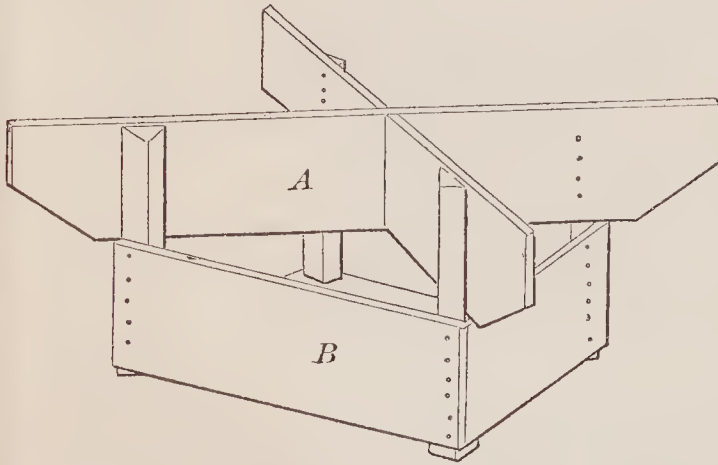

69610—L. B. Ball—*Horse Rake.*

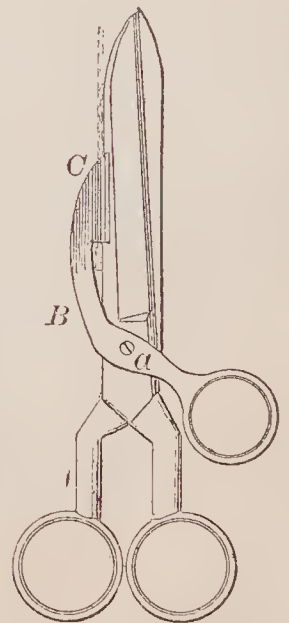
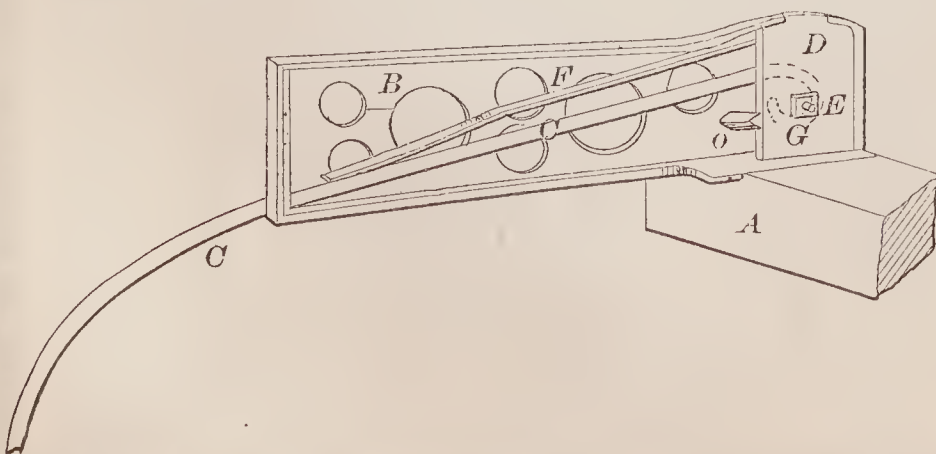

69605—J. A. Althouse—*Scissors and Button Hole Cutter.*

69611—W. W. Ballard—*Land Roller.*

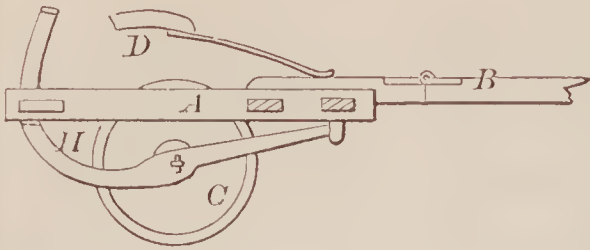

69614—J. B. Bean—*Constructing Moulds for Aluminium Plates.*

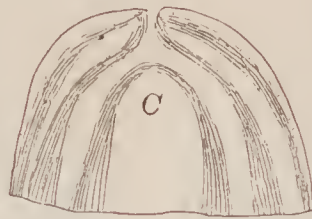

69615—J. B. Bean—*Securing Artificial Teeth to Cast Plates.*

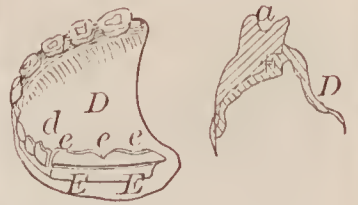

69613—J. M. Batchelor—*Sawing Machine.*

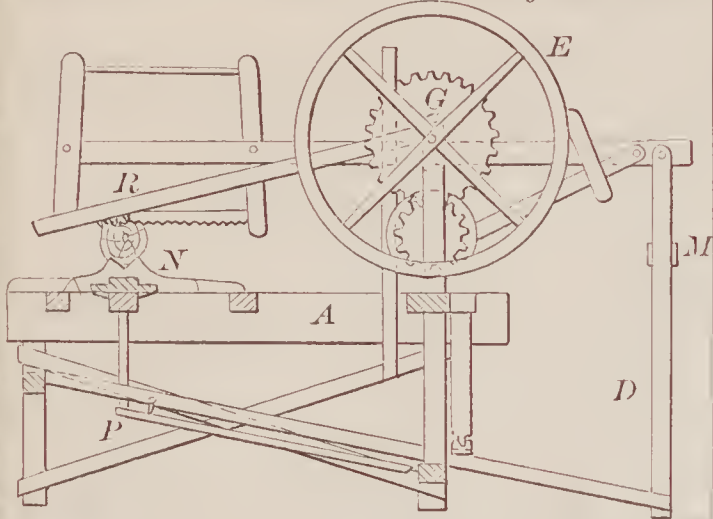

69617—L. M. Bolles—*Bed Bottom.*

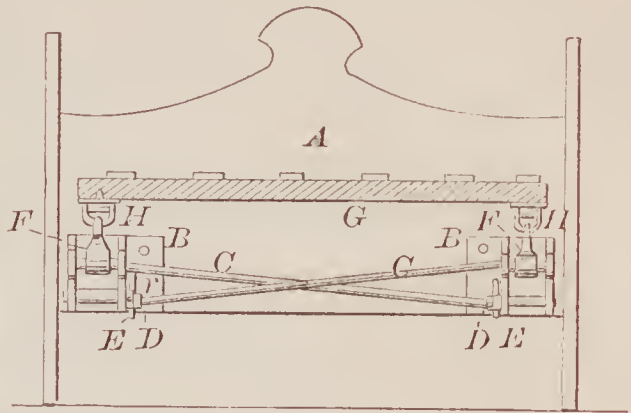

69616—J. E. Billings—*Automatic Blotter.*

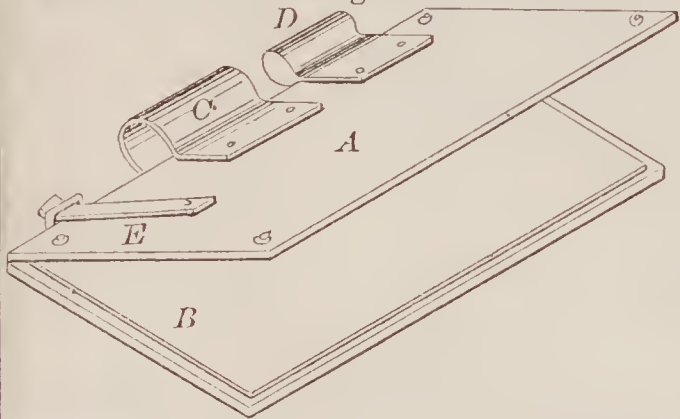

69619—H. Bosch—*Latch Lock.*

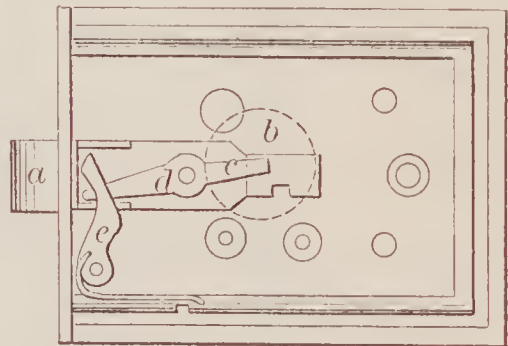

69620—C. Boyer—*Churn.*

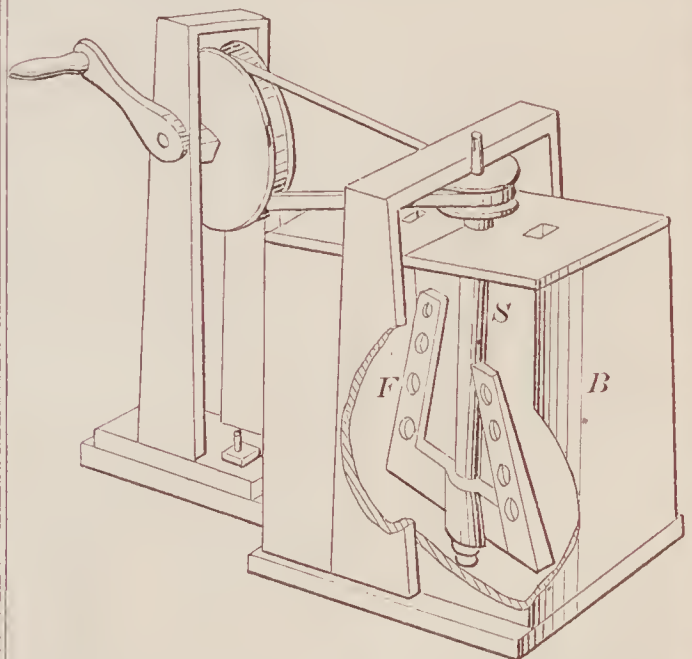

69622—D. Brooks—*Telegraph Insulator.*

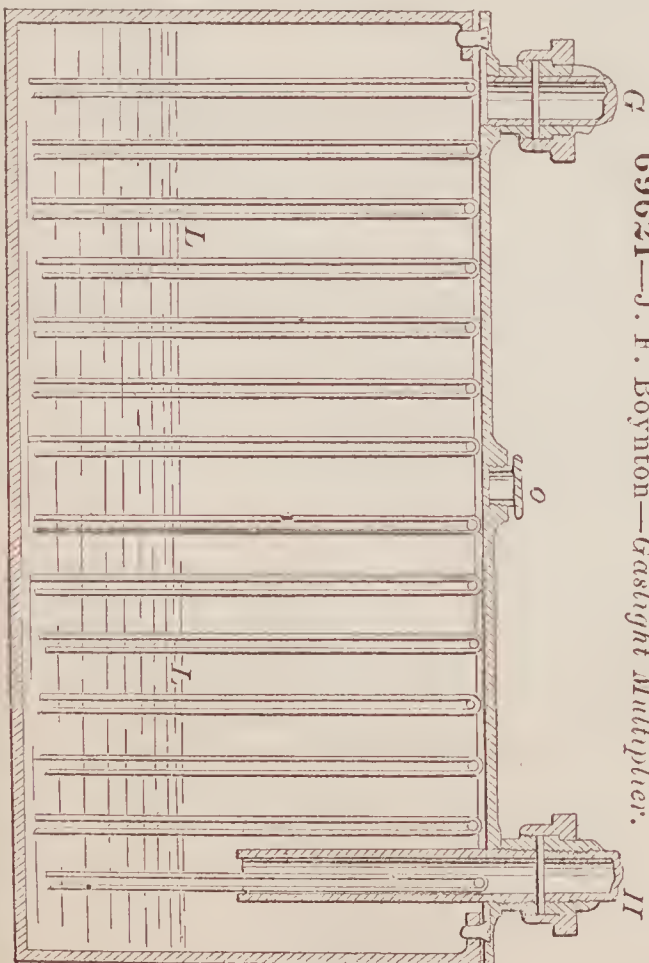
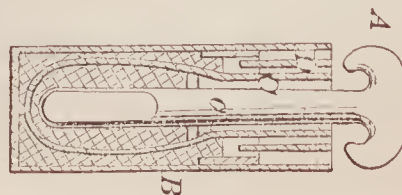

69621—J. F. Boynton—*Gaslight Multiplier.*



69623—A. H. Brown—Churn.

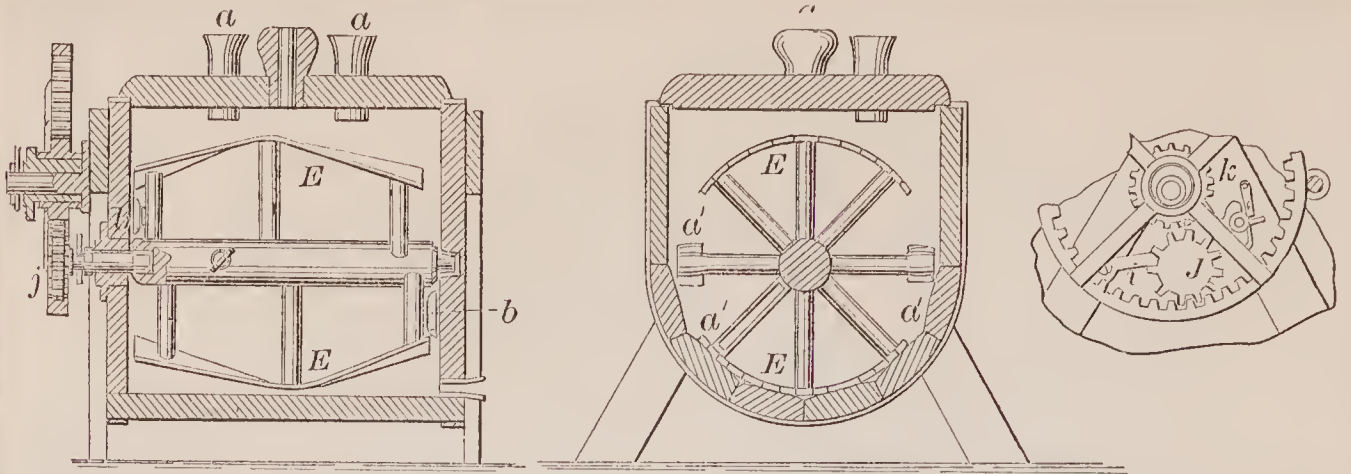

69624—M. M. Brown—Churn.

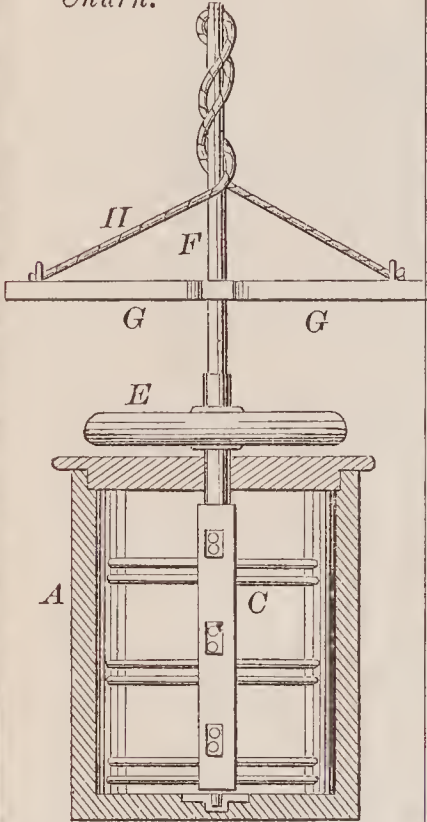

69626—J. G. Chase—Reversible Railway Ticket Safe.

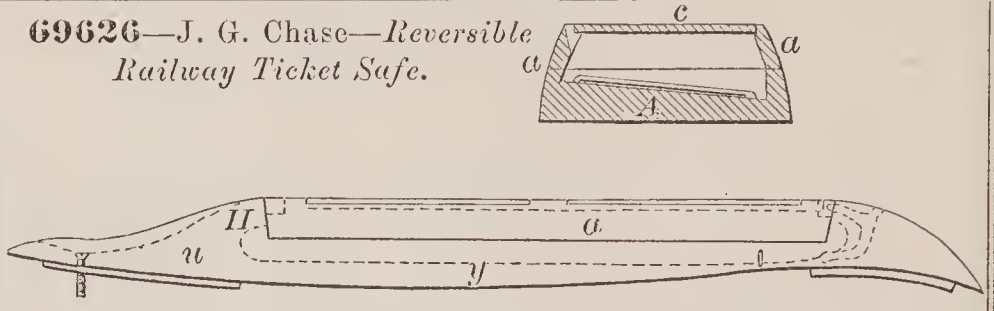

69625—P. Burnham—Hanse Pipe.

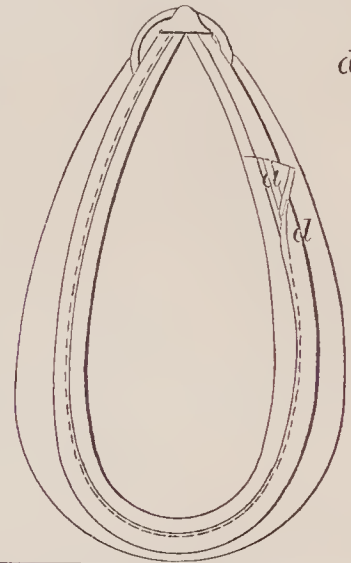
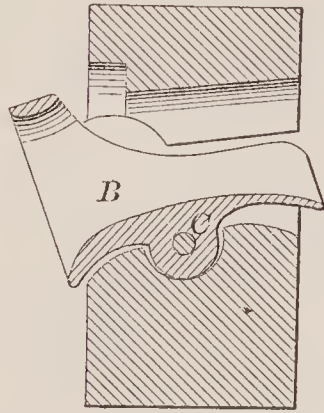

69627—Cheever & Forgie—Horse Collar.

69628—Chenoweth & McLain—Belt Clasp.

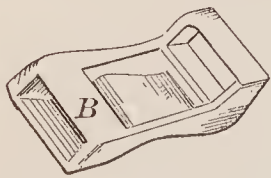

69630—J. F. Coburn—Hide Stretching Machine.

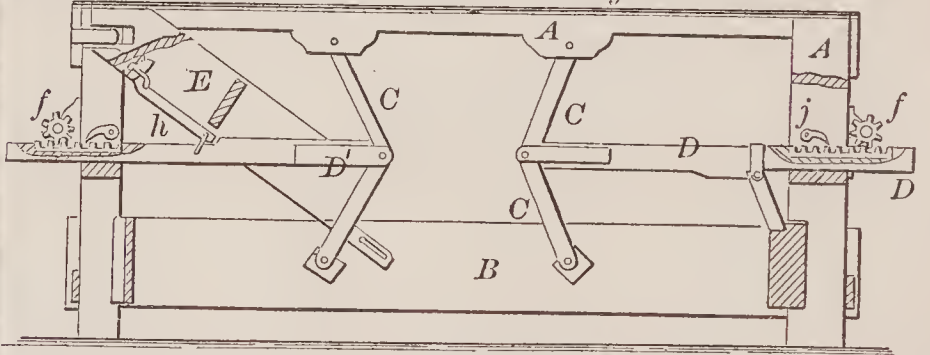

69631—M. S. Collar—Railway Water Elevator.

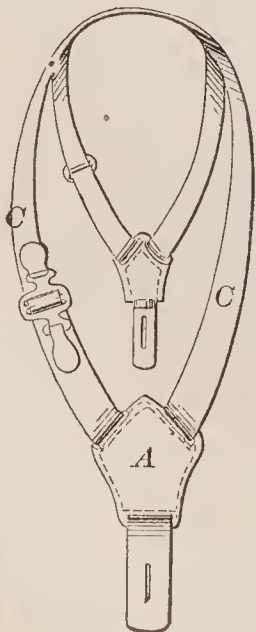
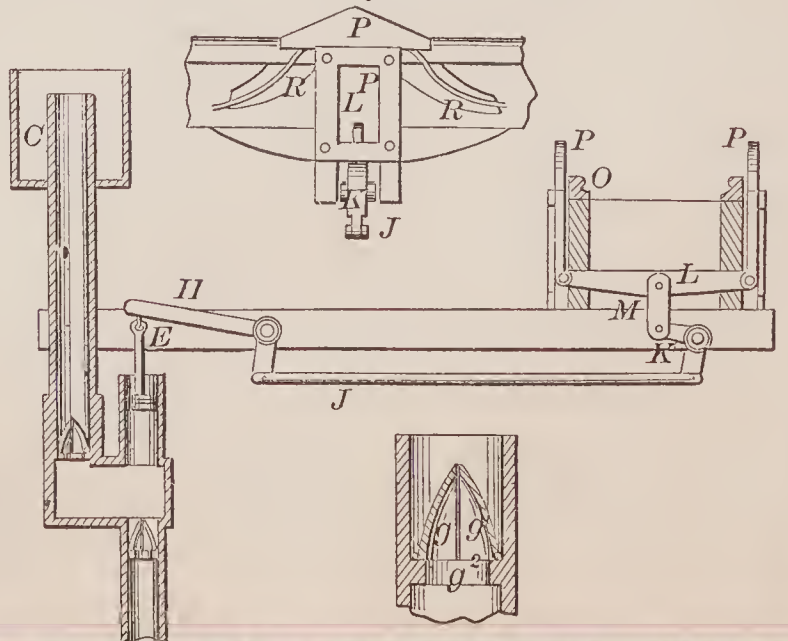

69629—C. H. Cleveland—Suspenders.



69632—H. M. Conklin—Bed Bottom.

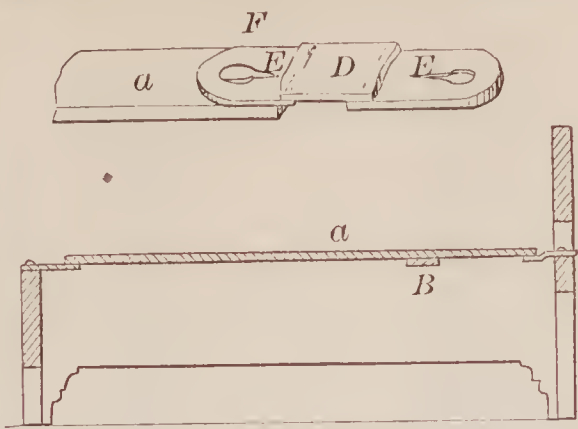

69633—Connelly & Hughes—For Stretching Leather.

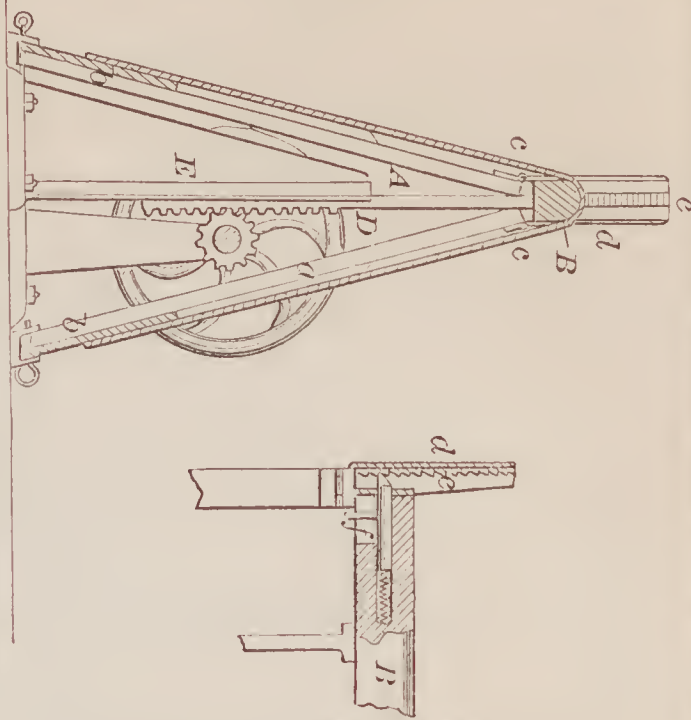

69634—W. W. Conner—Smut Machine.

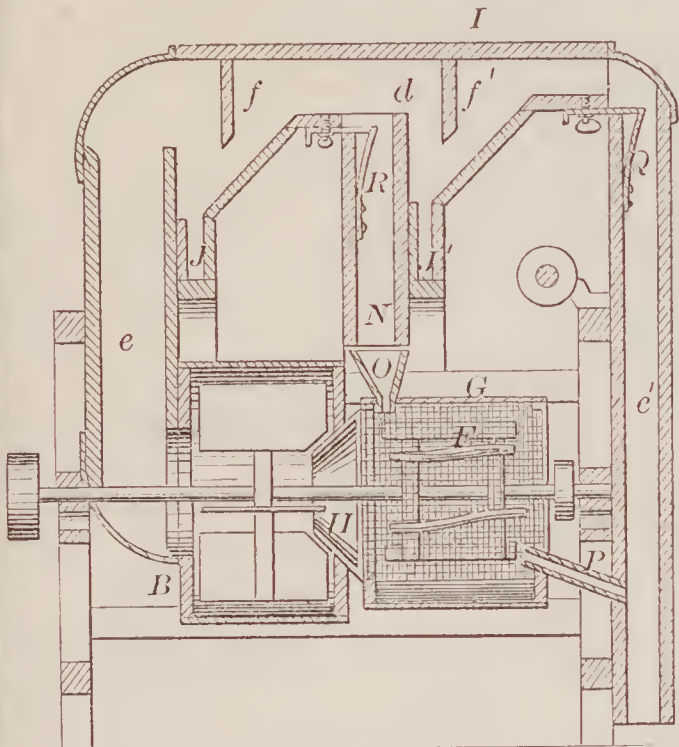

69637—A. Davis—Advertising Device.

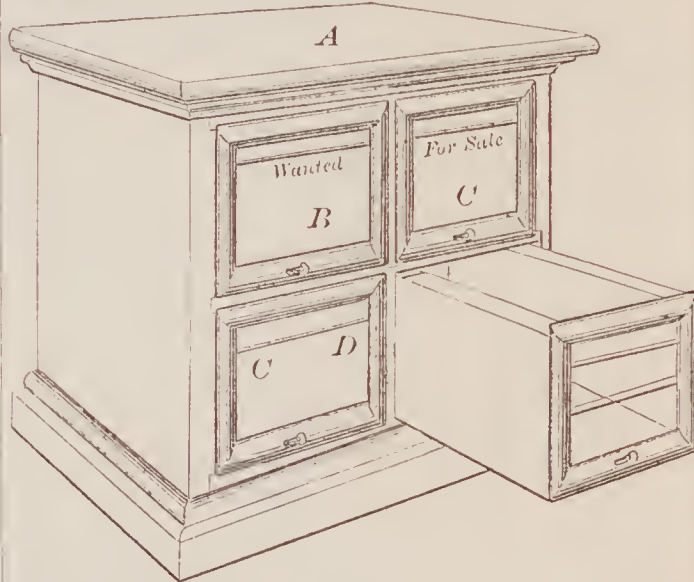

69638—J. Davis—For Oiling Propeller Cranks.

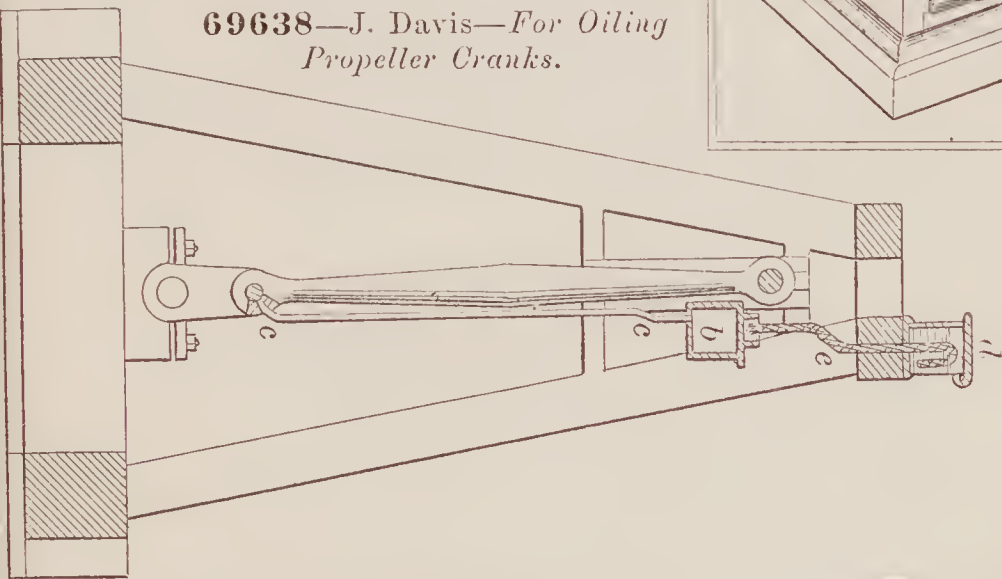

69639—H. H. Day—Canal Lock.

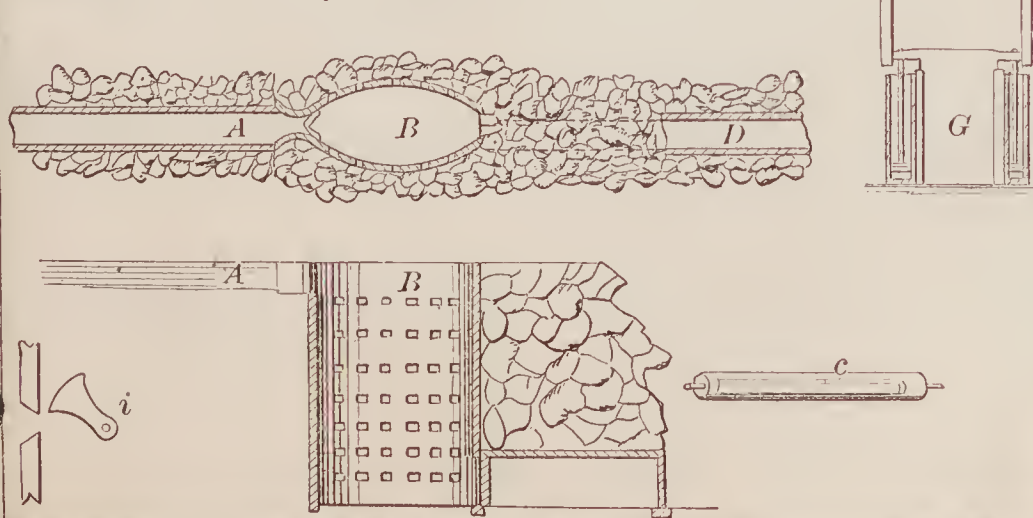

69635—J. E. Cronk—Pump Valve.

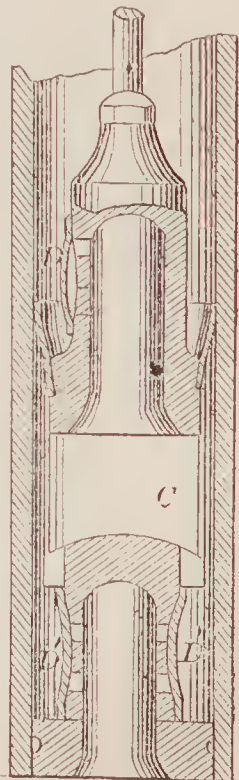



69640—S. M. Denniston—Gate.

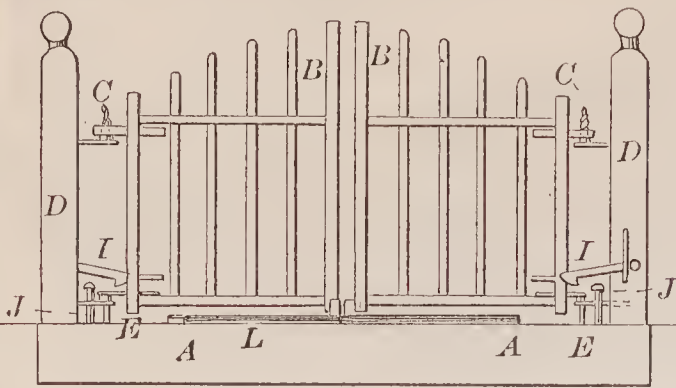

69641—Devillard & Postwieler—  
Carriage Door.

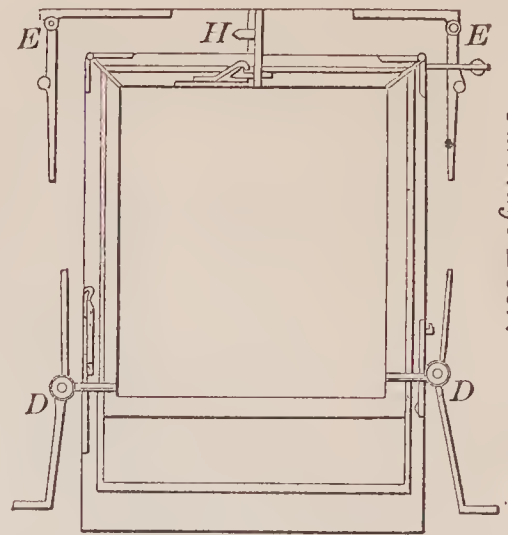

69642—C. R. Disbrow—Transplanter.

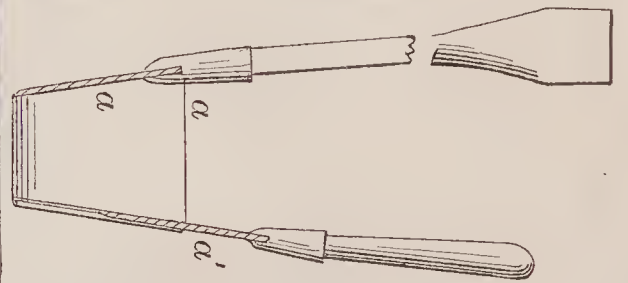

69643—J. G. Dodge—Plow.

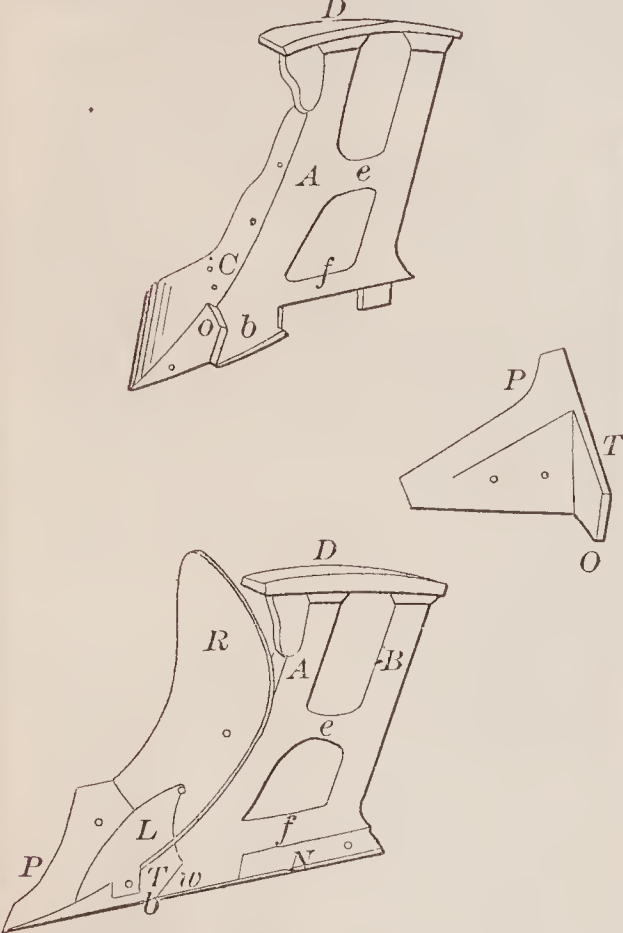

69645—B., J., S. B & A. H. Elbert—  
Padlock.

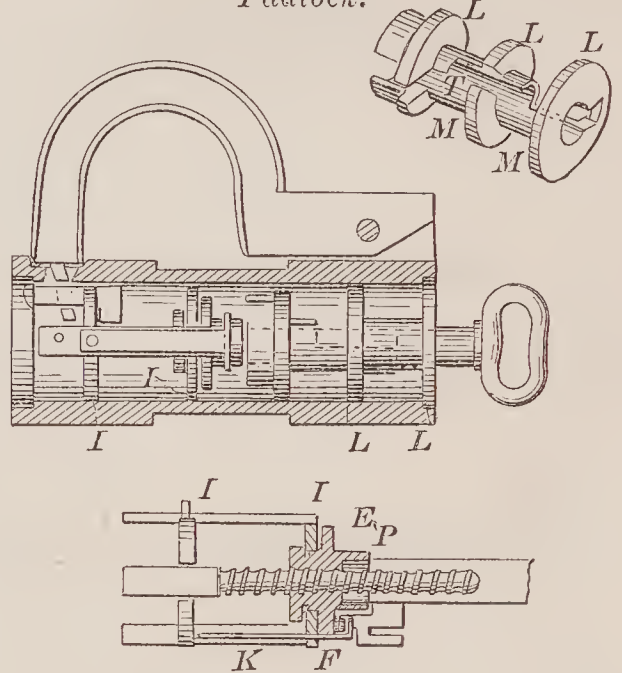

69644—J. D. Driggs—Die Plate.

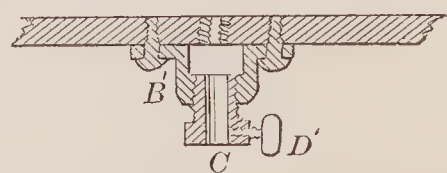

69647—G. Farmer—Tallying Instrument.

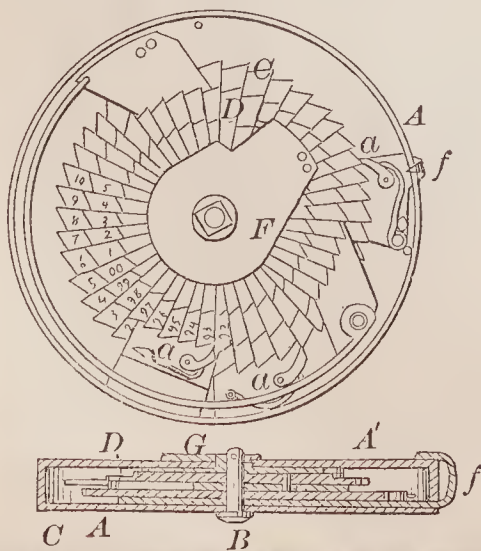

69646—J. H. Elward—Clamp for Ropes and  
Wires.

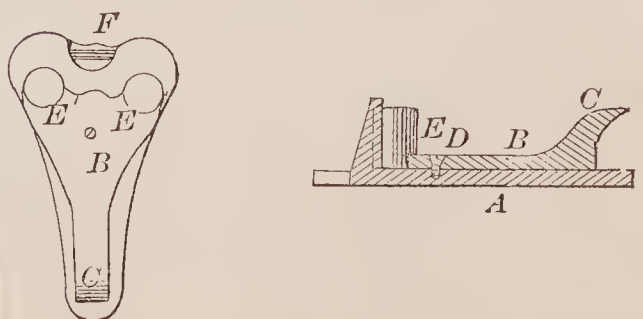

69651—C. H. Gifford—*Horse Hay Fork.*

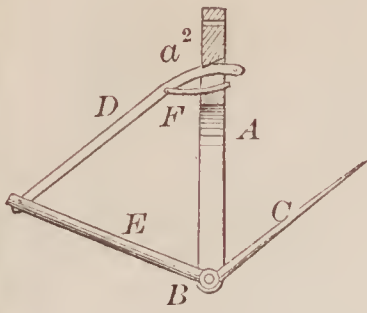

69648—A. & E. Fontaine—*Annunciating Fire Alarm.*

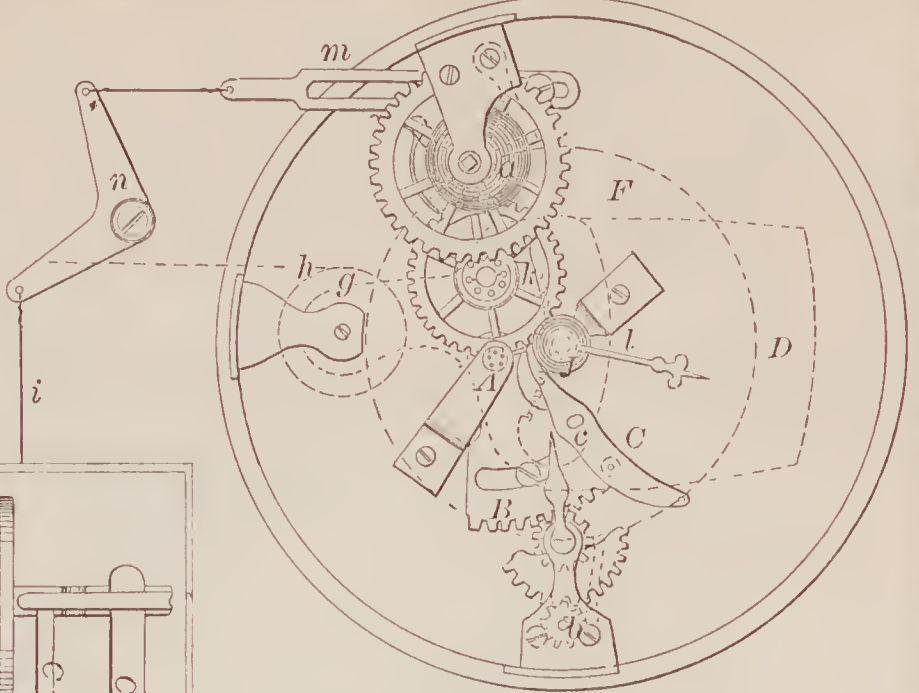

69652—C. H. Gifford—*Hay Loader.*

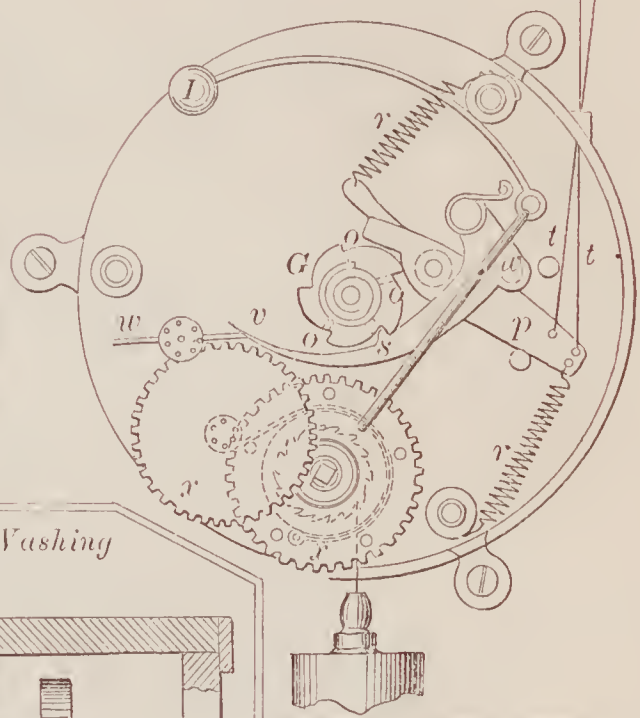
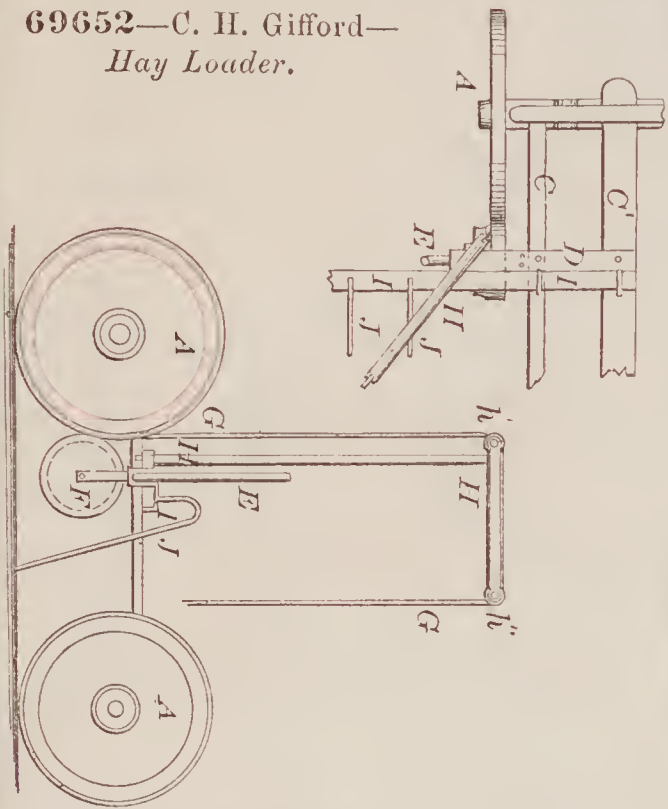

69650—D. L. Furnier—*For Washing Sand, &c.*

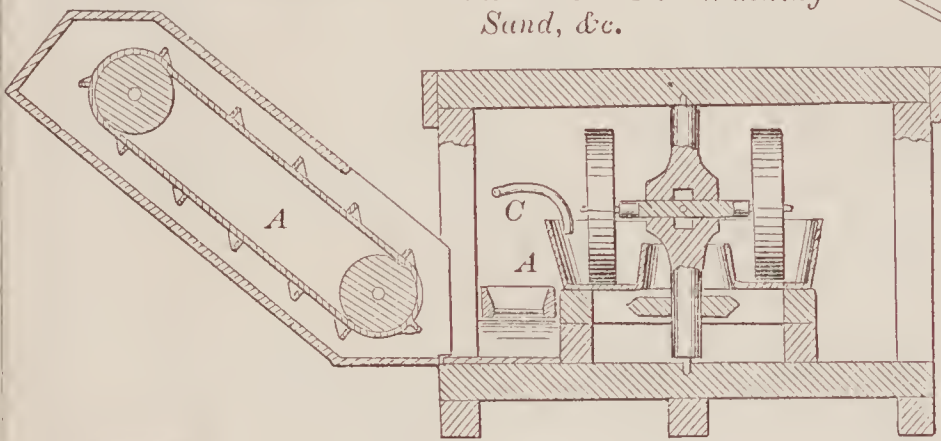

69649—J. Forbes—*Slate.*



69653—E. L. Gilman—*Churn.*

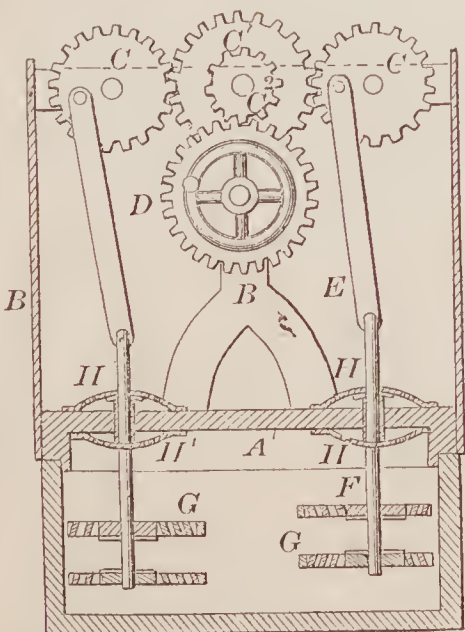

69654—N. J. Glover—*Portable Fence.*

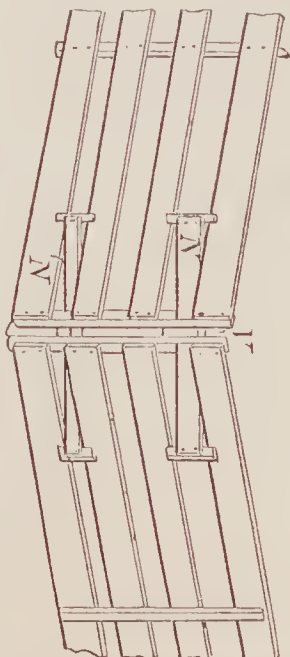



69655—Goodwin & Squire—For Pulverizing Rocks, Ores, &c.

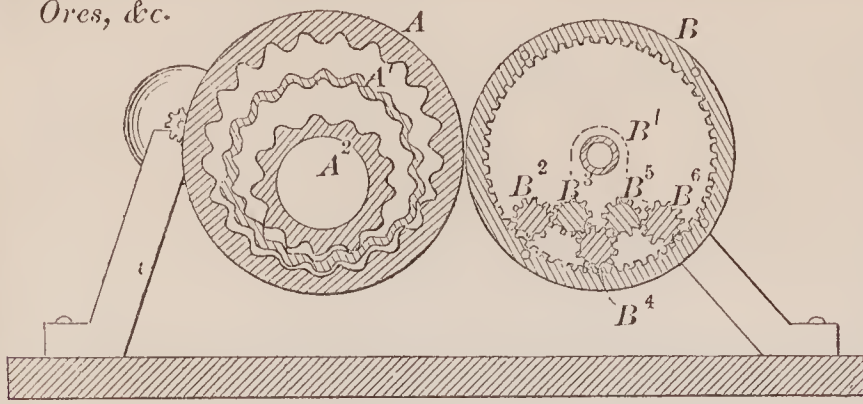

69659—J. O. Hamilton—Obstetrical Bandage.

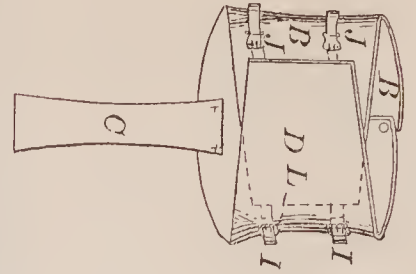

69656—Goodwin & Squire—For Crushing Rocks, Ores, &c.

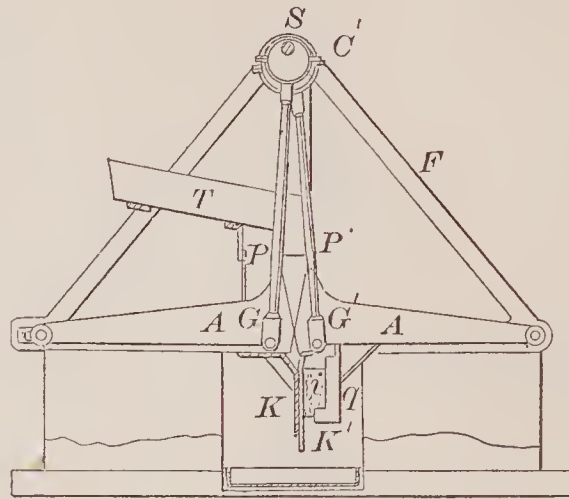
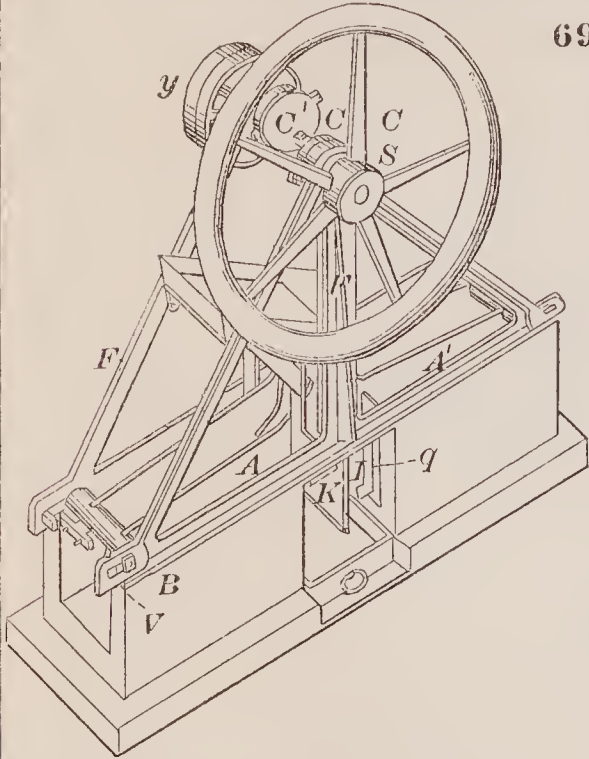

69660—J. Hammond—Chimney Cap.



69657—T. D. Guthrie, Jr.—Baling Press.

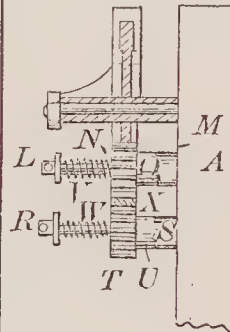
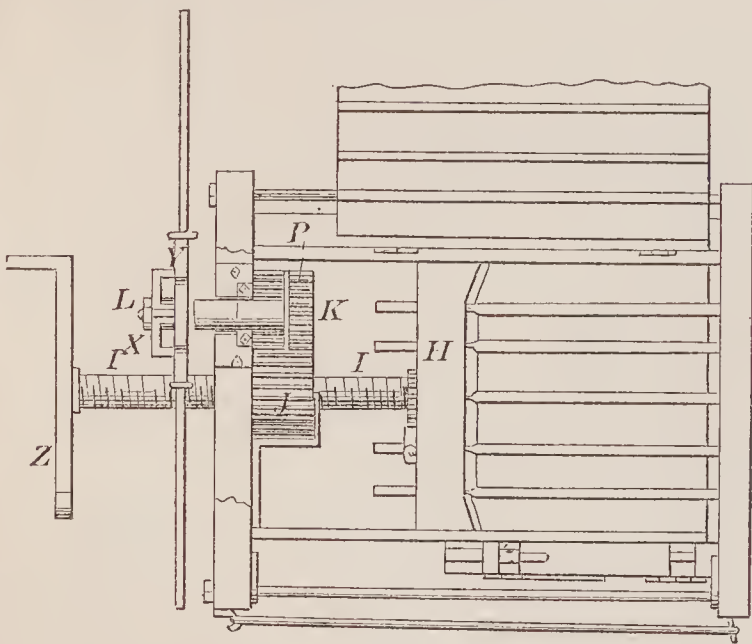

69658—W. Hamer—Siver Can for Cotton, &c.

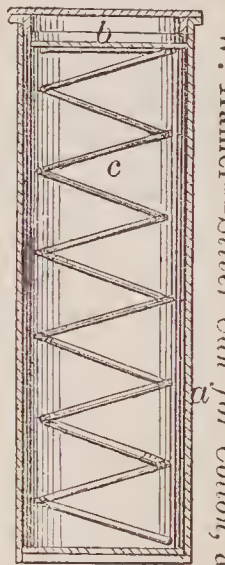

69661—J. B. Hannimann—Water Closet.

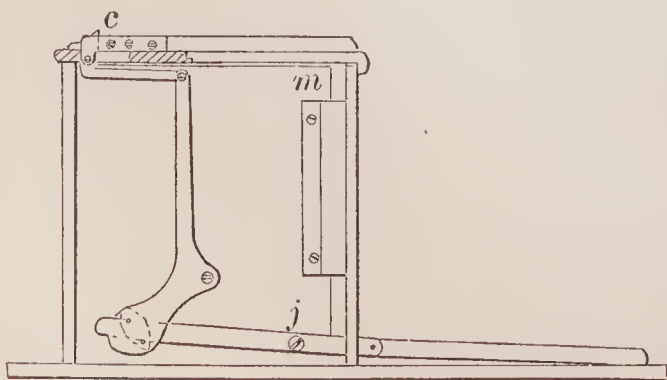

69662—C. Haskins—Universal Coupling.

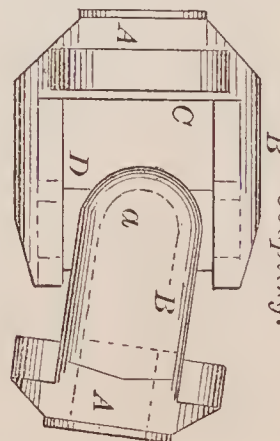
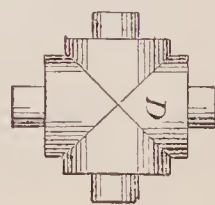

69666—C. Hodgkins—Sewing Machine.

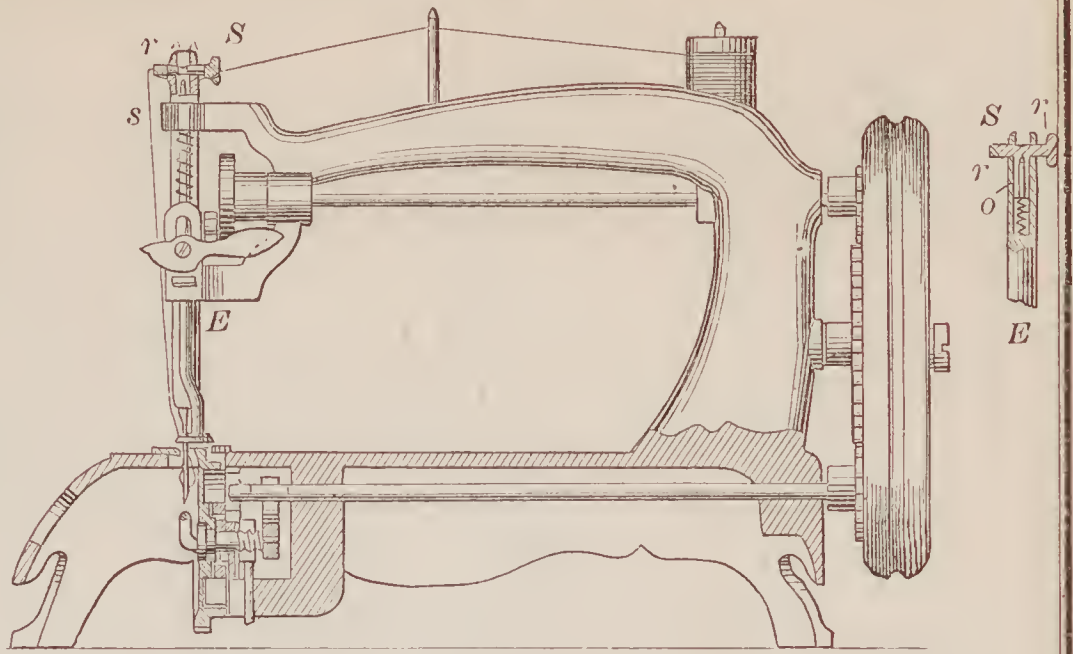

69665—O. Hellen—Egg Cup.

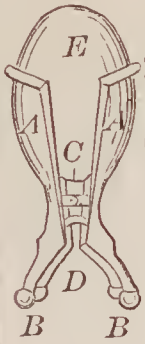

69664—M. C. Hawkins—Tip for Suspending Rooms, &c.



69667—F. Holden—Horse Rake.

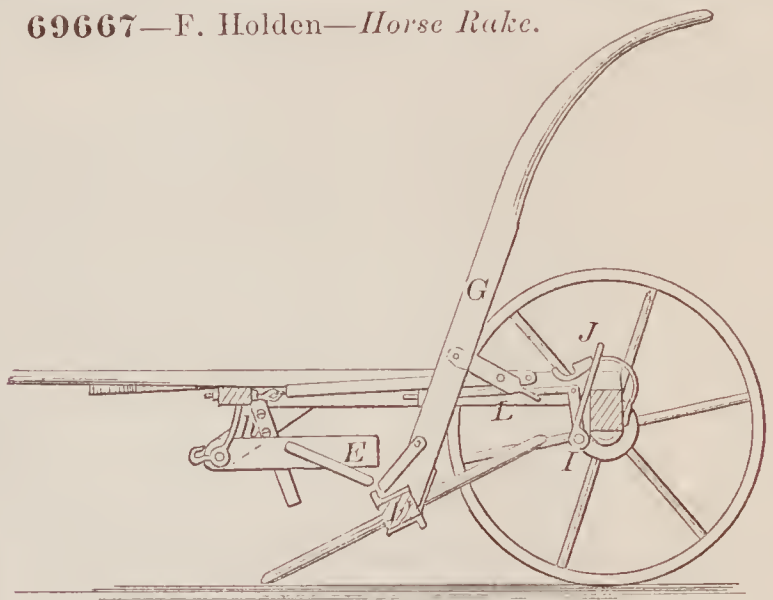

69668—S. R. Holmes—Washing Machine.

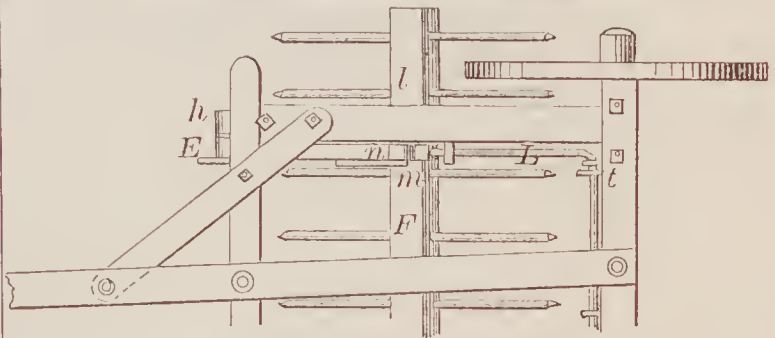
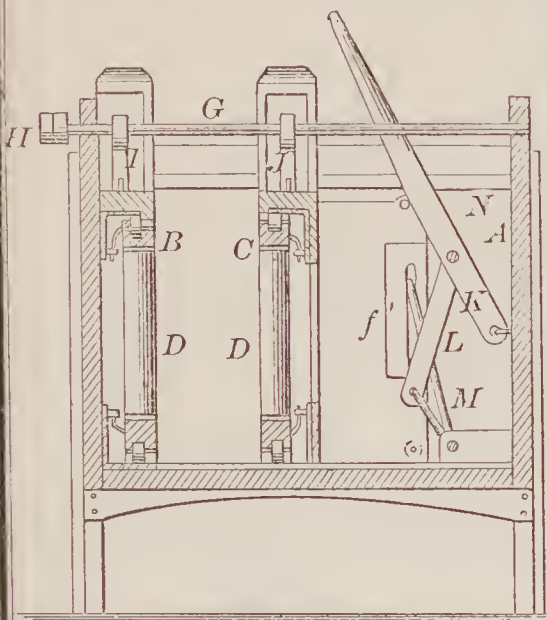

69671—Howard & Jackson—Button Hole Sewing Machine.

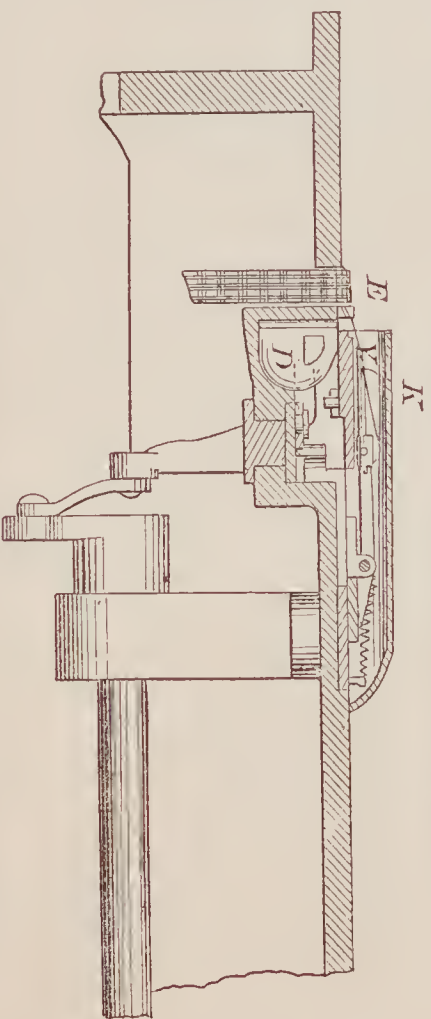

69670—J. C. House—Lamp Heater for Dental Purposes.

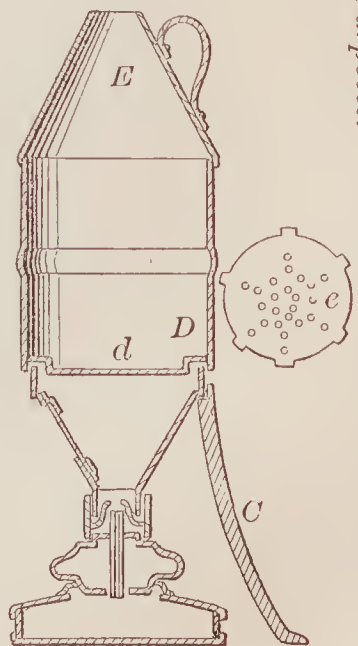

69669—A. H. Hopkins—Buckle.





69672—W. W. Hubbell—*Amalgamator.*

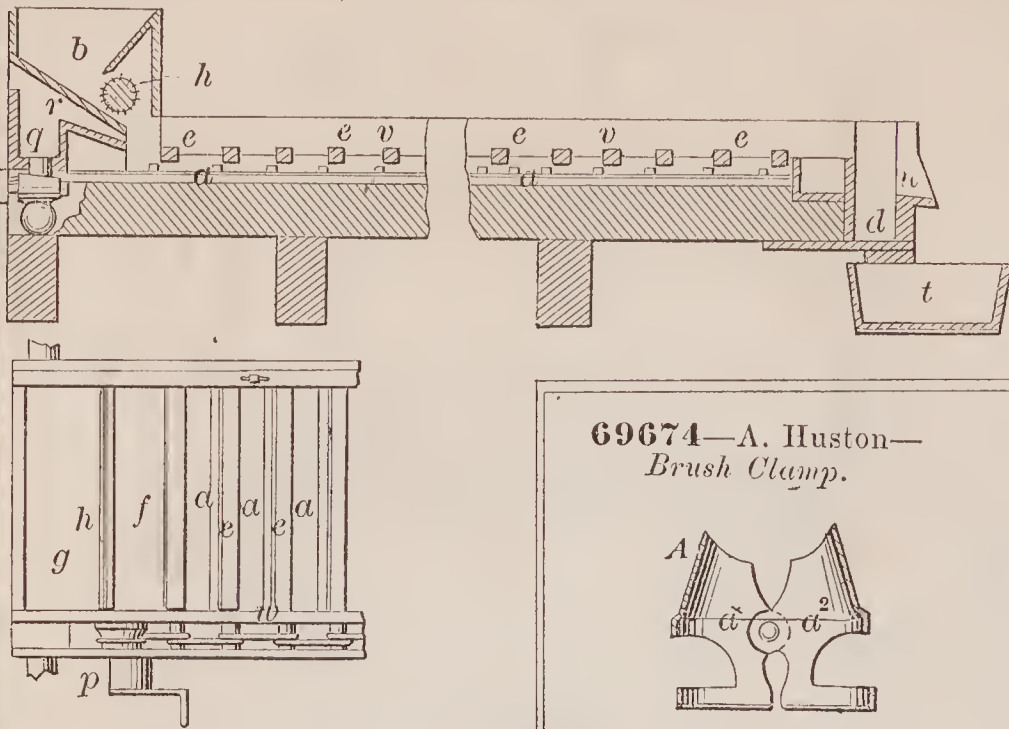

69675—J. Ingram—*Bathing Apparatus.*

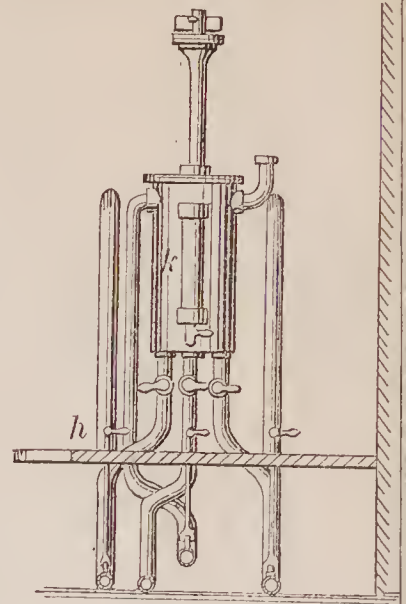

69674—A. Huston—*Brush Clamp.*

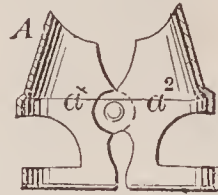

69673—H. D. Hunt—*Hand Loom.*

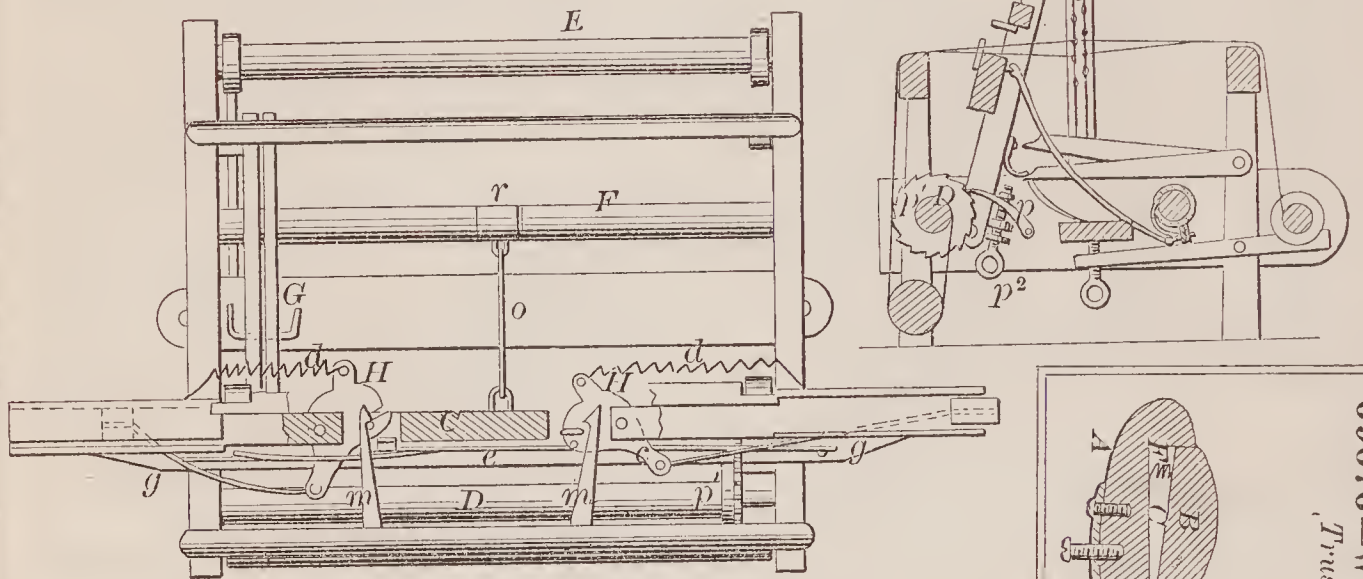

69677—J. Jones—*For Compressing Peat.*

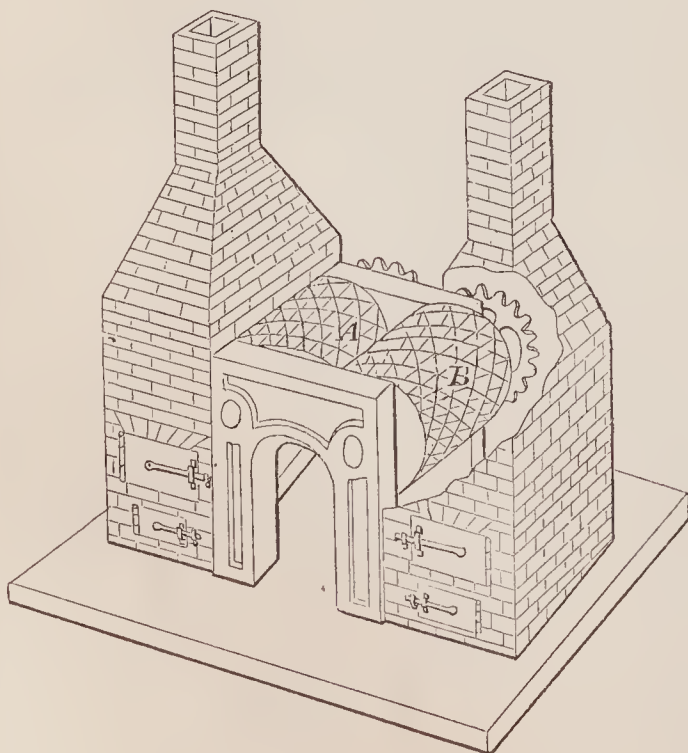

69676—W. J. Johnson—*Truss Pad.*

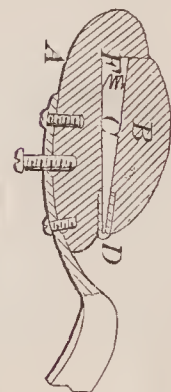

69678—J. L. Keasor—*Self-Acting Plow Holder.*

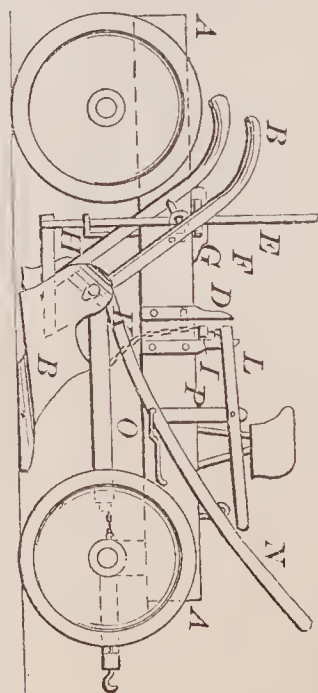





69685—B. M Lewy—*Lathe.*

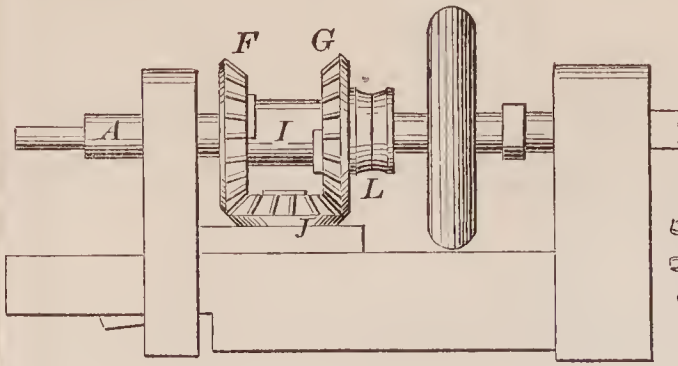

69688—J. Melling—*Passenger Register.*

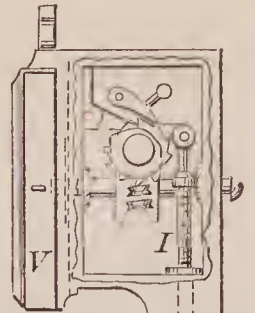

69686—A. Marshall—*Carriage Truck.*

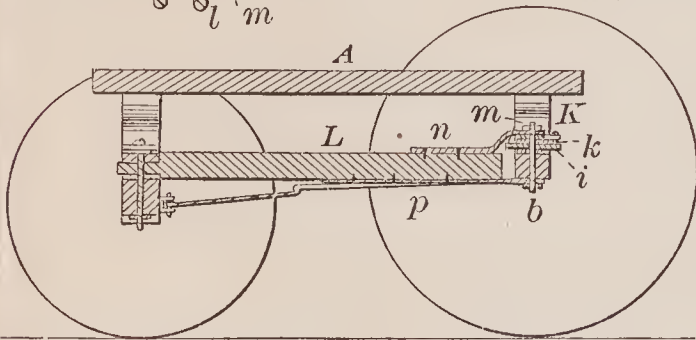
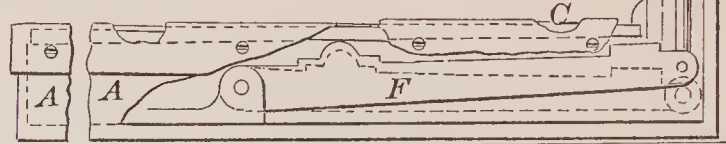
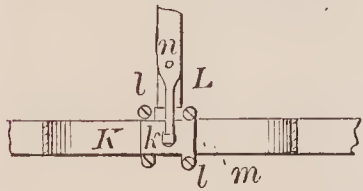

69687—E. L. McNett—*Governor.*

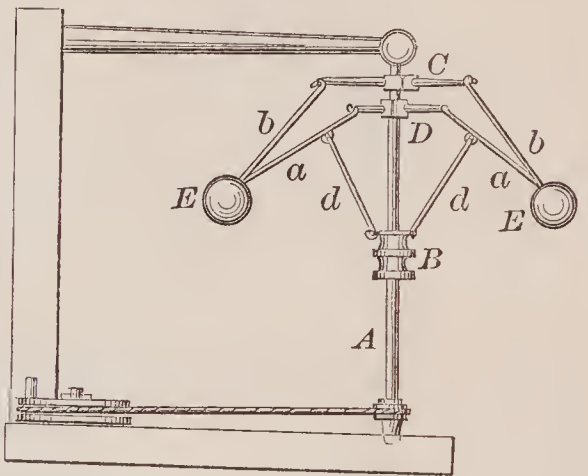

69691—F. Meyer—*Scoop for Scales.*



69689—M. J. Mellyn—*Cutting Tool.*

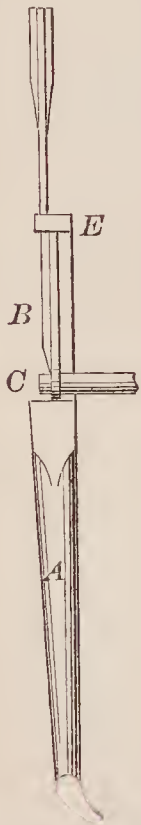

69692—T. S. Minniss—*Sled Brake.*

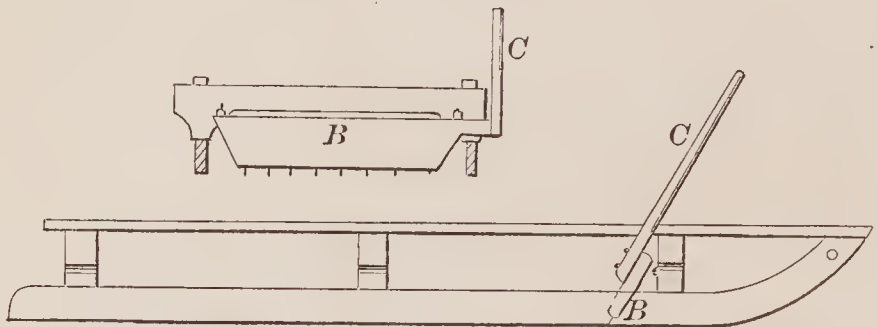

69693—Moore & Baker—*Car Coupling.*

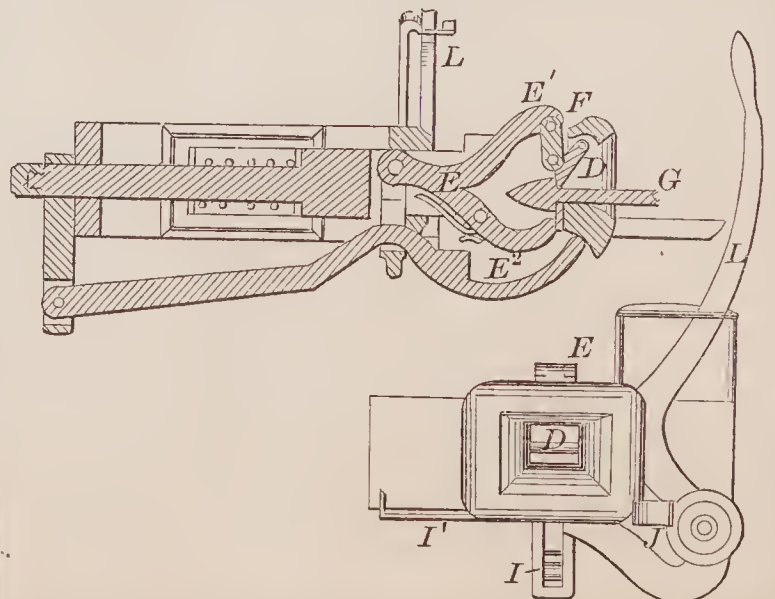

69690—A. N. Merritt—*Butter Cutter.*

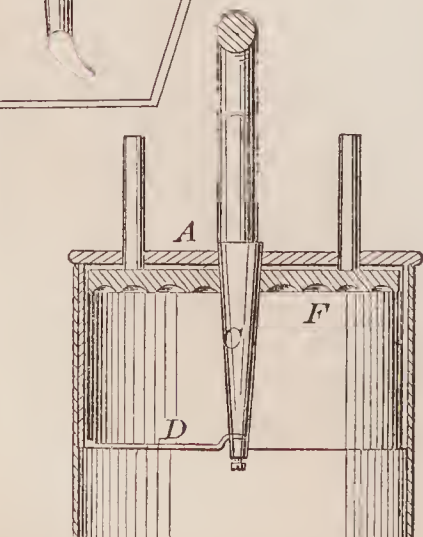

69694—D. Peck—Mop Wringer.

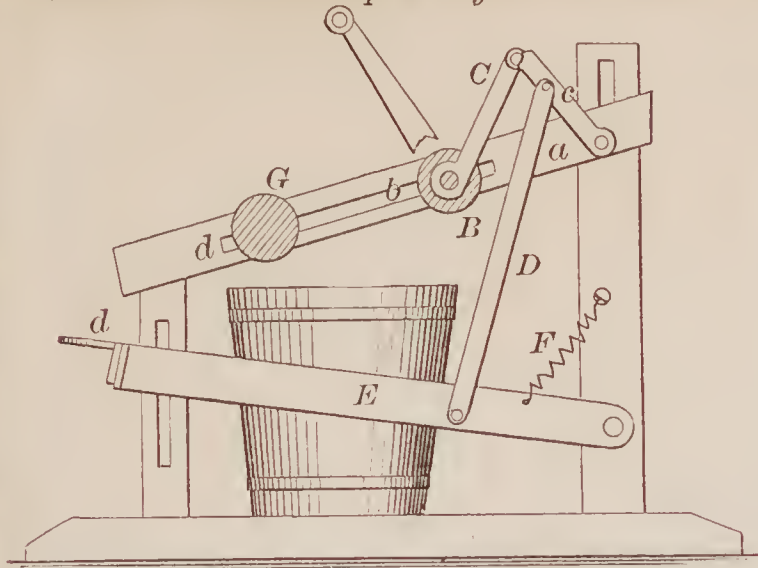

69695—S. Pence—Animal Trap.

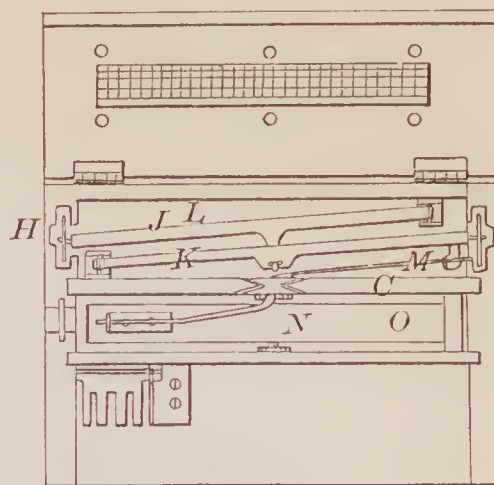

69696—Peters & Williams—Line Holder.

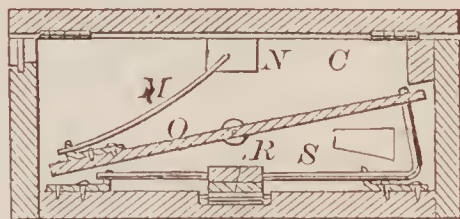
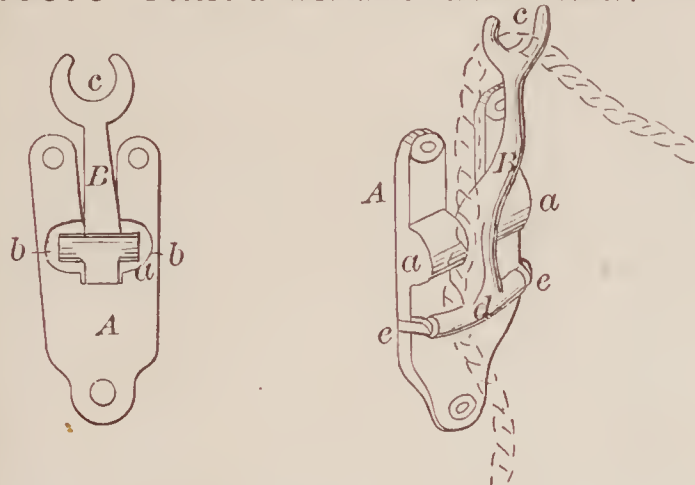

69697—J. Pierpont—Cultivator Coupling.

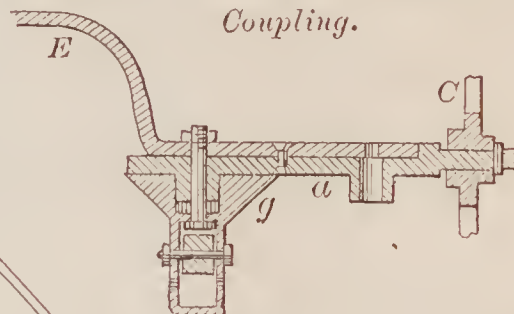

69699—D. A. Pratt—Motive Power.

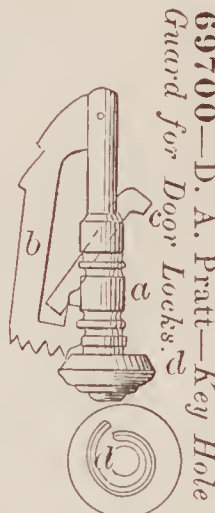
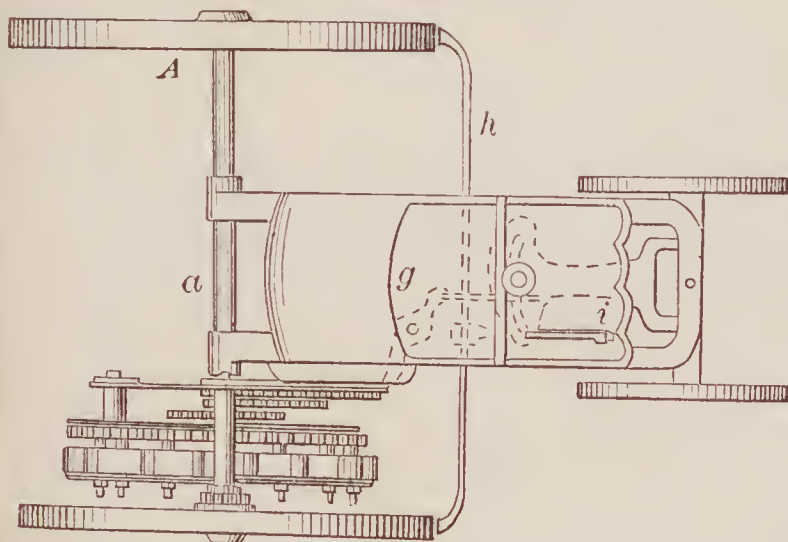

69700—D. A. Pratt—Key Hole Guard for Dog Locks.

69698—P. Power—Rocker for Cradles.

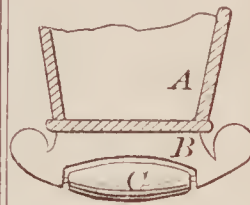

69701—G. W. Pressy—Stump Extractor.

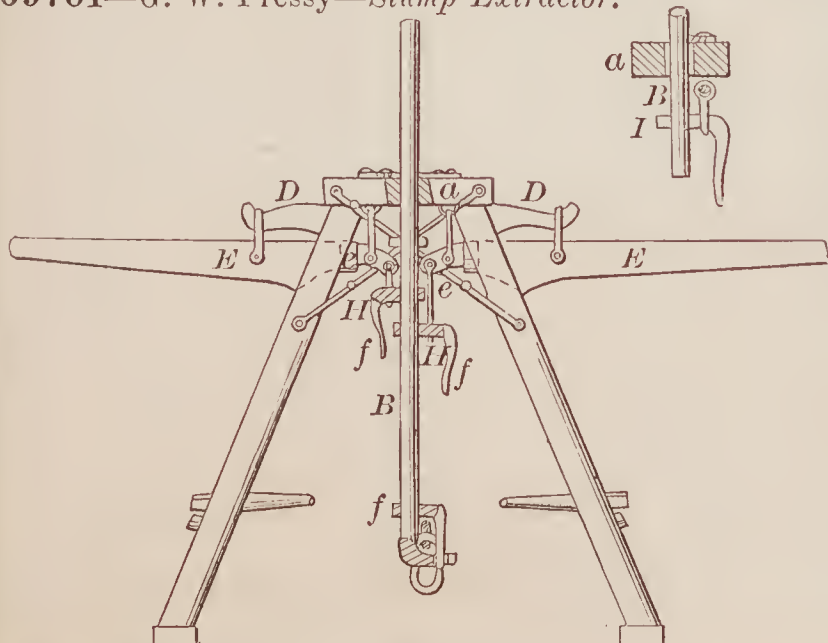

69702—J. G. Raymond—Boiler Gauge Cock.

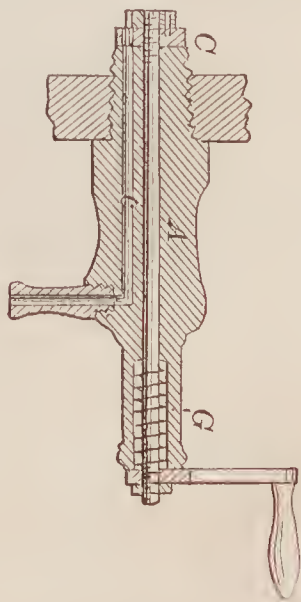



69703—R. L. Ream—Wooden Pavement.

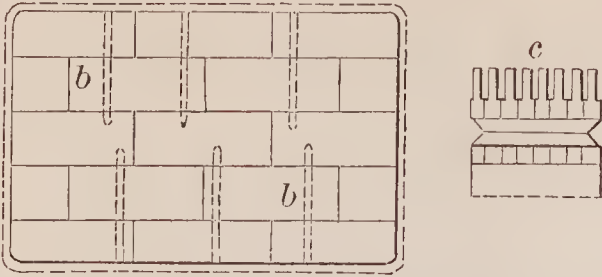

69705—R. W. Reiss—Rotary Steam Engine.

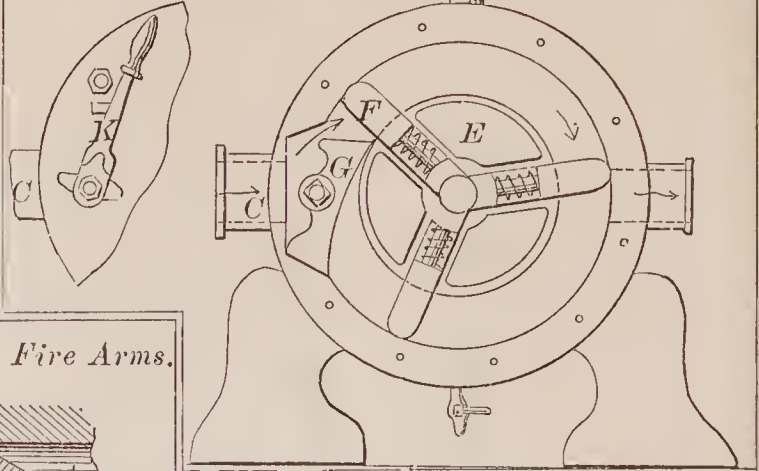

69707—J. Rupertus—Cartridge for Fire Arms.

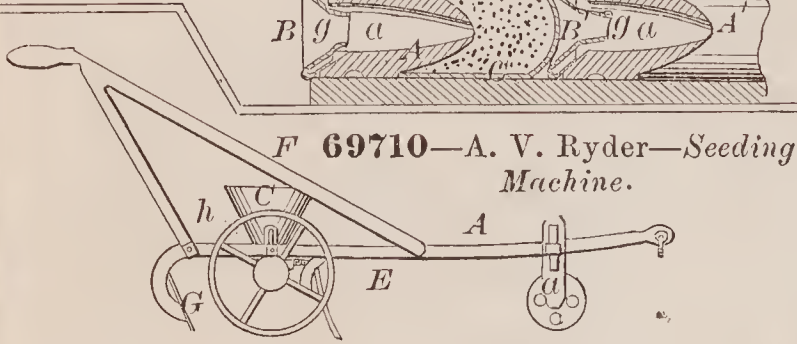
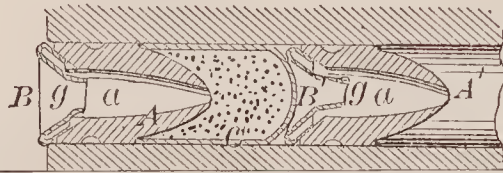

69710—A. V. Ryder—Seeding Machine.

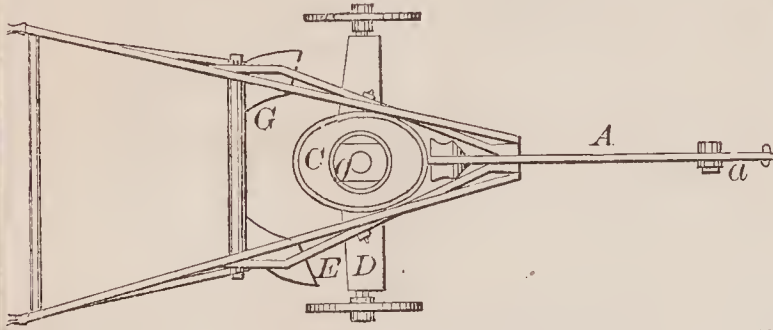

69709—J. Russell—Card Setting Machine.

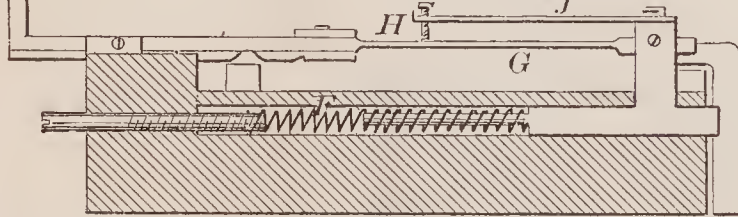

69711—L. Seofield—Loom.

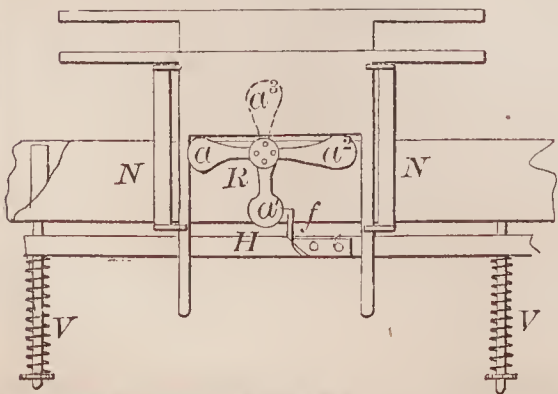
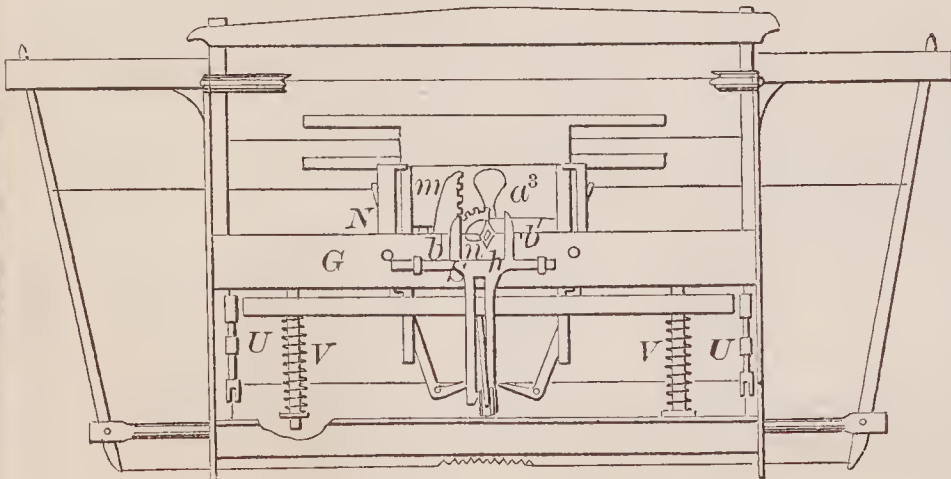

69704—P. S. Reist—Self-Adjusting Elastic Gate.

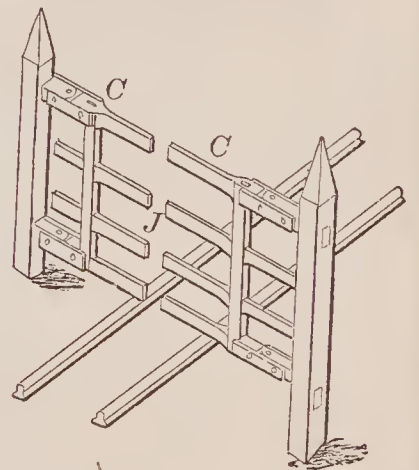

69706—L. J. Roberts—Hose Coupling.

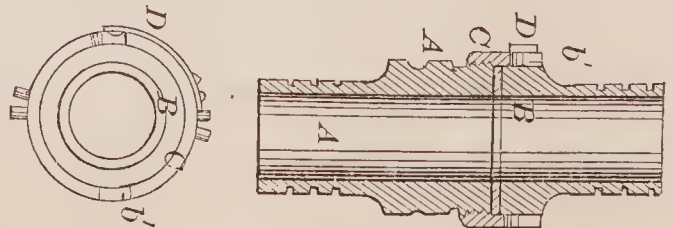

69708—J. Rushworth—Loom for Weaving Ribbons, &c.

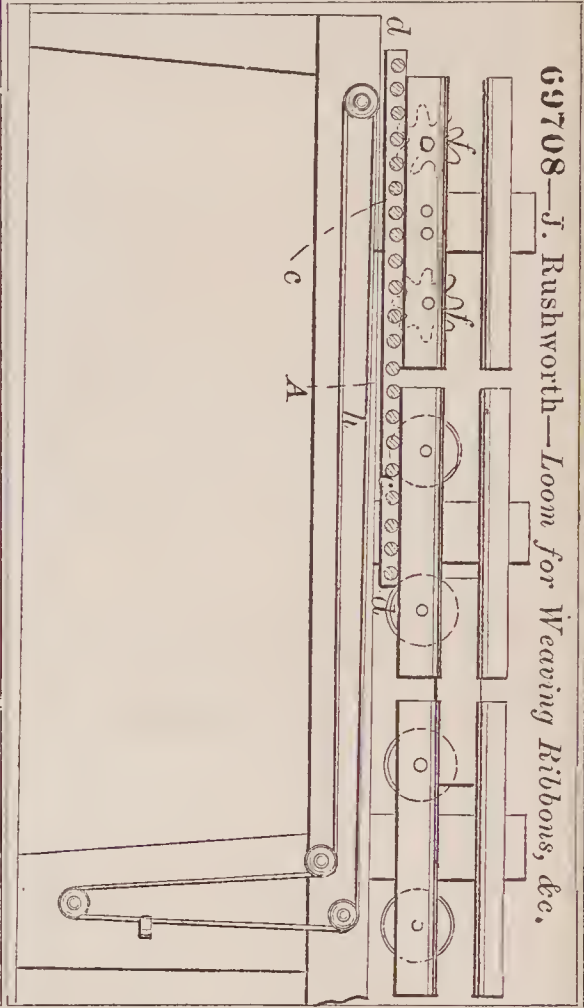

69712—Shipley & Moody—Horse Collar.

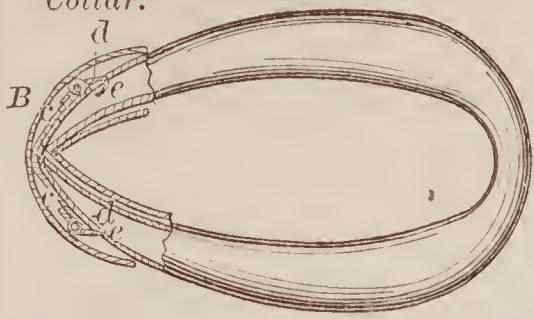

69716—F. Smith—Wagon Hound and Pole Brace.

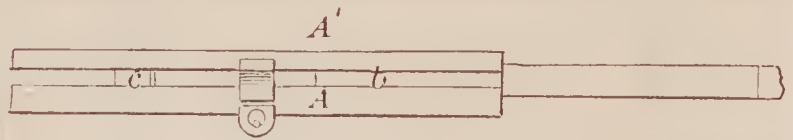

69714—Siemens & Halske—Spirit Meter.

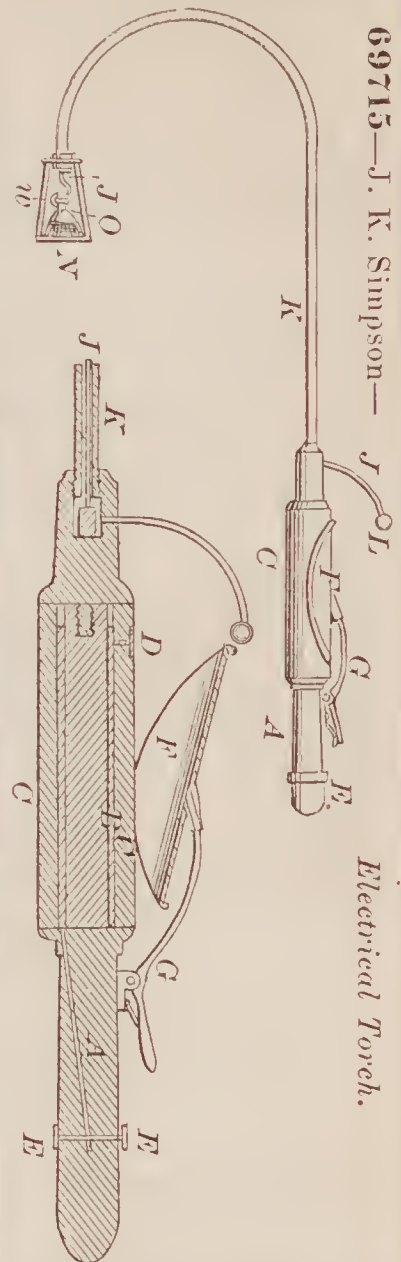
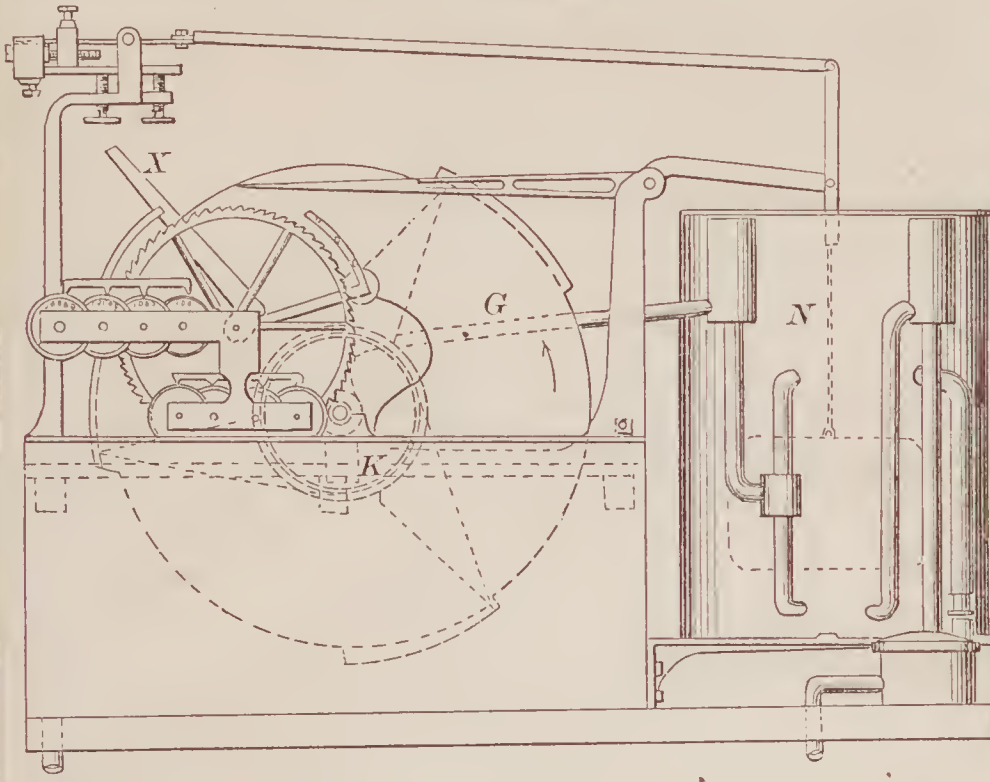

69715—J. K. Simpson—  
Electrical Torch.

69718—J. Smith—Churn Dasher.

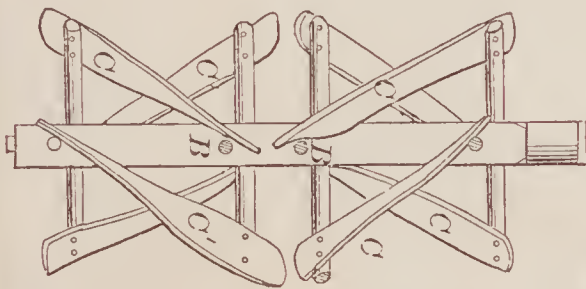

69713—J. H. Shireman—Horse Rake.

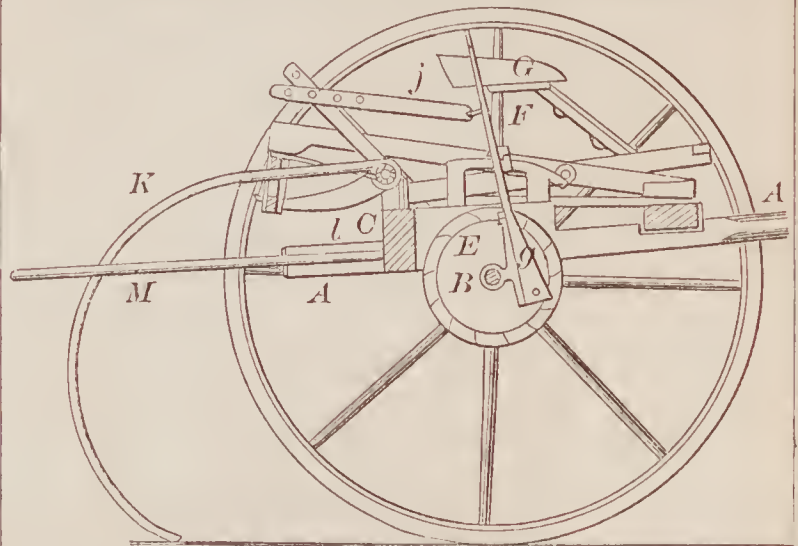

69719—Snell & Penney—Mechanical Movement.

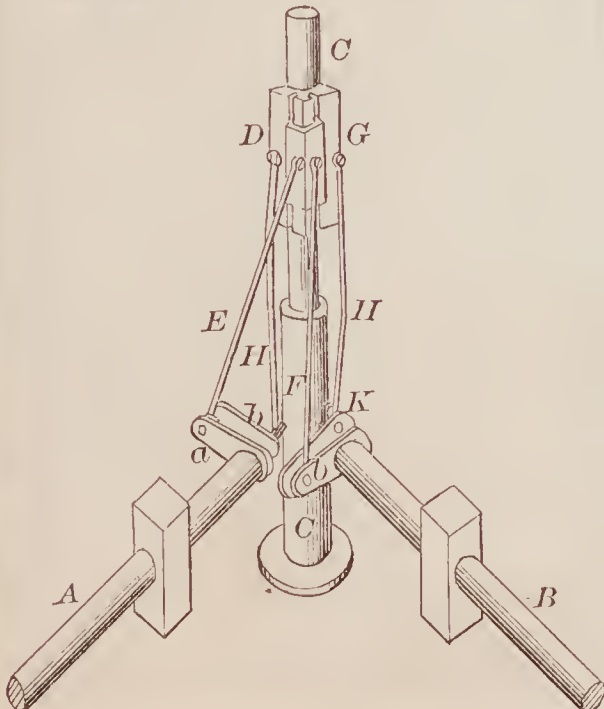

69717—H. W. & B. C. Smith—Sleigh Brake.

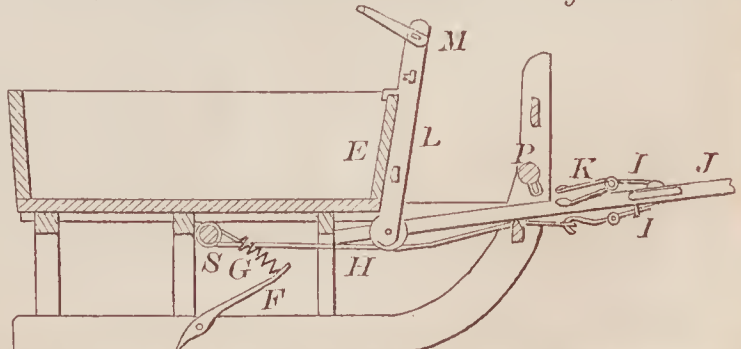



69720—H. Splittdorf—Armor for Horses' Hoofs.

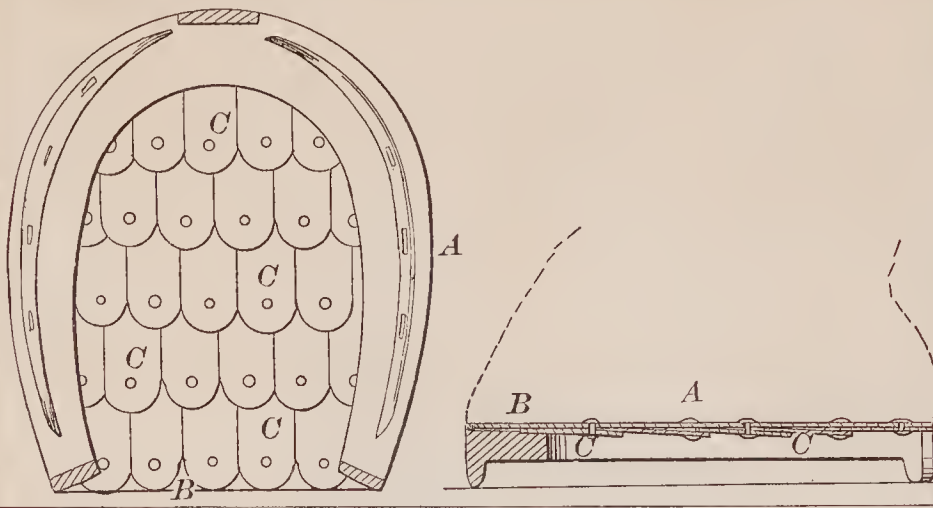

69722—J. E. Strode—Wagon Brace and Fender.

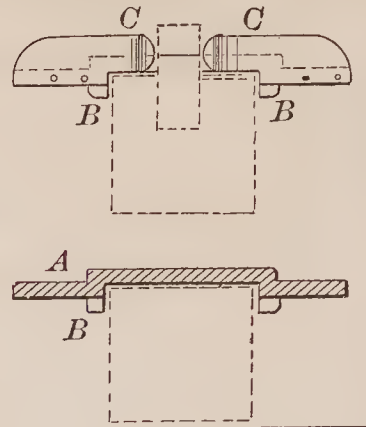

69721—Stover & Hutchinson—Cotton Press.

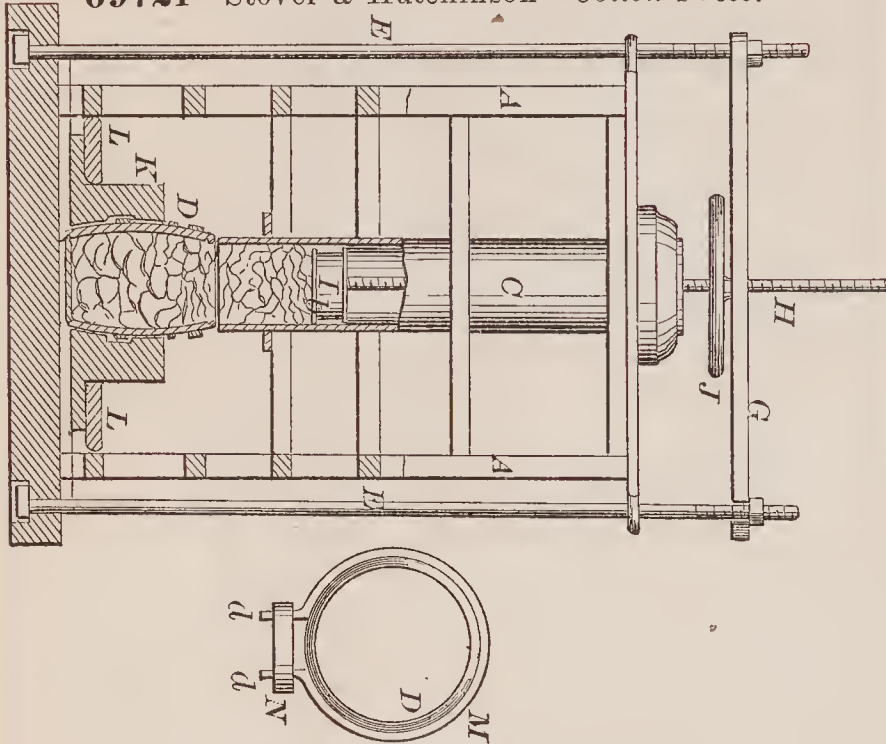

69723—J. B. Stryker—Metal Roofing.

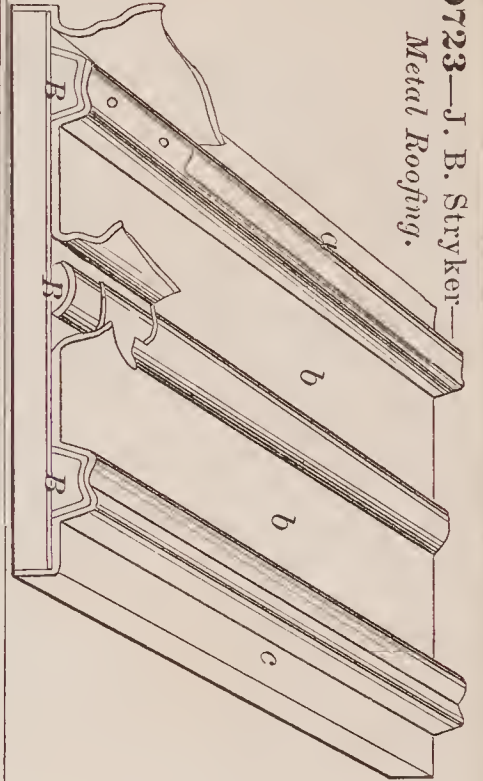

69724—Teelin & Swift—Sleigh Brake.

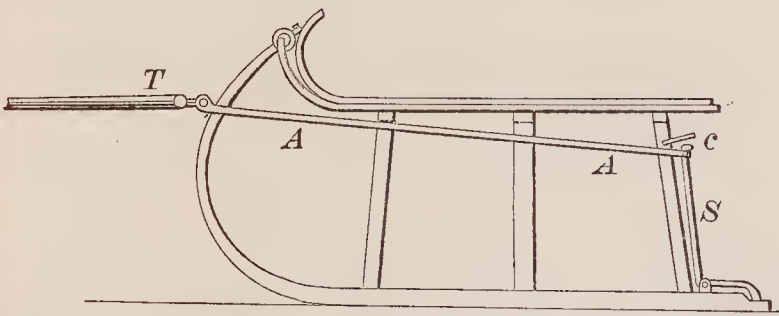

69726—J. Vail—Washing Machine.

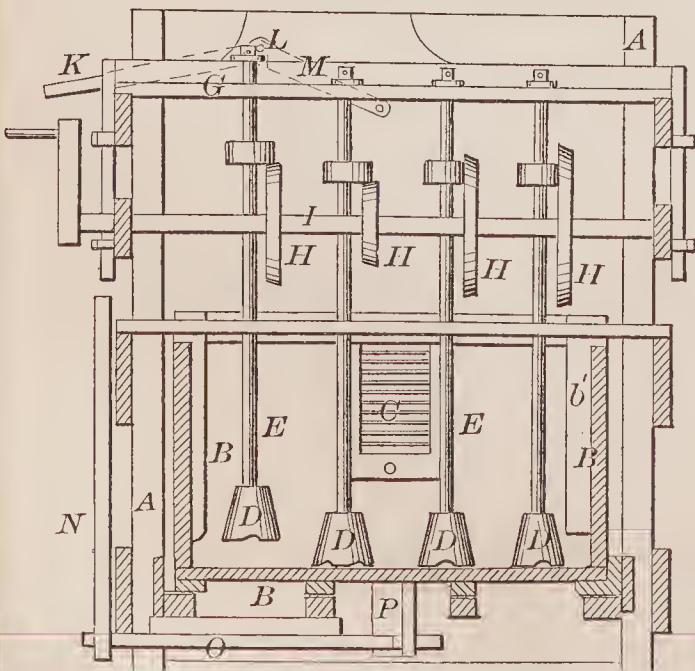

69725—Tuttle & Gans—Cultivator.

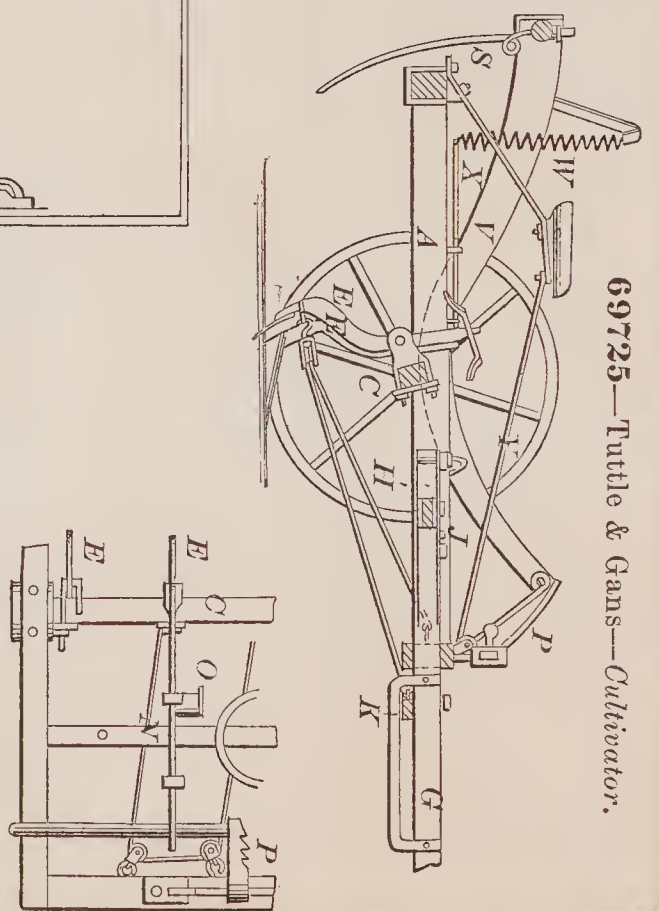



69727—R. M. Van Siekler—  
Crank, Friction Wheel and  
Brake.

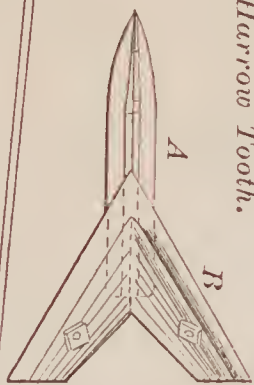
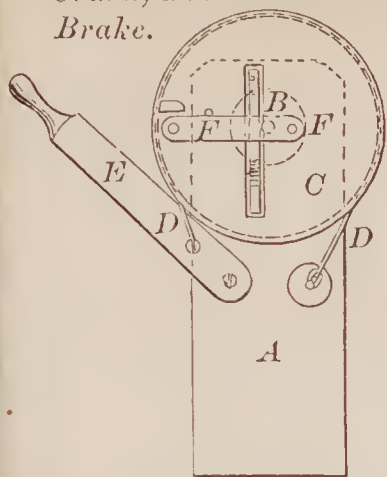

69731—West & Paul—Cultivator  
and Harrow Tooth.

69730—C. Weaver—Faucet.

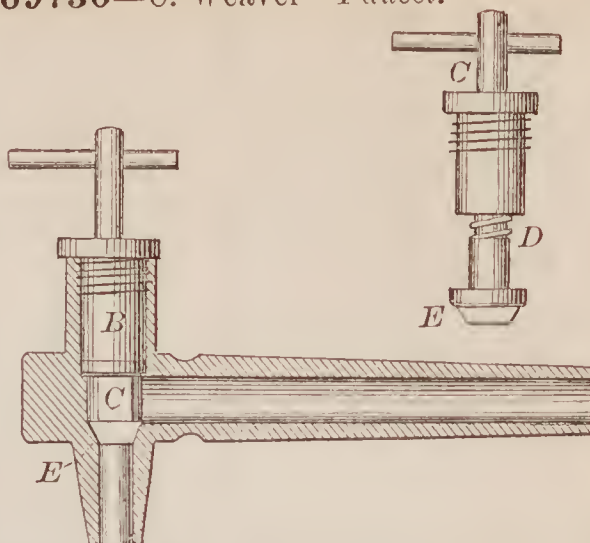

69728—F. Voegtli—Spinning Machine

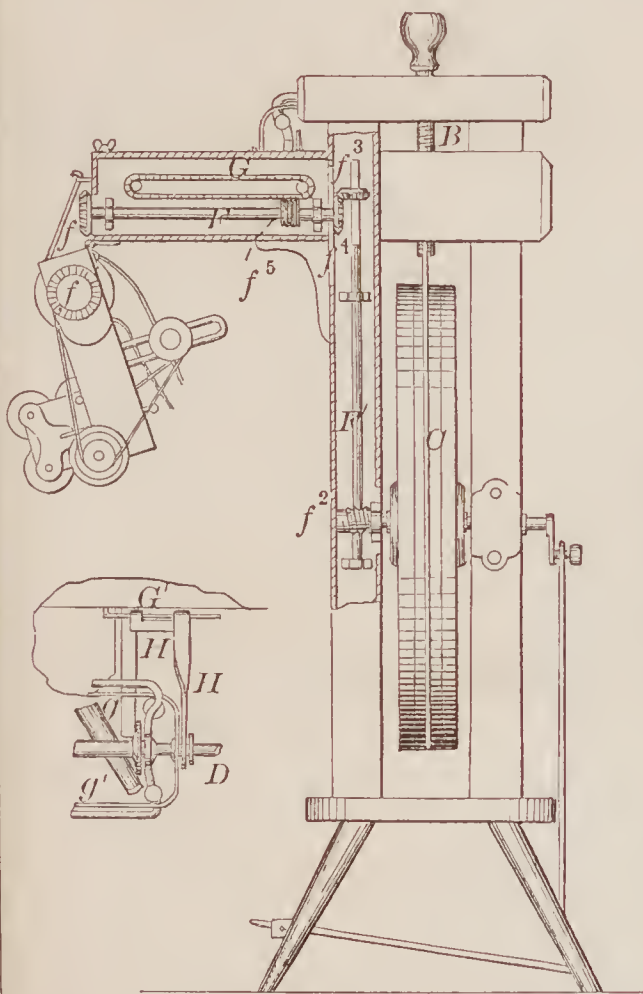
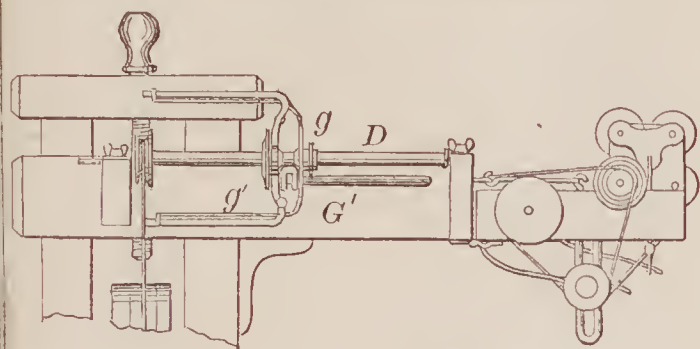

69732—C. Wheeler, Jr.—Harvester.

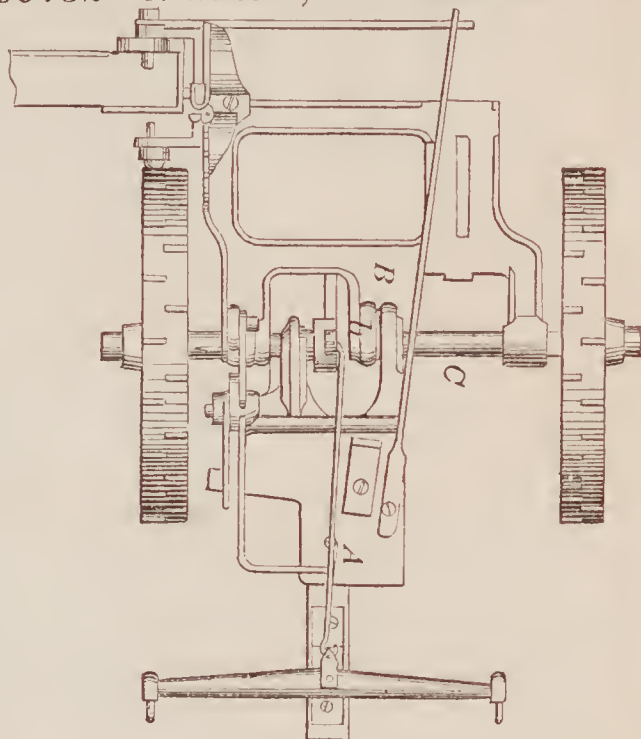

69733—T. Whittemore—Railway.

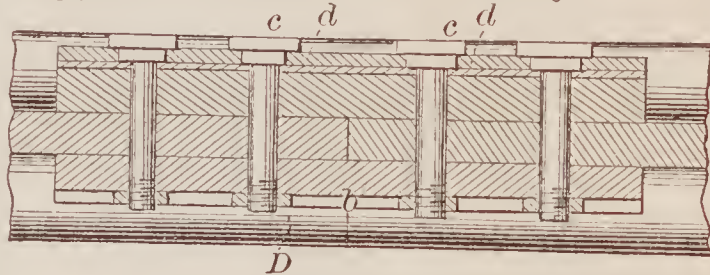

69729—J. C. Walker—Hot Air,  
Steam and Water Gauge.

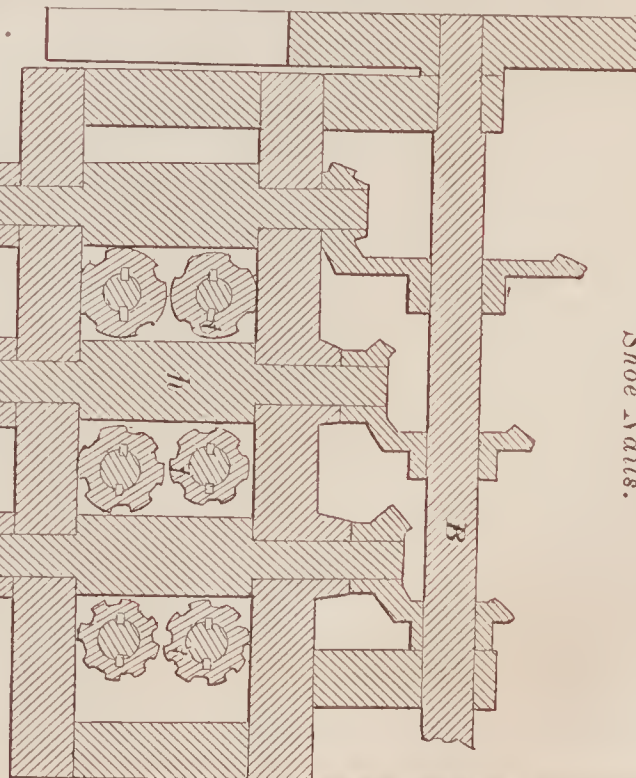
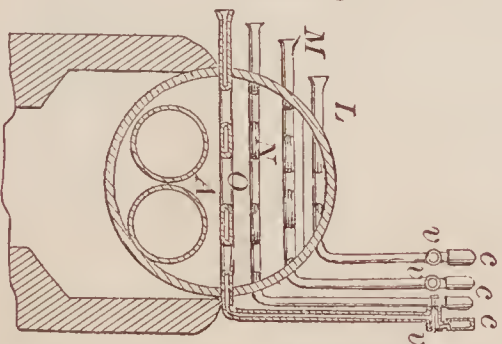

69734—W. Wickersham—For Making Horse  
Shoe Nails.





69741—Allen & Snow—*Railroad Switch.*

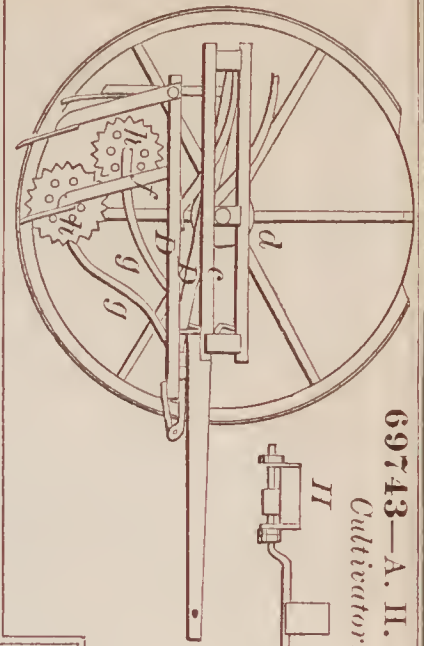
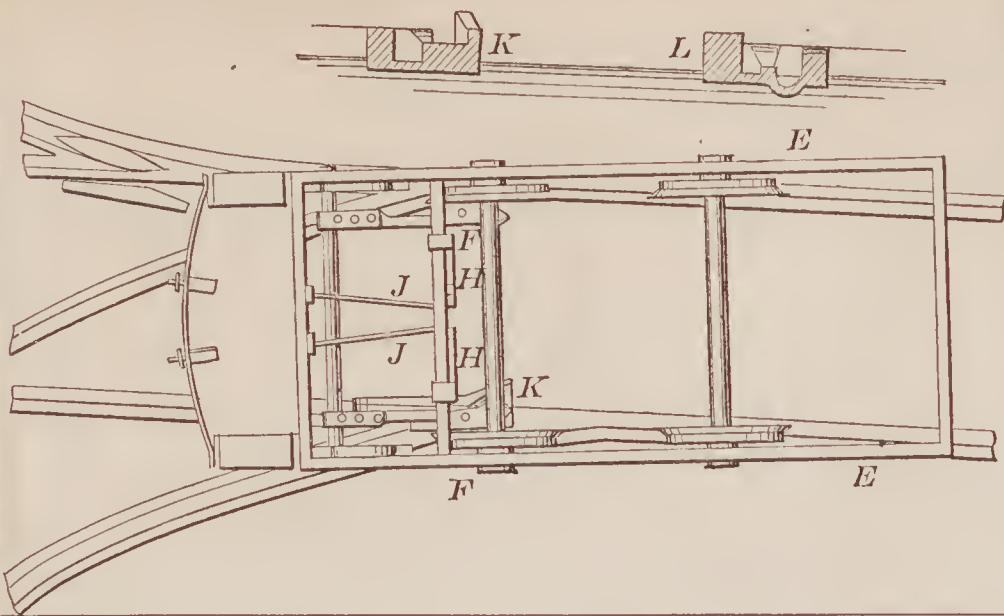

69743—A. H. Allison—*Cultivator.*



69744—L. Anderson—*Saw Mill.*

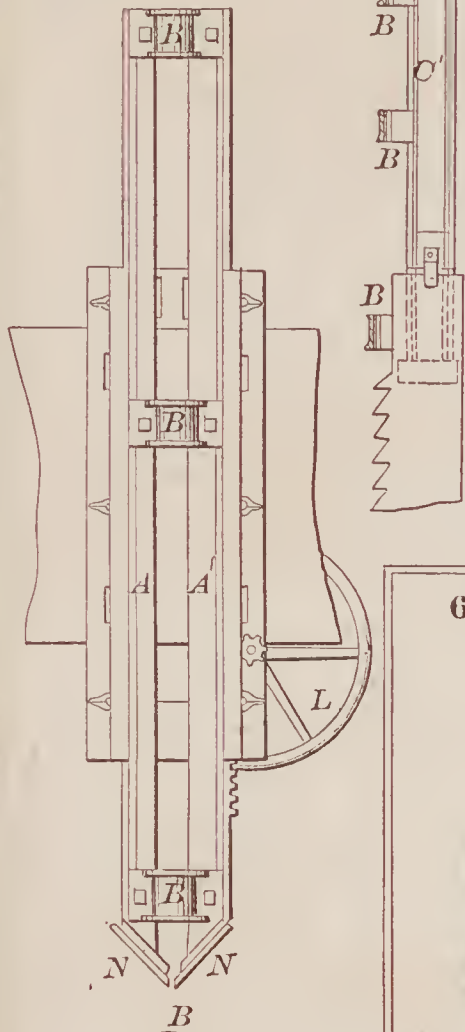

69745—S. Andrews—*Safety Valve for Oil Stills.*

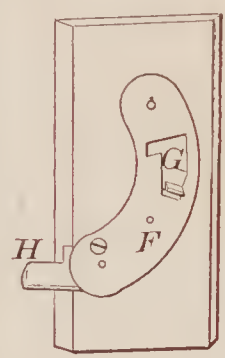
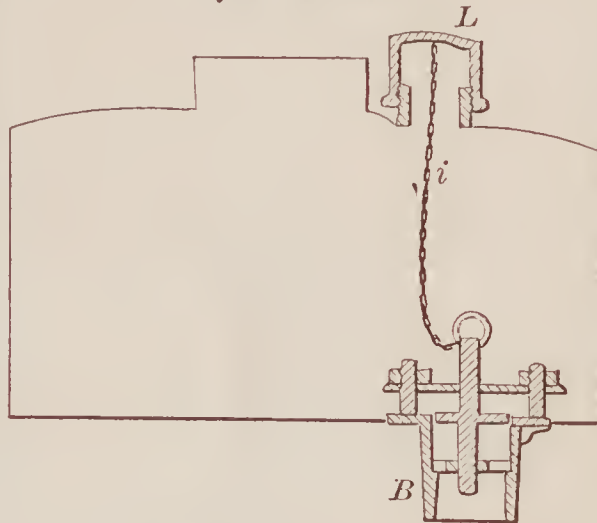

69746—H. G. Arnold—*Window Sash Fastener.*

69747—M. W. Baily—*Piston Packing.*

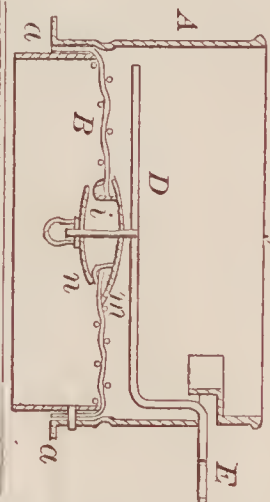
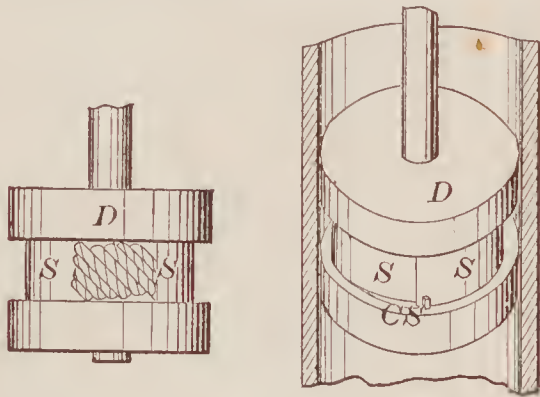

69748—D. W. Barker—*Ash Sifter.*

69749—J. Bea—*Cart Saddle.*

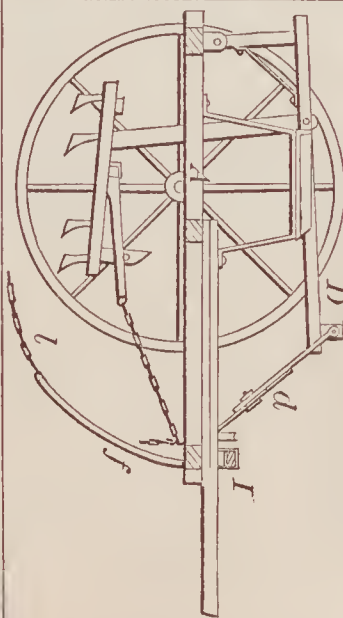
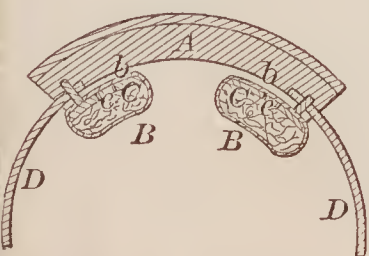

69750—Beam & Tyson—*Cultivator.*

69751—Bernhardt & Houston—*Washing Machine.*

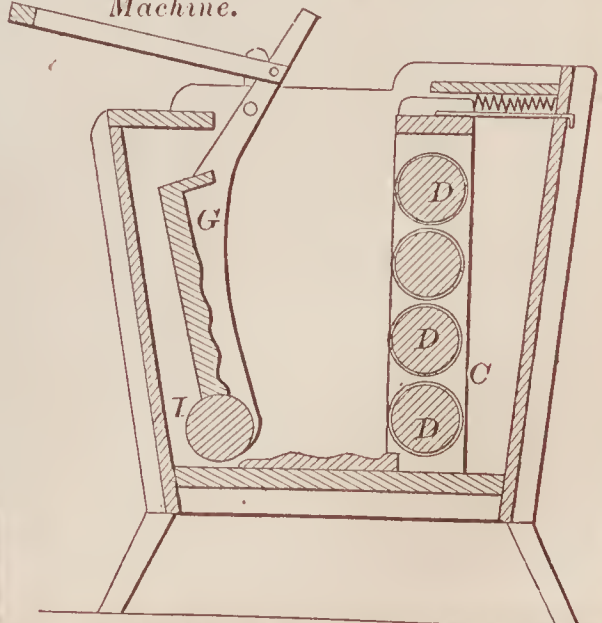



69753—A. H. Boyd—For Locking Doors and Windows.

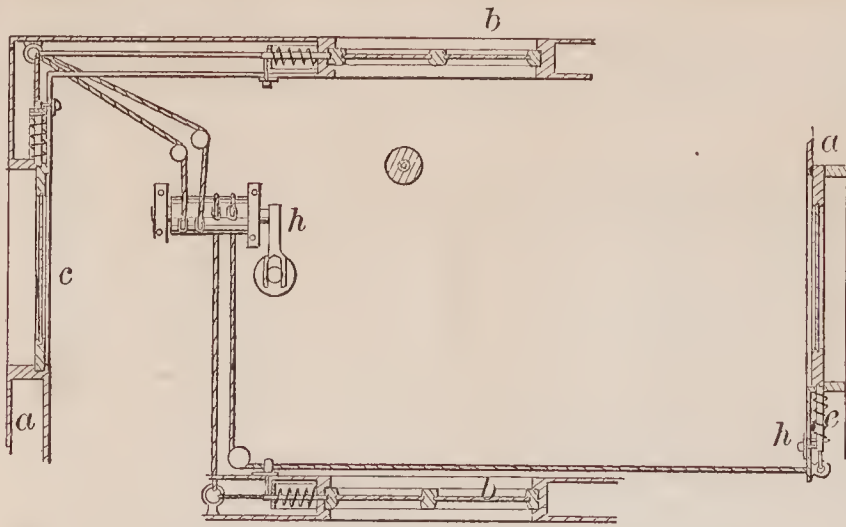

69754—A. N. Breneman—Shoe Holder.

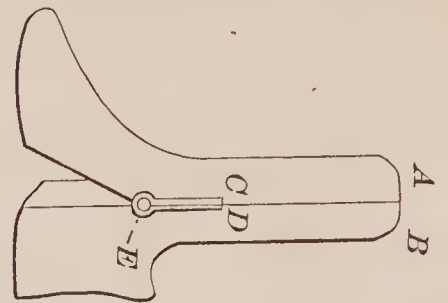

69755—J. H. Briggs—Comb.

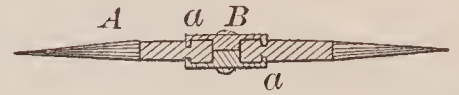

69756—Brooks & Munson—Pump and Measure.

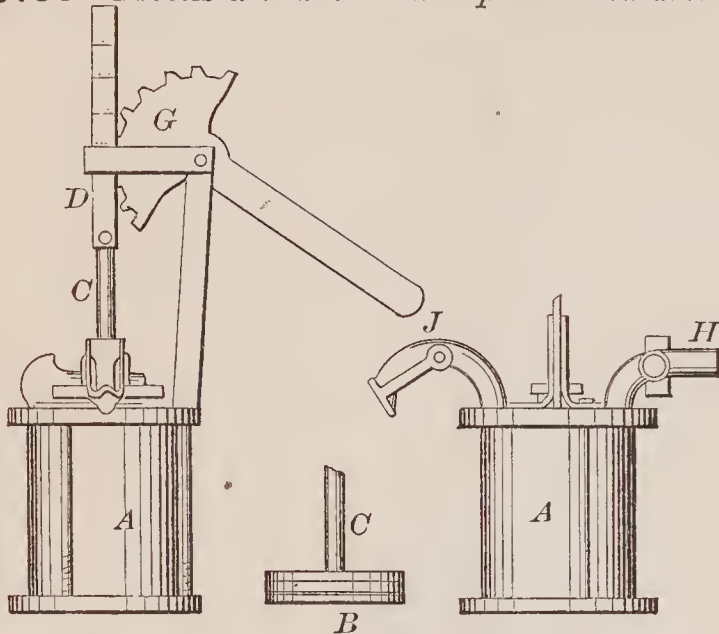

69758—G. Bruce—Pump.

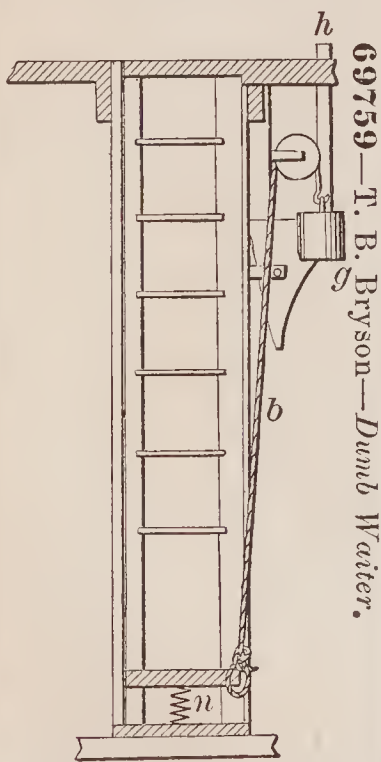
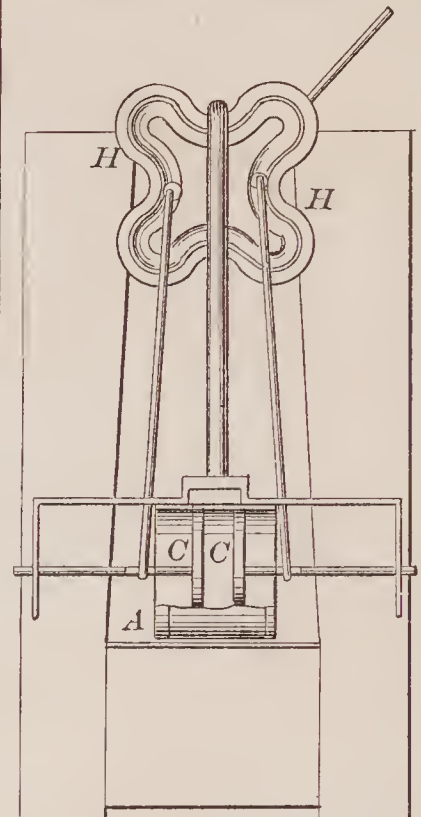

69759—T. B. Bryson—Dumb Waiter.

69757—R. Brooks, Jr.—Carriage Wheel.

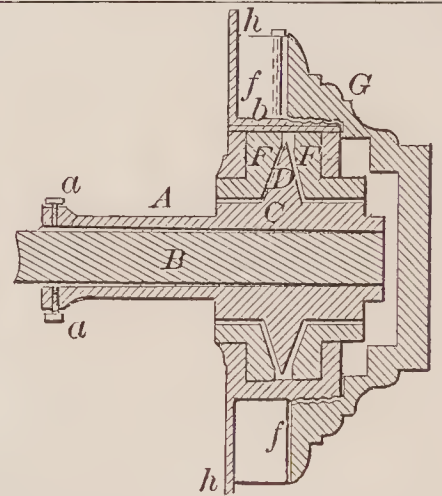
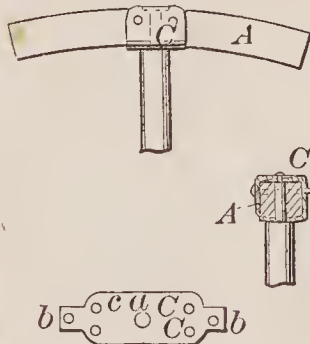

69760—D. M. Buckhout—Hub and Axle for Vehicles.

69763—H. G. Cady—Pump Valve.

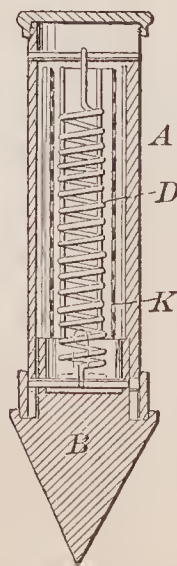
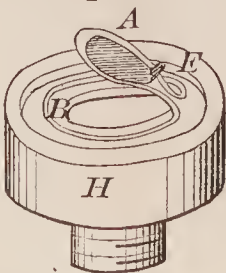

69762—H. G. Cady—Well Point.

69761—G. E. Burt—Hay Spreader.

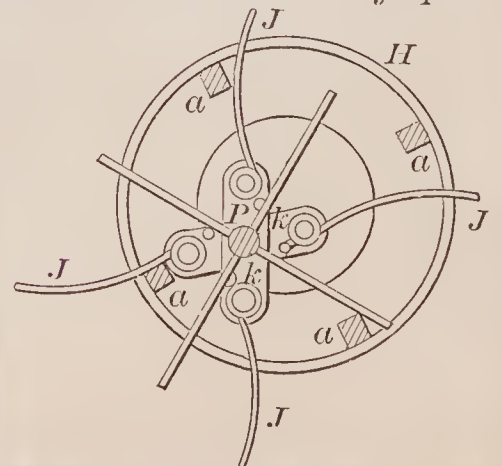

69764—A. Campbell—Hay Raker and Loader.

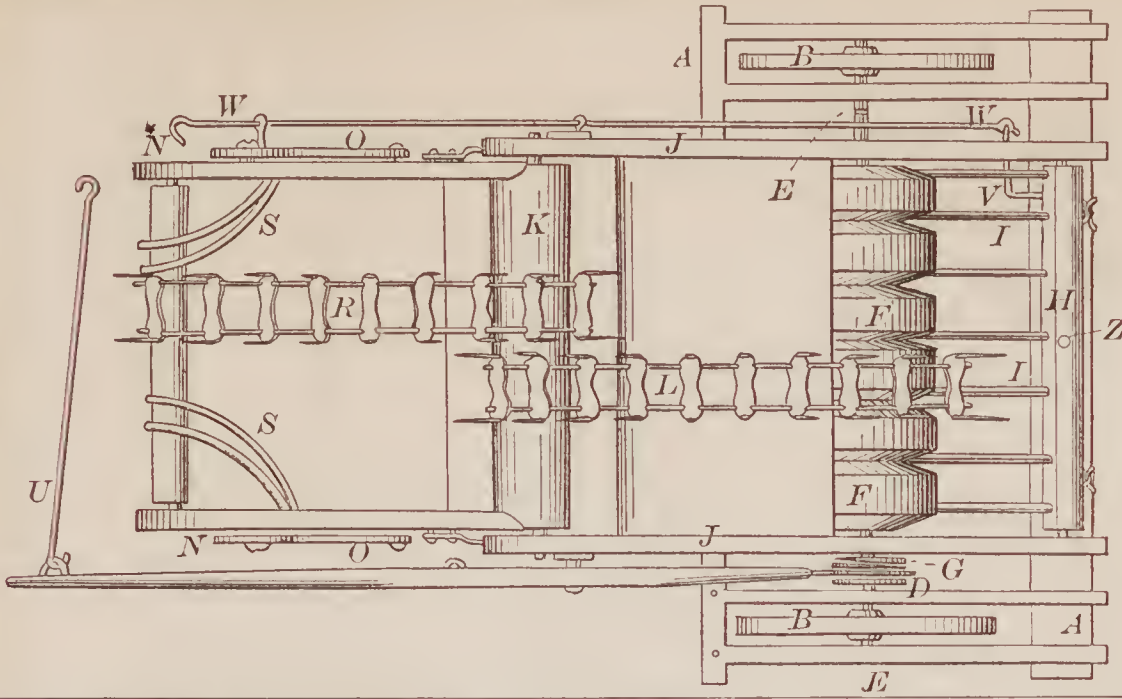

69766—E. Carrington—Drapery Hook.

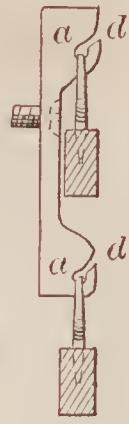

69765—M. B. Carleman—Vapor Bath.

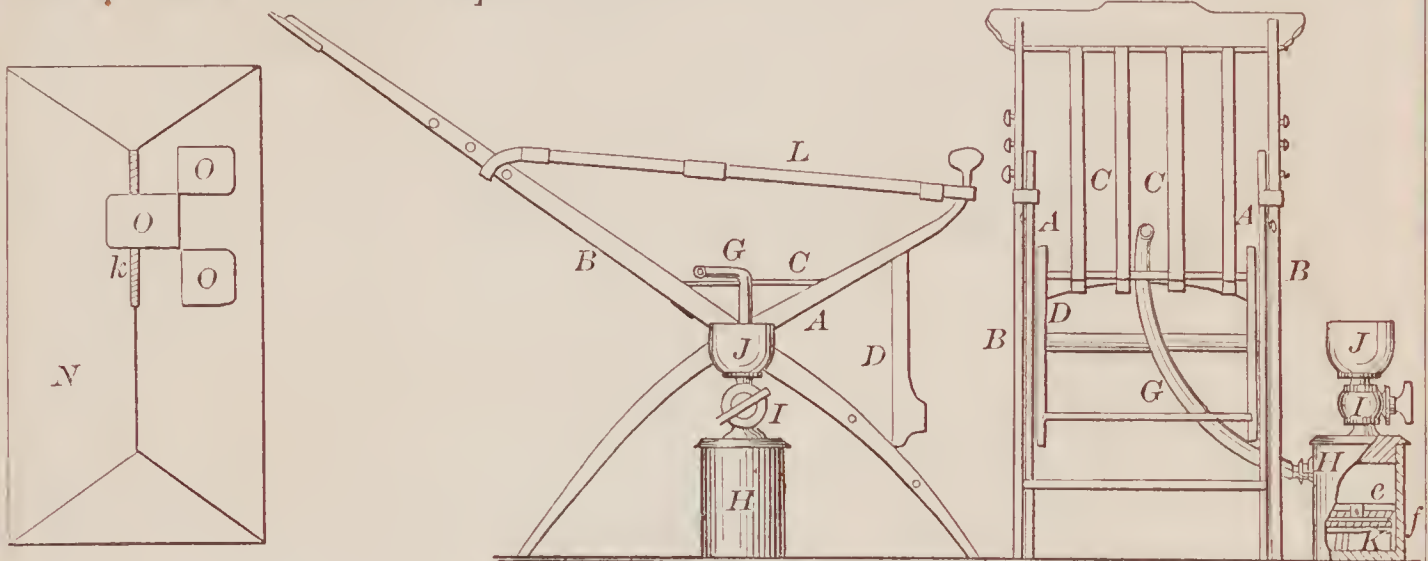

69767—A. J. Chase—Rope or Line Holder.

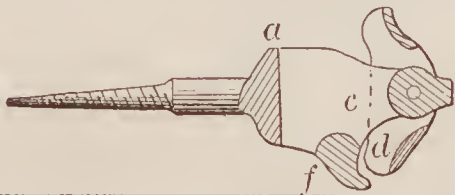

69768—L. C. Chase—Blanket Fastener.

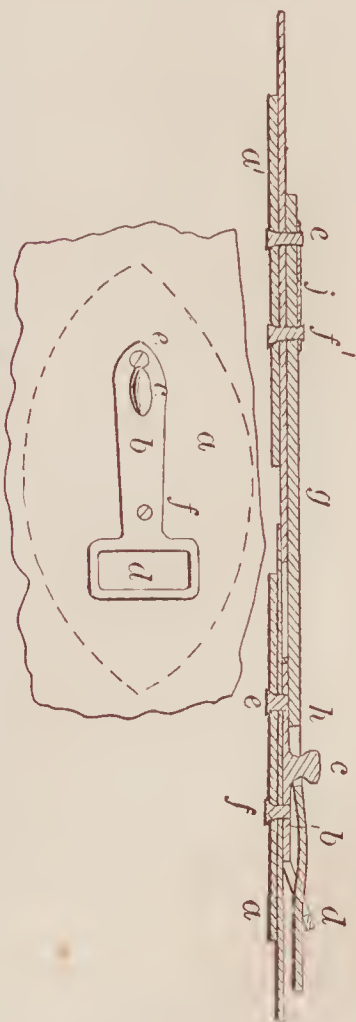

69770—C. C. Clapp—For Turning the Leaves of Books.

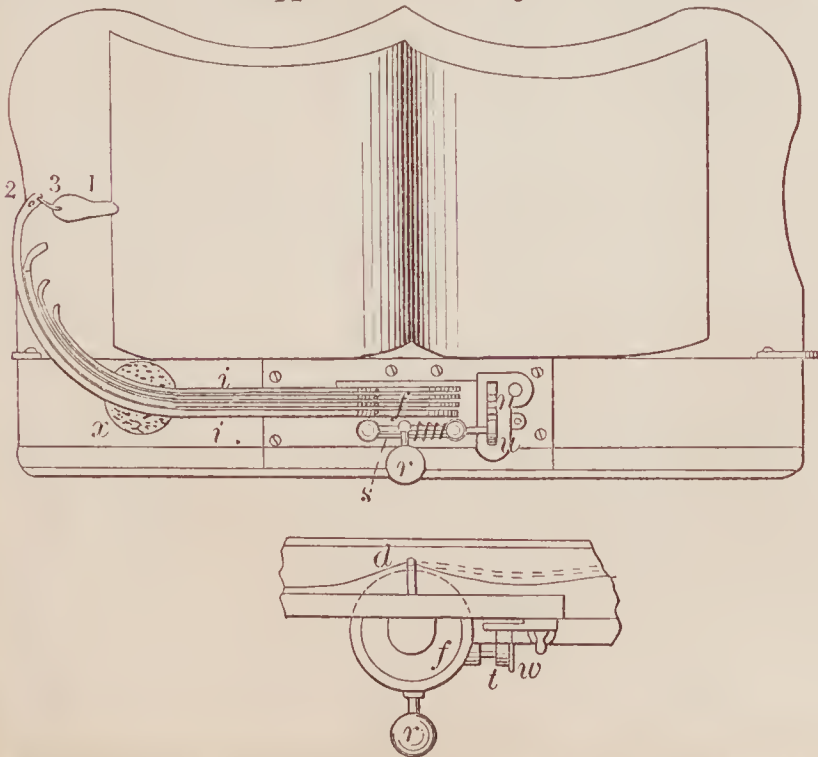



69771—L. C. Clark—Trace Fastening.

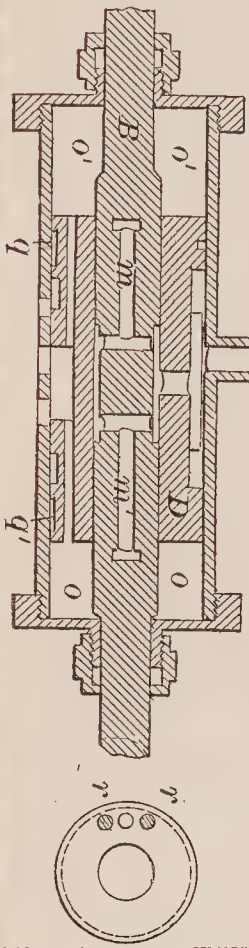
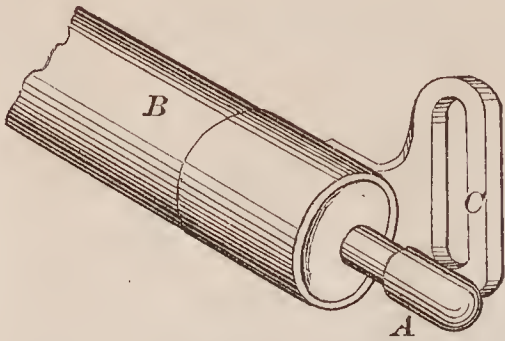

69772—J. Colbath—Valve for Steam Engines.

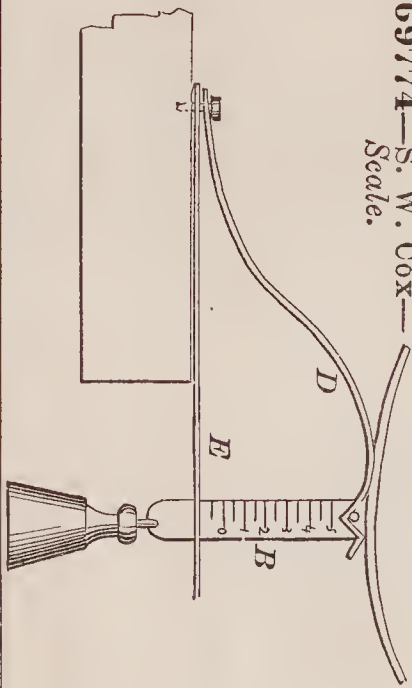

69774—S. W. Cox—Scale.



69773—J. E. Cowdery—Sash Frame.

69777—J. Curtis—Animal Trap.

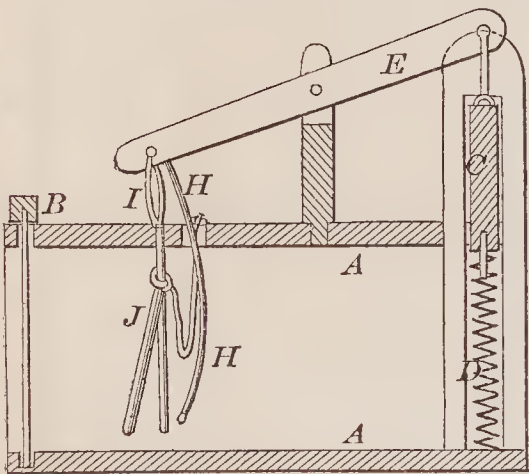

69776—T. Crane—Knitting Machine.

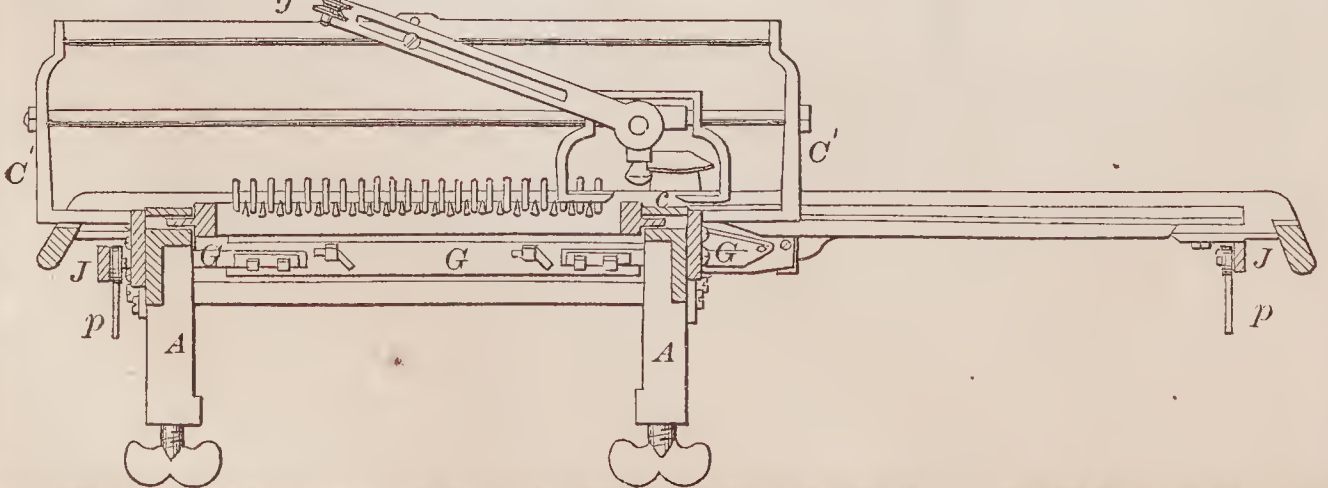

69775—T. Crane—Knitting Machine.

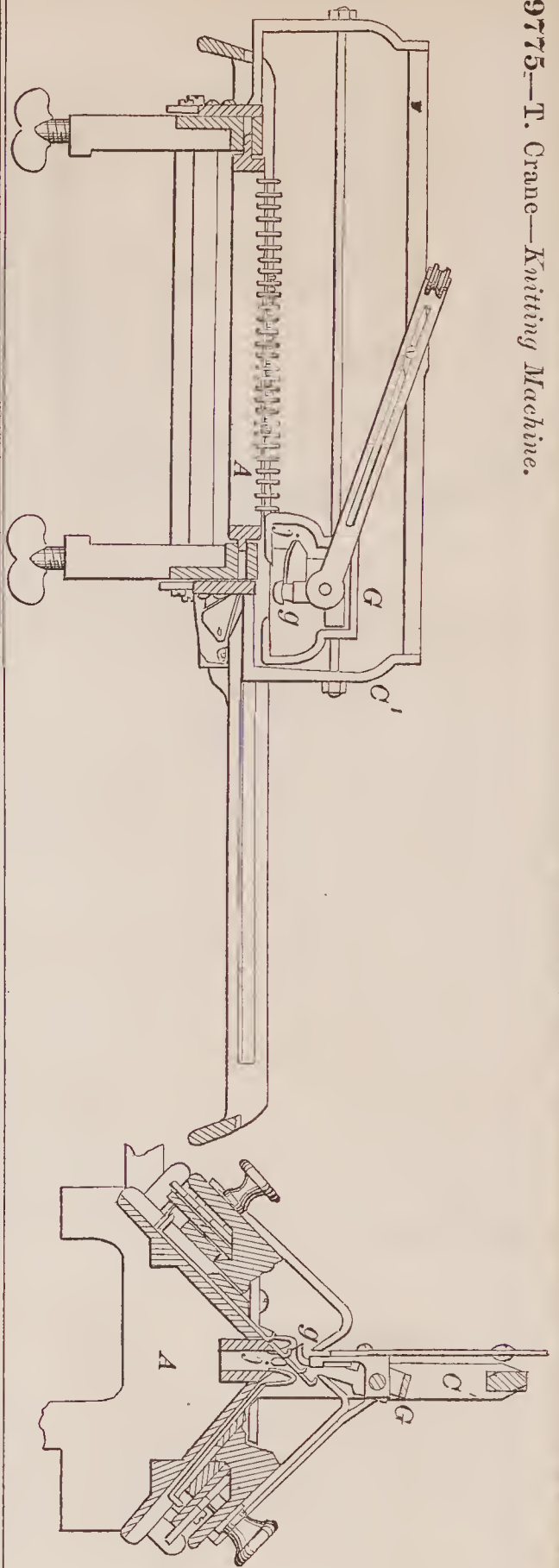

69778—M. S. Curtis—Hose Coupling.

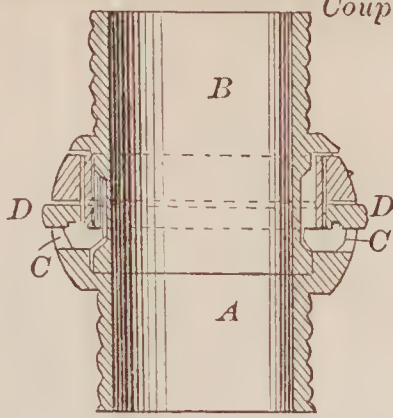

69781—G. S. Deane—Arch Bar for Furnaces.

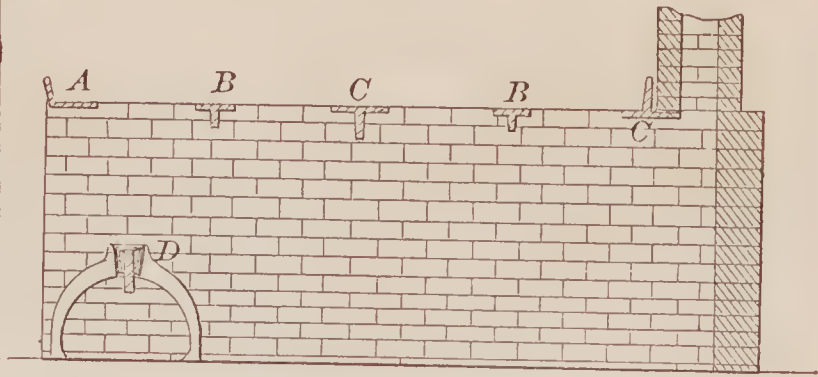

69779—W. F. Daugherty—Bed Bottom.

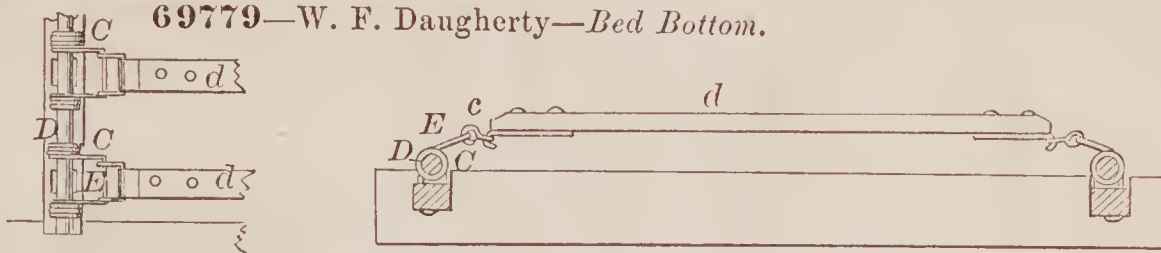

69780—J. Day—Broom Clamp.

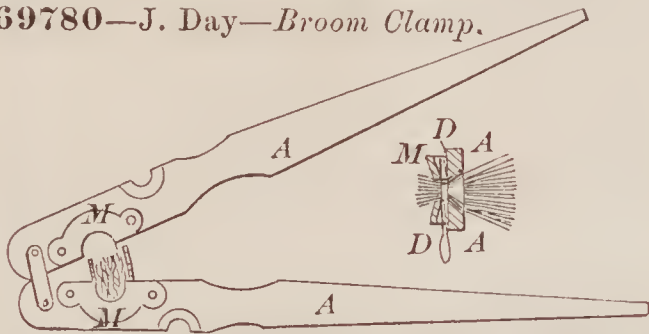

69782—T. B. Dexter—Steam Gauge Cock.

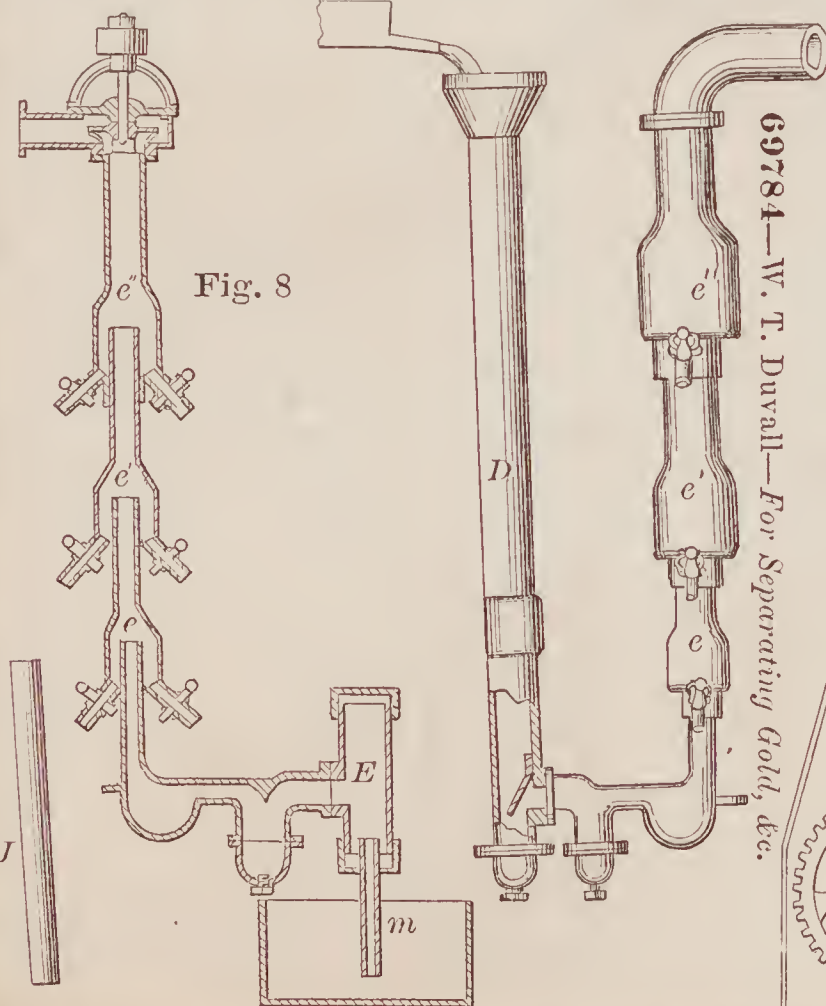
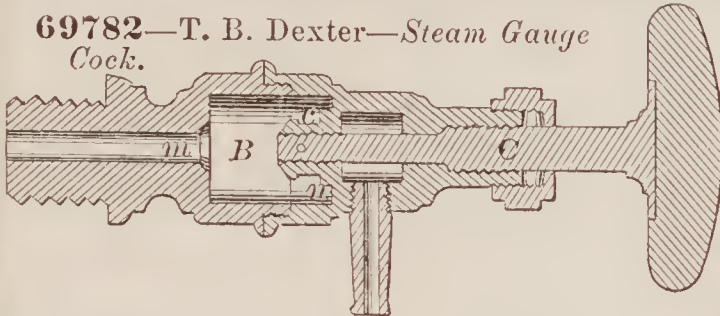

69784—W. T. Duvall—For Separating Gold, etc.

69786—D. Eynon—For Slotting the Lips of Railroad Chairs.

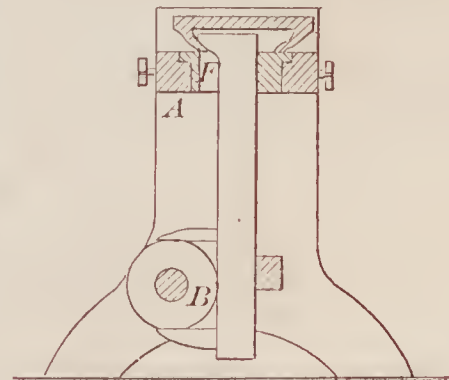

69787—L. B. Flanders—For Transmitting Rotary Motion.

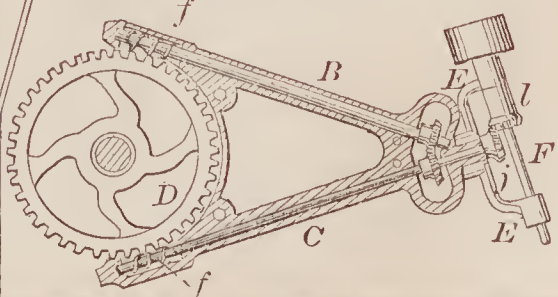

69785—J. R. Everson—Grain Dryer.

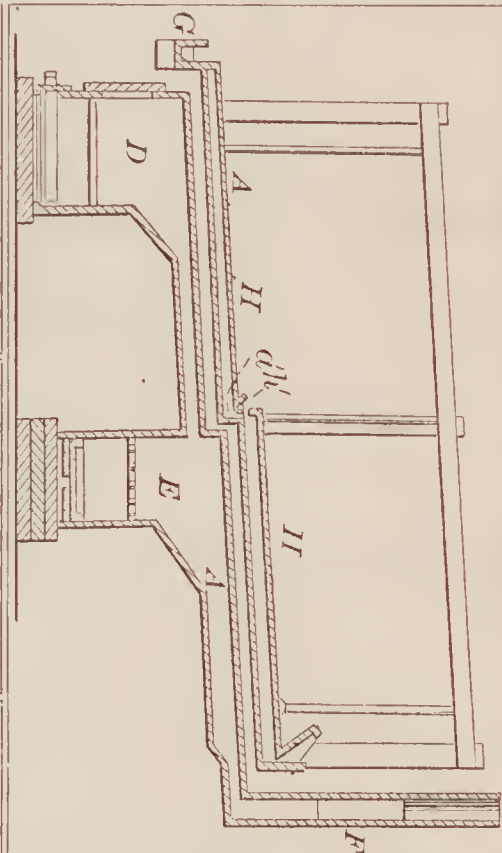



69788—D. Flint—Gate.

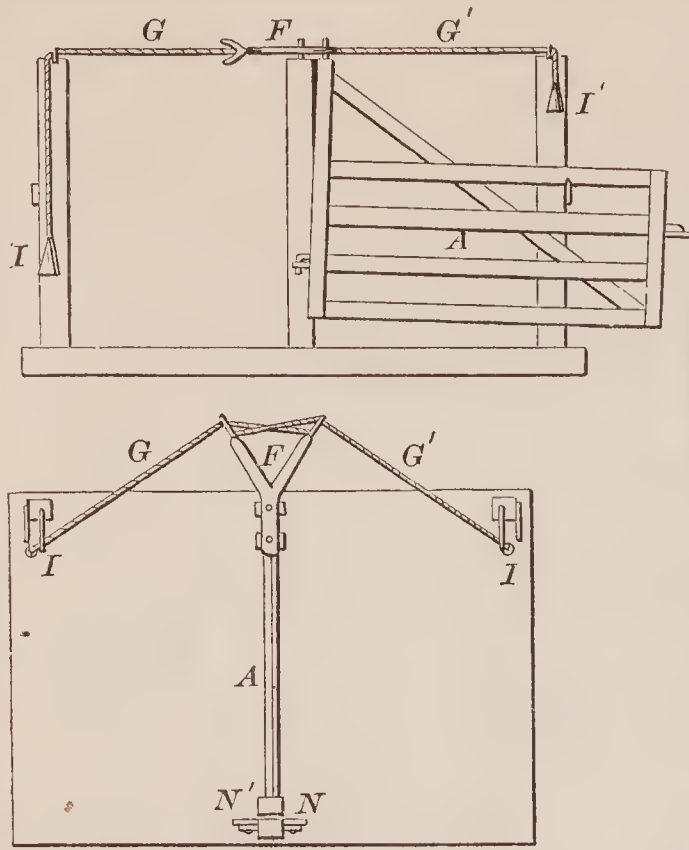

69790—H. R. Foote—Furnace for Steam Boilers, &c.

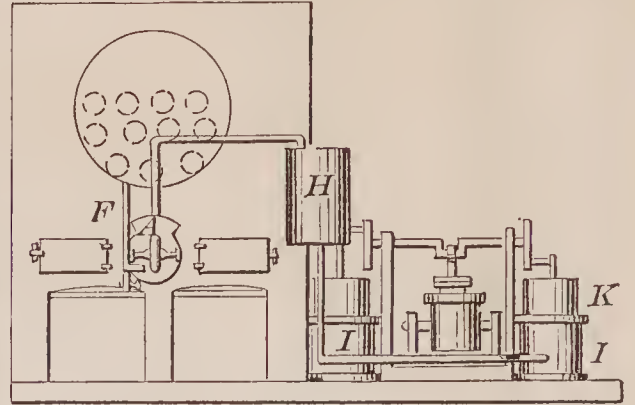

69791—I. L. Frankem—Damper.

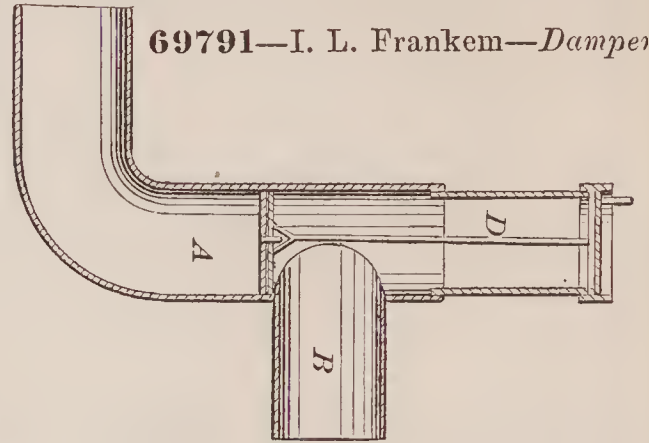

69789—E. F. Flood—Wagon Reach.

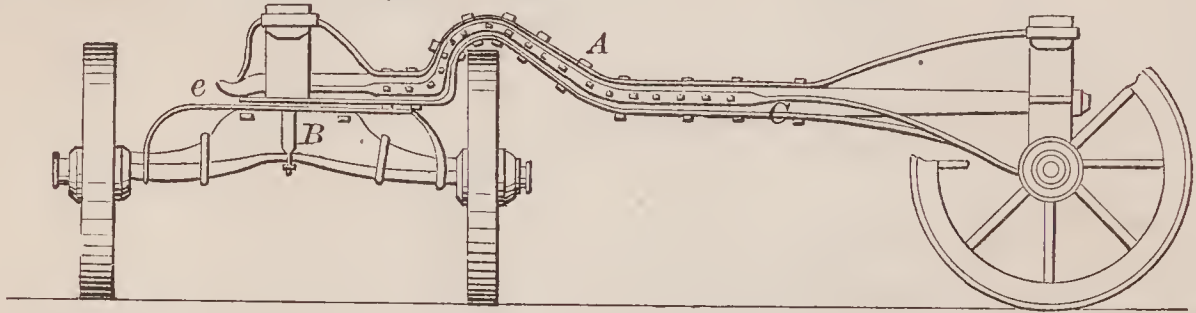

69793—J. N. Gaston—Buckle.

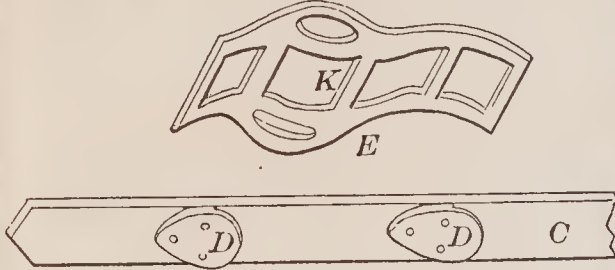

69794—A. Godfrey—Hay Raker and Loader.

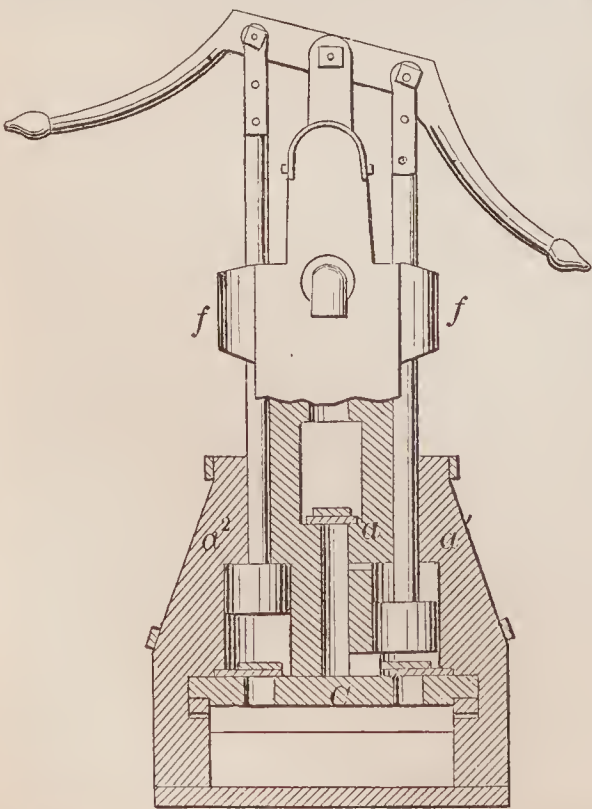
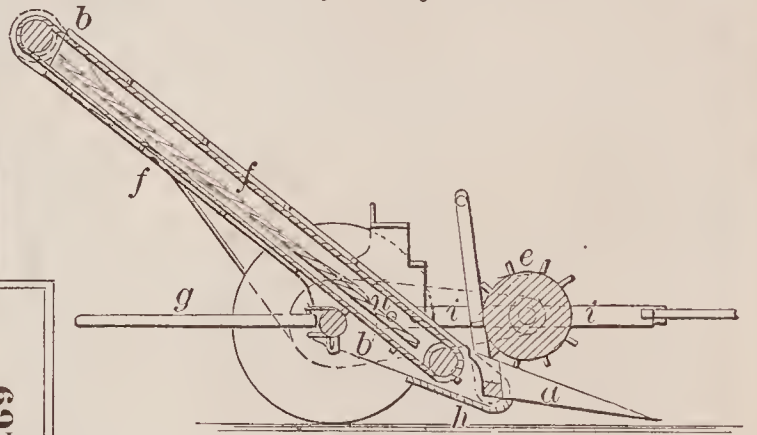

69792—W. A. Fry—Pump

69795—M. C. Gordon—Churn.

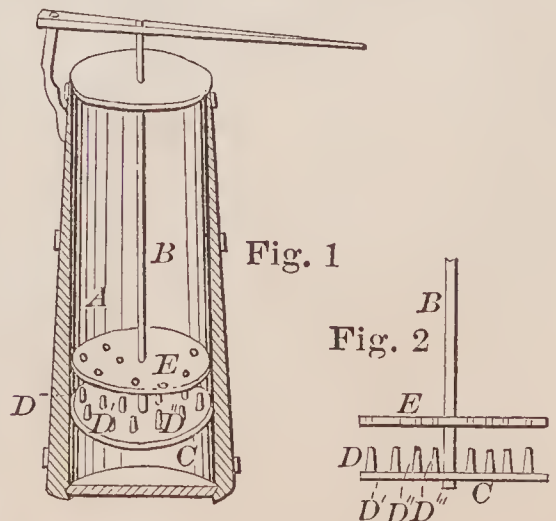

69797—M. Gould—For Cooling Liquids.

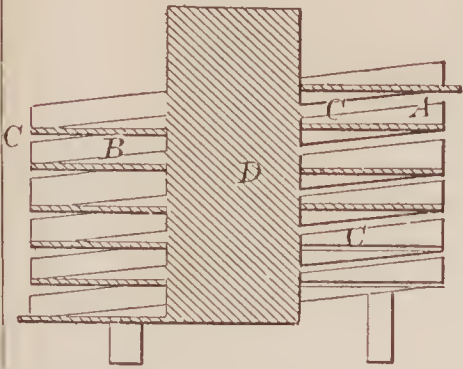

69798—J. Grabner—Heat Radiating Attachment.

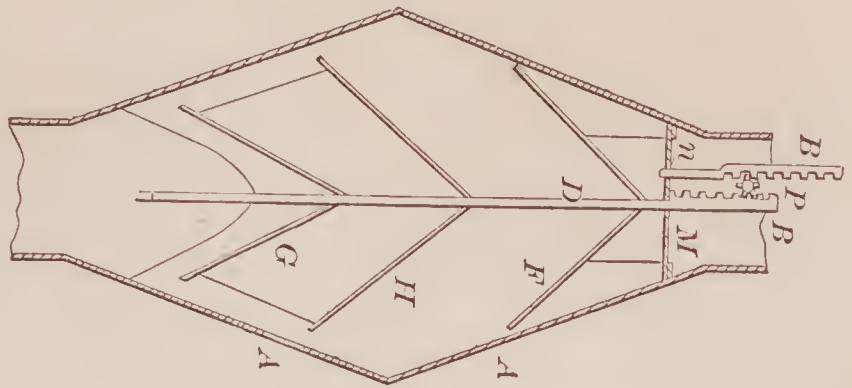

69802—Harrell & Hall—Self-Acting Fly Fan.

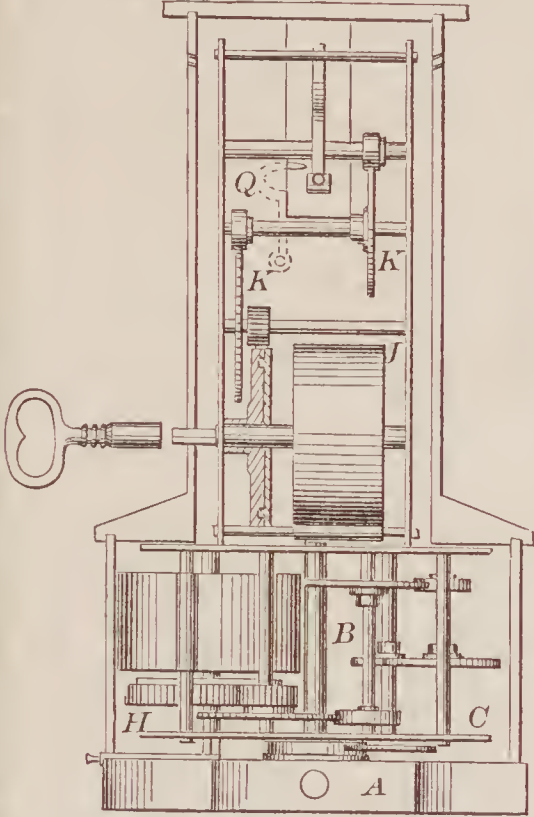

69800—J. T. Green—Door Plate and Letter Box.

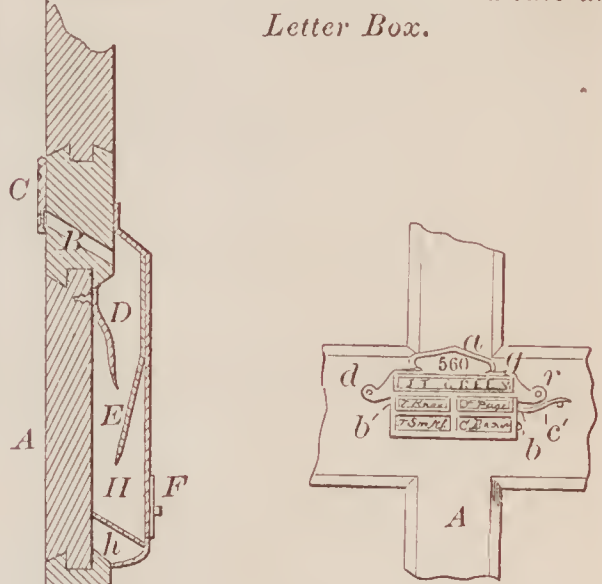

69799—J. G. Greene—Panel Table.



69804—T. S. Harris—Wagon Jack.

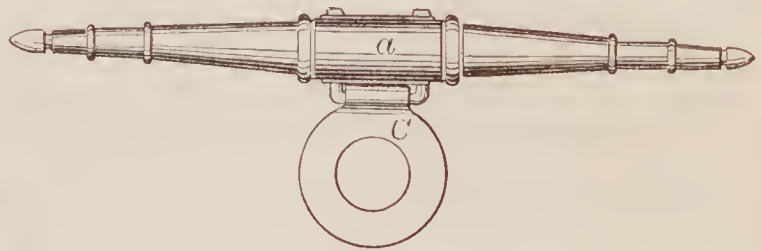

69801—D. Guptail—Cultivator.

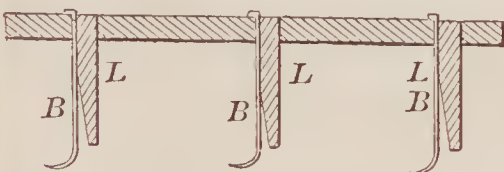

69803—C. A. Harris—Garden Plow Cultivator.

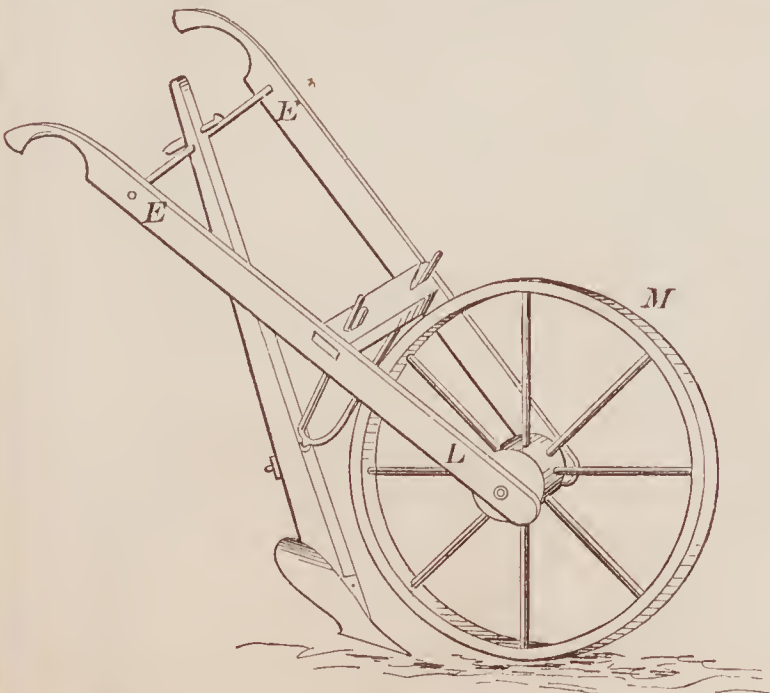

69805—T. Heaton—Carriage Tongue Holder.

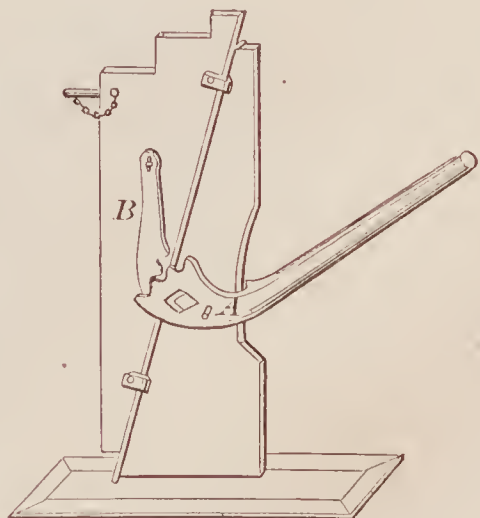



69806—N. Hellings—For Preserving Fruit.

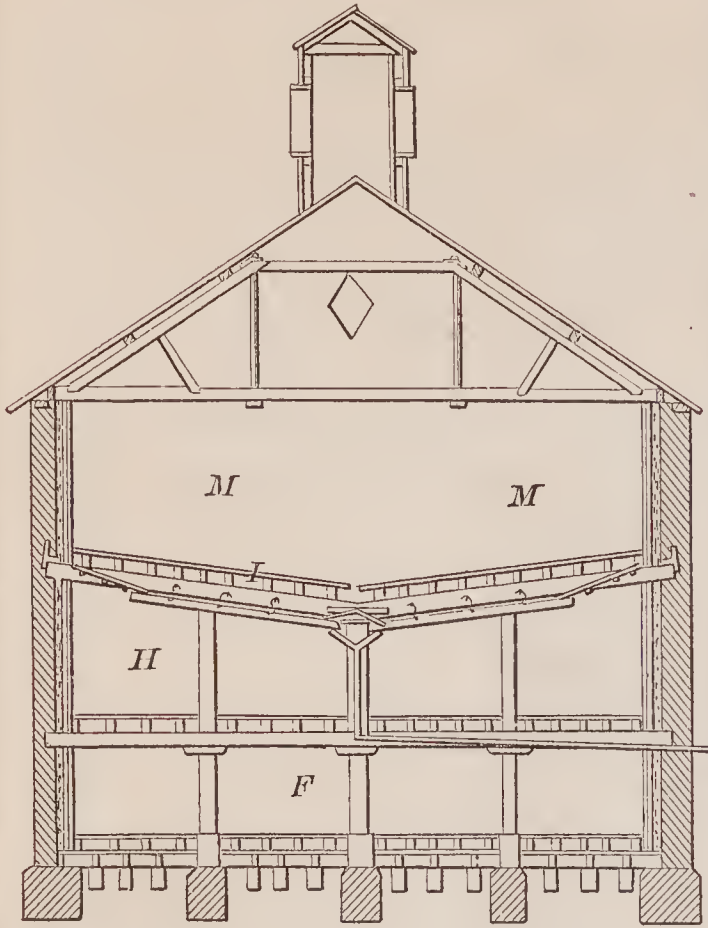

69807—Hoke & Brown—Baling Press.

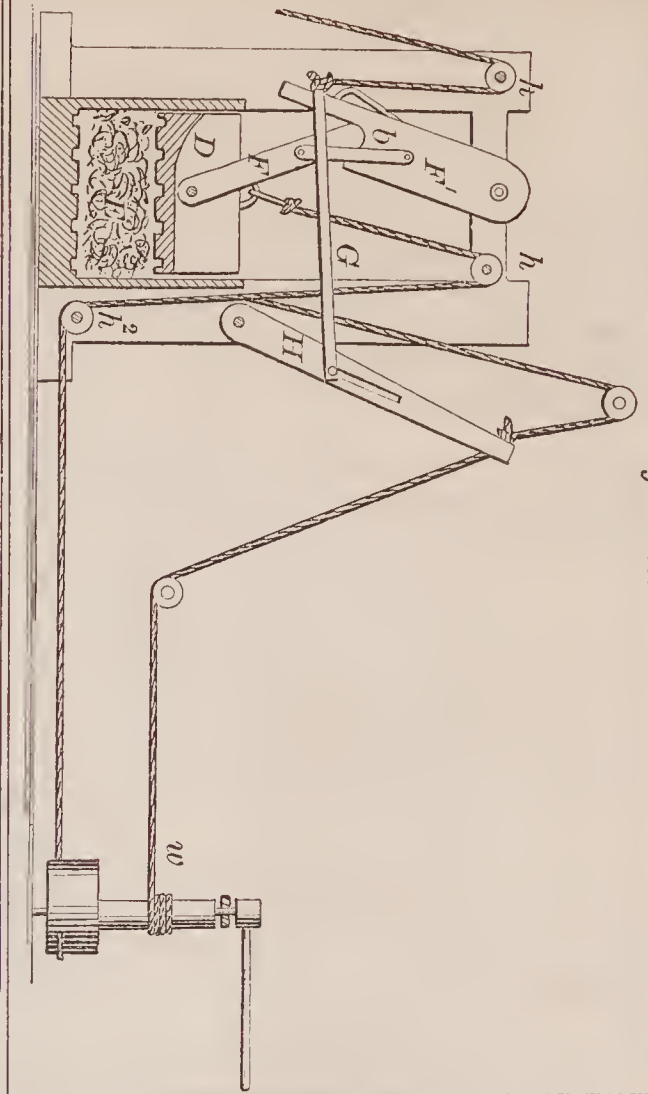

69808—A. W. Hopkins—Metallic Chair.

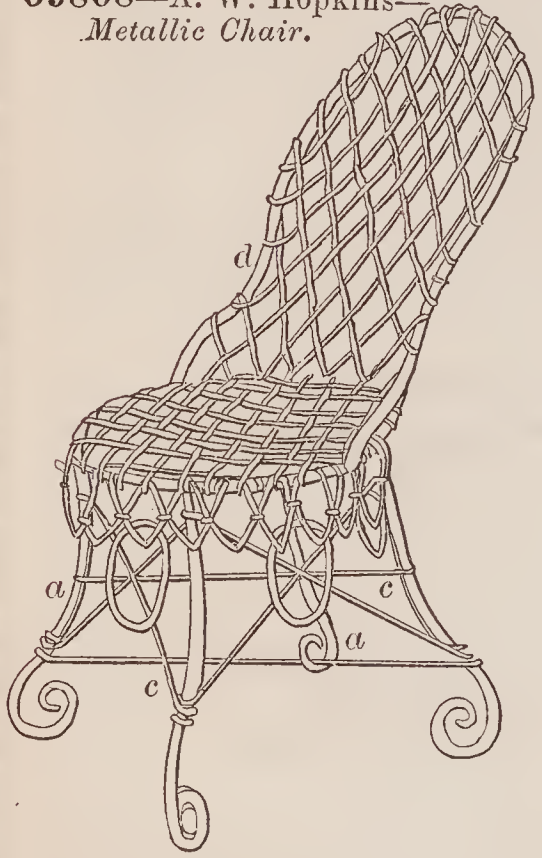

69809—D. S. Humphrey—Farm Fence.

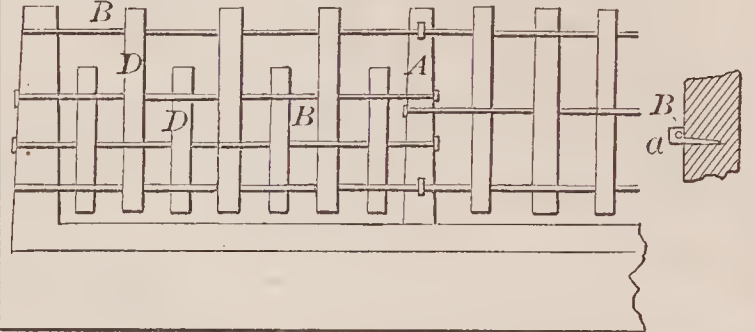

69812—J. C. Jewett—Refrigerator.

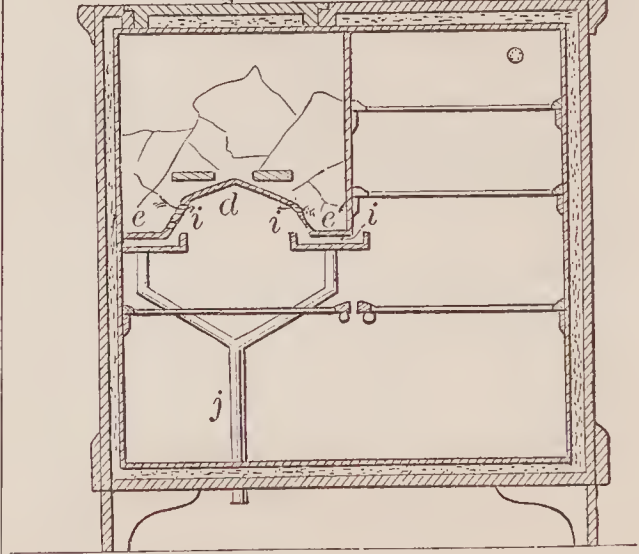

69810—J. Hunt, Jr.—Wagon Jack.

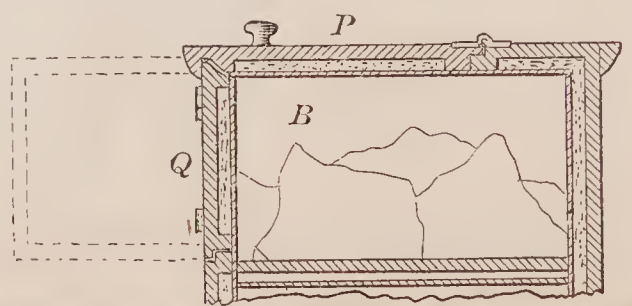
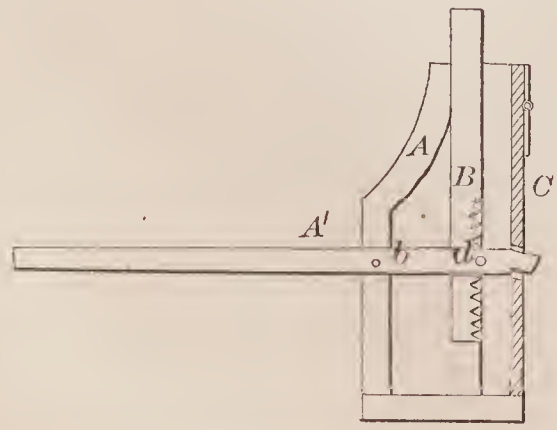

69813—J. Johansen—Mangle.

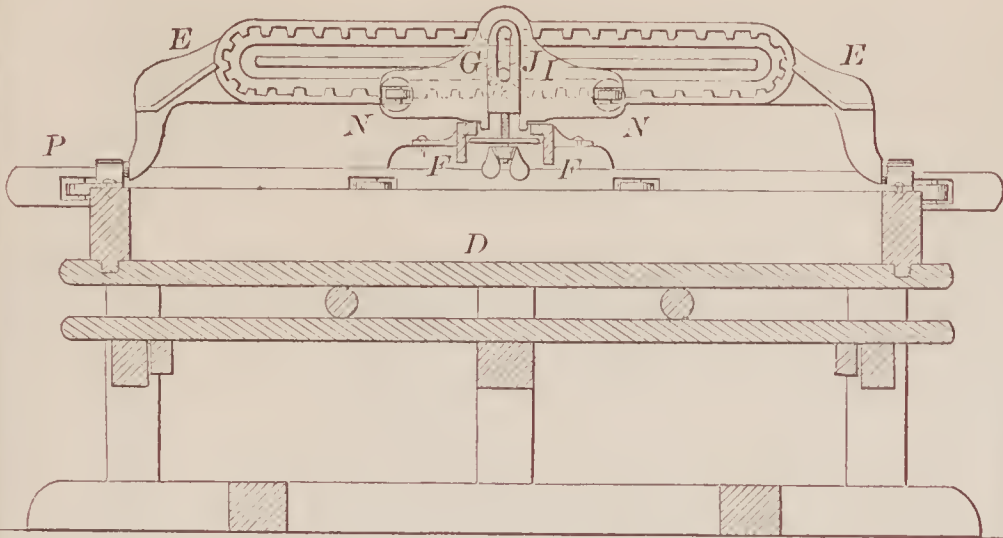

69816—J. Kaylor—Patch Bolt Machine.



69814—C. W. Jones—Street Railway Crossing.

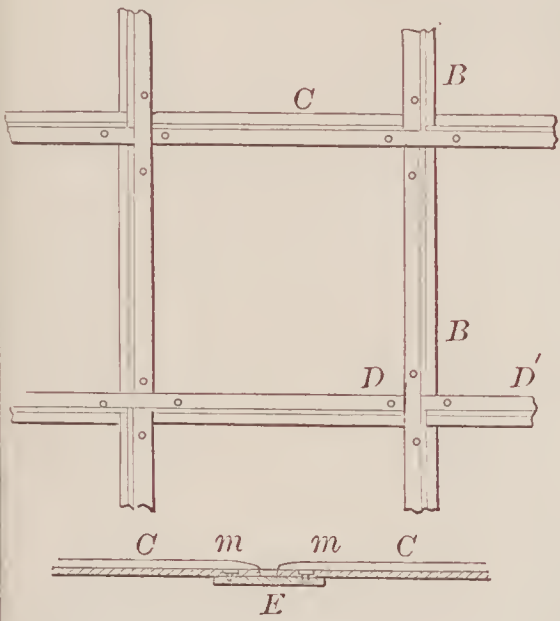

69815—A. Judson—Lamp.

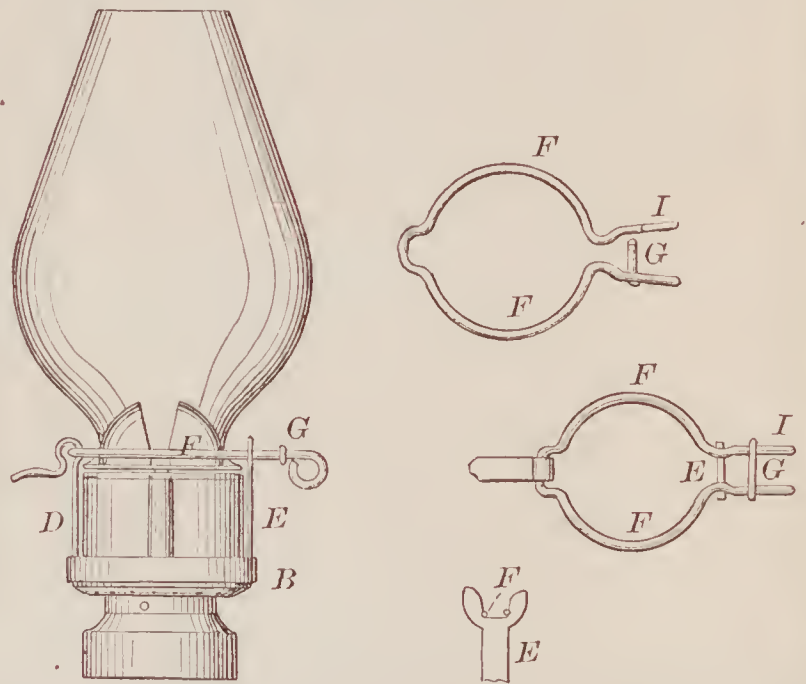

69818—H. Killam—For Compressing Carriage Wheels.

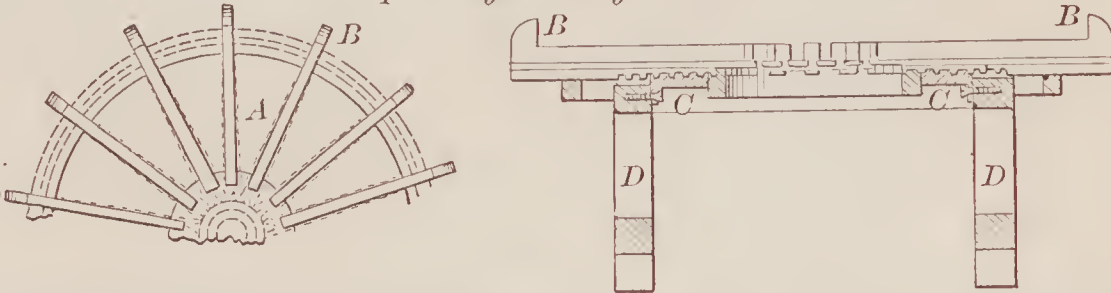

69817—P. Kelly—Spark Arrester.

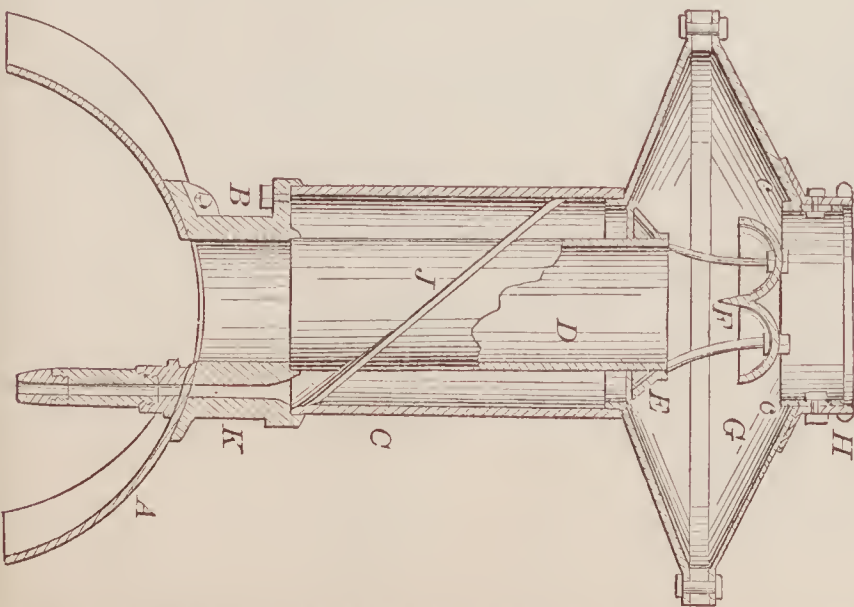

69819—G. P. Kimball—Wagons Axletree.

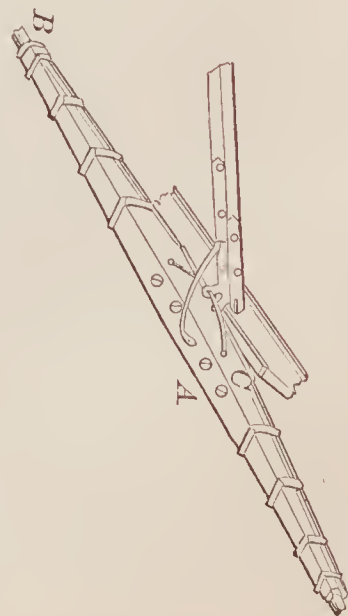



69820—A. Kohler—Hot Air Furnace.

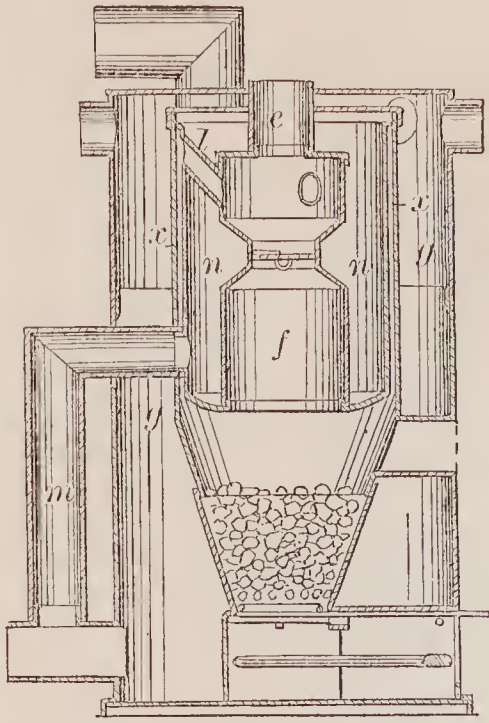

69822—E. F. Light—Journal Box.

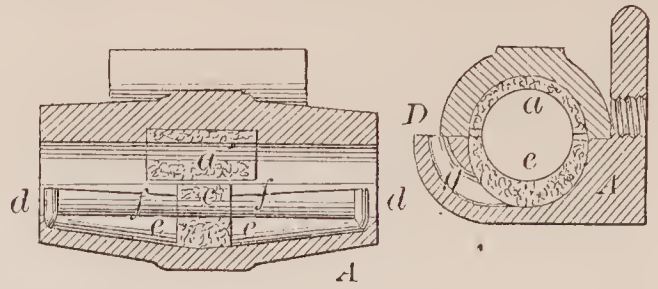

69824—D. T. Lyon—Butter Dish.

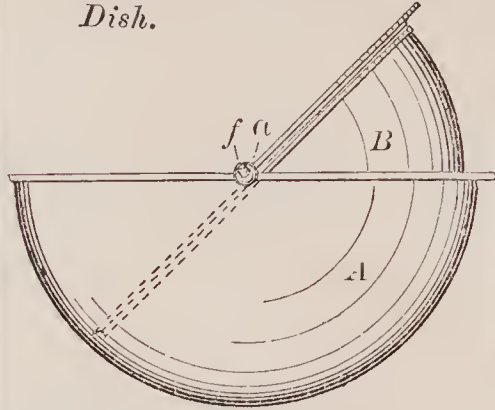

69823—H. & A. Lovie—Curtain Fixture.

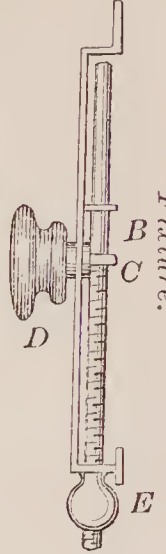

69821—J. F. Latimer—For Accumulating Power.

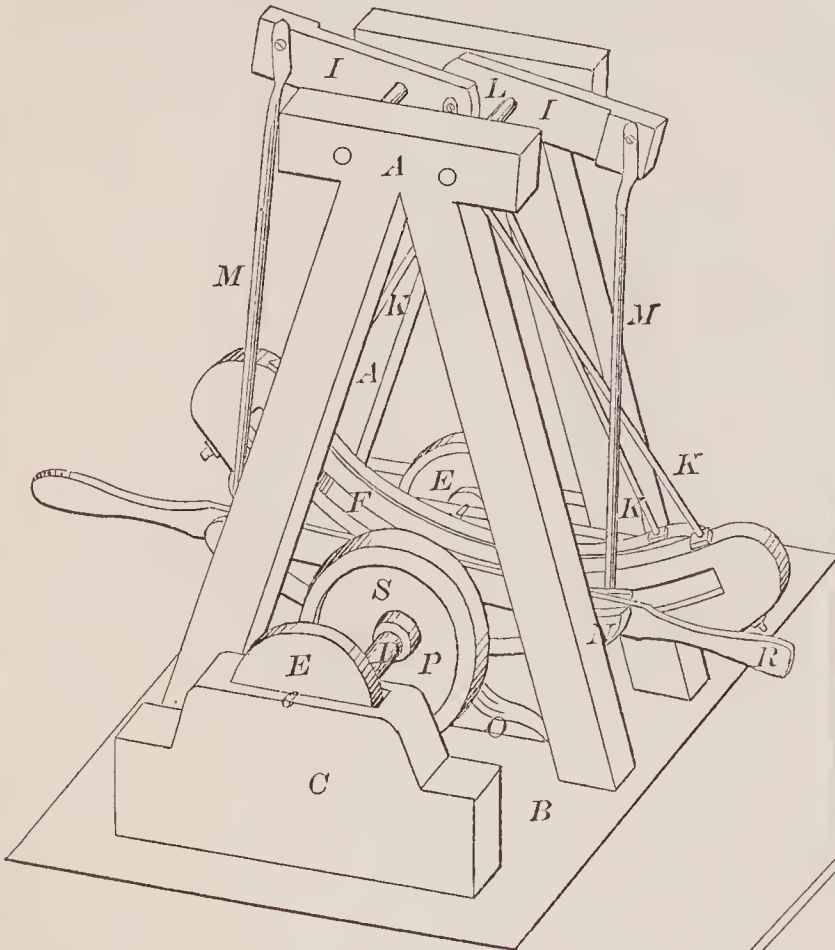

69825—G. Mackinnon—Expansion Drill.

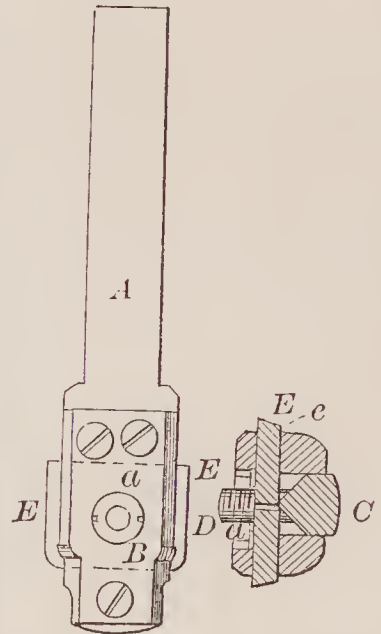

69828—E. W. Mills—Wind Mill.

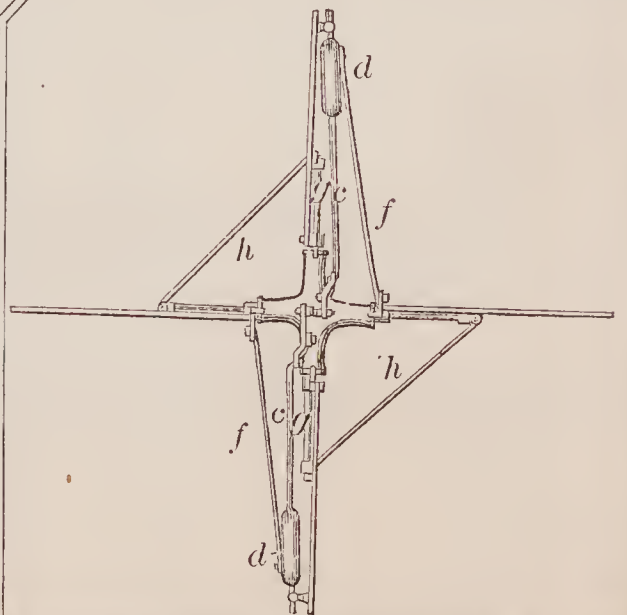

69827—E. Mecker—Carriage Clip.

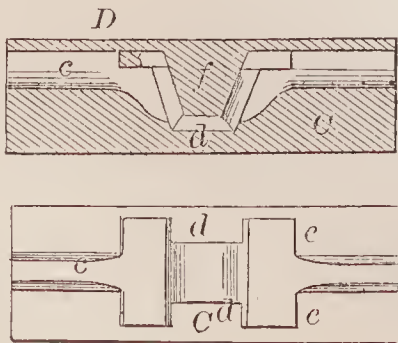

69826—S. Nardon—For Straining Bands about Boxes.

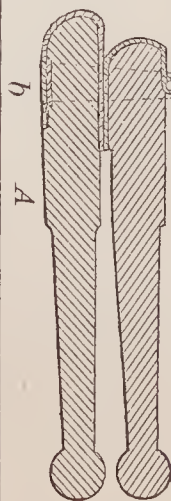

69828—Continued.

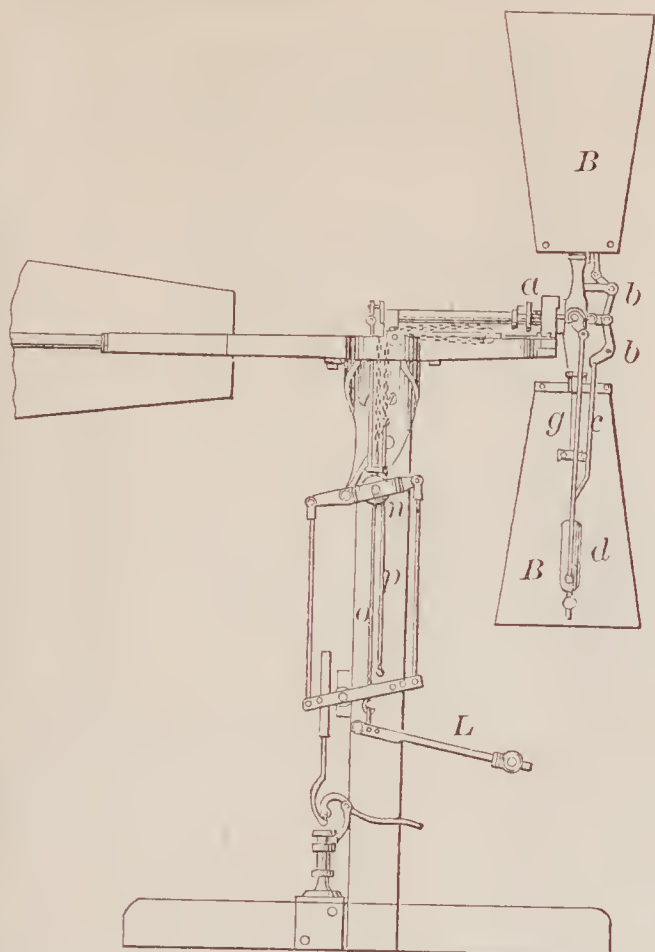

69830—G. W. Mitchell—Baking Pan.

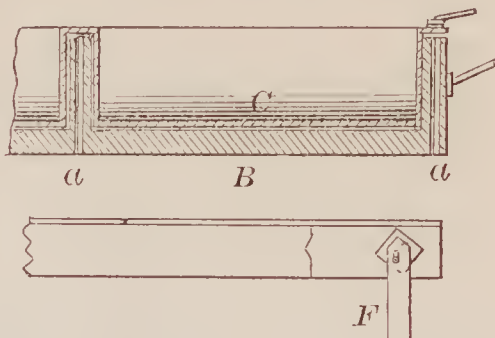

69831—L. Mooney—Kneeling Case for Churches.

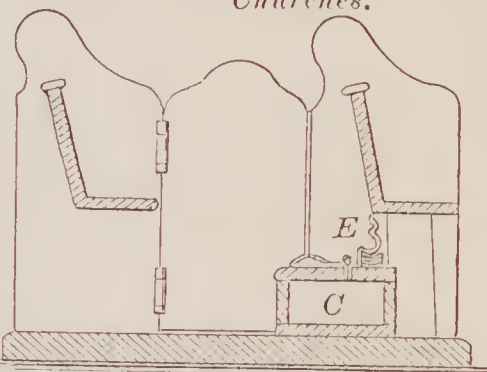

69832—G. J. Olendorf—Stump Extractor.

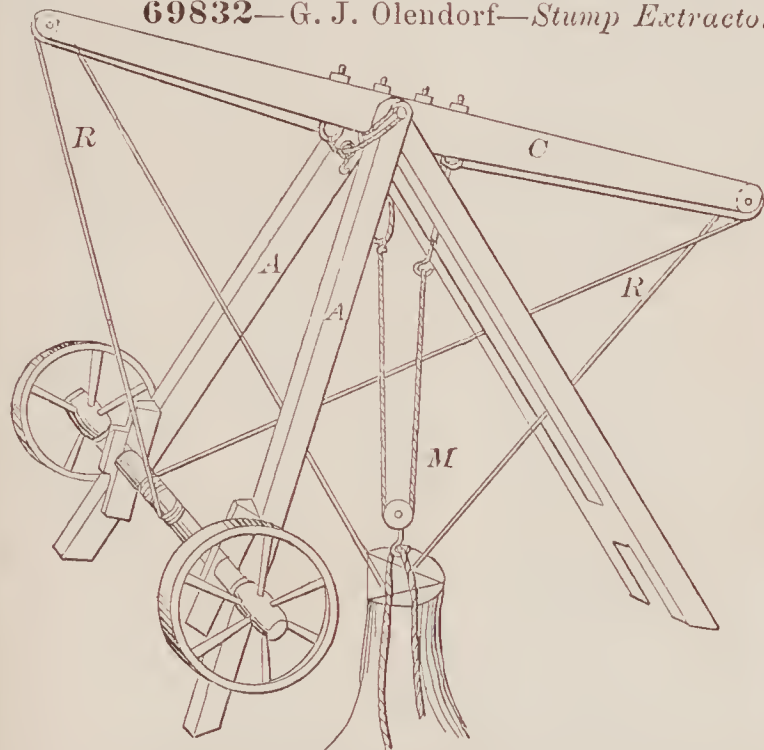

69829—H. L. Mills—Artificial Leg.

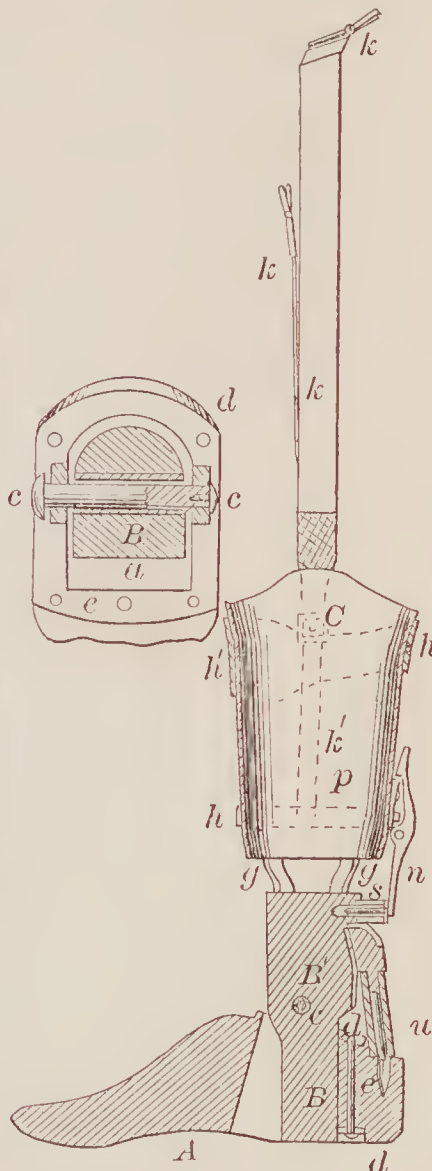

69833—O. Paddock—Ice Cream Freezer.

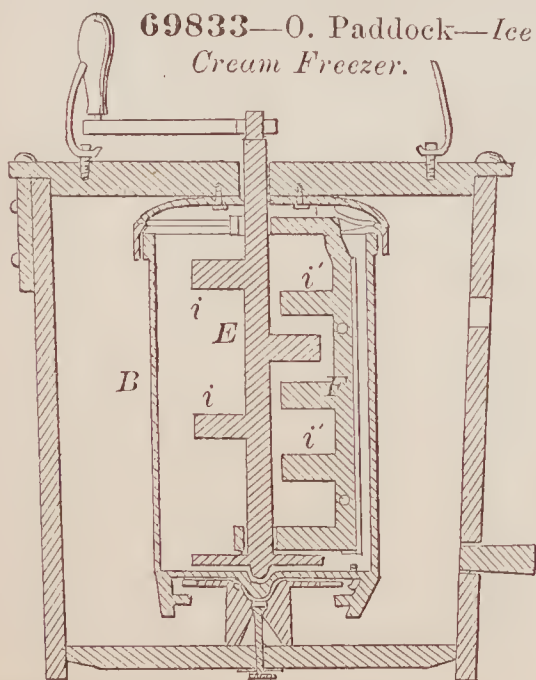

69834—L. E. Palmer—Plow Wheel.

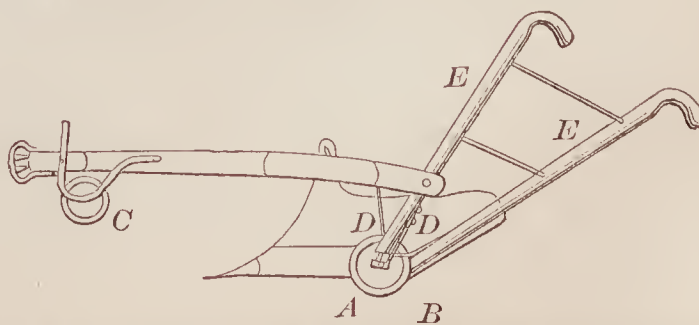



69835—J. Park—*Washing Machine.*

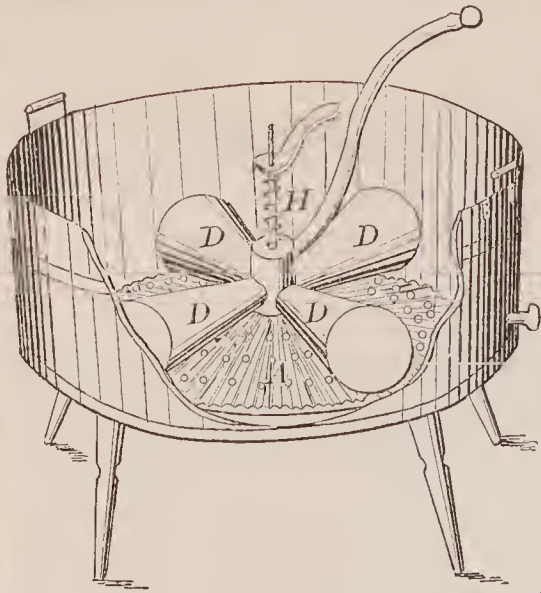

69837—M. Pond—*Stove.*

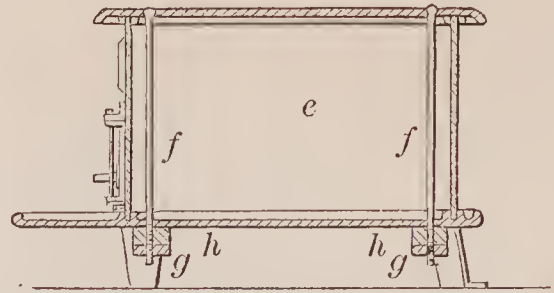

69838—K. H. C. Preston—*Harvester.*

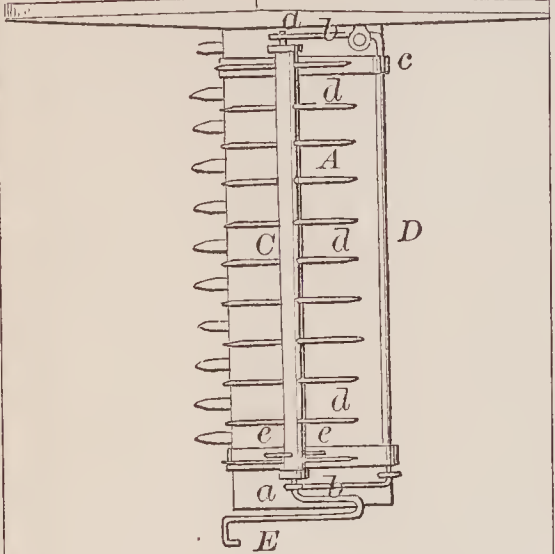

69839—G. H. Reynolds—*Steam Engine.*

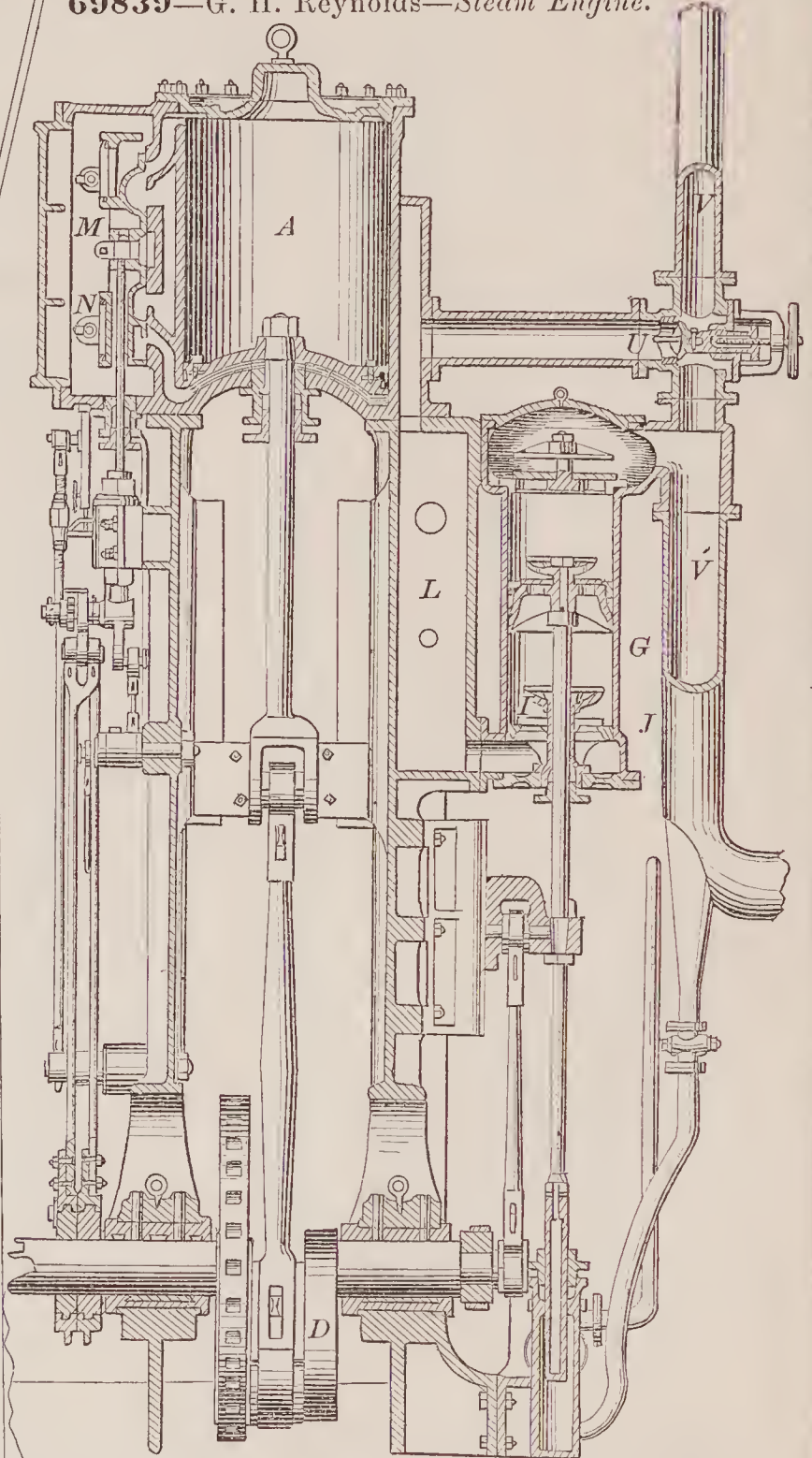

69836—Parker & Kellison—*Corn Planter.*

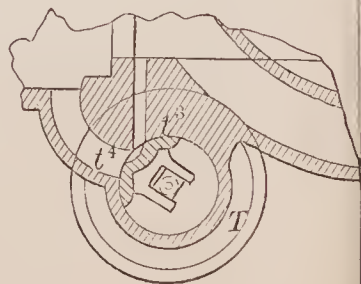
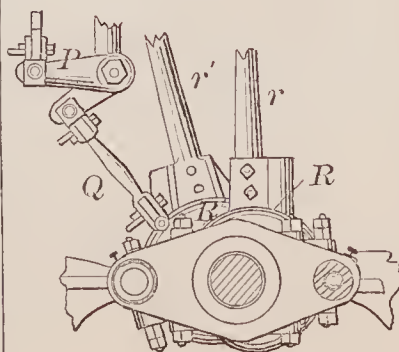
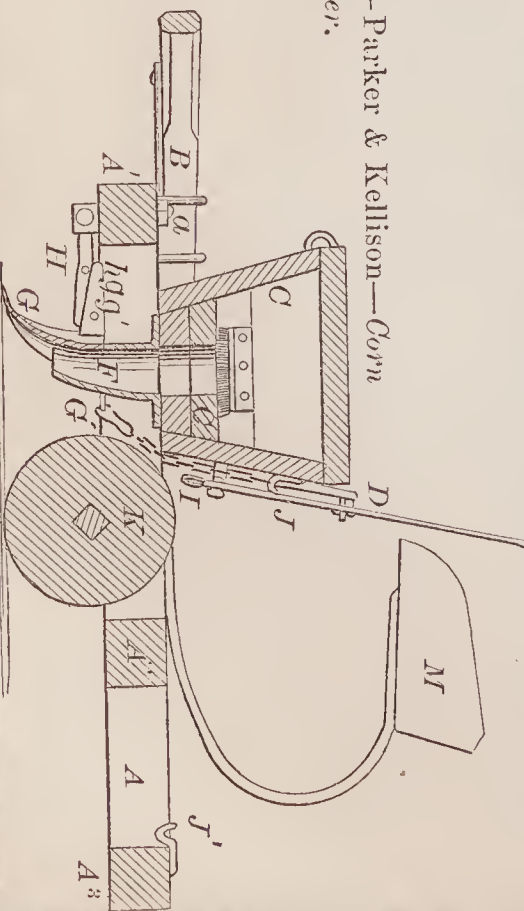





69850—G. Sherwood—*Folding Seat.*

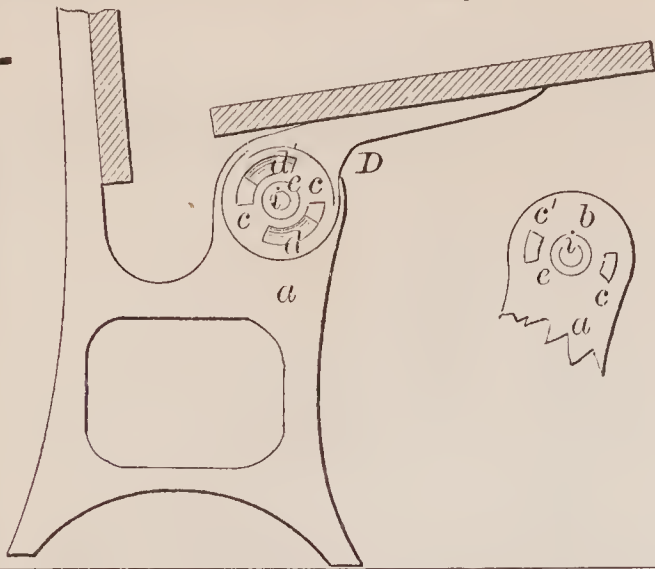

69853—J. W. Smith—*For Cutting Tobacco.*

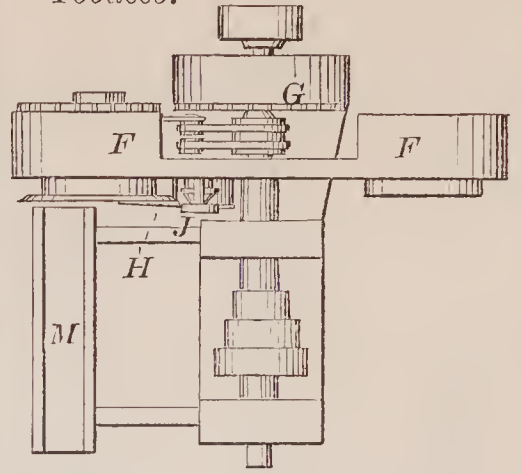

69856—G. W. Starr—*Railroad Switch.*

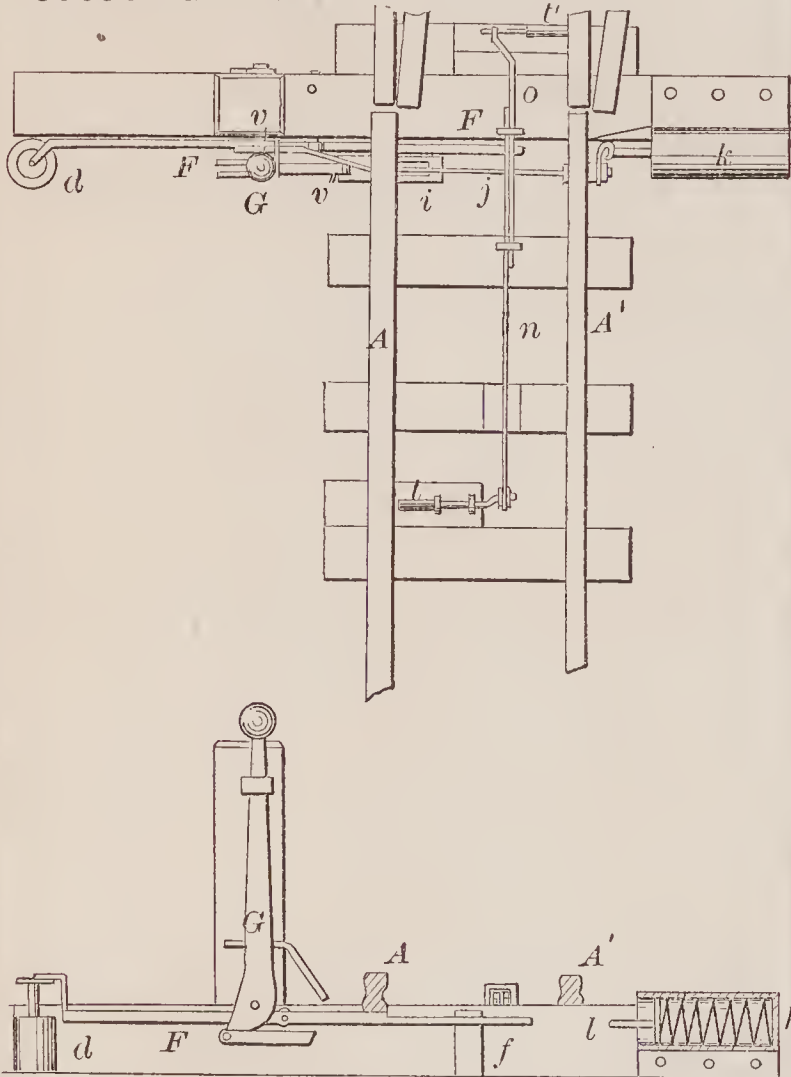

69854—W. Smith—*For Moulding Pipe.*

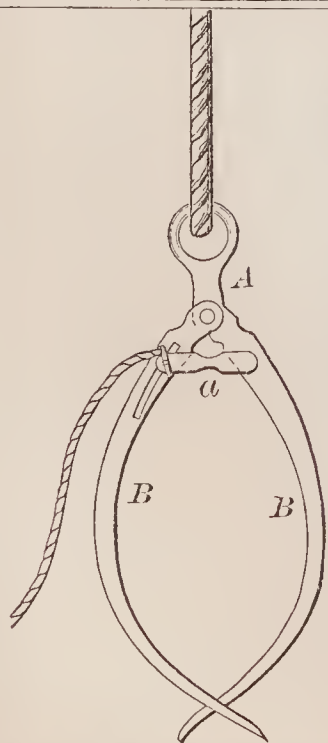
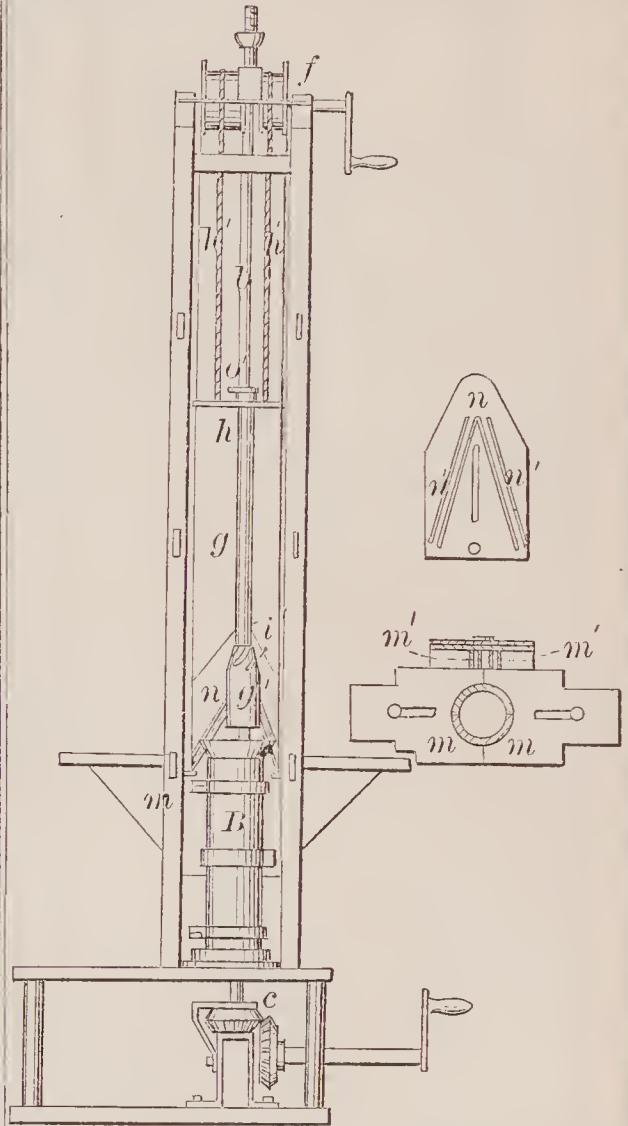

69857—B. F. Stewart—*Horse Hay Fork.*



69851—W. J. Shipman—*Toy Pistol.*

69855—I. H. Spelman—*Churn.*

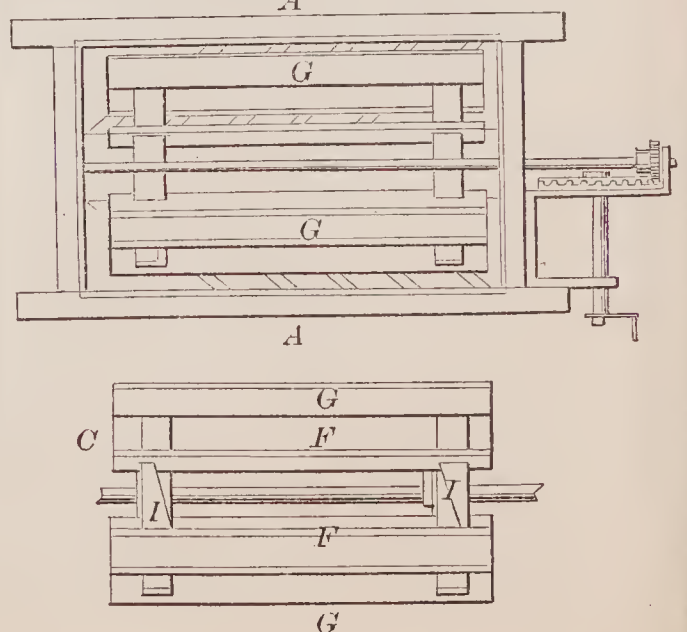

69858—E. Stiles—*Farm Fence.*

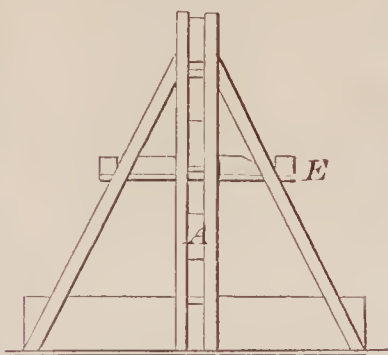

69859—S. C. Stokes—*Faucet.*

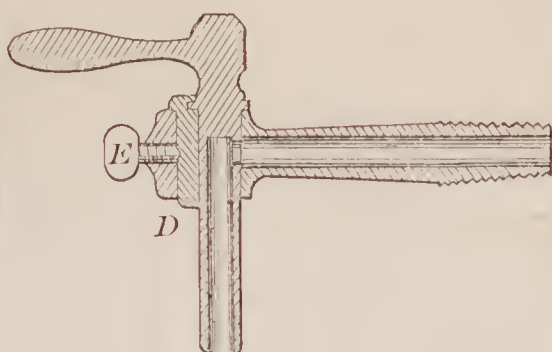

69860—J. B. Stoner—*Flood Gate.*

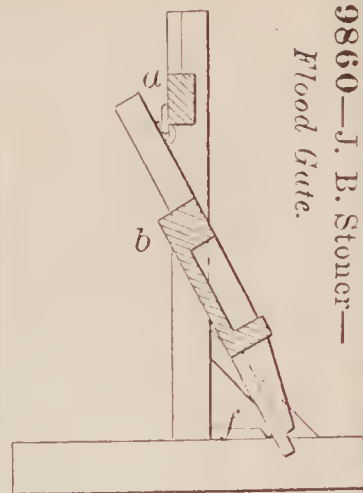

69861—J. B. Stoner—*Portable Flood Fence.*

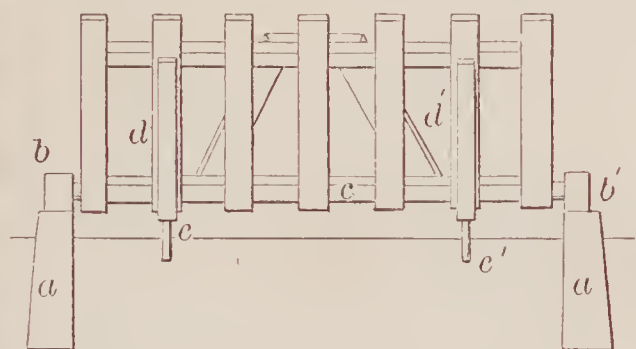

69863—O. W. Swift—*For Capping Screws.*

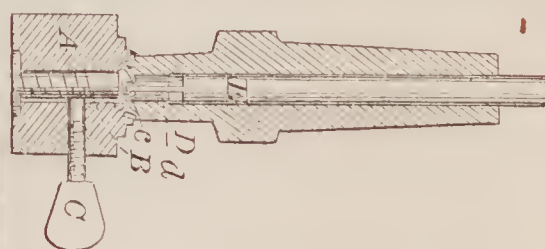

69862—L. Study—*Corn Planter.*

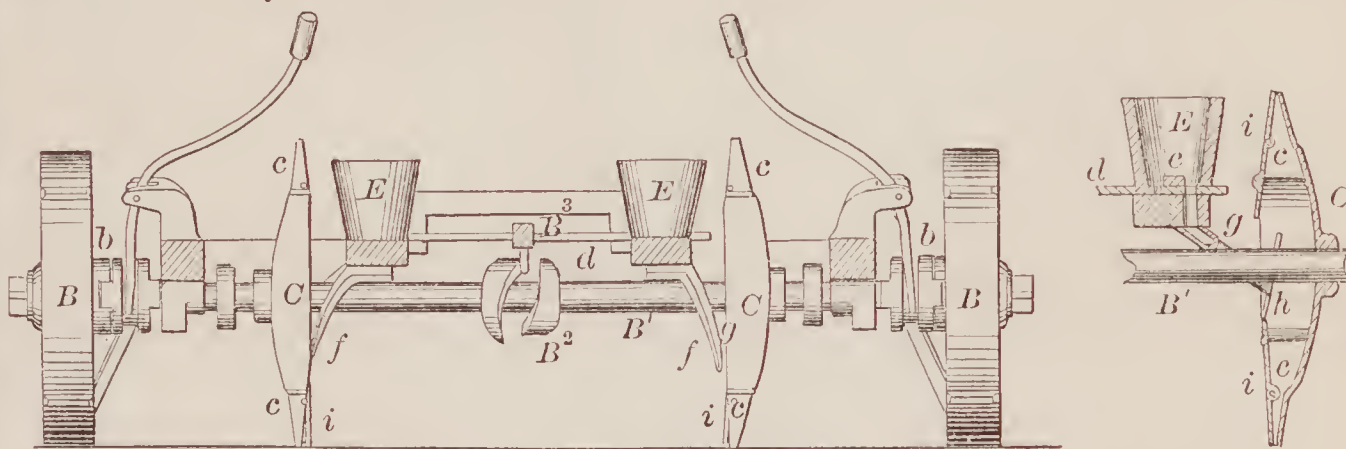

69865—Z. Tobias—*Horse Power.*

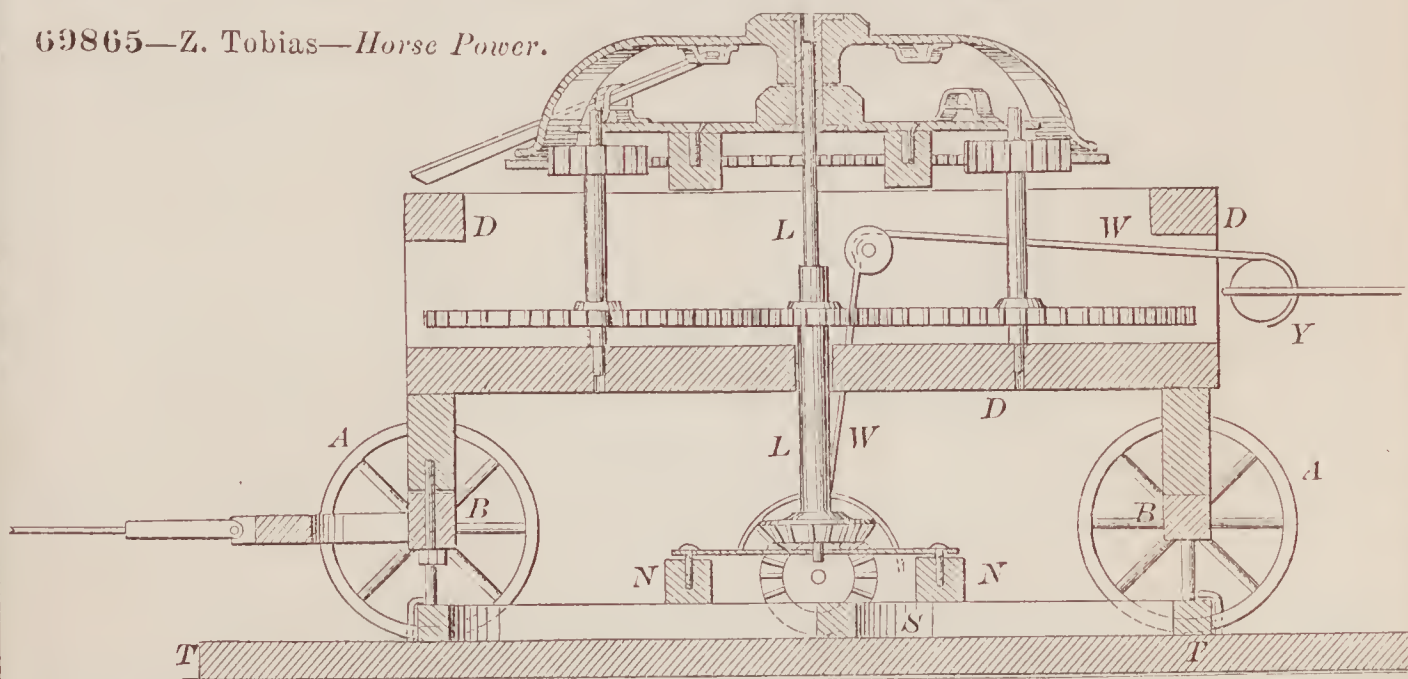

69864—J. Thompson—*Wash Board.*

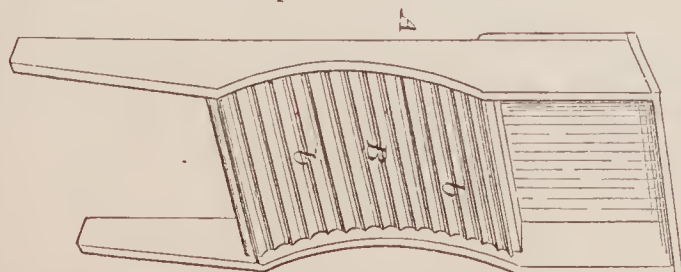

69866—I. N. Topliff—*Clip Circle.*

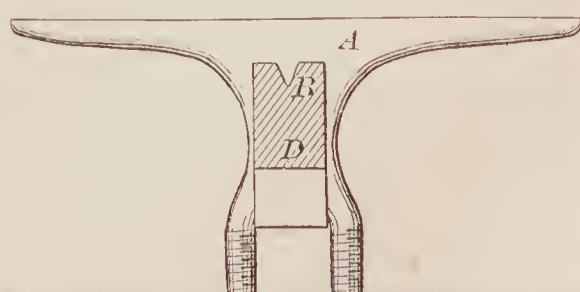



69867—J. Vandegrift—*Plow.*

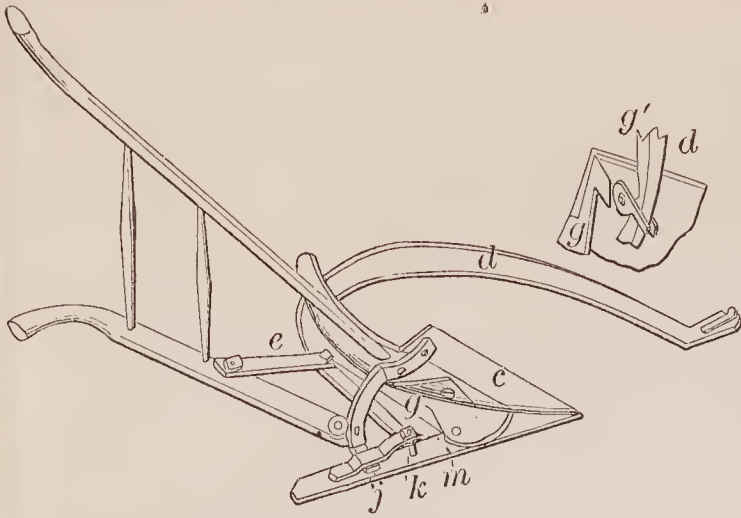

69868—R. M. Van Sickler—*Roller Frame for Elevator Platforms.*

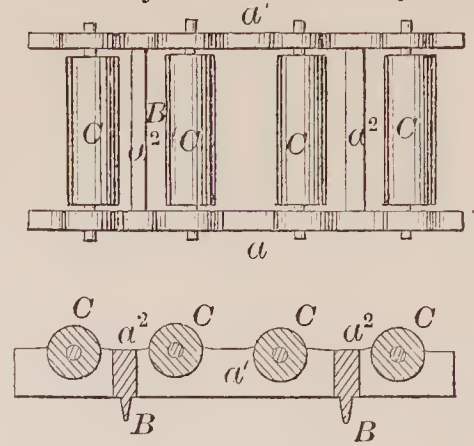

69869—E. P. Vaux—*Pipe for the Transmission of Fluids.*

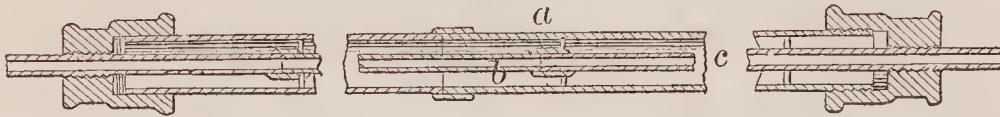

69871—J. Walker—*Elevator.*

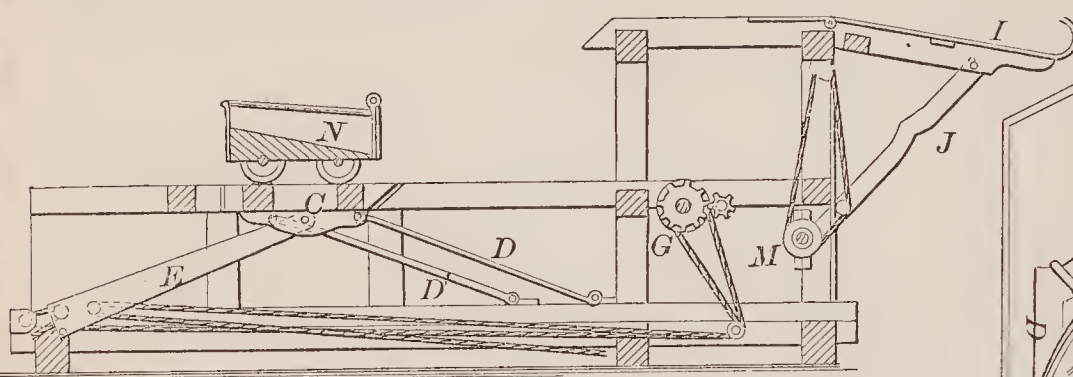

69874—F. Watson—*Plow.*

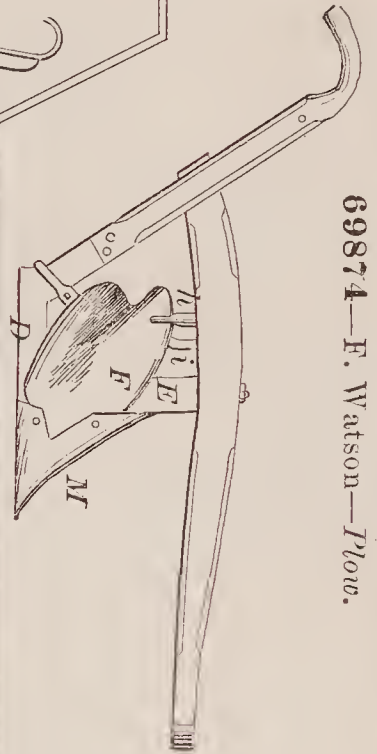

69870—C. W. Wailey—*Cotton Bale Tie.*

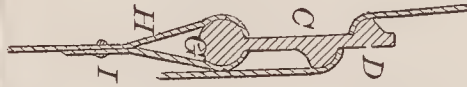

69872—Walters & Shaffer—*Fagot for Beams.*

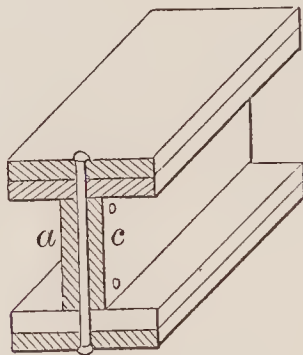

69873—J. L. Warner—*Toy Engine.*

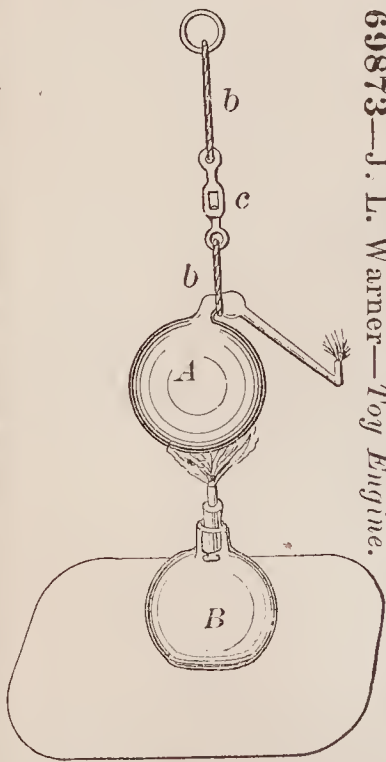

69875—Watson & Perry—*Extension Ladder.*

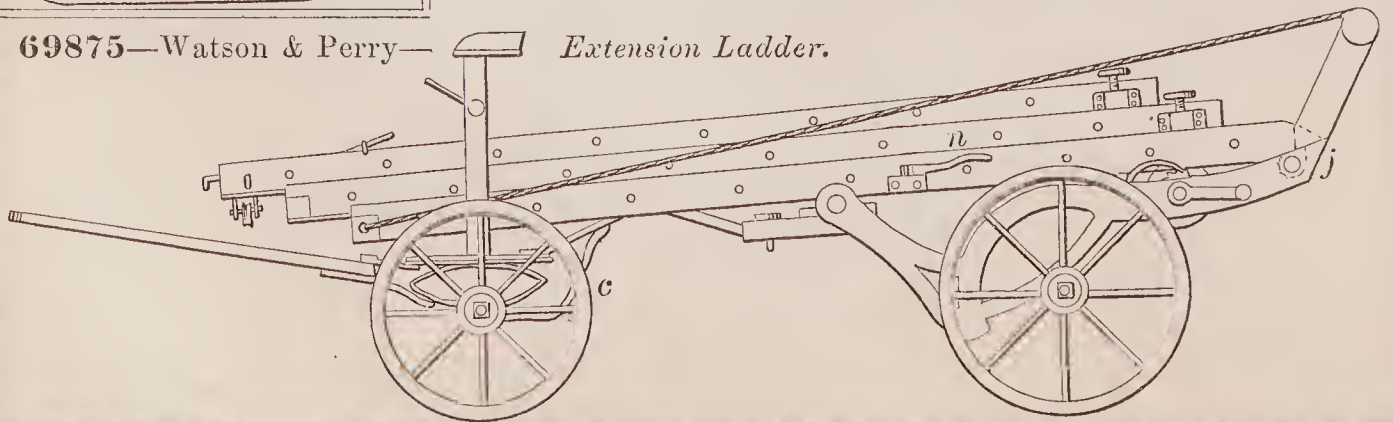

69876—L. Weaver—*Corn Dropper.*

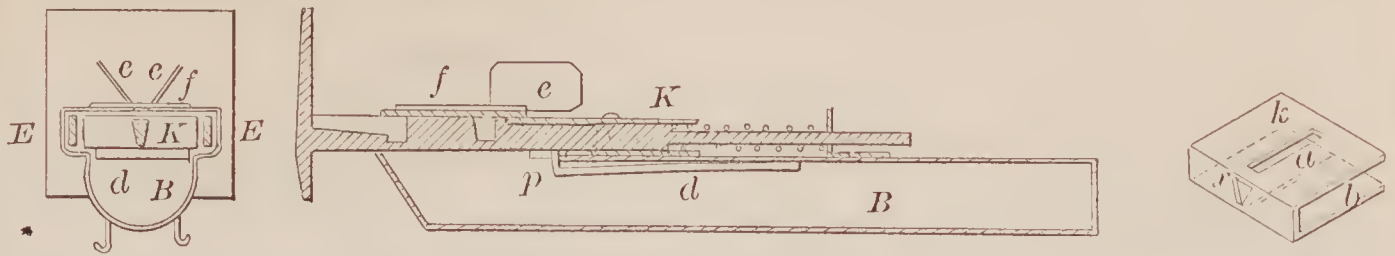

69877—W. Welch—*Indicator for Punching Machines.*

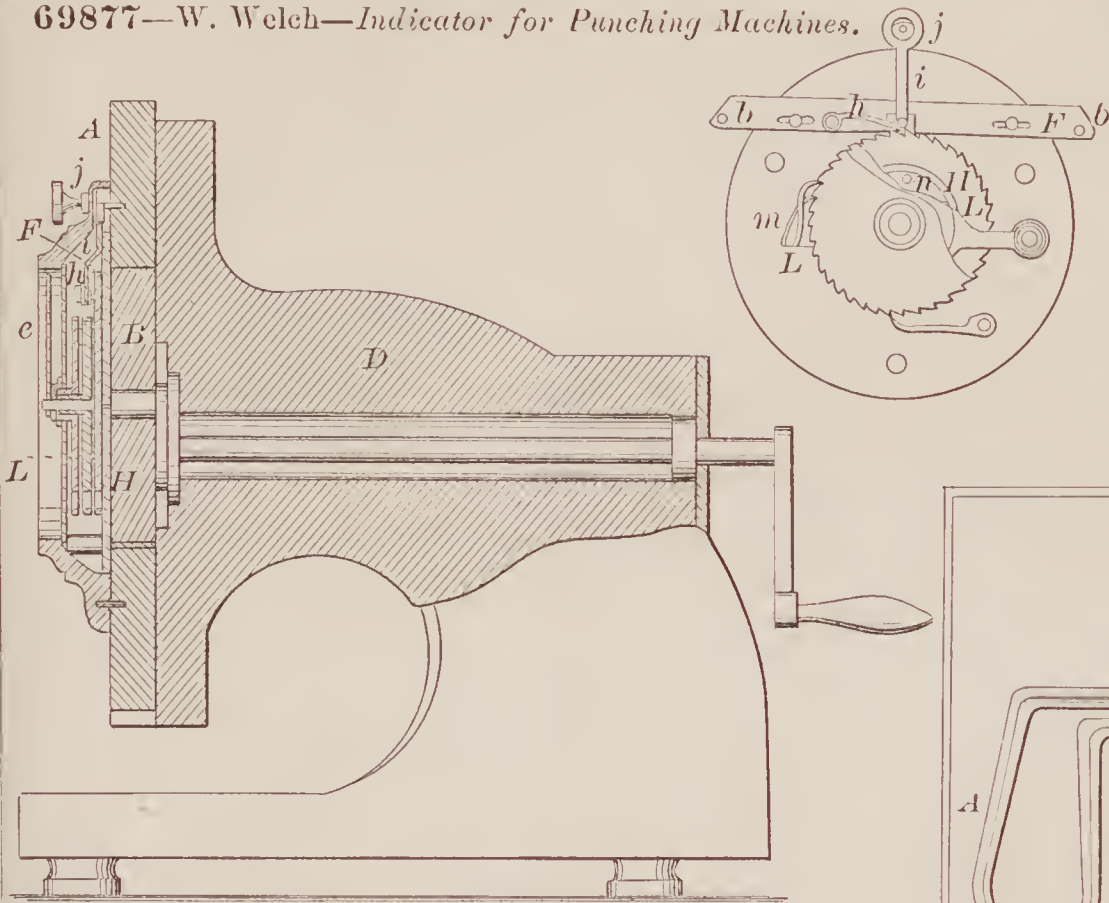

69878—J. Westcott—*Animal Trap.*

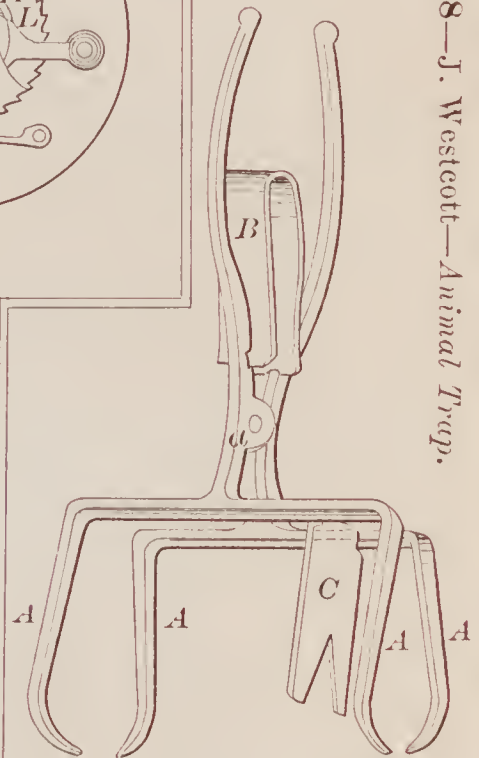

69880—W. Wickersham—*Electro-Magnetic Engine.*

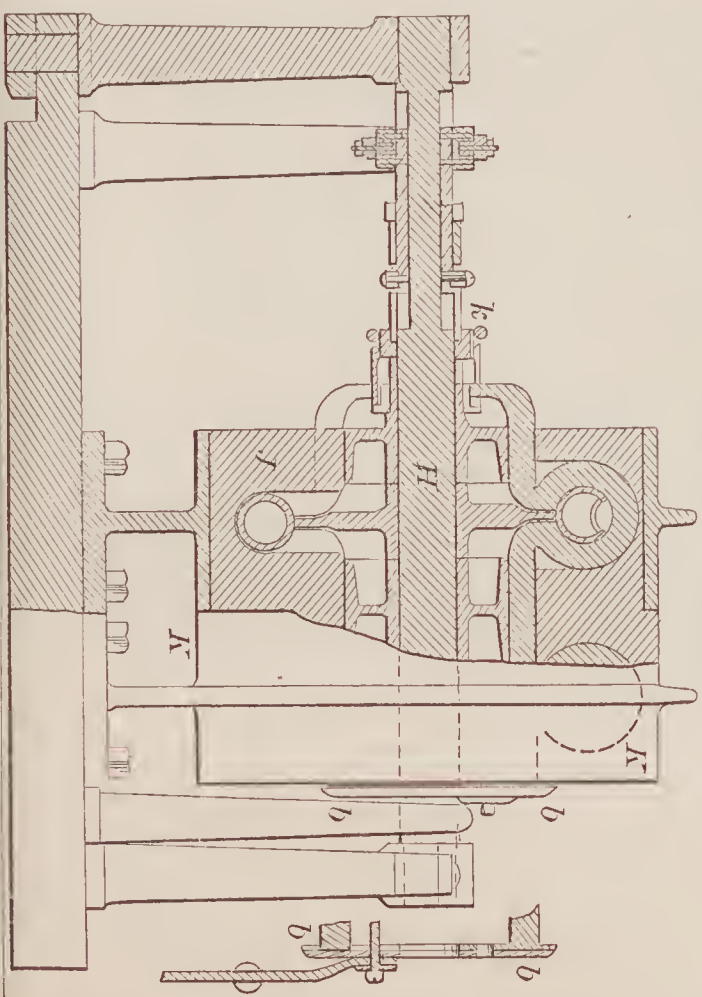

69879—W. H. Whitehead—*Cooking Stove Grate.*

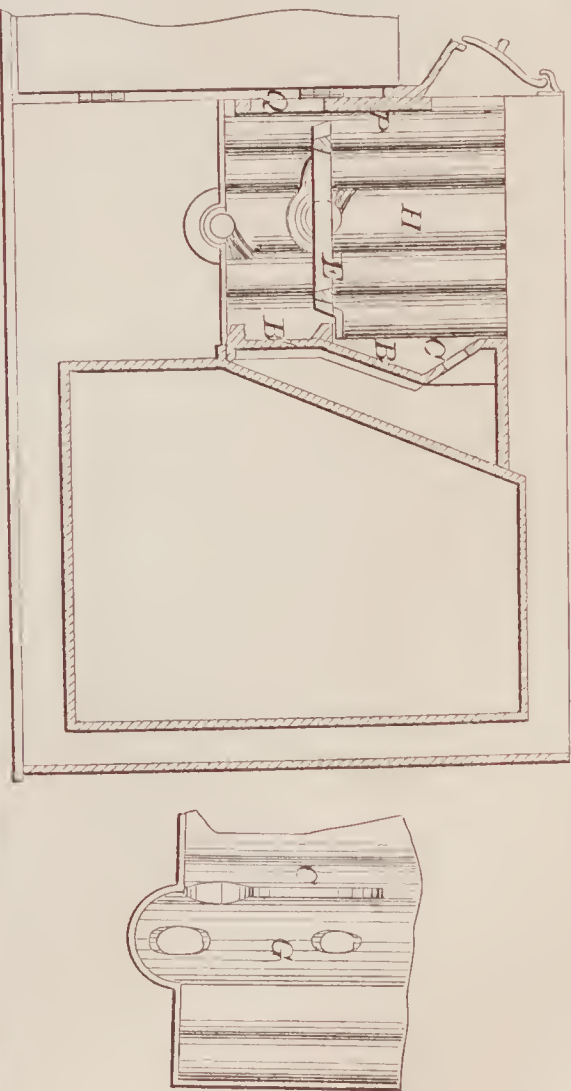



69881—H. Willard—Hay Raker and Loader.

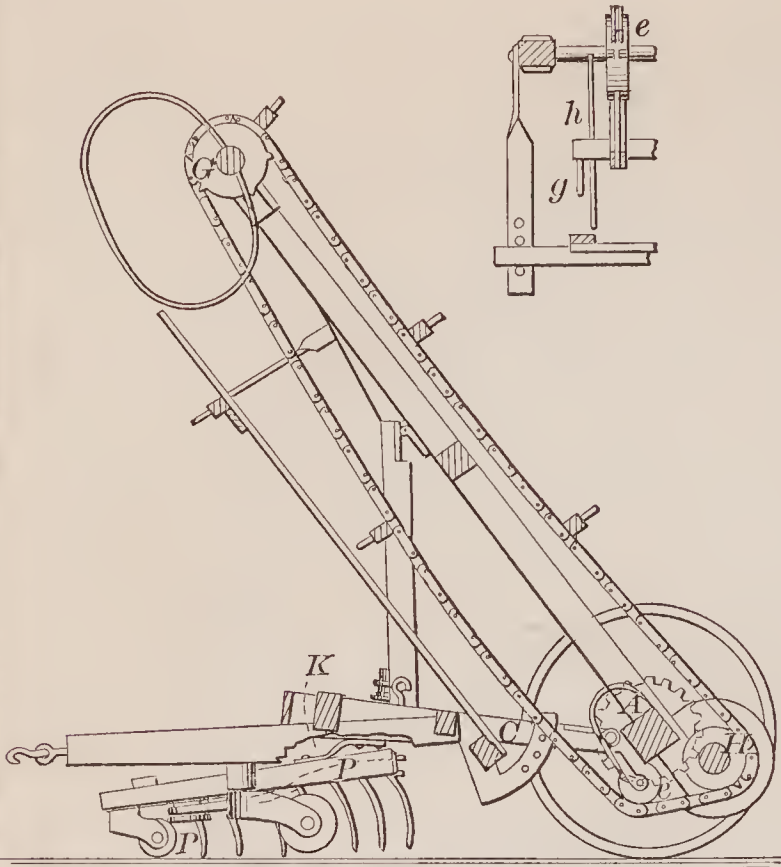

69882—C. Williams—Oil Cup.

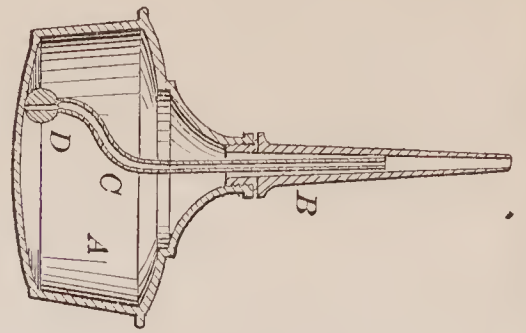

69884—Wisner & Rose—Broom Head.

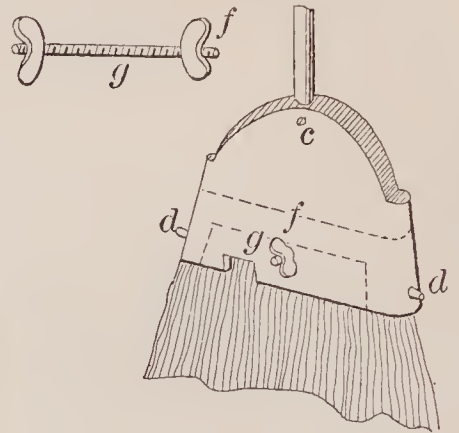

69887—H. Zellner—Cotton Press and Feeder.

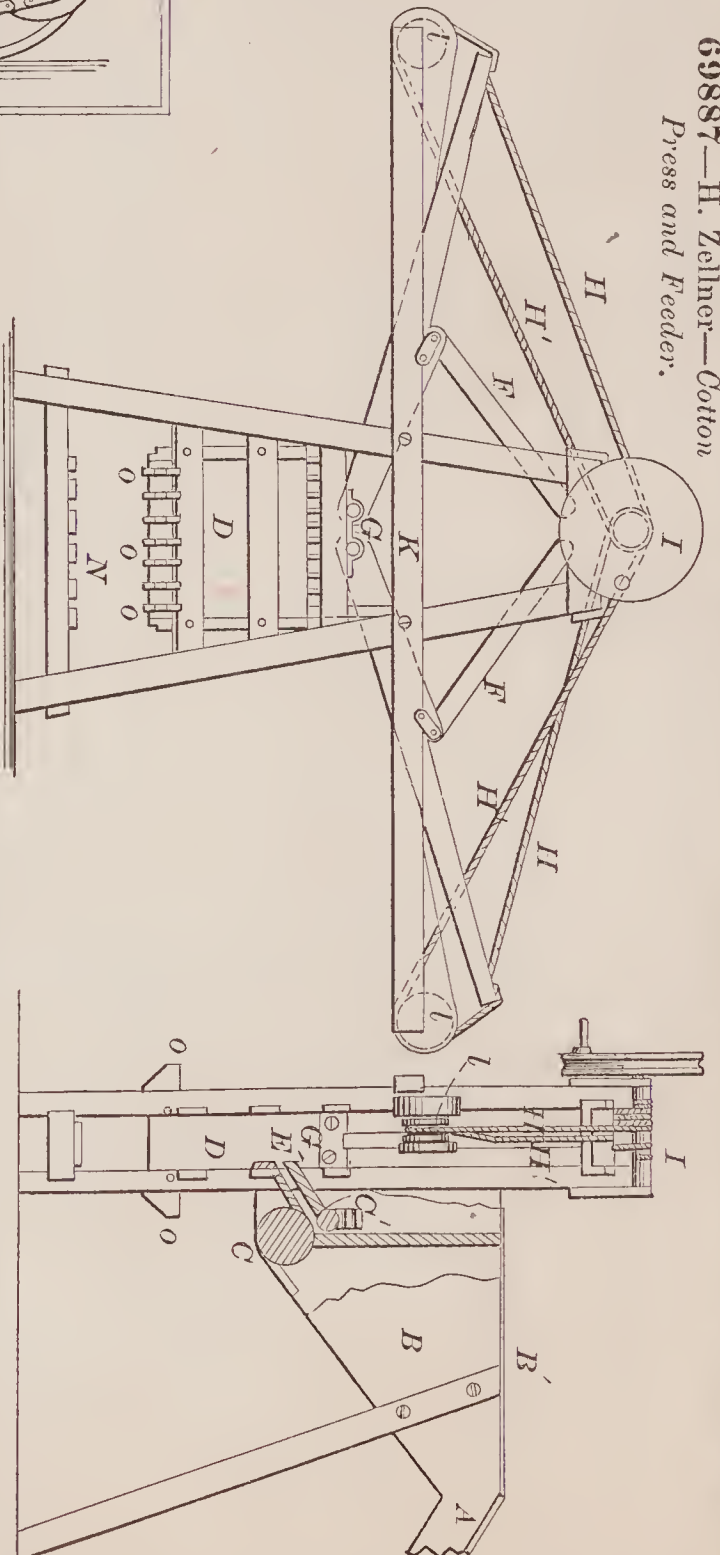

69883—N. Wilton—Jaw for Lathe Dogs and Bench Vises.

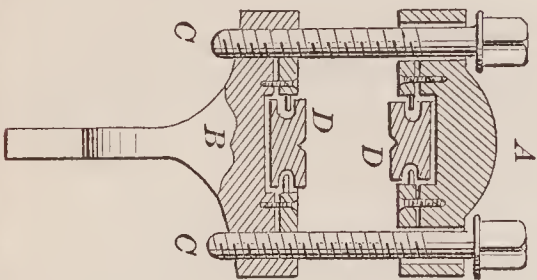

69885—G. & A. Woerber—Carriage and Buggy Top Bolt Iron.

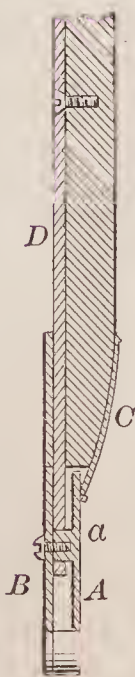

69886—L. E. Woodard—Wagon Brake.

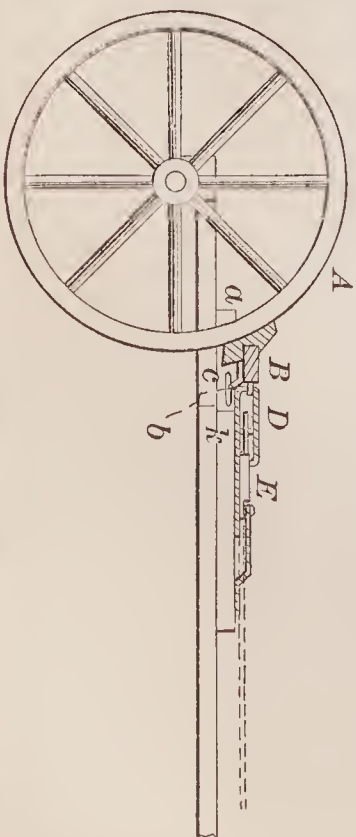

69888—G. S. Acker—*Burglar Alarm.*

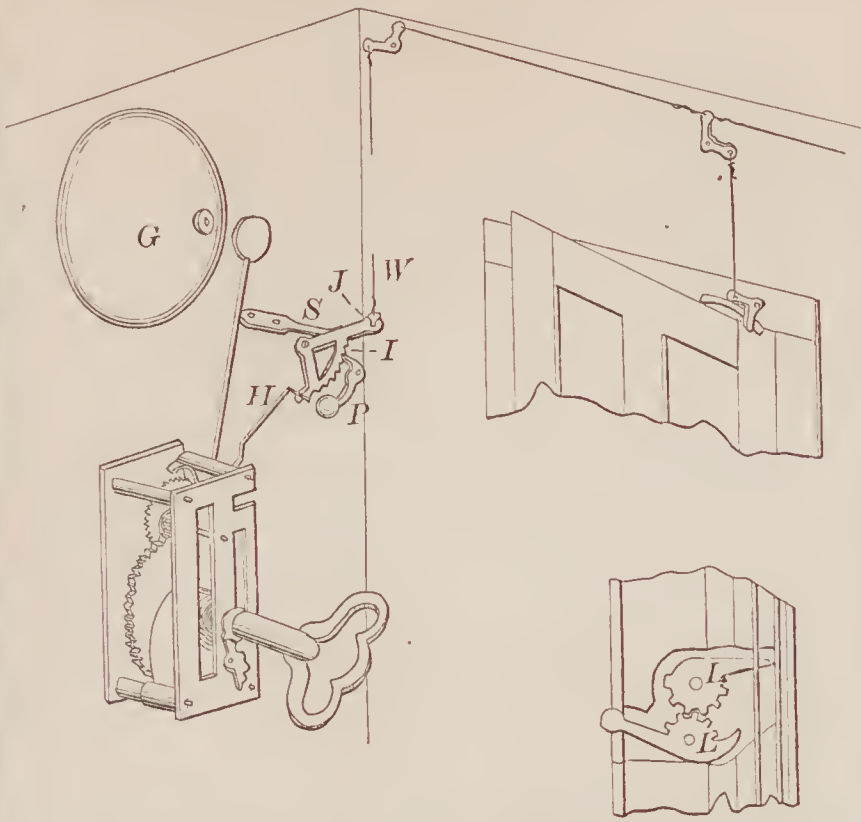

69891—E. Andrews—*Matches.*



69892—J. L. Barnes—*Car Brake.*

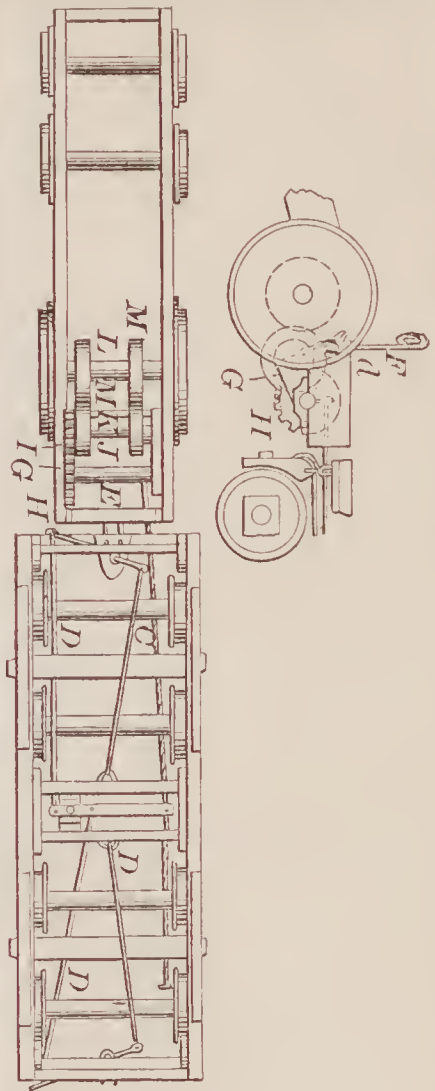

69890—H. Adler—*Boiler.*

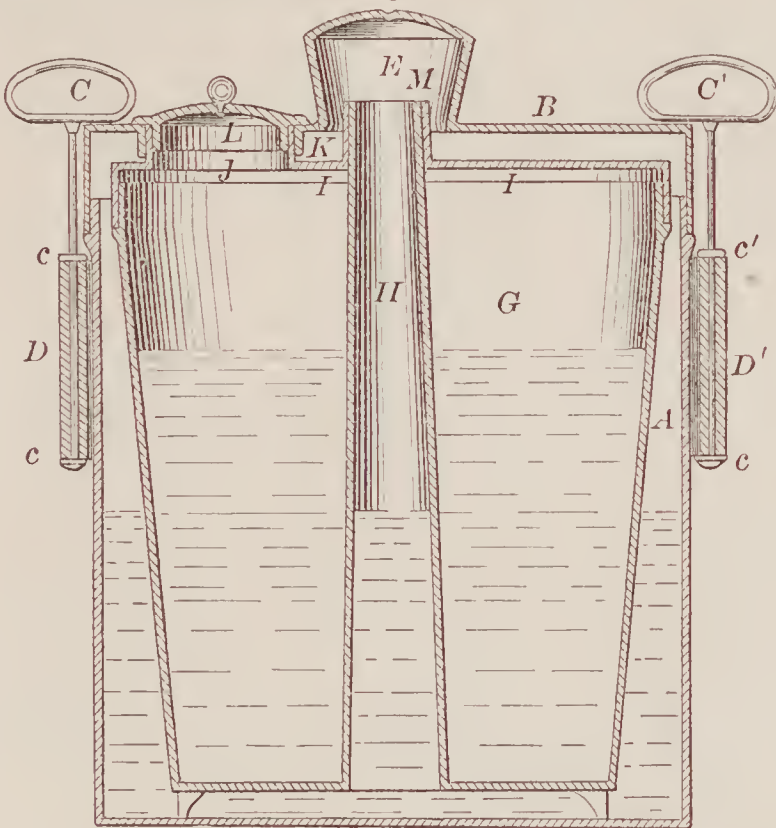

69894—A. C. Beardslee—*For Proving Gas Pipes.*

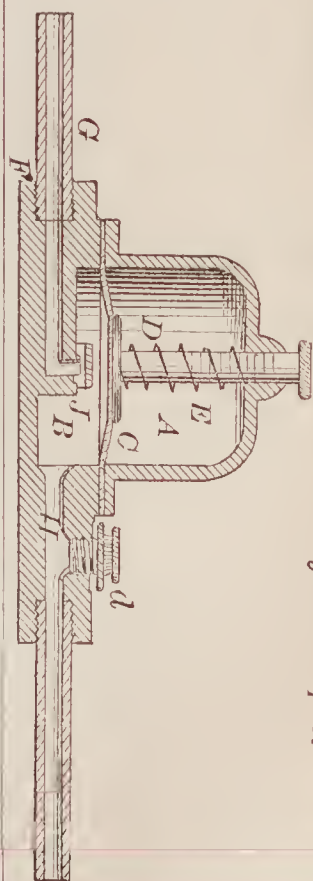

69895—Benn & Luckman—*For Damping and Gumming Labels.*

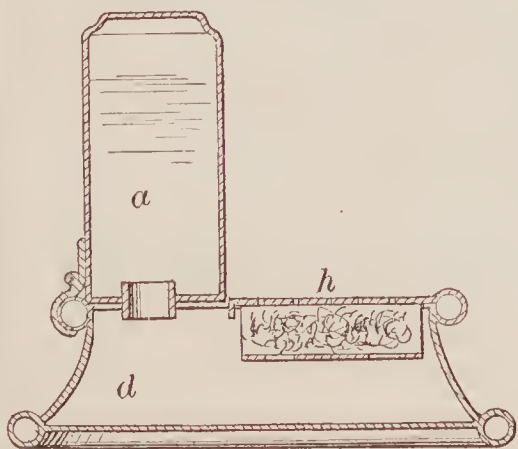

69893—W. R. Beans—*Bridle.*





69896—H. Bitter—Hose Tongs, Clamp, Winch and Pick.

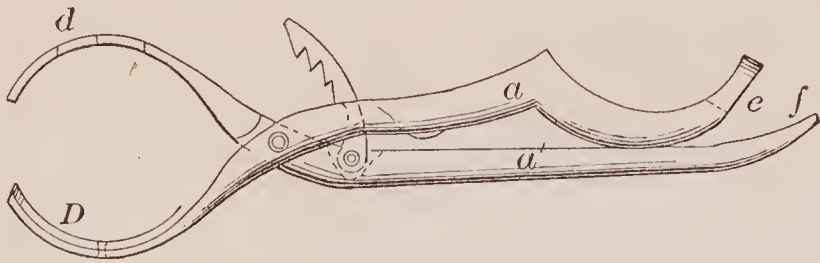

69900—C. H. Coffin—Hat Ventilator.

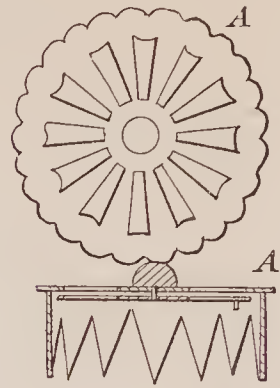

69897—A. Broadnax—For Rendering Lard and Tallow.

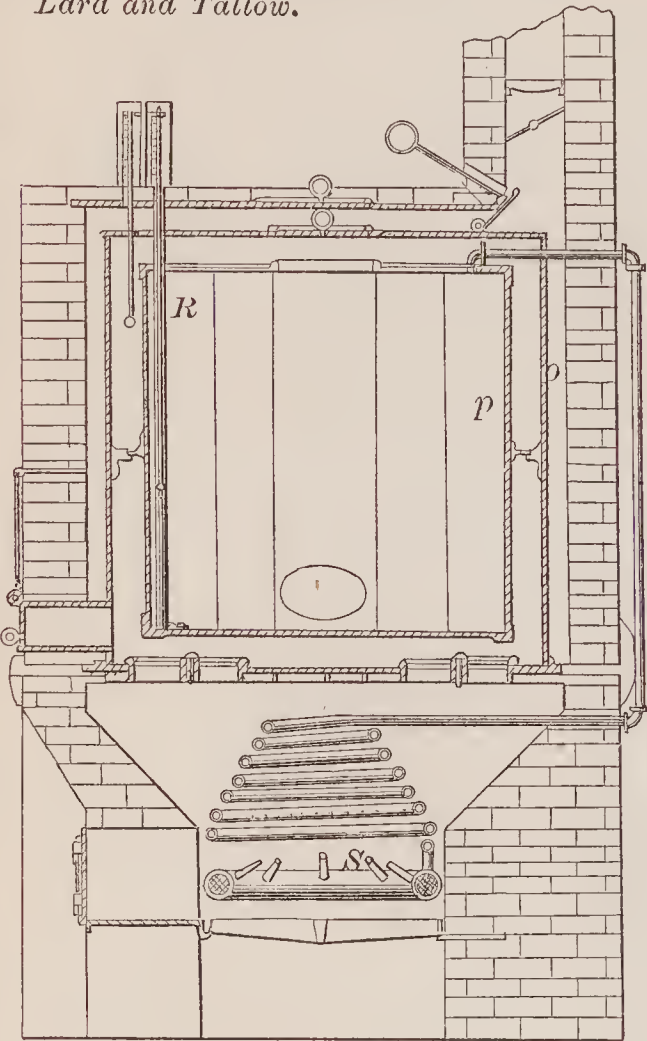

69898—M. D. Brooks—Bed Clothes Holder.

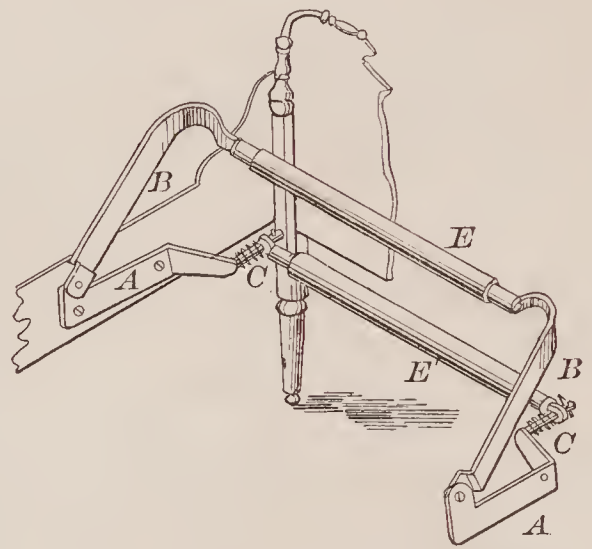

69899—C. C. Burrows—Rowlock for Boats.

Fig. 3

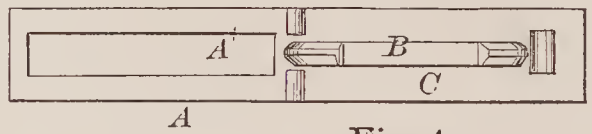
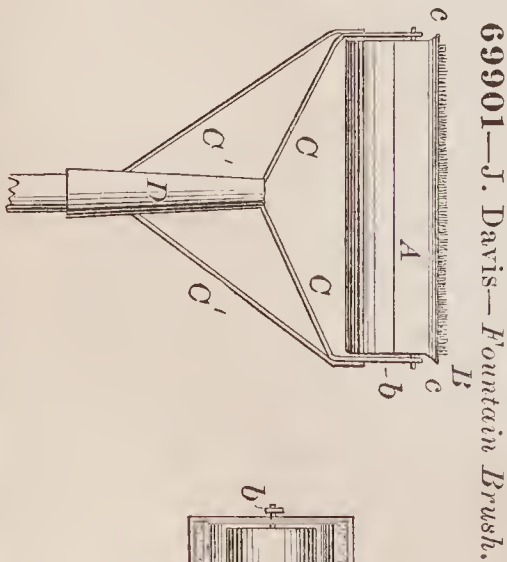
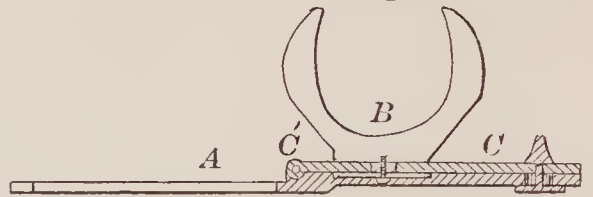
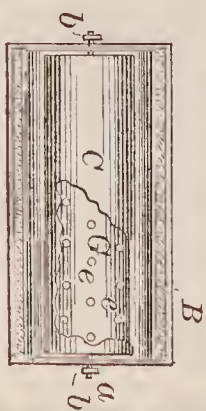

Fig. 4



69901—J. Davis—Fountain Brush.



69902—W. C. Davis—Cooking Stove.

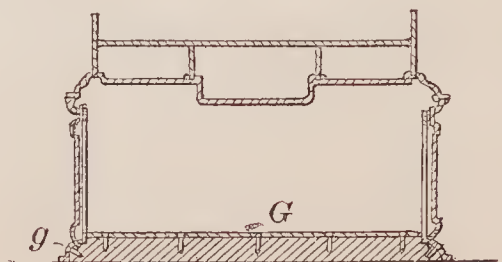
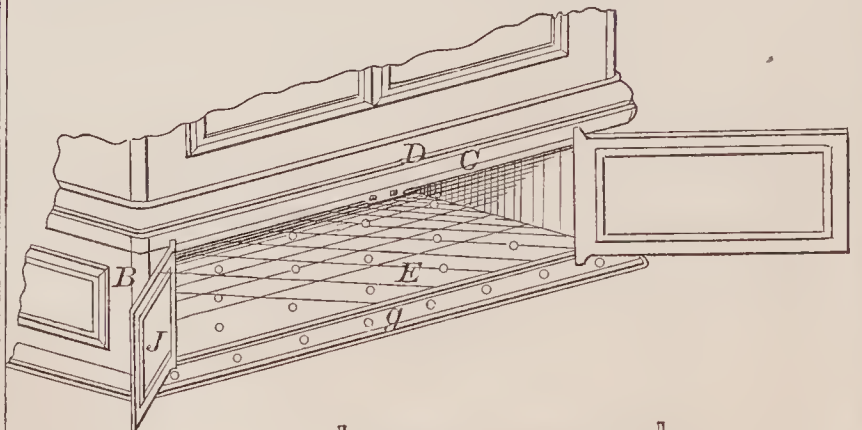

69905—J. A. Ewins—Knife Cleaner.

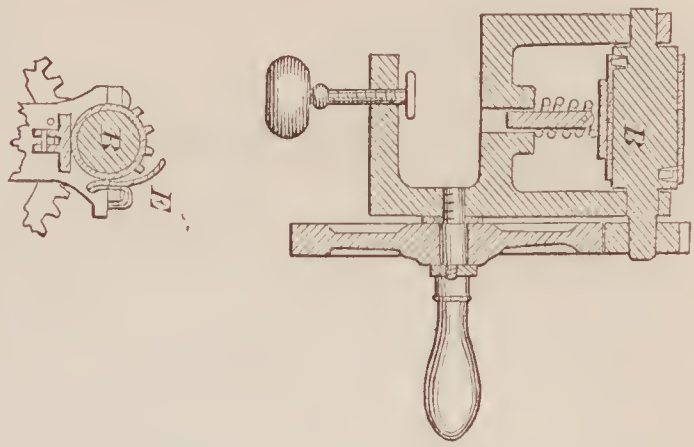

69906—F. Fisher—Tuyere.

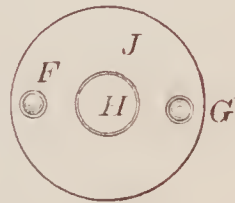
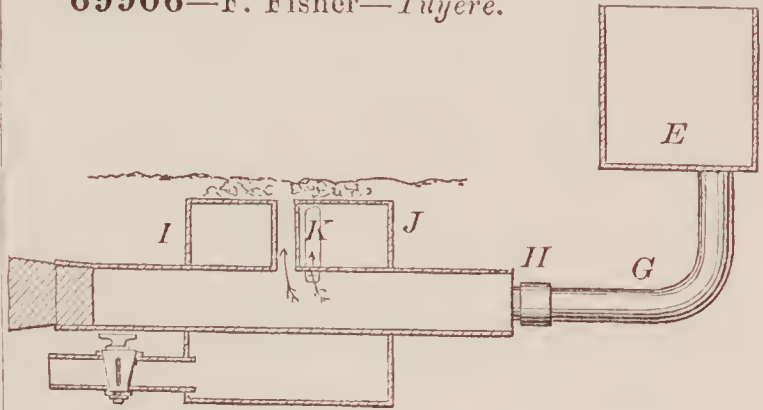

69908—J. Fox—Harvester.

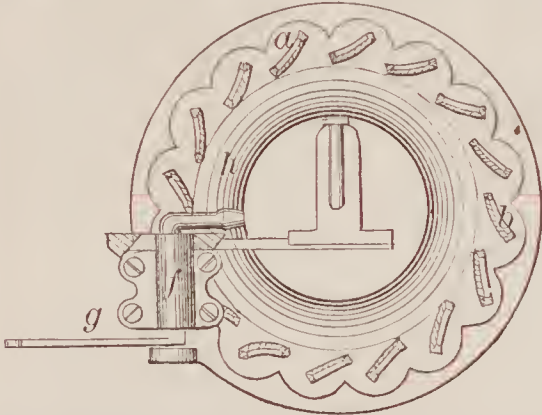

69907—Force & Renwick—Tenter Bar.

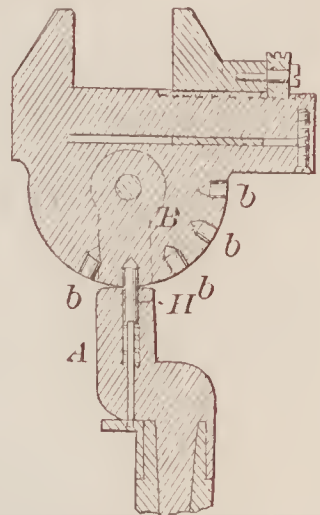
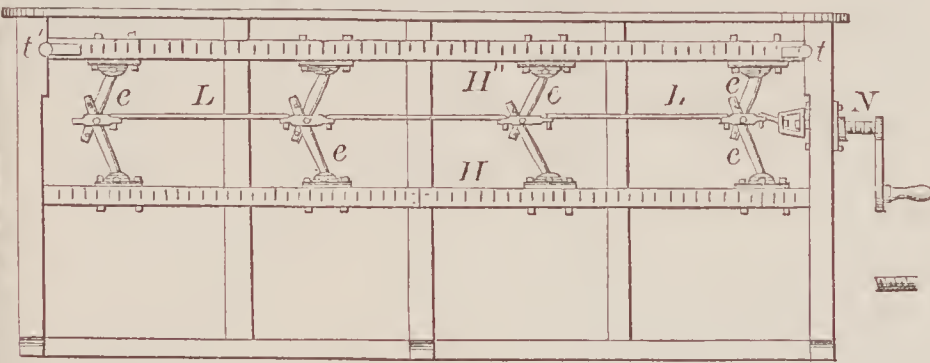

69911—D. Harrigan—Wrench.

69909—Franklin, McIntire & Whitely—Brick Mould.

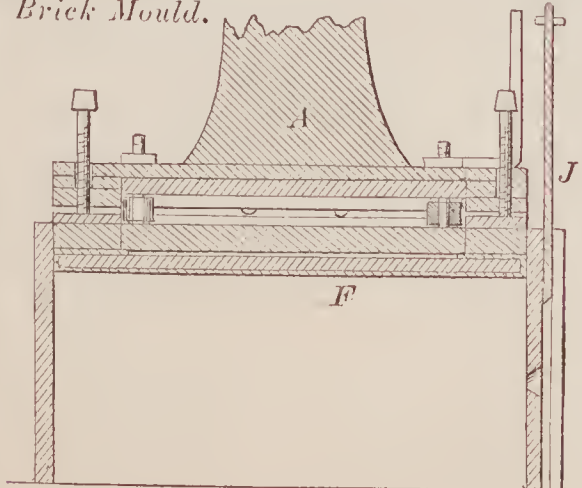

69910—J. P. Gates—Bridle Bit.

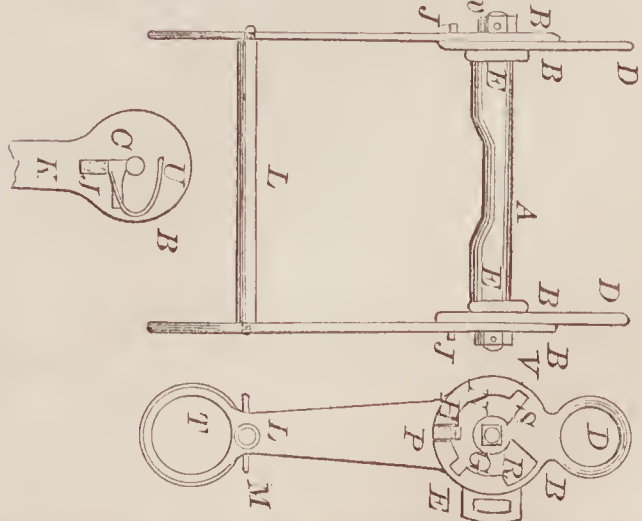

69903—J. Donaldson—Grinding Mill.

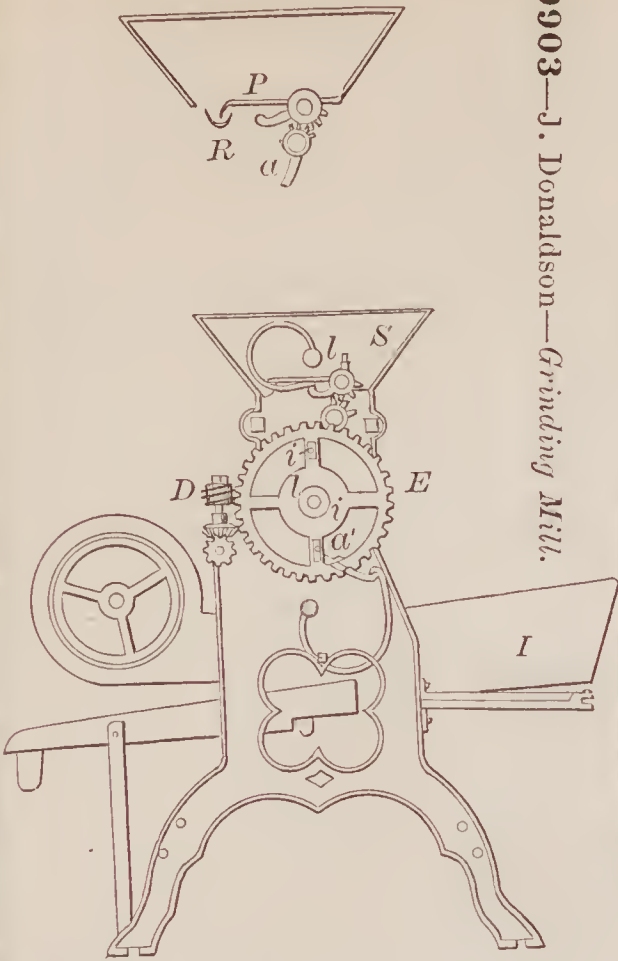



69912—Harris & Elliot—*Railroad Crossing.*

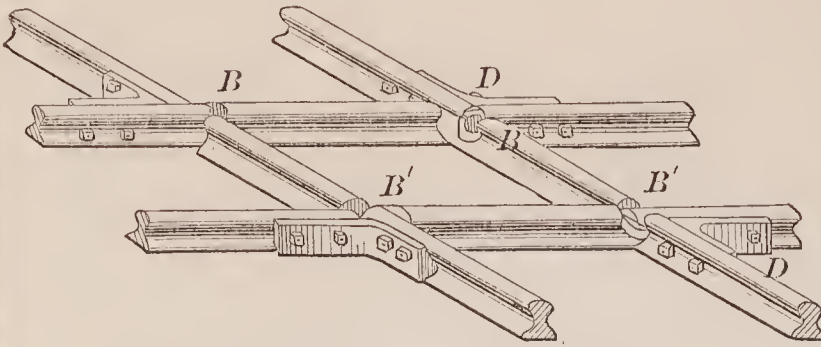

69914—L. Hermance—*Gate.*

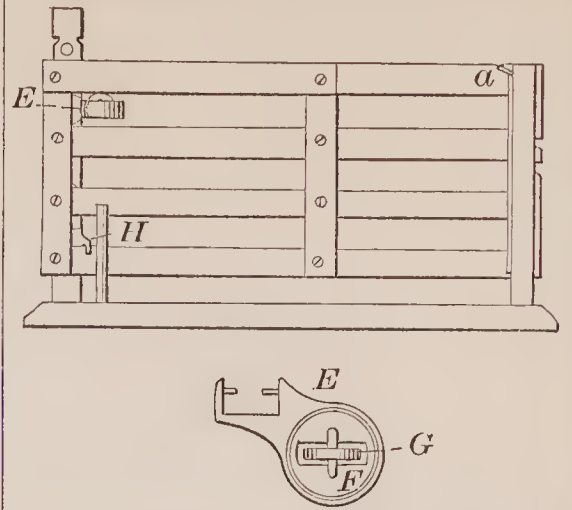

69913—A. L. Haskell—*Horse Rake.*

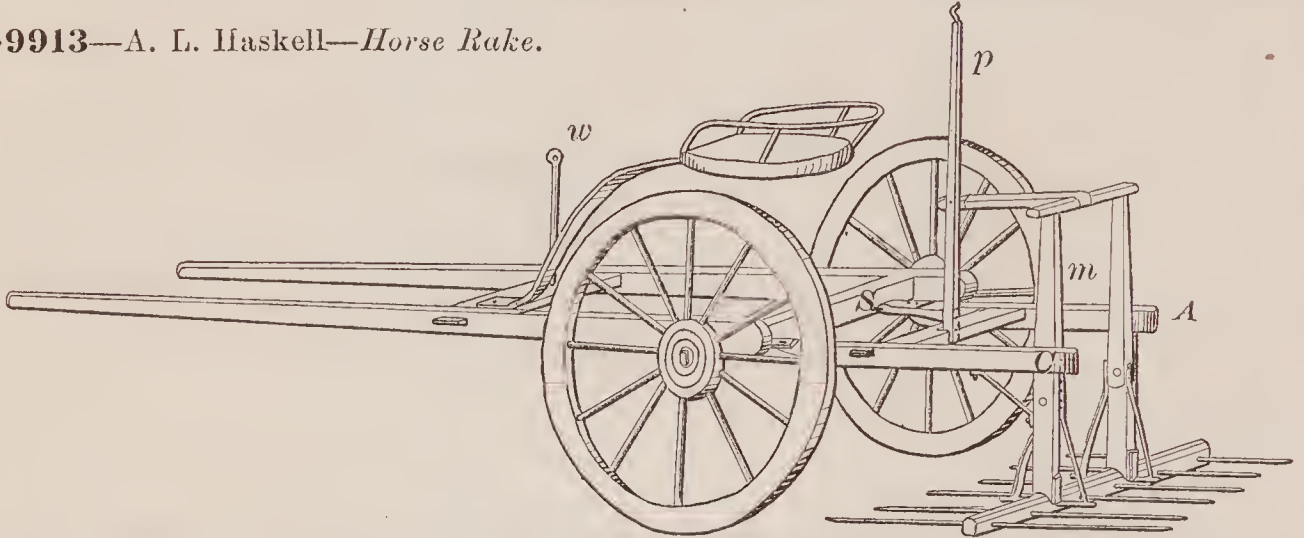

69915—N. Holmes—*Straw Cutter.*

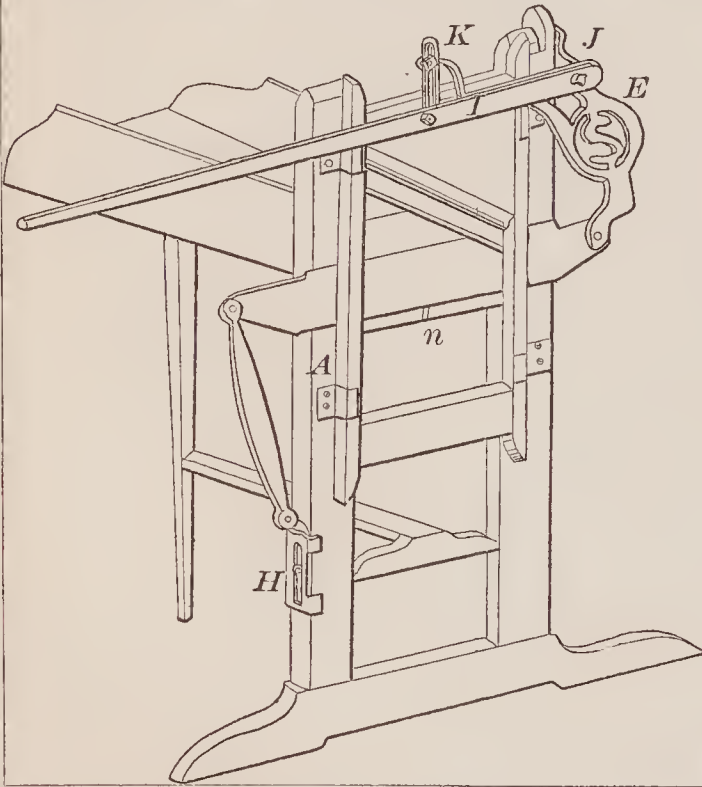

69919—W. F. Kussmaul—*Gun Lock.*

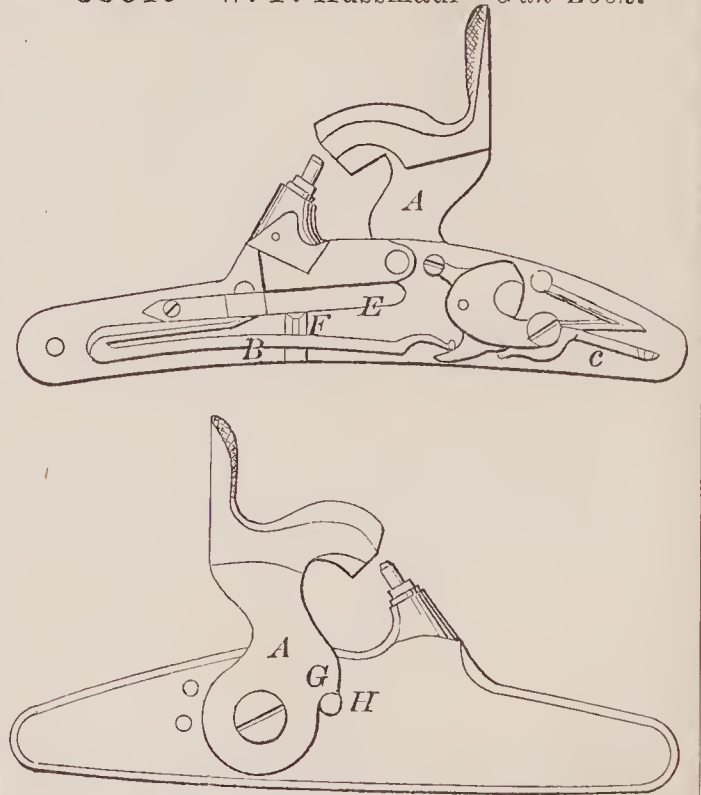

69918—J. L. Knoll—*Dumping Sled.*

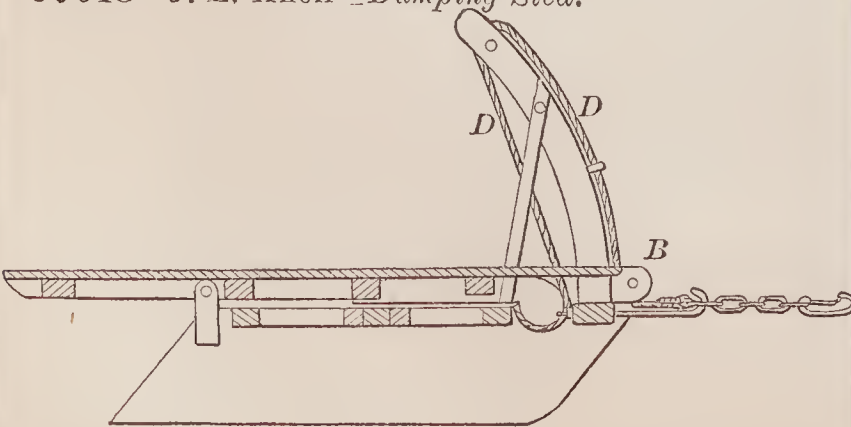

69916—G. Huntington—*Bending Machine.*

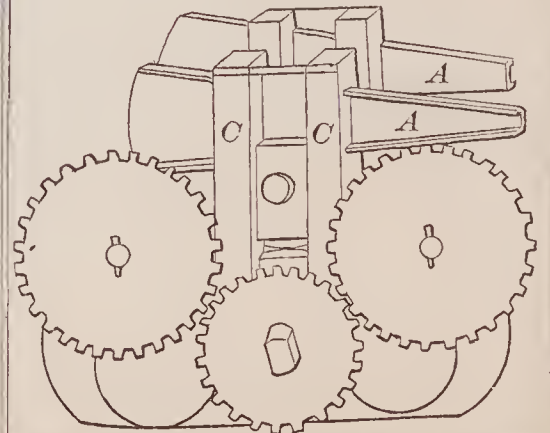

69928—Morris & Green—Hoe and Potato Digger.

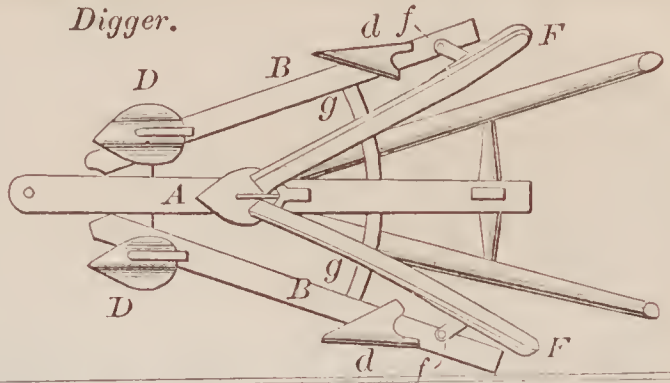

69929—J. Niebergall—Mechanical Movement.

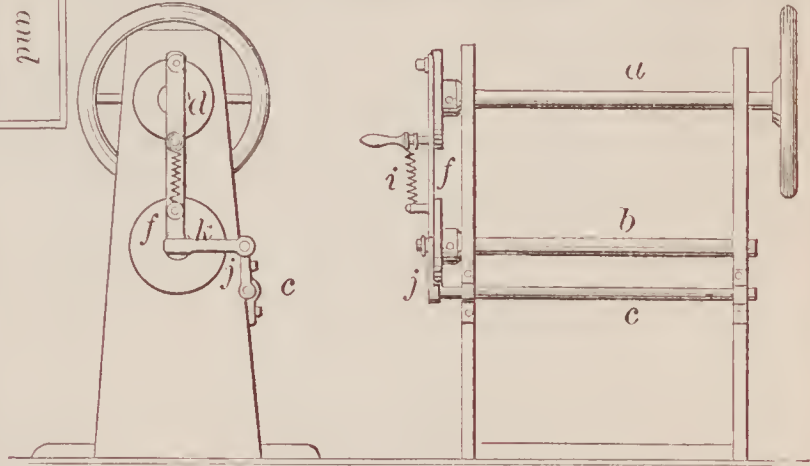

69920—I. L. Landis—Stirrup Attachment.

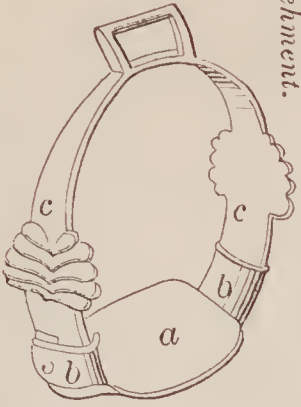

69922—W. W. Lyman—Tea and Coffee Pot.

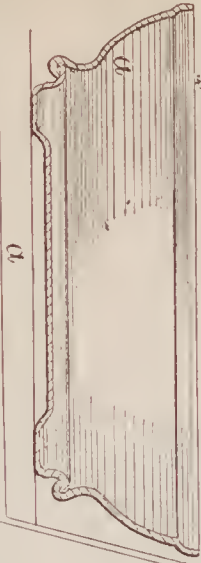

69923—A. S. & S. B. McDowell—Butter Working and Printing Machine.

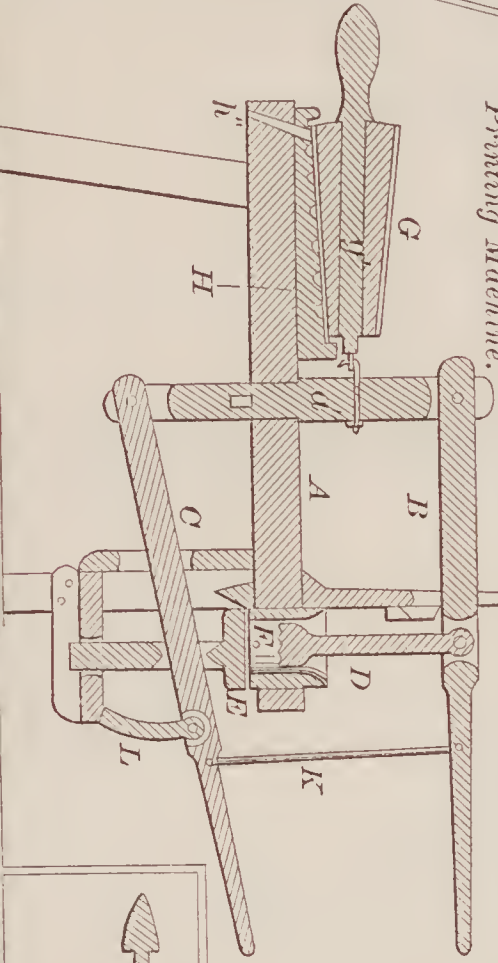

69924—J. G. McMillan—For Preserving Fruit, &c.

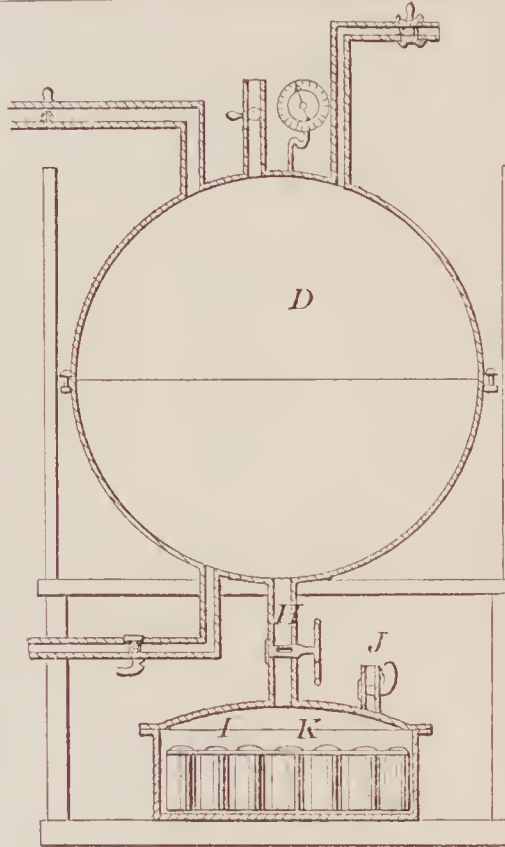

69925—G. McWilliams—Sheep Shed and Rack.

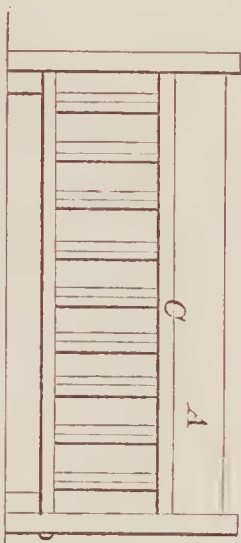

69920—W. Partington—For Cooling Malt Liquor.

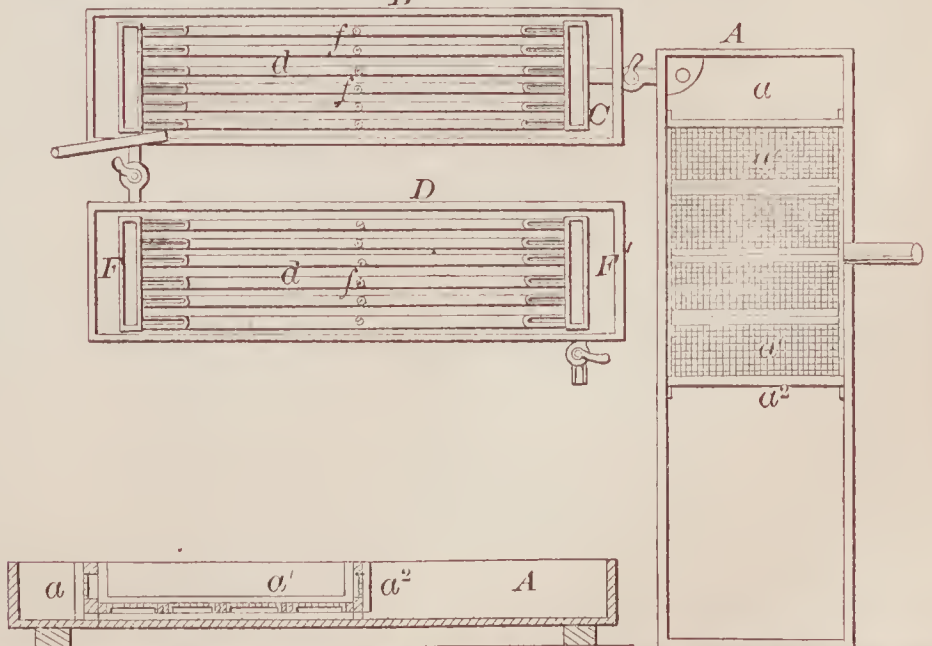

69927—J. Miller—Car Coupling.

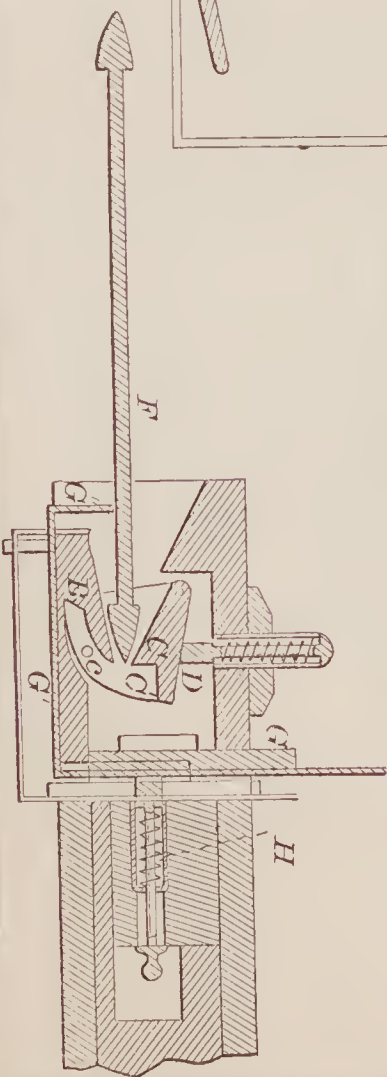



69931—A. Pearsall—Spark  
Arrester.

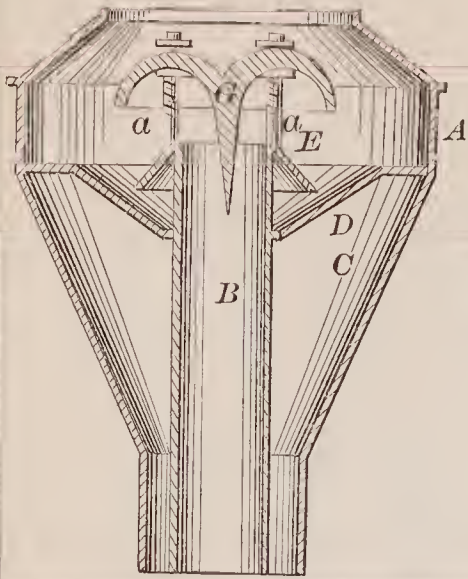

69933—Pope & Whipple—Weighing Scale.

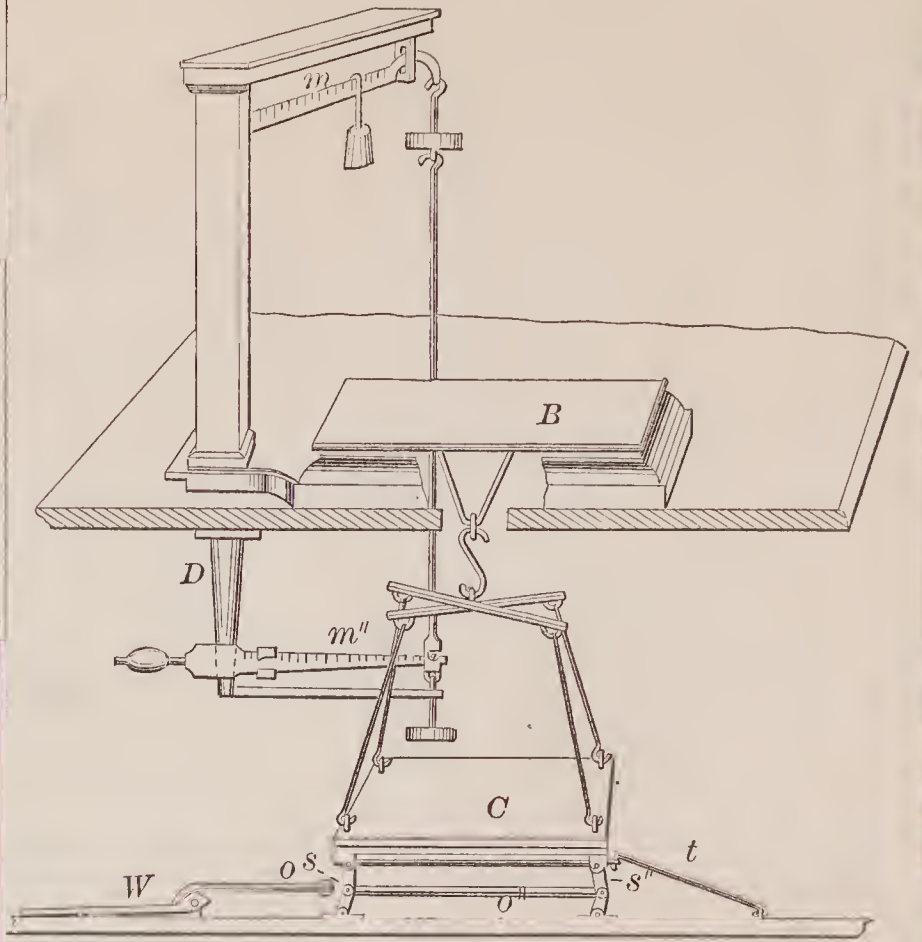

69935—Potter & Barling—  
Rein Holder.

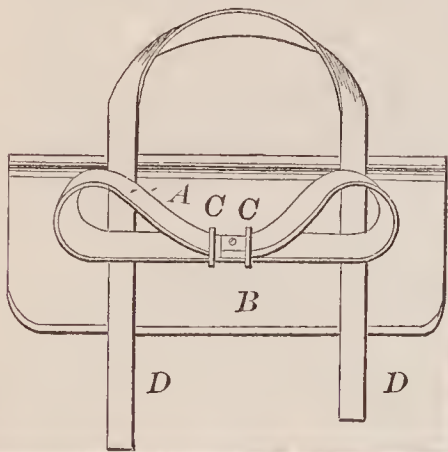

69932—P. D. Pike—Water Wheel.

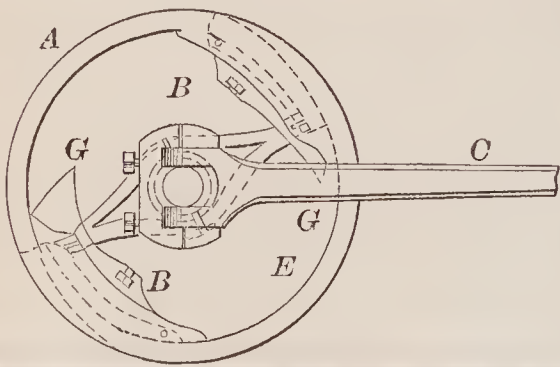

69934—E. Porter—Churn.

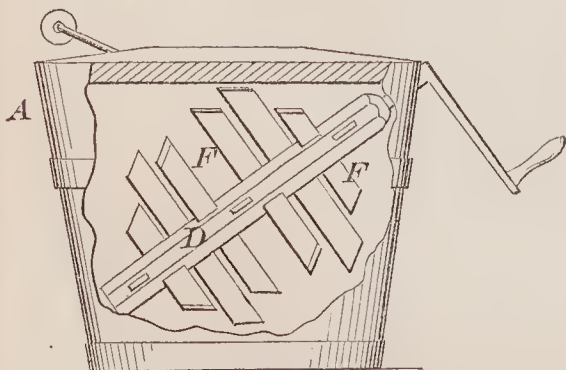

69936—R. Potts—For Bending Metals.

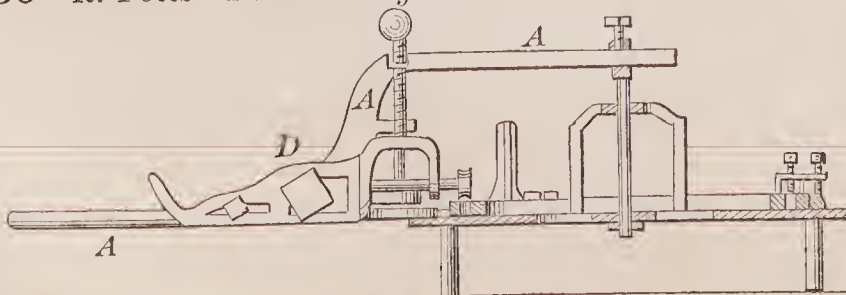

69937—A. E. Preston—Extension Table.

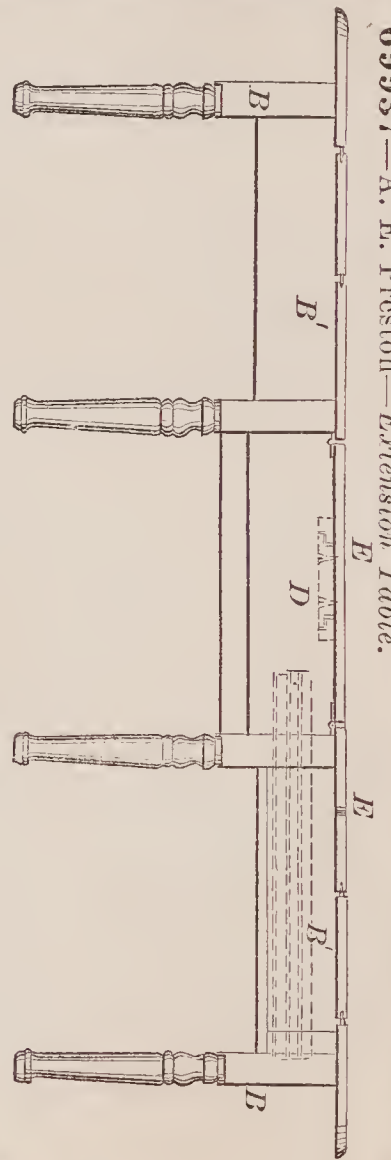

69938—Rhoades & Carroll—Railway Car Seat.

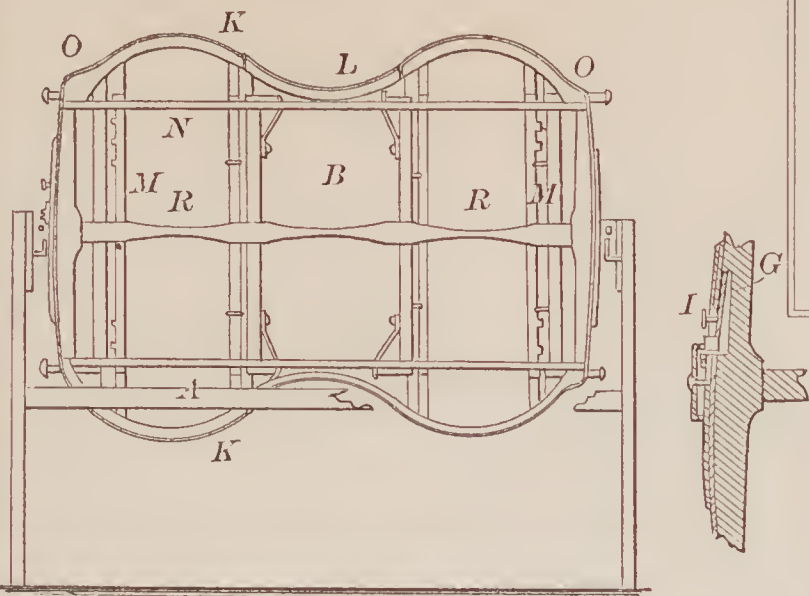

69939—T. C. Riddell—Baking Frame.

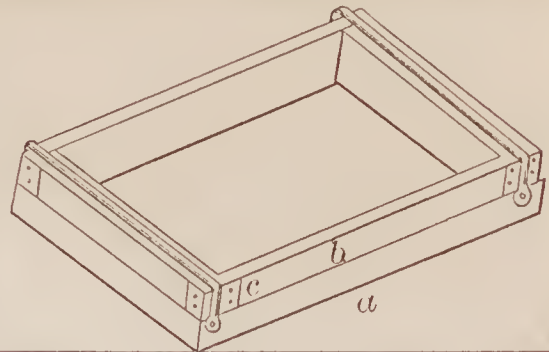

69940—E. C. B. Riek—Submarine Vessel.

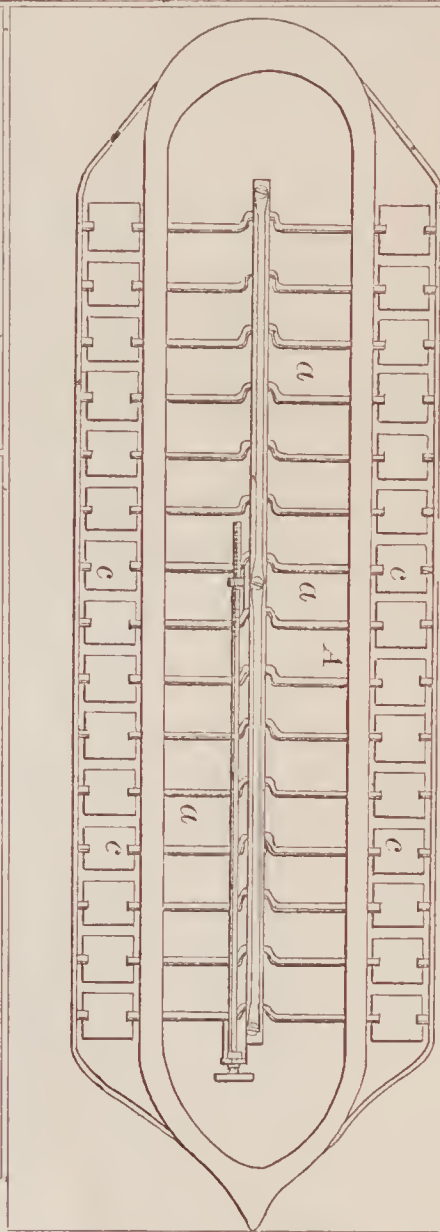

69941—A. Snider, Adm'x—Breech-Loading Fire Arm.

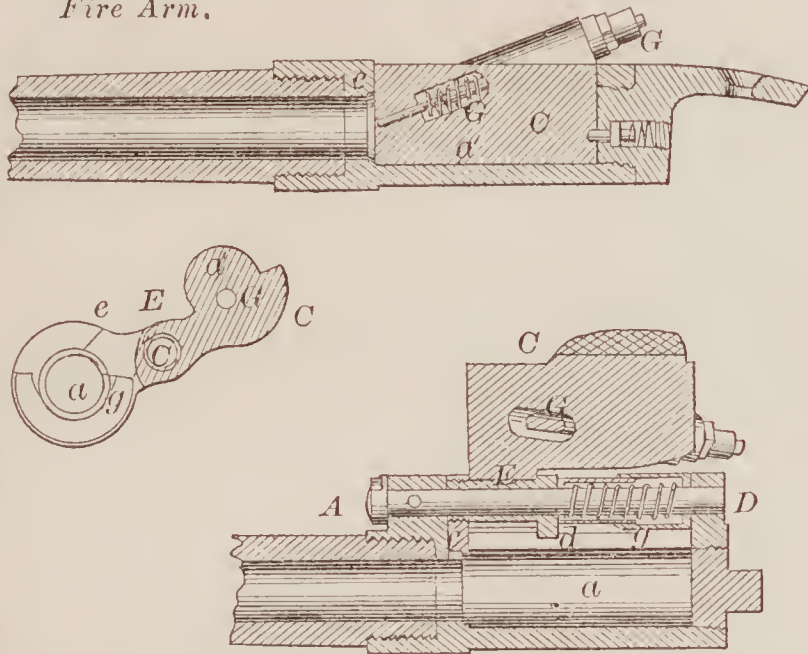

69942—R. W. Soper—Mop Wringer.

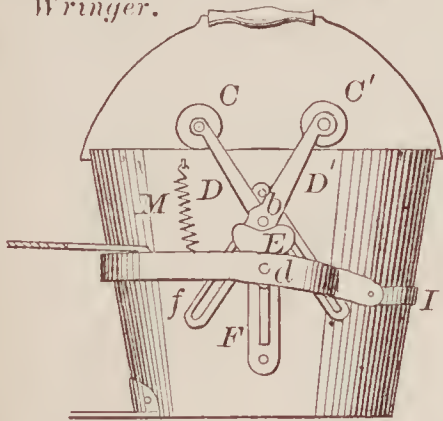

69943—G. Spielman—Plow.

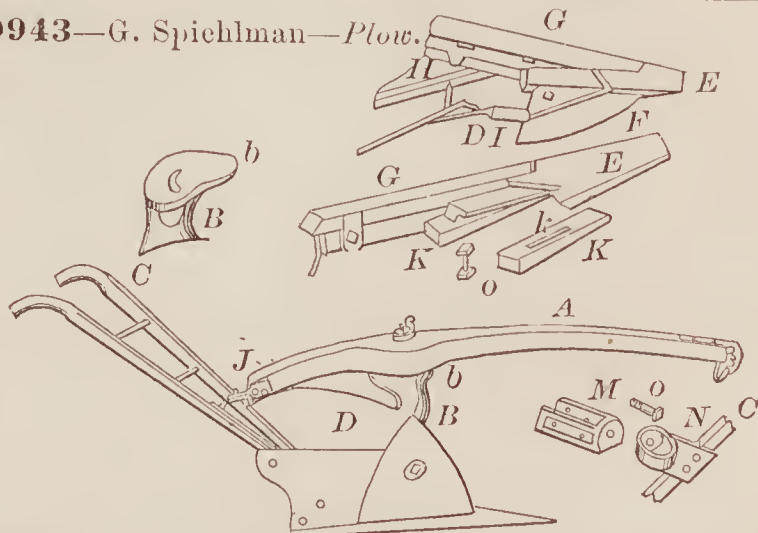

69944—F. Spineux—Drawing and Twisting Head for Spinning.

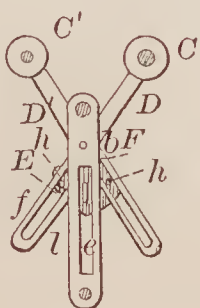
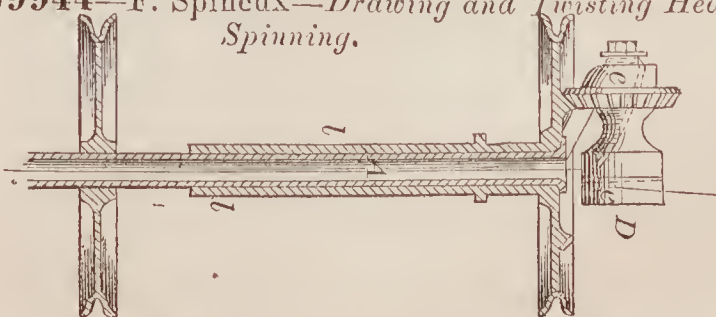



69945—W. H. Staats—*Railway Switch.*

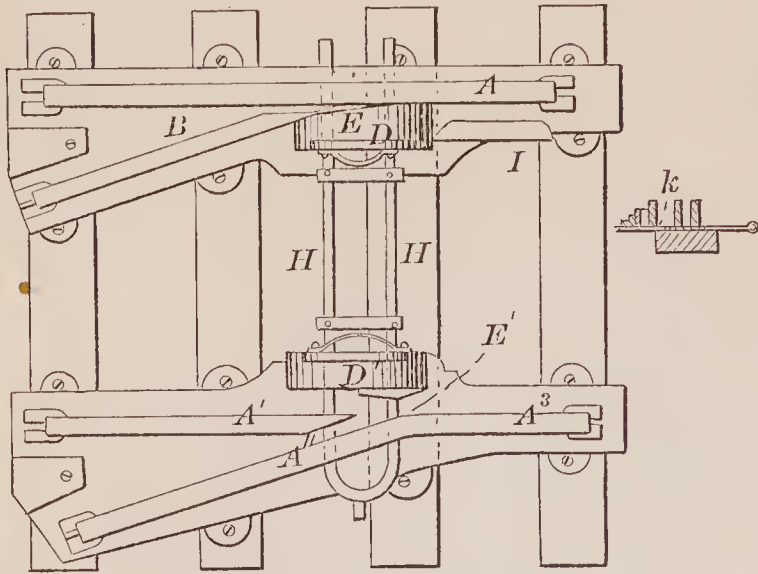

69948—T. G. Taylor—*Rule and Letter Scale.*

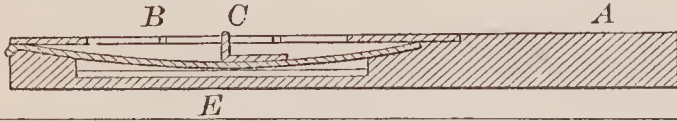

69949—J. W. Thorne—*Clamp for Traveling Trunks.*

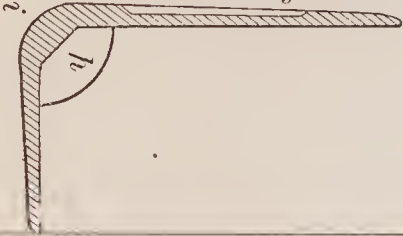

69954—J. Richards—*Standard Gauge.*

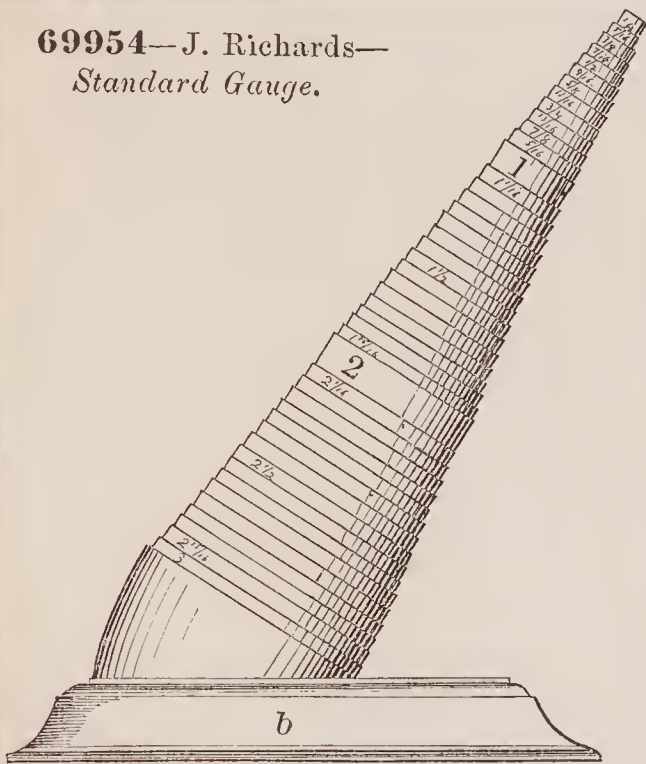

69955—D. E. Somes—*For Cooling, Freezing and Heating.*

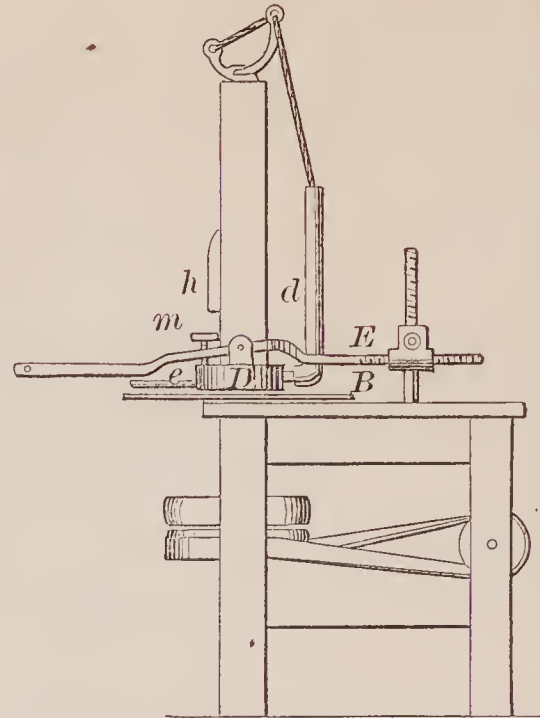
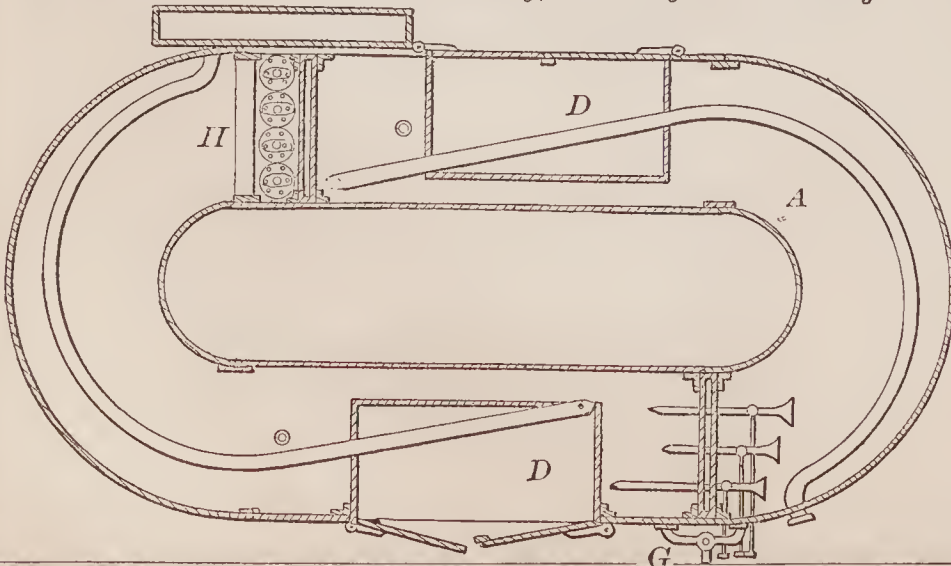

69950—J. T. Waring—*For Ironing Hats.*

69951—J. B. Crowley—*Top Plate of Cooking Stoves.*

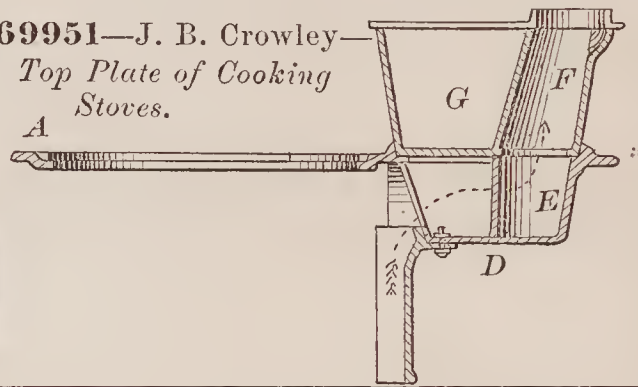

69947—D. W. Strong—*Laying Telegraph Wires on Railroads.*

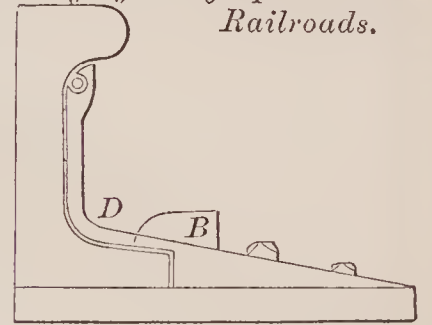

69952—J. L. Ferre—*Window Sash Elevator.*

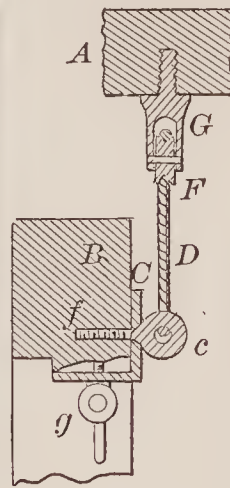

69953—J. Richards—*Fixed Caliper Gauge.*

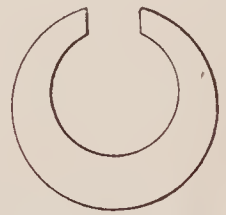

69946—A. Steward—*Ruffler for Sewing Machines.*

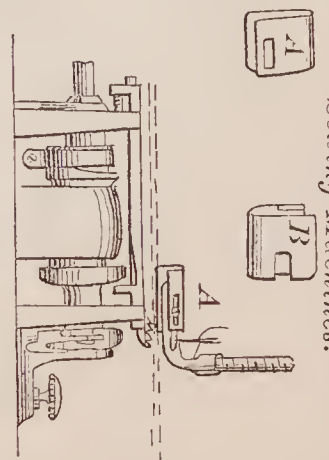

69956—G. W. Bacon—*Gymnastic Apparatus.*

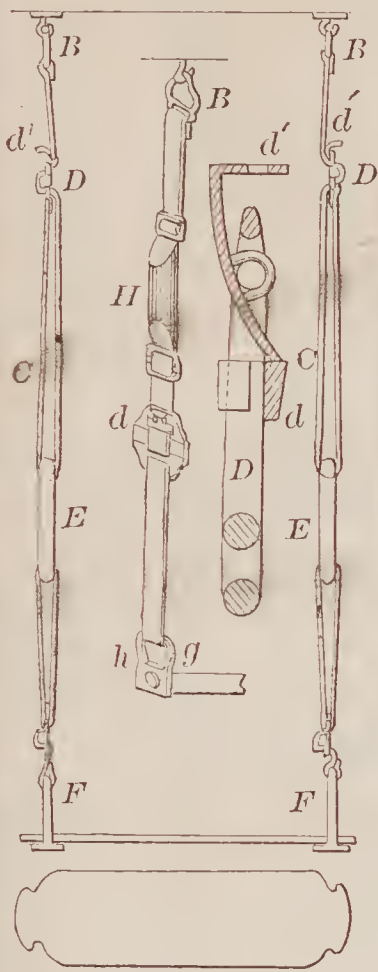

69957—S. H. Badger—*Slide Valve Lubricator.*

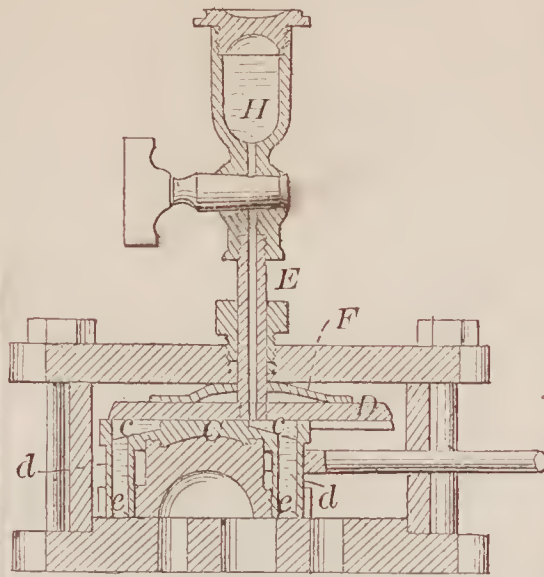

69959—J. Barelay—*Carriage Knob.*

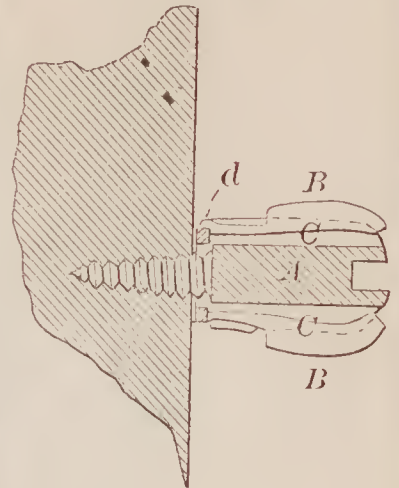

69958—C. S. Baker—*Invalid Bedstead.*

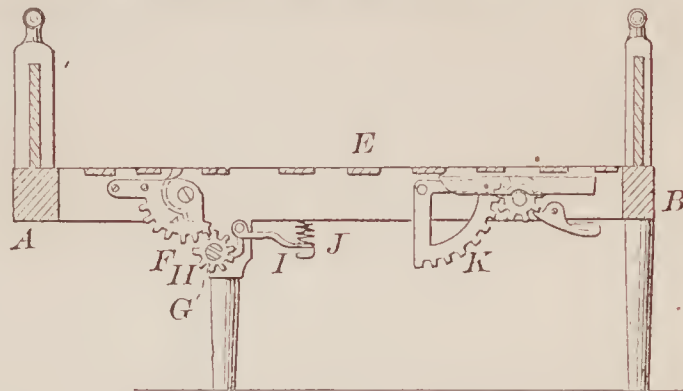

69960—W. B. Barnard—*Scissors and Shears.*

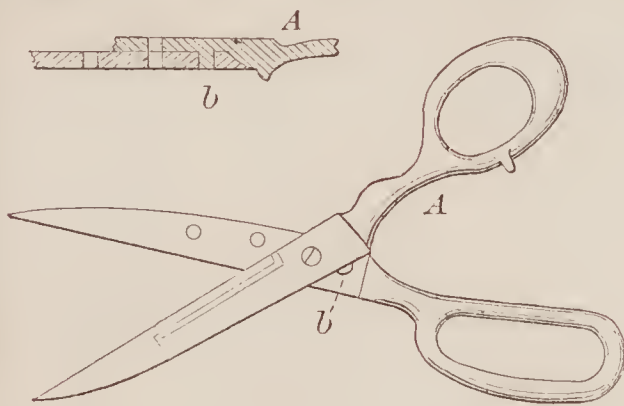

69961—H. Bartholomew—*Fence.*

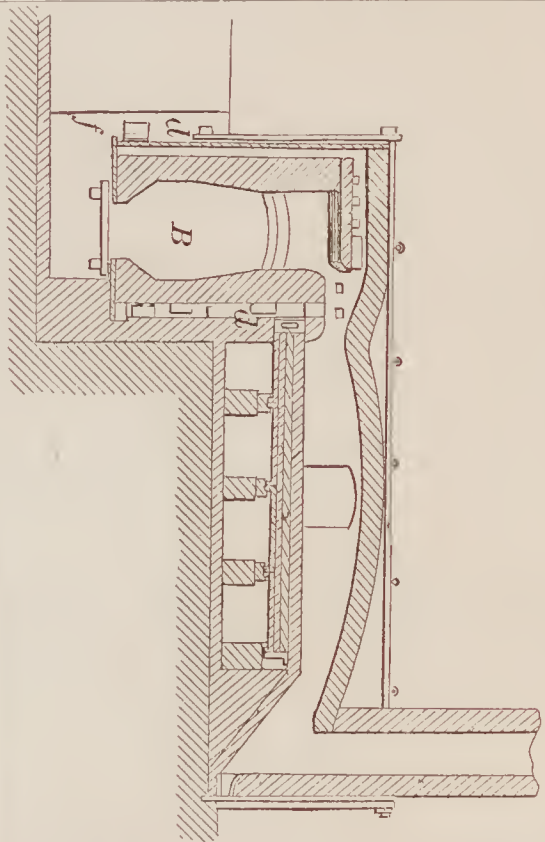
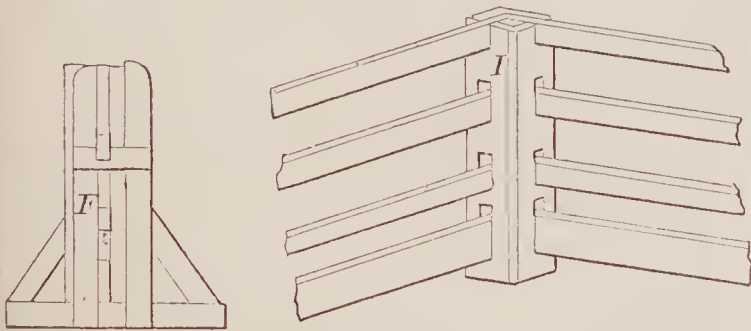

69963—H. Boetius—*Metallurgical Furnace.*

69964—H. G. Bulkley—*For Drying and Desiccating.*

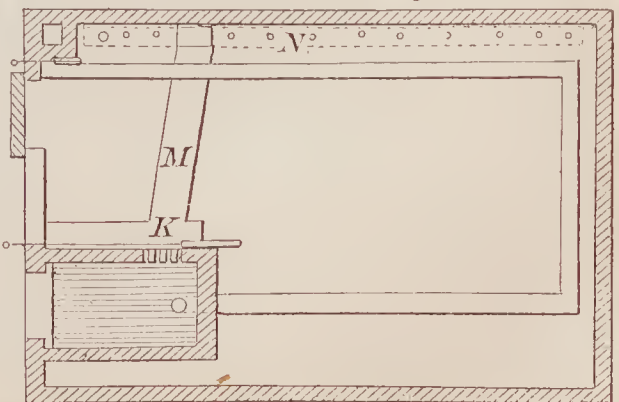

69962—J. Blackinton—*Bolt Trimmer.*

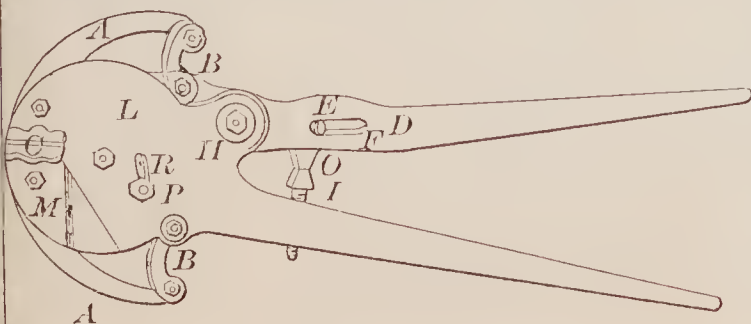



69964—Continued.

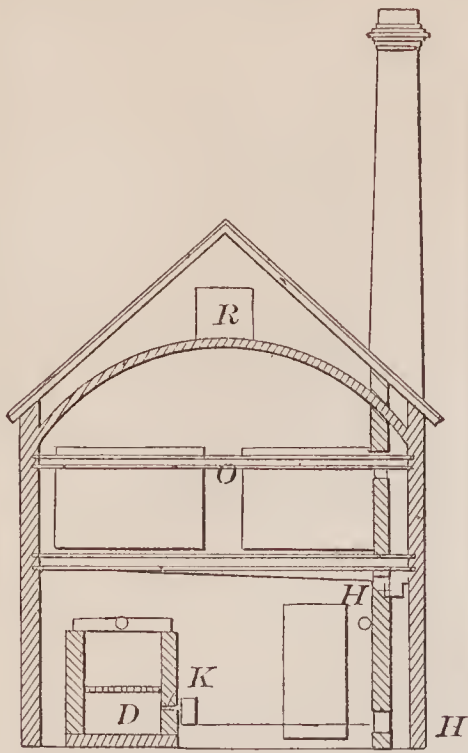

69965—Case & Barclay—  
Carriage Knob.

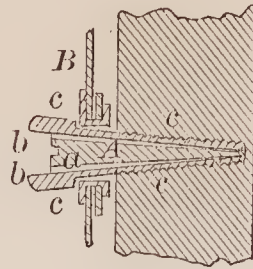

69966—J. Chadwick—  
Weather Strip for Doors.

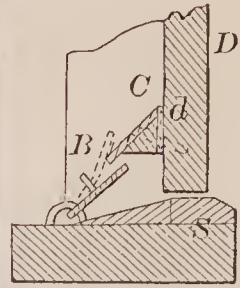

69968—J. C. Clapp—Bath Tub.

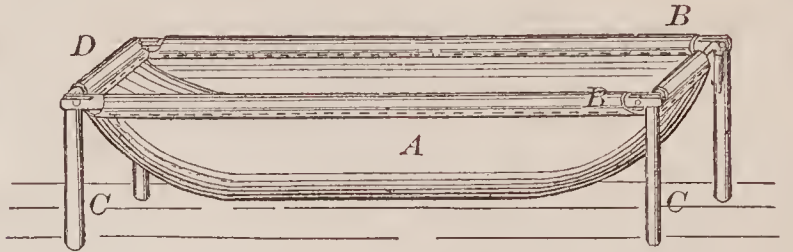

69969—A. H. Clement—Washing  
Machine.

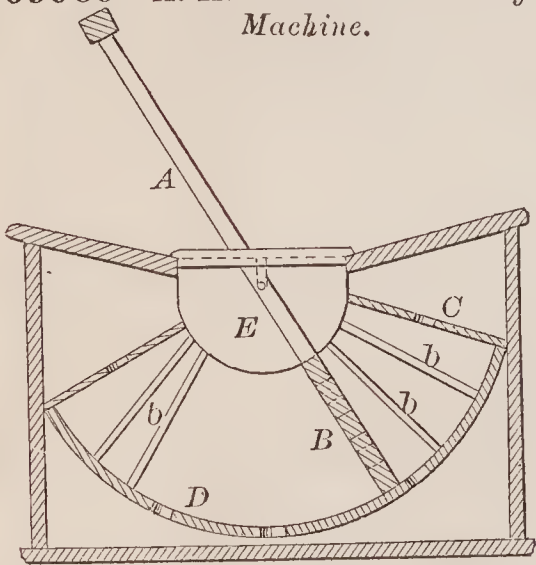

69967—J. Chase—ClouDED Yarn.



69971—E. S. Colton—Ice Cream Refrigerator.

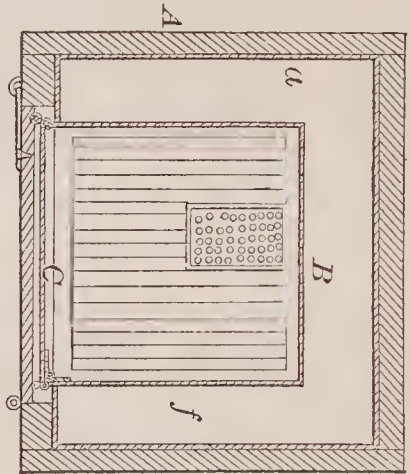

69972—T. F. Conner—Car Coupling.

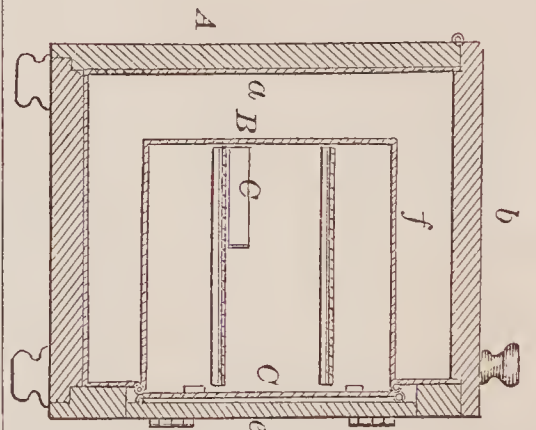
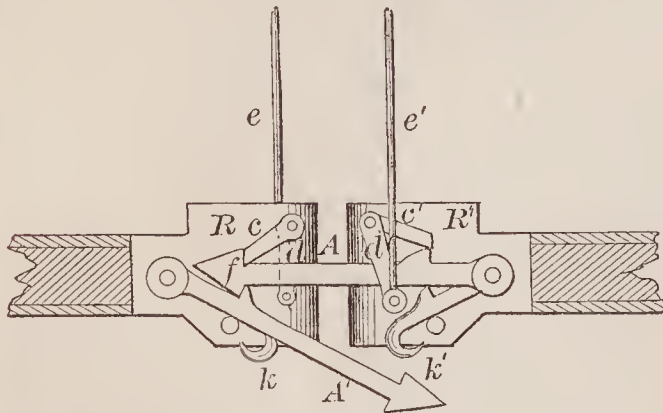

69973—J. W. Crannell—Tuyere.

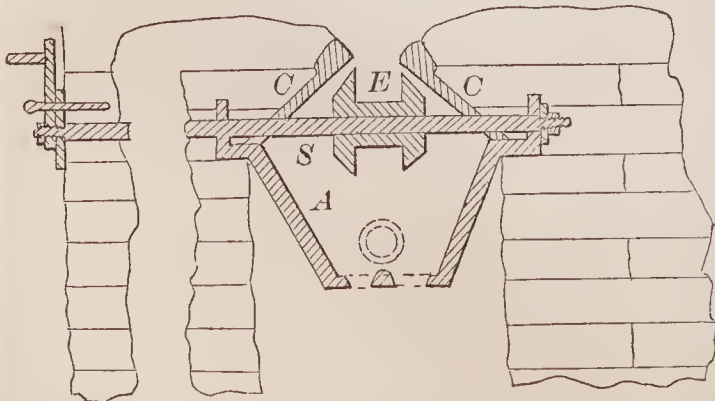

69974—G. Crompton—Weft Stop Motion  
for Looms.

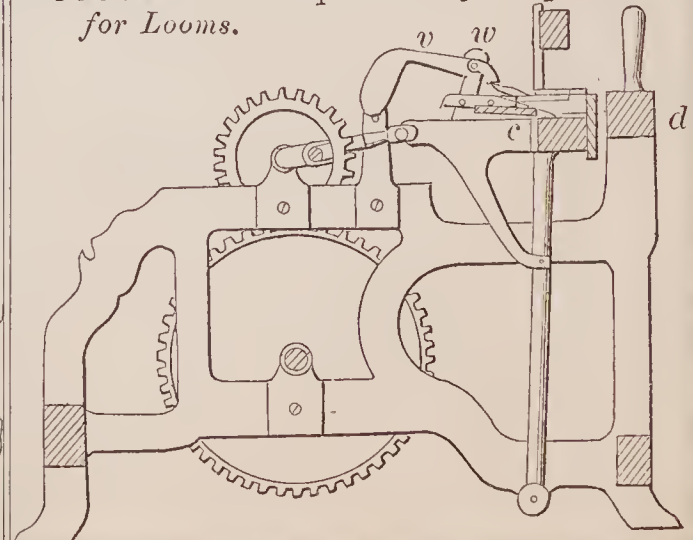

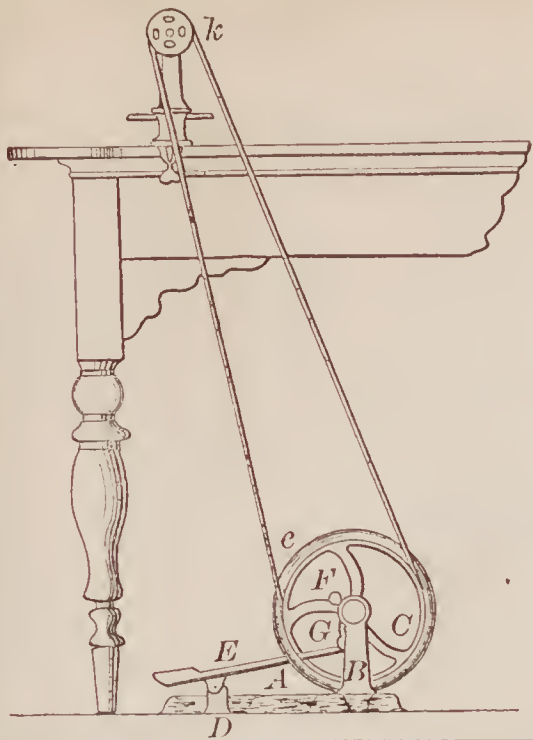

69975—W. J. Demorest—Movable Treacle.

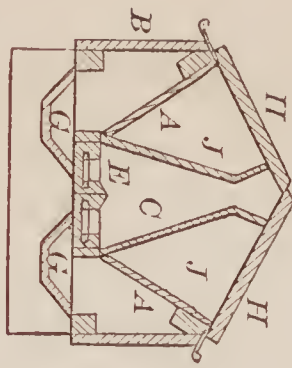

69976—G. Febles—Sheep Racks and Trough.

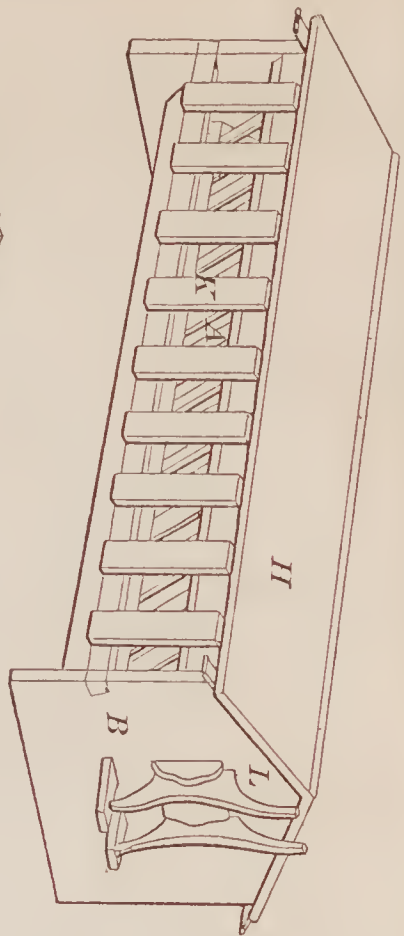

69978—R. Finnegan—Hoisting Apparatus.

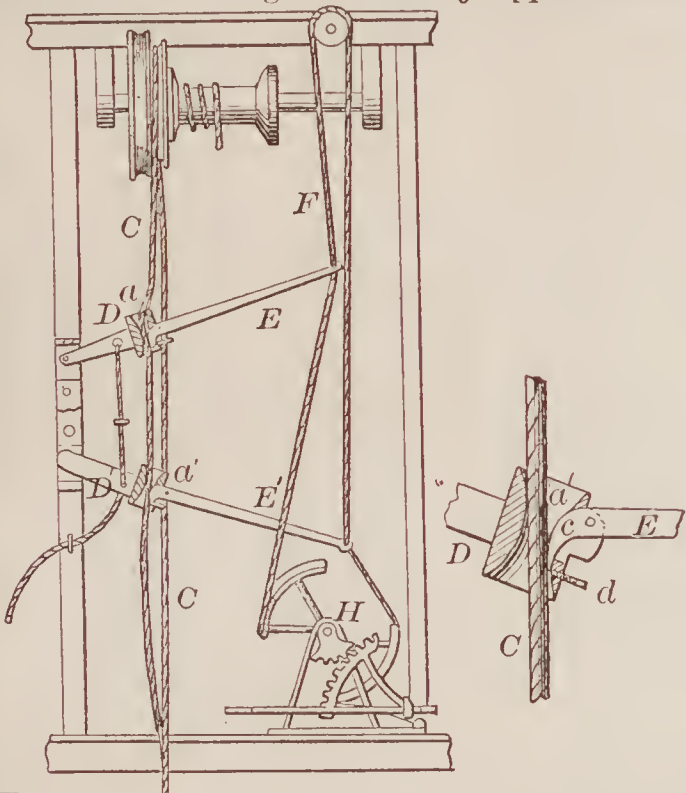

69979—Fisher & Meili—Sted.

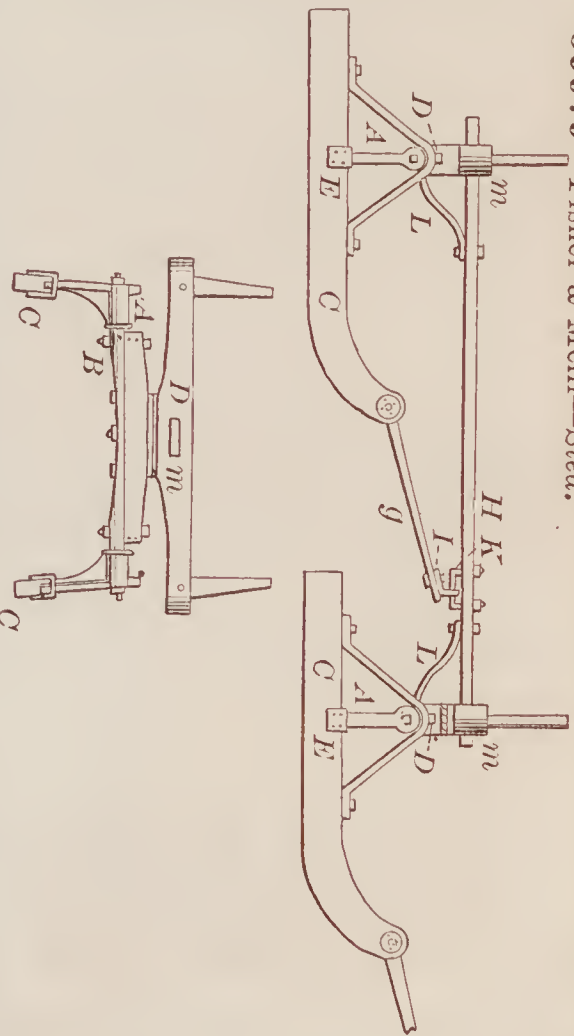

69977—C. C. Fellows—Clothes Line Clamp.

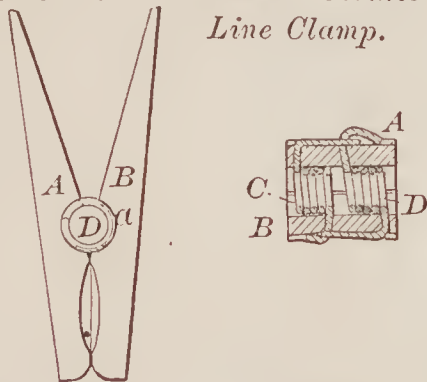

69980—T. Flagler—Fruit Gatherer.

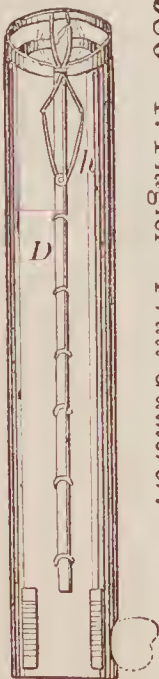

69981—C. Flory—Corn Cultivator.

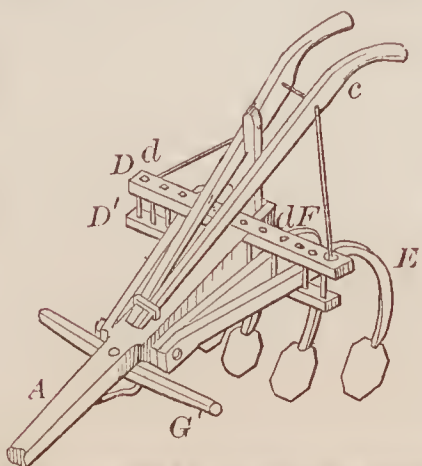

69982—W. T. Foster—Hood for Coal Grates and Fireplaces.

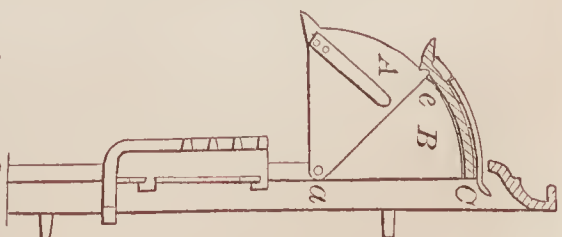



69983—S. W. Francis—Oar.

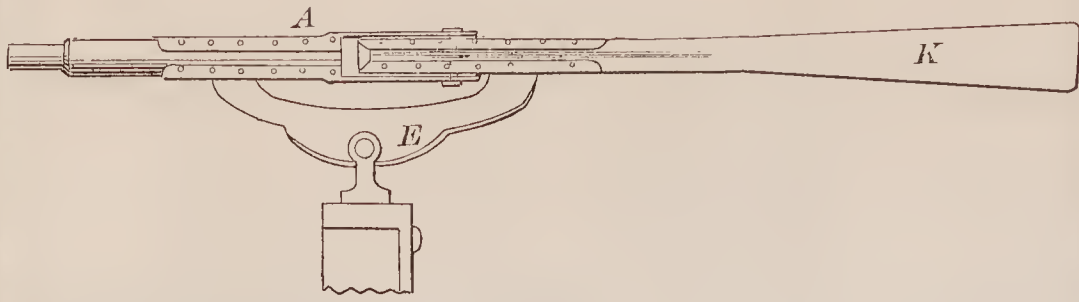

69987—J. K. Glenn—Motive Power.

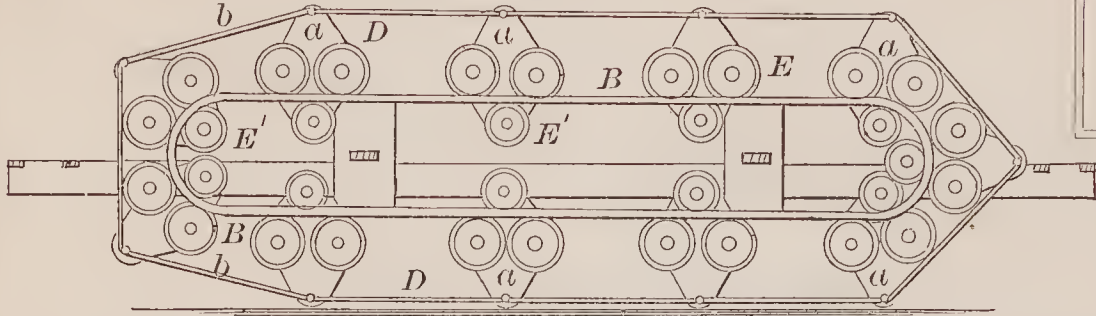

69984—W. M. Franz—Operating Telegraph Key.

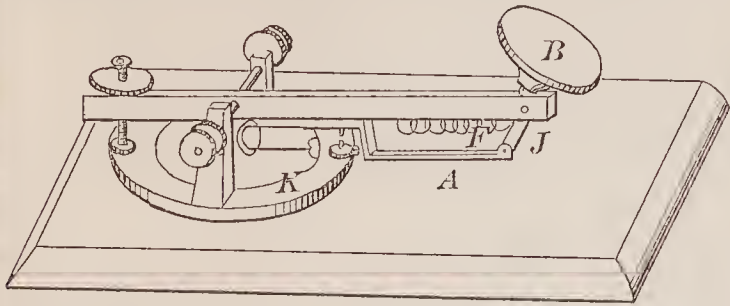

69989—T. Harding—Bag Holder.

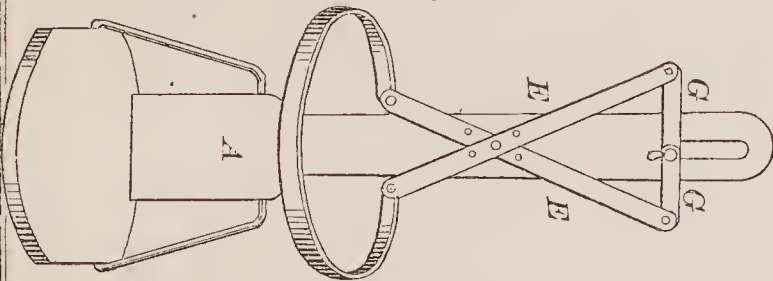

69991—J. H. Haskell—Leather Punching Machine.

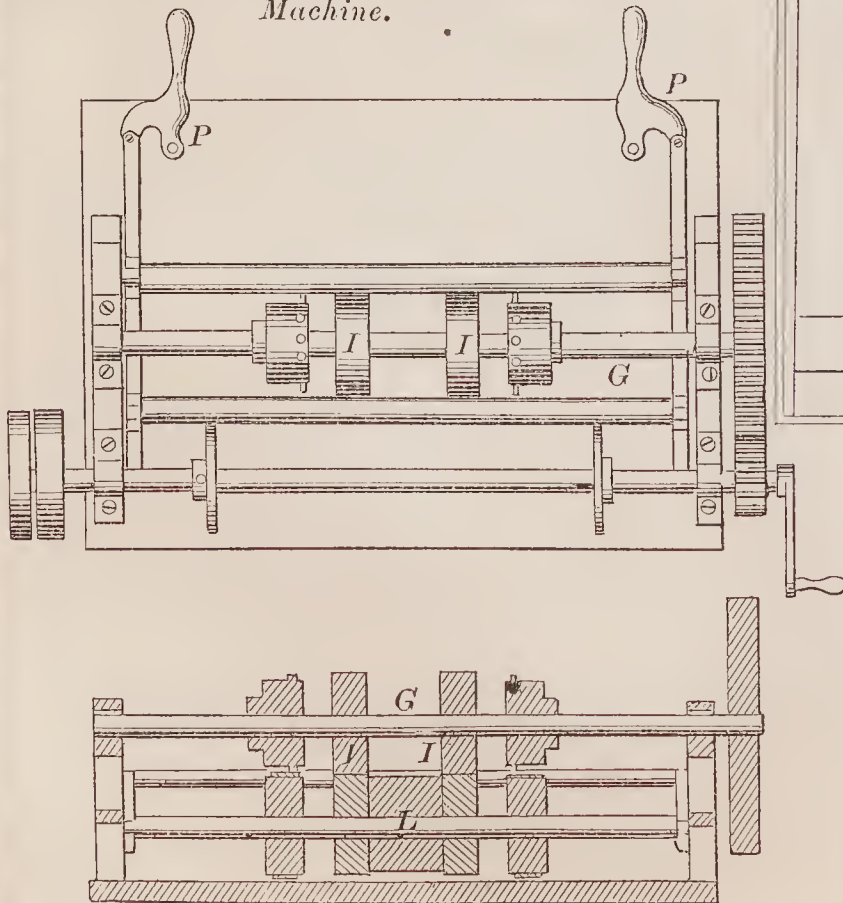

69990—J. M. Hart—Hand Spinning Machine.

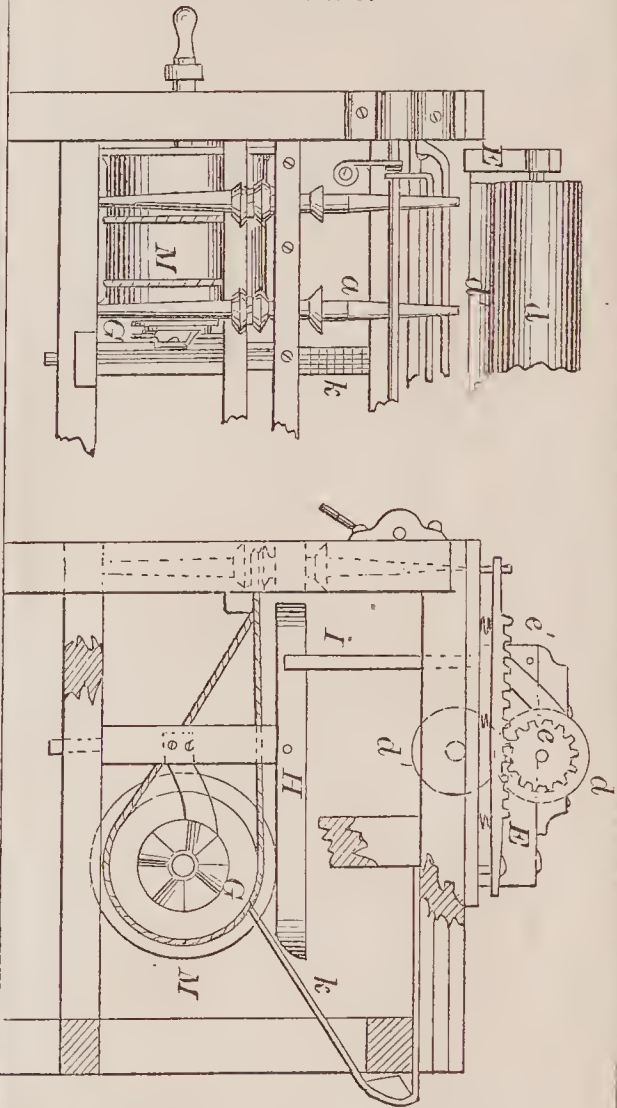

69986—W. Gee—Lining Soda Fountains.

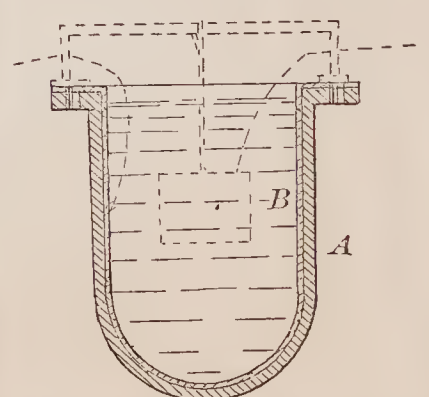

69988—E. W. Glover—Bosom Pad.

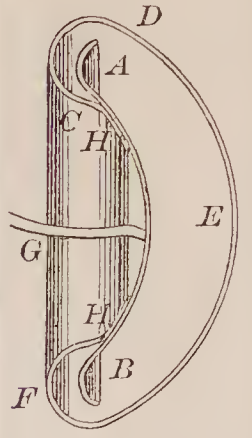

69992—W. H. Hawley—*Grappling Iron.*

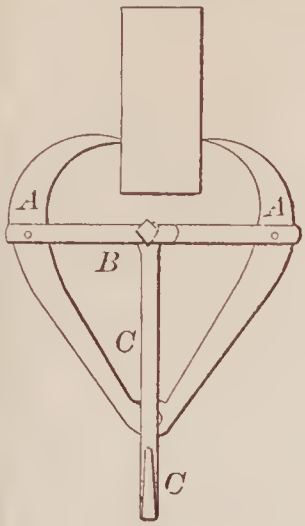

69993—T. Haynes—*Knife Sharpener.*

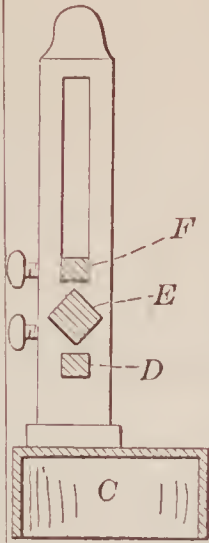

69994—J. Hegarty—*Portable Fountain.*

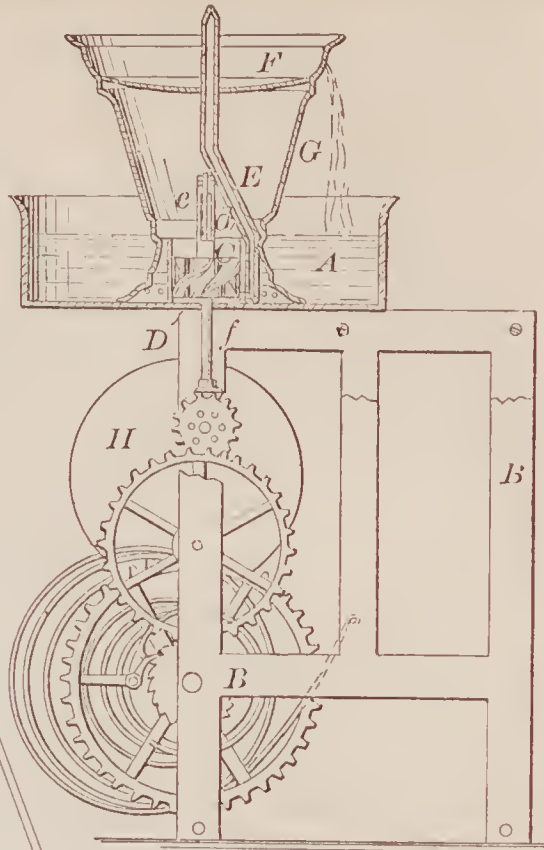

70000—A. Jusberg—*Pump.*

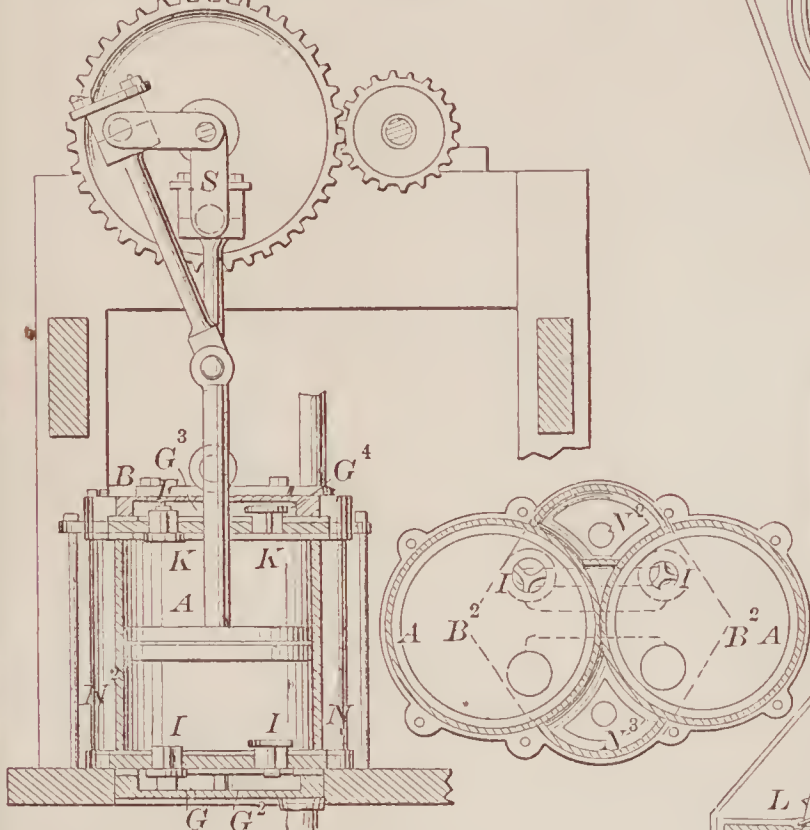

69998—D. Hyde—*Churn.*

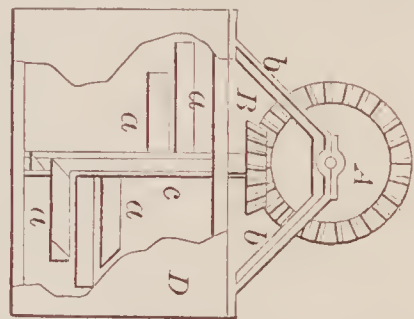

70001—M. A. Keller—*Harvester.*

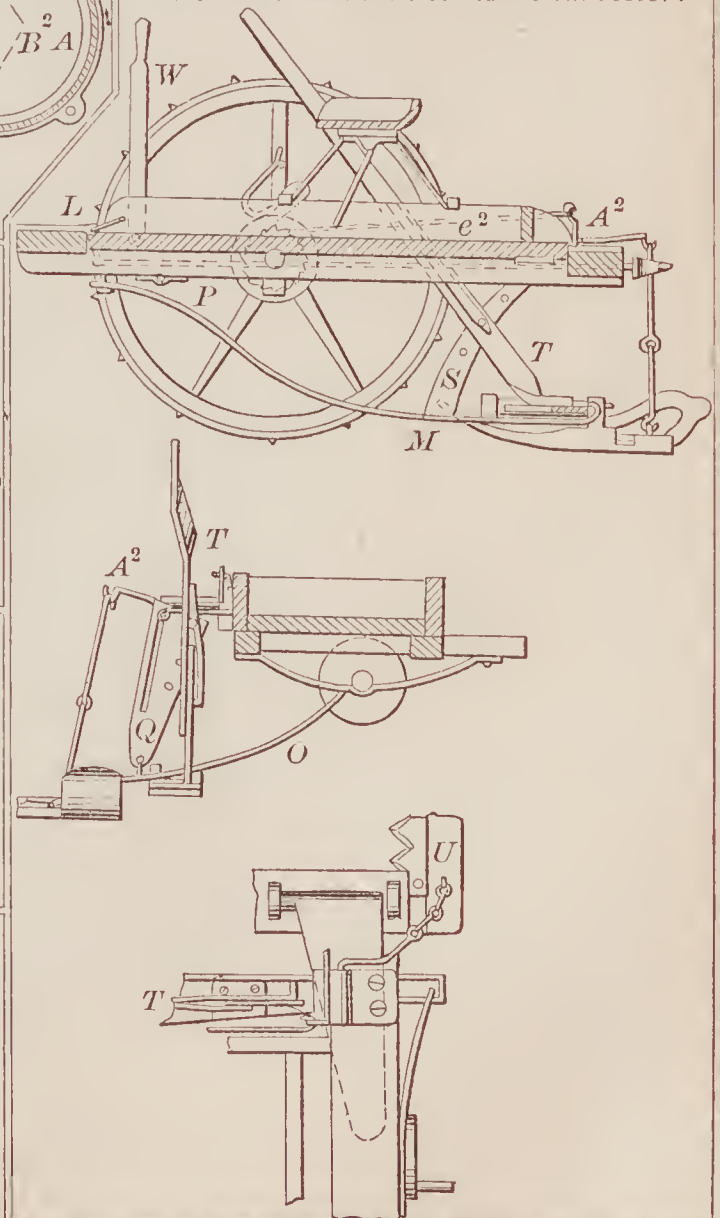

69999—J. E. Jenkins—*Plow.*

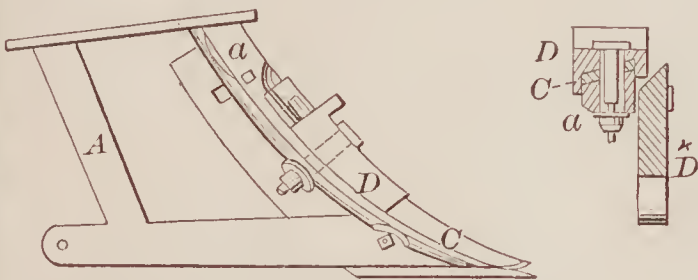

69996—W. L. Hubbell—*Can Opener.*

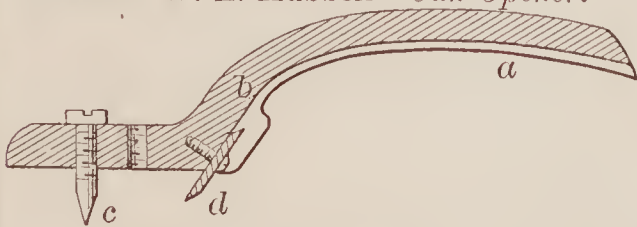

69997—A. Huston—*Needle Threader.*

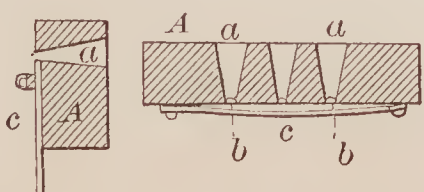



70002—J. H. Kendrick—*Horse Hay Fork.*

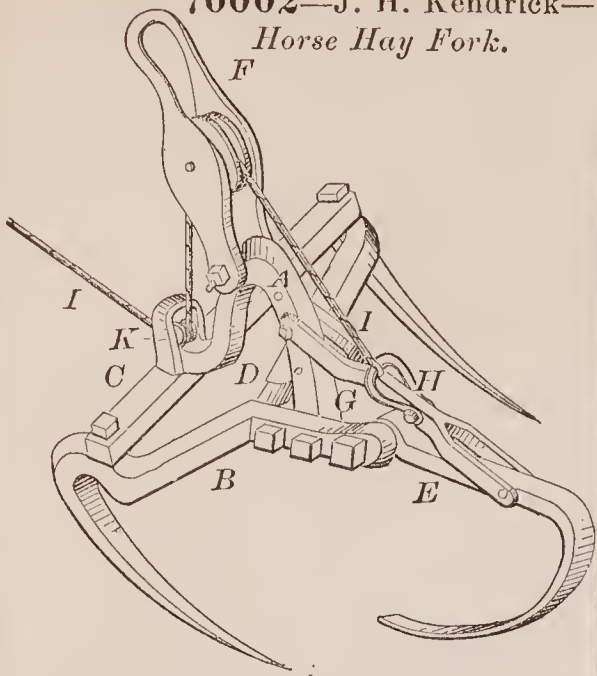

70004—G. W. King—*Horse Rake.*

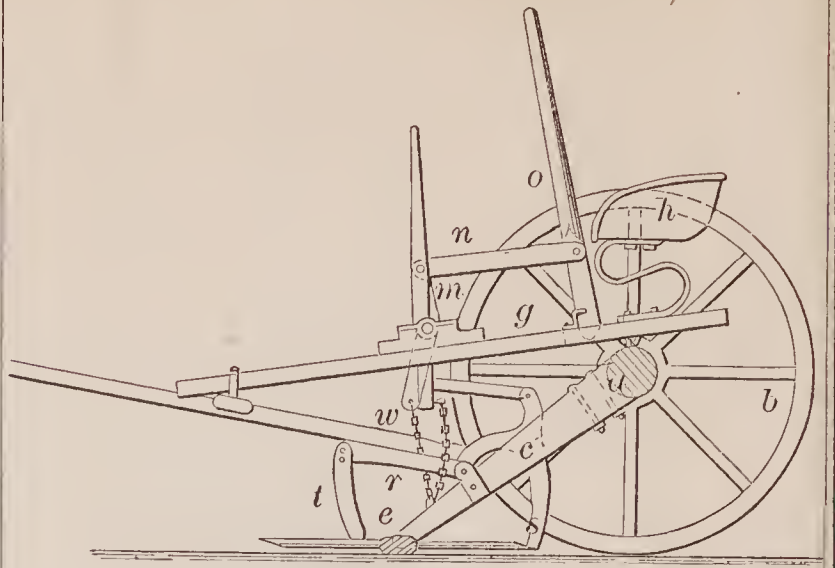

70003—E. W. Keyes—*Toy Cue.*

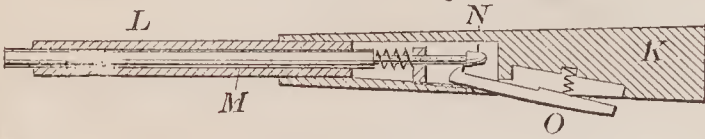

70007—E. J. Leyburn—*Harvester Rake.*

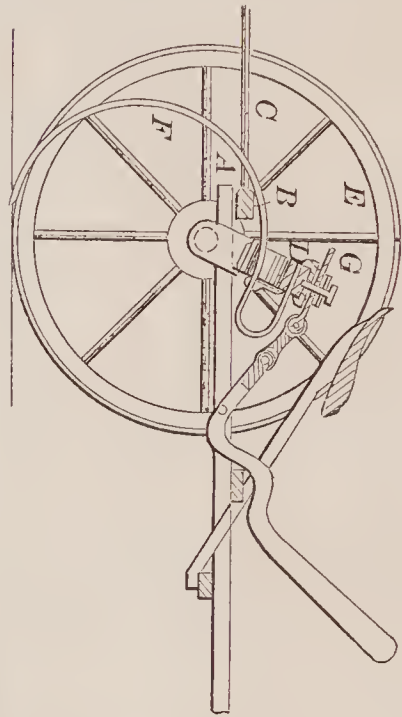
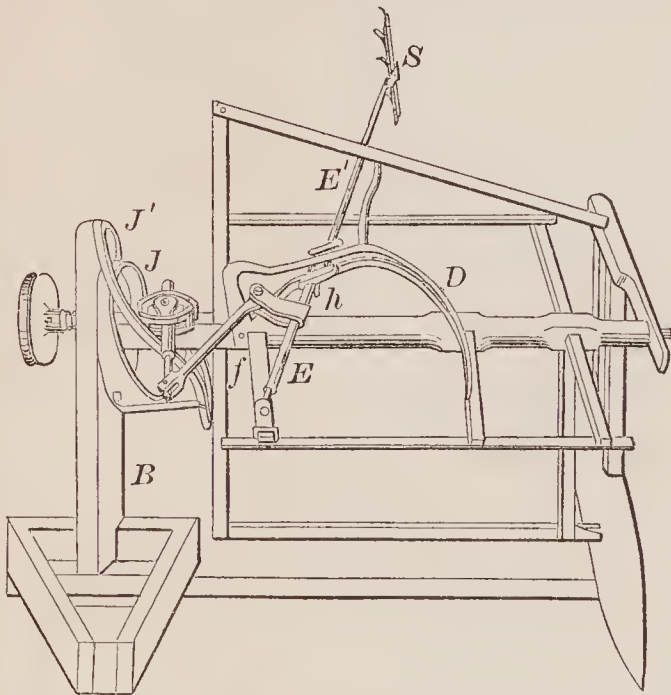

70008—J. M. Long—*Horse Rake.*

70009—H. H. Macklin—*Churn.*

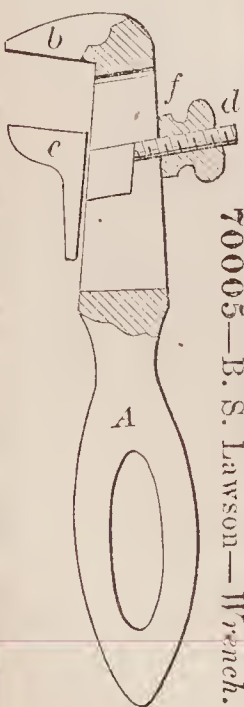
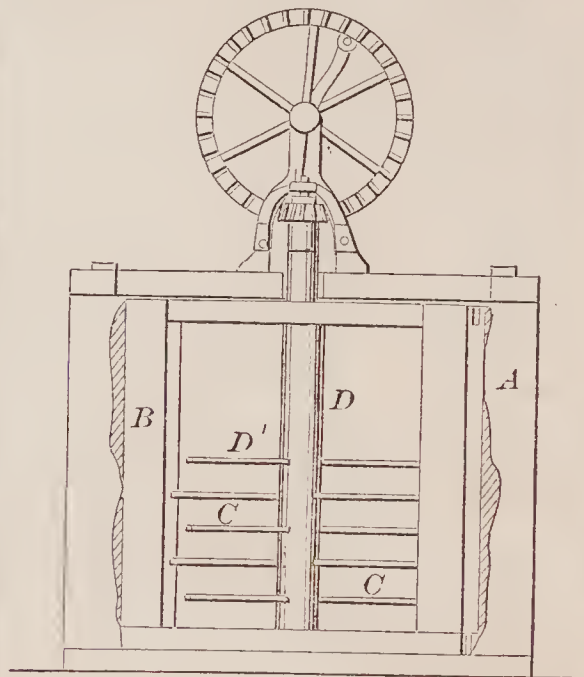

70005—B. S. Lawson—*Wrench.*

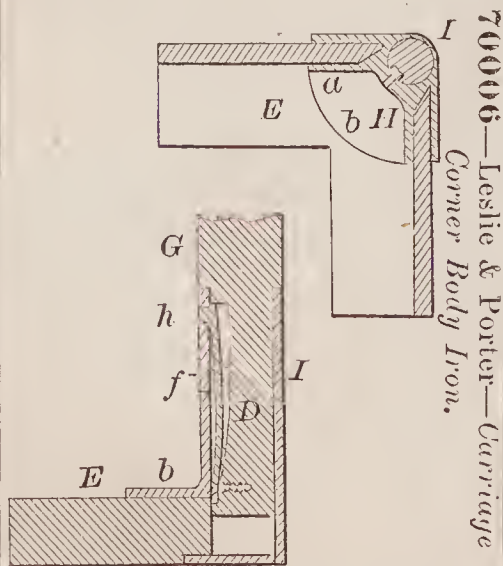

70006—Leslie & Porter—*Carriage Corner Body Iron.*

70010—C. Messenger—*For Opening Sheet Metal Cans.*







70024—J. Ruegg—Bung and Bush.

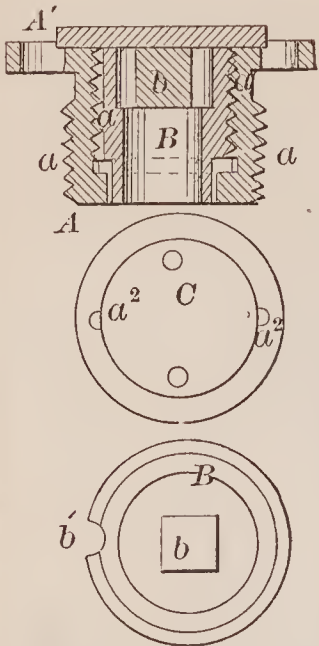

70025—C. W. Saladee—Protector for the Edges of Collars.



70026—F. W. Sawyer—Loom Shuttle.



70027—W. T. Sawyer—Vehicle Wheel.

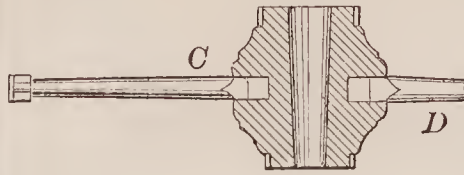

70029—J. Scanlan—Roofing Fabric.

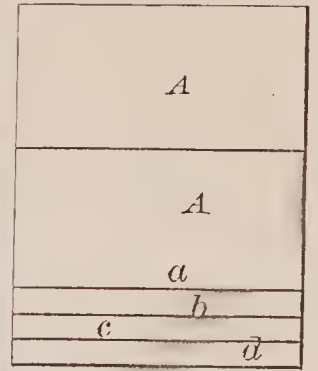

70030—J. Scanlan—Felt Roofing.



70028—J. Scanlan—Roofing.



70033—E. Shopbell—Slotting Machine.

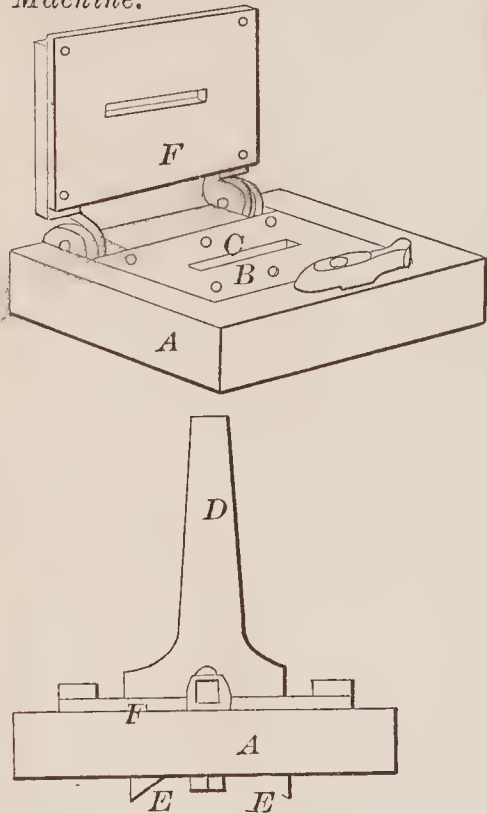

70031—E. G. Scovil—Protecting the Heated Parts of Furnaces.

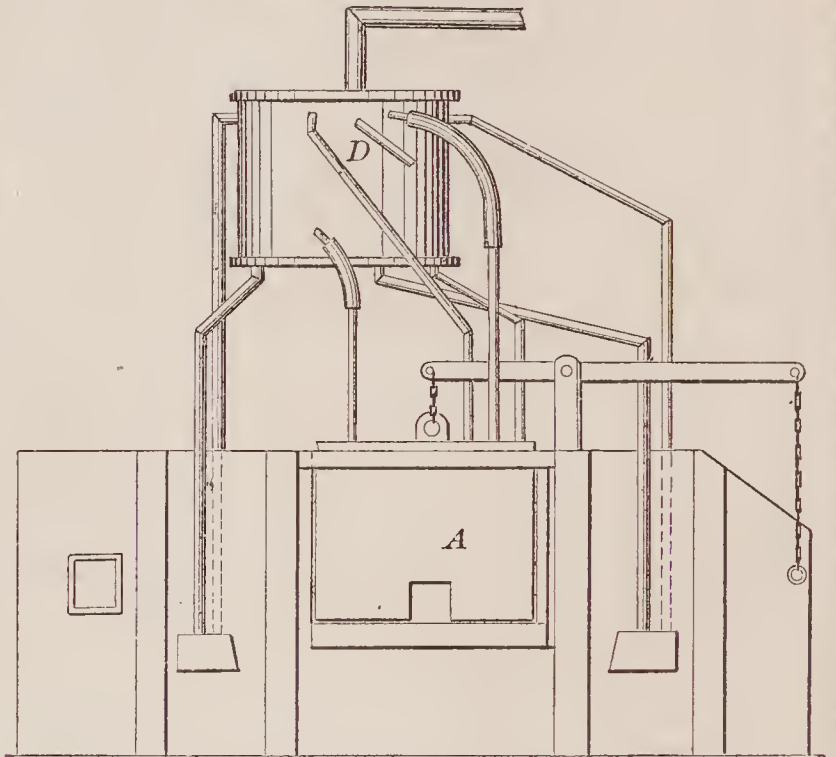

70032—B. Shirley—Hay Raker and Loader.

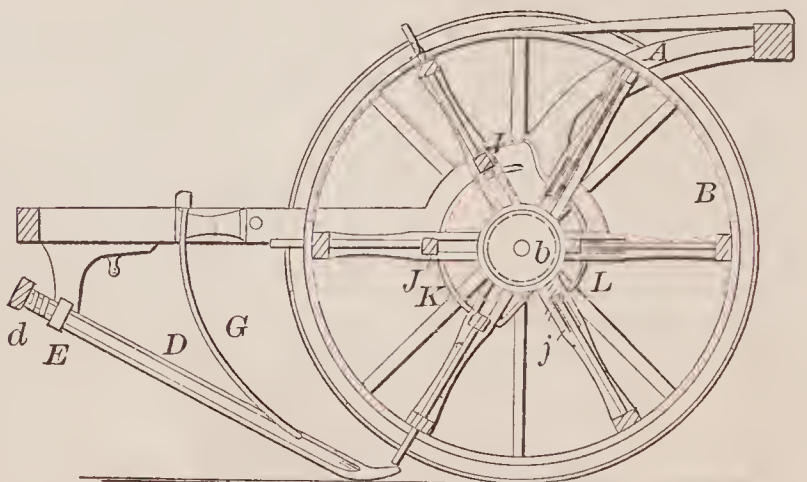

70034—E. Shopbell—Lifting Jack.

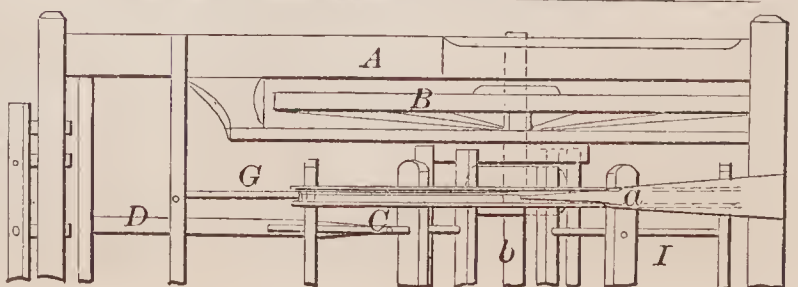
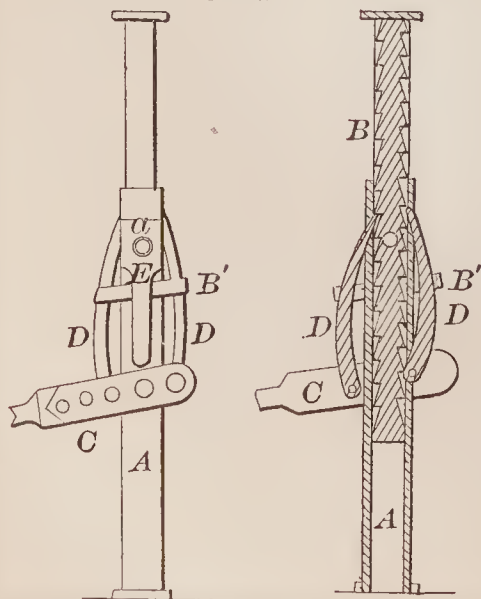

70035—S. Sloat—Horse Shoe.

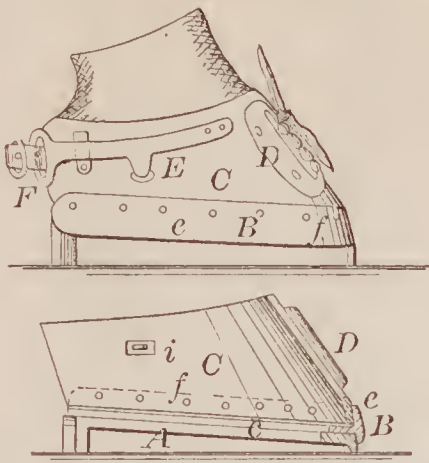

70038—M. Smith—For Casting Refractory Metals.

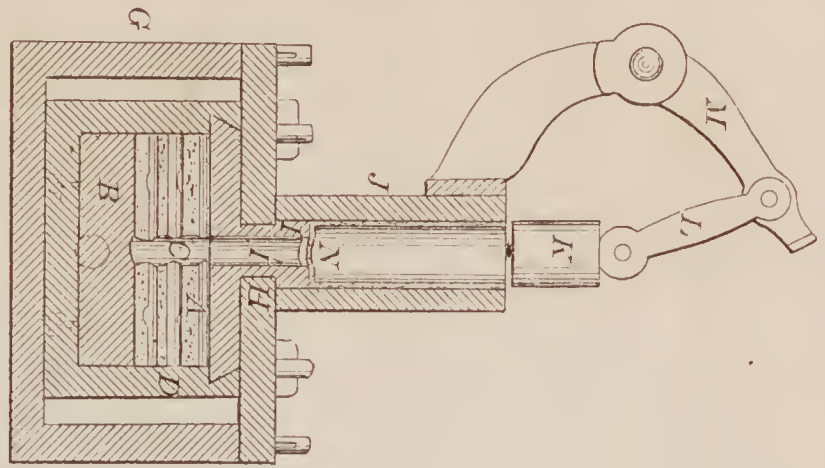

70037—A. F. Smith—Ventilator.

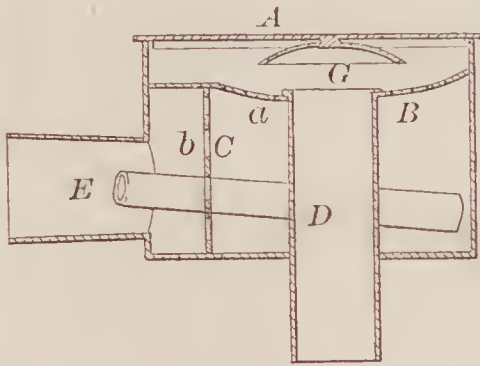

70040—Steele & Henderson—Shank Laster.

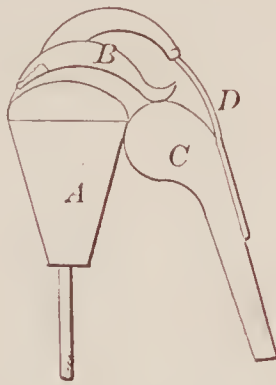

70041—A. C. Stich—Bed Spring Guide.

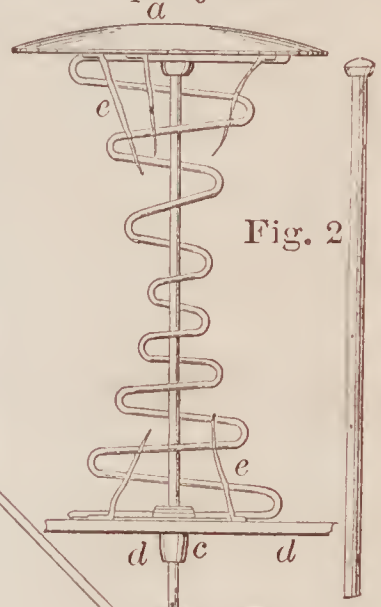

70036—A. B. Smith—Endless Chain Propeller.

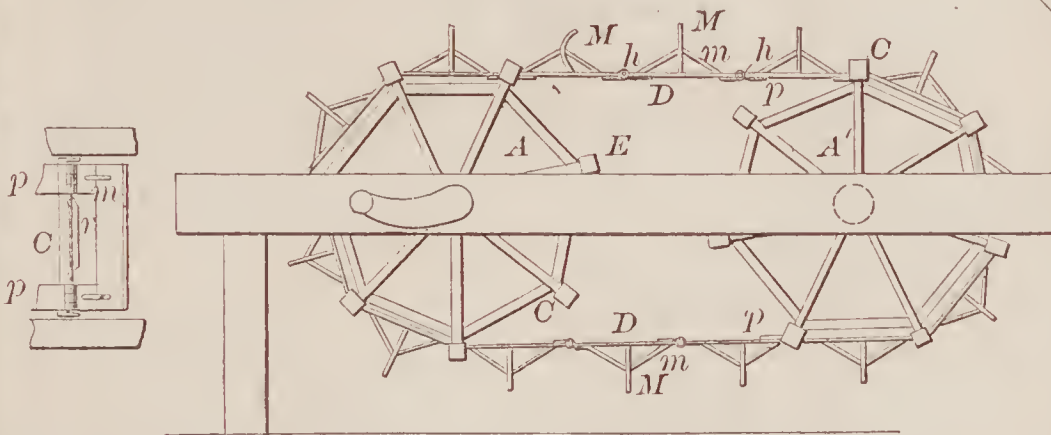

70039—D. M. Somers—Button.

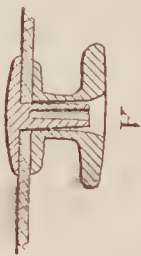

70042—W. Swindell—Furnace for the Manufacture of Steel.

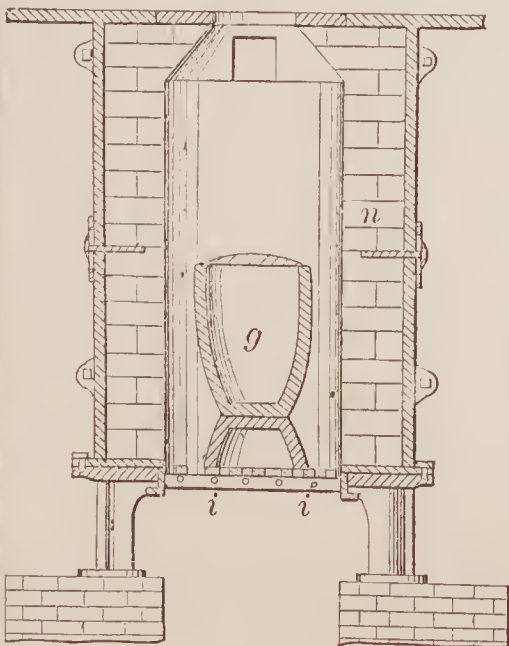

70043—D. Symonds—Vapor Burner.

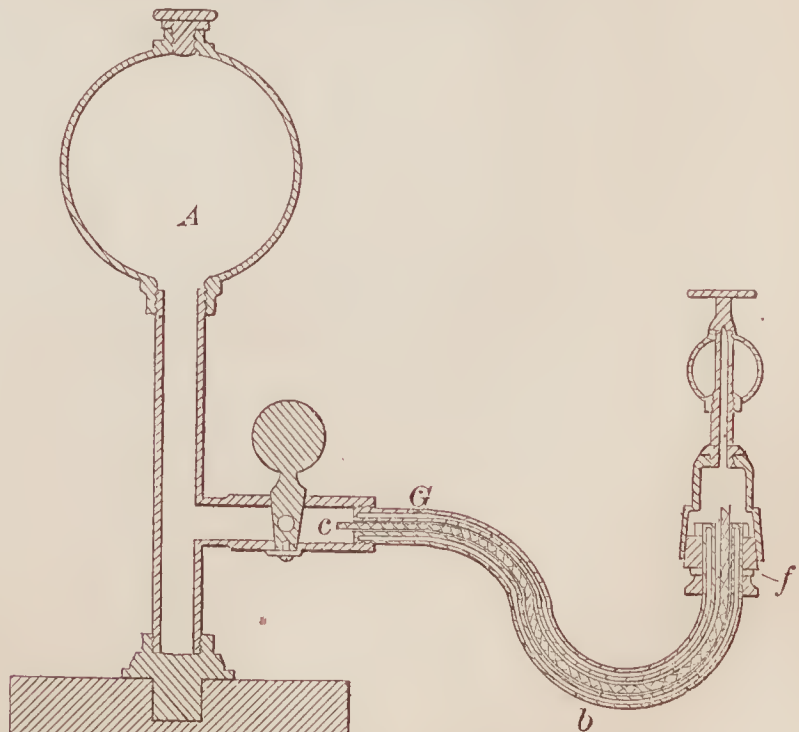



70046—A. Thoma—Furnace for Smelting Iron Ore.

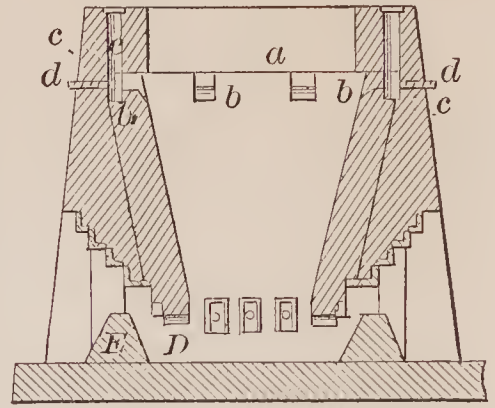

70045—A. Thoma—Kiln for Roasting Iron Ore.

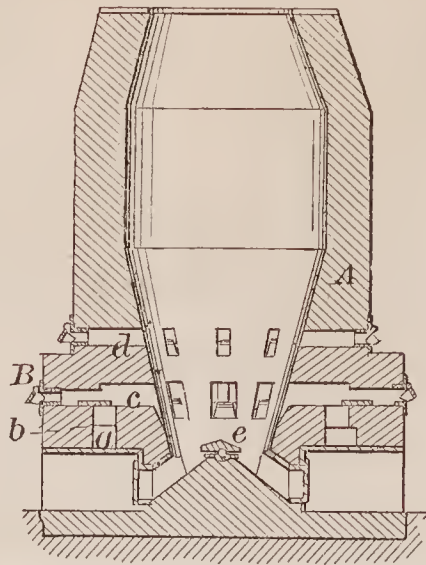

70044—L. H. Tears—Horse Hay Fork.

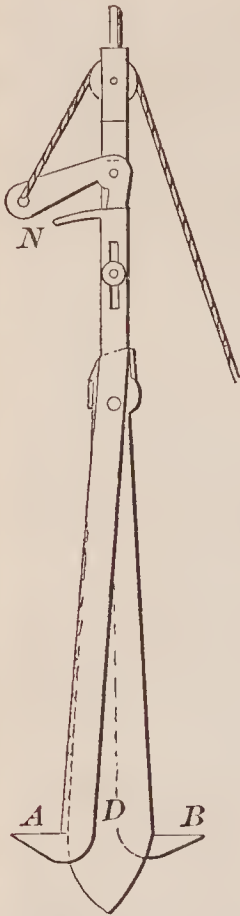

70048—A. Thoma—Furnace for Melting and Purifying Steel.

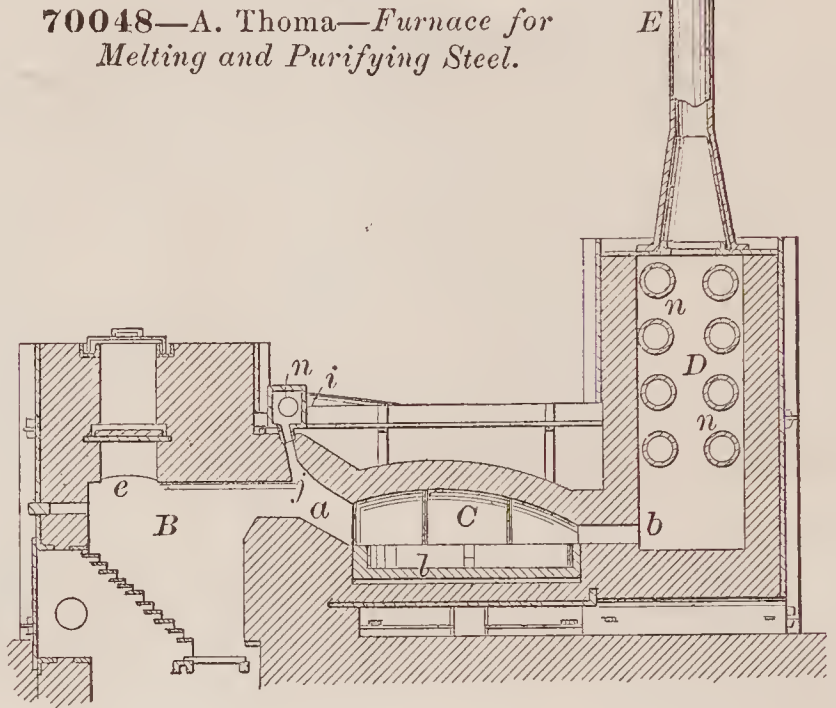

70050—M. L. Thompson—Barrel Head.

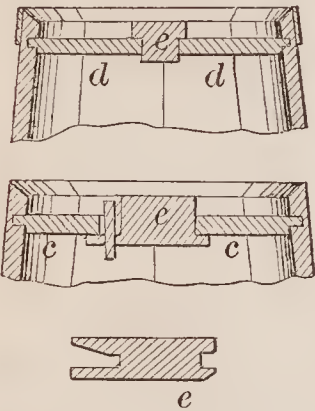

70047—A. Thoma—For Reducing Iron Ore.

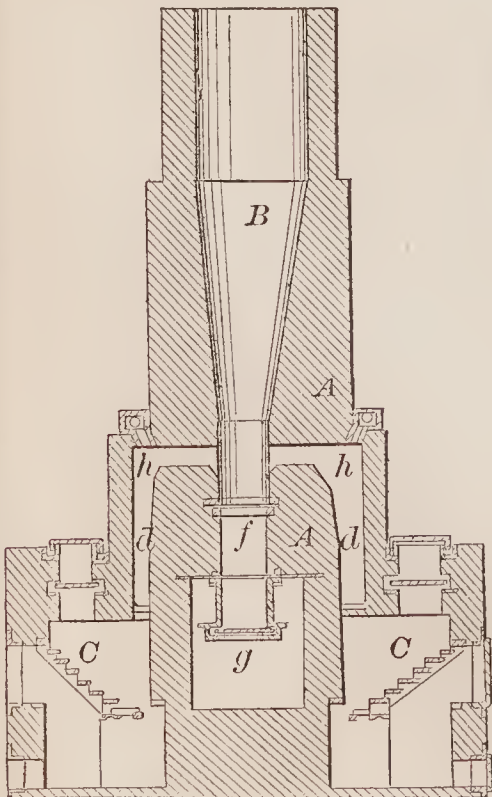

70049—A. Thoma, Sr.—Tool for Jeweling Watches.

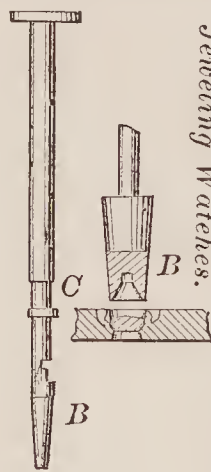

70052—J. L. Waite—Telegraph Insulator.

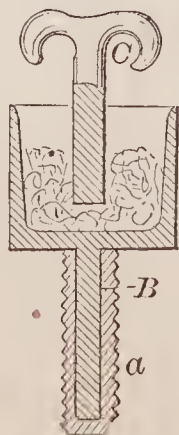

70051—C. R. Tompkins—Mortising Machine.

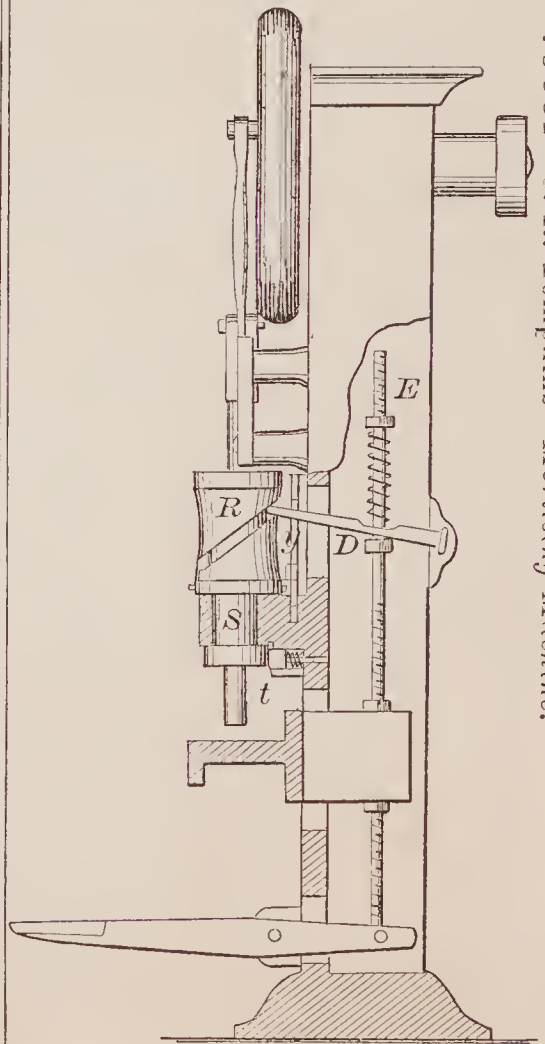

70053—W. Weddington—  
Stirrup.

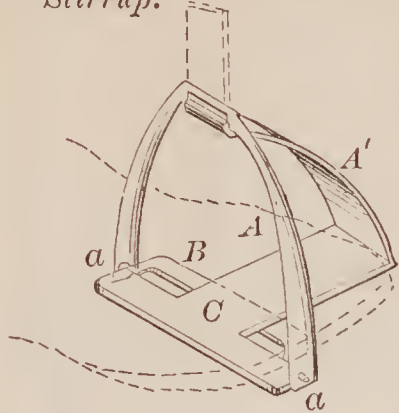

70056—S. Wheelock—*Portable Vehicle.*

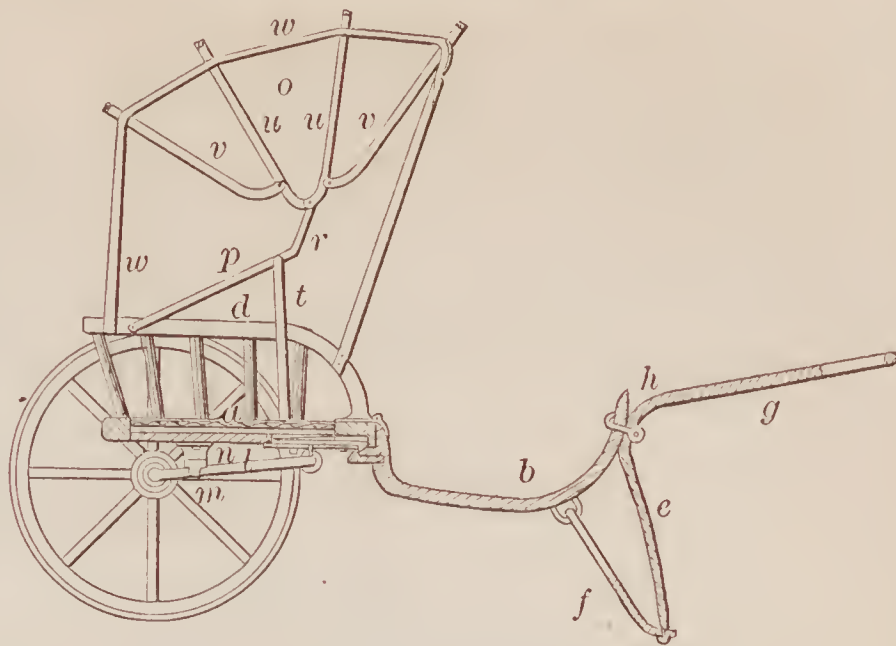

70058—J. B. Wickersham—*Lubricator.*

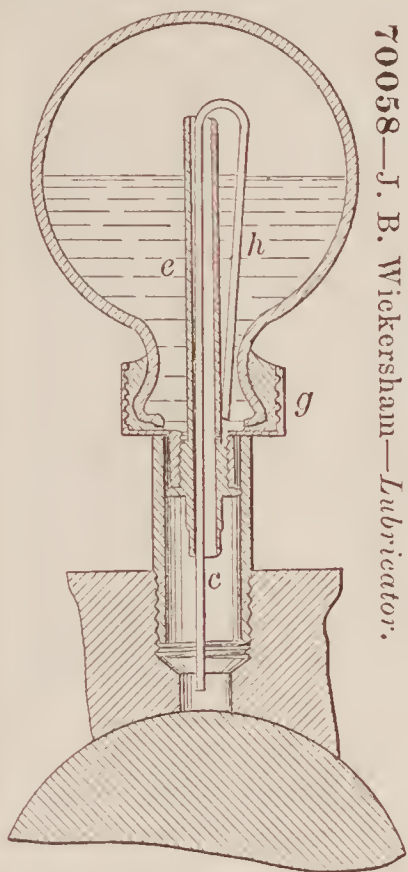

70057—R. White—*Cord Stretcher.*

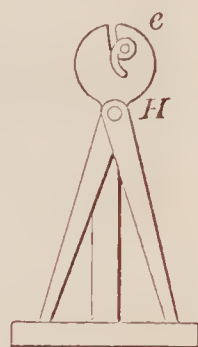
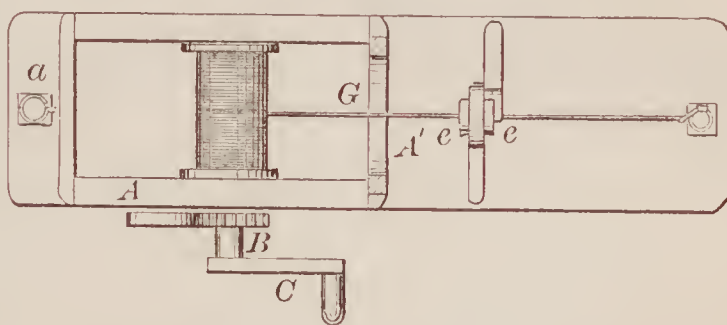

70060—J. N. Williams, Jr.—*Grain Separator.*

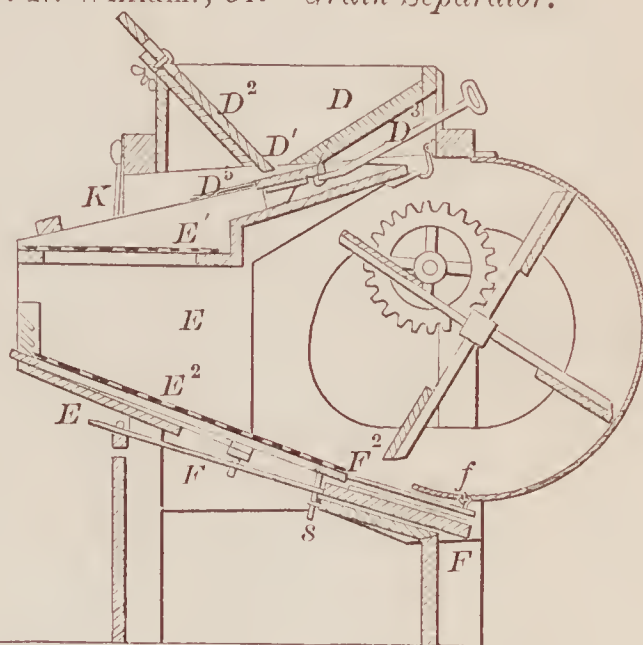

70059—J. D. Wilber—  
*Harvester.*



70055—West & Cunningham—  
*Carpet Fastener.*

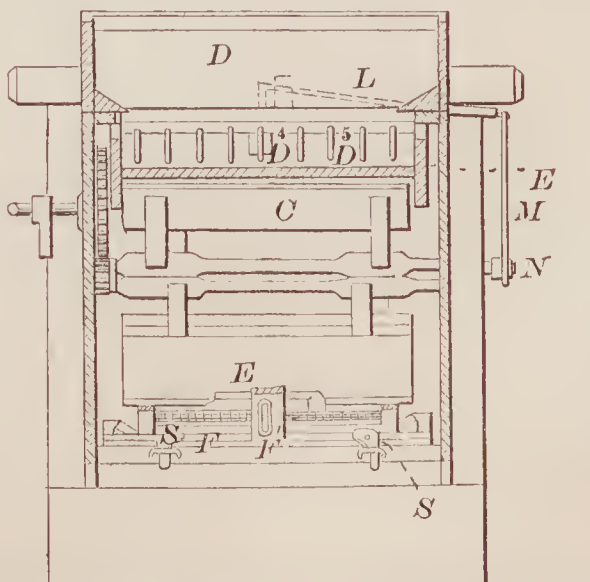
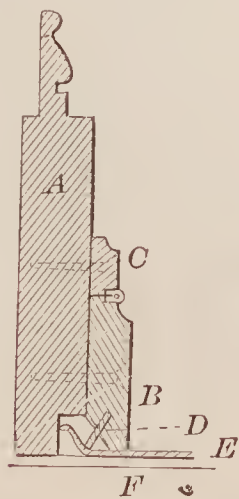



70061—J. Wixted—*Railway Frog.*

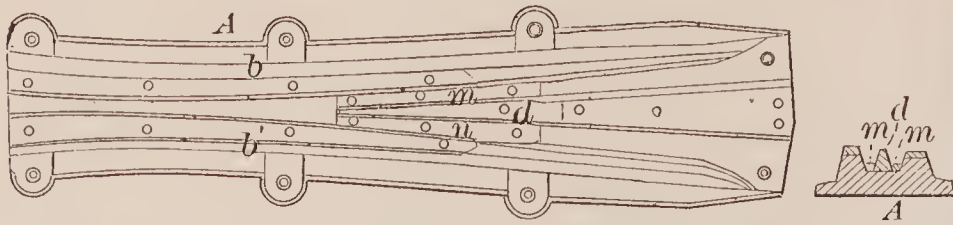

70064—D. Arndt—*Washing Machine.*

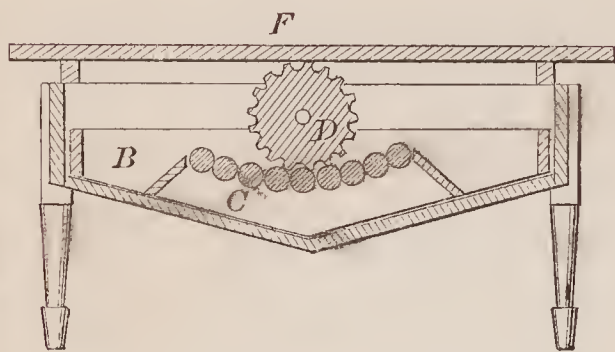
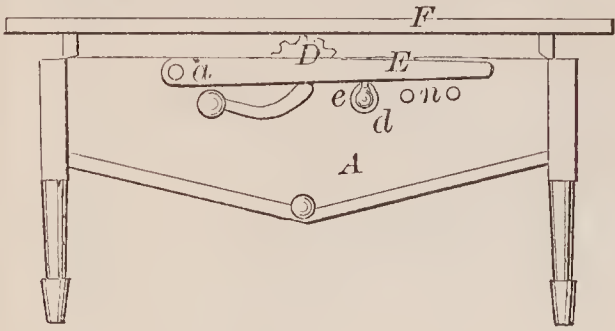

70062—G. C. Wright—*Apple Corer and Slicer.*

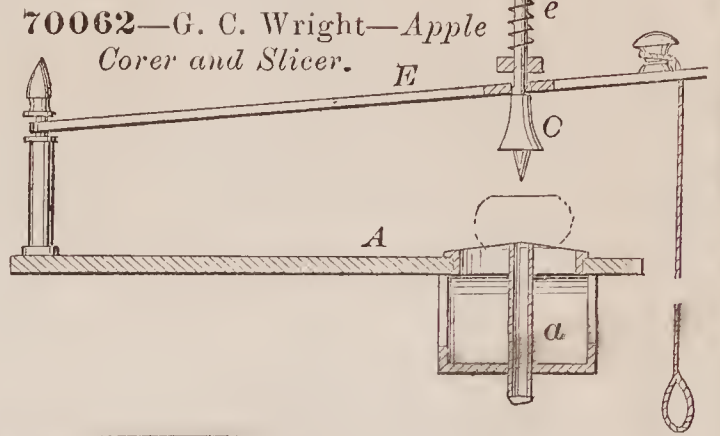

70066—J. F. Badoye—*Hat Felting Machine.*

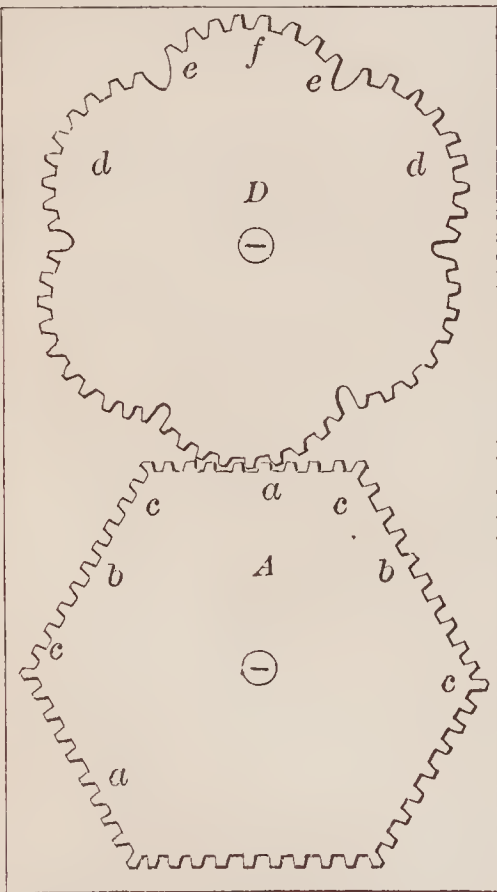
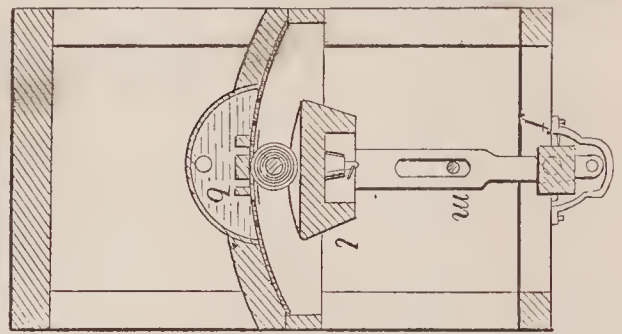

70063—E. Allen—*Mechanical Movement.*

70067—H. Barth—*Printing Press.*

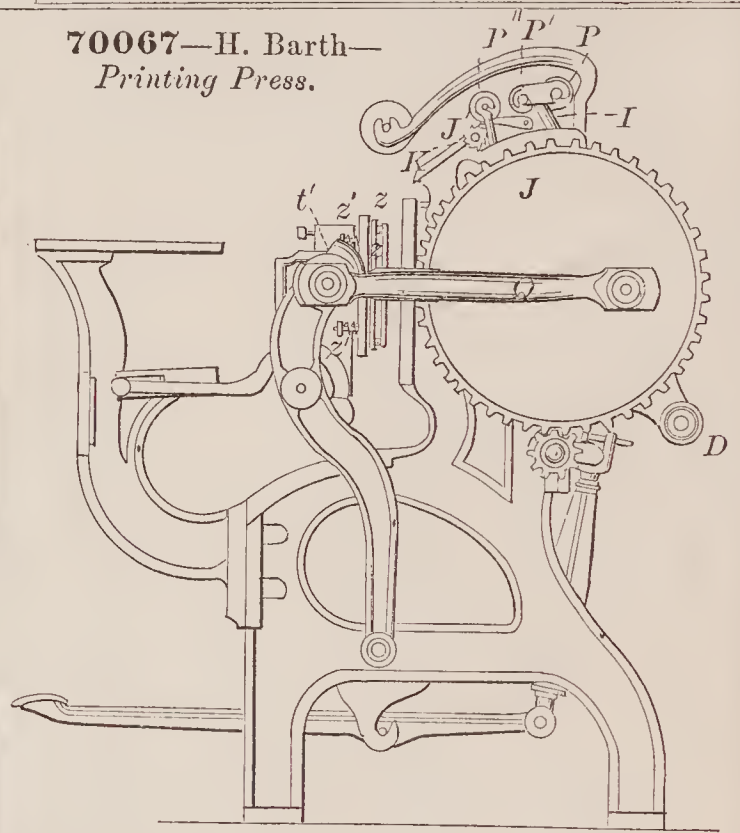

70065—A. C. Arnold—*For Crossing Bats for Felting.*

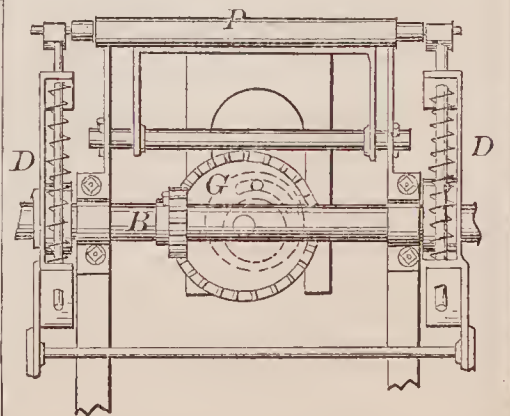
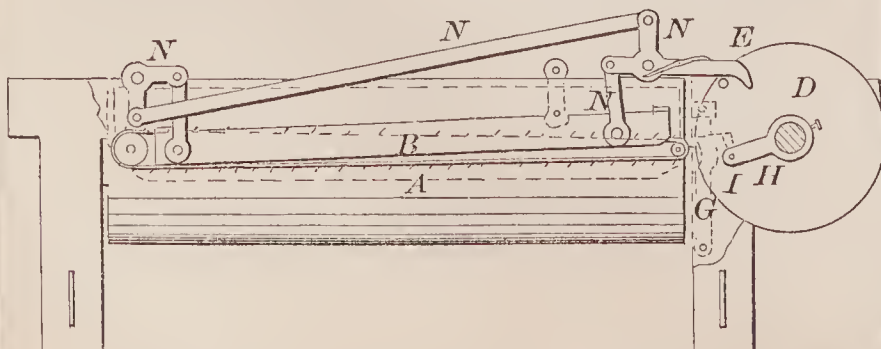





70073—Burr & Martyn—For Hulling and Scouring Wheat.

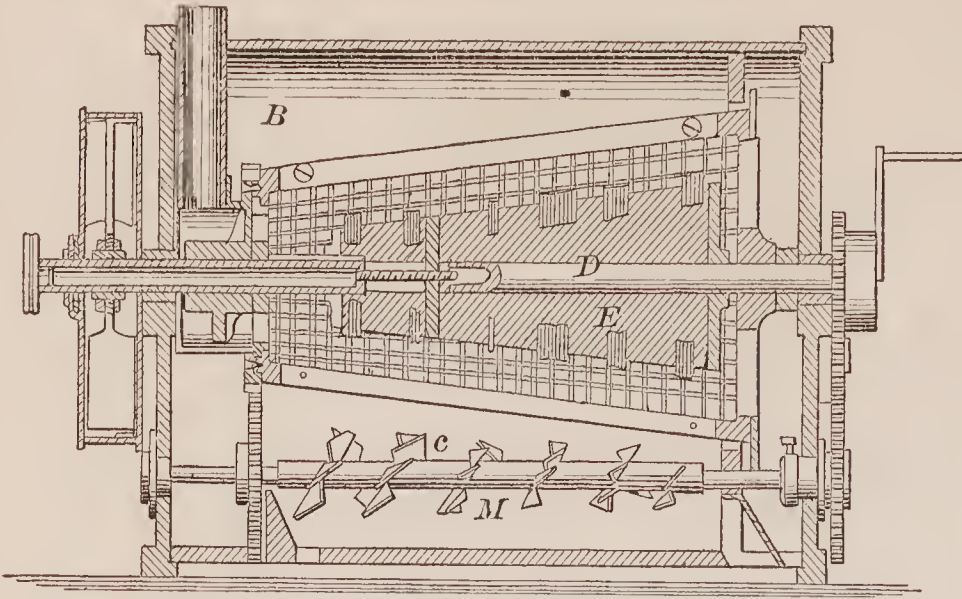

70077—G. Dewey—Water Back and Grate of Stoves.

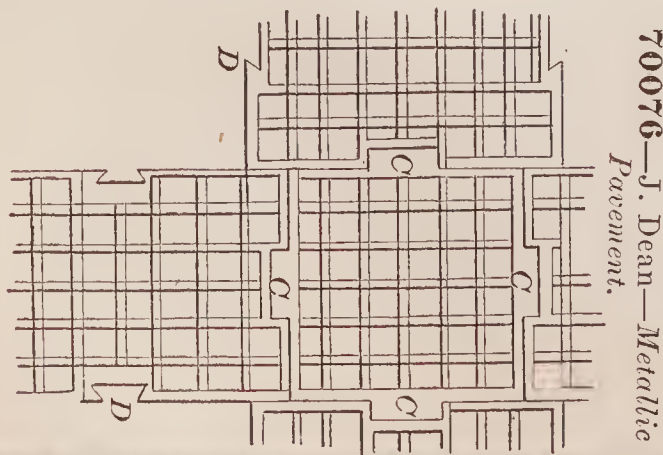
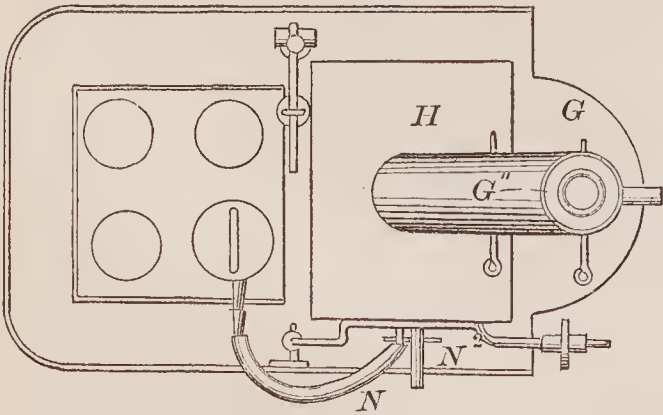
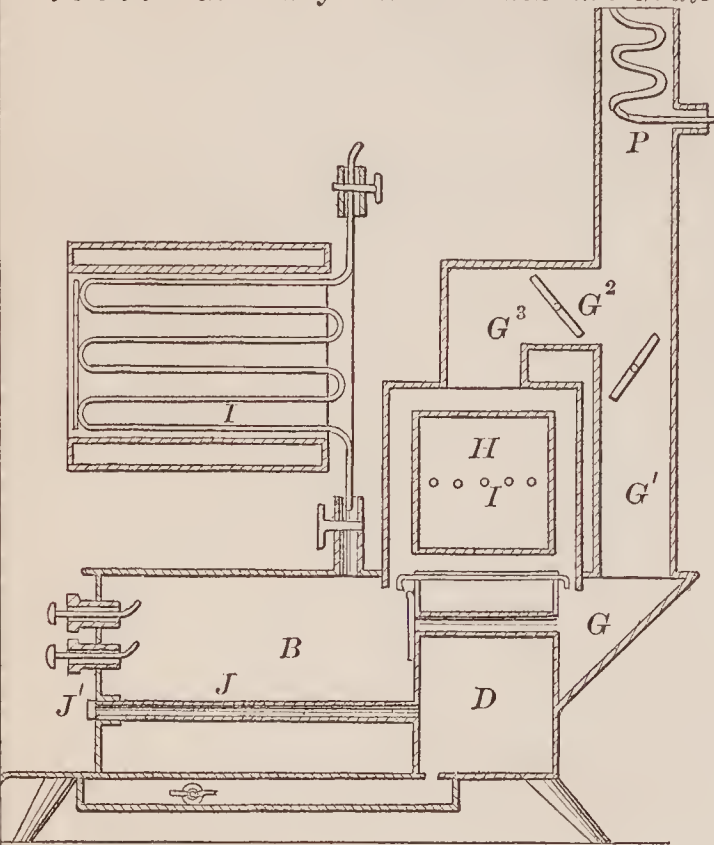

70076—J. Deam—Metallic Pavement.

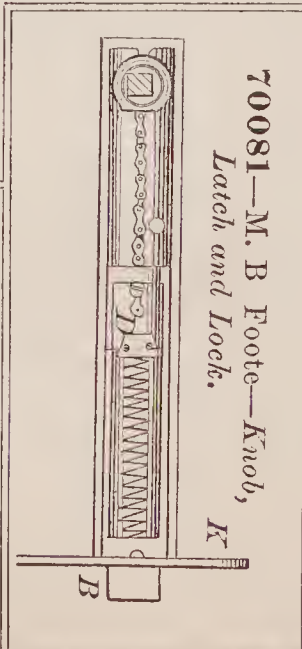
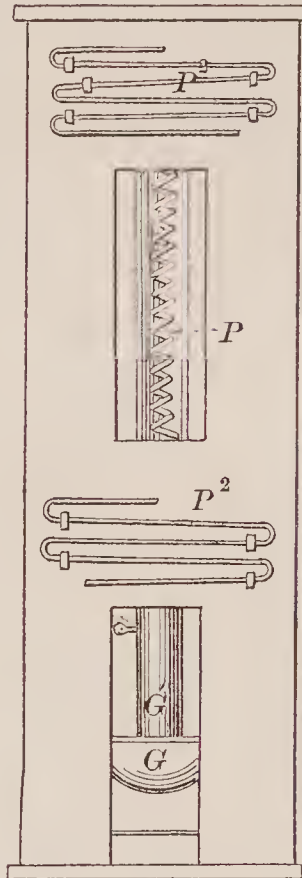

70081—M. B. Foote—Knob, Latch and Lock.

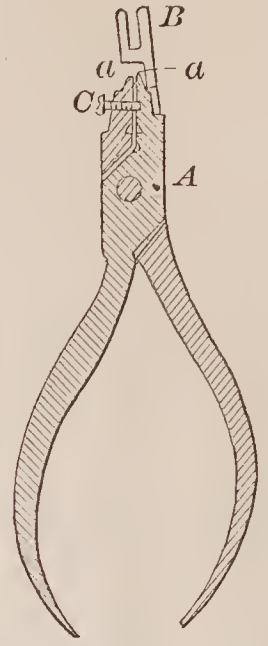

70074—J. M. Cayce—Watchmakers' Tool.

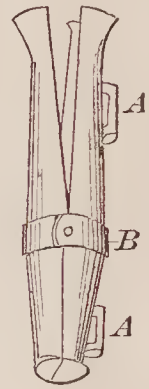

70075—Curtis & Worden—Self-Adjusting Whip Holder.

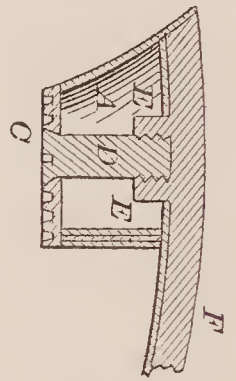

70078—Dyer & Drake—Boot and Shoe Heel.

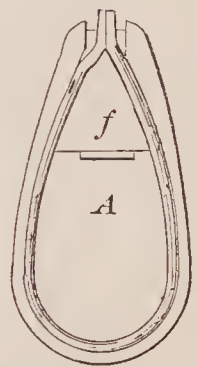

70079—E. P. Edstrom—Horse Collar.

70080—N. T. Fitch—Corn Crib

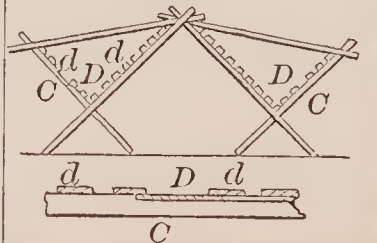

70082—W. K. Foster—Washer for Axle Boxes.

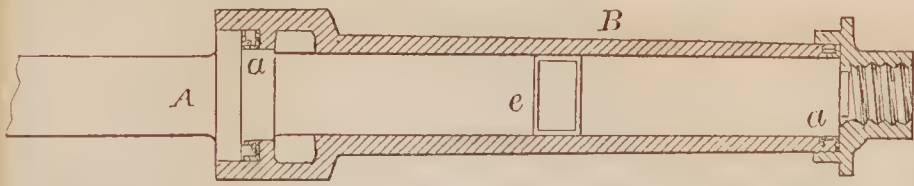

70087—G. Hadfield—Surgical Cup.

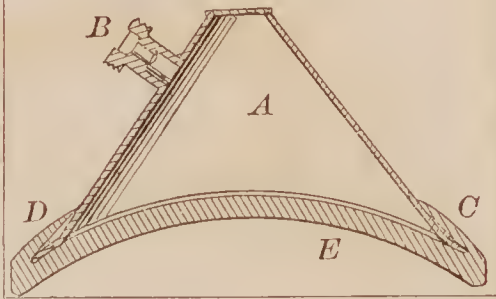

70084—W. Goodwin—Paddle Wheel.

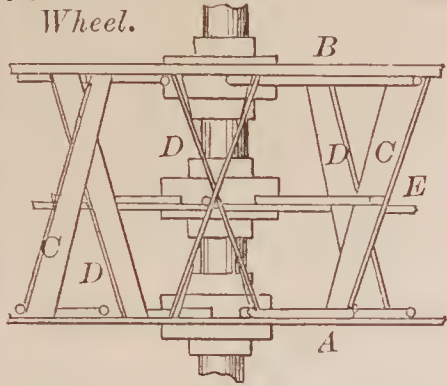

70089—F. A. Hannaford—Safety Bridle.

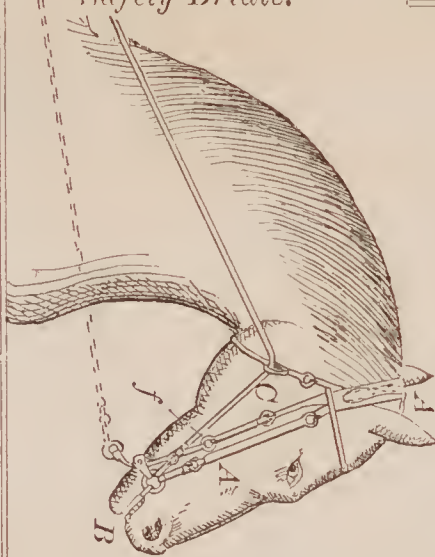

70088—G. Hadfield—Surgical Cup.

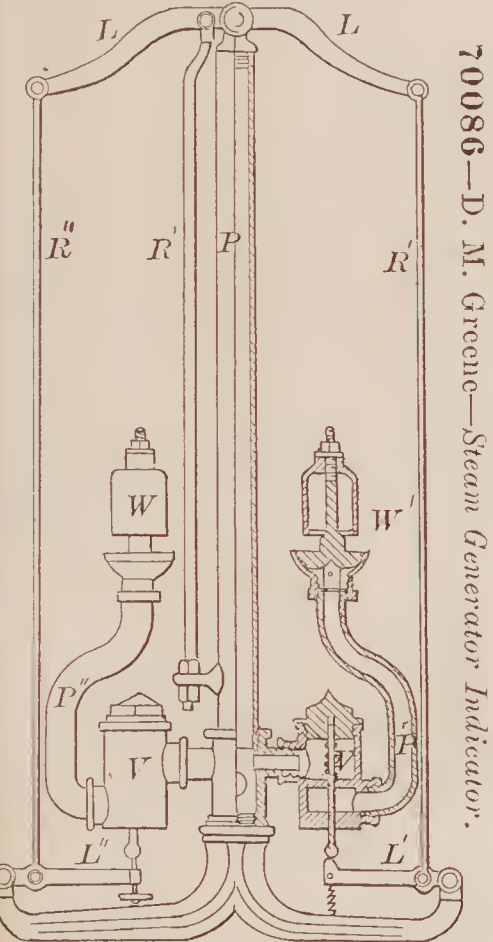
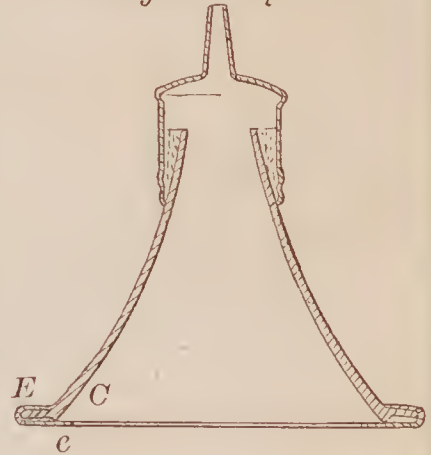

70086—D. M. Greene—Steam Generator Indicator.

70091—J. W. Hodges—Horse Shoe.

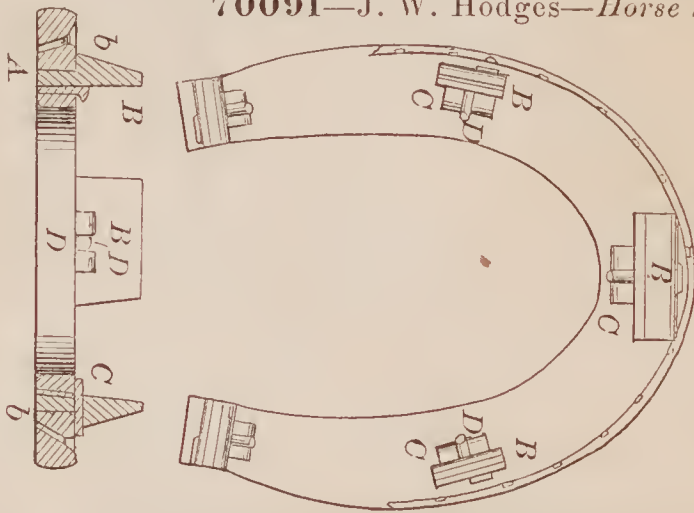

70093—B. Illingworth—Animal Trap.

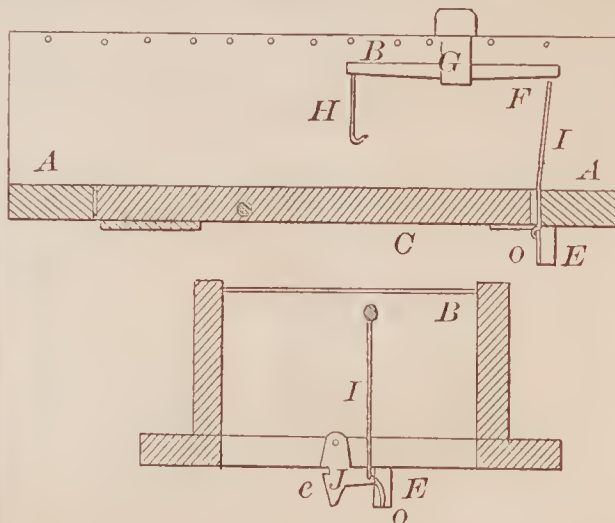

70090—J. L. Henderson—Framework for Fireplaces.

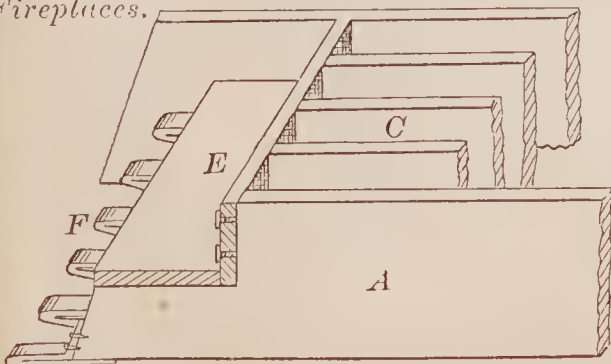

70095—N. L. Janney—Butter Stamp.

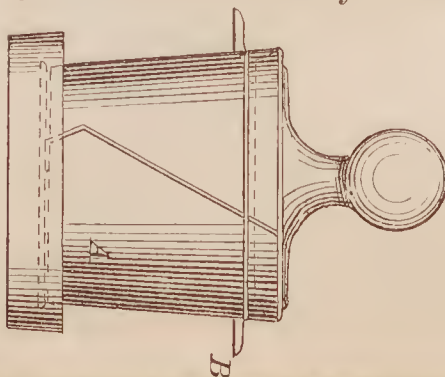

70094—G. C. James—Lamp Shade Supporter.

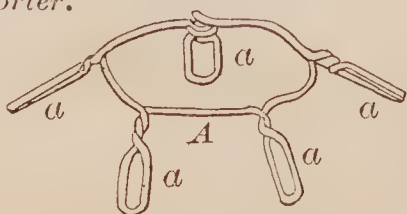



70096—G. H. Kidney—Washing Machine.

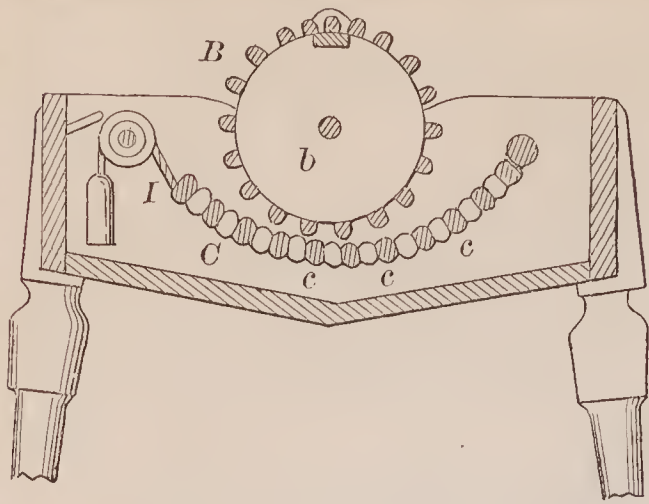

70097—J. E. Layton—Fence.

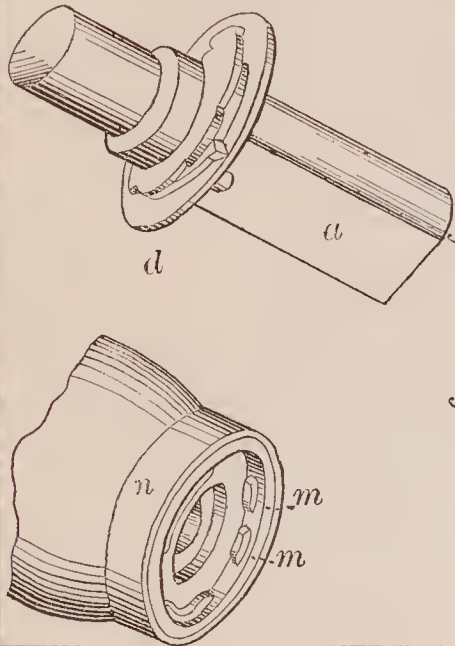
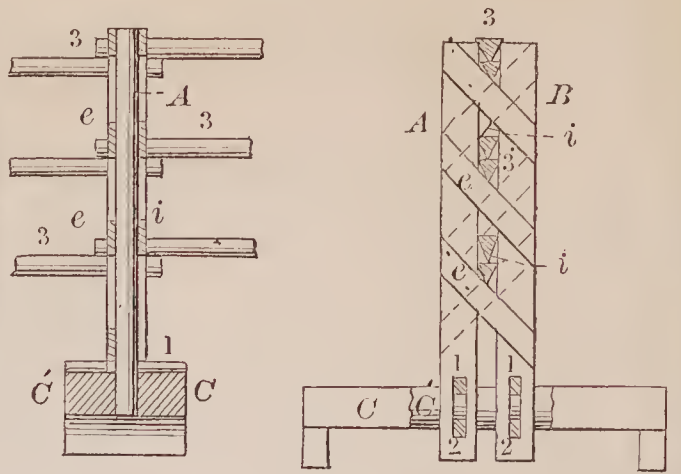

70098—J. H. Lewis—Wheel and Axle for Carriages.

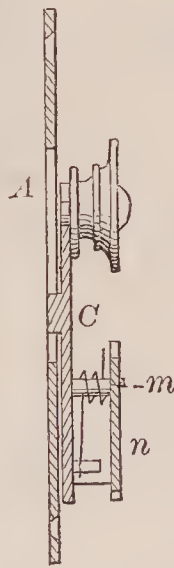

70099—T. Lyons—Curtain Fixture.

70102—J. H. Meissner—Grate.

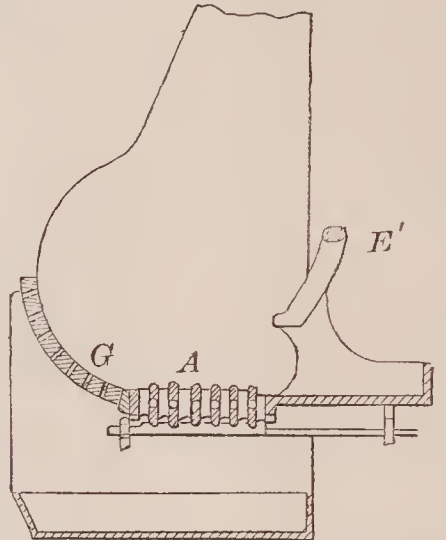

70100—J. L. Manlove—Seed Planter

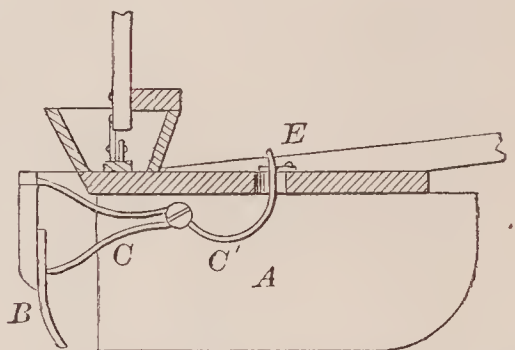
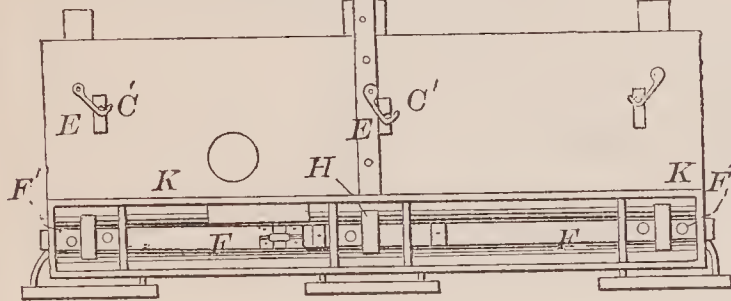

70101—J. Marquis—Siphon Propeller.

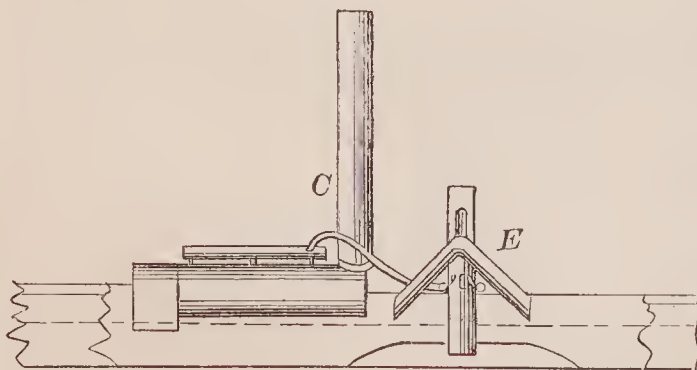

70104—J. D. Moore—Calender for Watch Cases

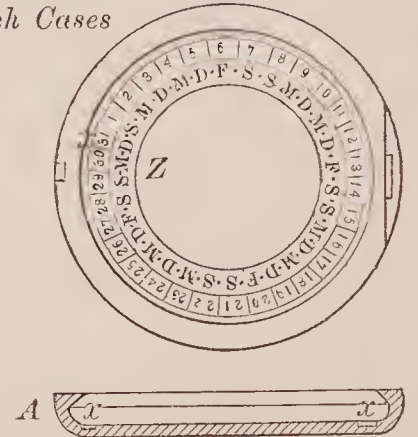

70103—J. Miller—Car Coupling.

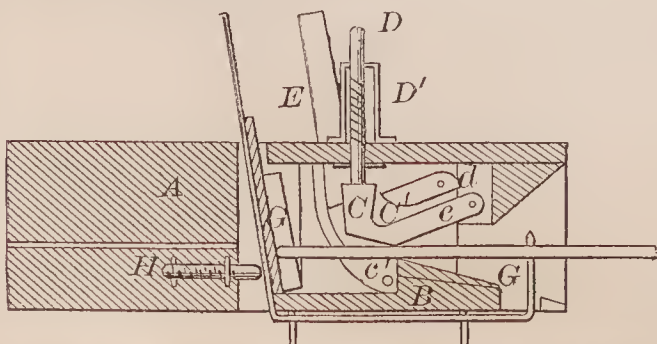

70105—R. T. Moss—Buckle Attachment.

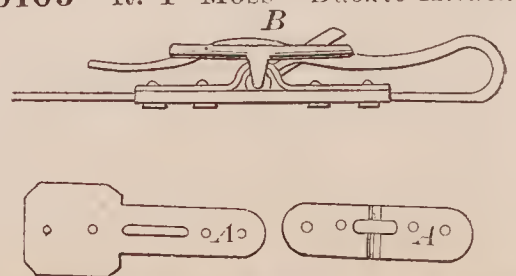

70106—G. L. Mowry—*Sawing Machine.*

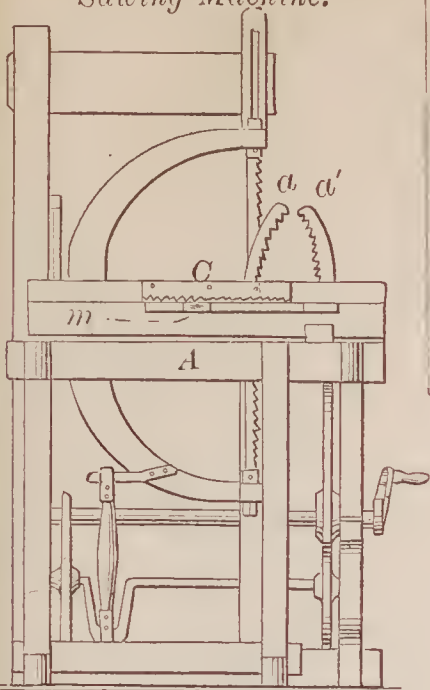

70107—G. A. Nelson—*Card Rack.*

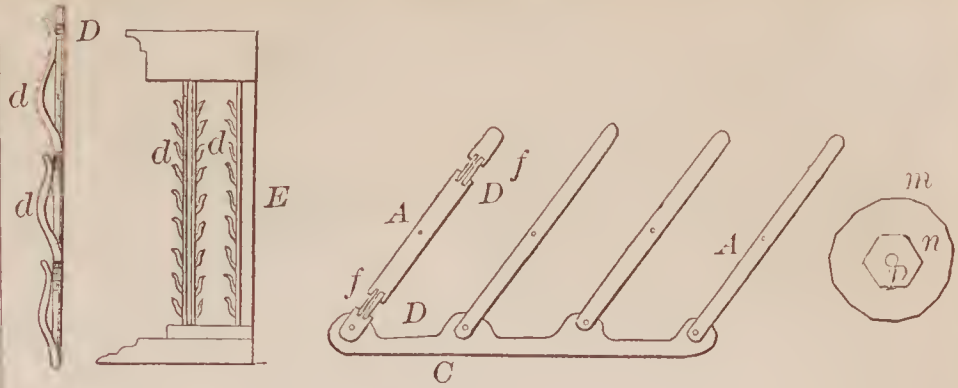

70108—H. B. Norton—*Potato Digger.*

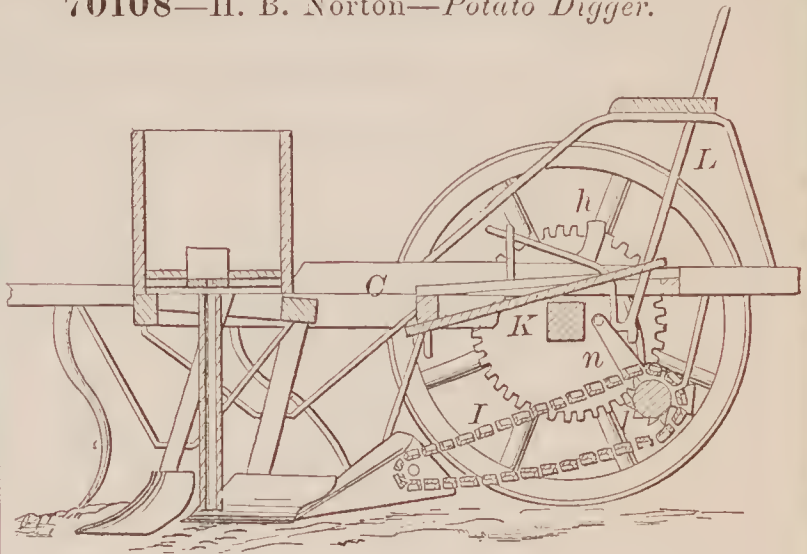

70110—J. S. Peasley—*For Renovating Feathers.*

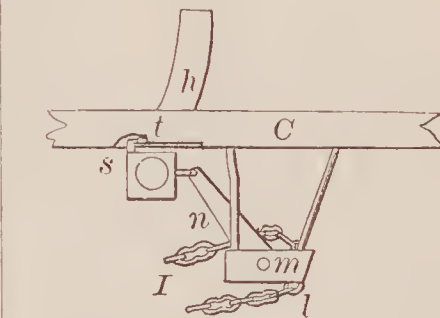
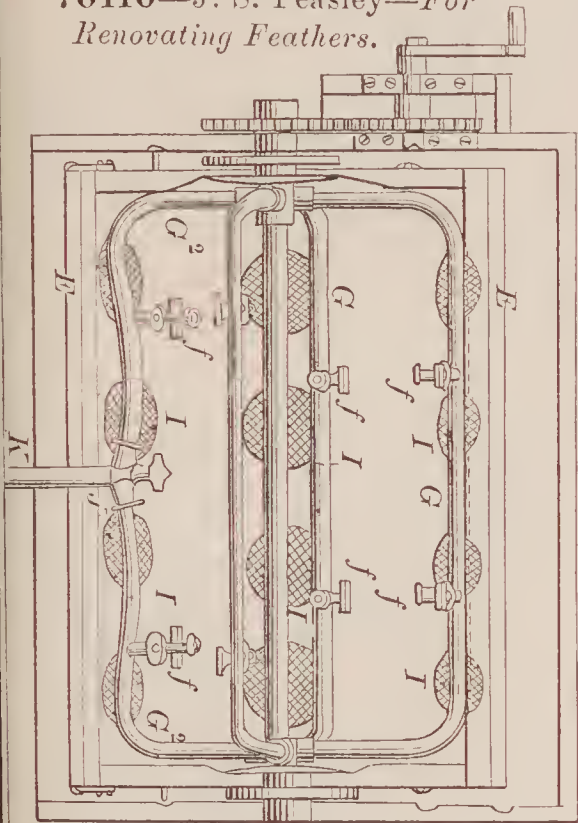

70109—W. P. Patton—*Switch.*

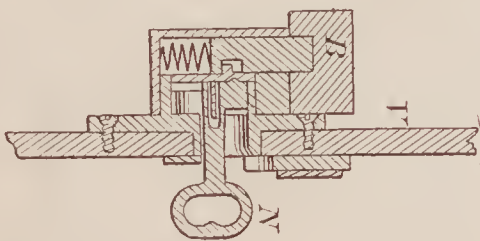
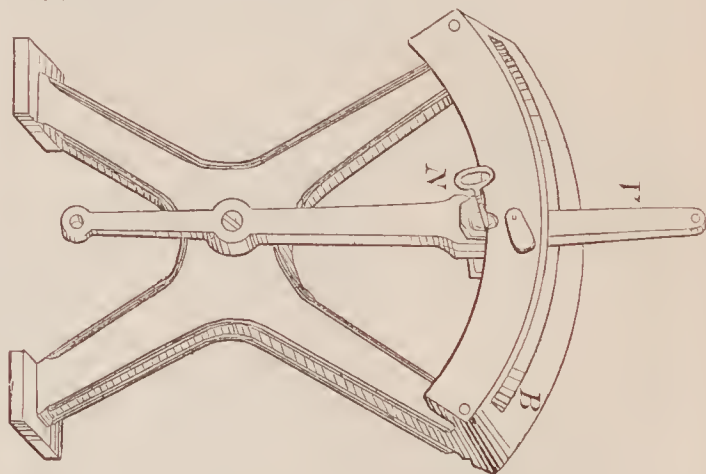

70111—E. Peck—*Cultivator.*

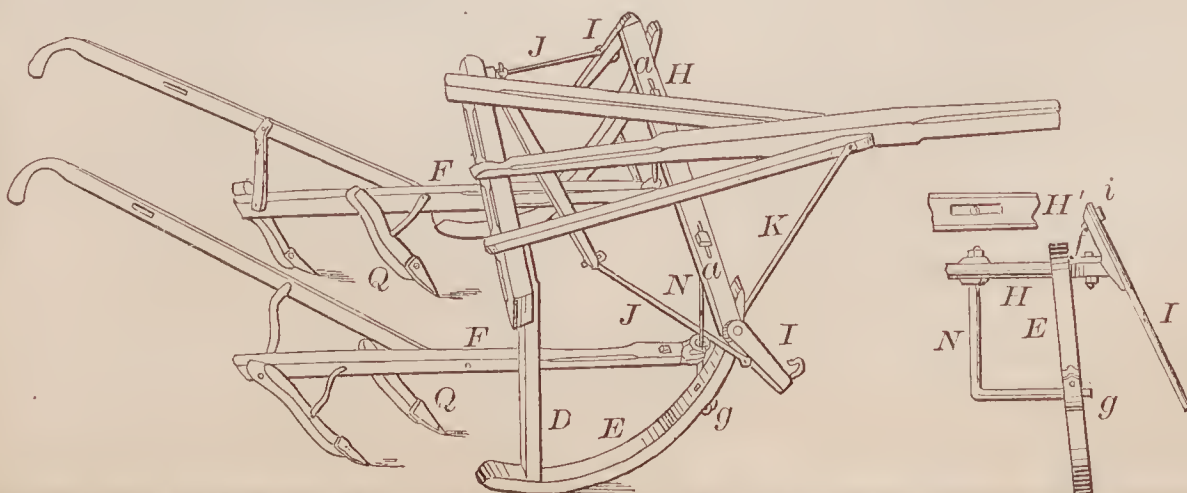



70112—B. W. Peirce—Chuck.

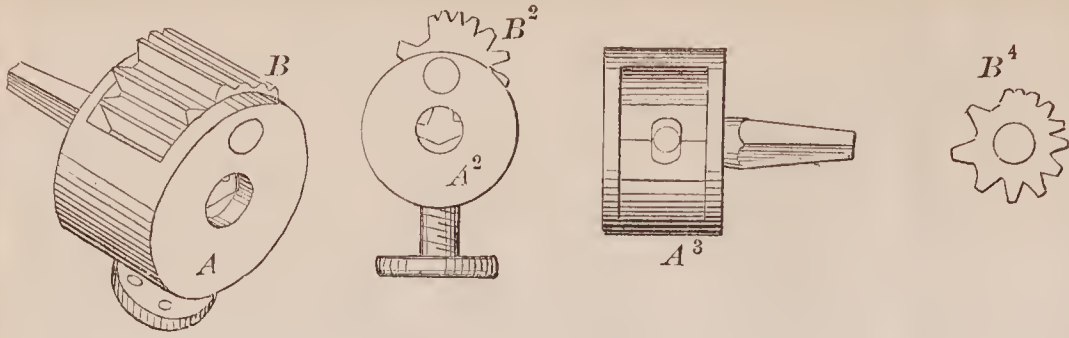

70113—A. S. Phillips—For Spooling Thread.

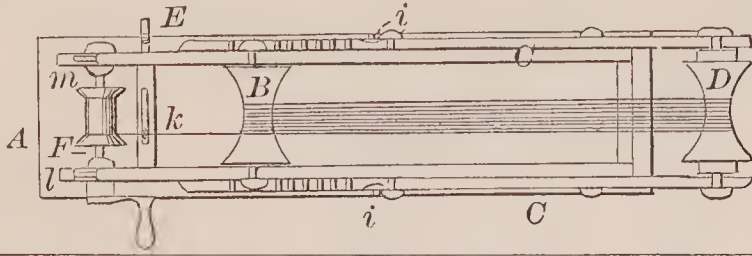

70114—Phillips, Southwick & Arnold—Starting and Stopping Cars.

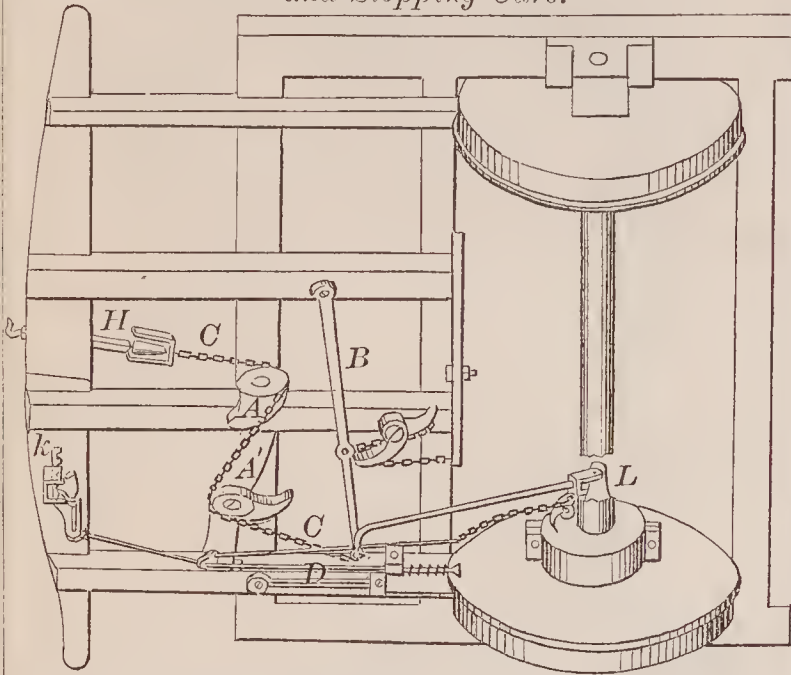

70117—Post & Gerrard—For Burning Hydro-Carbon.

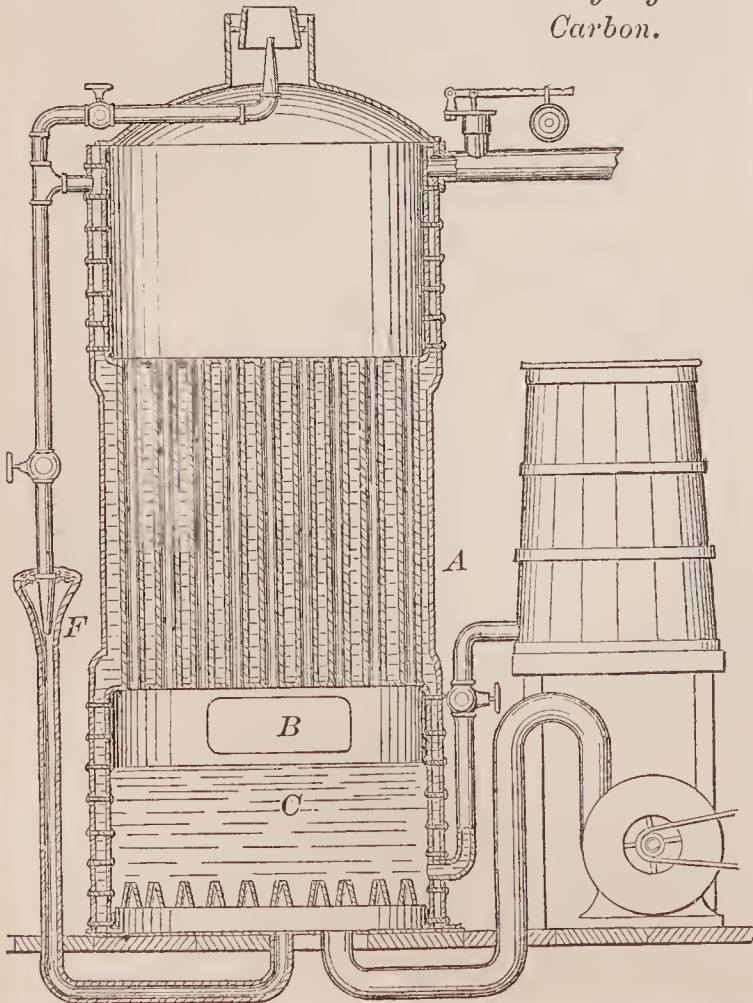

70116—C. P. Poirier—Frame for Pictures, &c.

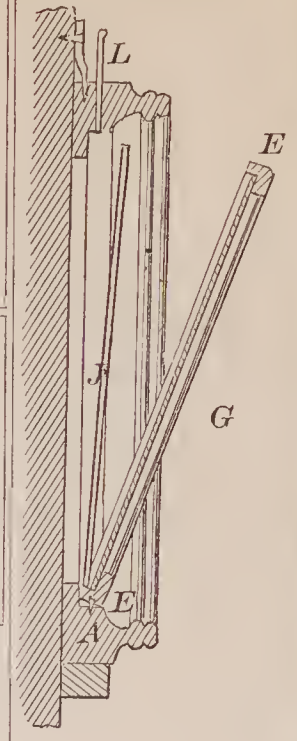

70115—O. L. Pinney—Lifting Jack.

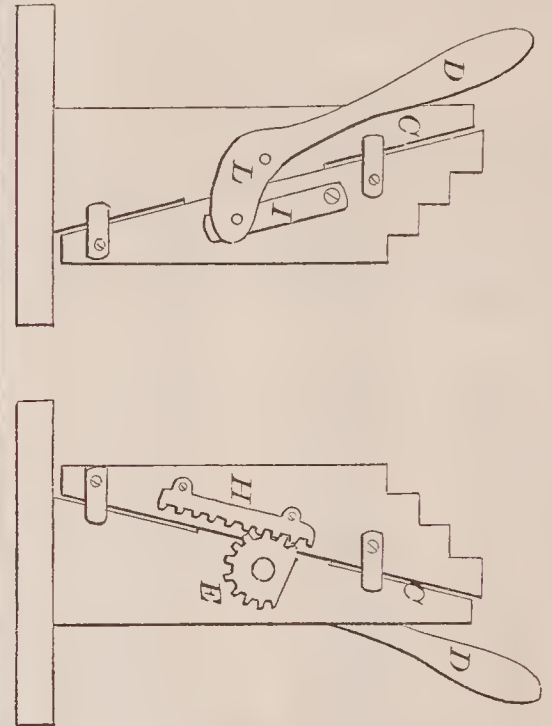

70118—C. C. & J. Purington—Washing Machine.

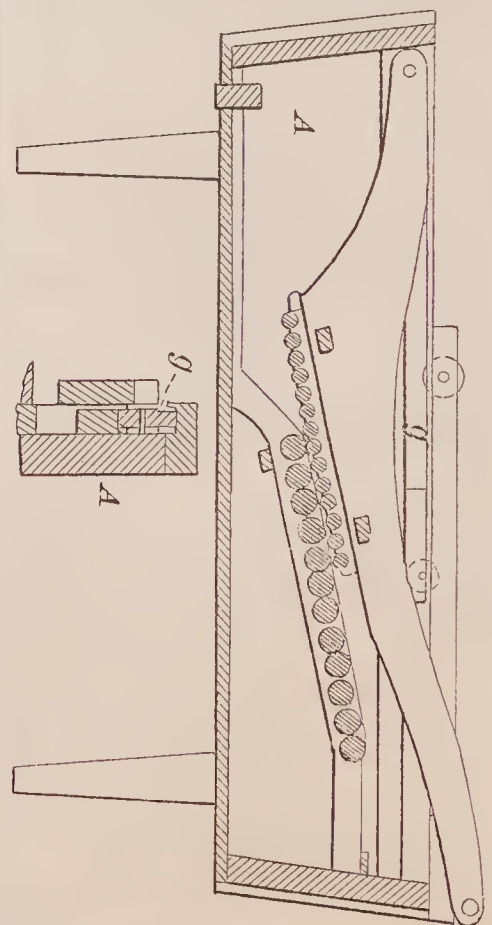

70119—J. Register—Hydrant.

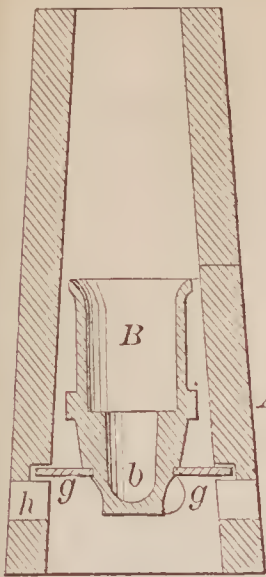

70125—L. M. Sargent—Lamp Extinguisher.

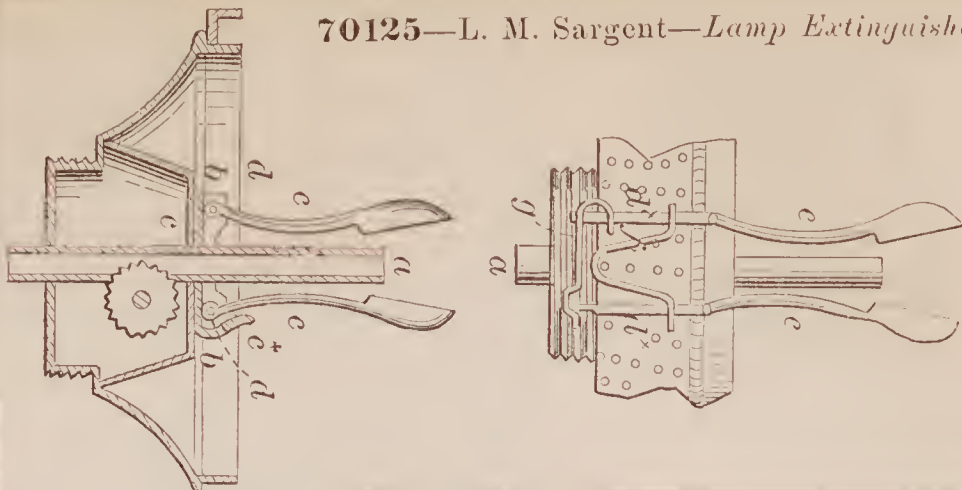

70120—D. C. Richardson—Cotton and Corn Plow.

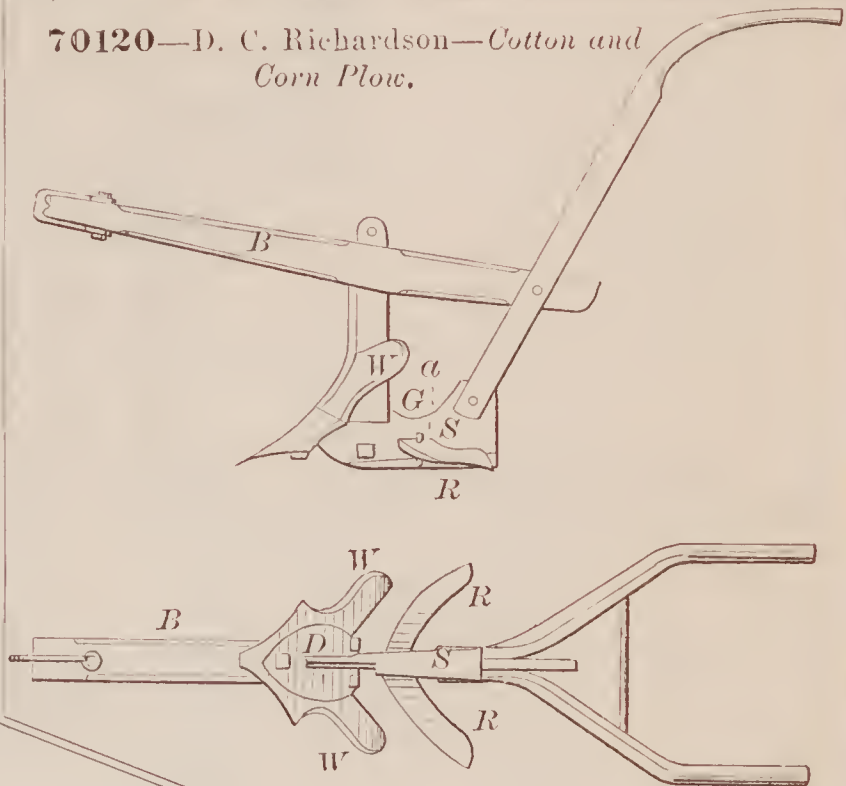

70121—R. Robinson—Life Preserver.

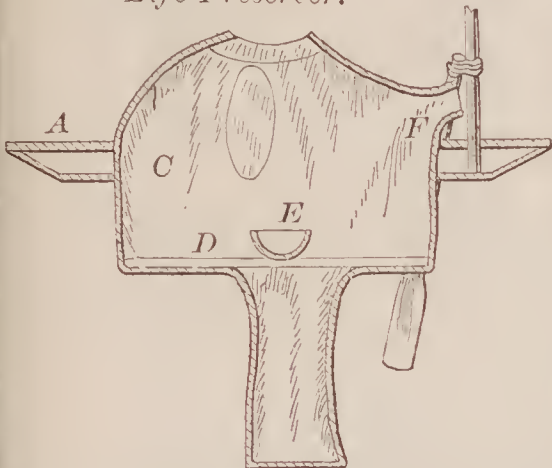

70123—H. J. Ruggles—Stone Channeling Machine.

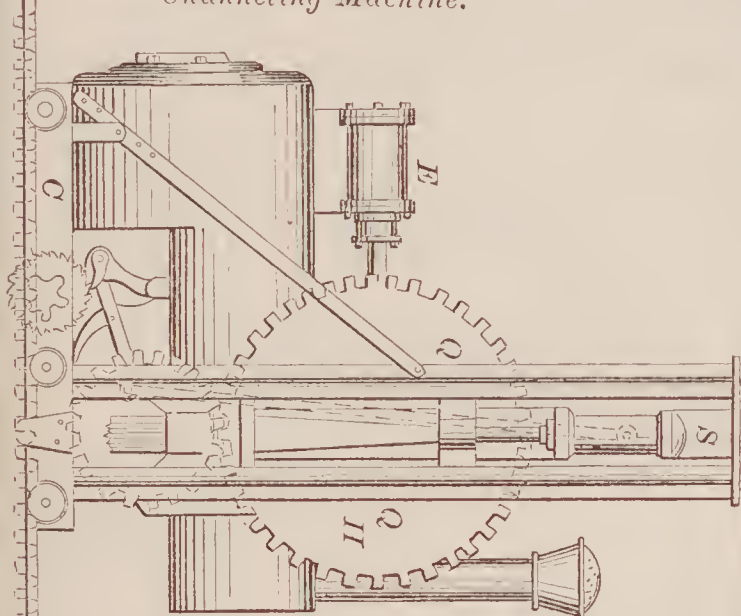

70124—T. C. Sachse—Pessary.

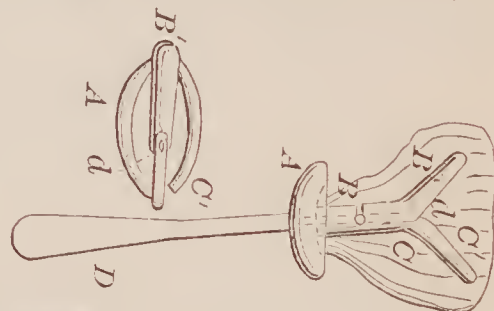

70122—J. F. Rochow—Hoisting Apparatus.

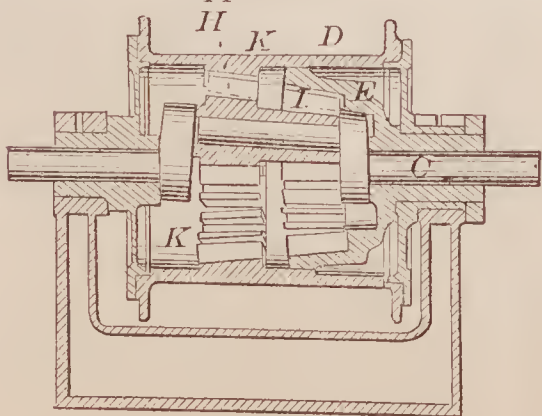

70126—B. F. Sherman—Grain Elevator and Feeder.

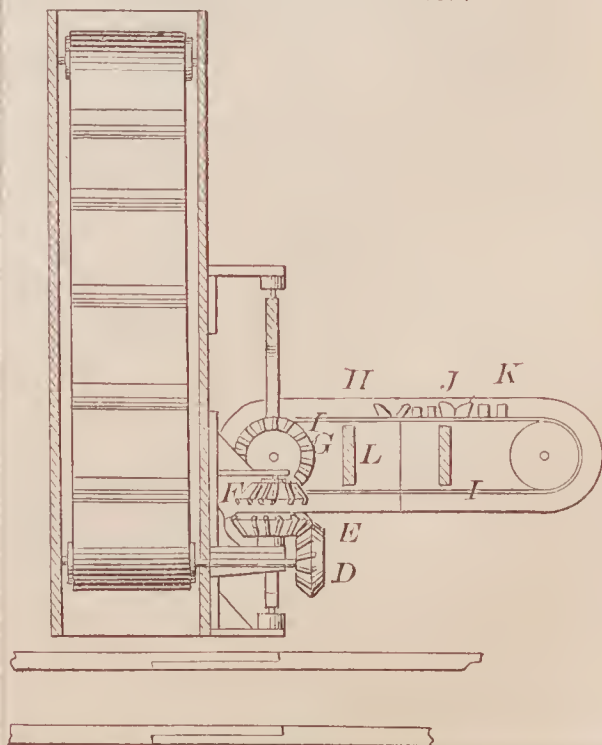



70127—Slute & Jackson—  
Extension Table Slide.

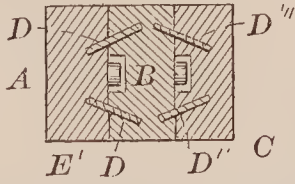

70128—C. Smith—Hanging  
Top to Buggies.

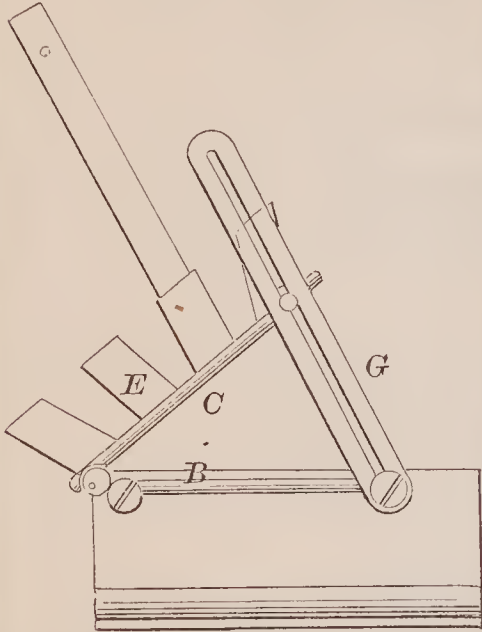

70129—R. D. Sterling—

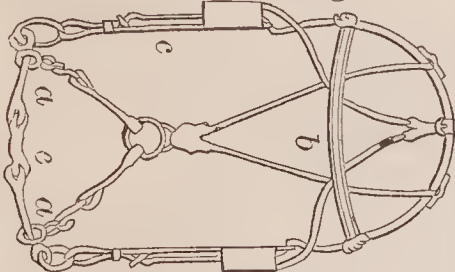

Joint Bit and Check.

70132—Teller & Savage—  
Telegraph Insulator.

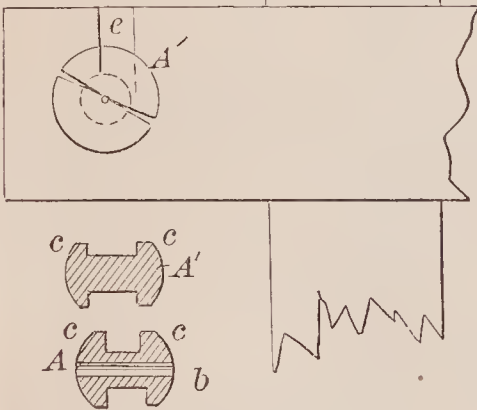

70133—J. Trainer—Animal Trap.

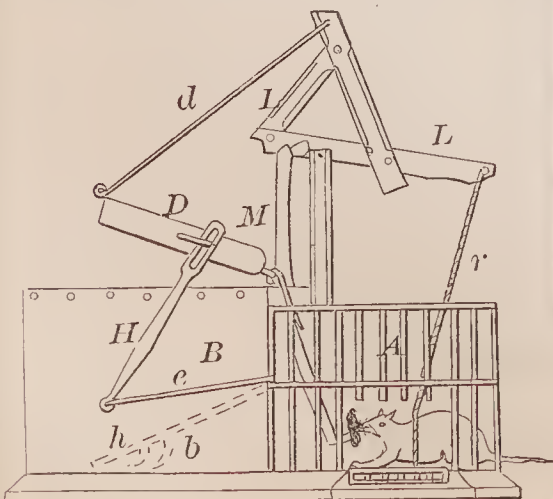

70130—R. R. Stevens—Propelling Vessels.

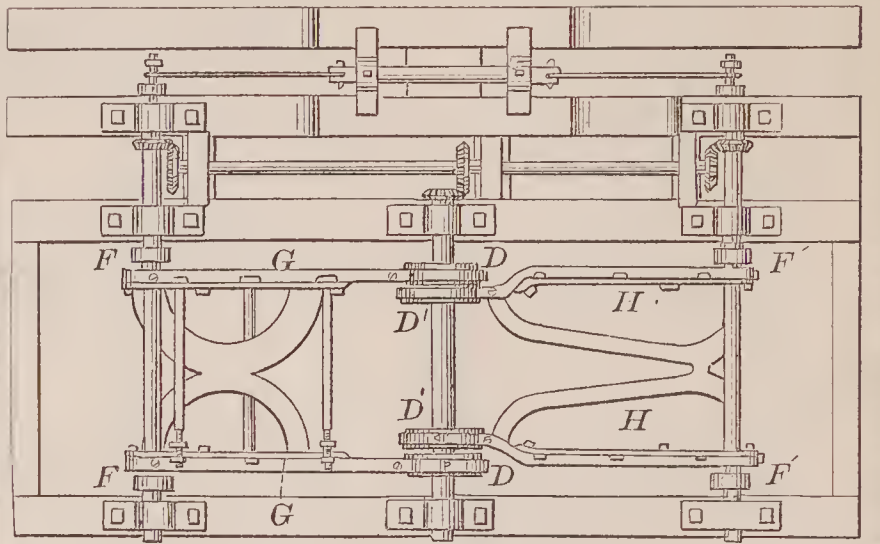
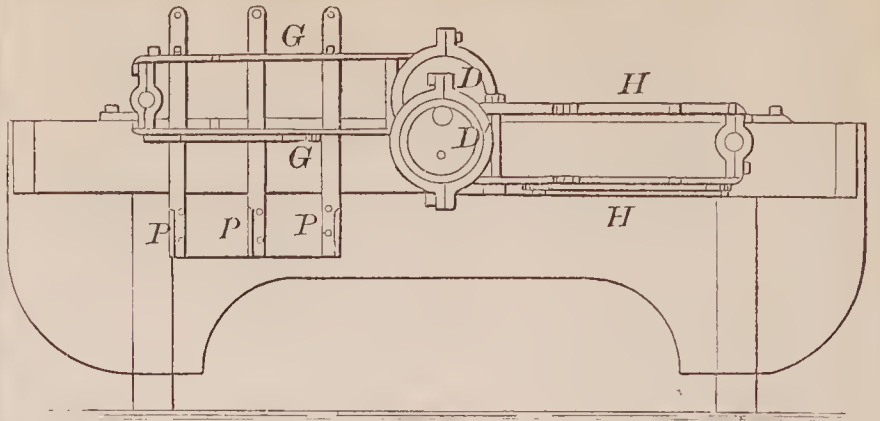

70131—J. Swan—Car Coupling.

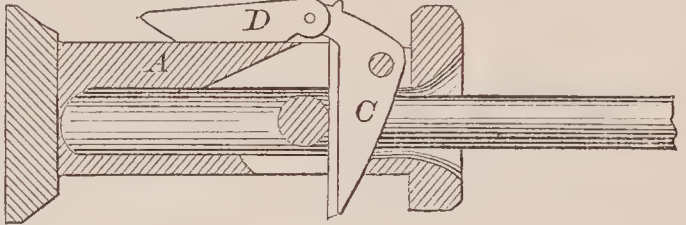

70134—C. S. Trevitt—Animal Trap.

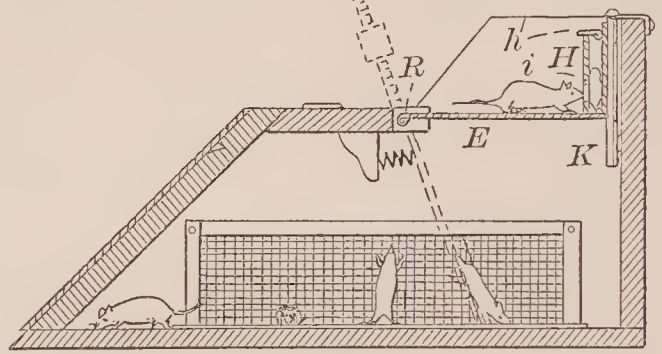

70136—C. M. Vail—Cooler  
for Water, Milk, Beer, &c.

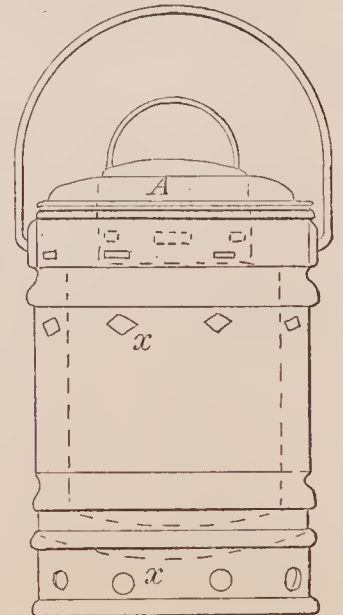

70135—W. Truby—Manure Fork, &c.

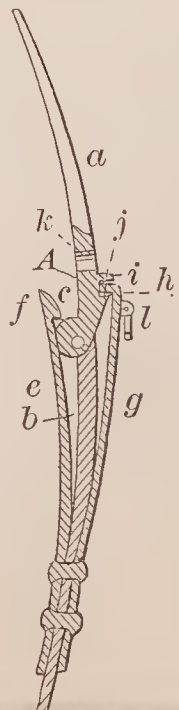

70137—Vance & Watkins—For Cutting Post Holes.

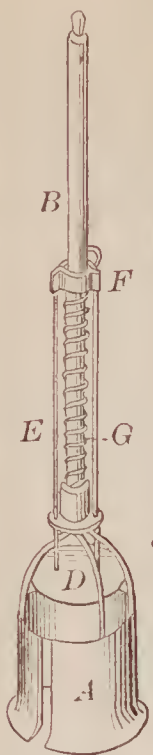

70139—G. W. Warfield—For Shaping Boot Heels.

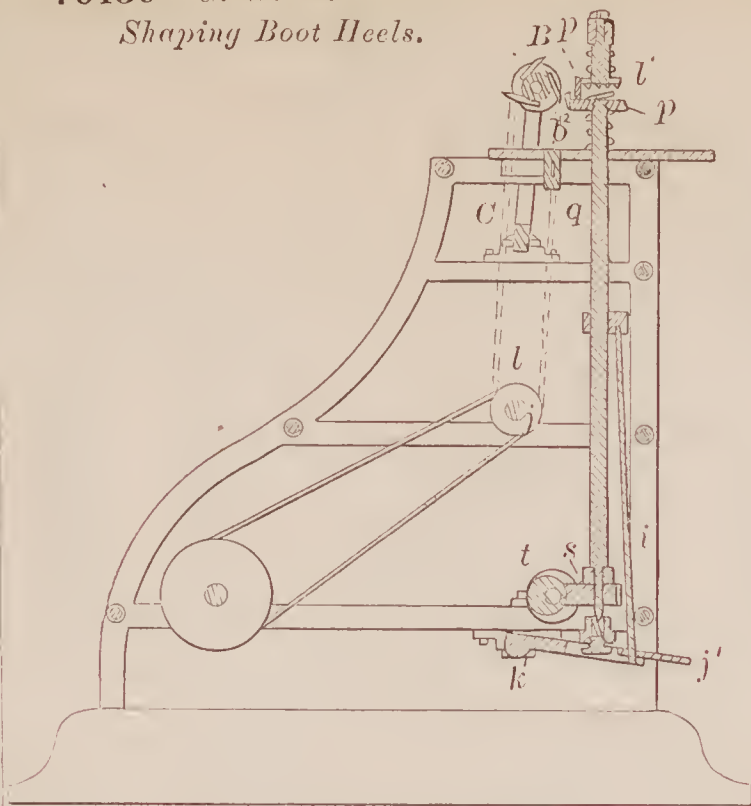

70141—L. Wheelock—Breech-Loading Fire Arm.

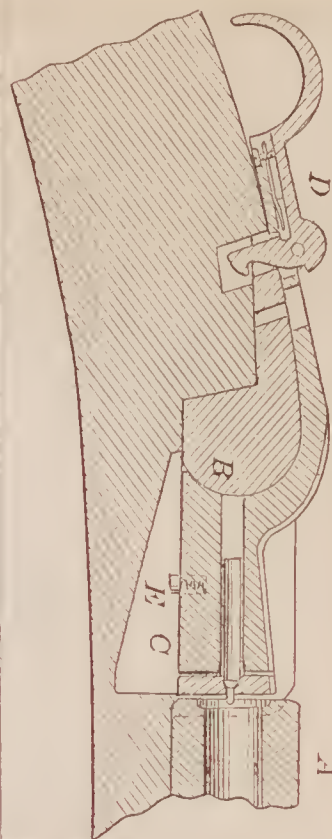

70142—R. Whitehill, Jr.—Motor for Sewing Machines.

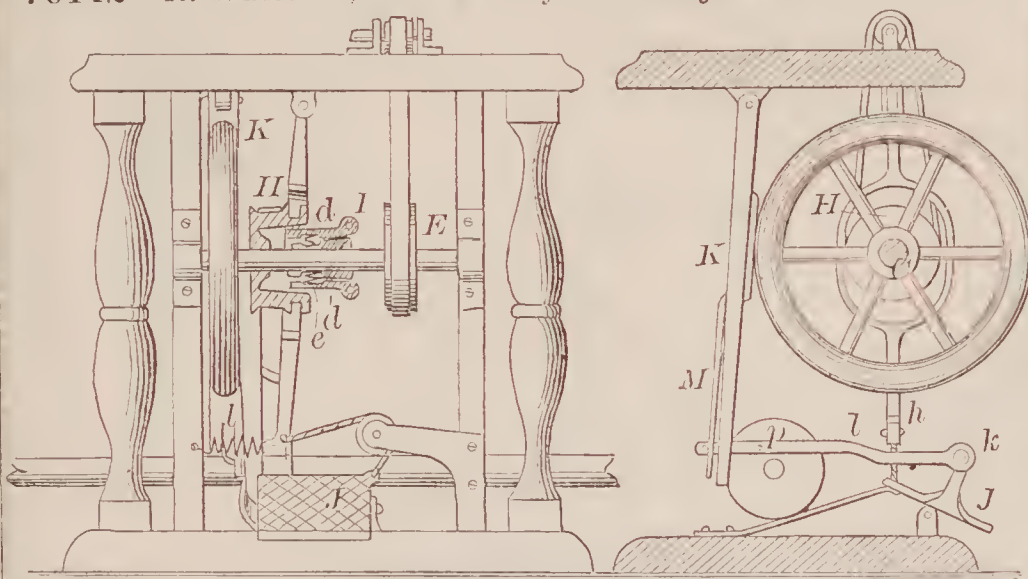

70138—J. C. Ward—Store Pipe Drum.

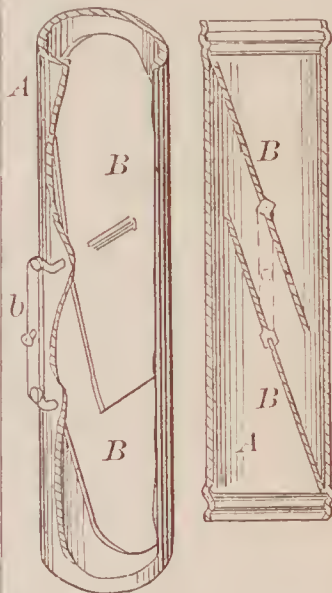

70143—W. N. Whiteley—Pitman Head and Wrist Pin.

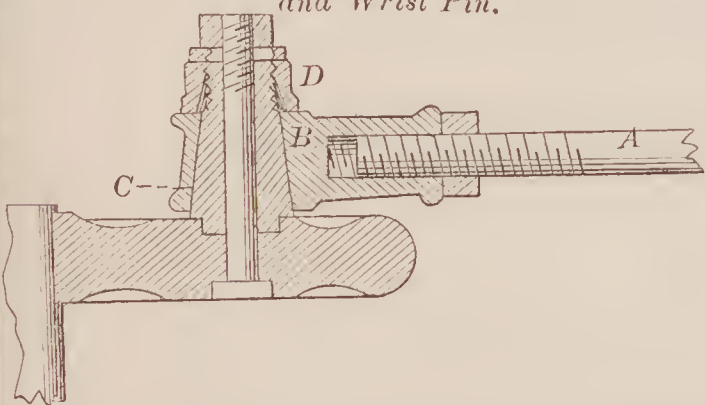

70140—West & Price—Blower for Forges.

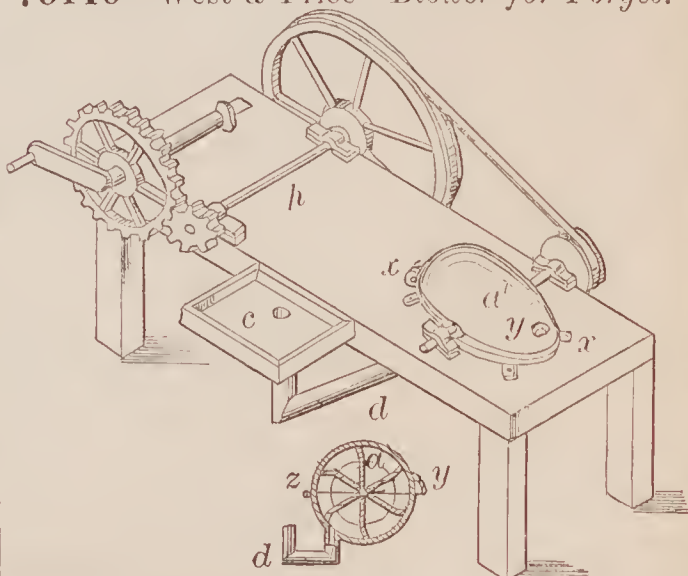

70145—J. F. Wood, 2d—Car Brake.

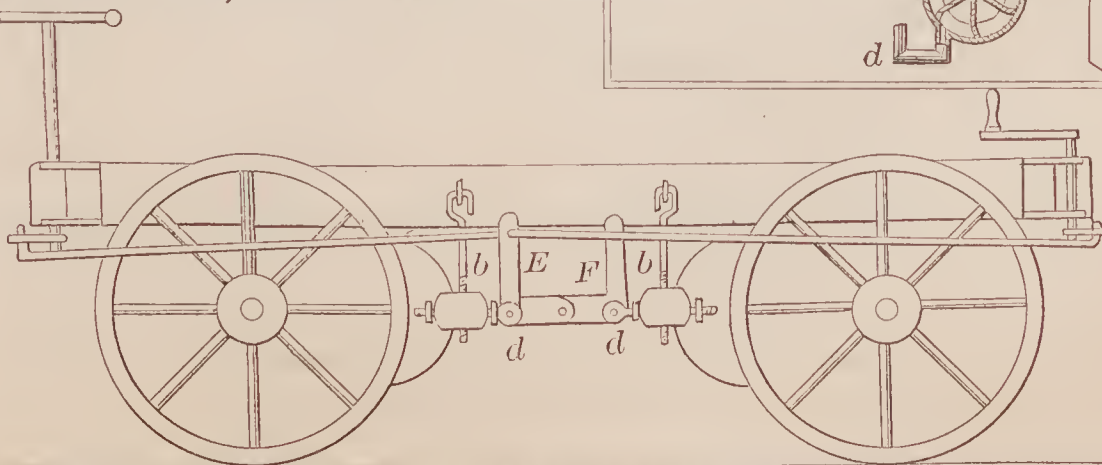



70146—A. T. Woolsey—Ironing Table.

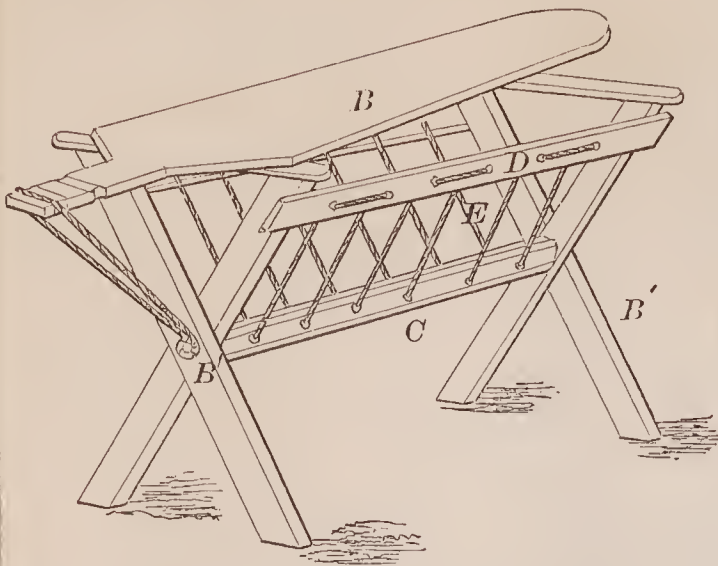

70150—S. O. Avery—Milk Can.

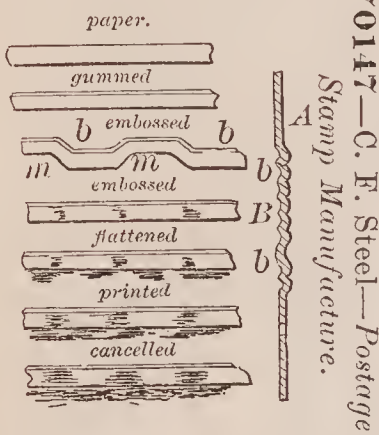
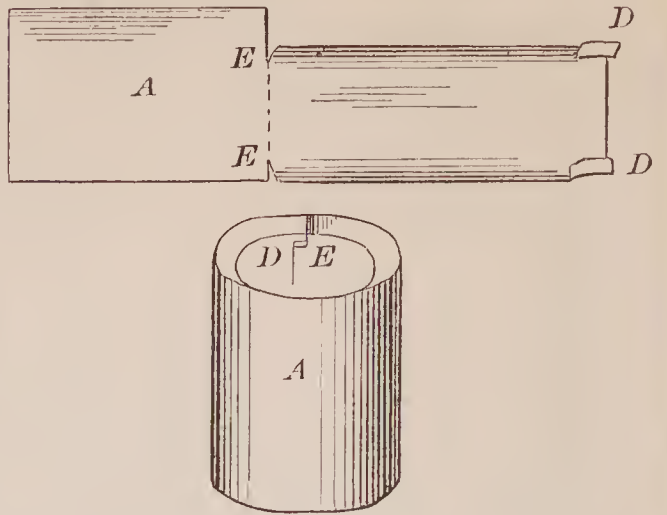

70147—C. F. Steel—Postage Stamp Manufacture.

70152—G. W. Baker—Sewing Machine.

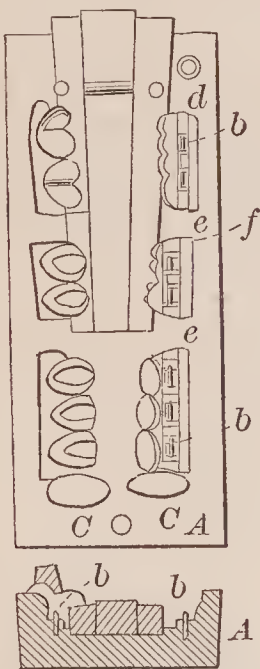
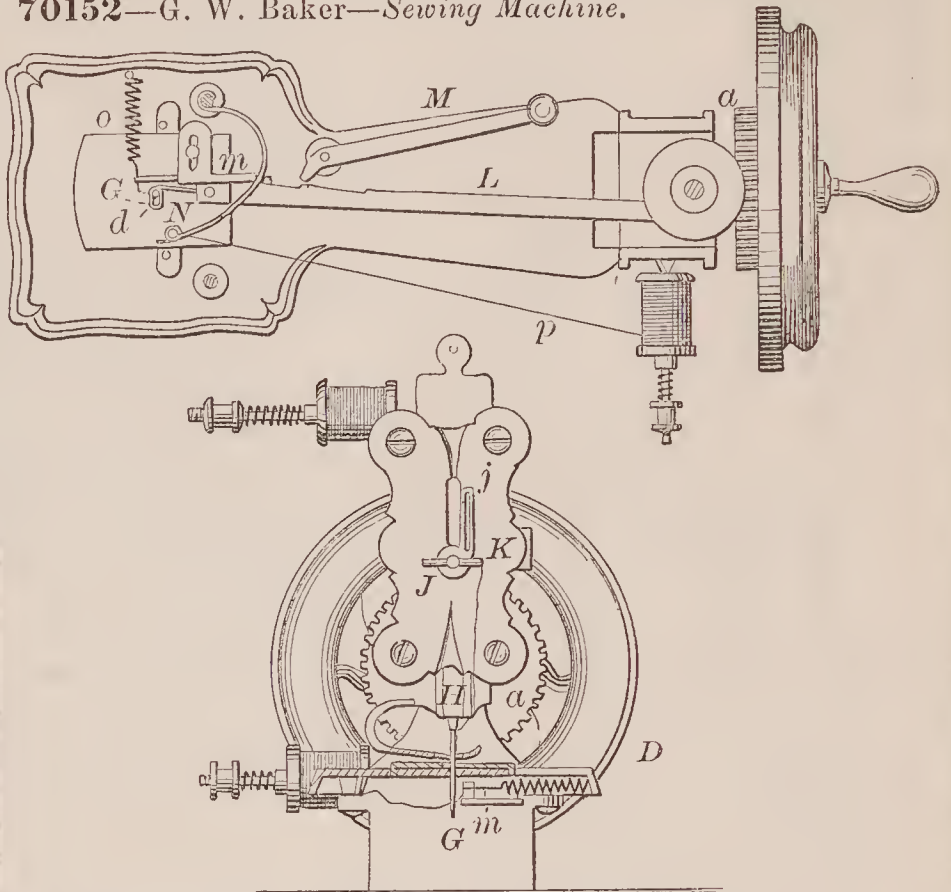

70148—A. M. Asay—Mould for Artificial Teeth.

70149—G. F. Atkinson—Spring Bolt for Doors.

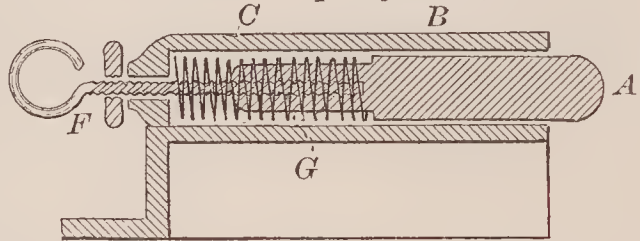

70151—J. Baird—Treenail.

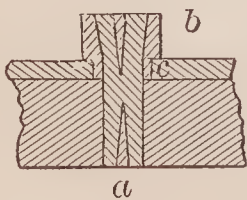

70153—T. H. Bellard—Field Fence.

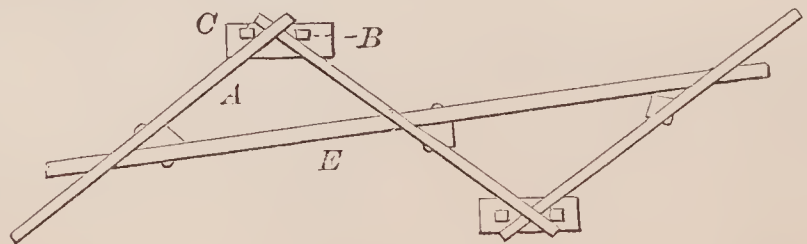

70154—R. N. Bennett—Sinking Well Tubing.

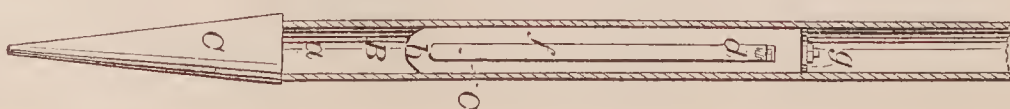

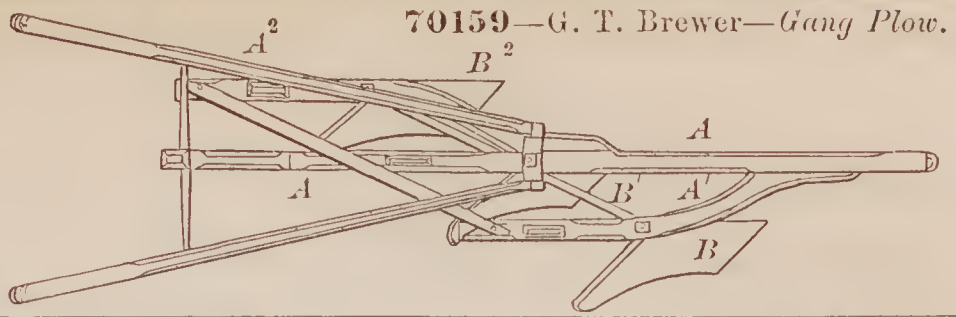

70159—G. T. Brewer—Gang Plow.

70158—A. G. Brewer—Leather Quilting Machine.

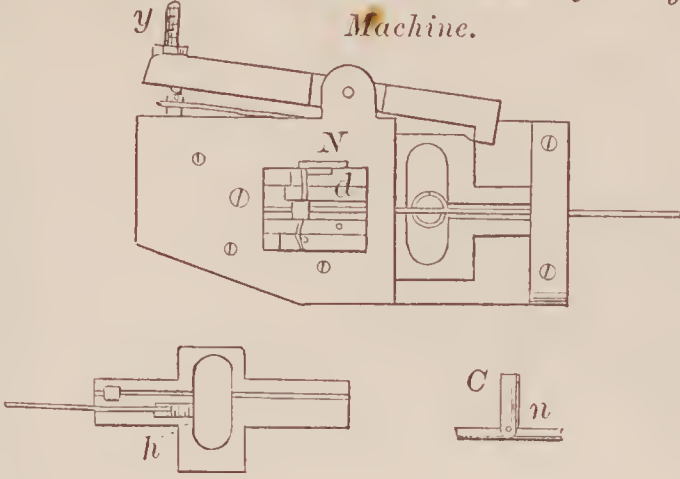

70156—J. C. Blackman—Plated Wire.



70160—F. H. Brown—For Braiding Openwork Baskets.

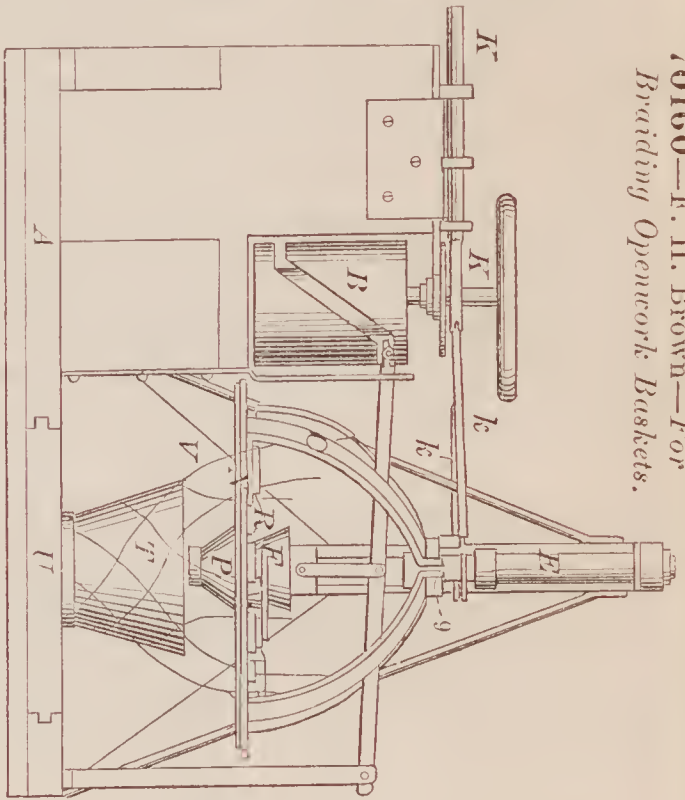

70155—J. G. Bicknell—Window Screen.

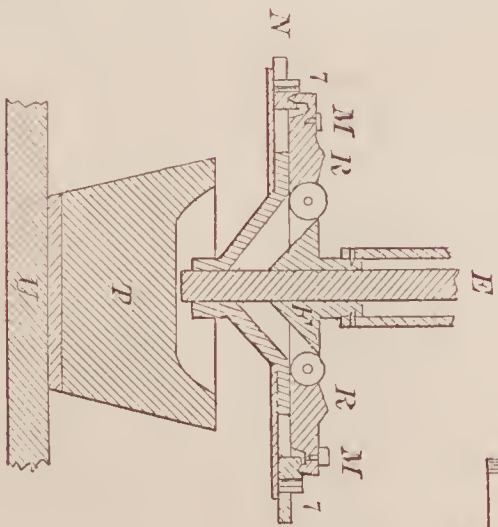
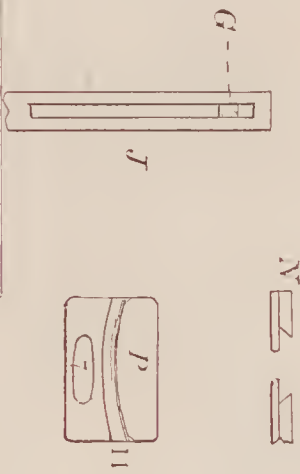
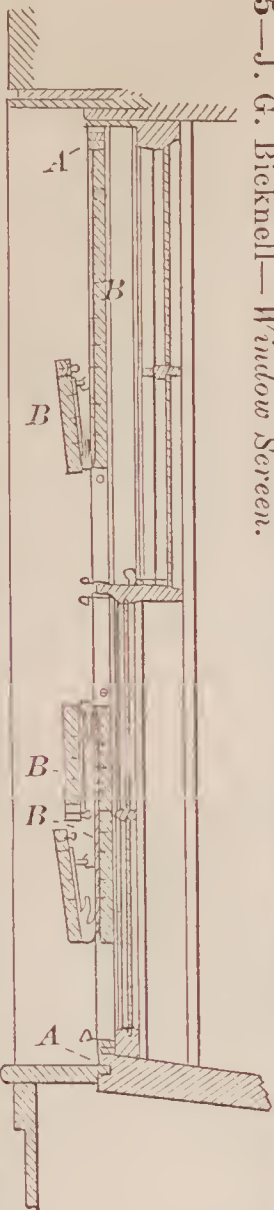

70157—J. P. Bradley—Boot and Shoe Shield.

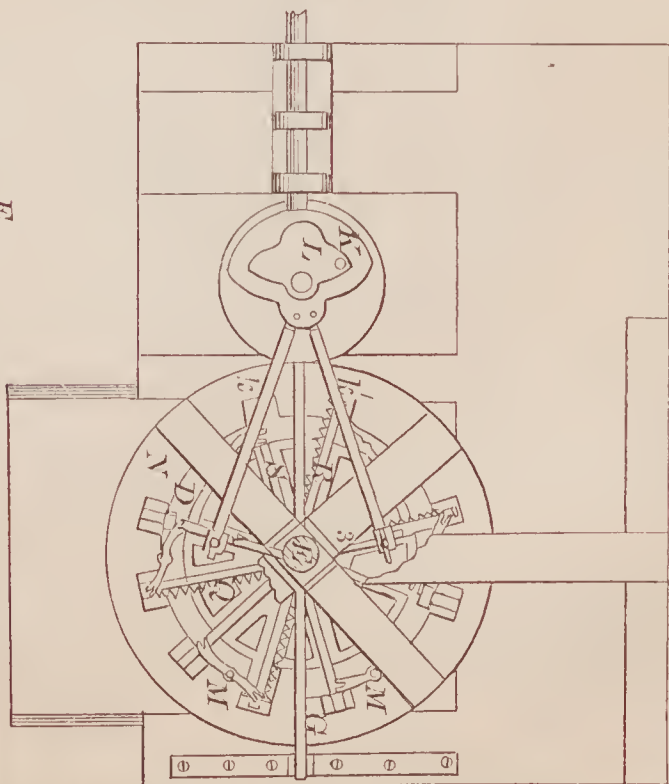
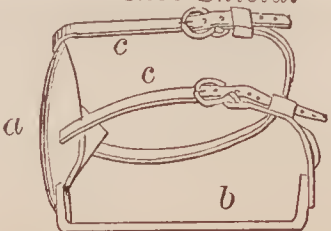





70171—G. L. Crandal—Shuttle.

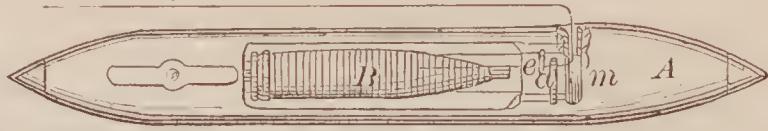
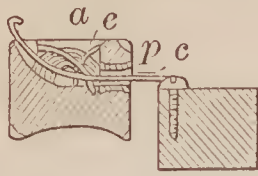

70172—R. Kreuzbauer—Connecting Link.

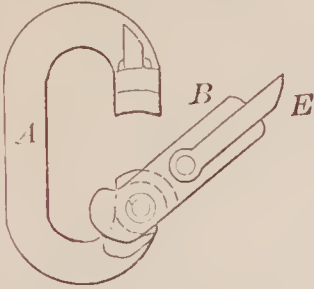

70173—J. M. & M. L. Cummings—Shutter Bowing Bolt.

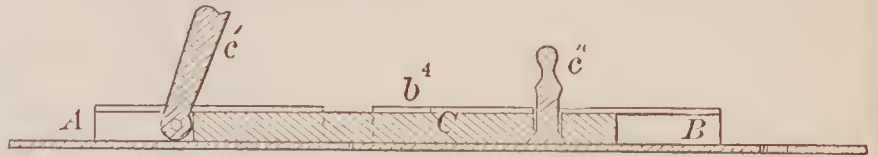
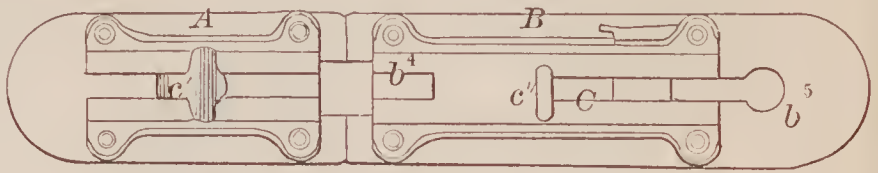

70178—H. W. Driver—Washing Machine.

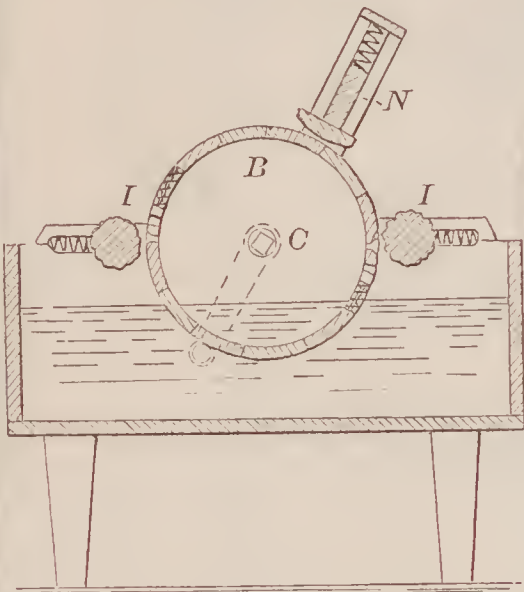

70174—J. P. Davis—Bunk for Logging Sleigh.

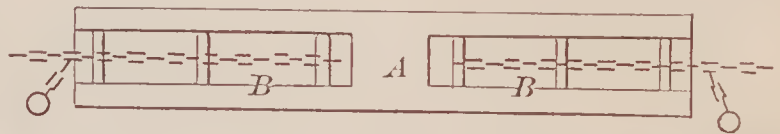

70175—A. Dawes—Leather Splitting Machine.

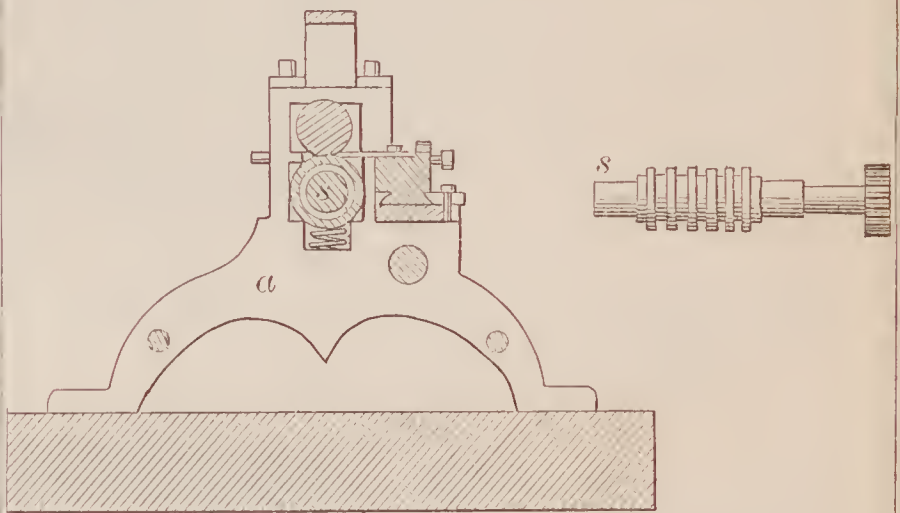

70179—D. A. Dunham—Cradle.

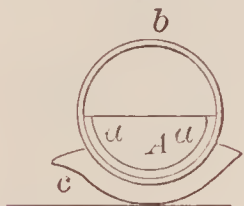

70177—W. A. Dripps—Pneumatic Spring.

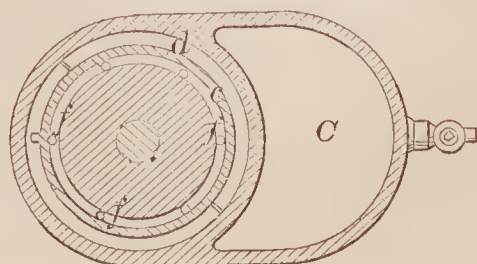
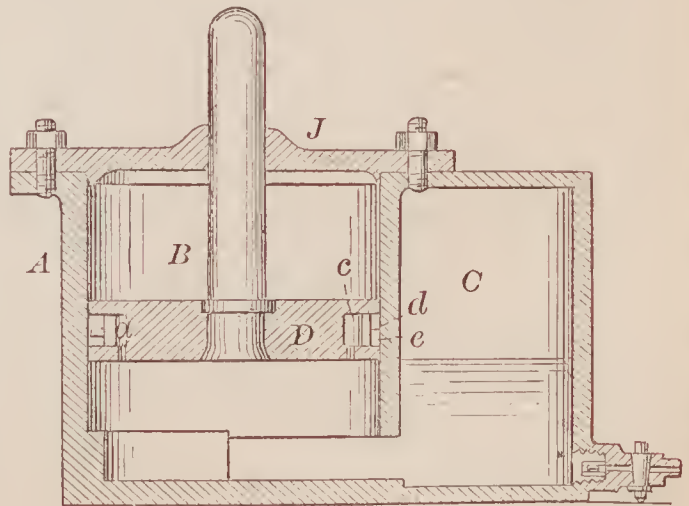

70180—J. Edson—Hoisting Machine.

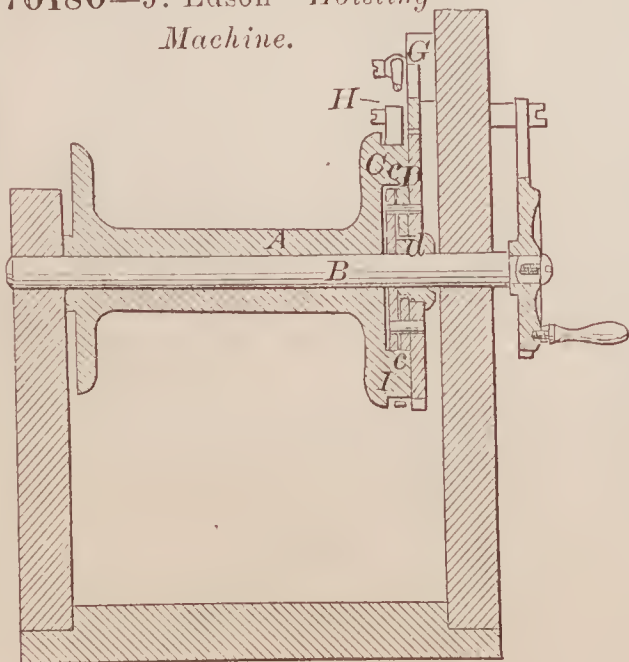



70182—J. M. Estabrook—Paint Brush.

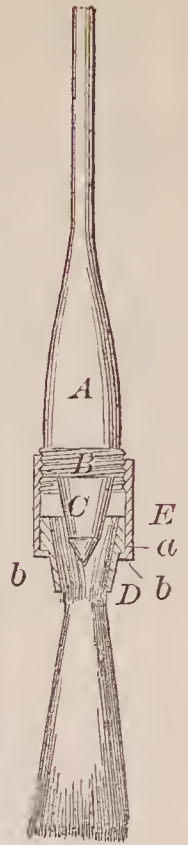

70183—A. Fagerstrom—Setting Tires on Wheels.

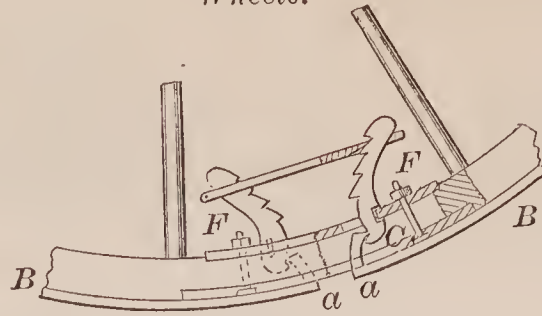

70185—O. H. P. Fancher—Anti-Kicking Attachment for Horses.

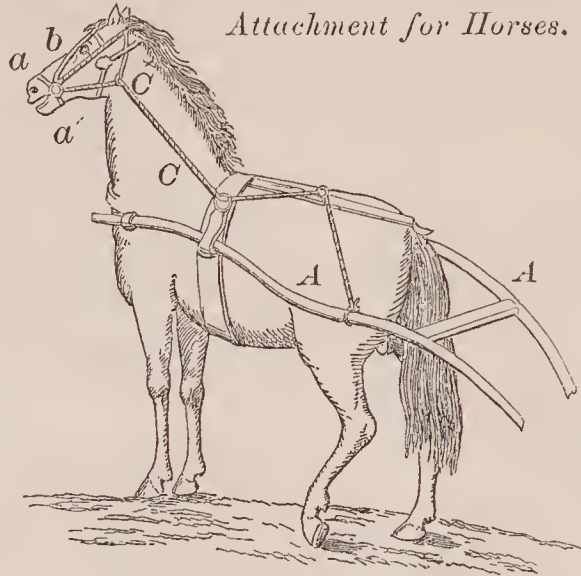

70180—Continued.

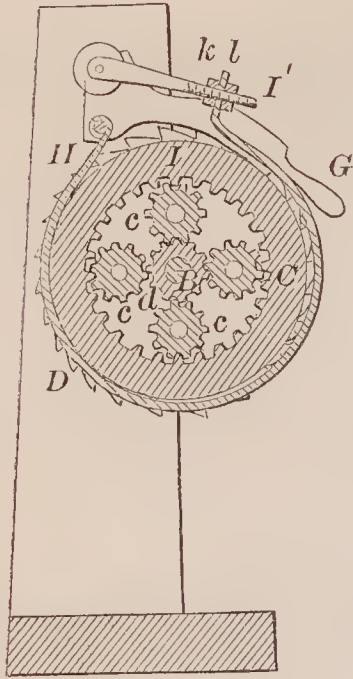

70181—T. B. Emerson—Clothes Wringer.

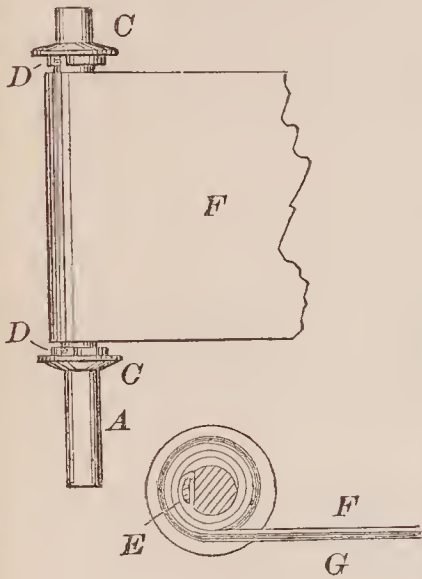

70186—G. W. Friestone—Hand Loom.

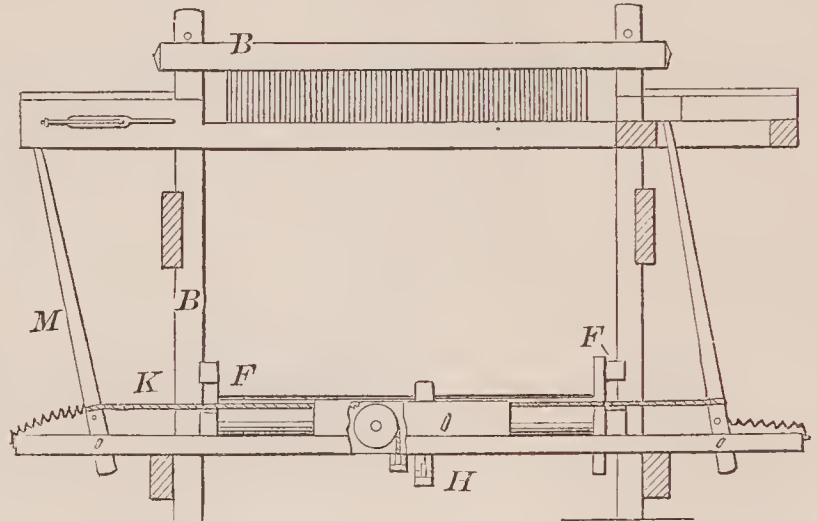

70184—M. Faloon—Gas Generator.

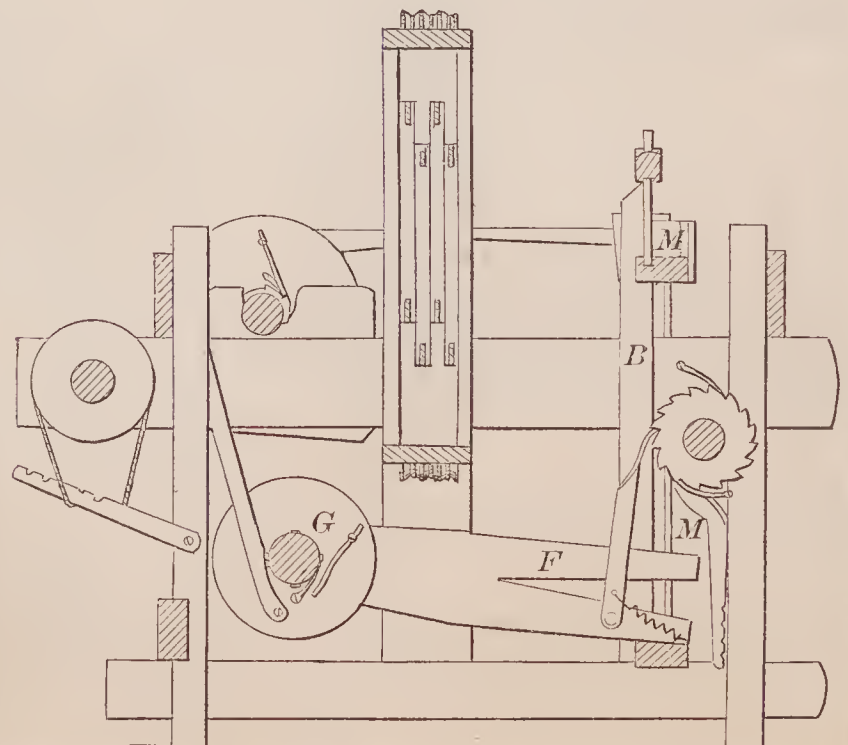
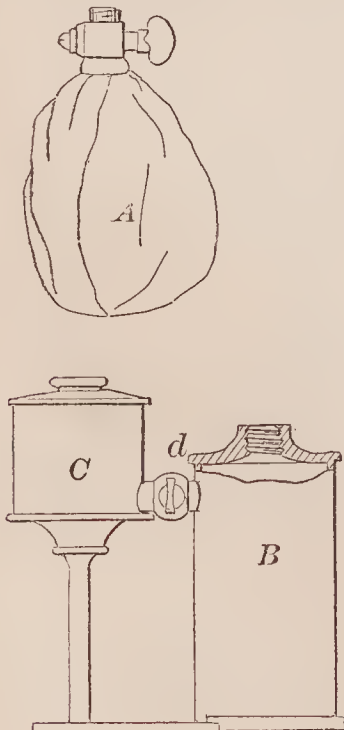

70189—Forshee & McCland—Hay Stacker.

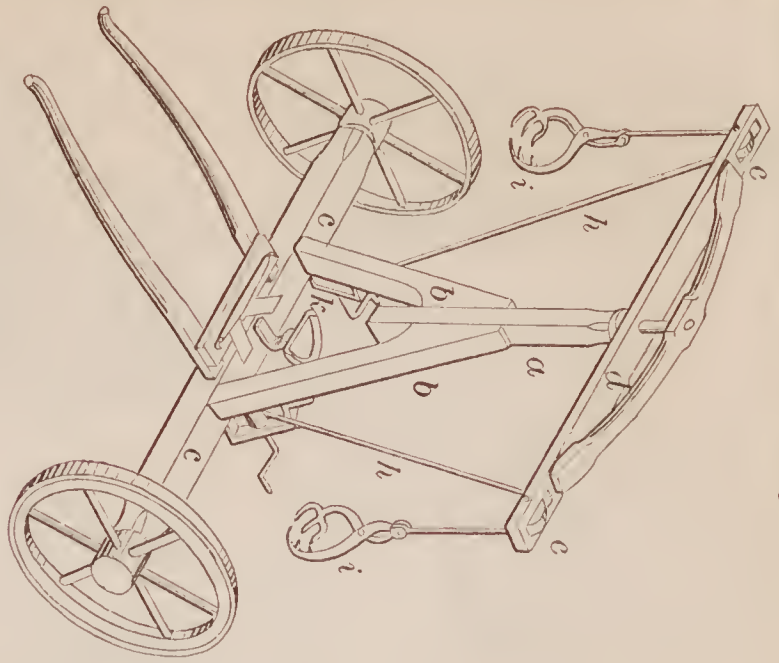

70191—I. Freed—Seat for Chamber Tassels



70190—M Fowler—Card for Hooks and Flyes.

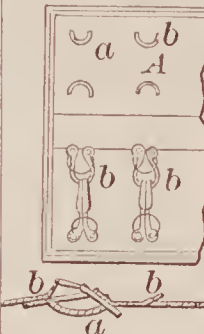

70193—J. Gardner—Clapping Screw.

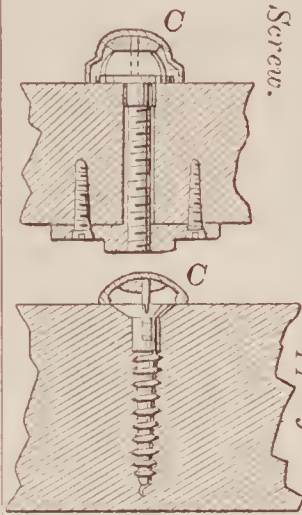

70192—T. F. Freeman—For Cutting Wood Gear.

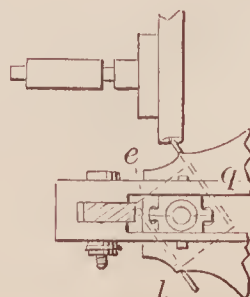
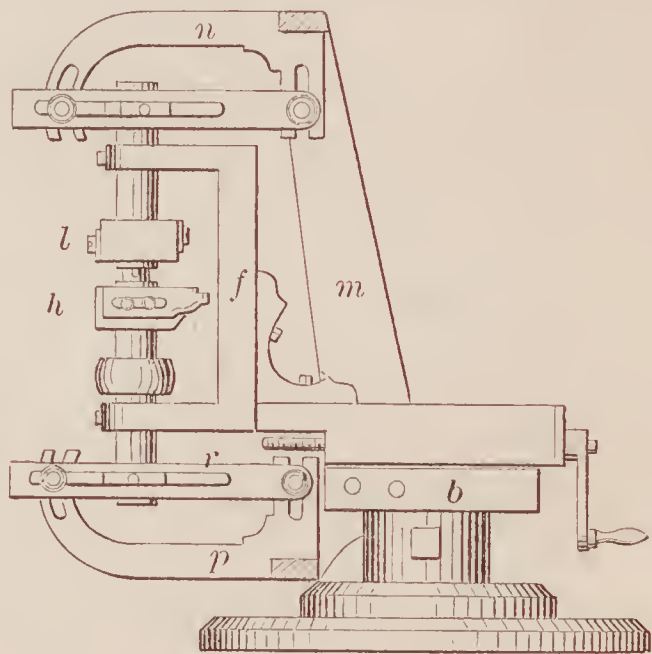

70187—T. Fogg—Railroad Switch.

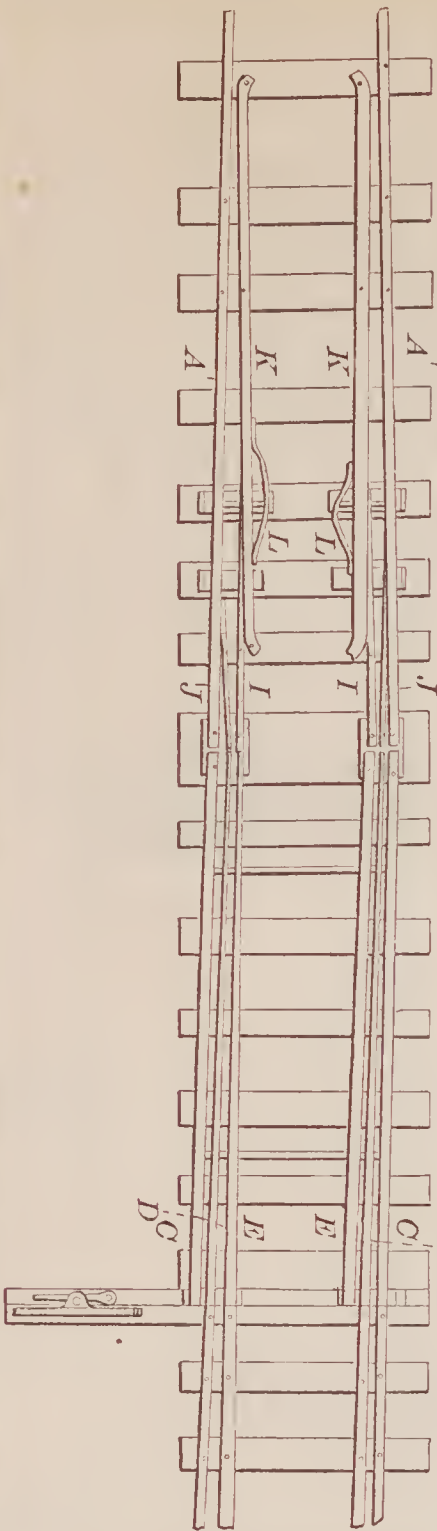

70188—W H Forker—For Opening Cans.

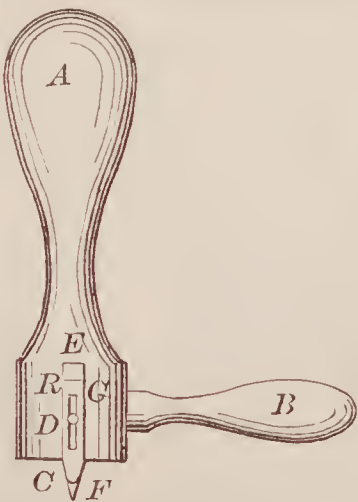

70194—George & Sanborn—Hair Brush.





70195—G. Goewey—Corn Sheller.

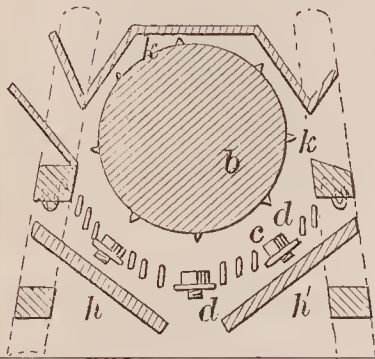
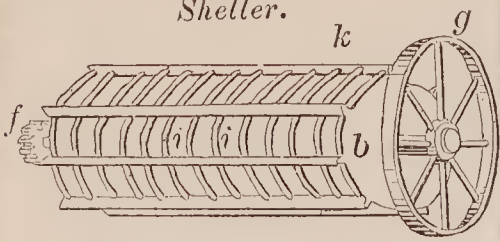

70196—W. Goff—Portable Dumping Machine.

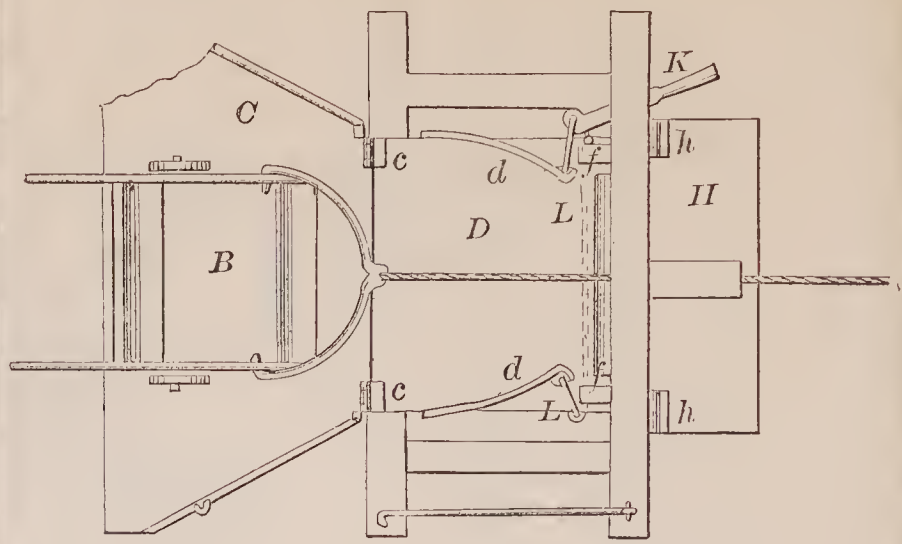

70199—J. Gray—Ratchet Drill.

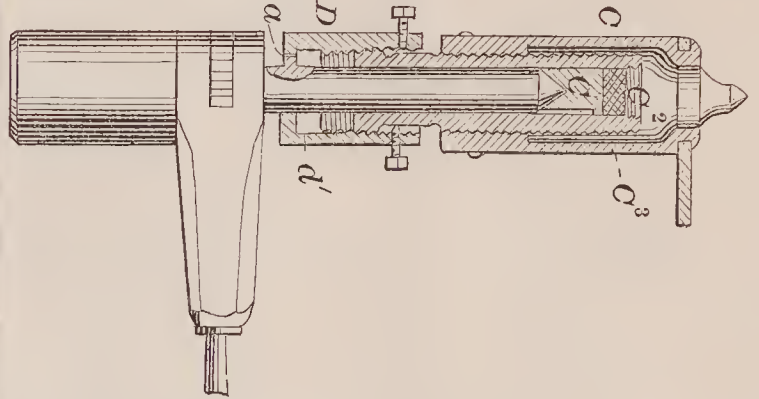

70197—W. W. Gordon—Whiffletree  
Fig. 5 Cock Eye. Fig. 4 Fig. 3

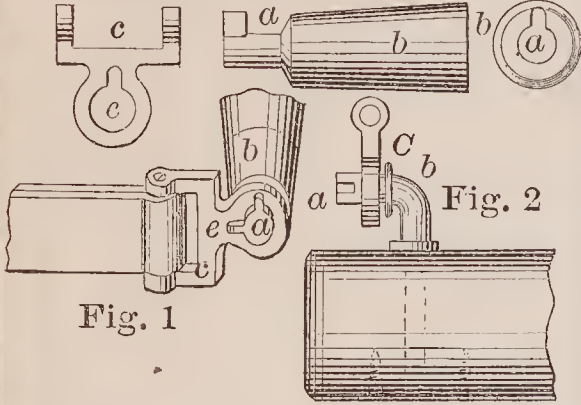

70201—J. Grimes—Bag Tie.

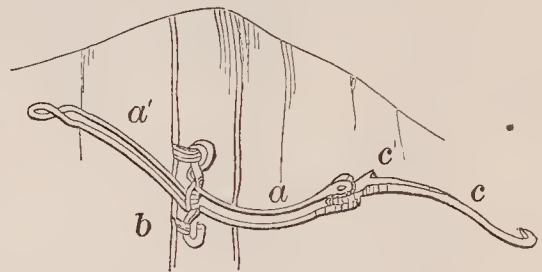

70198—J. Gray—Ventilating Mill Stones.

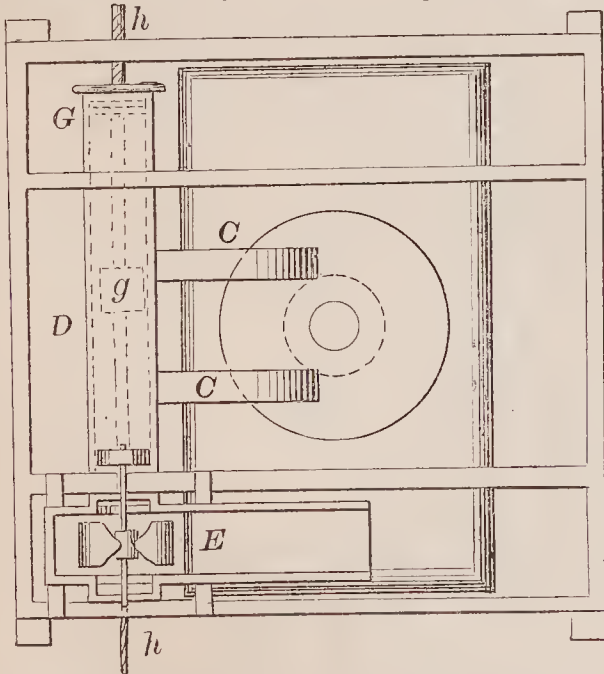

70202—J. L. Hall—Safe.

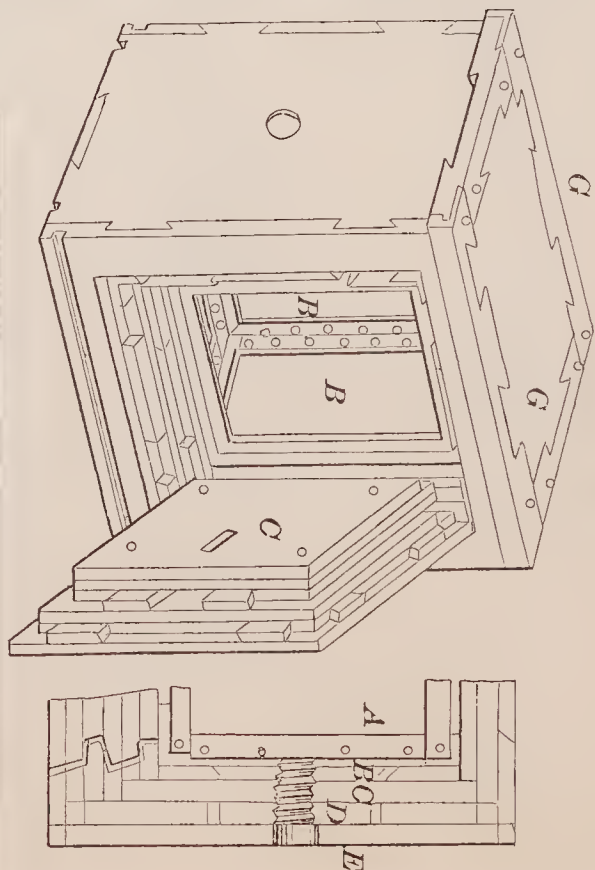

70200—J. Green—Furnace for Steam Boilers.

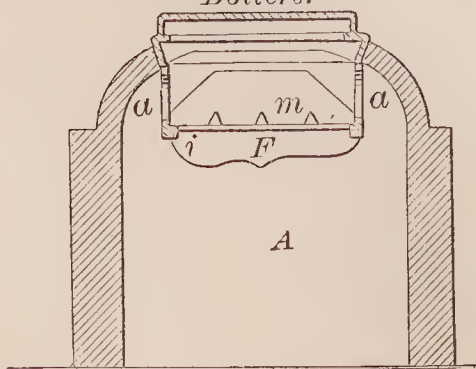

70203—W. H. Hall—*Lightning Arrester for Telegraph.*

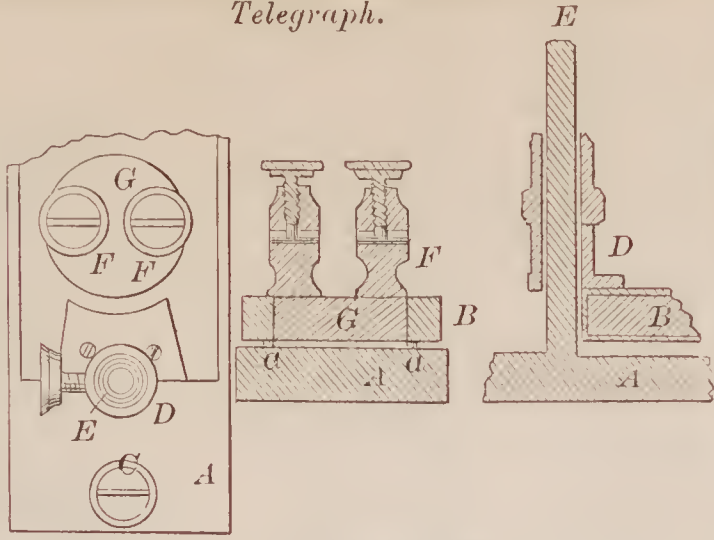

70207—D. G. Haskins—*Gas Cooking Apparatus.*

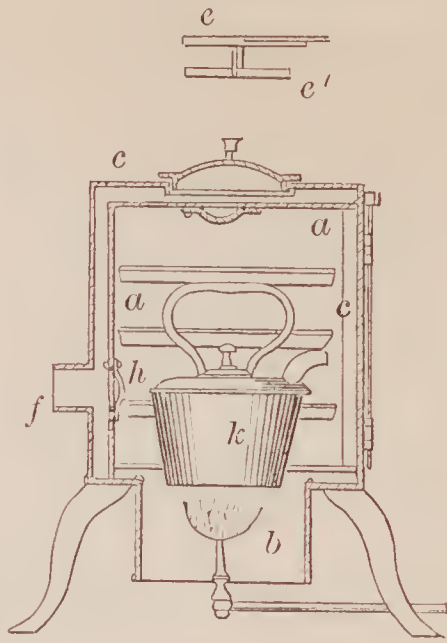

70205—C. H. Hardy—*For Cutting Soap.*

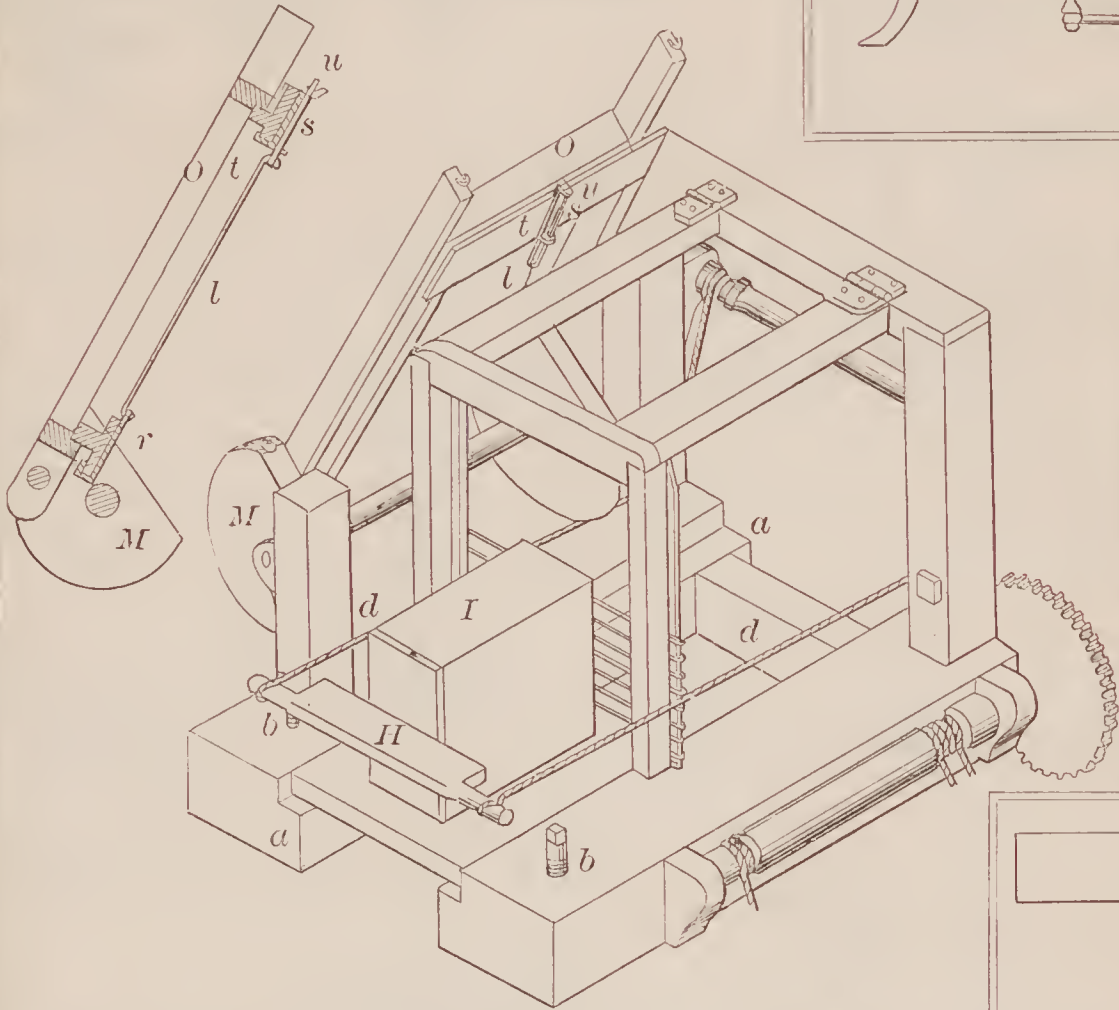

70204—N. Hamblin—*Try Square.*

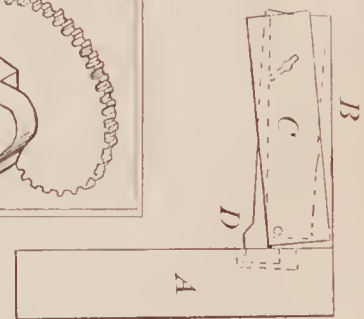

70206—Harris & Zoiner—*Water Reservoir for Cooking Stoves.*

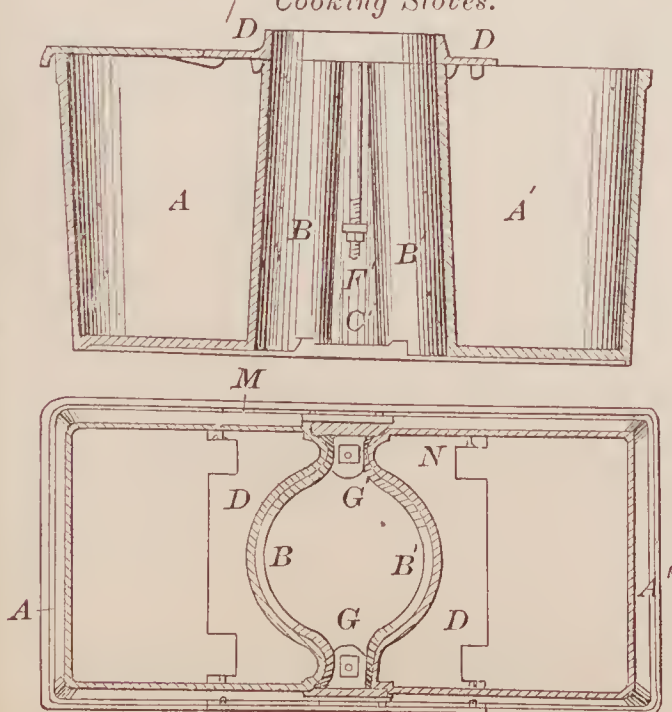

70208—W. D. Hatch—*Planing Machine.*

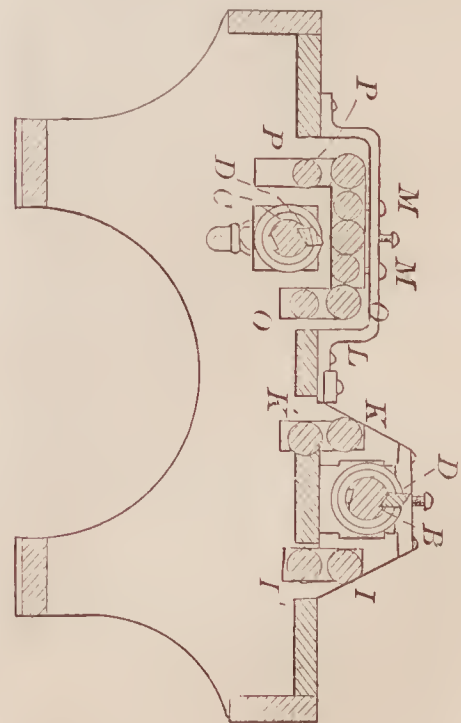



70213—J. P. Holt—Steam Gauge.

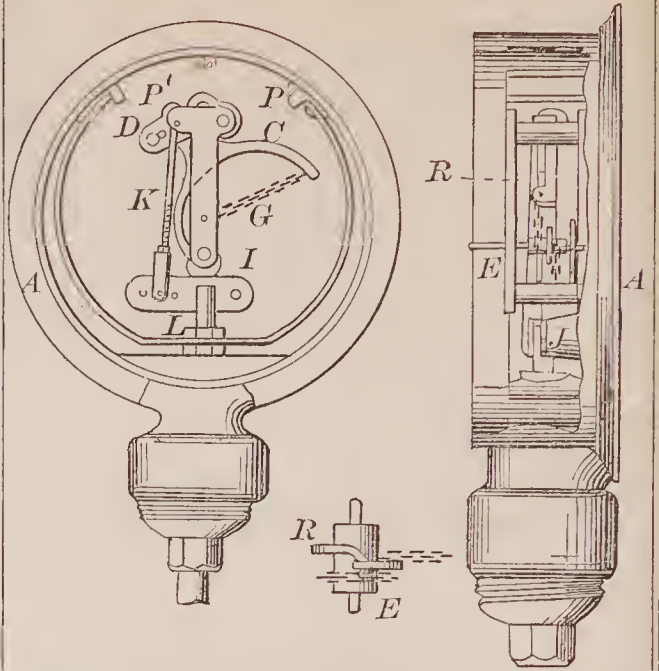

70212—A. J. Hindermeyer—Piling, Heating and Flaring Fagot for Railroad Rails.



70209—W. E. Hawkins—Crucet Caster.

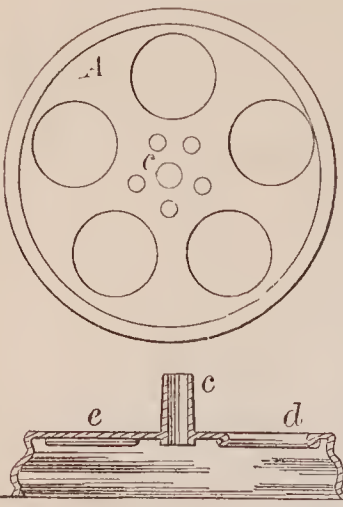

70211—G. W. Herring—Water Wheel.

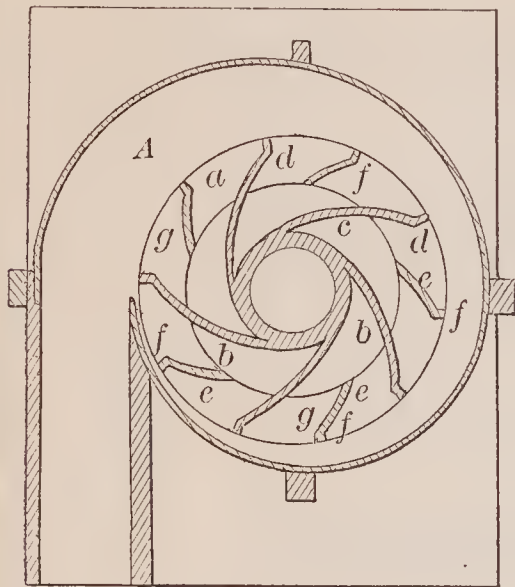

70214—C. Holmes—Lifting Jack.

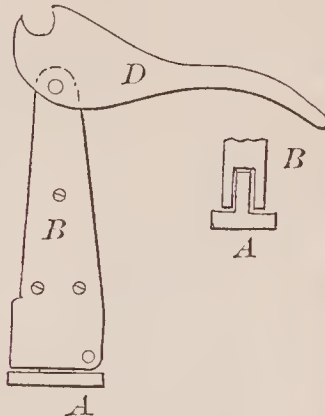

70216—D. W. Howard—Rudder.

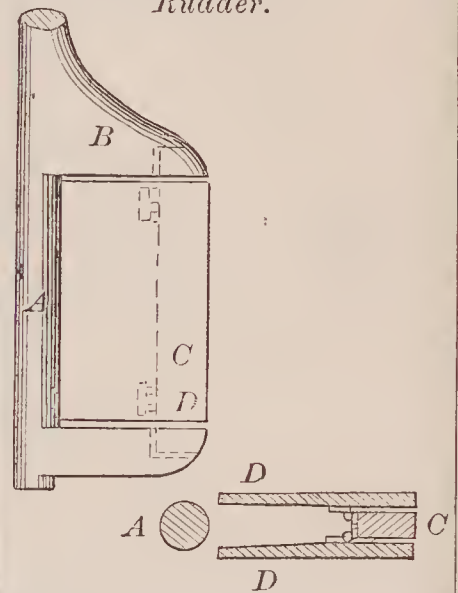

70216—J. L. Howard—Railroad Car Ventilator.

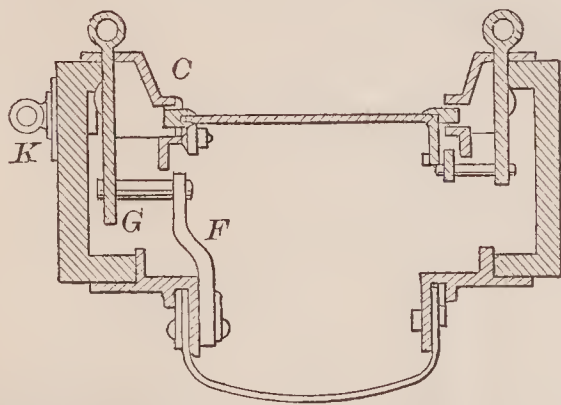

70218—H. Humphrey—Button Fastening.

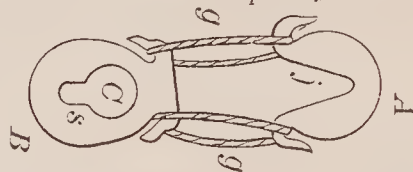

70217—W. Hull—Wagon Brake.

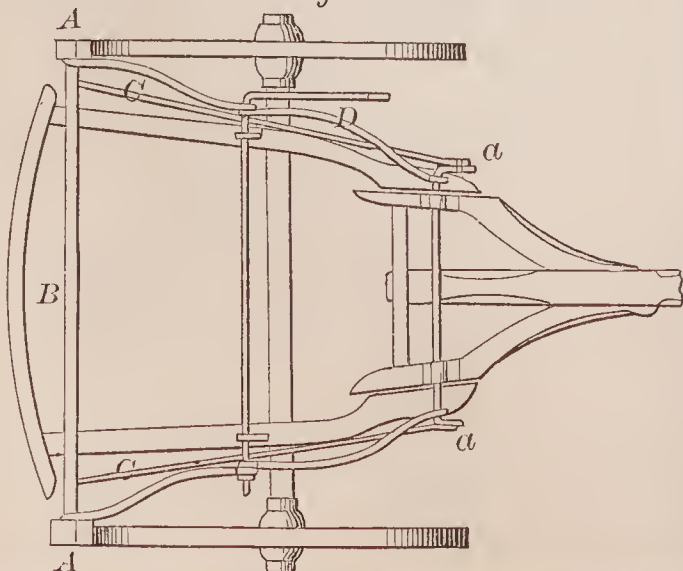

70219—W. Humphreys—Buggy Spring.



70220—J. Jacob—Umbrella.

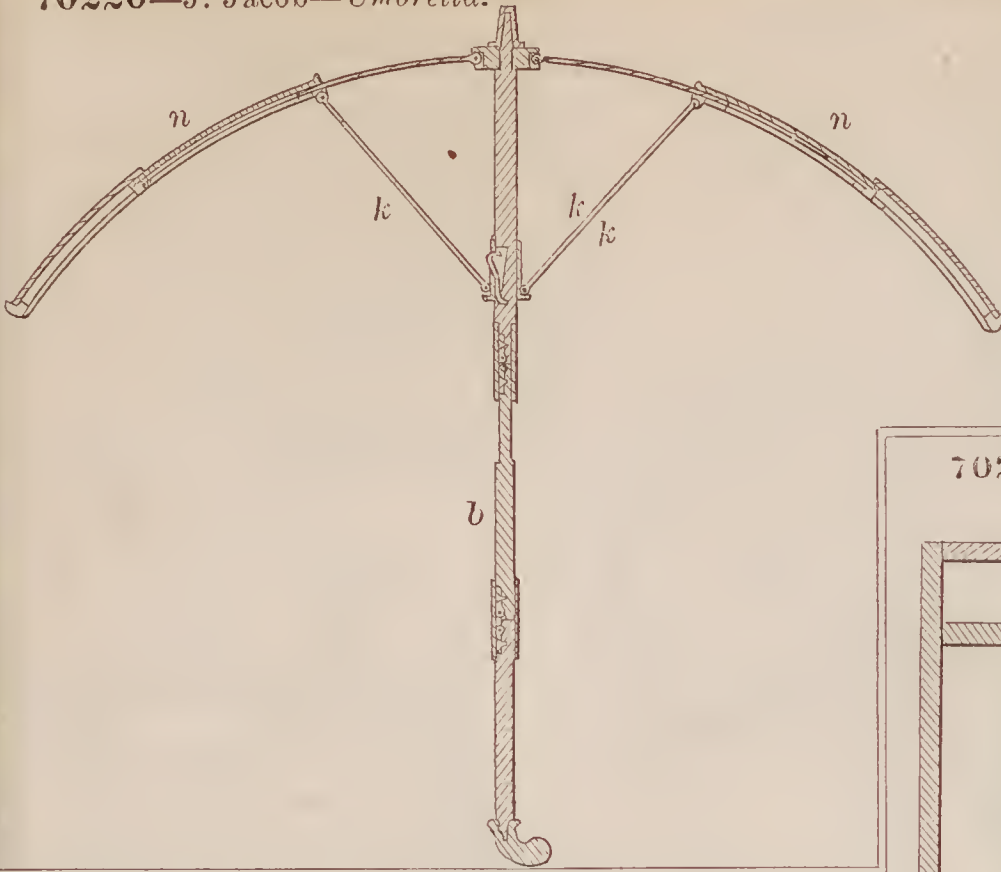

70226—G. L. Kelty—Window Shade Material.



70221—Jelley & Gowell—Sash Fastener.

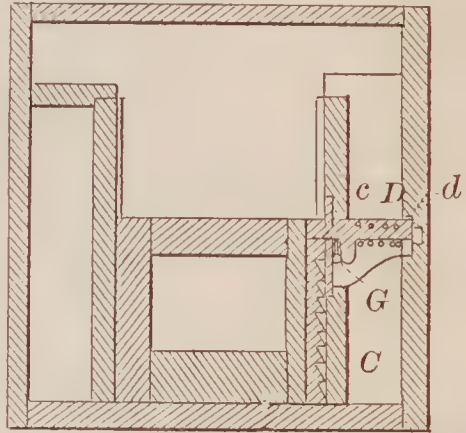

70223—S. E. Jewett—Joint Bolt.

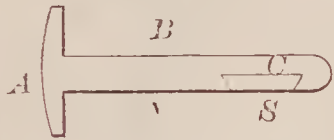

70222—J. G. Jewell—Window Sash Stop.



70227—H. Lake—Ox Shoe.

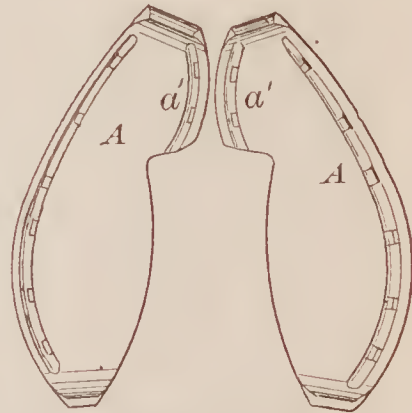

70224—W. J. Keeney—Pitman Coupling.

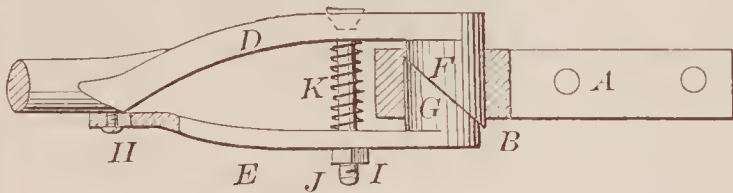

70225—W. J. Keeney—Pitman Coupling.

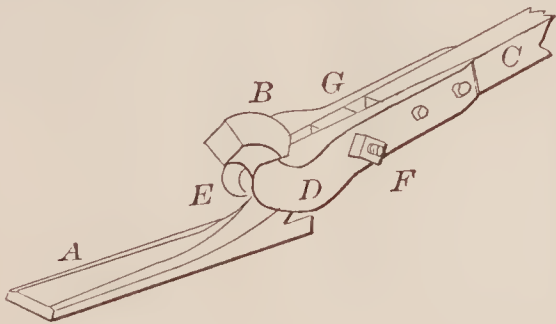

70228—G. A. Lamb—Label Holder for Mail Bags.



70230—R. H. Lecky—Cotton Bale Tie.

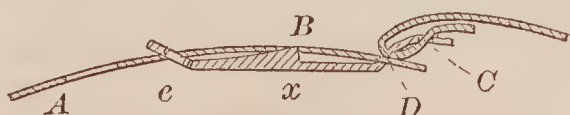

70231—G. W. Lewis—Horse Shoe.

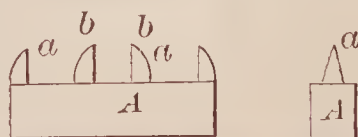

70229—J. Leaken—Churn Dasher.

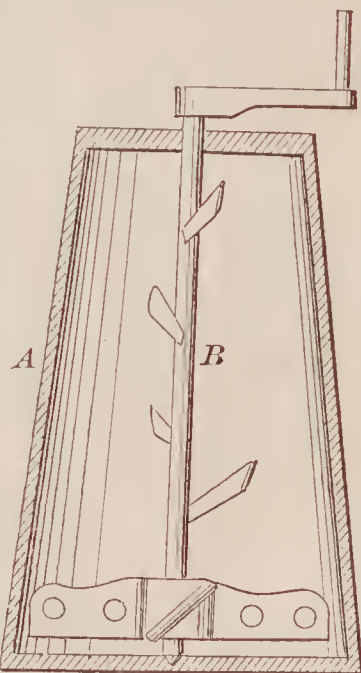



70232—R. Lewis—Safe Lock.

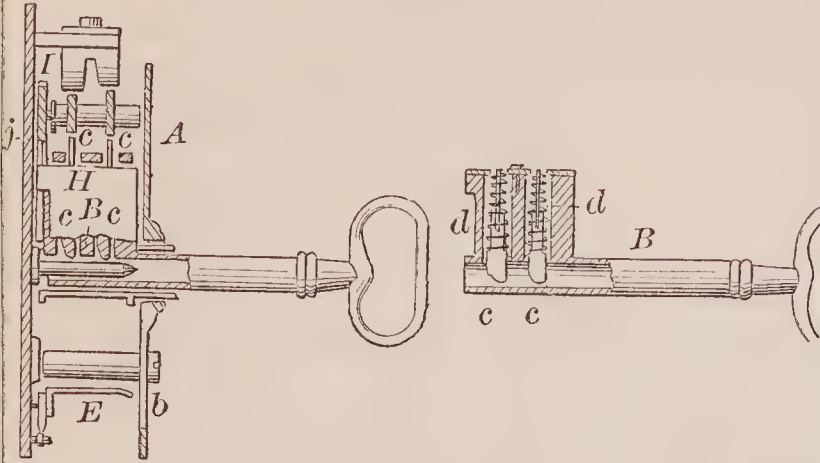
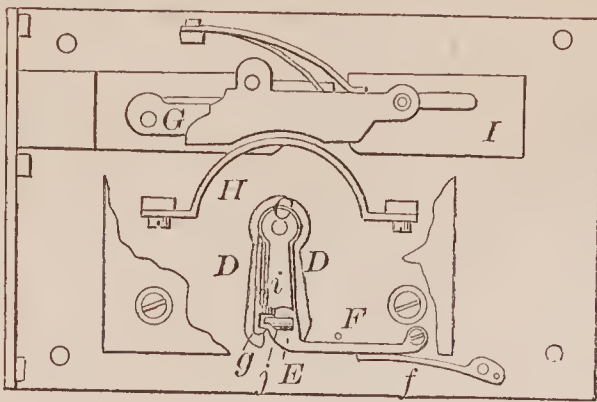

70233—J. Liddle—Furnace for Fireplaces.

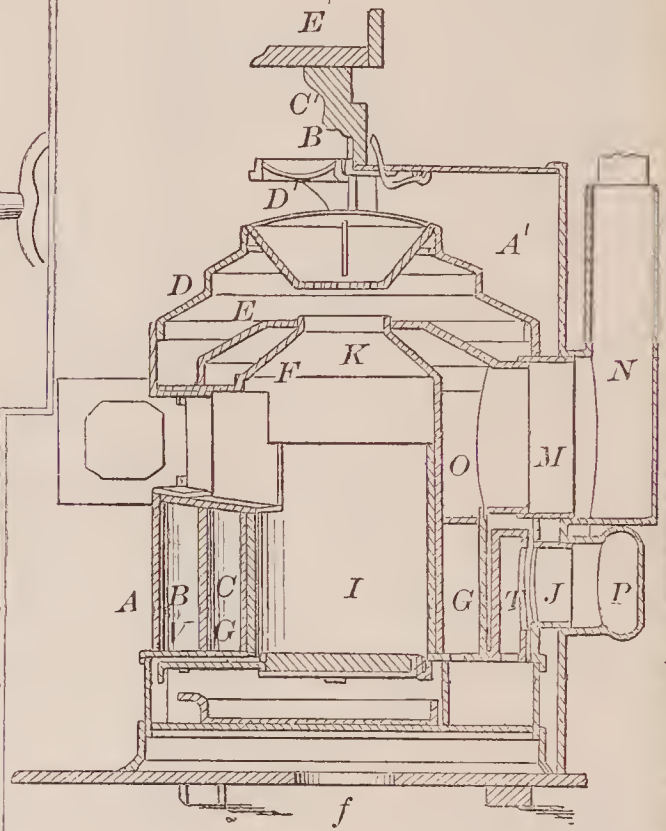
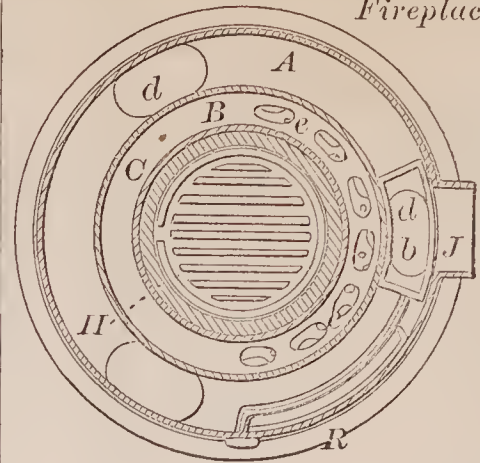

70234—J. L. Livingston—Lime Kiln.

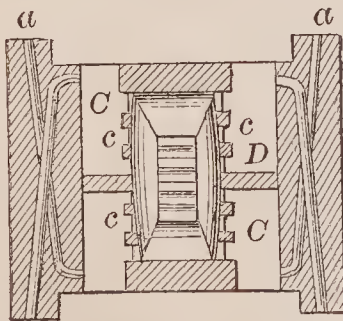
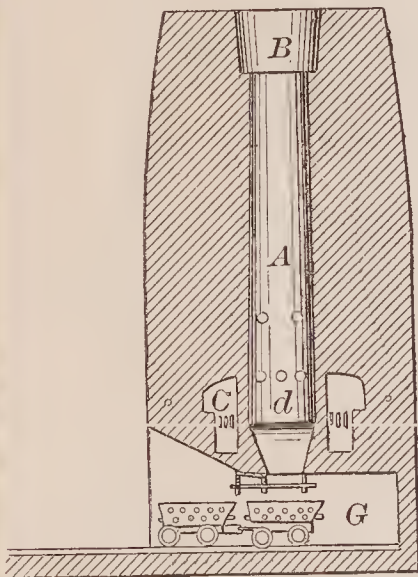

70236—G. H. Lupton—Sash Fastener.

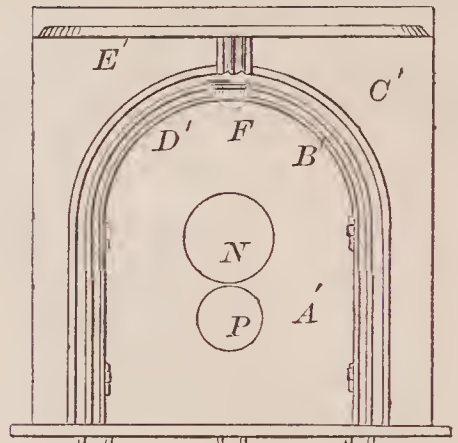
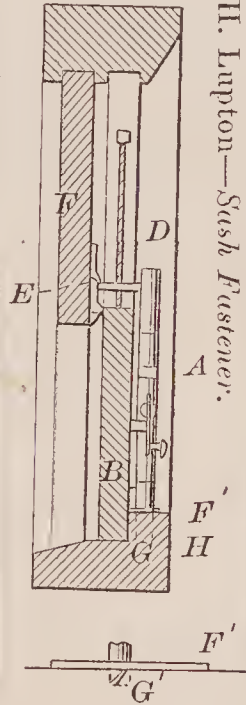

70235—A. Z. Long—Car Brake.

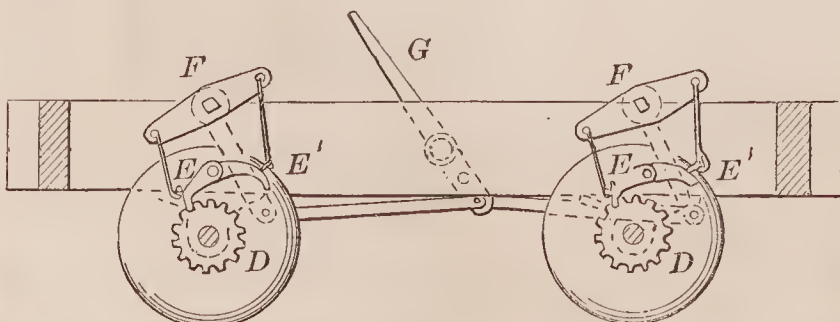

70237—J. D. Marshall—Plow and Planter.

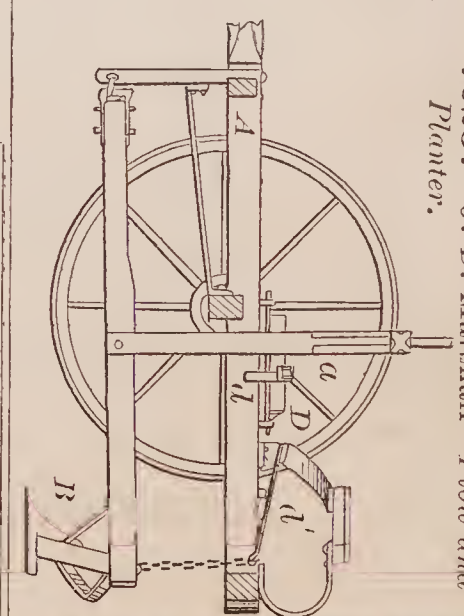

70238—McCoy & Wheeler—  
Metallic Garter.

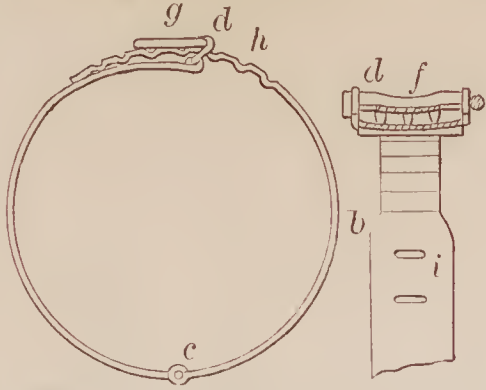

70239—G. D. Melotte—Clutch  
for Hay Forks.

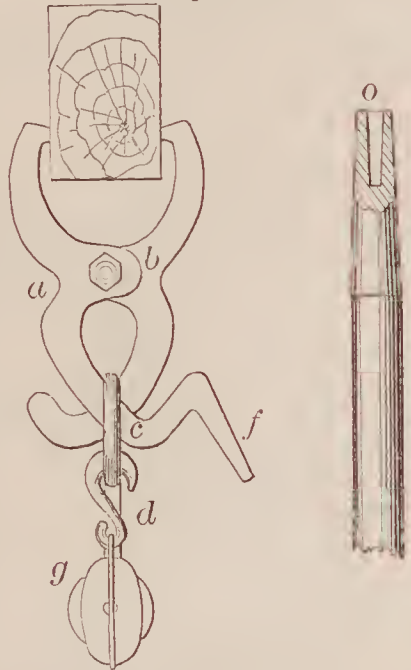

70241—W. Money—Fastening for  
for Umbrella Runners.

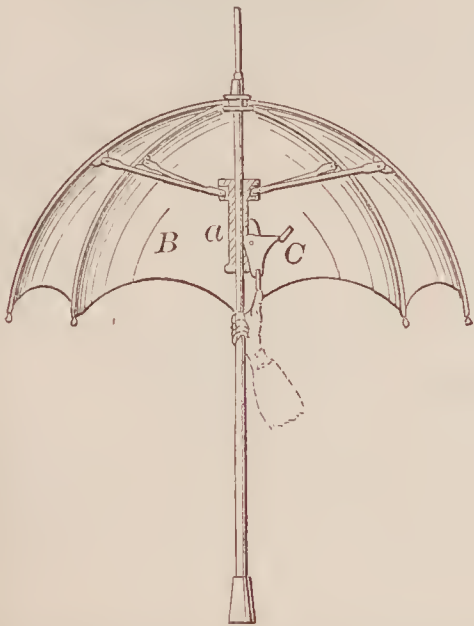

70242—Moore & Emery—Rotary Meter.

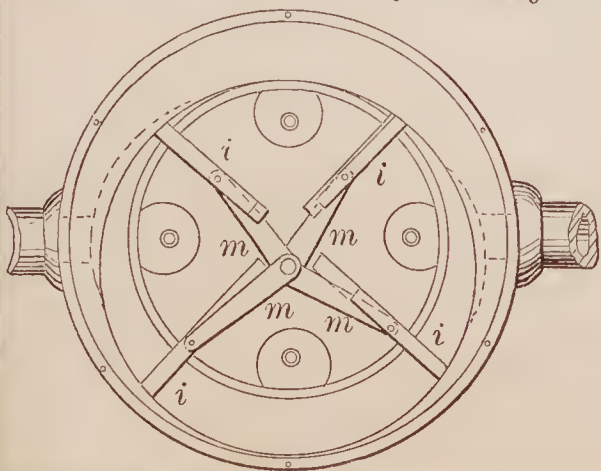

70243—J. Moore—Plow.

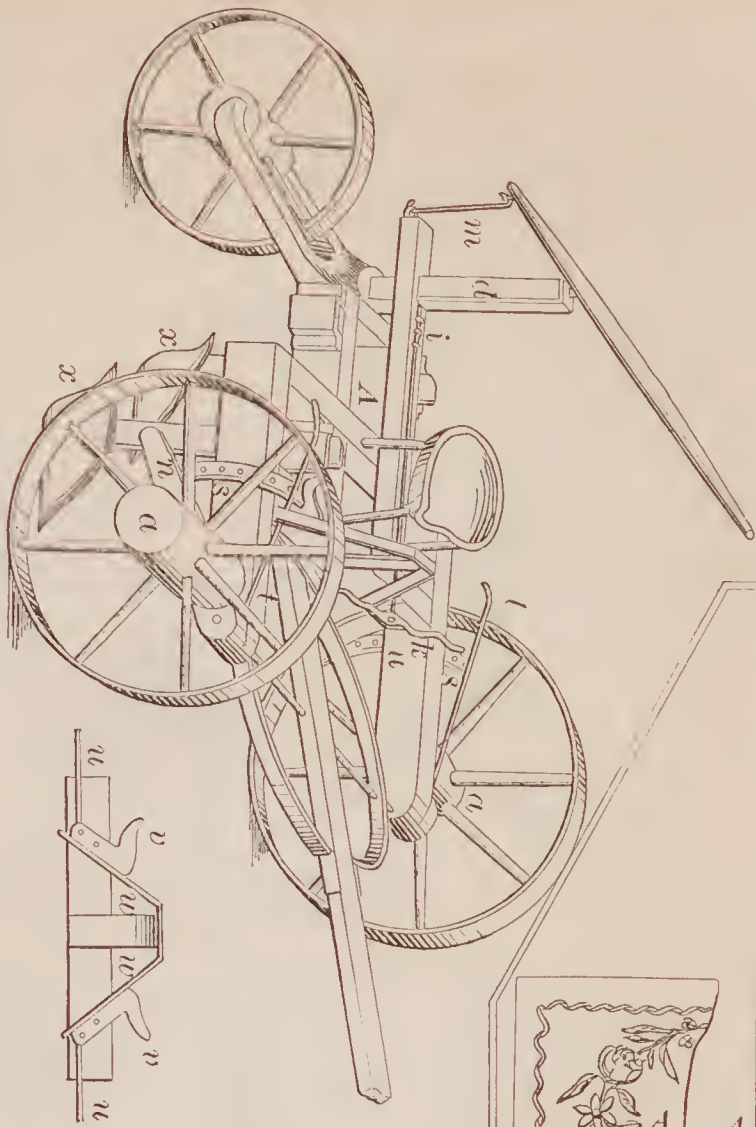

70240—J. C. Millward—Ornamenting  
Glass.

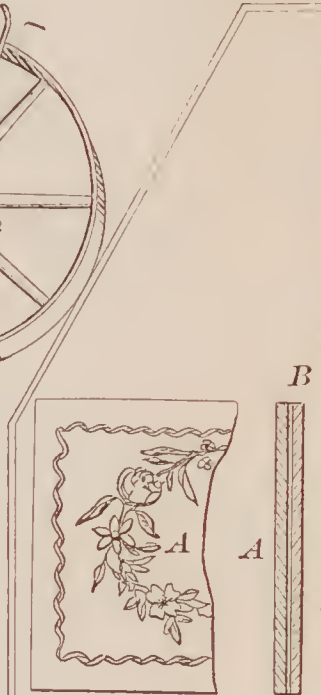

70244—J. A. Morrell—Pump.

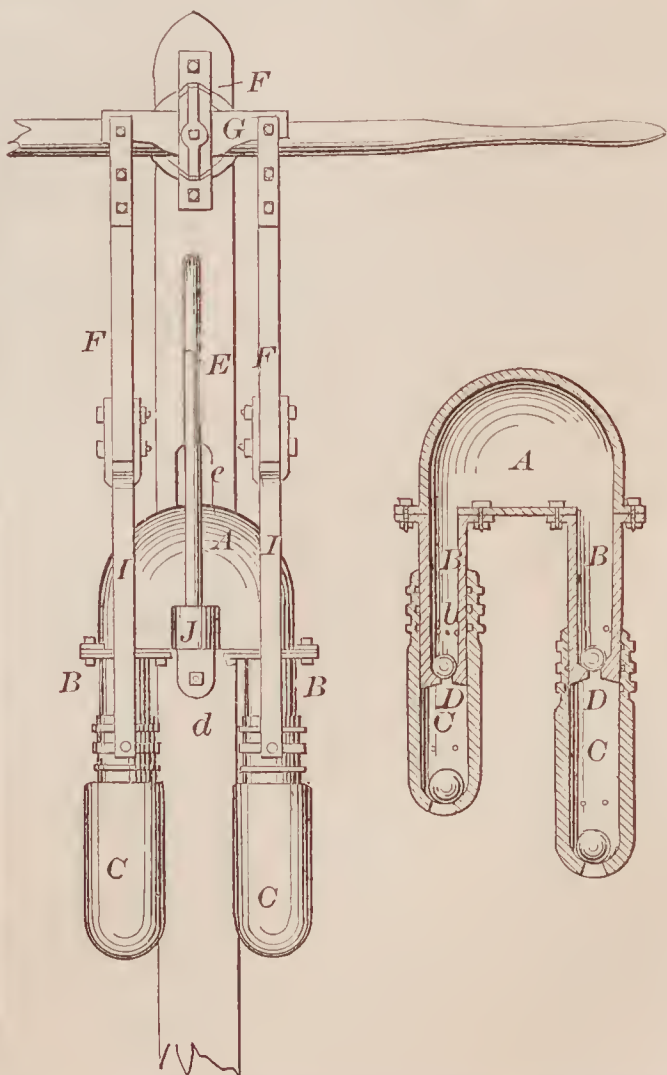



70245—D. H. Morrison—Iron Bridge.

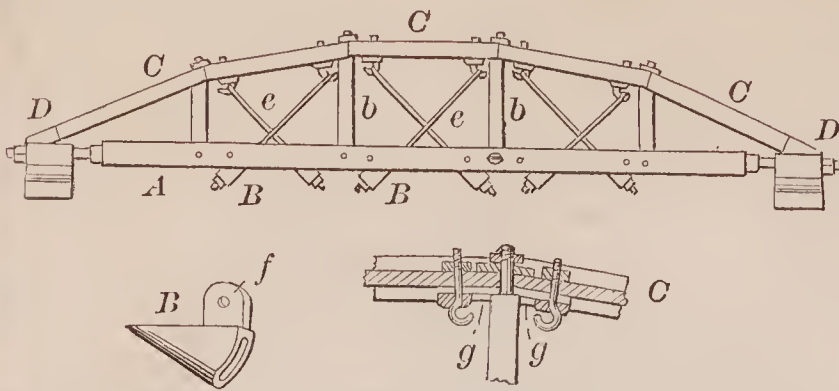

70246—J. G. Moulton—Boot Jack.

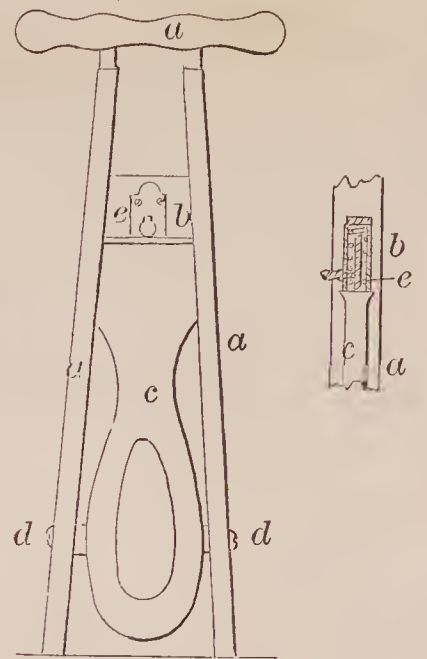

70247—W. Mullally—Lamp.

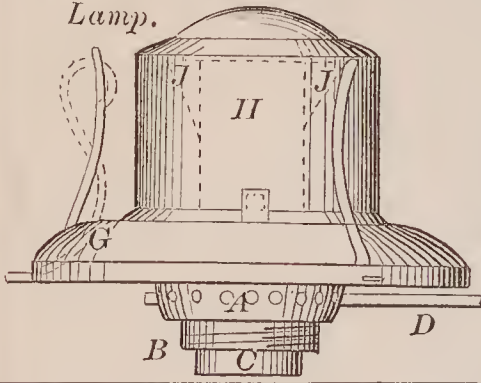

70251—W. F. Niles—Rosette for Bridles.

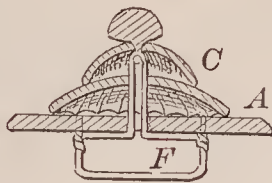

70252—G. K. Osborn—Lamp Burner.

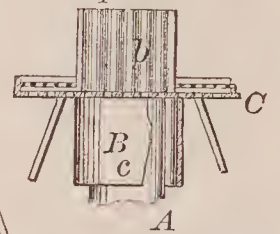

70253—F. Painter—Tension Regulator for Looms.

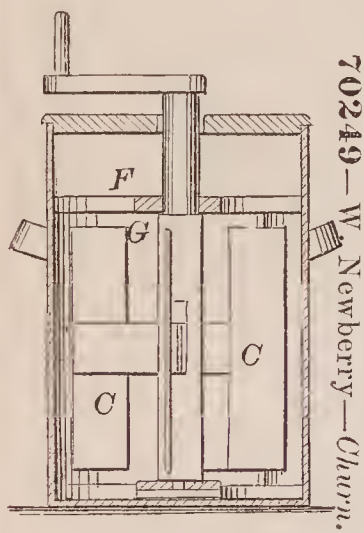
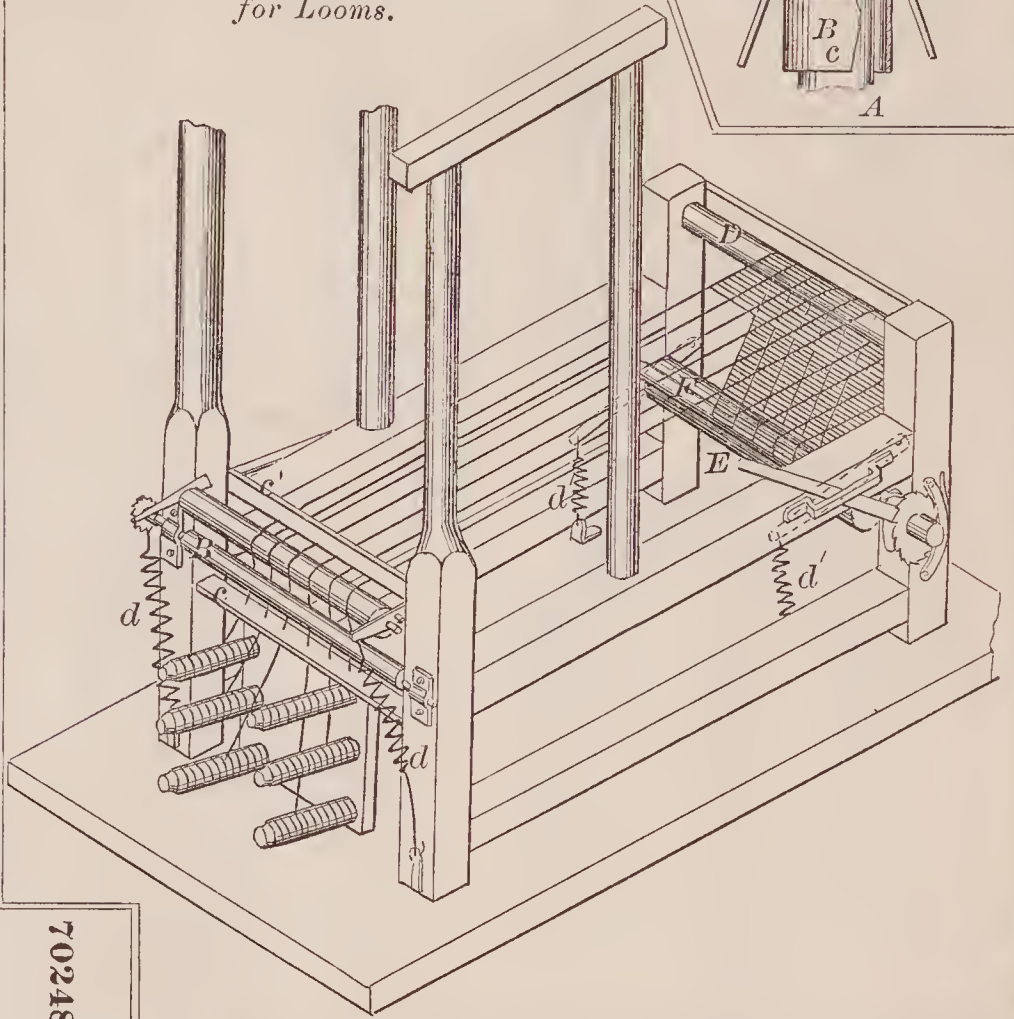

70249—W. Newberry—Churn.

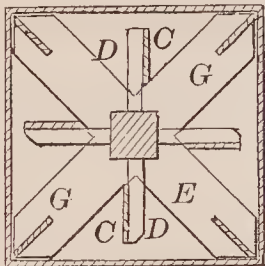

70248—J. Müss—Filtering Water Leader.

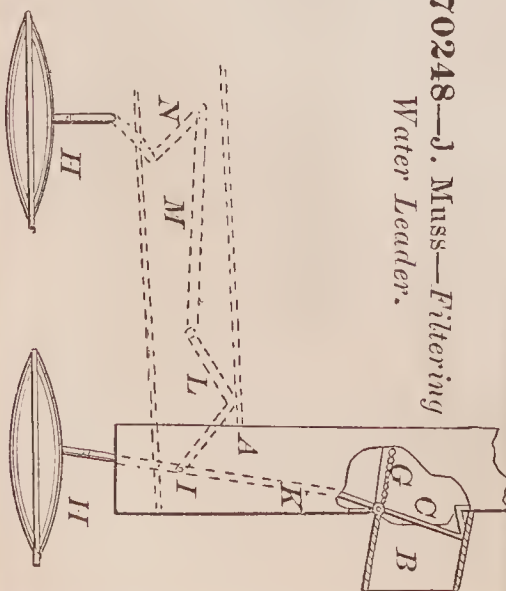

70254—T. P. Peck—Smoke Stack.

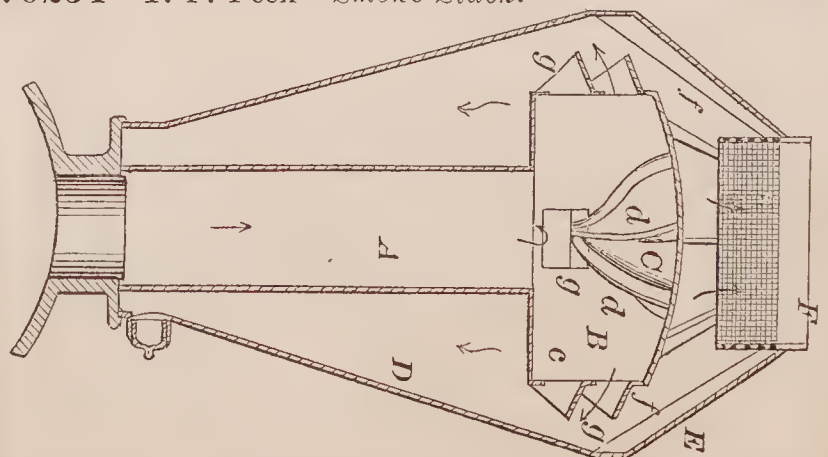

70255—J. Perkins—*Steering Apparatus.*

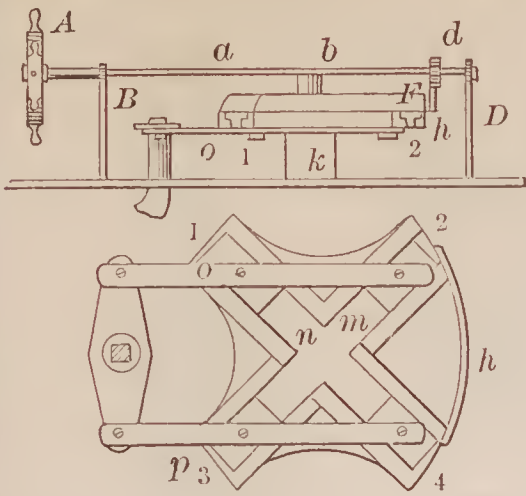

70257—E. S. Pierce—*For Feeding Screw Blanks.*

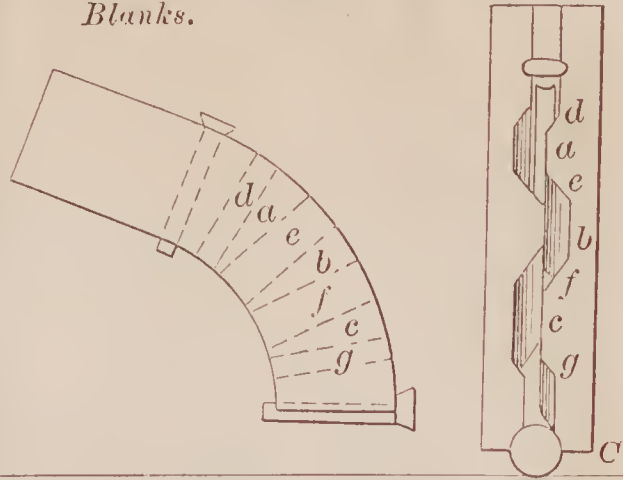

70256—C. Peterson—*For Setting, Reefing and Furling Sails.*

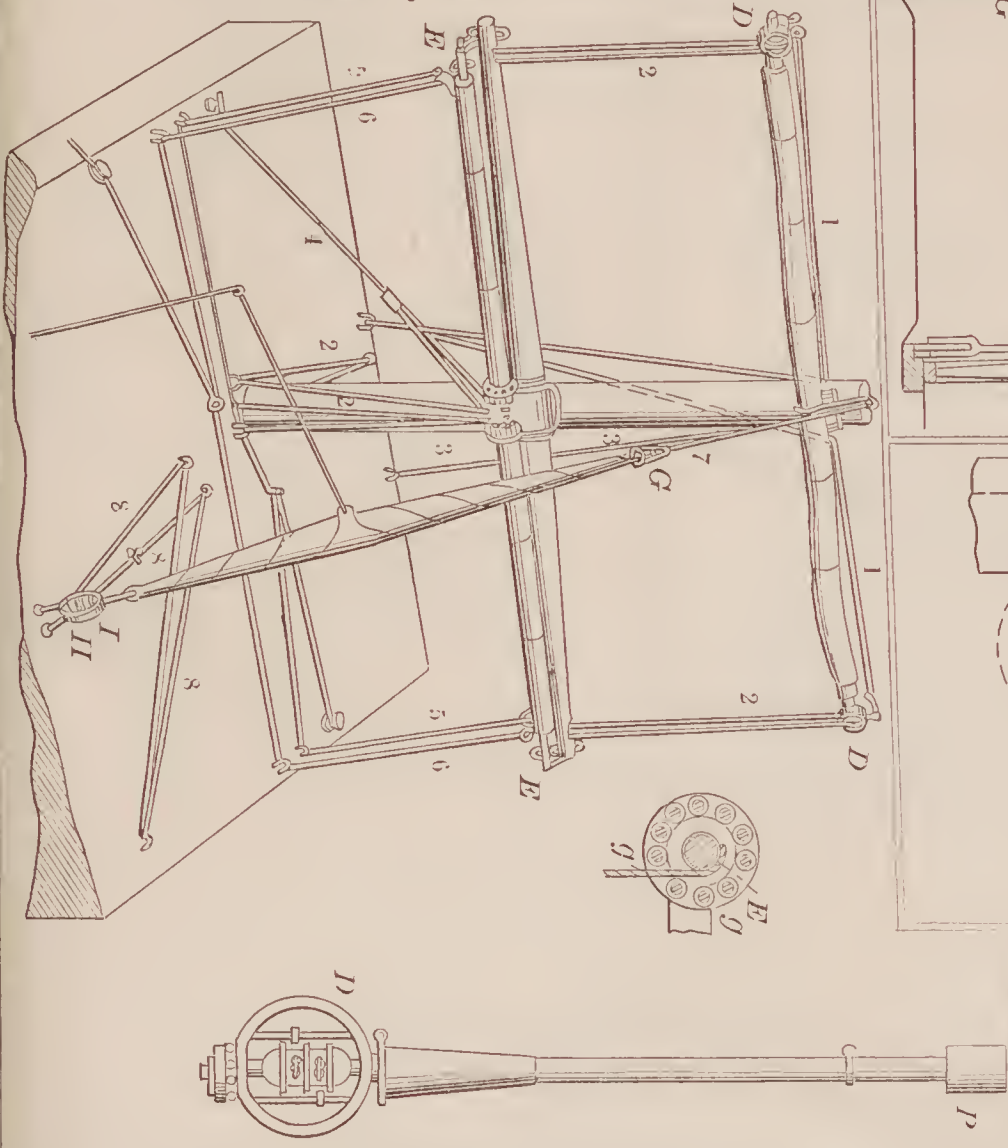

70259—C. Plagge—*Rail Guide for Guiding Wagons.*

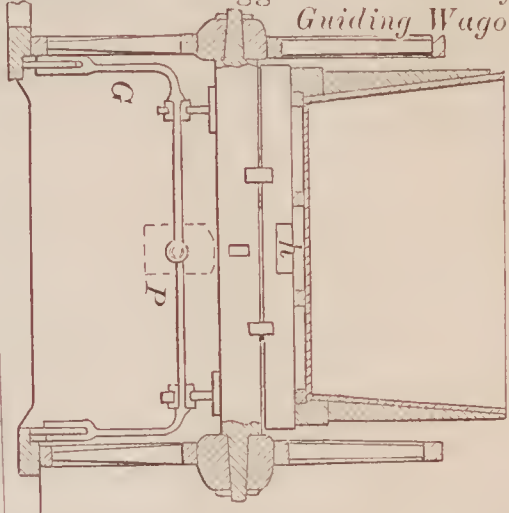

70260—M. O. Potter—*Creel for Winding Yarn.*

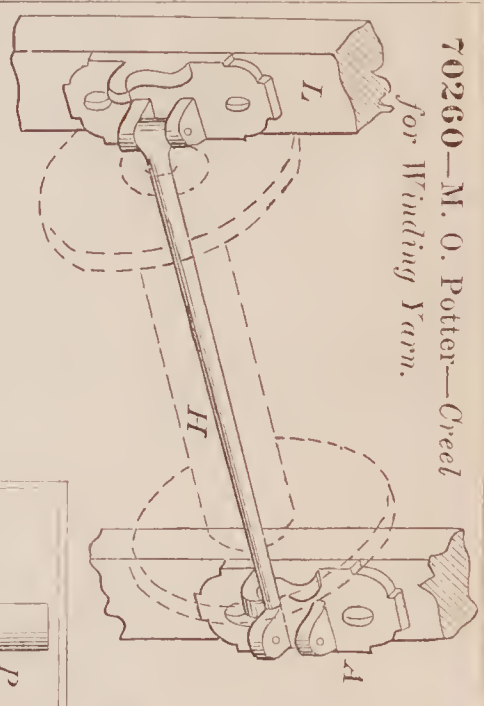

70258—E. W. Pike—*Cultivator.*

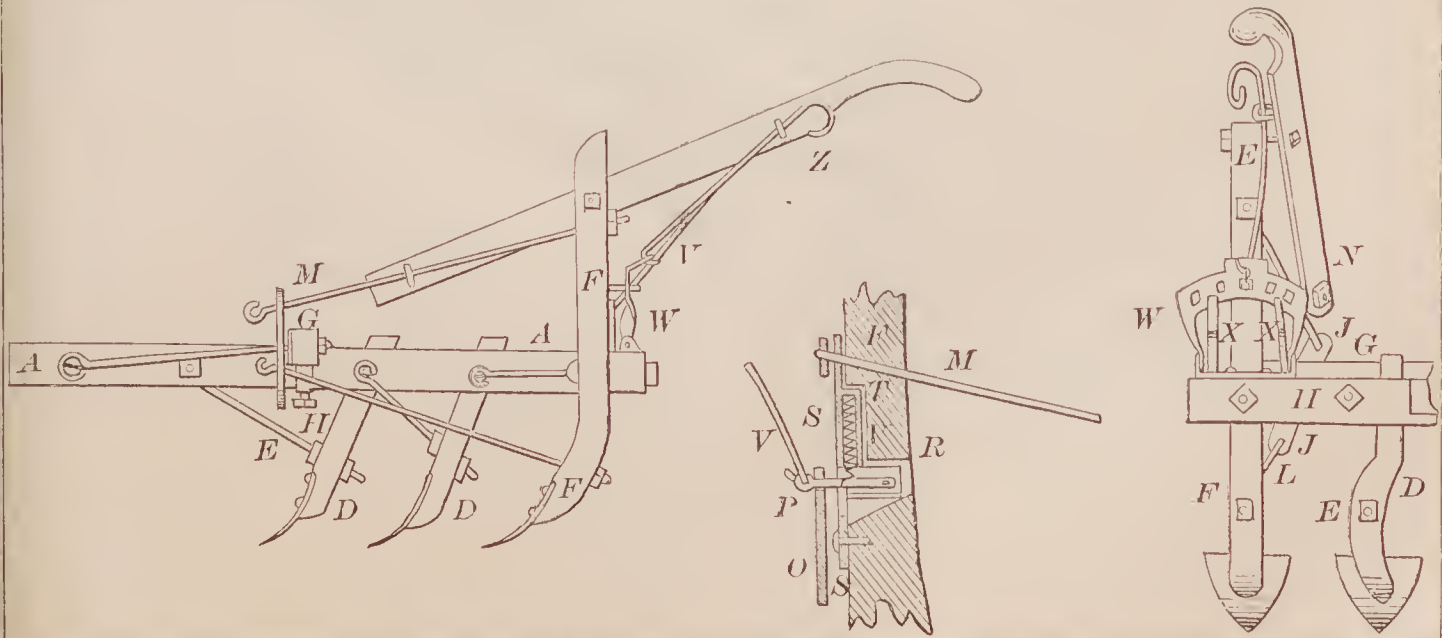



70264—S. S. Rembert—Breech-Loading Fire Arm.

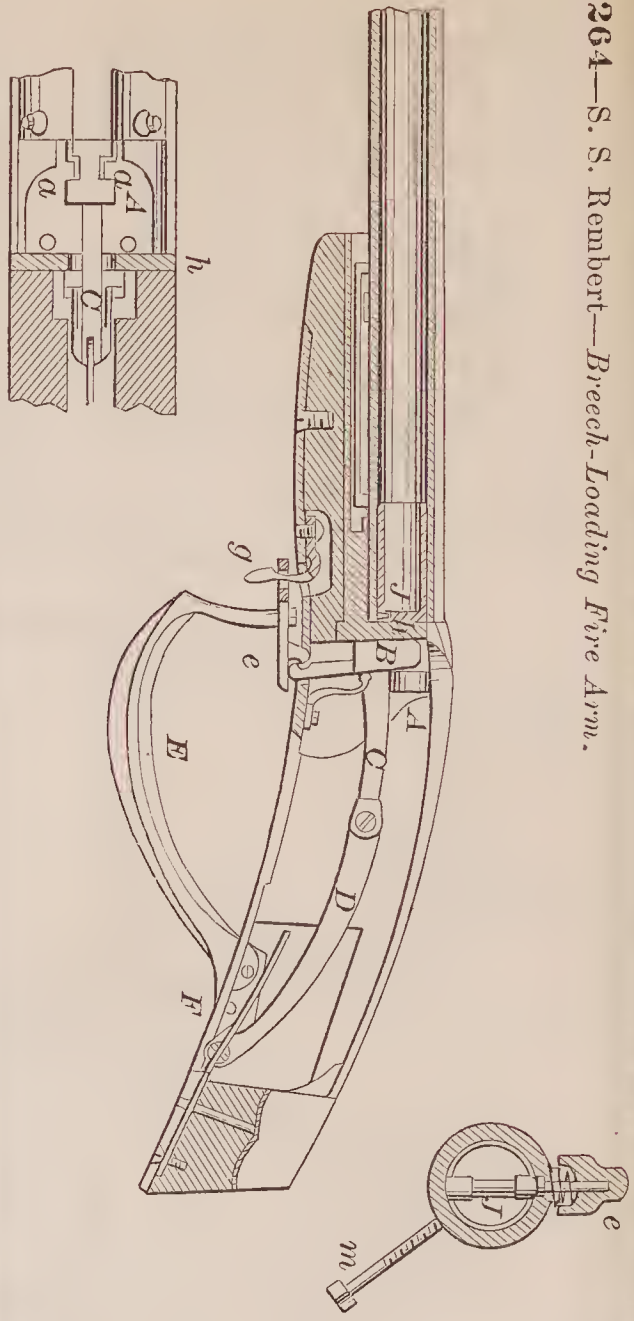

70262—F Raymond—Shutter Catch.

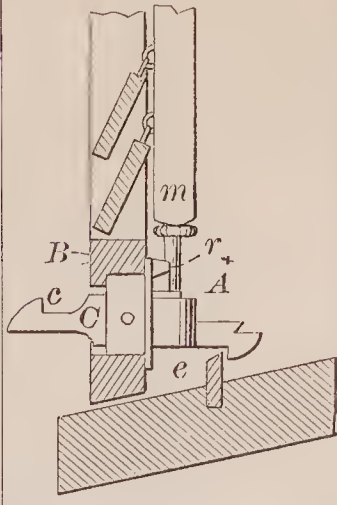

70261—W. Quail—Case for Bodkin and Tweezers.

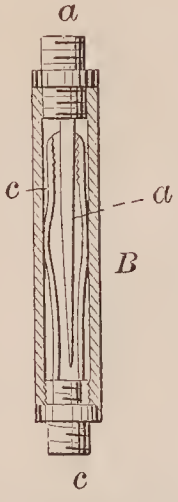

70263—A. R. Reese—For Making Wooden Ware.

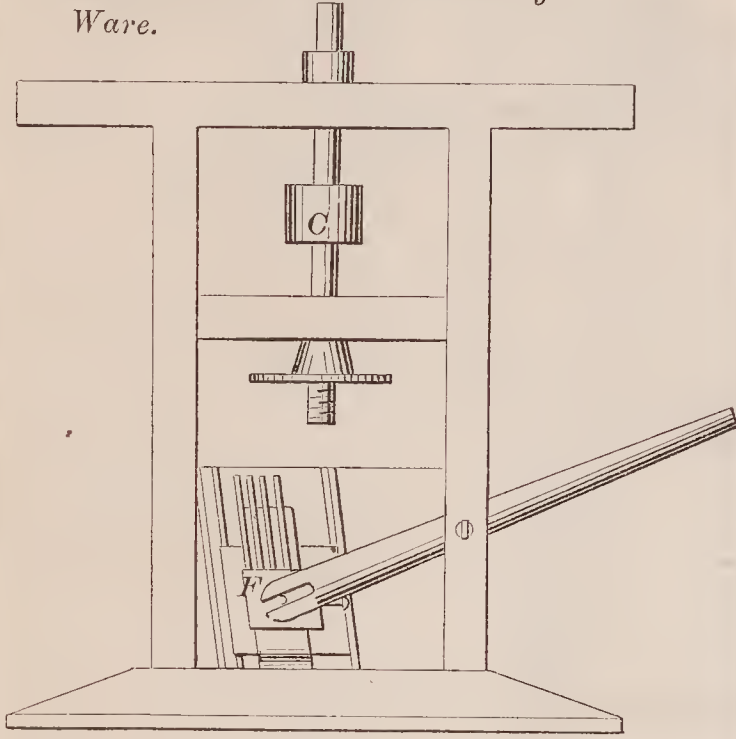

70265—J. Remick—Let-off for Looms.

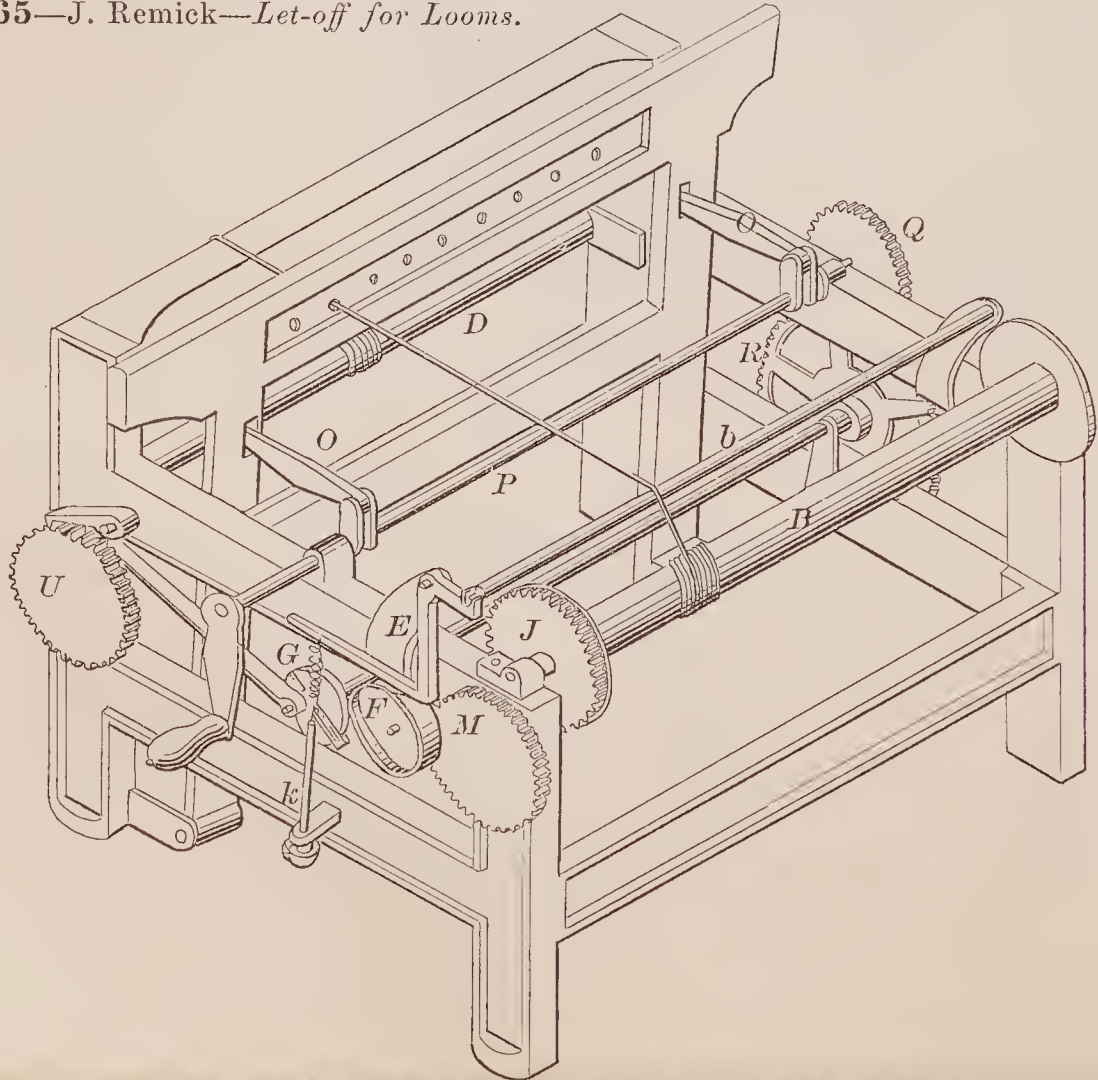

70266—W. Ring—*Tram Staff for Grinding Mills.*

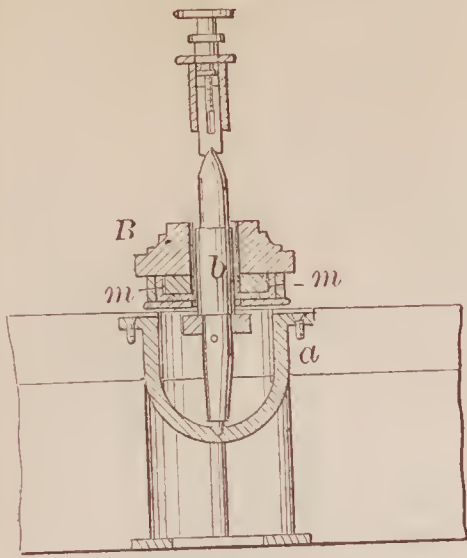

70268—Roberts & Lennox—*For Beaming Hides or Skins.*

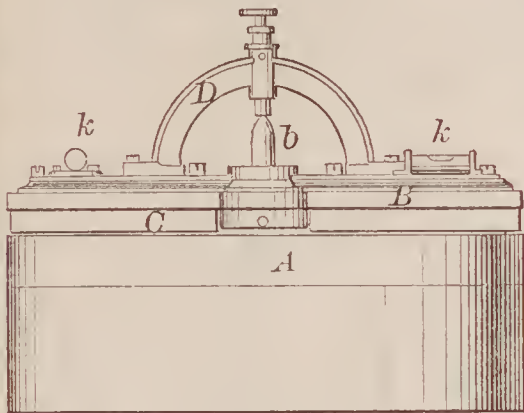
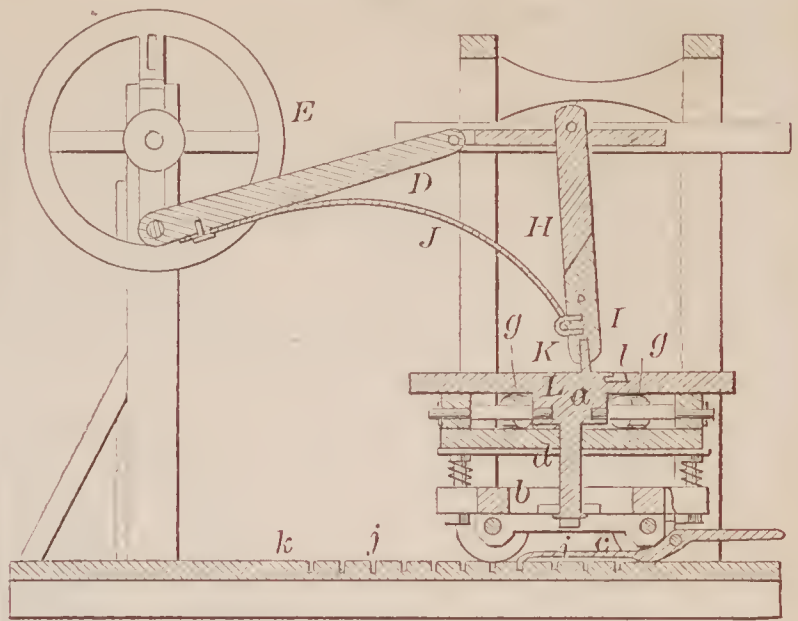

70269—D. T. Robinson—*Railway Car.*

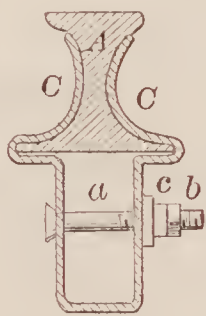
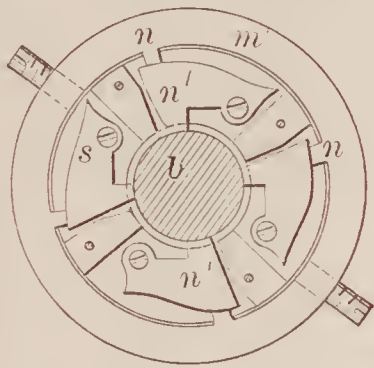
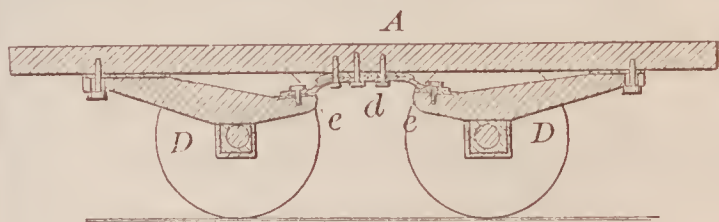

70271—B. J. Romaine—*Railroad Chair.*



70270—Rogers & Wilkins—*Holding Bristles in Brush Stocks.*

70272—E. P. Russell—*Lighting Street Gas Burners.*

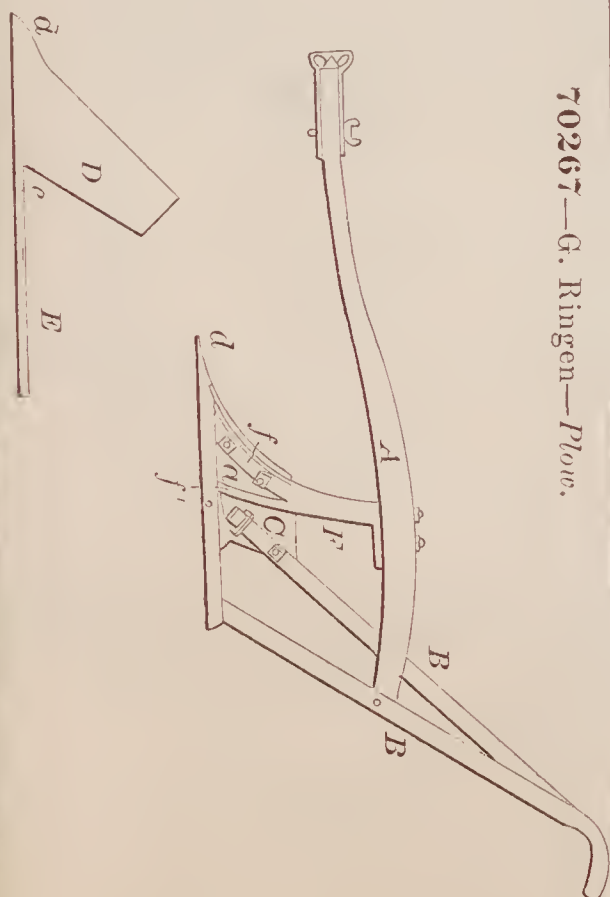
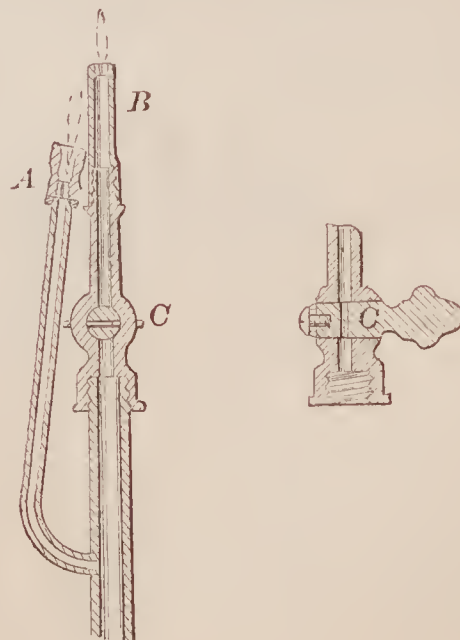

70267—G. Ringen—*Plow.*



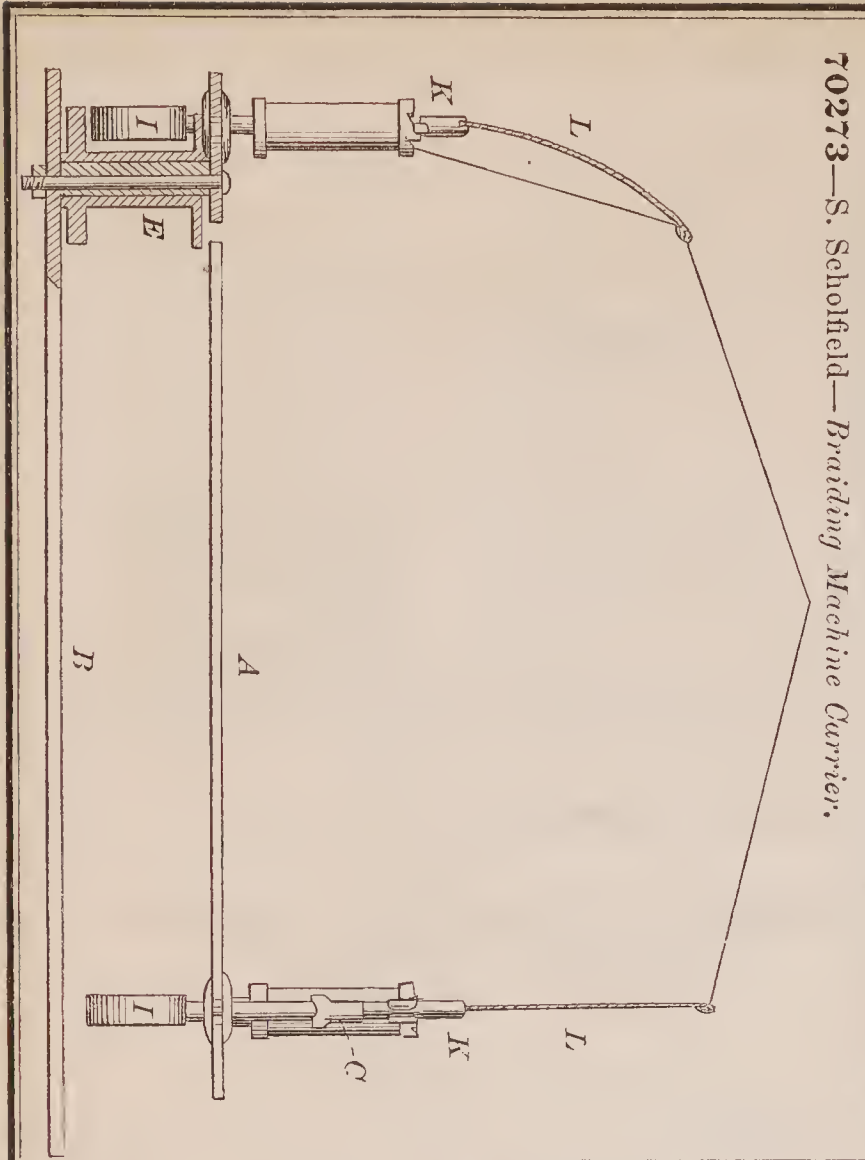

70274—H. Schreiner—Attaching Horse Shoes.

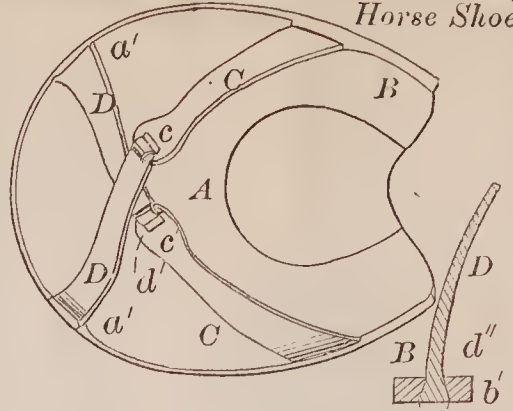

70275—A. P. Seymour, Jr.—Boot Jack. A

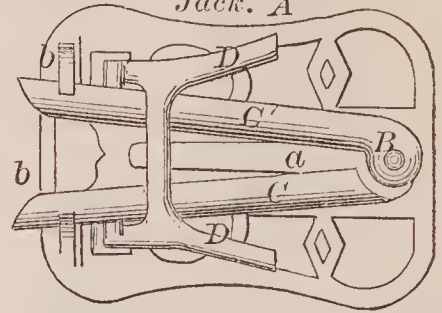

70279—J. L. Smith—Car Coupling.

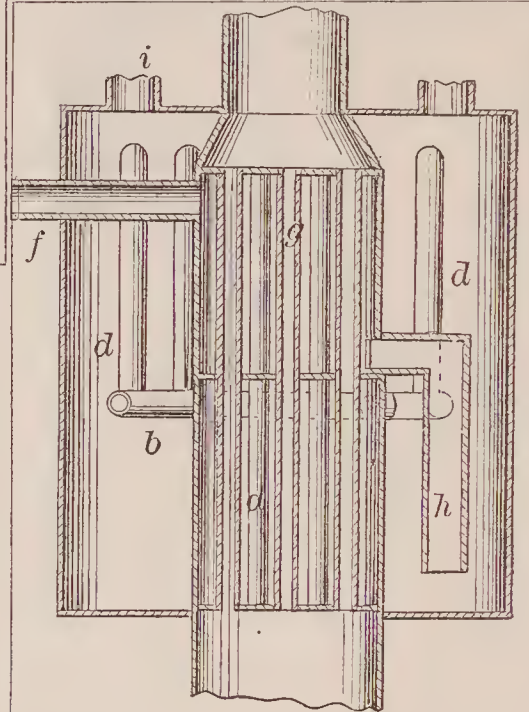
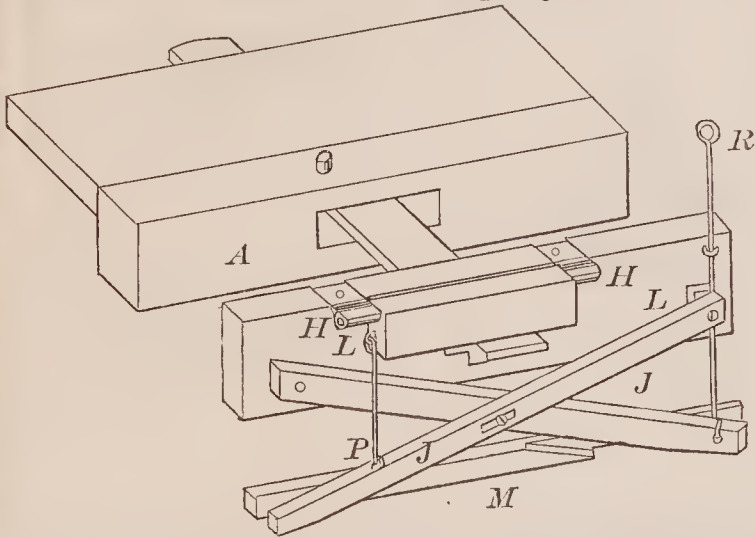

70276—T. Shipton—Heater.

70278—H. K. Smith—Sleigh Bell.

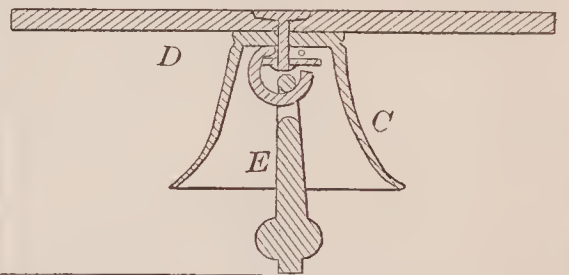

70280—C. L. Snyder—Threshing Machine.

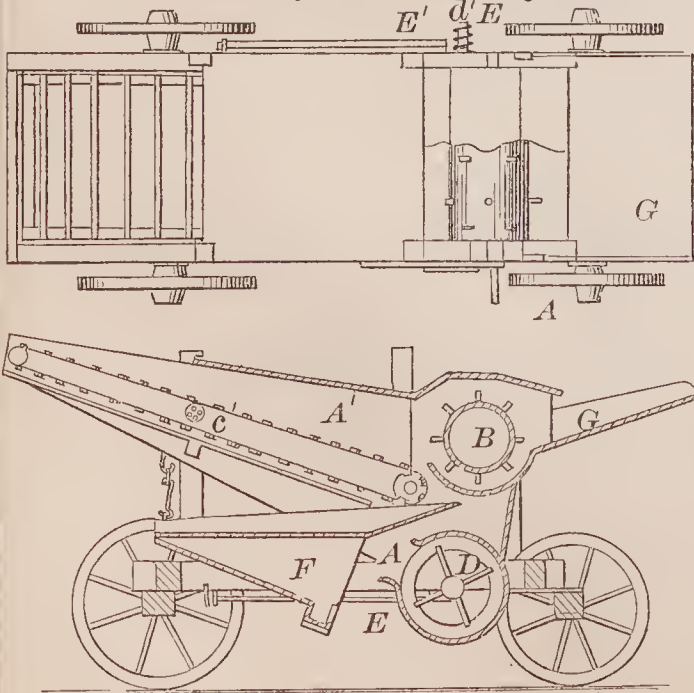

70281—C. F. Spaulding—For Spinning Metals.

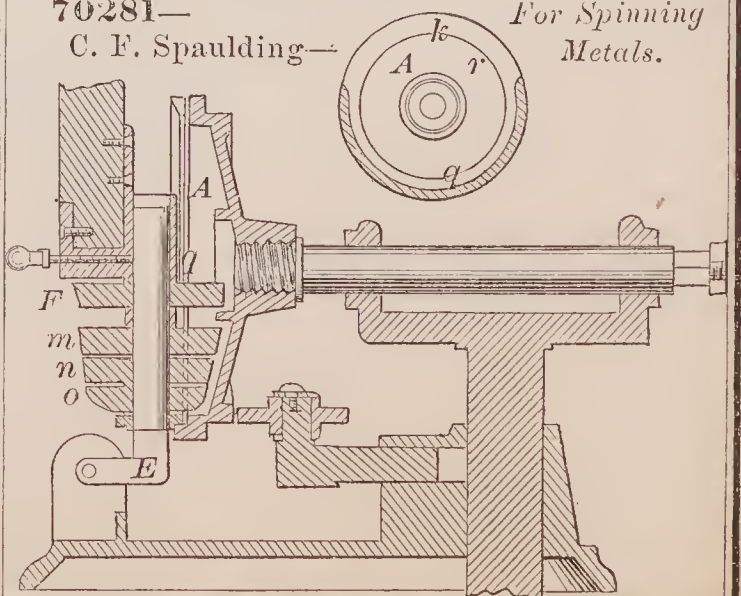

70283—A. Staley—Slide Valve.

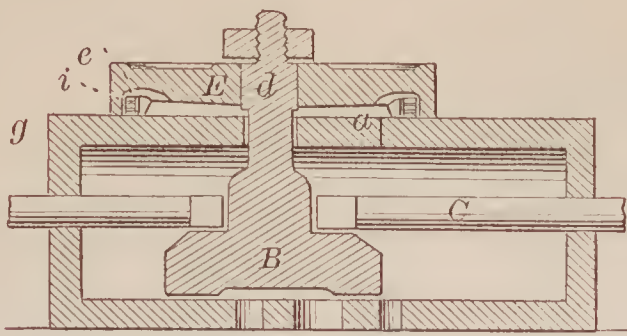

70286—B. F. Sturtevant—Blower Wheel.

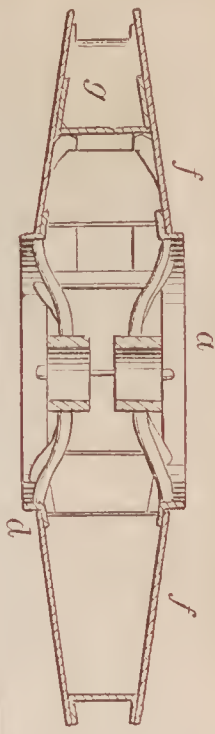

70282—N. B. Spooner—Hinge and Fastener.

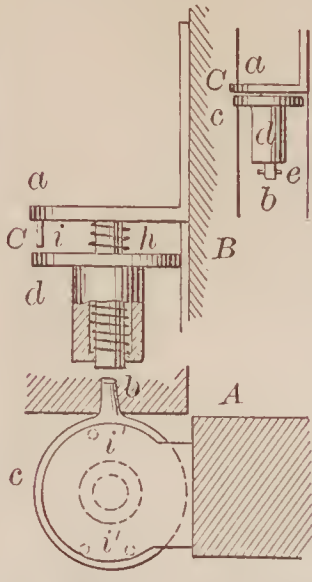

70284—J. Stewart—Attaching Axes to Handles.

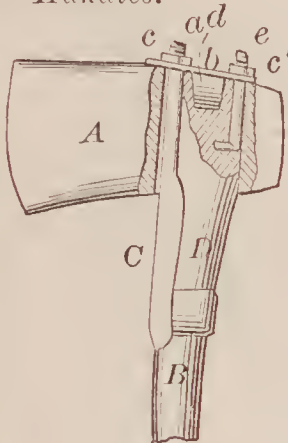

70285—R. E. Strait—Pump.

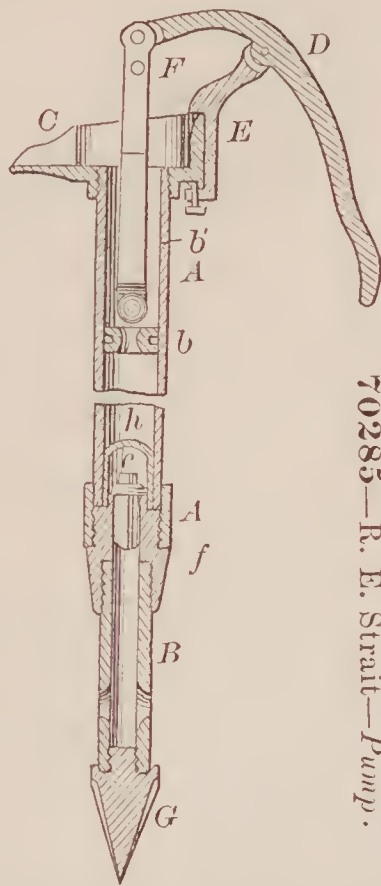

70287—S. K. Sutton—Sled Brake.

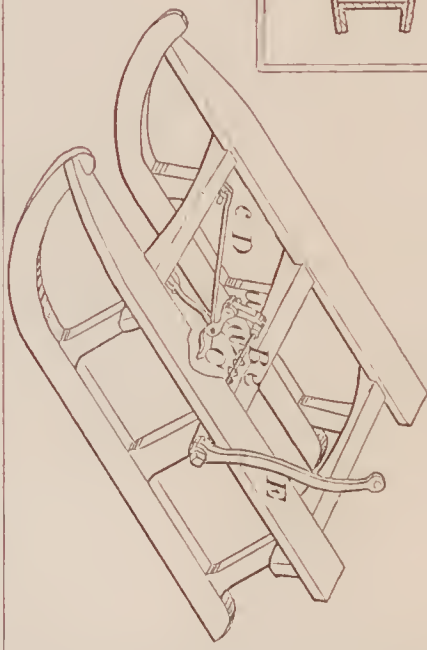

70288—J. Swan—For Stripping Willow.

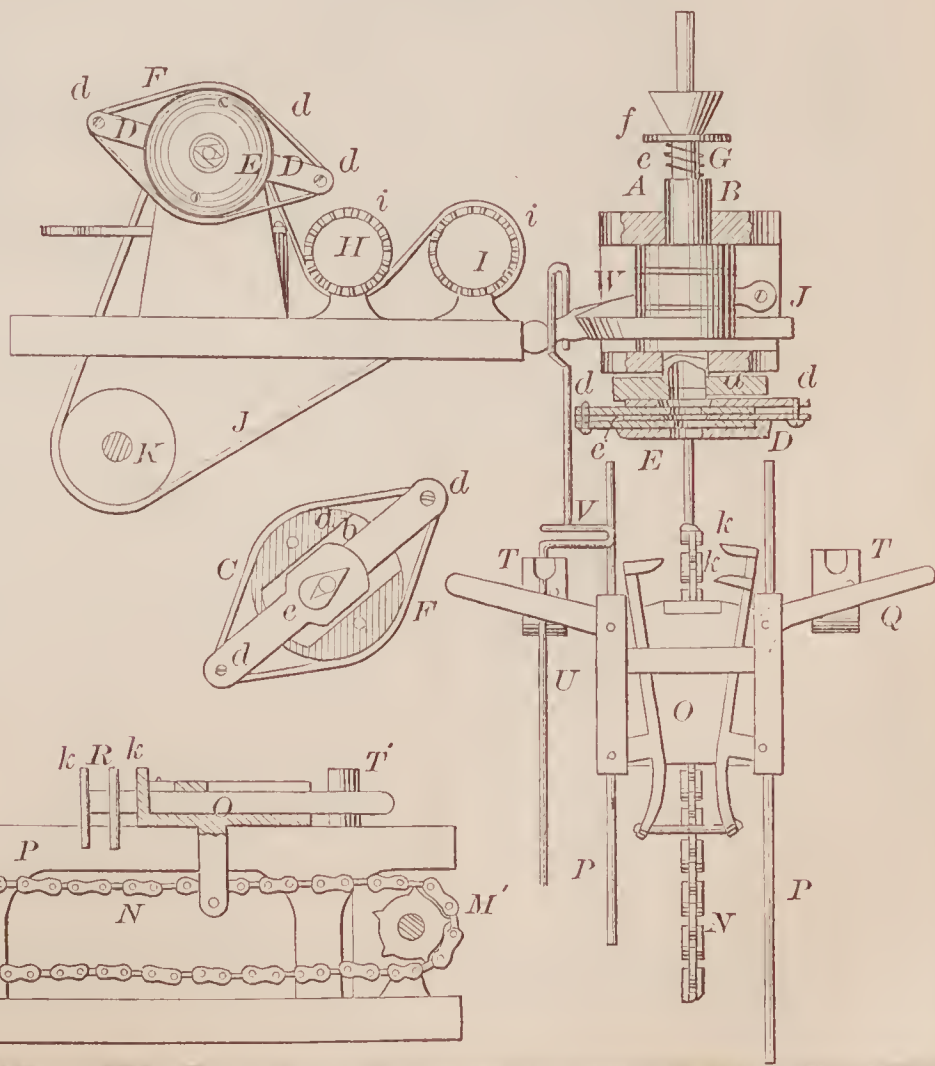

70289—C. Tholl—Carriage Shaft Connection.

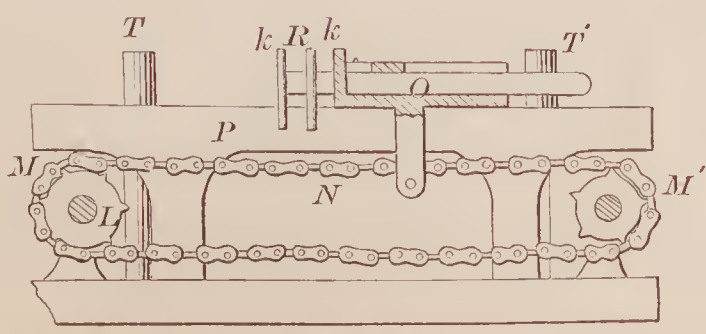
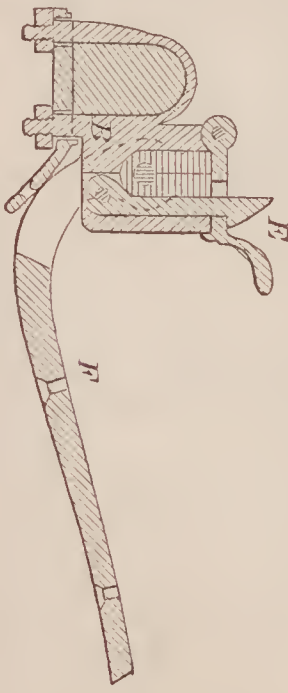



70290—W. R. Thomas—*Flask for Casting Car Wheels.*

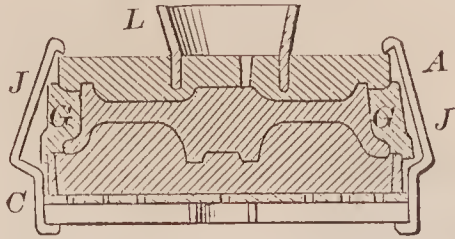

70292—S. D. Tucker—*For Cutting Paper, Pasteboard, &c.*

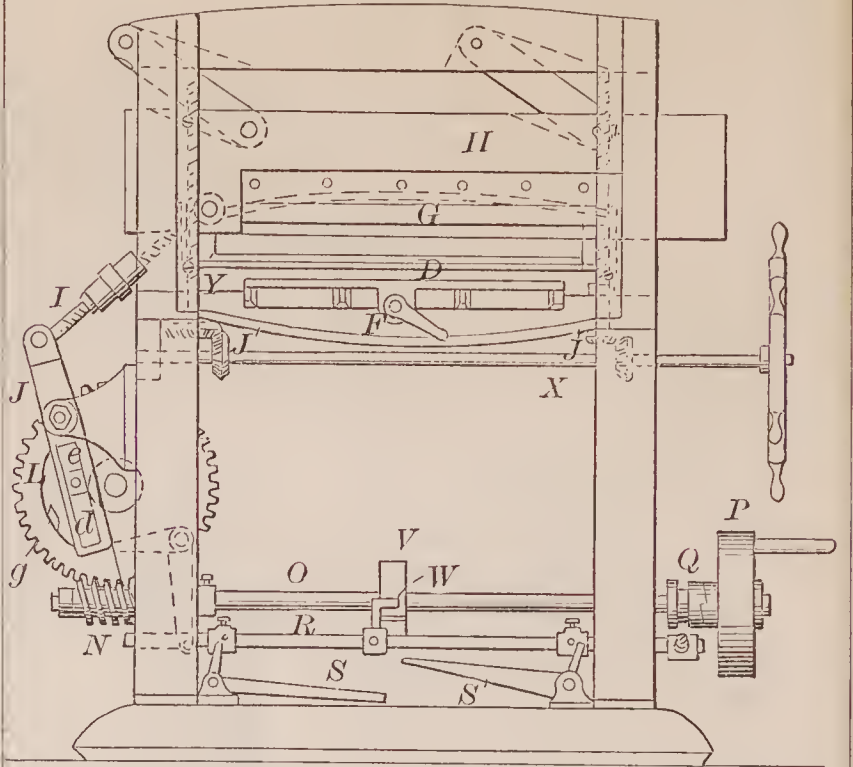

70291—W. H. Trusty—*Wagon Jack.*

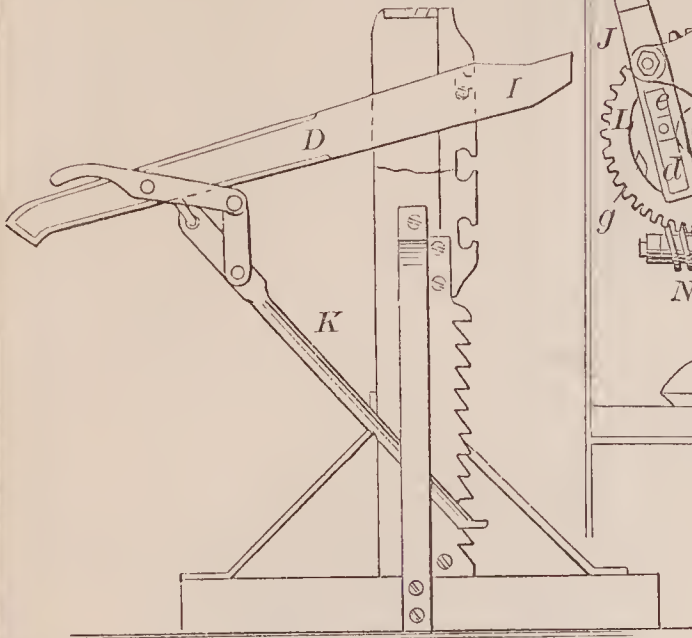

70294—J. Underwood—*Babbling and Drilling Jig.*

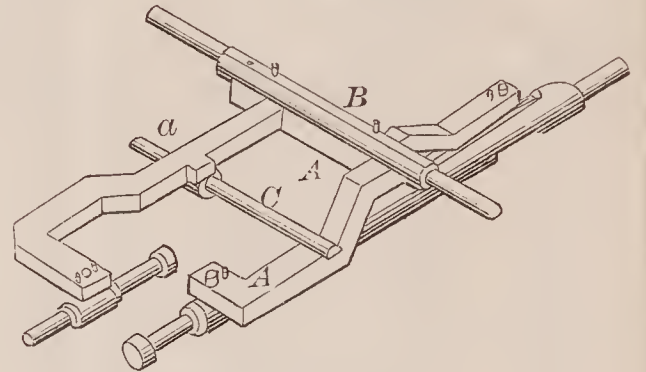

70293—J. Underwood—*For Cutting Teeth of Wheels.*

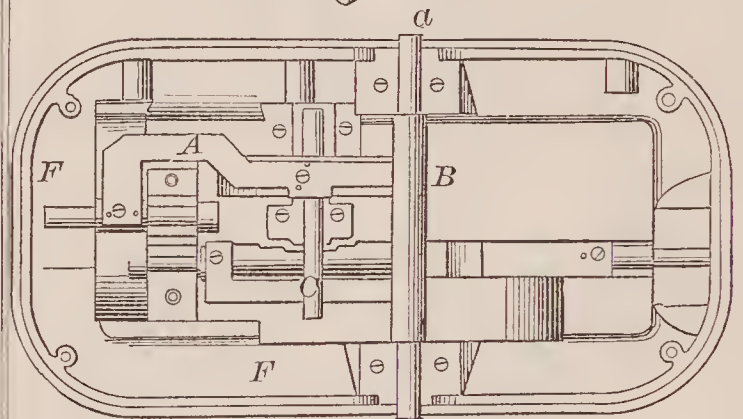
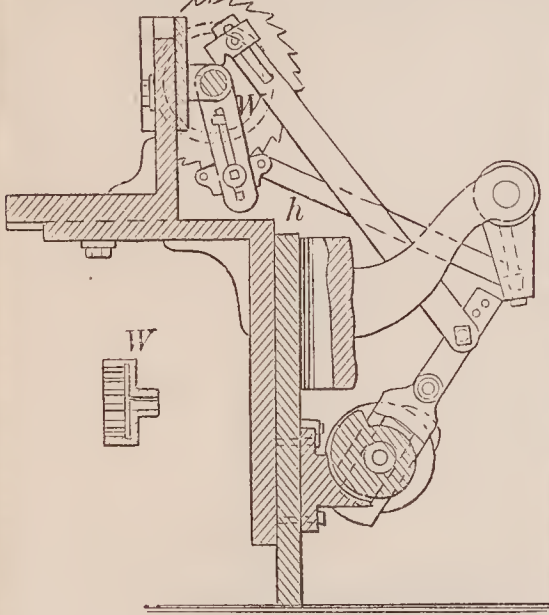

70297—R. Walker—*Let-off Motion for Looms.*

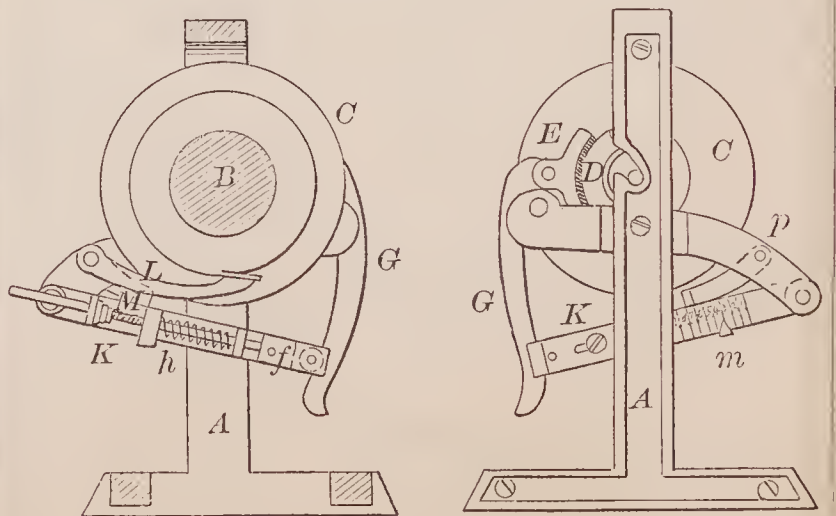

70295—J. D. Van Benthusen—*Bale Tie.*

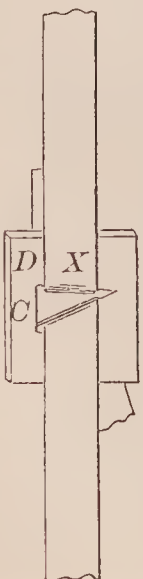

70296—J. Van Pelt—*Hull for Vessels.*

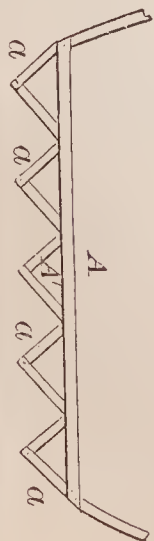

70298—S. H. Wallace—Miners' Pick

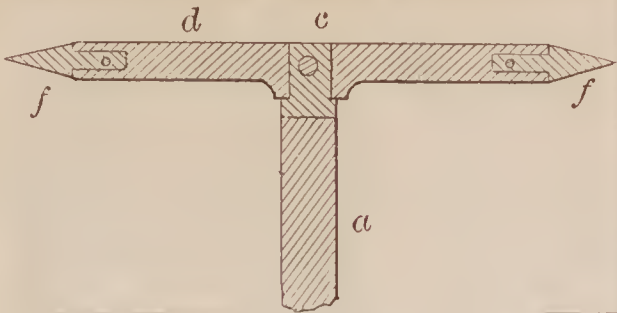

70299—B. D. Washburn—Hinge.

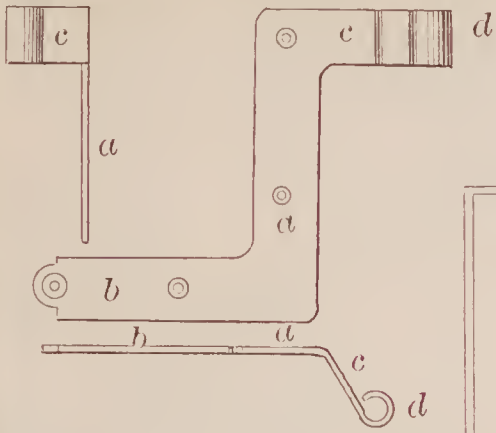

70300—W. H. Wayne—Shutter Fastener.

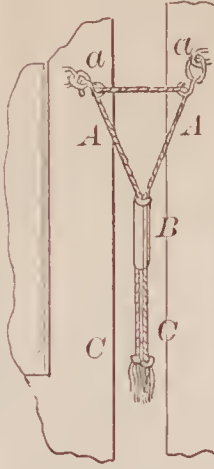

70301—S. Webb—Water Wheel.

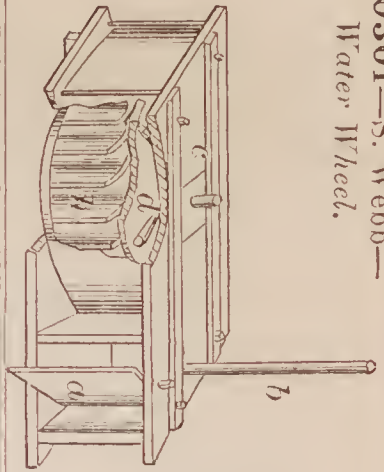

70305—G. Whittle—Coal Screen.

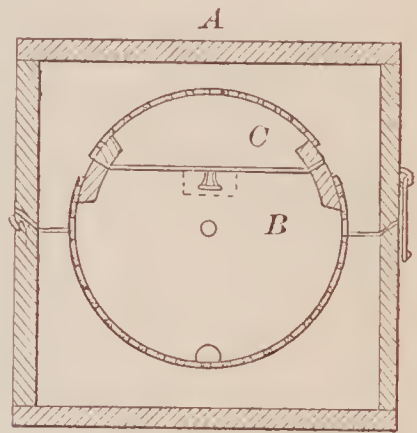

70303—J. T. Whipple—Hand Truck.

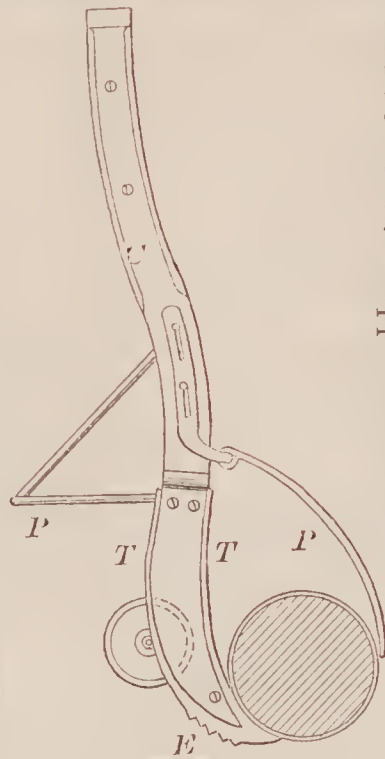

70302—P. L. Weimer—Door Stop.

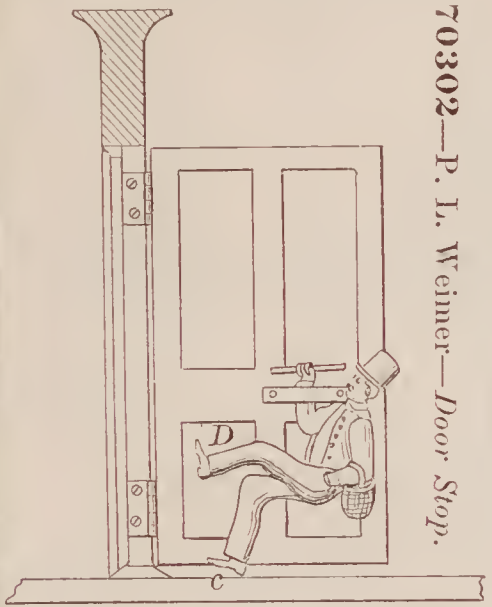

70306—I. C. Williams—Fat for Tanning.

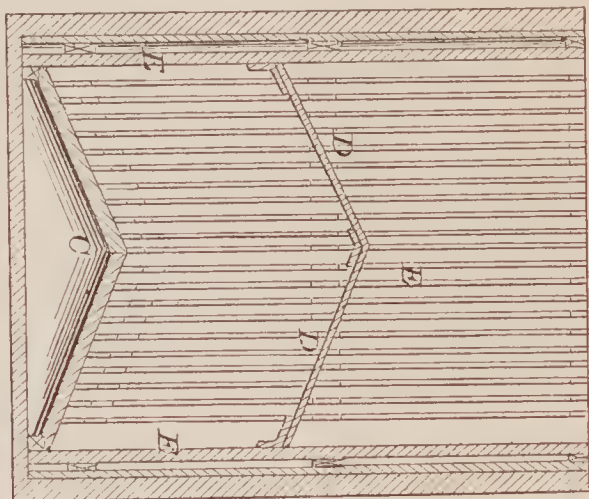

70304—W. W. Whiting—Fastening Metal Plates upon Door Hinges.

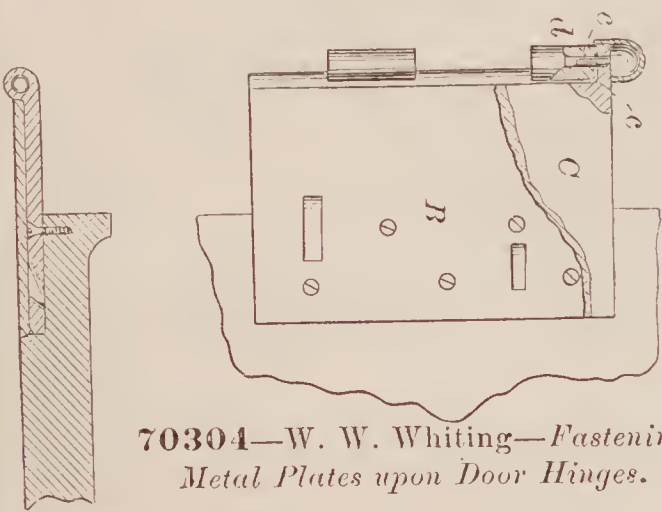

70308—E. Wright—Operating Picker-Staff for Looms.

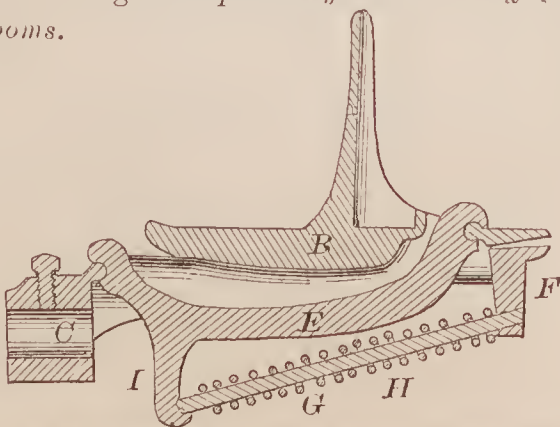

70307—M. S. Woodward—For Measuring Horses' Feet.

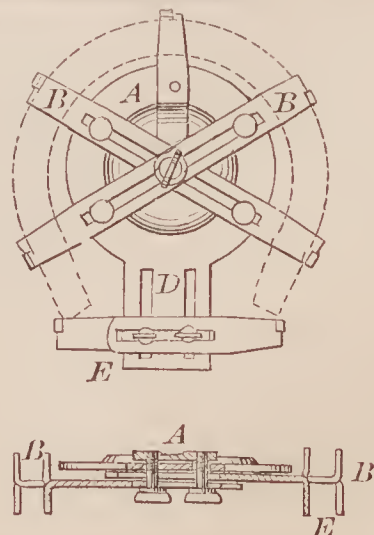



70309—H. Wyman—Loom.

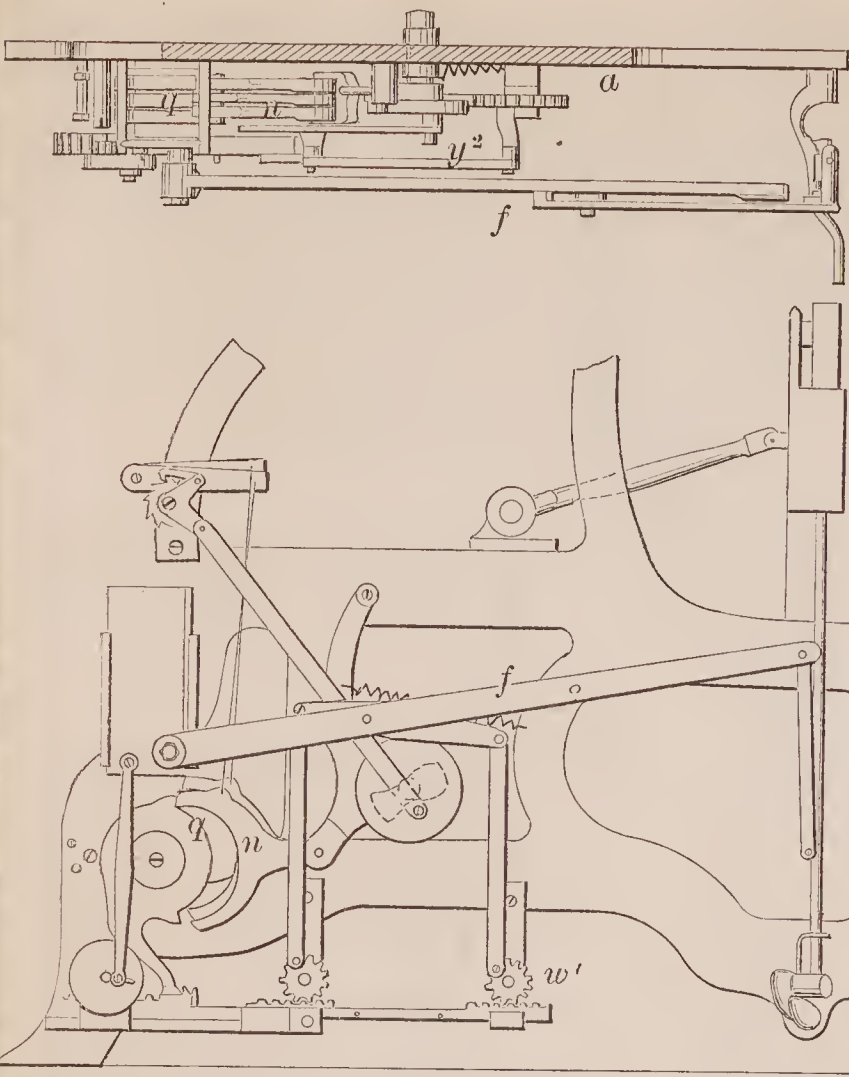

70310—J. Adams—Mop Wringer.

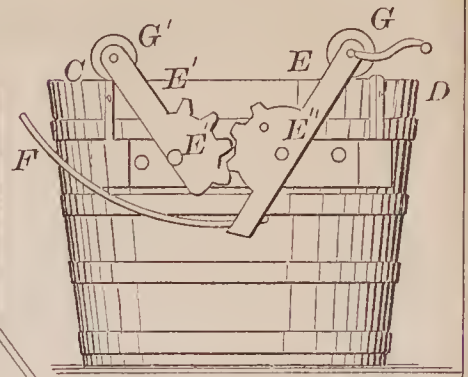

70312—I. R. Amsden—Hydrostatic Scale.

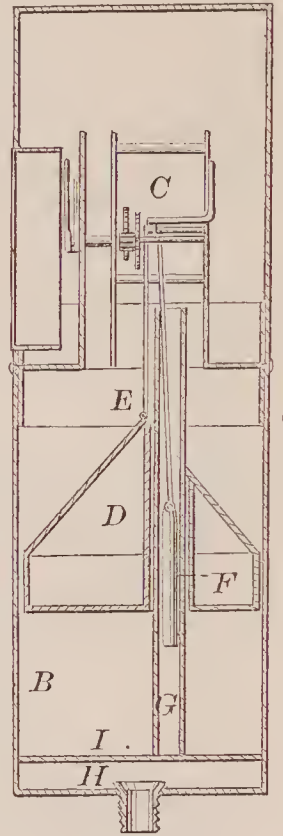

70313—A. C. Badgley—Beehive.

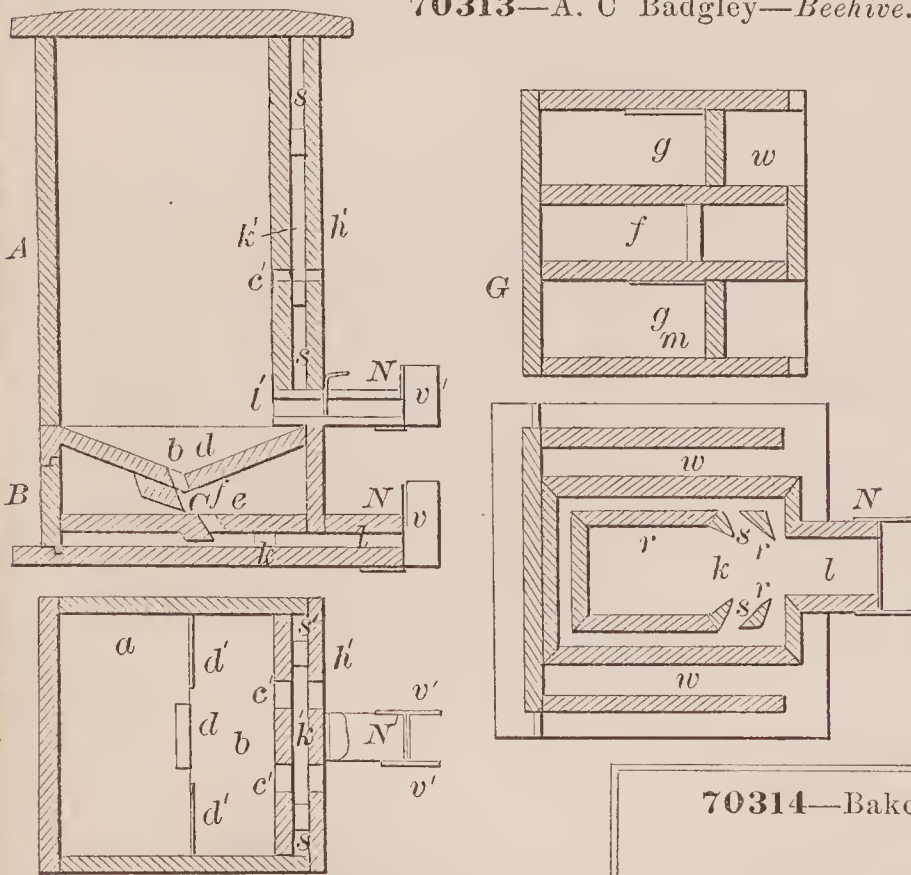

70311—Allen & Ross—Harvester Guard Finger.

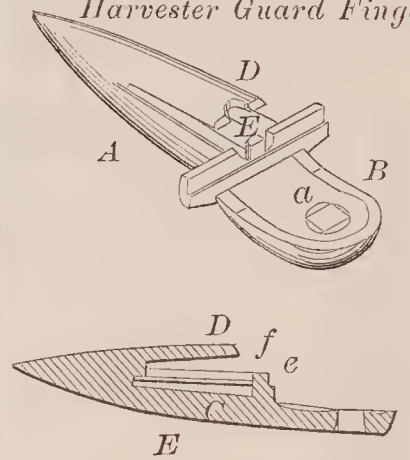

70314—Baker & Hoyt—Wheeled Harrow.

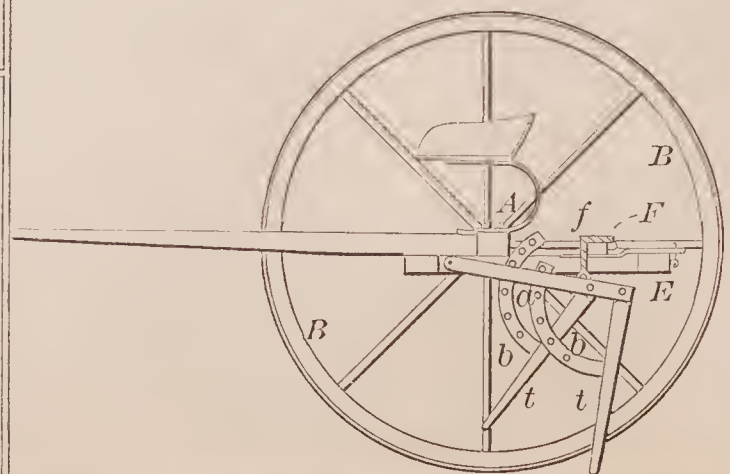

70315—J. C. Baxter—Check Piece for Bridles.

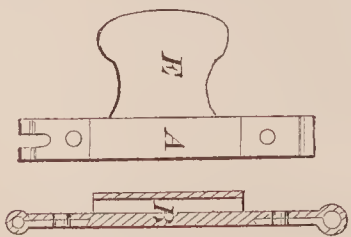

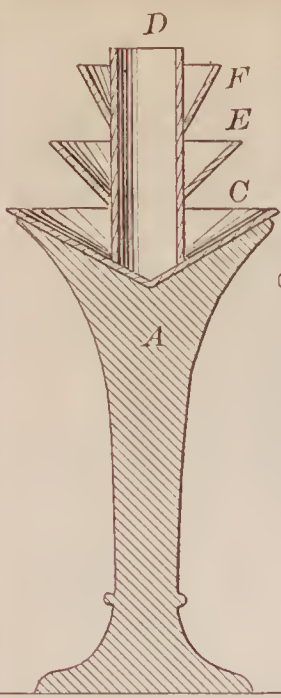

70316—L. H. Bigelow—Flower Vase.

70319—S. C. Brown—Chair.

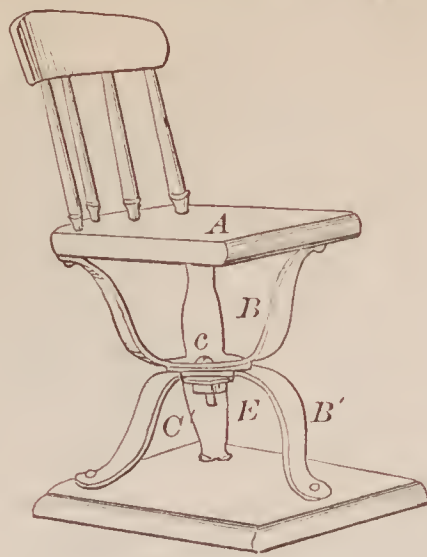

70323—I. N. Dann—Folding Chair.

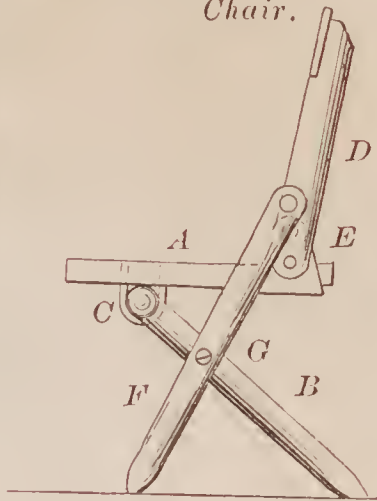

70318—F. H. Brown—For Finishing Baskets.

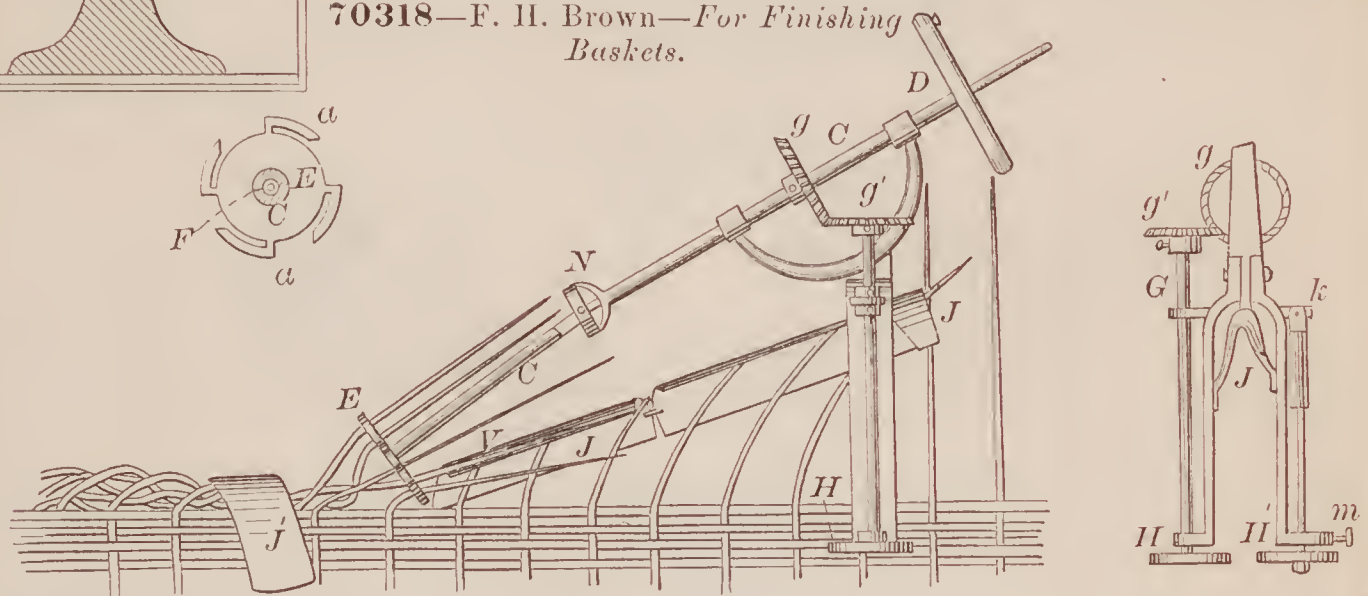

70320—G. W. R. Combs—Strap Holding Device.

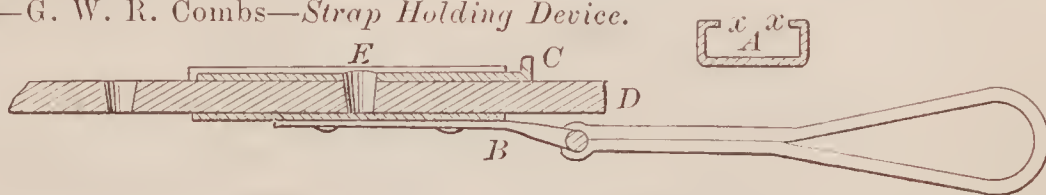

70321—J. C. Coult—For Reducing Quicksilver Ores.

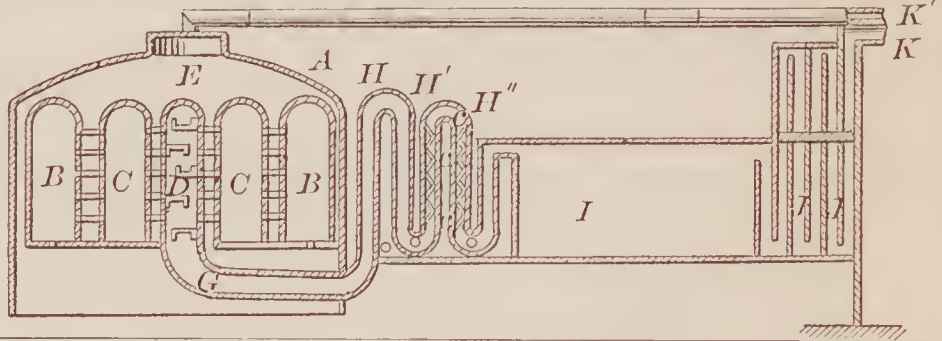

Fig. 1 70322—S. Cuddick—Puddling and Heating Furnace.

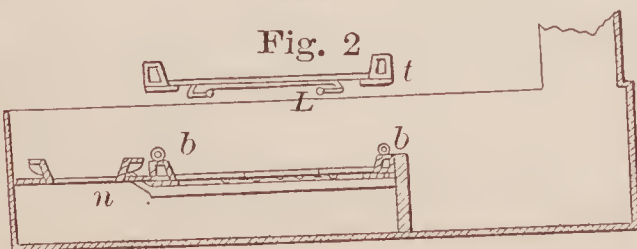
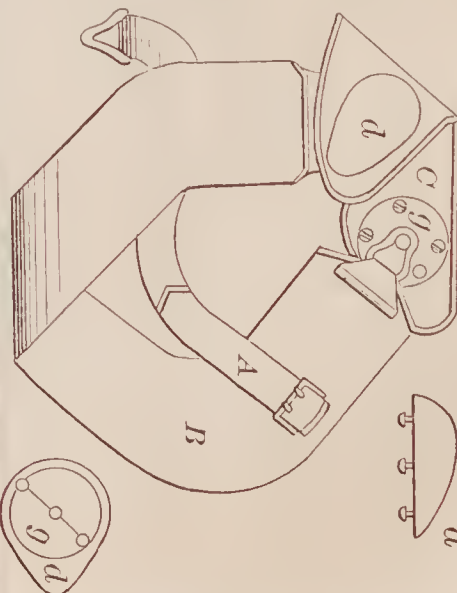

Fig. 12



70324—S. Dike—Truss and Supporter.



70326—J. Ebee—Car Coupling.

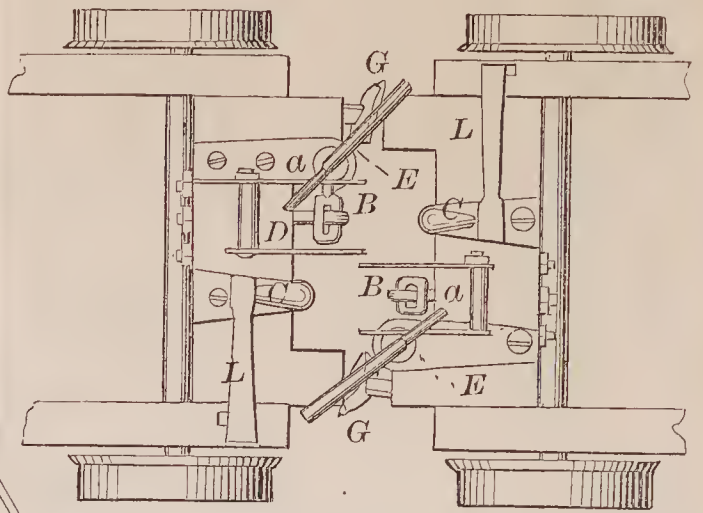

70330—Flanders & Wells—Bed Bottom.

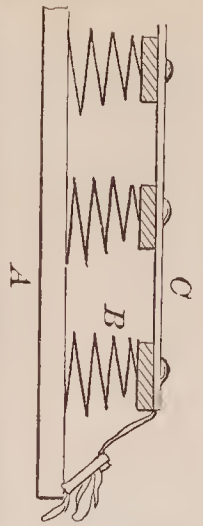

70325—E. Dithridge—Silvered Glass Ware Manufacture.

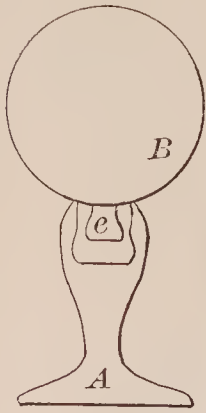

70328—C. A. Ewick—Cultivator.

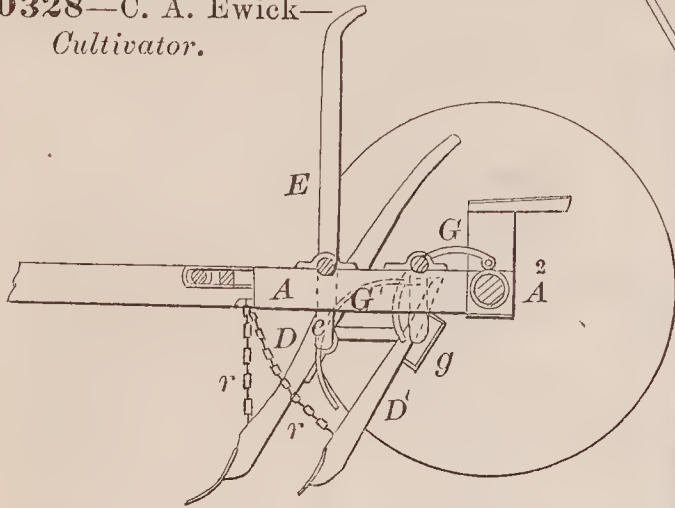

70327—Eberly & Hauck—Horse Rake.

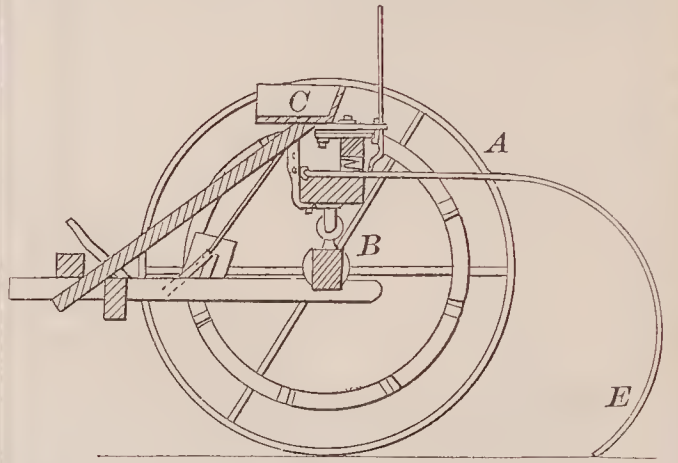

70333—J. Hale—Door Holder.

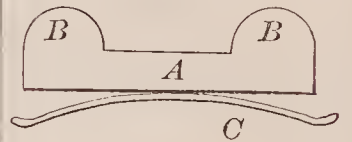

70331—F. D. Ford—Neck Tie.

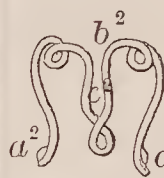

70332—G. W. Fosdick—Rein Holder.

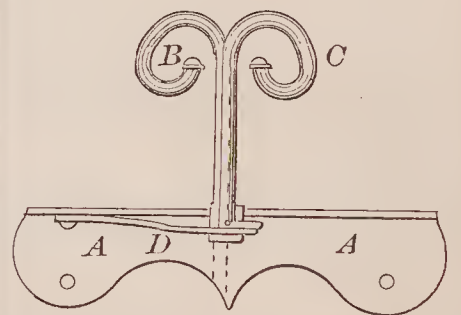

70329—H. Fayette—Cupola, Blast and Smelting Furnace.

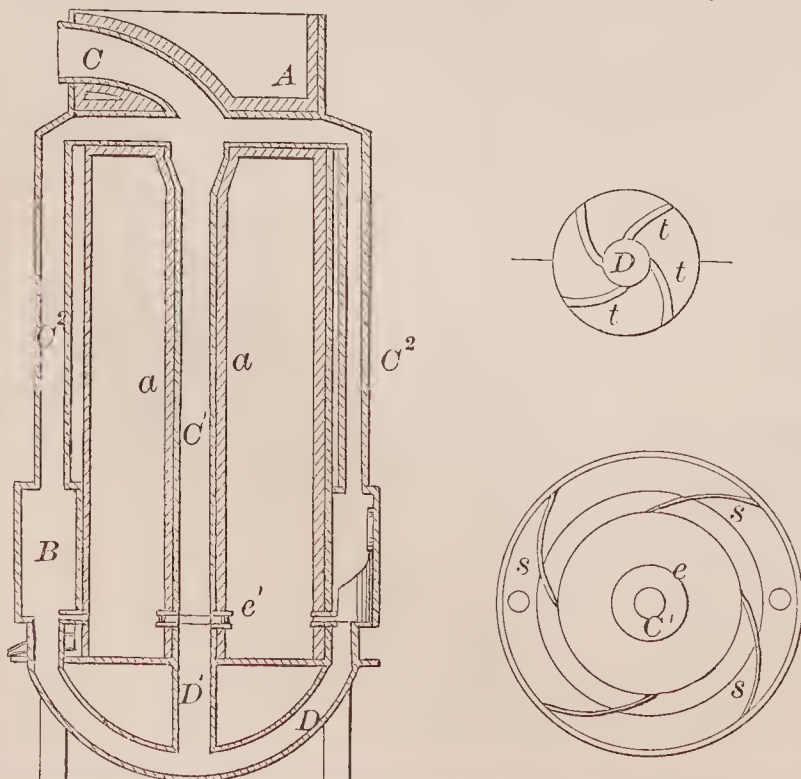

70334—W. P. Haskins—Ball and Socket Joint.

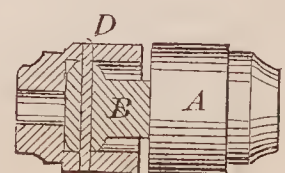

70335—Hill & Harpham—*Corn Harvester.*

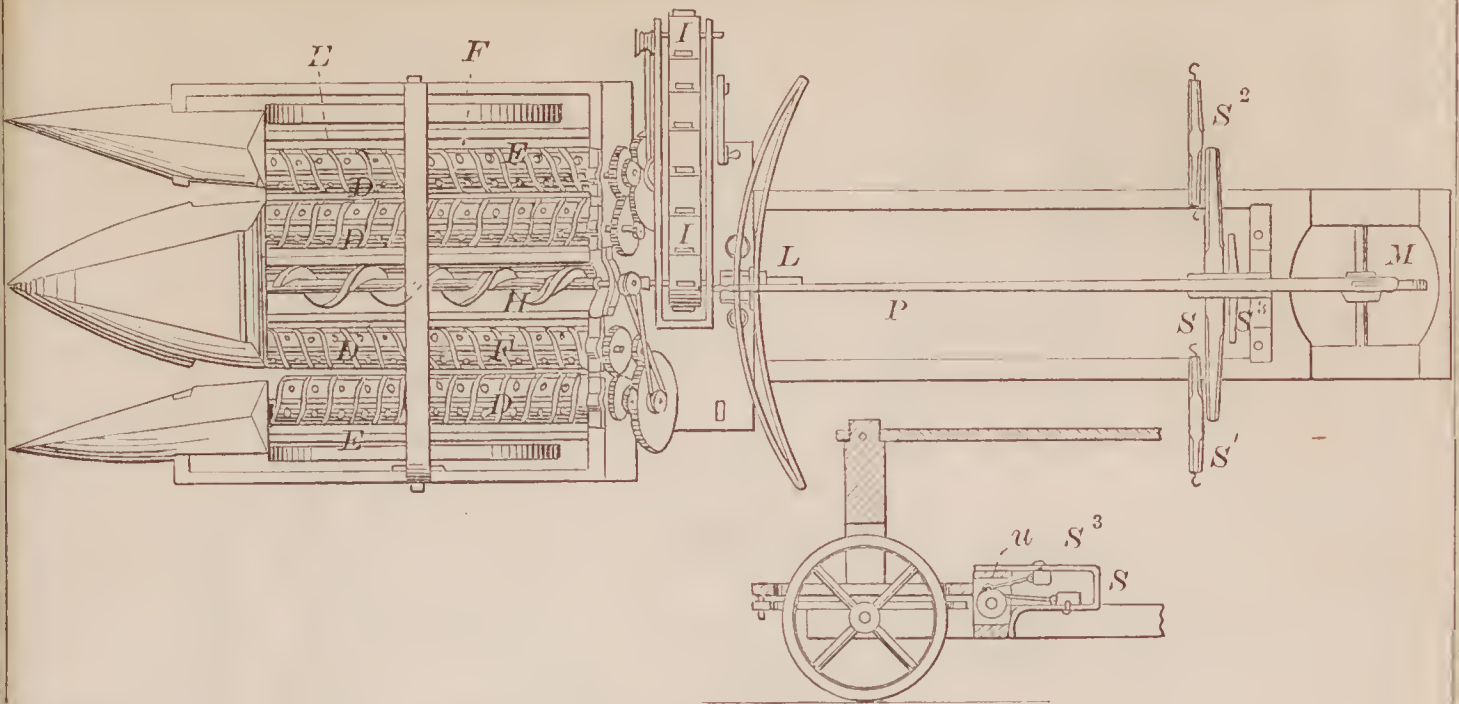

70336—S. Hoke—*Animal Trap.*

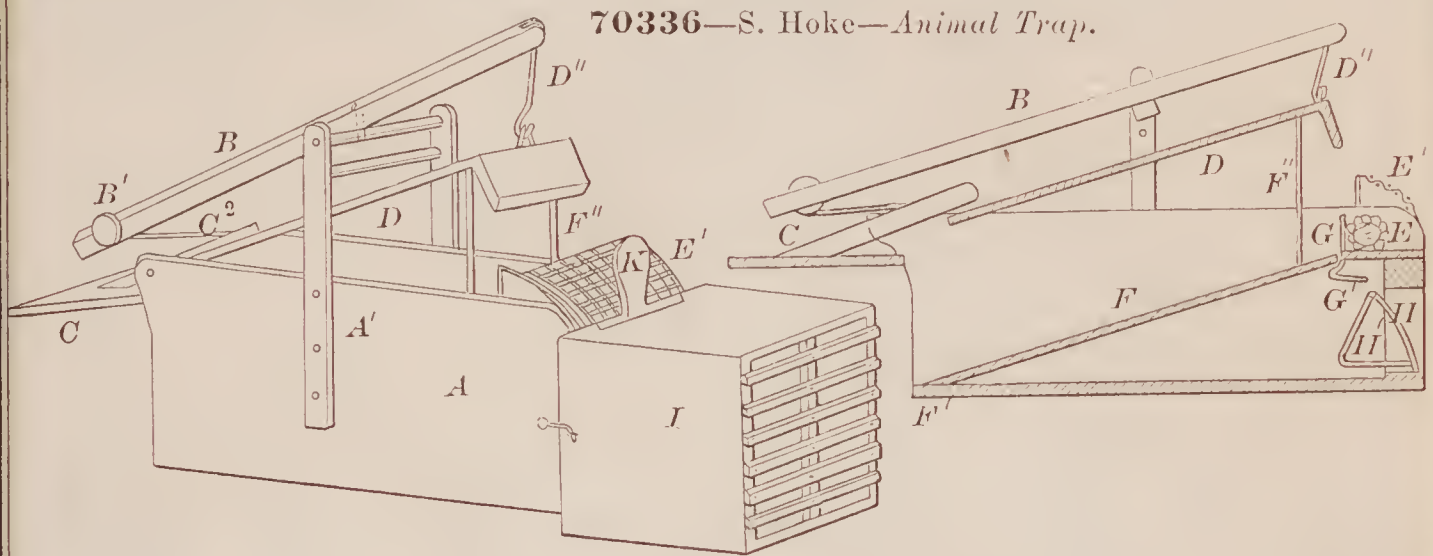

70338—R. Jones—*Beehive.*

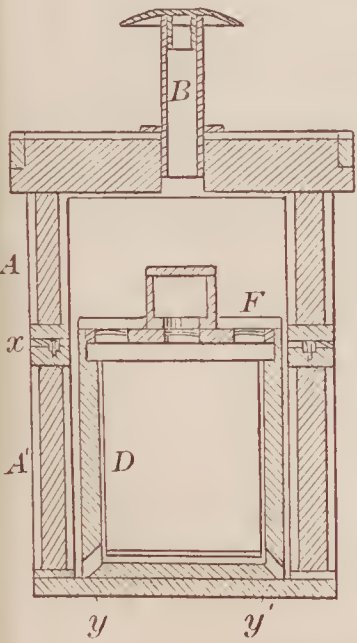

70339—T. W. Kreitz—*Folding Desk.*

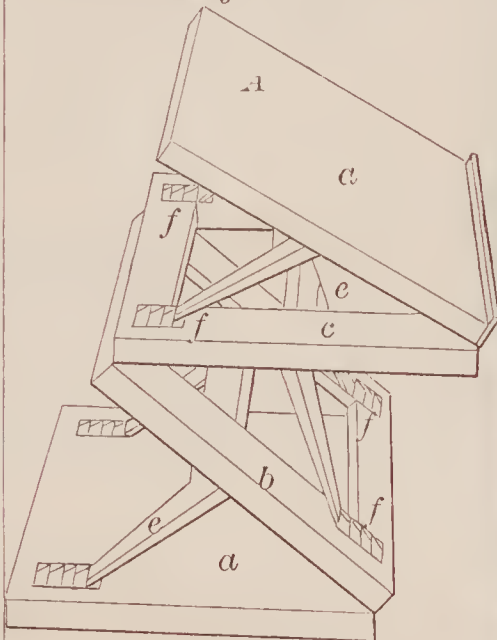

70341—J. L. Lay—*Locomotive.*

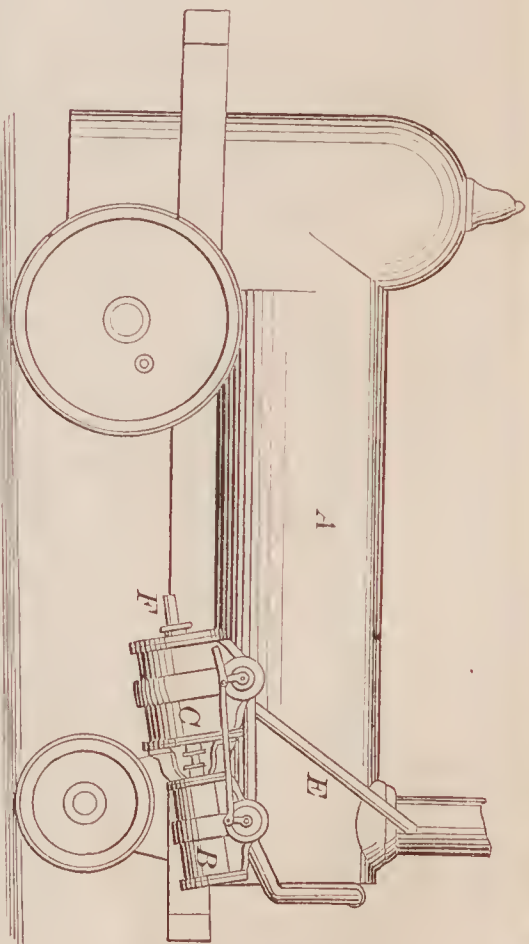

70340—C. E. Lattin—*Flush Bolt.*

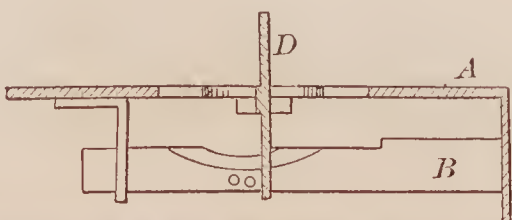



70343—E. W. Lowe—Washing Machine.

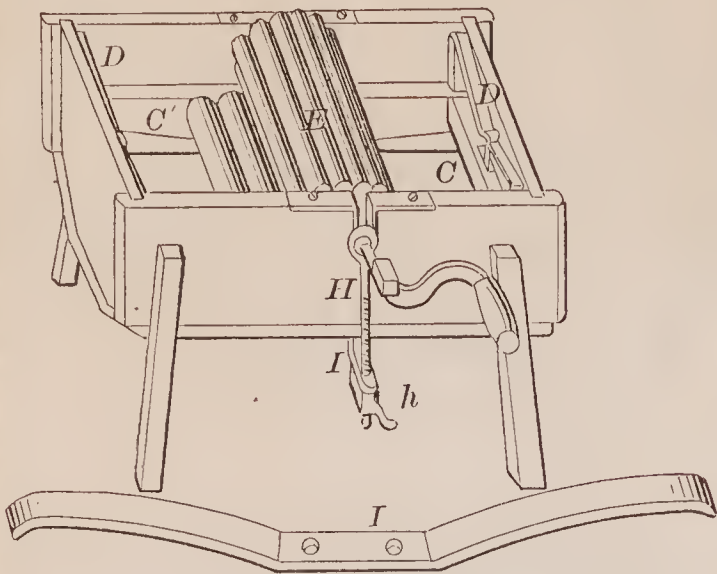

70344—G. Mallory—Fan and Parasol.

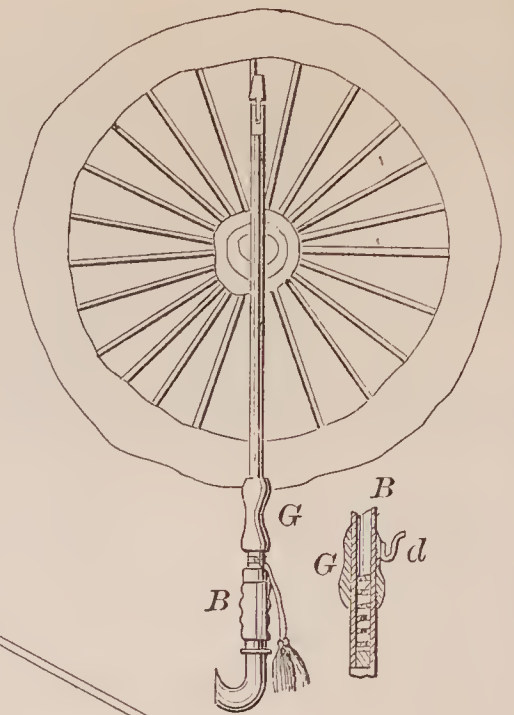

70348—J. W. Melcher—Detachable Whiffletree.

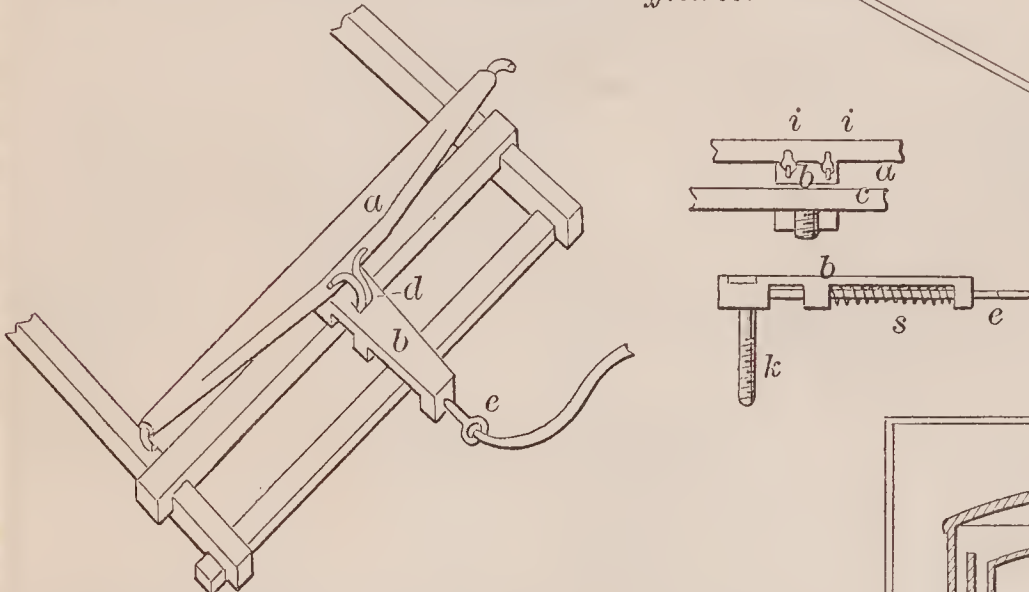

70345—A. S. Markham—Cultivator and Seeder.

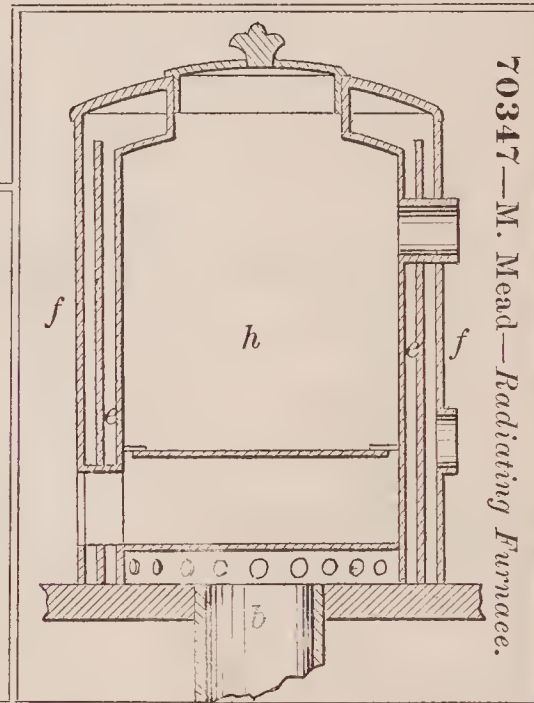
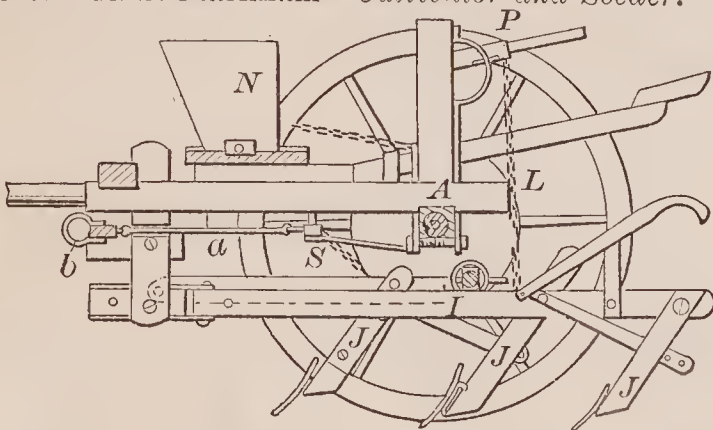

70347—M. Mead—Radiating Furnace.

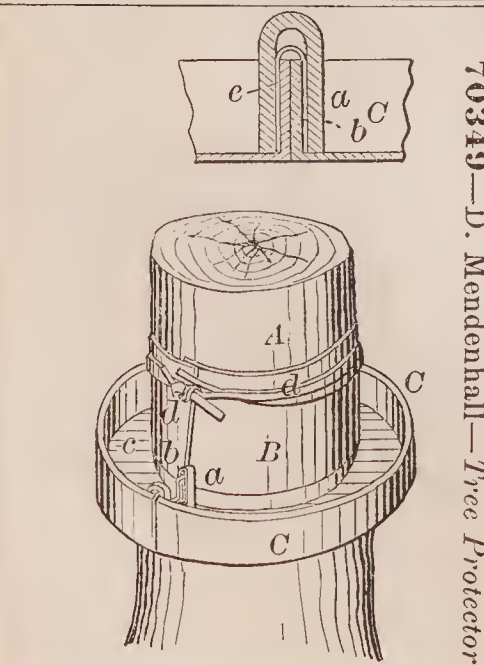

70349—D. Mendenhall—Tree Protector.

70350—J. Nathan—Egg Holder.

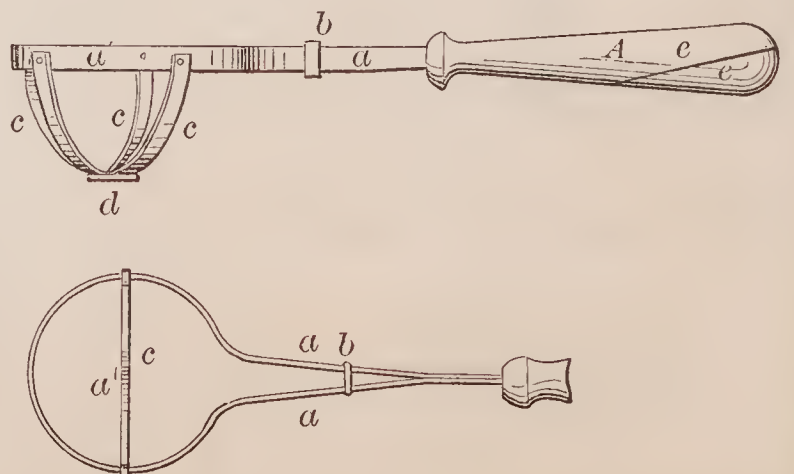

70351—J. Newhart—*Plow Clevis,*

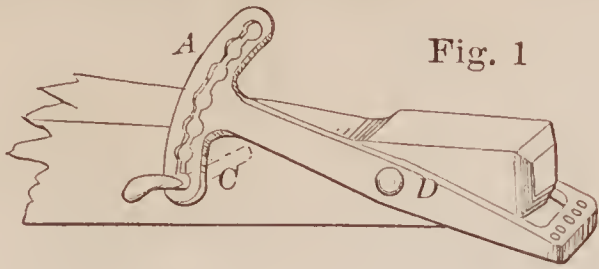

Fig. 1

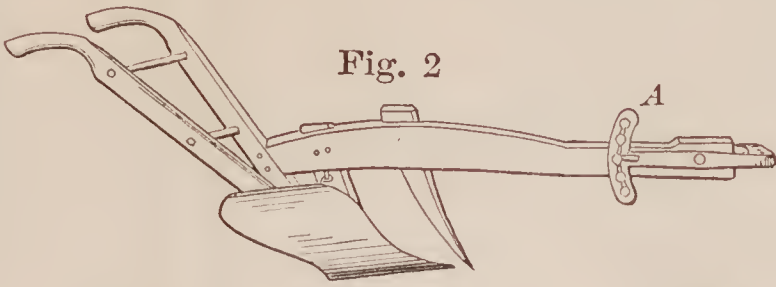

Fig. 2

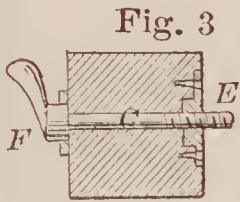

Fig. 3

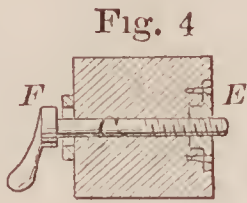
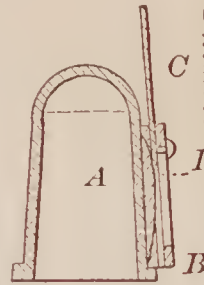

Fig. 4

70353—H. D. Peck—



Thimble.

70360—J. C. Reynolds—*Knife Sharpener.*



70355—M. Pierce—*Spring Bed Bottom.*

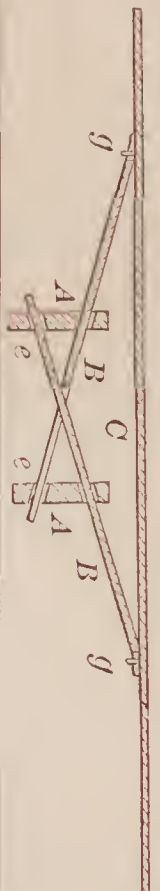

70354—Peterson & Gunner—*Boat Detaching Tackle.*

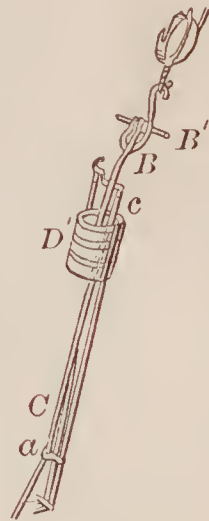
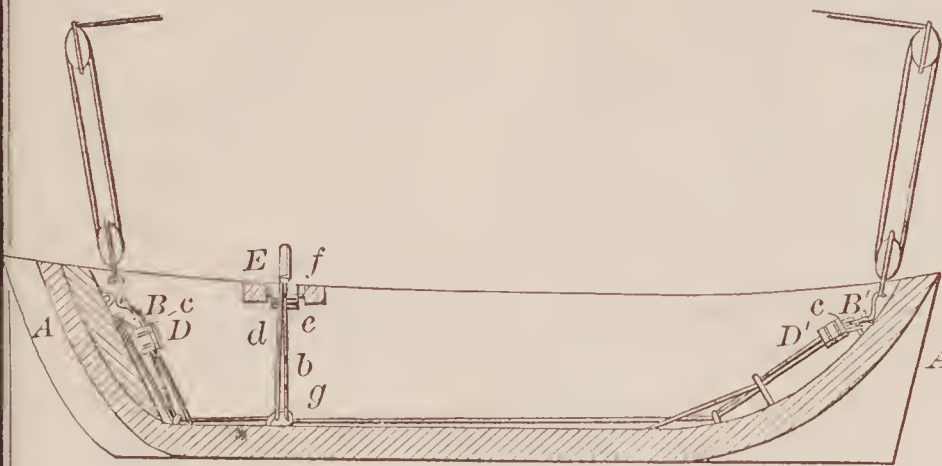

70350—J. H. Nichols—*Manufacturing Knives and Forks.*



70357—T. D. Powers—*Wagon Shackle.*

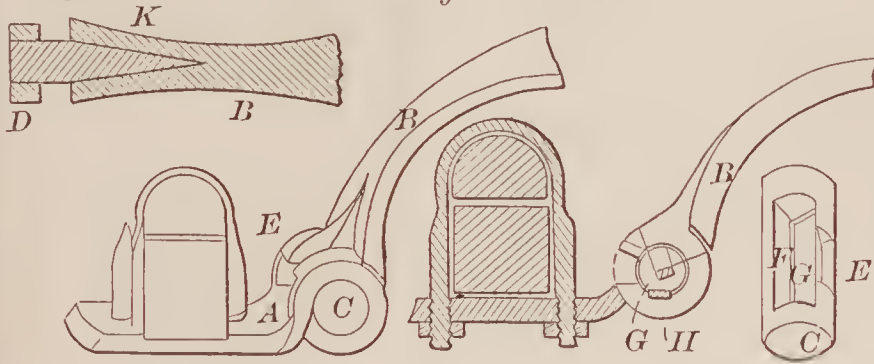

70356—Pinder & Robinson—*Car Axle Box.*

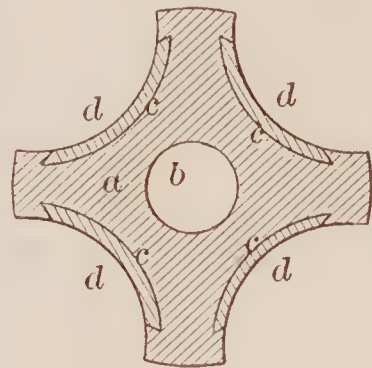

70362—A. Roesler—*Match Safe.*

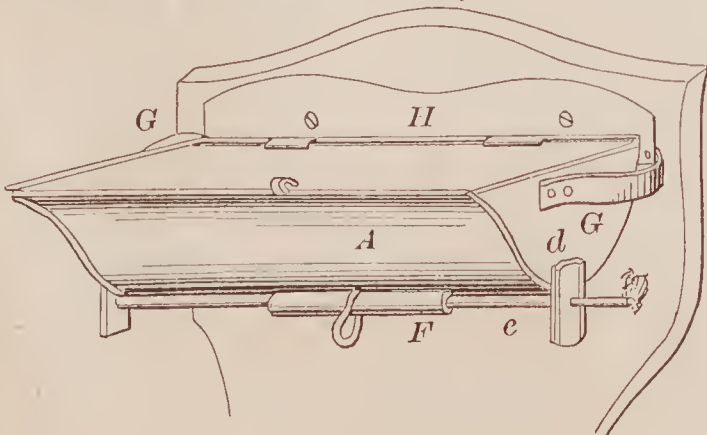

70358—J. E. Prudden—*Carriage Shackle.*

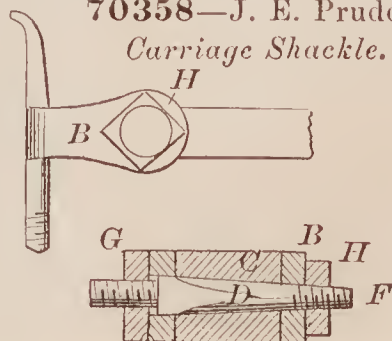



70365—J. F. Russell—Facilitating Flow of Gas through Pipes.

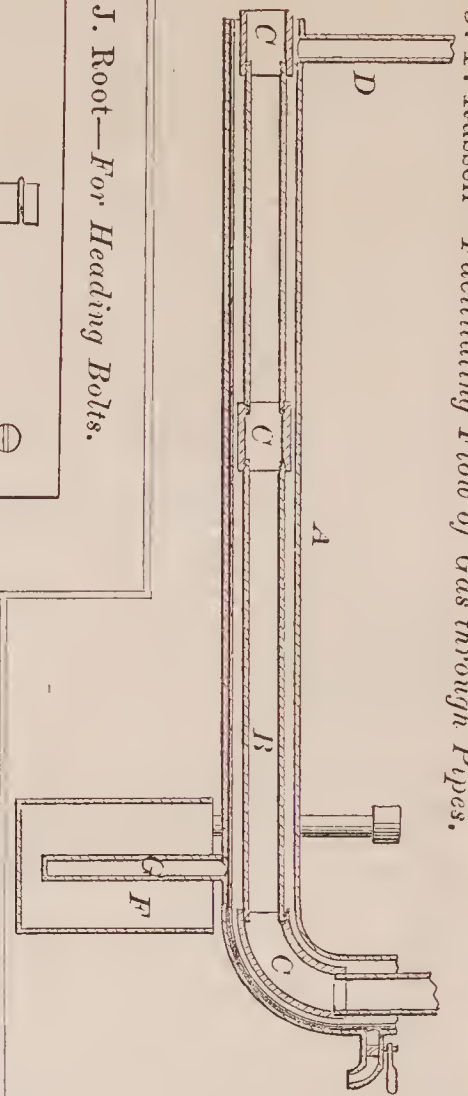

70363—J. Root—For Heading Bolts.

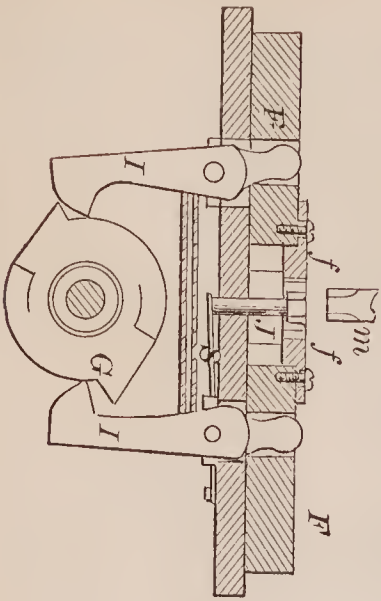
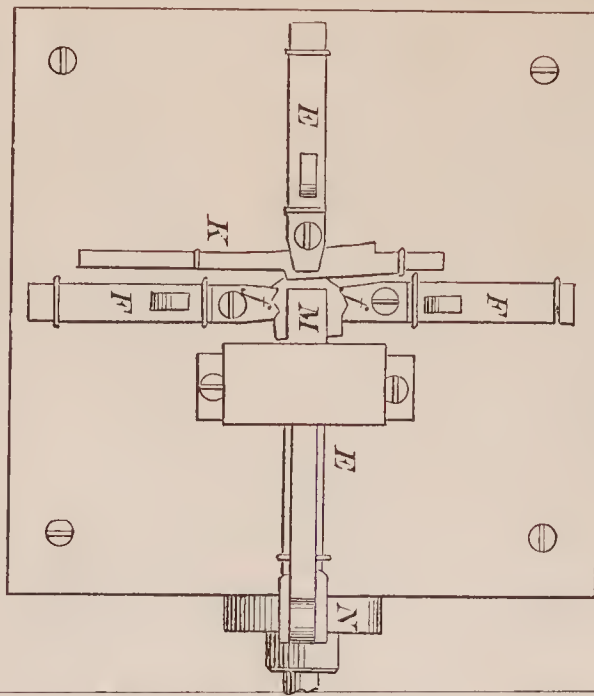

70367—D. Scanlin—Syrup Pitcher.

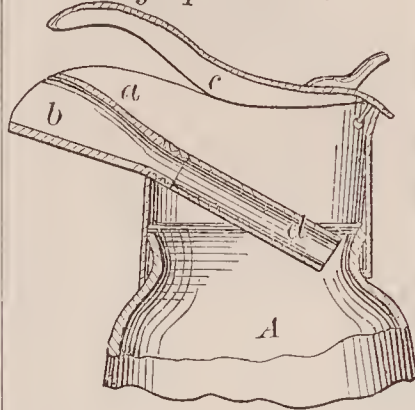

70360—H. Ruddick—Steam Generator.

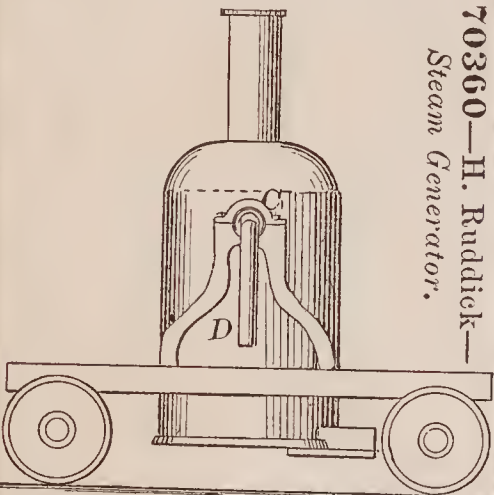

70368—C. H. S. Schultz—Corn Popper.

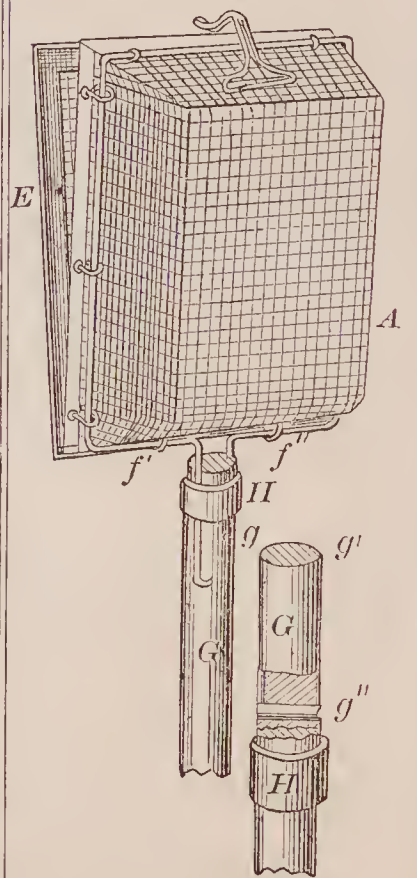

70366—J. J. Sandgren—For Shearing, Punching and Upsetting.

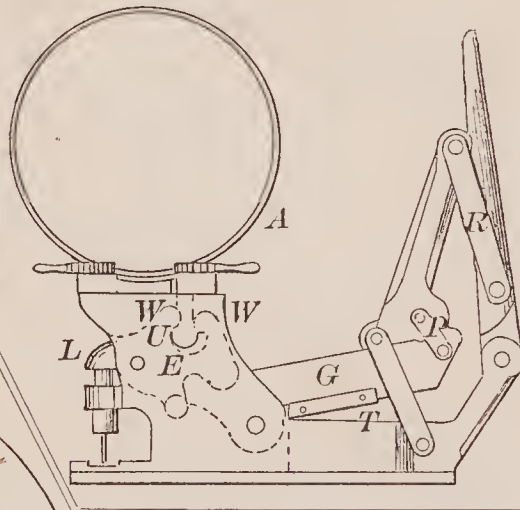

70369—W. & C. Sellers—Value Gear.

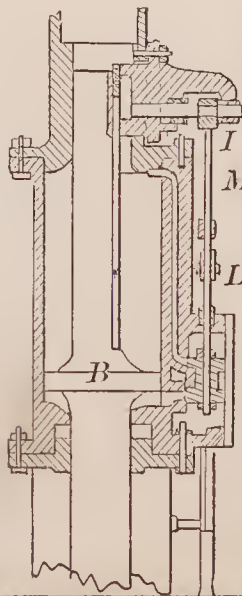

70369—W. & C. Sellers—Value Gear of Steam Hammers.

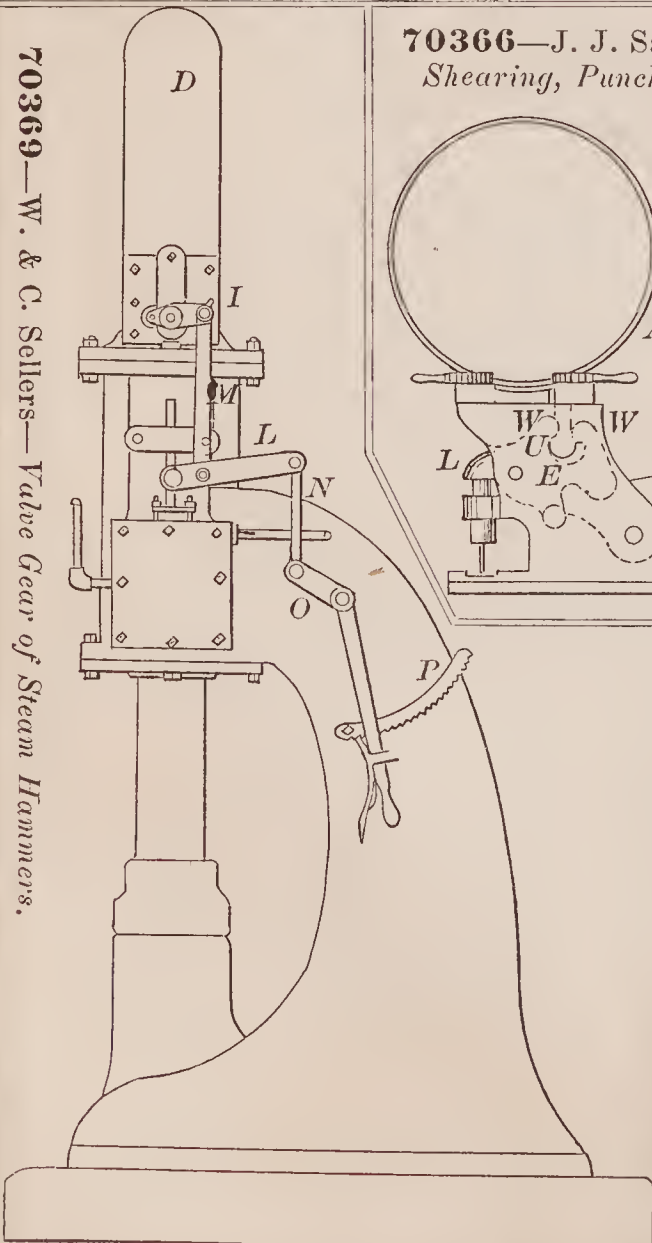

70370—R. Simpson—Animal Trap.

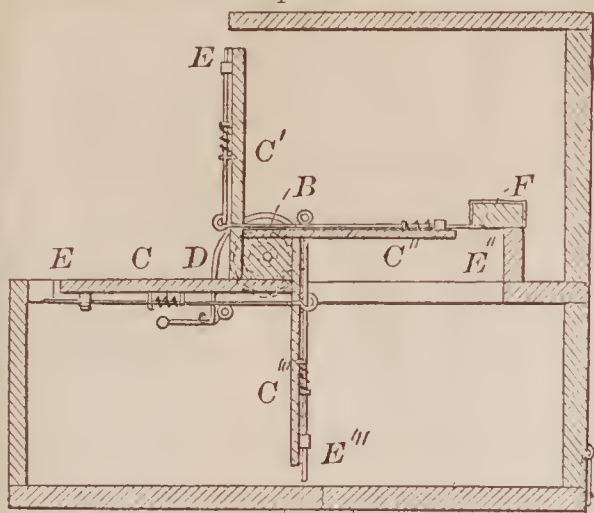

70371—W. W. Smith—Ratchet for Driving Wheels.

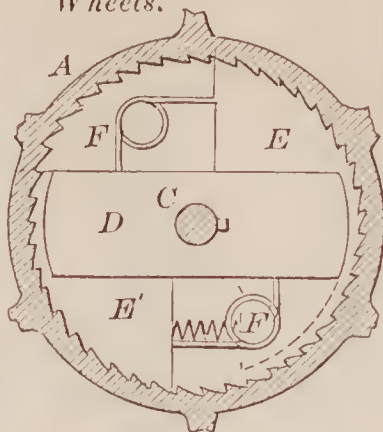

70372—H. D. Snyder—Safety Pocket.

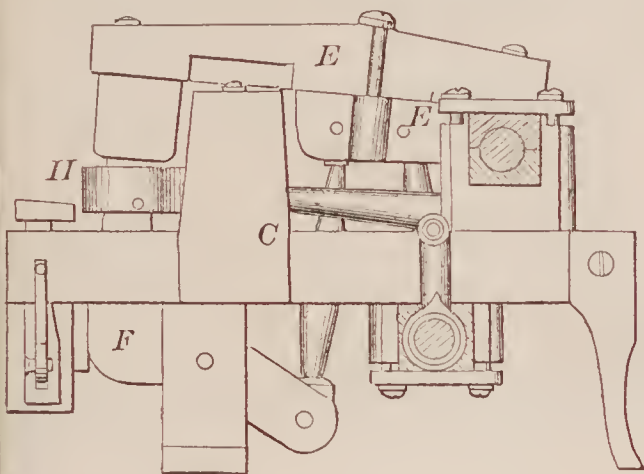
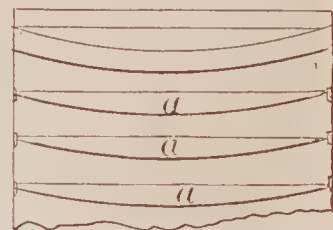

70374—A. St. Louis—Horse Shoe Nail Machine.

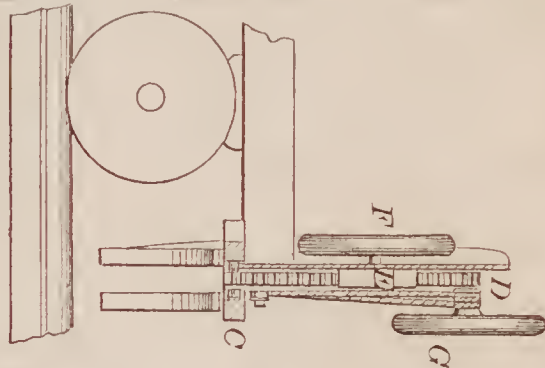

70375—L. Straus—Car Replacer.

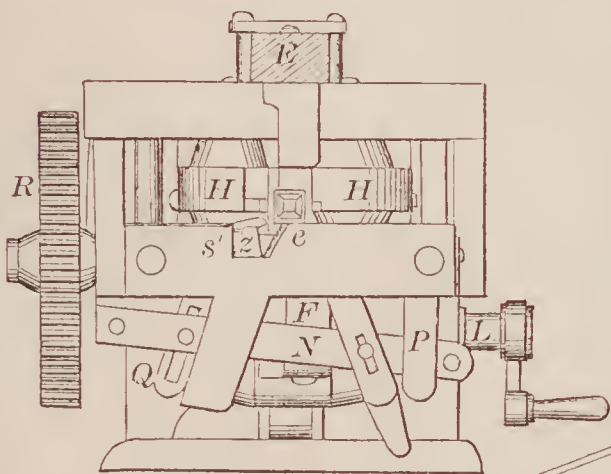
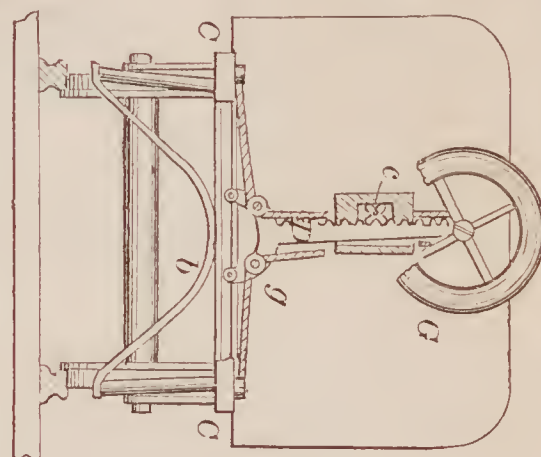

70373—W. P. Staley—Mill Burr Dresser.

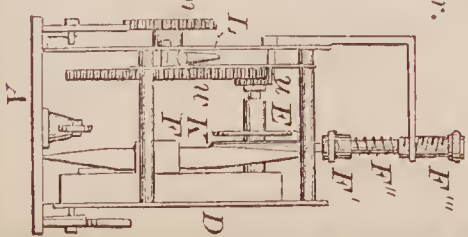
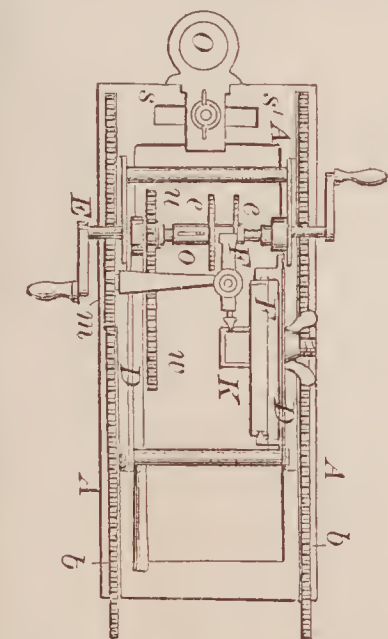

Fig. 4

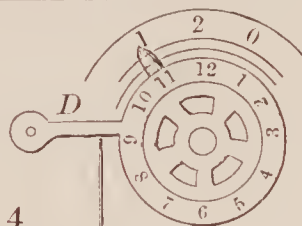

Fig. 1

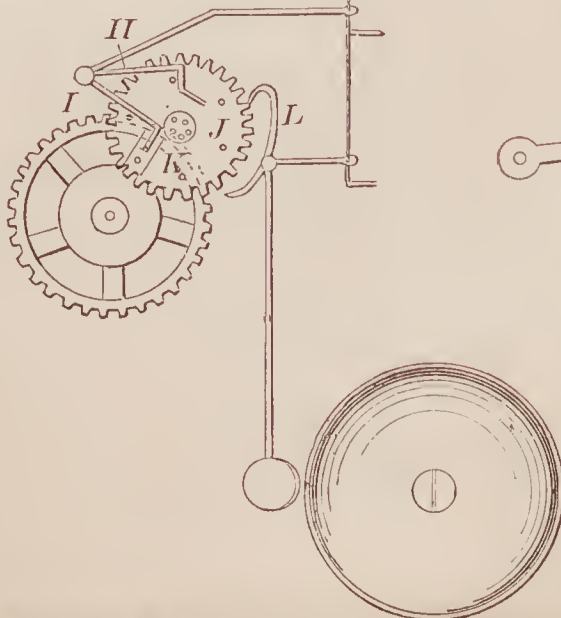
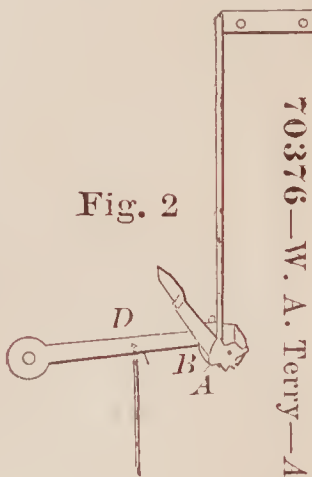

Fig. 2



70376—W. A. Terry—Alarm Clock.



70377—J. Tobin—*Flour Sifter.*

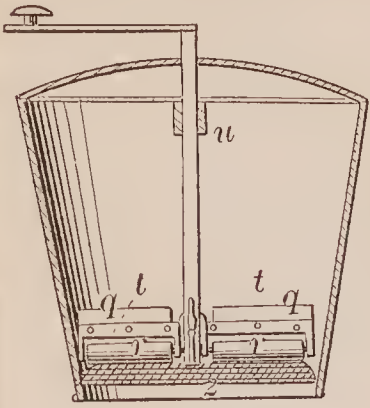

70378—W. F. Turner—*Umbrella.*

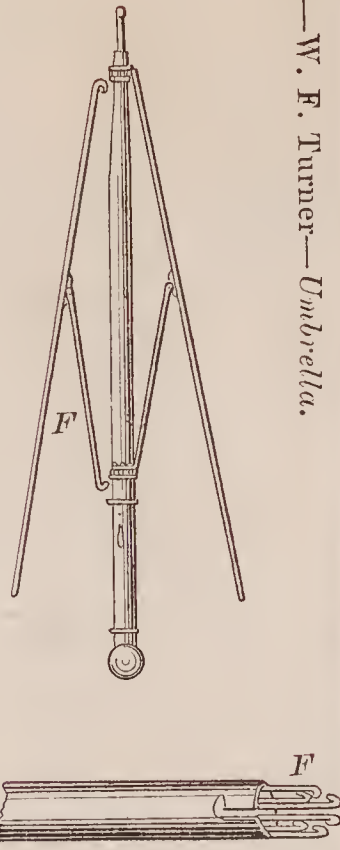

70379—H. Tyler—*Pump.*

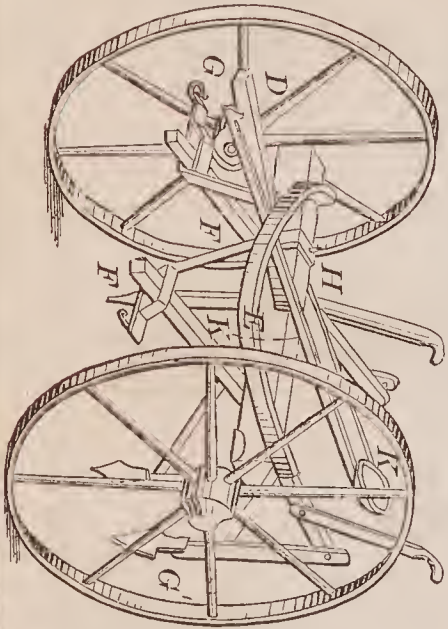
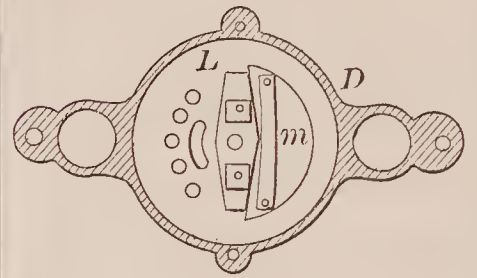
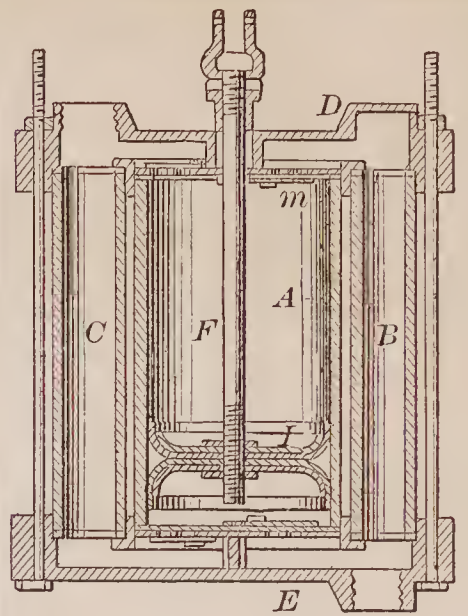

70381—Walker & Wood—*Cultivator.*

70382—F. W. White—*For Making Blind Slats.*

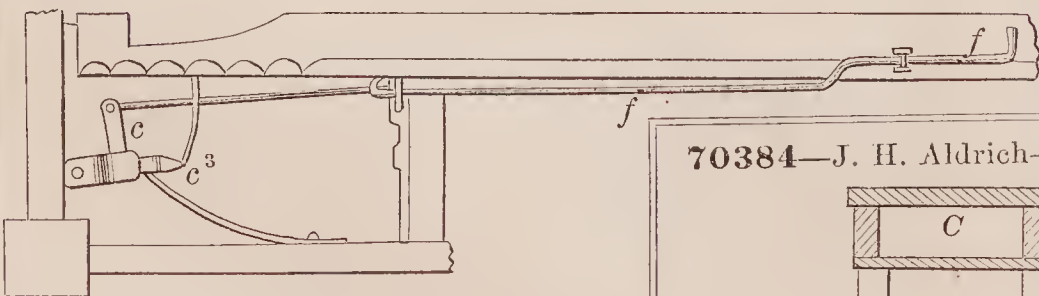
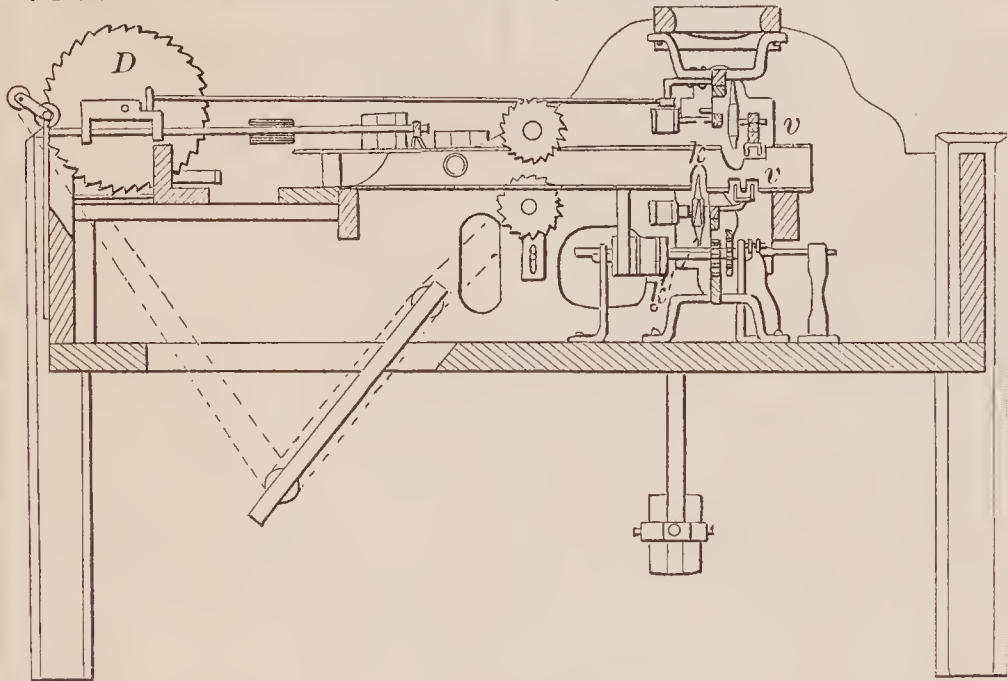

70385—J. M. Alexander—*Tobacco Smoking Tube. B*



70384—J. H. Aldrich—*Railroad Freight Car.*

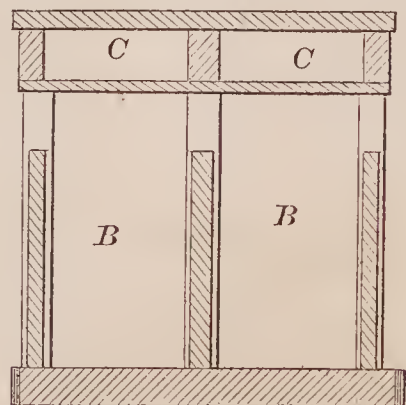

70380—S. Vanstone—*Connecting Link for Chains.*

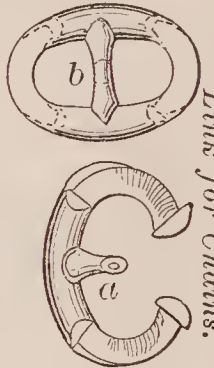

70383—S. R. Wilmot—*Uniting Sheet Metal*

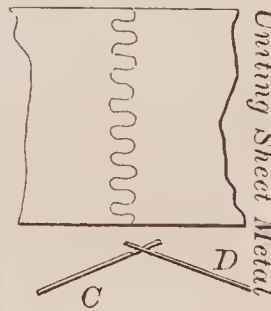

70387—E. H. Ashcroft—*Elevator.*

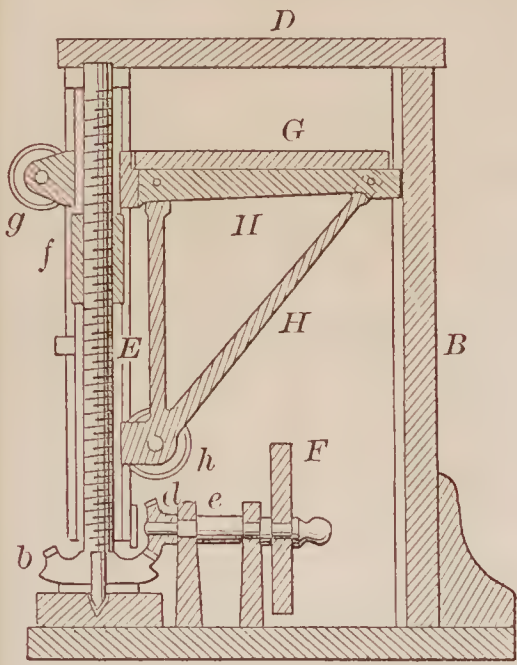

70389—E. H. Ashcroft—*Condenser.*

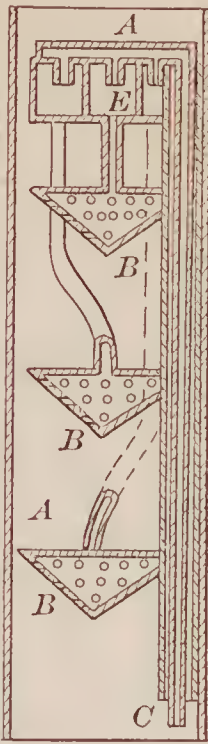

70390—E. H. Ashcroft—*Safe.*

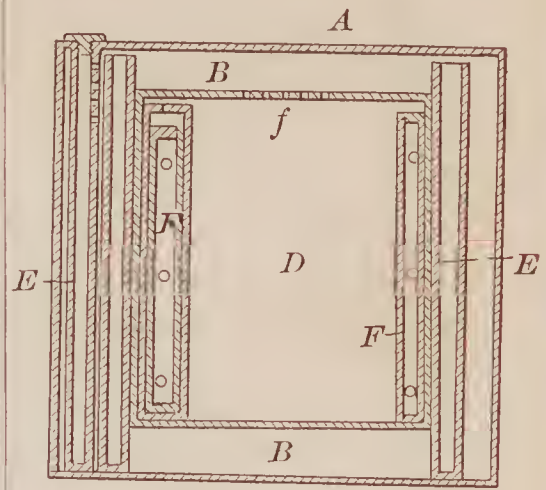

70388—E. H. Ashcroft—*Covering Steam Generators.*

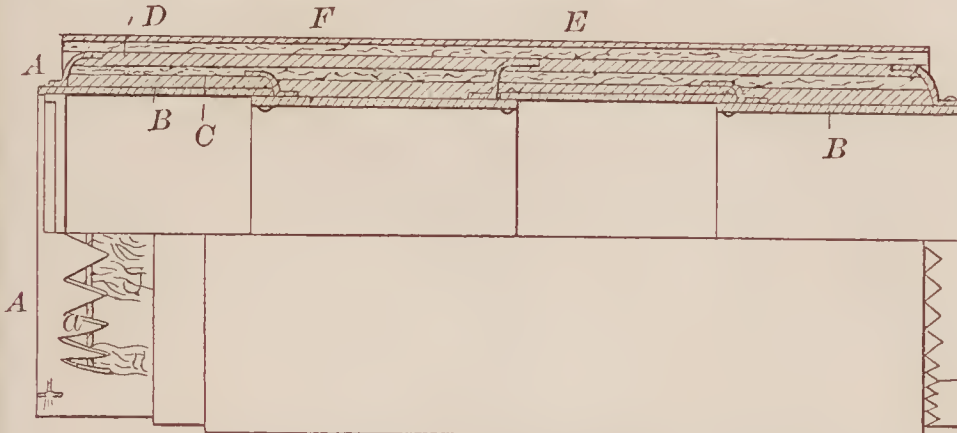

70392—W. P. Bennett—*Lamp Extinguisher.*

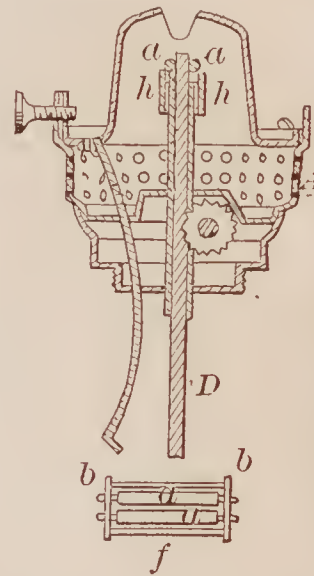

70391—G. Beigel—*Stereoscopic Apparatus.*

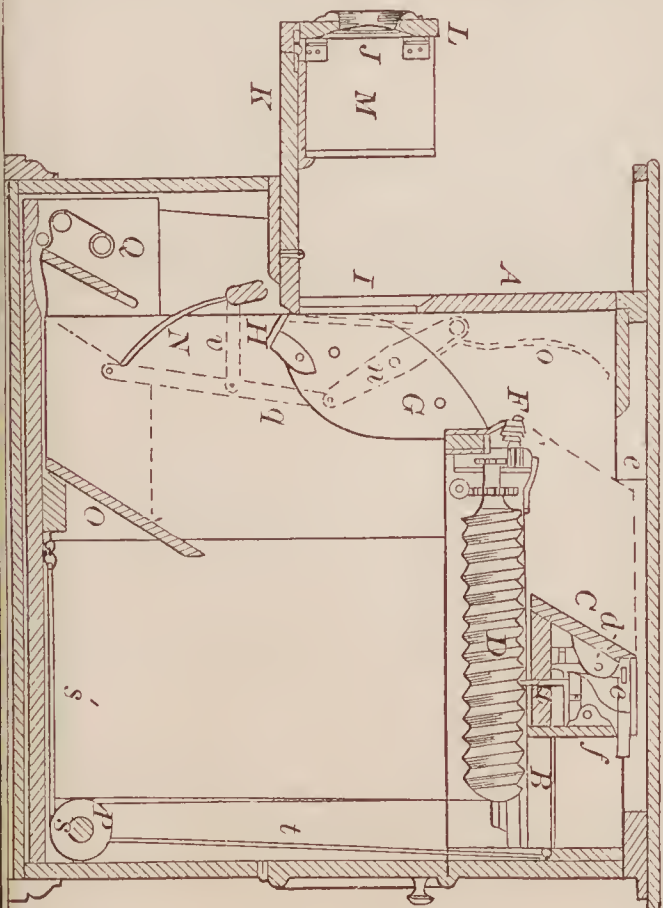

70393—G. L. Benton—*Emory Wheel for Grinding Saws.*

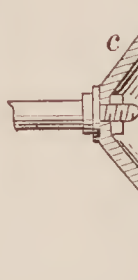

70394—J. Devins—*For Holding Saps Buckets.*

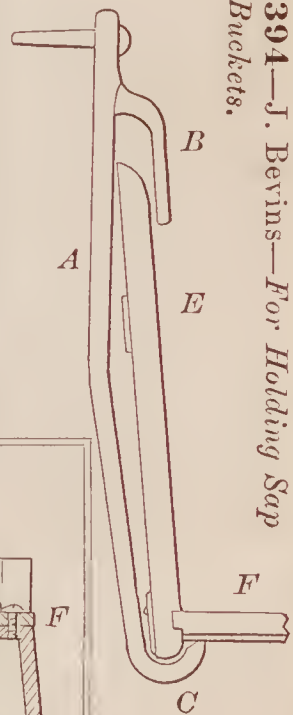

70395—J. Q. Birkey—*Gas Stove.*

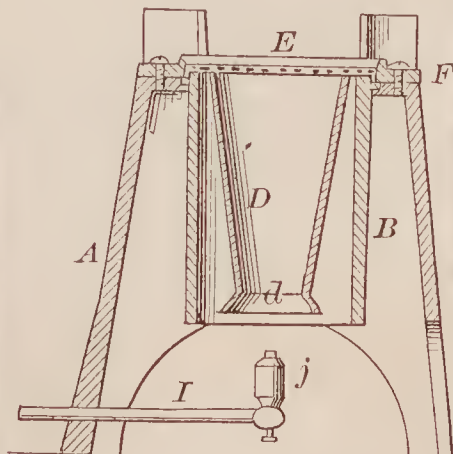



70396—T. W. Bishop—*Corn Sheller.*

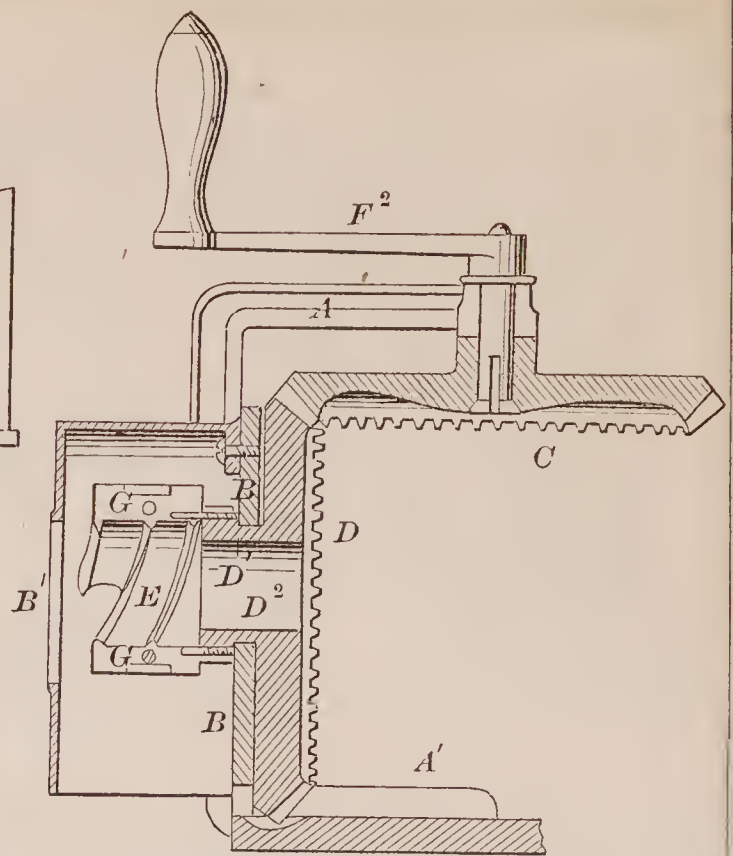
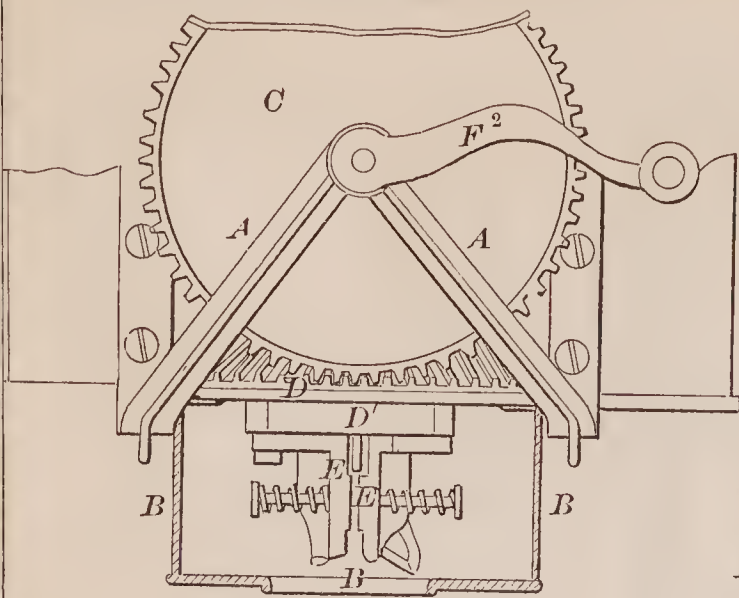

70397—M. Blakey—*Skelping Die.*

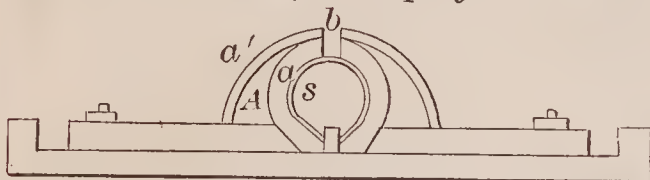

70399—J. L. Booth—*Manufacture of Rails for Railways.*

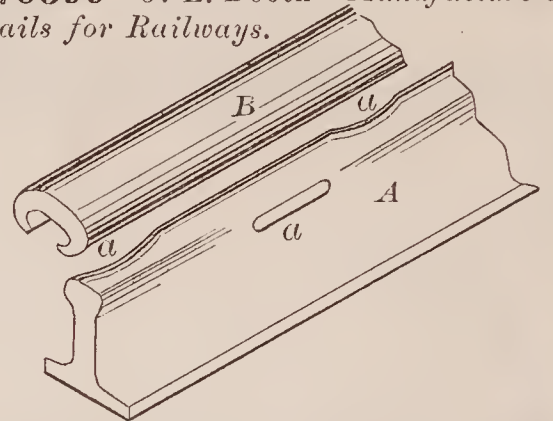

70398—A. Bliss—*Chandelier Attachment.*

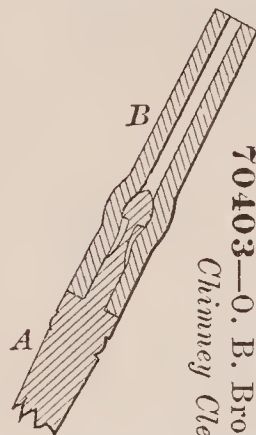
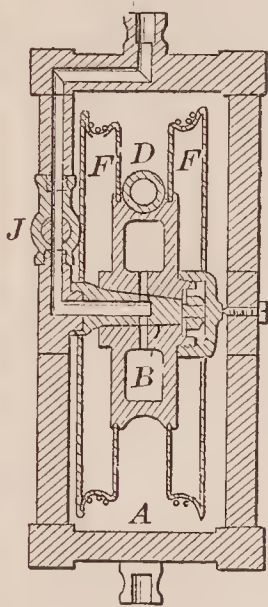

70403—O. B. Brown—*Lamp Chimney Cleaner.*

70402—H. D. Briggs—*Spinning Jack.*

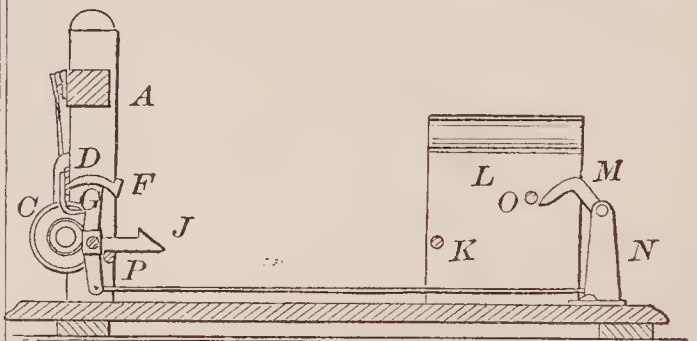

70401—G. Bowerman—*Stock and Poultry Feeder.*

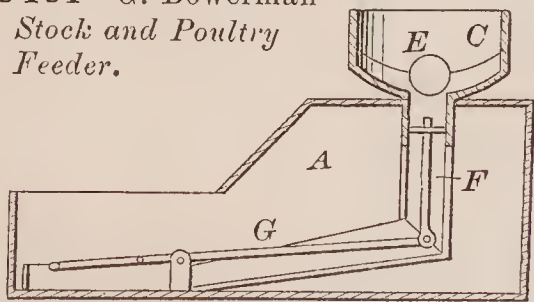

70404—A. Buch—*Straw Cutter.*

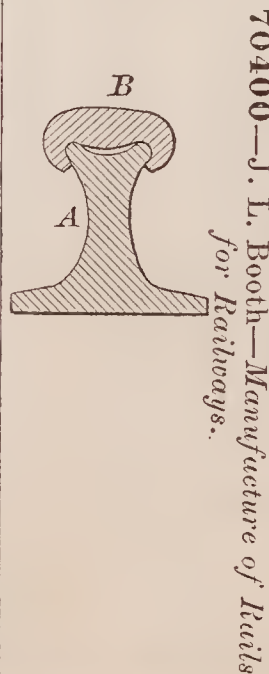
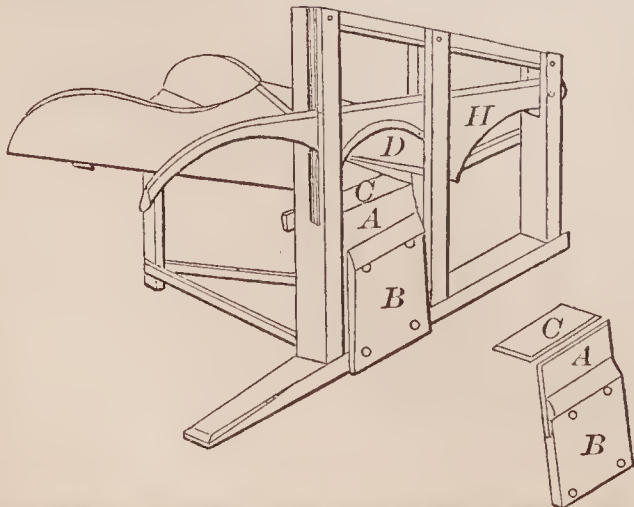

70400—J. L. Booth—*Manufacture of Rails for Railways.*

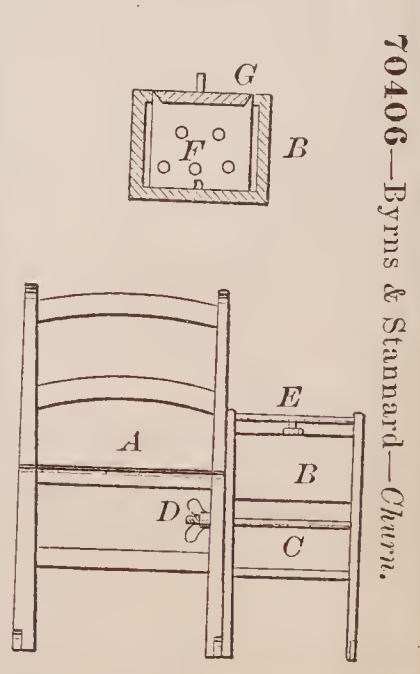

70406—Byrns & Stannard—*Churn.*

70407—C. W. Cahoon—*Steam Engine.*

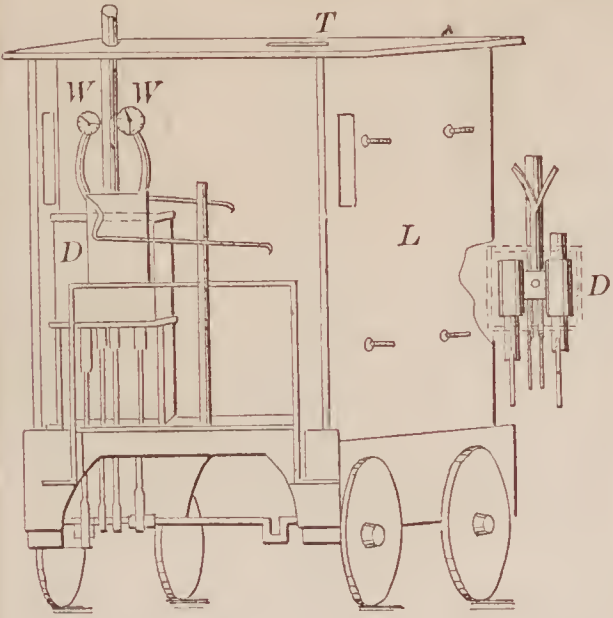

70409—J. L. Chambers—*Register Padlock.*

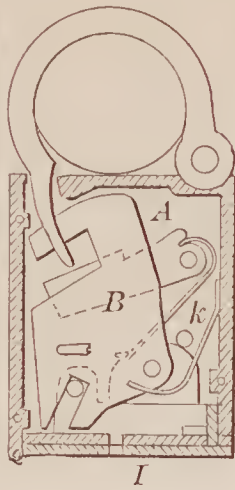

70411—S. A. Chase—*Elastic Sash Elevator.*

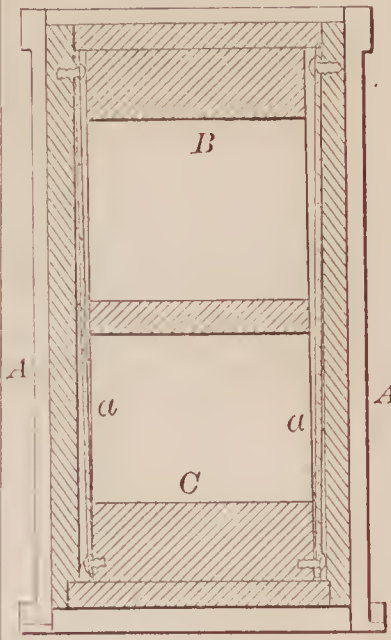

70410—J. Chandler—*Telegraph Clock.*

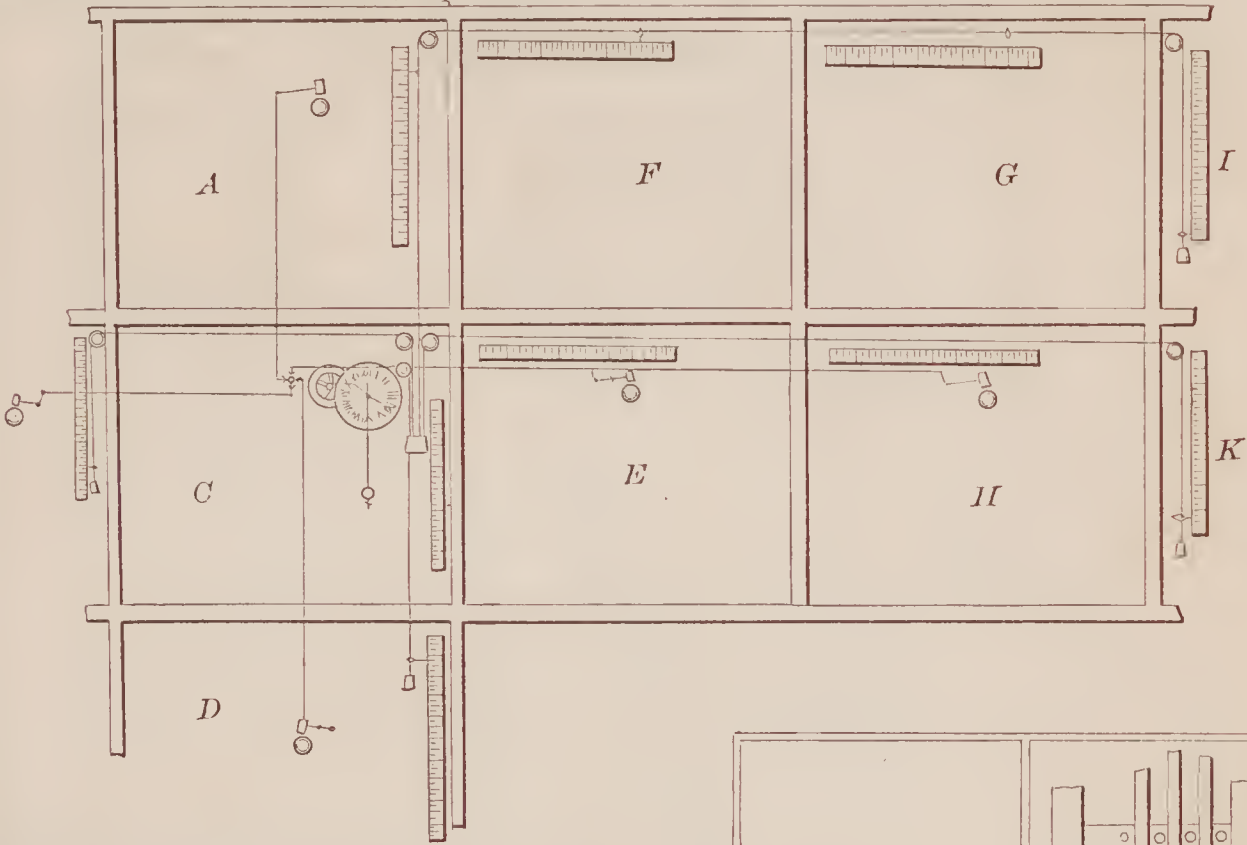

70408—D. O. Card—*Knee and Beam for Sleighs.*

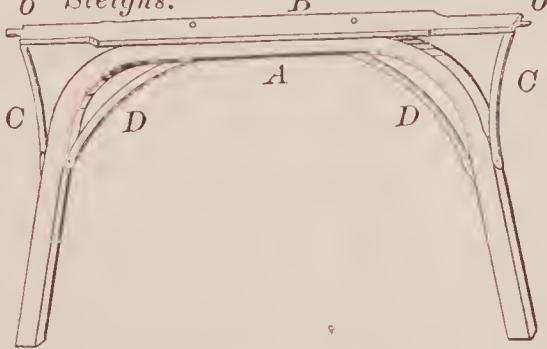

70413—S. Collinson—*Tongs.*



70412—H. Chatfield—*Hoisting Apparatus.*

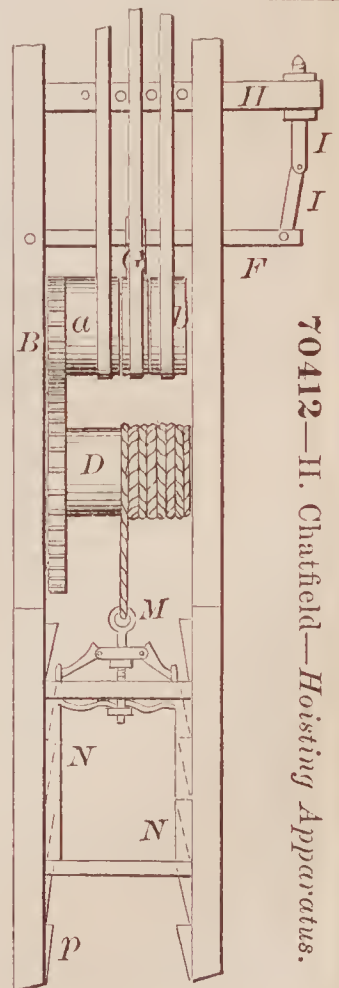

70414—T. R. Cook—*Lining Barrels with Sheet Metal*

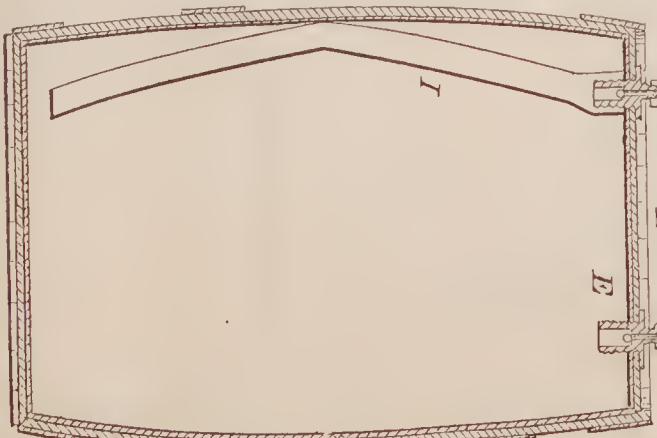



70415—T. Cook—*Fireproof Safe.*

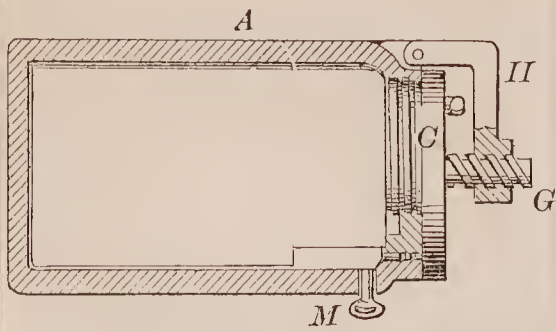

70418—M. Crohn—*Veterinary Narcotic Injector.*

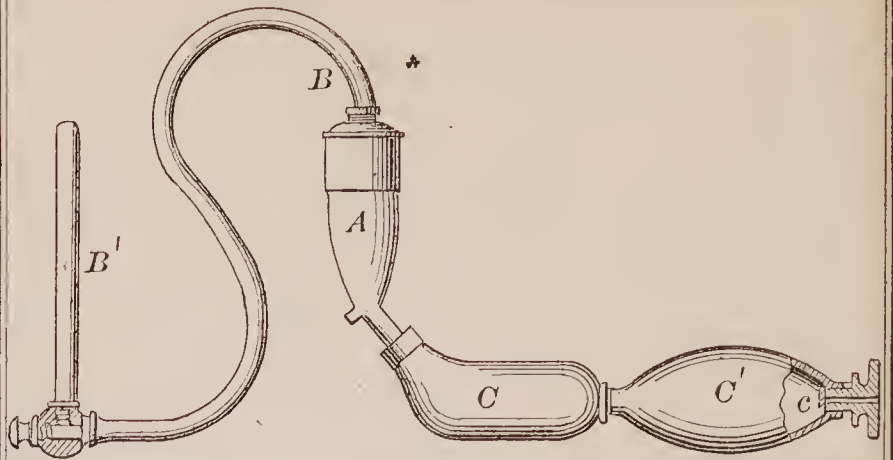

70416—Cooke & Standfield—*Wheel Gearing.*

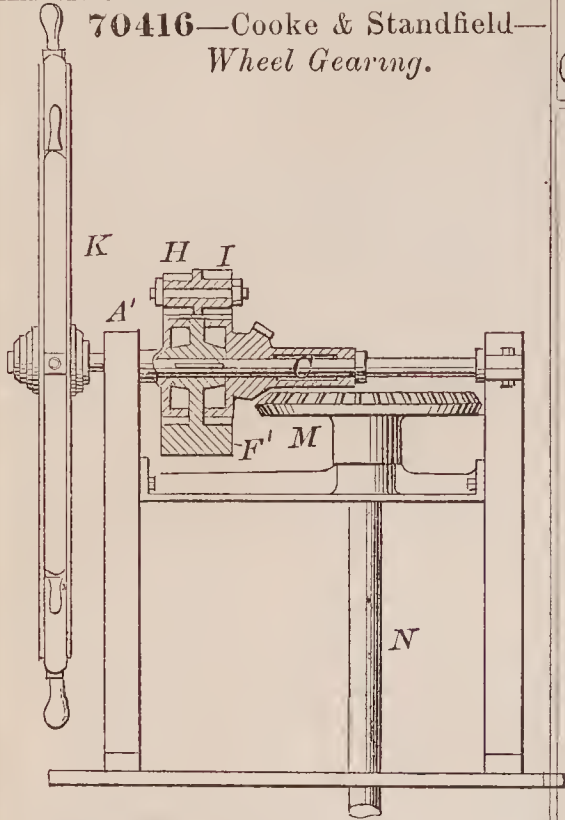

70419—C. Daniels—*Floating Water Power.*

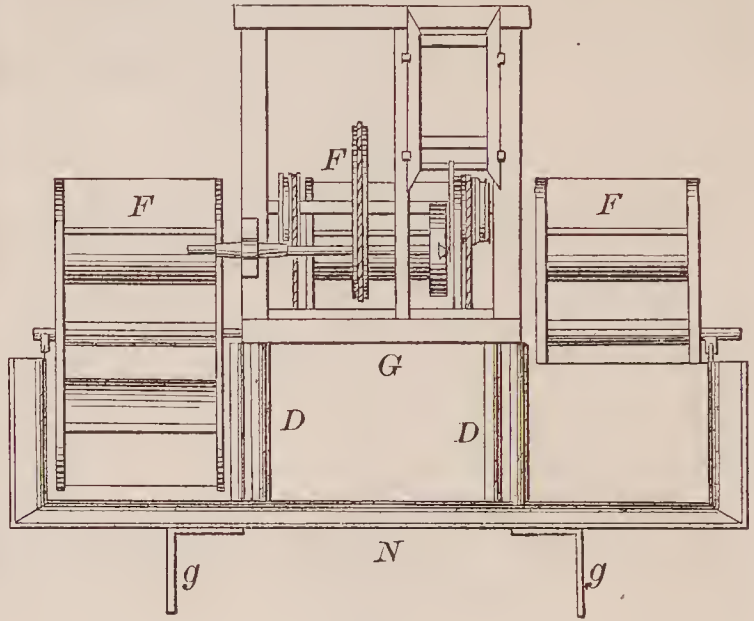

70420—B. A. Davis—*Curing Tobacco.*

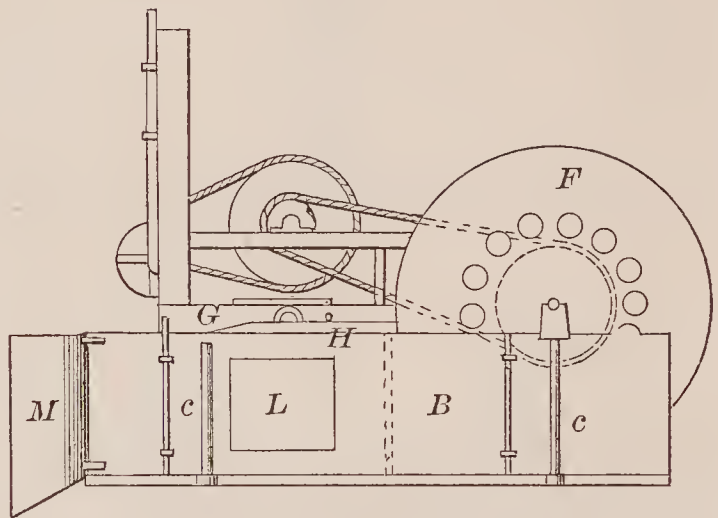
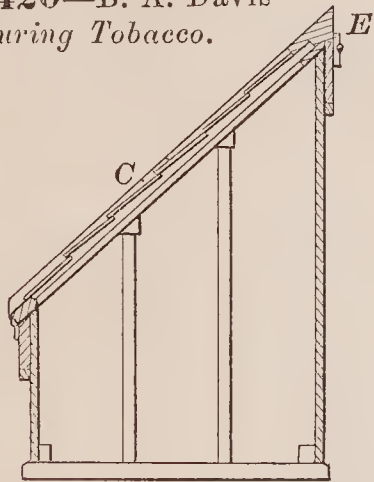

70422—M. De Voursney—*Fastening for Coach Lamps.*

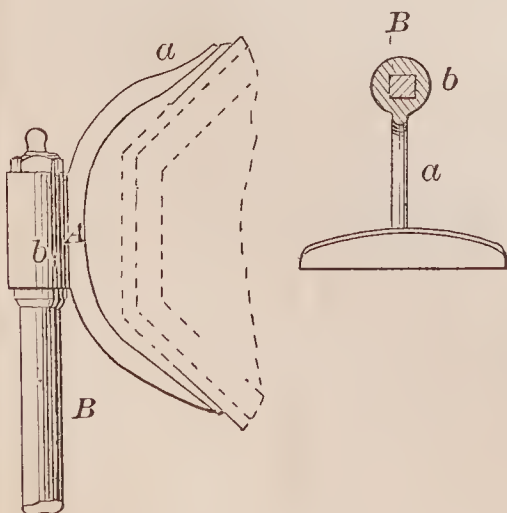

70423—H. Disston—*For Setting Saw Teeth.*

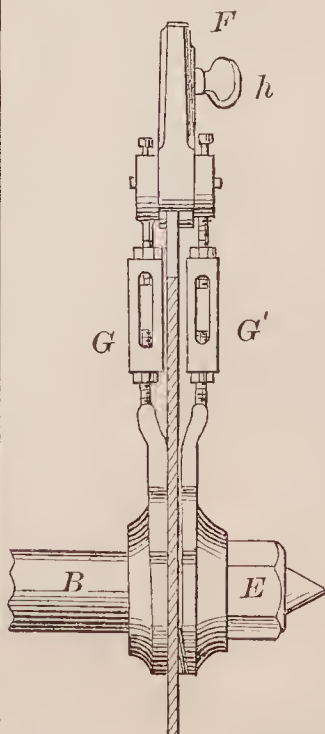

70424—H. Disston—*For Sharpening Saw Teeth.*

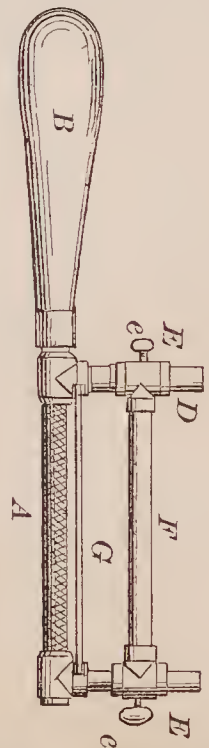

70425—D. A. Dixon—Saddle Tree.

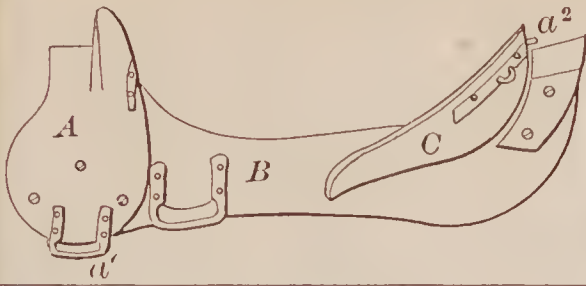

70431—Gruver & Wiggins—Churn.

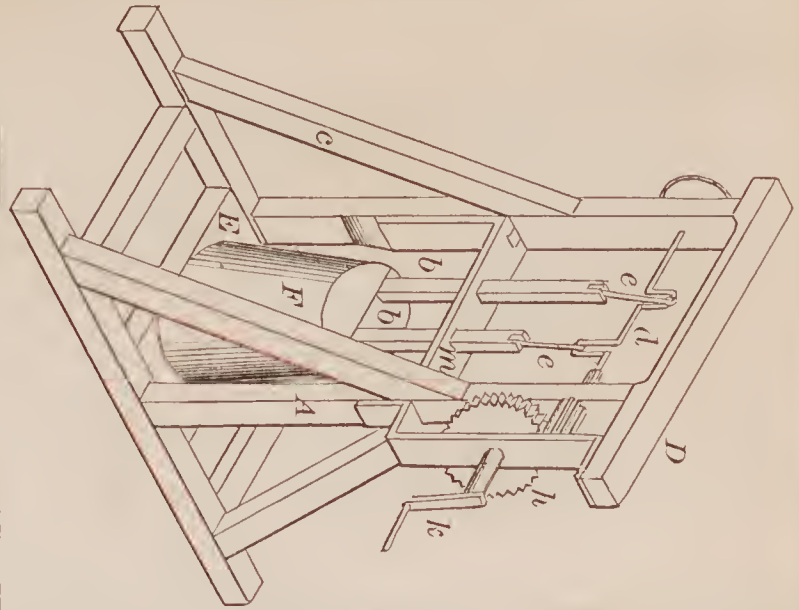

70430—H. J. Graham—Cultivator.

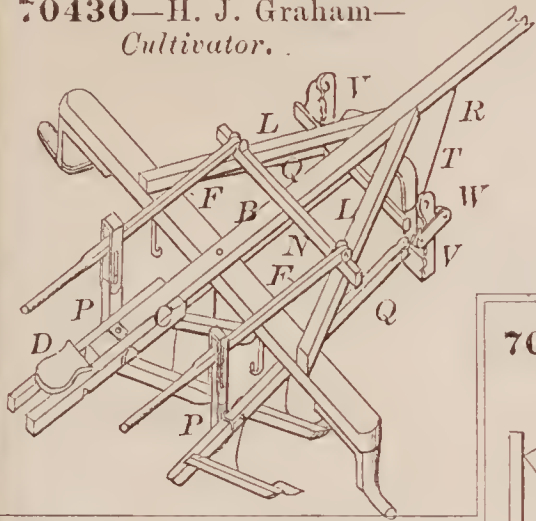

70429—A. Freeman—Cattle Guard Gate.

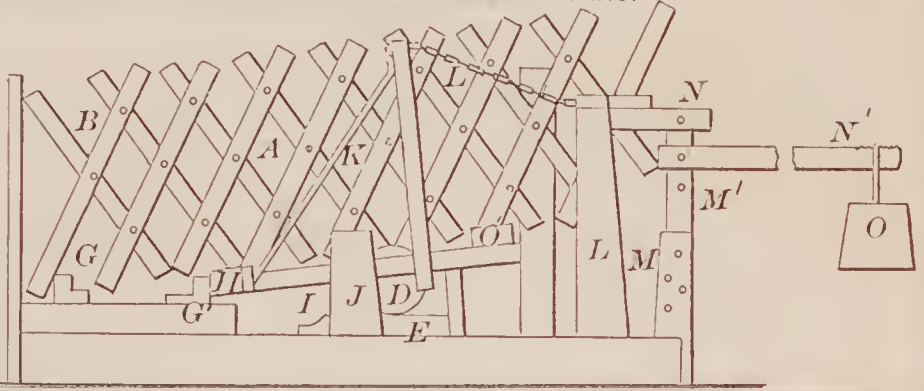

70426—Elmer & Hubert—Ozone Generator.

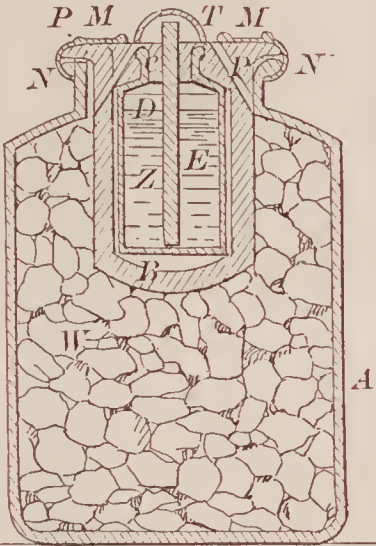

70427—J. Fallows—Sheet Metal Bucket.

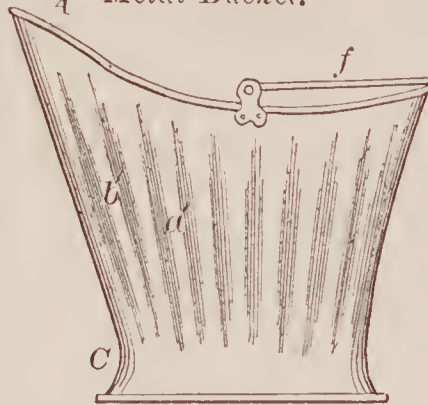

70428—W. H. Fitzgerald—Shutter Bolting Bolt.

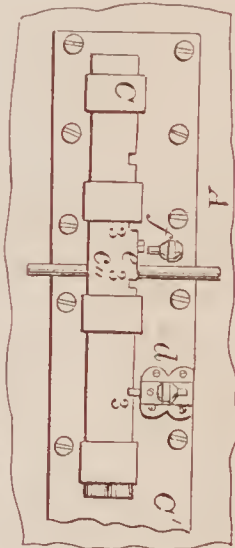

70432—D. G. Haskins—Gas Cooking Range.

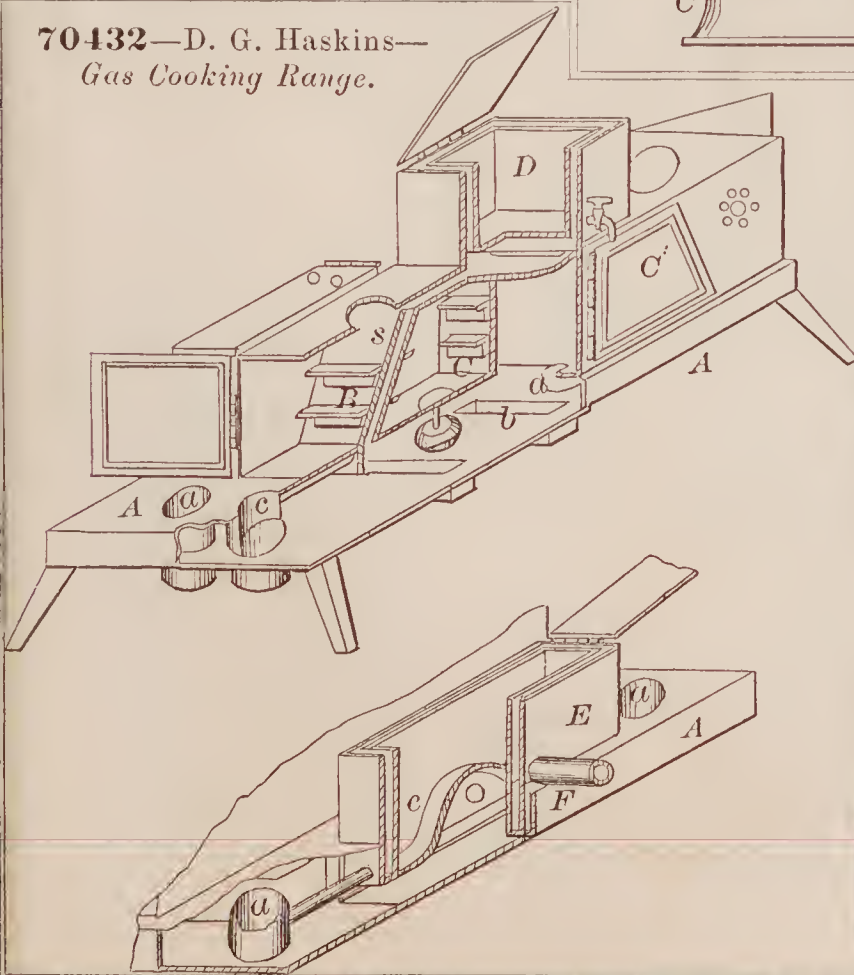

70433—Haskins & Wimlock—Lighting Rooms.

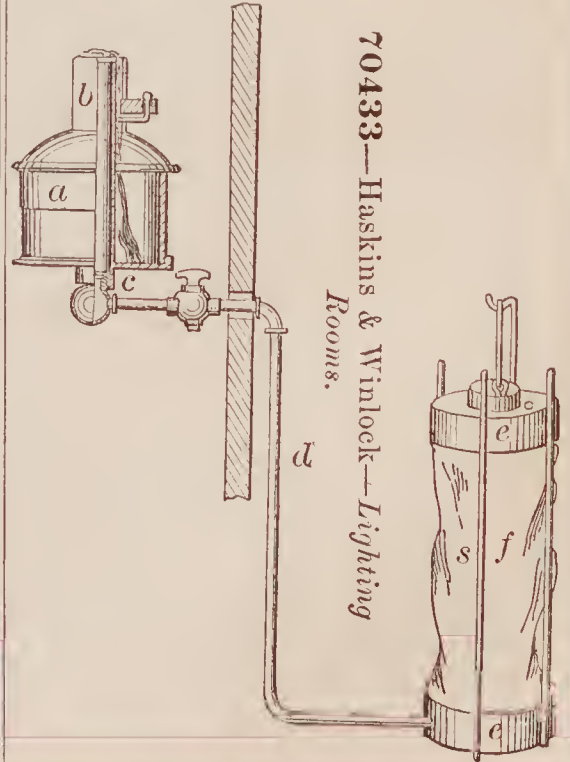



70434—N. T. Healy—*Harness.*

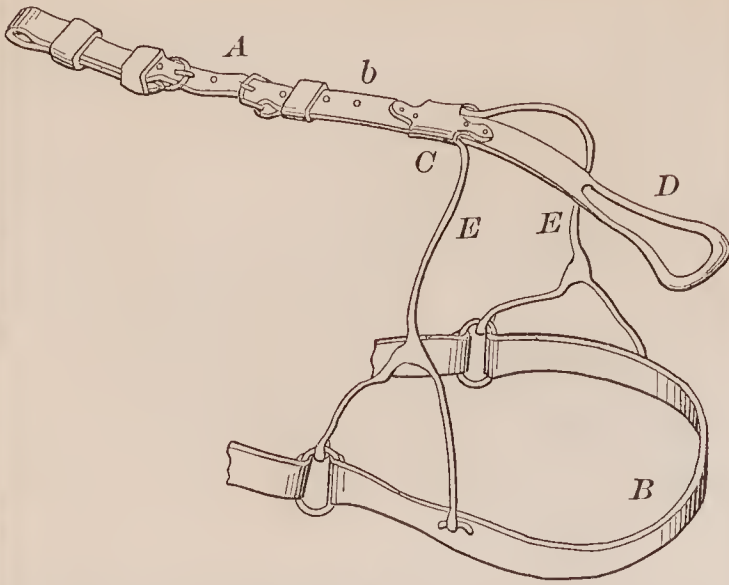

70440—Kali & Andrews—*Boot Crimp.*

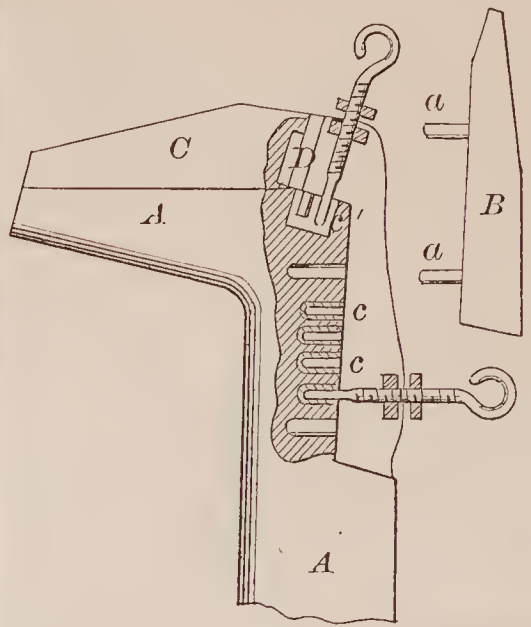

70436—J. Hiestand—*Beehive. D'*

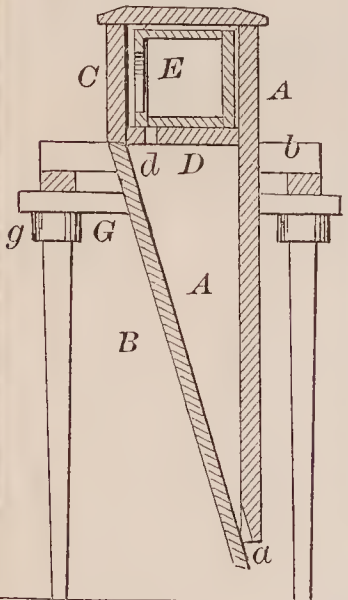

70441—E. Kaufmann—*Table Urn.*

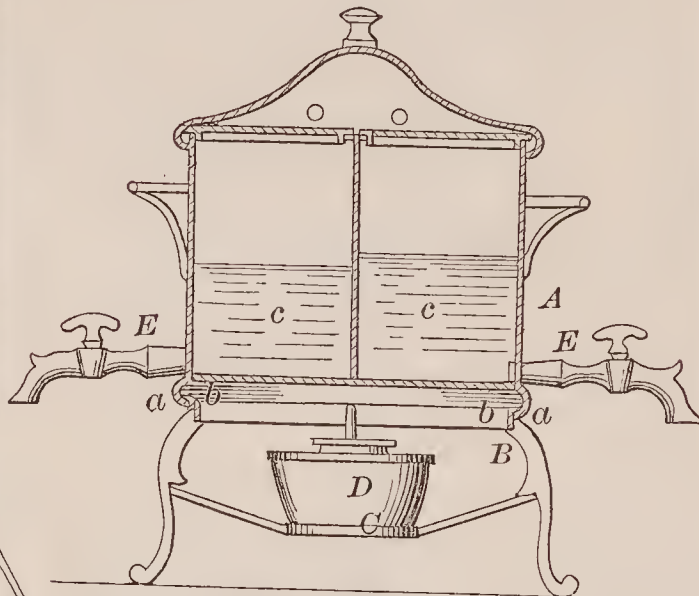

70438—H. & H. Inman—*Securing Ends of Fellos.*

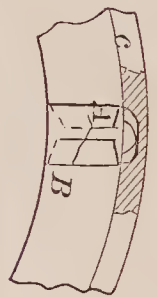

70439—J. W. Jones—*For Making Extracts from Bark.*

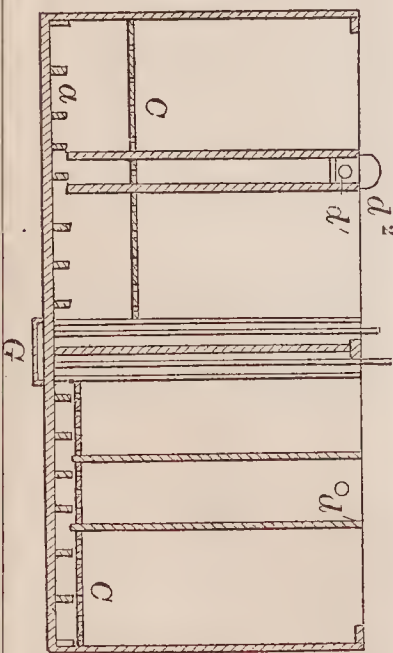

70442—C. A. Kihlgren—*Picture Envelope. a*

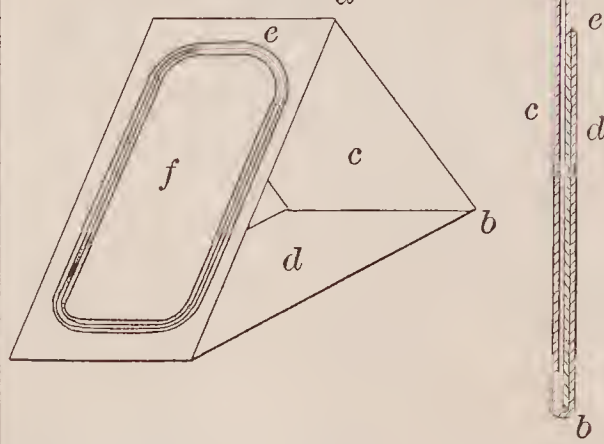

70443—J. T. Kimbel—*Pump.*

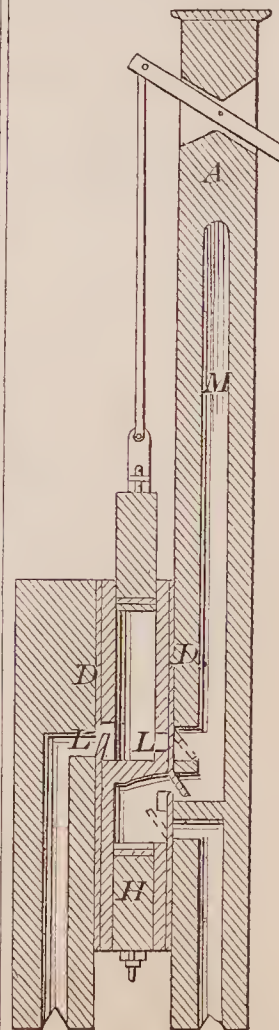

70444—G. B. Kirkham—*Window Fastening.*

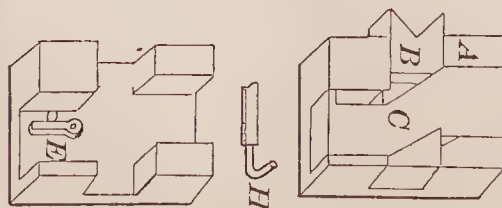

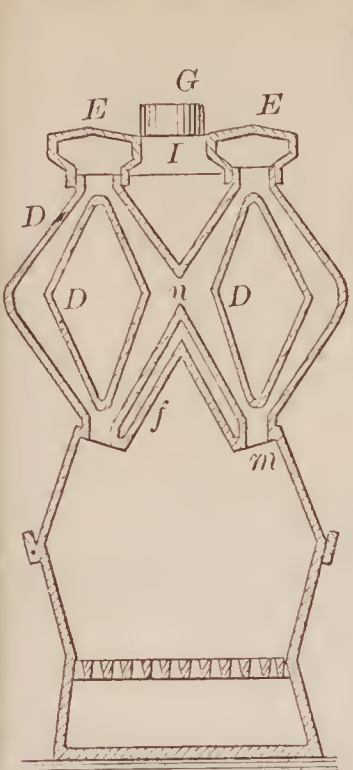

70445—J. A. Lawson—Hot Air Furnace.

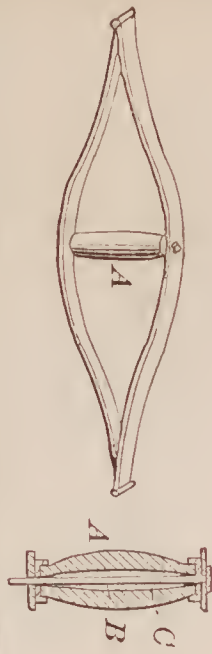

70446—T. Long—Elastic Spring for Carriages.

70448—J. I. Mabbett—Bed Bottom.

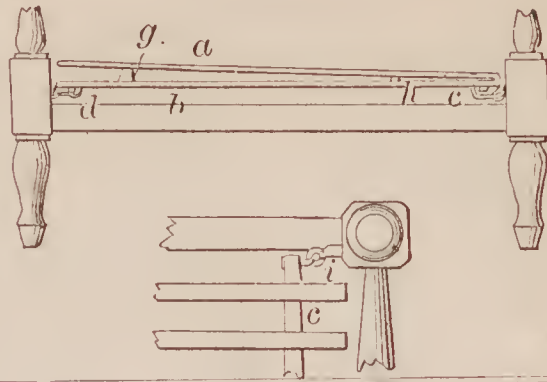

70449—J. W. Maloy—For Cutting Stone.

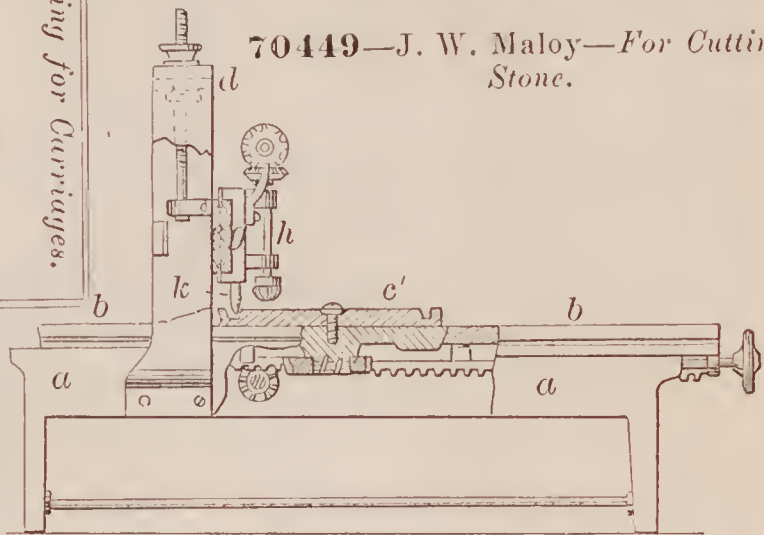

70450—McAvoy & Mills—Milk Can.

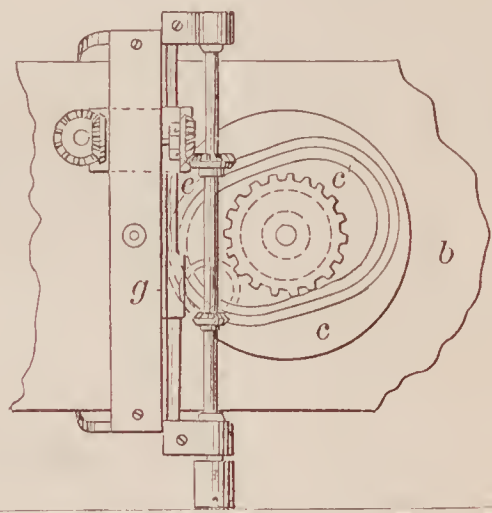
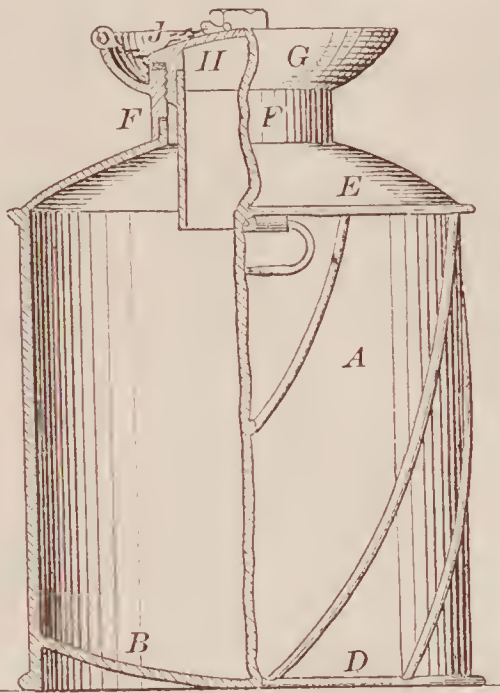

70451—S. McWorter—Sorghum Evaporator.

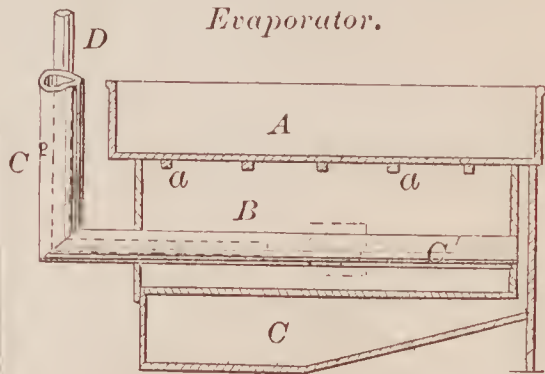

70452—H. B. Merritt—Cotton Bale Tie.

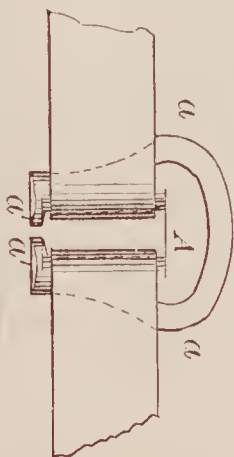

70447—F. W. Lurmann—Blast Furnace.

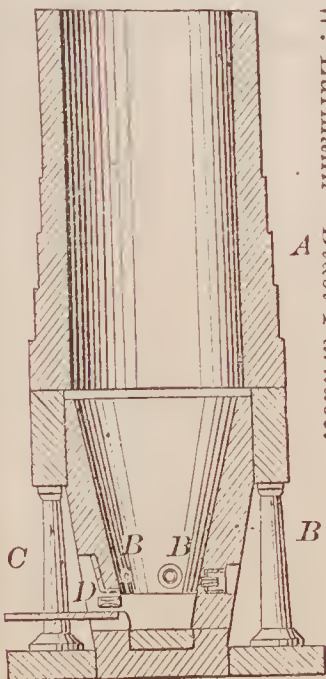

70453—G. R. Metten—Fountain Pen.

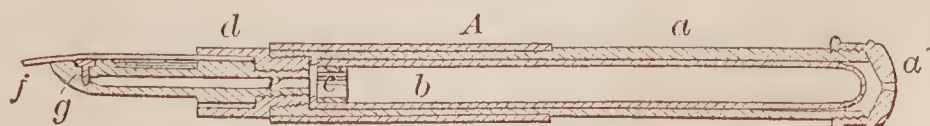





70459—G. Nimms—Eye for Pickaxes.

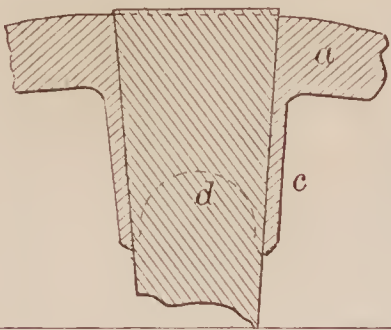

70461—W. W. Page—Cover for Tea Kettles, &c.

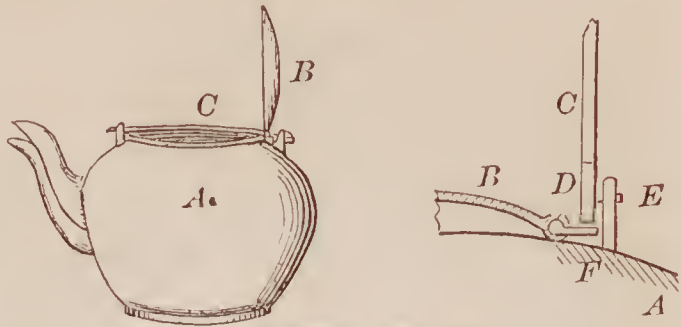

70460—C. M. O'Hara—Propeller for Vessels.

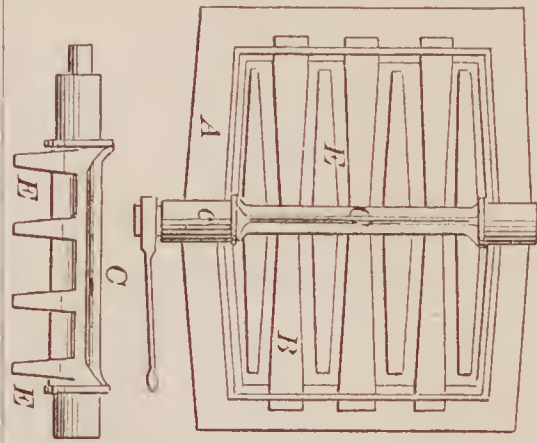
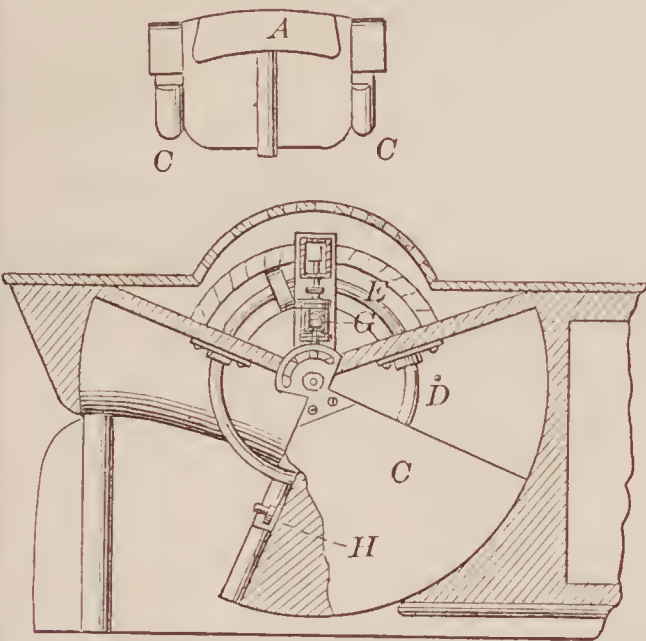

70462—P. A. Palmer—Grate.

70463—W. R. Pape—Breech-Loading Fire Arm.

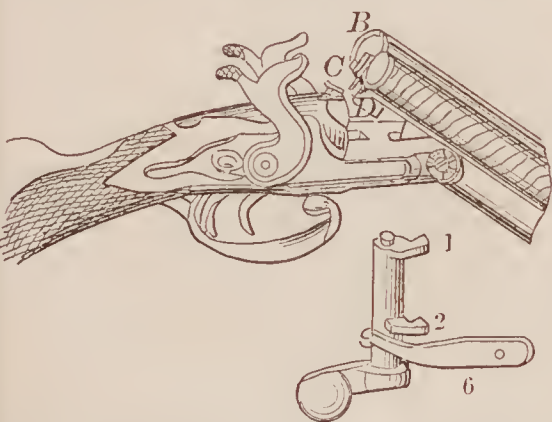

70464—R. Parks—Tag.

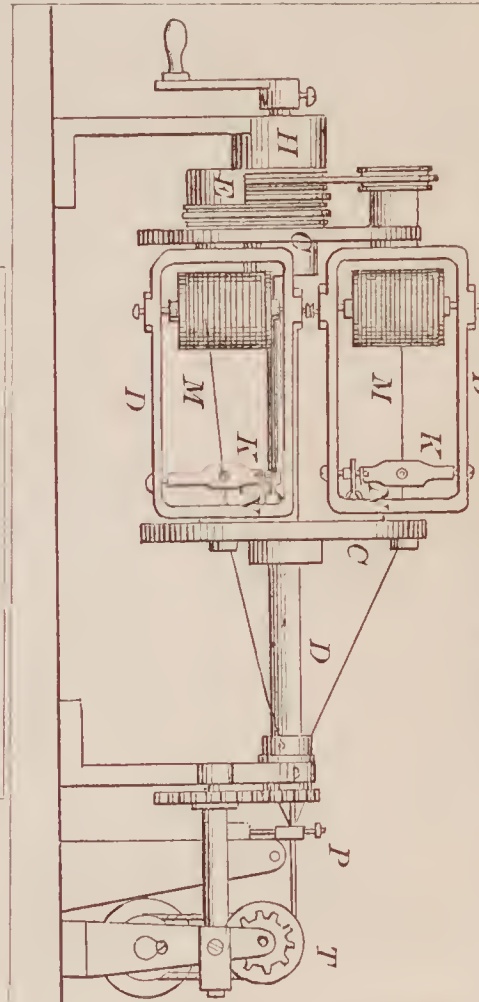

70466—H. Perkins—Rope Making Machine.

70467—W. F. Phelps—For Suspending Maps.

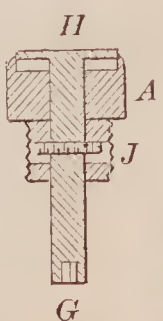
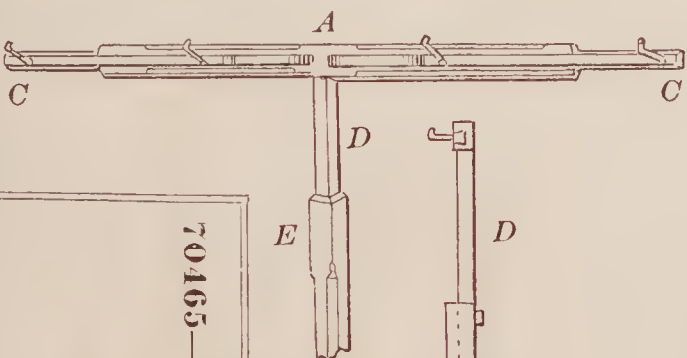

70465—E. Paulus—Watch Key.

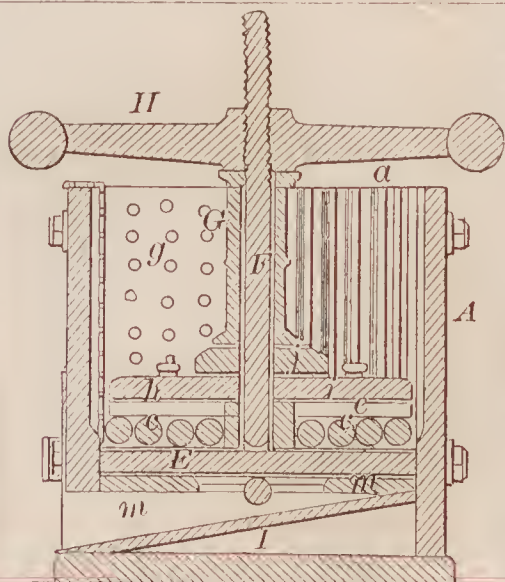

70468—A. L. Rand—Wine Press.



70469—L. Raymond—*Game Table.*

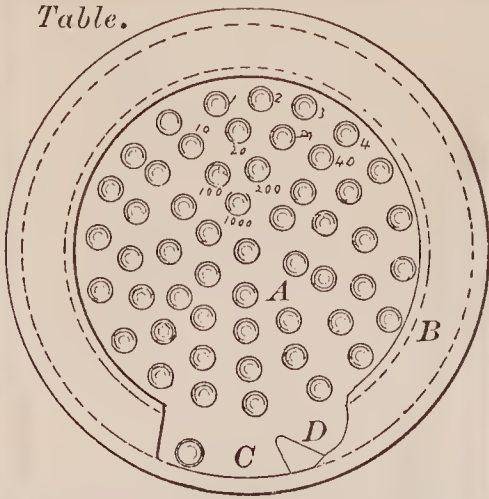

70471—A. R. & N. B. Reynolds—*Tempering Steel.*

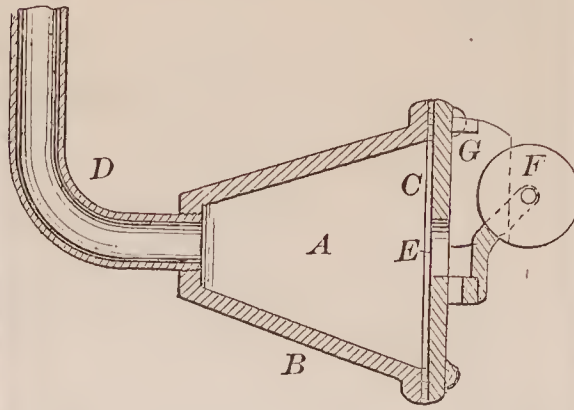

70475—W. Scott—*Carriage Seat Spring.*

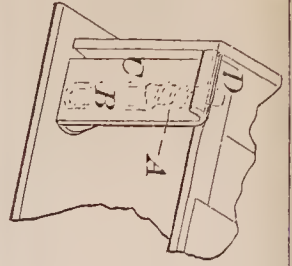

70470—T. Rettew—*Churn.*

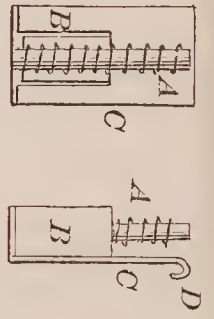
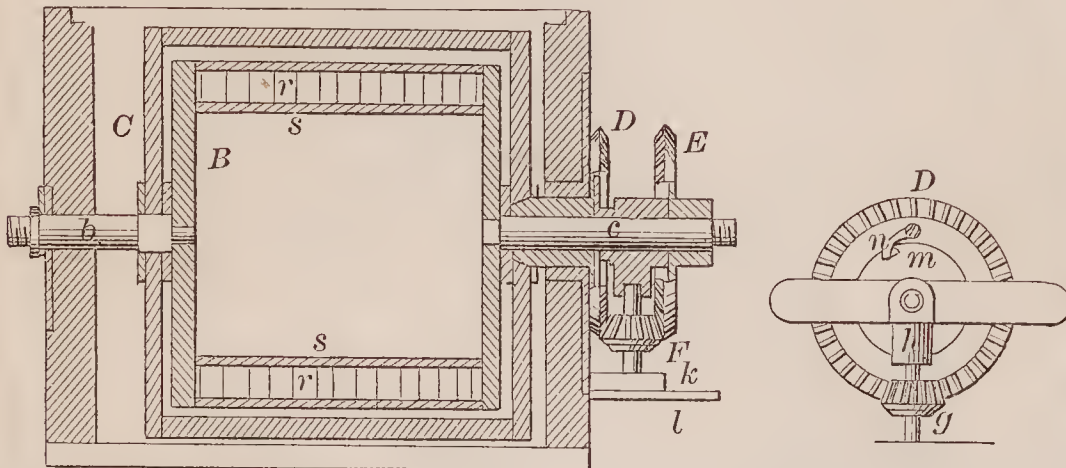

70472—Rice & Hitchcock—*Horse Hoe.*

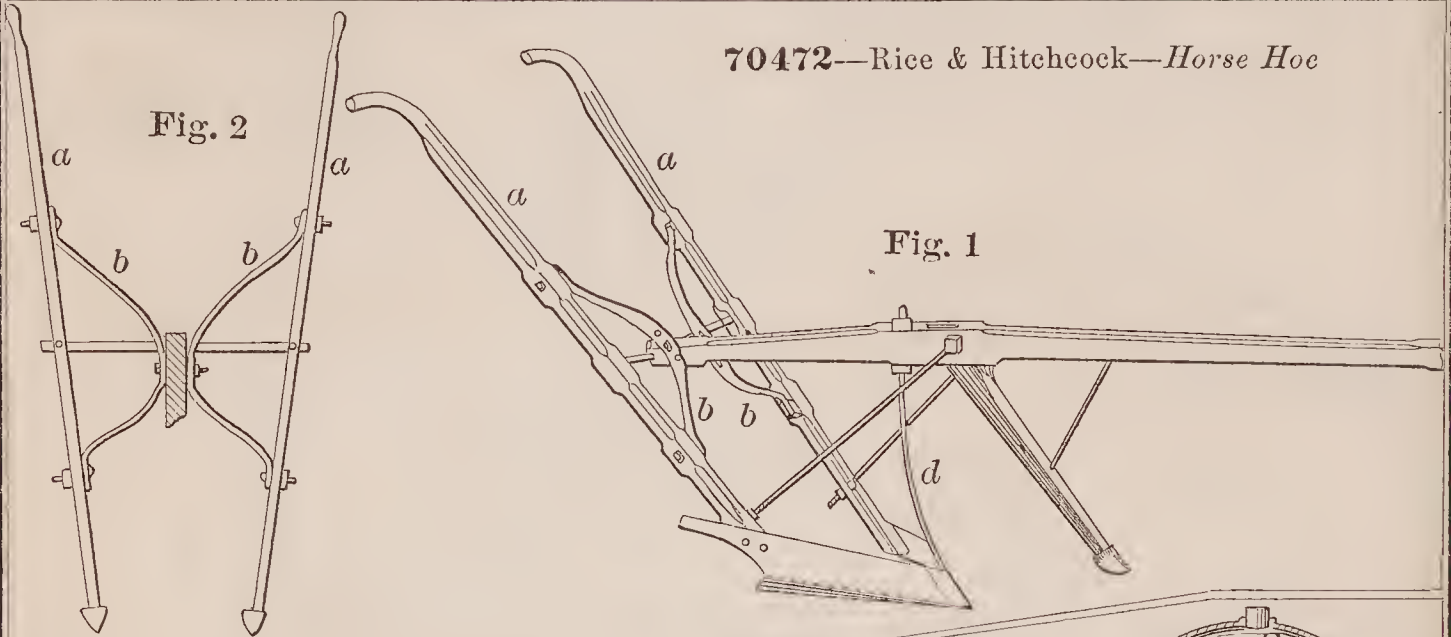

70473—A. J. Ross—*Hitching Strap.*

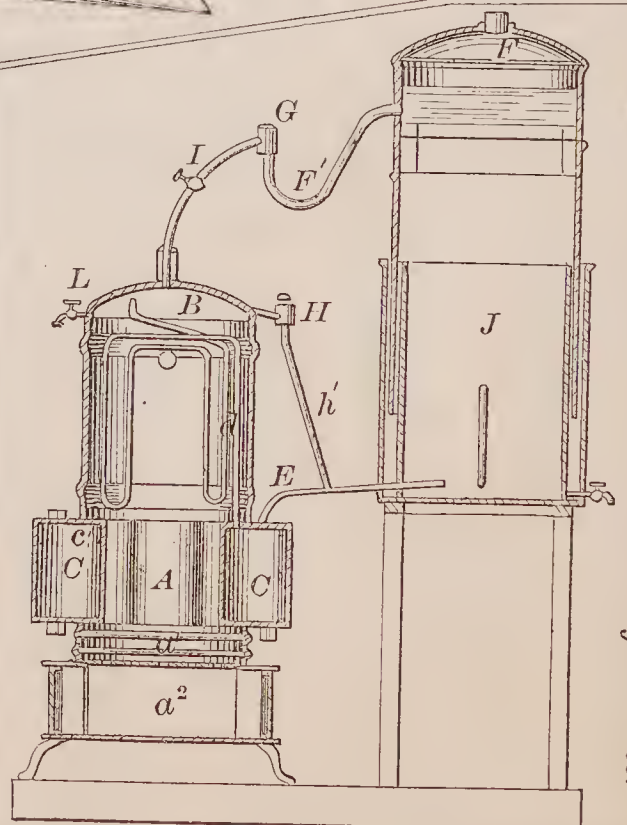
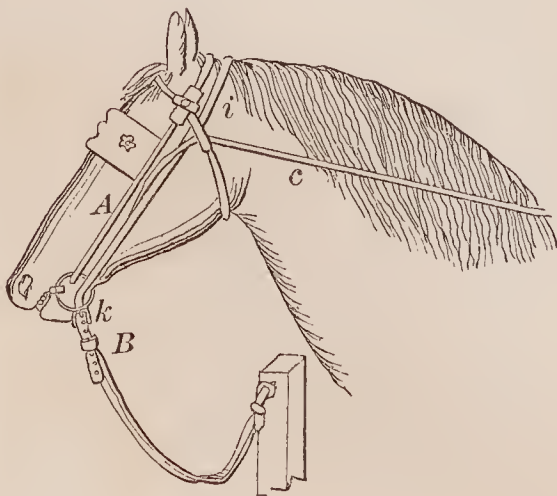

70477—W. M. Sloane—*Gas Generating Furnace.*

70479—J. H. Sternbergh—Metal Planer.

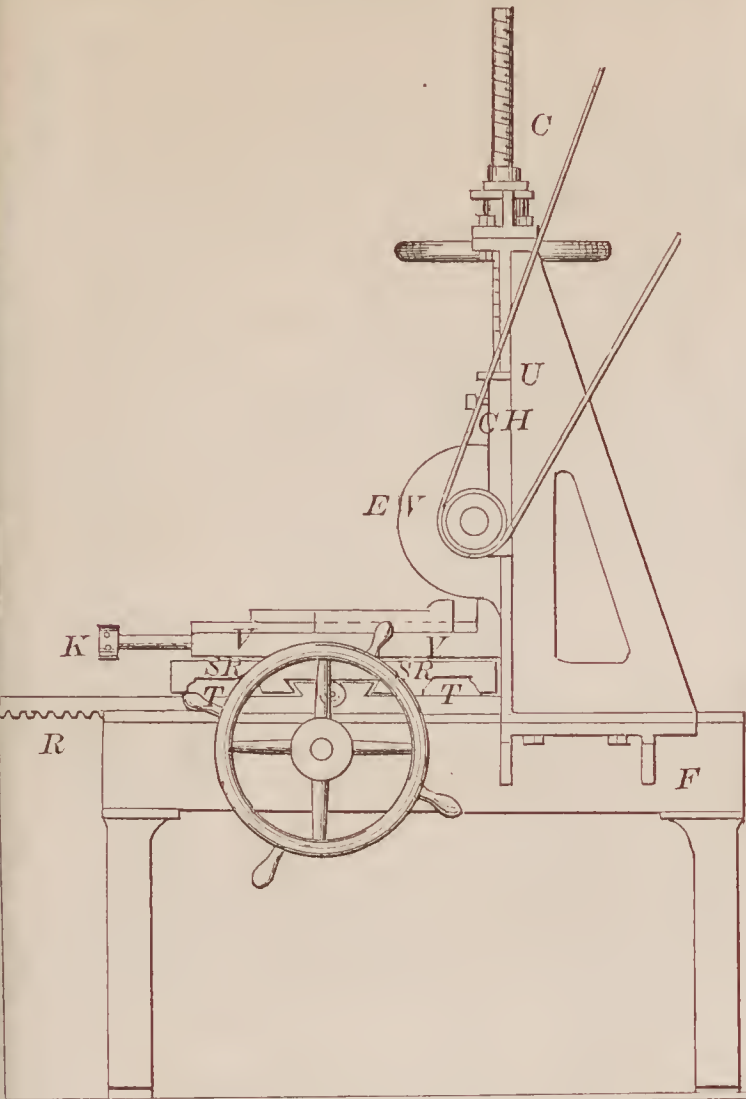

70480—Stevens & Knight—Mail Bag.

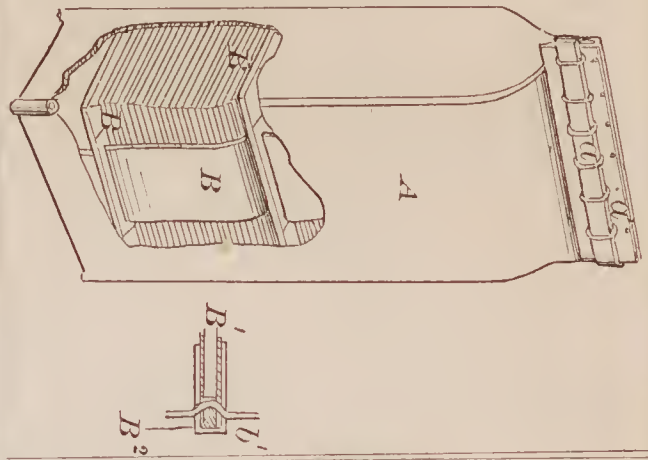

70483—A. Thomas—Lathe Way Smoother.

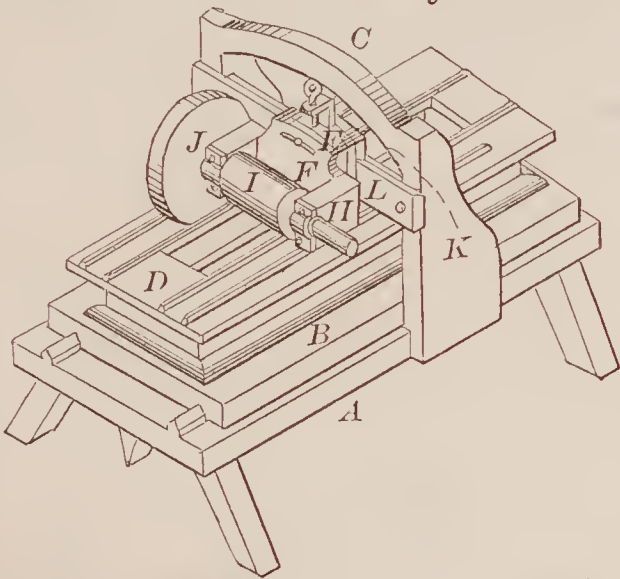

70481—E. M. Stevens—For Cutting Boot and Shoe Soles.

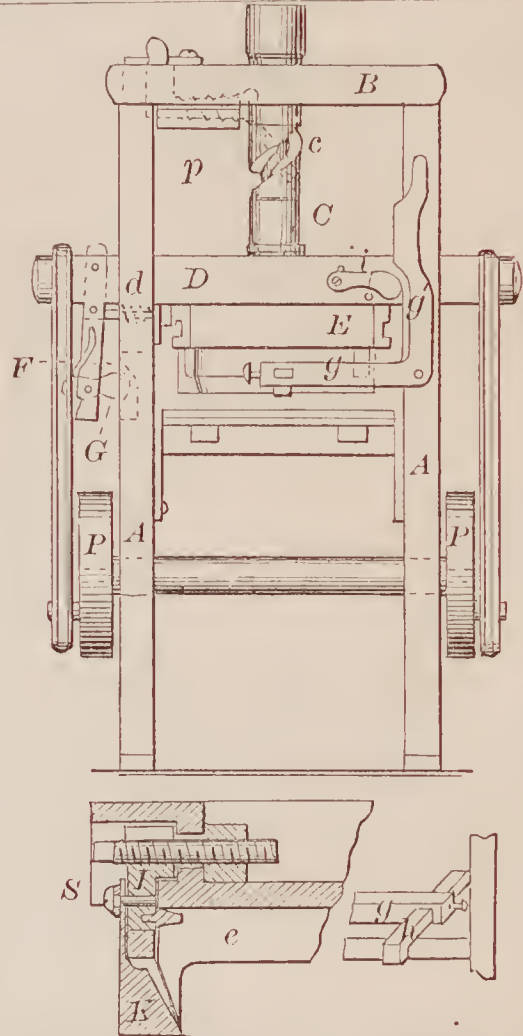

70482—J. B. Tarr—Mould for Casting Car Wheels.

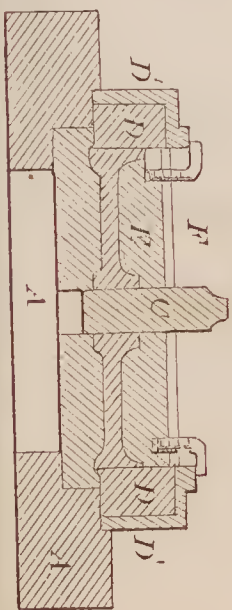

70484—H. C. Thompson—Wire Bell for Clocks.

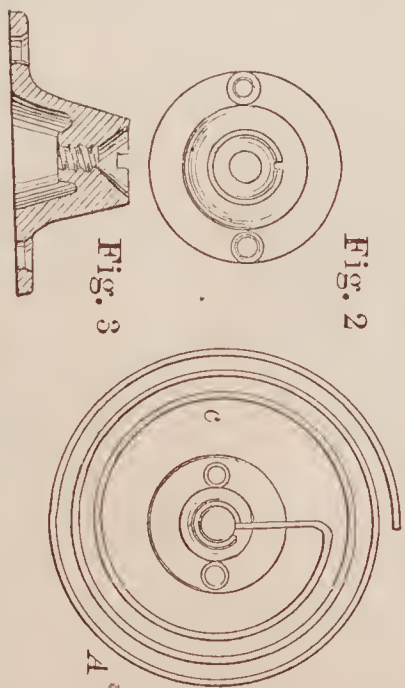

70486—S. H. Whitaker—For Casting Car Wheels.

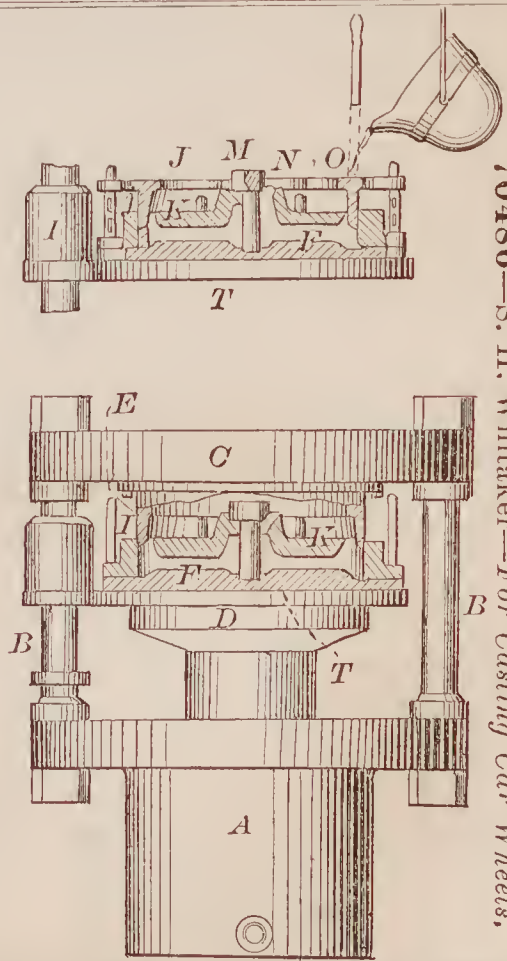



70487—C. F. Wickwire—Window Sash Fastener.

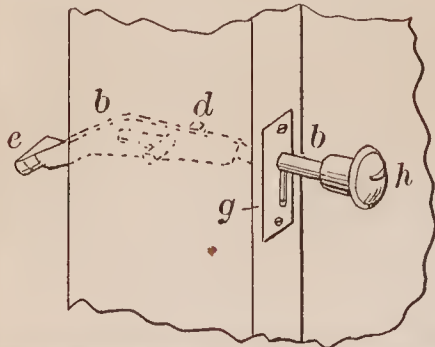

70488—W. W. Wilcox—Fastening Eyelets.

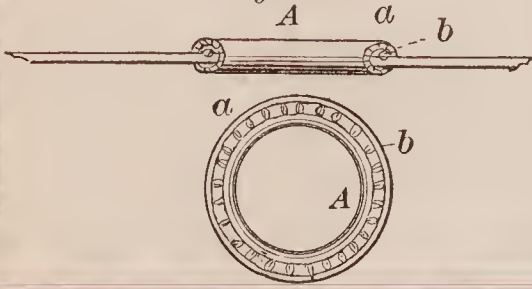

70493—Albright & De Lange—Hat.

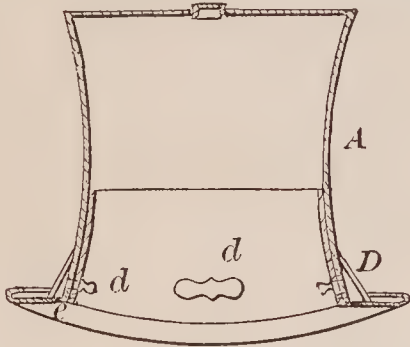

70492—W. Youmans—Car Truck.

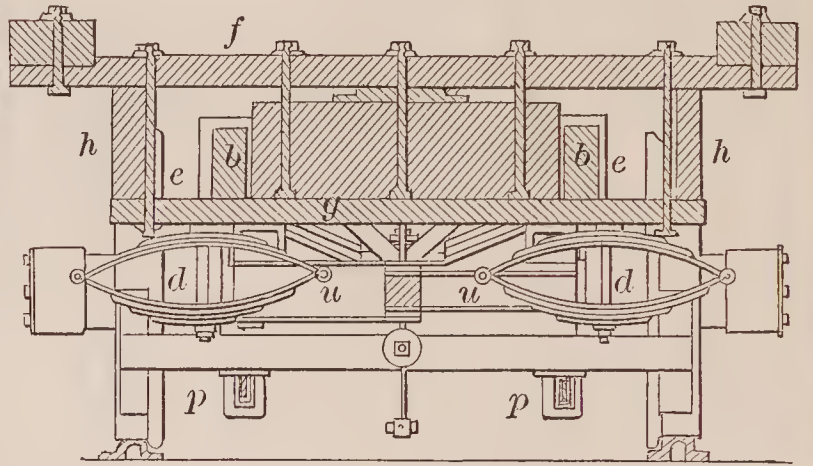
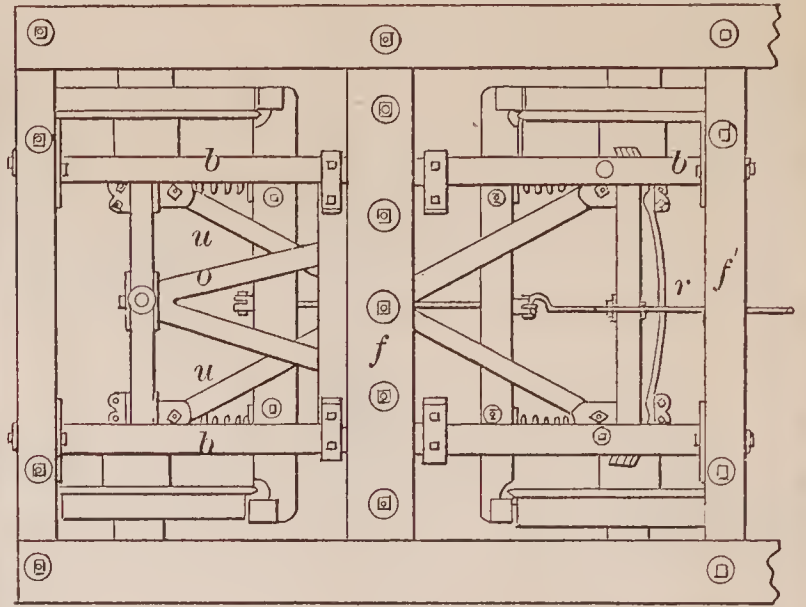

70489—H. W. Williams—Bed Bottom.

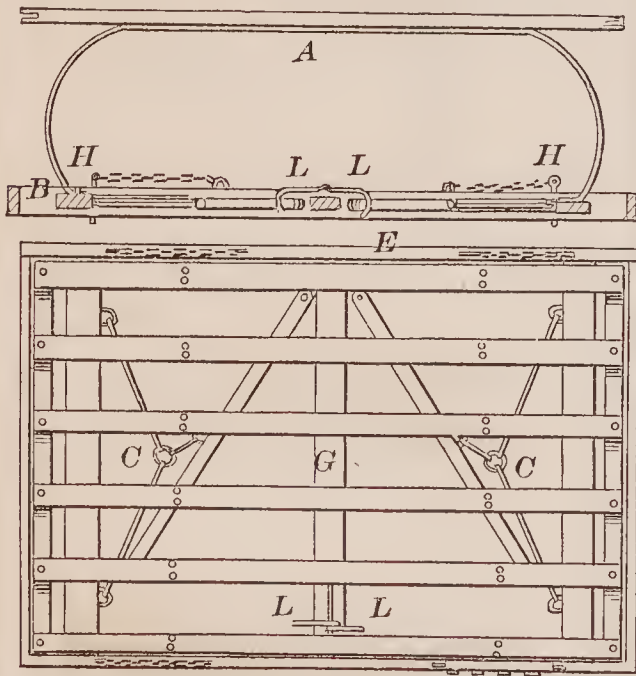

70491—Woolsey & Hubbell—Sled.

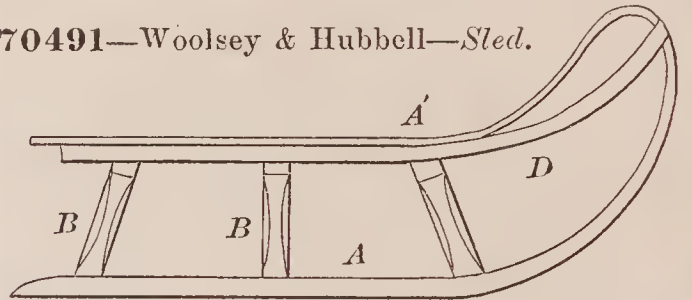

70495—Continued on next page.

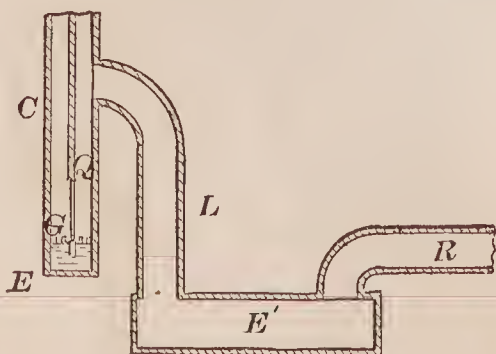

70490—E. S. Winchester—Tip for Chair Legs.

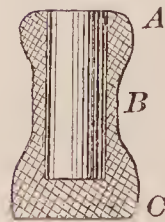

70494—C. E. Alden—Gas Stove.

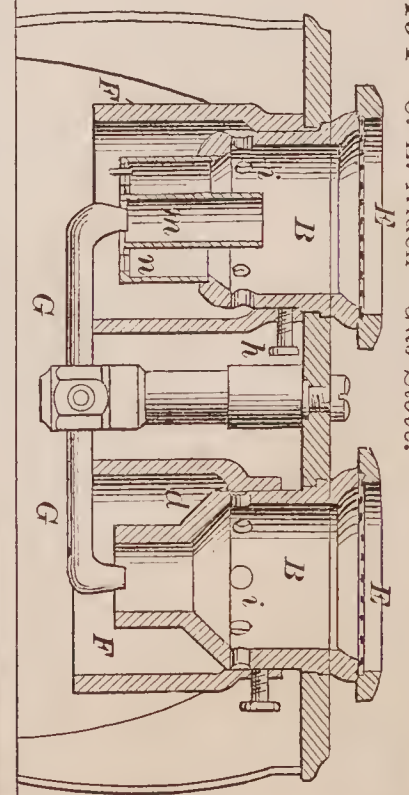

70499—C. H. Atwood—*Snap Hook.*

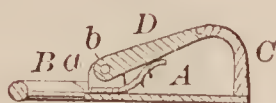

70498—Armstrong & Browne—*Anchor.*

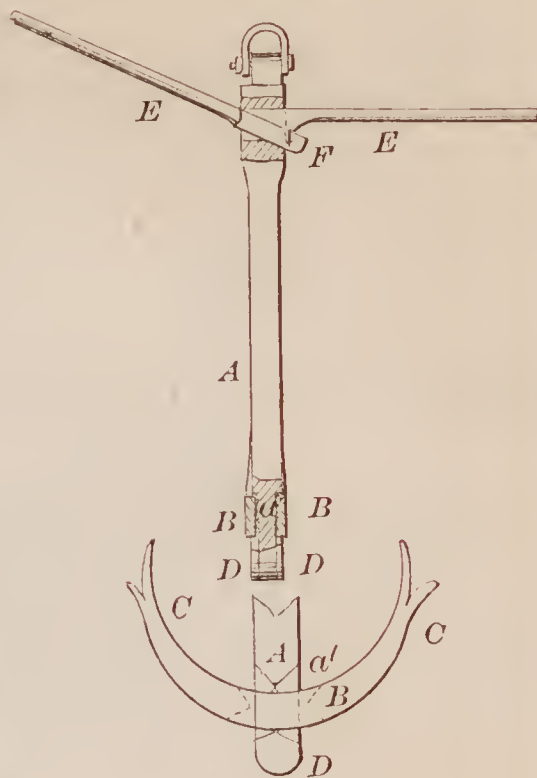

70495—Allen & Campbell—*Heating and Ventilating Railway Cars.*

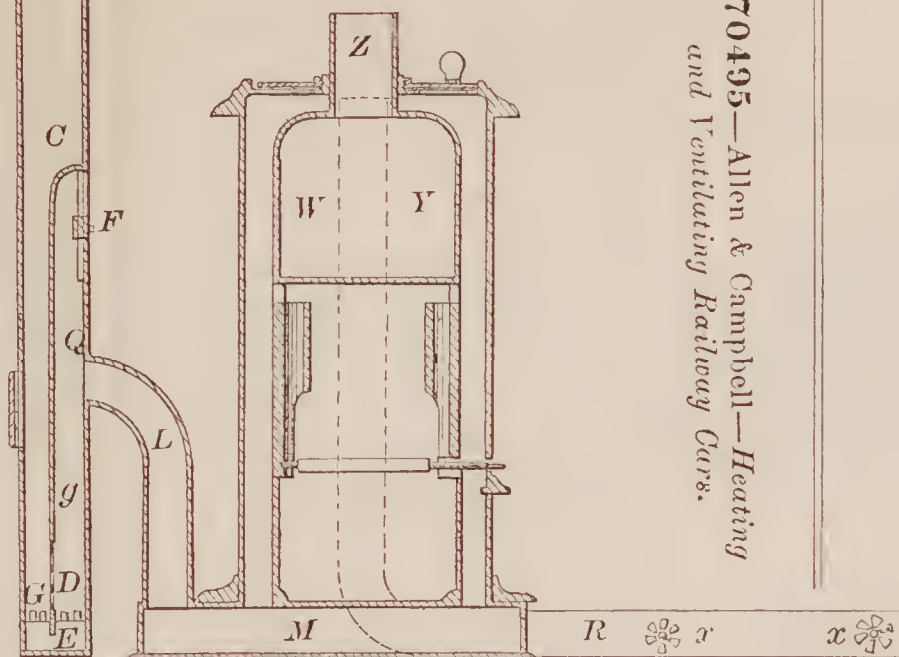

70496—J. M. Allen—*Nail Machine.*

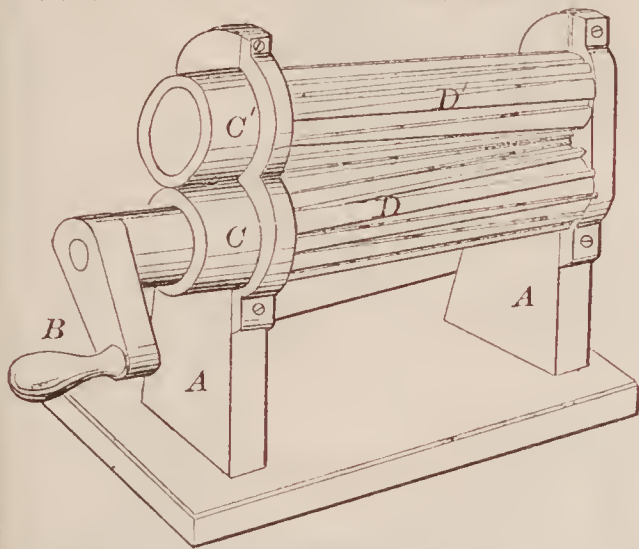

70497—P. Allen—*Railway Chair.*

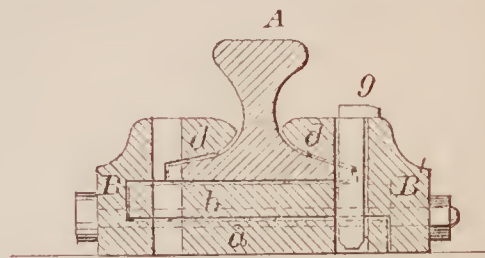

70500—E. D. Averell—*Card Rack.*

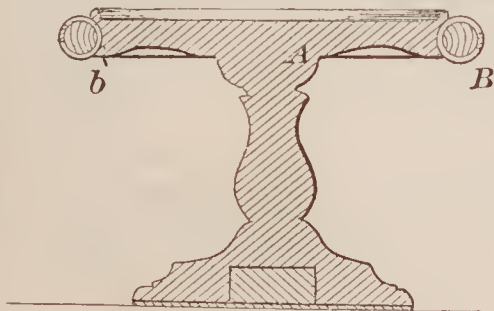

70501—H. Axtel—*Whip Rolling Machine.*

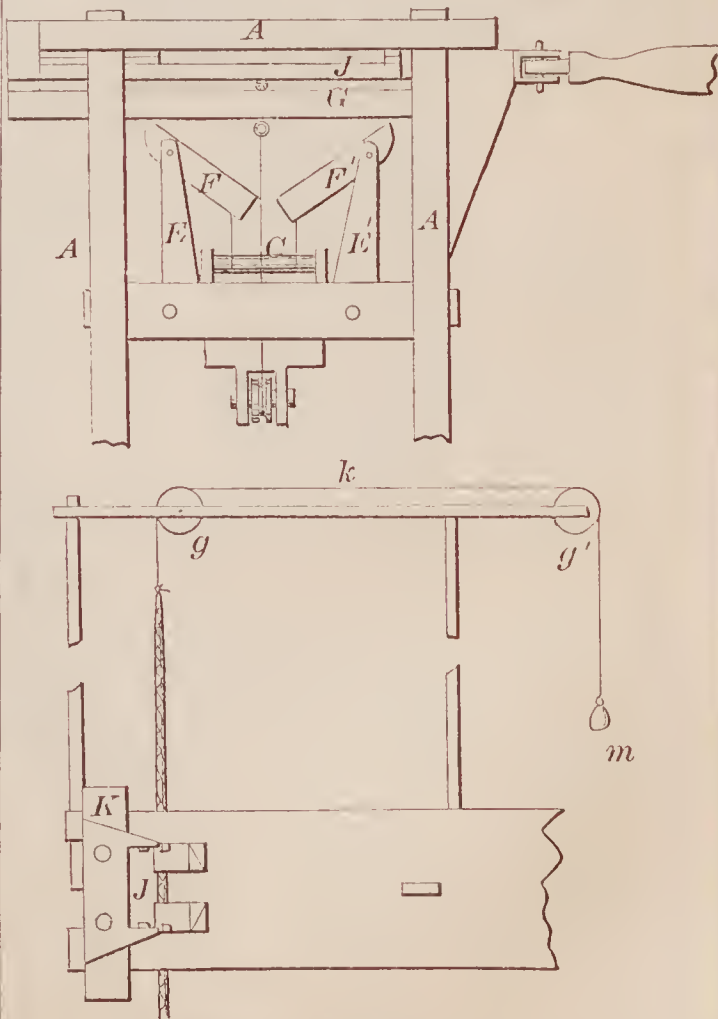

70502—T. J. Barnes—*Horse Yoke.*

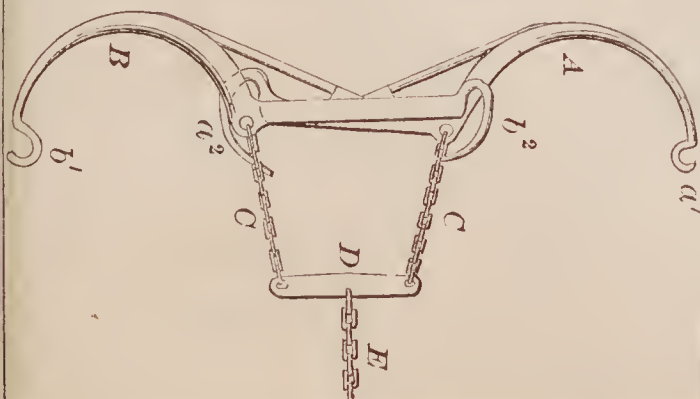



70503—J. W. Barnum—Cotton Bale Tie.

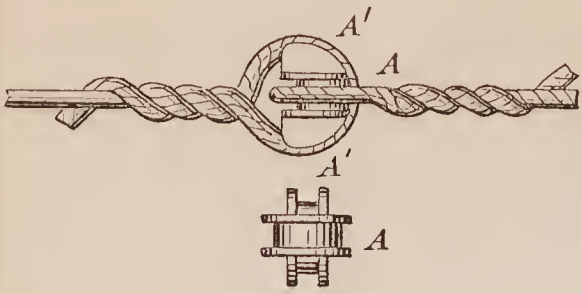

70504—A. E. Beach—Pneumatic Railway.

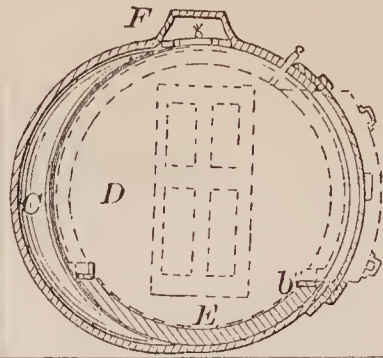

70506—H. Beebe—Cane and Umbrella.

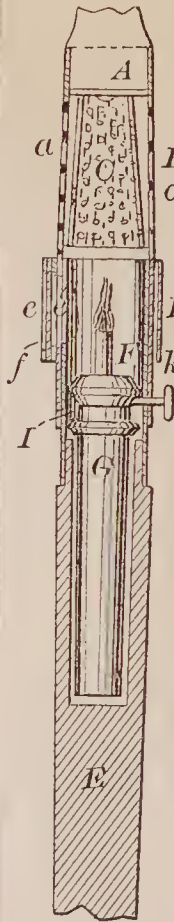

70507—W. J. Berne—Horse Shoe Calk.

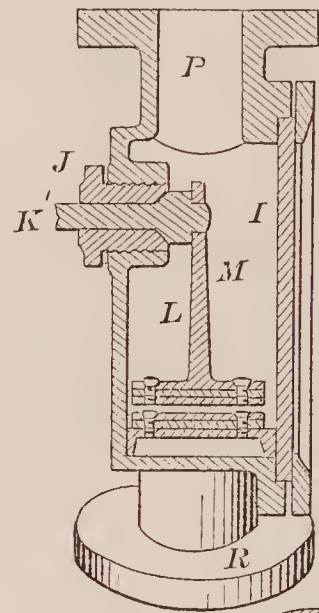
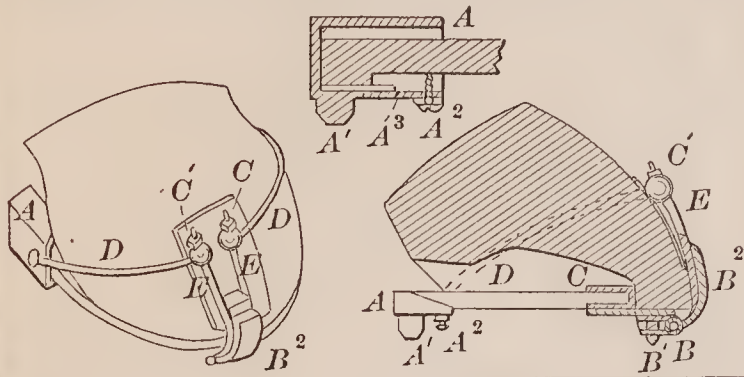

70508—J. Bevis—Washing Machine.

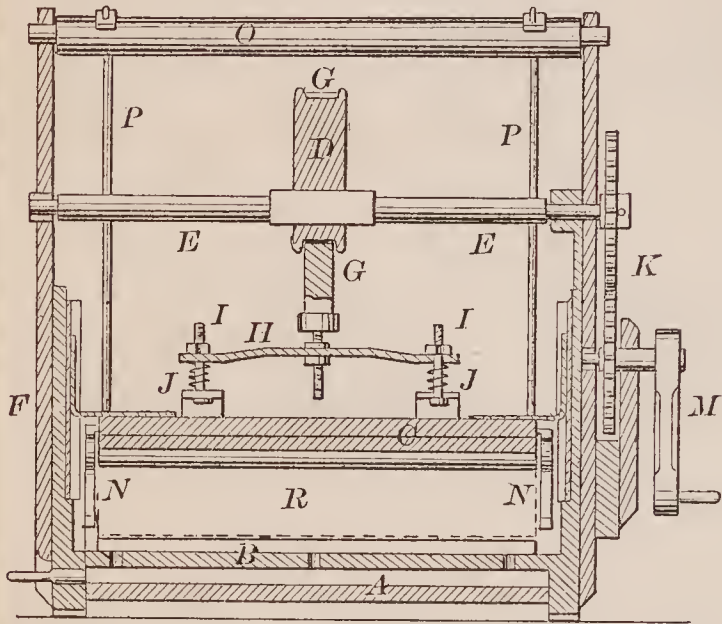

70511—E. Bourdon—For Operating Folding Valves.

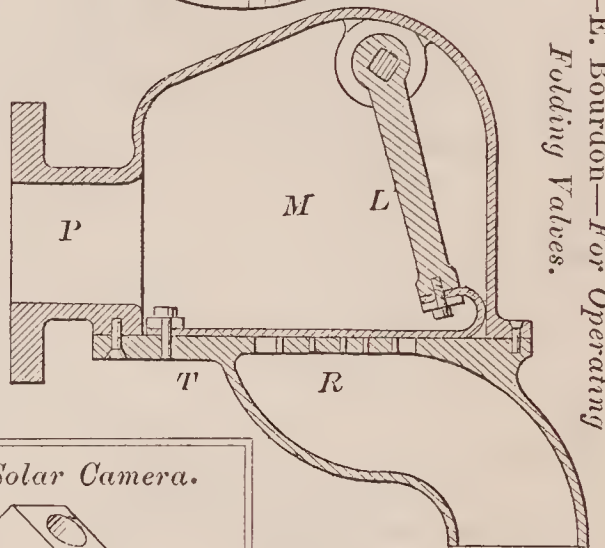

70509—L. G. Bigelow—Solar Camera.

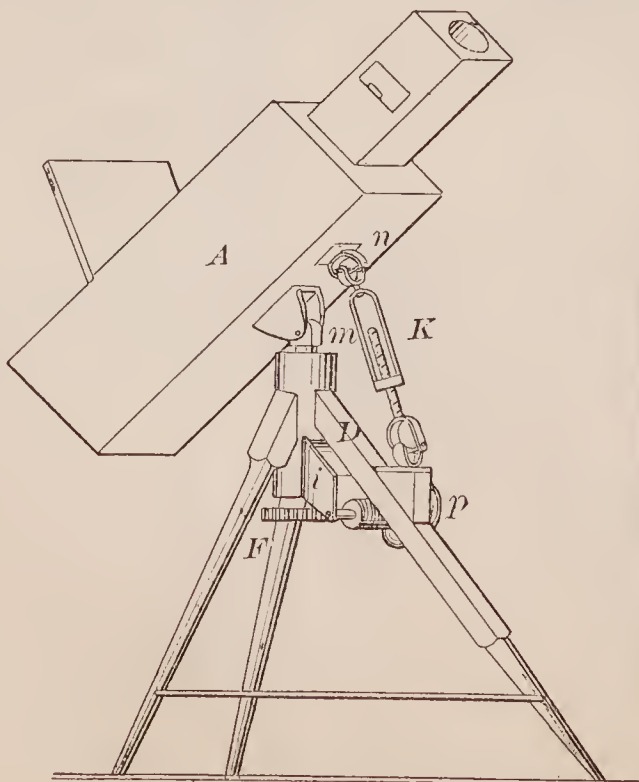

70505—G. M. Beardsley—Car Coupling.

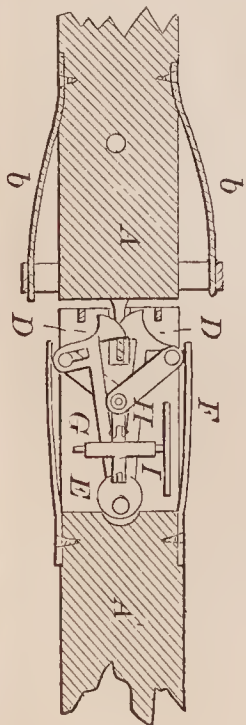

70512—J. F. Boynton—Car Warming Gas and Air.

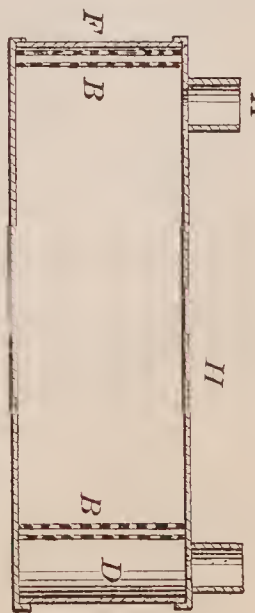



70514—J. L. Brown—Wood Pavement.

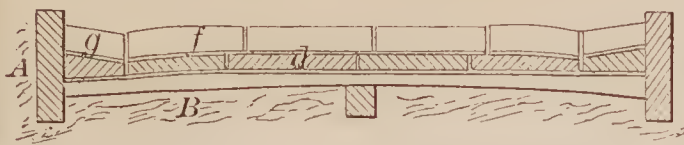

70515—G. R. Burdon—Blacking Brush.

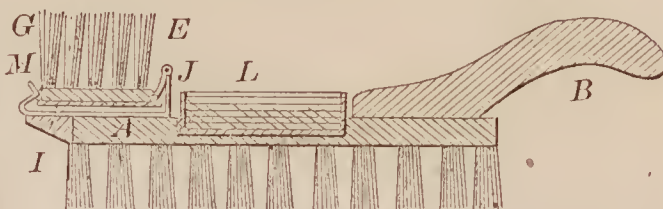

70516—N. C. Burnap—Milk Can.

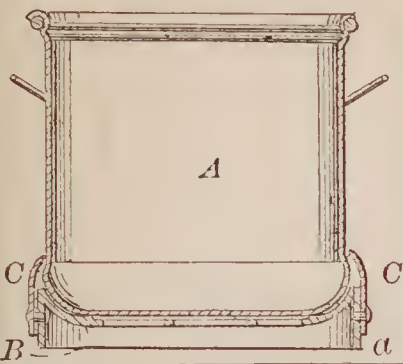

70517—J. Bart—Carriage Seat Back.

70519—W. M. Butler—For Sharpening Horse Shoe Calks.

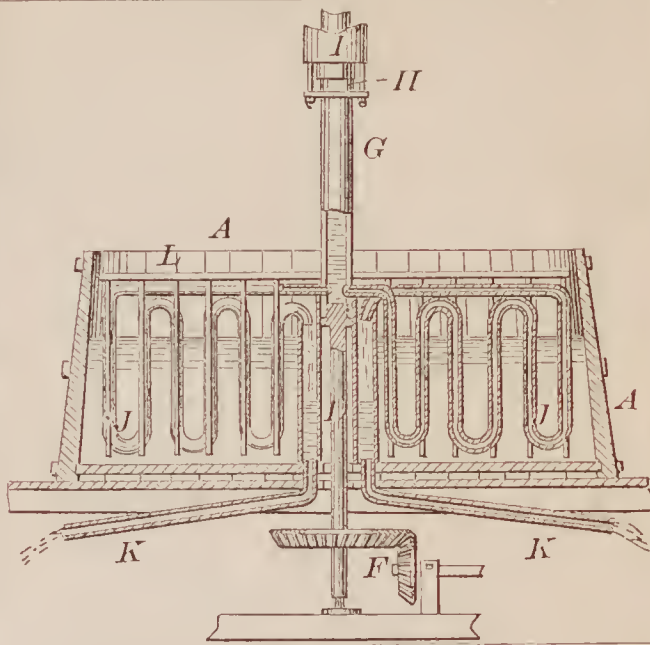
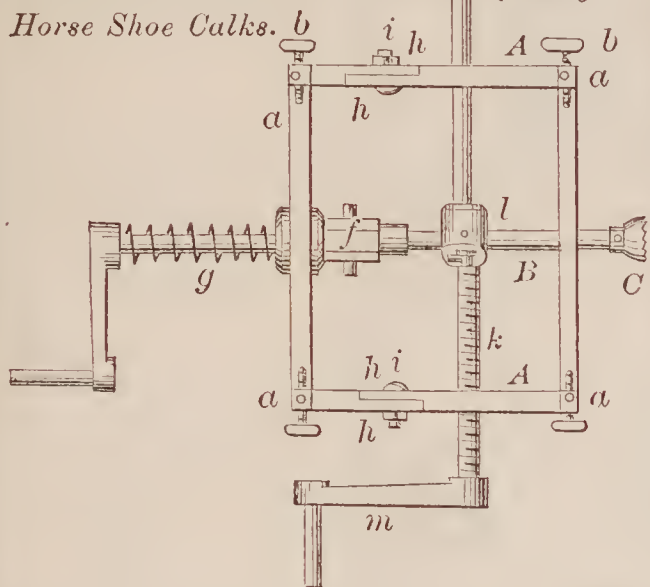

70518—F. P. Bush—Mash Cooler.

70522—L. W. Campbell—Piston Packing.

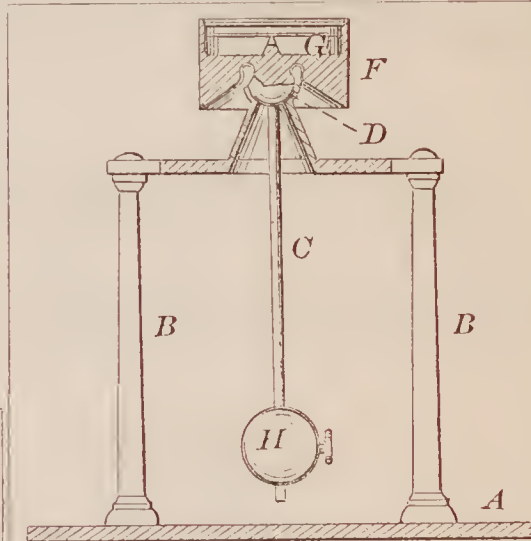
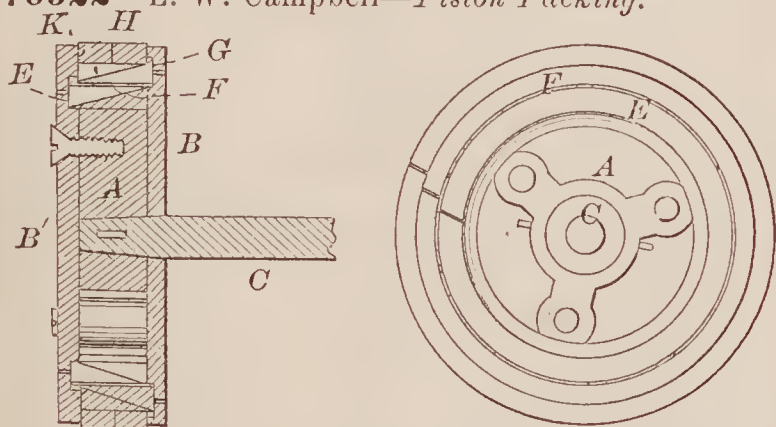

70520—J. Earl—Ship's Compass.

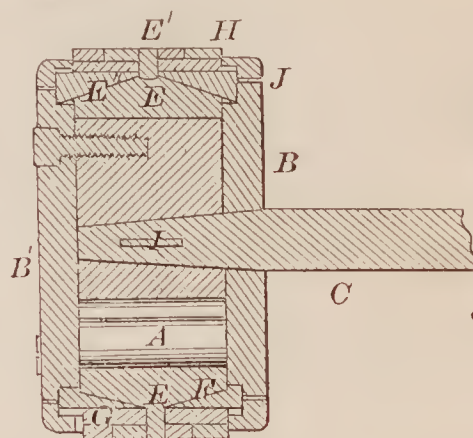

70521—L. W. Campbell—Piston Packing.

70524—H. C. Chandler—Cylinder Printing Press.

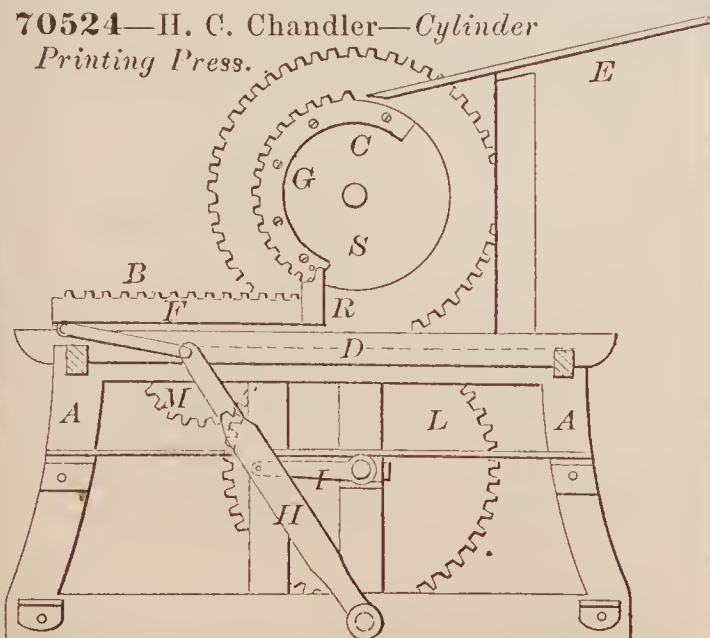

70523—J. P. Champion—For Raising Horses' Legs for Shoeing.

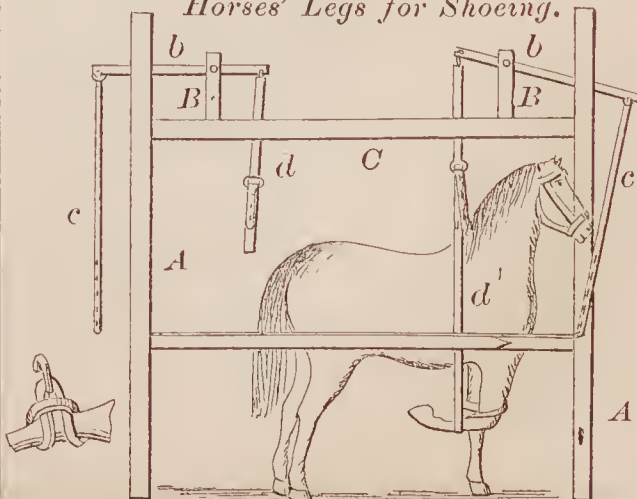



70525—M. Chapman—Table Cutlery.



70526—C. R. Clark—Sleigh Bell.

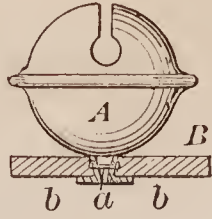

70529—B. W. Collier—Combined Tool.

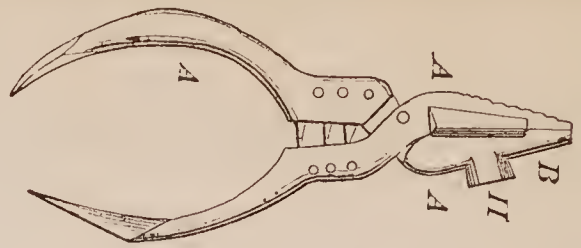

70527—M. Coffin—Horse Hay Fork.

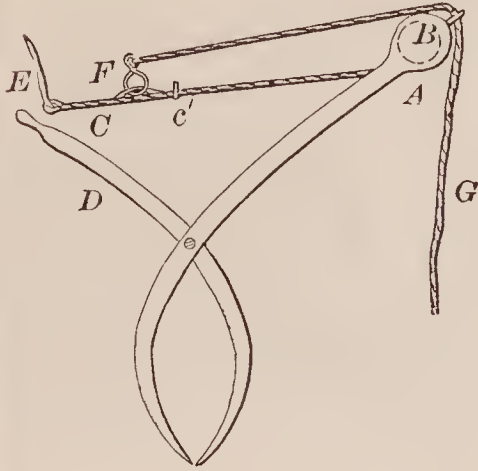

70530—C. W. Compton—Corpse Preserver.

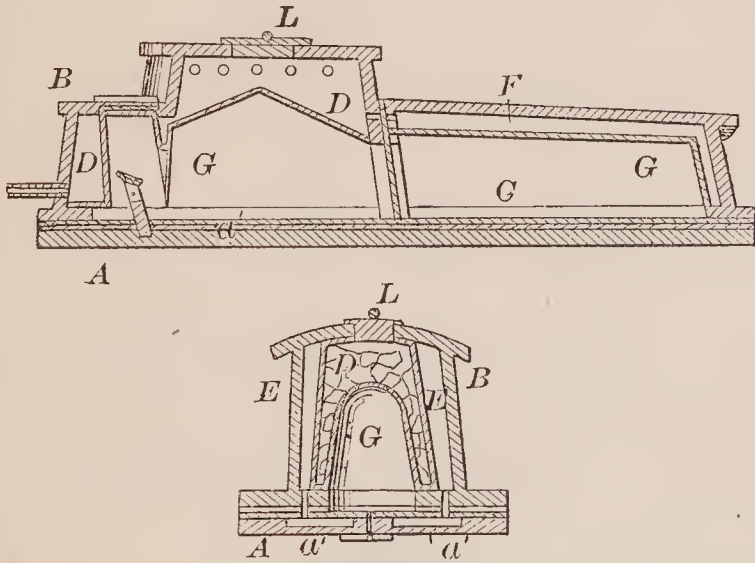

70528—E. T. Colburn—Stopping and Starting Cars.

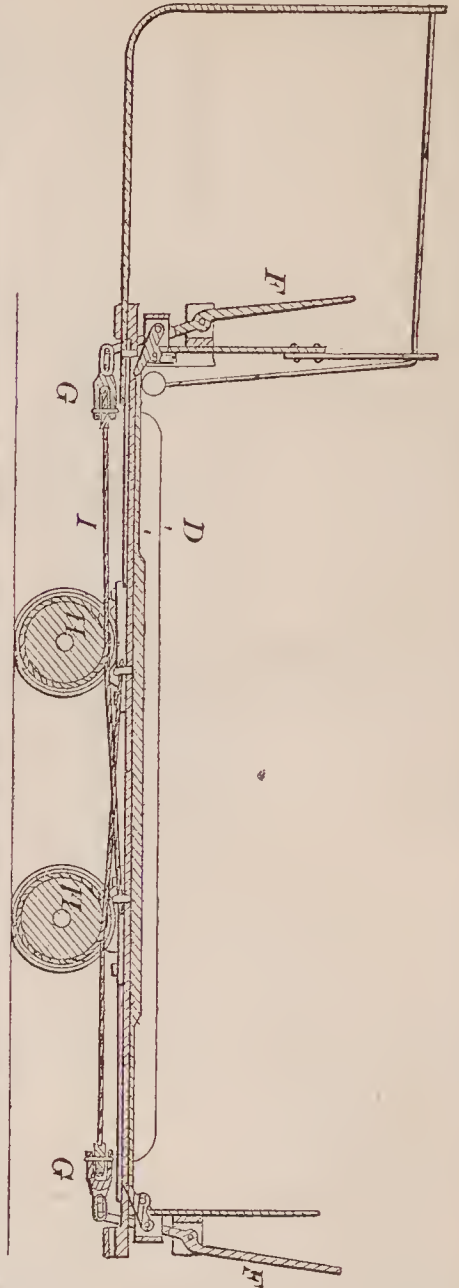

70531—H. W. Comstock—

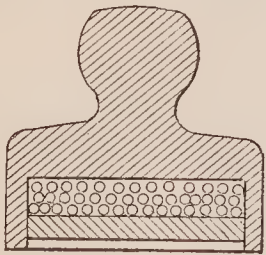

Weight for Scales.

70533—E. N. Curtice—Wagon Brake.

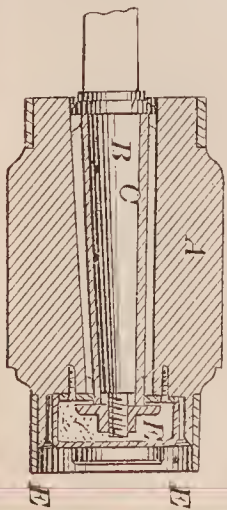
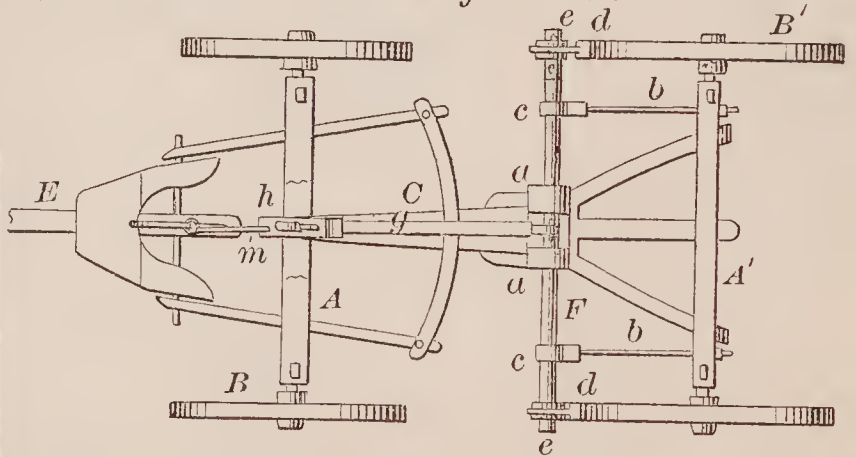

70532—L. Crouch—Attaching Wheels to Vehicles.

70534—F. Curtis—Suction Box for Paper Making.

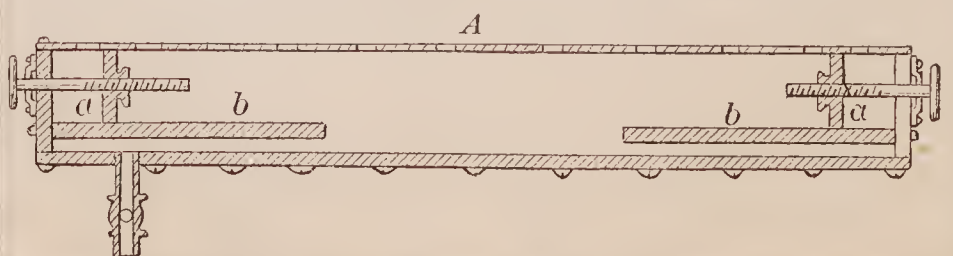

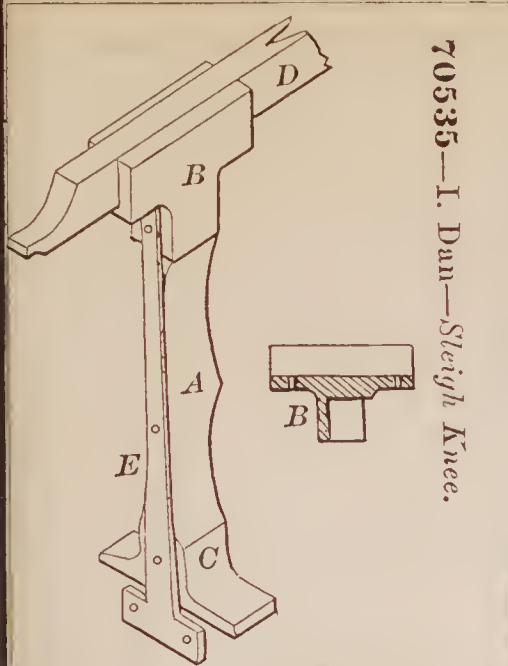

70535—I. Dan—Sleigh Knee.



70542—W. H. Forker—Paint Brush.

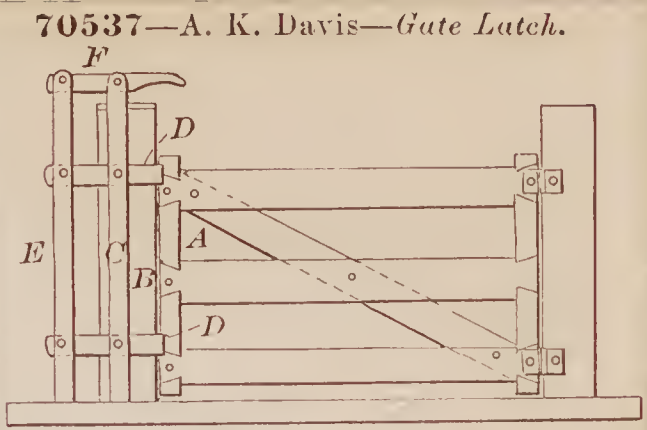

70537—A. K. Davis—Gate Latch.

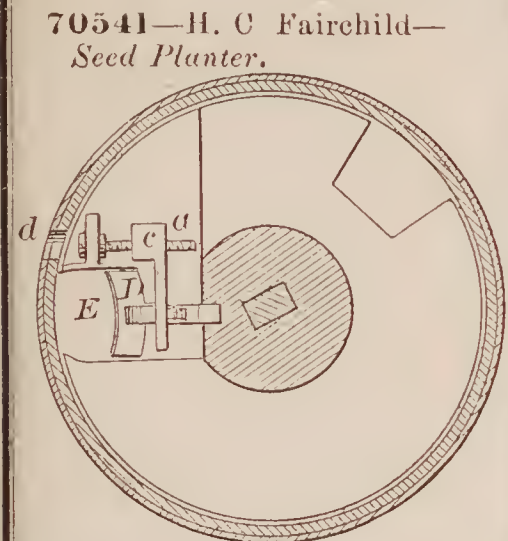

70541—H. C. Fairchild—Seed Planter.

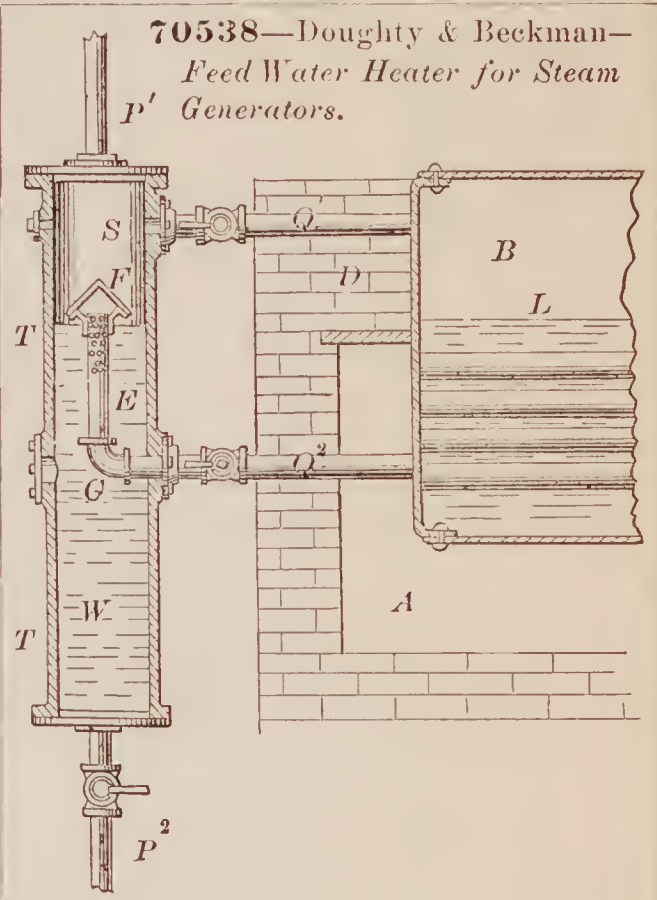

70538—Doughty & Beckman—Feed Water Heater for Steam P' Generators.

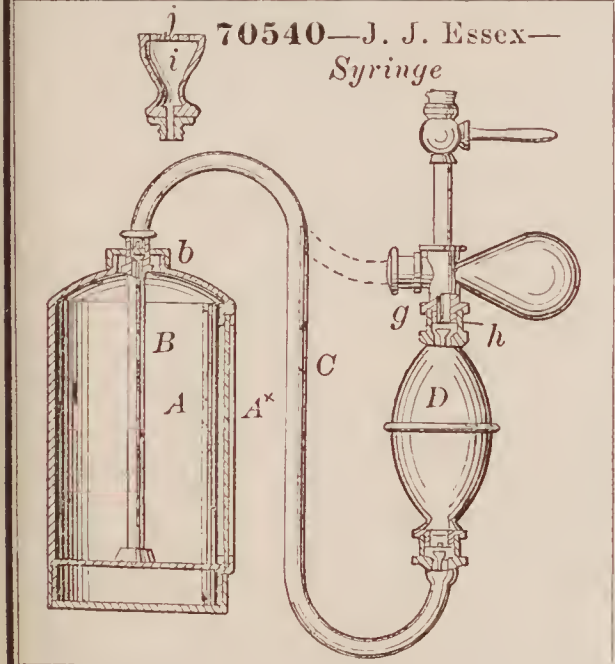

70540—J. J. Essex—Syringe

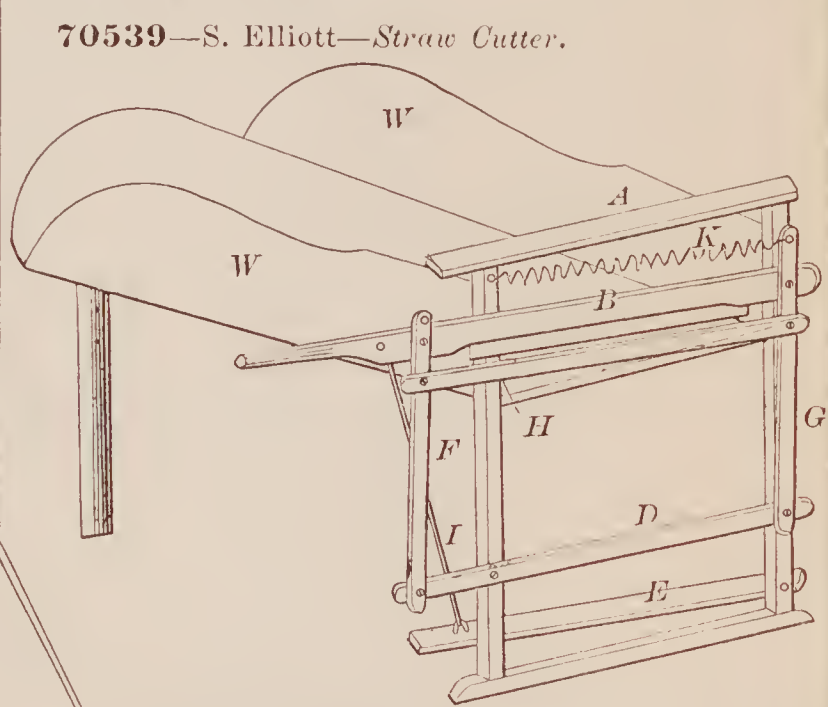

70539—S. Elliott—Straw Cutter.

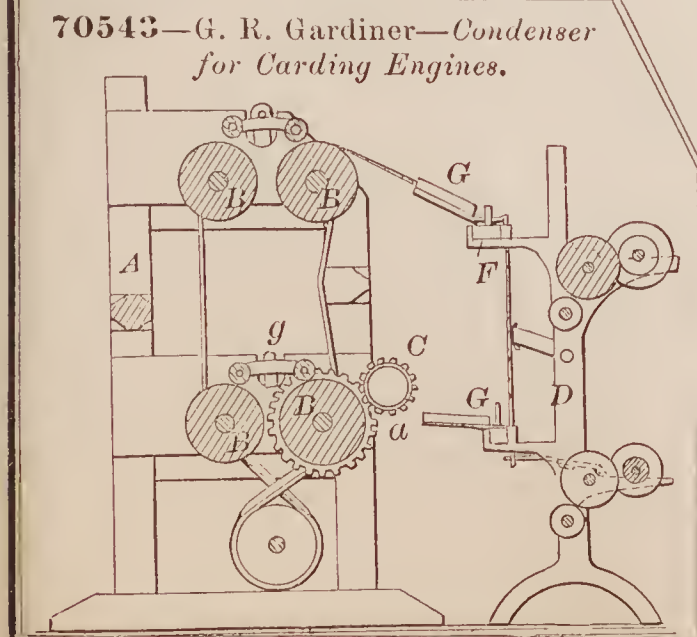

70543—G. R. Gardiner—Condenser for Carding Engines.

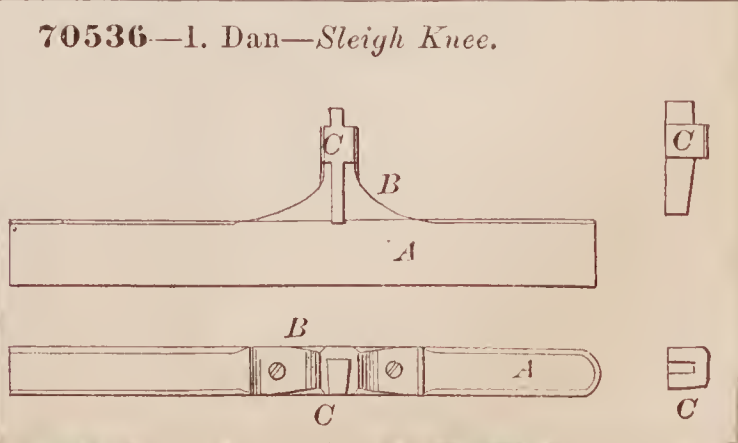

70536—I. Dan—Sleigh Knee.



70544—A. W. Gifford—Scissors Sharpener and Cloth Ripper.

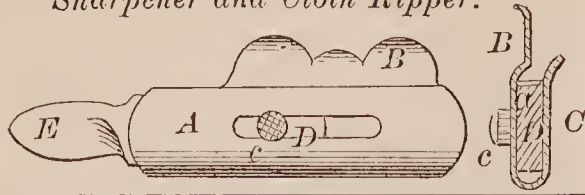

70545—N. Goddard—For Splitting Whalebone.

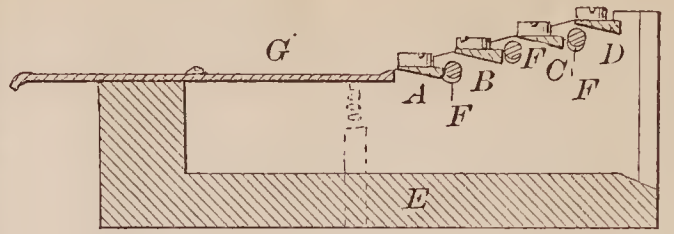

70546—E. A. Goodes—Weighing and Measuring Cup.

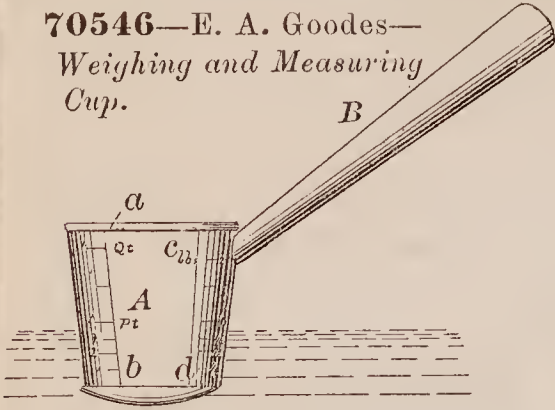

70550—A. J. Greene—Hay Rake.

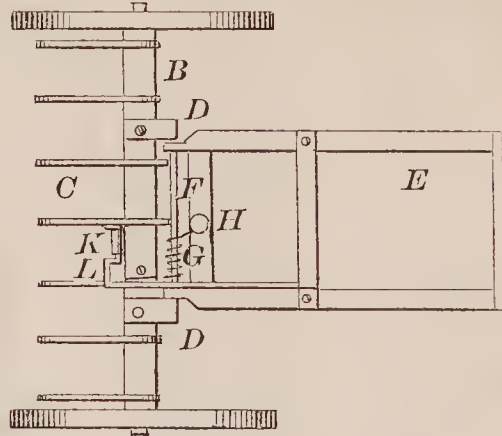

70549—I. M. Green—Fence.

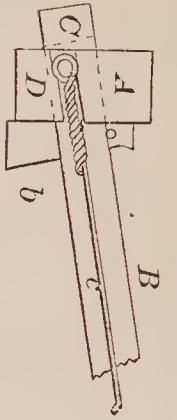

70547—J. Graham—Barel and Try Square.

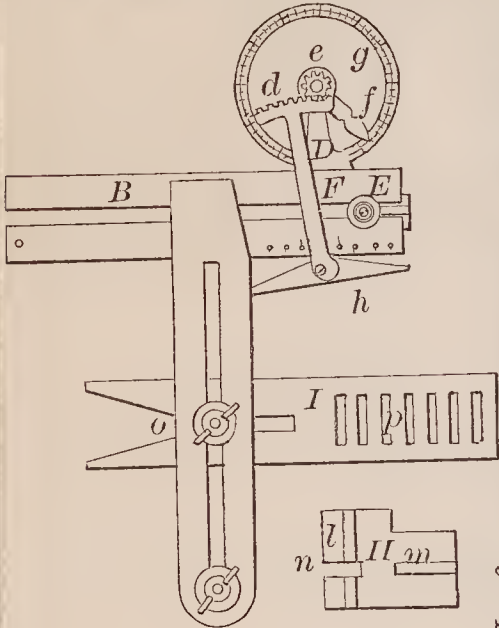

70548—O. Graham—Farm Gate.

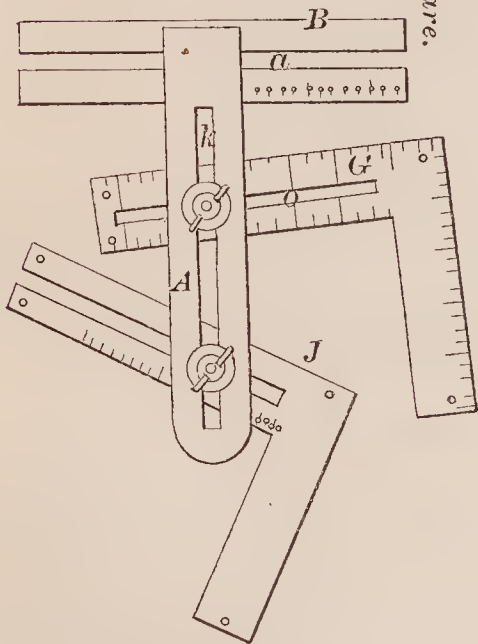
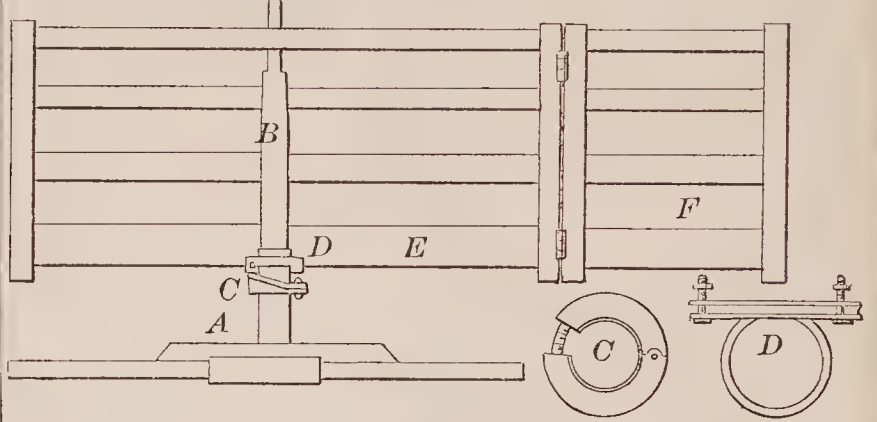

70552—Gross & Yingling—Annunciator.

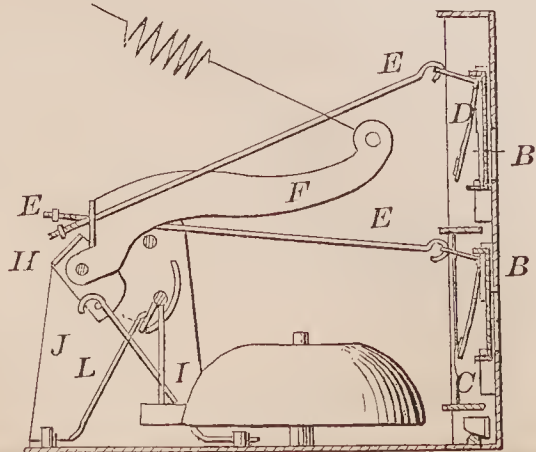

70553—J. C. Guerrant—Engraving Machine.

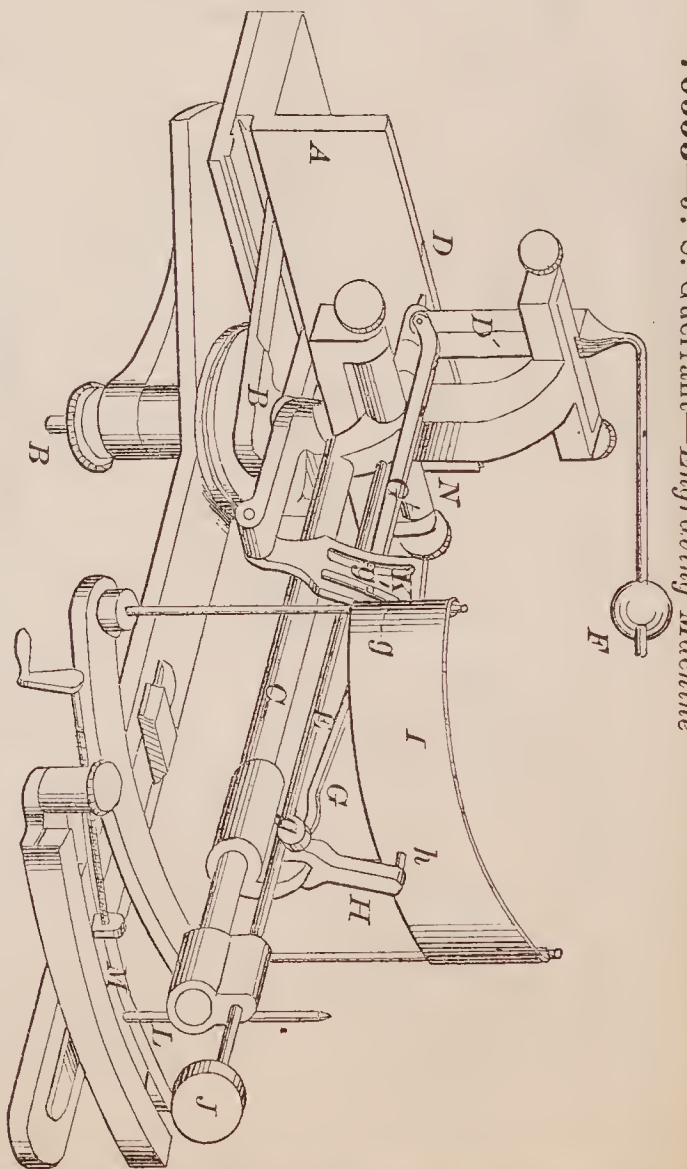

70554—Guthrie & Shearer—*Ornamenting Glass Shades.*

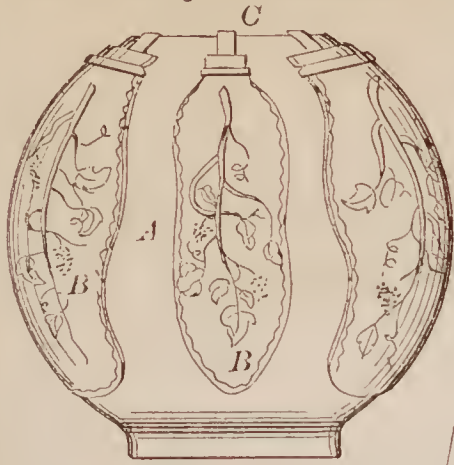

70555—R. Hale—*Head Rest.*

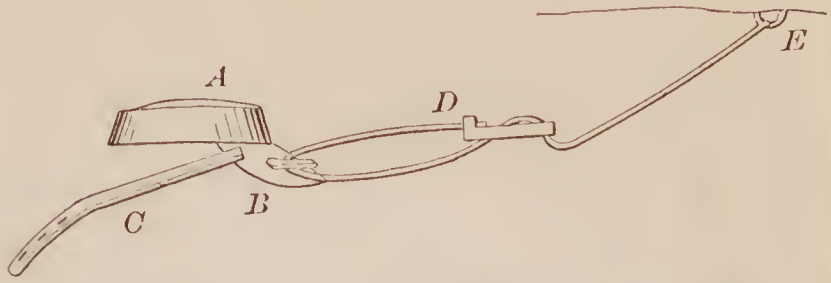

70557—D. Hargar—*Furnace.*

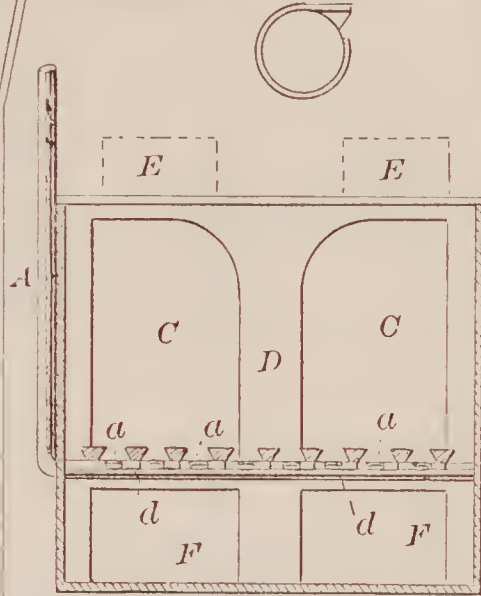

70560—J. Harris—*Car Wheel.*

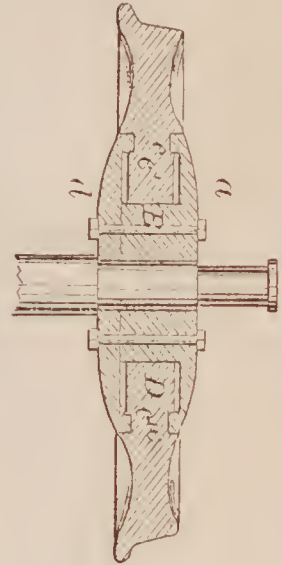

70556—M. Hamburger—*Reversible Chair Seat.*

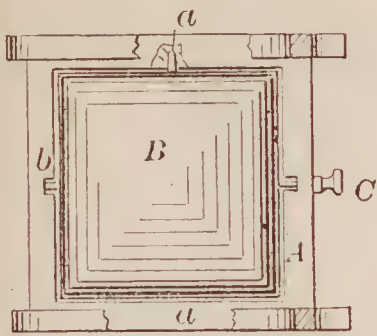

70558—B. B. Harris—*For Stamping and Shaping Leather.*

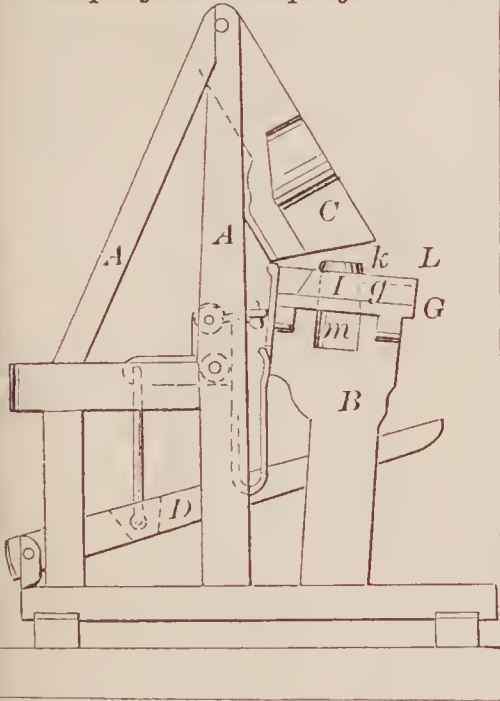

70562—Hayes & Morris—*Gate Fastening.*

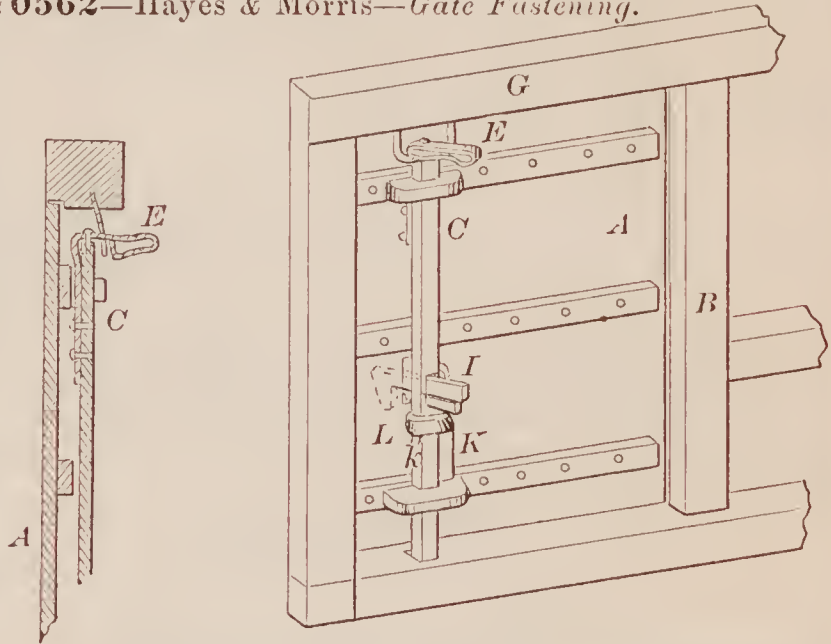

70563—J. E. Heath—*Tool for Cutting Bolts.*

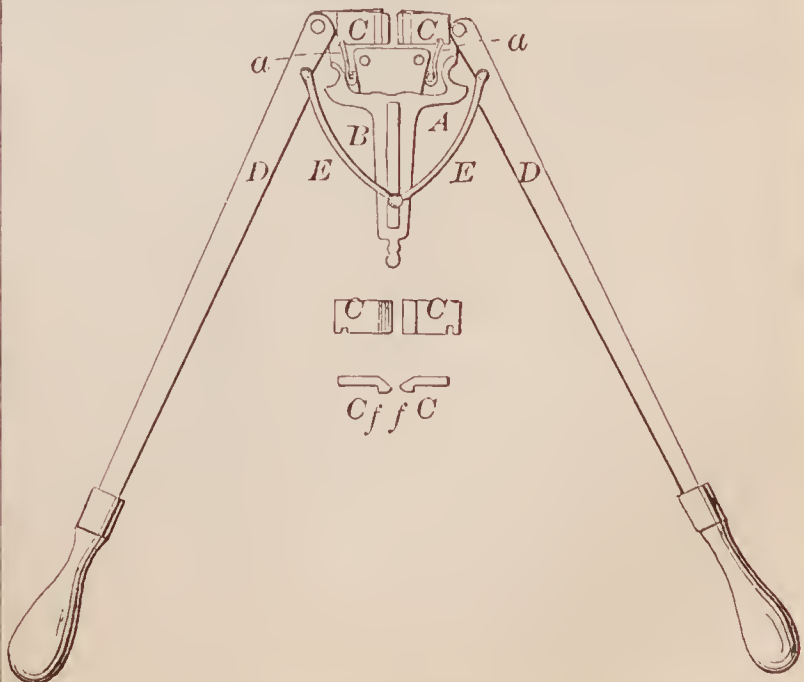

70561—J. H. Hartsuff—*Curb for Water Wheels.*

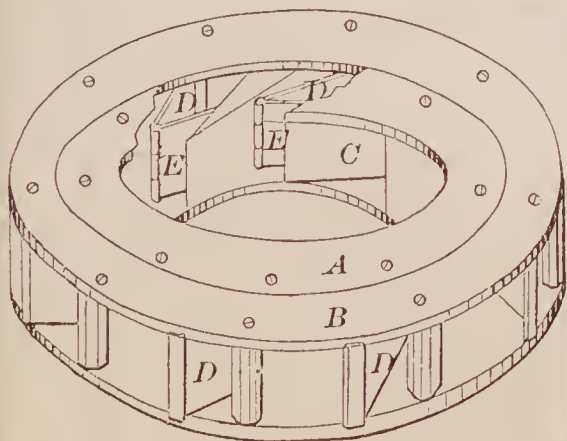



70564—J. Heddon—Photographic Printing Frame.

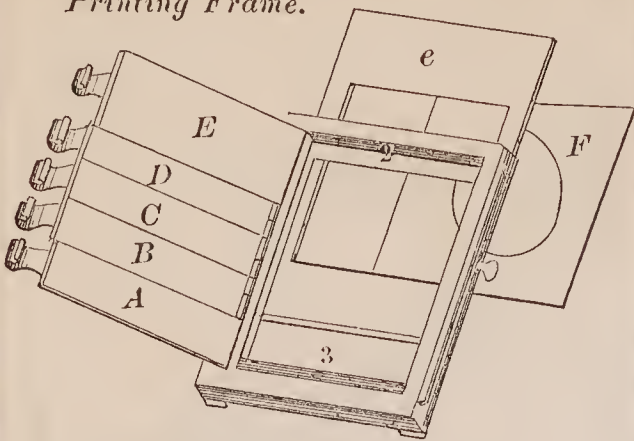

70566—C. W. Higgins—Children's Carriage and Cradle.

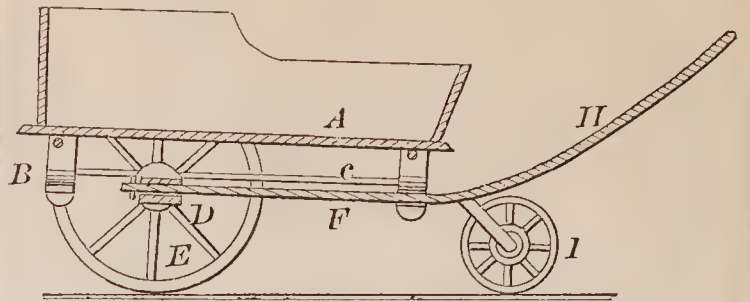

70565—P. Higdon—Hoisting Apparatus.

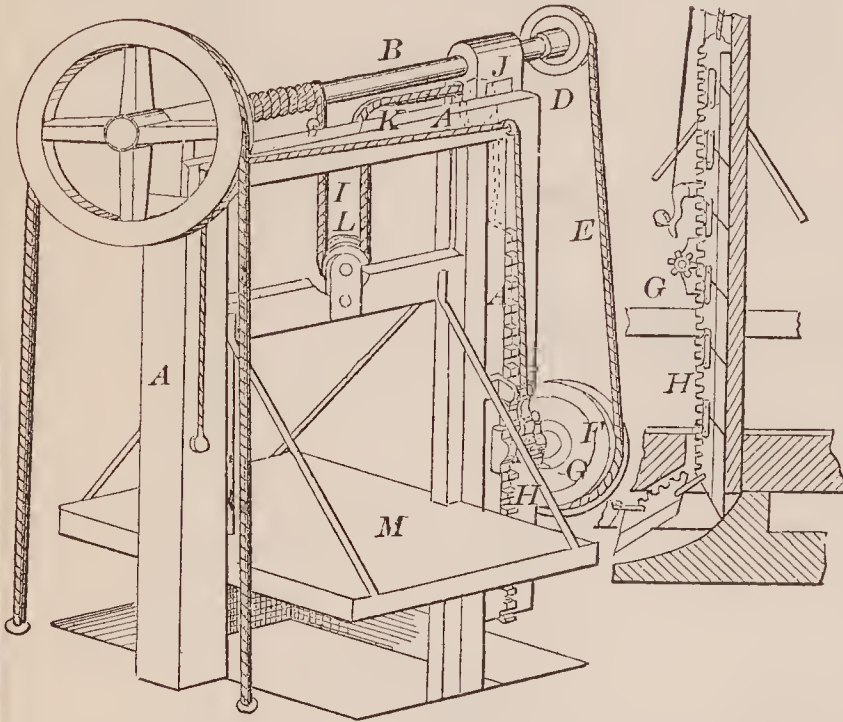

70567—Hill & McCoy—Lamp Extinguisher.

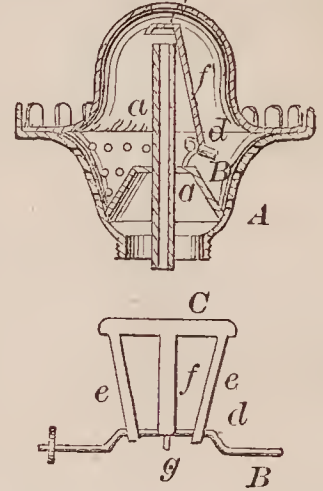

70568—N. Hopkins—Register Point for Printing Presses.

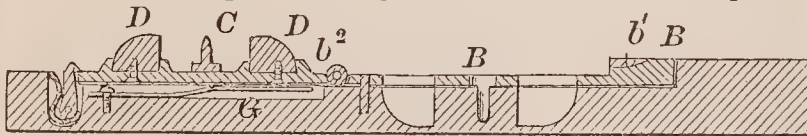

70569—K. Horde—Toy.

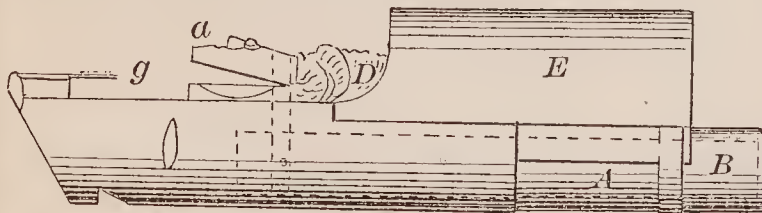

70571—S. W. Huntington—Boot Blacking Machine.

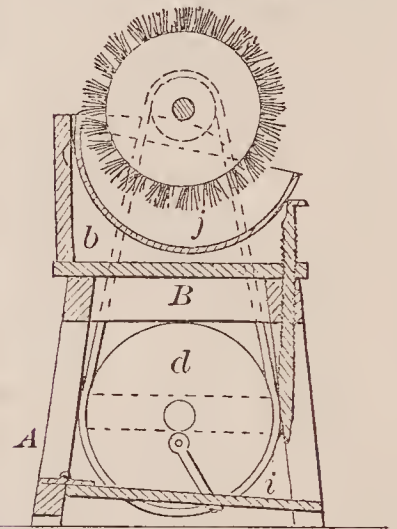

70570—L. D. Howard—Bevel.

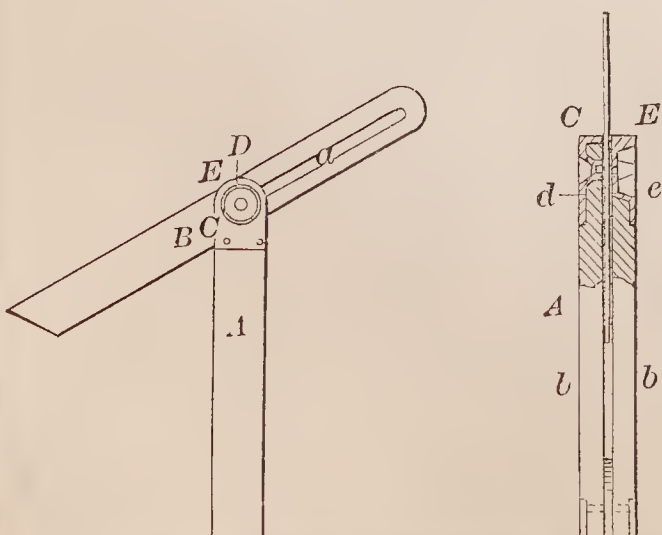

70572—G. Hurdman—Sad Iron Heater.

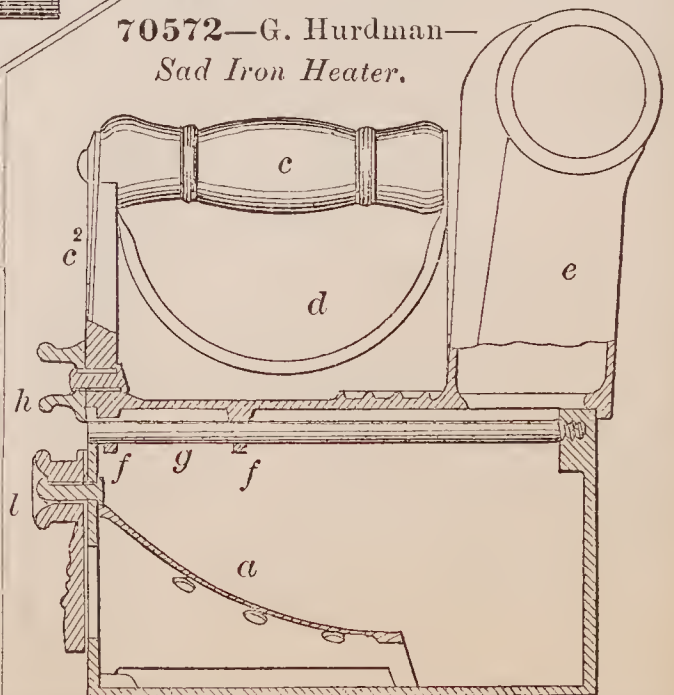

70573—W. W. Jacobs—Vapor Lamp Burner.

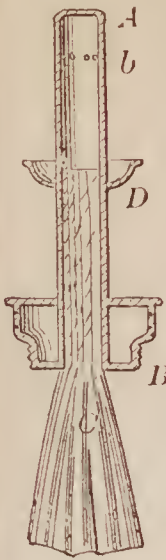

70574—L. J. Johnson—Knife Cleaner and Sharpener.

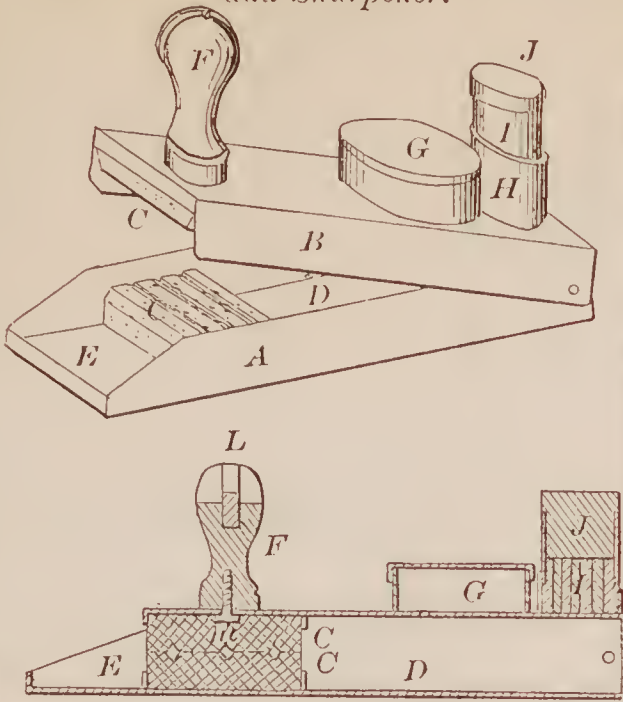

70575—G. W. Keller—Dress Elevator.

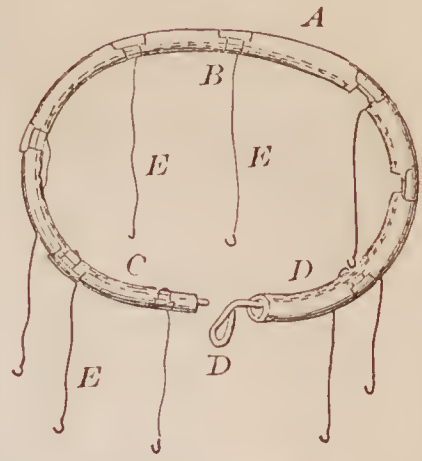

70578—S. A. Kroner—Cultivator.

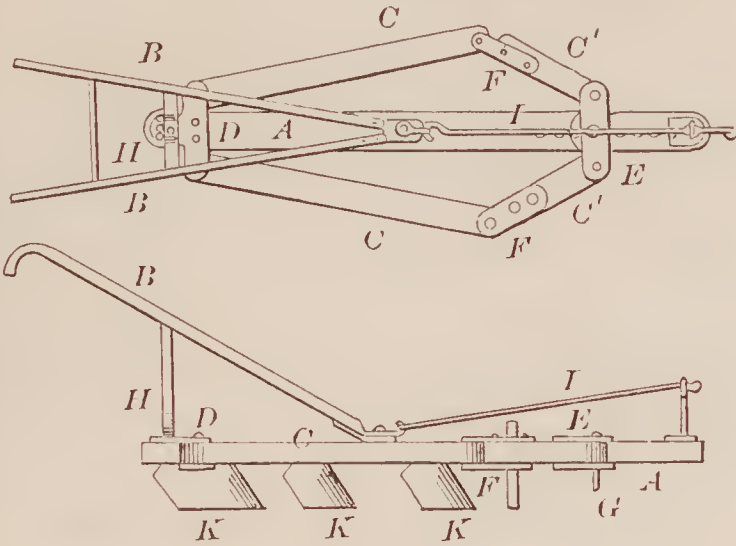

70577—J. K. Krieg—Pegging Jack.

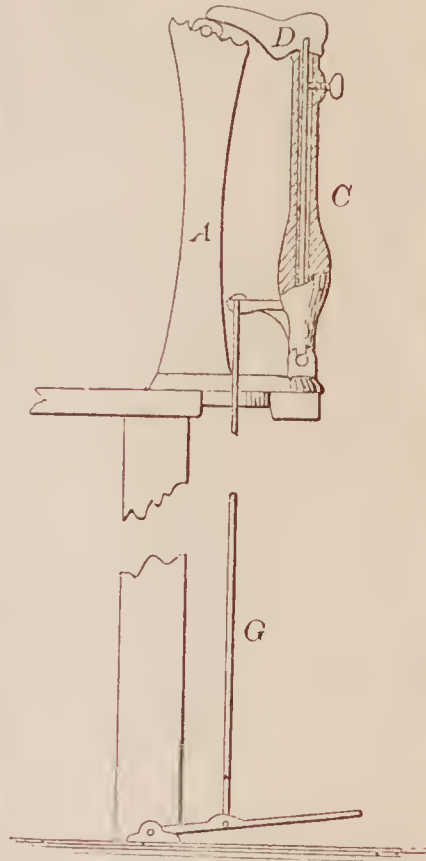

70579—H. Kurth—Umbrella Runner.

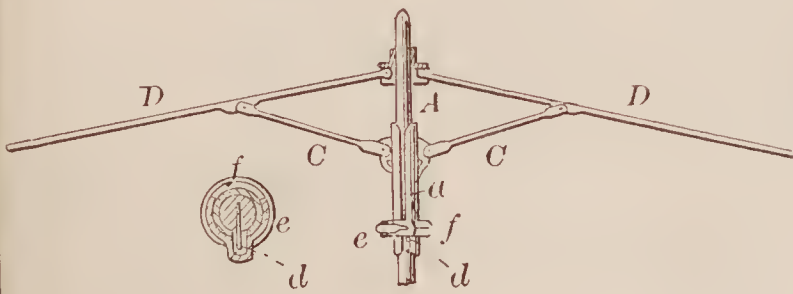

70580—A. Lake—Cleat Chock.

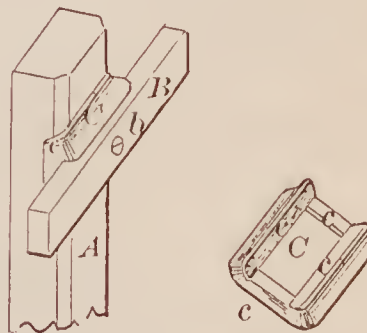

70576—M. & J. Knapp—Door Lock.

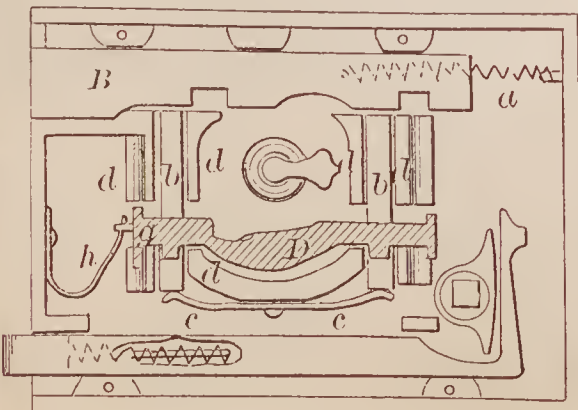

70581—W. R. Landfear—For Pegging Boots.

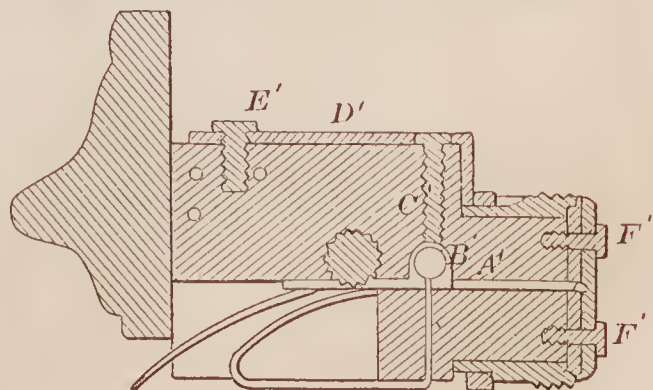



70582—N. Lawrence—Ice Pitcher.

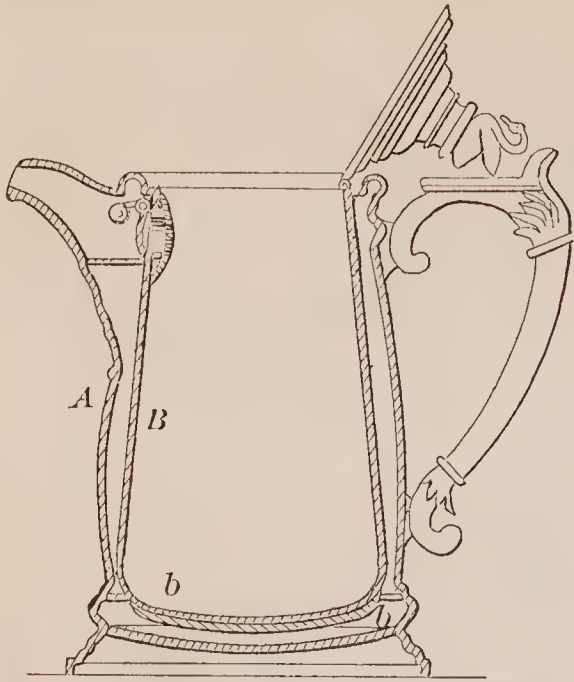

70583—F. Leadbetter—Bed Bottom.

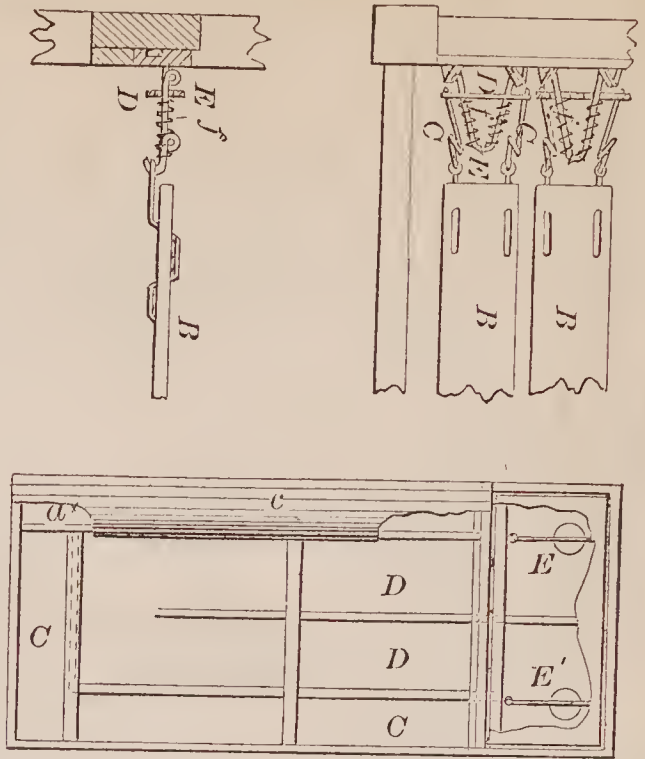

70585—S. W. Long—Brick Machine.

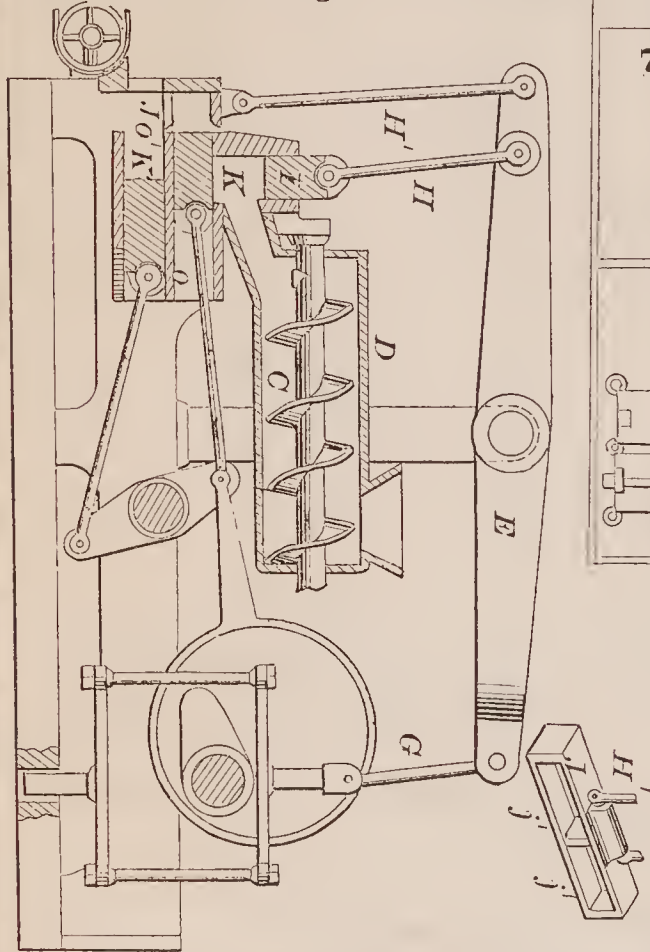

70584—N. H. Lindley—Propagating Tank and Bed.

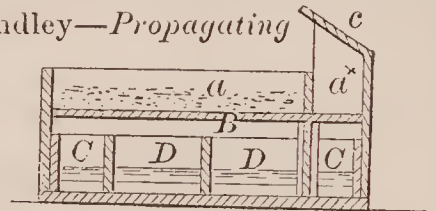

70587—K. Markuson—Handle for Ships' Pumps.

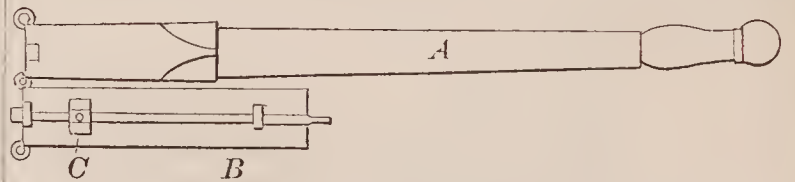

70586—R. M. Mansur—Ice Tongs.

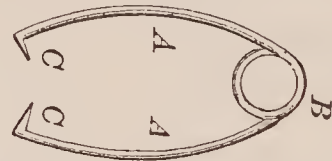

70590—E. McClintock—Steam Engine.

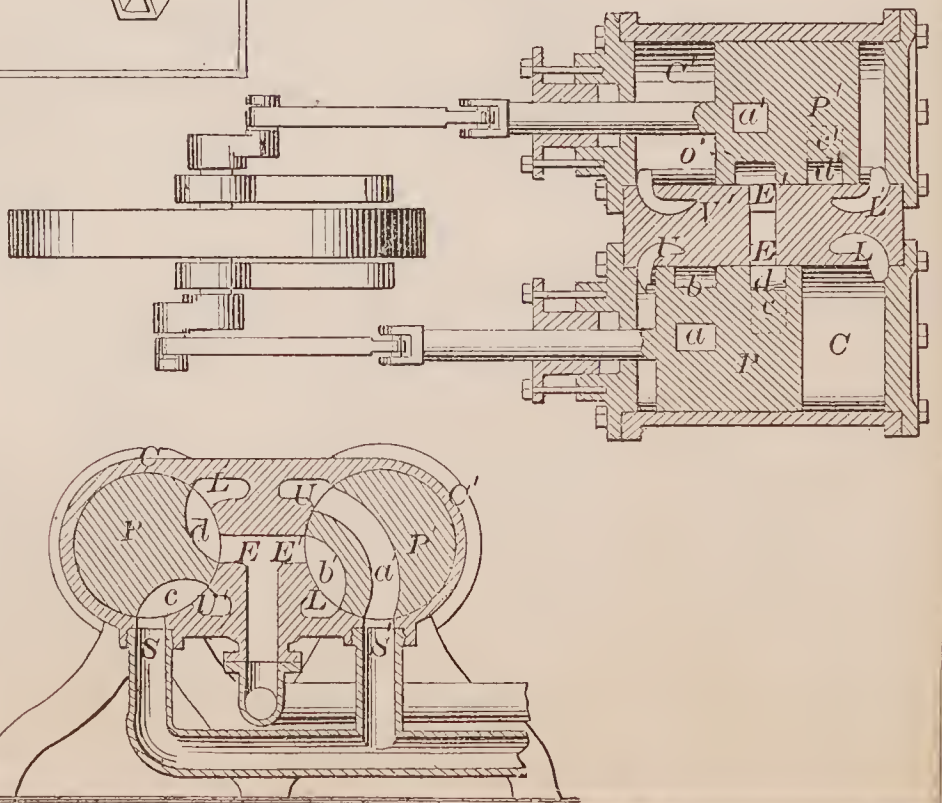

70589—G. Marshall—Harness Saddle.

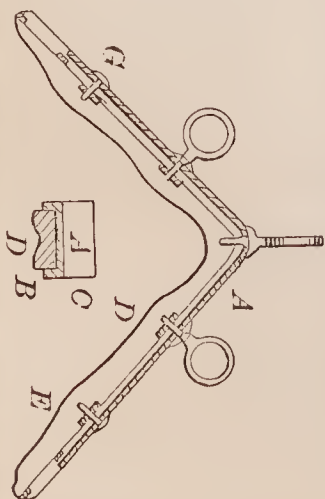

70591—W. McMiller—*Lifting Jack.*

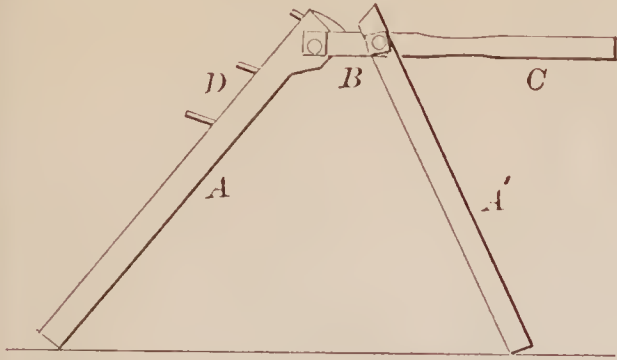

70592—R. N. Meriam—*Planing Machine.*

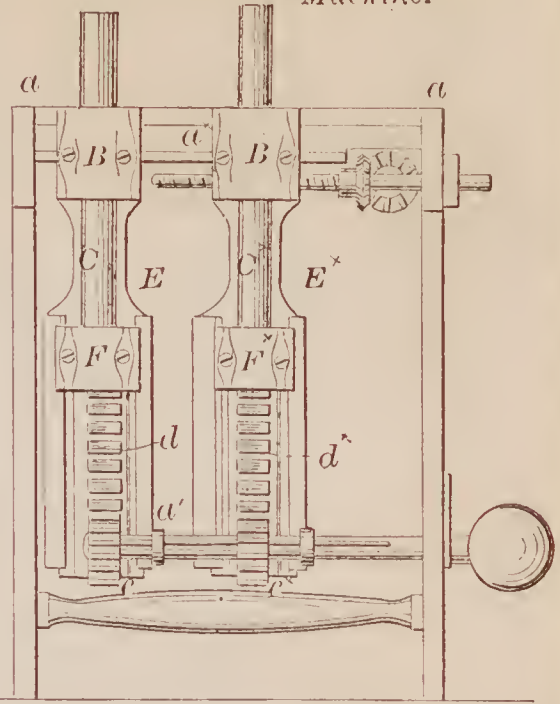

70594—J. Miller, Jr.—*Securing Wheels on Axles.*

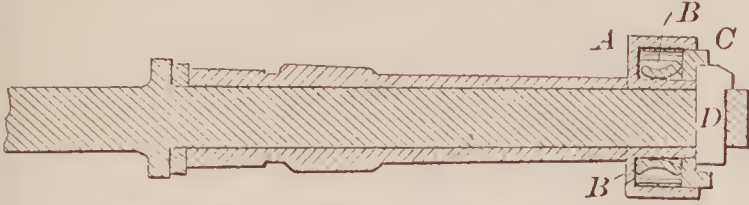

70595—R. Mitchell—*Steam Hammer.*

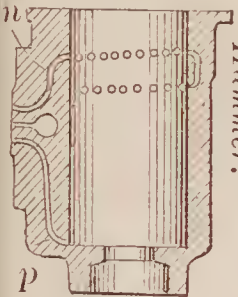
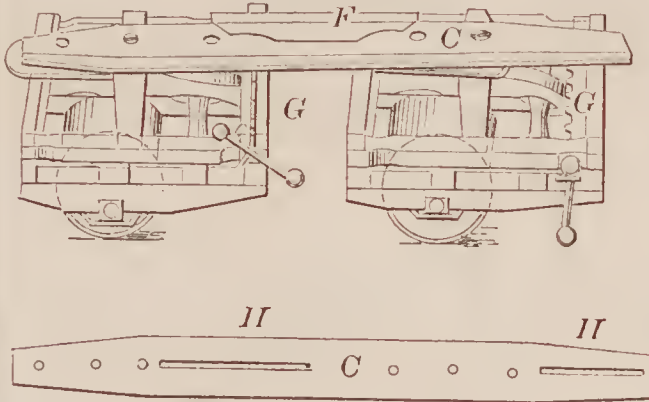
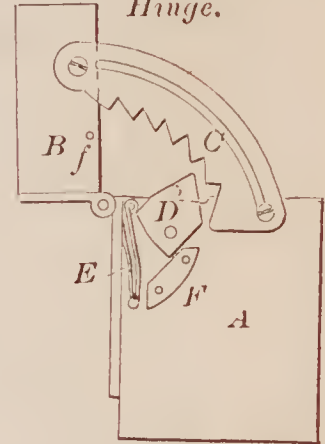

Fig. 5

70596—J. H. Moore—*For Moving Buildings.*



70597—A. L. Mora—*Hinge.*



70593—Miller & Prescott—*Sash Support and Fastener.*



70598—J. F. Morgan—*Lunch Box.*

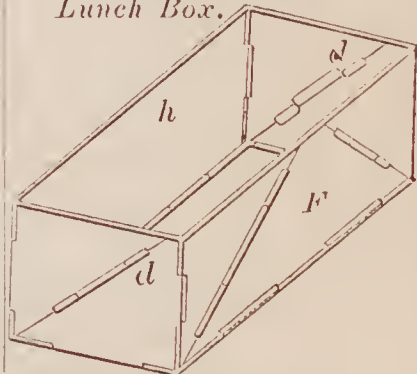

70600—C. P. Moyer—*For Administering Balls to Horses.*

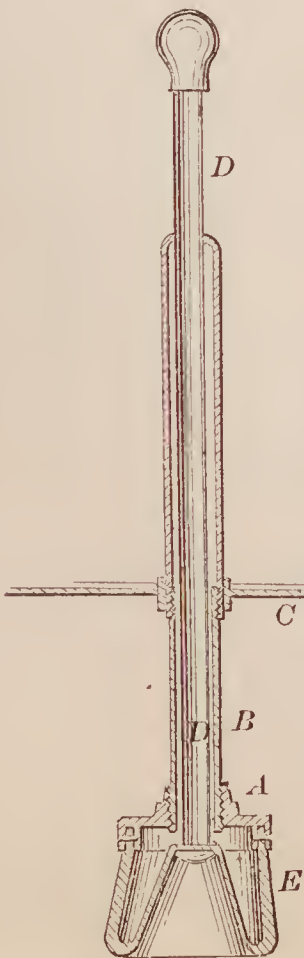

70599—J. H. Morse—*Permutation Lock.*

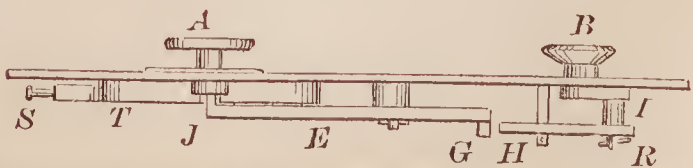
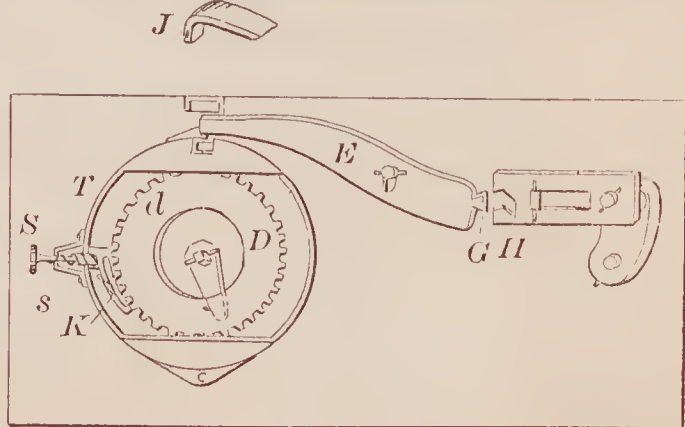



70601—E. B. Olmsted—For Making Paper Bags.

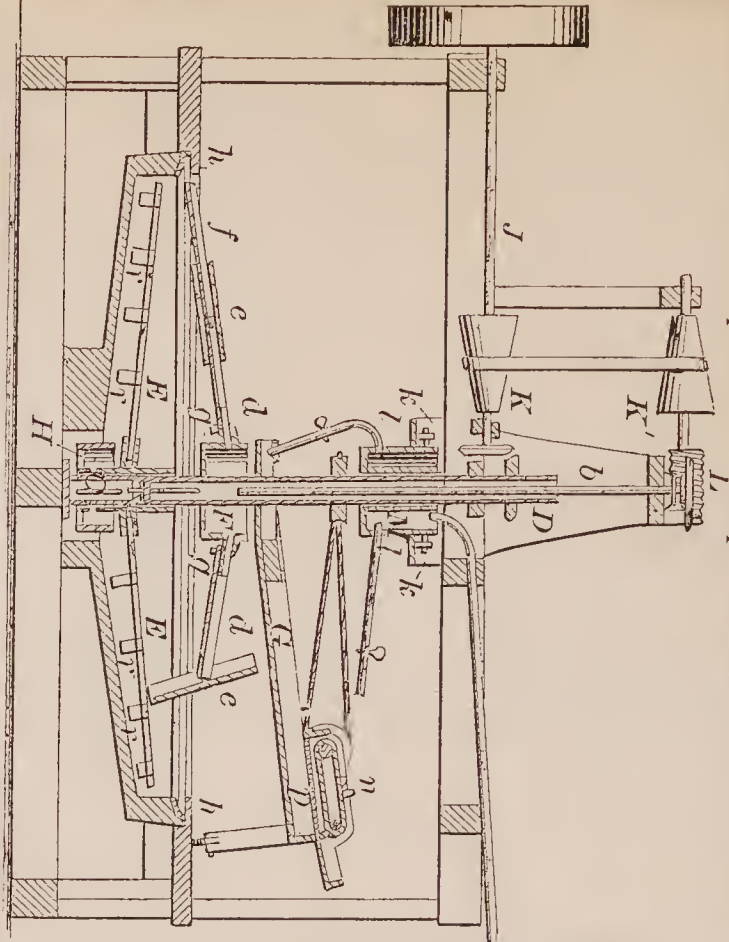
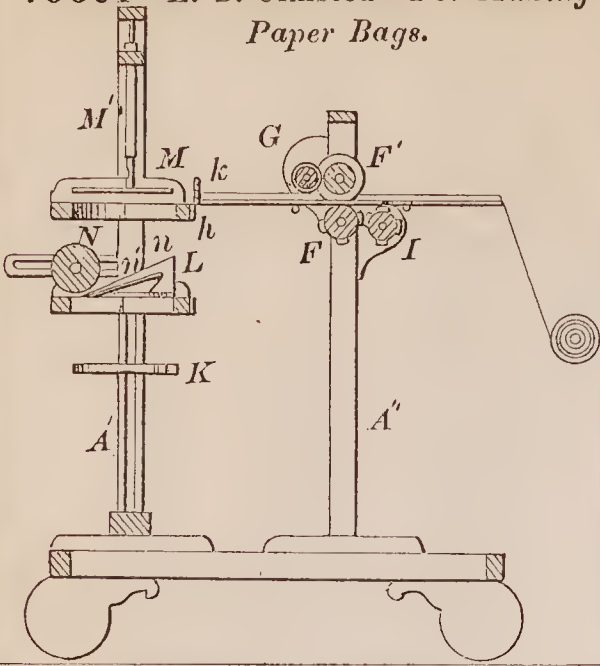

70603—Paine & Stephens—Ore Separator and Concentrator.

70606—F. Pidjeon—Rail Clamp Joint.

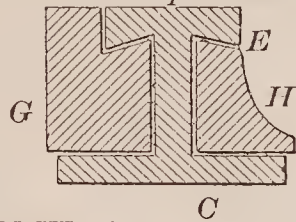

70604—J. R. Payson—Window Sash Supporter.

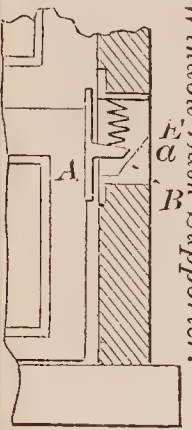

70609—B. F. Porter—Door Fastener and Pocket Knife.

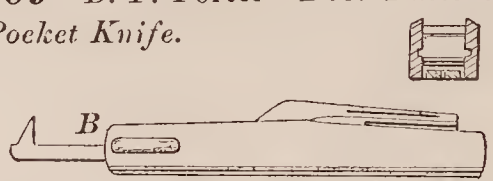

70610—W. D. Porter—Toy Humming Wheel.

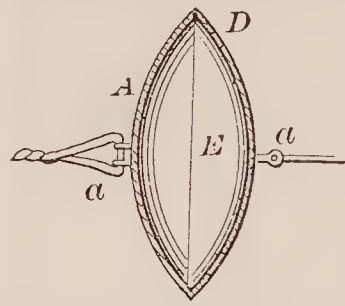

70613—G. W. Putnam—Dredging Box.

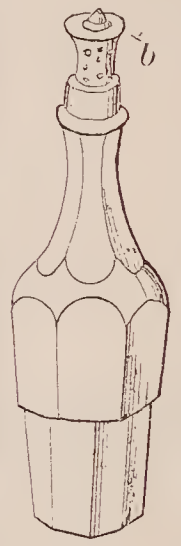

70611—Purse & Draper—Sack Fastener.

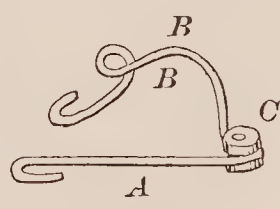

70612—J. Rider—Priming Metallic Cartridges.

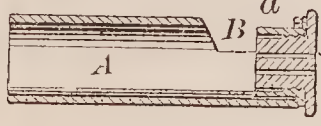

70615—J. H. Rankin—Sulky Plow.

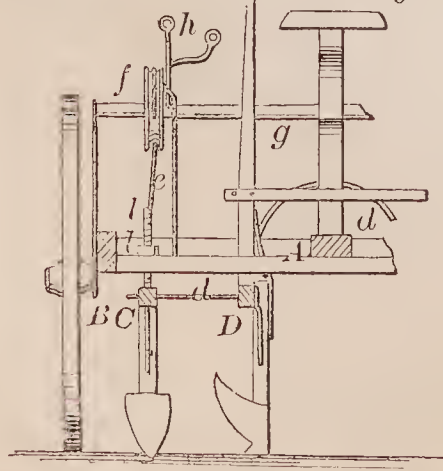

70614—A. Rank—Harvester.

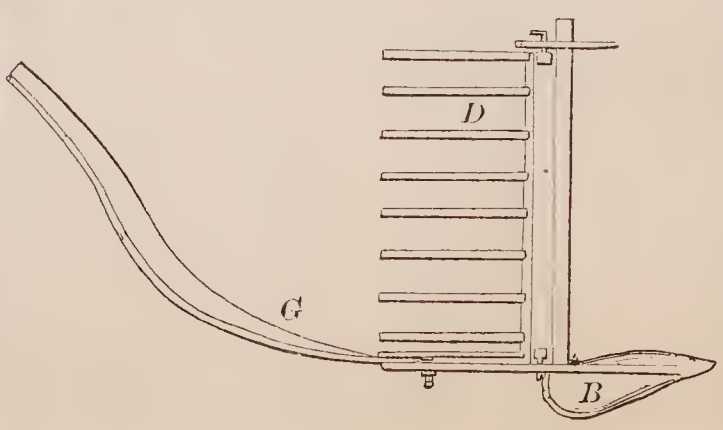

70615—Continued.

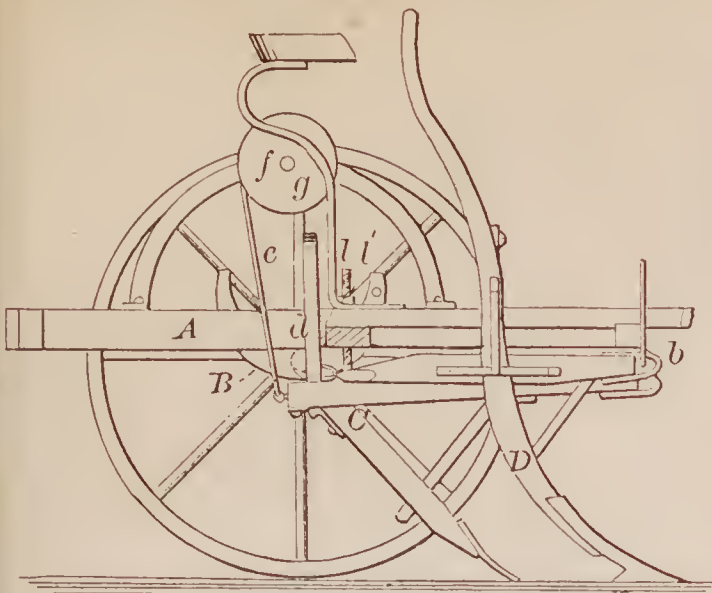

70619—R. N. Rockwell—Wagon Seat.

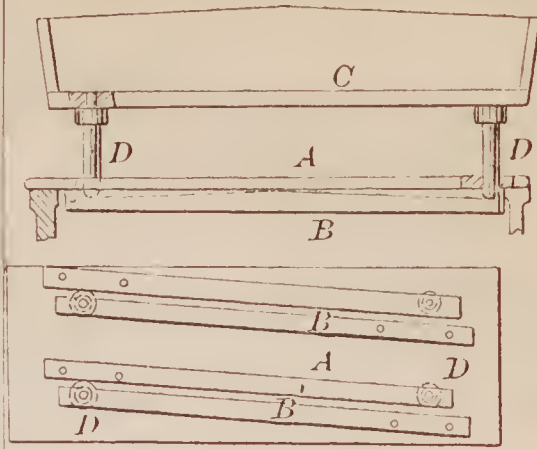

70620—E. Romans—Bag Fastener.

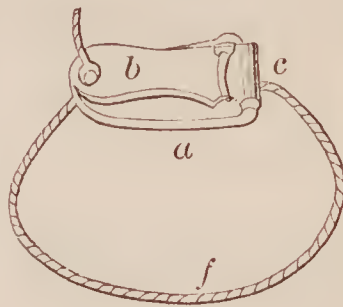

70616—M. J. Rhees—Pessary.

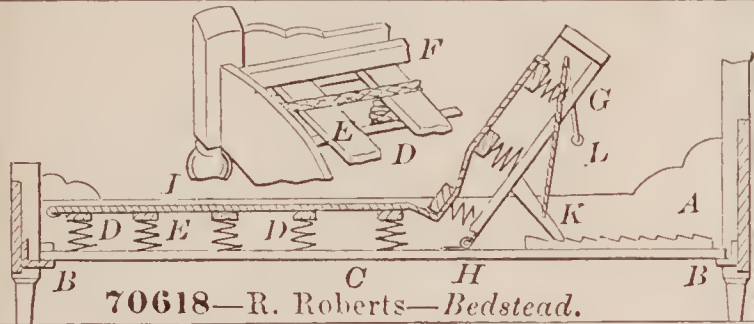
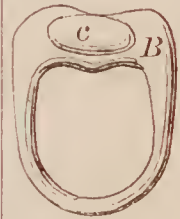

70618—R. Roberts—Bedstead.

70621—E. Rosen—Conformator.

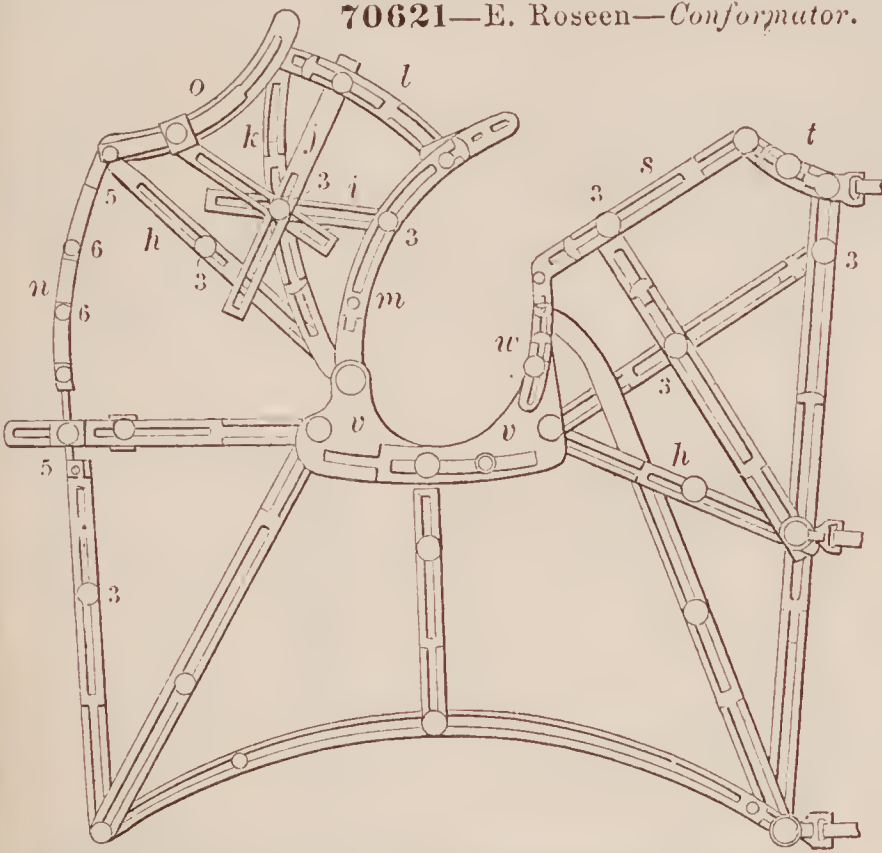

70617—J. W. Ricker—Well Tube.

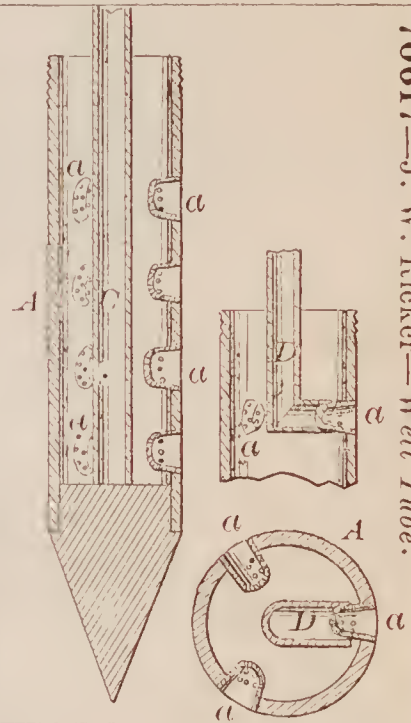

70623—R. Sargent—Rotary Cam for Looms.

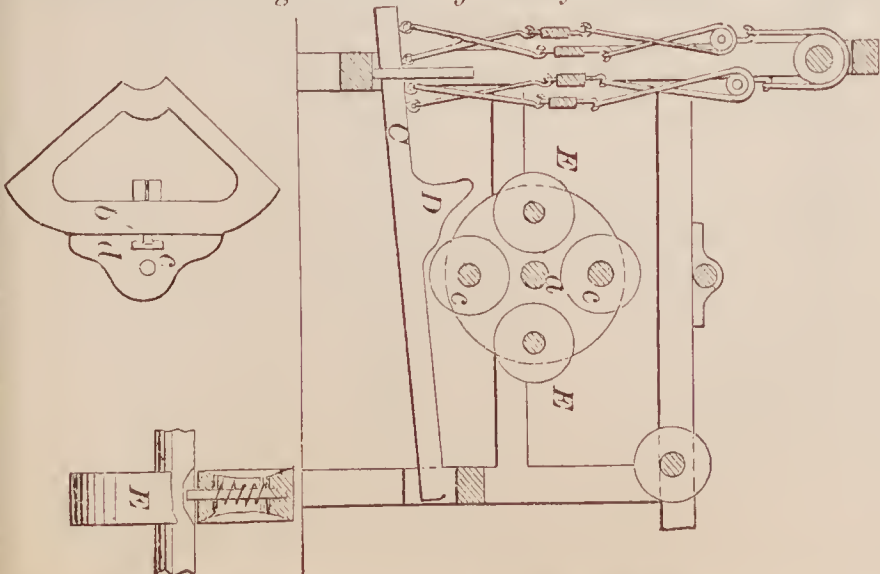

70622—J. H. Rowe—Spinning Wheel.

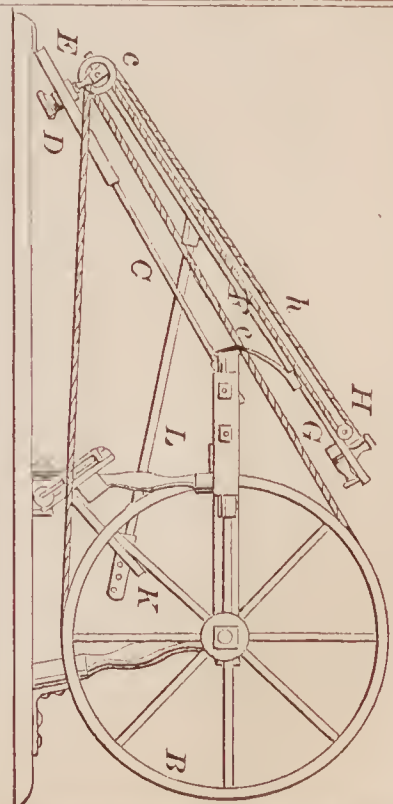



70624—J. Schroy—Animal Trap.

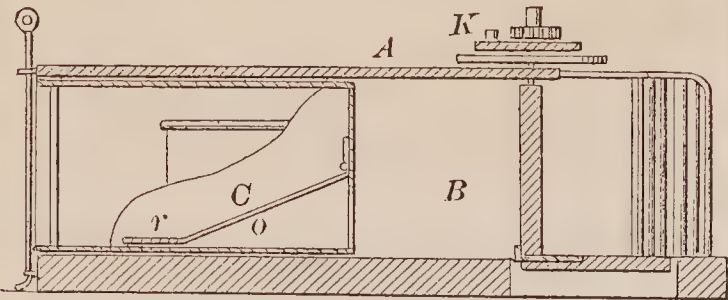

70630—G. C. Selfridge—Washing Machine.

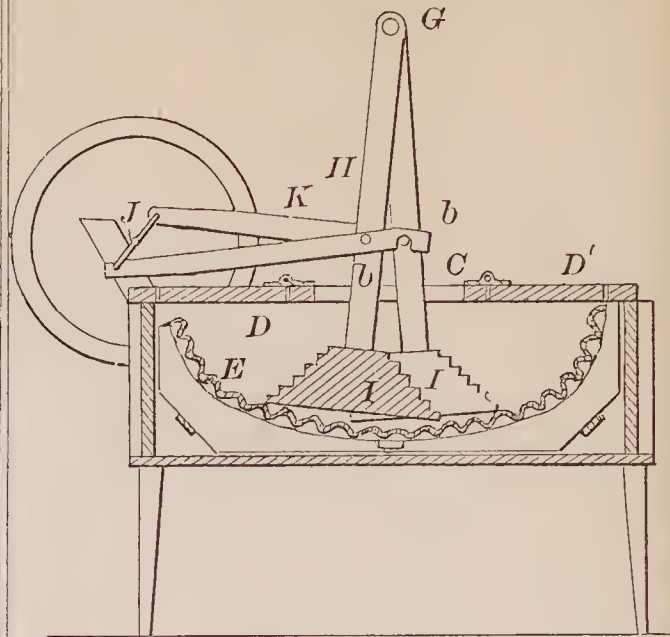

70625—L. O. Schultz—Car Coupling.

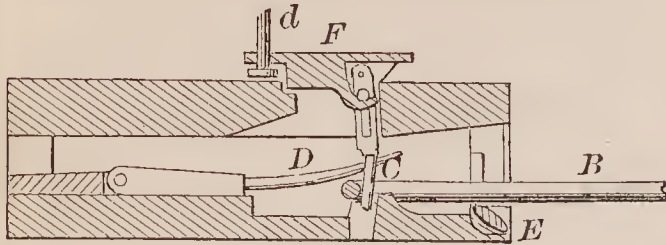

70626—L. M. Scothorn—Gate.

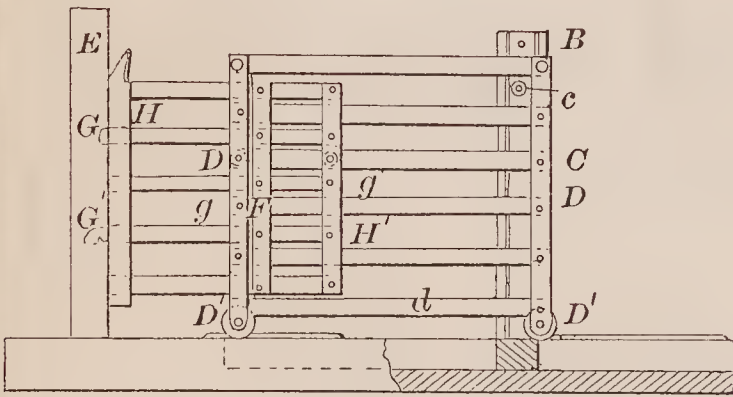

70631—A. B. Shaw—Folding Umbrella.

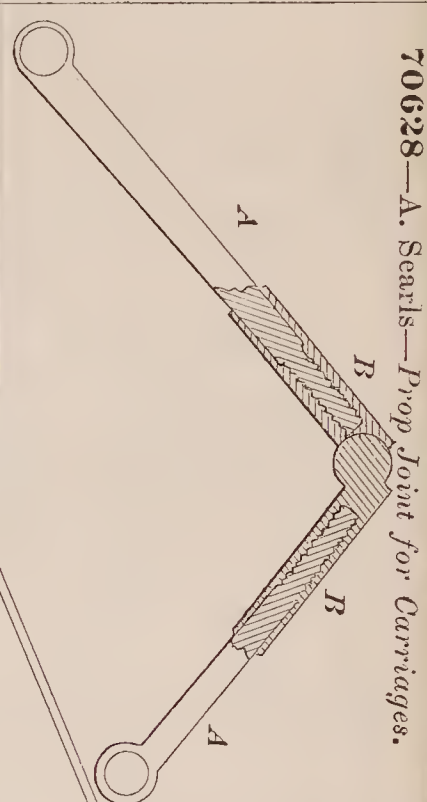
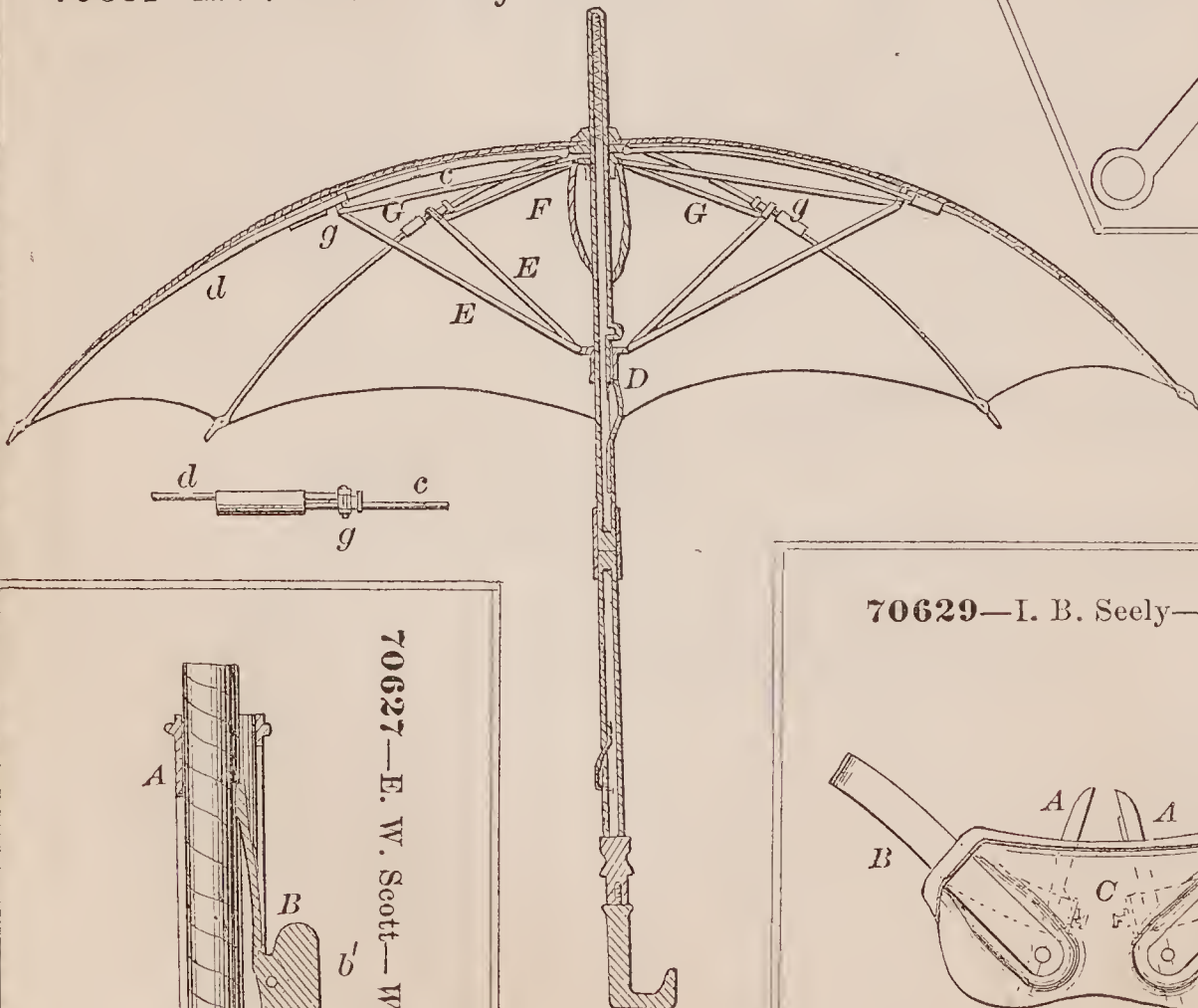

70628—A. Searls—Prop Joint for Carriages.

70629—I. B. Seely—Truss.

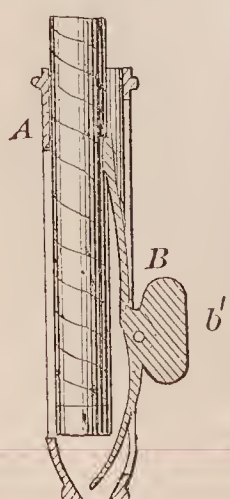
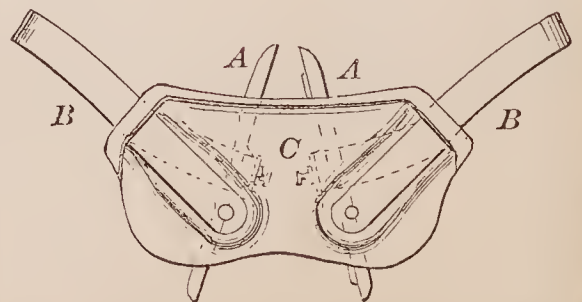

70627—E. W. Scott—Whip Socket

70632—A. B. Shaw—*Folding Umbrella.*

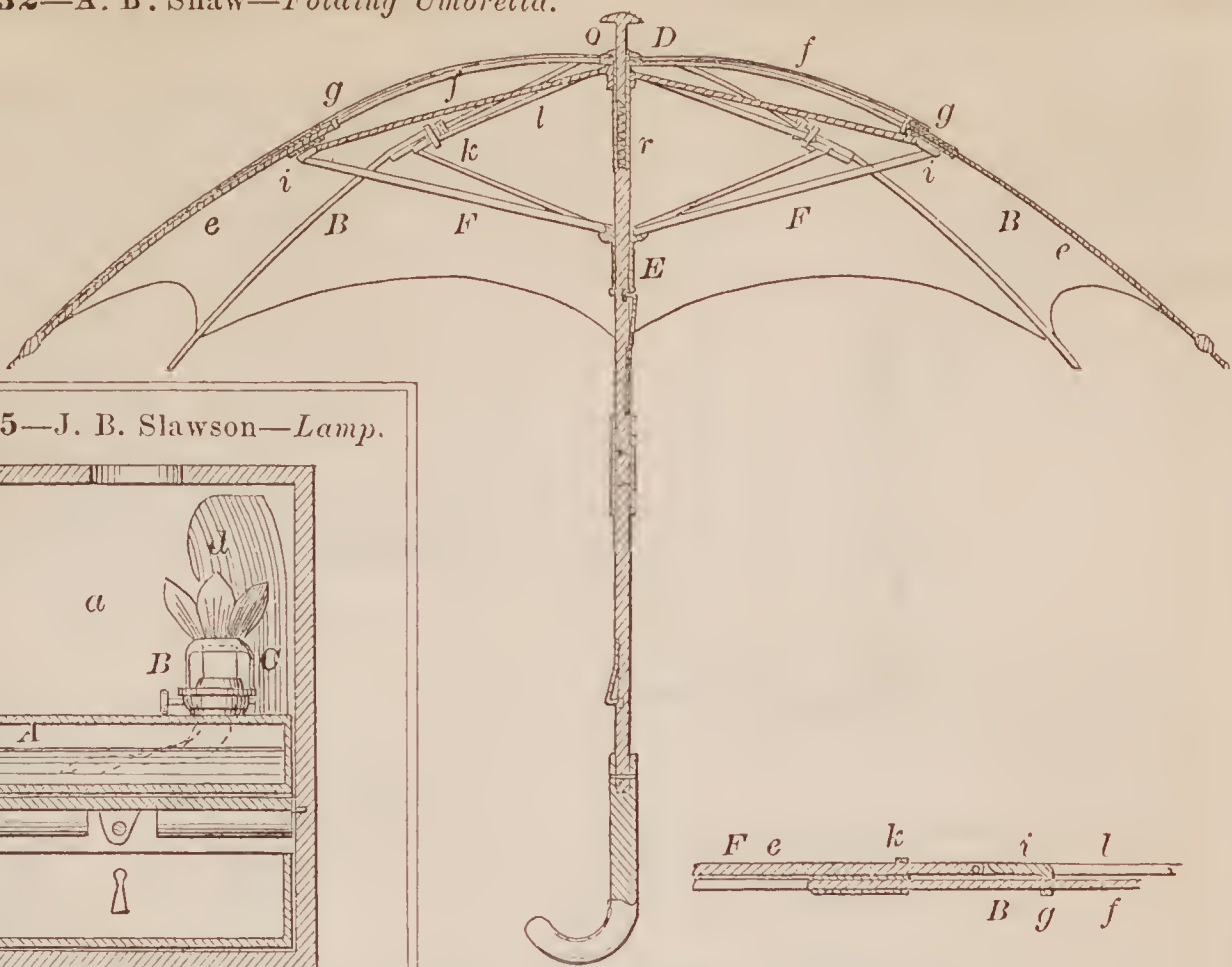

70635—J. B. Slawson—*Lamp.*

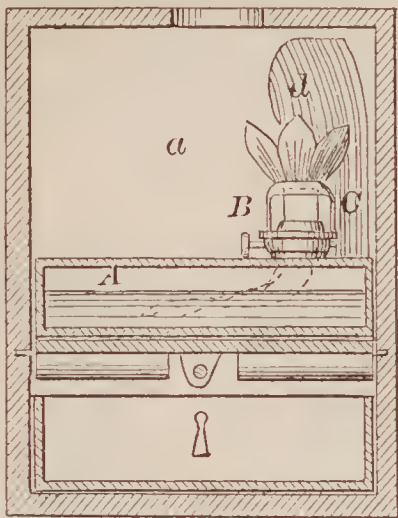

70636—A. W. Smith—*For Cleaning Stove Pipes.*

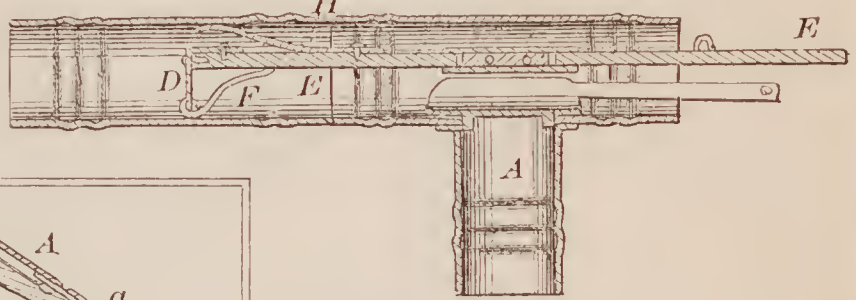

70633—Shaw & Dawson—*Harness Pad Tree.*

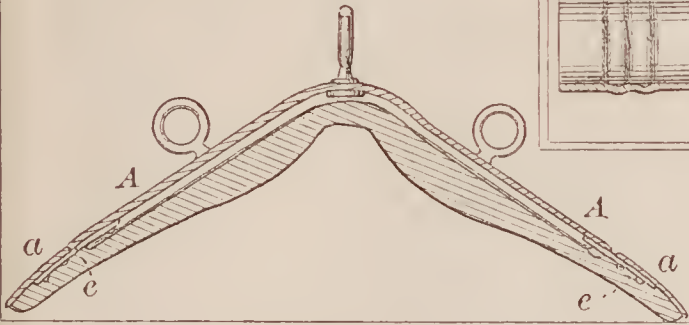

70637—E. C. Smith—*Paddle Wheel.*

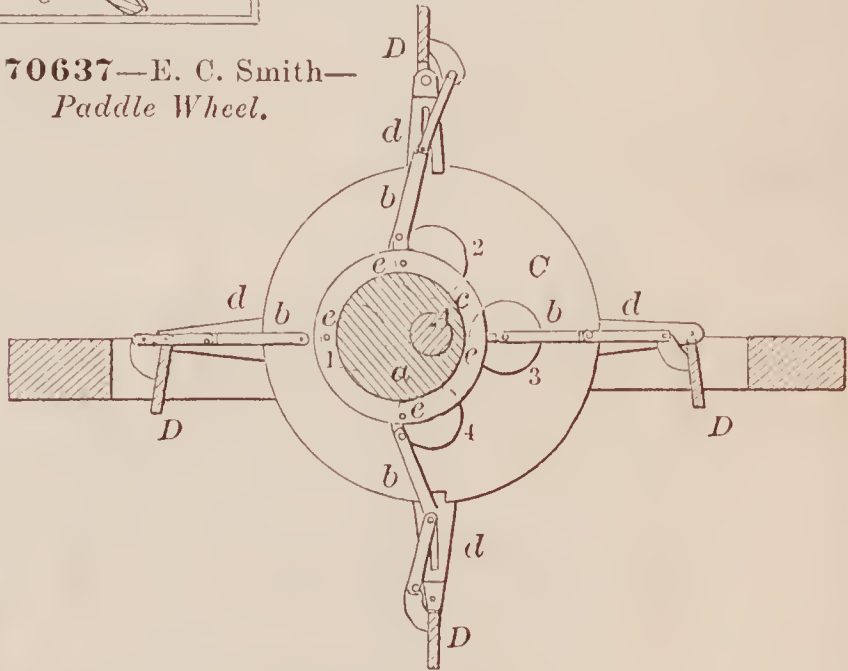

70634—G. Shield—*Pump.*

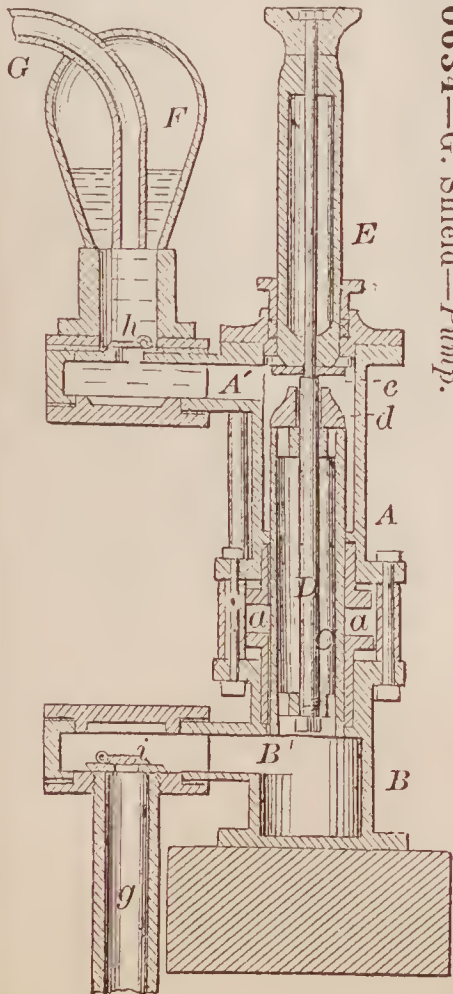

70638—J. R. Smith—*Grate Bar.*

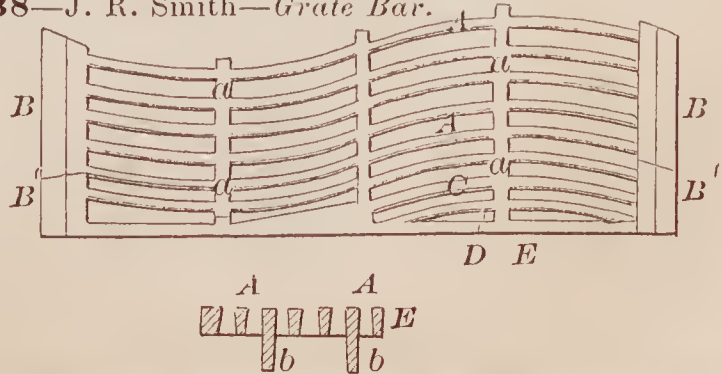



70639—T. Smith—Wagon Brake.

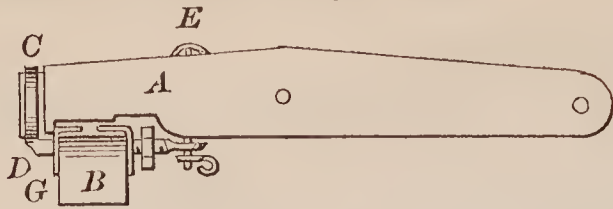

70640—J. M. Soutrenon—Covering for Walls.

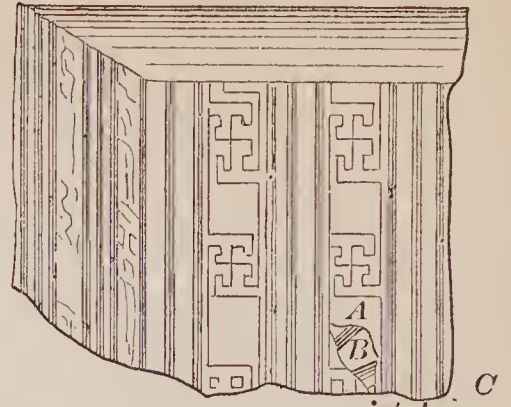

70641—J. D. Spang—Gasoline Cook Stove.

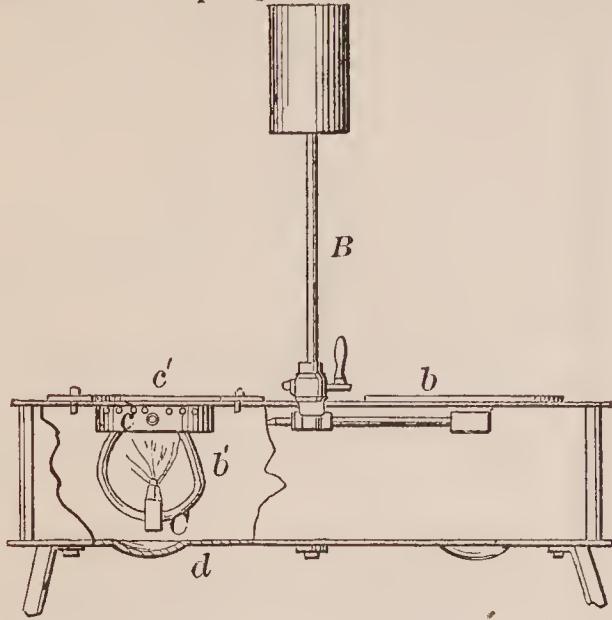

70643—H. K. Stoner—Horse Rake.

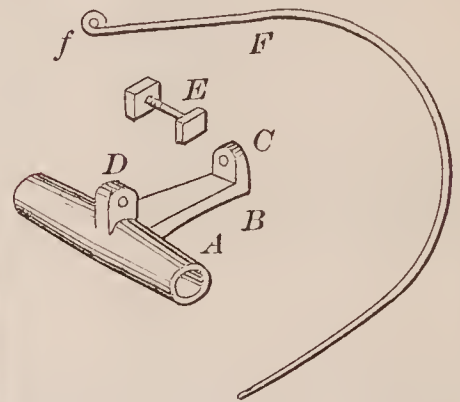

70644—J. Stody—Lifting Jack.

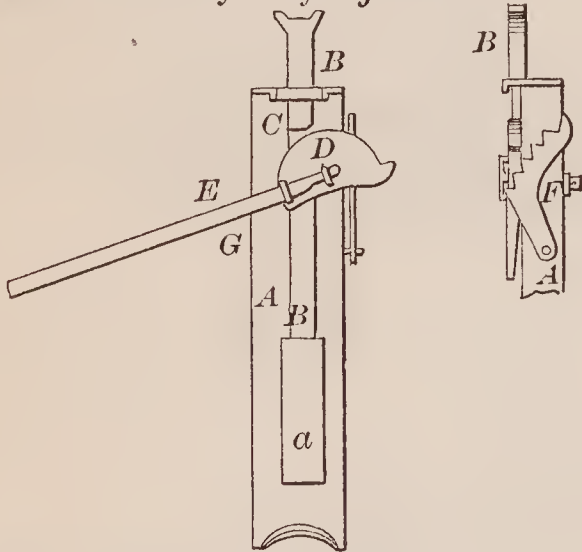

70647—Tait & Avis—Refrigerator.

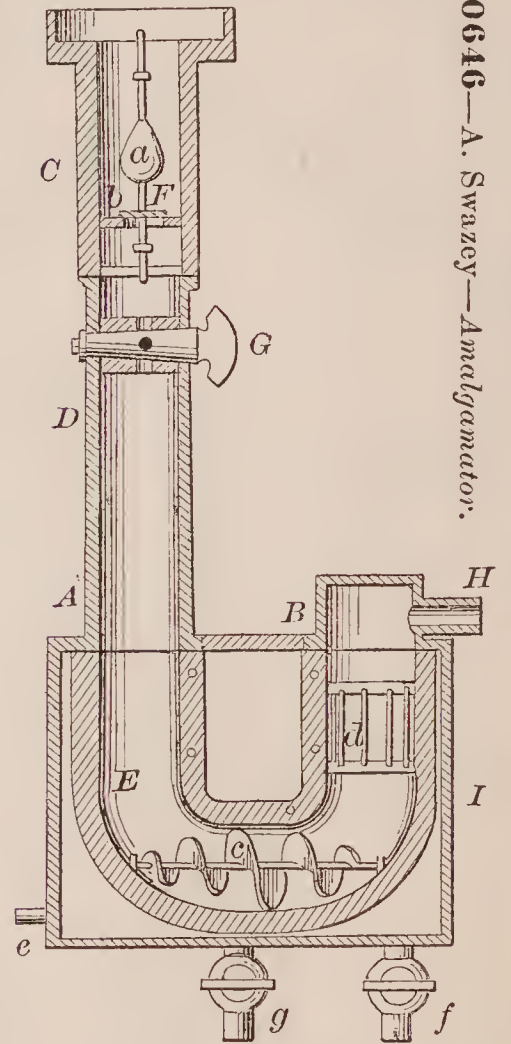
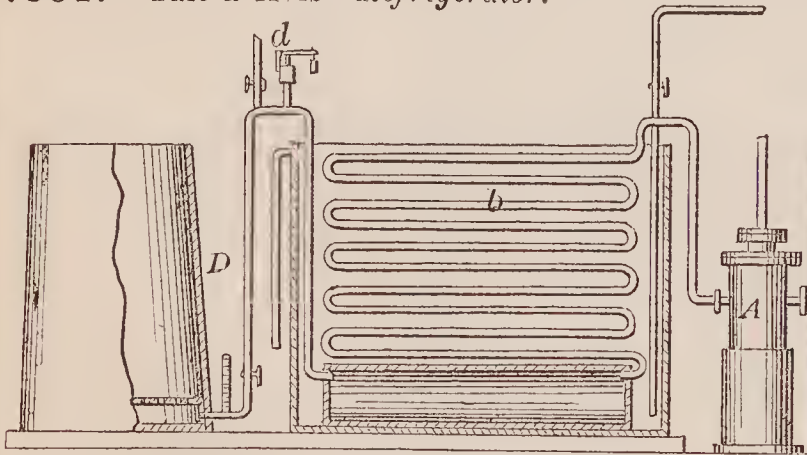

70646—A. Swazey—Amalgamator.

70645—I. Stratton—Pantaloons Fastening.

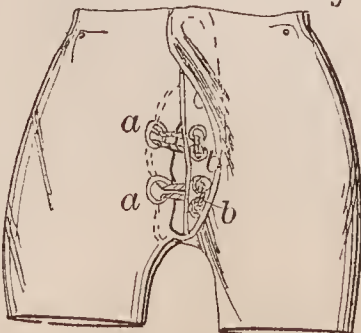

70612—H. Stanton—Finishing Brads.

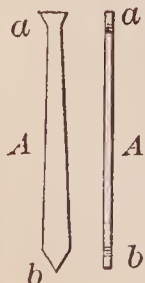

70648—A. Taylor—Last.

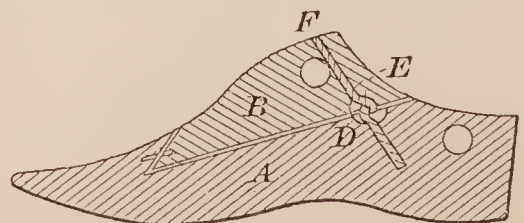

70649—Taylor & Baker—*Baling Press.*

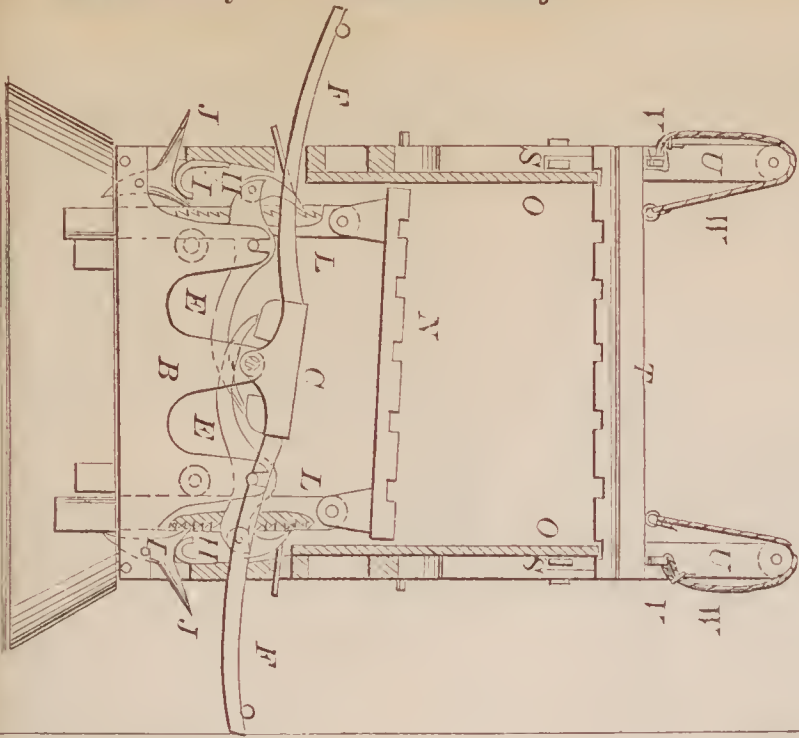

70651—M. Thomas—*Retaining Link for Shutters.*

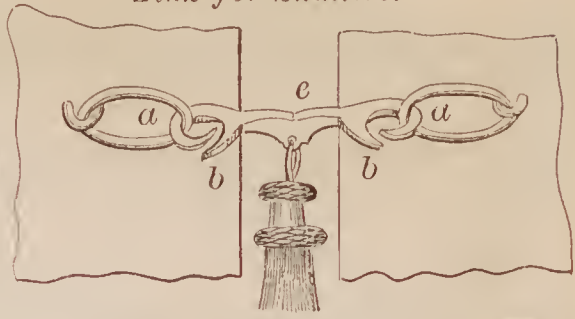

70653—S. B. H. Vance—*Suspending Drop Lights.*

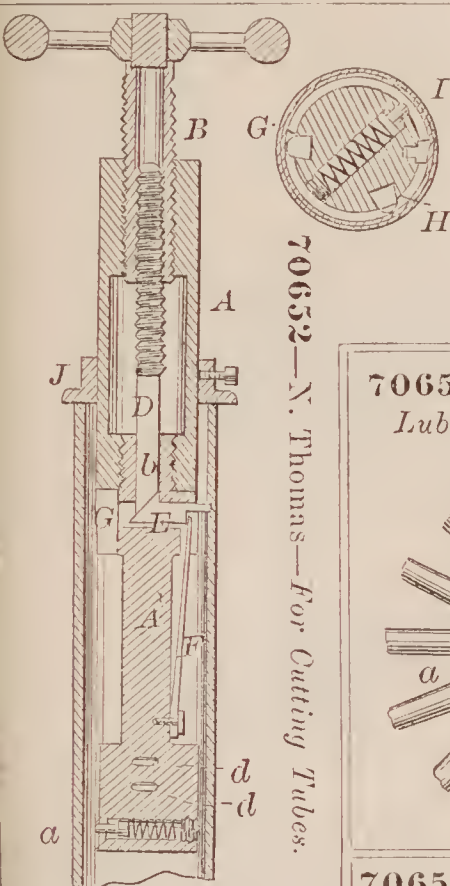
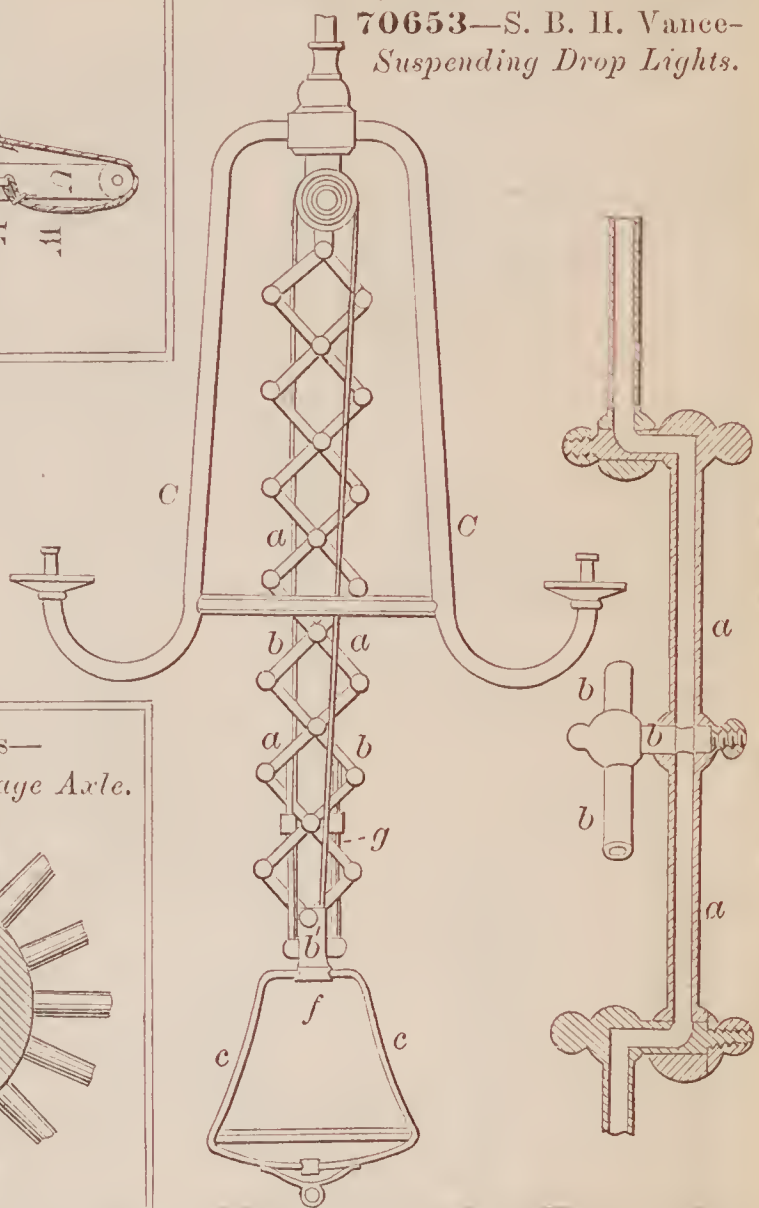

70652—N. Thomas—*For Cutting Tubes.*

70650—E. Thomas—*Lubricating Carriage Axle.*

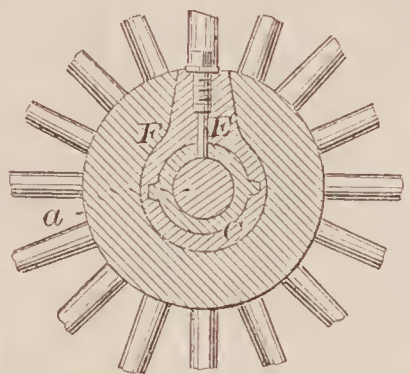

70657—W. Weaver—*Combination Bench. II*

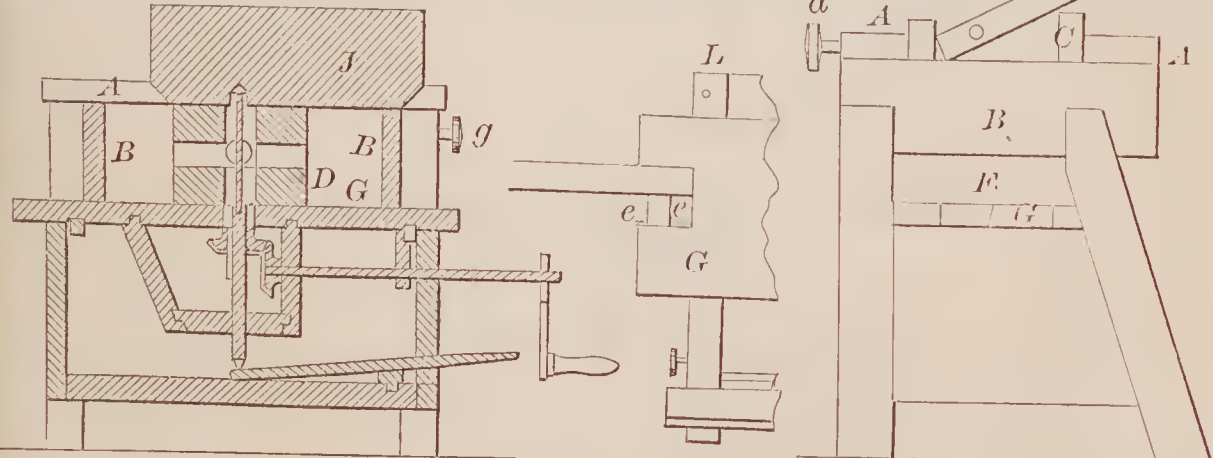

70656—W. Weaver—*For Scouring Marble*

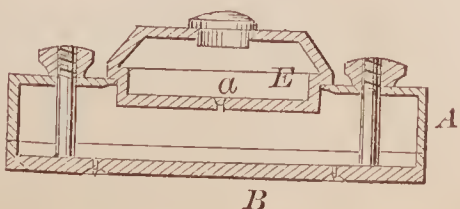

70654—W. Von Hofe—*Bottle Stopper.*

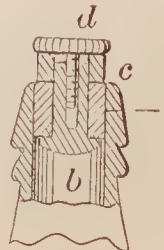



70658—A. Webster—Steam Cylinder for Finishing Cloth. A

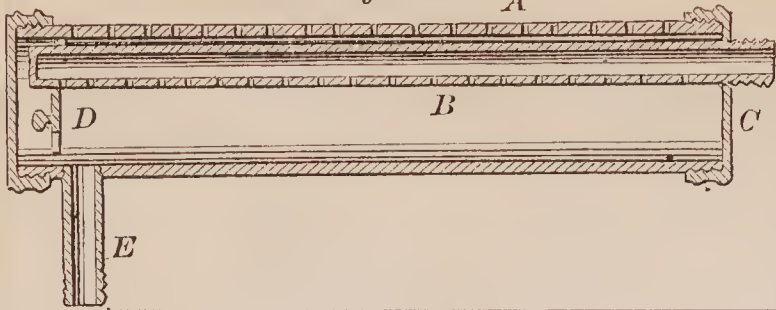

70661—W. N. Whiteley—  
Pitman Head and Crank  
Wrist Connection.

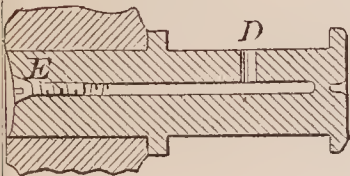
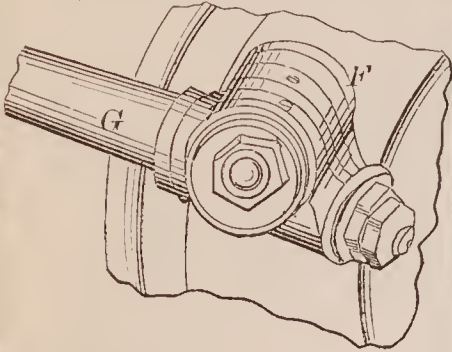

70659—E. Webster—  
Stove Pipe Drum.

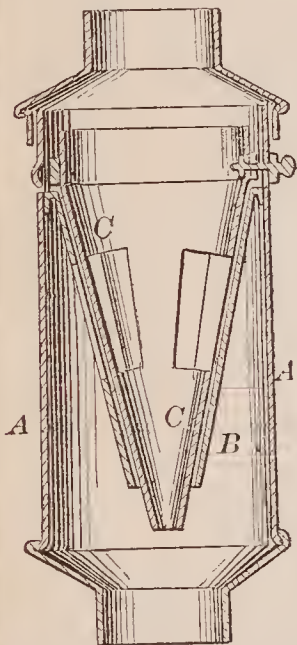

70662—D. Whittmore—For Pegging  
Boots and Shoes.

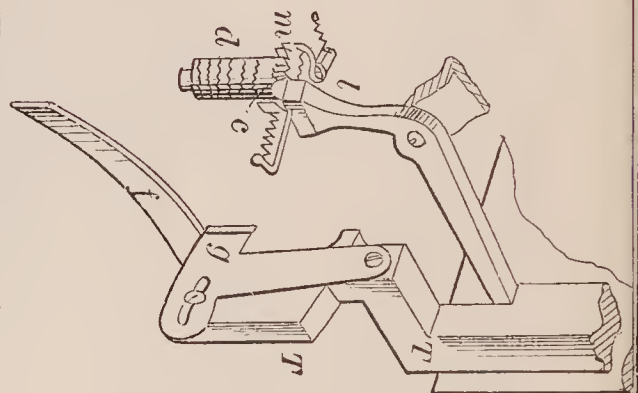
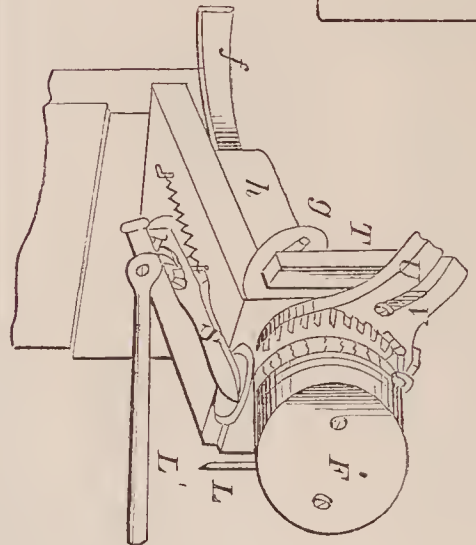
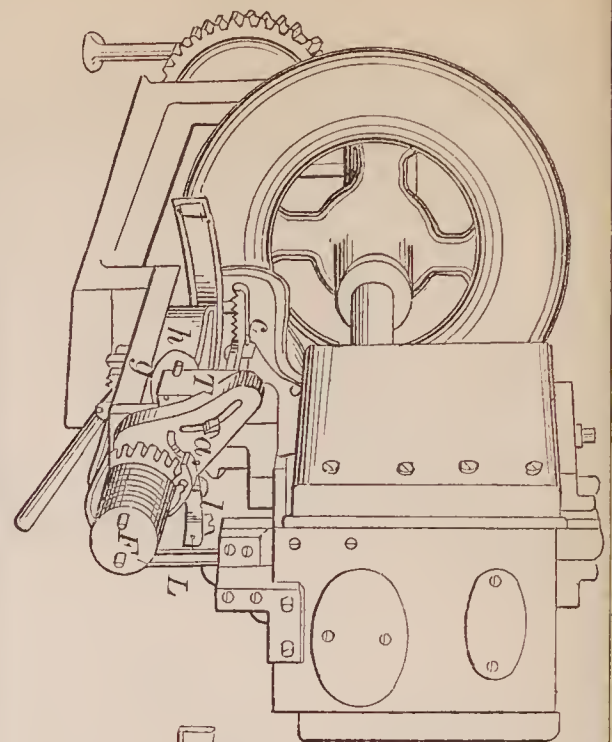

70663—J. W. Wilder—Bed Bottom.

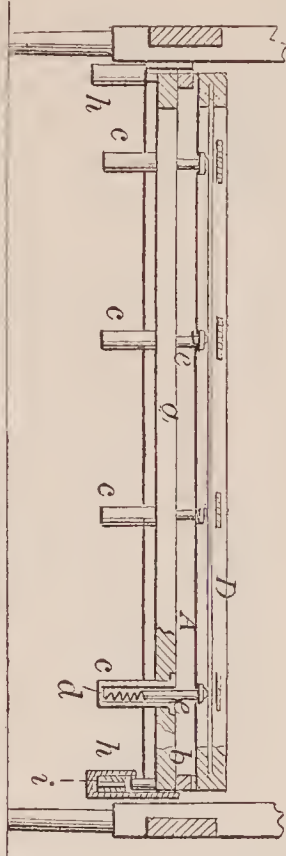

70660—J. Wheeler—  
Horse Shoe.

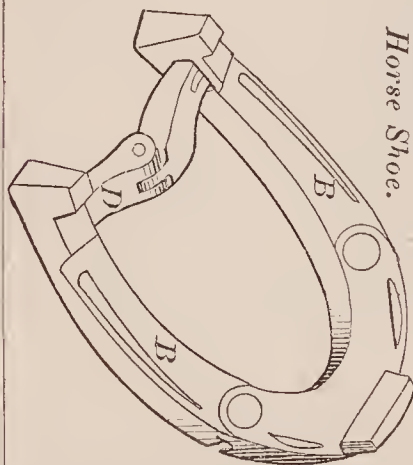

70665—J. L. Willcox—Clothes Line Holder.

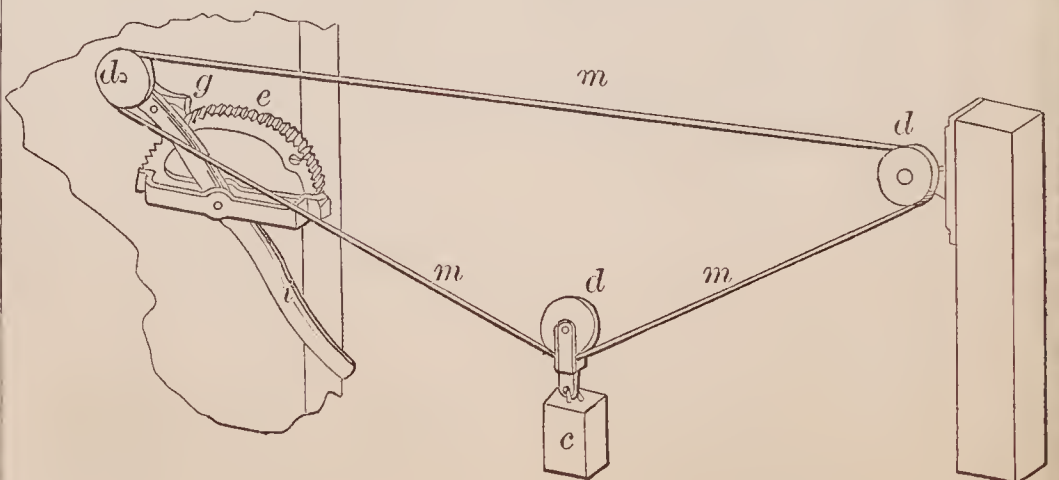

70664—L. Wilkinson—  
Shrinking Tire. h

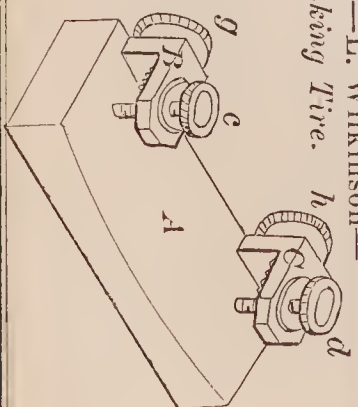

70666—W. H. Williams—Elevated Railroad.

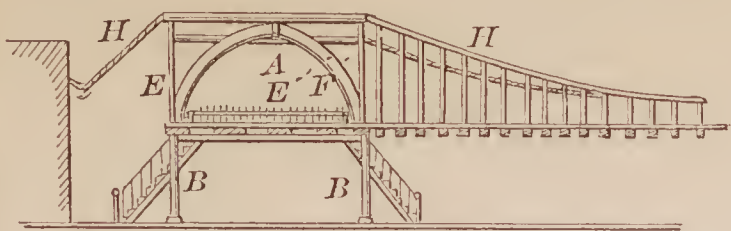

70667—G. L. Witsil—Washing Machine.

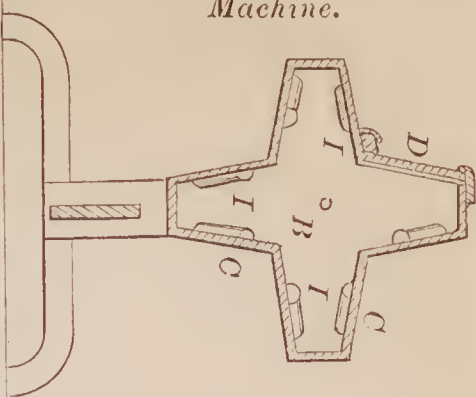

70668—F. R. Wolfinger—Extension Table.

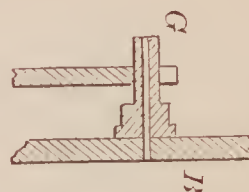
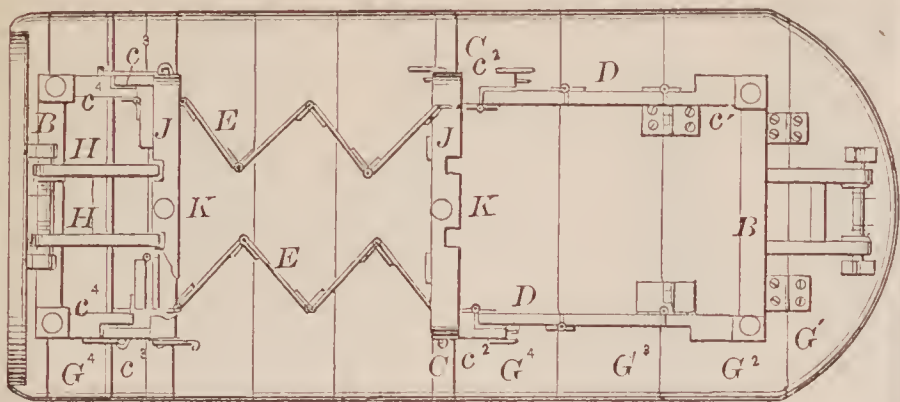

70669—D. Woodbury—  
For Making Bricks.

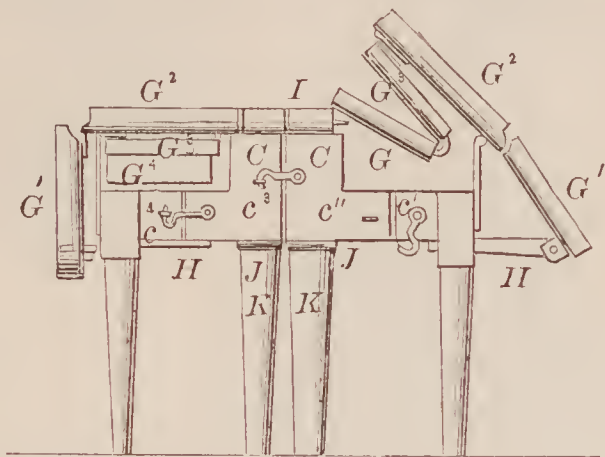
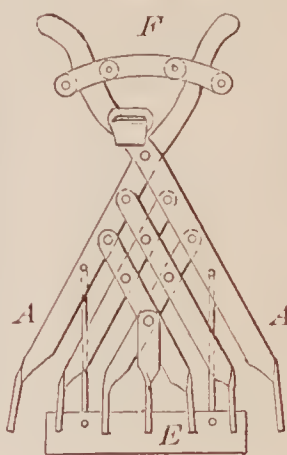

70673—J. M. Fairchild—For Opening  
and Closing Telegraphic Circuits.

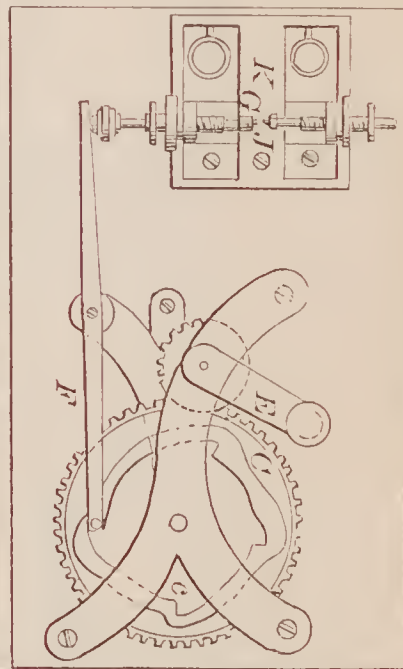

70672—J. M. Fairchild—Fire Alarm Telegraph.

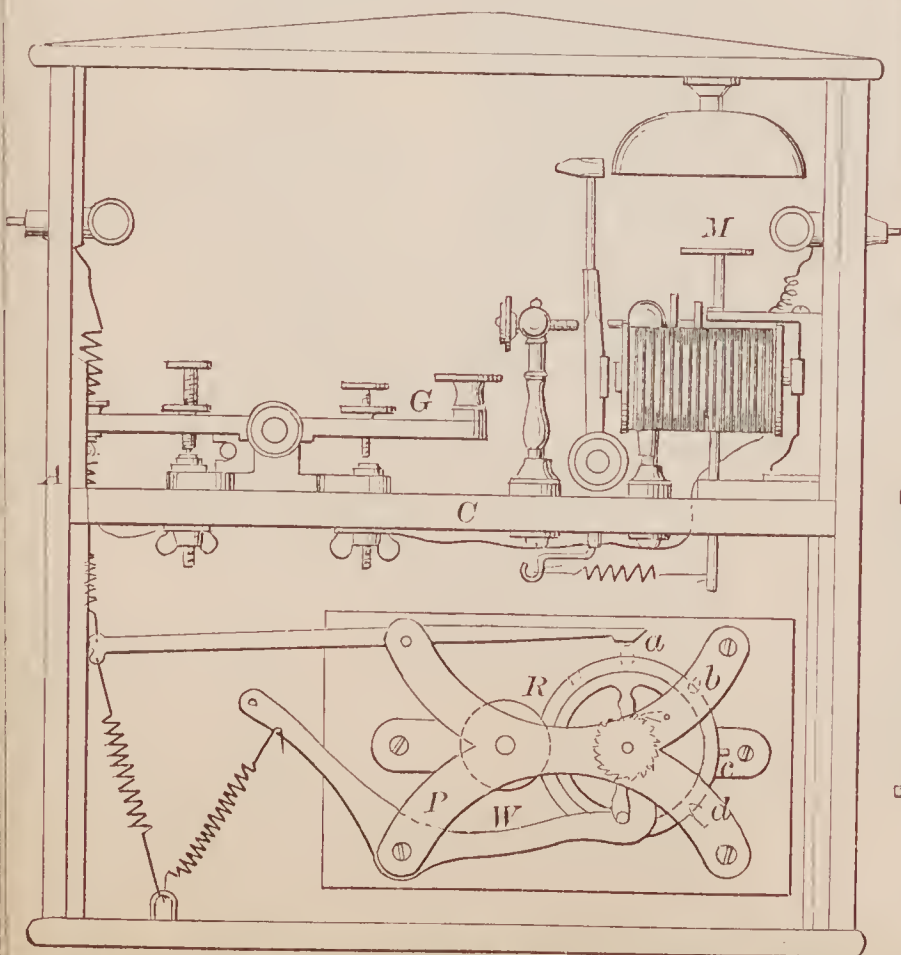

70670—E. G. Woodside—Wheel Hub  
Box.

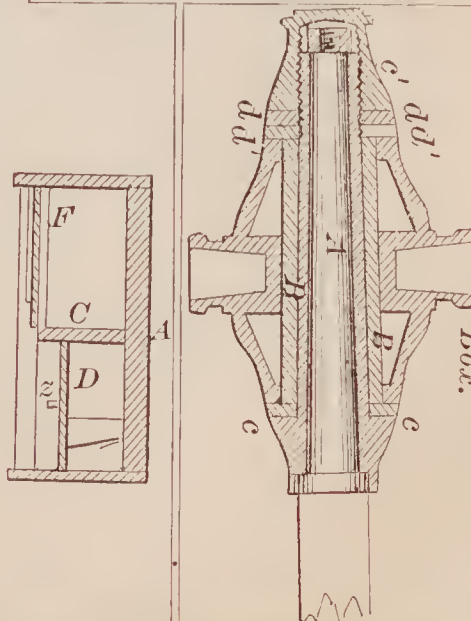



70674—H. G. Pearson—Pigeon Hole for Post Offices.

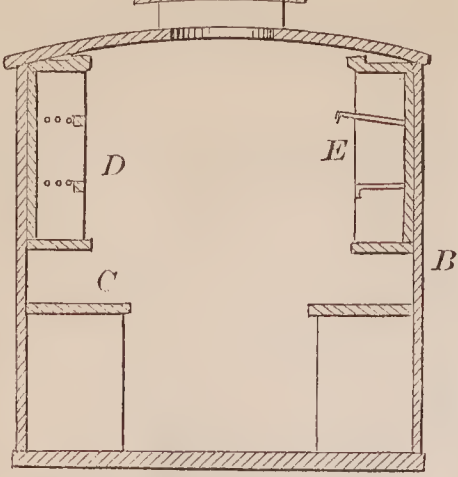

70675—A. T. Adams—Meat Mangler.

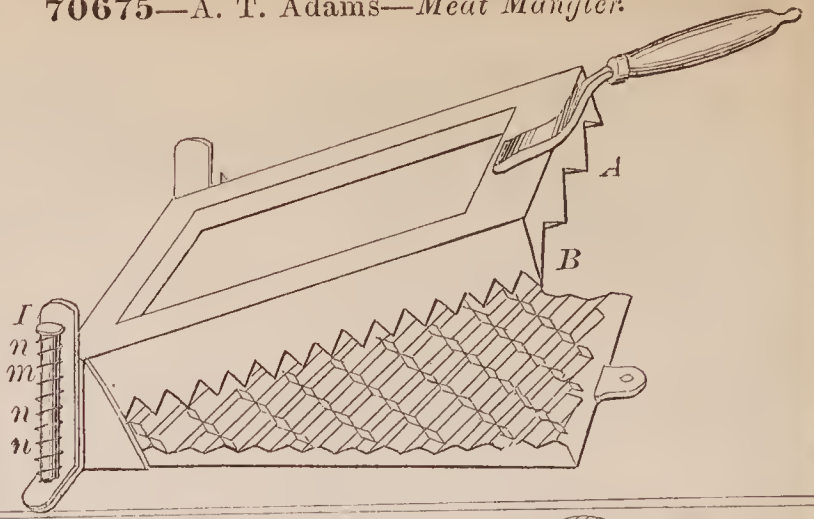

70676—Aikin & Stone—Moth Proof Case.

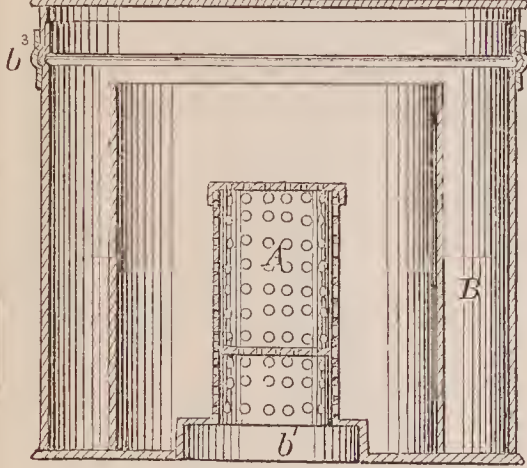

70678—W. Aiken—Machine Knitting Needle

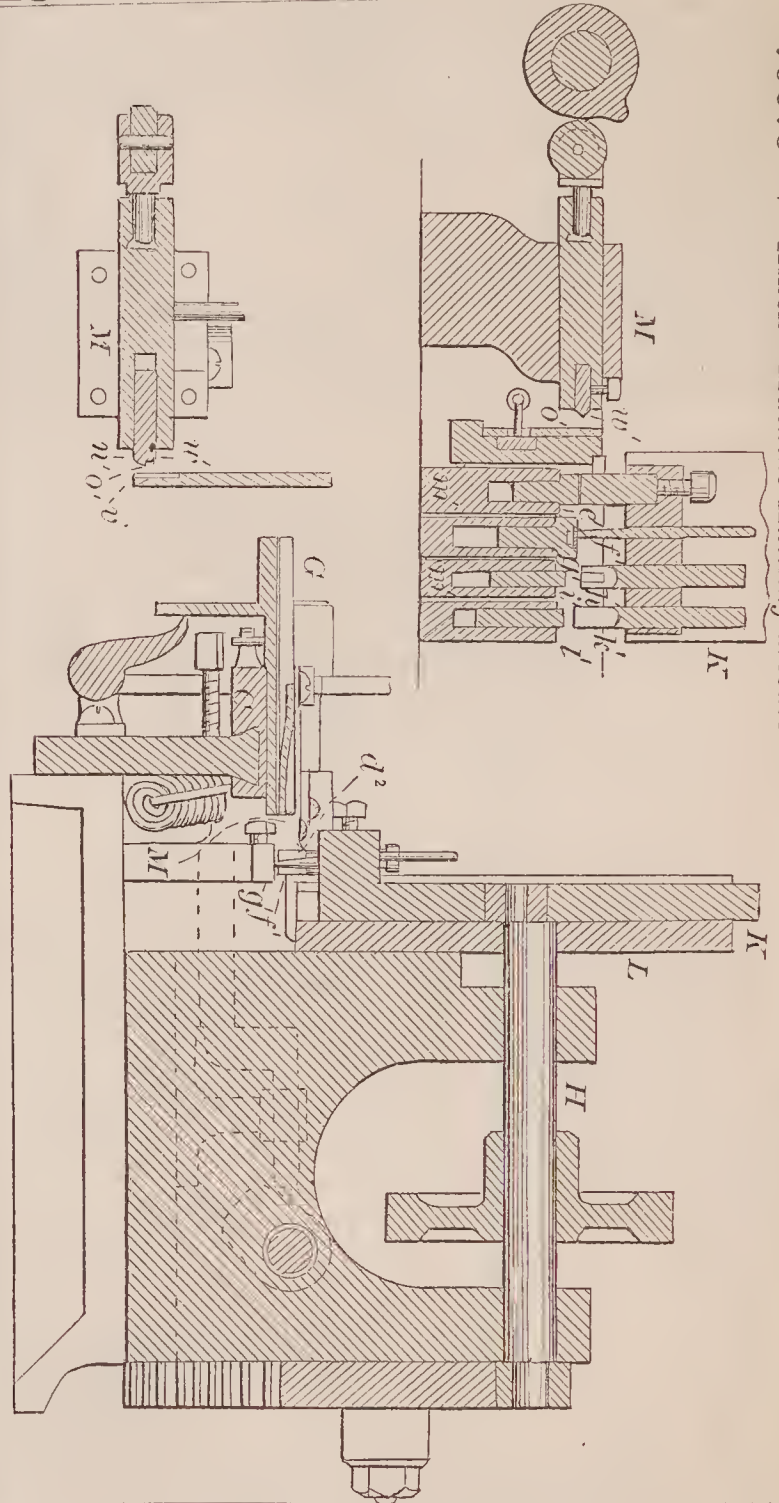

70677—W. Aiken—Needle Machine.

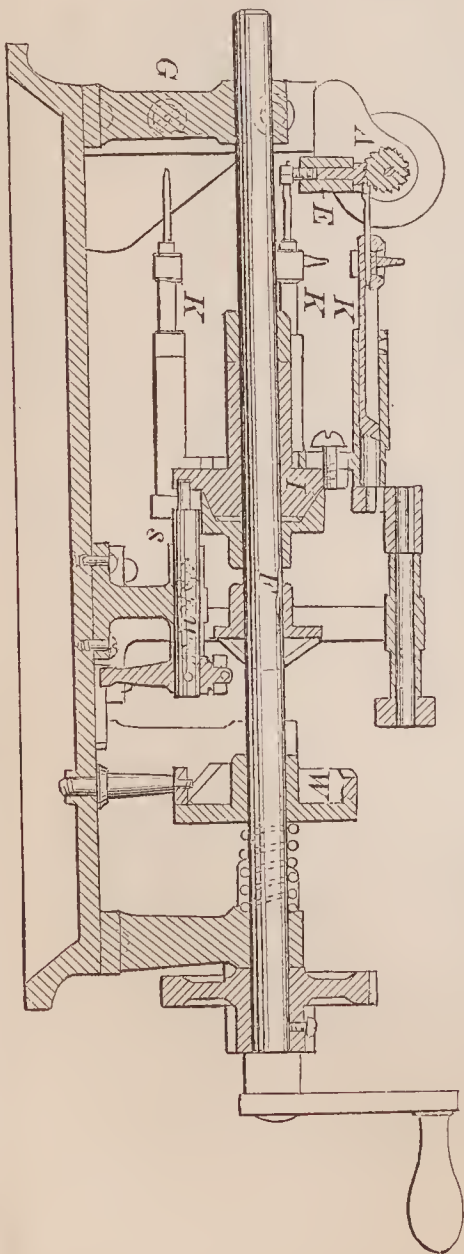

70679—B. Arthurs—Hot Air Furnace.

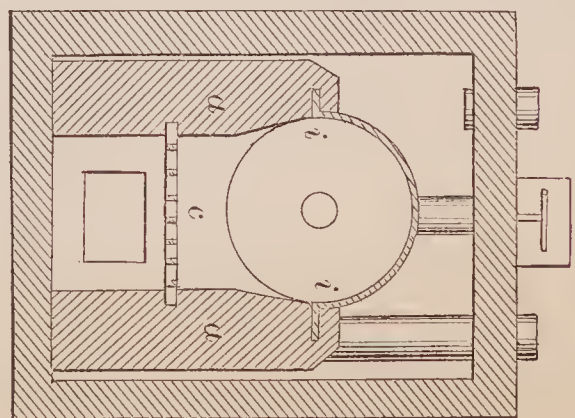

70680—  
J. E. Atwood—  
Saw.

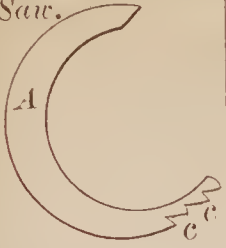

70681—C. C. Ayer—Carriage Wheel.

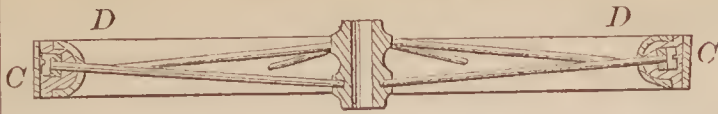

70682—S. C. Babbitt—  
Salver.



70683—C. A. Baker—Truss.

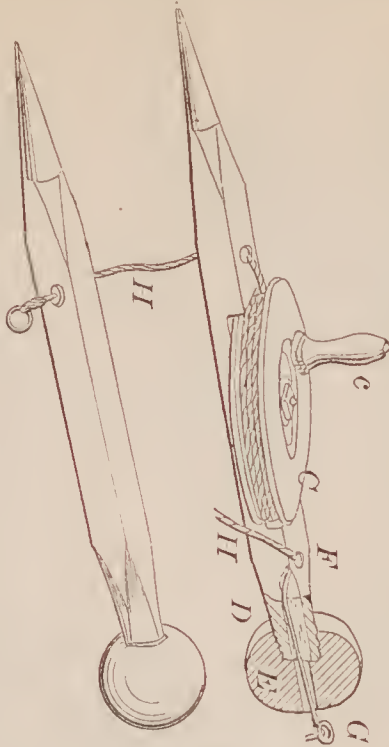
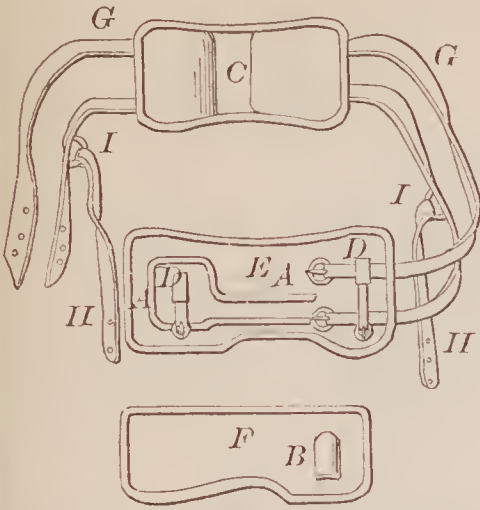

70684—J. Bathgate—Chalk Line Reel.

70686—J. A. Bidwell—Tapering Drill.

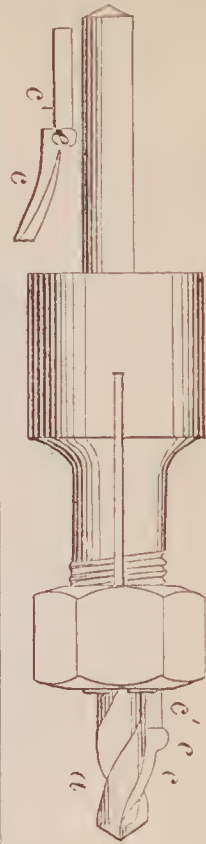

70685—S. & J. A. Bazin—For Laying and Twisting Rope

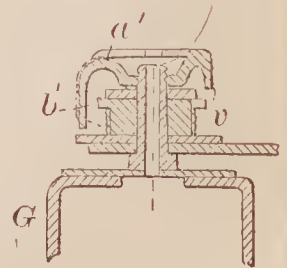
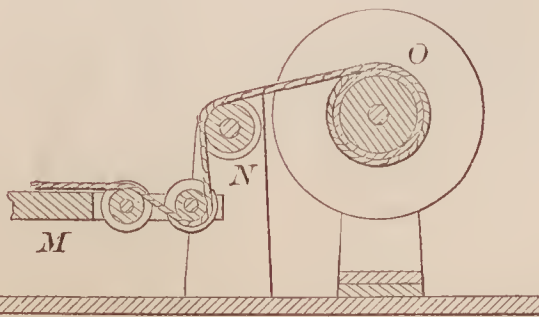
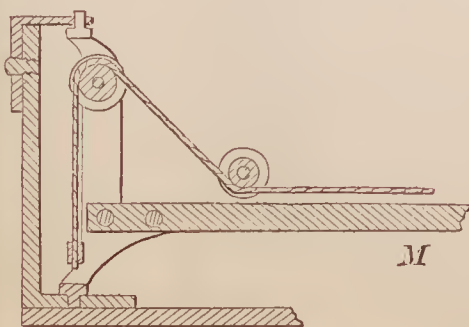
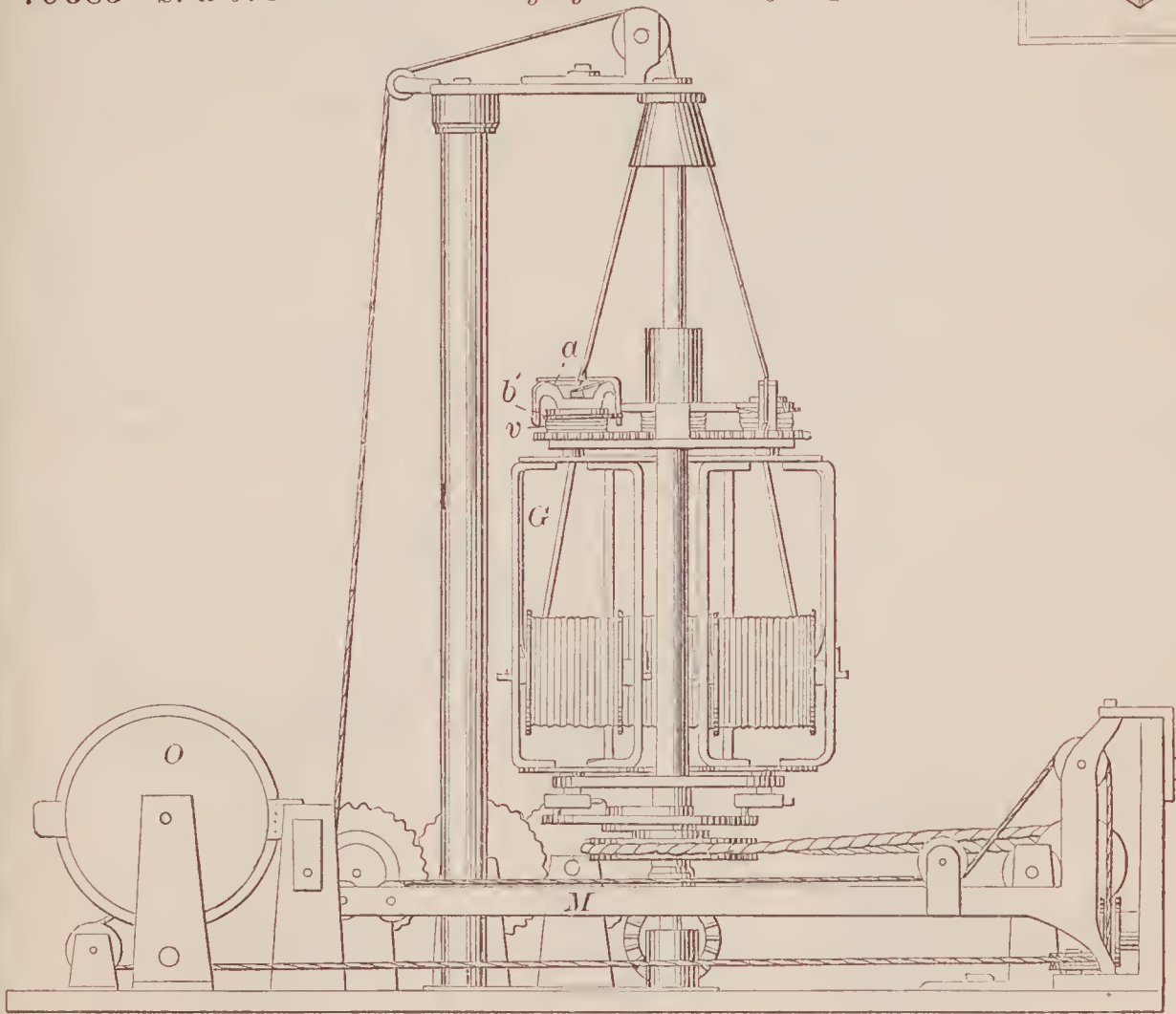



70687—A. Bingham—*Bed Bottom.*

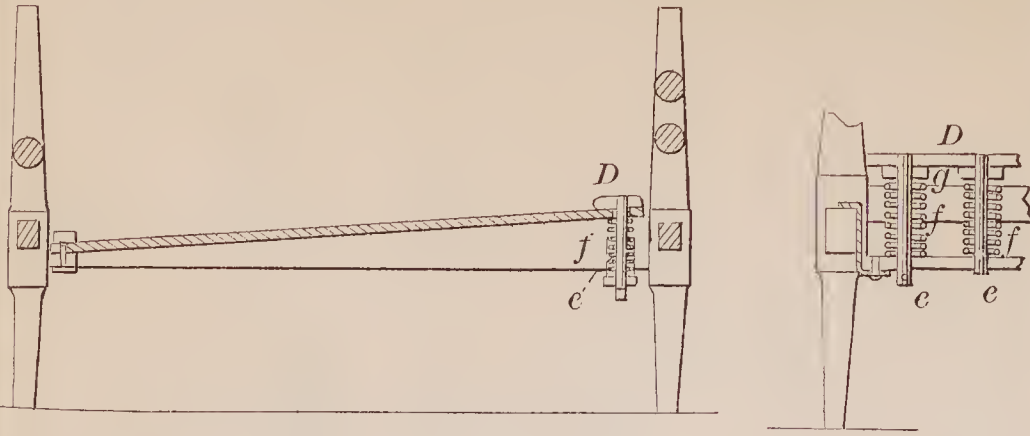

70689—

Boyd & Kriegbaum—*Car Coupling.*

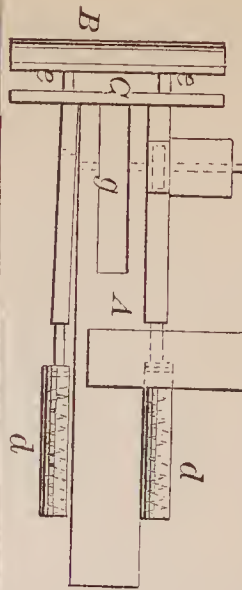

70688—E. Birkenshaw—*For Finishing Woolen Cloth.*

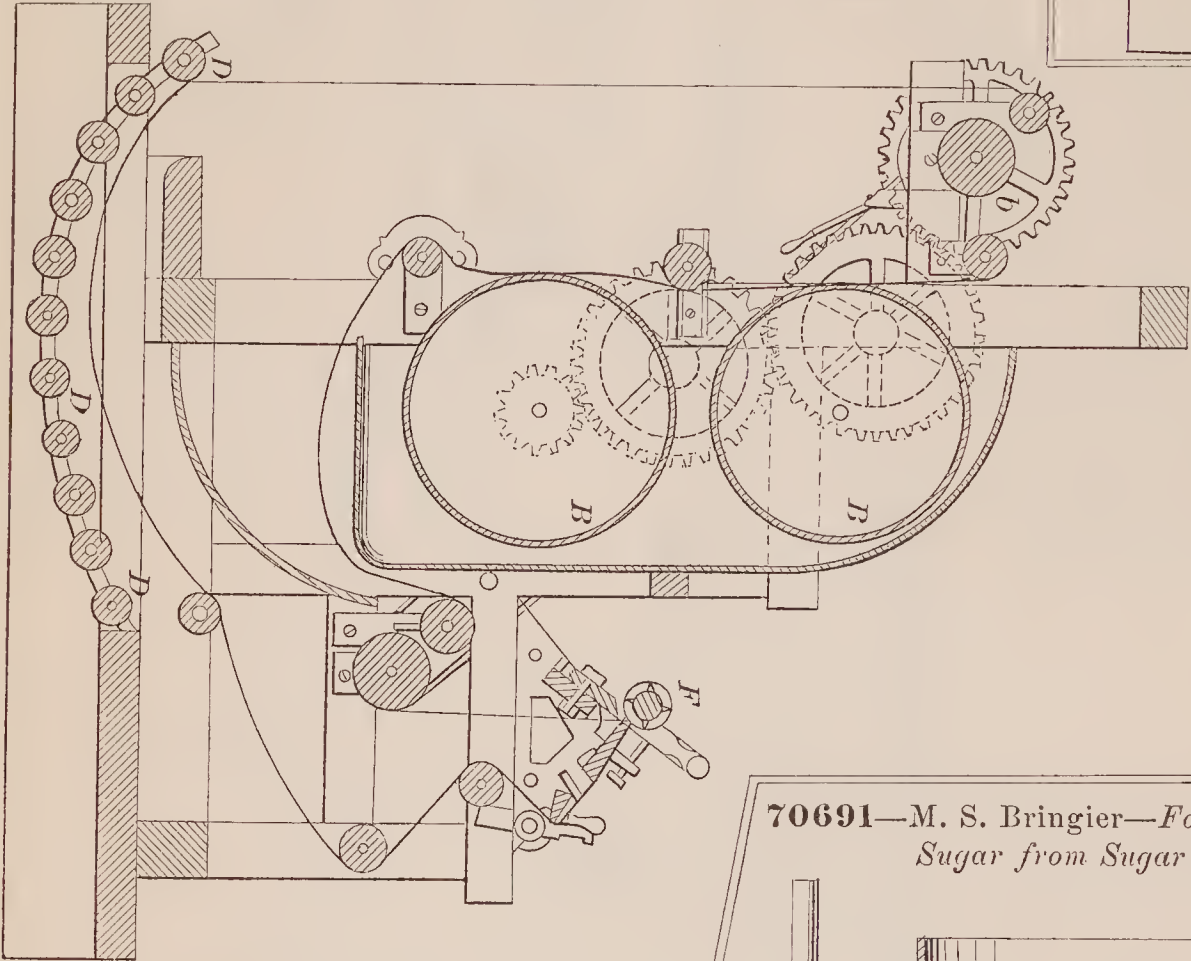

70691—M. S. Bringier—*For Extracting Sugar from Sugar Cane.*

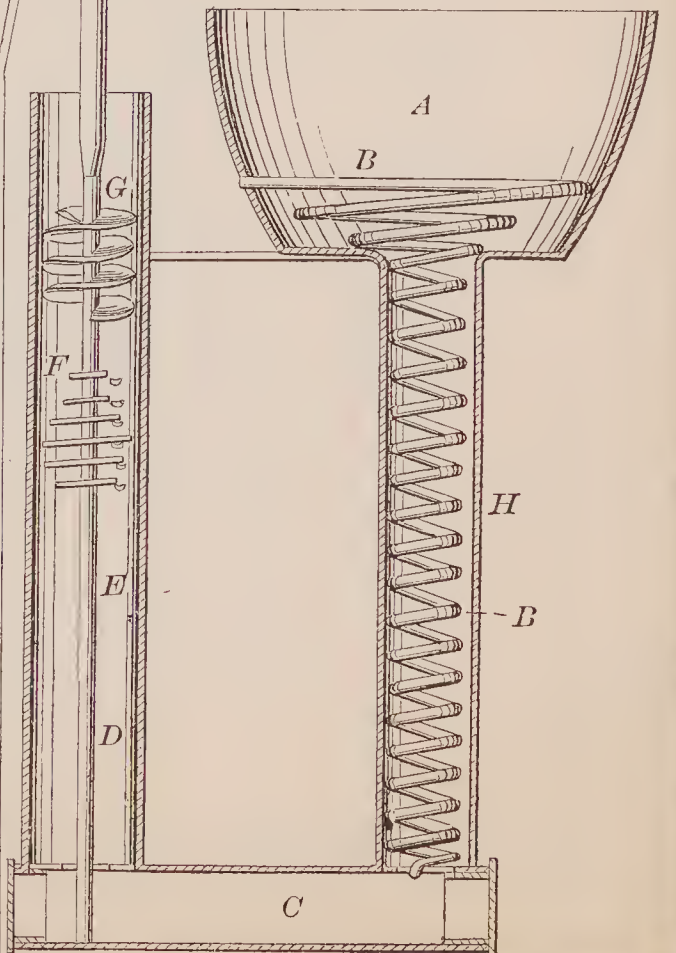

70690—M. S. Bringier—*For Evaporation.*

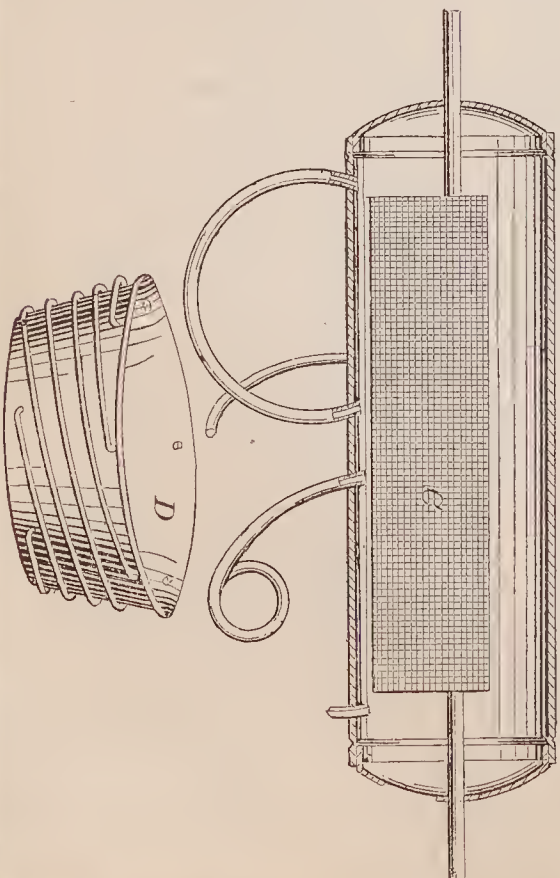

70692—Brooks & Matteson—Mop Wringer.

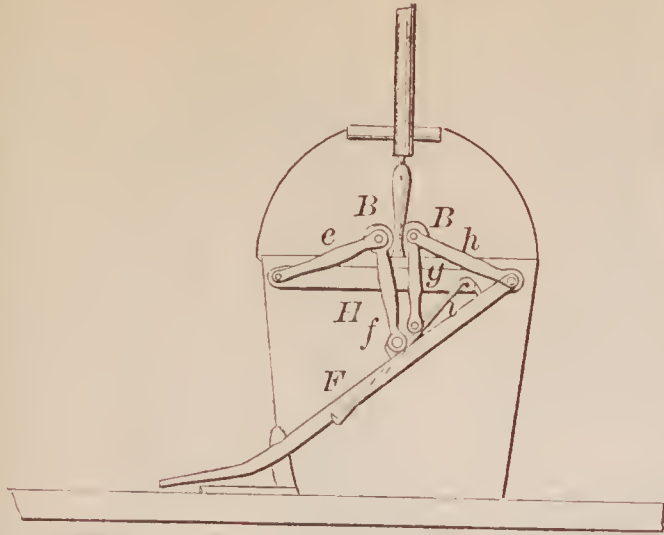

70693—A. R. Campbell—Washing Machine.

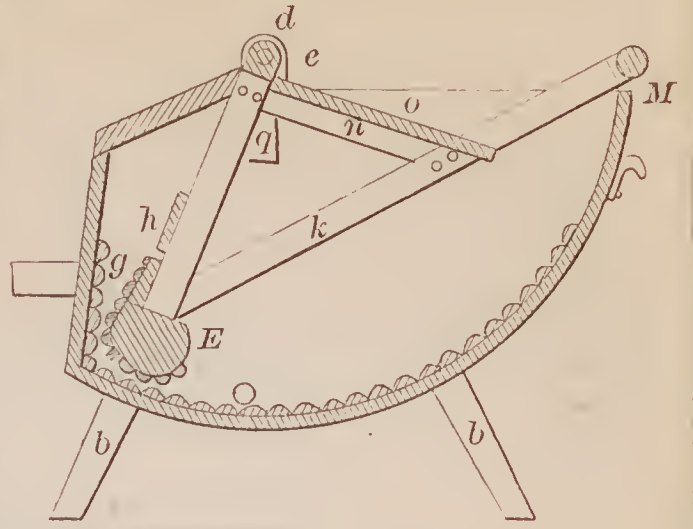

70694—A. L. Carrier—Attaching Ferrules to Handles.



70696—S. A. Chase—Car Truck.

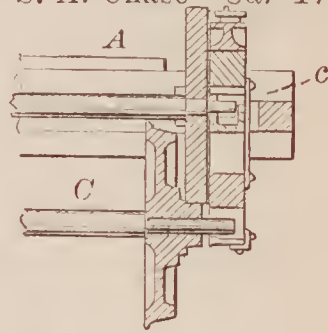

70697—G. H. Clemens—Journal Box.

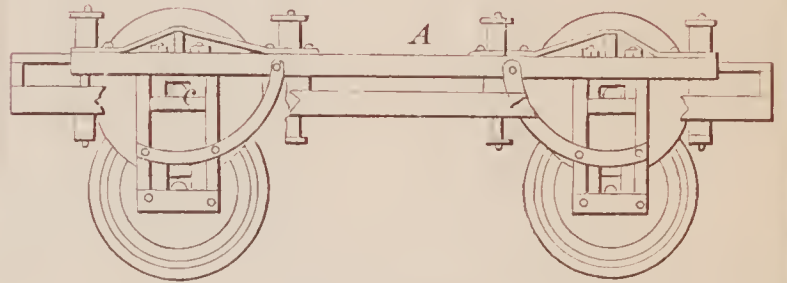
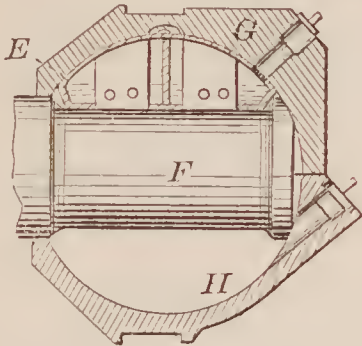

70698—H. Cole—Chair.

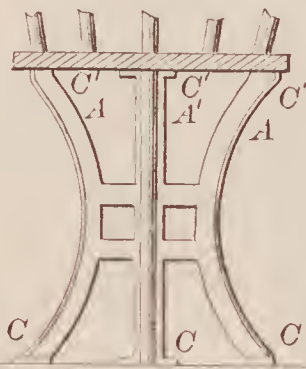

70700—J. S. Culver—Horse Hay Fork.

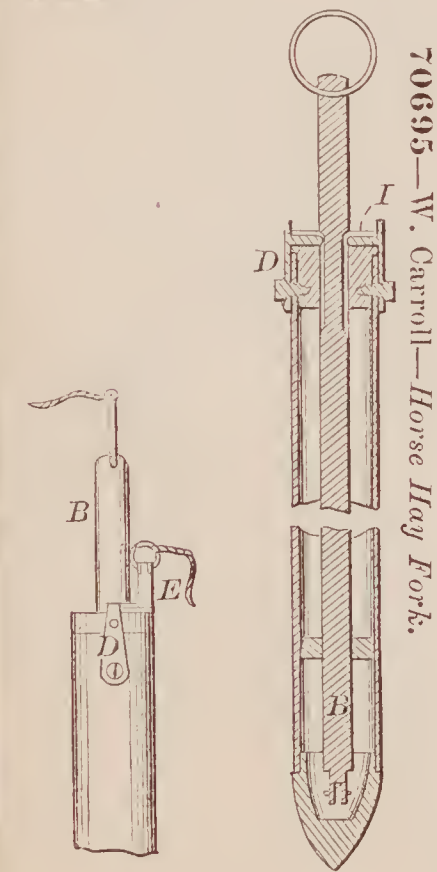
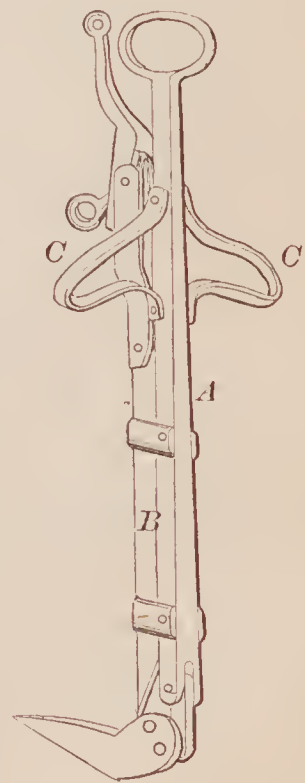

70695—W. Carroll—Horse Hay Fork.

70702—F. Douglas—Blind Staple.

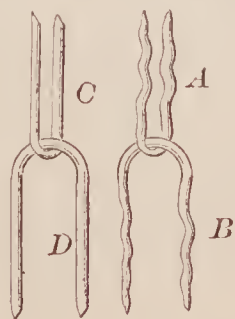

70701—R. Devereux—Lamp Bracket.

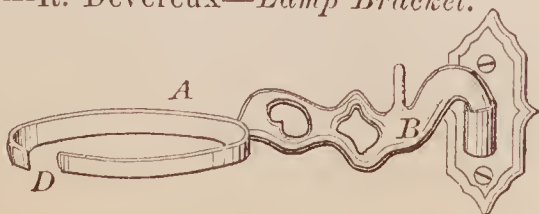

70699—Corthell & Richards—Door and Window Fastener.

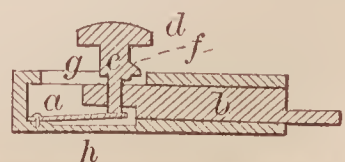



70706—H. Dunphy—Cloth Folding Machine.

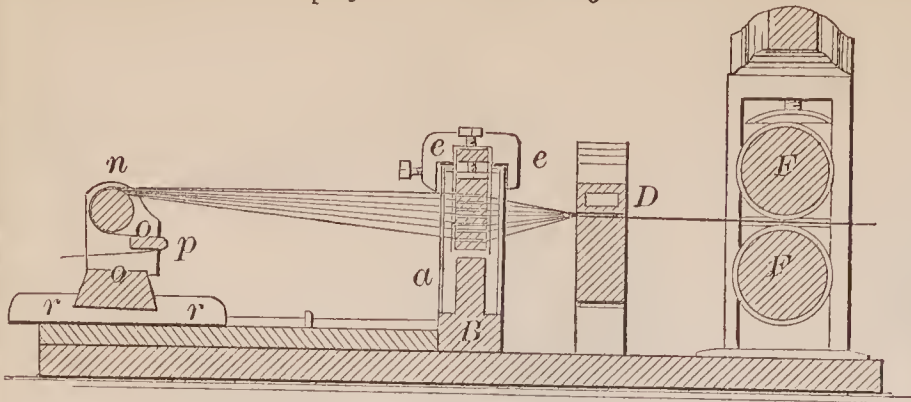

70708—W. Fallon—Paper File.

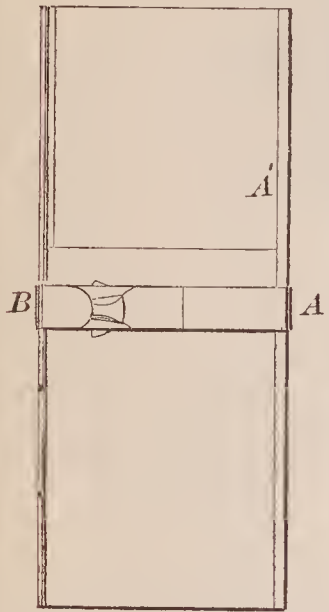
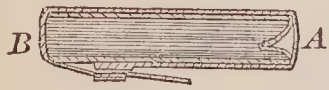

70709—W. A. Fenn—Salt Sifter.

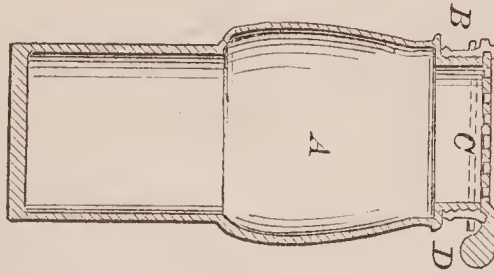

70710—J. E. Fry—Mould for Casting Steel Ingots.

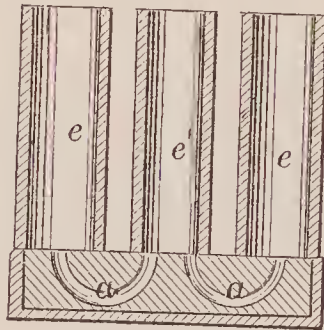

70714—E. Herbster—Sash Fastener.

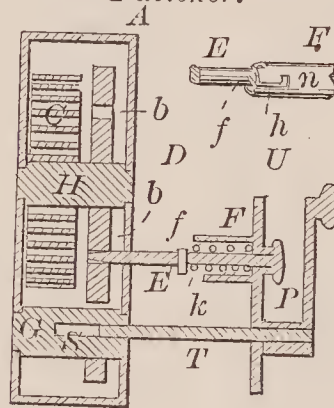

70712—M. T. Gosnell—For Burning Hydro-Carbon Oil.

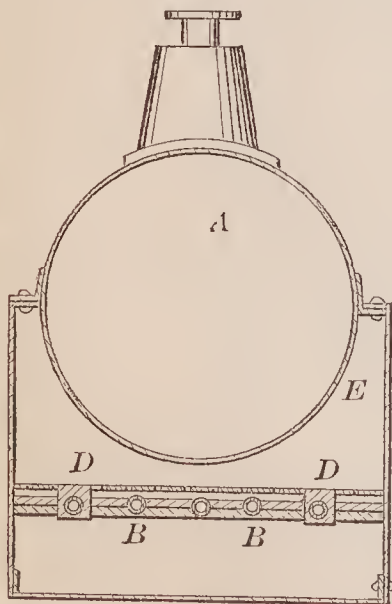

70713—Gray & Hyde—

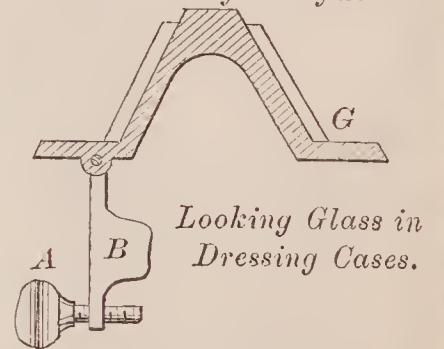

70711—M. C. Goodale—Belt Cutter.

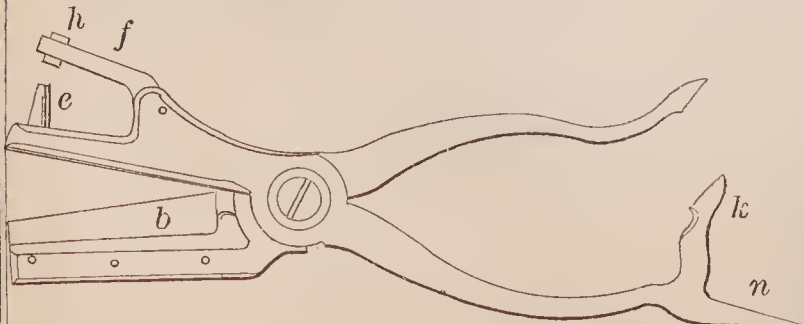

70715—W. O. Hickok—Paper Ruling Machine.

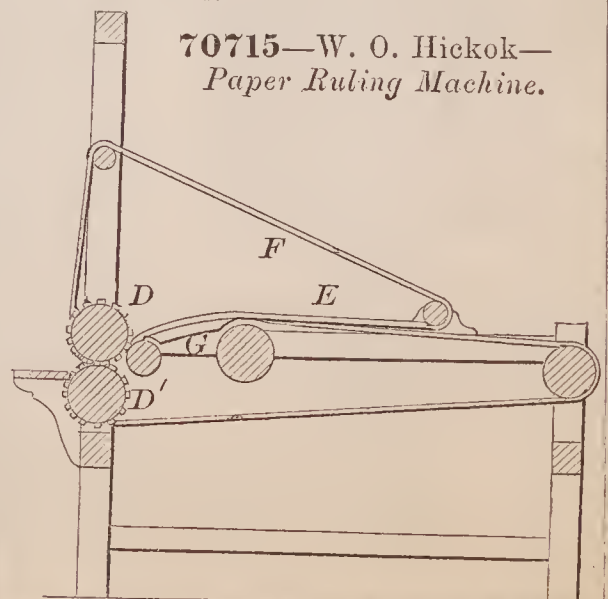

70707—C. E. Emery—Steam Engine.

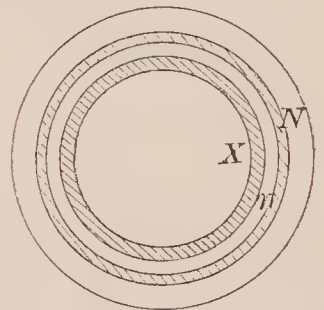
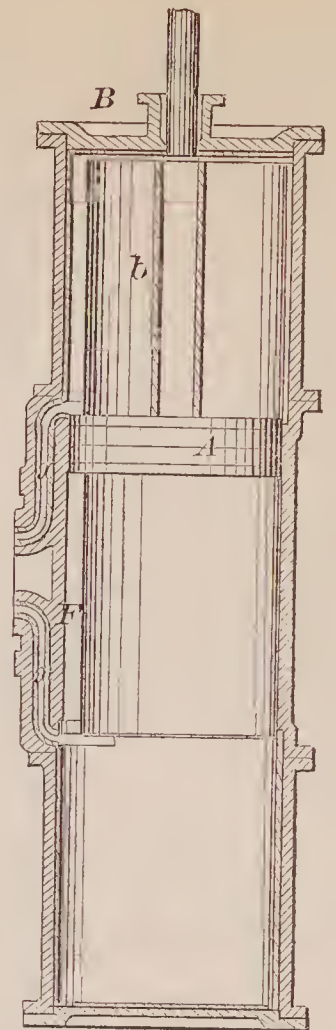

70716—J. Hill—Needle Wrapper.

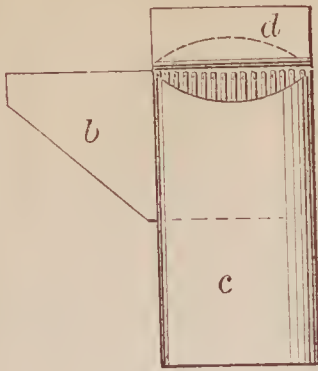

70717—N. D. Hinman—Clutch for Hay Elevators.

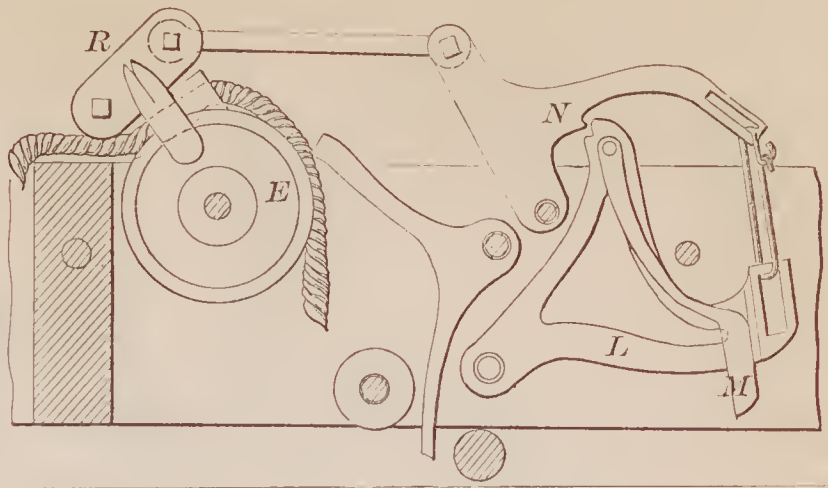

70719—W. J. Horner—Scraper.

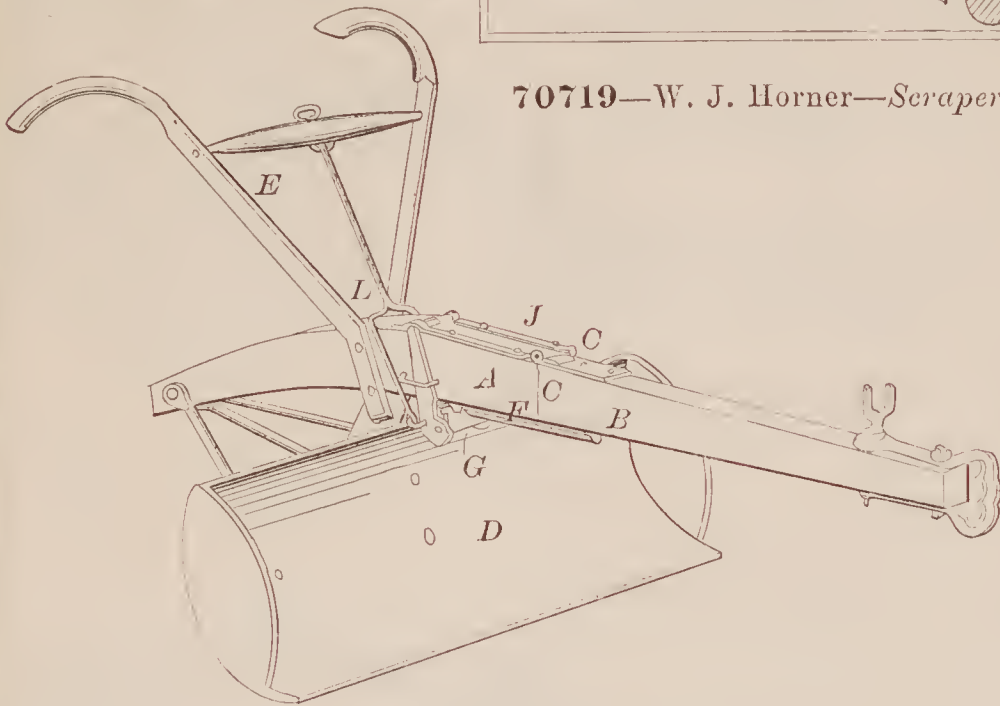

70718—P. S. Hoe—Pocket Cutlery.

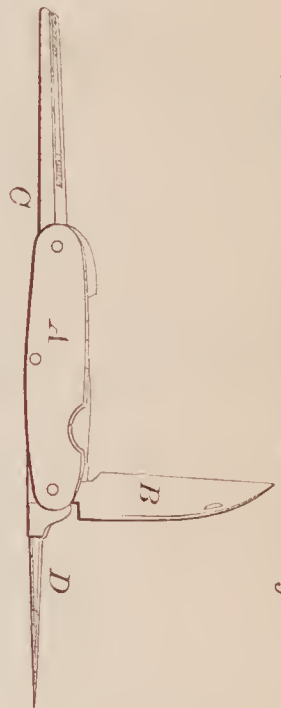

70720—F. Horton—Hay Press.

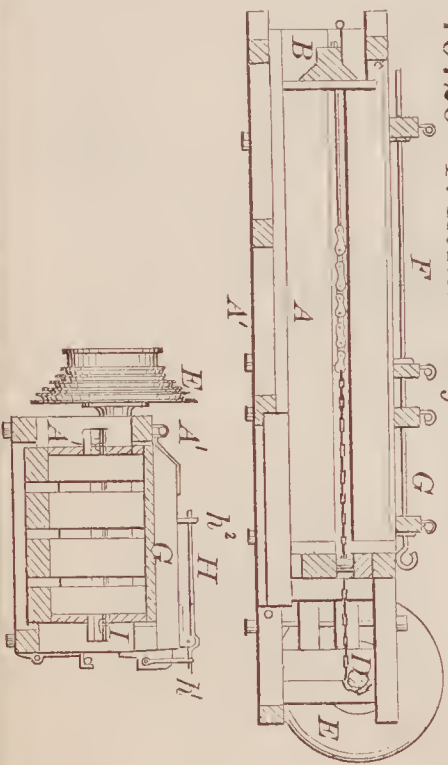

70722—S. P. Johnson—Invalid Bedstead.

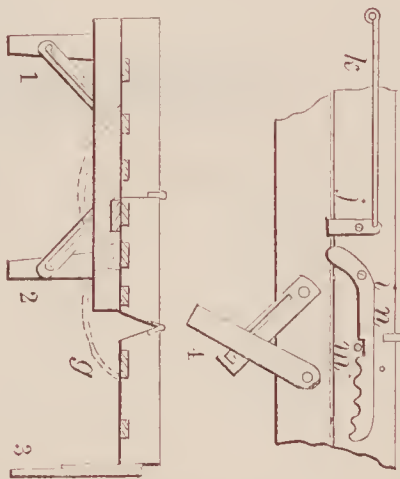

70721—E. Howard—Preventing Explosion of Lamps.

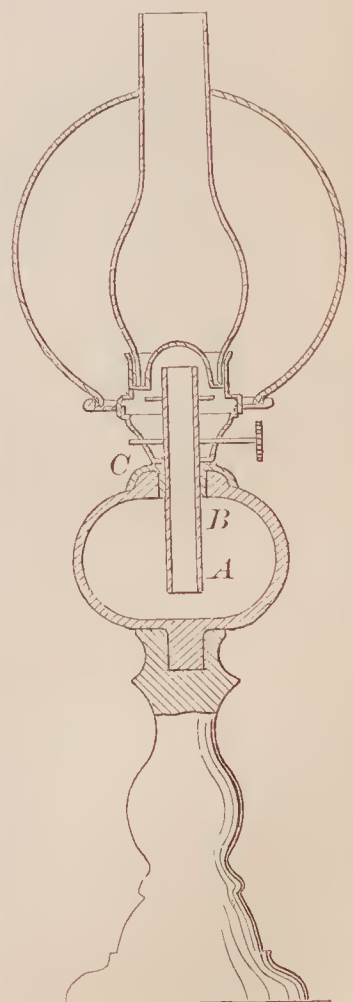

70723—E. G. Kinsley—Corn Popper.

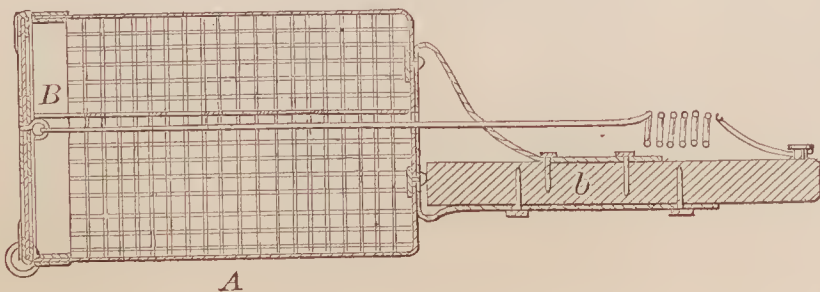



70724—W. H. Lamb—*Watch Escapement.*

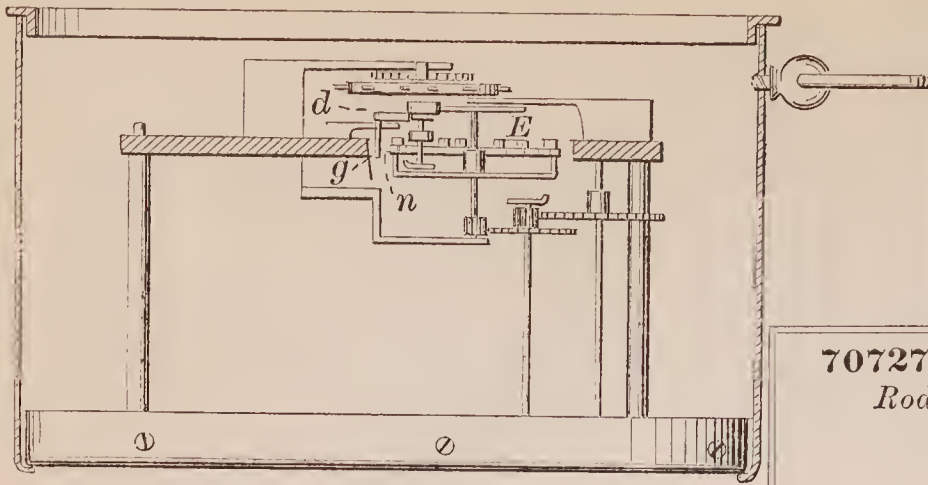

70726—G. Lightfoot—*Blind Fastening.*

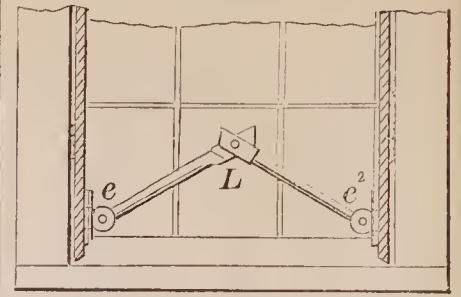

70727—Lockhart & Locke—*Lightning Rod Insulator.*

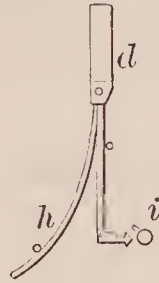
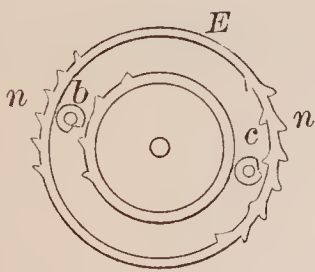
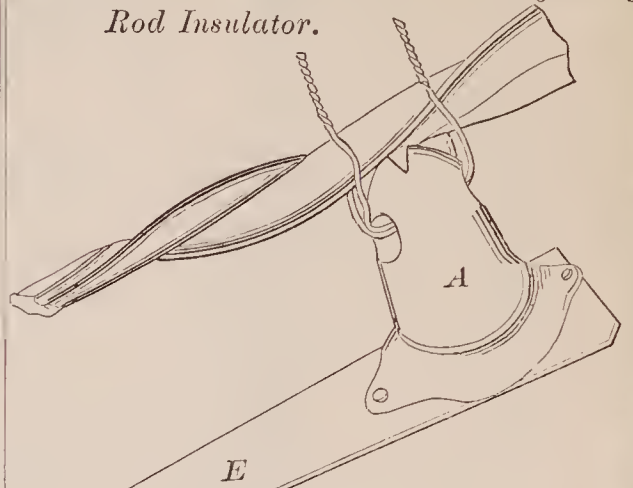

70728—J. K. Lockwood—*Saw.*

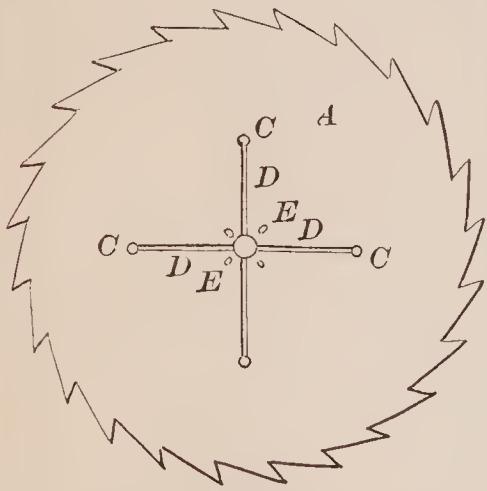

70725—C. H. Lee—*Churn.*

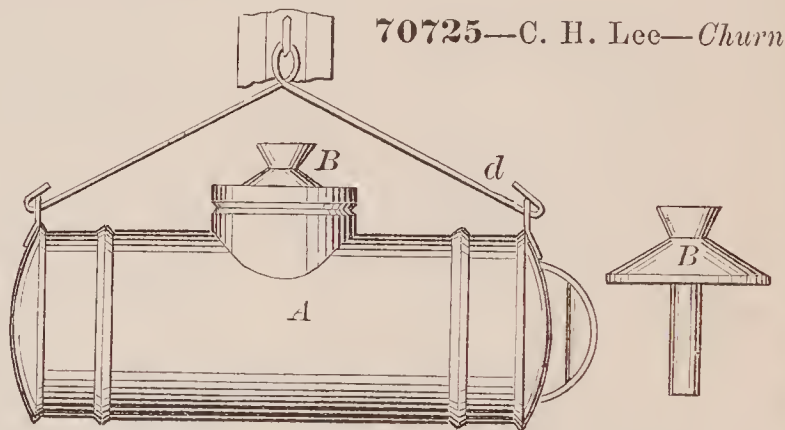

70729—S. I. Loomis—*Car Coupling.*

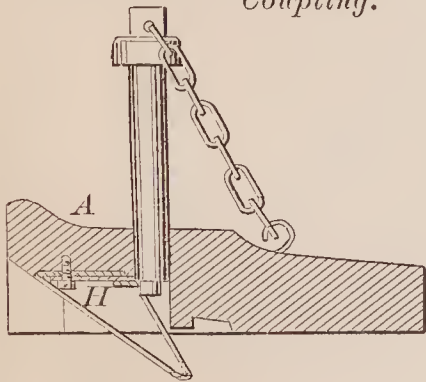

70730—C. W. & W. W. Marsh—*Harvester.*

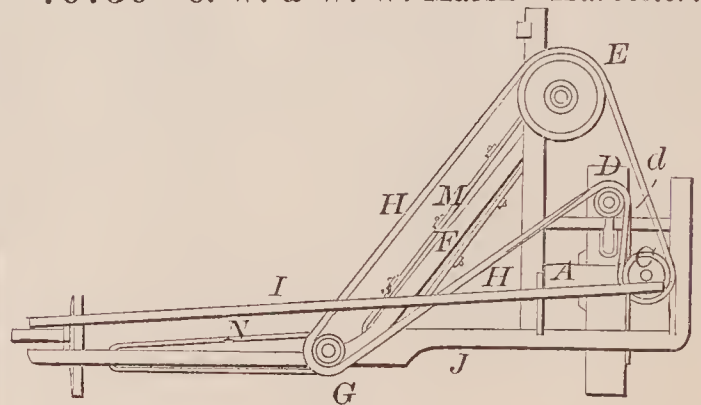

70731—H. McCan—*Railroad Track.*

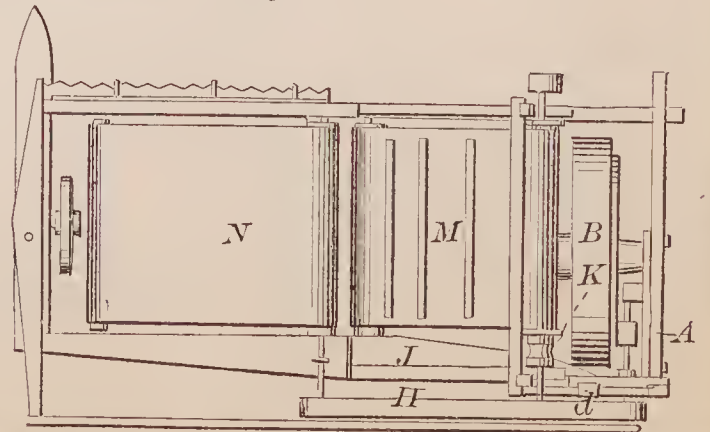
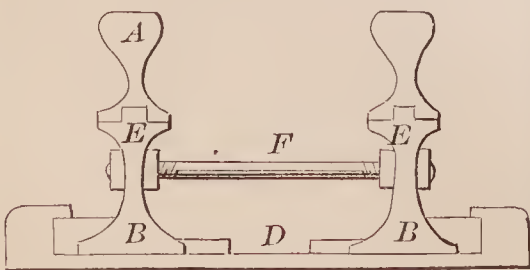

70734—C. G. Miller—Chimney Cap.

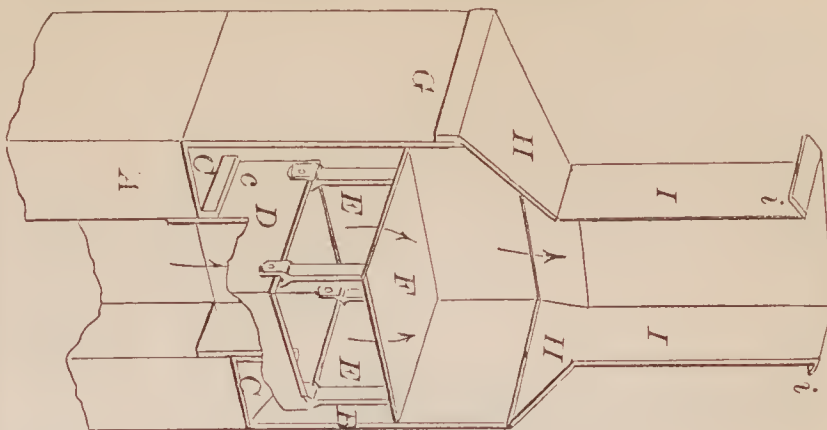

70733—J. H. & T. J. McGowan—Pump.

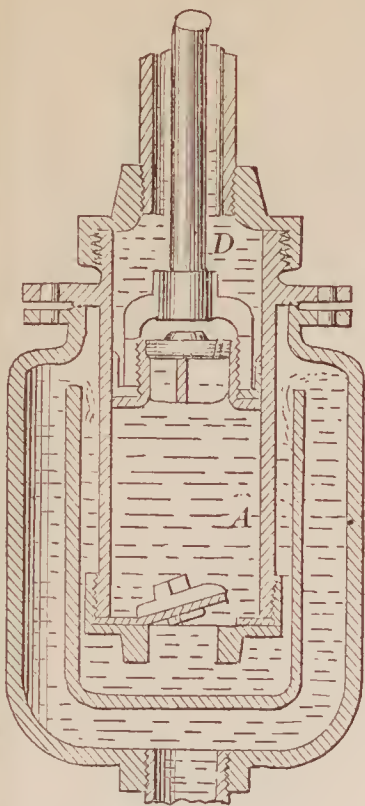

70736—W. P. Miller—Fan Blower.

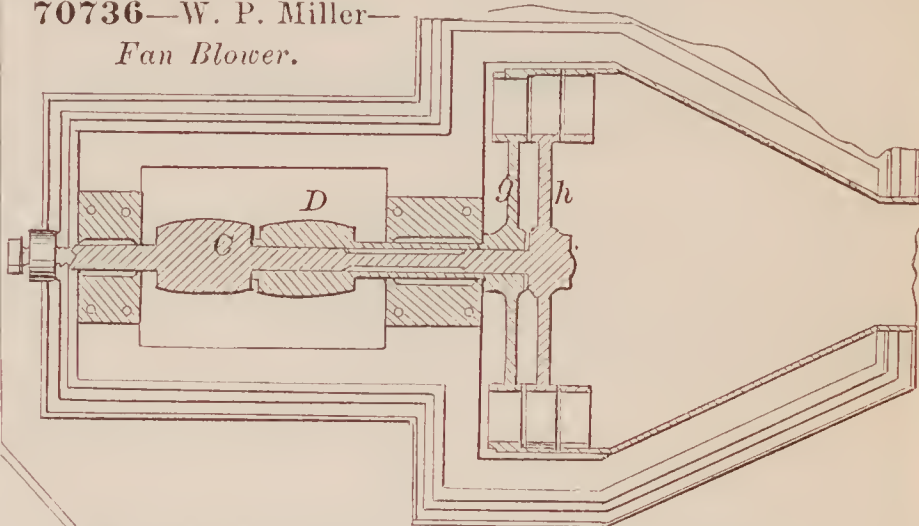

70738—J. A. Morrell—For Setting up Staves in Barrels.

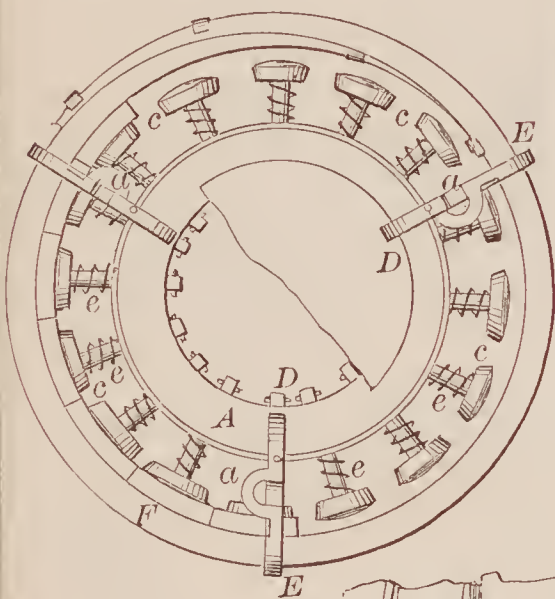

70735—L. Miller—Dropper for Harvesters.

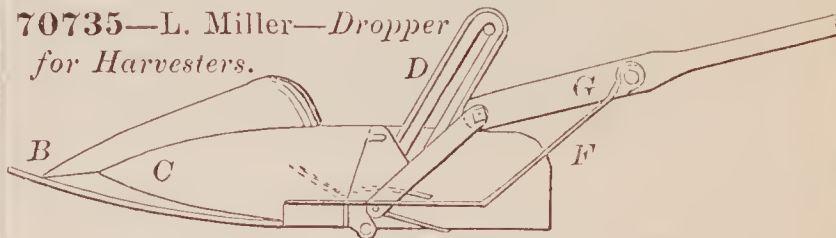

70740—B. C. Painter—Flask for Casting Tapers.

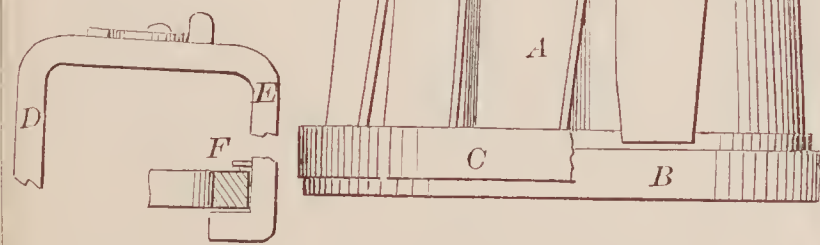
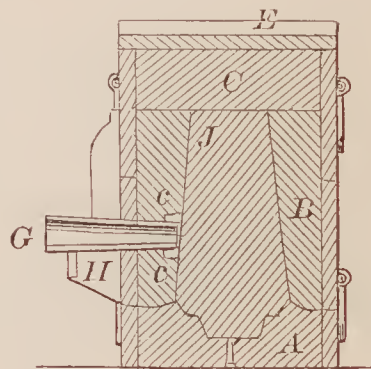

70739—E. F. Olds—Land Roller.

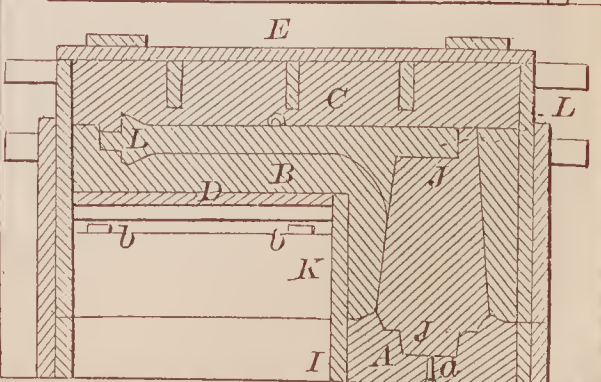
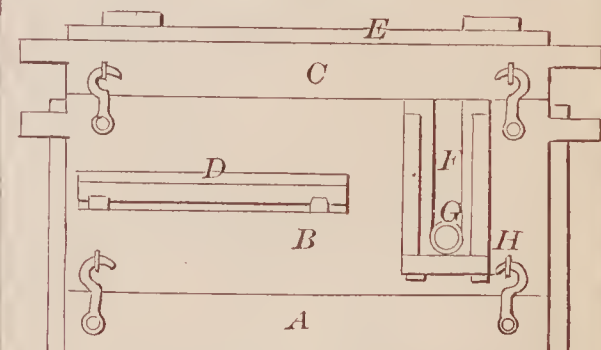
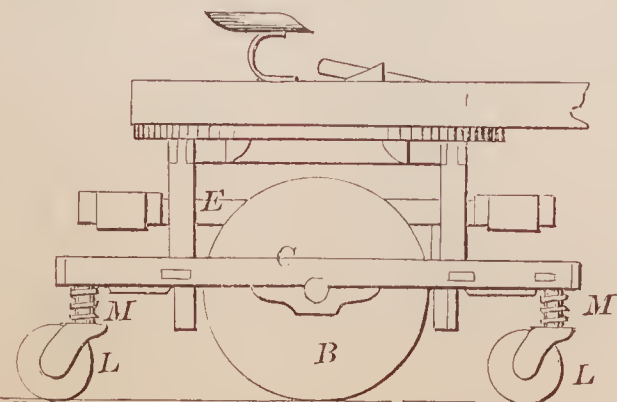



70741—W. G. Pike—*Lightning Conductor.*

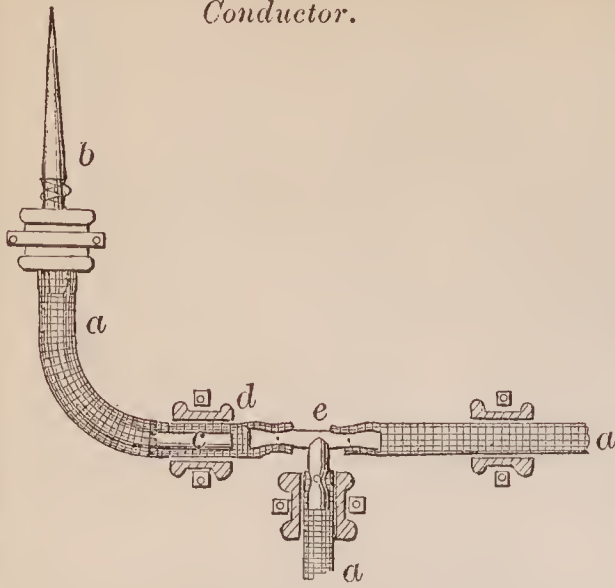

70742—L. B. Pitcher—*Mixing and Drying Cylinder.*

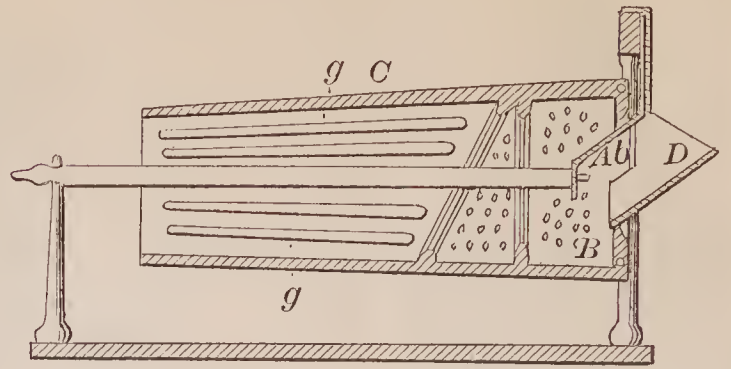

70743—G. W. Rawson—*Steam Engine Cut-off.*

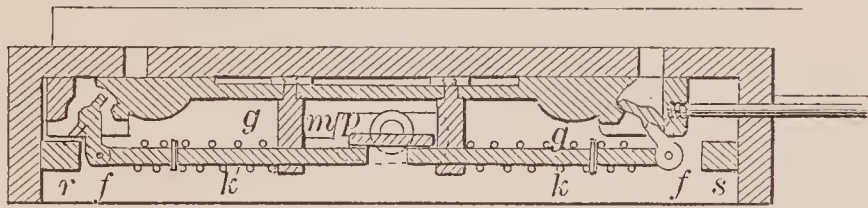
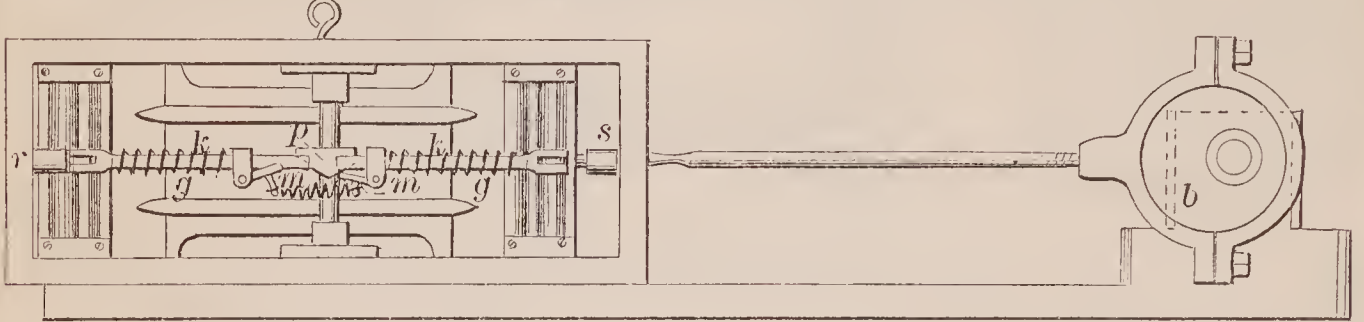

70744—G. Riemer—*Harvester.*

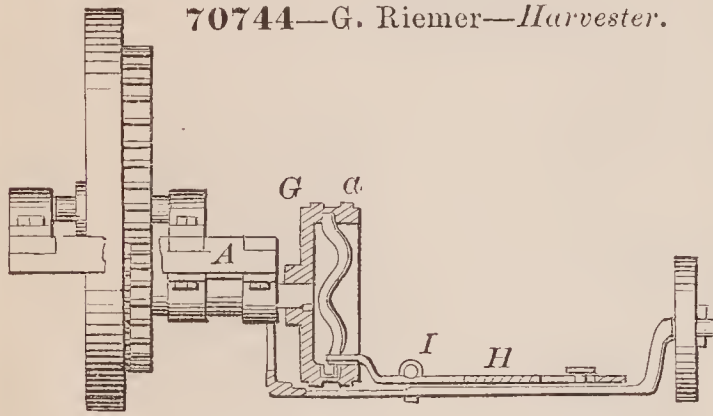

70747—Russell & Burdick—*Hand Corn Planter.*

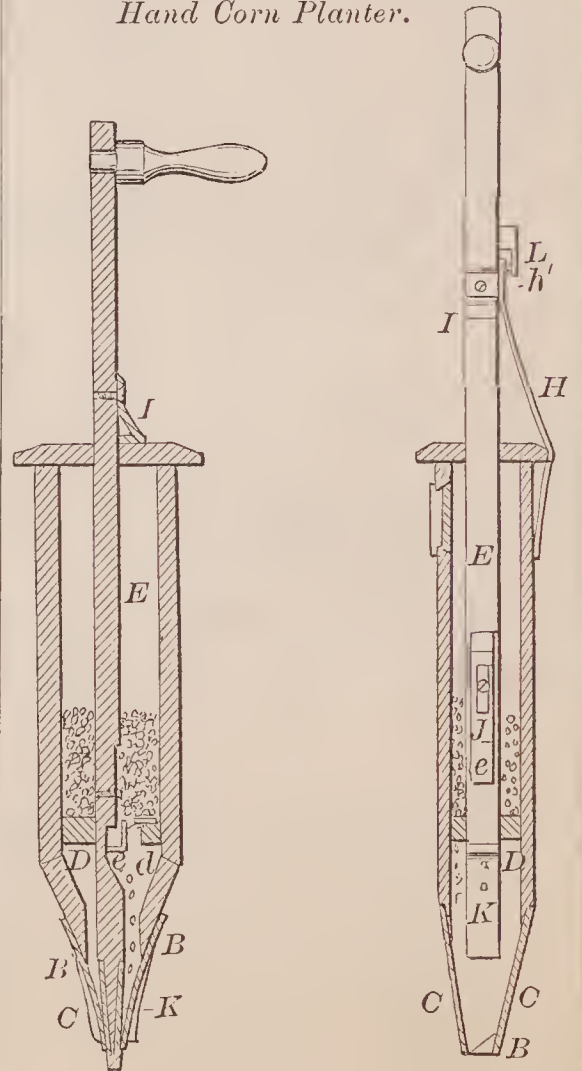

70745—A. H. Rockwell—*Bridle Bit.*

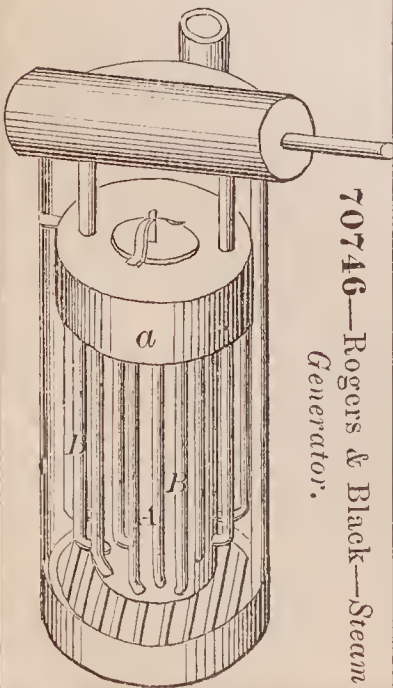
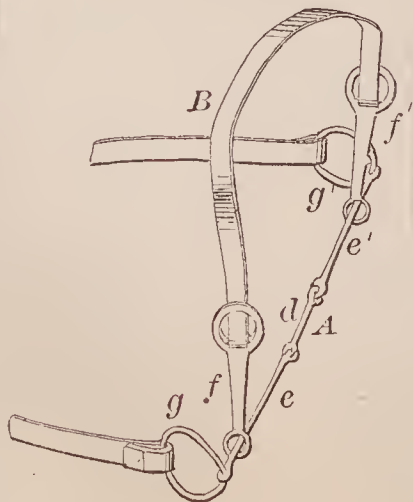

70746—Rogers & Black—*Steam Generator.*





70756—E. Smith, Jr.—*Spring Rocking Chair.*

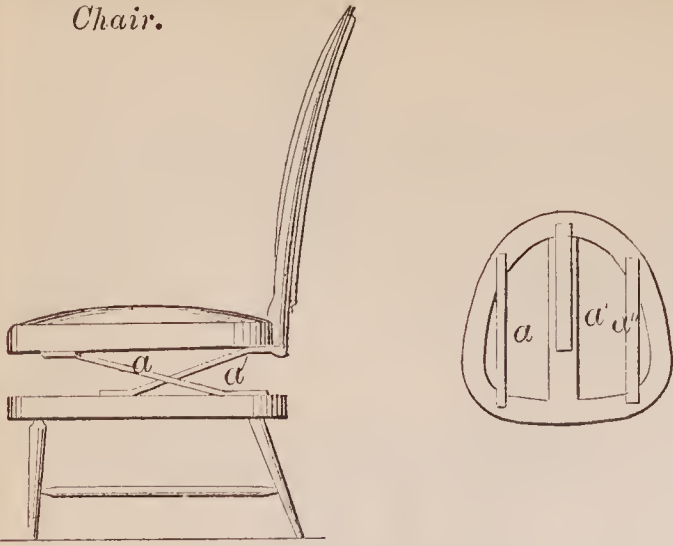

70757—Smith & Walter—*Steam Generator*

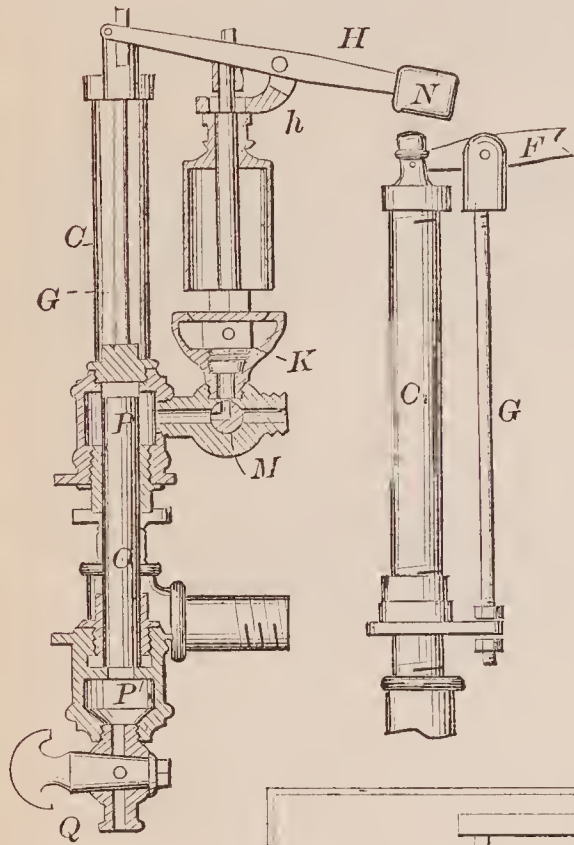
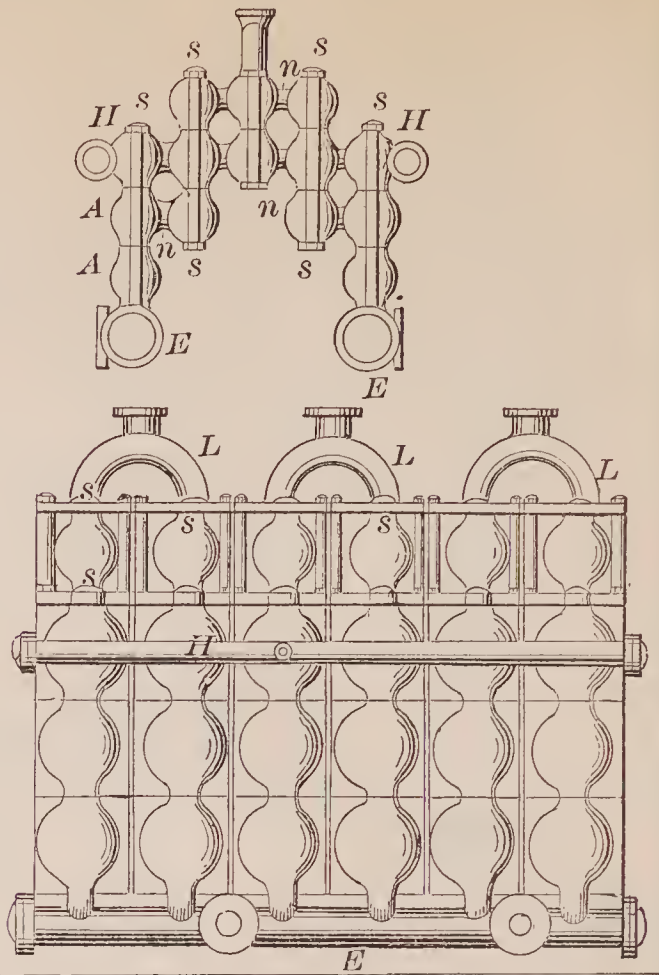

70758—L. F. Smith—*Low Water Indicator.*

70759—W. M. Smith—*Casket Handle.*

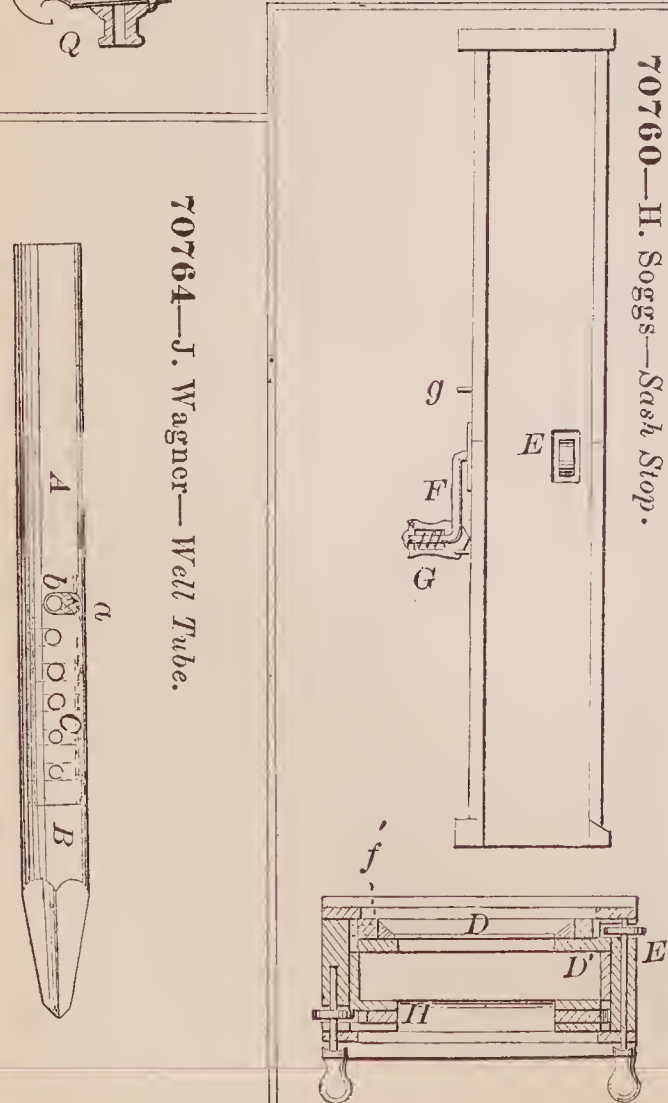
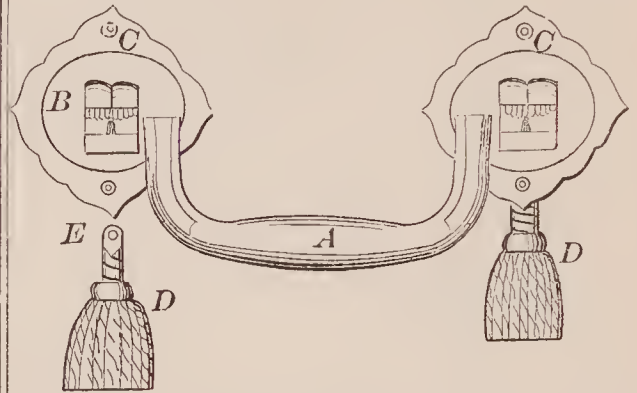

70760—H. Soggs—*Sash Stop.*

70764—J. Wagner—*Well Tube.*



70762—G. L. Templeton—*Gate.*

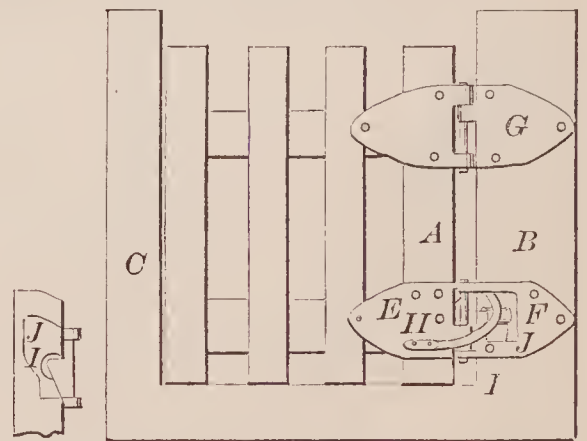

70763—I. Varney—*Carriage Jack.*

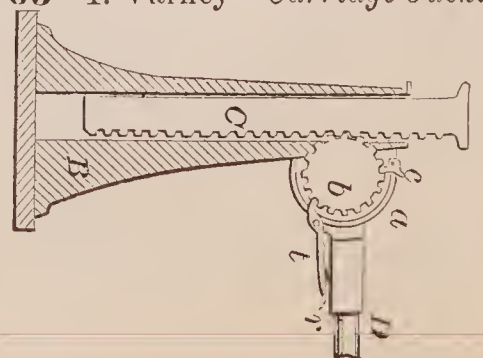





70773—E. Allen—*Printing Press.*

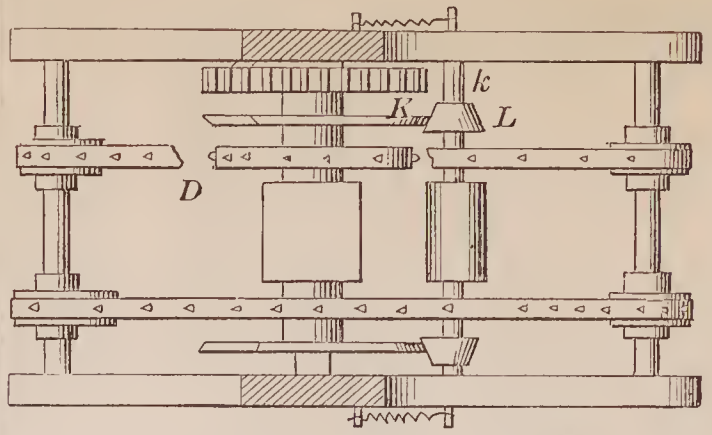

70776—P. Baker—*Car Coupling.*

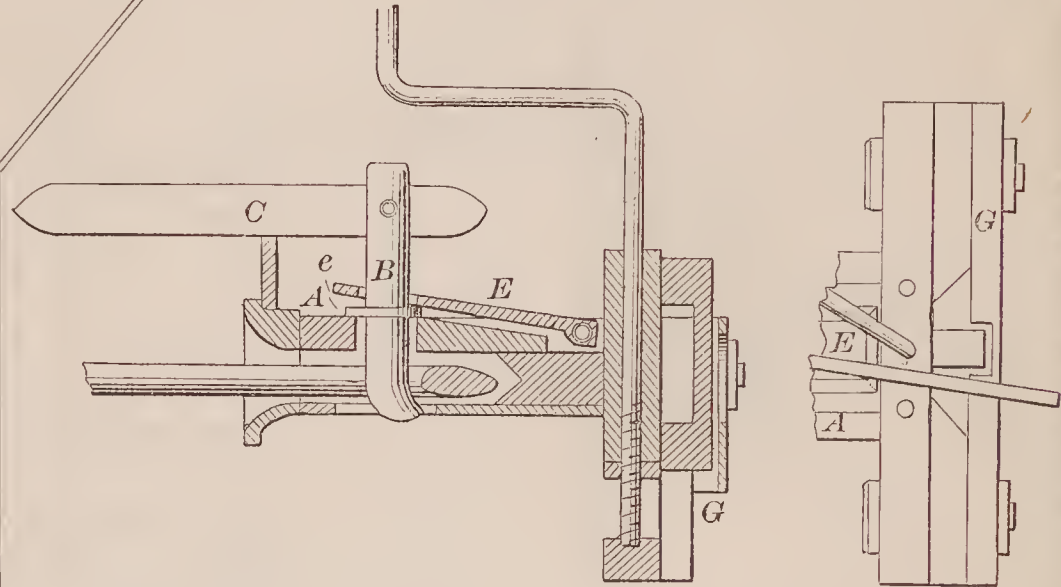

70772—I. V. Adair—*Ditching Machine.*

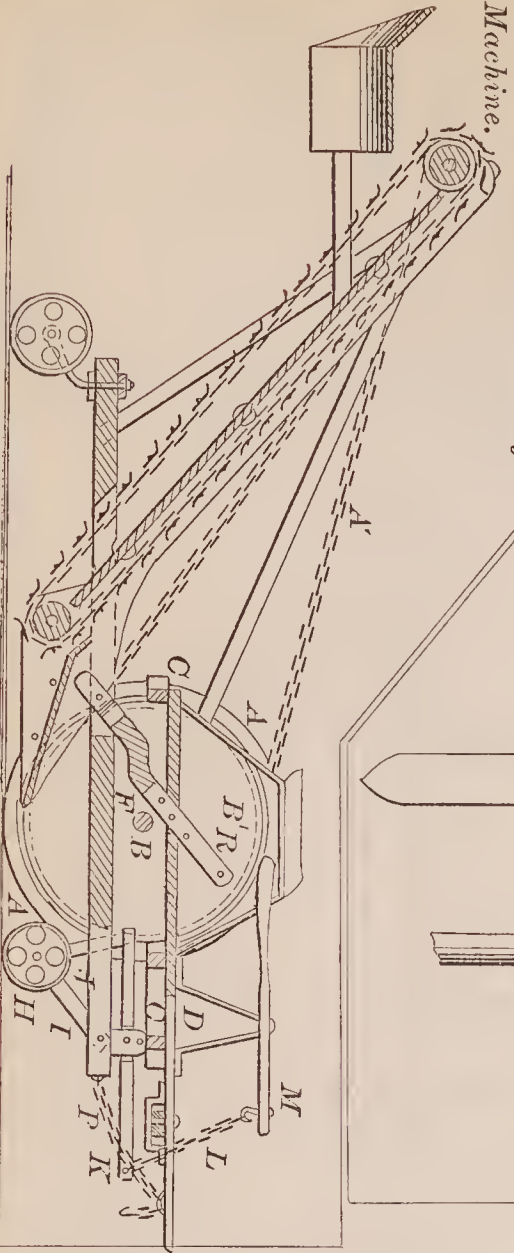

70775—H. C. Babcock—*Belt Lacing.*

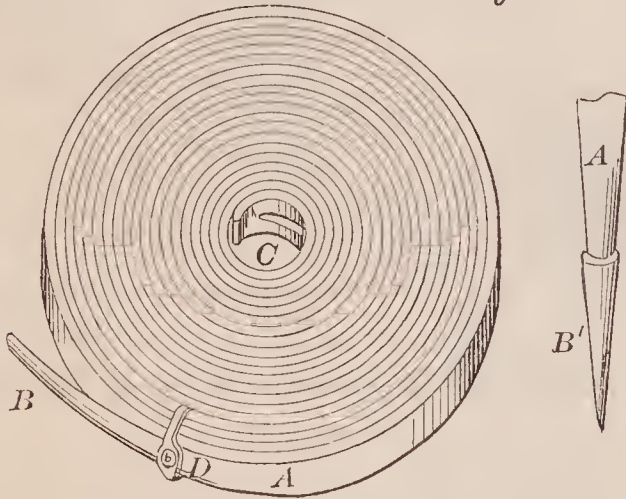

70774—E. Ansaldo—*Steam Engine.*

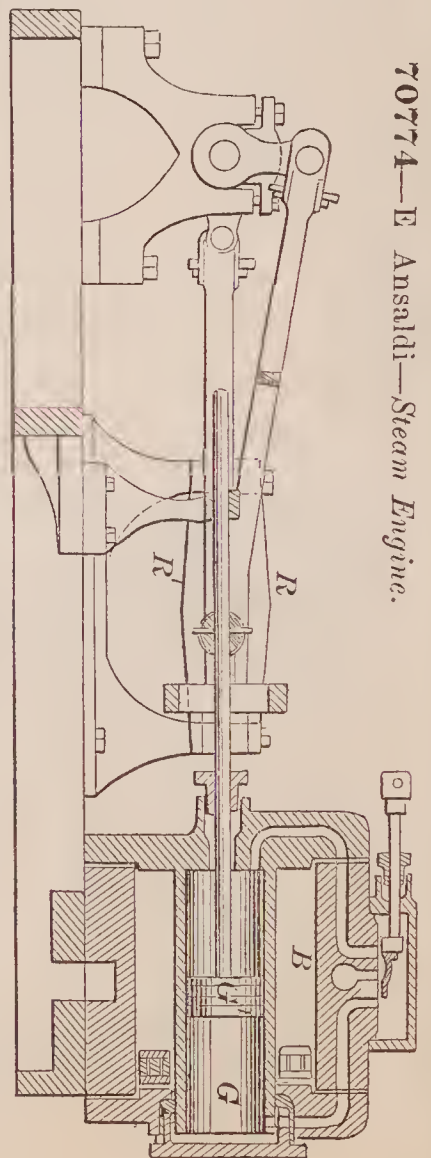

70777—J. S. Baldwin—*Elevator.*



70778—H. Barber—Attaching Bolsters to Knives.

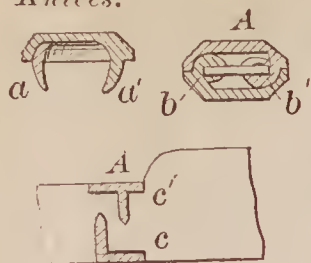

70779—Barnett & Wood—Cultivator.

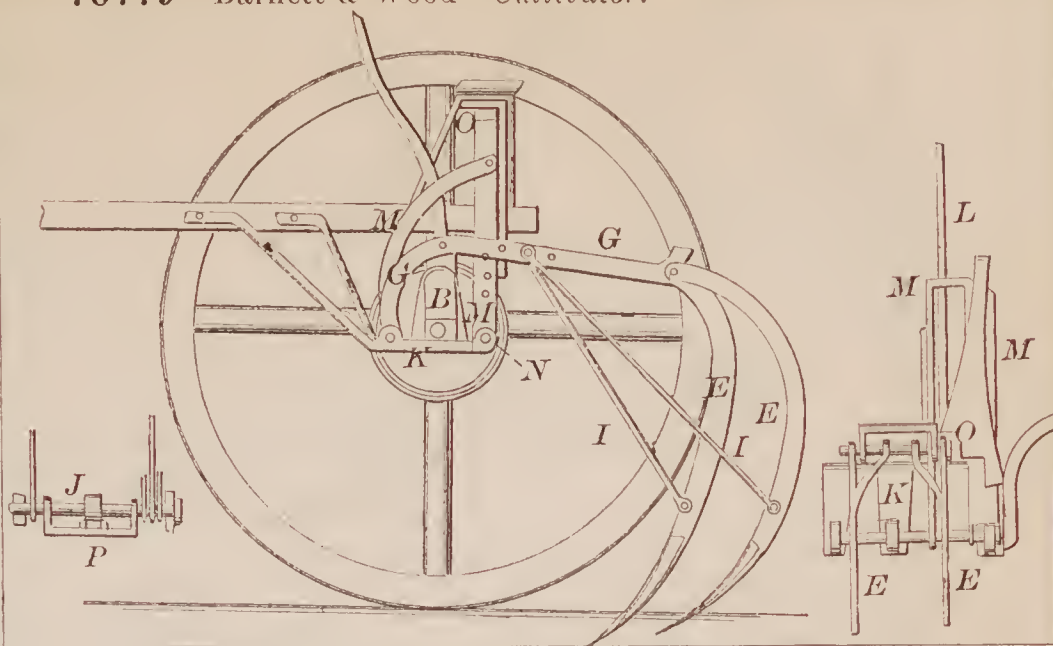

70780—Baumgartner & Angster—Ham-Slicing Holder.

70781—R. Baxter—Seeding Machine.

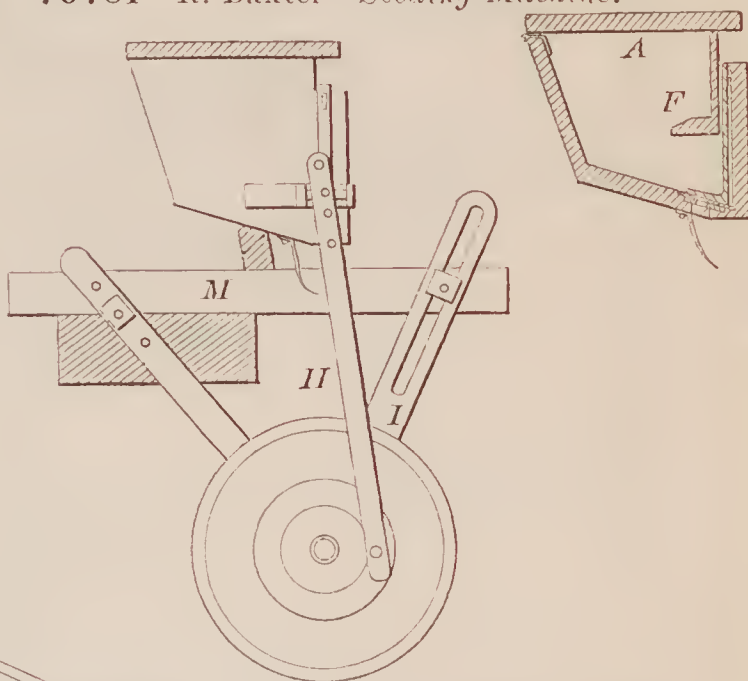

70782—J. M. Beebe—Beehive.

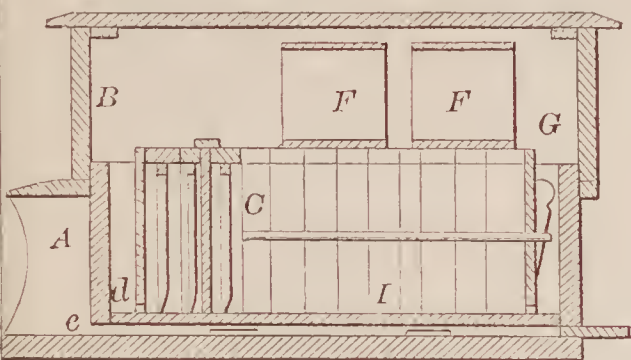

70783—Behel, Perrine & Buell—Horse Shoe.

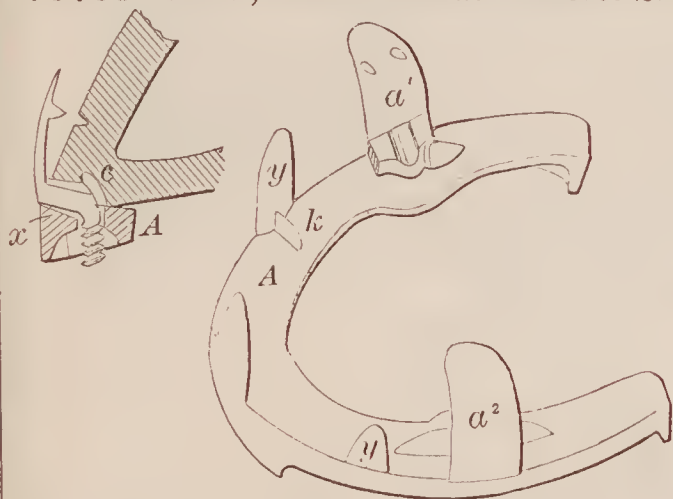

70785—A. C. Belt—Cultivator.

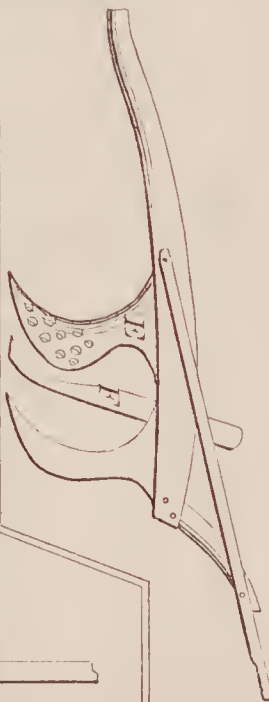

70784—E. H. Bellows—Steam Engine Slide Valve.

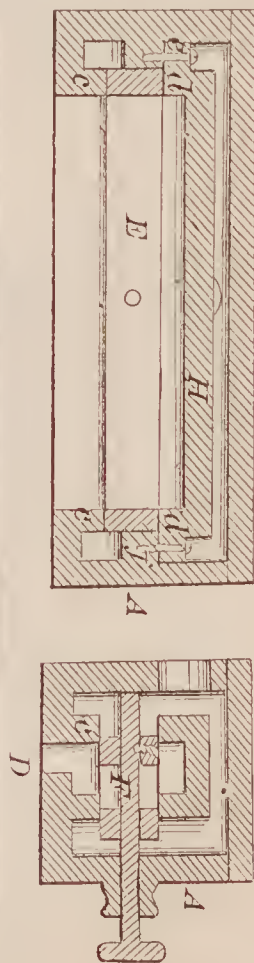

70786—Bendix & Dietsch—Potato Planter

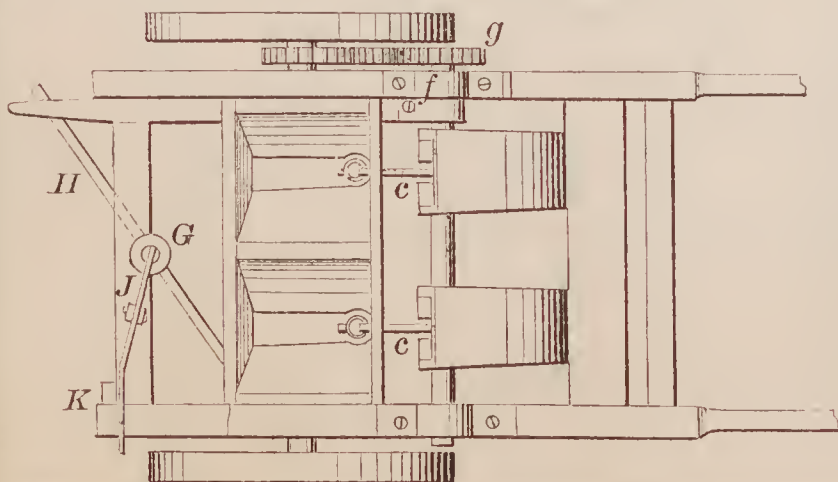



70786—Continued.

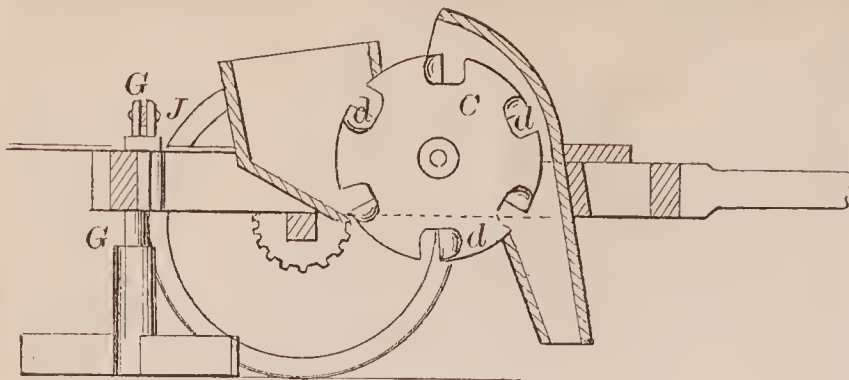

70792—R. Boyd—House Ventilator.

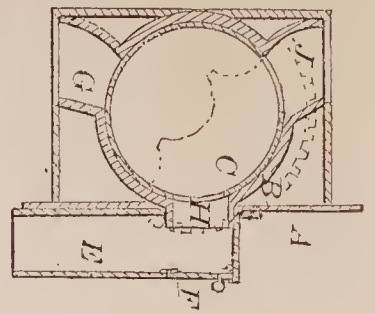

70788—Birch & Sowden—Grinding Machine for Circular Saws.

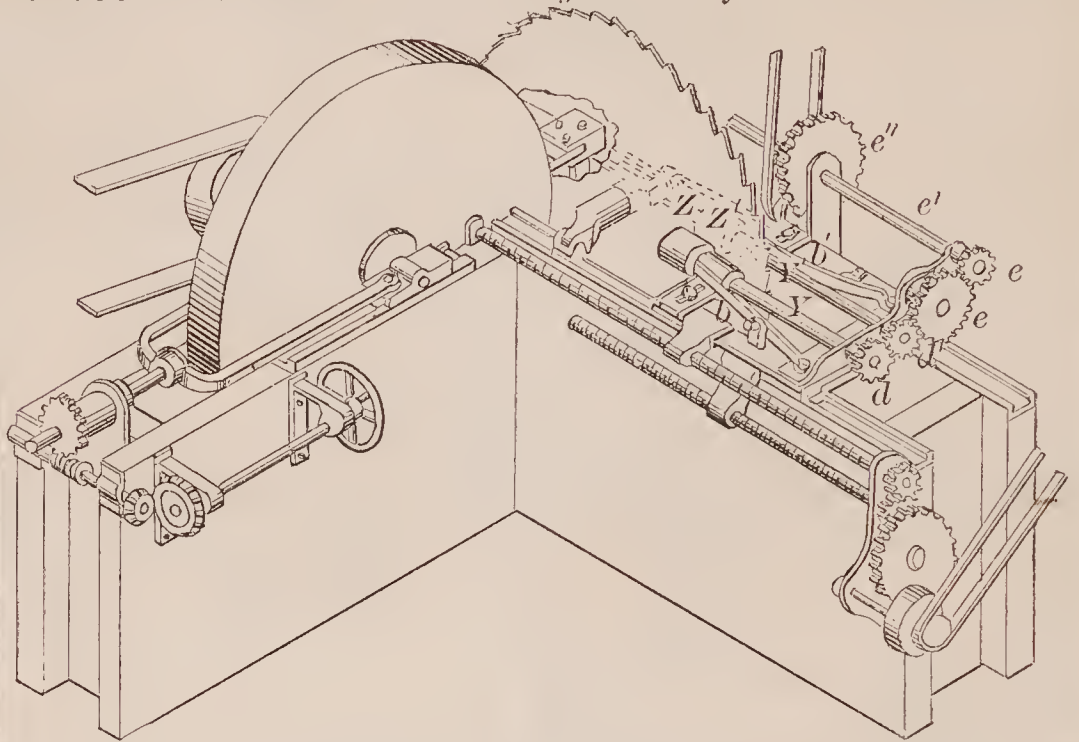

70787—J. S. Birch—Adjustable Watch Key.



70790—C. T. Boardman—Setting Steam Boilers.

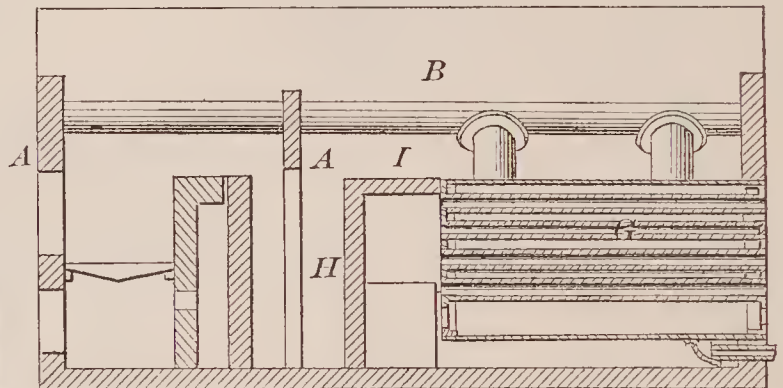

70789—C. Bird—Barrel Cover.



70791—C. Boulay—Galvanic Battery.

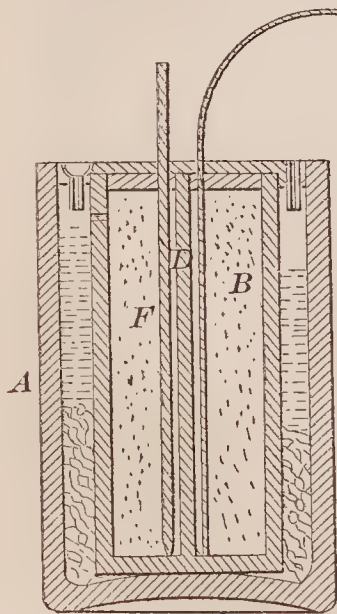

70793—C. B. Boynton—Railway Axle Box.

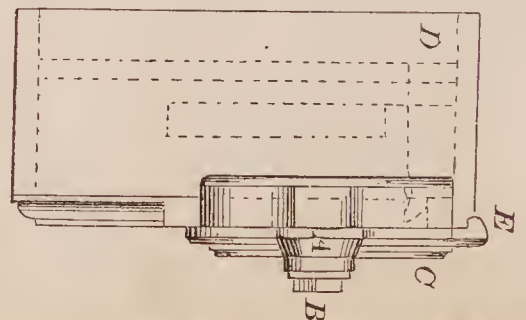

70794—M. J. Briar—Gate Latch.

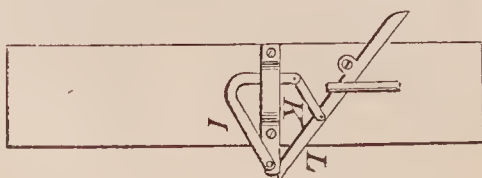

70795—G. Brosius—Sash Fastener.

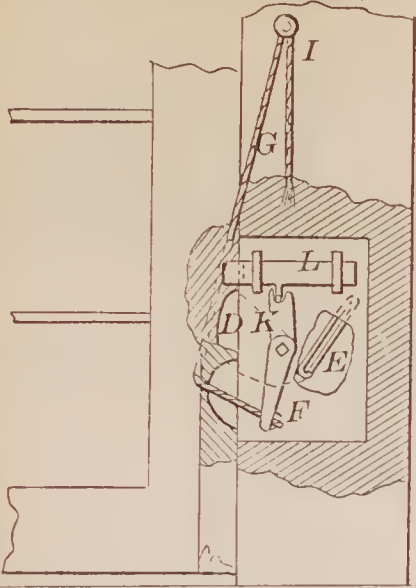

70798—J. Burke—Harvester.

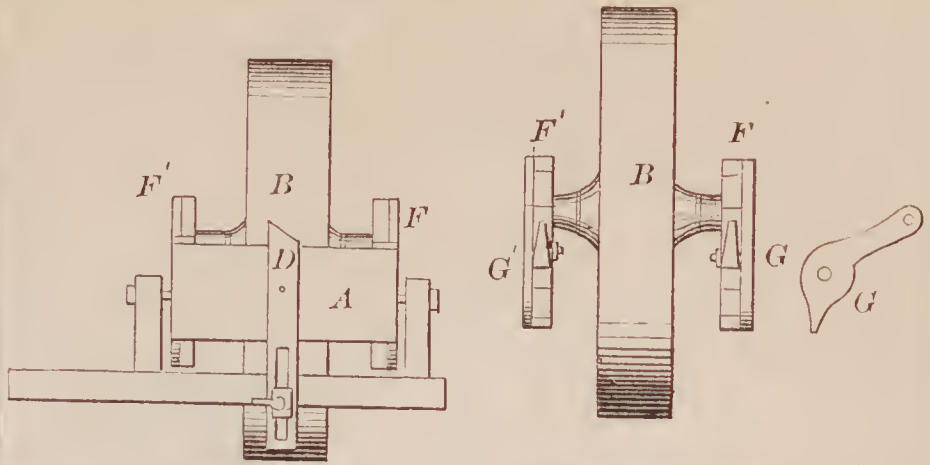

70796—W. H. Bryant—For Drawing Tires from Engine Driving Wheels.

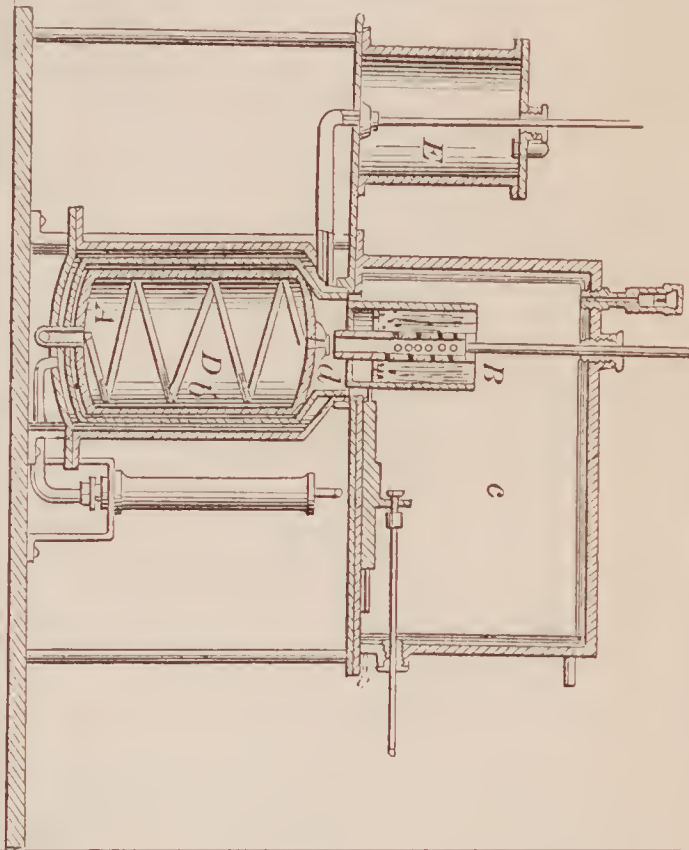
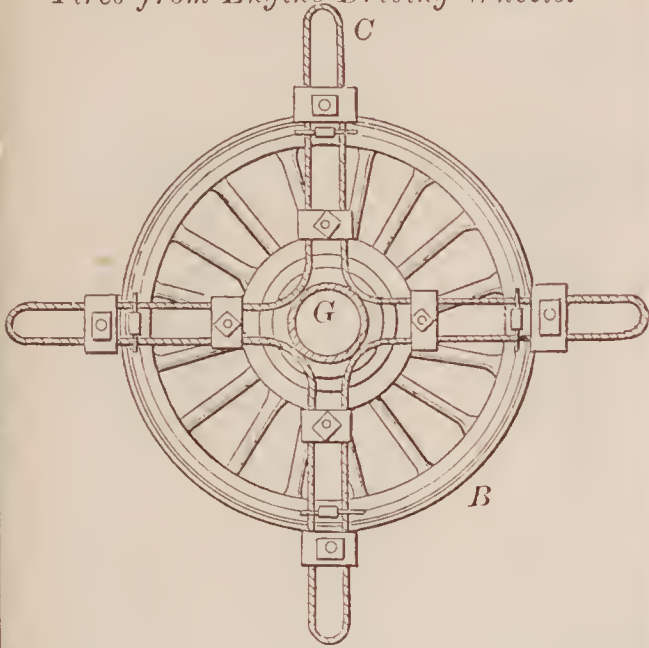

70800—J. R. Cameron—Air Engine.

70799—S. S. Burt—Car Axle.

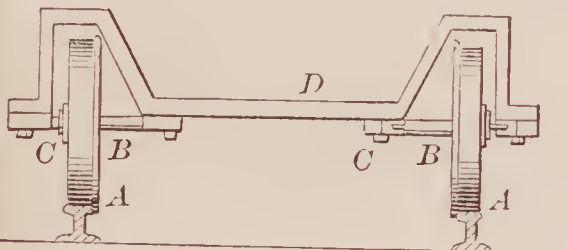

70801—M. M. Cashman—Infant's Robe.

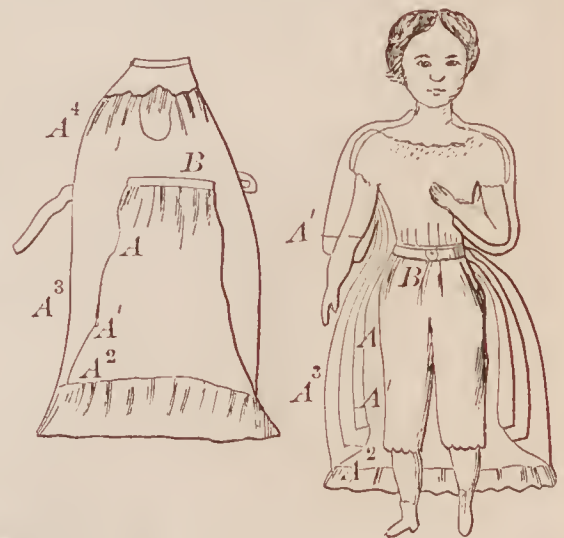

70797—S. A. Budd—Carriage Top Button Hole.

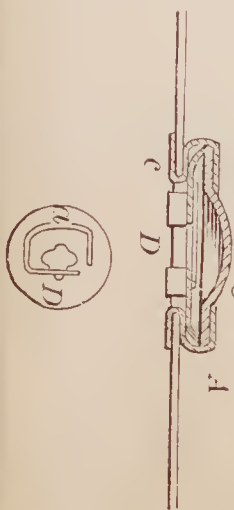

70802—E. Chapman—Rotary Engine.

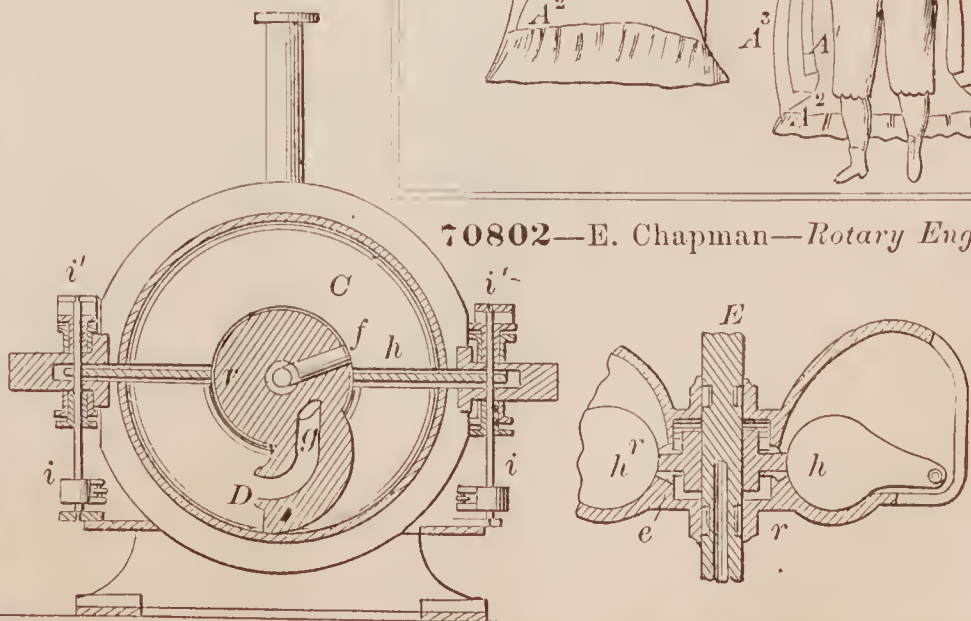



70803—Chapman, Goodspeed & Reed—Motor for Sewing Machines.

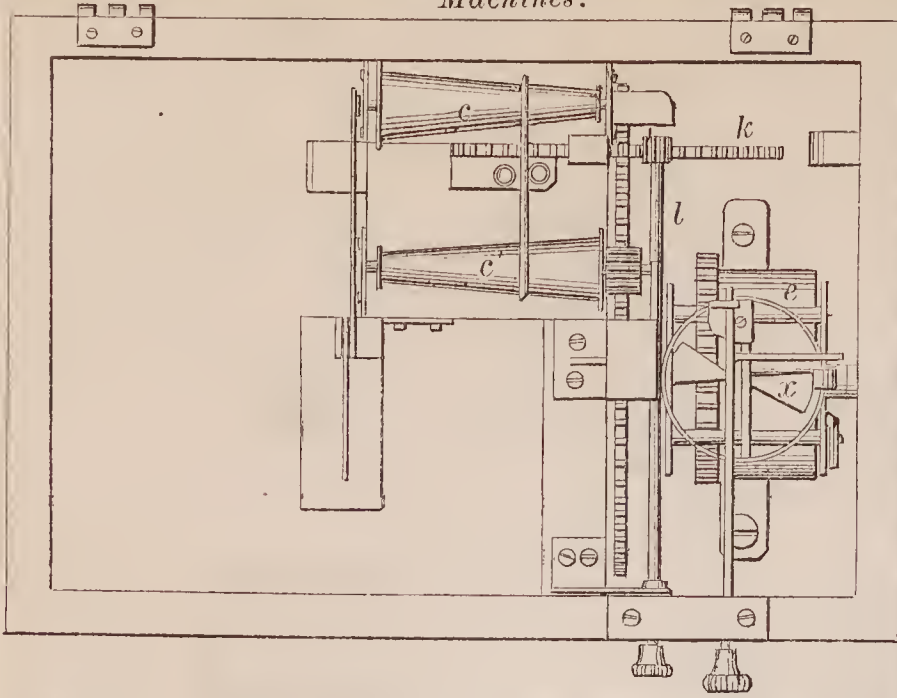

70807—C. F. Cosfeldt, Jr.—Low Water Detector.

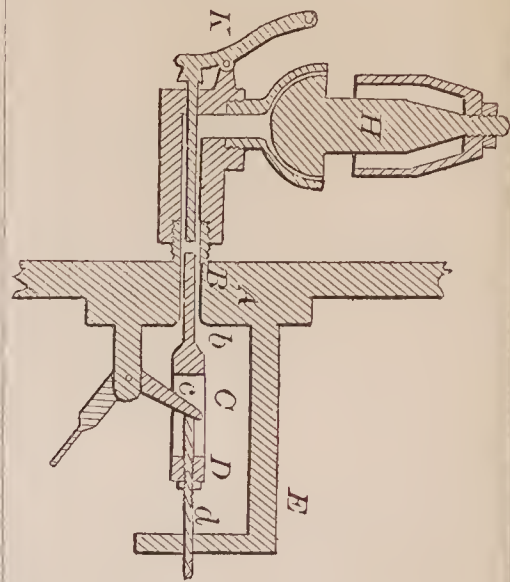

70805—G. Cook—Roofing.

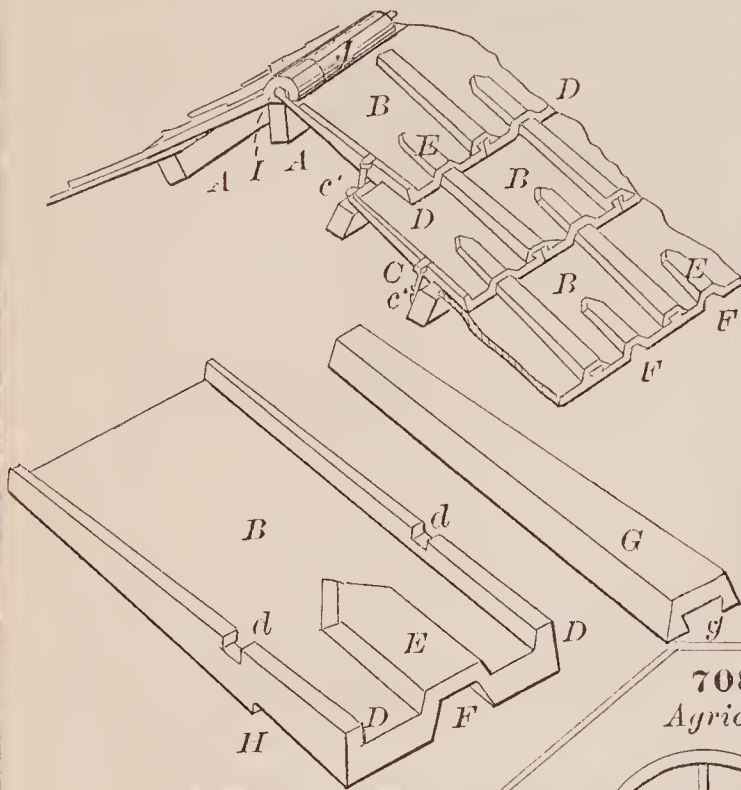

70806—J. Cornwell—Silent Bolt Feeder.

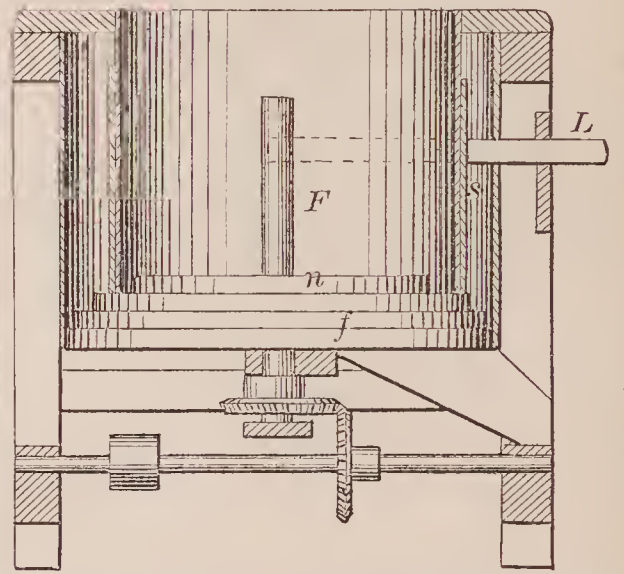

70804—B. F. Cook—Leveling Attachment to Agricultural Implements.

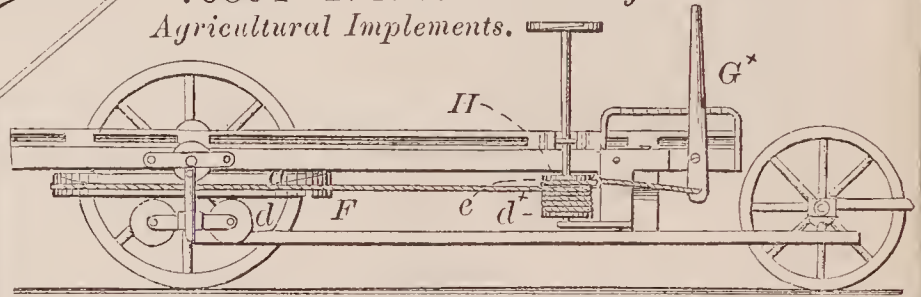

70808—E. H. Covel—Clothes Wringer.

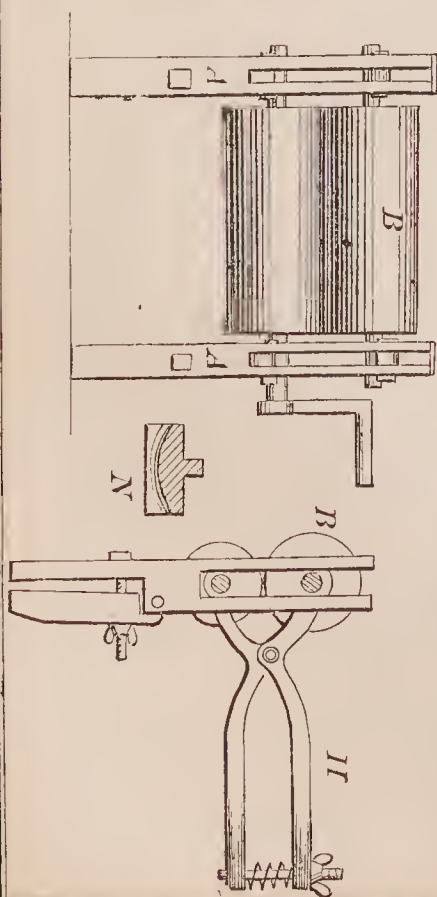

70809—Cozzens & Jones—For Carburetting Air.

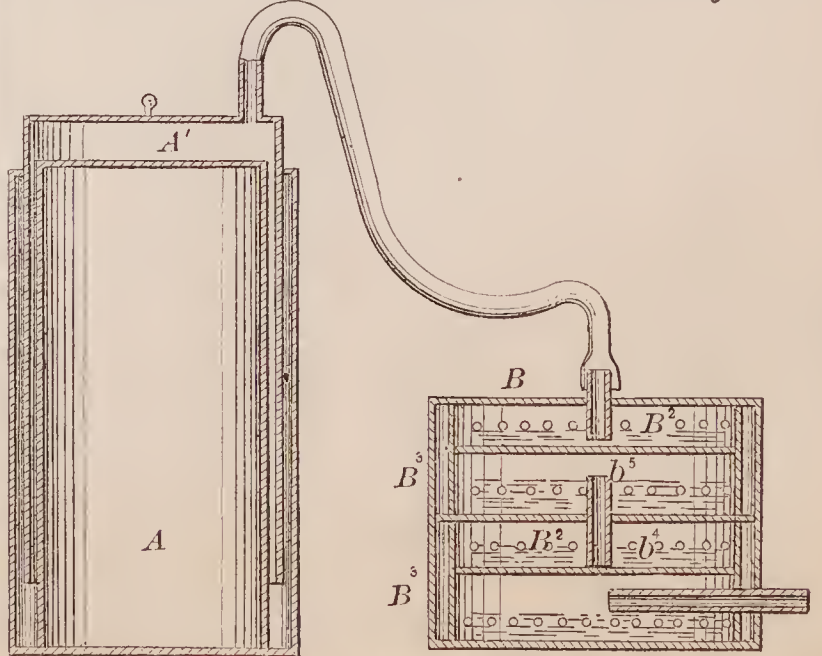

70810—E. J. Crane—*Cheese Press.*

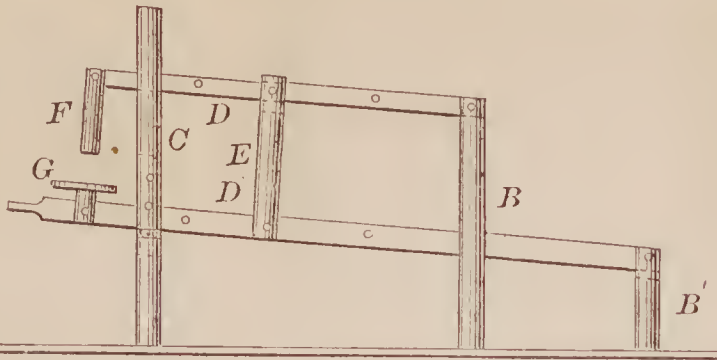

70813—A. F. Crosman—*Boat Hoisting Apparatus.*

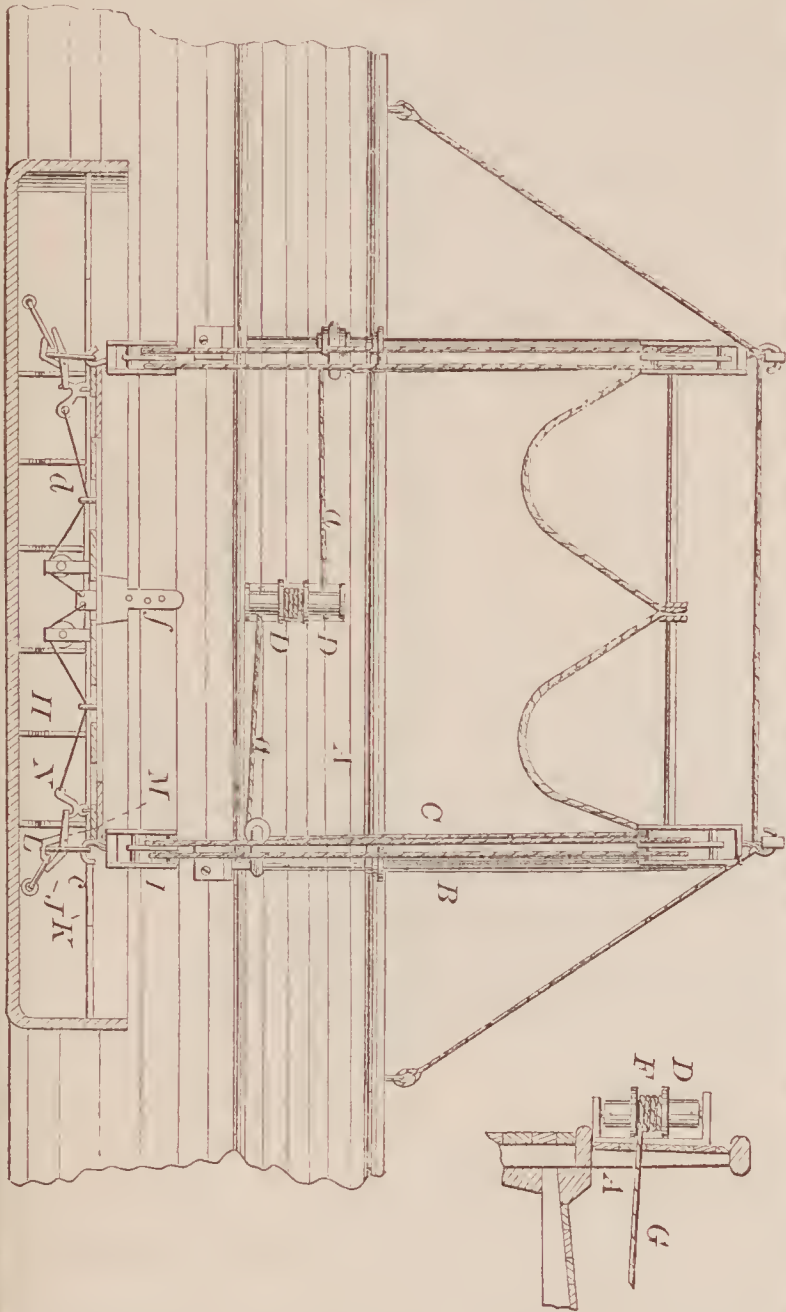

70814—A. G. Crossman—*Starting and Stopping Cars.*

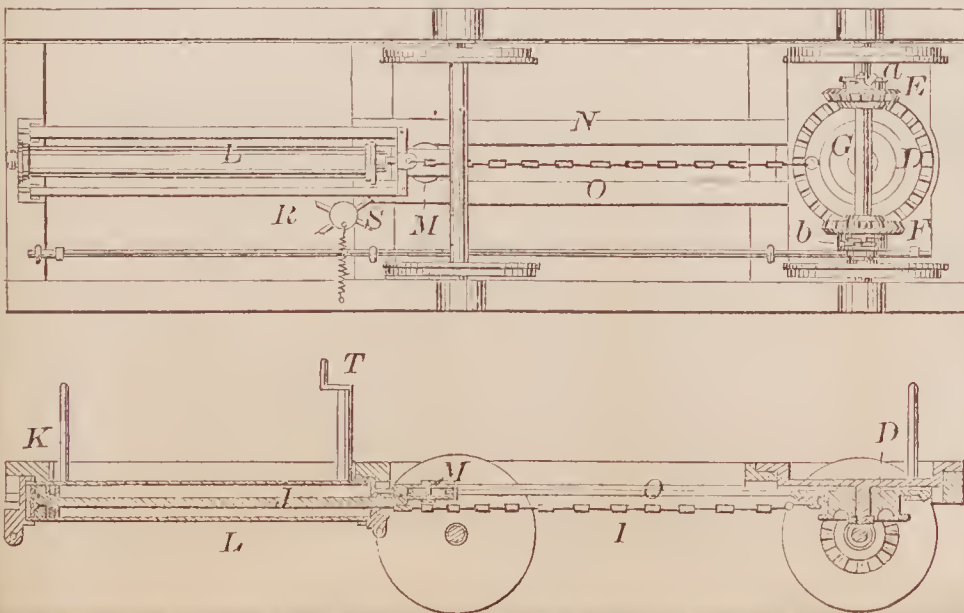

70811—M. H. Crane—*Sheet Metal Box.*

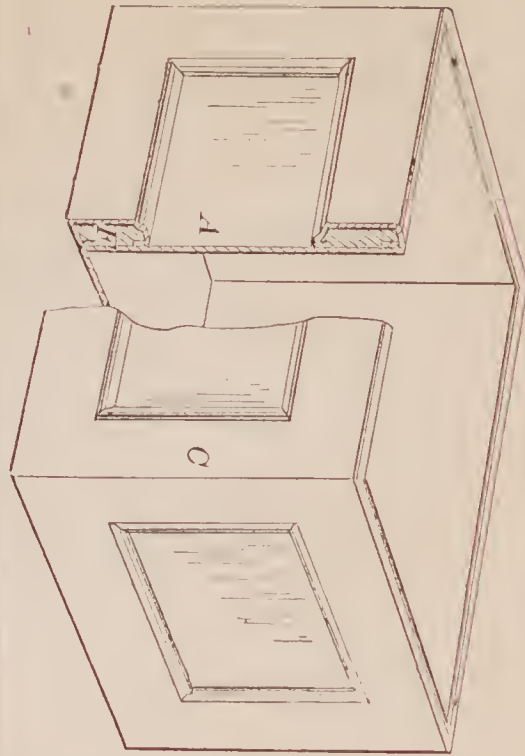

70812—W. G. Creamer—*Ventilating Device for Railroad Cars.*

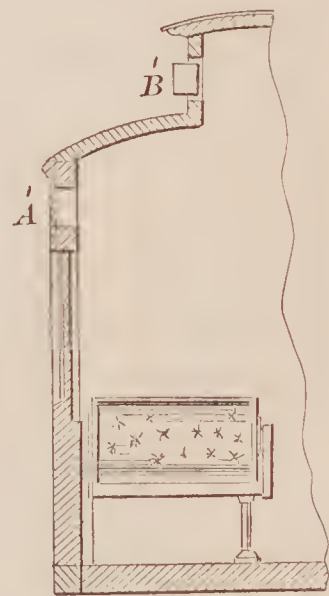
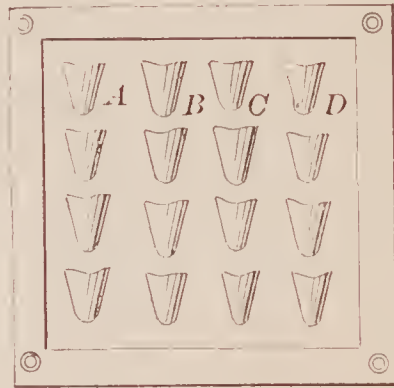



70815—J. B. Crowley—Faucet for Stove Reservoirs.

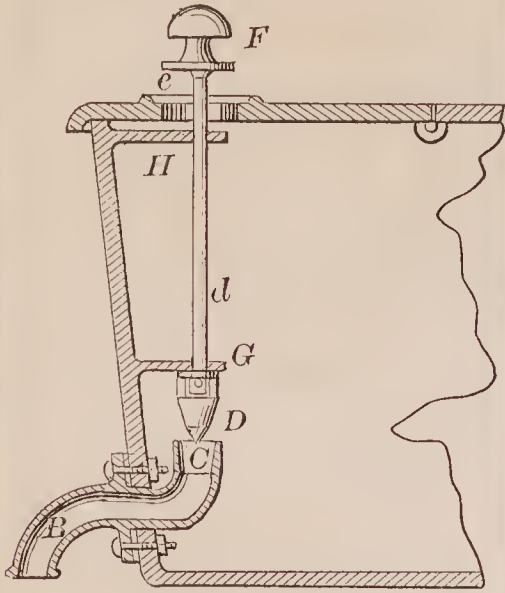

70817—J. W. Custer—Ash Sifter.

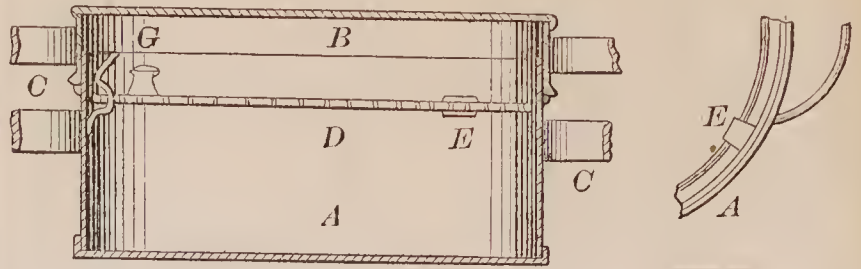

70821—D. B. Ellis—Wheelbarrow.

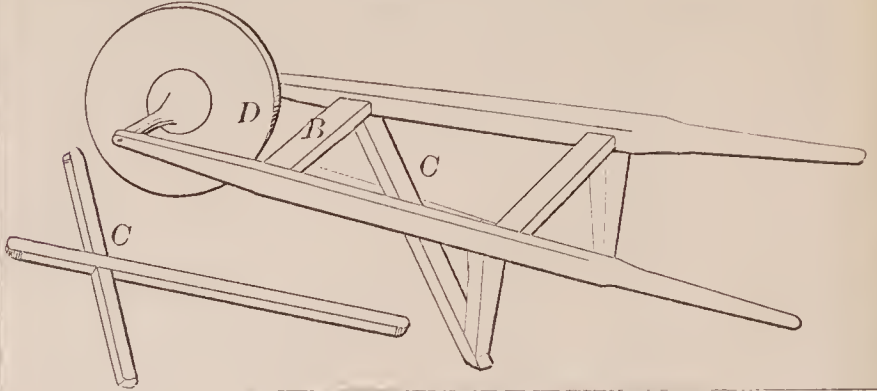

70818—A. Cutter—Sash Supporter and Fastener.

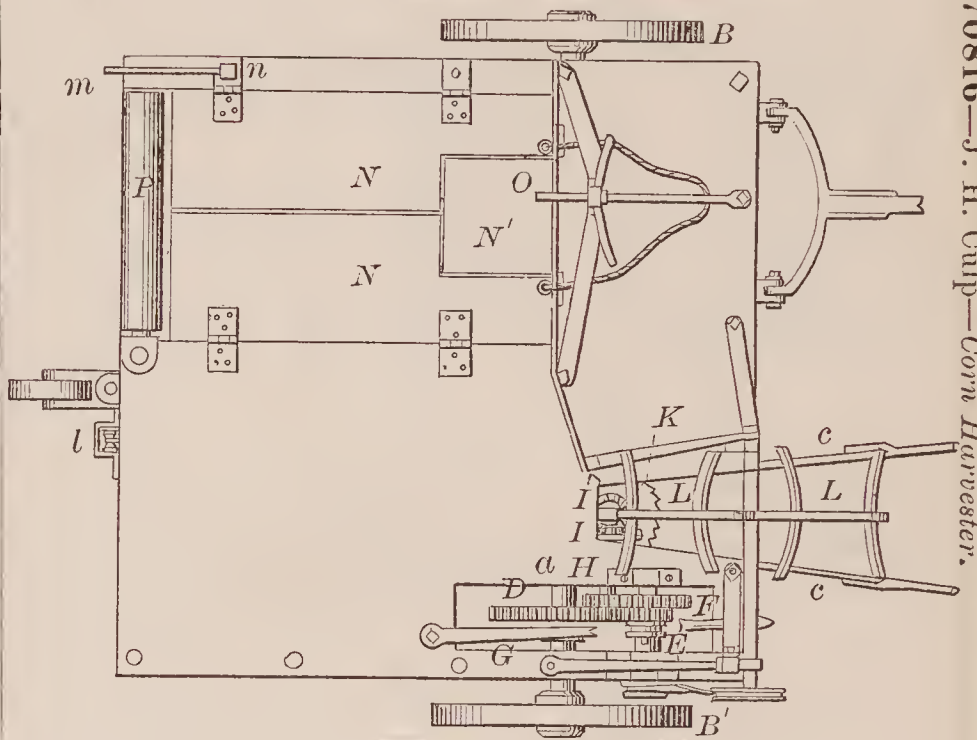
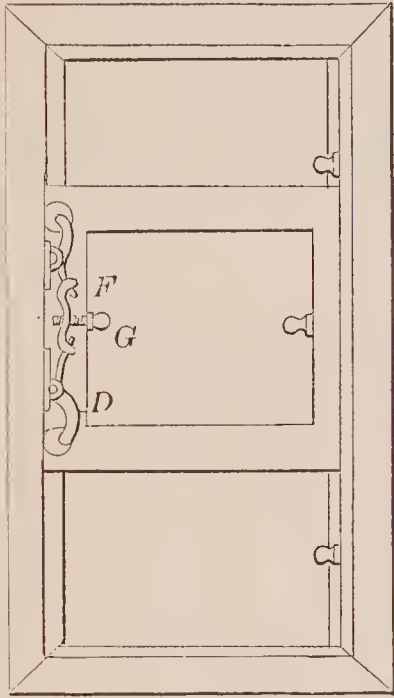

70816—J. H. Gulp—Corn Harvester.

70819—O. Doud—Gate.

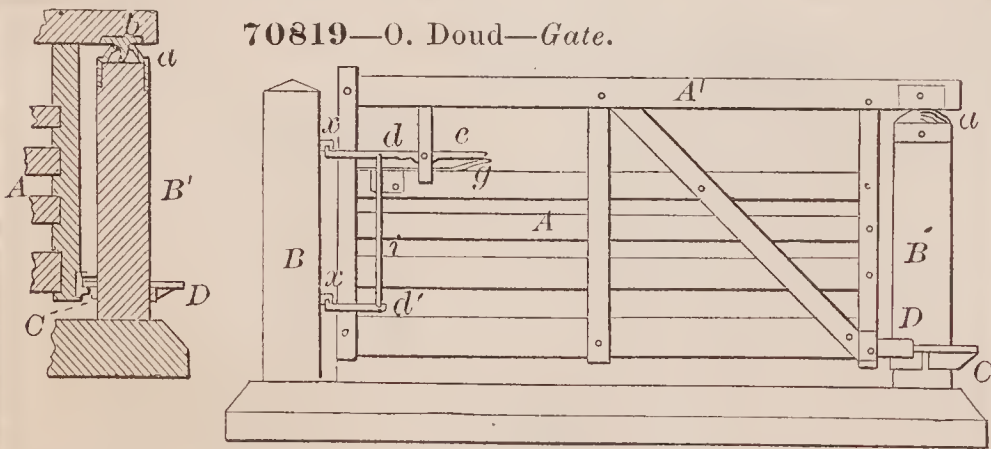

70823—C. J. Fisher—Door Holder.

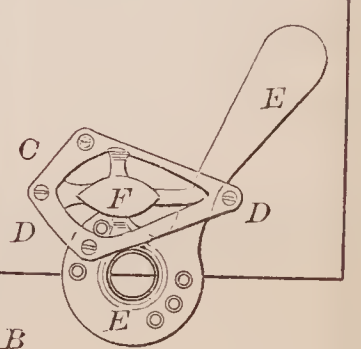

70820—J. Edson—Capstan.

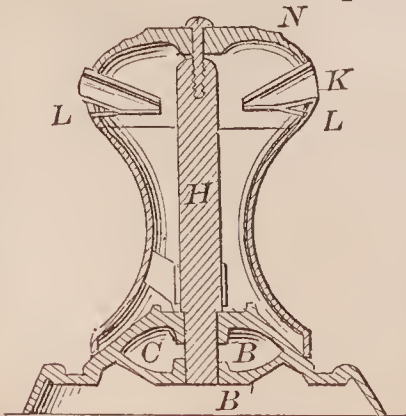

70822—W. F. Falls—Marble Shooter.

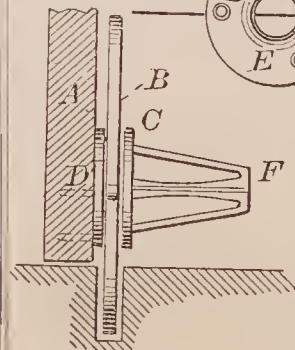
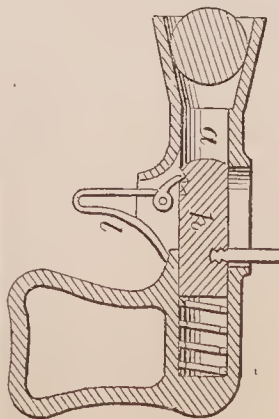

70824—I. Fiske—*Crook for Musical Instruments.*

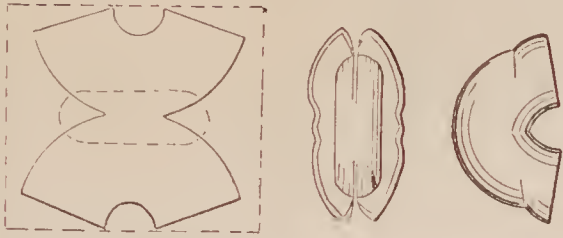

70825—J. S. Fletcher—*Work Box.*

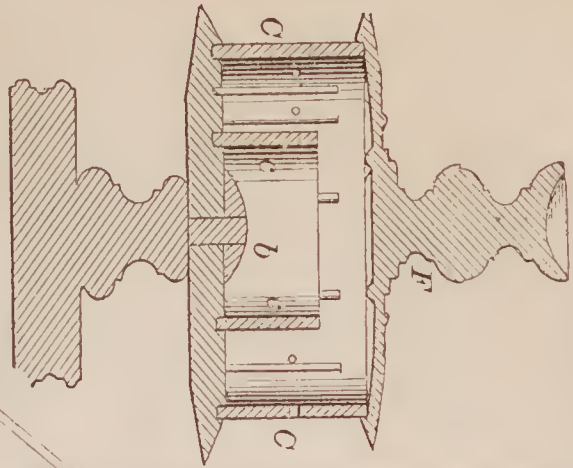

70827—C. Gardiner—*Sleigh Brake.*

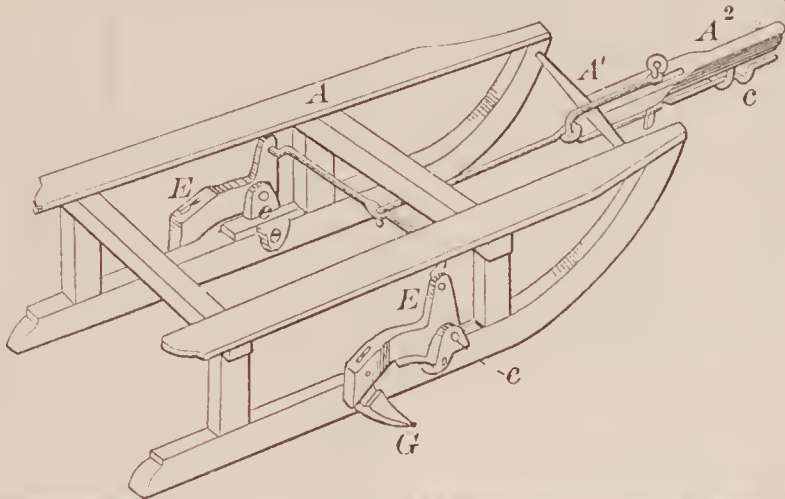

70828—E. K. Gardner—*Railroad Gate.*

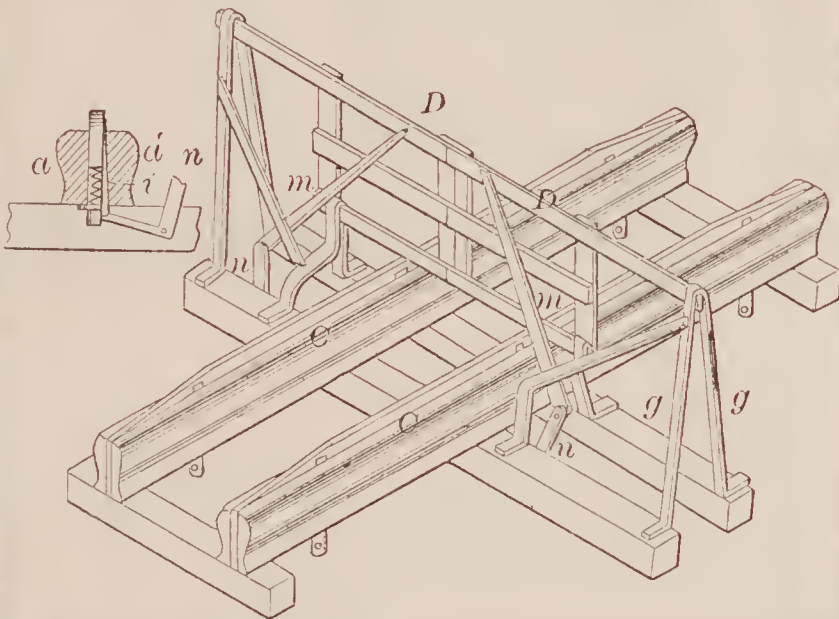

70831—E. A. Goodes—*Metamorphoscope.*

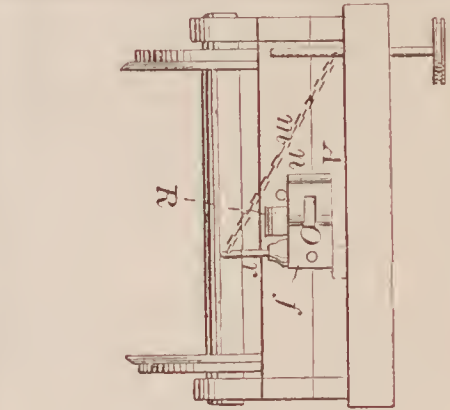
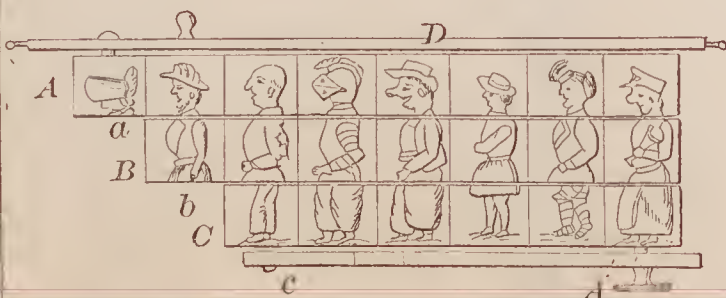
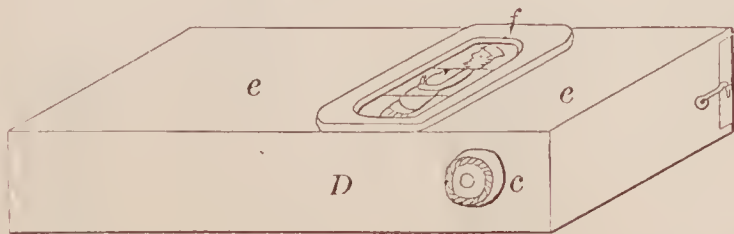

70829—S. Gissinger—*Car Coupling.*

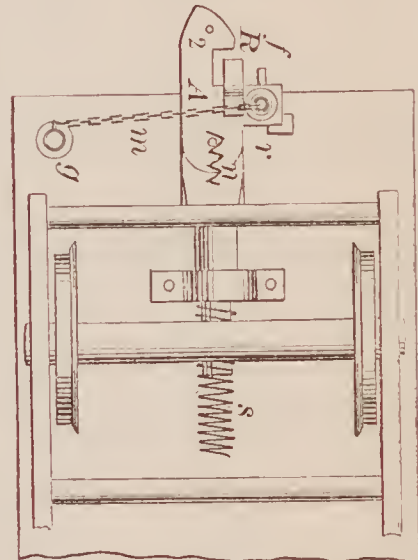

70830—W. Gleason—*Tool Rest.*

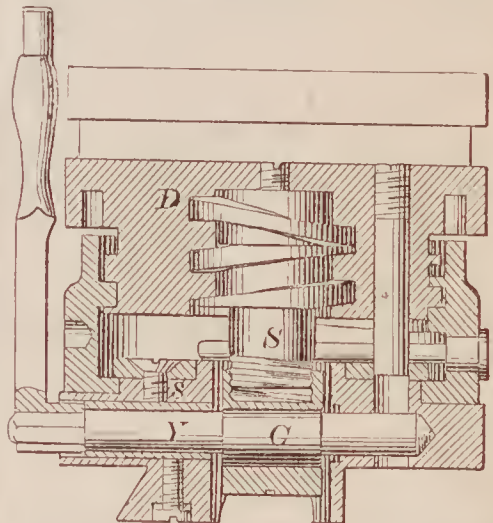

70832—N. Groel—*Traveling Bag and Valise.*

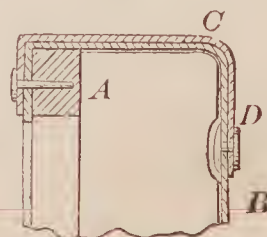



70837—M. McD. Hankins—Loom.

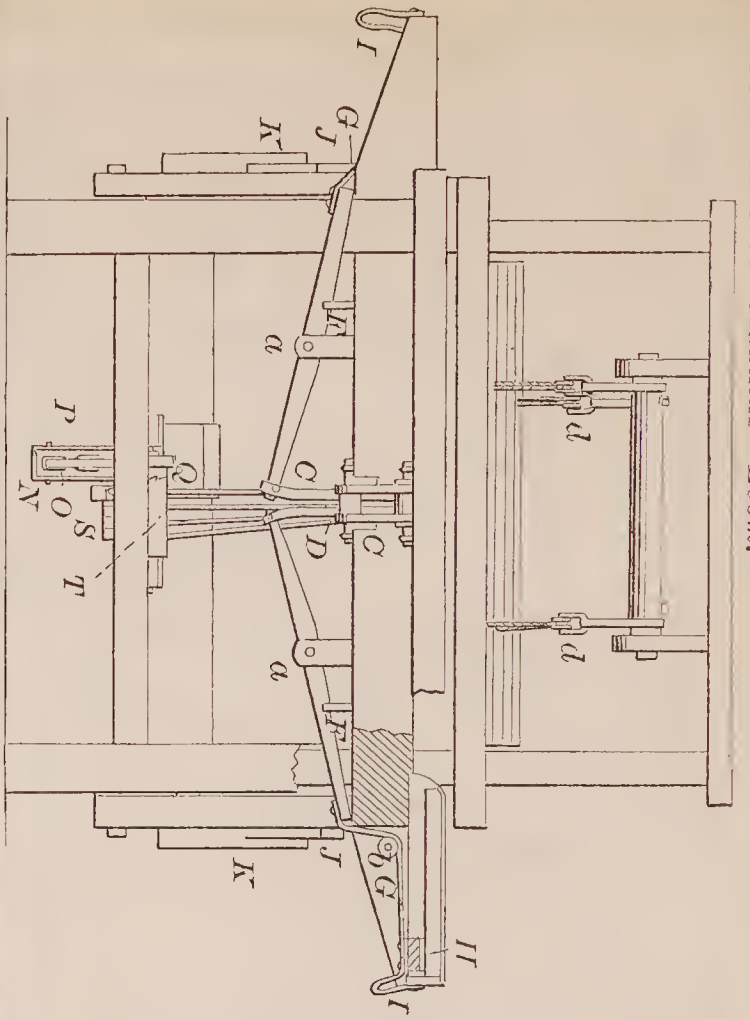

70833—J. J. Groshans—Paper Ruling Machine.

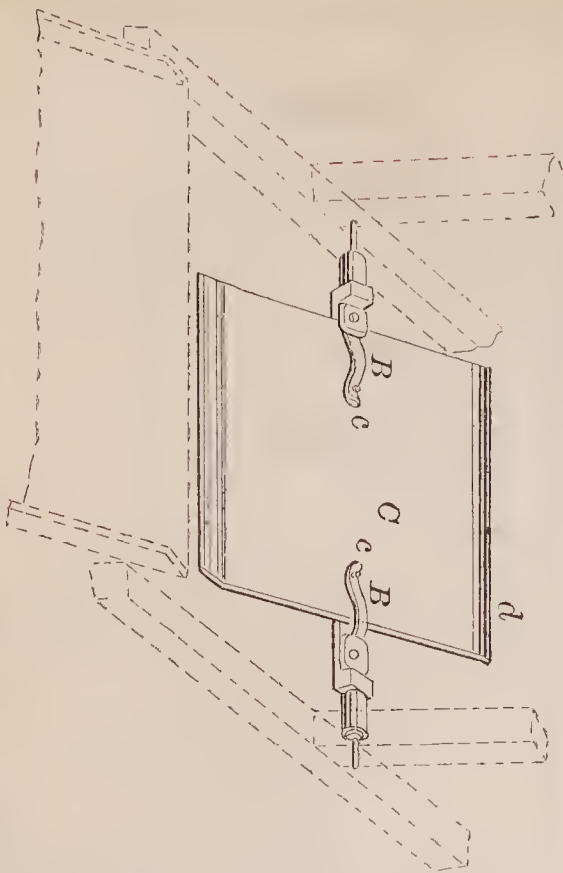

70834—A. Grushus—Tag Holder.

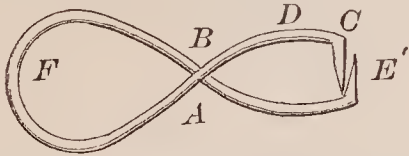

70836—G. B. Halsted—Stove Pipe Damper.

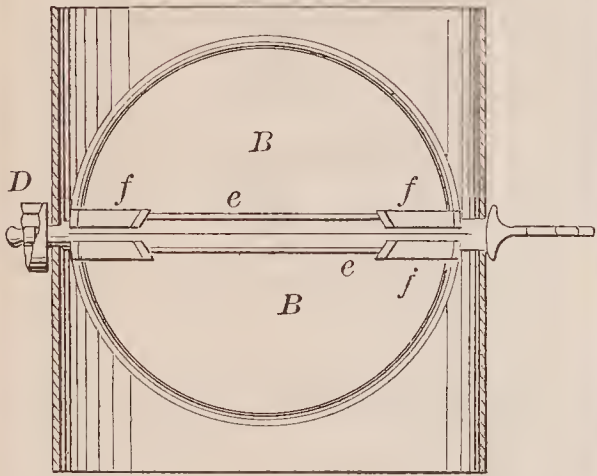

70835—T. J. Halligan—Treadle for Sewing Machines.

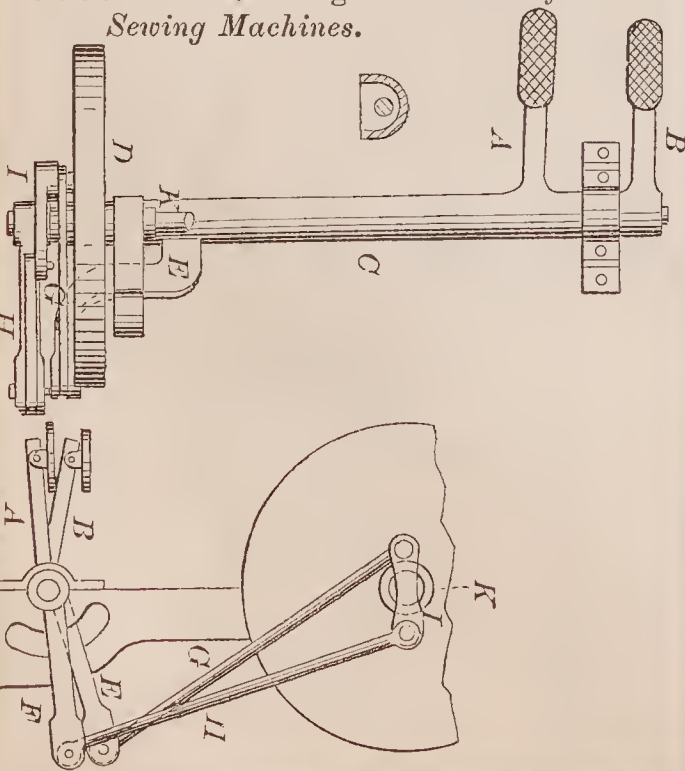

70839—F. G. Hesse—Amalgamator.

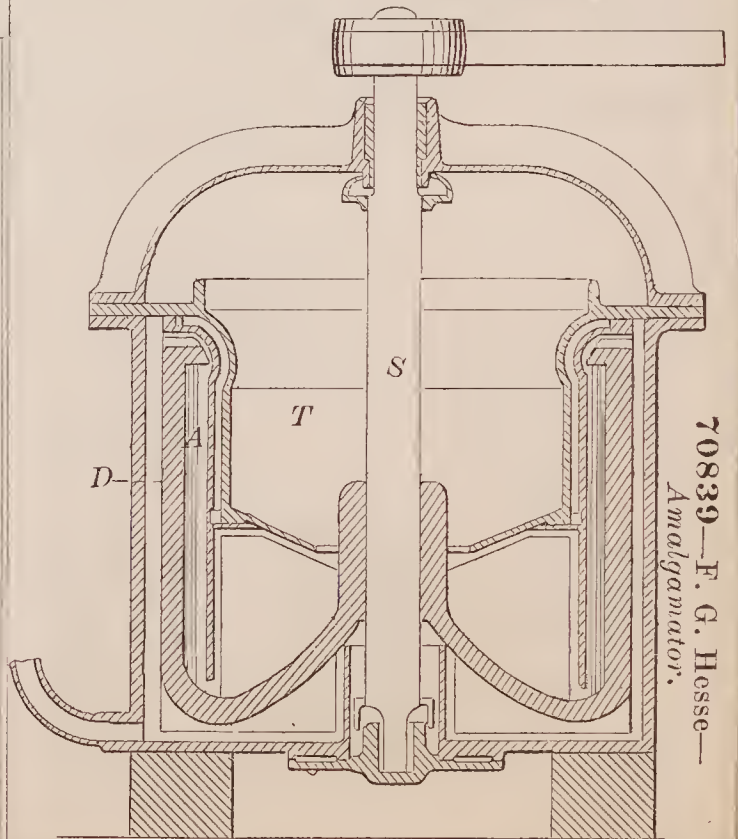

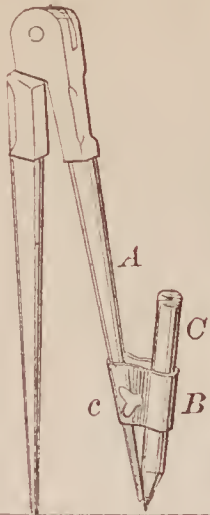

70840—W. G. Hillegass—Pencil Holder.

70841—J. M. Hirlinger—Steam Engine.

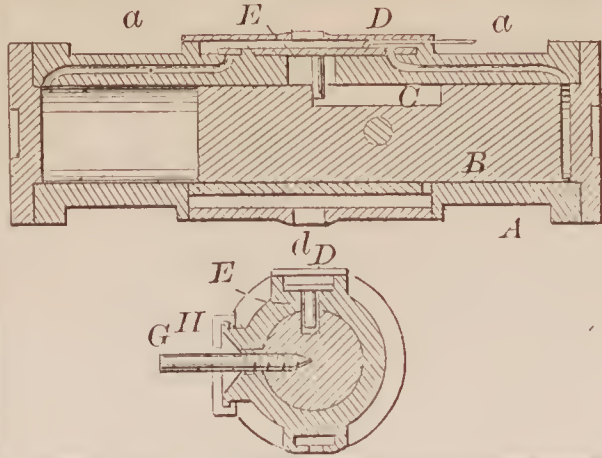

70842—J. M. Hirlinger—Pump.

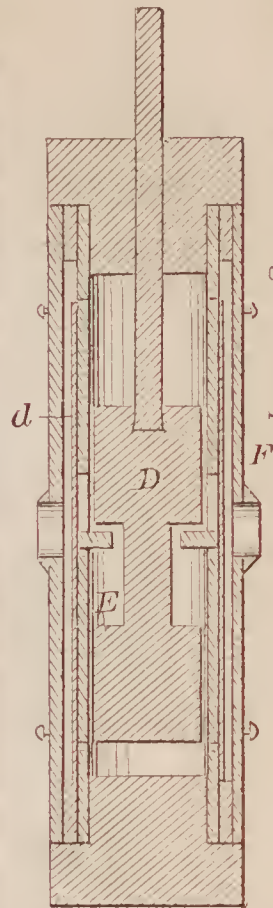

70846—N. Hornaday—Door Fastening.

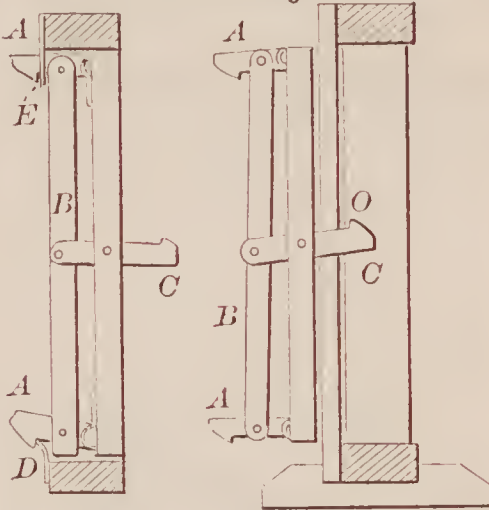

70843—S. L. Hockett—Menstrual Receiver.

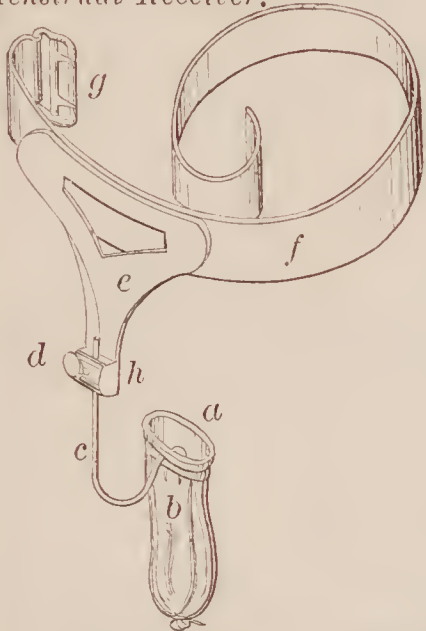

70844—D. C. Holdridge—Tube Well.



70845—A. Homfray—For Making Chain Links.

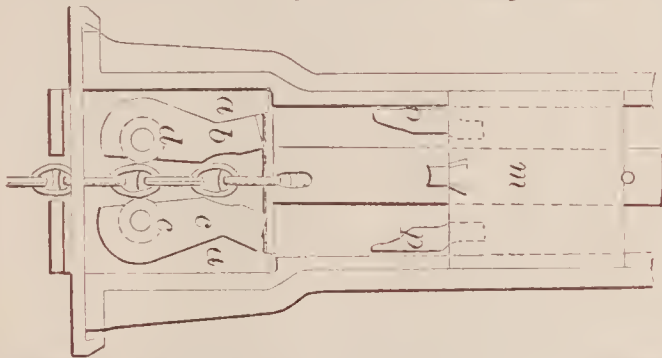

70847—R. Howdon—Moulding Facing Machine.

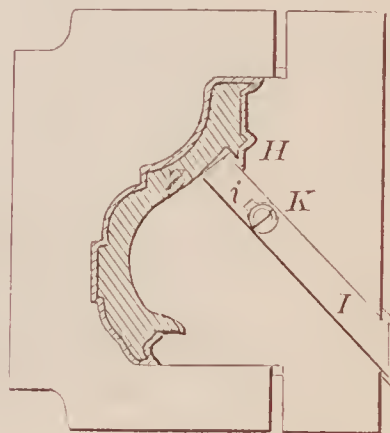

70848—A. H. Howe—Self-Adjusting Thill.

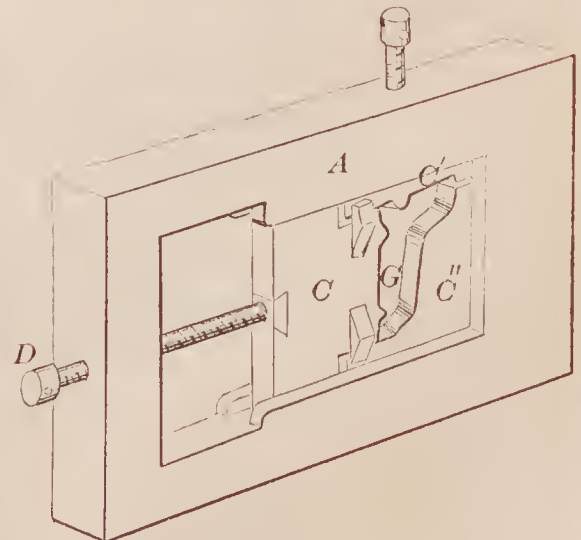
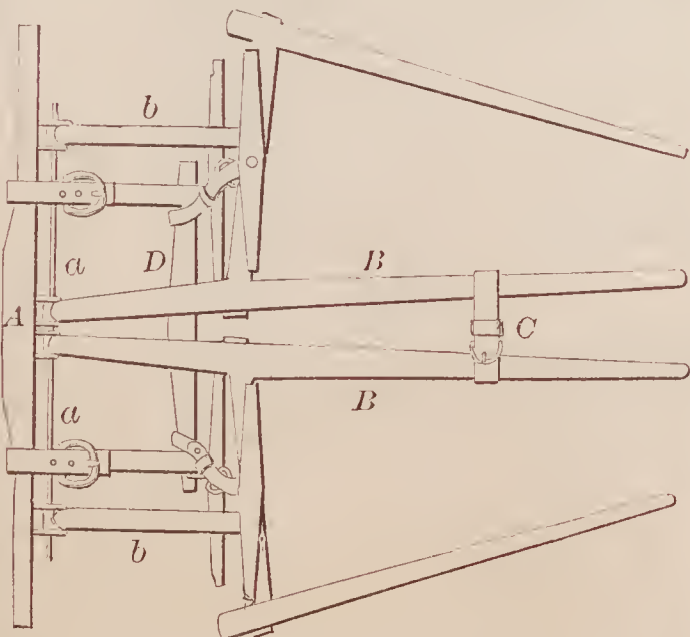



70849—G. Howell—*For Filling Marshes.*

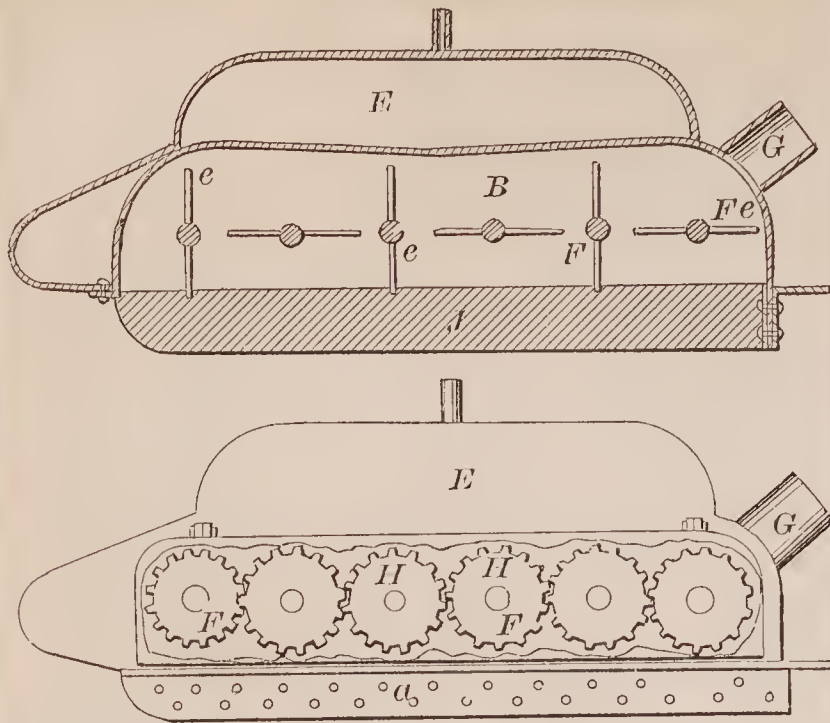

70850—W. Humans—*Rope Dancer.*

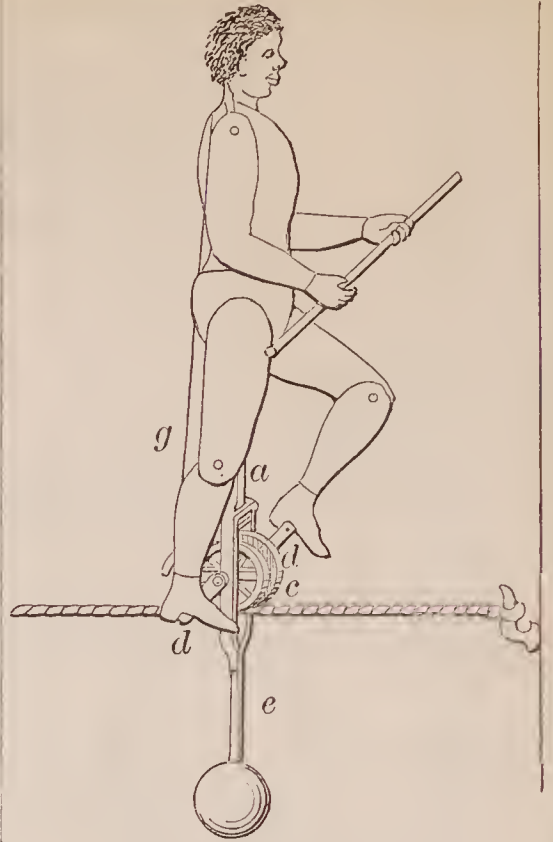

70852—J. M. Hurd—*Paper Flour Sack.*

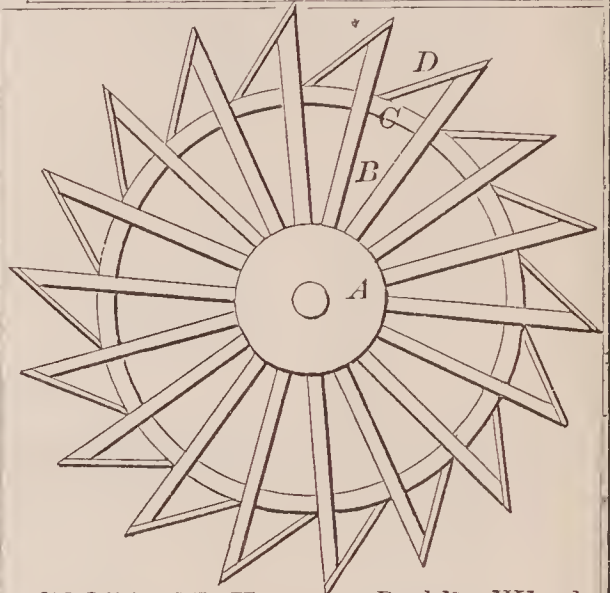
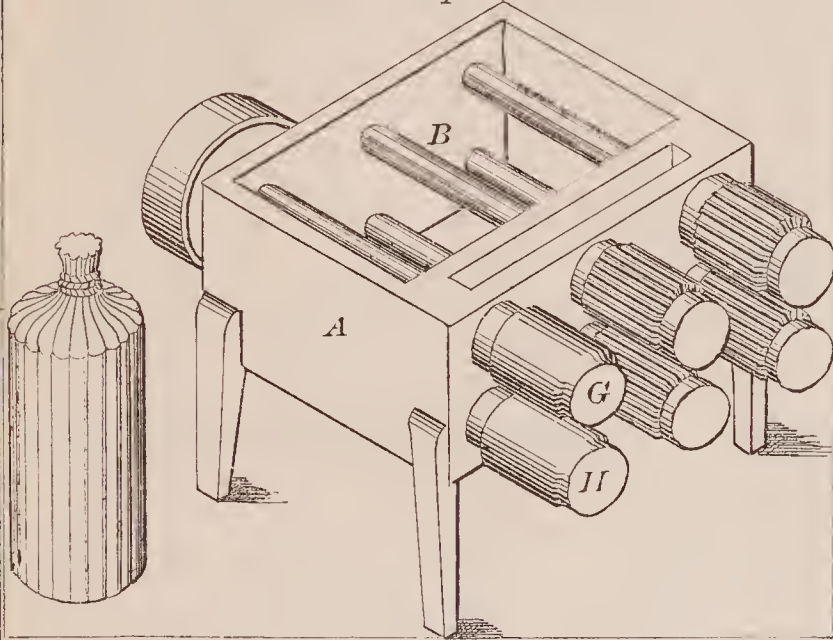

70851—W. Hunter—*Paddle Wheel.*

70853—E. Hutson—*Reel and Swifts.*

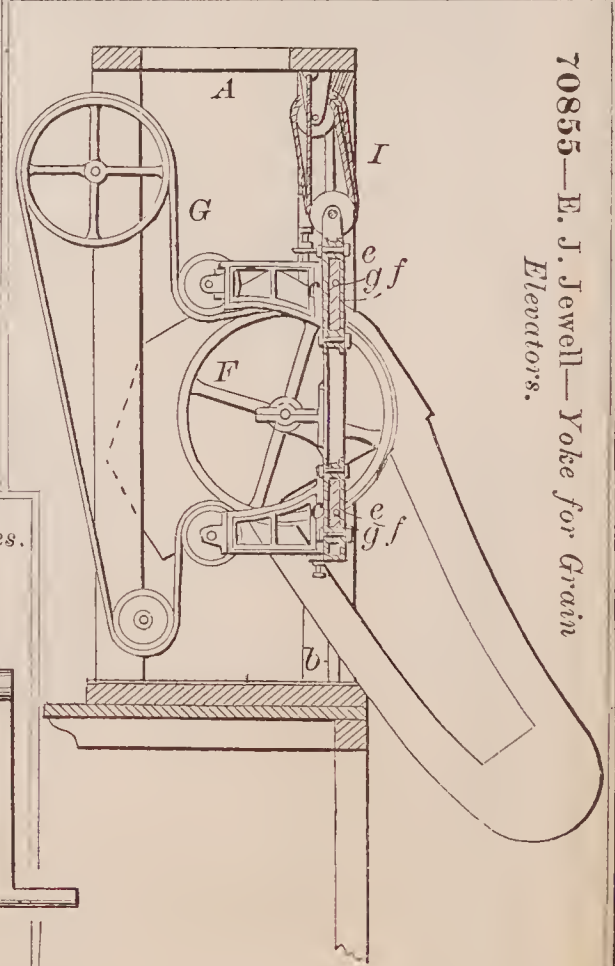
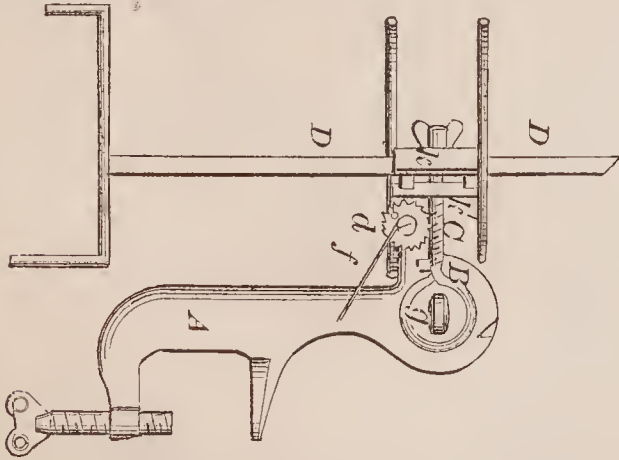

70855—E. J. Jewell—*Yoke for Grain Elevators.*

70854—J. B. & M. R. Jackson—*For Shrinking Tires.*

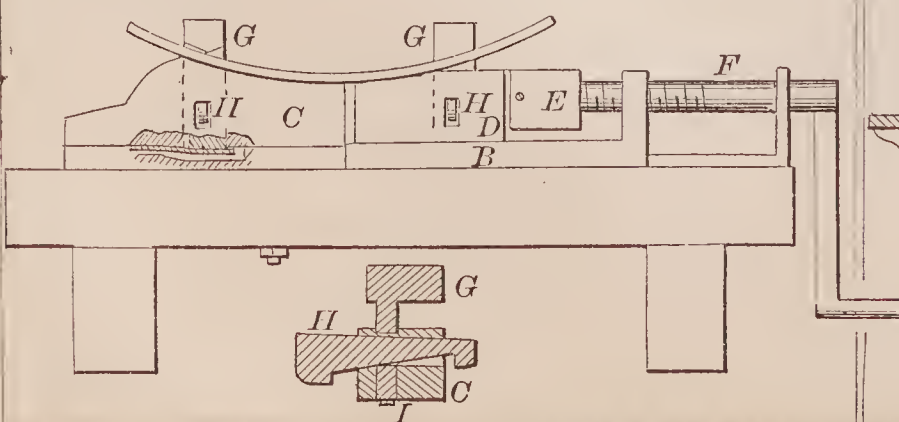

70856—M. Jincks—*Lamp.*

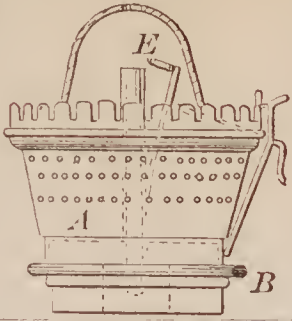

70859—F. Ketcham—*Sheep Trough.*

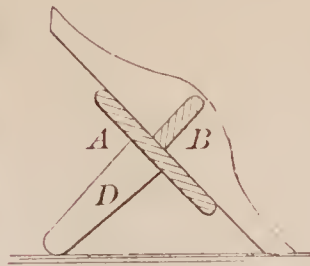

70860—E. King—*Door Latch.*

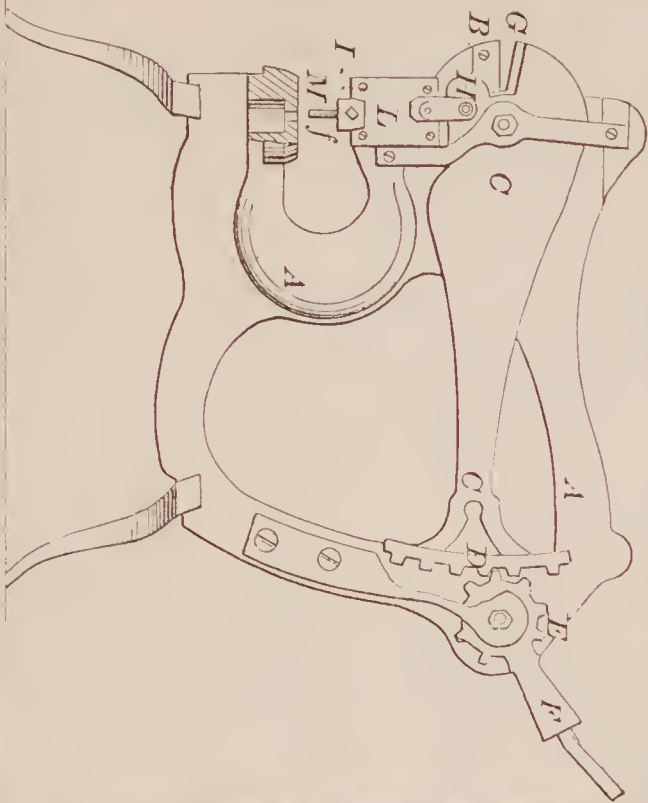
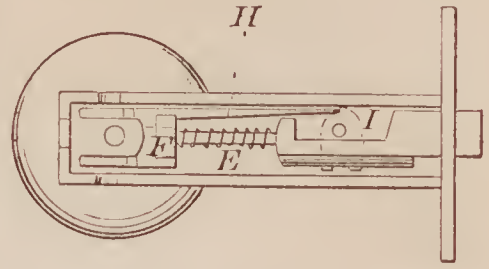

70857—J. C. Jordan—*For Punching and Shearing.*

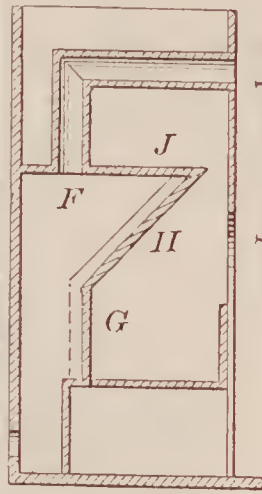

70858—I. Kepler—*Fireplace.*

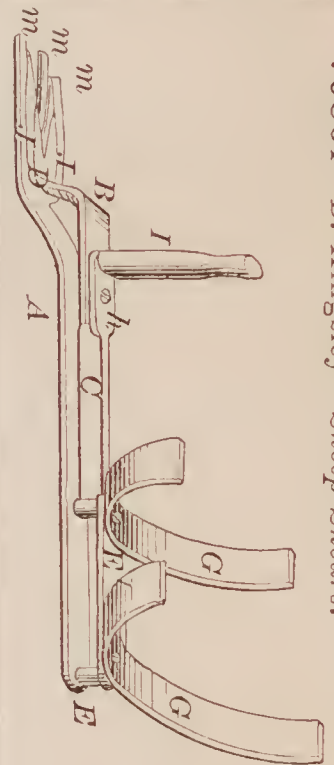

70861—B. Kingsley—*Sheep Shears.*

70862—J. Kirkley—*Nut Tapping Machine.*

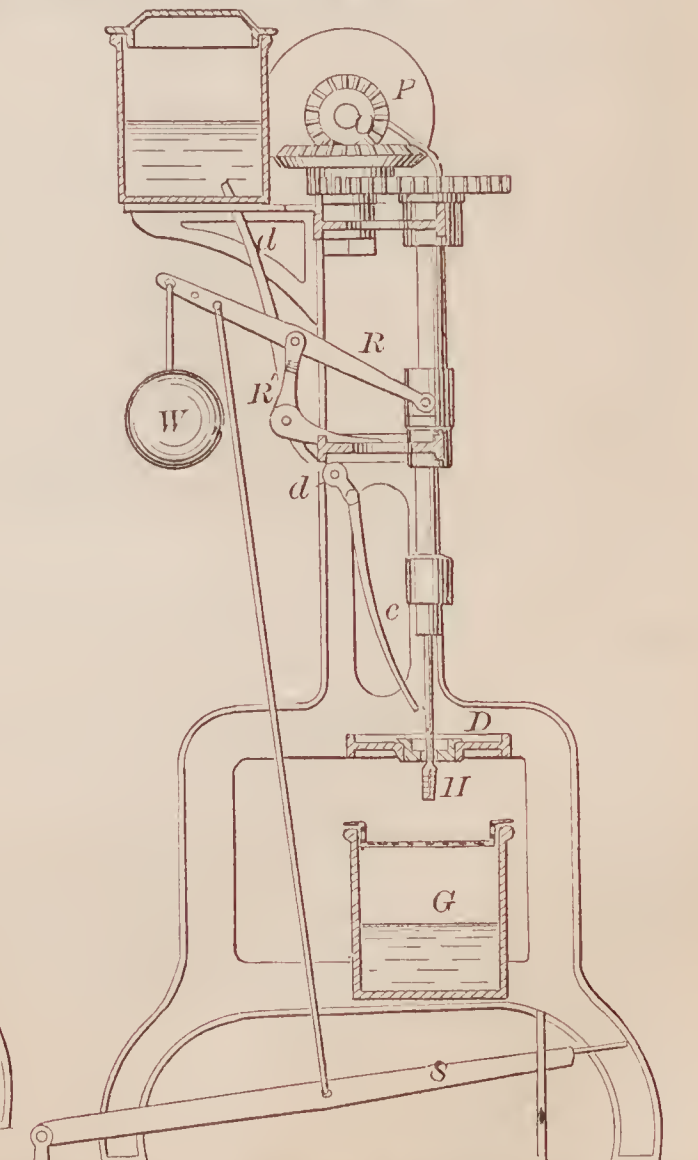
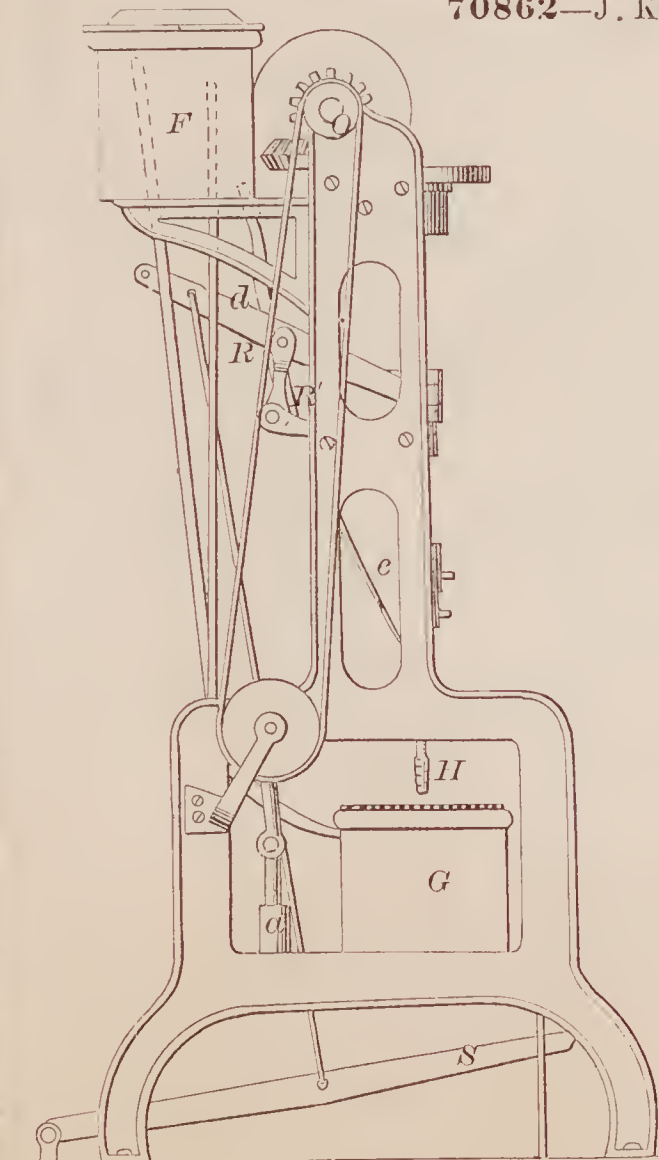



70863—A. L. Knight—For Cutting Paper Stock.

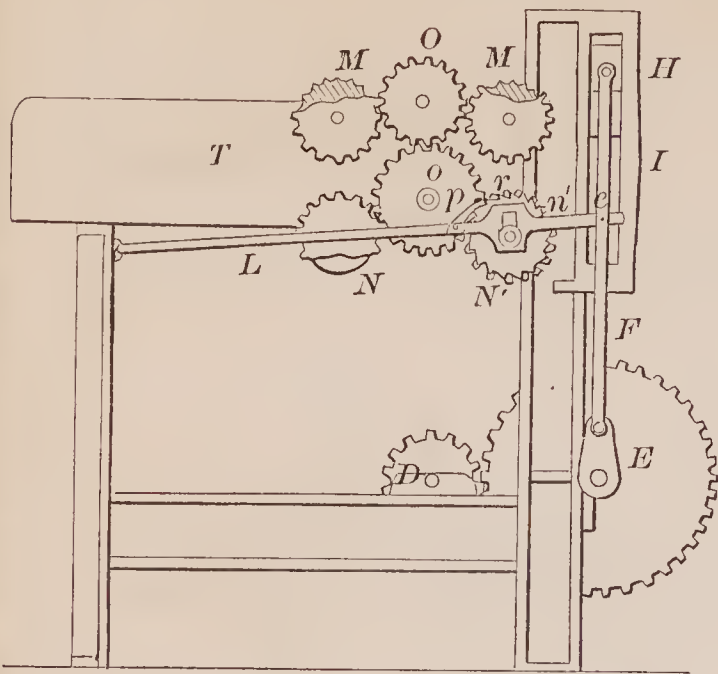

70864—T. R. & S. Knowles—For Moulding Pulleys.

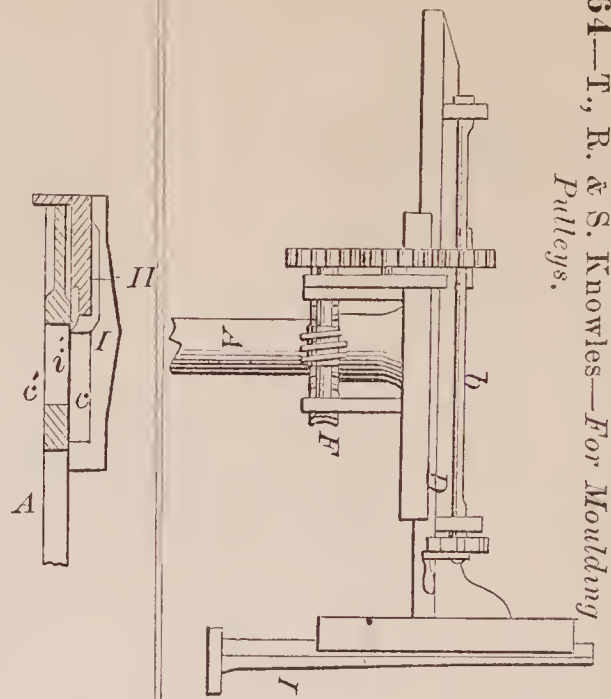

70868—A. I. Lenhart—Fish Hook.

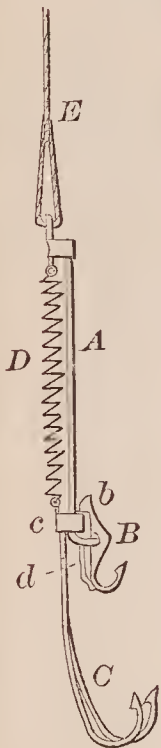

70867—J. Lee—Lamp.

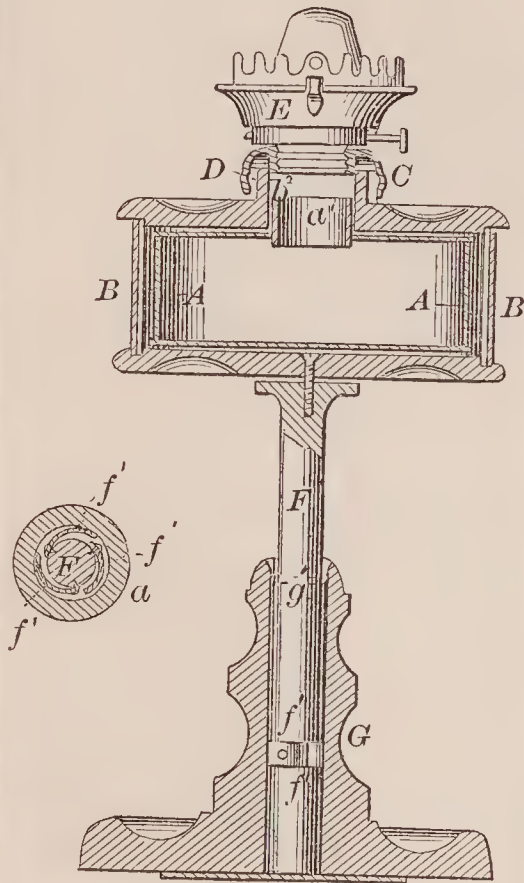

70865—P. A. La France—Compositors' Copy Holder.

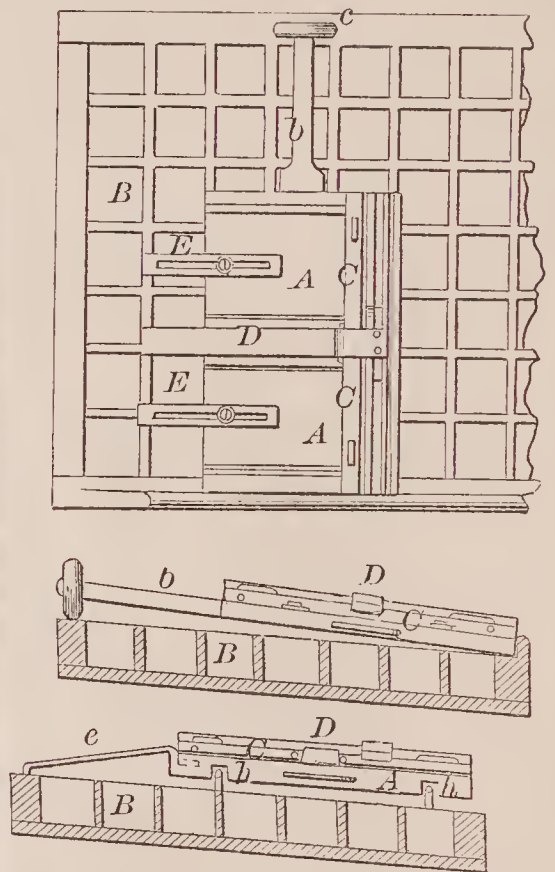

70869—W. E. London—Shaft Coupling.

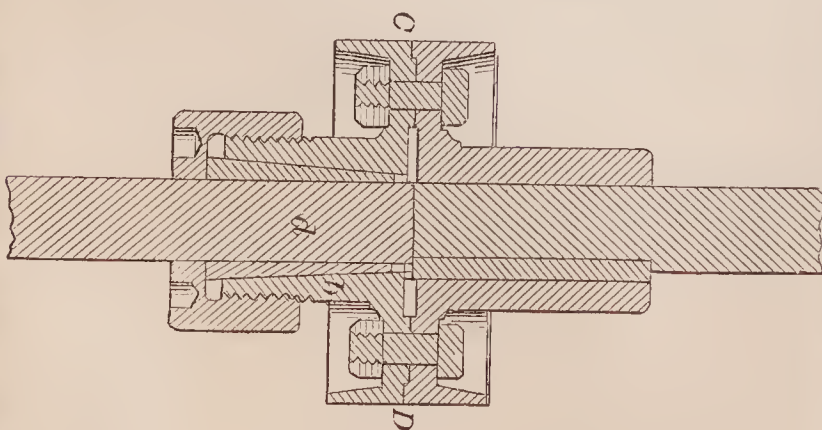

70866—V. Lapham—Bolt Fastening.

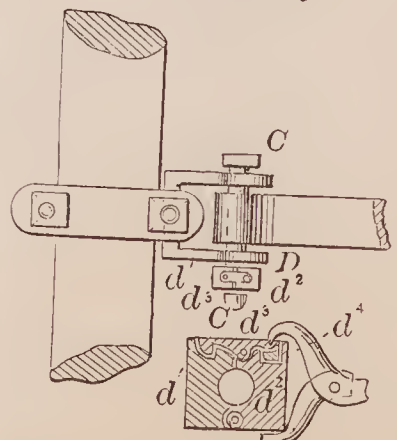

70870—J. M. Low—Horse Rake and Hay Spreader.

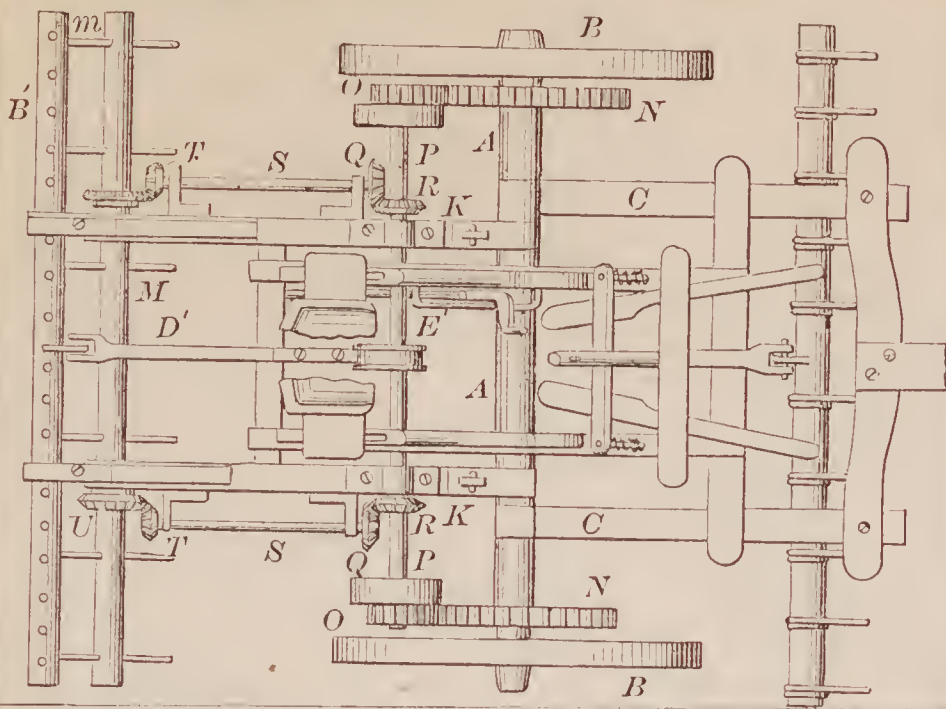

70874—J. Maunton—Heating Furnace.

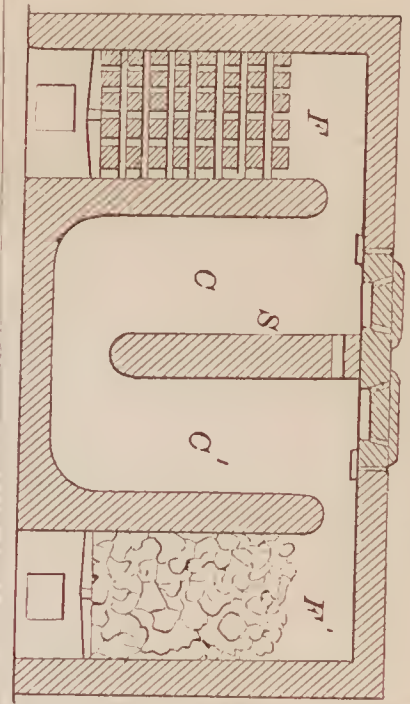

70873—J. Maunton—Furnace for Reducing Ores.

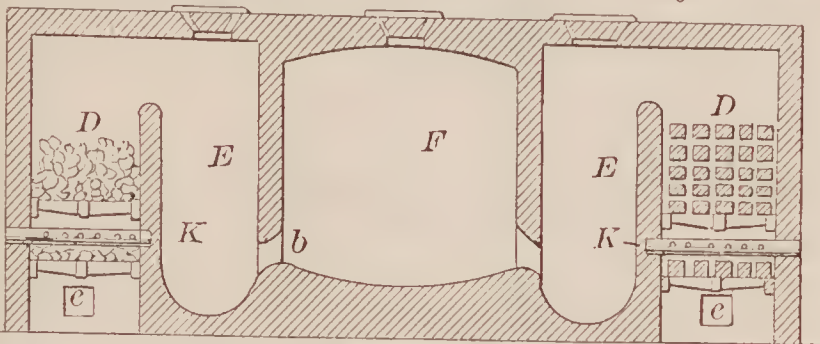

70871—Mallory & Fish—Quilting Frame and Clothes Dryer.

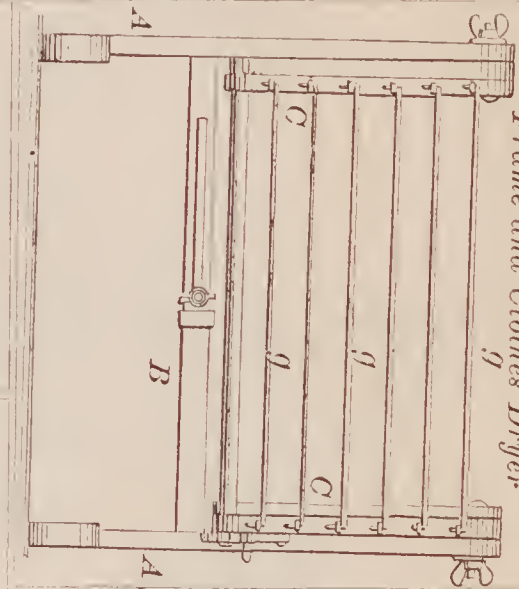

70876—W. McPherson—For Planing Metals.

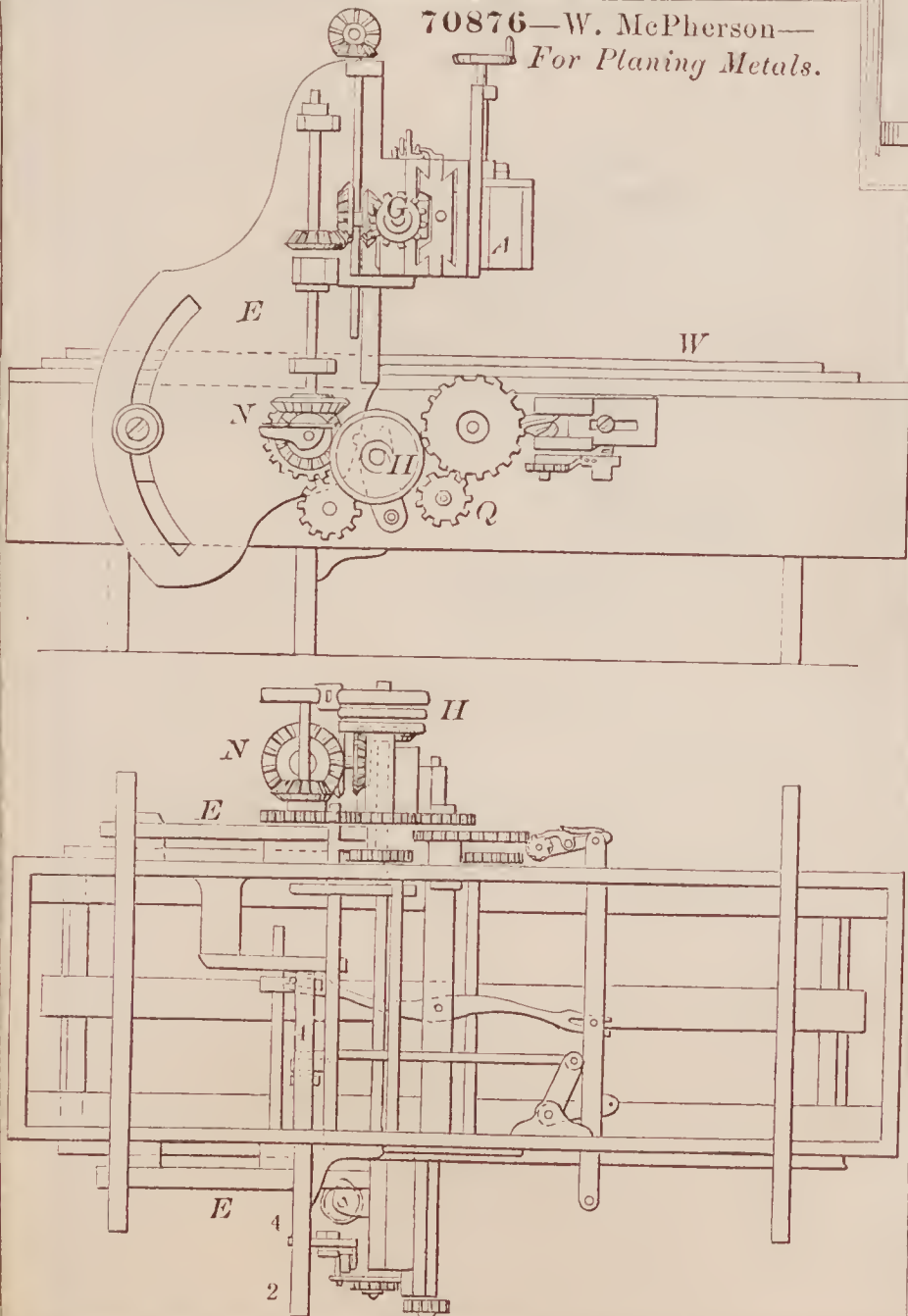

70875—J. A. Maxwell—Railway Superstructure.

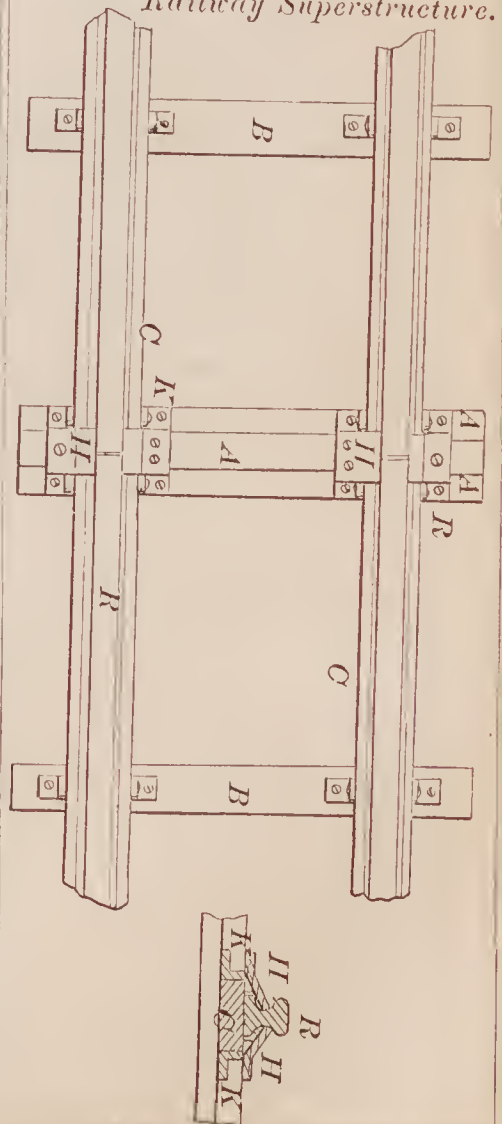



70877—S. C. Mendenhall—*Hand Loom.*

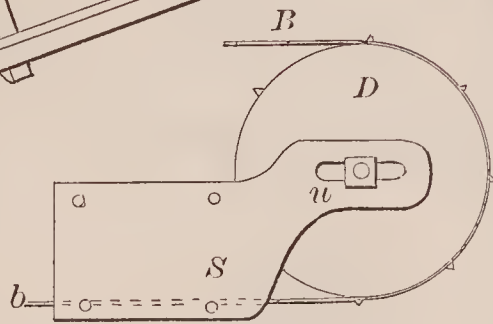
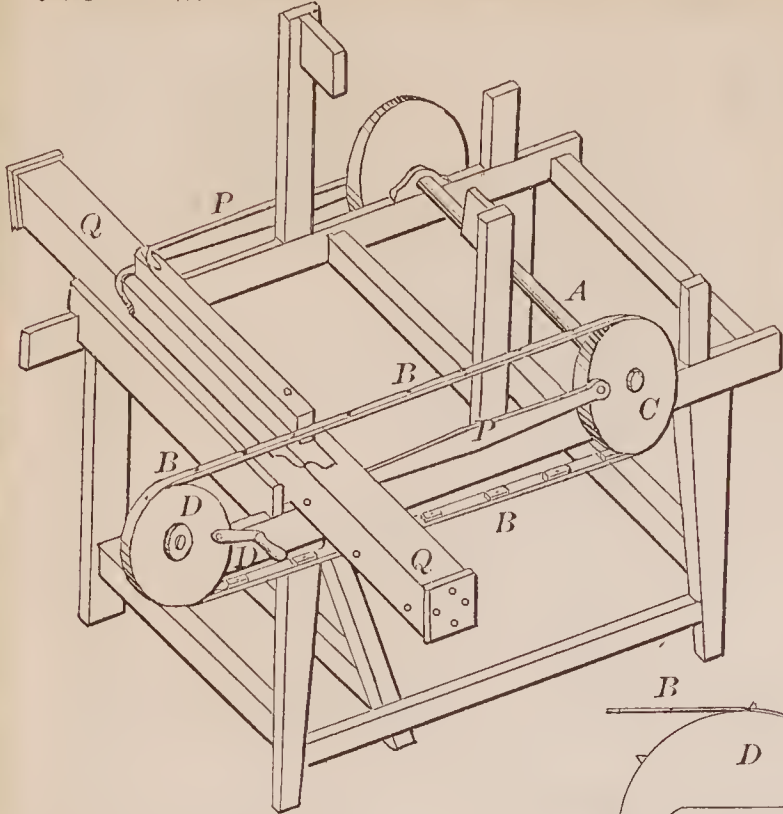

70878—S. T. Merrill—*Bleaching Stock for Paper.*

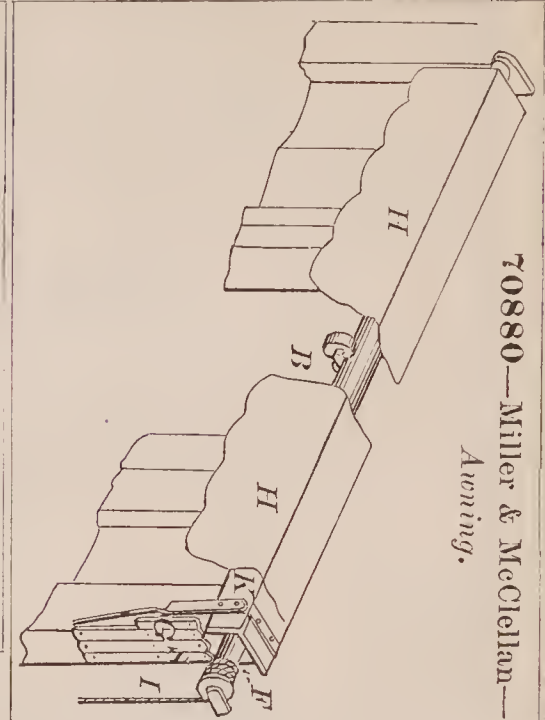
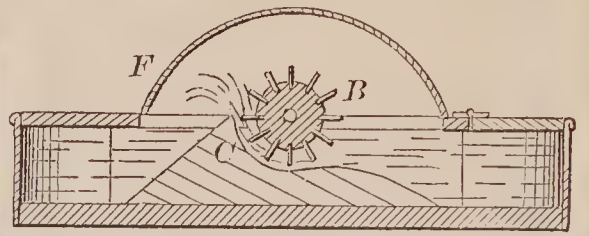

70880—Miller & McClellan—*Awning.*

70883—E. & J. S. B. Norton—*Dish Washer.*

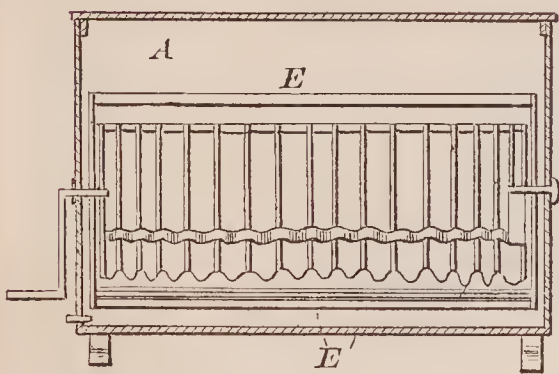
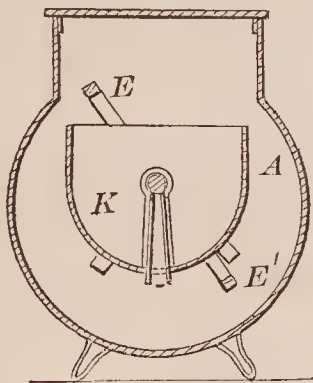

70882—A. Neilson—*Washing Machine.*

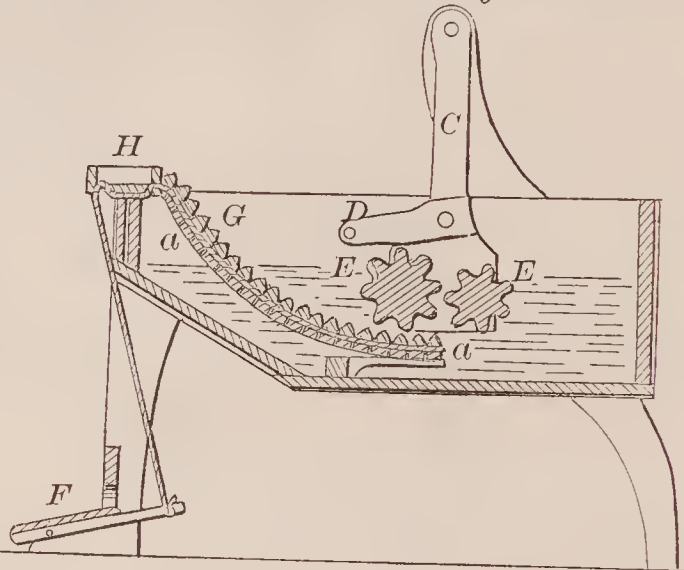

70879—E. Mets—*Slide for Extension Tables.*

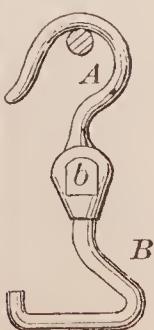
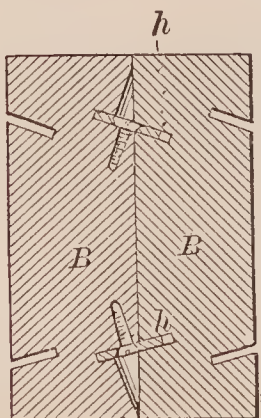

70884—W. R. Oatley—*Hook for Travelers.*

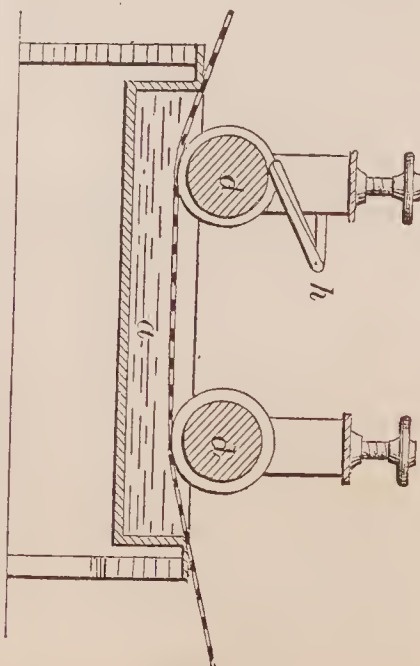

70881—J. H. Monk—*For Tempering Skirt Wire.*

70885—H. Ogborn—*Fanning Mill.*

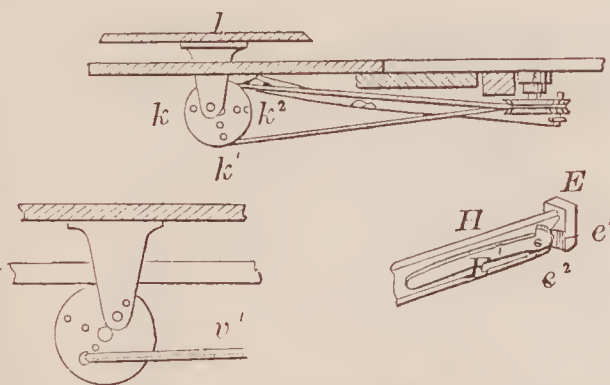
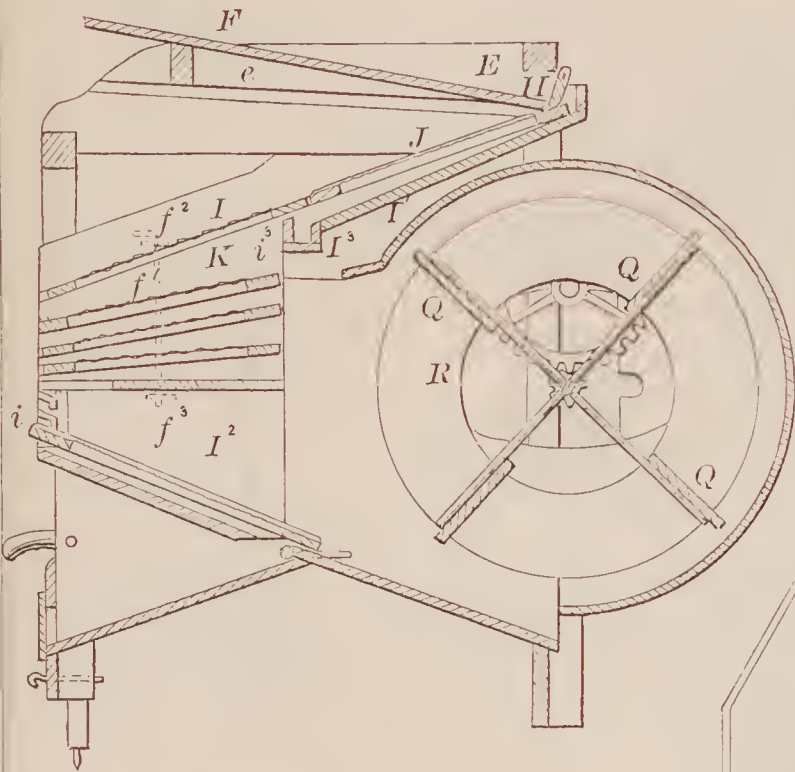
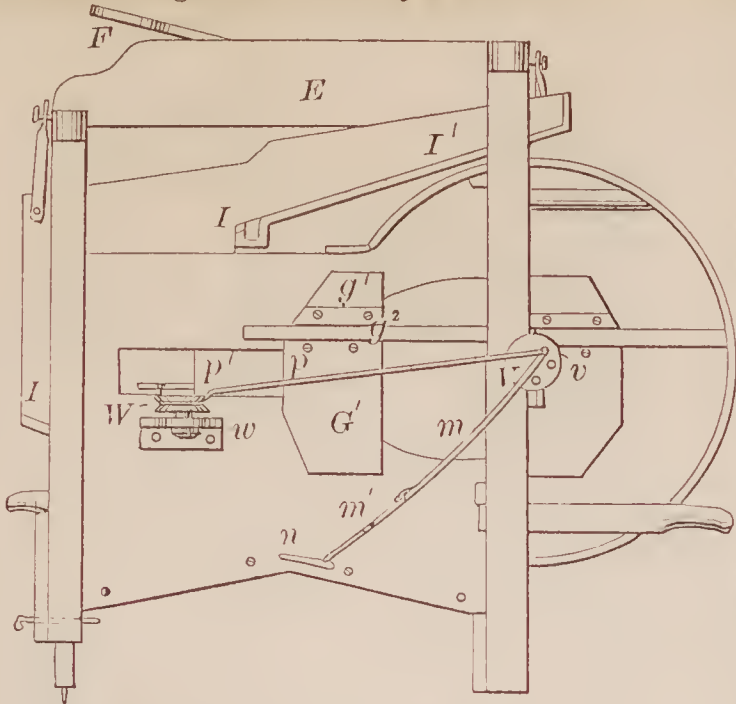

70891—H. Parks—*Straw Cutter.*

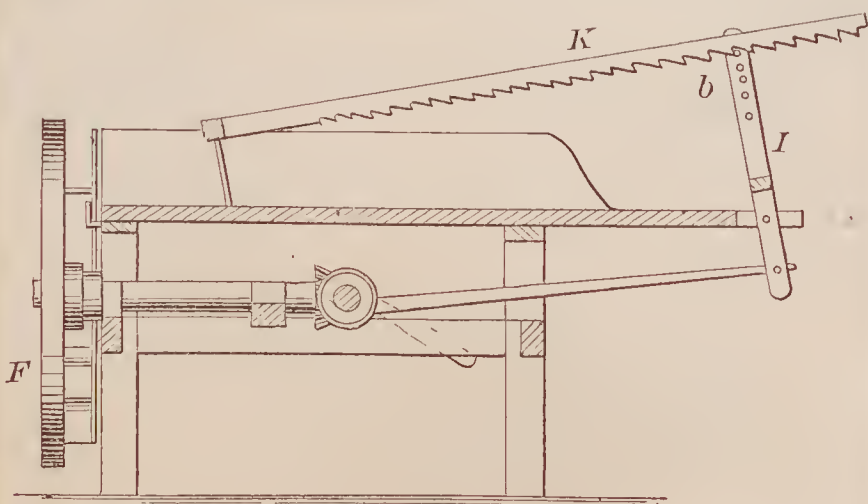

70886—N. F. Page—*Railway Chair.*

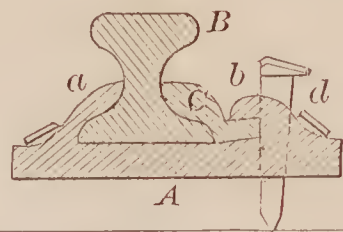

70887—W. L. Paine—*Card Holder for Trunks.*

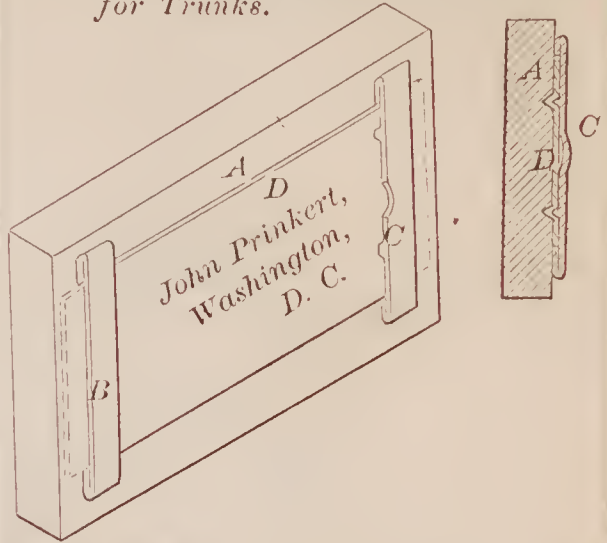

70889—C. A. Paret—*Blackening Brush.*

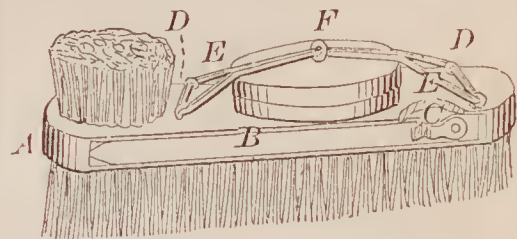

70888—C. D. Palmiter—*Friction Clutch Pulley.*

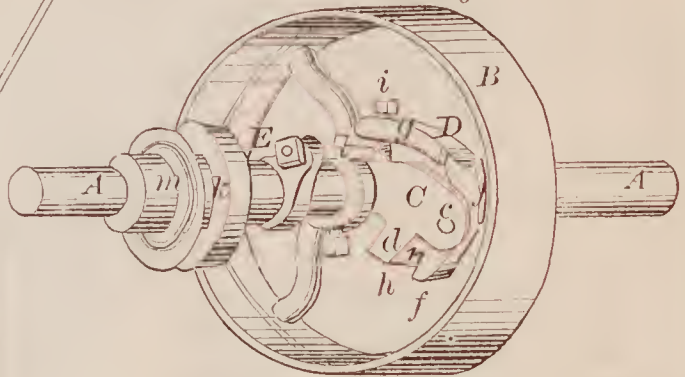

70890—D. E. Paris—*Ash Sifter.*

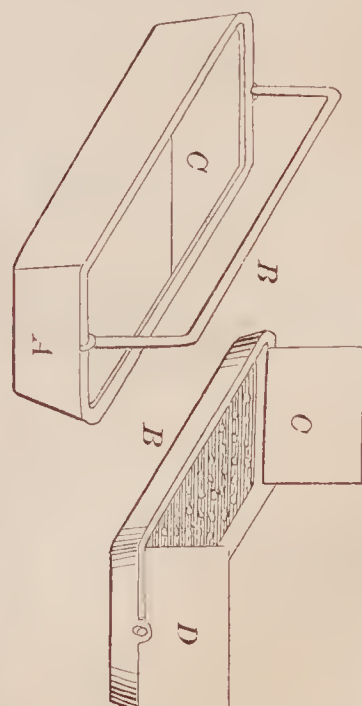



70892—T. K. Payson—*Blacking Box Holder.*

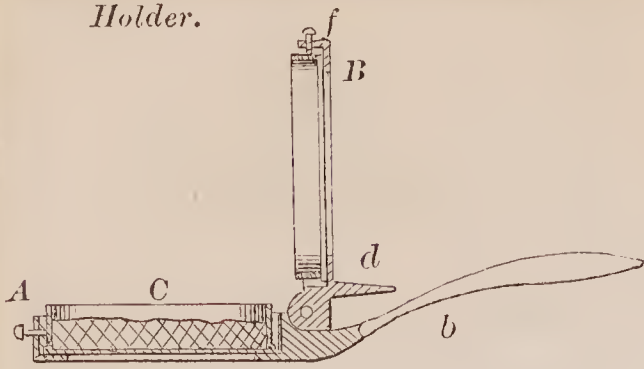

70893—S. & J. J. Perry—*Inkstand.*

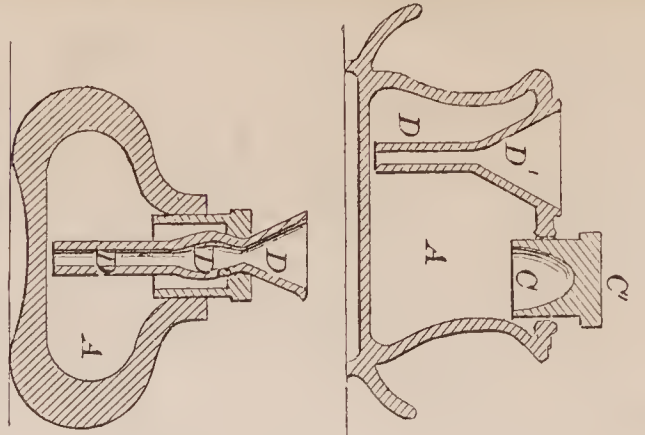

70896—H. Pulse—*Grain Drill.*

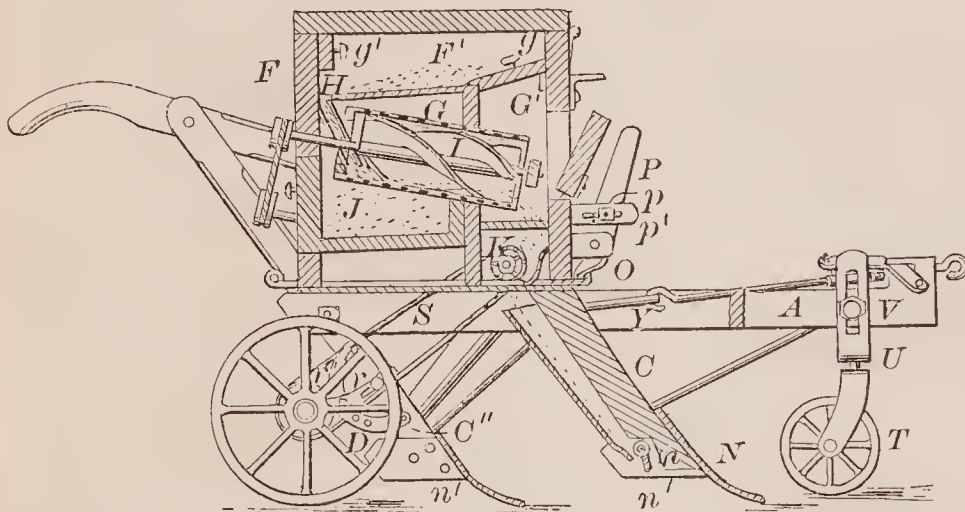
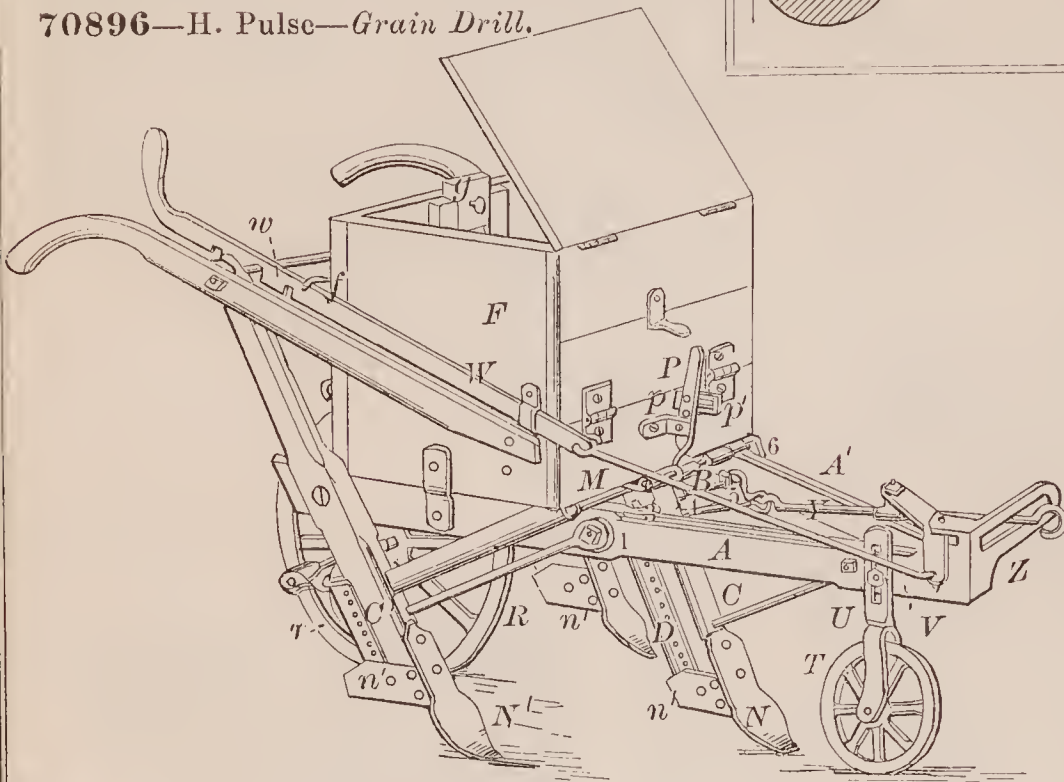

70897—J. Rancevan—*Disconnecting Horses from Vehicles.*

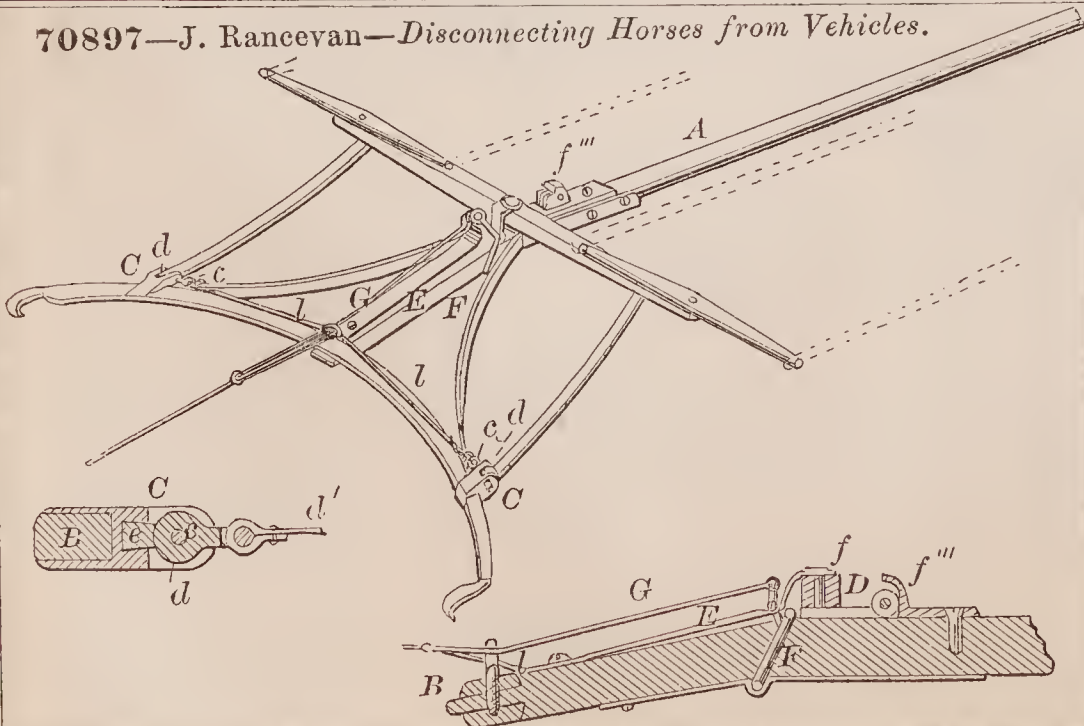

70894—J. E. Plummer—*Edge Plane.*

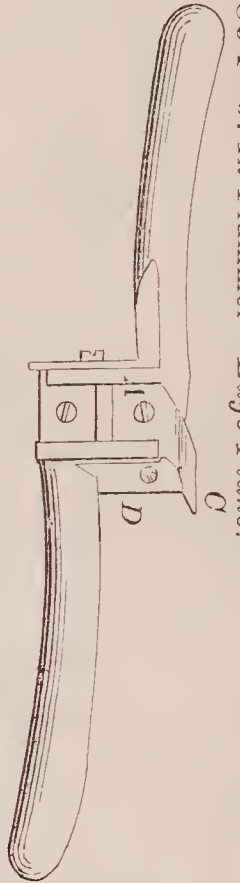

70895—G. A. Pridham—*Door Bolt.*

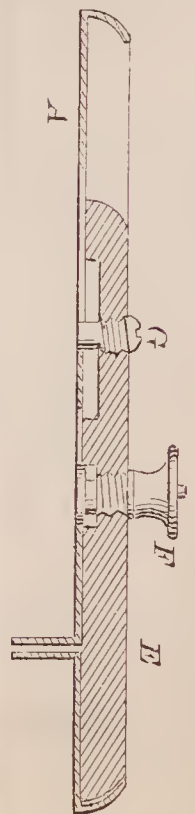

70898—B. Randall—Harrow and Seeder.

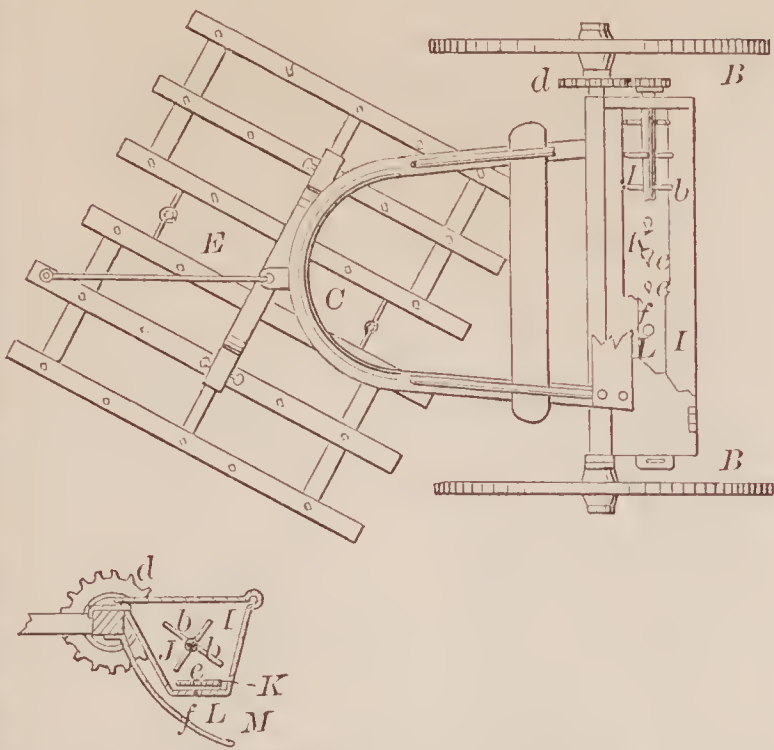

70899—D. W. Rawson—For Yethering Animals.

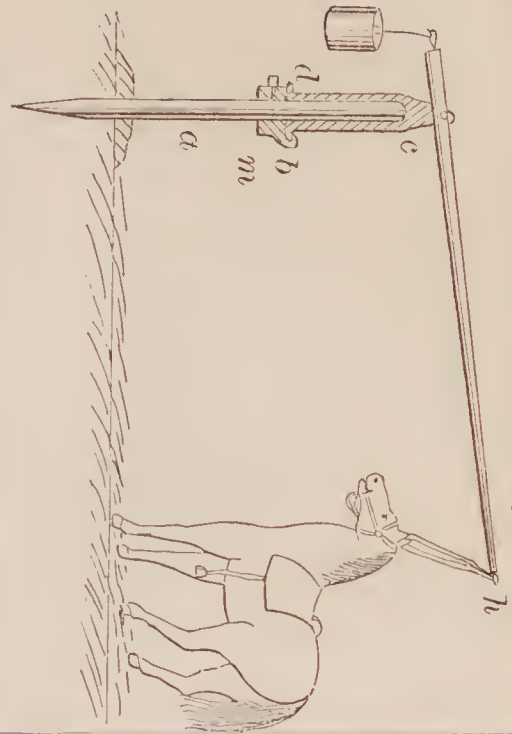

70901—O. H. P. Robinson—Carpenter's Square.

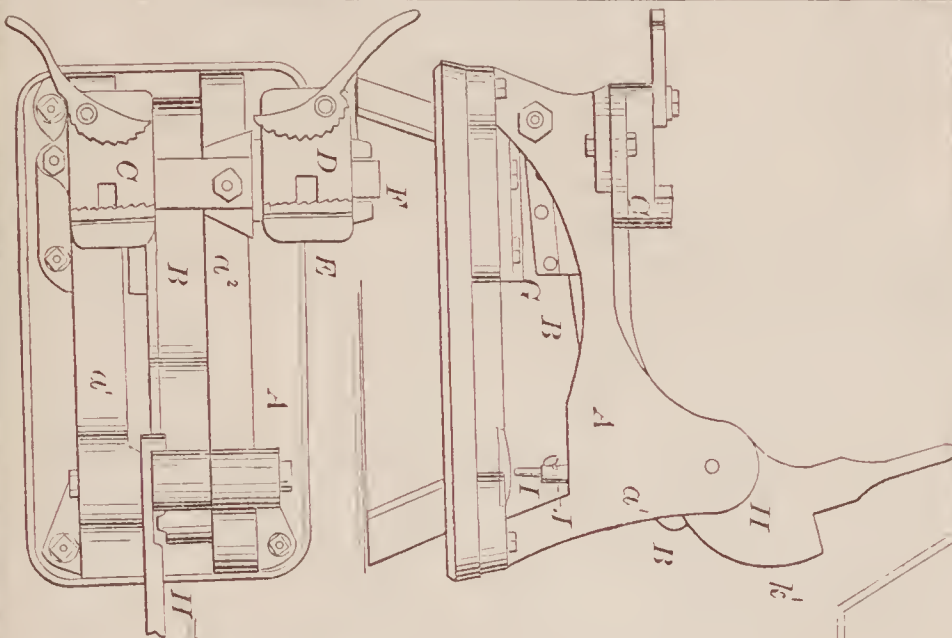
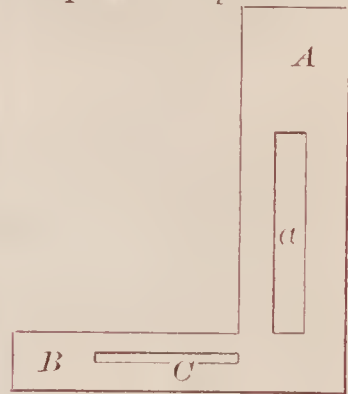

70902—J. J. Rose—For Cutting, Punching and Upsetting Iron.

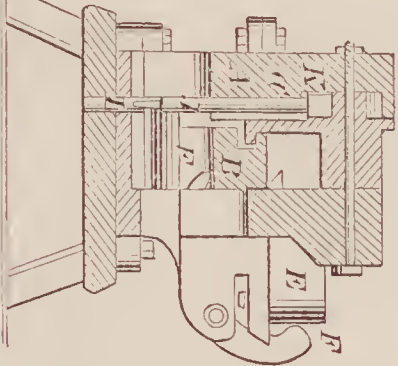

70900—T. A. Read—Tobacco Press.

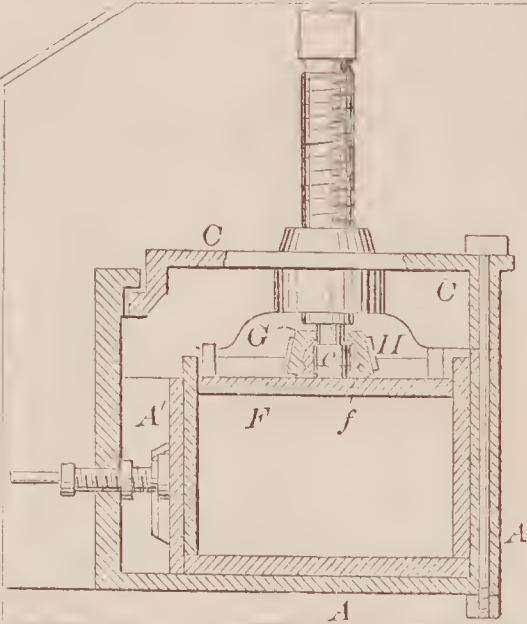

70903—C. W. Saladec—Door Spring.

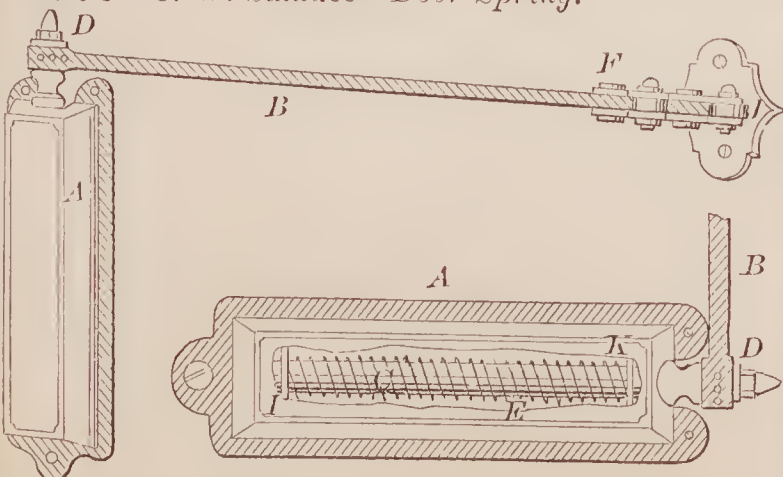

70904—J. P. Scott—School Desk and Seat.

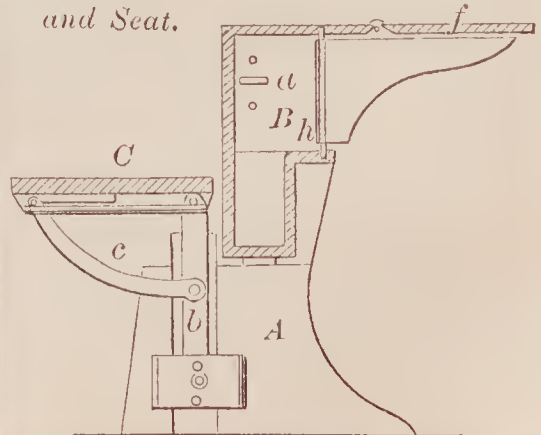



70905—M. Siefert—For Punching Sheet Metal.

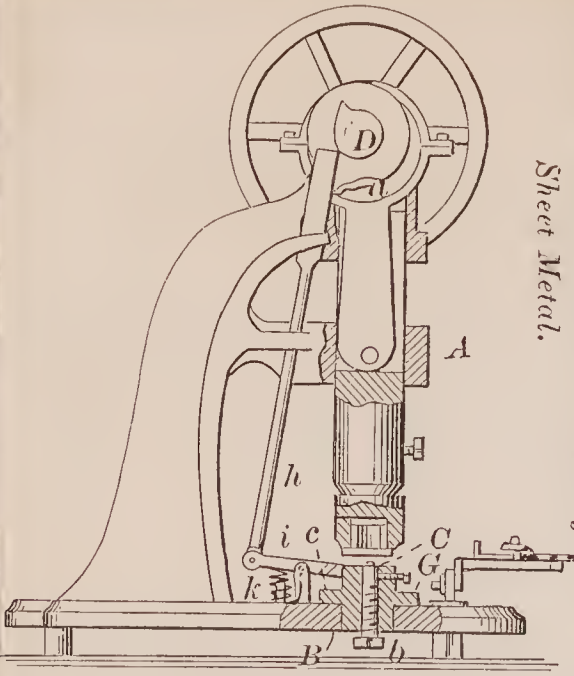

70906—G. W. Shearer—Skate.

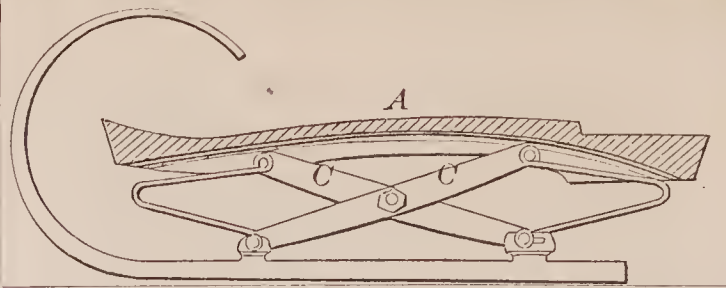

70907—L. M. Sims—Mail Bag.

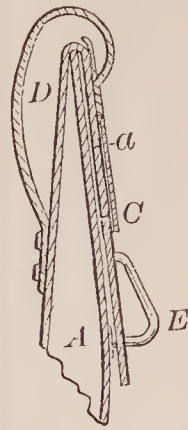

70908—J. B. Small—Carriage Jack.

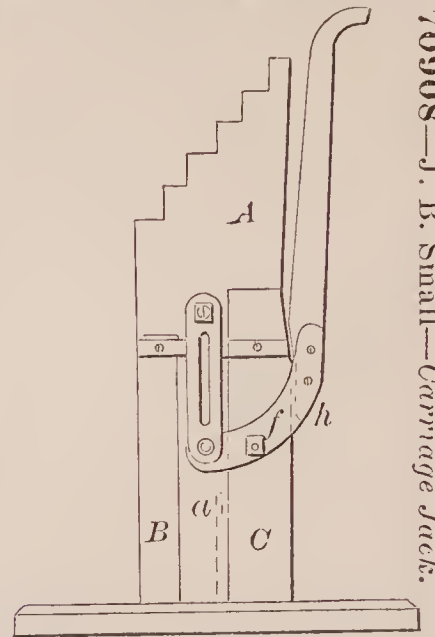

70911—C. Spofford—Car Brake.

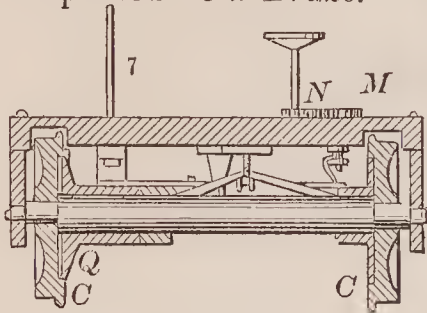

70909—D. E. Somes—Cooling Air.

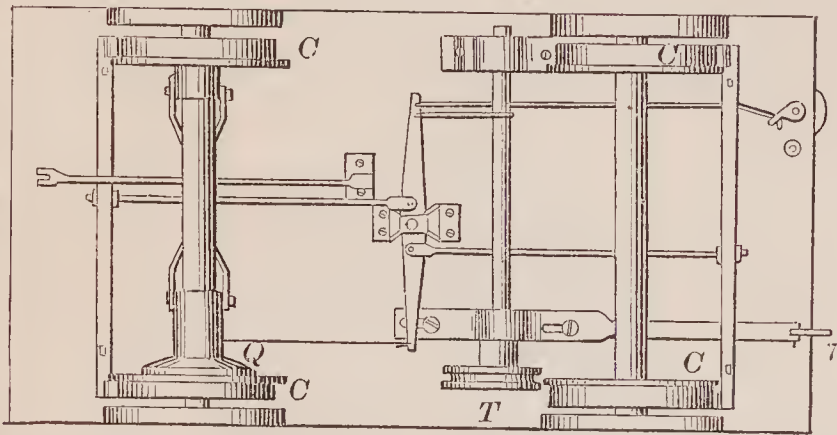
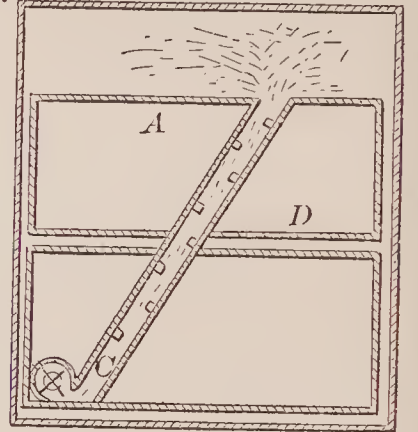

70912—S. & H. Squier—For Pressing Bonnets.

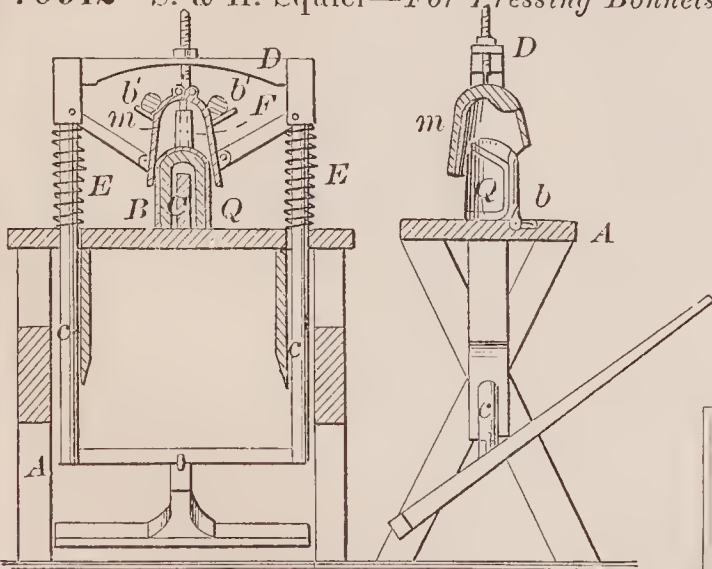

70913—E. Sterling—Fish Hook.

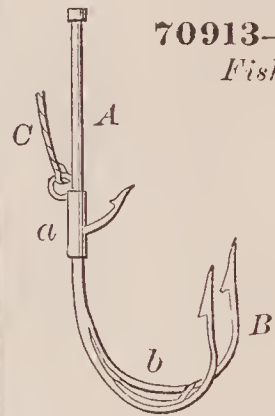

70910—D. E. Somes—Packing for Door Joints.

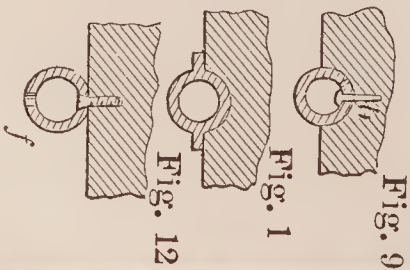

70914—W. C. Stiles—Gold Separator.

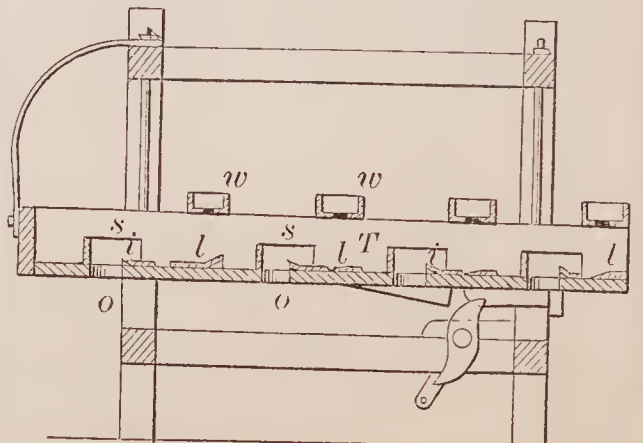

70915—A. Stocker—*Ventilating Boots and Shoes.*

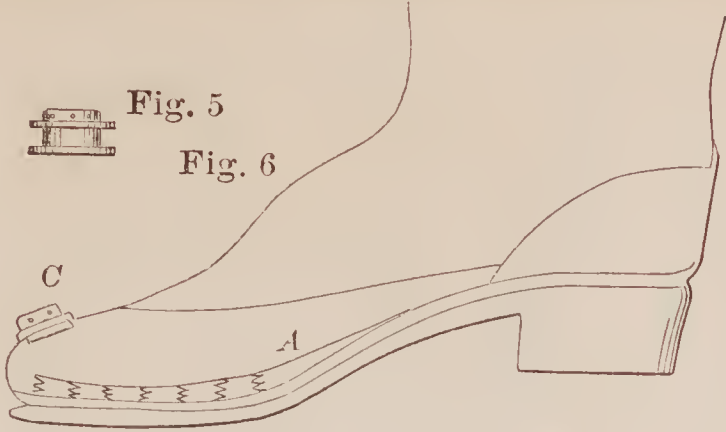

70918—A. W. Tucker—*Harvester.*

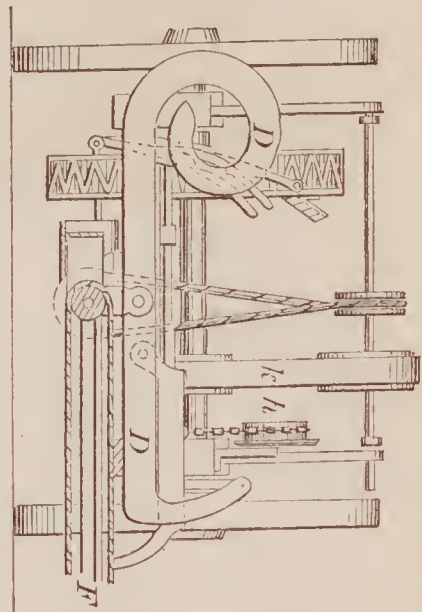

70916—G. M. Stone—*Grinding Mill.*

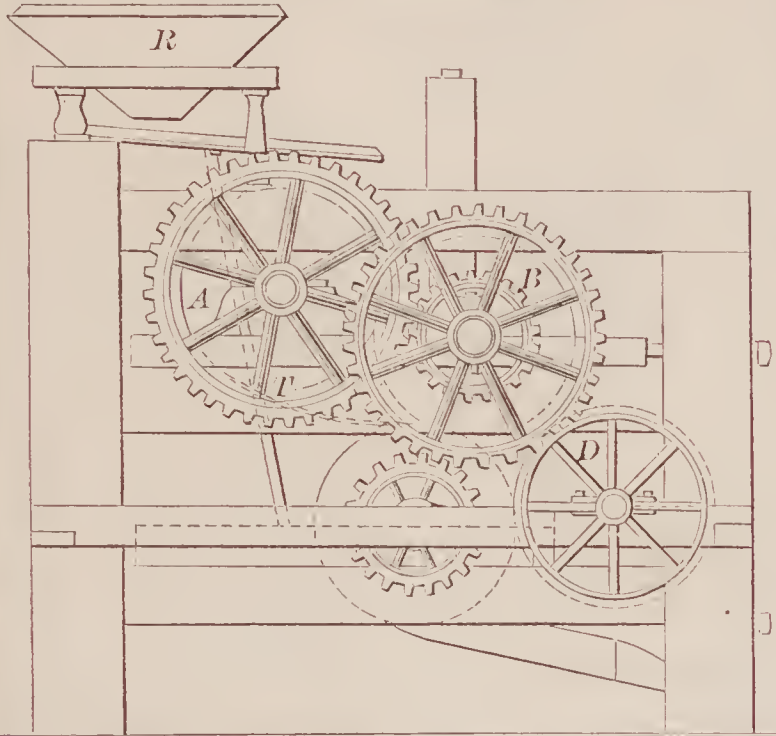

70919—J. E. Tucker—*Faucet.*

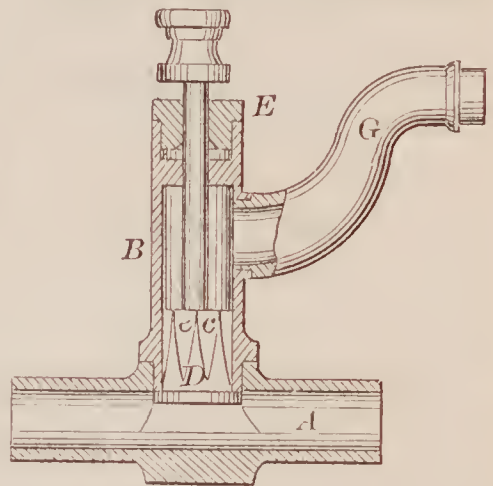

70917—O. W. Stow—*For Flanging and Wiring Metallic Plates.*

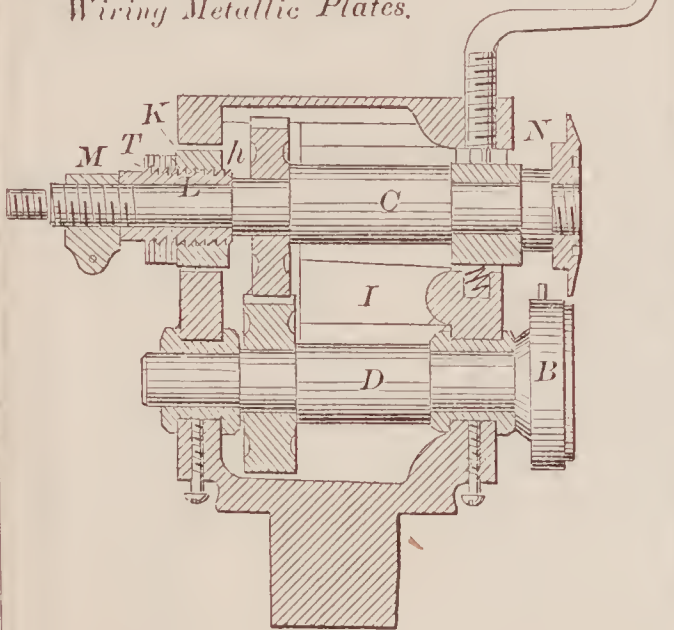

70923—T. D. Voorhees—*Screw Driver.*

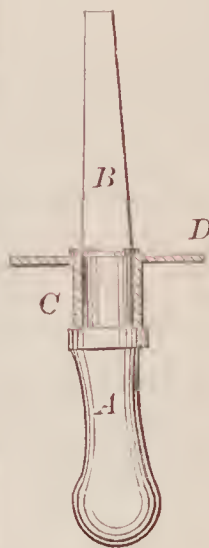

70921—C. Vetter—*Self-Closing Hinge.*

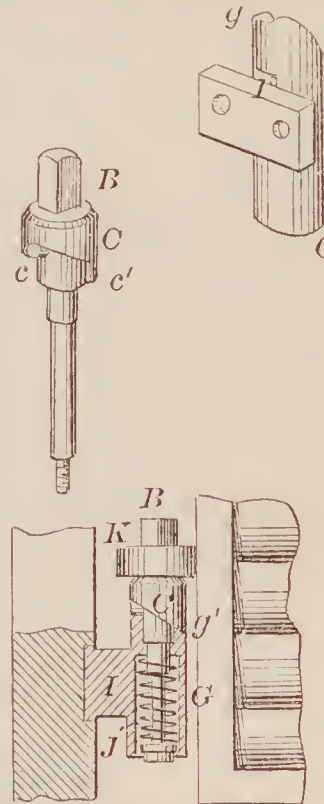

70924—J. Wallace—*Grate Combination.*

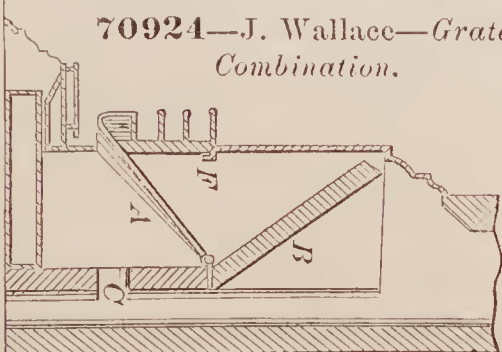

70922—A. S. Villec—*Clamp for Harness Frames.*

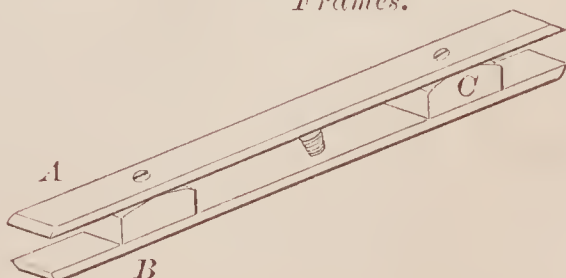



70925—E. A. Warren—Paper Ruling Machine.

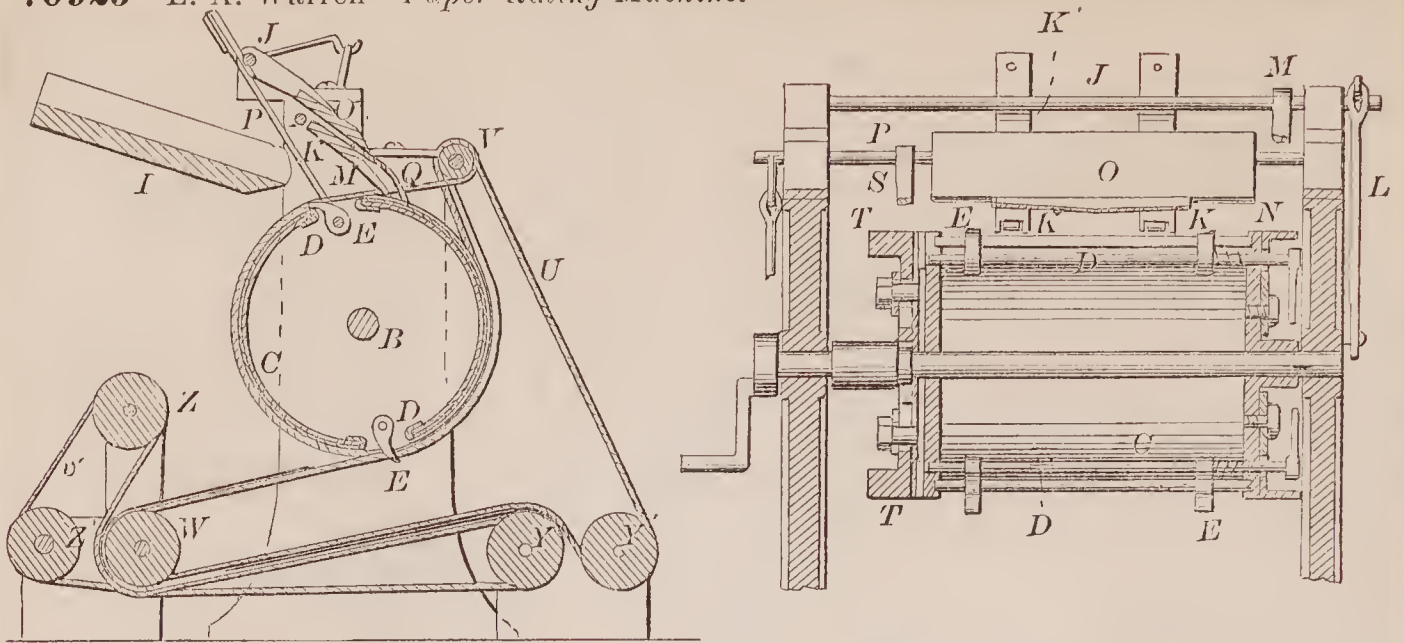

70926—W. N. White—Wages Indicator.

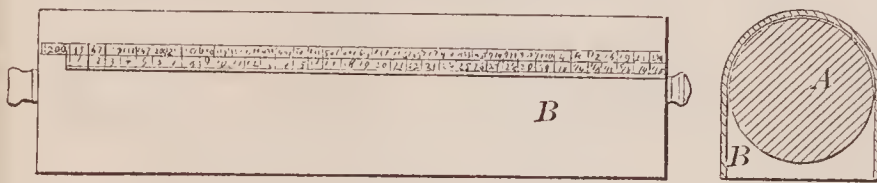

70928—D. Wigger—Axle and Axle Box.

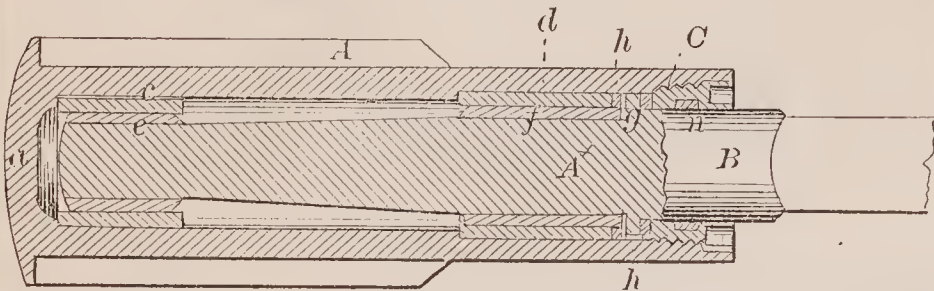

70929—A. Wilkin—Self-Setting Game Trap.

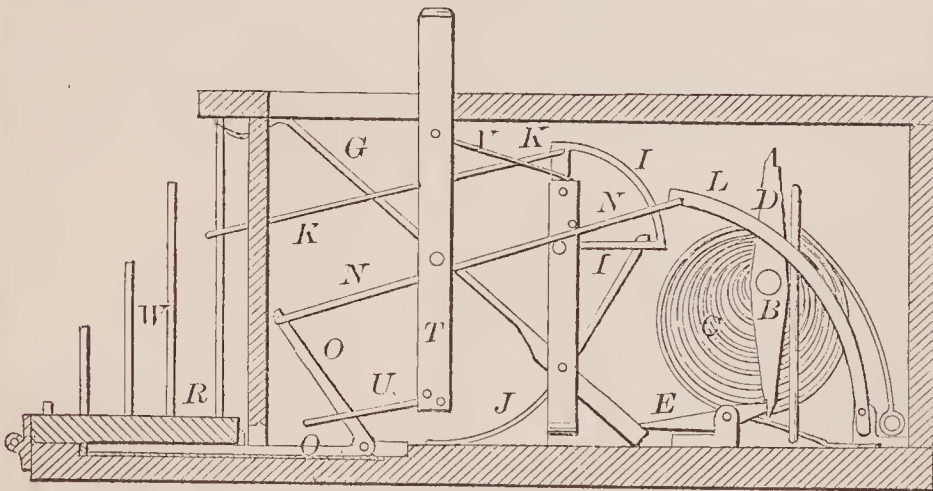

70927—A. S. Whitmore—Chimney

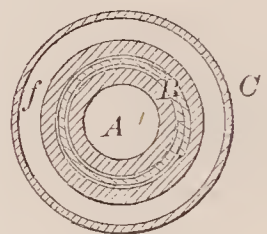
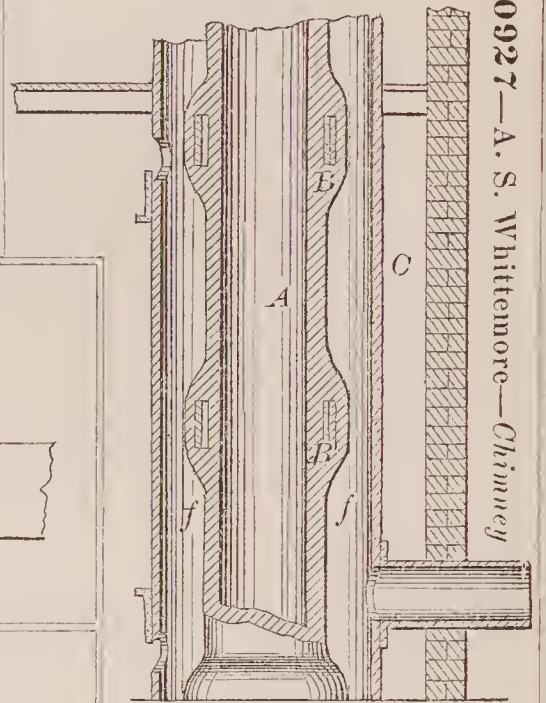

70931—M. B. Wright—Lantern.

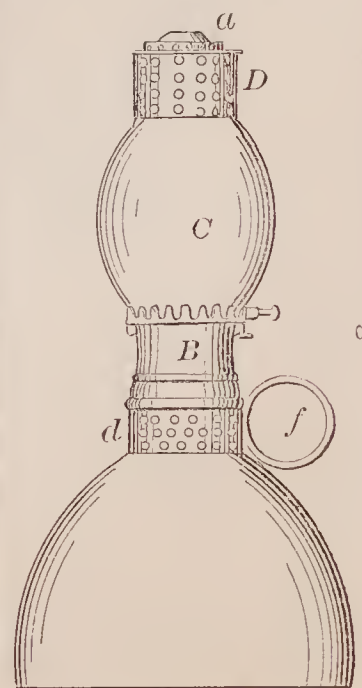

70930—D. Wigger—Belt Fastener.

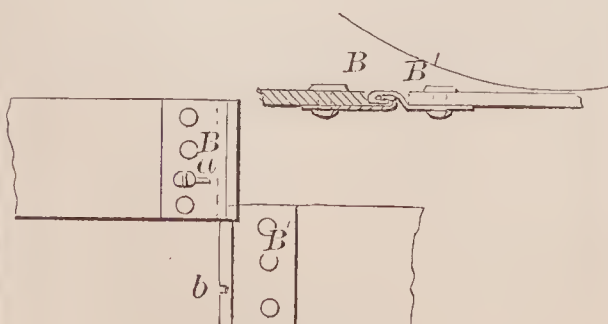

70932—J. E. Zender—Dice Box.

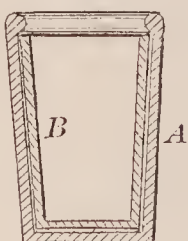

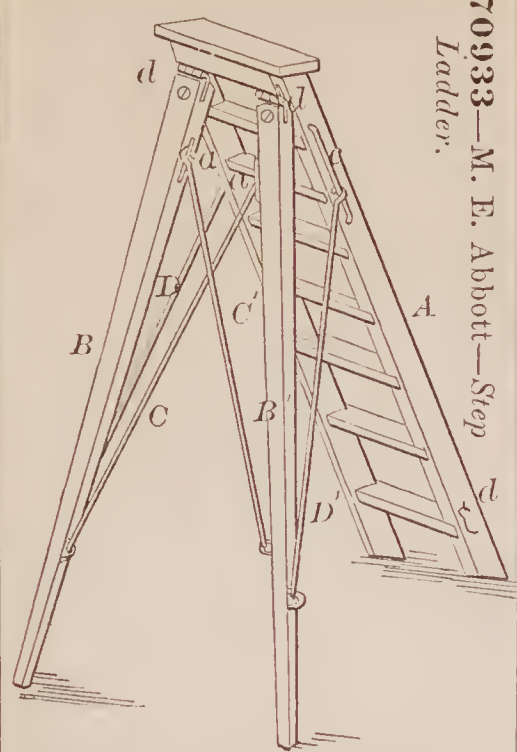

70933—M. E. Abbott—Step Ladder.

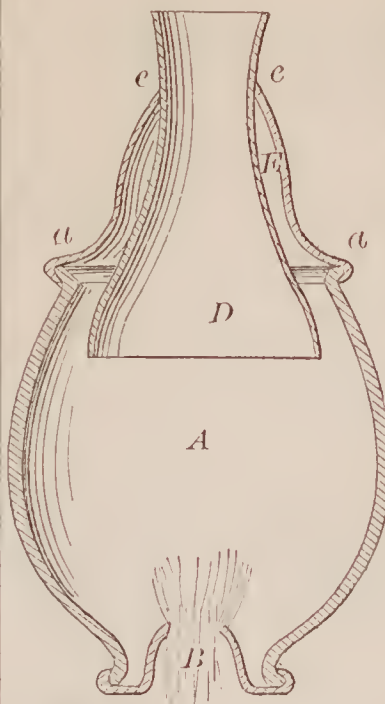

70935—E. R. Addison—Lamp Chimney.

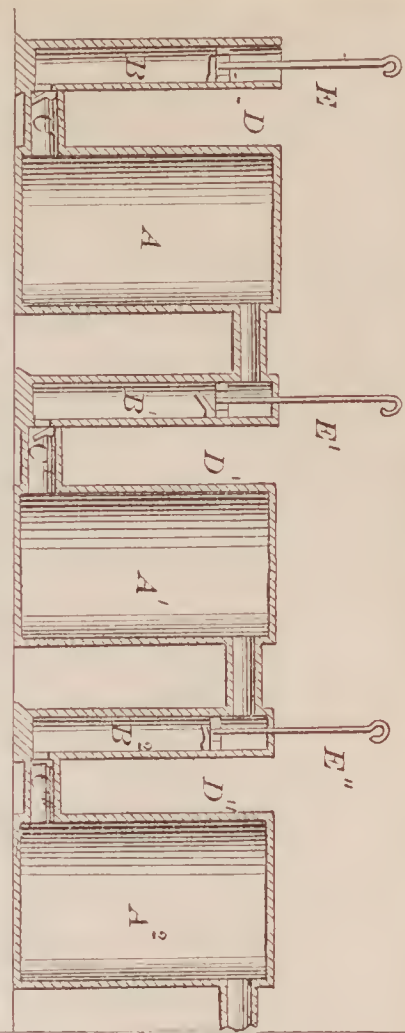

70934—O. Abruzzo—For Condensing Air.

70936—C. Aldrich—Type Case.

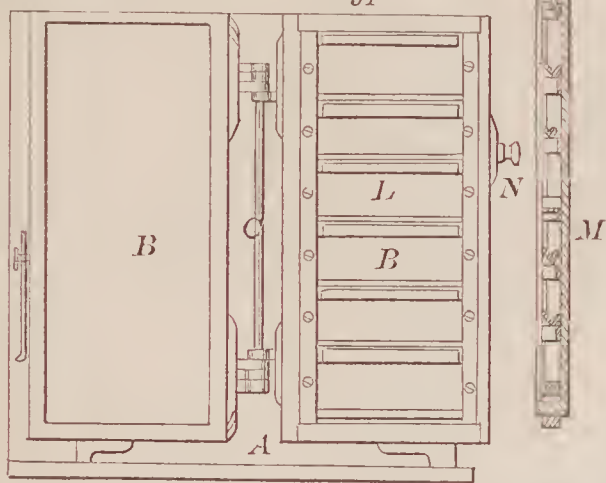

70938—W. A. Bagley—Hook for Hold-Back Straps.

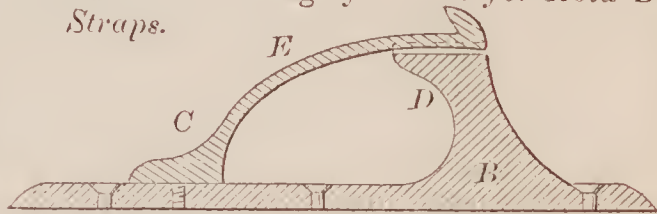

70940—Bailey & Nichols—Harness Buckle.

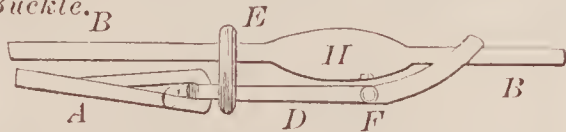

70941—C. W. Baldwin—Elevator.

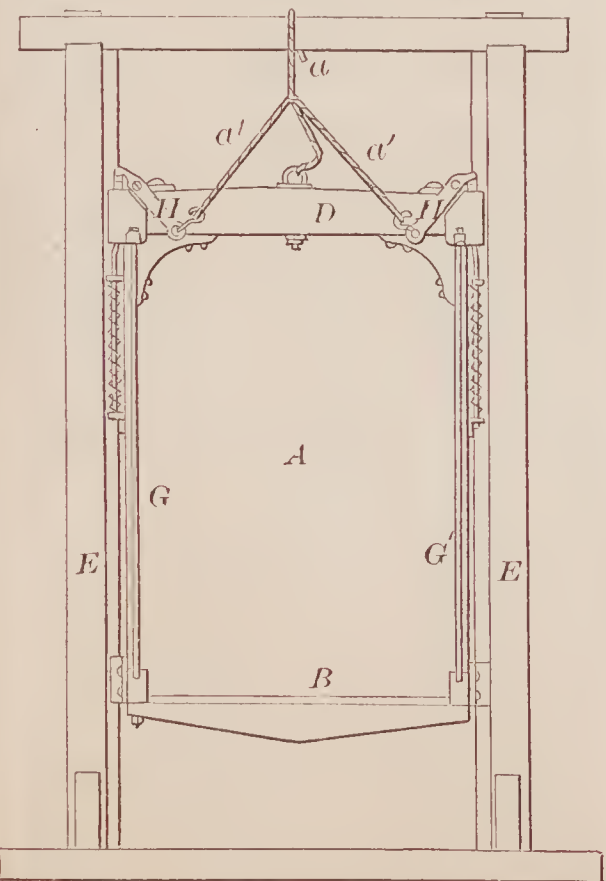

70937—M. C. Ames—Joiner's Gauge.

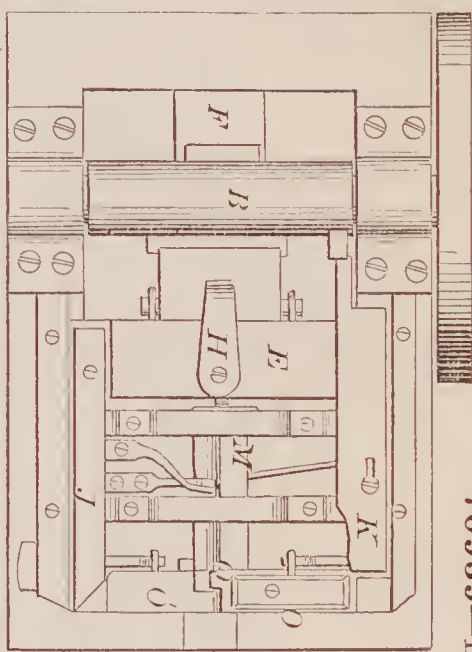
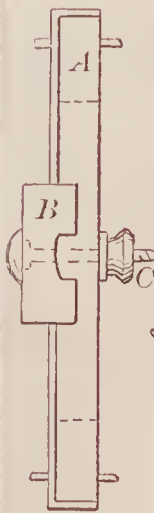

70939—Bailey & Knowles—Bolt Machine.

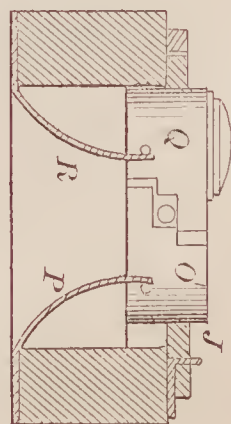



70942—I. Benham—Scales.

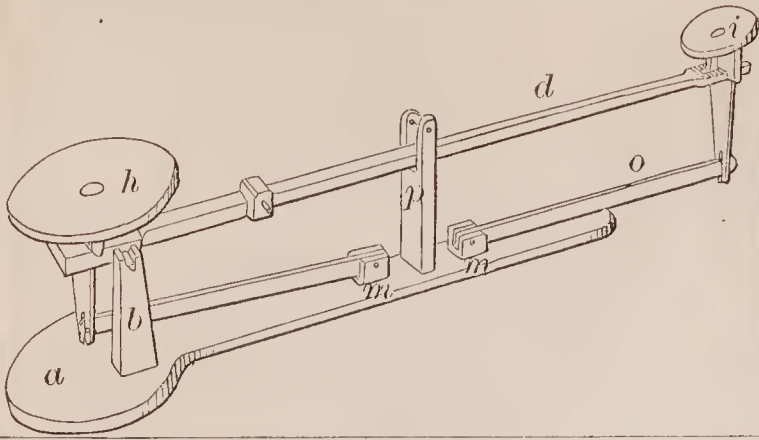

70945—A. Blood, Jr.—Door Catch.

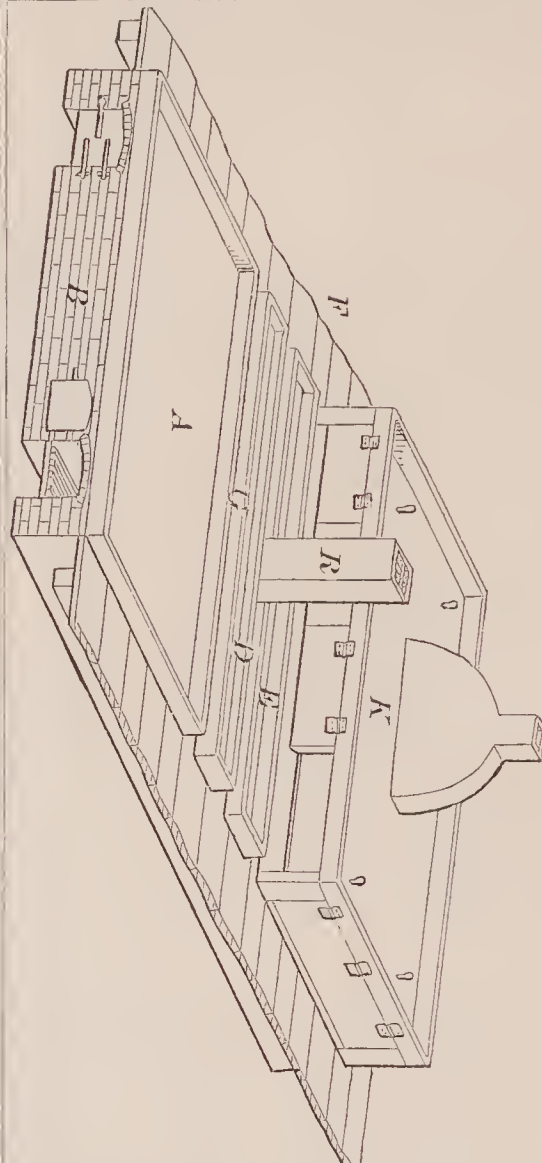
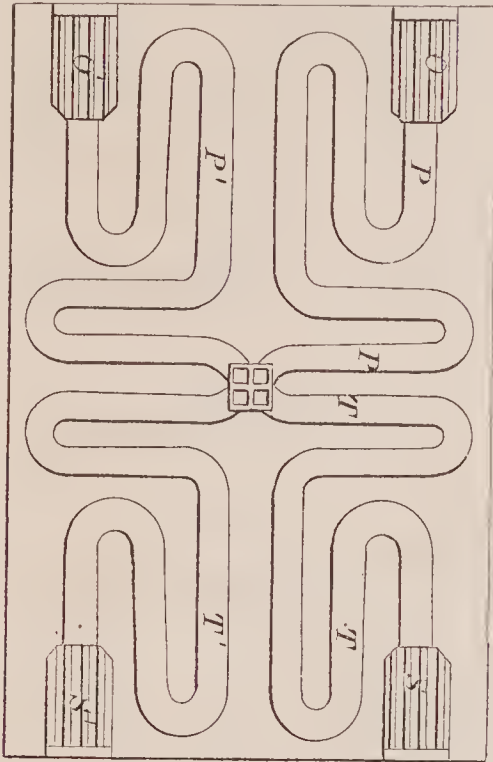
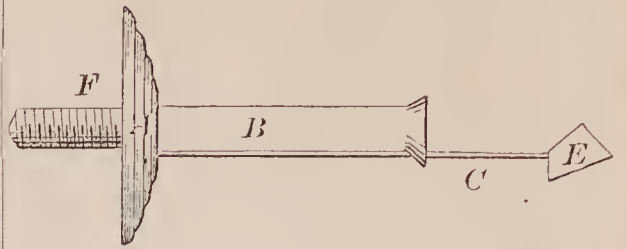

70943—H. Besckee—For Manufacture of Salt.

70947—E. T. Bostrom—Paddle Wheel.

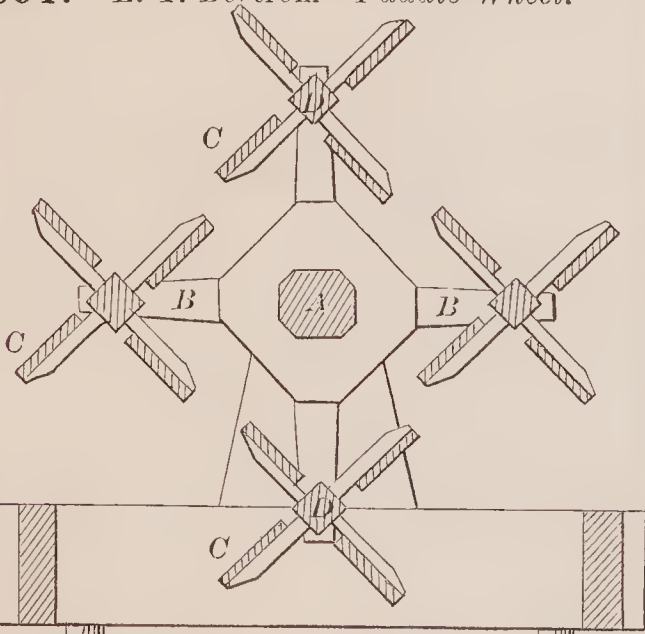

70946—W. R. Boerner—Wire Work.

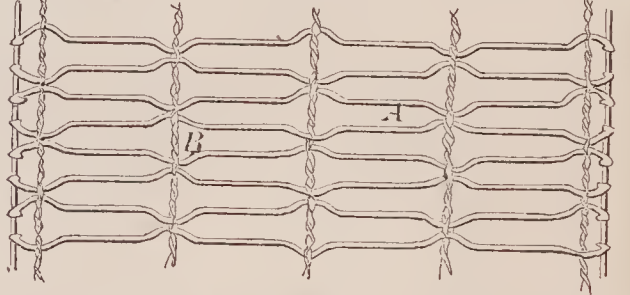

70948—E. Bourson—Steam Engine.

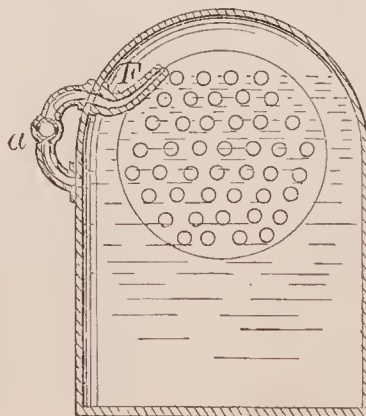
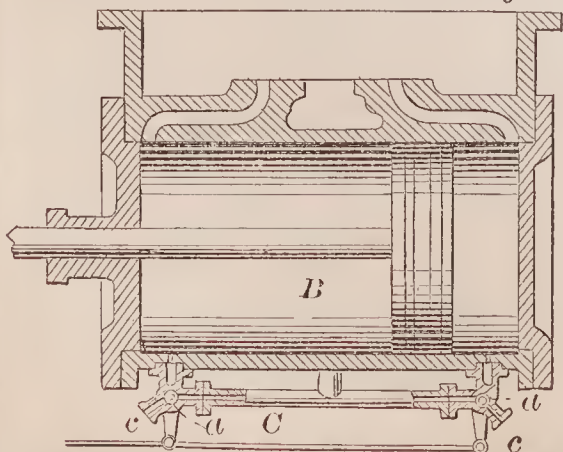

70944—E. C. Blakeslee—Buckle.

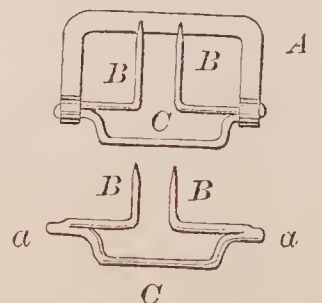

70949—G. W. Boynton—*Toy.*

70952—O. Brück—*Fan.*

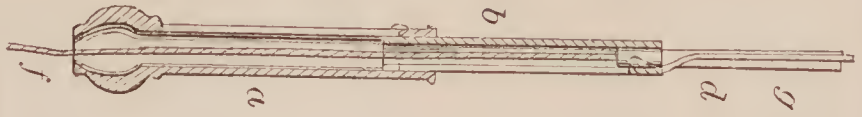
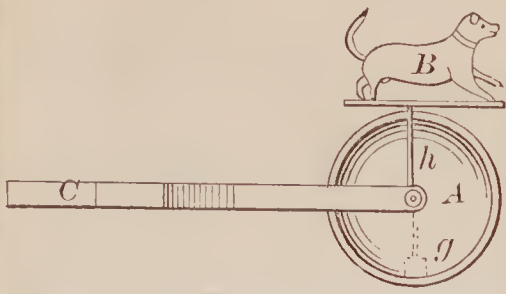

70950—C. H. Brookbank—*Head Block for Saw Mills.*

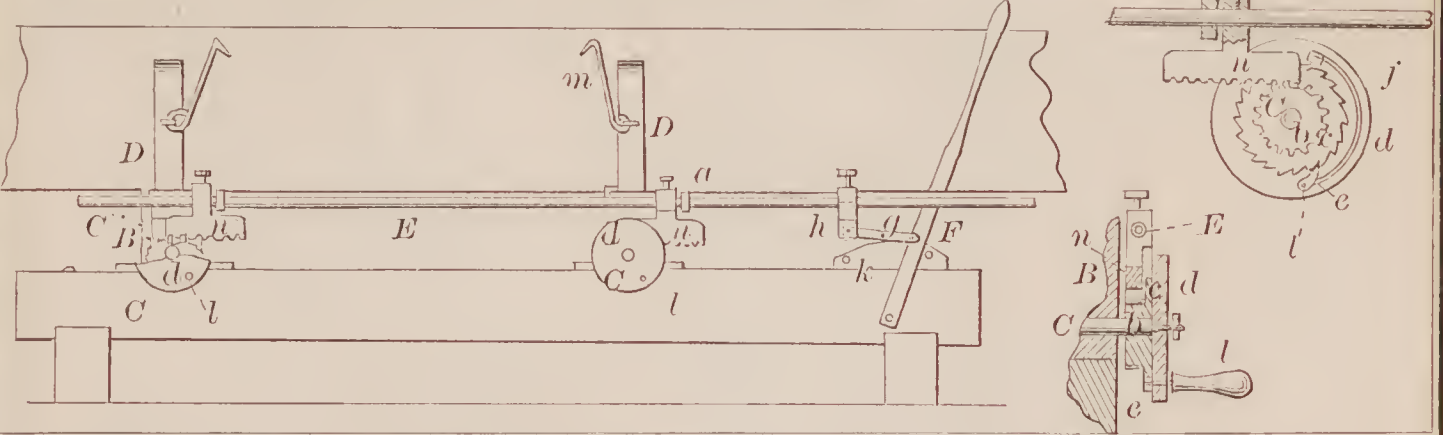

70951—I. S. & C. N. Brown—*For Grinding Saw Teeth.*

70955—J. & J. Cash, Jr.—*Towel.*

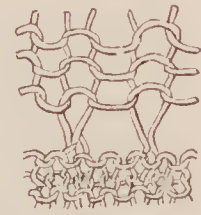
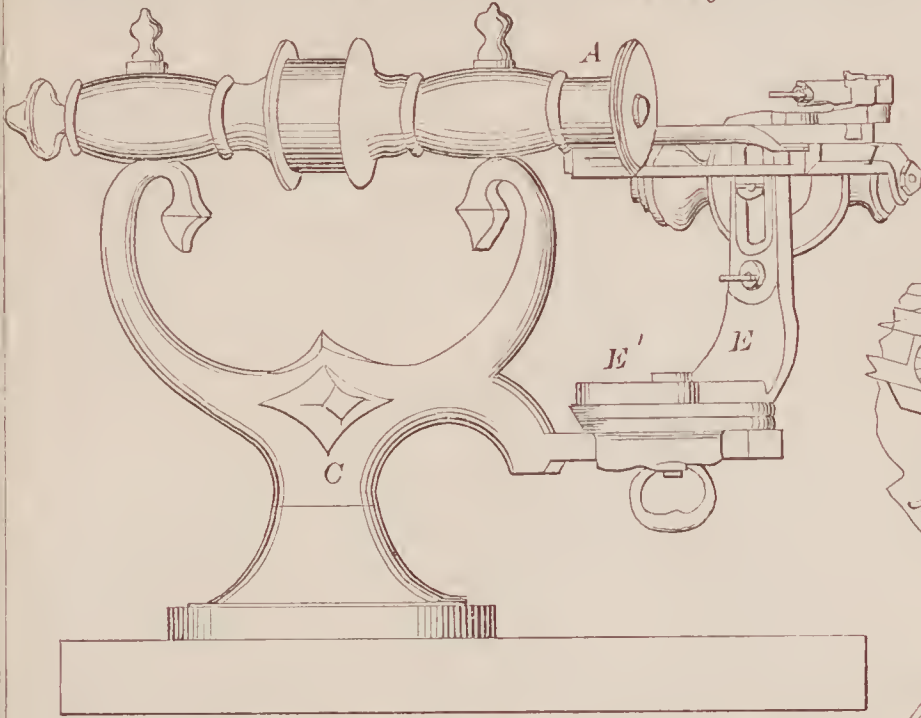

70954—I. Carman—*Horse Shoe.*

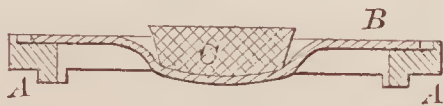

70956—D. Cashwell—*For Distilling Spirits of Turpentine.*

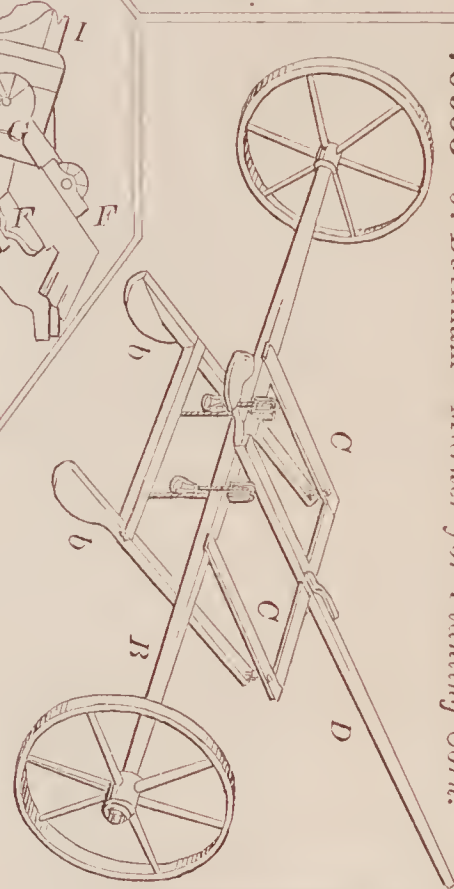
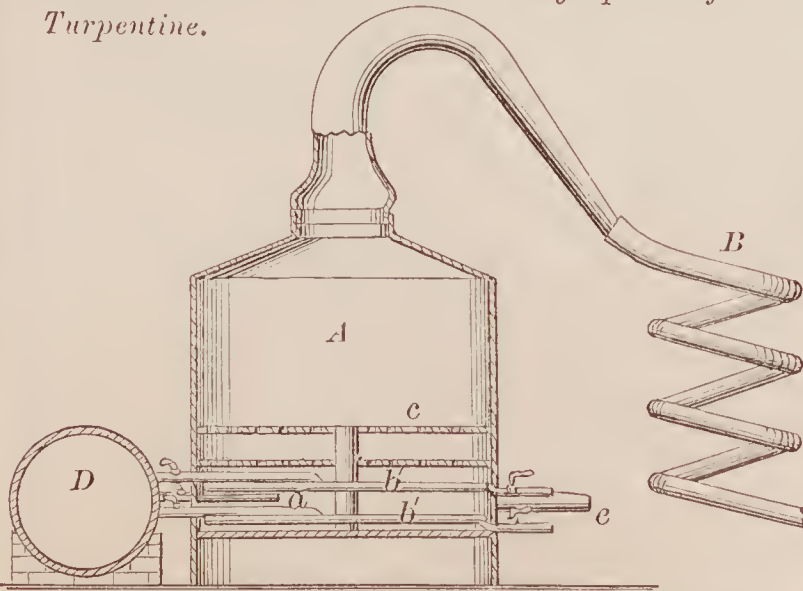

70953—J. Burnham—*Marker for Planting Corn.*

70957—S. Chamberlin—*Wagon.*

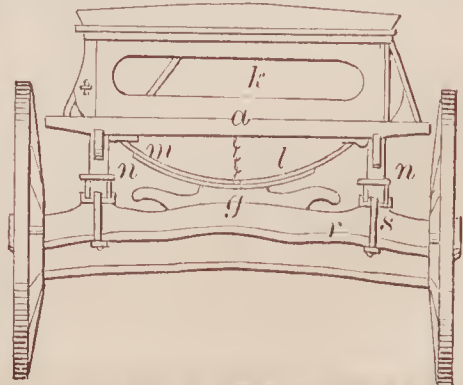



70958—A. A. Chittenden—Ironing Table.

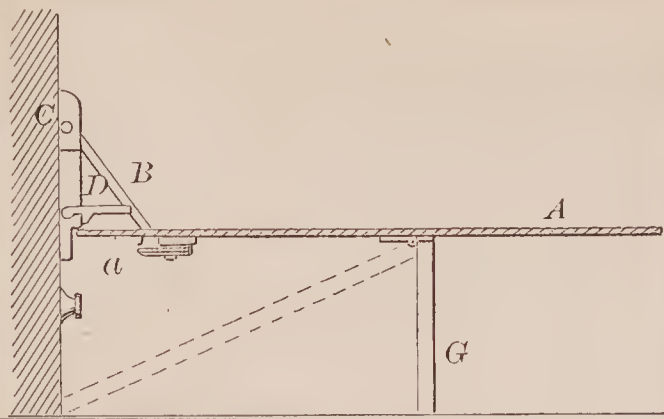

70959—C. Colby—Churn.

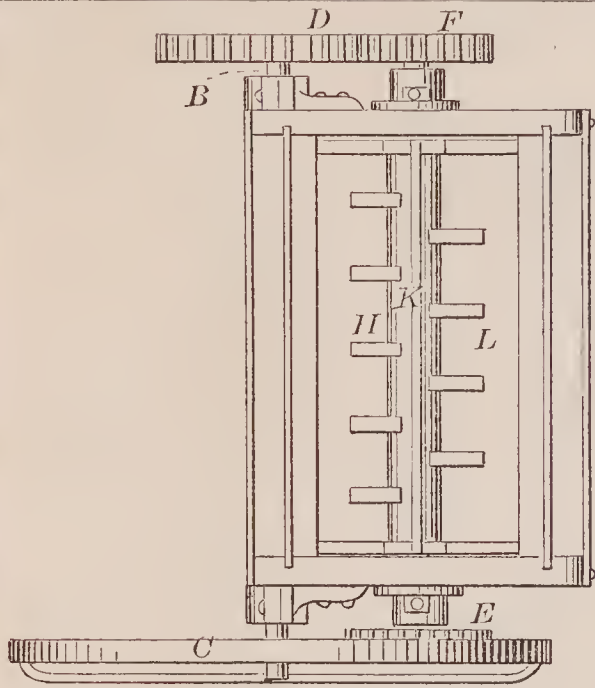

70961—J. Conver—Stove Pipe Drum.

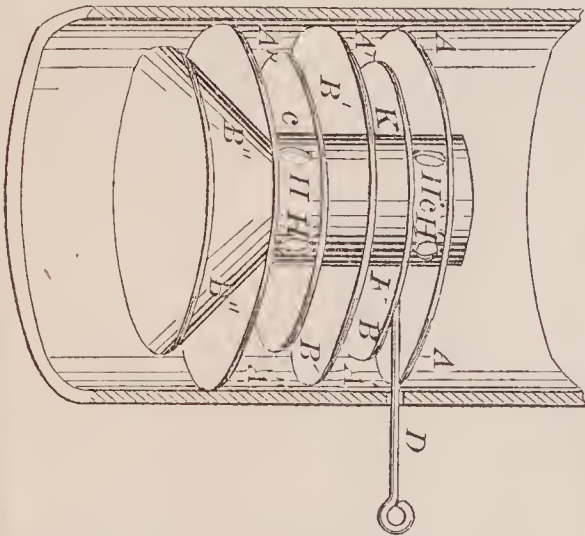

70962—A. J. Cook—Horse Hay Fork.

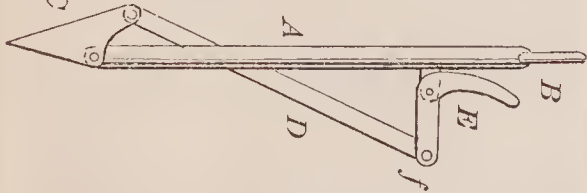

70963—W. Cooley—Gate.

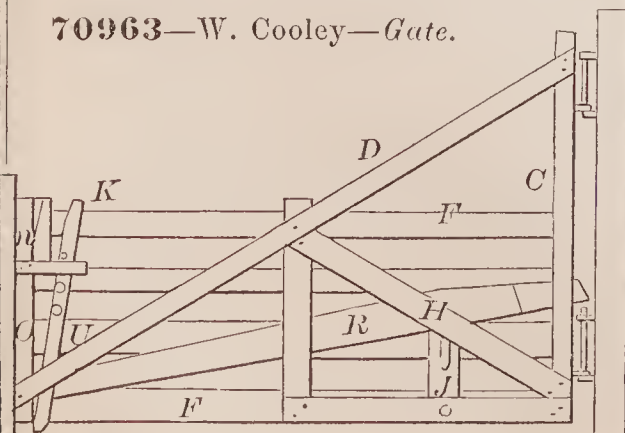

70964—H. M. Cooper—Loom.

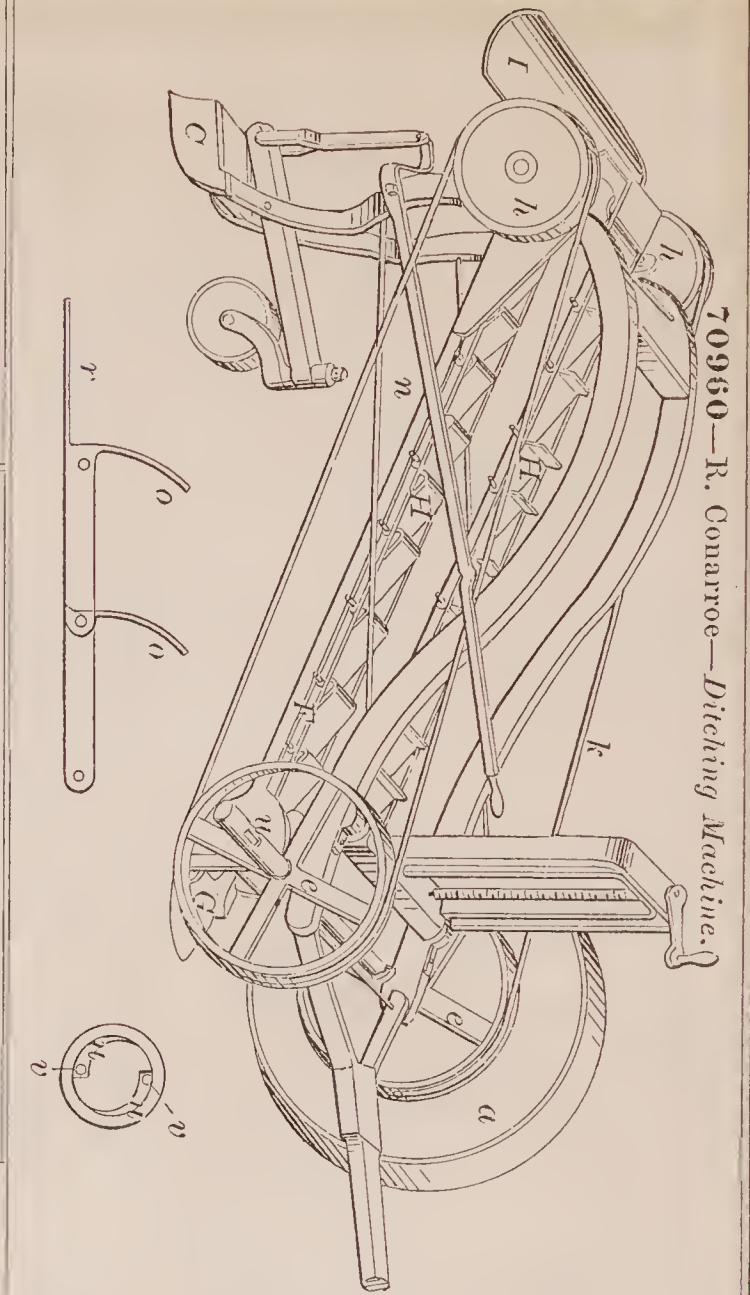
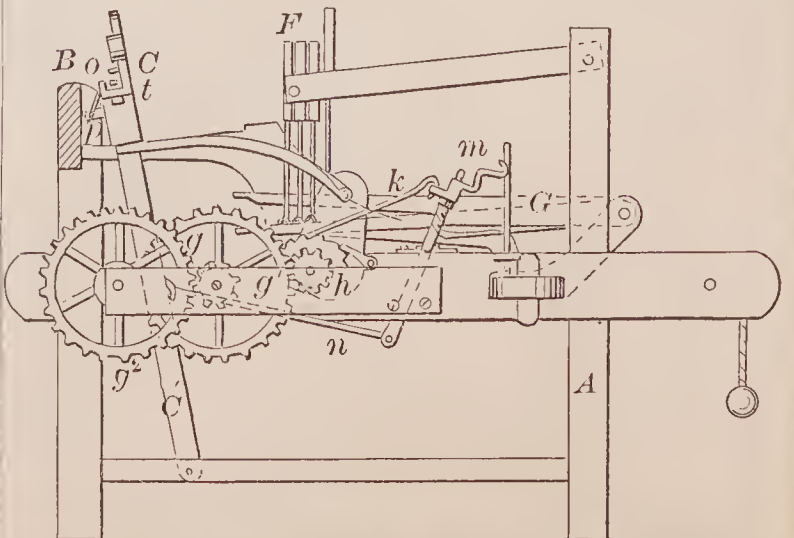
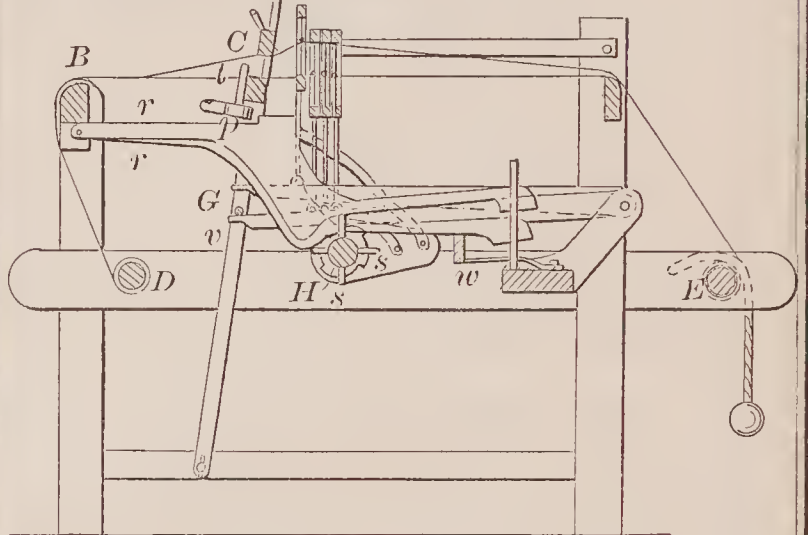

70960—R. Comaroe—Ditching Machine.

70965—J. M. Cooper—Mould for Casting Globe Valves.

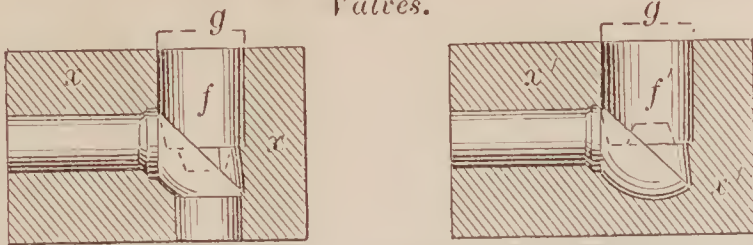

70970—J. C. Cunningham—Mill Gearing.

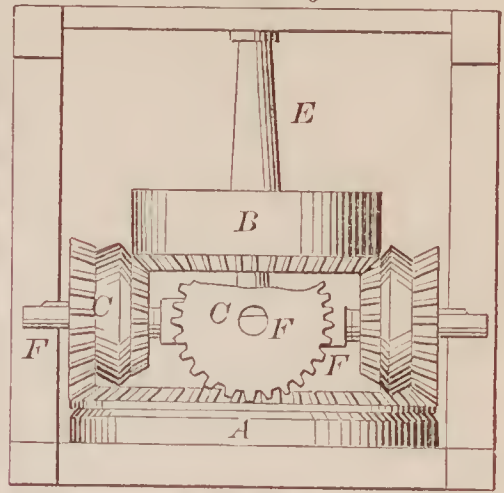

70966—J. E. Cowdry—Try Square.

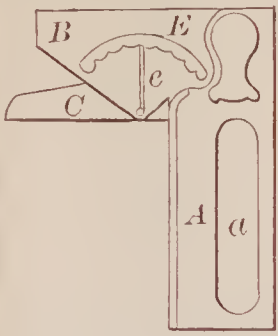

70968—Z. M. Crane—Tool Supporter or Rack

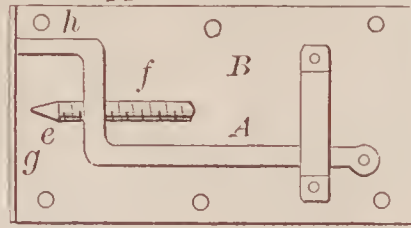

70969—E. W. Crittenden—Manufacturing Brick.



70971—J. D'Arcy—Loaf Bread Machine.

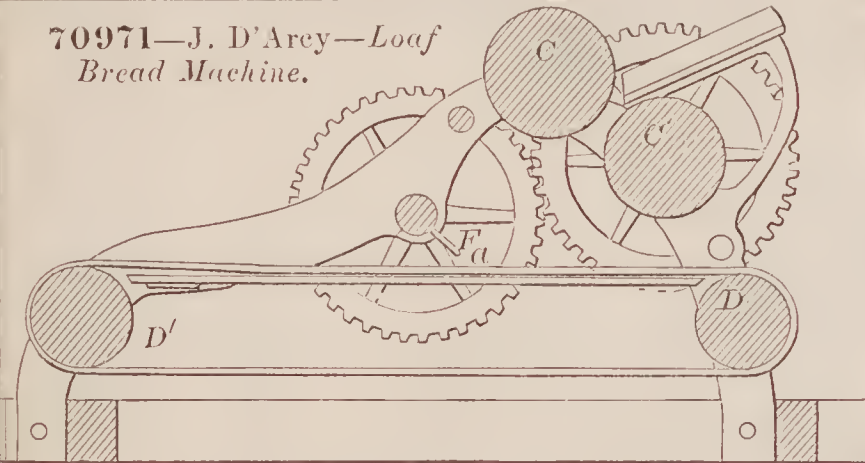

70967—W. W. Cox—Washing Machine.

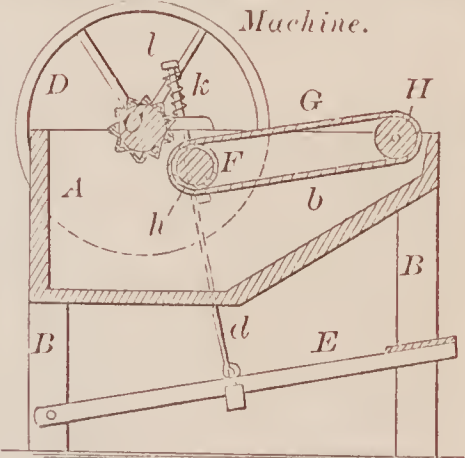

70972—J. R. Davis—Plow.

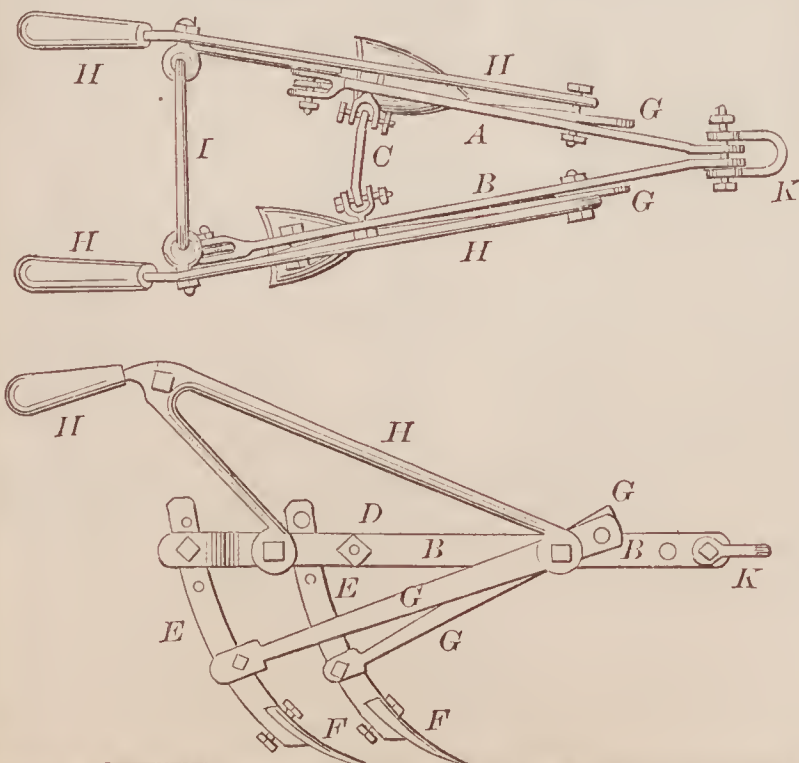

70973—H. B. Davison—Bottle Washer.

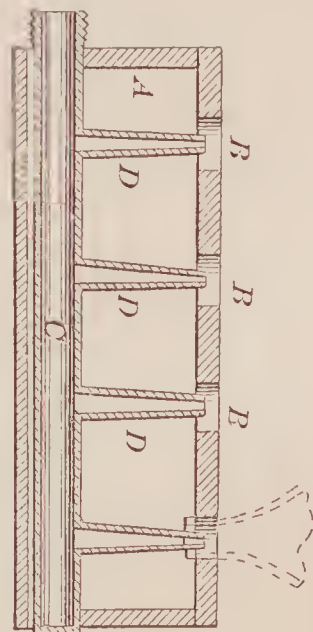



70974—J. G. De Coursey—  
Trundling Hoop.

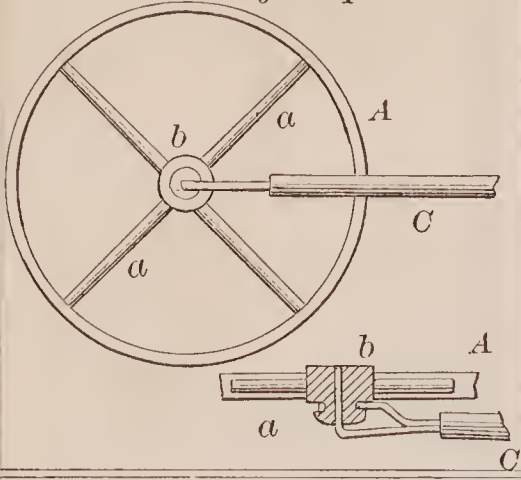

70978—G. Downing—  
Rocks Drilling Machine.

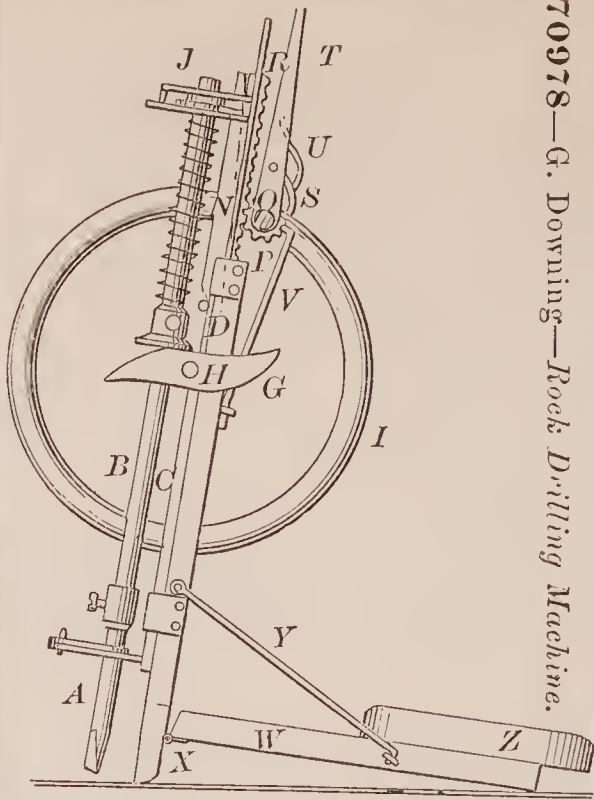

70976—W. P. Dillman—  
Harvester Rake.

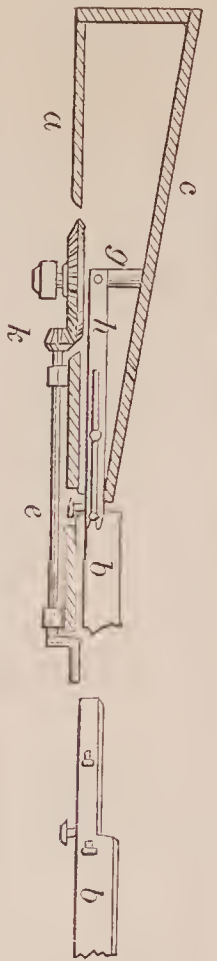

70975—P. De Vries—  
Boot Tree.

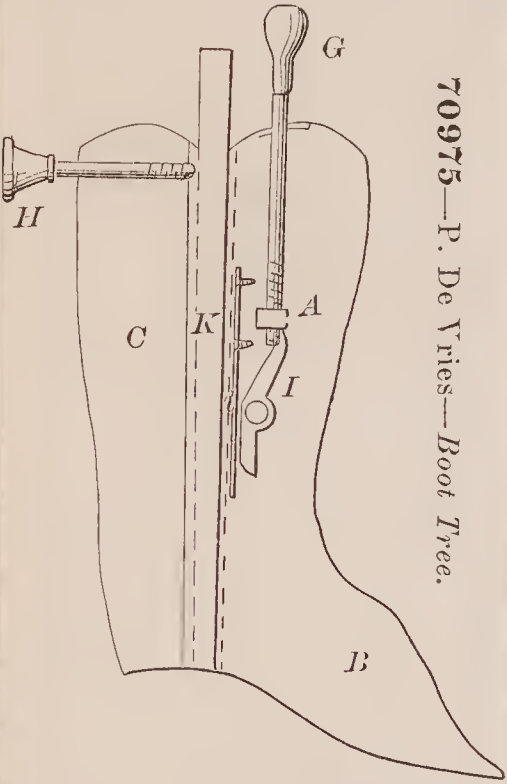

70977—F. Domy—  
Centre Board.



70980—S. J. Edwards—  
Gear for Vehicles.

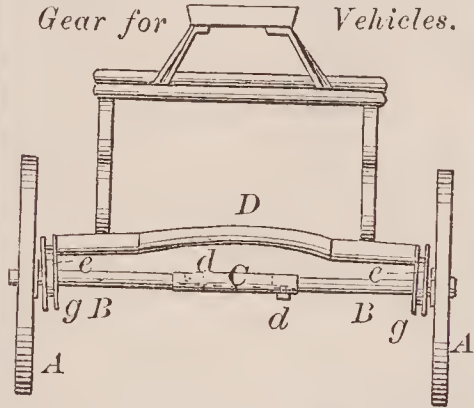

70982—W. H. Ferguson—  
Safety Attachment for Pocket  
Books.

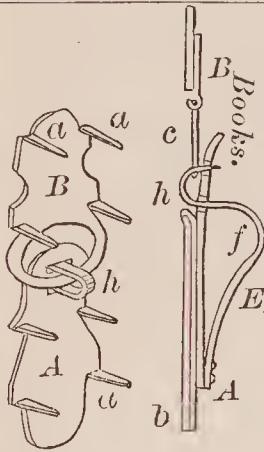

70983—G. B. Fisher—  
Peat and Brick Machine.

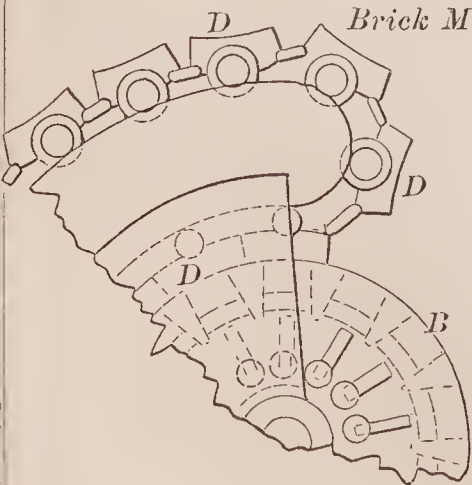

70979—K. Eaton—  
Automatic Ventilating Stove.

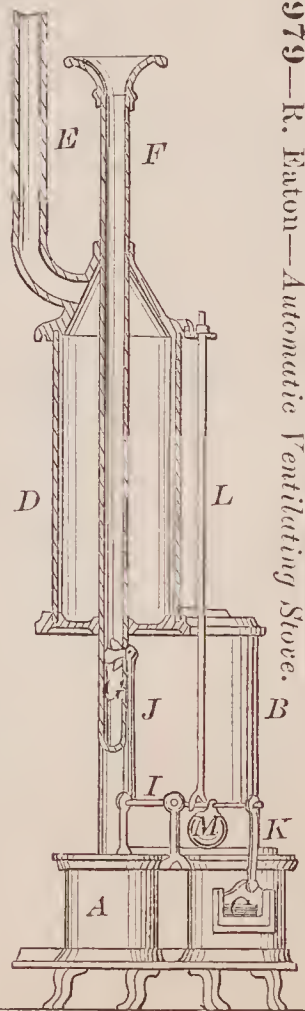

70981—H. Fautz—  
Lock.

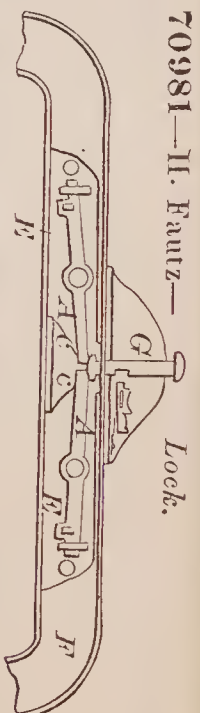





70993—B. J. Goodsell—  
*Chimney Cowl.*

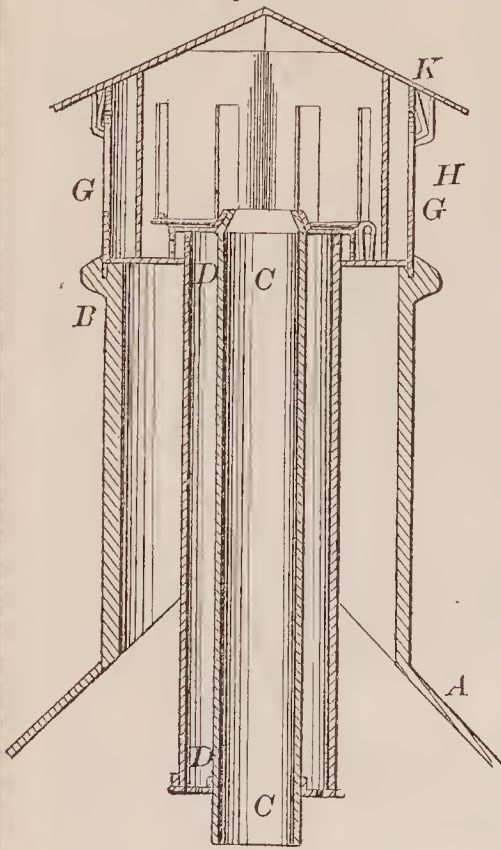

70994—W. F. Gordon—*Ice Cutting Machine.*

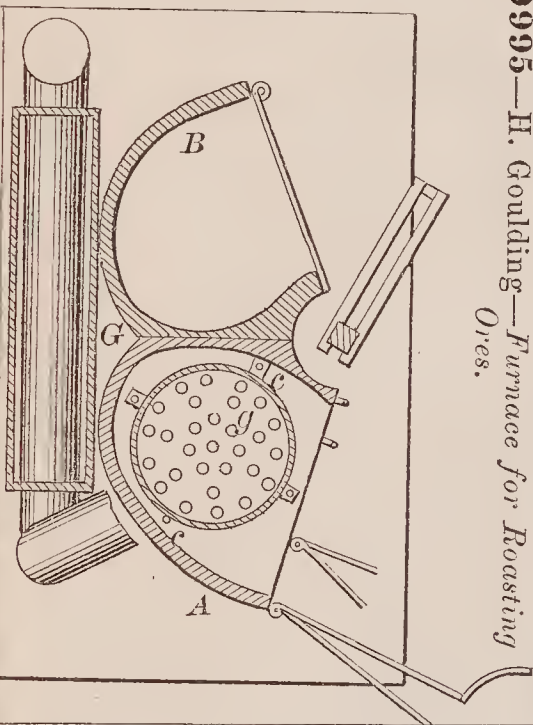
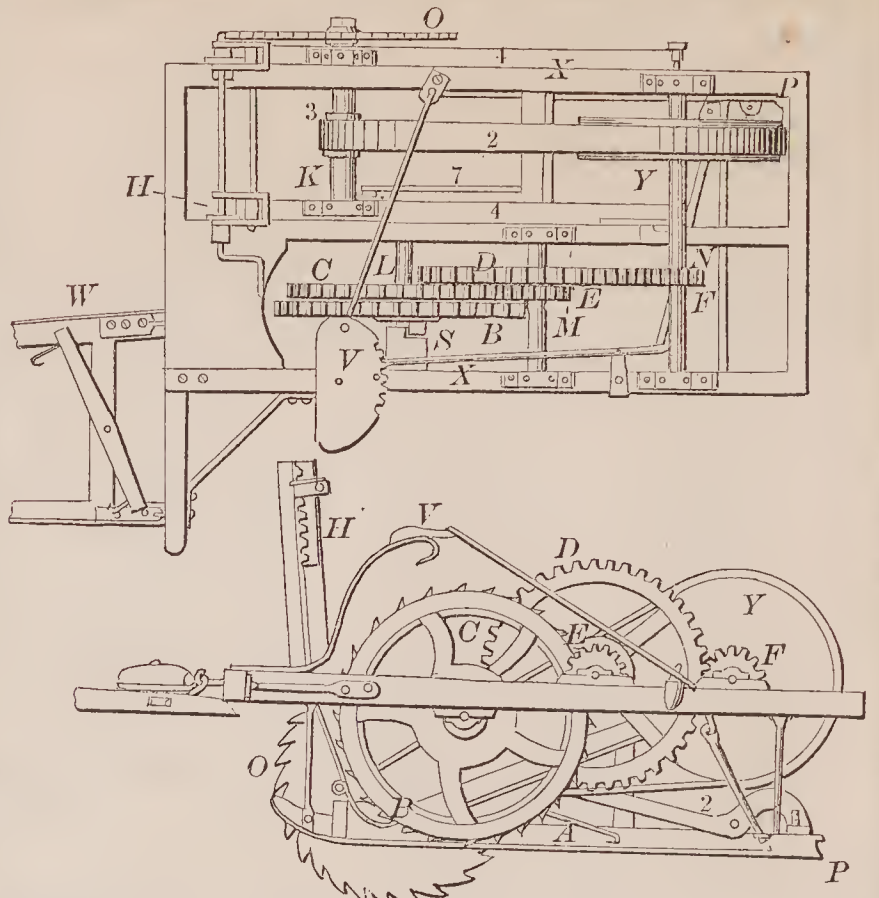

70995—H. Goulding—*Furnace for Roasting  
Ores.*

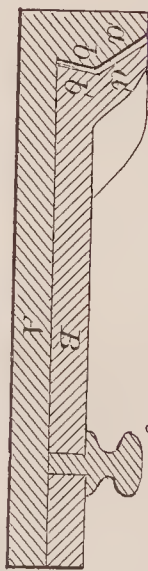

70996—S. S. Gray—*For Moulding Collars.*

70997—H. Hammond—*Die.*

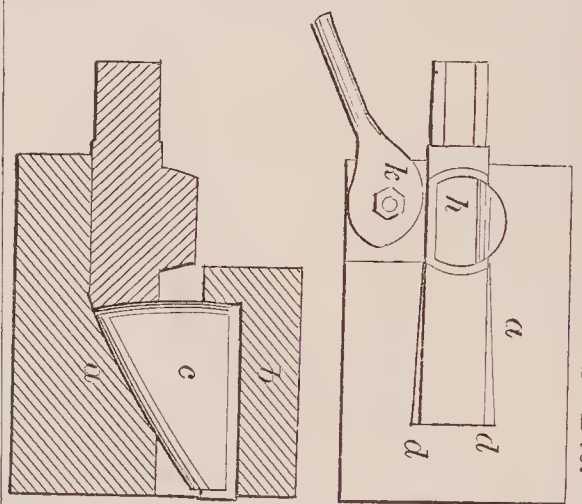
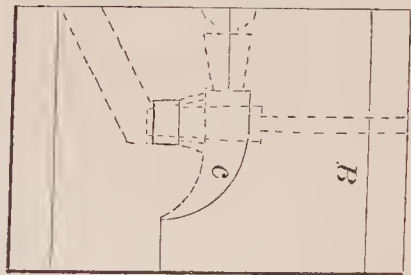

70998—H. Hammond—*Die.*

71000—J. T. Harvey—*Straw Cutter.*

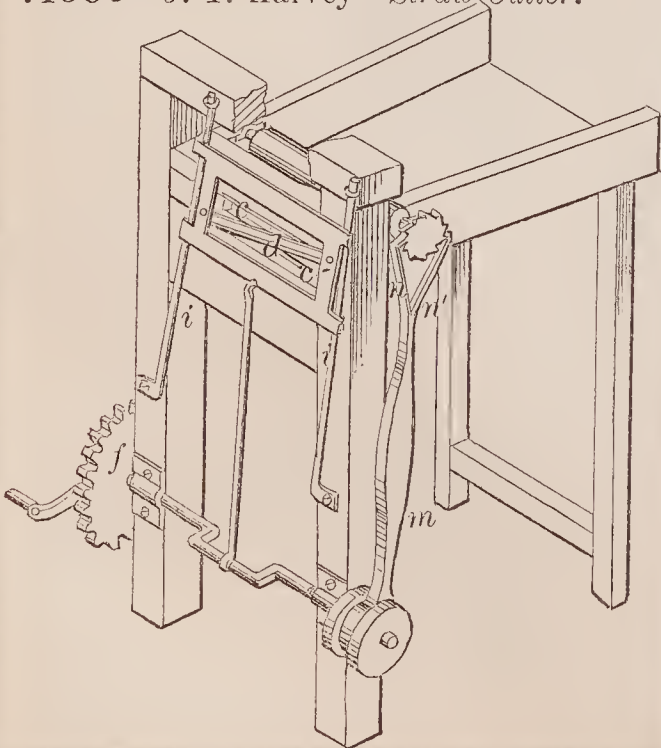

70999—M. S. Harsha—*Concrete Brick  
Machine.*

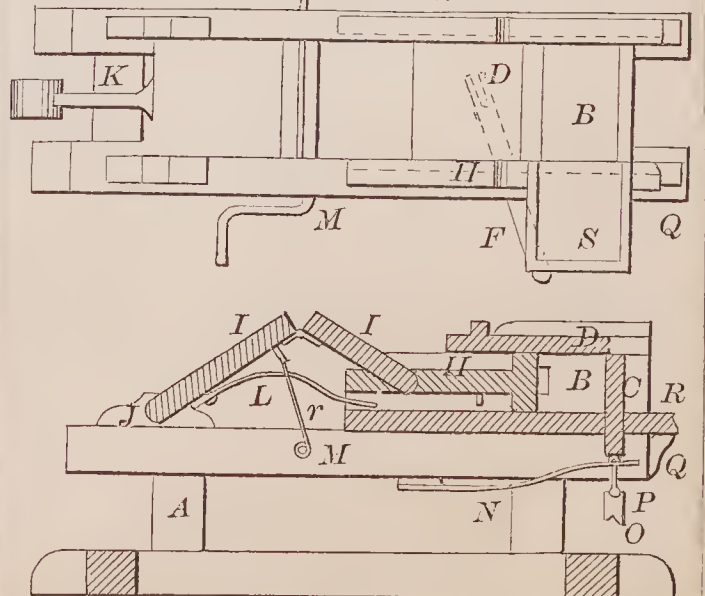

71001—G. S. Harwood—Feeder for Carding Machines.

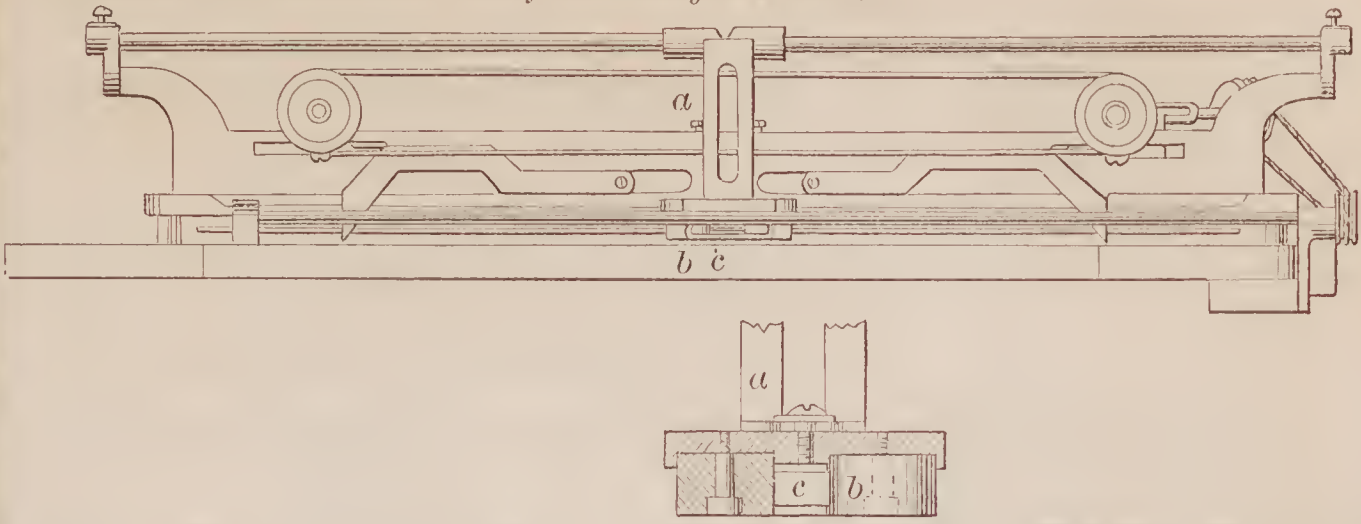

71002—D. G. Haskins—Gas Heating Apparatus.

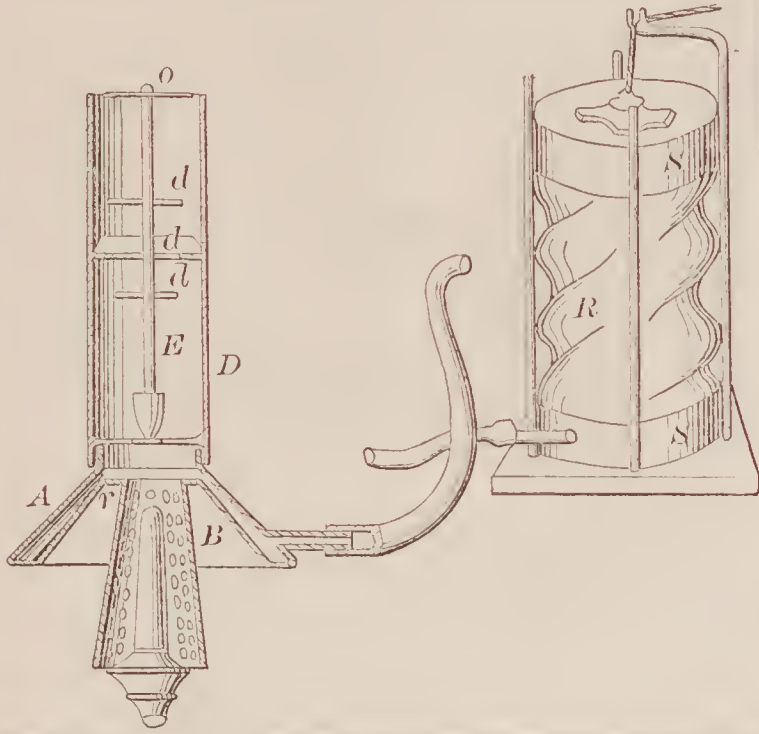

71003—E. Heaton—Shank Spring for Boots and Shoes.



71004—E. E. Hendrick—Drying Gunpowder.

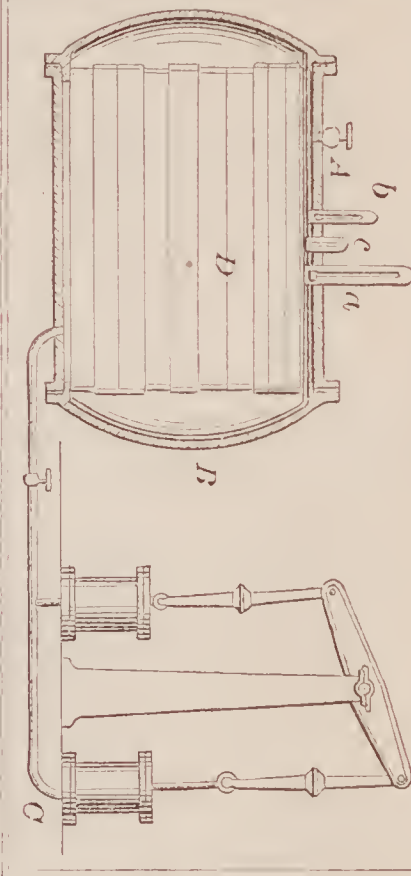

71005—J. M. Higgins—Lighting Gas by Electricity.

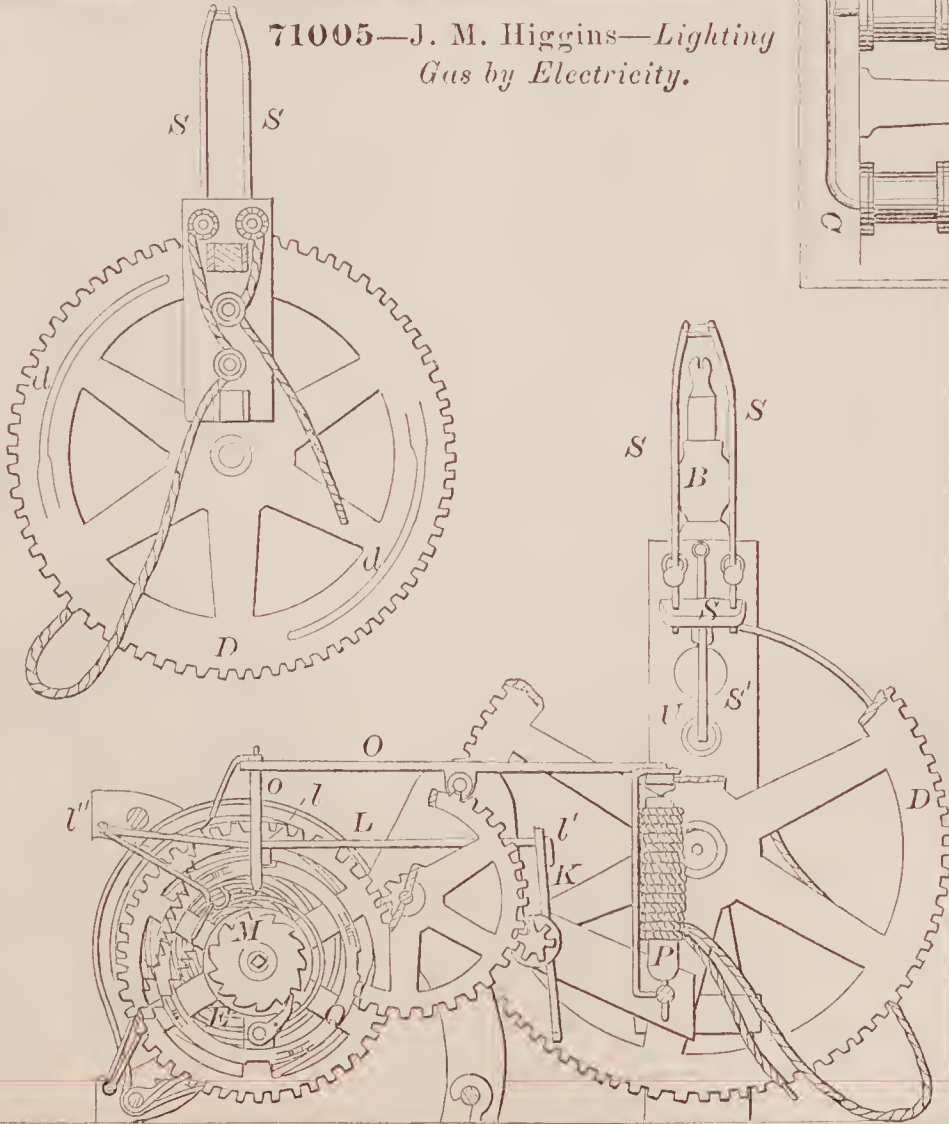

71007—R. H. Hilton—Air Chamber of Pumps.

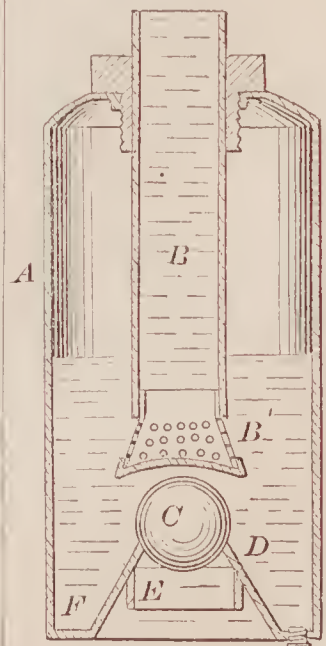



71010—J. H. Pe—*Pantographic Engraver.*

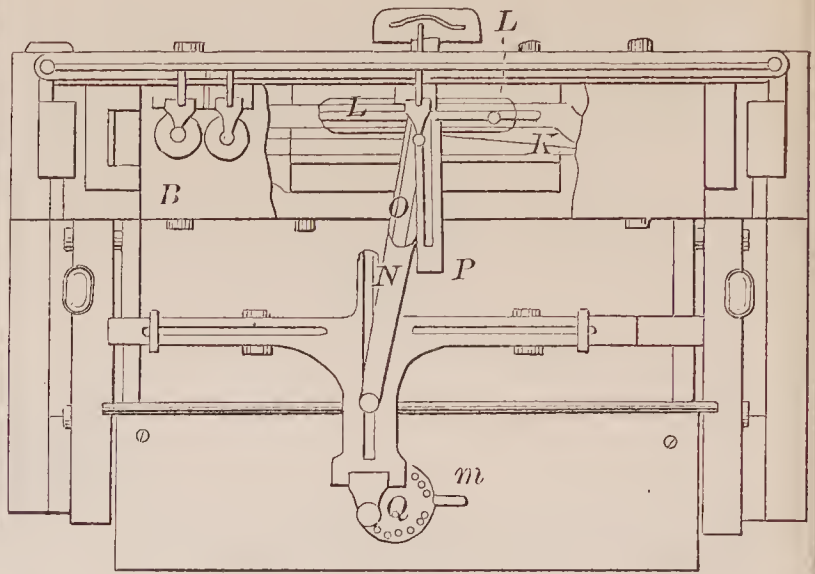

71008—G. P. & J. L. Hodson—*Shaft Coupling.*

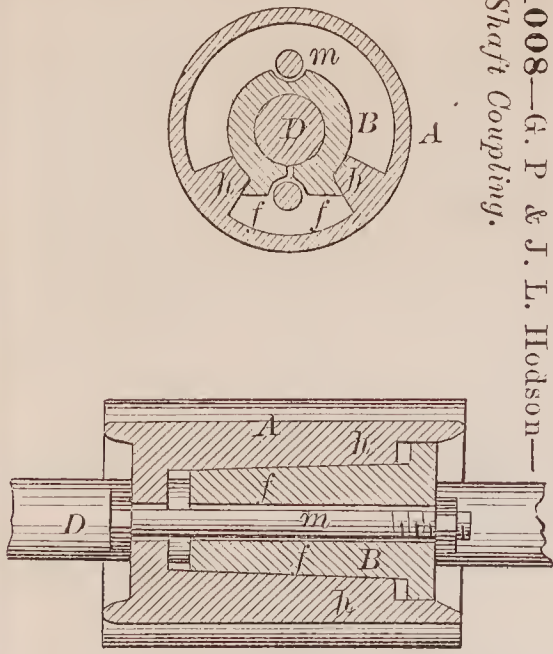

71009—Holbrook, Dodge & Marshall—*Window Blind Fastener.*

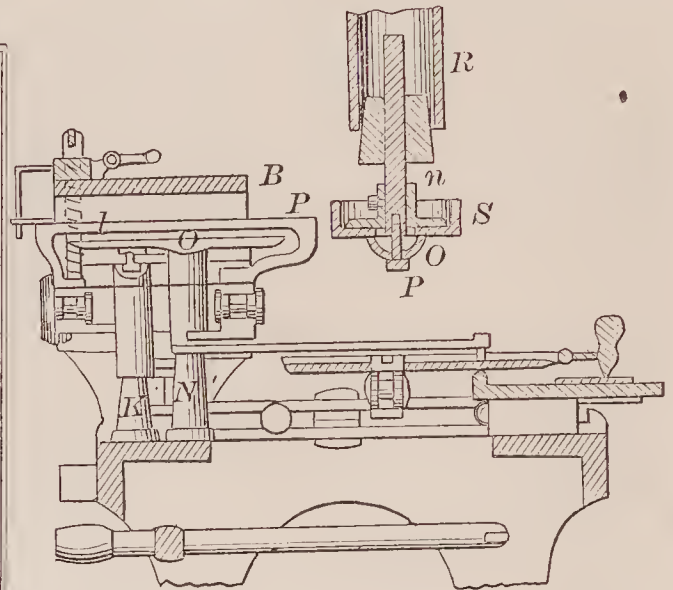
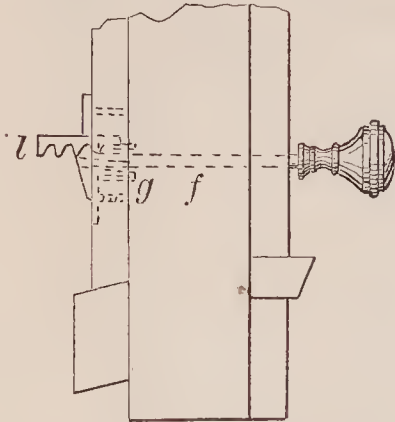

71012—W. W. Hubbard—*Bolt Machine.*

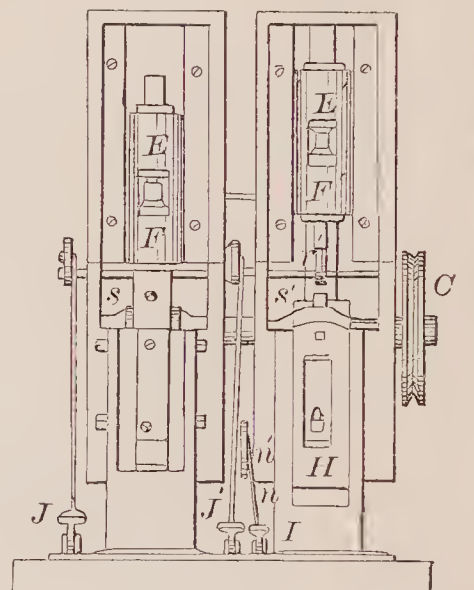
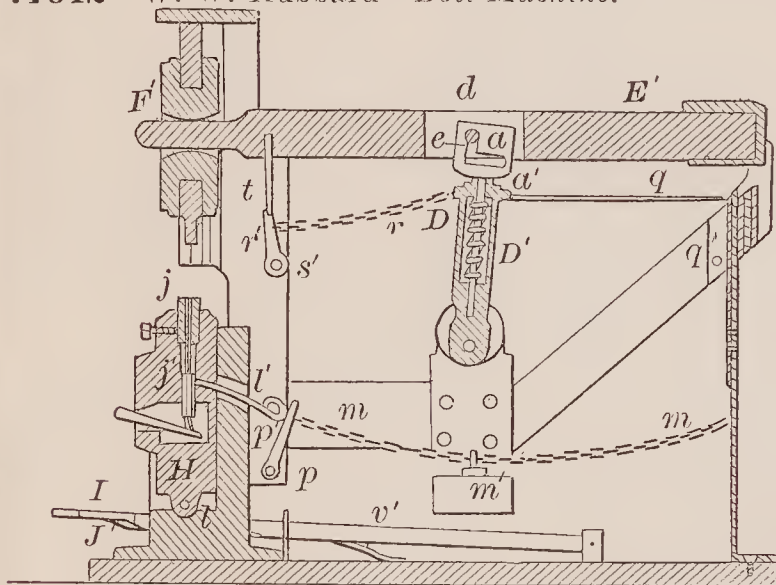

71014—H. L. Huntington—*Spring Bed Bottom.*

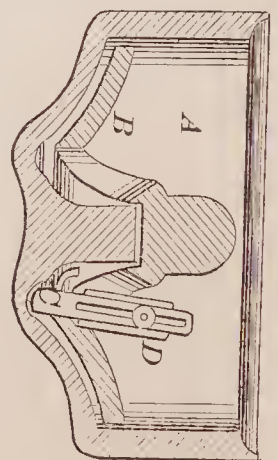
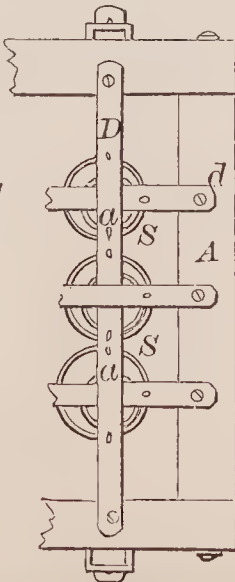
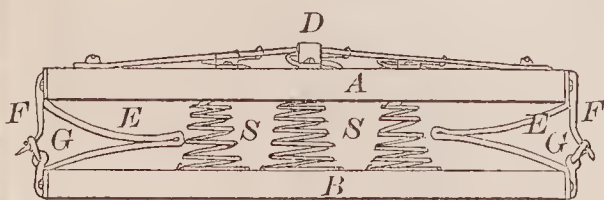

71011—A. Horn—*Amalgamator.*

71015—R. K. Huntoon—*Steam Engine Governor.*

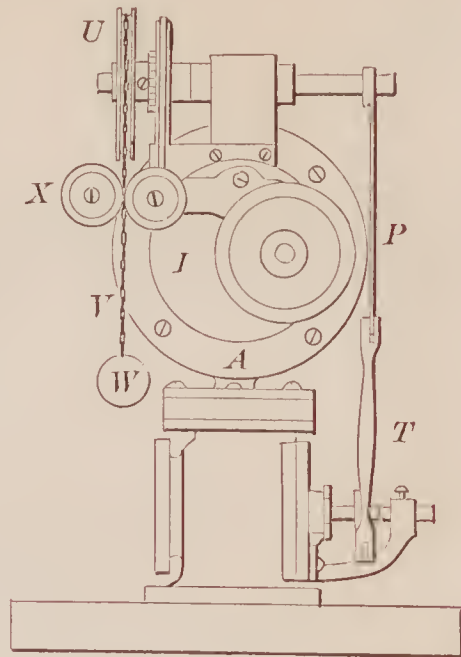
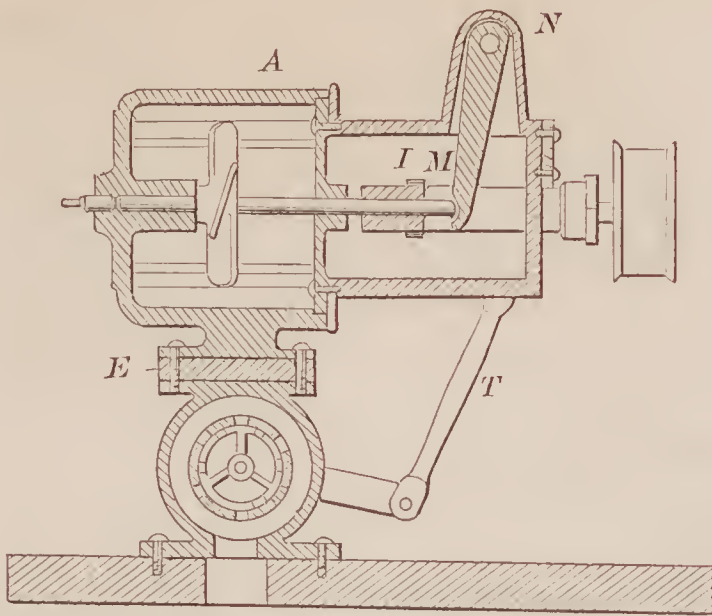

71016—A. Hutton—*Steam Engine Valve.*

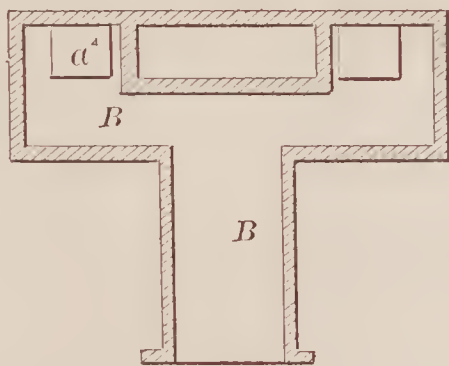
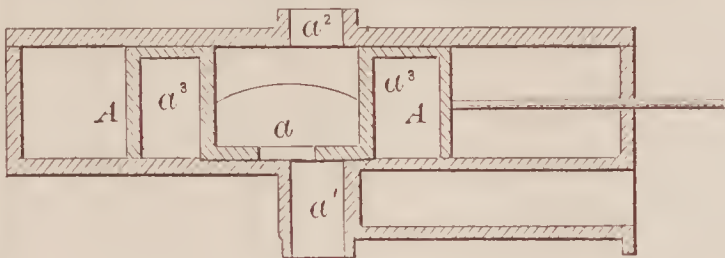

71017—C. R. Jenkins—*Sash Stop.*

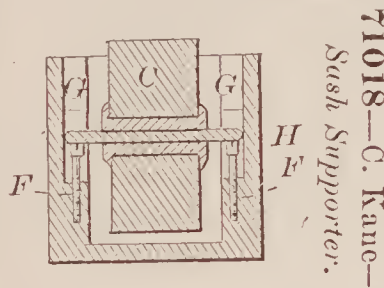
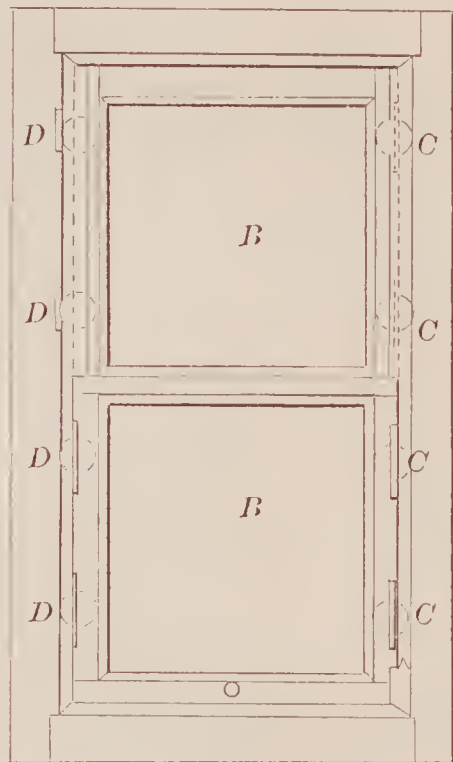

71020—J. J. Kents—*Slitting Machine.*

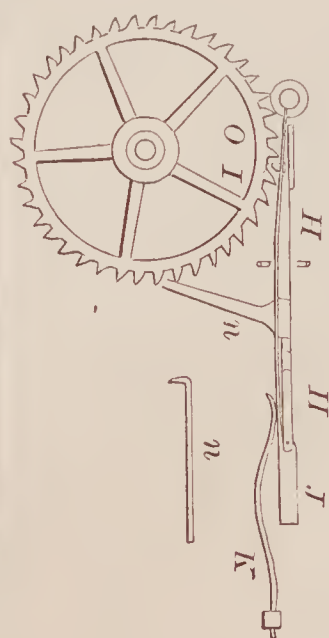
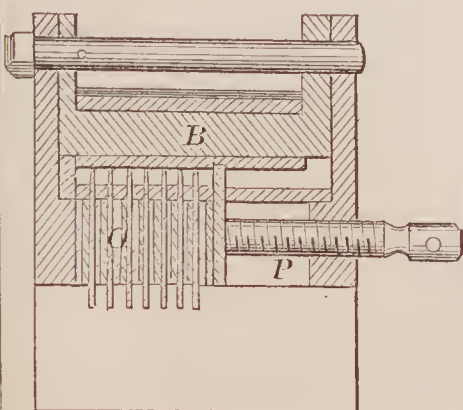

71019—W. C. Kellum—*Time Piece Escapement.*

71021—C. E. Kleinschmidt—*Car Wheel.*

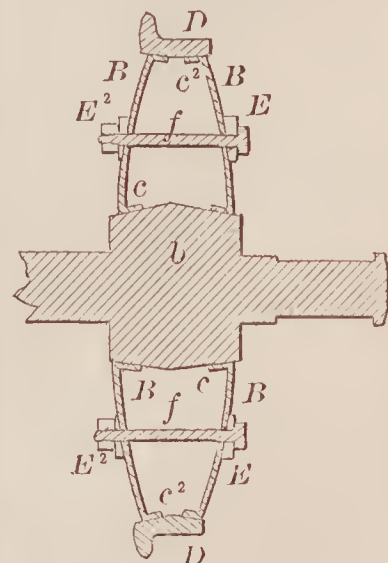



71022—F. Kopper—Toilet Table.

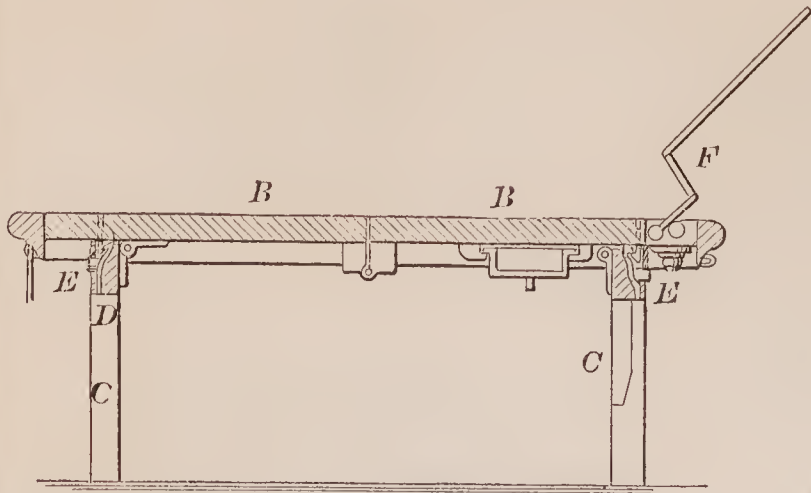

71025—G. Larson—Sleigh Knee.

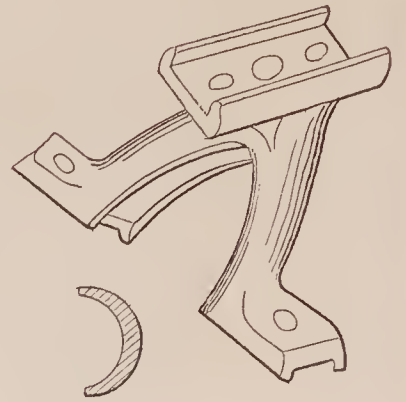

71023—I. Lancaster—Grain Binder.

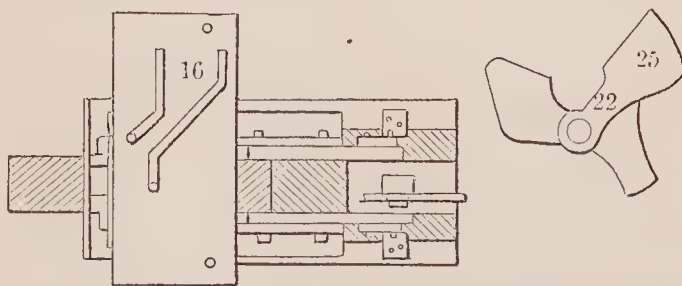
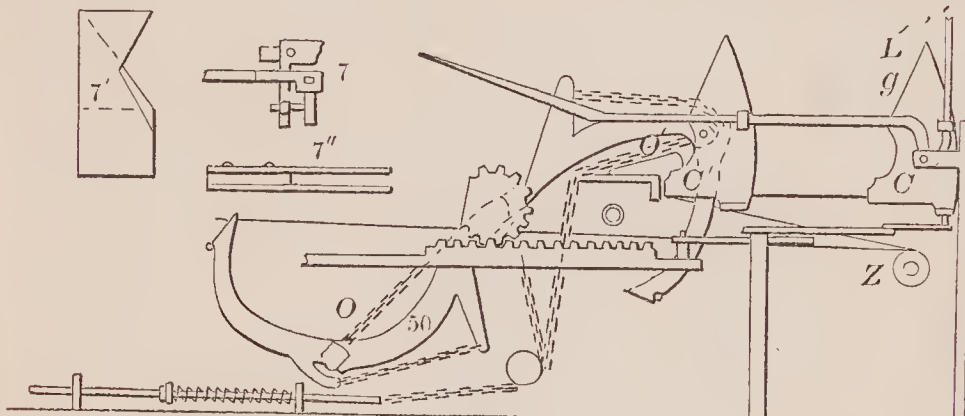
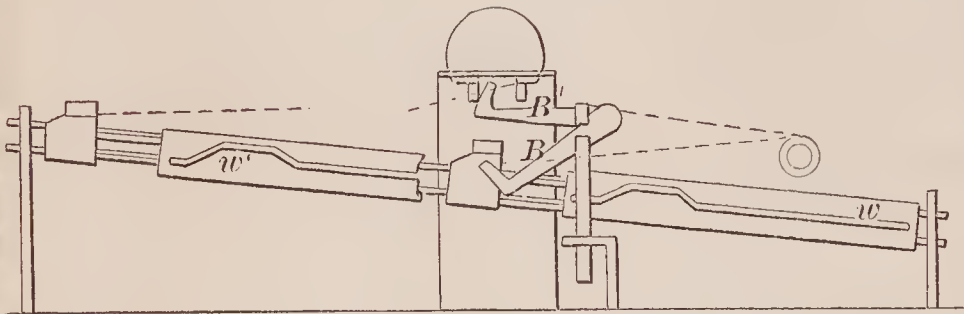
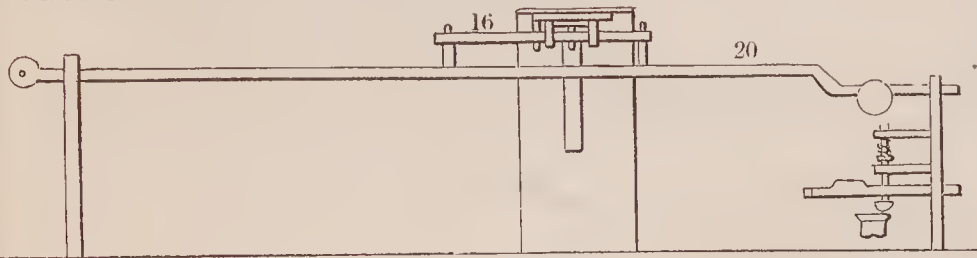

71028—J. D. Lynde—For Charging Soda Water.

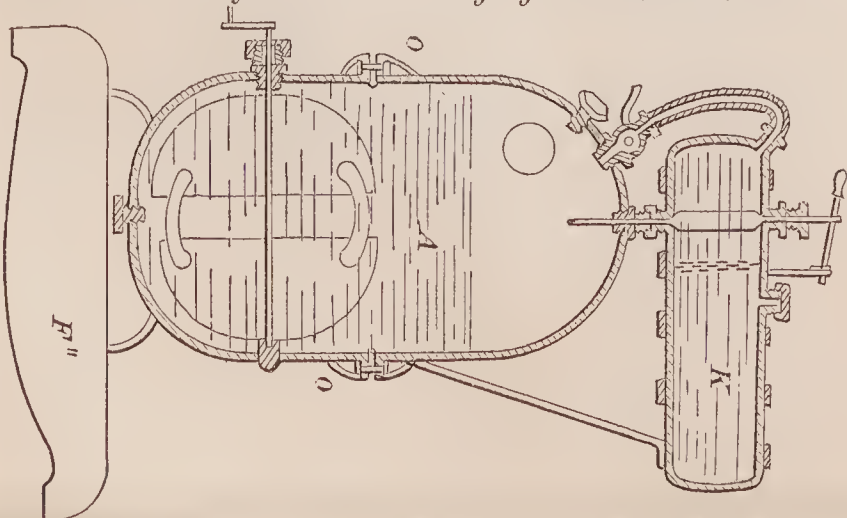

71024—C. B. Lang—Tassel Fastening

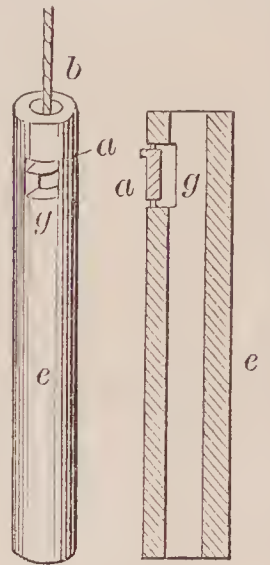

71026—D. P. Lewis—Hose Guard.

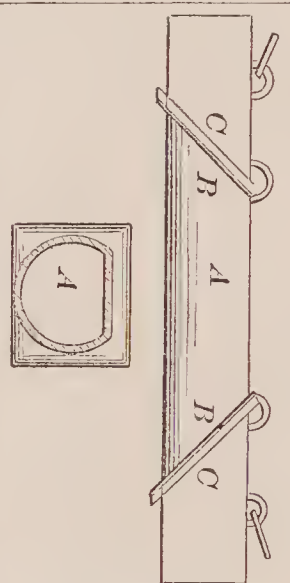

71027—S. P. Loomis—Painters' Window Jack.

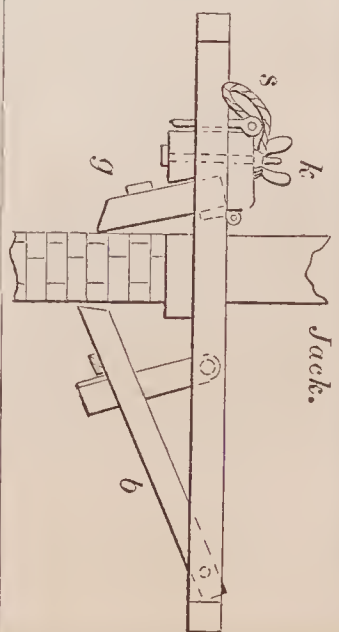

71029—R. Mahr—  
Churn.

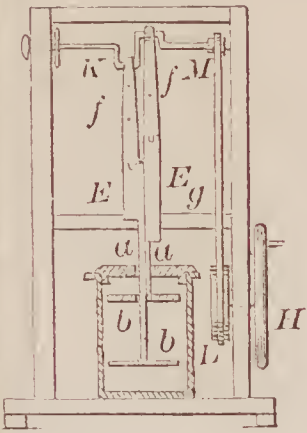

71030—J. Marx—*Fire Escape.*

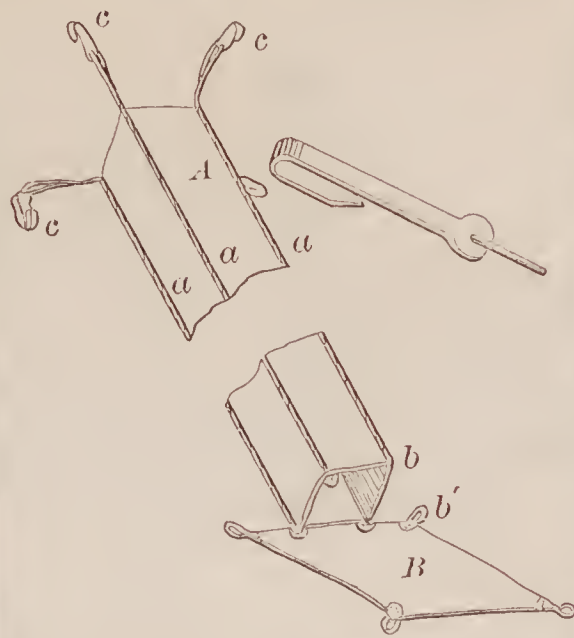

71031—B. Mayo—*Window Blind Fastening*

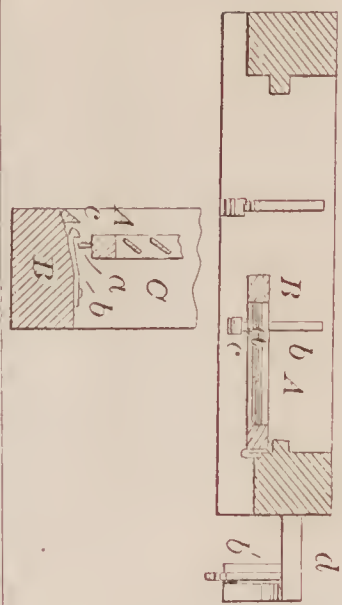

71032—J. McCoy—*Coal Hod.*

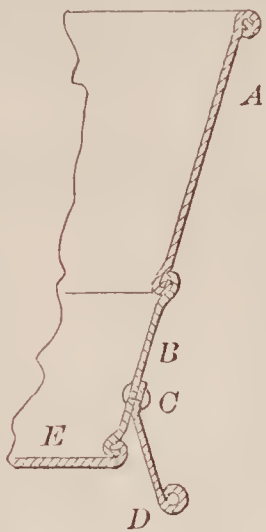

71033—J. McKeever—*Hoop Skirt.*

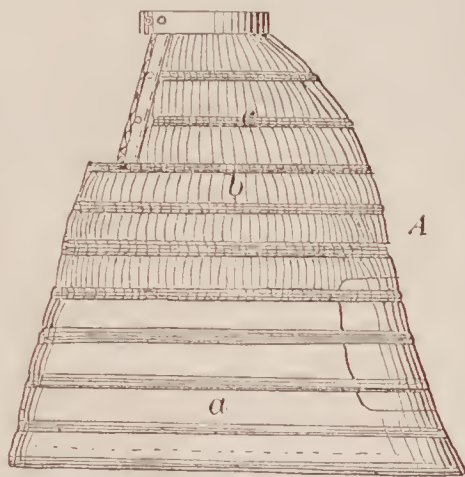

71036—C. Merritt—*For Dyeing Hair.*

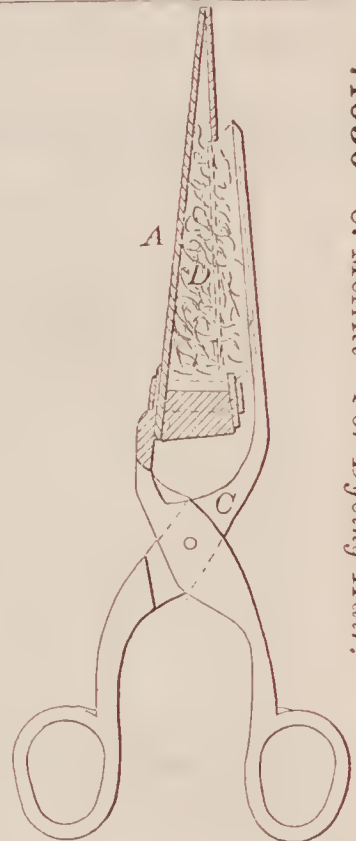

71035—A. & P. P. Meredith—*Hand Loom, L*

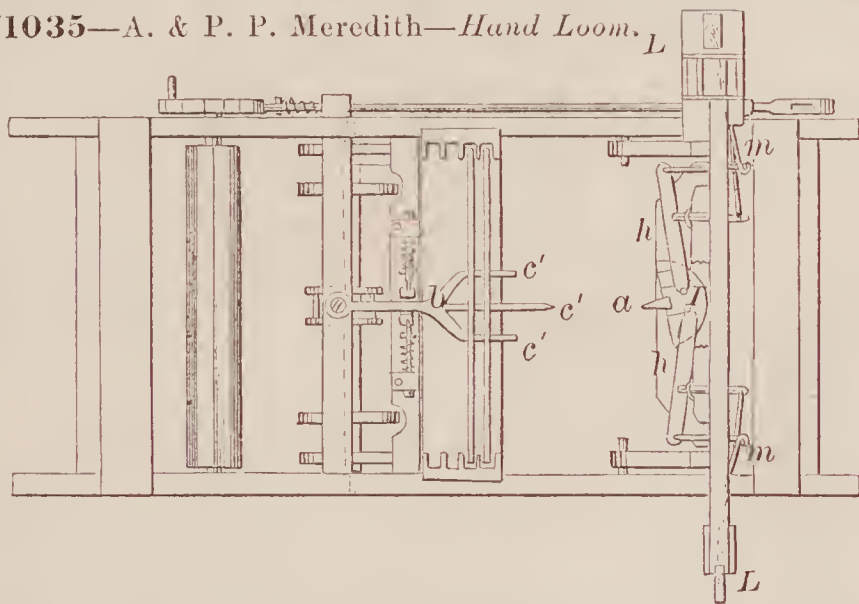

71038—J. & J. Miller, Jr.—  
*Elastic Gusset for Wearing Apparel.*

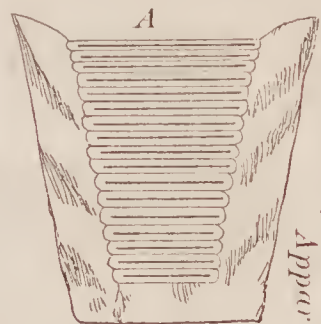

71039—J. Miller—*Knitting Machine Needle.*

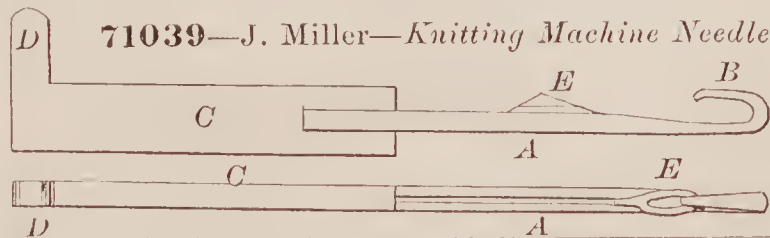

71040—J. W. Milroy—*Drain Tile Machine.*

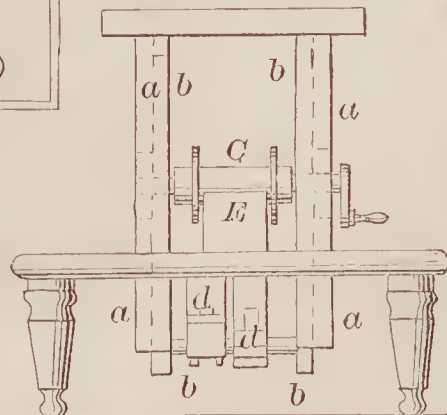

71037—J. Messinger—  
*Brush Holder.*

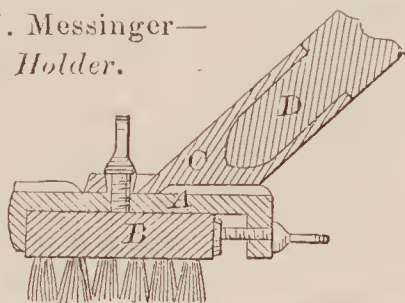



71041—J. F. Morsell—*Spring Buckle.*

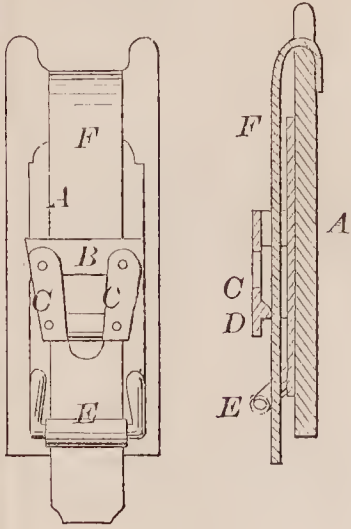

71045—J. Nicolai—*Folding Chair.*

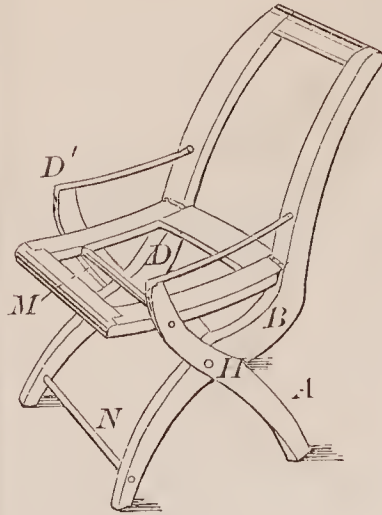

71042—D. T. Munger—*For Making Ball Chains.*

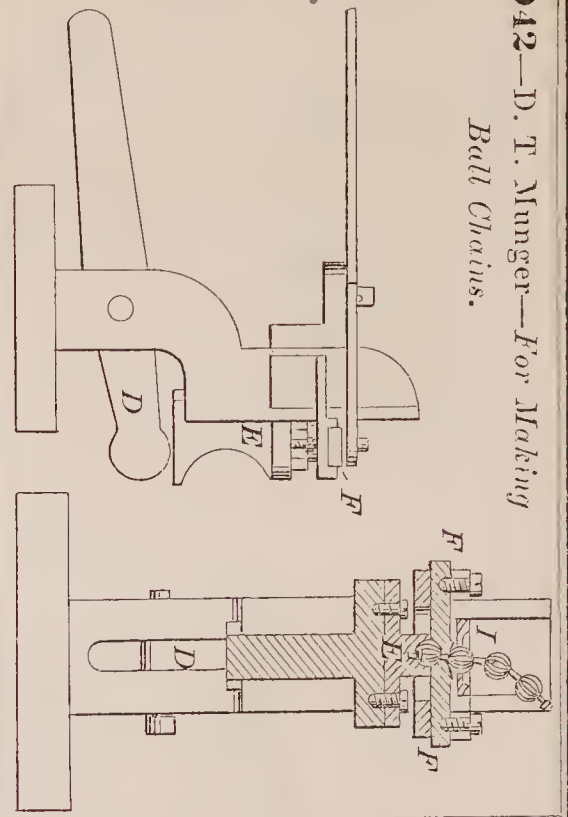

71043—W. Murray—*Hoisting Machine.*

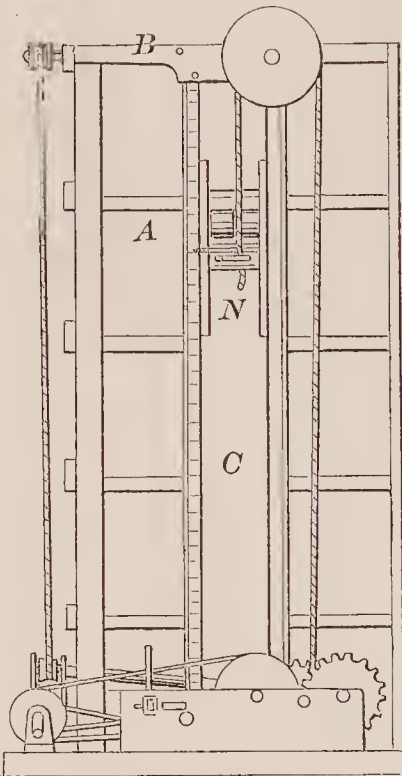

71044—E. Nickerson—*Pump and Reservoir.*

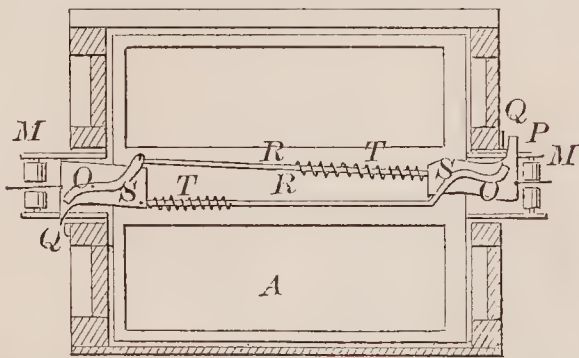
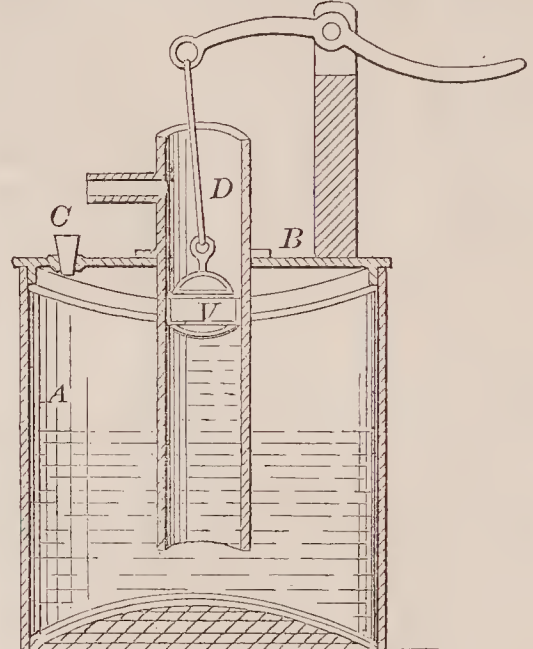

71046—J. Noble—*Lever for Railroad Cars.*

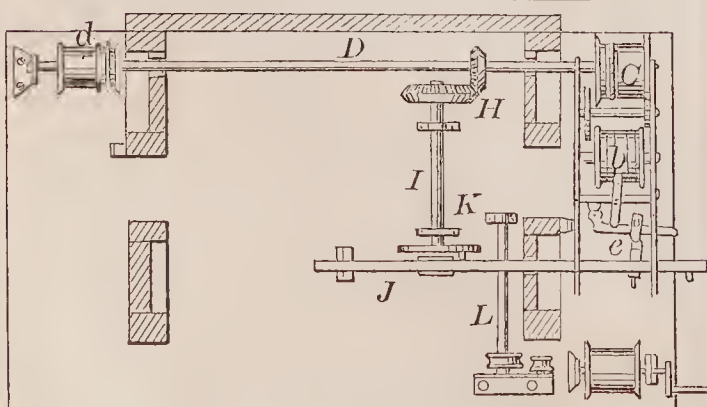
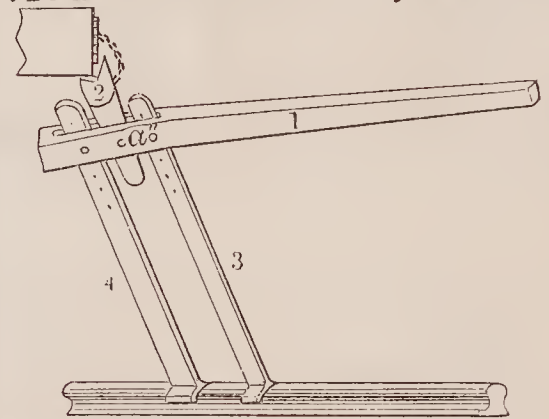

71047—J. G. Onk—*Show Stand.*

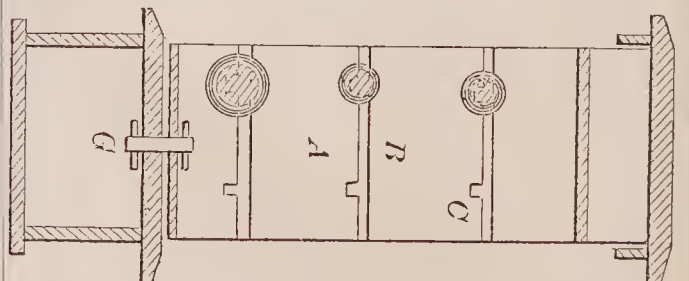

71048—S. Orth—For Cutting Pasteboard.

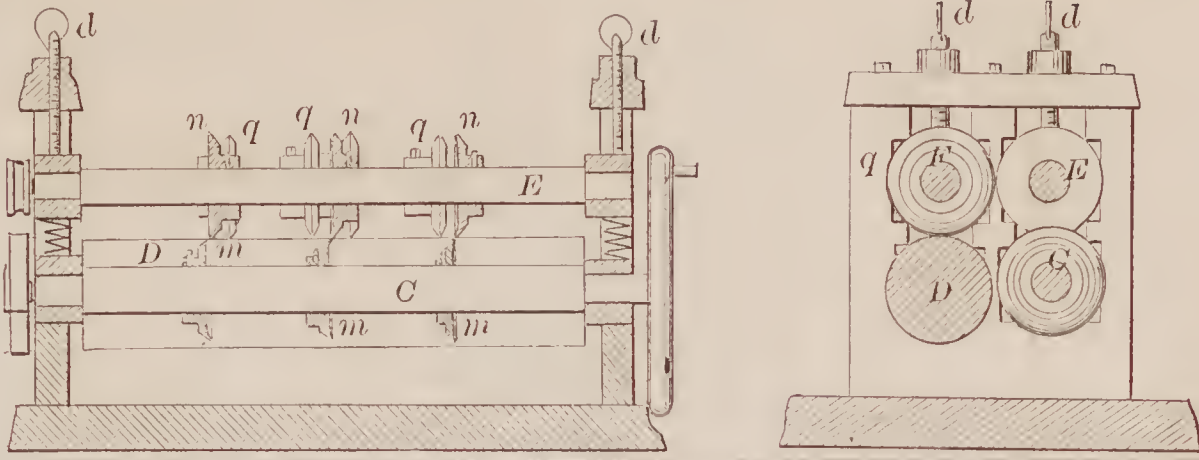

71049—W. W. Page—Stairs.

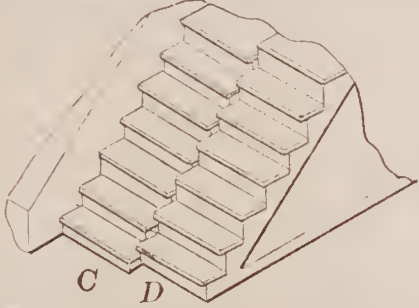

71050—J. Parker—For Raising Fluids.

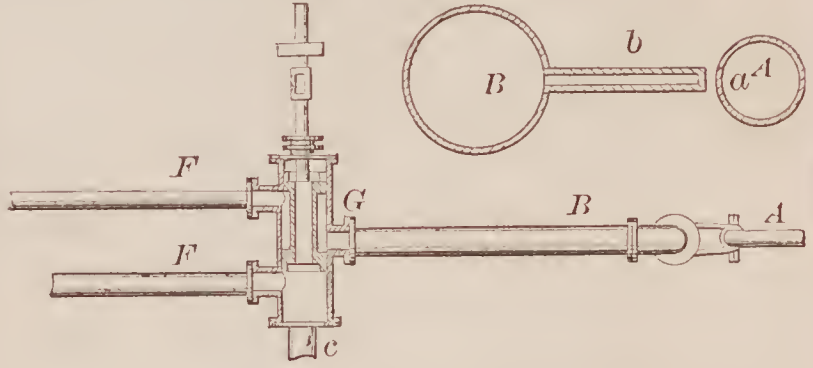

71051—J. H. Parsons—Label Holder for Railroad Cars.

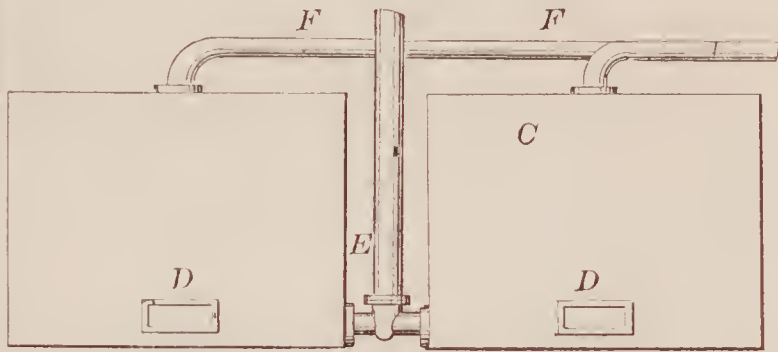
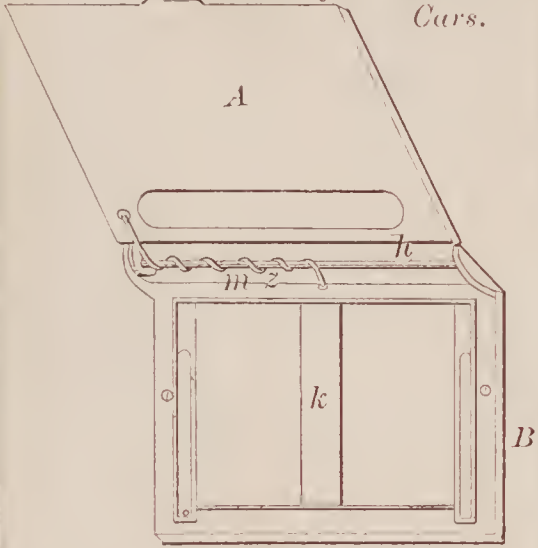

71053—H. L. Perry—Gang Plow.

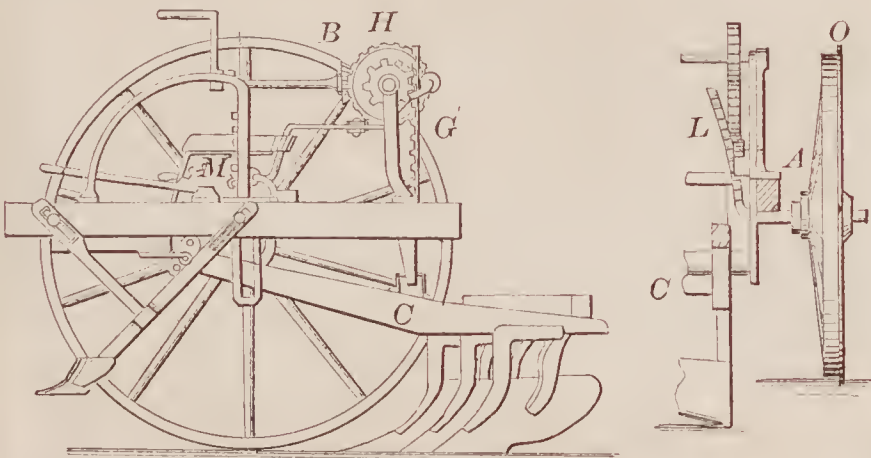

71052—M. Peatt—Belt Tightener.

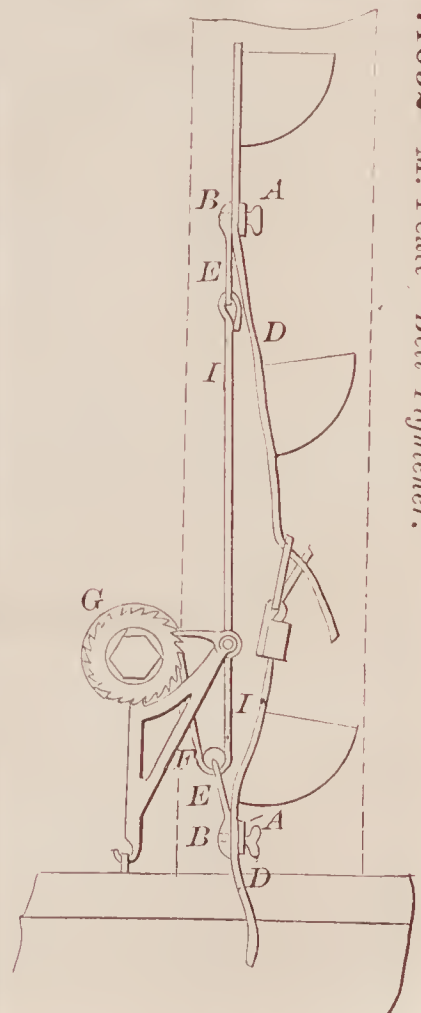

71054—C. Phelon—Brake for Vehicles.

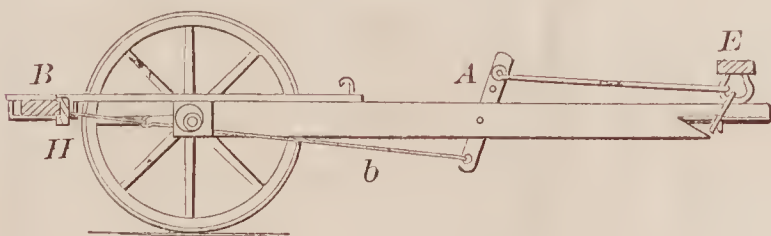



71055—Pickering & St. John—Quartz Mill.

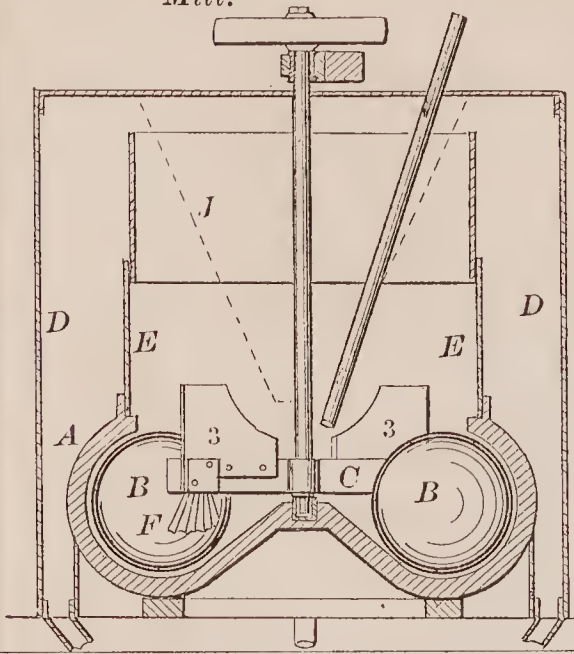

71056—W. Pierce—Rock Drilling Machine.

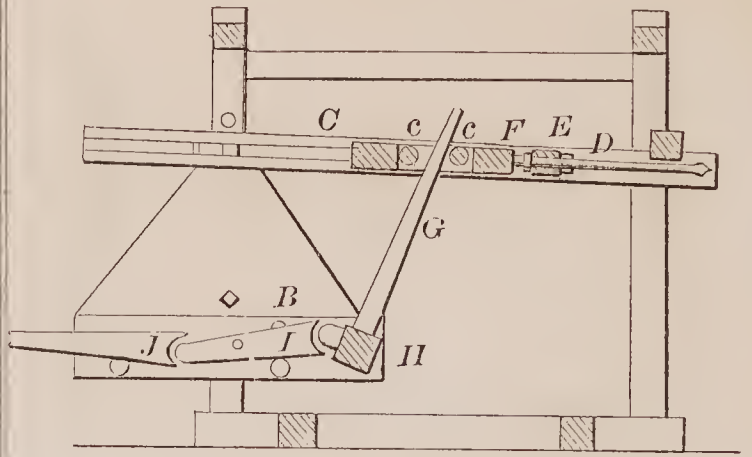

71058—Polhemus & Lilienthal—For Printing on Tin Foil.

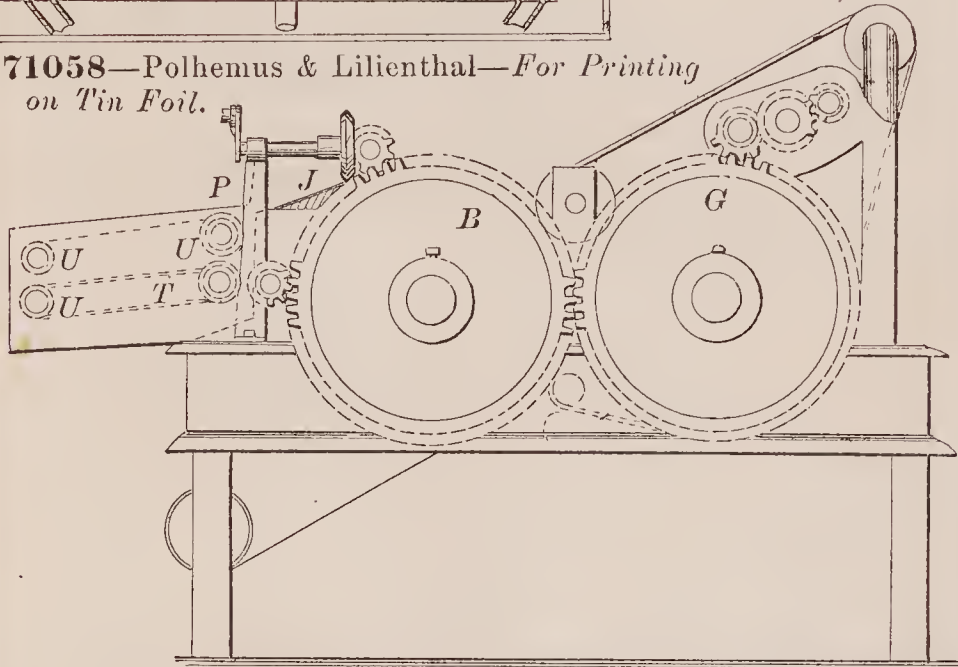

71057—L. B. Pitcher—Roller Wheel for Plows.

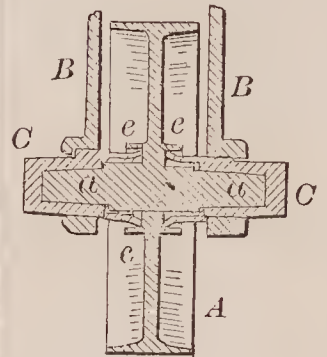

71061—H. H. & J. W. Prindle—Children's Carriage.

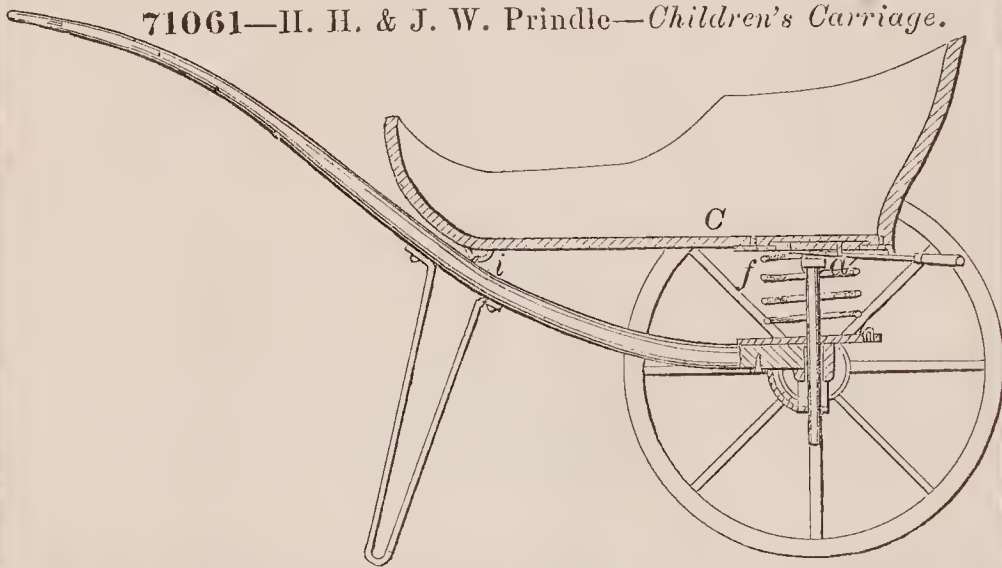

71059—G. W. Preston—Horse Block and Hitching Post.

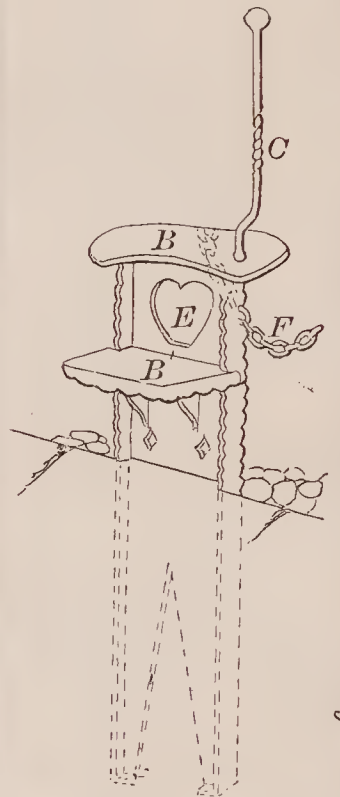

71060—C. L. English—Bellows.

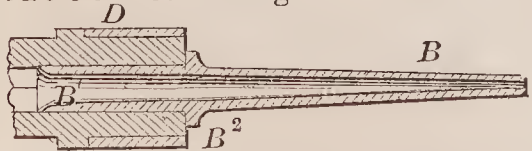

71063—L. Repsher—Railway Chair and Sleeper.

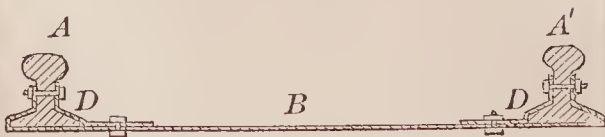

71064—J. C. Rhodes—Nail Plate Holder.

71062—A. Reese—Shaping Dies of Grooved Rolls.

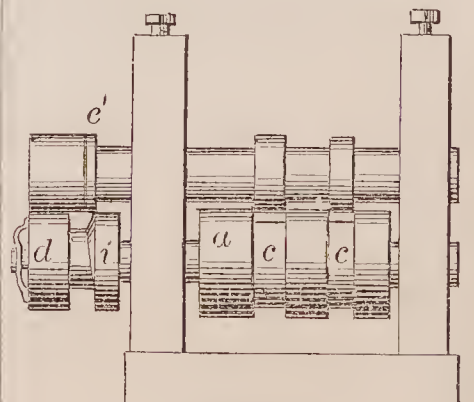

71065—  
R. W. Robinson—  
Churn Dasher.

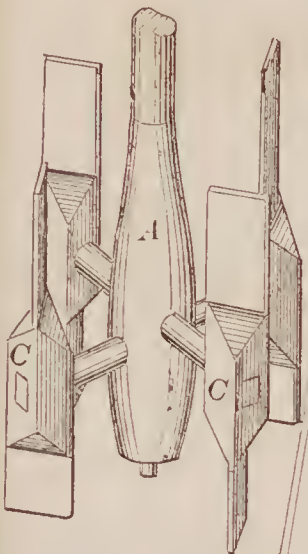

71067—C. W. Royse—Chair Bottom.

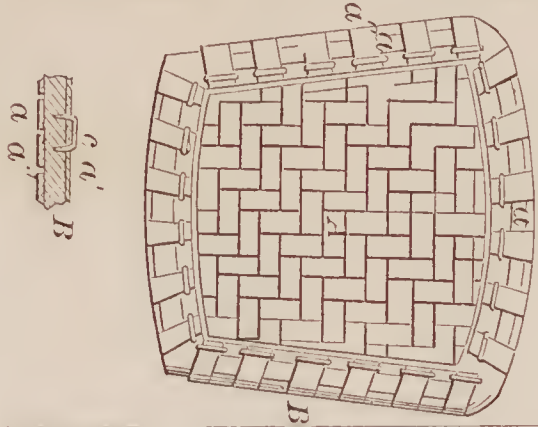

71069—S. A. Russell—Fruit Seeder.

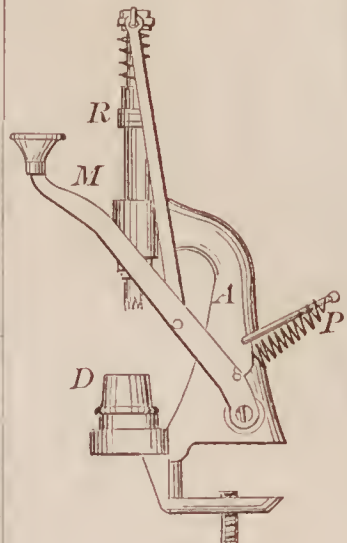

71068—C. Rundquist—Branding Iron.

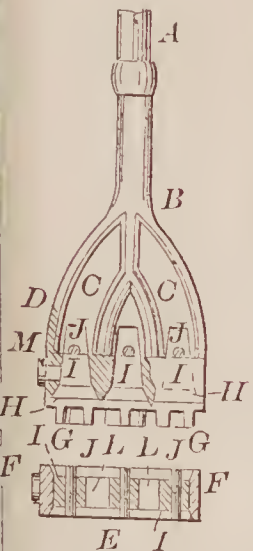

71070—J. M. Sampson—Corn Planter.

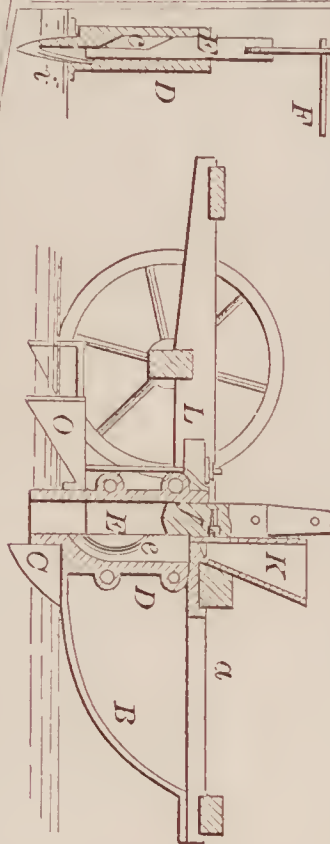

71066—S. Rogers—Thill Coupling.



71073—D. B. Skelly—Burglar Alarm.

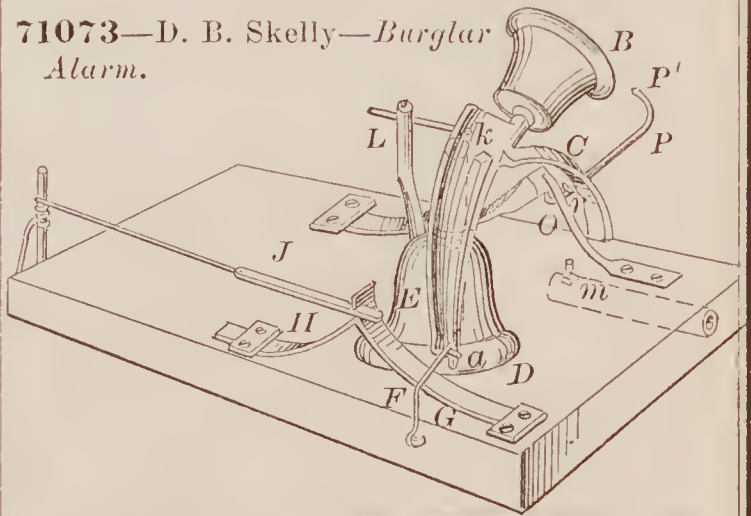

71071—U. Schegg—Press.

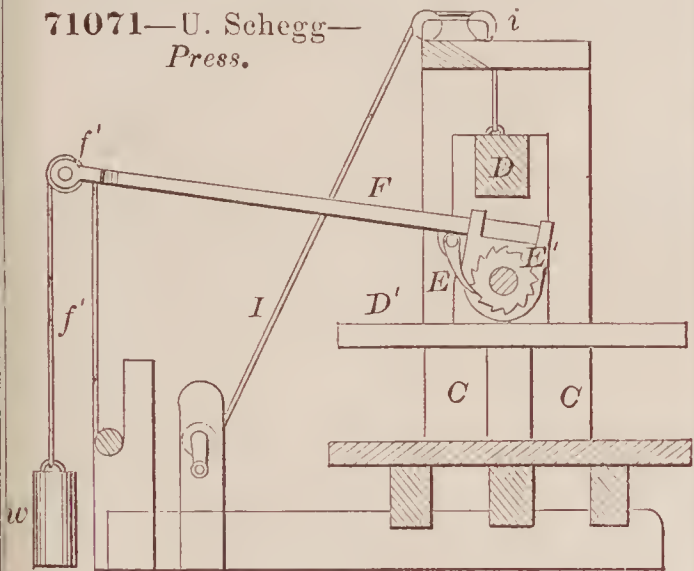

71074—D. M. Smyth—For Cutting Paper Collars.

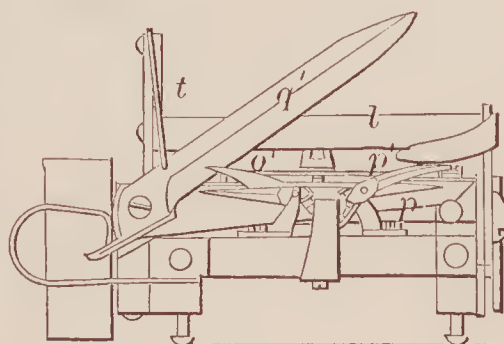
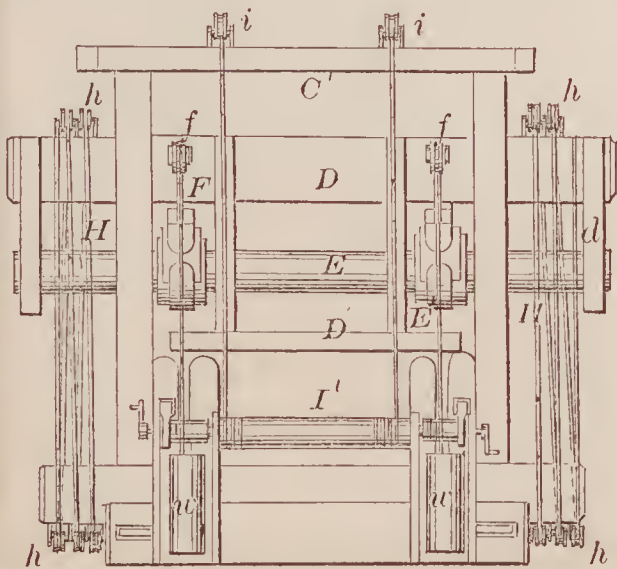
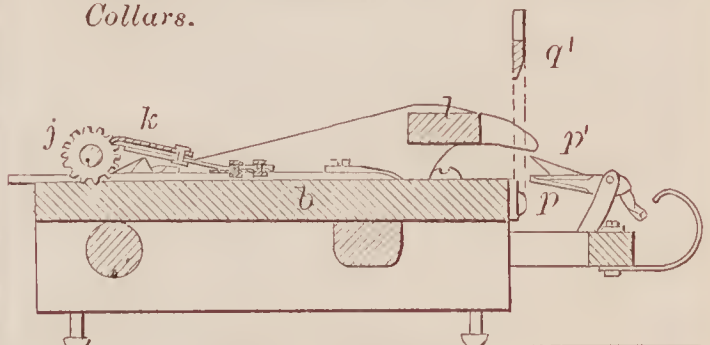



71075—W. Spillman—Bullet Machine.

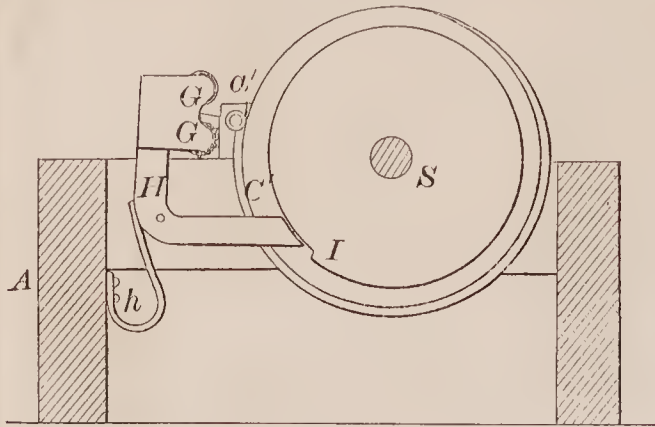

71076—C. Spofford—Die for Cutting Paper Collars.

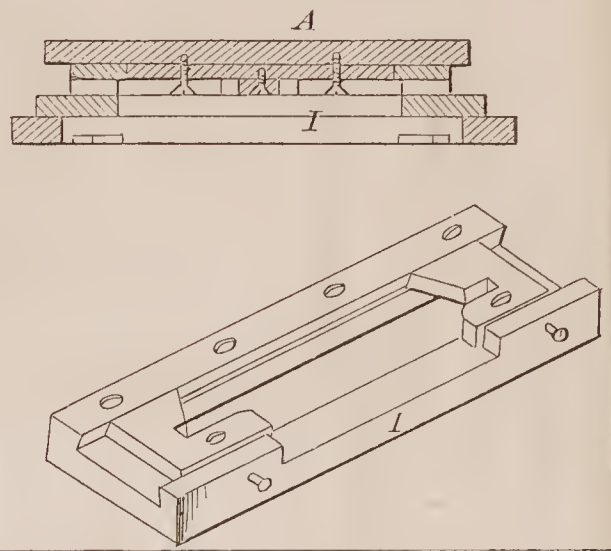

71078—W. Starkey—Attaching Thills to Carriages.

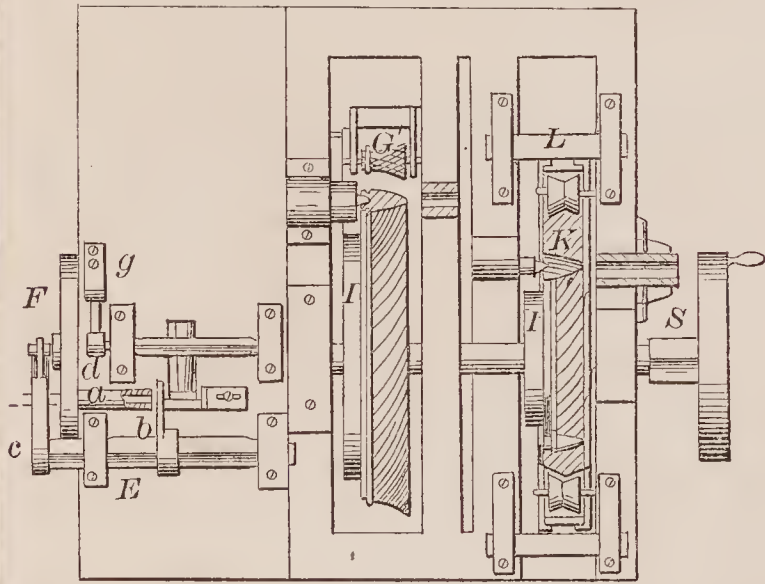
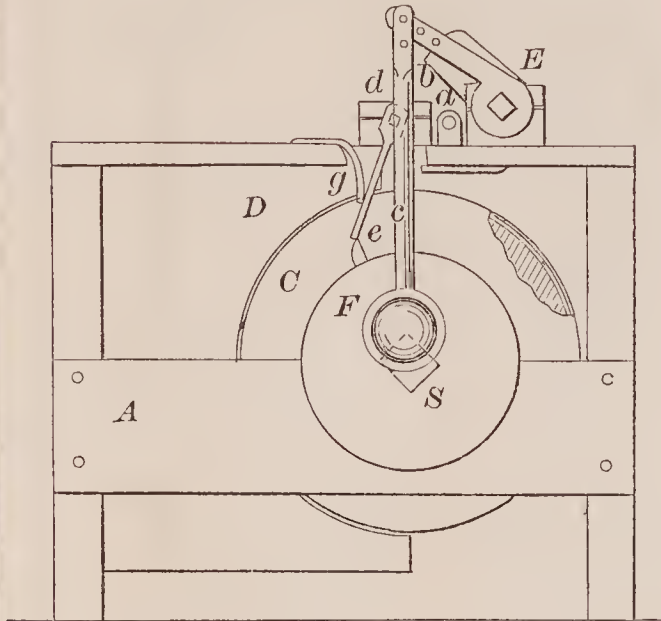
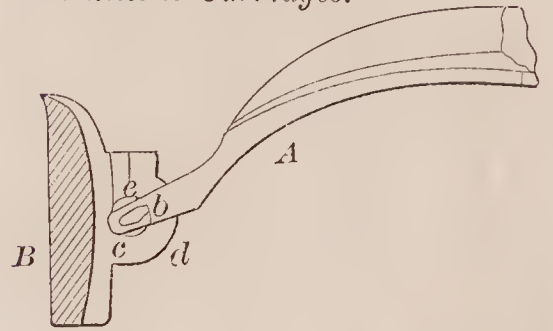

71077—J. F. Stafford—Damper.

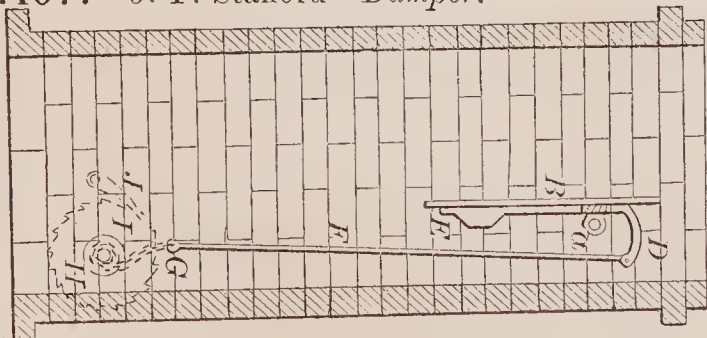

71079—C. V. Statler—Shrinking and Punching Machine.

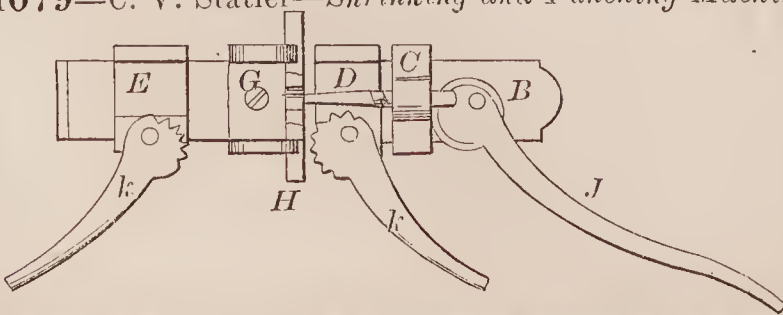

71080—Stiles & Miller—Drop Press.

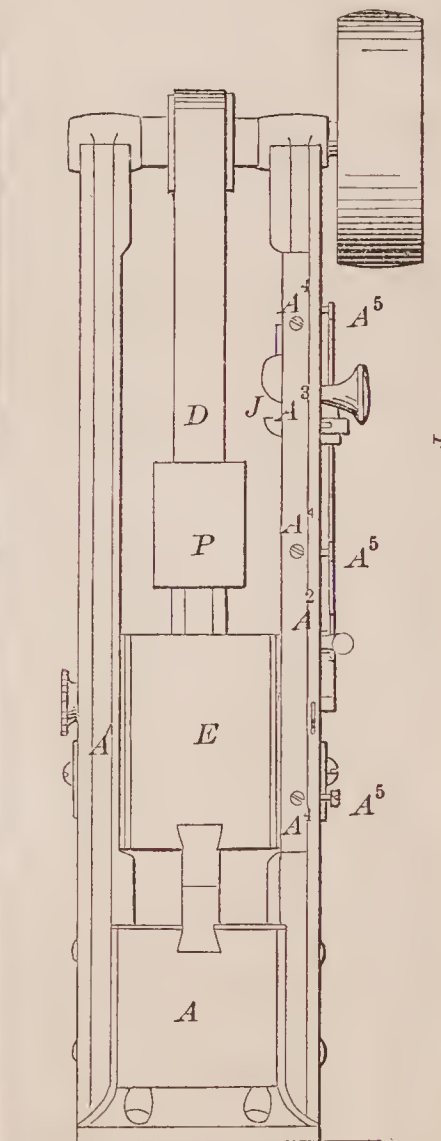

71080—Continued.

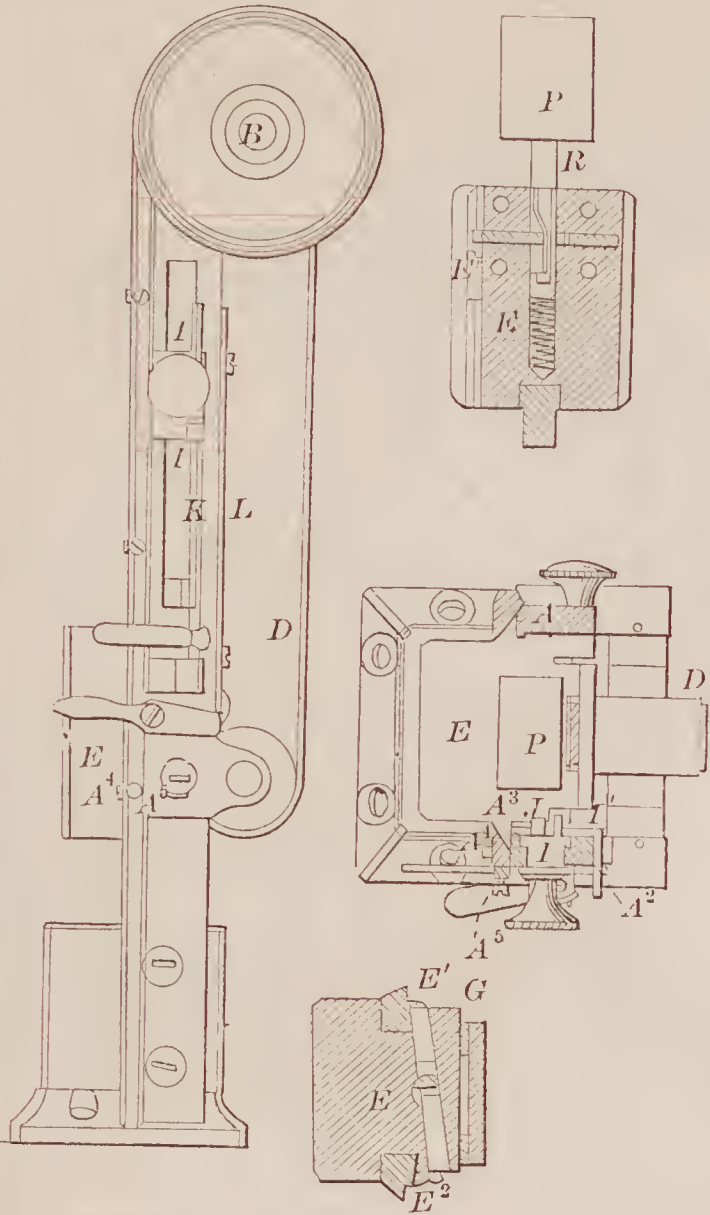

71082—J. Strobeck—Churning Butter.

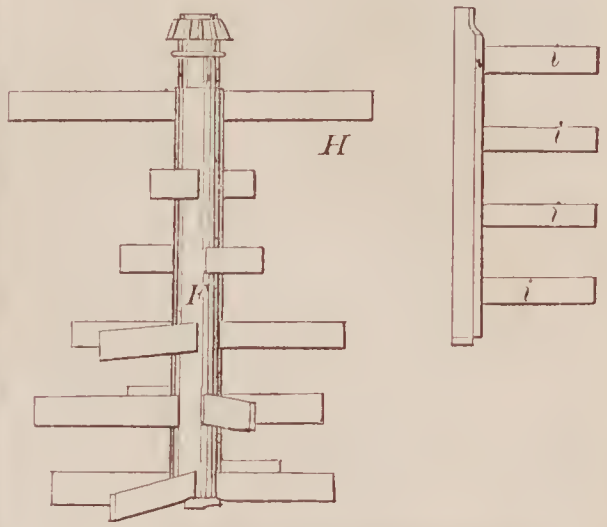

71081—J. Symmott—Writing Apparatus For the Blind.

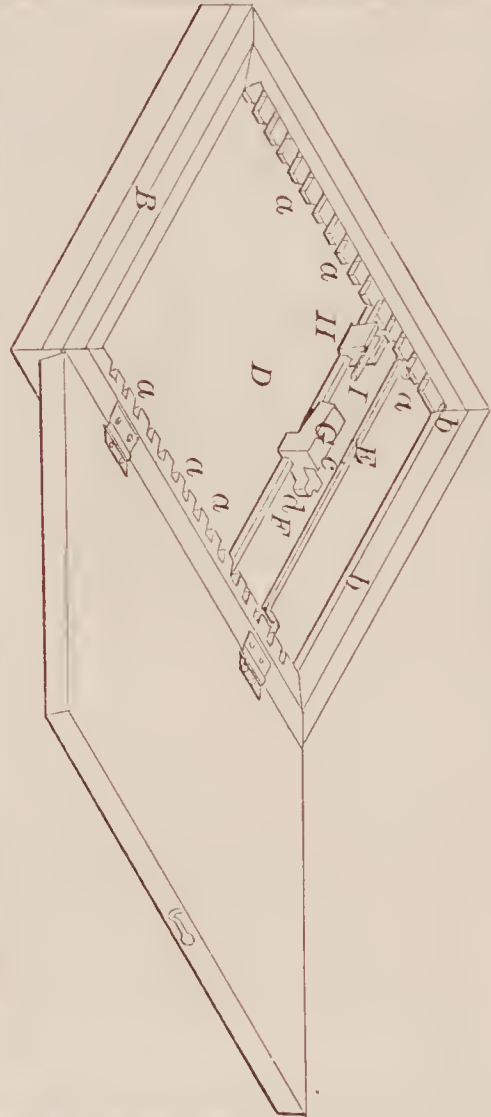

71081—E. Stimson—Door and Gate Spring.

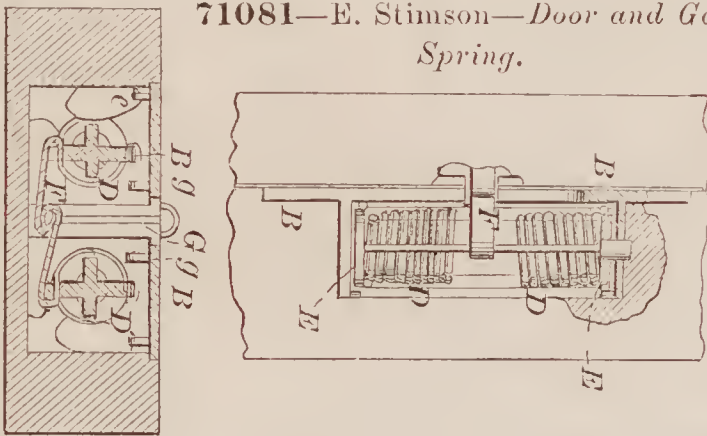

71085—J. F. Tapley—Bronzing Machine.

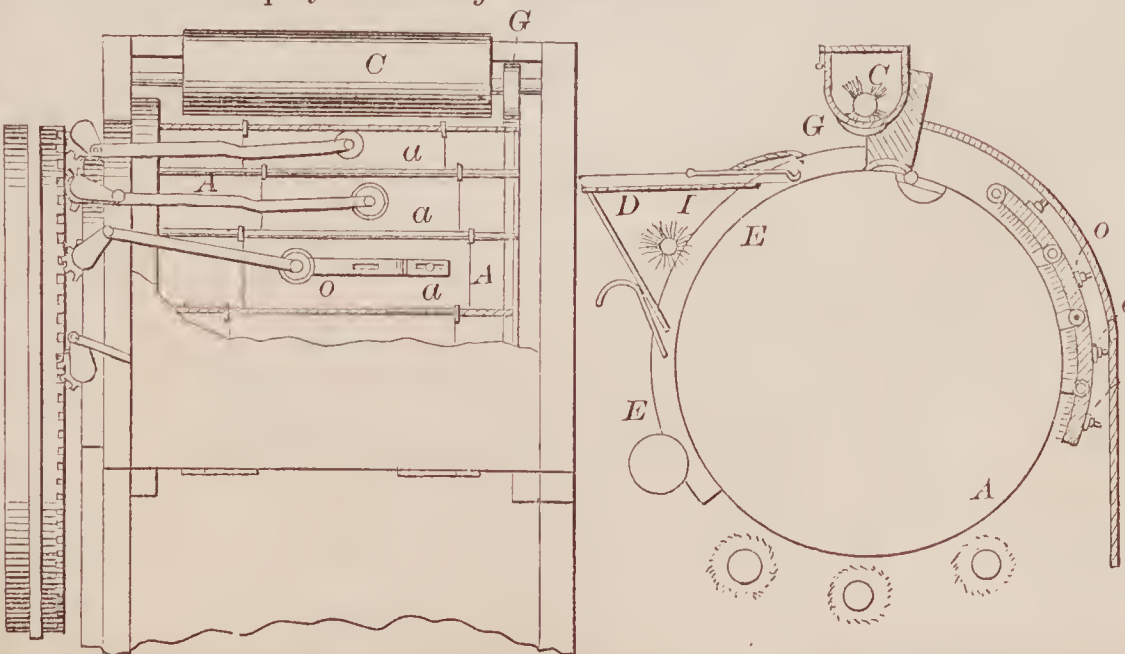

71083—W. W. Sutliff—Gate Spring.





71086—Thompson & Herrick—For Digging Post Holes.

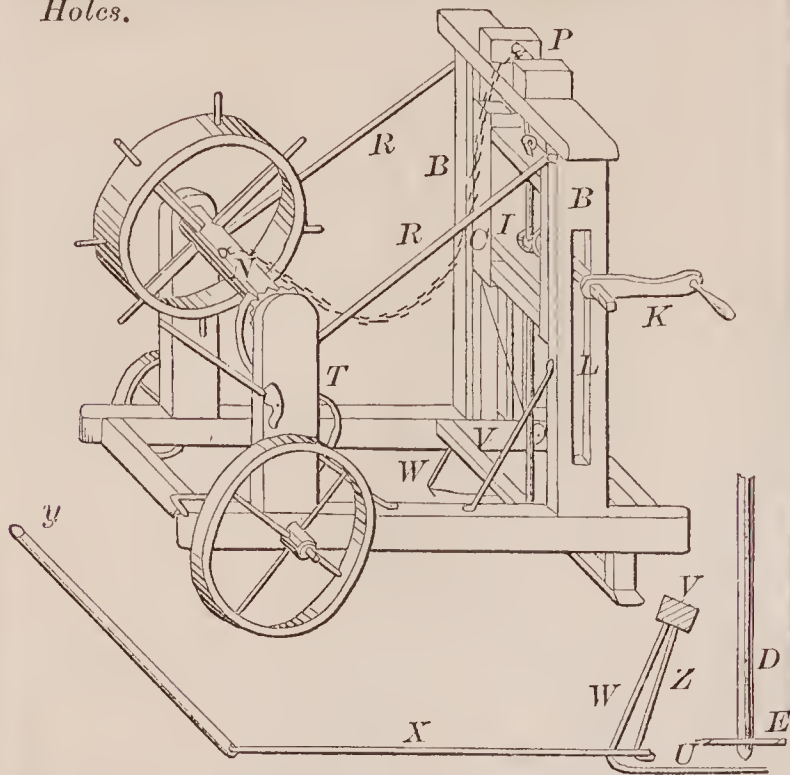

71089—F. Walter—Confectionery.

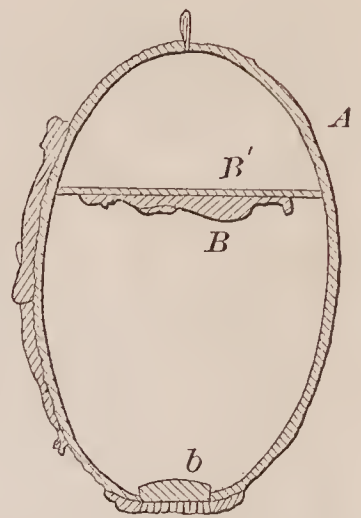

71090—H. Warner—Washing Machine.

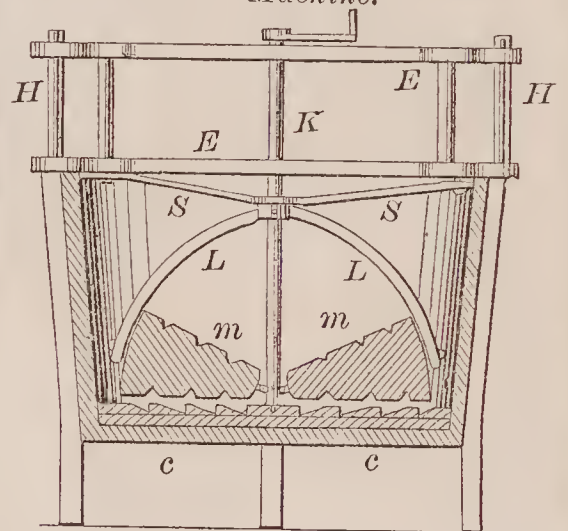

71087—T. H. Tibbles—Hand Loo

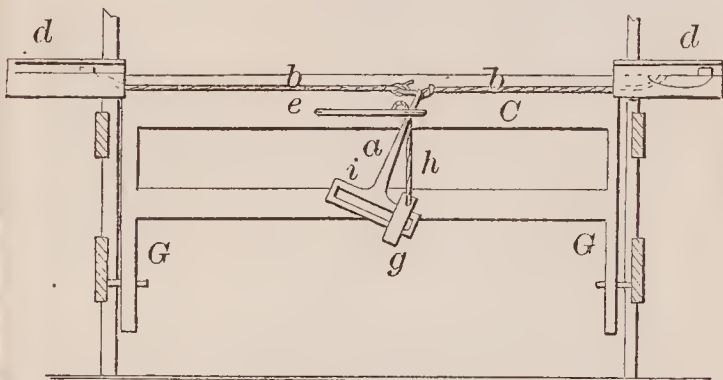
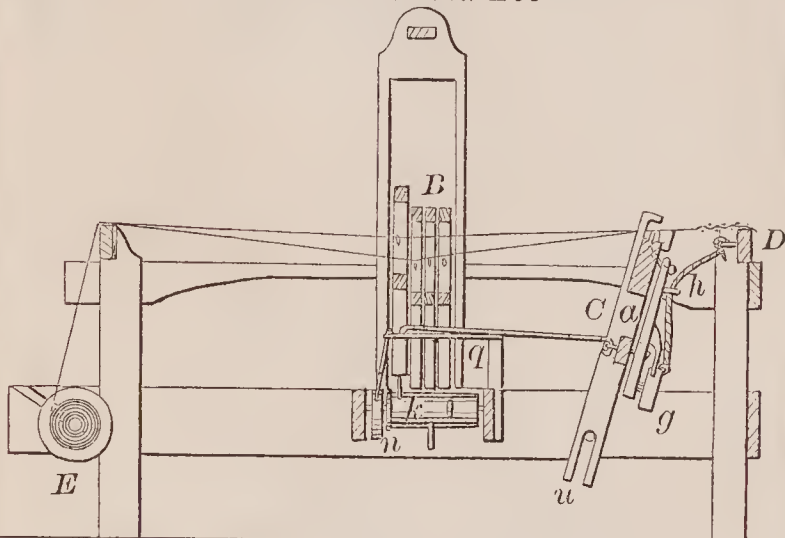

71088—J. Turner—Stump Extractor.

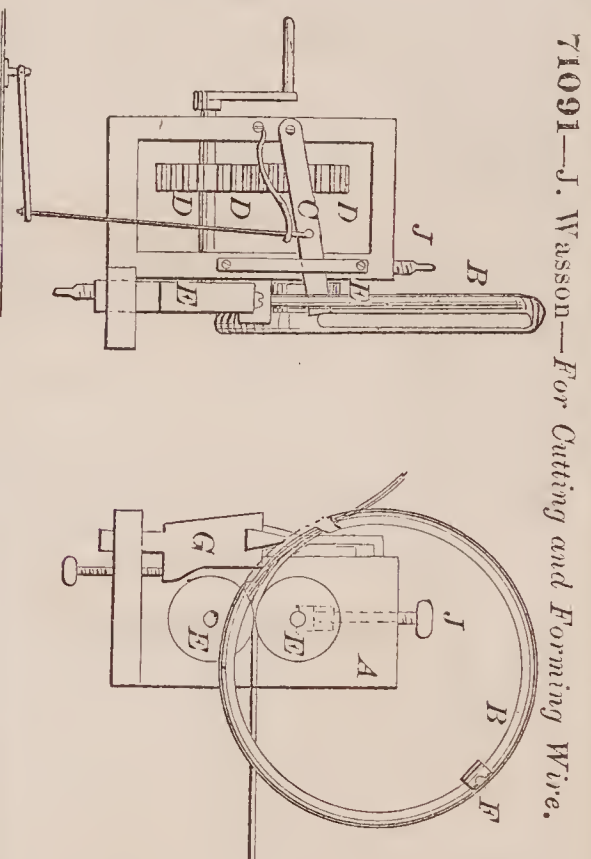
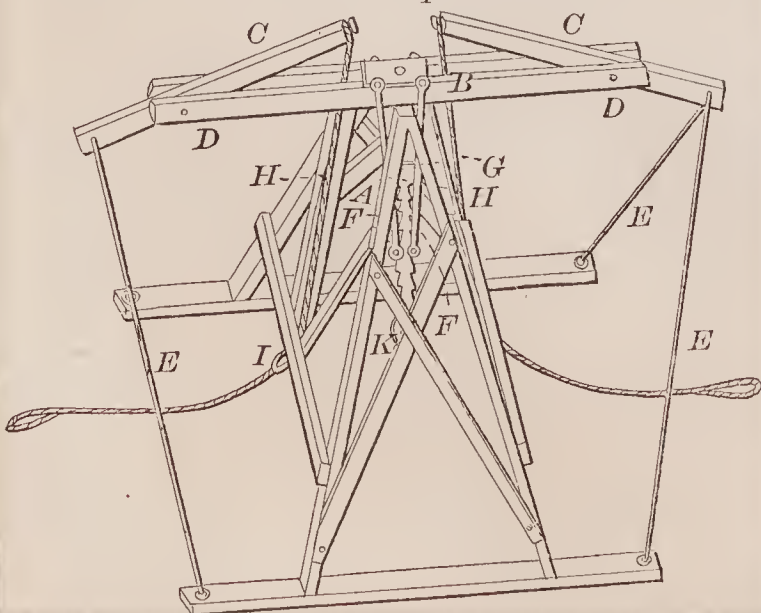

71091—J. Wasson—For Cutting and Forming Wire.

71092—A. W. Webster—Corset Fastening.

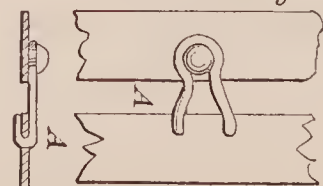

71093—S. D. Warner—*Threshing Machine.*

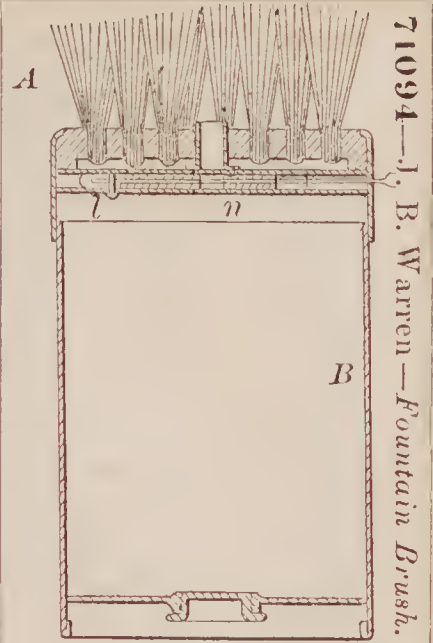
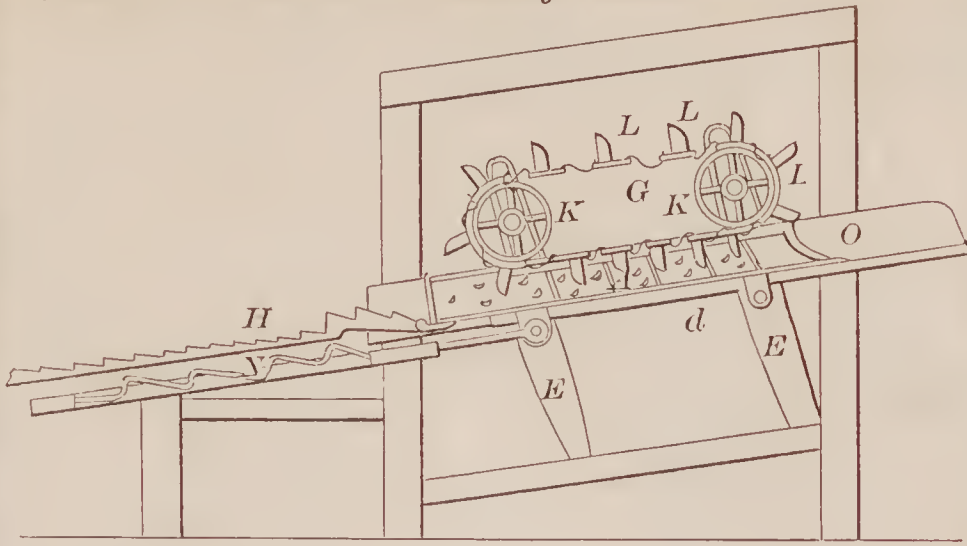

71094—J. B. Warren—*Fountain Brush.*

71096—A. Weitman—*Broadcast Seeding Machine.*

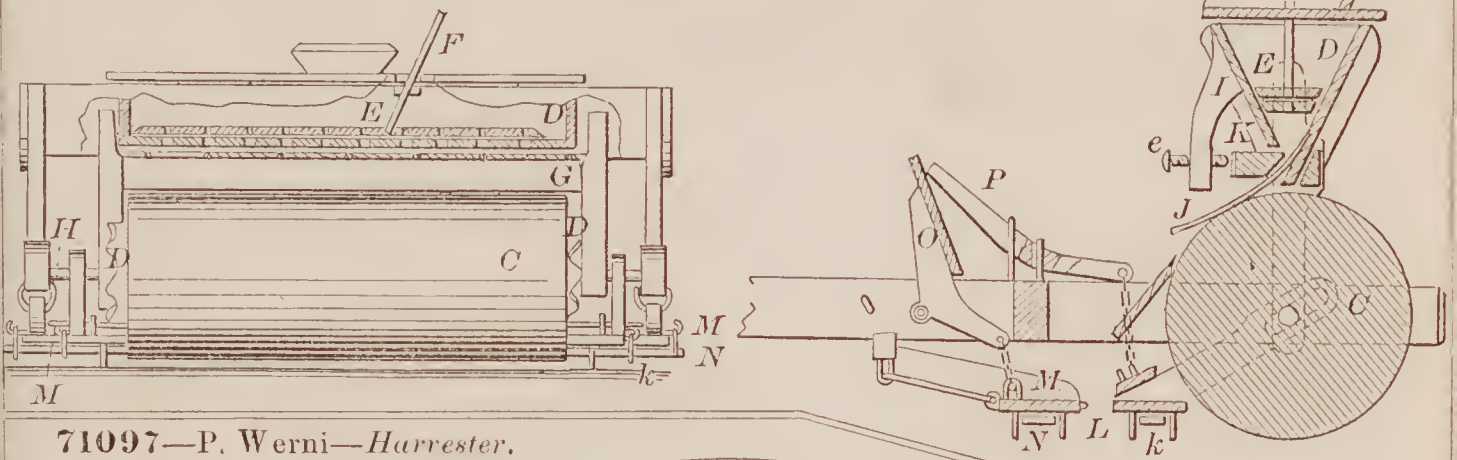

71097—P. Werni—*Harvester.*

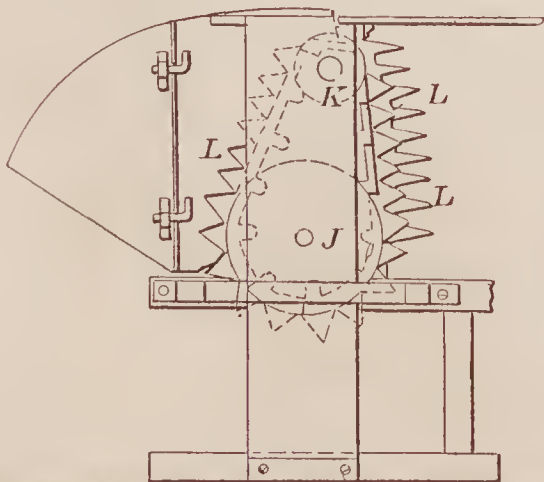
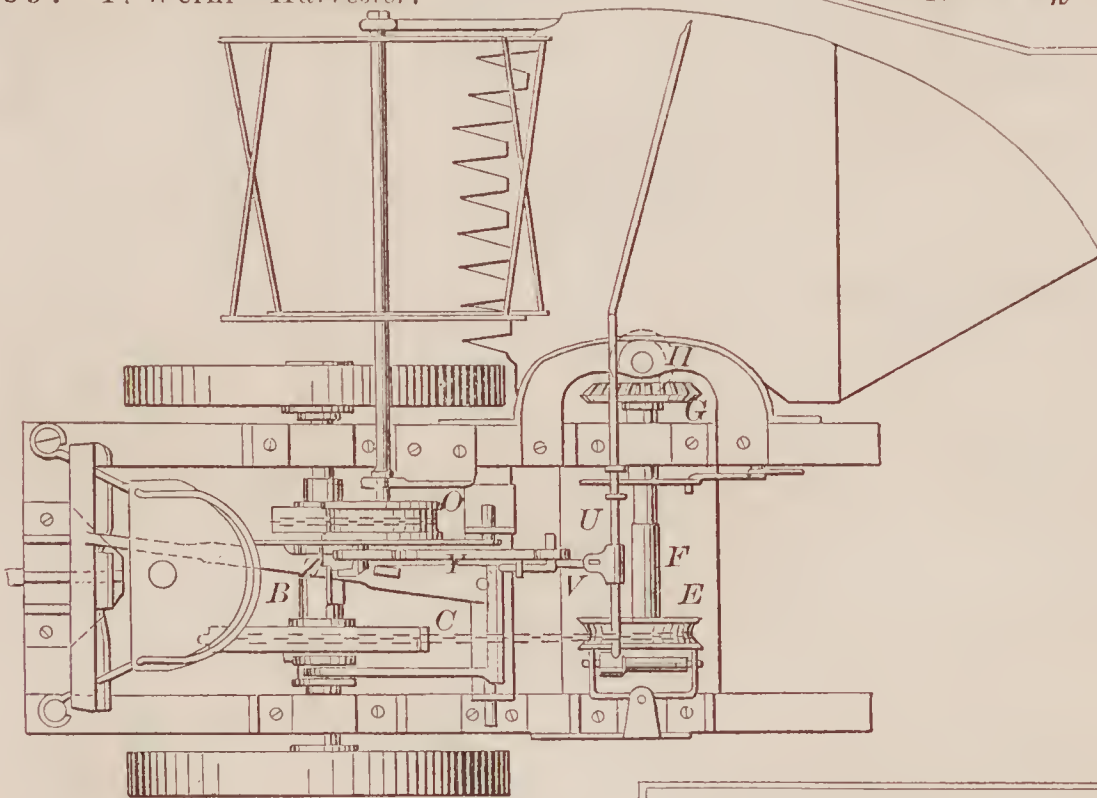

71095—J. Weidenman—*Rubber Shoe.*





71098—P. Werni—Harvester Rake.

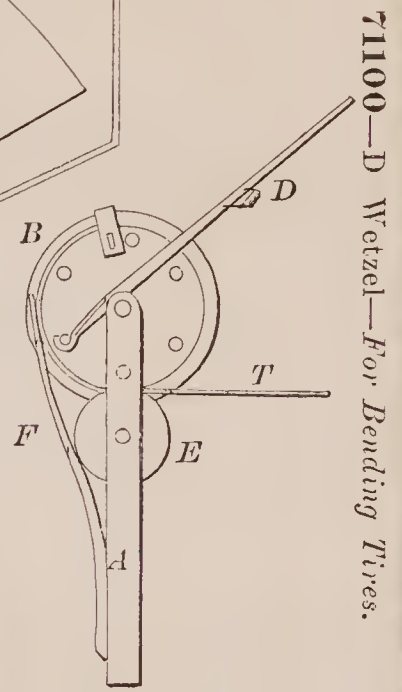
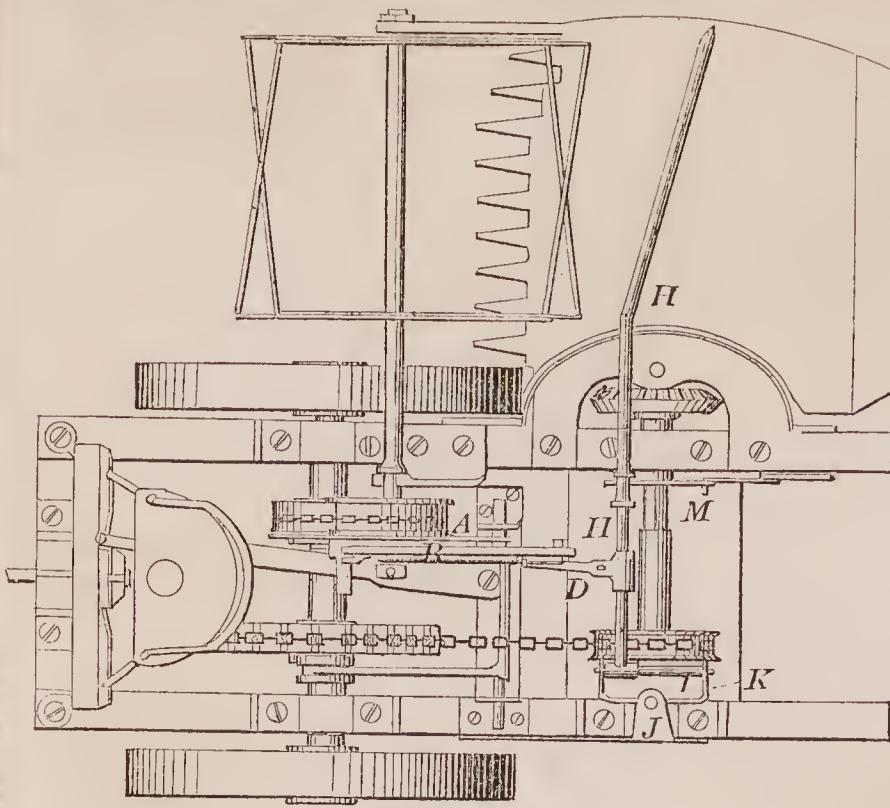

71100—D. Wetzel—For Bending Tires.

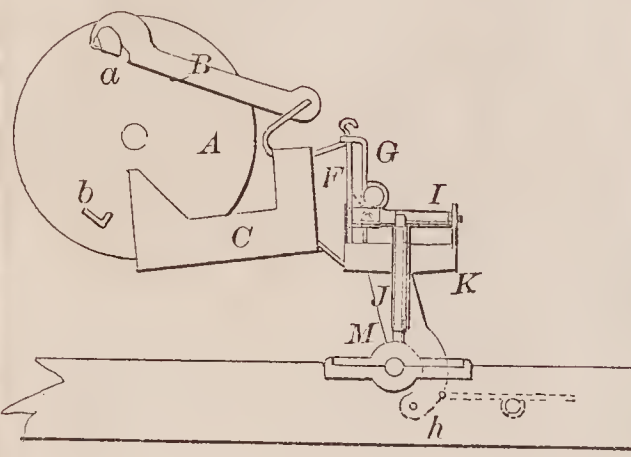

71099—E. W. Weston—Revolving Coal Screen.

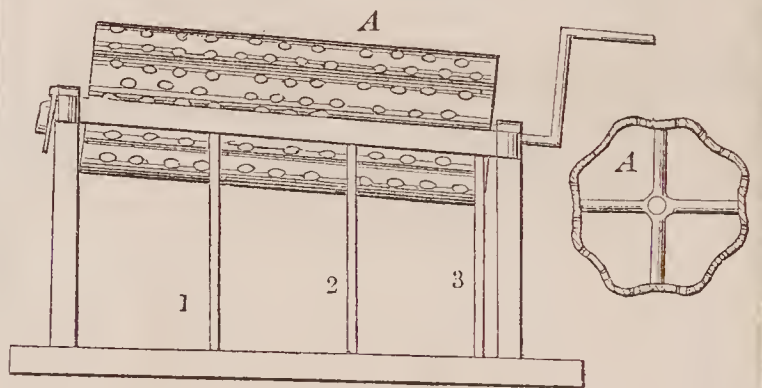

71102—J. Wiley, 2d—Car Brake and Starter.

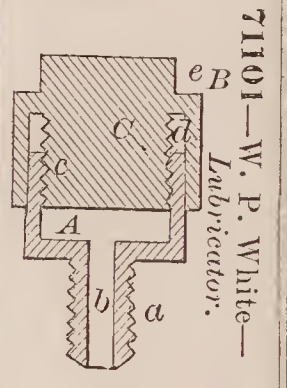
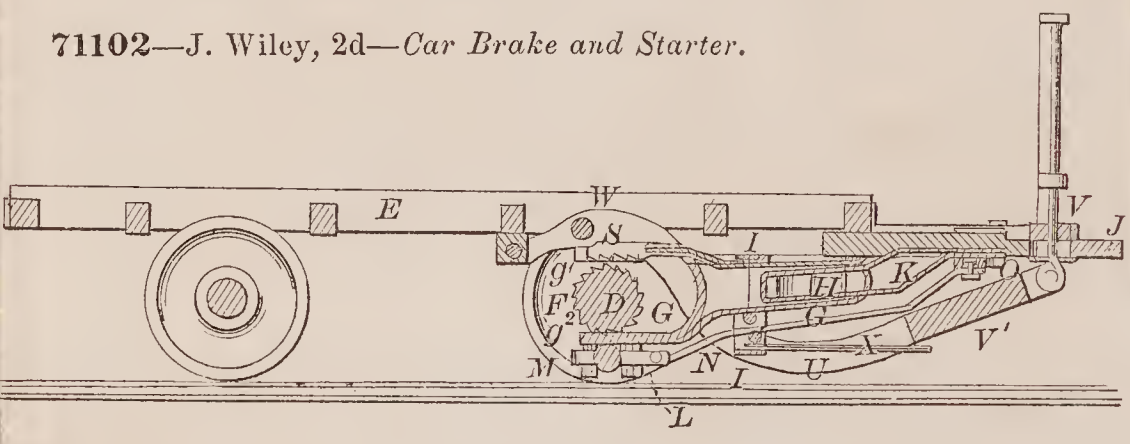

71101—W. P. White—Lubricator.

71103—J. M. Willbur—Printing Apparatus.

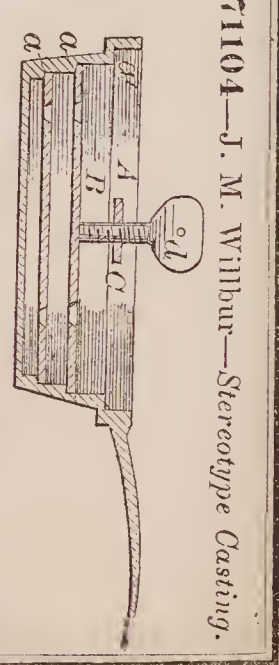
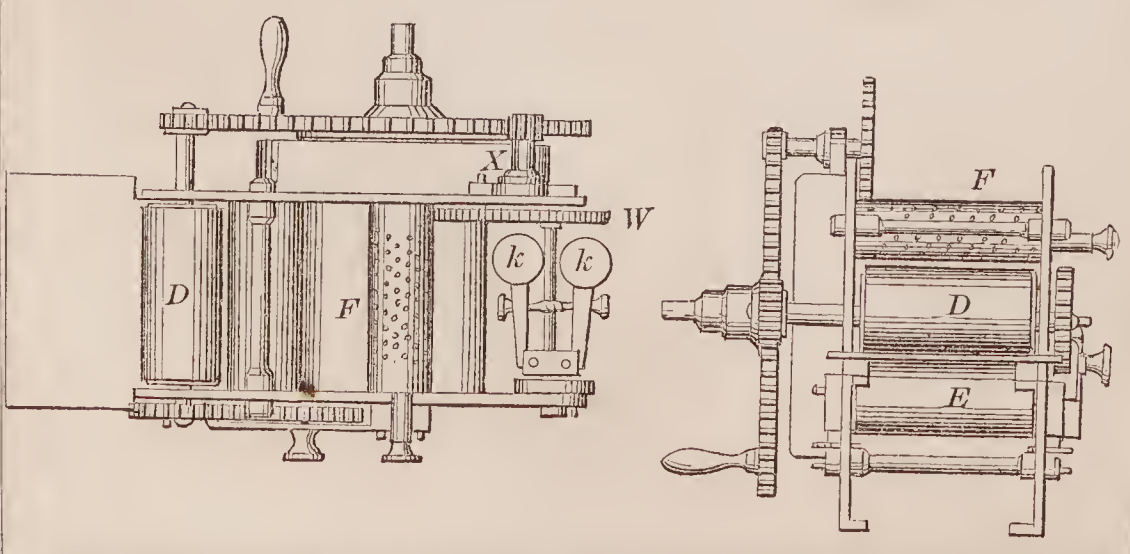

71104—J. M. Willbur—Stereotype Casting.



71105—J. M. Willburr—Hand Stamp.

71107—C. Wills—For Securing and Releasing Horses.

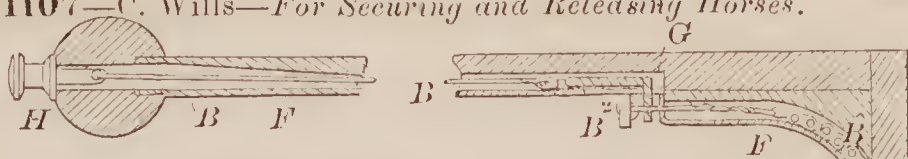

71106—E. Williams—Pocket Safety Attachment.

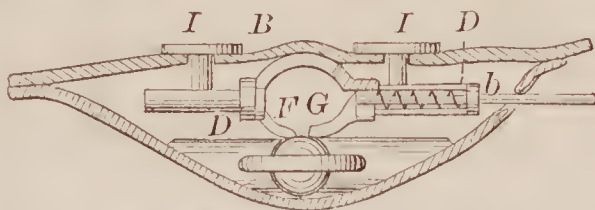

71108—E. Wilmont—Paper Making Machine.

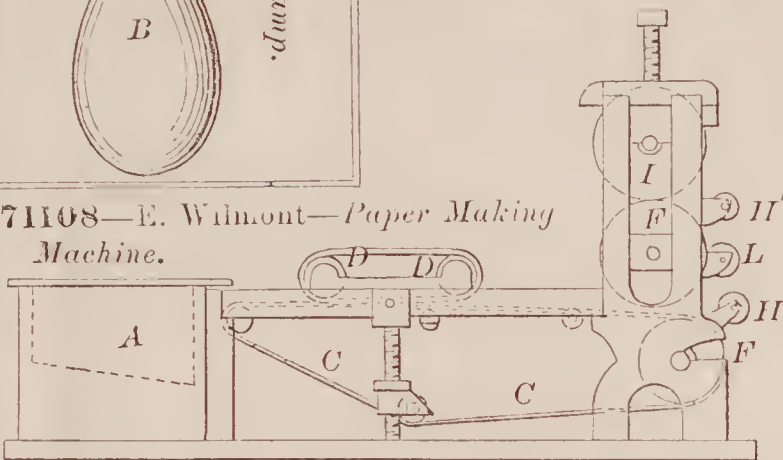

71109—G. W. Wiswell—Boiler Cleaner.

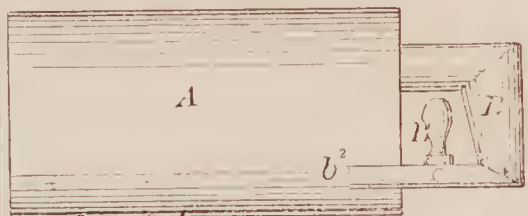

71111—J. S. Zane—Snow Plow.

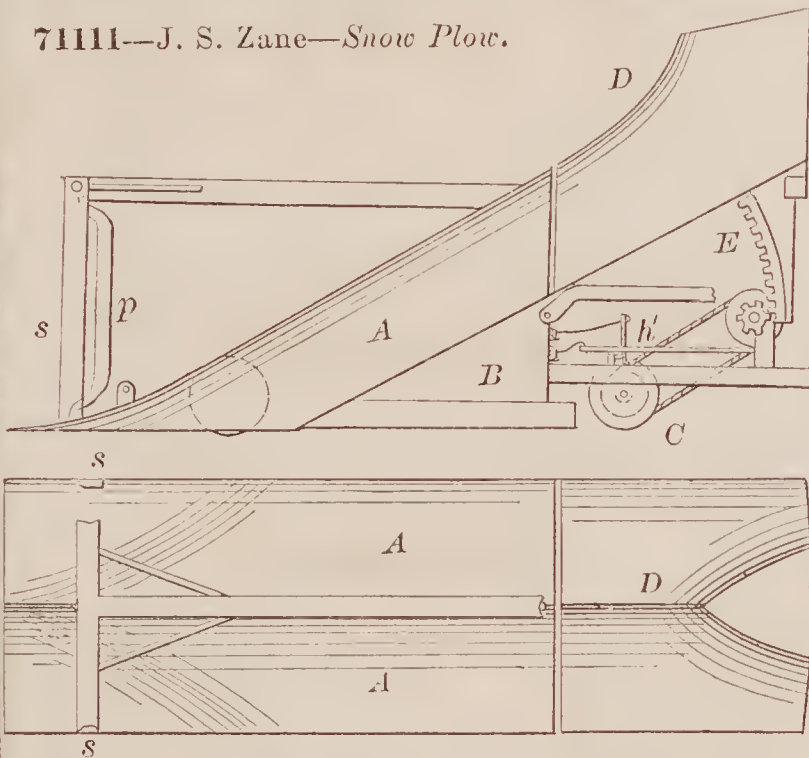

71112—C. E. Abbott—Lamp Extinguisher.



71113—B. B. Alfred—Cotton and Hay Press.

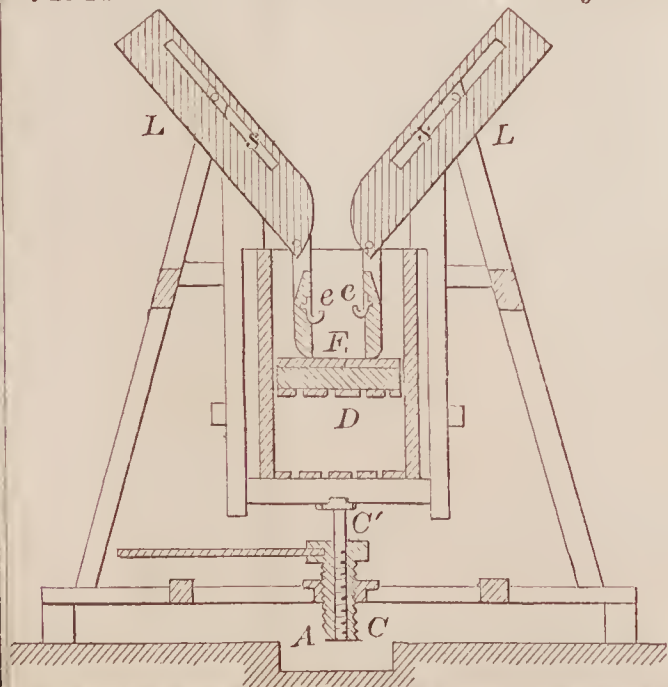

71110—L. Yale, Jr.—Burglar Proof Safe.

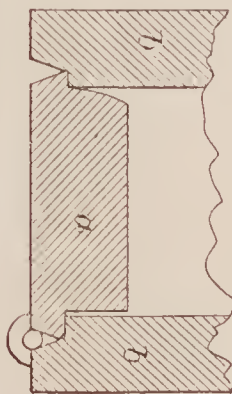

71114—G. Allix—For Raising Window Curtains.

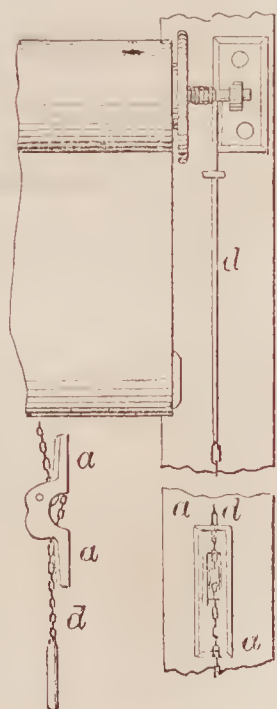



71115—  
J. K. Andrews—

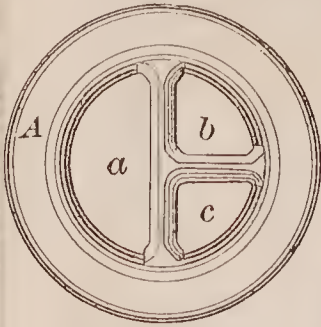

Dinner Plate.

71117—W. Appleton—Malt House or Kiln.

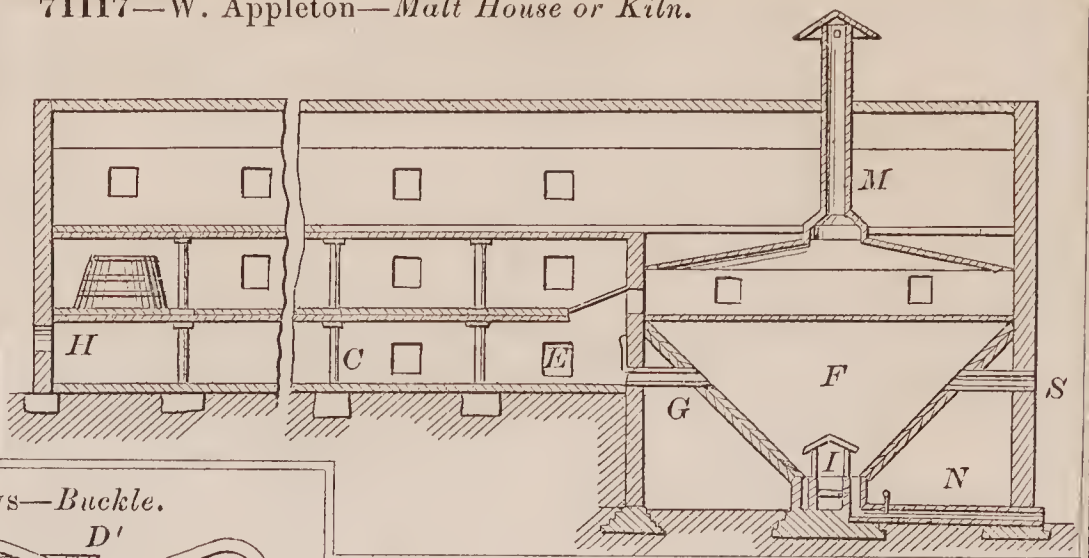

71116—J. K. Andrews—Buckle.

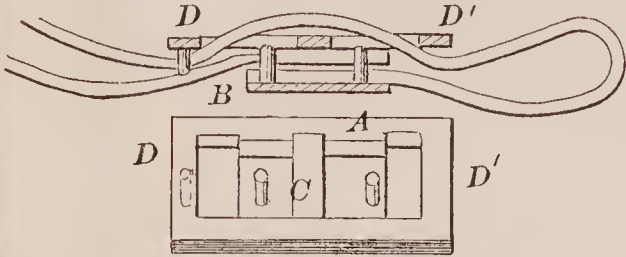

71120—W. Bailey—For Making Stamp Gilt Paper Hangings.

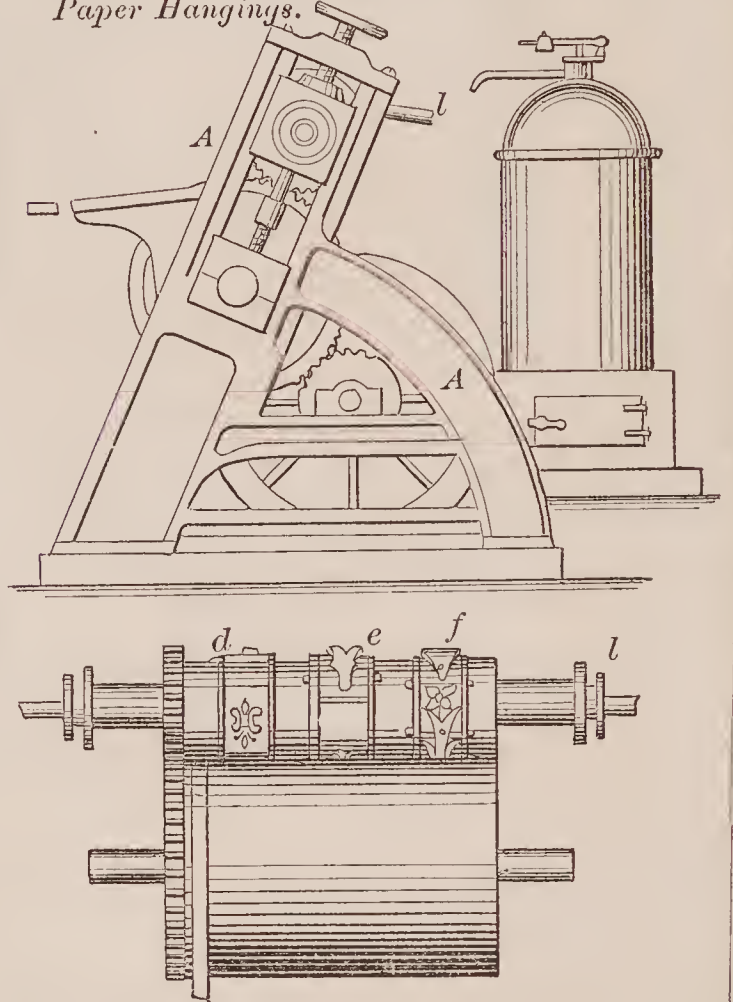

71118—J. R. Ashley—Carriage Spring.

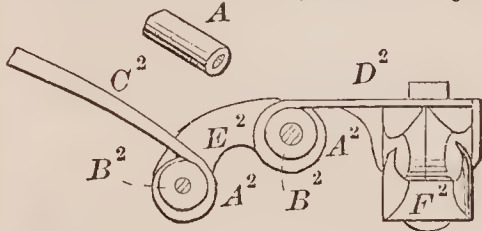

71123—N. Belvallette—Carriage Door Latch.

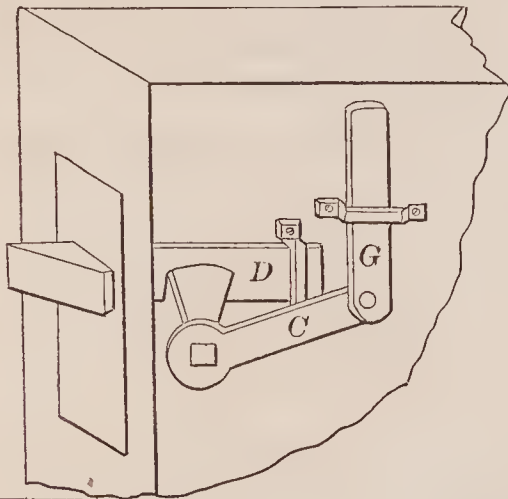

71125—W. A. Boyden—Axle Box.

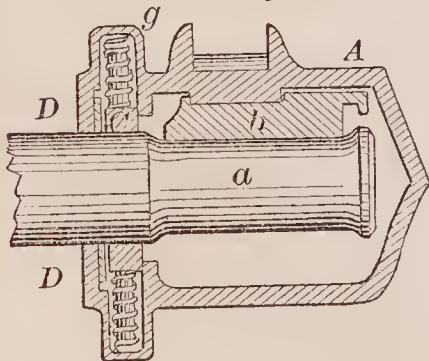

71124—W. Betts—Metallic Capsule for Bottles.

71126—J. Bragdon—Carpenters' Work Bench.

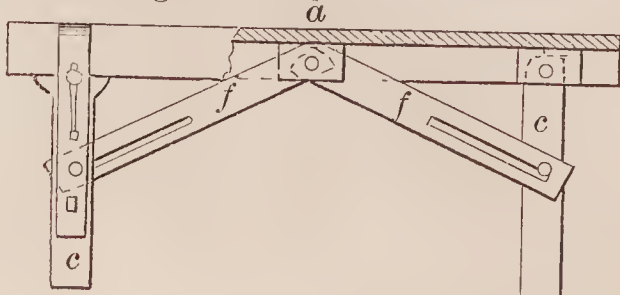

71122—J. Bean—Pump.

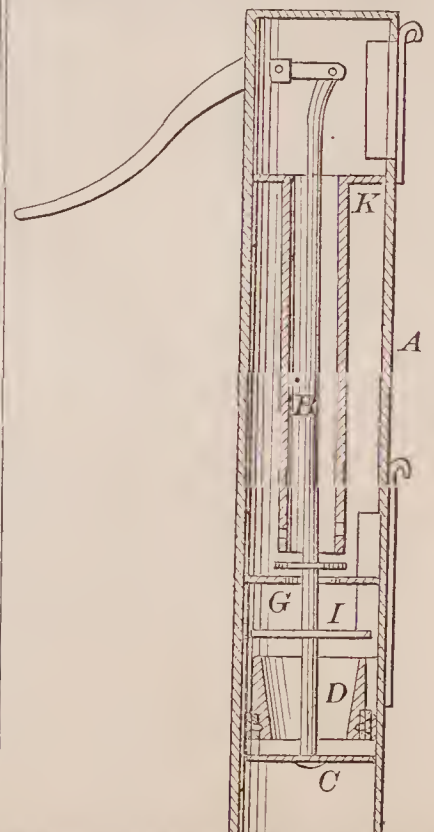

71128—C. T. Bush—Hop Vine Support.

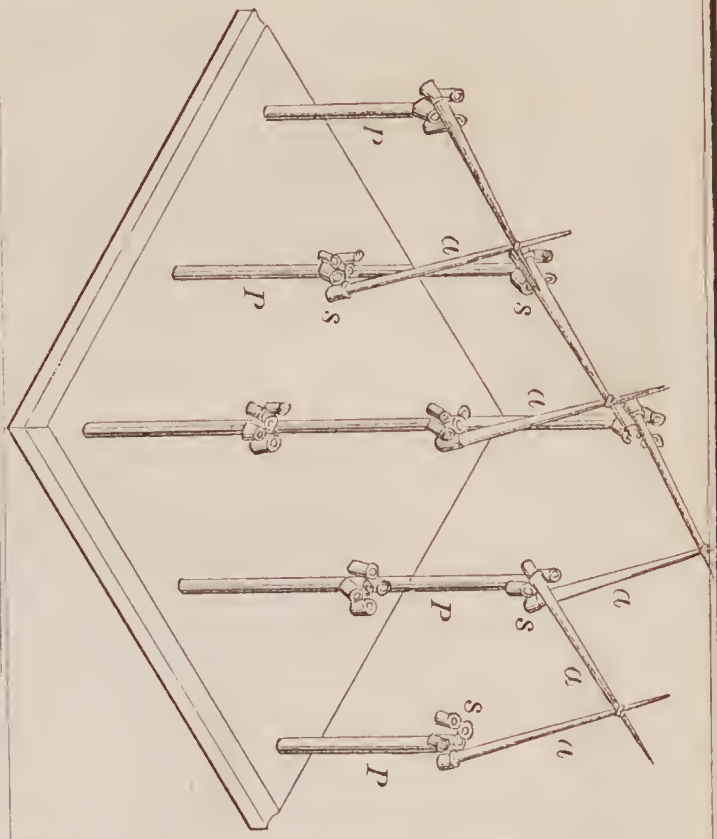

71130—J. Busser—Wooden Building.

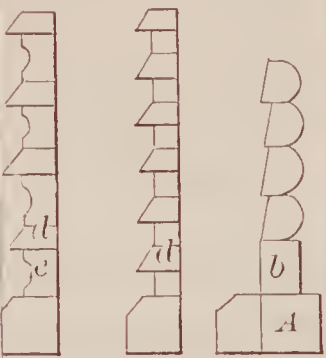

71127—J. E. Brown—Spindle Bolster.

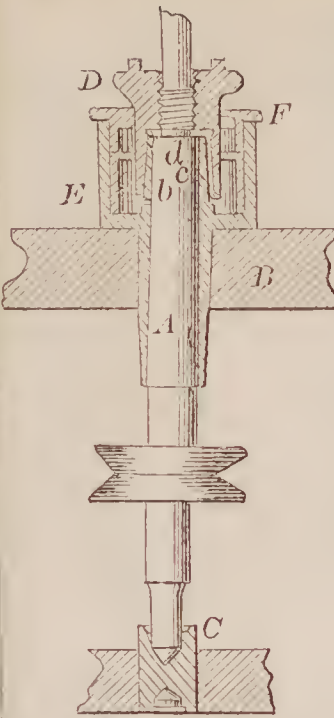

71131—C. Cadwell—Sewing Machine.

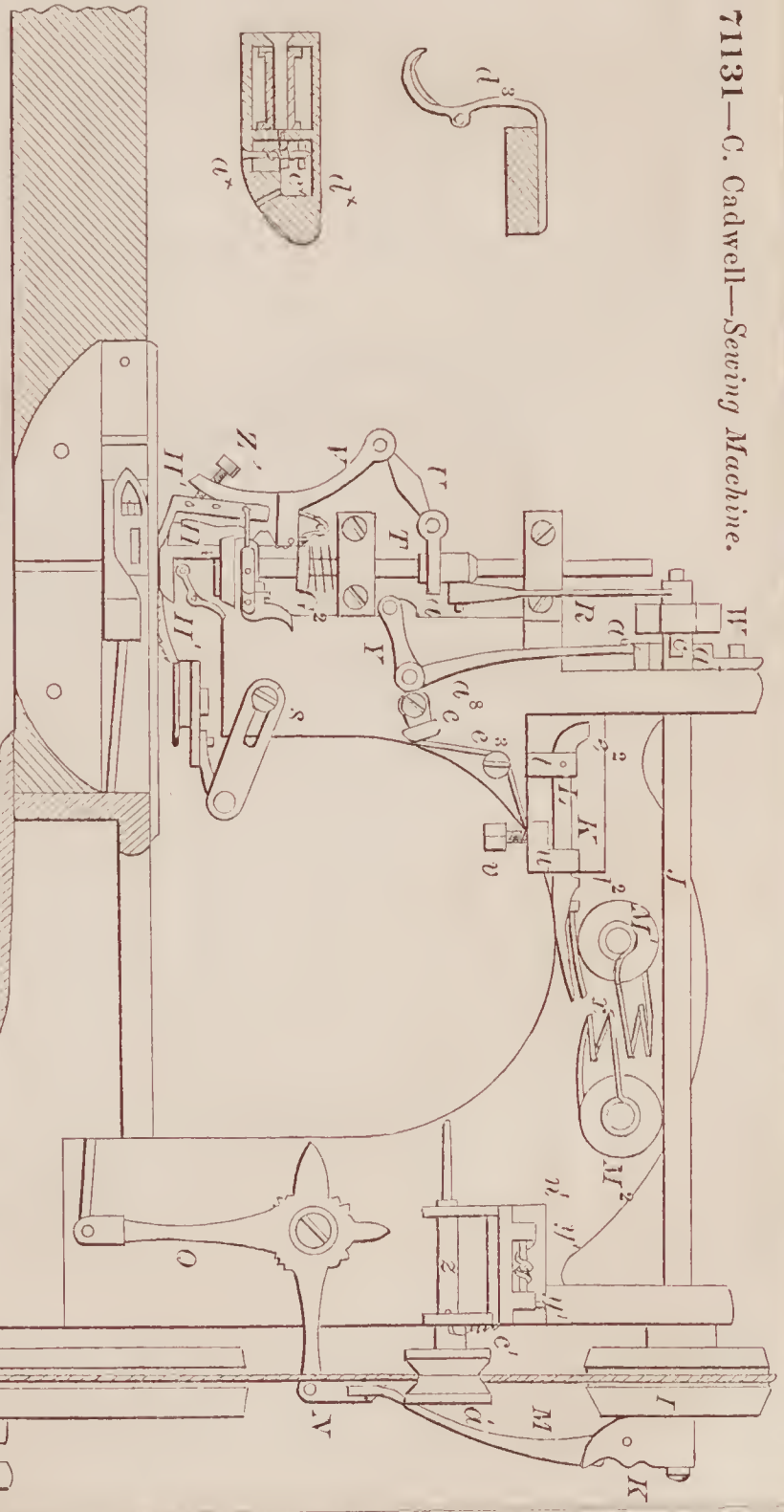

71129—Bush & Richards—Coal Stove.

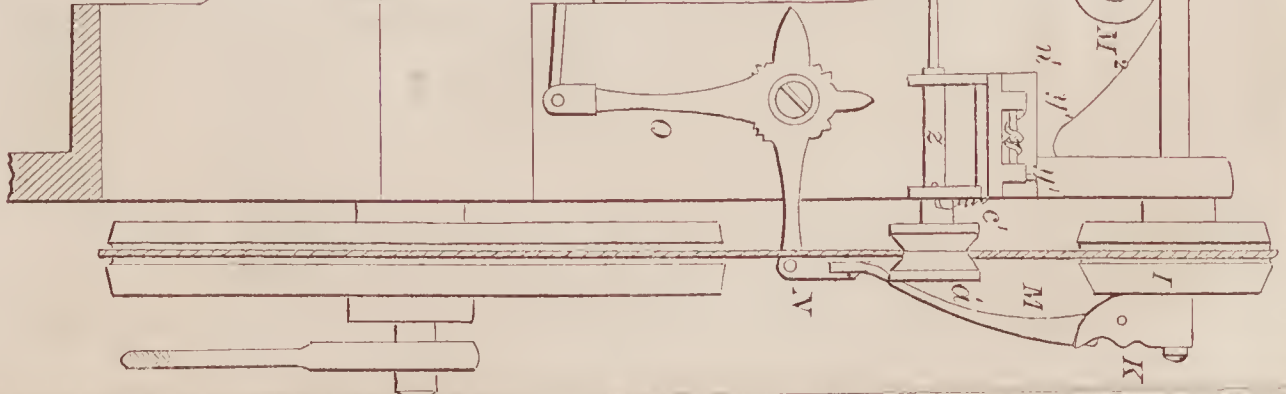
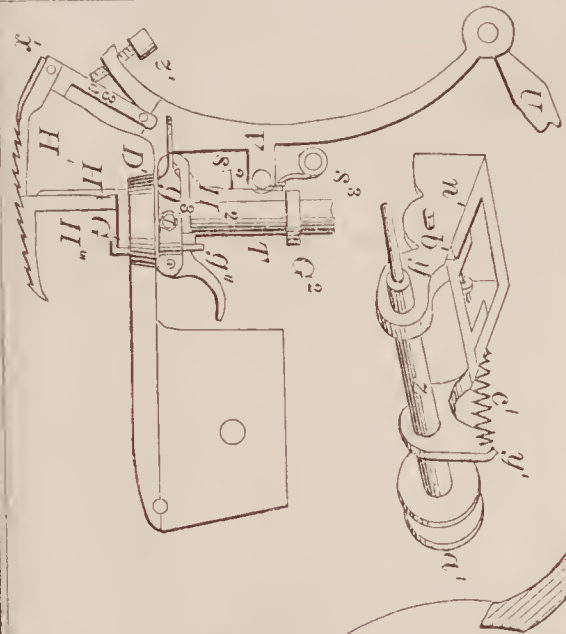
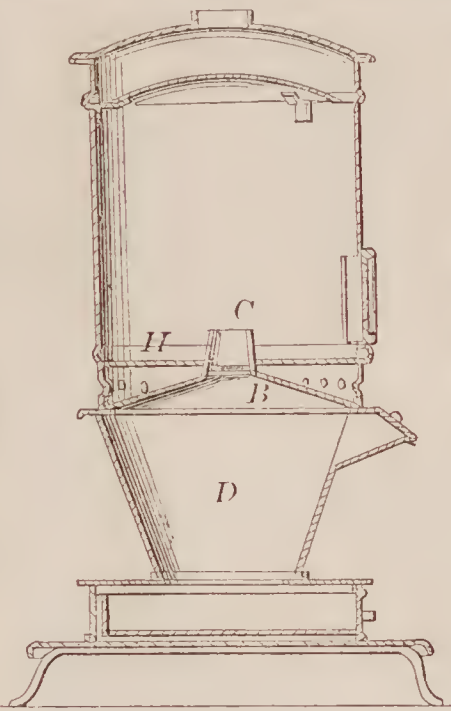



71134—I. H. Chappell—Planter and Cultivator.

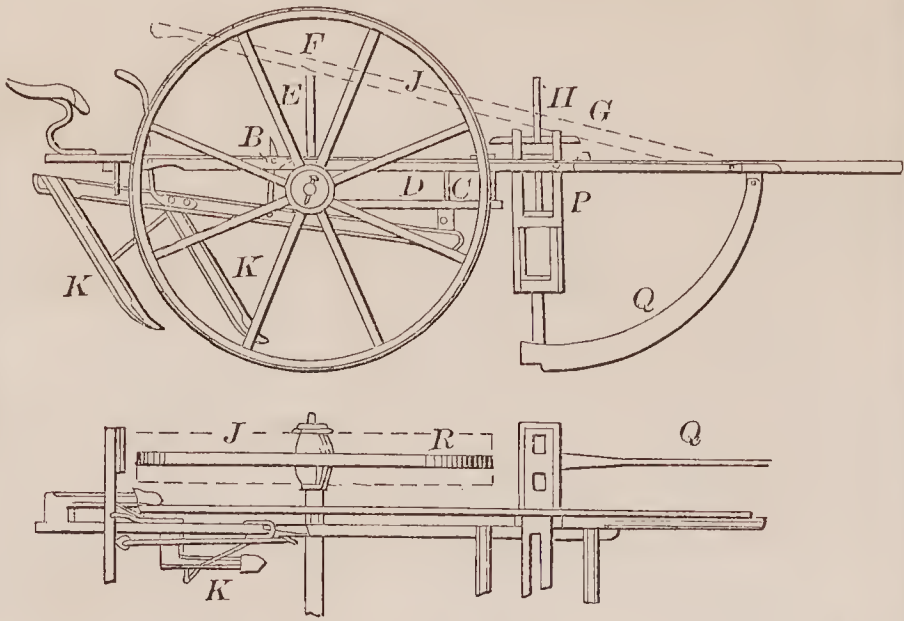

71132—G. S. Caldwell—  
Harness Rosette.

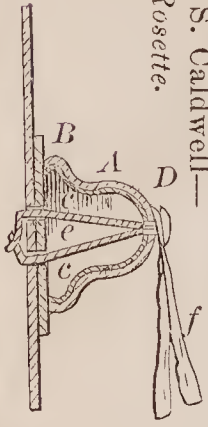

71136—H. M. Clemence—Garment  
Supporter.

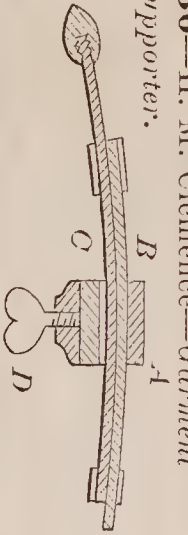

71137—A. Coates—Horse Hay Fork.

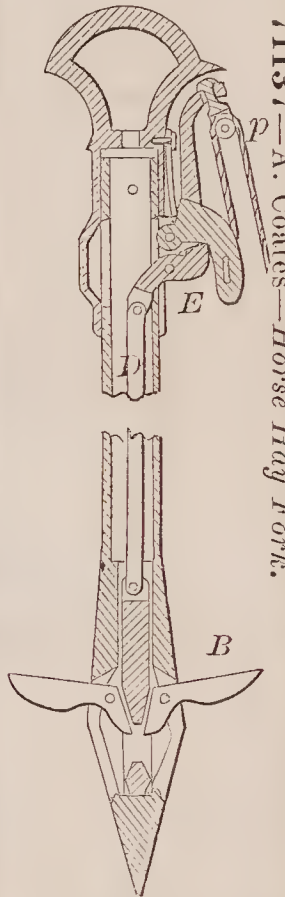

71133—H. Carmichael—Transplanter.

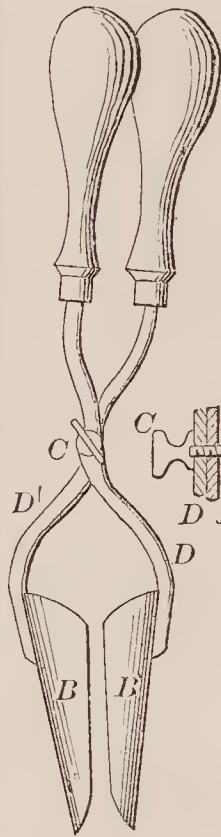

71135—F. A. Chavantre—  
Blind Fastening.

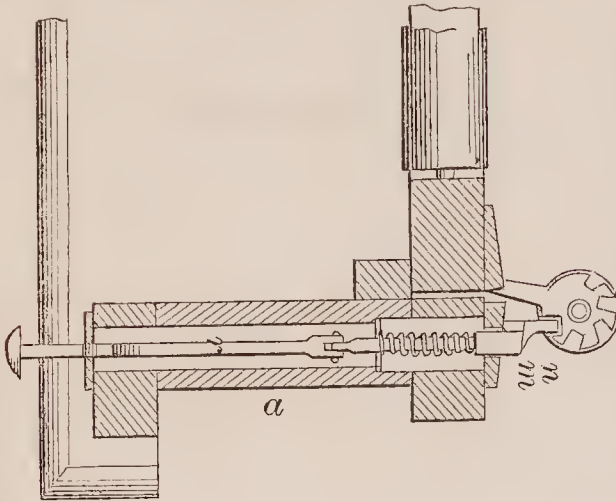

71139—N. B. Crawford—Building Scaffold.

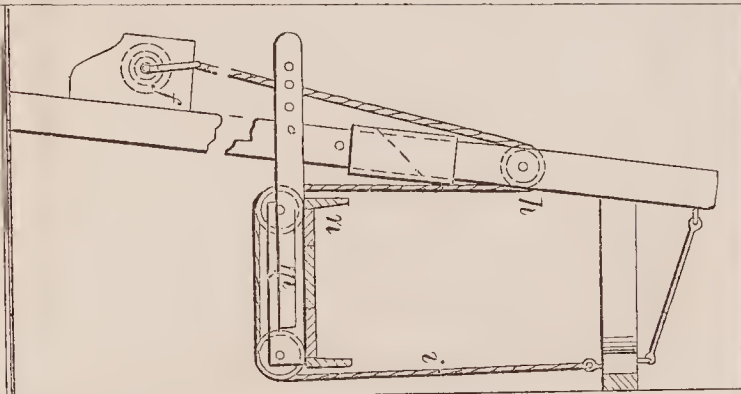

71140—N. B. Crawford—Scaffold for Roofs.

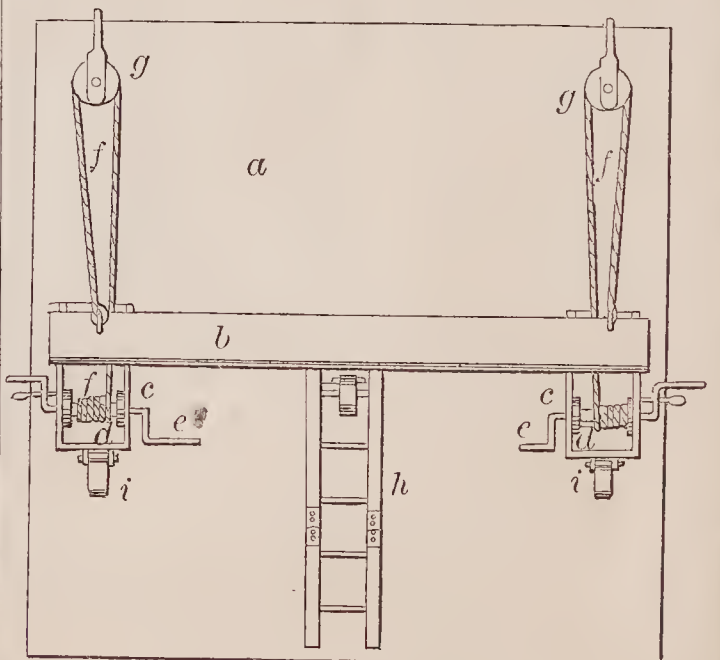

71138—Crawford & Hervey—Toy Hoop.

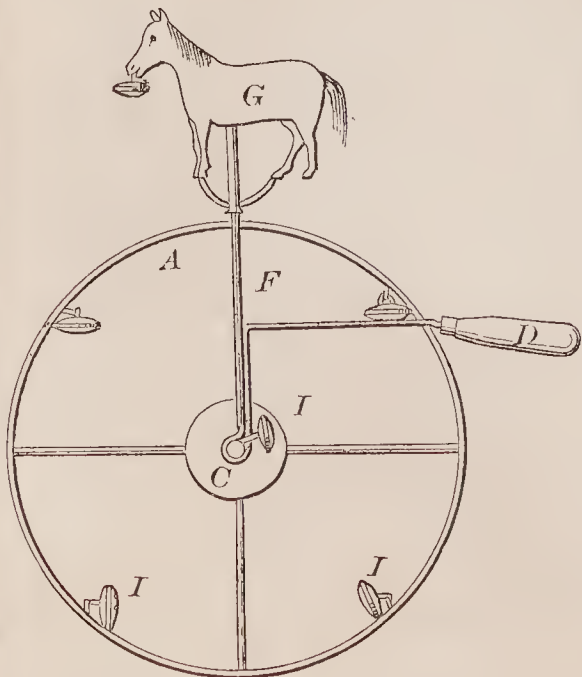

71141—L. Cutting—Soldering Furnace.

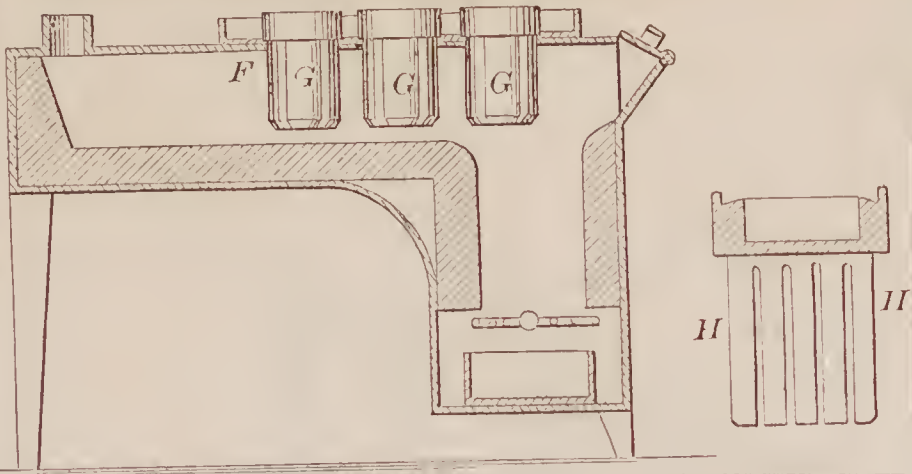

71143—G. & D. Dare—Paper Bag.

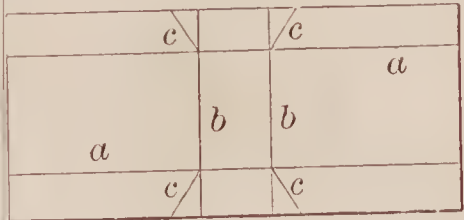

71146—Dorwart & Rote—Fence.

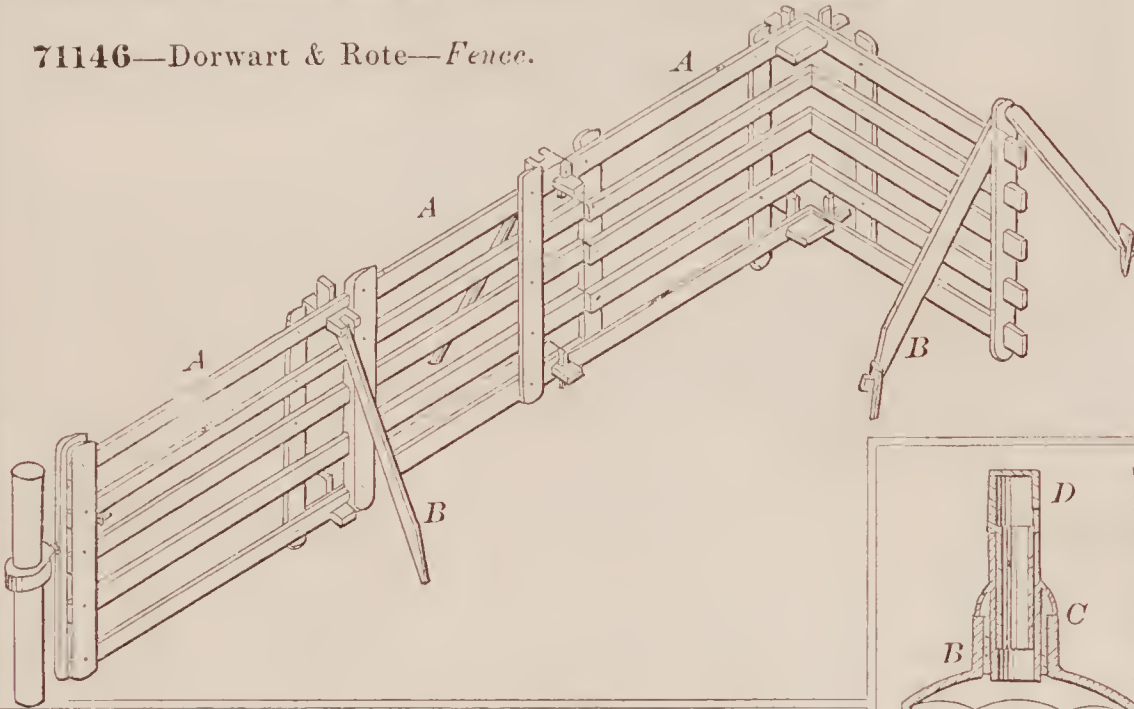

71144—T. J. Dean—Tube Well.

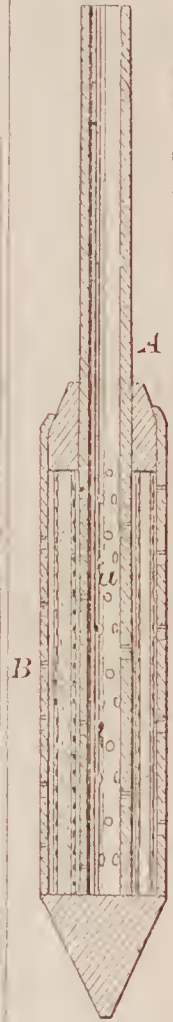

71142—J. B. Da Camara, Jr.—Tooth Powder Bottle.

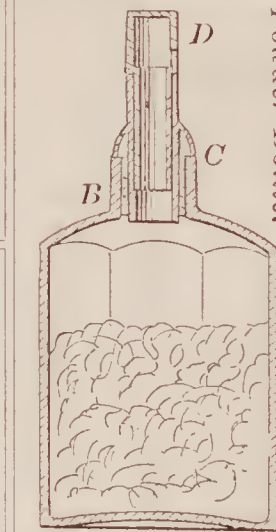

71147—Dorwart & Rote—Fence.

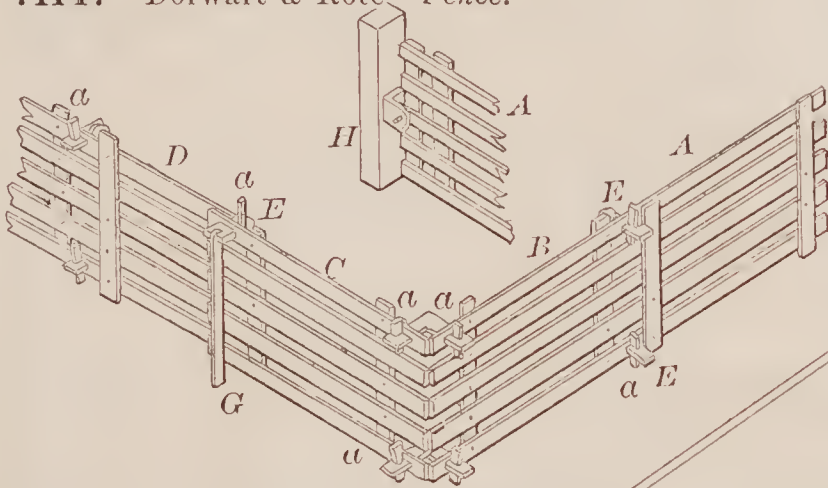

71148—D. Drawbaugh—Nail Plate Feeding Device.

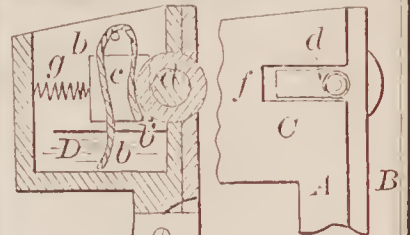
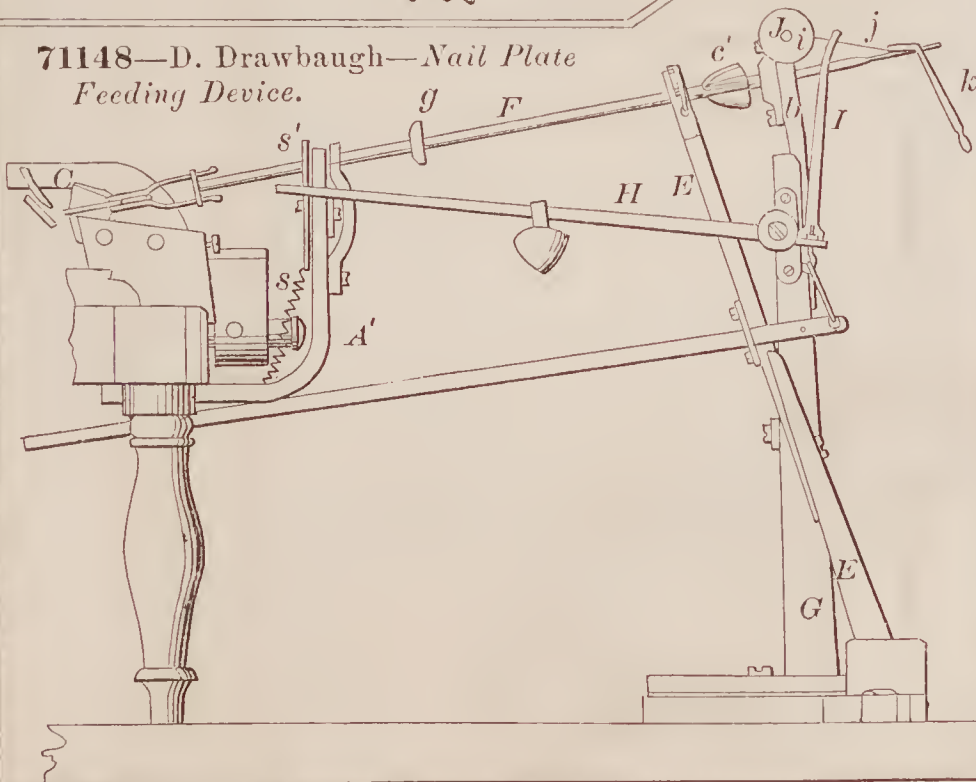

71145—W. A. Devon—Self-Lubricating Globe.



71148—Continued.

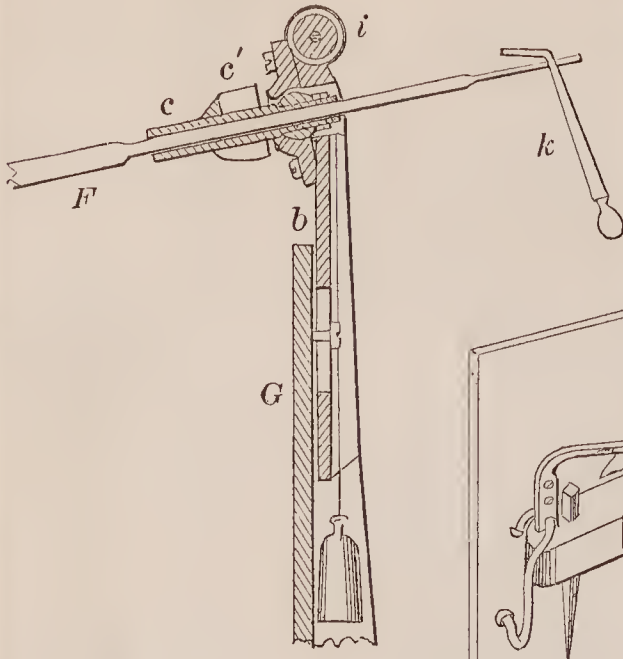

71152—J. W. Ernst—Adjustable Cultivator.

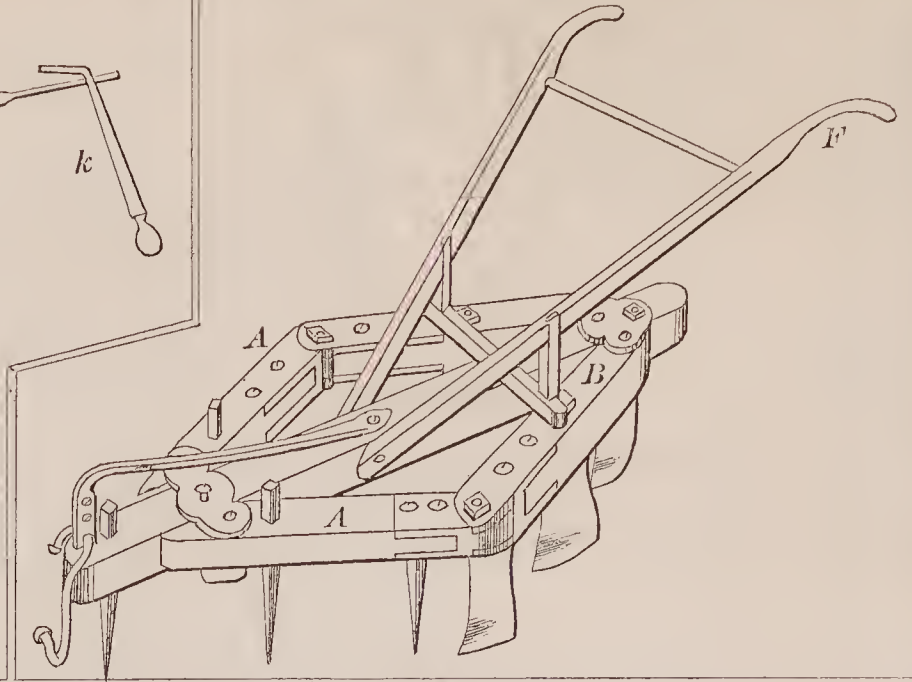

71149—J. Elson—Breech-Loading Fire Arm.

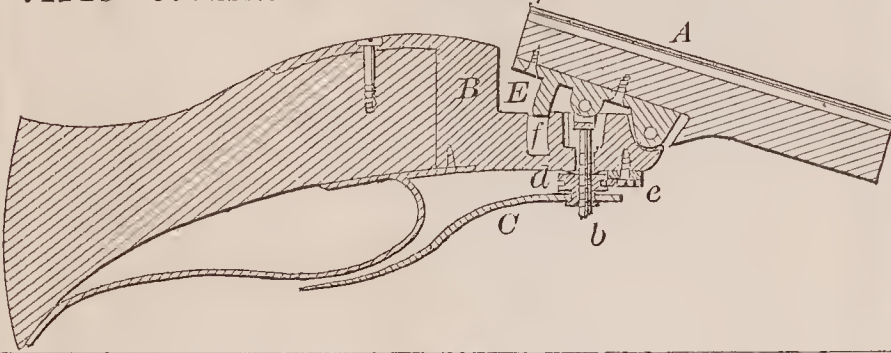

71151—Emmones & Simpson—Carriage Top.

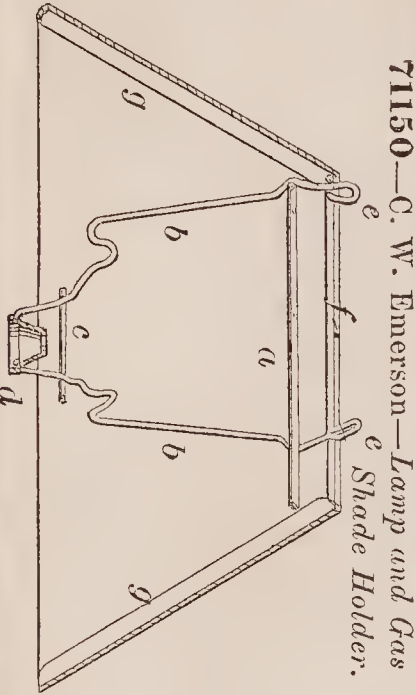
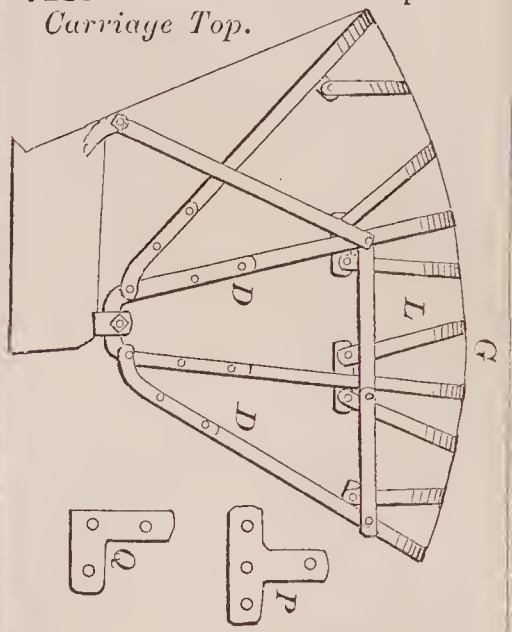

71150—C. W. Emerson—Lamp and Gas Shade Holder.

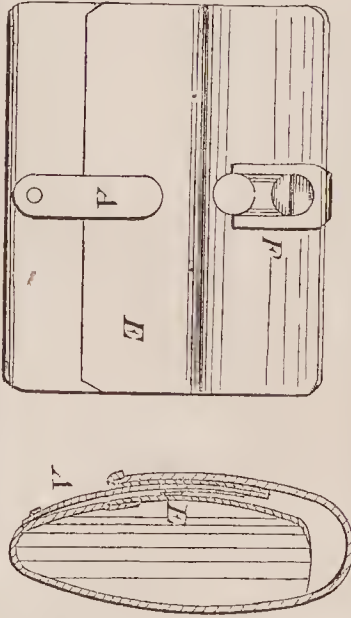

71154—D. E. Fisk—Pocket Book Clasp.

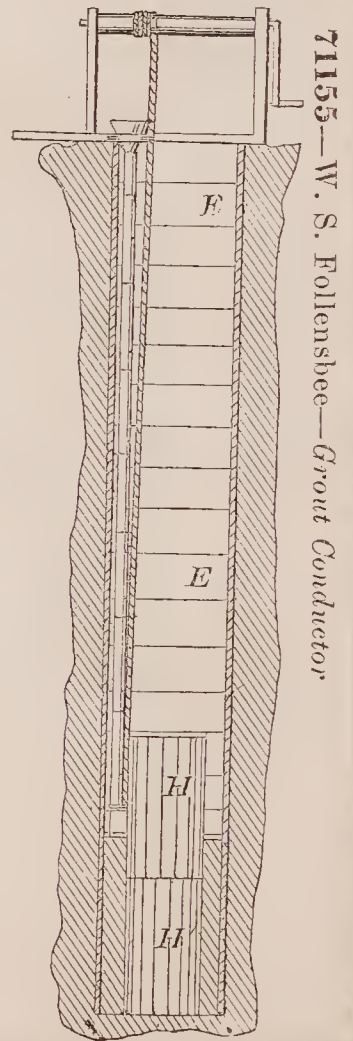

71155—W. S. Follensbee—Grout Conductor.

71153—W. Fields—Propeller.

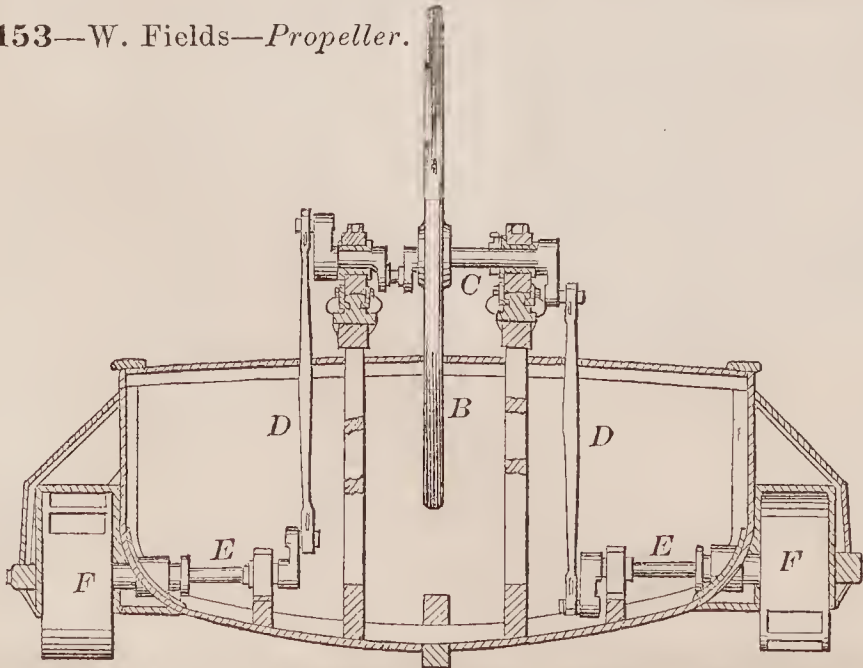

71156—A. Foubert—*For Distilling.*

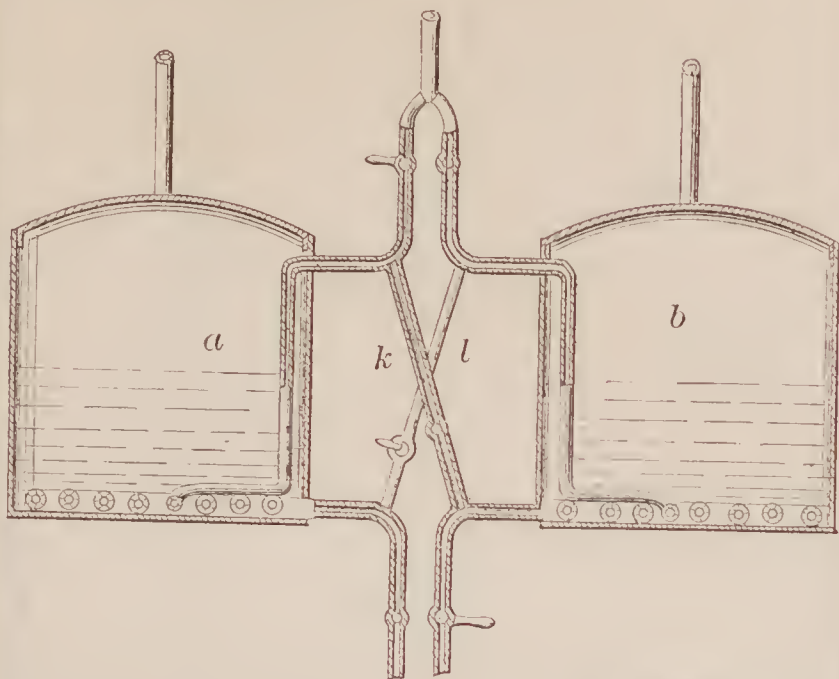

71157—W. L. Gallaudet—*Thread Cutter.*

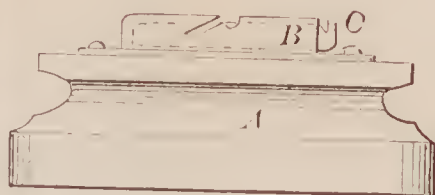

71158—S. Gardiner, Jr.—*Electric Switch.*

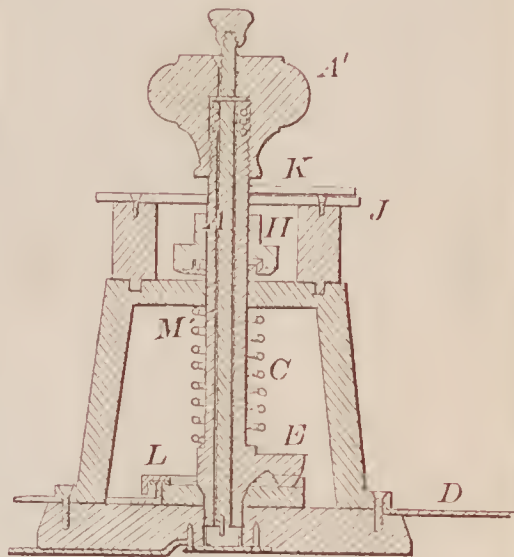

71159—E. Garfield—*Steam Engine.*

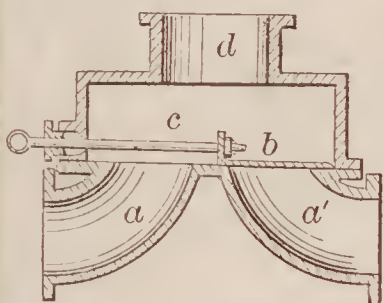

71161—C. P. Gorley—*Candlestick.*



71160—J. E. Gillespie—*Motive Power Regulator.*

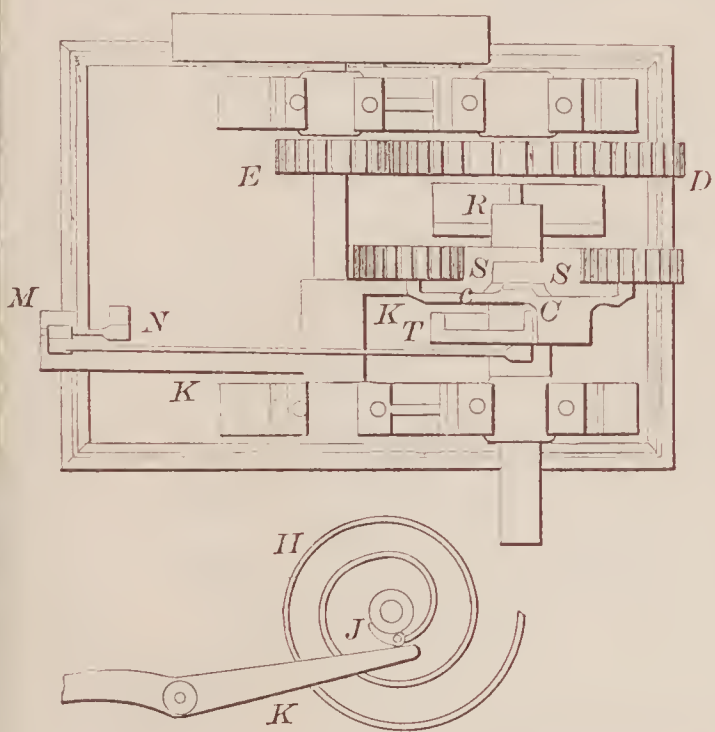

71163—E. M. Hamilton—*For Pressing Peat, Clay, &c.*

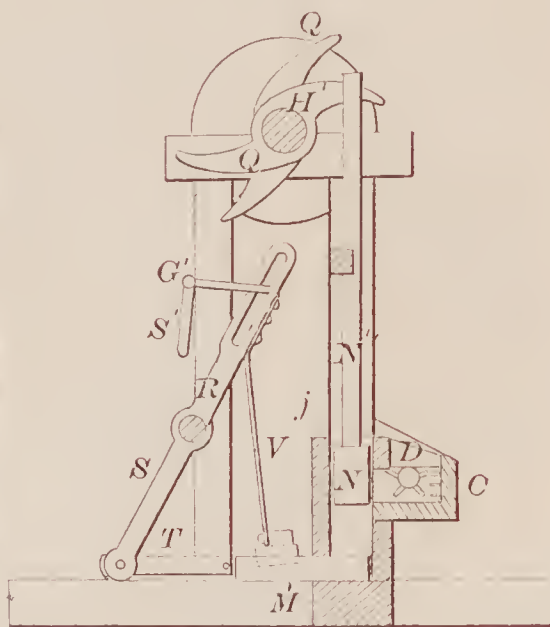

71162—J. Hall—*Toy Pistol.*

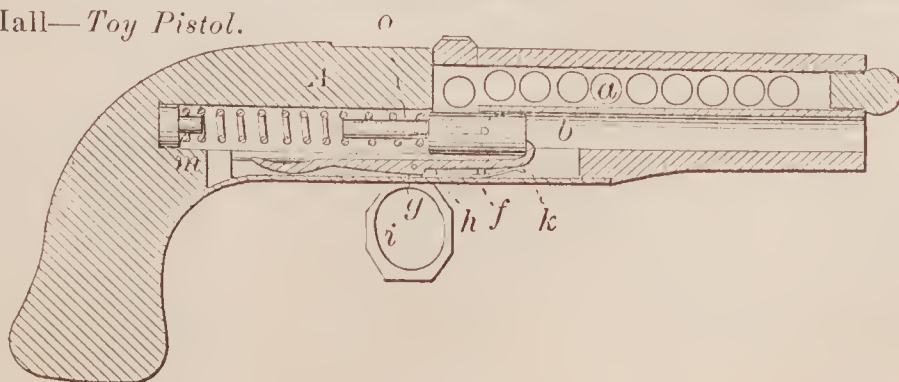



71164—D. S. Harner—Harvester.

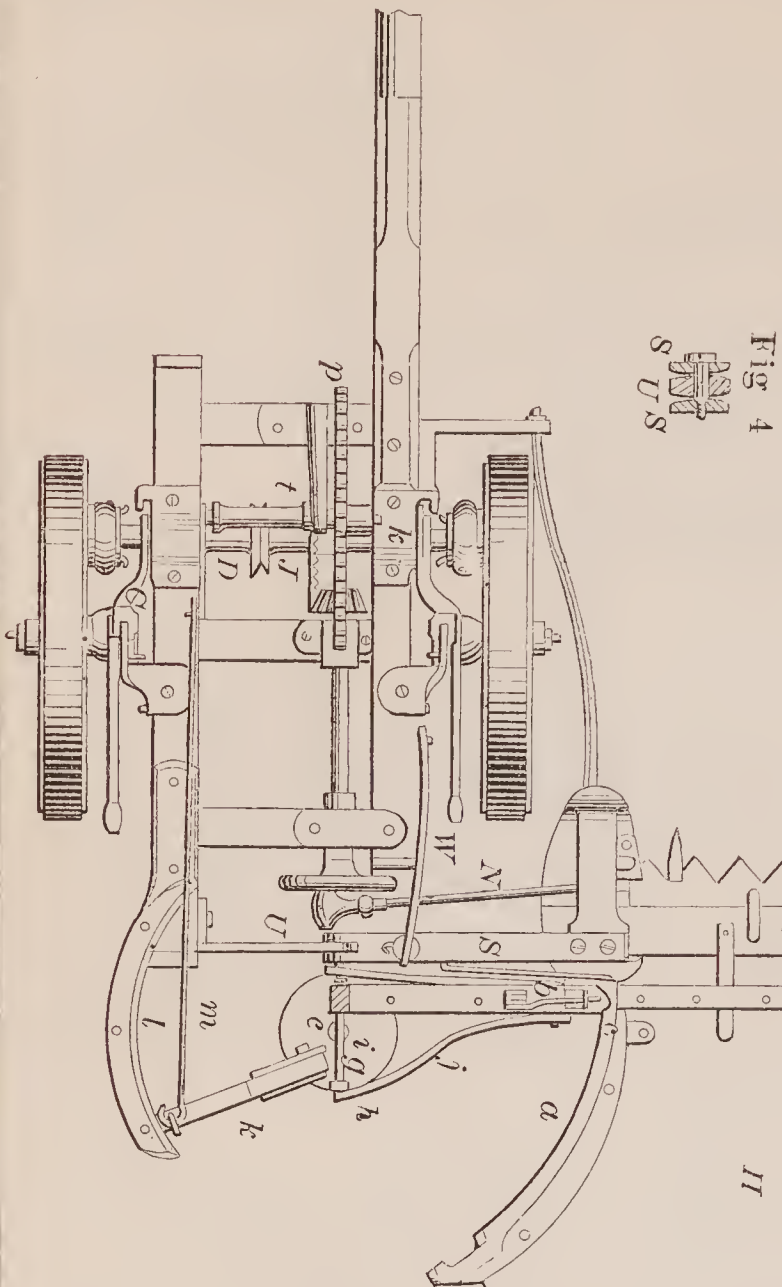
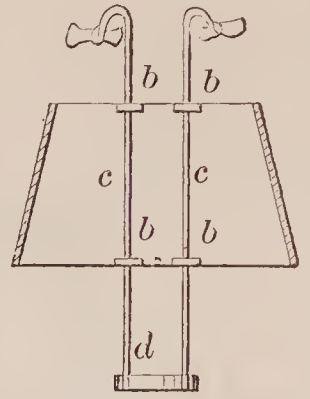
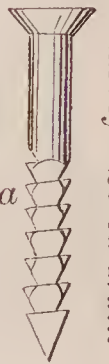

Fig. 4

71168—E. K. Haynes—Lamp Shade.



71166—H. A. Harvey—Screw Nail.



71165—J. H. Harper—Cider Press.

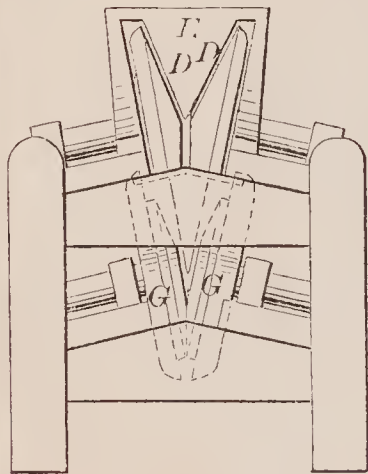

71169—E. S. Hayward—Bed Spring.

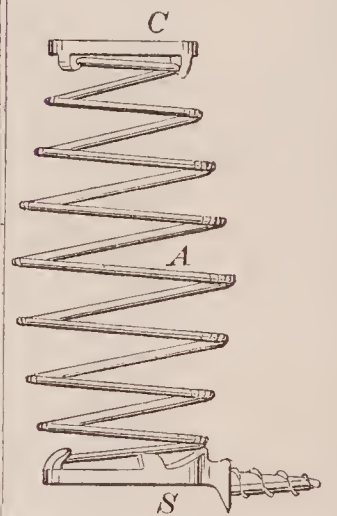

71167—I. J. Hattabough—Horse Hay Fork.

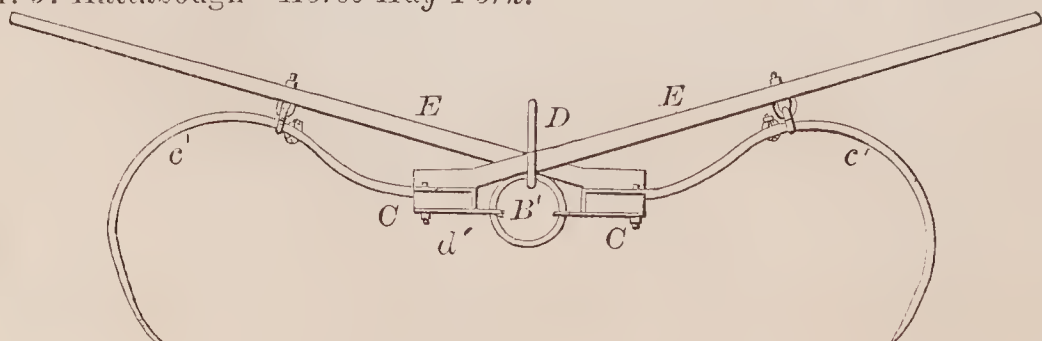

71171—T. Henney—Hot Air Stove.

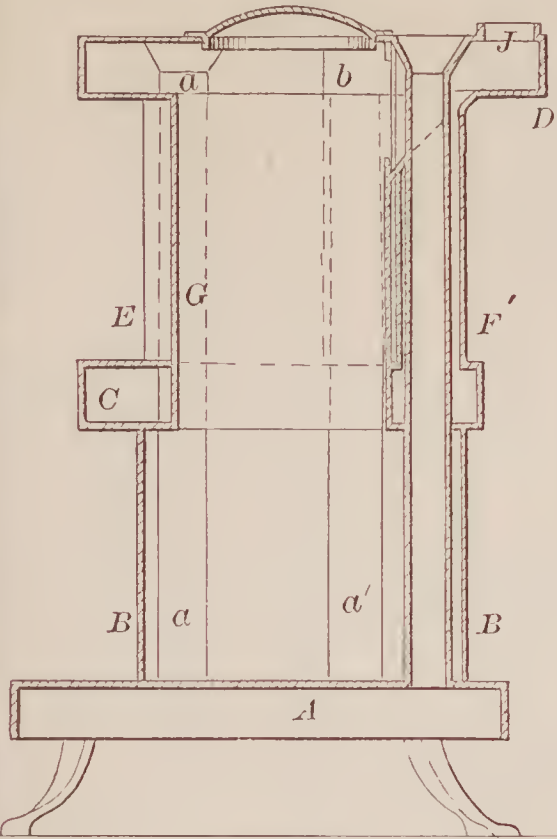

71175—Howard & Bousfield—Harvester.

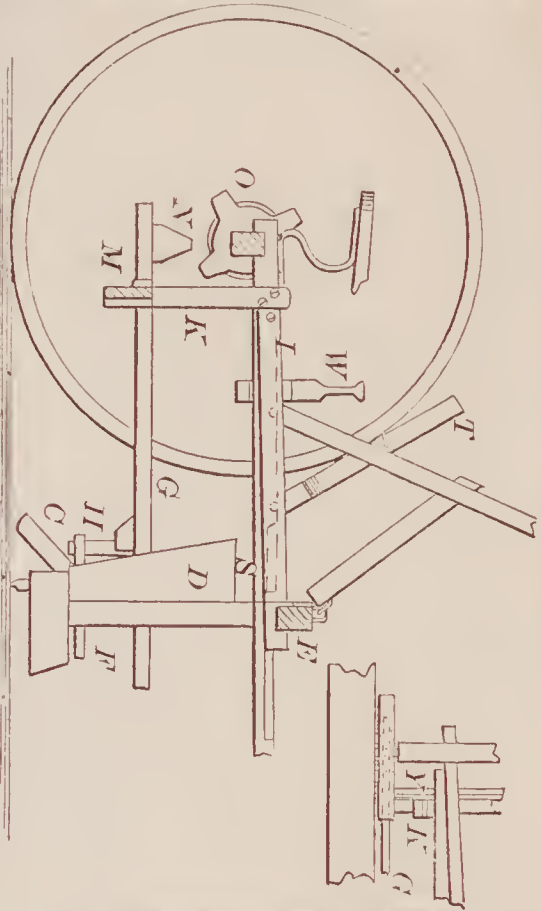
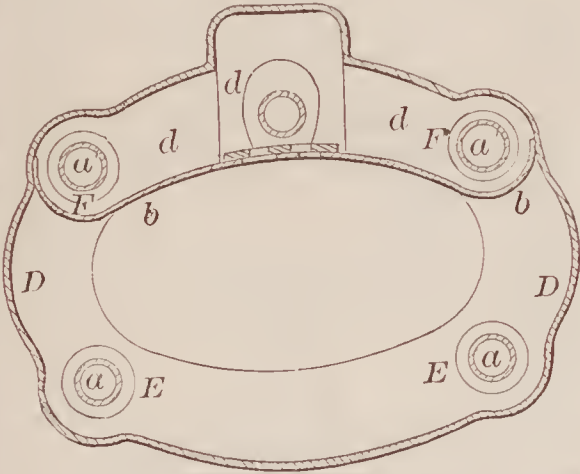
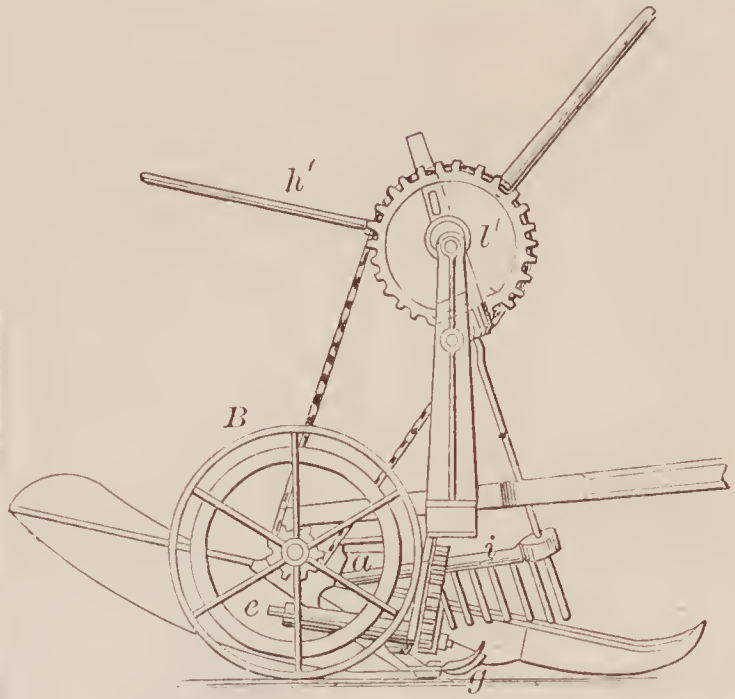

71172—Hitchcock & Deyo—Corn Planter.

71173—L. Hoszek—Ventilating Apparatus.

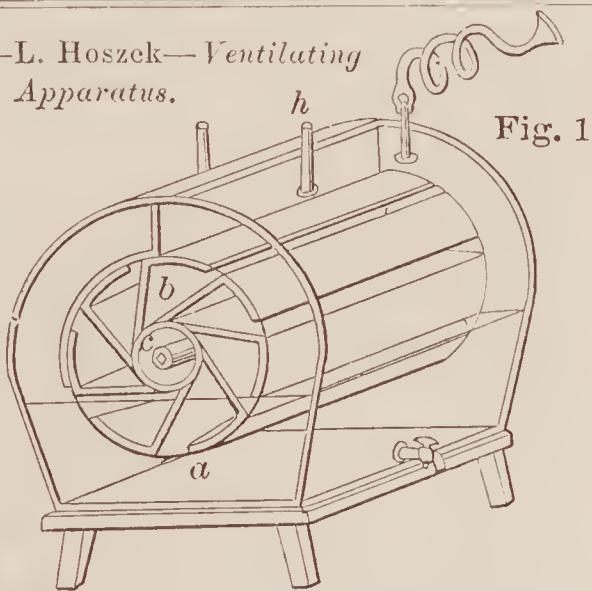

Fig. 1

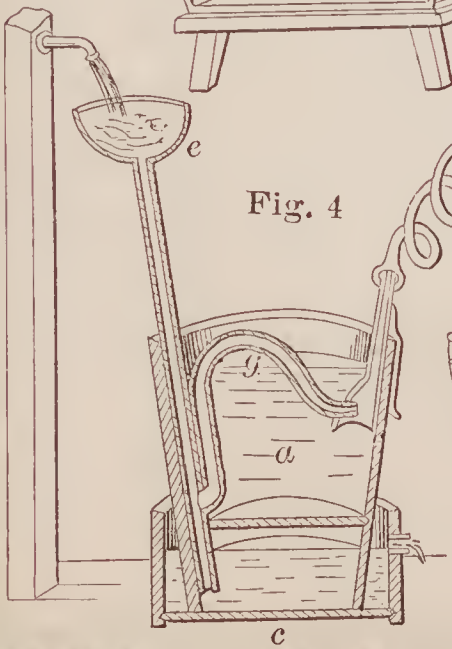

Fig. 4

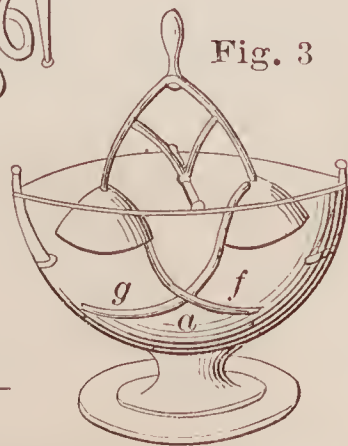
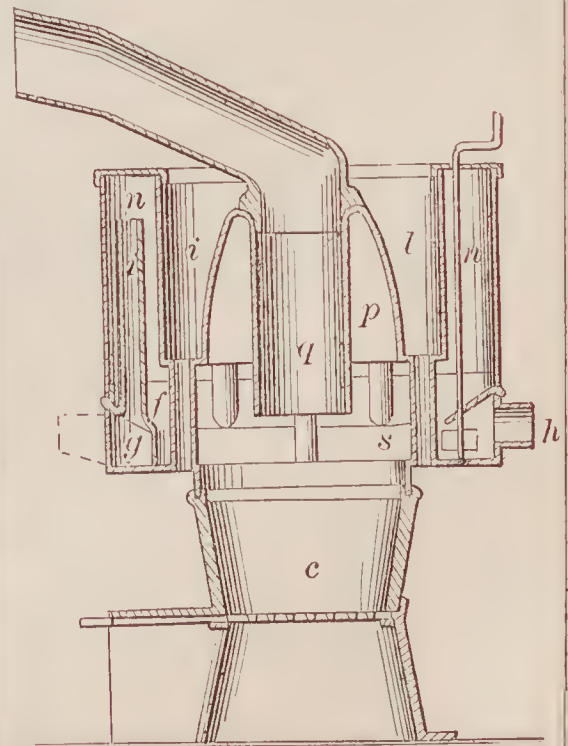

Fig. 3

71176—M. C. Hull—Heating Stove.





71177—W. H. Hutchins—*Potato Digger.*

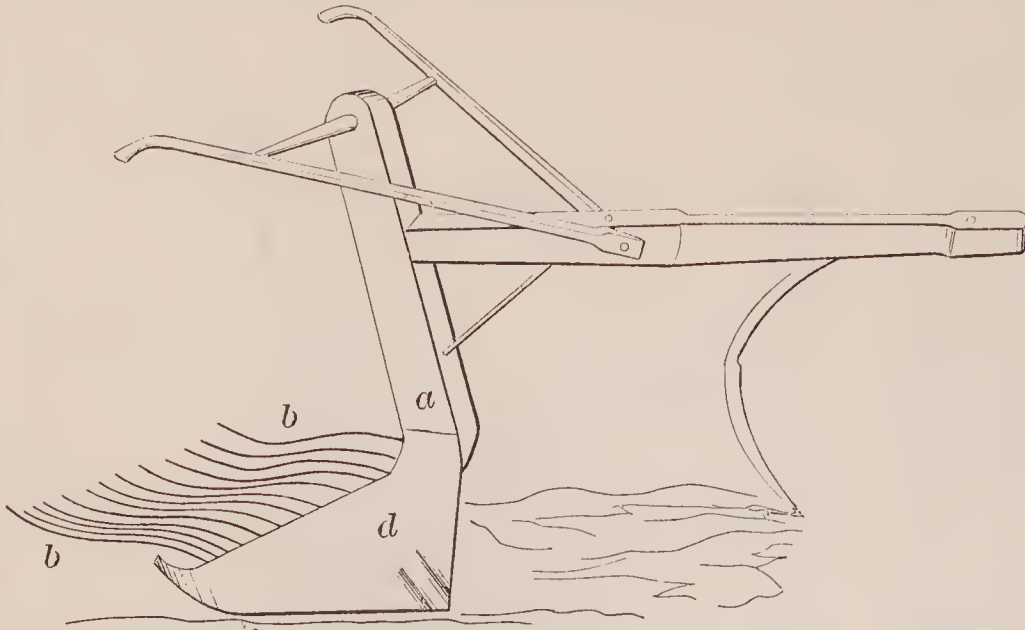

71178—M. G. Imbach—*Calipers or Dividers.*

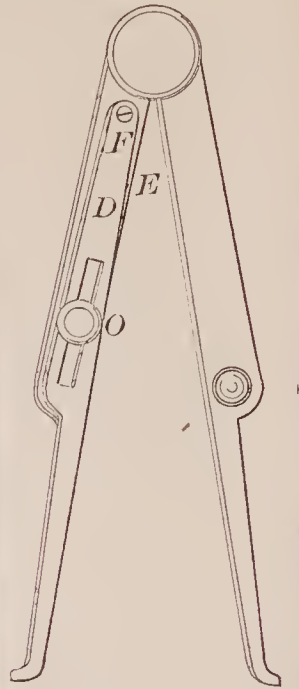

71179—G. W. Jackson—*Platform Scale.*

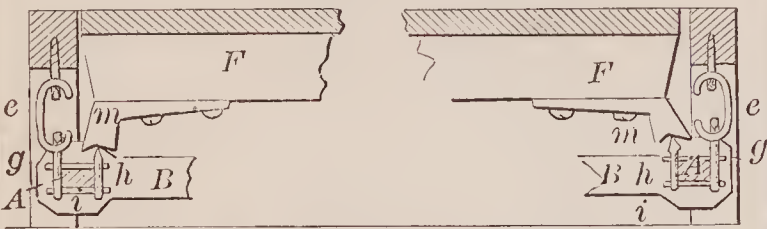

71182—M. W. Kilgore—*Churn.*

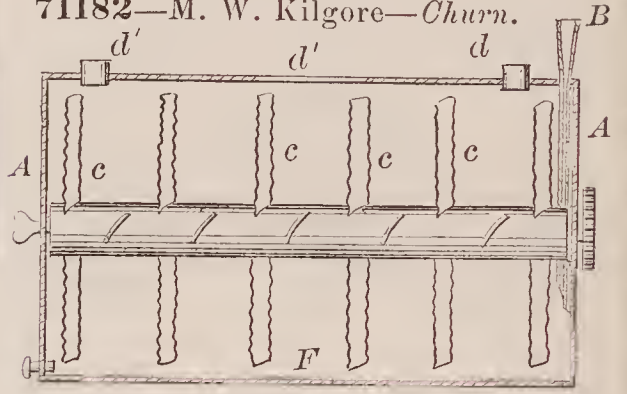

71181—A. A. Kent—*For Cutting, Punching and Upsetting.*

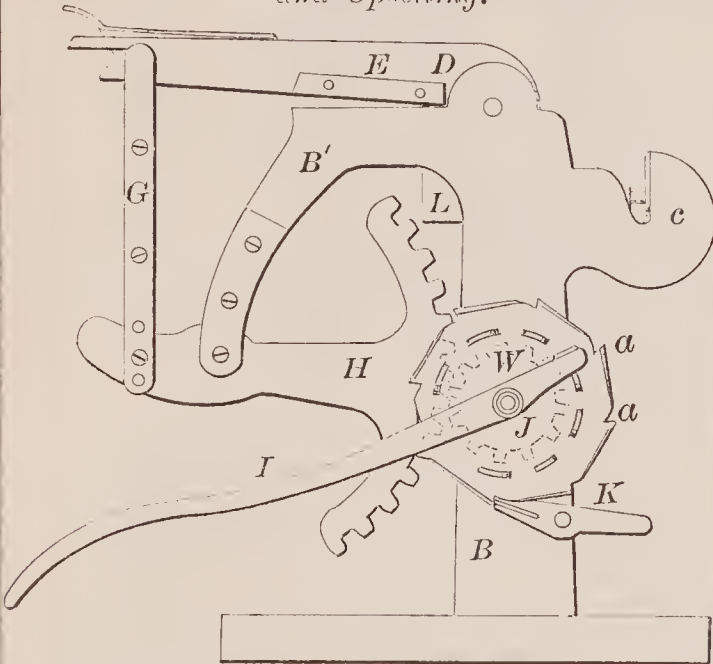

71180—E. C. C. Kellogg—*Burglar Alarm.*

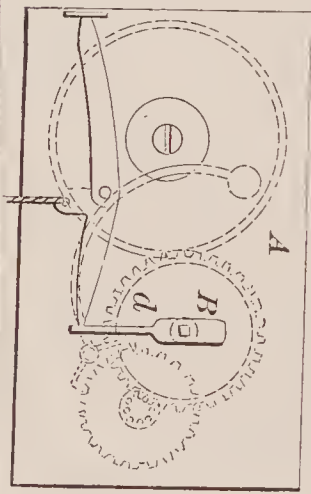

71183—T. J. Kindleberger—*Lever Jack.*

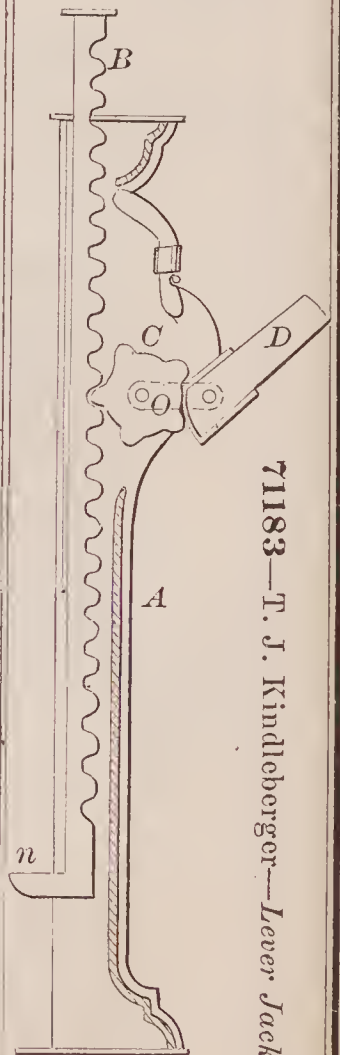

71185—B. J. La Mothe—*Construction of Buildings.*

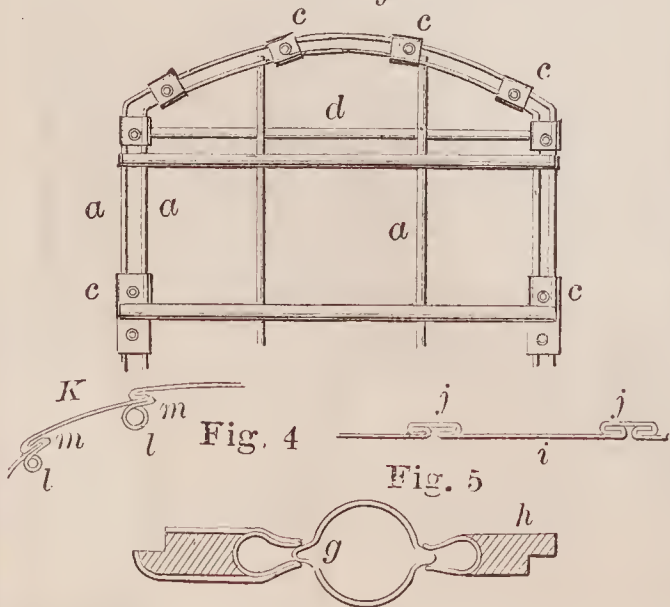

71184—H. W. Knight—*Attaching Picks to Handles.*

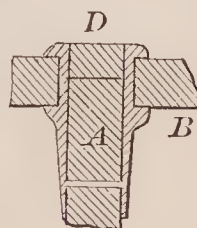







71203—G. R. Moore—*Car Coupling*

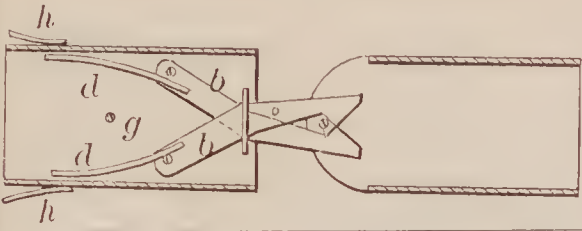

71204—Müller & Kaiser—*Flutina Melodeon.*

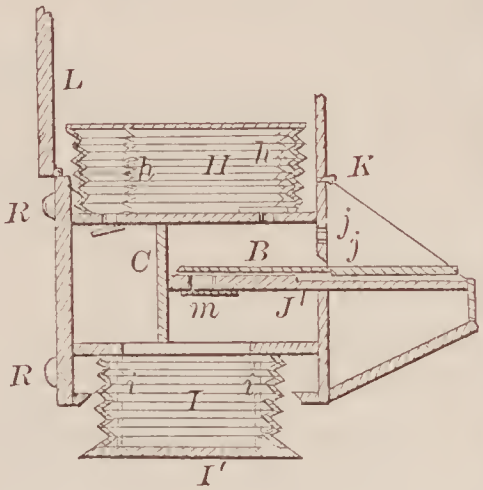
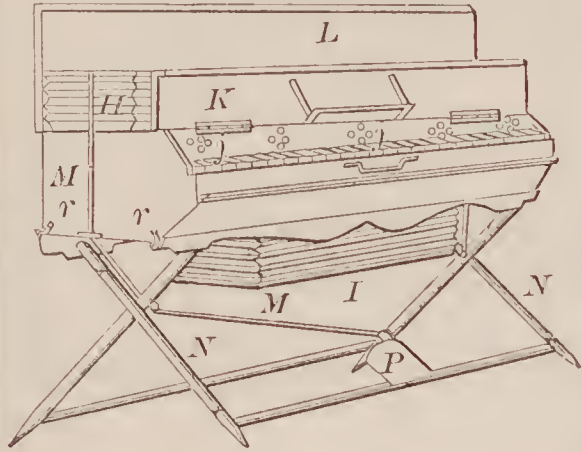

71206—H. Ogborn—*Animal Trap.*

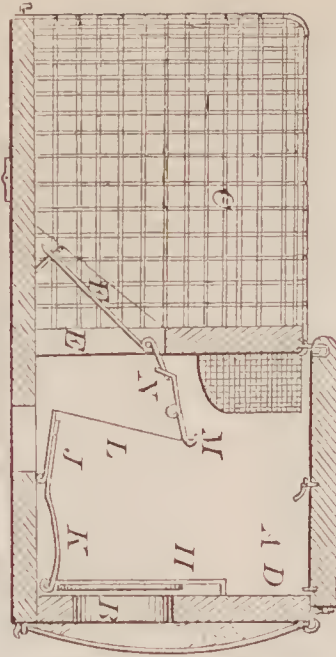

71211—F. B. Perry—*Pocket Outtery.*



71208—F. Ortlieb—*Rotary Engine.*

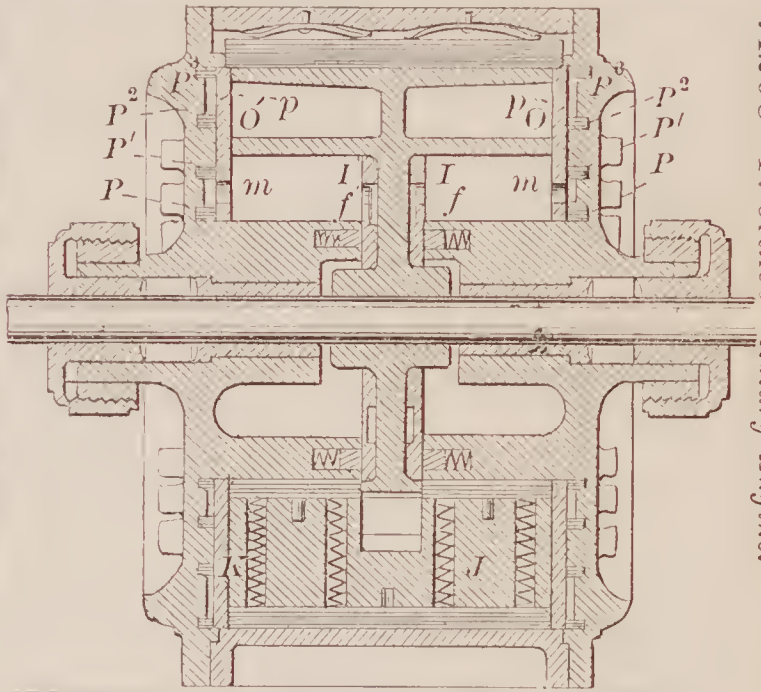

71209—A. Palmer—*Home Fastener.*

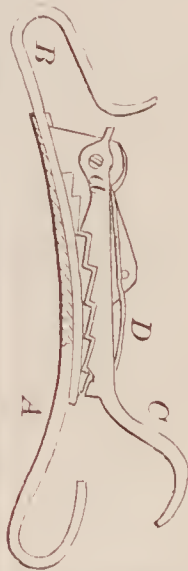

71205—O. Nicour—*Photographic Apparatus.*

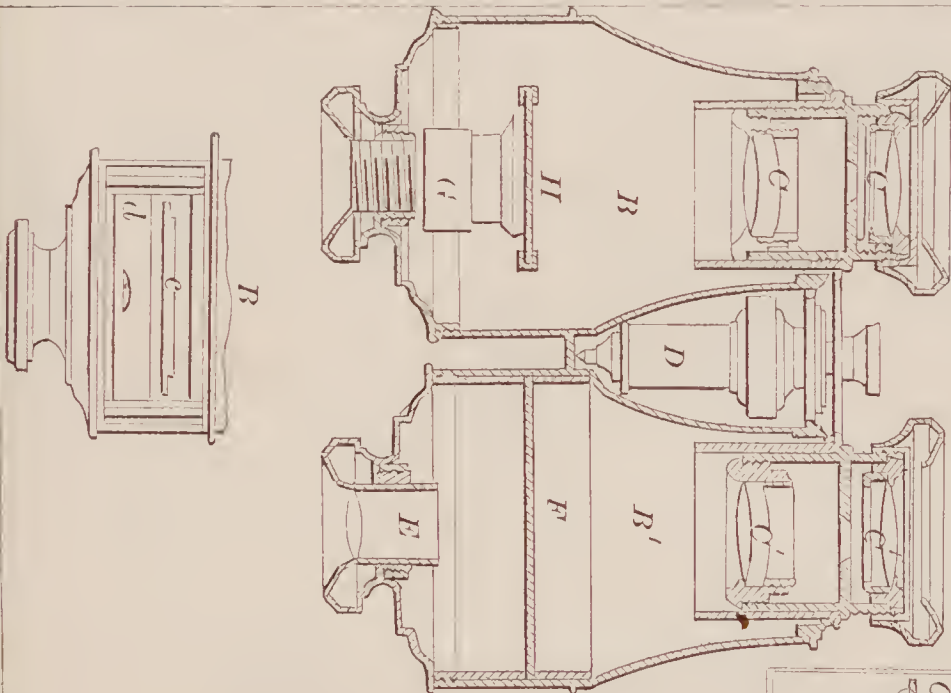

71207—C. Olhaber—*Water Boiler for Cooking Stores.*

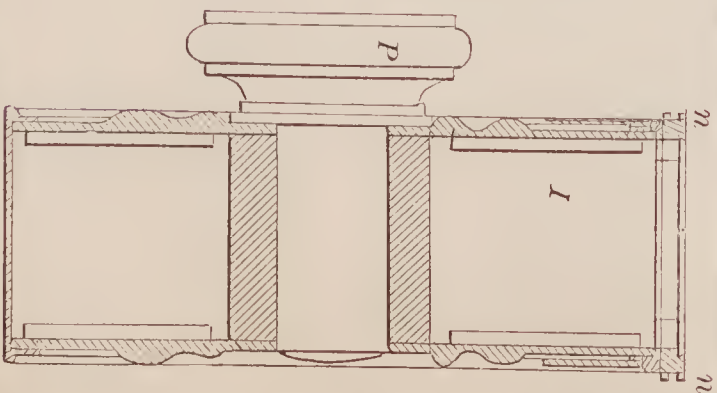
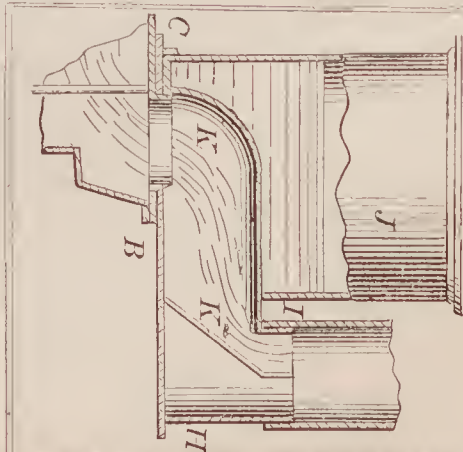



71212—E. S. Pierce—Balance Wheel.

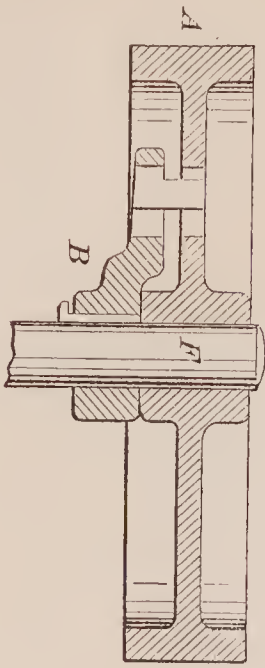

71214—H. B. Porter—Hotel Annunciator.

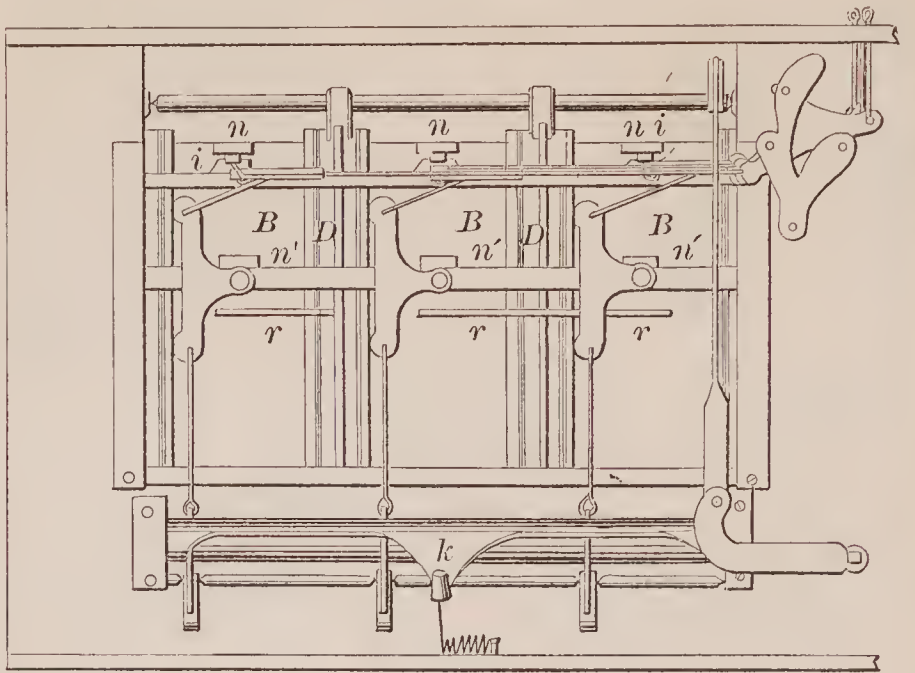

71216—J. H. Reighard—Glass Mould.

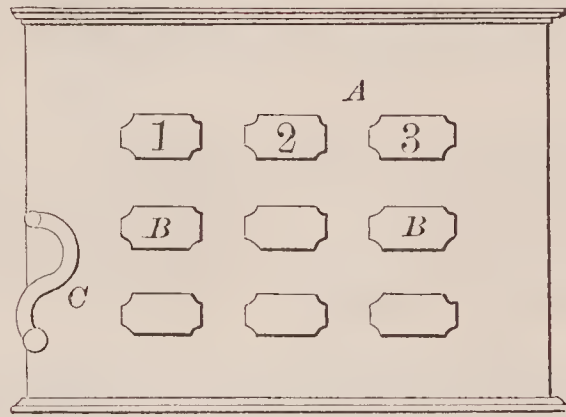
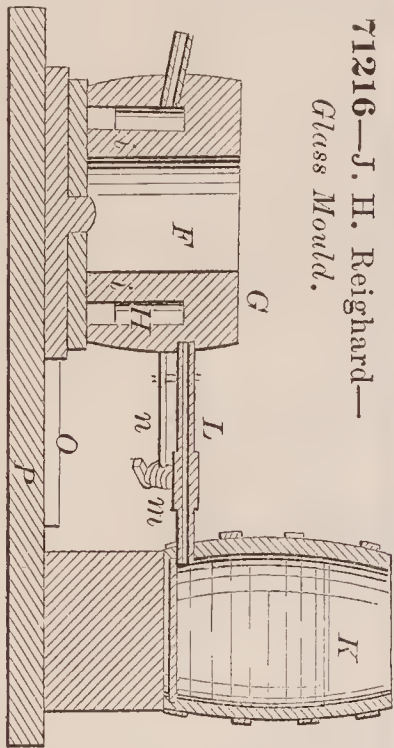

71215—G. M. Ramsay—Air Tight Jar.

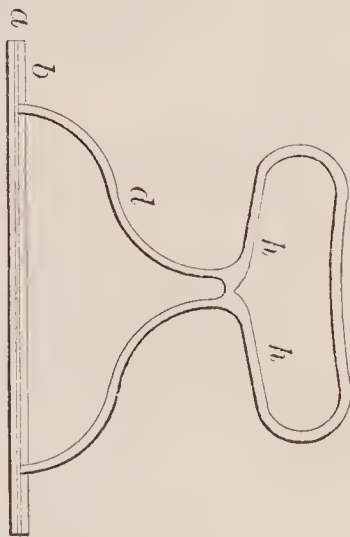
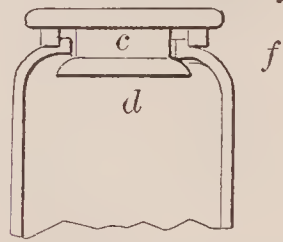

71217—F. H. Richards—Brand for Marking Animals.

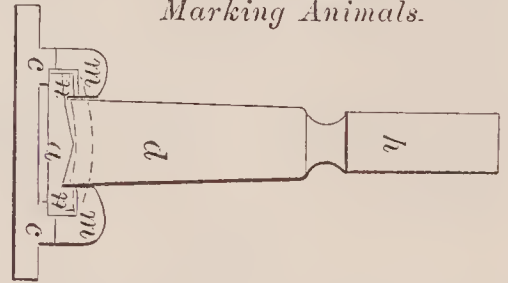

71219—S. S. Ritter—Trunk.

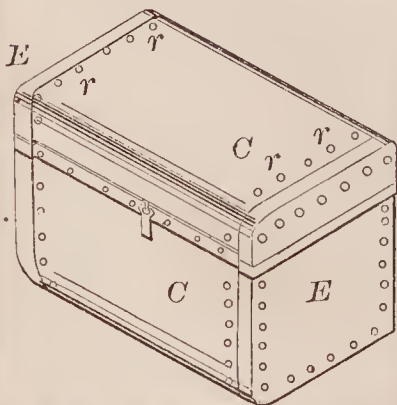
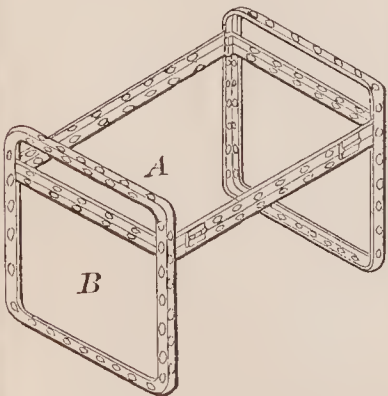

71218—E. S. Ritchie—Air Pump.

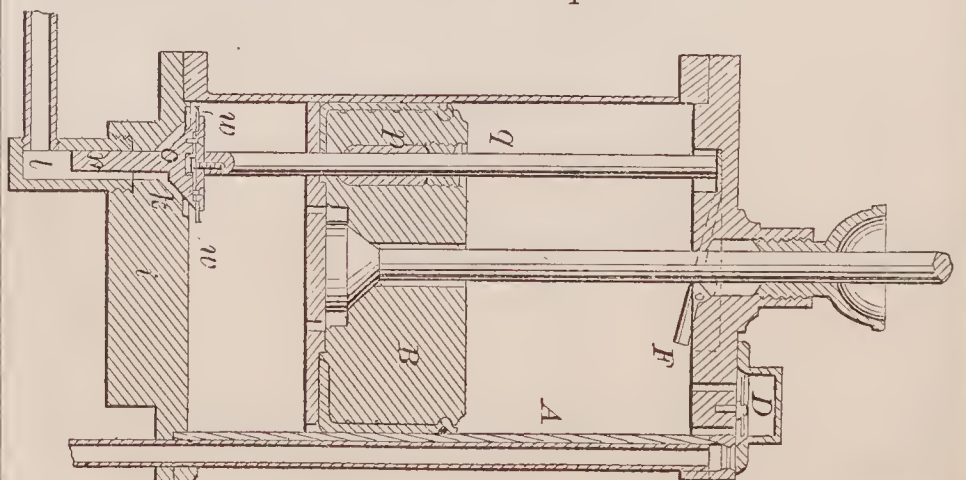

71220—J. Rohr—Baby Walker.

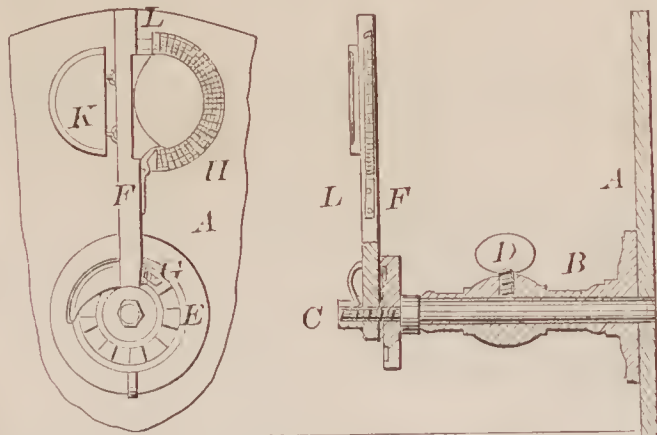

71224—C. H. S. Schultz—Fire Fender or Guard.

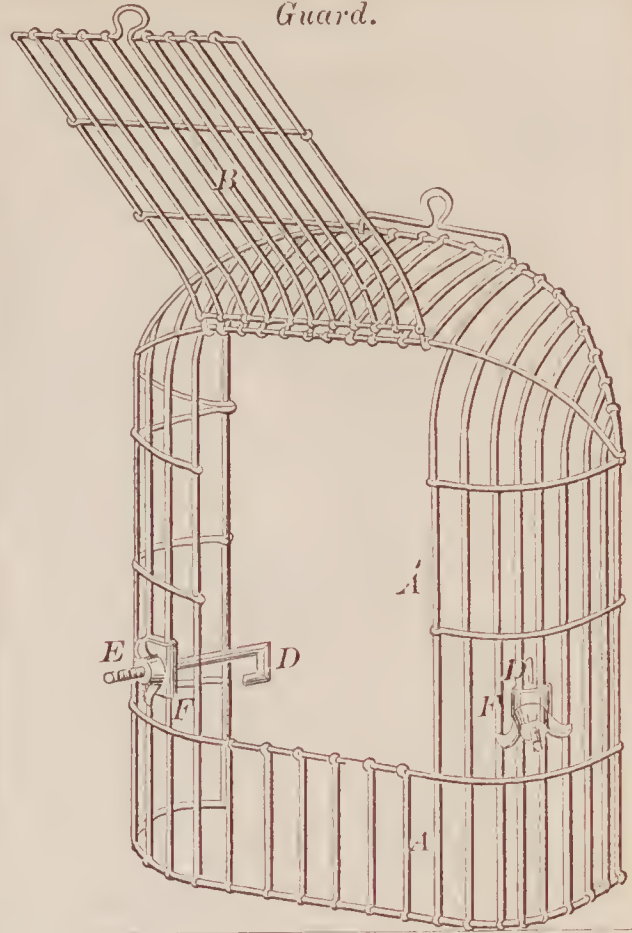

71223—E. A. G. Roulstone—Trunk.

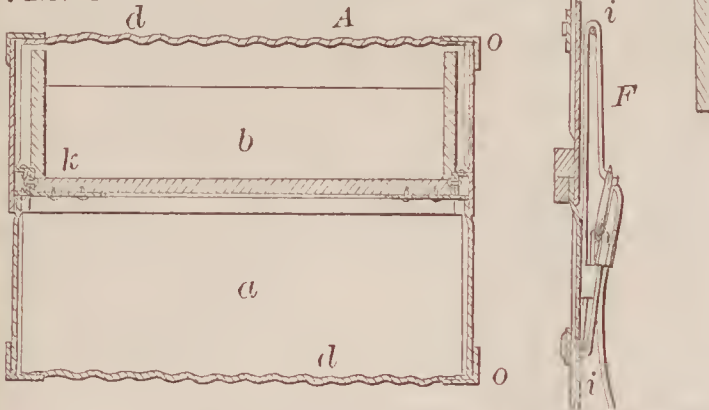

71222—J. C. Rohrman—Conductor Pipe.

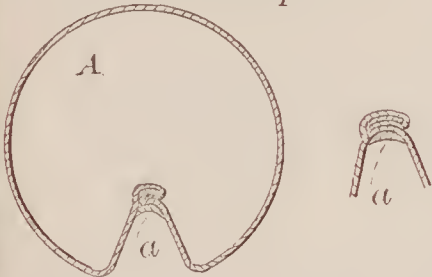

71225—Scott & Burdge—Bed Bottom.

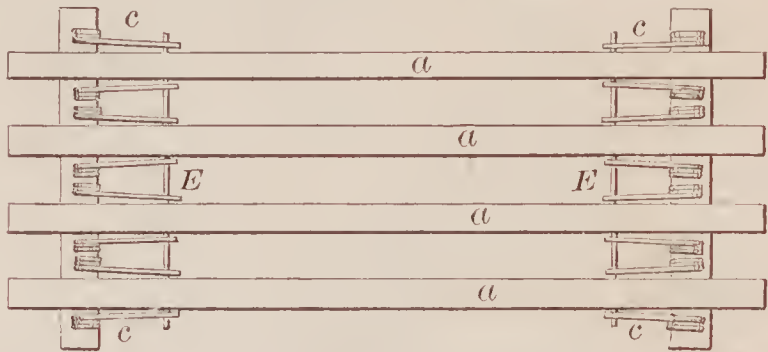

71226—Scott, Scott & Miller—Coal Scuttle.

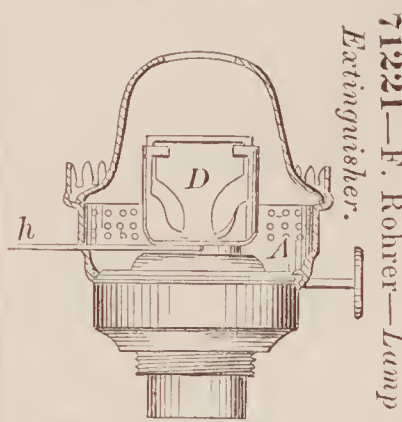
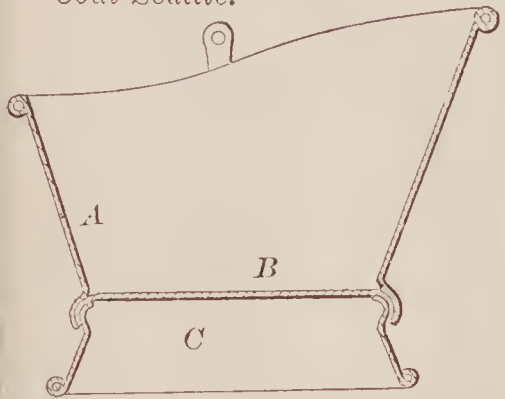

71221—F. Rohrer—Lamp Extinguisher.

71227—A. M. Seabury—Cross Cut Saw.

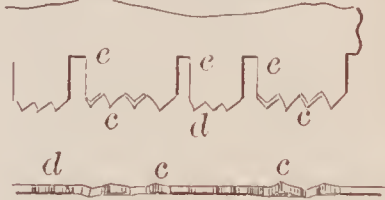

71232—J. Shepard—Kite Frame.

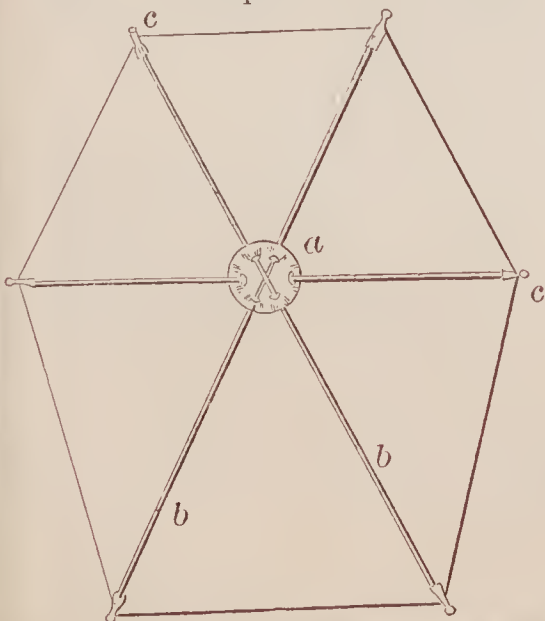

71228—A. Searls—Carriage Top Prop.

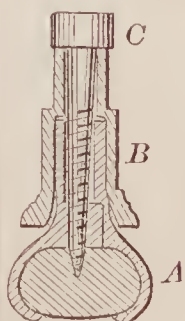

71231—J. Shelley—For Mixing Mortar.

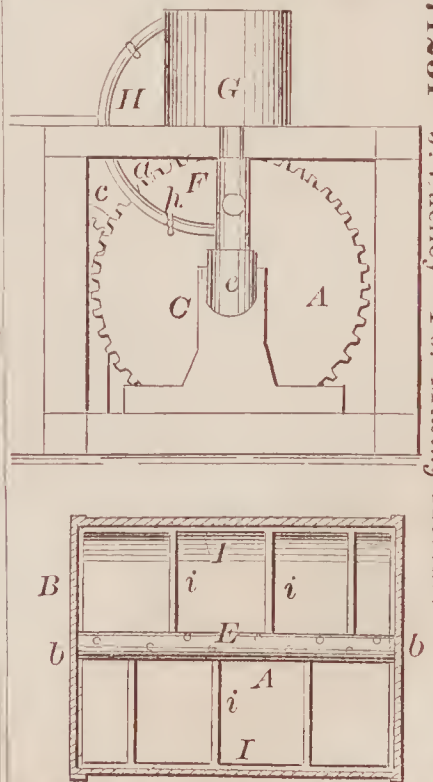



71234—A. Shunk, Sr.—Plow.

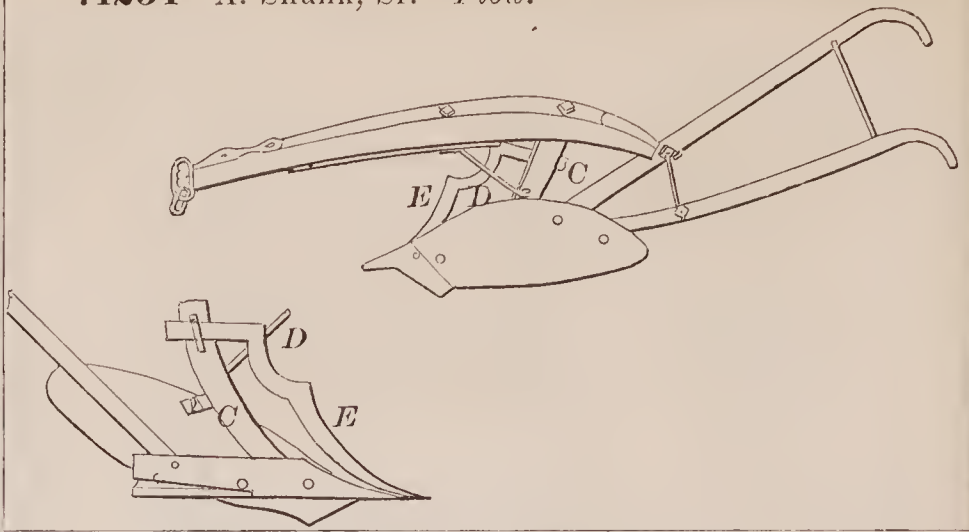

71233—J. Shoemaker—Manufacturing Gas.

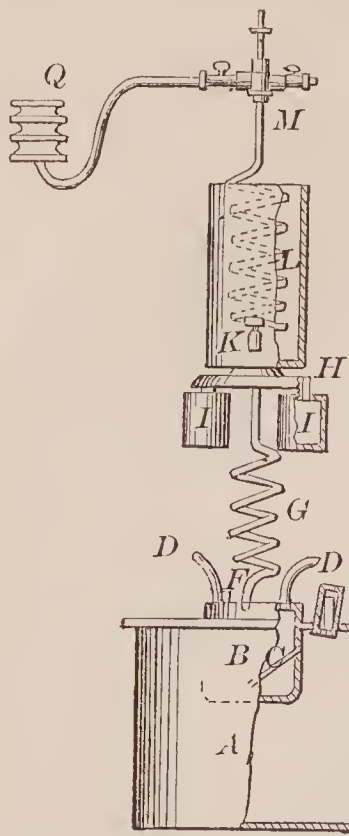

71235—Shloss, Veerkamp & Leopold—Key Hole Guard for Door Locks.

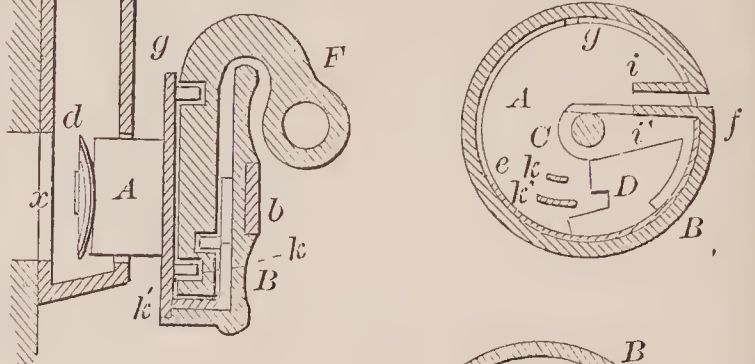

71238—L. S. Smith—Broom Head.

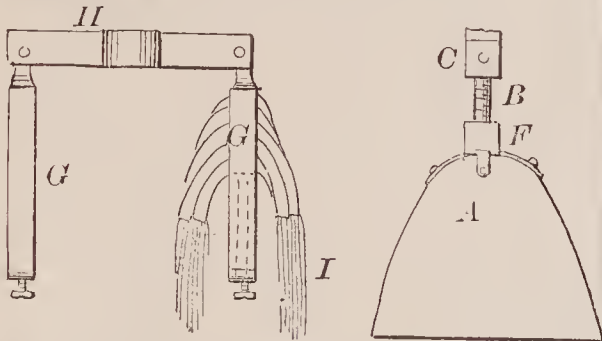

71239—C. F. Spencer—Sealing Fruit Cans.

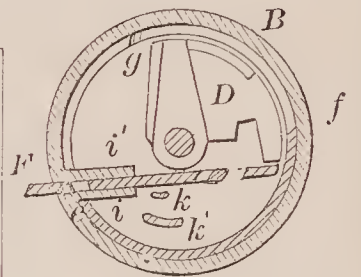
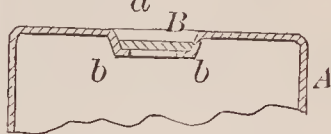

71240—S. J. Spencer—Vehicle.

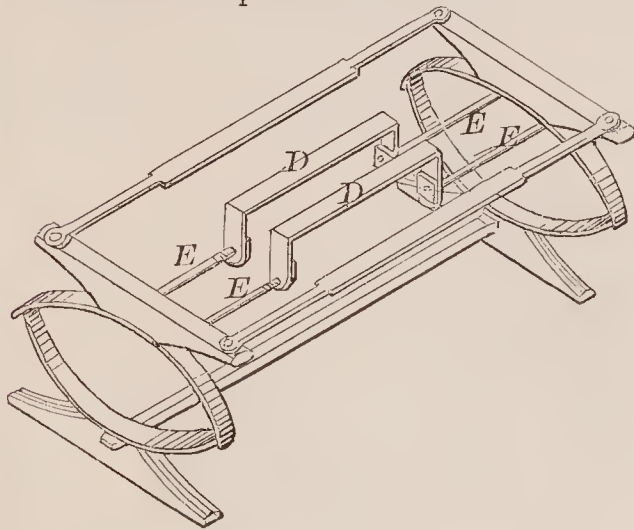

71236—J. B. Smith—Coffee Pot.

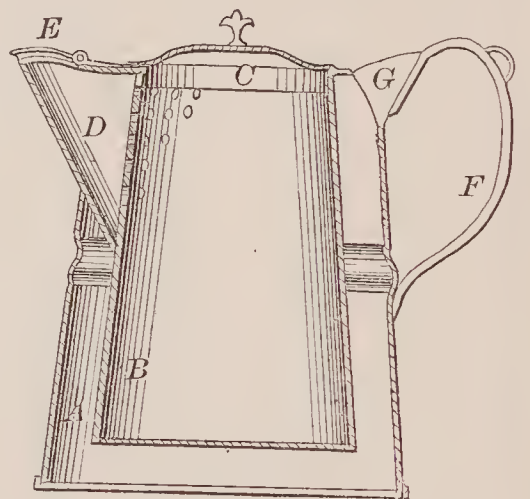

71237—J. B. Smith—Coffee Pot.

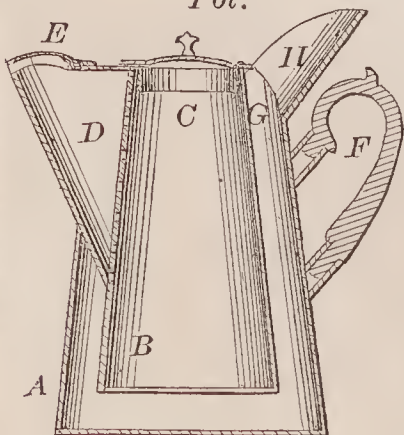

71243—W. Swathel—For Heading Bolts.

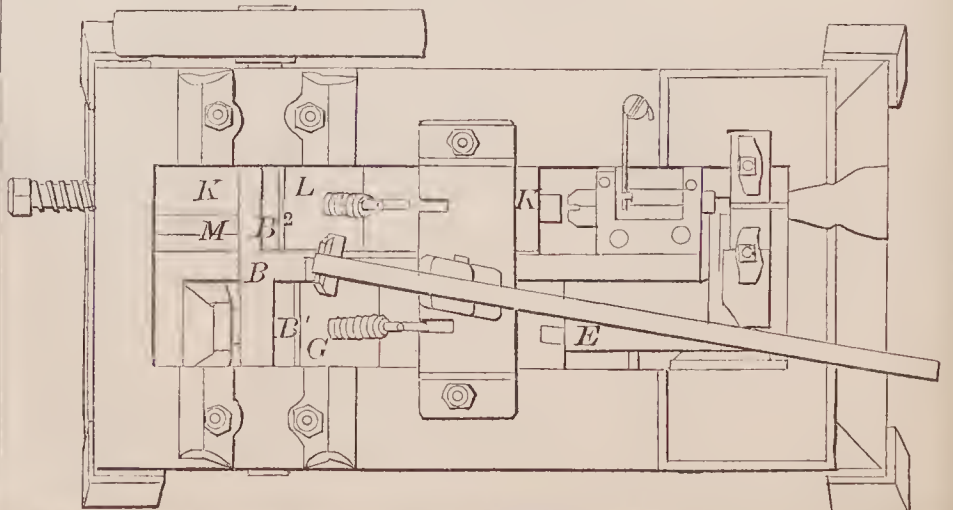

71244—J. M. Thatcher—*Air Heating Furnace.*

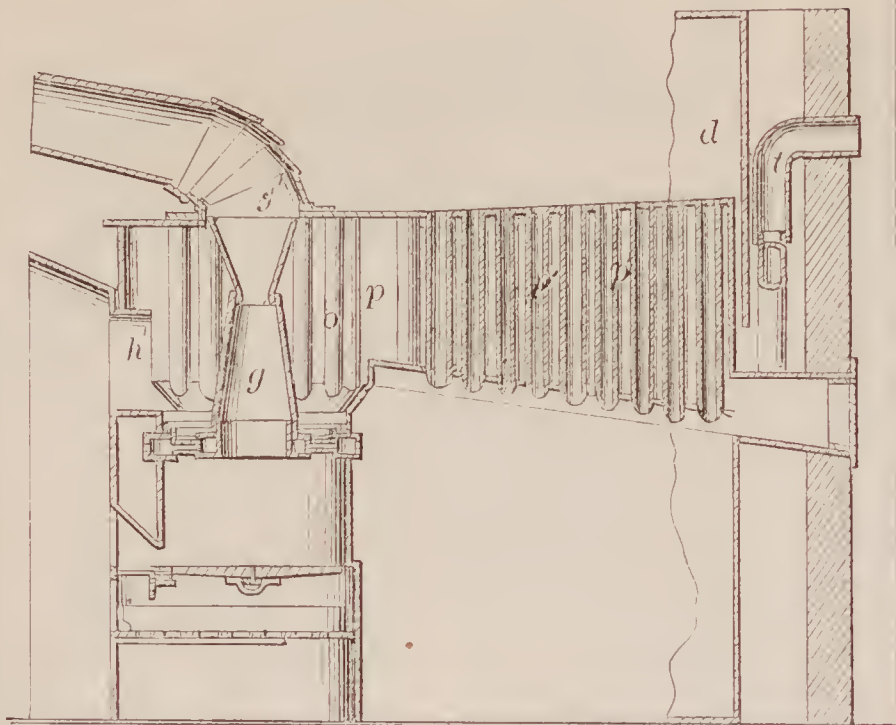

71246—J. Thompson—*Abdominal Supporter.*

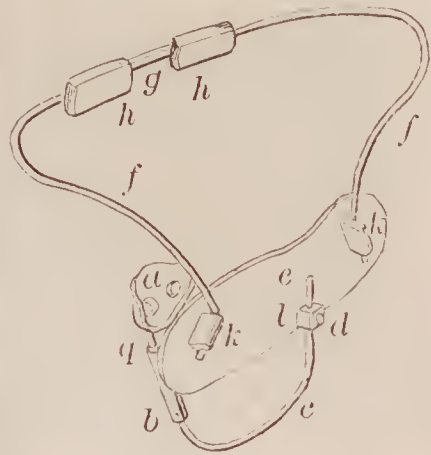

71248—C. N. Tyler—*Lamp.*

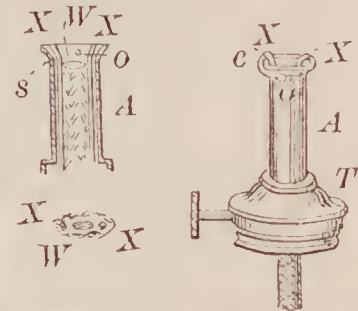

71245—E. H. Thomas, Jr.—*Organ Bellows.*

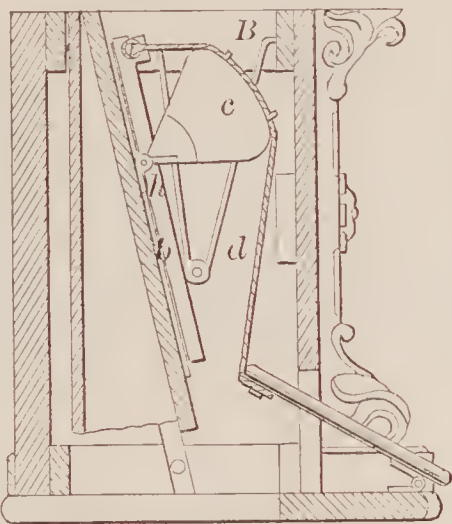

71249—P. Vonlaekum—*Snow Plow.*

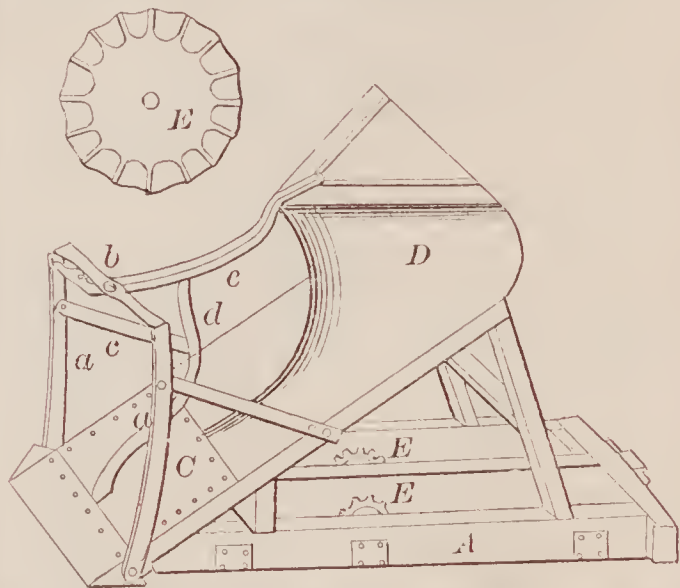

71250—A. Vose—*Hay Loader.*

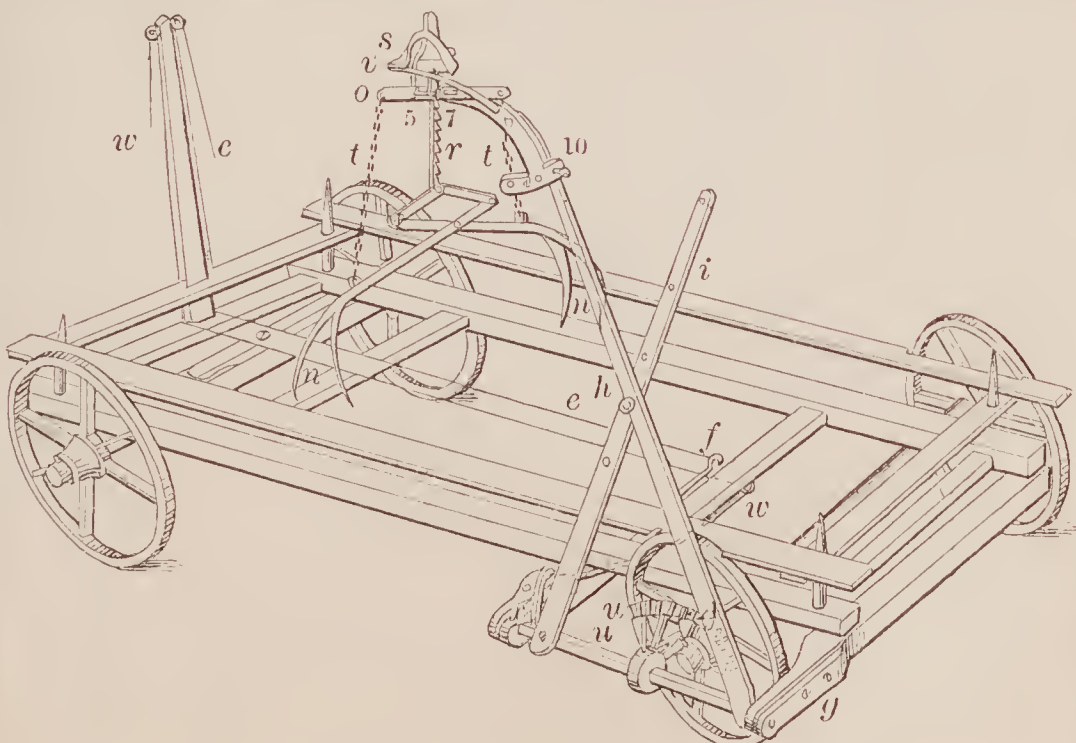

71247—S. A. Traugh—*Car Wheel.*





71251—R. L. Walker—Water Grate for  
for Furnaces.

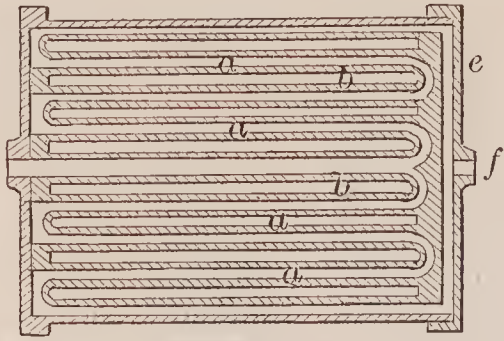

71257—W. A. Wood—Harvester Guard Finger.

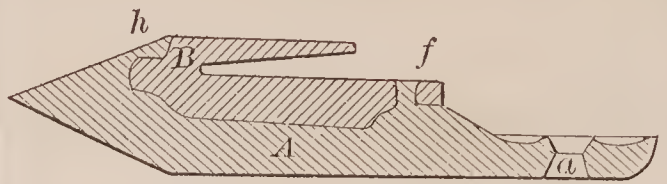

71252—T. V. Waymouth—Envelope  
Machine.

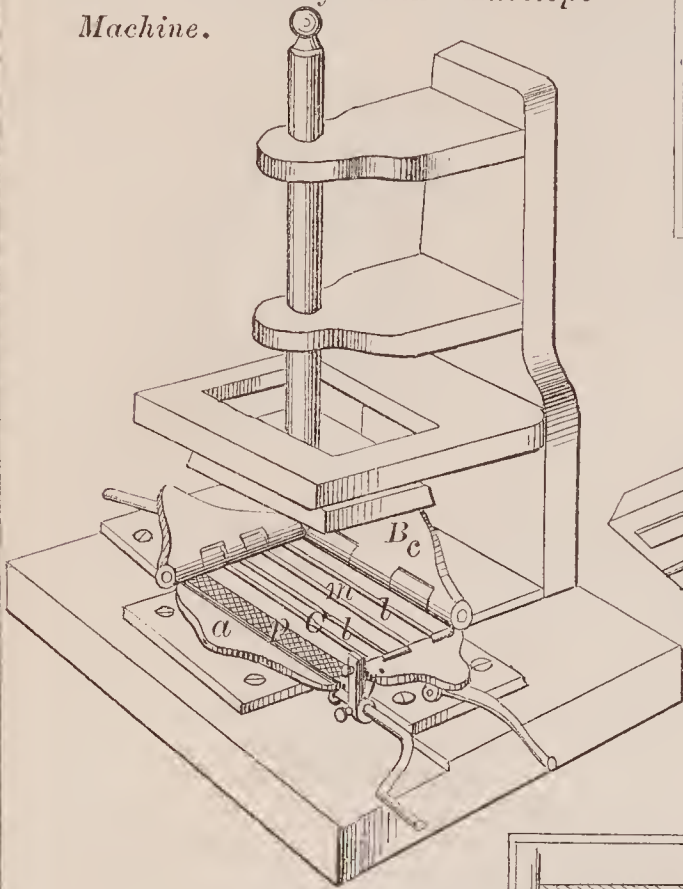

71253—M. D. Wellman—Grate.

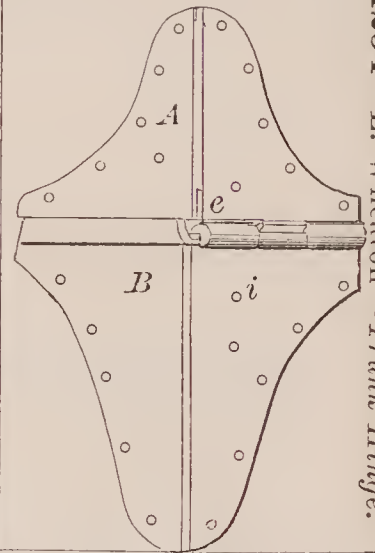
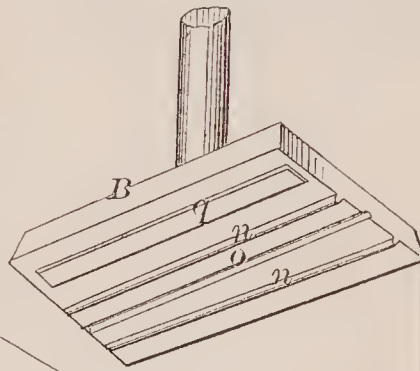
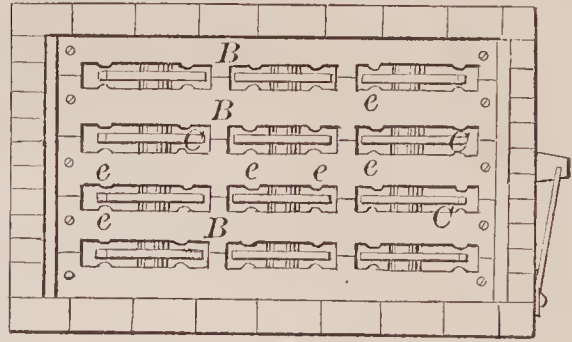

71254—L. Wheaton—Trunk Hinge.

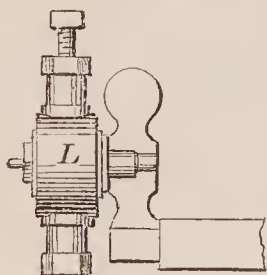

71255—W. N. Whiteley—Harvester.

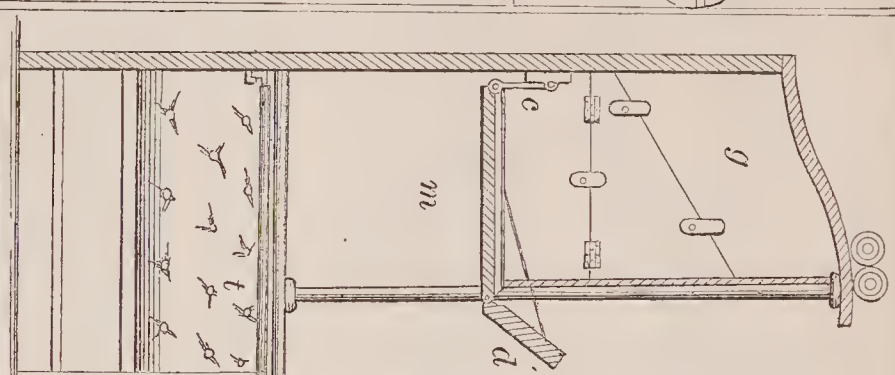
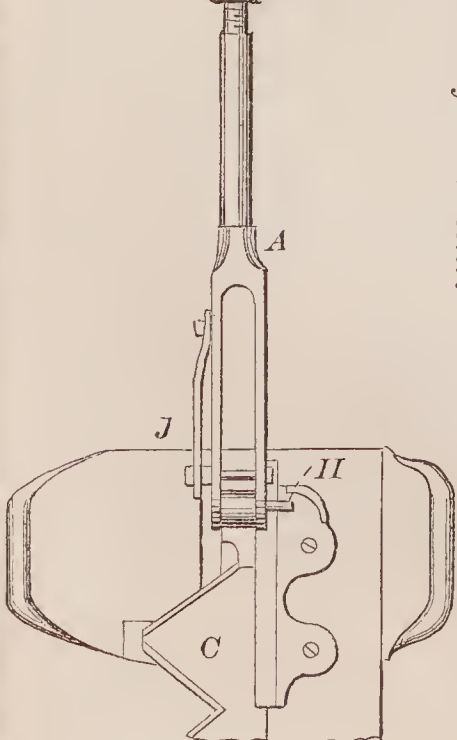

71258—J. Woodruff—Sleeping Car.

71259—J. Yeager—For Cutting and Punching Fly Nets.

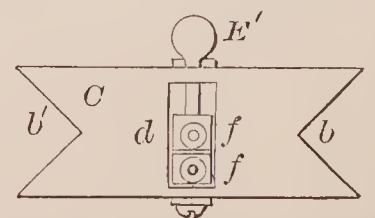
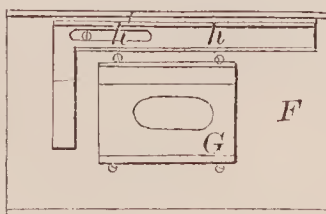
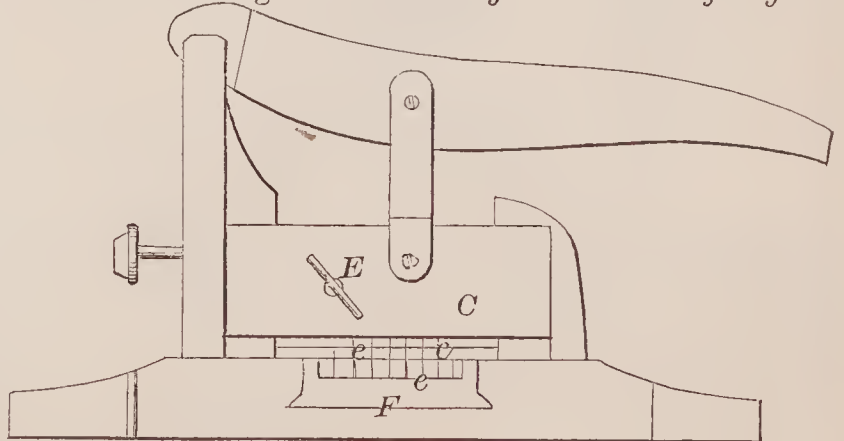

71260—W. Young—Grate, Fireplace and Furnace.

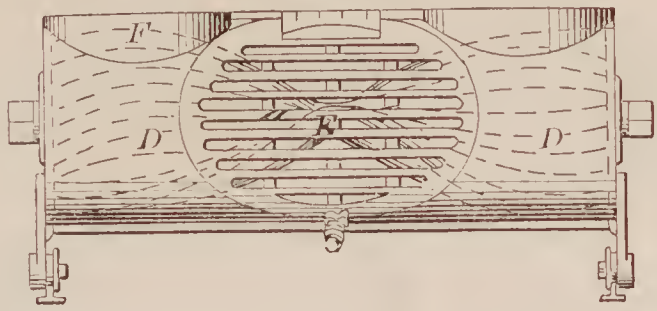

71262—C. L. Ames—Carriage Evener.

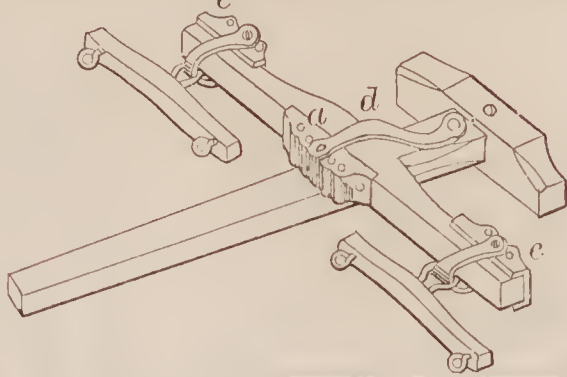

71261—J. B. Alexander—For Attaching Lamp Burners to Lamps.

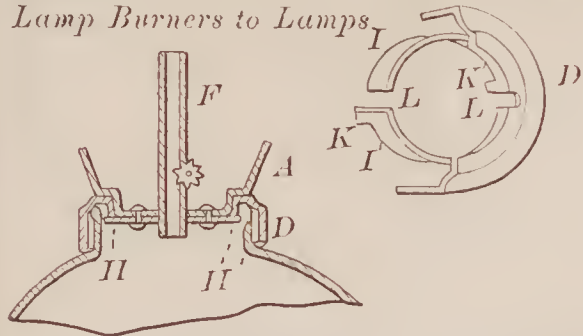

71266—W. G. Bedford—Hose Coupling.

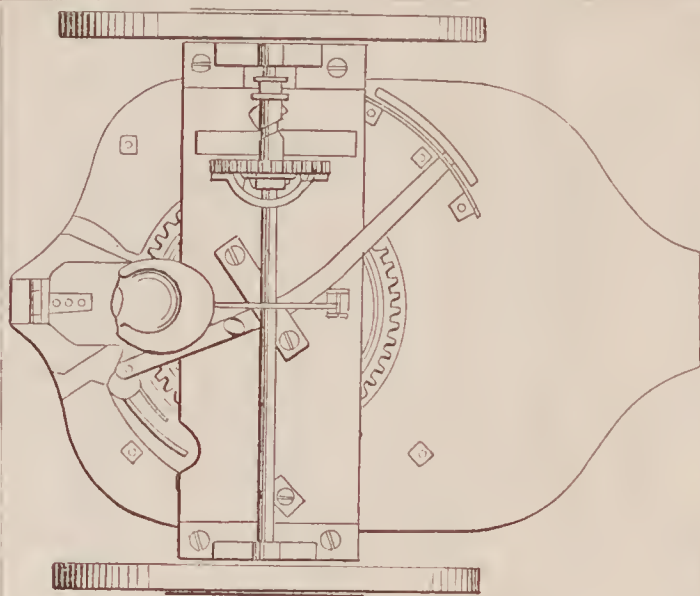
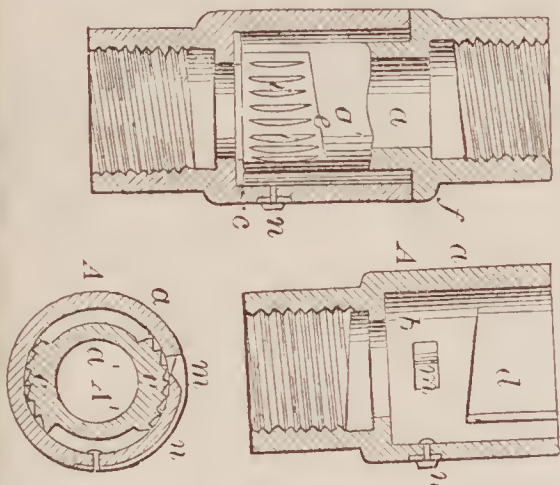

71263—J. Armstrong—For Planting Cotton Seed.

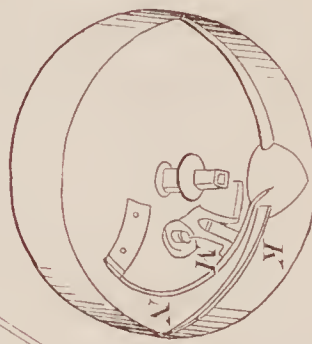

71265—H. L. Beach—Scroll Sawing Machine.

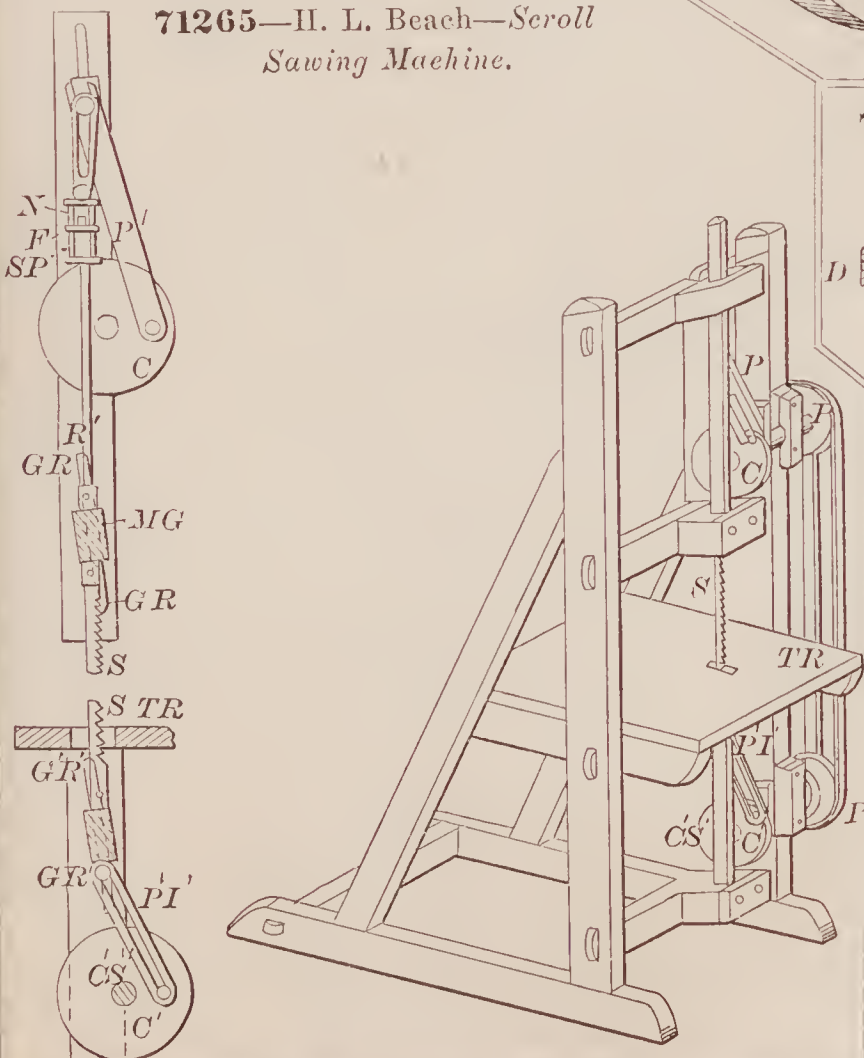

71264—W. D. Baughn—Thimble Skein for Axles.

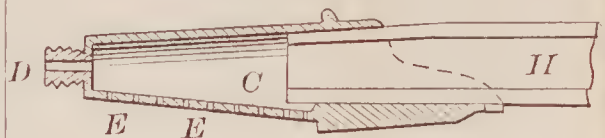

71267—L. Begon—Steam Rotary Valve.

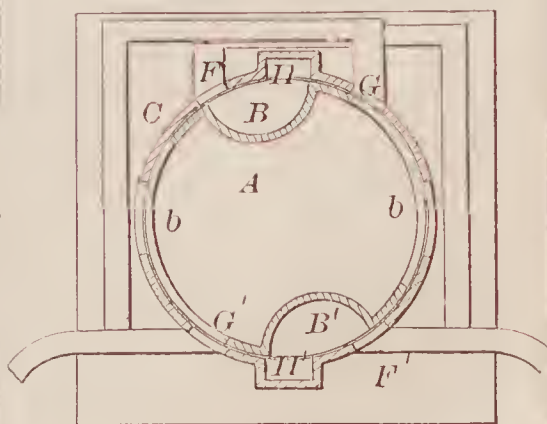



71268—G. A. Beidler—  
*Lamp.*

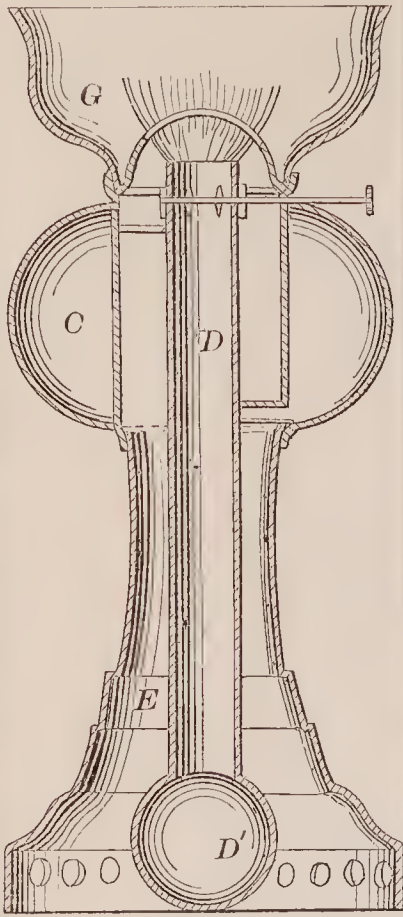

71269—A. L. Bogart—*Gas Stove.*

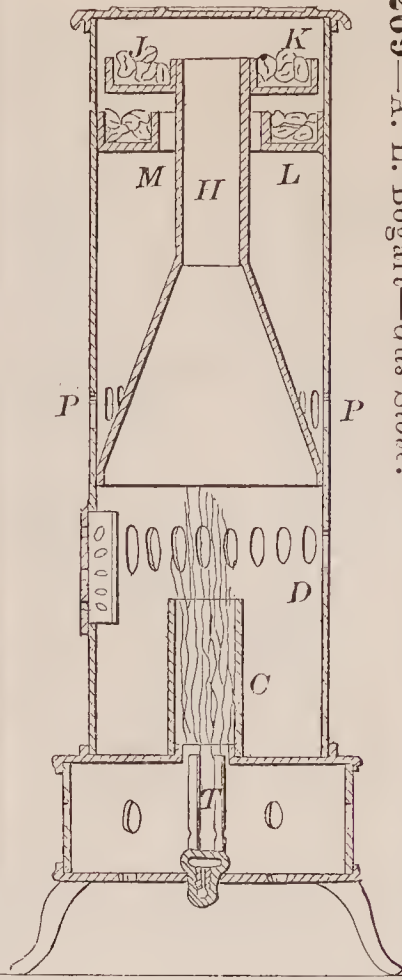

71270—G. W. Bookwalter—*Still.*

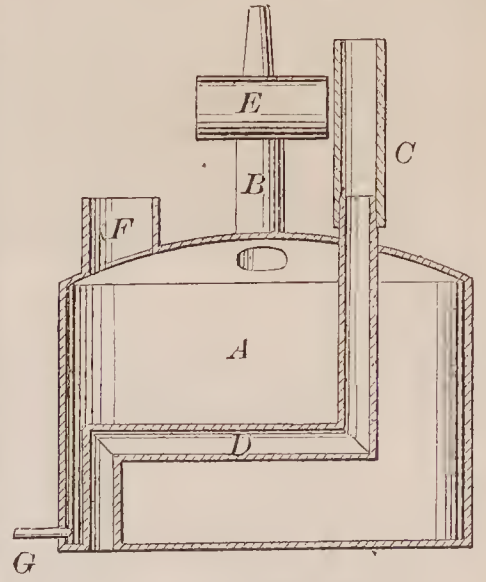

71271—Brady & Sloan—  
*Furnace for Roasting Ores.*

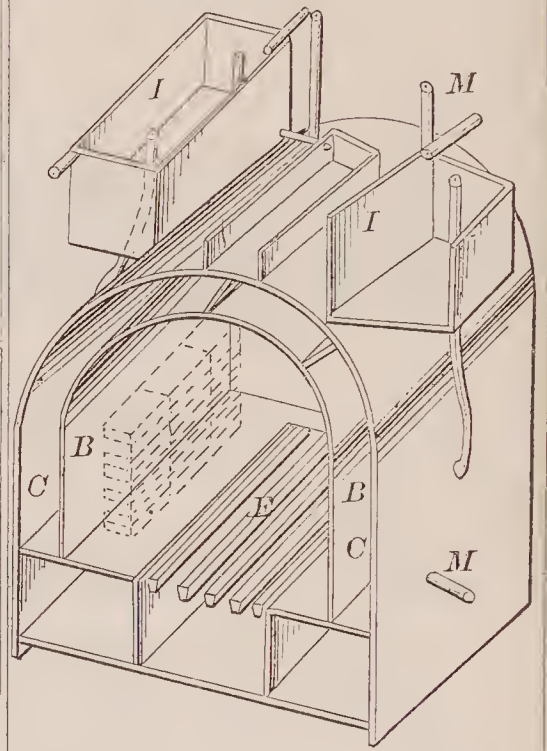

D 71274—N. N. Brown—*Pie Rimmer.*

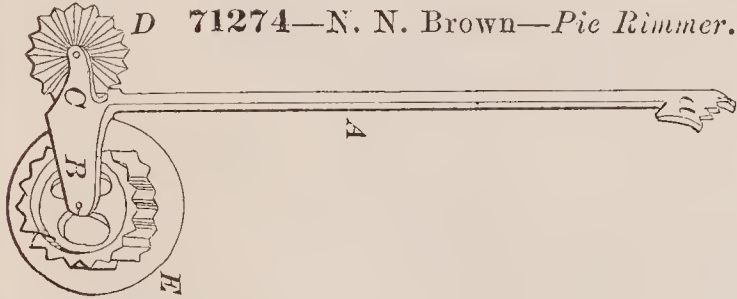

71273—W. H. Bridgens—*Pea Sheller.*

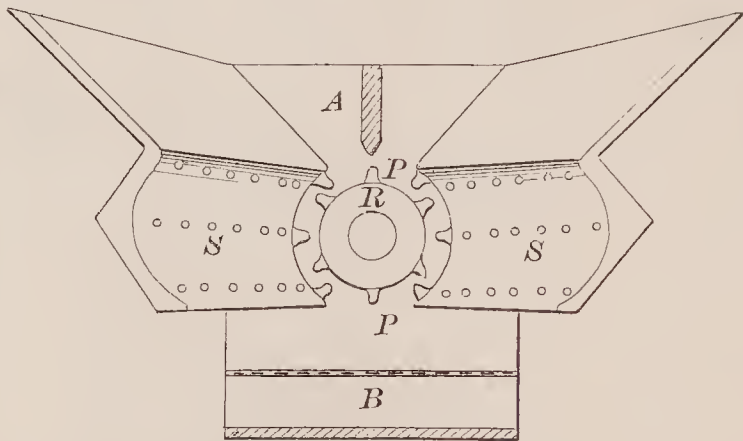

71275—Bymer & Imlay—*Ditching Machine.*

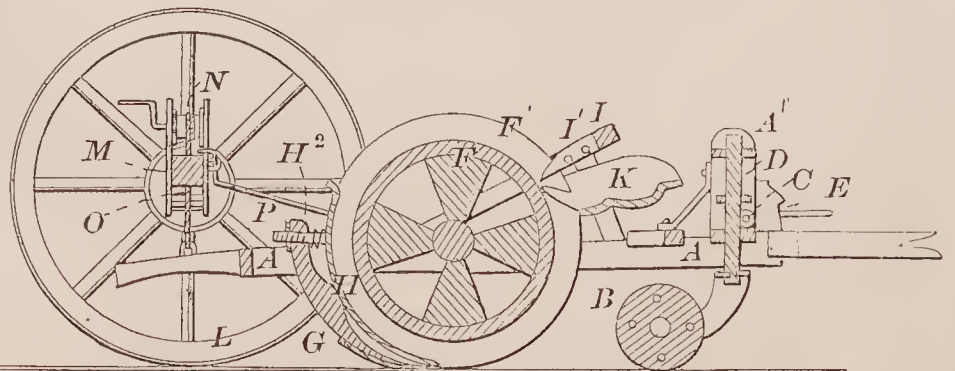

71272—C. Brennemann—*Cattle Guard for Railways.*

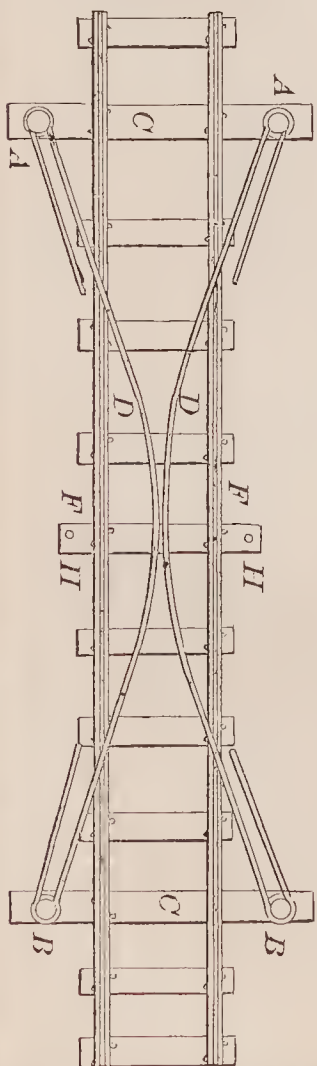

71276—F. O. Clark—Stave Machine.

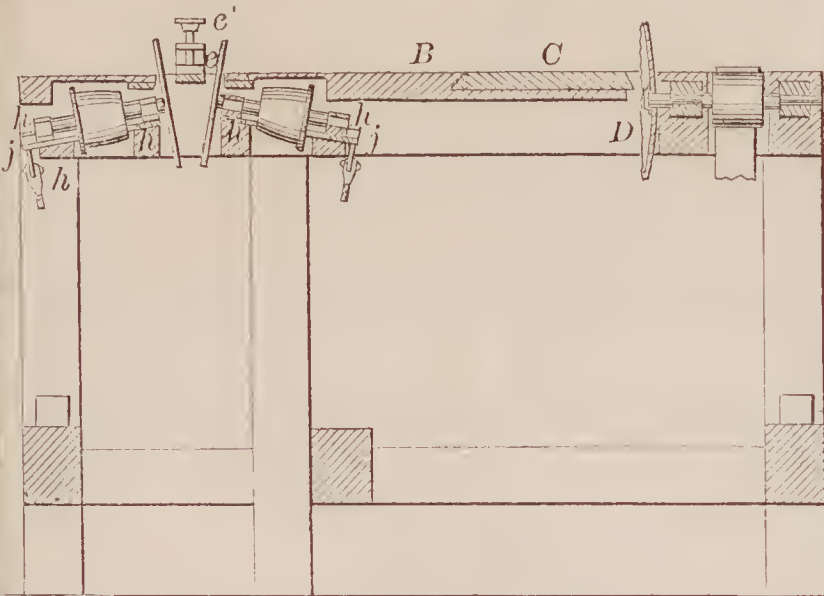

71278—J. M. Clark—Portable

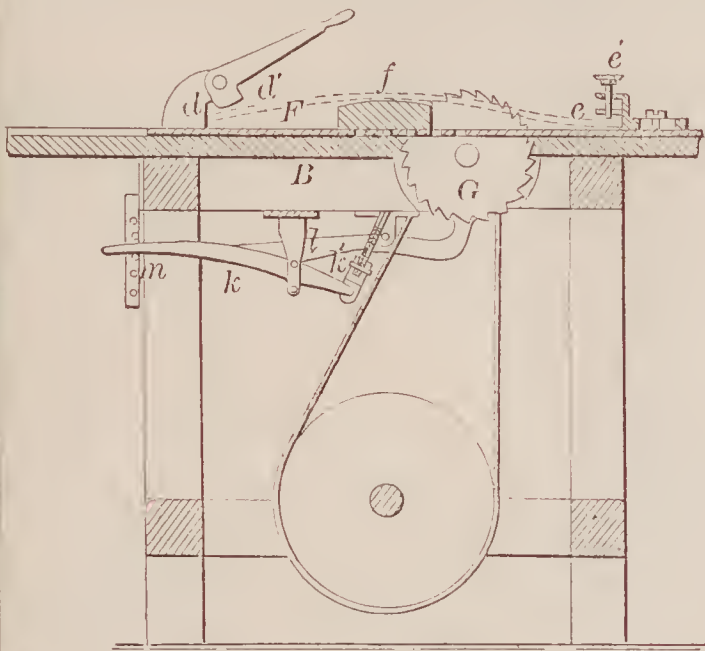
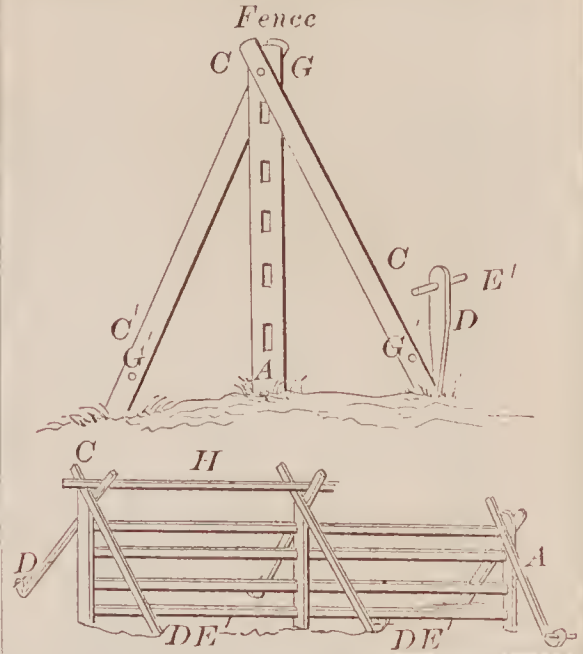

71277—F. O. Clark—Stave Machine.

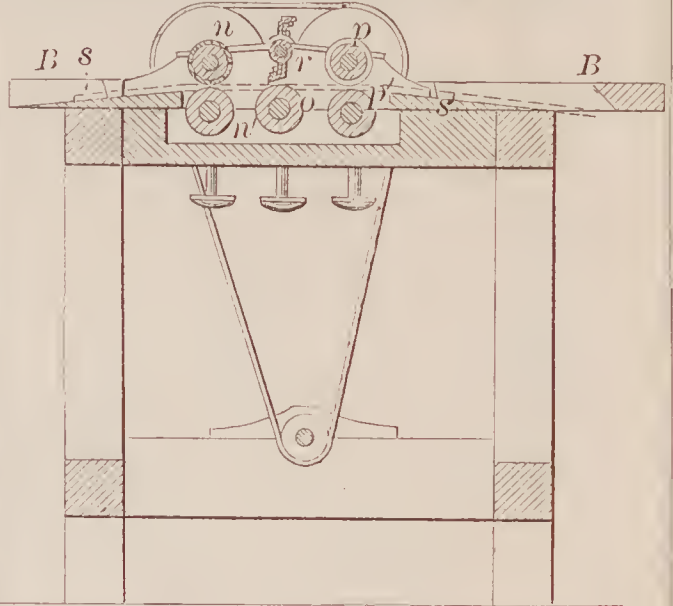

71279—P. Clifford—Adjustable Spirit Level.



71280—J. Clough—Lamp.



71281—J. Clough—Lamp.

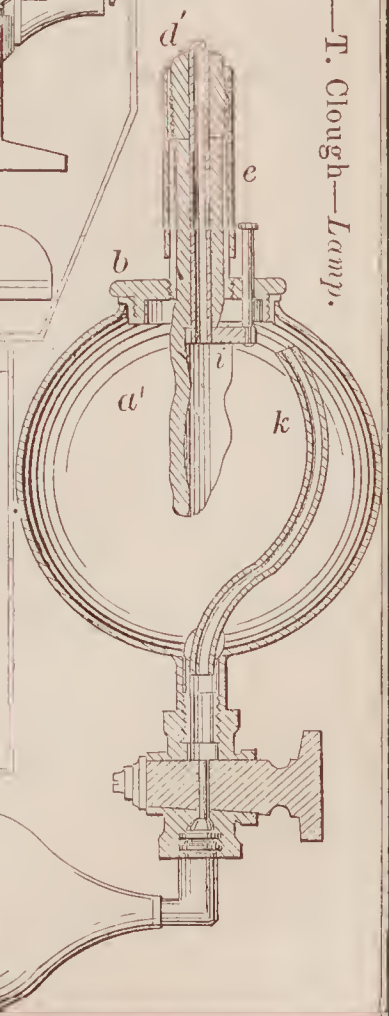

71282—H. W. Collender—Billiard Cushion.

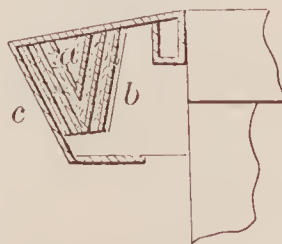

71283—H. V. Corbett—Winch for Centre Boards.

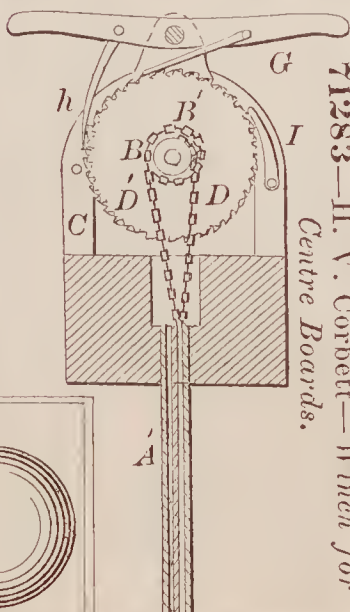



71284—M. C. Cronk—*Steamer for Cooking.*

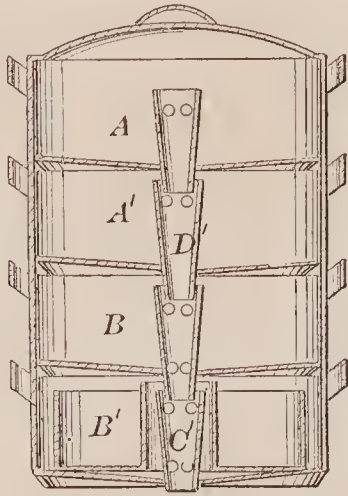

71287—Dennisson & Gould—*Pump for Fire Engines.*

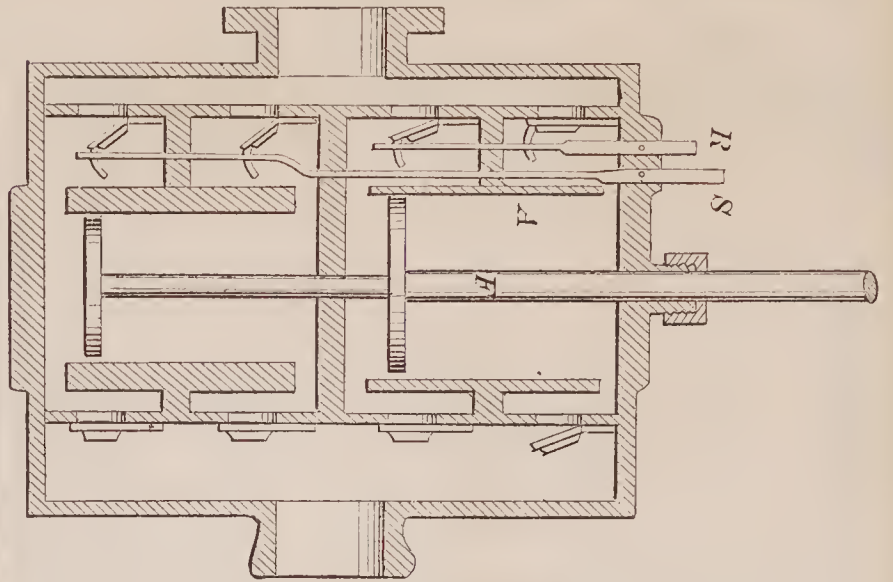

71290—T. Evans—*Tack Hammer.*

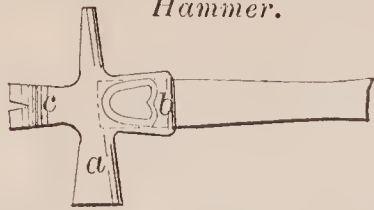

71291—J. Fewkes—*Spool Support.*

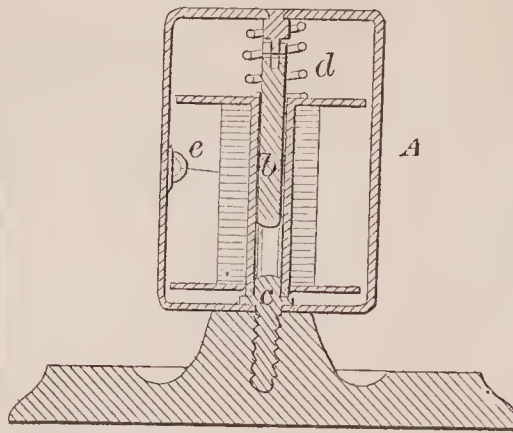

71286—A. M. Darling—*Bag Holder and Filler.*

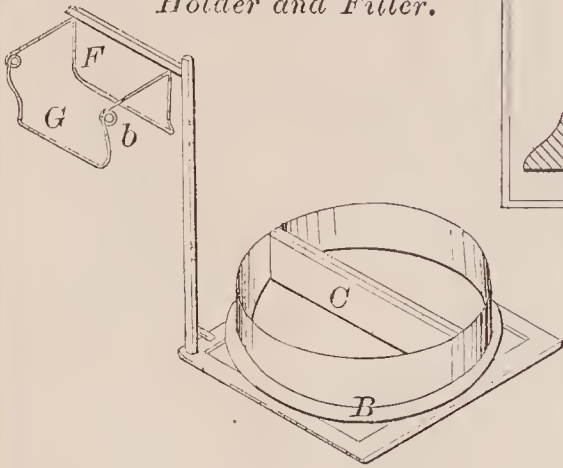

71292—J. H. Fleming—*Windlass Crank Power.*

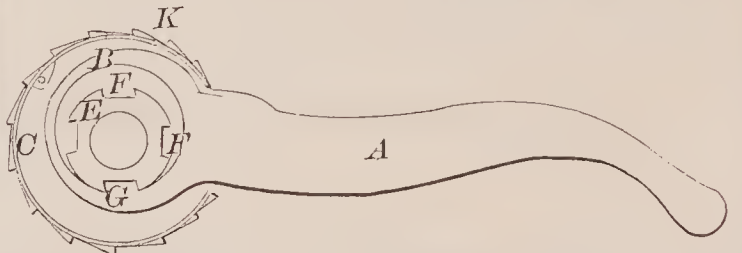

71288—Eaton & Ireland—*Safe.*

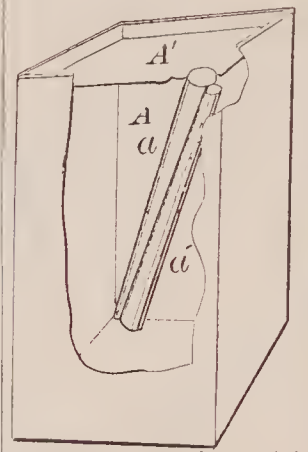

71285—J. W. Currier—*Trace Attachment for Whiffletrees.*

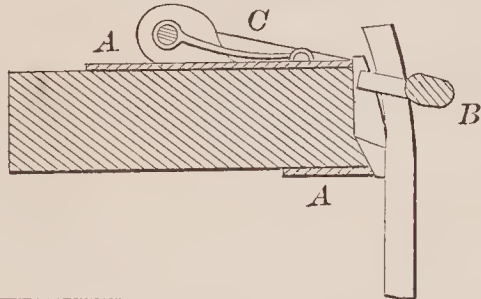

71289—A. N. Elzy—*Churn.*

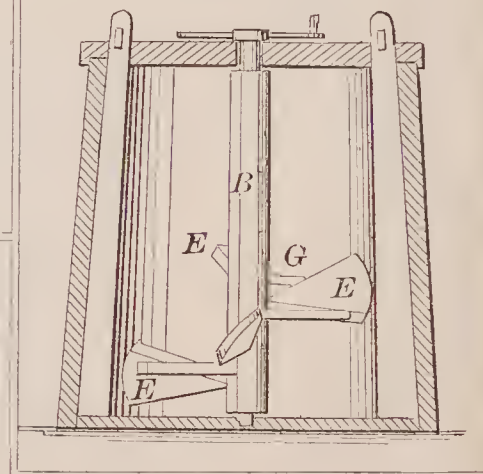

71295—E. H. & E. B. Goelet—*Seeding Machine.*

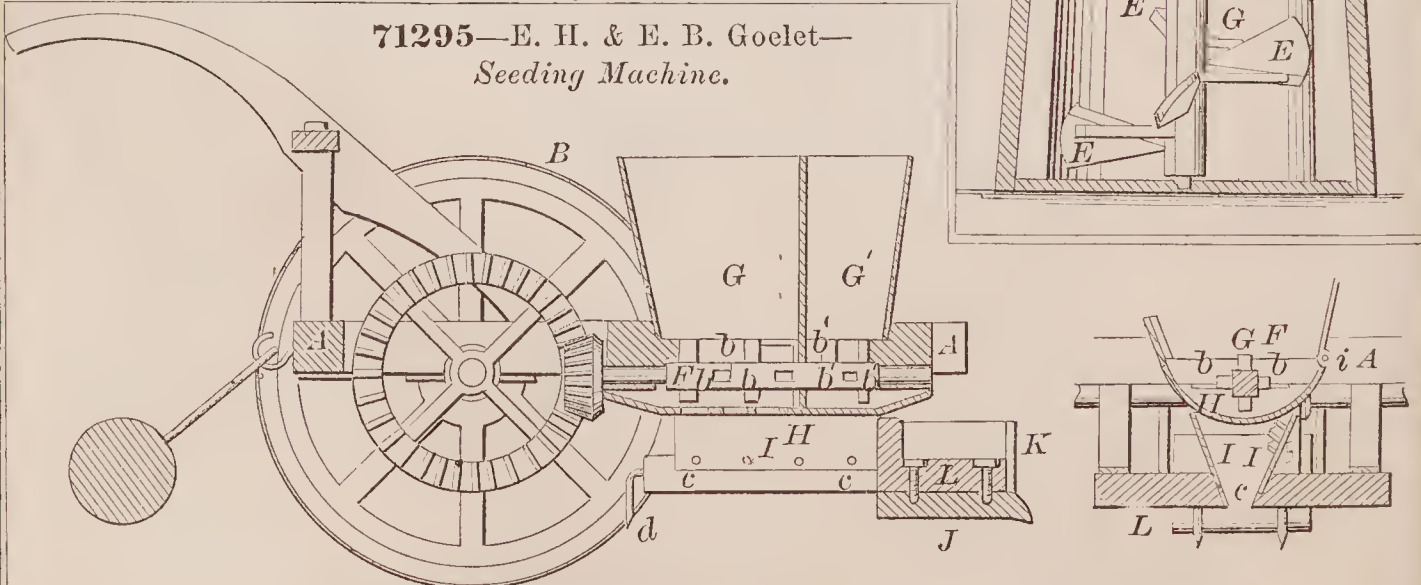

71297—J. Habermehl—*Fire Back for Grates.*



71299—W. Hainsworth—*Loom.*

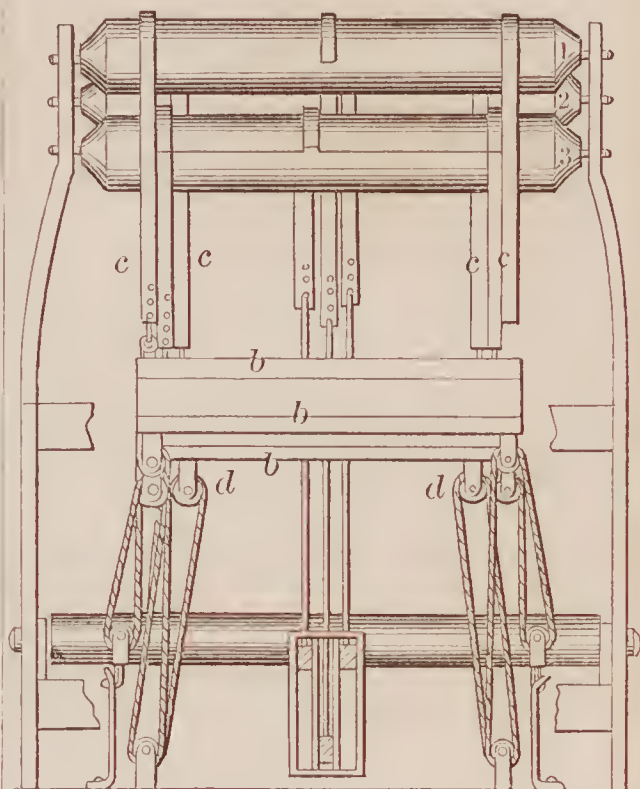

71300—J. B. Harris—*Packing for Smoke Flues.*

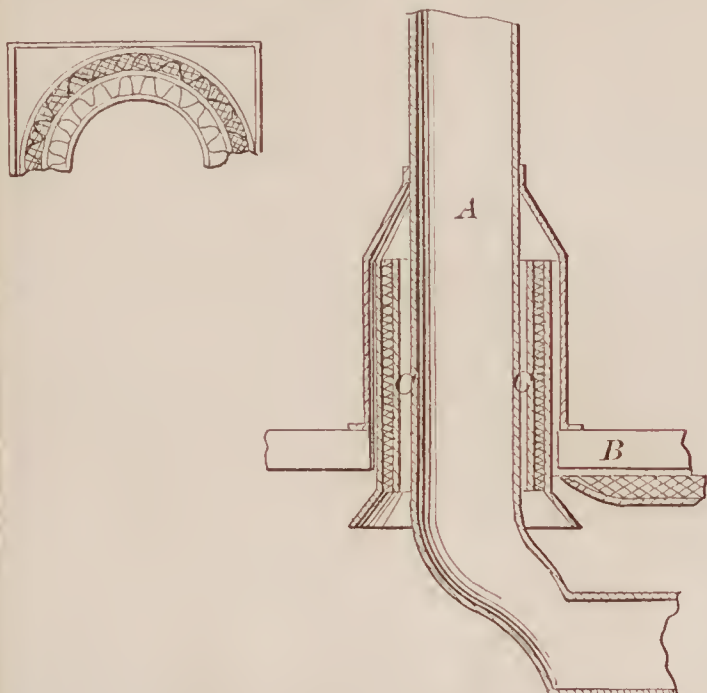

71298—F. L. Hagadorn—*Packing Ammunition.*

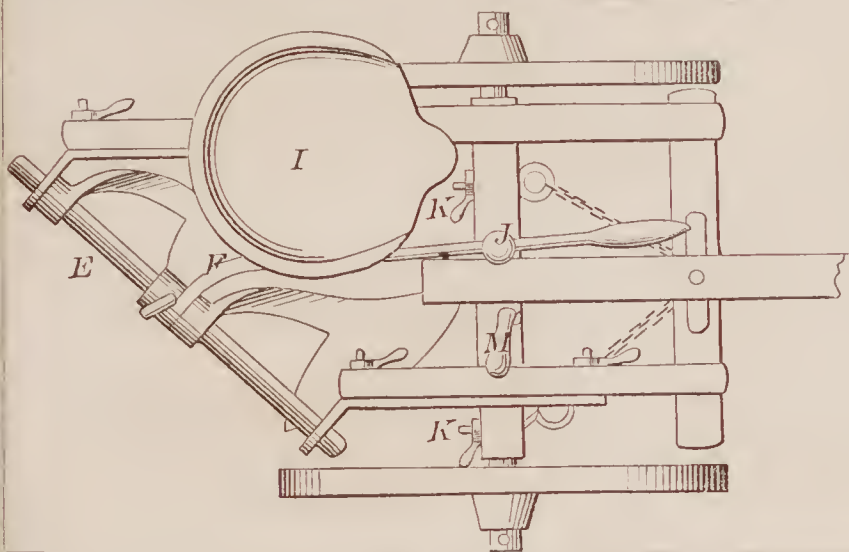
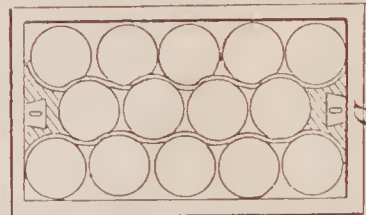

71301—J. Harris—*Gang Plow.*

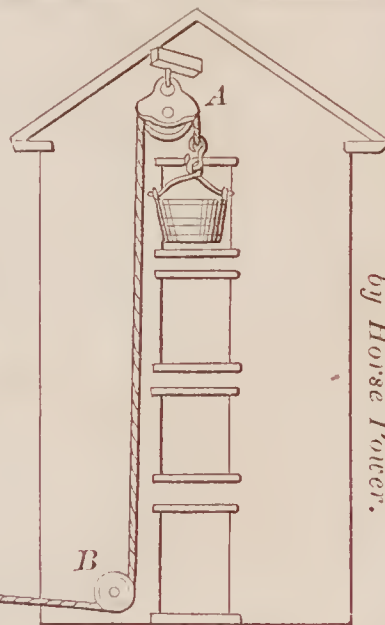

71303—W. H. Hawley—*For Elevating by Horse Power.*

71302—P. Hatch—*Saw Filing Machine.*

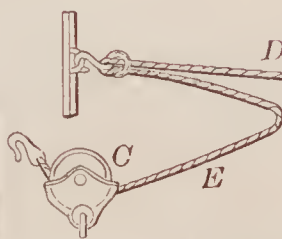
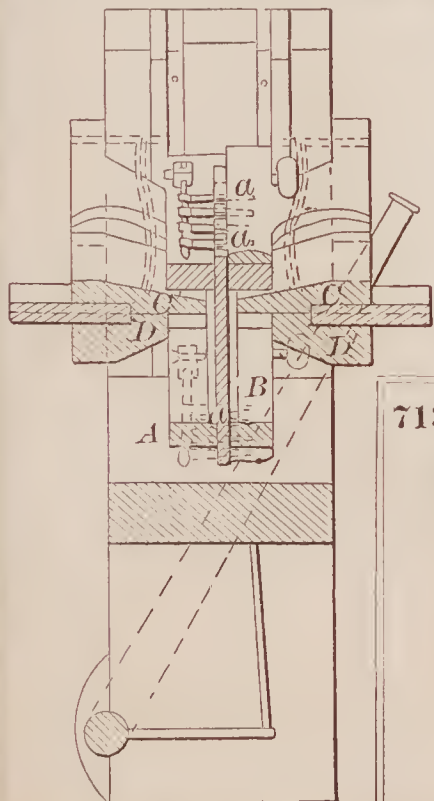

71304—H. F. Holt—*Fastening Tops to Buggies.*

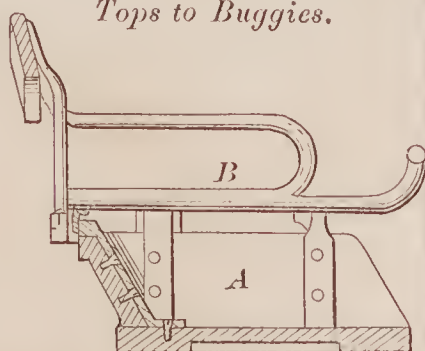

71305—D. Howarth—*Dinner Pail.*

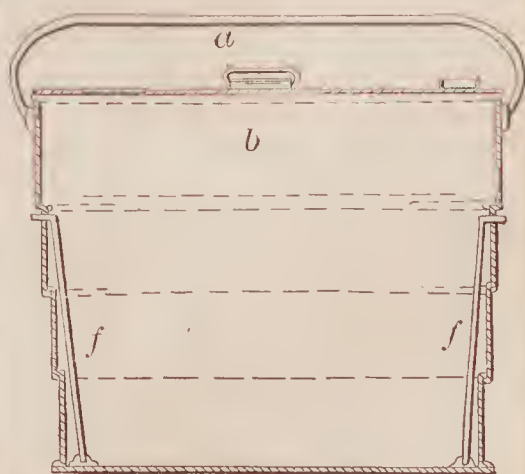



71306—G. G. Hunt—*Base Burning Stove.*

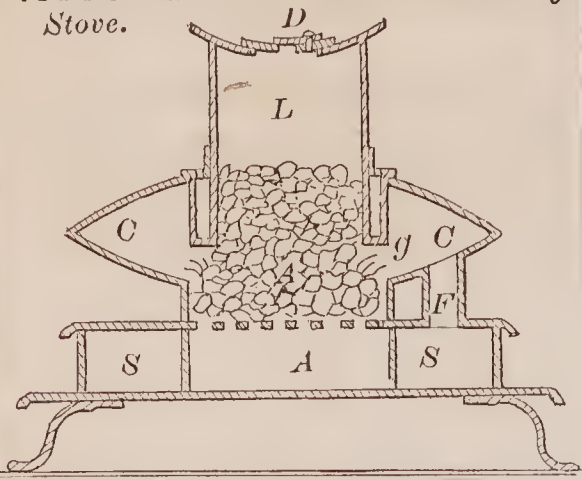

71310—G. H. Kendall—*For Pressing Reins.*

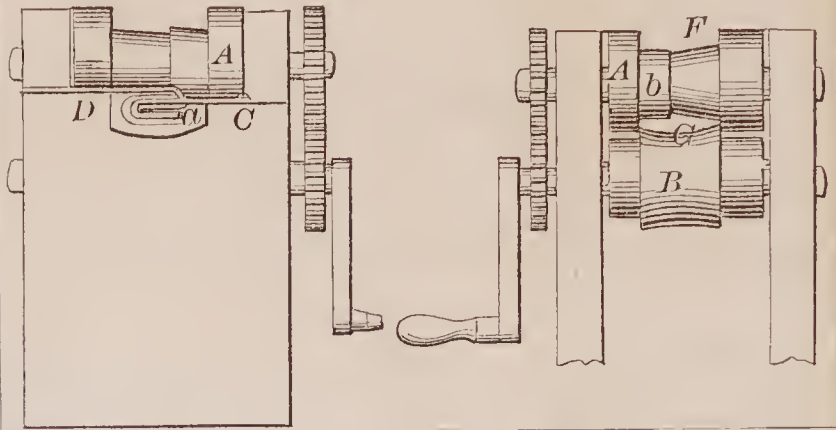

71308—C. W. Jones—*Railway Switch.*

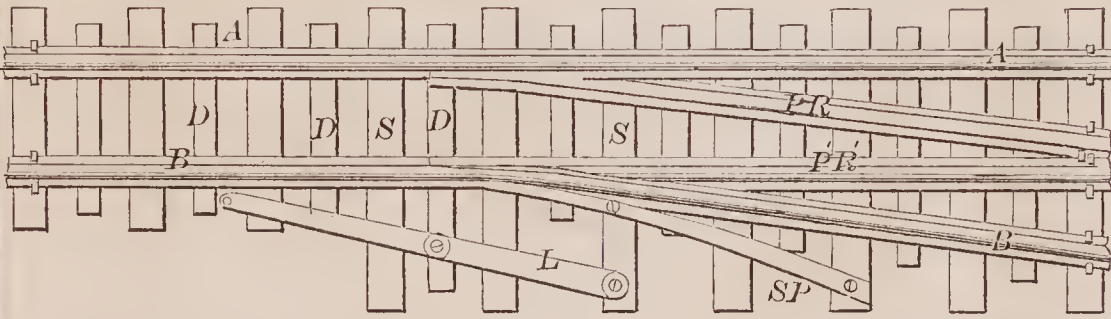

71311—J. W. Kendall—*Foot for Tubs.*

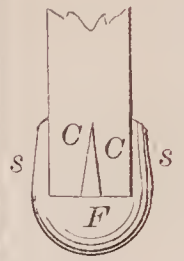

71309—B. Kane—*Water Prism.*

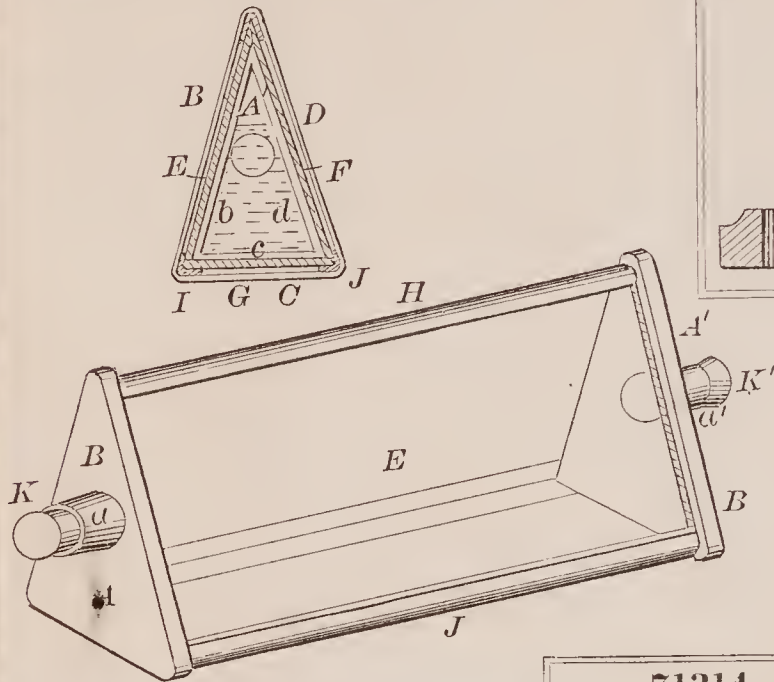

71313—P. P. Lane—*Journal Box.*

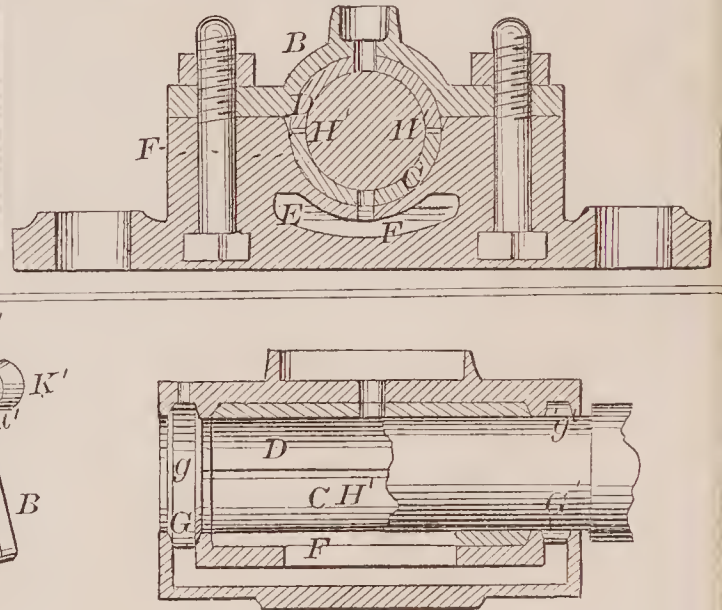

71312—H. J. Lamm—*Neck Yoke Fastening.*

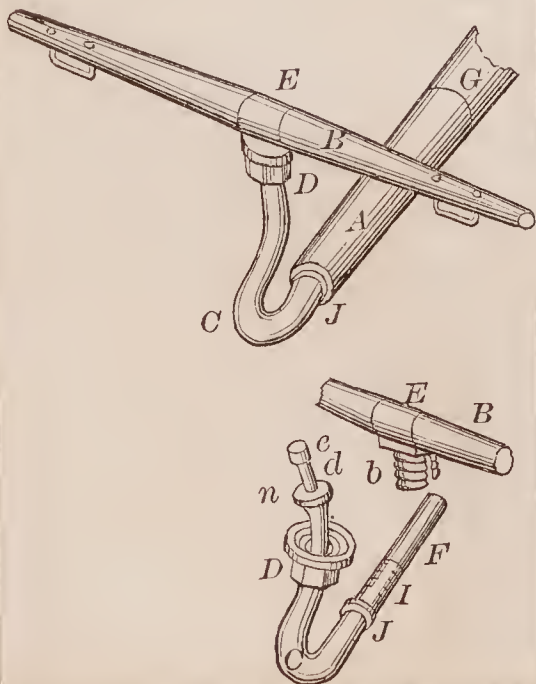

71314—Ling & Chandler—*Organ Coupling.*

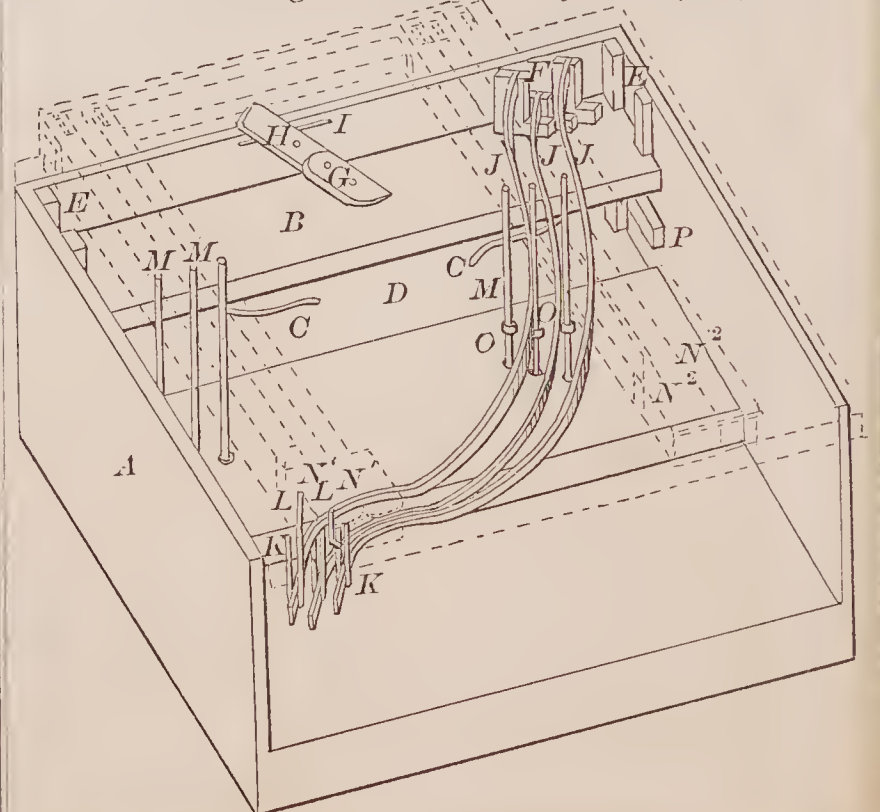



71315—A. Longstreet—*Door Knob.*

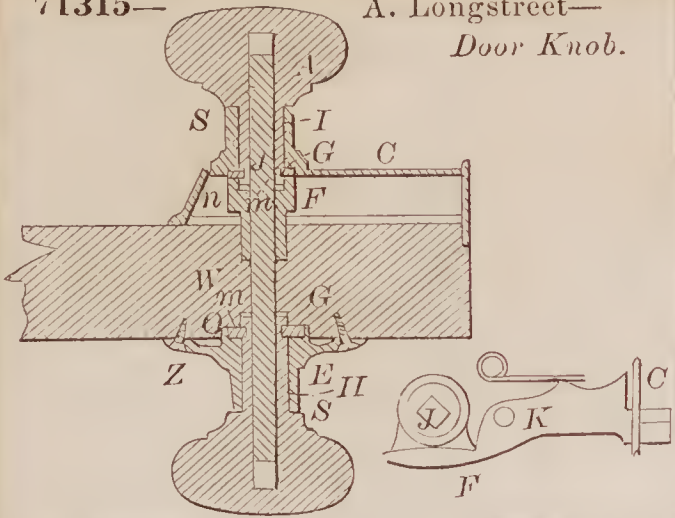

71318—W. C. Moser—*Butter Worker.*

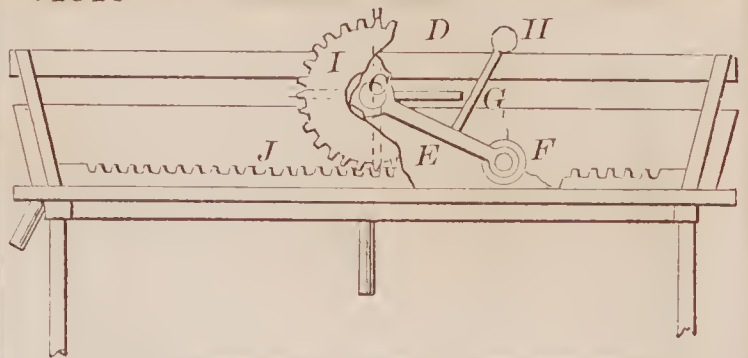

71316—S. McCoun—*Corkscrew.*

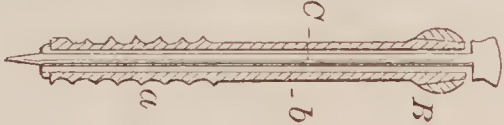

71321—G. J. Parham—*Animal Trap.*

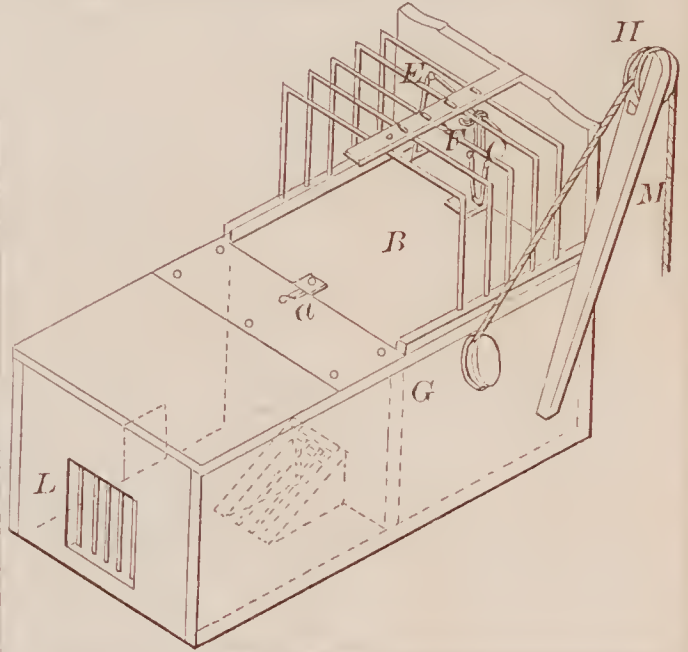

71317—G. W. McMinn—*Car Spring.*

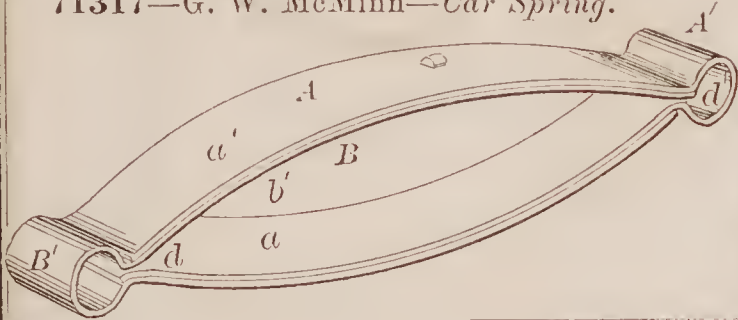

71320—L. F. Neagle—*Adjustable Mirror.*

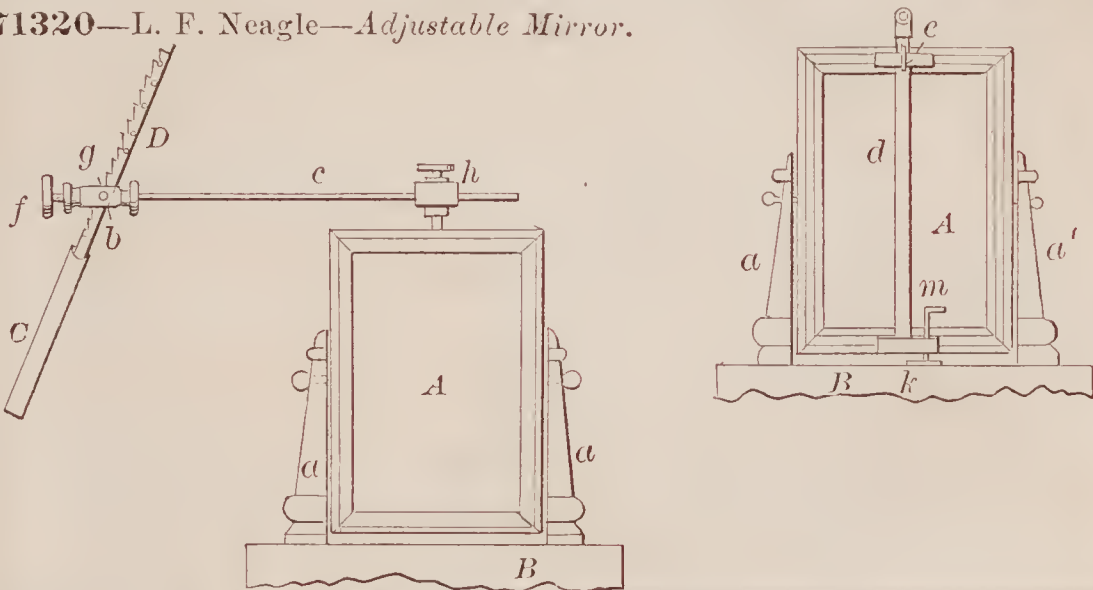

71319—W. Mullally—*Top Spinning Sward.*

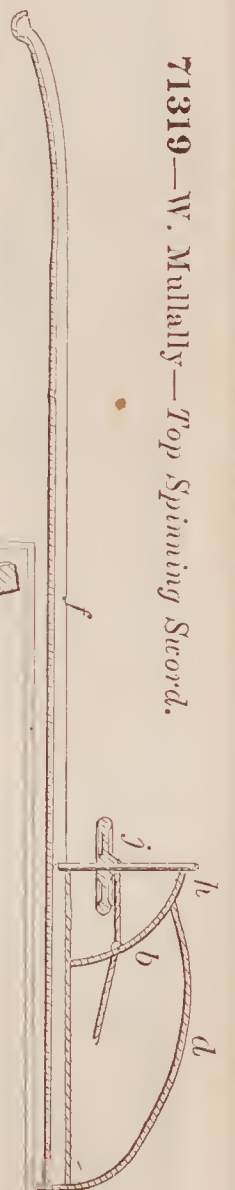

71323—T. Percival—*For Making Tags and Labels.*

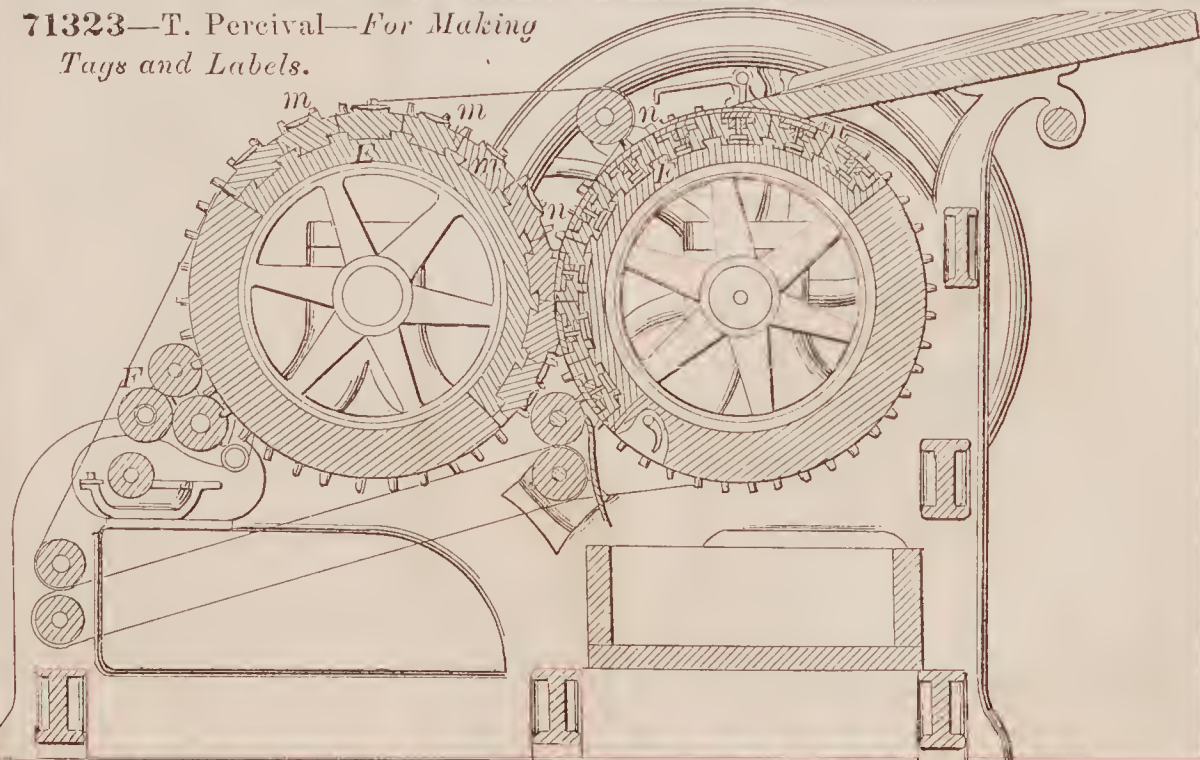



71324—J. A. Patt—Bridle.

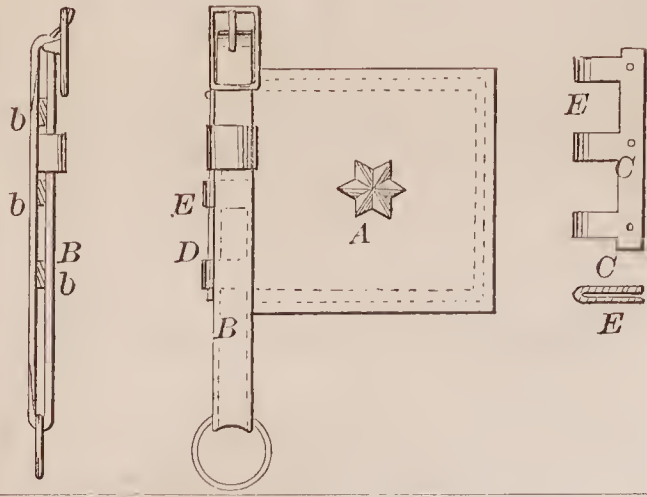

71325—Quick & Wallis—Car Brake.

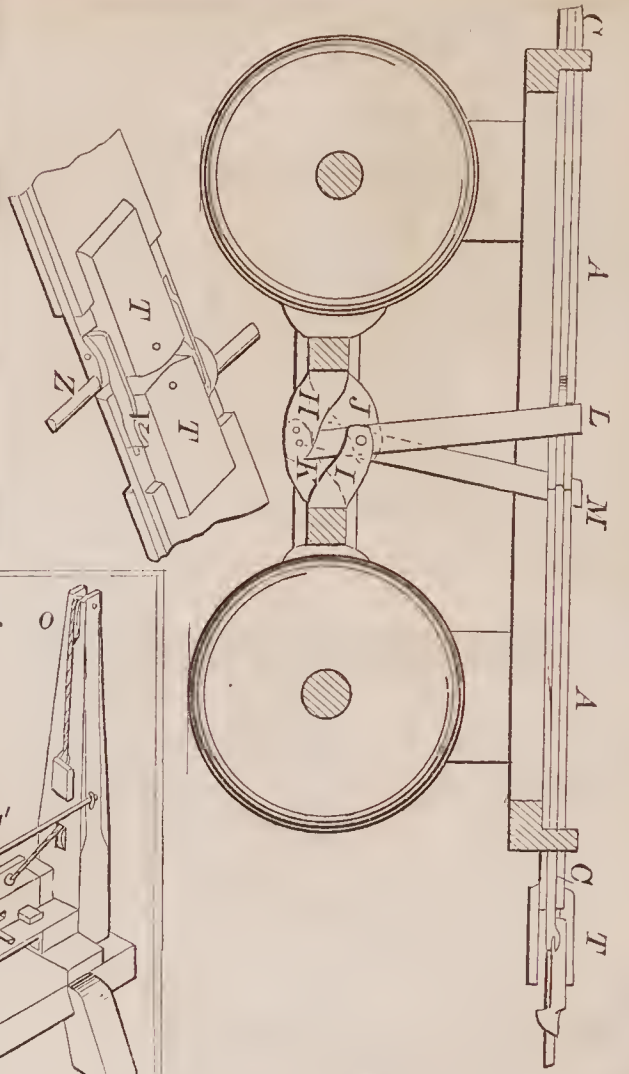

71326—J. J. Ralya—For Dressing Staves for Barrels.

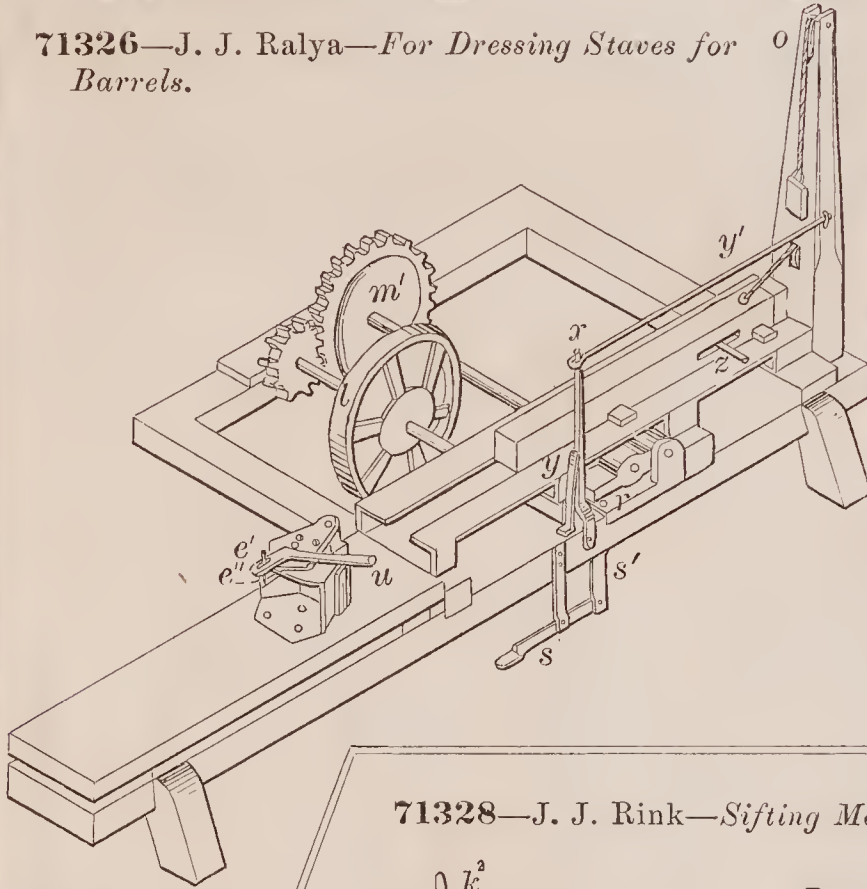

71327—S. C. Ridgeway—Harvester Rake.

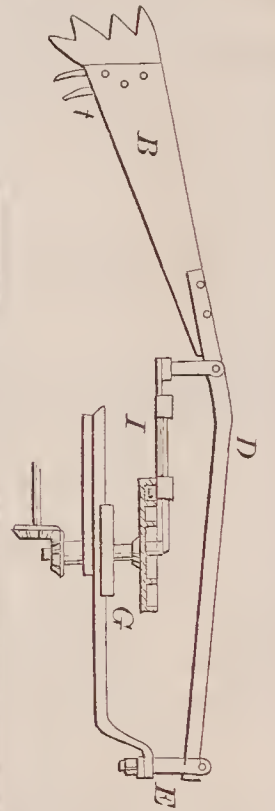

71328—J. J. Rink—Sifting Machine.

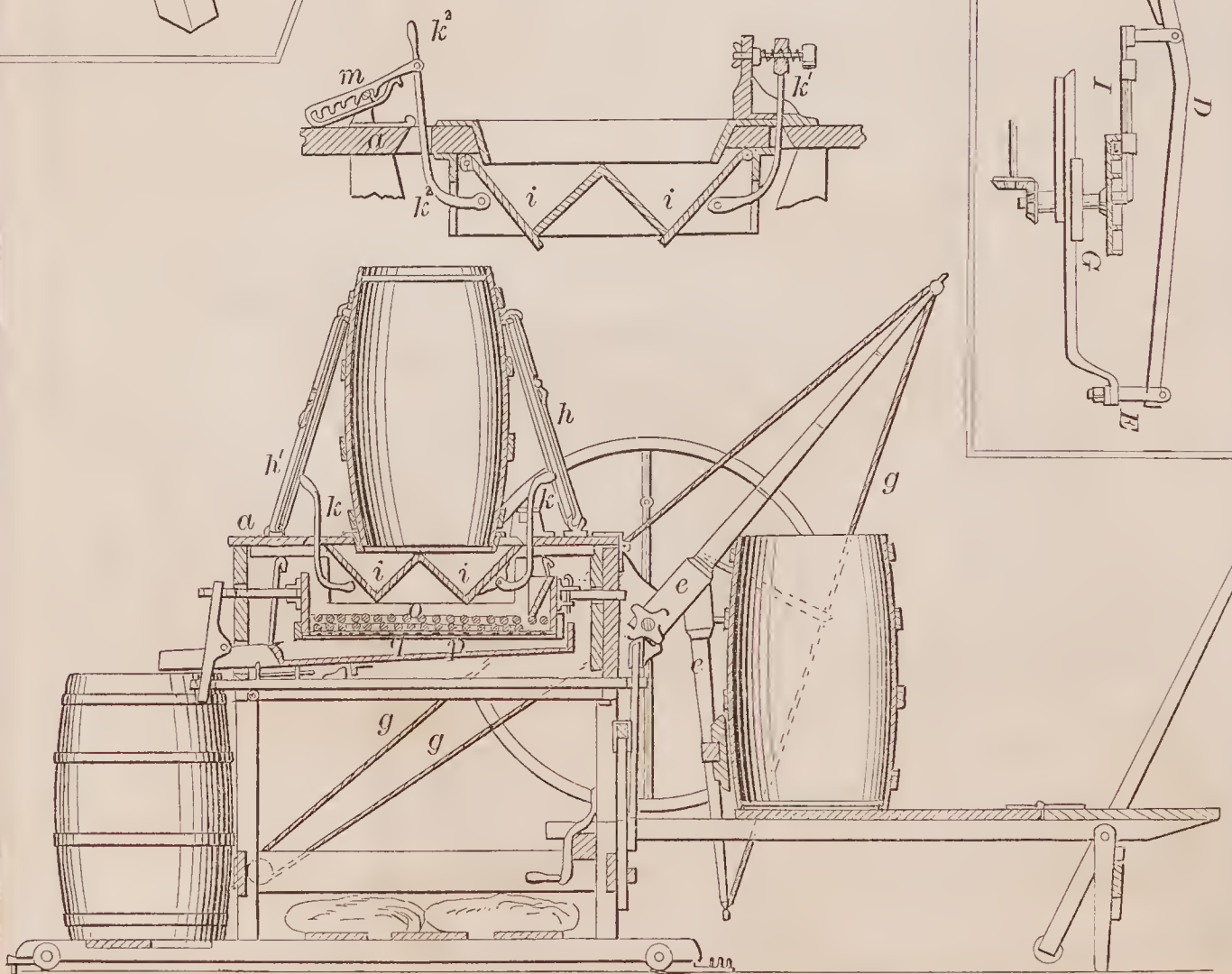

71329—Robinson & Wood—*Rock Drilling Machine.*

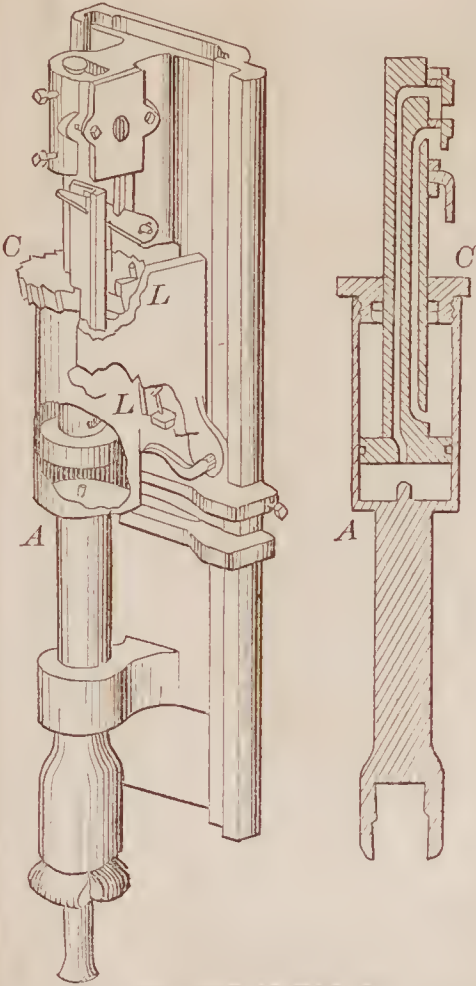

71335—H. W. Shipley—*Water Wheel.*

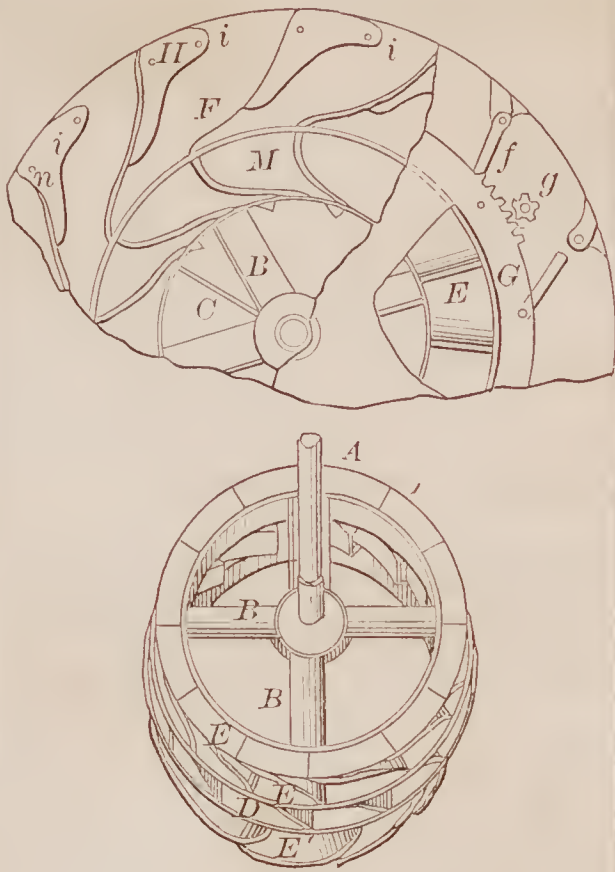

71334—J. Shearer—*Horse Hay Fork.*



71330—A. J. Rockafellow—*For Tempering Saw Plates.*

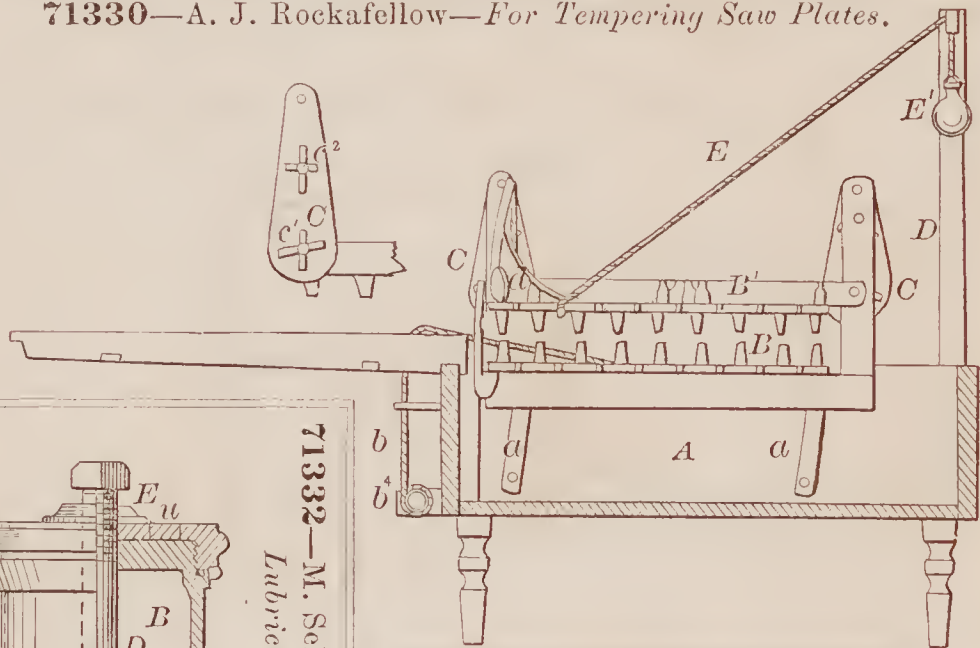

71331—I. R. Rogers—*Manufacture of Shoes.*

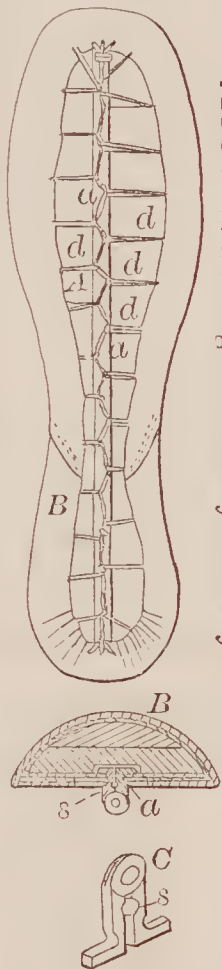

71332—M. Sellers—*Journal Lubricator.*

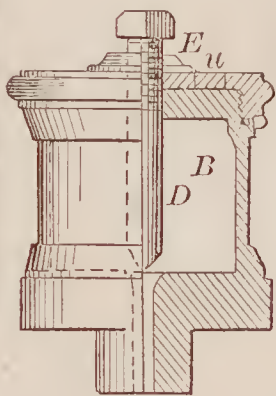

71337—I. Soule—*Piston Valve.*

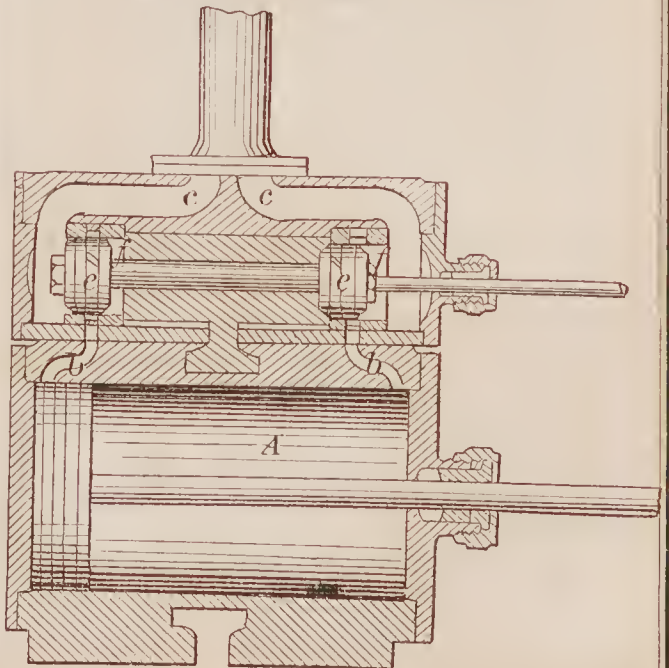

71336—J. M. Smith—*Plate Difter.*

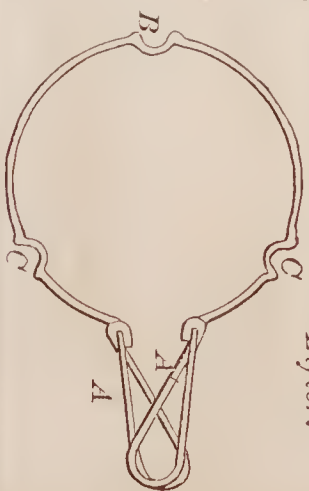

71333—W. F. Shaw—*Lamp Shade.*

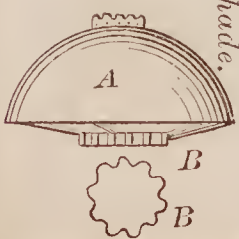



71338—J. R. Speer—Cotton Bale Tie.

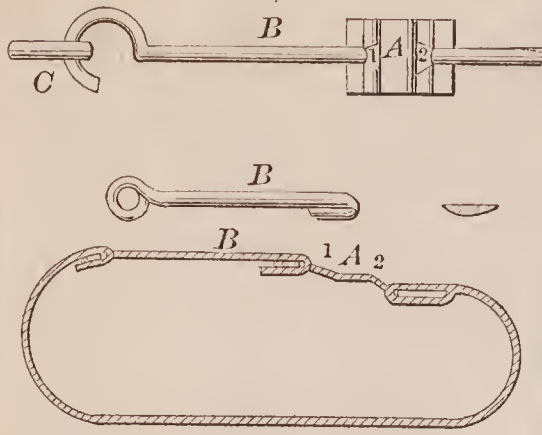

71341—C. R. Tompkins—Planing Machine.

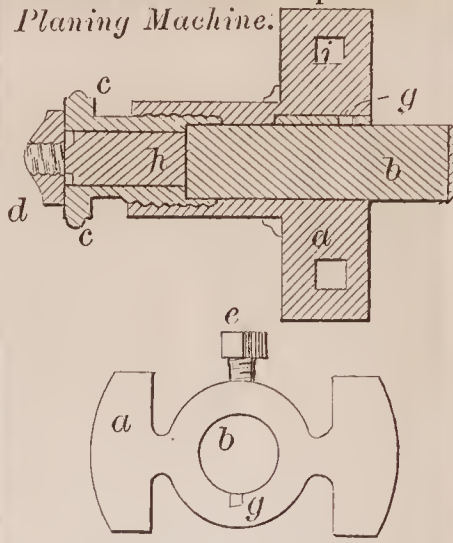

71339—Sylvester & Brooks—Reaming Tool.

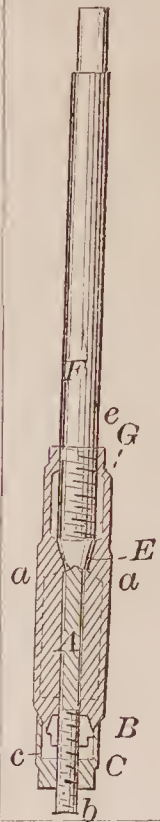

71342—A. J. Vandegrift—Parallel Movement.

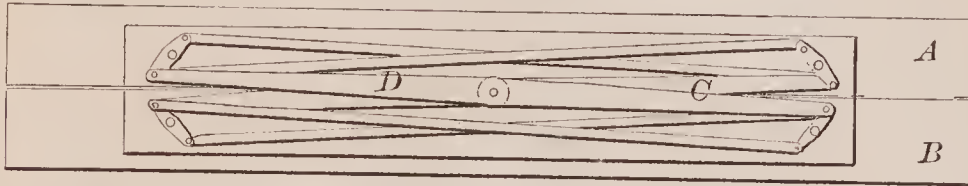

71340—A. Todd, Jr.—Fence.

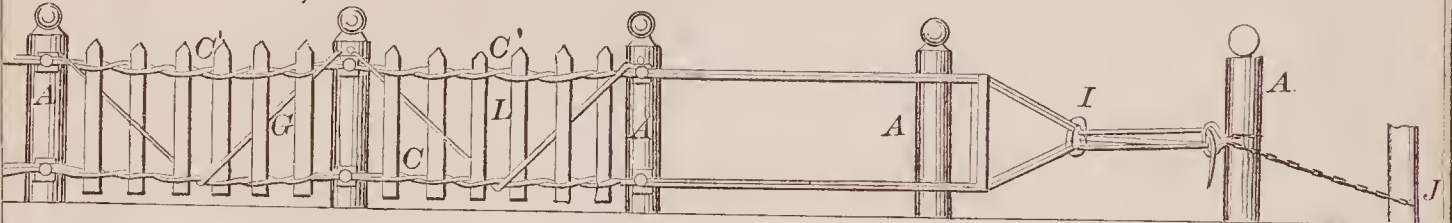

71344—J. Vom Hofe—Fishing Reel.

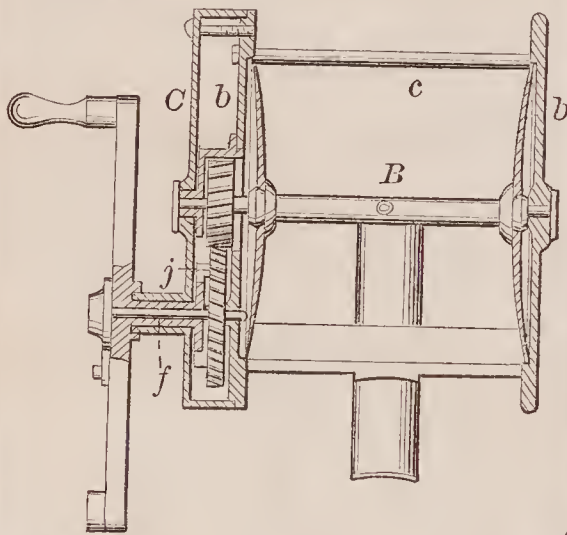

71346—W. Weaver—Insect Trap.

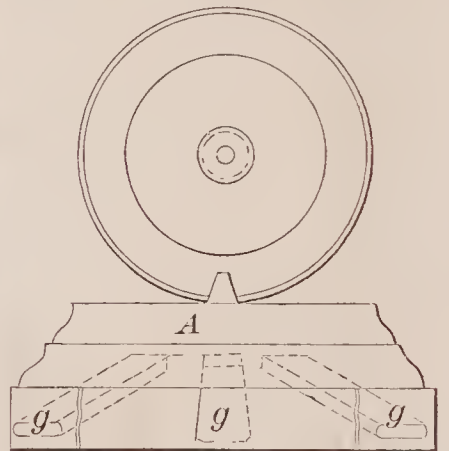

71343—P. Vanderbelt, Jr.—Horse Hay Fork.

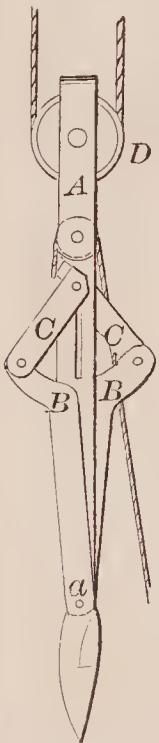

71347—C. M. Whelden—Stove.

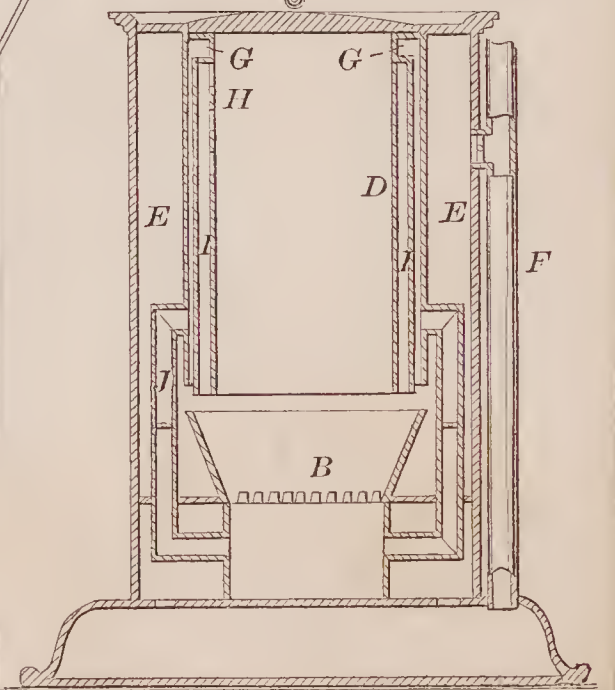

71345—Waters & Brown—Stove Grate.

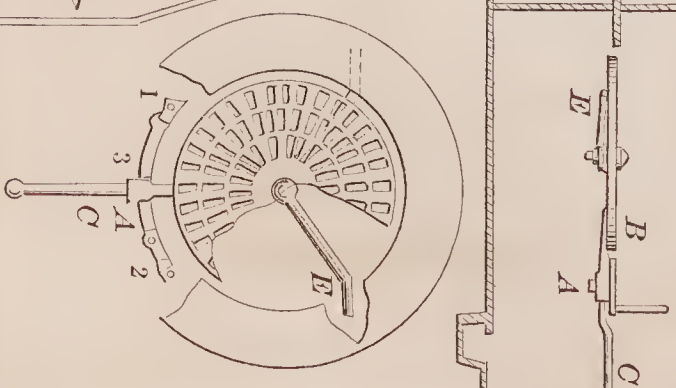

71348—Whitaker & Constantine—Hot Air Furnace.

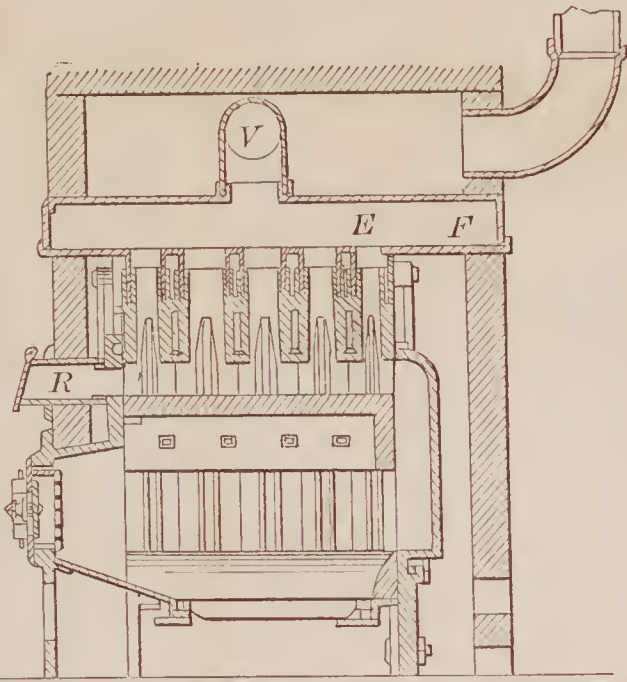

71350—J. Wiard—Key Guard for Door Locks.

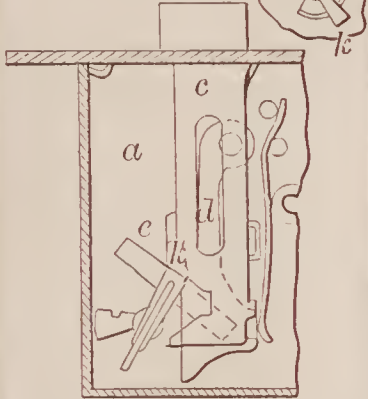

71353—P. Yengst—Manure Fork.

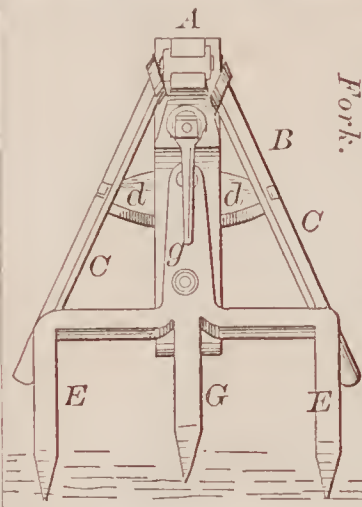

71349—E. Whitney—Breech-Loading Fire Arm.

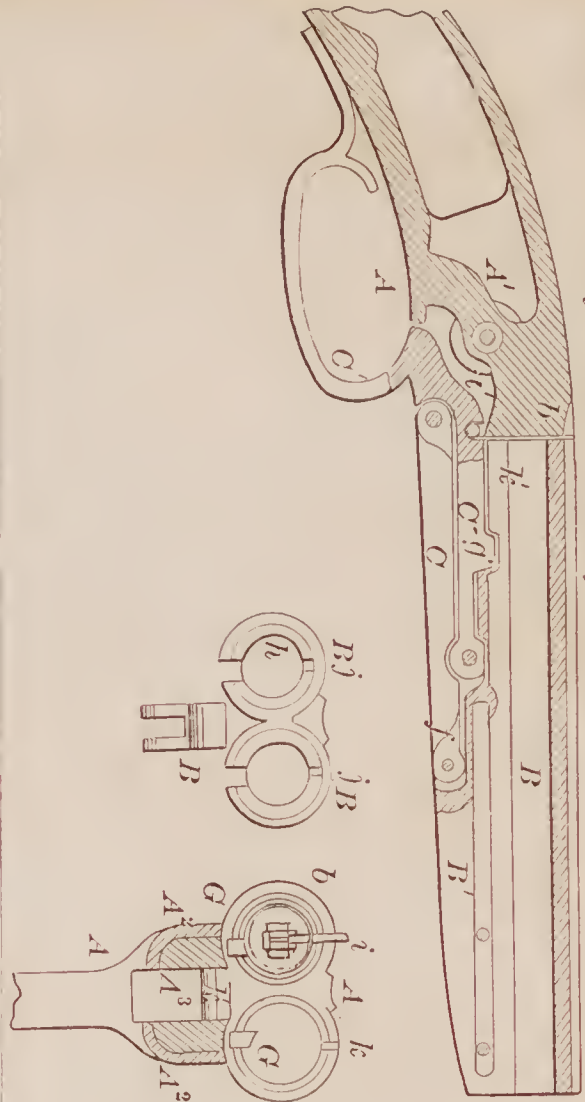

71351—J. Wild—For Making Metal Boxes.

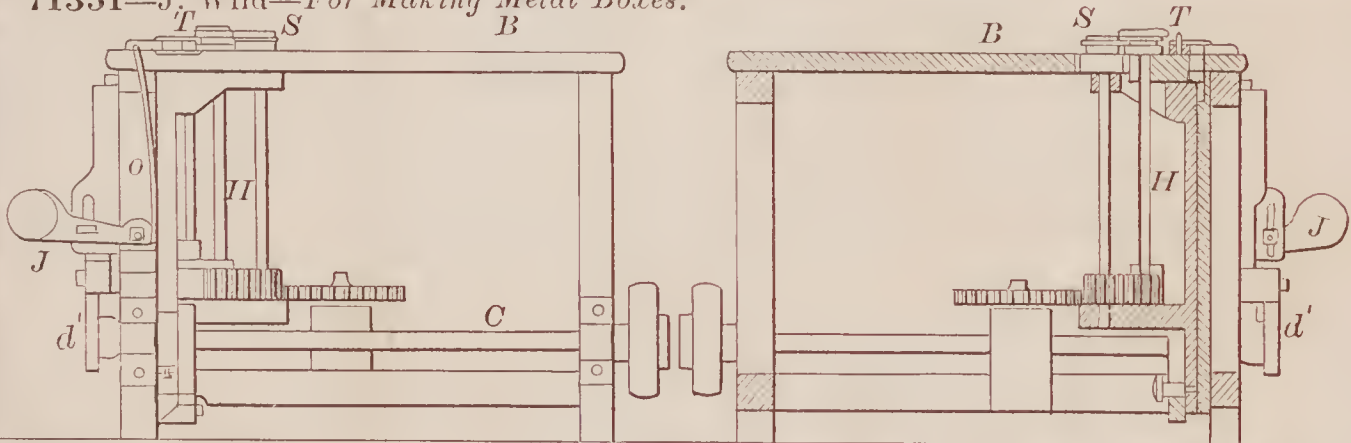

71352—L. Wilson—Bed Bottom.

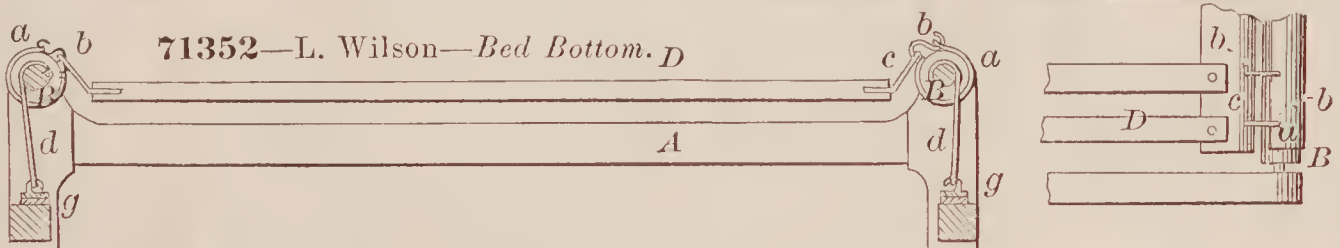

71354—H. Young—Lamp.

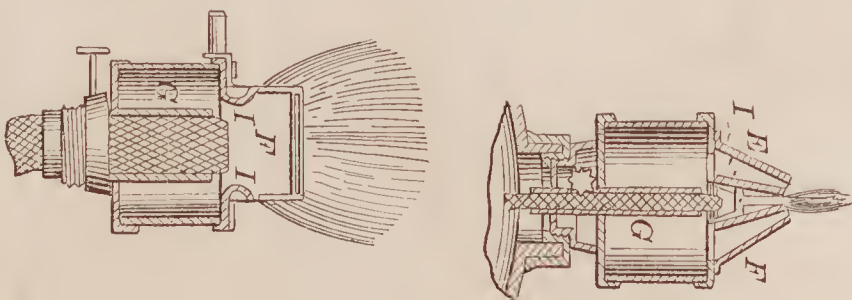

71355—C. Adams—Reducing Manganese Ores.

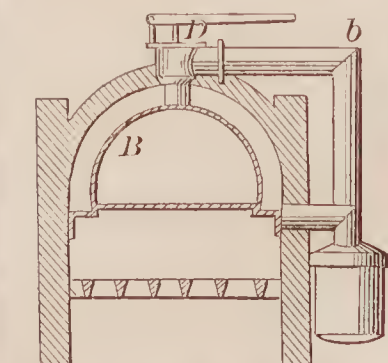



71357—J. Barron—Elastic Rocker for Chairs.

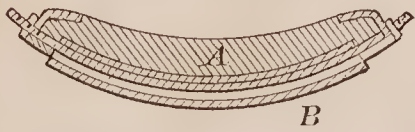

71360—G. B. Brayton—Dic for Threading Screws.

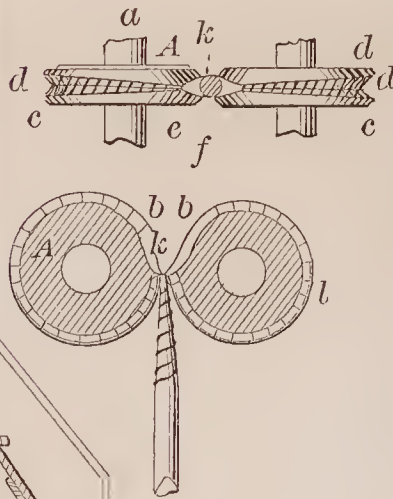

71358—G. W. Bishop—Ash Sifter.

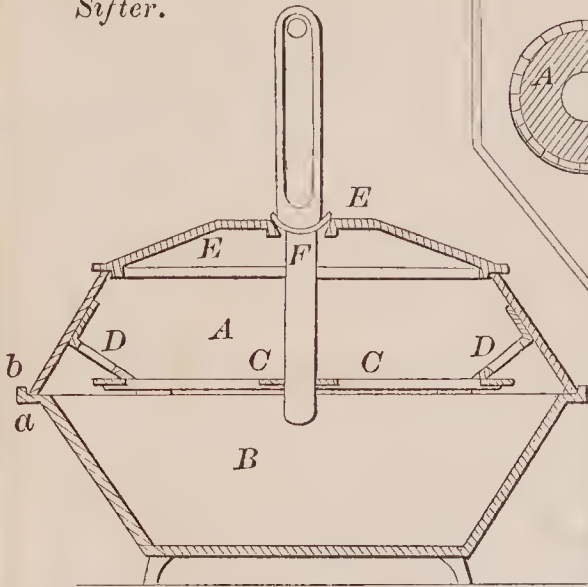

71362—Card & Studley—File Cutter.

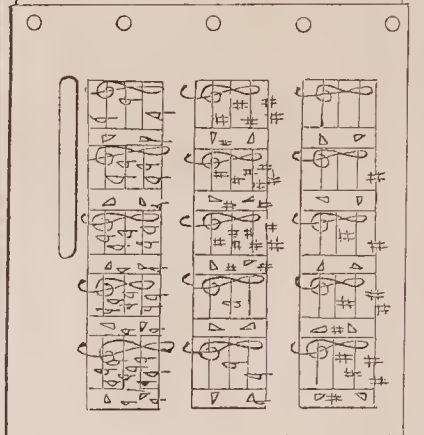
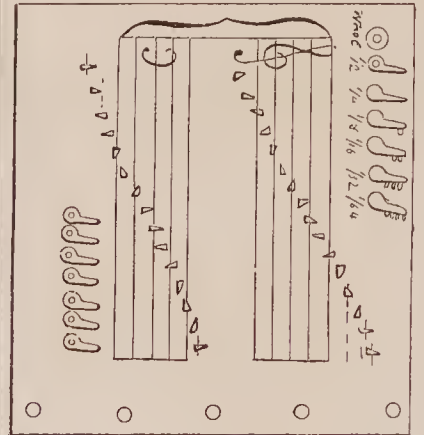
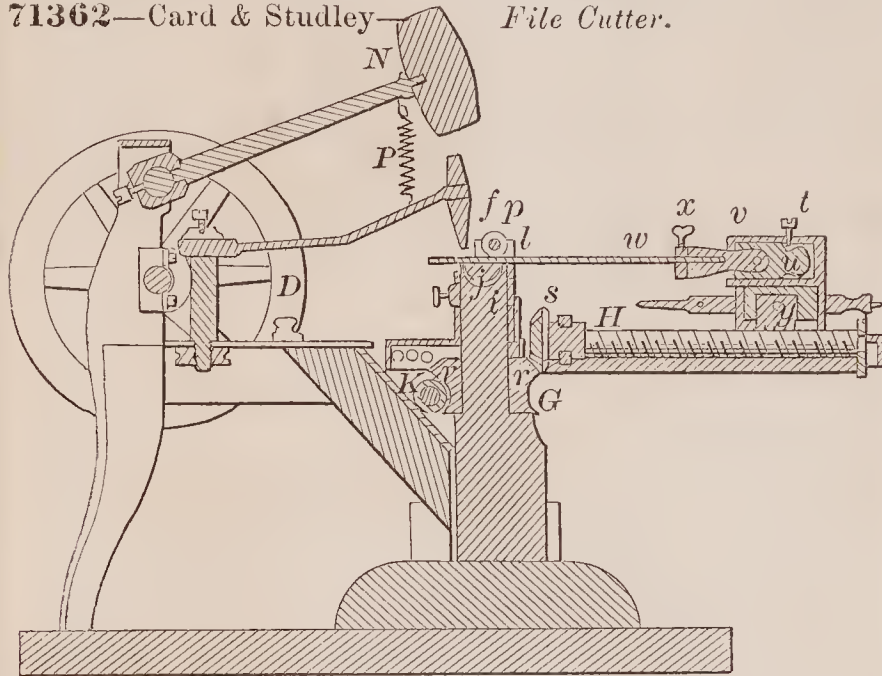

71359—J. Branique—Musical Tablet.

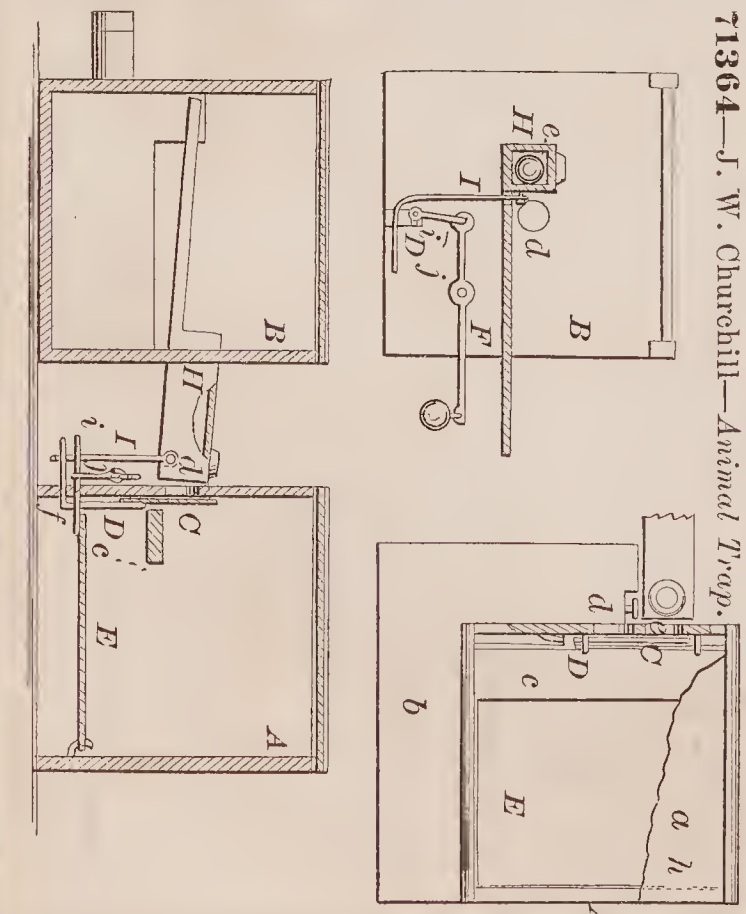

71364—J. W. Churchill—Animal Trap.

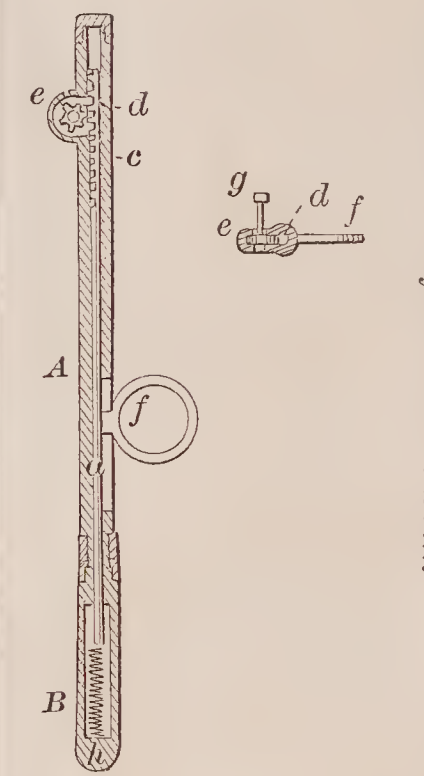

71361—H. F. Bryant—Dental Drill.

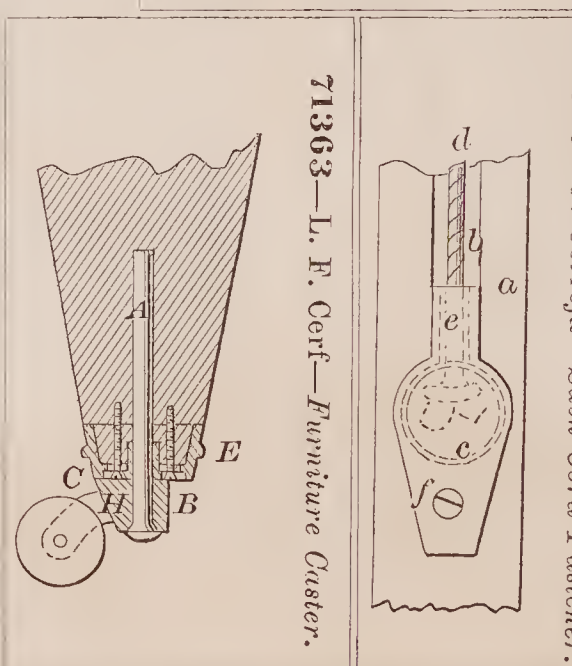

71365—J. Correya—Sash Cord Fastener.

71363—L. F. Cerf—Furniture Caster.

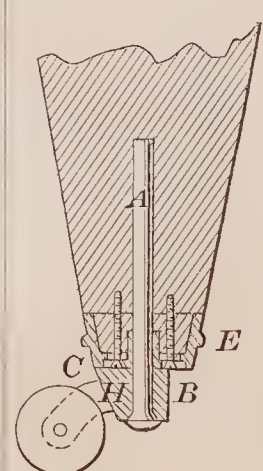

71366—E. N. Curtice—Hay Raker and Loader.

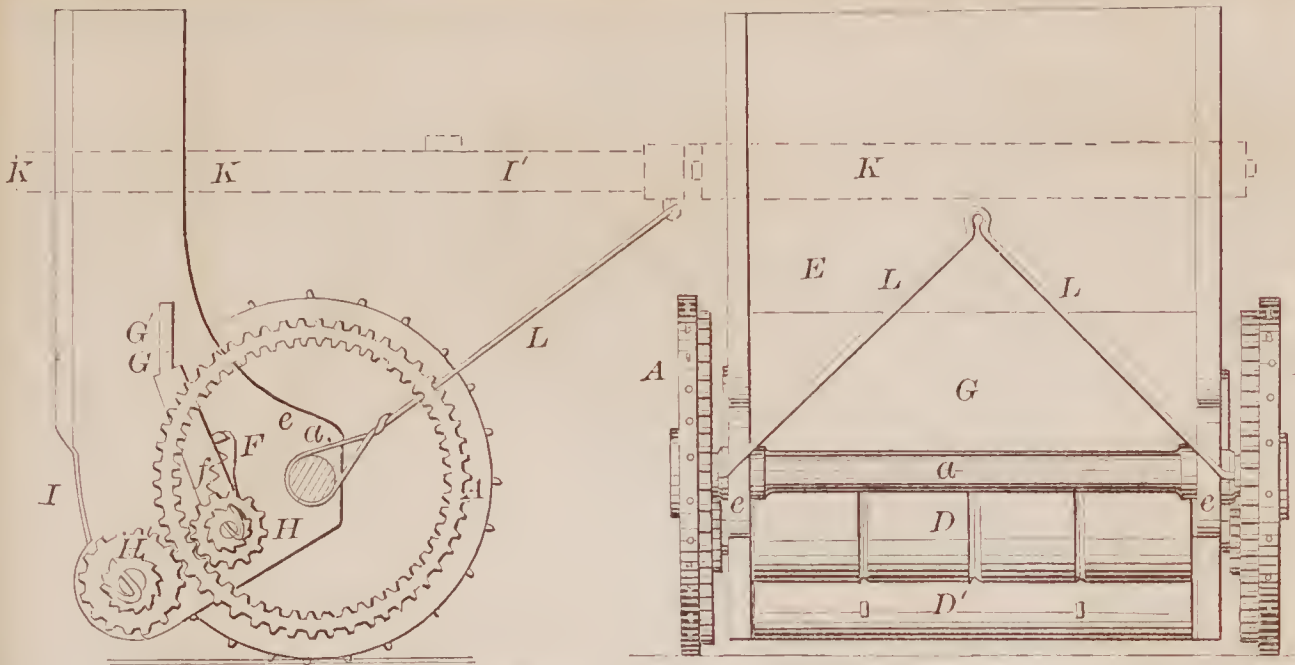

71369—J. Edwards—Belt Shifter for Roving Machines.

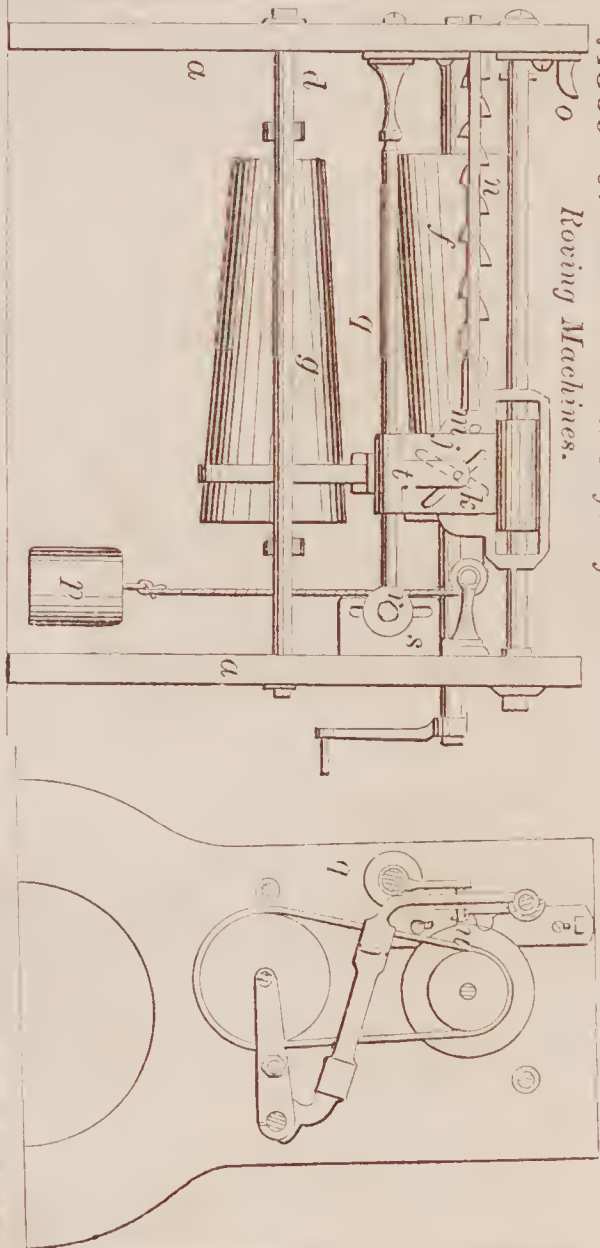

71371—G. H. Fiske—Bobbin.



71367—A. R. Davis—Covering for Plastered Walls.

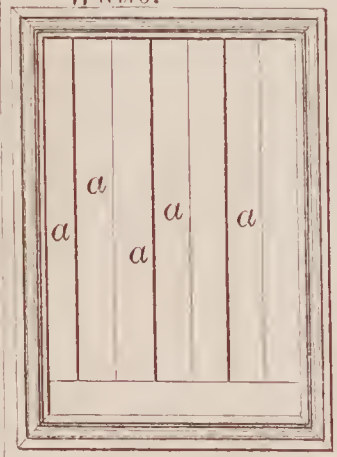

71370—E. S. Fisher—Dividers.

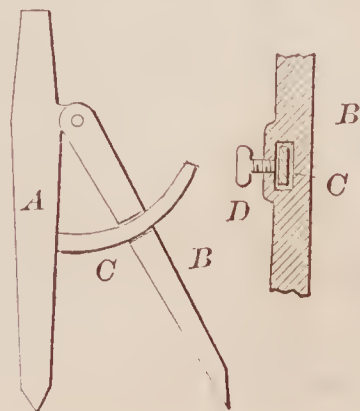

71368—E. T. Duke—Store Damper.

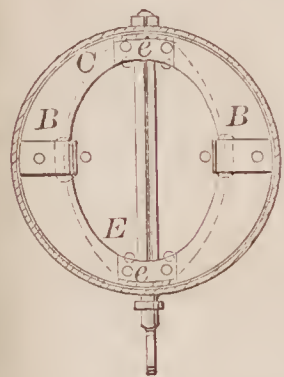
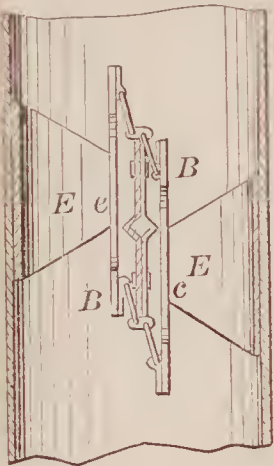

71372—C. T. Fitch—Post Driver.

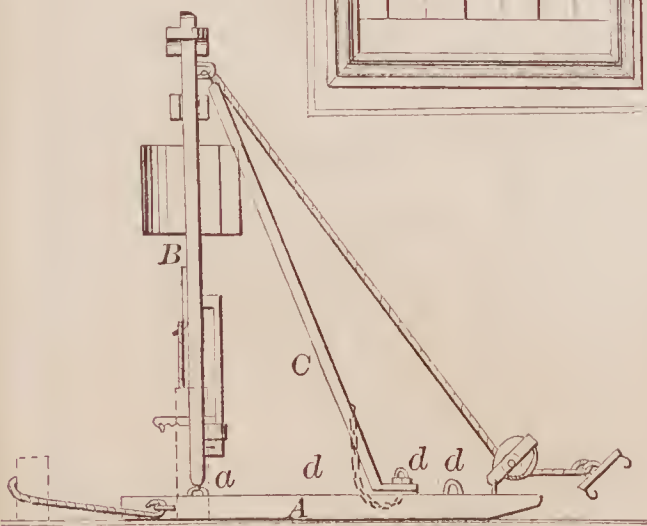



71373—C. Flesch—Permutation Lock.

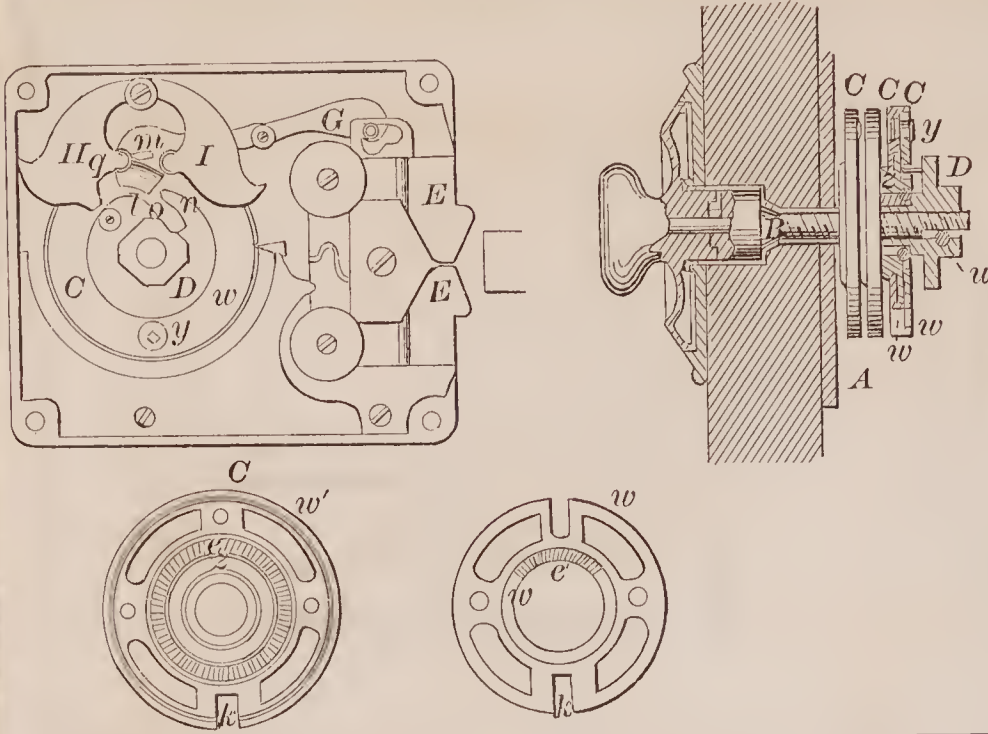

71378—J. Gondouin—Funnel.

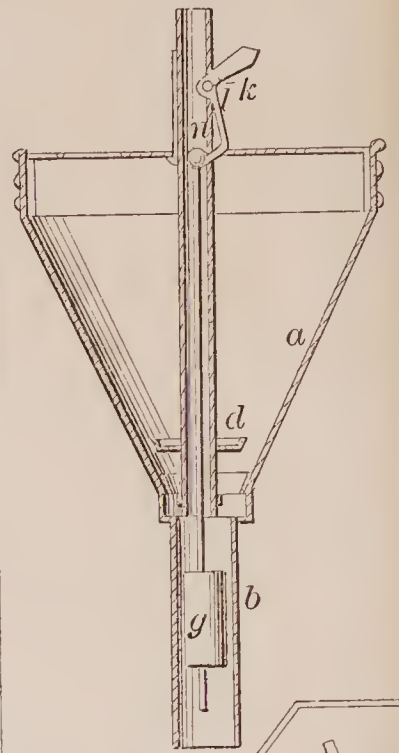

71374—C. T. Ford—Toy Fortune Teller.

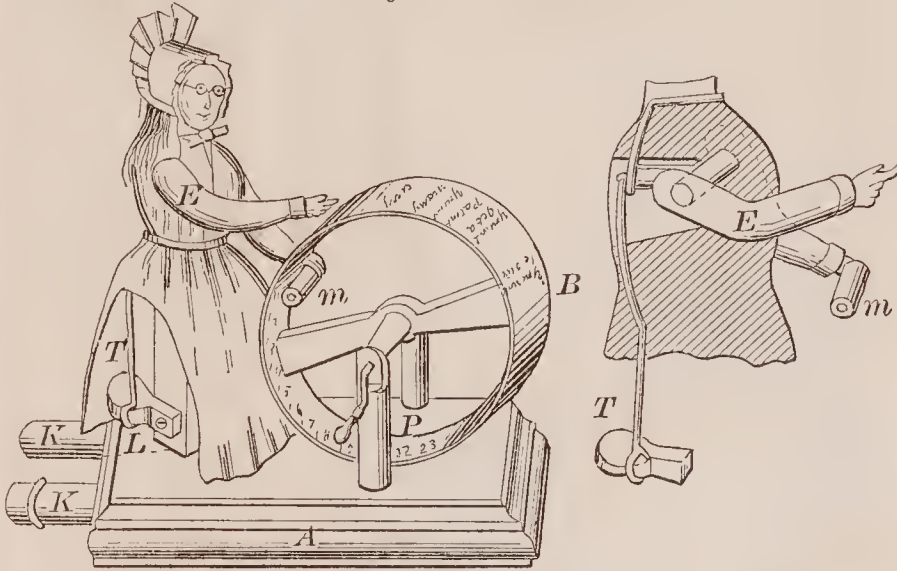

71376—C. Forster—Plow.

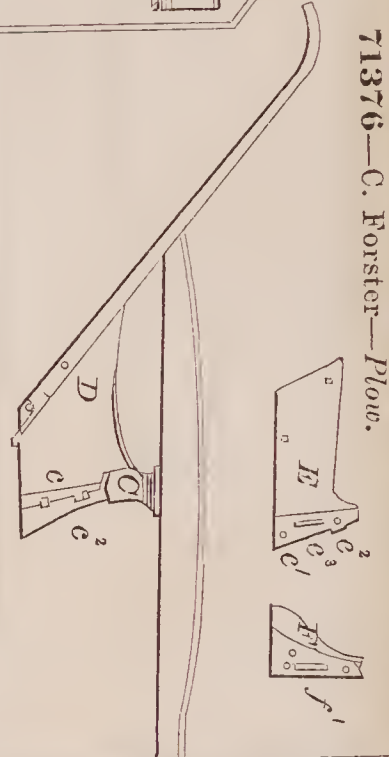

71379—Gordon & Christianson—Corn Planter.

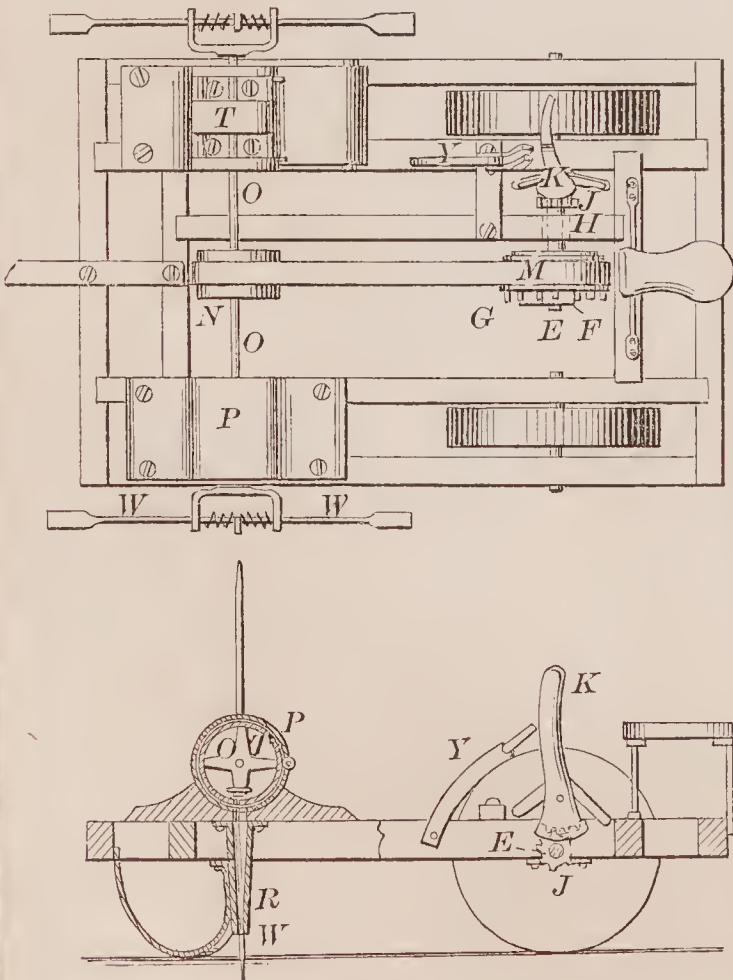

71375—D. Forrest—Gas Meter.

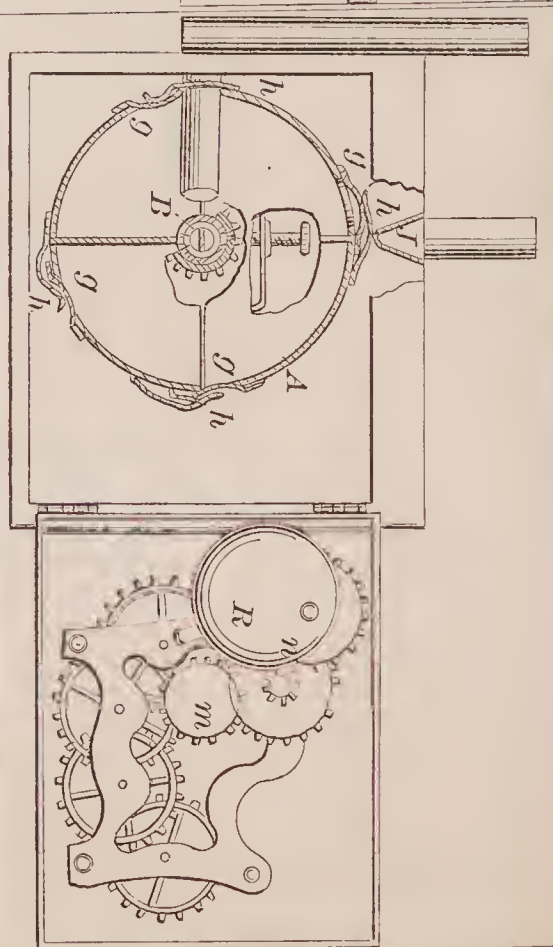

71380—H. Goss—Cement Stove Pipe  
Thimble.

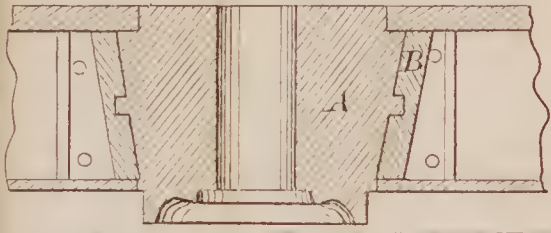

71381—A. Gray—Beehive.

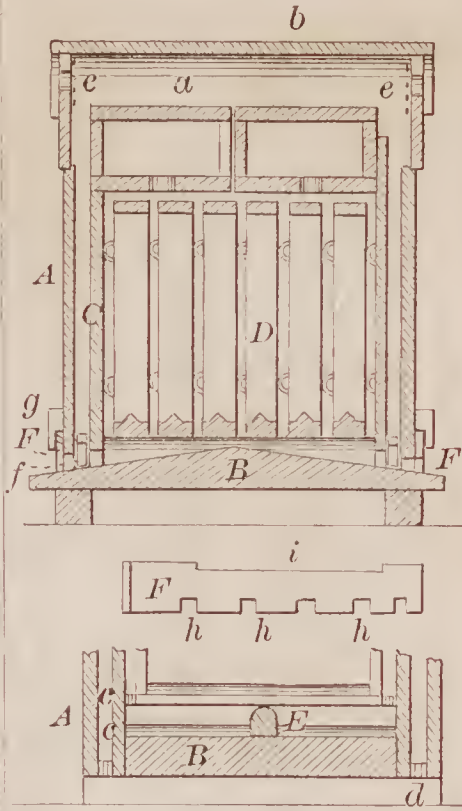

71383—Guignon & McDonald—Kiln  
for Charring Wood, &c.

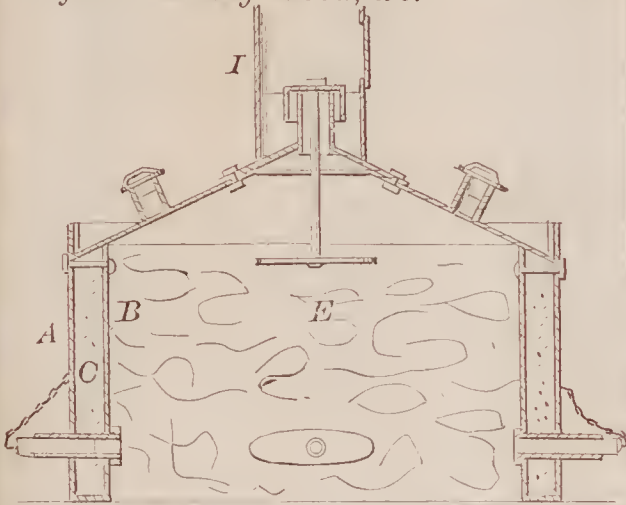

71386—R. P. Henry—Roofing.



71384—A. S. Harlan—Rotary Steam  
Engine.

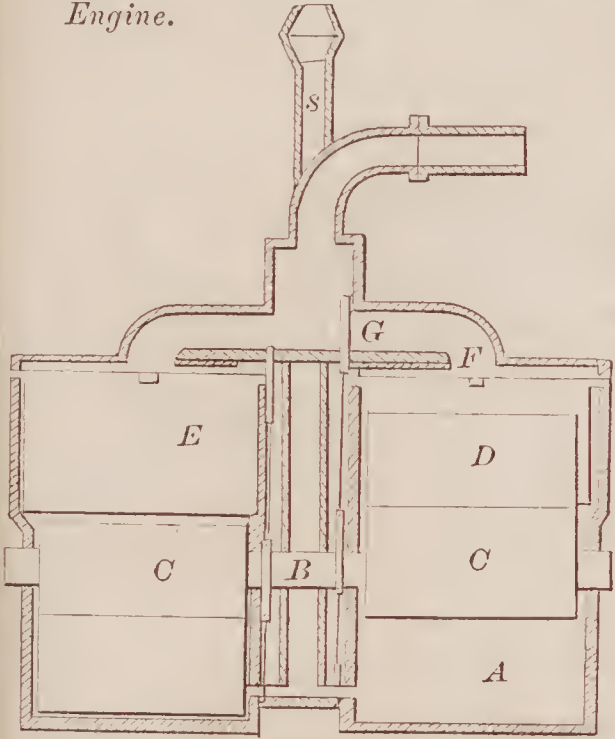

71385—C. H. Haskins—Car Ventilator.

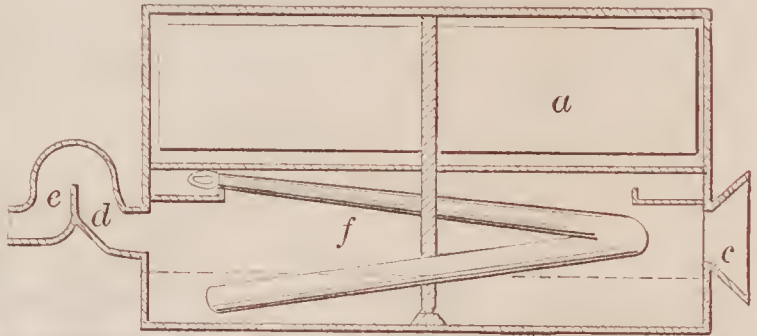

71387—J. J. Hill—Clamp for  
Planking Ships' Sides.

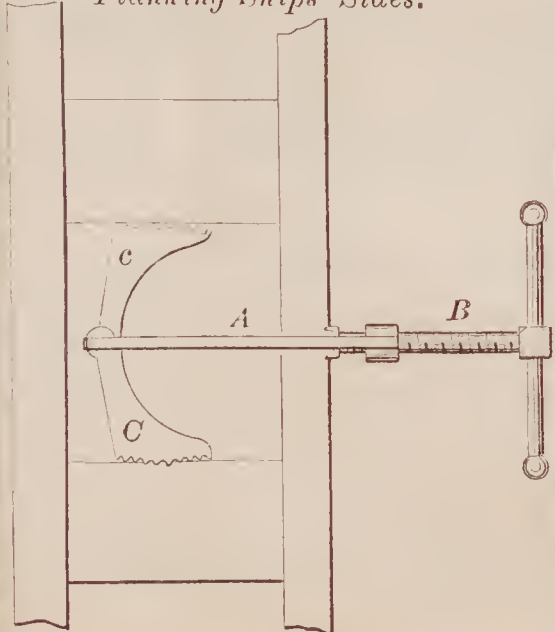

71382—R. B. Griffin, Jr.—  
Button Fastener.

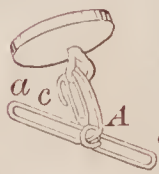

71389—C. E. Jacot—Winding  
Watches.



71388—G. W. Hunt—Stove  
Corner Lifter.

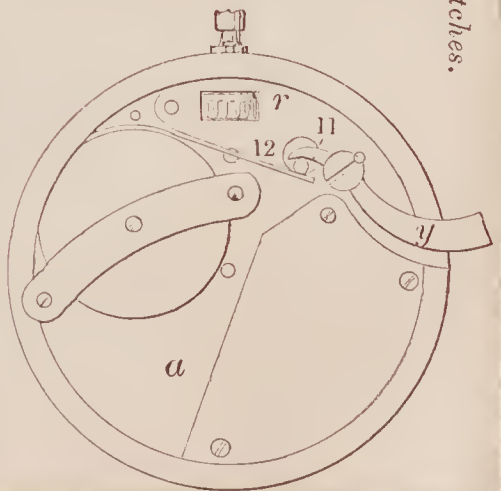







71399—J. A. Marvin—Heater.

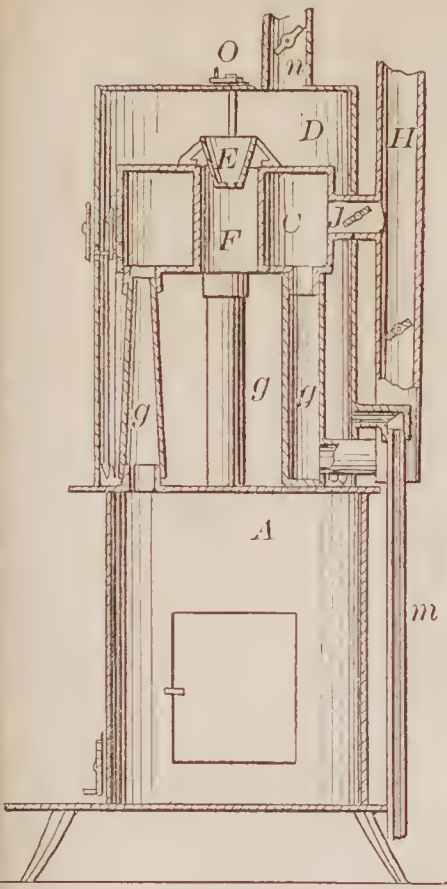

71400—H. S. Maxim—Steam Gas Generator.

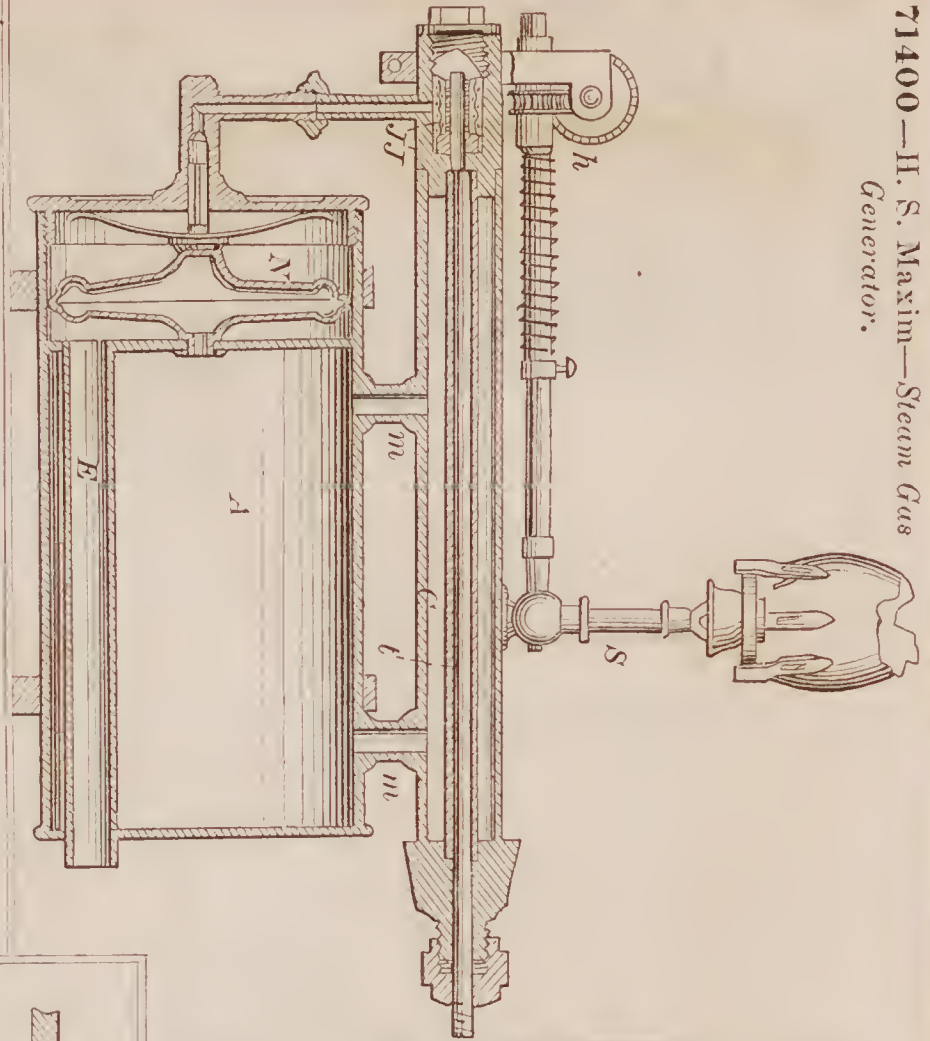

71401—C. A. Meinhard—For Planing and Slotting.

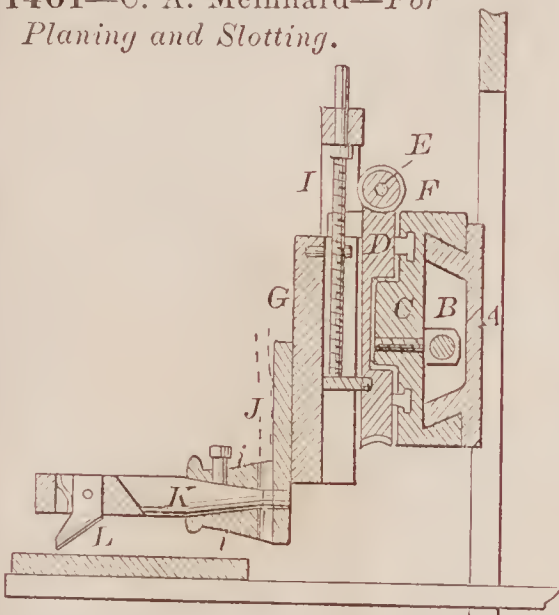

71404—E. C. Newton—Carriage Pole Coupling.

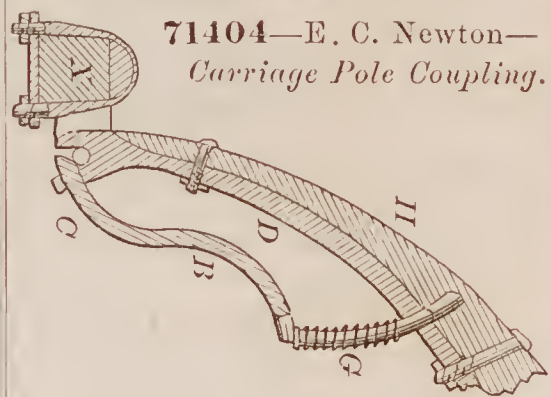

71402—Miller & Pernot—Bung Extractor.



71405—L. M. Olden—Beehive.

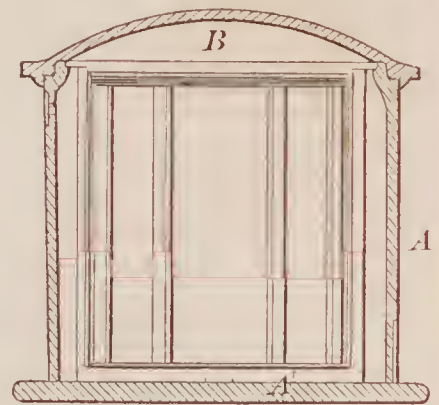

71403—E. Myers—Planing Machine.

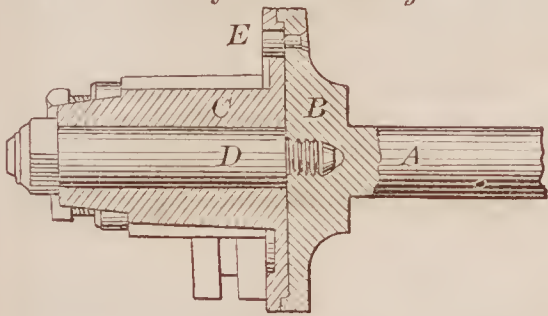

71406—H. Parker—Wagon.

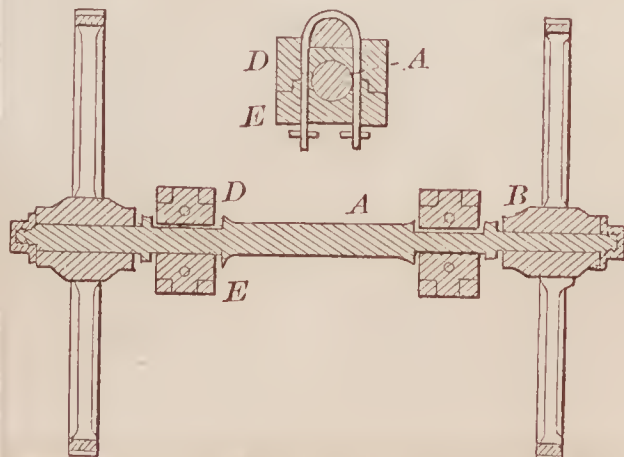

71408—G. Peacock—Cast Iron Car Wheel.

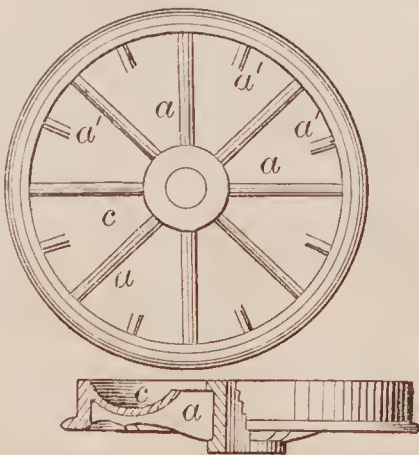



71409—F. R. Pearson—*Jack Centre for g Spinning Machines.*

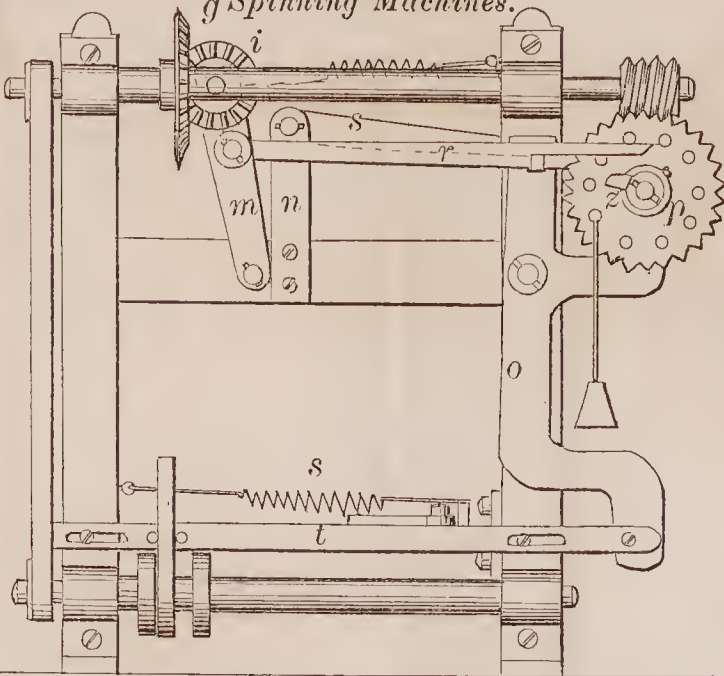

71411—Porter & Hallett—*Door Lock.*

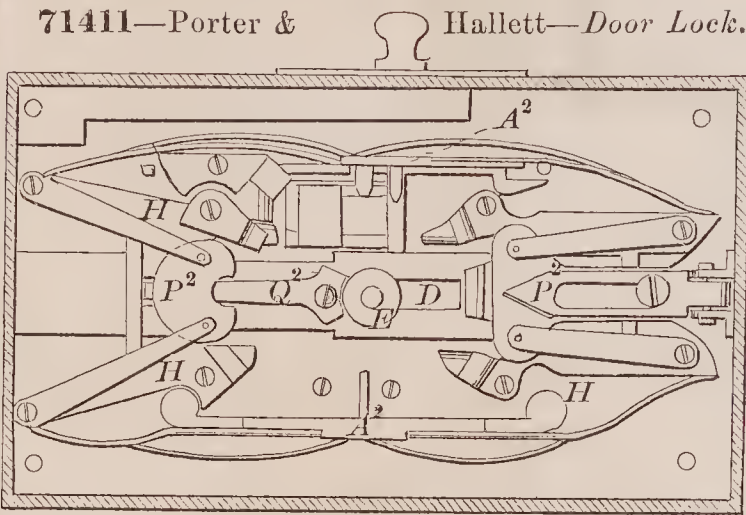

71414—A. C. Rohleder—*Uterine Supporter.*

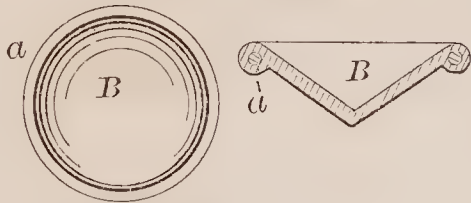

71419—S. S. Starnes—*Plow.*

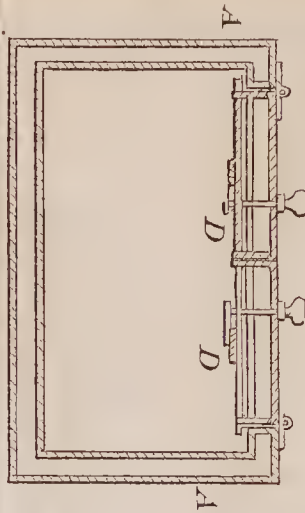
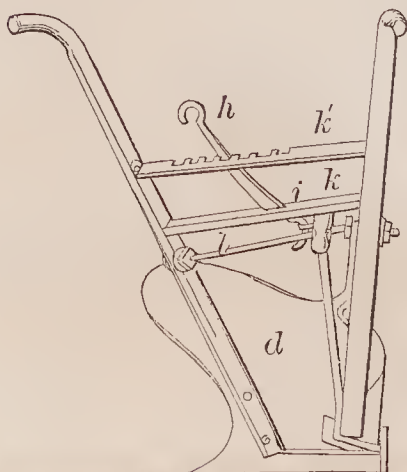
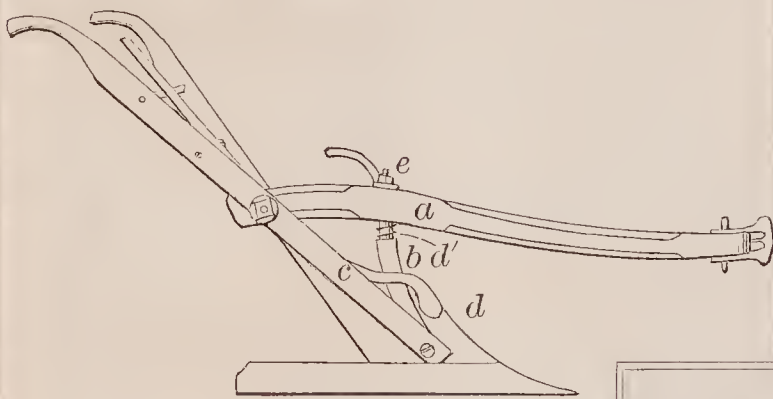

71410—J. R. Pierson—*Safe Door Bolt.*



71412—J. G. Pugsley—*Elastic Rein Pull.*

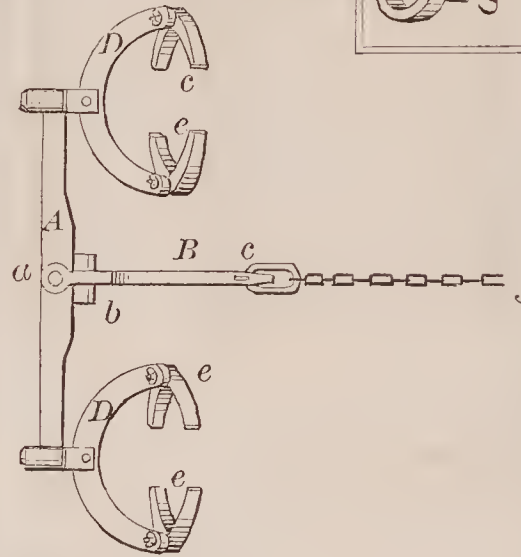

71415—E. Sanford—*Drayght Attachment for Horses.*

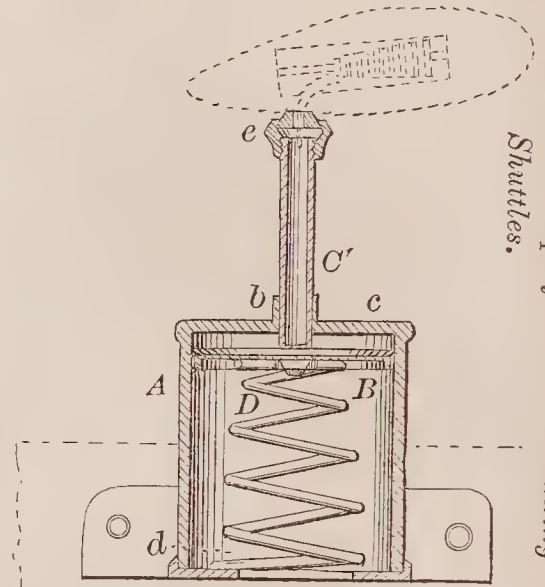

71413—L. Ripley—*For Threading Shuttles.*

71417—Sheffield & Whitcomb—*Railroad Rail.*



71418—W. E. Simonds—*Telegraph Insulator.*

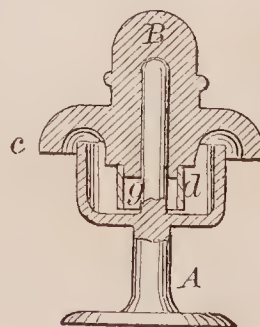

71416—J. T. Shank—*Hatchet.*

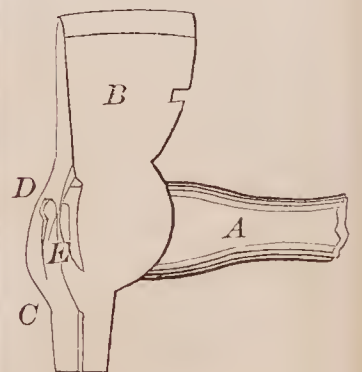

71420—D. Steward—Cracker Machine

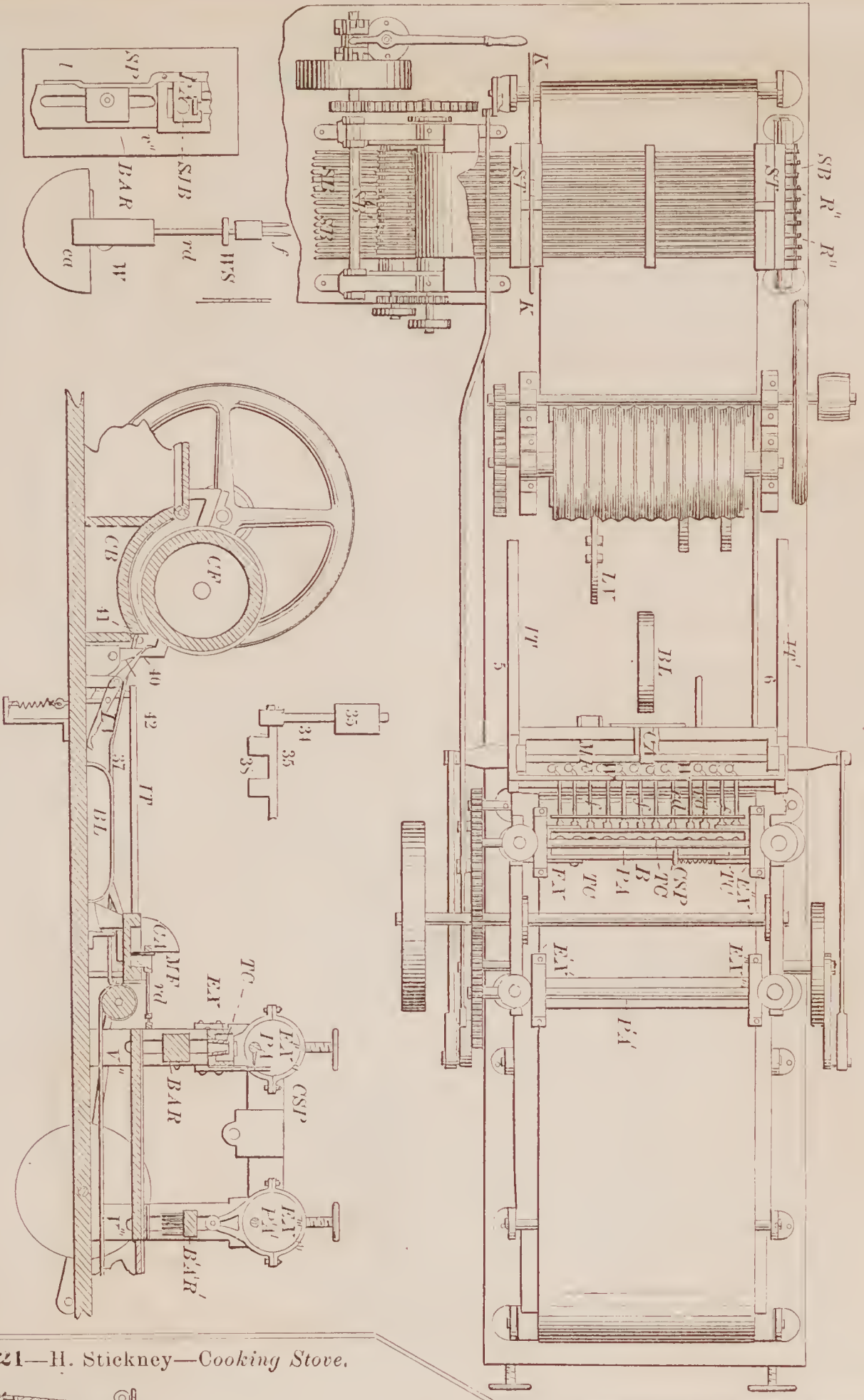

71421—H. Stickney—Cooking Stove.

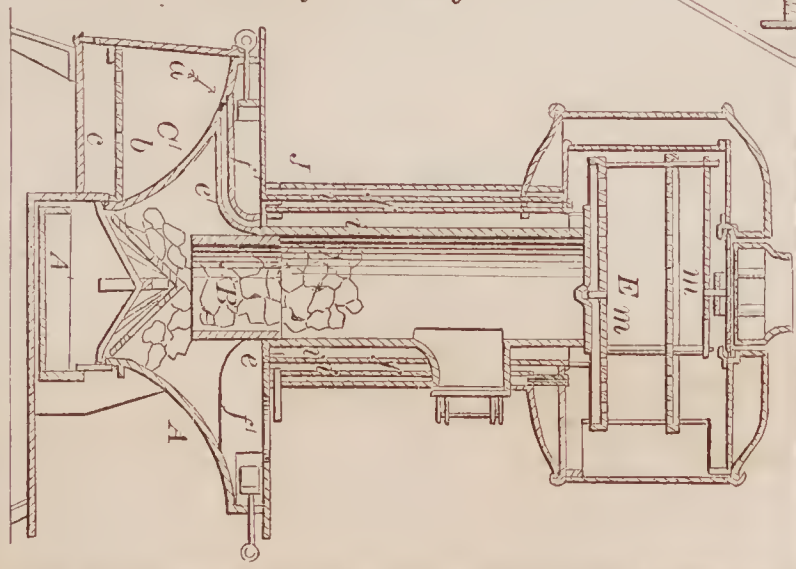

71422—W. Stone—Car Axle Box.

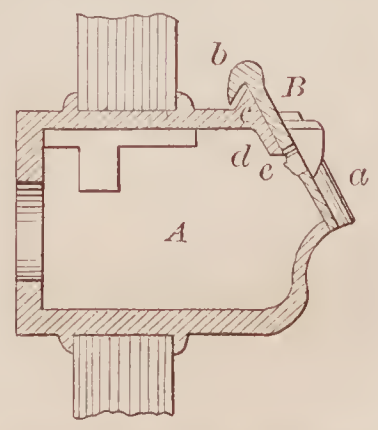



71423—J. B. Sutherland—Refrigerator Car.

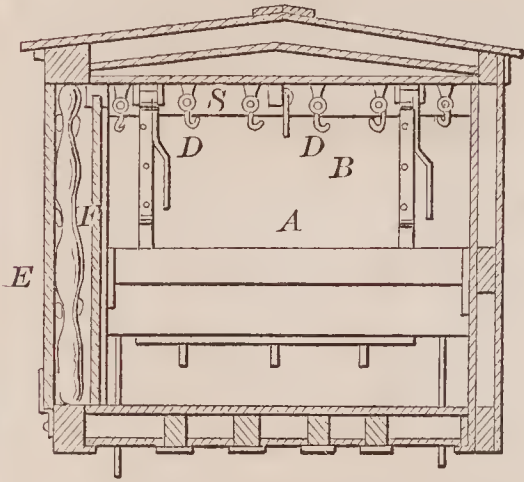
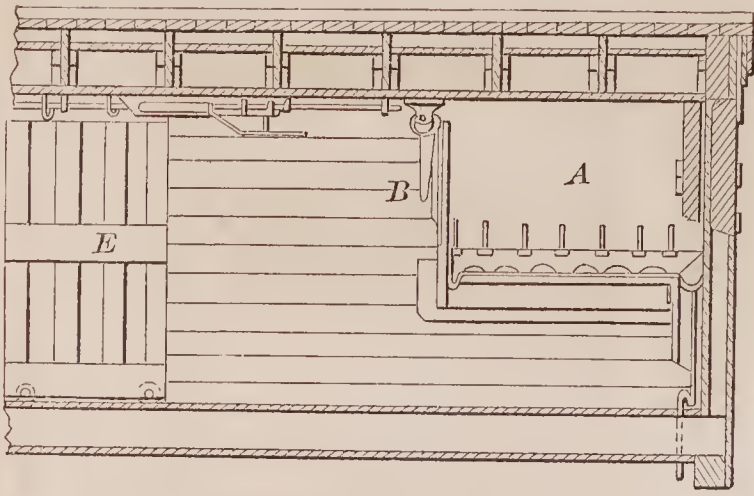

71425—J. B. Tarr—Steam and Air Engine.

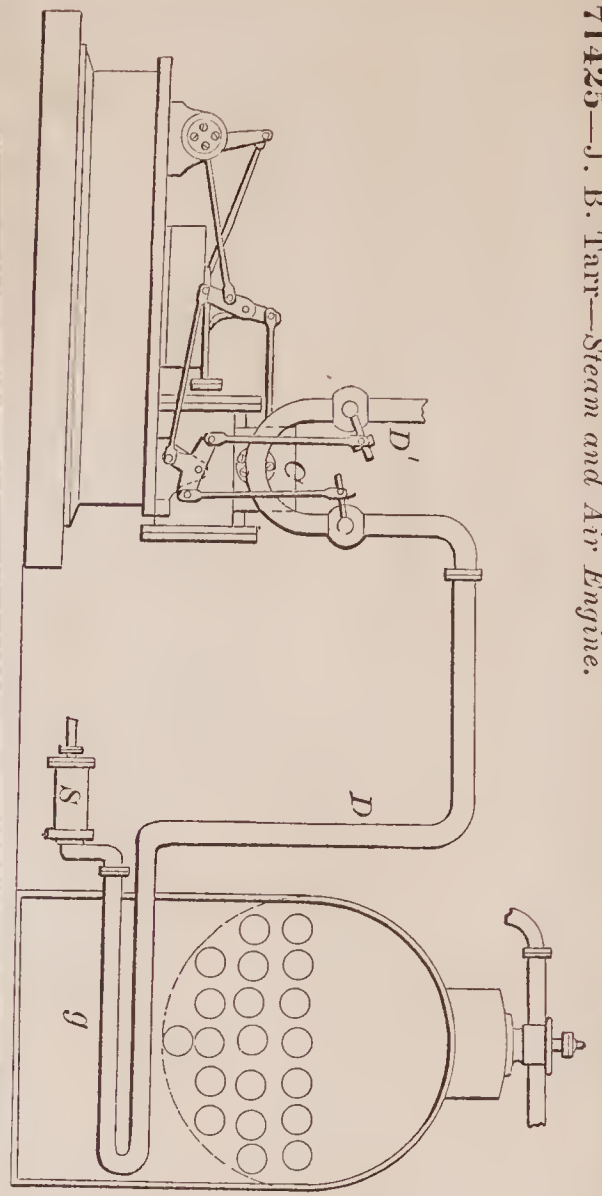

71424—C. Swett—Artificial Leg.

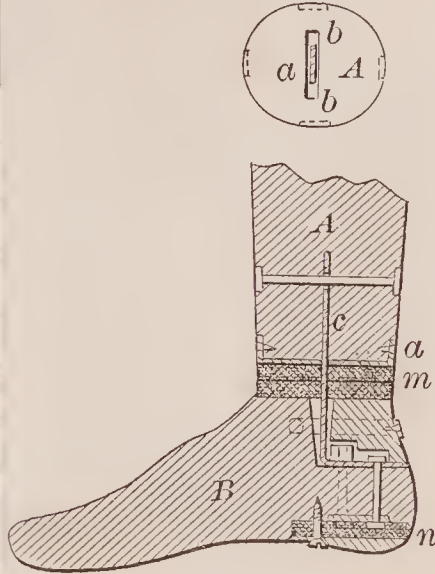

71428—J. W. Tracy—Gas Cigar Lighter.

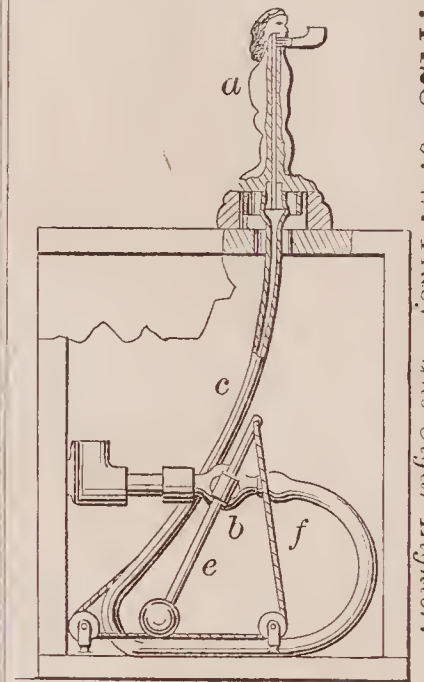

71427—E. Tourjee—Key Board Attachment.

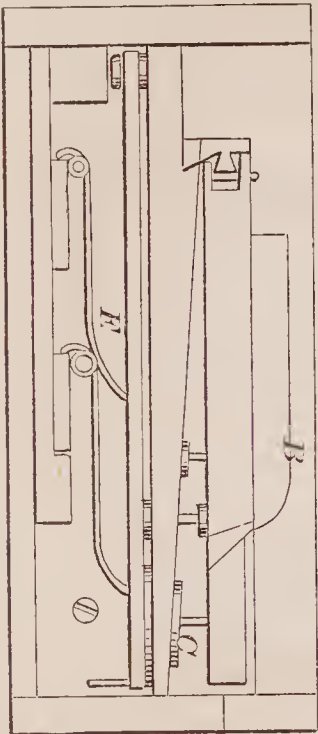

71429—Tunnicliff & Cahill—For Ornamenting Buttons.

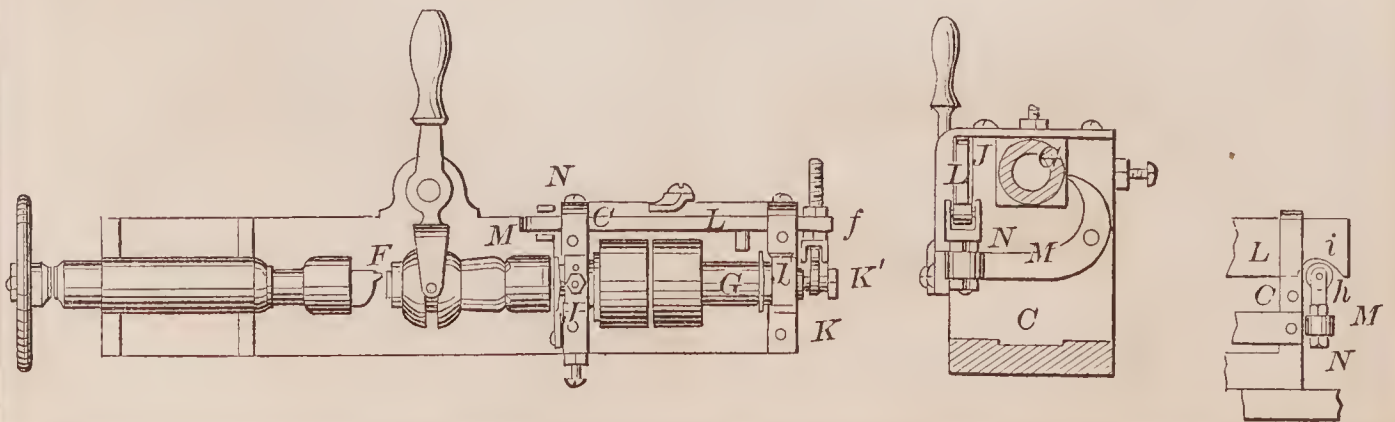

71432—Warren & Blume—Elevated Railway.

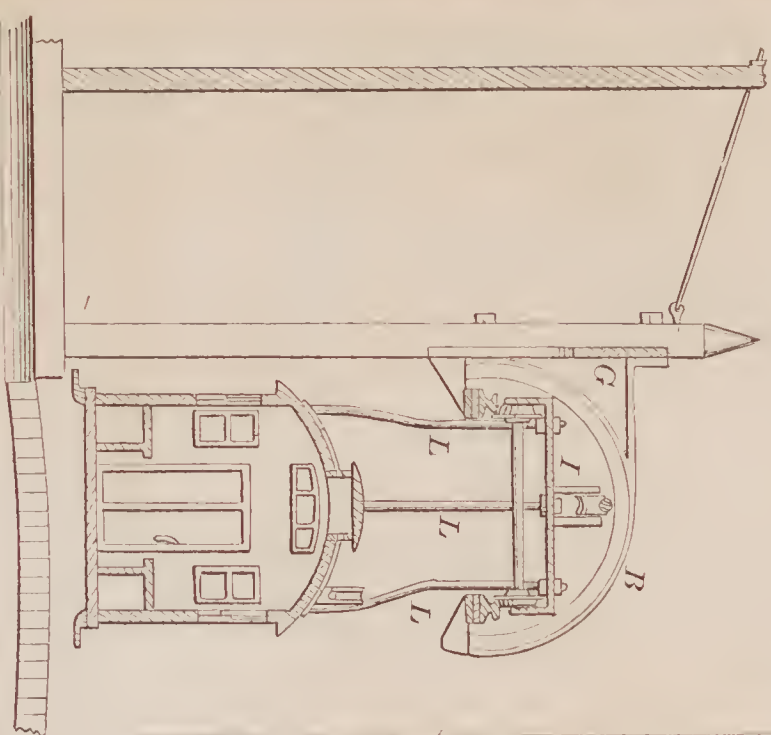

71430—A. C. Vaughan—Burner for Locomotive Head Lights.

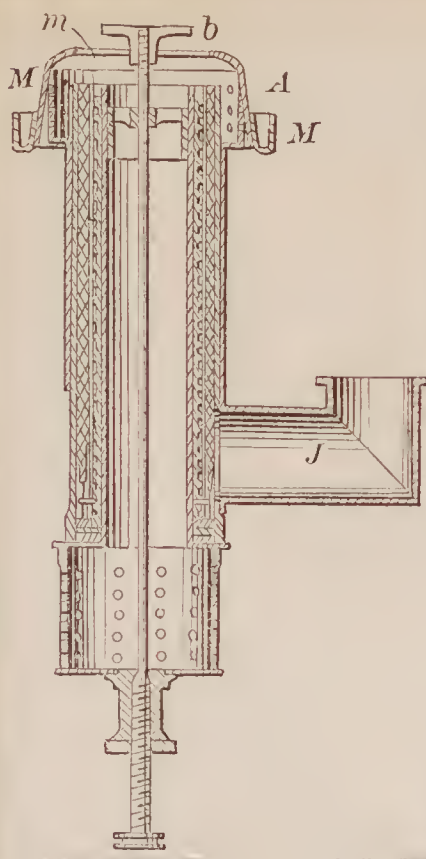

71435—H. B. Willecox—Fruit Box.

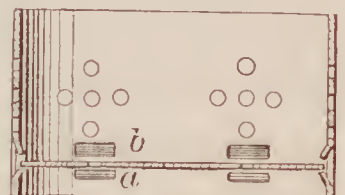

71434—N. B. White—For Sealing Fish.

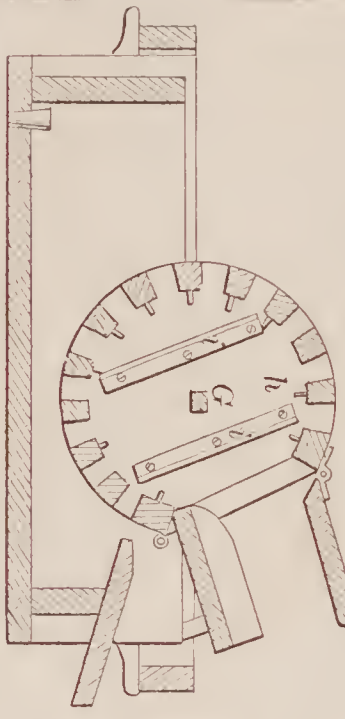

71438—A. Allen—Hinging Clock Fronts.

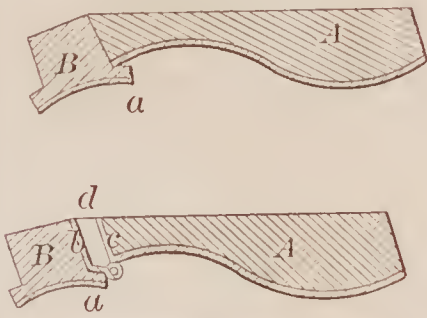

71431—A. C. Vaughan—Head Light for Locomotives.

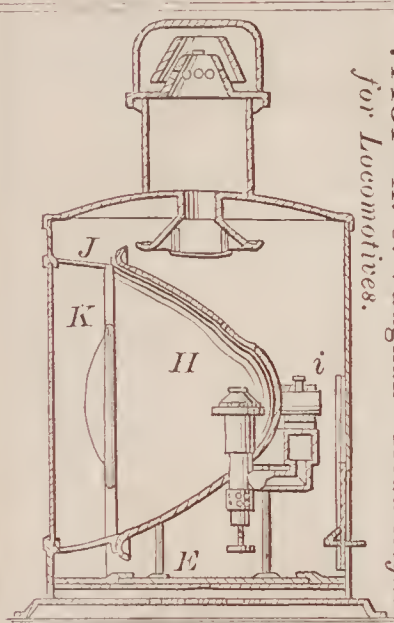

71437—O. Abbruzzo—Hydraulic Clock.

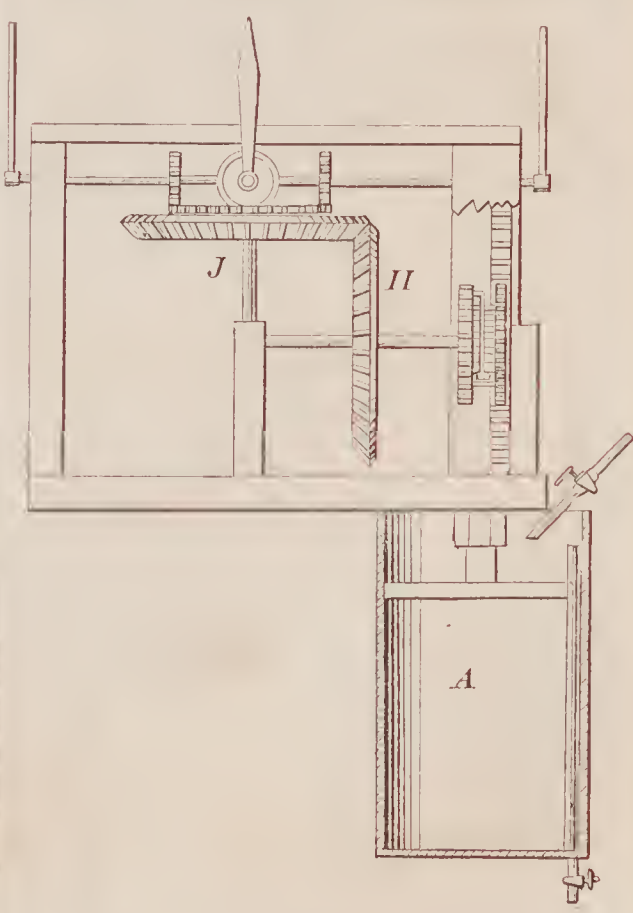

71433—J. Watson—Furnace Door.

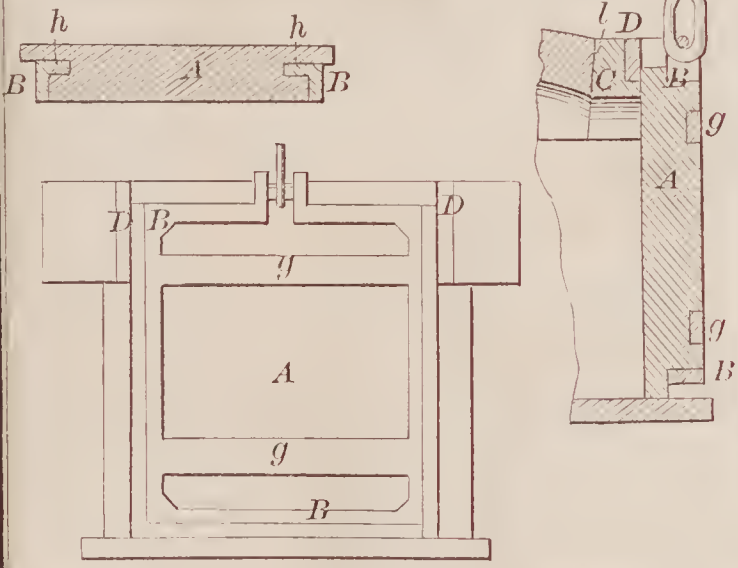

71436—N. Adkins—Stairs.

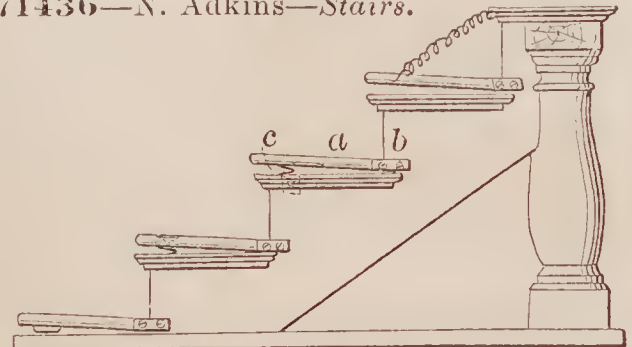



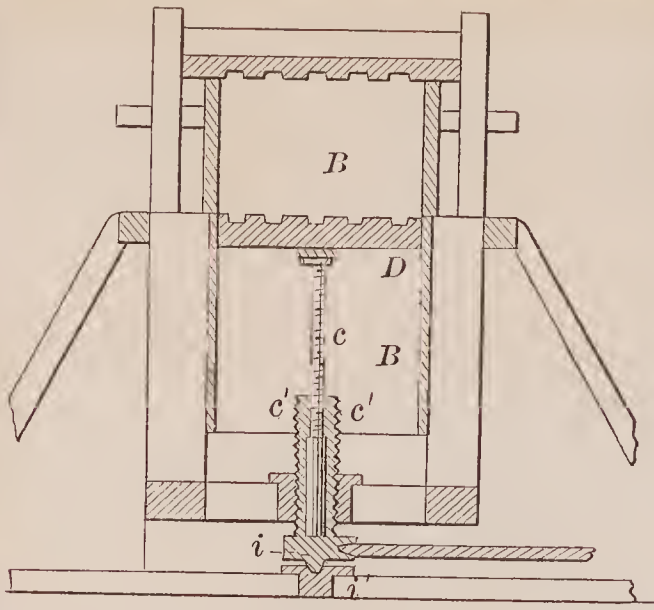

71439—B. B. Alfred—Cotton and Hay Press.

71440—H. D. Barnes—Floor Clamp.

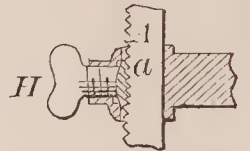
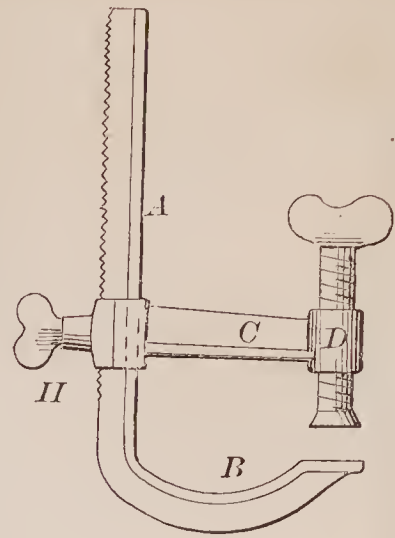

71442—A. B. Bean—Knife Sharpener.

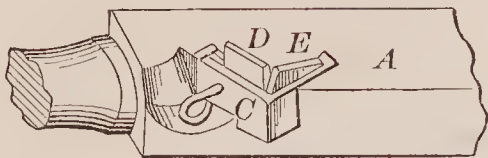

71445—J. Blackwood—Washing Machine.

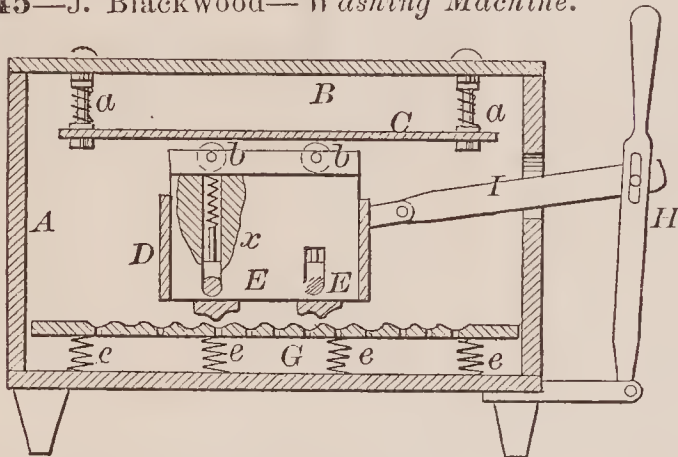

71444—L. F. Betts—Lantern.

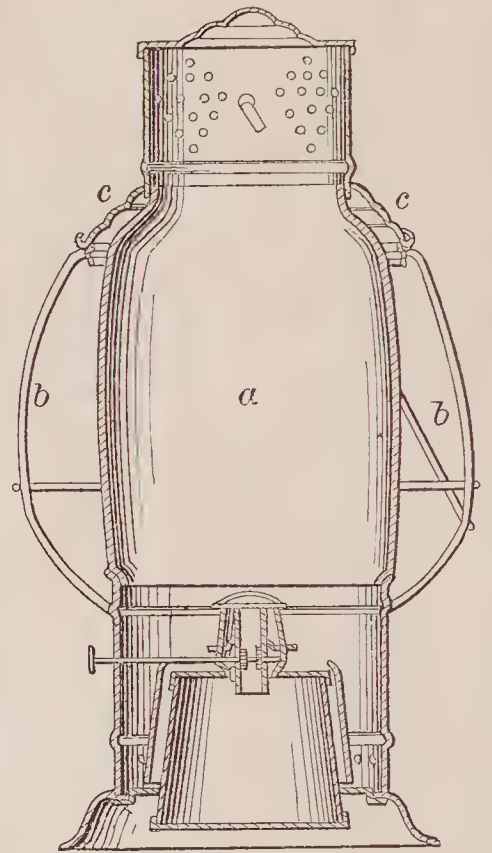

71441—E. Barrett—Lens for Lanterns.

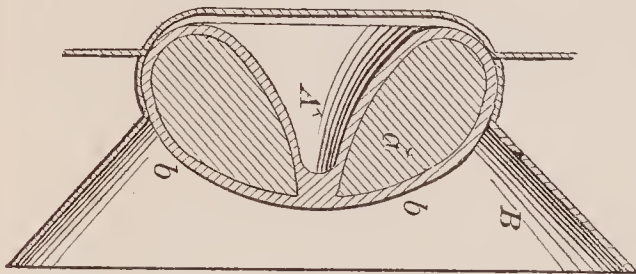

71446—N. A. Boynton—Range and Heater.

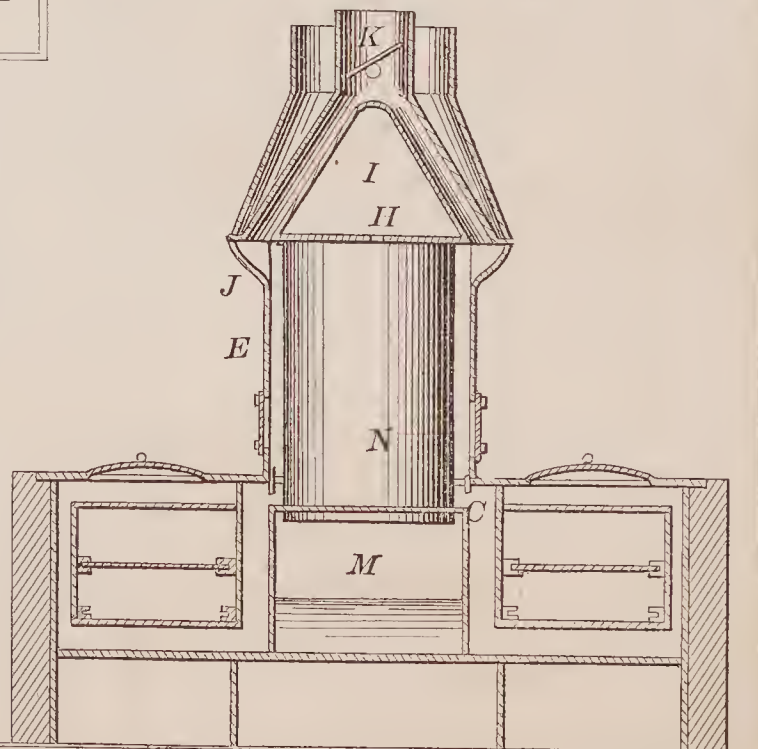

71447—O. B. Brigham—Snap for Glassware Makers.

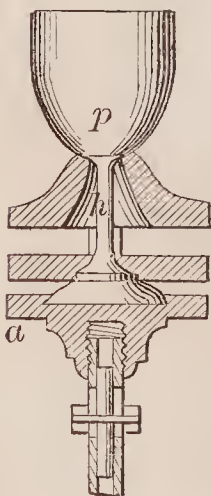

71443—E. O. Bennett—Instand.



71448—W. Bruckner—Ore Roasting Furnace.

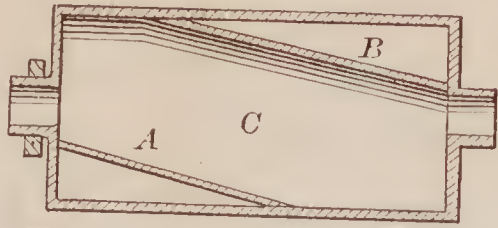

71451—S. G. Cabell—Preventing Incrustation of Boilers.

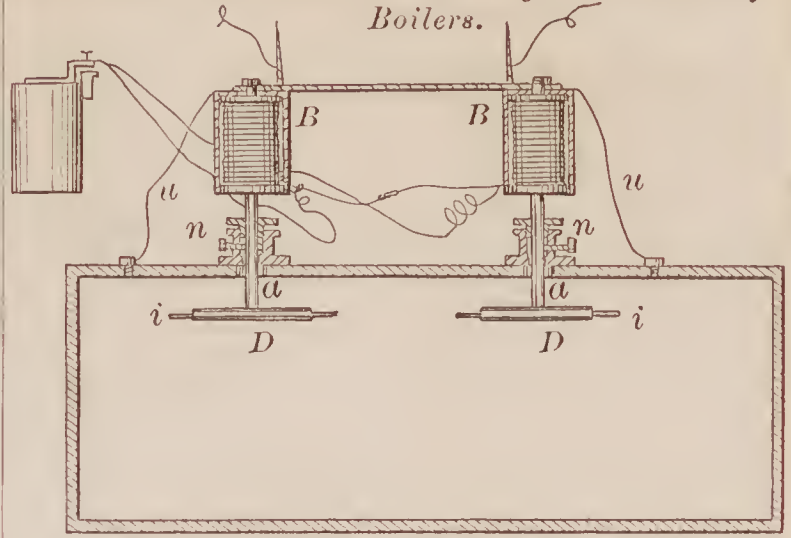

71450—J. Butter—Pitman.

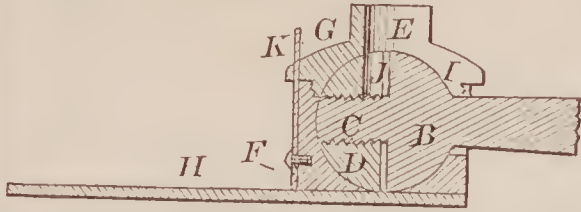

71449—H. E. Burton—Lamp.

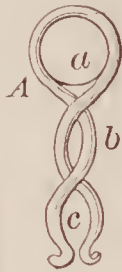
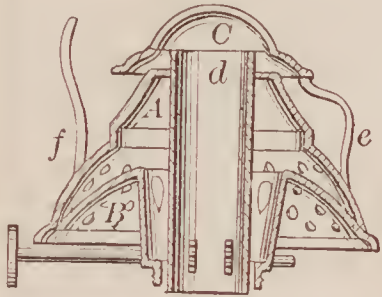

71457—N. B. Cooper—Clothes Pin.

71453—W. Carlton—Horse Hay Fork.

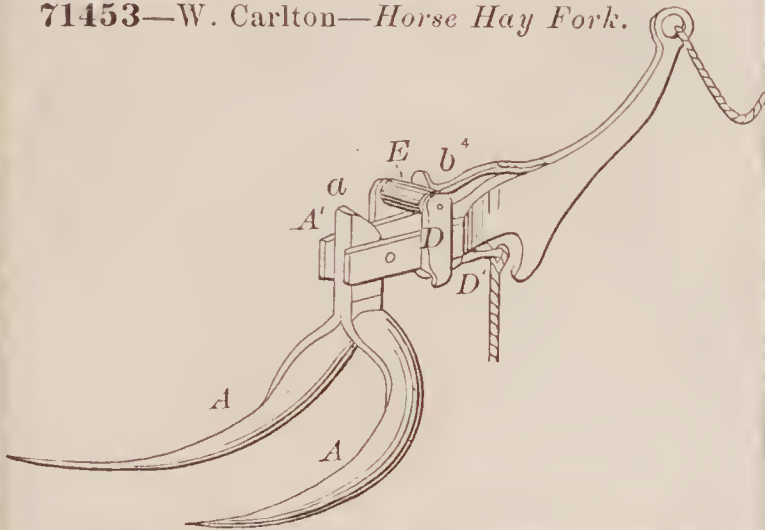

71454—P. Cavalier—Adjustable Scaffold.

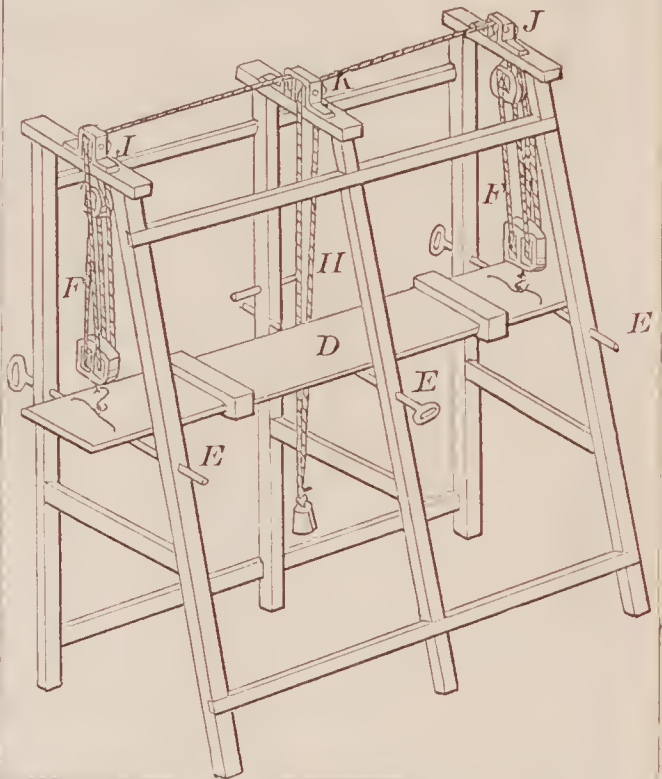

71455—W. H. Christie—Planing Machine.

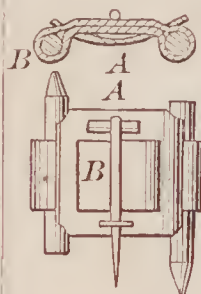
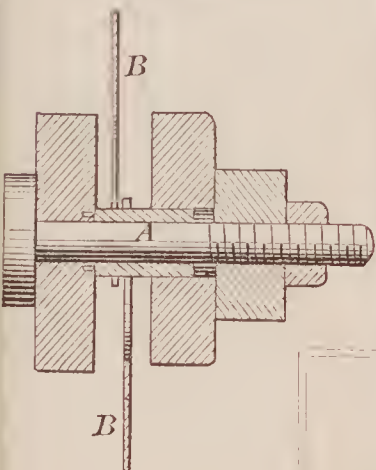

71456—N. B. Cooper—Pencil Holder.

71458—J. & W. H. Clark—Electrical Car Starter.

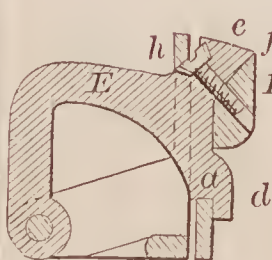
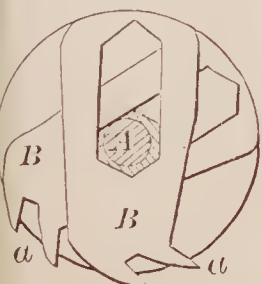
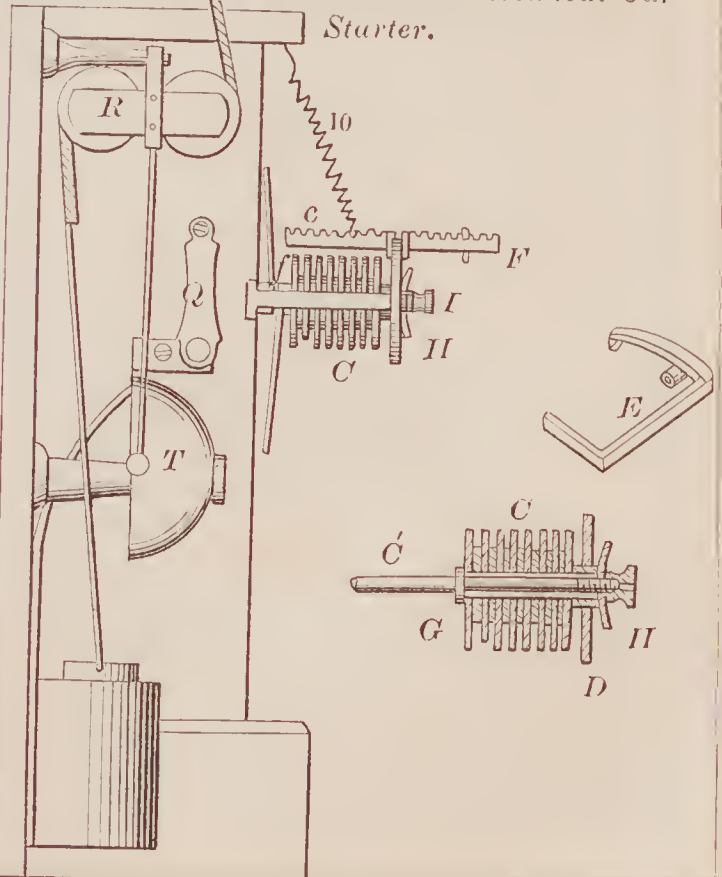

71452—Cady & Cooper—Concealed Hinge.



71459—J. M. Clark—*Breast Developer.*

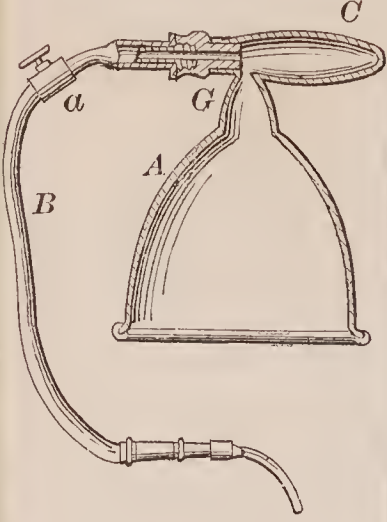

71462—B. A. Davis—*Spur*

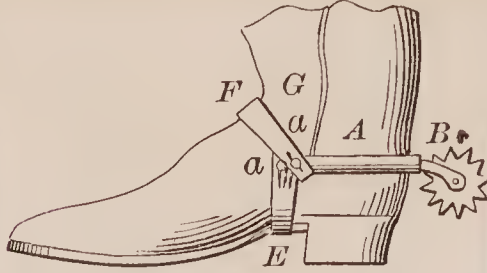

71461—A. H. Crozier—*Water Wheel.*

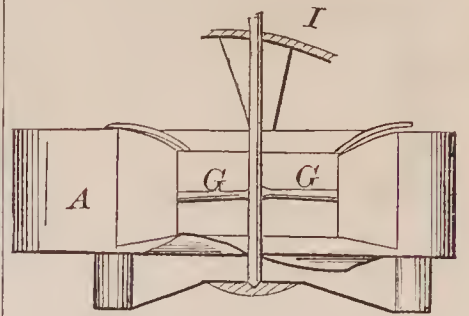

71465—J. B. Driscoll—*Stove and Furnace.*

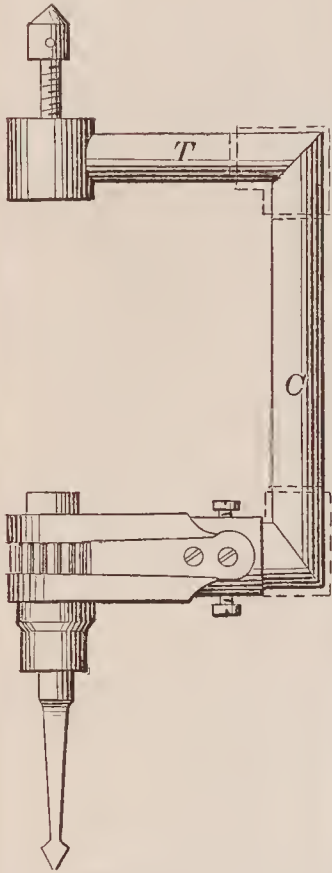
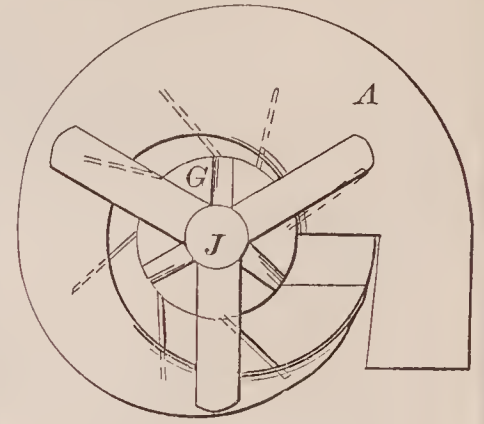
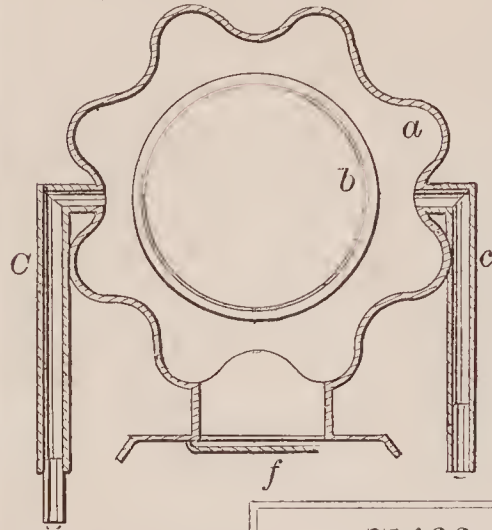

71463—Davies & Taunton—*For Drilling Metals.*

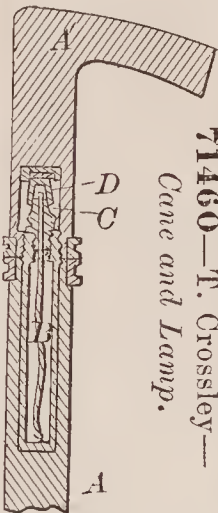

71460—T. Crossley—*Cane and Lamp.*

71466—H. Dueberg—*Brick Machine.*

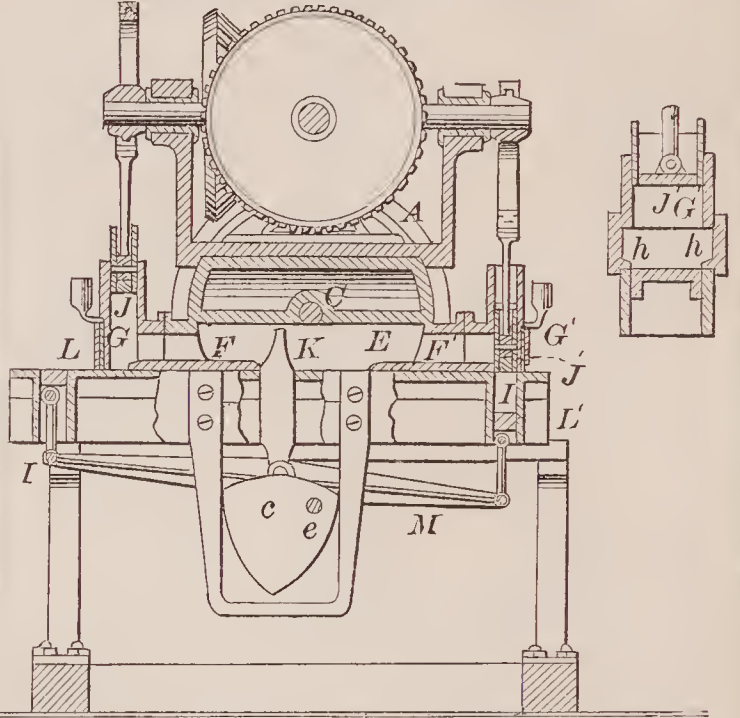

71468—E. S. Earley—*Fastening for Burial Caskets.*

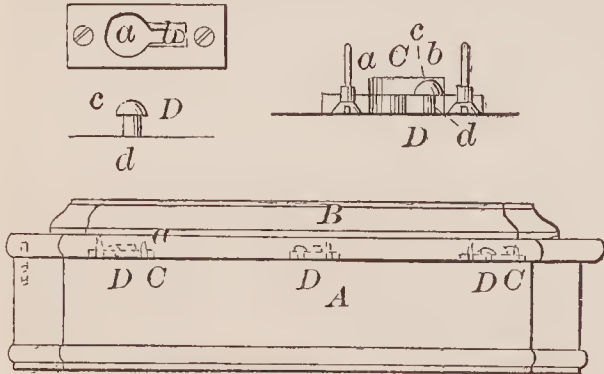

71469—W. T. Eastes—*Churn.*

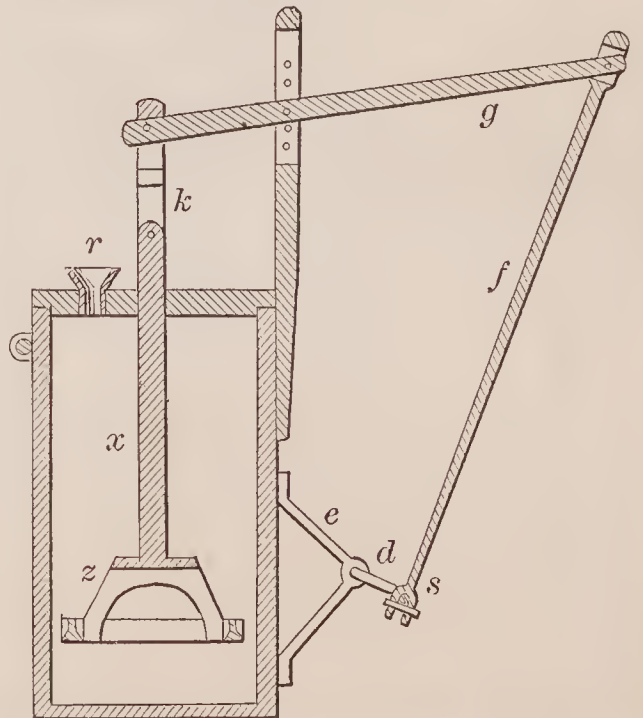

71470—Edmands & Hamblet—*Escapement for Electric Clocks.*

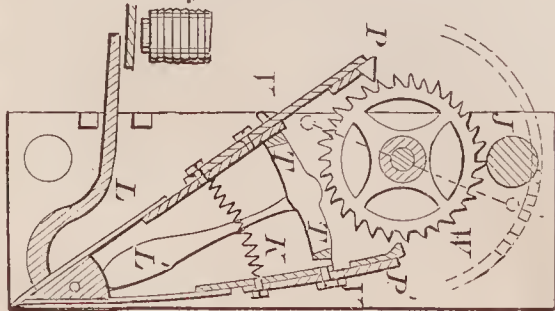

71471—L. Egleston—For Polishing Tubes.

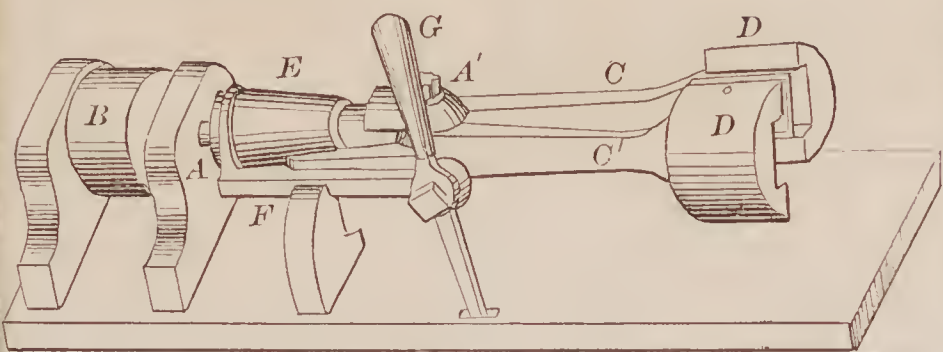

71474—J. B. Evans—Door Latch.

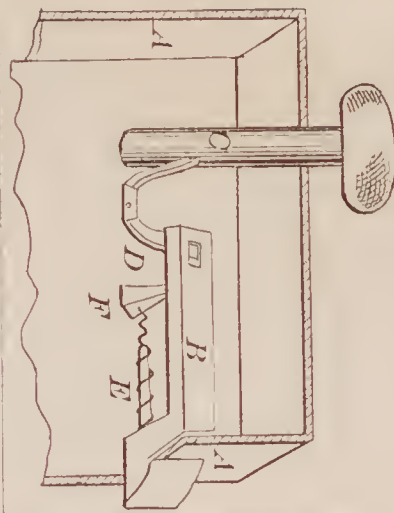

71473—J. E. Emerson—For Punching Saw Teeth.

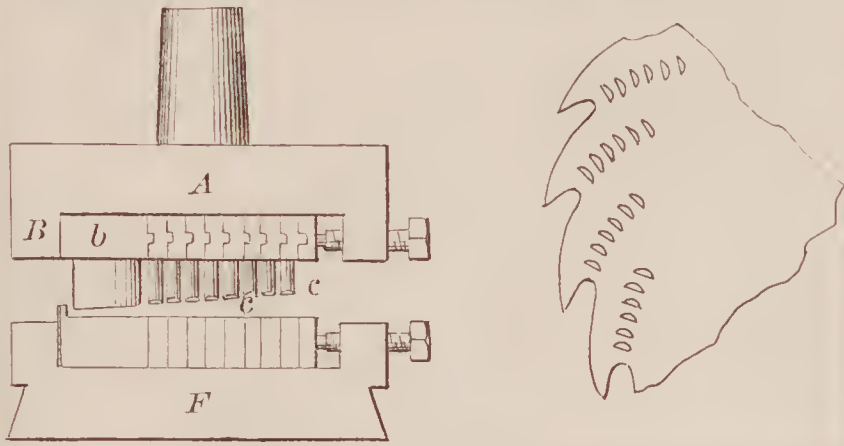

71472—J. J. Everst—Churn.

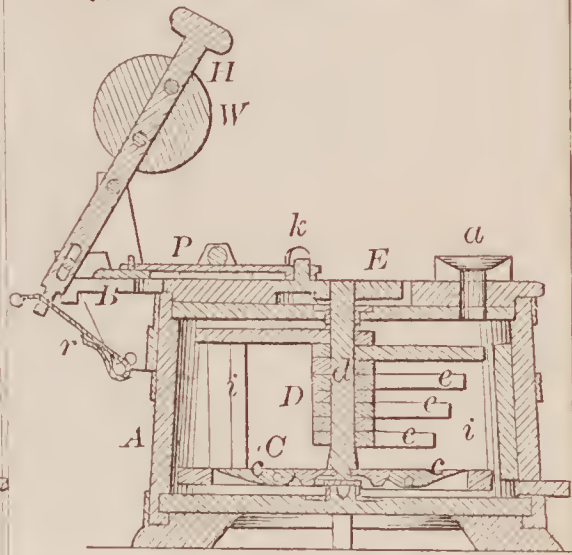

71475—F. Fitzgerald—Vault Light.



71476—A. Foucault—Marine Telegraph.

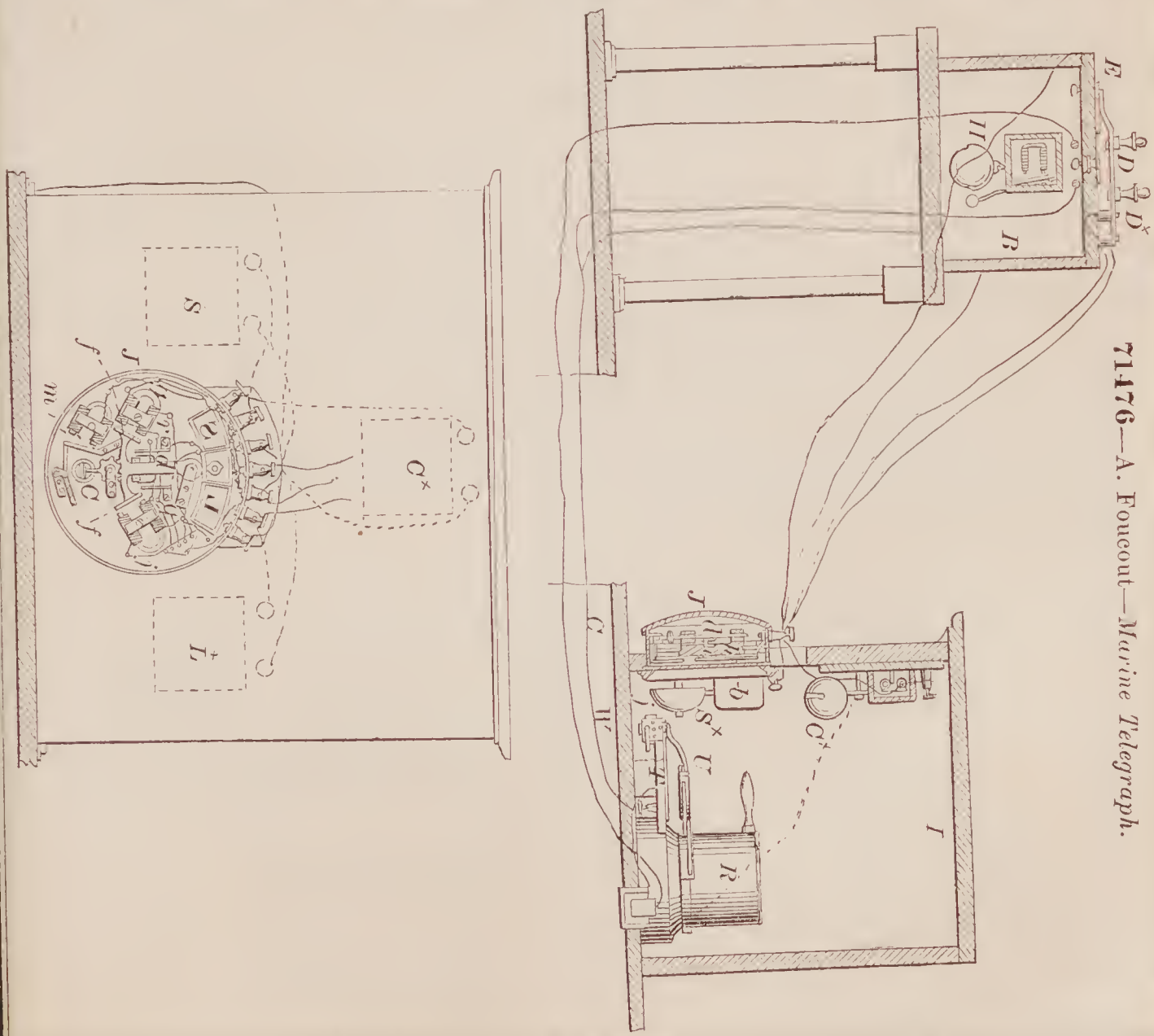



71477—F. C. Fuller—*Lubricating Roller in Spinning Machines.*

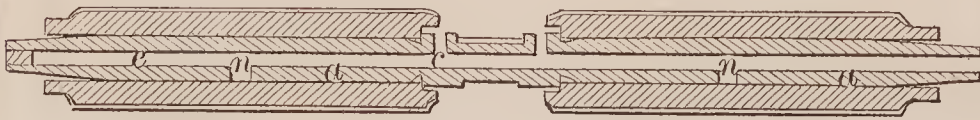

71478—J. C. Gould—*Gate and Door Spring*

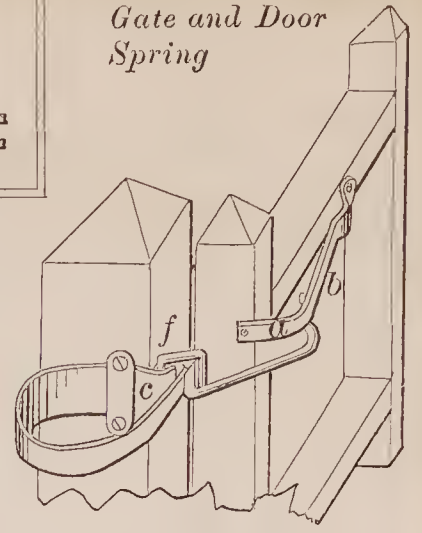

71481—Harper & Crane—*Oven and Drum.*

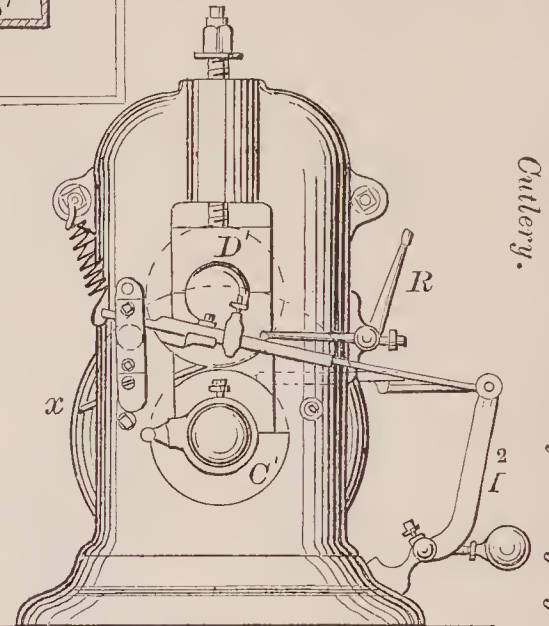
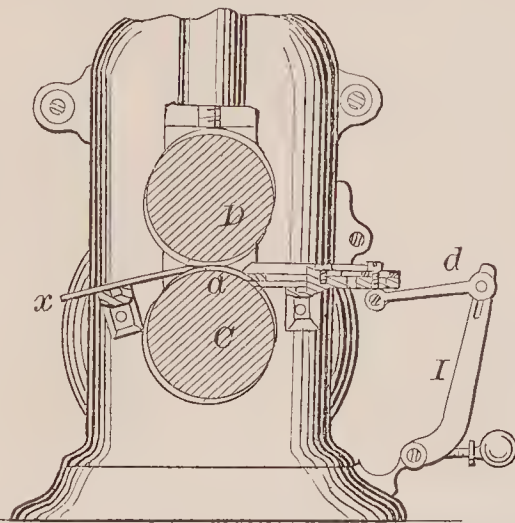
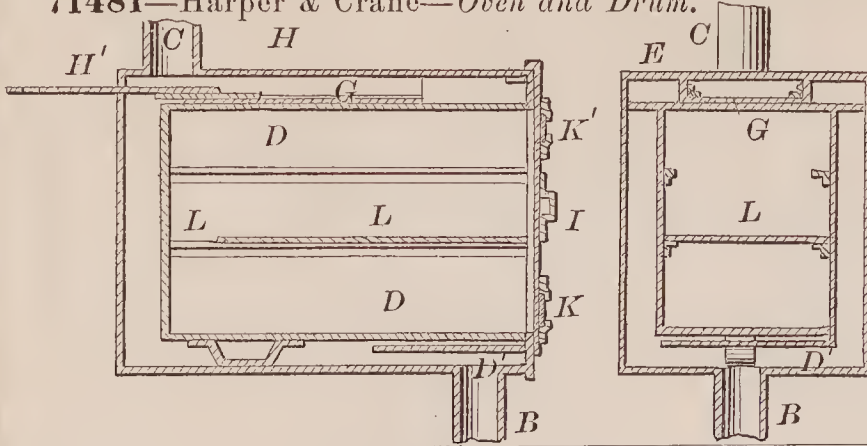

71482—H. B. Harvey—*Forging Outlet.*

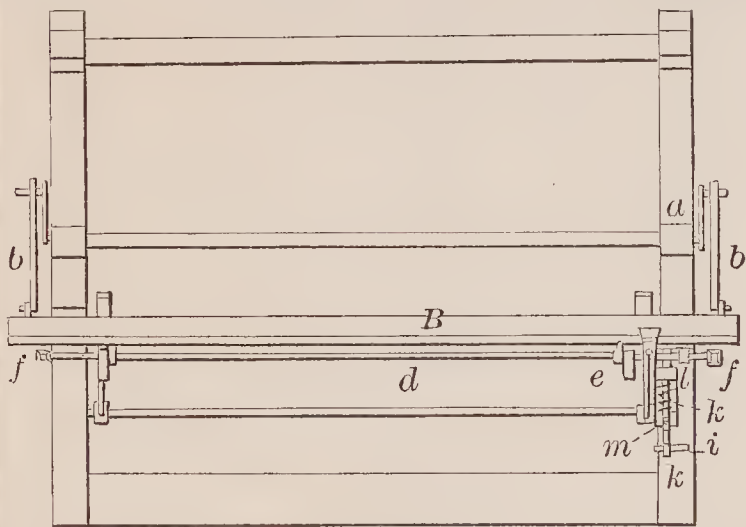

71480—F. Haigh—*Loom.*

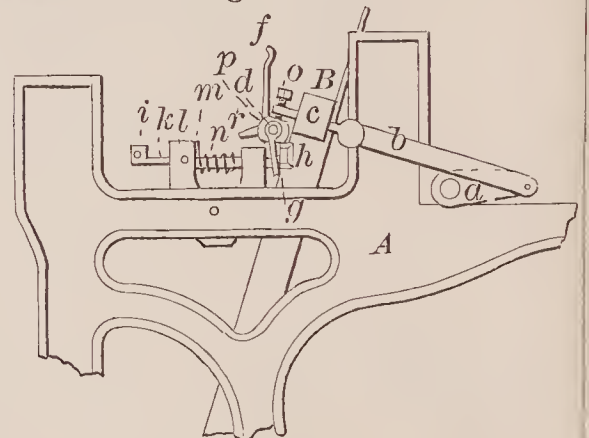

71483—P. Hendricks—*Bridge.*

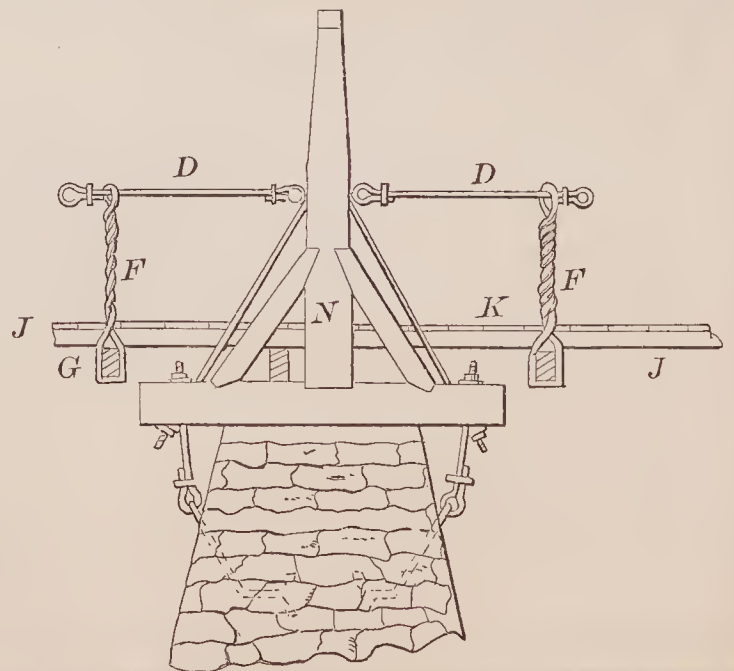
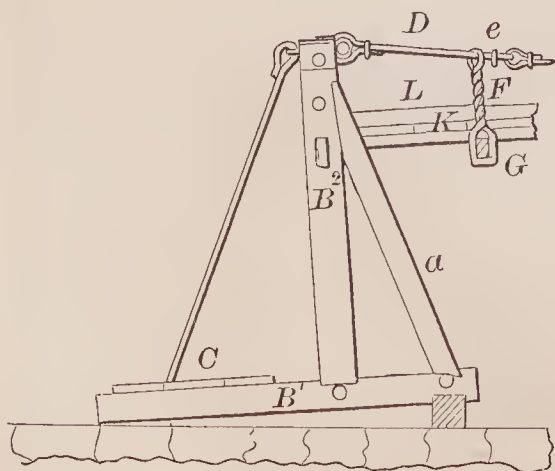

71484—G. P. Herthel, Jr.—Truss Bridge.

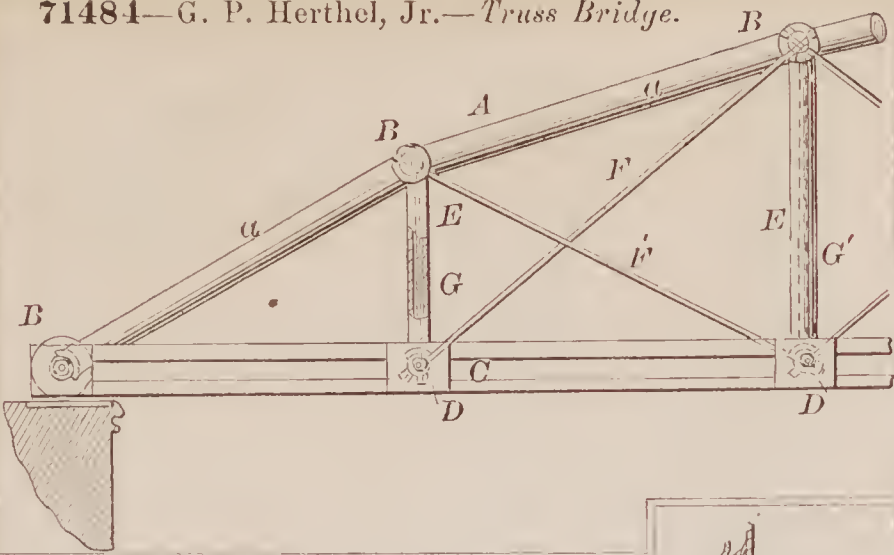

71488—S. C Hunter—Seed Planter.

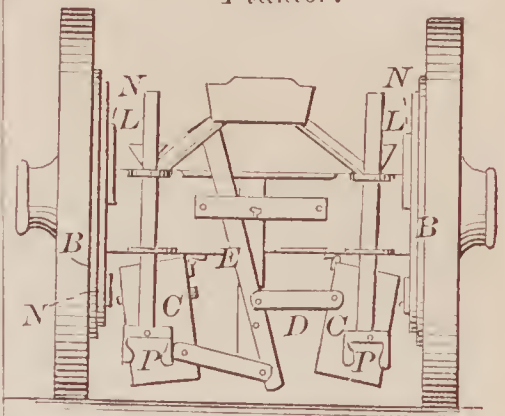

71486—Hill & Bush—For Killing Insects.



71487—F. Hull—Hoop Skirt.

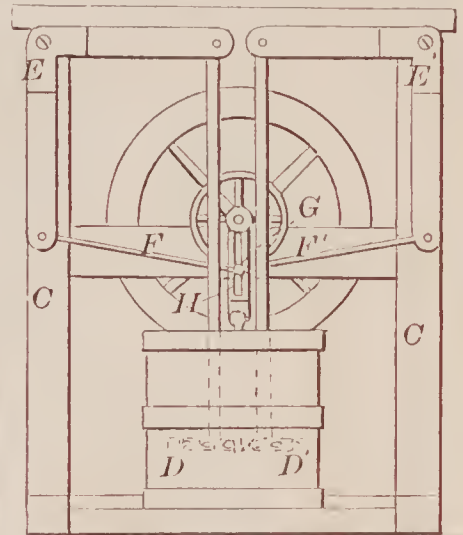

71486—P. Hutchinson—Churn.

71492—J. Jenkinson—For Applying Clasps to Skirts.

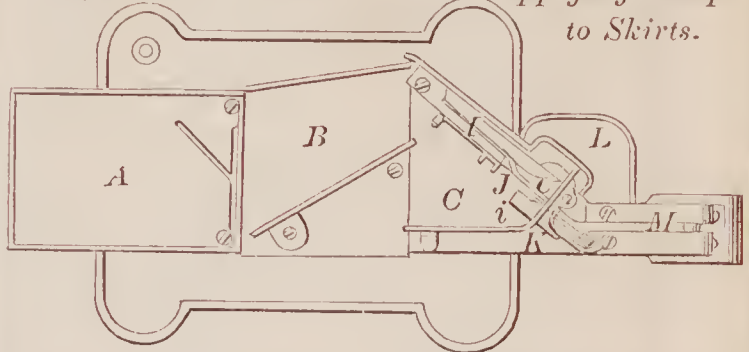

71491—J. N. Jacobs—Knife Sharpener.

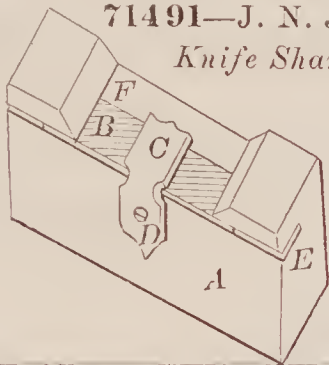

71493—J. John—Corn Planter.

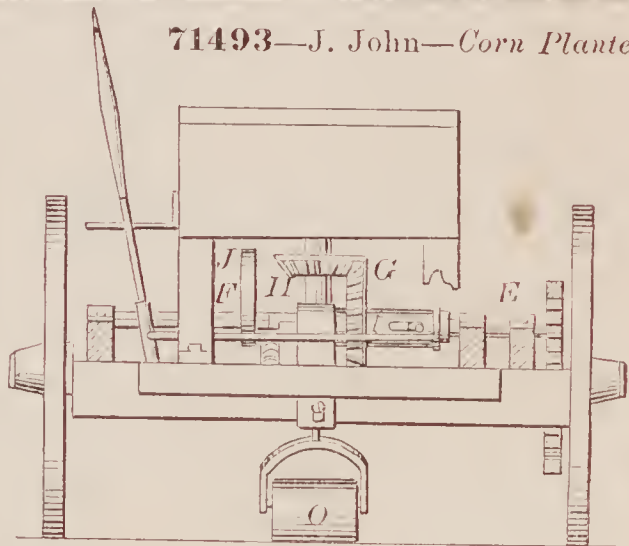

71490—G. L. Ingersoll—Water Heater for Stoves.

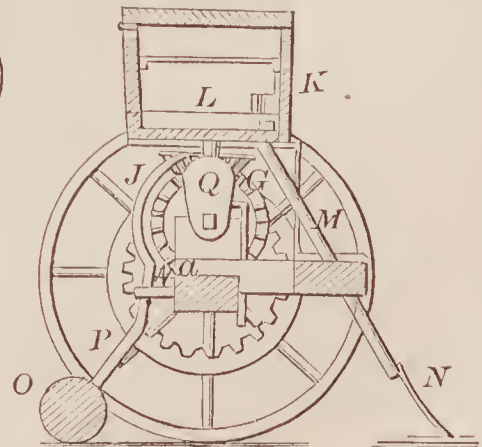
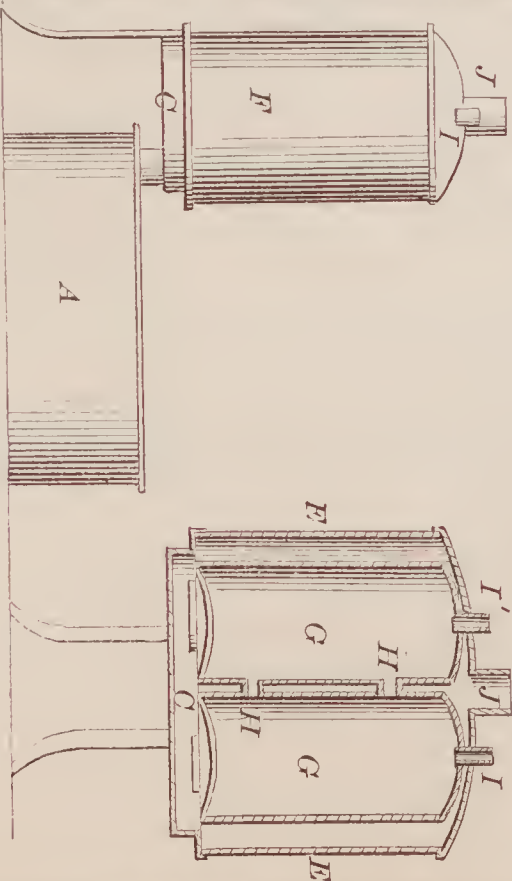



71498—C. L. Kingsley—Vise.

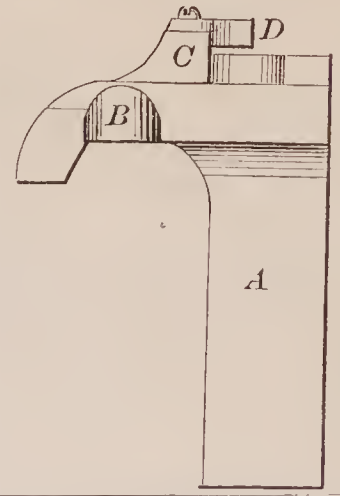

71495—J. B. Johnson—Shaping Soles of Boots and Shoes.

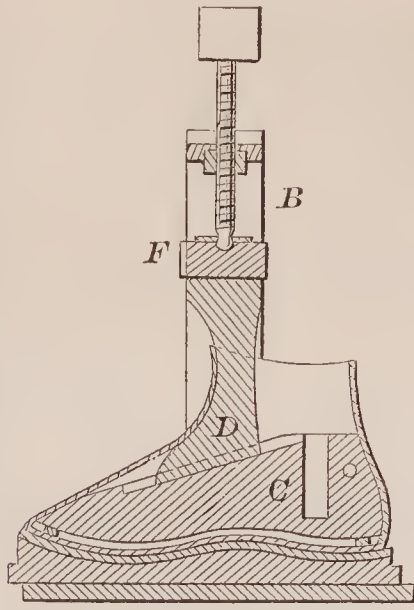

71494—C. F. Johnson—Manufacture Salls.

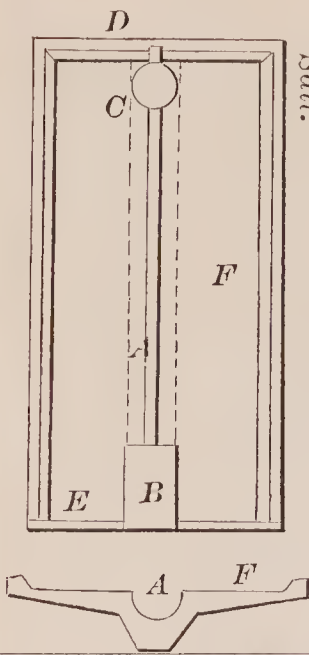

71500—W. J. Mace—For Cleaning Stone Pipes.



71497—W. H. N. Kimball—For Rounding up Soles

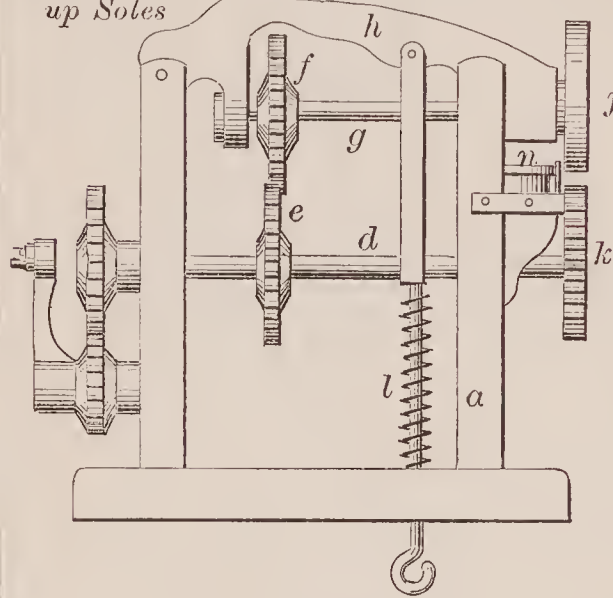

71496—J. D. Kellogg, Jr.—Tube Well.

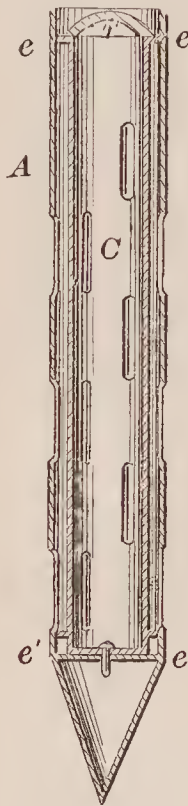

71501—Myers & N. & W. Lea —Furnace for Steam Boilers.

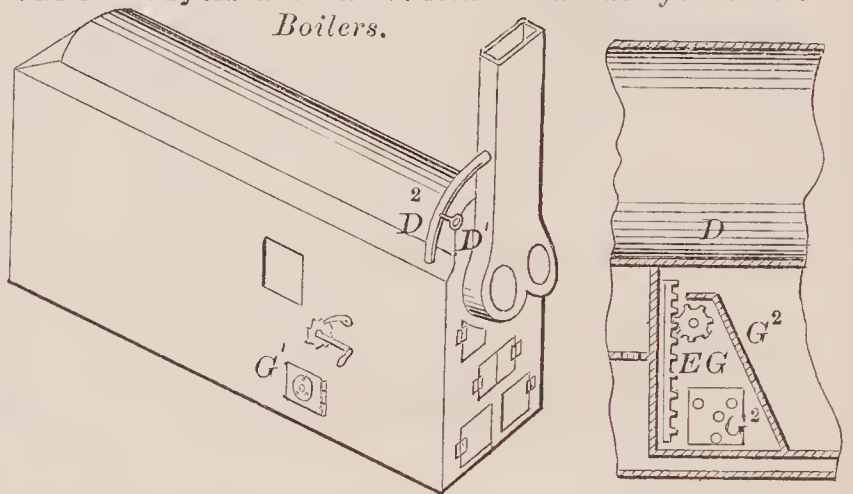

71502—W. P. Munger—Door Locks.

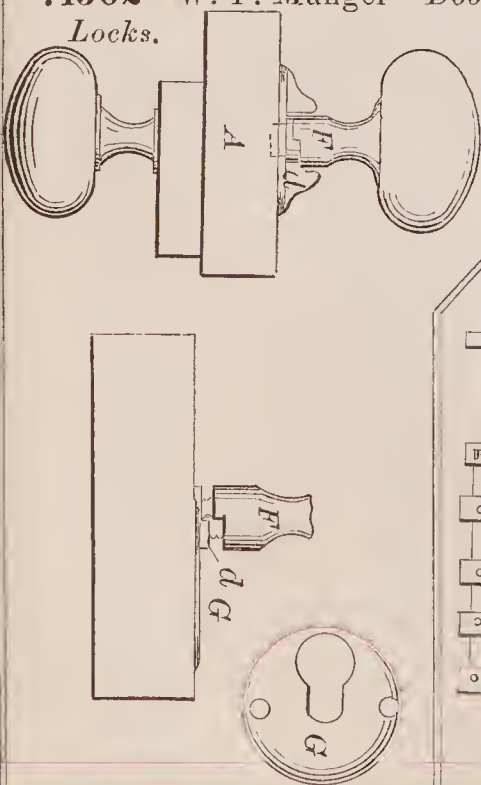

71503—T. Munger—Gate.

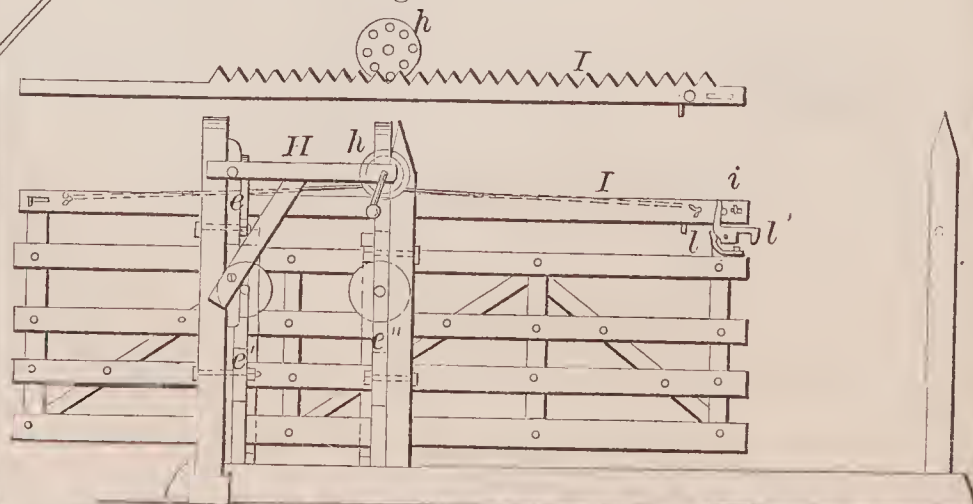

71504—L. Mudge—*Bed Bottom.*

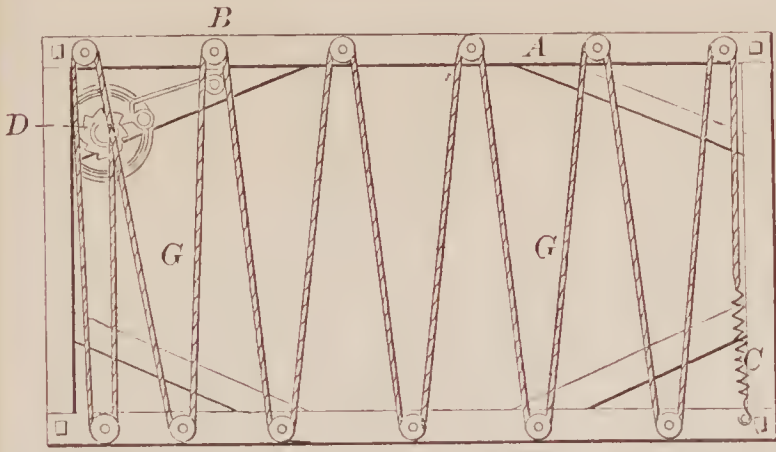

71505—E. A. Muckle—*Magie Watch Case.*

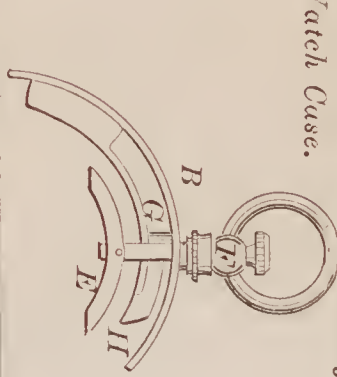

71507—G. Moore—*Plow.*

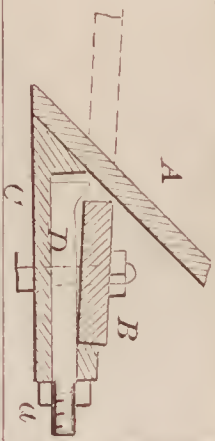

71506—D. Morrison—*For Converting Motion.*

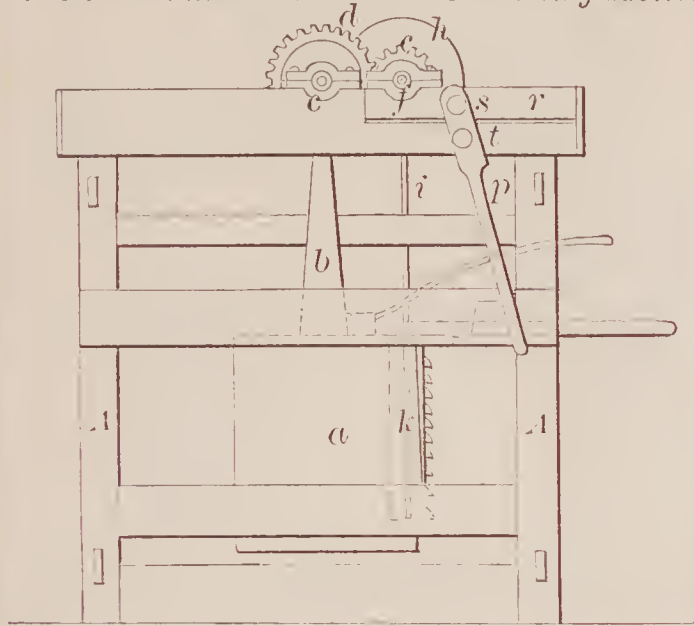

71508—J. Montgomery—*Manufacturing Tubular Bodies.*

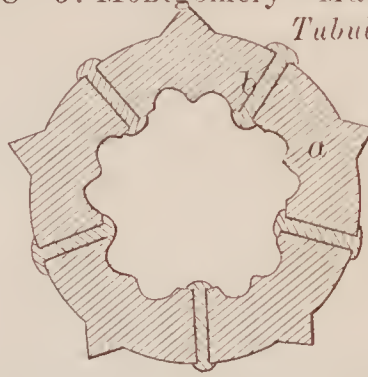

71510—C. H. Miller—*Water Closet Valve.*

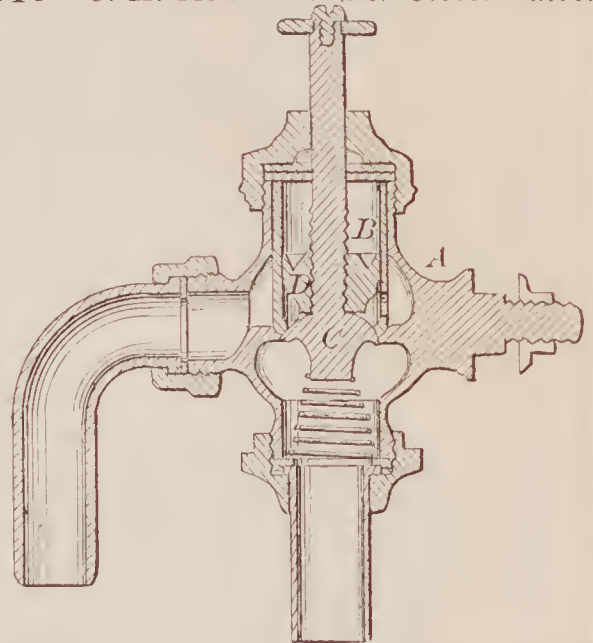

71509—Miller & McClellan—*Awning*



71511—G. B. Mershon—*Folding Box.*

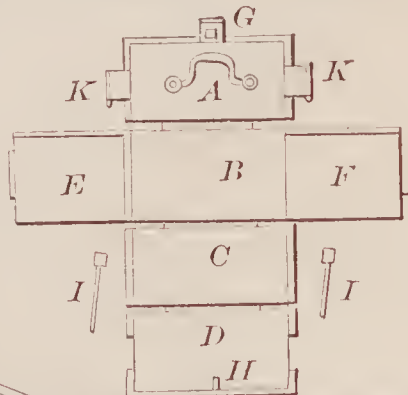

71512—E. M. Mayo—*For Tapping Bolts.*

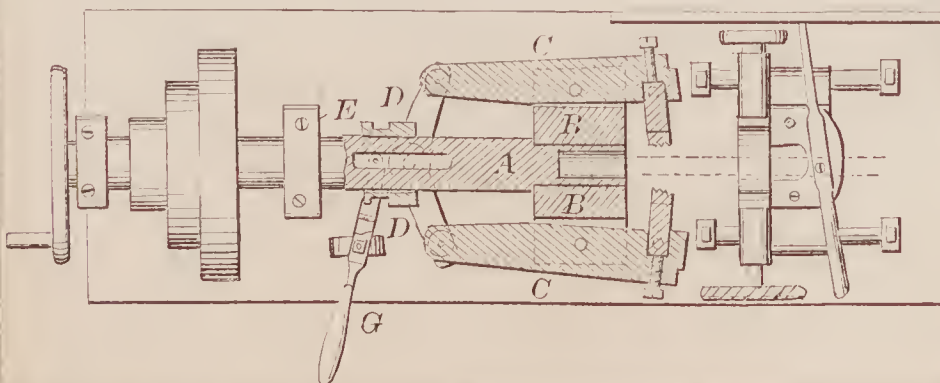

71513—E. G. Matthews—*Plow.*

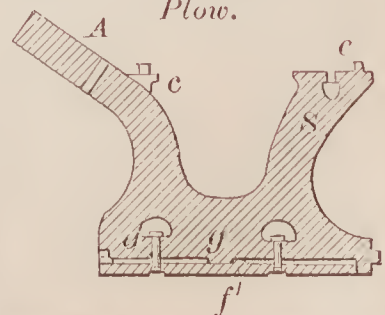



71514—J. Mac Dougall—Gas Apparatus and Carburettor.

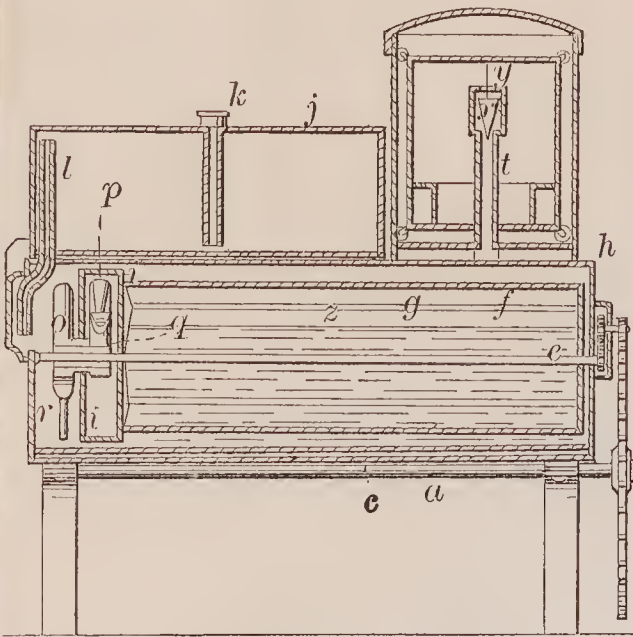

71516—Lodge & Platner—Felting Machine.

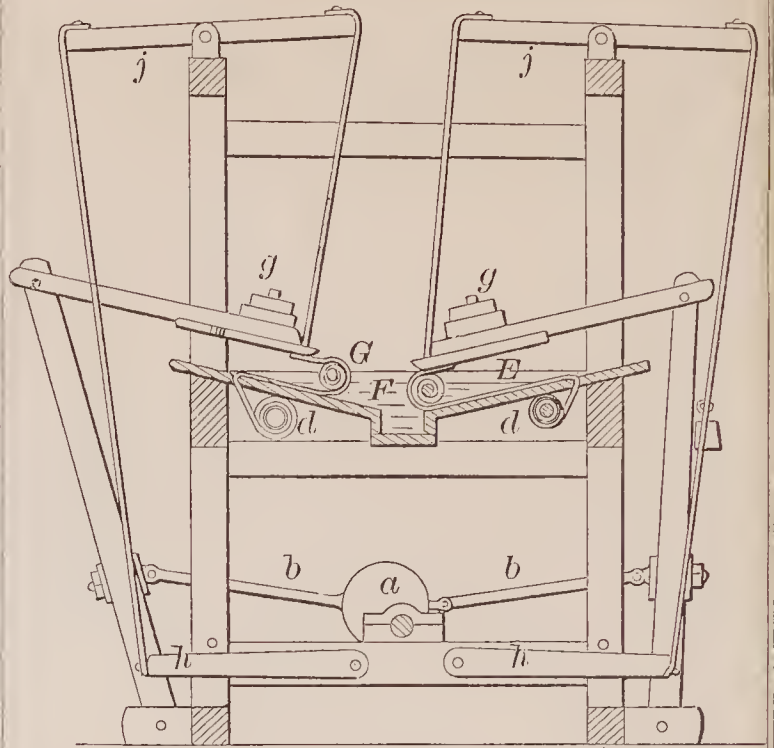

71518—C. C. Lloyd—Dry Gas Meter.

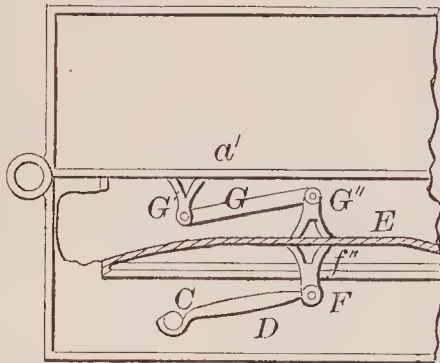
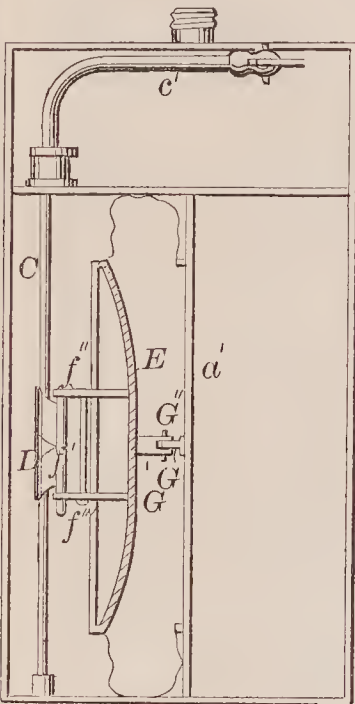

71517—R. Z. Liddle—Hot Air Furnace.

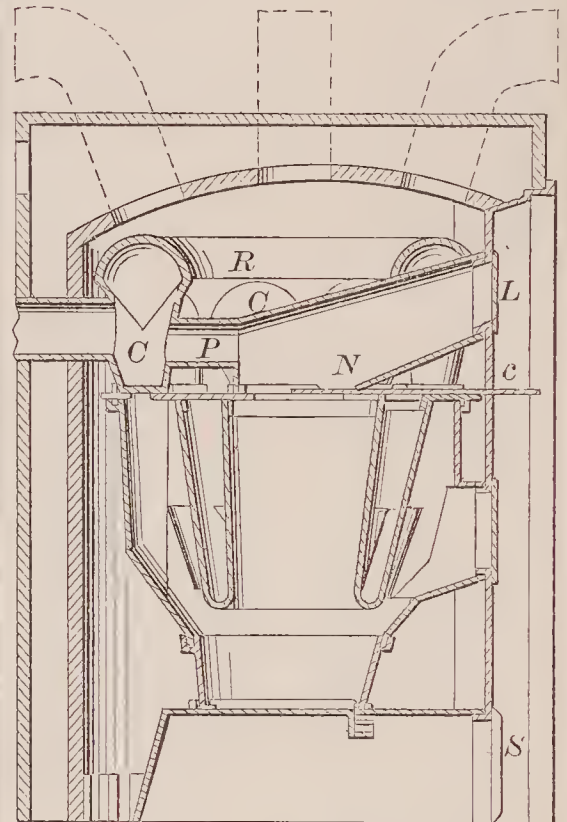

71515—S. J. Lowe—Lump.

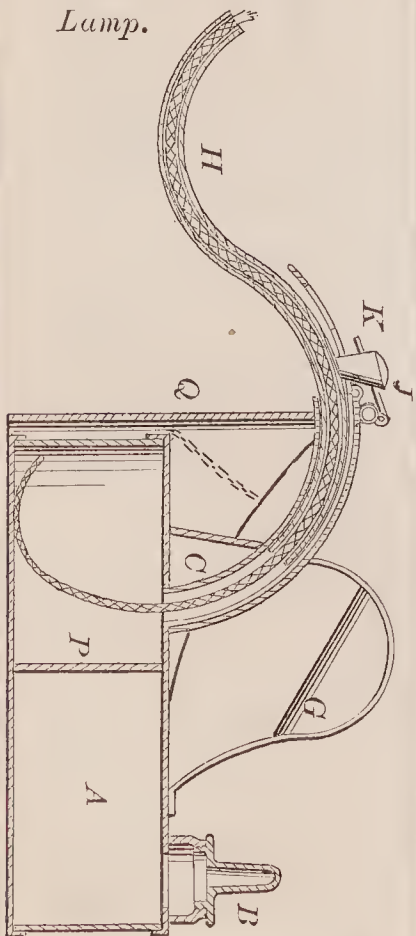

71519—W. Lindon—Clock.

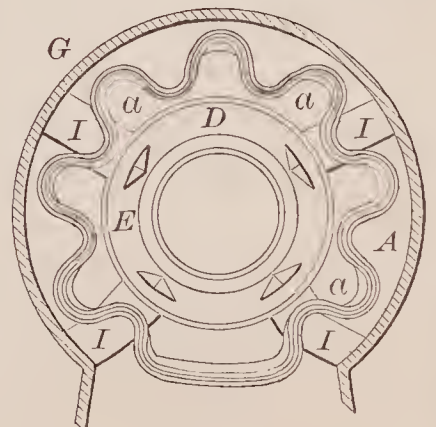
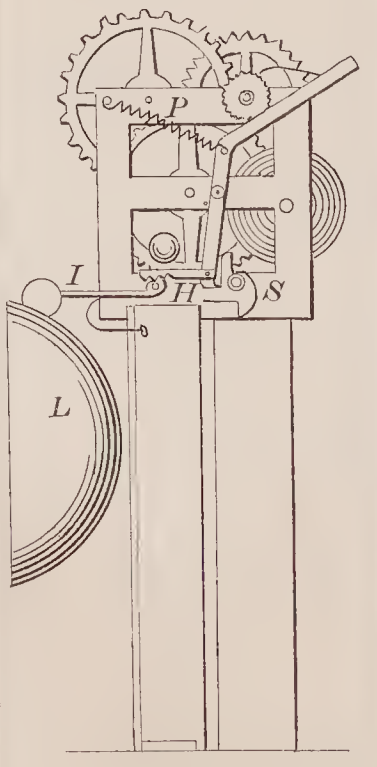

71520—J. Lemley, Jr.—*For Measuring and Laying out Garments.*

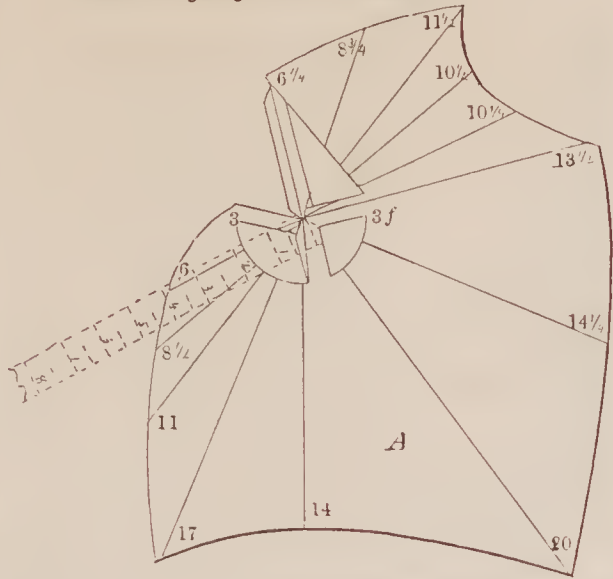

71522—J. A. Leibey—*Horse Power.*

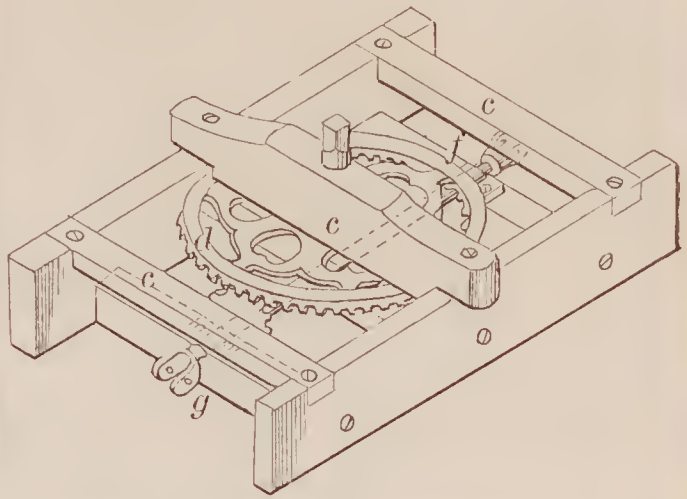

71521—E. B. Lake—*Nail Plate Feeder.*

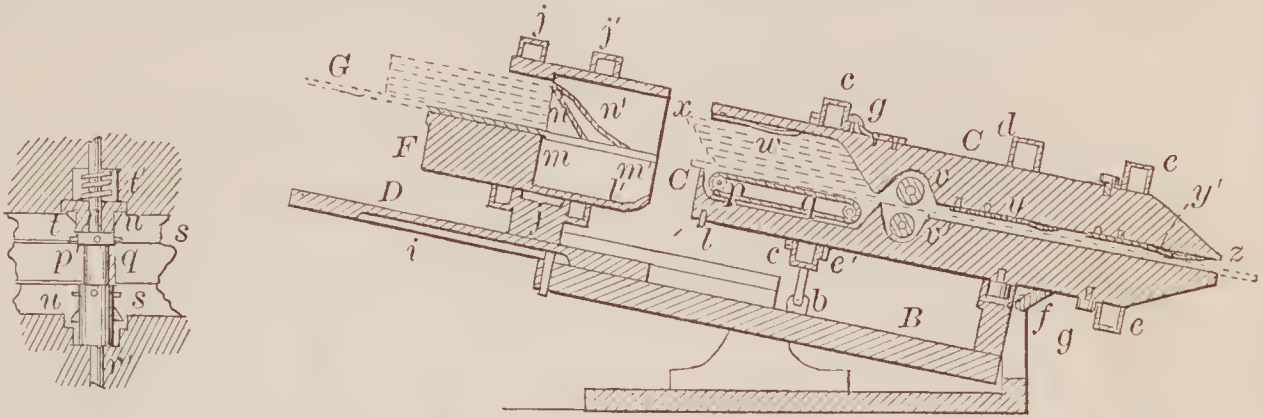

71523—W. Leighton—*Fagot for Railroad Rails.*

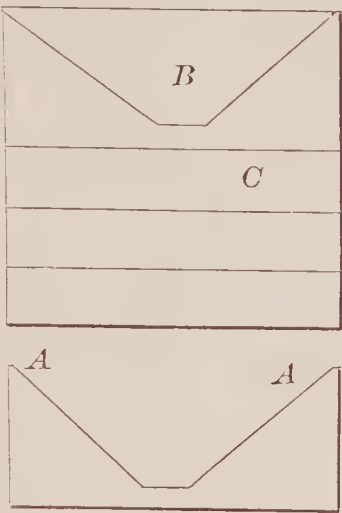

71524—H. Ogborn—*Store Pipe Dumper.*

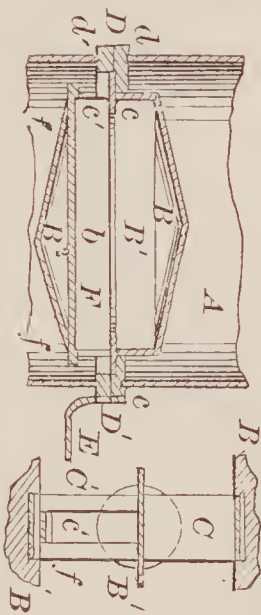

71527—C. H. Parshall—*Anti-Friction Journal for Car Wheels.*

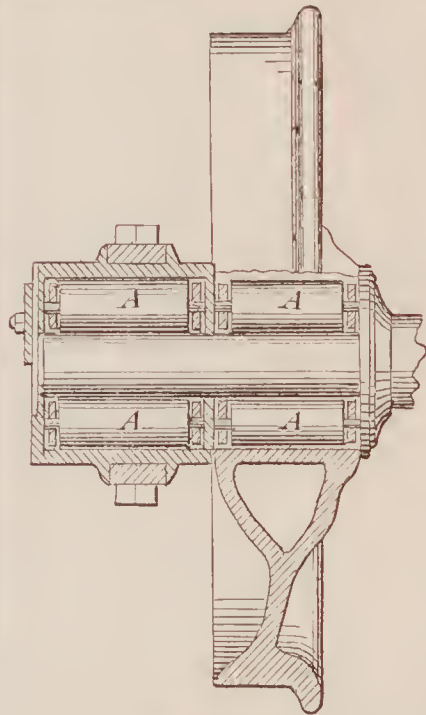

71525—J. D. C. Outwater—*Cultivator and Potato Digger.*

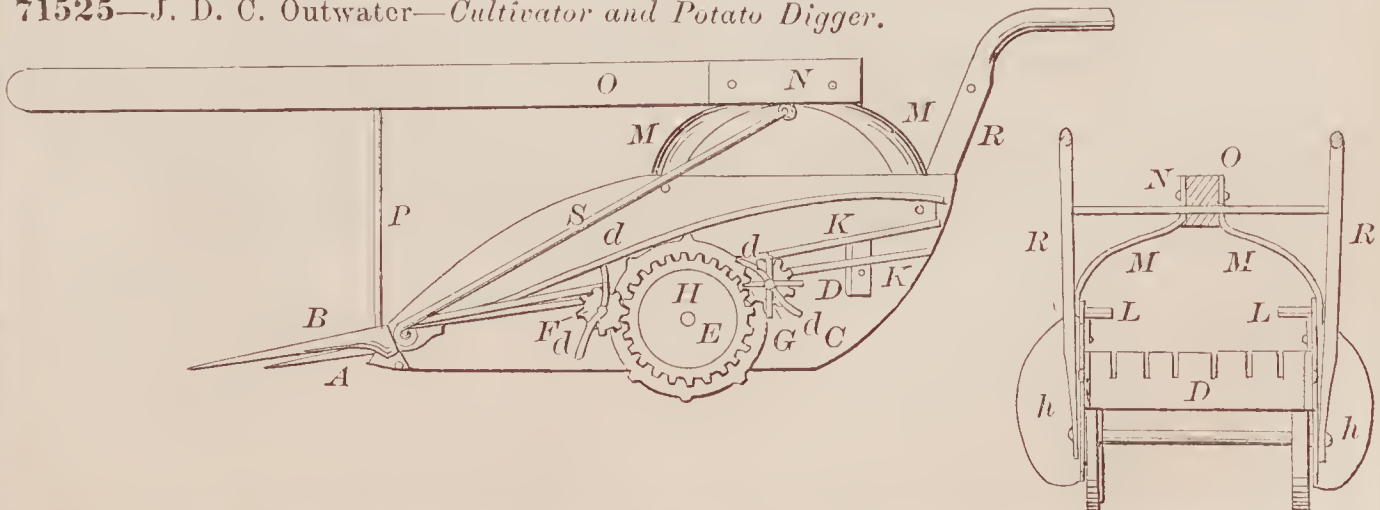



71528—Patric & Bickford—Grain Drill

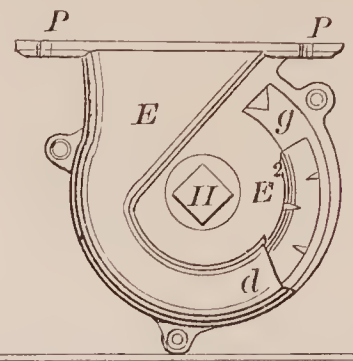
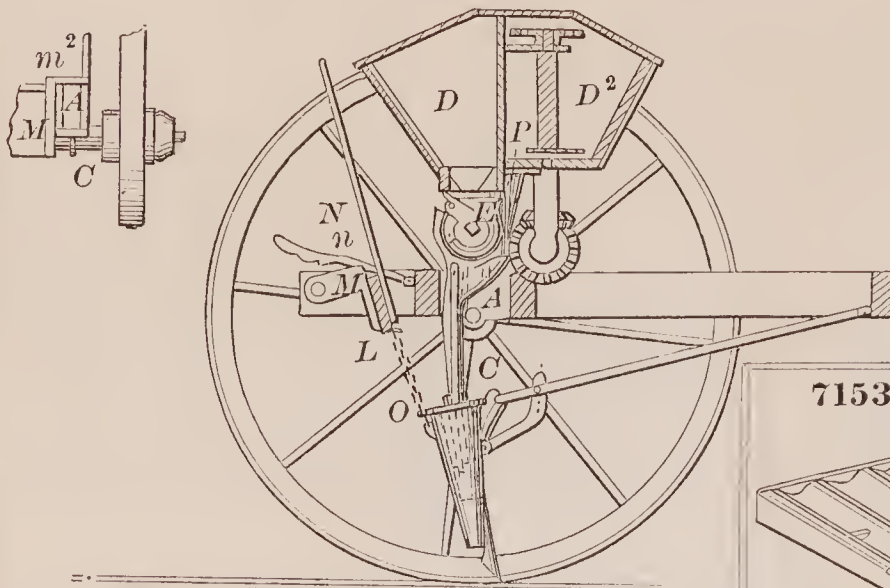

71530—H. Pennie—Refrigerator Ice Rack.

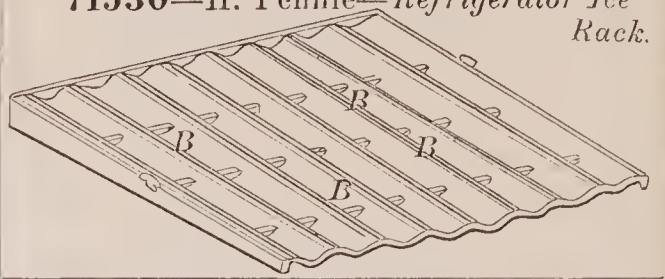

71529—J. R. Paul—For Sponging Cloth.

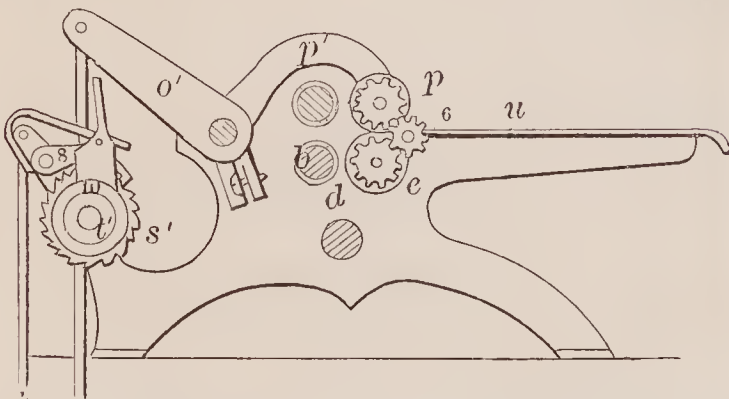
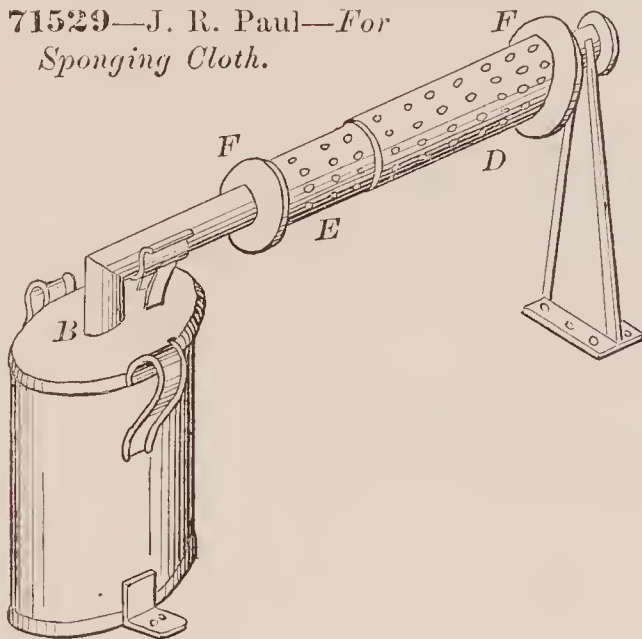

71531—O. H. Perry—Moulding Machine.

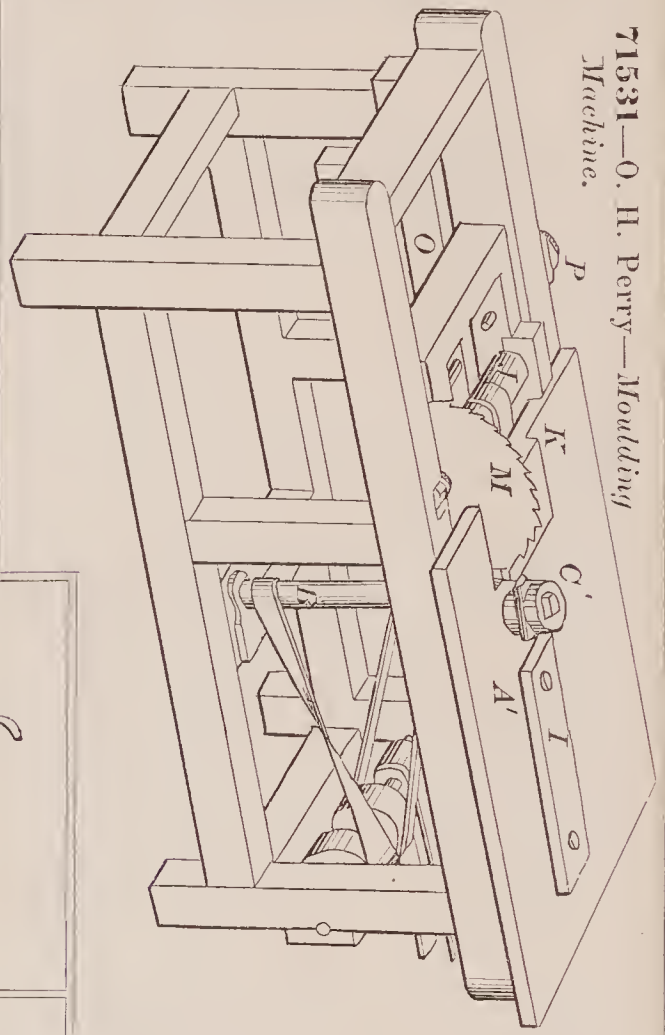

71532—Prentice & Wuterich—Cigar Machine.

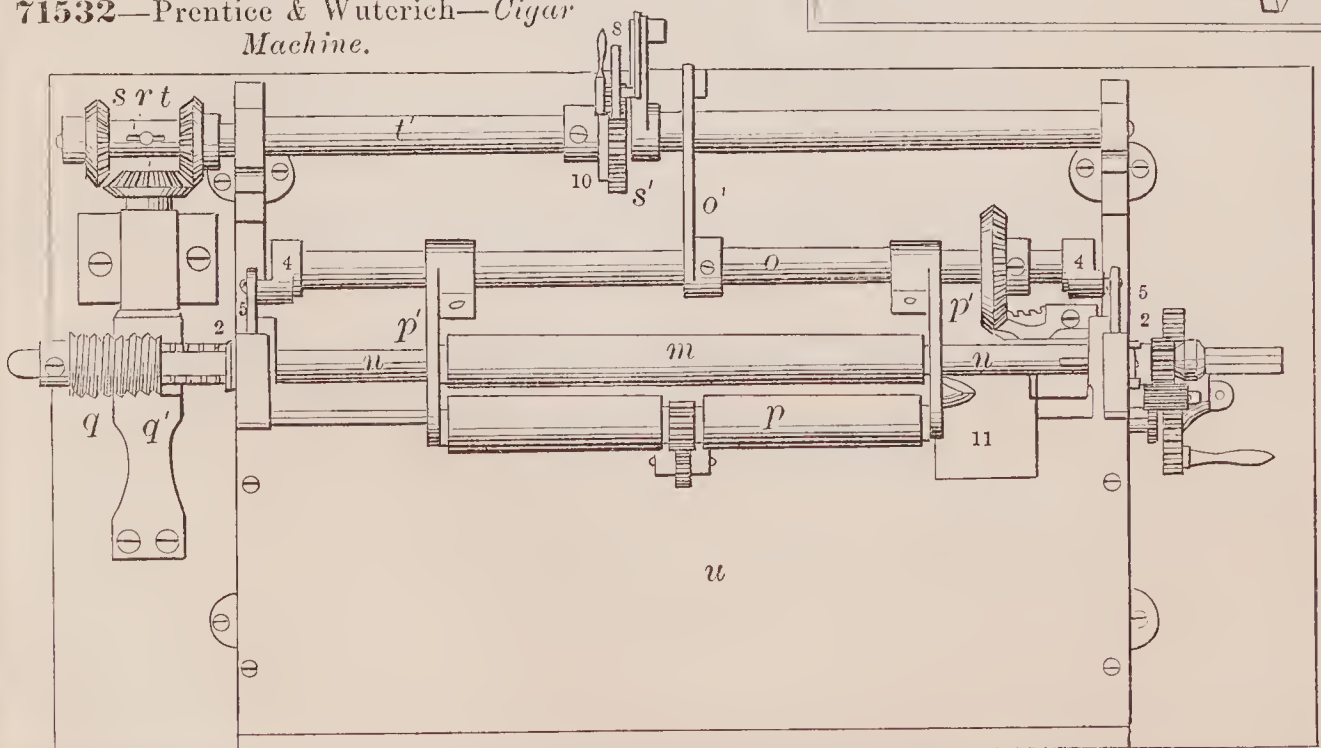





71539—J. Russell—Husking Machine.

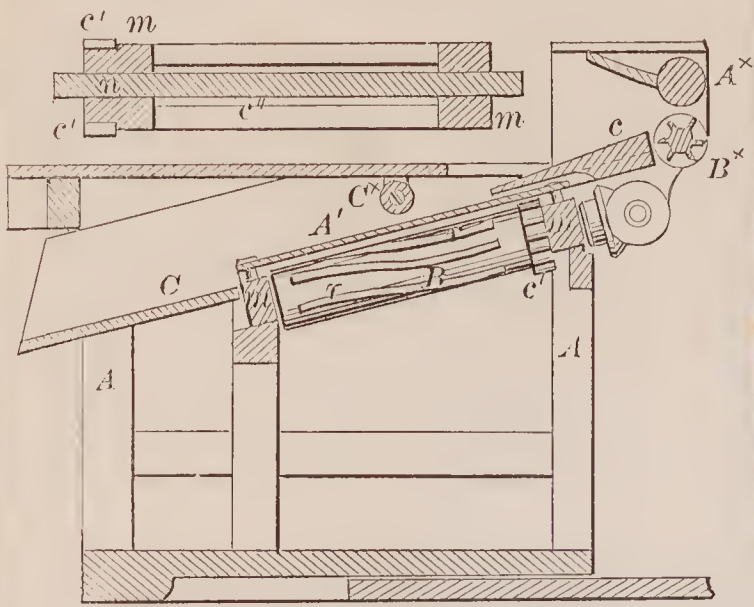

71543—T. Sillman—Animal Trap.

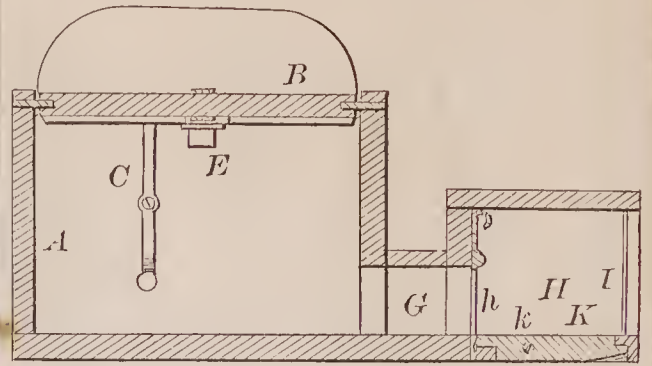

71540—Rutt & Baer—Corn and Seed Planter.

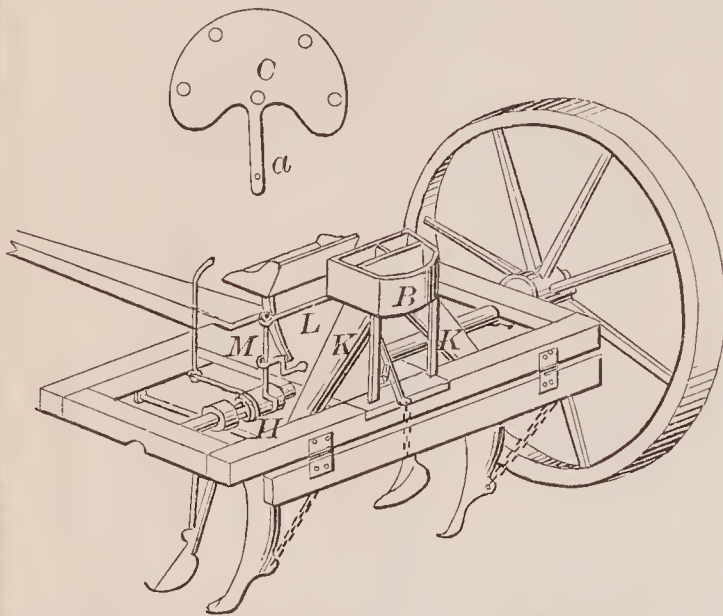

71541—E. F. Shaw—Temple for Looms.

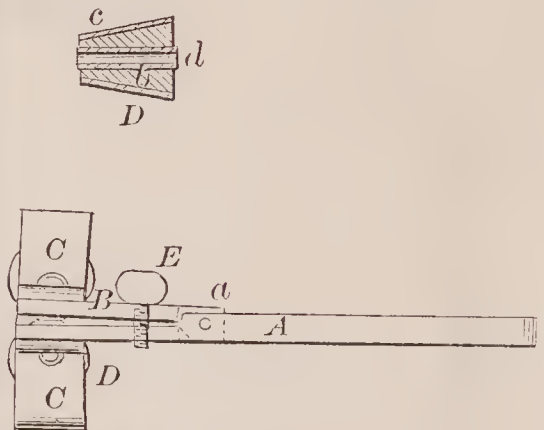

71544—A. Smith—For Grinding Animal Matter.

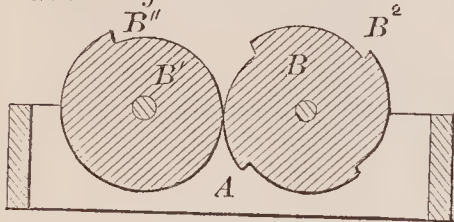

71546—T. S. Smith—Ball Caster.

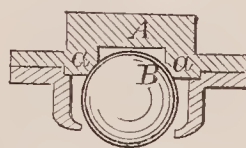

71545—A. Smith—For Reducing Cracklings.

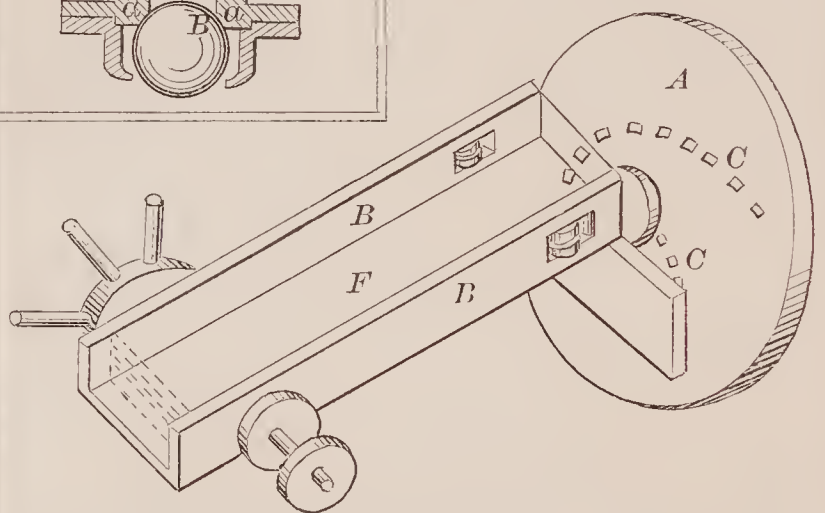

71542—J. Shoemaker—Steam Engine Valve.

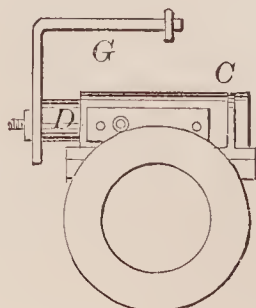

71547—W. M. Stevenson—Steam Cut-off Valve.

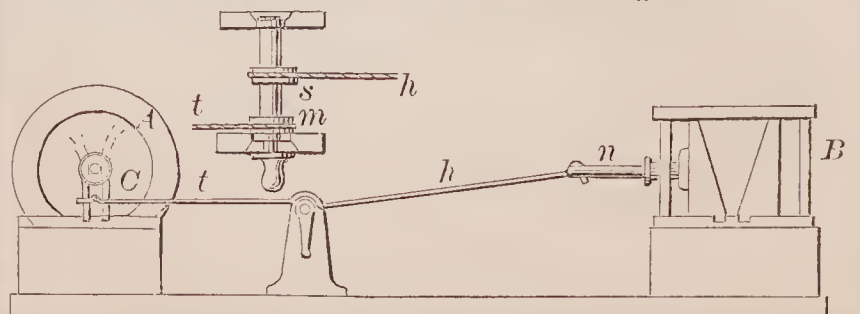

71548—J. B. Stockton—*Tobacco Pipe.*

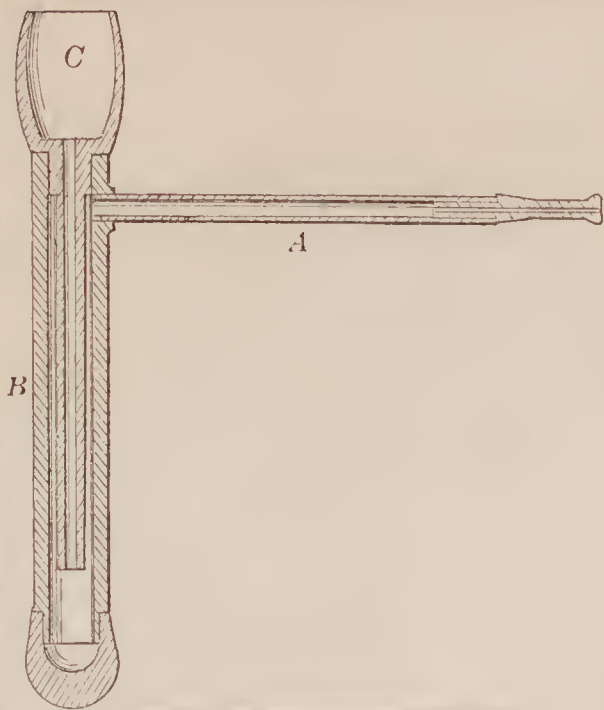

71553—E. Thompson—*For Constructing Railroads.*



71550—V. C. Taylor—*Music Staff.*



71554—L. F. V. Wiele—*Clamp Strap for School Books.*

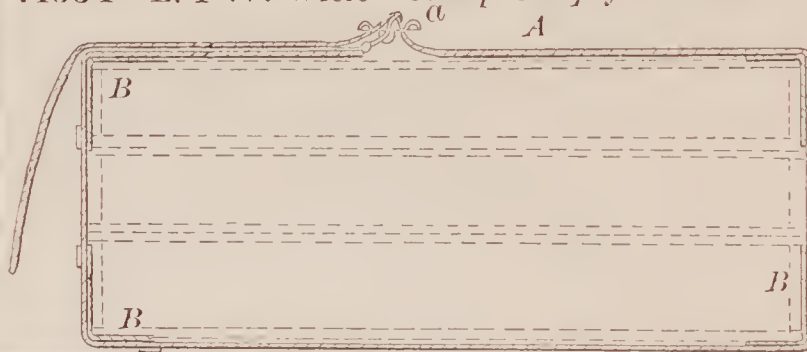

71552—E. Thompson—*Dumping Car.*

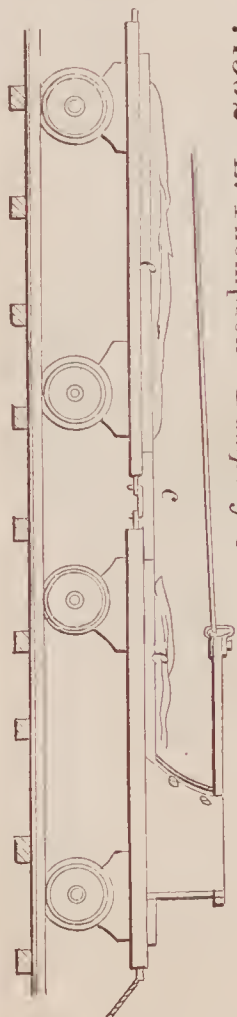

71551—S. Terry—*Corn Sheller.*

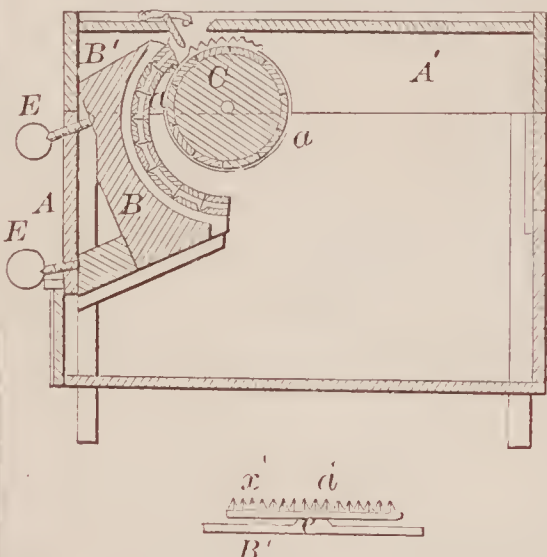

71555—U. B. Waddle—*Feather Renovator.*

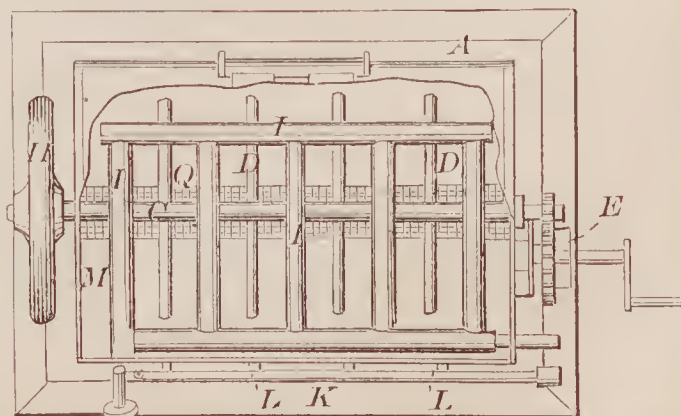
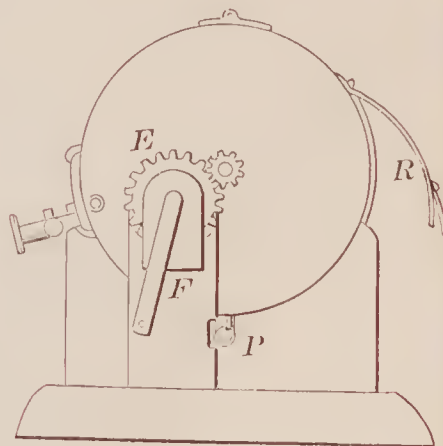



71556—M. P. Walton—  
Washing Machine.

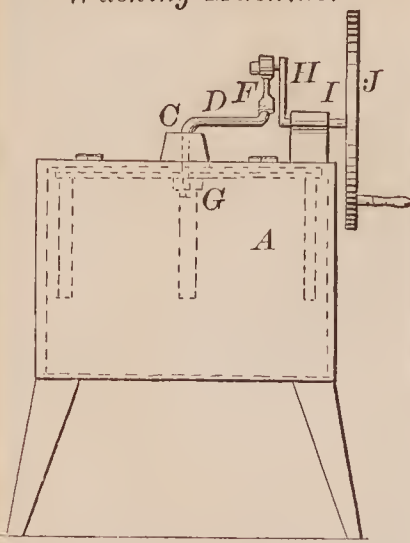

71557—S. B. Ward—*Seeding Machine.*

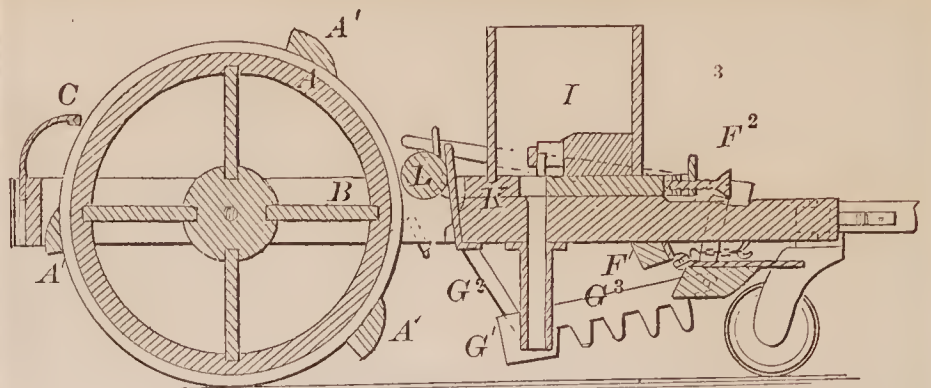

71558—W. H. Ward—  
*Railway Car Apron.*

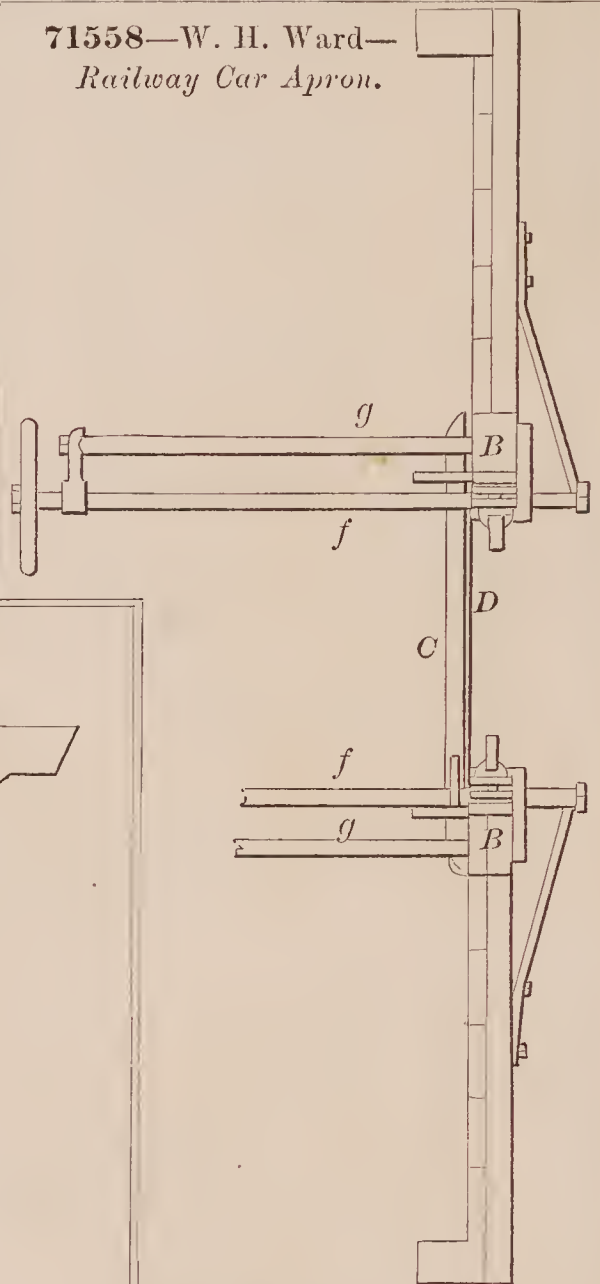

71559—W. Y. Warner—*Car Coupling.*

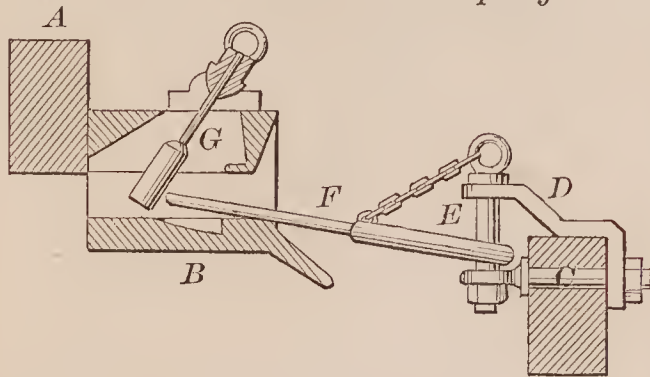

71560—G. Watt—*Plow.*

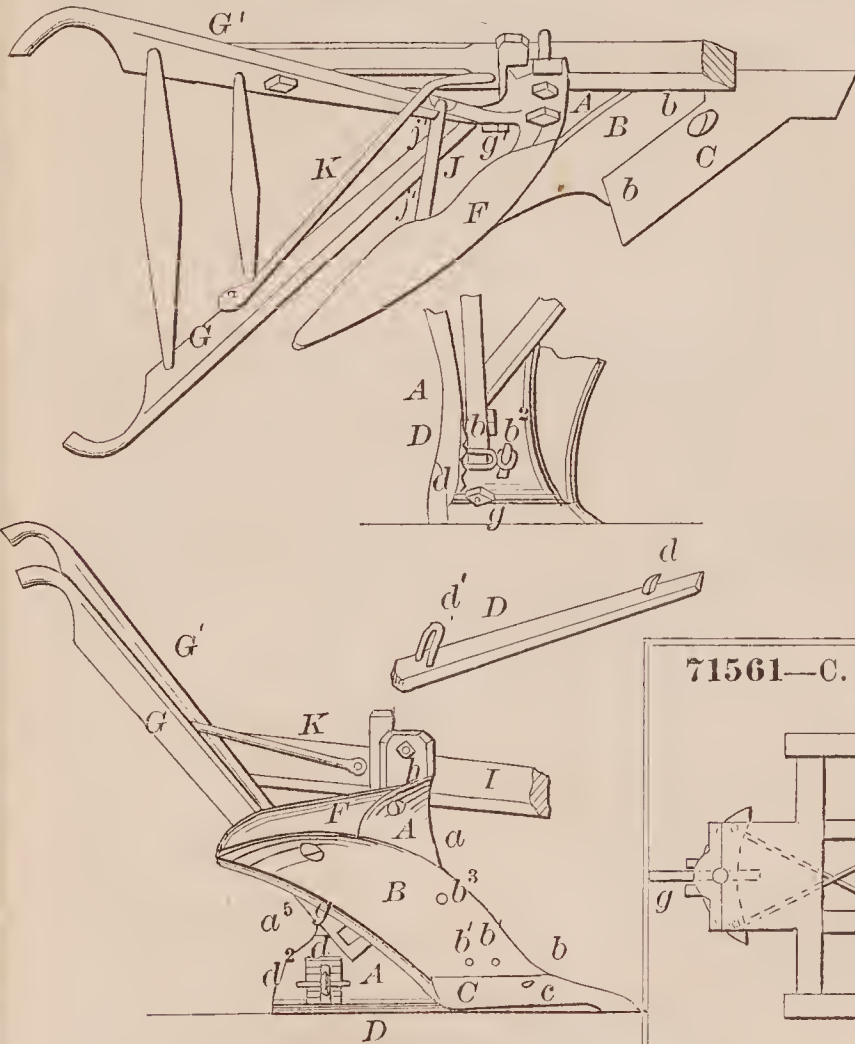

71561—C. A. Way—*Velocipede*

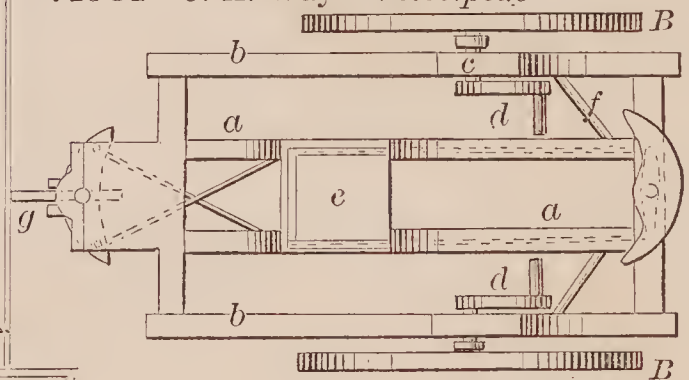

71562—C. A. Way—*Velocipede.*

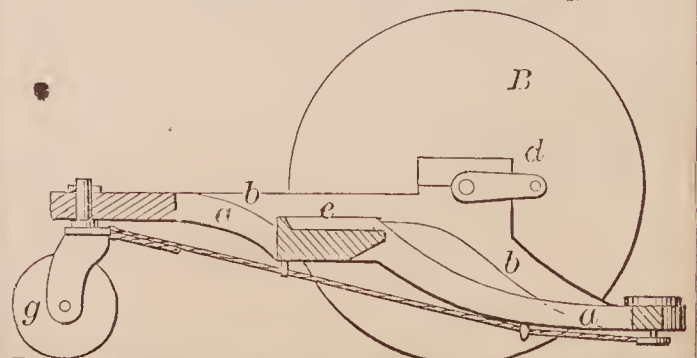
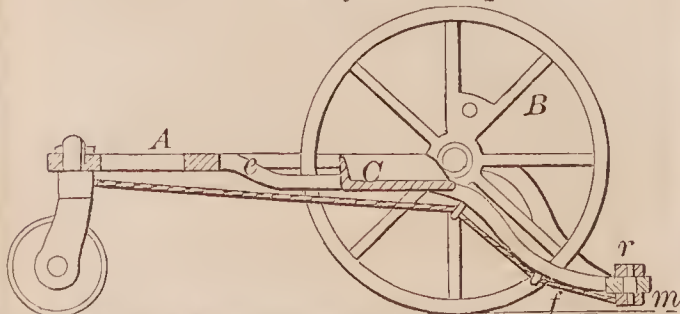

71563—J. Werntz—Spring Seat for Carriages.

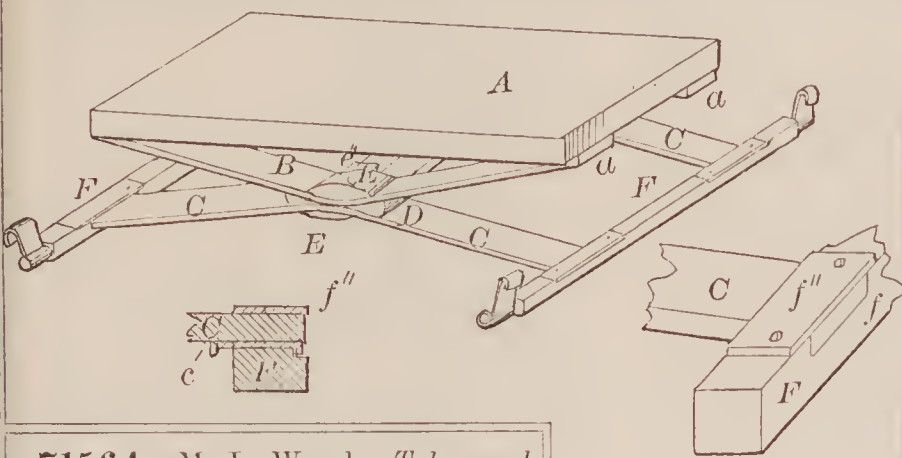

71565—D. B. Woodworth—Teapot.

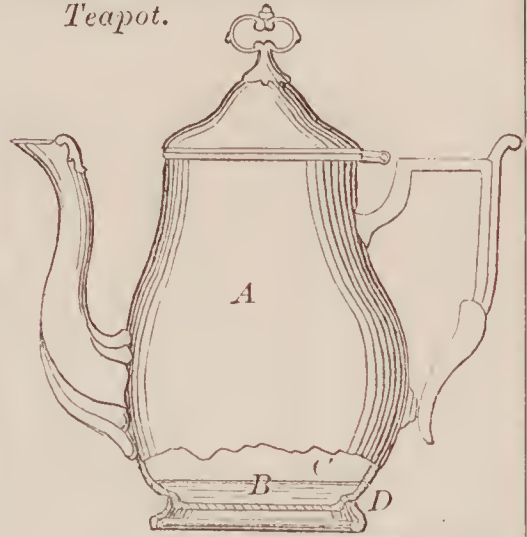

71564—M. L. Wood—Telegraph Insulator.

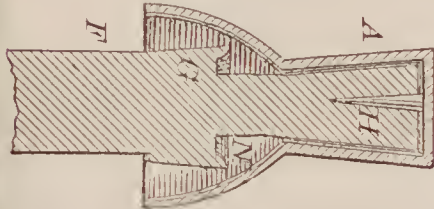

71568—A. Basse—For Carving Wood.

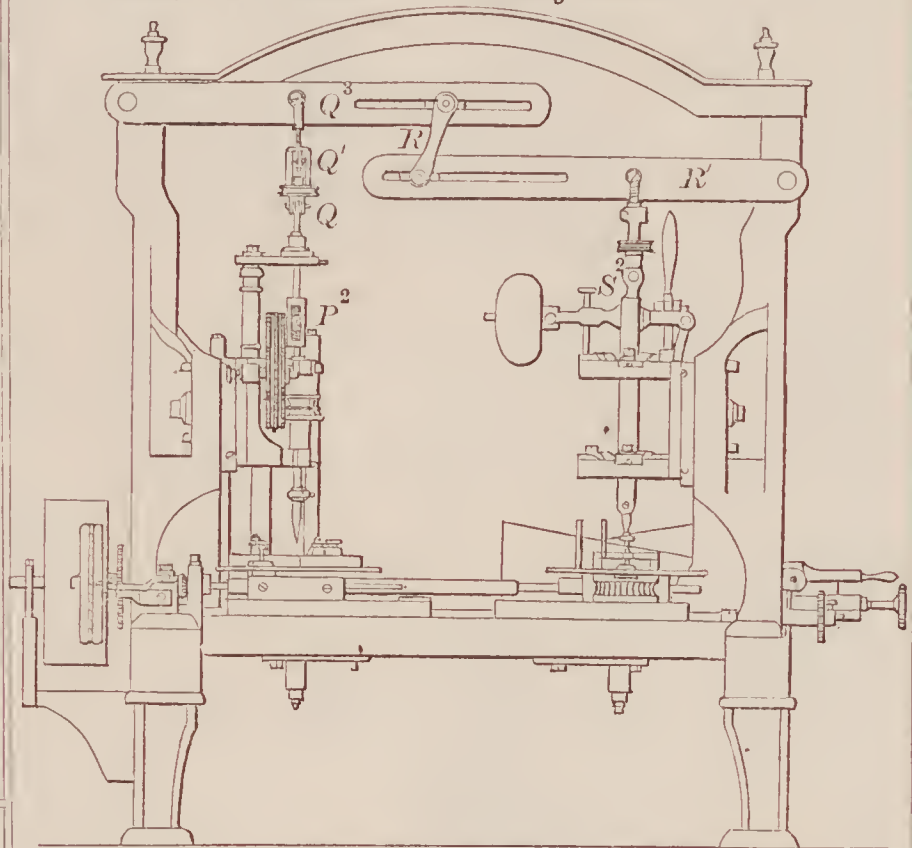

71566—J. B. Alexander—Lamp.

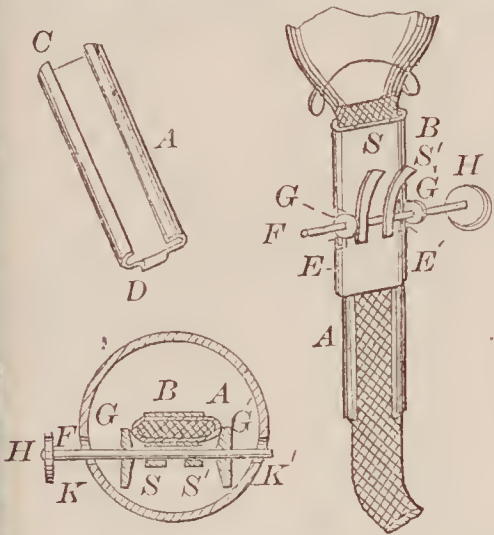

71567—A. E. Barnard—Die for Swaging Bunter Shapes.

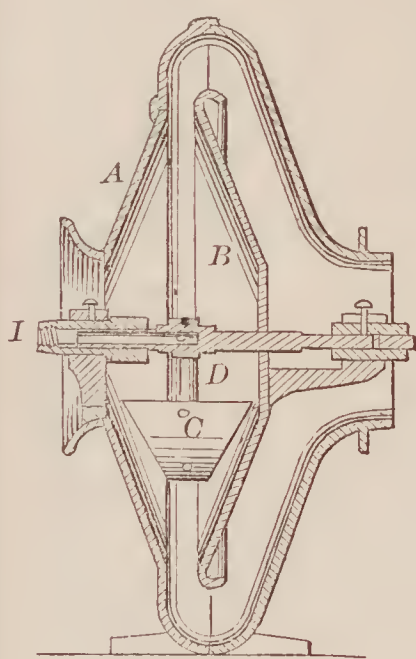
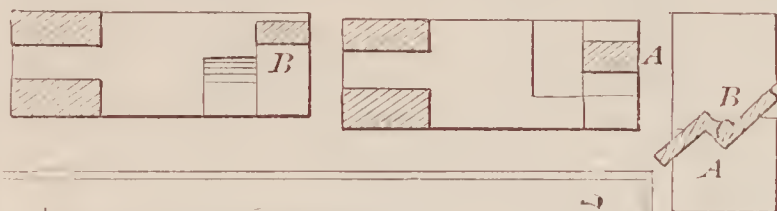

71569—Bassett & Smith—Steam Blower.

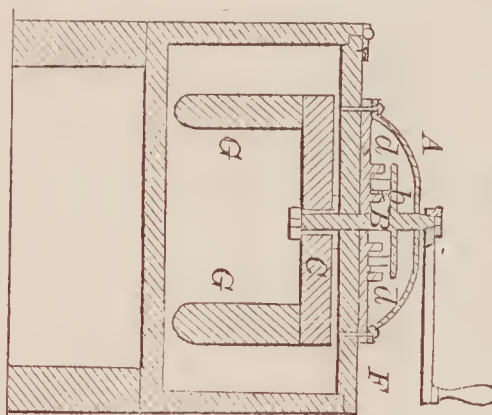

71570—M. Beek—Washing Machine.

71571—D. Bievez—Oven for Cooling Glass.

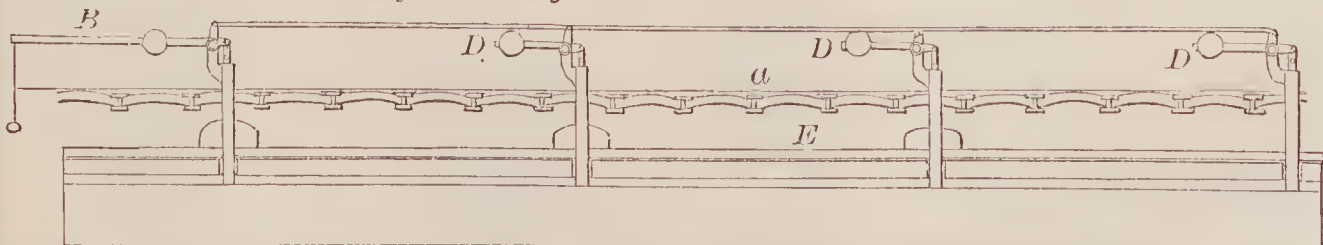



71572—O. Billings—Corn Planter.

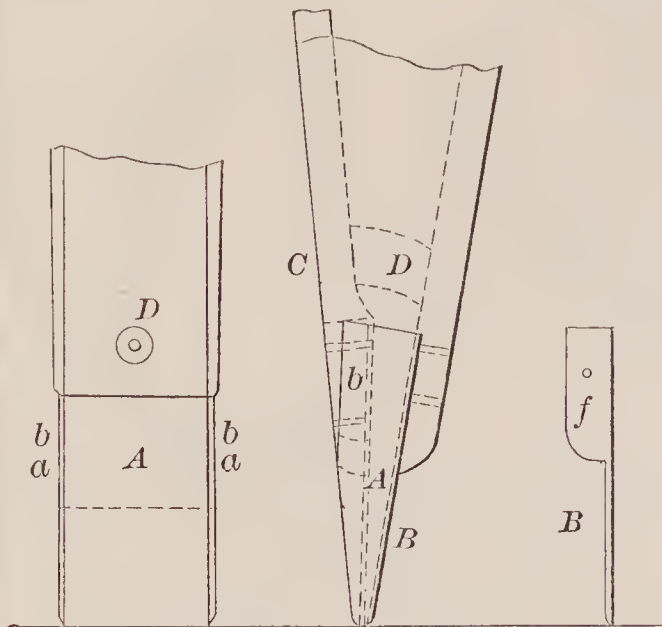

71573—W. R. Boerner—Wire Figure.

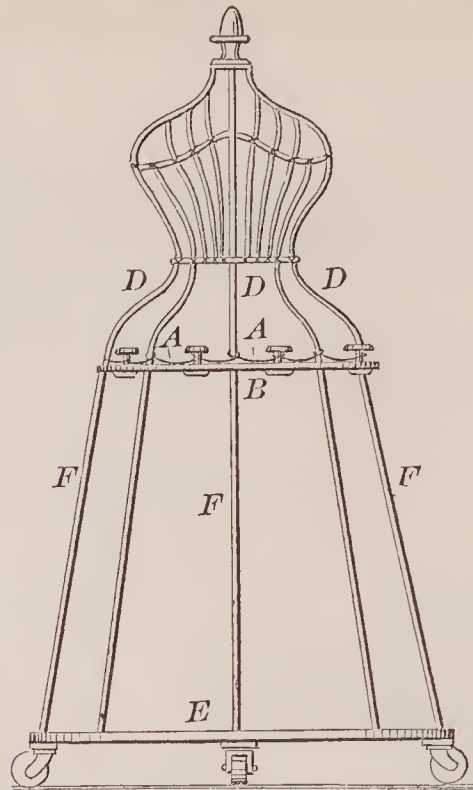

71576—F. T. L. Boyle—Runner for Wheeled Vehicles

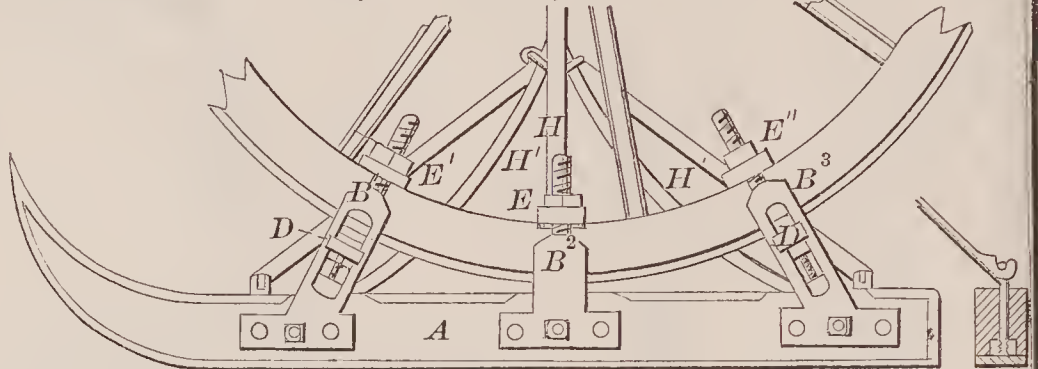

Fig. 6 II

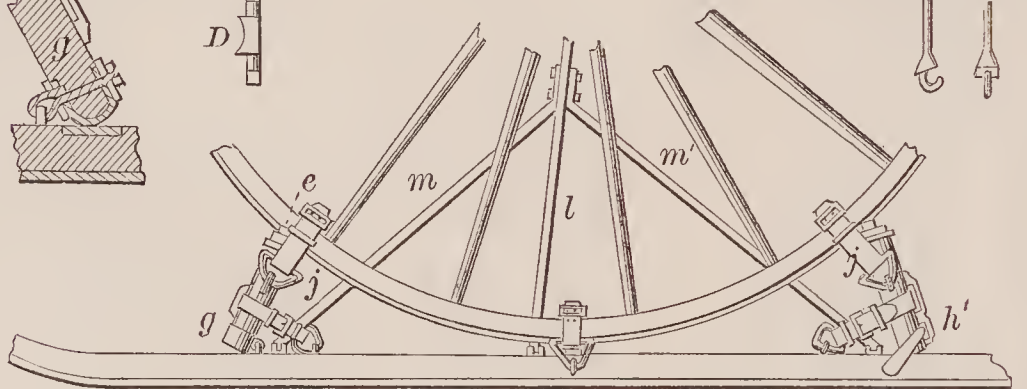
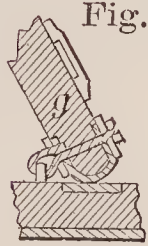

Fig. 18 II

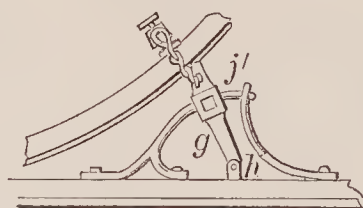

Fig. 19 II

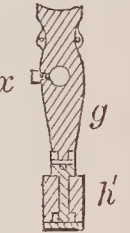

Fig. 16 II

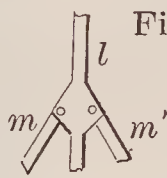

Fig. 4 II

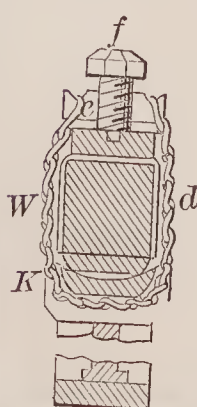
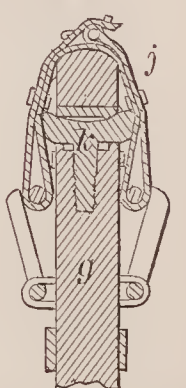
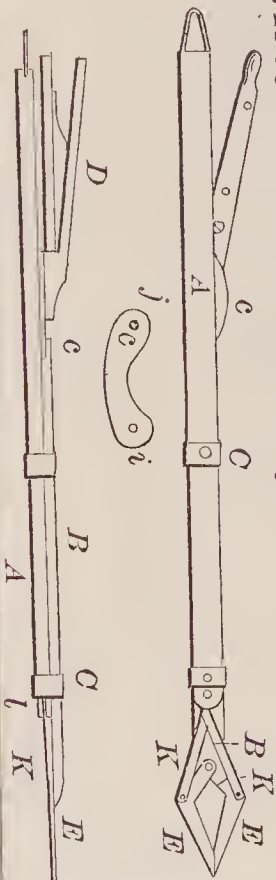

Fig. 7 II



71575—L. L. Bond—Horse Hay Fork.



71574—P. E. Bomboy—Carriage Spring.

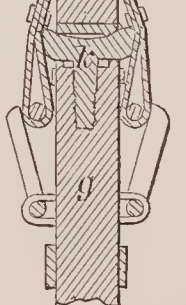
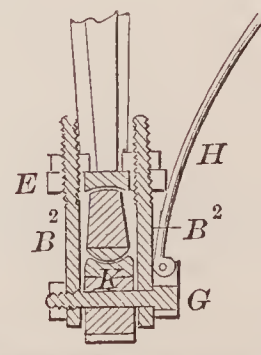
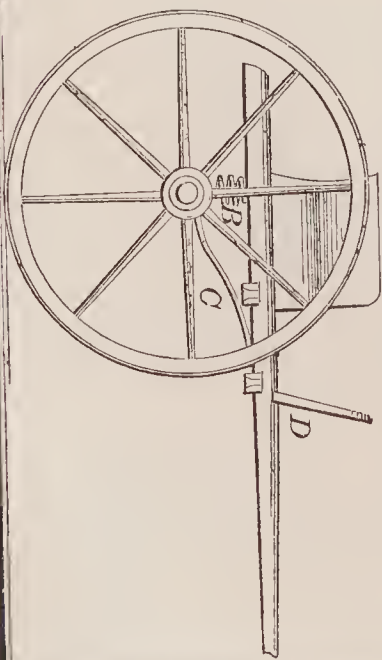

71577—Brown & Smith—Hay Raker and Loader.

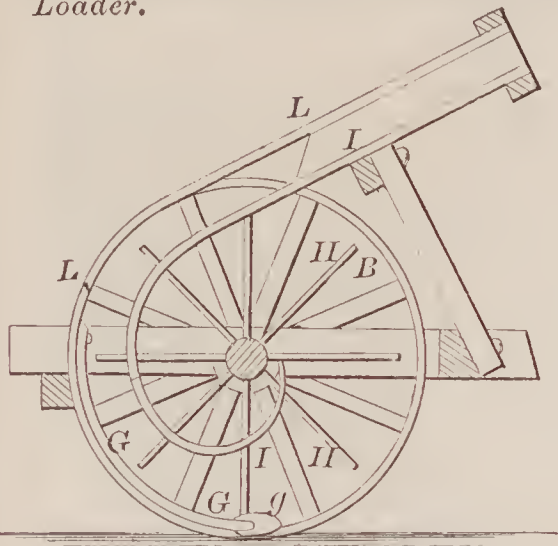

71581—N. Chappell—Cultivator Teeth.

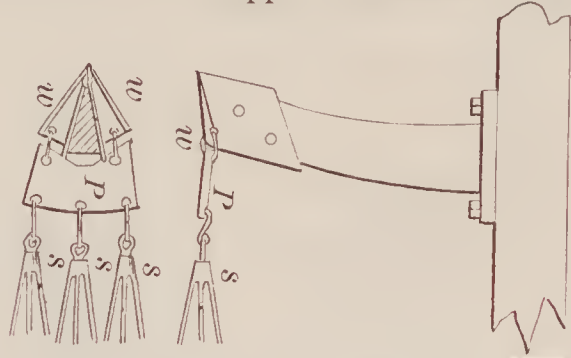

71579—S. Carpenter—Horse Rake. B

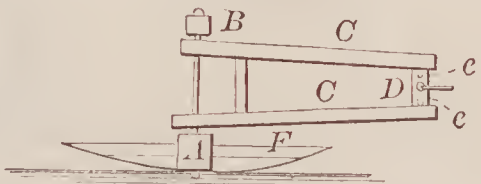

71609—H. W. Harper—For Dressing Slate Frames.

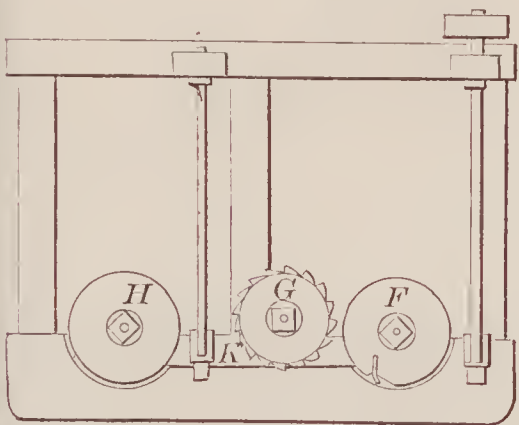
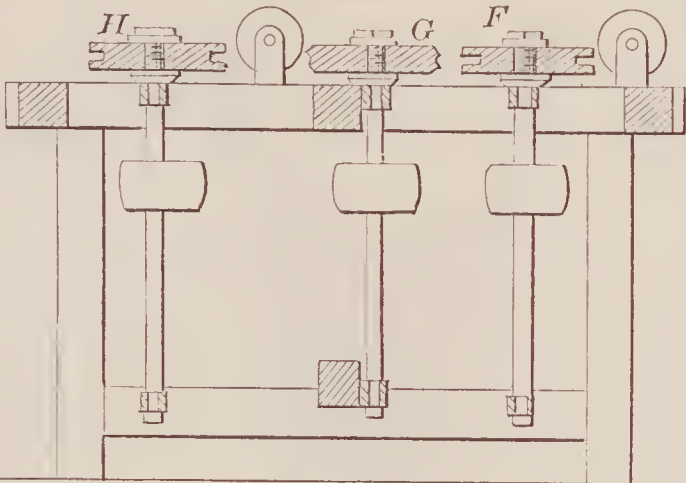

71583—W. Cranage—Roof Tile.

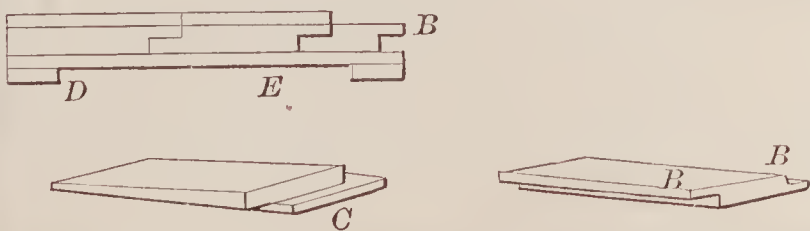

71578—W. H. Capewell—Glassmakers' Pot. A

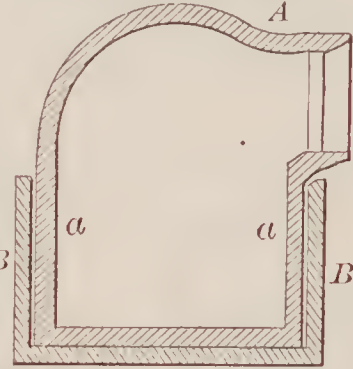

71584—J. J. Crispin—Eye Glass.

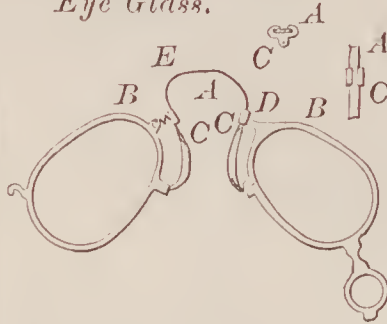

71586—J. P. Curtiss—For Grinding Cutlery.

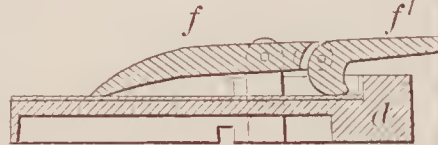

71582—I. Cook—Cow Milking Machine.

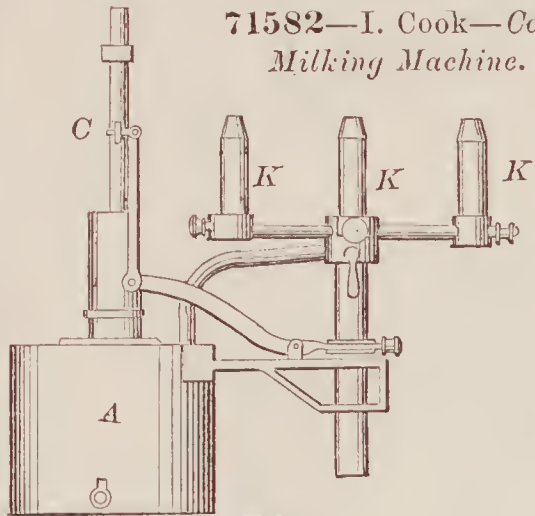

71580—E. L. Camm—Buffer for Railroad Cars.

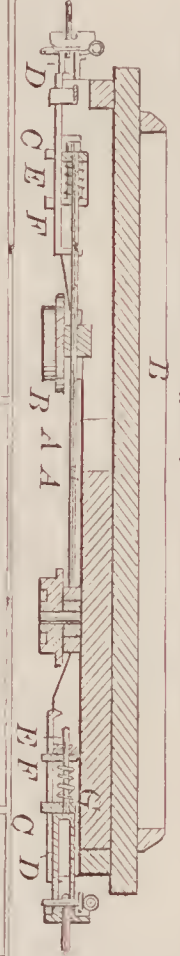
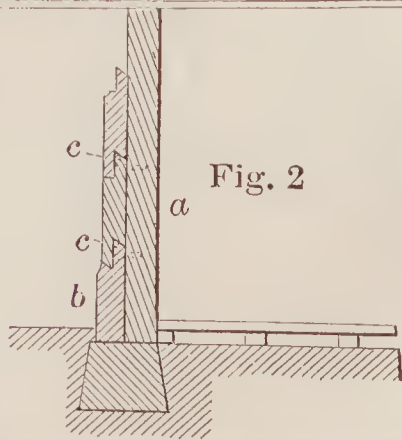

Fig. 2



71587—W. Damerel—Building.



71588—J. C. Dell—Scales.

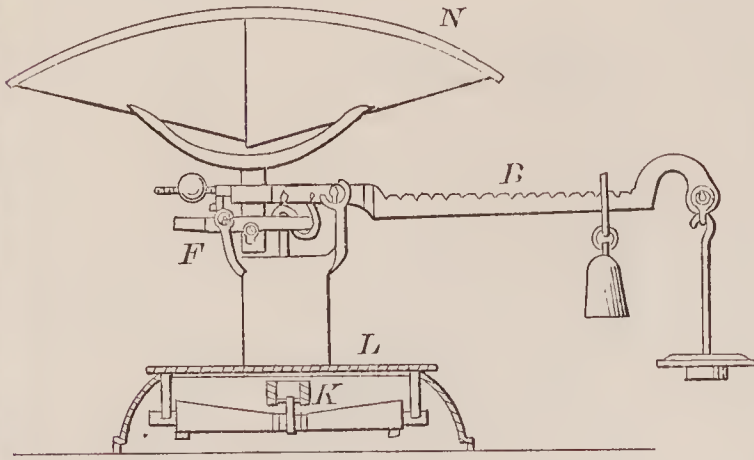

71590—R. de Roode—Conductors' Ticket Book.

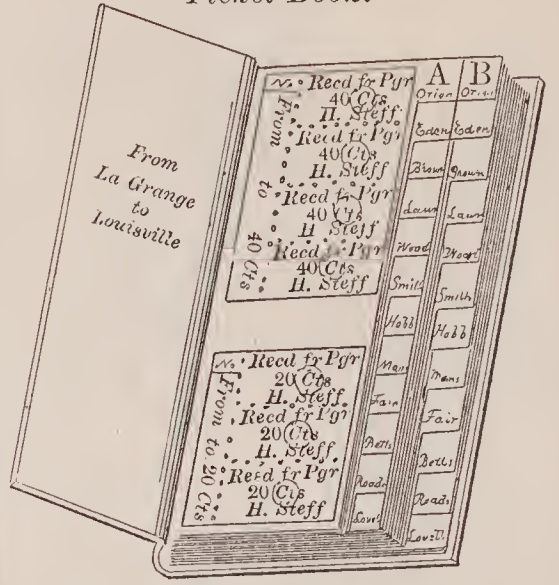

71589—J. Densmore—Rotating Tooth Cultivator.

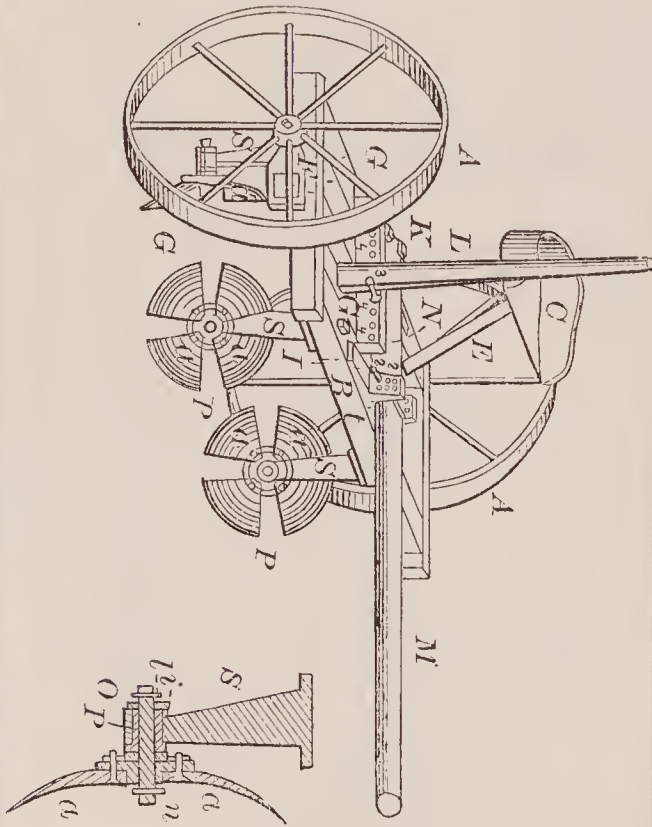

71592—J. B. Eads—Loading Ordnance.

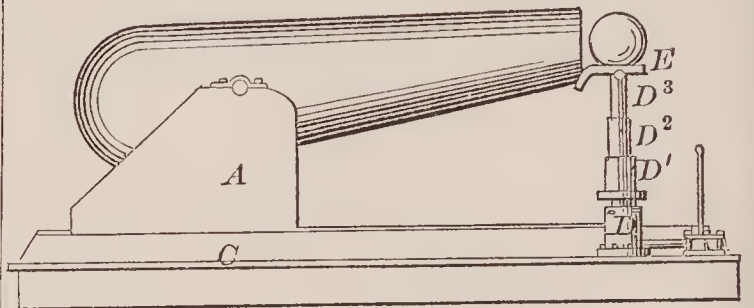

71591—Dunham & Widney—Car Brake.

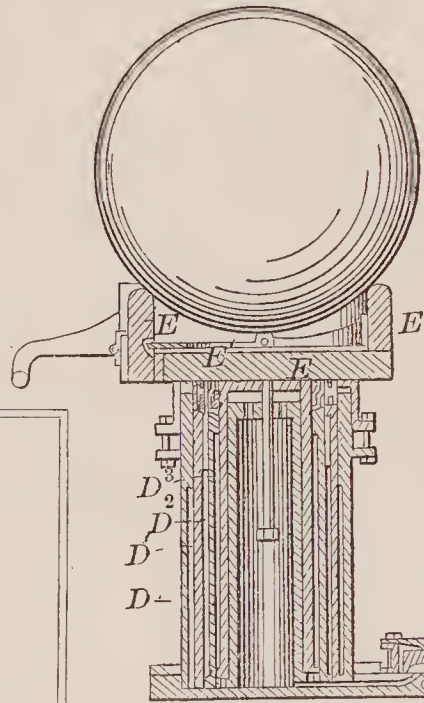
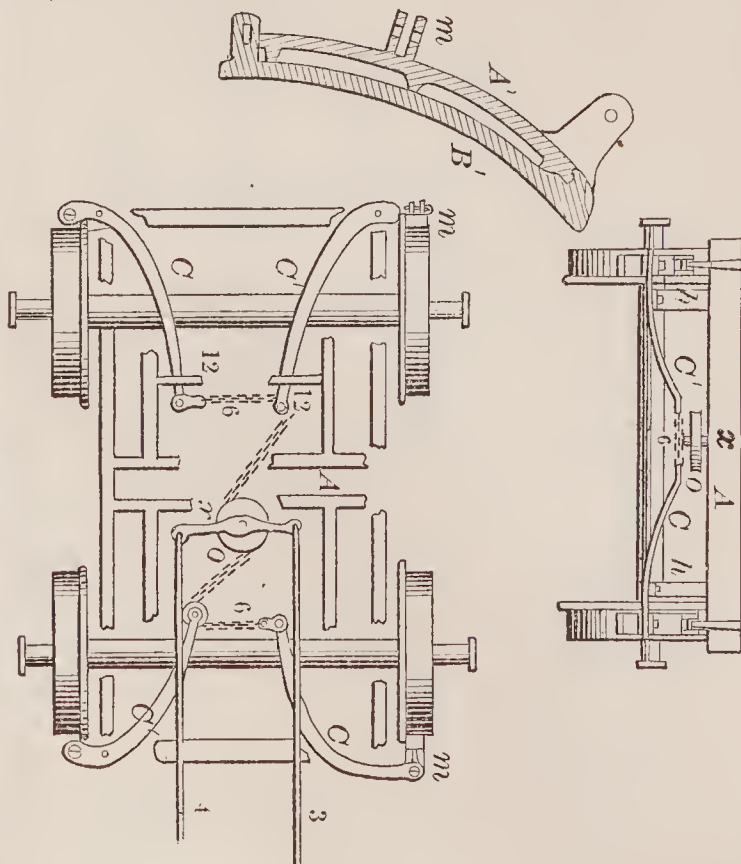

71593—K. Ebermeyr—Melodeon.

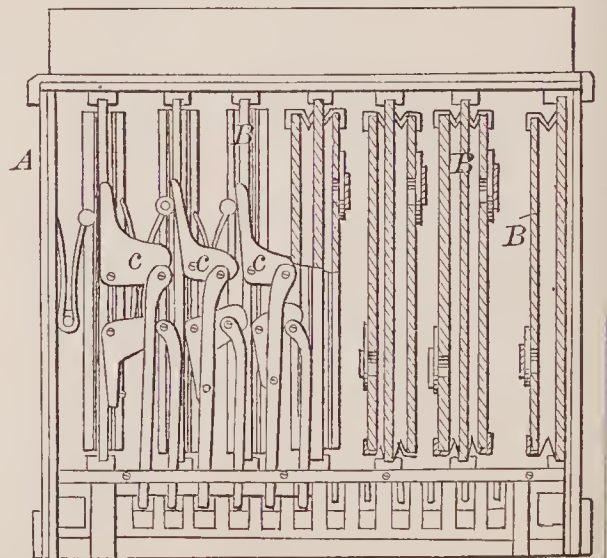

71595—T. Evans—Drafting Instrument.

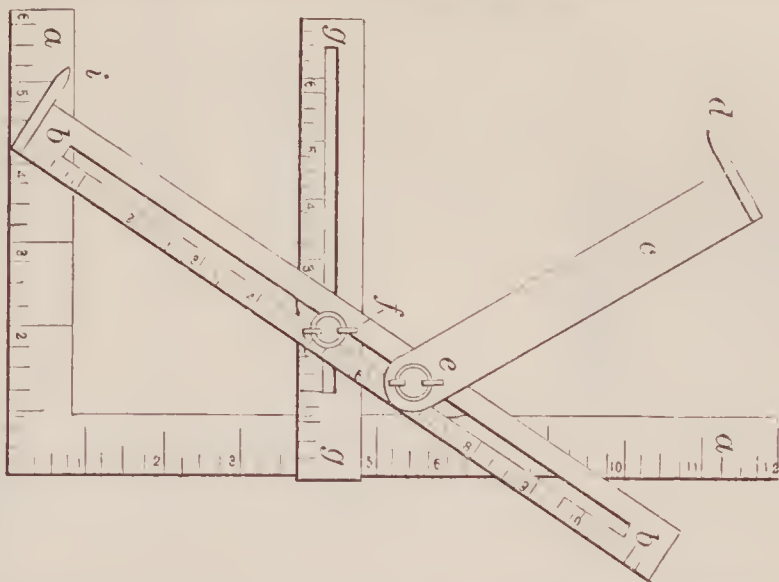

71594—J. E. Emerson—Attaching Handles to Cross Cut Saws.

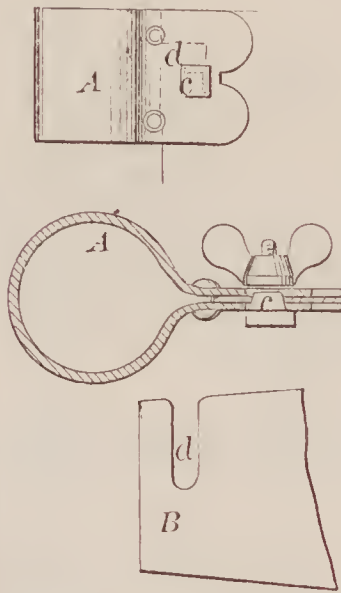

71598—A. D. Fox—Railroad Jack.

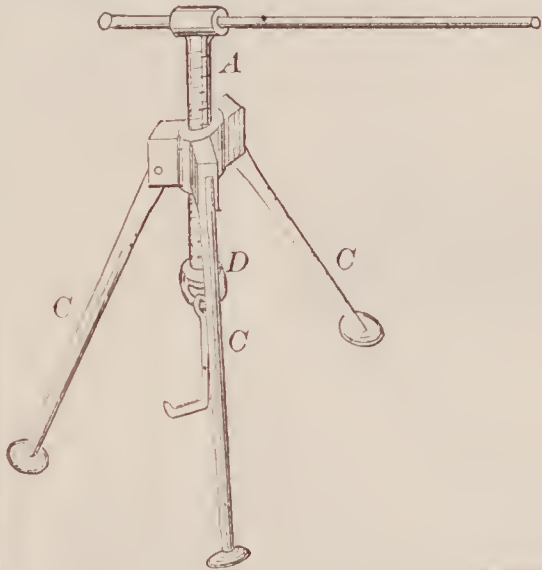

71602—J. P. Gallagher—Stove Pipe Thimble.

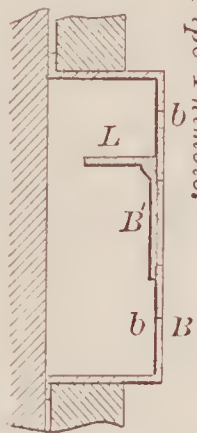

71596—B. W. Felton—Car Replacer.

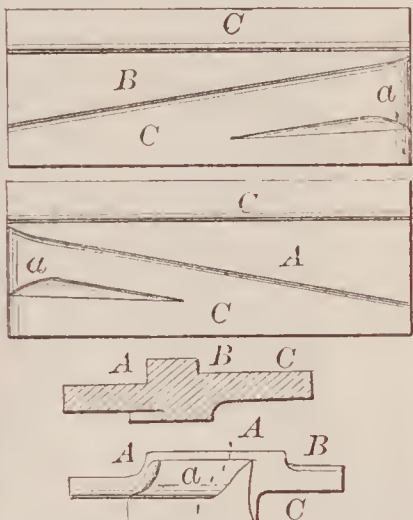

71600—C. Froehlich—For Cutting Tips from Cigars.

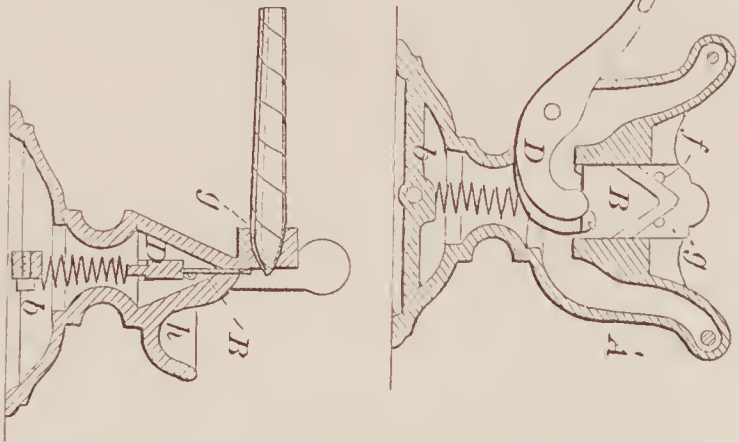

71599—C. L. Frink—For Smoothing Cloth.

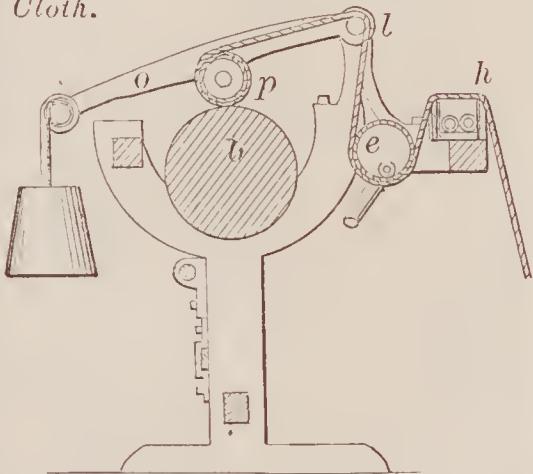

71601—C. C. Gale—Railroad Time Indicator.

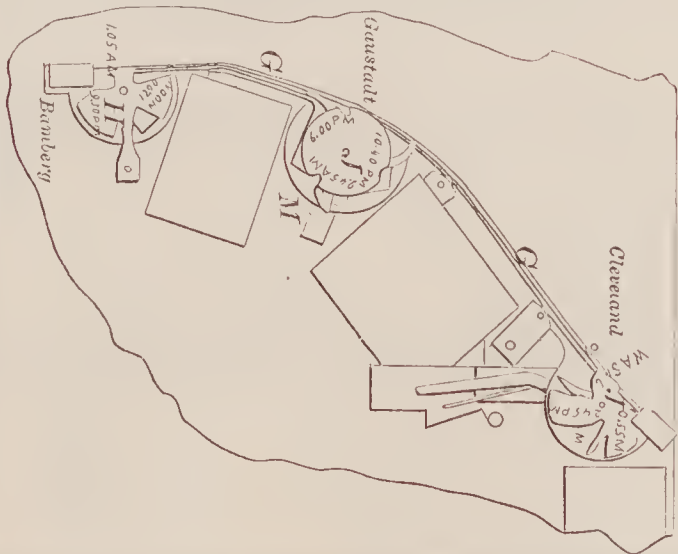

71603—Garretson & Clark—Sash Stop.

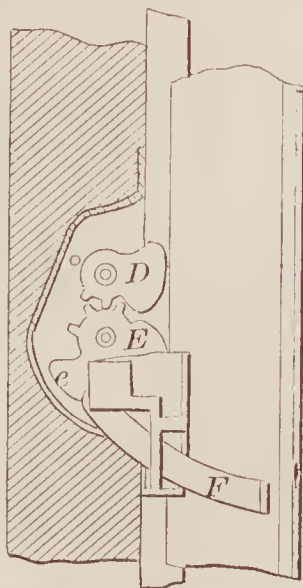



71604—Garvin & Pettibone—*Feed Water Heater for Locomotives.*

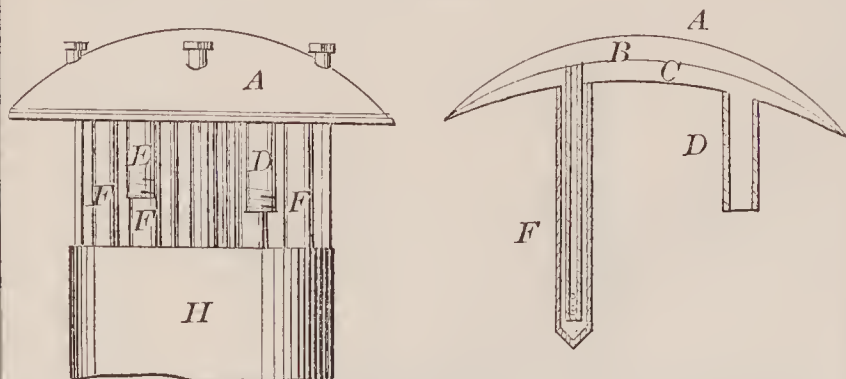

71606—T. Grey—*Grinding Mill.*

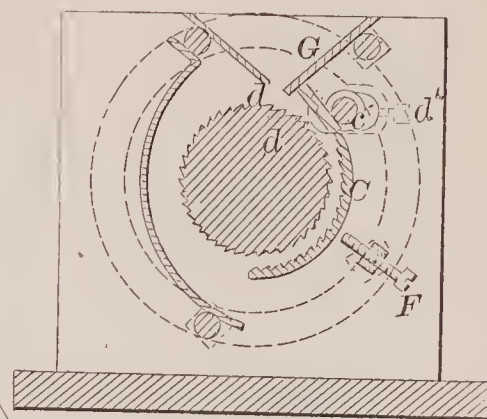

71605—W. T. Gillinder—*For Forming Threads on Sheet Metal Caps.*

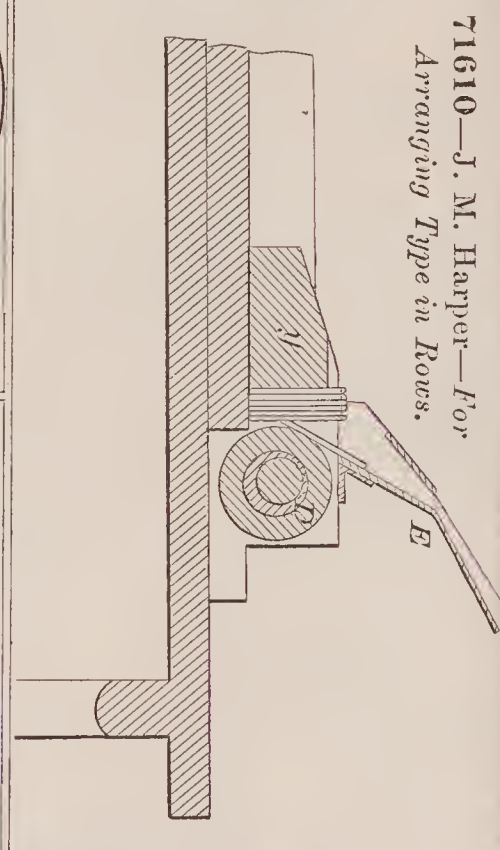
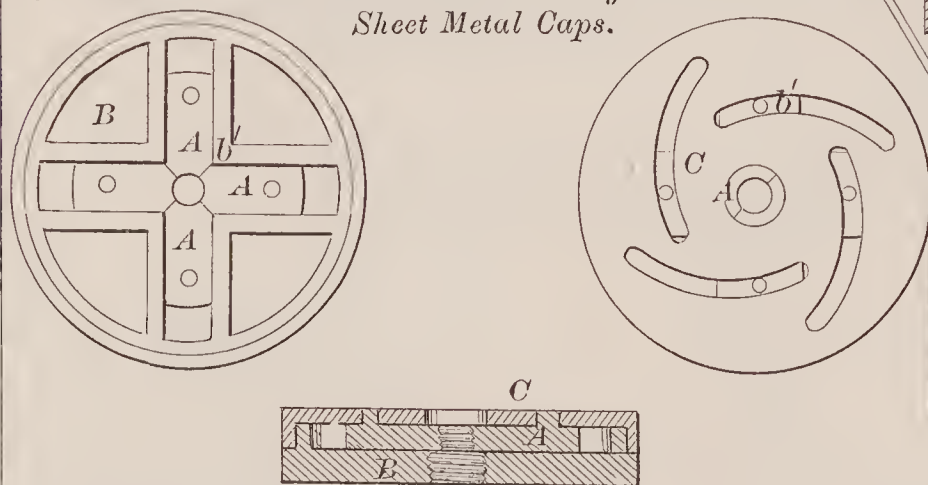

71610—J. M. Harper—*For Arranging Type in Rows.*

71608—D. I. Hall—*Grubbing Machine.*

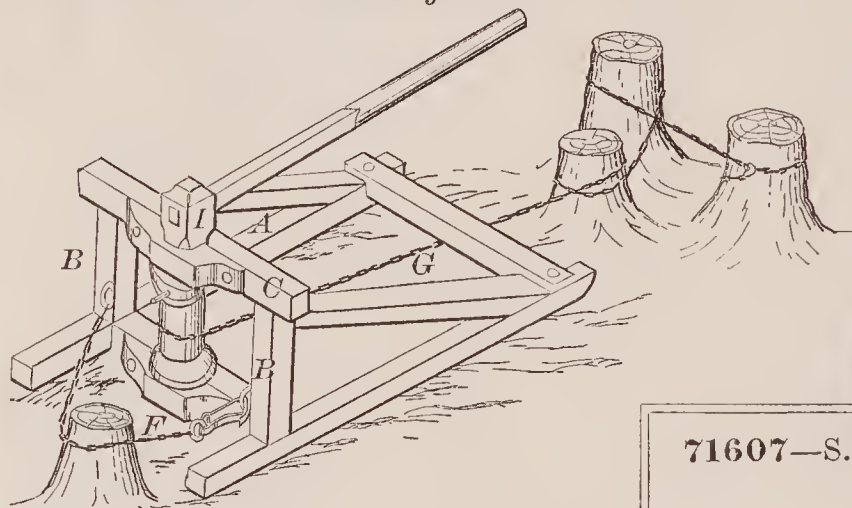

71612—J. Haslett, Jr—*For Mixing and Feeding White Lead.*

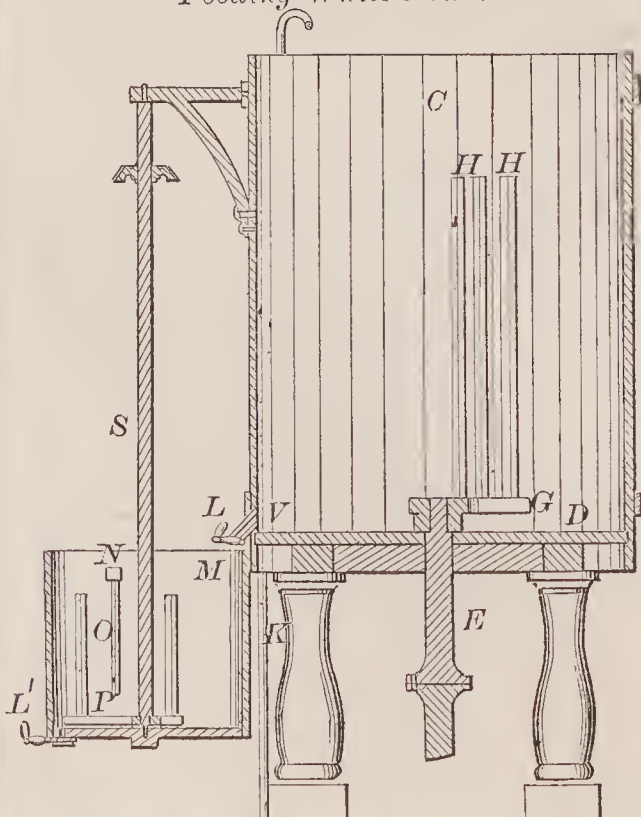

71607—S. G. Hadley—*Railroad Snow Plow.*

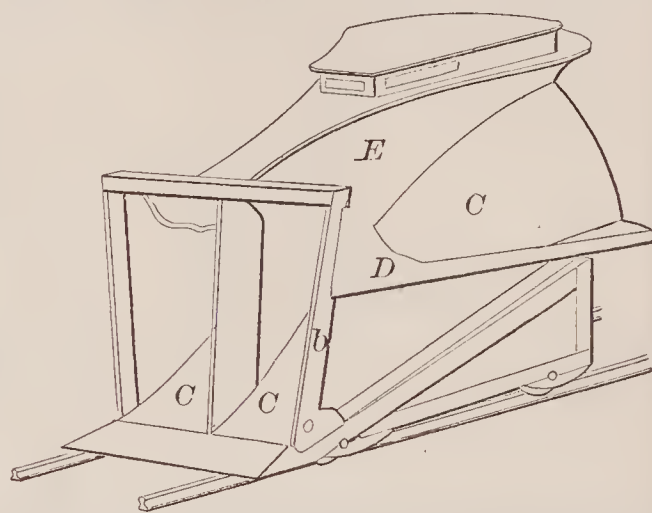

71611—Harrison & Condie—*Folding Step.*

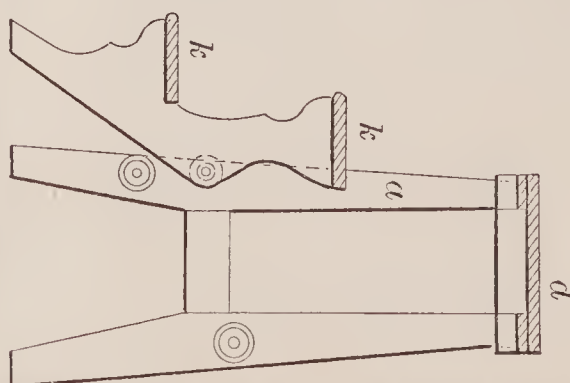

71612—Continued.

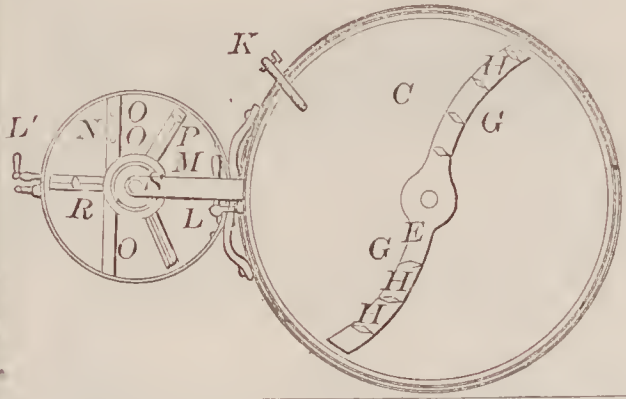

71615—L. Hill—Cleat for Sail Boats.

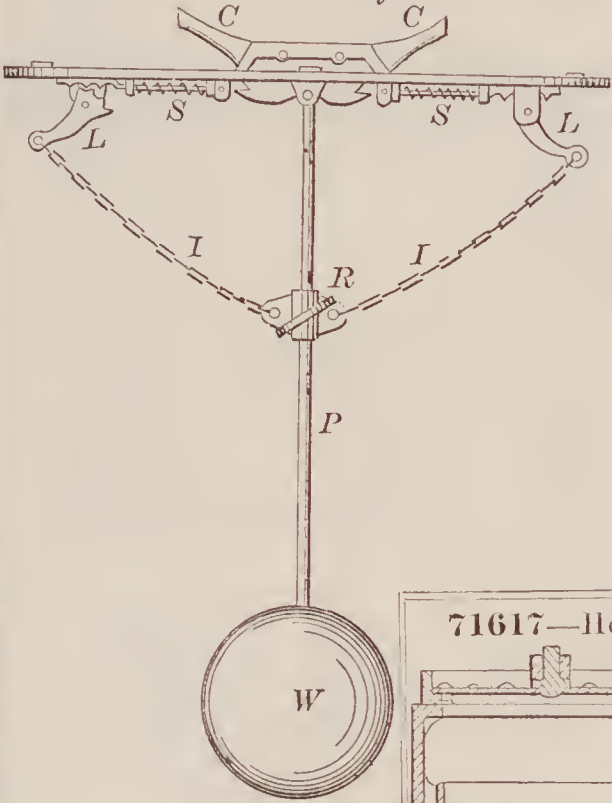

71618—B. W. Hudson—Steam Slide Valve.

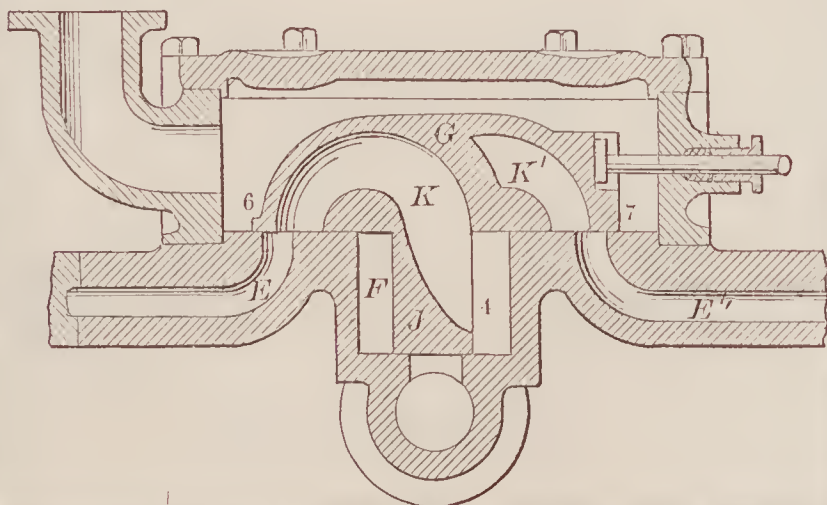
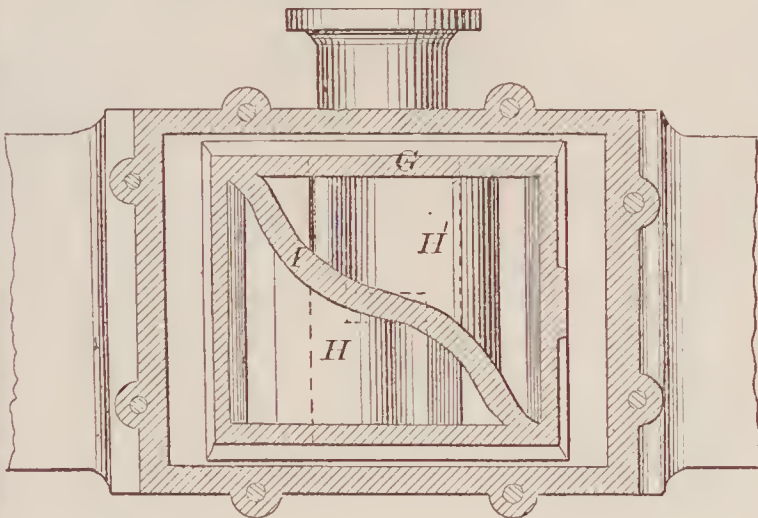

71614—J. P. Haynes—Head Block for Saw Mills.

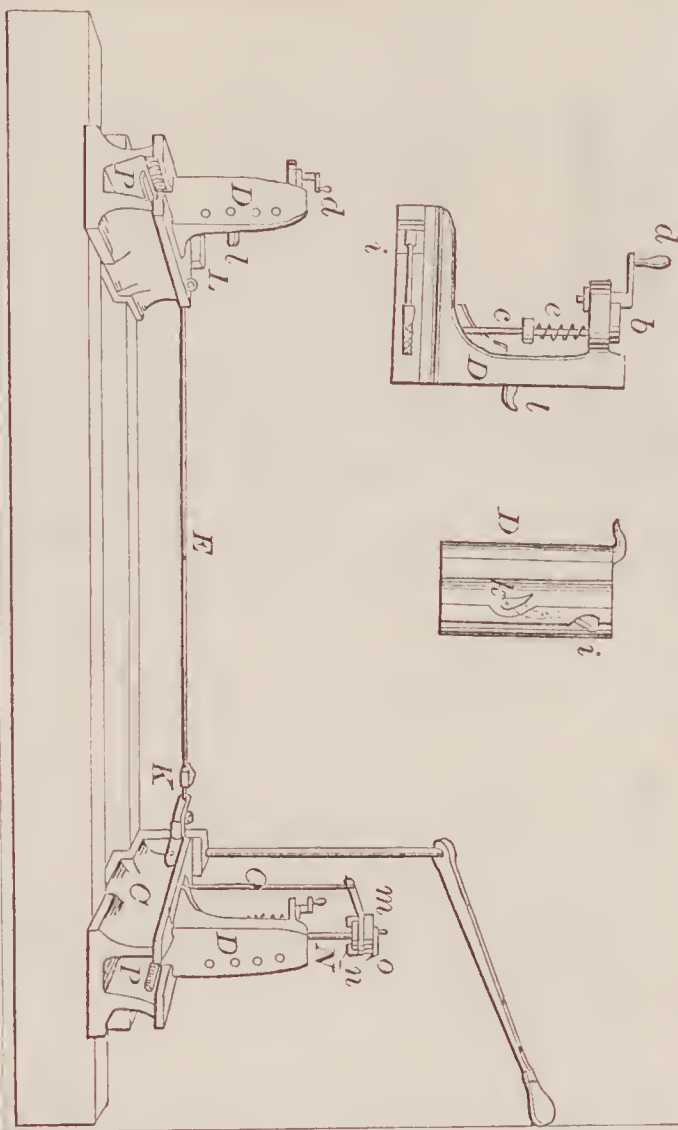

71617—Holden & Best—Gas Retort.

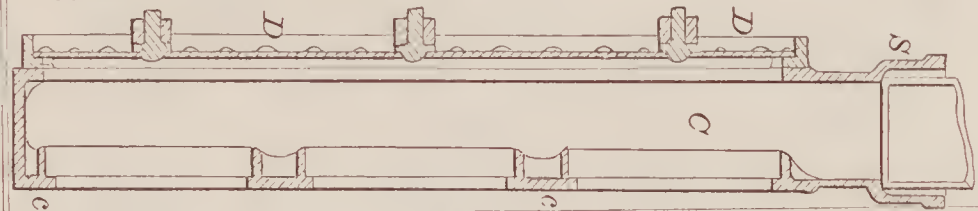

71613—W. H. Hawkins—Carriage Curtain Knob.

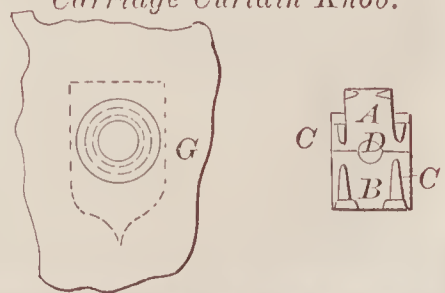

71616—L. Hillebrand—Door Spring.

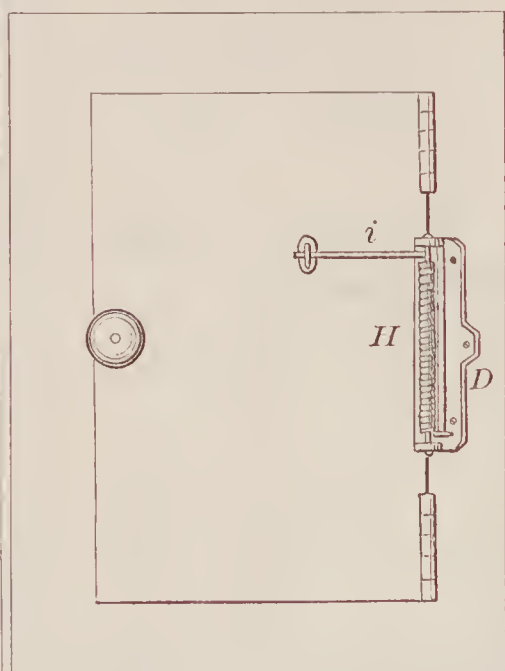



71619—F. Huot—*Treating Petroleum.*

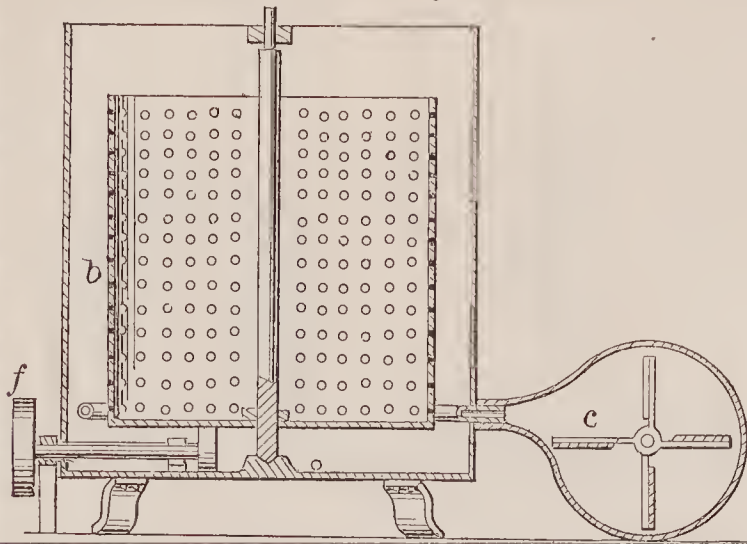

71621—J. Jenkinson—*Chalk Holder for Billiard Cues.*

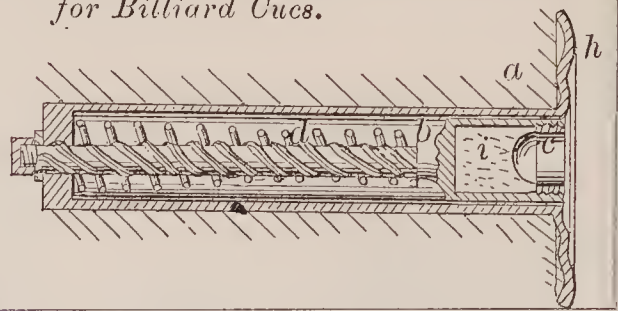

71622—Johnson & Milliken—*Faucet Attachment.*

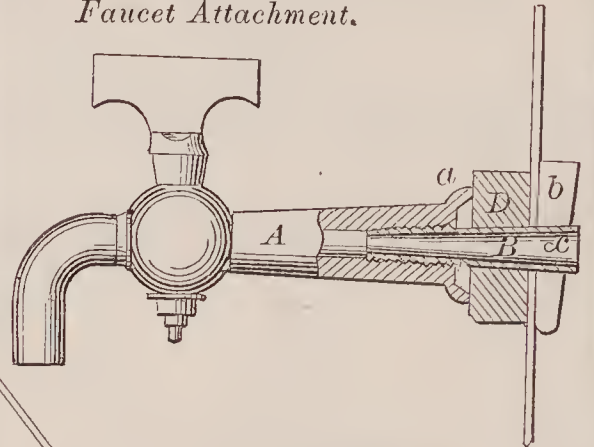

71623—J. P. Johnson—*Cultivator.*

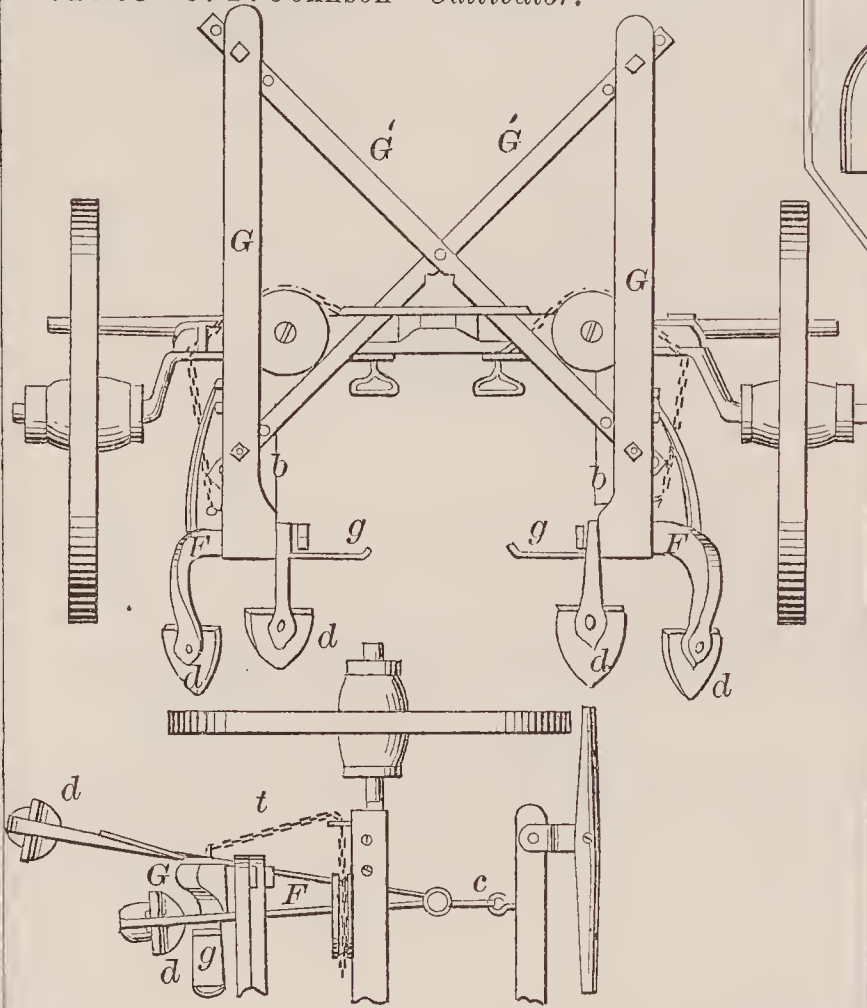

71624—Kennedy, Holt & Gerlach—*Electric Clock.*

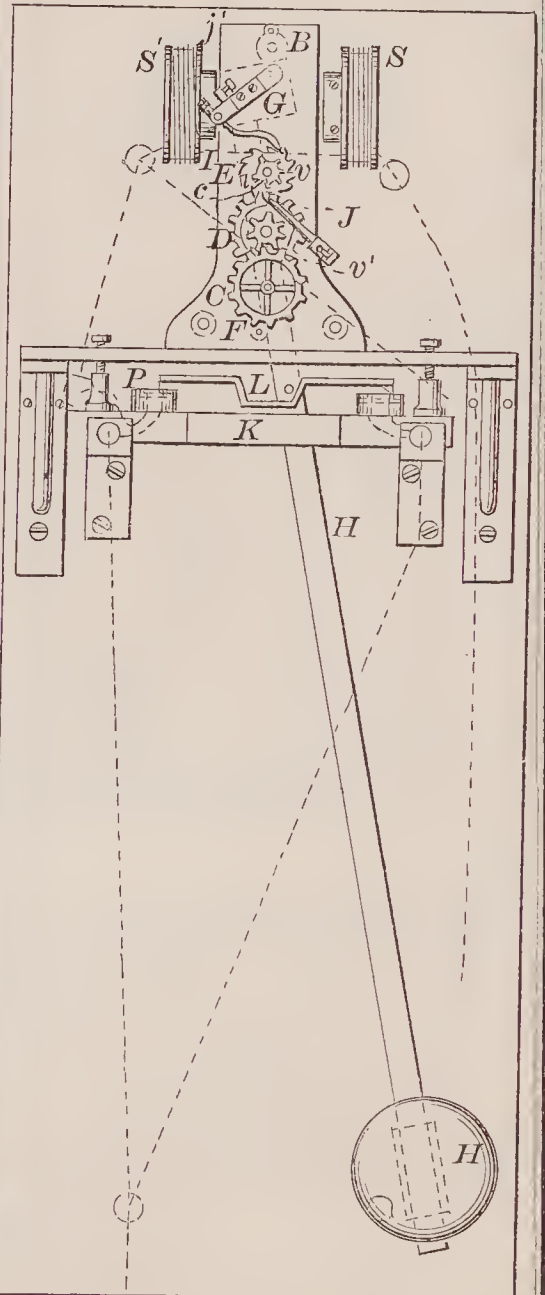
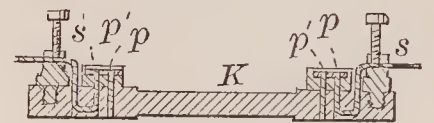

71625—J. L. Krauser—*Saw.*

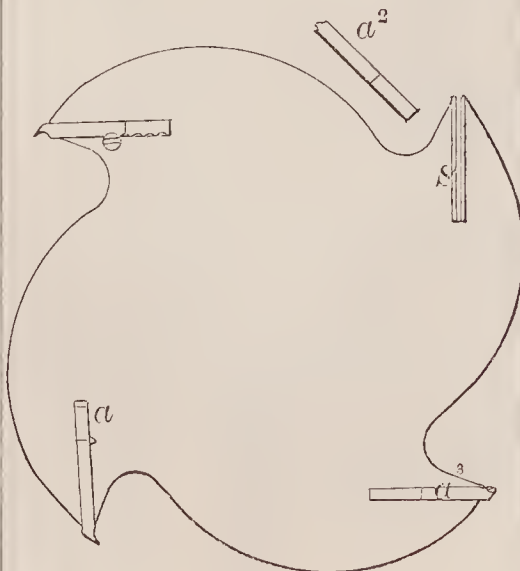

71626—G. Krotzinger—*Game.*

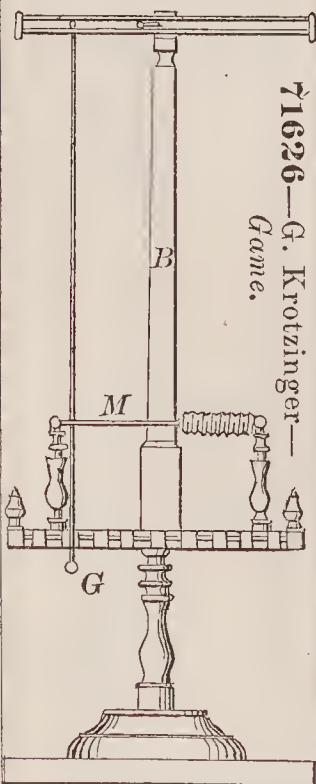

71632—G. R. Moore—Corrugated Sheet Metal Boilers.

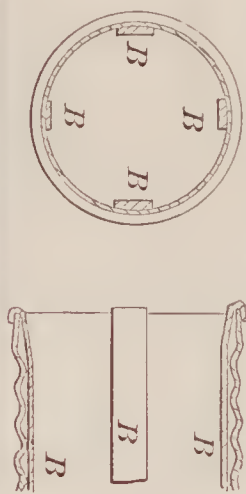

71631—D. Monnin—Clock Case.

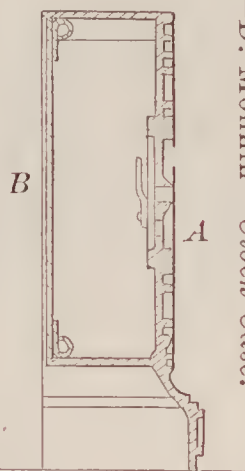

71630—B. F. Miller—Ventilating Cowls.

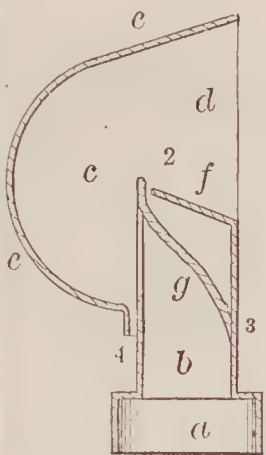

71627—D. Liebrich—Door Gong.

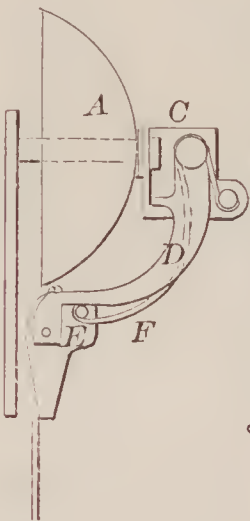

71634—B. J. Oleff—Spring Bed Bottom.

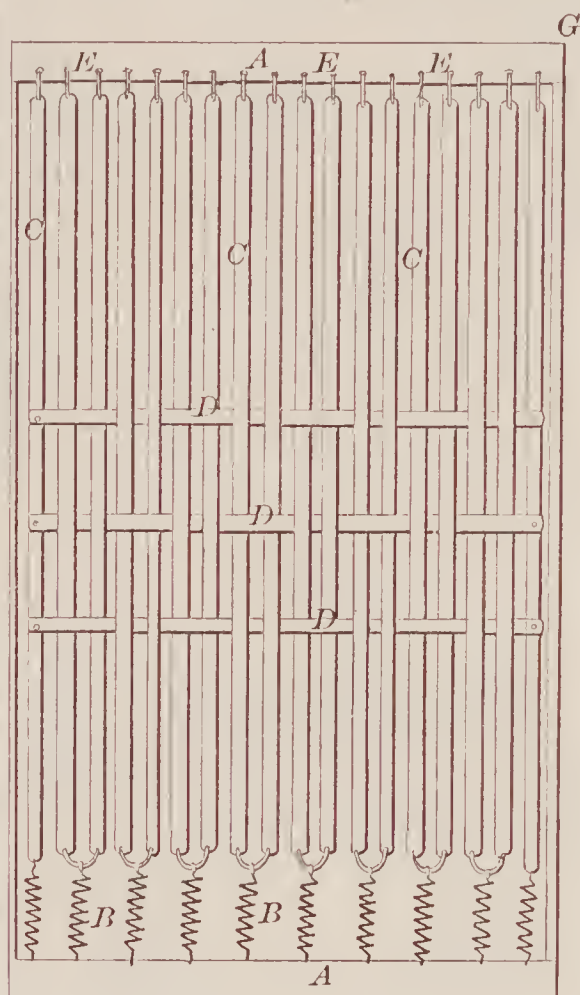

71633—Newcomb & Lyon—Cartridge Box.

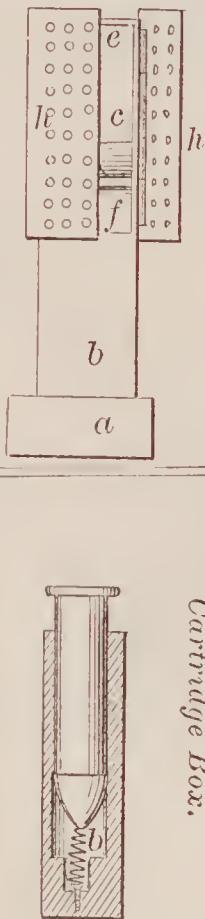

71628—J. K. Martin—For Hoisting Hogs in Slaughter Houses.

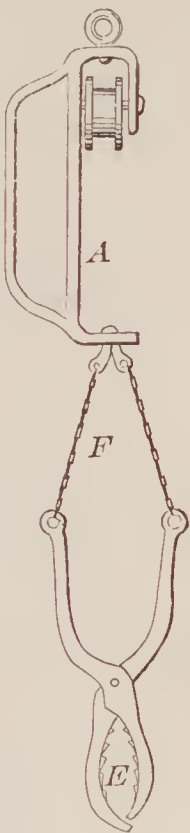

71635—J. H. Parsons—Paper Clip.

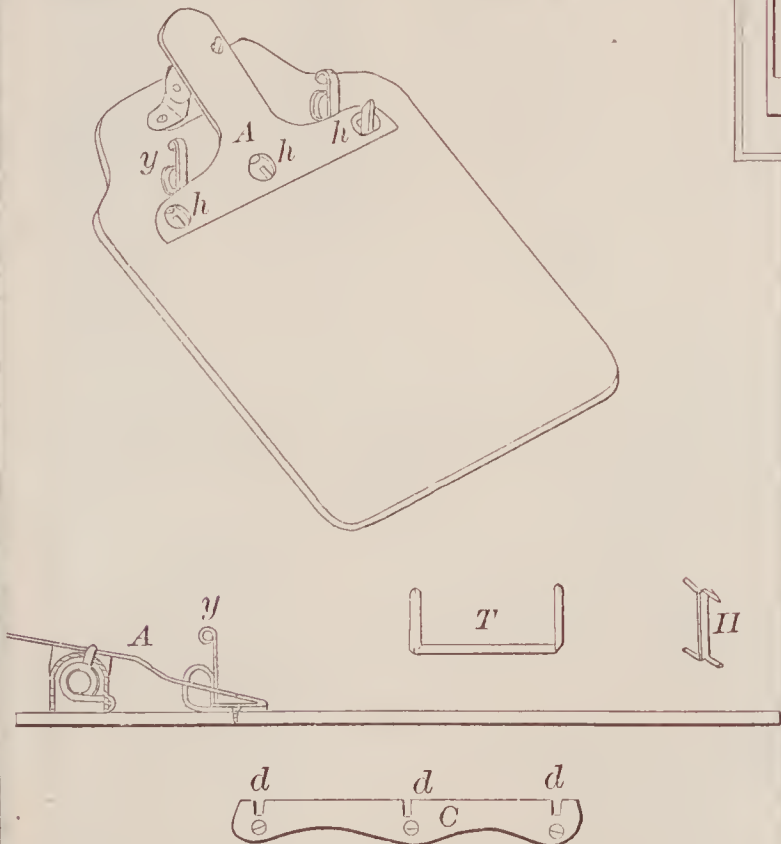

71636—E. Pea—Gate Fastening.

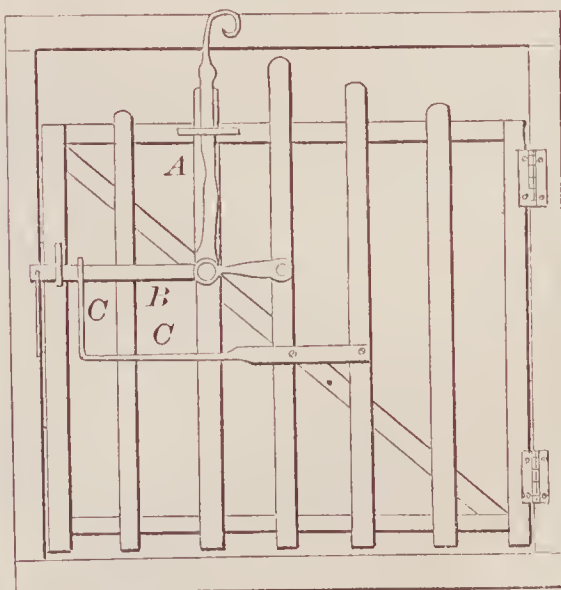



71637—C. E. Pierce—*Burglar Alarm.*

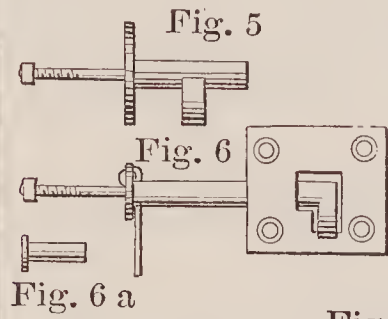
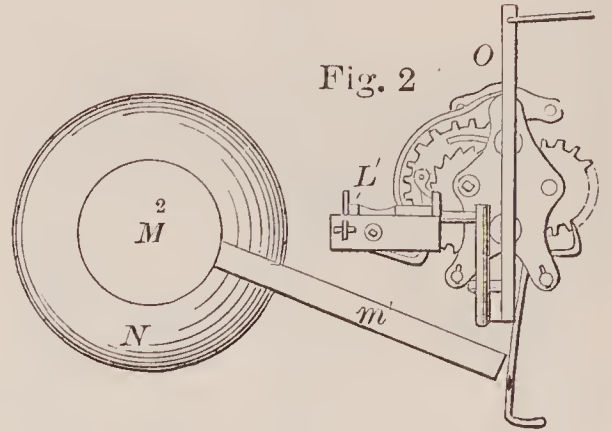
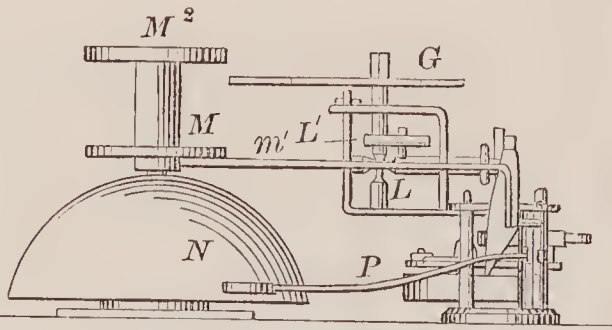

Fig. 6 a

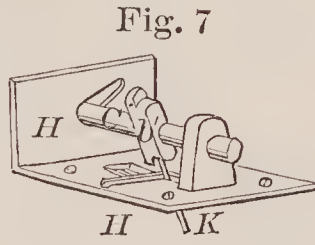
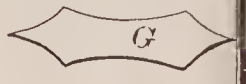
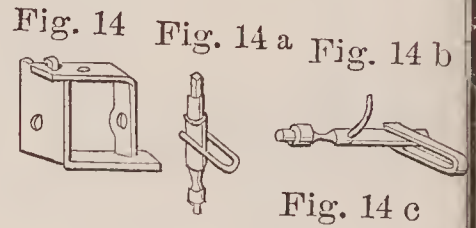
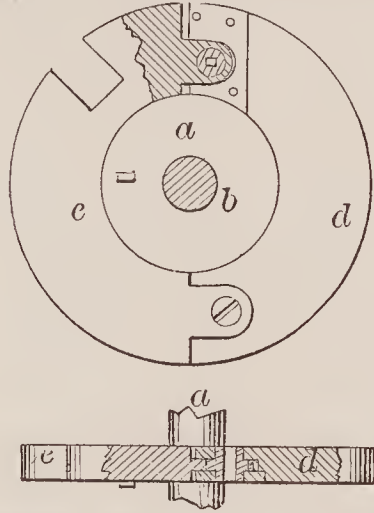

Fig. 7 a



71640—J. H. Porter—*Tumbler for Permutation Locks.*



71638—E. S. Pierce—*For Feeding Screw Blanks.*

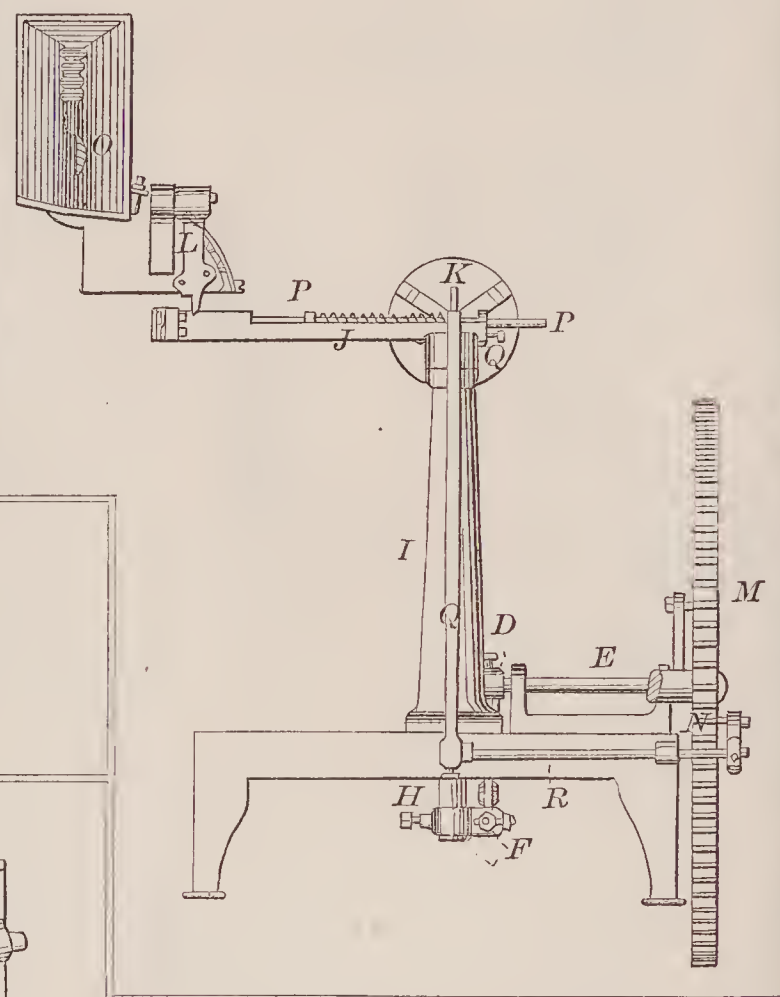

71641—H. Prouhet—*Button.*

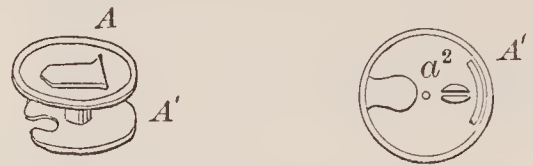

71642—S. Richards—*Snow Plow.*

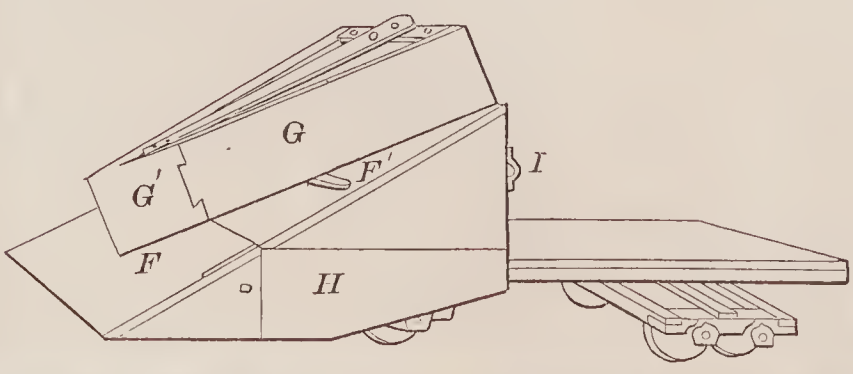
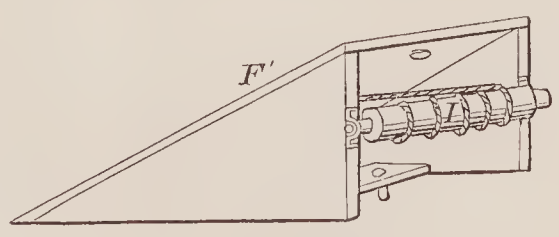

71639—O. E. Pillard—*Tumbler for Permutation Locks.*

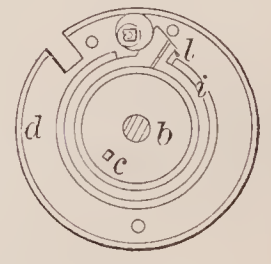

71647—H. P. Roche—*For Stretching Cloth.*

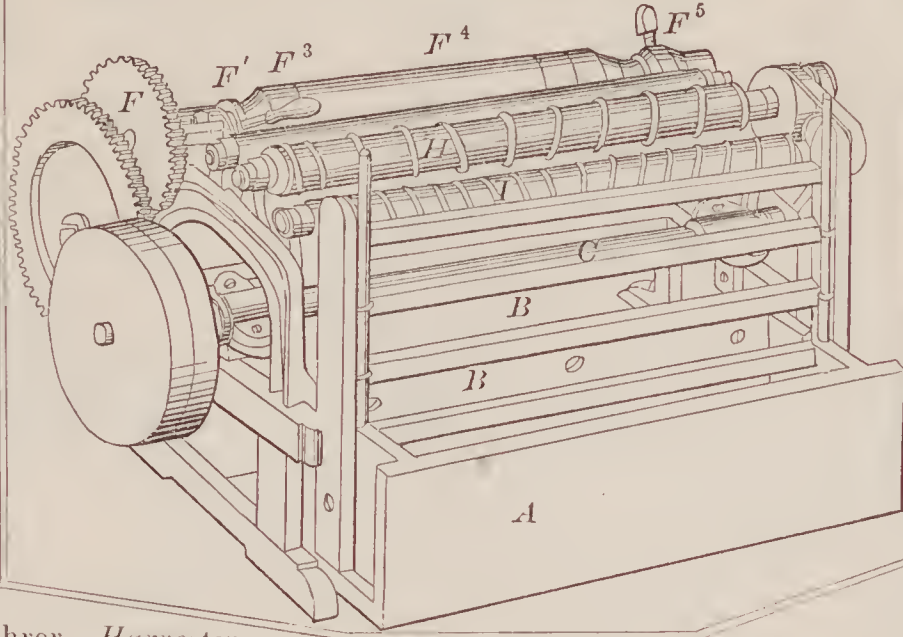

71648—H. H. Rockwell—*Safety Strap for Bridles.*

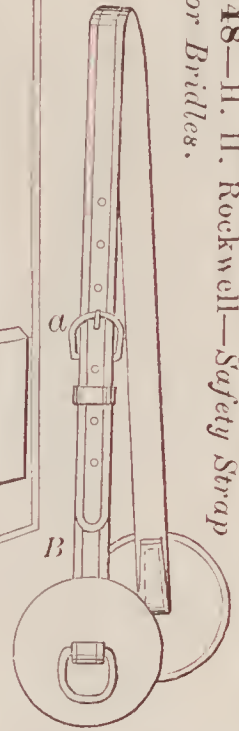

71643—G. B. Richardson—*Salt Bottle.*

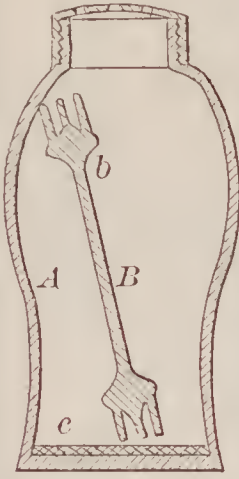

71649—J. L. Rohrer—*Harvester Rake.*

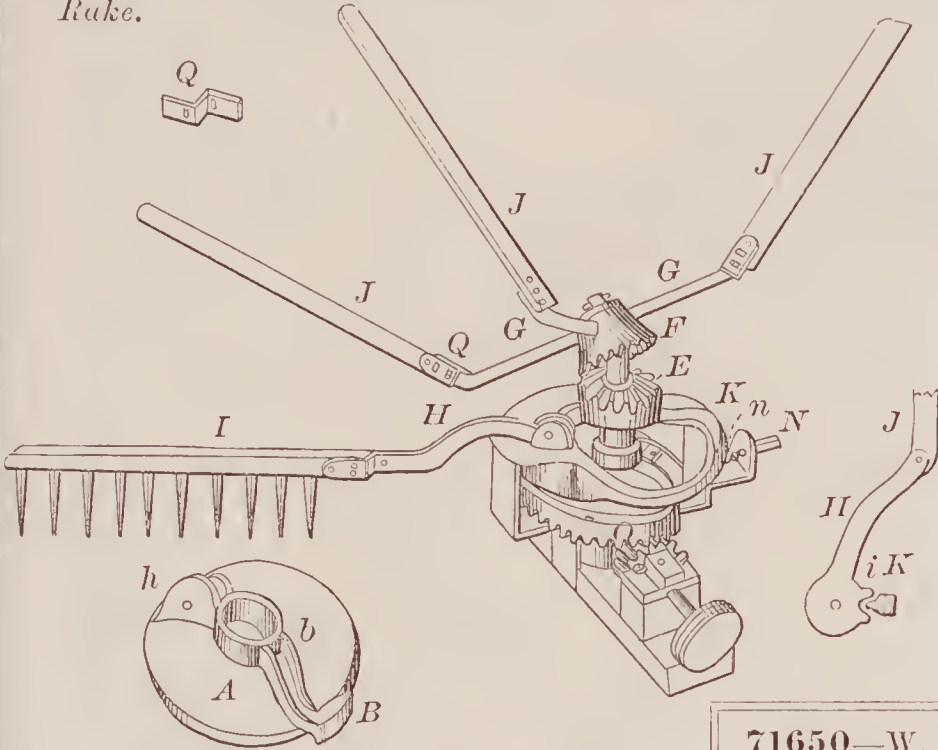

71644—W. Richter—*Steel Trap.*

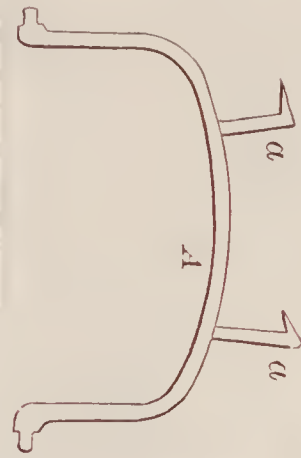

71650—W. T. C. Runnels—*Washing Machine.*

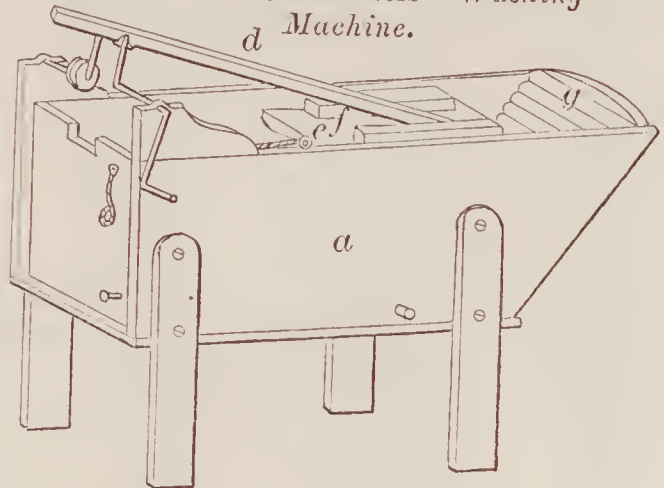

71646—Robinson & Lovejoy—*Lasting Shoe.*

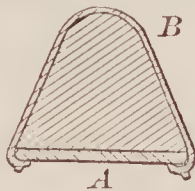

71645—F. W. Robbins—*Churn.*

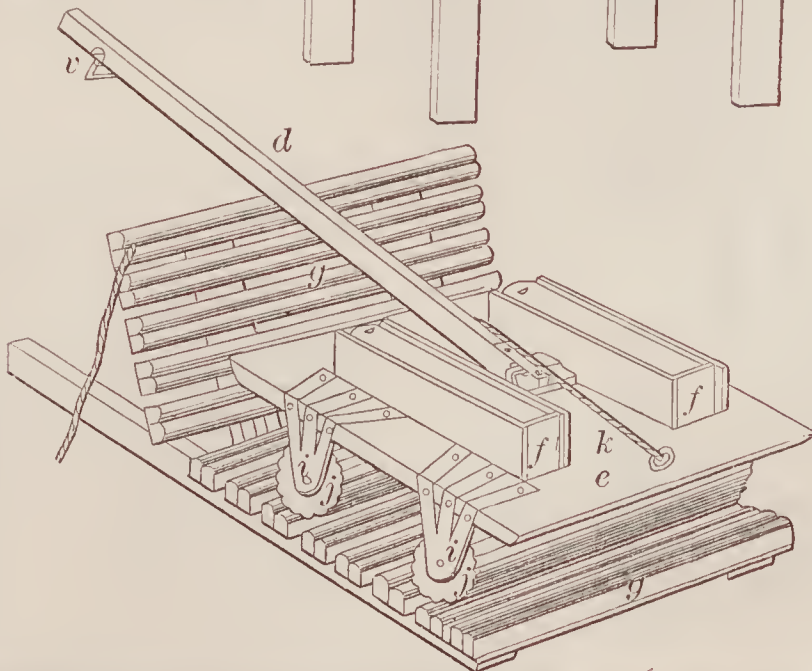
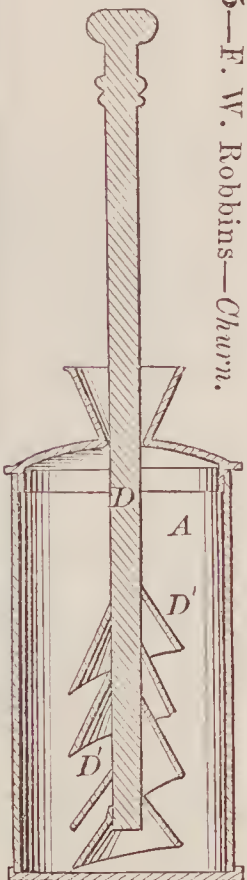



71651—E. O. Sehartan—Lamp Chimney.

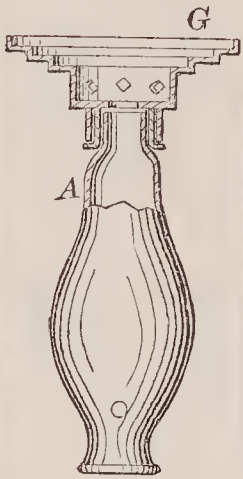
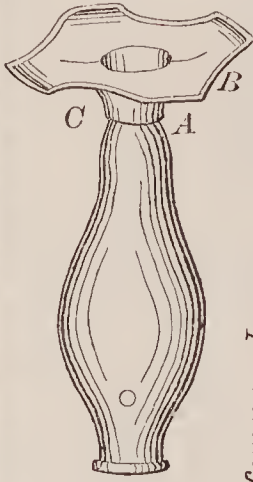

71652—A. M. Seymour, Jr.—Churn.

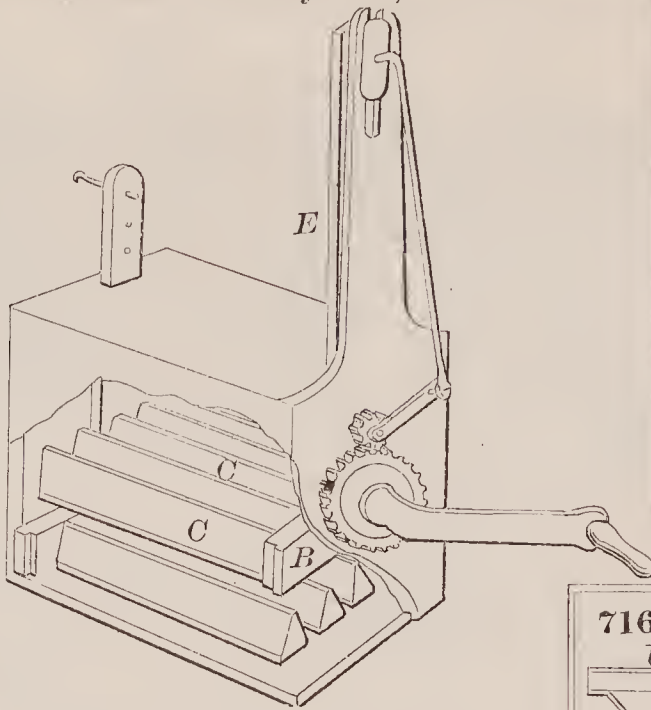

71655—R. L. Smith—Twine Holder.

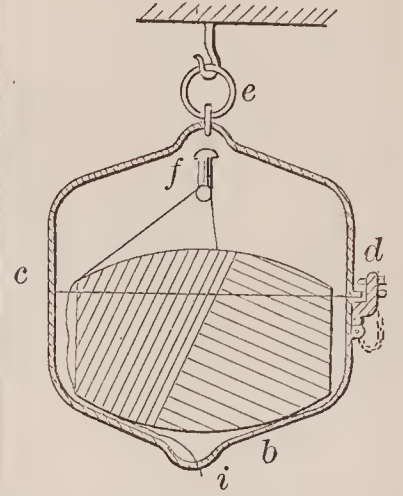

71653—P. Shaw—Harness Pad Block.

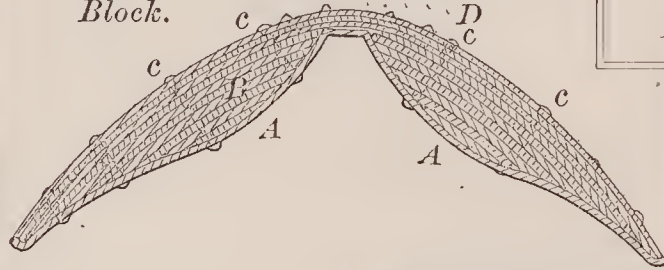

71658—J. M. Sporer—Lamp.

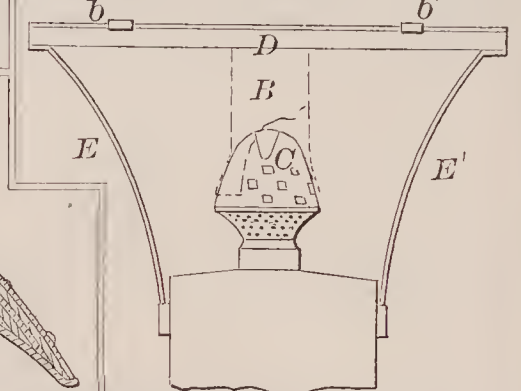

71659—S. B. Stewart—Stove Grate.

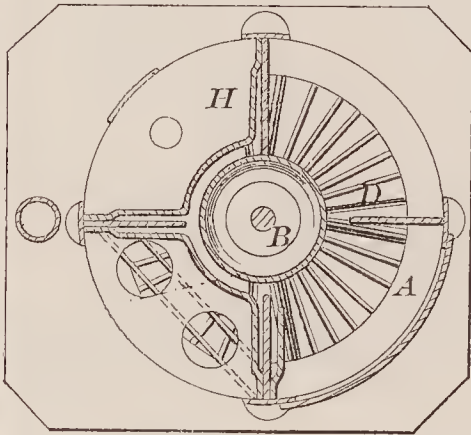

71656—T. Smith—Washing Machine.

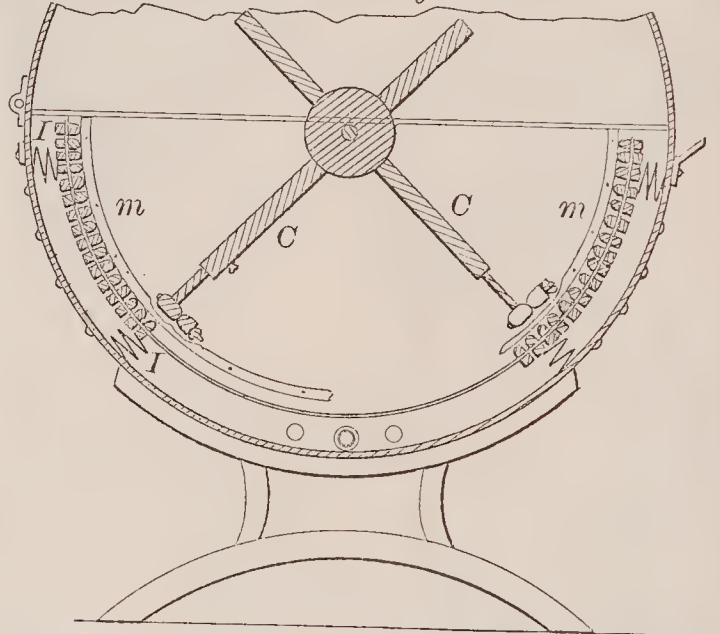

71657—B. R. Smithson—For Generating Oxygen Gas.

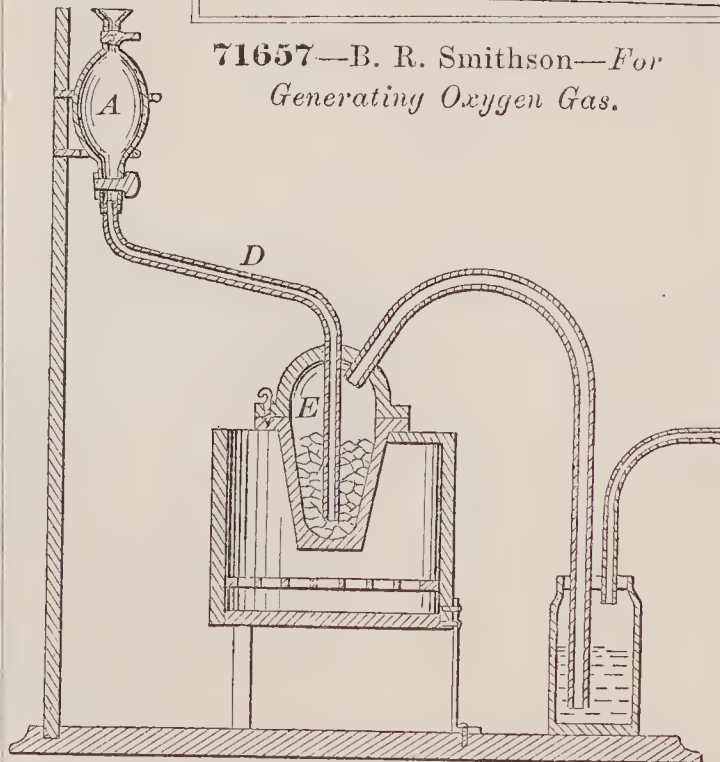

71654—O. E. Simmons—Bed Bottom.

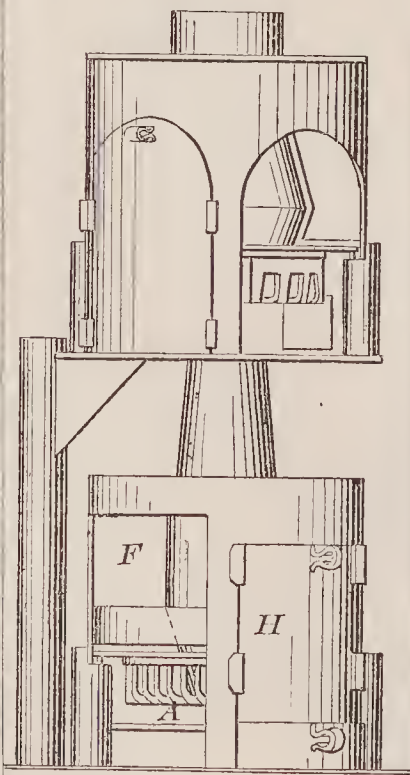



71660—O. O. Storle—*Grain Binder.*

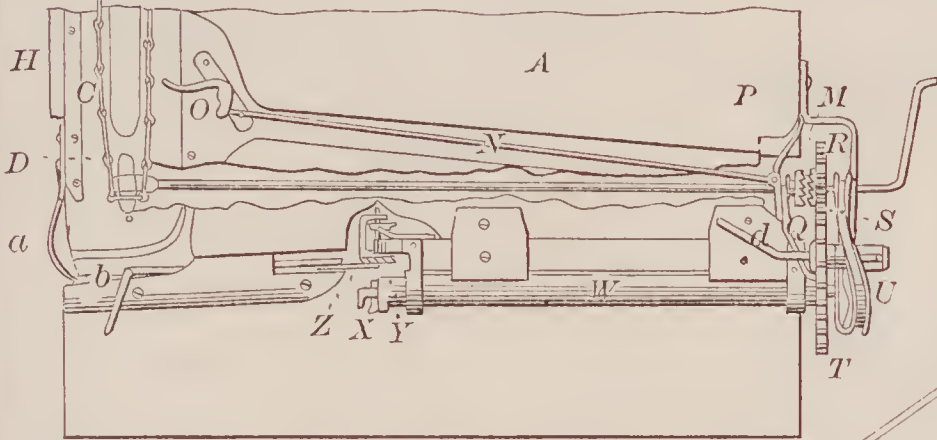
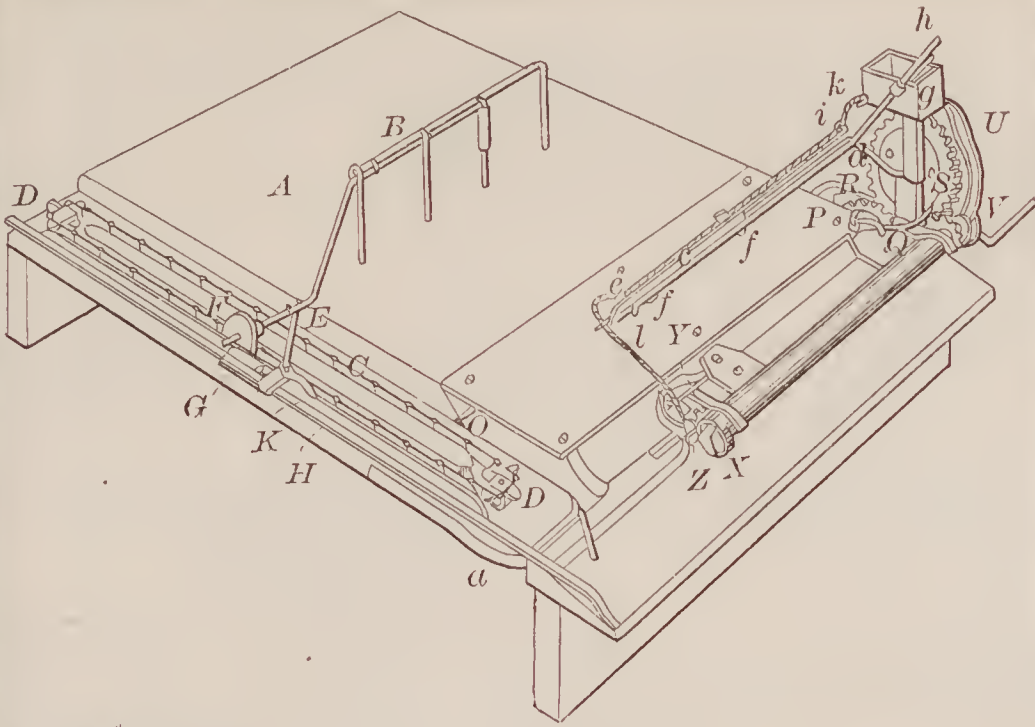

71661—Stouffer, Heaton & Bushong—*Horse Hay Fork.*

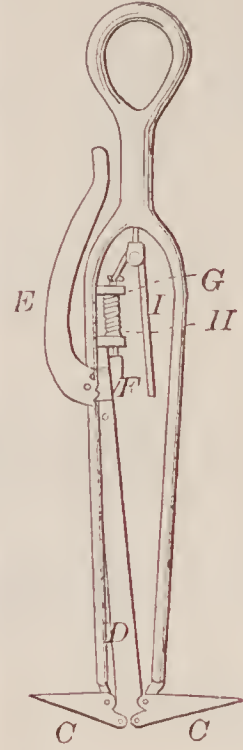

71662—Stout & Richardson—*Hat Ironing Machine.*

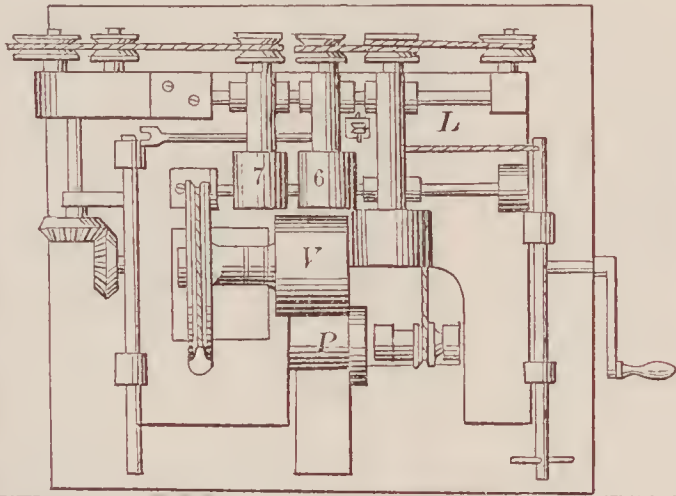

71665—Thompson & Hall—*Carburizing Apparatus.*

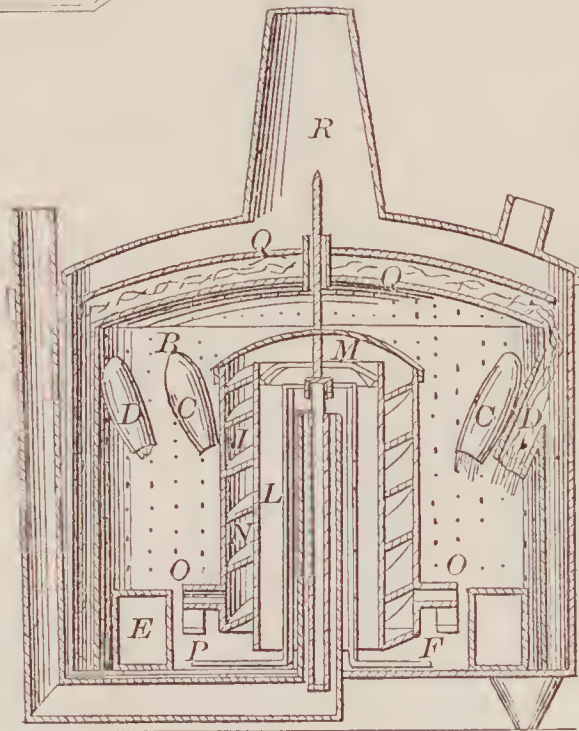

71668—R. Walker—*For Cutting and Mitering Printers' Rules.*

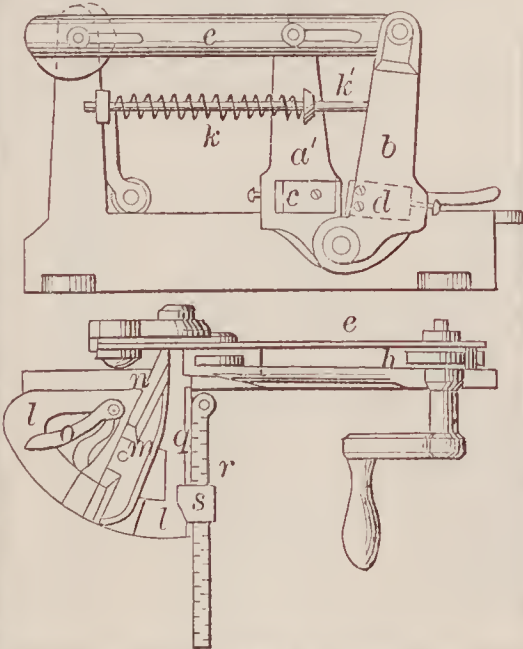

71664—C. M. Templeton—*Stuffing-Box Packing.*

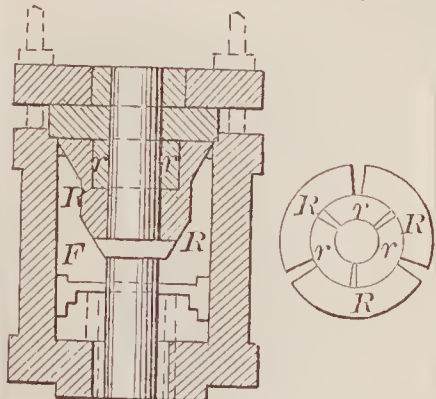

71666—H. Todd—*Regulating Watch.*

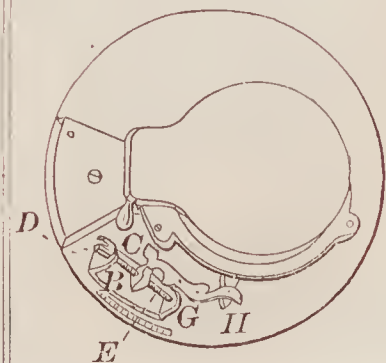



71669—Werni & De Bare—Sawing Machine.

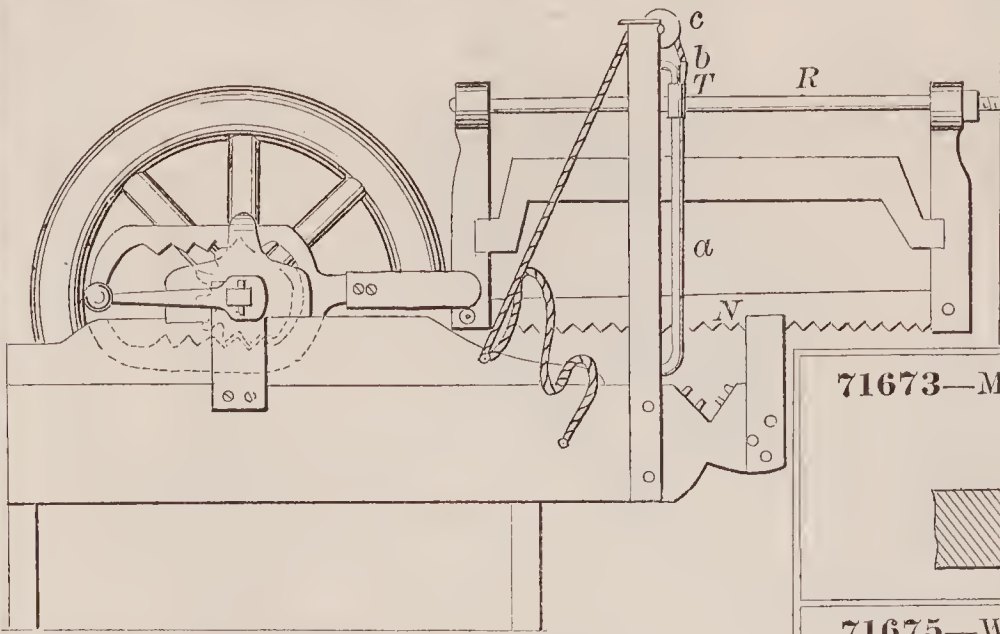

71670—J. Whitworth—Cutter Head for Mouldings.



71673—M. K. Adams—Car Coupling.

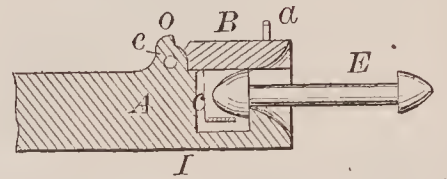

71671—Wilkinson & Beggs—Portable Hose Bridge.

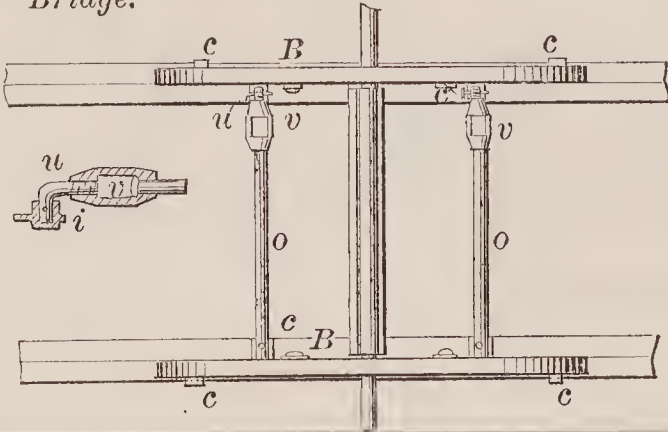

71675—W. J. Alexander—Gate.

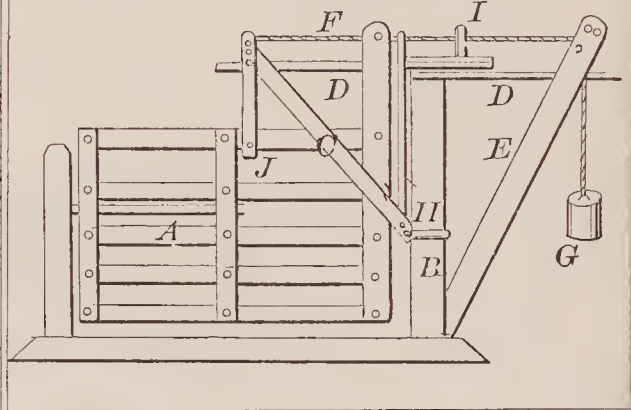

71672—B. F. Williamson—Scroll Saw Mill.

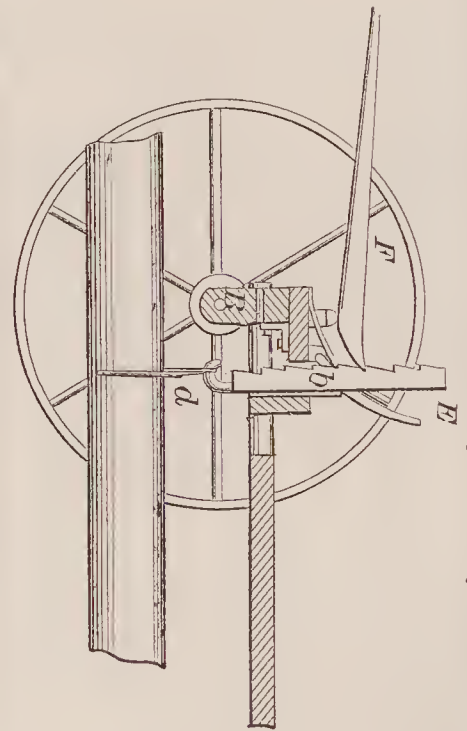
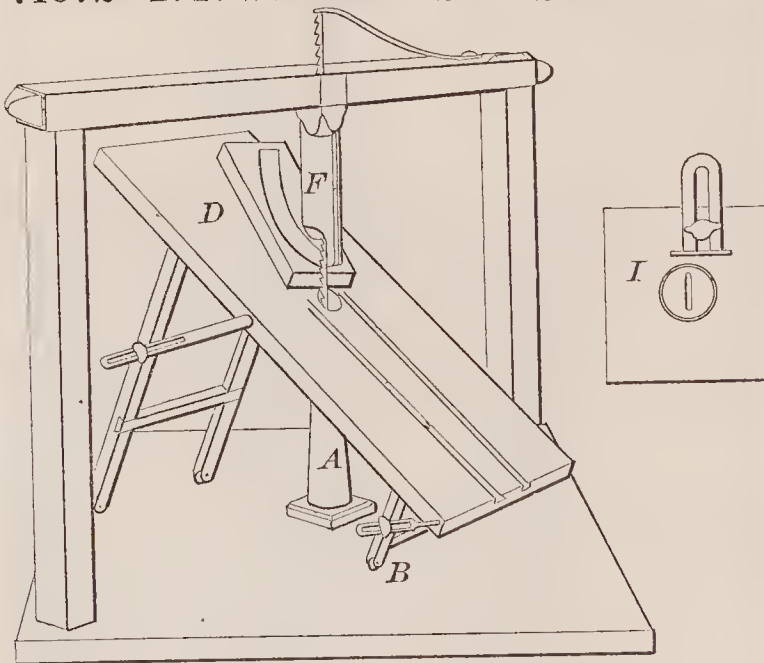

71674—N. Albertson—Hoisting Device for Trucks.

71677—D. Baird—Exhaust for Mill Stones.

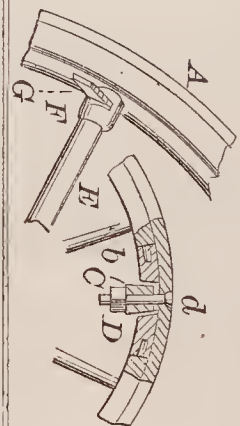
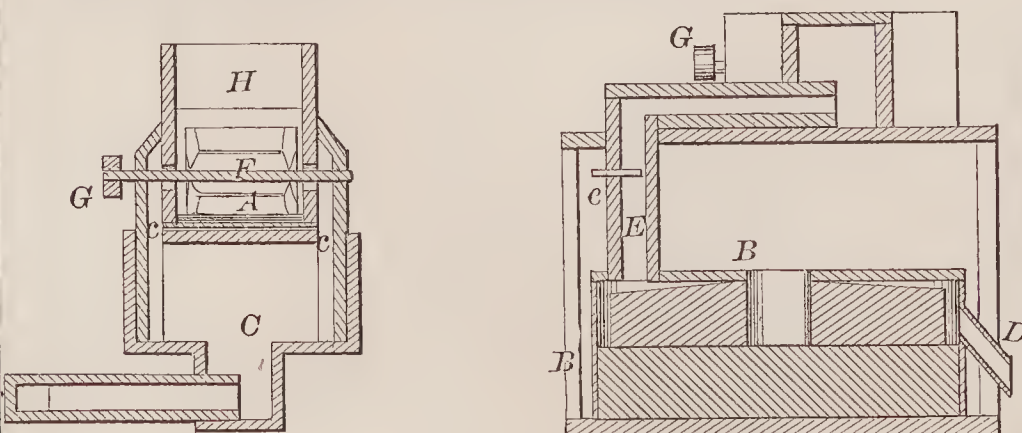

71676—J. M. Bailey—Wheel.

71678--T. C. Ball--Head Block for Saw Mills

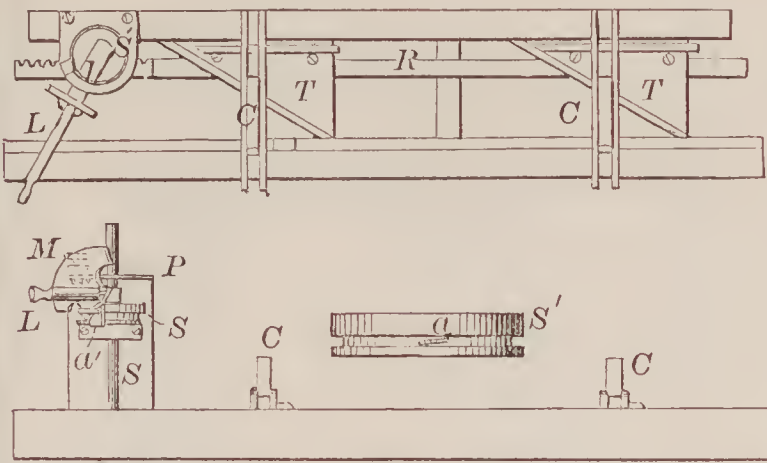

71682--A. S. Batten--Crane.

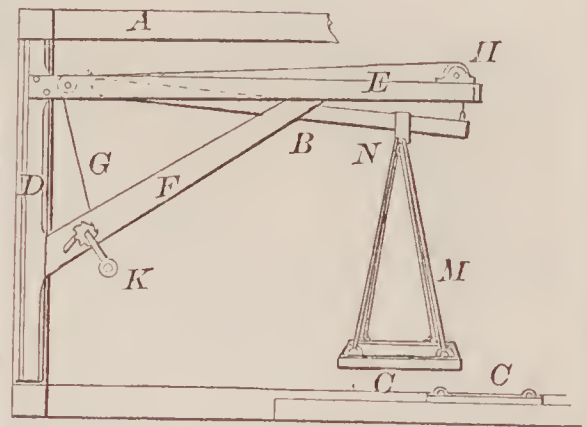

71680--C. Barry--For Making Tin Cans.

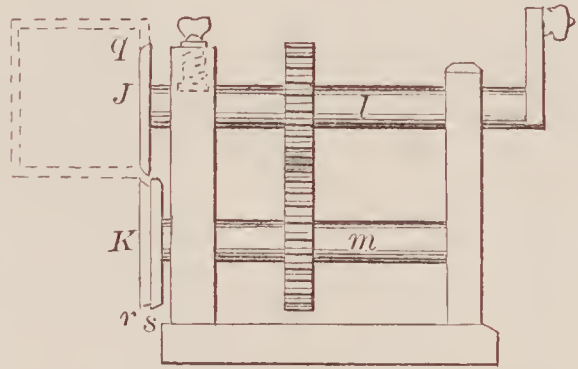
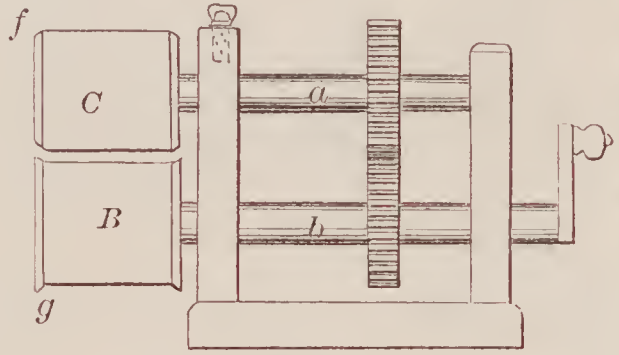

71681--C. Bartholomew--For Staining Paper.

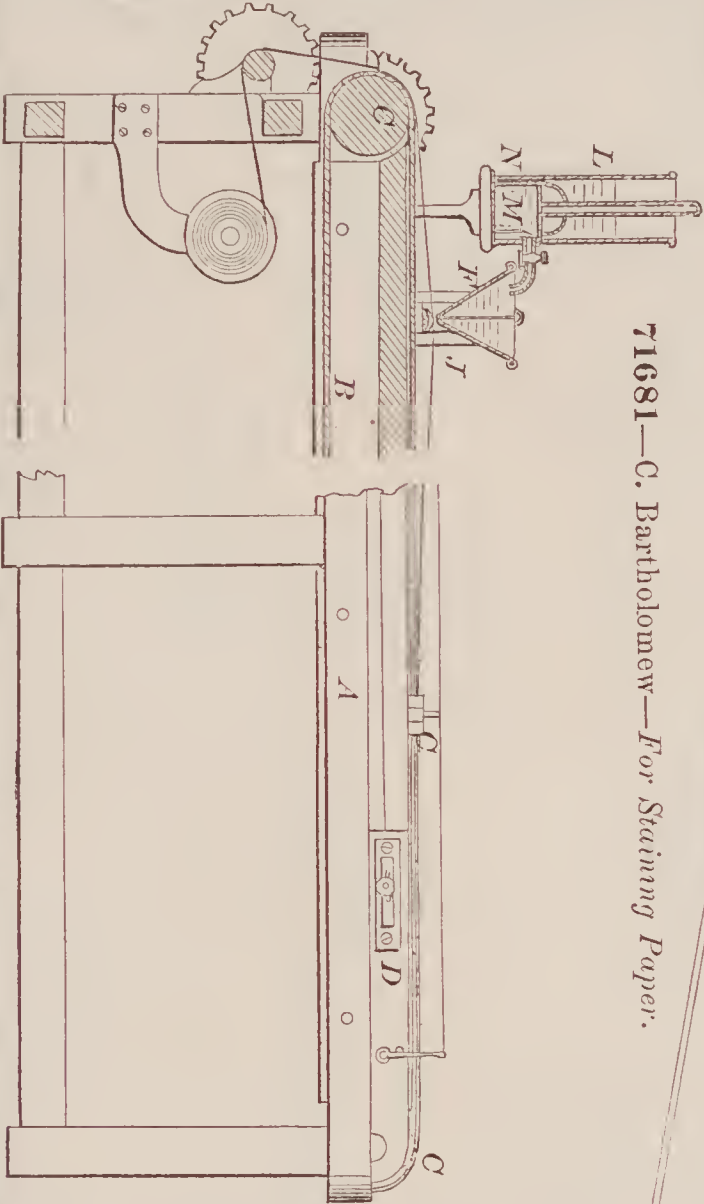

71683--P. D. Beach--For Boring Bobbins.

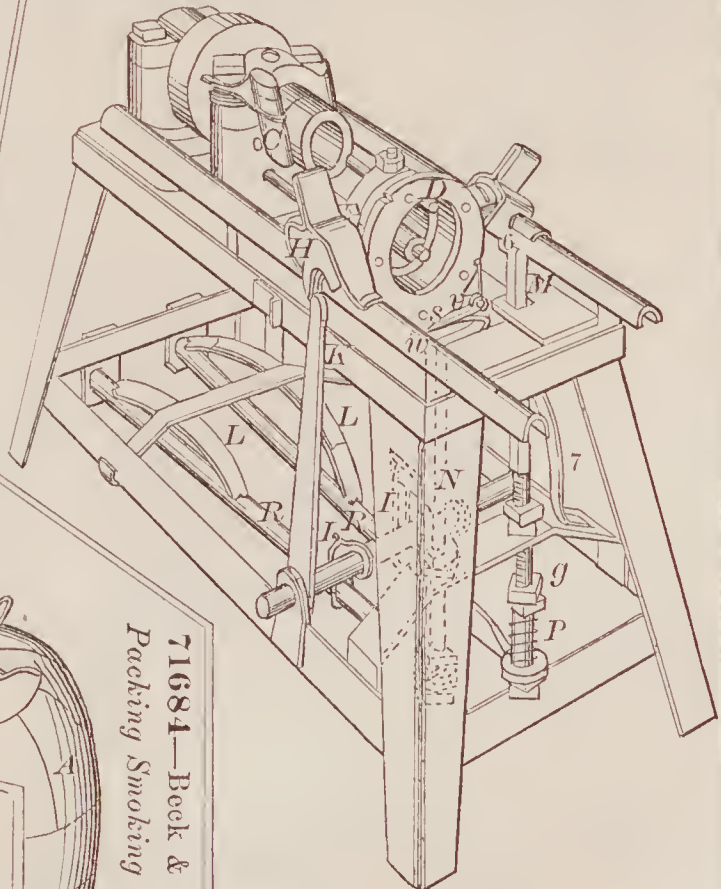

71679--A. P. Barlow--Curtain Fixture.

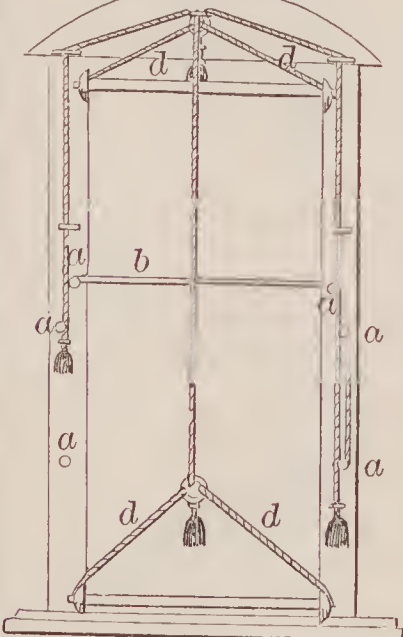

71684--Beck & Siebert--Packing Smoking Tobacco.





71685—W. P. F. Beggs—Truck.

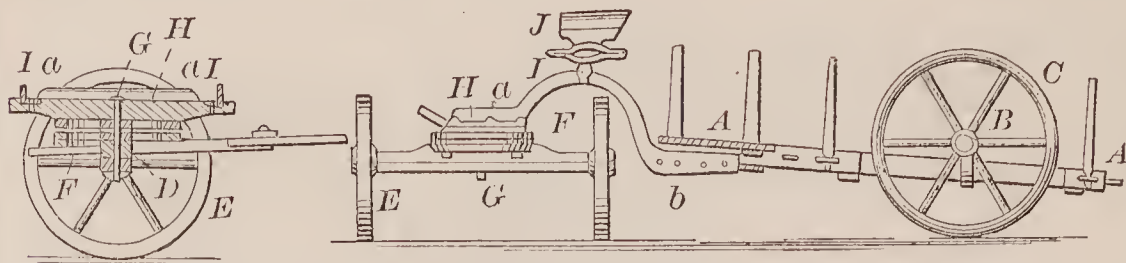

71686—T. Bell—Ink Well.

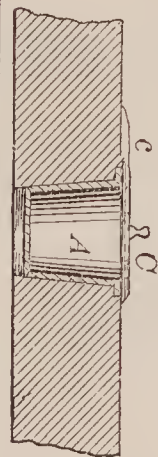

71687—B. S. Benson—Casting Metal Pipe.

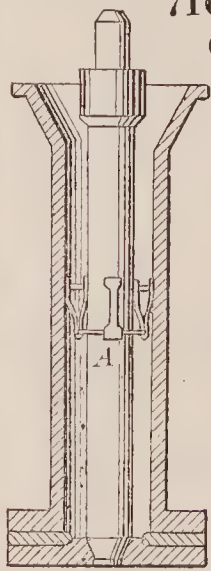

71688—S. C. Bishop—Insulating Covering for Telegraph Wires.



71694—J. Bull—Gate Fastening.

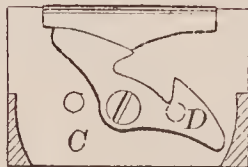

71697—L. Castaine—Fence.

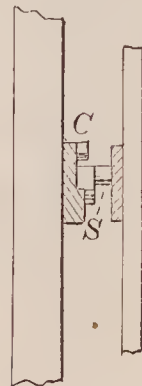
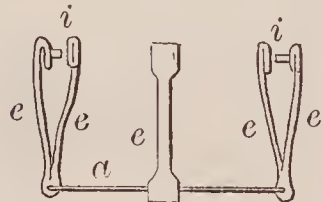
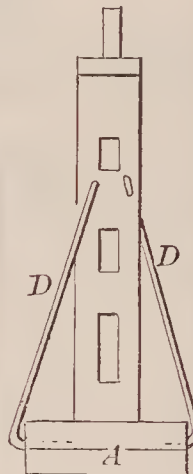

71692—E. T. Brigham—Pessary.

71690—M. Bradley—Preventing the Heating of Mill Burrs.

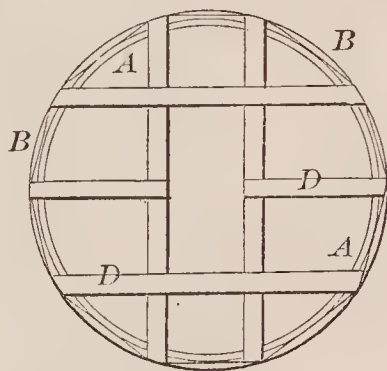

71693—G. W. Brown—Animal Trap.

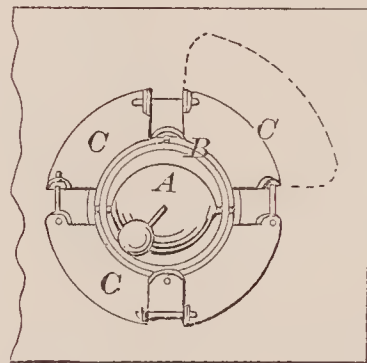

71695—H. H. Call—For Operating Pumps on Railroad Stations.

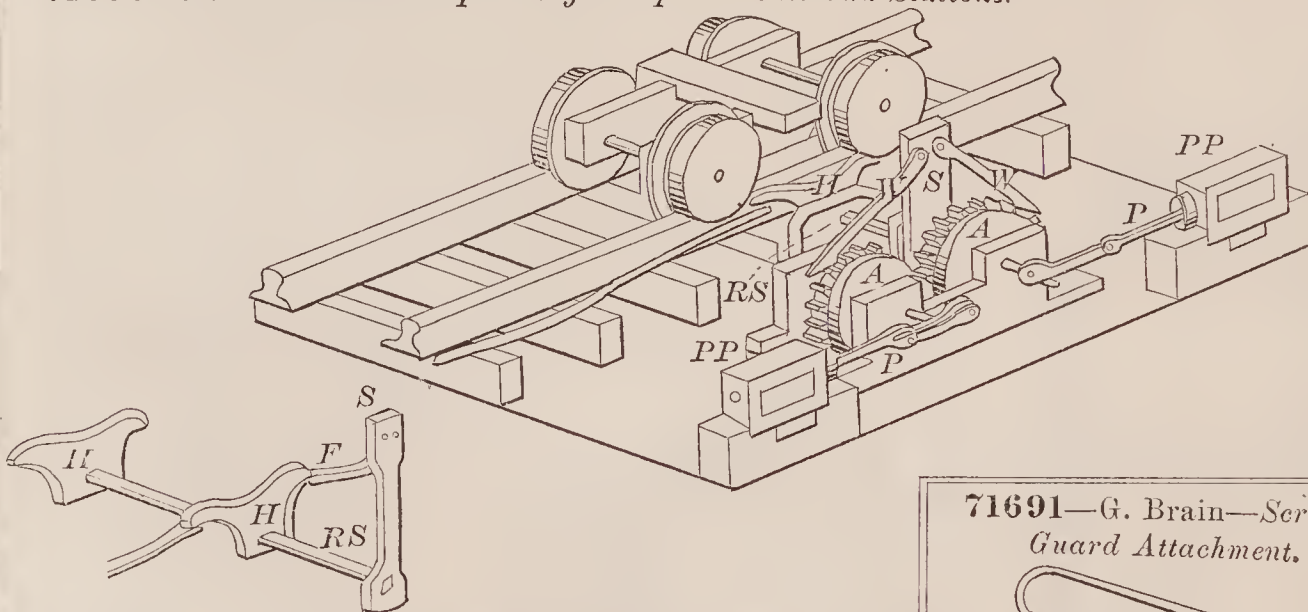

71691—G. Brain—Screen Guard Attachment.

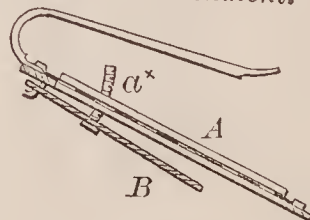

71696—G. C. Carver—Egg Beater.



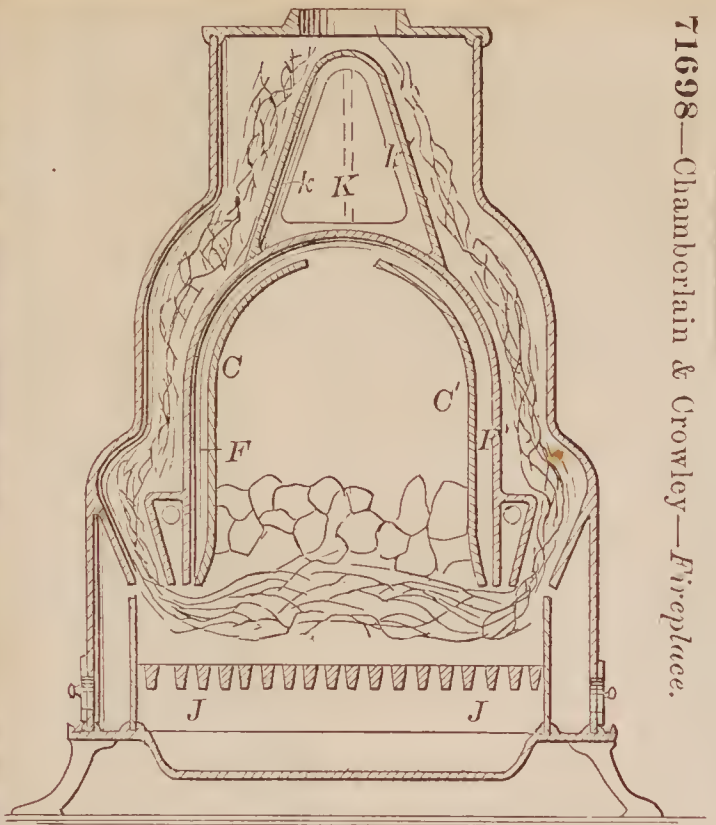

71698—Chamberlain & Crowley—Fireplace.

71999—T. P. Chambers—Hitching Strap.

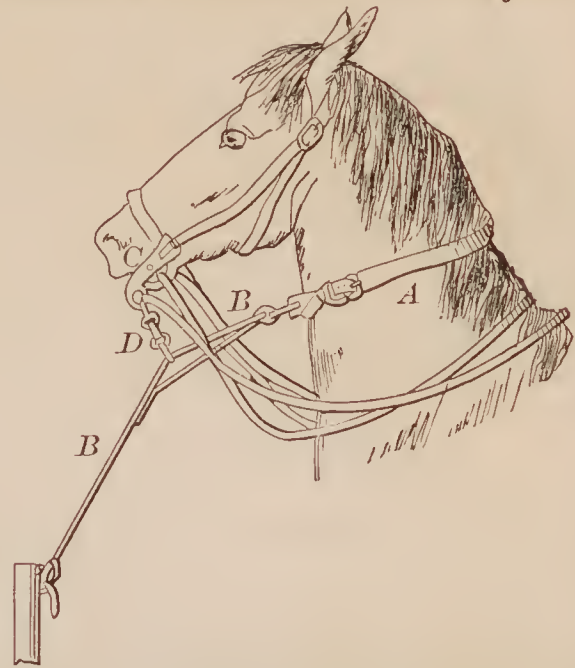

71701—C. T. Chester—Electro Automatic Signal Box.

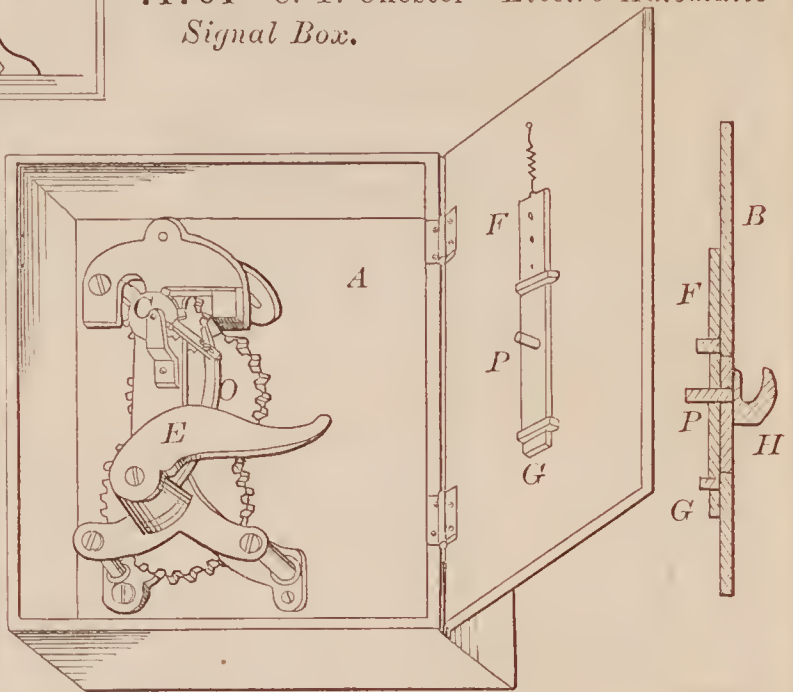

71700—D. G. Chapin—Bed Bottom.

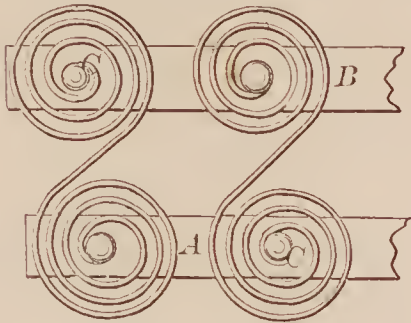

71702—S. J. Clark—Line Holder.

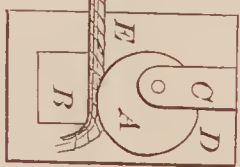

71703—J. C. Clark—Temporary Binder for Music, &c.

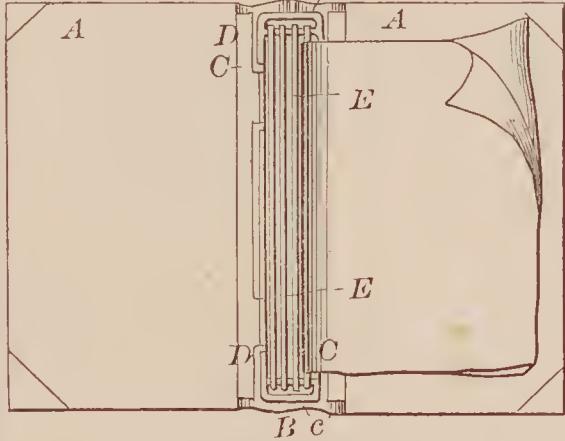

71704—Cogan & Russell—Track Clearer.

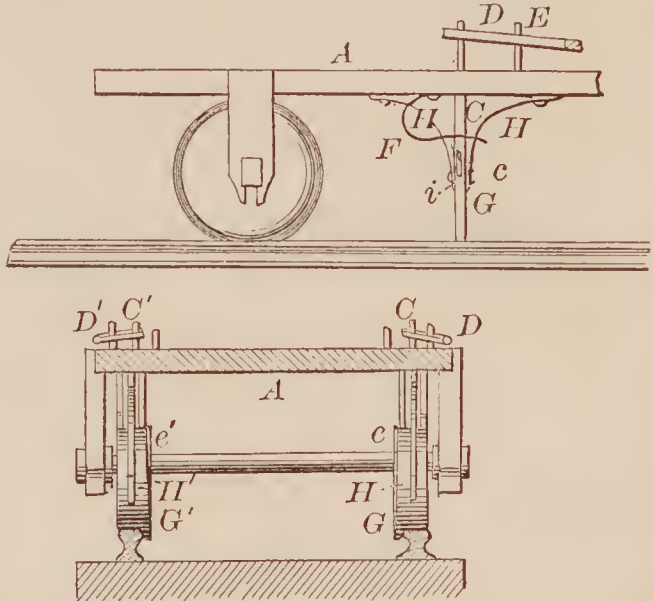

71706—J. Cotton—Safety Pocket.

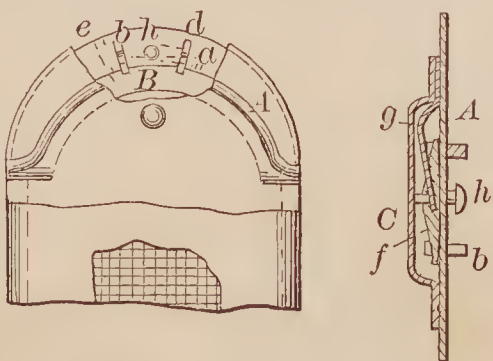

71705—J. P. Collins—Thill Coupling.

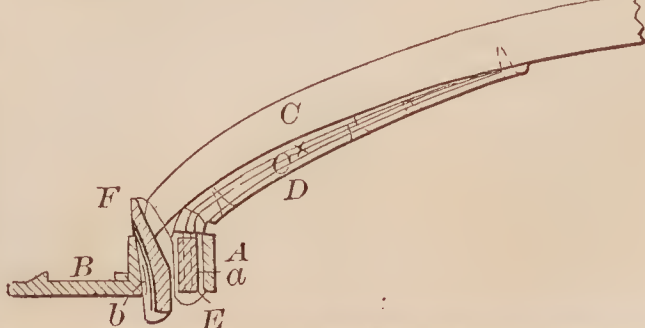



71707—G. W. Cool—*Dental Substitute.*

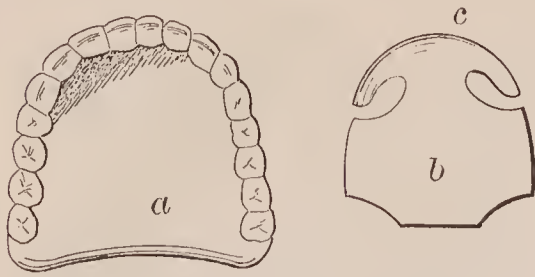

71708—J. Correja—*Fire Frame for Chimneys.*

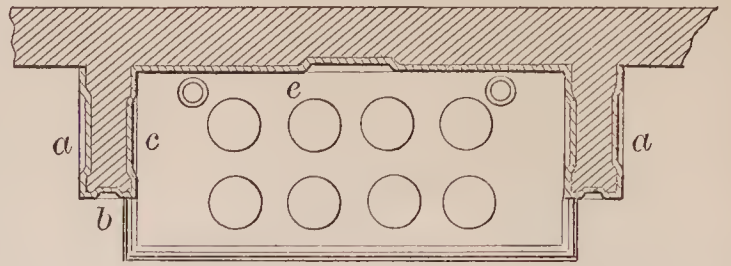

71709—M. Cosgro—*Flour Bolt.*

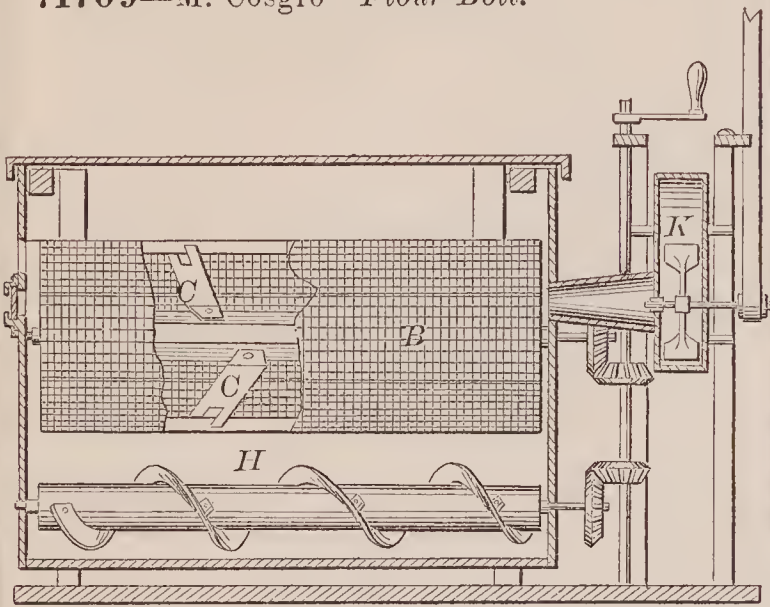

71710—H. D. Cowles—*Horse Shoe Nail.*

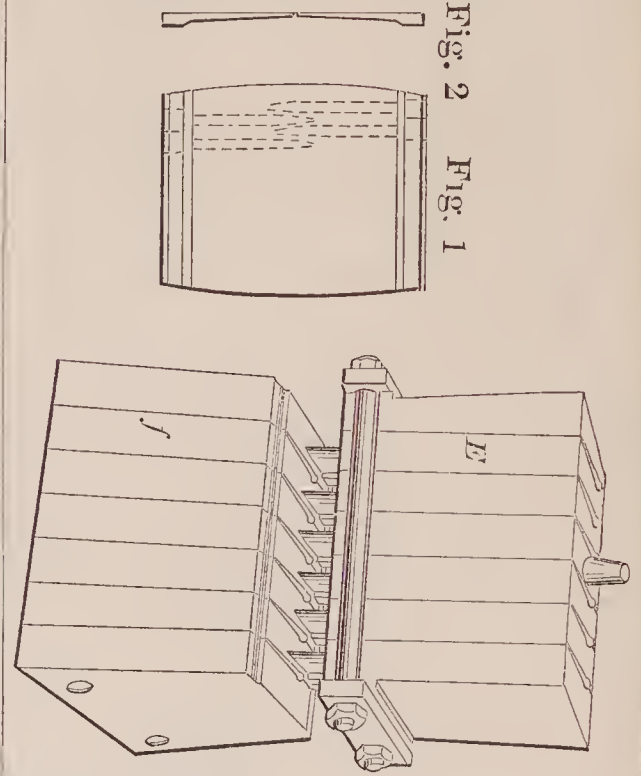

71711—J. M. Crockett—*Ventilating Device for Grates.*

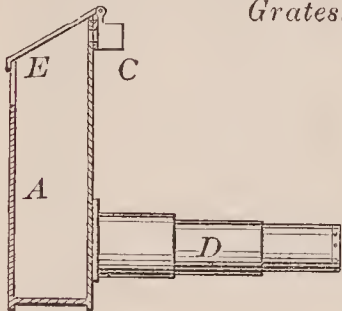

71714—B. Day—*Shingle Machine.*

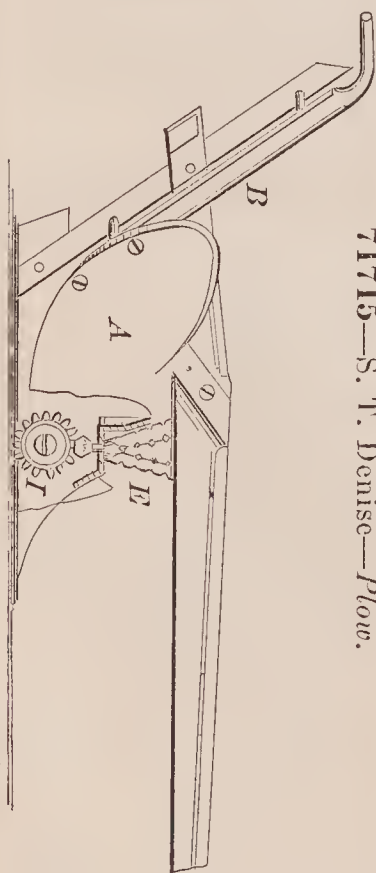
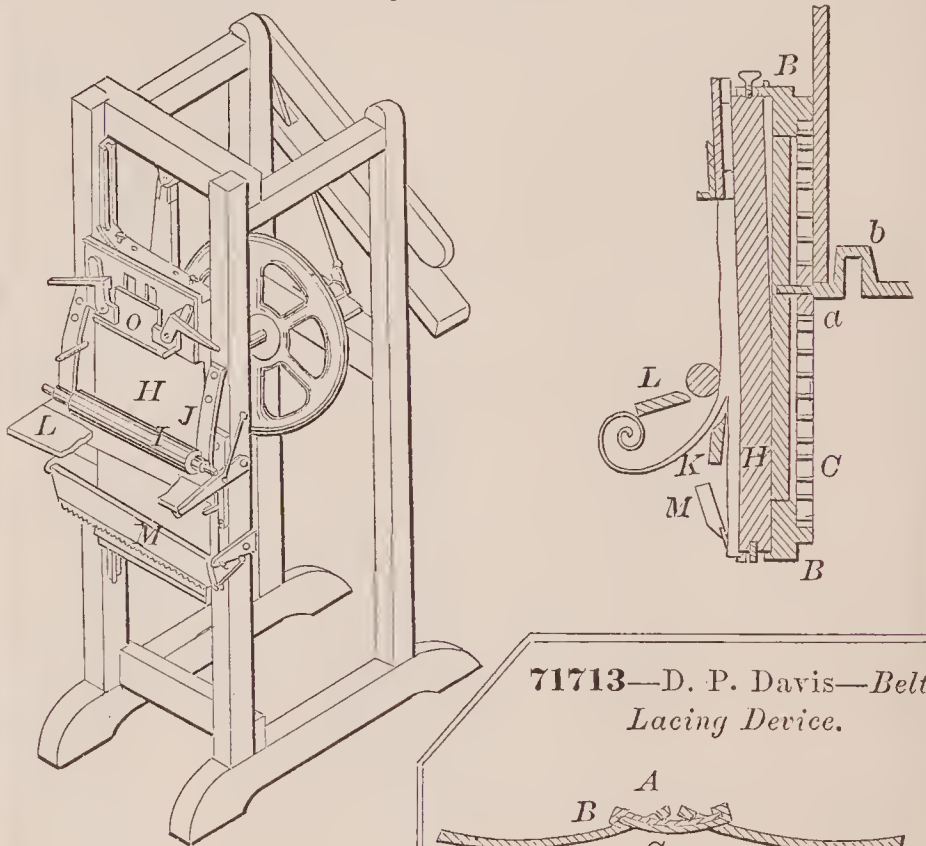

71715—S. T. Denise—*Plow.*

71713—D. P. Davis—*Belt Lacing Device.*



71716—G. M. Denison—*Washing Machine.*

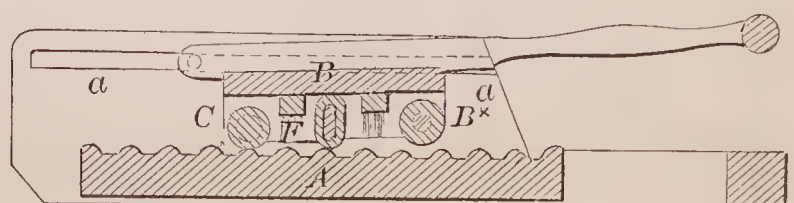

71717—M. Disney—*Car Coupling.*

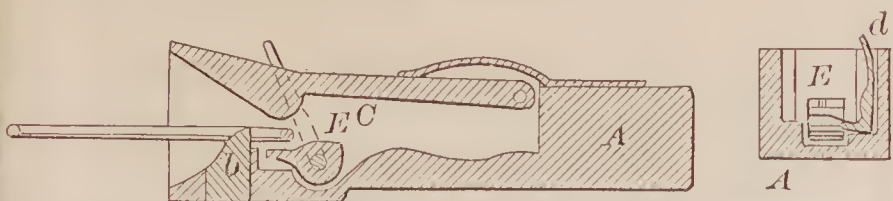

71721—C. H. Eifiler—*Locking Knob Latch.*

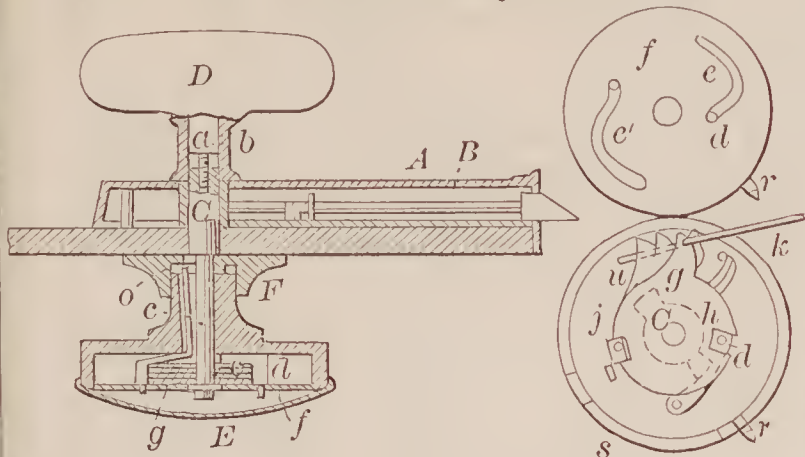

71719—J. Douglass—*Yard Measure.*

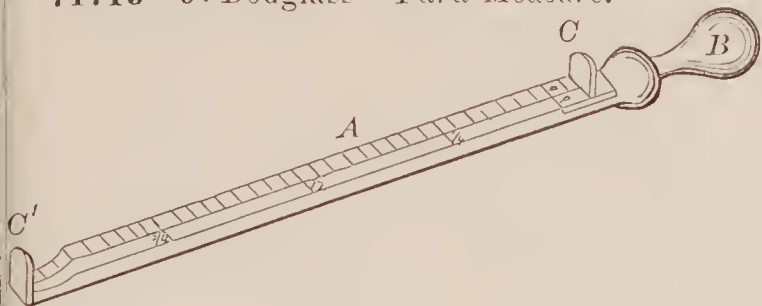

71720—E. H. Duru—*Car Brake.*

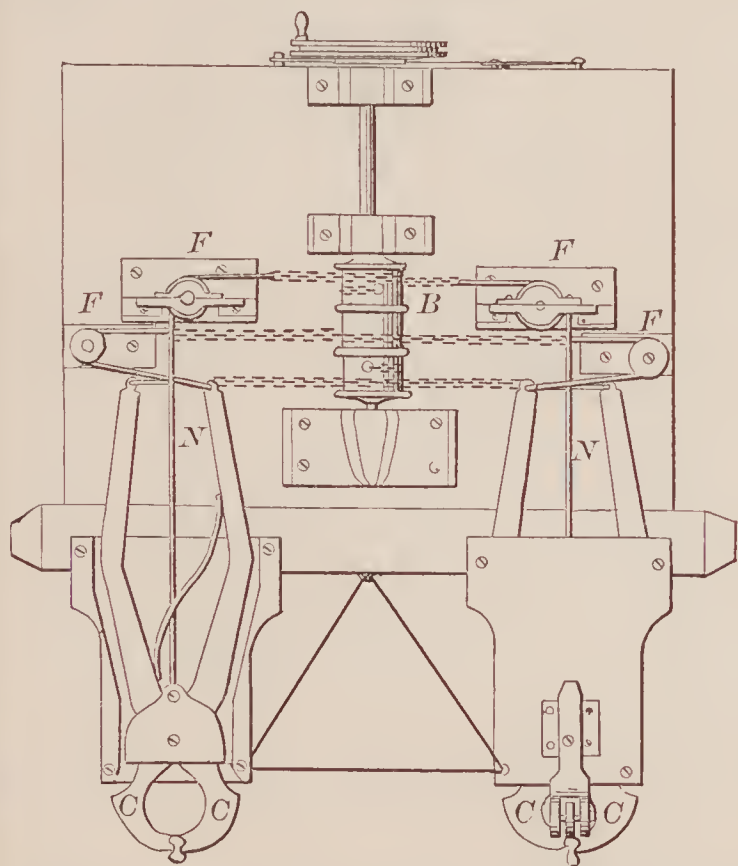

71726—Farr & Hall—*Saddlers' Tool.*

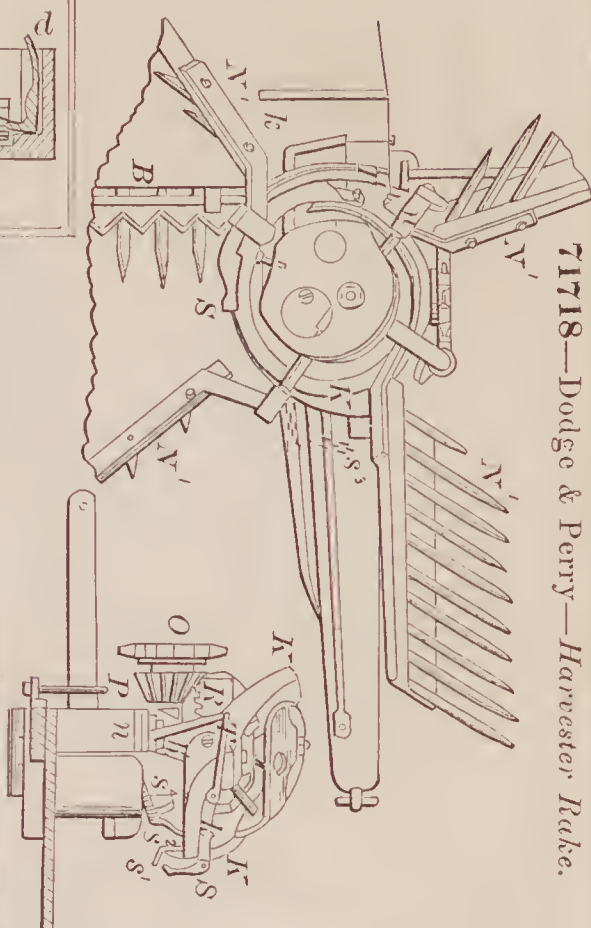
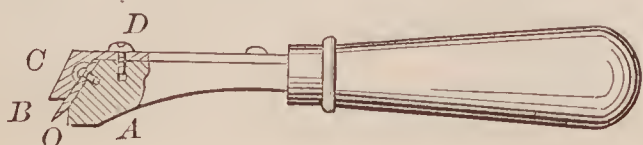

71718—Dodge & Perry—*Harvester Rake.*

71722—E. A. Ellsworth—*Nut Lock and Washer.*

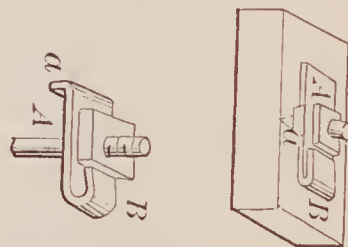

71723—S. Emmore—*Dough Kneading Machine*

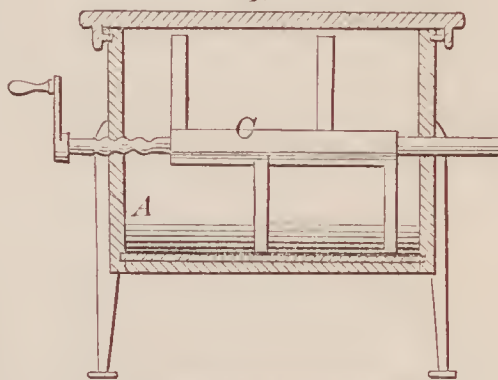

71727—S. F. Fenn—*Bit Brace.*

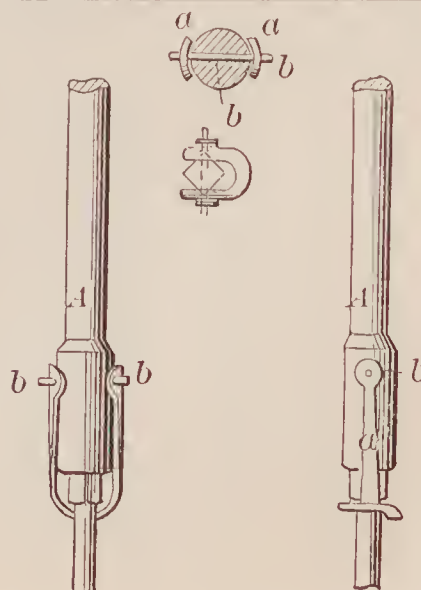



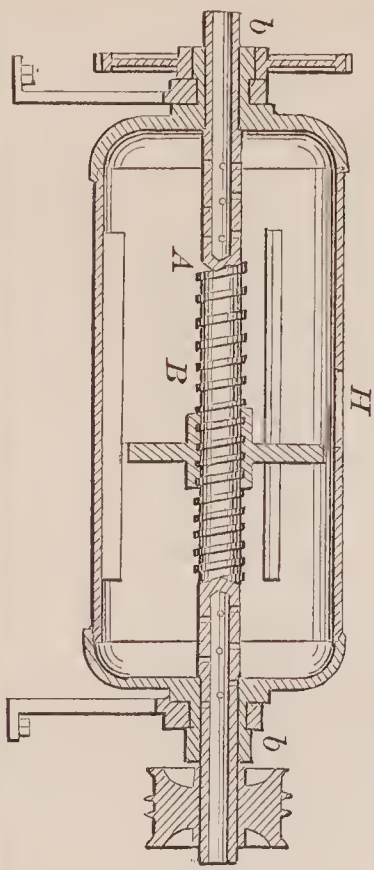

71728—A. Fickett—For Filling Rotary Paper Pulp Boilers

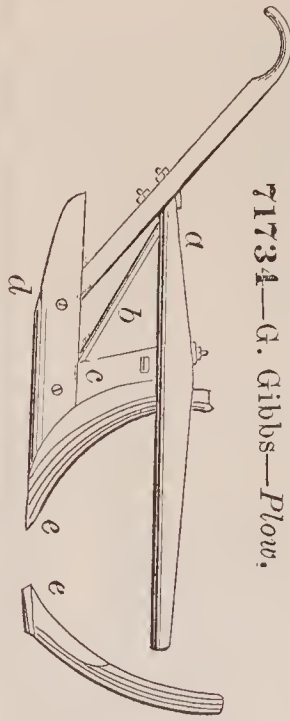

71734—G. Gibbs—Plow.

71729—R. A. Filkins—Low Water Indicator.

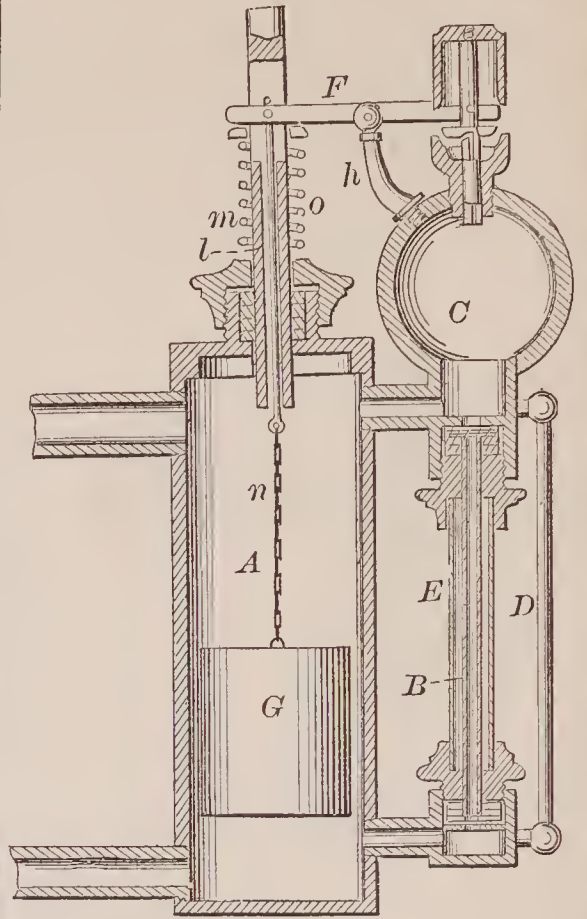

71730—R. A. Filkins—Rotary Steam Valve.

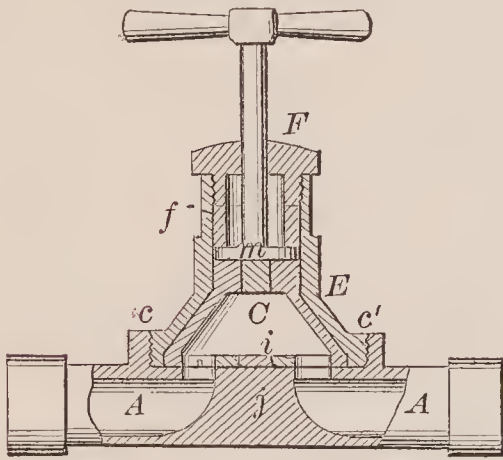

71732—F. Fuller—Toy Gun.

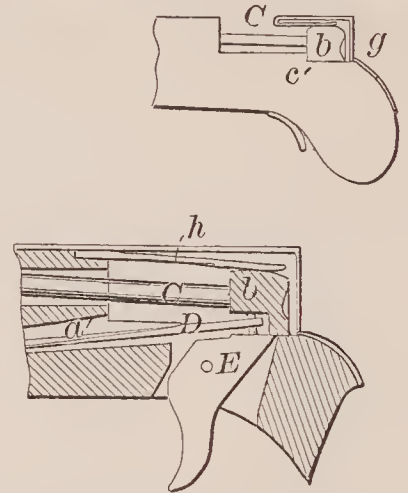

71733—A. N. Garland—Dress for Mill Stones.

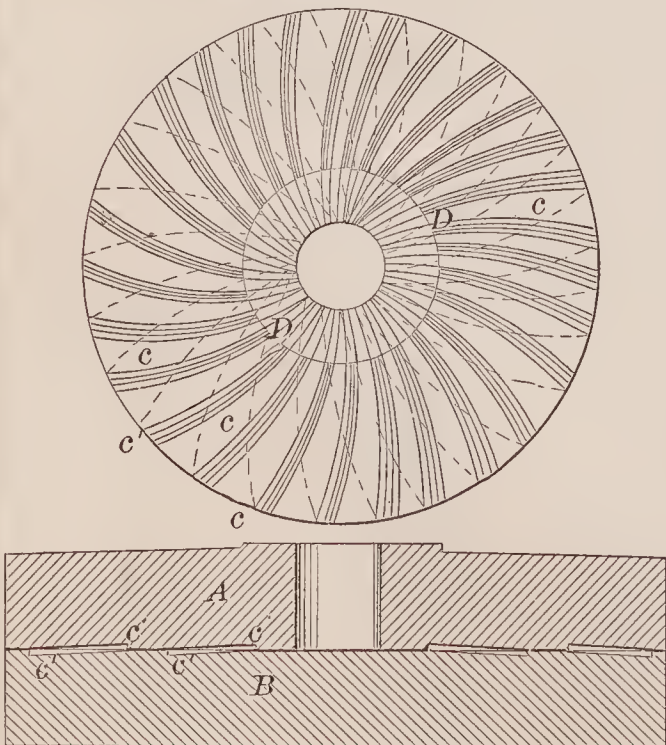

71735—Gibbs, Gibbs & Wikidal—Plow.

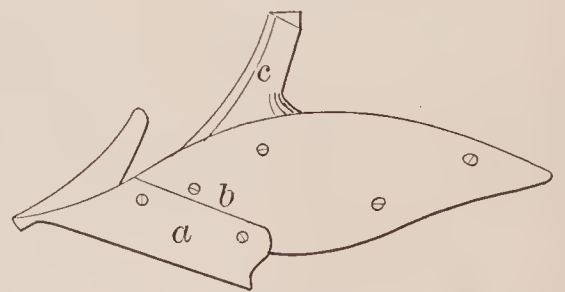

71736—S. Good—Fence.

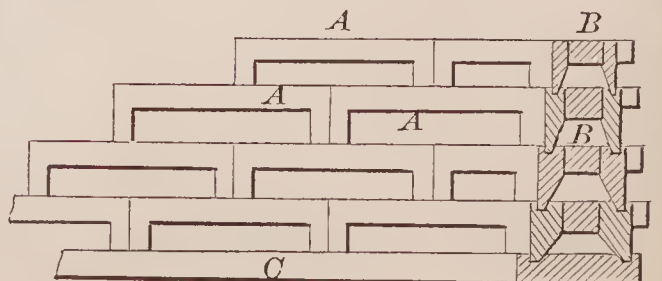

71737—Goodman & Fessler—*Railroad Gate.*

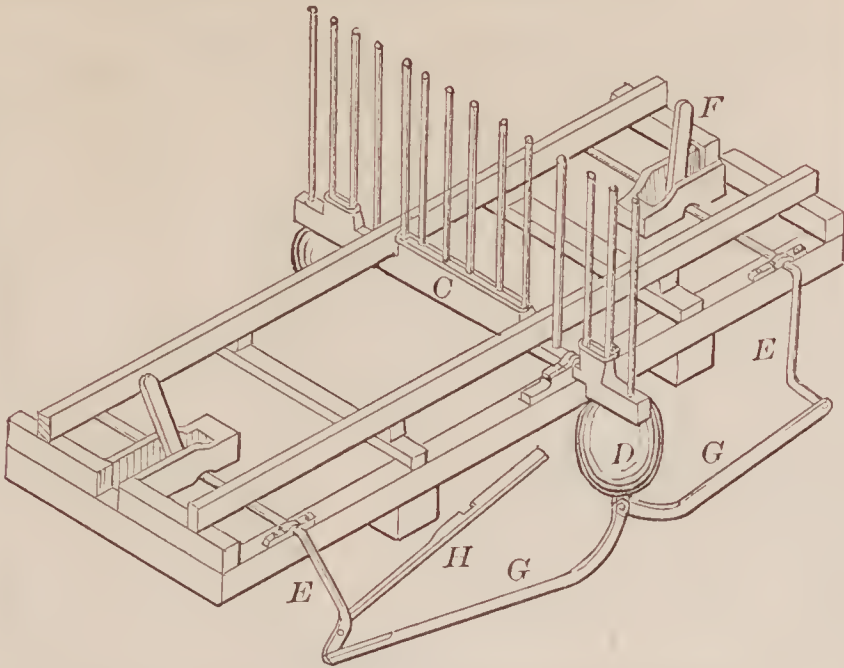

71739—J. J. Gordon—*Bag Tie.*

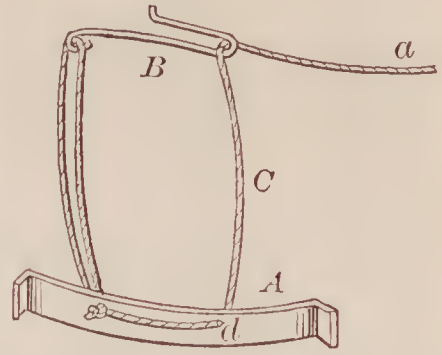

71738—A. I. Goodrich—*Regulator for Marine Clocks.*

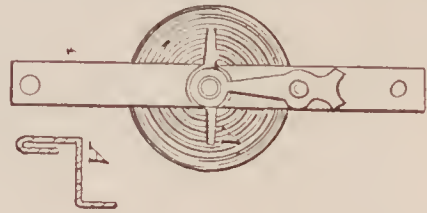

71741—J. Gorham—*Carriage Shaft Attachment.*



71744—T. Grundmann—*Distilling Apparatus.*

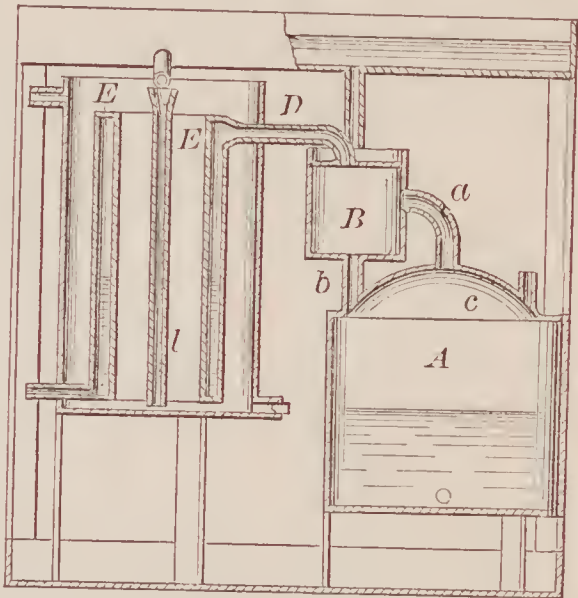

71742—H. Grambo—*For Making Paper Articles.*

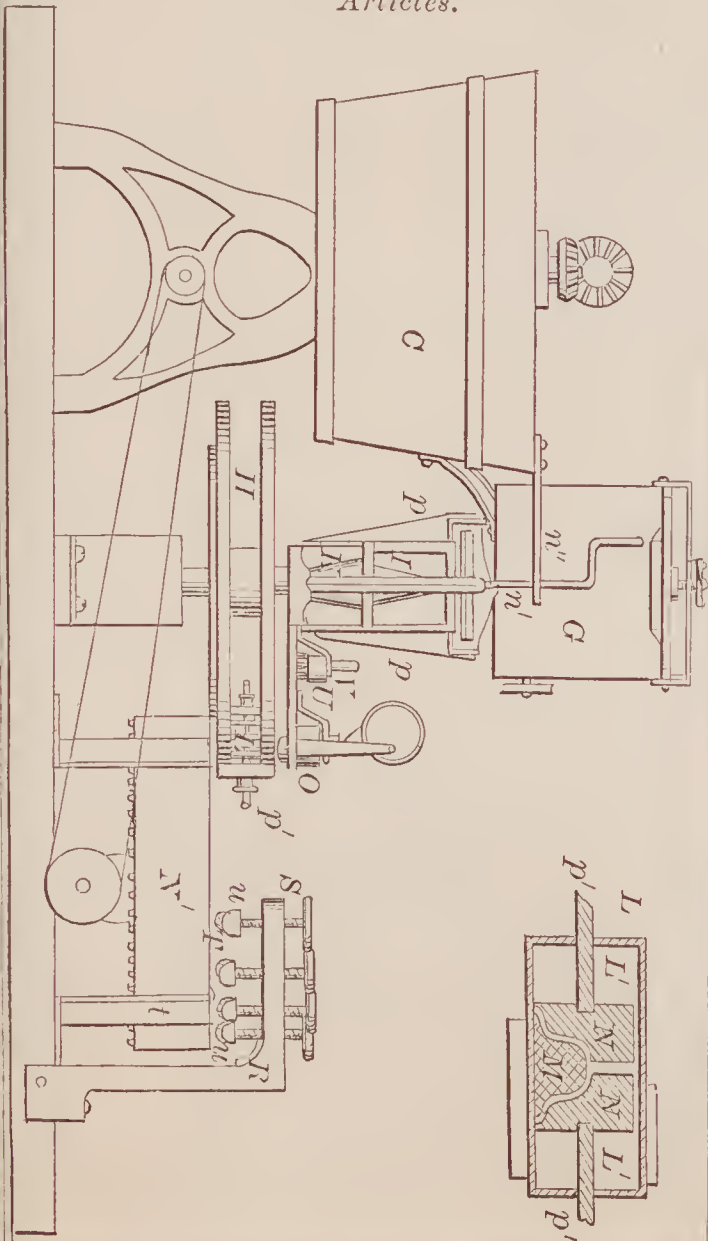

71740—J. Gorham—*Baling Press.*

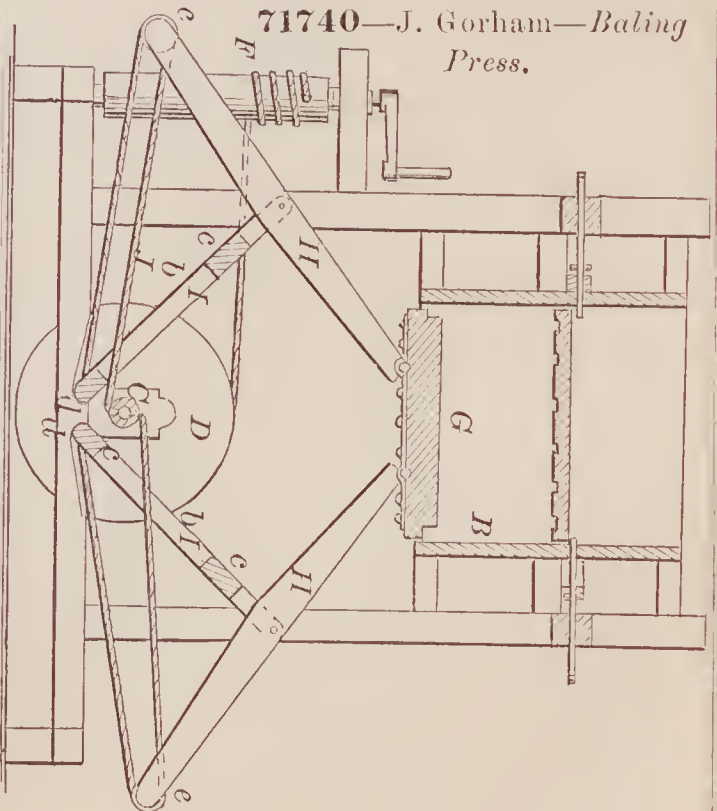



71745—J. R. Hall—*Sash Stop.*

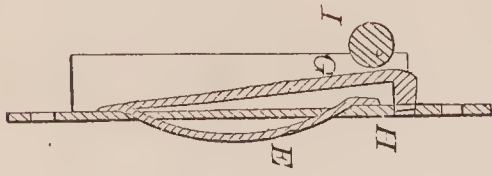
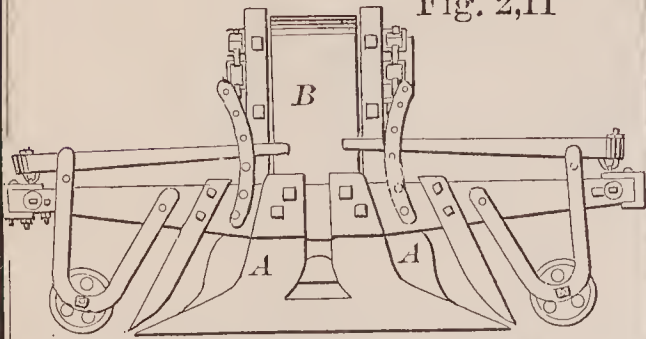
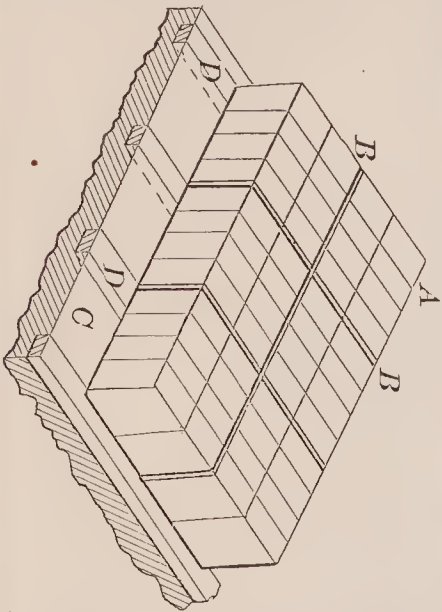
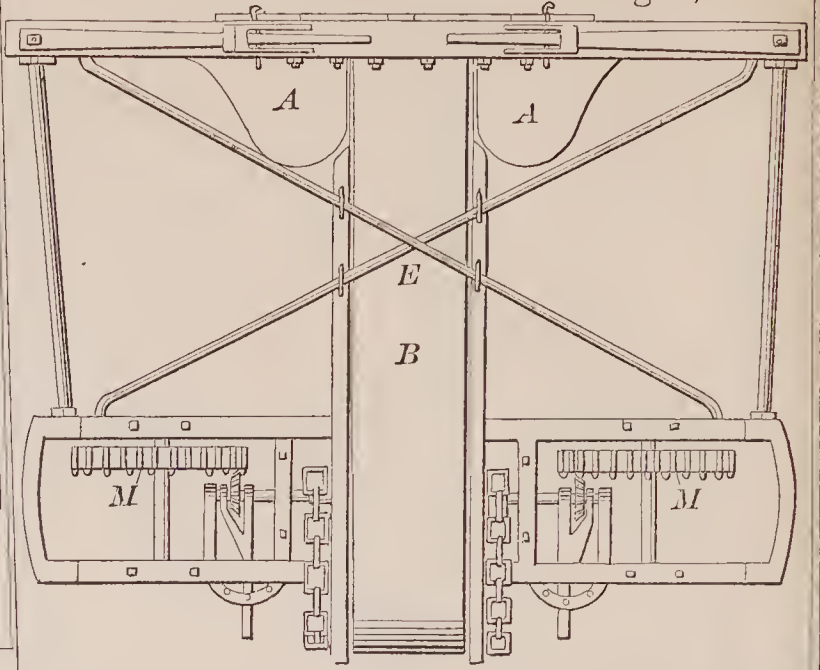

Fig. 2, II



71747—T. C. Hammond—*Grading and Excavating Machine.* Fig. 1, I



71746—A. Hammar—*Street Pavement.*

71748—C. C. Hare—*Hinging Tea Kettle Lid.*

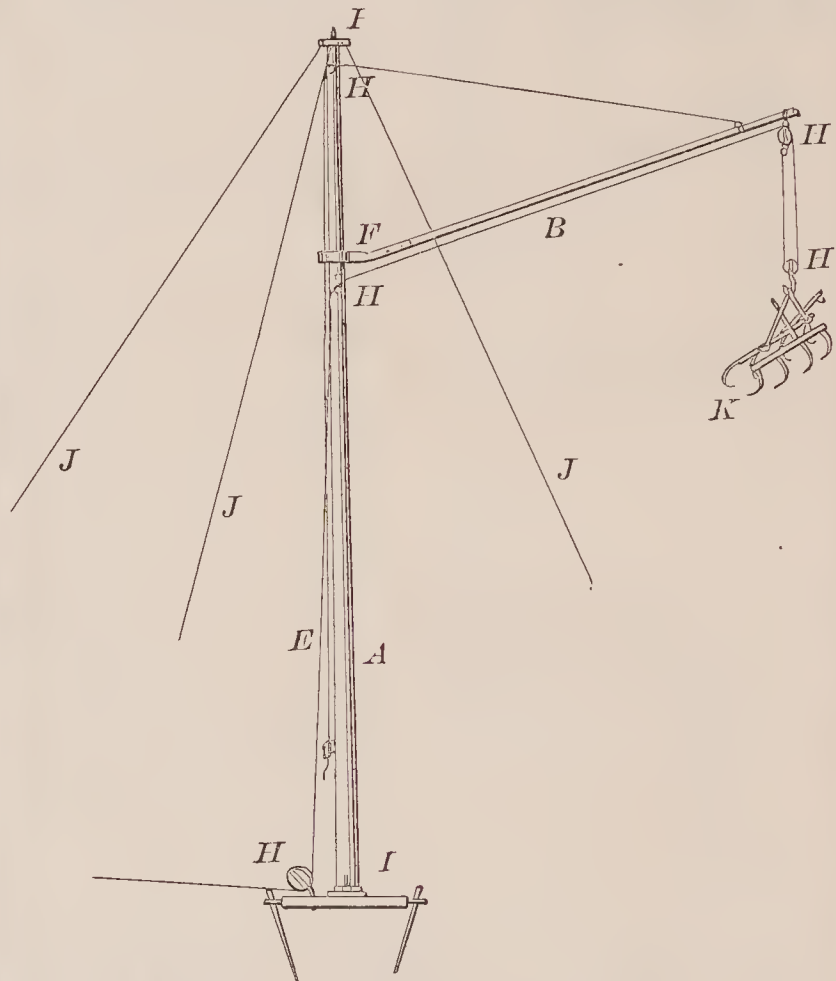
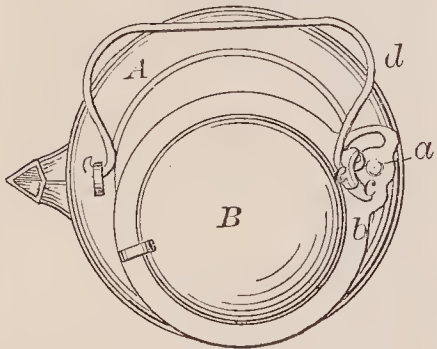

71749—L. J. Hattabough—*Field Derrick.*

71753—A. Heilburn—*Stereoscope.*

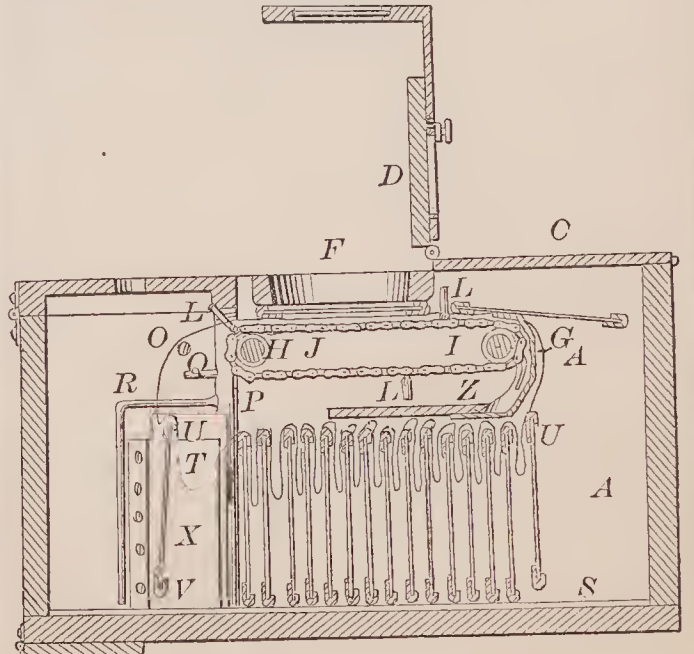

71751—G. H. Hawkins—*Pill Box.*



71750—C. A. Haviland—*Fence.*

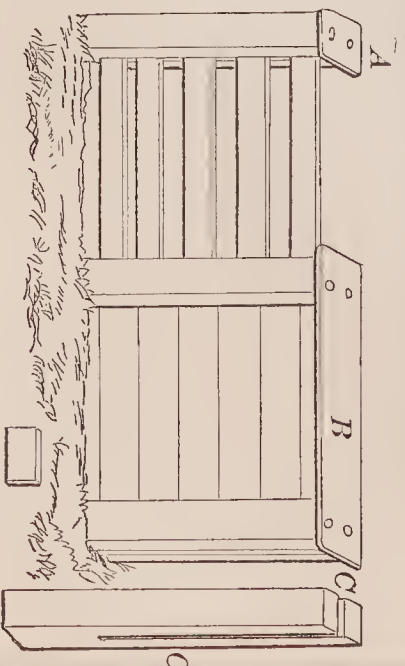

71753—Continued.

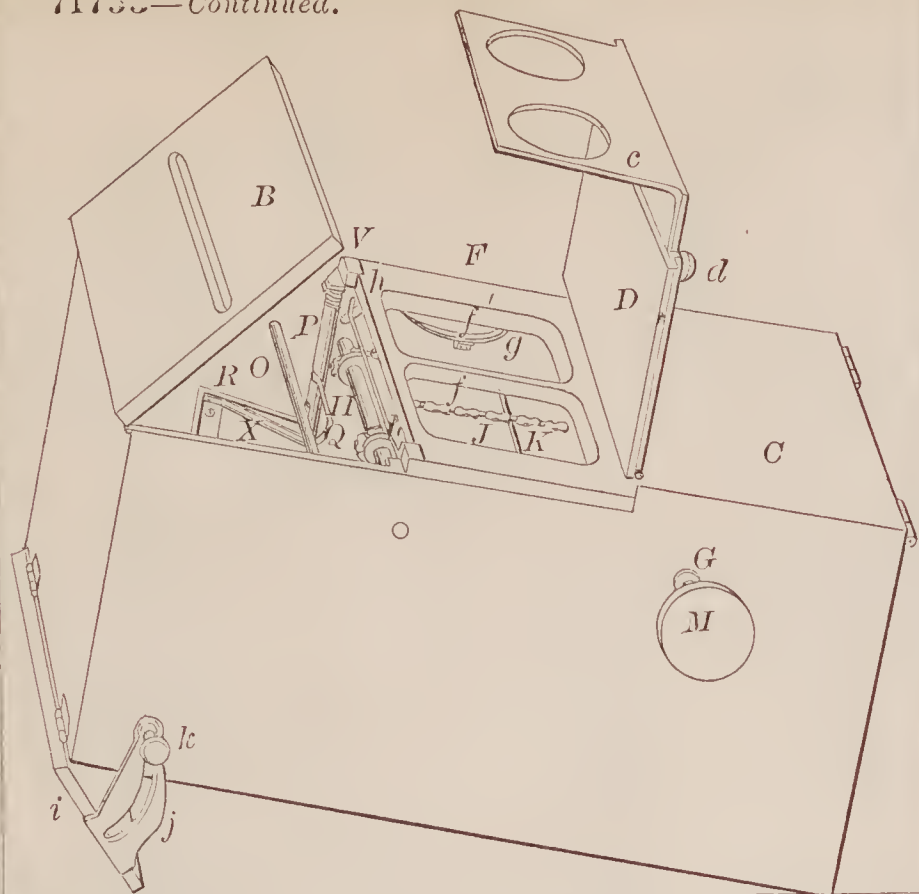

71754—D. W. Hendrickson—Manufacture of Iron.

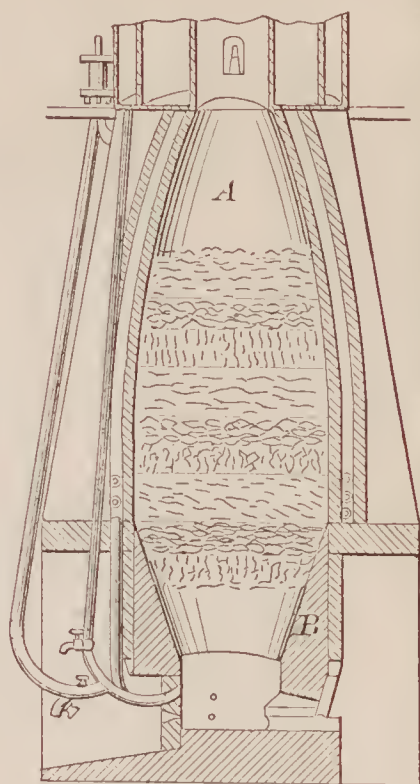

71756—J. J. Hofer—Fire Engine Nozzle.

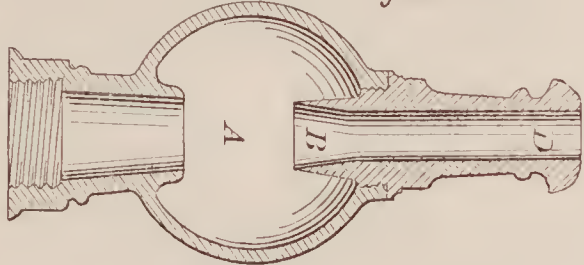

71755—D. H. Heyen—Life Preserver.

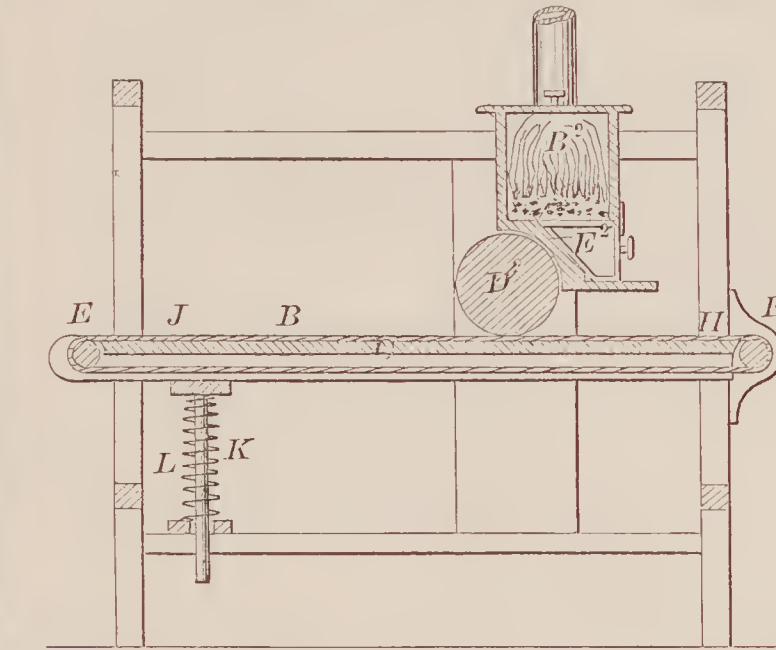
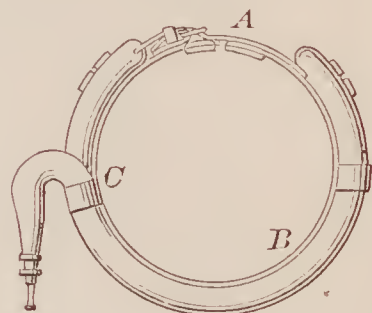

71758—C. R. Hoyt—For Ironing Clothes.

71757—J. B. Hoffman—Dry Gas Regulator.

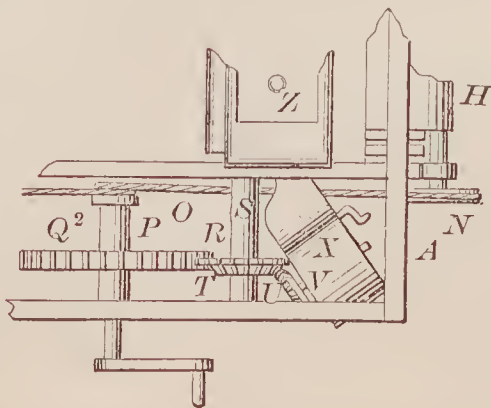
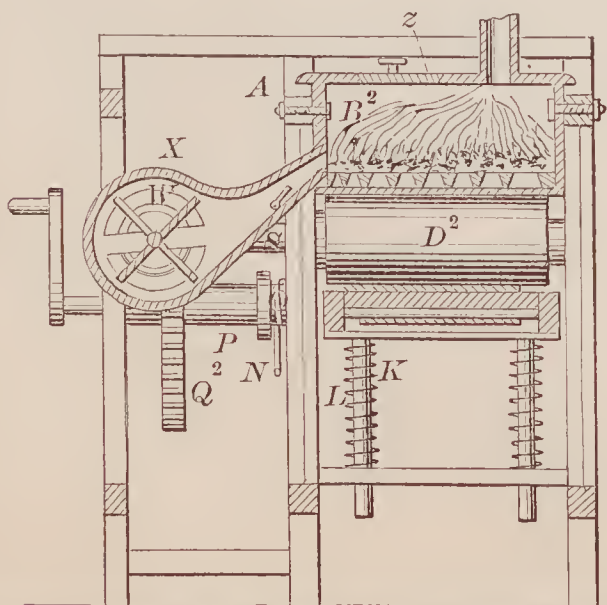
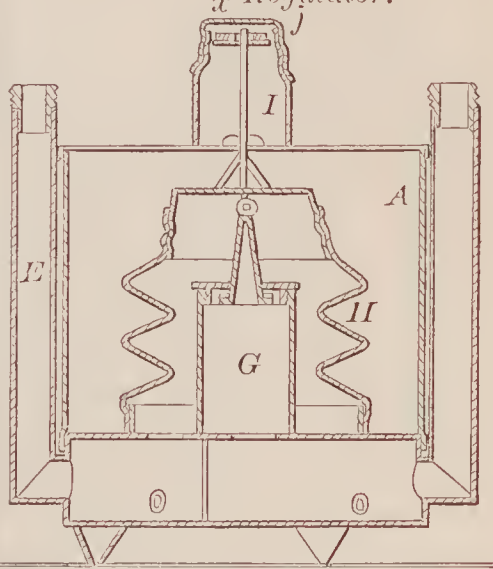



71759—  
J. R. Humphreys—  
Tire Heating Apparatus.

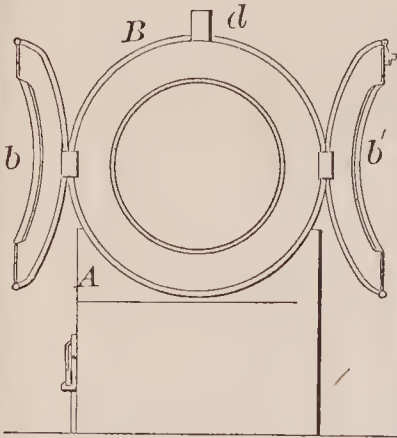

71760—E. Hunt—  
Washing Machine.

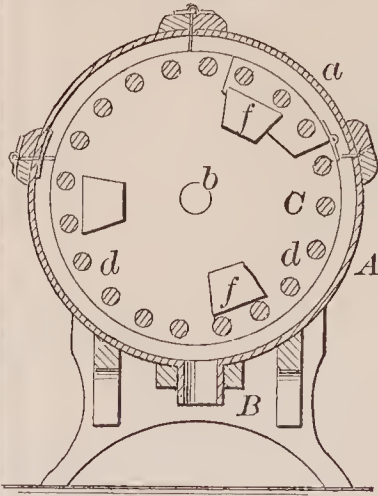

71761—R. K. Huntoon—Steam  
Engine Governor.

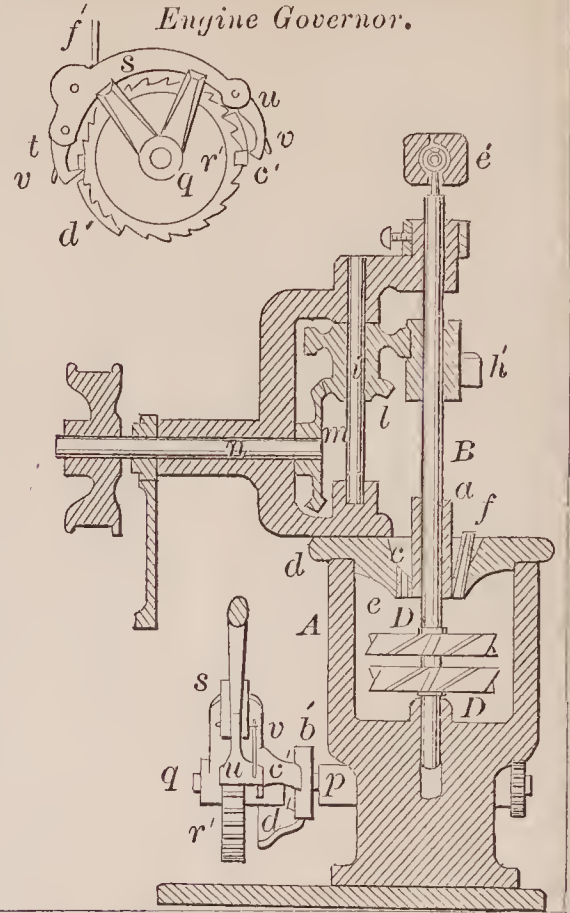

71762—E. Huson—Boat Windlass.

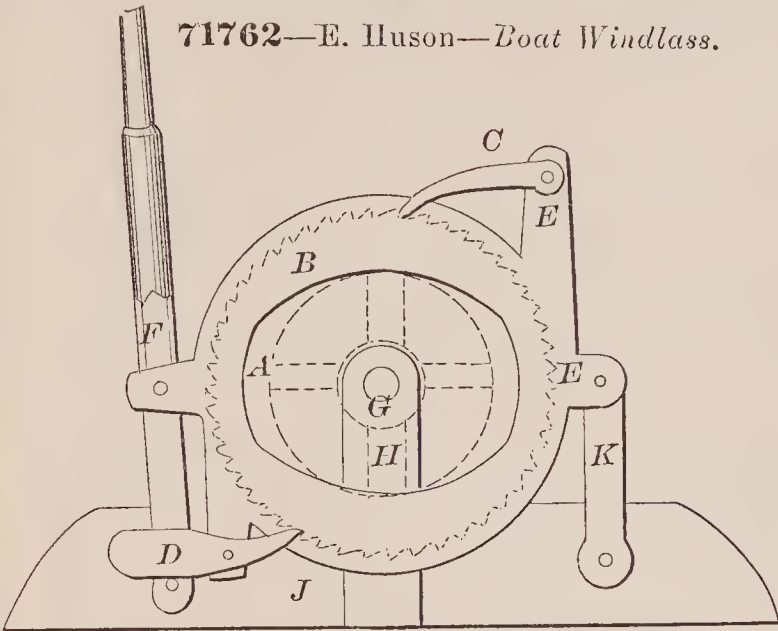

71764—H. Kewley—Hay Raker and Loader.

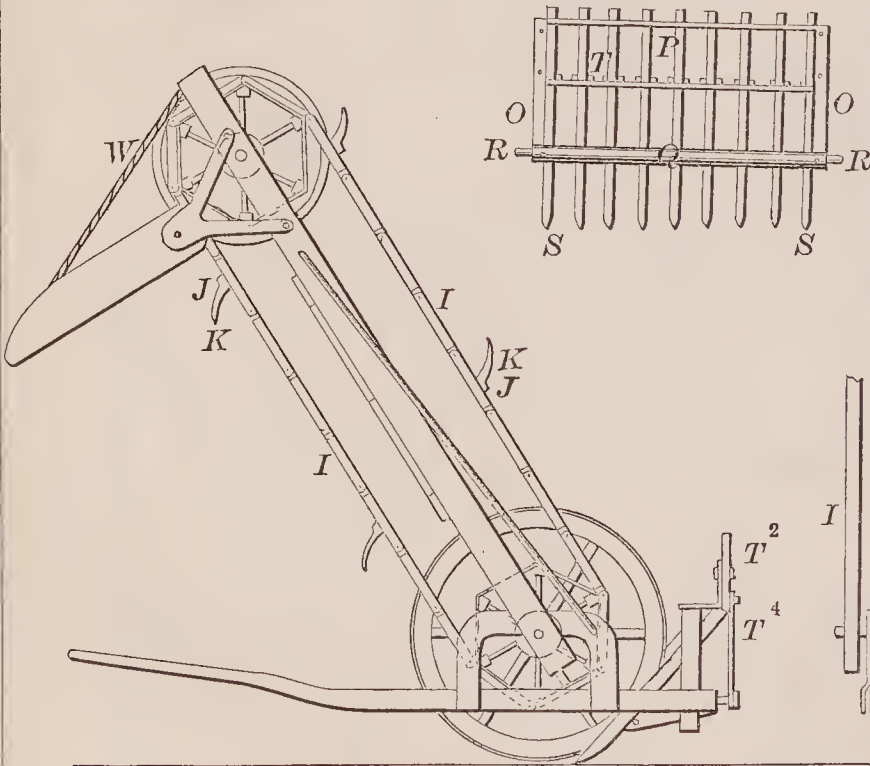

71765—C. Korn—For Leaching Bark.

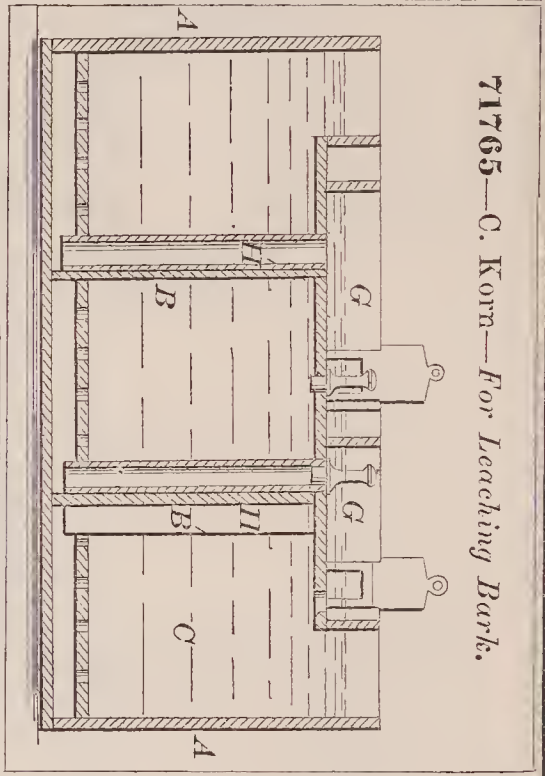

71763—L. Kelley—Harpoon.

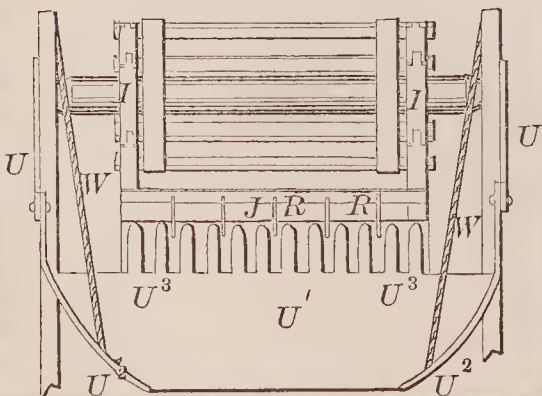
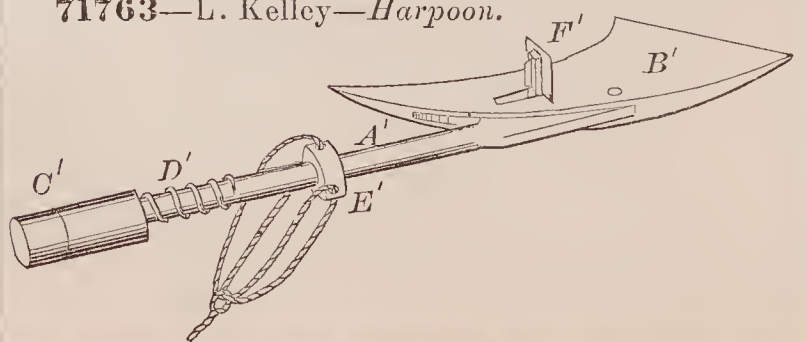

71766—R. Lapham—Inkstand.

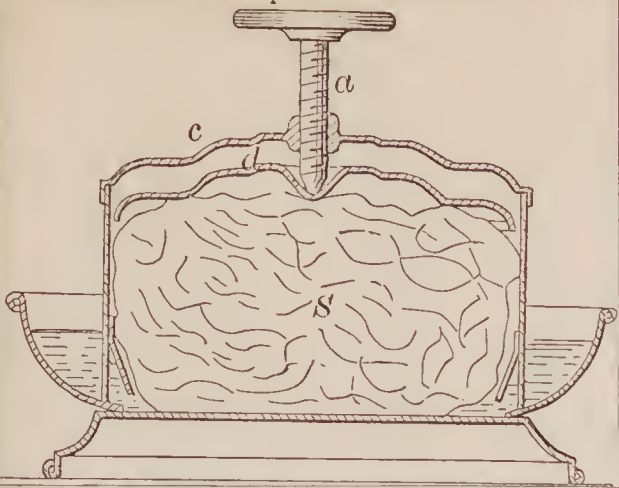

71767—S. Leonard, Jr.—Fence.

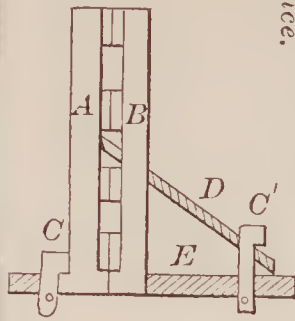

71768—T. Leonhard—Bleaching Vegetable Oil.

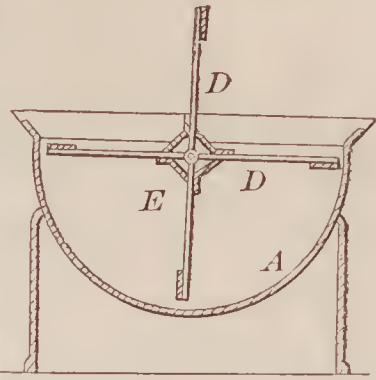

71771—W. London—For Stacking Hay.

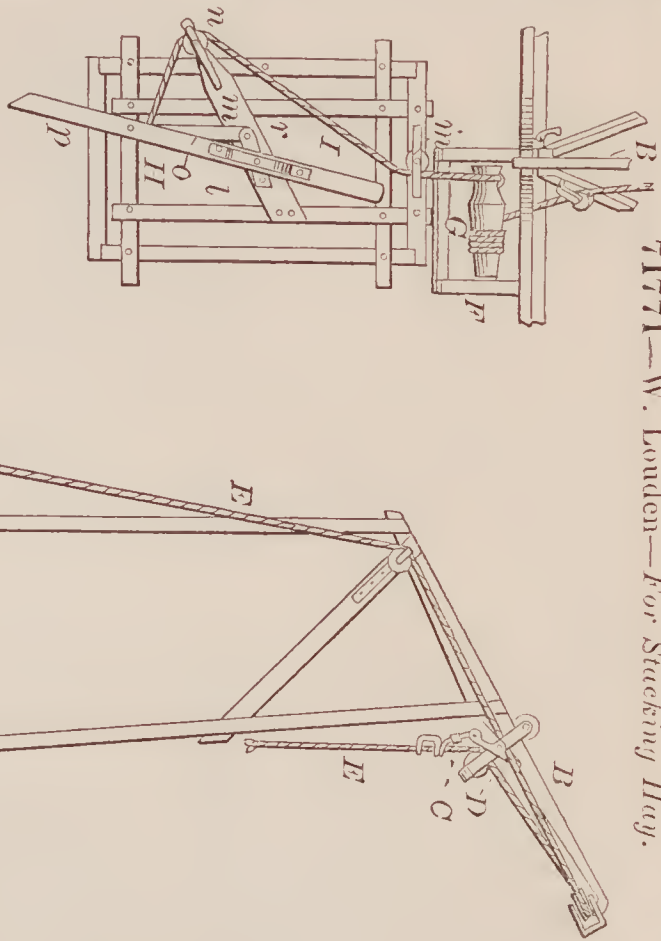

71769—H. C. Lewis—Railroad Switch.

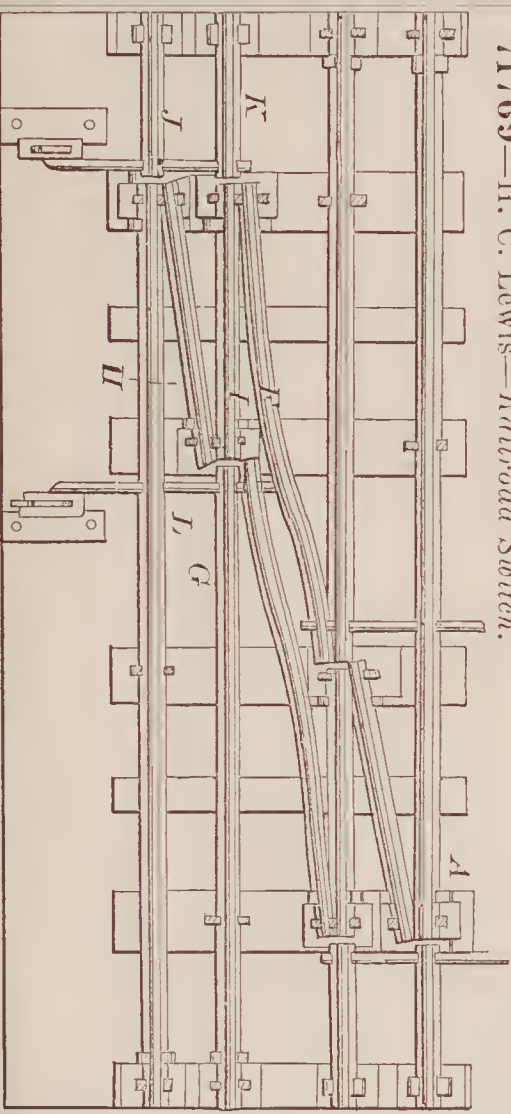

71770—H. Lomb—Eyeglass and Spectacles.

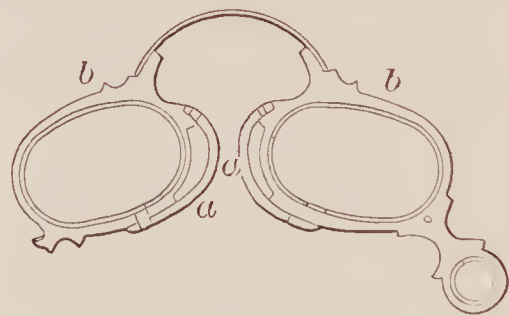

71774—J. Maris—Wagon Wheel.

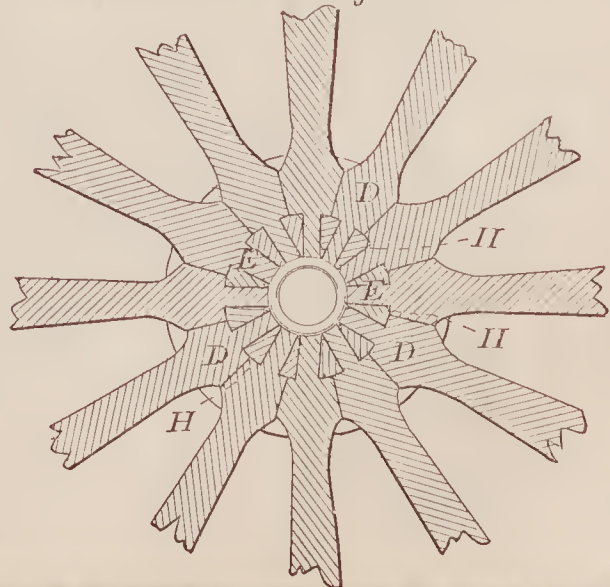

71773—J. W. Maloy—Pressure Gauge.

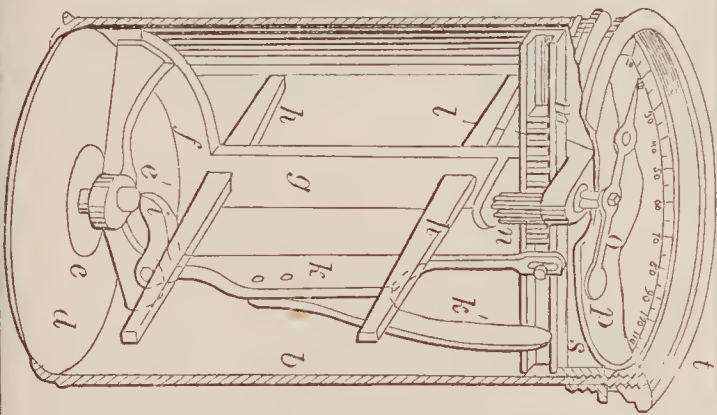

71772—J. J. Mackey—Door Spring.

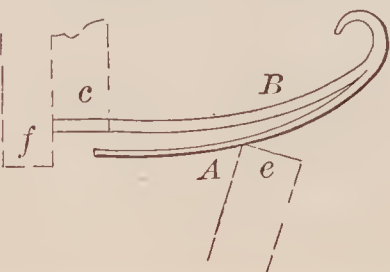



71775—M. Mattson—For Hand and Yoke Lifting.

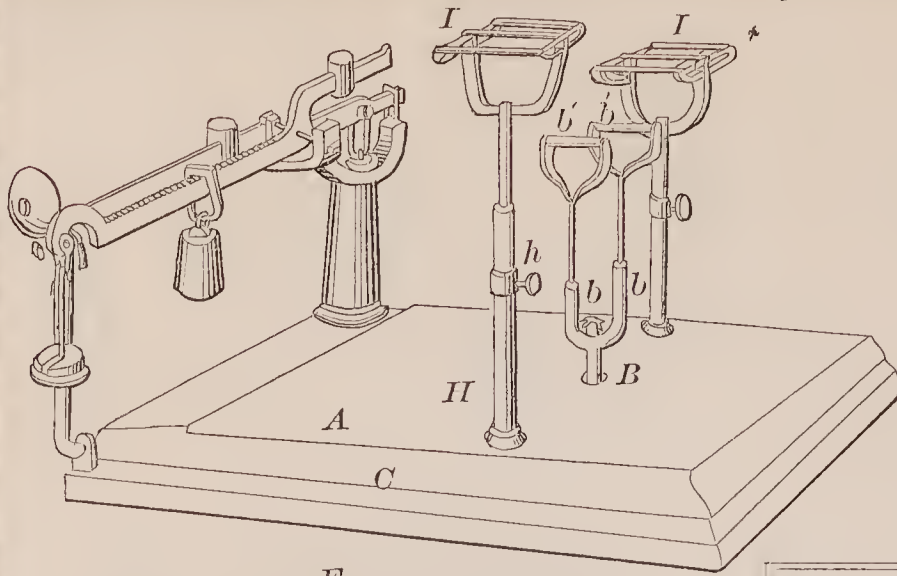

71779—G. J. Neveil—Retaining and Releasing Hook.

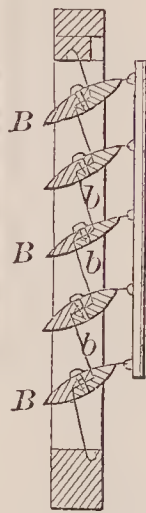
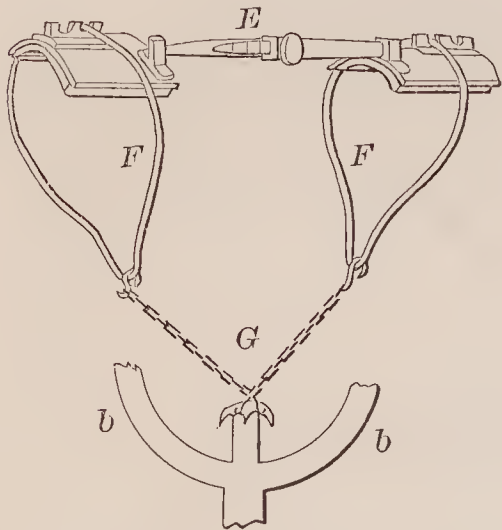
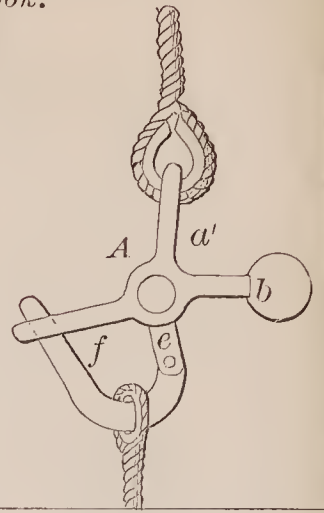

71778—G. W. Miles—Mosquito Net.

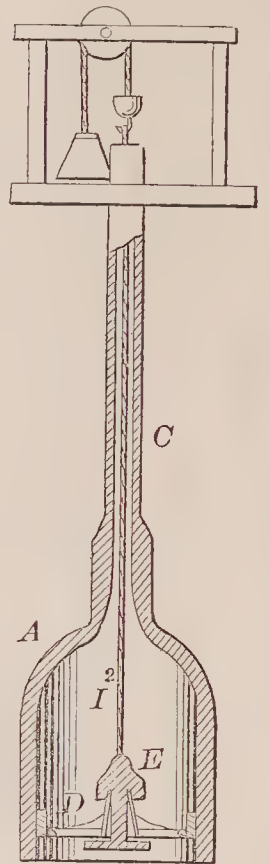

71781—A. Norris—Water Elevator.

71776—J. Maunton—For Roasting and Reducing Ores.

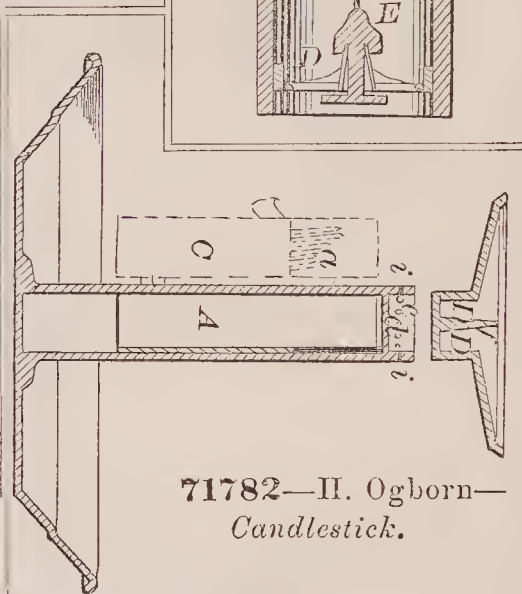
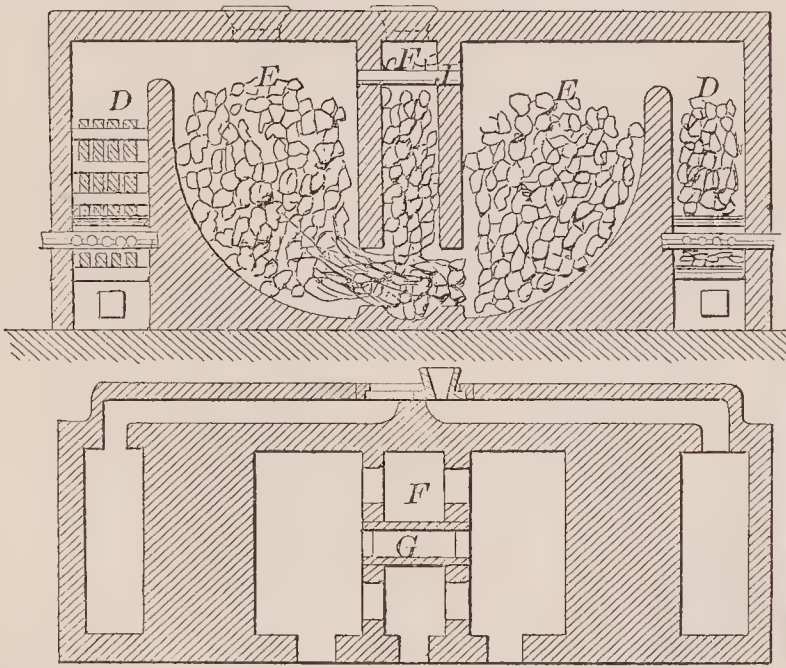

71782—H. Ogborn—Candlestick.

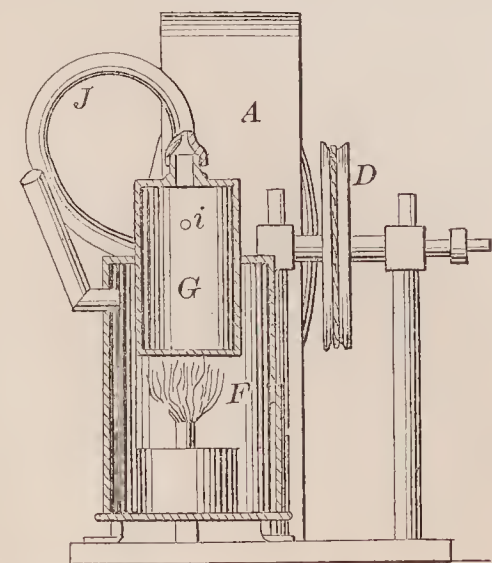

71780—M. V. Nobles—For Extermiating Vermin.

71784—S. C. Philbrick—Wool Carding Machine.

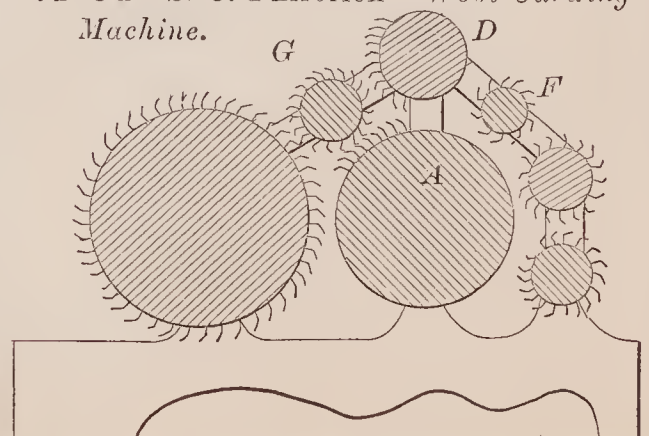



71785—I S. Pigott—Log Wagon.

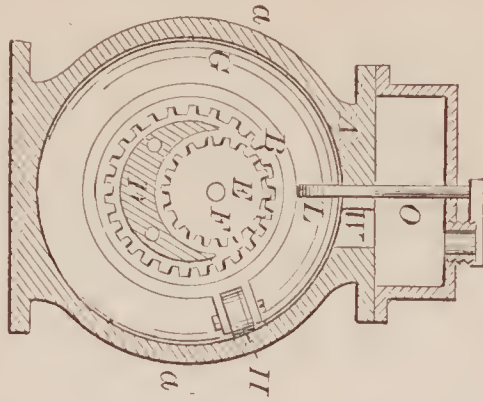
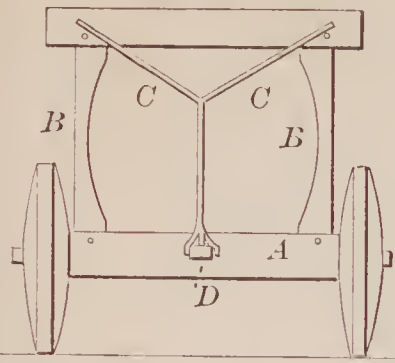

71786—J. Poppe—Rotary Pump.

71789—E. B. Requin—Lamp Chimney.

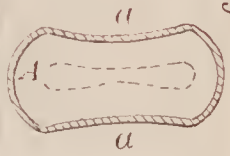
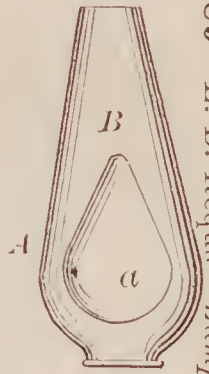

71790—F. Roach—t'aucet.

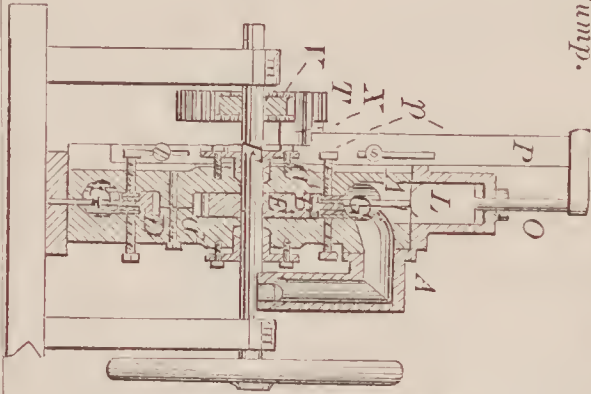
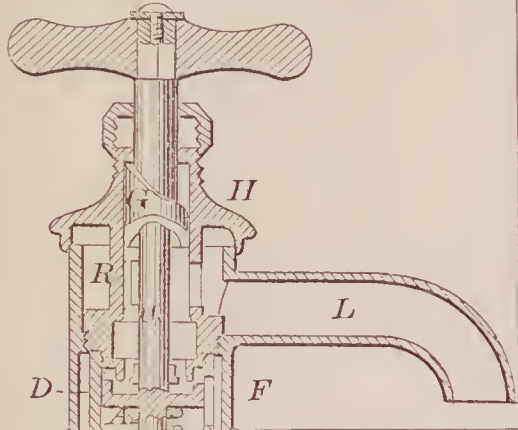

71791—C. Robinson—Scaffold.

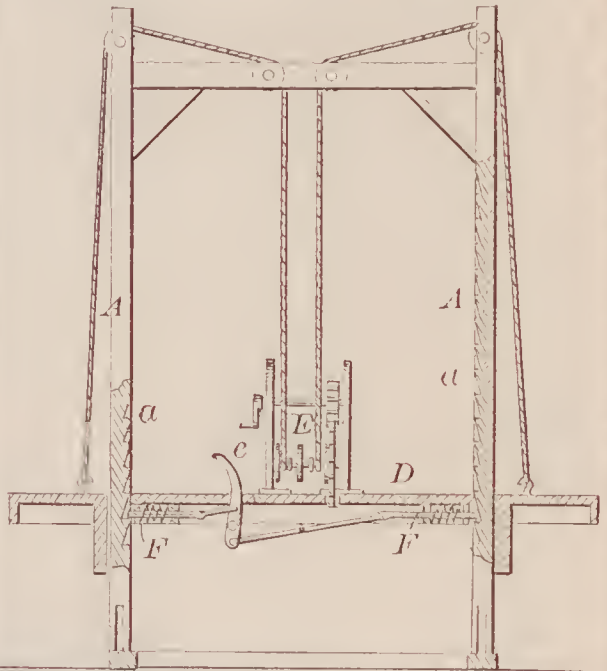

71788—J. P. Reynolds—Horse Holder

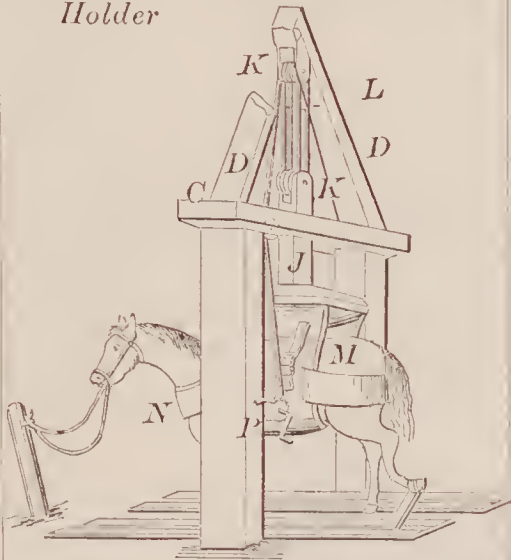

71793—G. H. Sanborn—For Cutting Paper.

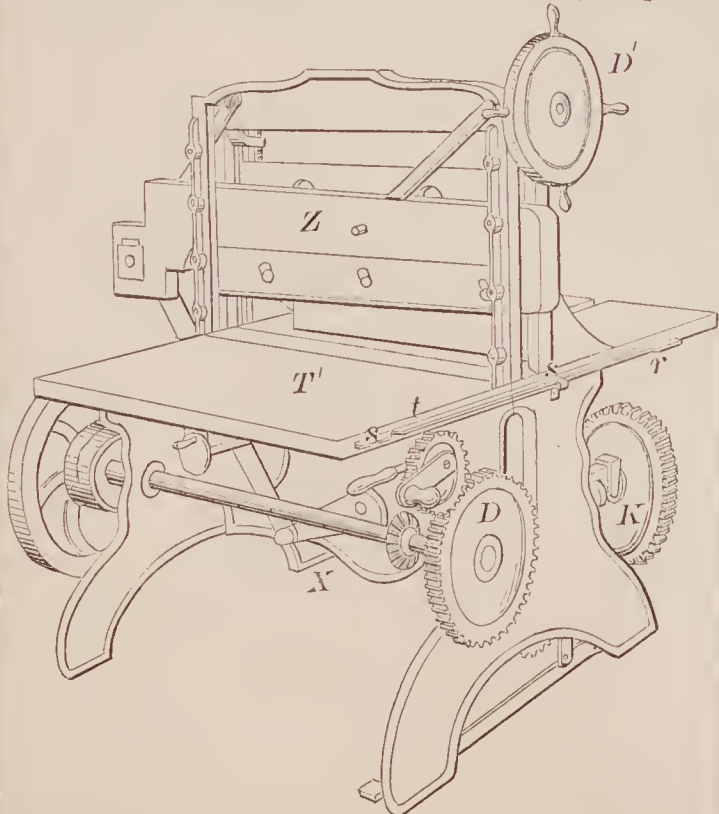

71792—Royse & Morris—Hay Raker and Loader.

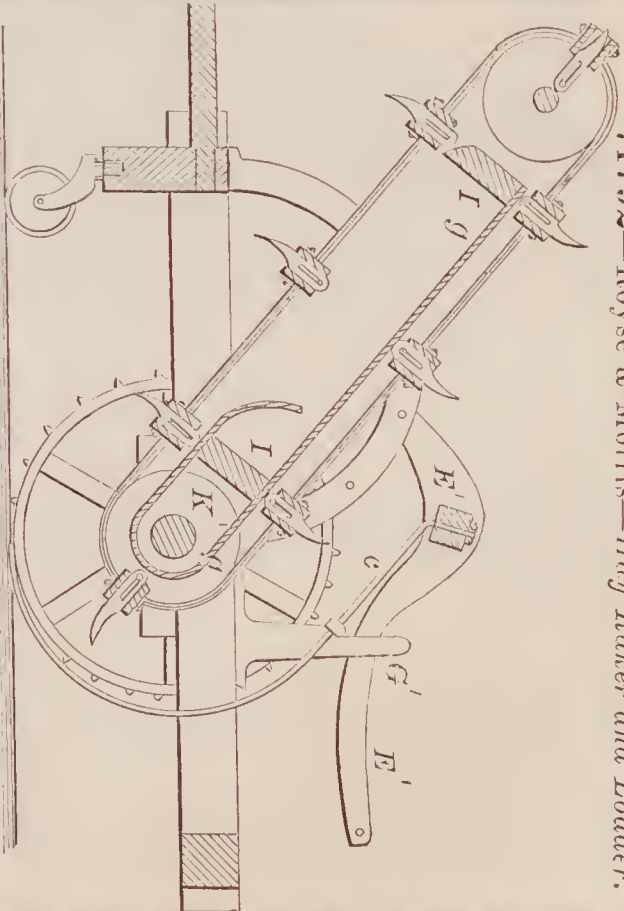



71794—J. W. Sanford—Cultivator.

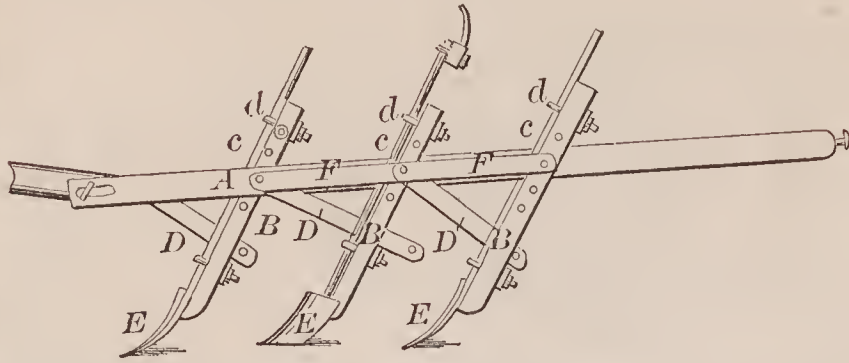

71796—A. Schenck—Grain Separator.

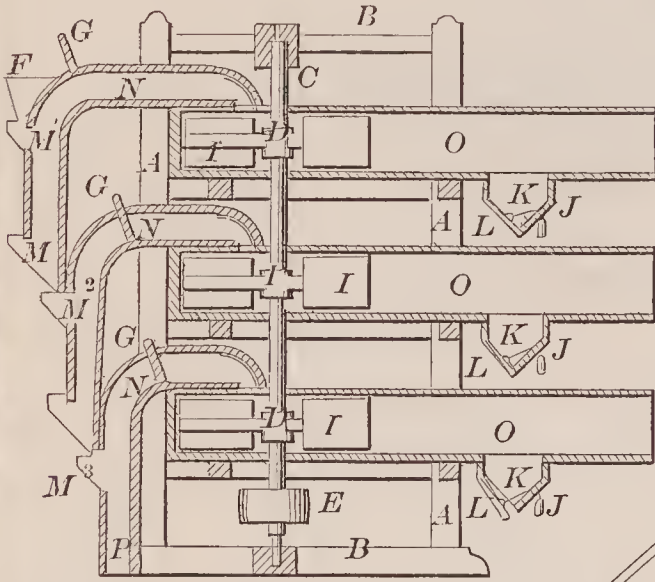

71798—D. D. Sherwood—For Bundling Wood.

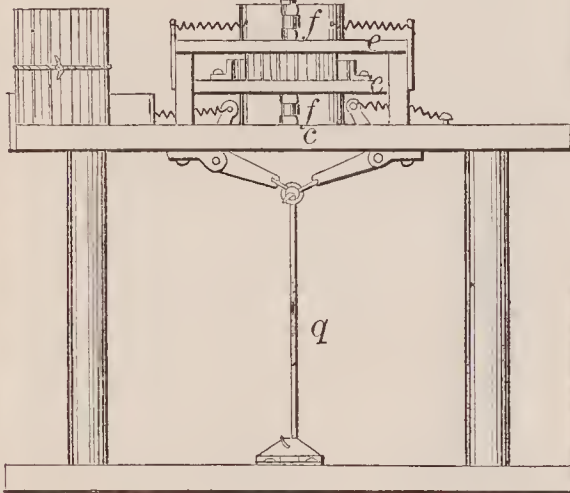

71801—S. W. Slocumb—Wagon Hub.

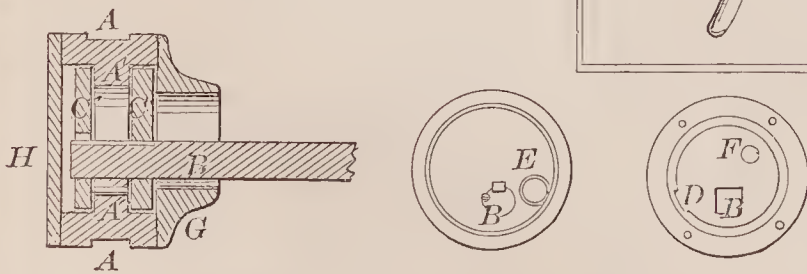

71803—L. F. Smith—Low Water Indicator.

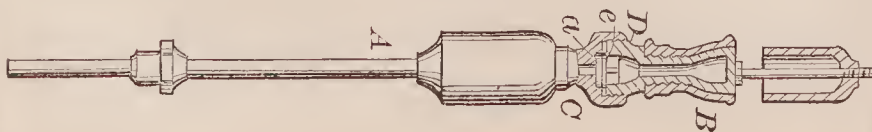

71797—A. Searls—Wooden Wagon Spring.

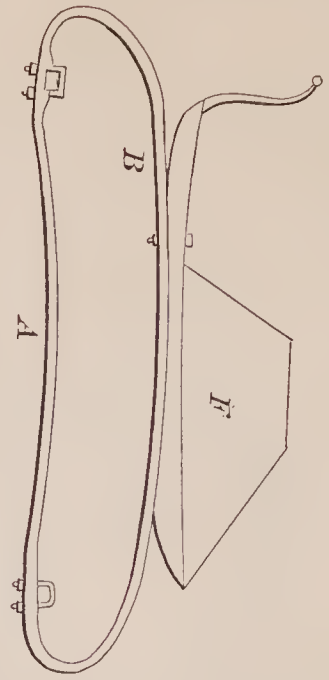

71799—A. M. Shurtleff—Saliva Pump.

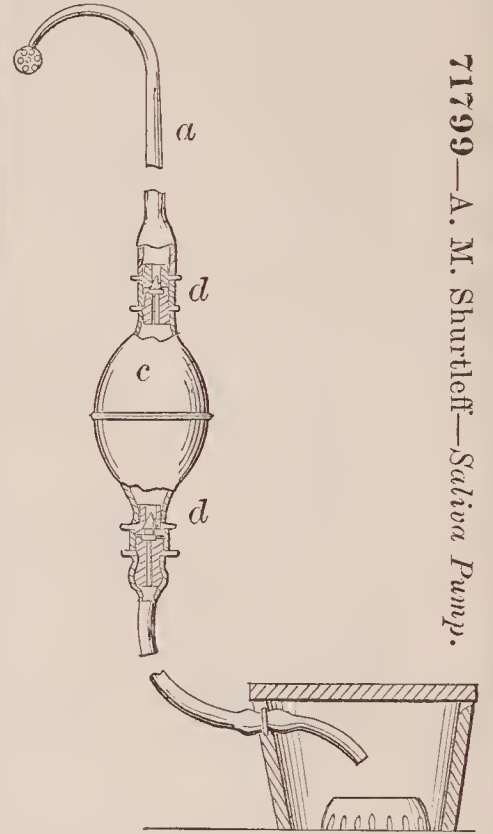

71795—F. G. Sargent—Tug.



71800—T. A. Stack—Hand Truck.

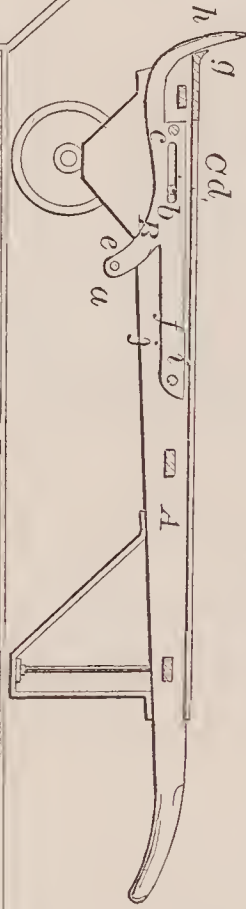

71802—Smith & Desso—Wagon Brake.

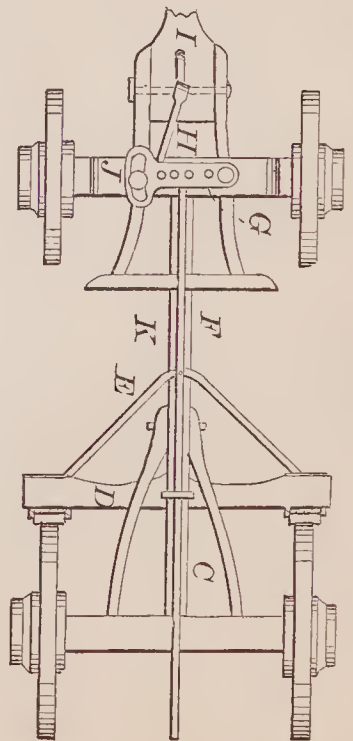

71804—S. A. Smith—*Bed Bottom.*

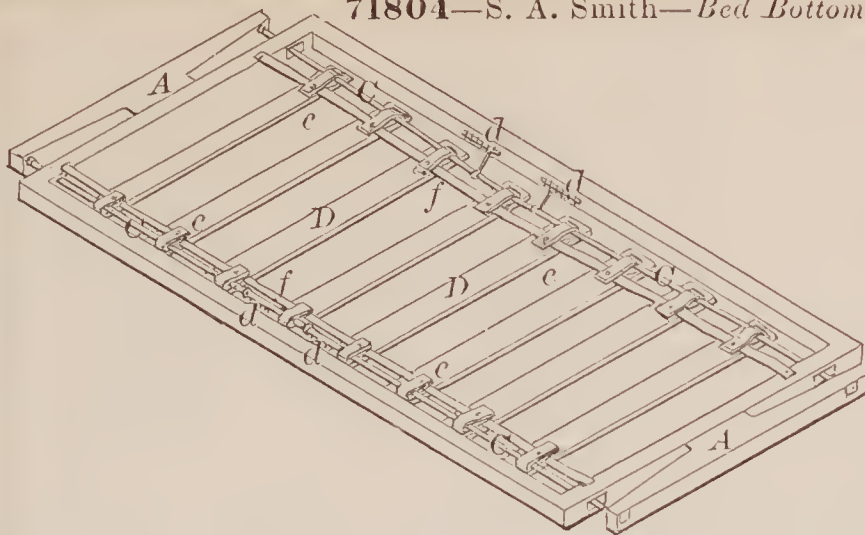

71806—J. Spoonhour—*Bridle Bit.*

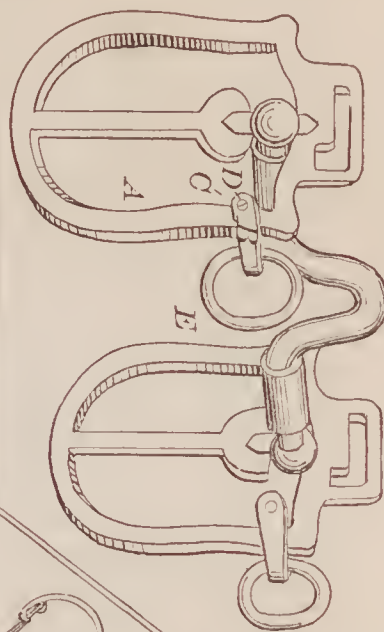

71805—E. Soper—*Carriage.*

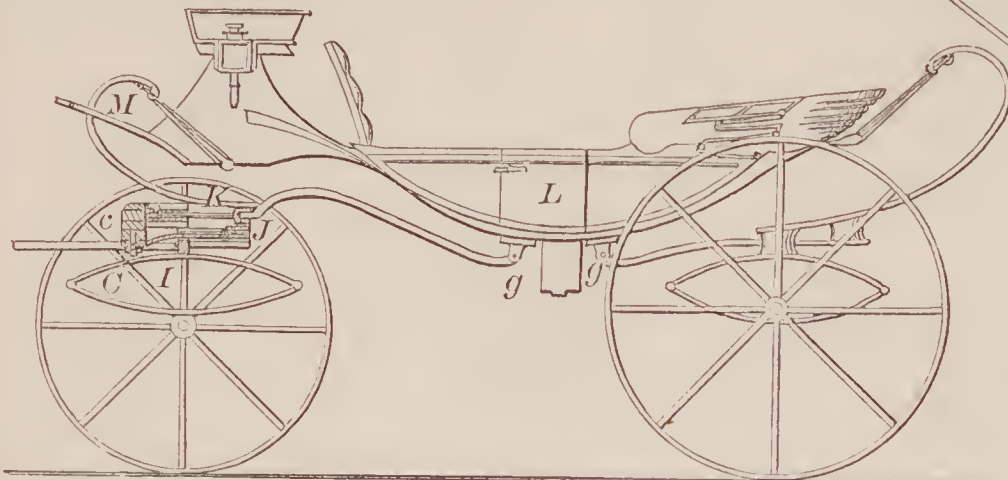

71811—U. Stewart—*Mill Pick.*

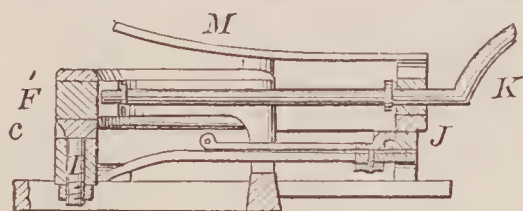

71807—W. H. Staats—*Railroad Switch.*

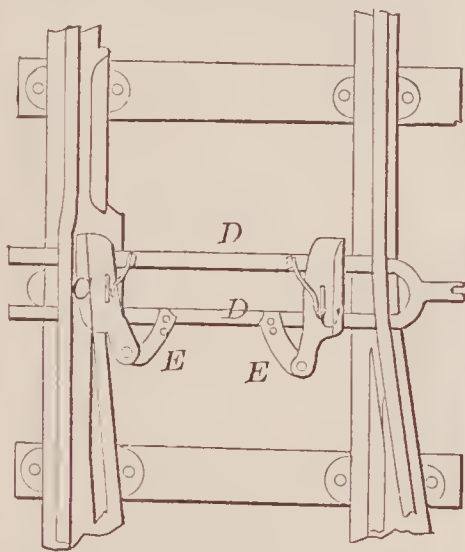

71808—E. Steinel—*Spring Bed Bottom.*

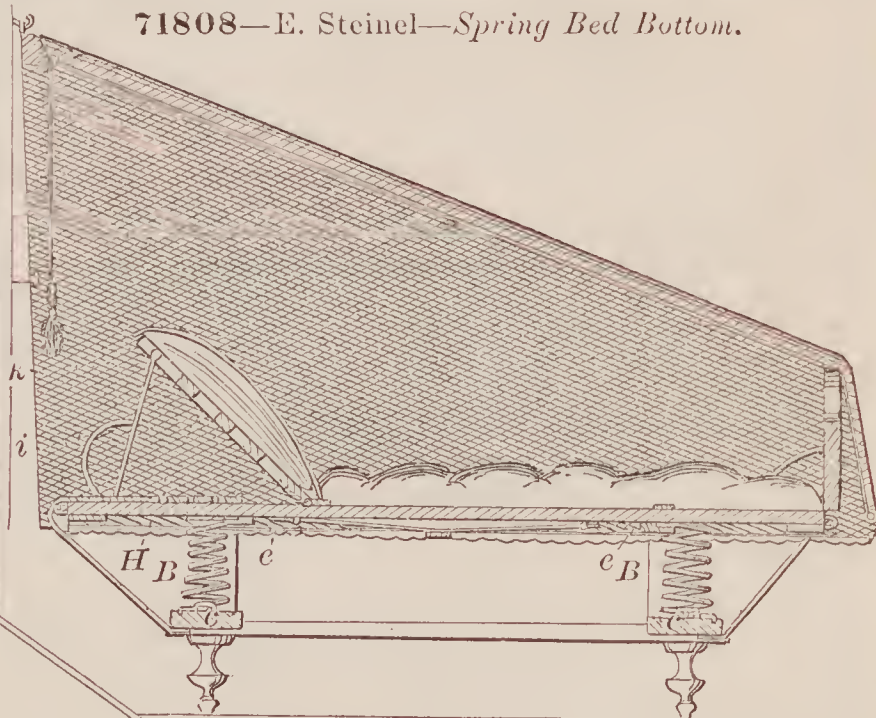

71812—J. St. John—*Folding Glass for Plants, &c.*

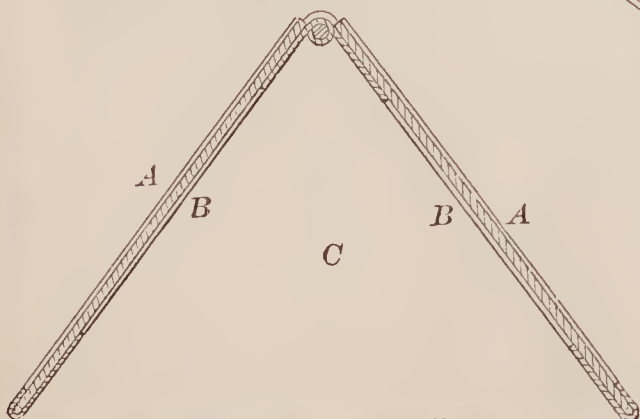

71809—F. A. Sterry—*Spindle Bolster.*

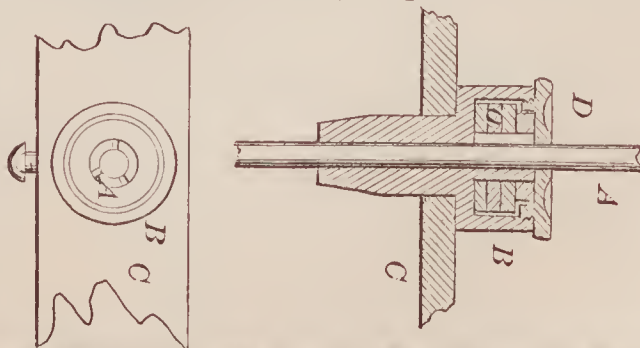



71813—T. Stone—*Brick Machine.*

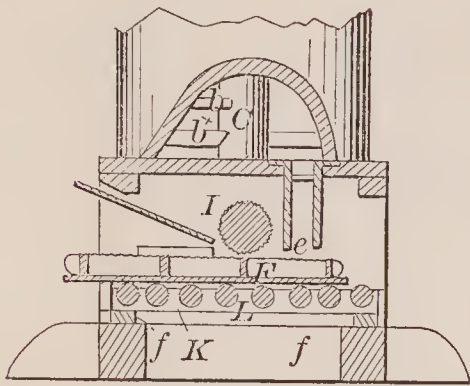
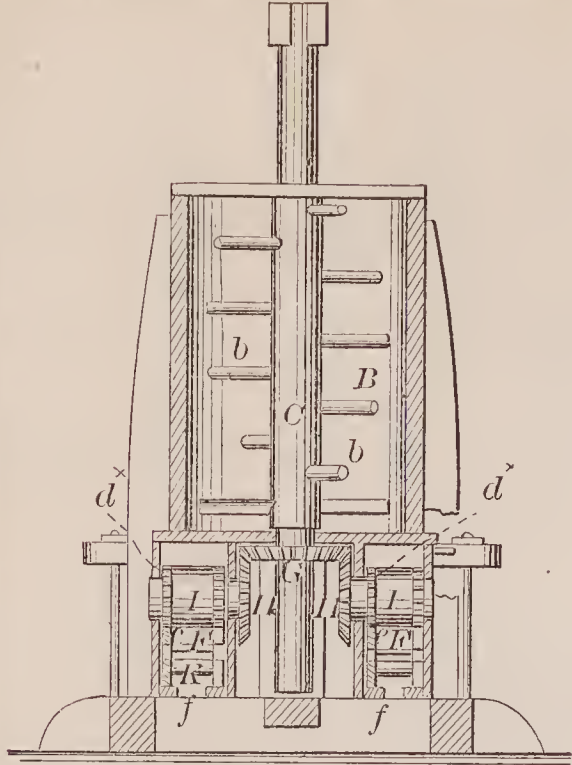

71819—C. M. Theberath—*Harness Mounting.*

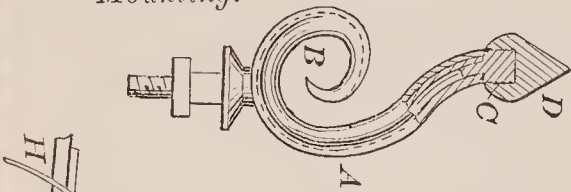

71816—J. B. Sweetland—*Harvester Rake.*

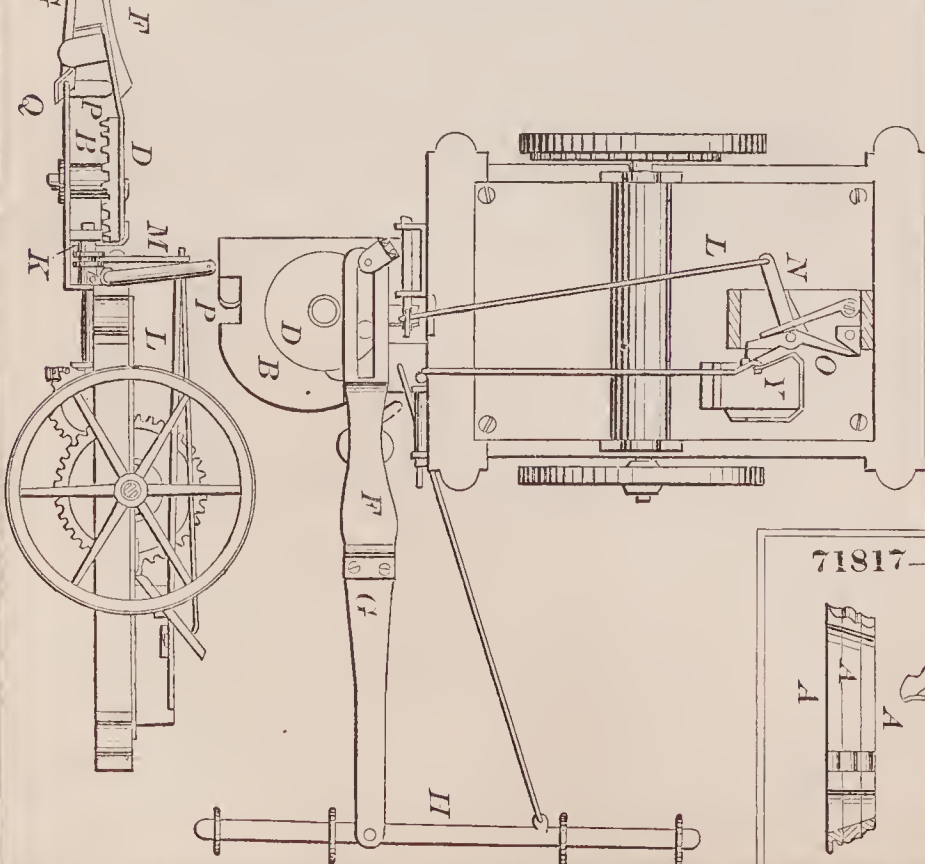

71815—J. B. Sweetland—*Corn Harvester.*

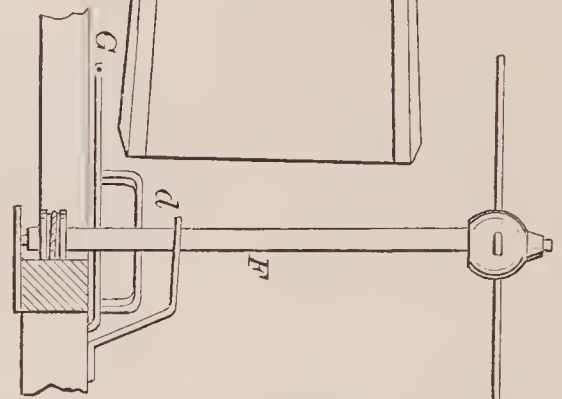
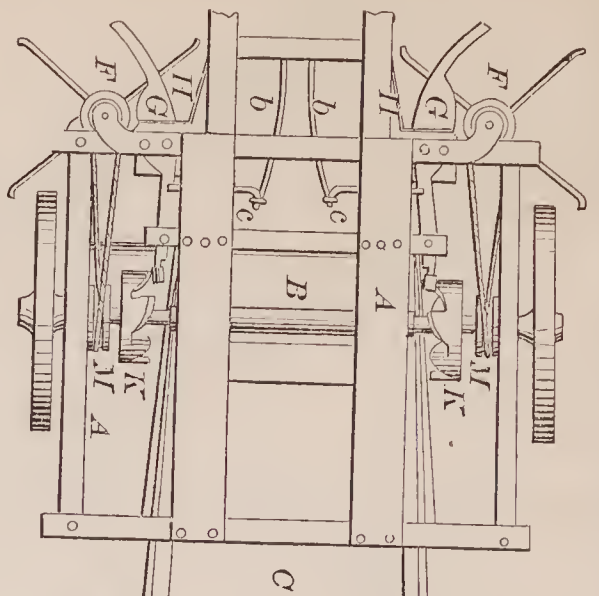

71814—A. & H. Streit—*Planing Machine.*

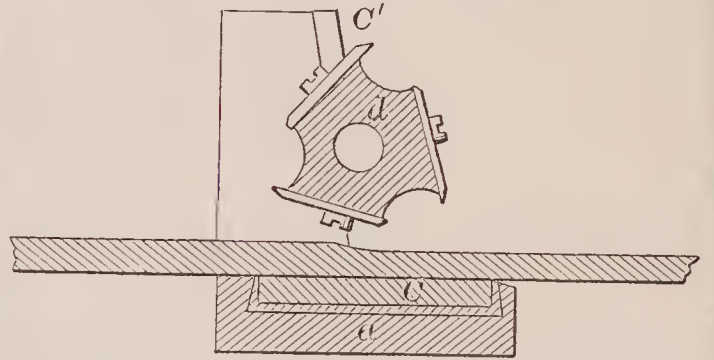

71818—J. Temple—*Stitching Clamp.*

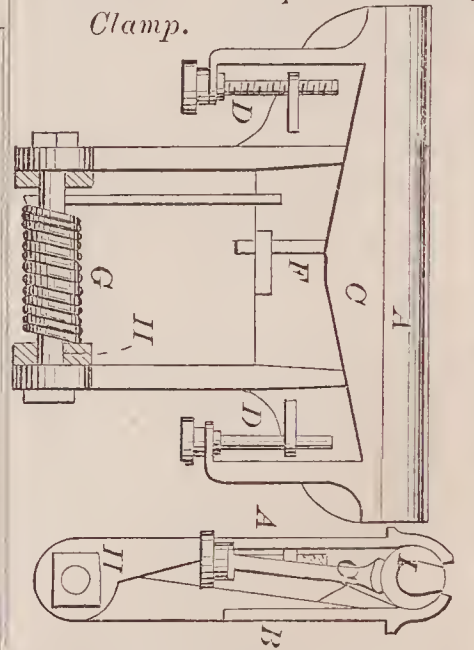

71817—J. Temple—*Cutter Head for Mouldings.*

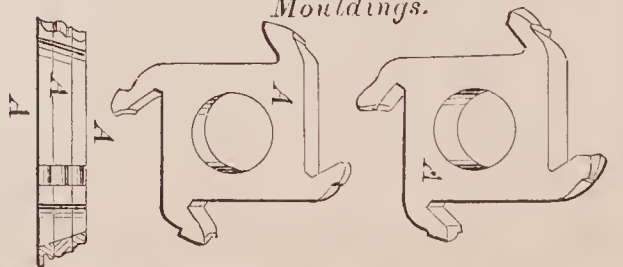

71821—W. T. Thornton—Seat Fastener.

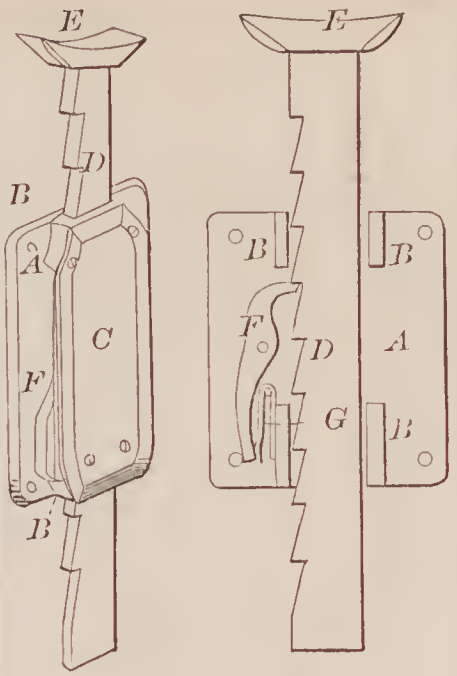

71827—Webster & Baxter—Plow Wheel.

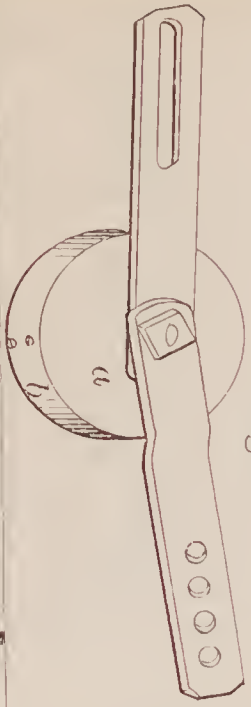
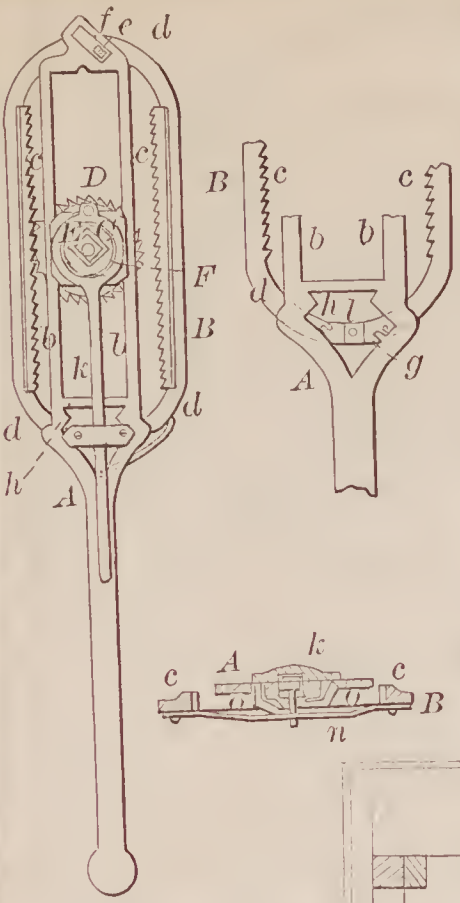

Fig. 1

71820—N. Thompson—For Transmitting Motion.



71823—B. Walker—

Forge Hammer.

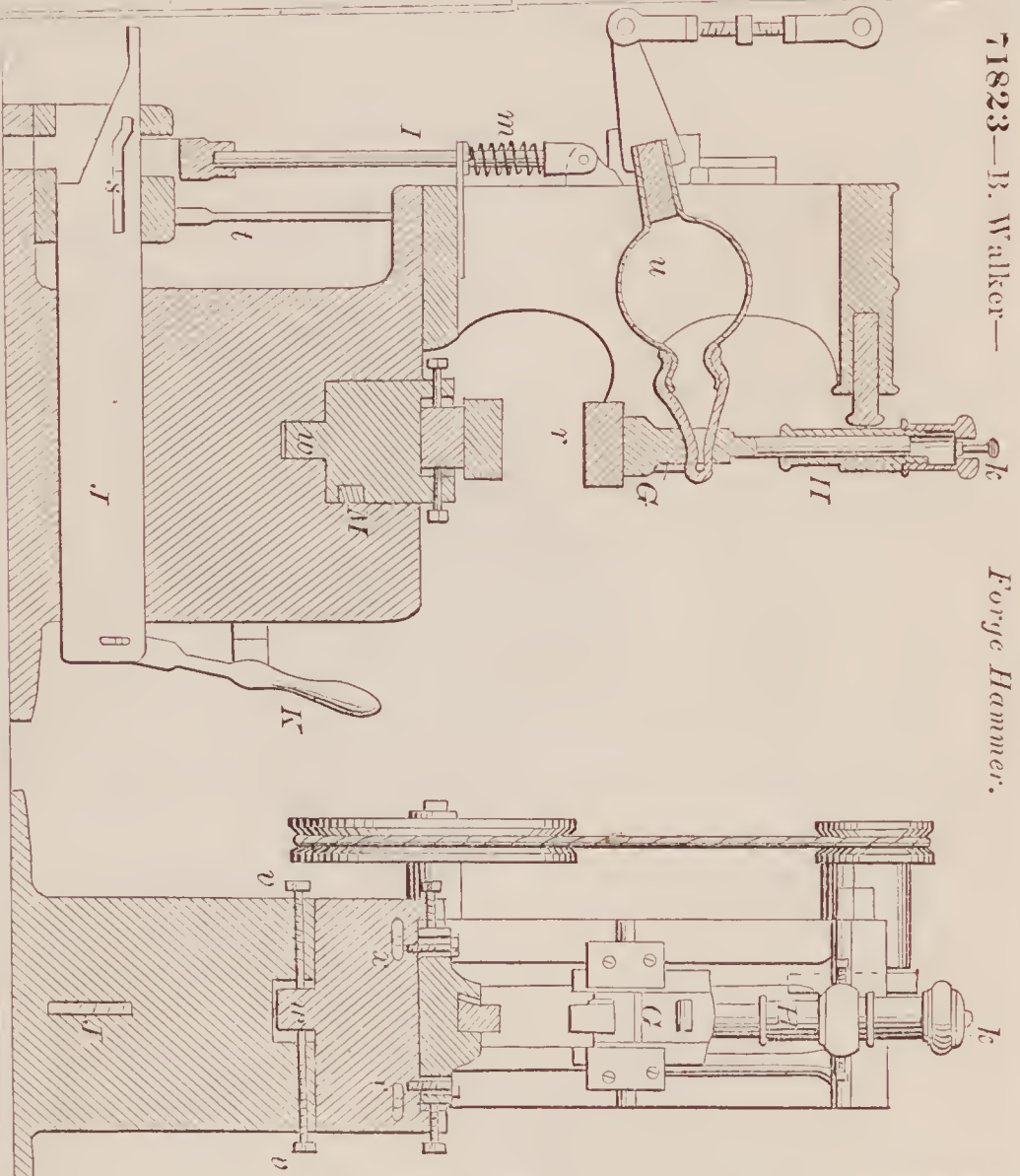

71825—S. K. Wallize—  
Steel Brake.

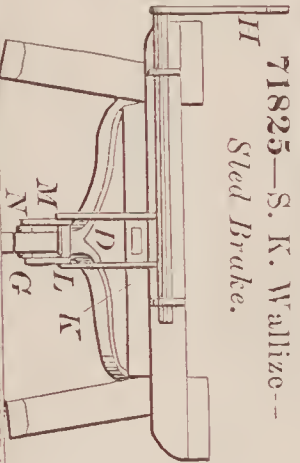

71824—A. Wallach—Safety  
Hook for Watch Chains.

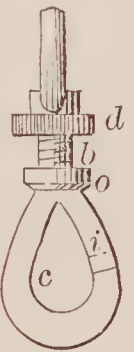

71822—E. Tracy—Burglar Alarm  
Door Lock.

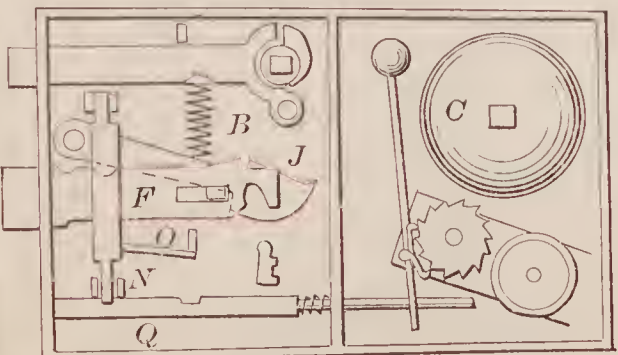

71826—G. Wanier—Plumbers'  
and Painters' Lamp.

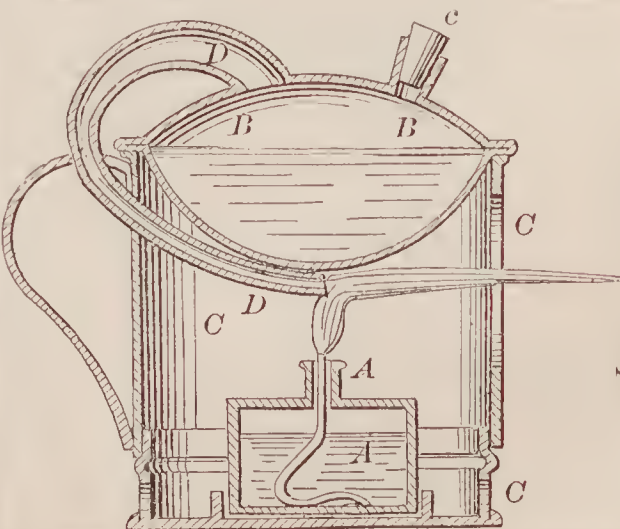



71828—G. Wells—Door Holder.

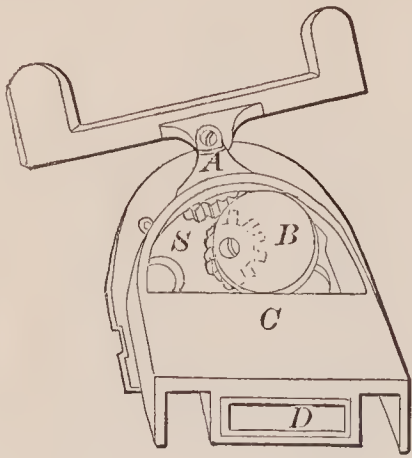

71830—H. Williamson—Concentric Globes.

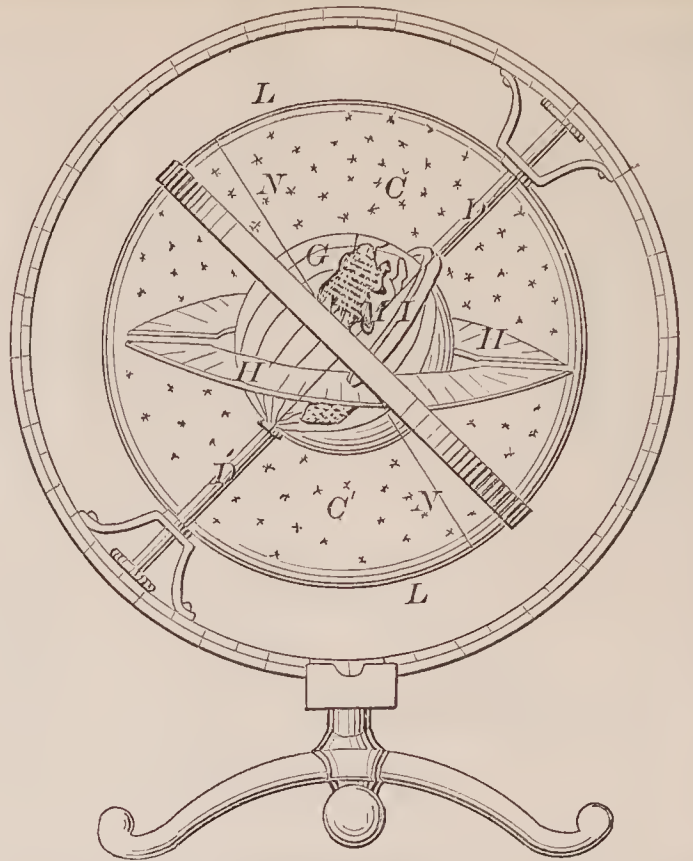

71829—H. Willard—Horse Hay Fork.

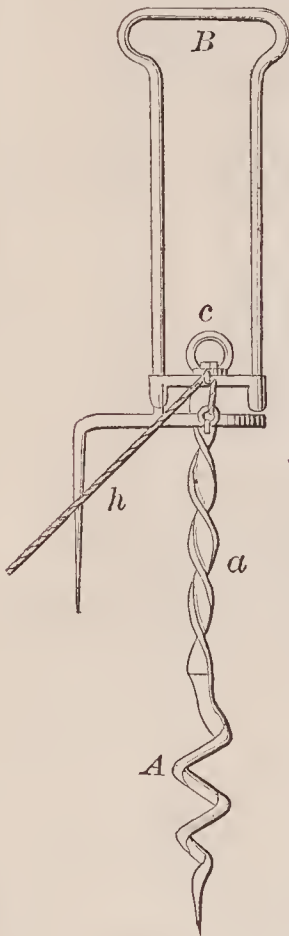

71832—W. A. Wood—Harvester.

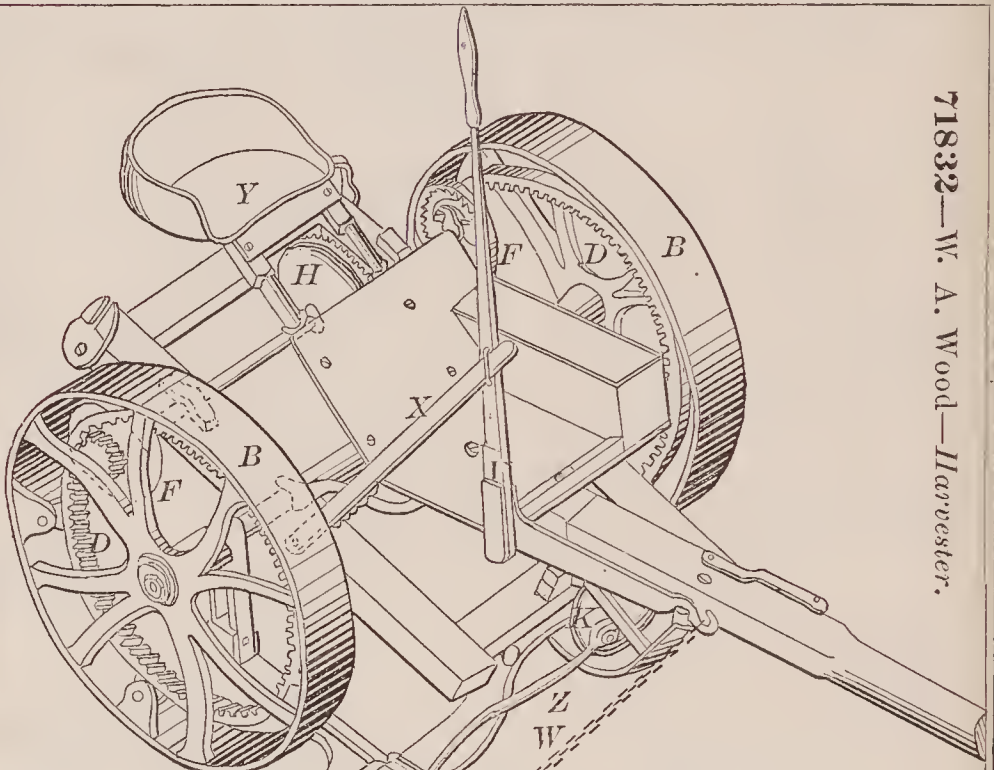

71833—O. B. Wright—Portable Derrick.

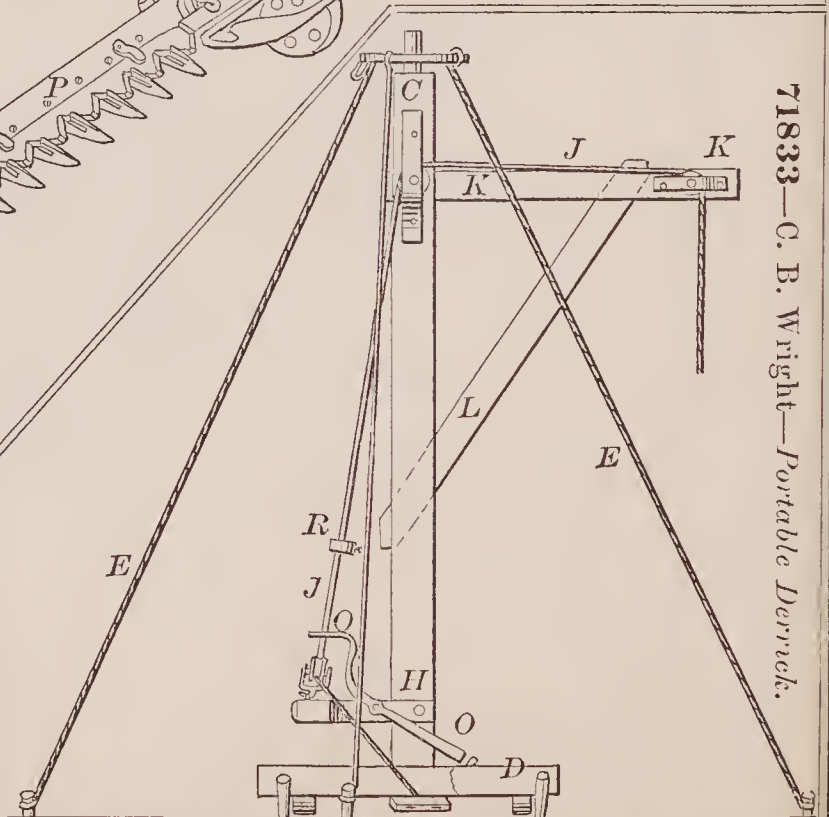

71831—B. Witherell—Corn Cake Mould.

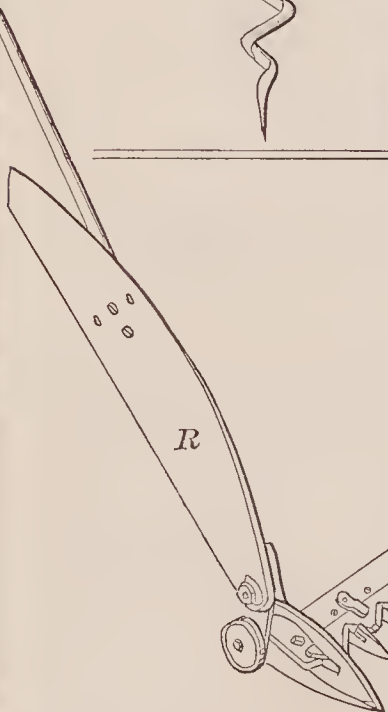

71835—T. S. Judson—Harness Trace.



71836—W. Aikin—For Notching Knitting Needles.

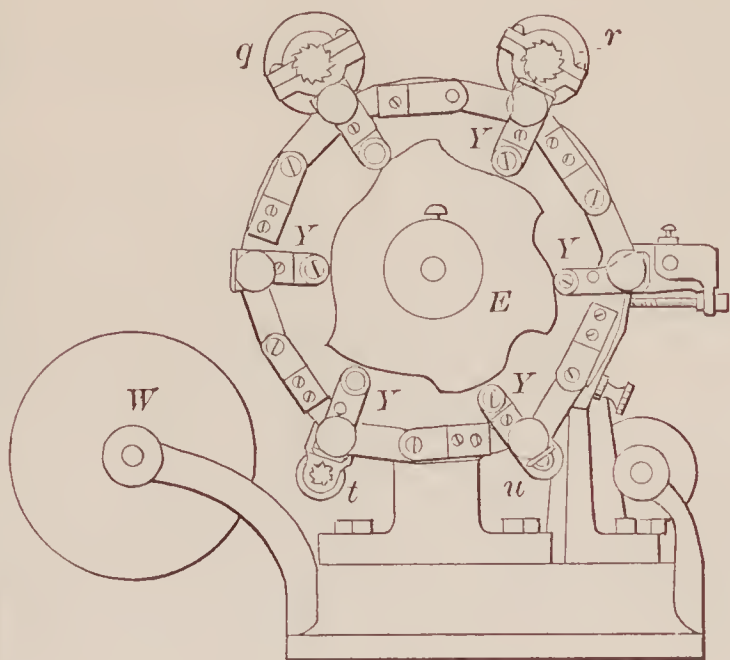

71834—L. Barber—Cultivator.

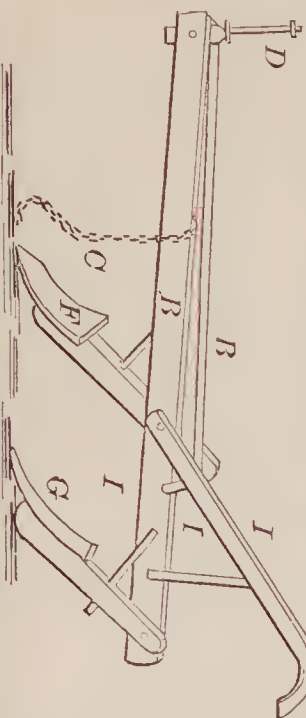

71838—L. J. Atwood—For Sizing Lamp Chimneys.

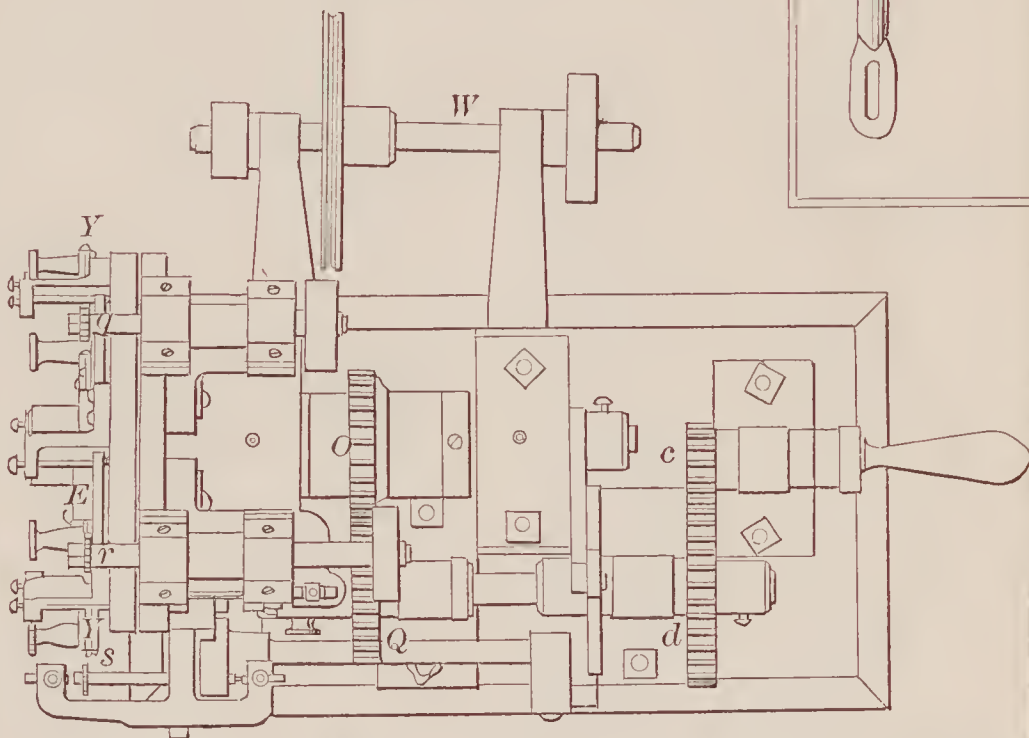
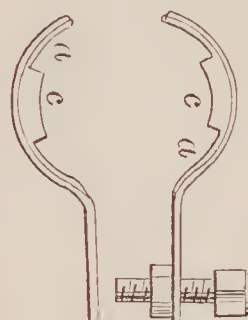
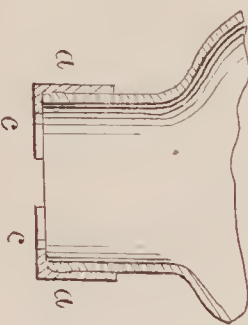

71839—A. Barberin—For Securing Ends of Wire Rope.

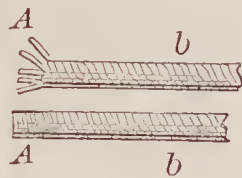

71840—A. B. Baty—Sprung Bed Bottom.

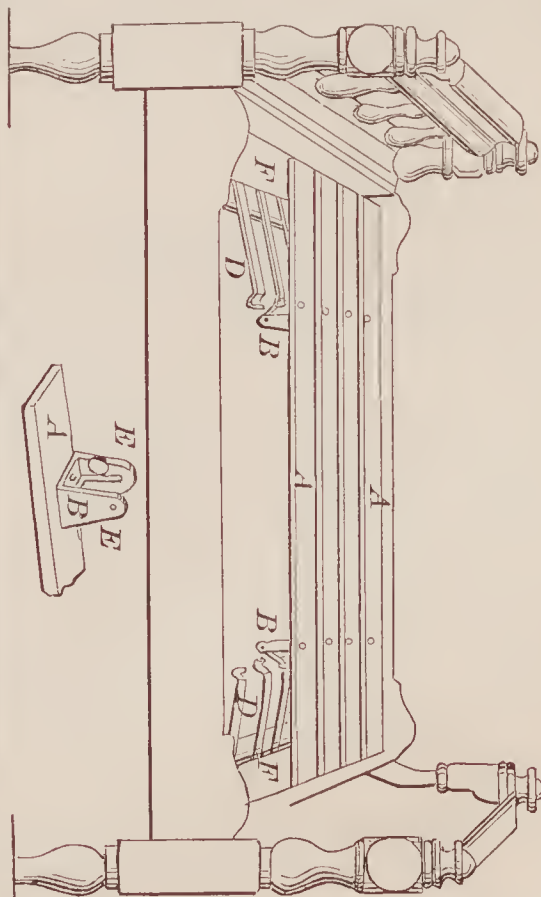

71837—A. Arnold—Tea and Coffee Pot.

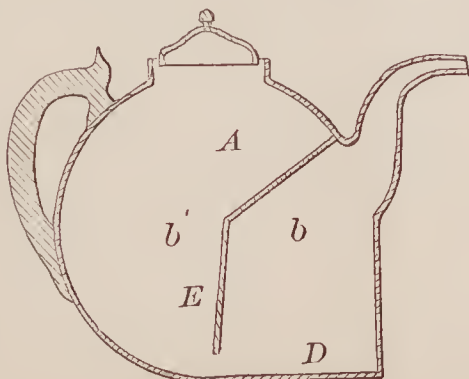





71848—C. H. Buck—Water Reservoir for Extension Top Stoves.

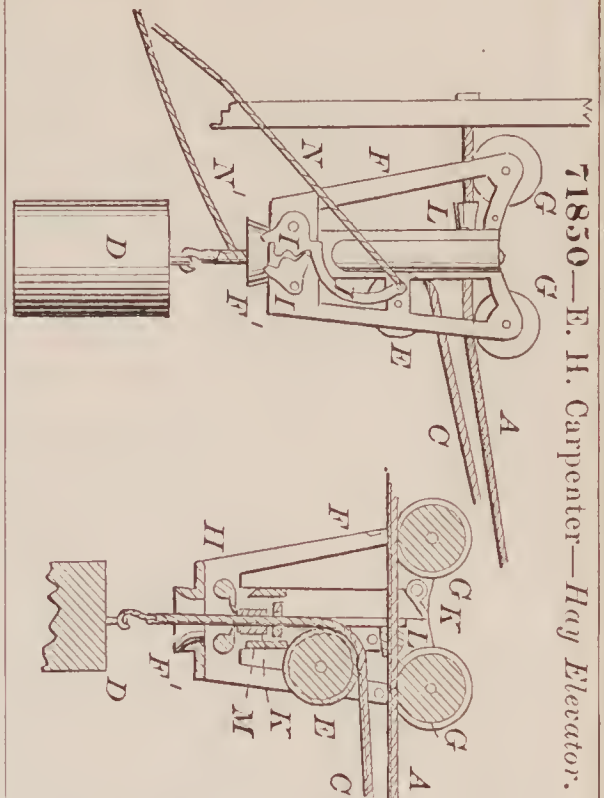
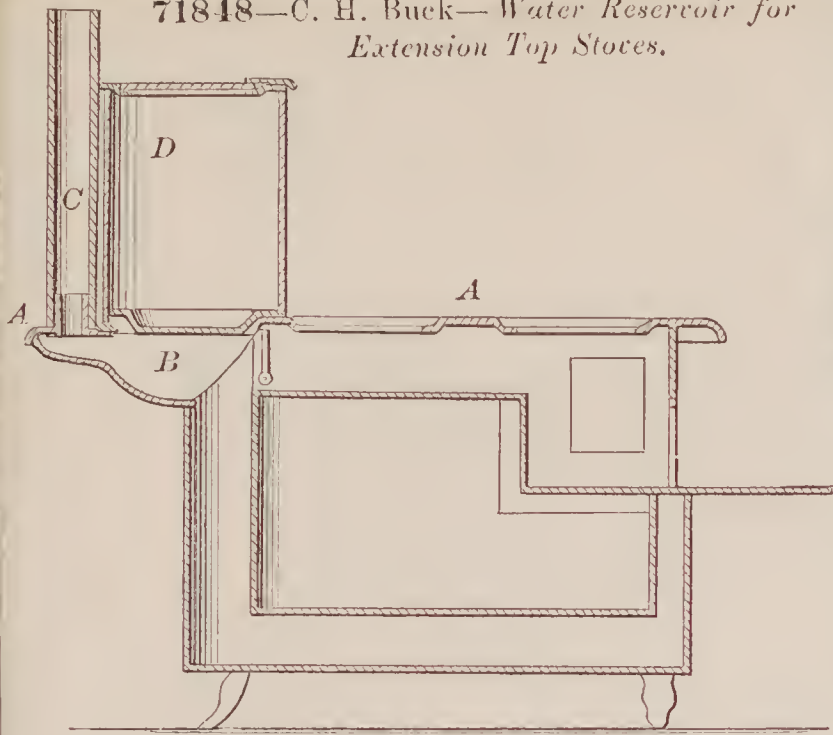

71850—E. H. Carpenter—Hay Elevator.

71851—C. E. Case—Steam Generator.

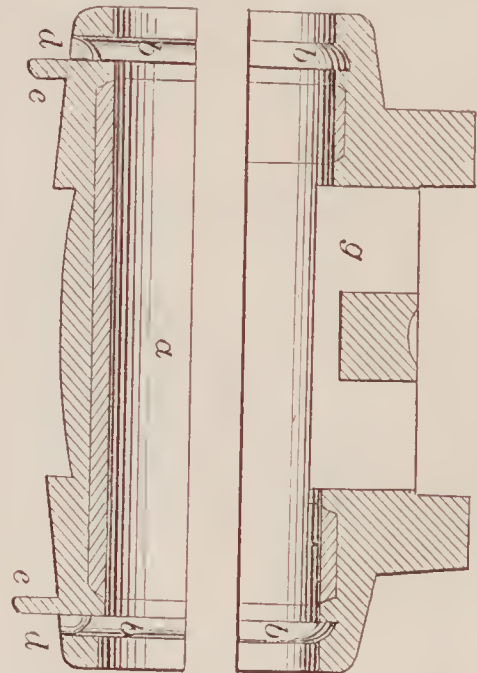
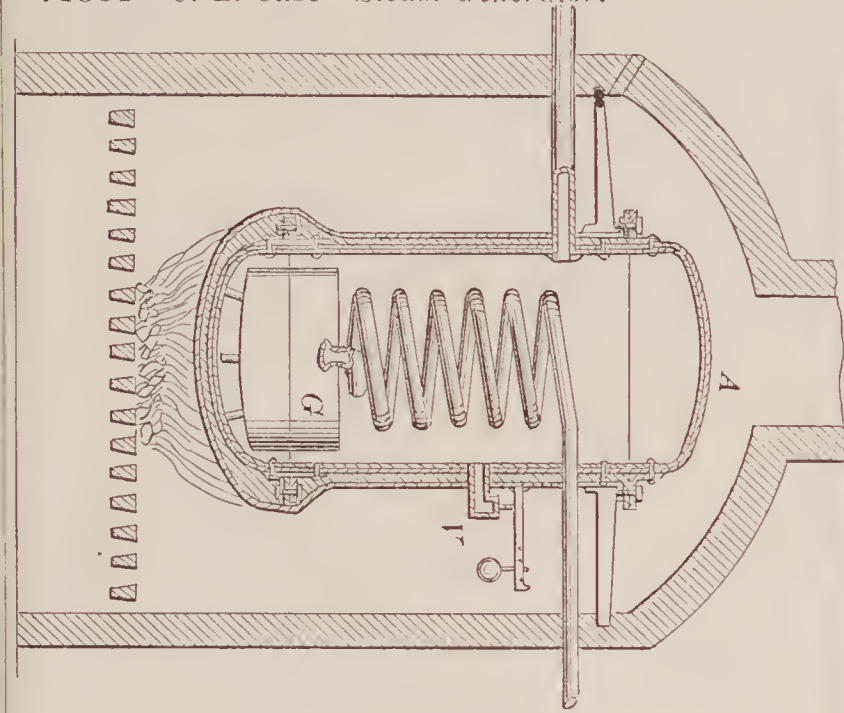

71849—T. F. Burgess—Journal Box.

71852—G. W. Chandler—Loom for Weaving Palm Leaf, &c.

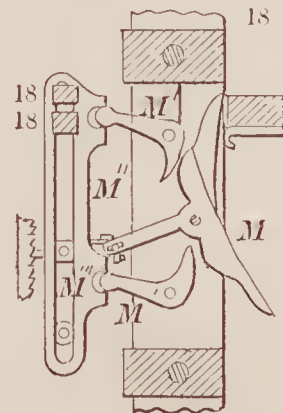
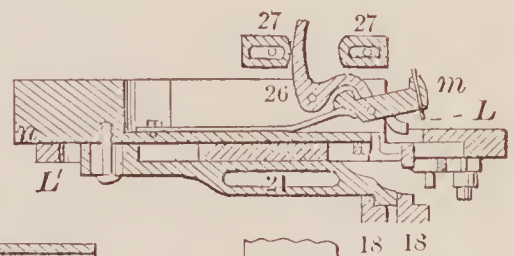
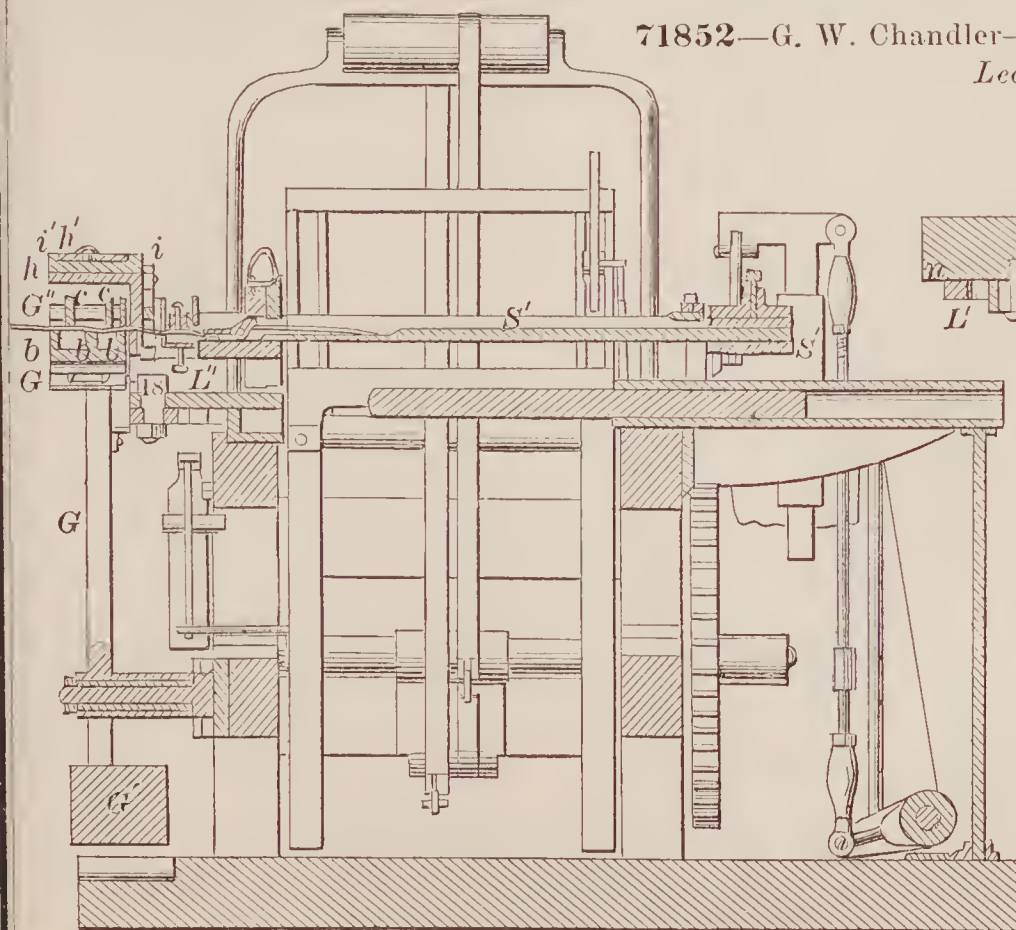



71854—E. Comeaux—For Making Levees.

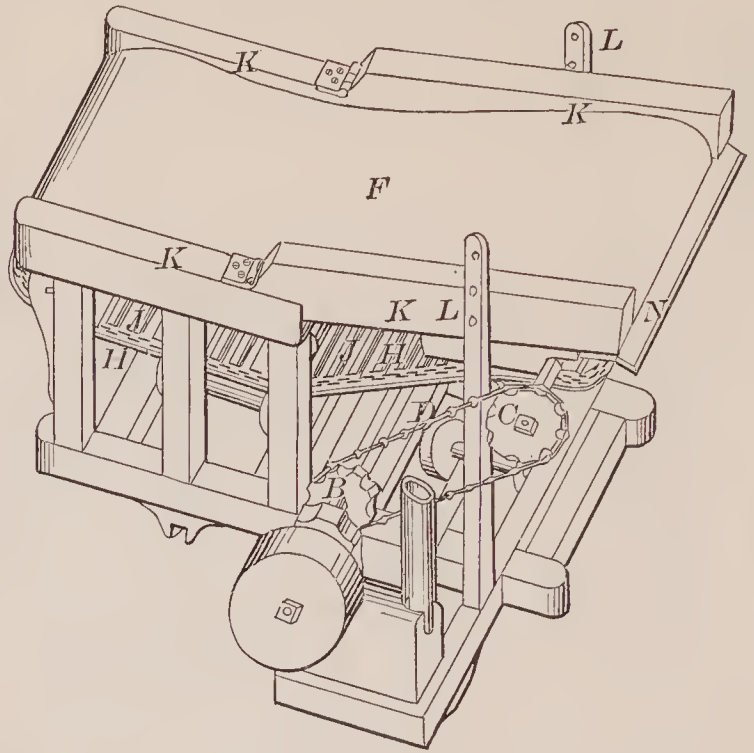

71853—G. W. Clark—Pitman Coupling.

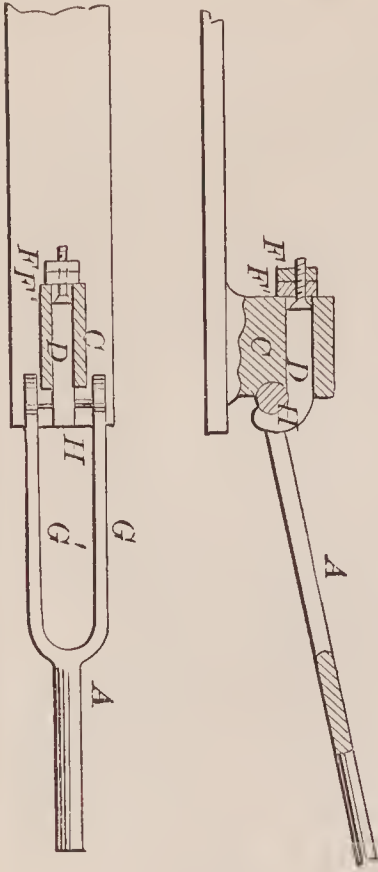

71856—S. Davis—Car Brake.

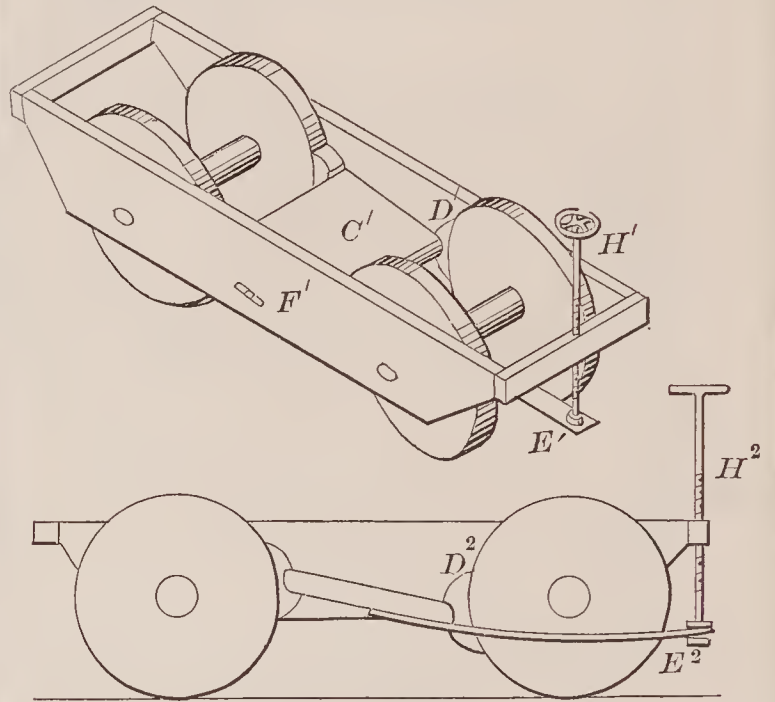

71857—M. Decamp—Feeder for Grain Mills.

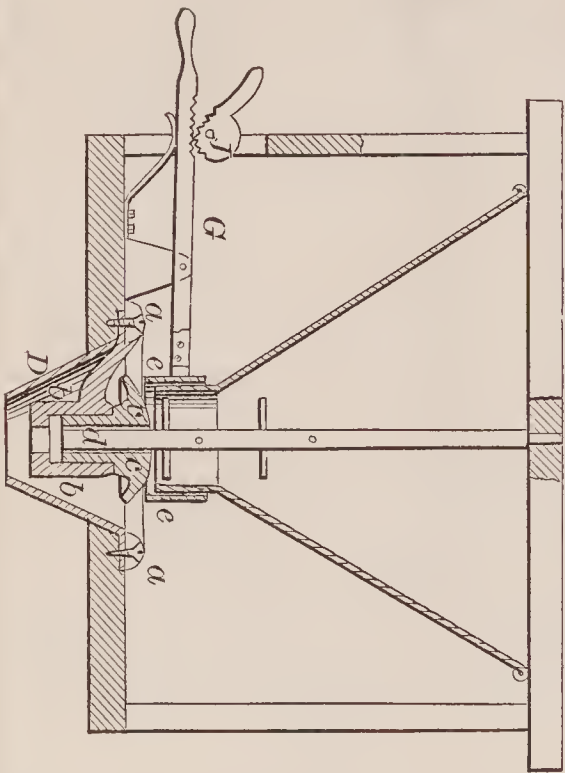

71858—P. Dechausc—Painters' Easel.

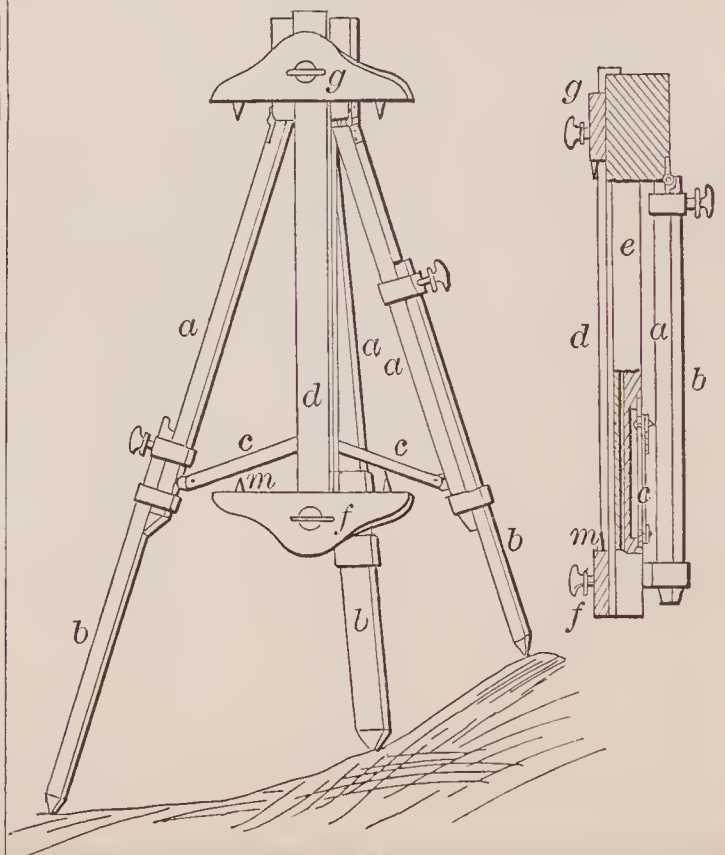

71855—M. Dek. Cuts—Construction of Roofs.

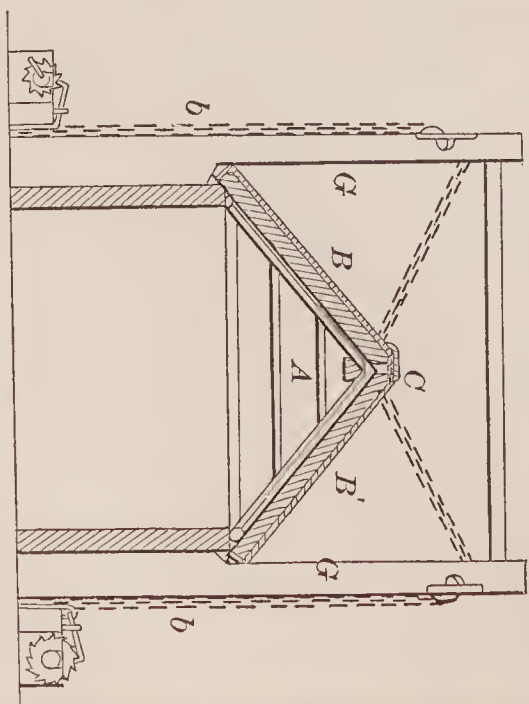

71859—H. P. Dillingham—  
*Guide for Saws in Saw Mills.*

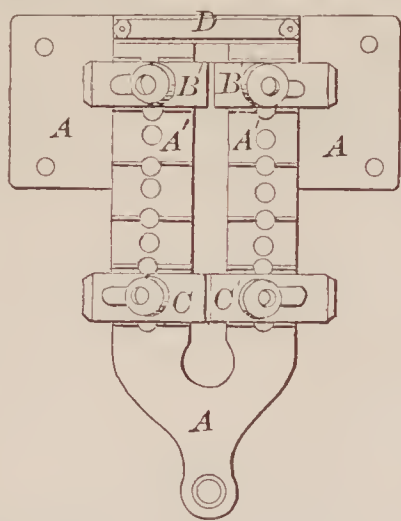

71862—Durkee & Murray—*Planing Machine.*

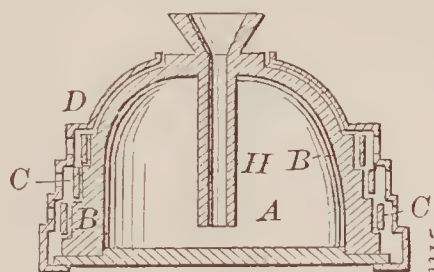
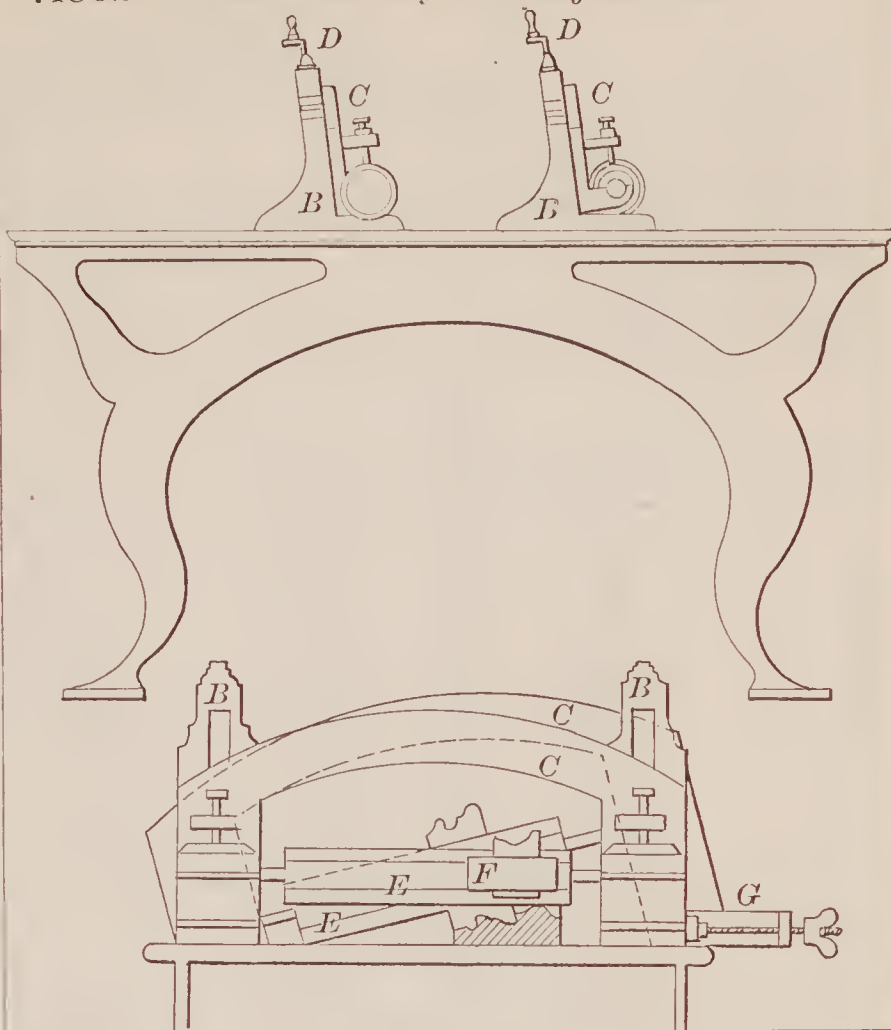

71861—S. R. Dummer—*Calendar Attachment to Inlstands.*

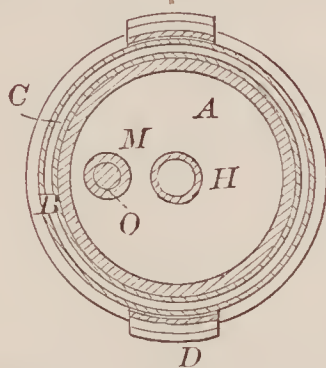

71864—L. Felker—*Corn Cake Cutter.*

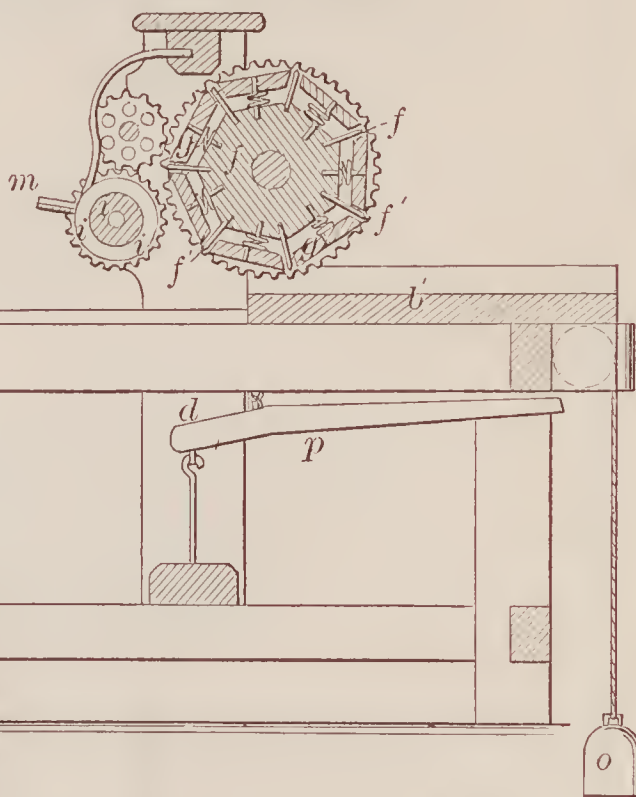

71863—J. M. Fairchild—*Self-Adjusting Relay Magnet.*

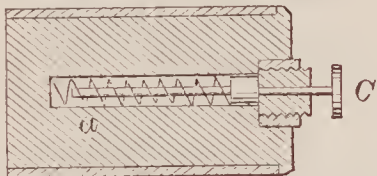

71865—E. Fitzgerald—*Measuring Faucet.*

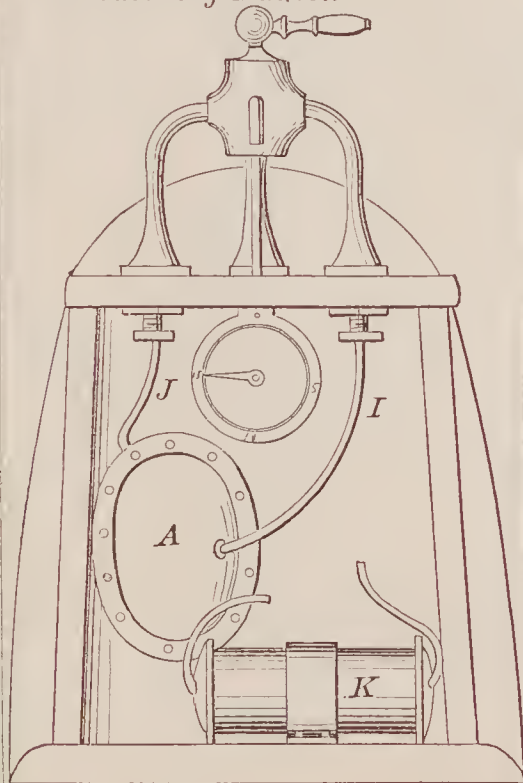

71866—C. C. Fornerook—*Tuyere.*

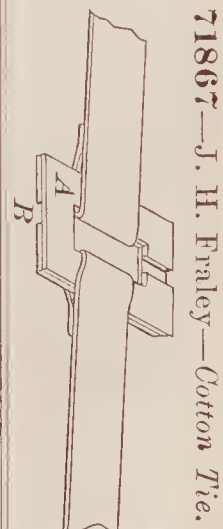
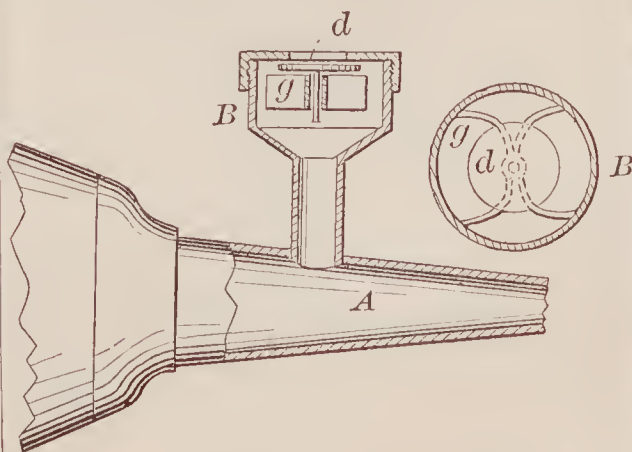

71867—J. H. Farley—*Cotton Tie.*



71868—Glass, Schneider & Regner—*Bridge.*

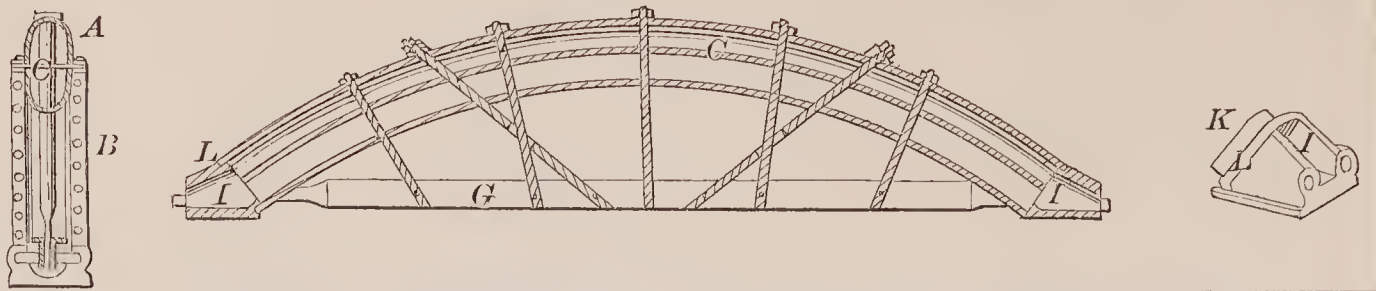

71870—G. D. Goodrich—*Peat Machine.*

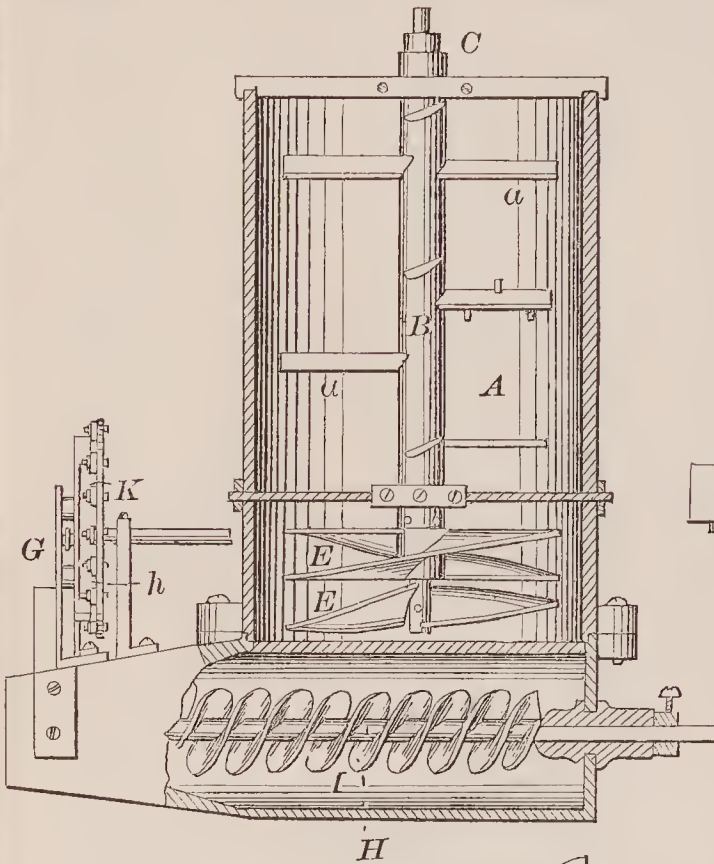

71869—J. H. Gomer—*Oil Cup.*

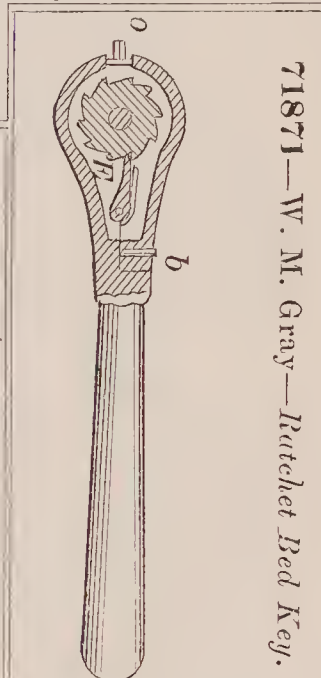
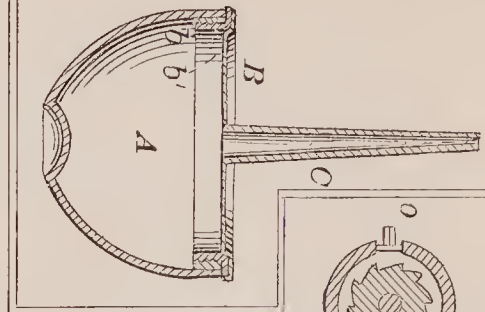

71871—W. M. Gray—*Ratchet Bed Key.*

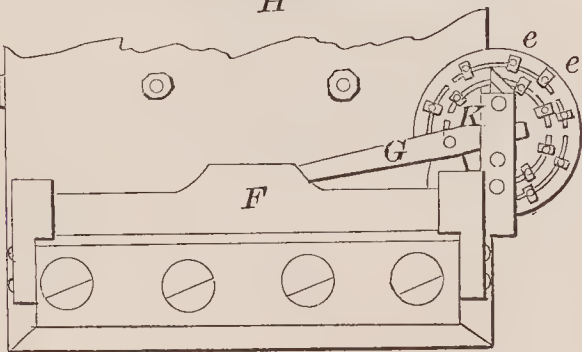

71872—C. P. Grosvenor—*Preventing Lamp Explosions.*

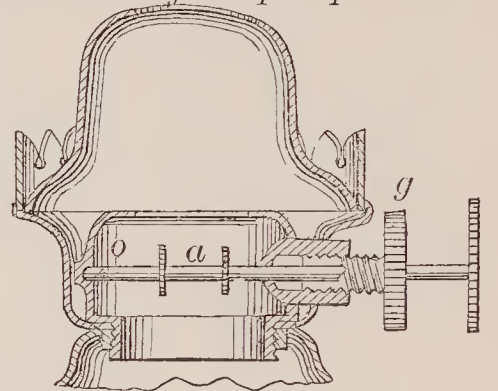

71873—J. Harris—*Car Axle Box.*

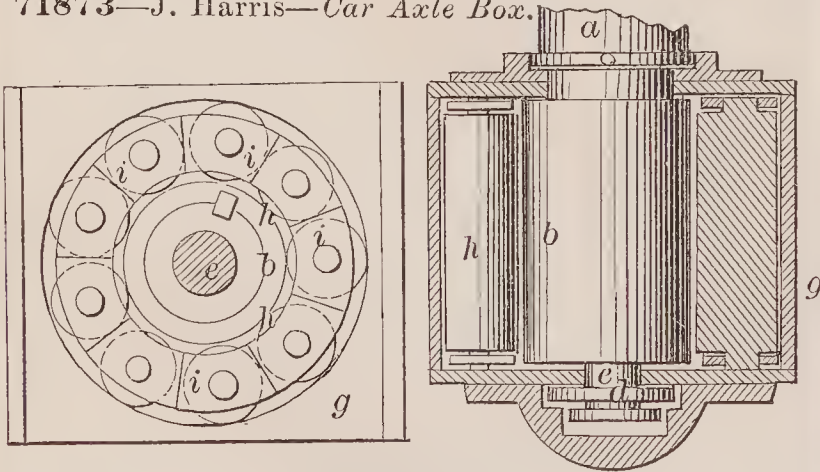

71874—J. H. Haskell—*Washing Machine.*

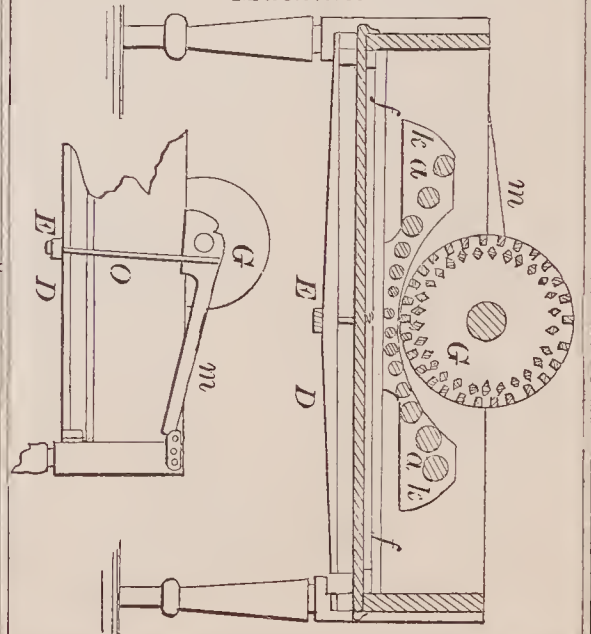

71875—J. V. Hawkey—*Horse Rake.*

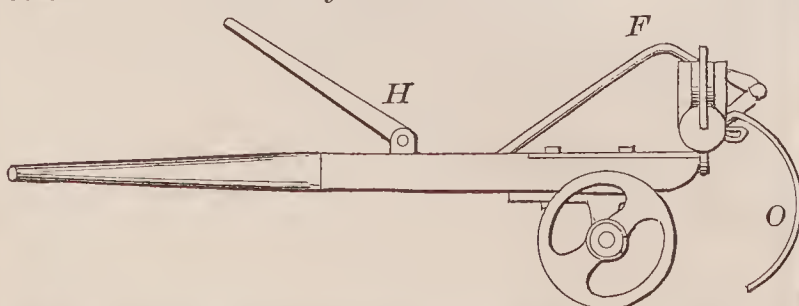

71876—J. B. Hill—For Draining Sugar.

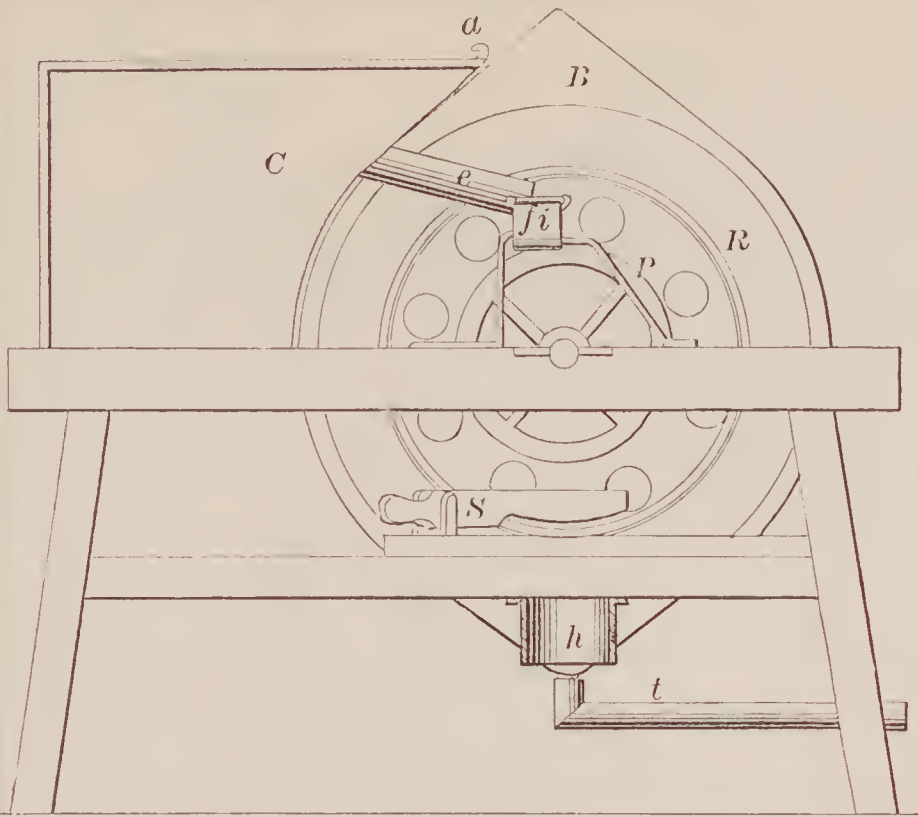

71879—M. Hitz—Fishing Line Swivel.

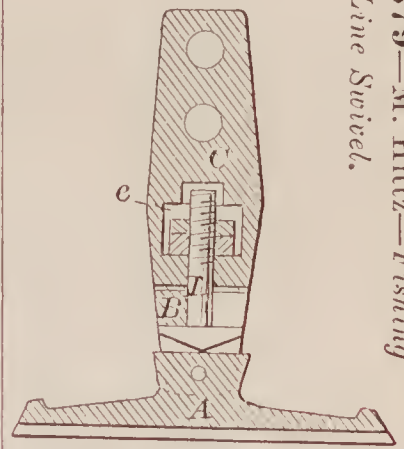

71880—T. W. Houchin—For Lighting Gas.

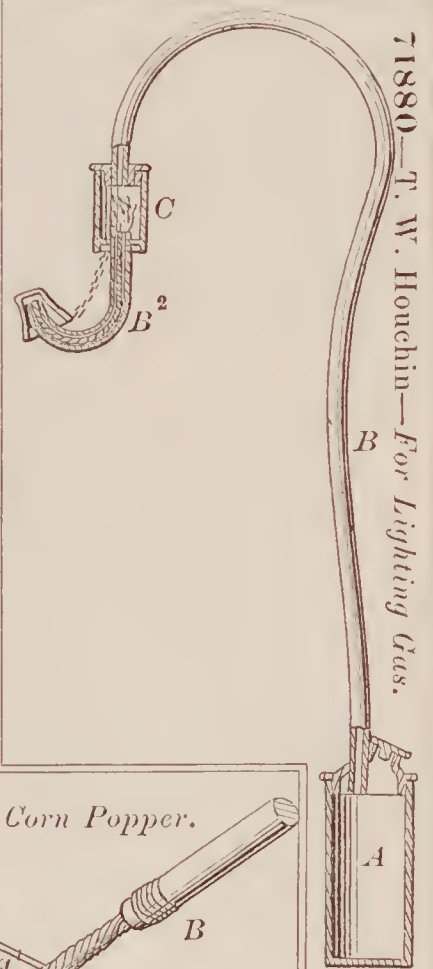

71877—J. B. Hill—Centrifugal Machine for Draining Sugar.

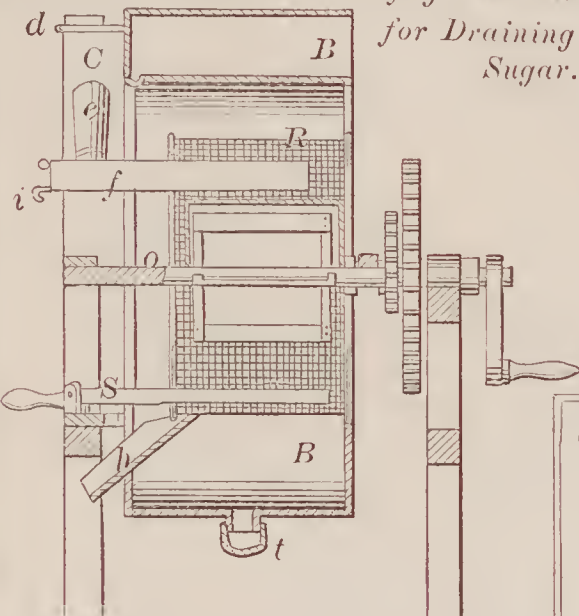

71878—S. L. Hill—Card Holder.



71881—Howe & Barton—Corn Popper.

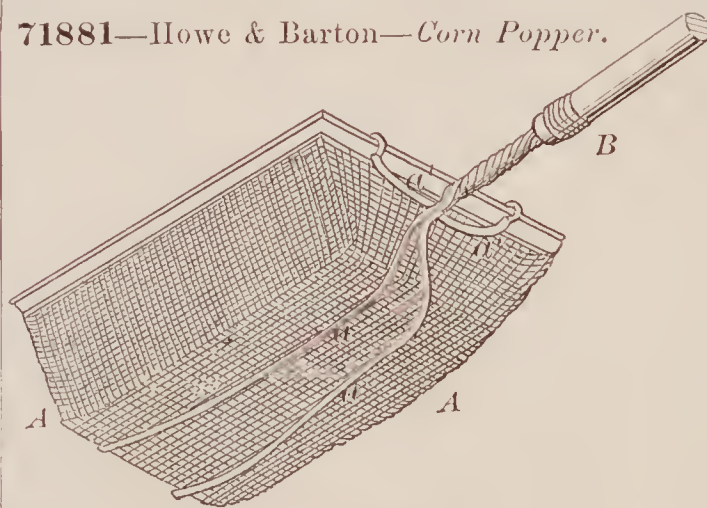

71882—B. G. Howes—Copy Book.

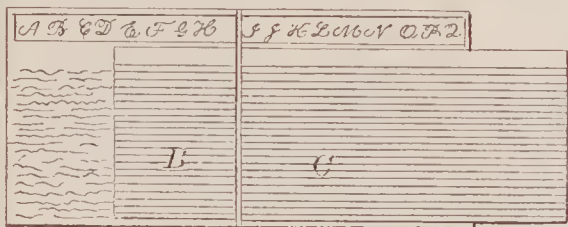

71883—G. A. Hyver—Petroleum Gas Burner.

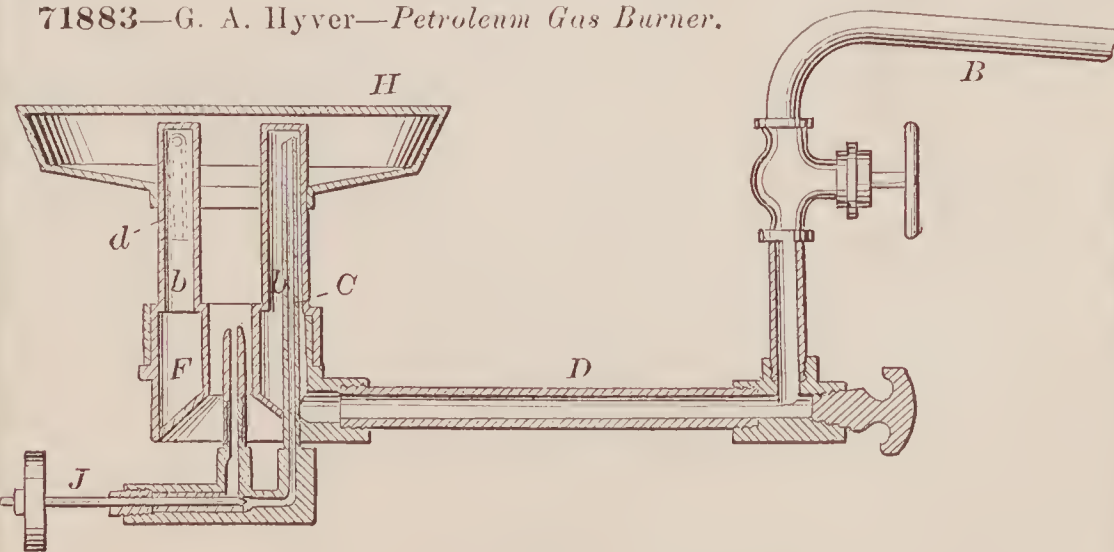

71884—J. Keesev—Shaft Coupling.

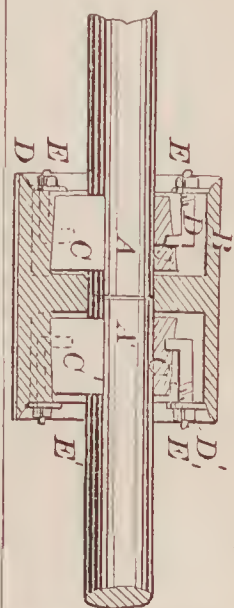



71885—C. L. Kingsley—*Clamp Screw.*

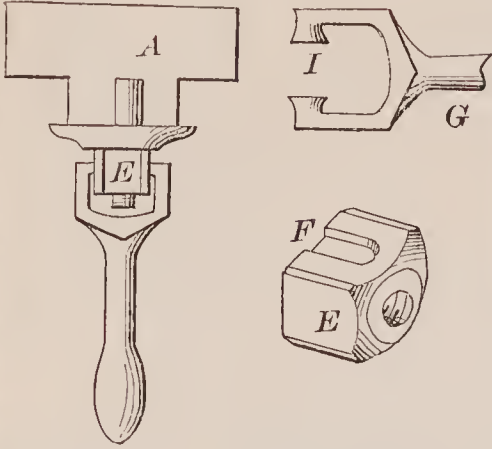

71886—J. Klahr—*For Bending Wood.*

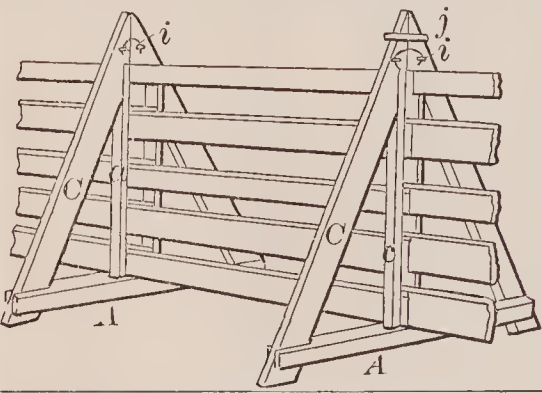
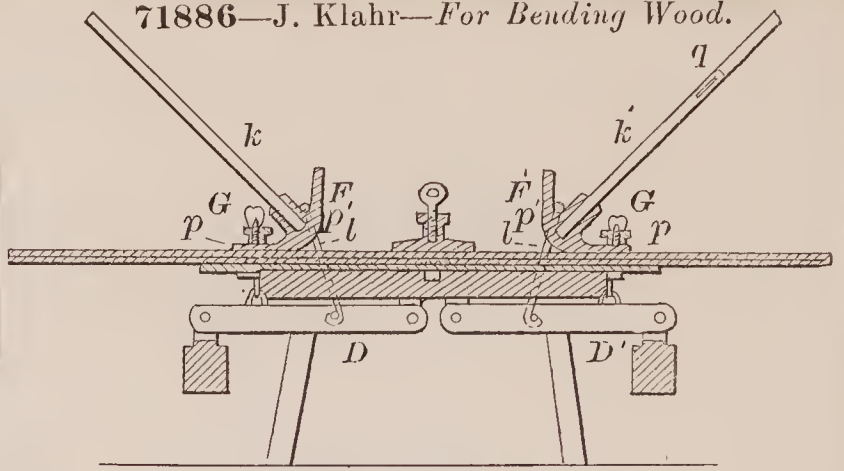

71888—I. Lackey—*Fence.*

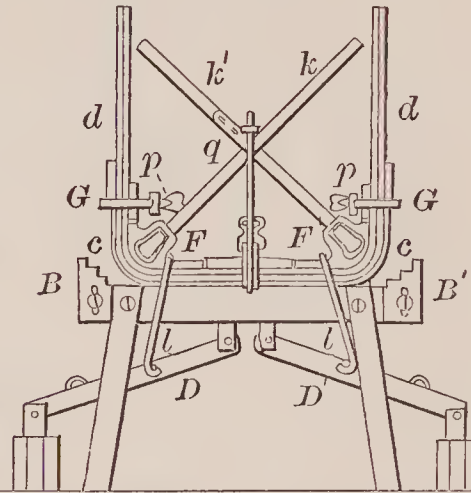

71889—N. Lawrence—*Butter Dish.*

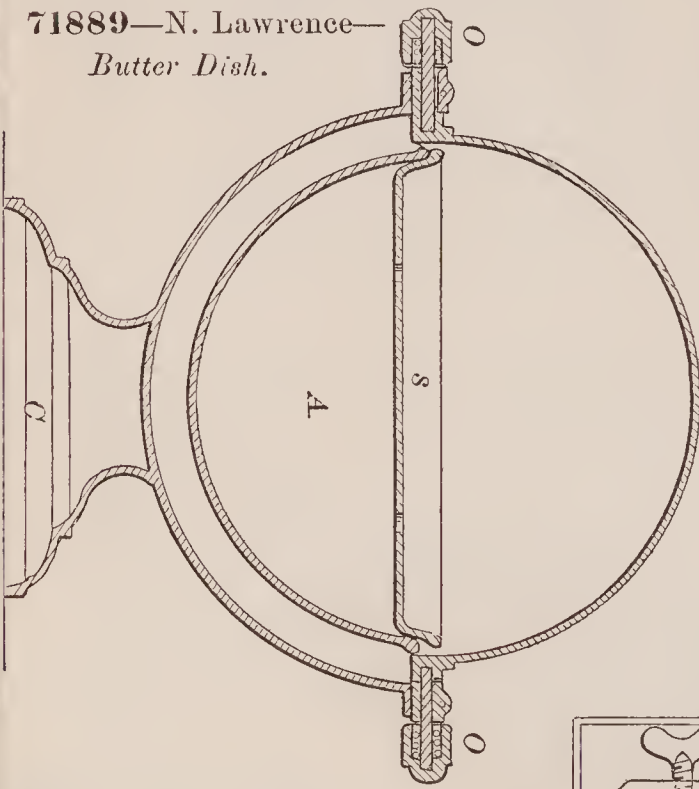

71890—E. J. Leyburn—*Harvester Rake.*

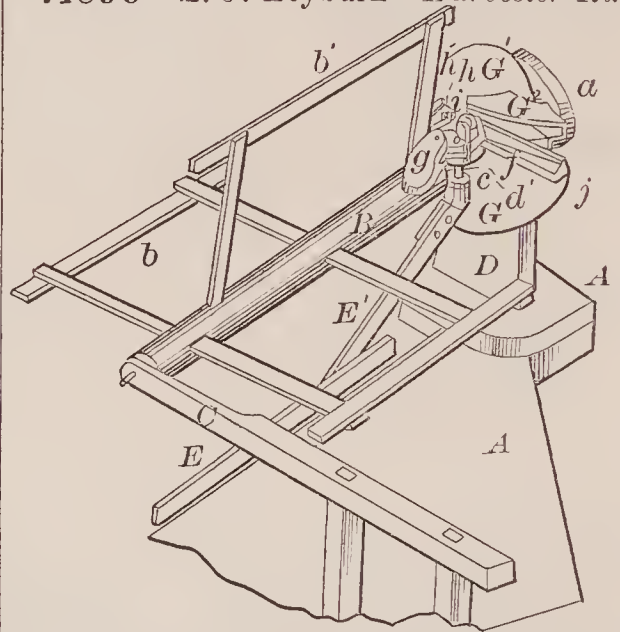

71891—R. Lighthall—*Washing Machine.*

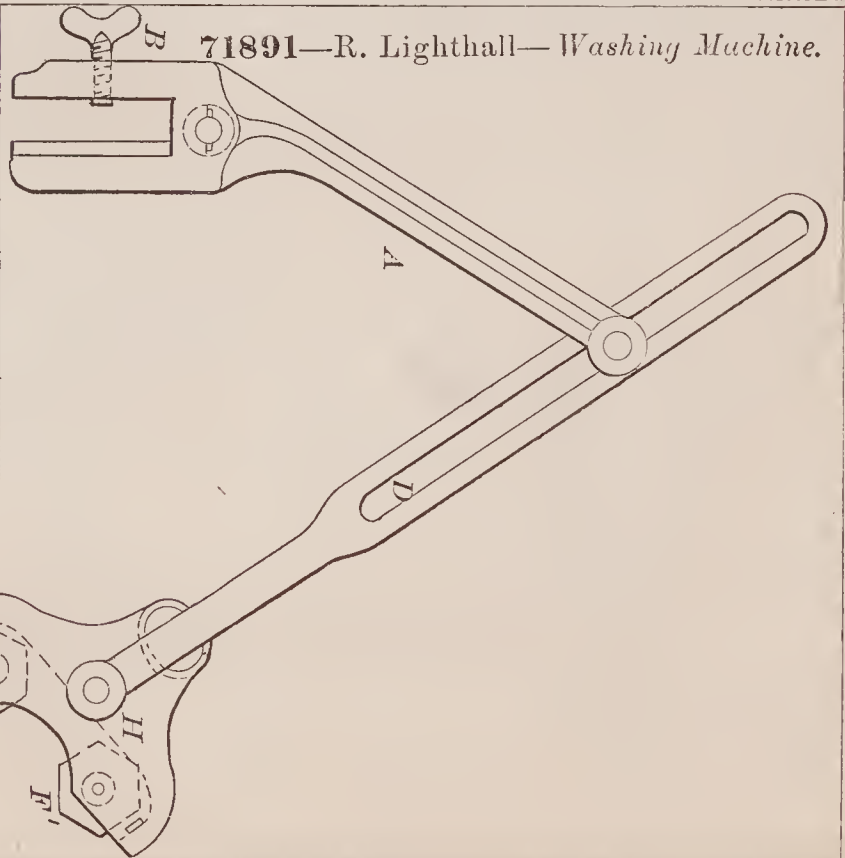

71887—G. A. Knowlton—*Oil Can.*

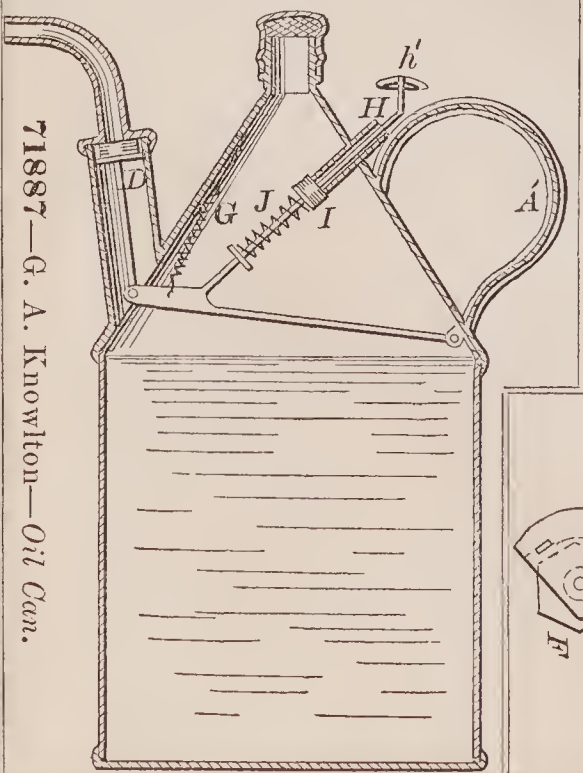

71894—McConnell & Pringle—Street Sweeper.

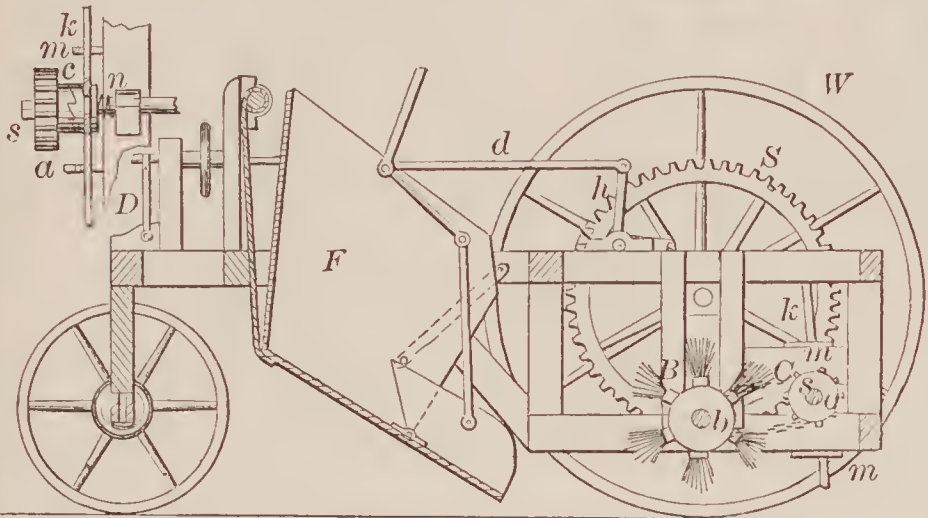
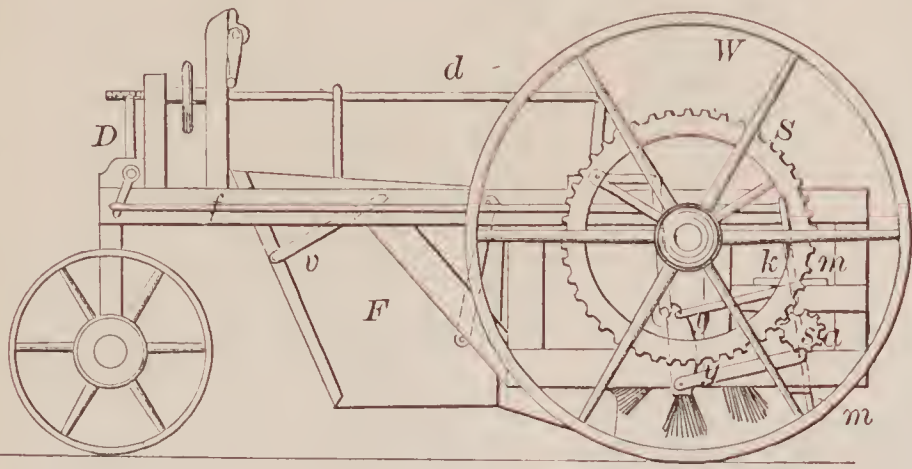

71895—F. Menwether—Uterine Supporter.

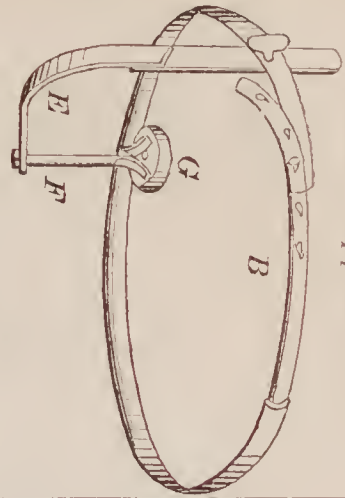

71899—Murdan & Cooper—Water Cooler and Refrigerator.

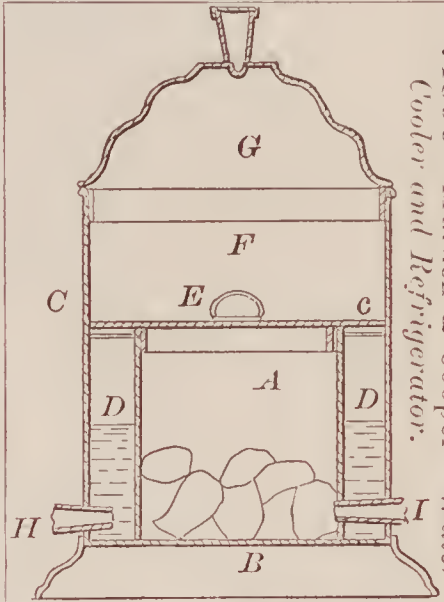

71896—A. S. Miller—Railroad Signal.

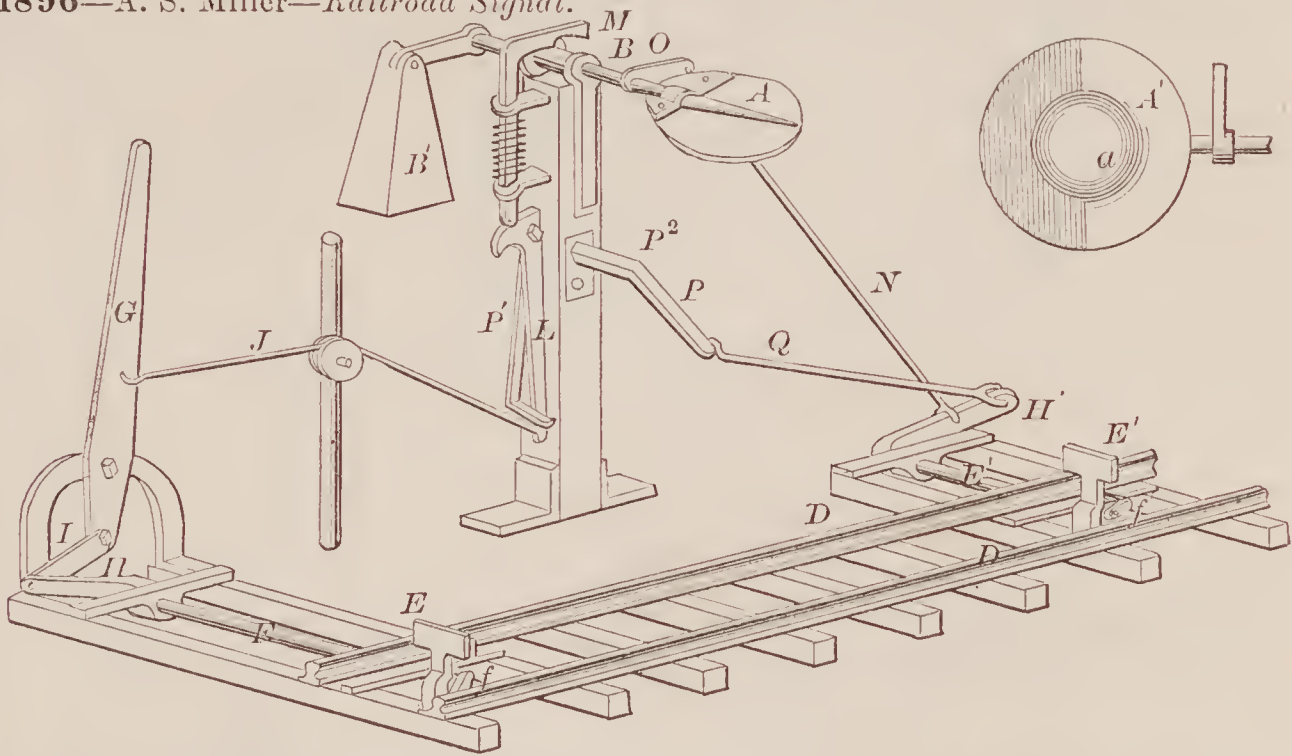

71897—H. Miller—Spinning Wheel.

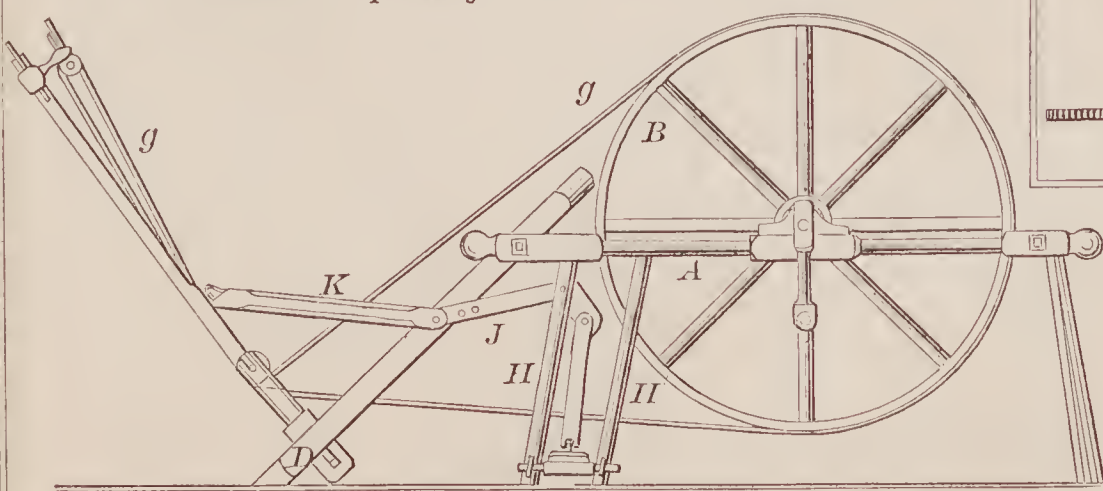

71898—C. Mole—Boot and Shoe.

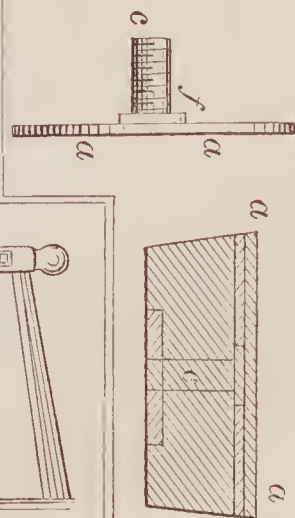



71900—F. G. & W. F. Niedringhaus—  
*Stamped Metal Kettle.*

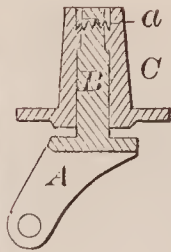
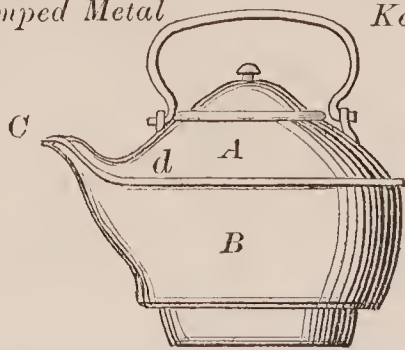

71904—O'Brien &  
*Sparks—Furniture Caster.*

71902—A. Nutting—*Snow Plow.*

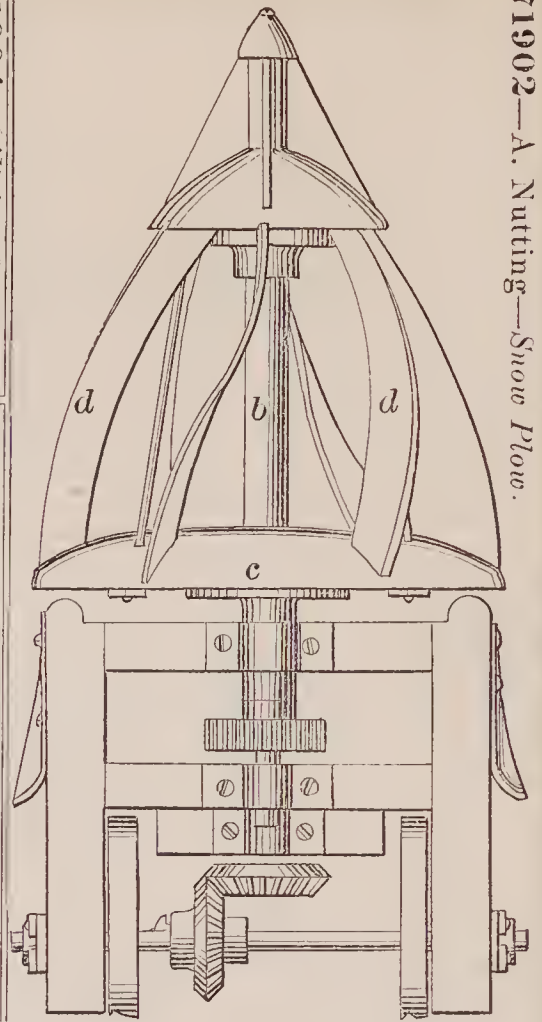

71903—I. R. Oakford—*Steam Generator.*

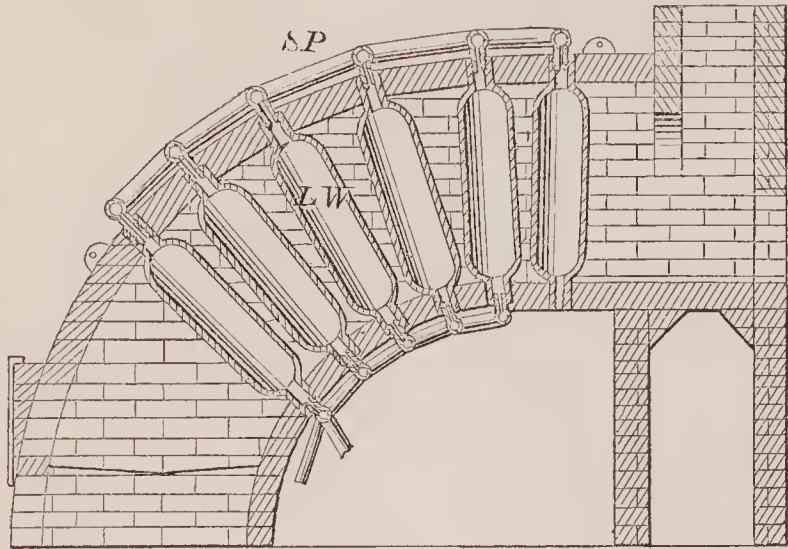

71905—S. N. Park—*Railway Frog.*

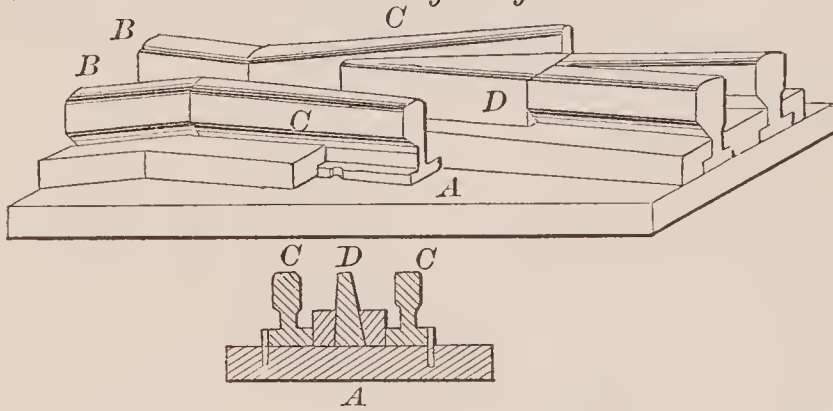

71901—O. B. North—*Breast Strap Slide.*

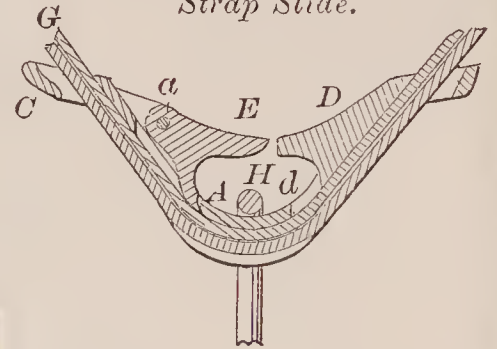

71908—E. S. Pierce—*For Shaving and Slotting Screws.*

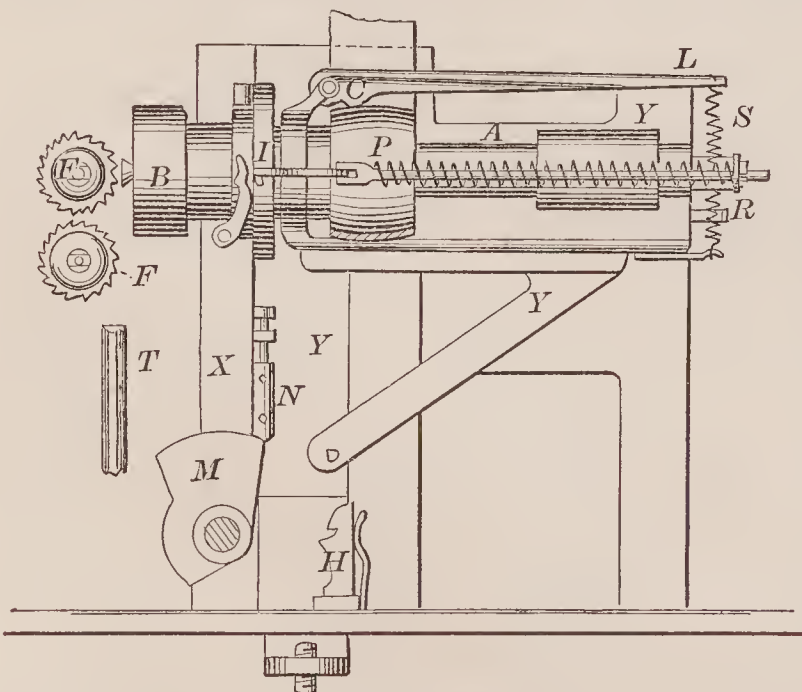

71909—E. S. Pierce—*Double Screw.*



71906—H. W. Pell—*Harvester.*

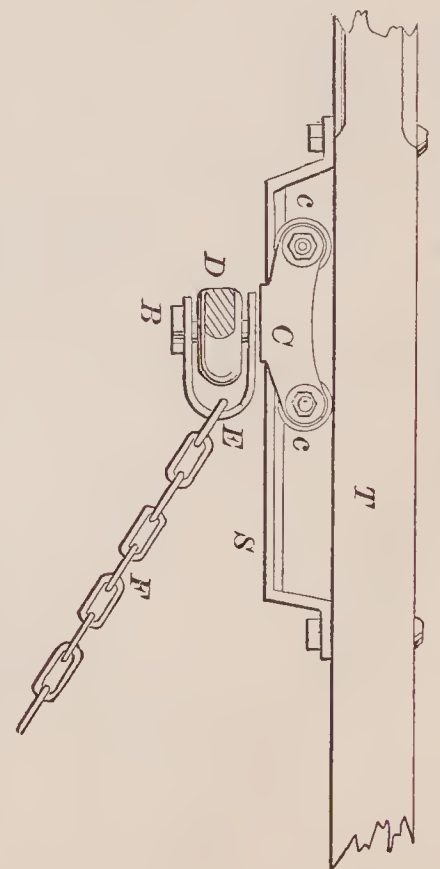

71910—C. F. Pike—For Preserving Perishable Articles.

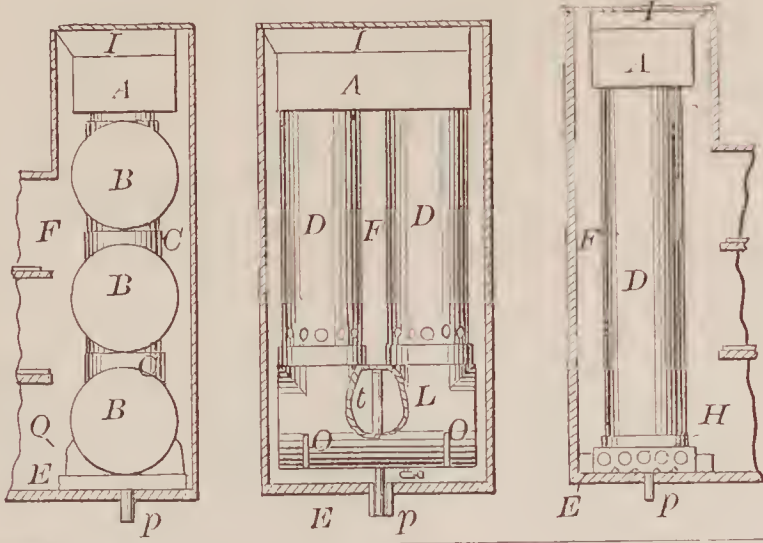

71911—D. W. S. Rawson—Reflector for Photographic Cameras.

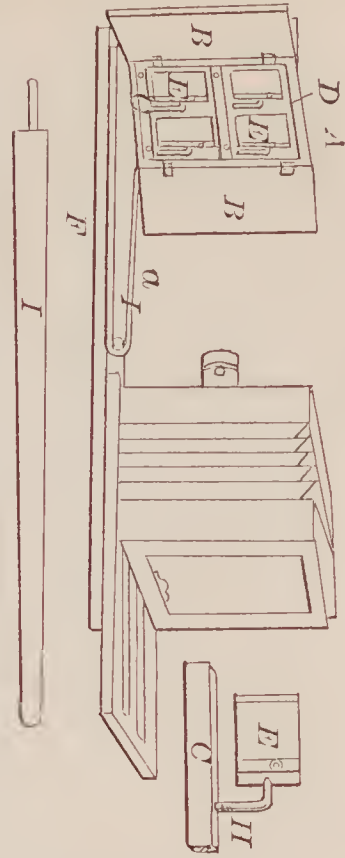

71912—W. F. Ray—Car Spring.

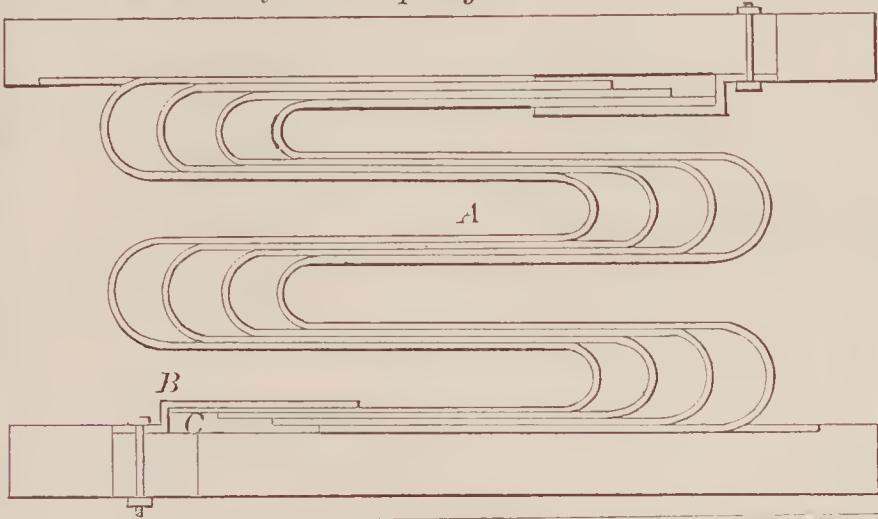

71916—N. Silvester—Horse and Cattle Poke.

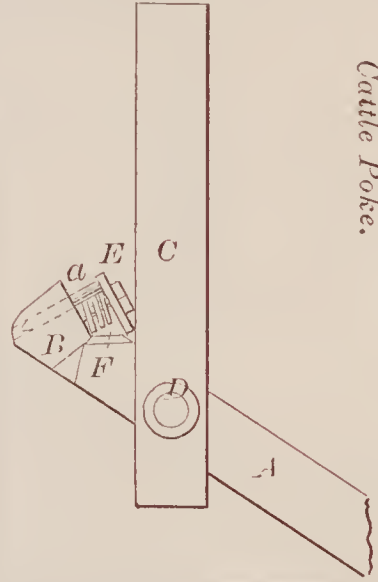

71913—H. Read—Lamp Burner.

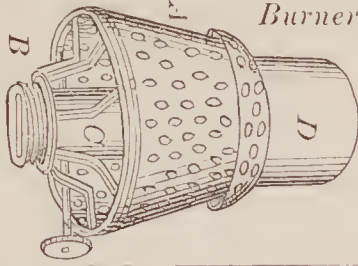

71914—P. R. Sanderson—For Taming Animals.

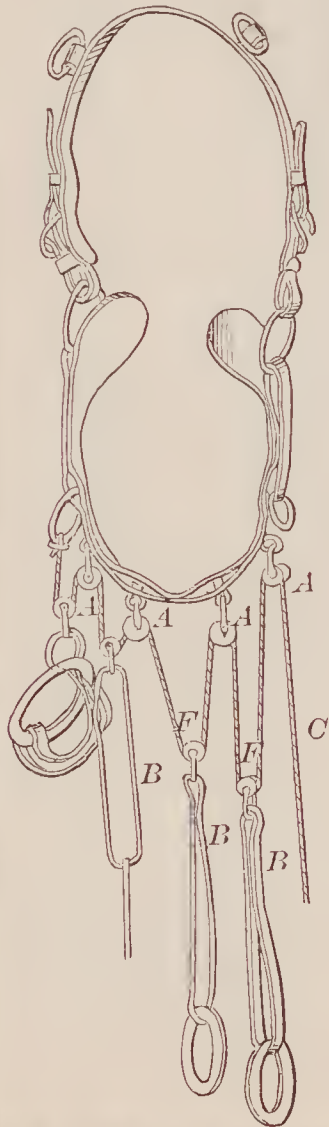

71917—F. J. Smiley—Corn Planter.

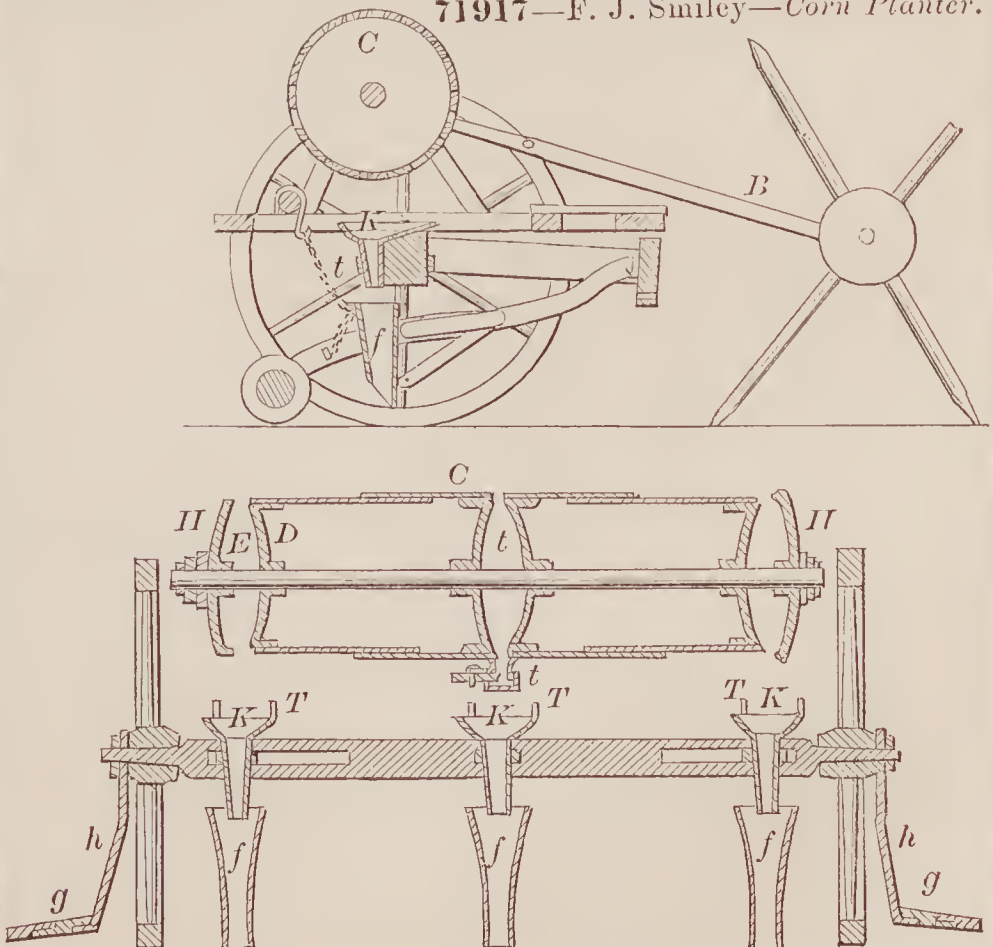



71918—C. A. Smith—Whip Rack.

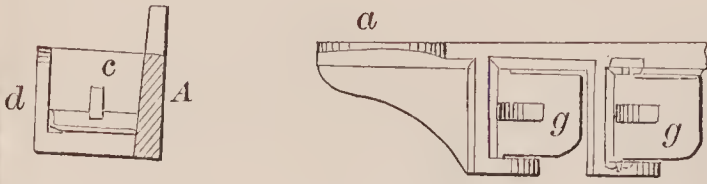

71920—E. E. Stow—Tea Pot Handle.

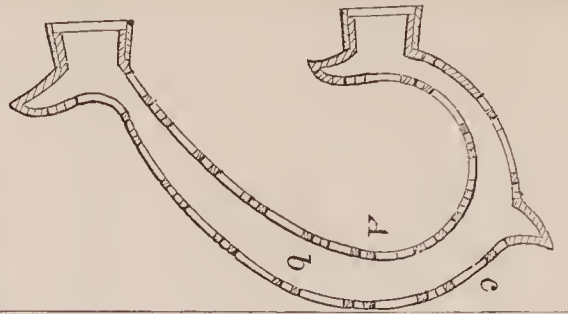

71921—D. Towse—Aerial Carriage and Way.

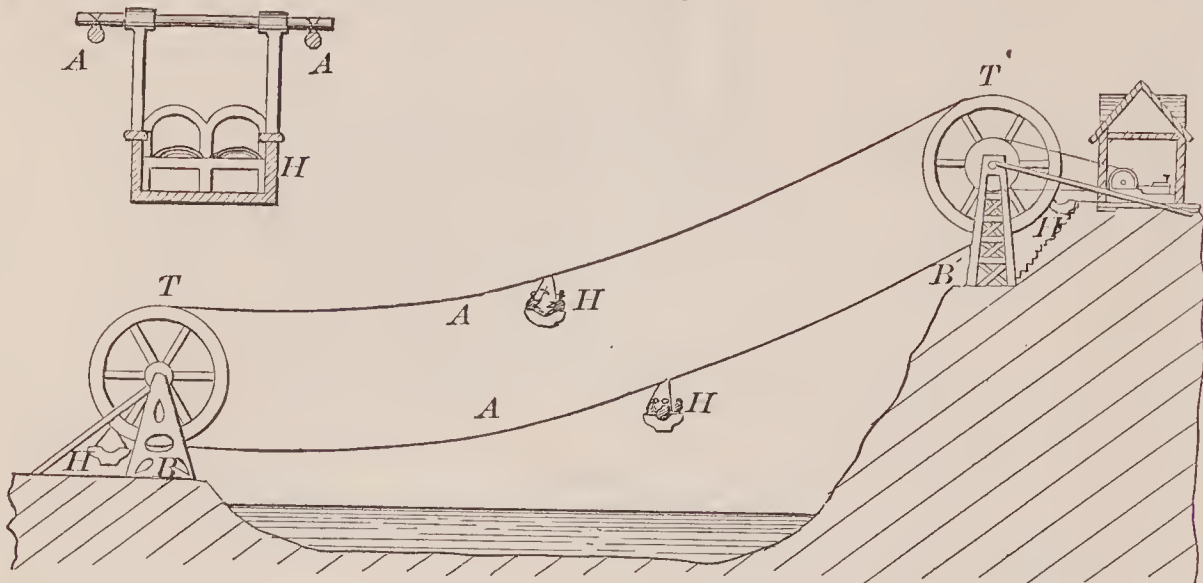

71923—D. Towse—Aerial Carriage and Way.

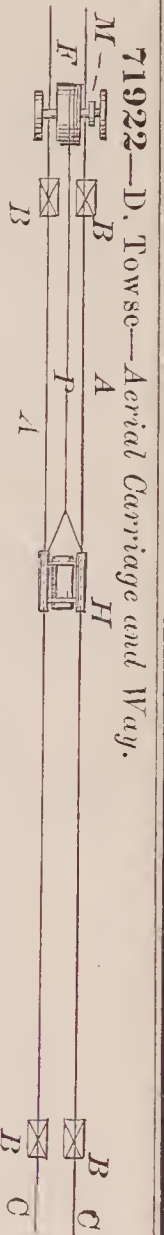

71925—J. A. Veazie—Billiard Billiard Cue Tip.



71928—G. H. Waldo—Horse Hay Fork.

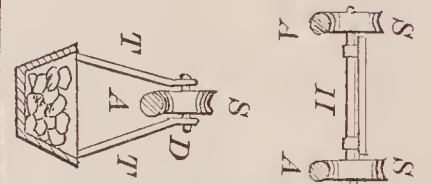
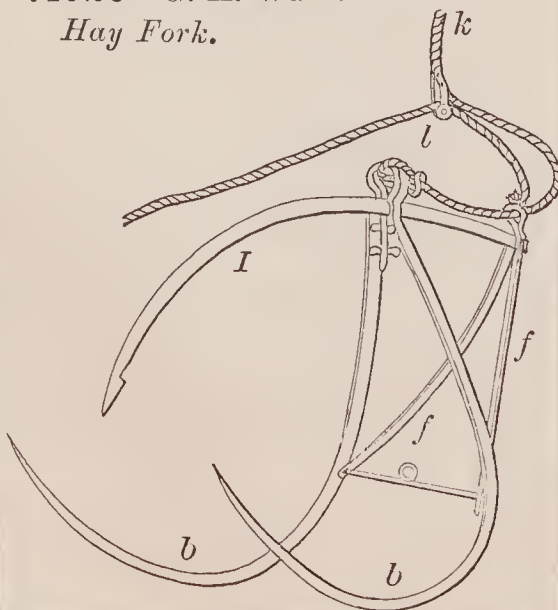

71927—W. P. Wage—For Turning on Gas.

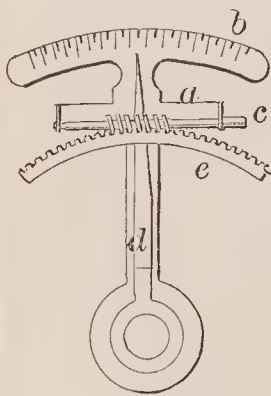
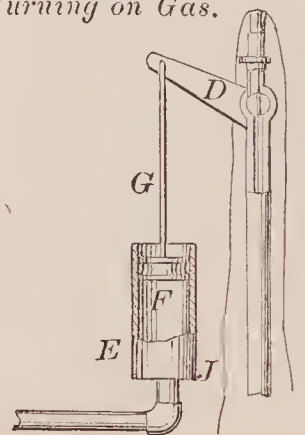

71924—W. B. Tucker—Watch Regulator.

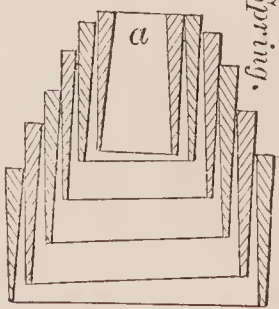

71923—R. Vose—Car Spring.

71929—J. H. Walker—For Rolling Leather.

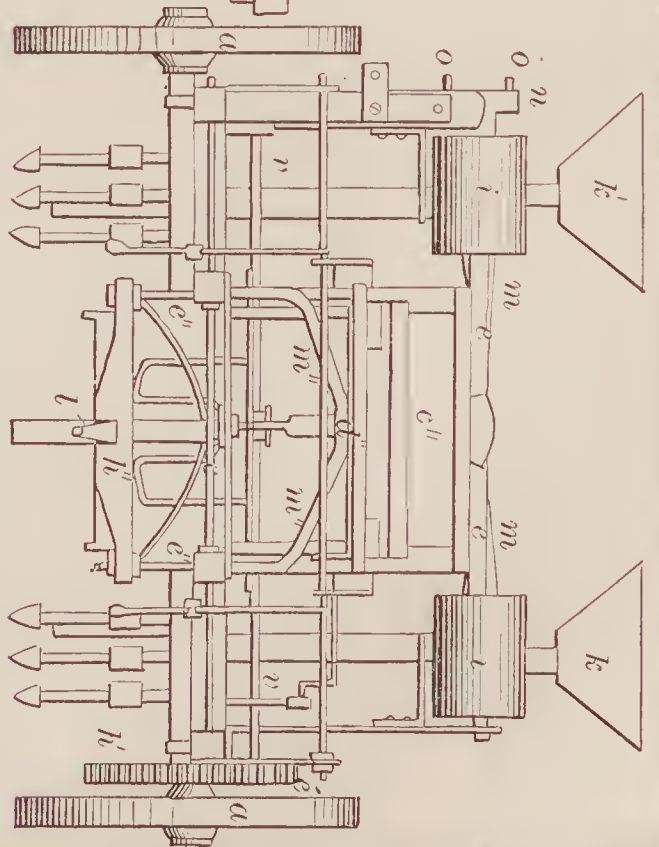
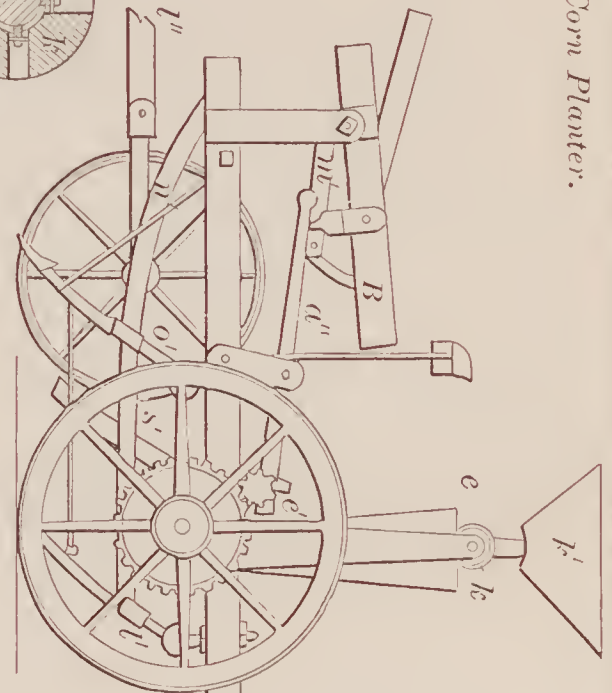
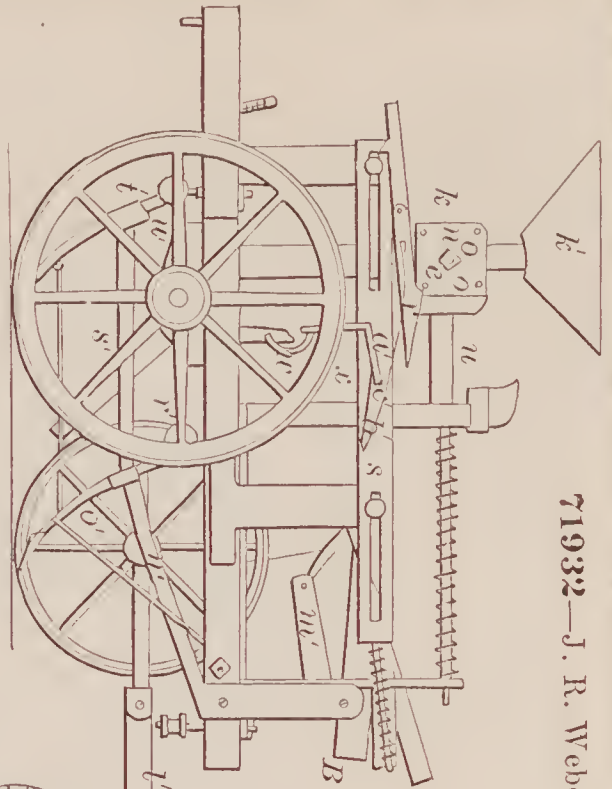
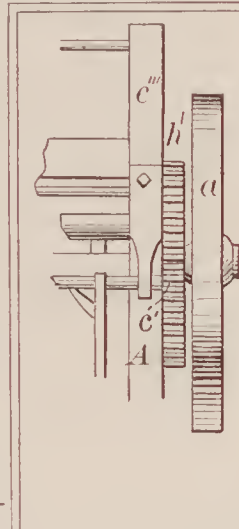
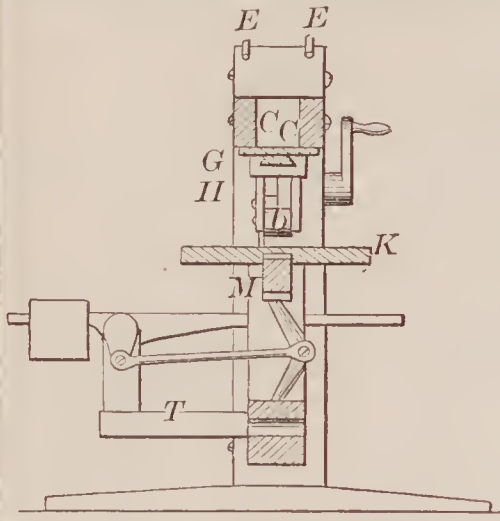
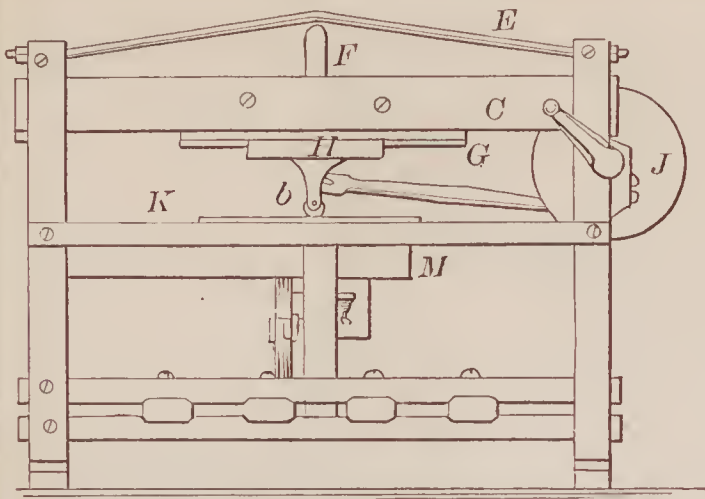

71932—J. R. Weber—Corn Planter.

71930—S. H. Wallize—Fertilizer and Corn Planter.

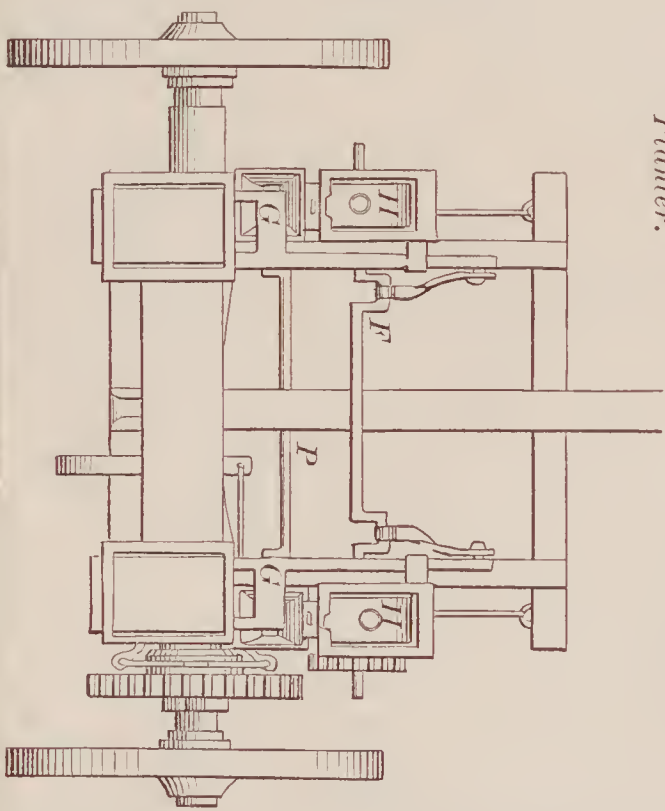

71931—D. T. Ward—Washing Machine.

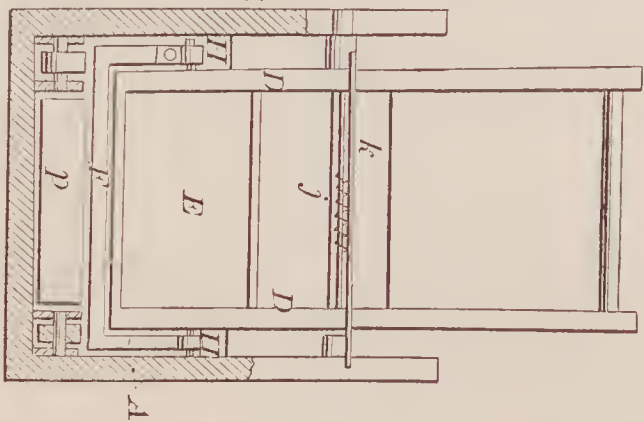



71933—D. S. Williams—Bed Bottom.

H

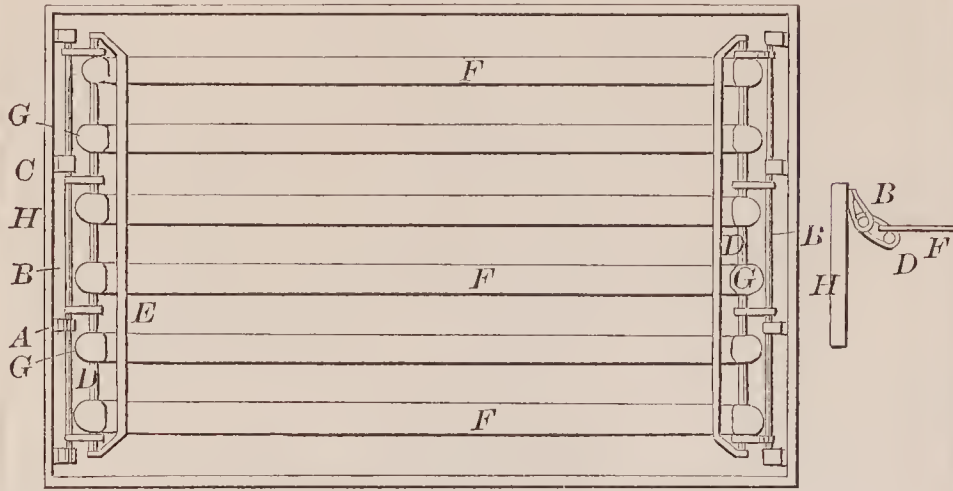

71934—O. Wilson—For Administration of Anesthetics.

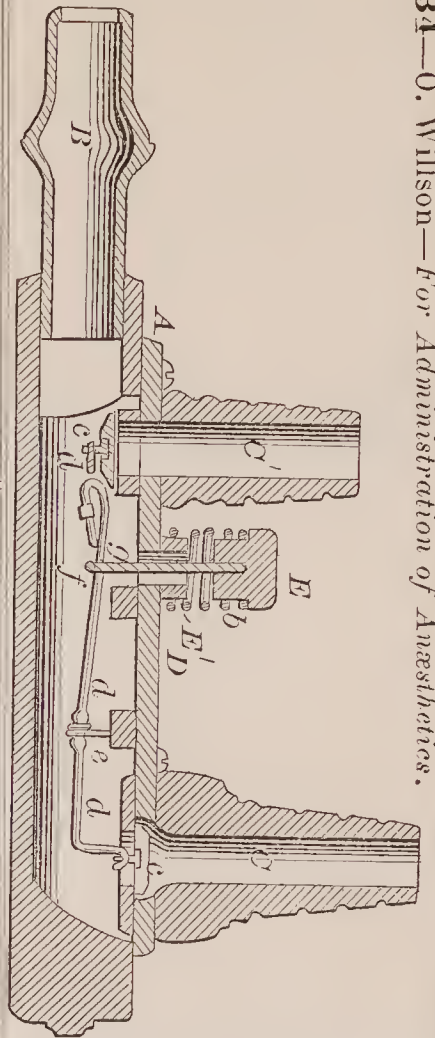

71935—M. Winger—Cider Mill and Press.

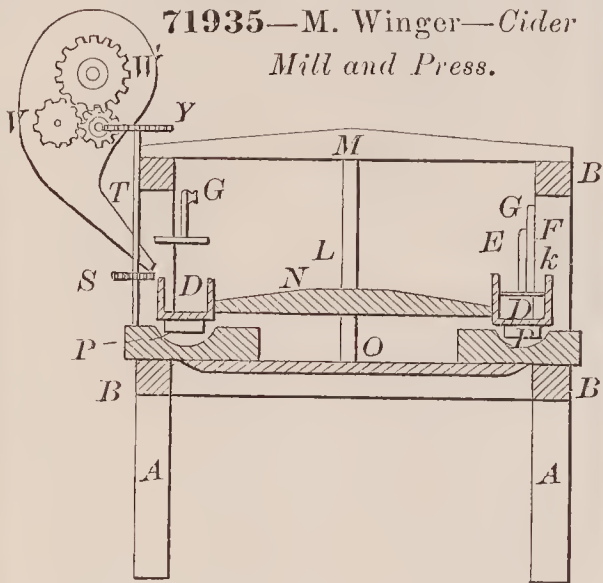

71938—O. E. Woodbury—Sash Stop.

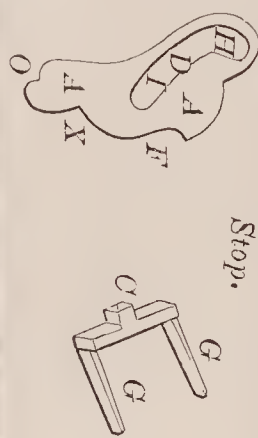

71936—A. Winton—Curb for Water Wheels.

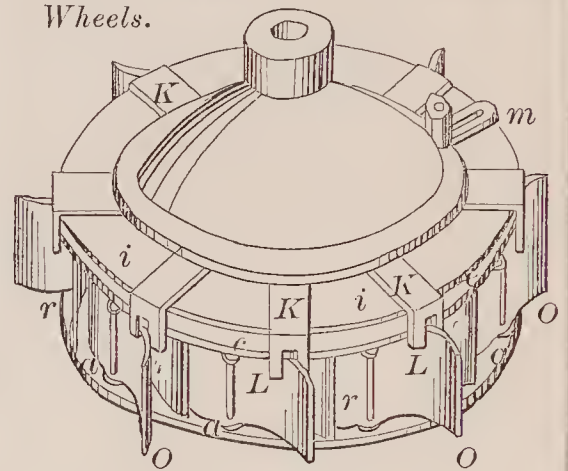

71939—C. D. Wrightington—Peat and Brick Machine.

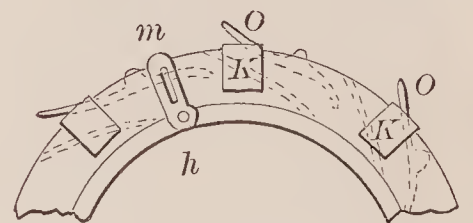
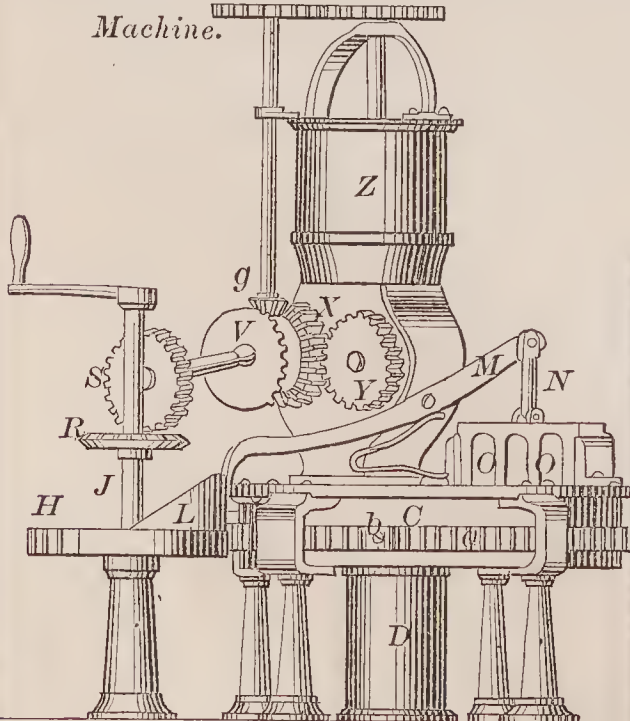

71937—J. Winters—Harvester.

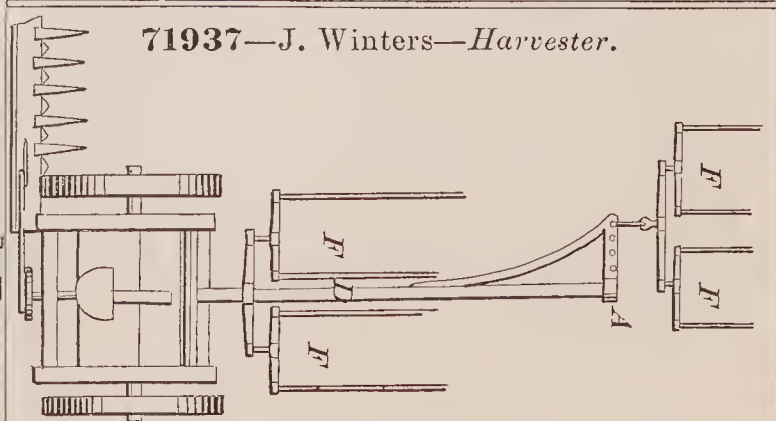

71939—Continued.

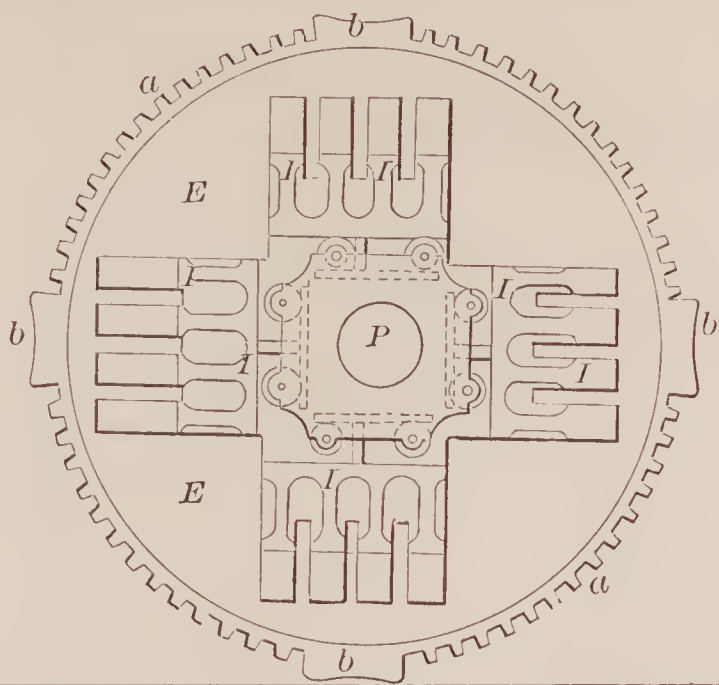

71940—D. Adams—Toy.

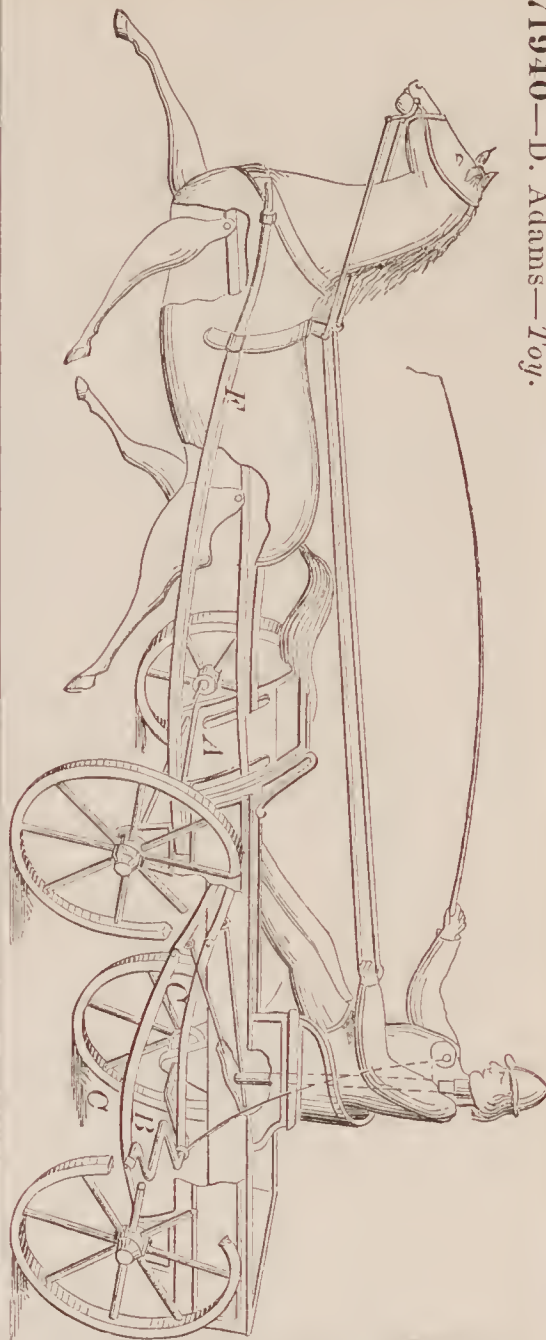

71942—F. A. Alden—Inflating Rubber Ball.

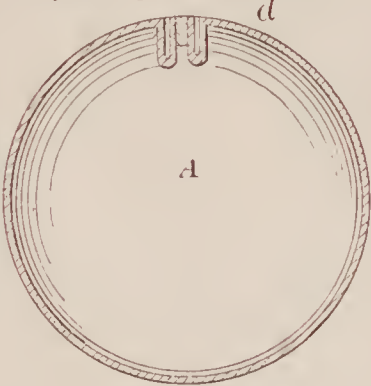

71941—P. Ahn—Eaves Trough Fastening.

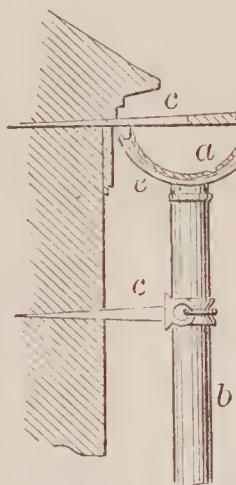

71943—C. Allardice—Reamer.

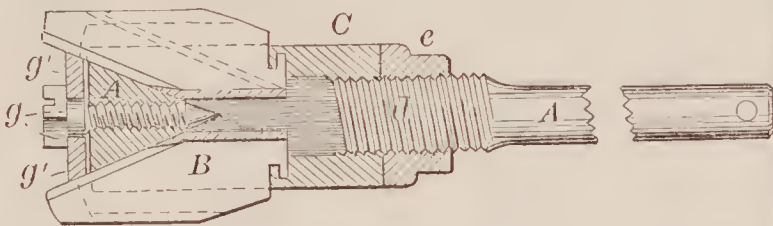

71944—W. H. Andrews—Bolt Attachment to Door Locks.

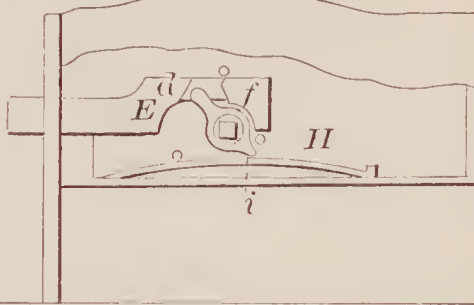

71945—I. Angell—For Presenting Palm Leaf to Looms.

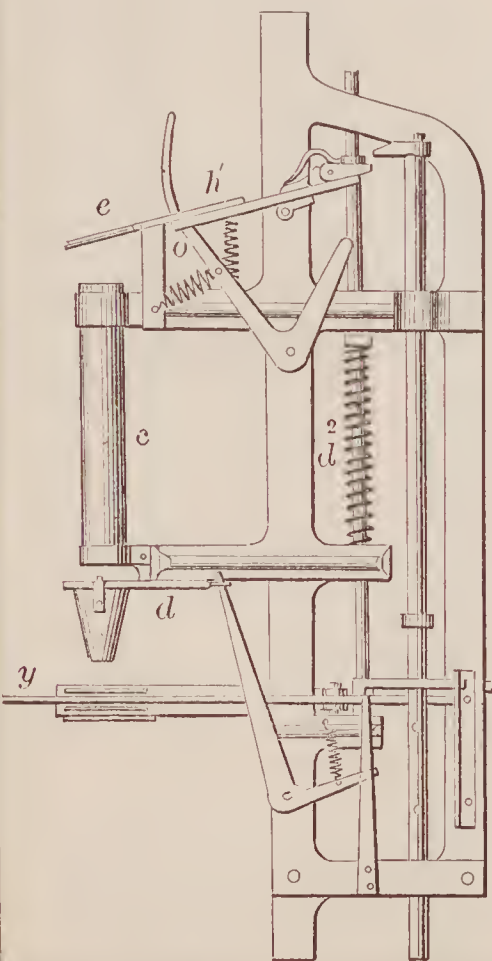

71946—W. Arrowquier—Blackboard for Schools.

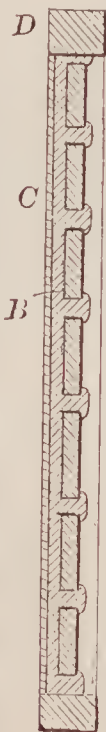

71947—C. E. Bacon—Operating Swell in Melodeons.

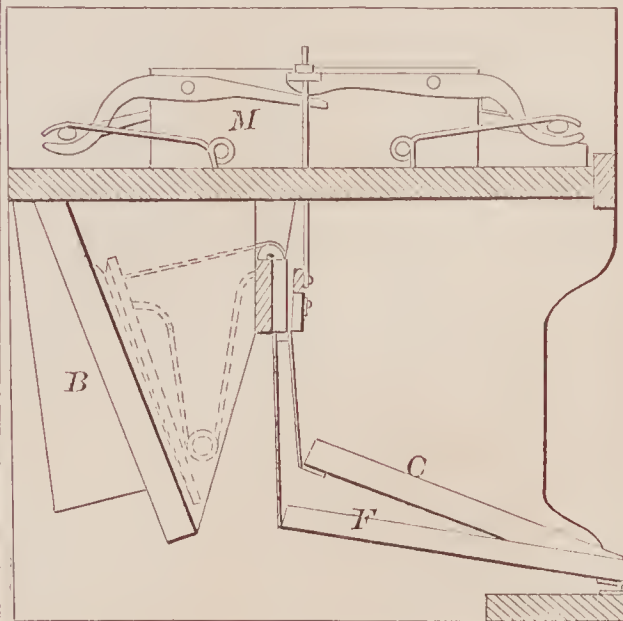



71949—G. E. Baldwin—*Lamp Burner.*

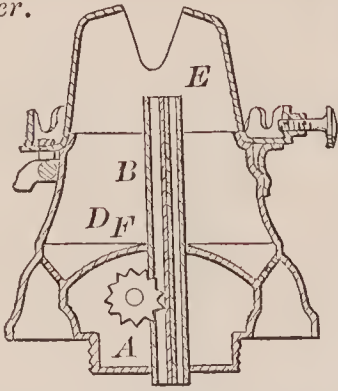

71950—Bannister & Green—*Automatic Tooth Plugger.*

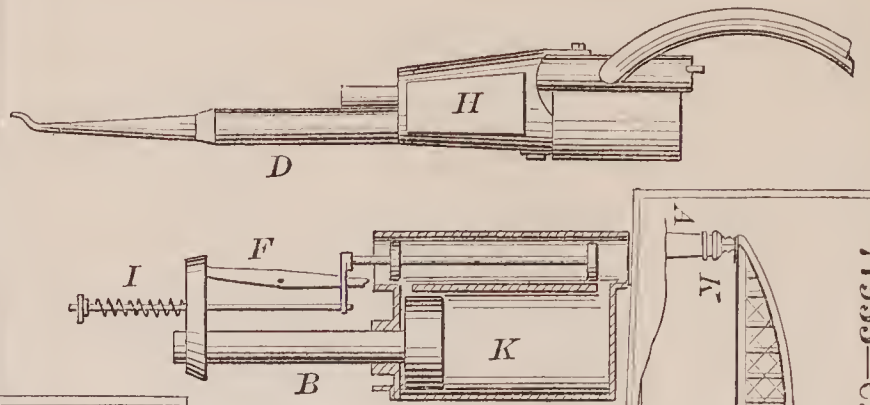

71951—W. F. Barlow—*Car Coupling.*

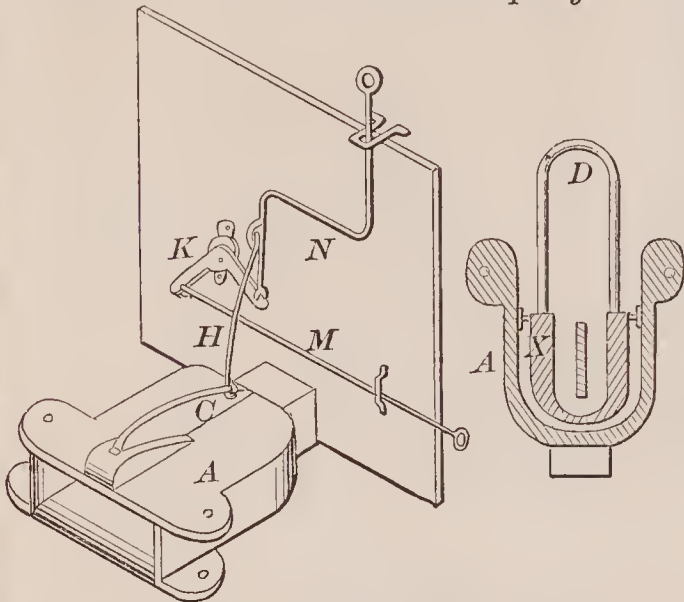

71954—D. B. Beatty—*Plate Lifter.*

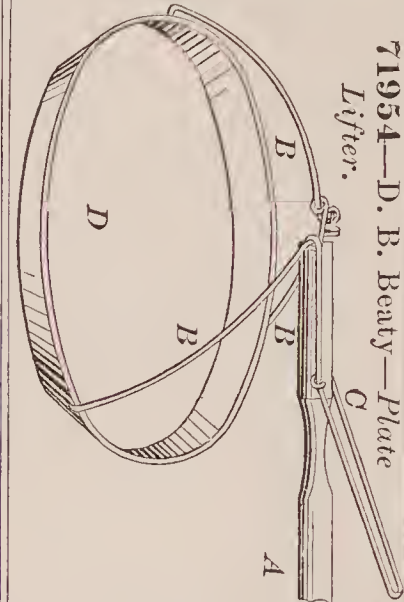

71955—C. Bender—*Suspension Bridge.*

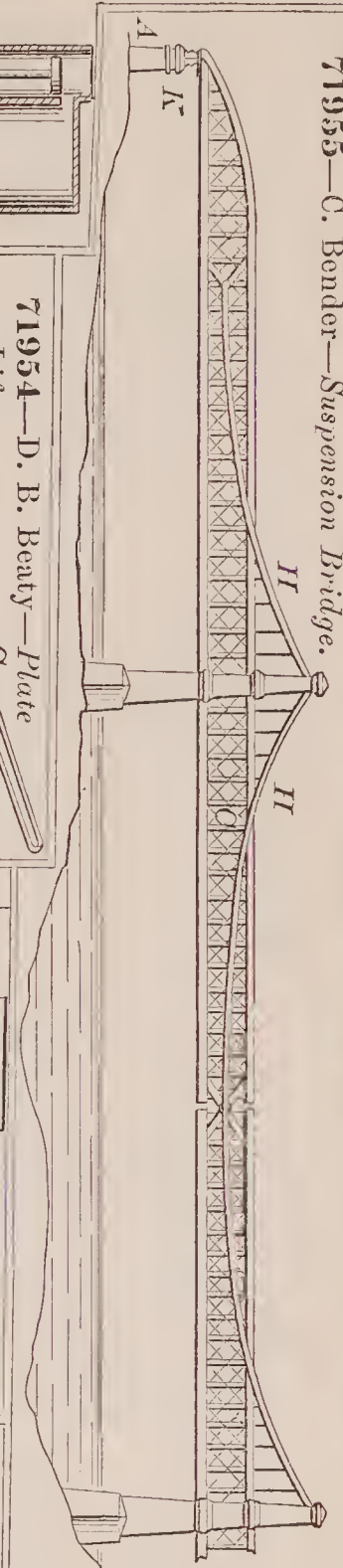

71952—J. Barnes—*Harvester Rake.*

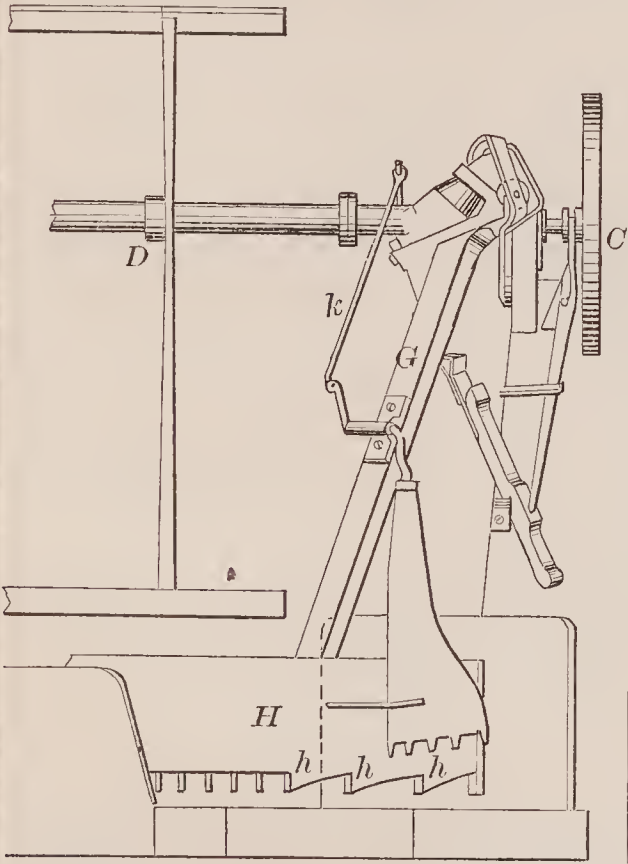

71953—S. N. Batchelder—*Try Square and Bevel.*

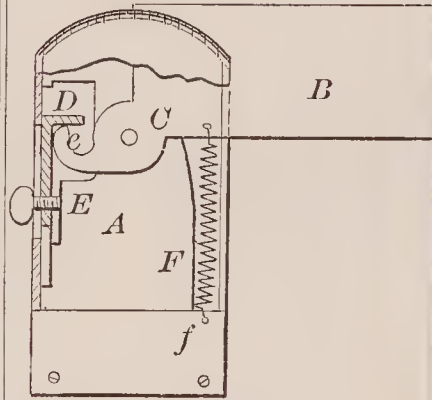

71957—C. H. Berry—*Sofa Bedstead.*

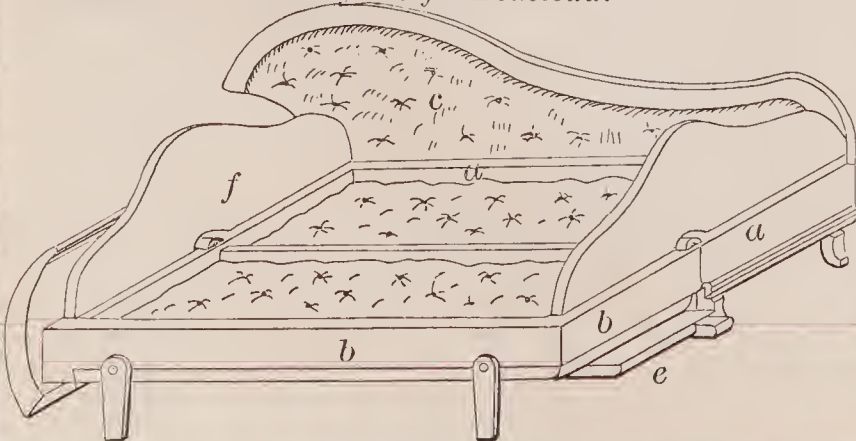

71956—O. K. Bernbaun—*Trunk.*

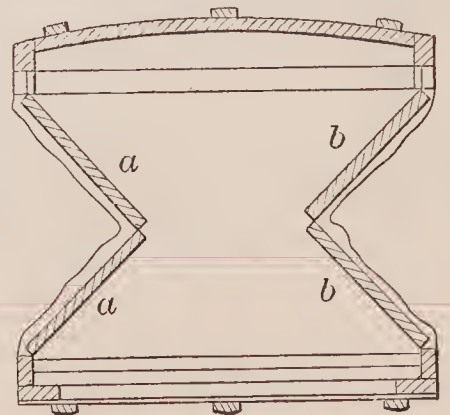

71958—T. Bisbing—Churn.

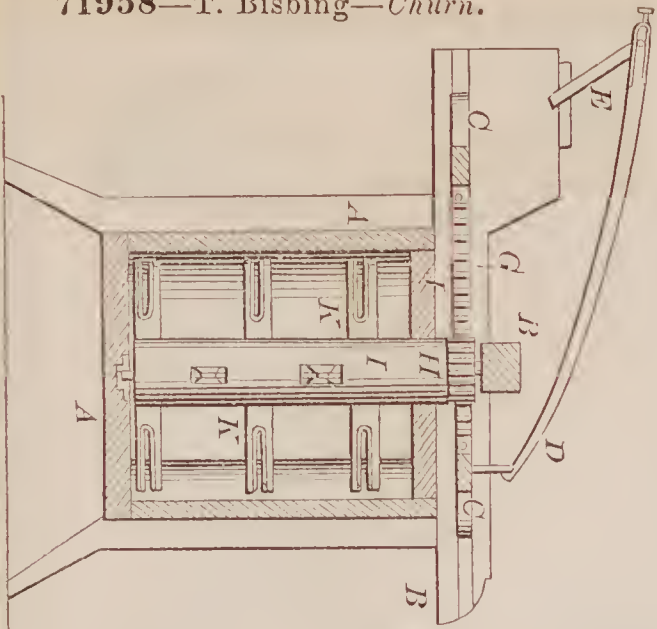

71959—J. W. Blackham—Hat Felting Machine.

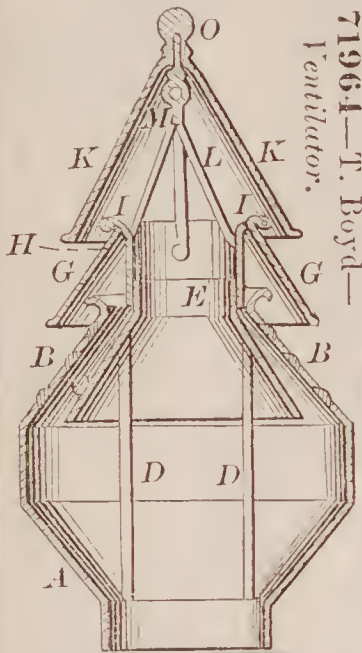
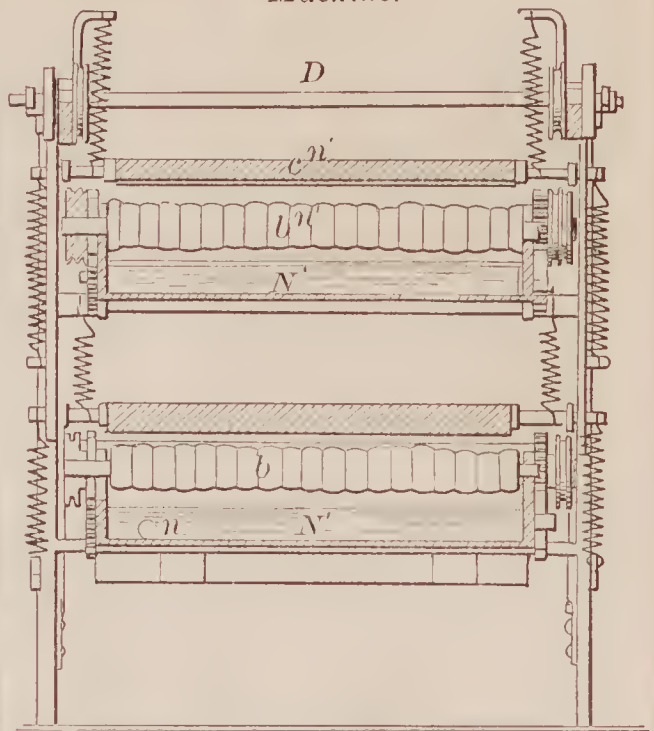

71964—T. Boyd—Ventilator.

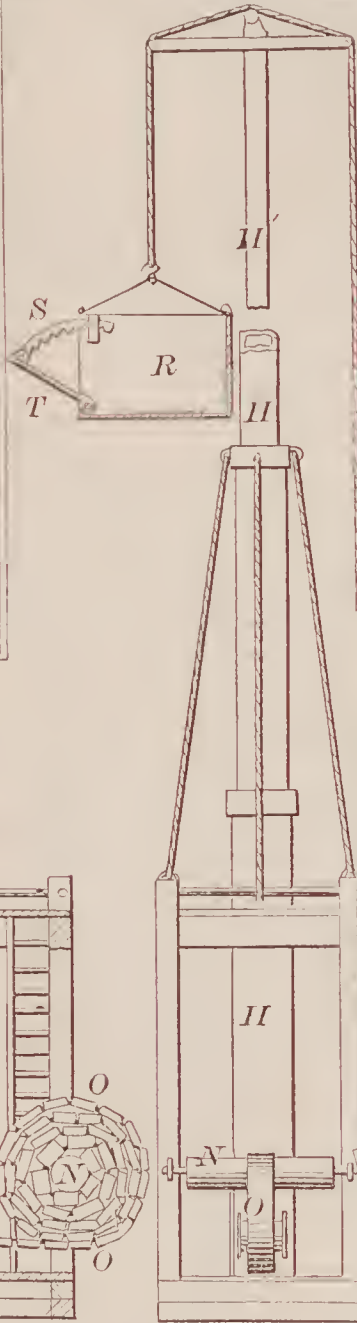

71962—J. Blomgren—Five Ladder.

71963—C. Bowlen—Gun Lock.

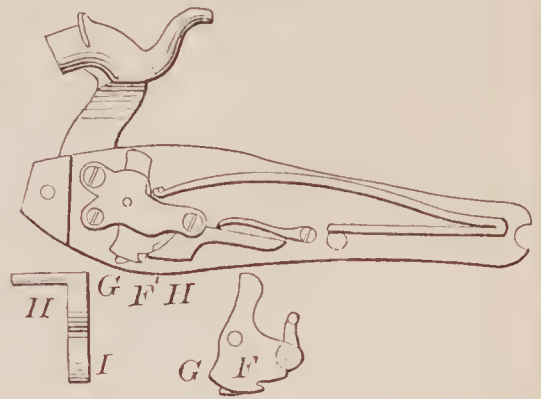

71965—P. Bradford—Door Latch.

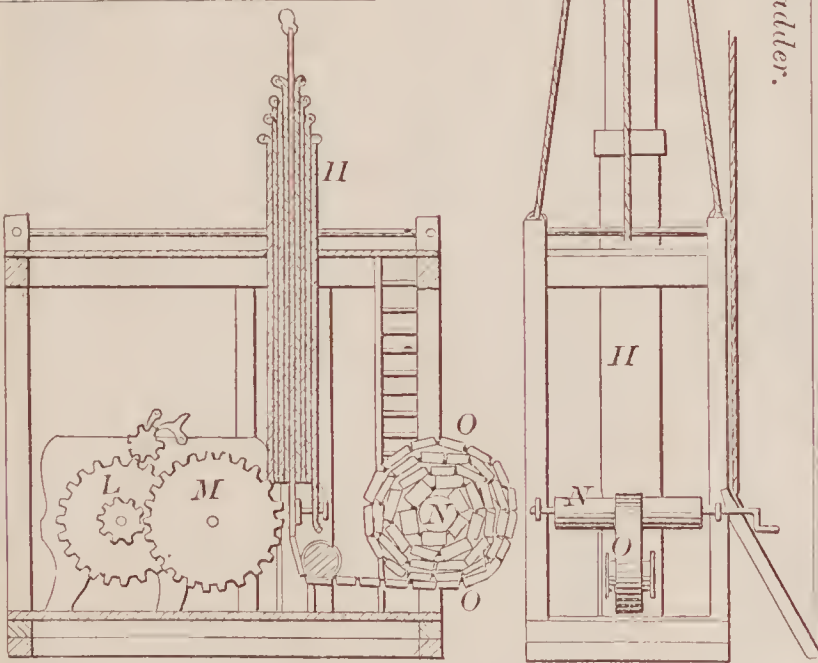
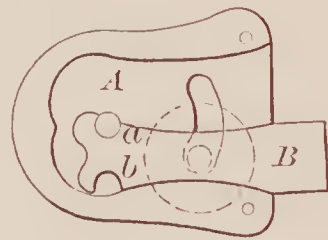

71960—J. E. Bliss—Builders' Scaffold.

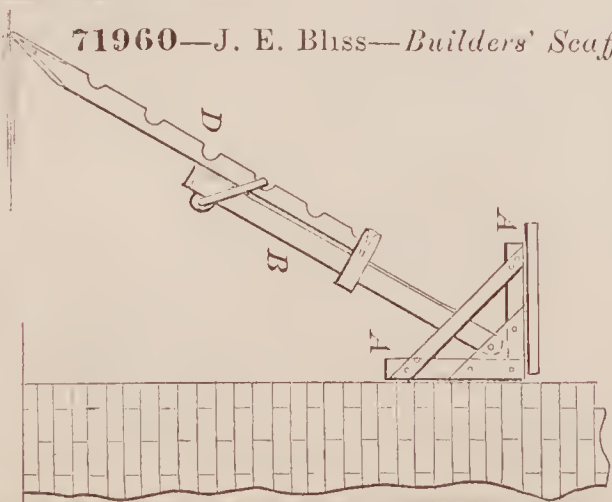

71966—H. Briggs—Plow.



71966—Continued.

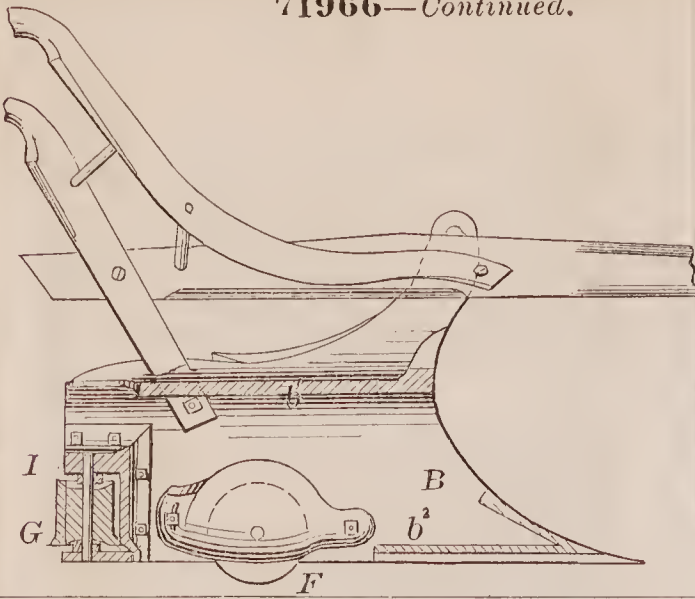

71967—J. Briggs—Piano Stool.

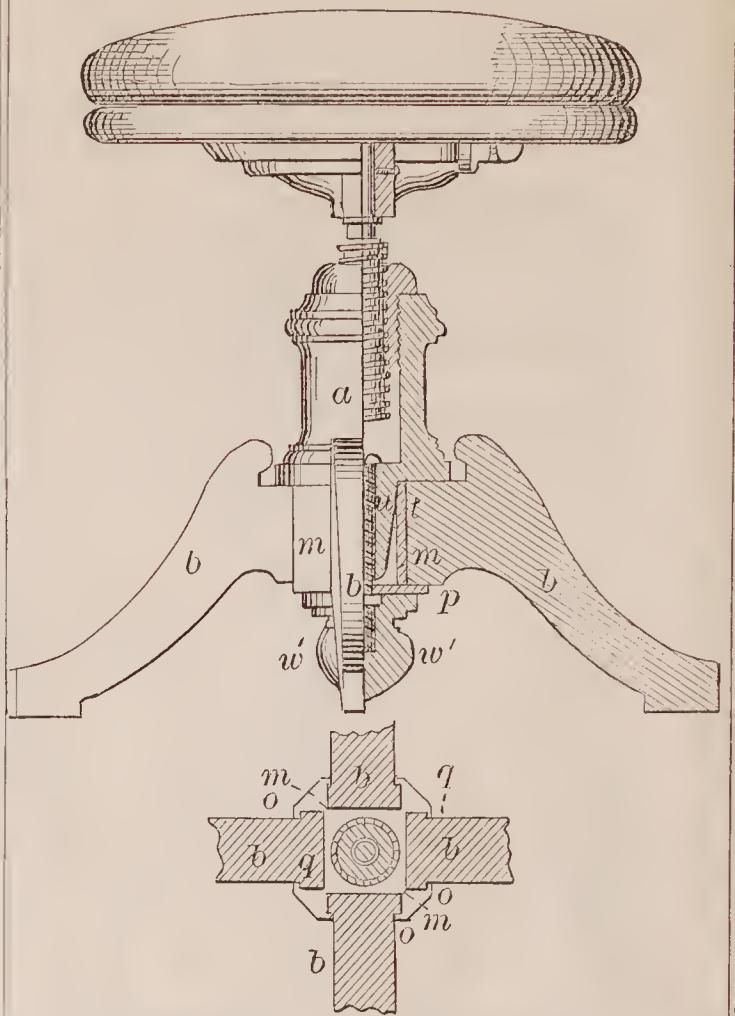

71968—T. E. C. Brinly—Plow.

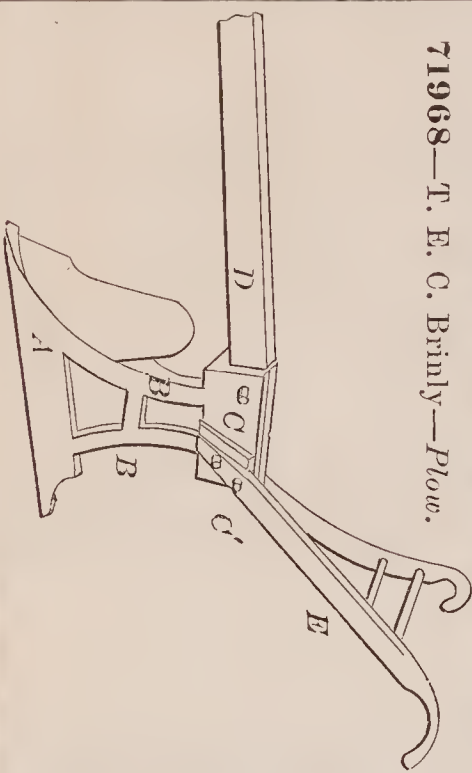

71969—S. P. Brooks—Shovel and Sifter.



71970—A. H. Brown—Seat and Desk.

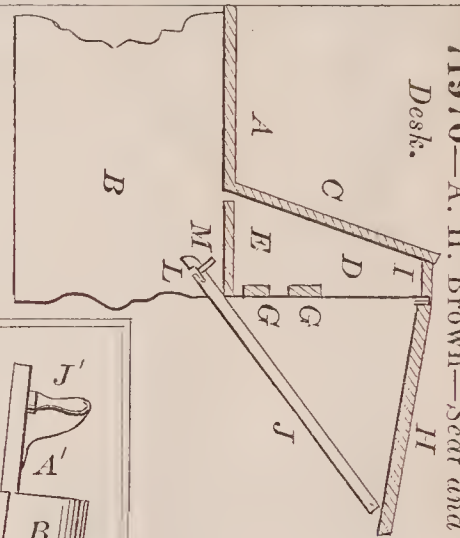

71972—M. S. Burdick—Seed Planter.

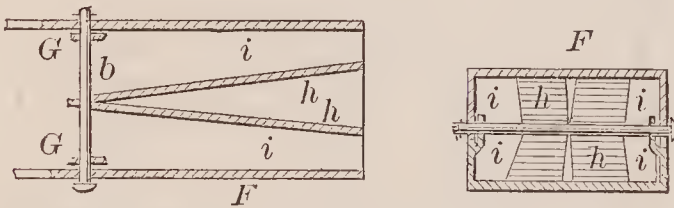

71973—J. A. Burwak—Pulley Block.

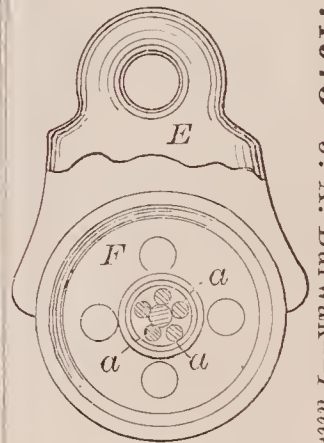

71974—Butterfield & Read—Sad Iron.

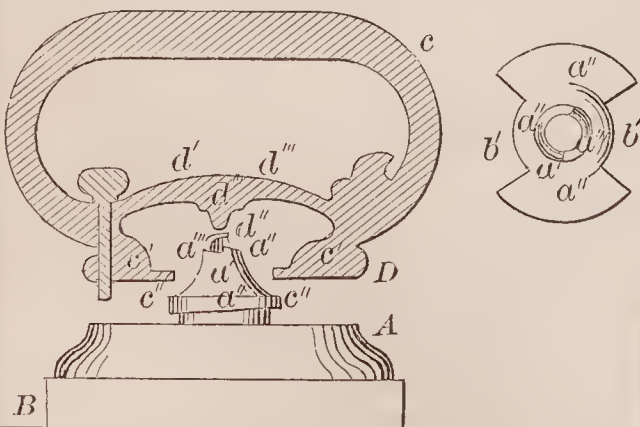

71971—E. G. Bullis—Grain Fork.

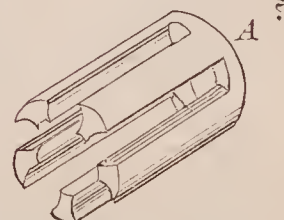
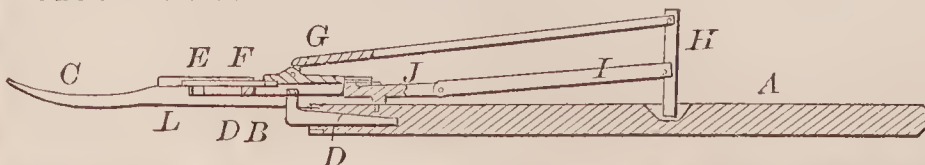

71977—Carter & Park—Spice Cuse.

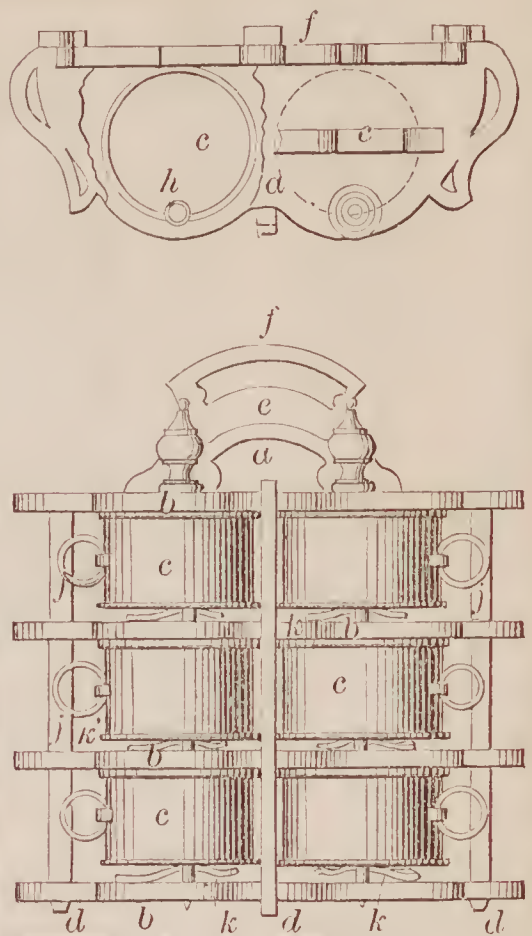

71976—F. H. Carrier—Wash Stand and Clothes Dryer.

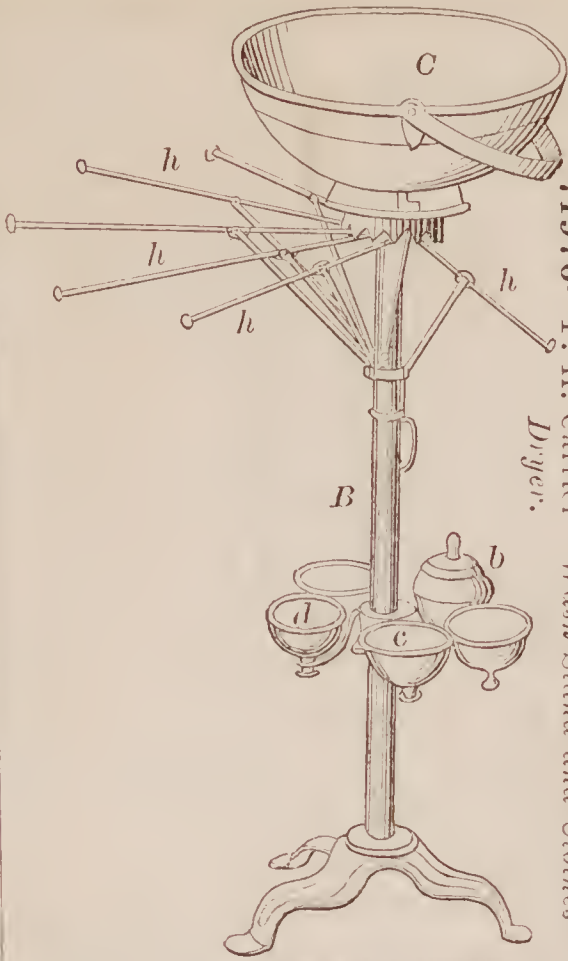

71975—S. P. Carpenter—Pruning Shears.



71978—J. Carter—For Graining Pails, &c.

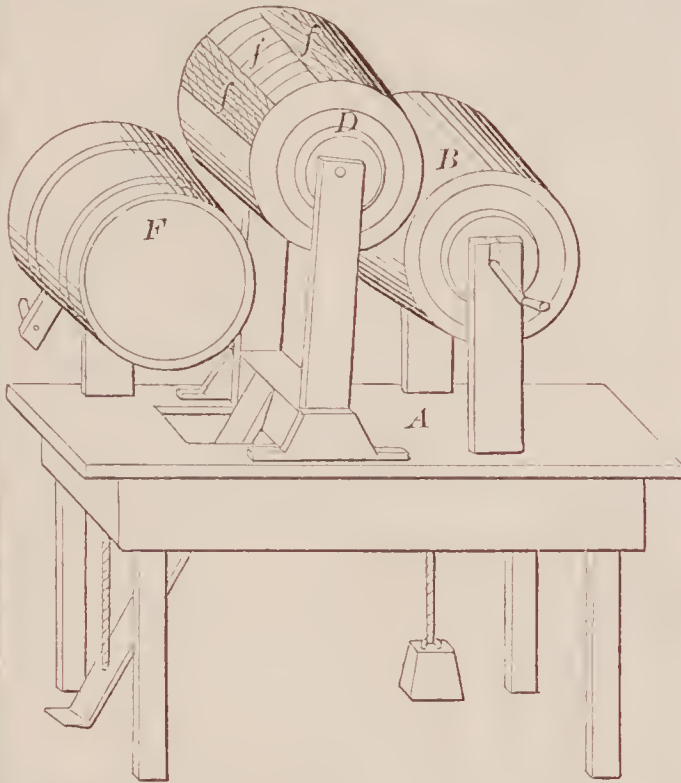

71979—F. Carter—Sawyers' Rule.

9	1	2	3	4	5	6	7	8	9	10	11	12	13	14	15	16	17	18	19	20	21	22	23	24	25	26	27	28	29	30	31	32	33	34	35	36	37	38	39	40	41	42	43	44	45	46	47	48	49	50
1	2	3	4	5	6	7	8	9	10	11	12	13	14	15	16	17	18	19	20	21	22	23	24	25	26	27	28	29	30	31	32	33	34	35	36	37	38	39	40	41	42	43	44	45	46	47	48	49	50	

71982—F. Clymer—Door Latch.

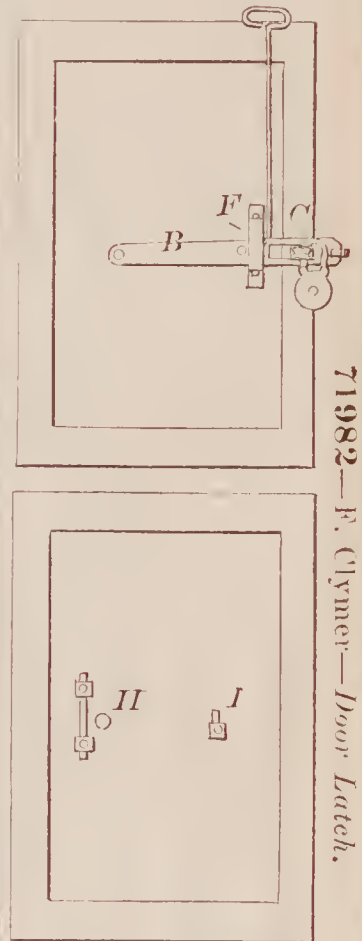

71981—G. Clark—Vacuum Grain Dryer.

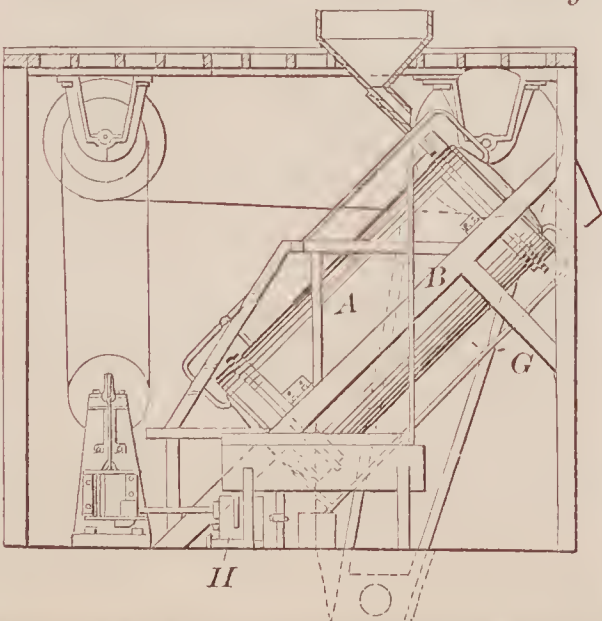

71983—Coe & Snow—Clamp.

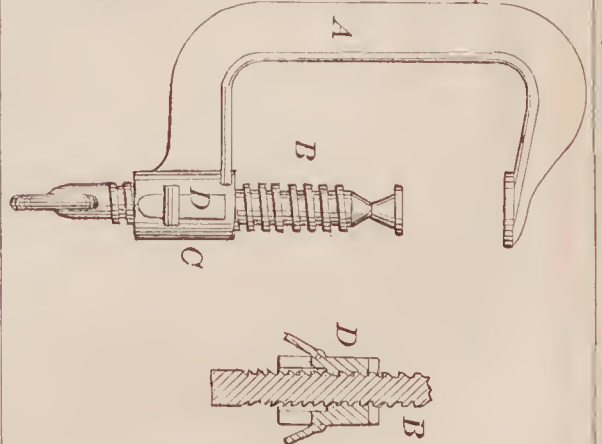

71980—J. Chatillon—Case for Spring Balance.





71985—J. R. Cole—*For Elevating Water.*

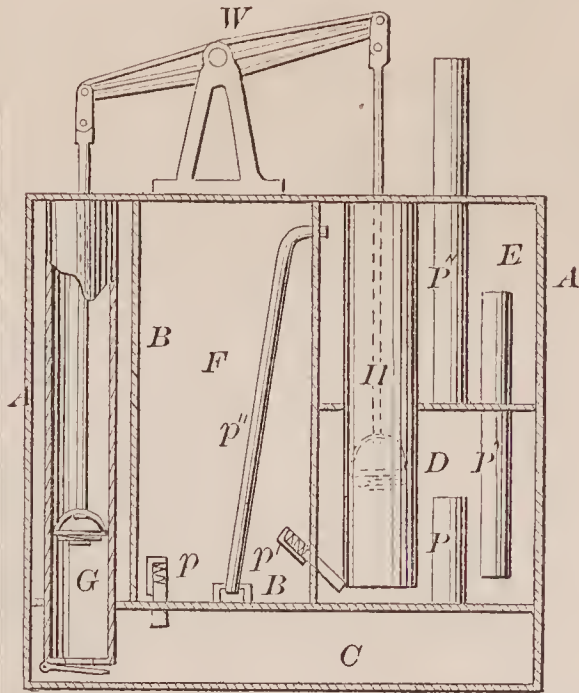

71986—F. A. Conklin—*Tack Hammer.*

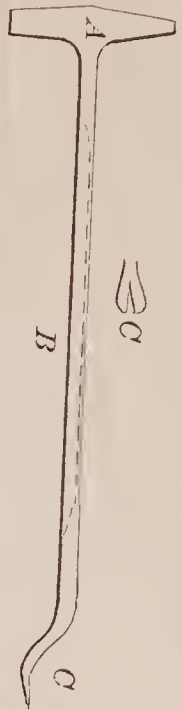

71984—D. L. Cohen—*Boat Detaching Tackle*

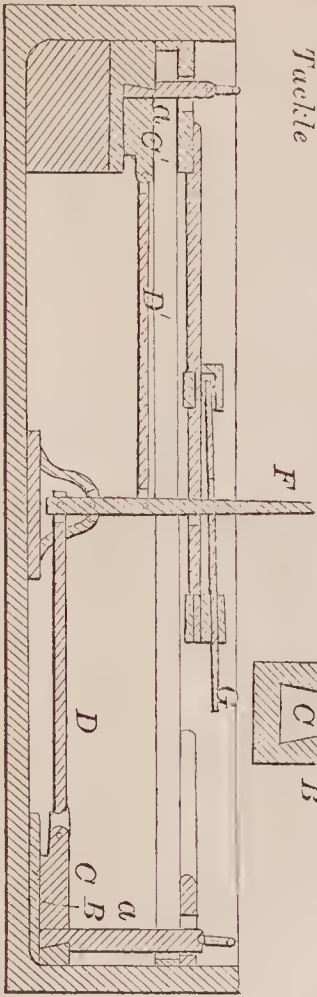

71989—F. C. Coppage—*Harvester.*

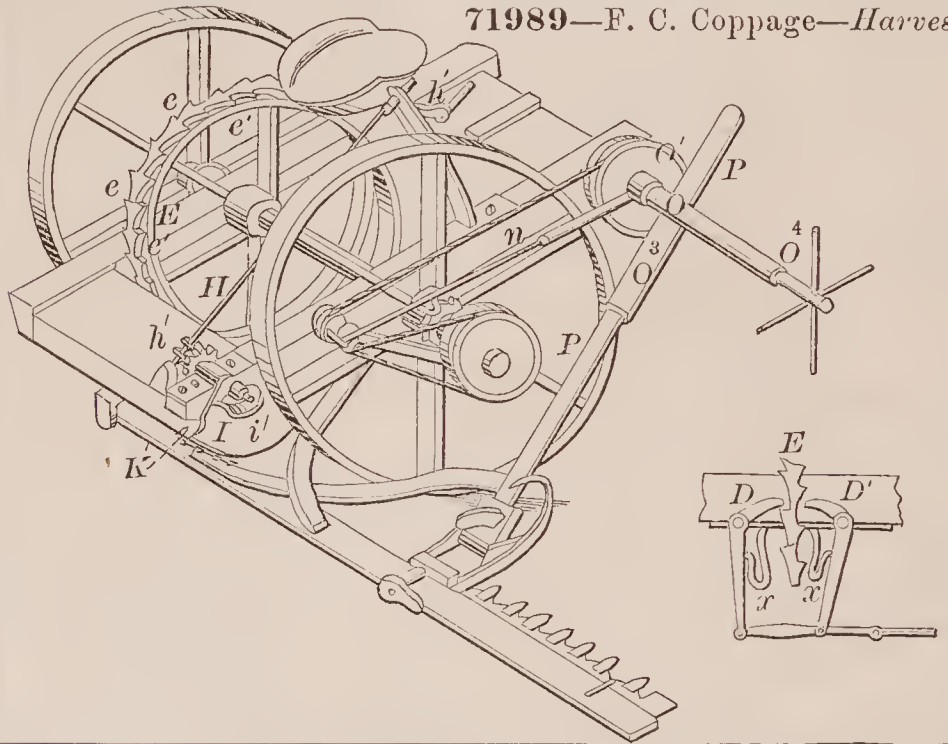

71987—Connor & Mitchell—*Floor Clamp.*

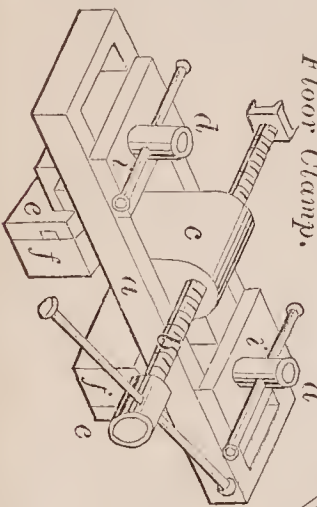

71990—A. C. Corpe—*For Stretching Cloth.*

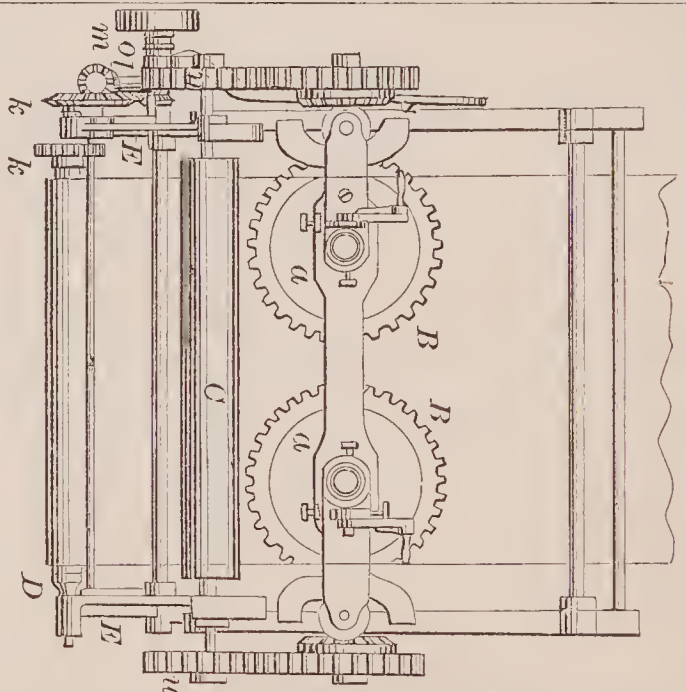

71991—B. R. Cotton—*Roller for Dressing.*

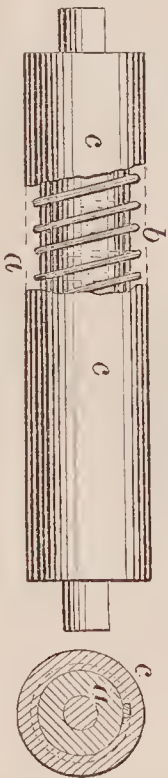

71988—G. Cooke—*Button.*

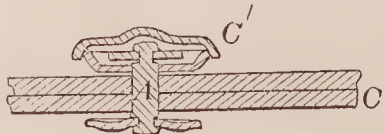

71992—J. A. Counts—*Wagon Lock.*

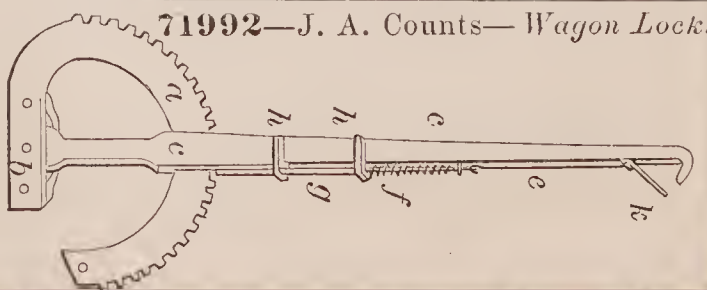

71993—J. C. Covert—Hame Tug.

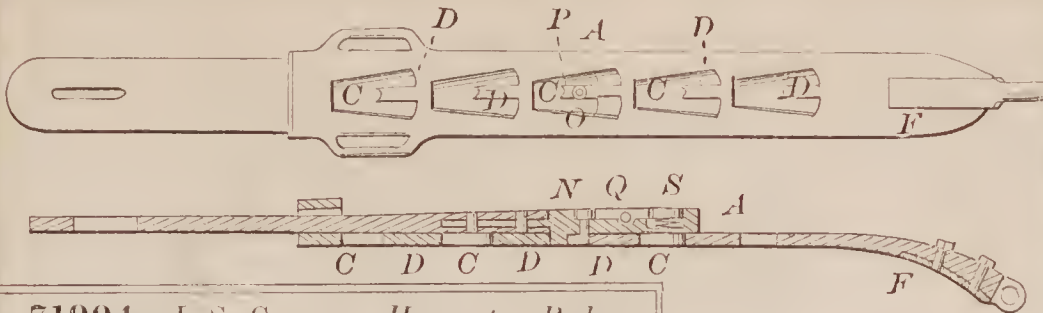

71995—S. W. Curtiss—Washing Machine.

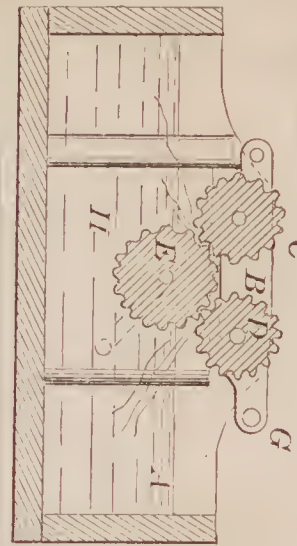

71994—J. S. Crump—Harvester Rake.

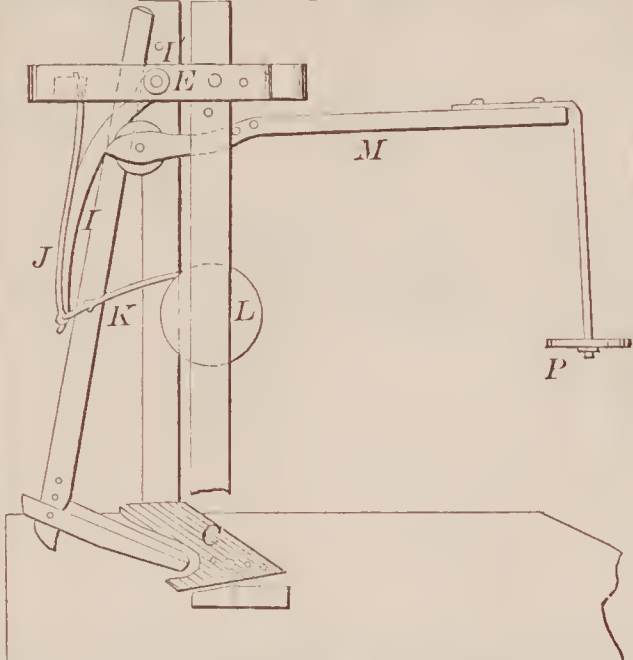

71997—S. Demison—Mail Bag Fastener.

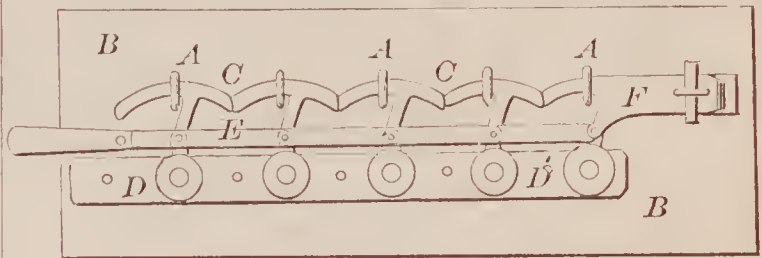

71998—H. J. Dill—Saw Buck

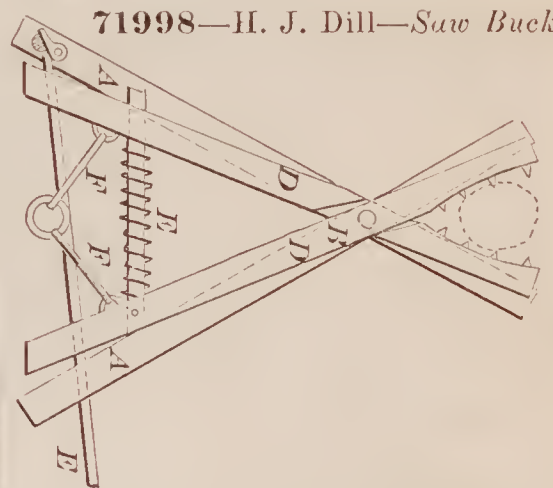

71996—F. Degen—For Forming Hat Bodies.

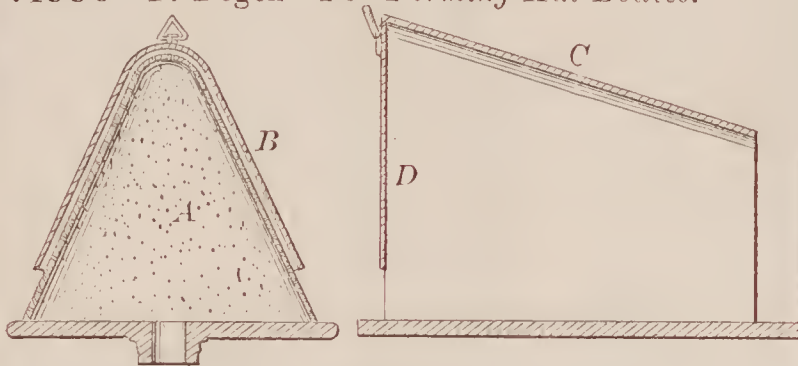

71999—T. Doane—Carriage for Rock Drills.

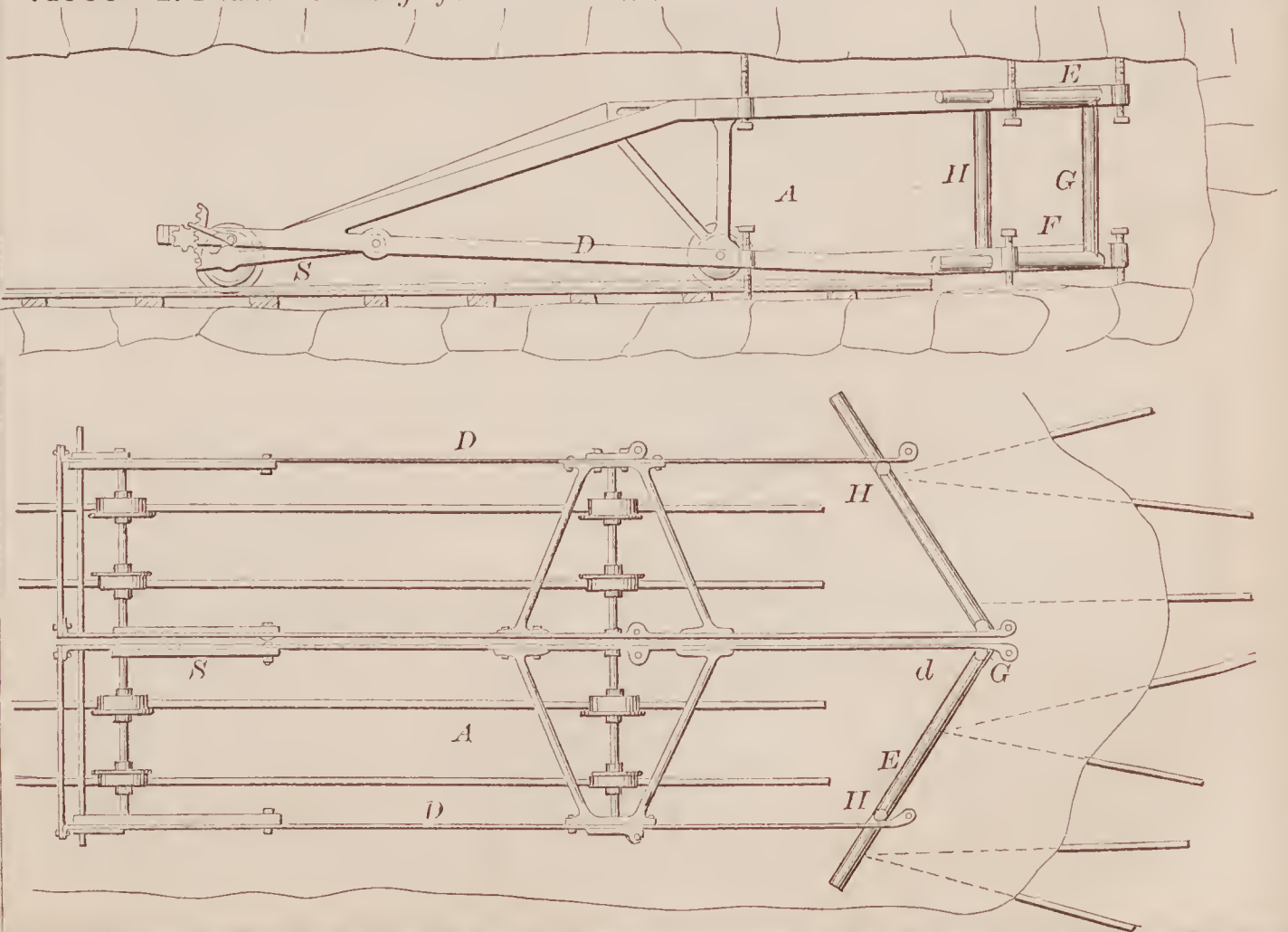



72000—  
J. H. Downing—  
Railway Chair.

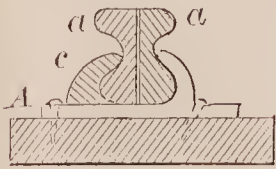

72001—Doyle & Martin—  
Rotary Pump.

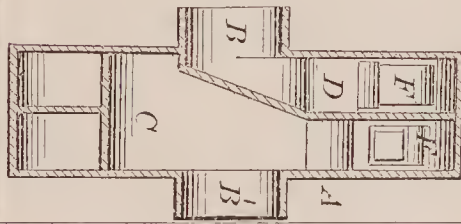
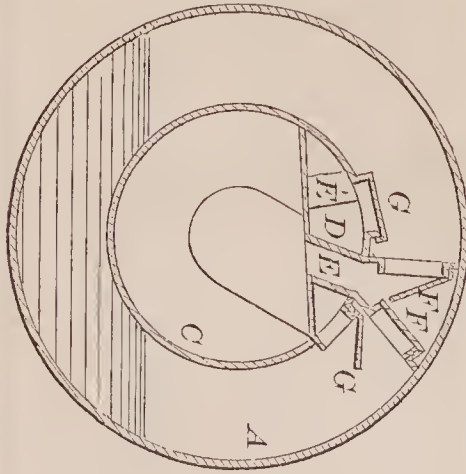

72005—J. Farnshaw—  
Woven Fabric.



72003—J. J. Duchesne—Pivot Gearing.

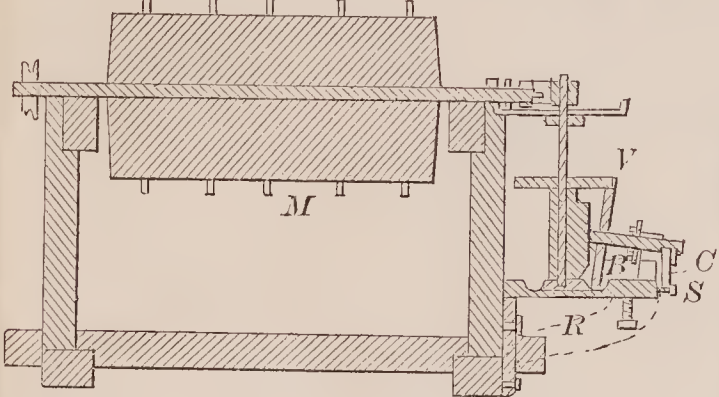

72008—J. Flinn—Spring for Webbing.

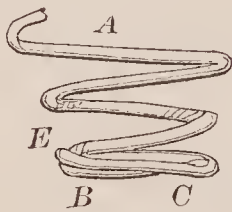
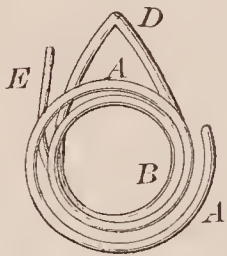

72007—C. D. Flesche—Punch for  
Forming Clasps.



72004—W. Duffner—Cultivator.

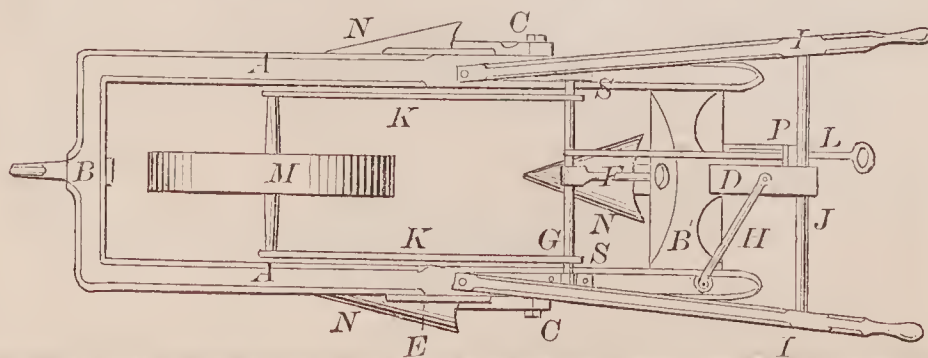
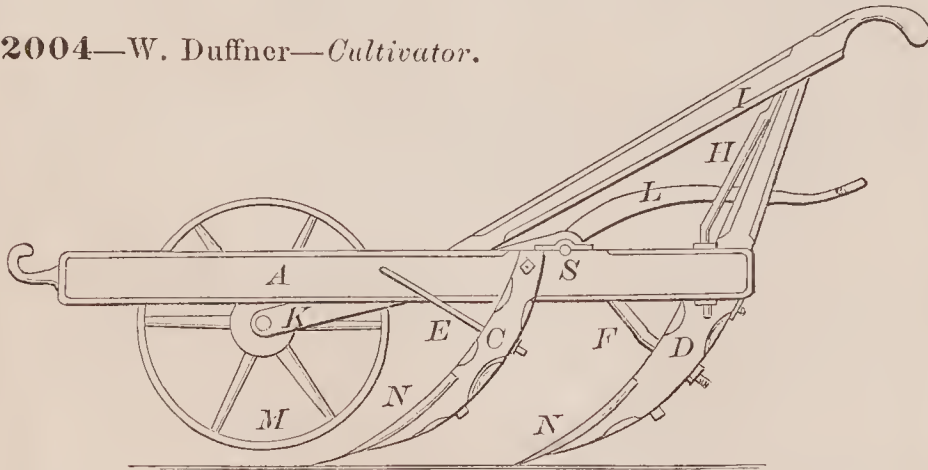

72002—J. F. Drummond—Grinding Mill.

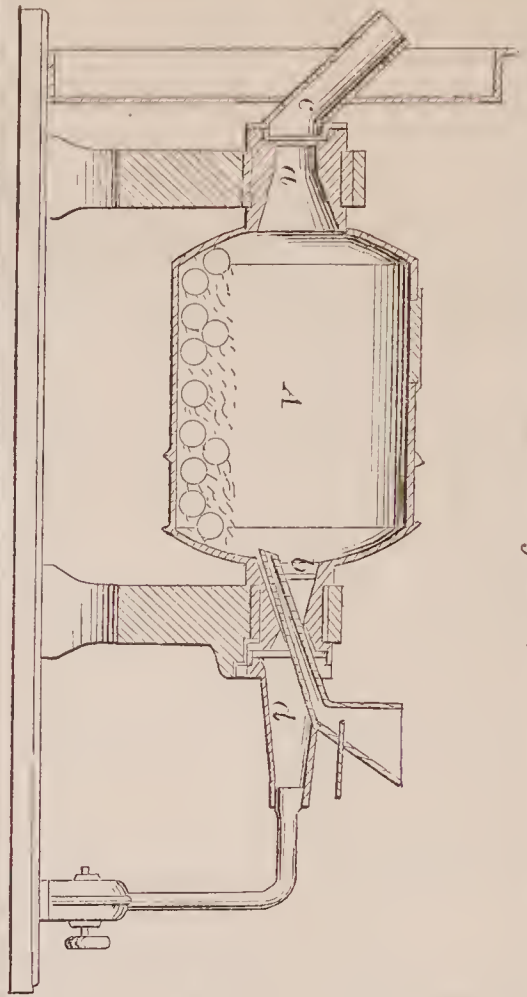

72006—E. A. Field—Horse Rake.

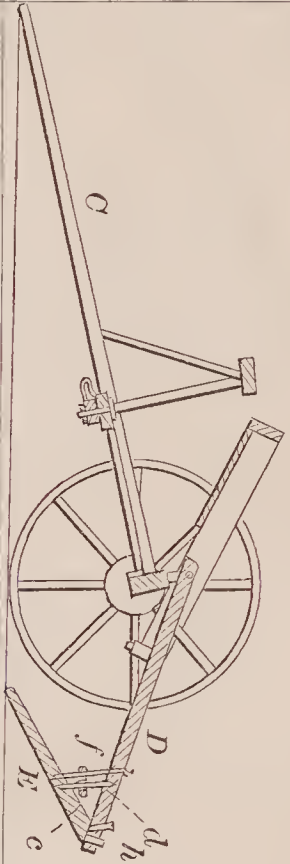

72009—A. W. Foster—Knife and  
Fork Holder.



72010—S. W. Fowler—*Lamp Chimney.*

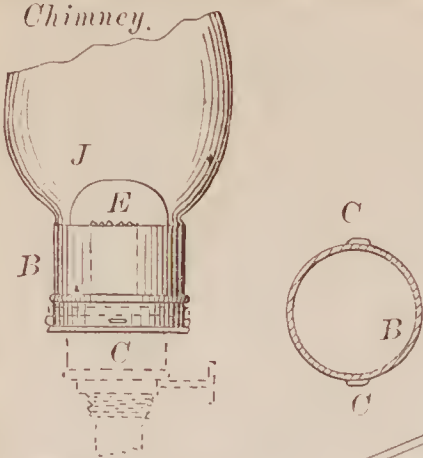

72013—J. Gardner—



72011—W. Freeborn—*Cartridge Box.*

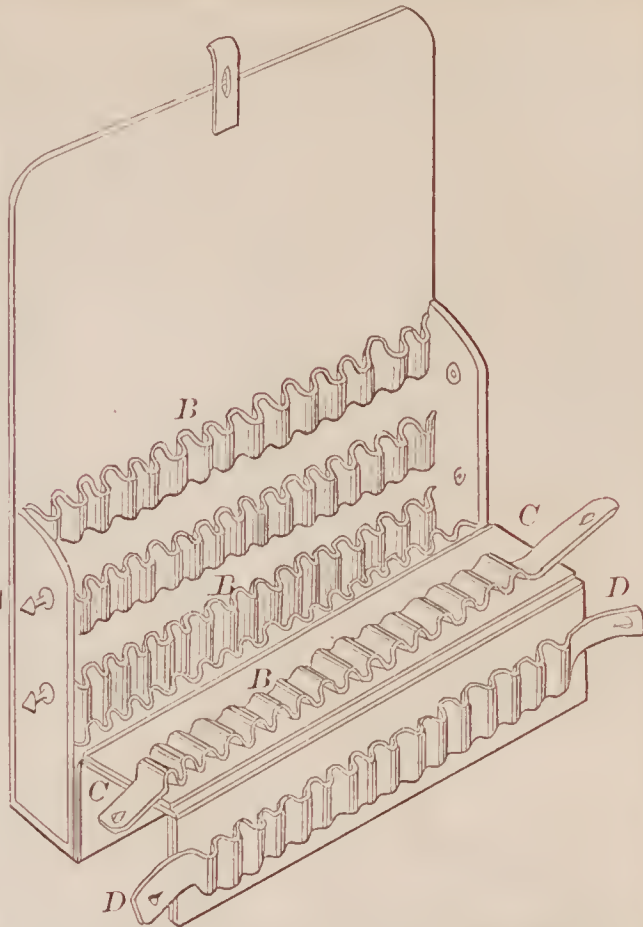

72012—S. Galbraith—*For Hitching Horses.*

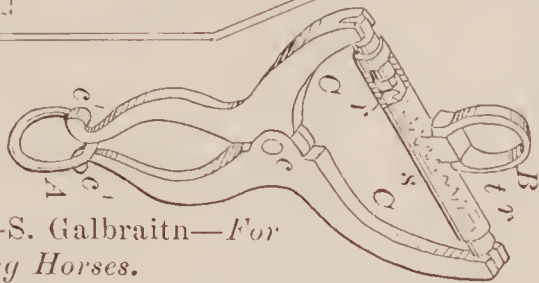

72015—S. Gassinger—*Brick Machine.*

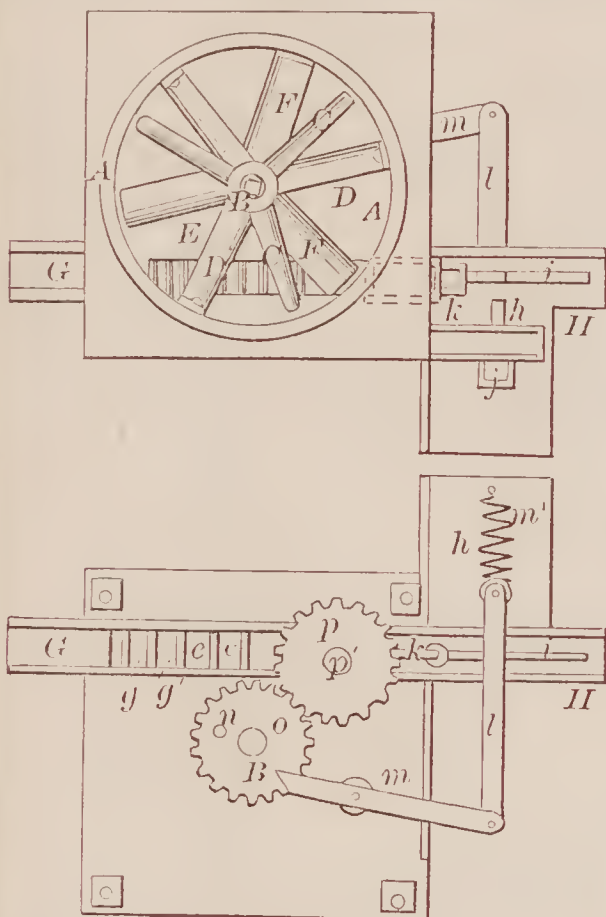

72014—J. P. Gates—*Tight and Loose Pulley.*

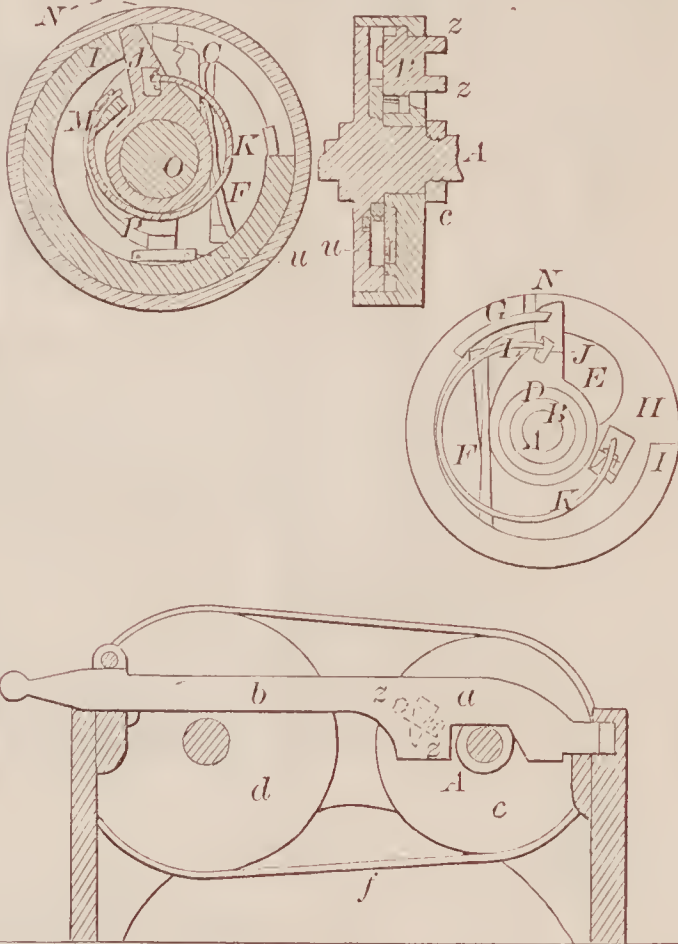

72016—J. H. & A. J. Glass—*Harvester Rake.*

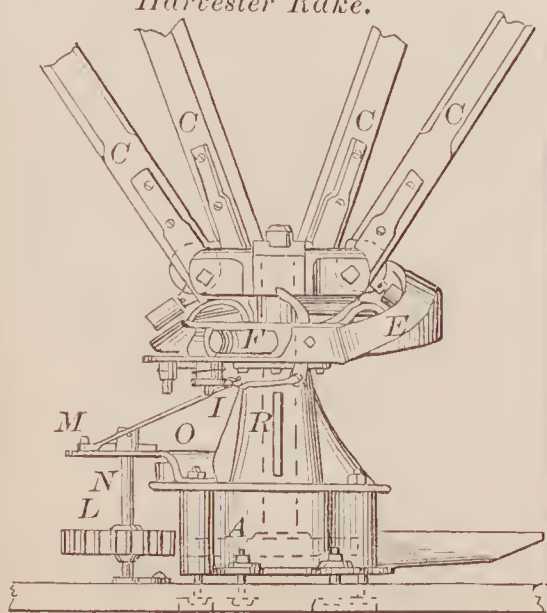

72018—W. C. Goodwin—*Hand Cultivator.*

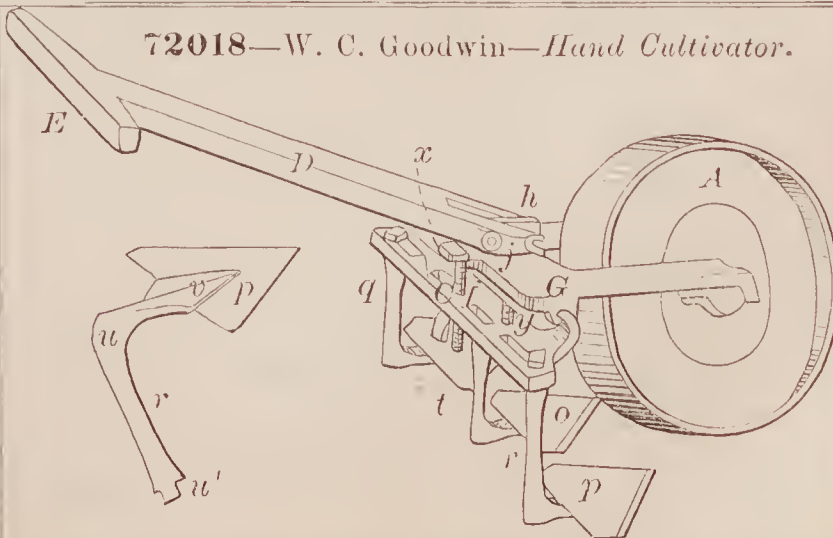



72019—P. R. Gottstein—Dipped Candle.

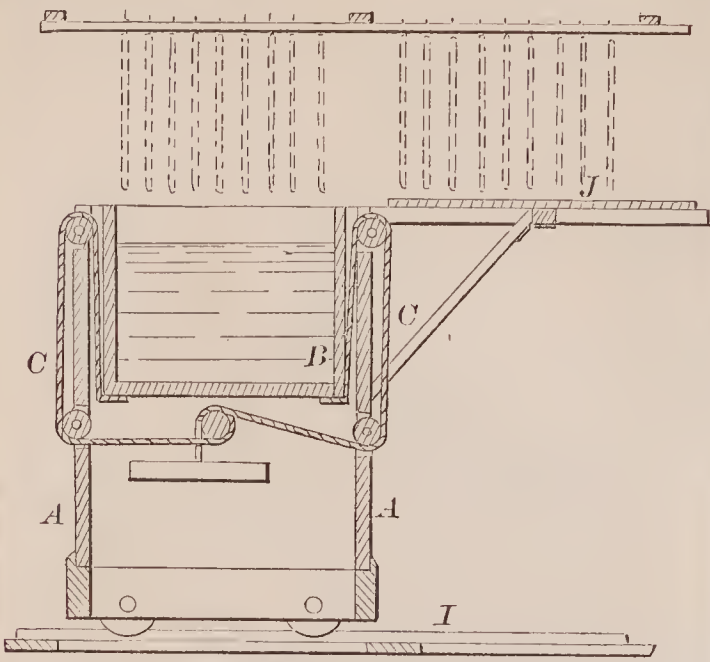

72020—J. Gould—Corn Sheller.

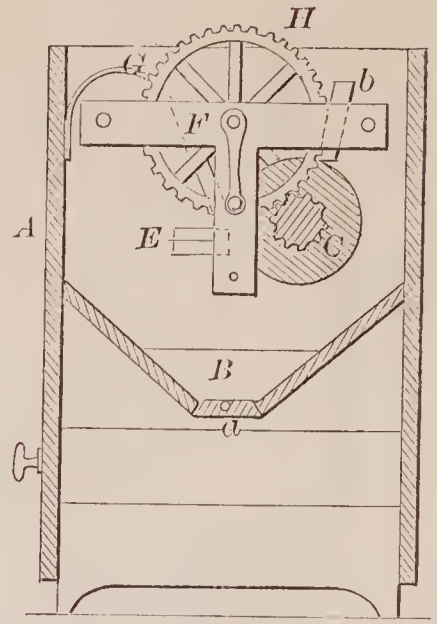

72025—A. W. Griffith—Window Screen.



72023—A. S. Greene—Steam Gauge.

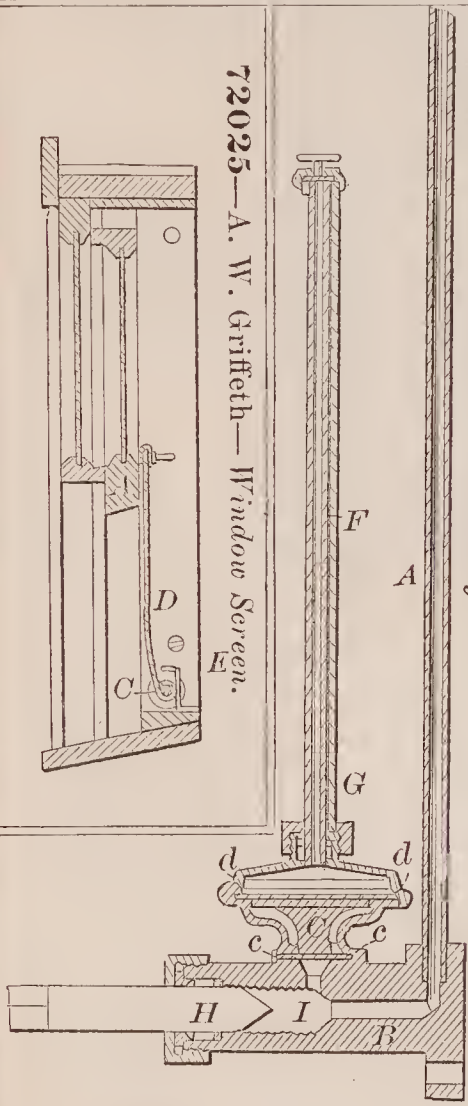

72022—D. M. Graham—Fence Post.

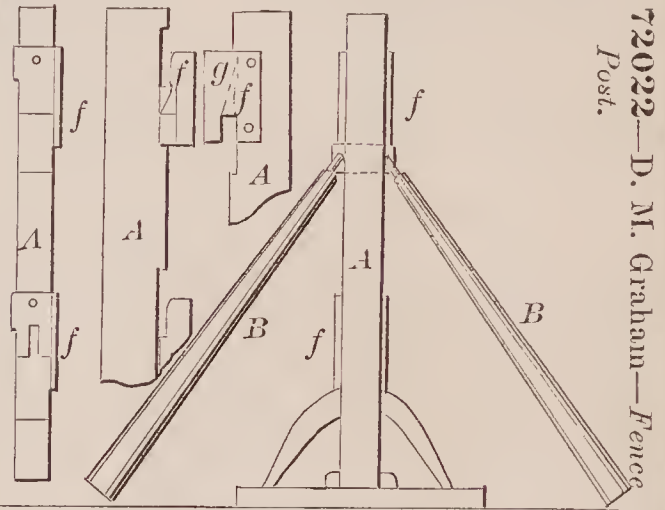

72024—T. S. Greenman—Stump Extractor.

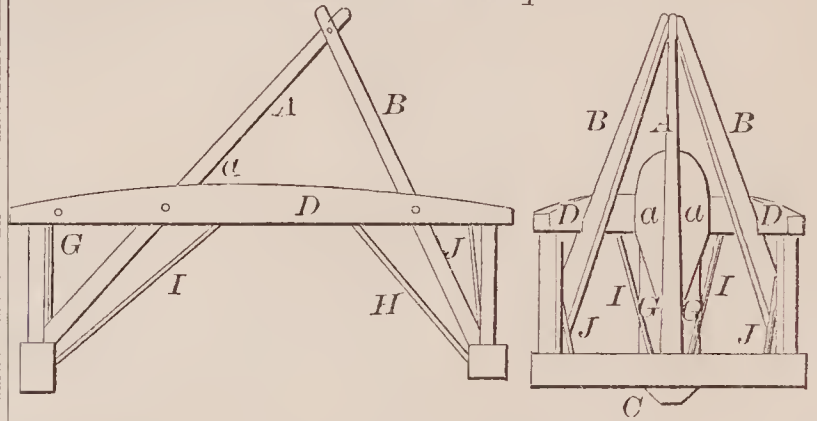

72027—Cross & Tunison—Cultivator.

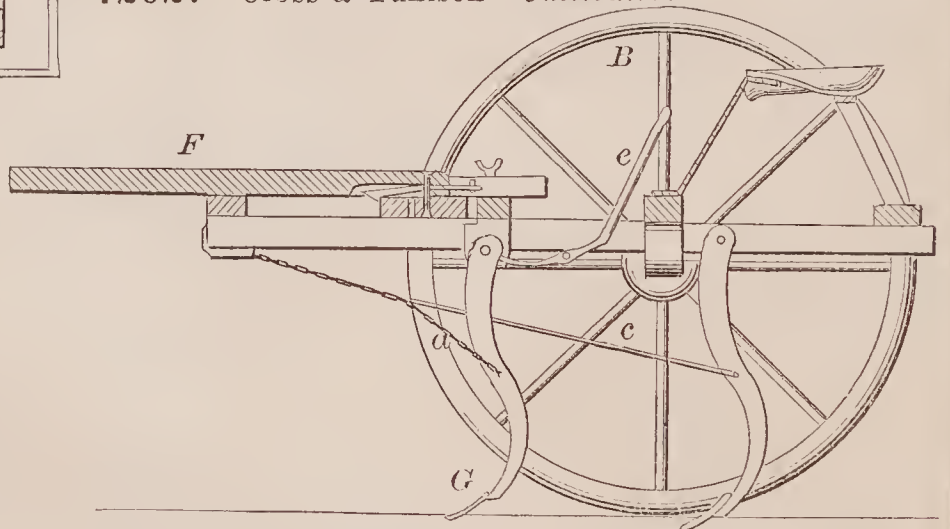

72021—L. Goulding—Knife Cleaner.

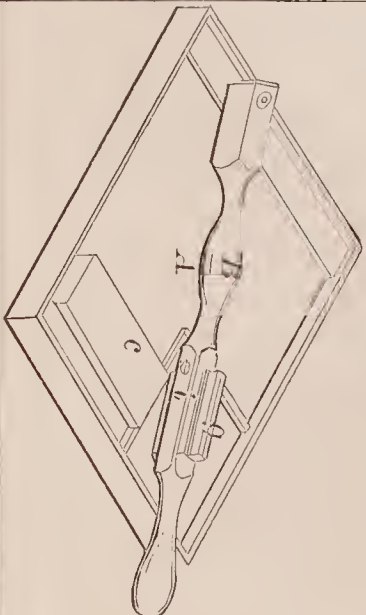

72028—J. A. Haase—Hose Shield.



72032—G. C. Hall—  
Collecting Oxide of Zinc.

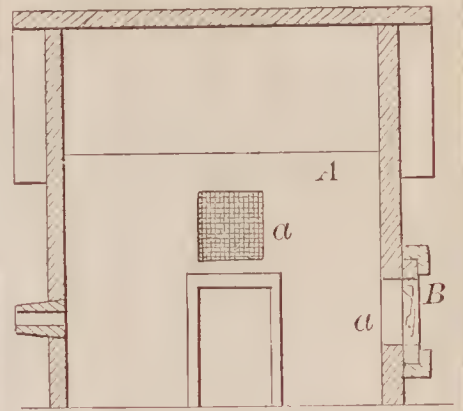

72034—W. H. Hart—Neck  
Tie.

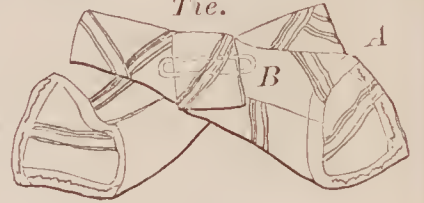

72031—C. F. Hall—For Refitting Conical Valves

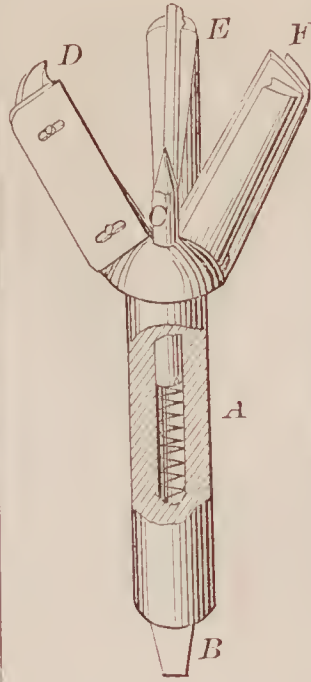

72030—J. W. Hadfield—Sky Rocket.



72029—J. W. Hadfield—Sky Rocket.

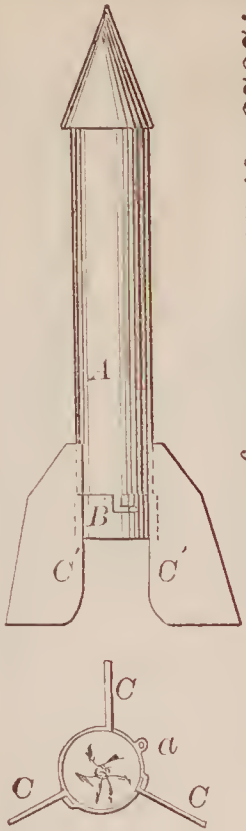

72039—J. B. Himberg—Tugere.

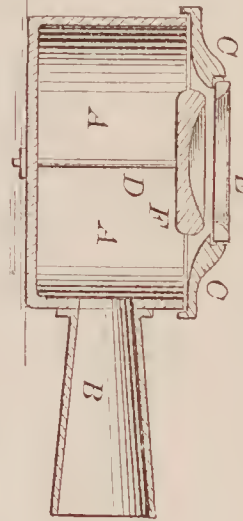

72035—H. R. Hawkins—Elliptic Carriage  
Spring.

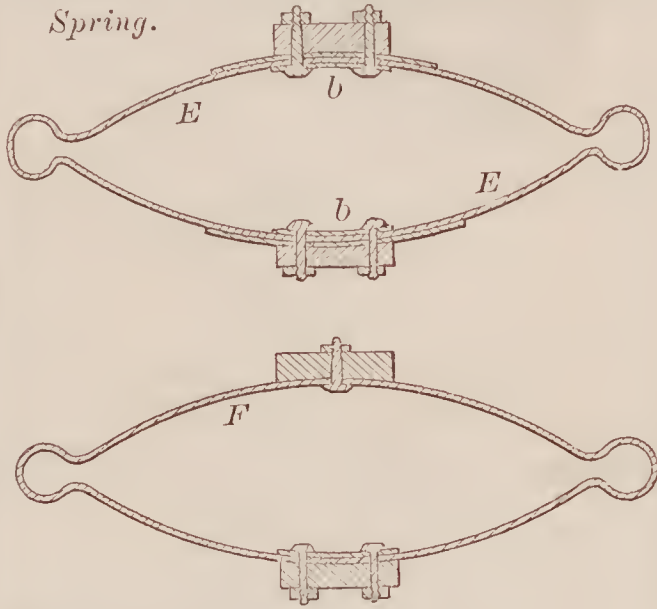

72033—H. F. Hart—Register for Odometers.

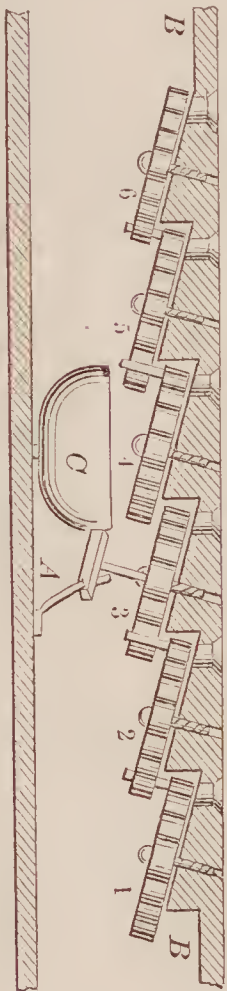

72040—J. & J. Hinks—Petroleum Burning Lamp

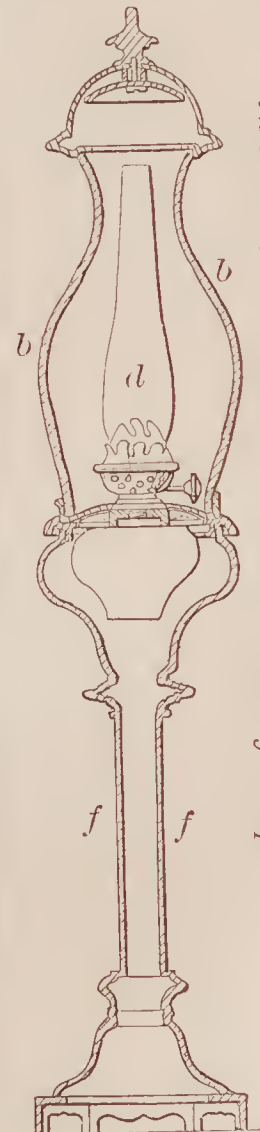

72037—D. Hazard—Platform Scale.

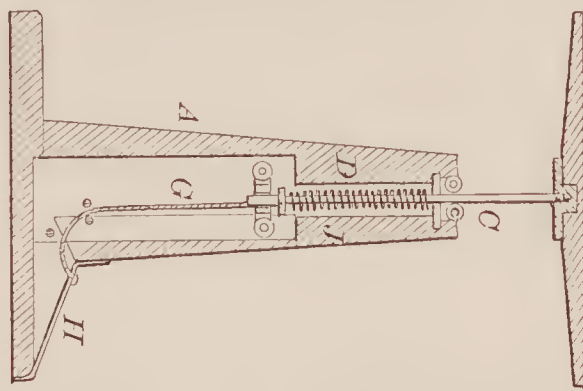

72036—E. K. Haynes—Hatch-Lining  
Drawing.

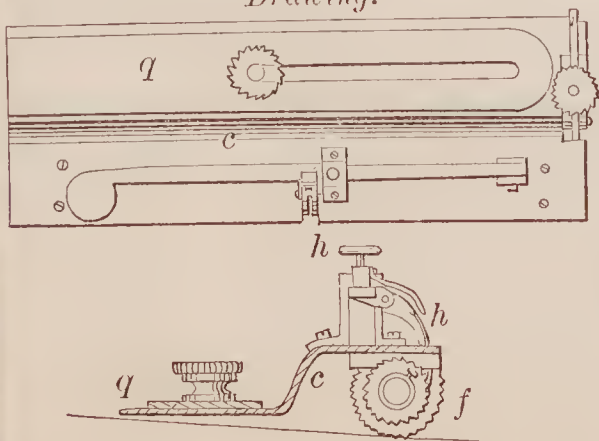

72038—A. Helmstaedter—  
Piano Lock.

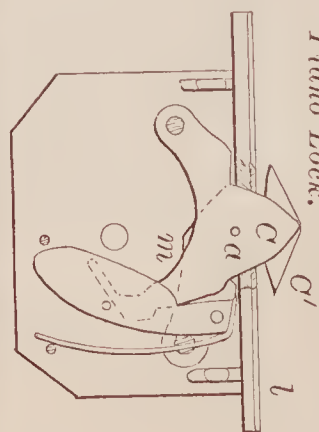



72040—Continued.

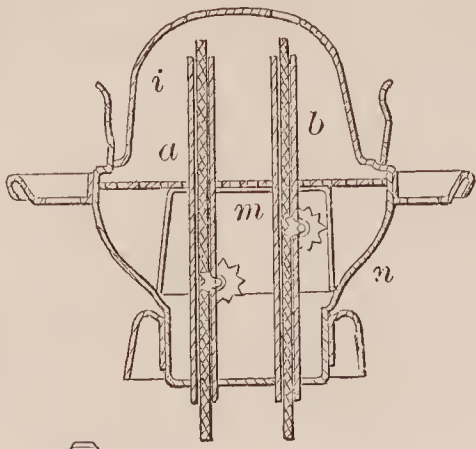

Fig. 2

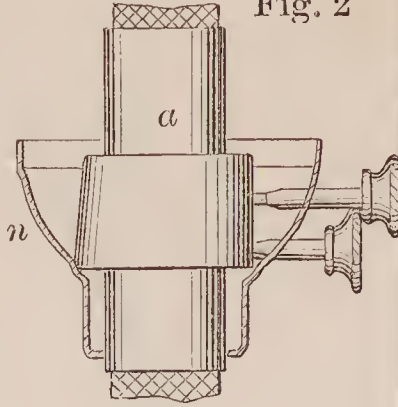

Fig. 13

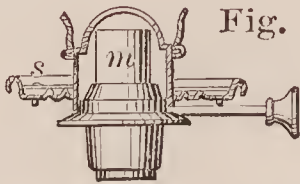

Fig. 14

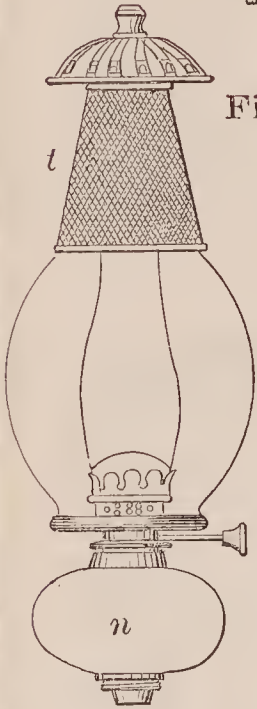
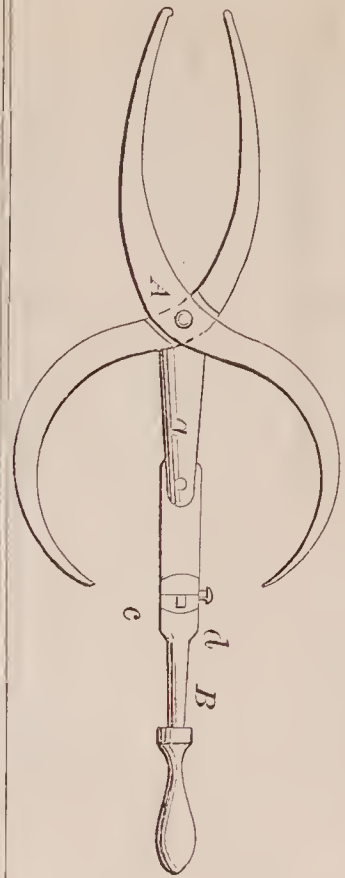

Fig. 9



72042—H. Holt—For Opening Fruit Cans.



72045—G. W. Hunt—Railway Sleeping Car. b

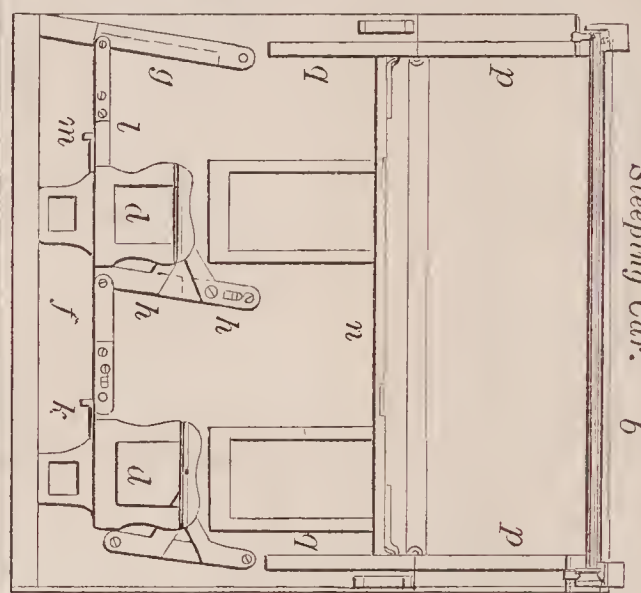

72044—D. K. Hoxsie—For Making Eyelets.

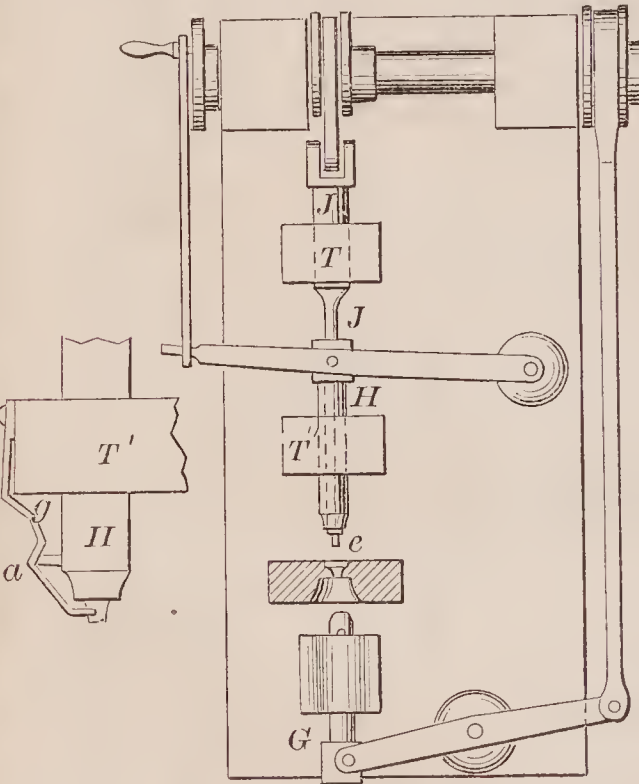

72046—G. W. Jackson—Harvester.

72041—J. M. Hirlinger—For Lashing and Binding.

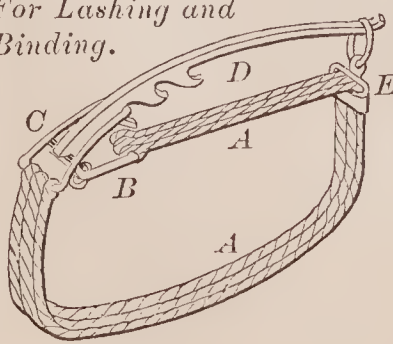

72043—Z. Lowe—Mop Wringer.

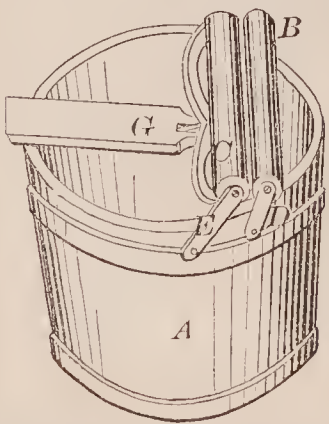

72047—S. M. Johnson—Sad Iron.

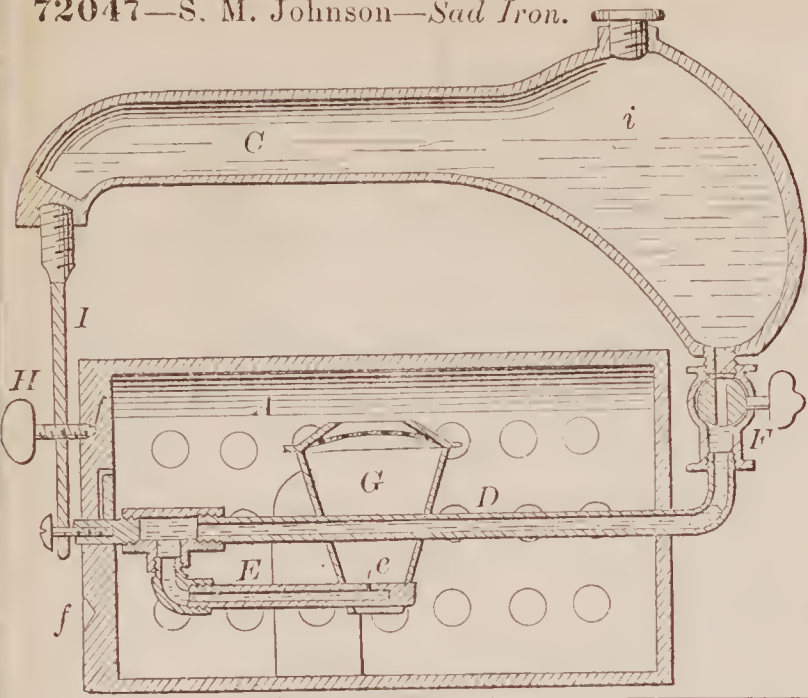

72049—M. A. King—Muff.

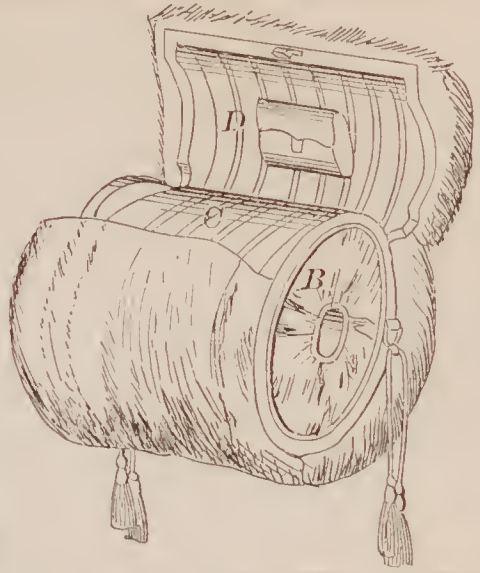

72048—W & J. Keats—Boots and Shoes.

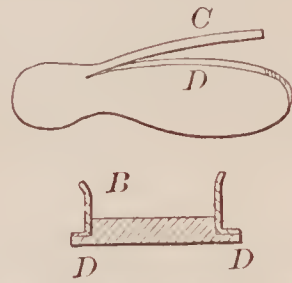

72051—J. Lawrence—Fifth Wheel for Carriages.

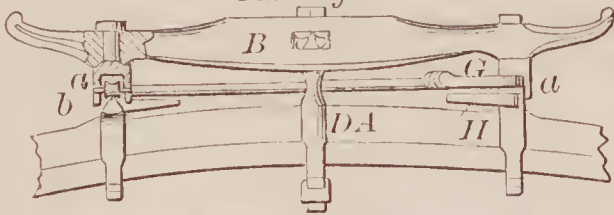

72050—A. Knapp—Horse Hay Fork.

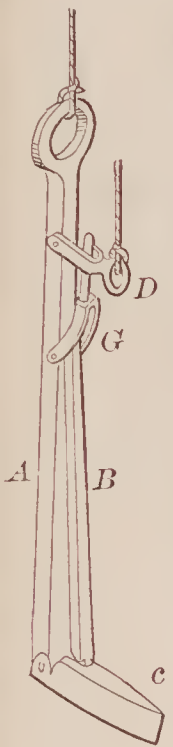

72053—F. C. Levalley—Door Fastener.

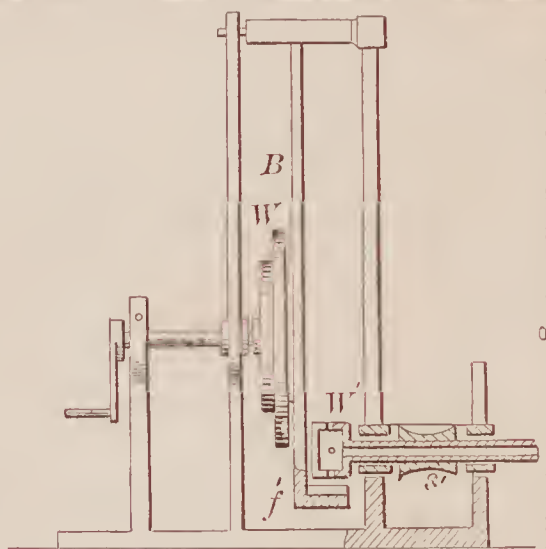
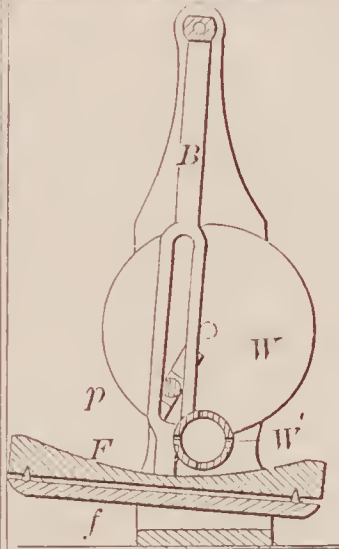
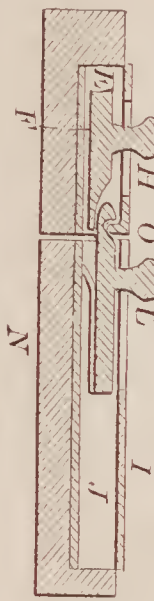

72055—G. S. Long—For Forming Elliptic Spring.

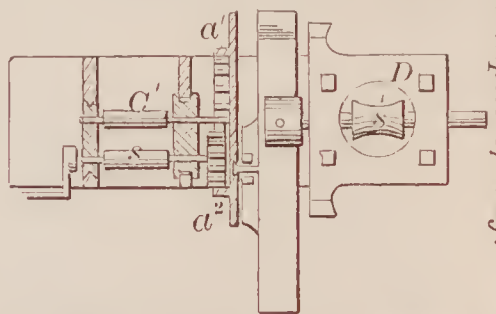

72052—J. Q. Leflingwell—Washing Machine. II

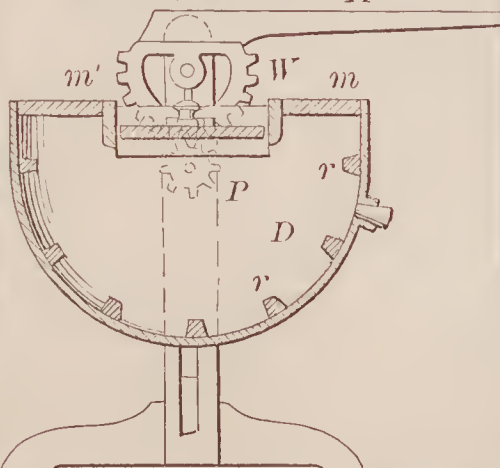

72054—W. A. Lighthall—Condensing Engine.

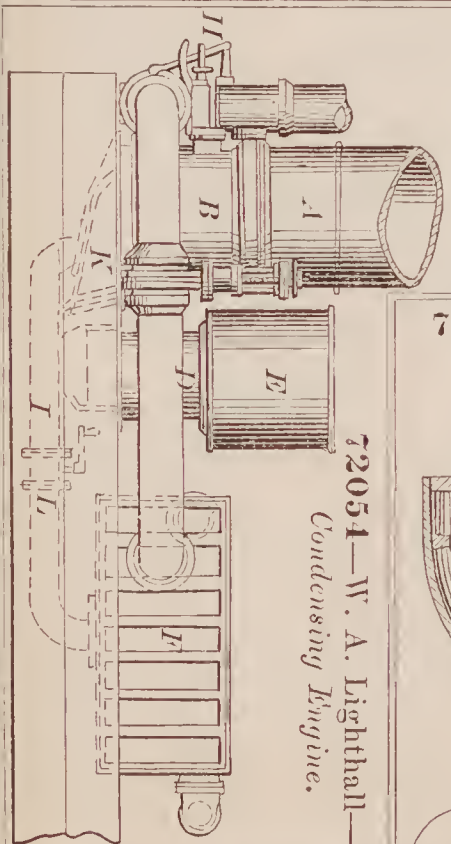

72056—R. Long—Furnace.

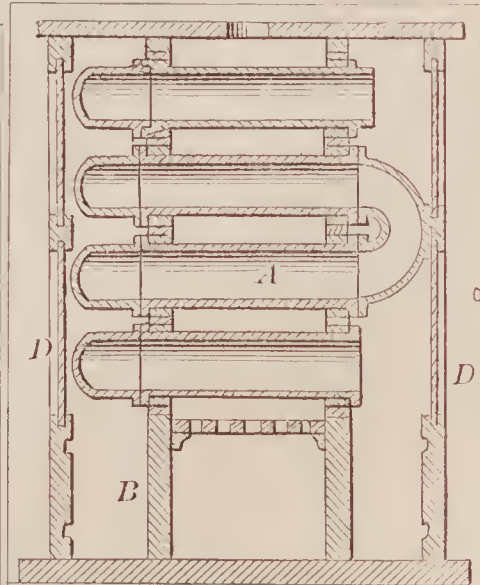



72057—E. F. Lyman—*Clothes Rack.*

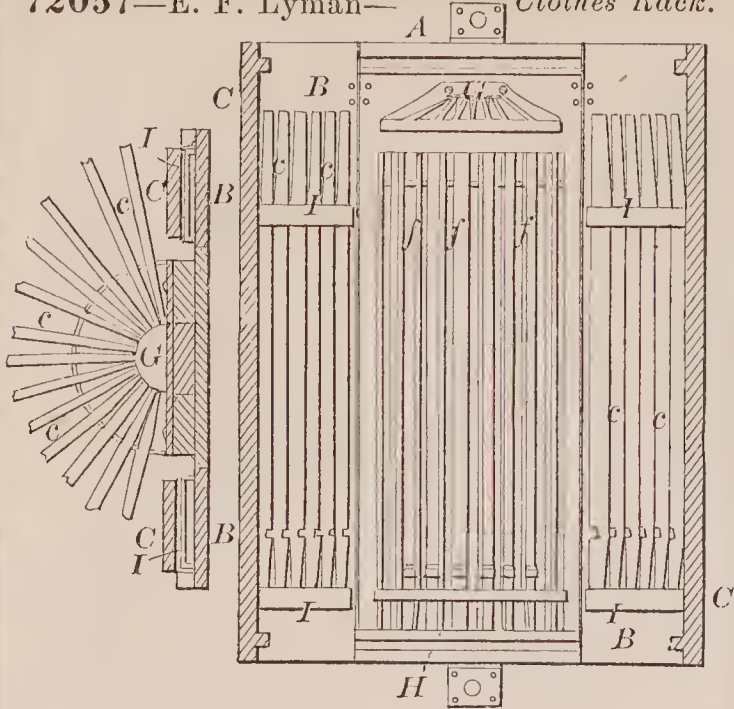

72060—O. Manly—*Roofing.*

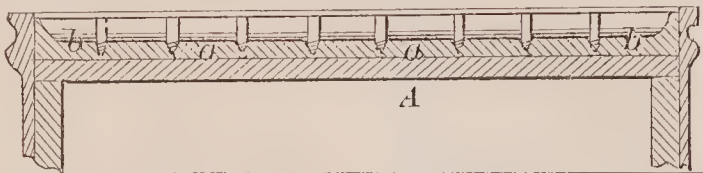

72062—Mauzy & Hughes—*Straw Cutter.*

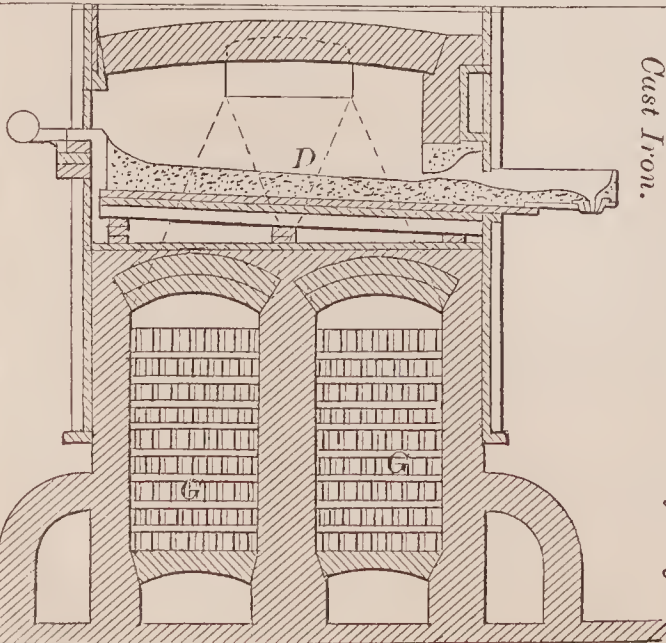
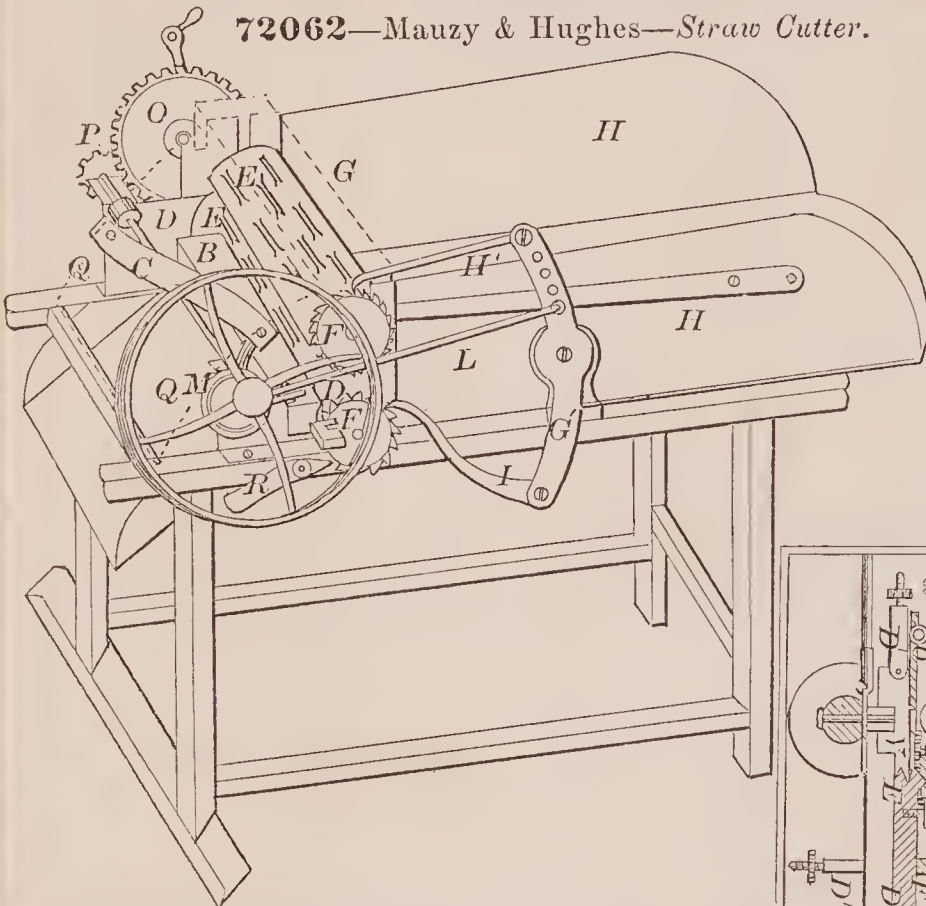

72061—E. & P. E. Martin—*Refining Cast Iron.*

72059—R. W. Macgowan—*Register Point for Printing Presses.*

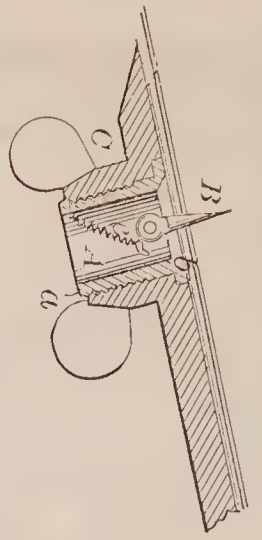

72058—F. J. Macfarlan—*Vessel Centre Board.*



72063—S. McCulloch—*Convertible Shot Gun and Rifle.*

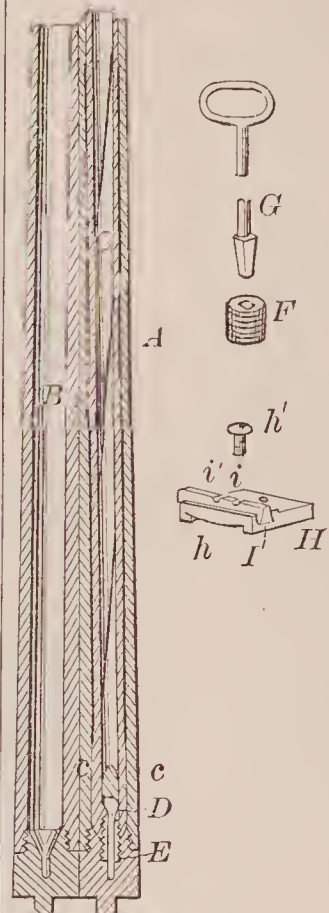

72064—D. J. McDonald—*Derrick.*

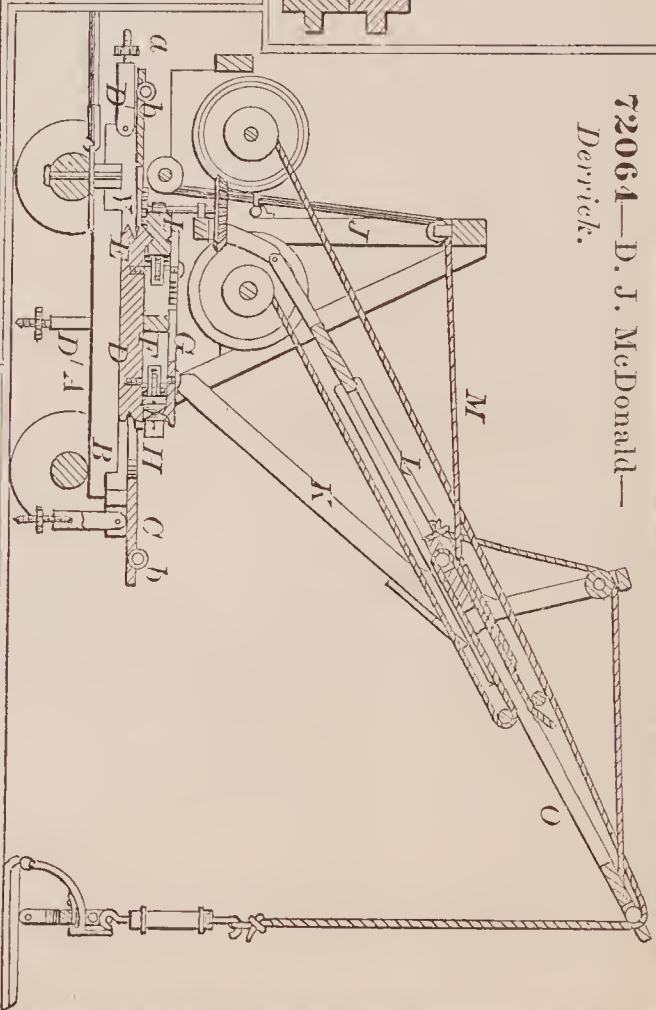



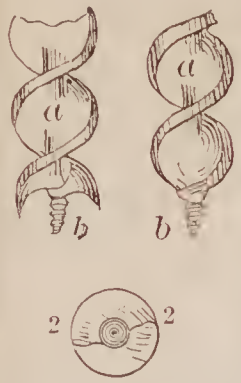

72065—J. A. McGee—Auger.

72066—I. J. Merritt—Dry Dock.

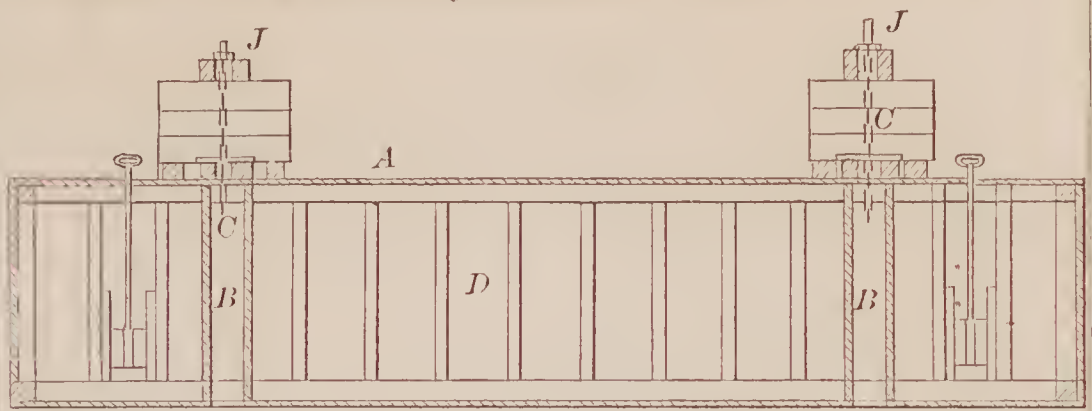

72067—J. Merritt—Knife and Fork Cleaner.

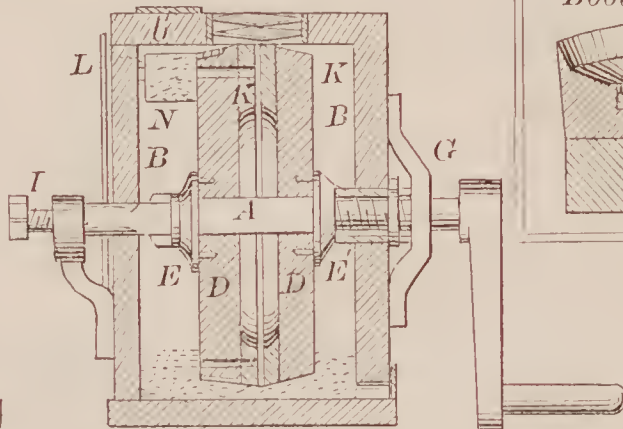
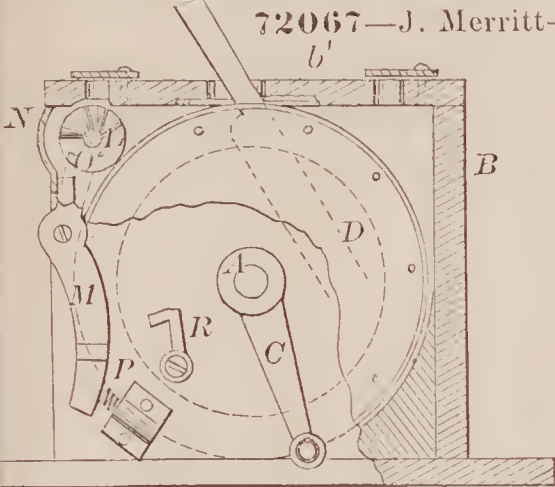

72073—E. Newhall—Boot and Shoe Heel.

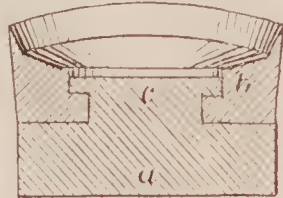

72068—A. Millochau—Manufacture of Lampblack.

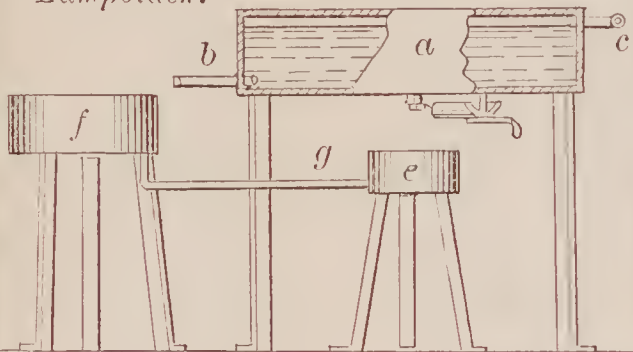

72070—H. Munson—Table for Teaching.

What is the	interest in	pres't day	rate in cent	
Princ.	Yrs.	Mo.	Day	
\$ 497.34	5	2	18	10
\$ 785.50	6	3	15	6
\$ 7200	1	4	9	12
\$ 387.34	4	11	13	20
\$ 47.25	2	1	12	11
\$ 37.87	3	5	14	5
\$ 378.40	9	7	1	4
\$ 77.30	7	6	8	3

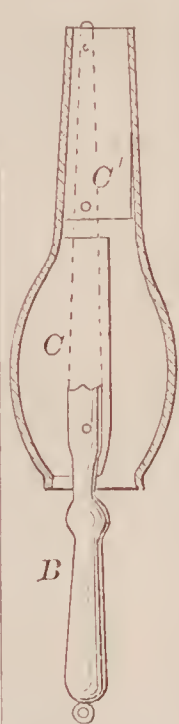

72072—R. B. Munson—Lamp Chimney Cleaner.

72069—J. Mitchell—Car Brake.

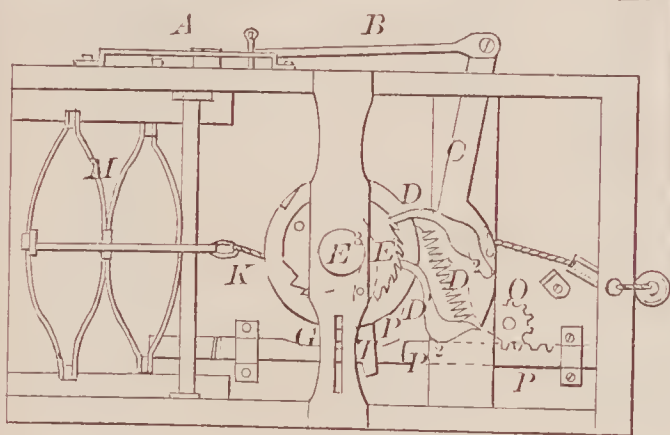

72071—J. G. Murdock—Hydrant.

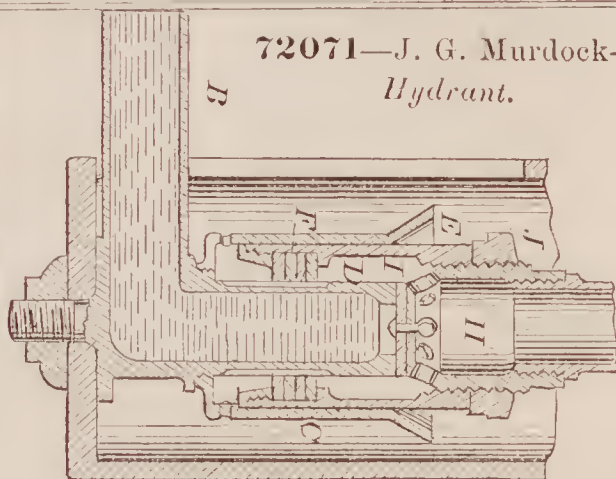

72074—J. B. Oldershaw—Hot Air Conductor.

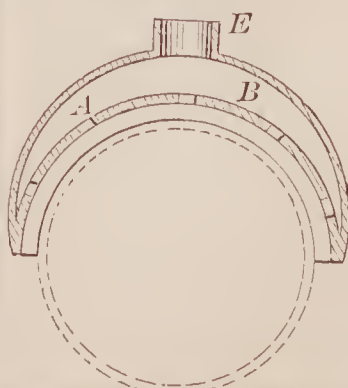

72075—Olendorf & Parshall—Vine Holder.

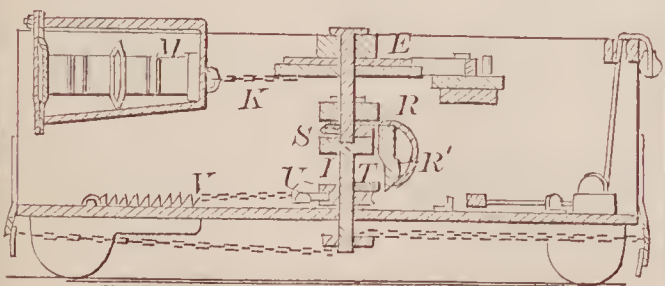
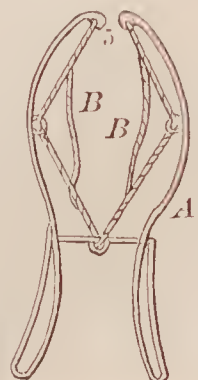



72076—H. O. Peabody—Breech-Loading Fire Arm.

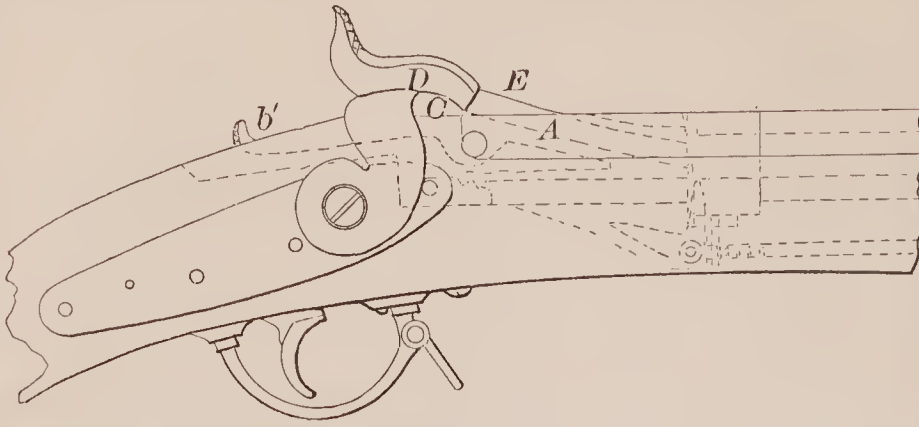

72078—R. N. Perlee—Manufacture of Lampblack.

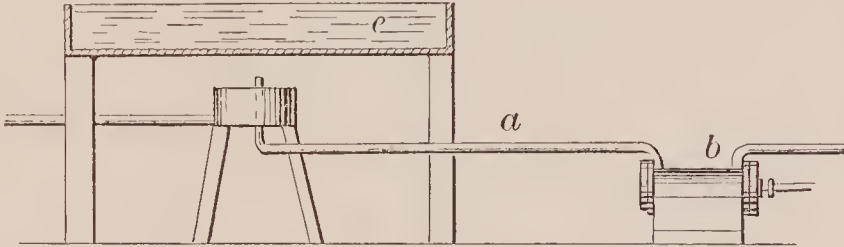

72082—L. Ransom—Pneumatic Car.

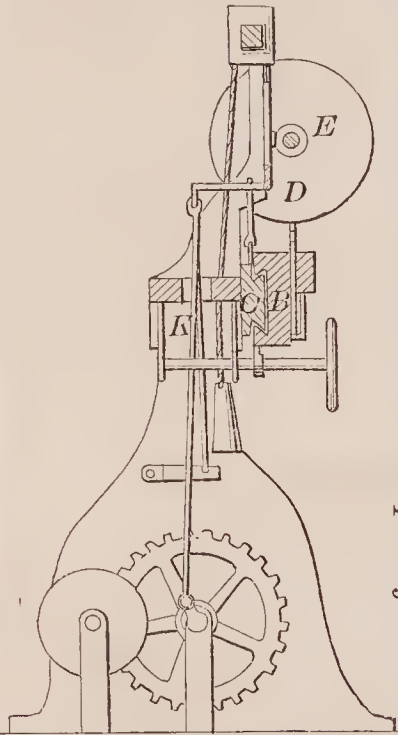
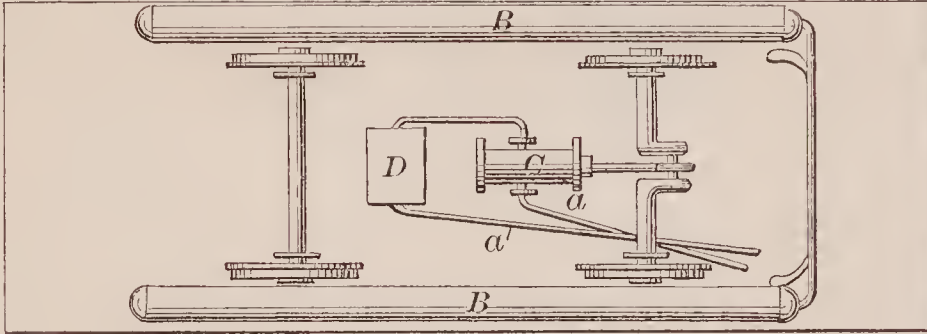

72083—E. B. Rich—For Sharpening Saws.

72079—H. B. Pitner—Axle Box

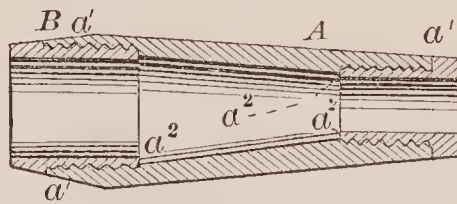

72080—L. Pollock—Railway Chair.

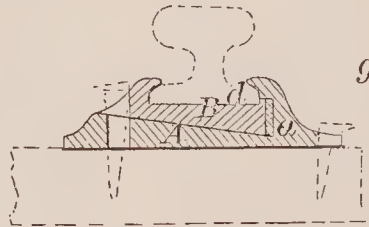

72084—J. T. Buckley—Automatic Register.

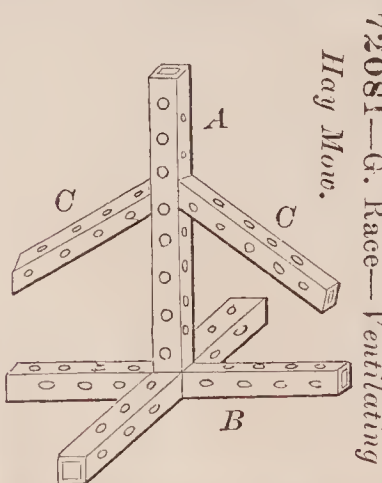

72081—G. Race—Ventilating Hay Mow.

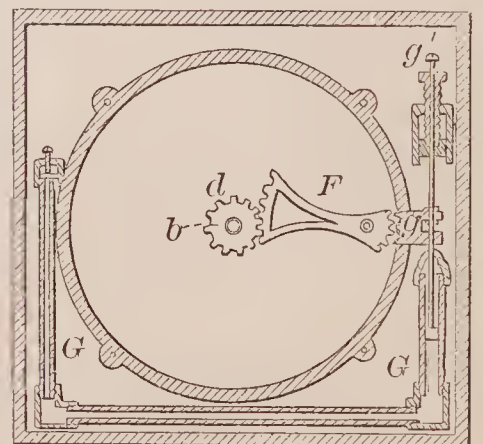
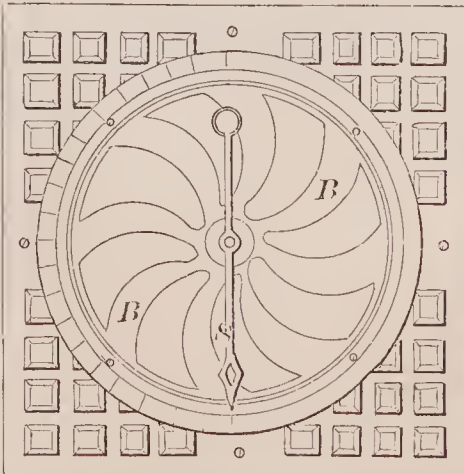

72077—S. Perkins—Railway Crossing.

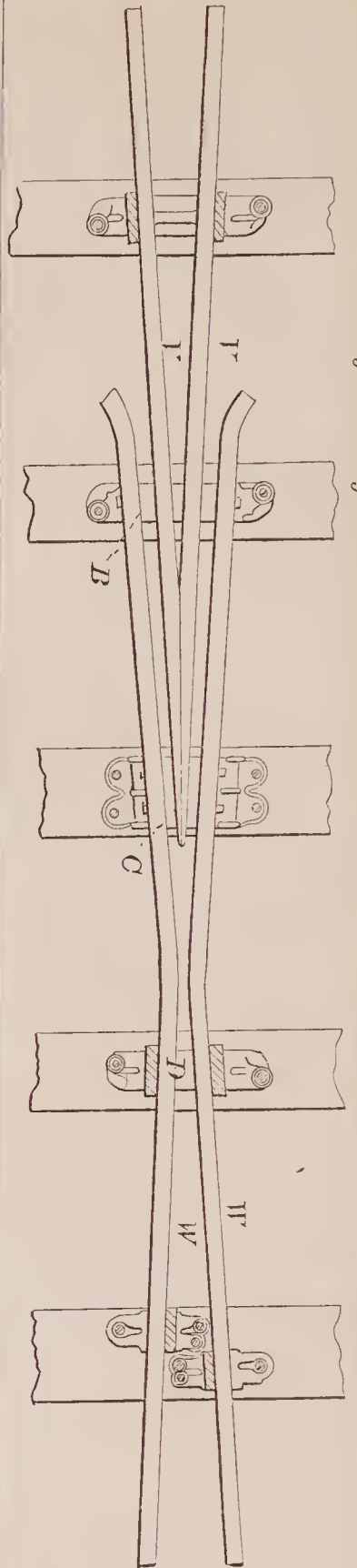

72085—P. A. Ross—Shovel Plow.

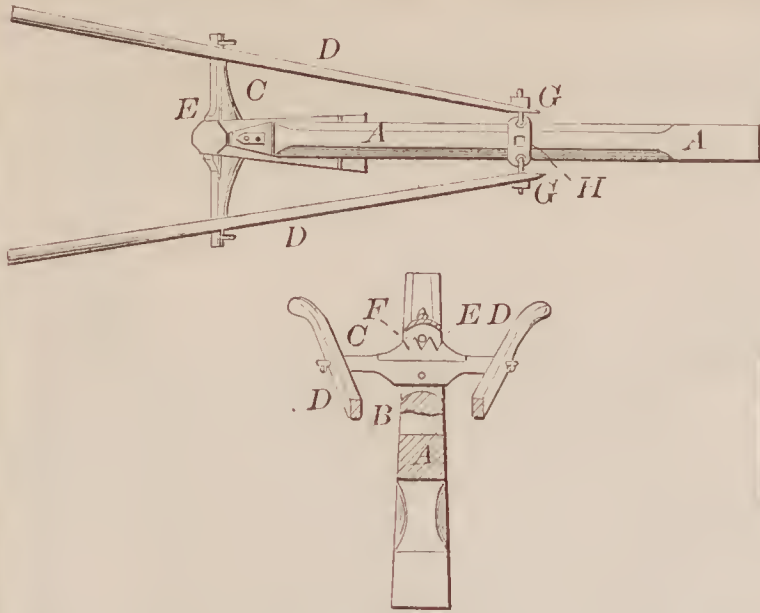

72086—R. Ramsey—Fence Post.

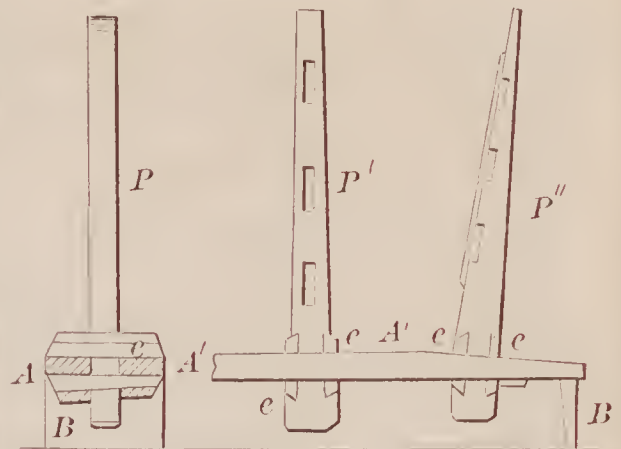

72087—J. H. Rowley—Churn.

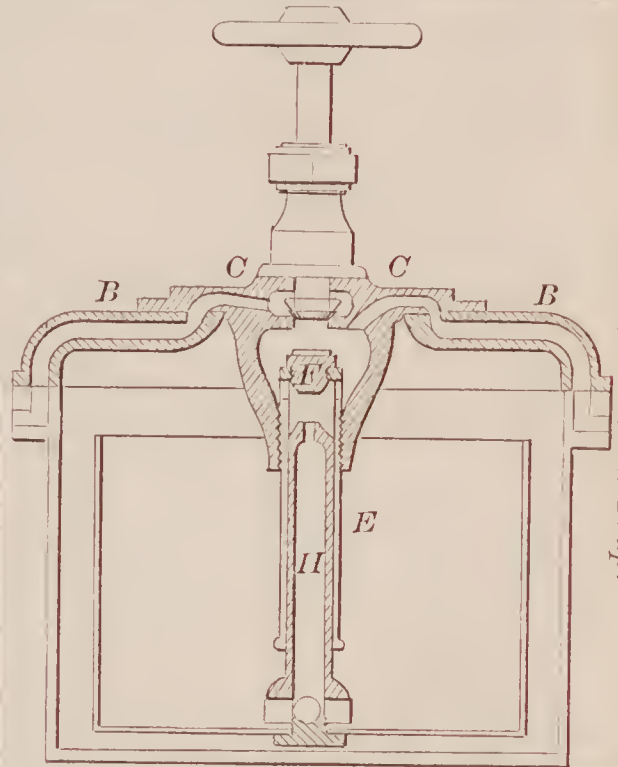
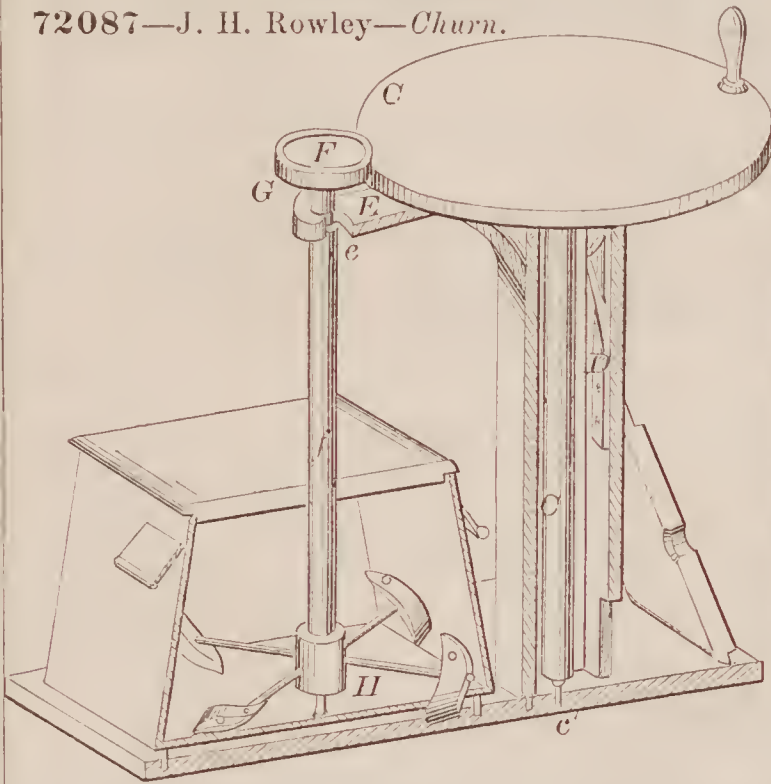

72088—D. Saunders—Steam Trap.

72089—R. Schrader—Door Spring.

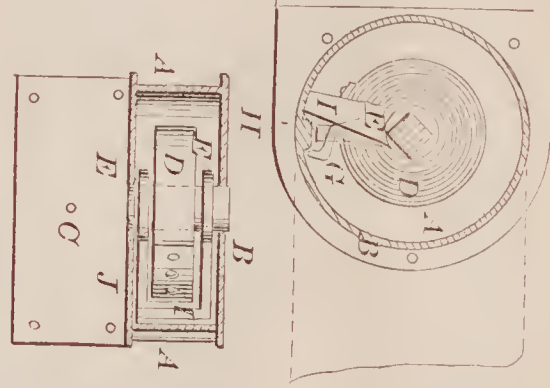

72092—G. Shale—Steam Engine.

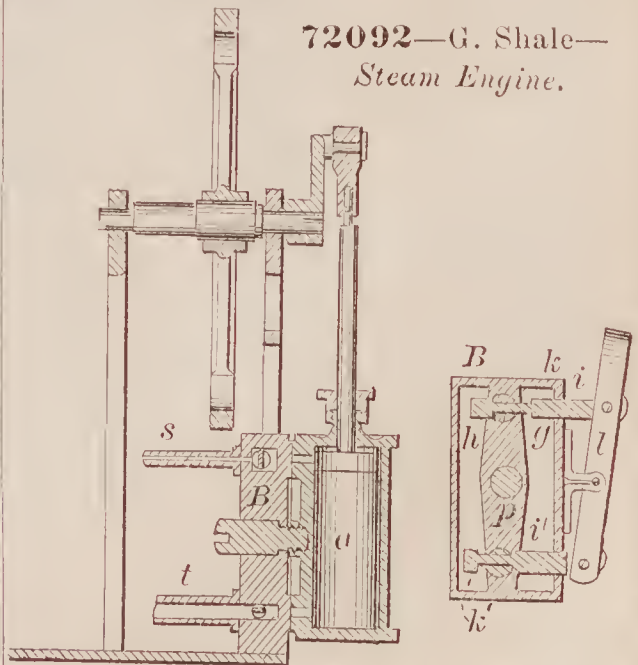

72090—A. Searls—Pole Coupling for Vehicles.

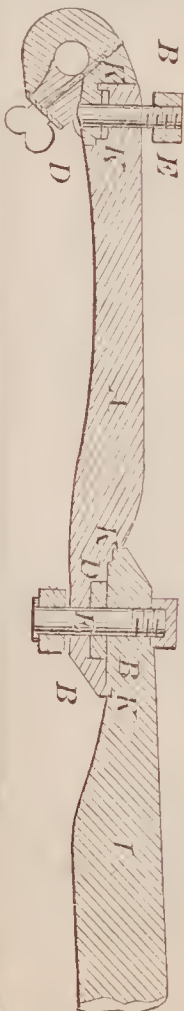

72091—A. Searls—Carriage.





72095—C. J. Shepard—*Tubular Heater.*

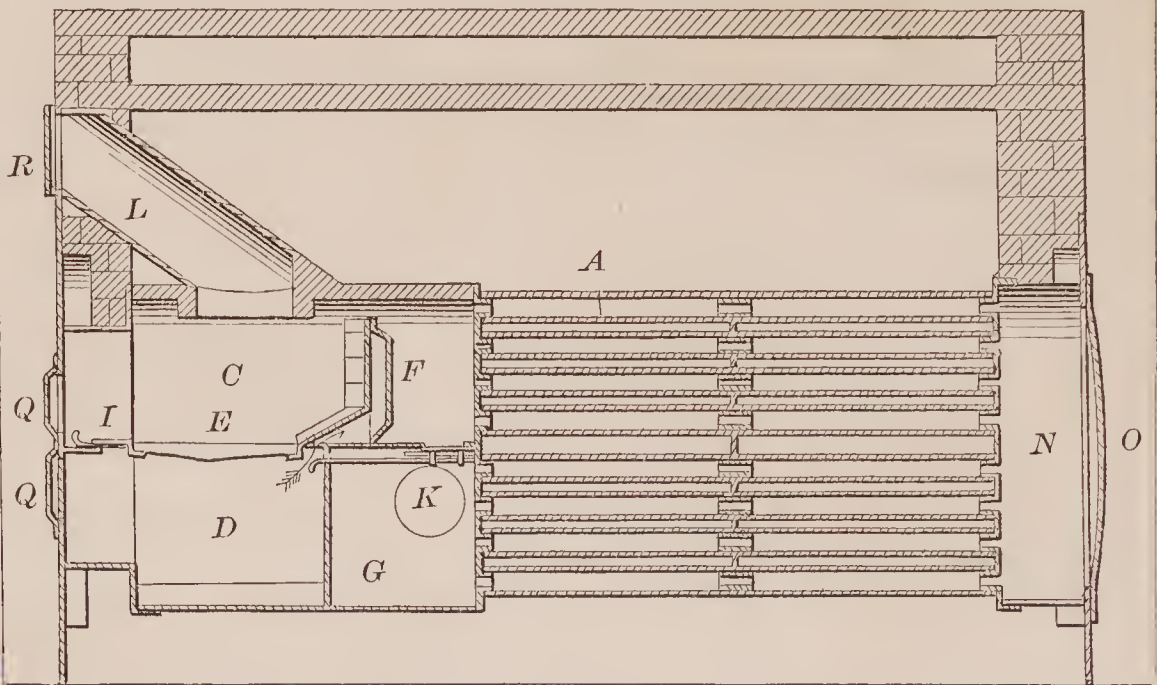
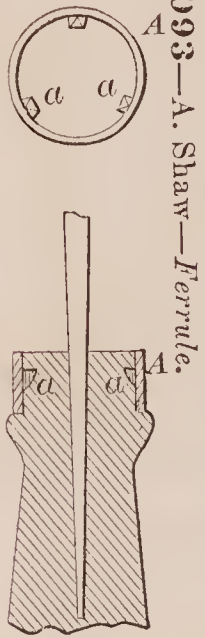

72097—T. A. Slack—*Stake Holder for Railroad Cars.*

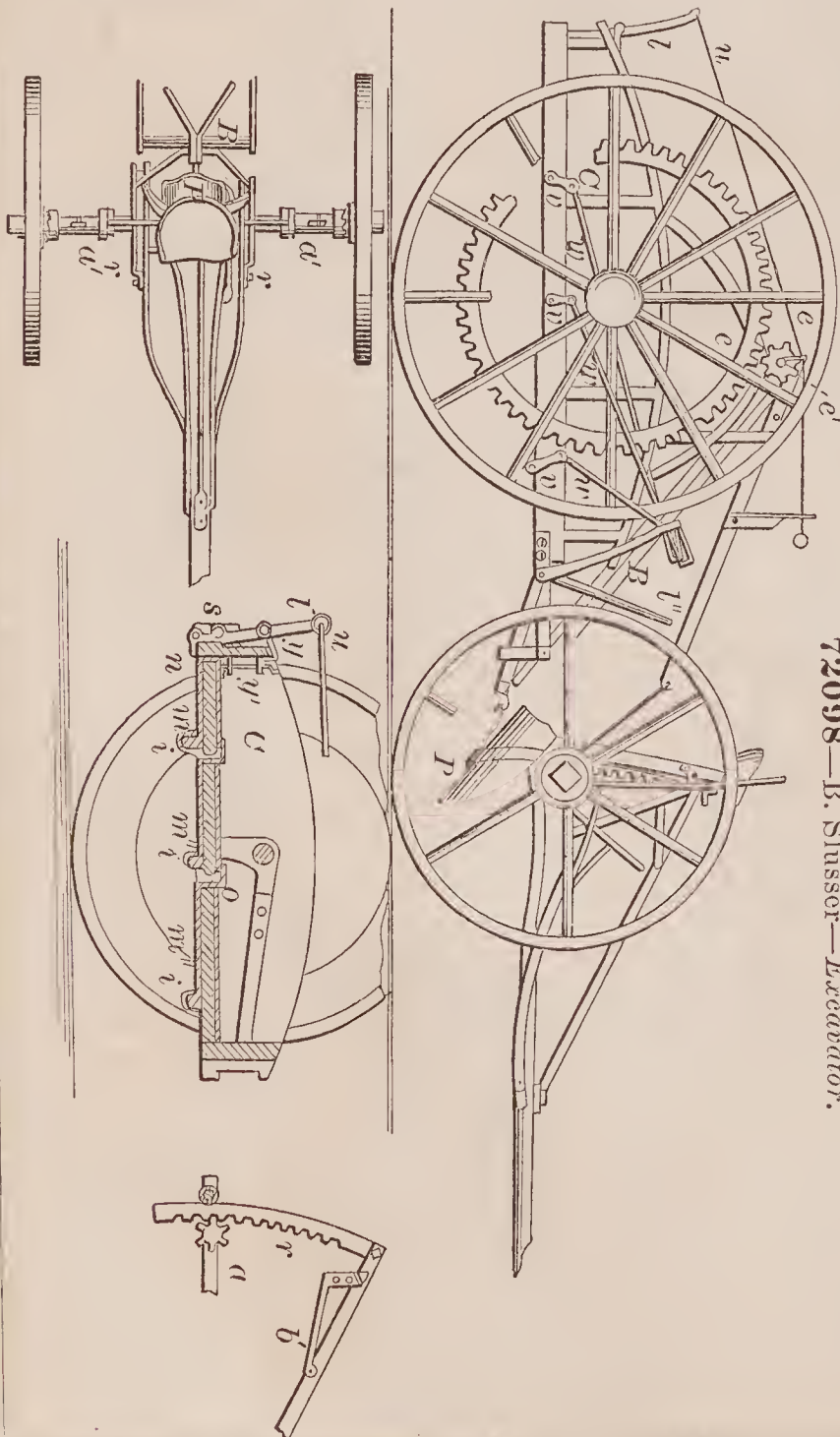
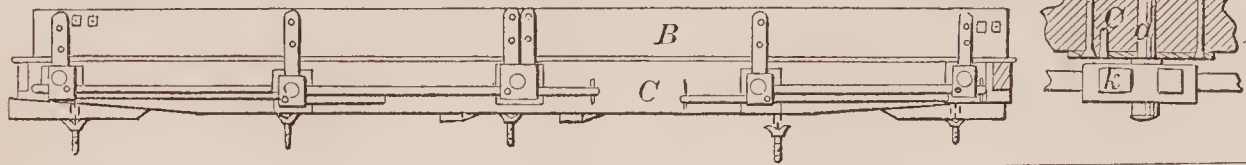

72098—B. Slusser—*Excavator.*

72094—W. H. Shay—*Fence Post.*

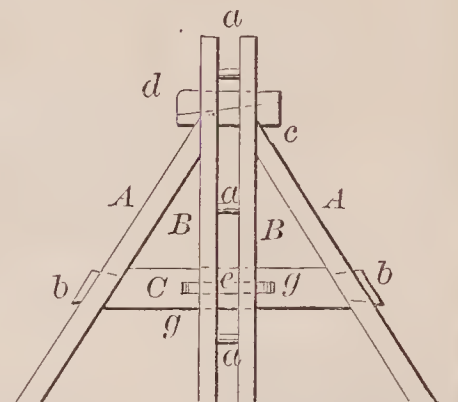

72096—J. W. Simpson—*Window Sash Supporter.*

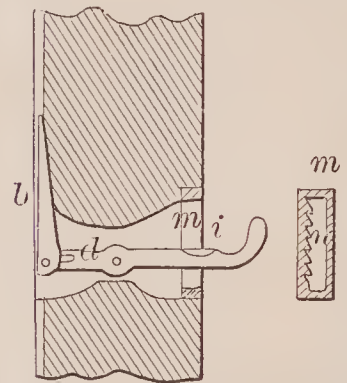

72099—D. Y. Smith—*Auger Handle.*

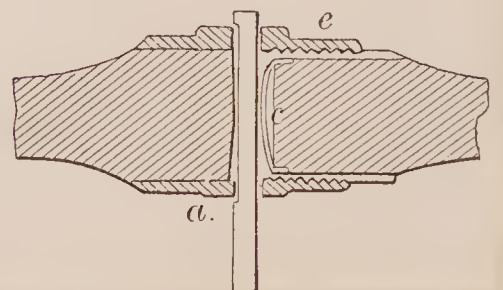



72100—J. B. Smith—For Sharpening Saws.

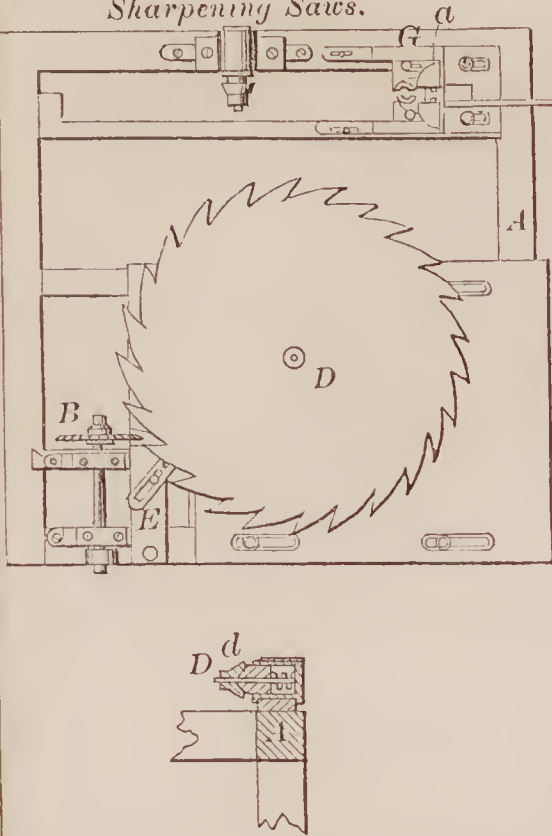

72102—J. II. Smith—Ship for Transporting Petroleum.

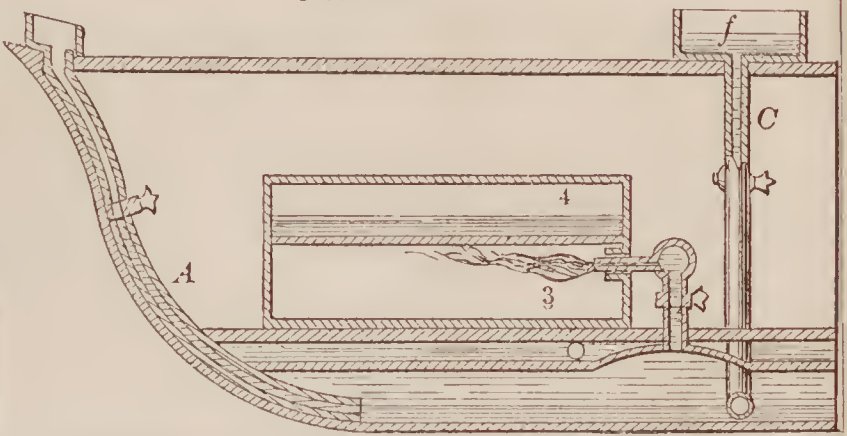

72101—J. II. Smith—Raising Oil by Pneumatic Pressure.

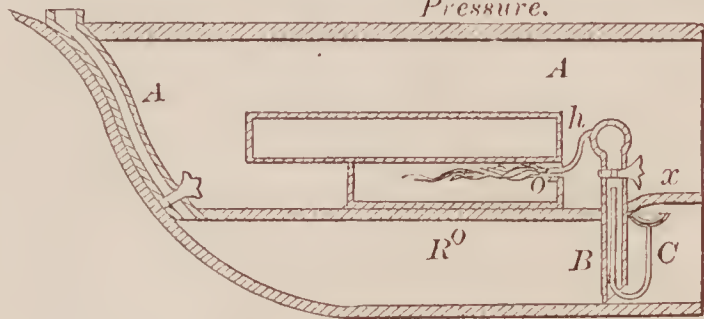

72103—Smith & Priest—For Shearing and Clipping Wool.

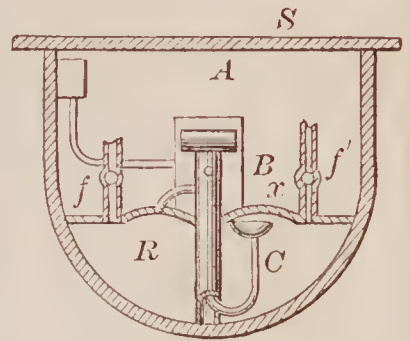
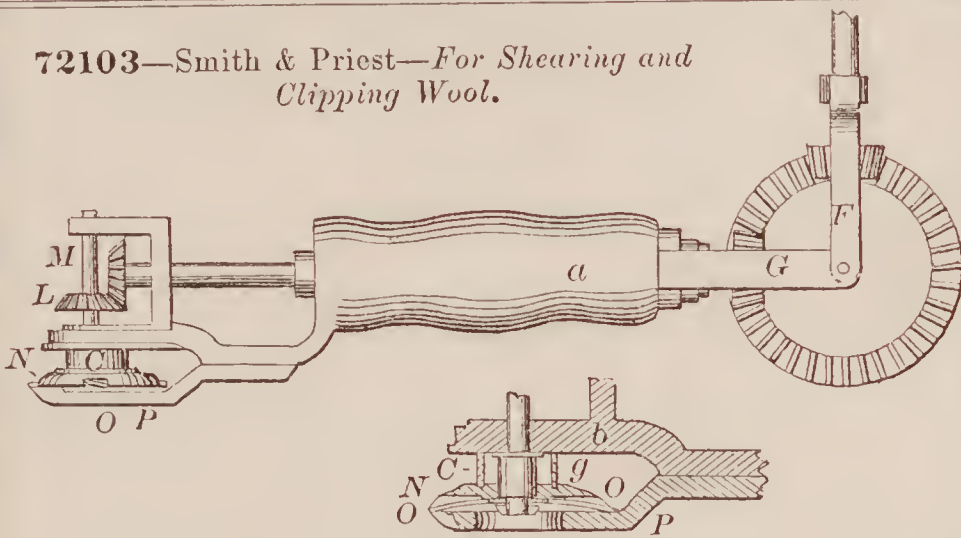

72105—V. K. Spear—Boot Heel Polisher.

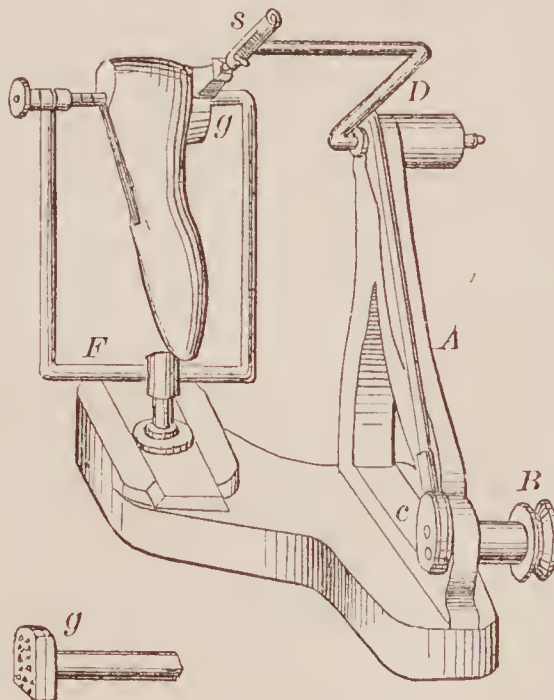

72104—J. Snyder—Corn Plow.

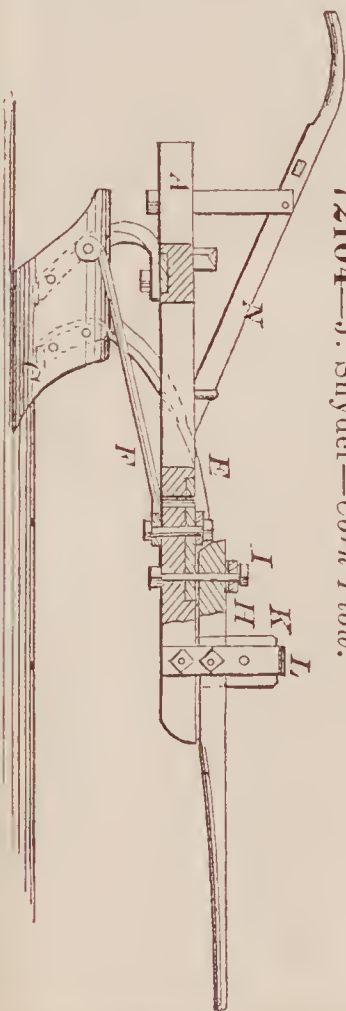

72106—Spedden & Stafford—Propelling Vessel.

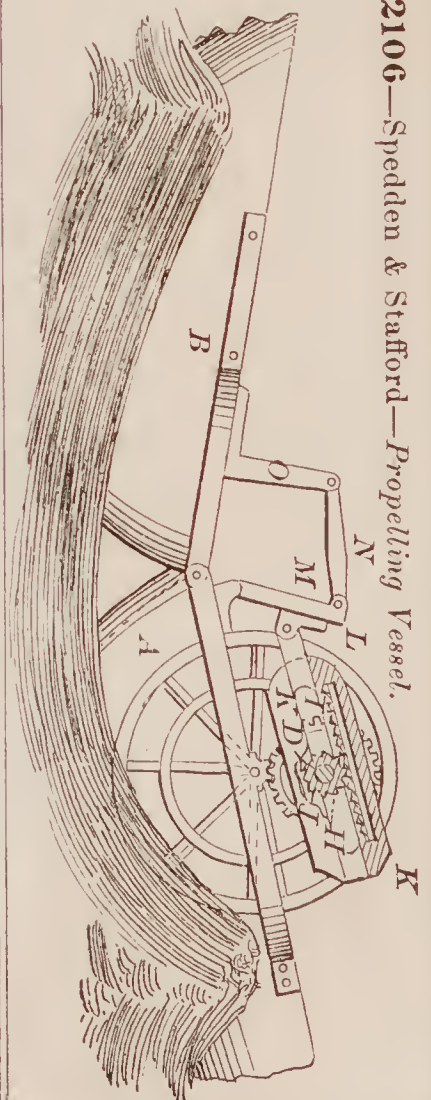



72107—C. E. Steller—Cultivator.

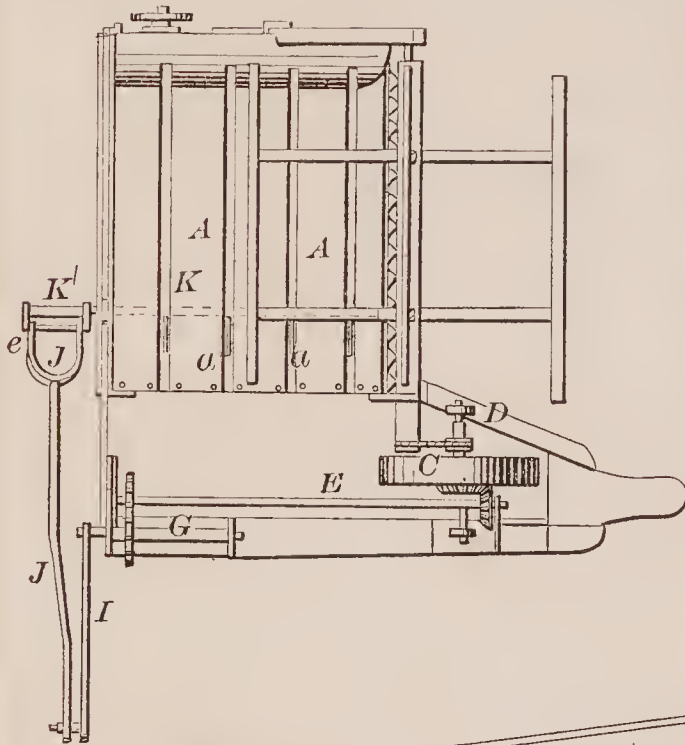
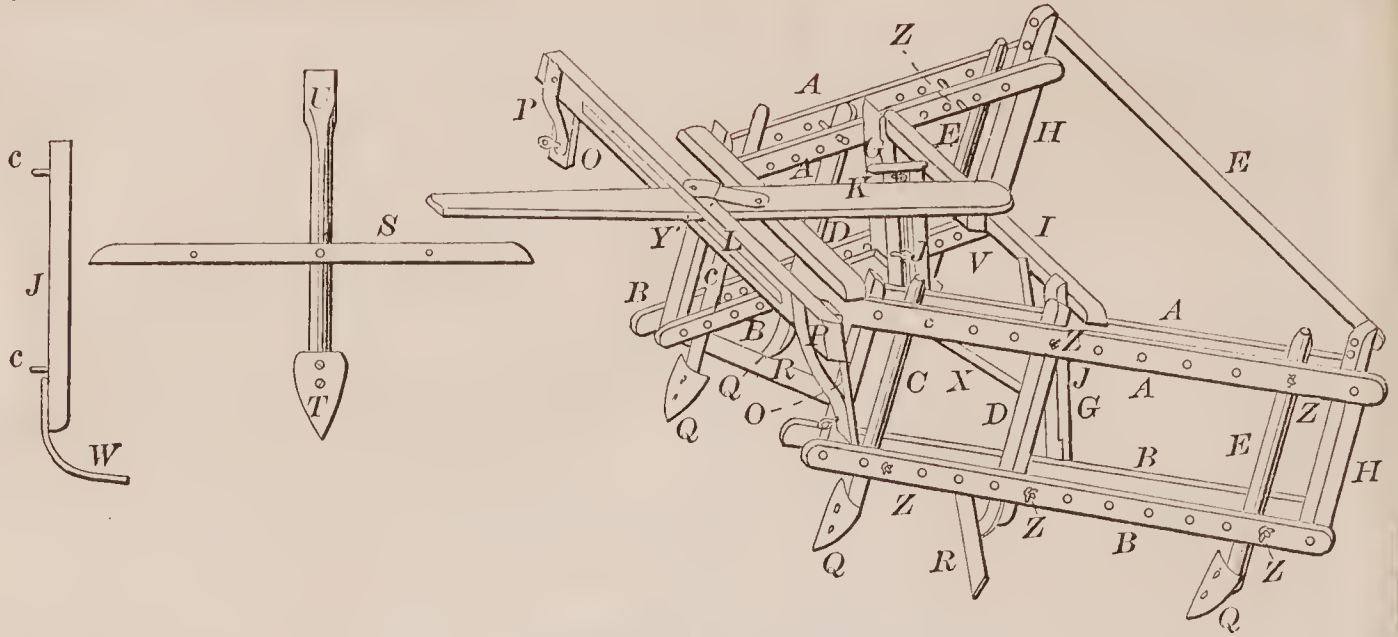

72109—E. Stewart—Harvester Rake.

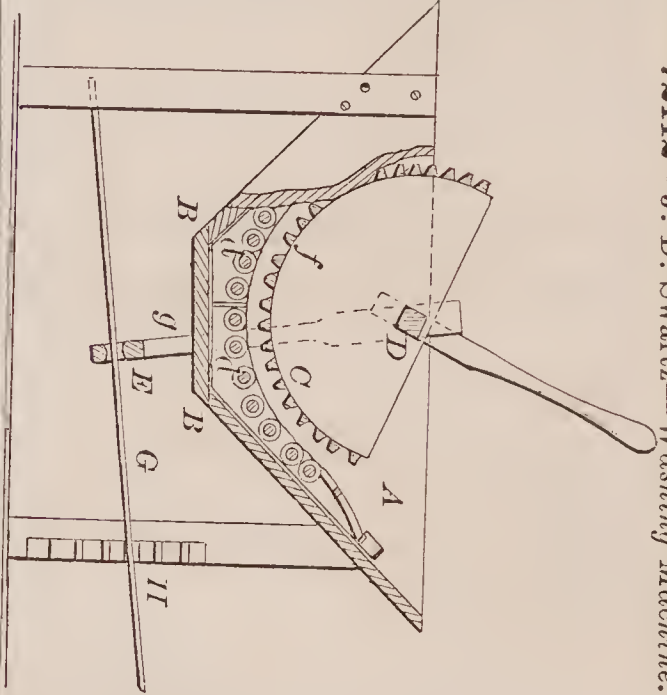

72112—J. D. Swartz—Washing Machine.

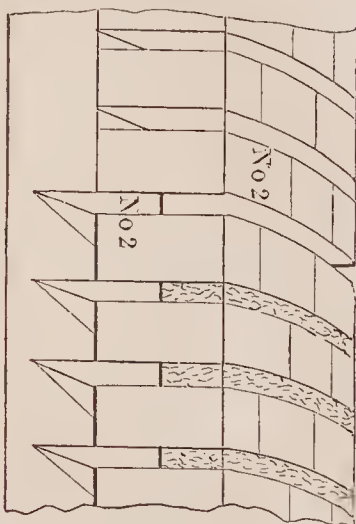

72110—H. M. Stow—Pavement.

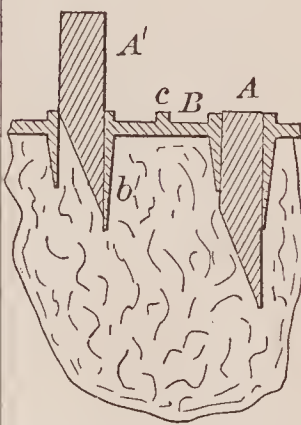

72111—H. M. Stow—Pavement.

72113—G. D. Sweigert—Fence.

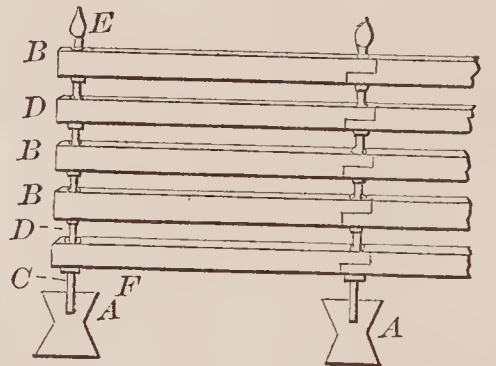

72108—B. F. Stephens—Eye Cup.

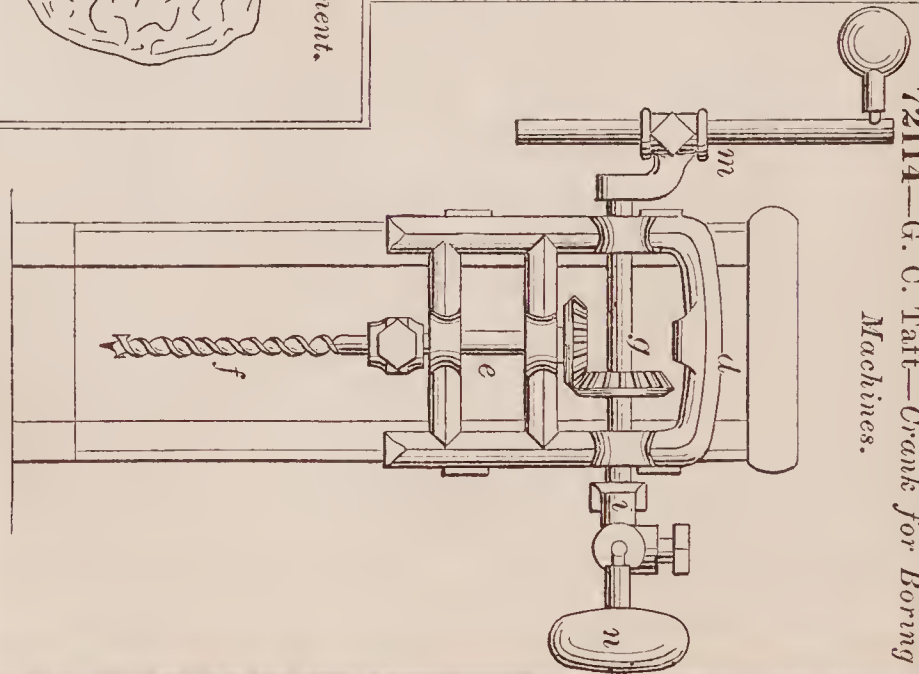
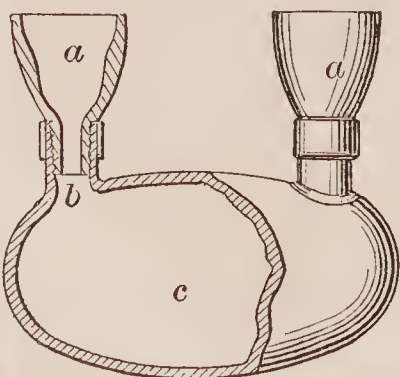

72114—G. C. Taft—Crank for Boring Machines.

72116—J. Teachout—Knitting Machine.



72118—J. B. Terry—Manufacturing Illuminating Gas.

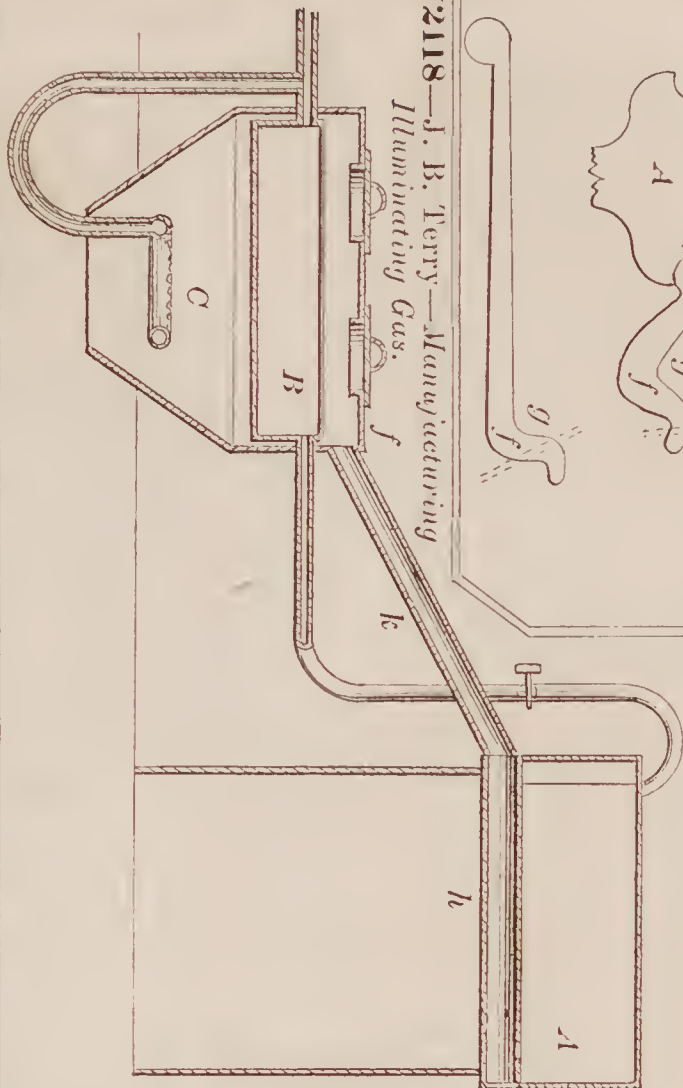

72115—J. Teachout—Rotary Take-up for Knitting Machines.

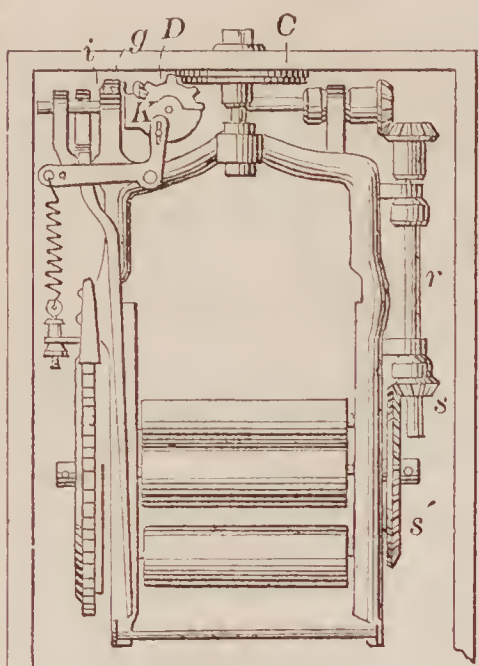

72117—J. Teachout—Knitting Machine.

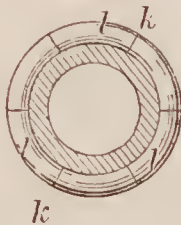
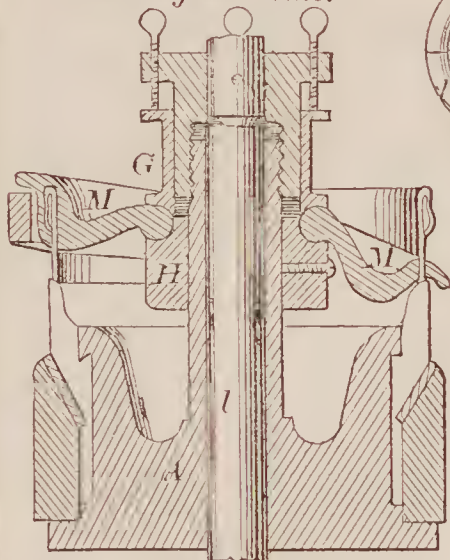

72120—J. H. Thompson—Gate.

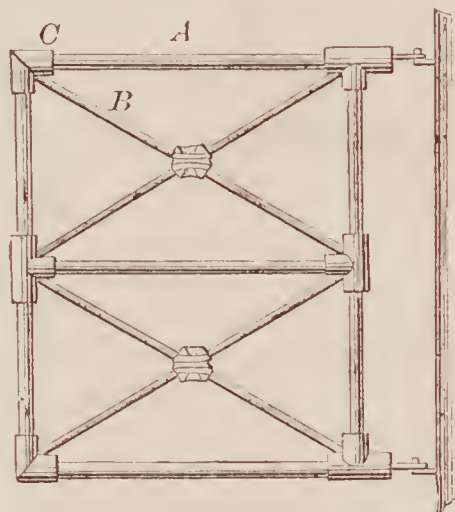
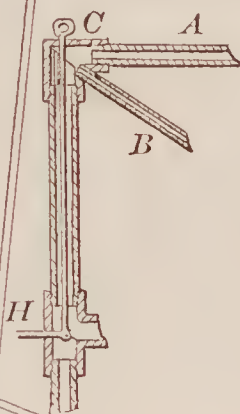

72119—Thomas & Dolley—Loom.

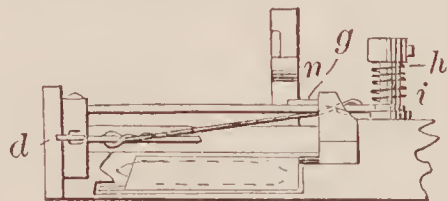

72121—J. Thoms—Violin Tail Piece.

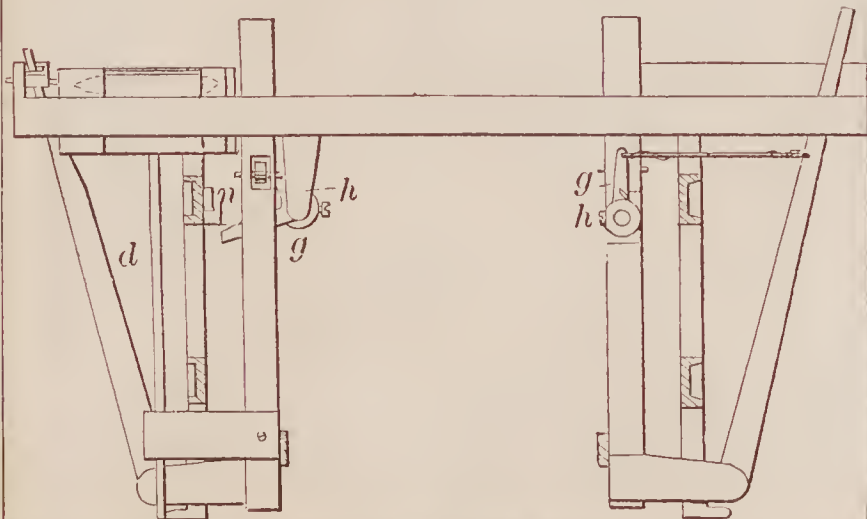
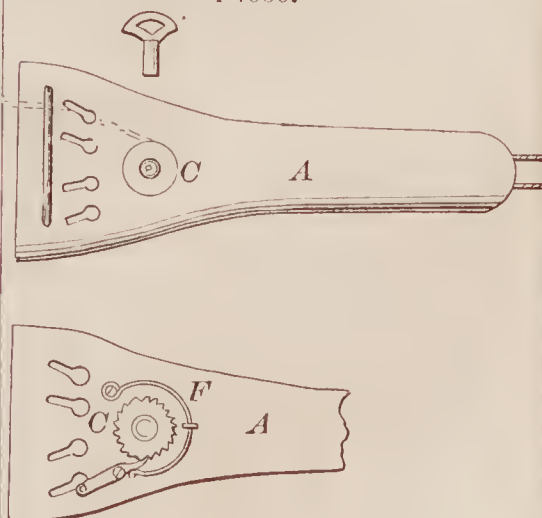



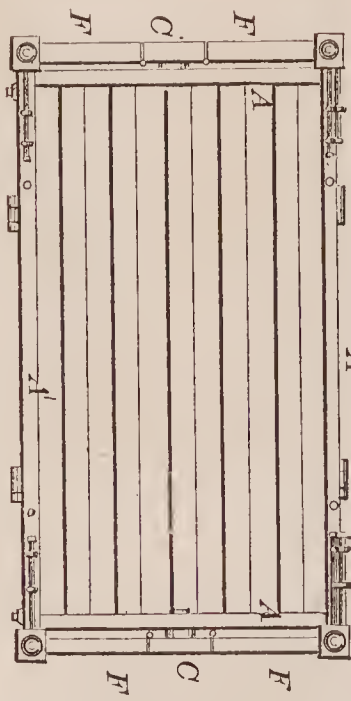

72122—R. S. Titcomb—*Folding Bedstead and Crib.*

72123—J. F. Troxel—*Steam Engine.*

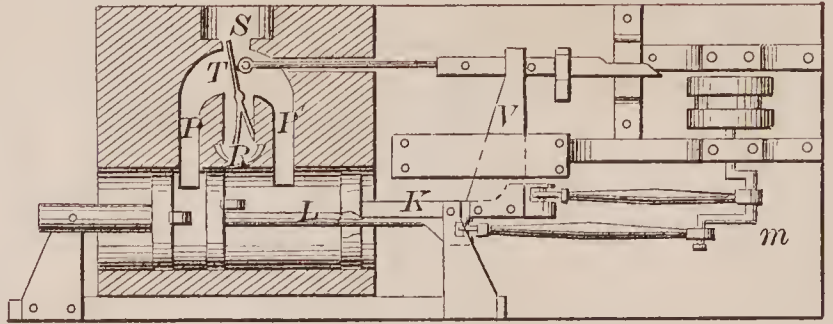

72124—N. Turner—*Wardrobe.*

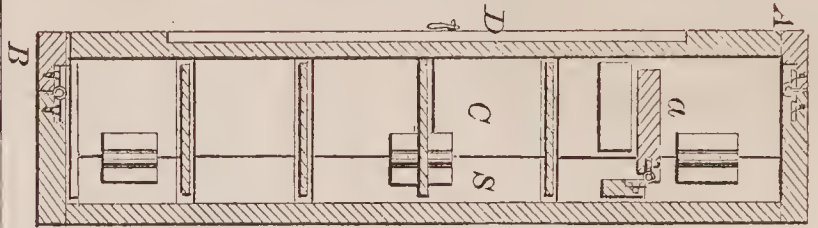

72127—J. G. Vale—*Grain Drill.*

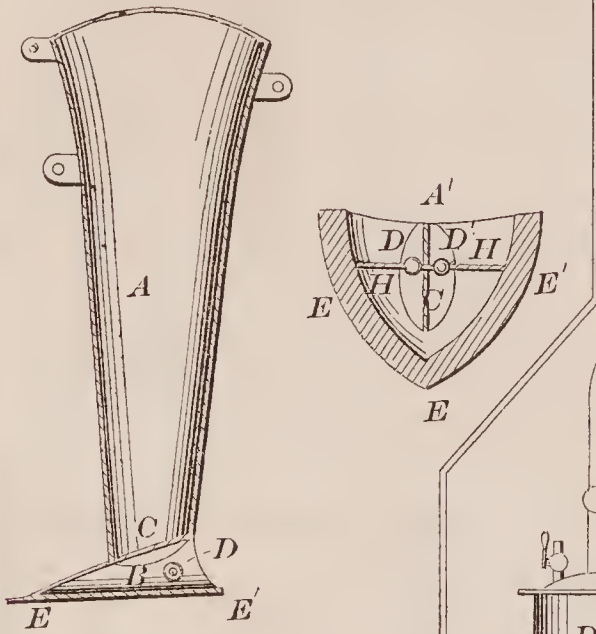

72125—H. W. C. Tweddle—*Distilling Oil.*

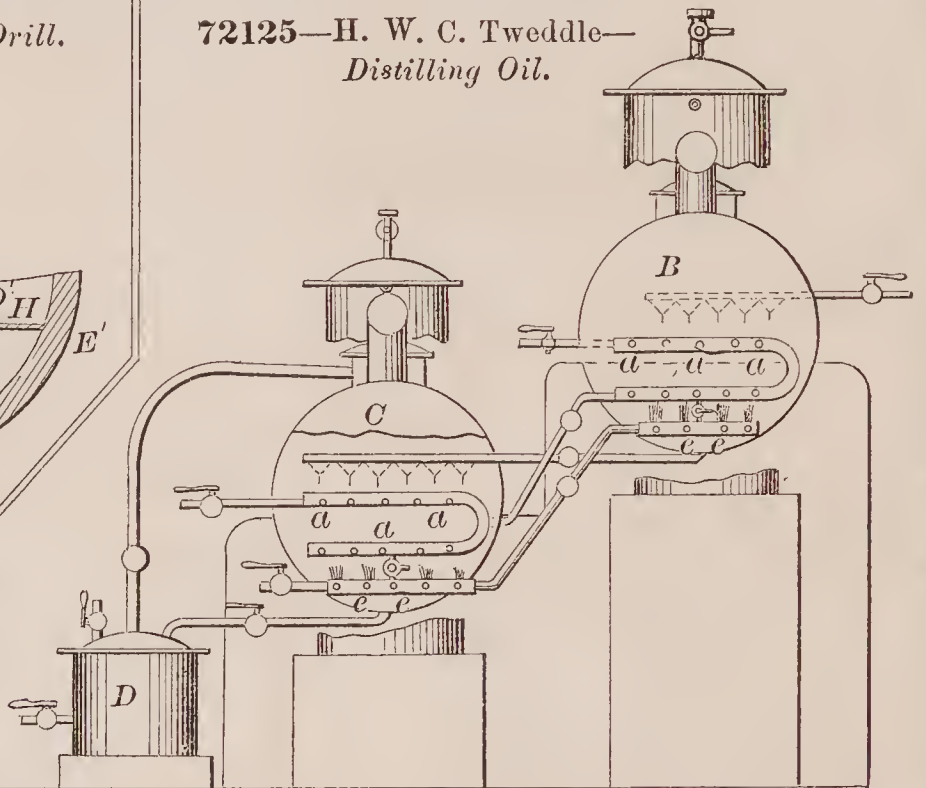

72126—H. W. C. Tweddle—*Distilling Hydro-Carbon Oil.*

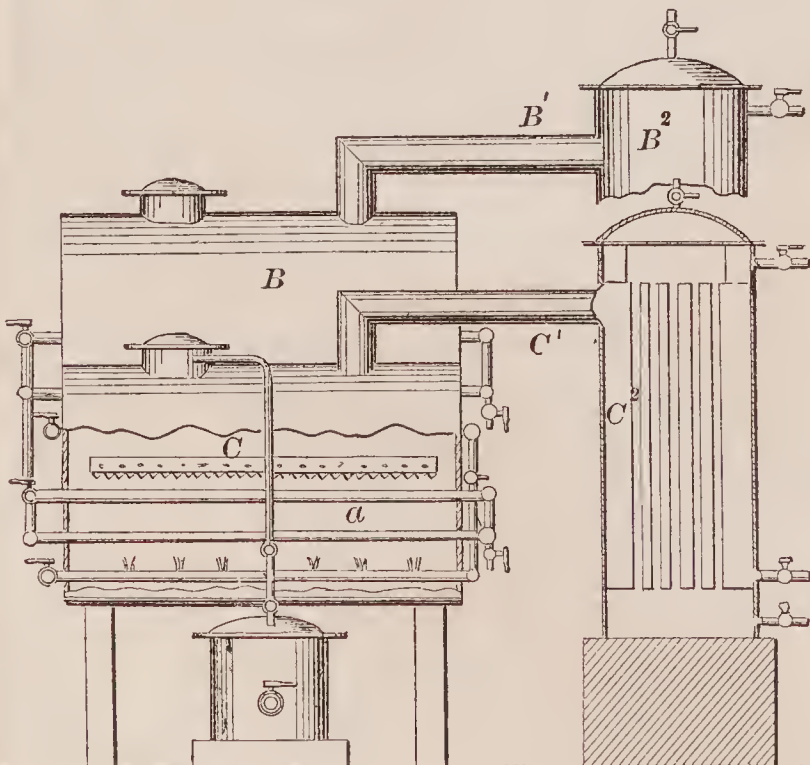

72128—G. R. Vanderbilt—*Window Sash Stop.*

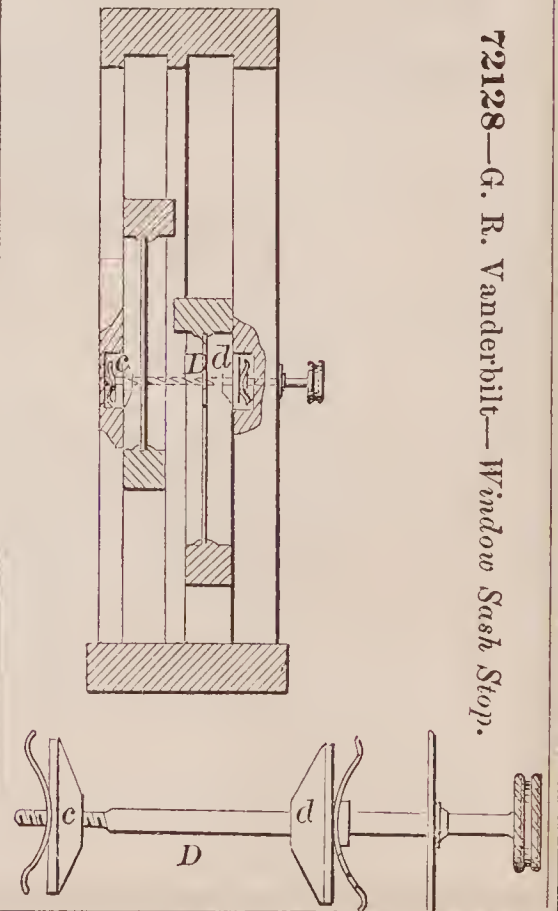





72135—J. Wakefield—Bolt and Rivet Machine.

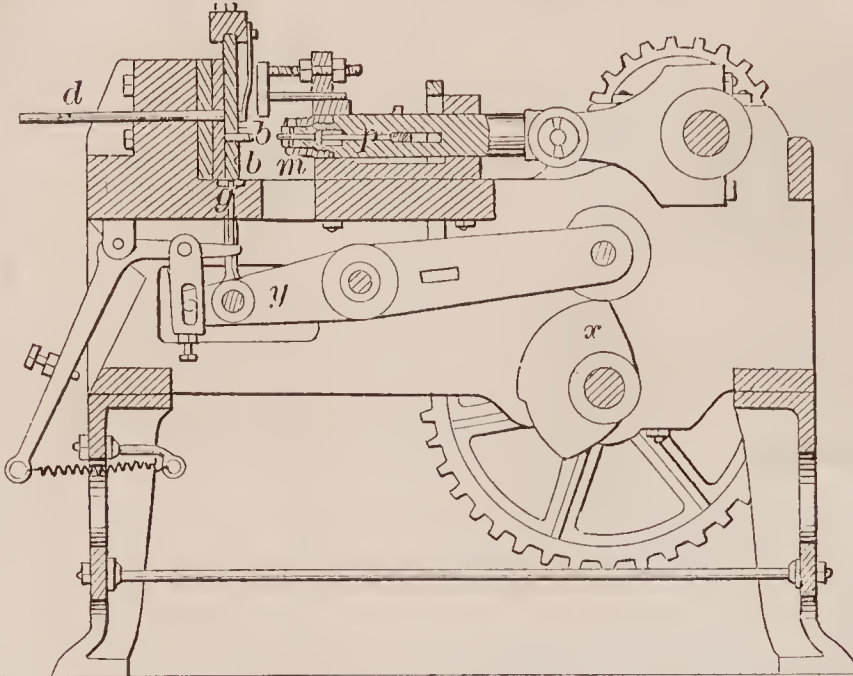

72137—P. V. Westfall—Brick Machine.

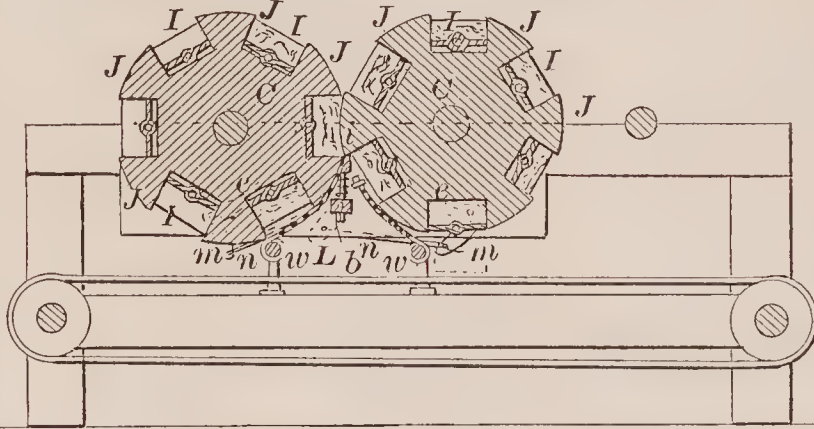

72138—N. Weston—For Enameling  
Photographic Pictures.

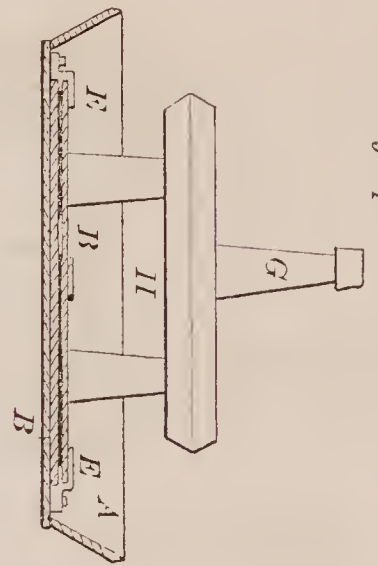

72139—N. W. Wheeler—Steam Engine Valve Gear.

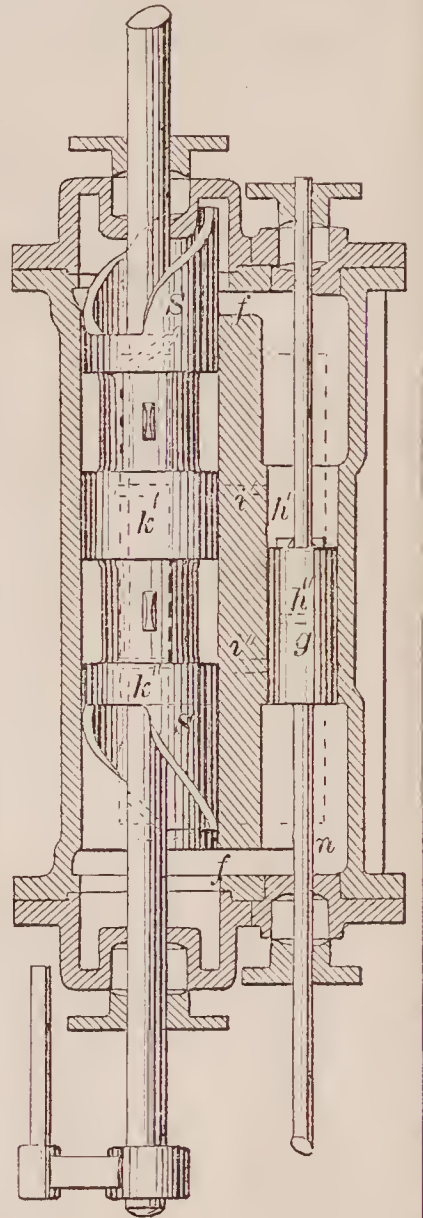

72140—A. H. & T. S. Whitacre—Ditching Machine.

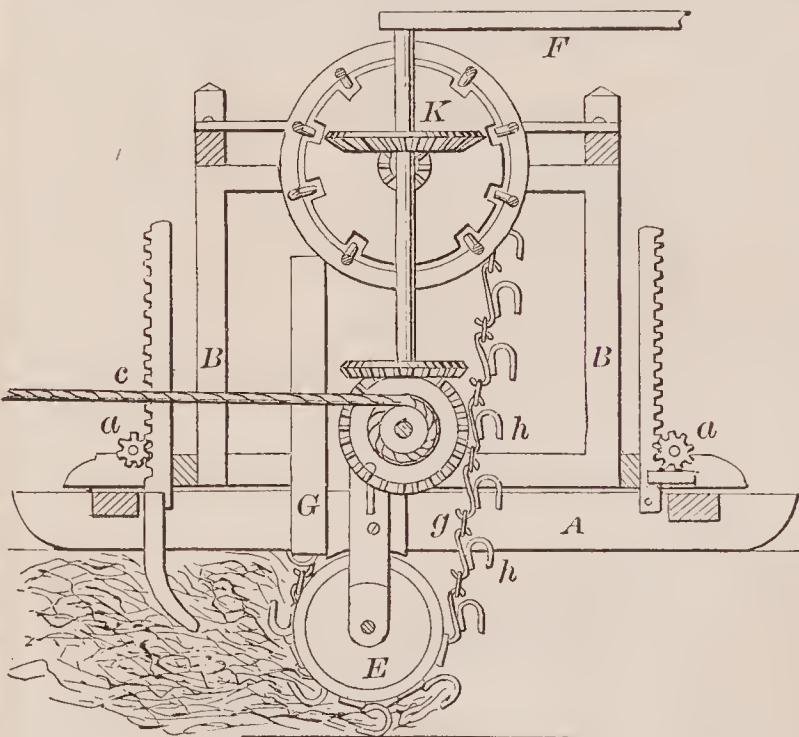

72141—S. P. Williams—Fence.

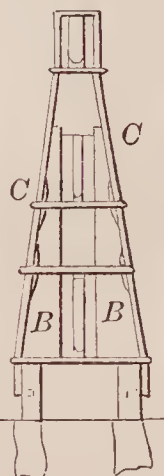

72136—D. Webster—Egg Beater.

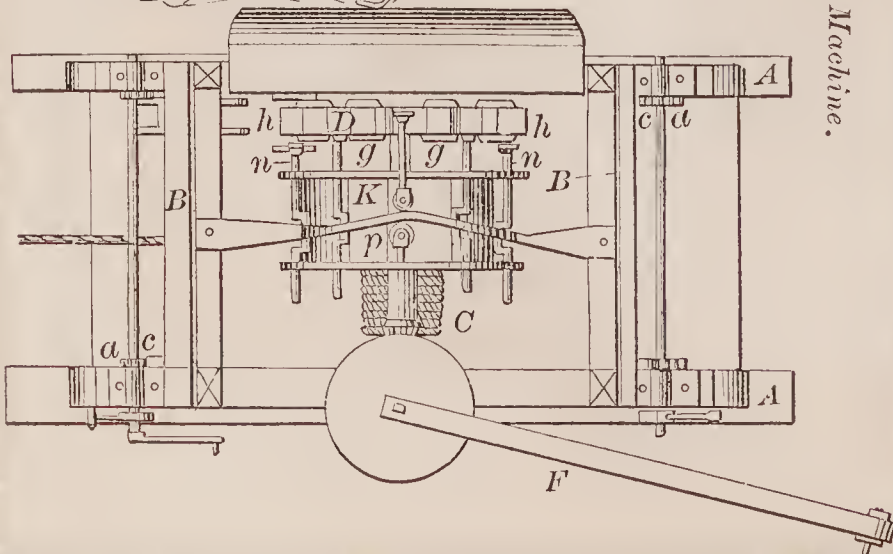

72142—H. B. Willson—Ventilating Tunnels.

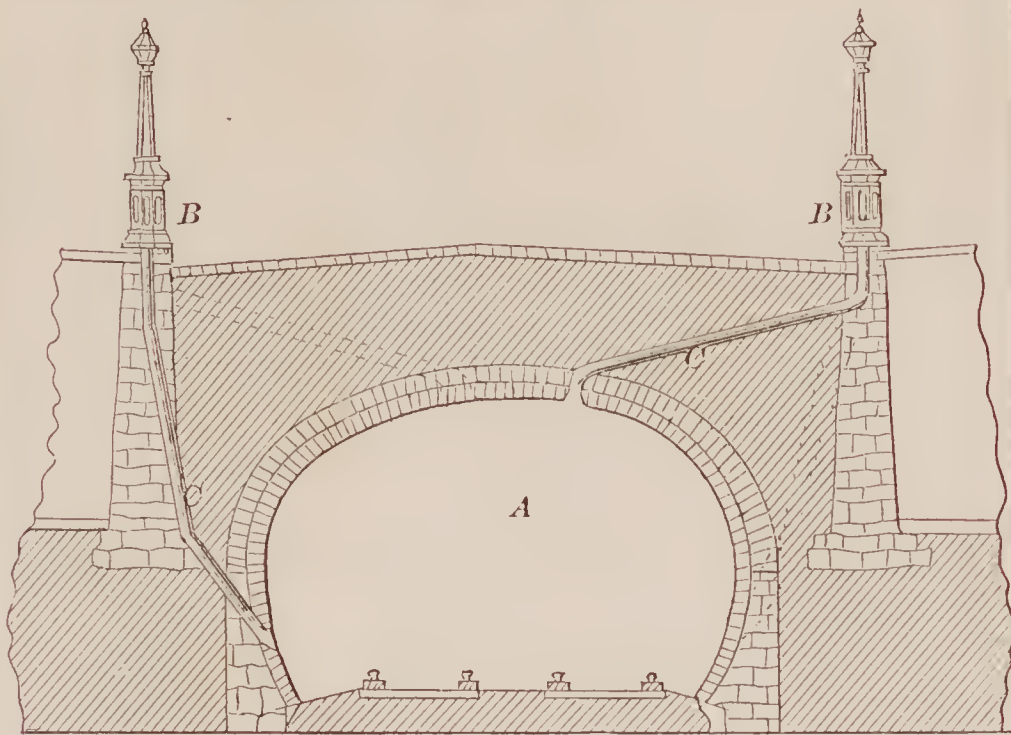

72146—J. Wolfe—Paper File.

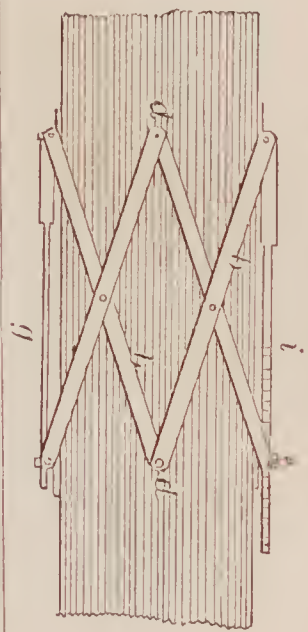

72144—W. H. Winans—Shoe Lifter.

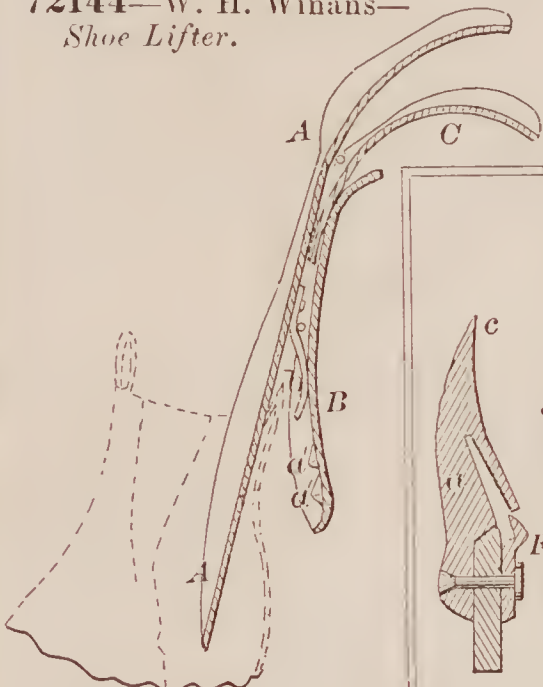

72145—T. W. Wisner—Stove.

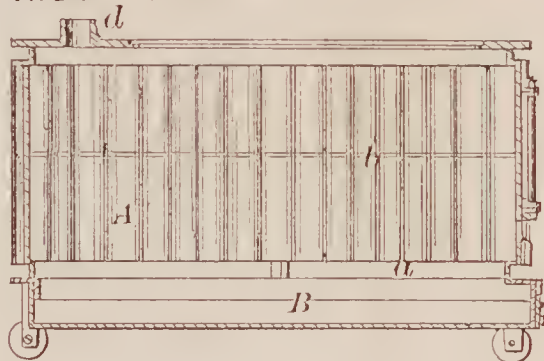

72149—W. A. Wood—Harvester.



72148—A. Wood—Lathe for Forming Shafting.

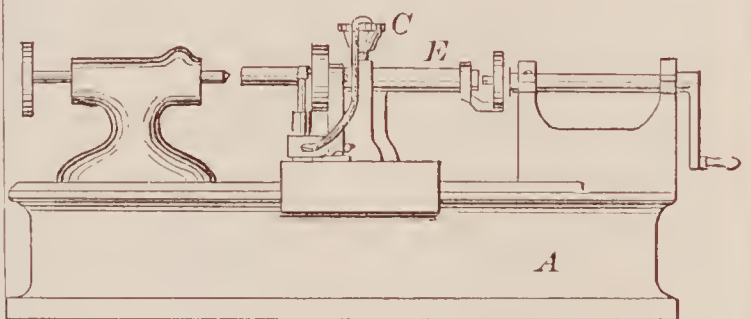

72147—A. Wood—Lathe Box and Journal.

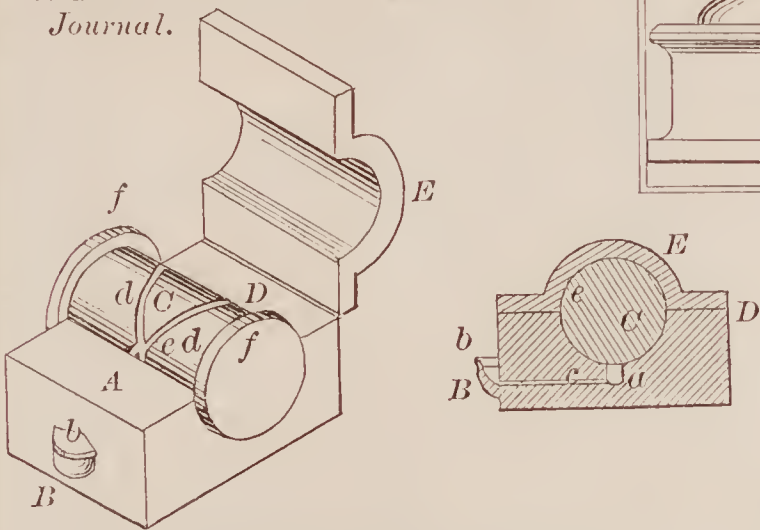

72151—E. S. Phelps, Jr.—Chimney.

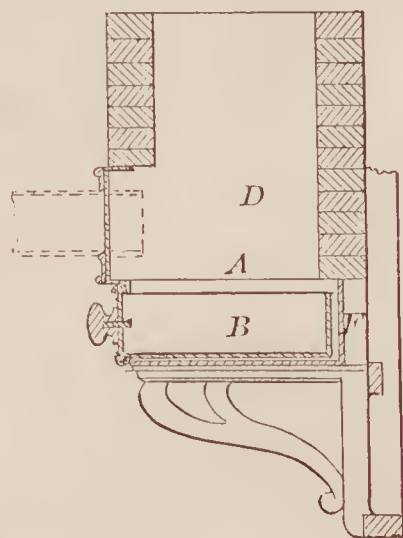

72150—W. H. Wood—Curtain Fixture.

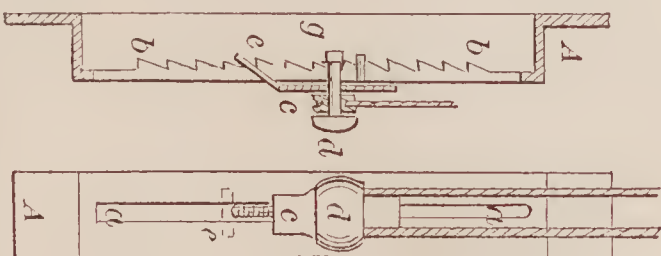



72152—A. Alexander—Bolt Making Machine.

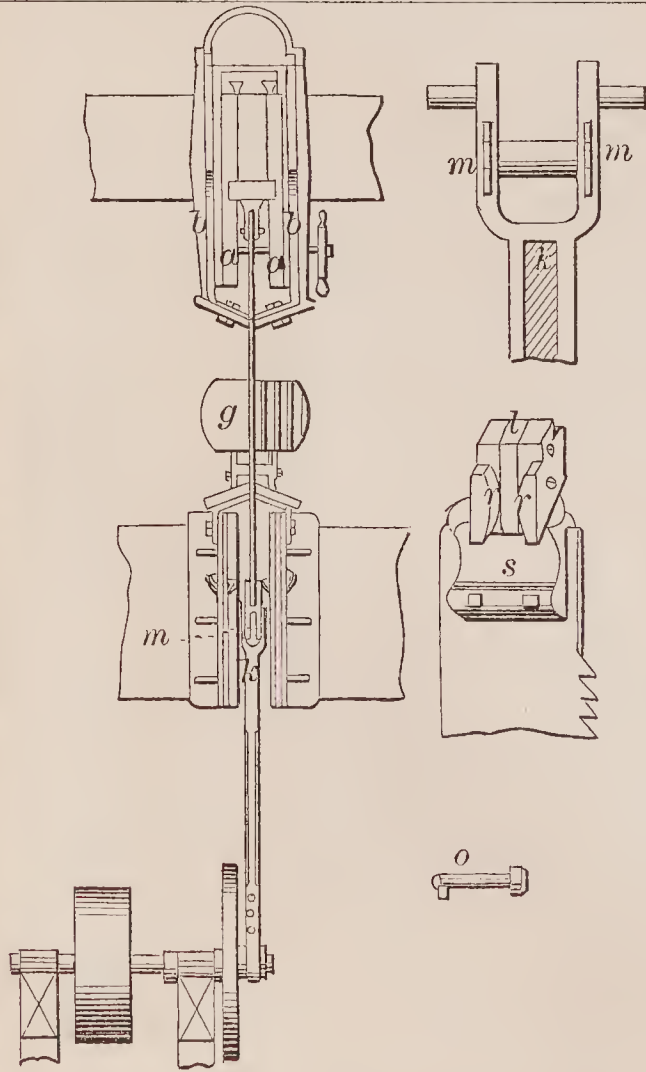
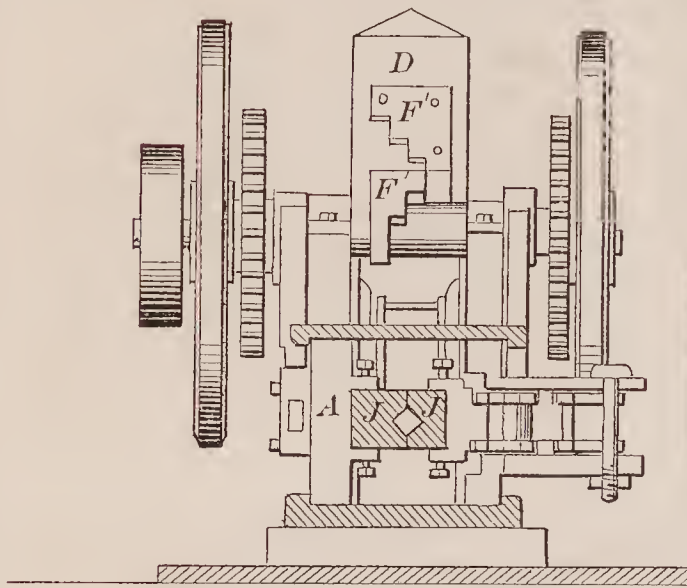
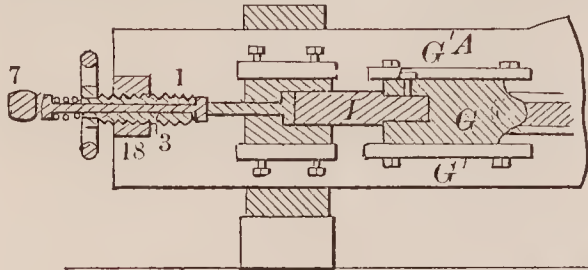
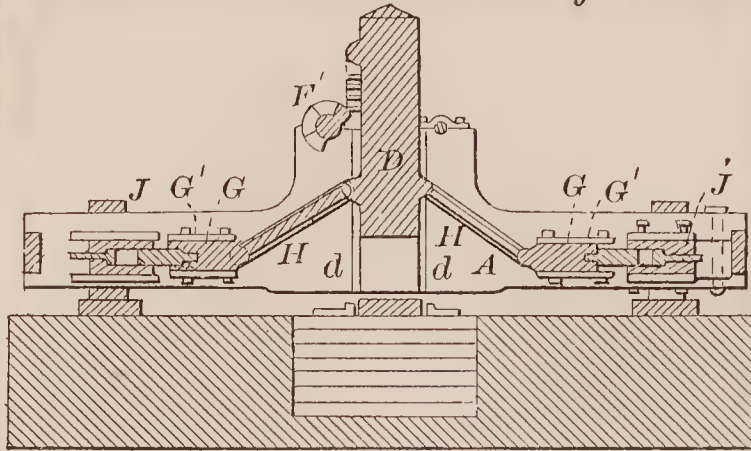

72155—A. P. Barlow—Saw Mill.

72153—A. Alexander—For Making Bolts.

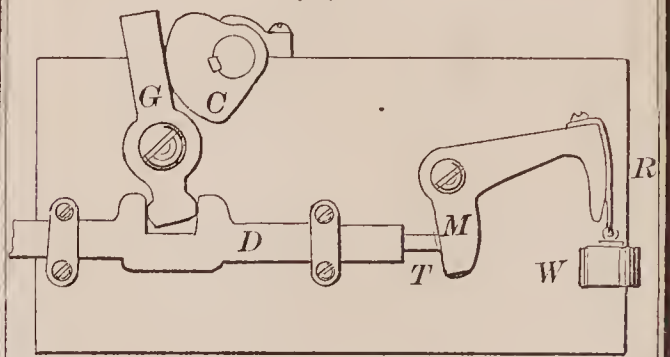

72154—A. E. Banks—Churn Dasher.

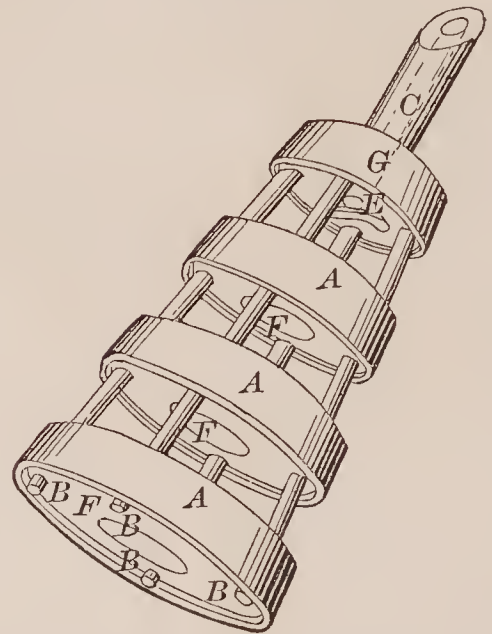

72156—G. H. Becker—For Accumulating Power.

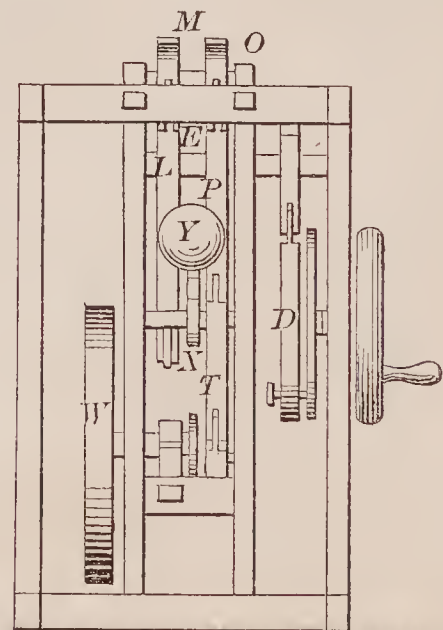
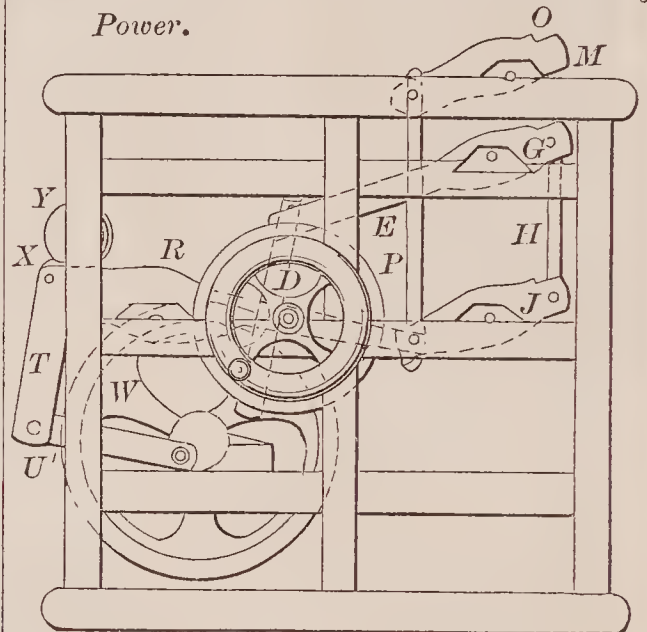

72157—Bender & Steffe—Drying and Seasoning Lumber.

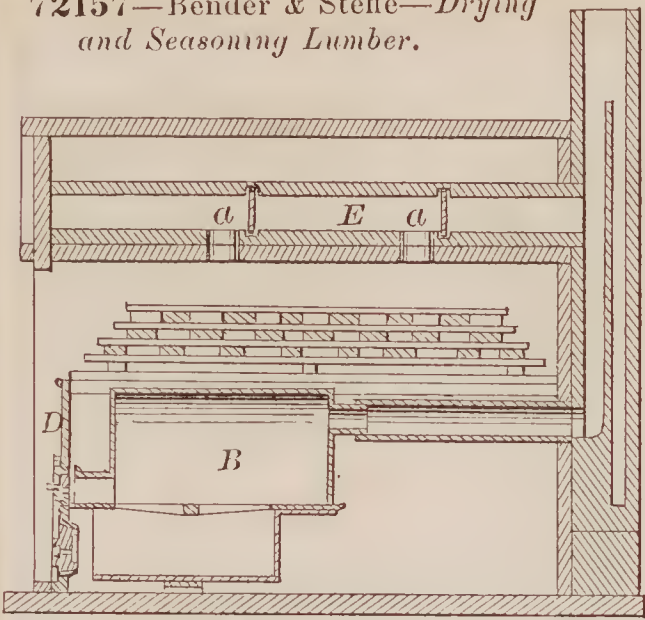

72161—S. Brackett—For Separating Roots from Peat.

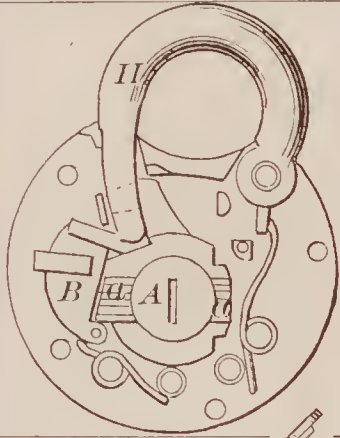
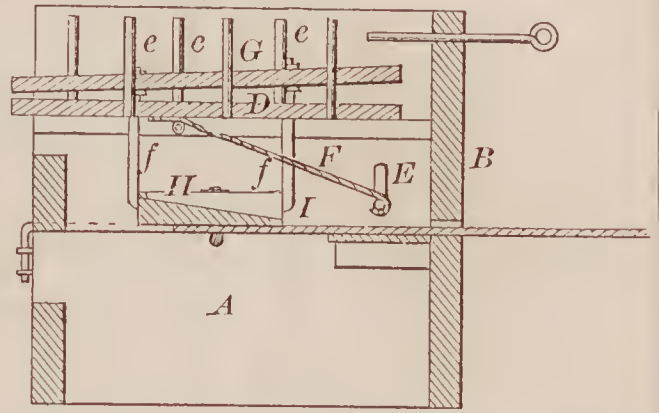

72166—C. J. Clements—Padlock.

72164—B. H. Camp—For Attaching Oversoles to Boots and Shoes.

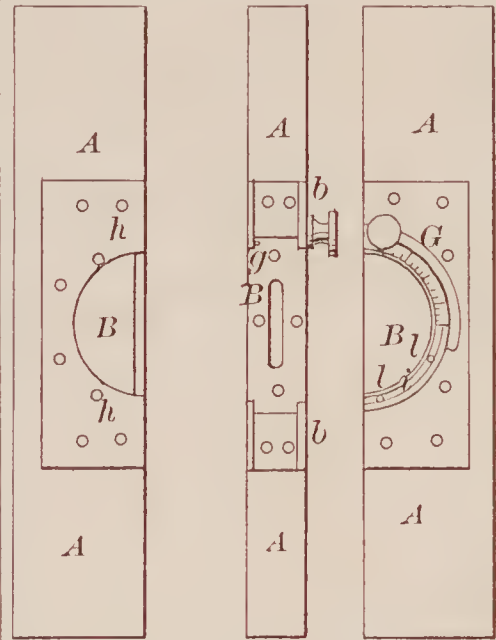
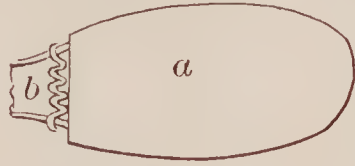

72159—S. A. Postwick—Plumb and Level.

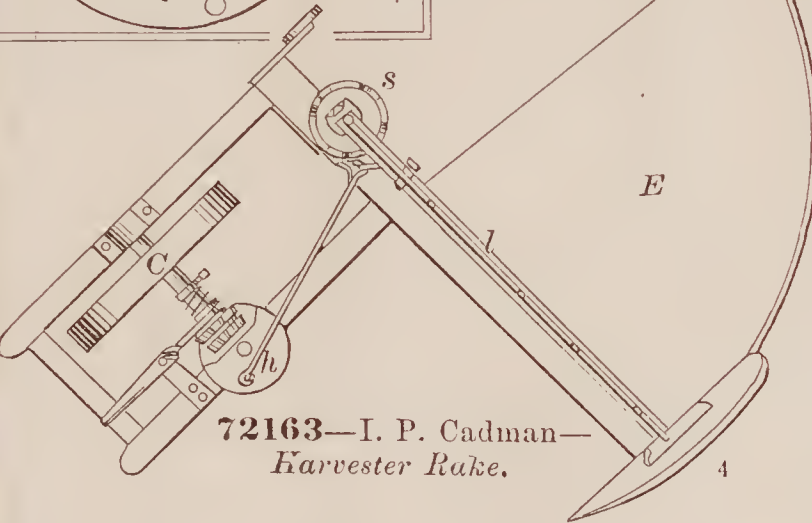

72163—I. P. Cadman—Harvester Rake.

72160—J. Boynton—Shovel and Sifter.

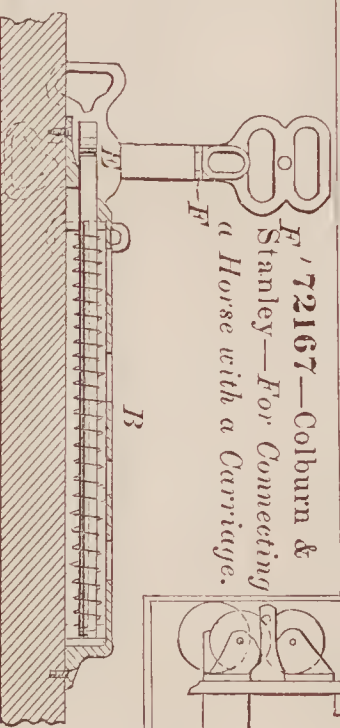
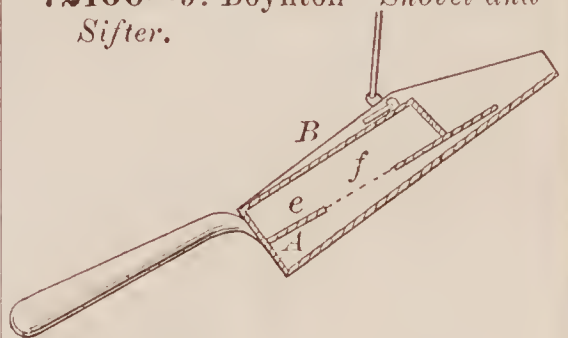

72167—Colburn & Stanley—For Connecting a Horse with a Carriage.

72165—T. Chambers—Elevator.

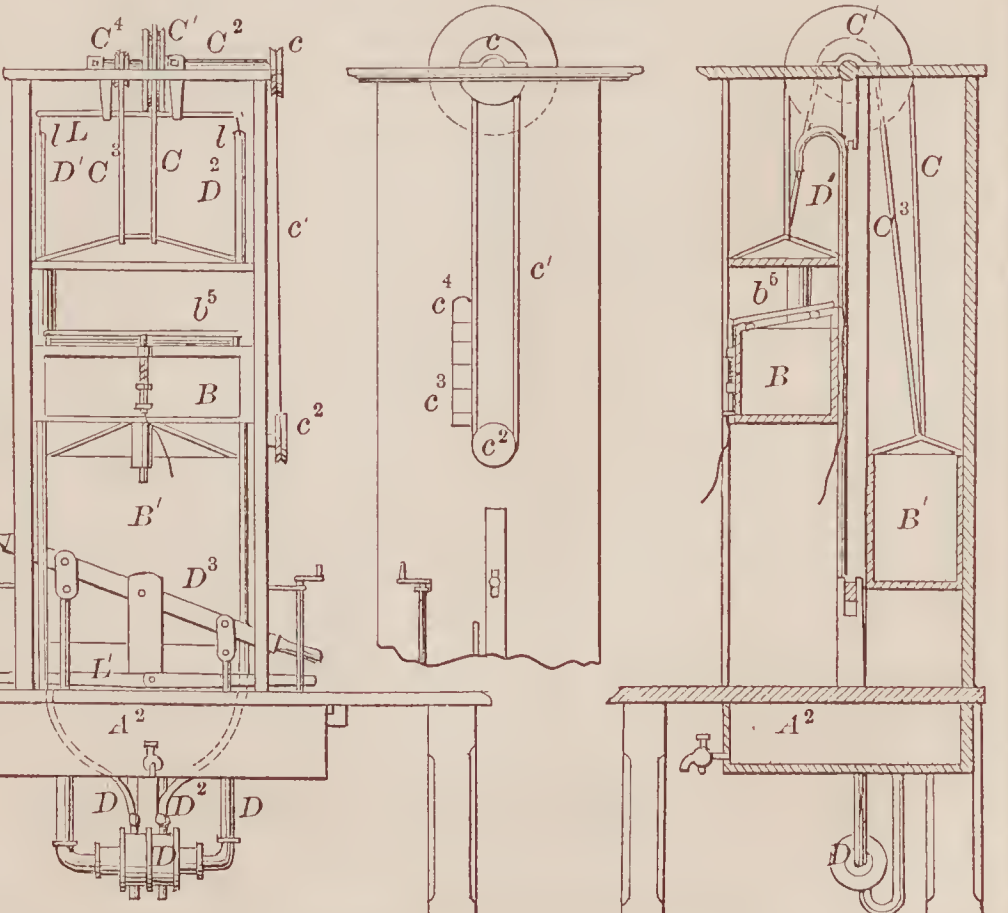



72173—D. A. Denison—Corn Popper.

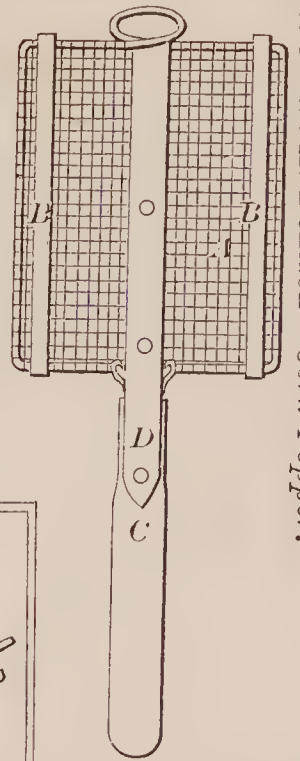

72169—G. M. Connor—Water Wheel.

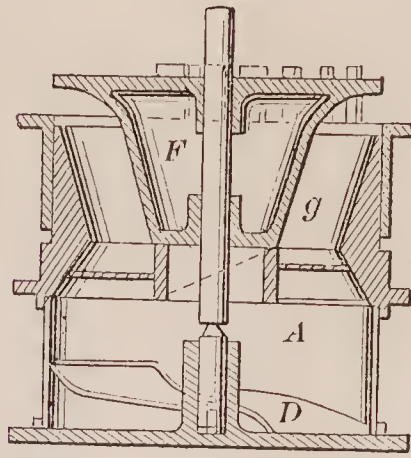

72168—J. B. Collin—Lubricating Cup.

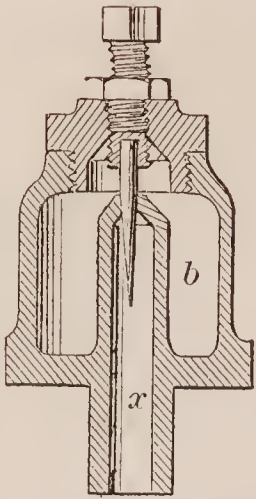

72170—R. Creuzbaur—Boat Lowering Apparatus.

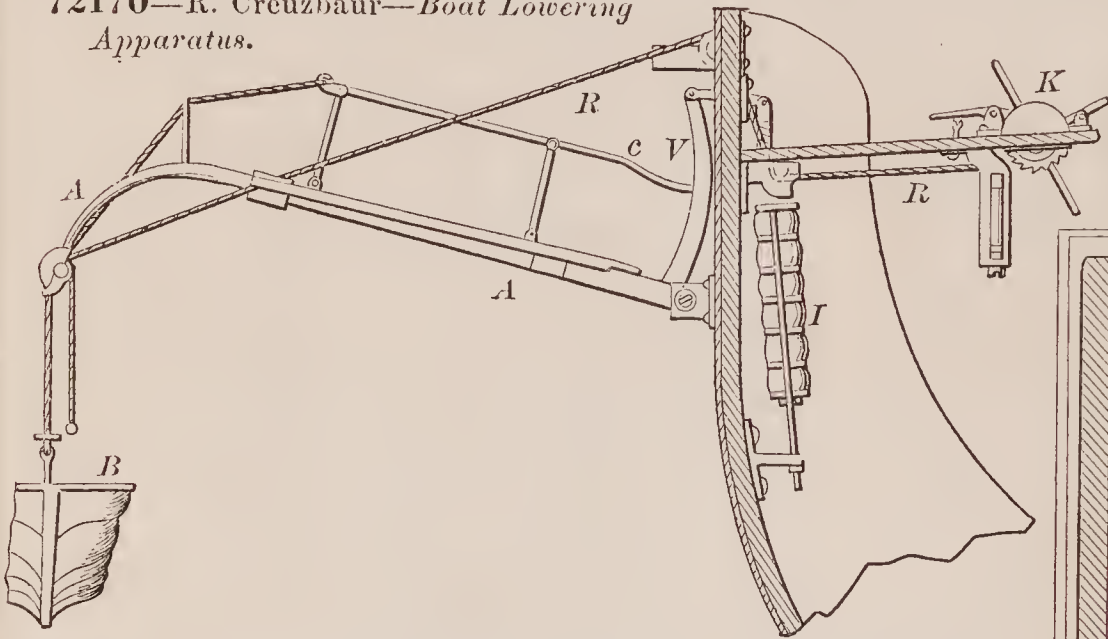

72172—R. Creuzbaur—Boat Detaching Apparatus.

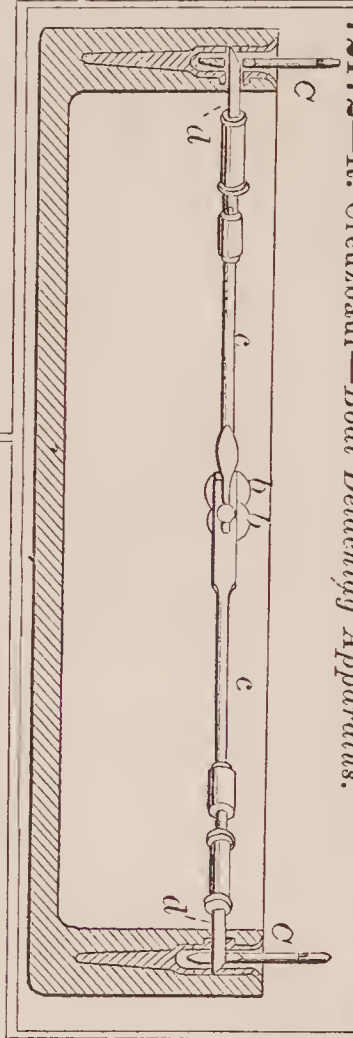

72171—R. Creuzbaur—Boat Lowering Apparatus.

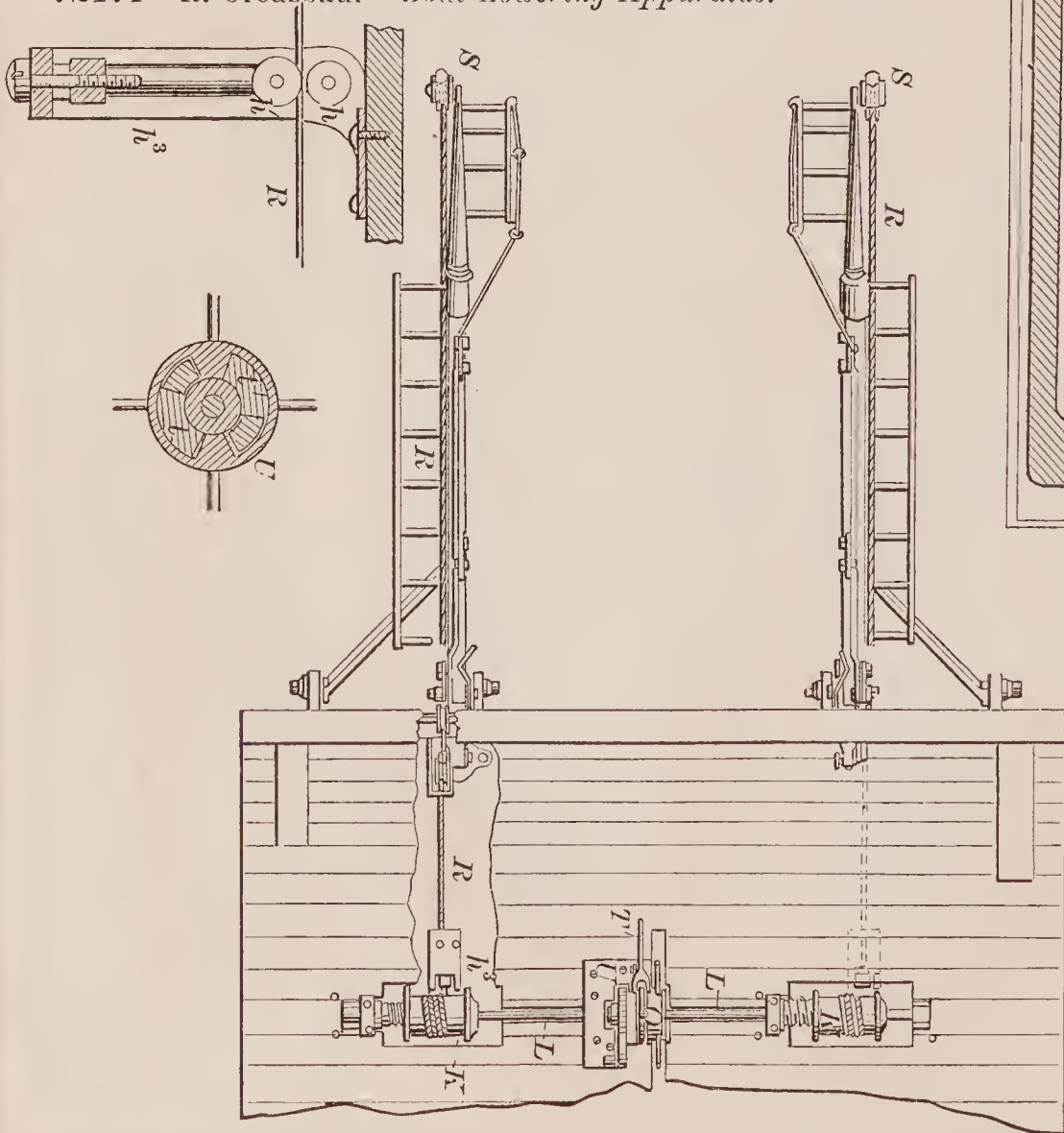

72174—A. Dohsy—Stick for Trundling Hoops.



72175—H. C. Dorman—Washing Machine.

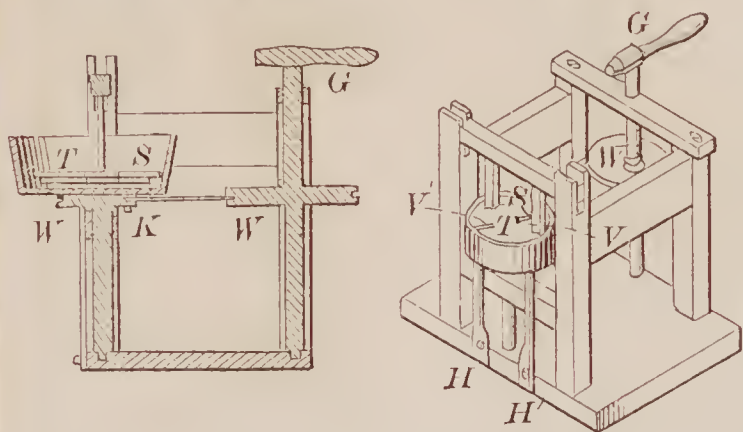

72176—Draper & Glover—Fireproof Safe.



72179—G. F. Filley—Stove Back Plate.



72177—C. Drexler—For Securing and Feeding Soft Crabs.

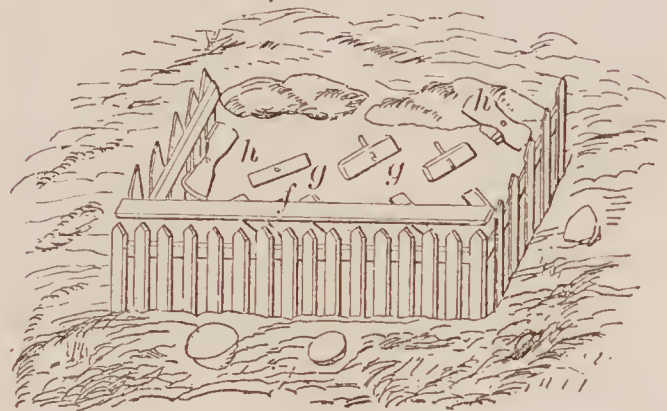

72178—C. S. Dunback—Chair Rocker.



72180—W. Fiske—Sewing Machine.

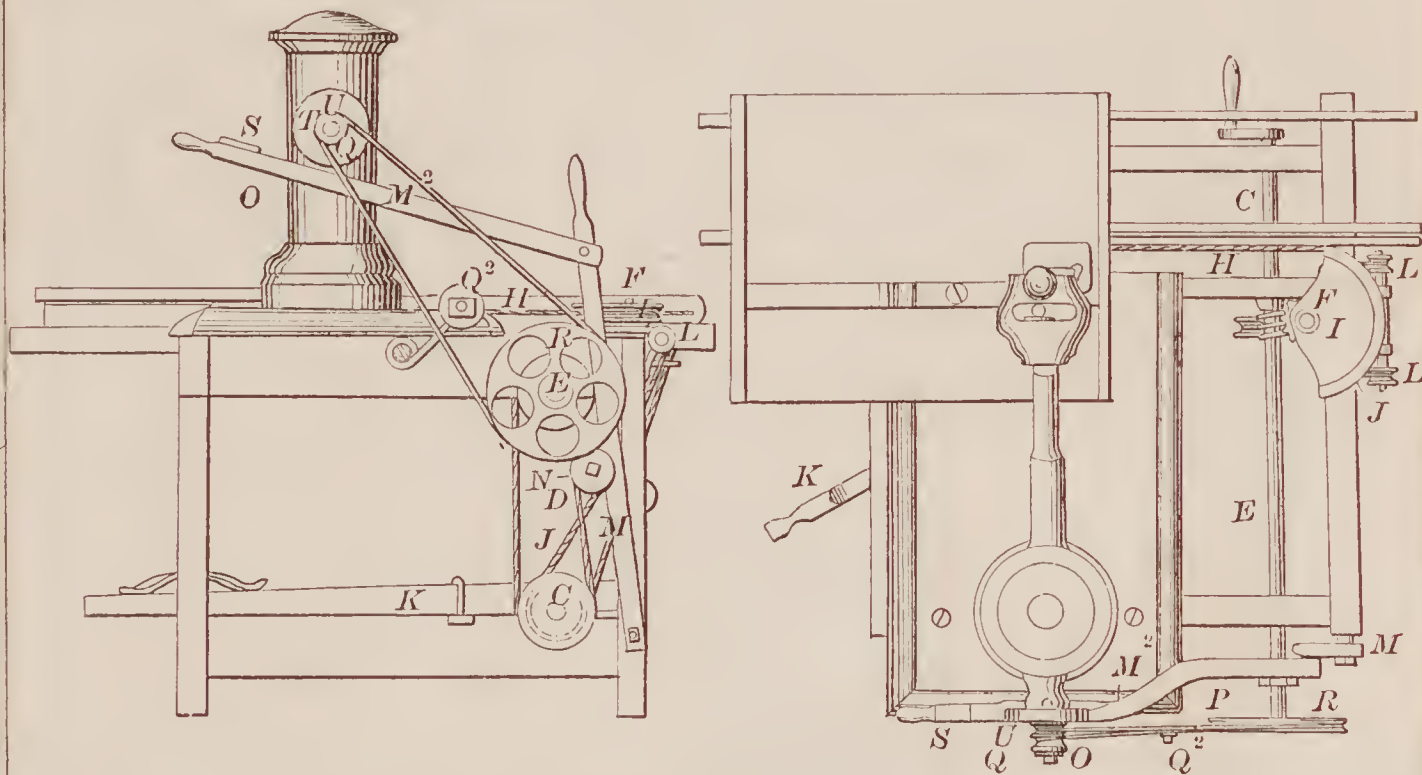

72182—S. Fountain—Concentrator and Amalgamator.

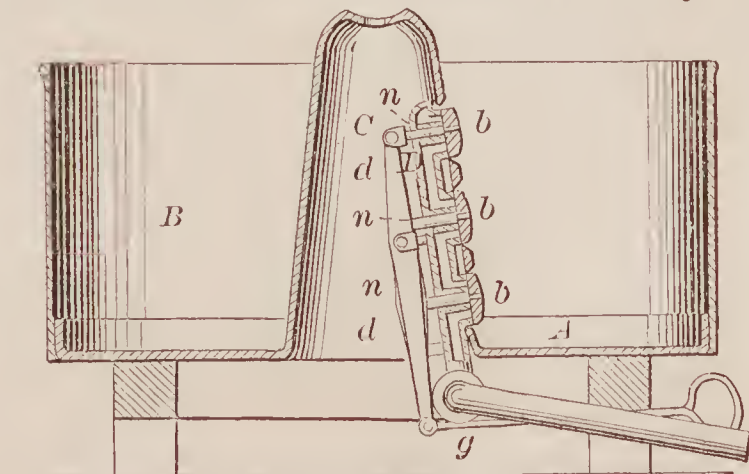

72181—V. Fountain—Machine Belting.



72183—O. C. Fox—Driven Well.





72184—B. C. Galvin—Portable Switch.

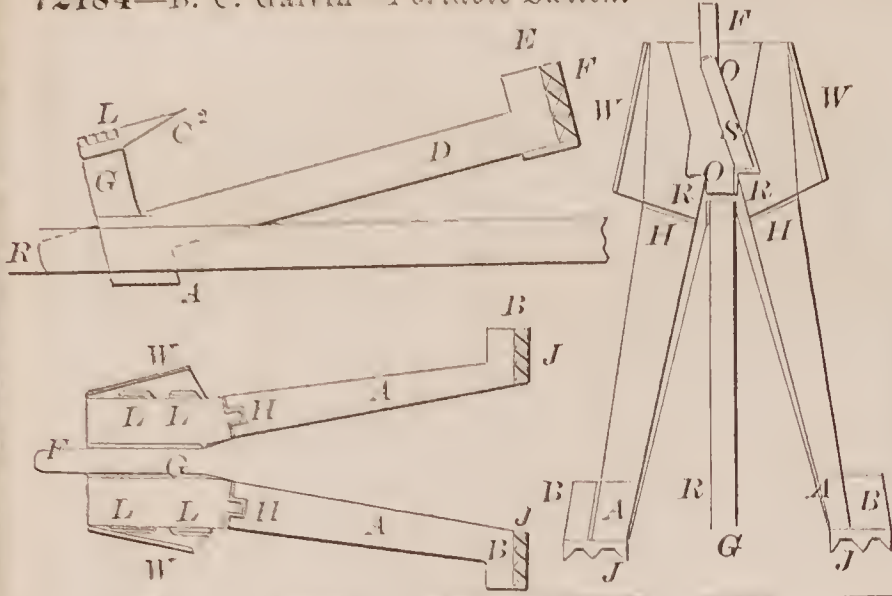

72185—B. C. Galvin—Railway Switch.

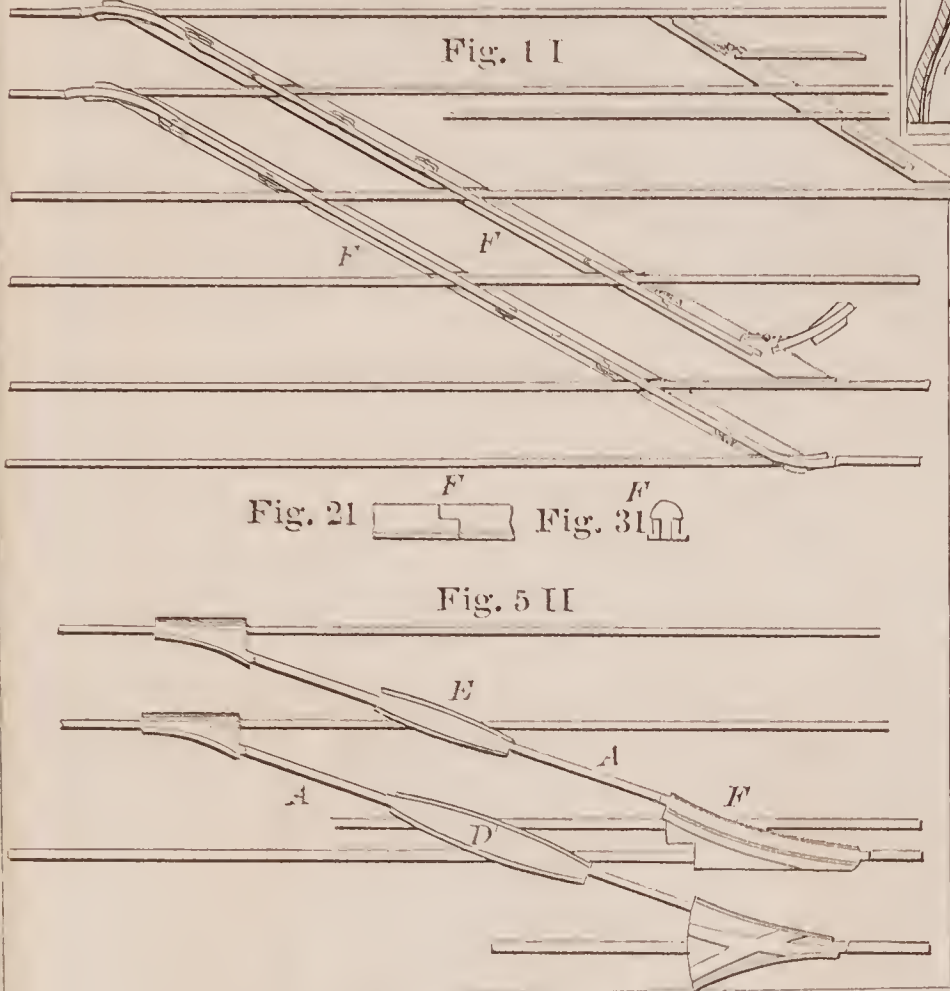

72186—T. Garrick—Twine Holder and Cutter.

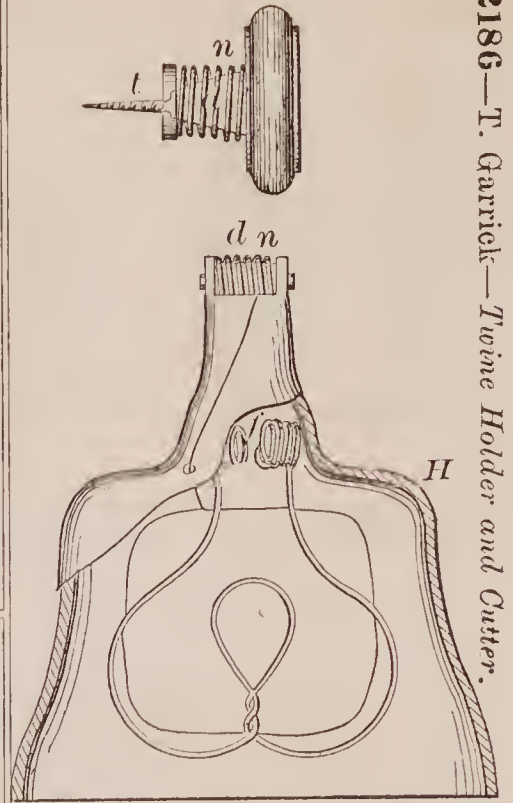

72189—H. A. Goll—

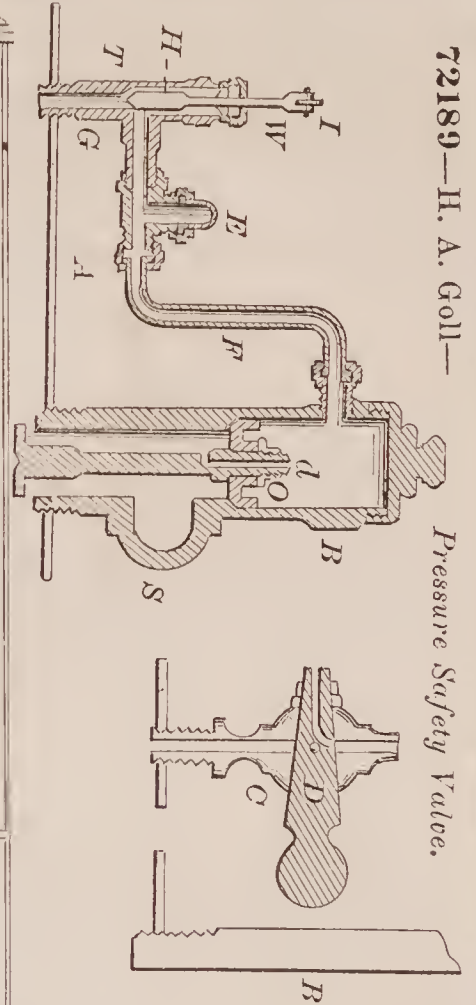

Pressure Safety Valve.

72187—E. P. Gleason—Argand Burner.

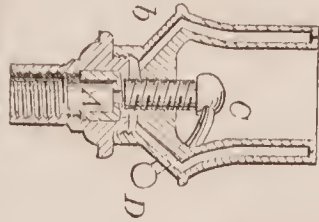

72190—C. P. Gorely—Letter Box.

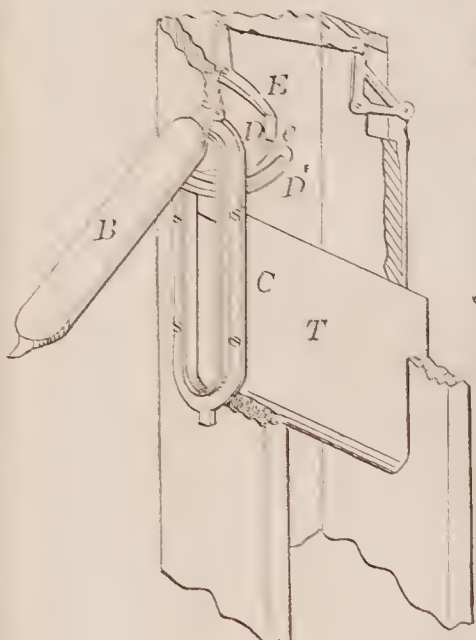

72191—L. A. Gouch—Naphtha Burner.

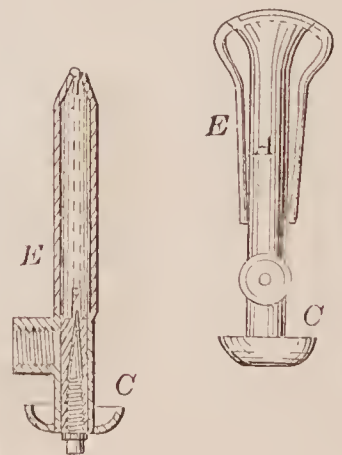

72188—E. P. Gleason—Gas Heating Burner.

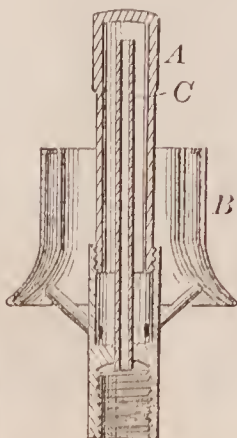

72192—V. D. Green—*Steam Safety Valve.*

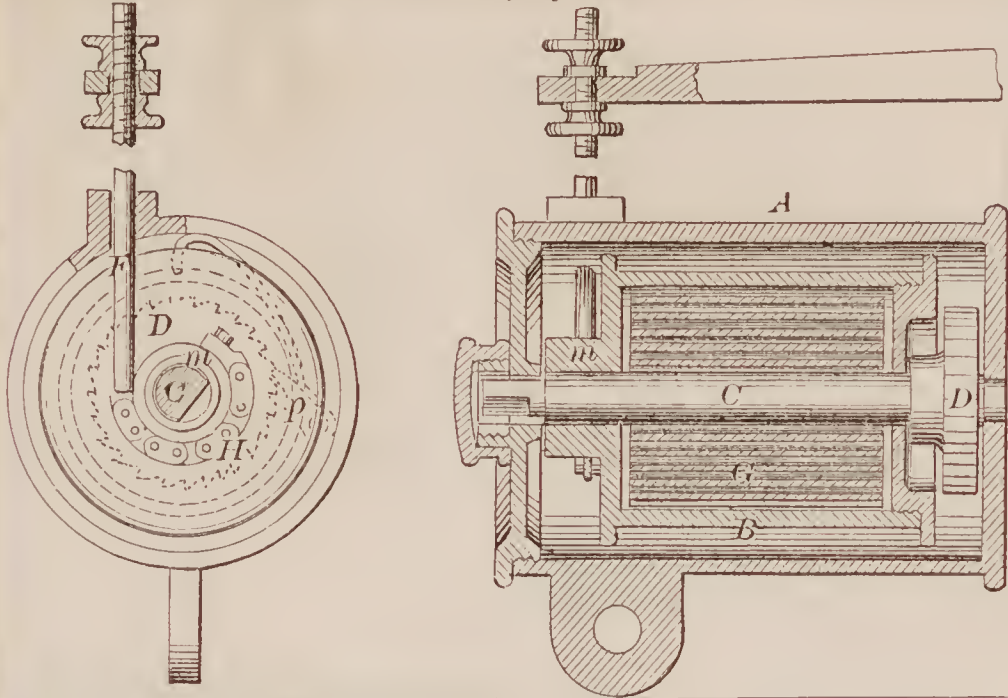

72196—J. Harding—*Lock Fastener for Lamps.*

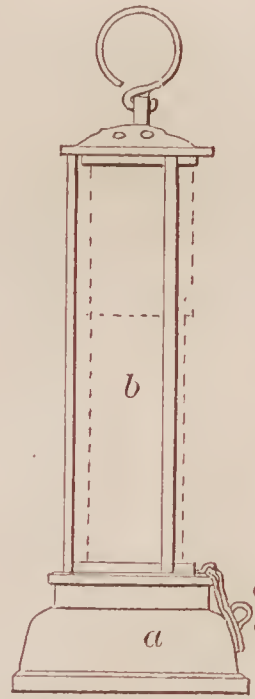

72195—W. Hailes—*Kettle Bail.*

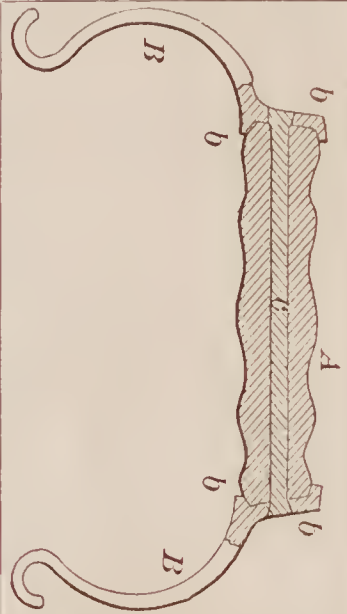

72194—E. F. Greffitt—*Bakers' Reel Oven.*

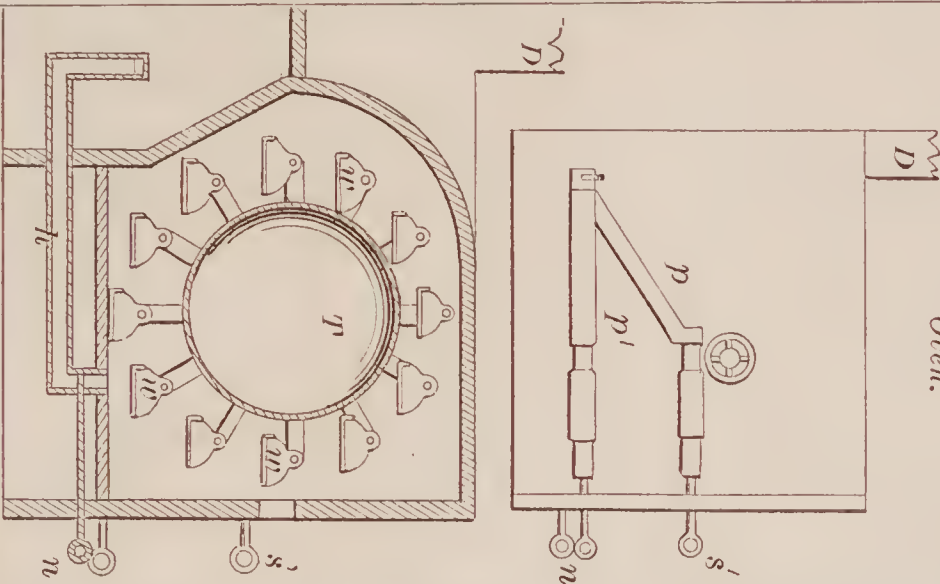

72198—H. A. M. Harris—*Harvester Rake.*

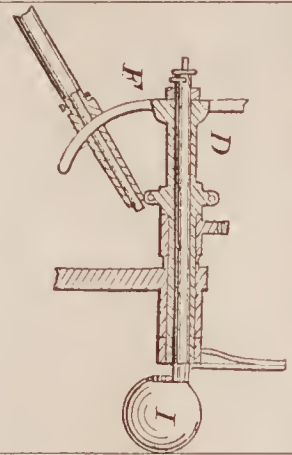
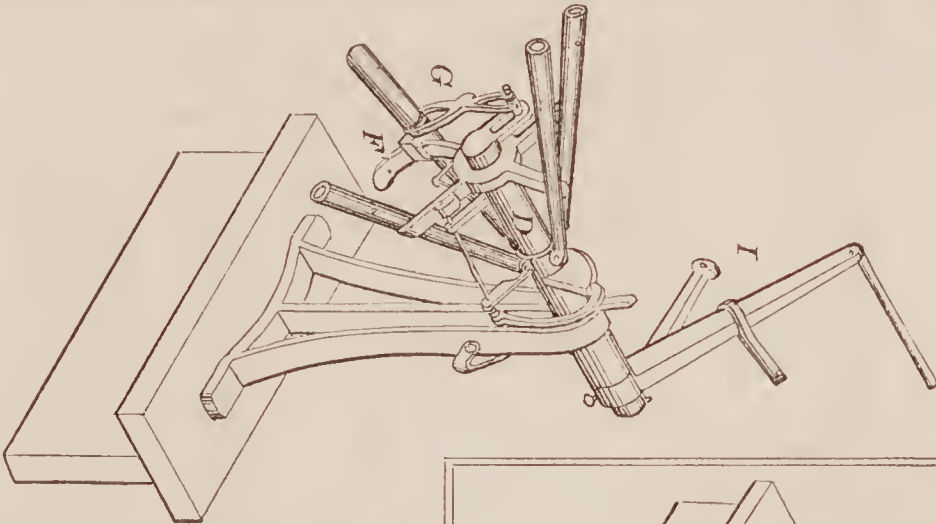

72197—Harlan & Pomeroy—*For Cutting out Gloves.*

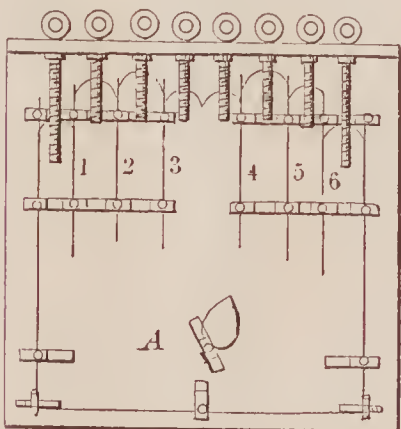

72199—H. A. M. Harris—*Harvester Rake.*

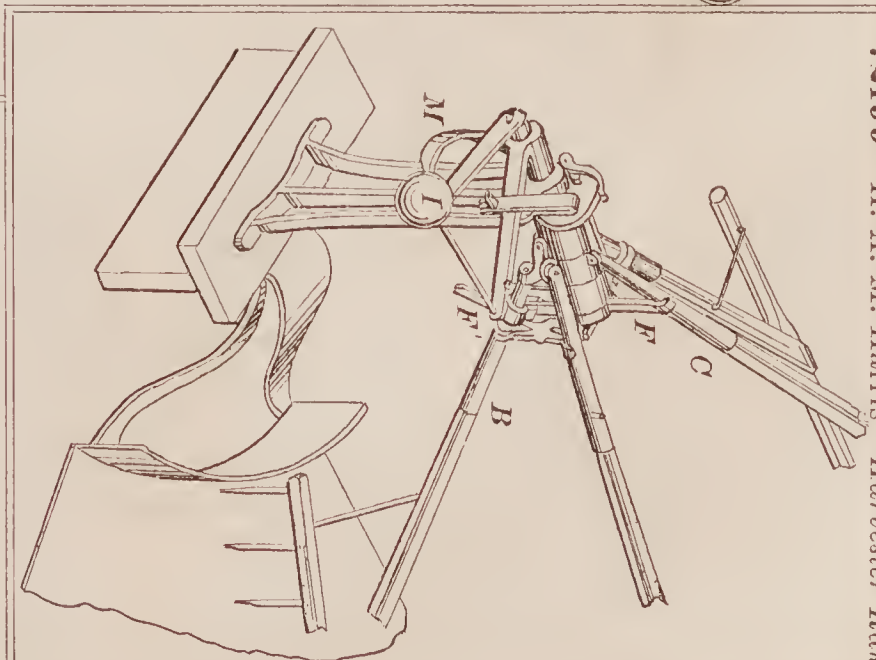



72200—A. Hillman—Car Coupling.

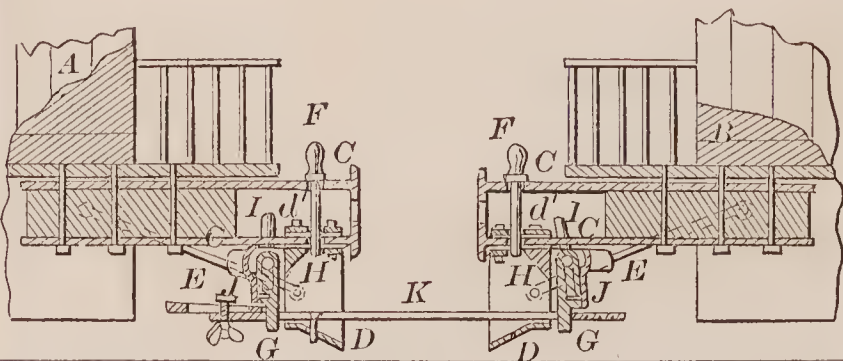

72203—M. G. Imbach—Car Ventilator.

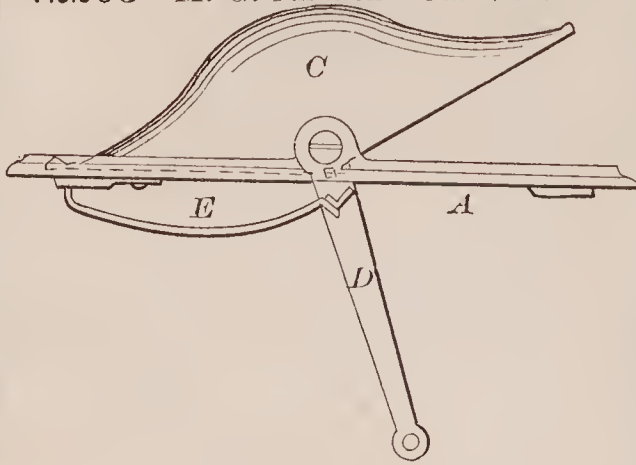

72202—F. A. Huntington—Spring Bed Bottom.



72201—H. G. Hubert—Furnace for Smelting Precious Metals.

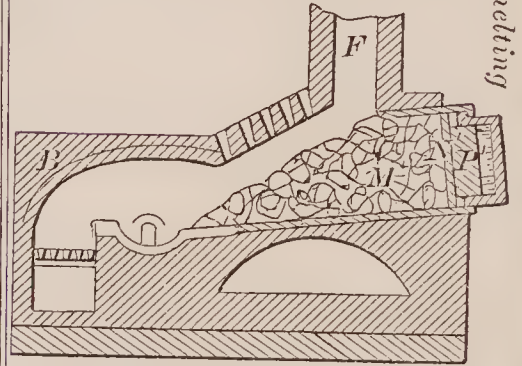
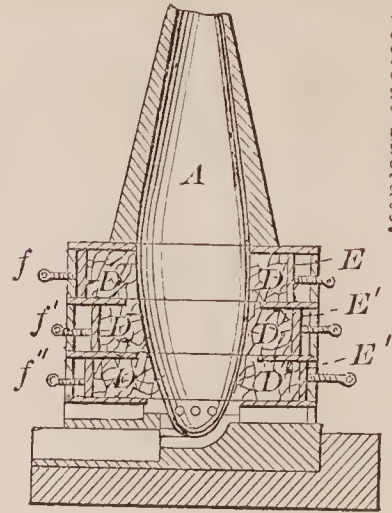

72206—G. F. Kolb—Jewel Case.

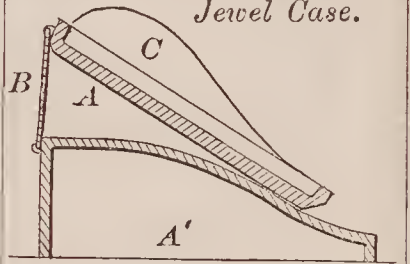

72205—W. C. Knight—For Saving Precious Metals.

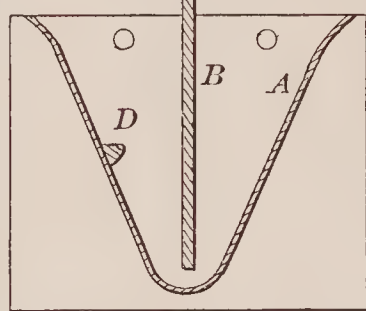

72207—Little & Bell—Summer Furnace.

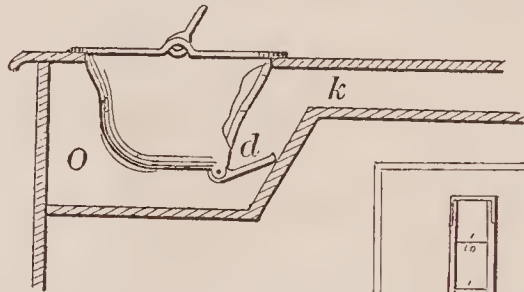

72204—O. A. Kelly—Steam Engine Governor.

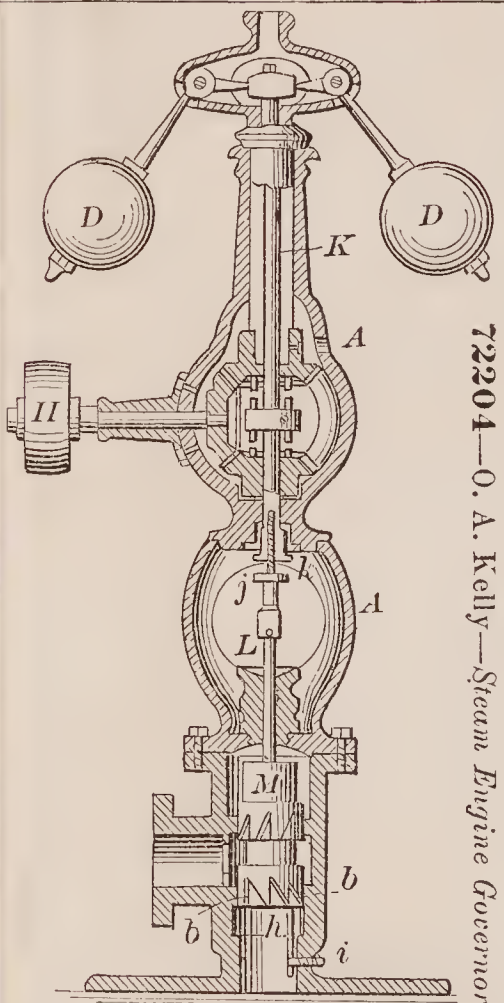

72209—J. C. Love—Lamp Burner.

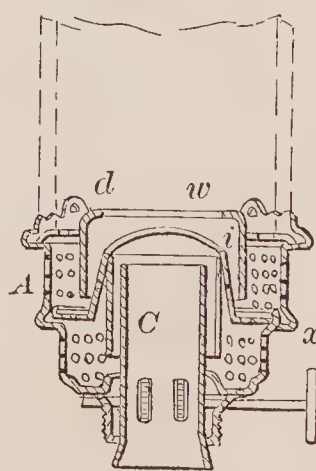

72210—Lupton & Talbot—Registering Yard Stick.

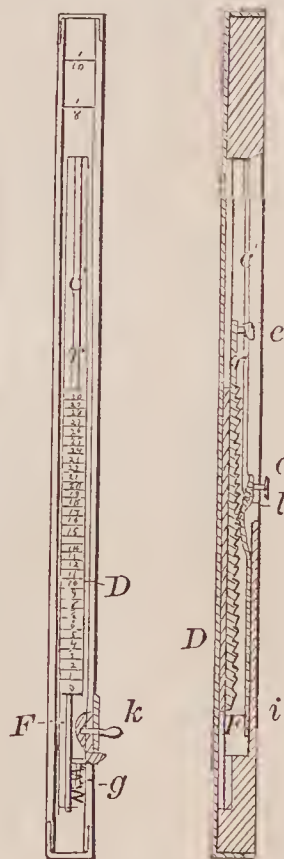

72208—Little & Gibbs—Harvester Rake.

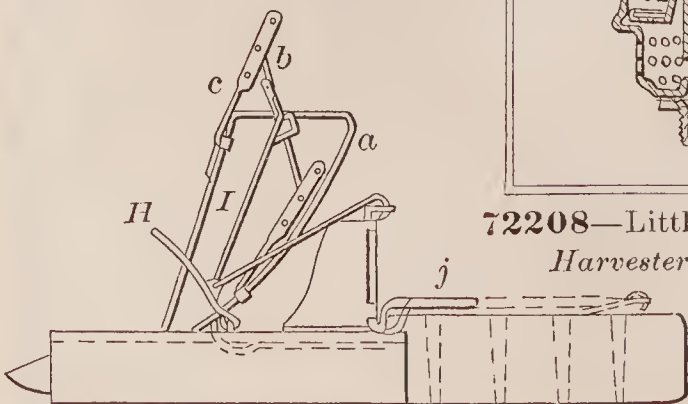





72220—J. North—Brick Machine.

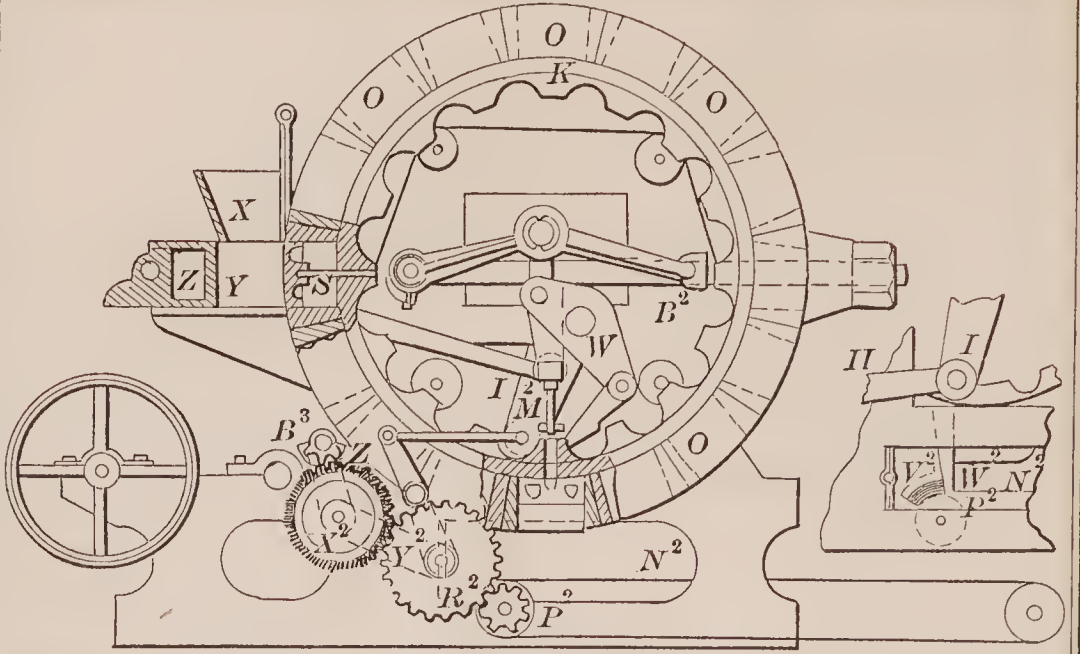

72223—Owen & Kelly—Nutmeg Grater.

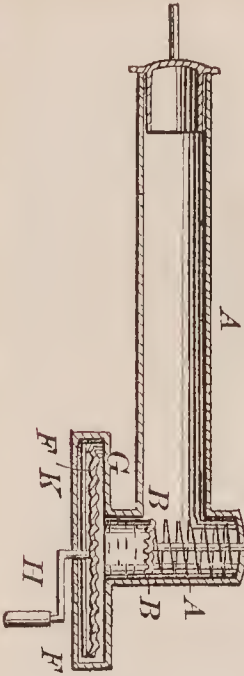

72222—C. Osgood—Railroad Rail.

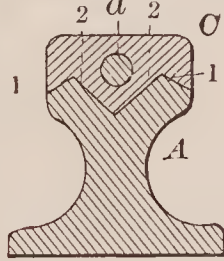

72226—O. R. Parmele—Car Stake Holder.

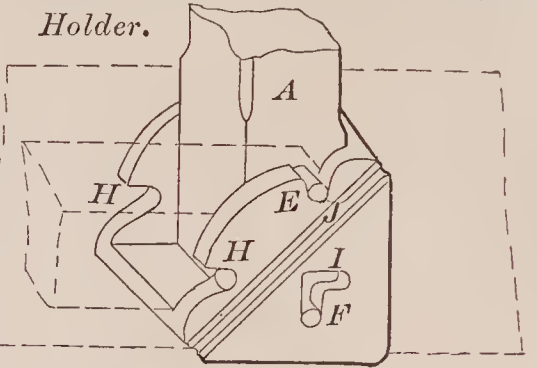

72219—G. Neilson—Lamp.

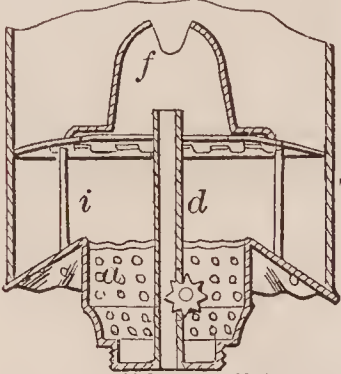

72225—R. Parks—For Folding Envelopes.

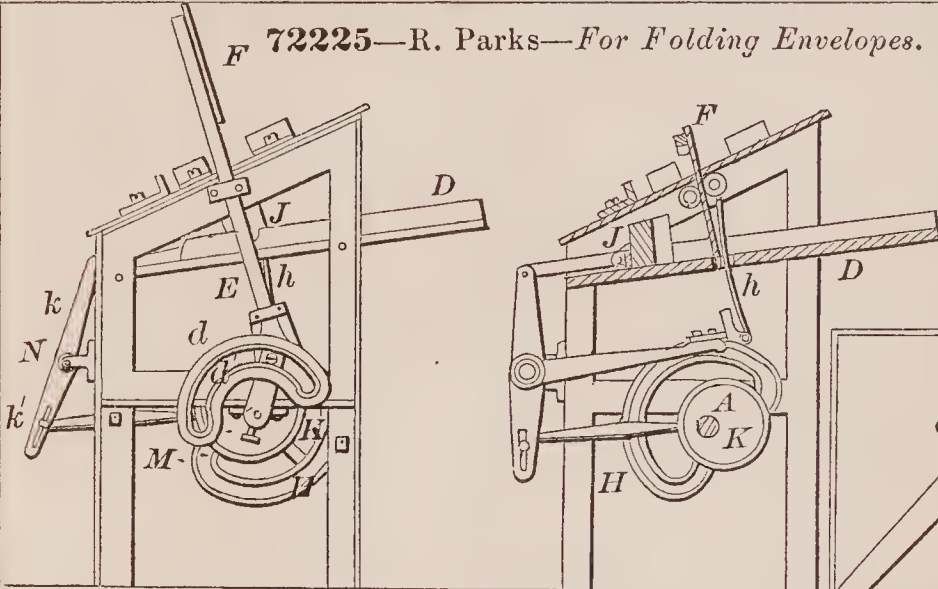

72221—G. Noyes—Hay Press.

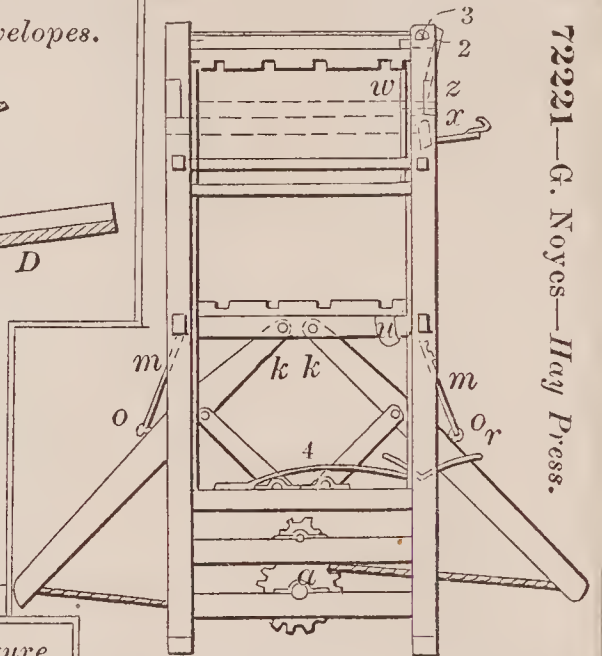

72224—J. S. Palmer—Manufacture of Jewelry.

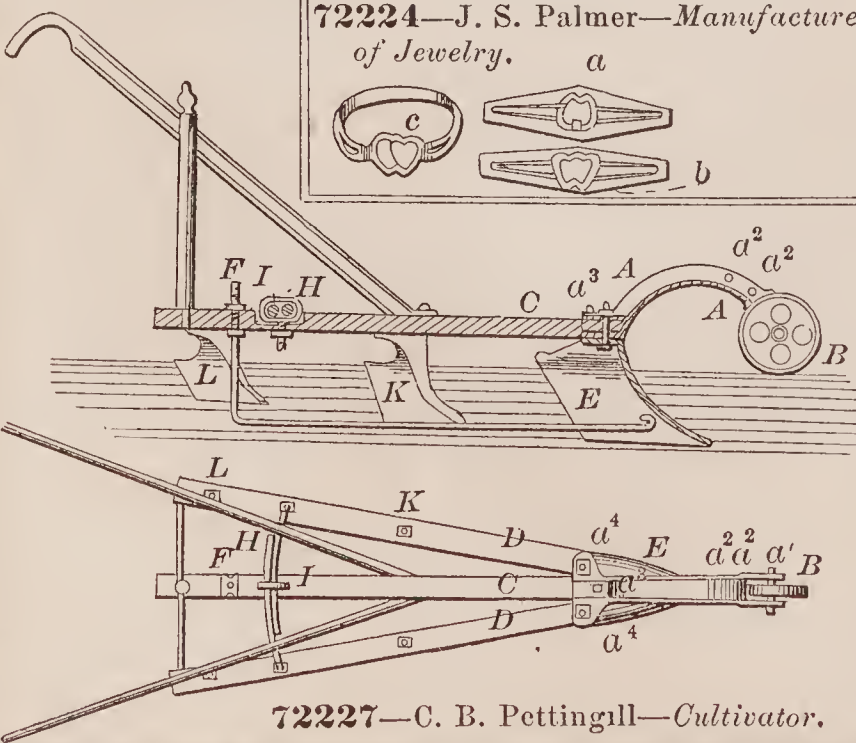

72227—C. B. Pettingill—Cultivator.

72228—A. S. Phillips—Skirt Ironing Table.

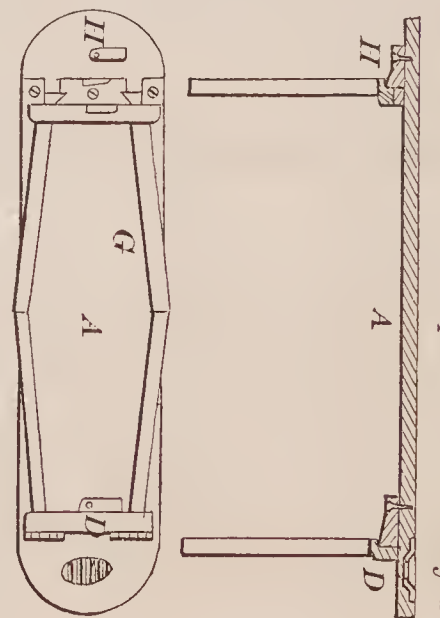

72229—C. R. Rand—Heating Furnace.

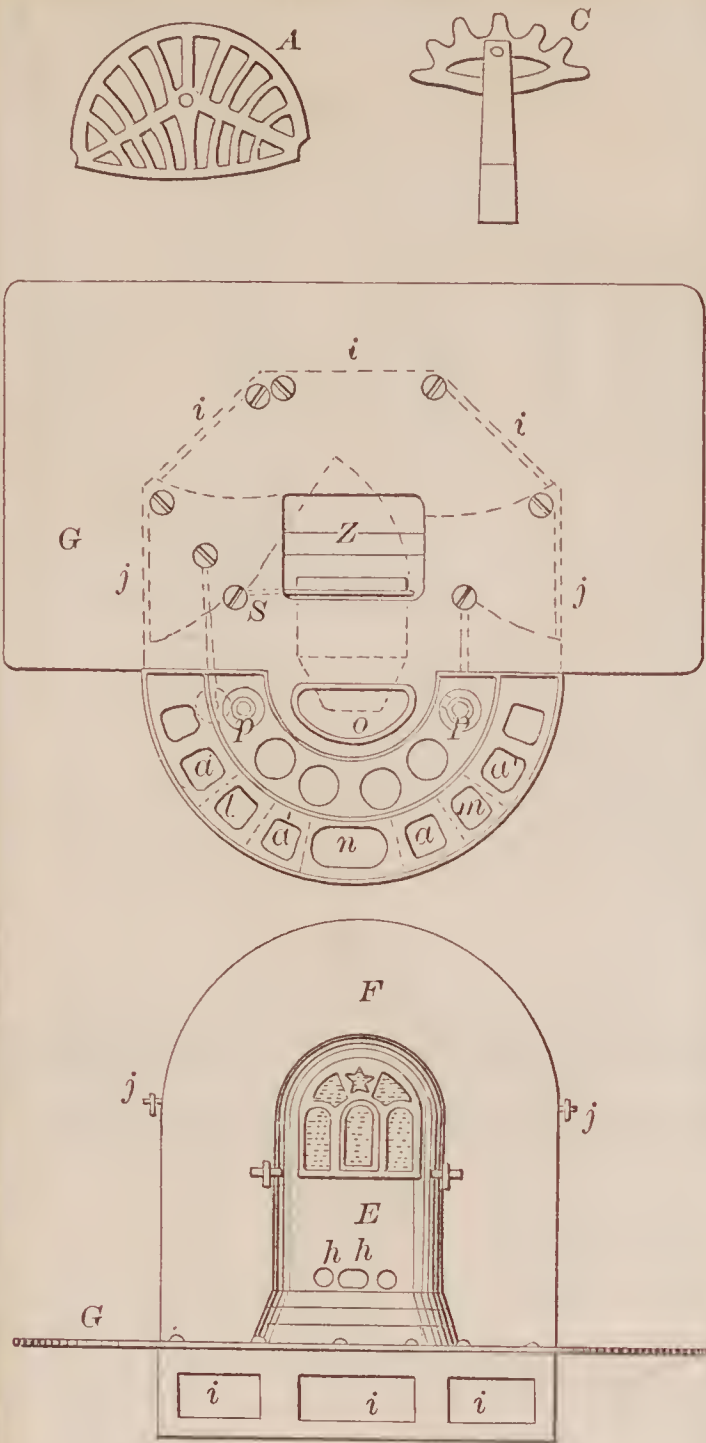

72230—B. Robinson—For Making Nails.

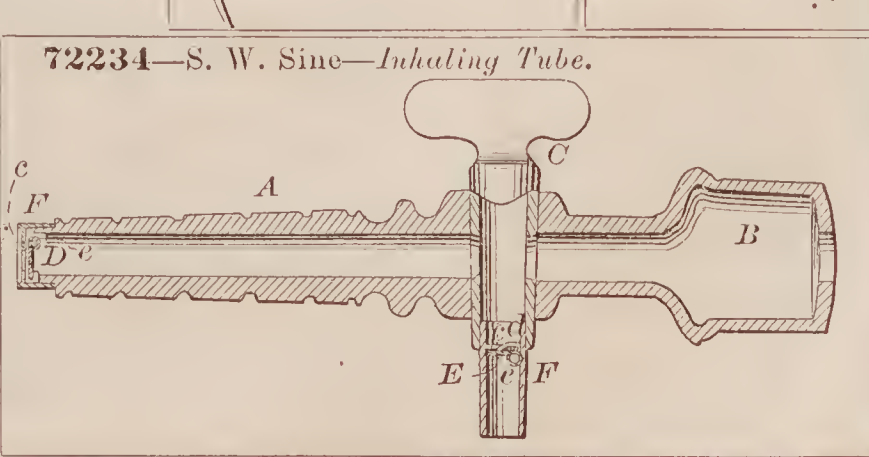
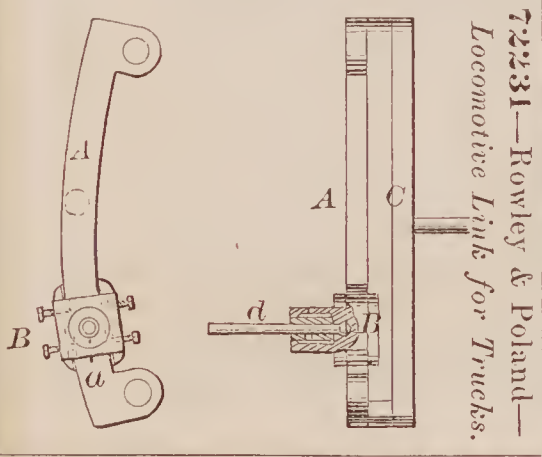
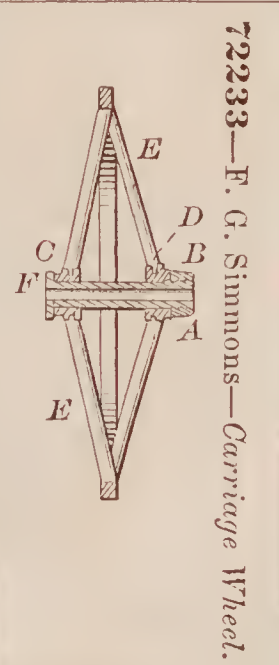
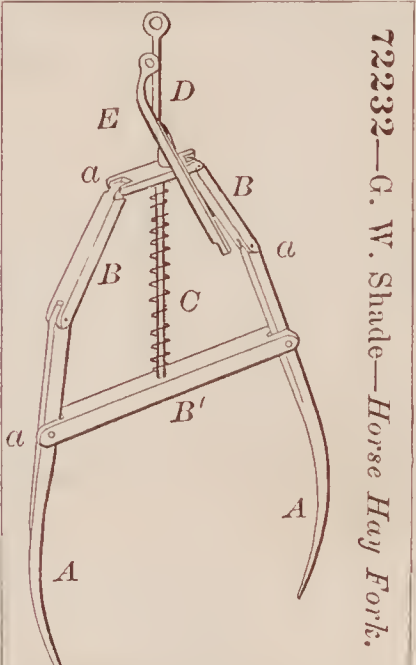
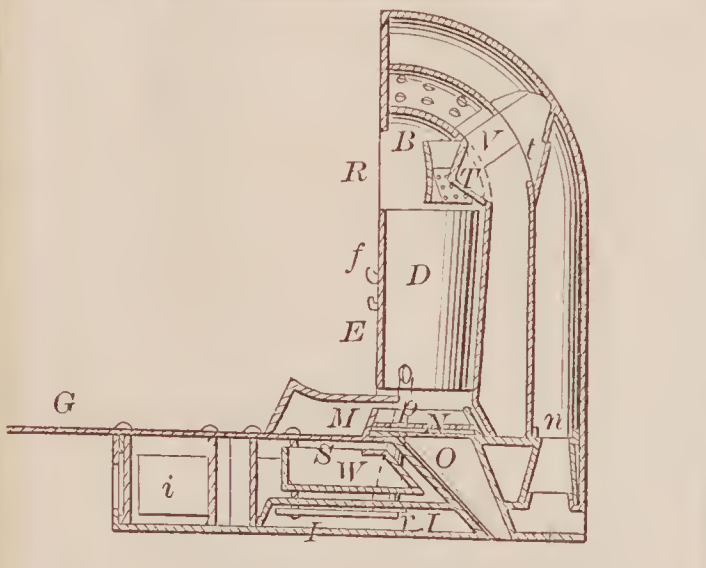
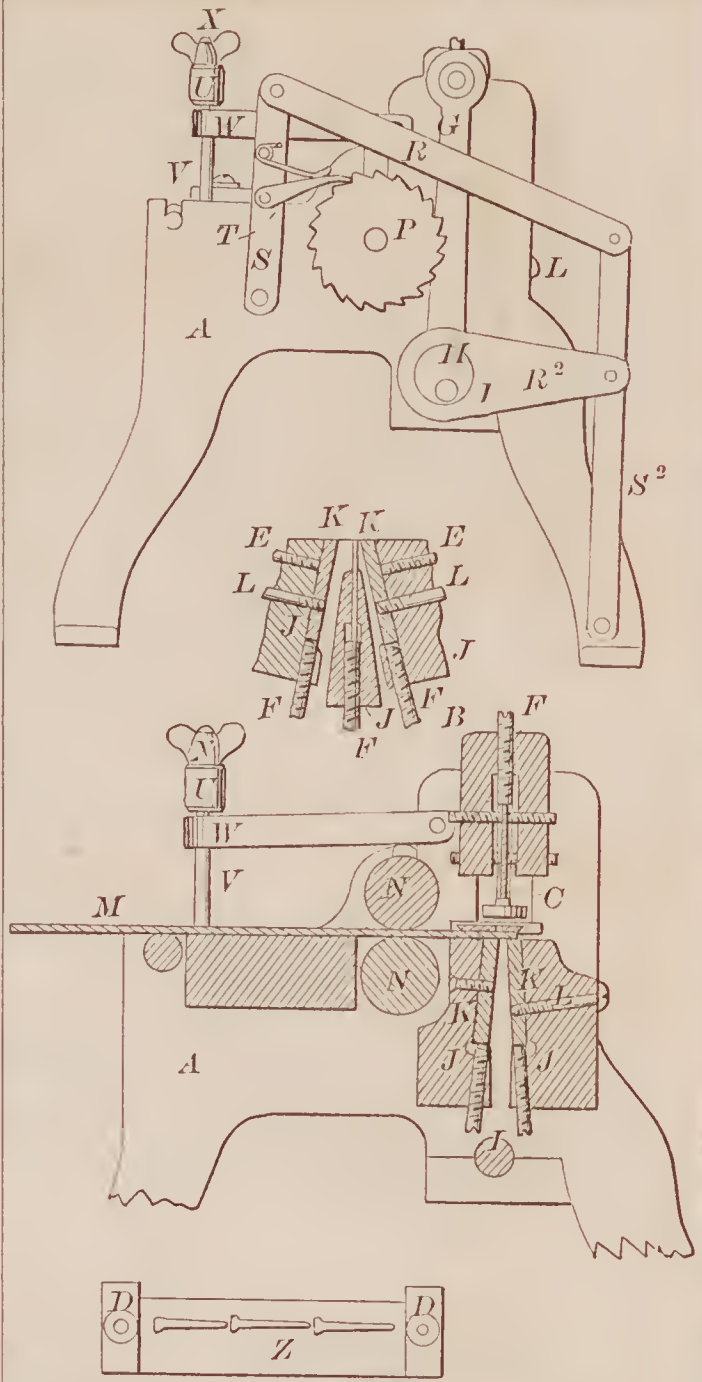



72235—G. Smith—*Let-off Motion for Looms.*

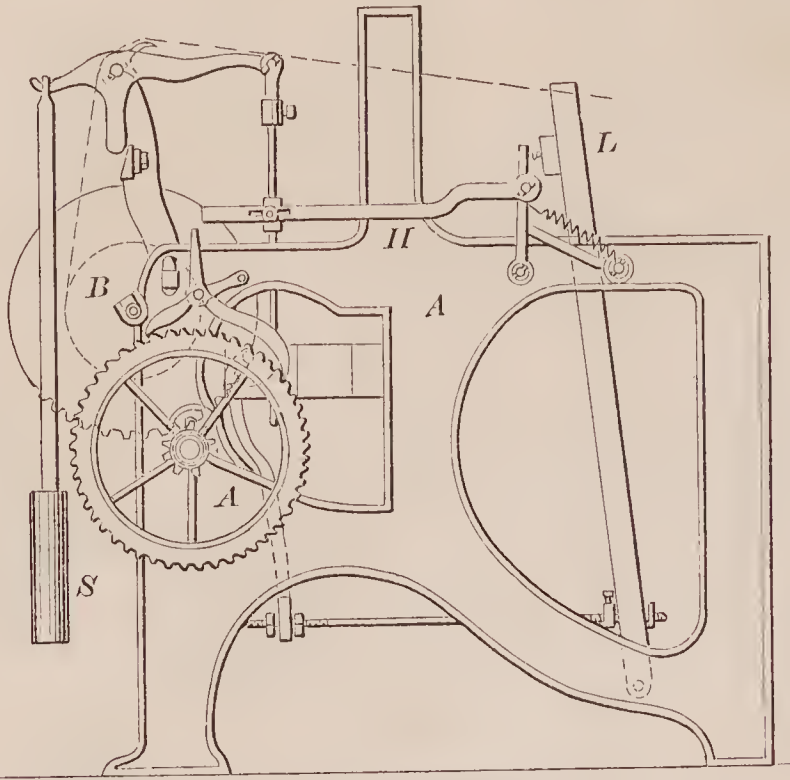

72238—G. H. Spaulding—*Harvester.*

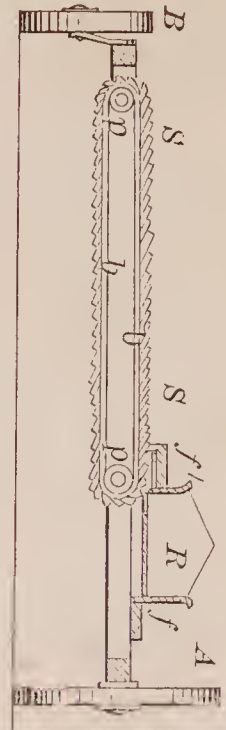

72236—H. L. Smith—*Corn Harvester.*

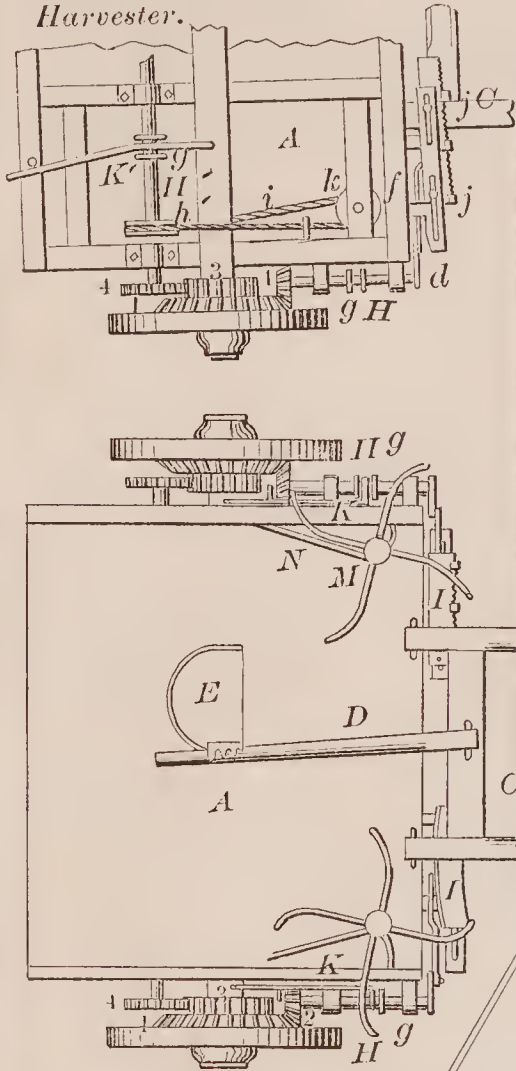

72239—J. Sullivan—*Marine Engine Governor.*

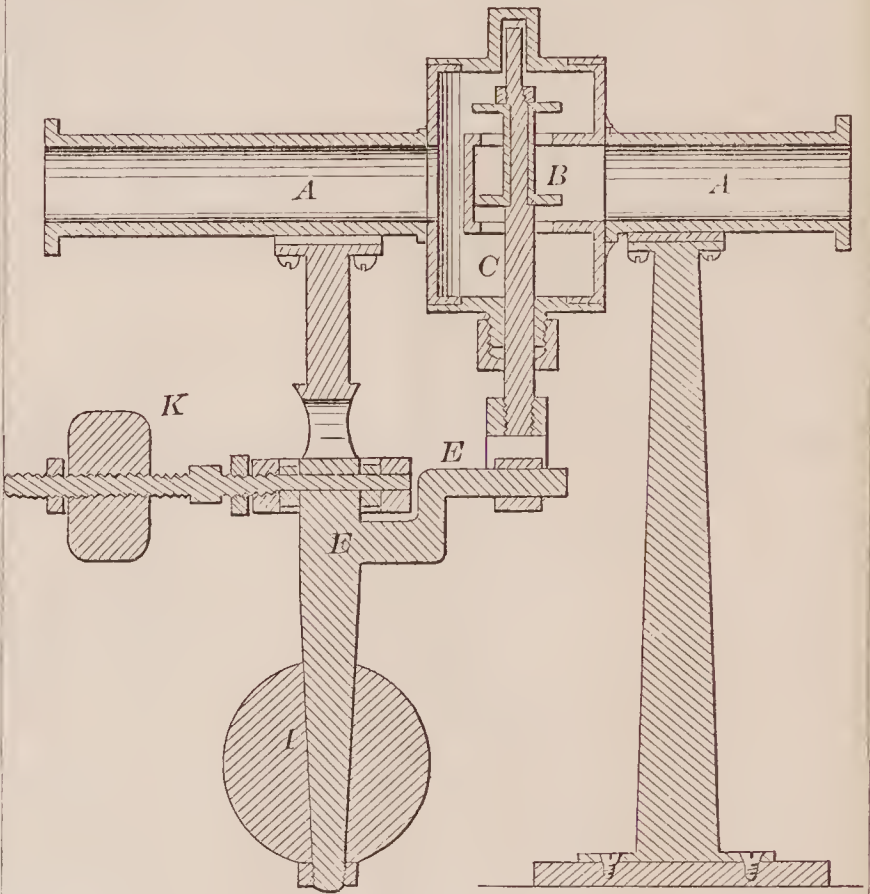

72240—Taylor & Coale—*Steam Generator Safety Valve.*

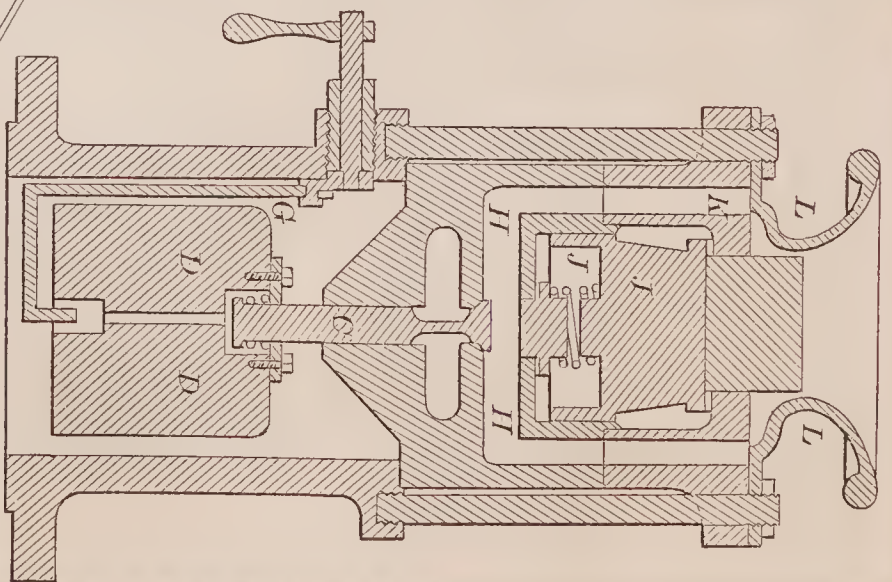

72237—T. Smith—*Trunk.*

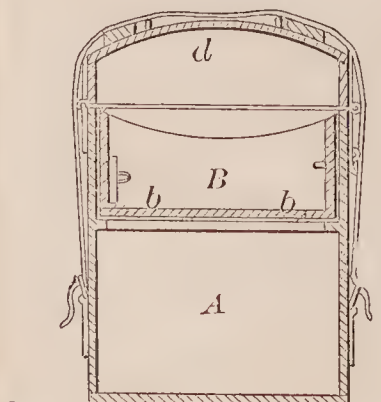

72241—I. P. Tice—Still.

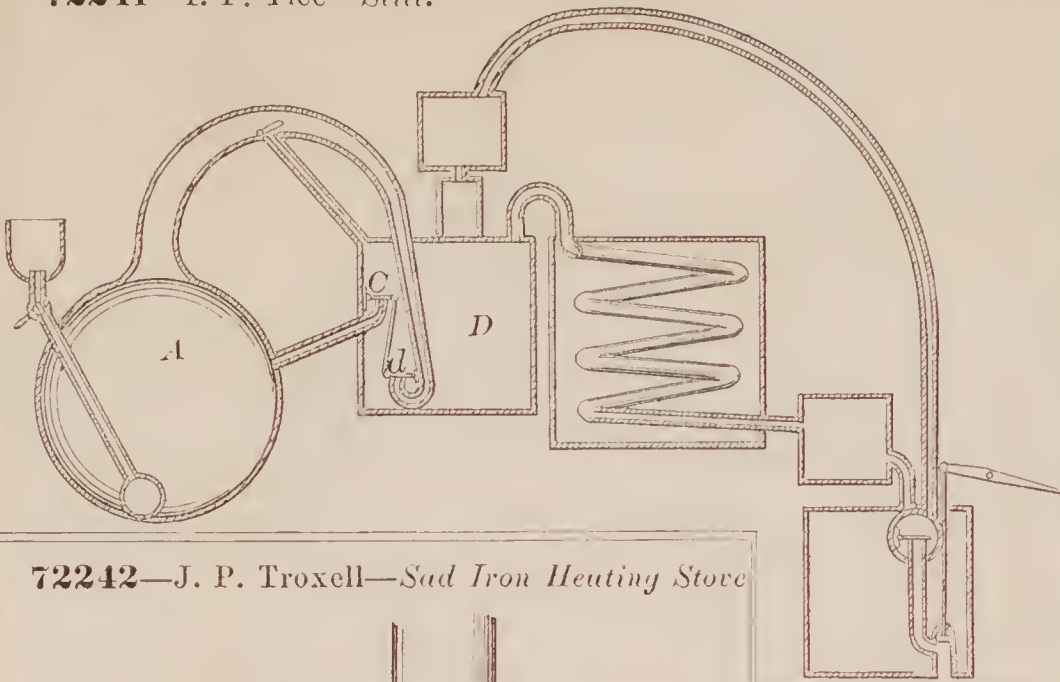

72244—E. R. Walker—Argand Burner.

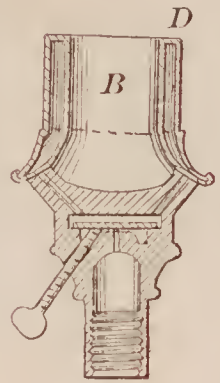

72242—J. P. Troxell—Sad Iron Heating Stove

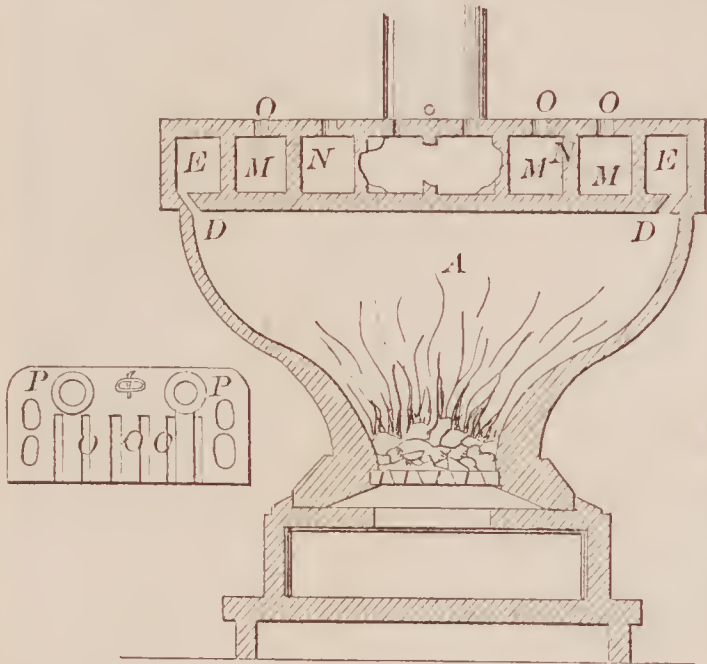

72243—H. L. Turny—Book Binders' Beveling Machine.

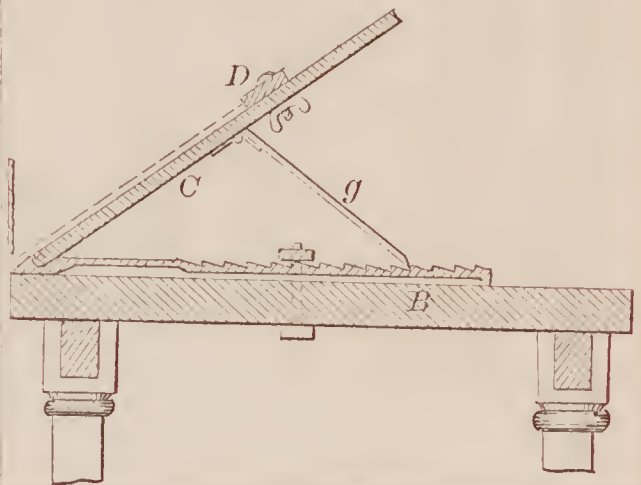

72248—G. Watt—Whiffletree.

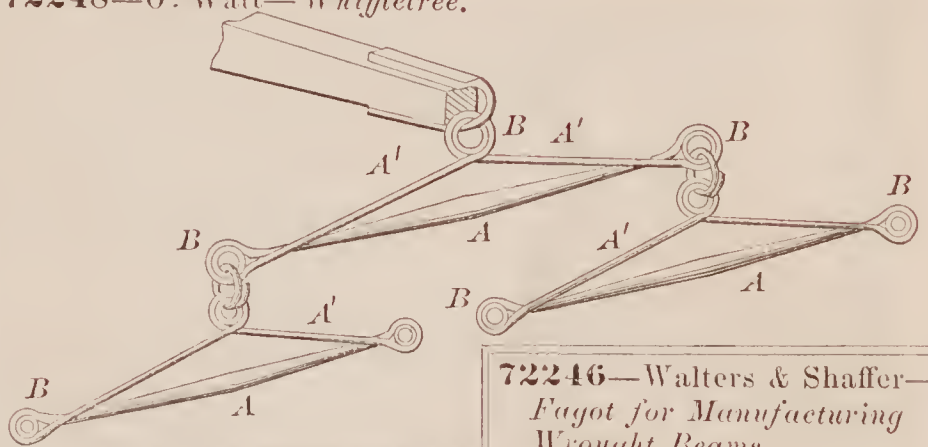

72246—Walters & Shaffer—Fagot for Manufacturing Wrought Beams.

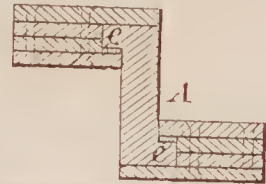

72245—J. P. Walsh—Attaching Picks to Handles.

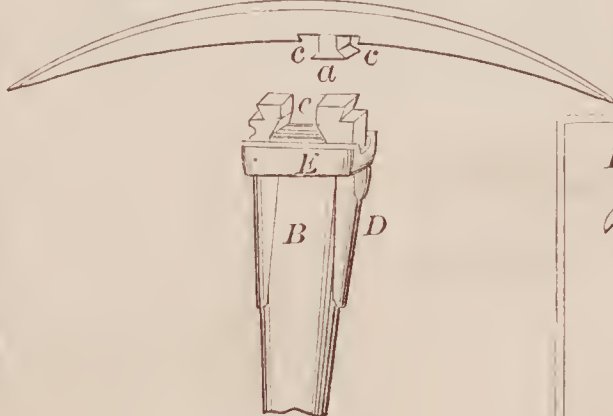

72247—W. G. Waterman—Cork Extractor.



72249—J. Weichart—Saw Cutter.

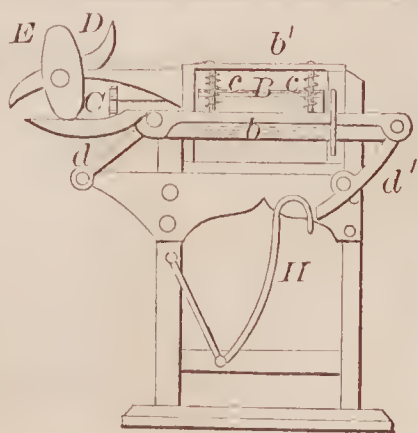



72250—Wheeler & Stevens—Marble Cutting Machine.

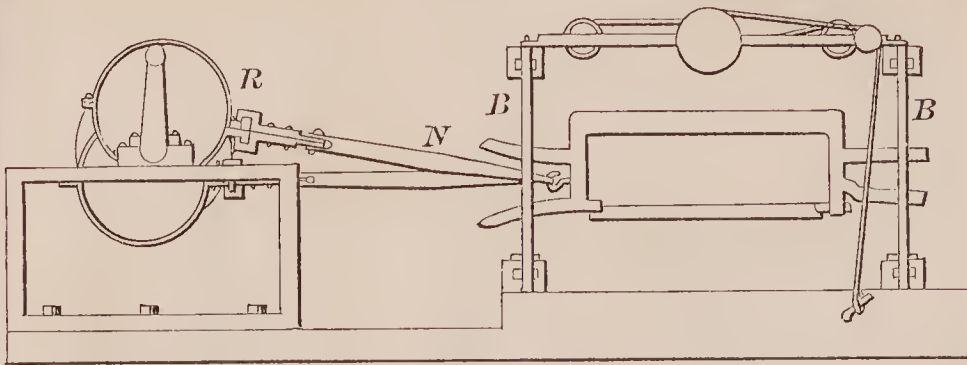

72253—J. D. Willoughby—Lamp Chimney.

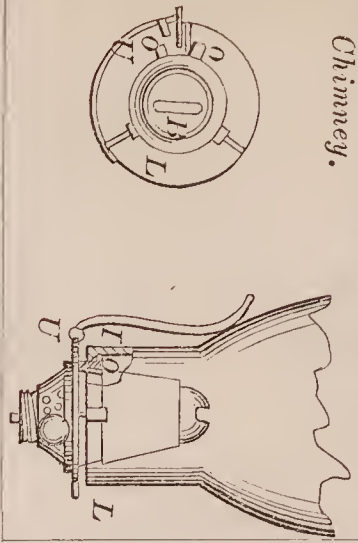

72251—J. M. Whiting—Railroad Switch.

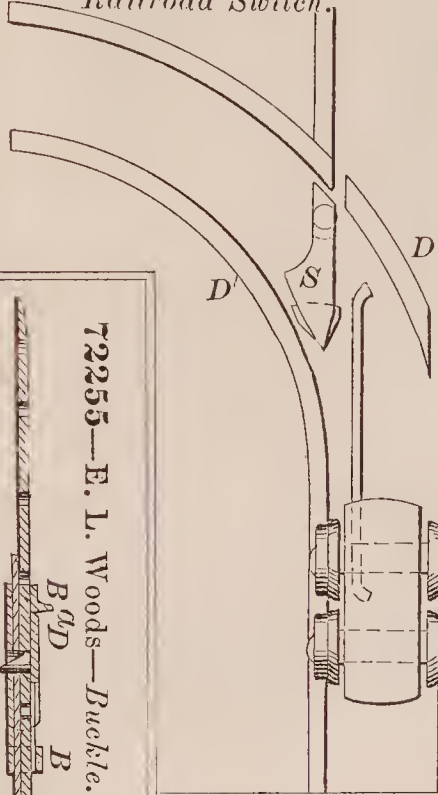

72252—J. Whitemore—Soap Rest

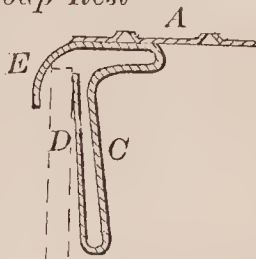

72254—J. E. Winants—For Melting Crude Turpentine.

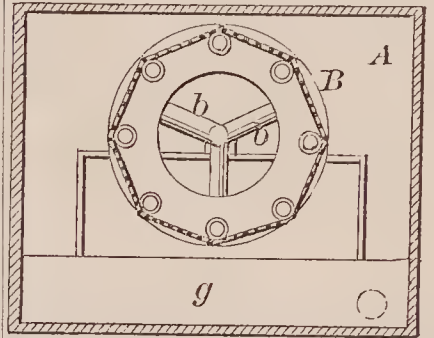

72256—N. W. Wortham—Mill Stone Dress.

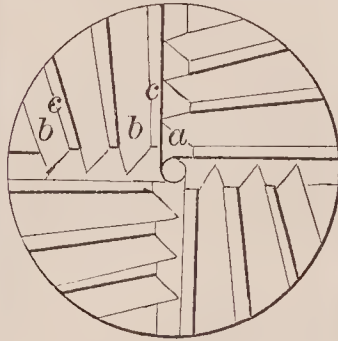

72257—L. B. F. Zitkor—Cattle Stall.

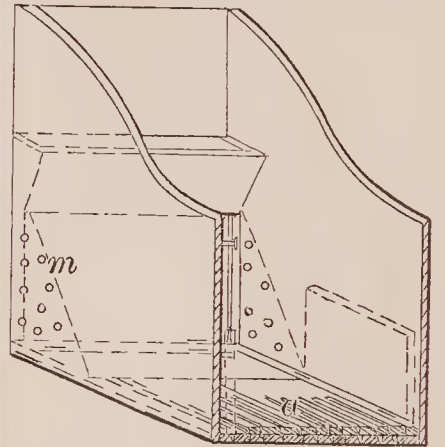

72259—J. R. Adams—Coffee Mill.

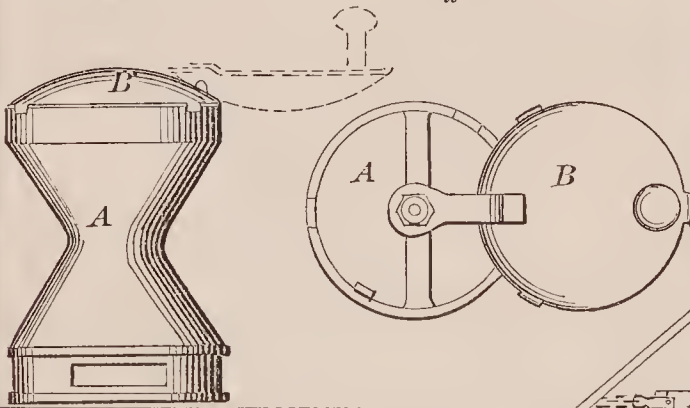

72260—J Aikin—Harrow.

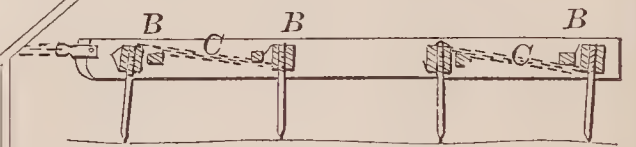

72262—L. V. Badger—Signal Lantern.

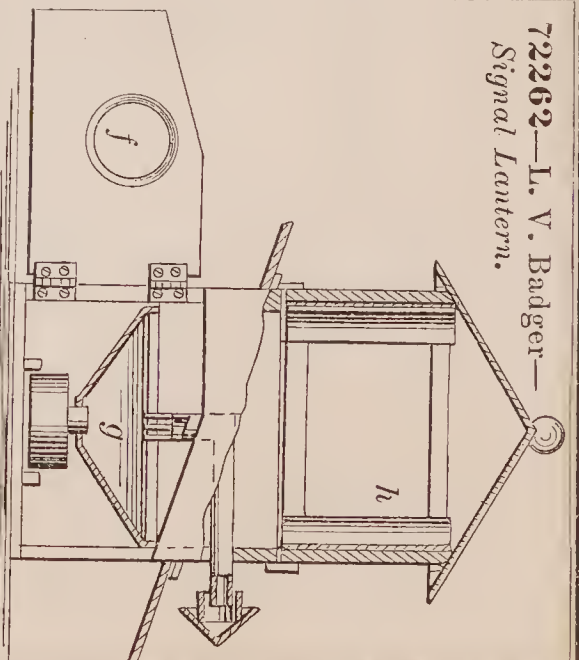

72255—E. L. Woods—Buckle.

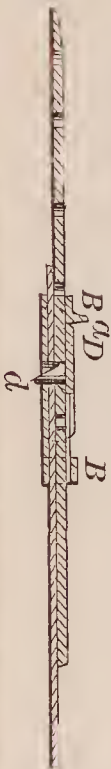

72258—C. K. Abbot—Steam Pipe.

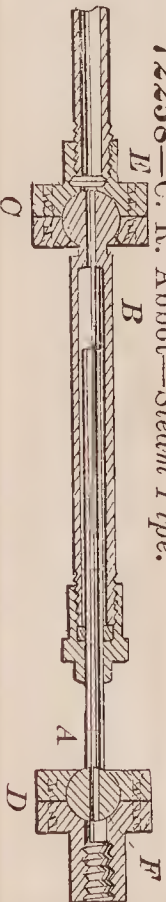

72261—A. Anderson—Damper and Ventilator.

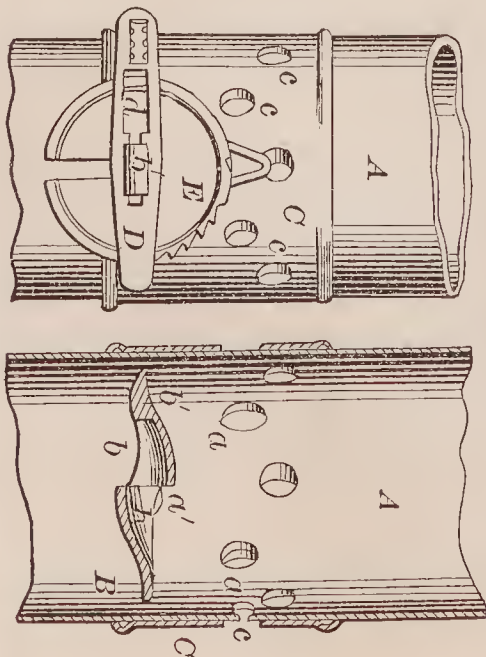

72263—J. S. Boicourt—*Railroad Weed Cutter.*

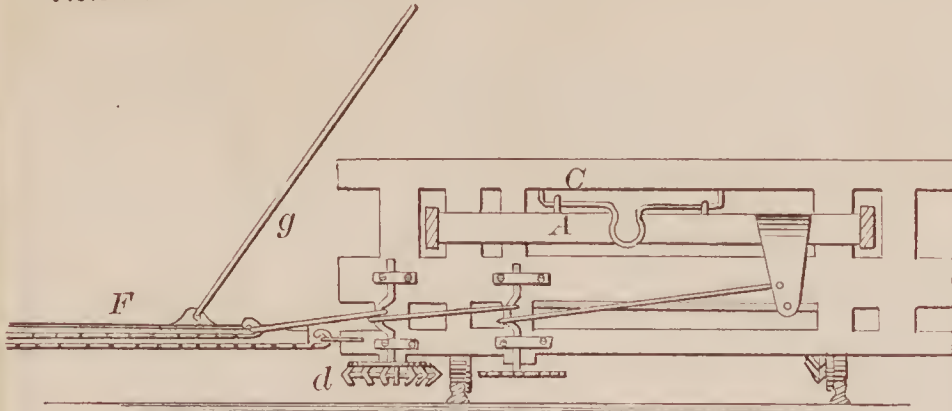

72264—M. C. Boyer—*Shaft Coupling.*

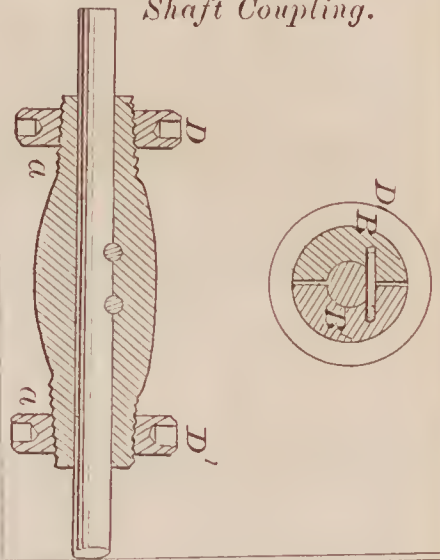

72268—A. F. Crosman—*Boat Lowering Apparatus.*

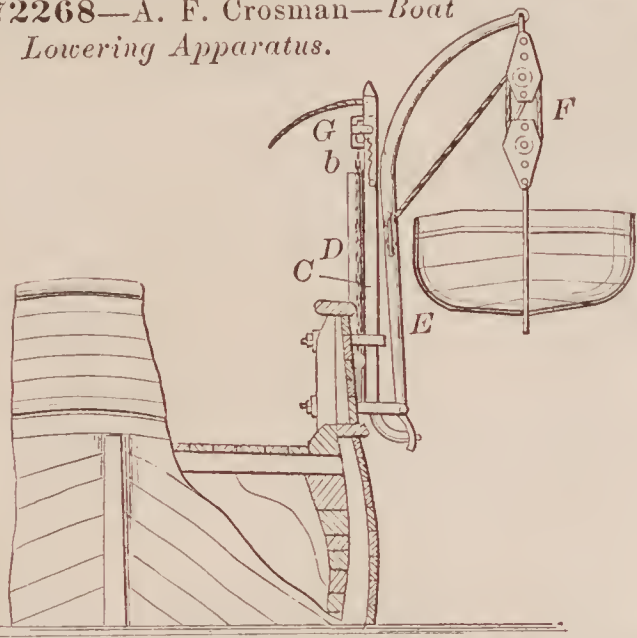

72265—G. W. Carpenter—*Animal Poke.*

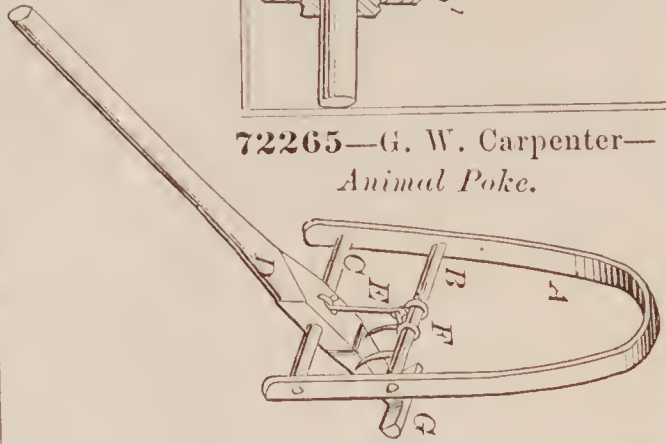

72266—D. H. Clock—*Trace Clamp.*

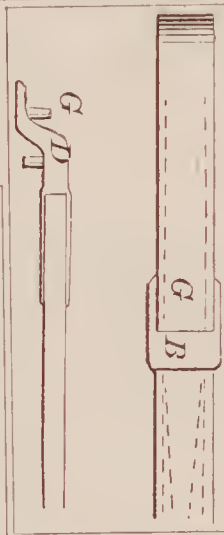

72267—N. Clouse—*Sorghum Evaporator.*

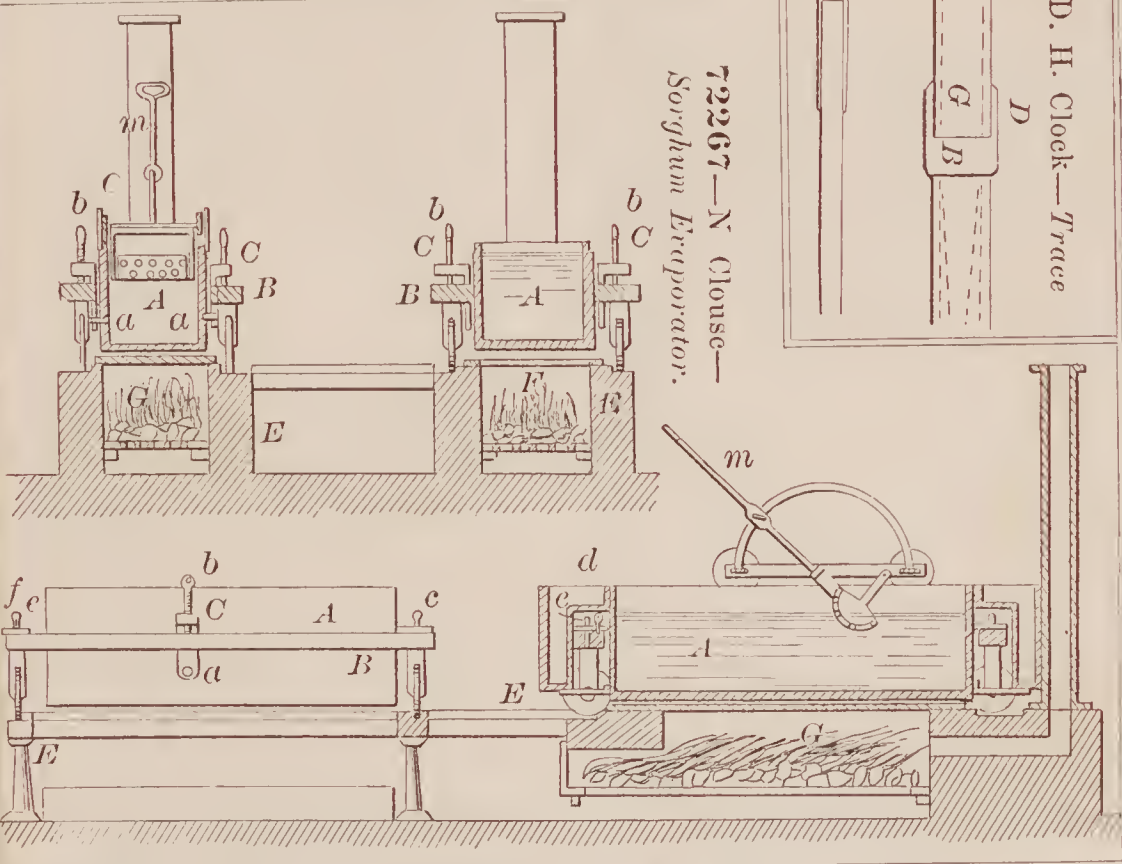

72269—A. Crowner—*Stump Extractor.*

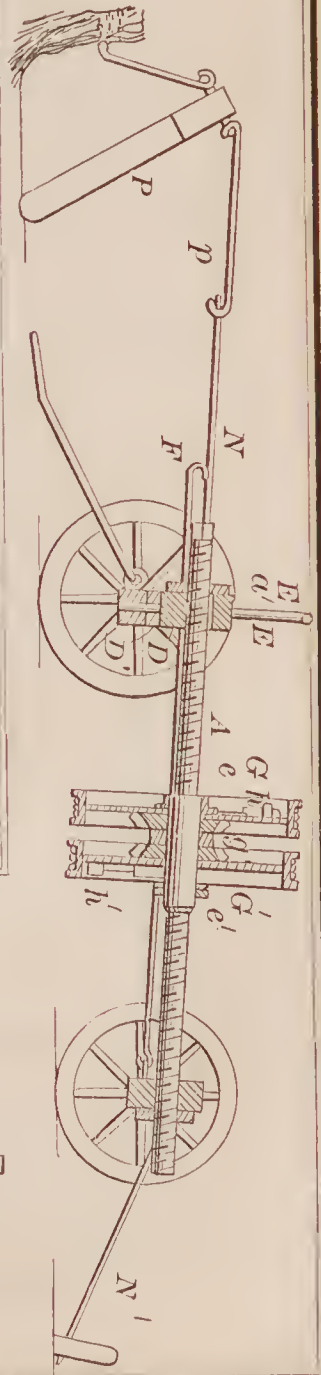
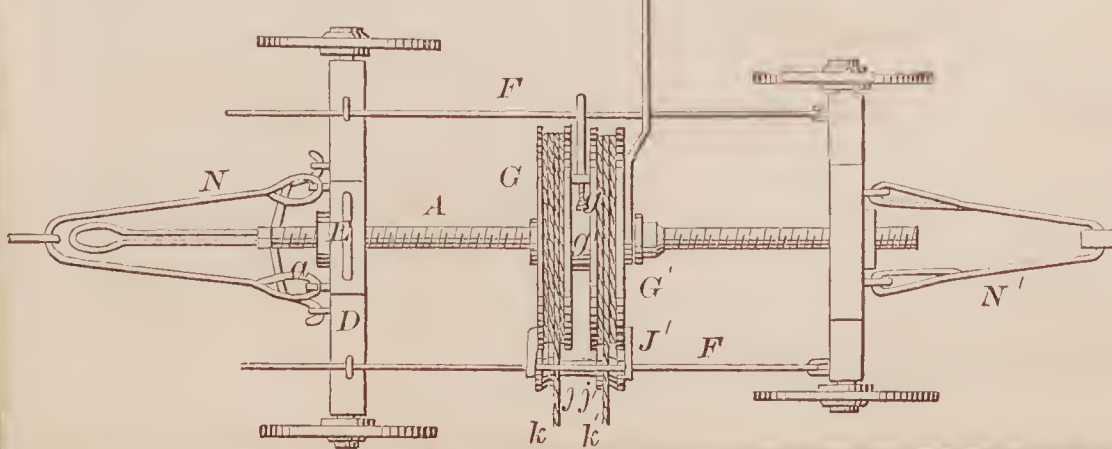



72270—F. Culver—Horse Hay Fork.

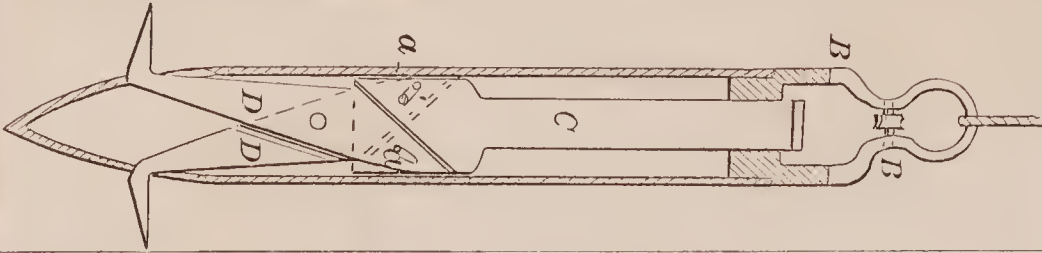

72272—D. Dick—Wood Turning Lathe.

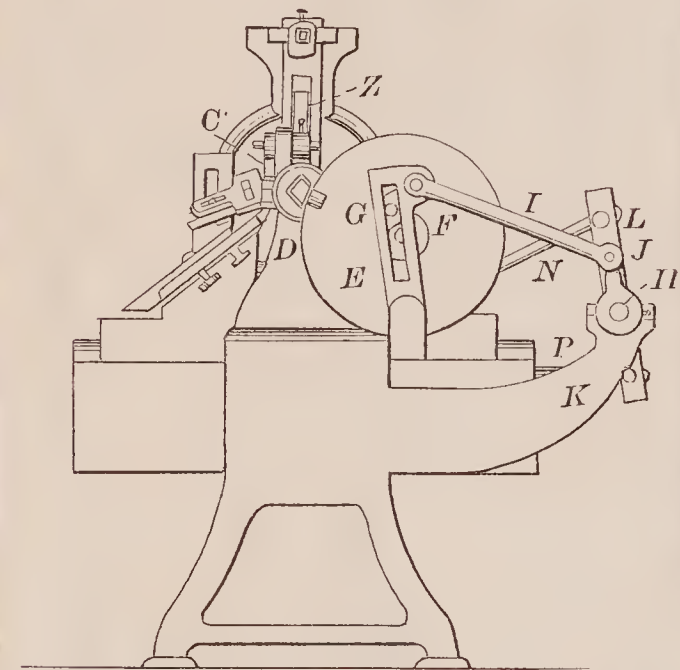
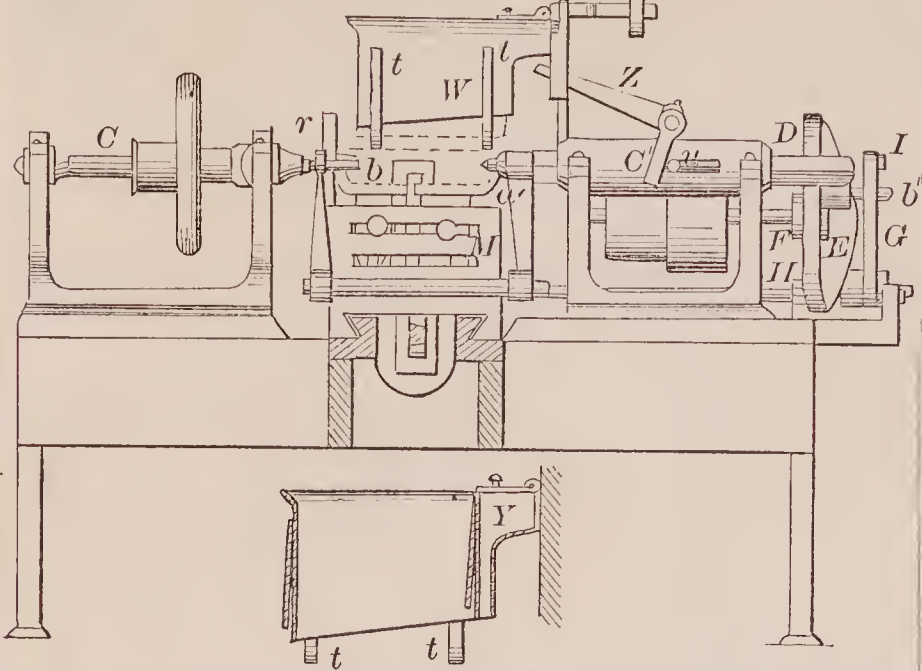

72276—M. Foster—Railroad Spike.

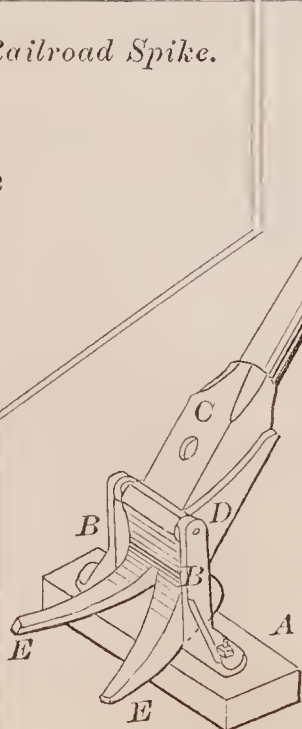
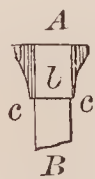
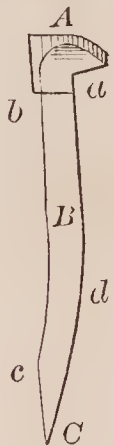

72277—O. S. Foster—Jacks for Pulling Hop Poles.

72275—J. Entennoer—Lamp Chimney Tongs.

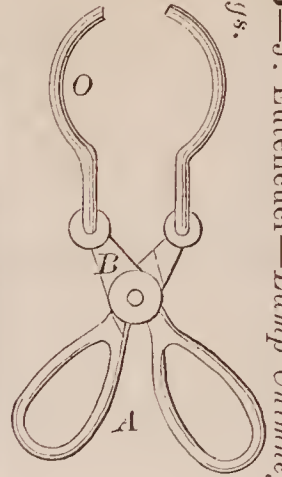

72274—W. B. Dunning—Car Ventilator.

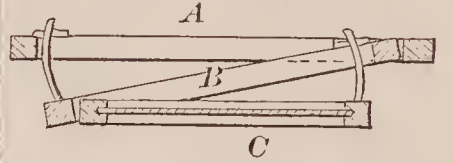

72278—C. Fownes—Furnace for Steam Boilers.

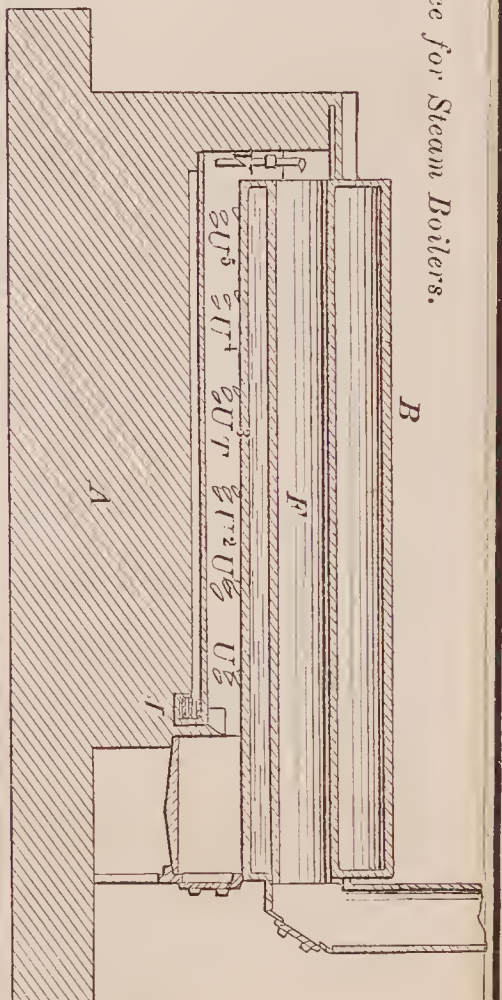
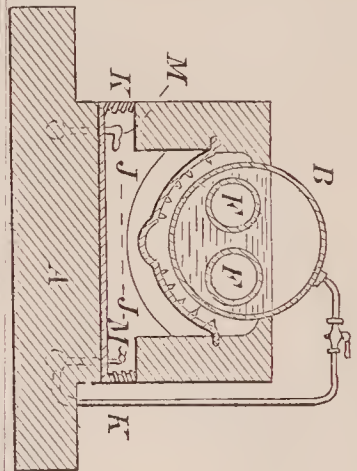

72271—P. D. Cummings—Needle Case.

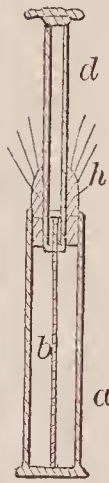

72279—C. Fownes—Hinging Tea Kettle Covers.

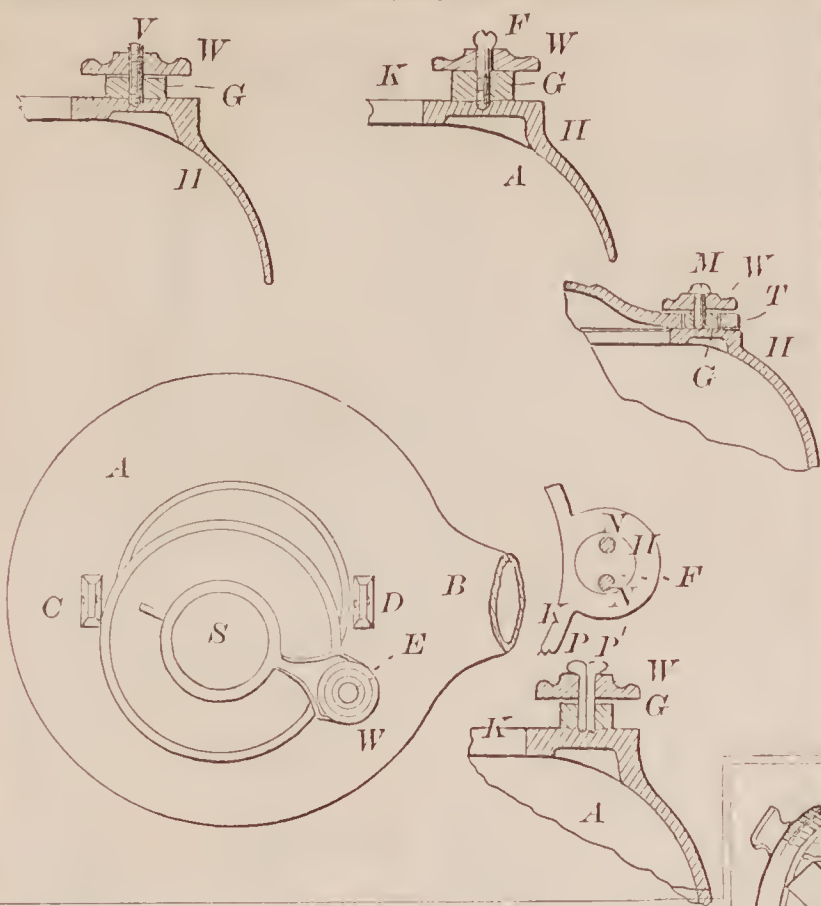

72281—T. Q. Frost—Washing Machine.

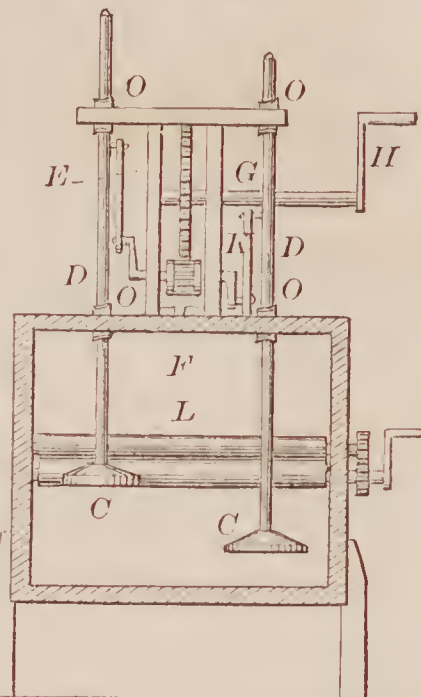

72282—W. B. Gabel—Horse Hay Fork.

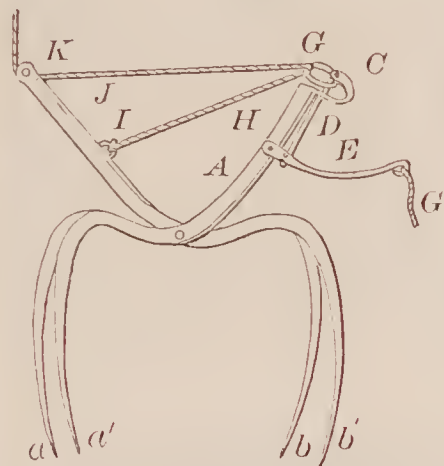

72283—W. Gardner—Iron Safe.

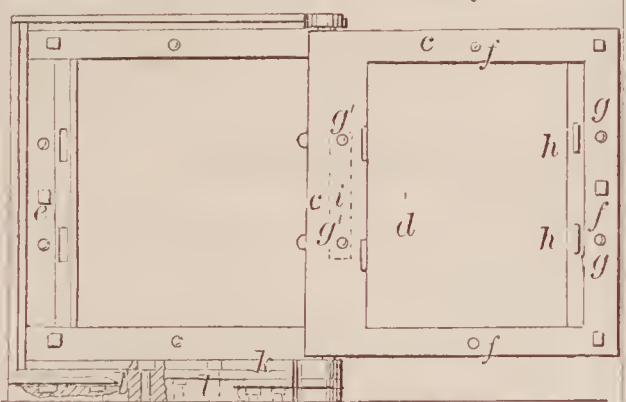

72284—M. A. Gates—Check Rein Attachment.

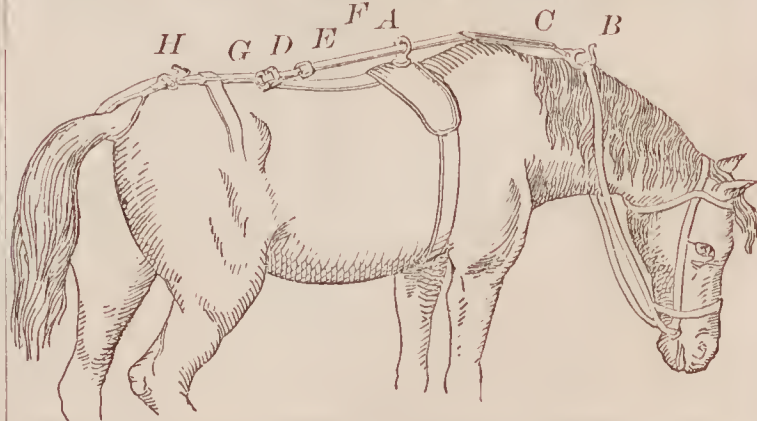

72285—A. H. Gilman—Lubricating Spindles.

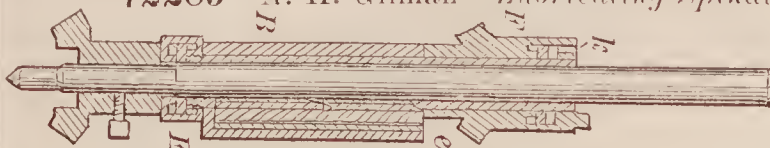

72280—S. O. Frink—Sadd Iron Heater.

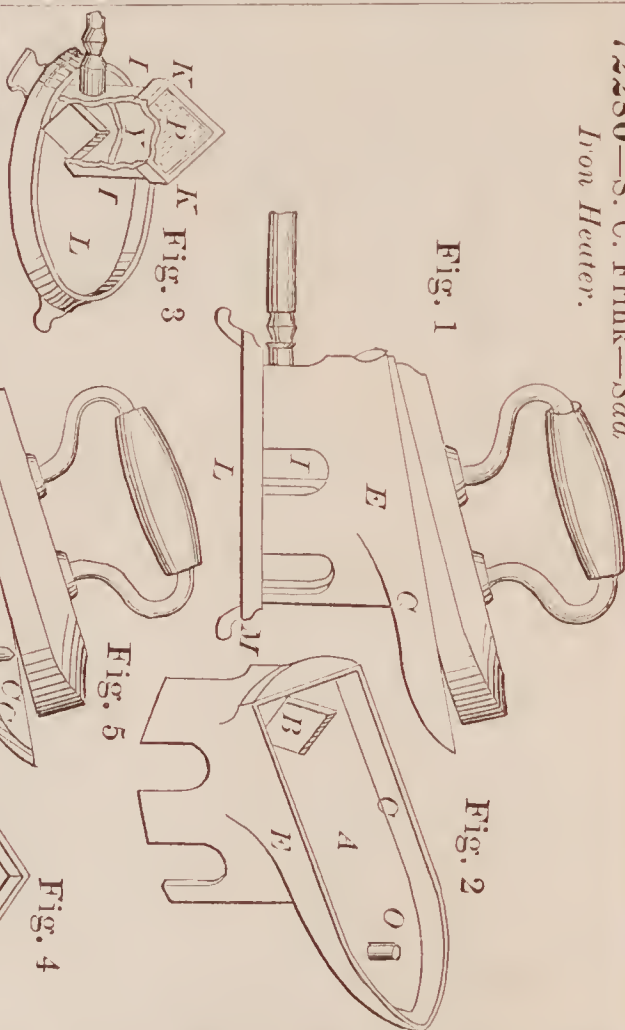



72286—J. S. Gochnauer—Horse Hay Fork.

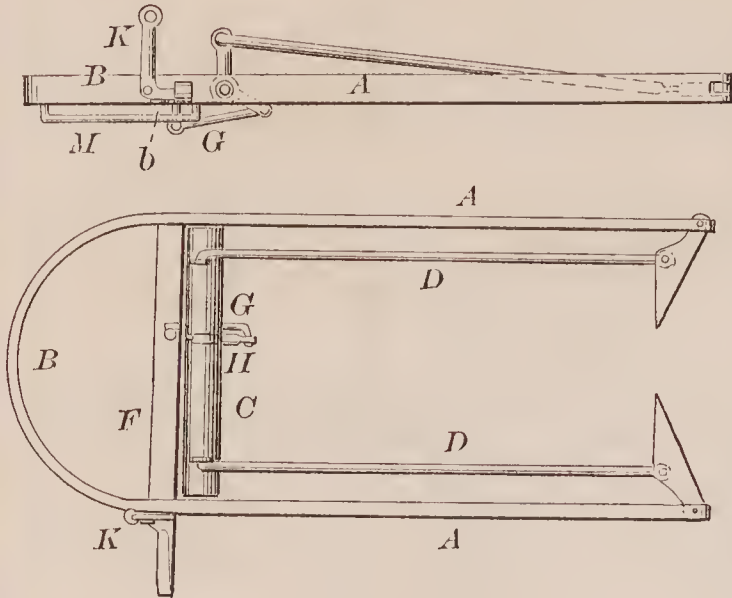

72290—M. Hall, Jr.—Ash House.

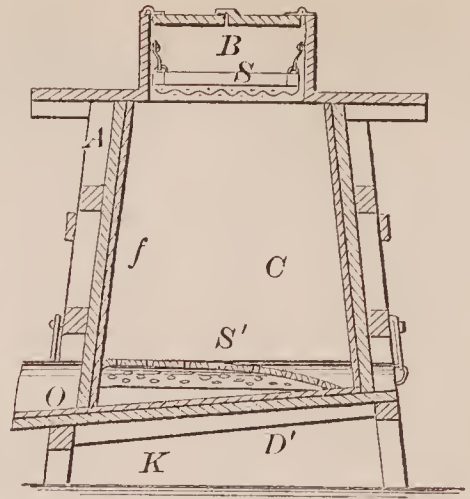

72288—R. Gracey—Bolt Heading Machine.

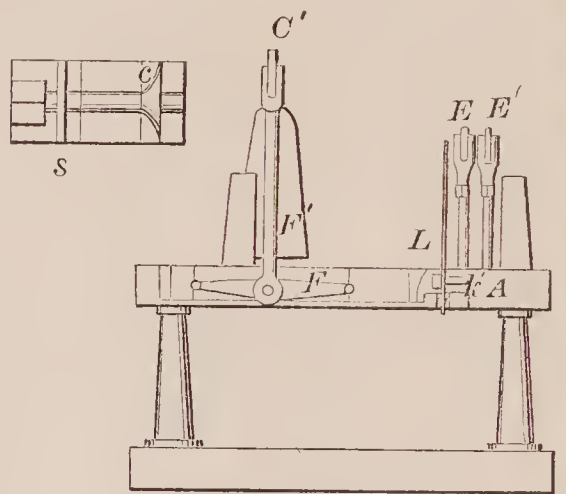
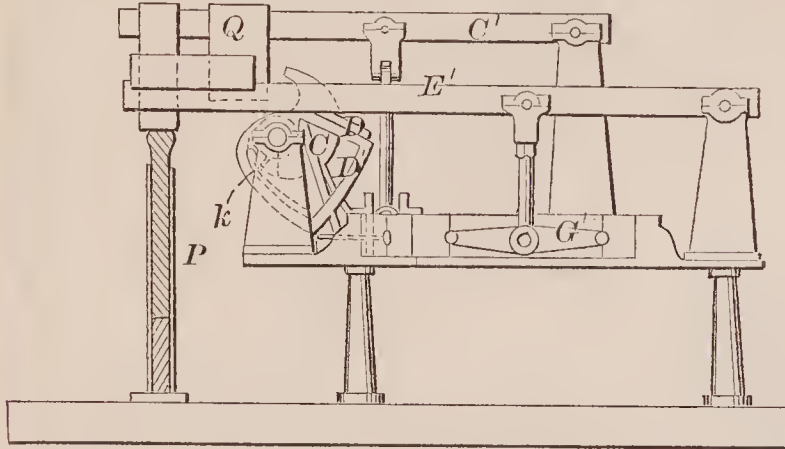

72289—E. V. W. Griffith—Potato Digger.

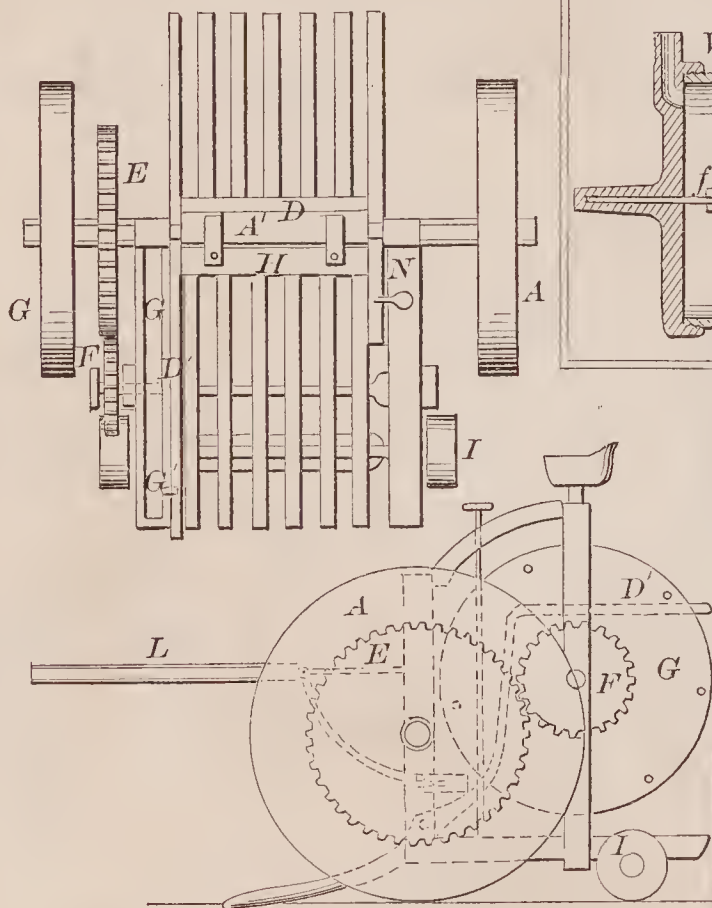

72287—R. Gornall—Valve for Boiler Feeders.

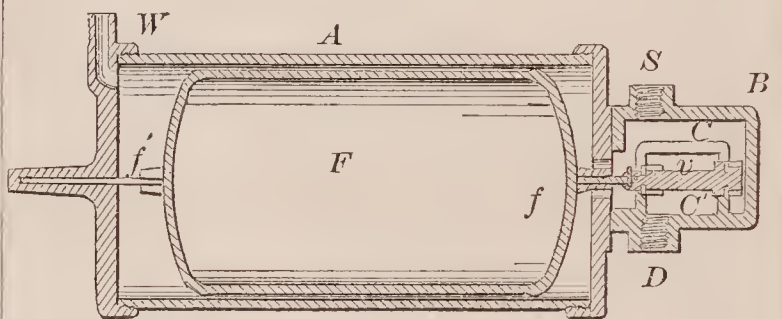

72291—L. Heywood—For Splitting Rattan.

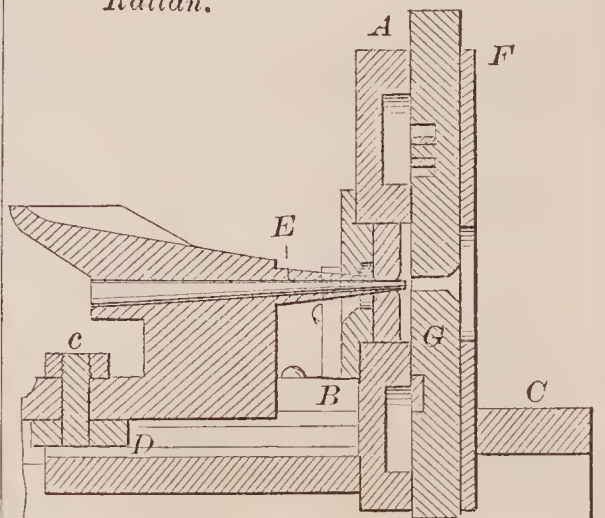

72292—L. Heywood—For Bending Wood.

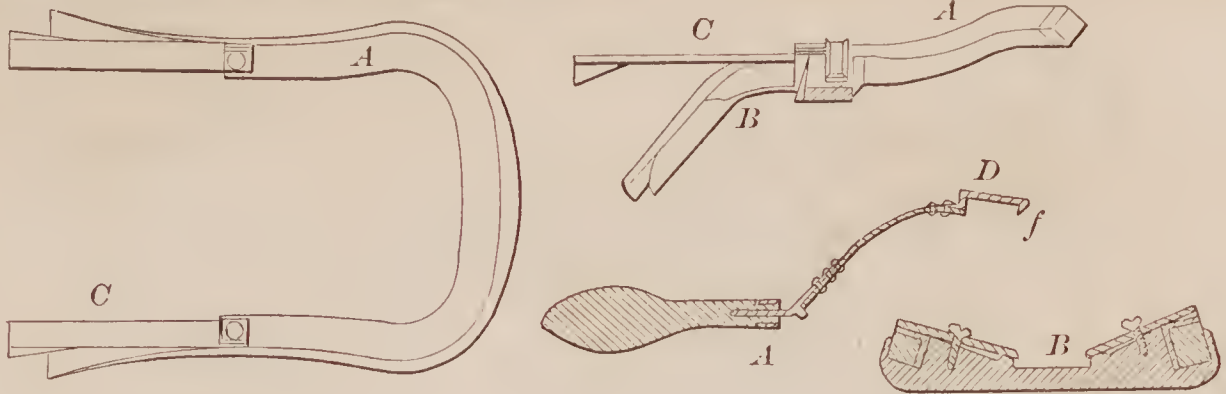

72296—W. H. H. Hollen—Knitting Machine.

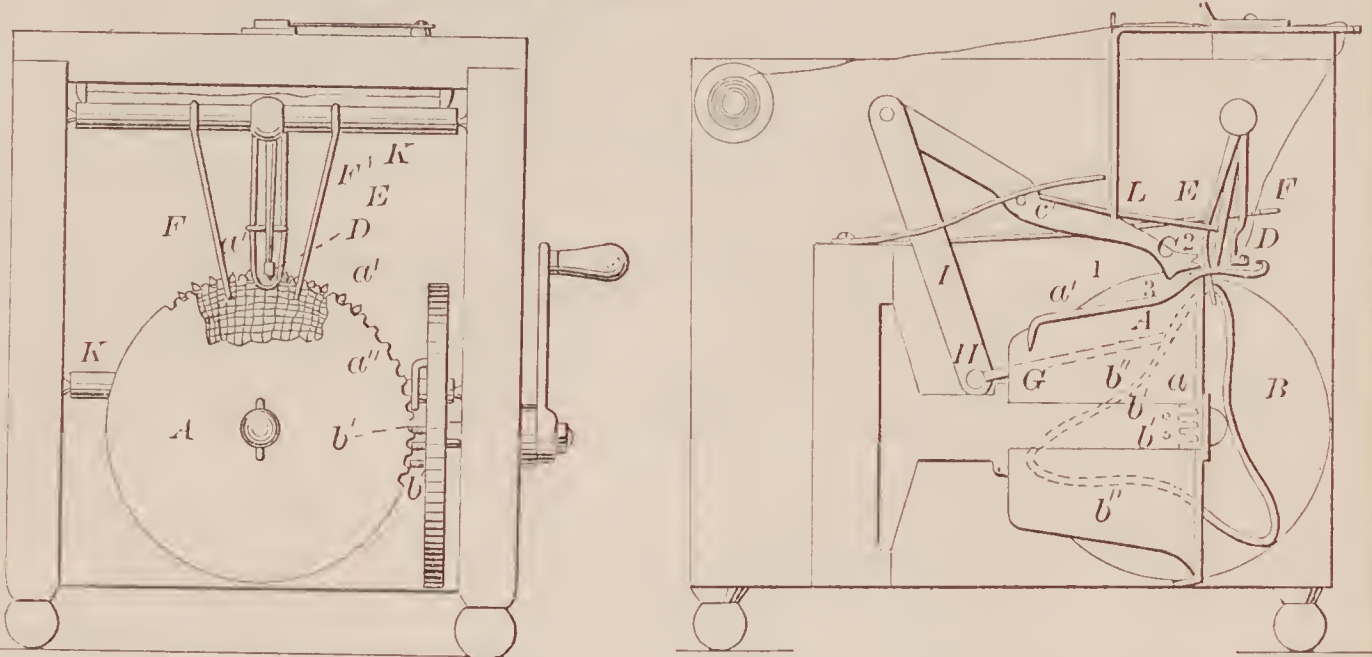

72293—L. Heywood—For Bending Wood.

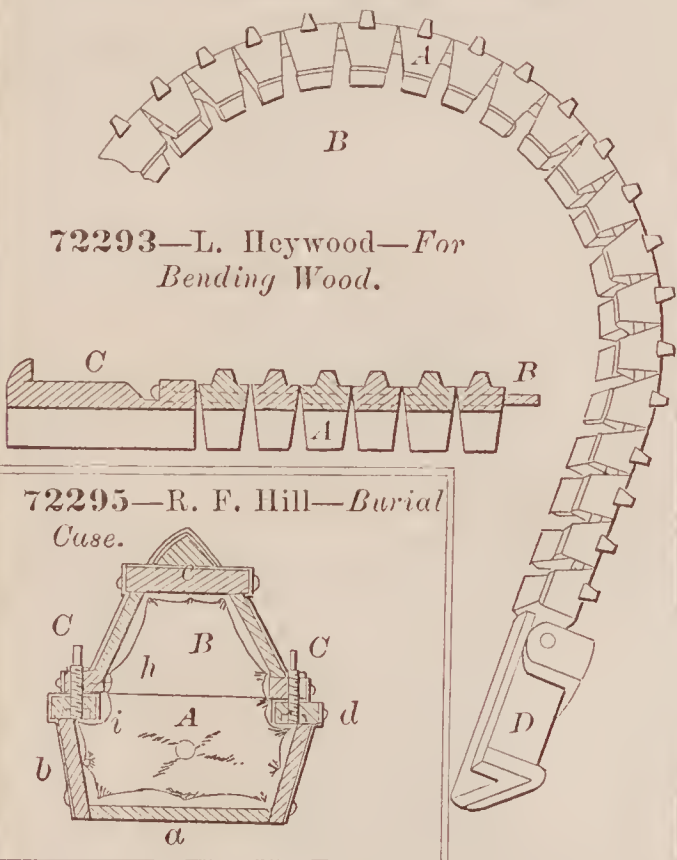

72294—J. E. Hignutt—Cinder Shovel.

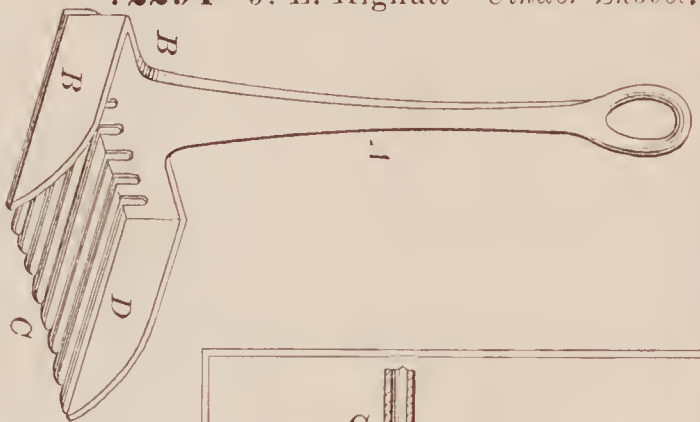

72295—R. F. Hill—Burial Case.

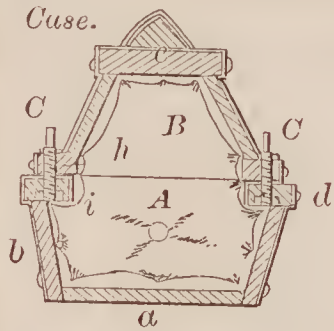

72297—H. Howe—Cultivator.

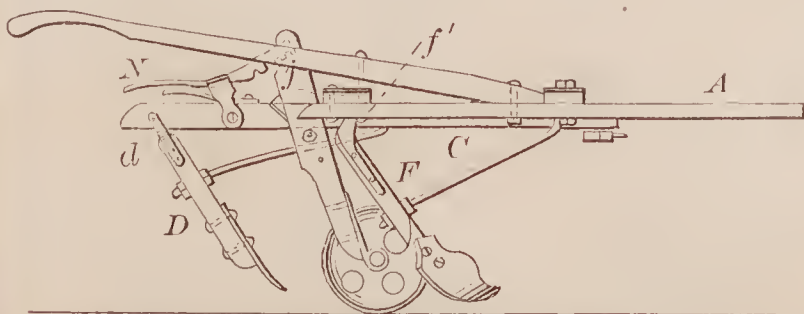

72298—J. B. Hudson—Automatic Rain Conductor.

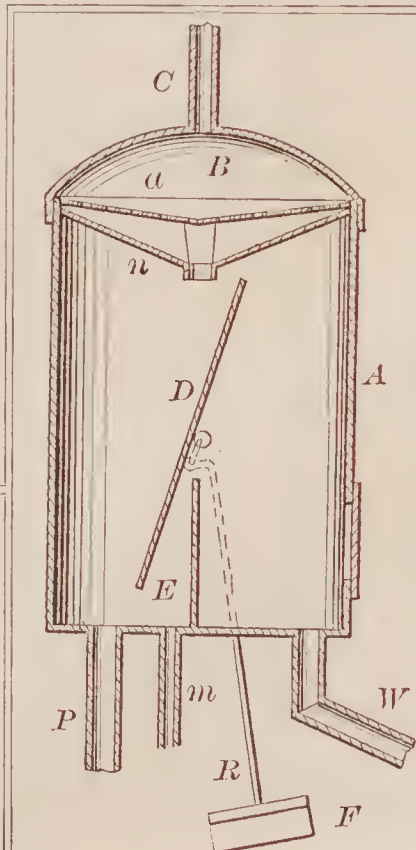



72299—J. W. Hull—For Trimming Hedges.

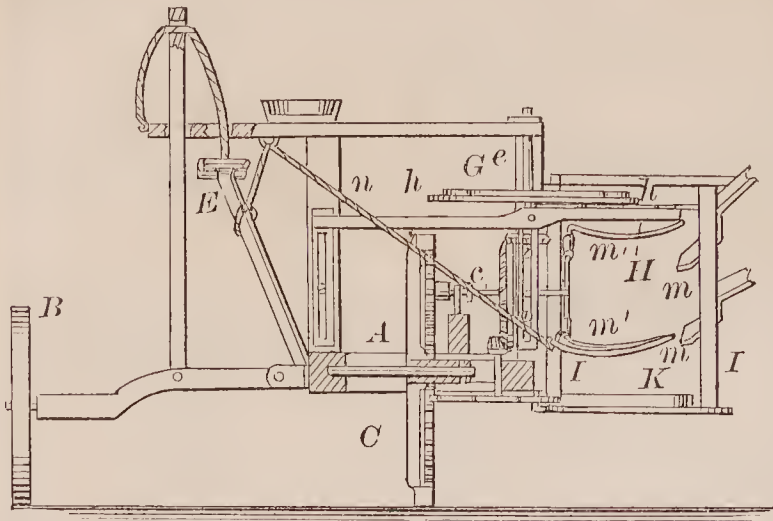

72300—E. Hutson—Foot Power

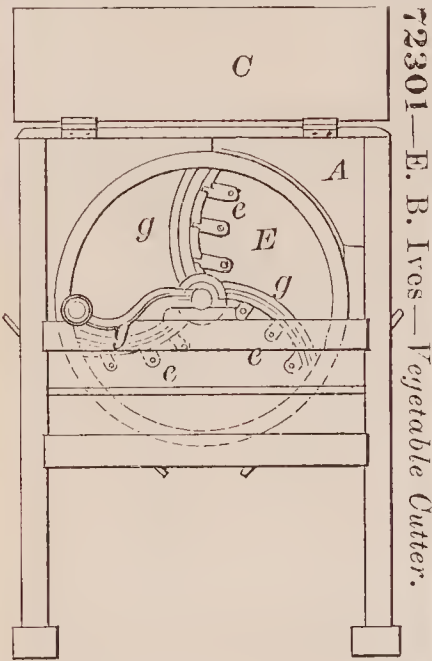
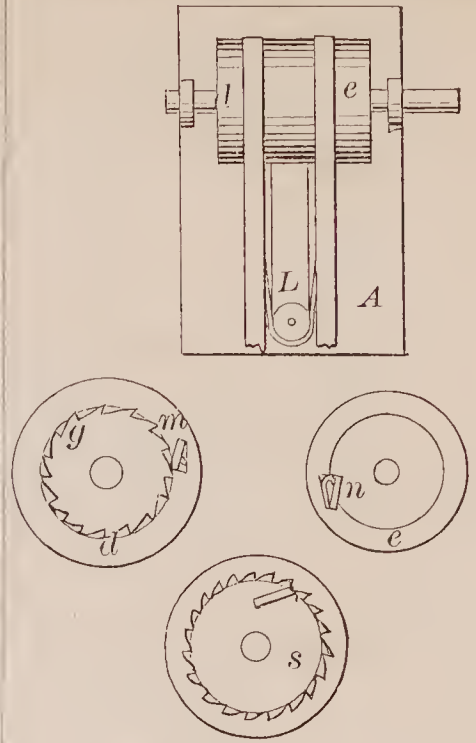

72301—E. B. Ives—Vegetable Cutter.

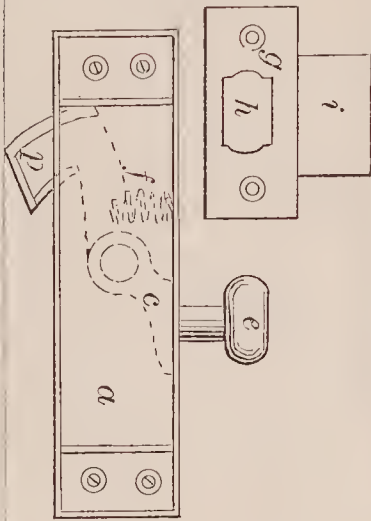

72302—C. C. Jones—Door Bolt.

72305—S. J. Leach—Plow.

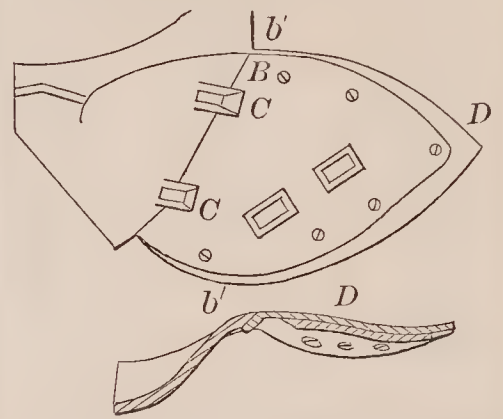

72303—G. F. Krollpfeiffer—Sled.



72306—G. Leas—Lamp Chimney Cleaner.

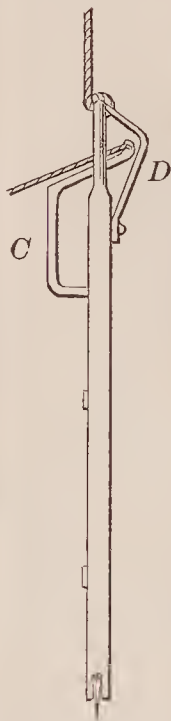

72304—M. J. Laird—Horse Hay Fork.

72307—J. R. D. V. Linton Vehicle Seat.

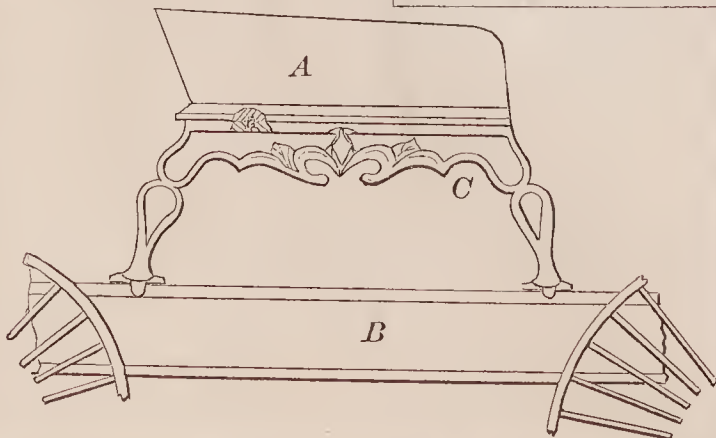

72308—J. R. Martin—Beehive.

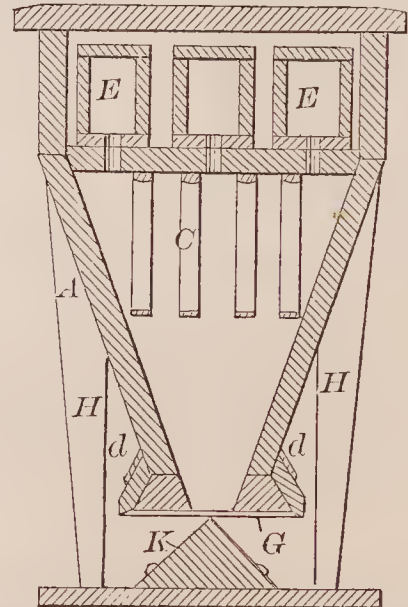

72309—D. Matthew—Protecting Steam Boilers from Corrosion.

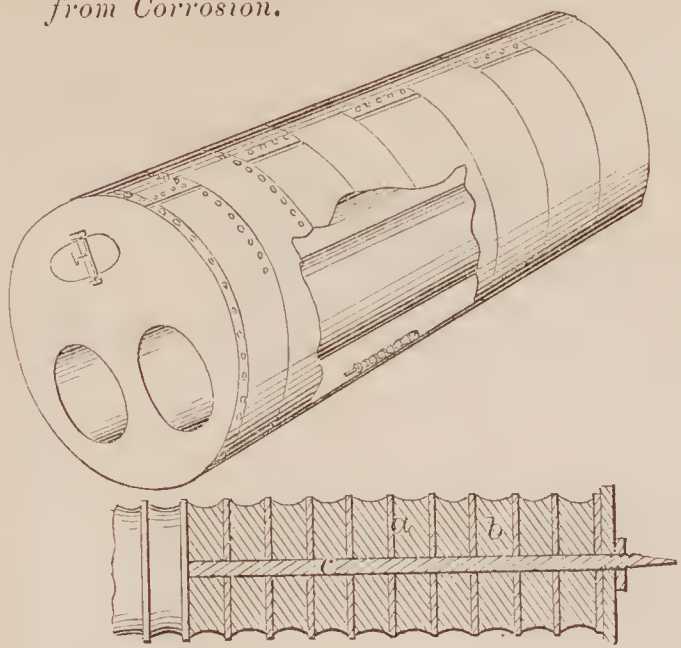

72311—I. C. McAllaster—Trace Fastener.

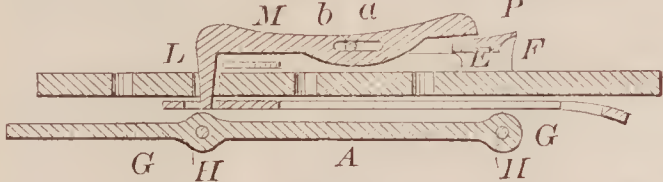

72310—J. Maxey—Churn.

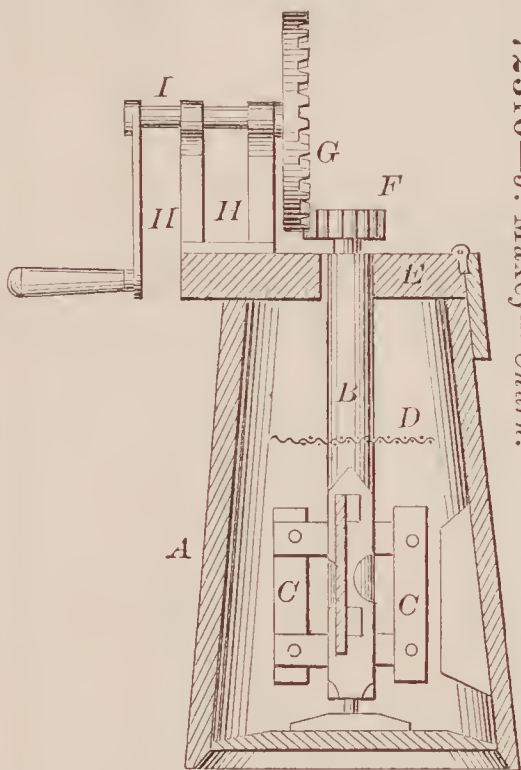

72316—J. Mitchell—Washing Machine.

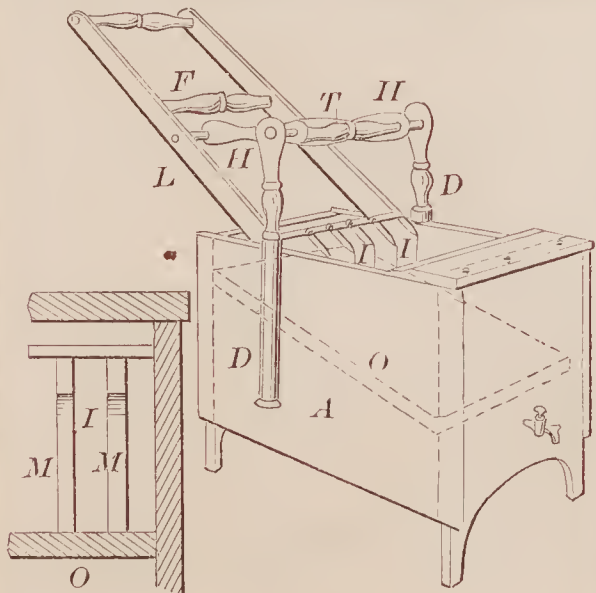

72315—M. Miles—Horse Rake.

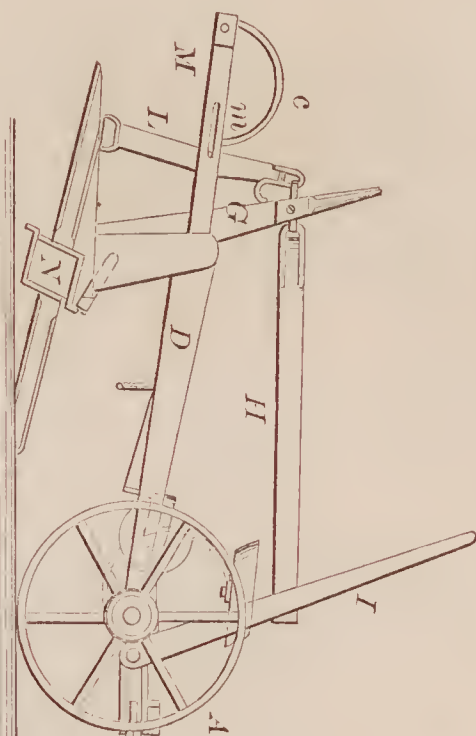

72314—J. S. Merrill—Window Sash Supporter.

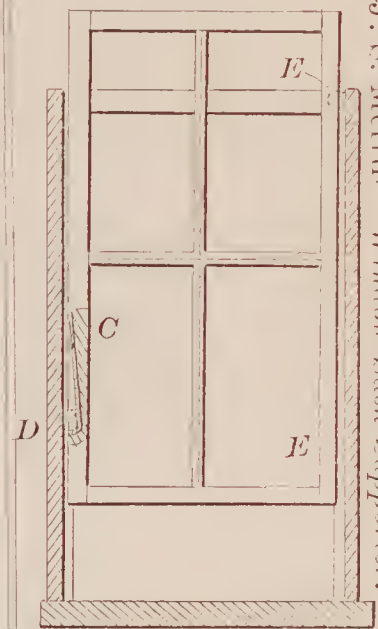

72312—D. L. McGregor—Back Band Fastener.

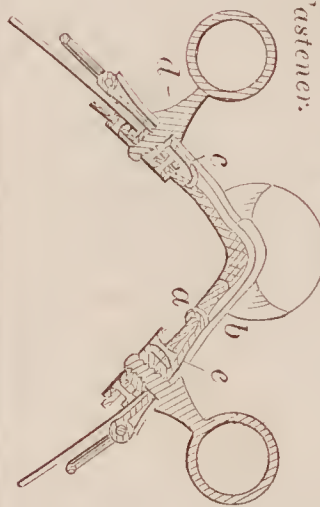

72313—J. N. McIntire—Sash Stopper.

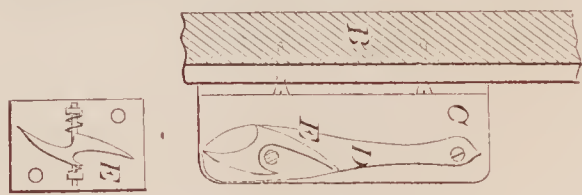

72317—C. Moegling—Flour Mill Ventilator.

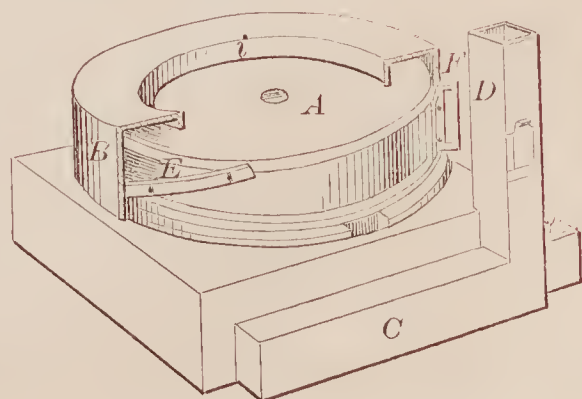



72317—Continued.

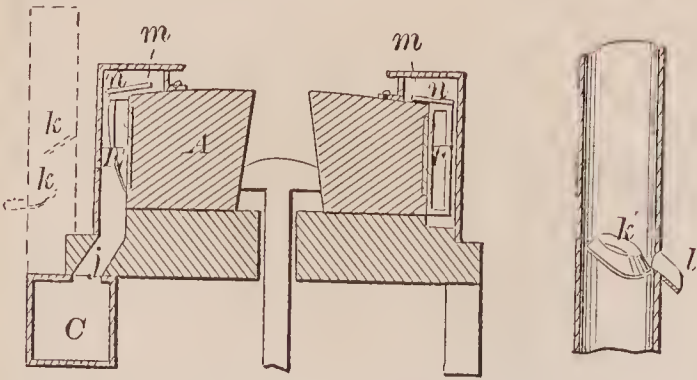

72324—W. Pauly—Comb.

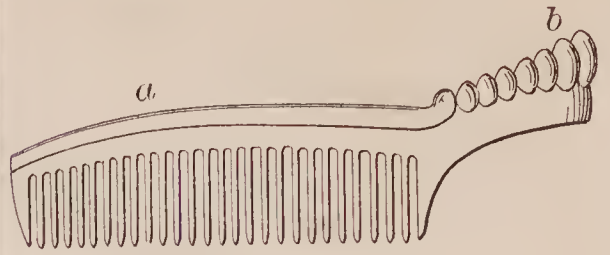

72318—W. R. Mozier—Seed Planter.

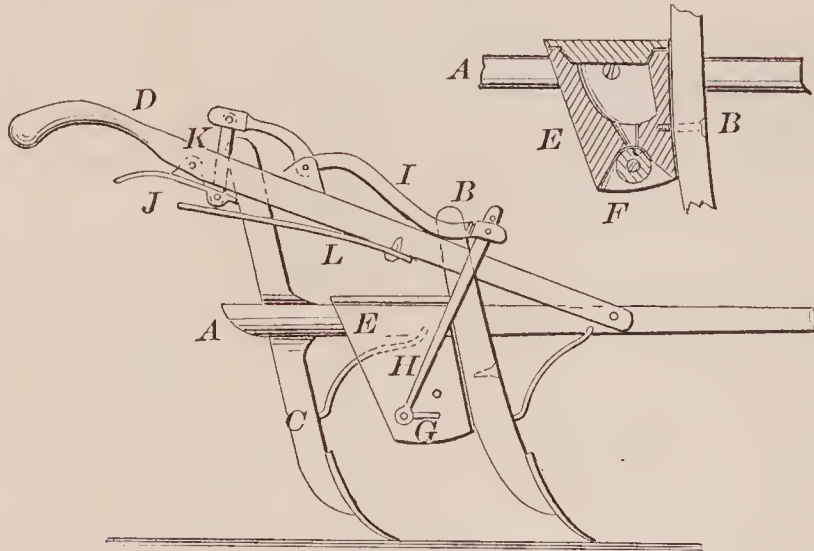

72320—F. G. Oehme—Sail Releasing Apparatus.

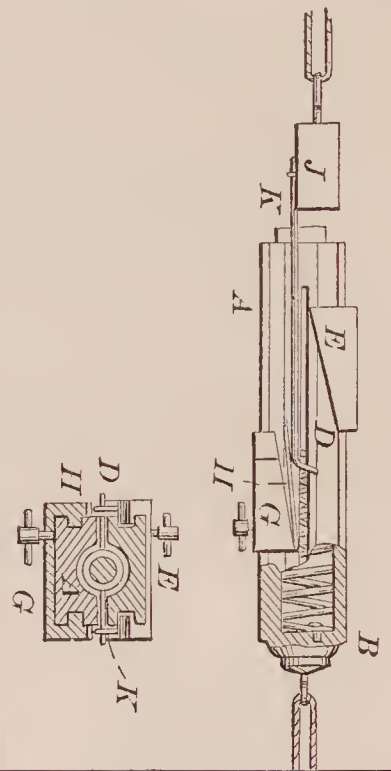

72319—N. Nolan—Propeller.

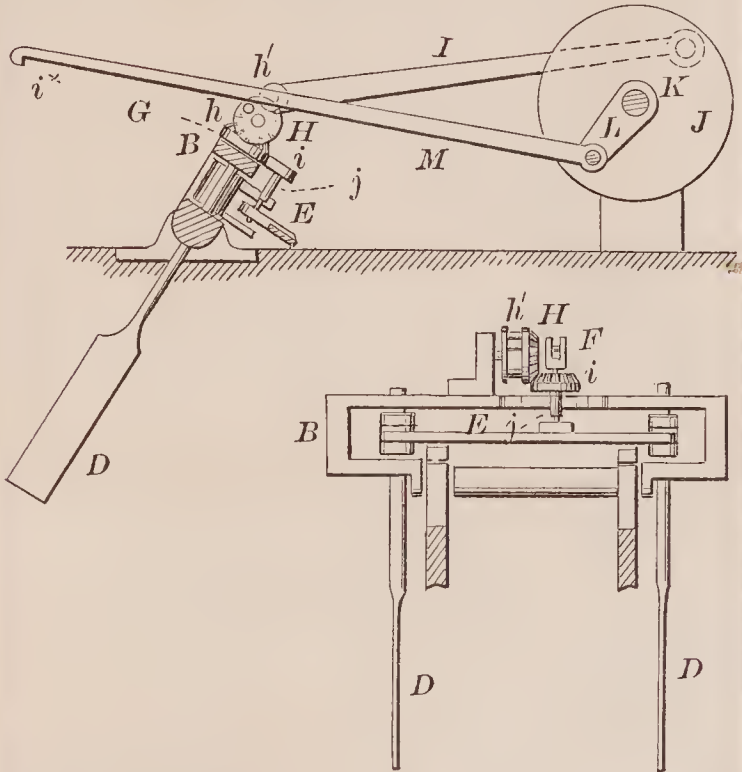

72323—C. E. Patrice—Lifting Apparatus for Grain Drills.

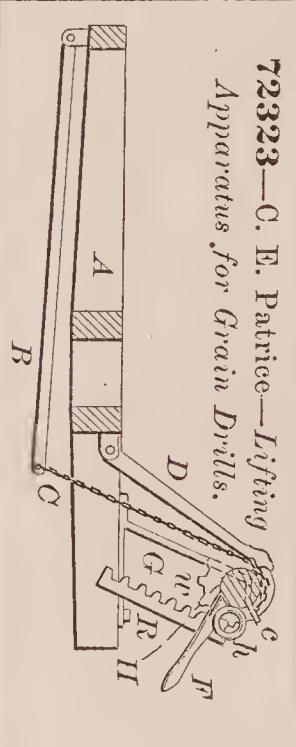

72321—S. Page—Horse Hay Fork.

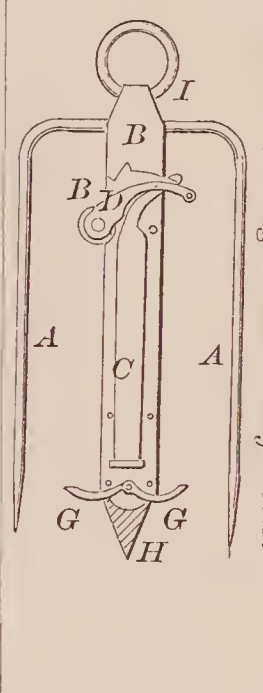

72325—C. O. Pike—Belt Fastener.

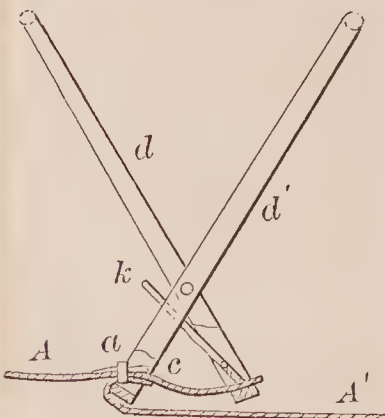

72326—H. A. Plumb—Portable Evaporator.

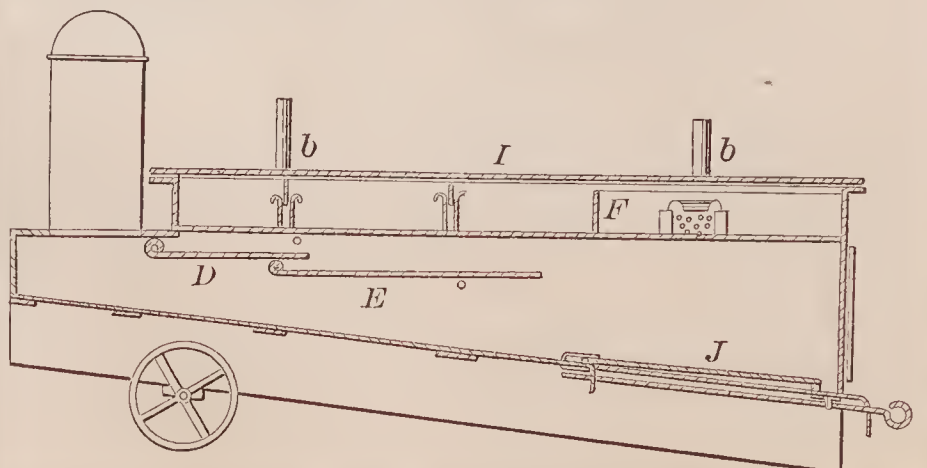

72327—H. K. & T. W. Porter—Vise.

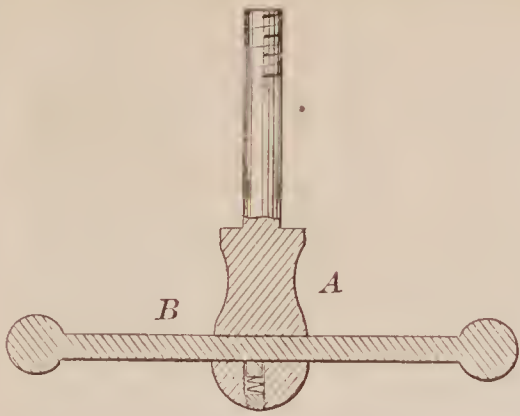

72328—Reneky & Keiss—Washing Machine.

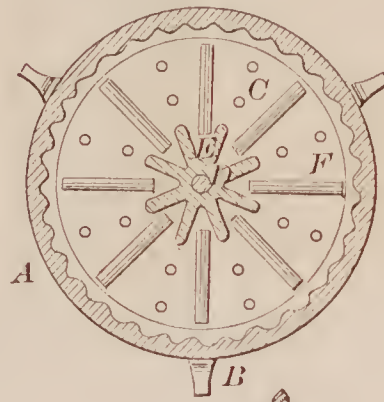

72329—S. B. Rittenhouse—Hoisting Jack.

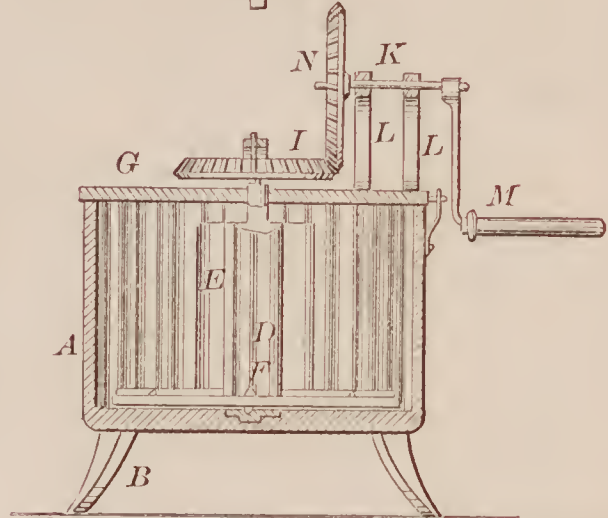
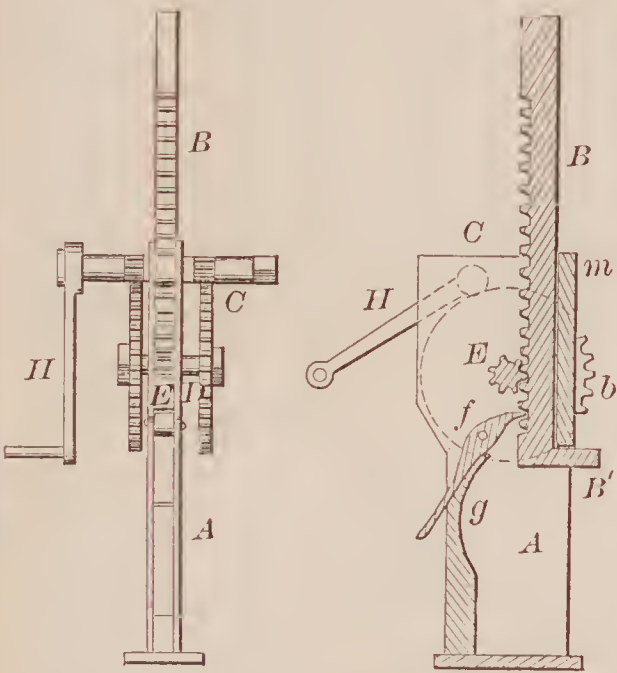

72331—H. W. Shipley—Water Wheel.

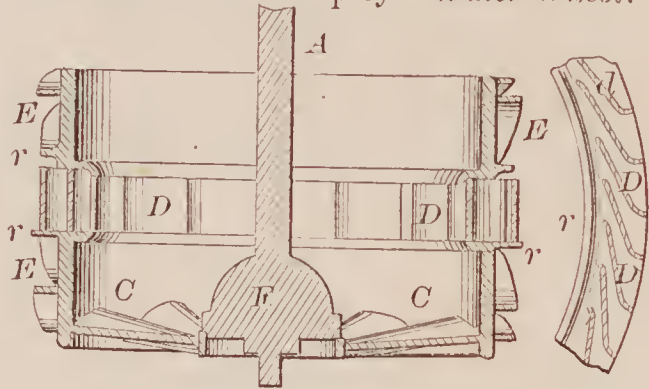

72330—W. F. Shanks—Brick Machine.

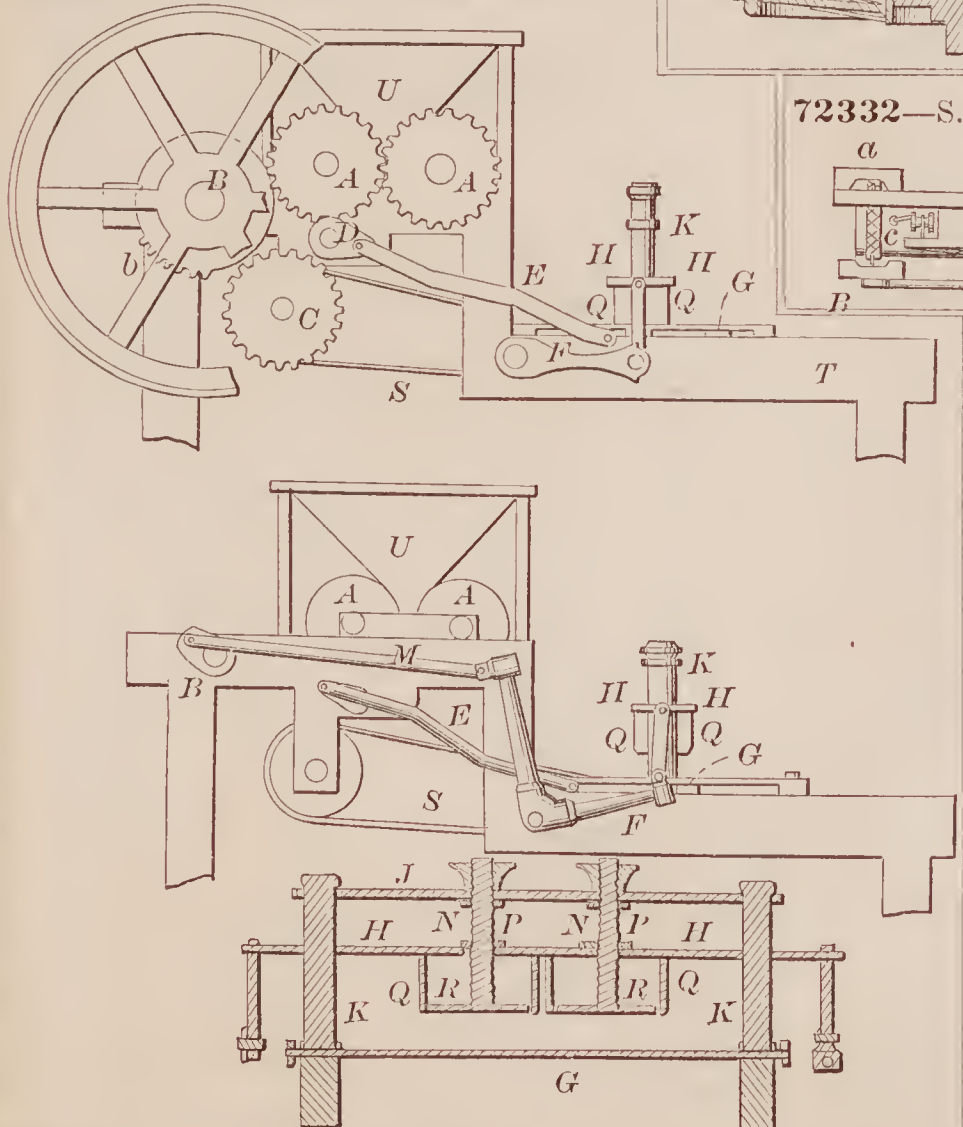

72332—S. W. Shorey—Window Blind.

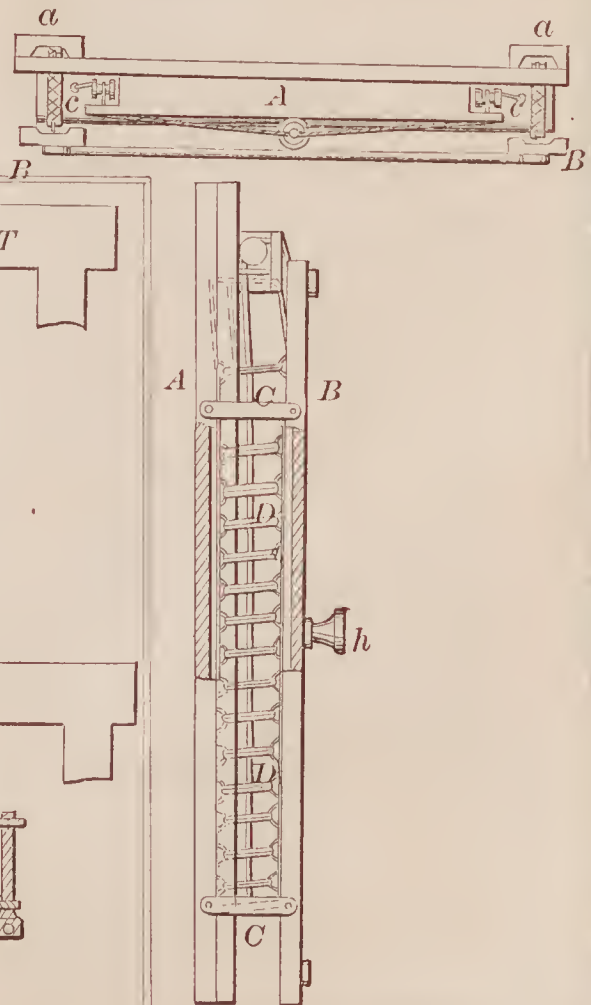



72333—J. Stark—Seed Planter.

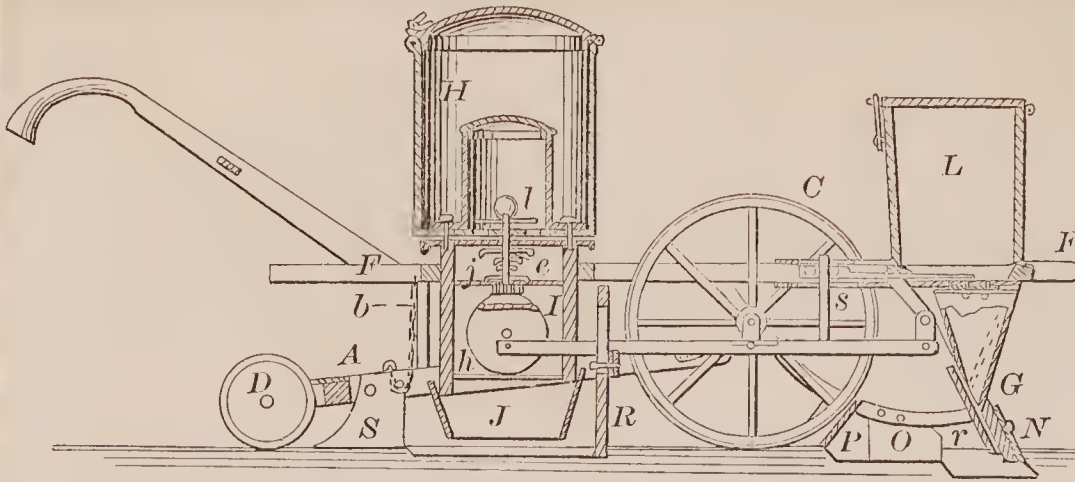

72340—S. S. Turner—Piston Rod Packing.

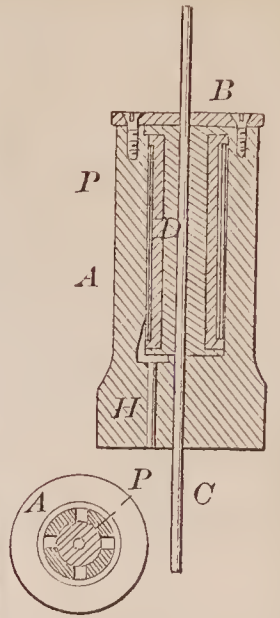

72336—B. T. Stowell—Excavator.

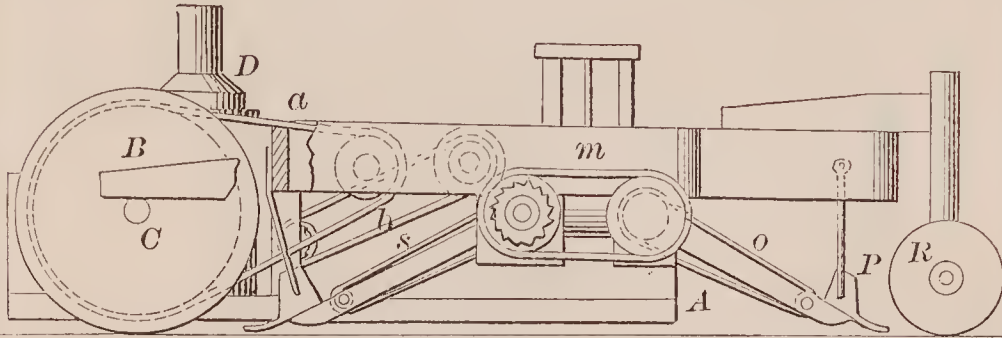

72334—N. Starr, Jr.—Harrow.

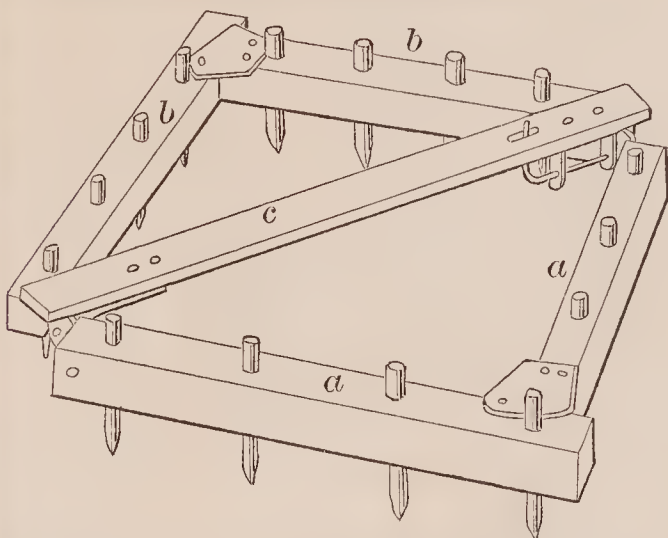

72337—H. Stroud, Jr.—Tire Heater.

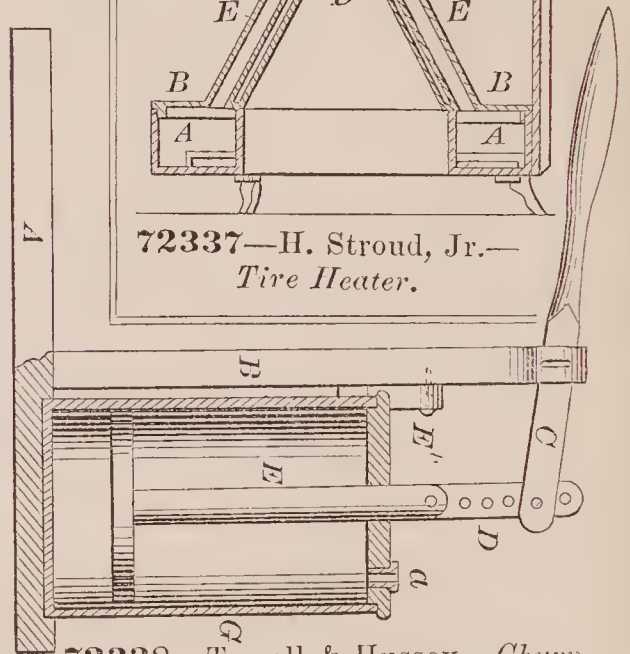

72339—J. Tiffany—Base Burning Stove.

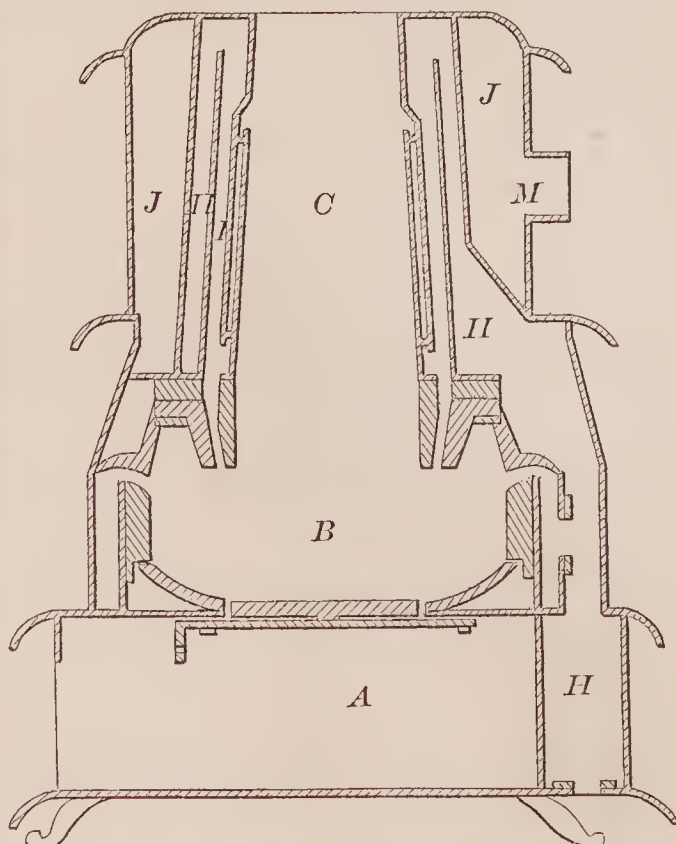

72338—Terrell & Hussey—Churn.

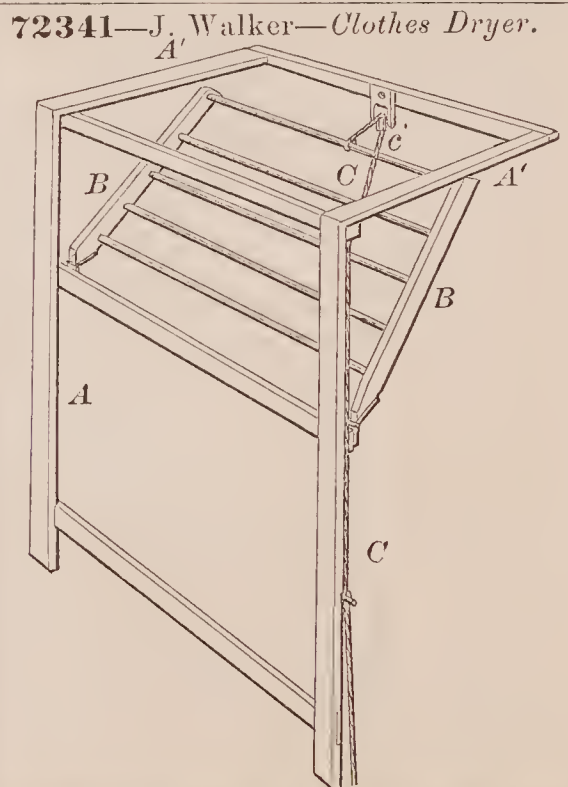

72341—J. Walker—Clothes Dryer.

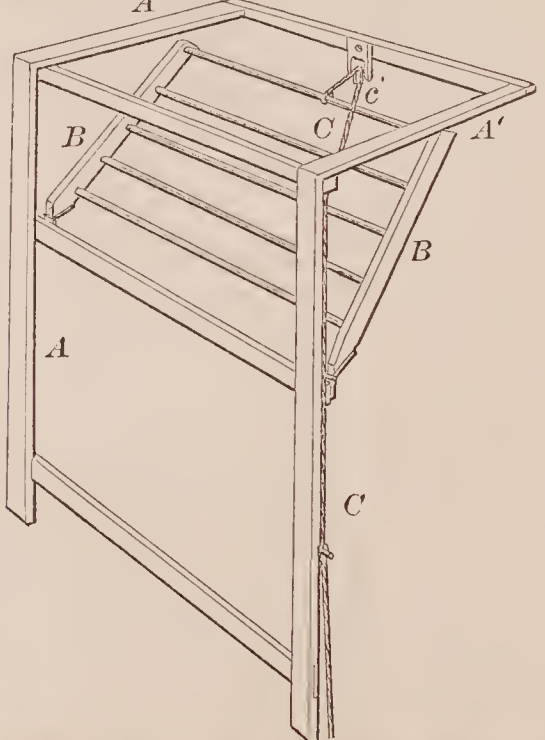



72342—G. W. Walker—Cooking Stove.

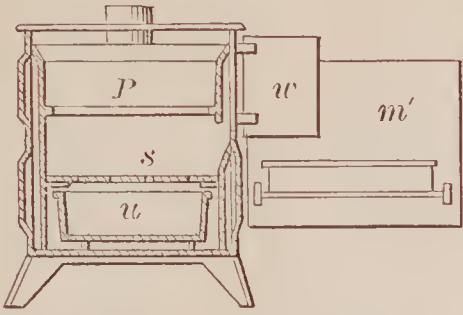
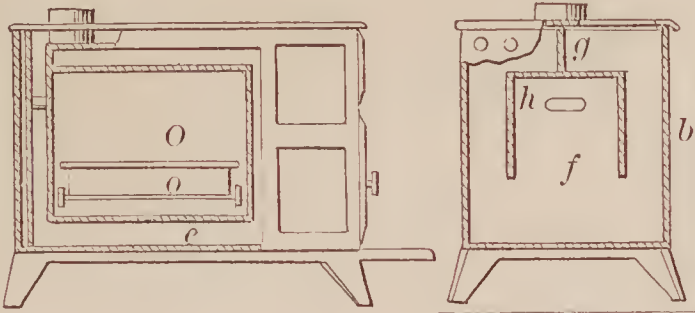

72348—J. M. Wheeler—Steam Jet.

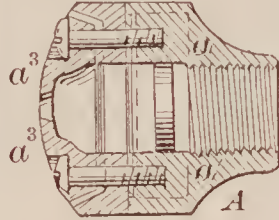

72343—P. Week—Tidal Water Elevator.

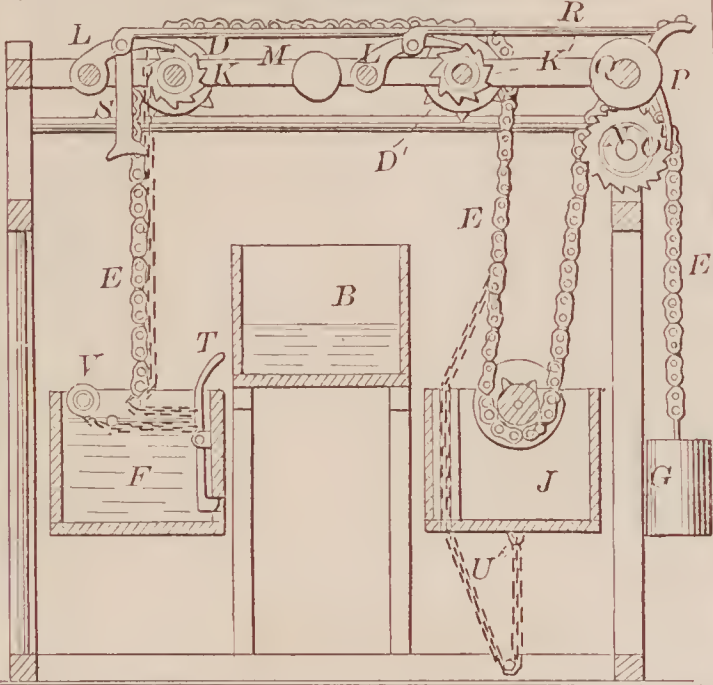

72346—P. Windhiser—Box For Preserving Corpses.

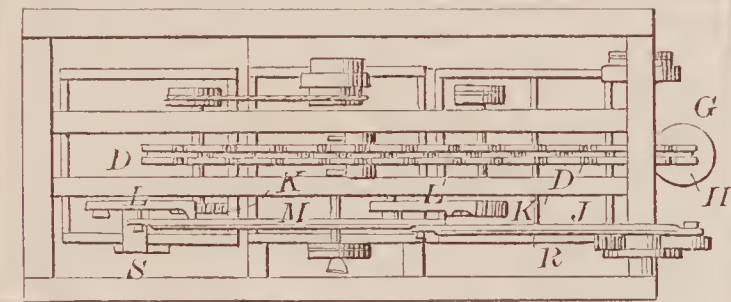
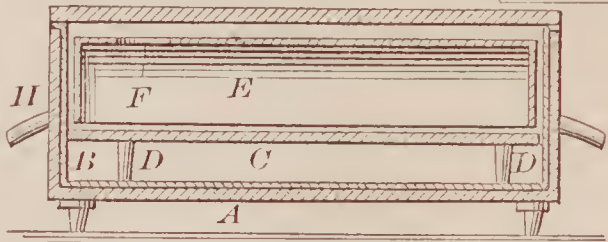

72345—I. H. Wells—Protecting Likenesses in Monuments.

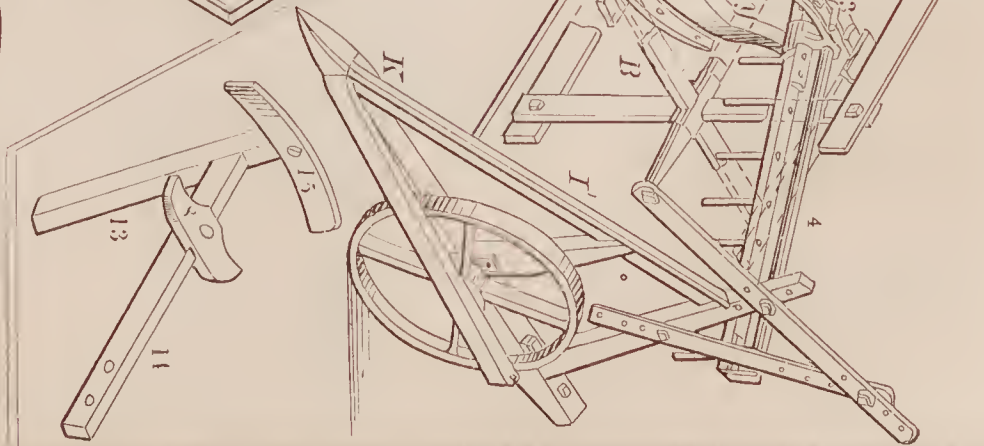
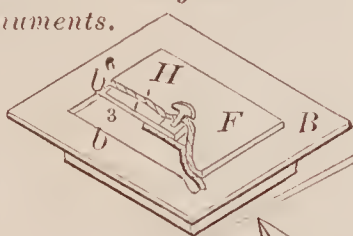
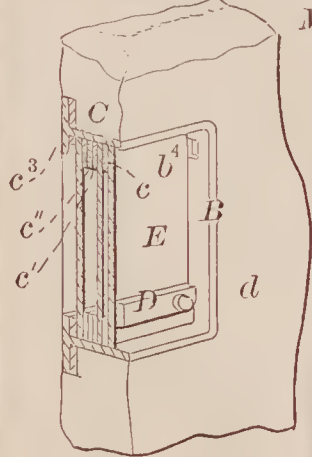

72349—W. N. & A. Whiteley—

Harvester.

72347—J. Wertsbaenger—Locking Knob Latch.

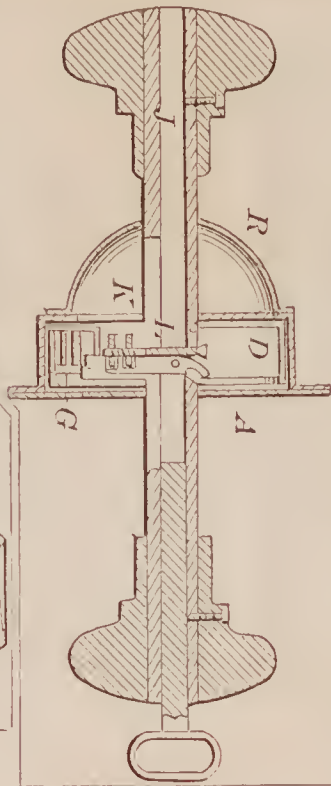

72344—T. Welch—Pitman.





72354—J. Zimmerman—Culinary Boiler.

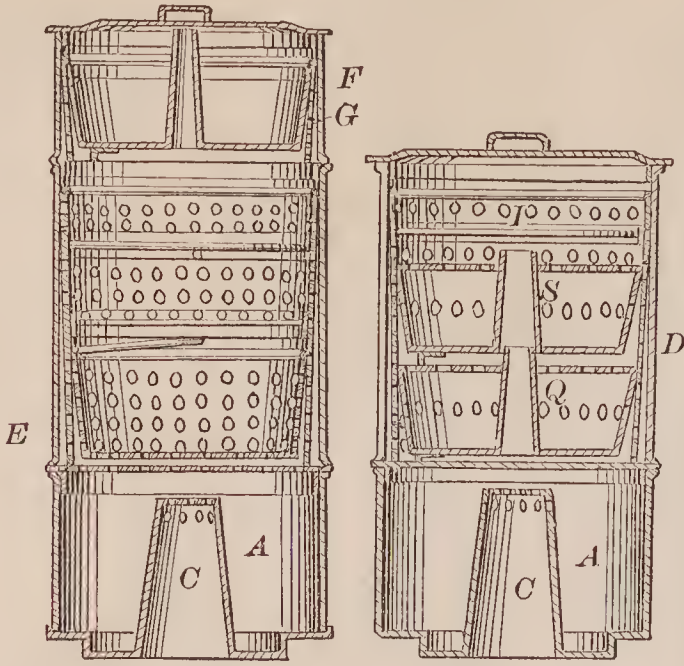

72352—R. Wright—Bricks for Pavements.

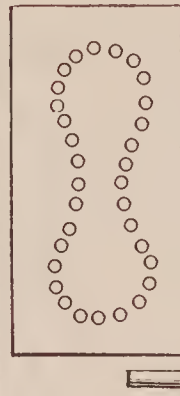

72351—F. S. Witt—Boot Tree.

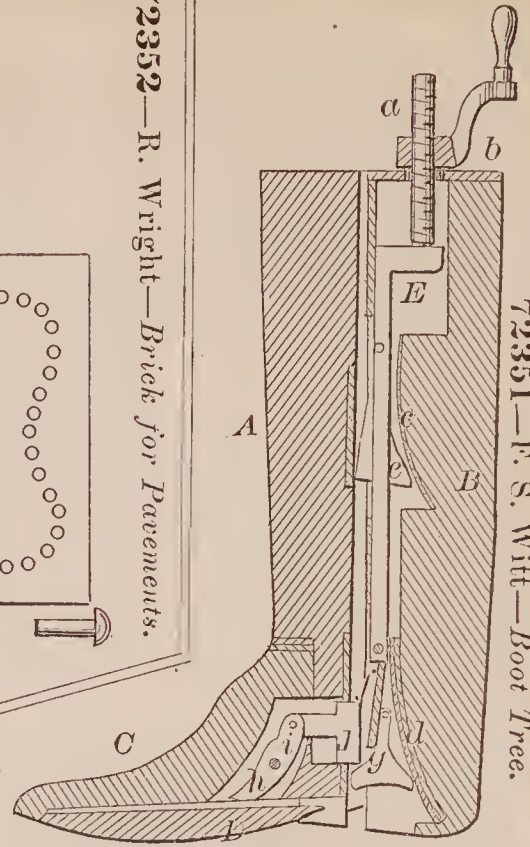

72350—G. Widdecomb—Spring Bed Bottom.

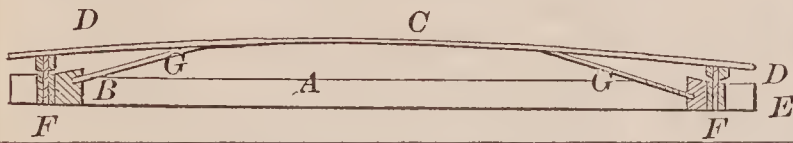

72353—J. Zimmerman—Coffee Pot.

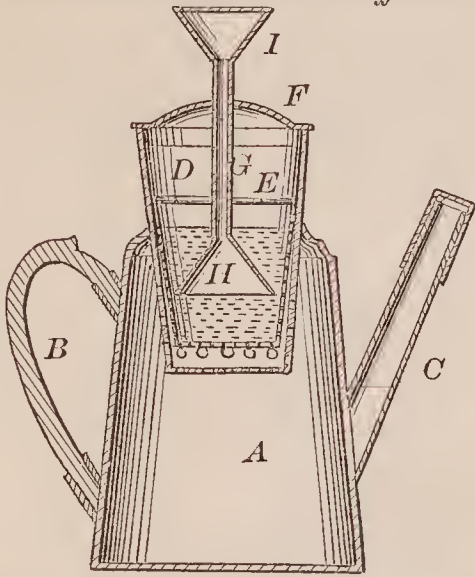

72358—J. W. Barlow—Tripod.

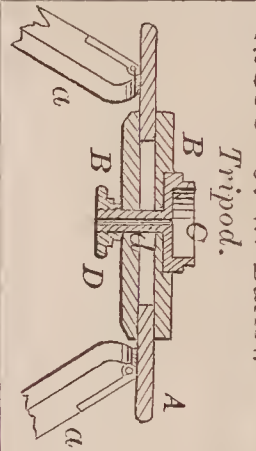

72357—C. W. Baldwin—For Preparing Peat.

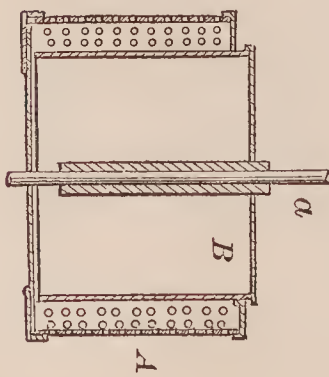
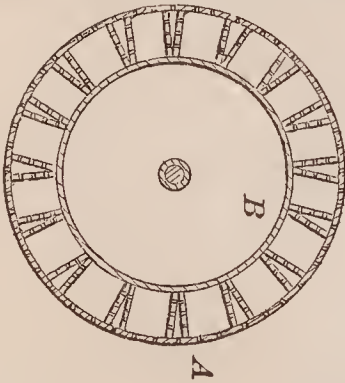

72360—E. L. Brady—Dredge Boat for Excavating.

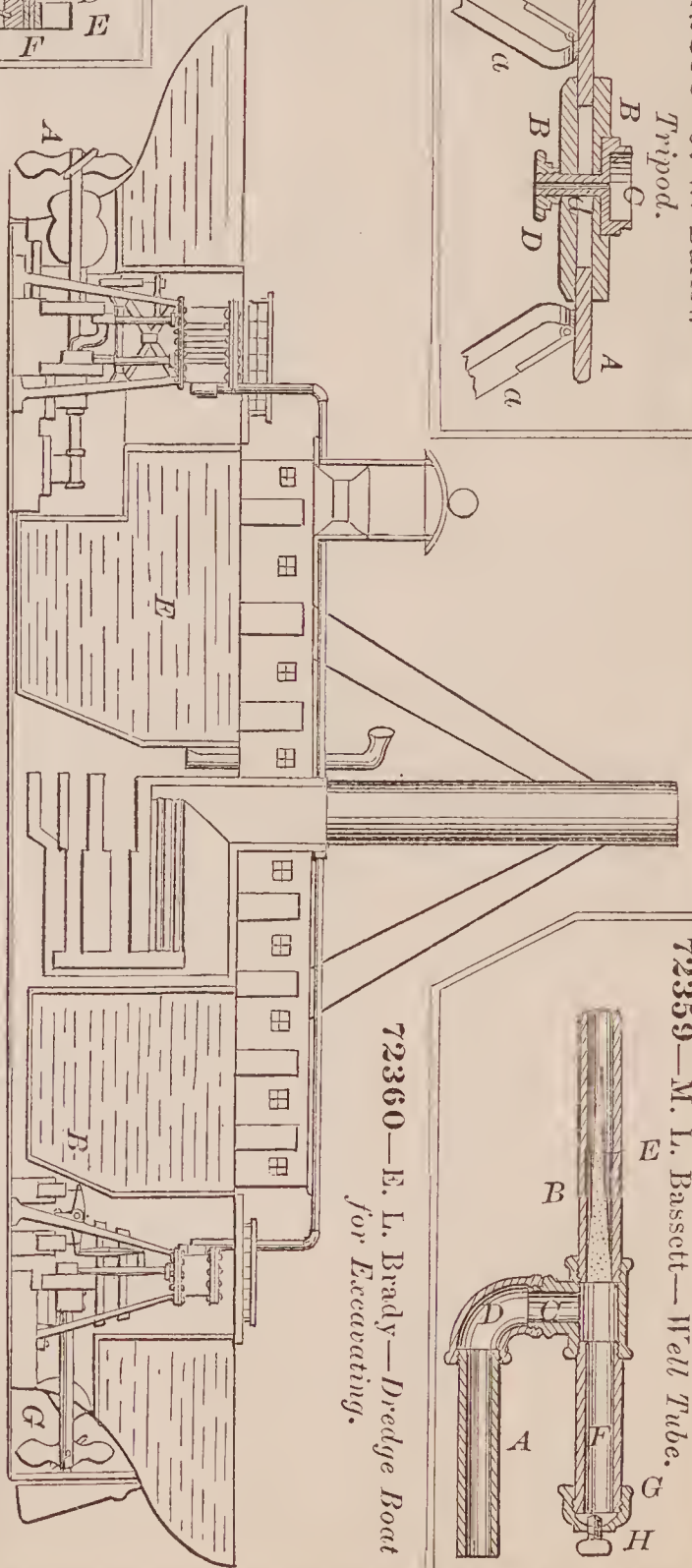

72359—M. L. Bassett—Well Tube.

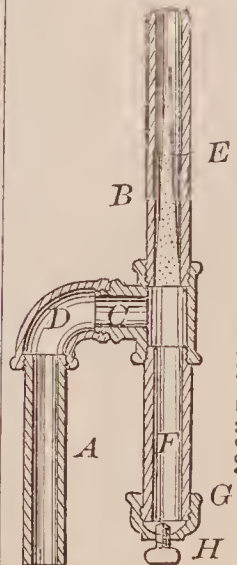









72379—A. B. Ely—Warp-Feeding Mechanism for Looms.

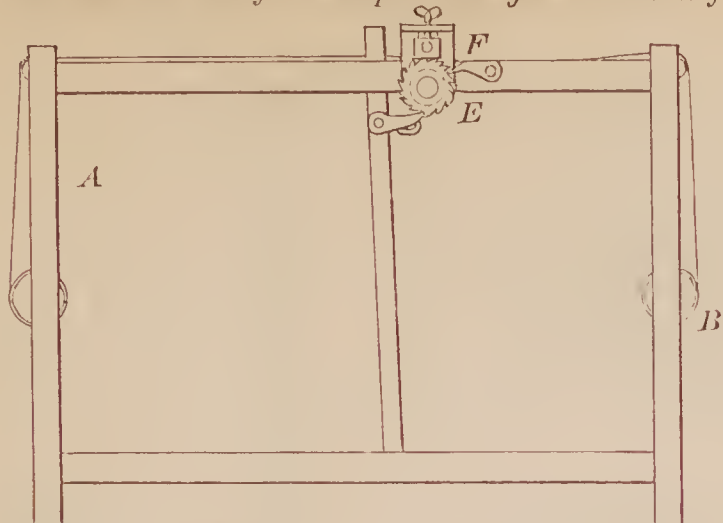

72381—C. N. Farnam—For Tanning.

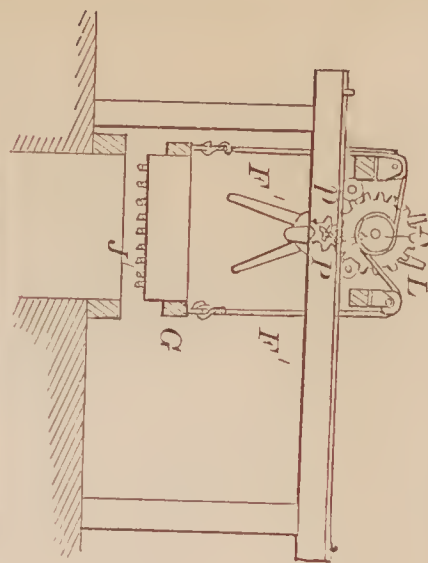

72378—H. Eiffler—Padlock.

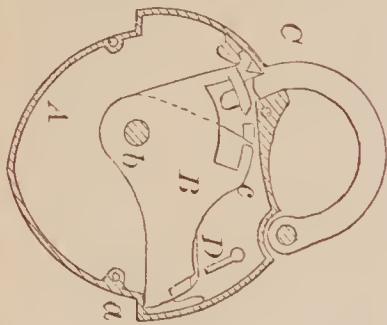

72376—Drake & Egginton—Lamp.

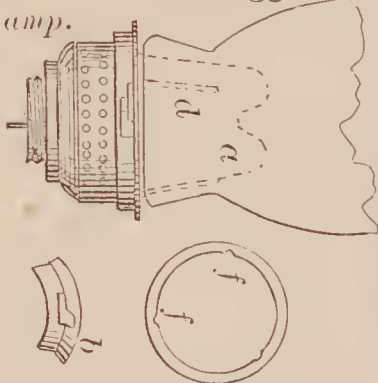

72380—C. K. Ely—Head Block for Saw Mills.

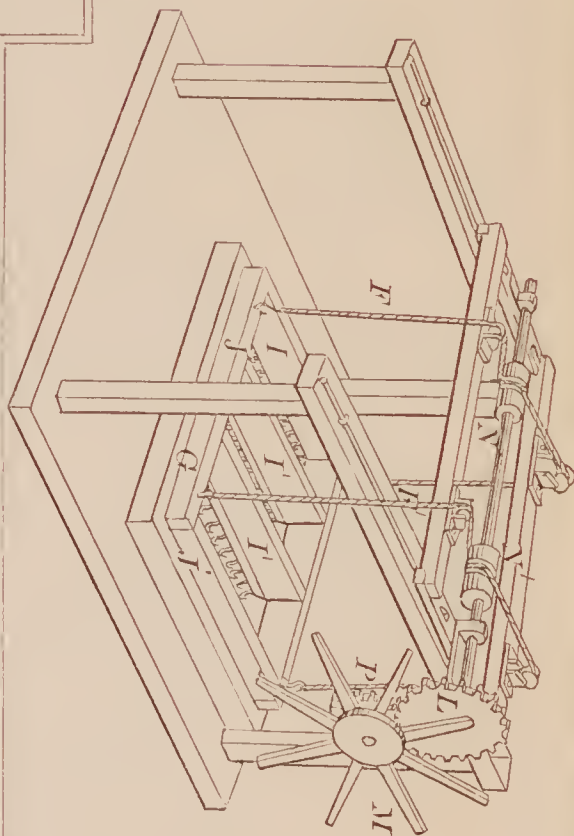
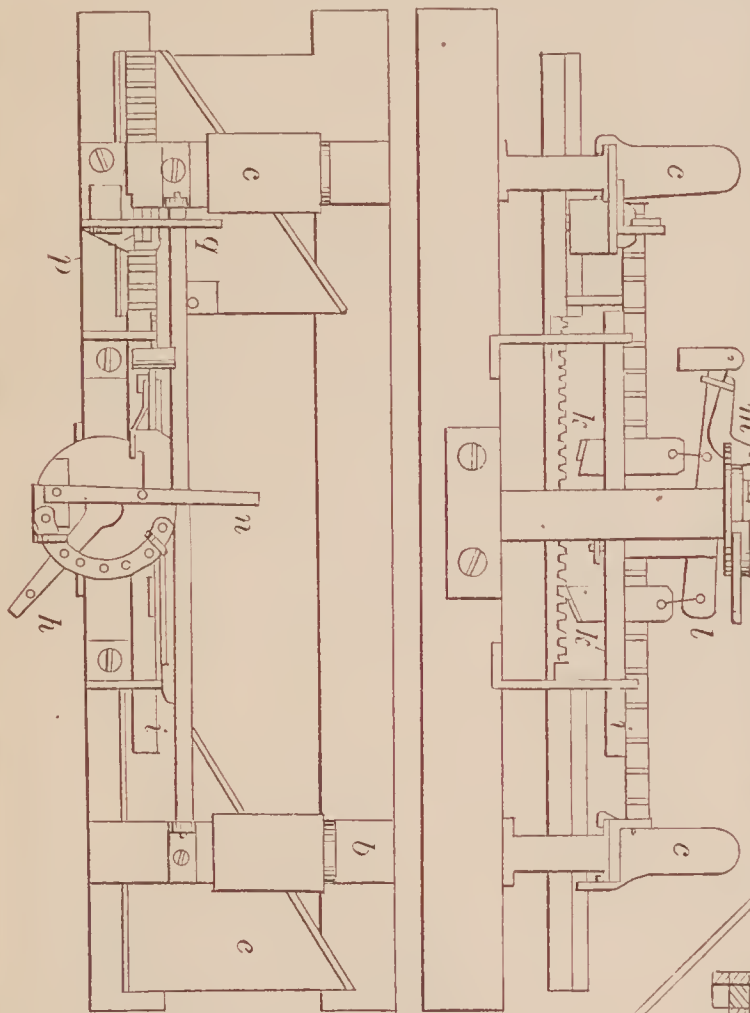

72377—D. Durfee—Fruit Dryer.

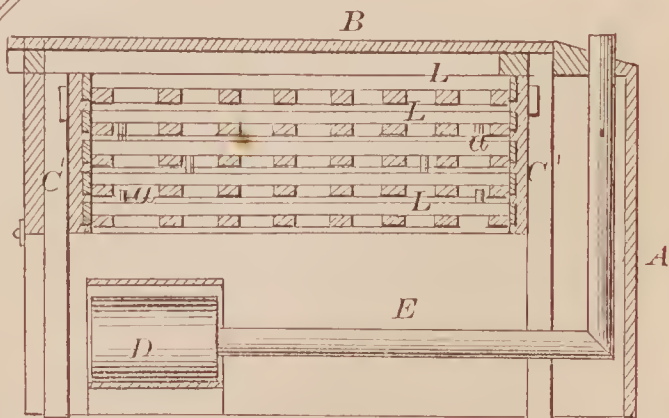

72377—D. Durfee—Fruit Dryer.

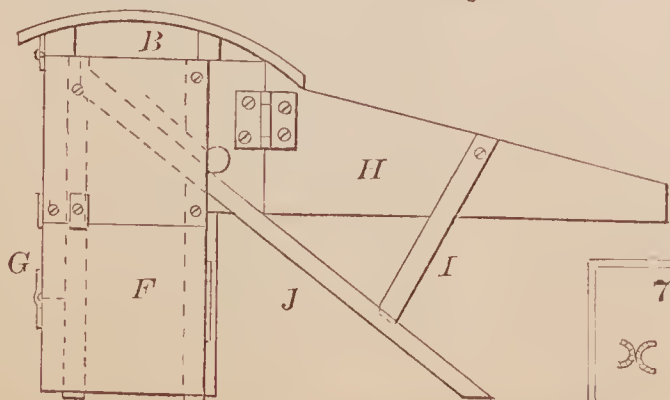

72382—D. D. Foley—Pen Holder.





72383—Gardiner & Hyde—Steam Pump.

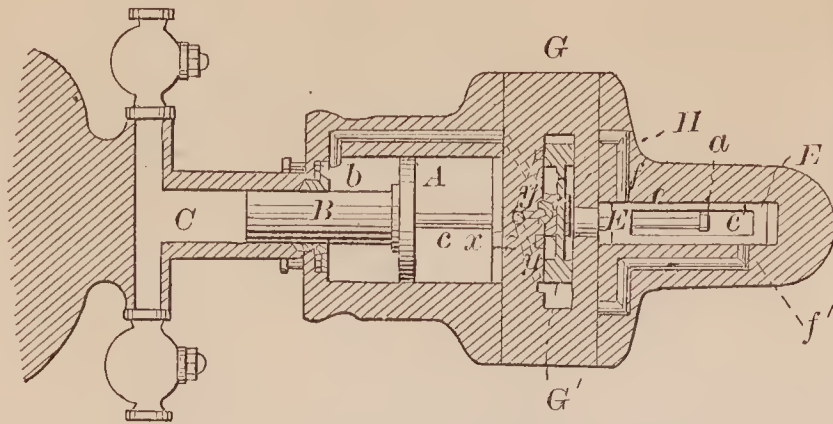

72384—J. B. Gayle—Oil Can.

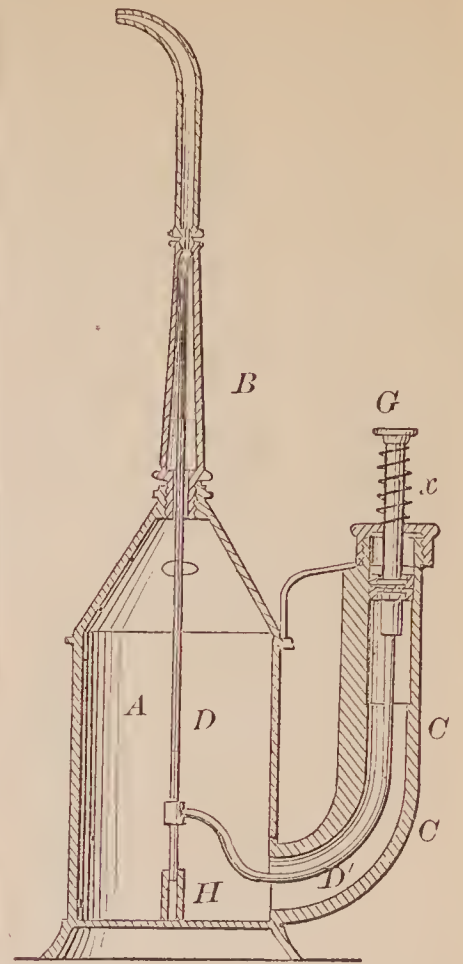

72386—A. Gilmore—Plow.

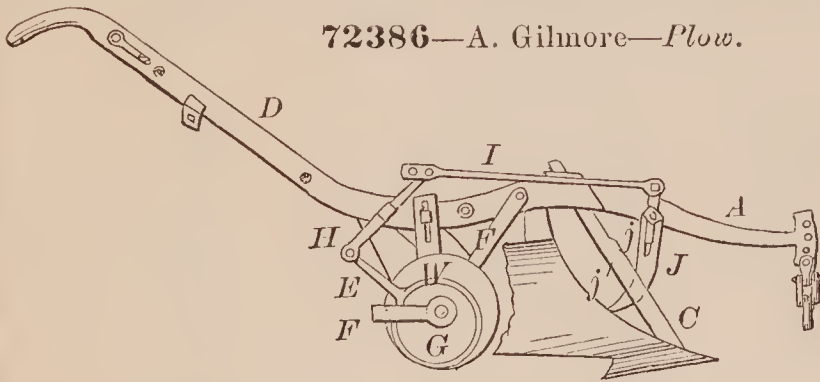

72387—S. Gissinger—For Squeezing Puddled Iron.

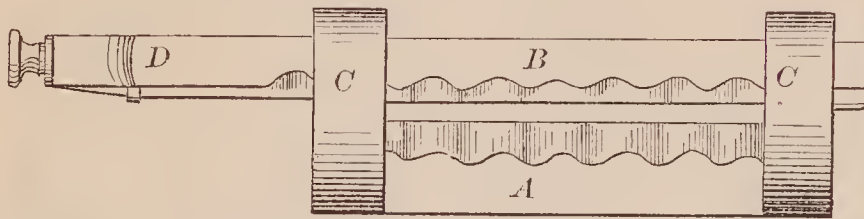

72385—R. Gibbons—Strap Fastening.

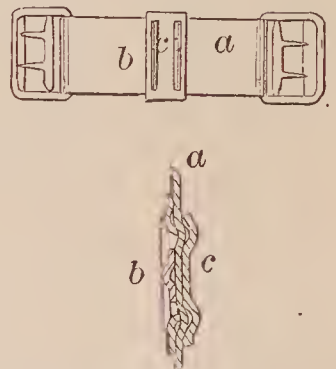

72389—S. Gissinger—Coal Boring Bit.

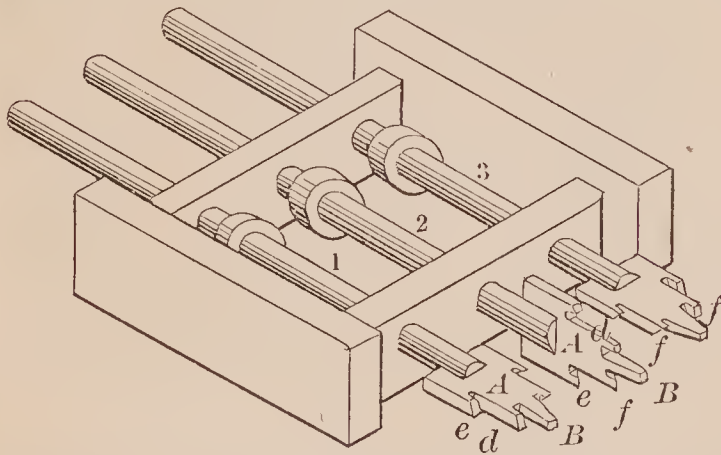

72390—S. Gissinger—Coal Mining Machine.

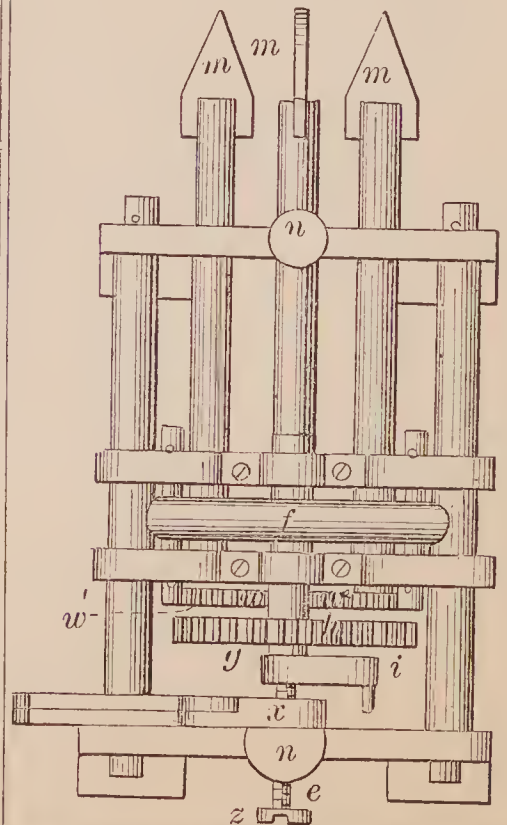

72388—S. Gissinger—For Squeezing Puddled Iron.

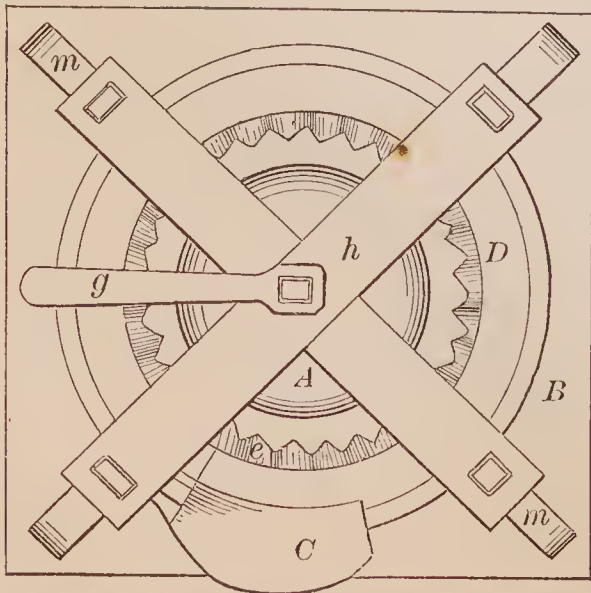

72391—W. Hagerty—*Ram for Vessels.*

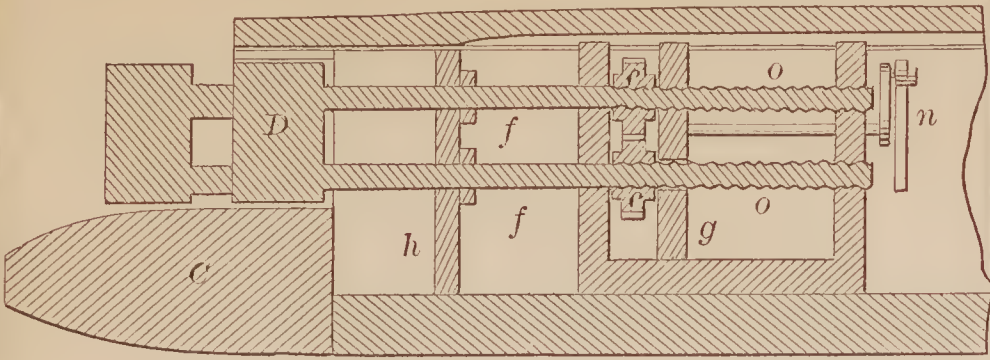

72395—E. Hartwell—*Rocking Chair.*

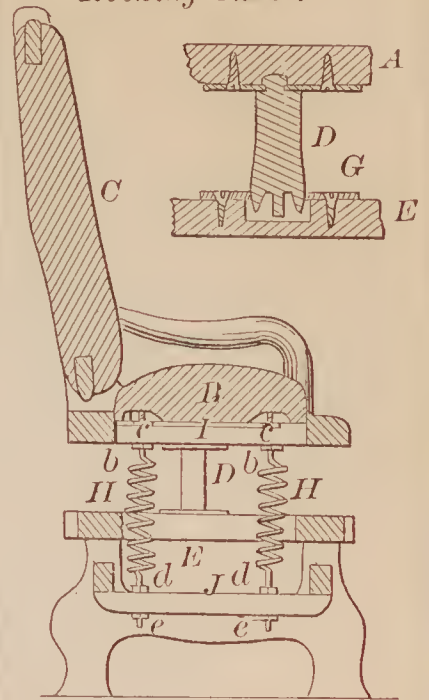

72392—F. Hain—*For Feeding Nail Plates.*

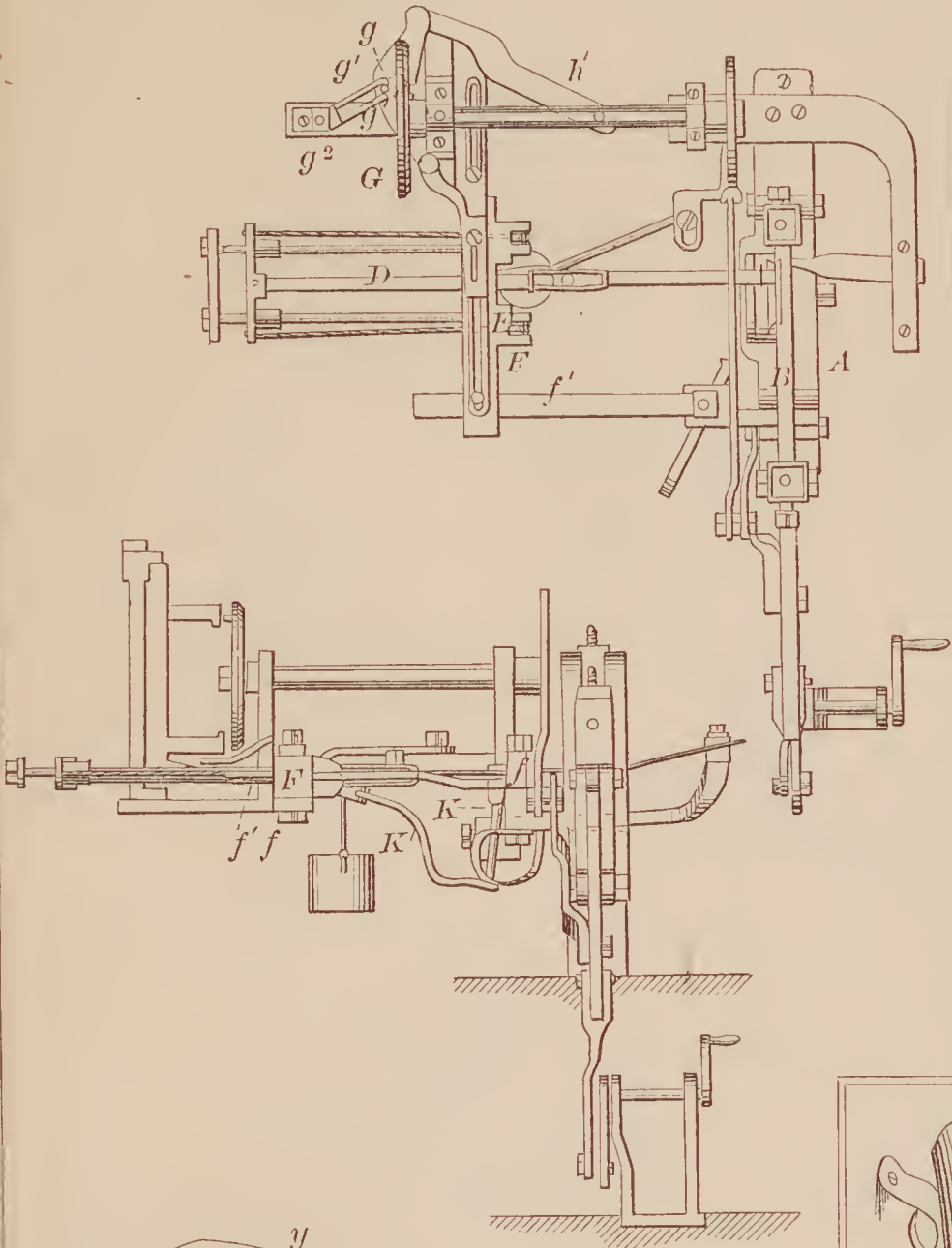

72394—B. J. Hartman—*Trace Fastener.*

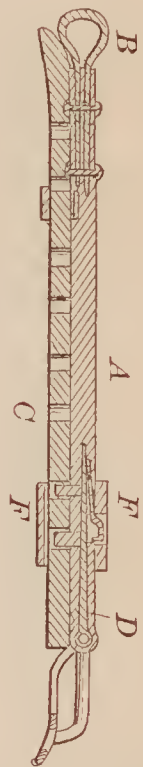

72393—A. W. Hale—*For Cutting and Working Fibrous Substances.*

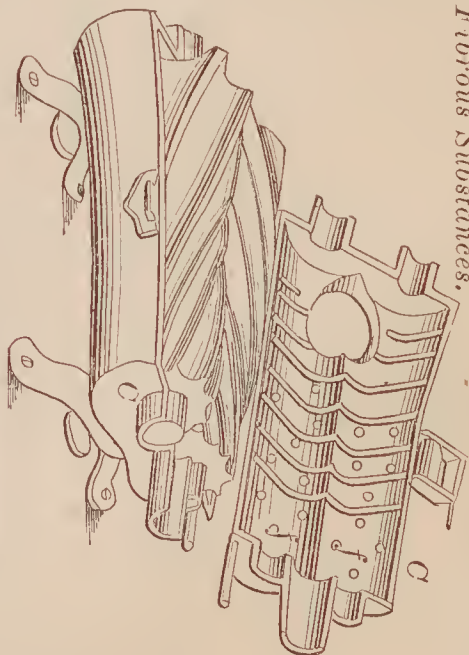



72396—W. Huntington—Animal Trap.

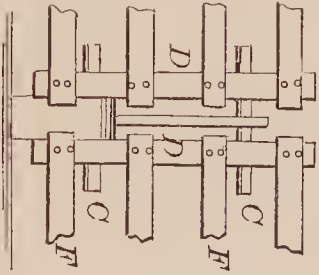
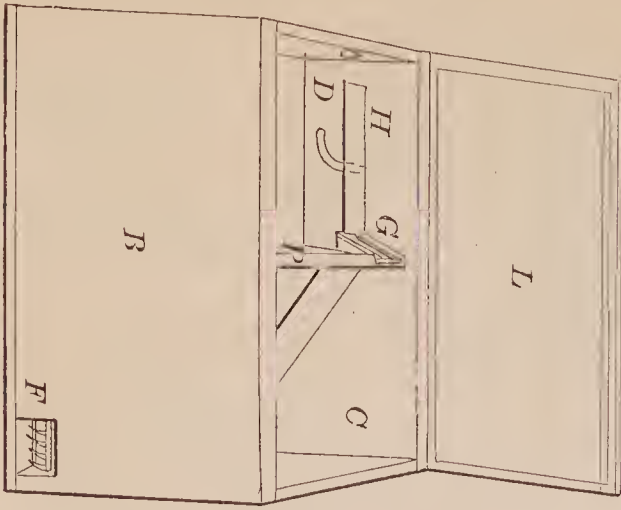

72402—J. B. Johnson—Fence.

72398—P. C. Ingersoll—Spring Bed Slat.

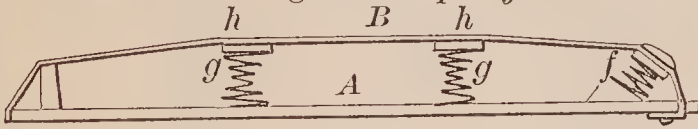

72397—E. C. James—Road Locomotive.

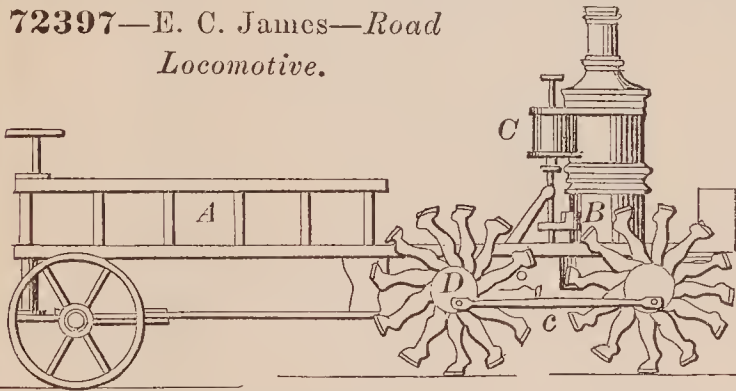

72401—J. Johnson—Sled.

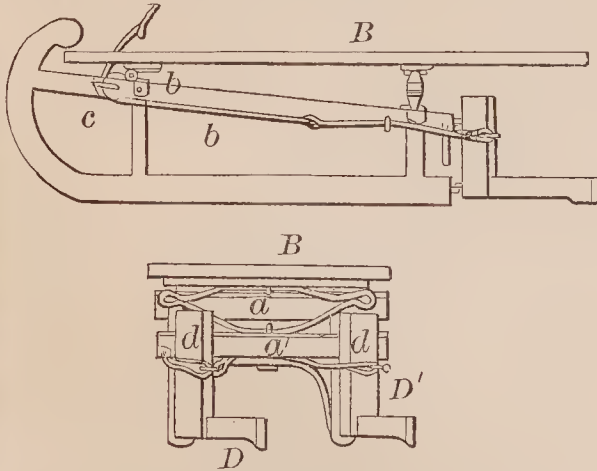

72400—G. L. Jaeger—Cutting Tool.

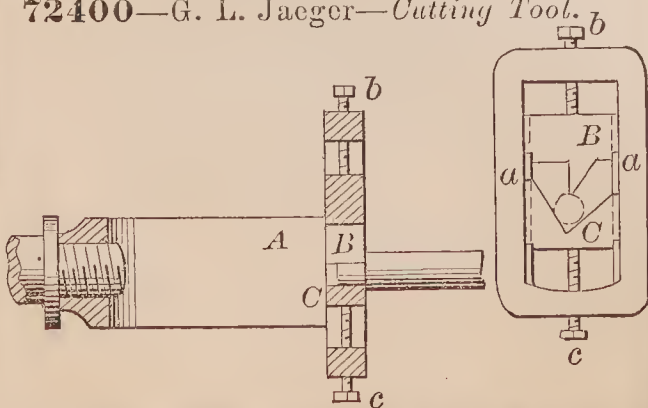

72399—H. C. Ingraham—Ditching Machine.

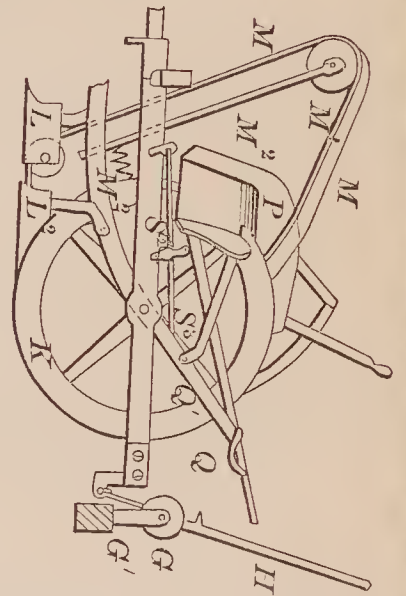
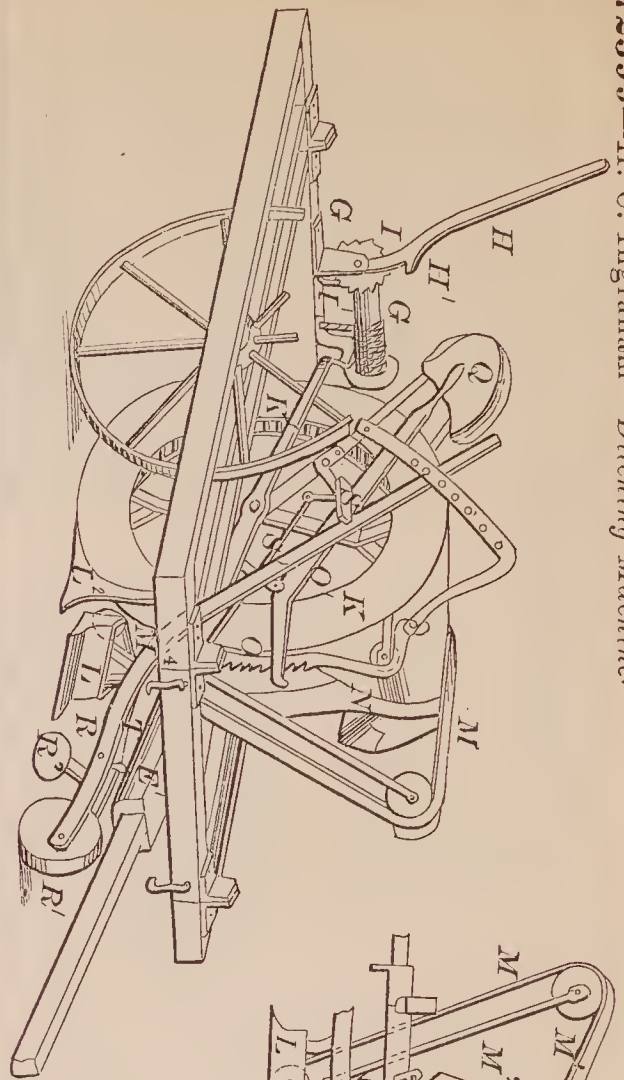

72404—J. E. Kendall—Horse Rake.

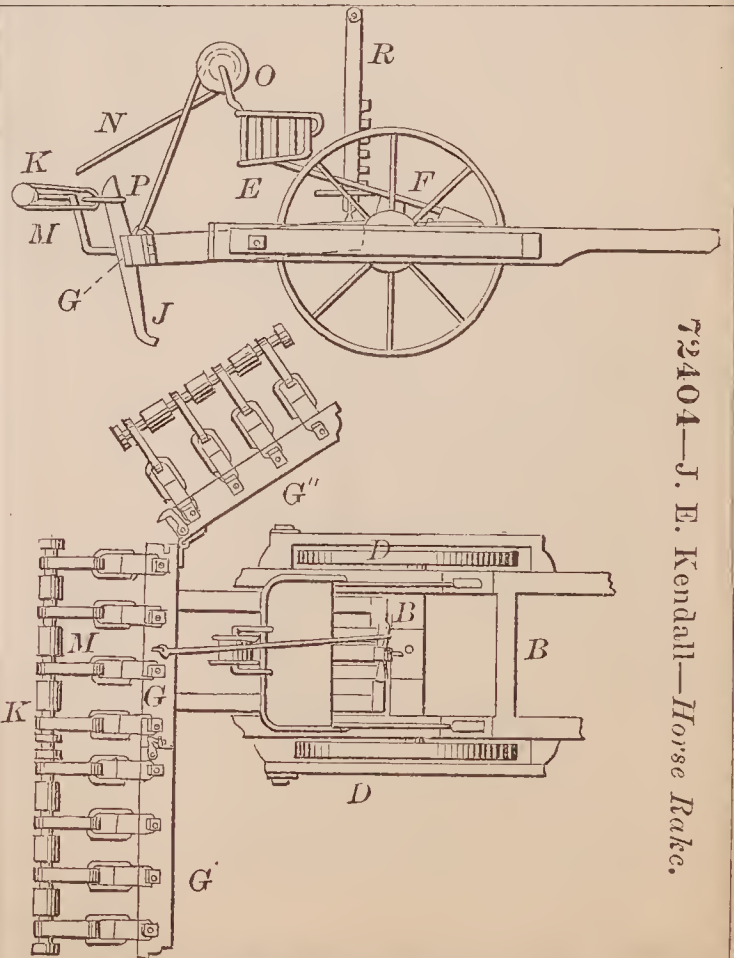

72405—C. Kingsland—*Constructing Car Wheels.*

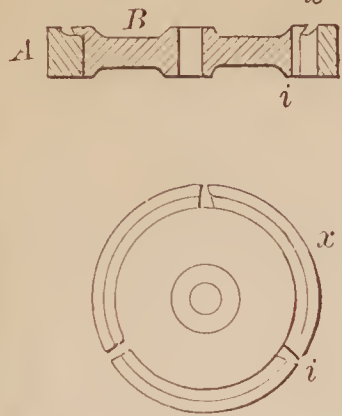

72409—J. M. Mason—*Coupling Shell to Rollers.*

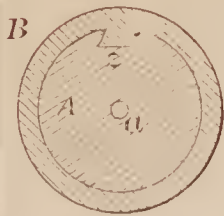

72407—D. Lyman—*Clothes Wringer.*

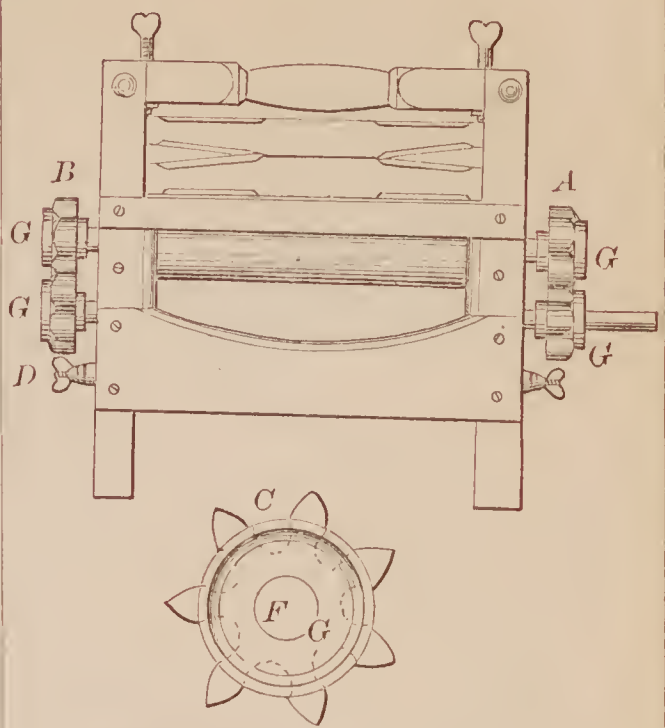

72406—A. S. Kinnear—*Scaffold.*

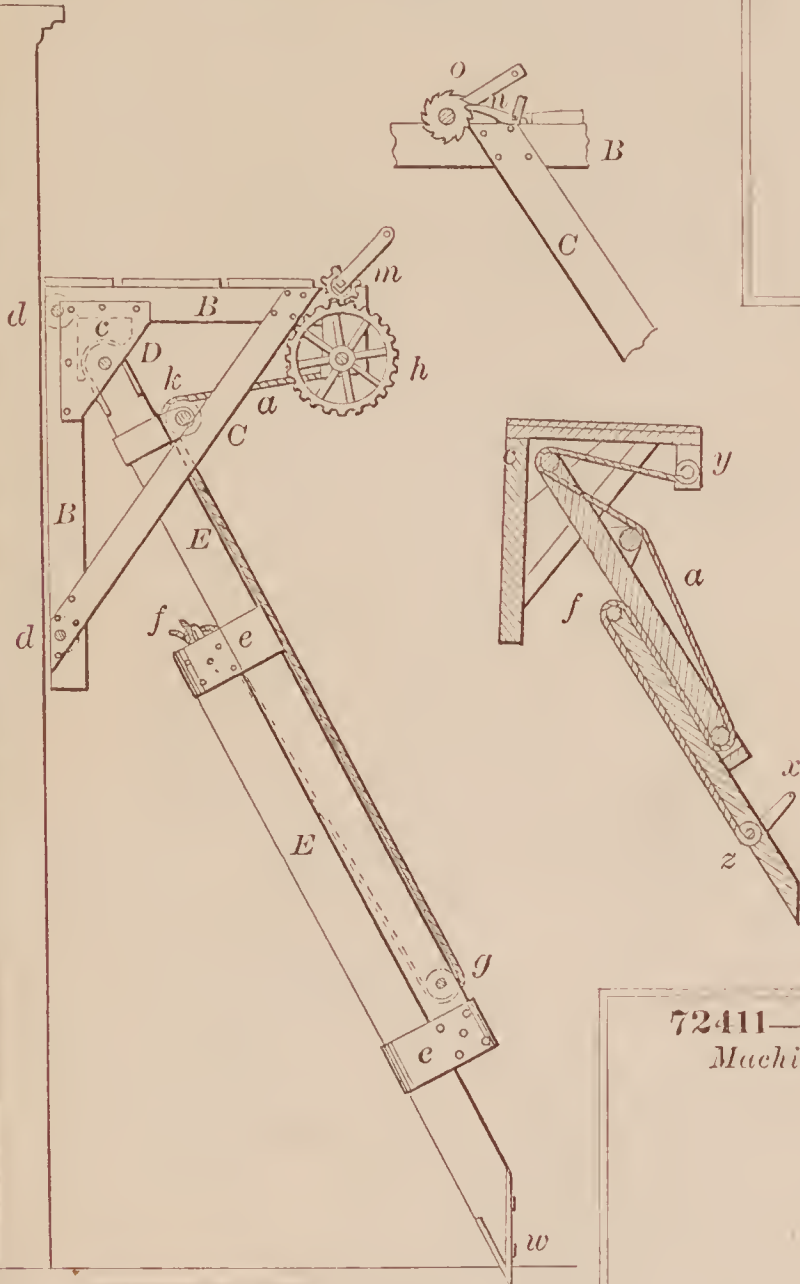

72410—L. Mason—*For Expanding Finger Rings.*

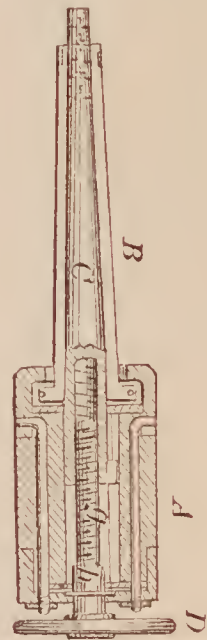

72411—A. A. Maxwell—*Grading and Ditching Machine.*

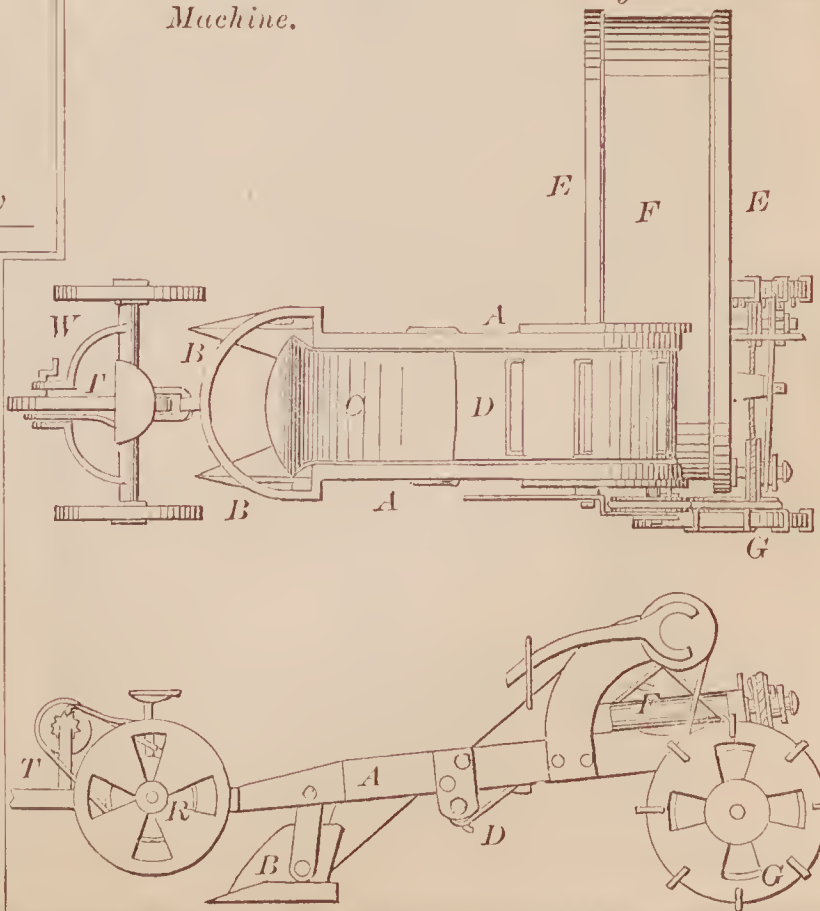

72408—I. W. Lamb—*Permutation Lock.*

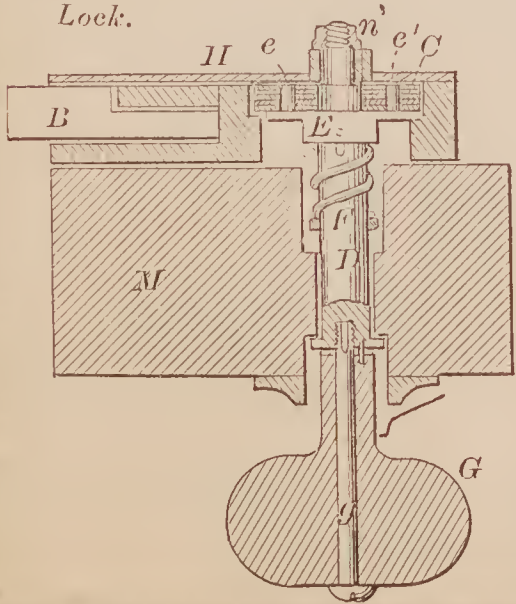



72413—W. McCormick—Boiler Feed Regulator.

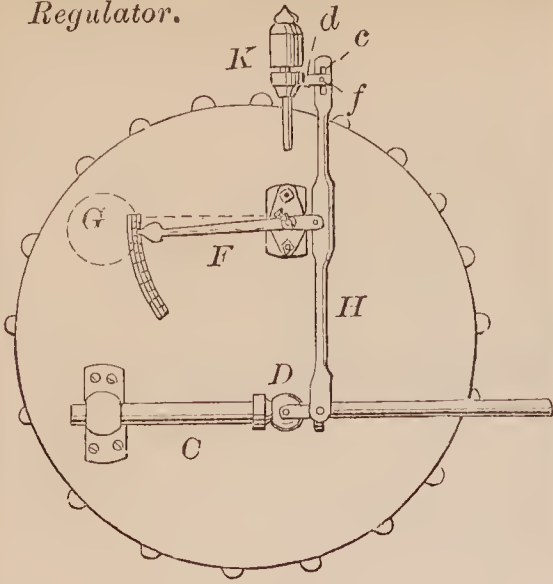

72416—N Parrish—Fan Blower

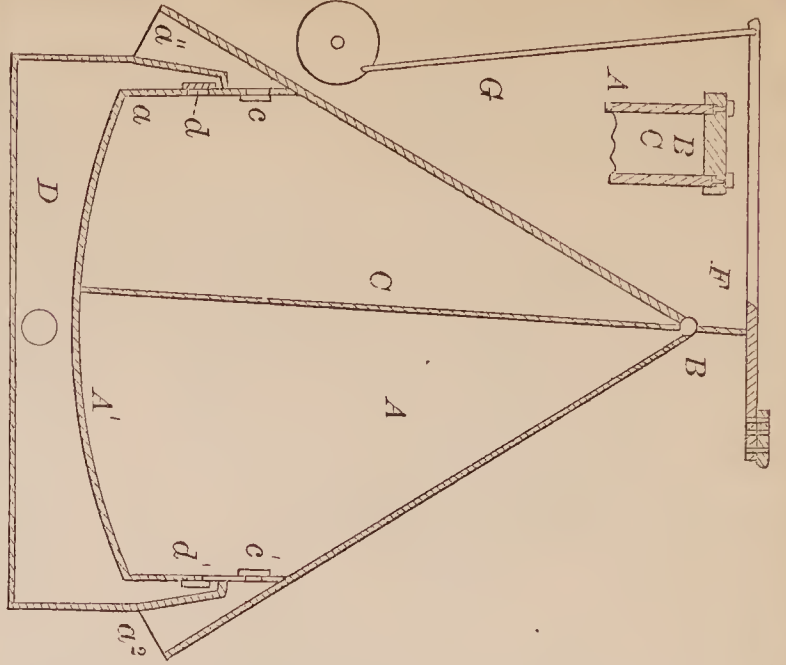

72414—R. S. Merrill—Burner for Hydro-Carbon Fluids.

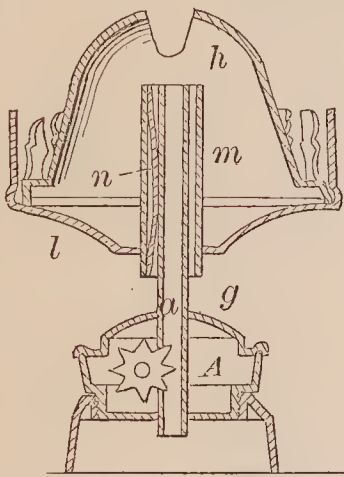

72419—C. C. Preston—For Fumigating Plants.

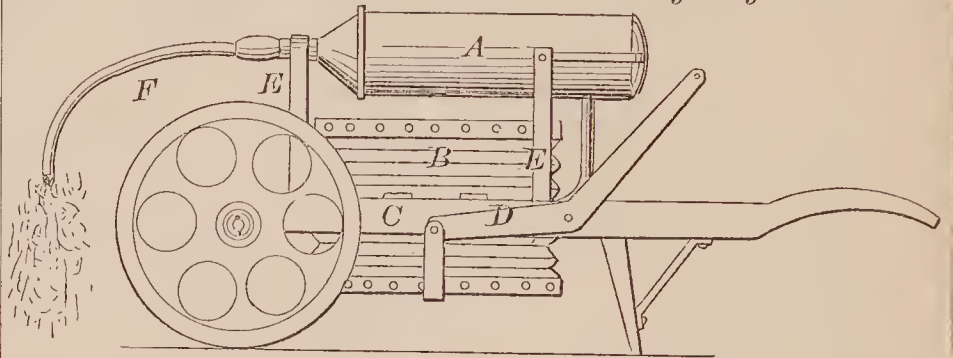

72418—S. W. Powell—Bone and Plaster Mill.

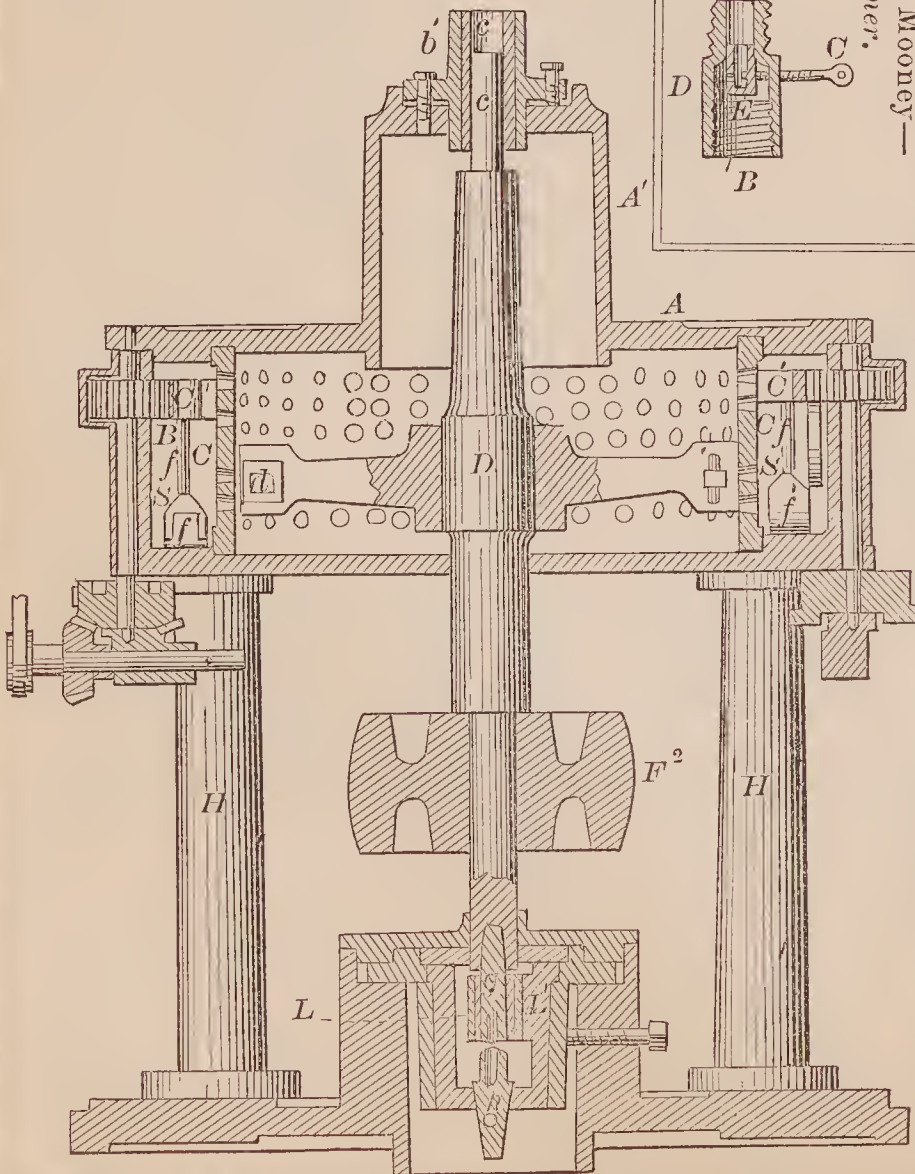

72415—G. Mooney—Gas Burner.

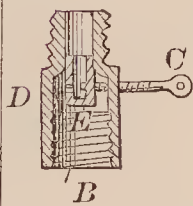

72417—E. Pond—Stirrup.

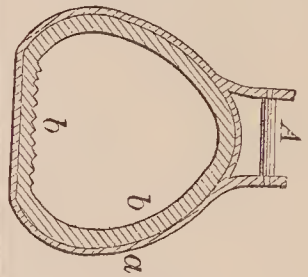

72420—A. Q. Ross—For Ejecting Hot Water on War Vessels.

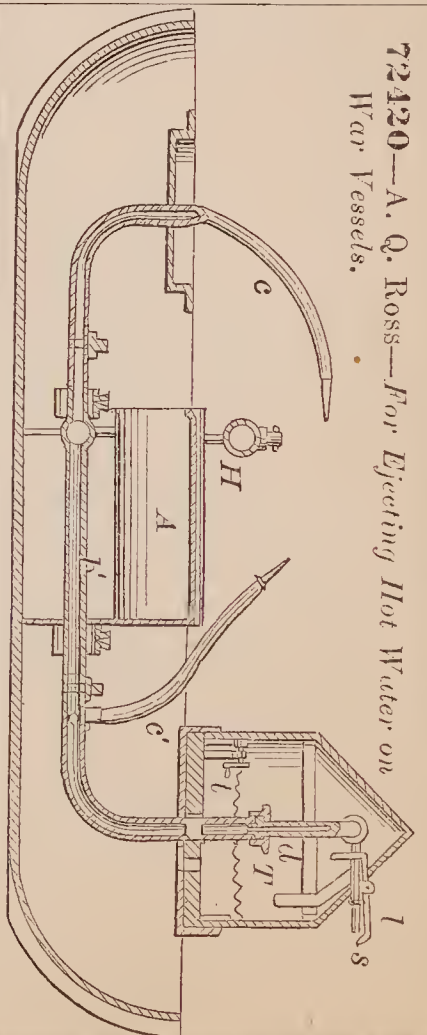

72421—W. Sangster—*Brick Machine.*

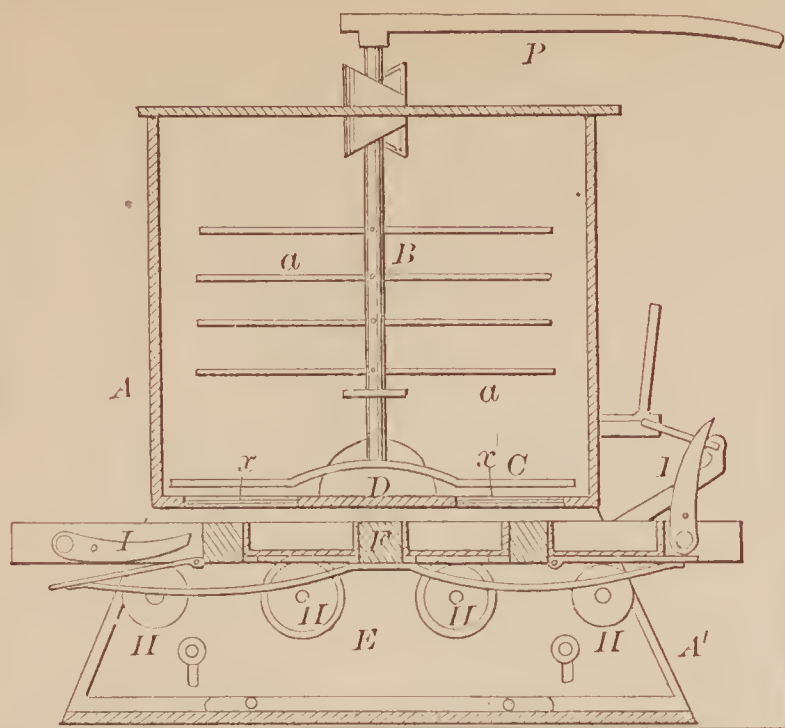

72422—G. S. Saxton—*Manufacture of Corrugated Bells.*

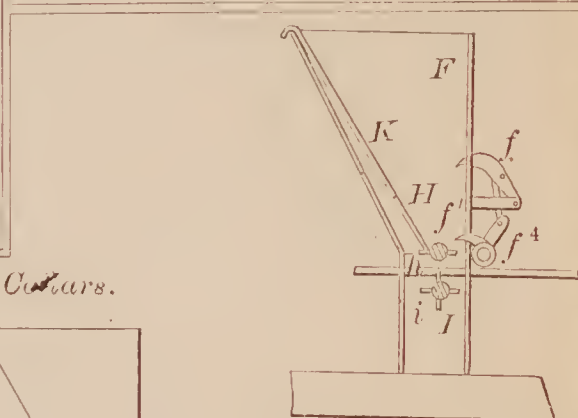
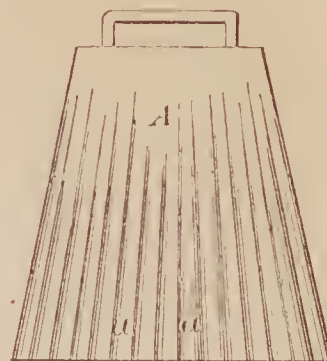

72423—Schrick & Hildenbrand—*For Filling Horse Coaches.*

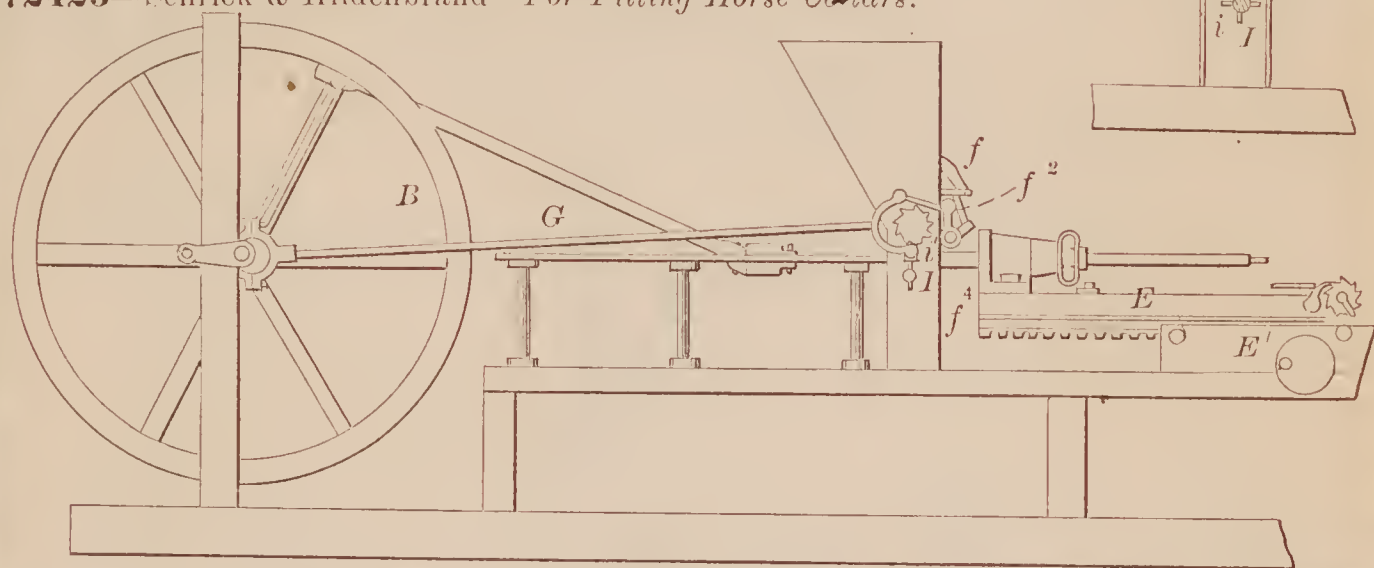

72424—J. Sebastian—*Wagon Seat.*

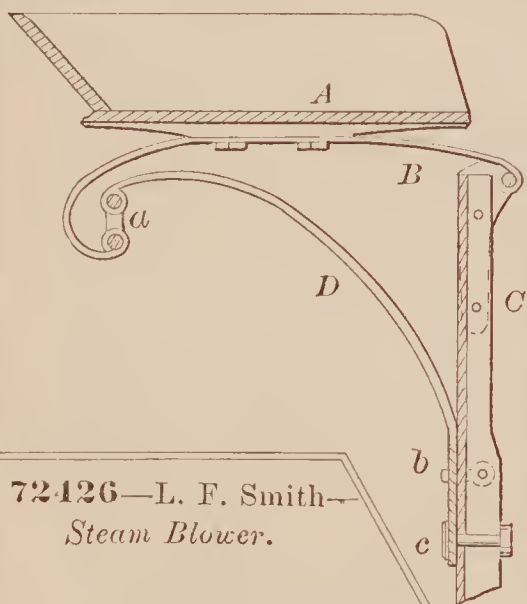

72425—J. Sebastian—*Wagon Spring.*

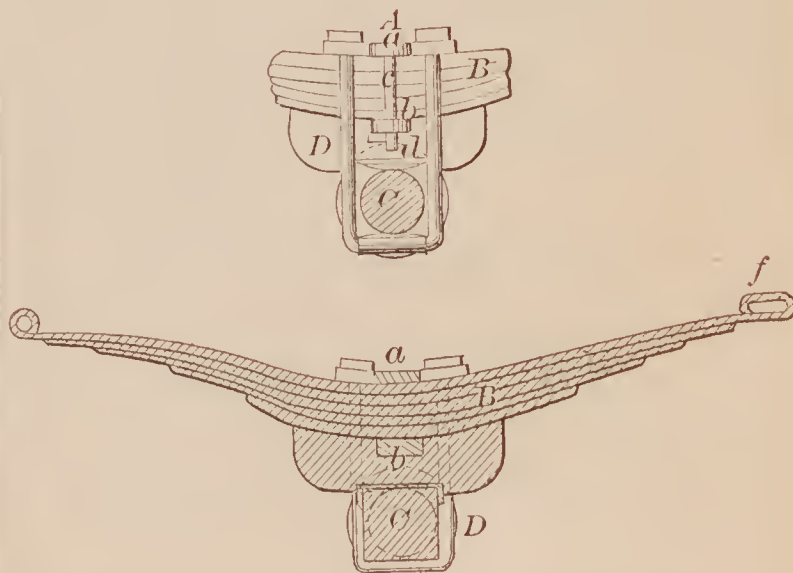

72426—L. F. Smith—*Steam Blower.*

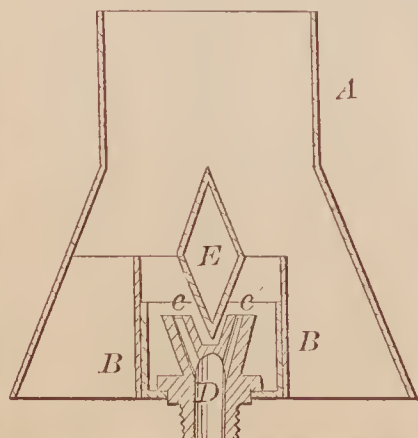

72427—D. F. Stratton—*Gauge for Setting Wagon Axles.*

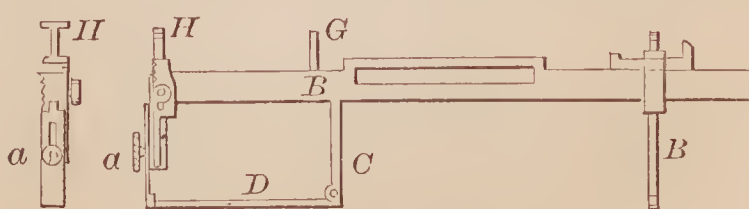



72429—J. W. Thyng—  
Coffee Maker.

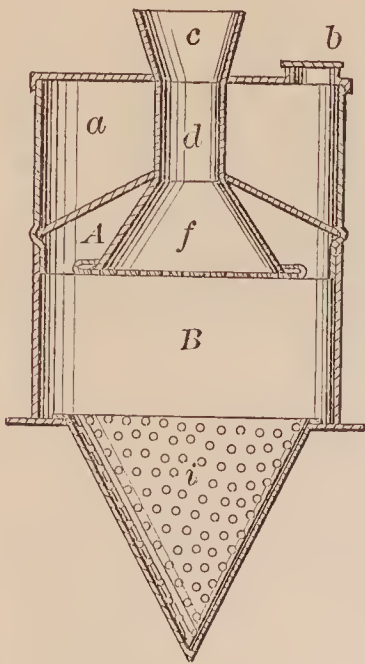

72432—T. Vandoren, Sr.—Taking Measure to  
Cut Coats and Vests.

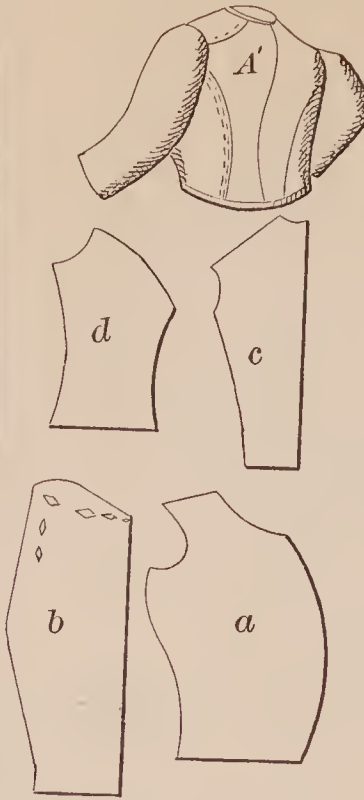

72433—O. E. Weatherhead—  
Dividers.

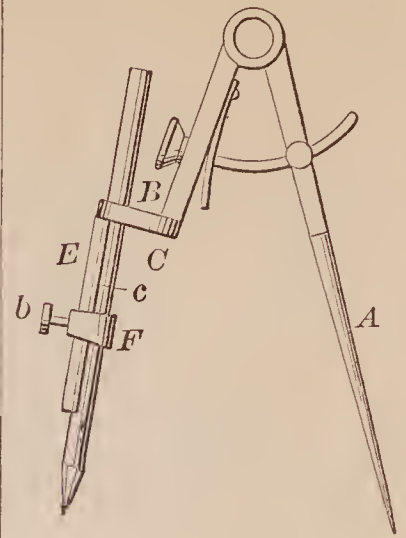

72430—J. M. Tiernan—Tongue Support for Street Cars.

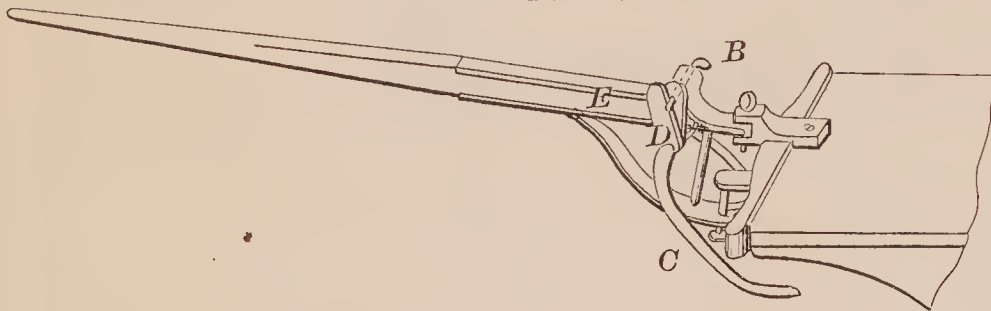

72437—G. B. Wiseman—Store Pipe Damper.

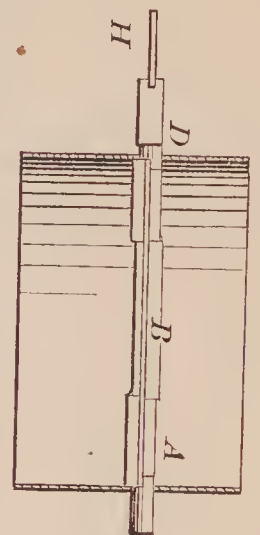

72434—D. B. Wesson—Breech-Loading Fire Arm.

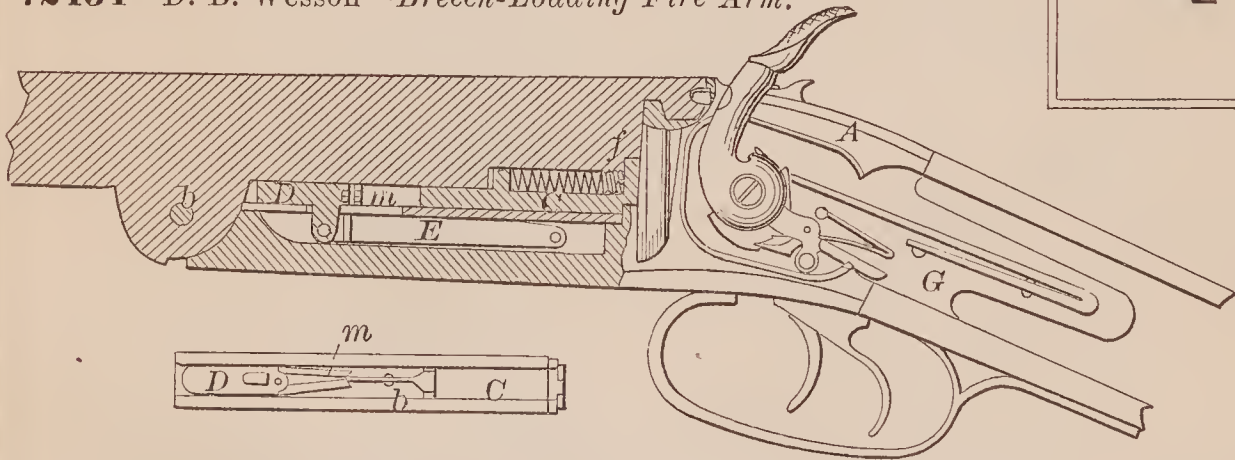

72435—H. F. Wheeler—Pen Holder.

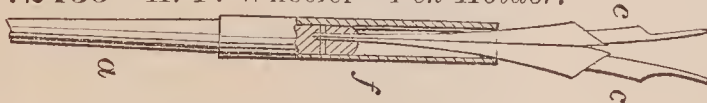

72438—W. S. Worley—Land Roller.

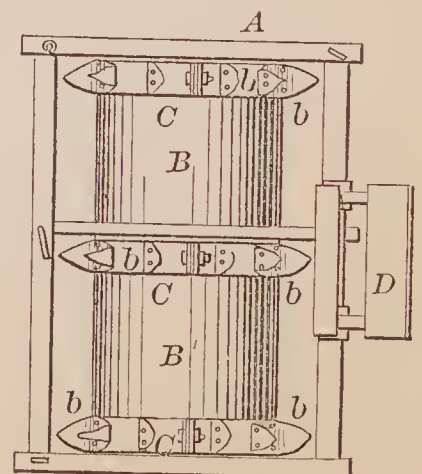

72436—A. Wippo—Boring Tool.

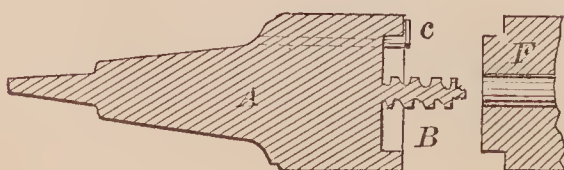

72439—E Abbiati—Track Clearer.

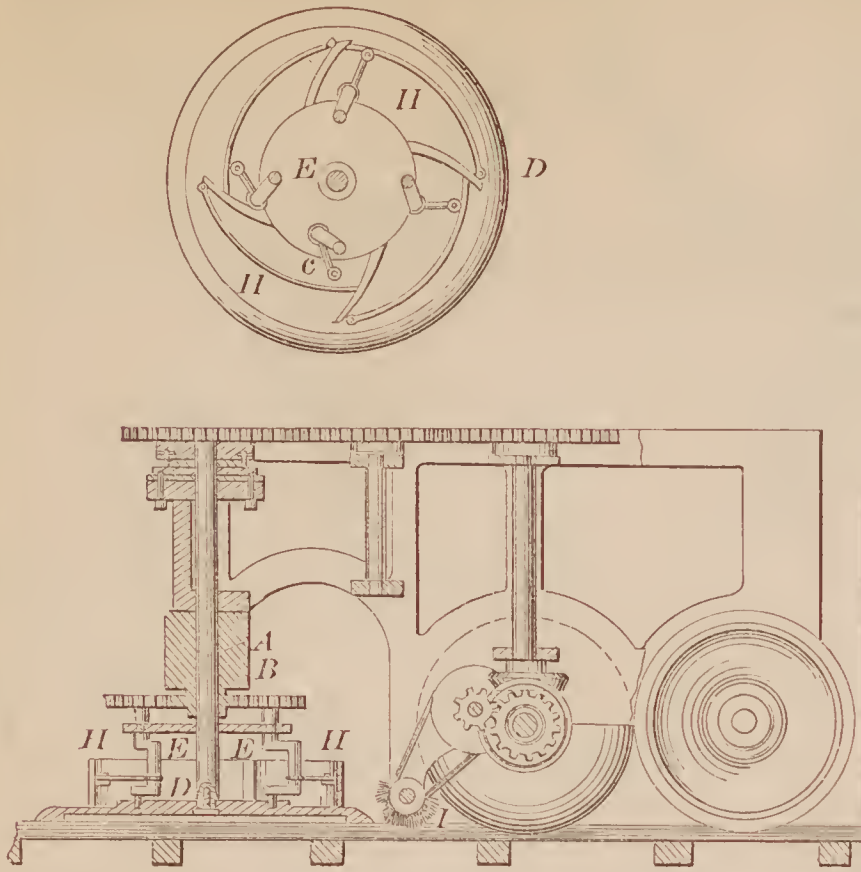

72440—A. A. Anderson—Mortar Mill.

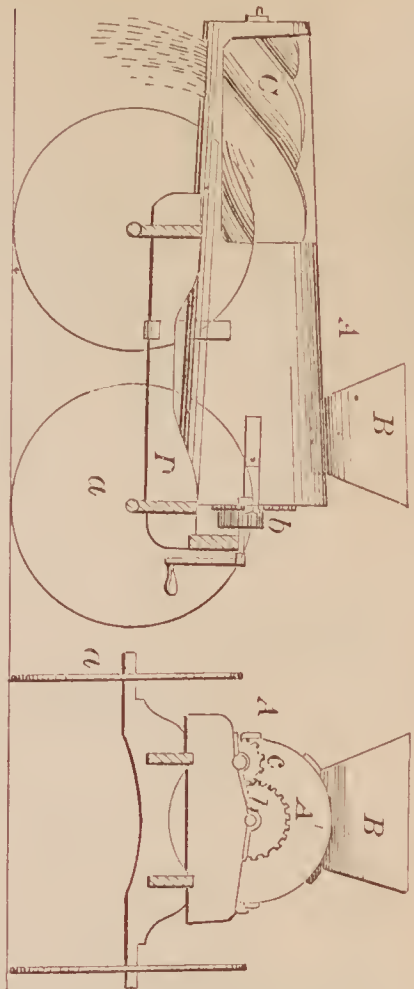

72441—C. P. Bachelder—Car Coupling.

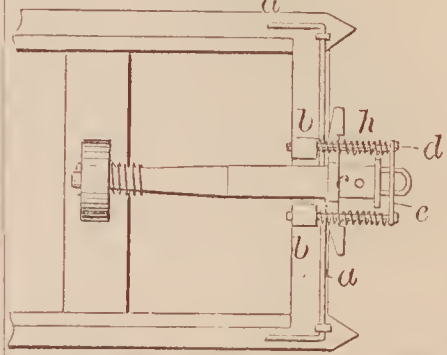

72442—C. H. Bacon—For Attaching Stamps.

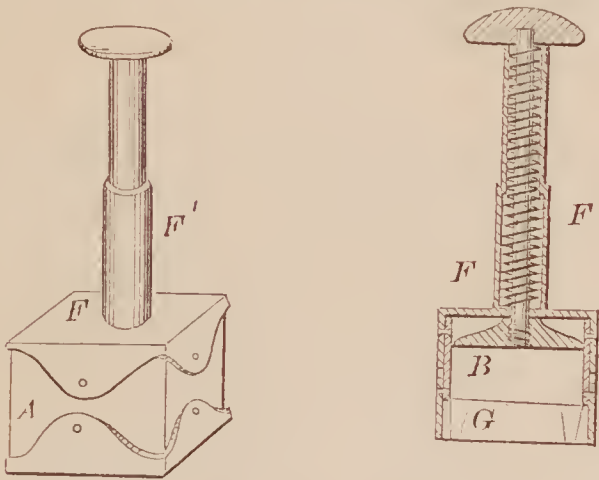

72443—L. Bailey—Carpenters' Plane.

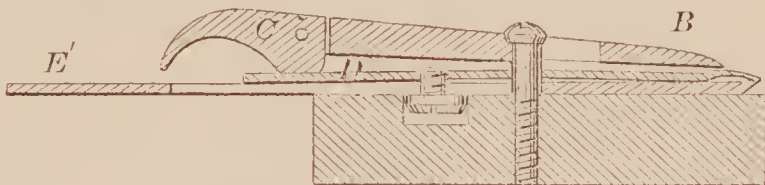

72444—H. Barns—Extension Ladder.



72445—Blake & Jarrell—Truss.

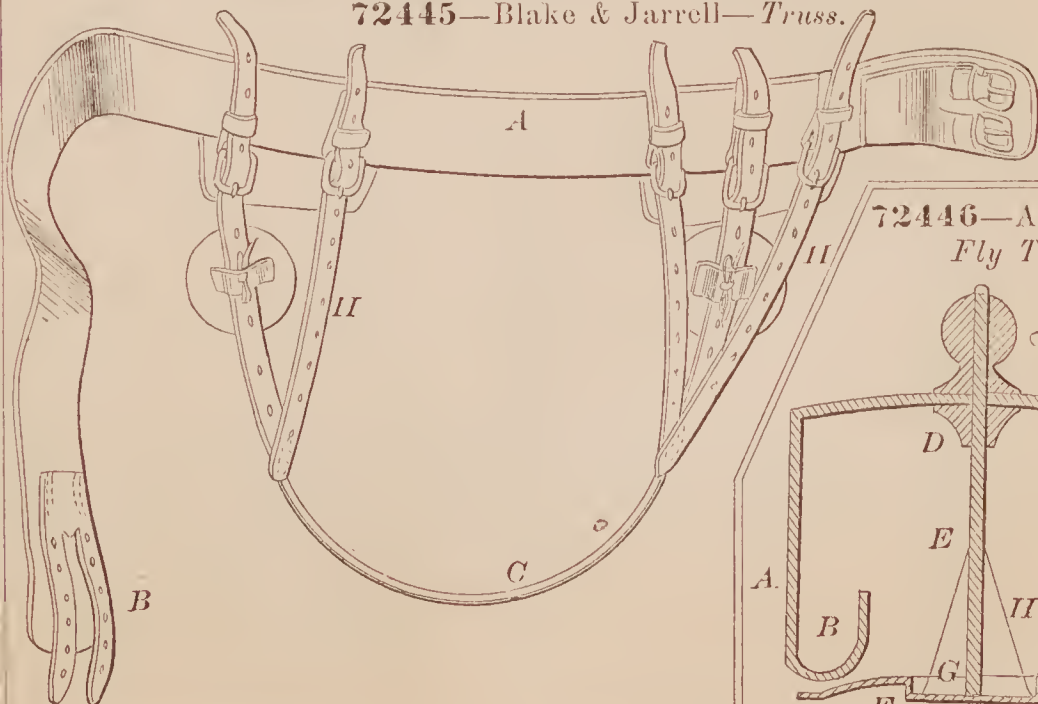

72446—A. Bristol—Fly Trap.

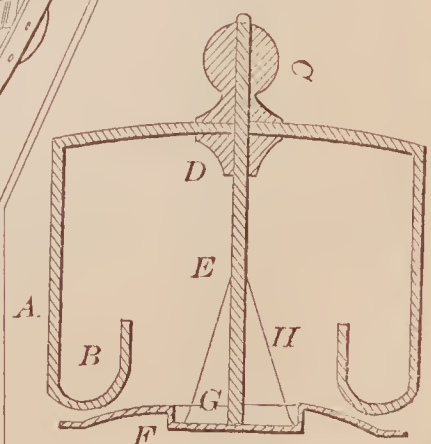



72450—N. F. Burnham—Guide for Water Wheels.

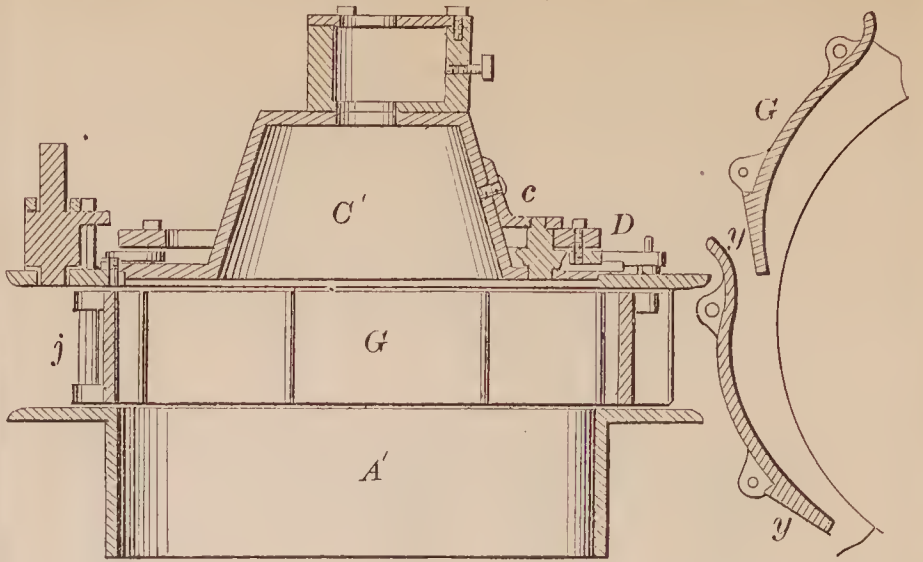

72447—I. F. Brown—Tool Holder for

Slide Rest.

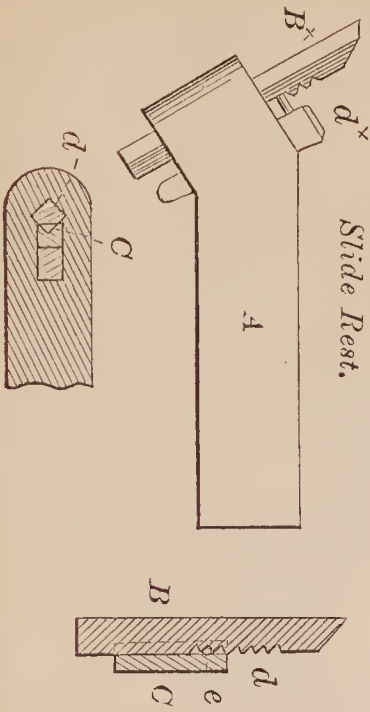

72448—G. Brownlee—Skate.

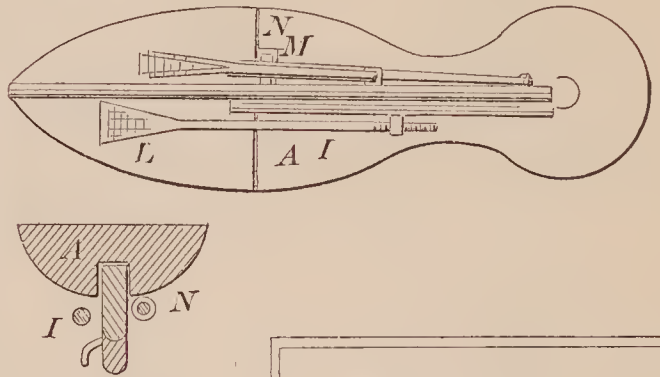

72451—J. B. Byers—Washing

Machine.

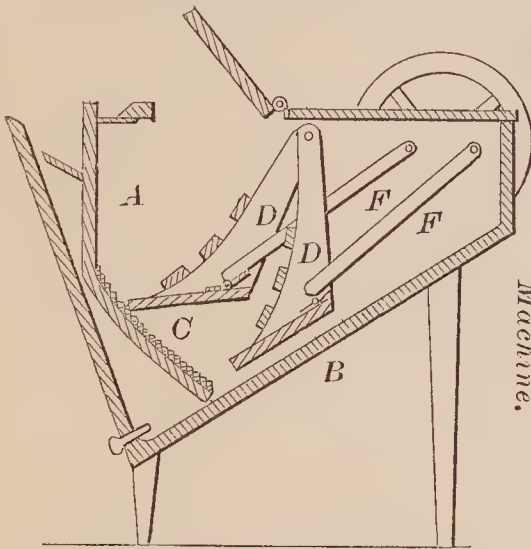

72452—E. O. Carrington—Mosquito Net.

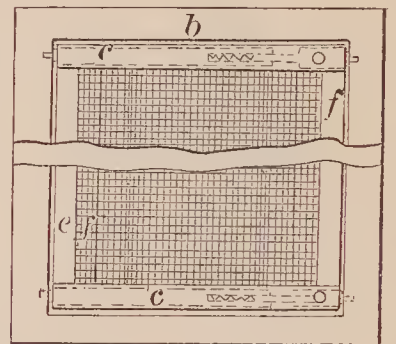

72449—C. Burnham—Door Spring.

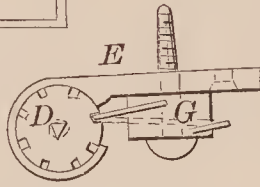

72453—J. Chambers—Faucet.

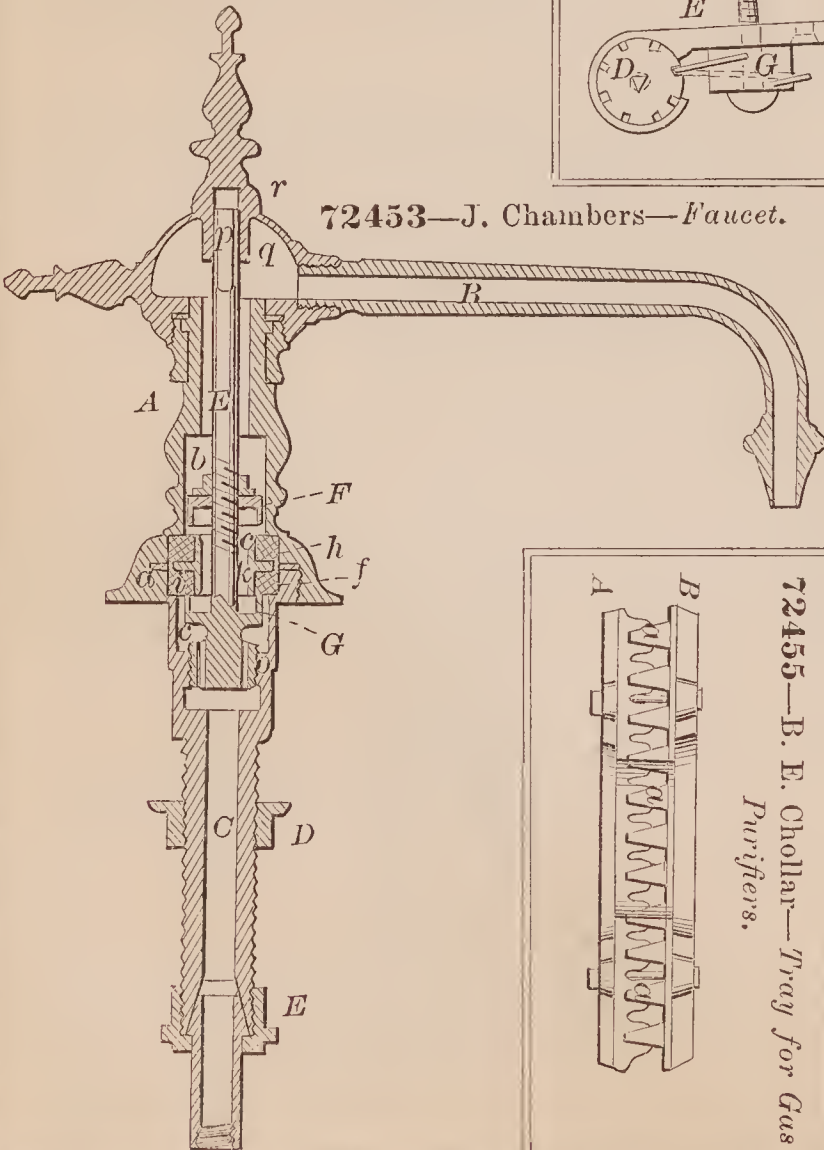

72454—R. Chapman—Water Wheel.

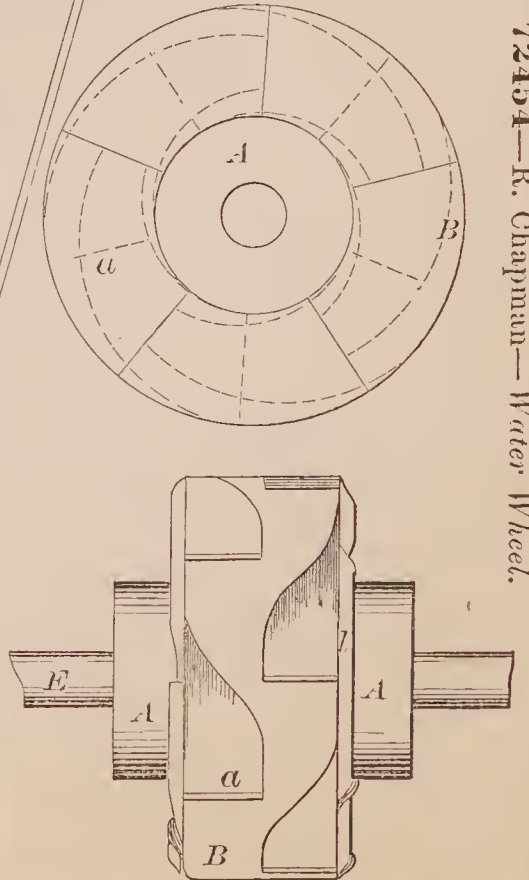

72455—B. E. Chollar—Tray for Gas Purifiers.

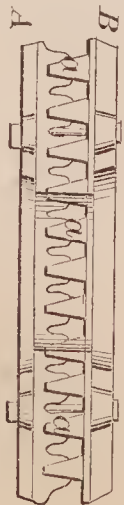

72462—Davison, Bates, Wilson & Russell—*Harness Snap.*

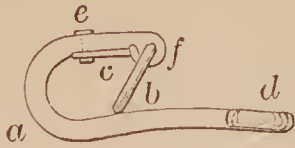

72456—P. Coonrod—*Double Cultivator Plow.*

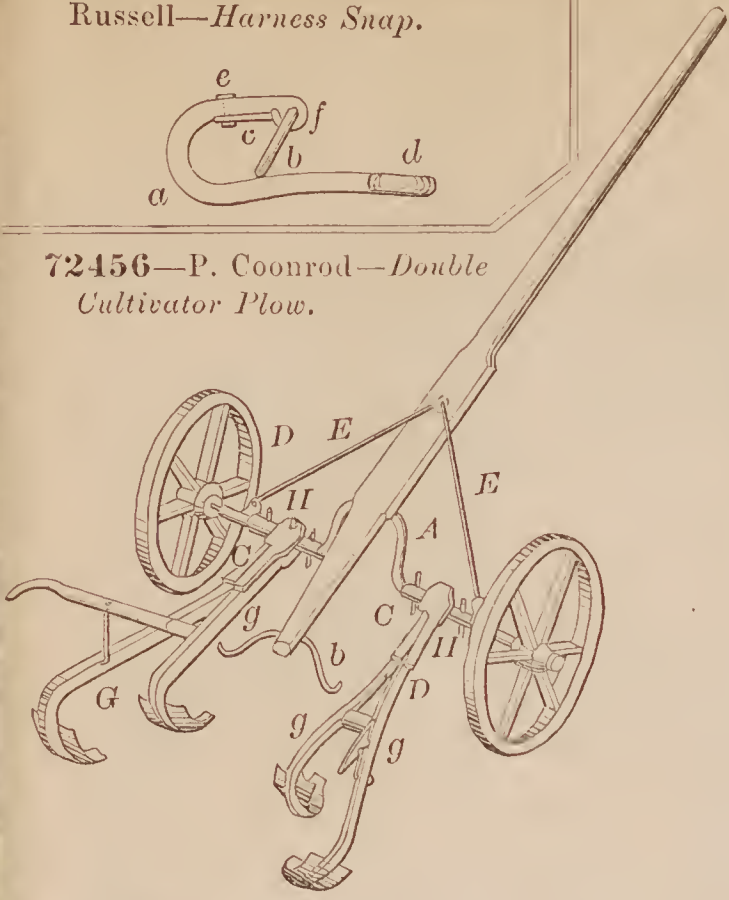

72461—W. H. Davis—*Animal Trap.*

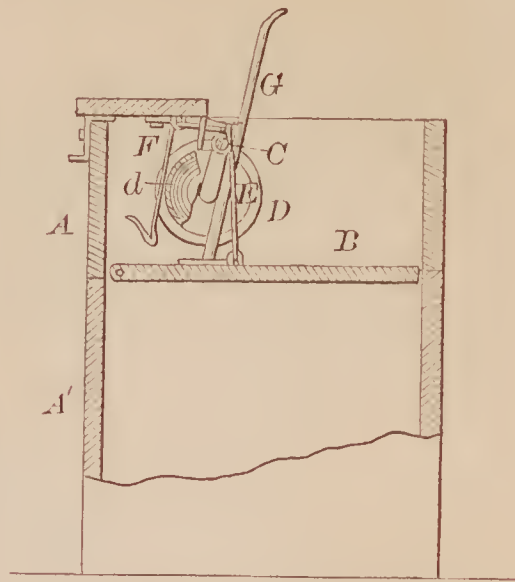

72458—A. Crossley—*Globe Valve.*

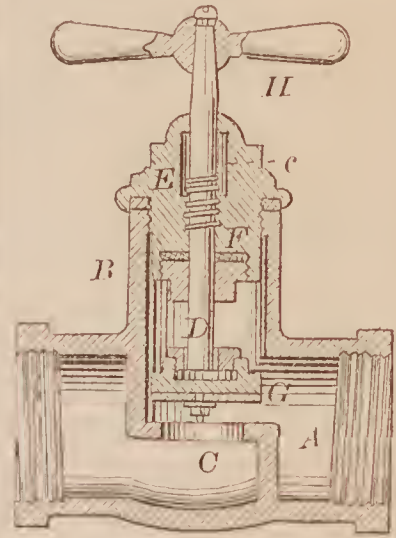

72457—G. Crompton—*Shuttle.*

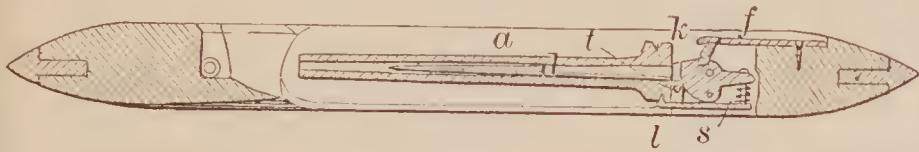

72459—B. F. & J. F. Cunningham—*Burglar Alarm.*

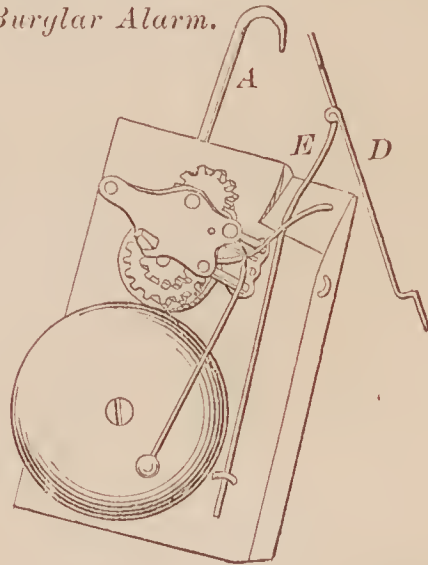

72463—O. Deam—*Screw Drivers.*

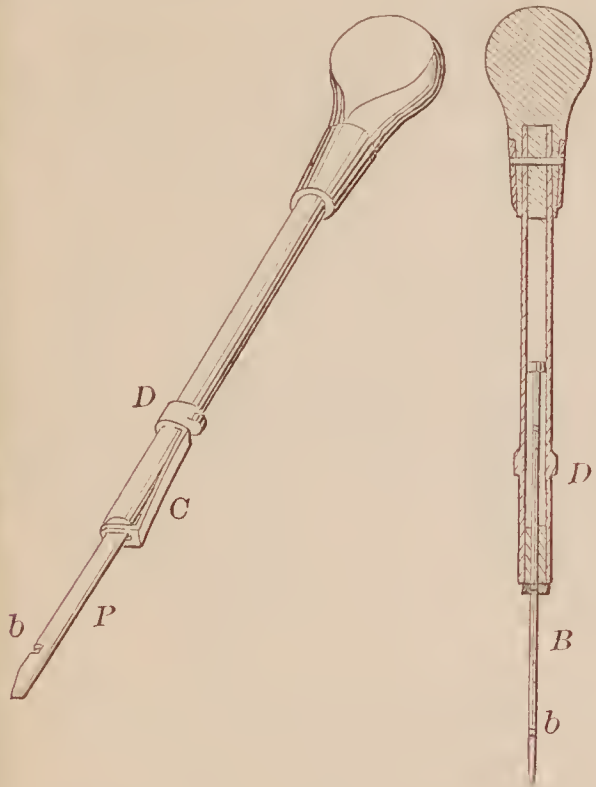

72465—F. B. Doering—*For Boring Rocks.*

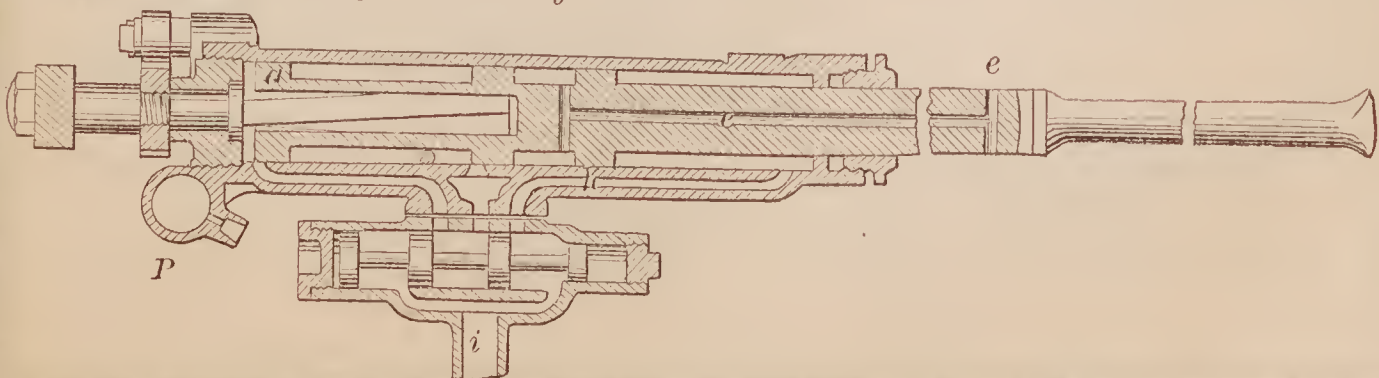



72466—F. B. Doering—Stand for Rock Drilling Engines.

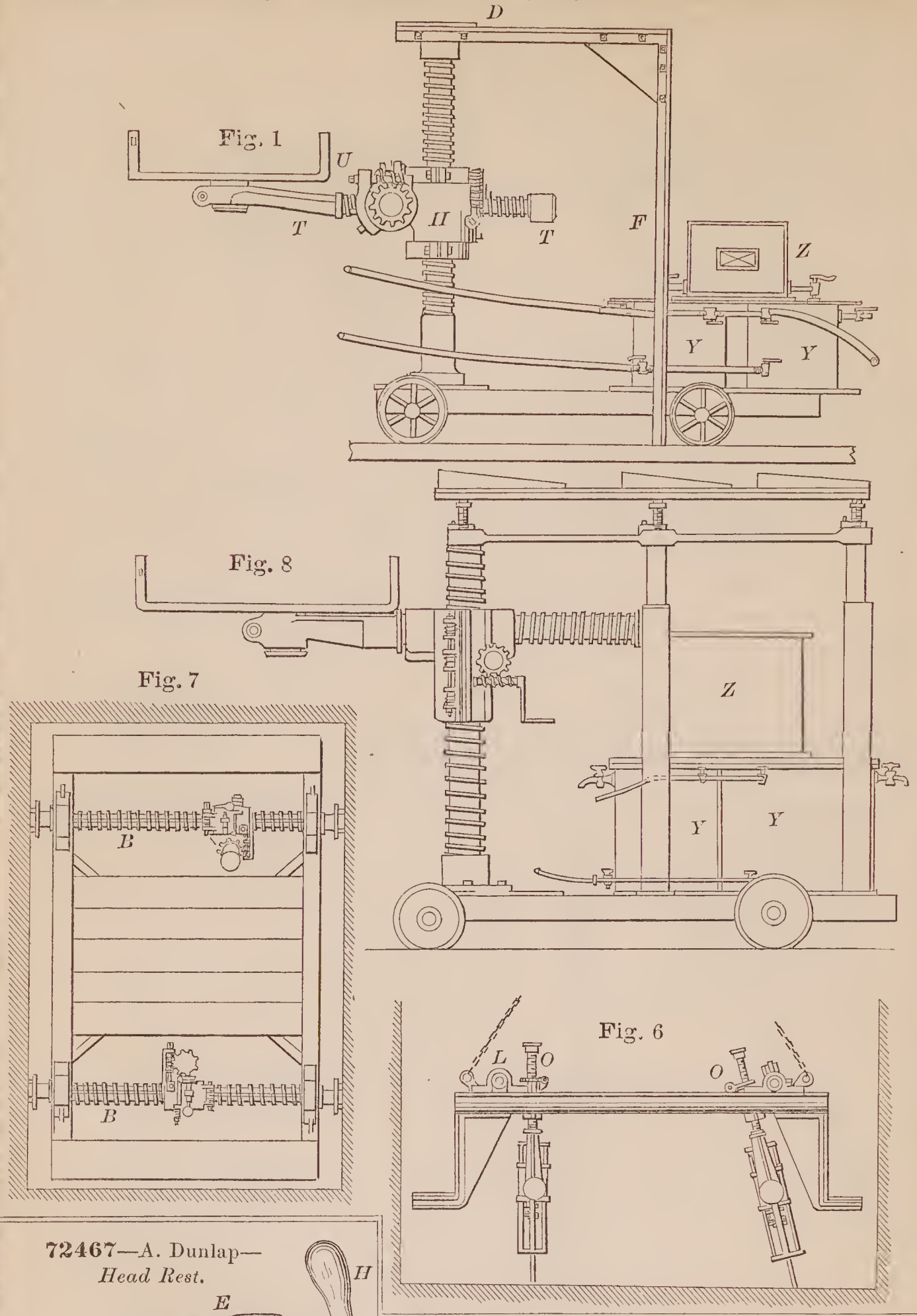

72467—A. Dunlap—Head Rest.

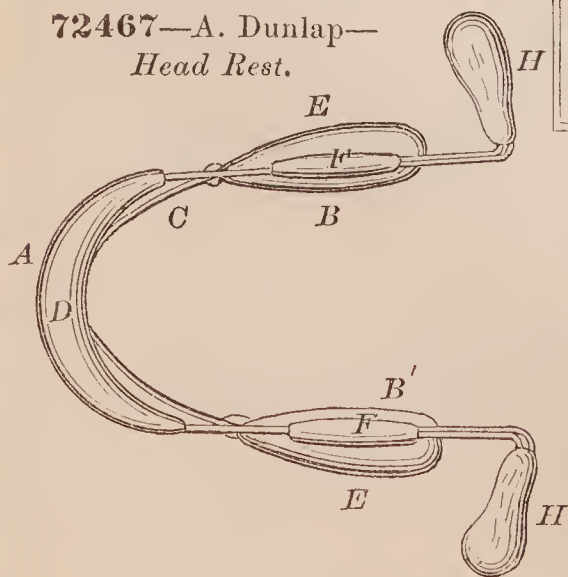

72468—J. Edson—Lathe Tool Holder.

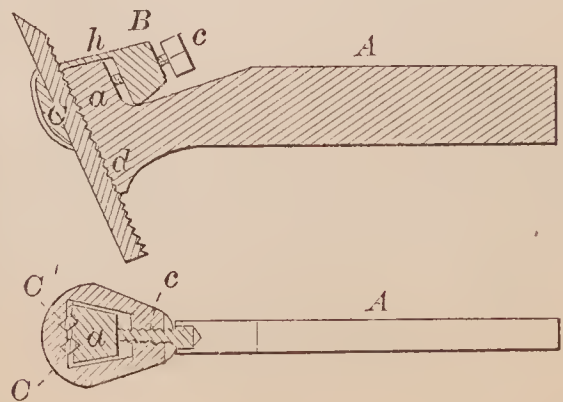

72470—Ellis & Albertson—Animal Trap.

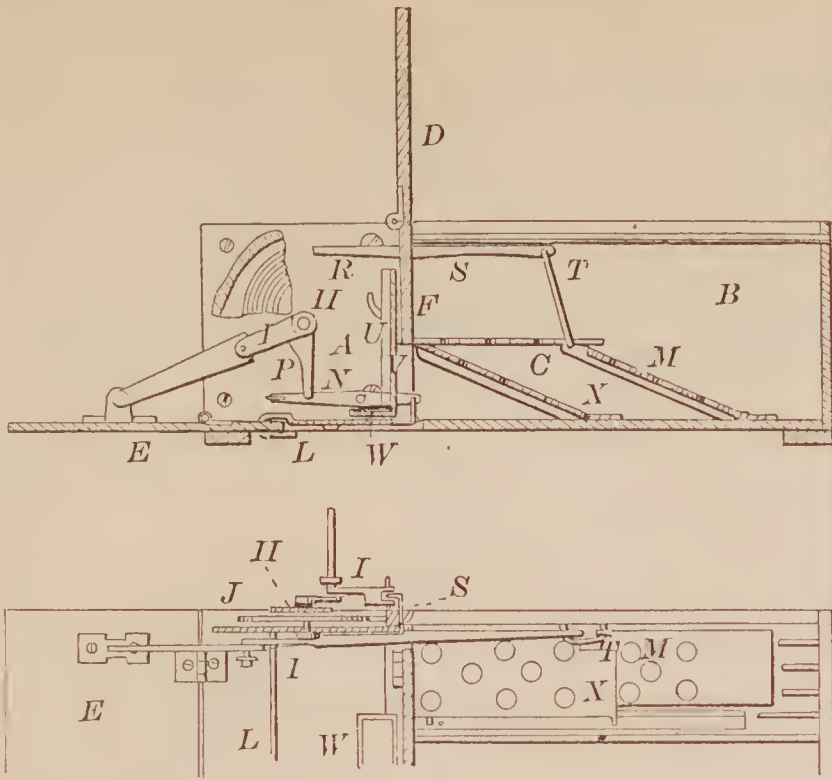

72471—M. W. Florer—Fruit Dryer.

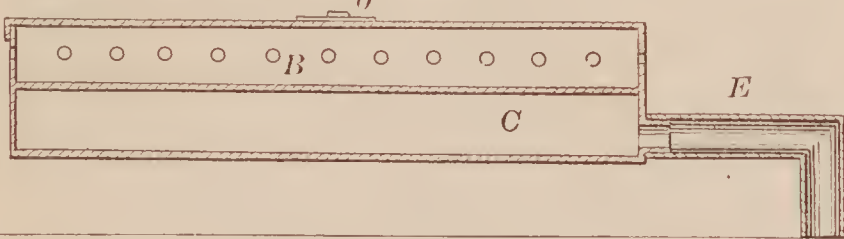

72472—J. K. Frantz—Seed Planter.

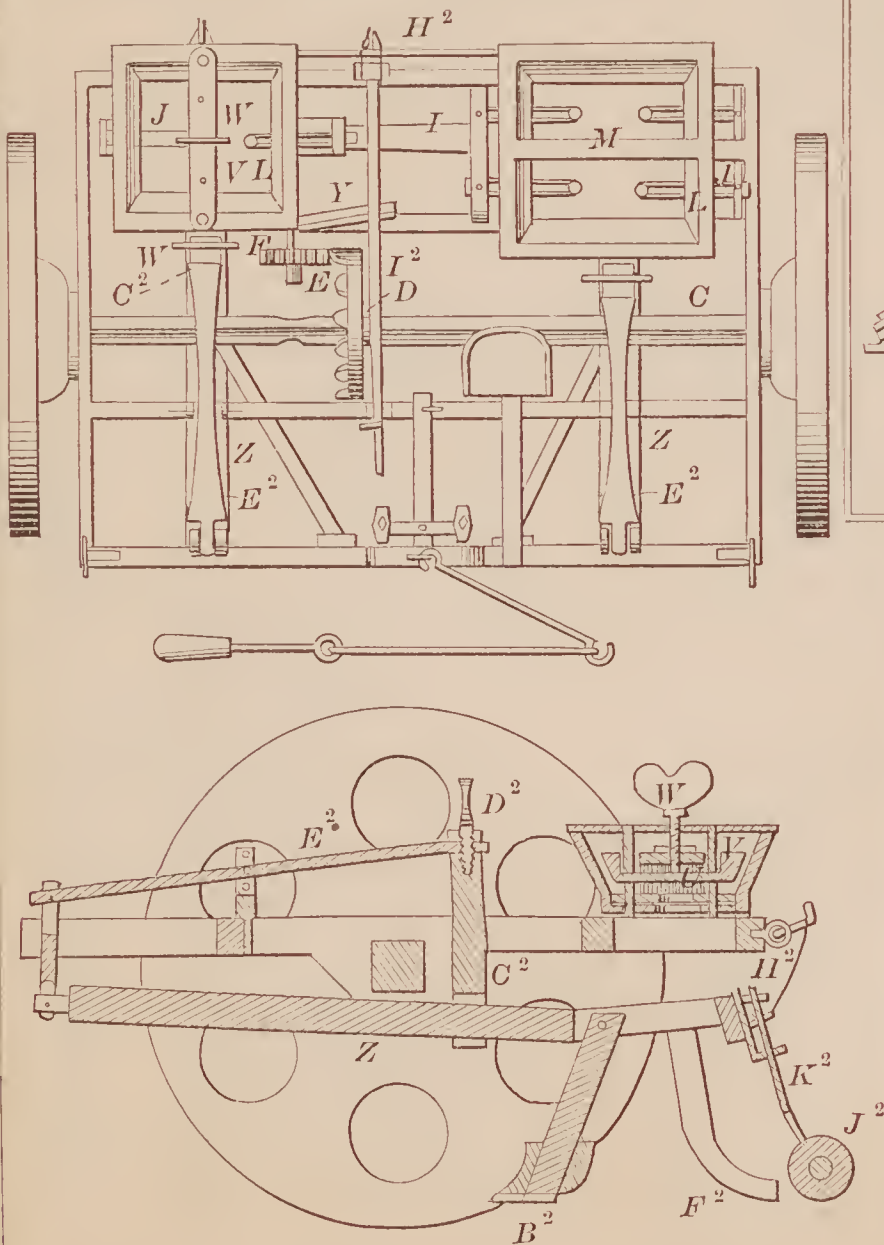

72473—A. Frayer—Rail Fence.

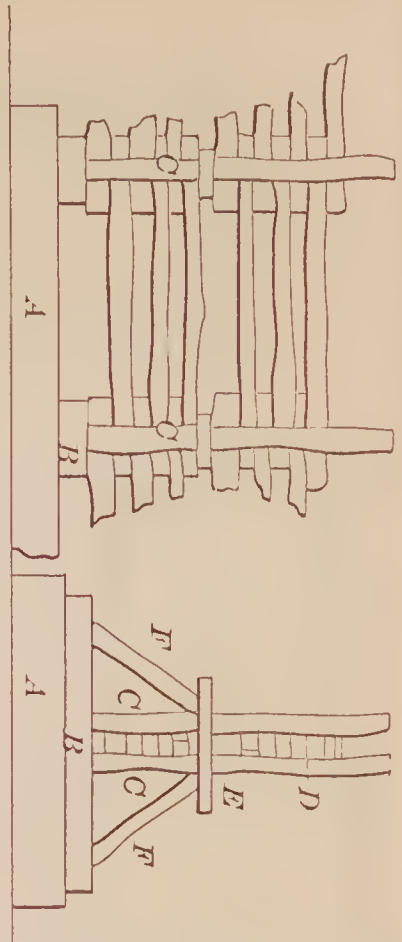

72469—Ellis & Albertson—Fence.

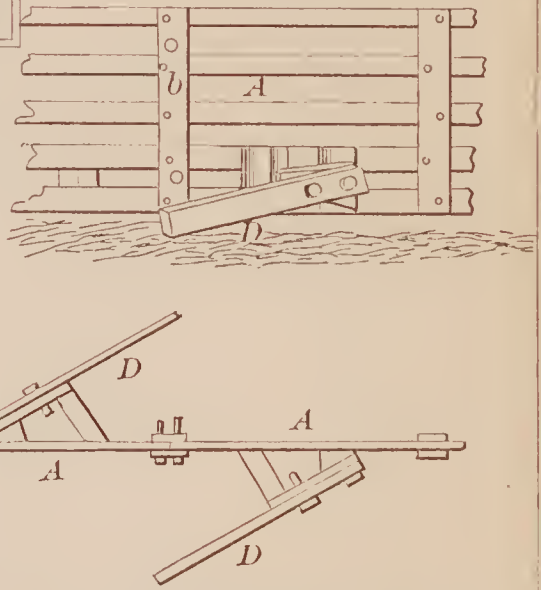

72474—W. K. Fuller—For Ventilating Mill Stones.

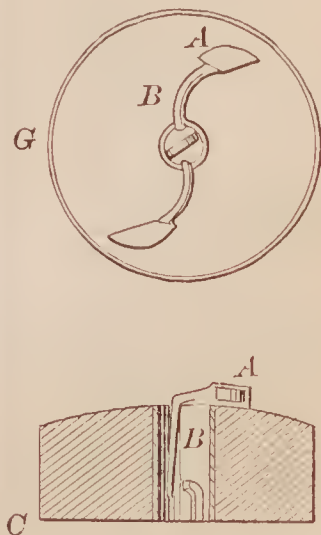



72475—J. C. Gaston—Churn.

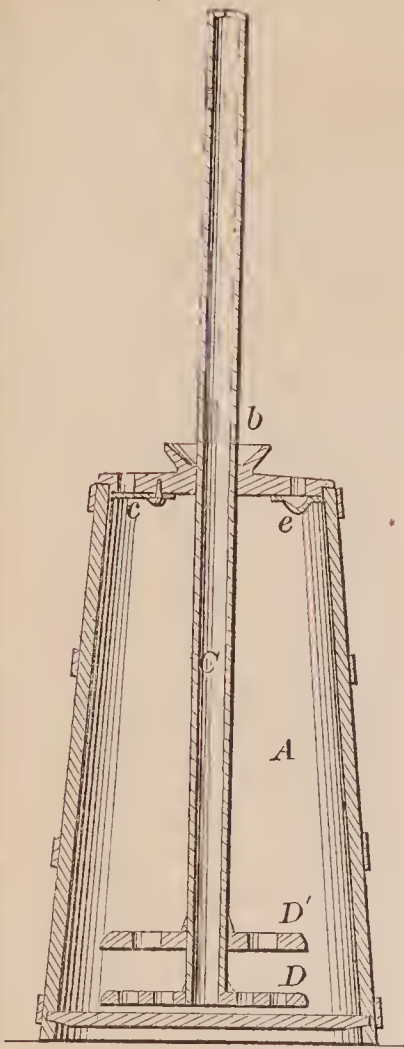

72476—J. Gettemy—Tire Bending and Shrinking.

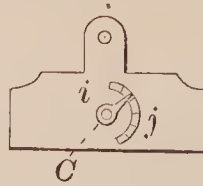
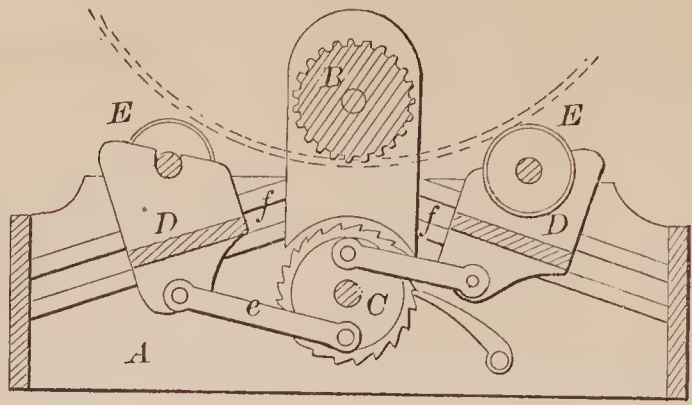

72478—L. A. Gleason—For Folding Sheet Metal.

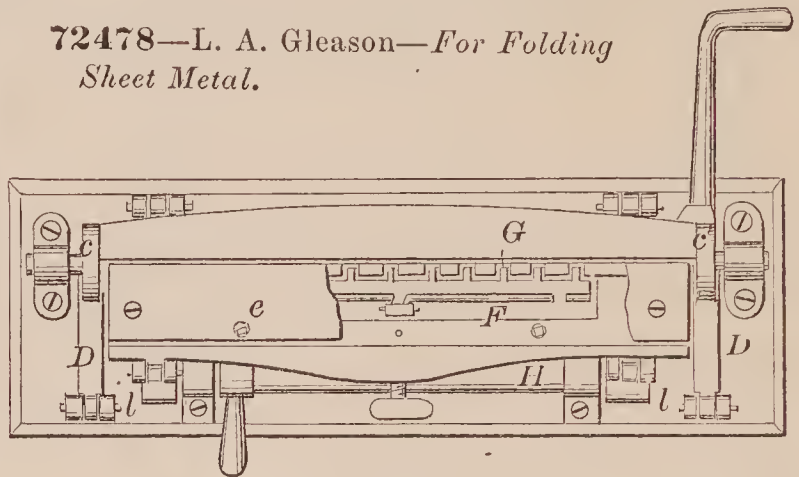

72477—R. Gidley—Gate.

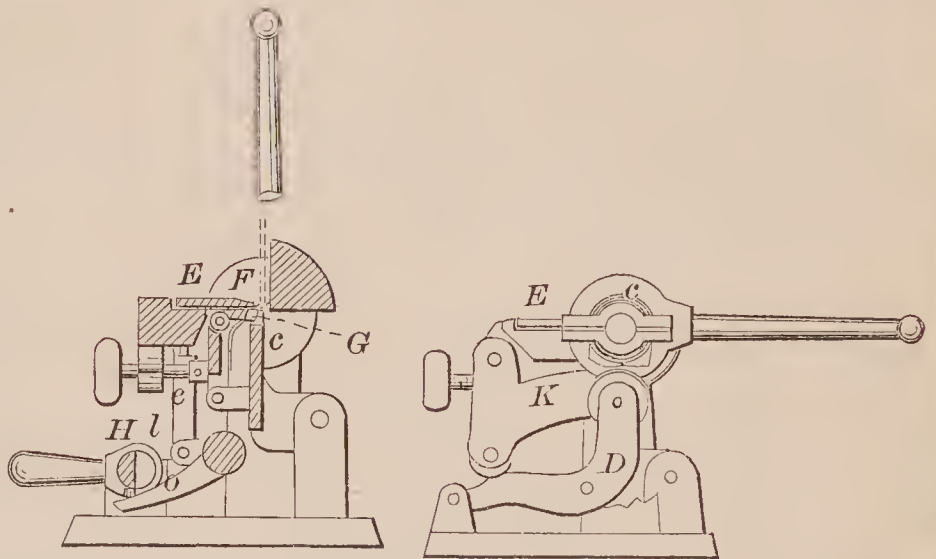
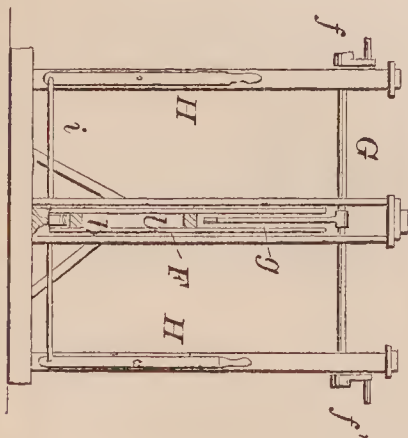
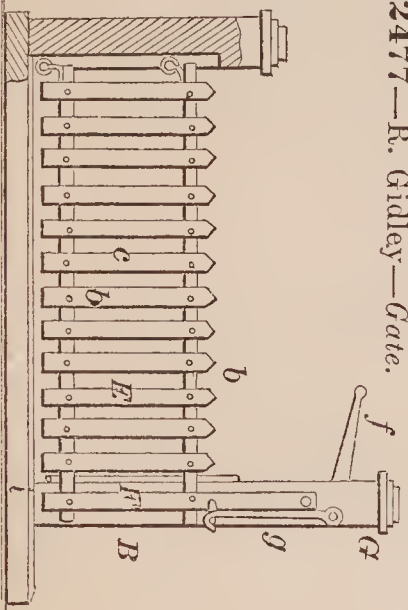

72479—E. H. & E. B. Goelet—Cotton Cultivator.

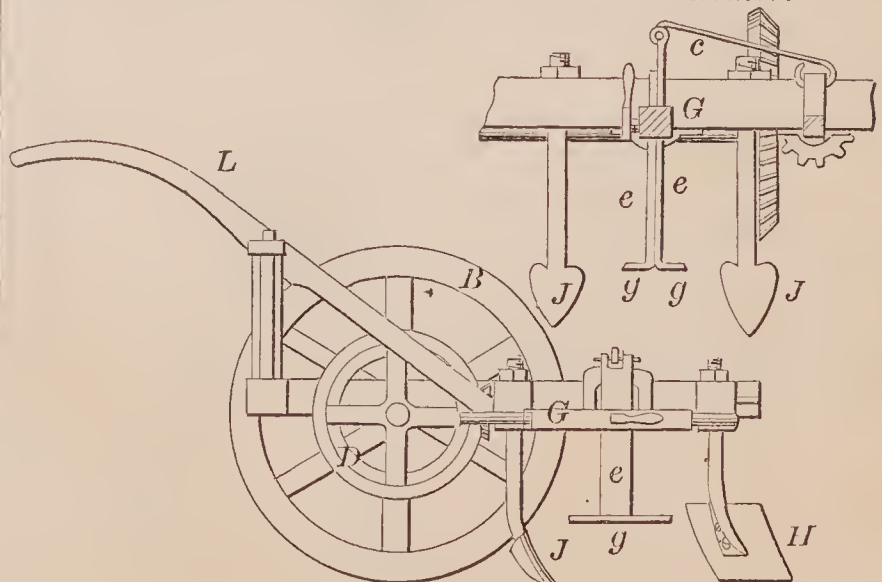

72480—O. Goerke—Stereoscope.

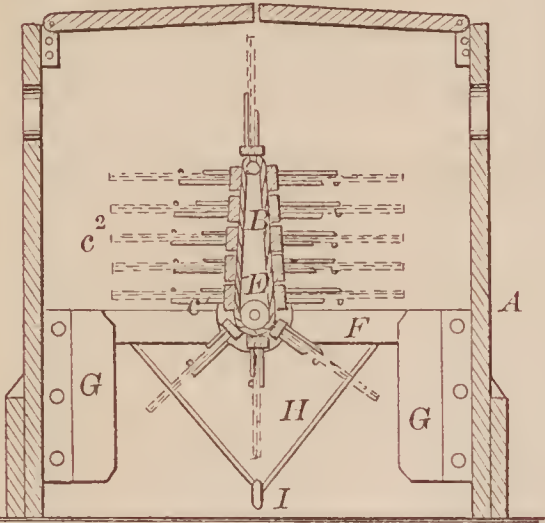
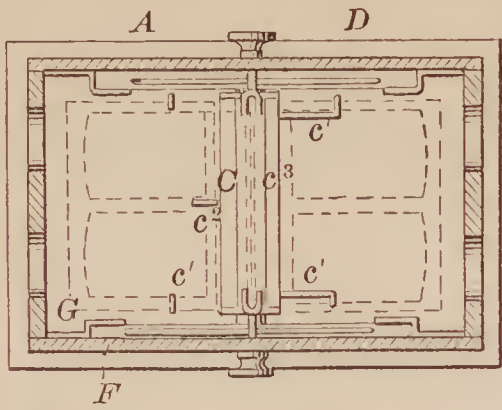

72481—G. W. W. Goodwyn—Filter.

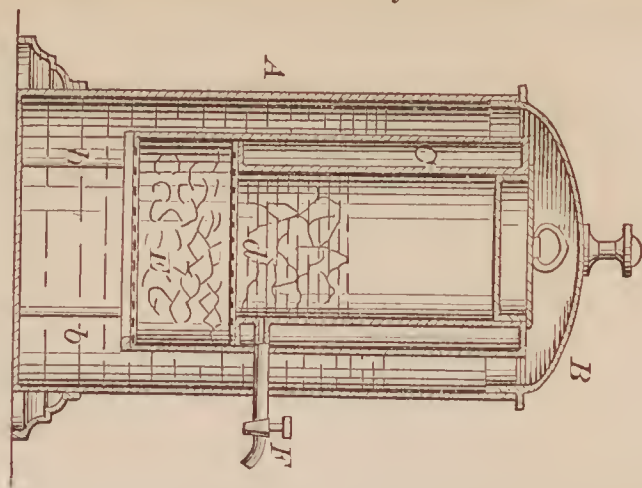

72483—Haase & Rost—Skate.

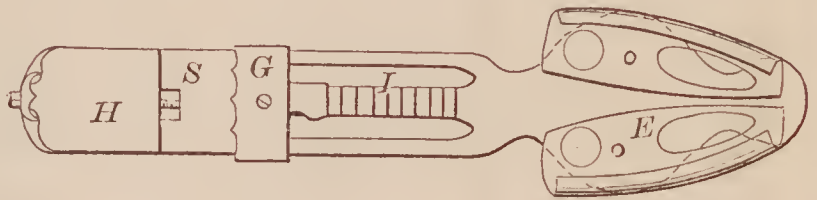
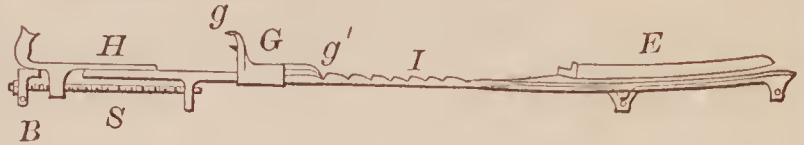

72482—R. Goole—Car Coupling.

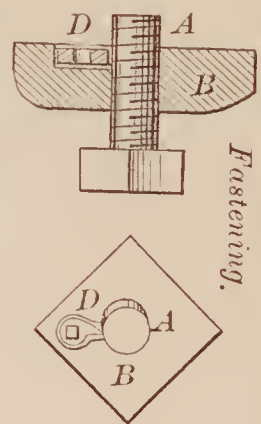
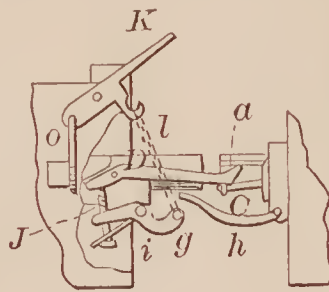
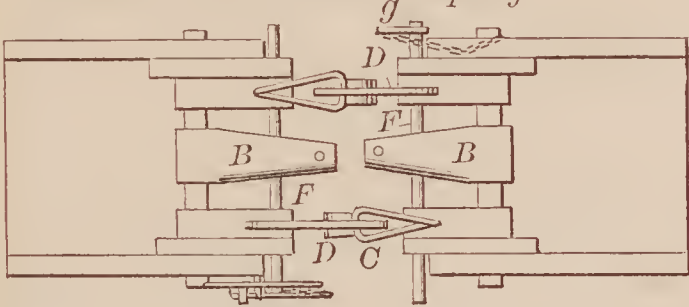

72486—W. Harris—Nut Fastening.

72485—P. Hanly—Horse Shoe.

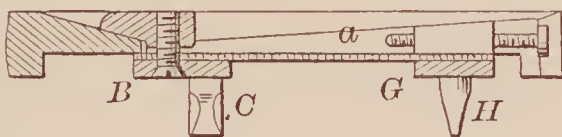

72484—G. Haberland—Horse and Wagon Brake.

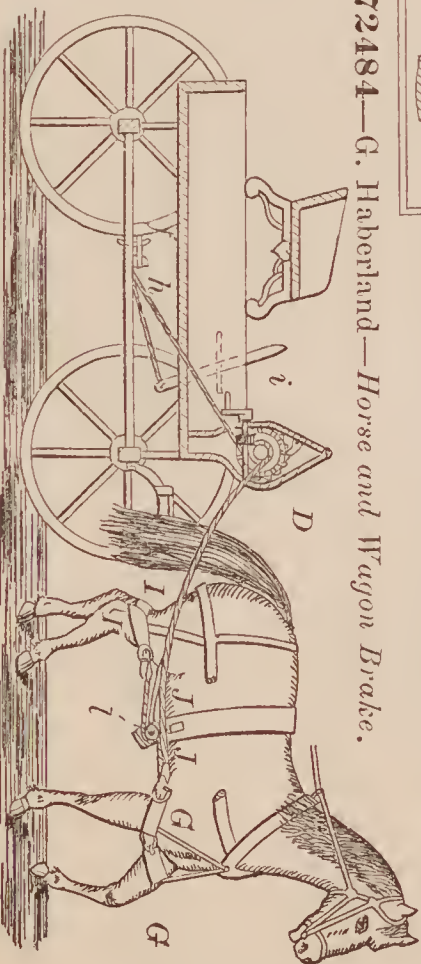

72487—Hart & Blakeslee—Tapping Nuts.

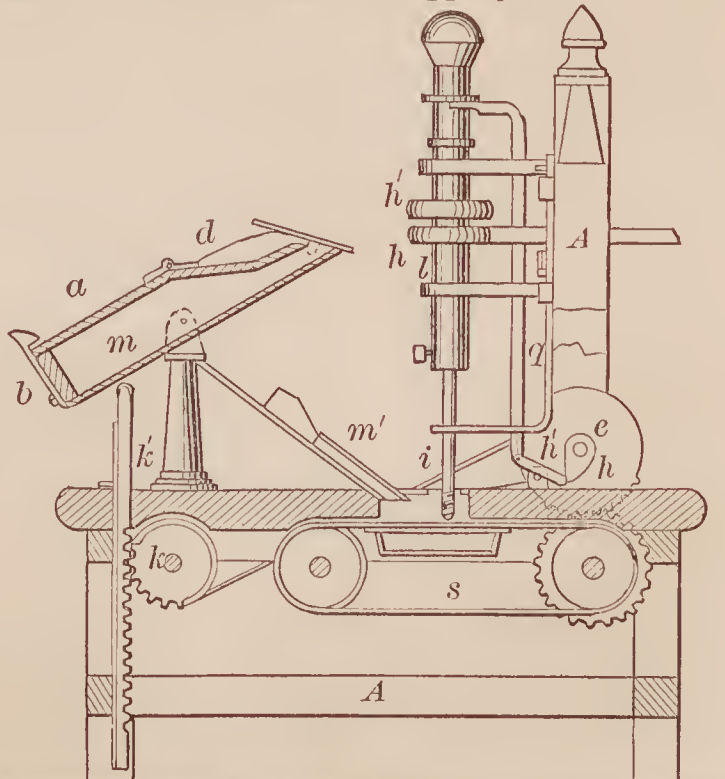



72488—H. Hartley—*Lining Hose.*

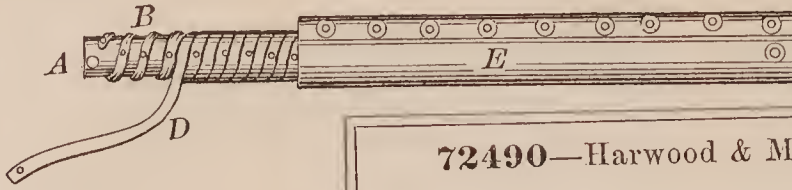

72490—Harwood & Mickle—*For Threading Screws.*

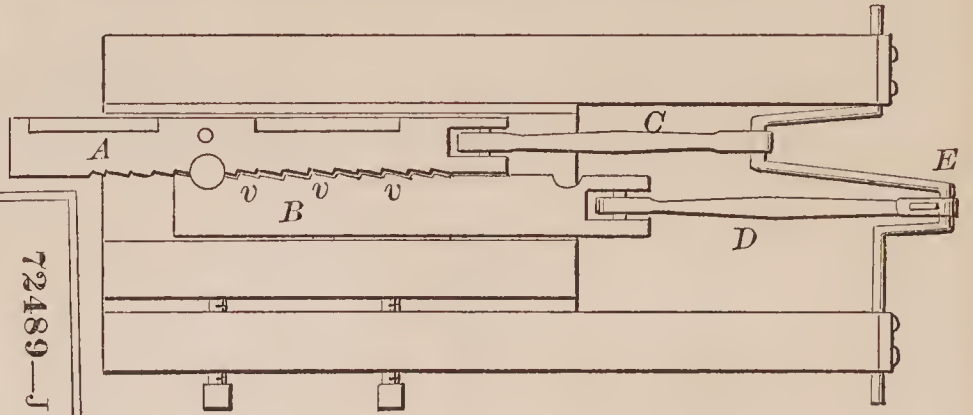

72489—J. M. Harvey—*Steam Generator.*

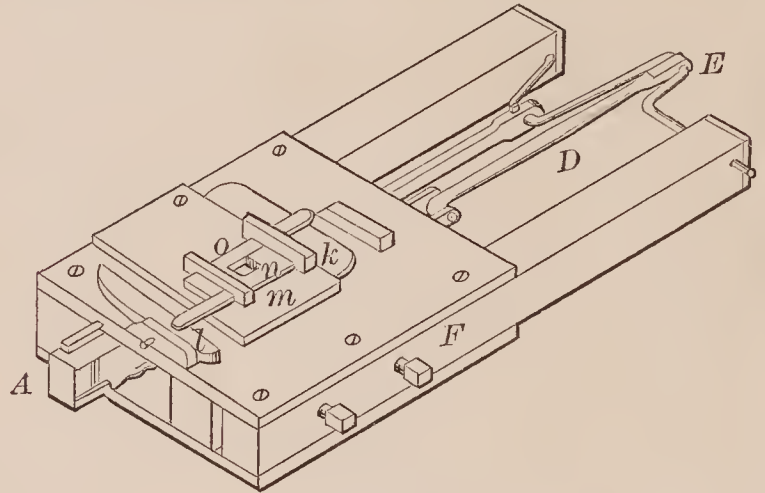
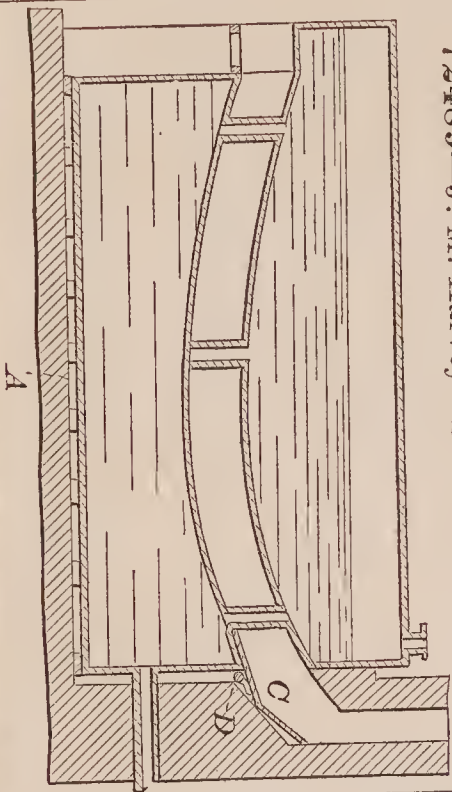

72491—Hays, Duncan & Bowen—*For Sharpening Horse Shoe Calks.*

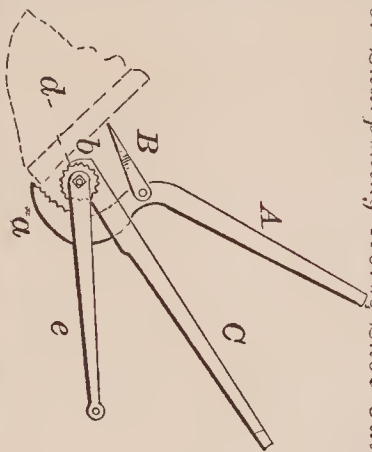

72492—E. A. Hill—*For Punching Rubber Inner Soles.*

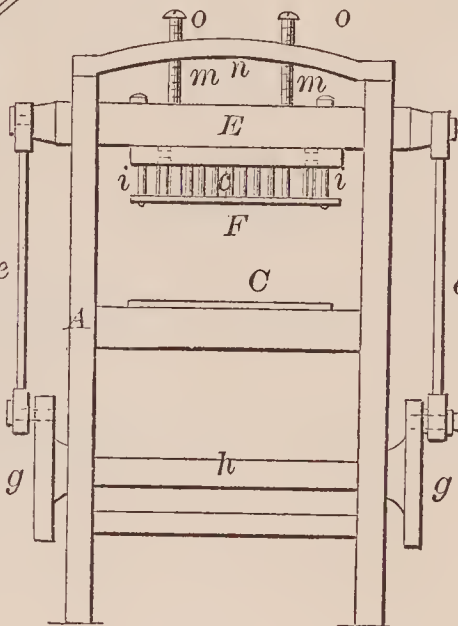

72493—E. A. Hopkins—*Door Plate and Letter Box.*

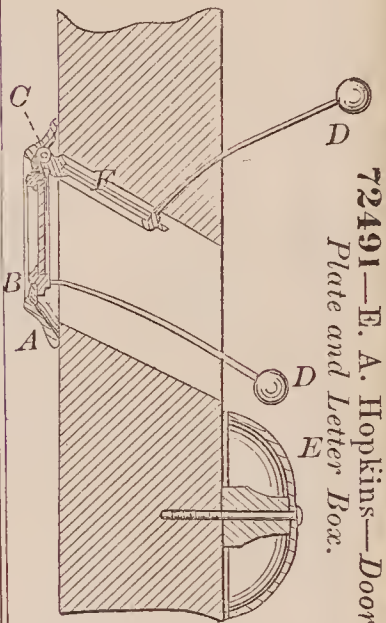

72494—B. B. Hotchkiss—*Time and Percussion Fuze for Explosive Shells.*

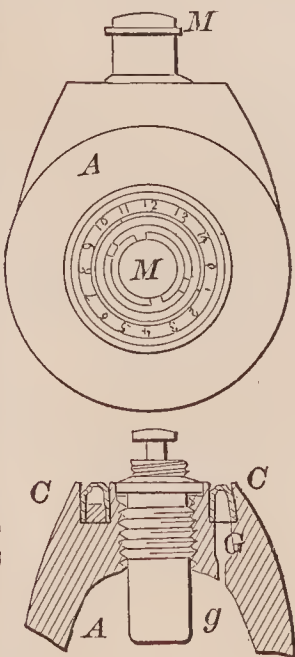

72495—H. Hunt—*Gate.*

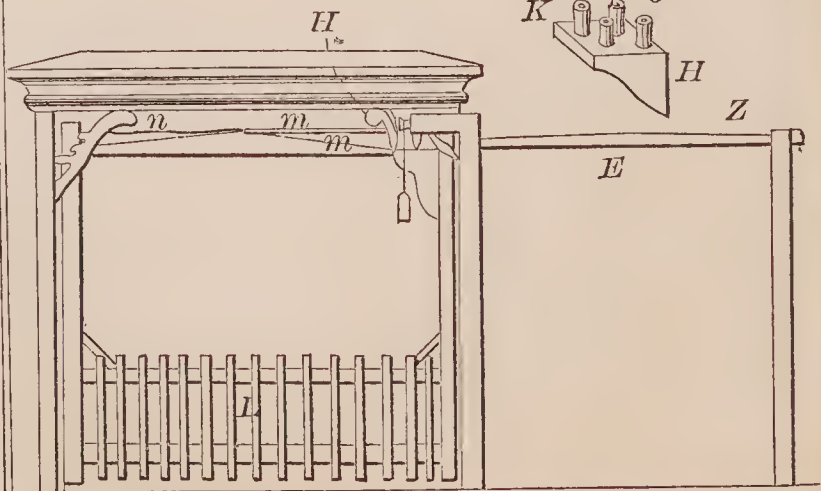

72496—D Hyre—Well Refrigerator.

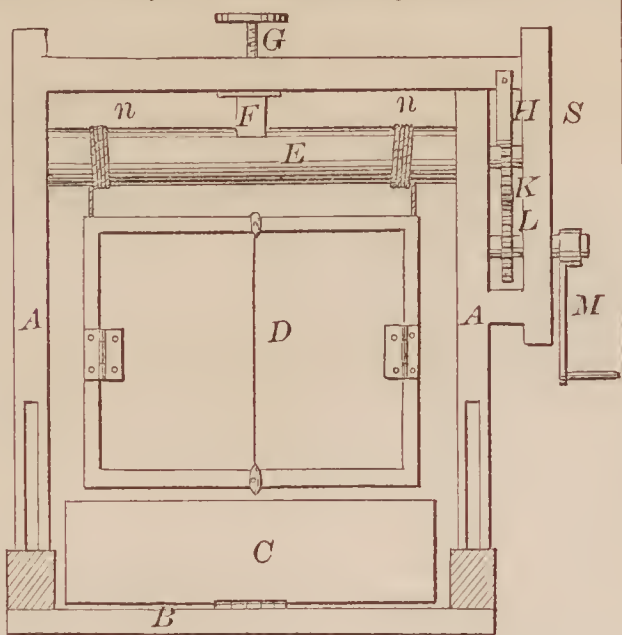

72497—W. R. Des—For Boring Post Holes

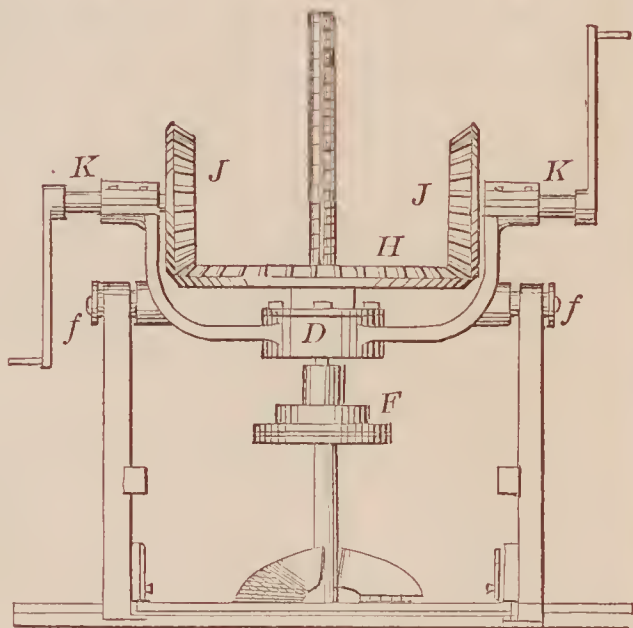
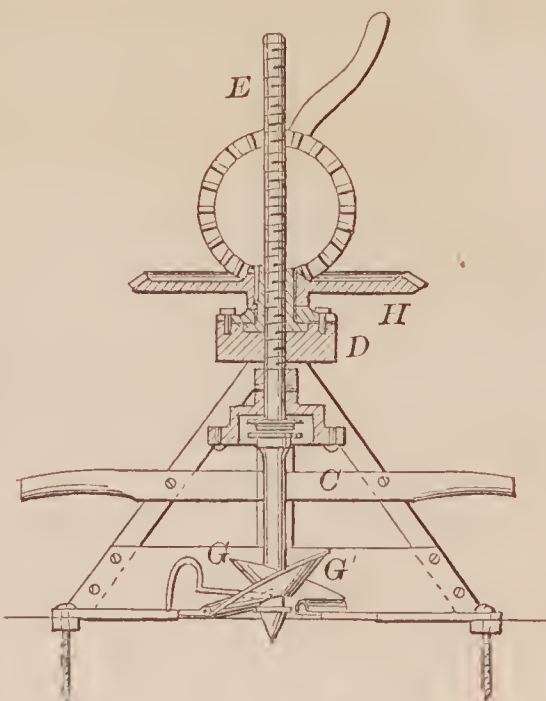

72499—H. Jackson—Door Lock.

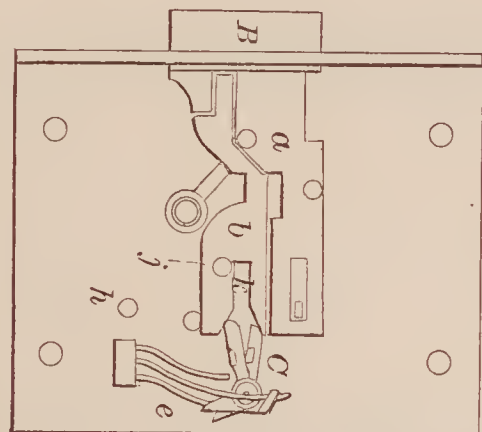
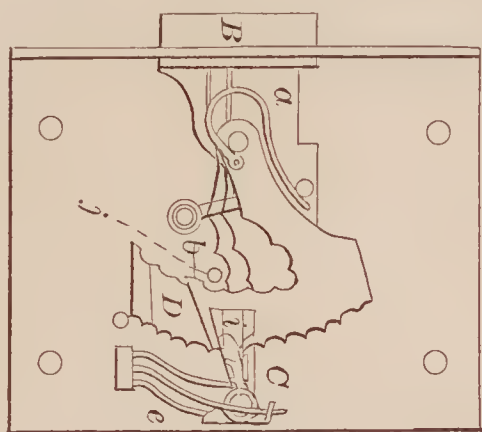

72500—L. Jarosson—Bleaching and Scouring Hemp, &c.

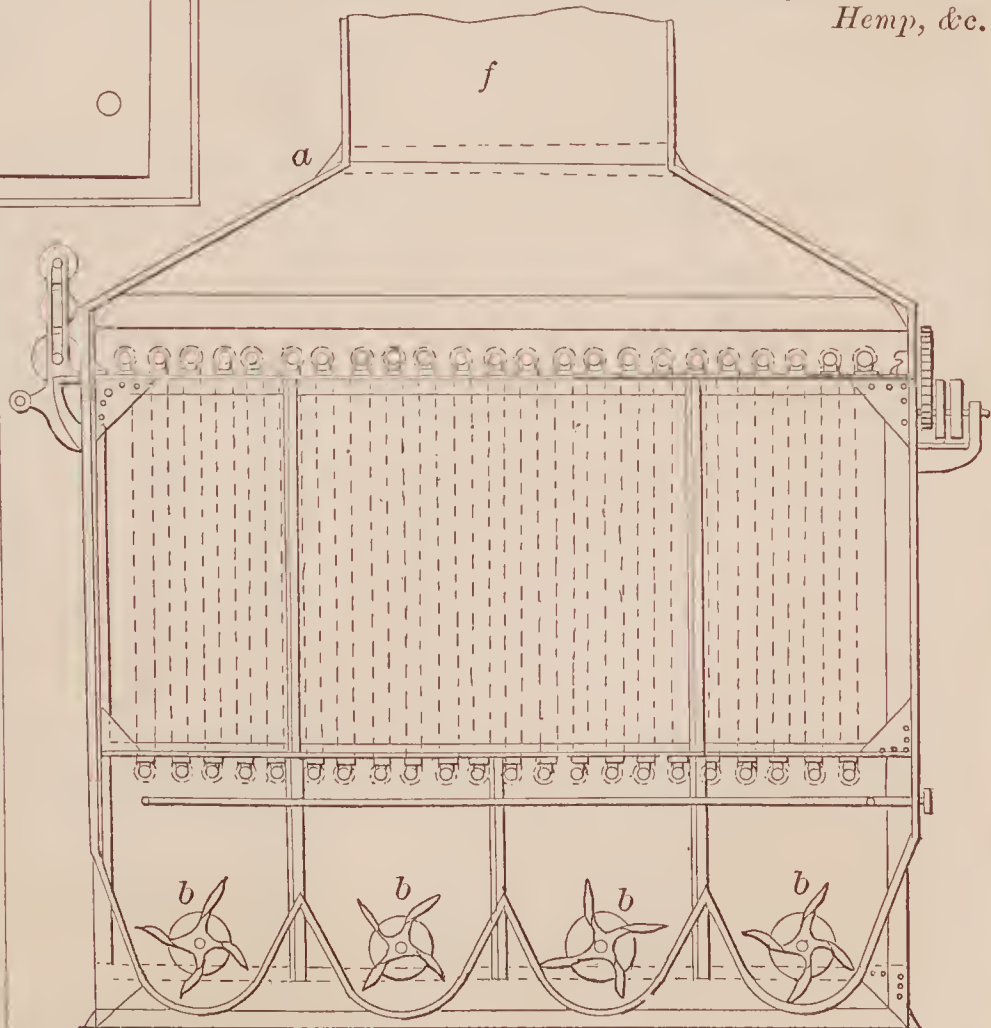

72498—W. Inman—Saw Mill.

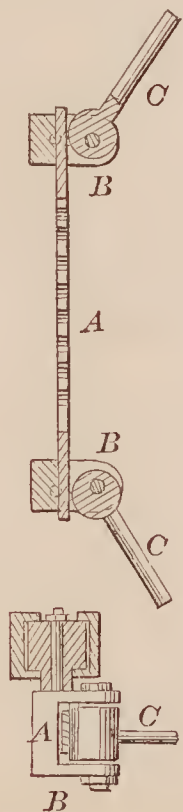



72504—H. A. Kephart—*Fence.*

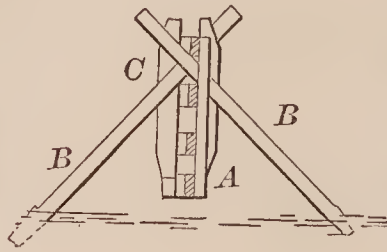

72501—H. J. Johnson—*Corn Planter.*

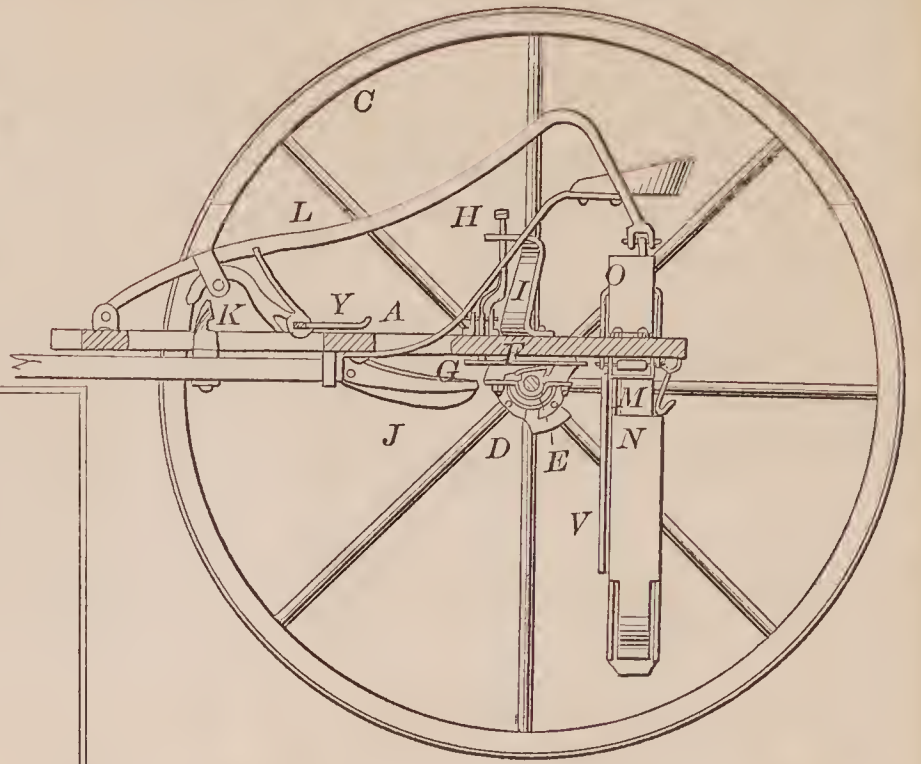

72503—T. W. Kennedy—*Hand Truck.*

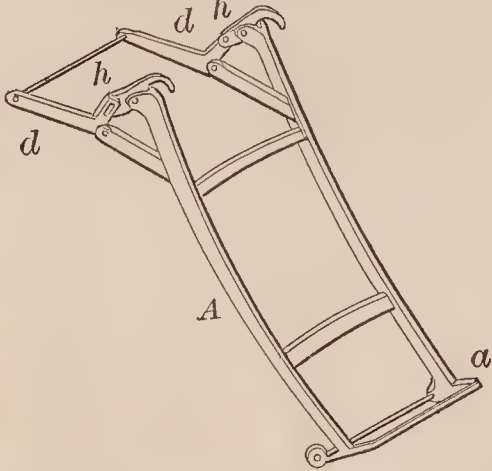

72506—C. Kirchof—*Candle Holder.*

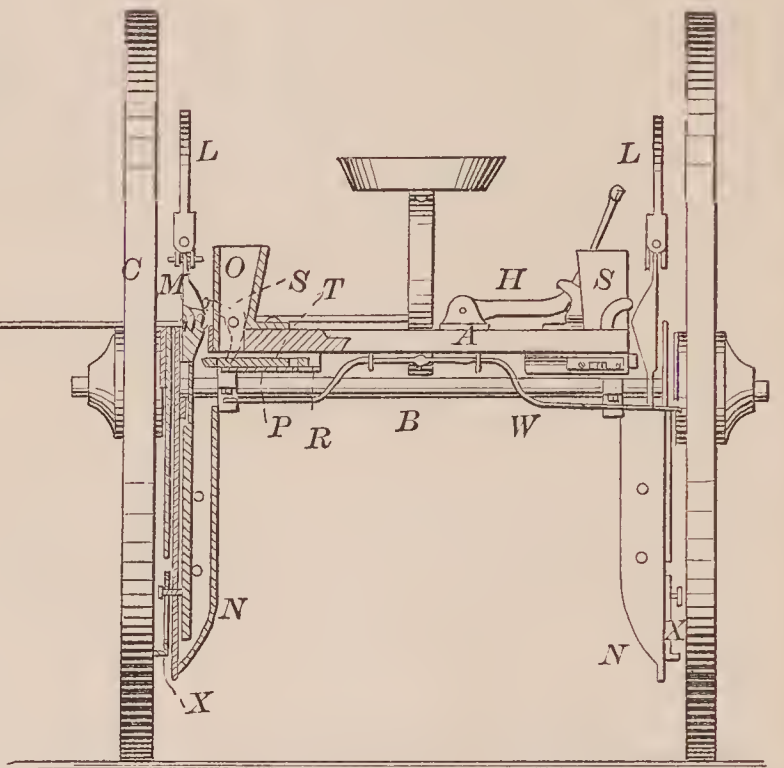

72505—J. Kirby—*Bung Cutter.*

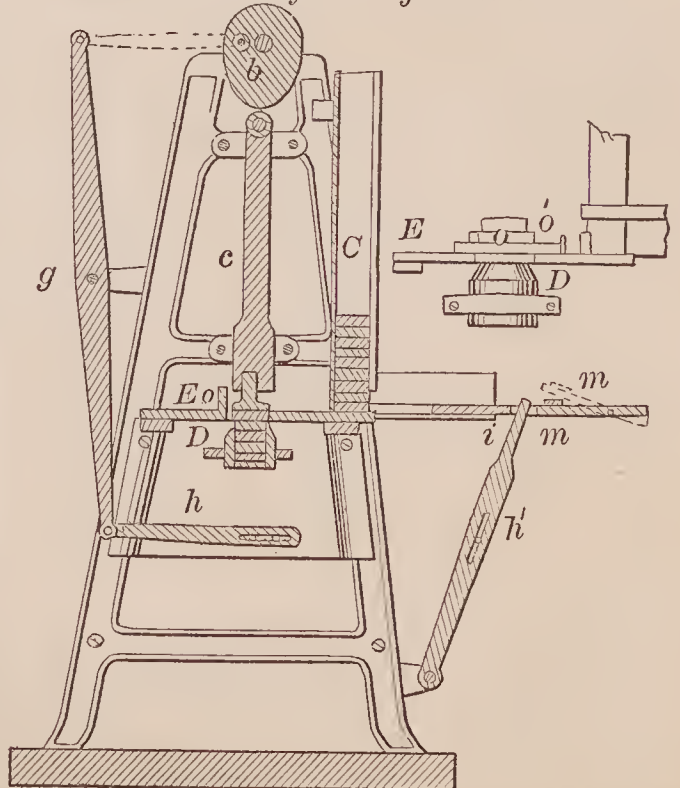

72502—W. K. Johnson—*Locks for Wagon Brakes.*

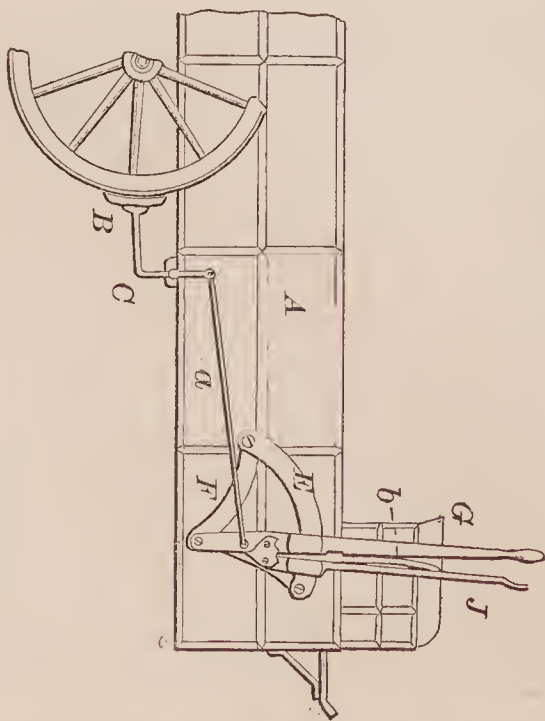

72512—M. Loughran—For Rolling Clevis Blanks.

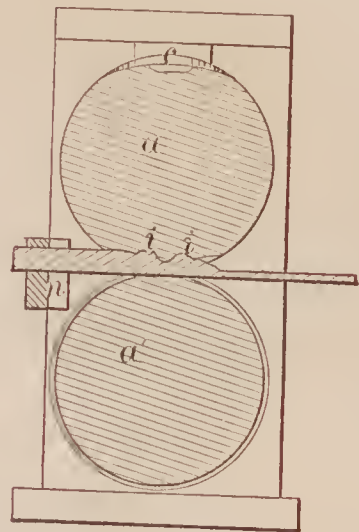

72509—J. O. Lewis—Card Grinding Cylinder.

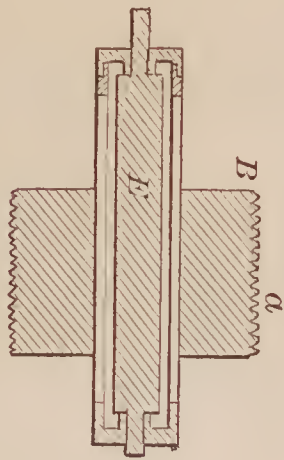

72507—J. Koch—Stairs.

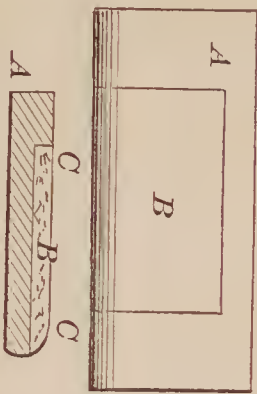

72508—N. Lawrence—Syringe Valve.

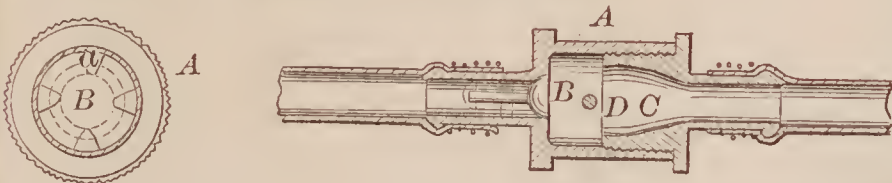

72511—L. W. T Lodge—Road Scraper.

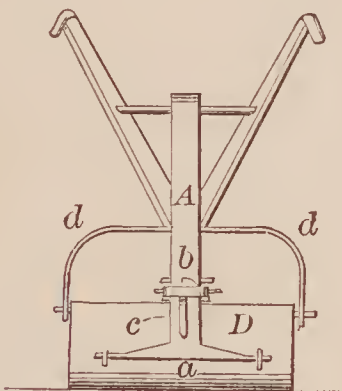
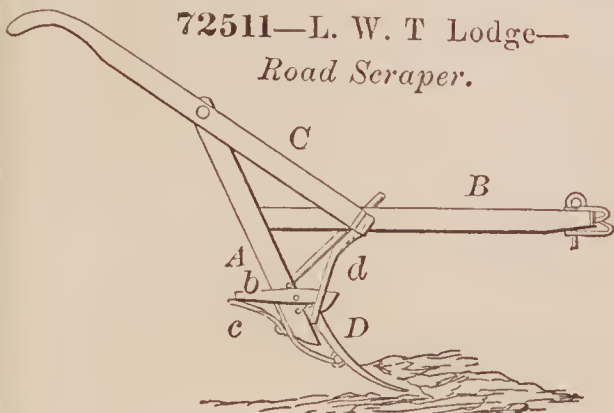

72513—J. B. Lyons—For Digging Peat.

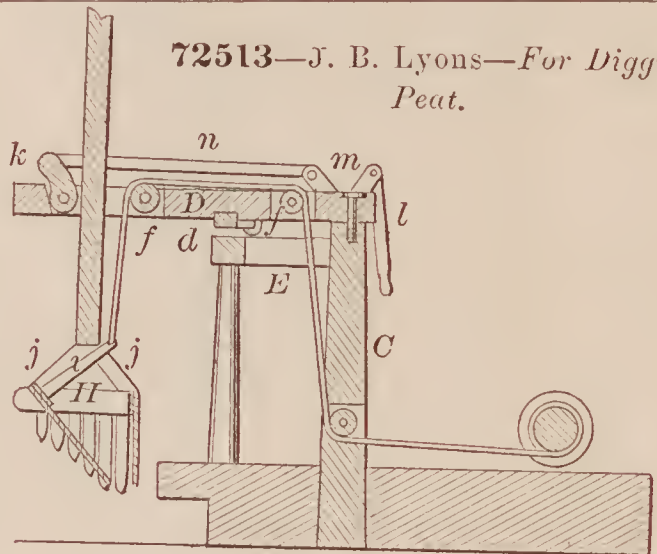

72514—J. Maclure—Harness Pad.

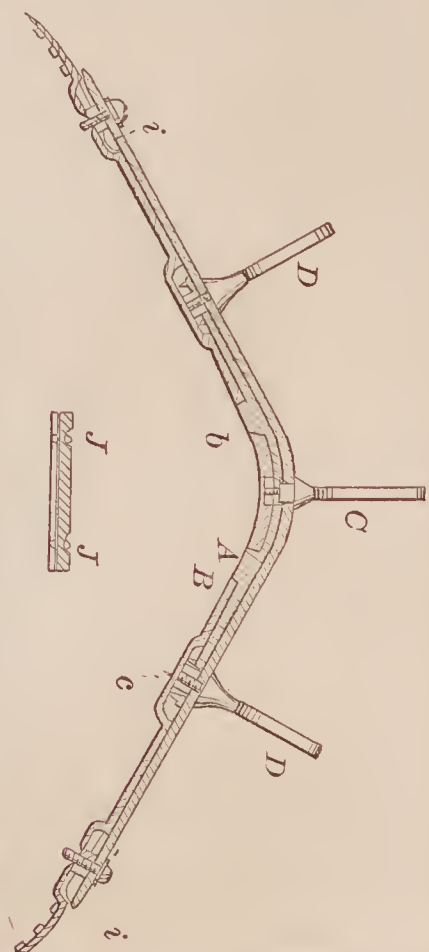

72510—W. C. Lewis—Head Block.

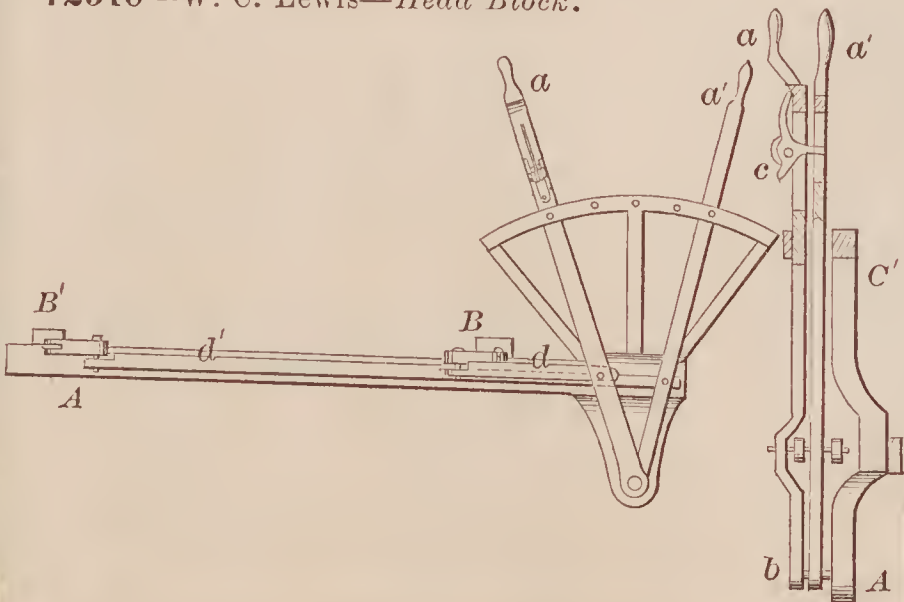





72525—R. W. Moran—*Corn Planter.*

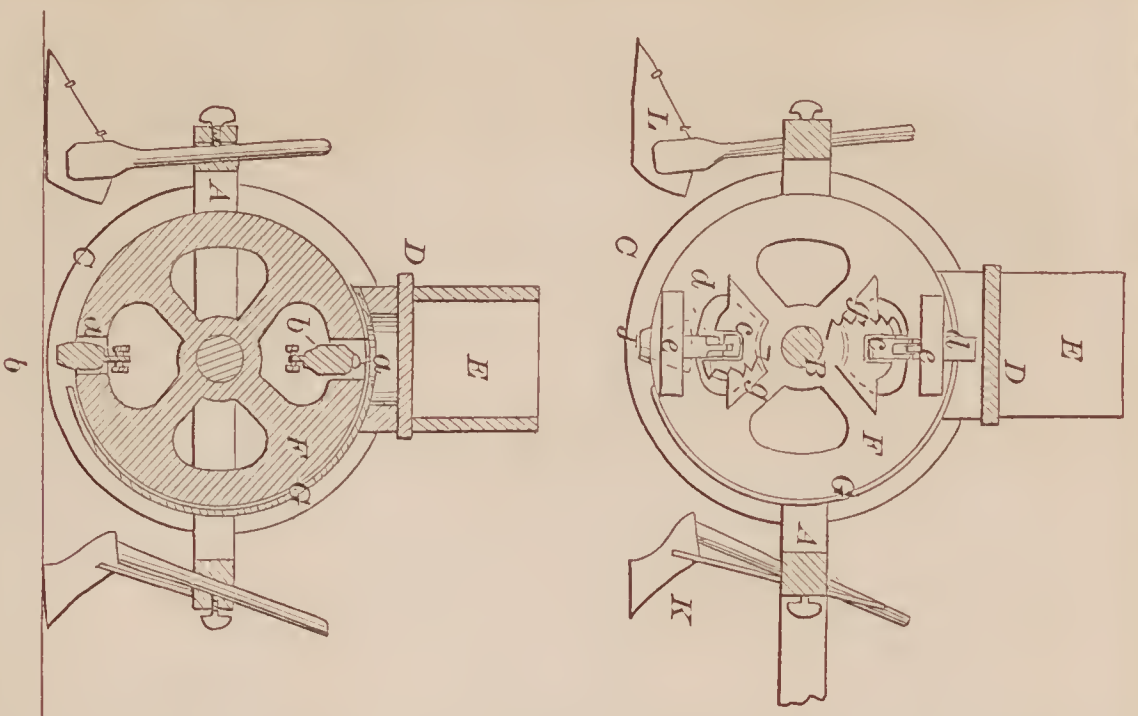

72521—R. S. Mershon—*Greener.*



72523—J. Miller—*Harvester Dropper.*

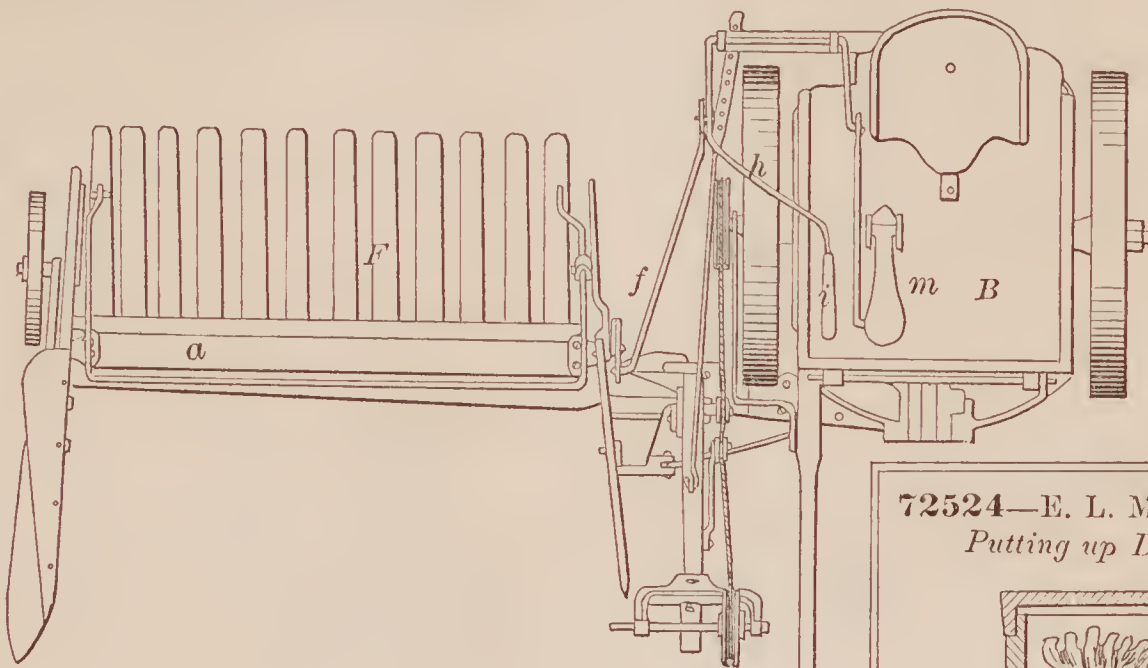

72524—E. L. Molineux—*Putting up Dyes.*

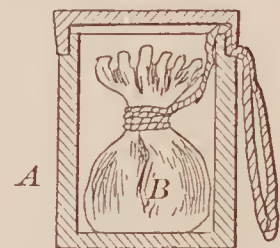

72527—J. Morton—*Railroad Truck Lifter.*

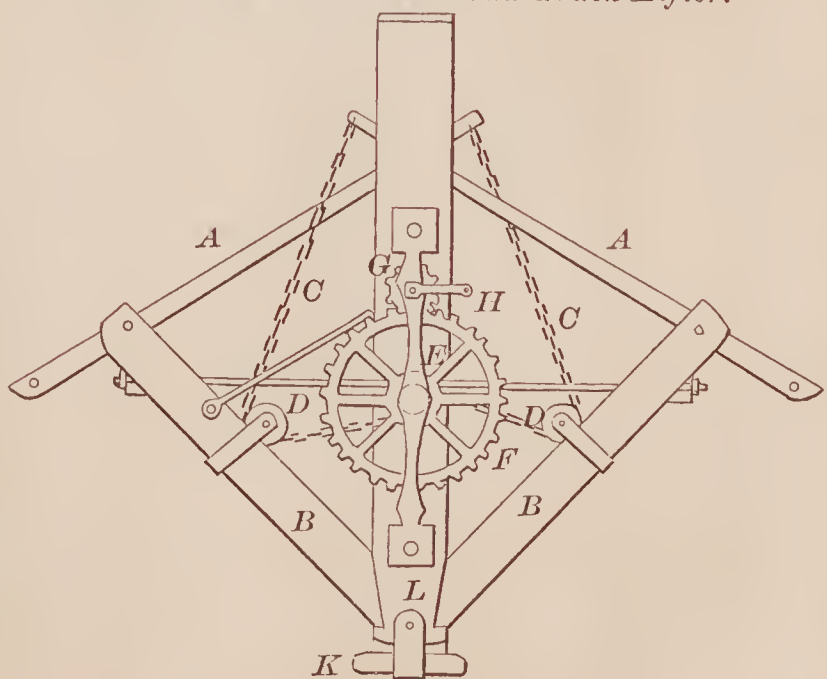

72526—W. Morgenstern—*Fire Arm.*

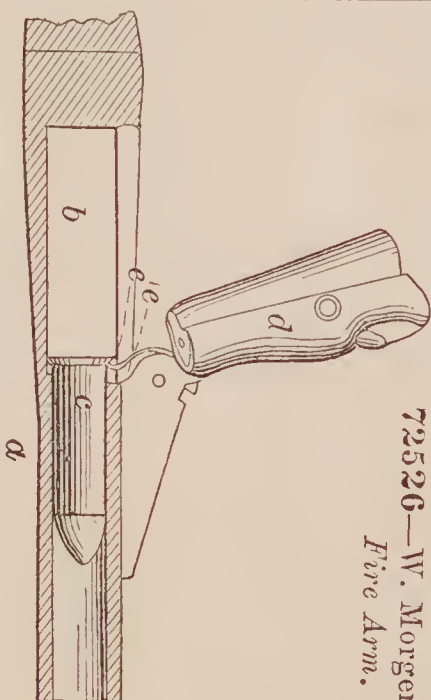



72528—D. J. Mozart—*Watch.*

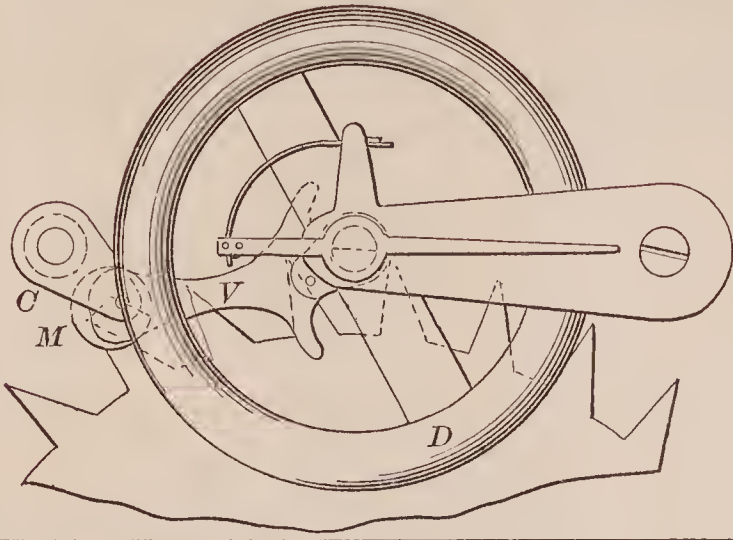
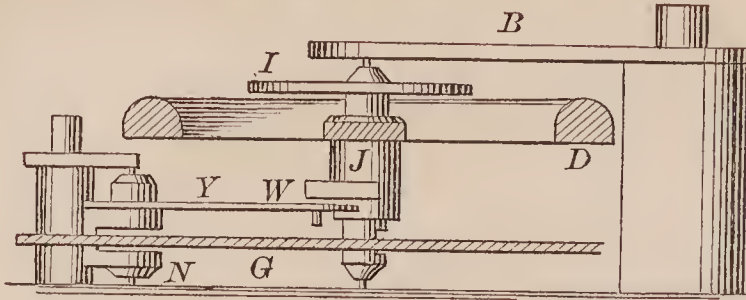

72530—A. W. Newell—*Steam Generator.*

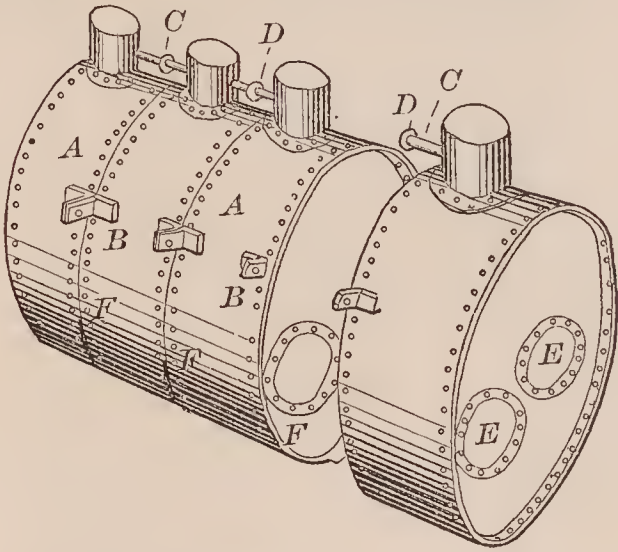

72532—Palmer & Beard—*Sleigh.*

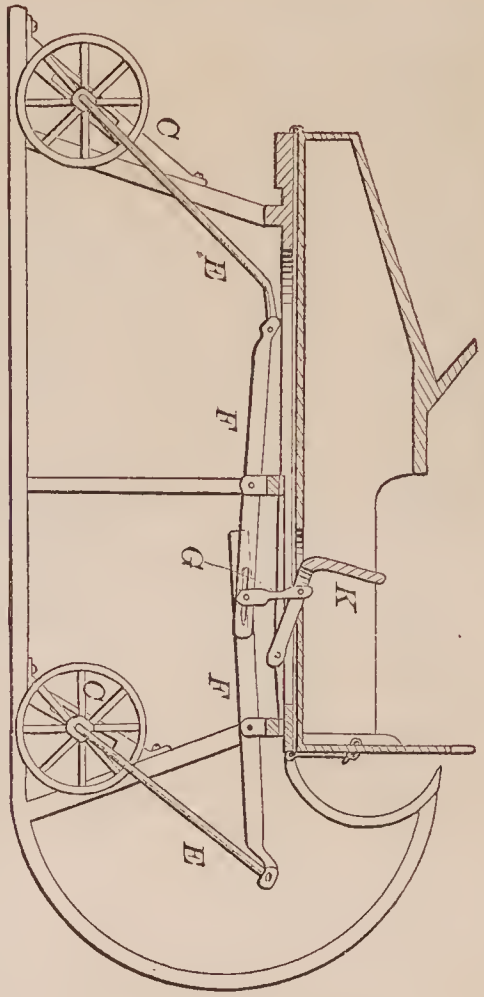

72529—G. Murray—*Valve.*

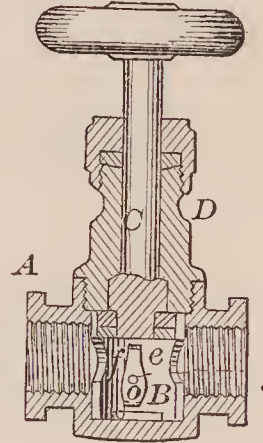

72531—G. H. Noble—*Spindle Step.*

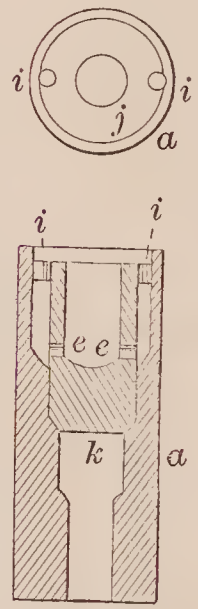

72533—S. Patten—*For Removing Moulded Forms from the Press.*

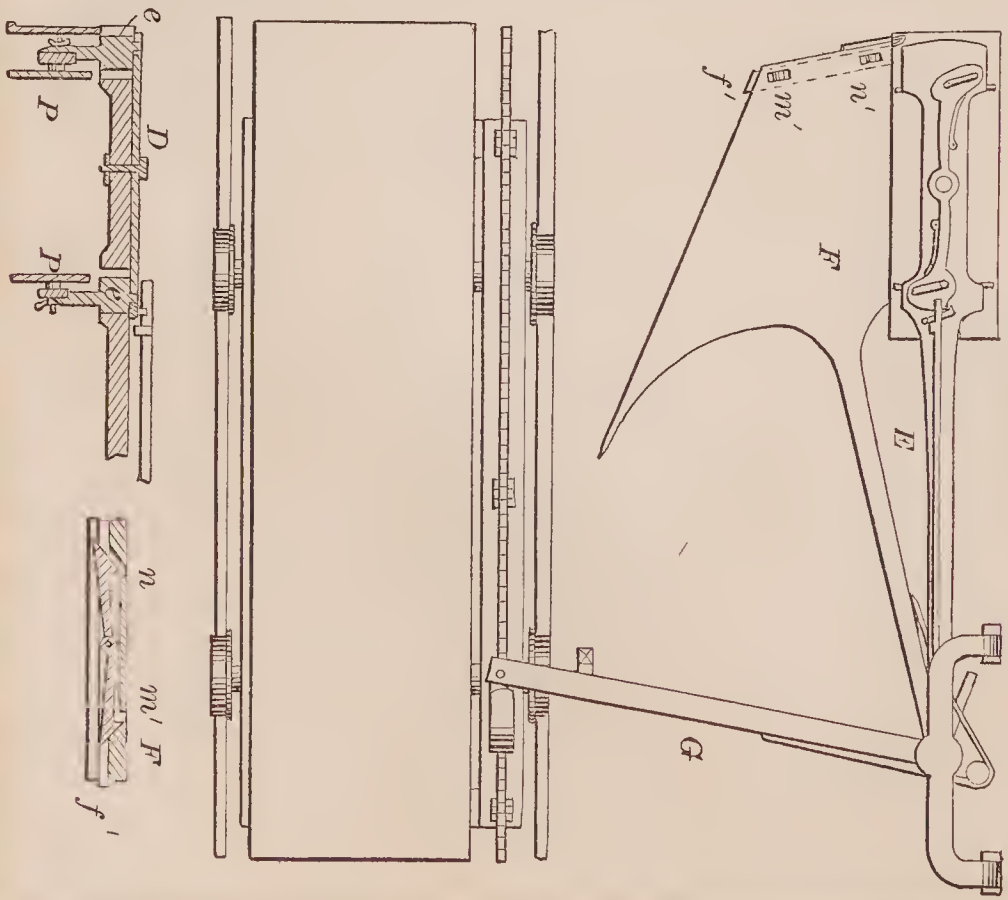

72534—W. P. Patton—*Ice Creeper.*

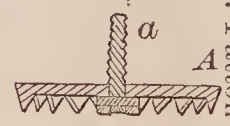

72535—T. Payne—Churn.

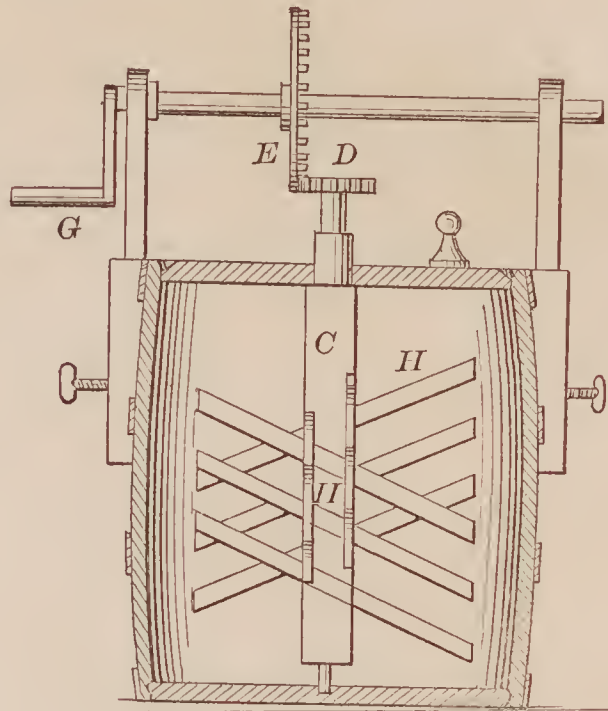

72537—R. D. Pettit—Rotary Steam Engine.

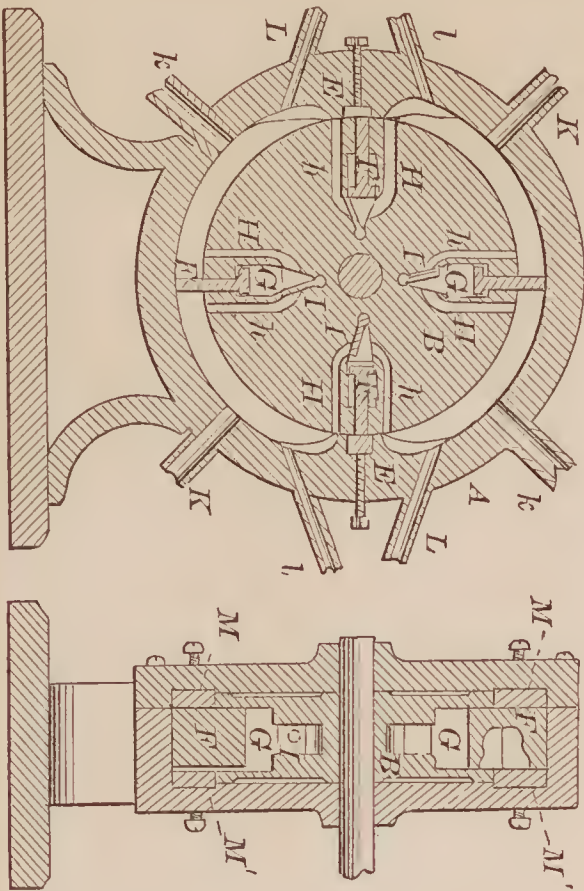

72538—J. Raddin—Carriage Wheel.

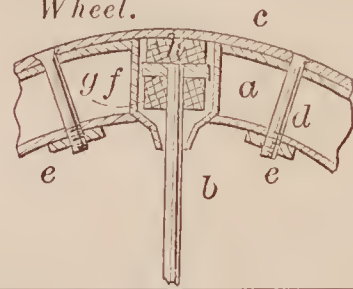

72536—W. W. Peck—Gate Fastening.

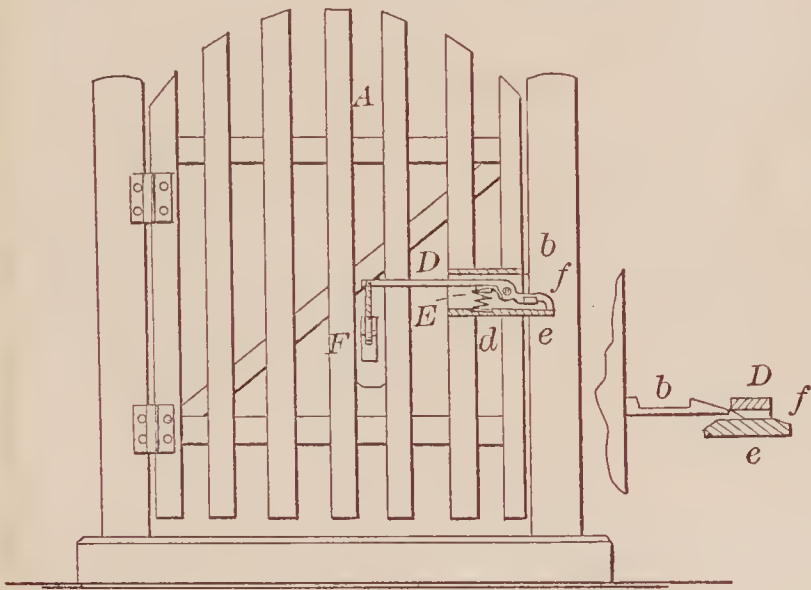

72541—W. Reynolds—Artificial Teeth.

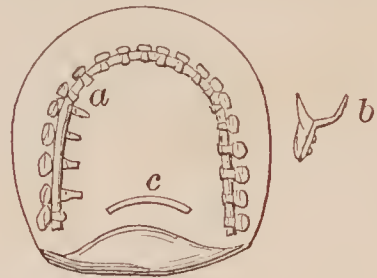

72542—J. H. Richardson—Lantern.

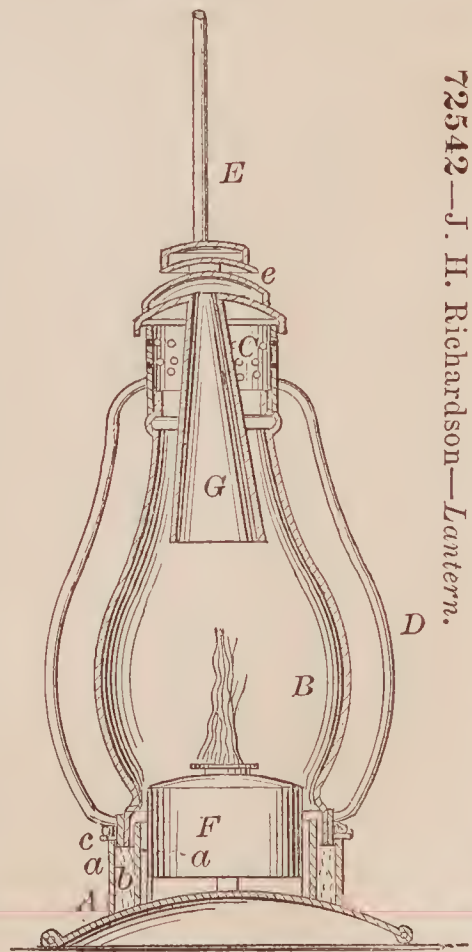

72540—C. W. Reed—Hay Fork.

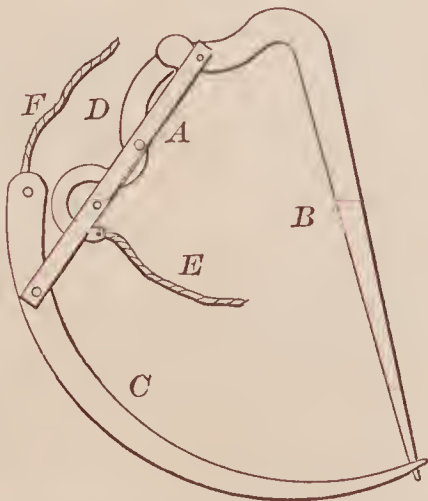

72539—J. L. Reber—Cane and Thermometer.





72547—R. B. Sears—*For Bending Hooks.*

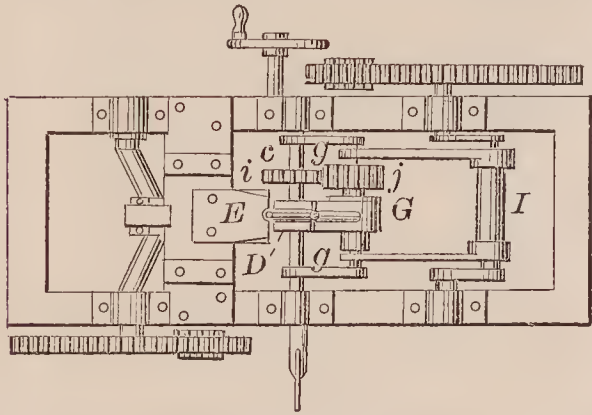
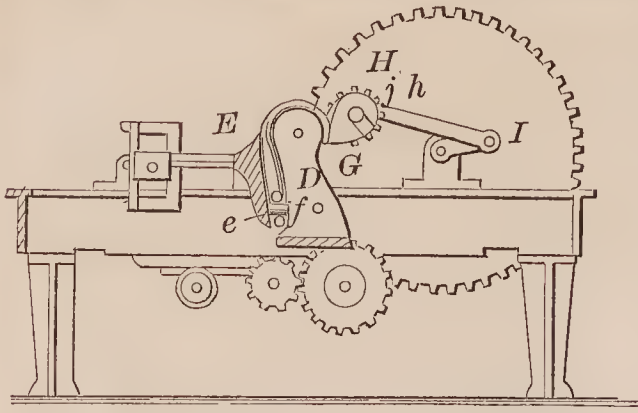

72549—J. Shartle—*Gate.*

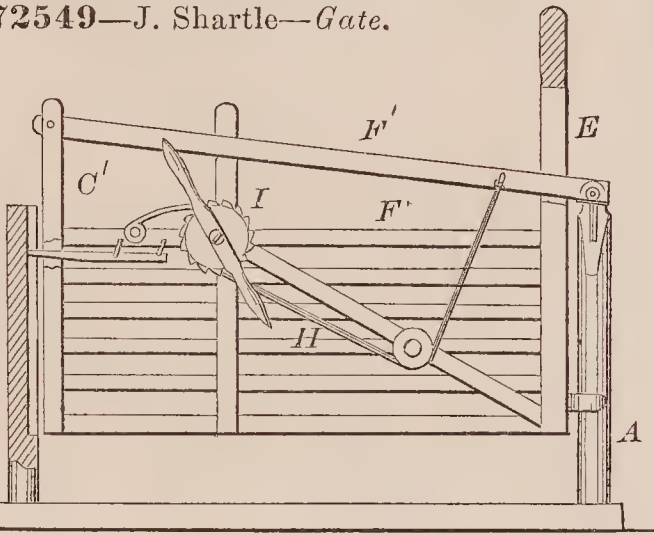

72543—H. A. Robinson—*Weather Strip.*

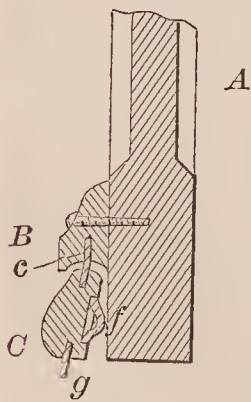

72545—J. Scholl—*Gas Burner.*

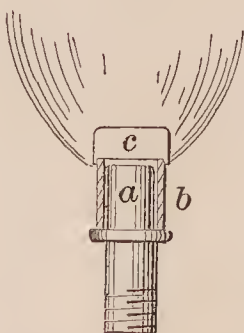

72550—A. Shaw—*For Making Horse Shoe Nails.*

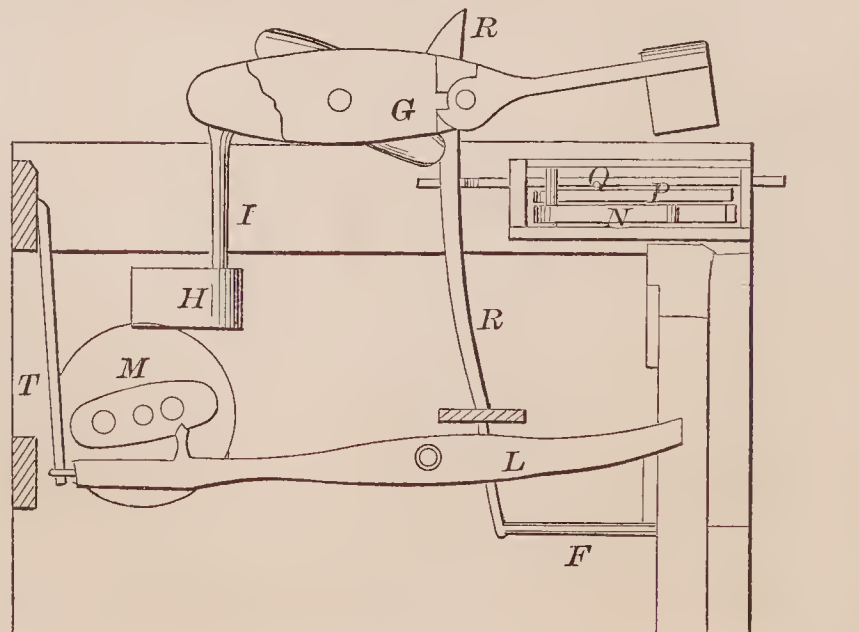

72544—N. Russell—*Earth Conveyor.*

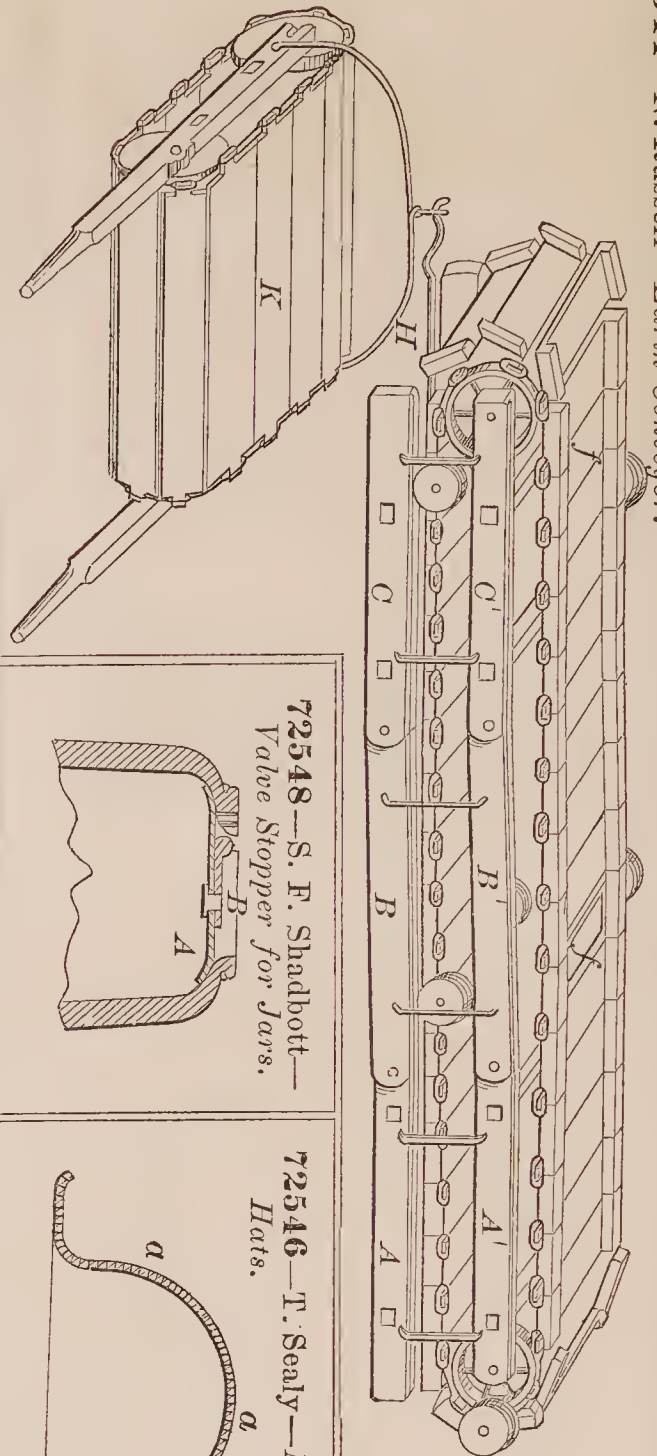

72548—S. F. Shadbot—*Value Stopper for Jars.*

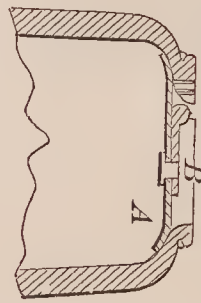

72546—T. Sealy—*Manufacturing Hats.*

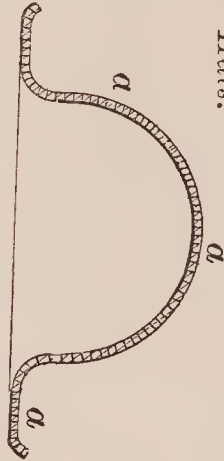

72556—M. R. Snodgrass—Seed Planter and Cultivator.

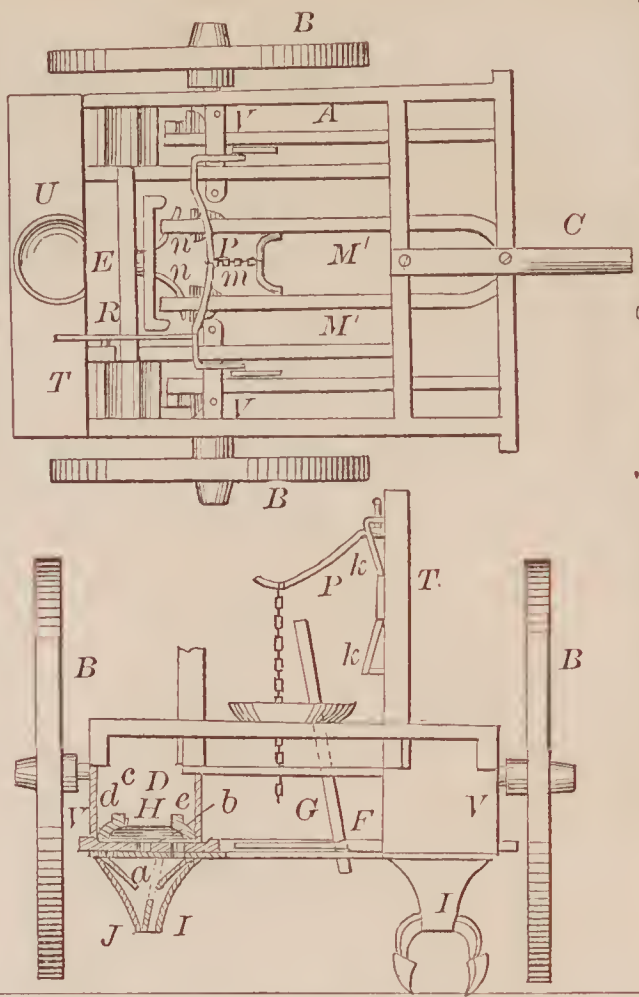

72550—Continued.

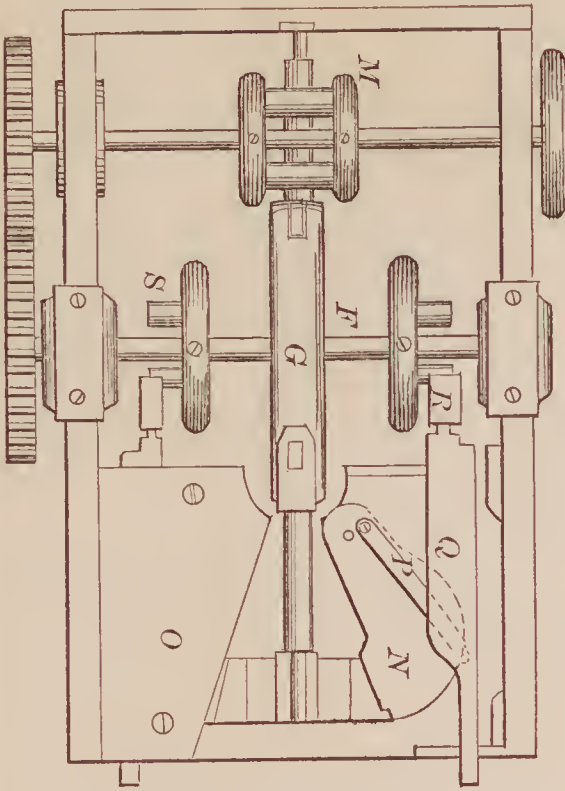

72551—G. H. Shearer—Sawing Machine for Barrel Hoops.

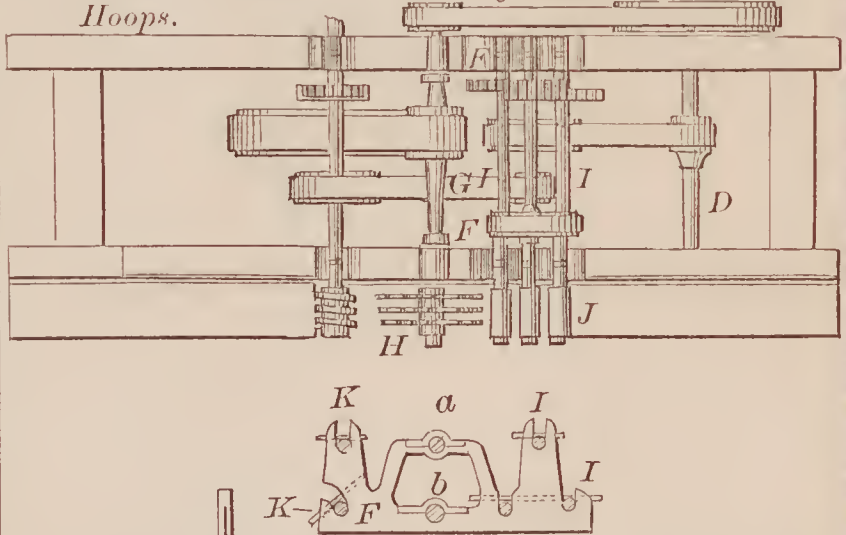

72554—J. Slater—Steam Safety Valve.

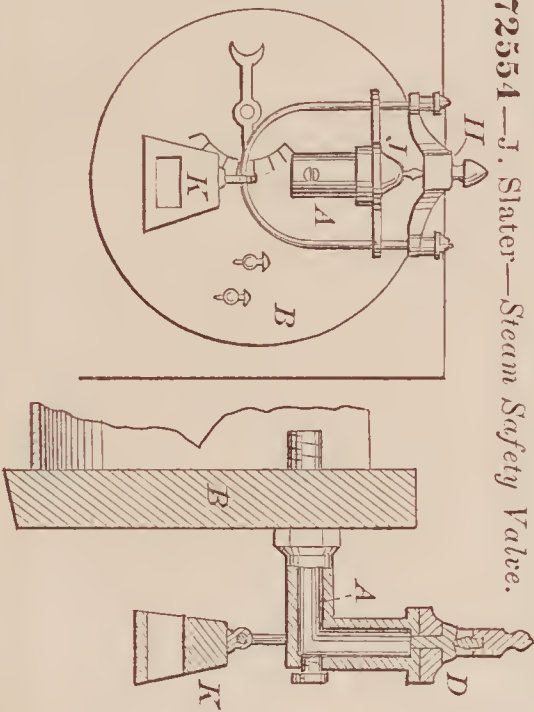

72552—T. W. Shepard—Potato Digger.

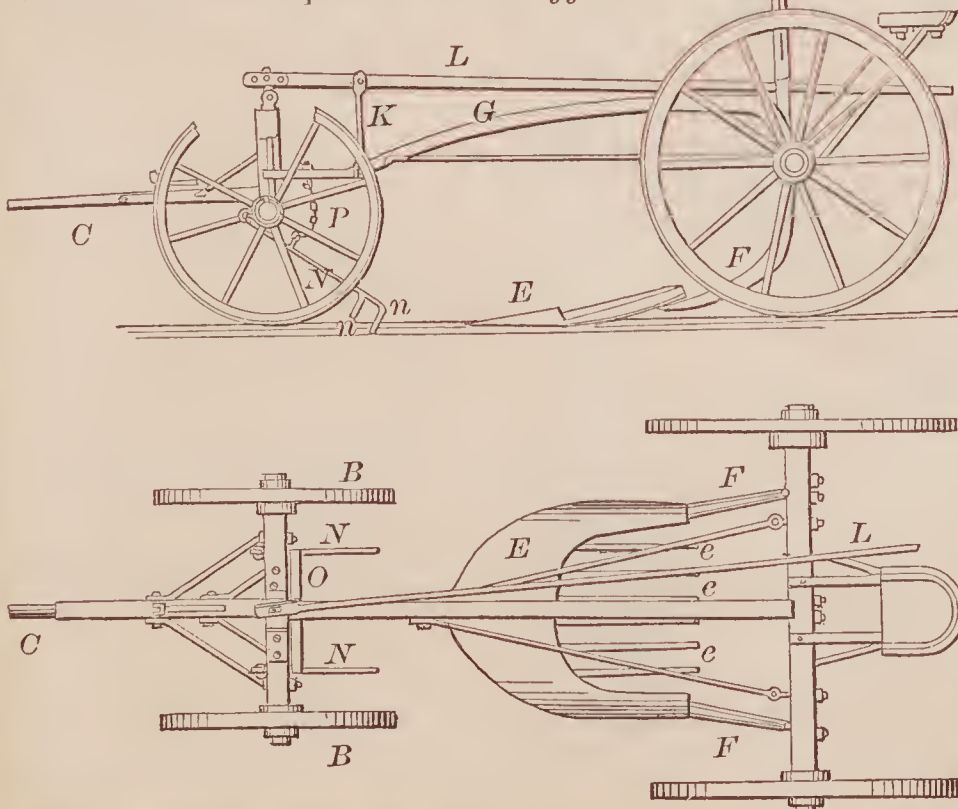

72555—A. E. Smith—Wagon Axle.

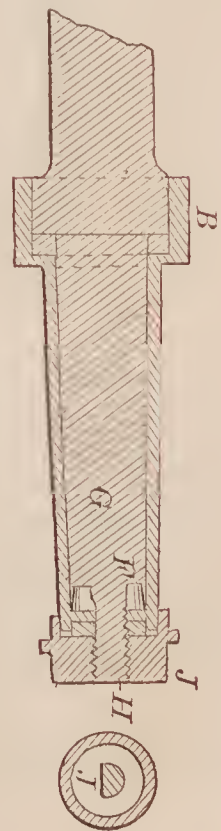



72557—J. S. Stewart—*Building Block.*

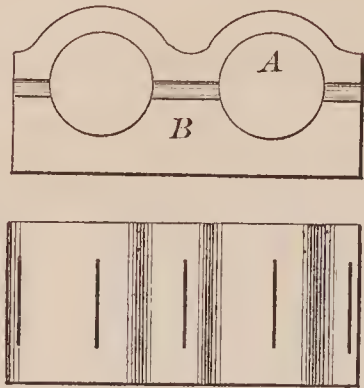

72558—L. S. Stimson—*For Dyeing Hair.*

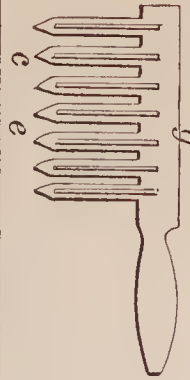

72562—J. Sutter—*Folding Table.*

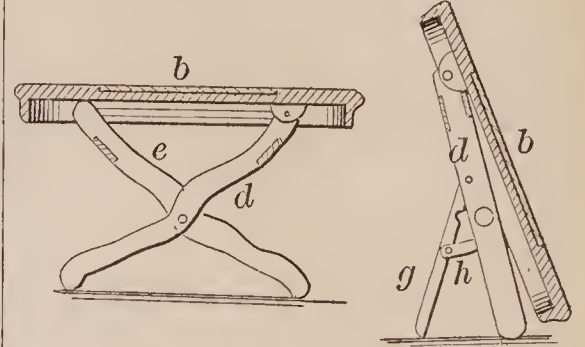

72561—O. W. Stow—*For Folding Tinned Plates.*

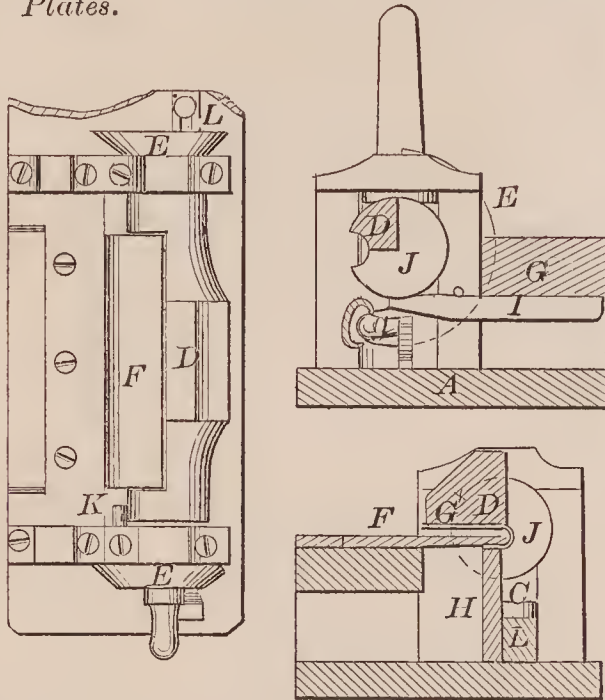

72560—Storrs, Keyes & Jones—*Cultivator.*

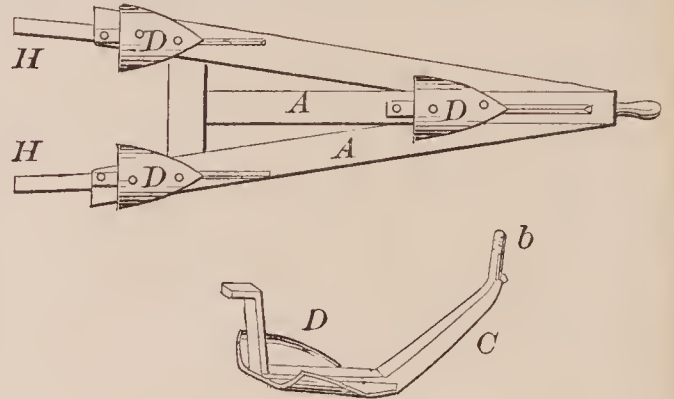

72566—N. Thompson—*Pipe Coupling.*

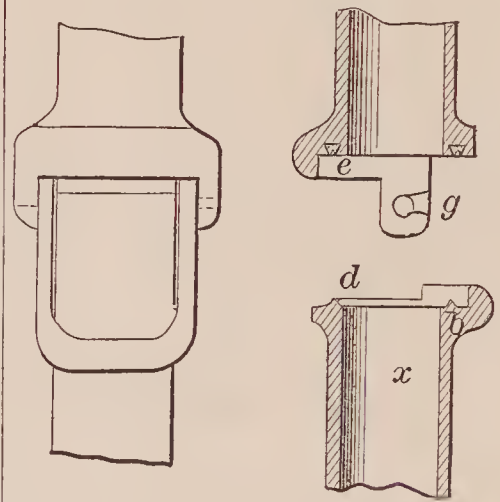

72564—F. Thiry—*Paper Machine.*

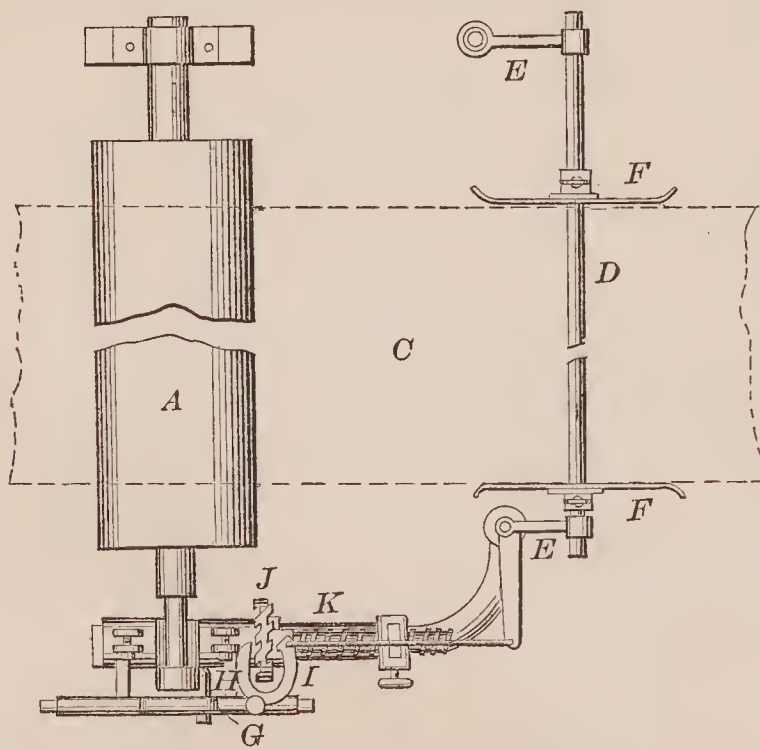

72567—L. N. Tinkham—*Horse Hay Fork.*

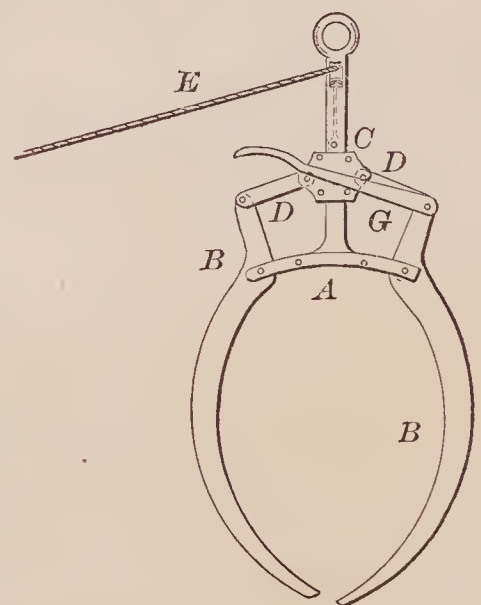

72565—N. Thompson—*Hose Coupling.*

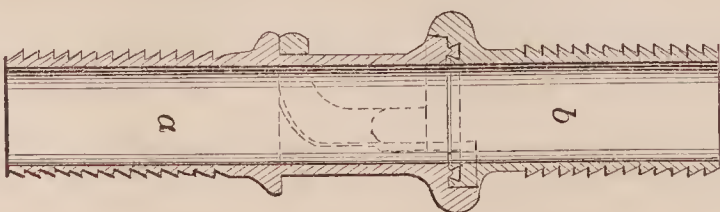

72568—W. D. Titus—Plow.

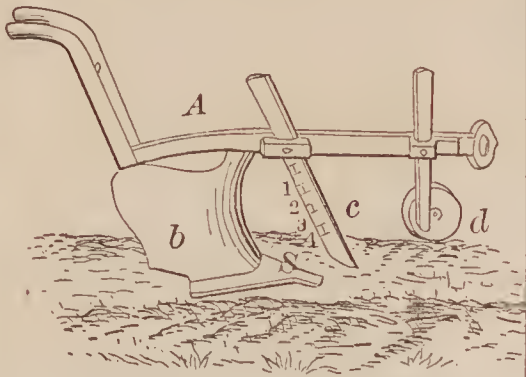

72569—H. A. Tremper—Copy Holder.

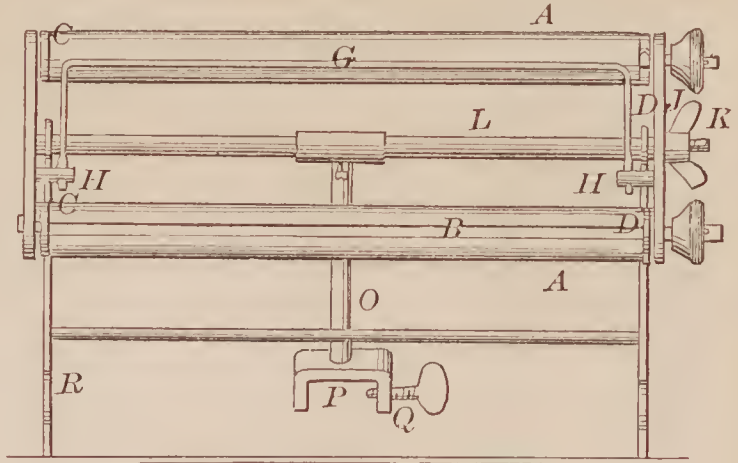

72572—A. O. Varela—Beehive.

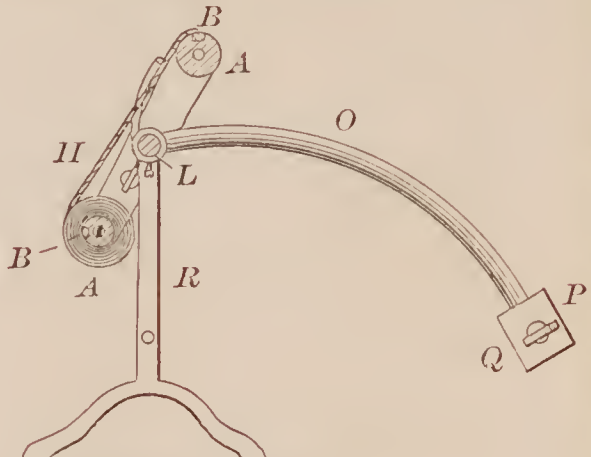
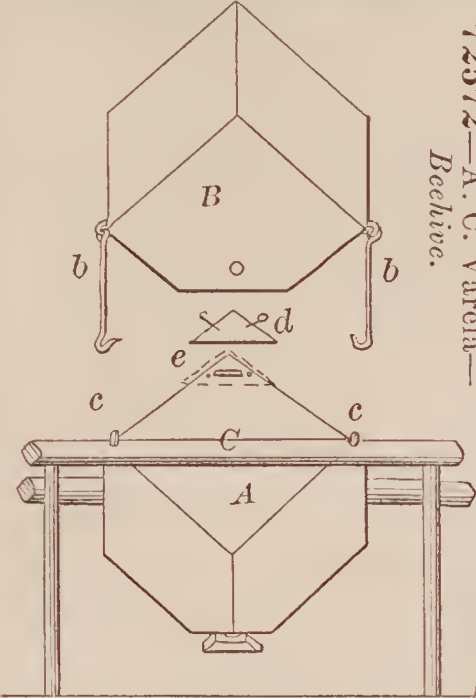

72570—W. Ulrich—Reflector.

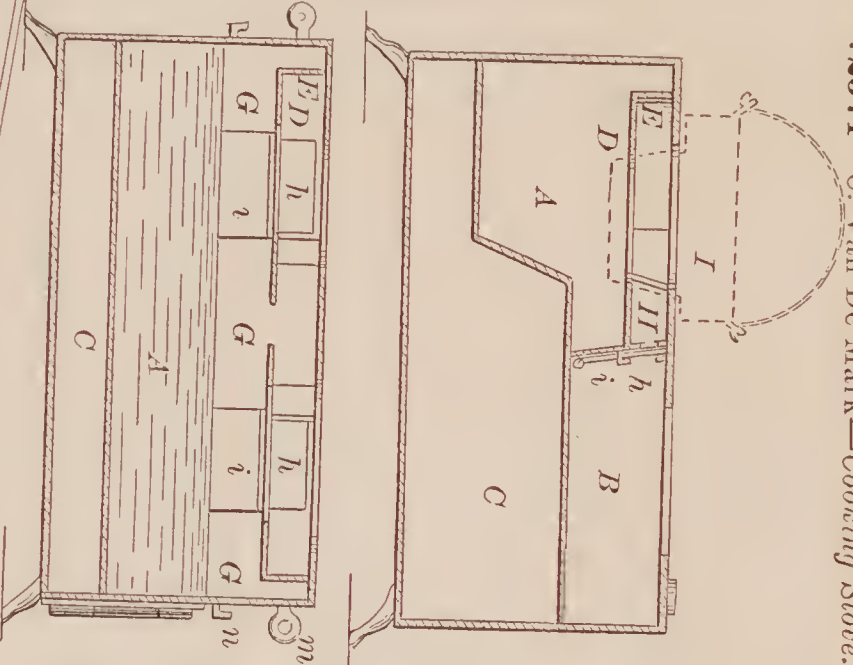
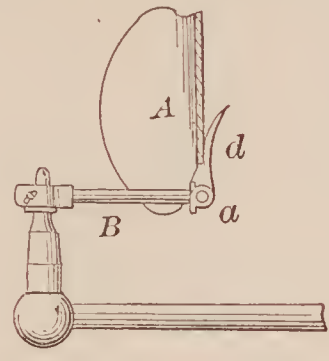

72571—C. Van De Mark—Cooking Stove.

72573—G. Weissenborn—For Making Peat Fuel.

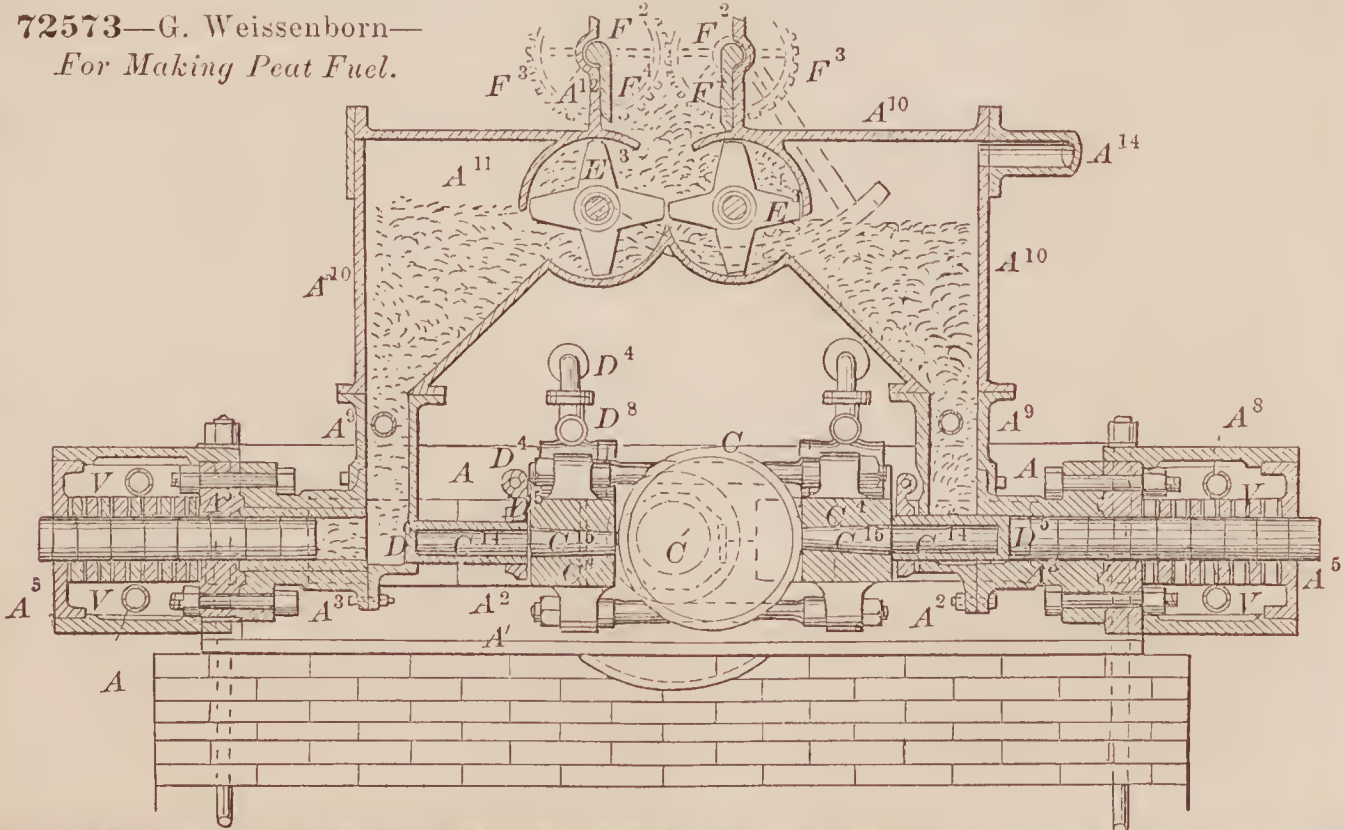





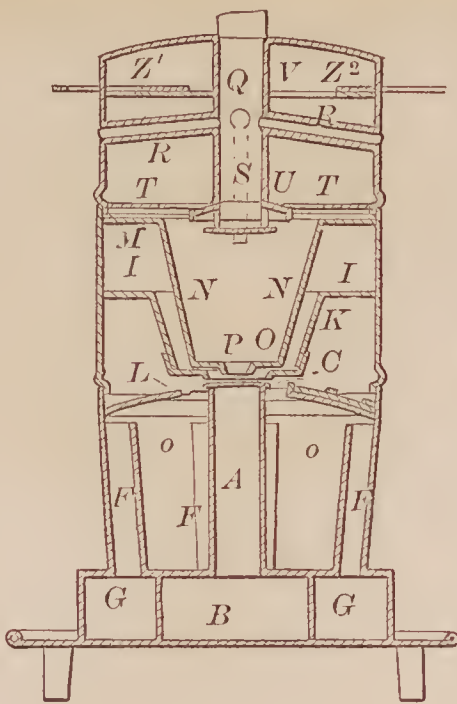

72580—Adams & Peckover—Coal Stove.

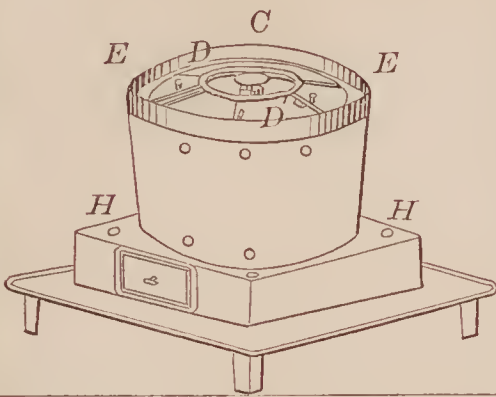

72581—J. W. Alesworth—Box for Gauging Shingles.

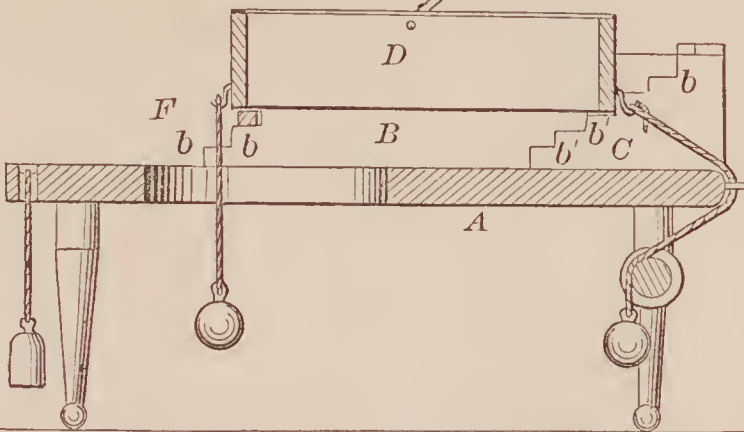

72582—J. F. Allen—Hand Saw.

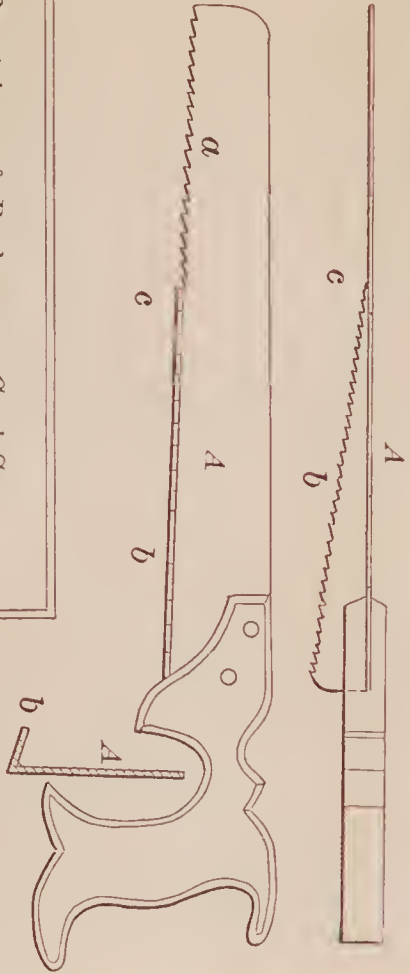

72583—R. N. Allen—Drying Apparatus.

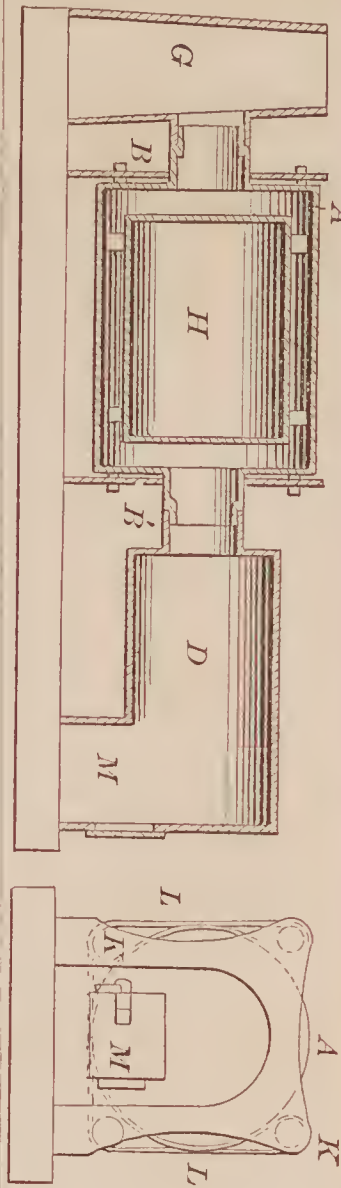

72585—E. H. Ashcroft—For Washing Sheep Skins.

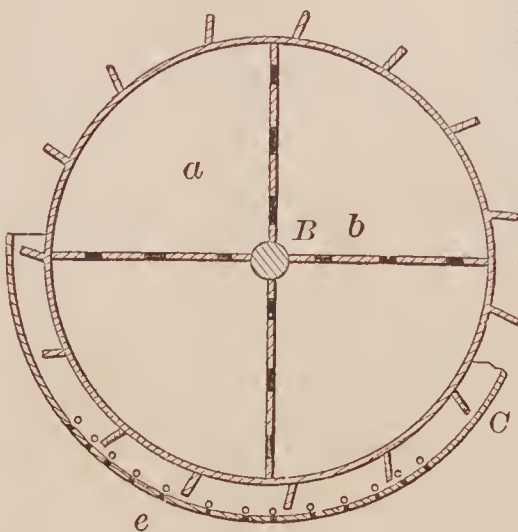

72584—J. Anthony—Car Axle.

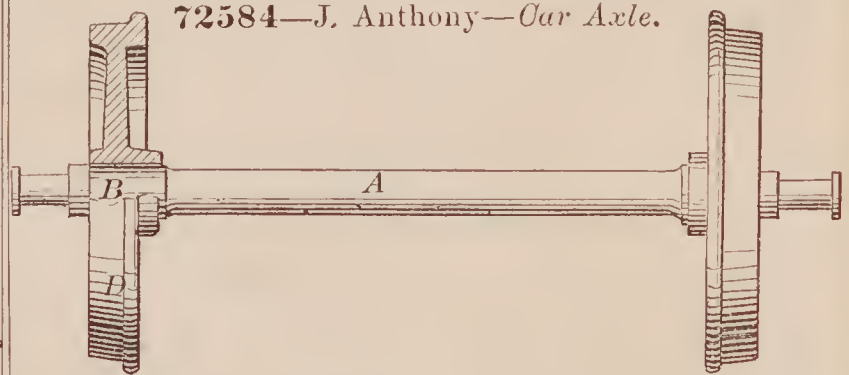

72586—E. R. Austin—Flask for Forming Cores.

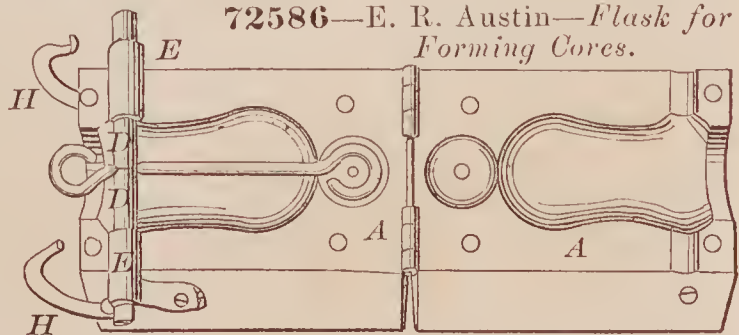



72587—W. Bahme—*Mill Stone.*

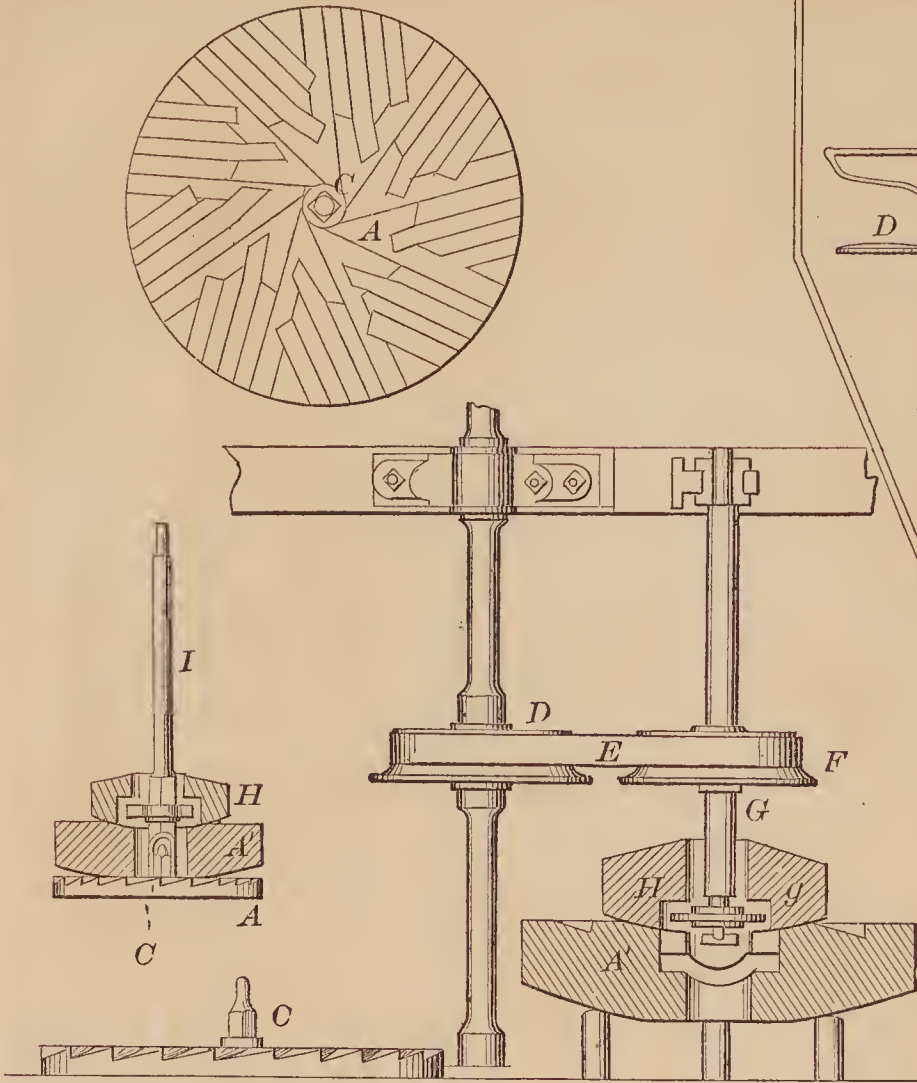

72593—I. Bisbee—*Balance.*

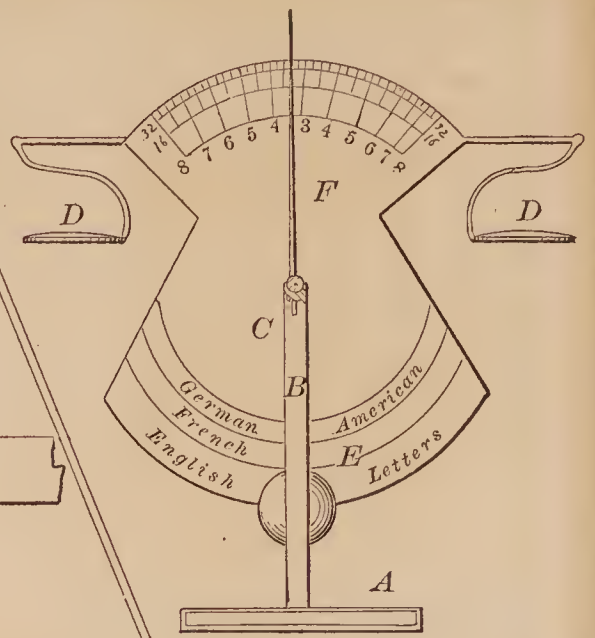

72588—H. B. Barber—*Churn.*

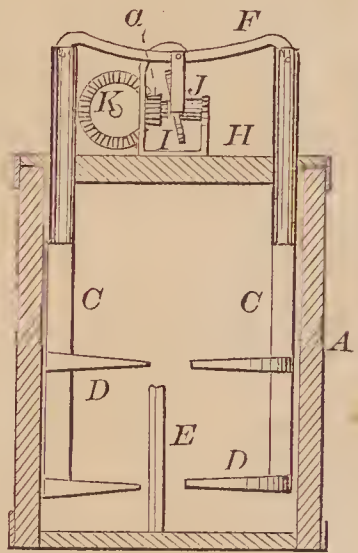

72595—M. Bötticher—*Steam Gauge.*

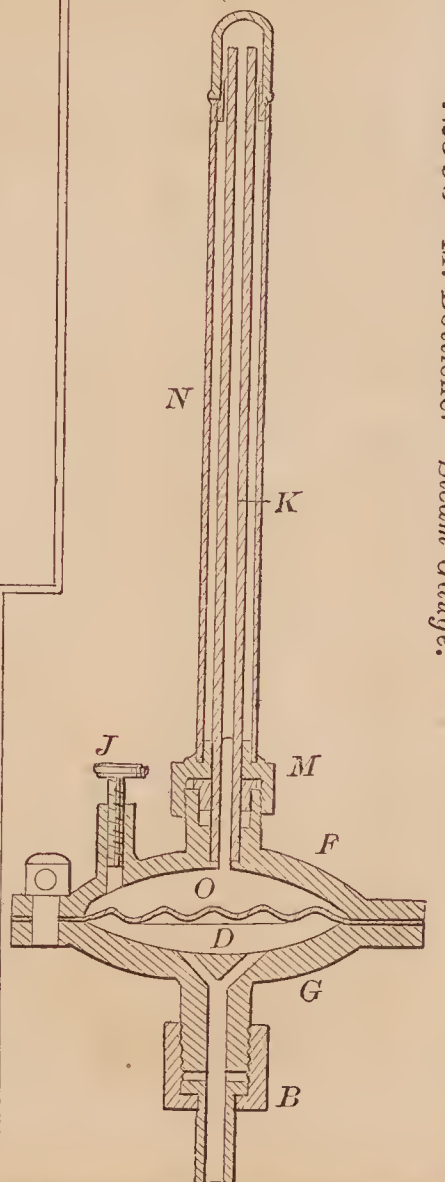

72591—J. E. Bini—*Bracing Sounding Boards of Guitars.*

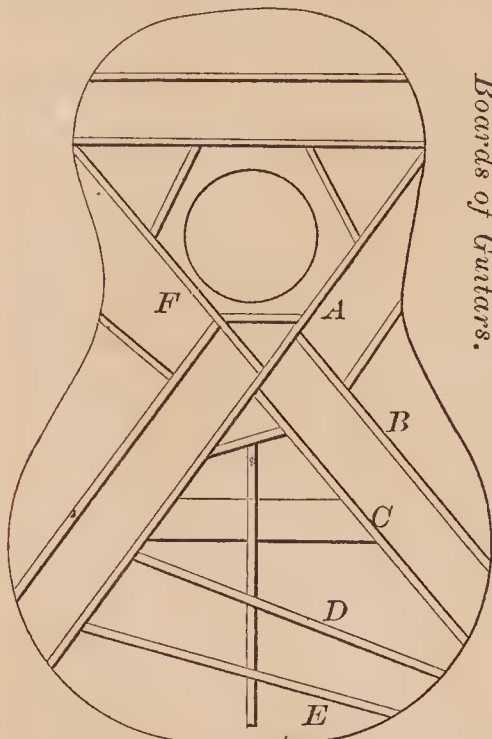

72589—H. Beebe—*Lantern.*

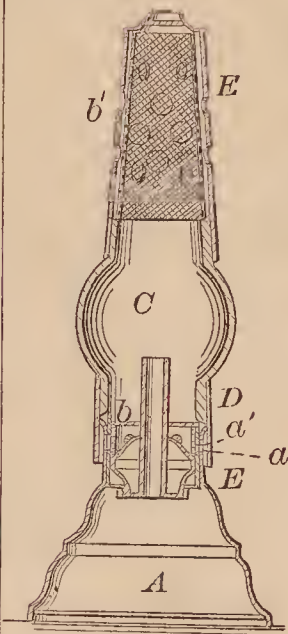

72594—T. B. Bishop—*Horse Shoe.*

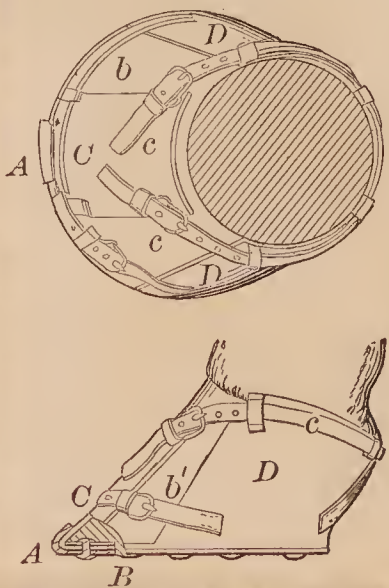

72592—W. E. Bird—*Washing Machine.*

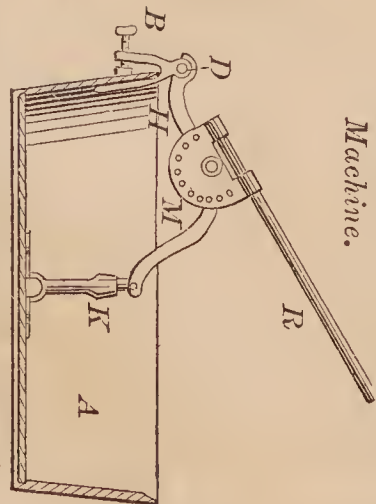

72598—J. E. Brooks—Cultivator.

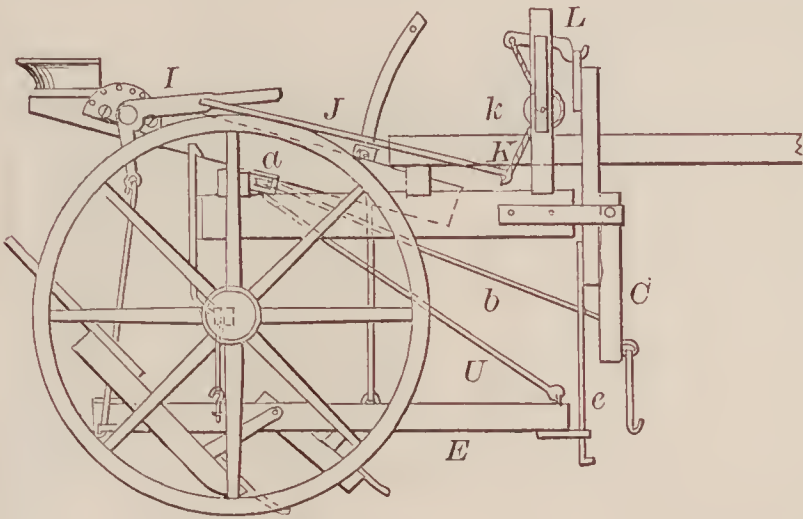

72596—T. E. O. Brinly—Plow Handle.

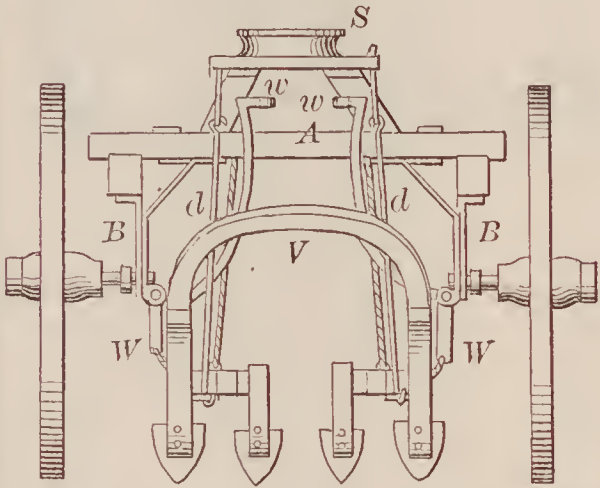
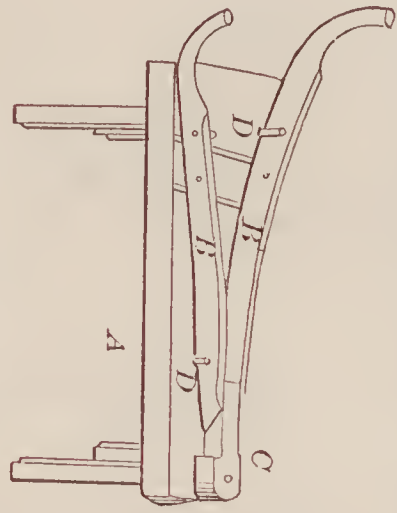

72602—E. Chamberlin—Carriage Seat.

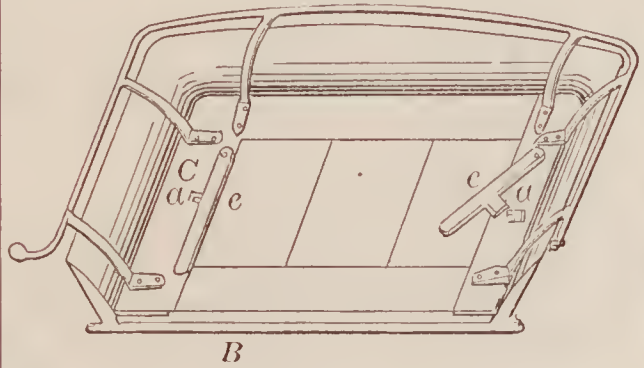

72599—R. D. Brown—Harvester Rake.

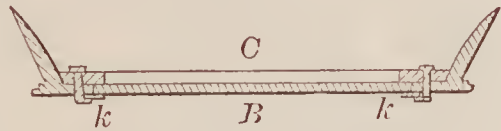
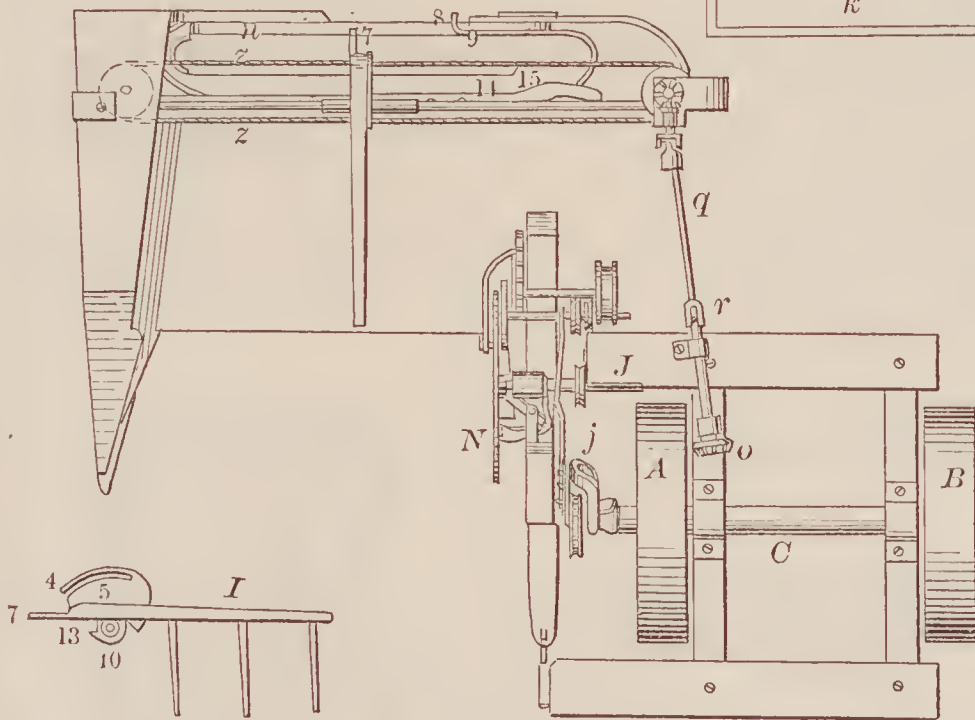

72597—C. B. Bristol—Attaching Door Knobs to Spindles.

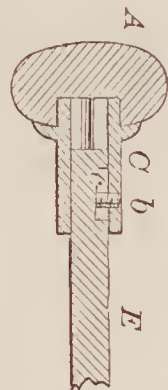

72600—P. Burke—Shutter Bolt.

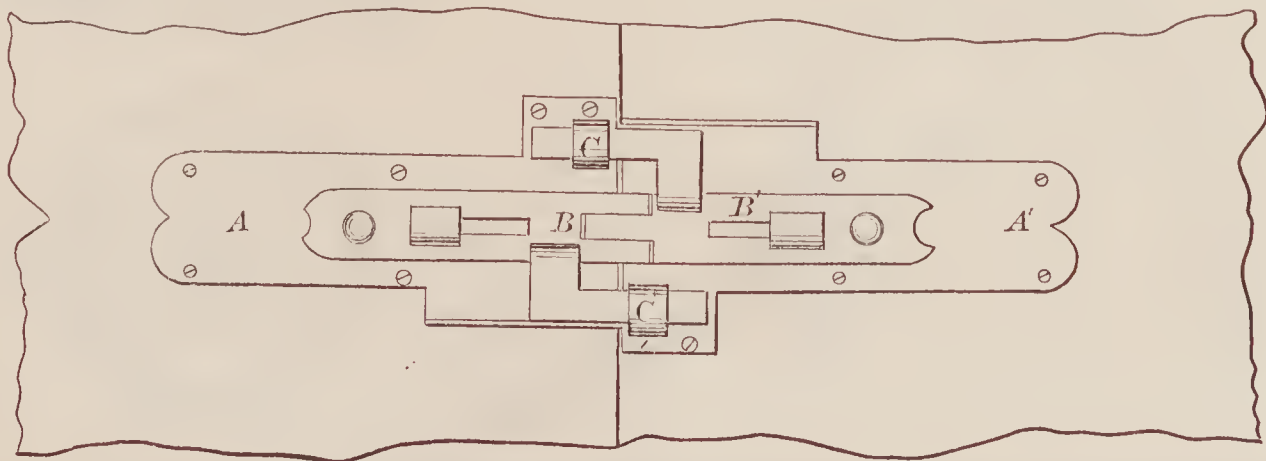



72603—P. P. Child—Window Shutter Hinge.

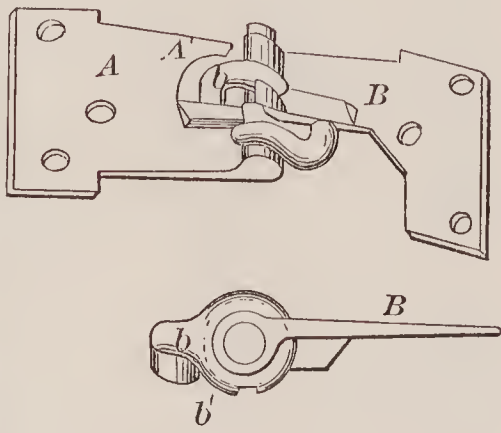

72607—G. Cuppers—Sewing Machine.

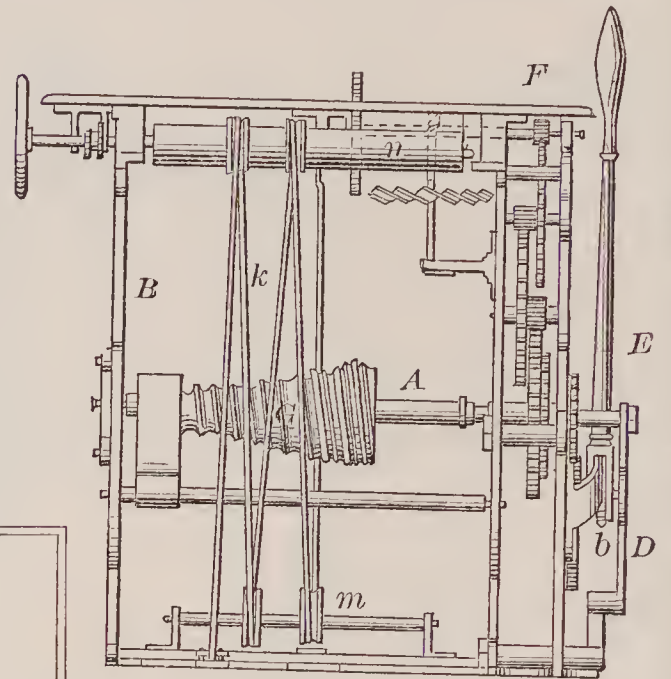

72608—C. M. Currey—Mechanical Movement.

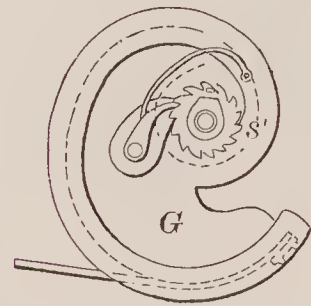
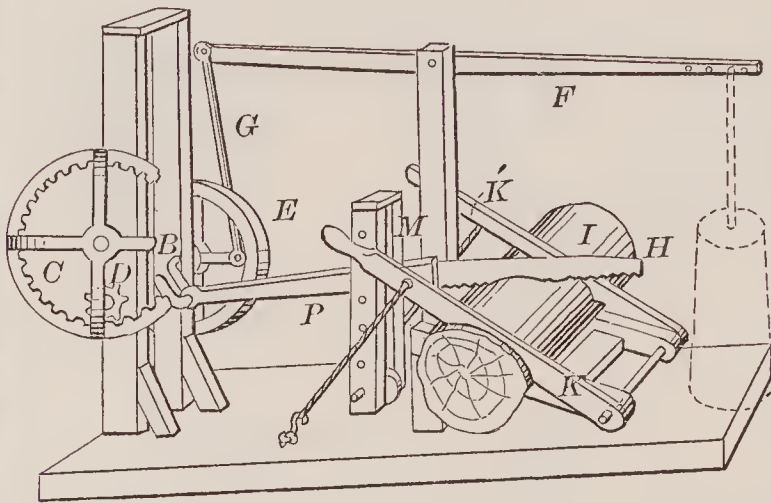

72606—F. W. Copeutt—For Labeling Bottle Corks.

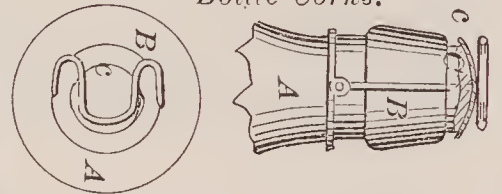

72605—Cook & Simmons—Bed Bottom.

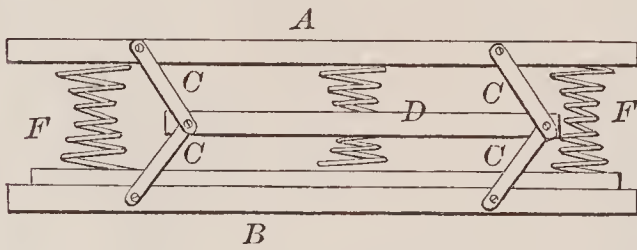

72610—A. Dart—Stove.

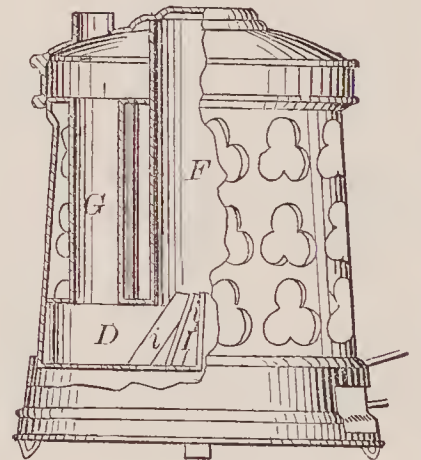

72609—J. Carrier—Blind Catch.

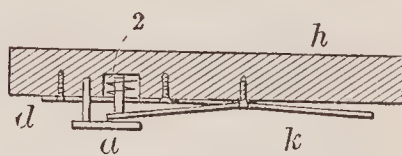

72604—J. Cole—Breast Pump.

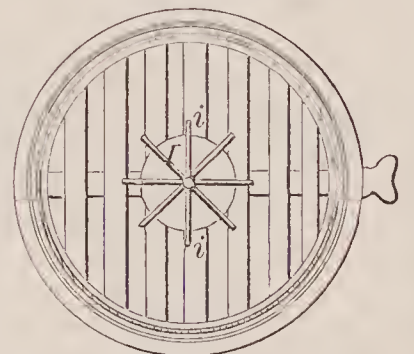
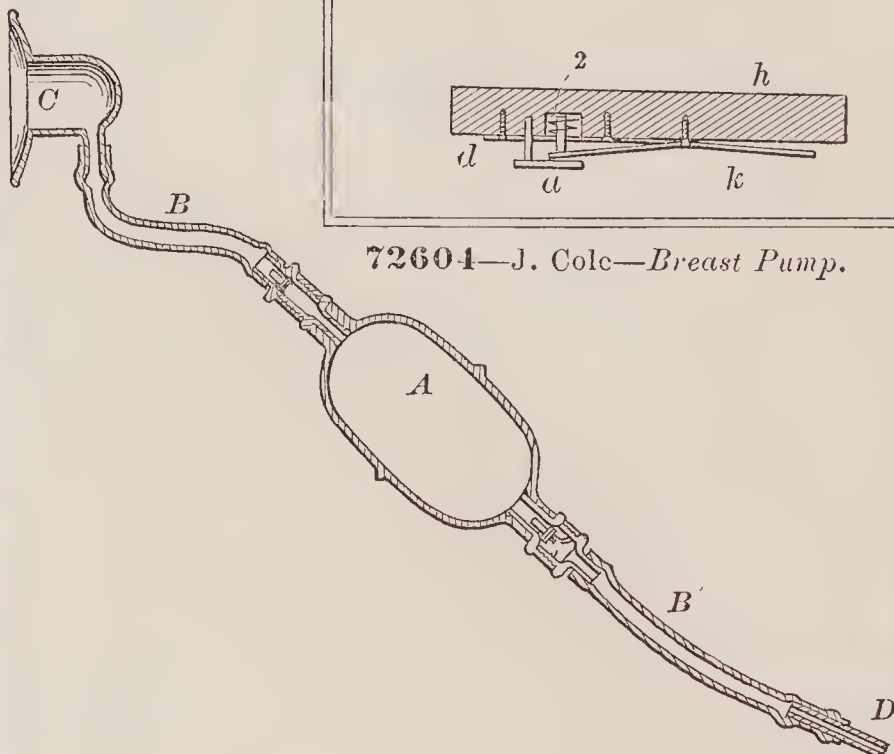

72612—J. Davis—Planetaryium.

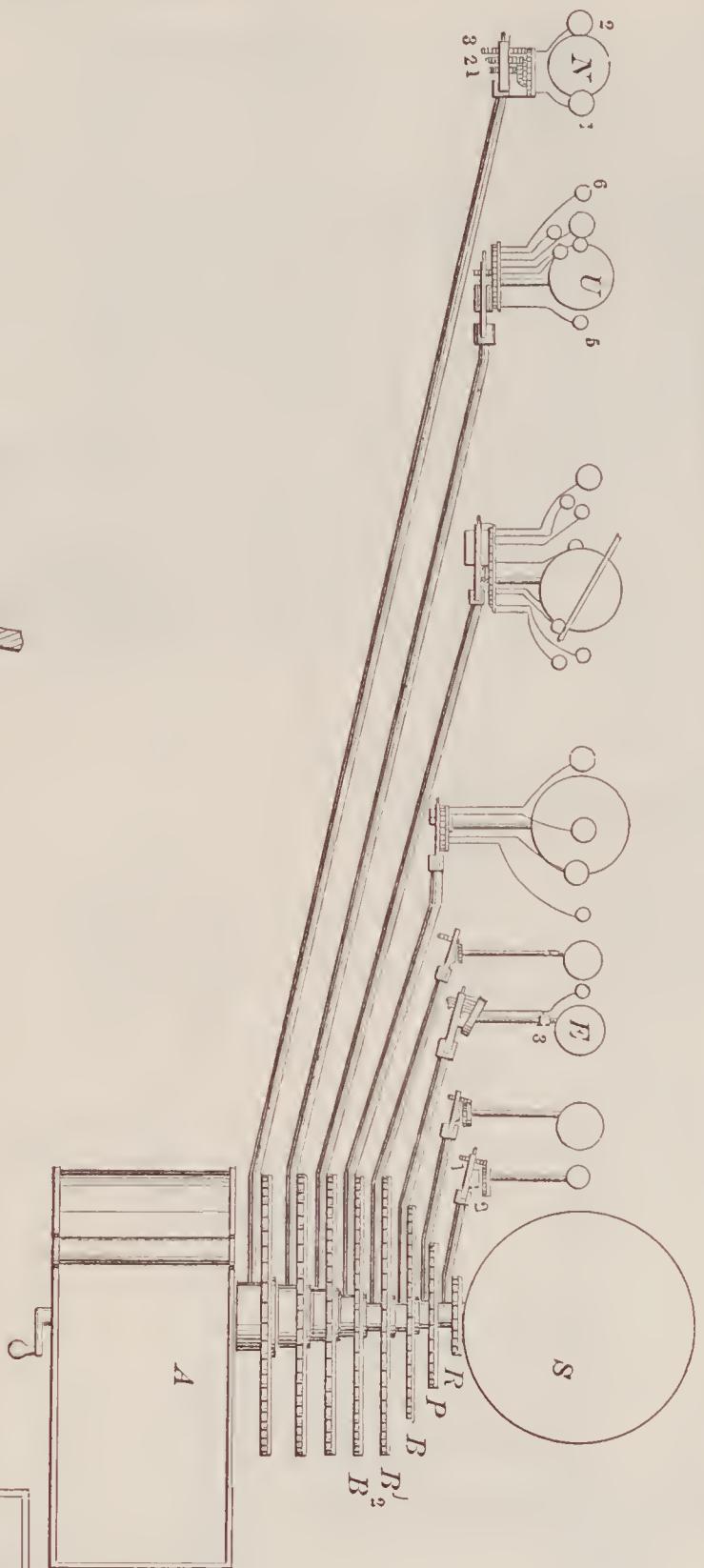

72611—J. Davenport—Bridge Girders.

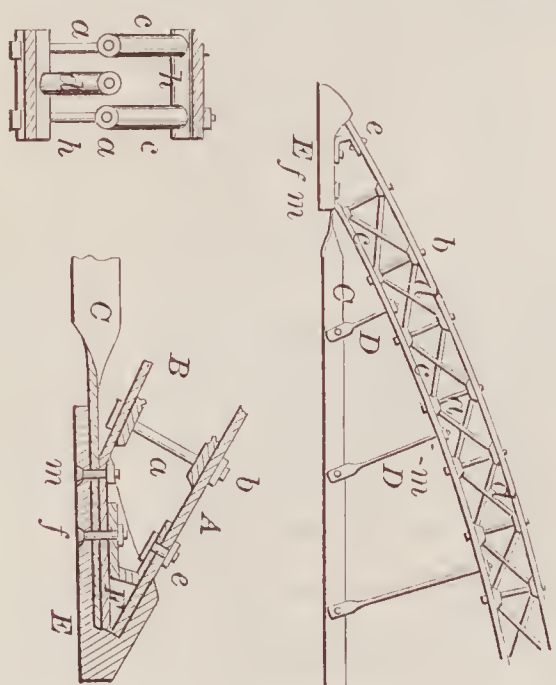

72615—L. Eddy—Weighing Scale.

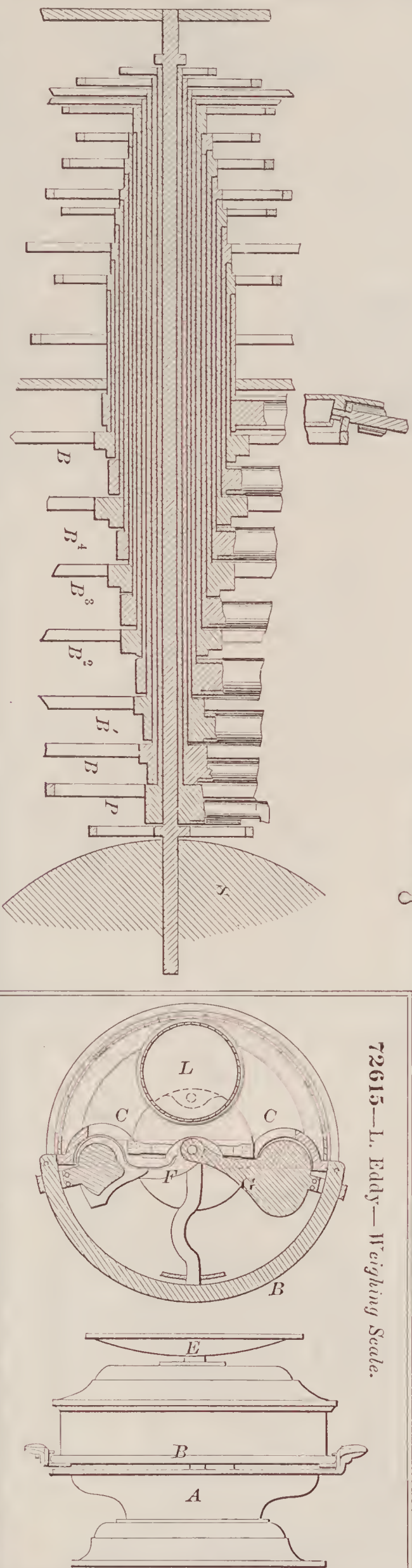



72618—B. Fitts—Planing Machine.

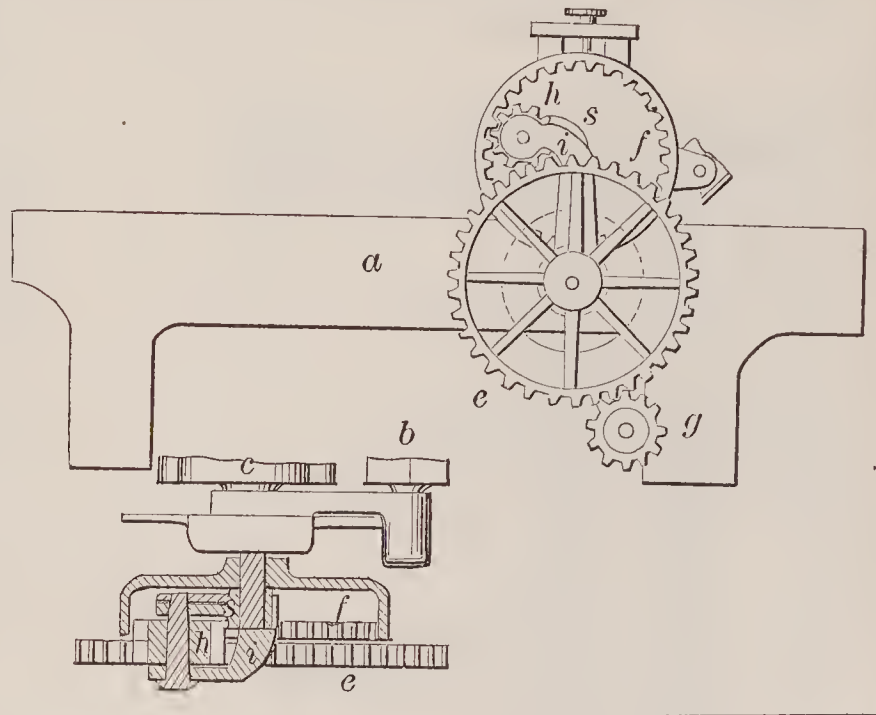

72616—M. G. Farmer—Lighting and Extinguishing Gas.

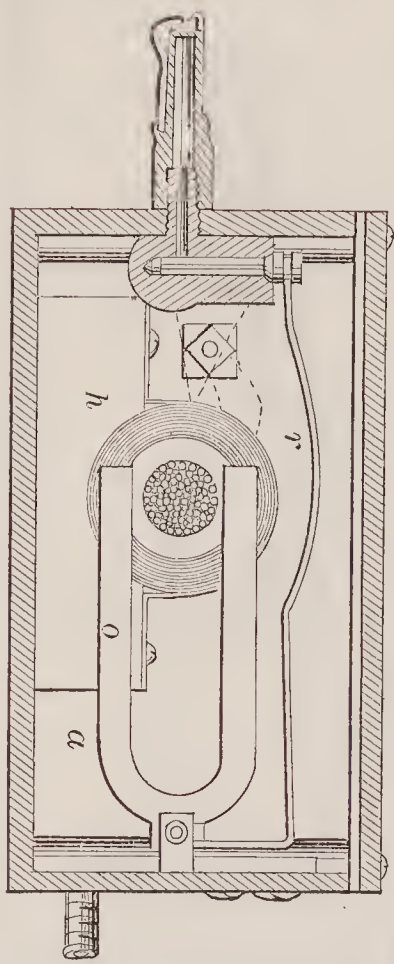

72620—G. R. Forsyth—Pump.

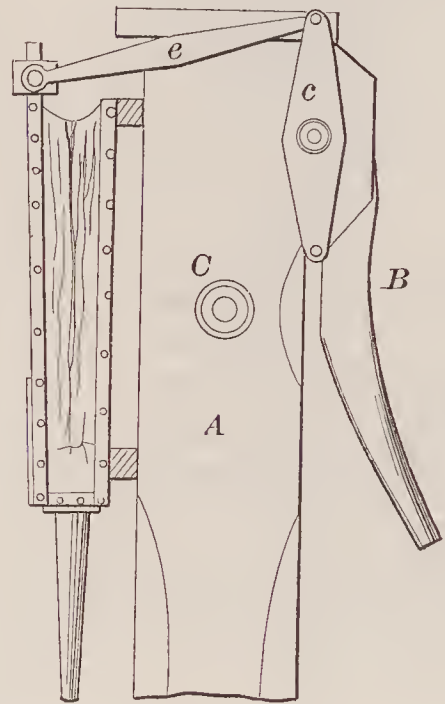

72622—J. T. Frankeberger—Cultivator.

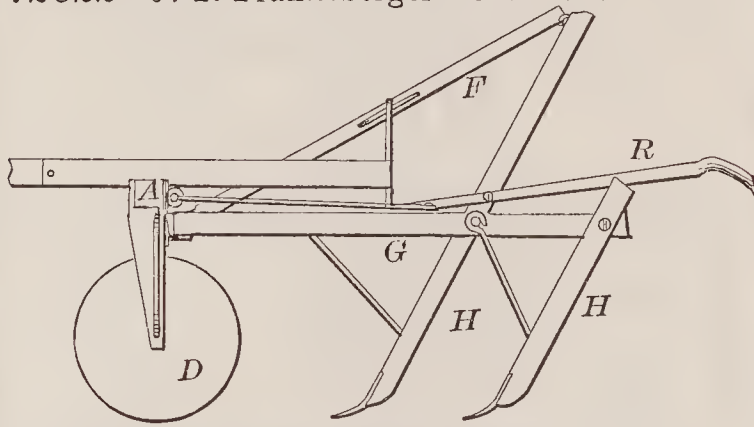

72623—J. T. Frankeberger—Harrow.

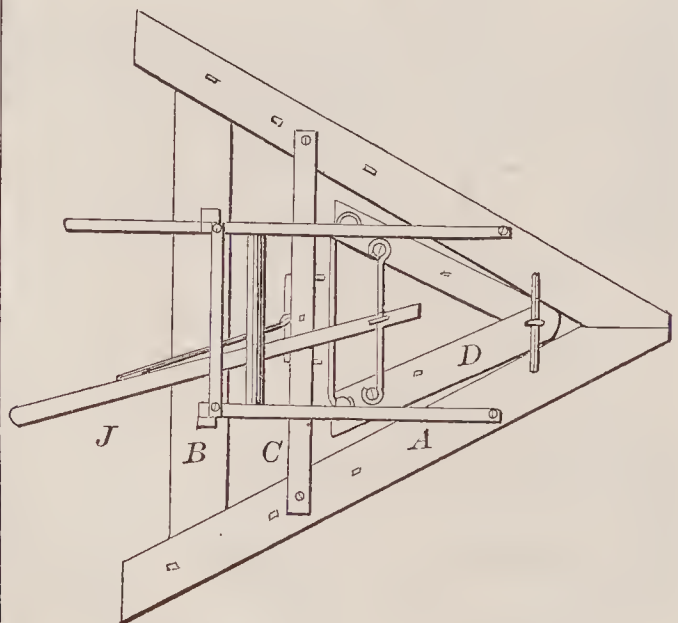

72619—B. Fitts—Planing Machine.

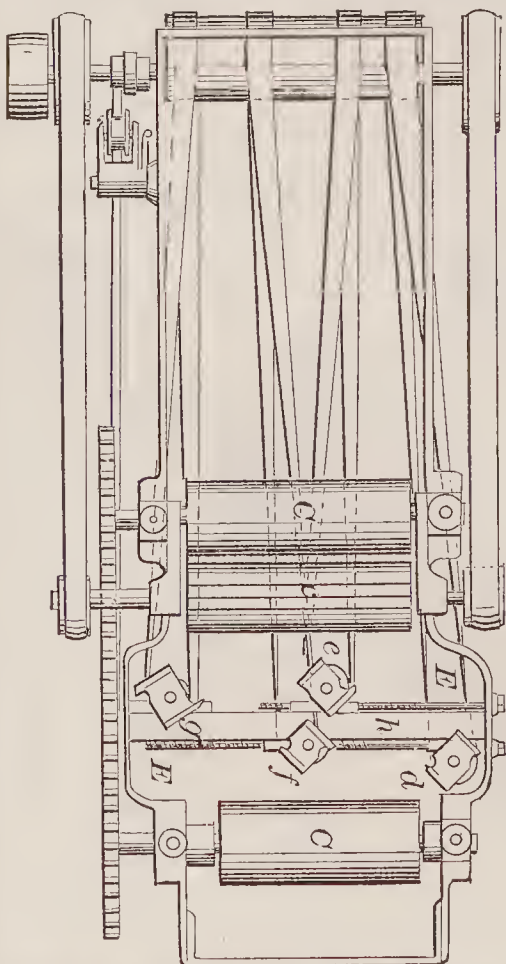





72631—J. G. Hadfield—*Medical Vacuum Apparatus.*

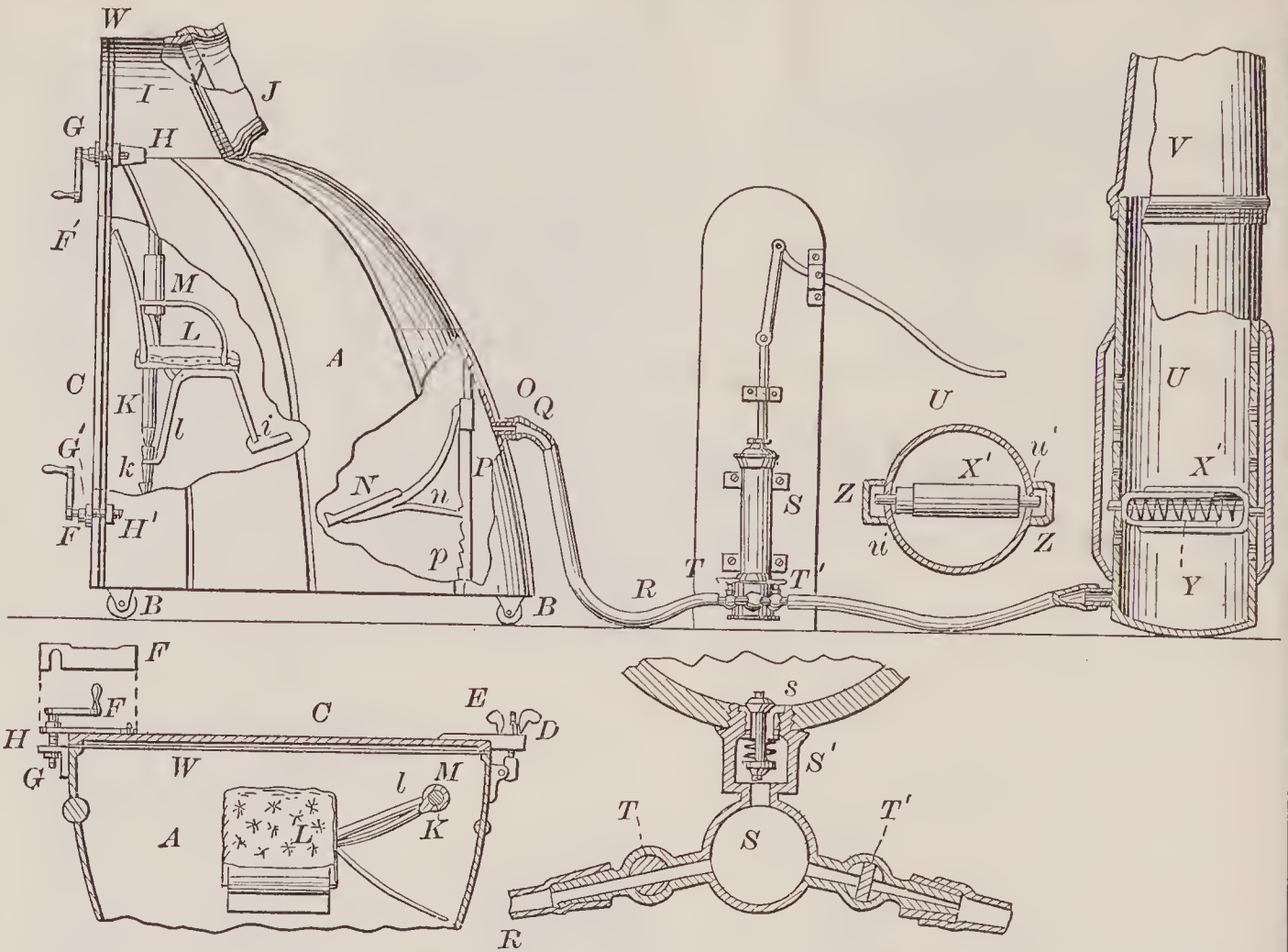

72632—D. F. Hartford—*Stringing Bow Drill Stock.*

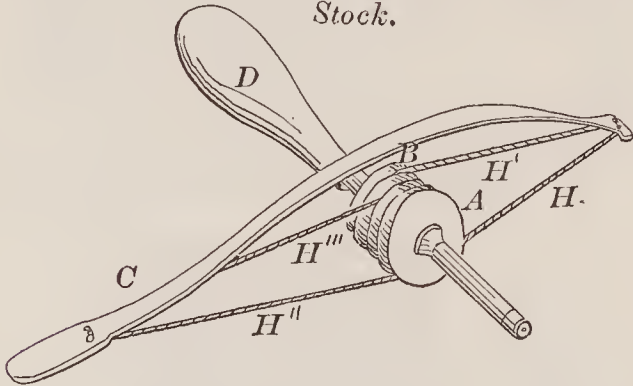

72634—L. Heywood—*Wooden Chair Seat.*

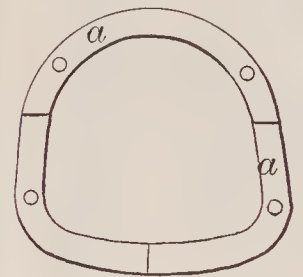

72633—H. A. Harvey—*Wood Screw.*



72635—L. Heywood—*Socket for Revolving Chairs.*

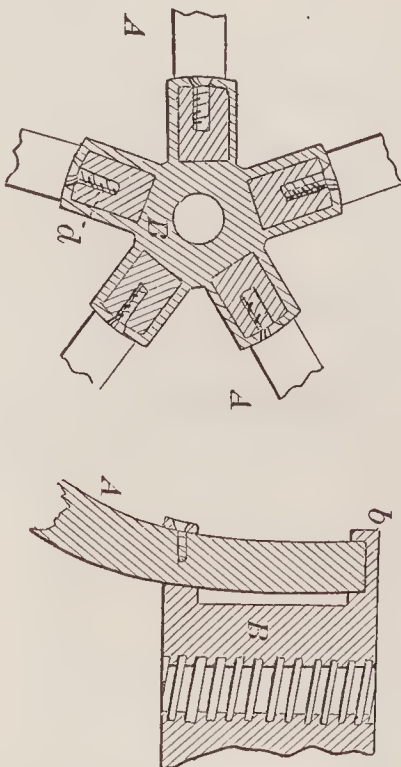

72636—W. C. Hicks—*For Polishing Cylindrical Concave Surfaces.*

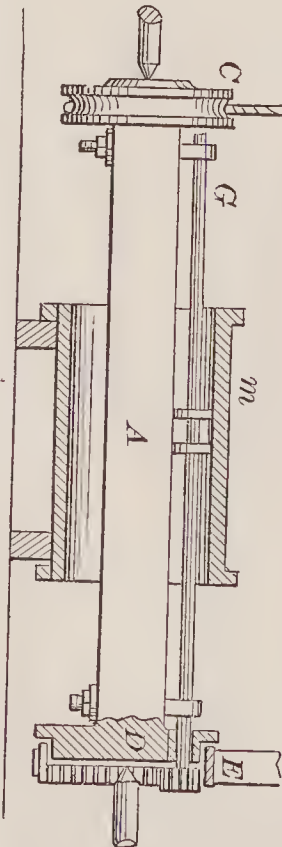

72638—C. M. Hodges—*Scythe.*

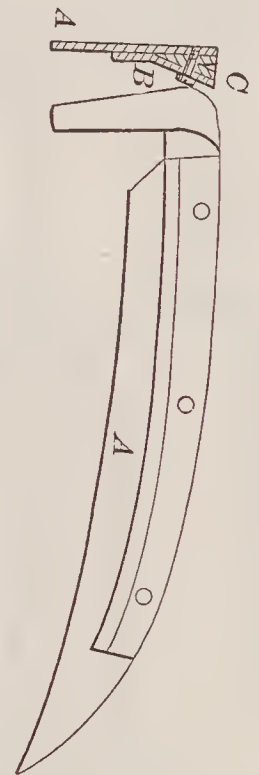

72640—W. E. Hopkins—*Stave Machine.*

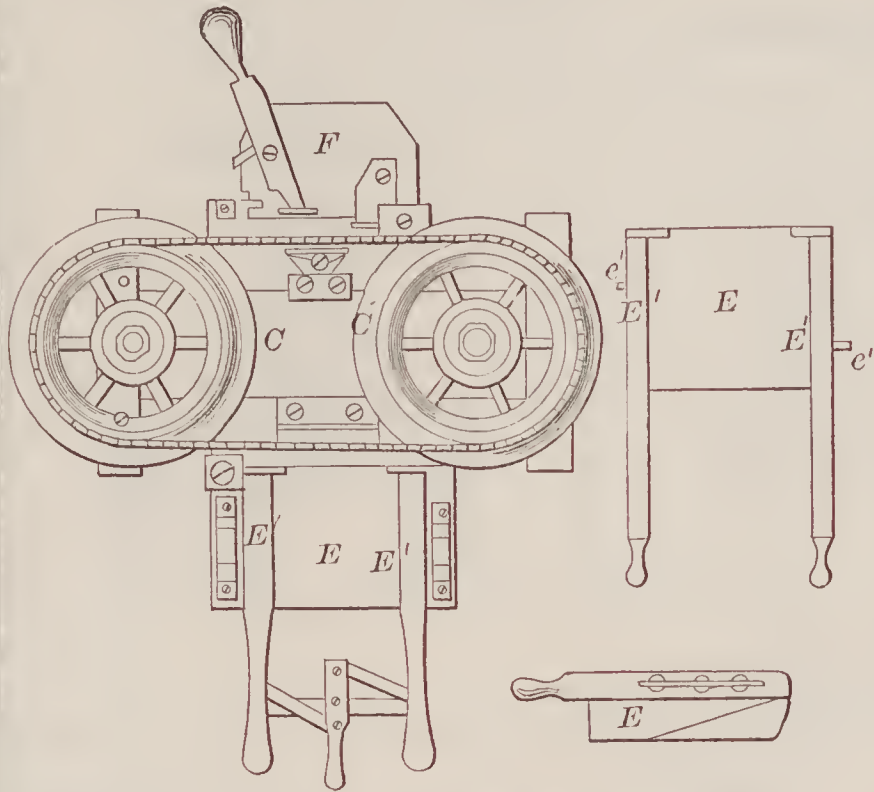

72641—E. B. Horn—*Watch.*

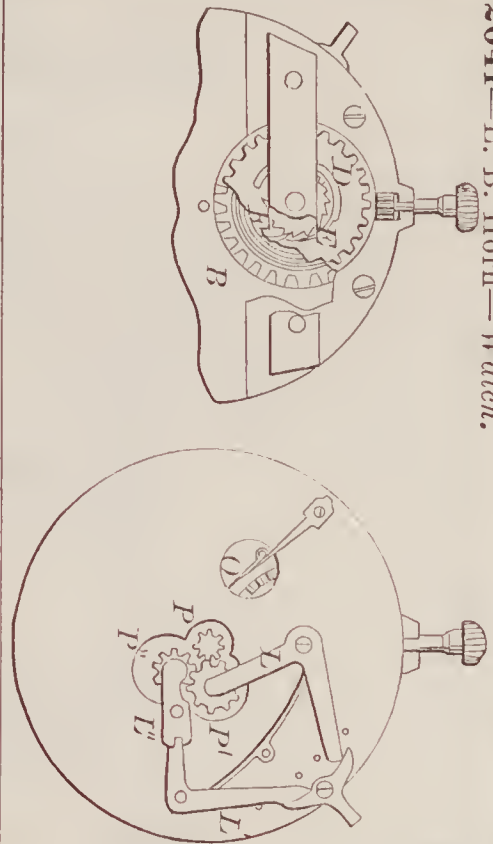

72639—C. J. Holman—*For Sawing Barrel Heading.*

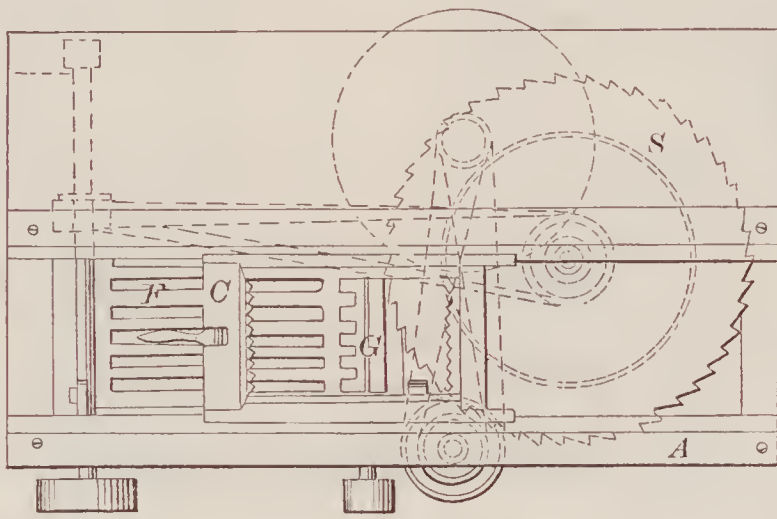

72644—W. B. Johns—*Harvester Rake.*

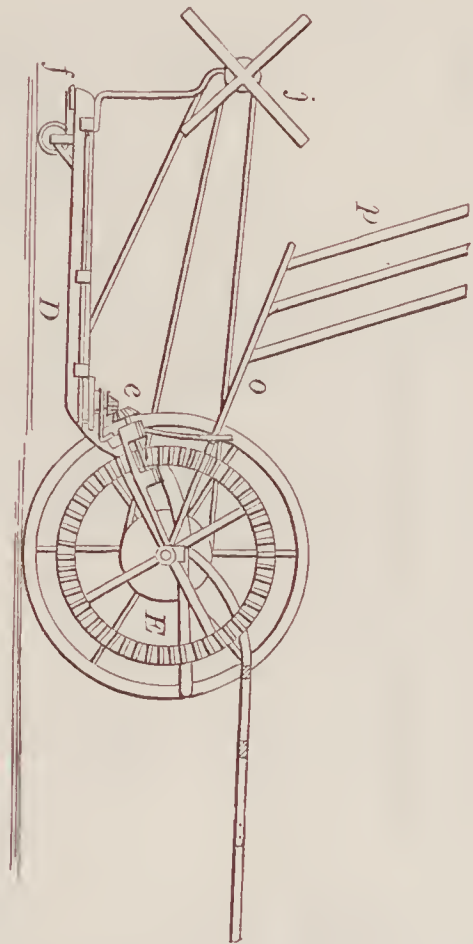

72642—O. T. Horr—*Sewing Machine.*

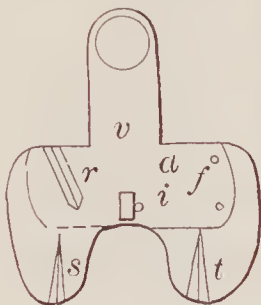

72643—H. G. Hubert—*Gas Regulator.*

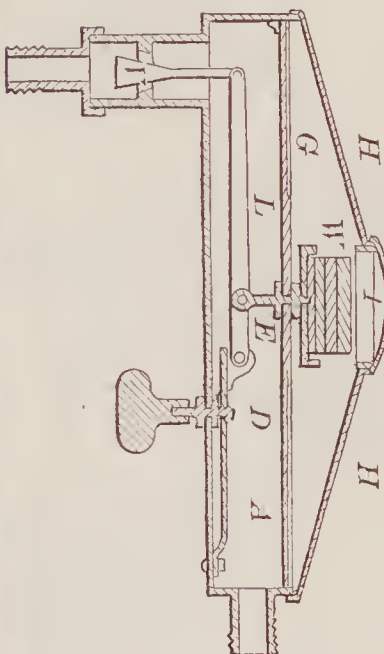

72645—J. A. Kinkle—*Oven.*

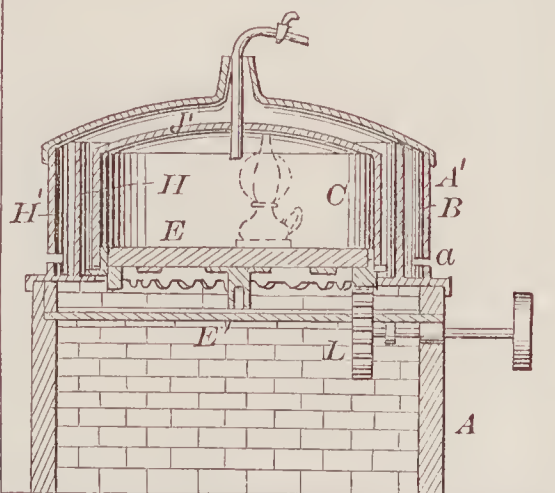



72646—G. Kuhlmann—Table.

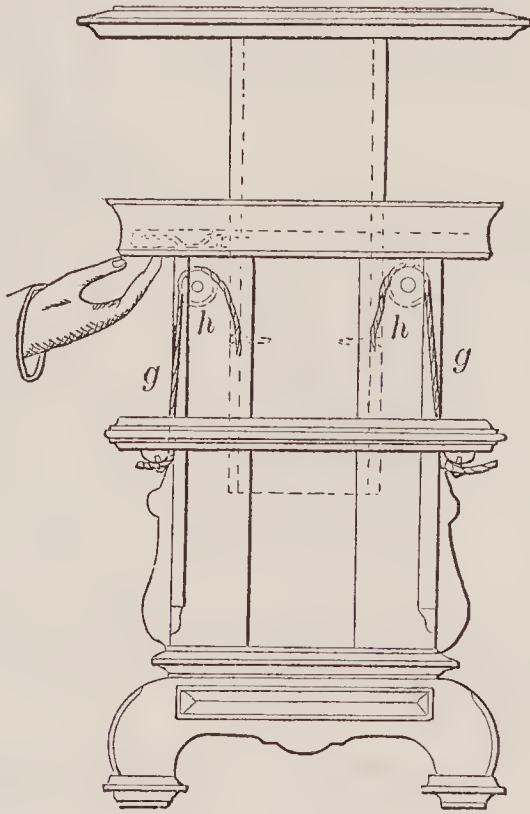
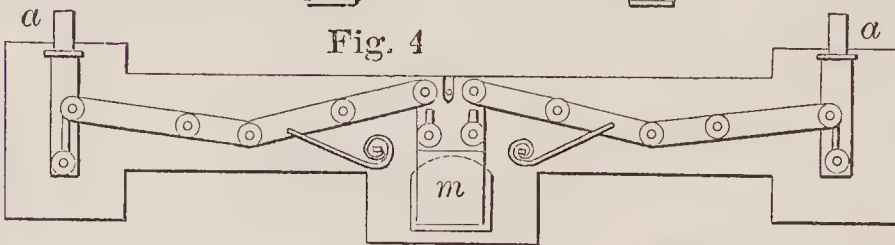
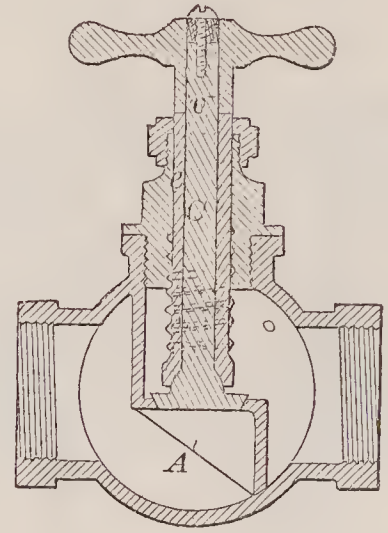

Fig. 4



72650—J. B. Lowell—Globe Valve.



72647—J. Lee, Jr.—Cloth Washing Machine

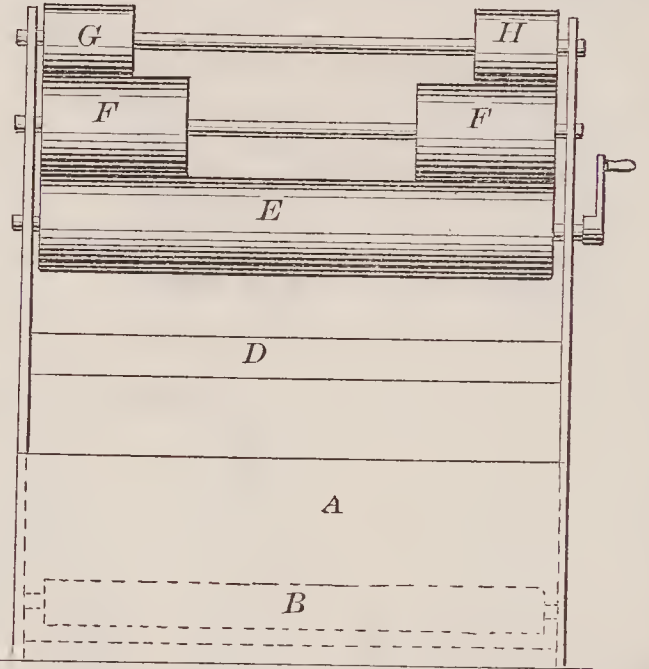

72649—Love & Ball—For Channeling Rock.

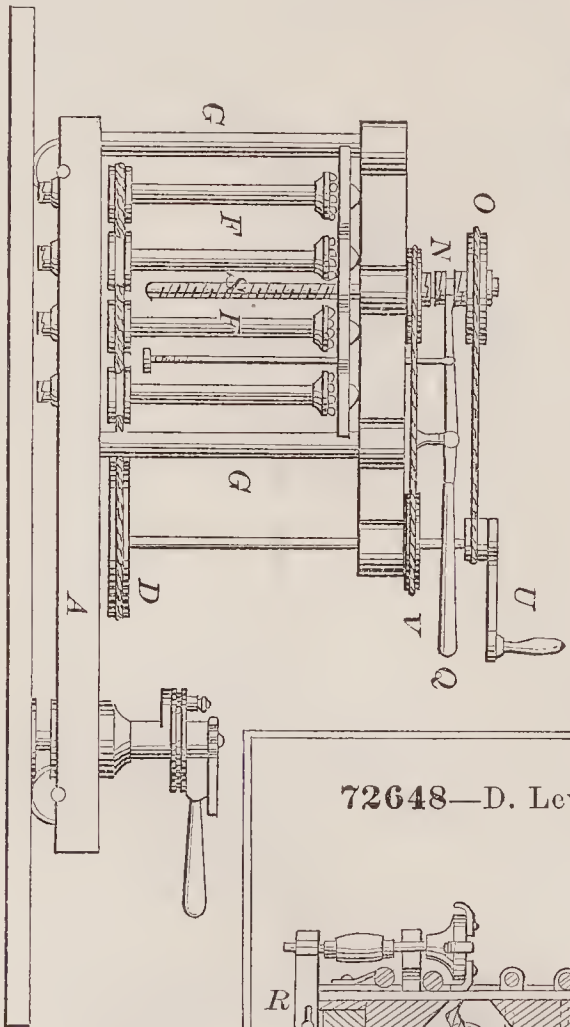

72648—D. Lewers—Stave Machine.

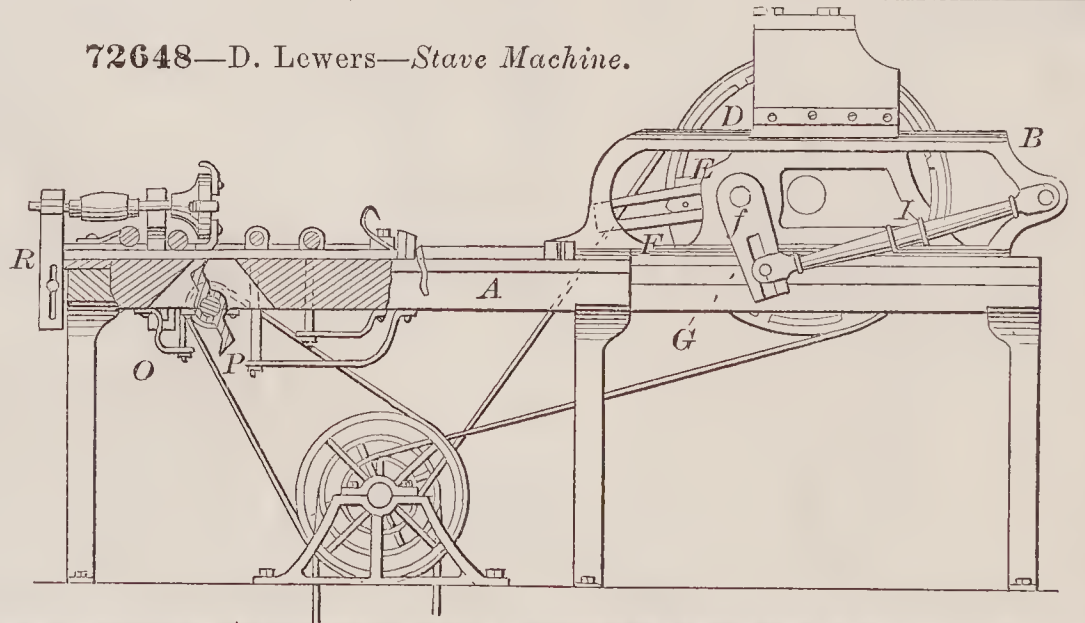

72651—J. J. Lower—Beehive.

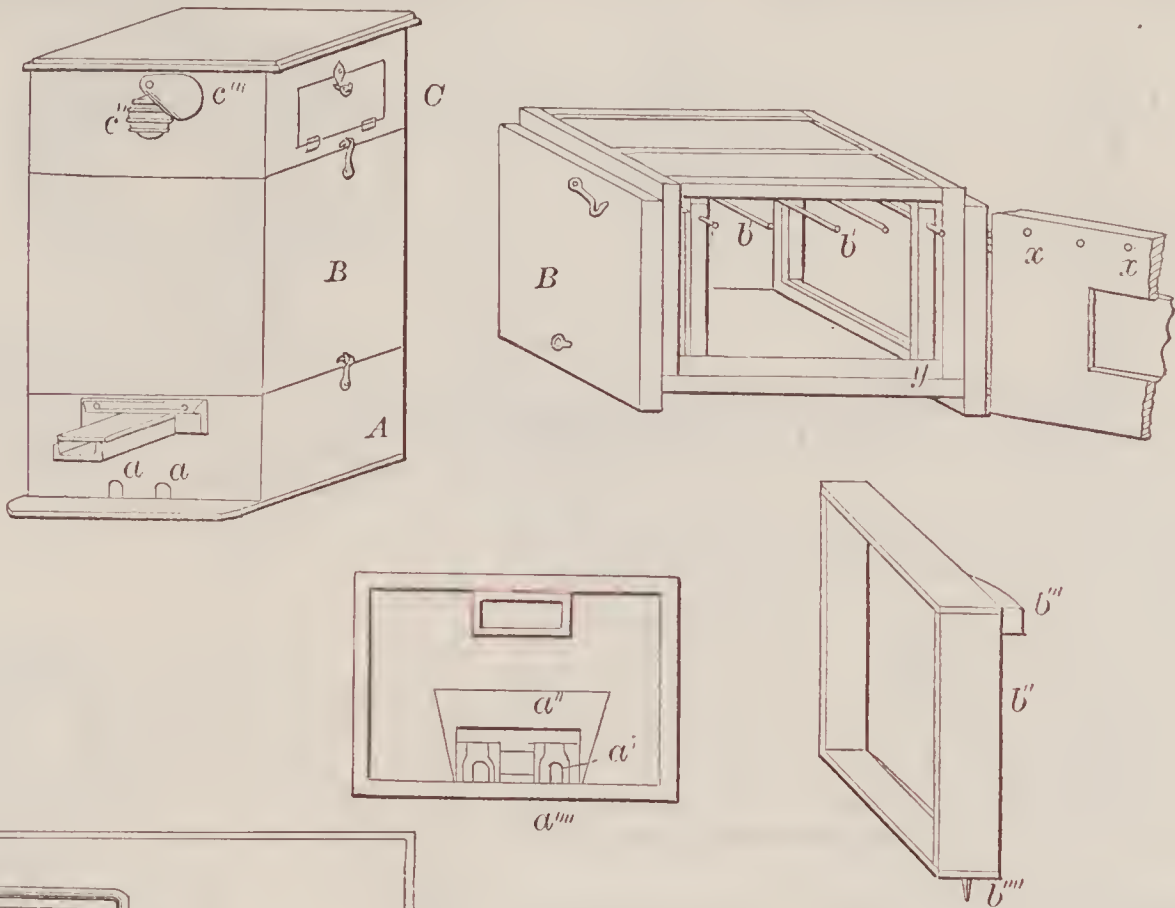

72653—S. B. Mann—Land Roller.

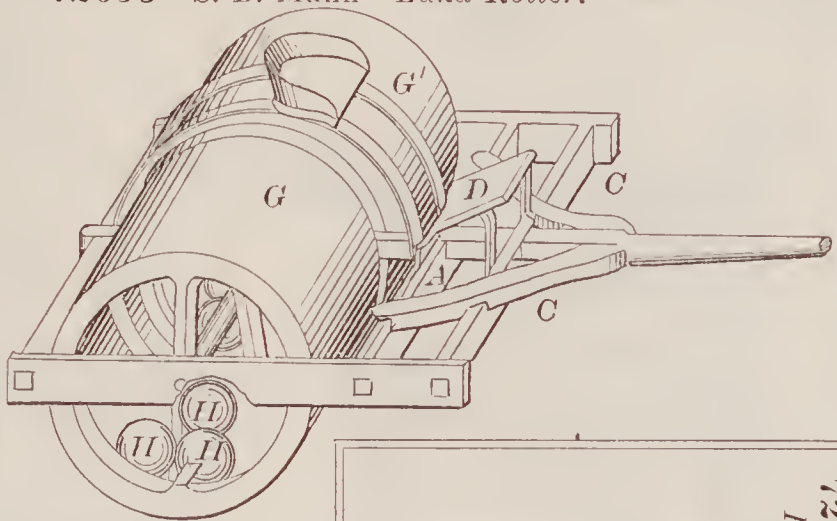

72652—J. Madden—Inward for Circular Saws.

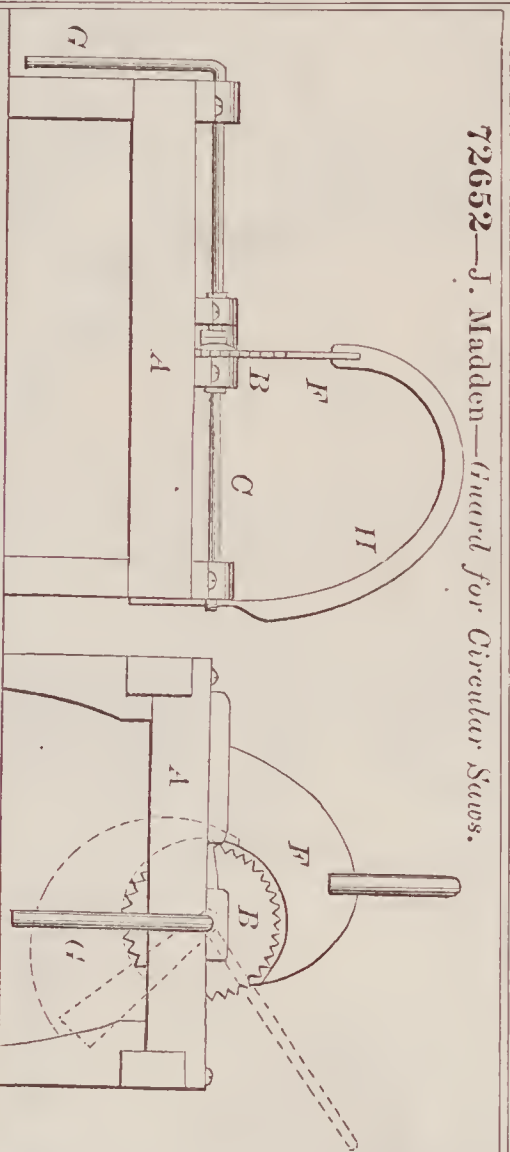

72656—T. P. Marshall—Stamp Wetting and Pen Cleaning.



72654—J. P. Manton—Tool Holder.

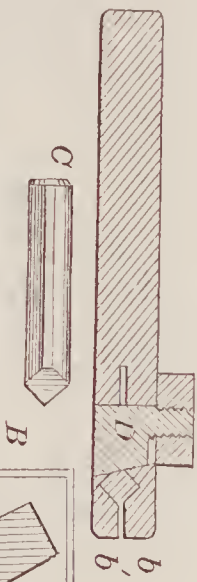

72655—S. Marden—Nail Drawer.

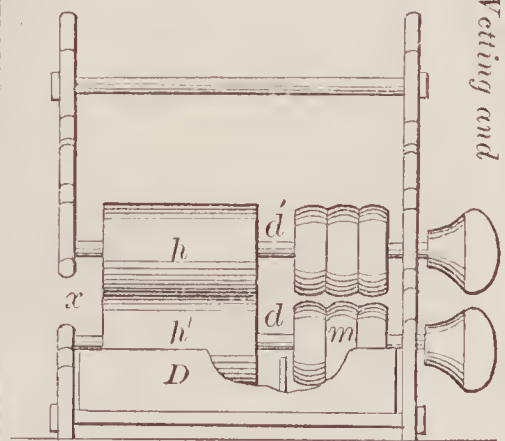
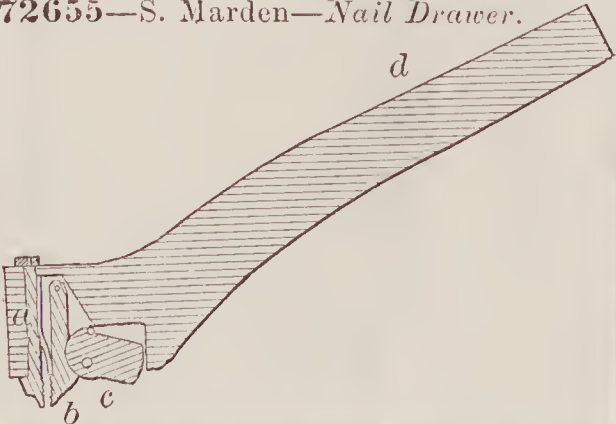



72657—C. F. Mawbey—Gate.

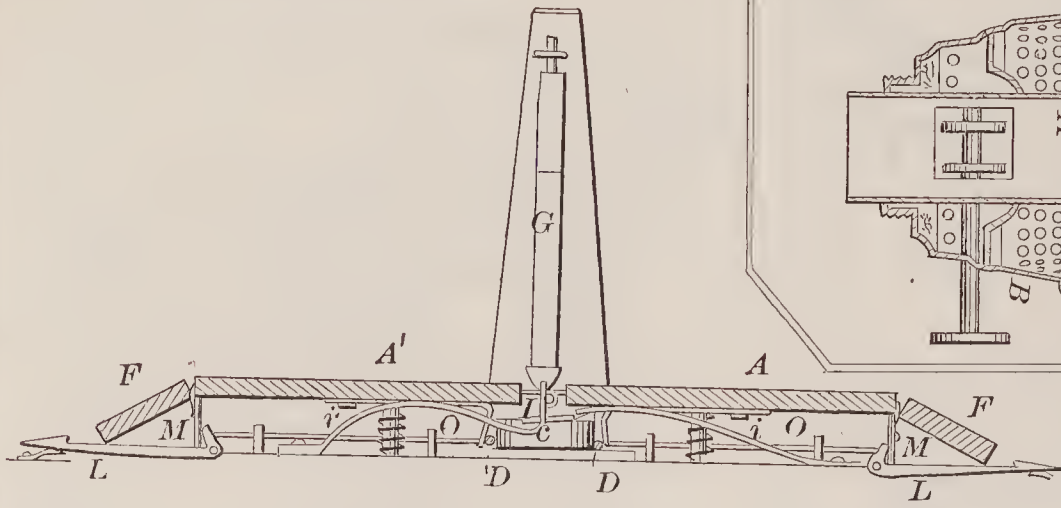

72659—W. McCaine—Lamp Burner.

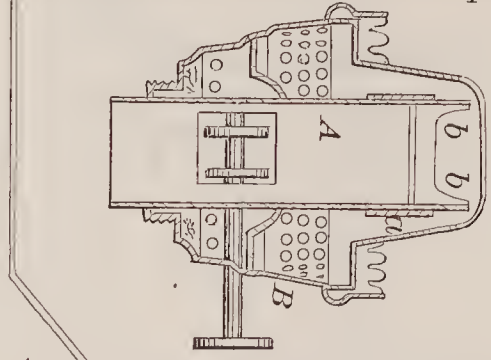

72660—J. W. McDonald—Printing Press.

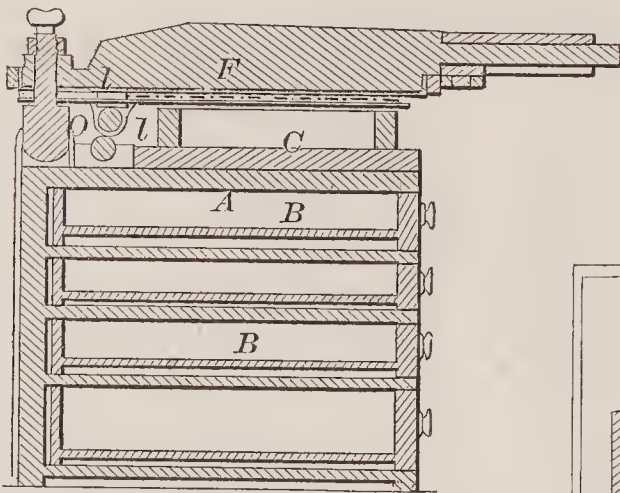
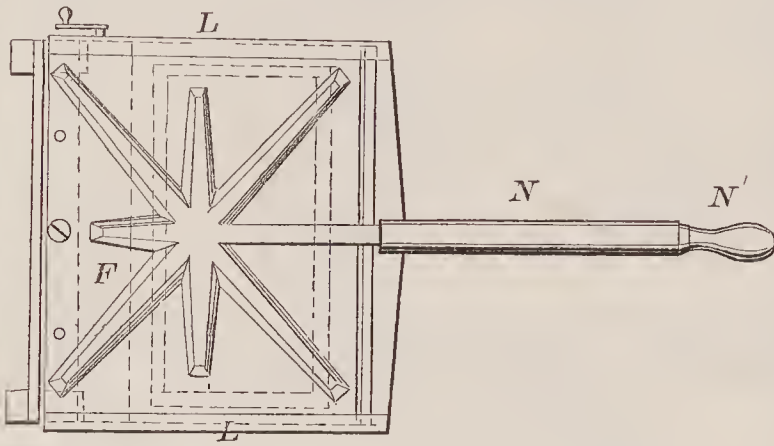

72662—H. S. McRae—School Desk.

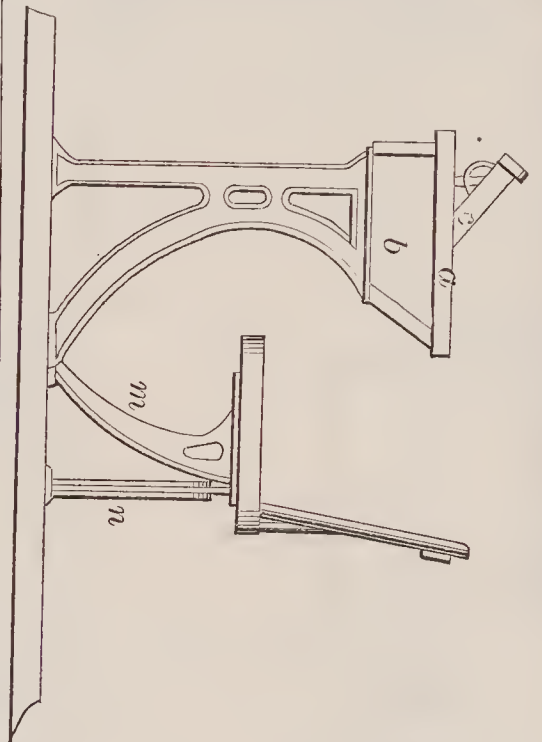

72664—W. J. Millar—Car Coupling.

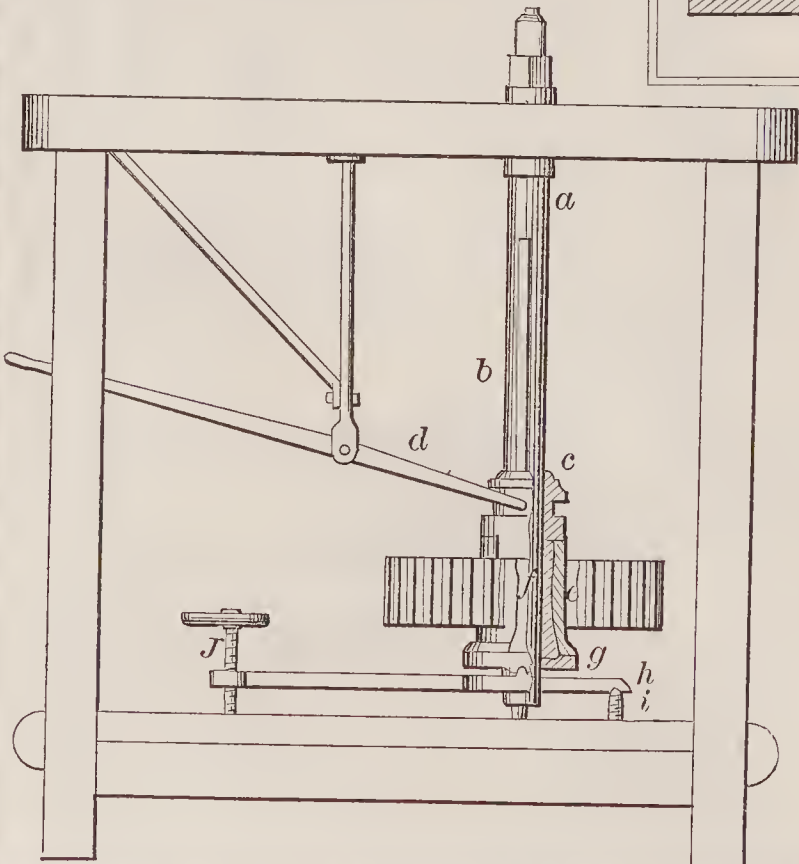
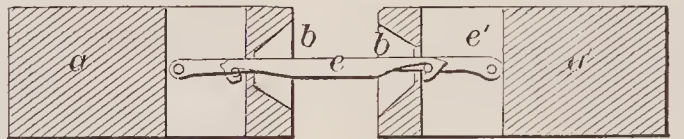

72661—J. H. McMinn—Mill Spindle.

72663—M. J. Mellyn—Securing Felloes.

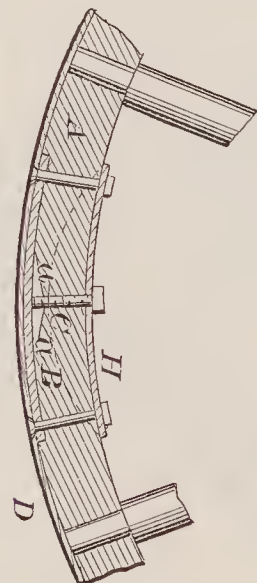

72665—S. Mills—*Car Coupling.*

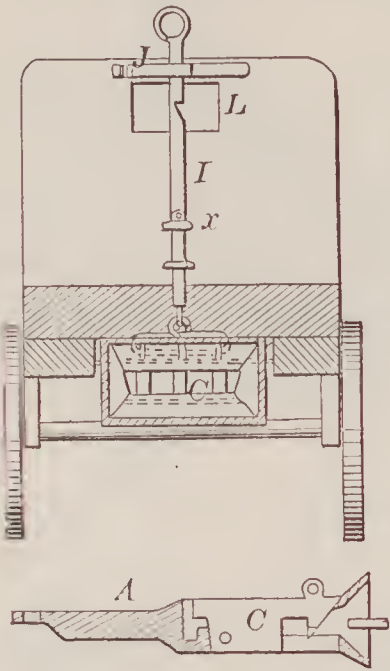

72666—T. A. Mitchell—*Carriage Curtain Fastening.*

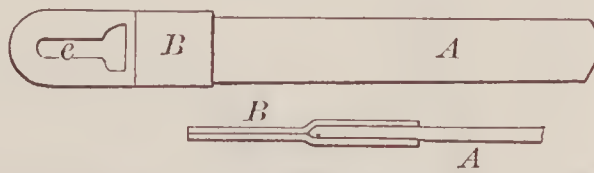

72667—J. H. Montrose—*Hinged Fishing Rod.*

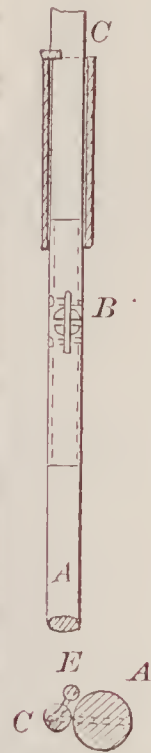

72668—C. J. Nelson—*Rocking Chair.*

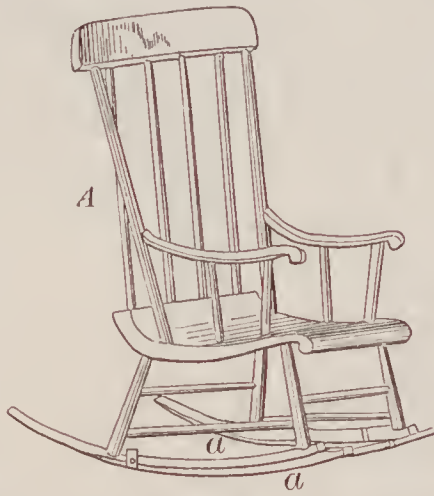

72672—I. T. Pease—*Fire Alarm.*

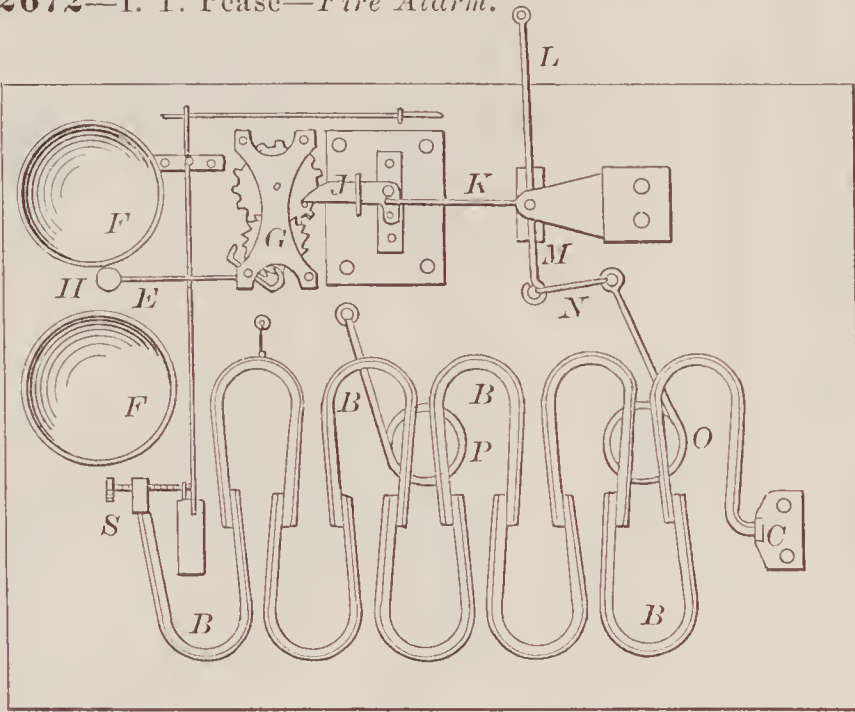

72669—J. Noland—*For Bending Metals.*

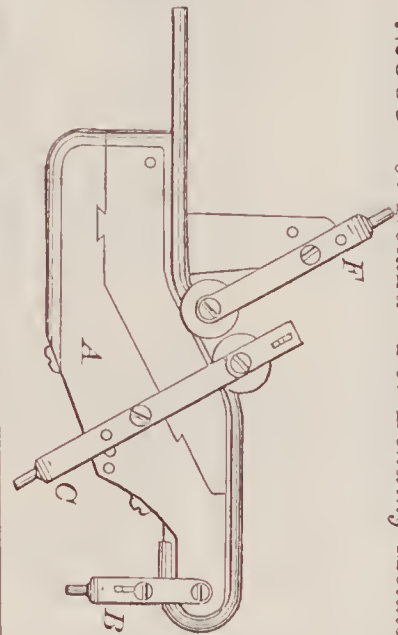

72673—J. Pelsor—*Churn.*

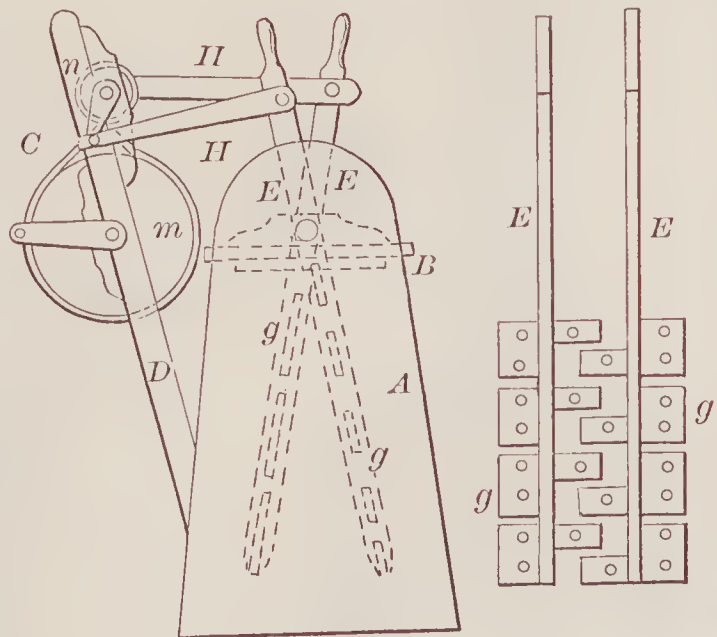

72671—J. Parish—*Drag Hook.*

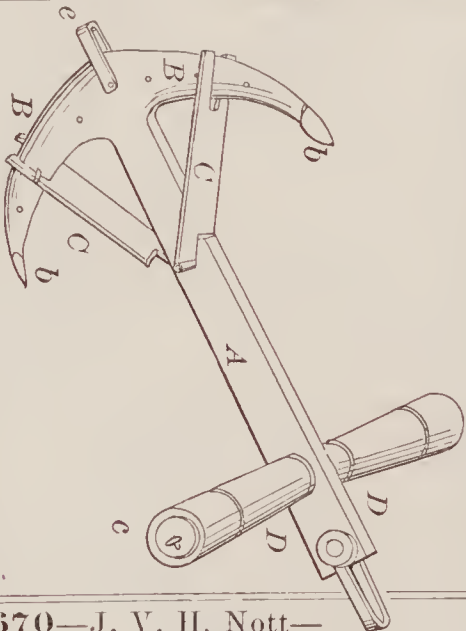

72670—J. V. H. Nott—*Construction of Checkers.*

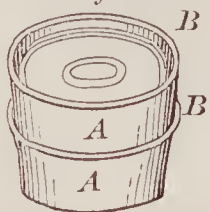



72675—M. E. Phillips—*Threshing Machine.*

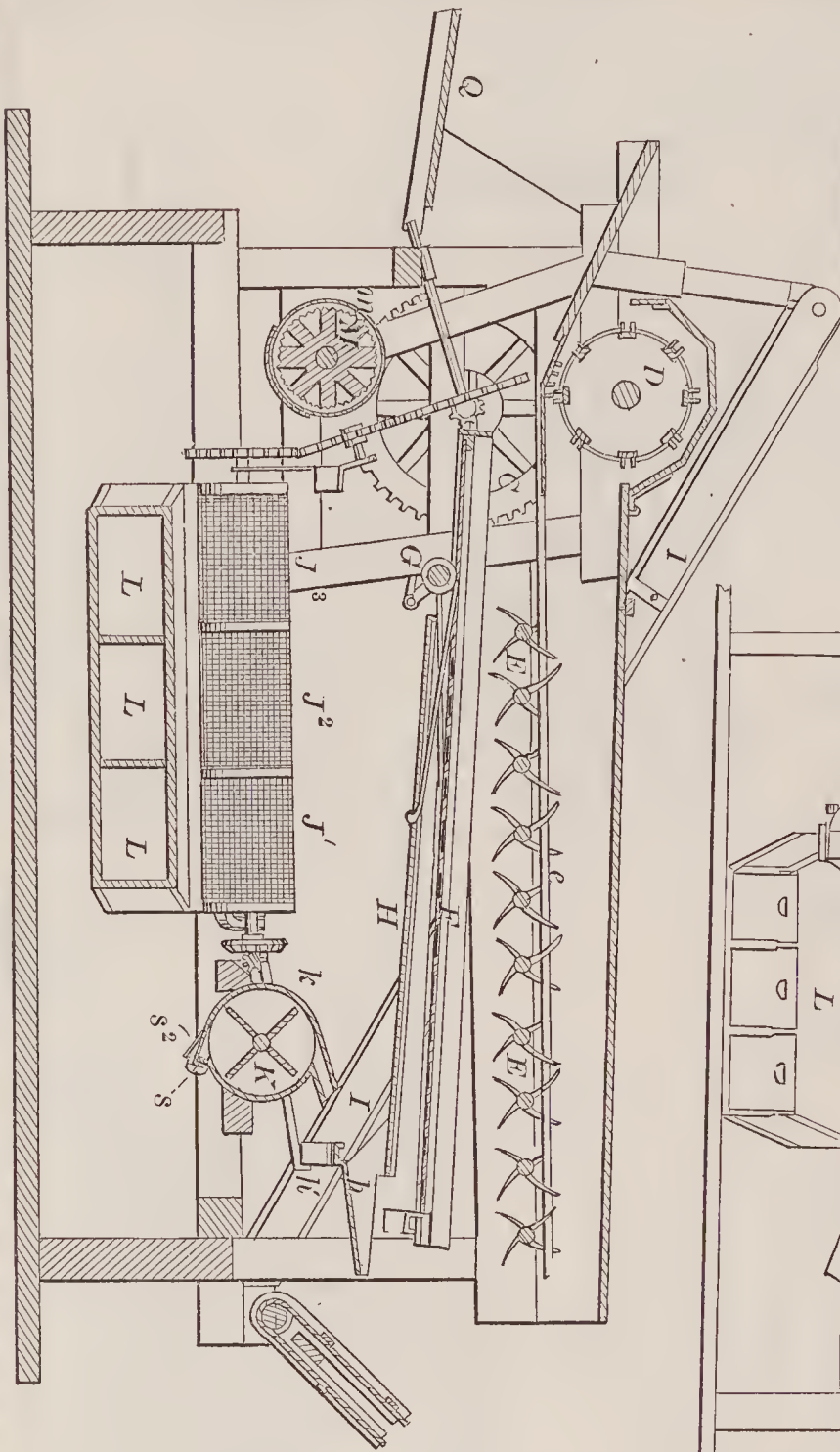

72676—G. W. Powers—*Sewing Machine.*

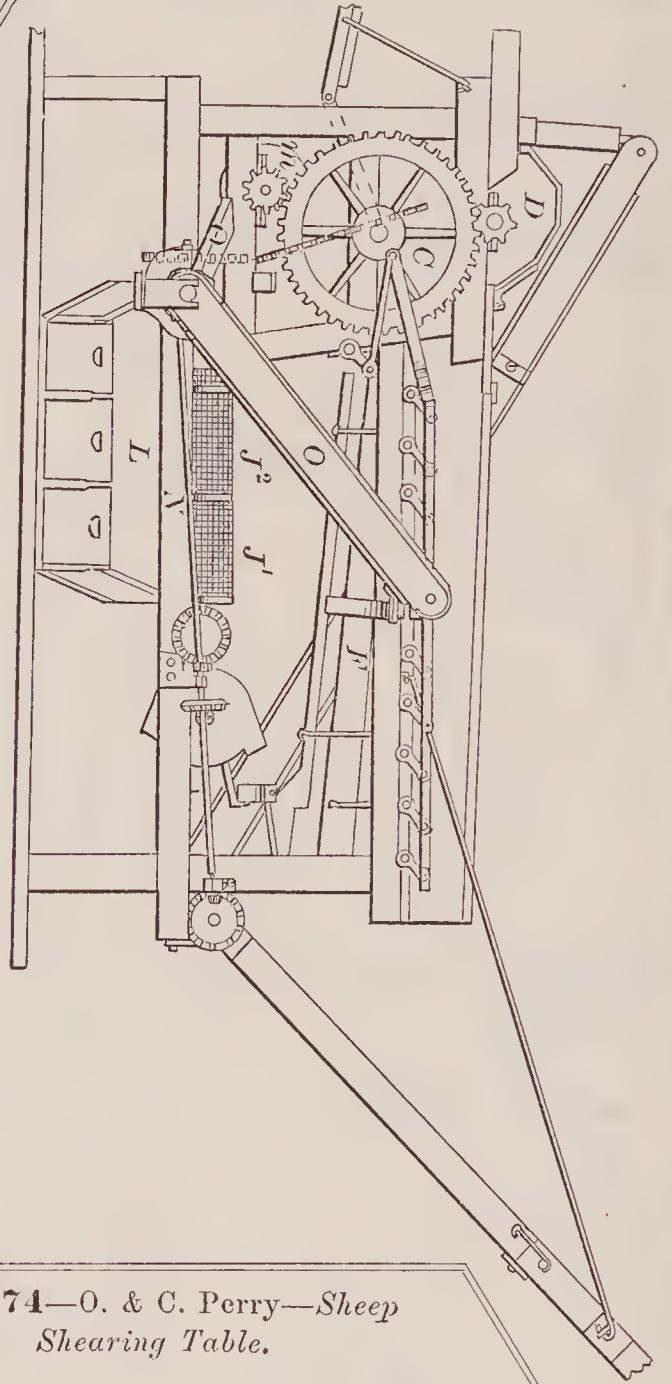
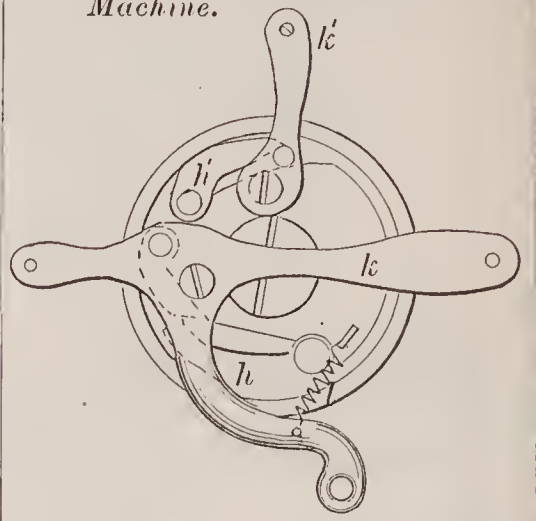

72677—T. T. Prosser—*Brush and Mop Head.*

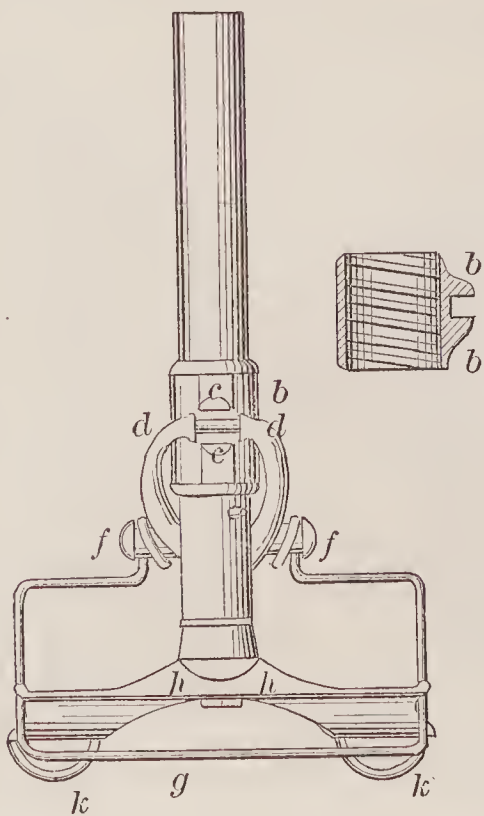

72674—O. & C. Perry—*Sheep Shearing Table.*

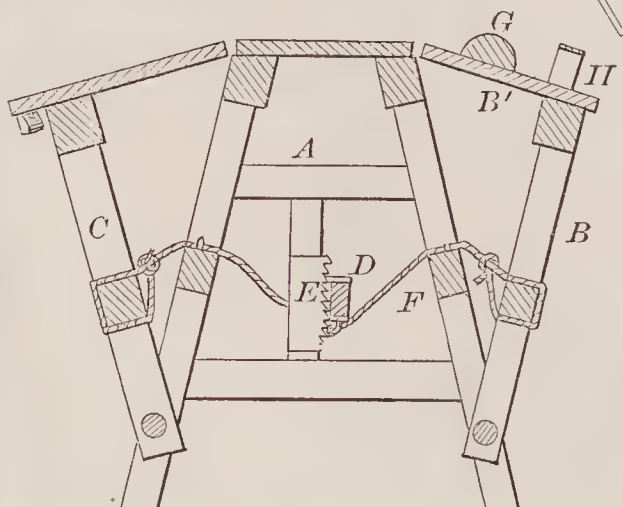

72678—Quick, Opie & Ferrand—Harvester.

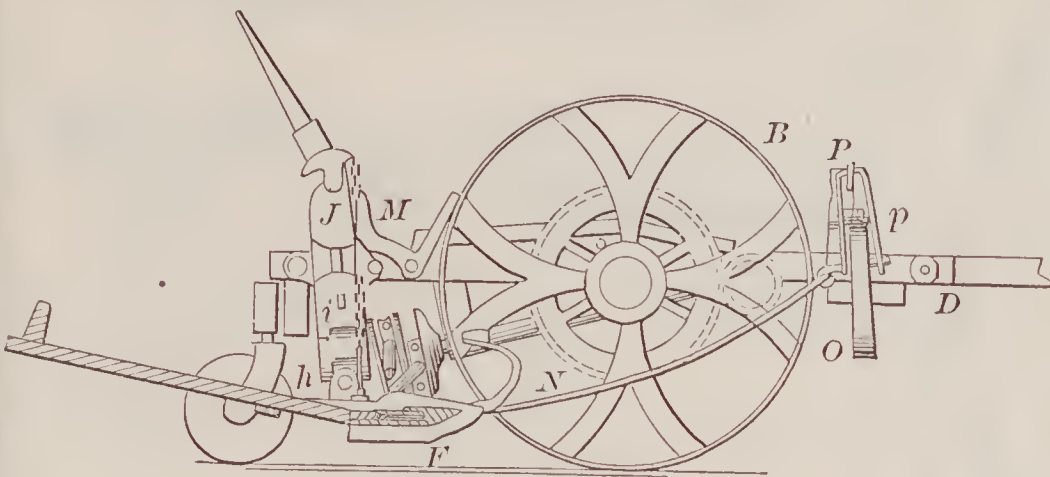

72679—B. L. Randall—Railway Carriage.

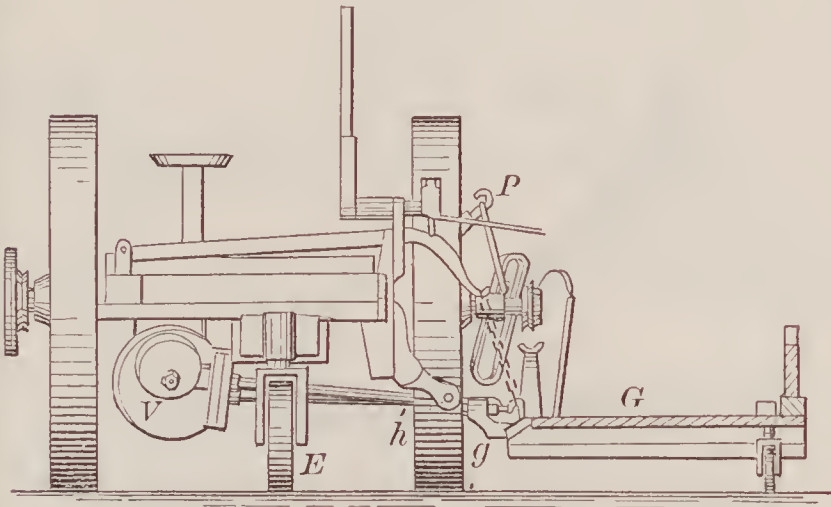
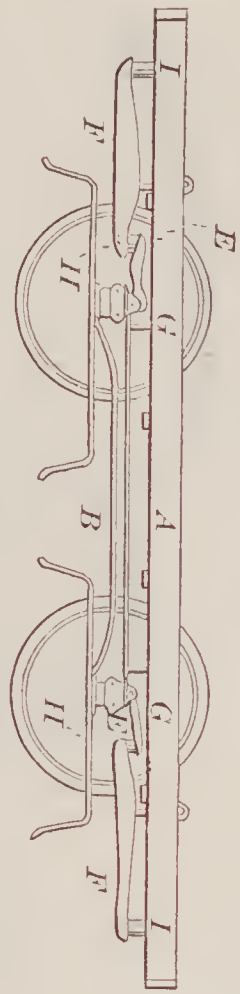

72681—A. C. Richards—Hay Press.

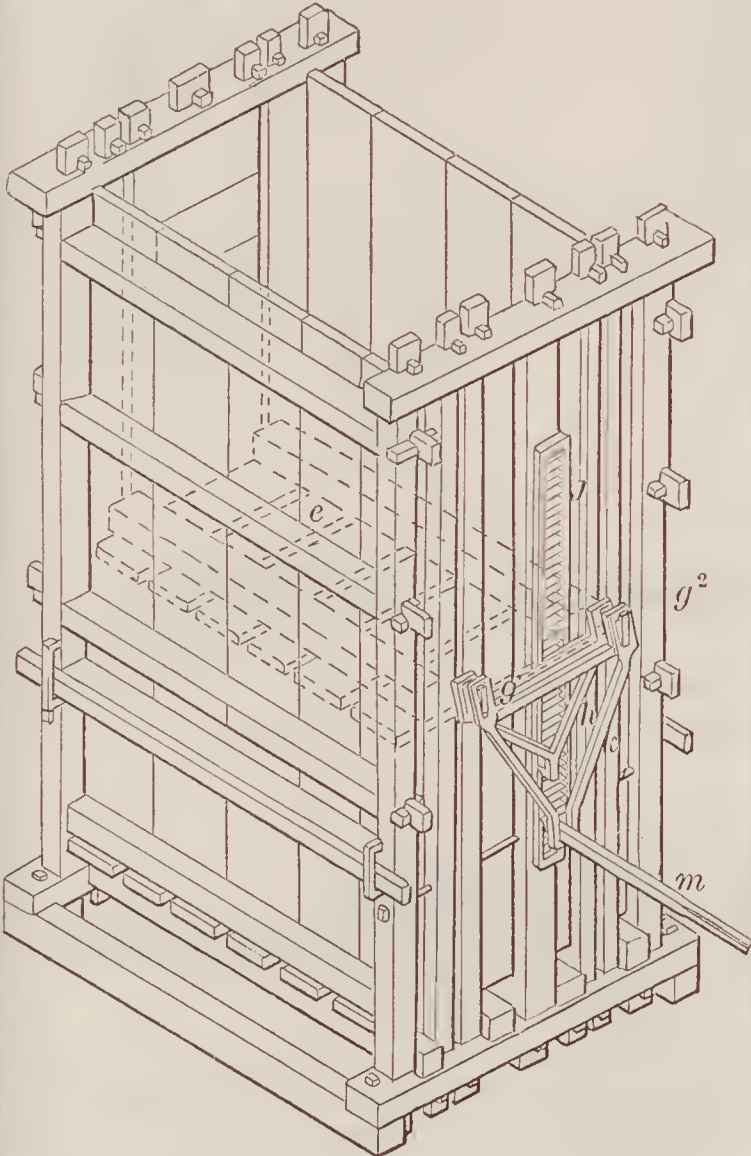

72680—J. Raney—Water Wheel.

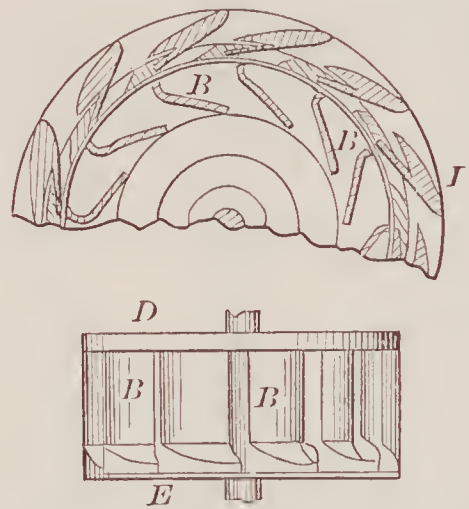

72682—J. Risher—Churn.

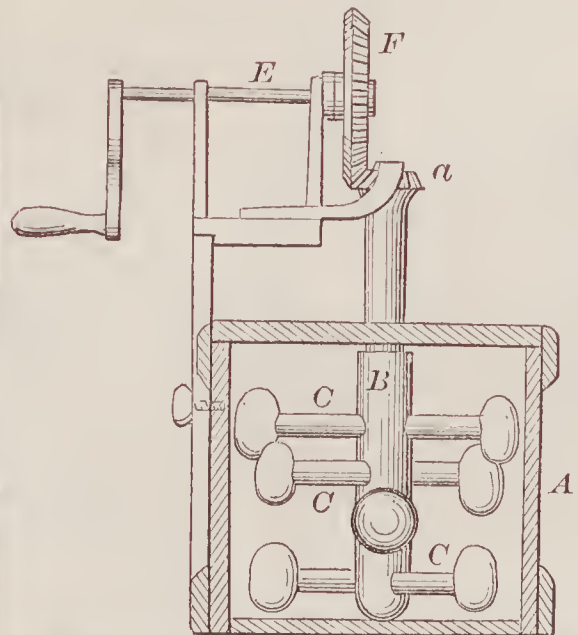



72688—W. Serviss—*For Making Rings.*

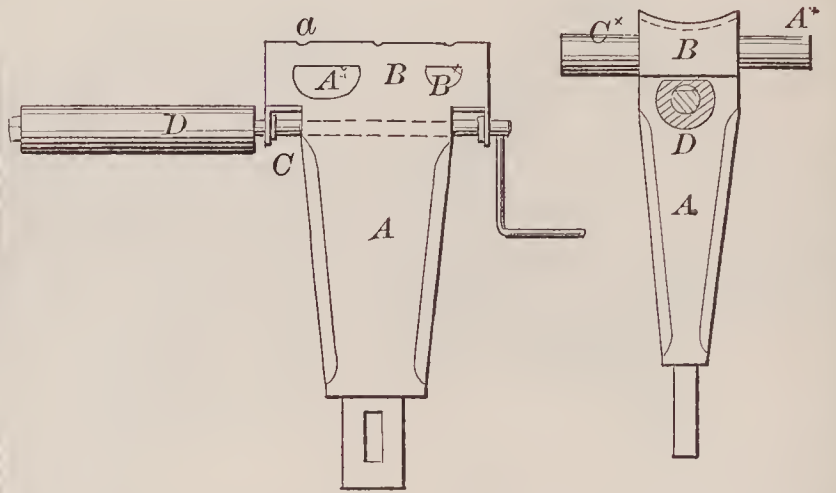

72687—W. Schmolz—*Solar and Transit Instrument.*

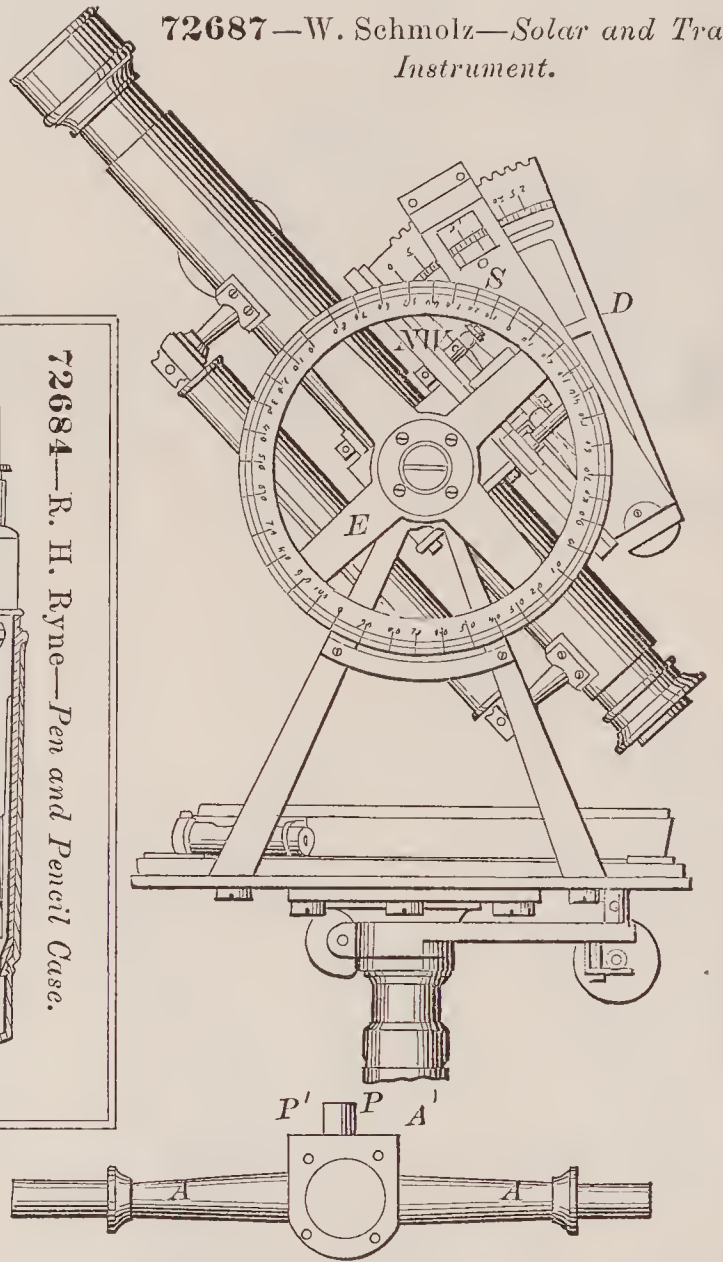

72684—R. H. Ryne—*Pen and Pencil Case.*



72683—Russell & Clifford—*Lamp.*

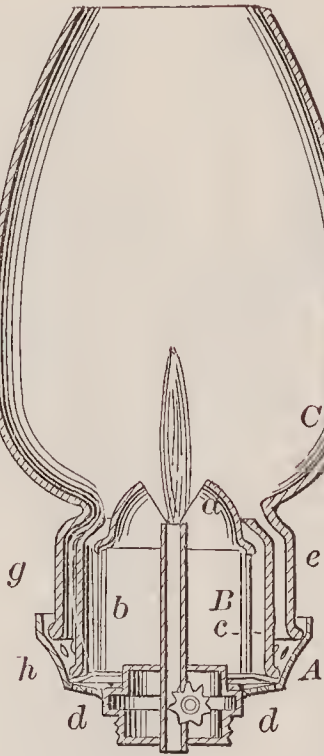

72686—W. H. Saltmarsh—*Belt Shipper for Mules*

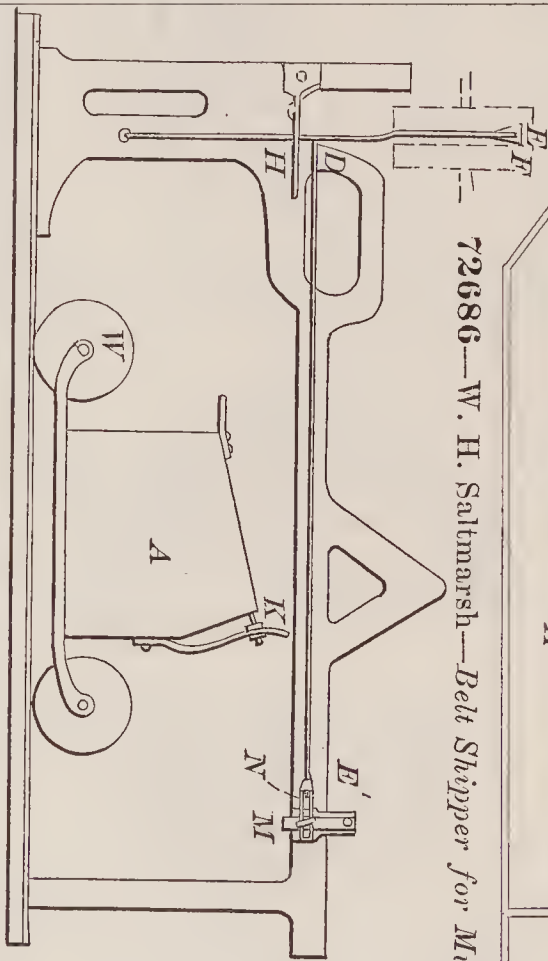

72689—G. V. Sheffield—*Steam Generator.*

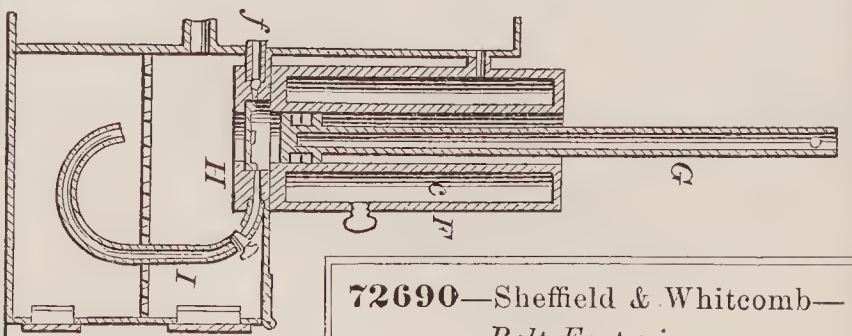

72690—Sheffield & Whitcomb—*Belt Fastening.*



72685—J. F. Sachse—*Cloth Plating Machine.*

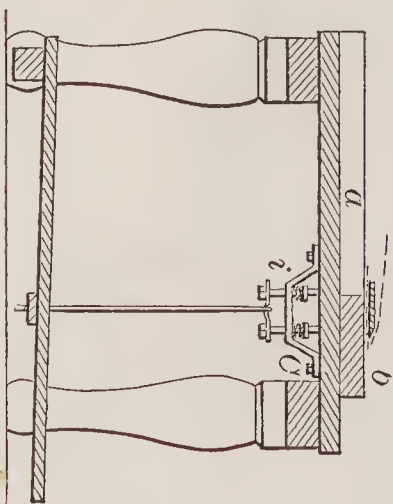

72691—T. Shapard—*Cleaning Cotton.*

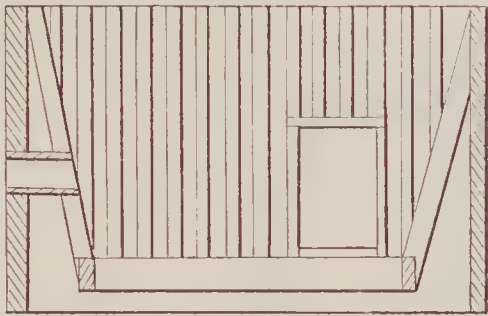

72692—A. M. Smith—*Sash Lock.*

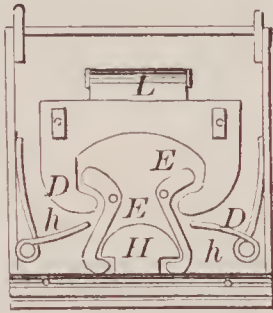

72693—Smith & Olds—*Fence.*

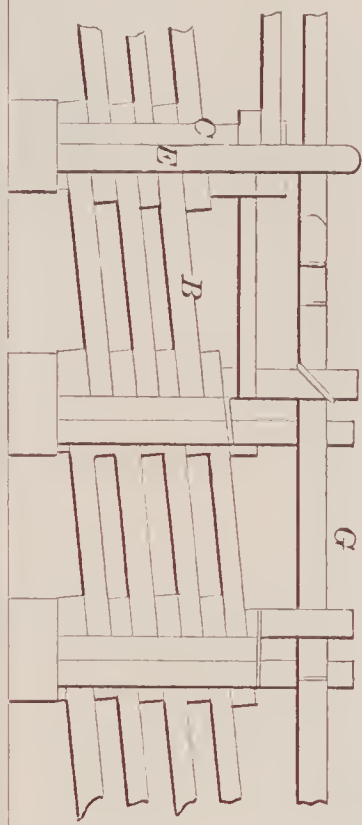

72697—J. B. Terry—*Gasoline Locomotive Headlight.*

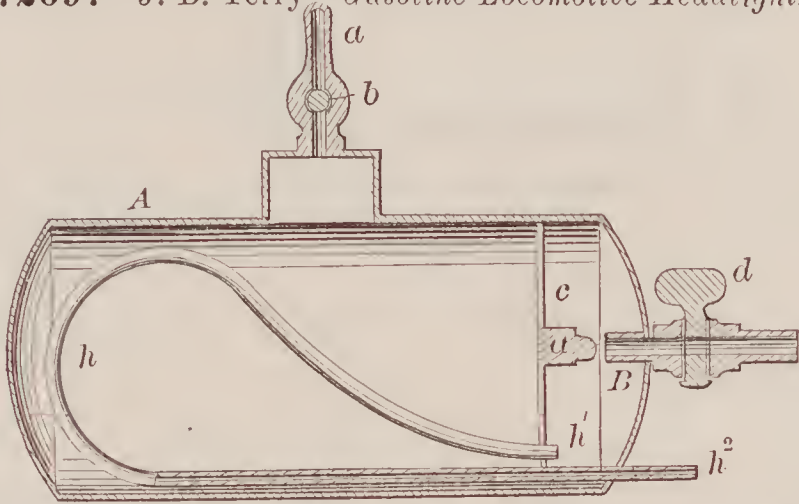

72694—H. Speeler—*Heating Pottery Oven.*

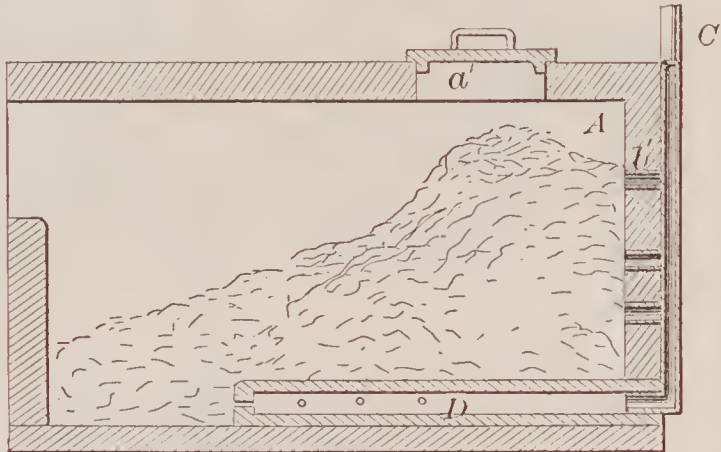

72696—F. Swift—*Grain Separator.*

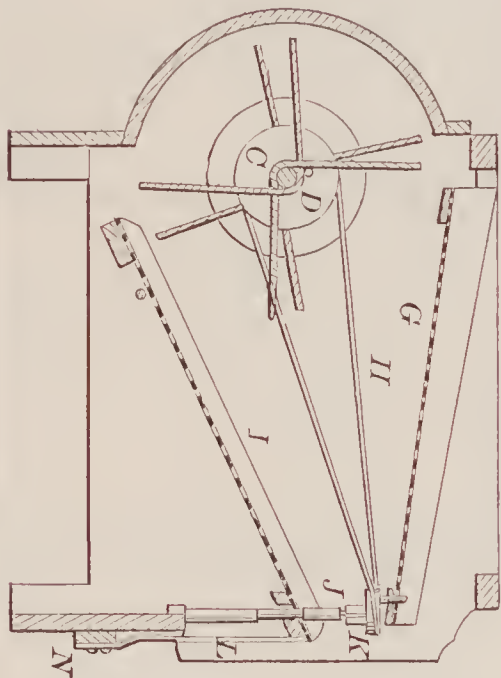

72695—C. St. John—*Parasol.*

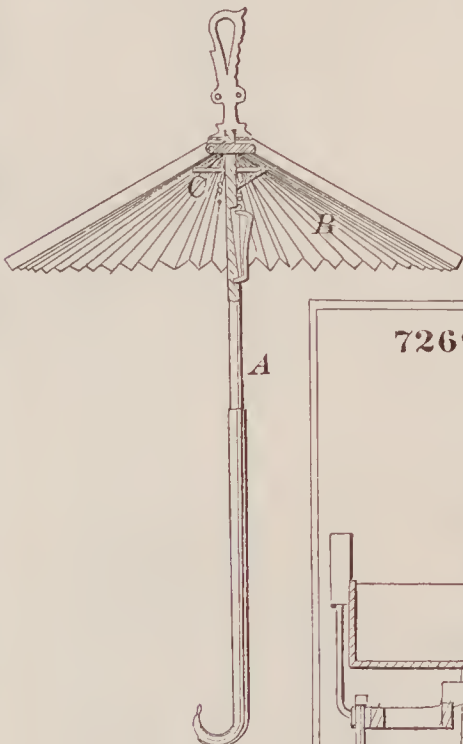

72698—I. P. Tice—*Spirit Meter.*

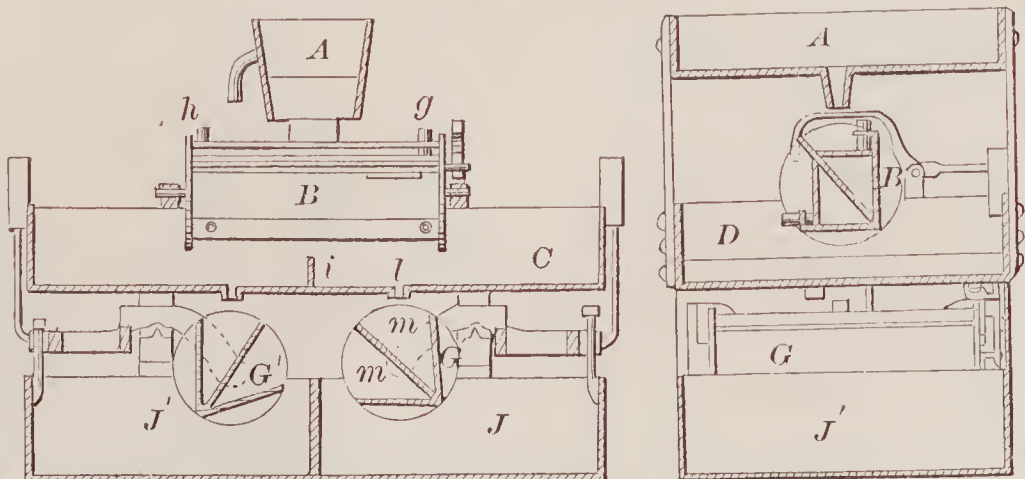



72701—I. P. Tice—Spirit Meter.

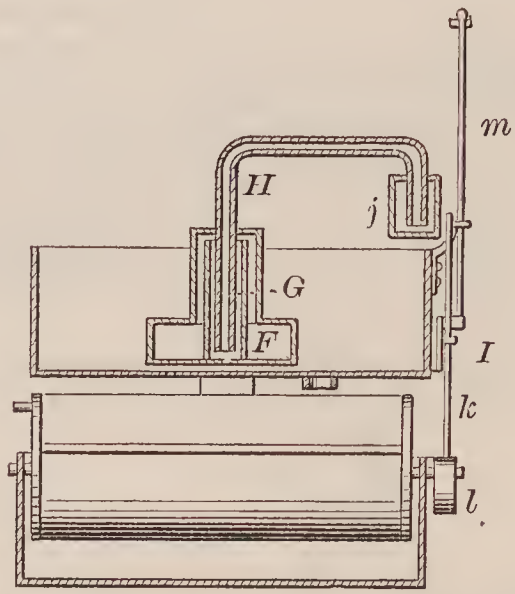
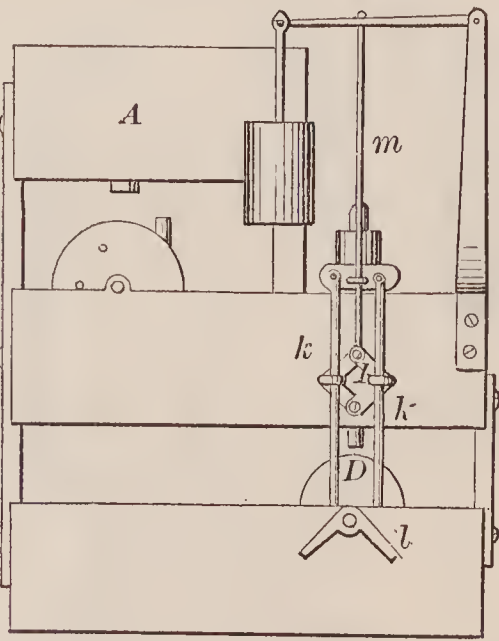

72699—I. P. Tice—Spirit Meter.

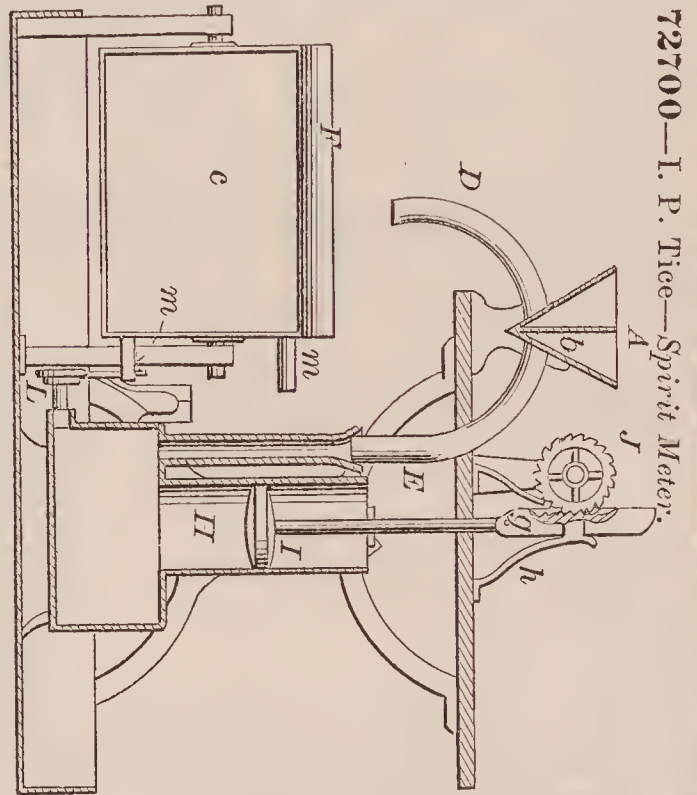
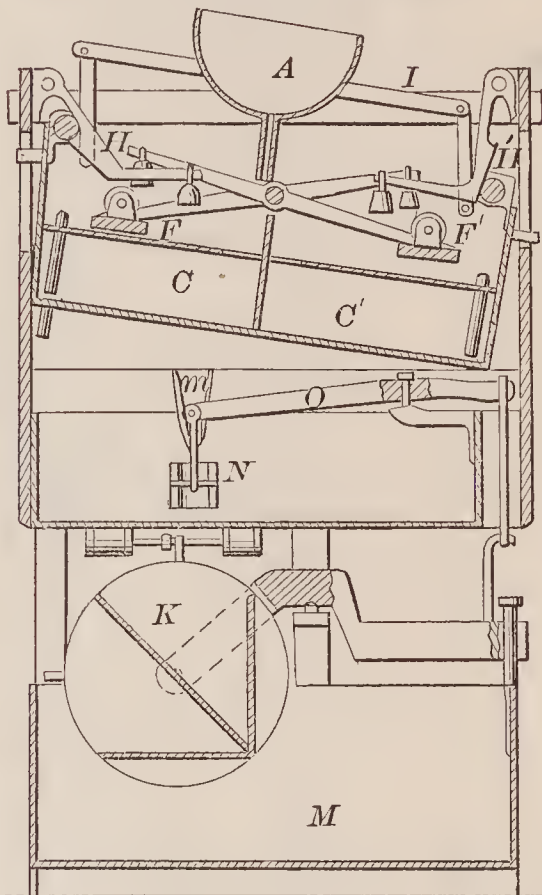

72700—I. P. Tice—Spirit Meter.

72703—J. Vaughn—Planter and Cultivator.

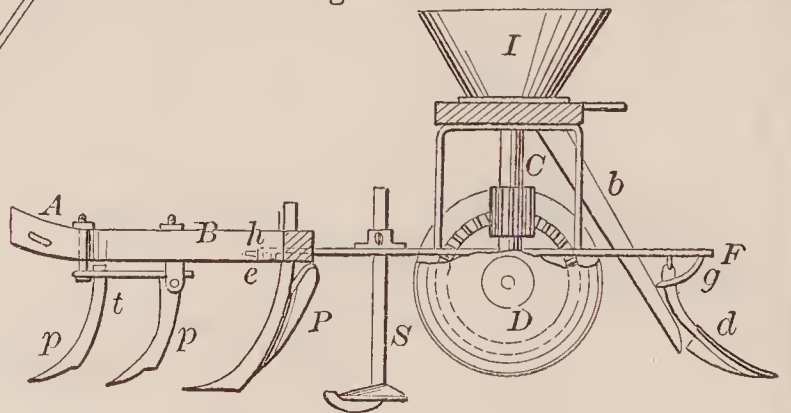

72702—I. P. Tice—Spirit Meter.

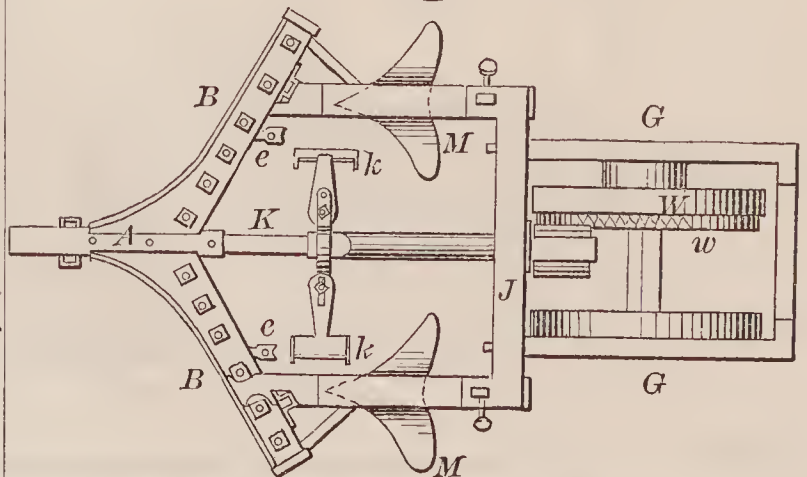
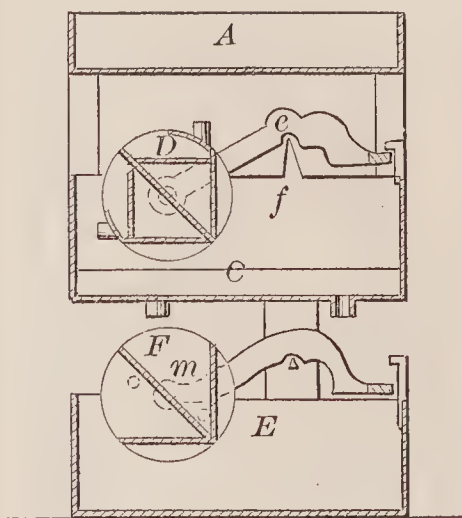

72704—C. F. Vollmer—*Extension Bed Lounge.*

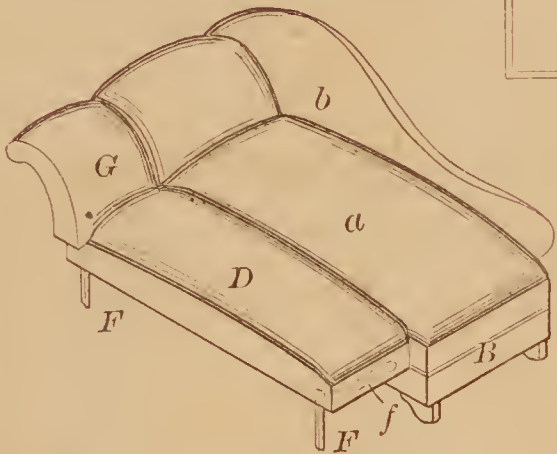
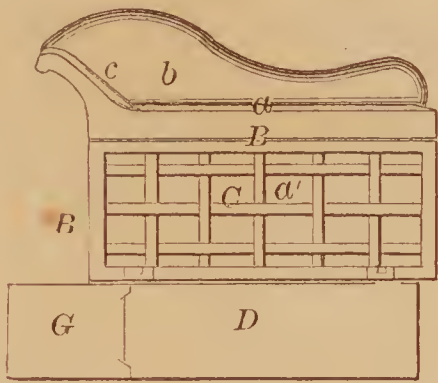

72709—G. D. Williams—*Bread Cutter.*

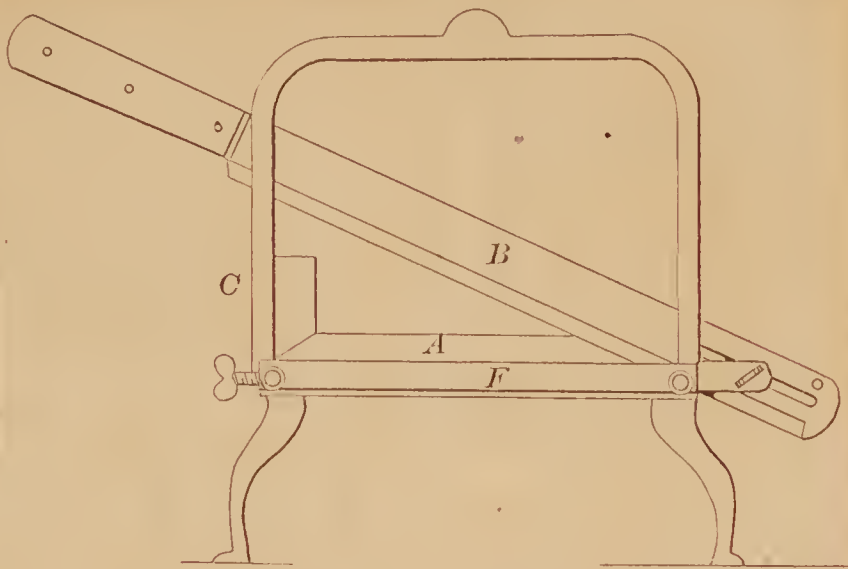

72707—C. Whittier—*Slide Valve.*

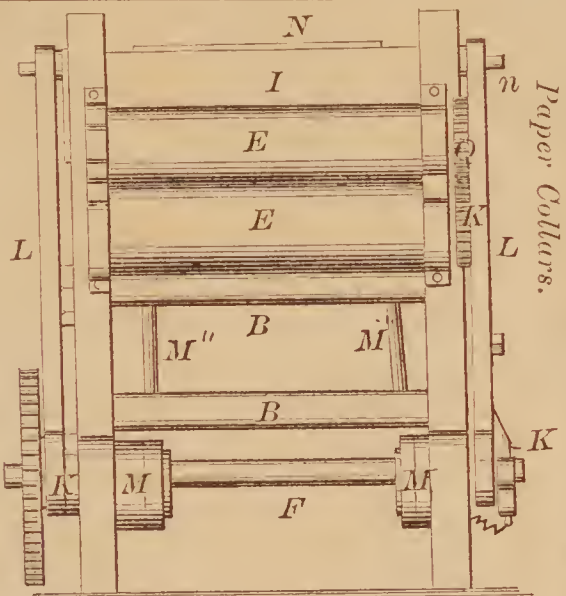
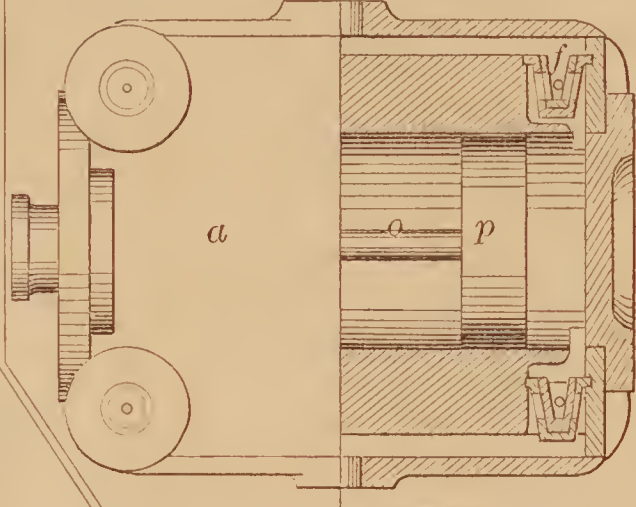

72705—O. F. Washburn—*For Making Paper Collars.*

72706—L. S. White—*Spoon Blank.*

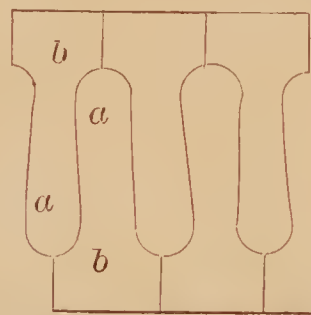

72710—W. M. Young—*Abdominal Supporter.*

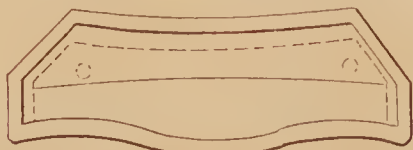
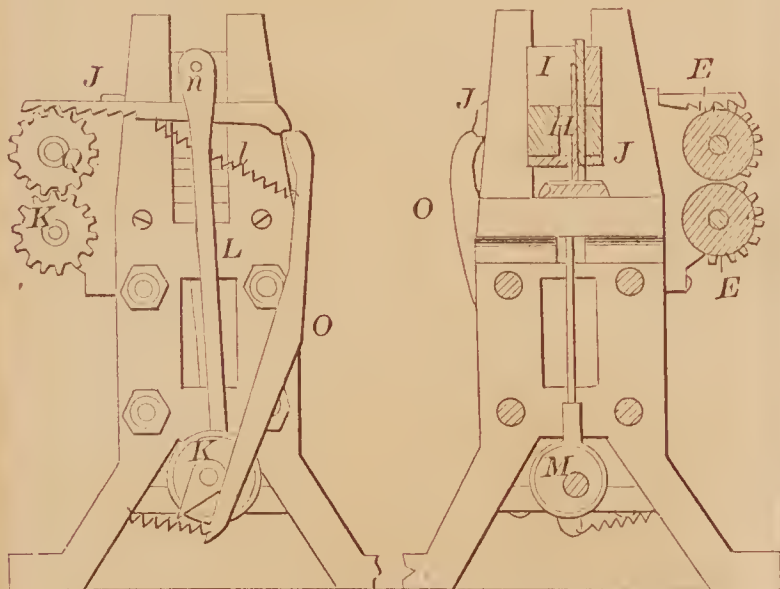
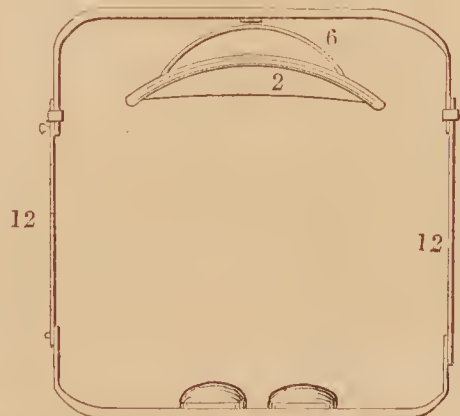
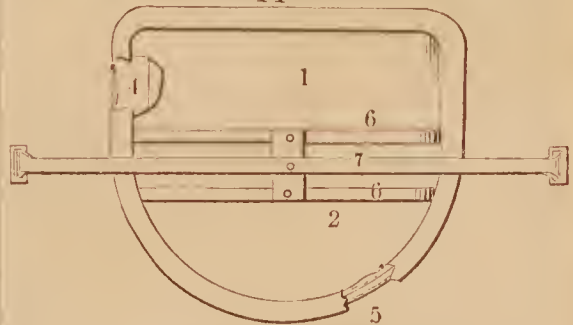



72715—W. Ball—*For Stamping Ores.*

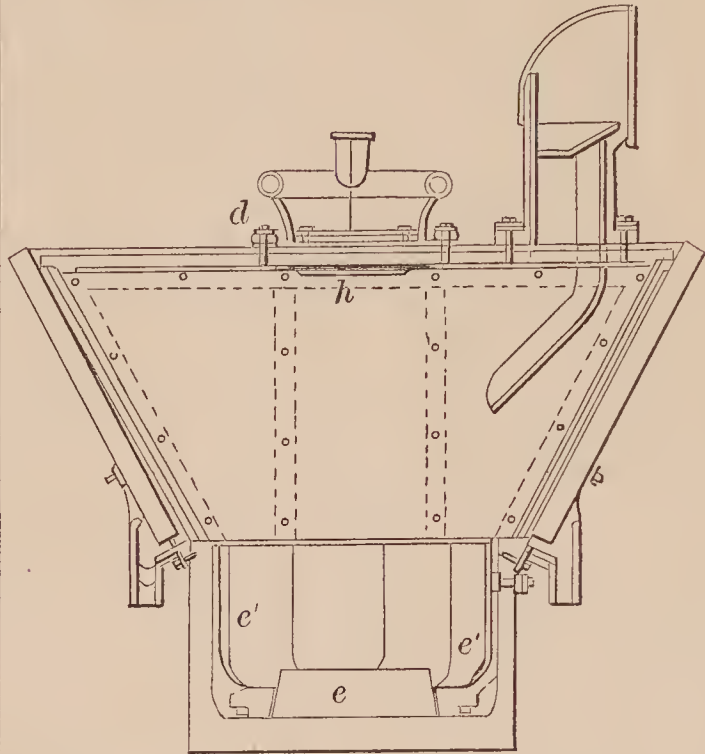
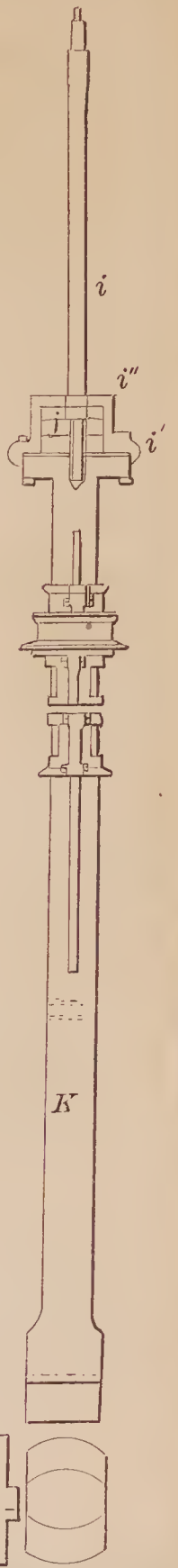
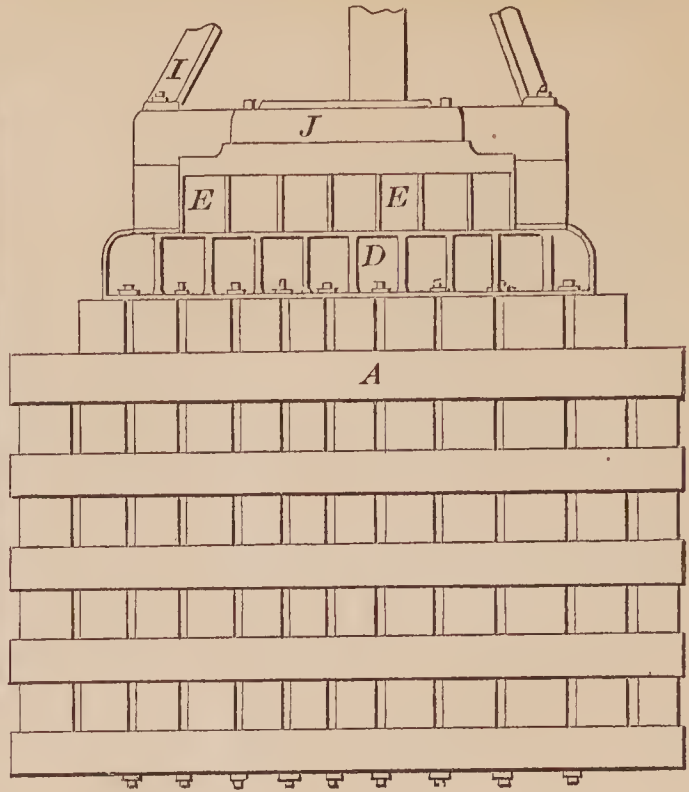

72711—J. Adair—*Paper File.*

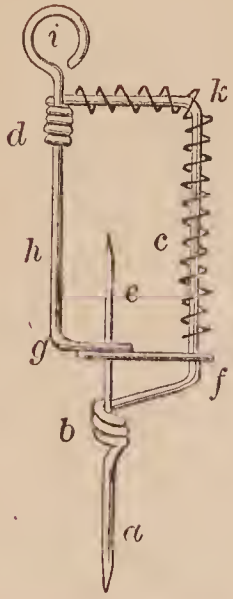

72712—E. A. Alpress—*Hand Gripping Tool.*

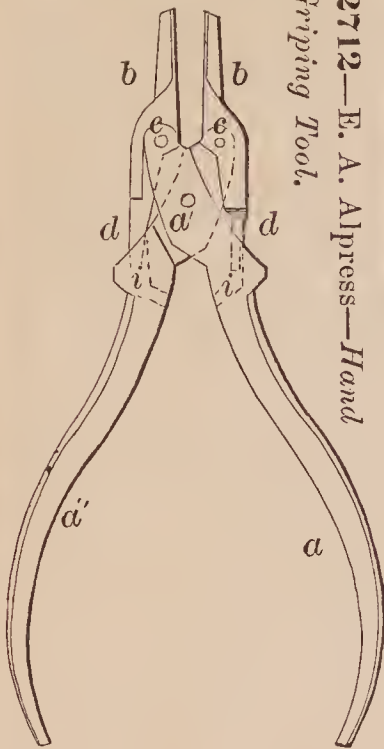

72714—W. Ball—*Steam Engine.*

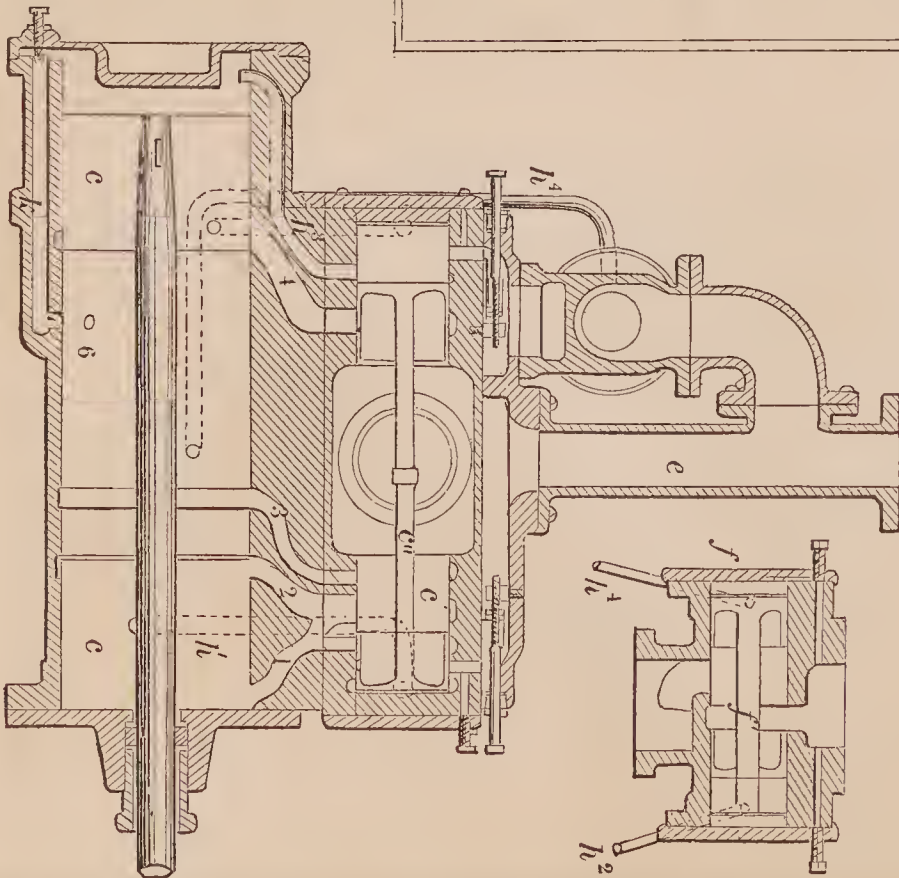

72713—S. M. Armstead—*Animal Trap.*

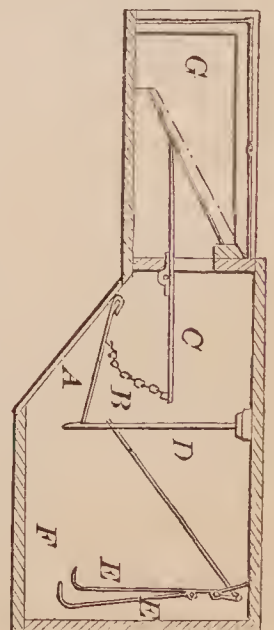

72719—E. B. Butler—  
Making Hat Bands.

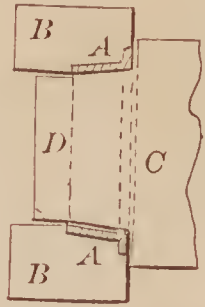

72717—E. R. Bigelow—Car Coupling.

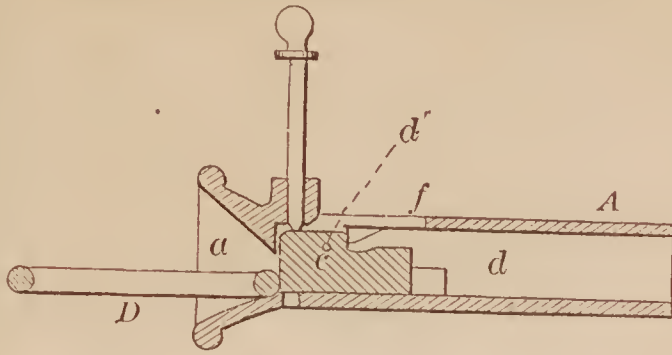

72716—W. E. Barton—  
Steigh Bell.

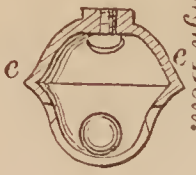

72720—G. H. Clarke—  
Steam Generator.

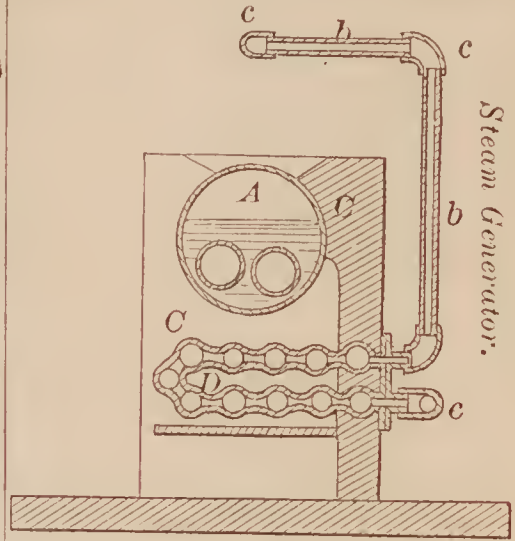

72718—E. F. Bradley—Head Roll for Pin Machines.

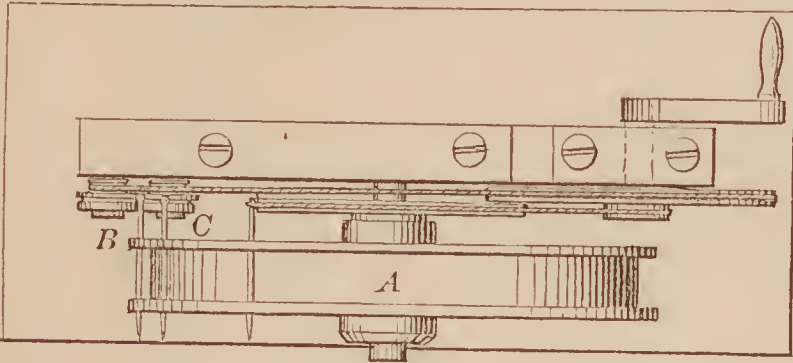

72722—R. F. Cooke—Harvester.

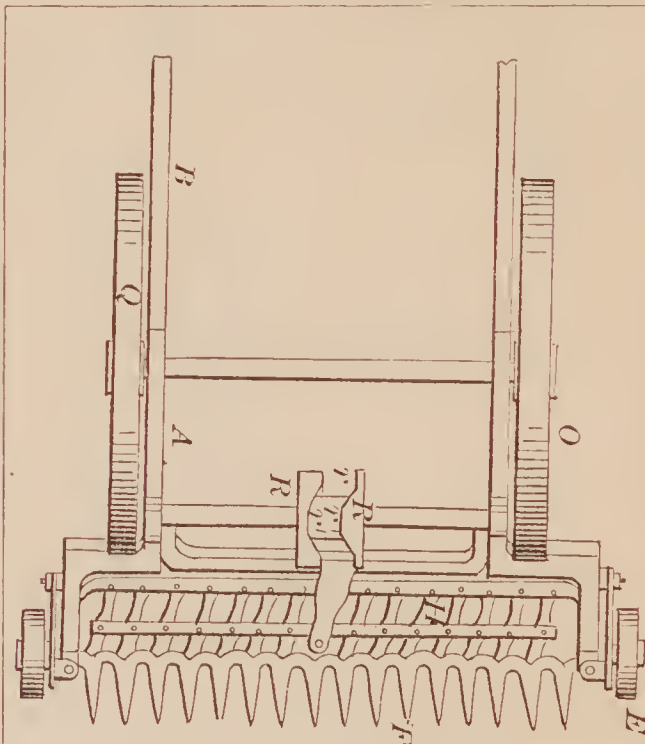

72721—C. F. Conrad—Windworm for Bellows.

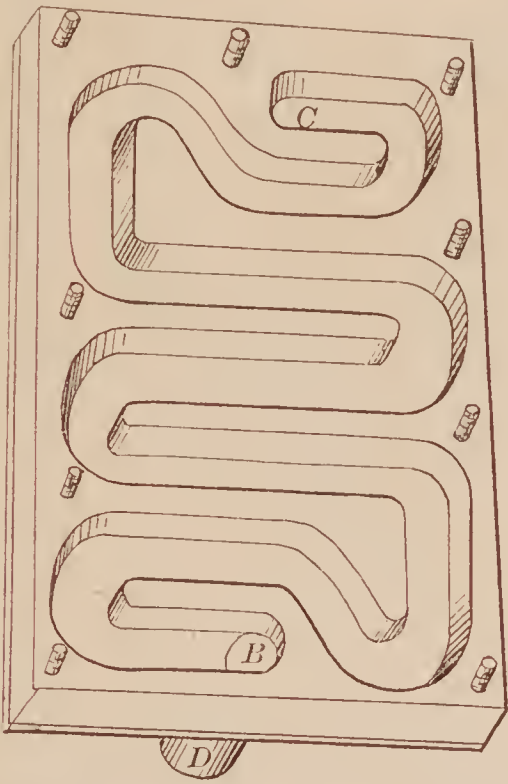

72723—Crum & Irwin—Burglar Alarm.

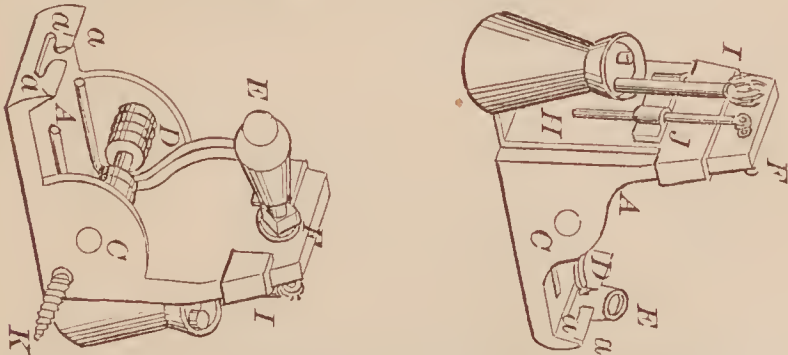

72725—J. Daykin—Water Drawer.

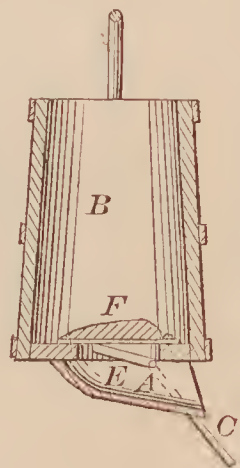

72724—F. S. Dawes—Heel Shave.

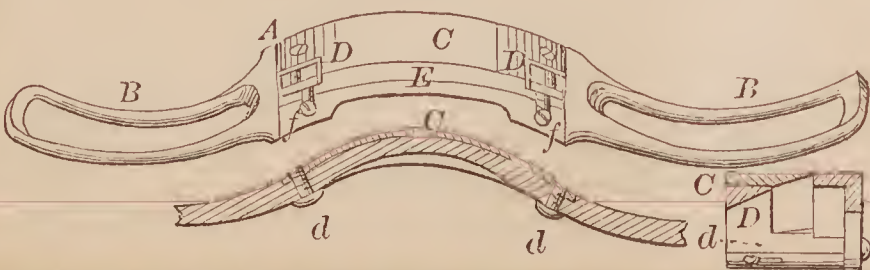









72740—J. L. L. Knox—Clinometer and Level.

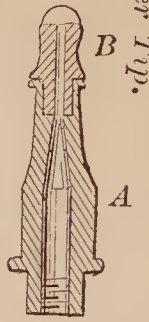
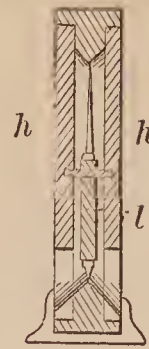
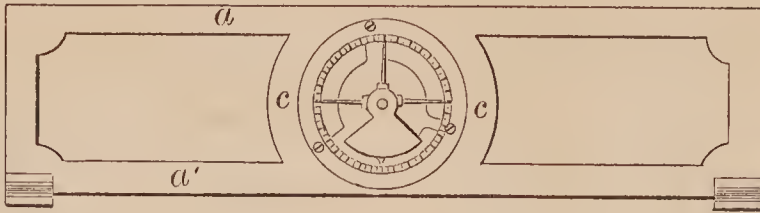

72741—R. Lannstrom—Gas Burner Tip.

72742—S. S. Laws—Electrical Indicator.

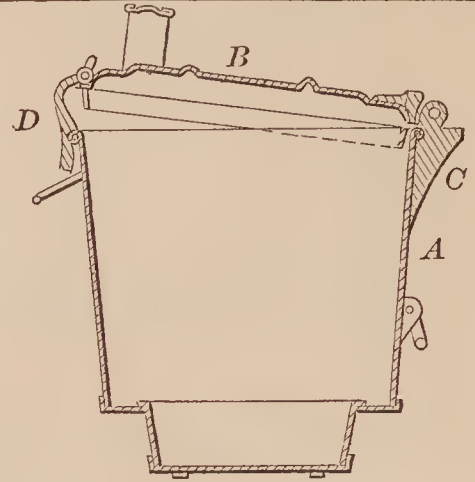
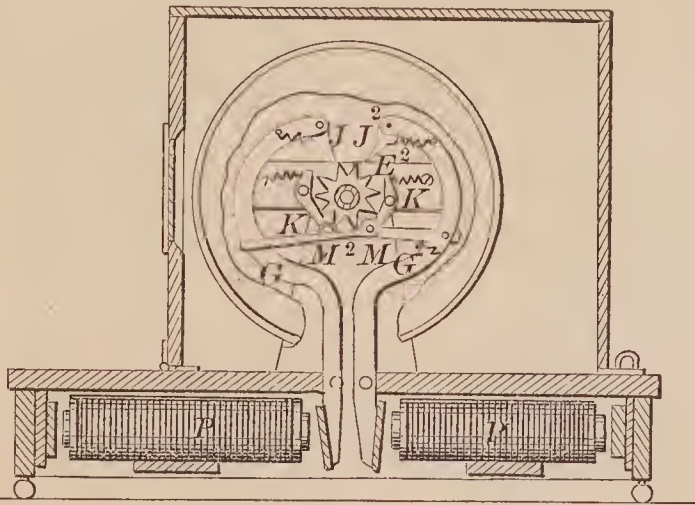

72746—H. Matthews—Kettle.

72744—J. Mallin—Cooling Millstone and Curb.

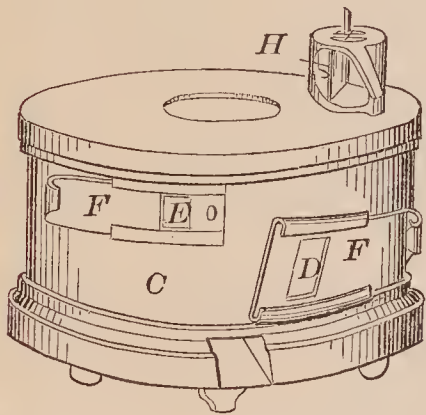

72743—W. Leonard—Harness Saddle.

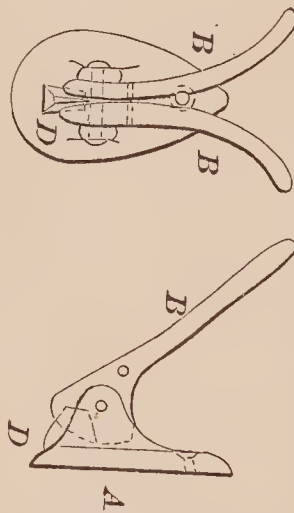
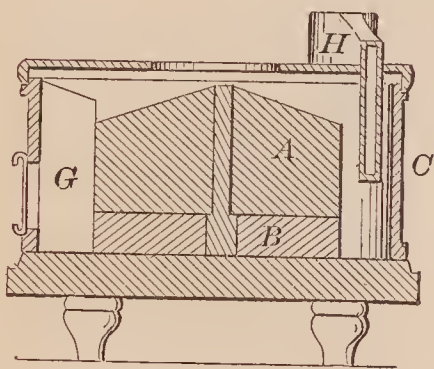
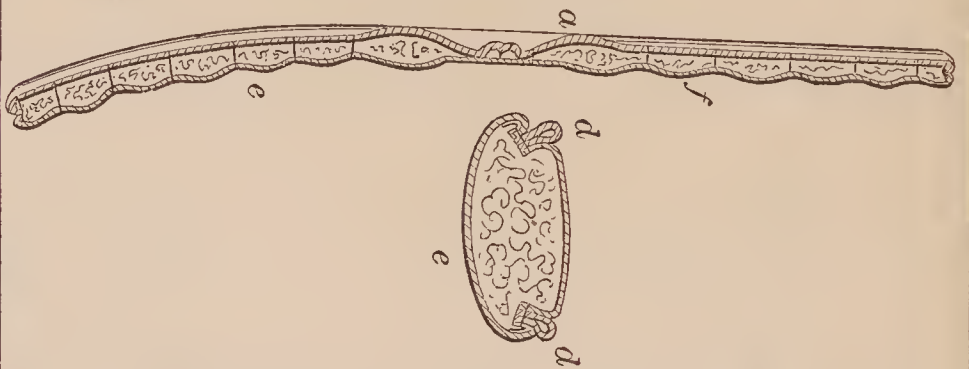

72748—S. S. Merriam—Whip Hanger.

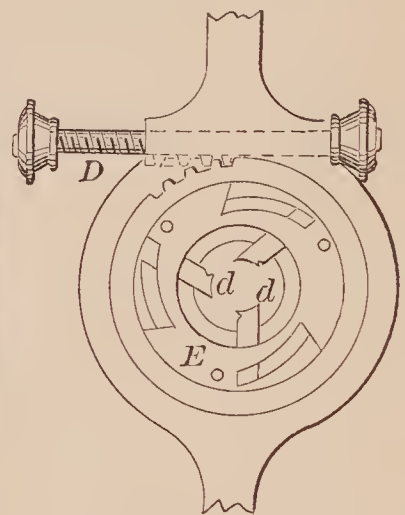

72747—D. McArthur—Die Stock for Cutting Screws.

72745—L. Matt—Piano Forte Sound Board.

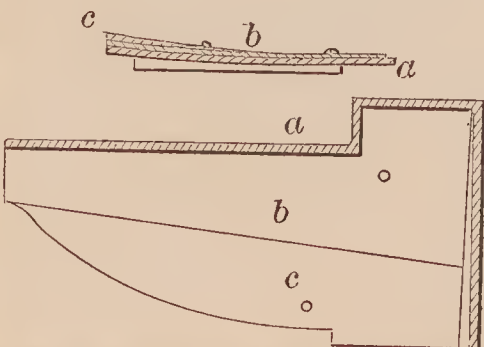

72749—P. Miller—Window Shutter.

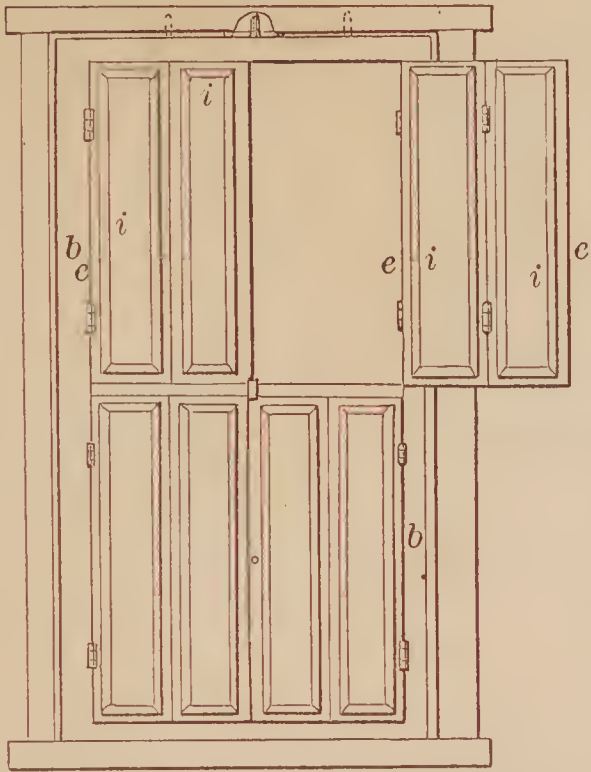

72753—D. D. Palmer—For Pegging Boots and Shoes.

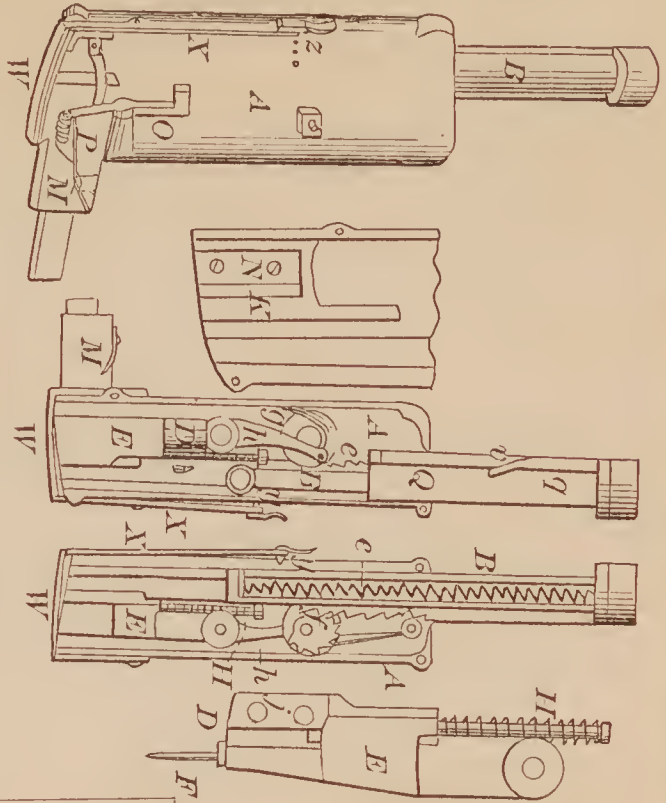

72750—J. F. Morse—Steam Engine Valve.

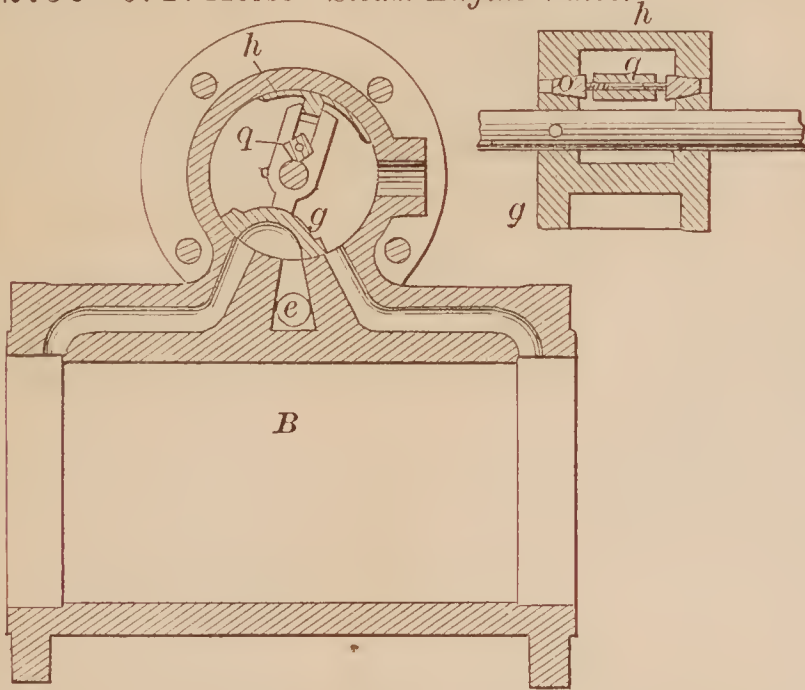

72754—D. E. Paris—Stove Grate.

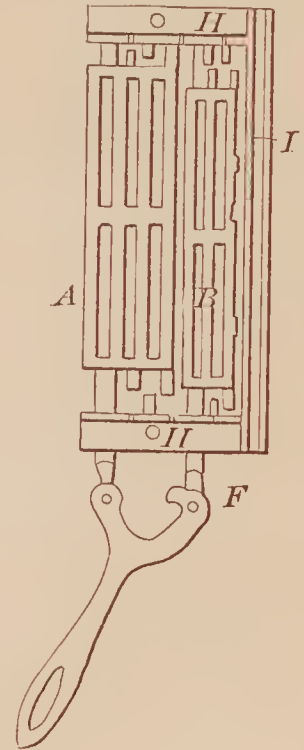

72752—W. J. Orr—Cow Catcher on Rail Cars.

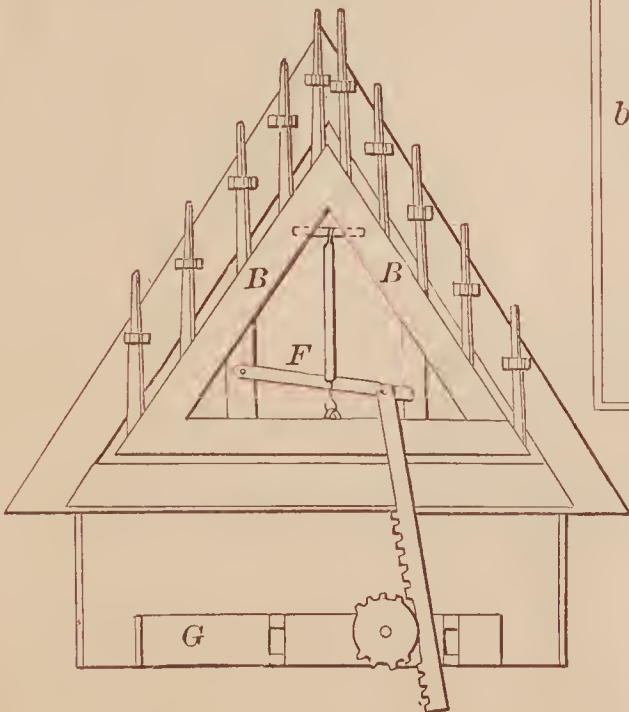

72751—P. H. Niles—Sewing Guide.

72756—T. E. Platt—Harvester.

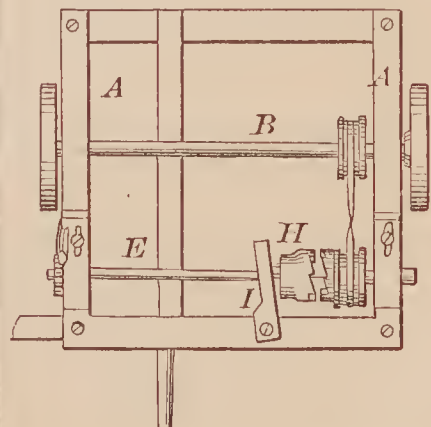



72757—A. J. Rayner—Tobacco Cutter.

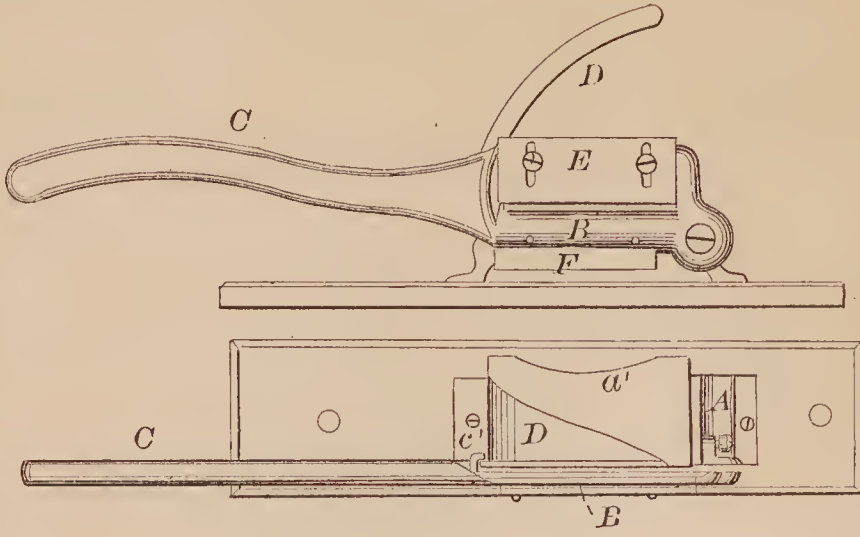

72760—H. Steeger—Hot Water Boiler.

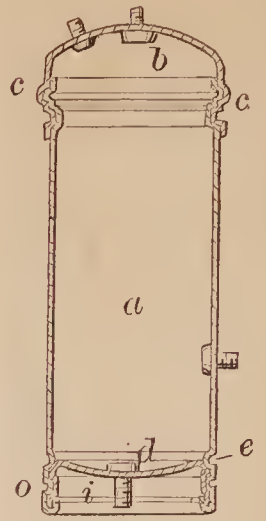

72762—C. Taft—Shingle Carriage.

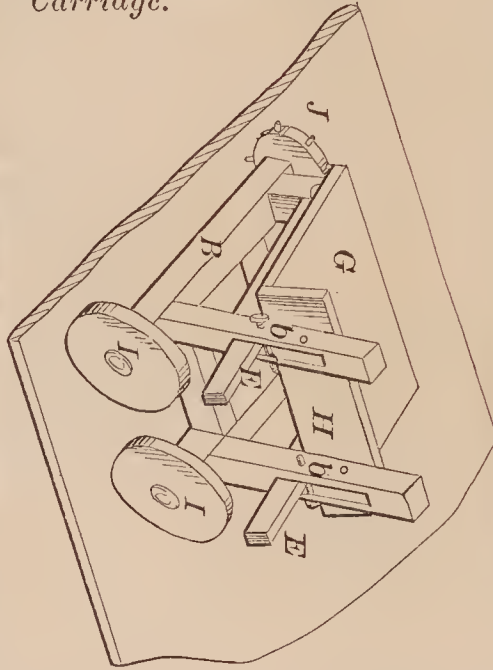

72758—C. Reistle—Caster Stand.

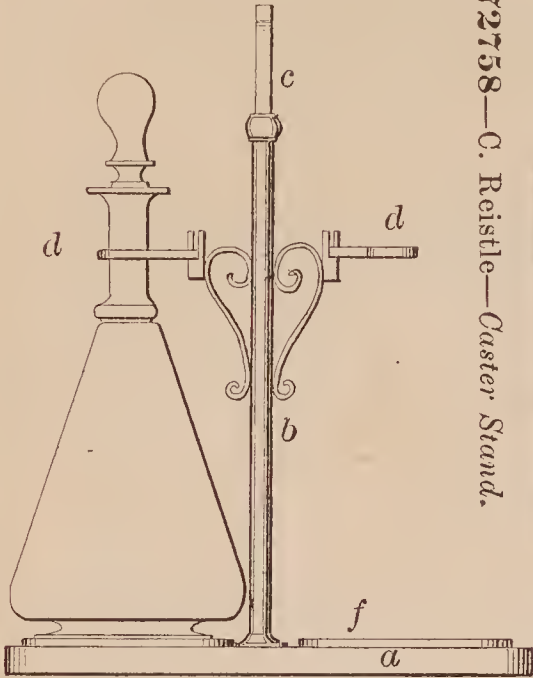

72761—R. S. Stubbs—Bottle Stopper Fastening.

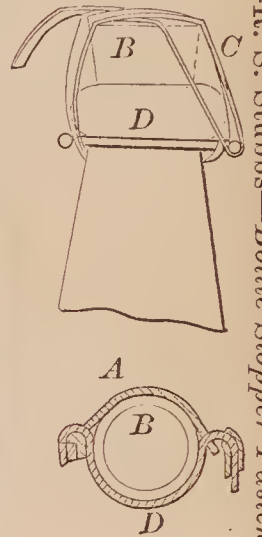

72759—J. O. Smith—Lantern.

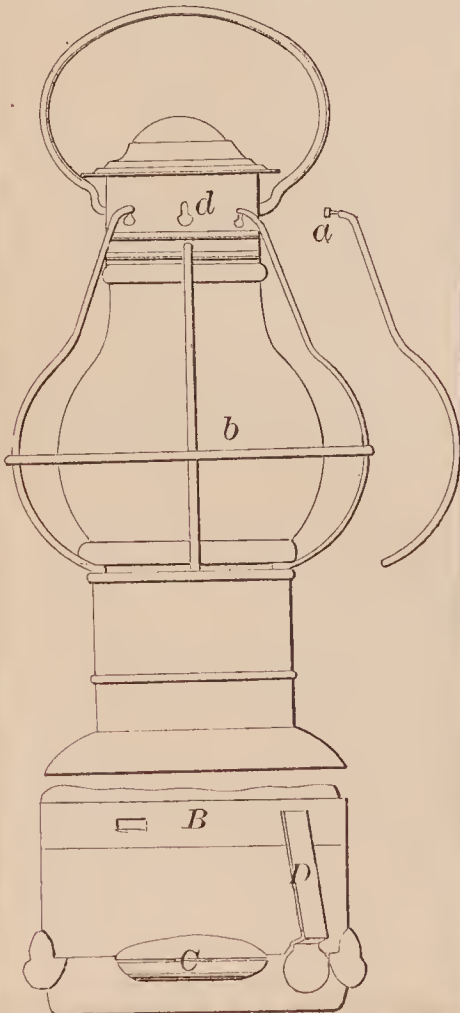

72763—J. Todd—Circular Saw Mill.

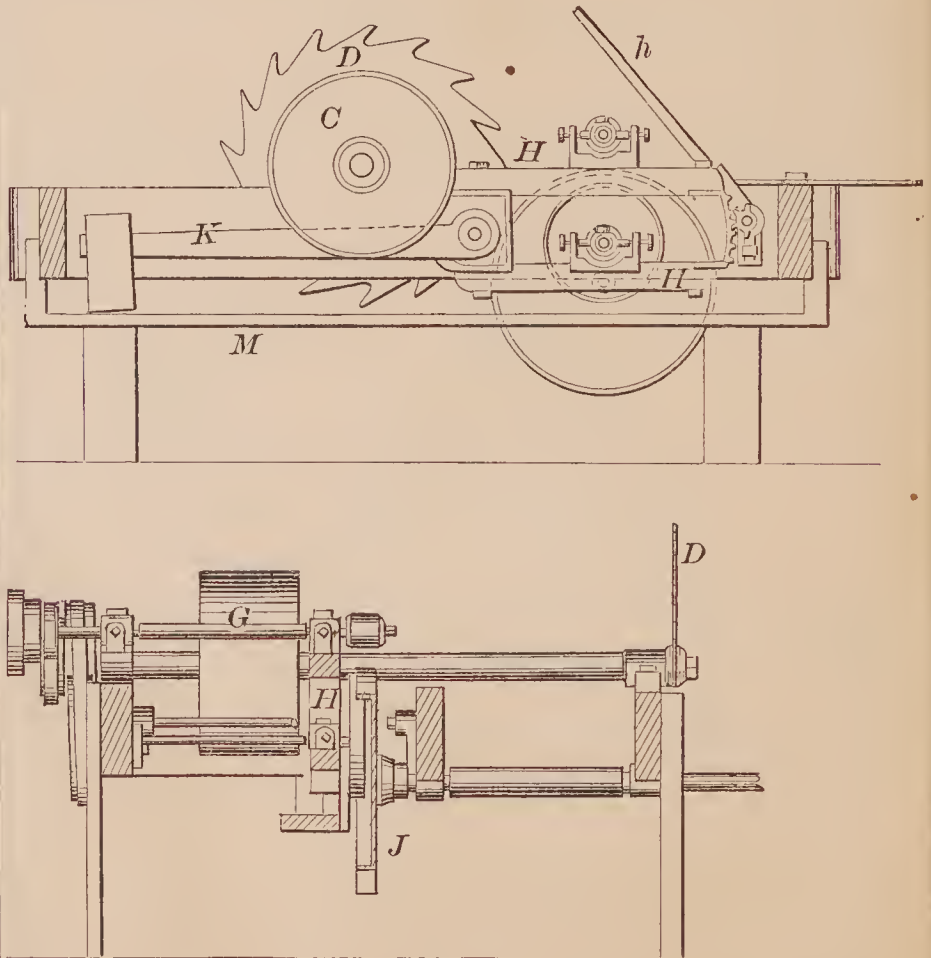

72764—A. P. Tyler—  
*Lamp.*

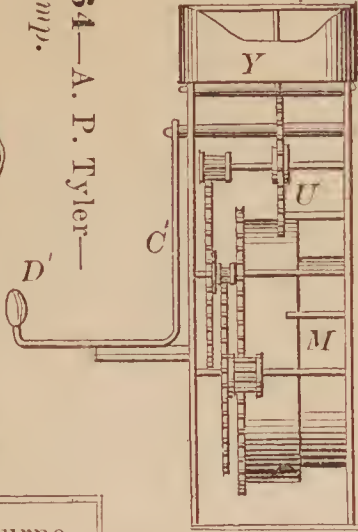
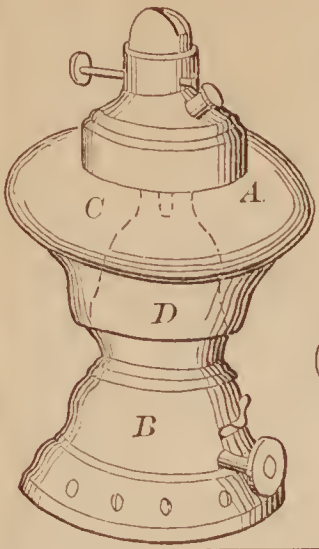

72769—E. Wright—*Let-off for Looms.*

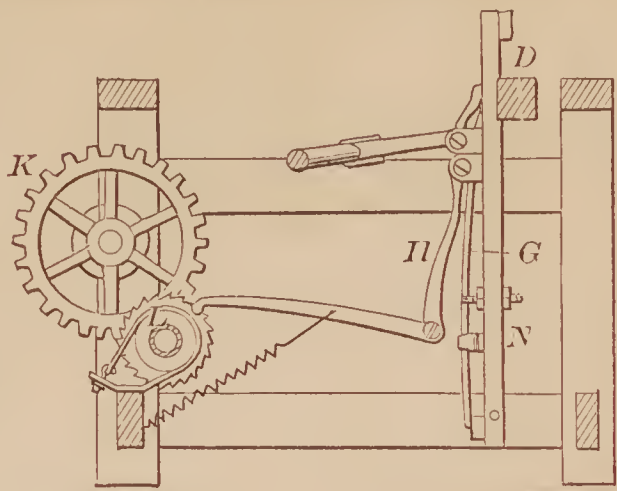

72766—F. Washburne—  
*Saw Frame Bolt.*



72770—Woods & Sherwood—  
*Wire Dish Stand.*

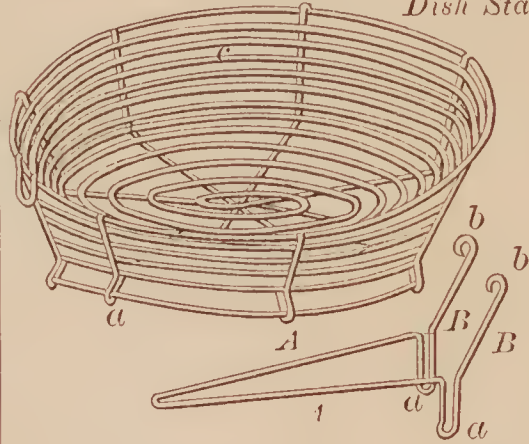

72765—F. N. Violet—  
*Window Sash Supporter.*



72771—W. Aikin—  
*Knitting Machine.*

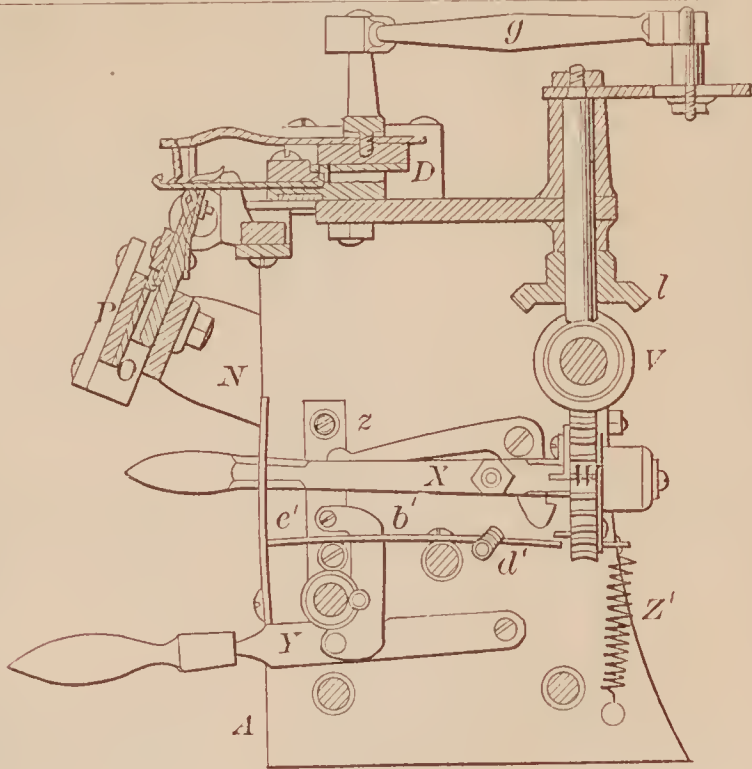

72767—Wocher & Geiger—  
*Curtain Fixture.*

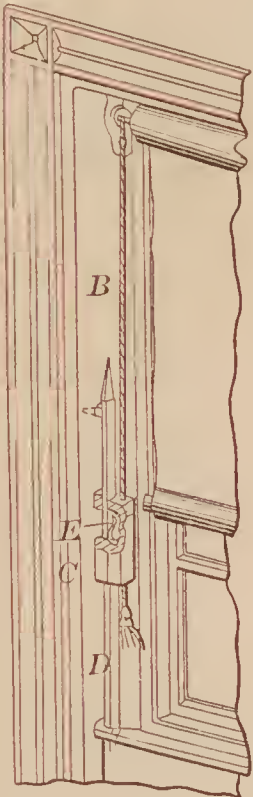

72768—Wocher & Geiger—  
*Curtain Fixture.*

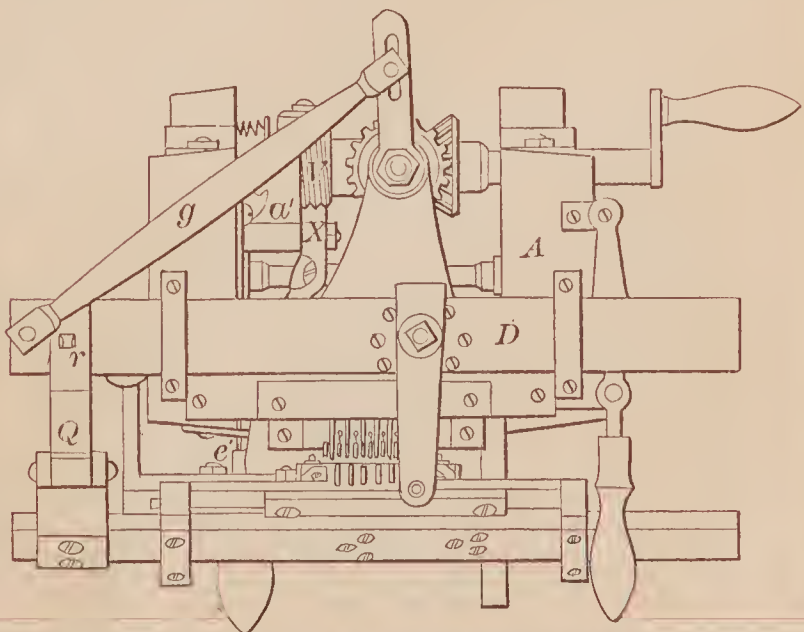
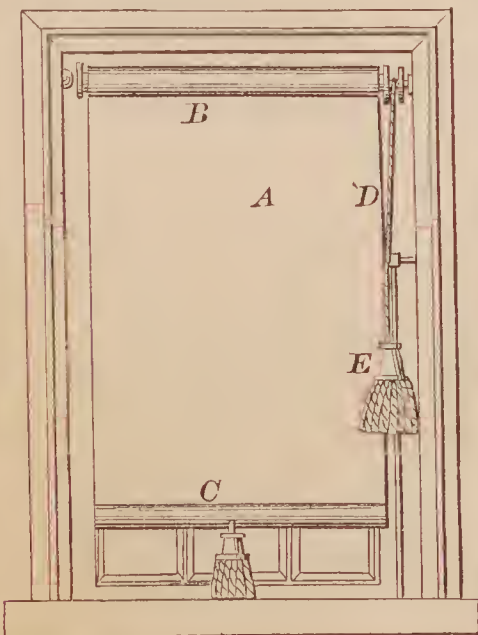



72773—P. Antonidus—Potato Digger.

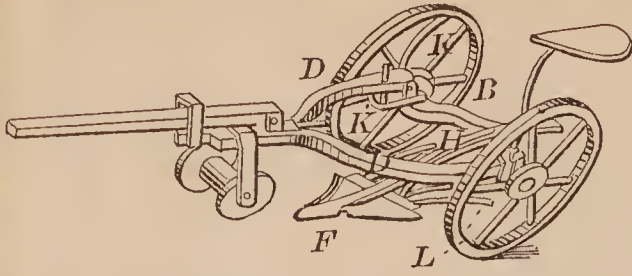

72774—M. Augenstein—Spirit Meter.

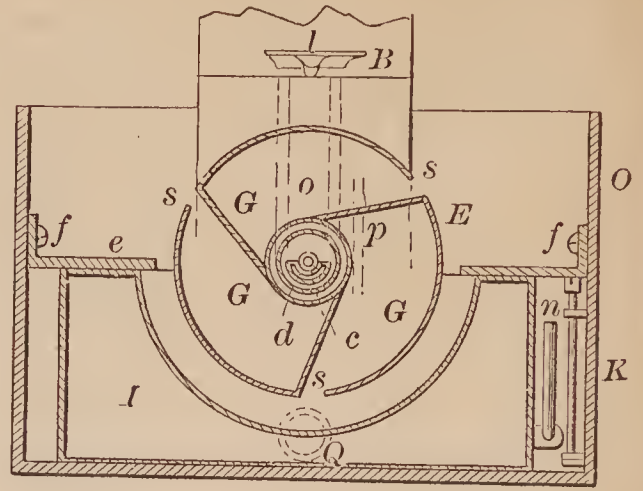

72775—C. Aultman—Harvester Rake.

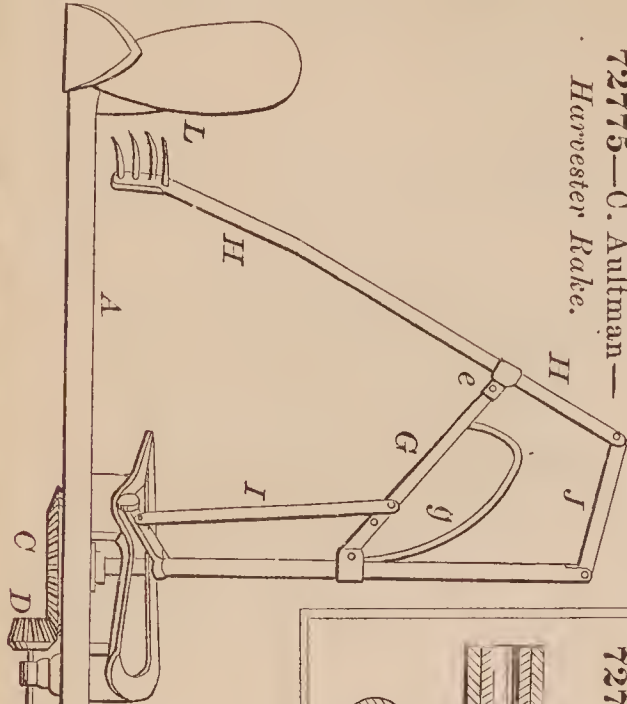

72777—C. E. Bailey—Altering Caliber of Gun Barrels.

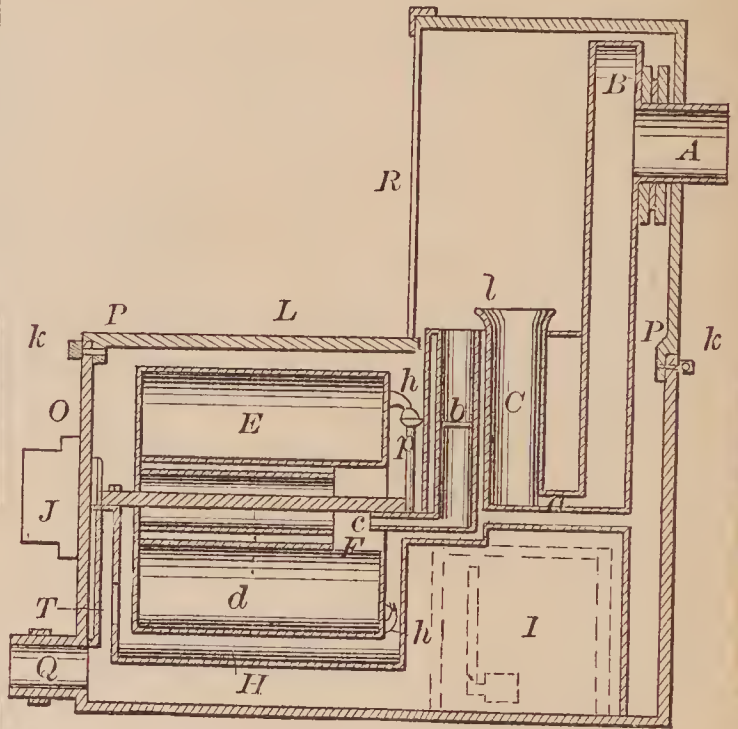
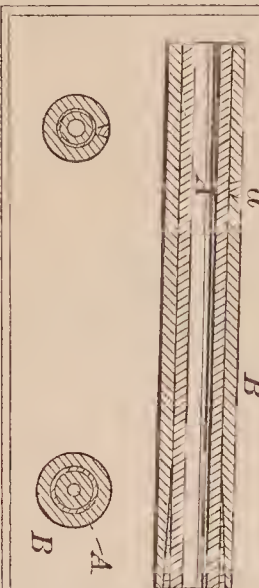

72776—B. H. Badger—For Holding Glass.

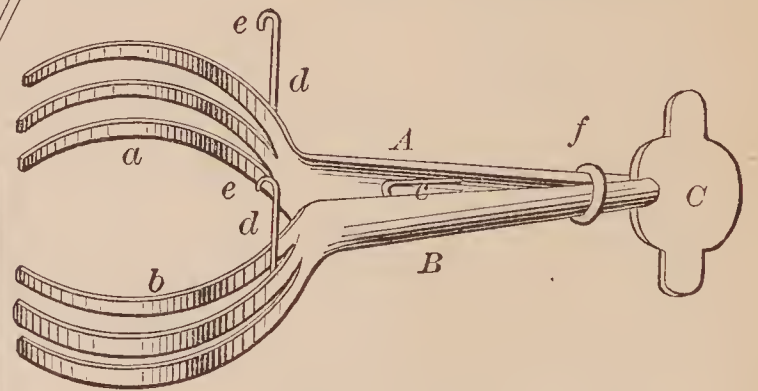

72778—D. B. Baker—Clutch for Horse Hay Rakes.

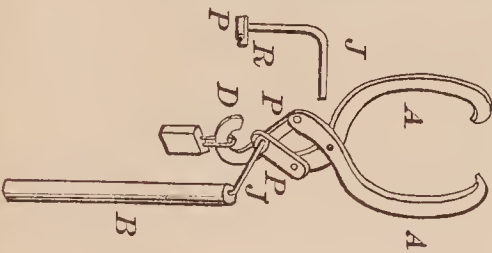

72780—J. T. Baltimore—Cultivator.

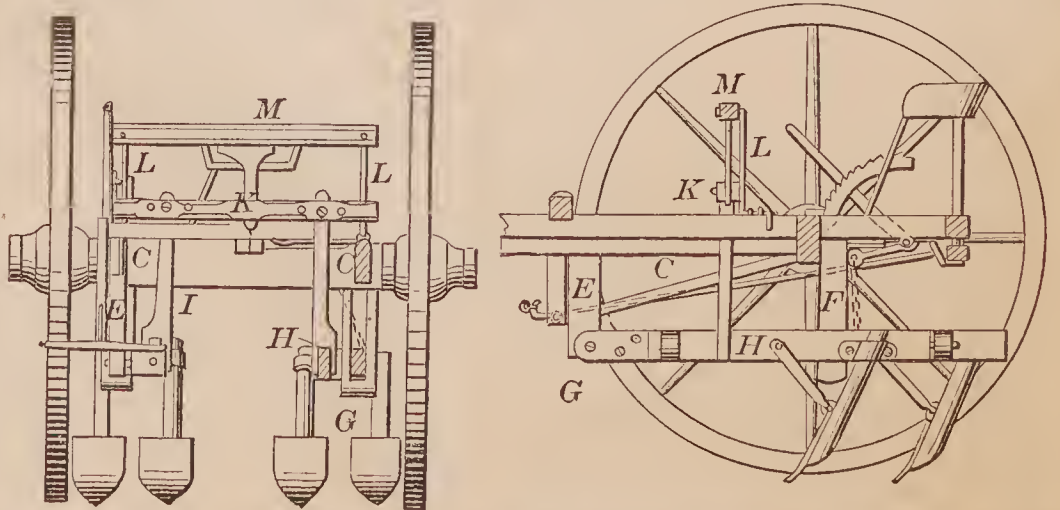

72779—L. G. M. Baker—Carriage Clip.

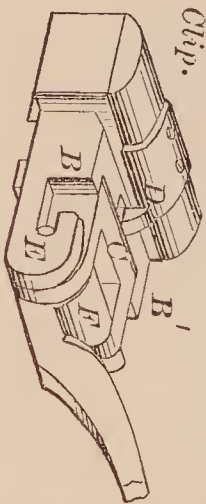

72781—H. Barr—*Sheep Shearing Table.*

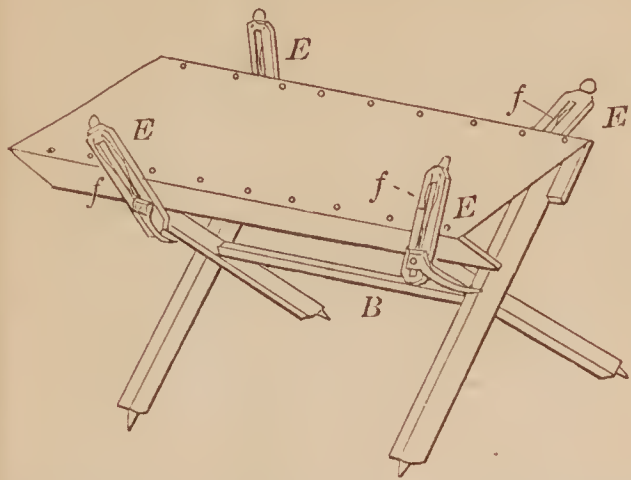

72782—C. B. Bennett—*Clothes Dryer.*

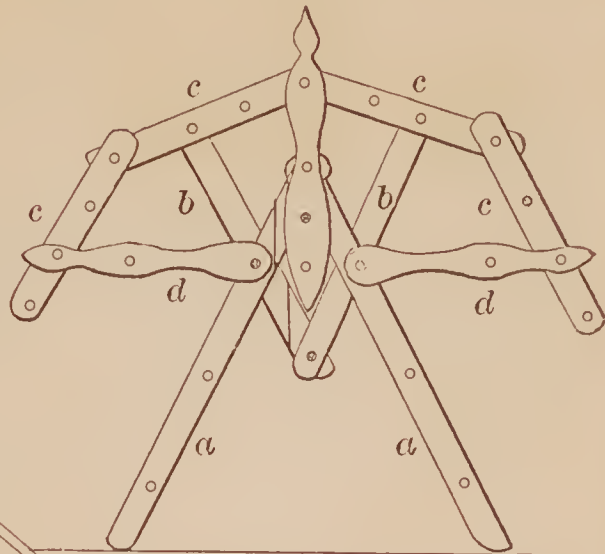

72783—J. Bernheisel, Sr.—*Corn Sheller and Separator*

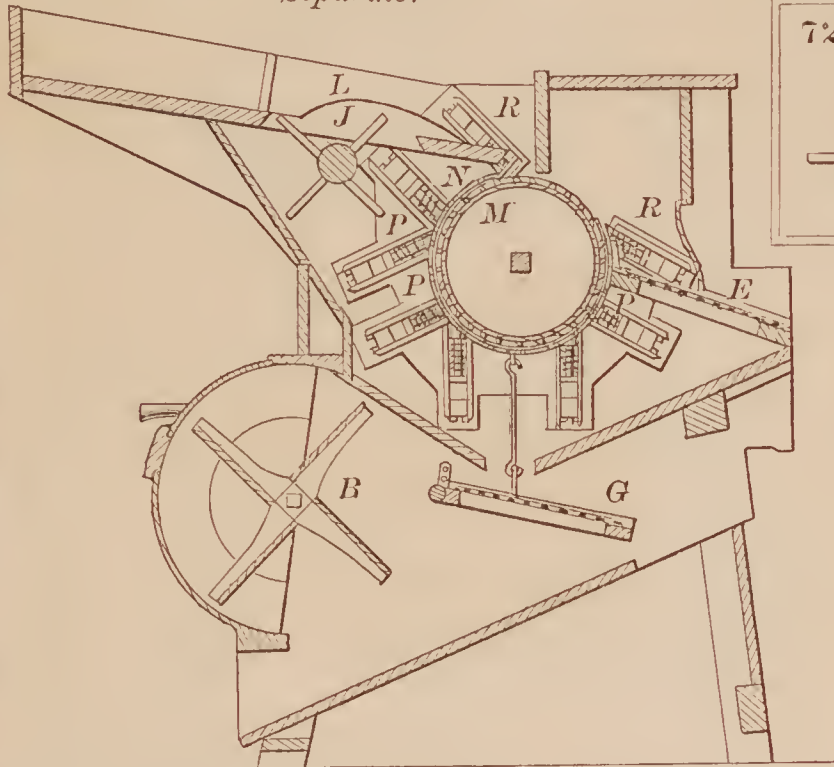

72784—Bisbee & Hearn—*Hasp and Hook.*



72785—F. A. Blaetterlein—*For Drawing Wicks through Burners.*

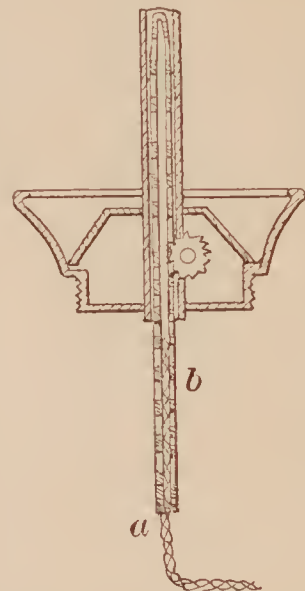

72786—Blakeslee & Smith—*Burglar Alarm.*



72788—C. D. Brainerd—*Bag Holder.*

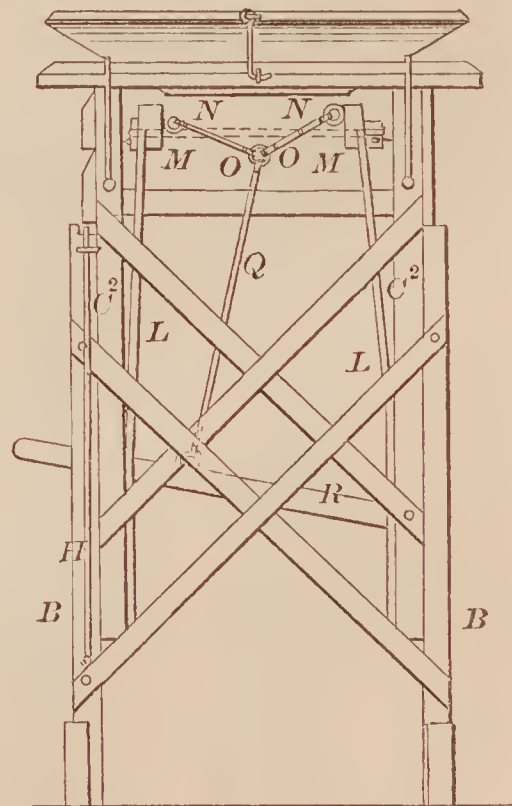

72787—J. Blank—*Sewer Pipe Machine.*

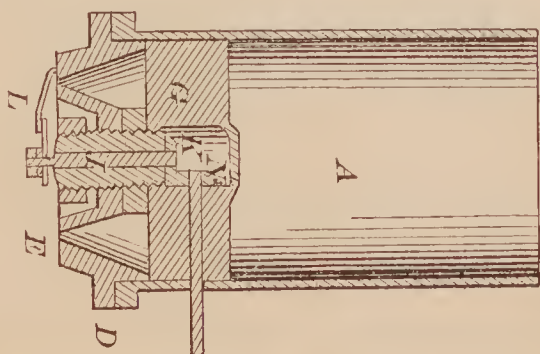



72791—A. T. Brooks—Door Bell.

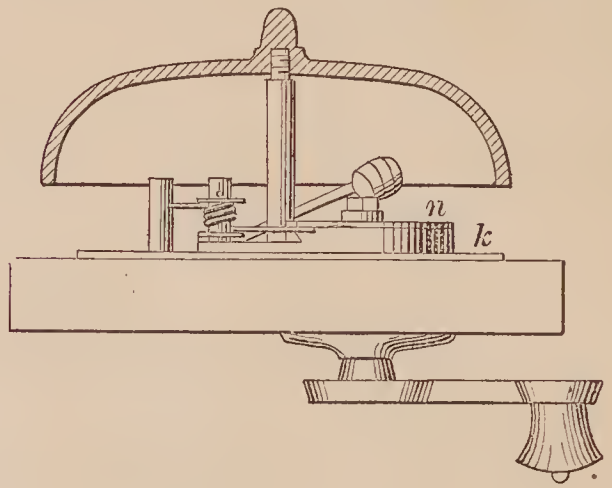
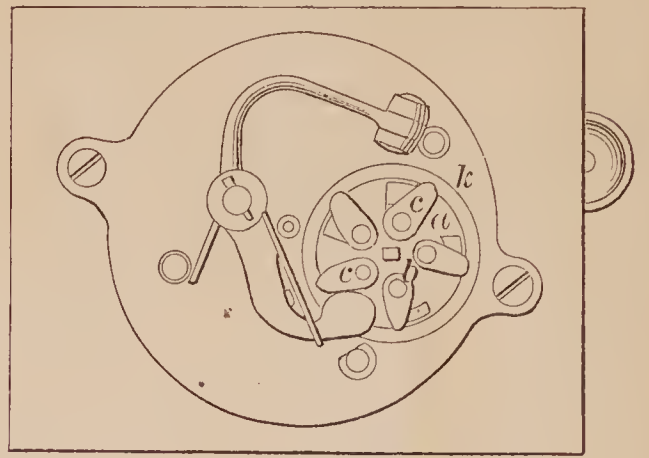

72795—J. W. Cahoon—Cart.

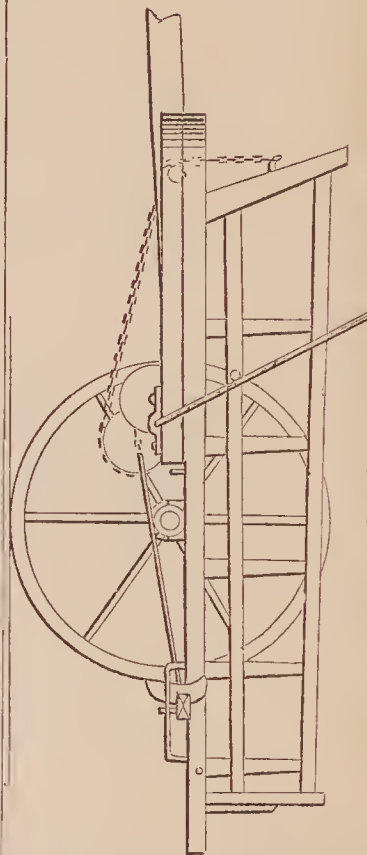

72796—J. H. Carkeet—Axle and Journal Box.

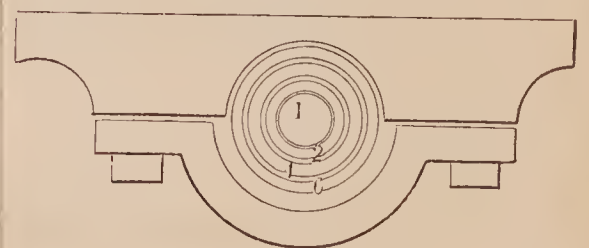

72794—S. G. Cabell—Preventing Incrustation of Steam Boilers.

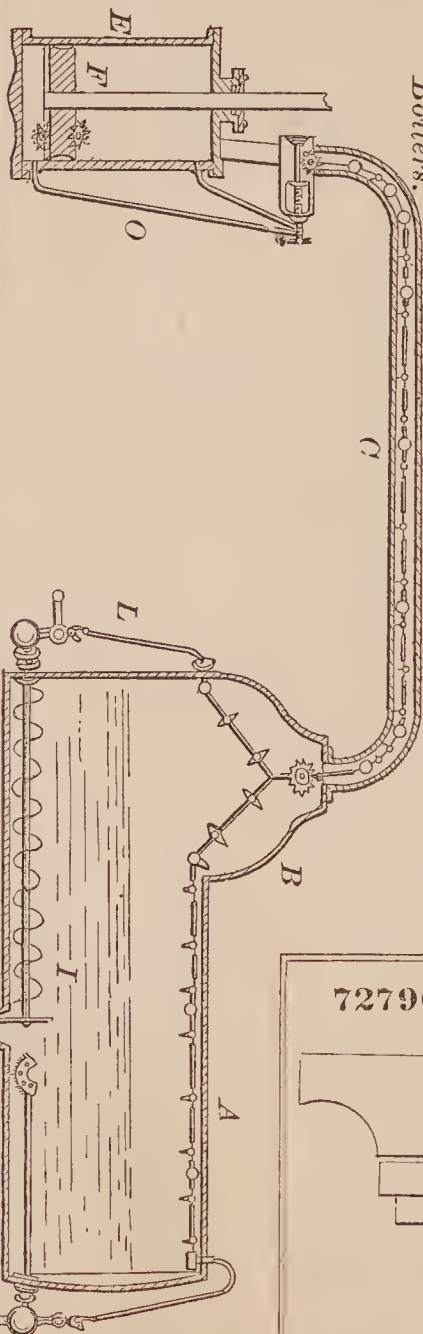

72790—G. B. Brayton—Making Eyelets.



72792—A. W. Browne—Mechanical Movement.

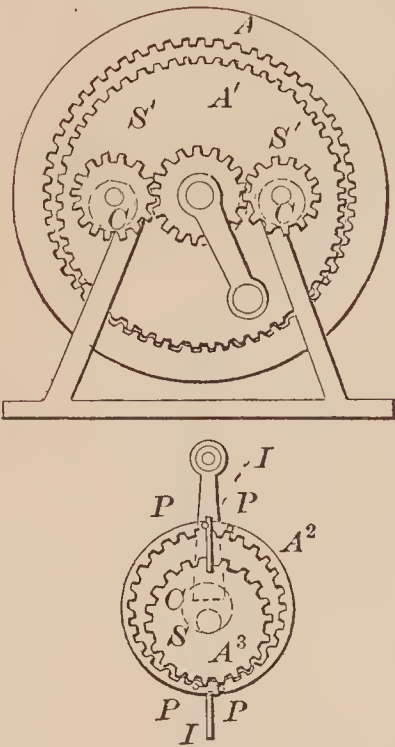

72793—N. H. Bundy—Boiler Water Gauge.

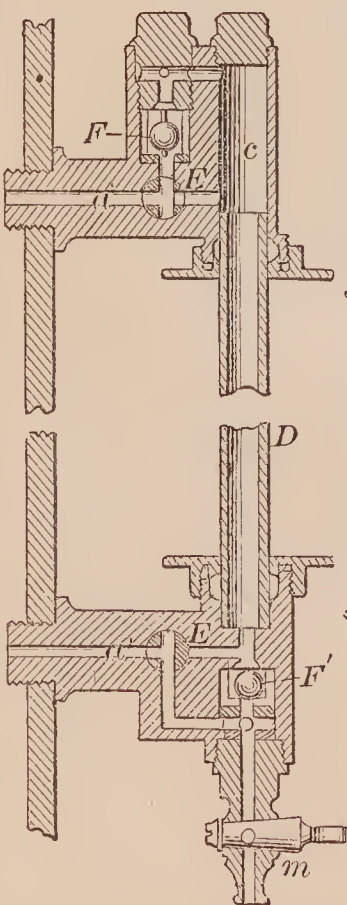

72789—A. F. H. Braum—Truss.

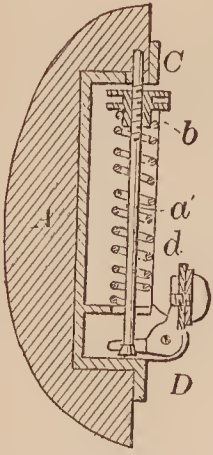

72797—H. Carpenter—*Form Block for Baskets.*

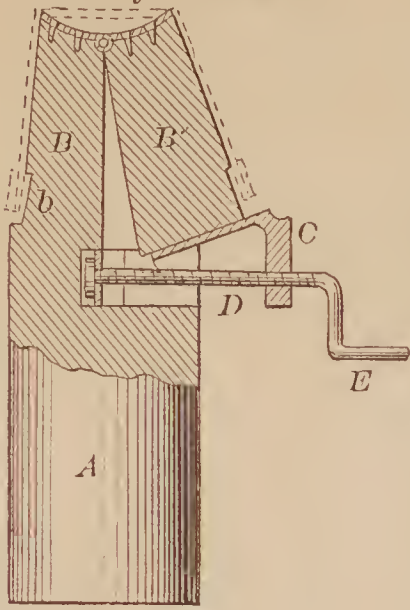

72799—C. Churchill—*Cultivator and Seeding Machine.*

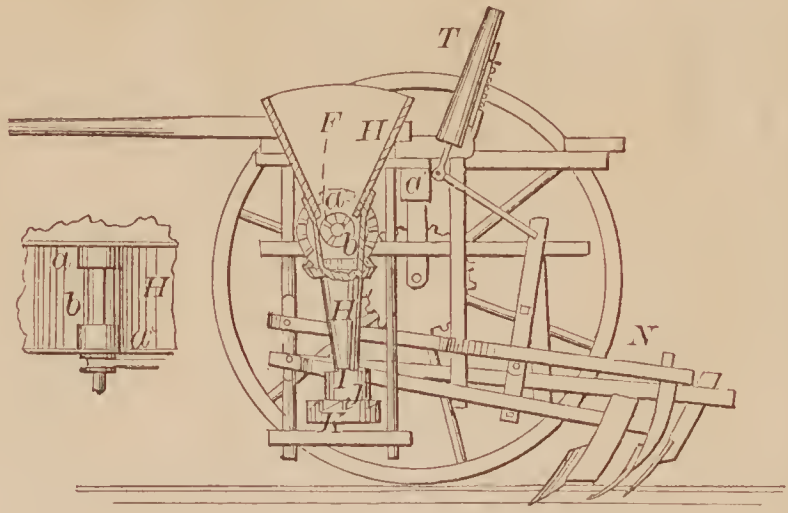

72768—Chapman & Hammett—*Bath Boiler.*

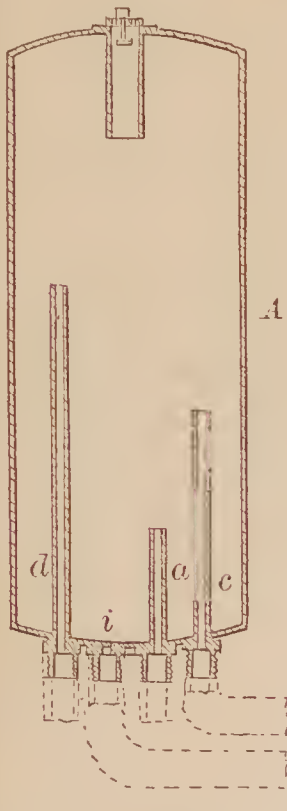

72800—F. M. Coffin—*Swifts.*

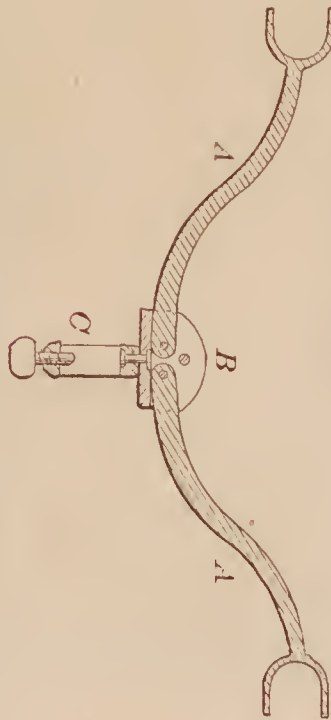

72801—J. S. Coffman—*Rotary Crane.*

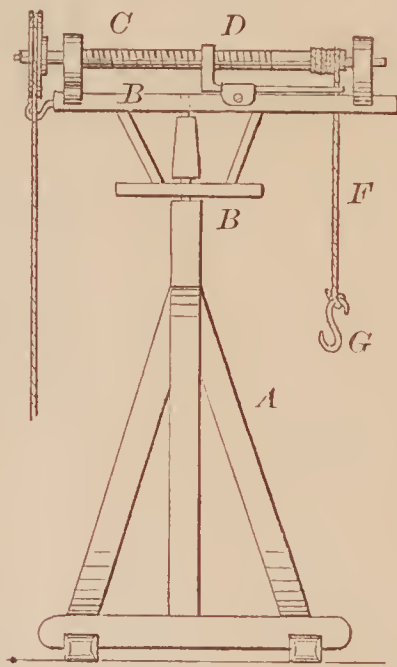

72804—P. & S. Conver—*Fruit Picker.*

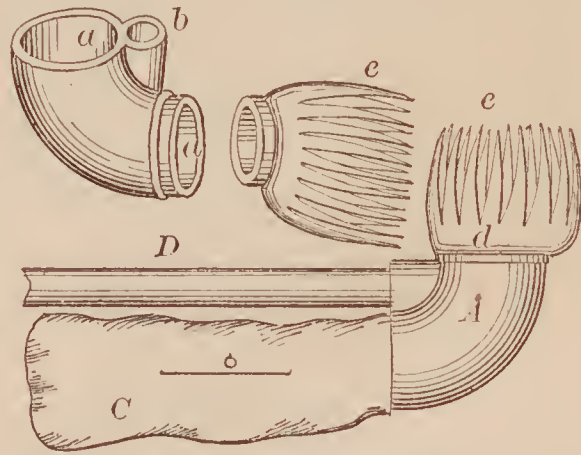

72802—R. Collins—*Breast Pad.*

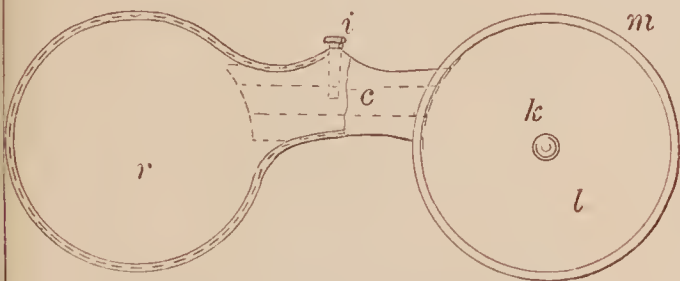

72803—L. Conroy—*Fire Arm.*

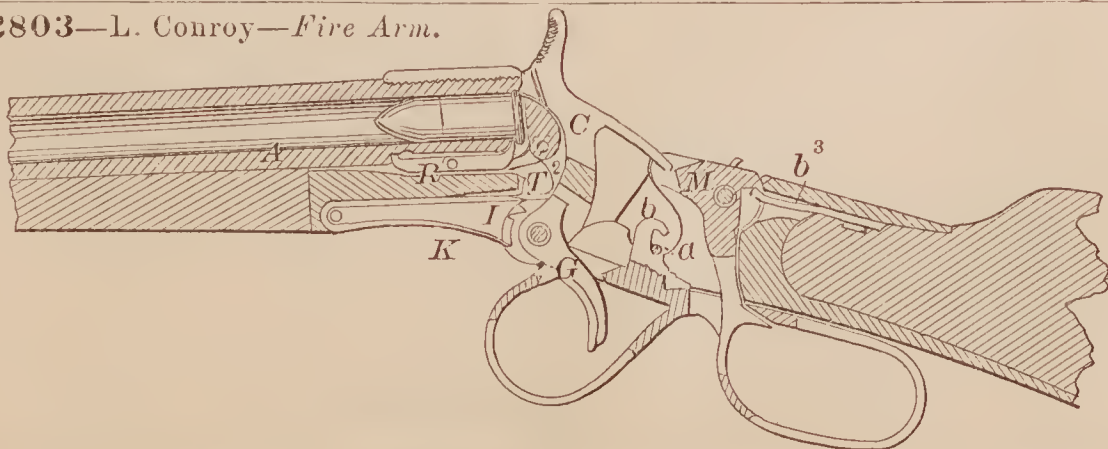



72805—G. E. Conwell—Beehive.

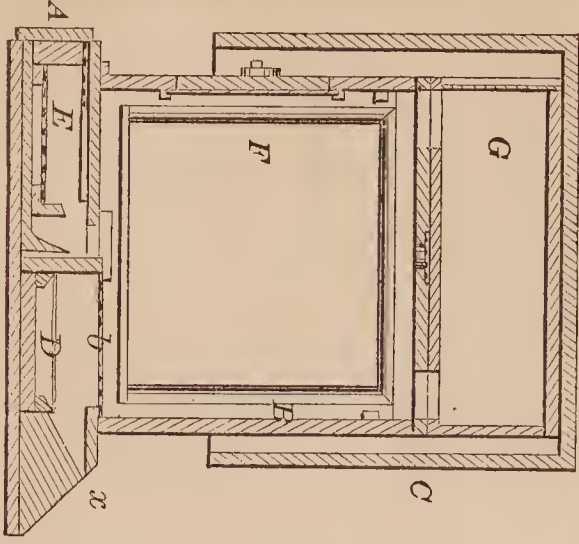

72808—W. Courtney—Beehive.

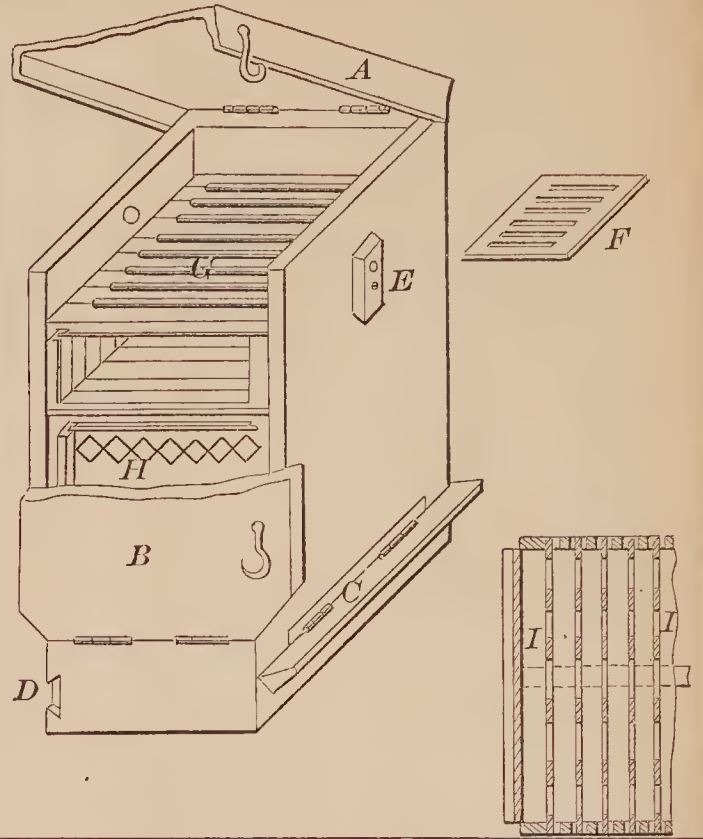

72806—T. V. Cook—Truck.

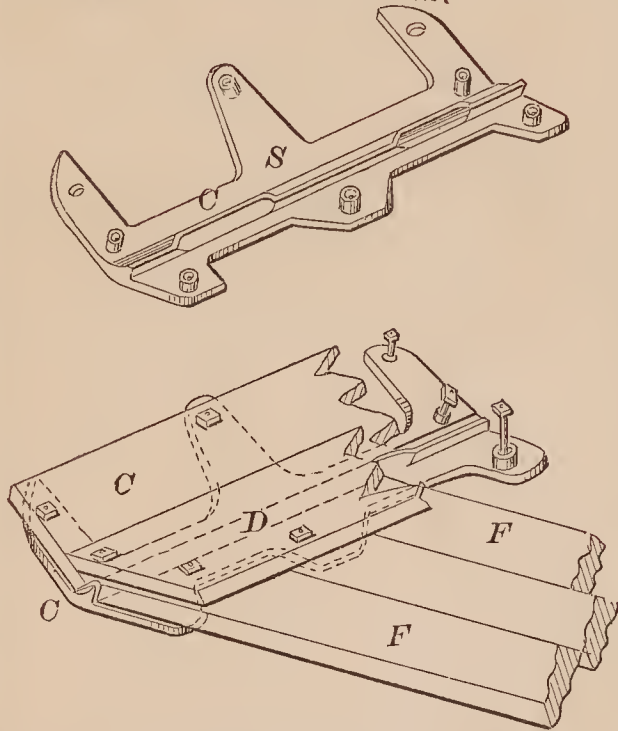

72809—H. H. Craigie—Valve for Water Closets.

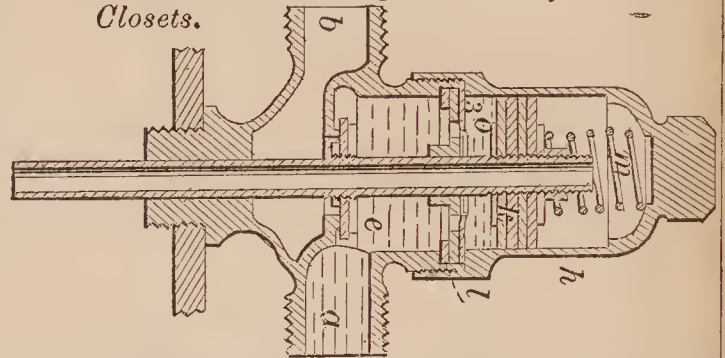

72810—H. H. Craigie—Water Supply for Water Closets.

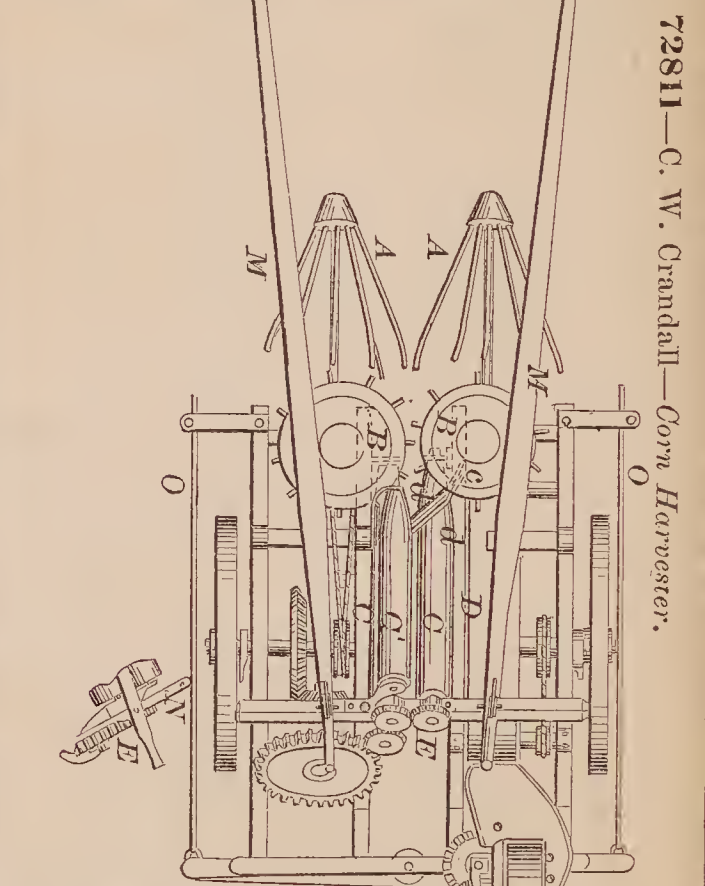
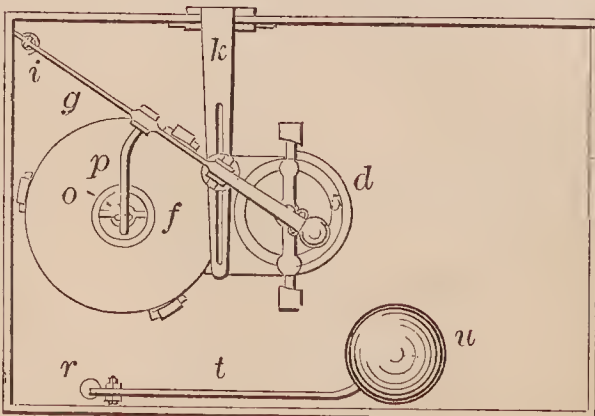
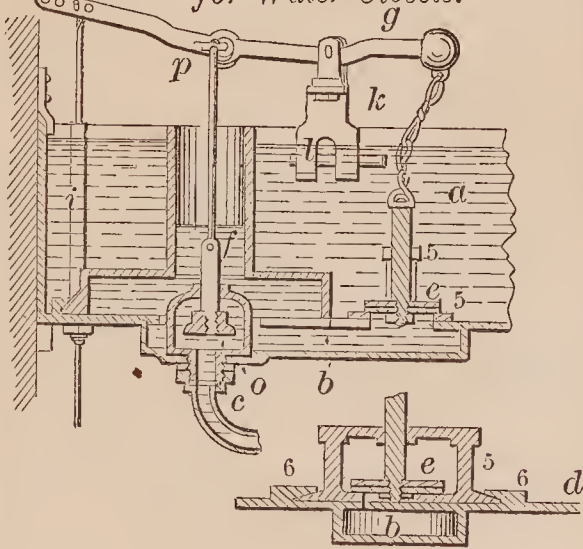

72811—C. W. Orndall—Corn Harvester.

72807—R. H. Cooper—Window Sash Stop

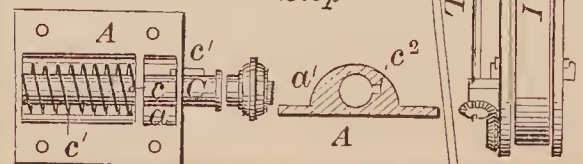



72819—E. W. Dixon—Washing Machine.

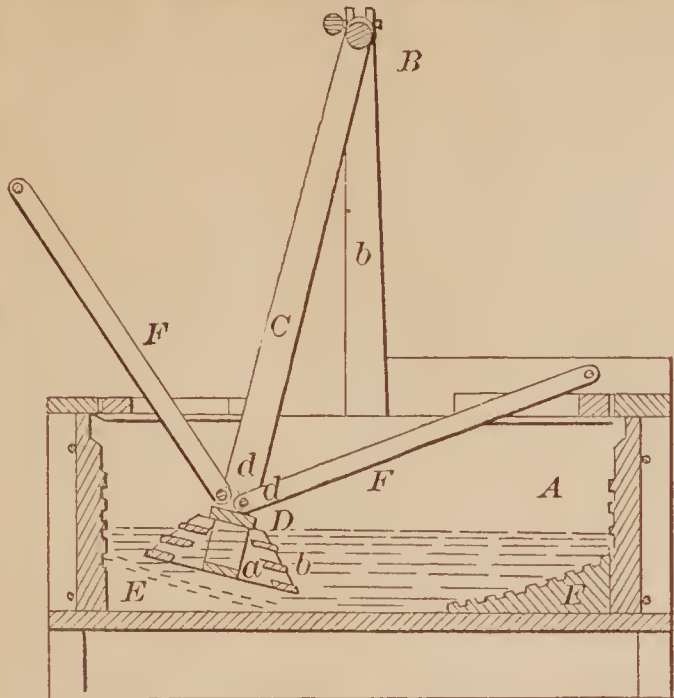

72815—A. Dawes—Spindle Knob.

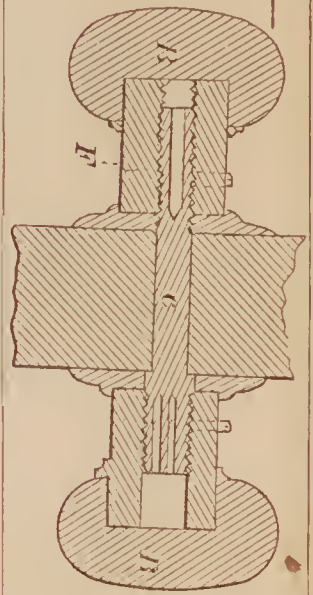

72820—T. Doane—Air Pump.

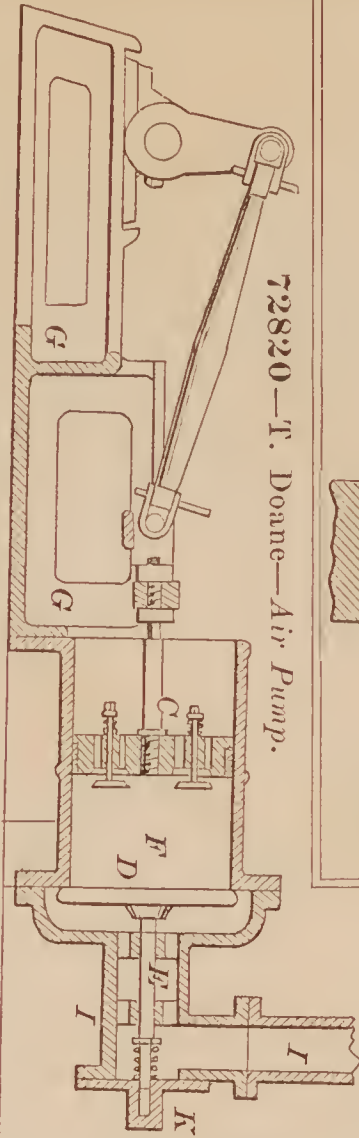

72816—H. G. Dayton—Spirit Still.

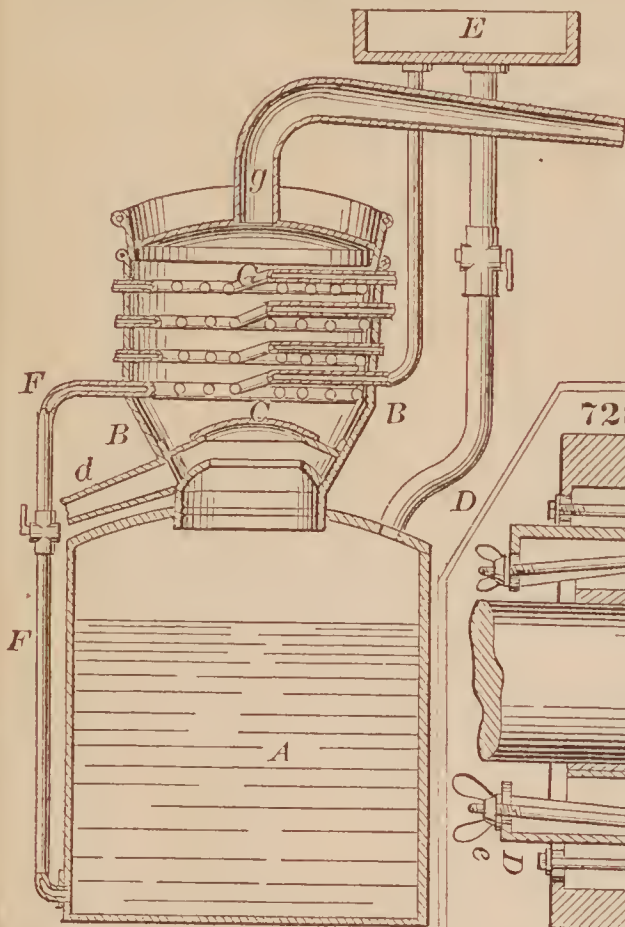

72812—C. Custer—Mill Stone Bush.

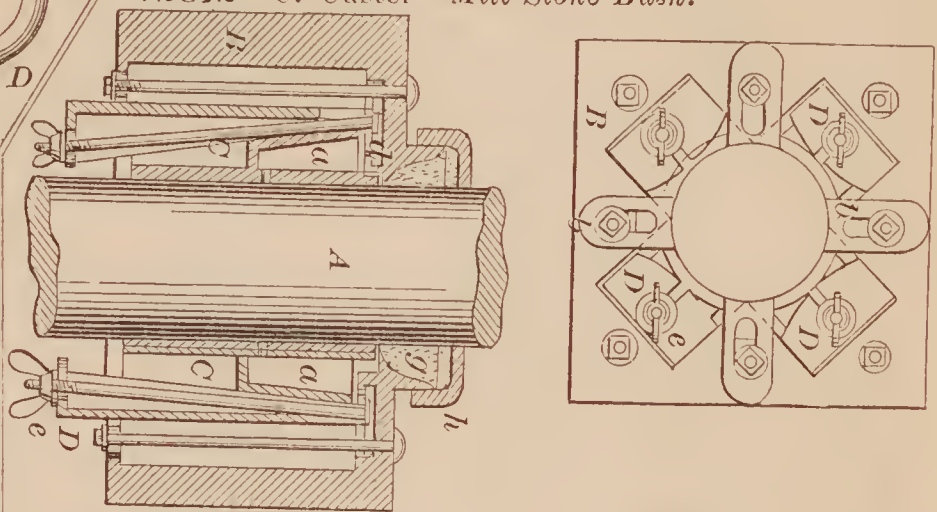

72821—L. A. Dochez—Axle Box.

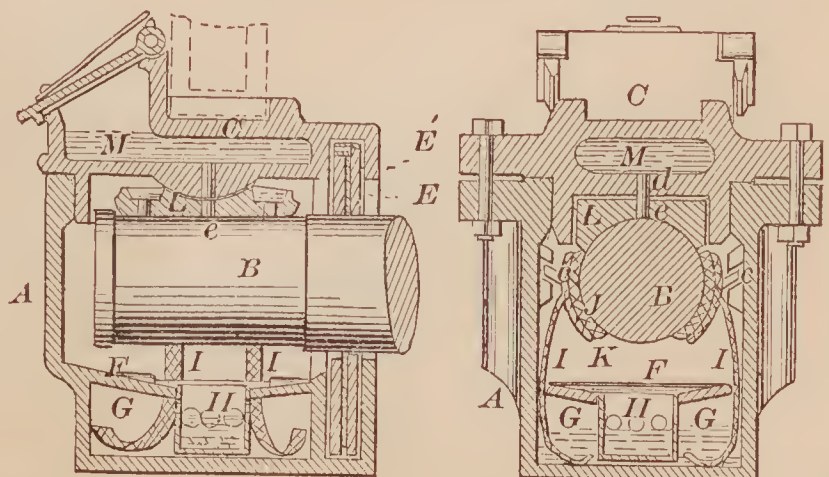
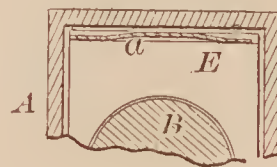

72814—J. C. Davis—Tester Frame for Bedsteads.

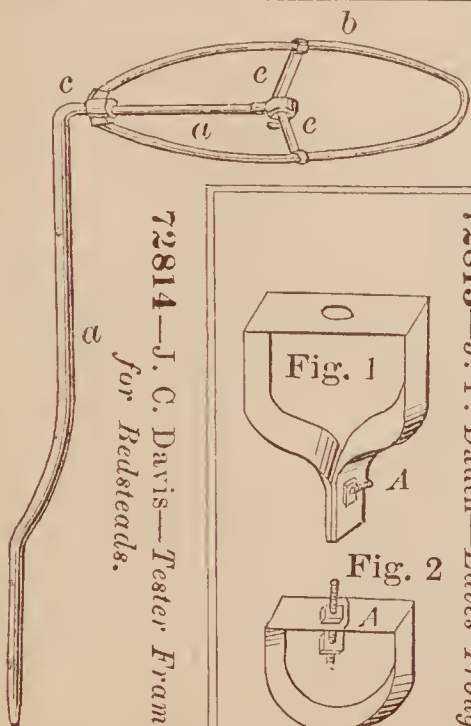

72813—J. P. Dauth—Eaves Trough.

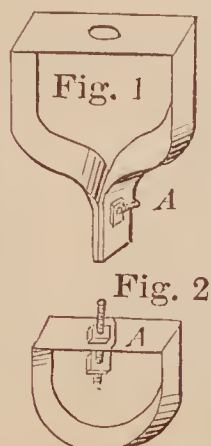



72822—L. Dodson—Portable Mill.

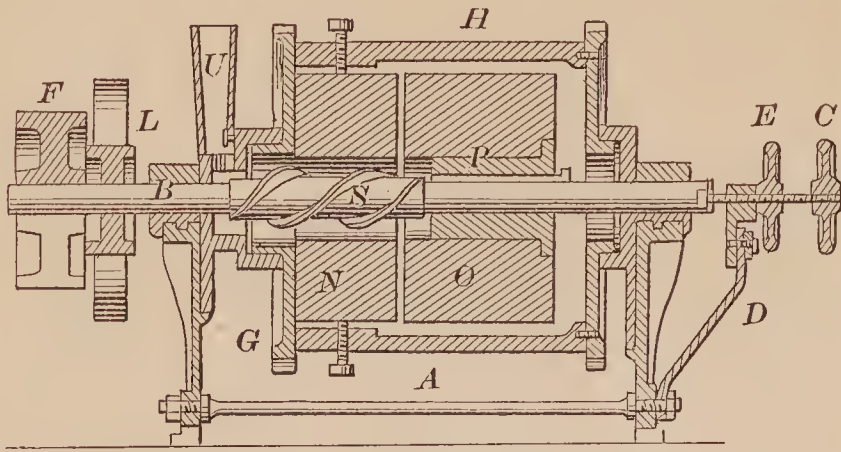

72823—W. M. Doty—Clothes Pin.

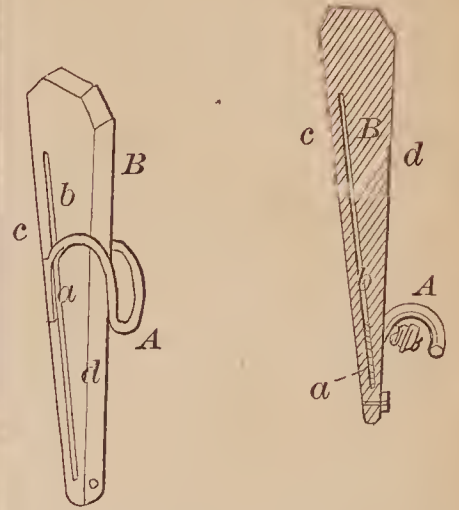

72825—Earseman & Gray—For Carburetting Coal Gas.

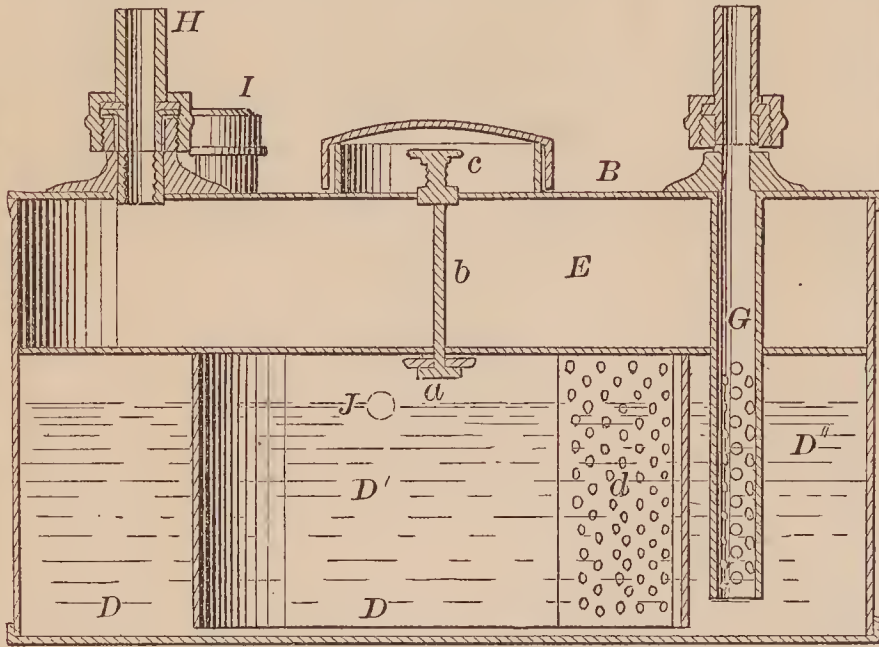

72826—J. Elliott—Stump Extractor.

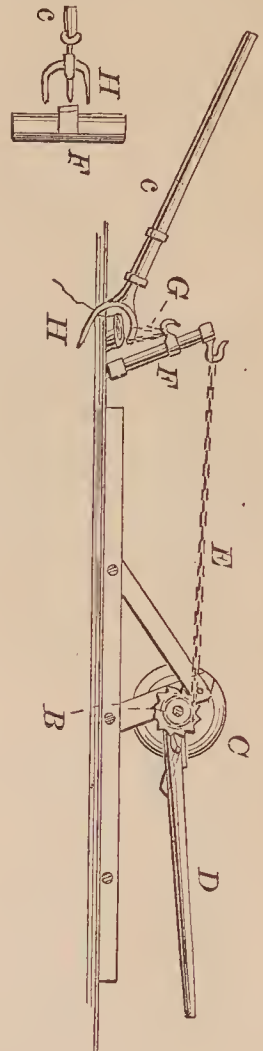

72824—E. Durand—Dulcimer.

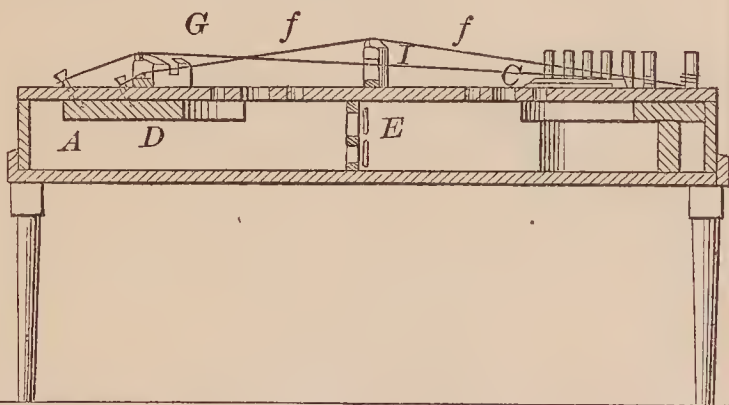

72829—J. Fanning—Sewing Machine.

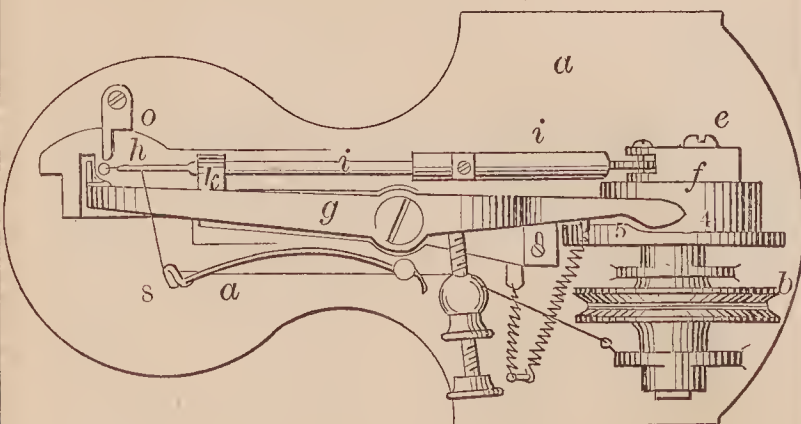

72828—P. Estes—Head Block.

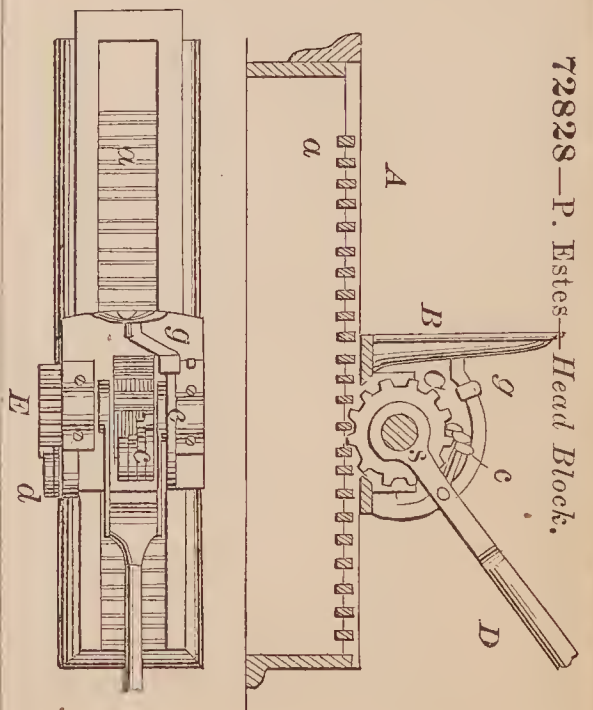

72831—E. R. Ferry—Check and Driving Rein.

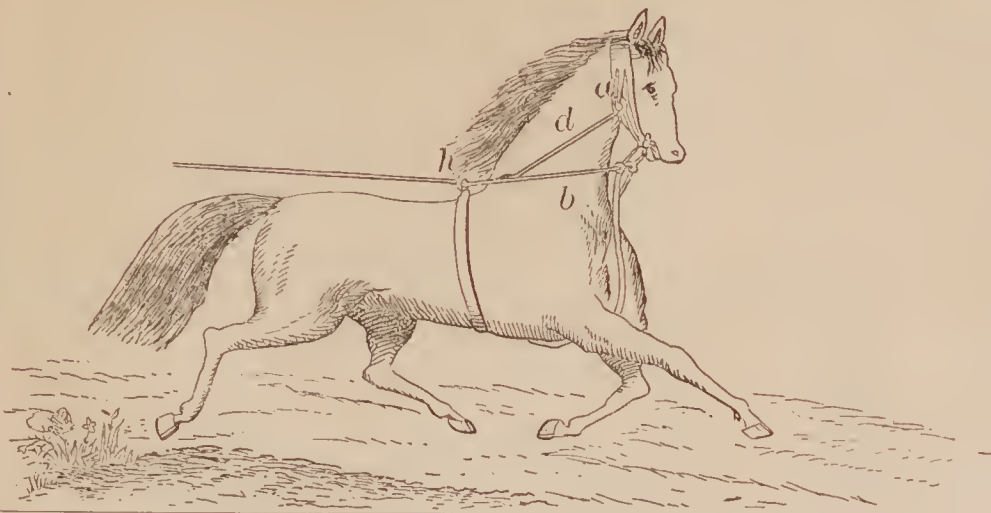

72832—C. Fillmore—Trace Buckle.



72834—S. Gantz—For Separating Wheat from Garlic.

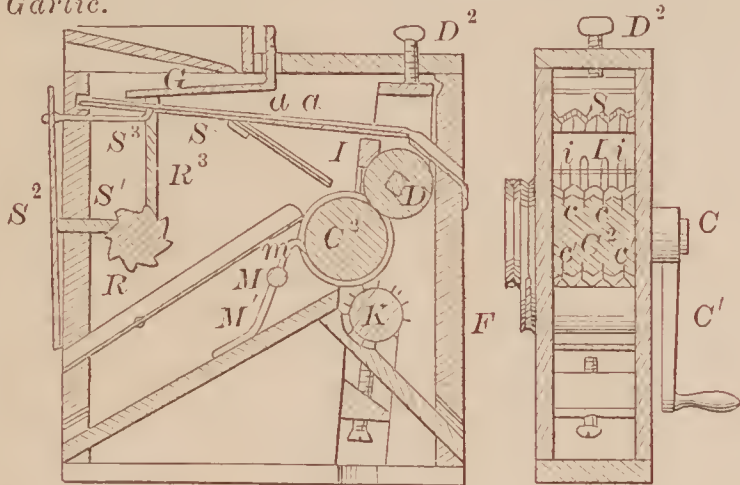

72833—A. D. Fowler—Children's Carriage.

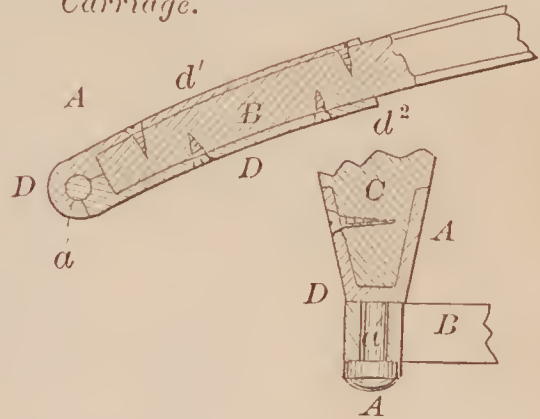

72835—R. Garter—Cultivator.

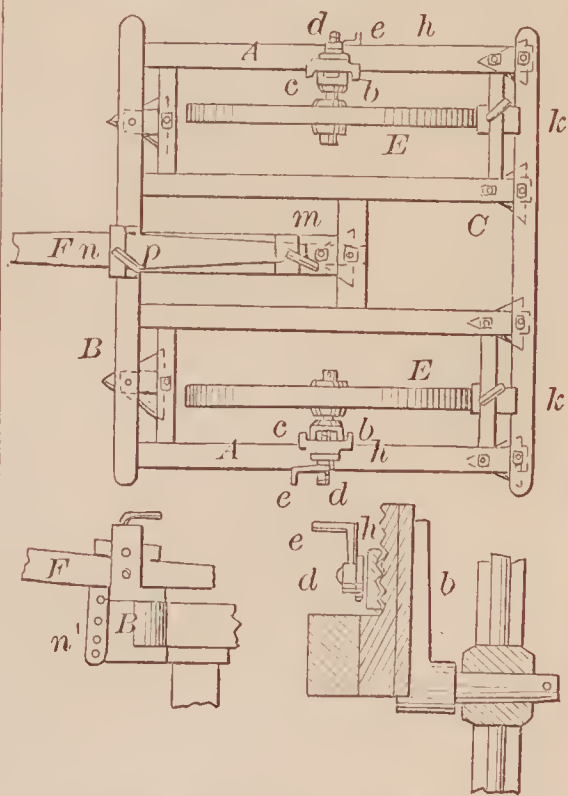

72836—J. C. Gaston—Envelope.

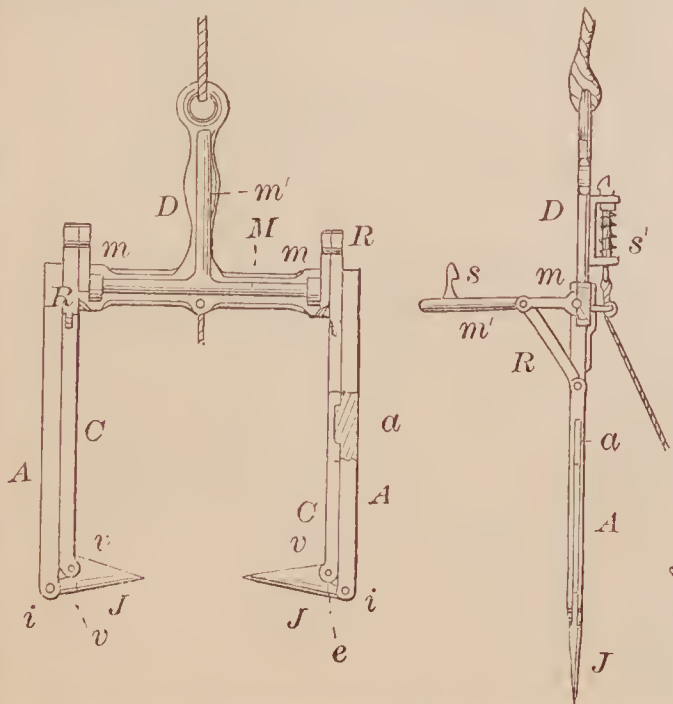
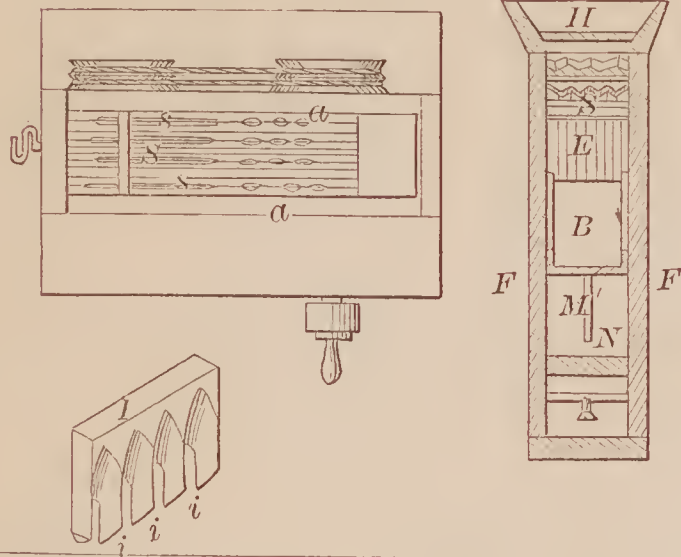
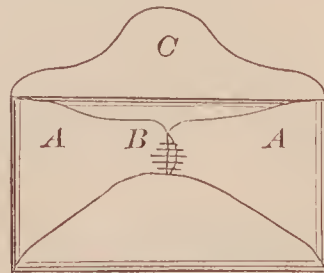

72837—J. Gilmore—Horse Hay Fork.



72840—W. F. Goodwin—Harvester Rake.

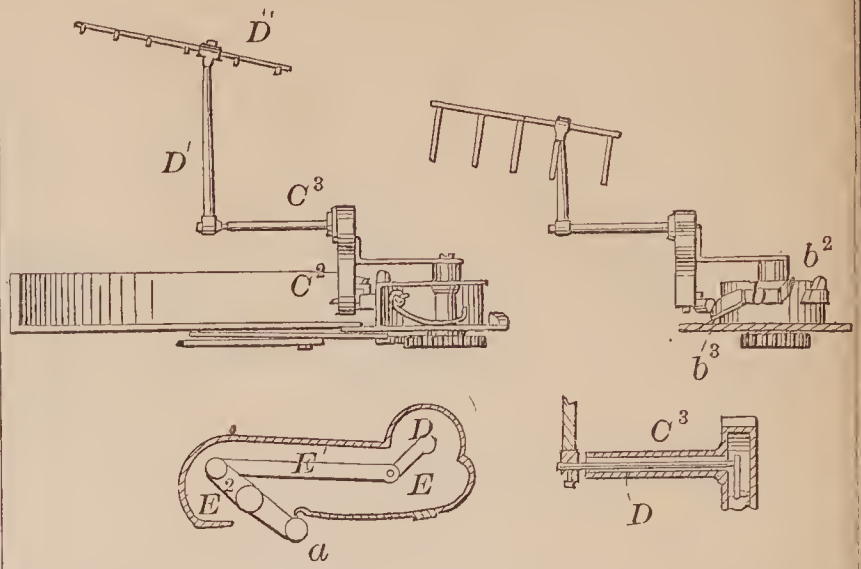

72838—W. C. Goodwin—For Trimming Strawberry Vines.

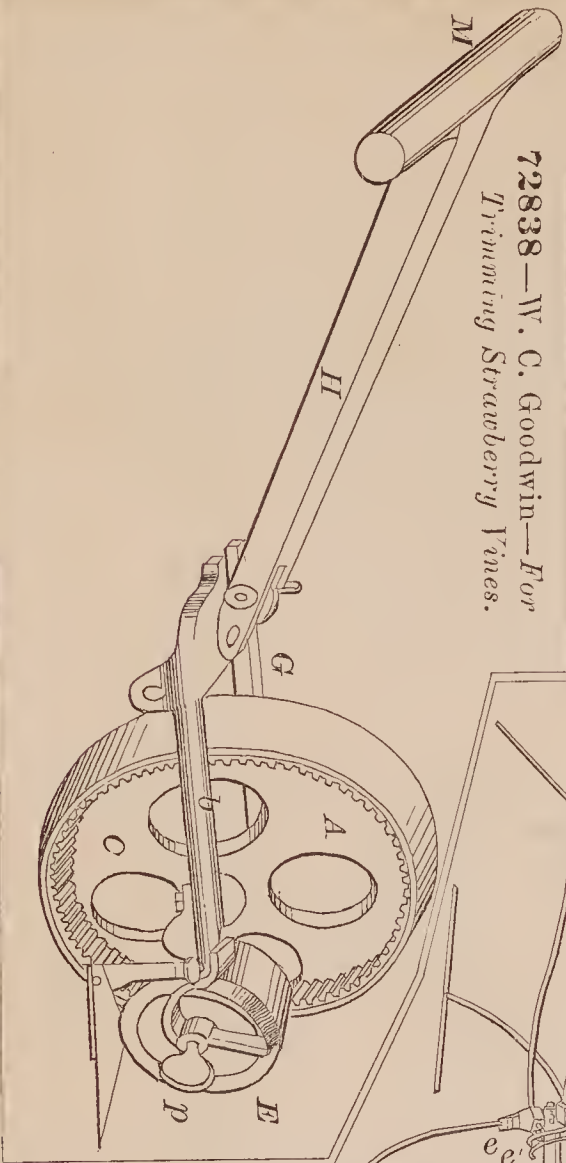

72839—W. F. Goodwin—Harvester Rake.

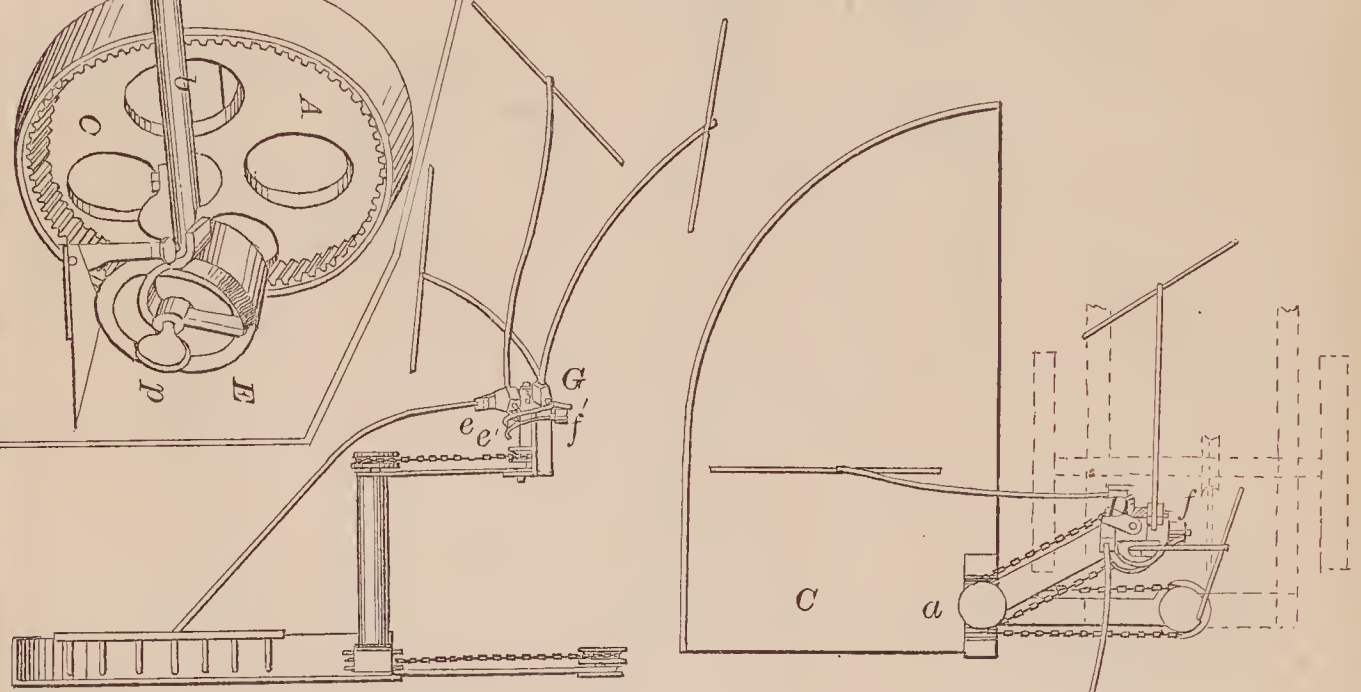

72841—W. F. Goodwin—Harvester Rake.

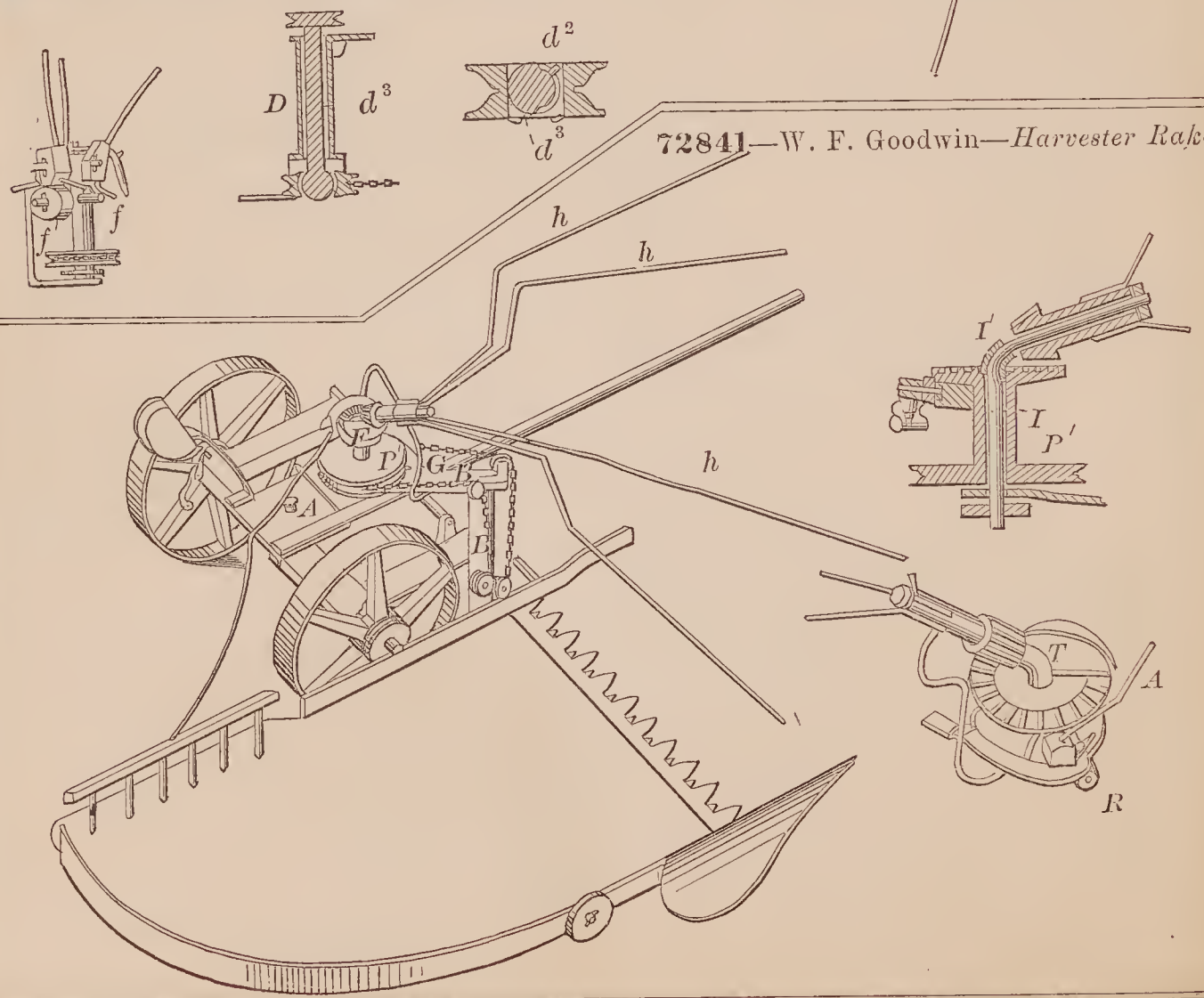

72818--J. B. Hamilton--Corn Harvester.

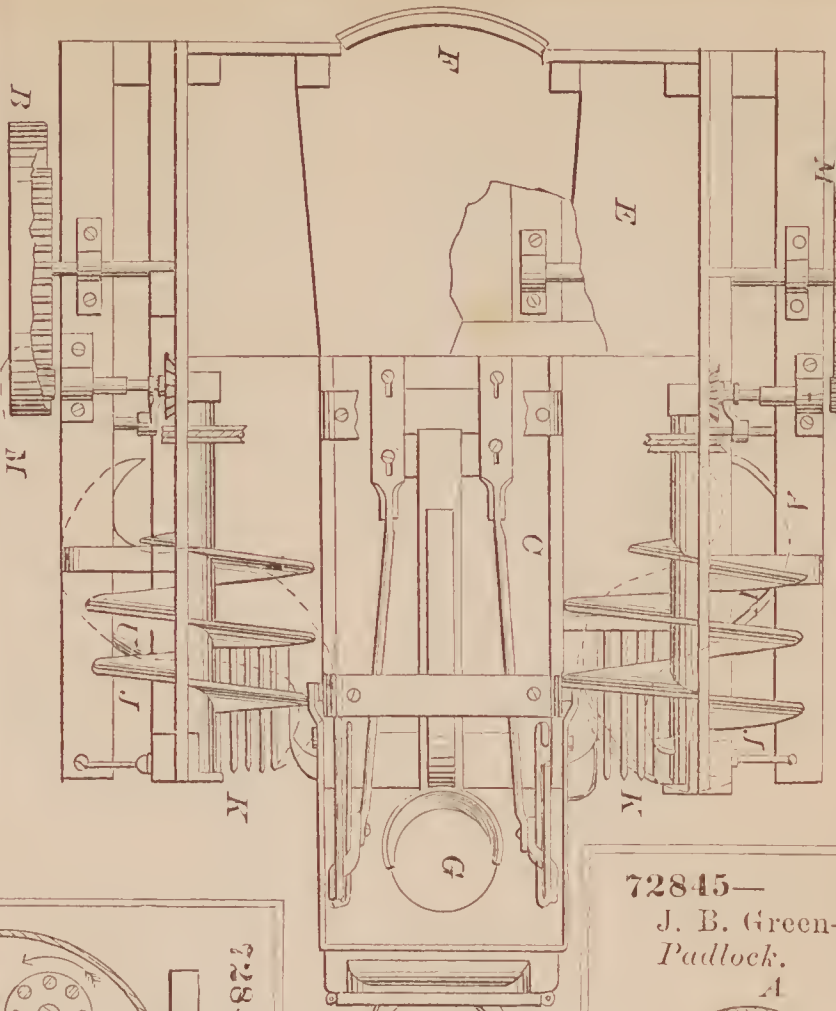

72845--  
J. B. Green--  
Padlock.

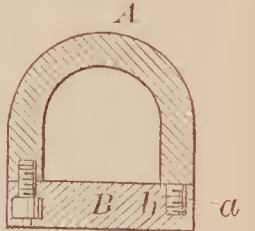

72817--E. Hall--Peat and Brick Machine.

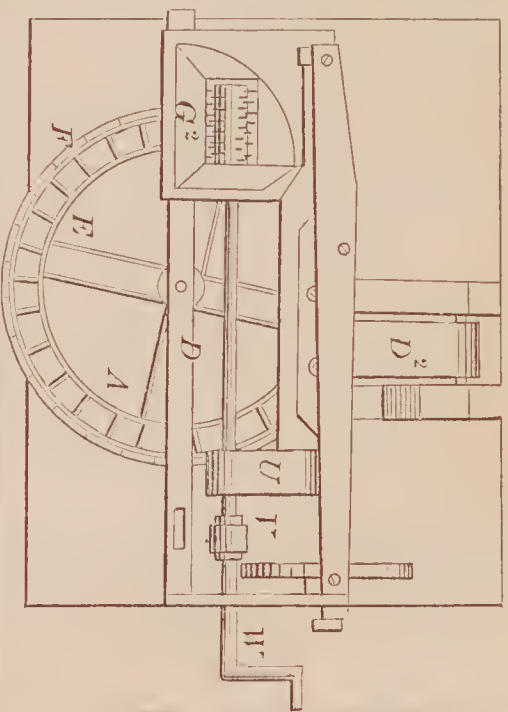

72816--R. K. Gwathmey--Cotton Ginning Machine.

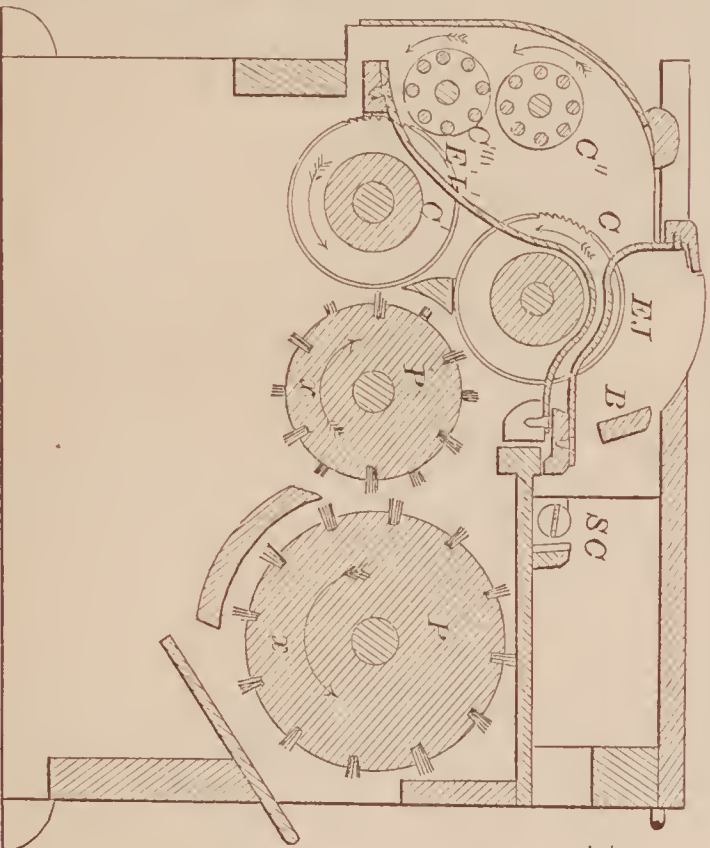

Fig. 1

72812--W. F. Goodwin--Mechanical Movement.

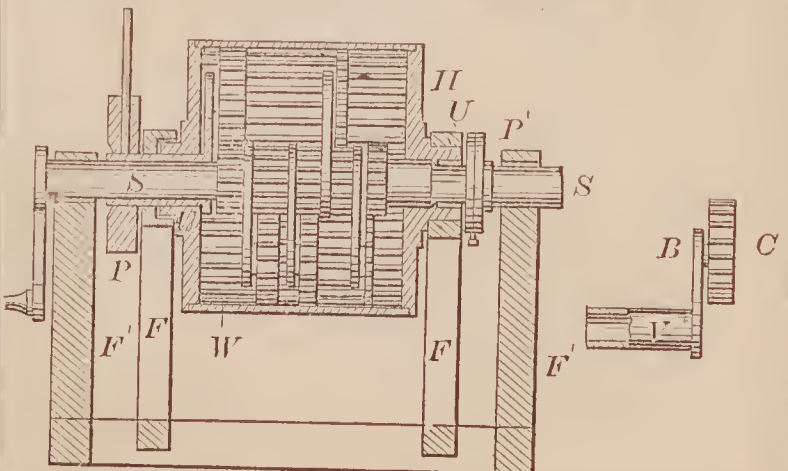
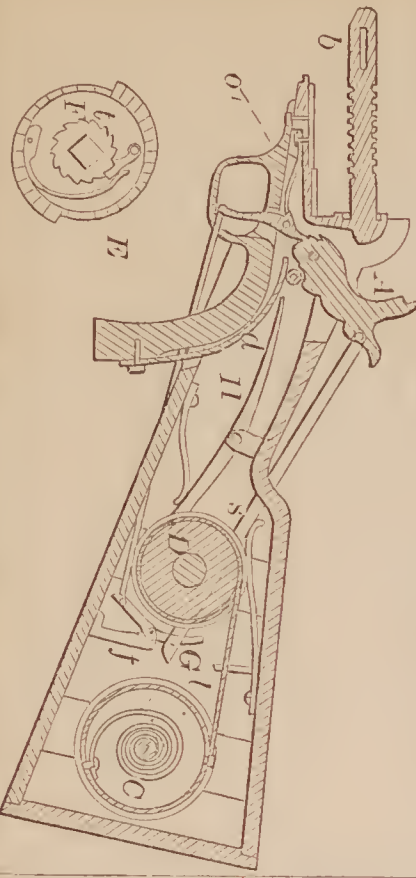

Fig. 3

72843--  
W. F. Goodwin--  
Retort.



72844--J. Gordon--Spring Power Repeating Fire Arm.







72859—A. B. Ives—*Metallic Column.*

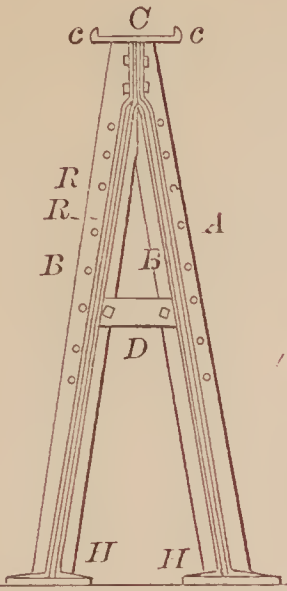

72860—R. V. Jones—*Horse Hay Fork.*

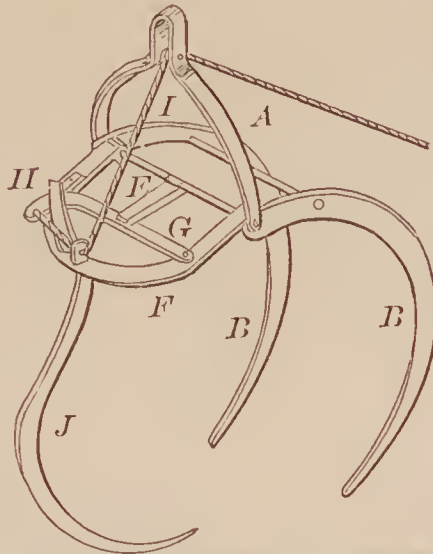

72861—J. Katzenberg—*Car Brake.*

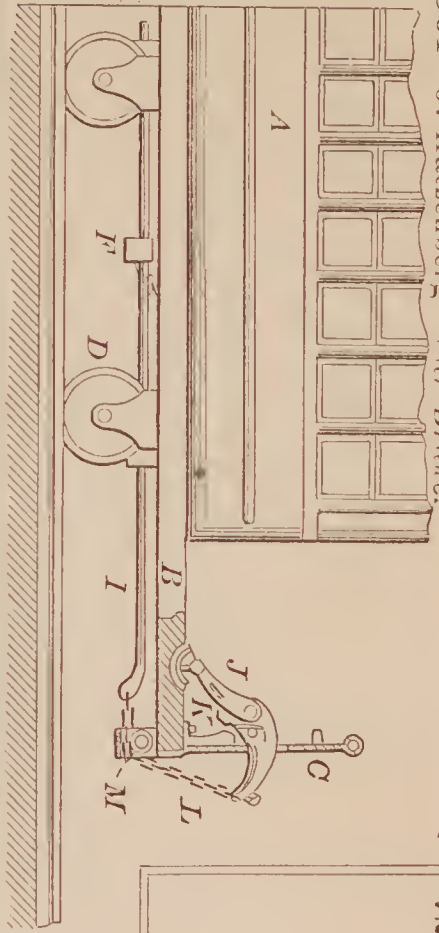

72865—M. A. Lanagan—*Lock.*

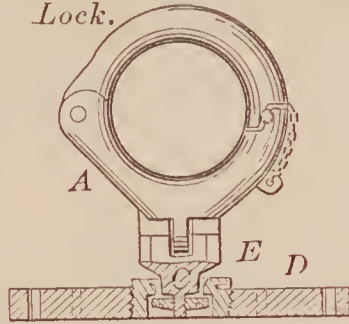

72868—L. Leigh—*Globe Valve.*

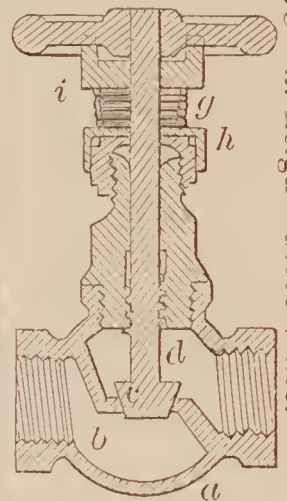

72863—A. Labhair—*Fence.*

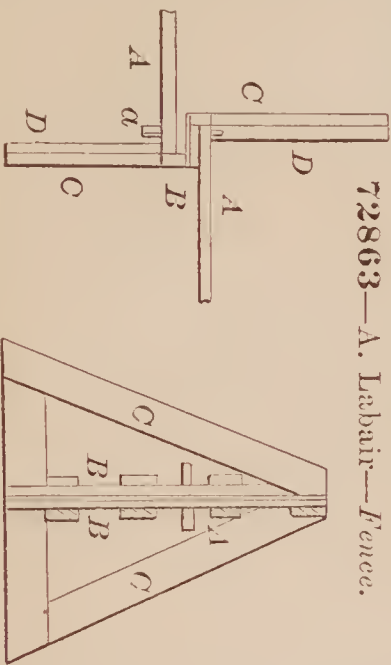

72867—L. J. Lavator—*For Attaching Brackets to Glass.*

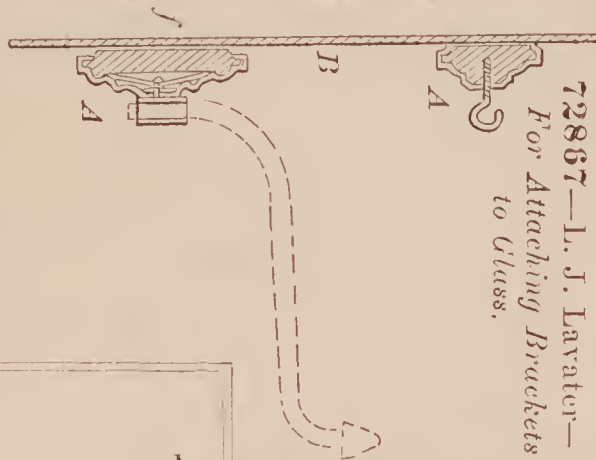

72862—M. A. Keilig—*Dress Hook.*



72869—C. Lewando—*Illuminated Sign.*

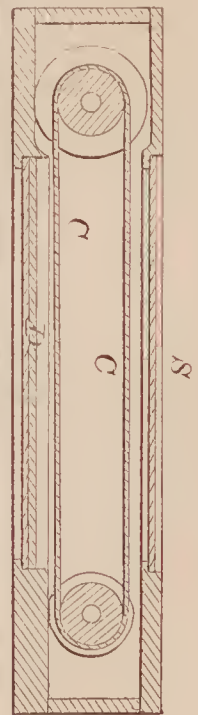

72866—M. A. Lanagan—*Boat Detaching Apparatus.*

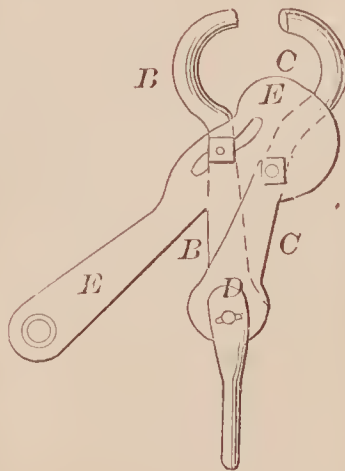

72864—E. B. Lake—*Scales.*

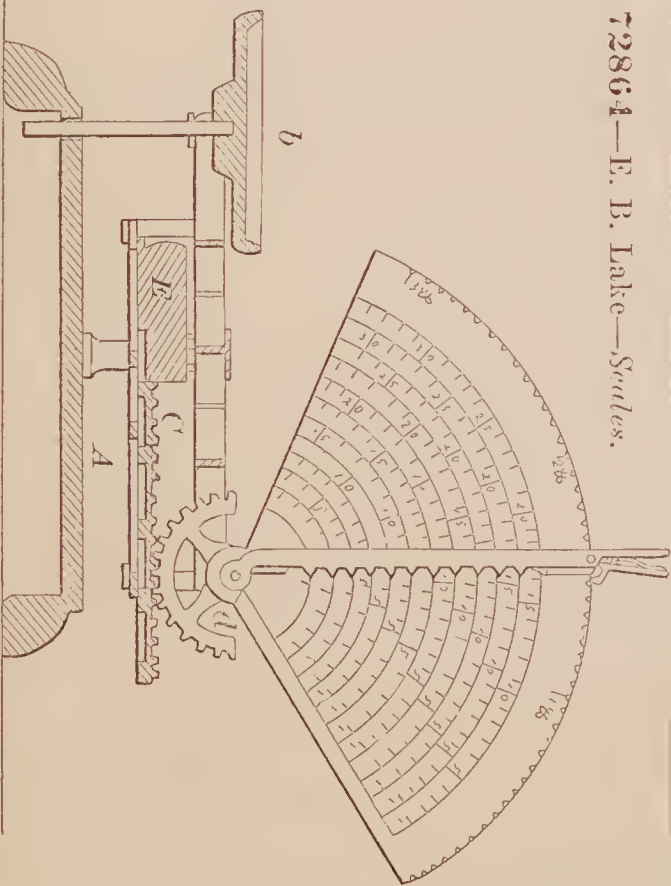





72881—D. Morrison—Carriage Motor.

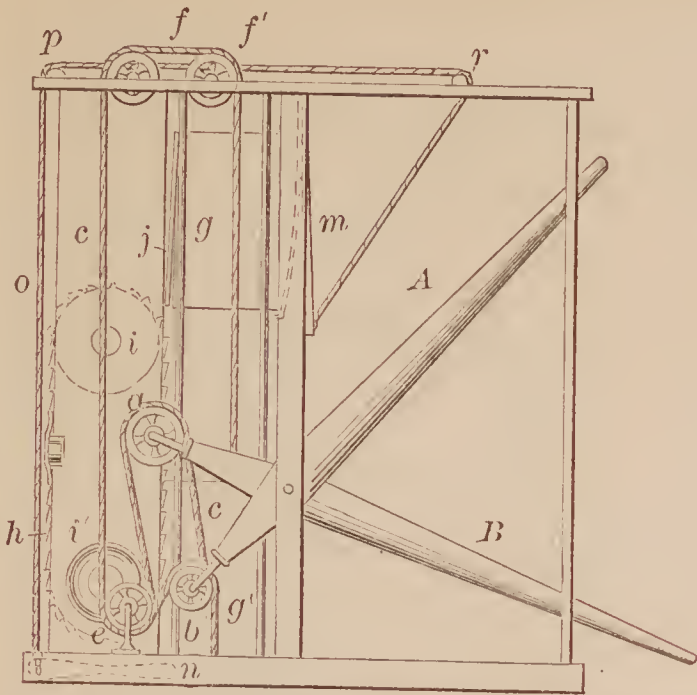

72885—J. Nester—Scribe Hook for Weather Boarding.

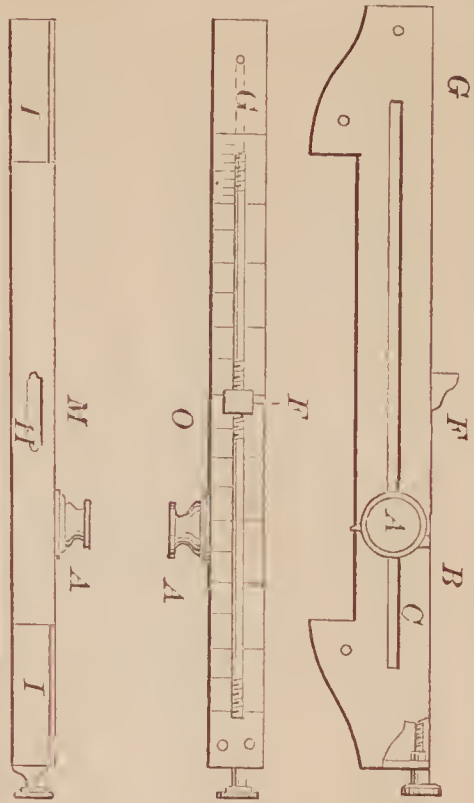

72883—M. C. Motch—Rotary Brick Machine.

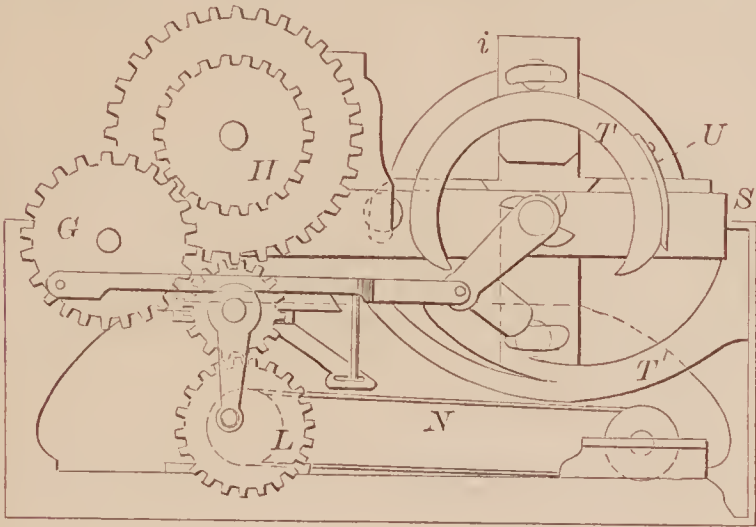

72884—B. H. Naves—Pump Piston.

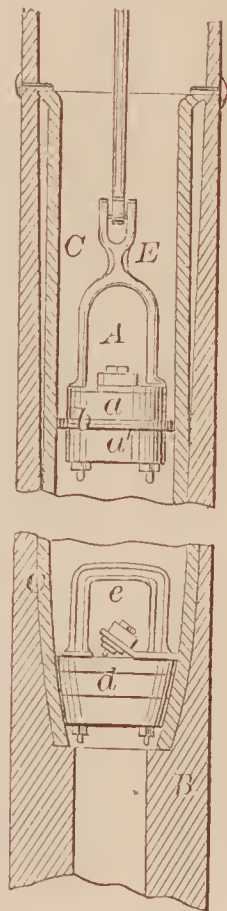

72882—D. F. Mosman—Steam Engine Governor.

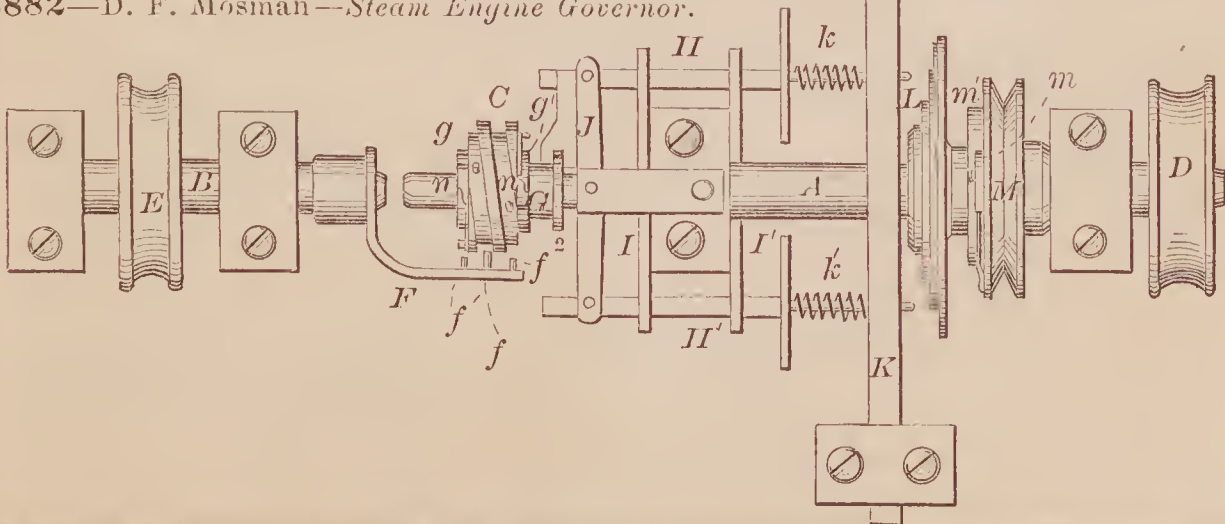



72889—S. J. Peabody—Cultivator.

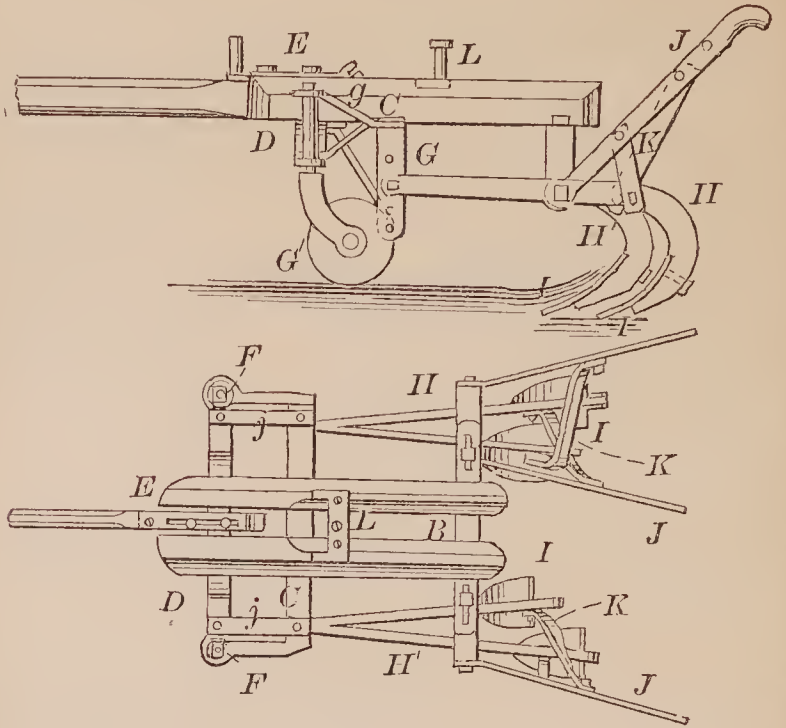

72886—W. H. Nobles—Smoke Extinguisher for Boilers.

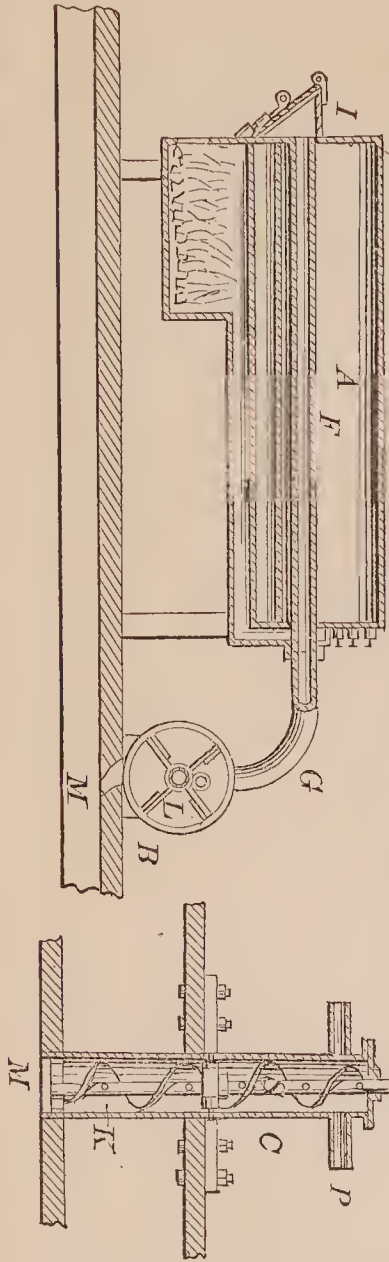

72887—D. J. Owen—For Boring Hubs.

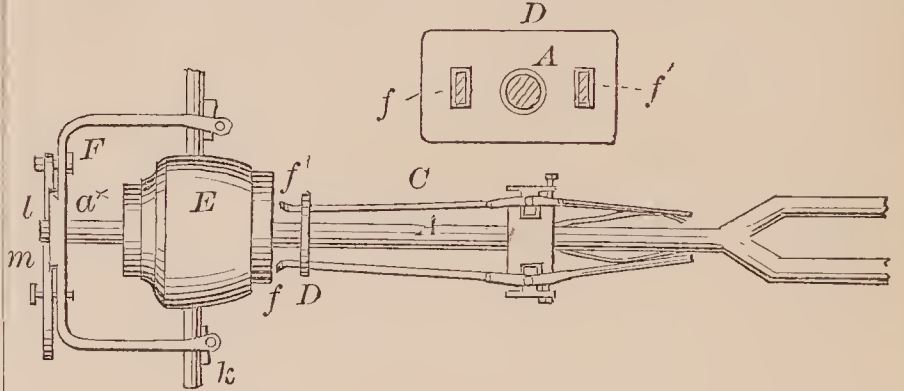

72890—W. Peck—Wind Mill.

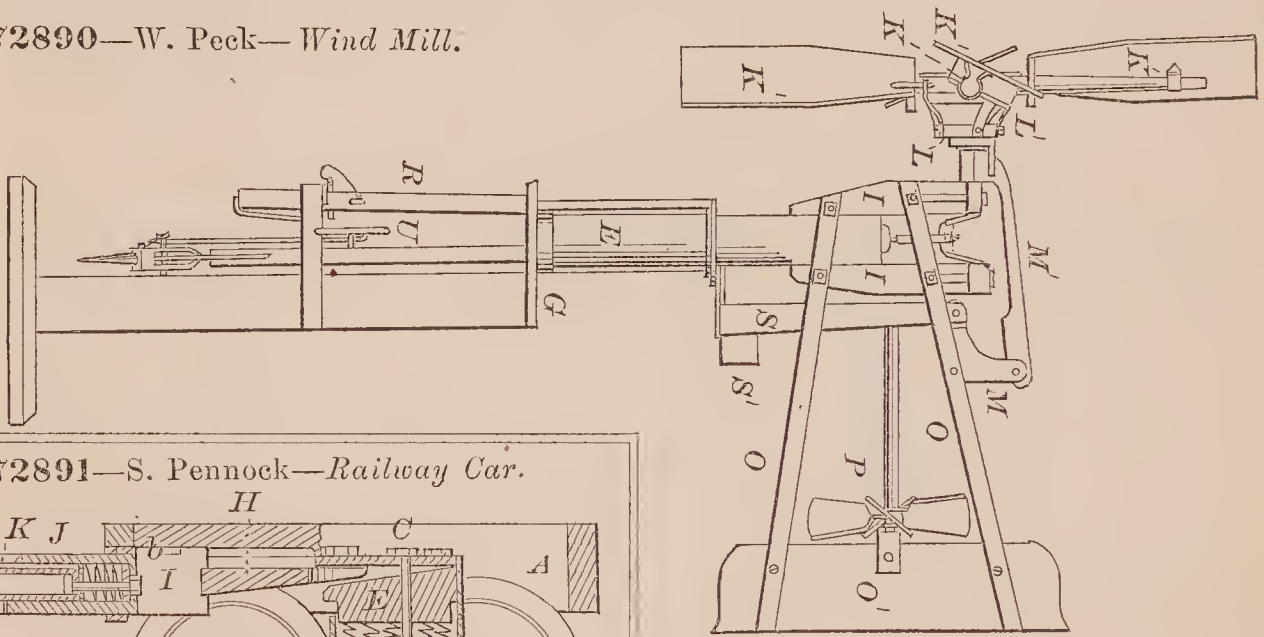

72891—S. Pennock—Railway Car.

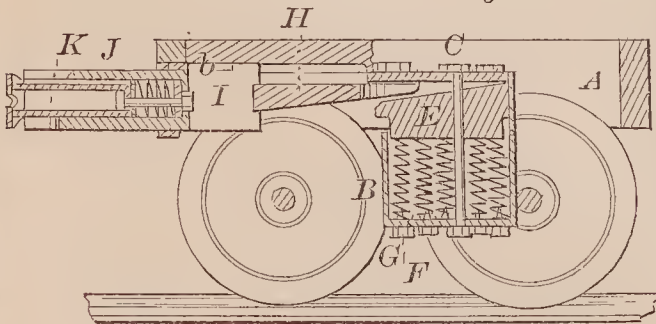

72888—M. J. Palmer—Whiffletree Coupling.

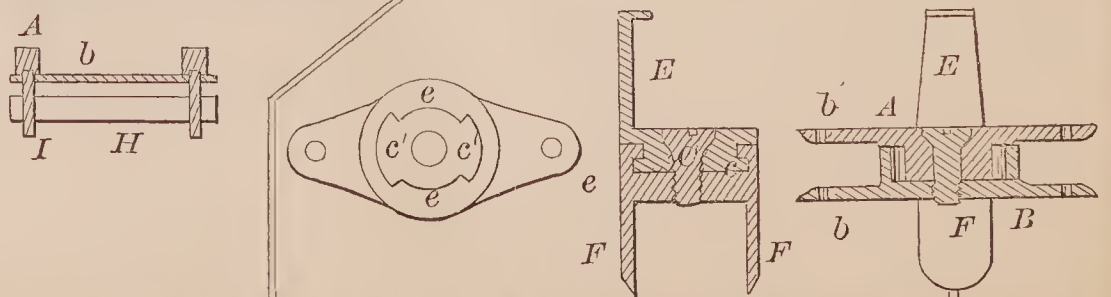

72892—Perkins & Hovey—Hose Coupling.

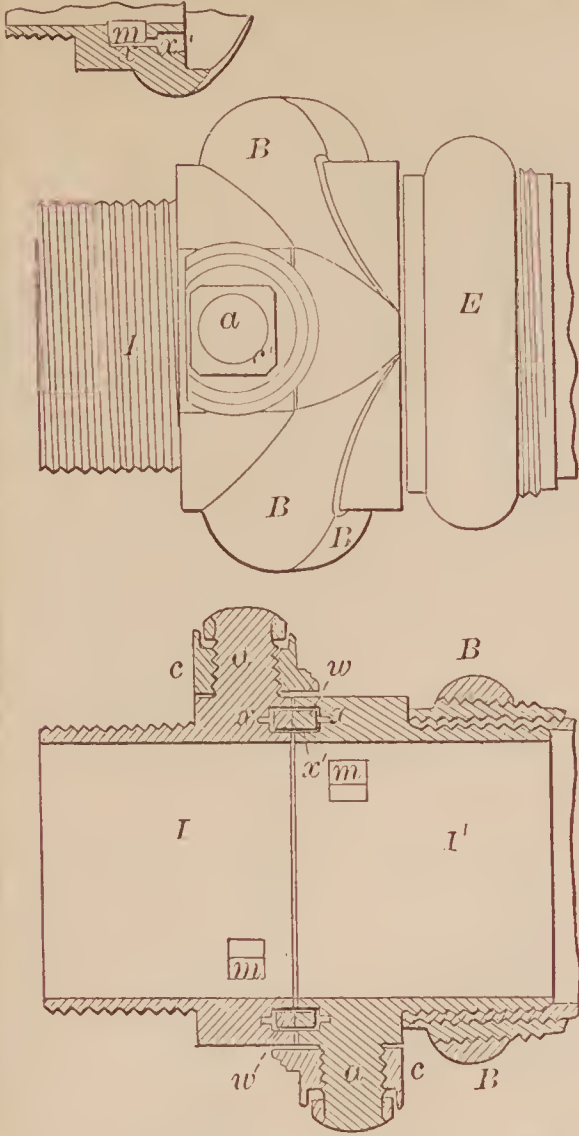

72895—C. F. Pike—Railroad Car for Preserving and Transporting Meats, &c.

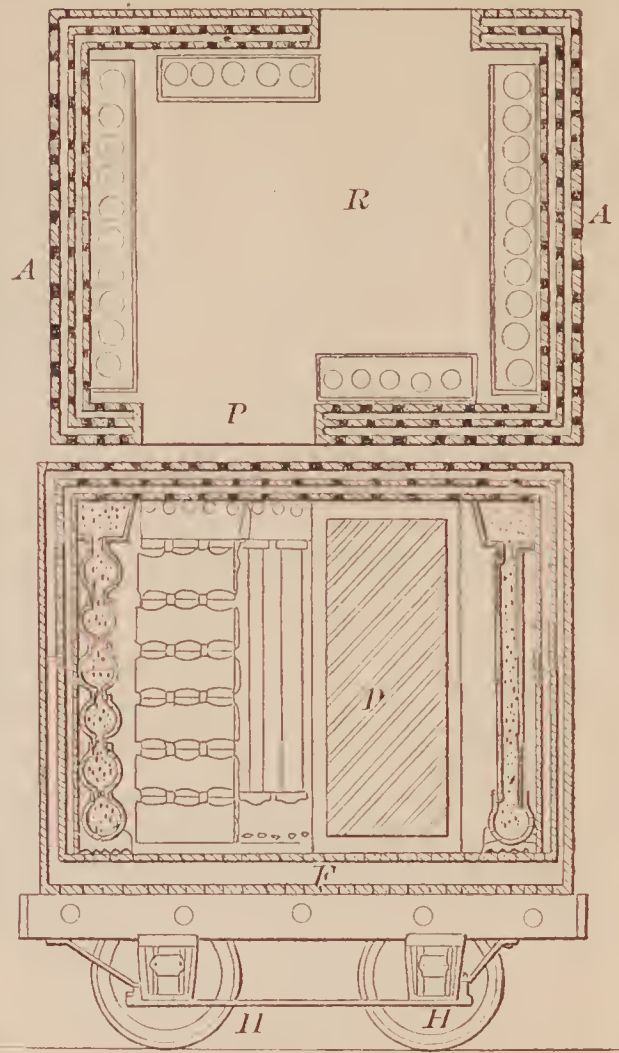

72894—C. F. Pike—Preserving Perishable Articles.

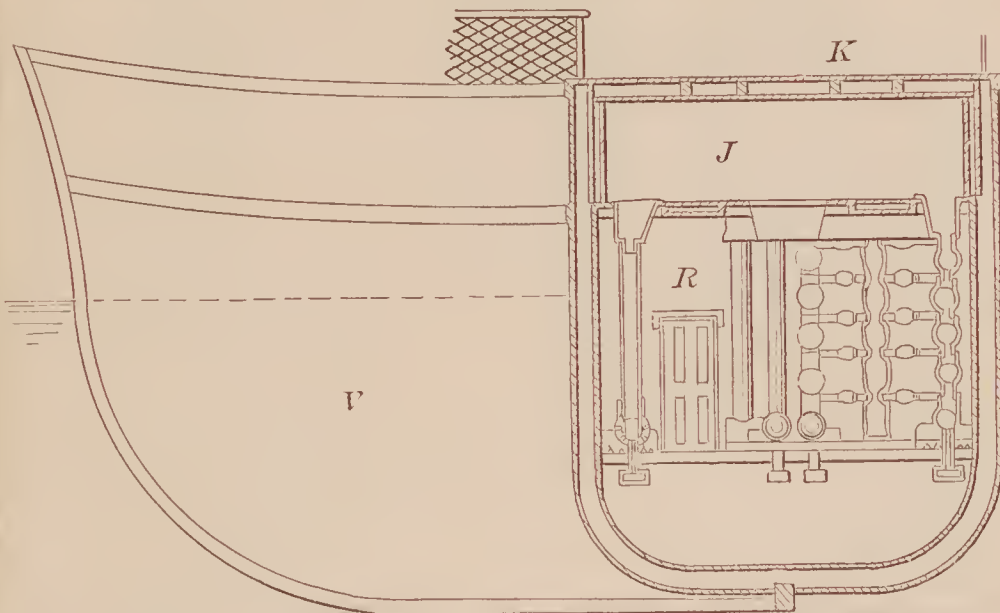

72893—C. F. Pike—Corpse Preserver.

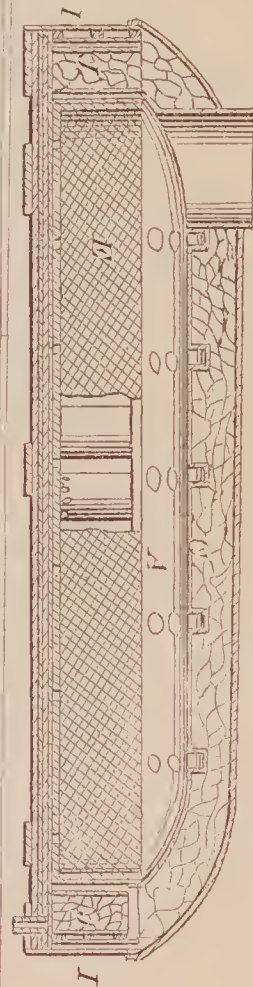

72896—M. Pirz—Dining Table.

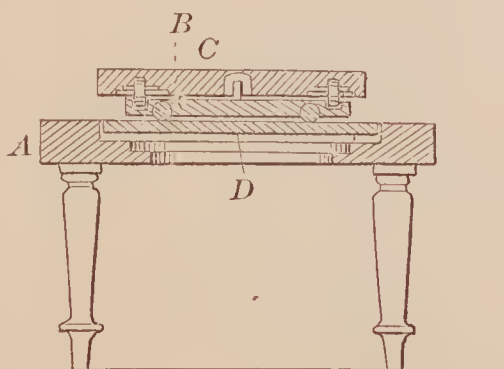

72897—C. H. Platt—Gate.





72899—F. B. Prindle—For Heading Bolts.

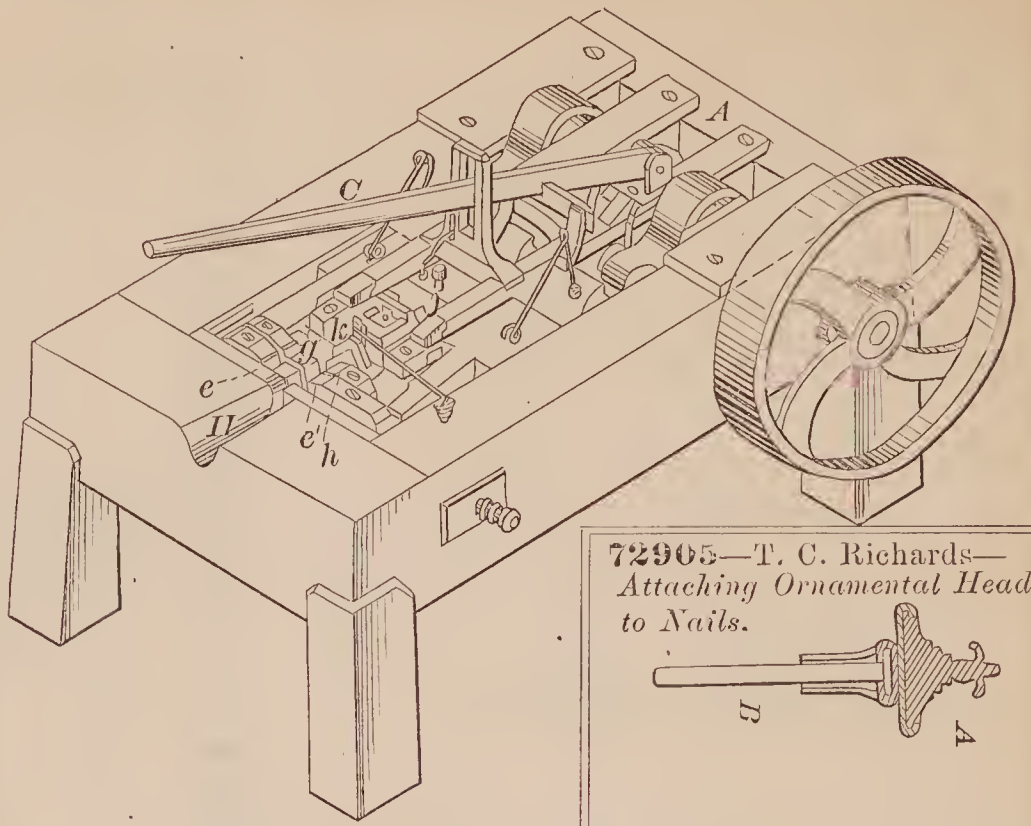

72898—F. L. Pratt—Tobacco Cutter.



72905—T. C. Richards—Attaching Ornamental Heads to Nails.

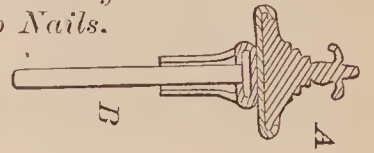

72900—Prindle & Wellfare—Lantern.

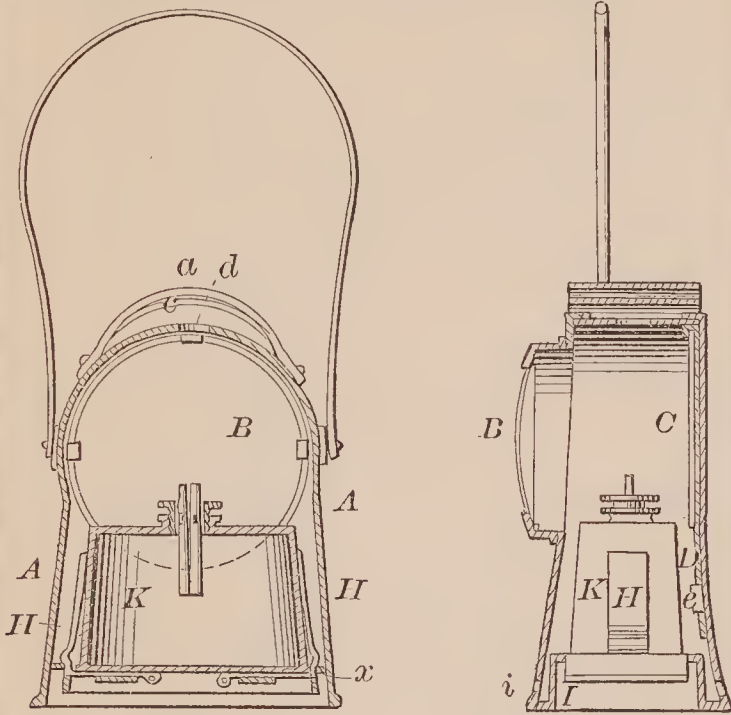

72902—E. D. Pritchard—Railroad Rail.



72904—P. Rees—For Soldering Sheet Metal Cans.

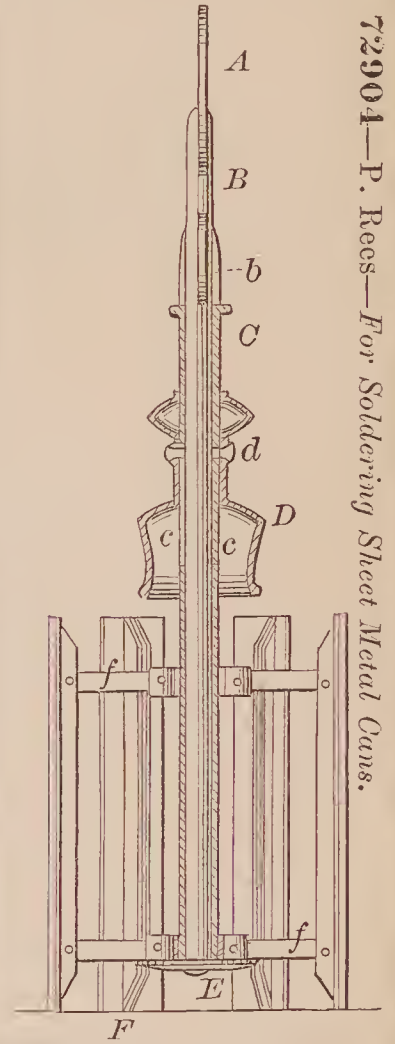

72903—R. Rathbone—Gun Wad Punch.

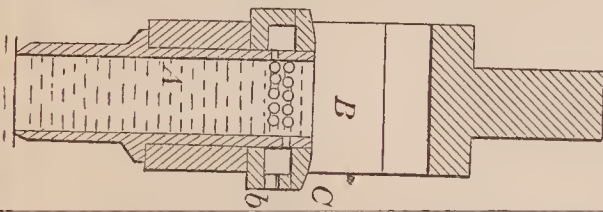

72901—R. B. Prindle—Wagon Jack.

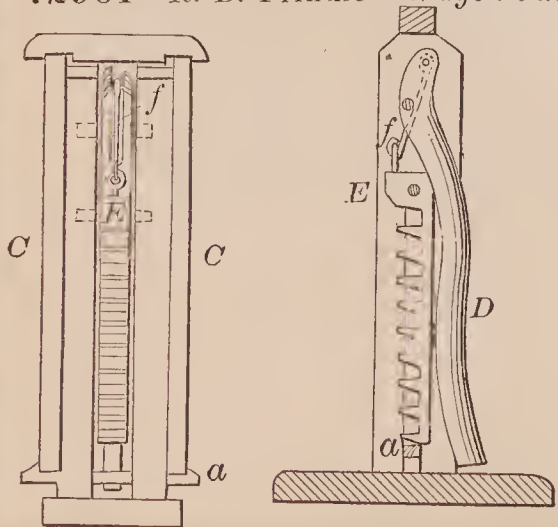

72906—J. W. Richardson—Mitre Box.

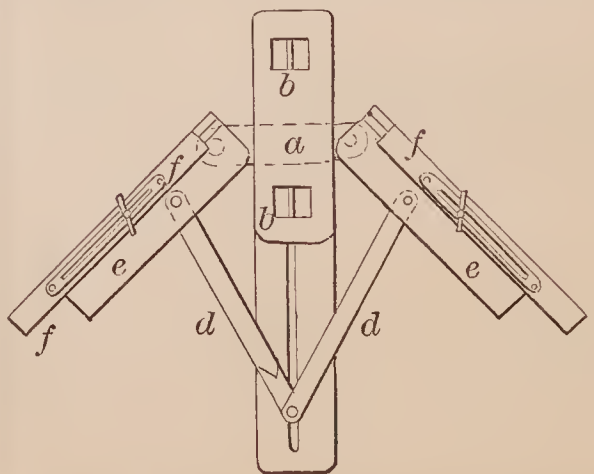

72907—O. Richardson—Cotton Seed Planter.

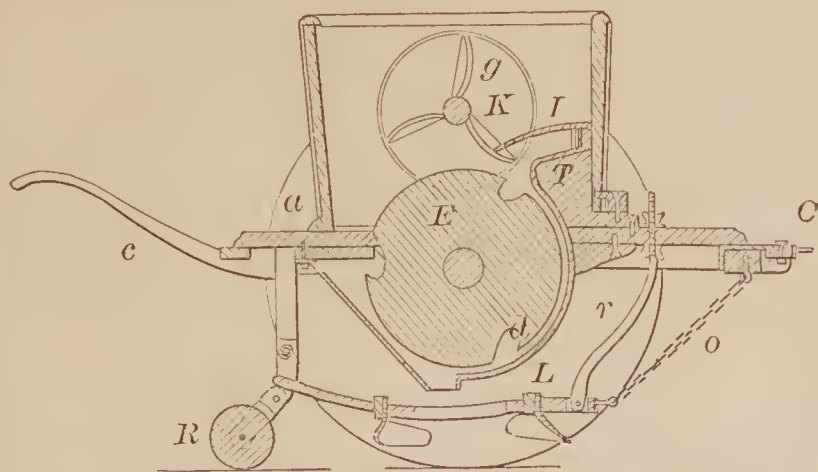

72910—W. F. Randall—Harvester Reel.

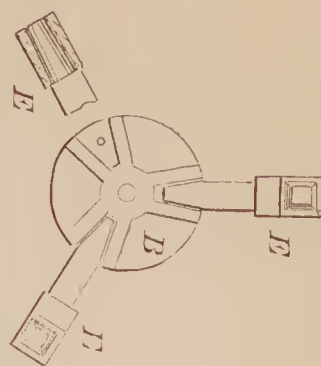

72908—P. Riordan—Clothes Line Holder.

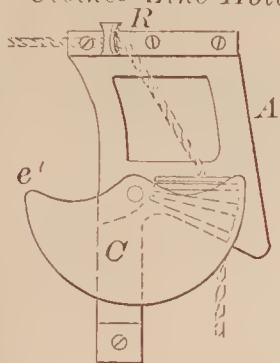

72911—E. W. Russell—Tumbler Washer.

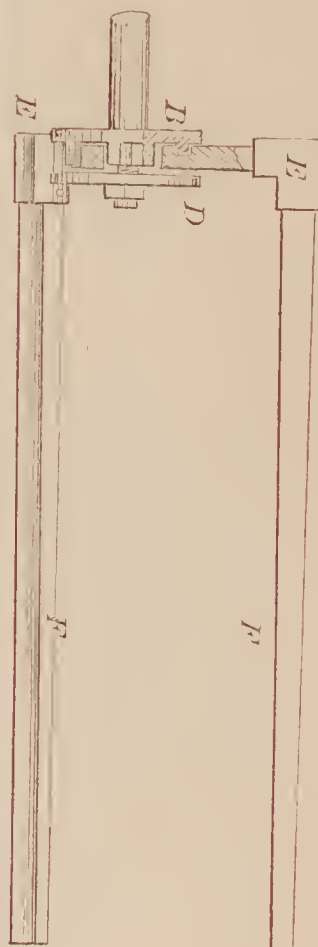
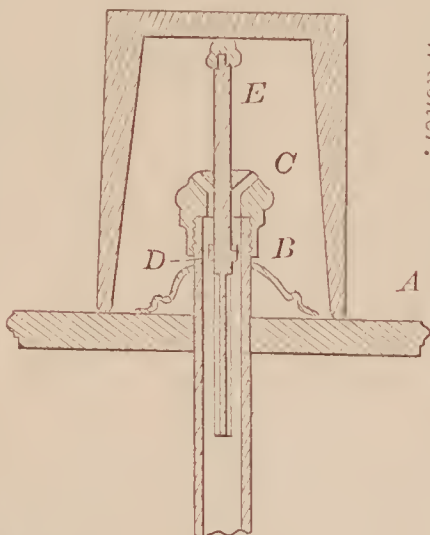

72909—J. S. Rogers—Sink Trap.

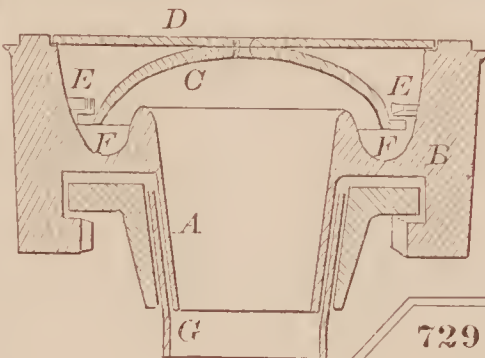

72913—J. C. Schooley—Construction of Embankments.



72912—E. Schlichting—Cigar Pipe.

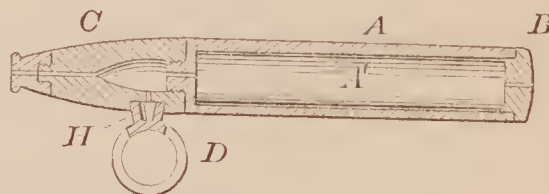

72914—C. H. Schubert—Lock for Traveling Bags.

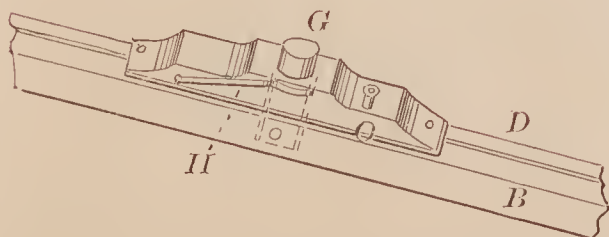
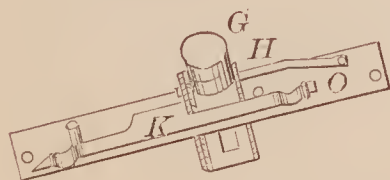
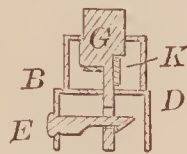

72915—J. M. Scott—Mechanical Movement.

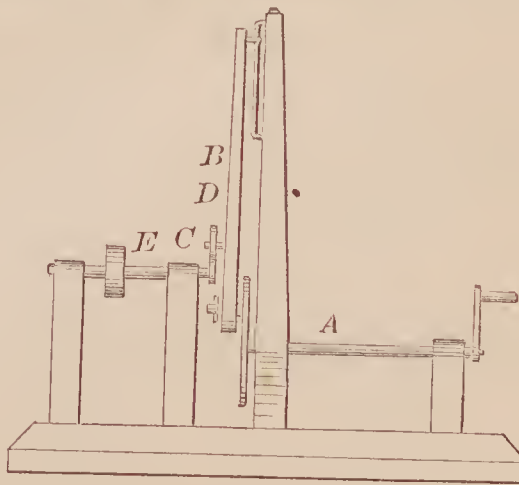



72916—O. Scott—Gunpowder Canister.

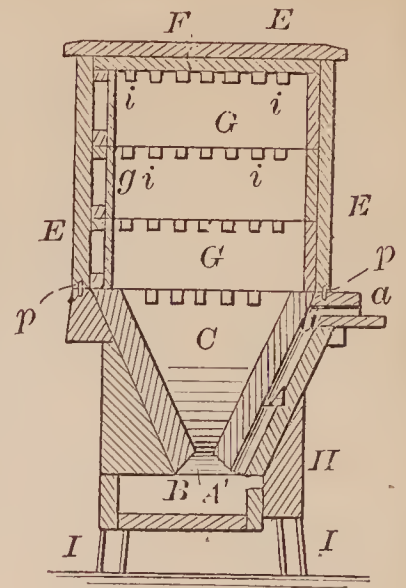
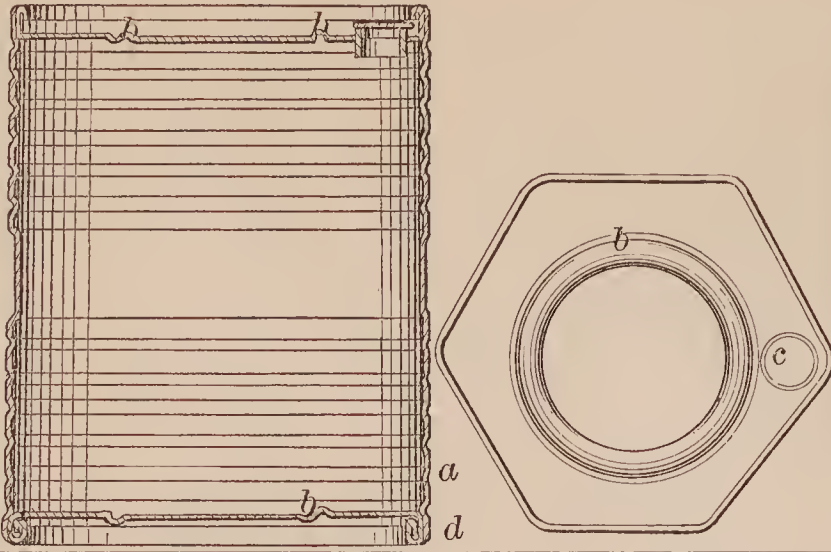

72918—L. & A. M. Shafer—Beehive.

72920—C. L. Sheldon—For Cooling Milk.

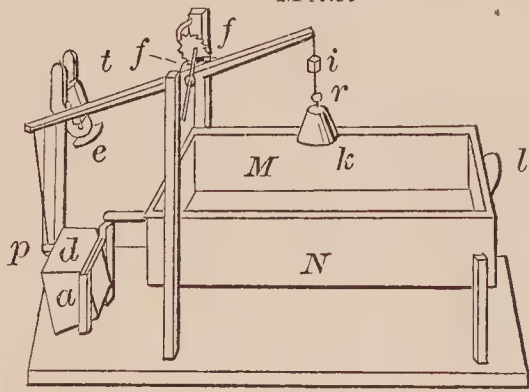

72922—S. Shetter—Plow, Potato Planter and Seeder.

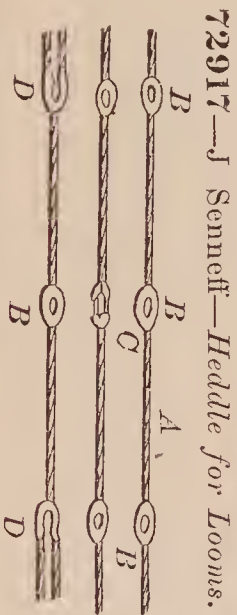
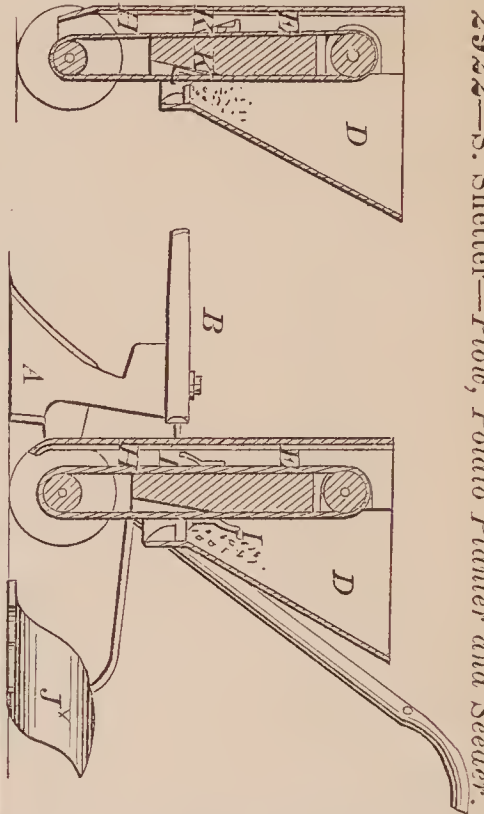

72917—J. Sennett—Heddle for Looms.

72921—P. Shellenbock—Vise.

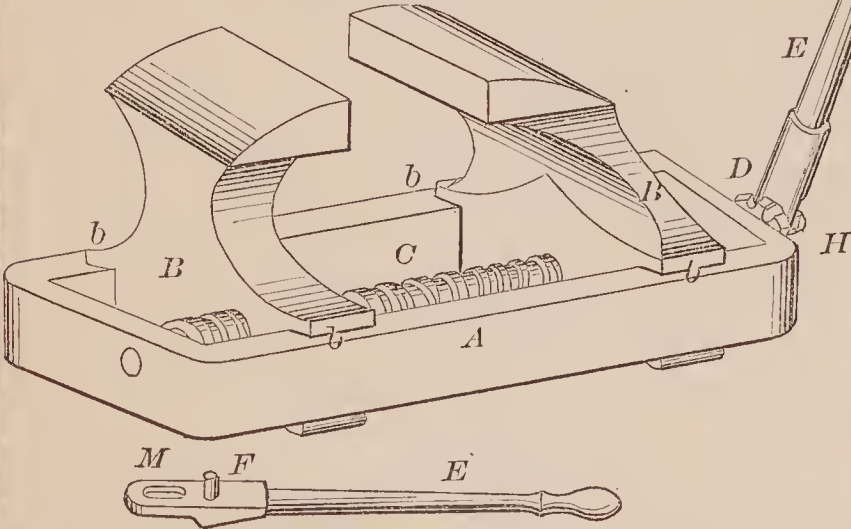

72923—J. Sill—Pruning Shears.

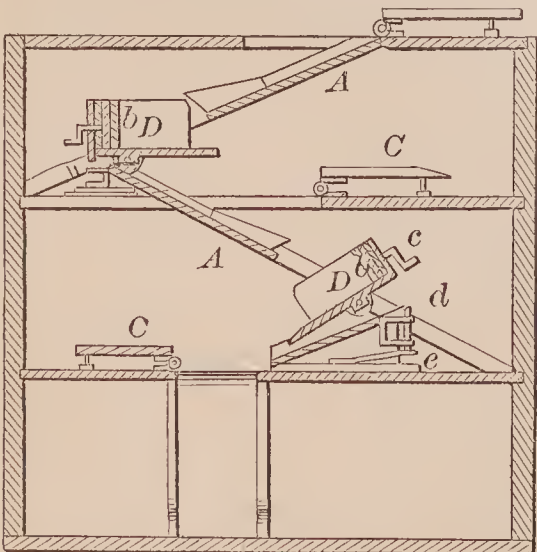
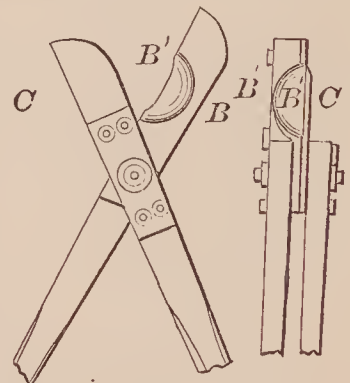

72924—J. D. Sinclair—For Delivering Goods.

72925—G. Smith—Lamp Burner.

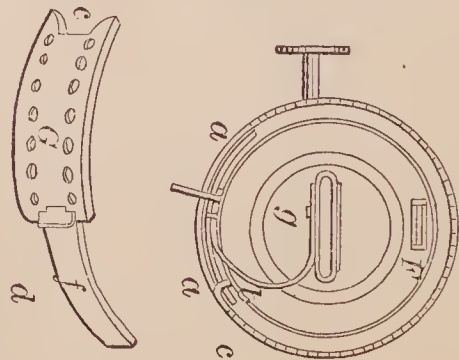

72928—W. W. Smith—*Snow Sweeper.*

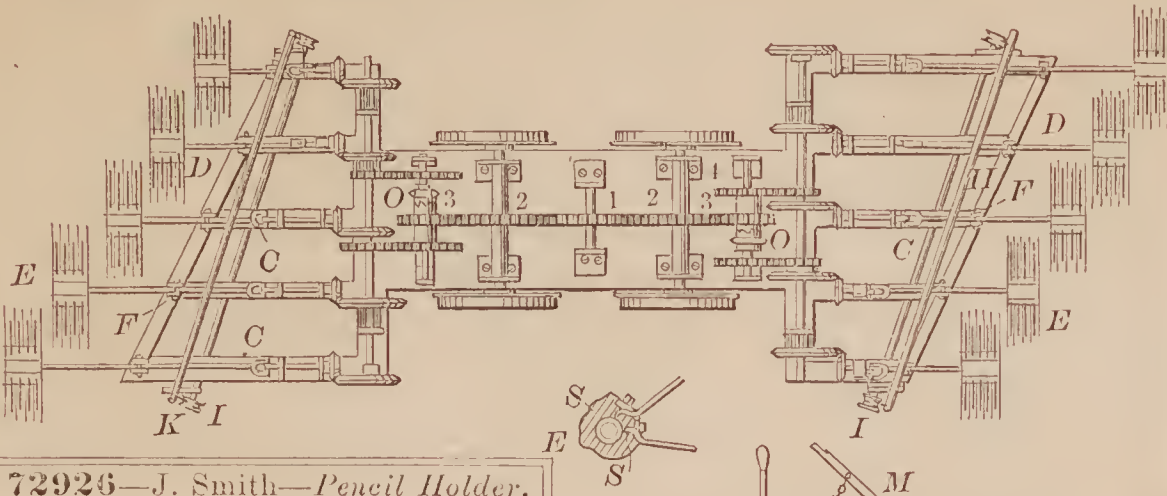

72926—J. Smith—*Pencil Holder.*

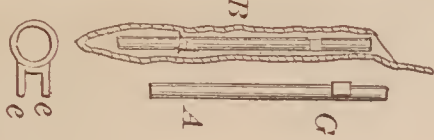

72929—Somers & Alwood—*Button.*  
 Fig. 3  
 Fig. 2



72927—W. B. Smith—*Boiler Tube Cutter.*

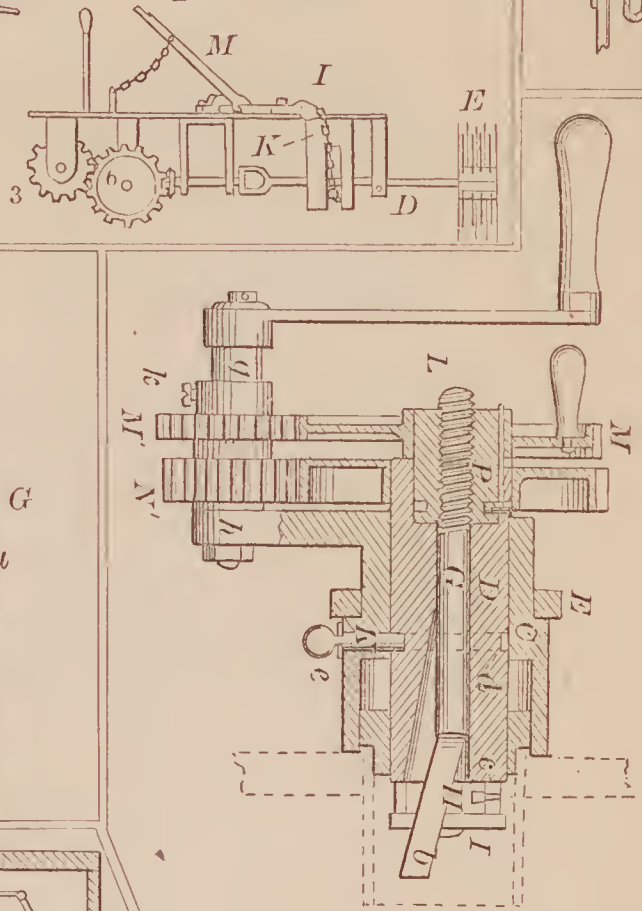

72931—W. M. Stoddard—*Sewing Machine Gauge.*

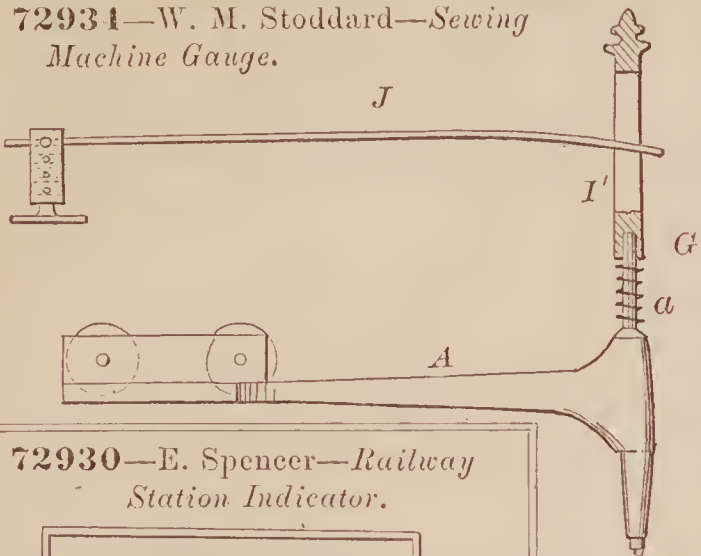

72930—E. Spencer—*Railway Station Indicator.*

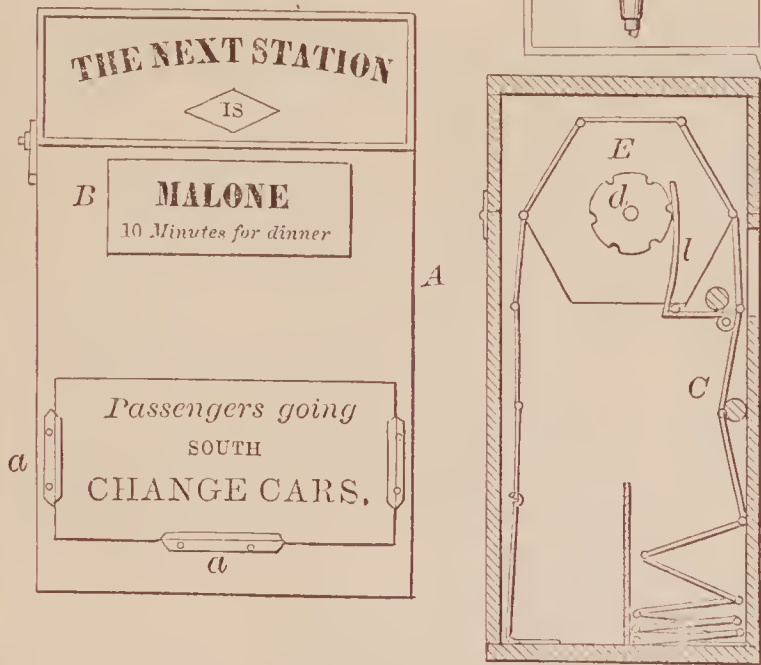

72933—J. T. Stoakes—*Car Coupling.*

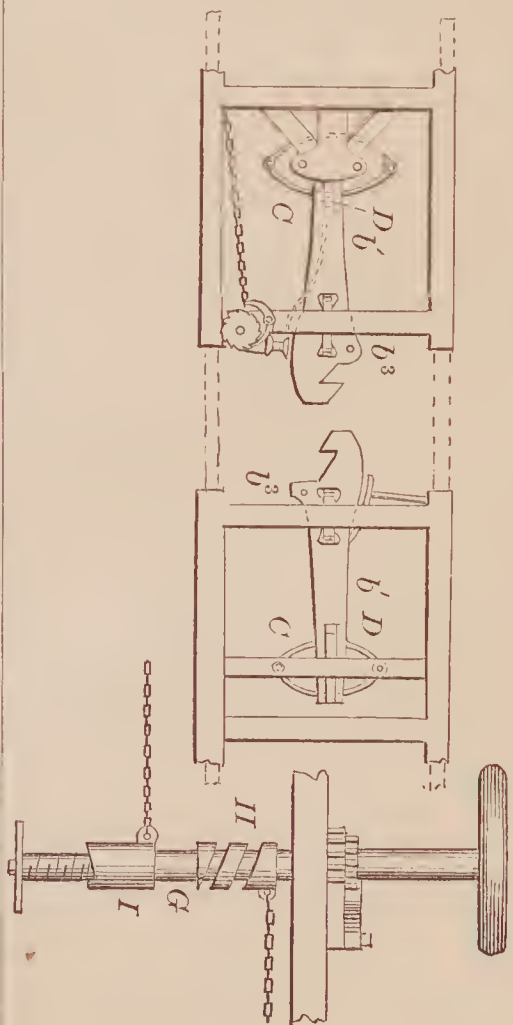

72931—C. Stetefeldt—*Ore Roasting Furnace.*

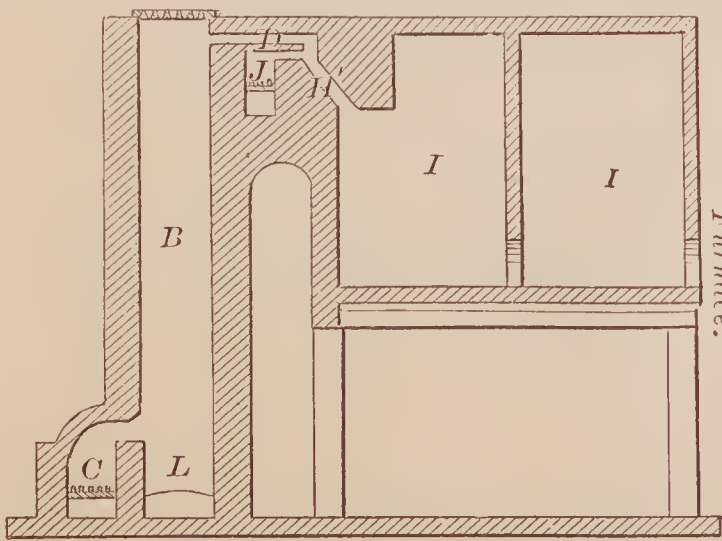



72938—W. B. Treadwell—Cooking Stove.

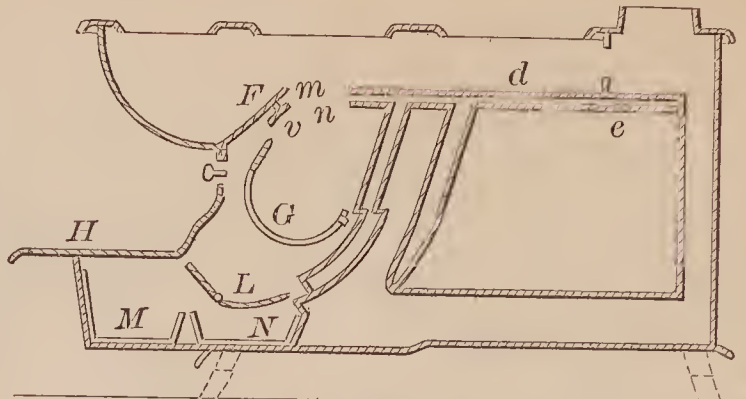

72939—E. M. Troth—Marine Steam Engine Governor.

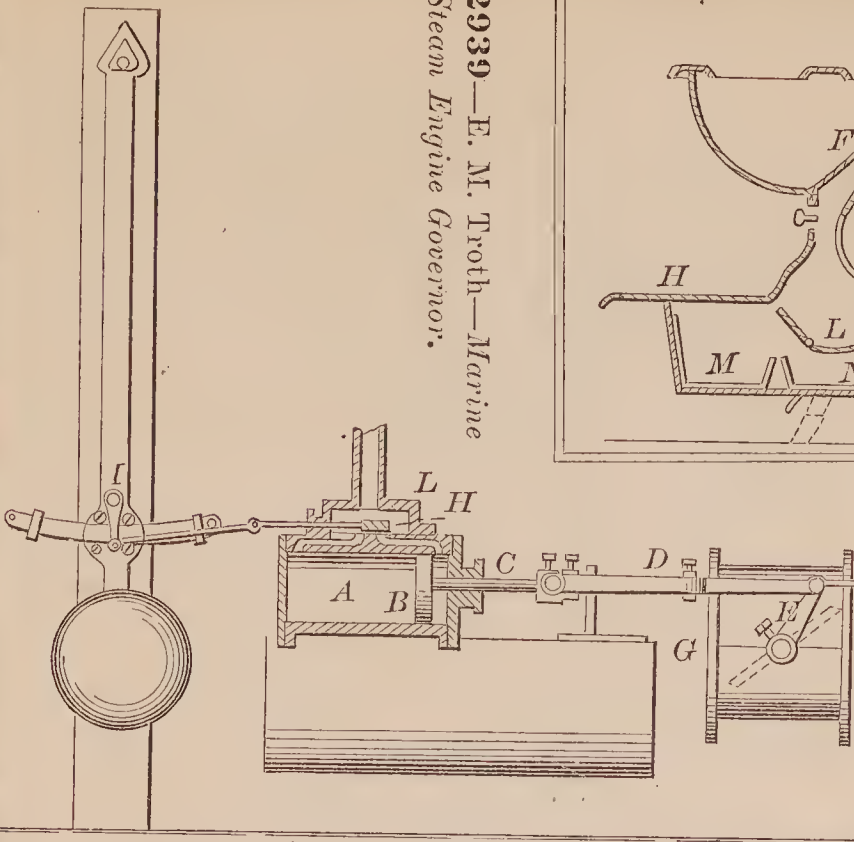

72935—R. C. Sturges—Feed Bucket.

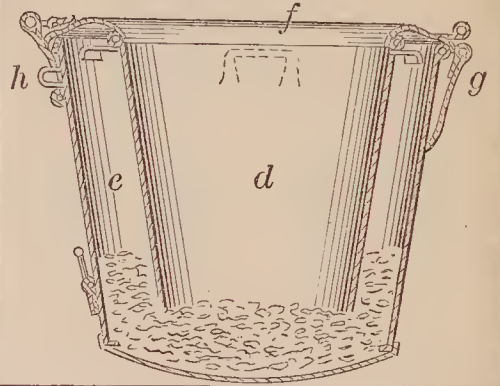

72936—B. Suverkrup—Straw Cutter.

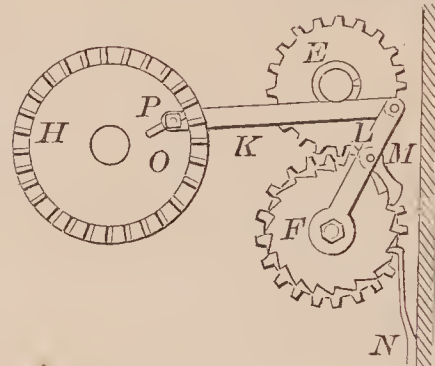
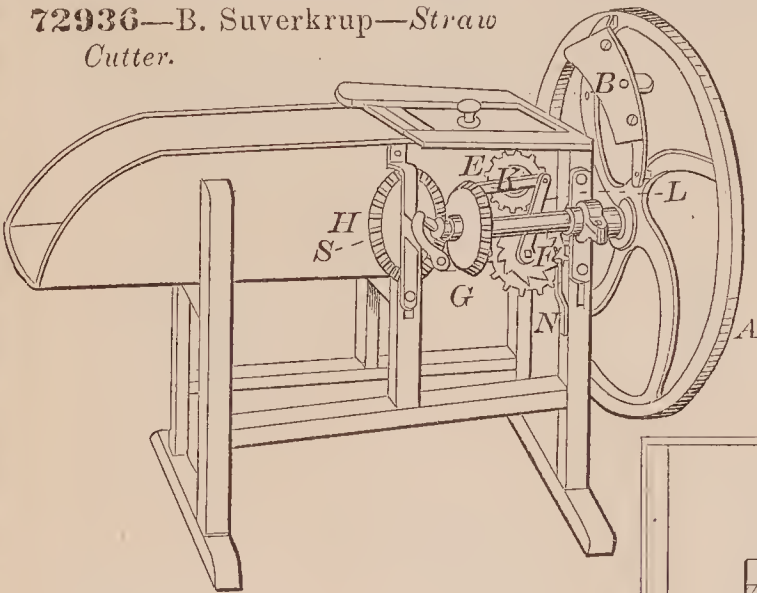

72940—A. W. Tucker—Threshing Machine.

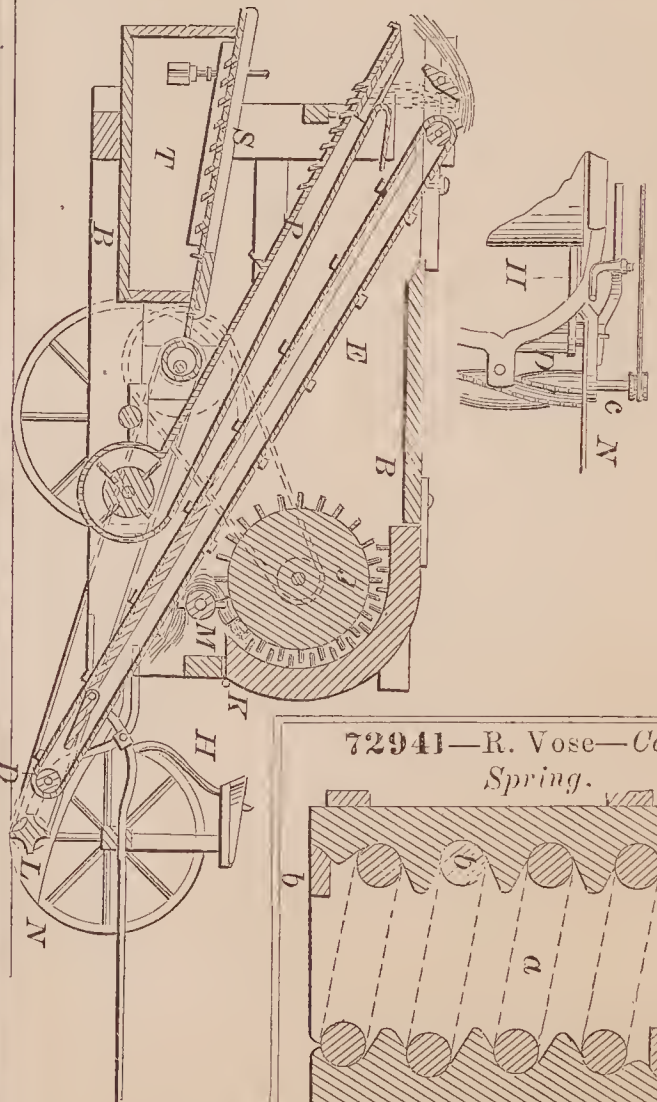

72937—W. B. Treadwell—Cooking Stove.

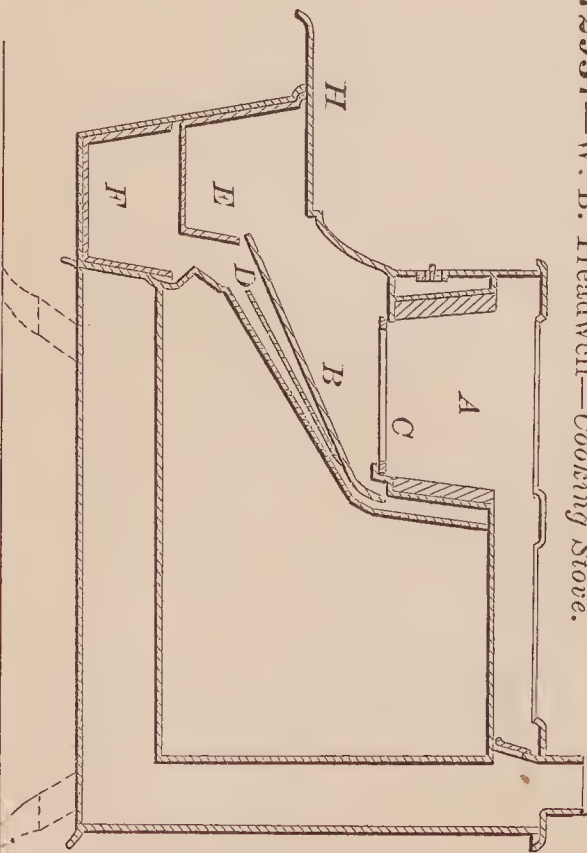

72941—R. Vose—Car Spring.

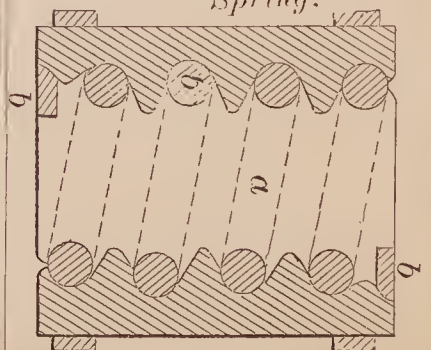

72947—Wegmann & Diessel—Horse Collar.

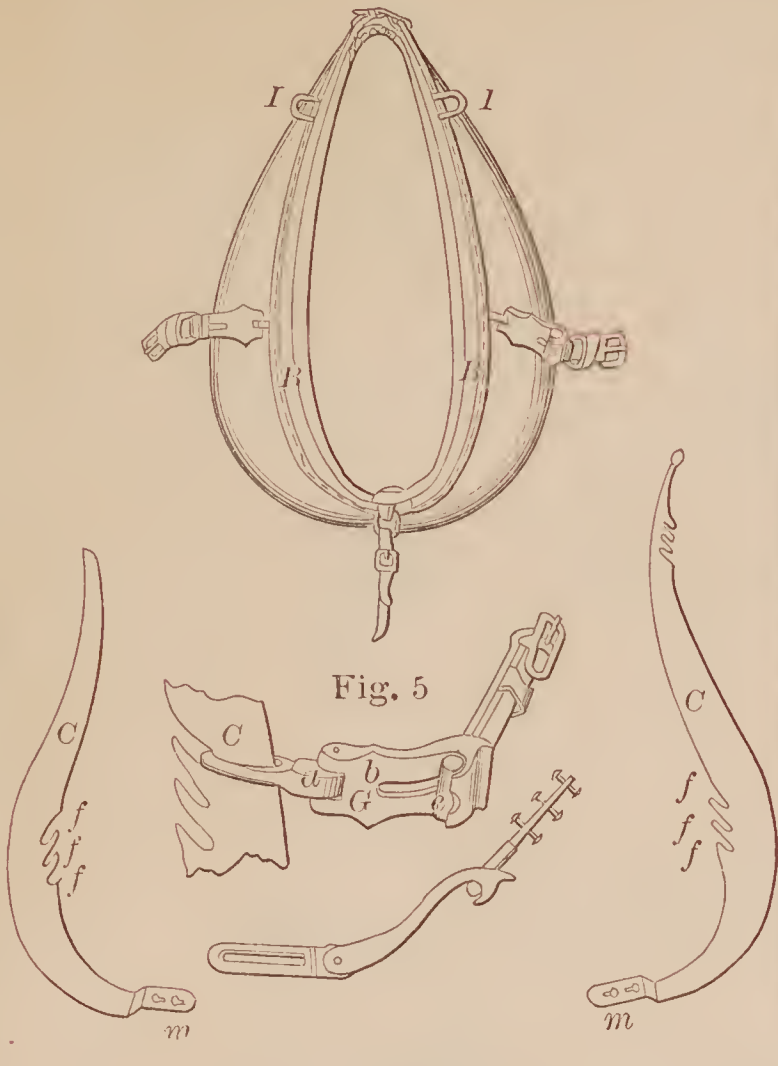

72945—J. H. Weaver—Steering Apparatus.

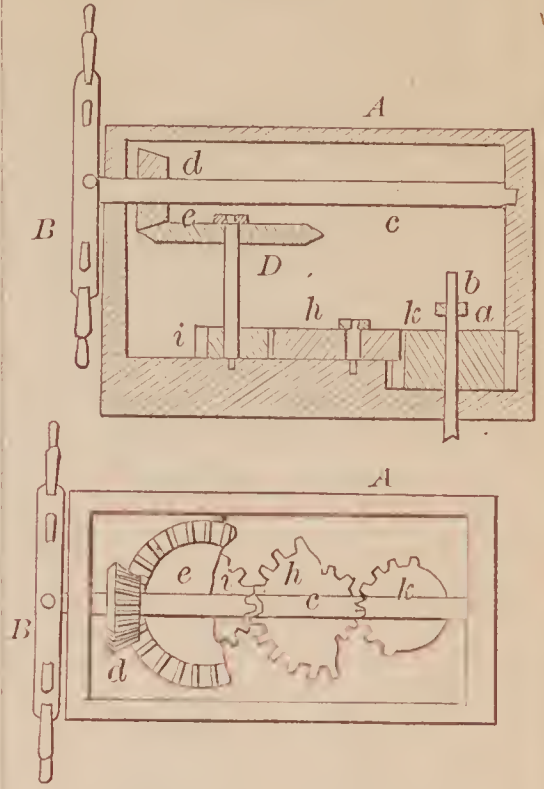

72946—R. L. Webb—Reversible Latch.

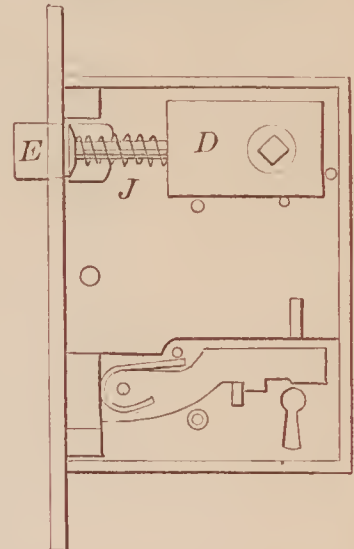

72943—A. Walker—Spring Bed.

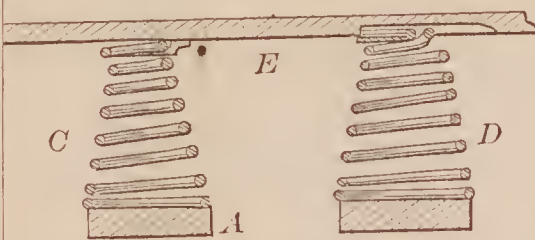

72944—Z. Walsh—Tapering Bag.

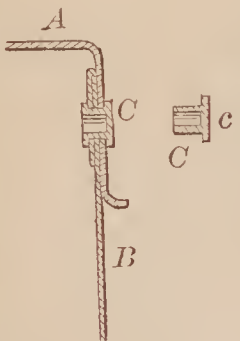

72948—Wemple & Richardson—Sash and Shutter Fastener.

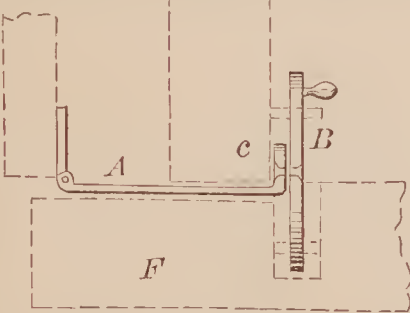

72949—Wesson & Blaze—Manufacturing Ribs and Bolsters for Double Barrel Guns.

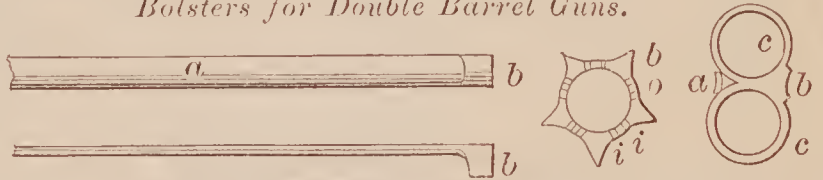

72950—R. P. Whelan—Bridle Bit.

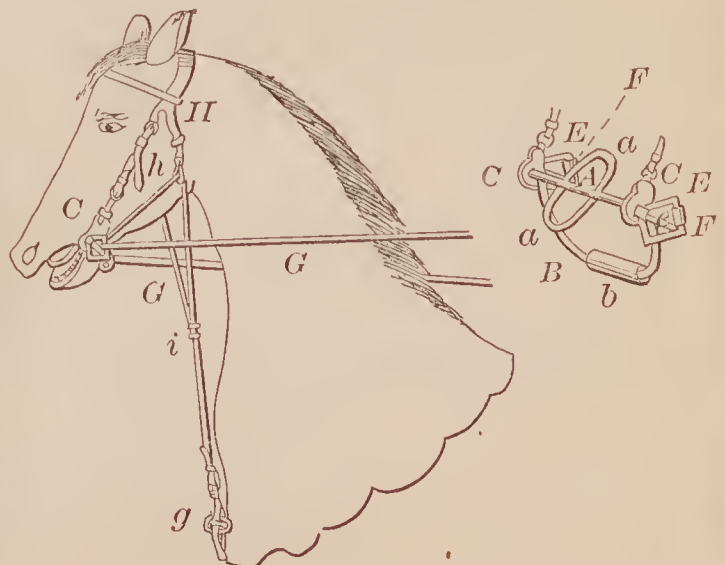

72942—E. Wadhams—Roller Journal Box.

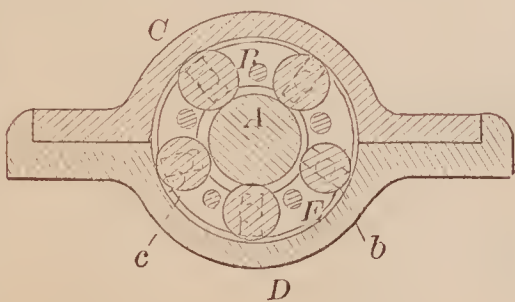



72951—J. A. Whelpley—For Polishing Metal.

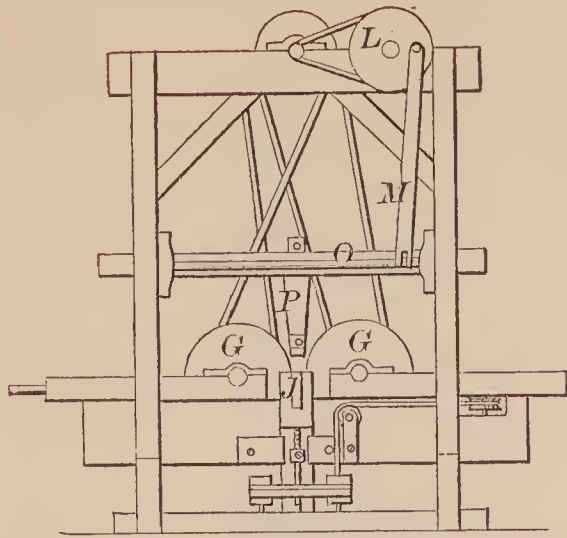

72953—D. Whisler—Ditching Machine.

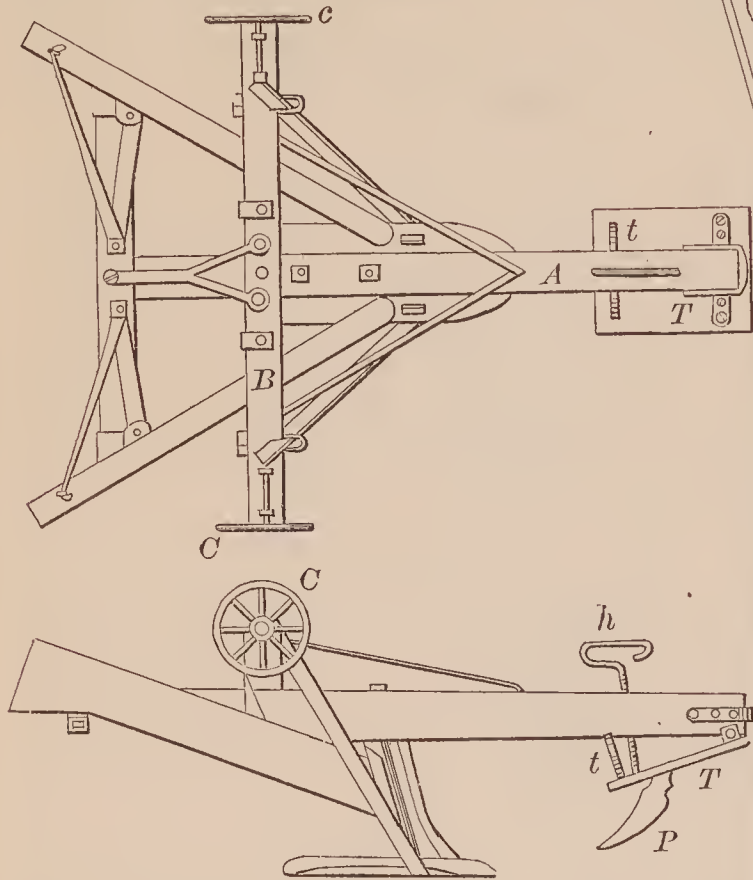

72957—I. N. Young—Gate.

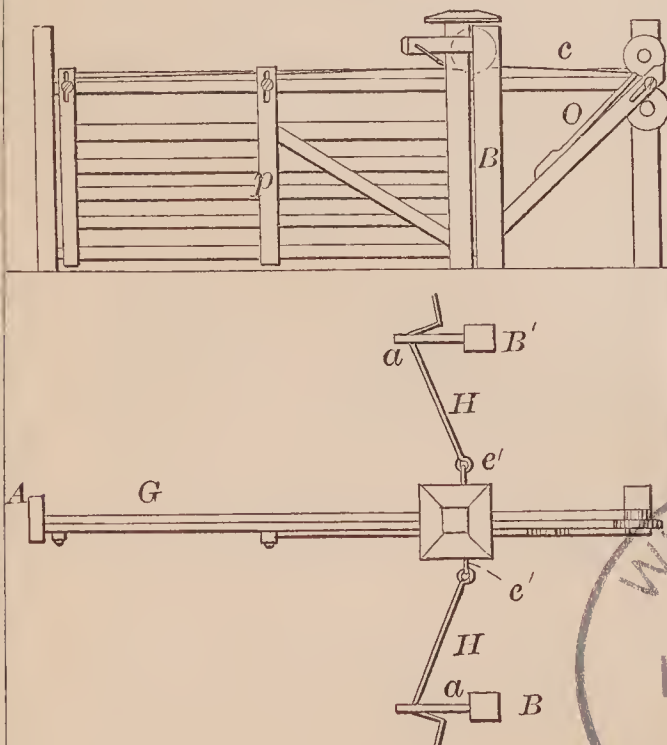

72958—W. Baldwin—Water Meter.

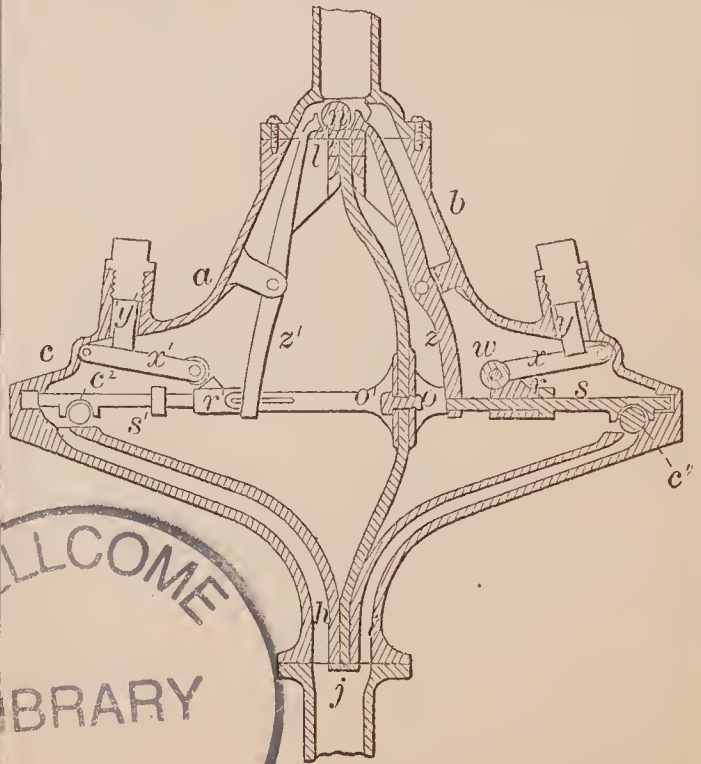

72955—A. Young—Lacing Device.

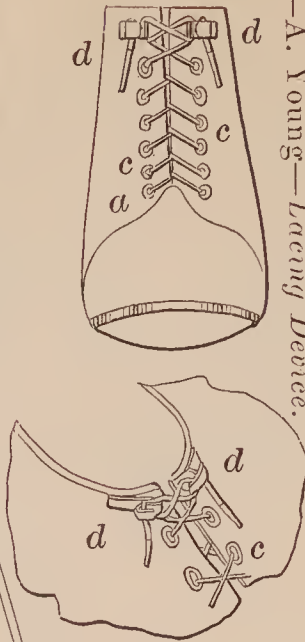

72954—W. W. Warden—Bolt Cutter.

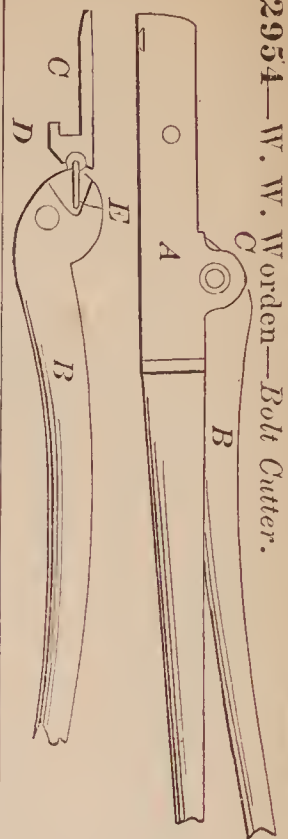

72956—W. H. & L. Young—Trunk Caster.

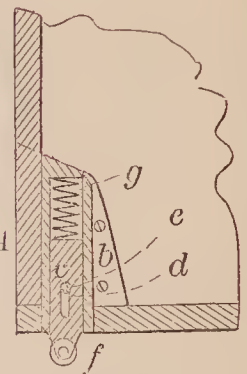

72952—Whipple & Bonzano—Lubricator.



















