

## **Historic, archived document**

Do not assume content reflects current scientific knowledge, policies, or practices.

84 F  
9

# HOW TO INCREASE THE POTATO CROP BY SPRAYING

cas. 11/17/20  
11/17/20  
11/17/20

F. H. CHITTENDEN

Entomologist in Charge of Truck Crop Insect Investigations  
and

W. A. ORTON

Pathologist in Charge of Cotton, Truck, and Forage Crop  
Disease Investigations

LIBRARY  
APR 6 1920  
U.S. DEPARTMENT OF AGRICULTURE



Colorado Potato Beetle and Its Larvæ, or "Slugs," Feeding

FARMERS' BULLETIN 868

UNITED STATES DEPARTMENT OF AGRICULTURE

Contribution from the Bureau of Entomology, L. O. Howard, Chief  
and the Bureau of Plant Industry, W. A. Taylor, Chief

Washington, D. C.

Issued September, 1917; revised January, 1920

Show this bulletin to a neighbor. Additional copies may be obtained free from the  
Division of Publications, United States Department of Agriculture

**I**T IS ESTIMATED that the potato crop of the country is reduced each year more than 100,000,000 bushels as the result of injury by insects and diseases. If spraying were not practiced, this loss would be much greater, but even at the present time spraying is not practiced as widely or as thoroughly as it should be, and the present crisis should impel all growers to increase their crops by preventing these enormous losses.

This bulletin tells how to control the Colorado potato beetle and late-blight (the worst two enemies of the potato), blister beetles, flea-beetles, cutworms, and other caterpillars, leafhoppers, "aphis" or plant-lice, early-blight, and other foliage diseases.

For most of these insects and for the diseases discussed in this bulletin, spraying with Bordeaux mixture and arsenate of lead is recommended, but for leafhoppers and plant-lice, contact sprays, such as nicotine sulphate and emulsions, are the best. For blight, Bordeaux mixture is an efficient means of control. Directions for preparing and applying these sprays are given. Other methods of control described in this bulletin, such as jarring and driving, together with crop rotation and clean cultural methods, also help considerably in protecting the crop.

The best spraying outfits available should be procured.

# HOW TO INCREASE THE POTATO CROP BY SPRAYING.

---

## CONTENTS.

	Page.		Page.
Colorado potato beetle.....	3	Other diseases.....	17
Blister beetles.....	8	Combined treatment for diseases and insects.....	18
Flea-beetles.....	9	Value of spraying.....	18
Cutworms.....	10	Spraying appliances.....	19
Leafhoppers and plant-lice.....	11	How to prepare Bordeaux mixture.....	20
Late-blight and rot.....	13		

---

**T**HE demand for an increased yield per acre in the potato crop has become urgent. In the year 1915 the average yield of potatoes in the United States was estimated at 96 bushels per acre. In the following year the estimated average yield decreased to about 80 bushels per acre.

Two of the causes of low crop yield are insects and diseases. It has been estimated that the total loss from potato diseases and insects in the United States frequently is as much as 100,000,000 bushels. In New York 20,000,000 bushels were lost to potato growers as a result of late-blight in 1912.

### COLORADO POTATO BEETLE.<sup>1</sup>

Injury by the Colorado potato beetle is the work of both the "slugs" (young, or larvæ) and the beetles (adults). The beetles, after they pass the winter, appear usually at about the same time as the potato plants, lay their eggs, continue feeding, and frequently destroy small areas entirely, especially those grown for garden purposes. On larger areas the species, as a rule, is somewhat less injurious. When the larvæ begin to grow, they usually finish the work begun by the beetles, so that in a very short time, or by the time the larvæ are

---

<sup>1</sup> *Leptinotarsa decemlineata* Say.

**NOTE.**—The insects treated in this bulletin are all leaf-feeders. Some of those which feed in the stalks and tubers, viz, the potato stalk-weevil, the common stalk-borer, the potato tuber-moth, white grubs, and wireworms, also are very injurious in certain areas, but these are controlled by methods different from those used against the leaf-feeders, and they will be treated in a separate publication. The diseases treated herein are those affecting the foliage and are preventable, in the main, by spraying. Other potato diseases affecting the tubers or controllable by seed selection are treated in Farmers' Bulletin 544, Potato-tuber Diseases, and in Department Bulletin 64, Potato Wilt, Leaf-roll, and Related Diseases.

nearly full grown, very little of the potato plants except denuded or bare stems and dry and black foliage remains. Afterwards the beetles and larvæ attack eggplant and other plants of the potato family.

The distribution of the potato beetle (see fig. 1) covers practically the entire United States from the Great Plains eastward to the

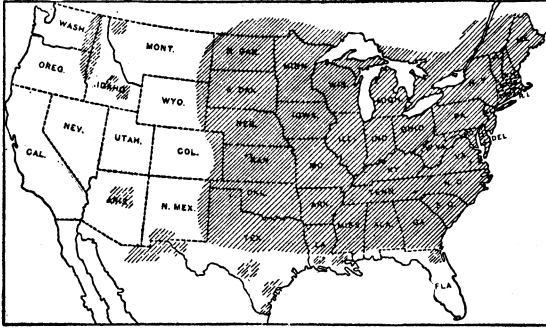

FIG. 1.—Map showing, by shaded areas, approximate distribution of the Colorado potato beetle.

Atlantic coast, excepting the extreme southern parts of Florida, Alabama, Mississippi, and Louisiana. In Texas it occurs in the tropical region bordering the Gulf of Mexico. It also occurs in restricted parts of Washington, Oregon, Idaho, Arizona, Montana, Wyoming, Colorado, and New Mexico. In a few of these States it is present, but not as a pest—for example, in some regions of Colorado, where it feeds on a wild plant belonging to the potato family. It is constantly extending its territory as a pest.

The potato beetle is well known to all growers of potatoes. The beetle is robust and yellow, and its wing-covers are ornamented with 10 black lines (see fig. 2, *a*; fig. 3, *a*). It is three-eighths of an inch long. The "slugs" (young, or larvæ) (fig. 2, *b*; fig. 3, *c, c, d, d*) are dark red when first hatched, becoming paler with larger growth. They are slimy, soft in texture, and of disgusting appearance. The pupa, or resting stage, is shown at *c* in figure 3. The eggs (fig. 3, *b, b*) are orange colored and are deposited in masses.

The Colorado potato beetle feeds on practically all plants of the potato family, attacking potato, eggplant, tomato, ground cherry, and Jimson weed, besides other weeds of this family.

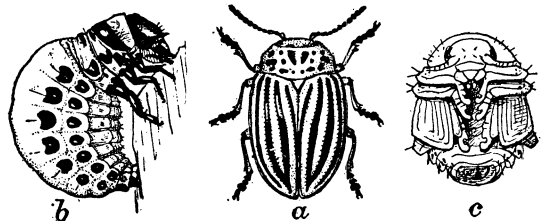

FIG. 2.—Colorado potato beetle: *a*, Beetle; *b*, larva, or "slug"; *c*, pupa. Enlarged.

In the more northern range of this insect there is probably only one generation a year, or, exceptionally, two generations. Farther southward three more or less complete generations occur. This insect pest passes the winter in the beetle stage from a few inches to several feet underground.



FIG. 3.—Section of potato plant showing Colorado potato beetle at work: *a*, Beetle; *b, b*, egg masses; *c, c*, half-grown larvæ; *d, d*, mature larvæ. Somewhat enlarged.

The beetles appear early in the spring, and with the first warm days may be seen in flight. As soon as the female can reach suitable plants after feeding she begins to lay her eggs. A single female is capable of producing between 1,800 and 1,900 eggs. Normally all the eggs hatch, and the entire life cycle from egg to egg may be passed in midsummer in a high temperature in five or six weeks. The possible progeny, therefore, is enormous.

Were it not for the fact that numerous species of insects and animals destroy large numbers of the beetles and "slugs" annually, the pest would be much more abundant than it is. (See fig. 4.) Setting aside the insects, of which between 30 and 40 species have been observed actually to prey upon this pest, the bobwhite or quail, robin, crow, and several other birds either pick the beetles

from the vines or dig them from the earth, and skunks, snakes, and toads frequently gorge on them. Domestic fowls, especially ducks and guinea fowl, also are of assistance in suppressing this pest.

#### HOW TO CONTROL THE COLORADO POTATO BEETLE.

The Colorado potato beetle is not difficult to control, no other method being necessary than the free use of arsenical preparations (see figs. 5 and 6) and mechanical devices. The following procedure is advised when this insect alone is to be combated. In the majority of cases, particularly in the Northern States, the combined treatment outlined on page 18 should be followed.

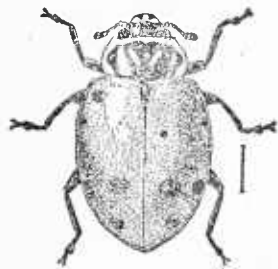

FIG. 4.—A ladybird (*Hippodamia convergens*) which preys on the eggs of the Colorado potato beetle. Much enlarged.

#### SPRAYING WITH ARSENATE OF LEAD.

As a spray for the potato beetle and similar pests, arsenate of lead, or lead arsenate, serves the same purpose as Paris green and its use for the last two years or more shows that it is even more valuable than Paris green. Conditions incident to the great war have caused a scarcity of copper compounds and the price of Paris green is so high that it can not be used economically.

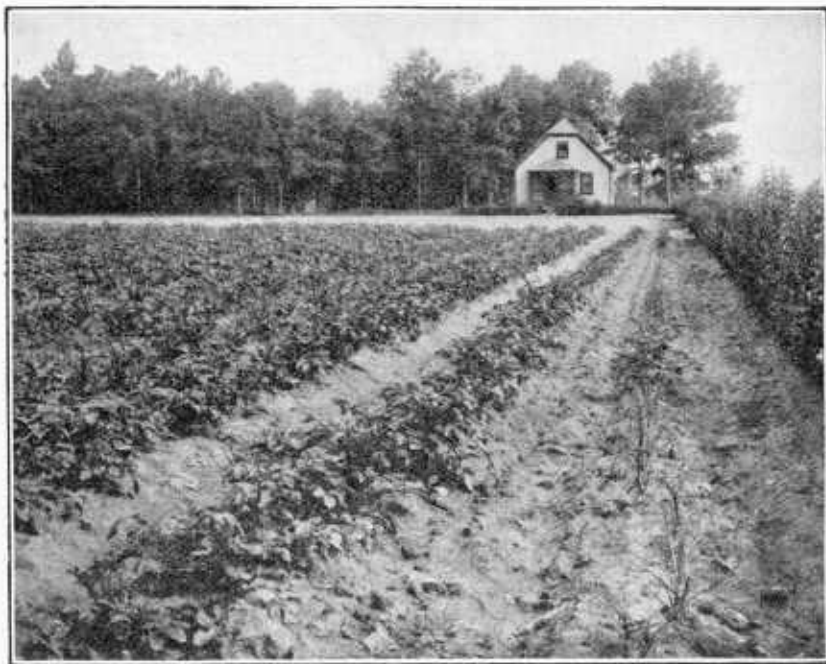

FIG. 5.—Field of potatoes showing outside row unsprayed in comparison to the remainder of the plot sprayed for the Colorado potato beetle with Paris green, one-half pound to 50 gallons of water.

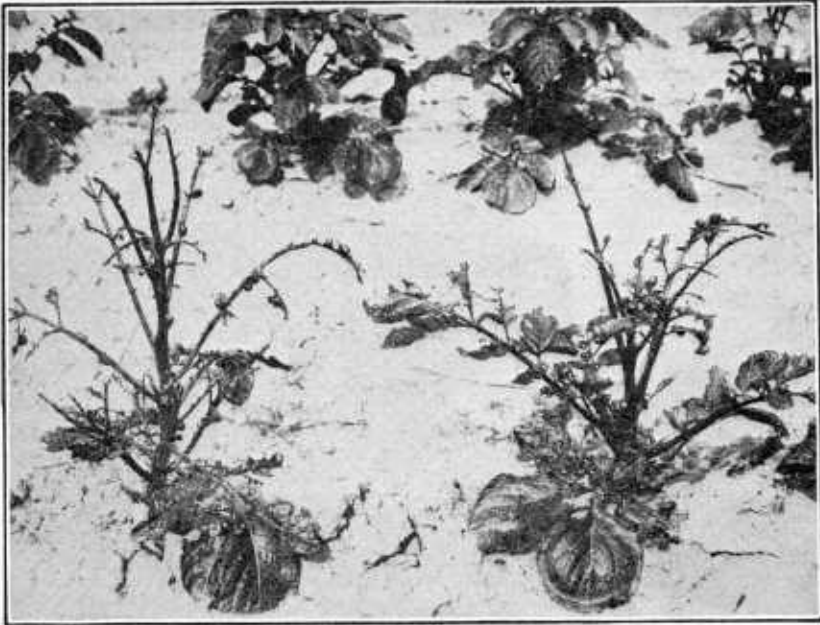

FIG. 6.—In foreground, potato plants not sprayed for the Colorado potato beetle; in background, sprayed potato plants.

Arsenate of lead has the following advantages over Paris green: (1) It contains less soluble arsenic; (2) it is less harmful to young growing plants, and when applied in the proper manner and at the proper strength does not scorch them; (3) it adheres more strongly to the foliage; (4) it is less troublesome to prepare; and (5) it is of greater value than other arsenicals (except zinc arsenite) in that it leaves a white coating on the foliage, so that its presence or absence can be determined readily after spraying.

The adhesiveness of spraying material is promoted by the addition of the same weight of soap as of the arsenical used. The soap may be either resin fish-oil, or laundry soap, preferably the former.

The formula is as follows:

Arsenate of lead (powder).....	pound..	1
Soap for "sticker".....	do....	1
Water or Bordeaux mixture.....	gallons..	25

If the paste form of arsenate of lead is used, 2 pounds to 25 gallons of the liquid is the proper proportion.

For small gardens two-thirds of an ounce, or 10 level teaspoonfuls, of the powder to 1 gallon of water is used.

Two or three sprayings ordinarily will suffice for the spring generation if applied before the eggs are hatched, and about the same number should be employed for the second generation. One or two sprayings for the third generation, when it appears, also should be given.



**Precaution to prevent poisoning.**—Arsenate of lead and other insecticides should be labeled properly and the word POISON should appear on the package. It is best to keep poisonous substances under lock and key and where children can not reach them.

Utensils employed in the preparation of arsenate of lead should be cleaned thoroughly after use.

#### OTHER REMEDIES.

Jarring, if done early in the season, is of value for small crops. It is performed usually by brushing the beetles and "slugs" into large, shallow milk pans or similar receptacles containing a little water on which a thin scum of kerosene is floating. Egg masses should be clipped off whenever observed and destroyed promptly.

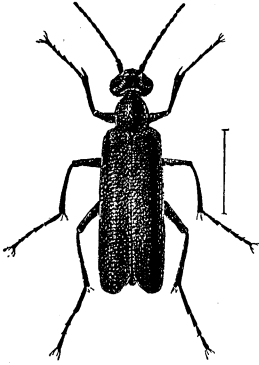

FIG. 7.—Black blister beetle: Adult. Enlarged.

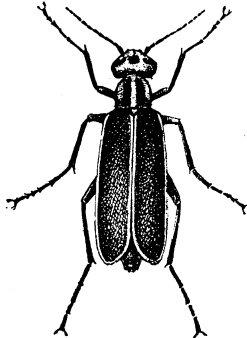

FIG. 8.—Margined blister beetle: Adult. Enlarged.

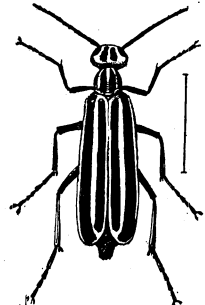

FIG. 9.—Striped blister beetle: Adult. Enlarged.

Fall and spring plowing, while valuable for most insects which pass the winter in the ground, are less valuable for the potato beetle, because hibernation takes place far under the surface and very deep plowing would be necessary.

Hand picking is effective early in the season, but later is too slow and laborious.

#### BLISTER BEETLES.

The potato is subject to injurious attack by blister beetles of several forms. These beetles are slender, comparatively soft bodied, and variously colored. All are general feeders, and a large proportion of them prefer potatoes to other foods. One of the commonest of these is the black blister beetle (fig. 7)<sup>1</sup>. It appears at about the time of the flowering of wild aster and goldenrod, and is known also as the "aster bug." Besides potato, it attacks beans, peas, cabbages, and various other plants. Other common species are the margined<sup>2</sup> and

<sup>1</sup> *Epicauta pennsylvanica* DeG.

<sup>2</sup> *Epicauta marginata* Fab.

the striped<sup>1</sup> blister beetles, shown in figures 8 and 9. These insects are gregarious and migratory in habit, feeding most voraciously, running rapidly, and flying from time to time. Frequently they descend on a crop and ruin it in a few days, eating both foliage and stems. They appear at different times, according to temperature, usually being most abundant from July to September.

#### REMEDIES FOR BLISTER BEETLES.

Arsenate of lead is the best remedy for blister beetles. It is prepared and applied as directed for the Colorado potato beetle. In addition, in some portions of the West a line of boys and men is sent through infested fields to drive the beetles ahead of them by short flights or running until they alight or come to rest in windrows of hay, straw, or other dry material, which previously has been prepared along the leeward side of the field. When the beetles take refuge in such a windrow it is burned promptly. This procedure has been followed with success.

*Prompt application of remedies at the very outset of attack is necessary to save the crop.*

#### FLEA-BEETLES.

The potato is attacked every year by flea-beetles, some of which are specific enemies of the crops of the potato family. Flea-beetles begin their work early in the season. The beetles riddle the leaves of young and tender plants with punctures, causing the leaves to die, thus depleting the vitality of the plant; and the larvæ, or young,

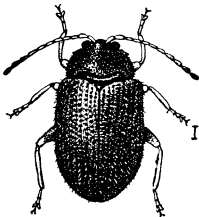

FIG. 10.—Potato flea-beetle: Adult. This species does much injury to young plants. Actual length shown by line at right.

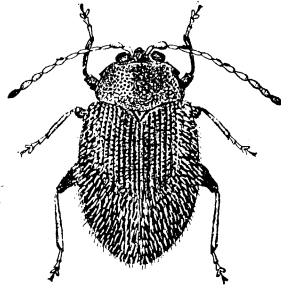

FIG. 11.—Eggplant flea-beetle, an insect which also attacks potato: Adult. Greatly enlarged.

feed at and injure the roots. These insects, a little larger than a flea, derive their common name from their small size, and from the fact that their powerful hind legs enable them to take long leaps.

The most important of these insects is the potato flea-beetle.<sup>2</sup> (Fig. 10.) This species occurs practically throughout the potato-growing regions of the country from Canada and New England to the

<sup>1</sup> *Epicauta vittata* Fab.

<sup>2</sup> *Epidrix cucumeris* Harr.

Gulf region and in some districts in California. The most severe injury, however, is done in the North. The larva is the cause of "pimply" potatoes, which bring a lower price in the market, sometimes 5 cents a bushel less than the regular price. Eggplant, tomato, and tobacco also are attacked, and when this insect is numerous it sometimes attacks other plants. Occasional injury is done to potatoes and tomatoes through gnawing of the sprouts. Eggs are laid early in May or June, and the life cycle may be completed in midsummer in about 35 days.

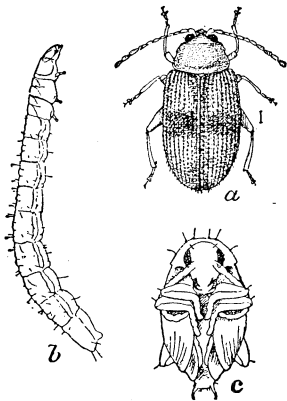

FIG. 12.—Tobacco flea-beetle, an insect which also attacks potato: a, Adult, or beetle; b, larva, side view; c, pupa from below.

During recent years this species has shown a great fondness for tomato, and during the spring and summer of 1917, from April 19 to about the middle of July, injury was widespread. In the case of tomato, the plants were sometimes destroyed by defoliation when potatoes also were present. The aggregate of attack shows injury about equal on these two crops. Attack was so sudden and severe that no remedies were applied so far as could be learned.

The eggplant flea-beetle<sup>1</sup> (fig. 11) and the tobacco flea-beetle<sup>2</sup> (fig. 12) also attack potato, but each is more common on the plant from which its English name is derived.

#### REMEDIES FOR FLEA-BEETLES ON POTATO.

When potatoes are sprayed with arsenate of lead for the Colorado potato beetle and with Bordeaux mixture for diseases, these beetles are repelled to a considerable extent. Because of their active jumping and flying habits these insects are not likely to remain on the plants during spraying, and so are not poisoned, but they do not seem to attack foliage that has been covered properly with either spray material.

Although the subject of experiment for many years, the most efficient remedy for the potato flea-beetle remains to be found. The general opinion seems to be, however, that Bordeaux mixture alone, acting as a repellent, is the best.

All wild plants of the potato family should be pulled up or otherwise destroyed throughout the season in order that the insects may have no other breeding place.

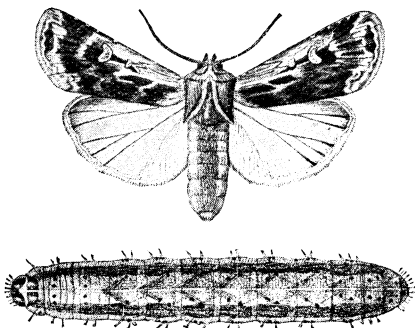

FIG. 13.—Granulated cutworm, an injurious potato insect: Moth above; cutworm, or larva, below. Somewhat enlarged.

<sup>1</sup> *Epitrix fuscula* Cr.

<sup>2</sup> *Epitrix parvula* Fab.

## CUTWORMS.

Cutworms frequently do considerable damage to potatoes early in the season and sometimes later. They feed chiefly at night and in the shade, cutting off the young plants about even with the ground. A common species is the so-called granulated cutworm<sup>1</sup> shown in figure 13.

The best remedy for cutworms is poisoned bait. To mix and apply this bait take a bushel of dry bran, add 1 pound of white arsenic or Paris green, and mix it thoroughly into a mash with 8 gallons of water, into which has been stirred 2 quarts of sorghum or other cheap molasses. This amount will be sufficient for the treatment of about 4 or 5 acres of cultivated crops. After the mash has stood for several hours, scatter it, in lumps about the size of a marble, over the fields where the injury is beginning to appear and about the bases of the plants attacked. Apply the bait late in the day, so as to place the poison about the plants before night, which is the time when the cutworms are active. Apply a second time if necessary. If this mash is made up with less water it may be applied with a grain or fertilizer drill to good advantage.<sup>2</sup>

**Caution** (see p. 8).—Arsenic and Paris green are deadly poisons. Handle them with great care. Keep children, live stock, and poultry away from this bait.

## LEAFHOPPERS AND PLANT-LICE.

Leafhoppers sometimes are very injurious to potatoes. The bean leafhopper,<sup>3</sup> a pale green insect (fig. 14), less than one-eighth inch in length, has been described as "probably our worst all-round leafhopper pest, so exceedingly abundant that notwithstanding its varied diet it is able to make serious attack on quite a number of cultivated plants on its list." Among its chief food plants are the potato, sugar beet, bean, cowpea, celery, currant, and apple, box elder, and other trees. From its abundance on the apple it is known as the apple leafhopper. During 1914 the Bureau of Entomology received information from Pennsylvania and New York that this species was the cause of a "blight," the injured leaves having the appearance of having been burned and scalded.

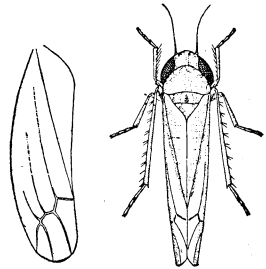

FIG. 14.—Bean leafhopper, an insect which is also injurious to potato: At right, adult insect; at left, wing extended, showing venation. Much enlarged.

Fortunately, this insect was largely destroyed that year by storms, but in 1898 it reappeared in the northern States from New York

<sup>1</sup> *Feltia annexa* Treit.

<sup>2</sup> Additional information with regard to cutworms may be obtained upon application to the Bureau of Entomology, U. S. Department of Agriculture.

<sup>3</sup> *Empoasca mali* LeB.

to Montana and south to Kansas and caused similar injury to the potato, the injury being known as "tipburn" and "hopperburn."

The potato aphid<sup>1</sup> has also been extremely injurious to the potato over about the same territory and during the same period as the bean leafhopper. This insect is of about the same length as the latter and is either pink or green in color, has long wings and possesses honey tubes—tail-like processes which extend beyond the body.

During the year 1917 the spinach aphid<sup>2</sup> became extremely abundant, its ravages extending from the Gulf region northward to New England and westward to Illinois and Minnesota. The principal injury was to potato, followed by tomato, cabbage, and many other food plants. In most cases it caused the greatest consternation and fear of losses, especially among owners of small gardens, who were absolutely unacquainted with the insect and the remedies to apply for it.

Leafhoppers and plant-lice do not feed upon leaf tissue, but insert their beaks into the tissue and drain the vital juices of the plants, thus weakening them so that a great reduction in the yield of potatoes results.

#### SPRAYS FOR LEAFHOPPERS AND PLANT-LICE ON POTATO.

Nicotine sulphate, a contact insecticide, has been used experimentally as a spray against the bean leafhopper and the potato aphid on potato, and its use has been attended with some success. The standard formula is as follows:

Nicotine sulphate, 40 per cent solution.....	pint..	$\frac{3}{4}$ to $\frac{1}{2}$
Fish-oil or other soap, dissolved.....	pounds..	2
Water.....	gallons..	50

Everything considered, nicotine sulphate is for several reasons preferable to kerosene emulsion or soap solutions, is more easily prepared, and is manufactured as a standard solution, containing 40 per cent, by weight, of nicotine. Usually it is used at a dilution of 1 part of 40 per cent solution to 1,000 parts of water. For a "spreader," or "sticker," about an equal quantity (see formula), or a little more, of soap is added to the entire solution. Common yellow bar soap is perfectly satisfactory for ordinary purposes. For thoroughness this solution should be applied in as fine a spray as possible. Most insects are reached more readily by a fine mist, but for sucking insects the spray should be applied at considerable pressure so that every insect is actually reached or hit by it.

For use in small gardens, 1 teaspoonful of nicotine sulphate is used in 1 gallon of water, and to this a 1-inch cube of hard soap is added and the whole thoroughly mixed. If a larger quantity is needed, 1 fluid ounce of nicotine sulphate, 8 gallons of water, and one-half pound of soap are used. Directions are furnished on the covers of packages, and frequently instructions accompany them.

Kerosene emulsion, applied as for other sucking insects, is valuable also but is being superseded by nicotine sulphate solutions.<sup>3</sup>

<sup>1</sup> *Macrosiphum solani folii* Ashm.

<sup>2</sup> *Myzus persicae* Sulz.

<sup>3</sup> Directions for the application of kerosene emulsion will be furnished by the Bureau of Entomology, U. S. Department of Agriculture.

For leafhoppers alone, as they occur on potato, bean, and other plants, still another remedy is used, a capturing device called a "hopperette," or hopperdozer. One of these is shown in figure 15. An account of others to be used on a larger scale is furnished in Farmers' Bulletin 747, Grasshopper Control.

During the present growing season (1917) to date it has been astonishing to learn how many growers have used Paris green and arsenate of lead as remedies for plant-lice. They are not only absolutely worthless against plant-lice, but sometimes they destroy some other insects which prey upon and which might otherwise greatly reduce the numbers of the plant-lice. Arsenate of lead and Paris green are stomach poisons and effective only against pests which devour leaf tissue.

#### LATE-BLIGHT AND ROT.

Late-blight is the most destructive potato disease. Originating in South America, it has spread to every potato country in the world and has destroyed crops to the extent of causing famine, as in Ireland in 1845.

In the United States late-blight is most common in the North-eastern States, as indicated on the map, figure 16. In the shaded areas in bad years 50 per cent of the crop in unsprayed fields may be destroyed. It occurs every year in northern New England, and usually visits New York and parts of the adjacent States; in wet seasons it extends as far west as Iowa and Minnesota. It occurs to some extent in the south Atlantic trucking sections from April to June and in the southern mountain region in autumn. The moist, cool climate of portions of the Pacific coast favors its development; but it is seldom or never found in the Great Plains, the Rocky Mountains, and other dry or hot parts of the country.

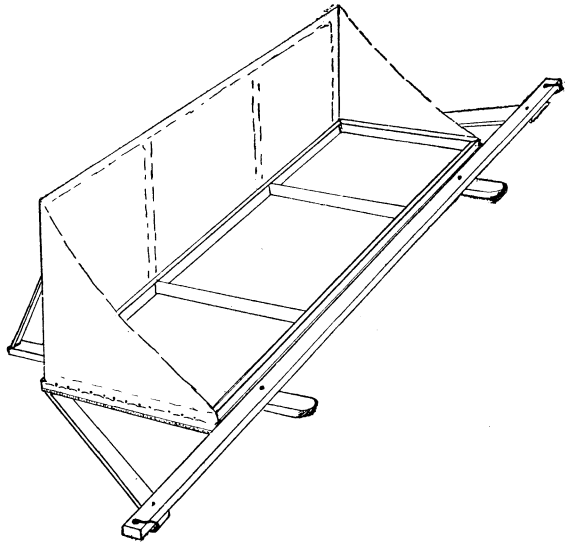

FIG. 15.—A successful type of horse-drawn hopperdozer. (Milliken.)

#### APPEARANCE OF LATE-BLIGHT AND ROT.

Late-blight develops after the blossom period and does its greatest damage toward the end of the growing season. It appears as purplish black or brownish black spots on the leaves, which, if examined when

moist with dew or rain, show a delicate, powdery bloom on the underside. (See fig. 17.) The stems are attacked later, and the entire plant may be destroyed in a few days. If weather conditions favor the disease, fields go down within a few days as if swept by fire, and a foul odor characteristic of the disease is very perceptible.

The blighting of the foliage is followed by decay of the tubers, owing to spores washed down through the soil from the foliage. If the soil is wet and heavy, there may be a rapid soft-rot caused principally by bacteria. The typical late-blight tuber injury, however, is a dry rot which develops in the field or after storage, as sunken brown spots near the outside of the tuber.

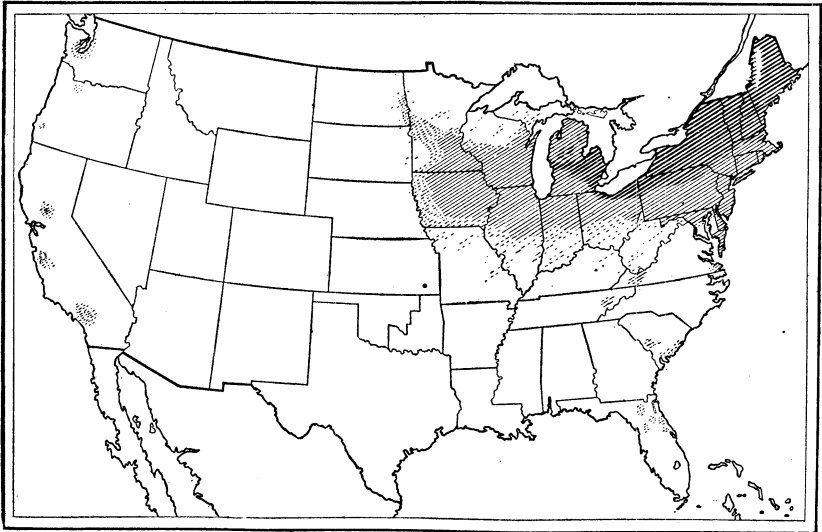

FIG. 16.—Map of the United States showing the distribution of potato late-blight. The sections where the disease is the more prevalent are indicated by the heavier shading.

#### CAUSE OF LATE-BLIGHT.

Late-blight is due to a fungus<sup>1</sup> which lives as a parasite on the potato plant and some of its relatives, notably the tomato. This fungus is itself a plant formed of slender, moldlike filaments (mycelium) which penetrate the potato plant and feed upon it and later produce vast numbers of minute spores or fruiting bodies. These are spread by wind and water to other plants, which may become infected and produce another crop of spores within five or six days. The tubers become infected by spores washed down through the soil or by contact with blighted tops when digging is being done.

<sup>1</sup>*Phytophthora infestans* (Mont.) DeBary.

## FACTORS INFLUENCING LATE-BLIGHT.

*The origin of the infection.*—Late-blight does not occur in the soil. It overwinters in stored tubers. Potatoes with more or less dry rot (18) are planted frequently, and some of them give rise to weak sprouts. The fungus grows up these shoots and produces spores on the above-ground parts, which are carried to adjacent plants and start centers of infection. Such first cases of late-blight often are present in the fields two weeks or more before the disease becomes epidemic.

In preparing potatoes for planting it is important to reject seed potatoes affected with late-blight dry rot, as infected tubers often decay in the ground without germinating, but there is little hope of avoiding the disease by this precaution, since under favorable weather conditions blight is carried many miles in a short time. No method of treating seed potatoes to kill late blight has been found practicable. Thorough spraying with Bordeaux mixture is the only preventive.

*Temperature.*—Late-blight spreads most rapidly when the daily mean temperature is 72° to 74° F. with abundant moisture. Weather which in the North is designated as "warm and muggy" is therefore favorable to the rapid development of late-blight, whereas the hot summer weather of the Southern and Central States checks it completely.

*Moisture.*—In dry weather the production of spores is checked, and the disease ceases to spread because the spores can not germinate except in the presence of moisture. Dry foliage can not be infected. It is only when drops of

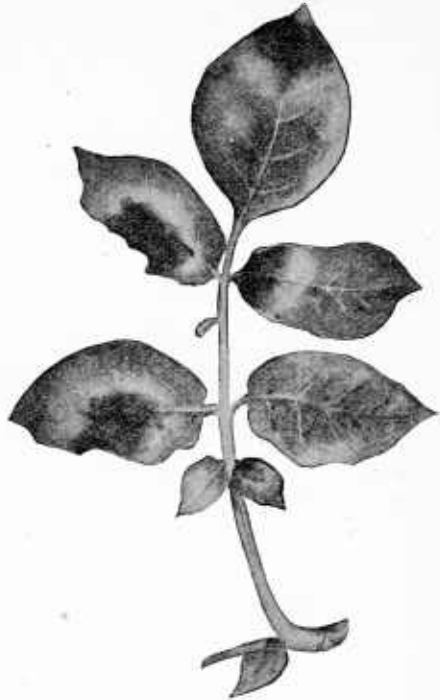

FIG. 17.—Potato late-blight.

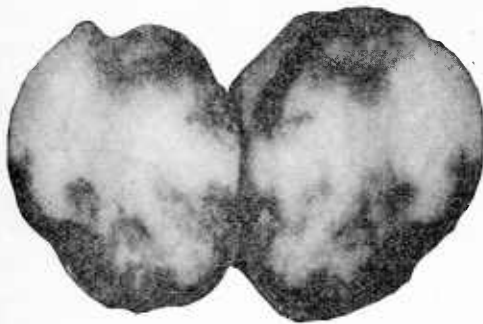

FIG. 18.—Late-blight tuber-rot.



water from rain or heavy dews stand for some hours on the leaves that the disease can gain a foothold. This is an important point to remember in connection with spraying; it explains why all portions of the plant should be covered with Bordeaux and why protection with the spray before rain is needed.



FIG. 19.—Potato tipburn.

*Soil and location.*—Hollows or low places in the fields, wherever moisture remains longest, are most likely to develop late-blight, and potatoes on clay soils are likely to suffer more from rot than those on sandy soil.

*Varieties.*—Partially resistant varieties of potatoes have been bred in Europe, but these are not well adapted to American conditions. We are now developing our own resistant strains, but at present no variety which meets the requirements for a standard commercial sort can be recommended as disease resistant. Select the best variety for your locality and market, and protect from late-blight by spraying with Bordeaux mixture.

#### PREVENTION OF LATE-BLIGHT TUBER-ROT.

1. *Spraying.*—The first essential is to spray, as recommended on page 18.

2. *Date of digging.*—It is unwise to dig potatoes when the first blight appears. The immature tubers are not in condition to keep well and they become infected by contact with the tops while being harvested. Consequently, the potatoes should not be dug until a week or more after the tops are entirely dead.

3. *Sorting and storage.*—Immediately after harvesting, sort out all potatoes showing any trace of dry rot and store the remainder in a dry cellar or storage house, kept cool, as near 36° F. as possible. Dry rot will not develop at this temperature, but in a warm place it will be spread from tuber to tuber.

No treatment with lime, formaldehyde, or other disinfectant is of any value against late-blight dry rot.

**OTHER DISEASES.**

Several other diseases of potato foliage should be mentioned, to avoid confusion with late-blight. They are listed below in the order of their appearance.

**SUNSCALD.**

Young potato plants that have made a rapid growth during cool and moist weather may suffer from hot, bright weather. The leaves droop and wilt, and some are killed, but the plants usually recover.

**TIPBURN.**

Protracted hot and dry weather, complicated by flea-beetle injury and early blight, results in the injury illustrated in figure 19. The tips and margin of the leaves turn brown and dry up. The yield of tubers is reduced in proportion to the loss of foliage. Spraying with Bordeaux mixture greatly reduces the injury from tipburn.

**EARLY-BLIGHT.**

Early-blight is a fungous disease which appears in the North before the late-blight. In the South, however, it is more common on the fall crop. It is likely to occur in all sections of the country.

This disease is marked by the appearance of nearly black spots in the otherwise green leaves. As these enlarge they are marked by faint concentric rings. (See fig. 20.) Eventually the

leaves yellow and die, and the tuber yield is reduced 10 to 25 per cent.

Early-blight attacks weakened plants and is worst upon light soils, not well adapted, by fertility and moisture supply, to potato growing. When conditions favor, it becomes widespread.

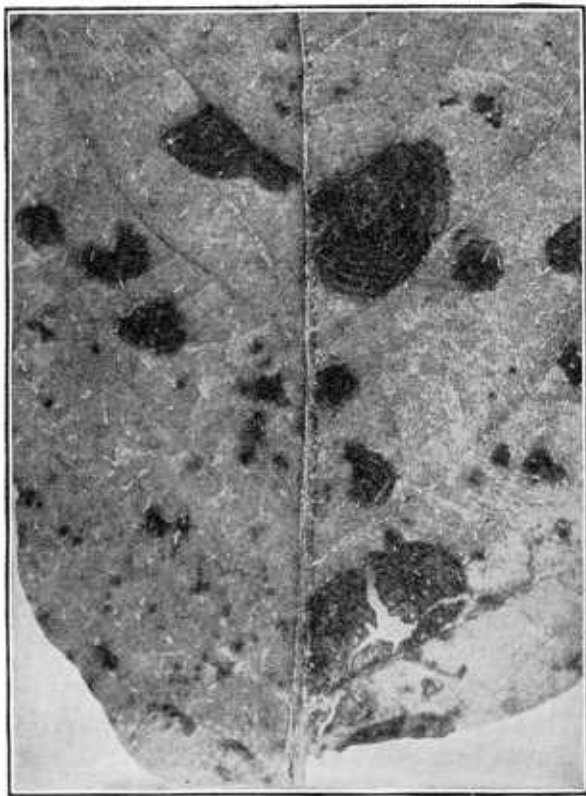

FIG. 20.—Potato early-blight.

The combined treatment advised below includes Bordeaux mixture for early-blight.

#### ARSENICAL POISONING.

The use of Paris green in water in large quantities results in a burning of the leaves, often in concentric spots centering at flea-beetle punctures, somewhat resembling early-blight. When the arsenical is combined with Bordeaux mixture, this injury is avoided.

#### COMBINED TREATMENT FOR DISEASES AND INSECTS.

Watch the young plants closely and spray with Bordeaux mixture and arsenate of lead as soon as the first evidence of the Colorado potato beetle or of flea-beetles is noted.

Repeat this application every 10 to 14 days to keep all of the new foliage protected. If no insects are present and the weather is dry, the intervals between sprayings may be lengthened.

As the late-blight season approaches, which in the North usually is after the middle of July, a protective spraying should be given and the weather watched more closely, for if continuous showers occur, with a mean temperature of 72° to 74° F., spraying every 5 to 7 days will be necessary.

A system for reporting the appearance and progress of late-blight should be organized in order that potato growers may be warned when to increase their efforts.

#### VALUE OF SPRAYING.

Throughout the late-blight area shaded on the map (fig. 16) it pays to spray potatoes with Bordeaux and arsenicals, whether blight develops or not. With few exceptions, large gains in yield are due to protection from flea-beetles, grasshoppers, early blight, tipburn, etc.

This fact has been established by extensive experiments which have been conducted in New York and Vermont. During a 10-year period, at different experiment stations in New York State, an average gain of 60 bushels per acre was secured. At the Vermont station, during a 20-year period, which involved all possible seasonal variations, an average gain of 105 bushels per acre, or 64 per cent over the unsprayed, resulted.

In addition, records taken from a business point of view on a series of experiments of a nine-year duration, conducted by farmers under the direction of the New York State Experiment Station, show large gains. The average cost of spraying, including materials, labor, and wear and tear on machinery, was \$4.74 per acre. The nine-year average increase in yield due to spraying was 361 bushels per acre, making a net profit of \$14.43 per acre. When these experiments were conducted the cost of materials was less than at the time this

bulletin was written, but the increased product warrants an increased expenditure.

The value of such applications of spray annually in regions not included in the blight area (fig. 16) is not so well established. Conditions in the Atlantic coastal region from New Jersey to Florida, for instance, are so different from those farther north that spraying can not be expected to give as large returns as in Maine or New York. In Florida there have been several years when late-blight has prevailed and spraying has been profitable. Here the argument for crop insurance is stronger and spray applications may be advised in number proportioned to the frequency of rain, but always thorough. In New Jersey also, as conditions begin to approach those of the North, gains from spraying may be expected. This is equally true in other regions of the United States, where blight occurs only in occasional years.

The foregoing figures show, however, that spraying is very profitable in districts where potato insects and diseases annually take a big toll. The most successful growers in these districts, who wish to be insured against loss, practice thorough and consistent spraying, knowing that there will be large returns on their investment.

#### SPRAYING APPLIANCES.

For home gardens small hand sprayers of varying cost and efficiency are to be had. Consult Farmers' Bulletin 856.

For the farm potato patch, where from one-half acre to 3 acres are grown and where orchard trees or small fruits are to be sprayed, a barrel spray pump of good capacity is recommended. This hand pump is mounted on a 50-gallon barrel and carried on a homemade two-wheel cart or in a farm wagon.

If a cart is used the nozzle may be fastened to the back to spray four rows, but to do good work with this it is necessary, as with the lighter traction sprayers, to go over the field twice, the second time in the opposite direction.

More thorough work can be done by hand spraying if the pump is fitted with one or two lines of  $\frac{1}{2}$ -inch hose, 25 feet long, ending in a 4-foot gas-pipe extension. This requires a man for each line and one to pump.

All commercial growers should provide themselves with the most effective traction sprayer they can secure. In these the pump is operated by a chain or gear drive from the wheels. It pays to get the best, as a high pressure of 120 to 150 pounds is needed for effective work. (See fig. 21.)

A good nozzle is one of the most important parts of a spray outfit. The cyclone or eddy chamber type, of which the Vermorel is an



FIG. 21.—Horse-driven air-power sprayer in use in a potato field.

example, are the best. The spray produced should be in the form of a fine mist covering every part of the plant.

For truck gardens the common compressed-air sprayer employing a tank holding 3 or 4 gallons and provided with a pump for developing the air pressure is the most effective type. An automatic cut-off in the spray rod retains the liquid in the tank until the desired pressure, as high as can be conveniently pumped, has been obtained. Then the liquid may be released as required. Such a machine costs \$5 to \$6 in galvanized iron, or \$8 to \$10 in brass. The latter is preferable, as it lasts longer and is less liable to corrosion by the chemicals used in spraying. (See fig. 22.) A smaller type known as the syringe atomizer, holding about a quart of spray mixture, and costing from 50 cents to \$2, according to construction, may be obtained from most seedsmen, and is suitable for small kitchen gardens.

#### HOW TO PREPARE BORDEAUX MIXTURE.

Bordeaux mixture is the only fungicide that has any practical value against potato diseases. Lime-sulphur, powdered sulphur, and other new mixtures that have come into use in orchards are injurious to the foliage, or weaker in fungicidal action, or both. The experiments to date show that for potatoes and other truck crops nothing has yet been found to replace the copper fungicides. The ingredients and method of preparation are as follows:

Copper sulphate.....	pounds..	4
Quicklime.....	do.....	4
Water to make.....	gallons..	50

Prepare the copper sulphate by suspending it in a gunny sack just below the surface of several gallons of water in a clean barrel. When

the sulphate is dissolved, which requires three or four hours, remove the sack and stir into the barrel enough additional water to make exactly 25 gallons of the copper solution.

Prepare the lime by slaking it slowly and thoroughly in a clean barrel, strain, and add enough additional water to make exactly 25 gallons of lime milk. Stir thoroughly.

Pour the two ingredients together into another barrel or, better, directly into the spray tank, if it will hold 50 gallons. It is highly important to stir the mixture very thoroughly and to strain both ingredients before they are combined, as otherwise clogging of the spray nozzles might result. Use copper or bronze wire strainer of 18 meshes to the inch. Do not put copper sulphate or Bordeaux mixture into tin or iron vessels; use wood or copper containers. Mix the Bordeaux as needed and apply at once. It is never so good after it has settled.

#### STOCK SOLUTIONS.

Everyone who uses Bordeaux mixture frequently and in quantity will find it convenient to keep on hand concentrated stock solutions of copper sulphate and of lime in separate containers. These stock solutions keep indefinitely if the water which evaporates is replaced.

Build an elevated platform to hold the barrels. Some time before the day on which you wish to commence spraying, suspend 50 pounds of copper sulphate to dissolve in a 50-gallon barrel of water. Slake 50 pounds of lime in another barrel. Add water to make 50 gallons of limo milk. When Bordeaux mixture is needed, stir both stock barrels and take from each as many gallons as the formula



FIG. 22.—Compressed-air sprayer standing upright, showing hose, nozzle, and other attachments.

calls for in pounds. Dilute the copper sulphate in one barrel and the lime milk in another, each with half the water, and let the two run together into the strainer of the spray tank. Add the arsenate of lead or other poison, and stir well. Thorough agitation is important in making a good Bordeaux mixture.

**PUBLICATIONS OF THE U. S. DEPARTMENT OF AGRICULTURE RELATING TO INSECTS INJURIOUS TO TRUCK CROPS.**

AVAILABLE FOR FREE DISTRIBUTION BY THE DEPARTMENT.

- Squash-vine Borer. (Farmers' Bulletin 668.)  
Grasshoppers and their Control on Sugar Beets and Truck Crops. (Farmers' Bulletin 691.)  
Fall Army Worm, or "Grass Worm," and its Control. (Farmers' Bulletin 752.)  
False Chinch Bug and Measures for Controlling it. (Farmers' Bulletin 762.)  
Common Cabbage Worm. (Farmers' Bulletin 766.)  
Mushroom Pests and How to Control Them. (Farmers' Bulletin 789.)  
Carbon Disulphid as an Insecticide. (Farmers' Bulletin 799.)  
Asparagus Beetles and Their Control. (Farmers' Bulletin 837.)  
How to Increase the Potato Crop by Spraying. (Farmers' Bulletin 868.)  
Bollworm or Corn Earworm. (Farmers' Bulletin 872.)  
Control of the Melon Aphis. (Farmers' Bulletin 914.)  
Common White Grubs. (Farmers' Bulletin 940.)  
Spotted Garden Slug. (Farmers' Bulletin 959.)  
Control of the Onion Thrips. (Farmers' Bulletin 1007.)  
Sweet-Potato Weevil and its Control. (Farmers' Bulletin 1020.)  
Striped Cucumber Beetle. (Farmers' Bulletin 1038.)  
Melon Fly in Hawaii. (Department Bulletin 491.)  
Melon Fly. (Department Bulletin 643.)  
Miscellaneous Truck Crop Insects in Louisiana. (Department Bulletin 703.)

FOR SALE BY THE SUPERINTENDENT OF DOCUMENTS, WASHINGTON, D. C.

- Potato Tuber Moth. 1913. (Farmers' Bulletin 557.) Price 5 cents.  
Cactus Solution as an Adhesive in Arsenical Sprays for Insects. 1915. (Department Bulletin 160.) Price 5 cents.  
Quassia as a Contact Insecticide. 1914. (Department Bulletin 165.) Price 5 cents.  
Insects Affecting Vegetable Crops in Porto Rico. 1915. (Department Bulletin 192.) Price 5 cents.  
Eggplant Lace-Bug. 1915. (Department Bulletin 239.) Price 5 cents.  
Eggplant Tortoise Beetle. 1916. (Department Bulletin 422.) Price 5 cents.  
Potato Tuber Moth. 1917. (Department Bulletin 427.) Price 15 cents.  
The Horse-radish Flea-Beetle. 1917. (Department Bulletin 535.) Price 5 cents.  
European Earwig and its Control. 1917. (Department Bulletin 566.) Price 5 cents.  
The Sweet-potato Leaf-folder. 1917. (Department Bulletin 609.) Price 5 cents.  
Southern Green Plant-Bug. 1918. (Department Bulletin 689.) Price 10 cents.  
Strawberry Weevil. 1908. (Entomology Circular 21.) Price 5 cents.  
Pea Aphis. 1909. (Entomology Circular 43, rev.) Price 5 cents.  
Greenhouse White Fly. 1905. (Entomology Circular 57.) Price 5 cents.  
Root Maggots and How to Control Them. 1906. (Entomology Circular 63.) Price 5 cents.  
Harlequin Cabbage Bug. 1908. (Entomology Circular 103.) Price 5 cents.  
Asparagus Miner. 1911. (Entomology Circular 135.) Price 5 cents.  
Flour Paste as Control for Red Spiders and as Spreader for Contact Insecticides. 1913. (Entomology Circular 166.) Price 5 cents.  
Fall Army Worm and Variegated Cutworm. 1901. (Entomology Bulletin 29, n. s.) Price 5 cents.



- Some Insects Injurious to Vegetable Crops. 1902. (Entomology Bulletin 33, n. s.) Price 10 cents.
- Brief Account of Principal Insect Enemies of Sugar Beet. 1903. (Entomology Bulletin 43.) Price 5 cents.
- Notes on Pepper Weevil. 1907. (Entomology Bulletin 63, pt. V.) Price 5 cents.
- Strawberry Weevil in South-central States in 1905. 1907. (Entomology Bulletin 63, pt. VI.) Price 5 cents.
- Some Insects Injurious to Truck Crops. 1910. (Entomology Bulletin 66, 7 pts.) Price 20 cents.
- Water-cress Sowbug; Water-cress Leaf-beetle. 1907. (Entomology Bulletin 66, pt. II.) Price 5 cents.
- Cranberry Spanworm; Striped Garden Caterpillar. 1907. (Entomology Bulletin 66, pt. III.) Price 5 cents.
- Leafhoppers of Sugar Beet and Their Relation to "Curly Leaf" Condition. 1909. (Entomology Bulletin 66, pt. IV.) Price 10 cents.
- Semitropical Army Worm. 1909. (Entomology Bulletin 66, pt. V.) Price 5 cents.
- Hop Flea-beetle. 1909. (Entomology Bulletin 66, pt. VI.) Price 5 cents.
- Miscellaneous Notes on Truck-crop Insects. 1909. (Entomology Bulletin 66, pt. VII.) Price 5 cents.
- Some Insects Injurious to Truck Crops. 1912. (Entomology Bulletin 82, 7 pts.) Price 20 cents.
- Colorado Potato Beetle in Virginia in 1908. (Entomology Bulletin 82, pt. I.) Price 5 cents.
- Parsnip Leaf-miner Parsley Stalk Weevil, and Celery Caterpillar. 1909. (Entomology Bulletin 82, pt. II.) Price 5 cents.
- Lima-bean Pod-bearer and Yellow-necked Flea-Beetle. 1909. (Entomology Bulletin 82, pt. III.) Price 5 cents.
- Life History and Control of Hop Flea-beetle. 1910. (Entomology Bulletin 82, pt. IV.) Price 10 cents.
- Biologic and Economic Notes on Yellow-Bear Caterpillar. 1910. (Entomology Bulletin 82, pt. V.) Price 5 cents.
- Notes on Cucumber Beetles; Biologic Notes on Species of Diabrotica in Southern Texas. 1910. (Entomology Bulletin 82, pt. VI.) Price 5 cents.
- Notes on Various Truck-crop Insects. 1911. (Entomology Bulletin 82, pt. VII.) Price 5 cents.
- Hawaiian Beet Webworm. 1911. (Entomology Bulletin 109, pt. I.) Price 5 cents.
- Southern Beet Webworm. 1911. (Entomology Bulletin 109, pt. II.) Price 5 cents.
- Imported Cabbage Webworm. 1912. (Entomology Bulletin 109, pt. III.) Price 5 cents.
- Little-known Cutworm. 1912. (Entomology Bulletin 109, pt. IV.) Price 5 cents.
- Arsenite of Zinc and Lead Chromate as Remedies Against Colorado Potato Beetle. 1912. (Entomology Bulletin 109, pt. V.) Price 5 cents.
- Horse-radish Webworm. 1913. (Entomology Bulletin 109, pt. VII.) Price 5 cents.
- Hop Aphis in Pacific Region. 1913. (Entomology Bulletin 111.) Price 5 cents.
- Red Spider on Hops in the Sacramento Valley of California. 1913. (Entomology Bulletin 117.) Price 15 cents.
- Bean Thrips. 1912. (Entomology Bulletin 118.) Price 5 cents.
- Preliminary Report on Sugar-beet Wireworm. 1914. (Entomology Bulletin 123.) Price 25 cents.
- Spotted Beet Webworm. 1913. (Entomology Bulletin 127, pt. I.) Price 5 cents.
- Striped Beet Caterpillar. 1913. (Entomology Bulletin 127, pt. II.) Price 5 cents.