

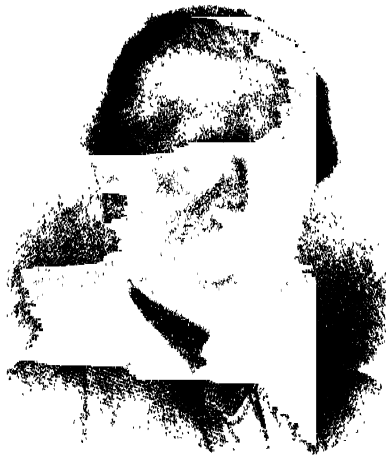

Resoio







# NATURE

A WEEKLY

ILLUSTRATED JOURNAL OF SCIENCE

VOLUME XV

NOVEMBER 1877

*"To the solid ground  
Of Nature trusts the mind which builds for aye."*—WORDSWORTH

London and New York:  
MACMILLAN AND CO.

1877

LONDON  
R. CLAY, SONS, AND TAYLOR, PRINTERS,  
BREAD STREET HILL, QUEEN VICTORIA STREET

# INDEX

- BRAY (Rev. K.), Patenas or Grass Lands of the Mountainous Region of Ceylon, 398; Lowest Temperature, 471  
 Abbott (Dr. Chas. C.), Pre-Glacial Man in America, 274  
 Abel (Prof. F.R.S.), Chemistry and Telegraphy, 321  
 Abercromby (Ralph), Is Meteorology a Science? 510  
 Abney (Capt. F.R.S.) "Instruction in Photography," 253; On the Photographic Image, 543  
 Abraham (Phin S.), "Stone Rivers," 431  
 Absorption Bands, M. Lippich on, 209  
 Absorption of Light in the Blood, 362  
 Absorption of Organic Matter by Plants, 105  
 Accipitres of Canada, "Venor's, 546  
 Acoustics, Light, and Heat," by William Lees, Dr. W. H. Stone, 352  
 Actinophrys, 108  
 Adams (Prof. A. I. Cuth), Sense of Hearing in Birds, 334; Gigantic Land Tortoises, 347  
 Aeronauts, French Schools of, 383  
 Africa: Piaggia's Exploration of, 89; Exploration of Central, 188; Antinori's Exploration of, 188; Portuguese Exploration of, 208; Cameron's "Across Africa," 277; The Berlin African Society, 283; Stanley's Exploration of, 480; Hydrography of W. Central Africa, 517, v. Bary's Expedition, 540  
 Agassiz (Prof.), the *Challenger* Collections, 256  
 Agriculture, French National School of, 128  
 Agriculture in the United States, 525  
 Air, Heated, 283  
 Airy (Sir G. B., F.R.S.), Ancient Solar Eclipses, 115; Solar Physics at the Present Time, 196  
 Aldis (W. Steadman), Owens College, Manchester, 509  
 Alga: a New Parasitic Green, 416; of the Gulf of Finland, 459; of the Kara Sea, 461  
 Algeria, Sicocco in, 89  
 Algid Swarm Spots, 15, 178  
 Alpenverein, German and Austrian, 68  
 Alpine Club, the Swiss, 383  
 Alpine Flowers, Collections of, 150  
 America, Traces of Pre-Glacial Man in, 274, 295  
 American Geographical Society, 345  
 American Journal of Science and Arts, 267, 286, 385, 541  
 Americanists, Congress of, at Luxemburg, 268  
 Ampère, Bust of, 69  
 Amphibia, Carboniferous, in Nova Scotia, 264  
 Amyl, Nitrite of, Dr. B. W. Richardson, F.R.S., 24  
 Anæsthetics, New Alcoholic, 209  
 "Andes and the Amazon," James Oton, 154  
 Aneroid Barometer, Improvement in, 460  
 Aniline in Photographs, 207  
 Animals, Colours of, 16  
 Antarctic, The Conditions of the, Sir Wyville Thomson, F.R.S., 104, 120  
 Antedated and Undated Books, 17  
 Antedon Rosaceus (*Comatula rosacea*), 7, 58, 158, 159, 197, 366  
 Antimony Pentachloride, action of, on certain Organic Substances, 282  
 "Anthracen," Auerbach's, 507  
 Anthropological Society at St. Petersburg, 363  
 Anthropology: Beitrage zur Anthropologie und Uigeschichte Bayerns, 89; Society at Munich, 89; Prof. Virchow on the present position of, 149; Paris School of, 149; Anthropological Institute, 131, 151, 171, 268, 307, 327, 367, 421, 483, 523, 543  
 Ants, Sir John Lubbock on, 386; Mr McCook on, 439  
 Apatite and Nephelin, 384  
 Aquarium, proposed, at Birmingham, 170  
 "Archæological Frauds," 150  
 Archer (S.), Mimetic Habits of Bats, 313  
 Archiv fur Anthropologie, 110  
 Archiv fur mikroskopische Anatomie, 111  
 Archives des Sciences Physiques et Naturelles, 542  
 Arctic Expedition, English: 1, 11, 68; Capt. Nares' Report, 24; Prof. Osborne Reynolds on, 87; Medals commemorative of, 89; Dr. Petermann's Map of the, 109; Wordsworth Donisthorpe, 116; Dr. Petermann on the, 148; Natural History and Geological Results of the, 432; Sir George Nares on the, 480; the Blue-Book on, 505  
 Arctic Expedition, Payer's Narrative of the Austrian, 62, 81  
 Arctic Expedition, the German, 148  
 Arctic Exploration, 51; German Society for, 17; by Balloons, 148; Capt. Howgate's Method of attaining the North Pole, 284, 365  
 Arctic Seas, Tides of the, 562  
 "Are We Drying Up?" 6, 217  
 Argyll (Duke of, F.R.S.), Holly-Berries and Rare Birds, 273; Hibernation of Birds, 527  
*Asphionemus olfax*, 265  
 Astronomical Bibliographies, 455  
 Astronomical Clock, a New, Sir William Thomson, F.R.S., 227  
 Astronomical Column, 14, 48, 65, 86, 107, 125, 146, 166, 186, 206, 243, 262, 281, 303, 323, 342, 361, 381, 414, 437, 457, 478, 500, 519, 531, 549  
 "Astronomical Myths," John F. Blake, 351  
 Astronomical Society. See Royal  
 Astronomy, Sidereal, Knobel's Catalogue of the Literature of, 48  
 Atkins (Edward), "Elements of Algebra," 115  
 Atlantic: Meteorology of the, 49; Temperature of the Northern part of the, 107; Physics of the, 263; Atlantic Ridge and the Distribution of Fossil Plants, 158; Atlantic Soundings, J. J. Wild, 377  
 Atmosphere of the Rocky Mountains, Dr. Henry Draper, 354  
 Atmospheric Currents, 294, 374, 450, 510  
 Atmospheric and Ocean Currents, 333  
 Atmospheric Pressure in Russia, 457  
 Auerbach (G.), "Anthracen," 507  
 Auroric Lights, G. H. Knab on, 334  
 Australia, Drought in, 523  
 Austrian Arctic Expedition, Payer's Narrative of, 62, 81  
 Austrian *Not tra* Expedition, Report on the, 261  
 Backhouse (T. W.), Spectrum of the New Star in Cygnus, 295  
 Baer (Karl Ernst von), Obituary Notice of, 138  
 Baer Medal, Award for 1877, 303  
 Bam (Alexander), Obituary Notice of, 218  
 Bakaganj, Beveridge's District of, 135  
 Ball Lightning, 539  
 Balloons: Large, at the Paris Exhibition, 501; Apparatus for Steering, 110; Sale of French, 266; for Meteorological Purposes, 458  
 Ballot (Dr. Buys), on a Mode of Investigating Storms and Cyclones, 216; the Physics of the Atlantic Ocean, 263  
 Baltic Provinces, Geological Map of, 70  
 Barkley (H. C.), "Between the Danube and the Black Sea," 134  
 Barometer, South Polar Depression of the, 157, 198, 253  
 Barometers: of Southern Russia, 49; Variations of, J. Allan Brown, F.R.S., 151; Distribution of, in France, 538  
 Barometric Range at High and Low Levels, 187, 275  
 Barometric Pressure, Experiments on, 502  
 Barth (Baron), Death of, 325, 344  
 Bashkirs, Anthropological Sketch of the, 382



- Basking Shark, Prof. Henry J. Giglioli, 273; Prof. E. Percival Wright, 292  
 Basques, the, Rev. A. H. Sayce, 394  
 Batrachians, the Development of, without Metamorphosis, 491; Non-Amphibious, Rev. George Henslow, 548  
 Bats, Mimetic Habits of, S. Archer, 313; Protective Mimicry among, G. E. Dobson, 354  
 Bauer's "Philological Introduction to Greek and Latin," 74  
 Baxendell (Mr.), the Protection of Buildings from Lightning, 88  
 Bayeux Tapestry, the Comet of the, 126  
 Bears, Polar, Fight between two, 70  
 Beaver in Siberia, 265  
 Beckesheim (M.), Experiments with Nitro-Glycerine, 71  
 Beer: Pasteur's Etudes sur la Bière, 213, 249  
 Bees: Toads eating, 502; Origin of the Flying Powers of, 559  
 Beetles, Blistering, as a Cure for Hydrophobia, 264  
 Belcher (Admiral Sir Edward), death of, 461  
 Belfast, Working Men's Institute, 128  
 Belgium: Geographical Society, 128; Geological Maps of, 304; Geological Society, 304; Education in, 326; Hurricane in, 253  
 Bellynck (Prof.), Death of, 304  
 Belt (Thomas), Pre-Glacial Man in America, 295  
 Bengal, Cyclone Wave in, 261  
 Beni, Prof. James Orton's Exploration of the River, 17  
 Bennett (A. W.), European Polygalas, 5  
 Berkeley (Rev. M. J.), the Fungus Disease of India, 21  
 Berlin: Gorilla in, 51, 208; Additions to the Ethnological Museum, 89, 304; Anthropological Society, 169, 304, 364; Ethnological Objects at the Royal Museum, 208; Geographical Society, 345; Chemical Society, 211, 327, 367, 422  
 Berliner Astronomisches Jahrbuch, 362  
 Bernardin (Prof.), Classification of Fécules, 209  
 Bernese Alps, Orography of, 188  
 Bessel's Treatises, 414  
 Bethnal Green Museum, 18  
 Bettany (G. T.), on the Primary Elements of the Skull, 127  
 Beveridge (H.), the District of Bakarganj, 135  
 Bianconi (Prof.), Experiments on Ice, 69  
 "Bibliographia Caucasica et Transcaucasica," 71  
 Biela's Comet in 1805, 479  
 Binary Stars, 186, 414, 500;  $\gamma$  Centauri, 303;  $\alpha$  Centauri, 510  
 Biological Notes, 15, 65, 108, 127, 167, 263, 324, 414, 438, 458, 558  
 Biology, Prof. Huxley's Lecture on the Study of, 219  
 Birds: Palmén on the Migration of, 465; Sense of Hearing in, Prof. A. Leith Adams, 334; can they Count? 345; Hibernation of, 465, 527; of Celebes, 559; Bird's Eggs, 502; Birds and Insects, Sense of Hearing in, 254, 292, 354  
 Birmingham (J.), the Suspected Intra-Mercurial Planet, 509; Occultation of Kappa Geminorum, 509  
 Bischofsheim Transit Instrument, 16  
 Bisons, the American, 167  
 Black Burgh Tumulus, Brighton, 131  
 "Black Drop," M. Ch. Andre on the, 285  
 Blake (John F.), "Astronomical Myths," 351  
 Blake and Tate's "Yorkshire Lias," 113  
 Blood, Absorption of Light in the, 362  
 Body-change, Relation of, to Temperature, 324  
 Bolide at Clercy, 69  
 Boltzmann (M.), on Gas Molecules, 306  
 Bombay, Meteorology of, 482  
 Bonney (Rev. T. G.), the Age of the Rocks of Charnwood Forest, 97, 137  
 Boomerang, the, 312, 510  
 Borely's Comet, 431, 549  
 Boring, Deep, at Rheinfelden, 128  
 Boron and its Specific Heat, 283  
 Bosanquet (R. H. M.), the Hindoo Division of the Octave, 420  
 Boston (U.S.), Natural History Society, 192, 388  
 Botanic Gardens: Calcutta, 71; Brisbane, 190  
 Botanical Geography of Russia, 459  
 Bottomley (J. T., M.A.), "Dynamics," 467  
 Bowerbank (Dr. John Scott, F.R.S.), Death of, 481  
 Boxwood, the Supply of Russian, 345  
 Bradford Scientific Association, 560  
 Brabé (Tycho), Notice of, 405; his Portrait, 530  
 Brain, the Functions of the, Dr. David Ferrier, F.R.S., 73, 93; its Action of the, 264  
 Braun (Alexander), Obituary Notice of, 490  
 Brazil, Geology in, 149  
 Bremen geographische Gesellschaft, 246  
 Bressa (Dr. C. A.), Prize instituted by, 207  
 Brighton Aquarium, 365  
 Brighton, Black Burgh Tumulus, 131  
 Brisbane Botanic Gardens, 190  
 Bristol, University College, 459  
 British Guiana, C. Barrington Brown's Camp Life in, 311  
 "British Manufacturing Industries," 54, 96, 445  
 British Museum: Semitic Remains in the, 247; the Estimate on the, 382  
 Broca's Stereograph, 558  
 Bronze, Steel, 522  
 Broun (J. Allan, F.R.S.), Variations of the Barometer, 151  
*Browallia data*, Supposed Self-Fertilisation of, 24  
 Brown (Rev. G.), Exploration of Polynesia, 246  
 Brown (C. Barrington), Canoe and Camp Life in British Guiana, 311  
 Brussels Observatory, New Instruments for, 304  
 Buchan (Alexander), Greenwich as a Meteorological Observatory, 450, 528  
 Buckland (Frank) on the Breeding of the Salmon, 375  
 Bulletin de l'Académie Impériale des Sciences de St. Pétersbourg, 20  
 Bulletin des Sciences Mathématiques et Astronomiques, 332  
 Burial-Ground near Rauschenburg, Discovery of, 51  
 Burrows and Colton, "Concise Instructions in the Art of Re-touching," 156  
 Butterflies of America, Edward's Work on the, 70  
 Cæsium and Rubidium, Atomic Weights of, 282  
 Calabria, Natural History of, 541  
 Calcutta, Report of the Royal Botanic Gardens, 71  
 California, Glacial Drift in, A. R. Wallace, 274  
 Cambridge, Natural Science Club, 70; Philosophical Society, 87, 132, 151, 444, 573; Natural Science Scholarships and Exhibitions, 70, 89, 322, 325; Lectures in Science at, 325, 540  
 Cambridge, Mass., U.S.: Science at, 432; Observatory, 201  
 Cameldix, the evolution of the, 168  
 Cameron (Commander V. L.), "Across Africa," 277; Lecture at the Sorbonne, 305  
 Campbell (Lord George), "Log Letters from the Challenger," 290  
 Canada: the Emigrant and Sportsman in, John J. Rowan, 216; Catalogue of the Minerals of, 272  
 Caucasica and Transcaucasica, Bibliography of, 71  
 "Canoe and Camp Life in Brit. Guiana," Barrington Brown, 311  
 Cape Astronomical Results, 1871-1873, 478  
 Capercailzie in Northumberland, W. Topley, 7  
 Carbon Dioxide in Minerals, Variations of, 167  
 Carboniferous System of Northumberland, 189  
 Carboniferous Amphibia, in Nova Scotia, 264  
 Carnivorous Water-Beetles, Respiratory Functions of, 91  
 Carob, the, in Madras, 419  
 Carrick (Alick), "The Secret of the Circle," 155  
 Carruthers (Mr.) on Evolution and the Vegetable Kingdom, 467  
 Cast-Iron, 529  
 Caterpillar: J. A. Osborne, 7; Commensalism among, 264  
 Cayley's Elliptic Functions, C. W. Merrifield, F.R.S., 252  
 Celebes, Birds of, 559  
 Celts, Discovery of, in Gurnet Bay, 128  
 Cerebellum, the Functions of the, 438  
 Cetus, Red Star in, 281  
 Ceylon, Patenas of, 398, 548  
 Chad Basin, Races and Tribes of the, 550  
 Challenger Collections: Sir C. Wyville Thomson, F.R.S., 254; Prof. Agassiz on the, 256; Henry H. Higgins, 274  
 Challenger Expedition: Lord George Campbell's "Log Letters," 290  
 Spry's "Cruise of the Challenger," 290  
 Challenger Soundings and the "Lost Atlantis," 553  
 Chappell (Wm., F.S.A.), Just Intonation, 196, 430  
 Charnwood Forest, Rocks of, 78, 97, 116, 137, 470, 548  
 Chekanoffsky (M.), Death of, 50  
 Chemical Notes, 167, 282, 362, 520  
 Chemical Society: 72, 91, 210, 286, 327, 367, 420, 463, 523, 563; Goldsmith's Company's Grant to, 16; Research Fund, 88; Dinner, 459  
 Chemistry: Hofmann's Lecture on Liebig, 193; Eltoft's Combined Note-book and Lecture Notes, 195; the Article in the Encyclopædia Britannica, 269; Vacher's Primer of, 527  
 Chemistry and Telegraphy, Prof. Abel, F.R.S., 381  
 Chester Society of Natural History, 461  
 Chevrenl (M.), Dinner to, 87  
 Chlorine. Action of. on Peroxydes, 283

istie (W. H. M.), Centralisation of Spectroscopy, 489  
 onometers, Ships, Parkinson and Frödsam, 470  
 tridium with True Reproduction, 458  
 chona Cultivation in India, George King, 446  
 ic, Books on Squaring the, 155  
 lang, "the Vowel, 441  
 rke (Col. A. R.), Just Intonation, 253, 353  
 valina Szabó, Dr. von Hantken's Foraminifera of, 115  
 nate, the Cause of Changes of, 17  
 nates: Former, D. Pidgeon, 275; Investigation of, T. Ste-  
 enson, 556  
 nbing Plants, Tendrils of, 558  
 ck: Public, in Paris, 169; a New Astronomical, Sir Wm.  
 homson, F.R.S., 227  
 cks, Pneumatic Tube applied to Regulating, 418  
 nda, Measurement of the Height of, 313, 431  
 de, the River, 99  
 il-fields of Nova Scotia, 462, 488  
 fee Cultivation in Coorg, 418  
 fee-leaves as a Substitute for Tea, 540  
 enis Julia in Texas, Dr. L. Heiligbrodt, 339  
 orado, the Upper, Prof. A. Geikie, F.R.S., 337  
 our-blindness, 110, 346  
 ours of Animals, 16  
 ours, Accidental or Subjective, 384  
 ton and Burrows, "Concise Instructions in the Art of Re-  
 ouching," 156  
 nder (Thomas), Evolution and the Vegetable Kingdom, 467;  
 orphology of *Selaginella*, 548  
 nbusion, Influence of Pressure on, 167  
 nets: The Fourth of 1857, 15; the Comet of the Bayeux  
 'apestry, 126; Periodical Comets in 1877, 186, 206; De  
 'ico's, of Short Period, 206; of 1812, 323; the New Comet,  
 42, 361, 381; Borely's, 431; D'Arrest's, 457; Biela's  
 'omet in 1805, 479; of 1873 (Tempel), 520; Winnecke's,  
 20, 531, 549  
 nmensalism among Caterpillars, 264  
 npass-Plant, 298  
 npasses at the Tiflis Observatory, 109  
 nte (Prof. Joseph Le), Hog-Wallows, or Prairie Mounds, 530  
 ng, Coffee Cultivation in, 418  
 neland (Ralph), the New Star in Cygnus, 315, 361  
 'al, Pink, Discovery of a Bed of, 128  
 'al: Growth of, 418; Coralean Rocks of England, 347  
 oba, Observations at the Observatory, 531  
 nu (Prof. A.), the Spectrum of the New Star, 158  
 mos, 127  
 niology, Prof. Virchow on Bulgarian, 364  
 tinism in Austria, 384  
 uses, Yellow, A. G. Renshaw, 530  
 okes (Wm., F.R.S.), Experiments with the Radiometer, 224,  
 99; "Translation of Auerbach's Anthracen," 507  
 staceans, Eyeless, 559  
 ptogamic Flora of Russia, 459  
 stals, Prof. Maskelyne, F.R.S., on, 523  
 stallised Nitro-glycerine, Experimenters with, 71  
 rystallography, Groth's, 372  
 skoo and Swallows at Menton, Douglas A. Spalding, 528  
 nberland Scientific and Literary Societies, 129  
 nning's (Linnaeus) "Theory of Electricity," 526, 549  
 ningham (R. O.), Hearing in Insects and Birds, 293  
 lones: of October 31, 1876, 89, 126; at Backergunge, 68;  
 t Chittagong, 69; Storm Waves of, 261, 311; Polar, 312  
 lones and Storms, on a Mode of investigating, Dr. Buys  
 Ballot, 216  
 nous, a new Star in, 146, 166, 186, 206, 295, 303, 315, 361  
 hovicz (Prof.), Influence of Electricity on Certain Spectra, 70  
 rny (Dr. Francis), the Action of the Winds in determining  
 he Form of the Earth, 239

Albertis's Expedition to New Guinea, 165, 452  
 le (T. Nelson), the Rhætic Strata in the Southern Tyrol, 4  
 orseau's Tables of Jupiter's Satellites, 414  
 anube and the Black Sea," Barkley's, 134  
 rrest's Comet, 457  
 rwin (Charles, F.R.S.), Sexual Selection in Relation to  
 onkeys, 18; "Geological Observations," 289; "The  
 Effects of Cross- and Self-Fertilisation in the Vegetable  
 Kingdom," Prof. Dyer, 329; Testimonial to, 356, 410  
 rwin (Francis), Hygroscopic Seeds, 374

Darwin (G. H.), Influence of Geological Changes on the Earth's  
 Axis of Rotation, 360  
 Darwin'sche Theorien und ihre Stellung zur Philosophie, Re-  
 ligion und Moral, 176  
 Davenport Academy of Natural Sciences, 247  
 Davis (Capt. J. E.), Death of, 325  
 Dawkins (Prof. Boyd, F.R.S.) on Museums, 129  
 De Notaris (Giuseppe), Notice of, 561  
 Deas (James), the River Clyde, 99  
 Deep-Sea Manganiferous Muds, E. T. Hardman, 57  
 Deep-Sea Muds, John Murray, 319, 340  
 Deer, Persian, 66  
 Definiteness and Accuracy, Prof. P. G. Tait, 77  
 De Mosenthal and Harting, "Ostriches and Ostrich Farming," 176  
 Denmark, Geographical Society, 128, 188  
 Denning (Wm. F.), Radiant Points of Shooting Stars, 158, 217;  
 Meteor of January 7, 1877, 335  
 Dental Anatomy, Tomes's Manual of, 161  
 Descent Theory, Weismann's Researches on the, 451  
 Deutsche geologische Gesellschaft, 208  
 De Vico's Comet of Short Period, 206  
 Dewar (Prof. James), Physiological Action of Light, 433, 453  
*Dionna mucipula*, Contractions of the Leaf of, 379  
 Diseases Germinated in Hospitals, 15  
 Disinfectants, Report of Russian Committee on, 16  
 Diurnal Barometric Range at High and Low Levels, 187  
 Dobson (G. E.), Protective Mimicry among Bats, 354  
 Dodge (Col.), "The Hunting Grounds of the Great West," 194  
 Dobson (Dr. Anton), Proposed Zoological Stations in Heligo-  
 land and Kiel, 57  
 Donnelly (Major), the London Industrial University, 519  
 Donnisthorpe (Wordsworth), the Arctic Expedition, 116  
 Double Stars: 14, 470; Variable Components of, 303; Lord  
 Lindsay's List of, 381  
 Douse (T. Le M.), "Grimm's Law," Rev. A. H. Sayce, 309  
 Draper (Prof. H.), Photographs of the Spectra of Venus and  
 a Lyre, 218; Atmosphere of the Rocky Mountains, 354  
 Drew's "Northern Barrier of India," 396  
*Drosera rotundifolia*, Abnormal Growth of, 18  
 Drummond (James), Death of, 208  
 Dreyer (J. L. E.), Tycho Brahe's Portrait, 530  
 Dumont (Andre), Geological Maps of Belgium, 304  
 Duncan (Wm. S.), Mind and Matter, 78, 295  
 Dan Echt Observatory Publications, 381  
 Duplex Telegraphy, an Account of, 180  
 Dupre (Dr. A.), Estimation of Urea of Means of *Hypobromite*,  
 399  
 Dutch Society of Sciences, Gold Medal of, 207  
 Dutch Guiana, W. G. Palgrave, 311  
 Dyer (Prof. Thistelton), Darwin on Fertilisation, 329; Mor-  
 phology of "*Selaginella*," 489  
 "Dynamics," Bottomley's, 467  
 Dynamo-Magnetic Phenomena, 72

Earth: the Solidity of the, W. M. Williams, 5; Internal Fluidity  
 of the, Prof. H. Hennessey, 78; Population of, 127; Actio-  
 of the Winds in Determining the Form of, 239  
 Earth's Axis of Rotation: Influence of Geological Change on the,  
 G. H. Darwin, 360; Possible Displacements of, 443  
 Earthquakes: at Irkutsk, 18; in Germany, 18; in the Canton  
 of Neuchatel, 189; in Sweden, 461; at Oban, 561  
 East Anglia, Geology of, 130  
 Eaton (H. S.), Greenwich as a Meteorological Observatory, 489  
*Echidna*, a new Species of, 66  
 Eclipses: the Nineveh of B.C. 763, 65; Sir G. B. Airy on  
 Ancient Solar, 115; Ancient Solar, 186; Solar, of Stukas-  
 tad, 1030, 206; Solar, of 1567, 342; Total Solar, 457  
 Edinburgh: Royal Society, 109, 192; Royal Physical Society,  
 422; Observatory, Deep Soil Thermometers at, 521  
 Edward (Thomas, A.L.S.), Life of, by Samuel Smiles, 349,  
 439; Testimonial to, 479  
 Edwardes (Rev. D.), Holly-Berries, 295  
 Edwards' Butterflies of America, 70  
 Eel, the, 324; Electric, 414, 501  
 Effendi (Emin), Travels of, in Africa, 169  
 Egypt, Educational and Scientific Institutions in, 364  
 Electric Motor Pendulum, Dr. Paget Higgs, 98  
 Electric Light in Paris, 284  
 Electrical Phenomenon, Prof. George Forbes, 450  
 Electricity: Influence of, on certain Spectra, 70; Cumming's  
 Introduction to the Theory of, 526, 549

- Electro-Capillary Phenomena, Dr. Paget Higg, 7  
*Electricista*, 441  
 Ellery (Robt. L. J.), Southern Double Stars, 470  
 Elliptic Functions, Cayley's, 252  
 Ellis (Alex. J., F.R.S.), Recently proposed Improvements in Musical Intonation, 475  
 Eltoft (Thomas), "Combined Note-book and Lecture Notes for Chemical Students," 195  
 Embryology: The Progress of, 65; Packard's Life-Histories of Animals, 271  
 "Encyclopædia Britannica," vol. v., 269  
 Endogens, Re-arrangement of the Order of, 108  
 Entomological Society, 92, 210, 421, 483  
 Entomology of the Polar Regions, 208  
*Epigomethys Cullatus*, 66  
 "Equine Anatomy," J. H. Steele, 310  
 Esthonia, The Post-Glacial period in, 88  
 Ethnology, Museum at Berlin, 89  
 Etna, Observatory on, 262, 312  
 Euganean Mountains, Dr. Reyer on the, 447  
 Europe, the Weather of, 538  
 Evolution in Geology, 285  
 Evolution in the Netherlands, 410  
 Evolution and the Vegetable Kingdom, 467  
 Ewing (J. A.), Sumner's Method at Sea, 22  
 Examinations in Science, W. Baptiste Scoones, 137  
 Explosions, Velocity of Sound-waves in, 266  
 Eyeless Crustaceans, 559
- Fairbairn (Sir Wm., F.R.S.), Life of, by Dr. Wm. Pole, F.R.S., 370; Statue of, 416; Scholarship in Memory of, 416  
 Falkland Islands, 359  
 Faraday, Foley's Statue of, 70  
 Faraday Lecture for 1875, 193  
 Fawcett (Thomas), Minimum Thermometers, 97  
 Fermentation, Charles Graham, 213, 249  
 Ferrier (David, M.D., F.R.S.), "The Functions of the Brain," G. H. Lewes, 73, 93  
 Fertilisation, Darwin on, Prof. Thistleton Dyer, 329  
 Fertilisation of Flowers by Insects, XV., Dr. Hermann Müller, 317; XVI., 473; Thomas Meehan, 138; by Birds, 416  
 Fertilisation of Plants, 168  
 Fisheries, Sea, and the British Association, 23, 55  
 Fishes: New Species, 66; of the Aralo-Caspio-Euxine Region, 66; Fresh-water, of India, 150; Nest-building, 265  
 Fitzgerald (G. F.), the Rotation of the Plane of Polarisation of Light, 306  
 Fixed Stars, the Spectra of, 344  
 Flints, Prof. Hughes on, 132  
 Floods and Storms, 263  
 Floods in Russia, 266  
 Floods in Switzerland and South-Eastern France, 418  
 Flora of New Guinea, 438  
 Flower (Prof. W. H.), "Osteology of the Mammalia," 96; Museum Specimens for Teaching Purposes, 144, 184, 204  
 Flowers, Fertilisation of, 138, 178, 237, 317, 473  
 Fluorescence: M. Lallemand on, 209; M. Lommel on, 441  
 Fogs, the Nature of, 305  
 Fog-Signals, Prof. Henry on, 129  
 Foavielle (W. de), Exploration of Arctic Regions by Balloons, 148  
*Foraminifera*, 461  
*Foraminifera* of Clavulina Szabó, Dr. von Hantken, 115  
 Forbes (David, F.R.S.), Death of, 127; Obituary Notice of, 139  
 Forbes (Prof. George), Electrical Phenomenon, 450  
 Forbes (W. A.), Mr. Wallace on the Distribution of Passerine Birds, 58  
 Force, Newton on, P. T. Main, 8  
 "Force," on the Word, 96  
 Forests, Influence of, on Ozone, 188  
 Form of the Earth, Action of Winds in Determining the, 239  
 Förster (Prof.), Scientific Lectures, 167  
 Fossil Plants: the Atlantic Ridge and the Distribution of, 158; from Greenland and Spitzbergen, 208  
 Foster (Dr. Michael, F.R.S.), "Elementary Physiology," 53; Mr. Trotter on University Reform, 428  
 France, University of, 479  
 Frankland (E., F.R.S.), Transport of Solid and Liquid Particles in Sewer Gases, 385  
 Frankland (F. W.), the Simplest Continuous Manifolds of Two Dimensions and of Finite Extent, 515
- Freeman (A.), Tints and Polarisation of Moonlight in Eclipse, 398  
 French Accent, A. H. Keane, 396  
 French Anthropological Society, 418  
 French Geographical Society, 110, 365  
 French Guiana, Exploration of, 149  
 Freshwater Fishes of India, 150  
 Friswell (R. J.), Eltoft's Combined Note-book and Lecture Notes for the Use of Chemical Students, 195  
 Fritz (Prof. H.), the Geographical Distribution of Hail, 17  
 Fungus Disease of India, by Lewis and Cunningham, 21
- Gaffron (Ed.), Collections of Alpine Flowers, 150  
 Gallaway (Charles), Longmynd Rocks, 313  
 Gallium, Physical Properties of, 362  
 Galtou's Whistles, Dr. Lawson Tait, 294  
 Galton (F., F.R.S.), Typical Laws of Heredity, 492, 512, 532  
 Gangee (Prof. Arthur, F.R.S.), Photo-Chemical Processes in the Retina, 296, 477  
 Gardner (H. Dent), Principles of Time-Measuring Apparatus, 9  
 Gardner (J. S.), Tropical Forests of Hampshire, 229, 258, 274  
 Garrod (Prof. A. H., F.R.S.), Lectures on the Human Form, 466  
 Gas-Synthesis in Plants, M. Merget on, 71  
 Gas Molecules, M. Boltzmann on, 306  
 Gases: Specific Heat of, 282; Solution of Gases in Iron, Steel, and Manganese, 362  
 Gasteropods, Natural Selection in, 168; the Embryology of, 64  
 Gauss (Carl Friedrich), Statue to, 324, 363; Notice of, by R. Tucker, M.A., 533  
*Gazelle* Expedition, Collections of, 283  
 Geikie (Prof. A., F.R.S.), The Upper Colorado, 337  
 Geikie (James, F.R.S.), The Movement of the Soil-cap, 397  
 Gelatine in Relation to Nutrition, 168; Manufacture of, 344  
 Geneva: Faculty of Medicine at, 51; Climate of, 152, 187; Physical and Nat. Hist. Society, 152, 192, 423, 464, 484, 504  
 Geographical Curiosities, 233  
 Geographical Society, *See* Royal  
 Geological Society, 130, 151, 192, 287, 347, 366, 387, 443, 482, 543  
 Geological Survey of Ohio, 485  
 Geologists' Association, 211  
 Geology: Indian, 98; Geology in Brazil, 149; Evolution in Geology, 285; Miniature Physical Geology, 410; Geology of the Lake Country, J. C. Ward, 545  
 Geometrid Moths of the United States, Dr. A. S. Packard, 75  
 Germ Theory, Dr. MacLagan on the, 446, 511  
 German African Society, 522  
 German Arctic Expedition, 148  
 German Chemical Society, 211, 327, 367, 422  
 German Naturalists, Meeting at Hamburg, 149  
 German Universities, Statistics of, 51  
 Germany, Science in, 451  
 Gessi (M.), Exploration of the Nile, 68  
 Giglioli (Prof. Henry J.), the Basking Shark, 273  
 Gill (Mr.), Expedition to Measure the Parallax of Mars, 539  
 Gisard (M.) on Marine Mosses, 15  
 Glacial Drift in California, A. R. Wallace, 274  
 Glacial Period, the Existence of Man during, 87  
 Glaciation of the Shetland Isles, John Horne, 139  
 Glaciers, Prof. Bianconi on, 69  
 Glasgow, Proposed Chair of Physiology at, 326  
 Glass, Imperviousness of, 523  
 Gokcha, Fauna of Lake, 438  
 Gold Mines in Australia, 382  
 Goldsmiths' Company, Gift to the Chemical Society's Research Fund, 88  
 Gordon (Col.), Exploration of the Nile, 68  
 Gorilla: in the Berlin Aquarium, 51, 208; the Anatomy of the, 127; the Brain of the, G. D. Thane, 142  
 Göttingen Academy of Sciences, 308  
 Government Grants in Aid of Science, 369, 398  
 Graham (Charles), Fermentation, 213, 249  
 Graham's Chemical and Physical Researches, W. Chandler Roberts, F.R.S., 153  
 Gray (Prof. Asa), Self-Fertilisation of Flowers, 24  
 Green (Prof. A. H.), the Rocks of Charnwood Forest, 97  
 Greenland and Spitzbergen, Fossil Plants from, 208  
 Greenwich as a Meteorological Station, 450, 489, 528  
 Grenfell (J. G.), Supersaturated Solutions, 138  
 "Grimm's Law," T. Le M. Douse, Rev. A. H. Sayce, 309  
 Groth (P.), "Krystallographie," 372

- Grove (Sir William, F.R.S.), on the Radiometer, 435  
 Guiana, Dutch, W. G. Palgrave, 311  
 Günther (Dr. A. F.R.S.), Gigantic Land Tortoises, 327  
 Gurnet Bay, Discovery of Celts in, 128
- Haarlem, Gold Medal of the Dutch Society of Sciences, 207  
 Haggerston Entomological Society, 69  
 Hail, Prof. H. Fritz on the Geographical Distribution of, 17  
 Hailstones in India, 538; Hailstones and Raindrops, Formation of, Prof. Osborne Reynolds, 163  
 Hair and Eyes, Statistics of the Colour of, 346  
 Halphysema, New Forms of, 439  
 Halo Round Shadow, Arnulph Malloch, 375  
 Hamburg (Dr.), his Meteorological Tour, 17  
 Hamburg, Meeting of German Naturalists at, 149  
 Hampshire, the Tropical Forests of, J. Starkie Gardner, 229, 258, 279  
 Hansen's Lunar Tables, Newcomb's Corrections of, 166  
 Hantken (Max von), "Die Fauna der Clavulina Schichten," 115  
 Hardman (E. T.), Deep-sea Manganiferous Muds, 57  
 Harris (Mr.), Challenge to Mathematicians, 117  
 Harrison (W. Jerome), Rocks of Charnwood Forest, 97  
 Harvard University, Science at, 432  
 Harting's "White's Selborne," 128  
 Haughton (Prof., F.R.S.), Notes on Physical Geology, 542; the Tides of the Arctic Seas, 562  
 Hayden (Dr. F. V.), Survey of the United States, 335  
 Hearing, Sense of, in Birds and Insects, G. J. Romanes, 177; 292; R. M'Lachlan, in 254; Prof. A. Leith Adams, 334  
 Heated Air, 283  
 Heelis (E.), Patenas of Ceylon, 548  
 Heer (Prof.), "The Primæval World of Switzerland," 140  
 Heiligbrodt (Dr. L.), Colonia Julia in Texas, 399  
 Heim (Dr. Isidor), the Sensation of Sound, 108  
 Heligoland and Kiel, Proposed Zoological Stations in, 57  
 Helmholtz (Prof.), Notice of, by Prof. Clerk Maxwell, F.R.S., 389  
 Helsingfors, Ethnological Museum at, 418  
 Hennessy (Prof. H.), the Internal Fluidity of the Earth, 78  
 Henry (Prof.), on Fog-Signals, 129  
 Henslow (Rev. George), Non-Amphibious Batrachians, 548  
 Heredity Typical Laws of, Francis Galton, F.R.S., 492, 512, 532  
 Heughlin (Theodor von), Death of, 67  
 Hibernation of Birds, 465, 527  
 Higgins (H. H.), Squirrels, 117; the *Challenger* Collections, 274  
 Higgs (Dr. Paget), Electro-Capillary Phenomena, 7; Electric Motor Pendulum, 98
- Hofmann (A. W., F.R.S.), the *Life Work of Liebig in Experimental and Philosophic Chemistry*, 193  
 Hofmeister (Prof. Wilhelm, F. B.), Death of, 284  
 Hog Wallows, or Prairie Mounds, 431, 530  
 Holdsworth (E. W. H.), Sea Fisheries, 23, 135, 198  
 Holly Berries, Scarcity of, 266; and Rare Birds, Duke of Argyll, 273, 295  
 Honeydew in Plants, 324  
 Hopkins University, 501  
 Horck (Herr v. Horn von der) and the Sioux Indians, 245  
 Horne (John), Glaciation of the Shetland Isles, 139  
 Howgate (Capt.), Method of Attaining the North Pole, 284, 365  
 Howitt (A. W.), the Boomerang, 312  
 Huggins (Wm., F.R.S.), Photographic Spectra of Stars, 171  
 Hughes (Prof.), Existence of Man during the Glacial Period, 87  
 Hull (Prof. E., F.R.S.), Rocks of Charnwood Forest, 78, 116  
 Hughes (W. K.), Antedon Rosacens (*Comatula rosacea*), 7, 158  
 Humbert (Alois), Eyeless Crustaceans, 559  
 Hummocky Moraine Drift, G. H. Kinahan, 379  
 Hunterian Lectures at the Royal College of Surgeons, 383  
 Hurricane in Belgium and Holland, 343  
 Huxley (Prof. T. H., F.R.S.), on the Study of Biology, 219; Number of Species of Insects, 275  
 Hydrogen, Absorption of, by Organic Substances under the Influence of the Silent Discharge, 520  
 Hydrography in France, 284  
 Hydrography of West Central Africa, 517  
 .. obia, Blistering Beetles a Cure for, 264  
 .. ic Seeds, Francis Darwin, 374  
 .. mite, Estimation of Urea by, Dr. A. Dupré, 399
- Ice, Prof. Bianconi's Experiments on, 69  
 Iliumium, the Metal, 520  
 India : Fungus Disease of, 21; Freshwater Fishes of, 150; the Northern Barriers of, 396; Proposed Museum for, 439; Hailstones in, 538; Geology of, 98  
 "Indian Miscellany," Munsell's, 265  
 Indians : N. American, 194  
 Industrial University, London, 519  
 Ingleby (Dr. C. M.), Rooks Building at Christmas, 217; Meteor, 375  
 Insects : Our Insect Foes, 84; Insecticides and Phylloxera, 200; Number of Species of, 275; Fertilisation of Flowers by, Dr. H. Müller, XV. 317, XVI. 473; Sense of Hearing in Insects and Birds, 254, 292, 354; on the Relation between Insects and Flowers, Dr. H. Müller, 178  
 Institute of Civil Engineers, 131, 151, 327, 348, 484  
 Intonation, Just, 159, 196, 253, 291, 353, 430  
 Intra-Mercurial Planet Question, 14, 68, 282, 437, 442, 457, 509  
 Iron and Steel Institute, Dr. Siemen's Presidential Address, 462  
 Irtysch and Obi, Exploration of, 207  
 Italian Meteorological Society, Proposed, 363
- Jahrbuch der k. k. geologischen Reichsanstalt zu Wien, 210  
 Jahresbericht über die Fortschritte der Chemie, 247  
 James (Dr.), Death of, 67  
 Janson College, Paris, 265  
 Jansen (M.), Planets between Mercury and the Sun, 171  
 Jardin des Plantes, Paris, 50  
 Jelinek (Dr. Carl), Death of, 16; Obituary Notice of, 65, 115  
 Jellett (Rev. J. H.), on the Potato Disease, 263  
 Jena, University of, 344  
 Jenissei, Nordenskjöld's Expedition to the, 123, 265  
 Jenkins (B. G.), Sea Fisheries, 176  
 Jordan (D. S., M.D.), Manual of the Vertebrates of the Northern United States, 216  
 Joubert (M.) and Pasteur (M.), the Spontaneous Generation Question, 313  
 Journal de Physique, 20, 191, 210, 346, 419  
 Journal of the Russian Chemical and Physical Societies, 542  
 Judd (Prof. J. W.), "Darwin's Geological Observations," 289  
 Jupiter : Coloured Belts of, 282; the Brightness of Jupiter's Satellites, 65; Damoiseau's Tables of Jupiter's Satellites, 414  
 Just Intonation, 159, 196, 253, 291, 353, 430
- "Kames," the, near Newport, N.B., 266  
 Kara Sea, Alga of the, 461  
 Keane (A. H.), French Accent, 396; Races and Tribes of the  
 .. welcome Visitors, 237  
 .. Kiel : New University Buildings, 110; the New Observatory, 438  
 .. Kiel and Heligoland, Proposed Zoological Stations in, 57  
 .. Kimberley Diamond Mine, South Africa, 277  
 .. Kinahan (G. H.), Towering of Birds, 217; Auroric 334; Hummocky Moraine Drift, 379  
 .. King (Dr.), Report of the Royal Botanic Gardens, Calcutta, 71  
 .. King (George, M.B.), "Cinchona Cultivation in India," 426  
 .. Knobell's Catalogue of the Literature of Sidereal Astronomy, 48  
 .. Konkoly (Dr. N. v.), Observations on the Spectra of the Fixed Stars, 344  
 .. Koorgans, the Ancient, of Russia, 384  
 .. Kühne's Researches on Photo-Chemical Processes in the Retina, Prof. Arthur Gamgee, 296
- Lake Country, Geology of the, J. C. Ward, 545  
 Lake-Dwellings on Lake Neuchâtel, 188  
 Lallemand (M.), Fluorescence, 209  
 Langley (Prof.), Sun-spots, 90  
 Lankester (E. Ray, F.R.S.), Packard's Life-Histories of Animals, 271  
 Lapland, Russian, 382  
 Lees (William), "Acoustics, Light, and Heat," Dr. W. H. Stone, 352  
 Letters Patent, Goodeve's Abstract of Cases relating to, 22  
 Lewes (G. H.), "Ferrier's Functions of the Brain," 73, 93  
 Lewis and Cunningham's Fungus Disease of India, 21  
 Ley (Rev. W. Clement), Ocean Currents, 157, 198; South Polar Depression of the Barometer, 253; Ocean and Atmospheric Currents, 333; Atmospheric Currents, 450  
 Libyan Desert, Meteorology of the, ---

- Liebig, Monuments to, 147, 325; Prof. Hofmann on the Work of, 193  
 "Life of a Scottish Naturalist; Thomas Edward, A.L.S.," by Samuel Smiles, 349  
 Life-Histories of Animals, A. S. Packard, Jun., 271  
 Light, the Physiological Action of, Prof. Dewar, 433, 453  
 Lighting of Rooms and the Human System, 247  
 Lightning, Protection of Buildings from, 88; Ball Lightning, 539  
 Lindsay (Lord), List of Double Stars, 381  
 Linnæan Society, 91, 111, 150, 267, 327, 386, 420, 442, 562  
 Linnaeus, Monument to, 147  
 Littrow (Dr. Ch. de), Carl Jelinek, 115  
 Lizards, Fossil, in the Royal Cabinet of Natural History, Stuttgart, 245  
 Loan Collection of Scientific Apparatus, 188, 207, 459, 490  
 Lobster, Sagacity of, 415  
 Local Museums, 61  
 Locusts, Commission on, 539  
 Lomonosoff, Memorial to, at Moscow, 383  
 London Industrial University, 519  
 Longmynd Rocks, Charles Galway, 313  
 "Lost Atlantis" and the *Challenger* Soundings, 553  
 Lowe (E. J., F.R.S.), Parhelia and Paraselenæ seen on March 20, 1877, 508  
 Lowest Temperature, Rev. R. Abhay, 471  
 Lubbock (Sir John, F.R.S.), McLennan's "Primitive Marriage," 133; The Southern Tendencies of Peninsulas, 273; on Ants, 386  
 Lucas (Louis A.), Death of, 127  
 Luminous Flames, the Theory of, 521  
 Lund, the Climate of, 187  
 Lyra,  $\alpha$ , Spectrum of the Star, 307
- M'Lachlan (Robert), Sense of Hearing in Birds and Insects, 254; Number of Species of Insects, 275  
 MacLagan (Dr. T.), "The Germ Theory Applied to the Explanation of the Phenomena of Disease," 446, 511  
 MacLay (Dr.), Journey through the Malay Peninsula, 169  
 McLennan (J. F.), Studies in Ancient History, comprising a Reprint of "Primitive Marriage," Sir J. Lubbock, F.R.S., 133  
 MacMunn (Dr. C. A.), Method for Measuring Spectra, 18  
 McNab (Prof. W. R.), Sexuality in Plants, 511  
 McNeill (Sir John), Hibernation of Birds, 527  
 Madrid, Free University in, 68  
 Main (P. T.), Newton on Force, 8; on the Word "Force," 96  
 Malloch (Arnulph), Measurement of the Height of Clouds, 313; Halo round Shadow, 375  
 Mamma, the Development of the, 66  
 Manchester Literary and Philosophical Society, 151, 192, 248, 484, 523, 544  
 Manitoba, the Climate of, 49  
 Manganiferous Muds, the Deep-sea, E. T. Hardman, 57  
 Manifolddness of Two Dimensions, the Simplest Continuous, F. W. Frankland, 515  
 Mantchuria, Russian, Geography of, 209  
*Mannocodia*, the Windpipe in, 127  
 Manufacturing, British, Industries, 54, 445  
 Marine Mosses, M. Gisard on, 15  
 Marine Sounder, New Form of, 383  
 "Marius's Law," Prof. Mendelëff's Researches on, 69, 455, 498  
 Marriage, Primitive, McLennan's, 133  
 Mars, the Opposition of, 147, 519; Expedition to Measure the Parallax of, 533  
 Marseilles, Geographical Society at, 440  
 Mathematical Science, the Present State of, Prof. H. J. S. Smith, F.R.S., 79  
 Mathematical Society; 90, 191, 267, 347, 463, 563; Proceedings of, 527  
 Mauritius, Meteorology of, 458  
 Maxwell (Prof. Clerk, F.R.S.), the Protection of Buildings from Lightning, 88; Notice of Prof. Hermann L. F. Helmholtz (*with Portrait*), 389  
 Meat, Frozen, from Brazil, 128  
 Medical Microscopical Society, 388  
 Meehan (Thomas), Self-Fertilisation in Flowers, 138  
 Meek (F. B.), Death of, 245, 363  
 Melbourne Observatory, 244  
 Melos, the Obsidian Cutlers of, Rev. Gerald S. Davies, 332  
 Memoria della Società degli Spettroscopisti Italiani, 171, 419
- Mendelëff (Prof.), Researches on Mariotte's Law, 69, 455, 498  
 Menton, Swallows and Cuckoo at, Doug'as A. Spalding, 488, 528  
 Mercury Rheostat, a New, 325  
 Merget (M.), Gas Synthesis in Plants, 71  
 Merion Island, the Flora of, 111  
 Merrifield (C. W., F.R.S.), Cayley's Elliptic Functions, 252  
 Metalloids, Researches on the Spectra of, 401, 447  
 Metals, Pitch of Sounds given by, 481; Iminium and Neptunium, 520  
 Meteorites: Structure and Origin of, H. C. Sorby, F.R.S., 495; H. N. Moseley, 547  
 Meteorology: Meteorological Notes, 49, 107, 126, 186, 244, 263, 342, 343, 457, 538; Continental, 17; Fall of Temperature in October, 1876, 50; Prof. Balfour Stewart on Meteorological Research, 76; Great Storm of Wind at Sydney, 107; the Sudden Cold in November, 1876, 110; Meteorological Society, 111, 210, 287, 421, 504; Observatory on Monte Cavo, 126; on Pic du Midi, 147; in France, 149; Climate of Geneva, 152; Stations at Hautes-Alpes, 190; Report of Meteorological Commission, 363; Proposed Italian Meteorological Society, 363; Report on the Government Meteorological Grant, 399, 425, 448; Greenwich as a Meteorological Station, Alex. Buchan, 450; Exploring Balloons for Meteorological Purposes, 458; Meteorology of Mauritius, 458; Meteorology in France, 460; Meteorology of the Bombay Presidency, 482; Greenwich as a Meteorological Observatory, 489, 528; Is Meteorology a Science? 510  
 Meteors: 59, 79, 178, 207, 275, 375, 399, 451, 460, 471, 549; The November, 48; Telescopic, 125; at Blackwater, 170; of January 7, 1877, 244, 295, 335  
 Metric Standard of Length, Alloy of Platinum and Iridium for, W. Chandler Roberts, F.R.S., 336  
 Meyer (C. J. A.), Sense of Hearing in Birds and Insects, 354  
 Miansaroff (M.), "Bibliographia Caucasica et Transcaucasica," 71  
 Microscopical Investigation of Sands and Clays, H. C. Sorby, F.R.S., 356  
 Microscopical Society. *See* Royal  
 Migration of Birds, Palmén on the, 465  
 Millett (F. W.), "Towering" of Birds, 158  
 Mimicry, Protective, among Bats, G. E. Dobson, 354  
 Miniature Physical Geology, C. Lloyd Morgan, 410  
 Mind and Matter: Wm. S. Duncan, 78, 295; J. L. Tupper, 217, 374  
 Mineralogical Society, 483  
 Minerals of Canada, Catalogue of, 272  
 Minimum Thermometers, Thomas Fawcett, 97  
 Minor Planets, 166, 303, 342  
 Missouri, Annual Report on the Insects of, 84  
 Mitchell's "Sidereal Messenger," 49  
 Mitchell (W. S.), "Lost Atlantis" and the *Challenger* Soundings, 553  
 Mock Suns, 384  
 Mohr (Eduard), Exploration of Africa, 18; Death of, 325  
 Molecular Volumes of Sulphates and Selenates, 521  
 Molluccan and Papuan Islands, 69  
 Mollusca, Development of, 559  
 Mongolia, Exploration of, 143  
 Monkeys, Sexual Selection in Relation to, Charles Darwin, F.R.S., 18  
 Monotreme, New, from New Guinea, 257  
 Monro (C. J.), Postulates and Axioms, 353  
 Monte Cavo, Meteorological Observatory on, 126  
 Moonlight, Tints and Polarisation of, in Eclipse, 398  
 Moraine Drift, Hummocky, G. H. Kinahan, 379  
 Morgan (C. Lloyd), Miniature Physical Geology, 410  
 Morphologisches Jahrbuch, 111, 191, 385, 419  
 Morphology of "Selaginella," 489, 548  
 Morren (Prof. E.), "La Digestion Végétale," 373  
 Moseley (H. N.), *Peripatus N. Zealandic*, 96; Flora of Marion's Island, 111; Structure and Origin of Meteorites, 547  
 "Mosses of Europe," Schimper's, 3  
 Mosses, Marine, M. Gisard on, 15  
 Moths, Geometrid, of the United States, Dr. A. S. Packard, 75  
 Motion of Projectiles, the Resistance of the Air to the, 60  
 Mott (A. J.), Meteor, 399  
 Mouillefert (Prof.), Phylloxera Insecticide, 200  
 Muds, Deep-Sea, John Murray, 319, 340  
 Muirhead (Dr. Henry), Sense of Hearing in Insects and Birds, 294; Proposed Gift to Glasgow University, 326

- Müller (Dr. Hermann), On the Relation between Flowers and Insects, 178; Fertilisation of Flowers by Insects, XV., 317; XVI., 473  
 Munich, Anthropological Society, 89  
 Murphy (J. J.), "Are we Drying Up?" 6; South Polar Depression of the Barometer, 198; Polar Cyclones—Etna Observatory, 312; Atmospheric Currents, 374, 510  
 Murray (Capt. Digby), Ocean and Atmospheric Currents, 76, 294, 333  
 Murray (John), Deep-Sea Muds, 319, 340  
 Museum, a Local, 61, 344  
 Museum Specimens for Teaching Purposes, Prof. Flower, F.R.S., 144, 184, 204  
 Museums, 276; Prof. Boyd Dawkins on, 129  
 Mushrooms and Toadstools, Worthington G. Smith, 134  
 Musical Association, 59  
 Musical Intonation, Recently Proposed Improvements in, Alexander J. Ellis, 475  
 Muslin and Tungstate of Soda, 460  
 Mycenæ, Dr. Schliemann's Discoveries at, 173, 471  
 Myopia, 366
- Nachtigal (Dr. Gustav), Exploration of Africa, 417  
 Nansouty (Gen.), Meteorological Observatory on the Pic du Midi, 147  
 Nares (Sir George), Report of the Arctic Expedition, 24; at the Geographical Society, 147; on the Arctic Expedition, 480  
 Natural History Museum, Kensington, 382  
 Natural Selection, Unusual Case of, 168  
 "Natureen," 326  
 Naturforscher, Der, 130, 191, 385, 441, 542  
 Nautical Almanac for 1880, 107  
 Naval College, Greenwich, 512  
 Navigation, Sir Wm. Thomson on, 403  
 Nebulæ of Orion, Rev. T. R. Robinson, 292  
 Nebulæ—What are They? 550  
 Nebulous Star in the Pleiades, Lord Rosse, 397  
 Negretti's Reversible Thermometers, 116  
 Nepal, History of, 488  
 Nephelin and Apatite, 384  
 Neptune, the Mass of, 107  
 Neptunium, the Metal, 520  
 Nepveu (M.), on Diseases Germinated in Hospitals, 15  
 Nerve and Muscle Current, Influence of Temperature on, 415  
 Nest-building Fish, 265  
 Netherlands Zoological Association, 169  
 Netherlands: Evolution in the, 410; Arctic Expedition, 522  
 Neuchâtel, Lake, Lake-dwellings on, 188  
 Neuchâtel, the Canton of, Earthquake in, 189  
 New Guinea: Exploration of, 90, 109; Dr. Maclay's Exploration of, 149; D'Alberit's Expedition up the Fly River, 165, 452; New Monotreme from, 257; Flora of, 438  
 "New Lands within the Arctic Circle," Lieut. Payer, 62, 81  
 New South Wales, Science in, 150  
 New York Aquarium, Journal of, 150  
 Newcomb's Corrections of Hansen's Lunar Tables, 166  
 Newton on Force, P. T. Main, 8  
 Newton (Prof. A., F.R.S.), Sea Fisheries, 55, 156  
 Nichols (Arthur), the Boomerang, 510  
 Nile, Exploration of the, 68  
 Nineveh Solar Eclipse of B.C. 763, 65  
 Nitrite of Amyl, Dr. B. W. Richardson, F.R.S., 424  
 Nitro-Glycerine, Experiments with, 71  
 Nordenskjöld's Expedition to the Jenissei, 123, 461  
 North Pole, Capt. Howgate's Method of attaining the, 284  
 North Sea, Zoological Station in the, 117  
 North Sea Expedition, the Norwegian, 412, 435  
 Northampton Naturalists' Society, 481  
 Northumberland, Carboniferous System of, 189  
 Norway, Snowstorm in, 284  
 Norwegian Atlantic Expedition, 49  
 Norwegian North Sea Expedition of 1876, 412, 435  
 Nosai Bé, Volcanic Lakes of, 417  
 Nova Scotia: Carboniferous Amphibia in, 264; the Coal-fields of, 462, 488  
 Novara, Report on the Austrian, Expedition, 261
- Ober (Fredk. A.), Exploration of the West India Islands, 267  
 Obi, Wild Dogs on the, 415  
 Obi and Irtysh, Exploration of, 207
- Observatories: Paris, 69; Cambridge, U.S., 201; Melbourne, 244; the Vilna, 245; Proposed Observatory on Etna, 262; Brussels, 304; Dun Echt, 381; Kiel, 438; Edinburgh, 521; Cordoba, 531; Washington U.S. Naval, 549  
 "Observatory," The, 550  
 Obsidian Cutlers of Melos, Rev. Gerald S. Davies, 332  
 Ocean Currents: Capt. Digby Murray, 76; Rev. W. Clement Ley, 157, 198; and Temperatures in the South Pacific, 237; and Atmospheric Currents, 333  
 Octave, the Hindoo Division of the, 423  
 Ohio, Geological Survey of, 485  
 Omotepe, Island of, Antiquities from, 503  
 Ophite of Pando, 190  
 Oratorical Utterance, the Rate of, 266  
 Orchids, some Curious, 357  
 Orion, Nebulæ of Rev. T. R. Robinson, 292  
 Orton (Dr. James), Exploration of the River Beni, 17; the Andes and the Amazon, 154  
 Osborne (J. A.), Caterpillars, 7  
 Oscillations of Tides, 343  
 Osprey in Captivity, 481  
 "Ostriches and Ostrich Farming," 176  
 Our Insect Foes, 84  
 Owens College, Manchester, 509  
 Oxford, Science at, 430, 437  
 Ozone, Influence of Forests on, 188
- Packard (Dr. A. S.), Geometrid Moths of the United States, 75; Life Histories of Animals, 271  
 Page (F. J. M.), on *Dionæa muscipula*, 379  
 Palgrave (W. G.), Dutch Guiana, 311  
 Palladium and Carbon, 522  
 Palmén on the Migration of Birds, 465  
 Pandora, Return of the, 18, 50  
 Papadakis (Prof. J.), Death of, 325  
 Papuan and Moluccan Islands, Birds of, 69; Papuan Plants, 264; Papuan Skull, Remarkable, 549  
 Paradise Bird, the Windpipe in, 127  
 Parhelia and Paraselenæ seen on March 20, 1877, E. J. Lowe, F.R.S., 508  
 Paris: Academy of Sciences, 20, 52, 72, 92, 112, 132, 152, 172, 211, 248, 268, 287, 308, 328, 348, 368, 388, 424, 444, 464, 484, 504, 524, 544, 564; Ventilation of the Hall, 169; Anniversary of, 560. Anthropological Society, 128; Geographical Society, 68; International Exhibition, 87; the Janson College, 265; Medical Conference, 169; Observatory, 69; School of Anthropology, 149  
 Parker (Prof.), On the Primary Elements of the Skull, 127  
 Parkinson and Prodsham, Ship's Chronometers, 470  
 Parthenogenesis in a Phanerogam, 559  
 Pascal Hexagram, a New View of the, 463  
 Plasserine Birds, Mr. Wallace on the Distribution of, 58  
 Pasteur (M. L.), "Études sur la Bière," 213, 249; and Joubert (M.), the Spontaneous Generation Question, 313  
 Patenas of Ceylon, Rev. R. Abbay, 398; E. Heeli's, 548  
 Patent Laws: Administration of the, 22; Petition against, 266  
 Pau, Sirocco at, 49  
 Payer (Lieut.), "New Lands within the Arctic Circle," 62, 81  
 Pendulum, Electric Motor, Dr. Paget Higgs, 98  
 Peninsula, the Southern Tendencies of, Sir John Lubbock, F.R.S., 273  
 Pennington (Rooke), Museum at Castleton, 150  
 Pennsylvania, Petroleum Works in, 209  
*Perizatus*, 66, 96  
 Perceval (Cecil H. Sp.), Meteor, 79  
 Perry (Rev. S. J., F.R.S.), Lowest Temperature, 399, 471  
 Persian Deer, 66  
 Peschel's "Races of Man," A. R. Wallace, 174  
 Petermann's Mittheilungen, 17, 326, 365, 383, 417, 502, 540  
 Petermann (Dr.), the English Arctic Expedition, 109, 148  
 Petersburg, Society of Naturalists, 442  
 Petrie (W. M. F.), Measurement of the Height of Clouds, 431  
 Petroleum Works in Pennsylvania, 209  
 Phalœnidæ of the United States, Dr. A. S. Packard, 75  
 Phanerogam, Parthenogenesis in a, 559  
 Philadelphia Exhibition, Geology at, 87  
 Philadelphia Academy of Natural Sciences, 172  
 Philology, Greek and Latin, Rev. A. H. Sayce, 74  
 Phono-Telegraphy, 305  
 Phosphorus Pentafluoride, 521

- Photo-Chemical Processes in the Retina, Prof. Gamgee, F.R.S., 477
- Photographic Image, Capt. Abney on the, 543
- Photographs, Aniline in, 207
- Photography of Tones, 170
- Photography, Abney's Instruction in, 253
- Phylloxera: in Madeira, 190; and Insecticides, 200
- Physical Geology, Notes on, R. ev. Prof. Haughton, F.R.S., 542
- Physical Society, 91, 131, 171, 210, 307, 347, 421, 483, 543, 564
- Physics of the Atlantic Ocean, 263
- Physiology, Dr. M. Foster's Elementary, 53
- Piaggia (Signor), Exploration of Africa, 89
- Pic du Midi, Meteorological Observations on, 147
- Pidgeon (D.), Former Climates, 275
- Planets: Minor, 166, 303; a New, 342; Intra-Mercurial Planet(?), 171, 282, 437, 442, 457, 509; the Opposition of Mars in 1892, 519
- Plant (James), Rocks of Charnwood Forest, 548
- Plantamour (Prof.), Climate of Geneva, 152
- Plants: the Absorption of Organic Matter by, 108; Self-fertilisation of, 168; Sexuality in, Prof. W. R. McNab, 511
- Plants, Remarkable. I. The Compass Plant, 298; II. Some Curious Orchids, 357
- Pleiades: the Nebula in the, 244, 397
- Plesio-saurus, a Fine Specimen of, 52
- Pliocene Equidae, Italian, 559
- Plummer (J. I.), Greenwich as a Meteorological Observatory, 528
- Pock Lymph, M. Hiller on, 15
- Poggendorff (Prof. J. C.), 304, 314
- Poggendorff's Annalen der Physik und Chemie, 130, 170, 171, 191, 210, 344, 382, 385, 419, 540, 541
- Polar Bears, Fight between Two, 70
- Polar Cyclones, 312
- Polariscope Objects, W. Spottiswoode, F.R.S., 275
- Polarisation of Light, the Rotation of the Plane of, 306
- Pole (Dr. W., F.R.S.), "Life of Sir Wm. Fairbairn, F.R.S.," 370
- Polygalas, European, 5
- Polynesia, Exploration of, 246
- Population of the Earth, 127
- Post-Glacial Period in Esthonia, 88
- Postulates and Axioms, C. J. Monro, 353
- Potassium Tri-iodide, 362
- Potato Disease, 263
- Pouchet, Statue to, 246
- Prairie Mounds, or Hog-Wallows, Prof. Joseph le Conte, 530
- Precessional Motion of a Liquid, Sir Wm. Thomson, F.R.S., 297
- Pre-Glacial Man in America, Traces of, 274, 295
- Pressure on Combustion, Influence of, 167
- Price (Major Sir R. Lambert), the Two Americas, 396
- "Primitive World of Switzerland," Prof. Heer's, 140
- Primitive Agriculture, Mias Buckland on, 387
- Primitive Marriage, McLennan's, 133
- Professors in the Universities of France and Germany, 16
- Projectiles, the Resistance of the Air to the Motion of, 60
- Quarterly Journal of Microscopical Science, 346
- Rabbits: Tape-Worms of, G. J. Romanes, 275, 375; R. D. Turner, 335
- Radiant Points of Shooting Stars, 158, 217
- Radiometers: 169, 420, 521, 522; Prof. Wartmann on, 51; Researches on, Prof. Paul Volpicelli, 101; Experiments with the, Wm. Crookes, F.R.S., 224, 299; and Thermo-Multiplier, 384; Sir William Grove on the, 435
- Raindrops and Hailstones, Formation of, Prof. Osborne Reynolds, 163
- Rammelsberg Mountain, 208
- Rauschenburg, Discovery of Ancient Burial-Ground near, 51
- Reale Istituto Lombardi, 385, 419, 542
- Red Star in Cetus, 281
- Regulus, the Occultation of, 342
- Reichert and Du Bois Reymond's Archiv, 111
- Renshaw (A. G.), Yellow Crocuses, 530
- Retina, Kühne's Researches on Photo-Chemical Processes in the, Prof. Arthur Gamgee, 296, 477
- Retouching, Instructions in the Art of, Burrows and Colton, 156
- Revue des Sciences Naturelles, 419
- Revue Geographique, 52
- Reyer (Dr. Ed.), on the Euganean Mountains, 447
- Reynolds (Prof. Osborne), on the Arctic Expedition, 87; Raindrops and Hailstones, 163; Vortex Motion in Fluids, 347
- Rhaetic Strata in the Southern Tyrol, T. Nelson Dale, 4
- Rheinfelden, Deep Boring at, 128
- Rheostat, a New Mercury, 325
- Rhinoceroses, Examination of the Fodder Remains of, 109
- Rhizopods, New Fresh-water, 108
- Richardson (Dr. B. W., F.R.S.), Nitrite of Amyl, 24
- Ridout (R. H.), Sensitive Flame Apparatus for Ordinary Gas Pressure, 119
- Rivers, Stone, Phin. S. Abraham, 431
- Roberts (W. Chandler, F.R.S.), Graham's Chemical and Physical Researches, 153; Alloy of Platinum and Iridium for a New Metric System of Length, 336
- Robinson (Rev. T. R.), Nebula of Orion, 292
- Rock Crystals for Normal Scientific Apparatus, 305
- Rocks of Charnwood Forest, the Age of the, 78, 97, 470, 548
- Rocky Mountains, Atmosphere of the, Dr. H. Draper, 354
- Rodier (E.), Algid Swarm-spores, 178
- Romanes (G. J.), "Towering" of Grouse, Partridges, &c., 116
- Sense of Hearing in Birds and Insects, 177, 292; Tape-worms of Rabbits, 275, 375
- Rome, R. Accademia dei Lincei, 308, 348, 444
- Rooks Building at Christmas, C. M. Ingleby, 217
- Roots, Respiration of, 559
- Roscoe and Schorlemmer's New Treatise on Chemistry, 168
- Rosenberg (E., M.D.), Use of the Spectroscope in its Application to Medicine, 547
- Rosse (Earl of), Nebulous Star in the Pleiades, 397
- Routledge (R.), "Science in Sport made Philosophy in Earnest," 134
- Rowan (J. J.), "The Emigrant and Sportsman in Canada," 216
- Royal Astronomical Society, 90, 286, 366, 442, 563
- Royal Geographical Society, 68, 110, 147, 440
- Royal Irish Academy, Proceedings of, 345
- Royal Microscopical Society, 72, 151, 247, 348, 443, 543
- Royal School of Mines Magazine, 311
- Royal Society, 171, 306, 327, 385, 420, 482, 503, 542, 562; Award of Medals, 50; New Fellows, 560
- Rubidium and Cesium, Atomic Weight of, 282
- Rundell (W. W.), Diurnal Barometric Range at High and Low Levels, 275
- Russia: Barometers of Southern, 49; Meeting at Warsaw of Russian Naturalists, 69, 70; Statistics of Russian Universities, 129; Floods in, 206; Mean Atmospheric Pressure, 457; Cryptogamic Flora of, 459; Botanical Geography of, 459
- Russian Lapland, 382
- "Rust" in Sugar Cane, 189
- Rutherford (W., M.D., F.R.S.), "Outlines of Practical Histology," 4
- St. David's, Pre Cambrian Rocks of, 151
- St. Petersburg: Chemical Society, 190; Academy of Science, 284; Anthropological Society at, 363; Aquarium at, 363
- Geographical Society, 461
- Salmon, a Problem in the Natural History of the, 375; *Salmo arcturus*, 438
- Salpæ, Coloration of Water by, 188
- Samoan Language, Dictionary of, 207
- Sanderson (Dr. J. Burdon, F.R.S.), on *Dionna muscipula*, 379
- Government Grants to Science, 398
- Sands and Clays, Microscopical Investigation of, H. C. Sorby, F.R.S., 356
- Sars (Prof. G. D.), Norwegian North Sea Expedition of 1876, 412, 435
- Saturn, the Rotation of, on his Axis, 243
- Sayce (Rev. A. H.), Bauer's "Philological Introduction to Greek and Latin for Students," 74; Grimm's Law, 309; the Basques, 394
- Schimper's "Mosses of Europe," 3
- Schliemann's (Dr.), Discoveries at Mycenæ, 173, 471
- Schmid (von Rudolf), die Darwin'sche Theorien und ihre Stellung zur Philosophie, Religion und Moral, 176
- Schmidt (Prof. Fr.), Tertiary Formations on the Northern Shores of the Pacific, 88; Post-Glacial Period in Esthonia, 88
- School of Mines Magazine, 311
- Schriften der physikalisch-oekonomischen Gesellschaft zu Königsberg, 90
- Schuster (Dr. Arthur), Researches on the Spectra of Metalloids, 401, 447; "Cumming's Introduction to the Theory of Electricity," 526

Science in Sport made Philosophy in Earnest," R. Routledge, 134  
 Science: Examinations in, W. Baptiste Scoones, 137; Government Grants in Aid of, 369  
 Scientific Apparatus, Loan Collection of, 188, 207, 459, 490  
 Scientific Club, 364  
 SCIENTIFIC WORTHIES. X. Prof. Hermann I. F. Helmholtz (with Portrait), 389  
 Sater (P. L., F.R.S.), Meteor, 178  
 Scoones (W. Baptiste), Examinations in Science, 137  
 Scottish Meteorological Society, 363  
 Sea Fisheries, 23, 55, 135, 156, 176, 198  
 Seals, Fur, Introduction into Lake Superior, 147  
 Secchi (Father), New Star in Cygnus, 315; List of Coloured Stars, 365; Typical Division of Stars, 430; Borely's Comet, 431  
 Seiches, of the Swiss Lakes, 91  
 Seine, Height of the, in 1876, 343  
 Selaginella, Morphology of, Prof. Thielton Dyer, 489; Thos. Comber, 548  
 Sentient Remains in the British Museum, 247  
 Sensation of Sound, 108  
 Sense of Hearing in Birds and Insects, 177, 292, 354  
 Sensitive Flame Apparatus for Ordinary Gas Pressure, R. H. Kidout, 119  
 Settle Cave Exploration, 479  
 Sexual Selection in Relation to Monkeys, Charles Darwin, F.R.S., 18  
 Sexuality in Plants, Prof. W. R. McNab, 511  
 Sewer Gases, Dr. Frankland on the Transport of Solid and Liquid Particles in, 385  
 Shadow, Halo round, Arnlup Malloch, 375  
 Shark, Basking, Prof. Henry J. Giglioli, 273; Prof. E. Perceval Wright, 292  
 Shaw (J.), a Local Museum, 61  
 Shetland Isles, Glaciation of, John Horne, 139  
 Ship's Chronometers, Parkinson and Frodsham, 470  
 Shooting Stars, Radiant Points of, 158, 217  
 Siberia, Exploration of, 265, 417; the Beaver in, 265  
 Siddall (J. D.), on Foraminifera, 461  
 Sidereal Astronomy, Knobel's Catalogue of the Literature of, 48  
 Sidereal Messenger, Ormond Stone, 198  
 Siemens (Dr. C. W., F.R.S.), Presidential Address at the Iron and Steel Institute, 462  
 Sioux Indians, Skulls of the, 245  
 Siphon Recorder and Automatic Curb Sender, Sir Wm. Thomson's, 101  
 Siroccos, at Pau, 49; in Algeria, 89  
 Skull, the Primary Elements of the, 127  
 Snee (Alfred, F.R.S.), Death of, 284  
 Snails (Samuel), "Life of a Scottish Naturalist," 349  
 Smith (Alexander J.), "The Impossible Problem," 155  
 Smith (Prof. H. J. S., F.R.S.), The Present State of Mathematical Science, 79  
 Smyth (Prof. Piazzi), Solar Physics at the Present Time, 157, 217; Centralism in Spectroscopy, 449, 508  
 Smith (Worthington G.), Mushrooms and Foodstuffs, 134  
 Snakes Devouring each other, 399  
 Snowstorm in Norway, 284  
 Snow-Cap, the Movement of the, Sir C. Wyville Thomson, F.R.S., 359; James Geikie, F.R.S., 397  
 Solar Eclipses: the Nineveh, of B.C. 763, 65; of 1239 and 1241, 86; Ancient, 115, 186; of Stiklastad, 1030, 206; of 1507, 342; Total, 457  
 Solar Physics at the Present Time, Prof. Piazzi Smyth, 157, 217; Sir G. B. Airy, F.R.S., 196  
 Solar Radiation, Caloric Intensity of, 384  
 Solar Spectrum, Prof. C. A. Young on the, 98  
 Solar Spots, Early Observations on, 549  
 Solutions, Supersaturated, J. G. Grenfell, 138  
 Solby (H. C., F.R.S.), Microscopical Investigation of Sands and Clays, 356; Structure and Origin of Meteorites, 495  
 Sound, the Sensation of, 108  
 Sound Waves in Explosions, Velocity of, 266  
 South African Museum, 377  
 South Pacific, Temperatures and Ocean Currents in the, 237  
 South Polar Depression of the Barometer, 157, 198, 253  
 Southern Double Stars, 470  
 Southern Tendencies of Peninsulas, Sir J. Lubbock, F.R.S., 275  
 Spalding (D. A.), Swallows and Cuckoo at Menton, 488, 528  
 Spectra: Dr. MacMunn's Method for Measuring, 18; Influence of Electricity on Certain, 70; Dr. Higgin on the Photographic

Spectra of Stars, 171; Dr. N. v. Konkoly on the Spectra of Fixed Stars, 344; Researches on the Spectra of Metalloids, 401, 447; Prof. A. Cornu on the Spectrum of the New Star, 158; Spectrum of the Star  $\alpha$  Lyrae, 307  
 Sphenodon (Gurntheri), 66  
 Spicer (W. W.), the Tasmanians, 178  
 Sponges, Early Development of, 414; a New Sponge, 415  
 Spontaneous Generation Question, 302, 313, 380  
 Spottiswoode (W., F.R.S.), Polariscopes Objects, 275; Stratified Discharges, 482  
 Spry (W. J. J.), "The Cruise of H.M.S. Challenger," 290  
 Spectroscopy, Centralisation of, 449, 489, 508  
 Spectroscope, Rosenberg's Application of, to Medicine, 547  
 Squirrels, Henry H. Higgins 117  
 Stanford's Physical Geography Wall Maps, 480  
 Stanley (H. M.), Exploration of Africa, 440, 480  
 Stars:  $\mu$  Doradus, 14; Uranus, 48; the Distance of the, 86; Change of Colour in, 107; New Double, 107; Binary Star  $\eta$  Cassiopee, 107; The Mass of Neptune, 107; A New Star in Cygnus, 146, 166, 186, 206, 303, 315, 361; The Spectrum of the New Star in Cygnus, 158, 295; Radiant Points of Shooting, 158, 217; Remarkable Star Spectrum, 166; Dr. Huggins on the Photographic Spectra of Stars, 171; Binary Stars, 186, 303, 500; Variable Stars, 244, 281, 414, 478, 549; The New Star of 1604, 262; Red Star in Cetus 281; Double Stars, 24, 303; Spectrum of the Star  $\alpha$  Lyrae, 307; Father Secchi's List of Coloured Stars, 365; Nebulous Star in the Pleiades, 397; Typical Division of Stars, 430; 65 Ophiuchi, 438; Strange Star in Serpens, 451  
 Steam-Boat, New Fast, 209  
 Stebbing (Rev. T. R. R.), *Anteloa rosaceus* (*Comutula rosacea*), 58; Pronunciation of the word *Anteloa*, 366  
 Steele's "Equine Anatomy," 310  
 Steine (Dr.), Photography of Tones, 170  
 Stereograph, Broca's, 558  
 Stevenson (Thos.), Prof. B. Stewart on Meteorological Research, 76; on the Investigation of Climates, 556  
 Stewart (Prof. Balfour, F.R.S.), on Meteorological Research, 76  
 Sticklebacks, Irish, 91  
 Stockholm: Proposed Scientific College at, 283; Academy of Sciences, 367  
 "Stone Rivers," Phin. S. Abraham, 431  
 Stone (Ormond), "The Sidereal Messenger," 198  
 Stone (Dr. W. H.), The Musical Association, 59  
 Storms, 126, 186, 263, 311, 538  
 Storms and Cyclones, On a Mode of Investigating, Dr. Buys Ballot, 216  
 Stratified Discharges, W. Spottiswoode, F.R.S., 482  
 Surgeon's Method of Protecting Buildings from Lightning, 83  
 Sugar Canes, "Rust" in, 189  
 Sulphates and Selenates, Molecular Volumes of, 521  
 Sumatra, Exploration of, 284  
 Sumner's Method at Sea, J. A. Ewing, 22  
 Superior, Lake, Introduction of Seals into, 147  
 Supersaturated Solutions, J. G. Grenfell, 138  
 Sun, Annular Eclipse of, 1737, 500  
 Sun-spots, Prof. Langley on, 90; Sun-spots and Weather, 263  
 Sutton's "Volumetric Analysis, 67  
 Swallows and Cuckoo at Menton, D. A. Spalding, 488, 528  
 Swarm-Spores, Algold, E. Rodier, 178  
 Swedish Anthropological Society, 305  
 Switzerland: Prof. Heer's Primeval World of, 140; Cartography in, 365  
 Sydney, Great Storm of Wind at, 107  
 Sylvester (Prof.), On Education, 501  
 Tait (Dr. Lawson), Galton's Whistles, 294  
 Tait (Prof. P. G.), Definiteness and Accuracy, 77  
 Tape-worm of Rabbits, 275, 335, 375  
 Tasmanians, the, W. W. Spicer, 178  
 Tate and Blake's "Yorkshire Lias," 113  
 Tea, Theine in, 167; Tea Plants, Blight in, 419  
 Teeth, Tomes' Anatomy of the, 161  
 Telegraphic Engineers, The Society of, 199, 388  
 Telegraphy, Duplex, an Account of, 180  
 Telegraphy and Chemistry, Prof. Abel, F.R.S., 321  
 Telescopic Meteors, 125  
 Telluride of Gold, 418  
 Temperature, Relations of Body-change to, 324  
 Temperature, Low, 244; Lowest, 399, 471; Underground, Report of the British Association Committee on, 240



- Temperatures and Ocean Currents in the South Pacific, 237  
 Tendrils of Climbing Plants, 558  
 Tertiary Formations of the Northern Shores of the Pacific, 88  
 Thane (G. D.), the Brain of the Gorilla, 142  
 Theobald (W.), Tropical Forests of Hampshire, 530  
 Thermo-Chemical Researches, 167  
 Thermometers, Minimum, Thomas Fawcett, 97  
 Thermo-multiplier and Radiometer, 384  
 Thielmann's "Journey in the Caucasus," 547  
 Thomson (John M.), Hofmann's Life-work of Liebig in Experimental and Philosophic Chemistry, 193  
 Thomson (Sir Wm., F.R.S.), the Siphon Recorder and Automatic Curb Sender, 101; a New Astronomical Clock, 227; the Precessional Motion of a Liquid, 297; on Navigation, 403  
 Thomson (Sir C. Wyville, F.R.S.), the Conditions of the Antarctic, 104, 120; the *Challenger* Collections, 254; the Movement of the Soil-cap, 359  
 Thunderstorm in Central Europe, 263  
 Tides, Oscillations of, 343  
 Time-Measuring Apparatus, H. Dent Gardner on the Principles of, 9  
 Titicaca, Lake, Exploration of, 67  
 Toads Eating bees, 502  
 Toadstools and Mushrooms, Worthington G. Smith, 134  
 Tomes (C. S.), "Manual of Dental Anatomy," 161  
 Tones, Photography of, 170  
 Topley (W.), Capercailzie in Northumberland, 7  
 Tortoises, Gigantic Land, Prof. A. Leith Adams, 347; Dr. A. Günther on, 327  
 "Towering" of Birds, 116, 158, 177, 199, 217, 292, 440  
 Tropical Forests of Hampshire, W. Theobald, 530  
 Transit of Venus, Photographs of, 265; Medal to Commemorate, 344  
 Traquair's Monograph on British Carboniferous Canoids, 489  
 Trees, Amount of Water in, 324  
 Tropical Forests of Hampshire, J. S. Gardner, 229, 258, 279  
 Trotter (Coultts), "Some Questions of University Reform," Dr. Michael Foster, F.R.S., 428  
 Tucker (R.), Carl Friedrich Gauss, 533  
 Tungstate of Soda and Muslin Dresses, 460, 489  
 Tuning Forks, Phenomena connected with, 285  
 Turkestan, Flora of, 416  
 Two Dimensions, the Simplest Continuous Manifolds of, F. W. Frankland, 515  
 Tyndall (Prof. F.R.S.), Spontaneous Generation, 302
- Undated and Antedated Books, 17  
 Underground Temperature, Report of the British Association Committee on, 240  
 United States. *See also* New York, Philadelphia, &c.; Annual Report on the Insects of, 84; Geological Collections at the Philadelphia Exhibition, 87; New York Aquarium, 150; Geographical Survey of, 189; Cambridge Observatory, 201; Vertebrates of the Northern, 216; Dr. Hayden's Geological and Geographical Survey, 335; Science at Cambridge, Mass., 432; Agriculture in the, 525  
 Universities Bill, 391  
 University College, London, 69; Legacy to, 521  
 University Reform, Mr. Coultts Trotter on, 428  
 Upper Colorado, Prof. A. Calkie, F.R.S., 337  
 Upsala, 400th Anniversary of the University of, 245  
 Ural Mountains, Traces of Glaciers in the, 306  
 Uranus, Herschel's First Glimpse of, 48  
 "Uranophotometer," M. Wild's, 170  
 Urea, Estimation of, by Hypobromite, Dr. A. Dupre, 399
- Vacher (Arthur), "Primer of Chemistry," 527  
 Variable Components of Double Stars, 303  
 Variable Stars, 244, 281, 381, 414, 478, 549  
 Venour's "Accipitres of Canada," 546  
 Venus: Transit of, 1882, 48; Photographs of the Spectra of Venus and a Lyra, Prof. H. Draper, M.D., 218; Photographs of the Transit of, 265
- Verhandlungen der k.k. zoologisch-botanischen Gesellschaft Wien, 130  
 Verhandlungen des naturhistorischen Vereins der preussisch Rheinlande und Westfalens, 286, 385  
 Vertebrates of the Northern United States, Dr. Jordan, 216  
 Vesuvius, Threatened Eruption of Mount, 246  
 Vienna: Academy of Science, 112, 192, 368, 423, 444, 52  
 I. R. Geological Institution, 212; Geological Society, 42  
 Vienna Refractor, the Crown-Glass Lens for, 16  
 Vilna Observatory, Destruction of, 245  
 Virchow (Prof.), Address on Anthropology, 149; Craniology Bulgaria, 364; on Diluvial Remains found near Weimar, 30  
 Vision, some Phenomena connected with, 307  
 Vogel (H.), the New Star in Cygnus, 315  
 Volcanic Phenomena during 1875, 557  
 Volpicelli (Prof. Paul), Researches on the Radiometer, 101  
 Voltaic Electricity, Prize for Improvements in, 304  
 Vortex Motion in Fluids, Prof. Osborne Reynolds, 347
- Wade (Charles H.), Science at Oxford, 430  
 Wallace's "Geographical Distribution of Animals," 5, 24  
 Wallace (A. R.), on the Distribution of Passerine Birds, 51  
 Peschel's "Races of Man," 174; Glacial Drift in California, 274; "Hog-Wallows" of California, 431  
 Ward (J. C.), Geology of the Lake Country, 545  
 Warsaw: Meeting of Russian Naturalists at, 69, 70; Zoologic Museum, 70  
 Washington, United States Naval Observatory, 549  
 Walters (J. Hopkins), "Towering" of Birds, 177  
 Walterhausen (Dr. von), Death of, 16  
 Water, in Trees, Amount of, 324; Methods of Decomposing, 4  
 Water-Beetles, Carnivorous, Respiratory Functions of, 91  
 Weather and Sun-spots, 263  
 Weather of Europe, 538  
 Weather Maps: Accelerated Transmission of, 107; a New Daily, 244; International, 343  
 Weismann's Researches on the Descent Theory, 451  
 West India Islands, Explorations of, 267  
 Westminster Aquarium, 501  
 Weyprecht (Lieut.), Scheme for Arctic Exploration, 2  
 White (Dr. F. Buchanan), Sense of Hearing in Insects and Birds, 292  
 Wiedemann (Prof. Dr. G.), Editor of Poggendorff's Annalen, 3  
 Wild (J. J.), Atlantic Soundings, 377  
 Wilkes (Admiral), Death of, 382  
 Williams (Matthew W.), Tungstate of Soda, 489  
 Williams (W. Mattieu), the Solidity of the Earth, 5  
 Wind, Great, at Sydney, 107  
 Winnecke's Comet, 520, 531  
 Wojeikoff (Dr. A.), Meteorological Tour Round the World, 17  
 Wolves in Russia, 303  
 Wood (W. H.), the Meteor of January 7, 295  
 Woodpecker, the, 415  
 Wright (Prof. E. Percival), Basking Shark, 292  
 Wyndham (T. Heathcote G.), Death of, 67
- "Year Book of Facts, 1877," 201  
 Yellow Crocuses, A. G. Kershaw, 530  
 Yorkshire College of Science, 325, 479, 539  
 Yorkshire Lias, the, Tate and Blake, 113  
 Yorkshire Naturalists' Union, 539  
 Young (Prof. C. A.) on the Solar Spectrum, 98
- Zeitschrift für Biologie, 247  
 Zeitschrift für Krystallographie und Mineralogie, 168  
 Zeitschrift für wissenschaftliche Zoologie, 191, 419  
 Zodiacal Light, 324  
 Zoological Gardens, Additions, 18, 52, 71, 90, 110, 129, 170, 190, 210, 247, 267, 286, 306, 326, 346, 366, 384, 441, 461, 484, 503, 523, 541, 562  
 Zoological Society, 72, 111, 150, 247, 286, 347, 387, 443, 50  
 Zoological Station on the North Sea, 117  
 Zoological Stations, Dr. Anton Dohrn on, 57

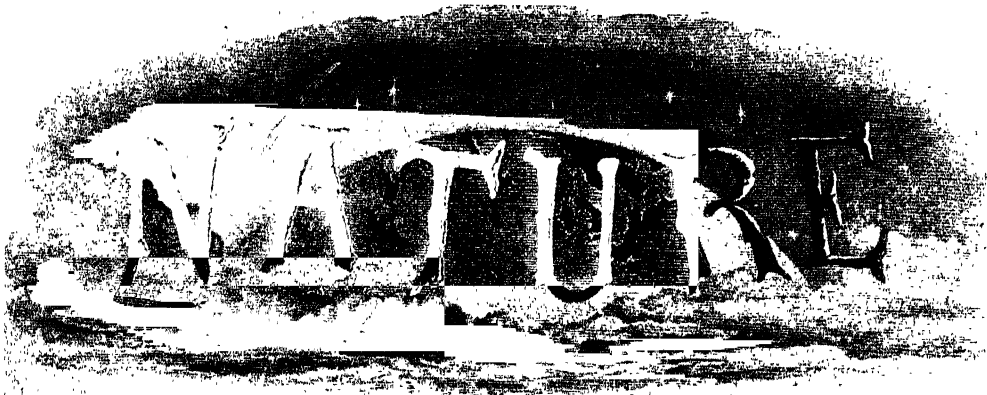

## A WEEKLY ILLUSTRATED JOURNAL OF SCIENCE

*"To the solid ground*

*Of Nature trusts the mind which builds for aye."*—WORDSWORTH

THURSDAY, NOVEMBER 2, 1876

### THE ARCTIC EXPEDITION

IT is pleasing to be able to begin our fifteenth volume with congratulations to the officers and men of a British Arctic Expedition on their safe return. On another page we give a summary of the results obtained so far as these can yet be known. It will be seen that substantial additions have been made to our knowledge in many directions, and that the expedition must be pronounced a success. True, the Pole has not been reached, but this, in the consideration of all but the mere lovers of sensation, is a small matter; our explorers have done the next best thing to reaching it, they have proved that the Pole was impracticable this year from the quarter whence success was most to be expected. It is evident from the few hints which have already been published, that when all the tale is told, it will be quite as thrilling, and full of dangers and bravery, as any previous narrative of Arctic exploration. So far as the conduct of the expedition is concerned, it seems to have been all that could be wished; the original programme was, on the whole, closely stuck to, and the desperately hard and dangerous work was done in the most systematic and economical way at present possible. Everybody seems to have behaved admirably; there seems to have been no fault whatever to find with anyone; and so much has Capt. Nares endeared himself to officers and men, that he earned for himself the common title of "the father" of the expedition.

It was hardly to be expected that an expedition, on such an errand, and with such unprecedented dangers to face as this one has had, would return without casualties; they have left four of their comrades behind them. Of these one only died as the result of frost bite, the three others succumbing to that most dreaded of all Arctic foes, scurvy. No similar expedition ever left any country so well provided with everything that could be thought of conducive to sustenance and protection. There was an ample supply of fresh provisions of all kinds, sufficient staff, and all precautions were evidently taken

throughout the long winter to keep everyone employed, and cheerful, and duly exercised. Yet, in all the sledge-parties, scurvy broke out with a virulence and to an extent not experienced, we believe, in any recent Arctic expedition. The cause of this outbreak will no doubt give much food for thought for some time to come, some thinking that the unusual length and intensity of the darkness may have had something to do with it. The darkness seems to have been much more intense, and certainly was longer-continued than ever before experienced, and such a condition, not to mention its effect on the spirits of the men, must necessarily, one would think, exercise some deleterious physical influence on the body. This is a point deserving of careful consideration; meantime we cannot but admire the way in which officers and men of these sledge-parties did their work in spite of physical exhaustion and terrible suffering; it would, however, have been surprising had the record been otherwise.

No men could have exerted themselves more to accomplish the popular, but really minor, object of their expedition, and none could have been more honourably battled. The ice was met with off Cape Sabine in 41' N., and from that time till the *Alert* was compelled to take up her quarters in 82° 27', it was a constant battle with ice of a thickness never before met with. The ice was from 100 to 150 and even 200 feet thick, resembling more a pell-mell assemblage of icebergs than the usual floes; to have been nipped between the masses of such ice would certainly have been fatal. Commander Markham in his daring attempt to carry out the instructions of the expedition by penetrating as far to the north as possible, found the ice piled in such rough and hilly hummocks that progress was only possible at the rate of a mile a day, and he wisely returned after reaching 83° 20' N., the highest authentic latitude yet attained.

Capt. Parry's long and weary journey, which reminds one to a certain extent of that of Commander Markham, was only as far as 82° 45'; the Austro-Hungarian expedition of 1872-4 reached 82° 5', though they saw as far as 83°; while Hall with the *Polaris* sailed without let or hindrance in 1872 over the same ground as the *Alert* and *Discovery* for 700 miles to 82° 16' N. in the short space of one week.

Any such frightful ice-barrier as that reported, and, let us add, admirably photographed, by our expedition was not seen by Hall and his men; and indeed it has been stated that had it not been for the scruples of the second in command, Buddington, Hall would have pushed still further northwards, all on board, except Buddington, who had no heart in the work, agreeing that the undertaking was perfectly practicable. Meyer, in his evidence before the U.S. Commission, declared that if  $82^{\circ} 16'$  could have been passed, there was nothing to hinder a ship reaching  $85^{\circ}$  or  $86^{\circ}$  "or even farther. Had poor Hall not met with an untimely death, the attempt would certainly have been made in the following summer. This terrible ice-barrier, then, before which our expedition has wisely returned, does not appear to be a constant phenomenon so far south, for Hall's observations have been generally accepted as perfectly trustworthy. May there not have been some cause at work in the high north to push the thick-ribbed ice south to the northern entrance of Robeson Channel? This seems to have been an unusually severe season in the north; icebergs were met with in abundance a week or two ago far south in the Atlantic, and last week we reported the wreck of a whole fleet of whalers in the Behring Straits region. If the latter casualty has been produced by ice, it would seem to show that some cause has been at work this season to render it unusually unfavourable for Arctic work. It is perhaps worth noting here, at least, that 1871 was a maximum, while 1876 is a minimum, sun-spot year. The temperature was undoubtedly the coldest on record, neither the *Polaris* nor the Austro-Hungarian expedition experiencing anything like it, namely,  $104^{\circ}$  of frost. There was no stint of animal life in the region in which the *Polaris* wintered, and as far north as the expedition penetrated, it was observed, while the Austro-Hungarian expedition found the cliffs swarming with life at their farthest north point. The dearth of animal life is a noticeable feature in the results of our expedition; it ceased altogether at a short distance to the north of the *Alert's* quarters. The prevailing wind during the sojourn of the *Polaris* was from the north-east; this year it is stated scarcely any easterly wind was noticed, but a strong current and drift set constantly in from the west along the north coast of America. We mention these points simply to suggest that the conditions met with by our gallant expedition can hardly without further observations be regarded as the normal ones. Round the Pole doubtless there must be a permanent barrier of impenetrable floe-bergs, for it would be ridiculous to suppose that 150 feet thick ice of thousands of square miles in extent is melted and re-formed every year. But is it possible that usually this barrier lies further north than our expedition found it?

As to positive discoveries, an unprecedentedly rich collection of observations in all departments have been obtained. It will be seen from our map that positive additions have never been made to Arctic geography. With the exception of Hayes Inlet, all the coast from Cape Farewell to the northern end of Robeson Channel is now laid down, and considerable advances have been made west along the American, and east along the North Greenland coast, in the former case to  $86^{\circ} 30' W.$ , and in the latter to  $48^{\circ} 33' W.$  President Land does not exist, no land having been seen north of Cape Columbia in  $83^{\circ} 7' N.$  It was a pity that Peter-

mann Fjord was blocked up with ice, otherwise it might have been ascertained whether or not it divides Greenland in two, as has been conjectured. There is little doubt, at any rate, that Greenland is an island, and that it does not extend right across to Wrangell Land as Petermann conjectured. For the more important scientific observations we must wait some little time, but we have reason to believe they are abundant and of the highest value. The drift of the current along the North American coast it will be seen, is from the west, and it is possible it may come right across from Behring Straits. A magnificent series of tidal observations has been obtained, entirely confirmatory of the conclusions that Bessels came to, viz. that the tides in the north of Smith's Sound come from the Pacific. It would be interesting now to know what lies between Parry Islands and the newly discovered coast, and whether currents have an unobstructed passage from Behring Straits across the Polar Sea. The magnetic observations entirely endorse the theory on which the charts have been constructed; and had it not been for a change of officers and an accident to the clock, the pendulum observations for determining the figure of the earth would have been completed and of the greatest interest. Capt. Feilden, the naturalist, whose exertions are beyond all praise, obtained admirable results in his department.

We may be permitted to say that we think Capt. Nares has acted gracefully and generously in his selection of names for the lands discovered; the most northern point discovered now bears the name of Cape Columbia. It was in keeping with this disposition to recognise America's claims to remembrance that Capt. Nares paid a deserved tribute to the brave Hall by affixing to his no longer lonely grave a brass tablet containing a suitable inscription.

Altogether we have every reason to be satisfied with the conduct and results of the expedition, and thankful that these results have been obtained with so little loss. It might have been otherwise, for the *Discovery* was within a minute of being crushed by an iceberg, and had it not been for an accident to the *Alert's* screw, she would certainly have pushed further north and got into a position from which it would have been impossible to extricate her. Many lessons with regard to future Arctic work are to be learned from the experiences of this latest expedition. We would also remind our readers of the plan advocated by Weyprecht, and recommended by a German Government Commission, to establish at suitable points all round the Polar region a series of permanent stations from which the Arctic citadel can be slowly but surely sapped. The recommendations of the German Government Commission we consider so important, that although we published them at the time, we think it appropriate to reproduce them here in the present connection, and the admirable scientific spirit in which the subject is approached is worthy of note.

"1. The exploration of the Arctic regions is of great importance for all branches of science. The Commission recommends for such exploration the establishment of fixed observing stations. From the principal station, and supported by it, are to be made exploring expeditions by sea and by land.

"2. The Commission is of opinion that the region

which should be explored by organised German Arctic explorers, is the great inlet to the higher Arctic regions situated between the eastern shore of Greenland and the western shore of Spitzbergen.

"Considering the results of the second German Arctic expedition, a principal station should be established on the eastern shore of Greenland, and, at least, two secondary stations, fitted out for permanent investigation of different scientific questions, at Jan Mayen and on the western shore of Spitzbergen. For certain researches the principal station should establish temporary stations.

"3. It appears very desirable, and, so far as scientific preparations are concerned, possible, to commence these Arctic explorations in the year 1877.

"4. The Commission is convinced that an exploration of the Arctic regions, based on such principles, will furnish valuable results, even if limited to the region between Greenland and Spitzbergen; but it is also of opinion than an exhaustive solution of the problems to be solved can only be expected when the exploration is extended over the whole Arctic zone, and when other countries take their share in the undertaking.

"The Commission recommends, therefore, that the principles adopted for the German undertaking should be communicated to the Governments of the States which take interest in Arctic inquiry, in order to establish, if possible, a complete circle of observing stations in the Arctic zones."

But to come to any final decision on the subject at present, as have some of the daily papers, is premature, more especially as we have only mere hints of the work of the latest expedition before us. It is evident, however, that three courses are open to us: we may rest on our oars and comfort ourselves with the belief that no more can be done; we may make another dash, blind to a certain extent it must be with our present knowledge; or, accepting the recommendation of the German Commission, a united and continuous sap may be commenced. But in order to come to a wise decision, men of science must long ponder over the enormous mass of new facts collected by the expedition, and not until this has been done can any opinion worth the stating be possibly arrived at.

Here we would have ended had it not been for the lamentable tone assumed by our leading newspaper in an article on the expedition in Tuesday's issue. It will be remembered that from the first, for some unaccountable reason, the *Times* set its face against the expedition, and prophesied that no good could come of it; now it utters a lonely shout of triumph at the supposed success of its prophecy. For the *Times* appears to be so ill-informed as to believe that the main, if not the sole, object of the expedition was to reach the Pole; if it failed in doing this, then, in the eyes of the *Times*, it was a complete failure. But this is sheer ignorance, real or assumed, on the part of the *Times*; for no informed person ever dreamt that the only object of the well-equipped expedition was to gratify unintelligent curiosity and craving after sensation. The printed instructions of the expedition were essentially: "Reach the Pole if you can, but at any rate, in the light of the latest scientific knowledge, make all possible observations on the multifarious phenomena which can be seen to advantage alone in the Arctic regions." These instructions have been faithfully carried out and with complete success. Every  
made to reach the Pole, and when the

results are published it will be seen that no expedition ever brought home a richer harvest. Whether these results are worth the suffering and the sacrifice of life which the expedition experienced, is a question which will be answered in accordance with one's idea of what is worth running the risk of life for. In spite of the scream of the *Times*, and although no new market has been opened, the people of this country will simply feel proud, and be ennobled by the thought, that the latest deed of heroism has been done by Englishmen—that "the ancient spirit is not dead."

The nation desired the expedition, scientific bodies and scientific men counselled it and worked for it, Government, only after long consideration, willing and liberally granted funds; and out of the volunteers, officers and men, who, well knowing all the risks that would be run, eagerly offered themselves for the service, a dozen similar expeditions could have been equipped. Under these circumstances the *Times*' article is simply an impertinence.

#### SCHIMPER'S "MOSSSES OF EUROPE"

*Synopsis Muscorum Europaorum.* Auctore W. P. Schimper. Vol. I.—Introductio, pp. 130. Vol. II.—Specierum descriptio, pp. 886. Edit. 2. Stuttgartiæ, 1876. (London: Williams and Norgate.)

THIS long expected work has at last made its appearance, and all students of bryology will be grateful to possess such a vast storehouse of carefully arranged descriptive matter to help them in the determination of species; no easy task at any time, and sometimes one of difficulty and trouble even to an expert.

The first edition appeared in 1860, and we must frankly admit that we experienced some feelings of disappointment, on finding that almost the entire nomenclature and arrangement are identical with those of that edition; nay, in some respects we must look upon the classification as retrograde, for while in his classical work on the Sphagnaceæ, Prof. Schimper strongly insists on the elevation of this family to the rank of a class equivalent to those of Mosses and Hepaticæ, we here find him placing them along with *Andreaea* and *Archidium*, as an appendage to the mosses, under the title of BRVINE ANOMALÆ; surely a most unphilosophical mode of dealing with them, since the three genera have nothing else in common but the large saccate calyptra, which had already led Hampe to separate them as a section—*Sacomitria*.

The Cleistocarpous order heads the series, though the author half apologises for still retaining it "as being convenient for beginners, and because the position of some of them among the Stegocarpi is uncertain." Several of our best bryologists, however, have long felt that the solitary character of possessing a capsule without a separable lid, is not sufficient to outweigh all other points of structure and habit, especially when it also necessitates keeping up two parallel series of forms in widely separated families, e.g., *Phascaceæ* and *Pottiaceæ*. We would venture to differ from our author, and consider that *Archidium* is a near ally of *Pleuridium*, and that the absence of a columella is not so momentous a character as to require the separation of these genera to the extreme ends of the system; while *Andreaea* as to its vegetative organs is essentially Grimmiaceous, but in its fruit standing apart

and thus representing a most distinct natural family, imitating as it were the Hepaticæ by its quadrid capsule, but not having any real affinity with that group.

About 200 new species are described in the present edition, many of them only known in a barren state, and in several instances misgivings are expressed by the author as to their stability. We may glance at some of these *en passant*. *Ephemerum* has one new species, *E.*, and we surmise our Sussex plant (*E. inter-* Wils., *E. tenuinerve*, Lindb.) is also distinct. The *Ephemeraceæ* really seem to merit the rank of a natural family rather allied to *Trichostomaceæ* than to *Funariaceæ*, for which the diminutive size, permanent protonema, and leaf structure would supply the chief characters.

In *Weissiaceæ* we find *Anæctangium*, a genus which has exercised the minds of most bryologists as to its systematic position, but which perhaps is as happily settled here as is possible. *Gyroweisia*,

and *Rhabdoweisia*, standing as sections of *Weisia* in the previous edition, are now raised to the rank of genera. In *Dicranaceæ* we have also a new genus—*Metsleria*—which appears to be very close to *Dicraodontium*, and *Campylopus* now includes twelve species, while those of *Fissidens* number no less than nineteen. *Leptotrichum*, Hampe, is still retained as a genus, though its author has himself replaced it by the much older name, *Ditrichum*, Timm.

*Didymodon* and *Trichostomum* receive considerable additions, chiefly, however, only known in a barren state, as is also the genus *Gcheobia*, established to receive *Tortula gigantea*.

We pass next to the great genus we find no less than forty-two species; so uniform are these in habit and foliage, that they have hitherto proved a most troublesome group to deal with, nor do we find that the nine sections into which it is divided help us readily to determine the species. In no genus of mosses do we require so full a series of specimens, for we must have the capsule with its calyptra, and with and without the lid, in order satisfactorily to determine them, and we fear that more species have been established than will eventually prove tenable.

*Bryum* is another genus receiving a large accession of species—no less than thirty-four new ones—and *Zieria* is still maintained, though used long ago by Sir J. E. Smith for a genus of *Rutaceæ*, and therefore altered by Prof. Lindberg to *Plagiobryum*, which must certainly be adopted. In the Addenda we also find a new genus, *Mercyia*, founded on the *Eucalypta ligulata* of Spruce, but strictly we should say that this name must give place to *Scopelophila*, Mitten. Another new genus, *Anacolia*, is also established for *Glyphocarpus Webbii*.

Among Pleurocarpous mosses, *Myurella Careyana* does not find a place, although recorded as found in Europe. *Thuidium decipiens*, De Not., the author states he has not seen, yet it was distributed in Rabenhorst's Bryotheca under both No. 1,141 and 1,182. It has no relation to the genus *Thuidium*, is erroneously described as monoicous, and indeed can only be regarded as one of the many forms of *Hypnum commutatum*. Of the great tribe *Hypnææ* thirty-six new species are described.

In the BRYINÆ ANOMALÆ we find *Sphagnum* now

numbering twenty species, grouped in six sections according to Schliephacke's arrangement. These we fancy will have to be somewhat reduced, as it now appears to be certain that in this family at least, a dioicous and monoicous condition of the inflorescence may occur in the same species.

Neglect of the work of other writers and especially of papers in the various botanical journals of this and other countries is the principal shortcoming of the work before us, and probably the author has not had time properly to consult them; in every other respect the Synopsis maintains the high character it had already acquired, for no description of species could be more accurate and painstaking, while the paper and printing are superior to the ordinary run of foreign books.

It will thus be seen that Schimper's Synopsis must still continue to be the standard work on the mosses of Europe, and fitly comes to us from an author whose name has been identified with the study of these interesting plants for the past forty

#### OUR BOOK SHELF

*Outlines of Practical Histology.* By William Rutherford, M.D., F.R.S. Second Edition. (J. and A. Churchill, 1876.)

WHEN, a year ago, we reviewed this work upon its first appearance, it consisted of but seventy-two pages, and contained four illustrations; the second edition occupies very nearly two hundred pages, and is illustrated with sixty-three woodcuts. The enlargement gives the author an opportunity of entering with considerably greater detail into his subject, and he is able to introduce much new matter. Among the most important additions we may mention a chapter on the optical principles upon which the microscope is constructed, including immersion lenses, and an instrument manufactured by Mr. Swift of London, which is apparently as good as those of continental celebrity. The histological sections may be said, practically, to be re-written, for to almost every one is added matter of great value, essential to all but the merest commencer. Among these we notice paragraphs upon the effects of gases on the blood, the enumeration of the discs, the "prickle" cells of the epidermis, lymphatics of the diaphragm, coverings of hair, structure of the retina and of the cerebral convolutions. In the fourth part of the work, which is devoted to general considerations regarding histological methods, the application of vapours and gases to tissues is explained, as are the hot stage for the microscope, with its heating apparatus and the moist chamber of Dallinger and Drysdale. The author's microscope is figured, as is the apparatus necessary for injecting tissues by the pressure-bottle. All the figures are excellently drawn, and very lucid, and so greatly has the book increased in value, instructive as it was before, that we feel quite justified in recommending those who possess the first edition to purchase the second, and those who are studying the first principles of practical histology to obtain it without fail.

*A Study of the Rhaetic Strata of the Val di Ledro in the Southern Tyrol.* By T. Nelson Dale, jun., Member of the Geological Society of France. Pp. 69, with and Sections. (Paterson, New Jersey, 1876.)

ON the western side of the Lago di Garda is situated a tract of Secondary rocks which has been comparatively little explored by geologists. Lying as it does exactly upon the Austro-Italian frontier, this area has neither been described by Stoppani and the Italian geologists, nor has it received full justice from the officers of the Vienna

*geologische Reichsanstalt*; and under these circumstances Prof. Zittel of Munich has pointed it out to the author of the present paper as a promising field of study. Mr. Dale's work will certainly be of considerable use to future explorers of the district, though not carried out in sufficient detail to warrant, in his own case, any very important generalisations. Indeed, the memoir consists almost wholly of transcriptions of notes and rough drawings of sections relating to a number of different localities which are indicated by reference to a key-map. The author's general conclusions, so far as they go, are shown in a very clear and useful table, from which it appears that at this point of the Alps, the Jurassic and Rhætic strata (including in the former the Tithonian) have a united thickness of from 6,000 to 7,000 feet. Vast as is the estimate, no one acquainted with this or the surrounding districts will be inclined to regard it as excessive.

Mr. Dale has evidently made good use of his opportunities, so far as they have gone, and has given us in this memoir the results of a piece of well-directed observation. We hope to have further details from his pen concerning the same interesting region. The list of *errata*, which is rather long for a memoir of the proportions of the present, does not by any means exhaust the whole of the printer's errors. We are tempted to fear that Mr. Dale is not sufficiently careful in keeping so distinct from one another, as behoves a working geologist, his notes relating to various subjects; for, by some strange chance a stray page of a sermon seems to have fallen into the hands of the compositor and to have been set up by him at the end of the author's geological notes.

J. W. J.

#### LETTERS TO THE EDITOR

[The Editor does not hold himself responsible for opinions expressed by his correspondents. Neither can he undertake to return, or to correspond with the writers of, rejected manuscripts. No notice is taken of anonymous communications.]

##### "Geographical Distribution of Animals"

I FIND that Mr. Wallace in his new work on the "Geographical Distribution of Animals" when stating the limits of his Ceylon sub-region (vol. i. p. 327), gives among mammals the genus *Tupaia* and among birds "a species of *Mvophonus*, whose nearest ally is in Java" as characteristic of that sub-region. Further, in the tabular statement (vol. ii. p. 187), *Tupaia* is altogether omitted from the Indian sub-region.

It is not my intention to enter here into the general question of the divisions of the oriental region which Mr. Wallace has adopted. The subject has I know been undertaken by at least one well-known Indian naturalist. My object at present is simply to record the fact that I have found both *Tupaia Elliotti* and *Mvophonus Horsfieldi* ranging together far to the north of the limits given by Mr. Wallace for his Ceylon sub-region.

*Tupaia* I first met with at an elevation of about 1,500 feet in the Sutpuru Hills, near the *Pahmari* plateau in the Central Provinces (P.I.A.S.B., April, 1874), lat. 22° 20'. Subsequently I found it in Sambalpur, which is the most eastern district of the Central Provinces (lat. 21° 30'). But the former does not even give its extreme northern limit as it has been found in the Kurruccpur hills of the Monghyr district (lat. 25°).

*Mvophonus Horsfieldi* I first shot in Sirguja—a native state in Western Bengal (lat. 23°). Afterwards in the Sutpuru, where it occurred with *Tupaia* as above, and finally I obtained it also in Sambalpur, where it was found at elevations under 1,000 feet above the sea. Still further north it has been obtained at Mount Aboo ("Stray Feathers," vol. iii. p. 469), lat. 25°.

*Mvophonus* is, it is true, included in Mr. Wallace's list of Oriental genera in Central India, but its special employment as a characteristic form of the Ceylon sub-region seems scarcely compatible with a knowledge of its now ascertained wide range through continental India.

During the ensuing field season I expect to be engaged in the geological examination of one of the wildest and least known parts of India—the area between the Godavari and Mahanudi Rivers. I have great hopes of discovering there further facts regarding the range of species whose limits are now only imperfectly known. In the meantime I may state that during the

present year I have shot *Harpactes fasciatus* in Sambalpur, thus confirming the late Col. Tukell's statement of its occurrence in the same general tract of country. The above allusion to *Tupaia* leads me on to record here that I have met with two other species of the genus.

During an ornithological tour which was made in 1873 by a party of which I was a member—through the islands of the Andaman and Nicobar groups—we obtained a species of *Tupaia* on the Island of Preparis. Our specimen appears to be identical with *T. Peguensis*, which occurs from Pegu to Sikkim. On the Great Nicobar we shot a specimen of the species described in the Novara account as *Nicobariensis*, and considered then to be worthy of generic distinction.

In Preparis, it may be added, we also shot a small grey squirrel which is allied to if not identical with *S. Assamensis*. These, with a monkey (*M. carbonarius*?), pigs, and probably rats and bats, constituted so far as we could ascertain the mammal fauna of the island.

Preparis I should perhaps explain is the most northern of the Andaman group lying between Cape Negrais and the Cocos.

Mr. Wallace has I observe included the Nicobar Islands in the Malayan sub-region and the Andamans in the Indo-Chinese. This separation of the two groups is, I believe, fully justified by the facts.

Some years ago when working at the avifauna of these islands (J.A.S.B., 1872, p. 274), while recognising the fact of a number of species being common to both groups, I could not resist a conviction as to the existence of a strong Malayan stamp upon the birds which are peculiar to the Nicobars.

In conclusion Mr. Wallace's magnificent work needs no praise from me; but as a field worker and observer I may perhaps venture here to offer my thanks for the valuable mine of information which it affords.

V. BALL,

Calcutta, September 28 Geographical Survey of India

#### European Polygalas

IN view of a monograph of the order Polygalaceæ which I have in preparation, may I make use of your columns to say that I should be greatly obliged to any correspondents who can send me specimens of any of the less common European *Polygalas*, especially *P. exilis*, *montpelicæ*, *microphylla*, *saxatilis*, *Prelii*, *nicaensis*, *flavescens*, *rosæ*, *sibirica*, *sepium*, *venulosa*, *anatolica*, or any well-marked varieties. I shall be glad to offer in exchange specimens of some of the rarer British plants.

6, Park Village, East, Regent's Park, London, October 28 ALFRED W. BENNETT

#### The Solidity of the Earth

IN his opening address to the Mathematical and Physical Section of the British Association, Sir William Thomson affirmed "with almost perfect certainty, that, whatever may be the relative densities of rock, solid and melted, or at about the temperature of liquefaction, it is, I think, quite certain that cold solid rock is denser than hot melted rock; and no possible degree of rigidity in the crust could prevent it from breaking in pieces and sinking wholly below the liquid lava," and that "this process must go on until the sunk portions of the crust build up from the bottom a sufficiently close-ribbed skeleton or frame, to allow fresh incrustations to remain bridging across the now small areas of lava, pools, or lakes" (NATURE, vol. xiv. p. 429).

This would doubtless be the case if the material of the earth were chemically homogeneous or of equal specific gravity throughout, and if it were chemically inert in reference to its superficial or atmospheric surroundings. But such is not the case. All we know of the earth shows that it is composed of materials of varying specific gravities, and that the range of this variation exceeds that which is due to the difference between the theoretical internal heat of the earth and its actual surface temperature.

We know by direct experiment that these materials, when fused together, arrange themselves according to their specific gravities, with the slight modification due to their mutual diffusibilities. If we take a mixture of the solid elements of which the earth, so far as we know it, is composed, fuse them, and leave them exposed to atmospheric action, what will occur?

The heavy metals will sink, the heaviest to the bottom, the lighter metals (i.e. those we call the metals of the earths, because they form the basis of the earth's crust) will rise along with the silicon, &c., to the surface; these and the silicon will oxidise and combine, forming silicates, and with a sufficient supply of

"reason to believe that this is the first specimen of a wild Capercaillie which has been shot in Northumberland in the memory of man."

Probably the writer's glee was somewhat chilled by the appearance in the same paper of an indignant letter from the Earl of Ravensworth, stating that the bird was reared in his park at Eslington from eggs sent from the Highlands, in the hope of naturalising the species in our country; the bird had strayed from its home.

All naturalists—and especially such as know this noble bird in its northern home—must hope that Lord Ravensworth will not be discouraged by this mishap, nor by others like it, but that he will persevere in his experiment. Eslington Park is situated in the valley of the Aln, near the foot of the Cheviots. Perhaps this is not the best part of the country in which to rear the birds, as, although not devoid of timber, the woodland there is scarcely that most suited to the Capercaillie. Pine woods on rocky ground are probably the best. Not far from Eslington, and partly on the Ravensworth estates, there is a superb piece of woodland and crag. Thrunton Crags, and the adjoining crags of Callaly, are very little known except to those who live near them, for they are out of the usual tourists' routes. But in all the county we do not know a district better worth a visit, nor one which so closely resembles the fir-clad mountain sides of southern Norway. The rocks are craggy sandstones, whilst those of Norway are mostly bosses of schists, and there is none of the water which gives such a charm to Norwegian scenery, but, in spite of these differences, the other resemblances point out this as the Capercaillie's fitting home.

A wide area of high sandstone moorland stretches through Northumberland, attaining a height of over 1,400 feet at Simonside, near Rothbury, and approaching 1,000 feet in other places. This runs to the west of Alnwick, and thence north-west to Chillingham and away towards the Tweed. Another similar district branches from that of Simonside and spreads over a wide area around Harbottle, and between the Coquet and the Reed. Of the first-named range the crags of Thrunton and Callaly form conspicuous features. Only a small part of this range is wooded. It is much to be wished, for the sake of the springs and streams, that plantations were more numerous; and for many reasons, artistic and others, we could wish the same. In such parts of these wild hills as fir plantations occur, the Capercaillie should do well; and, as plantations increase, we might hope that the birds would here find a permanent home. Besides the crags of Thrunton and Callaly we may note, as districts especially well suited to them, the fir woods of Harbottle; parts of the Duke of Northumberland's extensive park at Alnwick; and the wild forest-like park at Chillingham, the home of the far-famed "wild cattle." In years to come, when the plantations increase, Sir W. Armstrong's grounds at Craggside, near Rothbury, will afford the birds a shelter. Here, amidst a profusion of sub-Alpine plants, the Capercaillie should be quite at home.

W. TOPLEY

#### NEWTON ON FORCE

MANY English mathematicians are in the habit not only of using the word "force" in a certain technical sense—briefly, as cause of change of motion—but of regarding all other senses as loose and inaccurate. Of late years there has been an increasing tendency, largely due to Sir W. Thomson and Prof. Tait, to return to the methods of expressing dynamical principles used by Newton; so that at the present time his statement of the laws of motion is adopted to the exclusion of others which had usurped its place. This return to Newton has led to a very prevalent notion that for all the statements of fundamental dynamical principles current in modern English mathematical literature, we have his authority, and in particular for the above-mentioned restriction of the use of the word "force." As the authority of Newton

seems to me to be here claimed without warrant, and as Newton's conception of force cannot be without interest, I propose to examine as briefly as possible what this conception was. In doing so I shall assume that the English word "force" is the equivalent of Newton's Latin word *vis*.

Newton commences the Principia with eight definitions, among which are definitions of the intrinsic force of matter (*vis insita* or *vis inertiae*), impressed force, and centripetal force; he then proceeds to state and explain the laws of motion. From the chapters on the definitions and the laws of motion, we are able to infer with much probability the sense in which the word "force" is used. To show this it will only be necessary to translate a few extracts.

"Def. III.—*The intrinsic force of matter* is its power of resistance, by which every body, as far as depends on itself, persists in its state either of rest or of uniform rectilinear motion."

"Def. IV.—*An impressed force* is an action exerted on a body towards changing its state either of rest or of uniform rectilinear motion."

"Def. V.—*A centripetal force* is one by which bodies are pulled, pushed, or in any way tend from all parts towards any point as a centre."

"Just as in cases of impact and rebound bodies are equipollent whose velocities are reciprocally as their intrinsic forces; so in moving mechanical instruments agents are equipollent, and mutually support each other by their contrary efforts, whose velocities, estimated in the direction of the forces, are reciprocally as the forces." (Scholium to the Laws of Motion.) In the latter part of this quotation the word "forces" is used in the sense of impressed forces as defined by Def. IV.

One more quotation must be made; it is from Newton's comment on Def. III.:—"but a body exerts this force [*vis inertiae*] only while a change is being made in its state by another force impressed on it."

In the quotation from the Scholium, Newton is considering two cases in which bodies are to be moved; in one the power of resisting the motion arises from the intrinsic force of the body (or its *vis inertiae*), in the other from the impressed force; in each case he seeks a measure of the effort required to move the bodies. Newton argues that, in the first case, this is to be measured by the intrinsic force and velocity conjointly, and in the second by the impressed force and [virtual] velocity conjointly; implying that, in the first case, to give a body a certain velocity is equivalent to giving a body of twice its intrinsic force half that velocity; and in the second case—to take an example—that to lift a body vertically at a certain rate is equivalent to lifting a body of twice its weight at half the rate.

In this Scholium, in the case both of intrinsic force and of impressed force, the word "force" indicates some power of resistance to change of state; a general power due to the intrinsic force, and a special power due to the impressed force. And throughout it will be found that Newton's use of the word in its most general sense indicates a power of resistance, which professed metaphysicians are not alone in attributing to matter as essential to the conception of it. This most general sense of the word does not prevent Newton using it in any one of its special senses, and in particular very frequently for *impressed* force, where no confusion is likely to arise; but his language is very far from sanctioning the dictum that this is the sense and the *only* sense in which the word "force" may be used.

It is painful to reflect that Newton, great as he undoubtedly was, does not seem to have been sufficiently advanced to doubt whether there is such a *thing* as force, nor to have had a proper sense of the heinousness of his conduct in writing of accelerative force, motive force, and—worst of all—centrifugal force.

P. T. MAIN

PRINCIPLES OF TIME-MEASURING APPARATUS  
IV.

THE earliest watches were constructed, so far as the escapement and balance were concerned, upon exactly the same plan as the clock from Dover Castle, and in this condition they must have perpetually remained (useless as time-measurers), but for the invention of the balance-spring (sometimes called the pendulum-spring, on account of the uniformity it imparts) by Dr. Hooke.

This spring bears the same relation to the balance which gravity does to the pendulum. Everybody, I presume, knows the form it usually takes in watches; and in chronometers it is coiled up around an imaginary cylinder. This spring (as in the case of the pendulum) absorbs the energy of the impulse, and when the balance has reached the limit of its swing, redelivers to it all it has received. A watch is regulated by shortening or lengthening the balance-spring, which makes it more or less rigid.

Watches and chronometers vary their time to a much greater extent upon any change of temperature than clocks do. For instance, if we regulate a chronometer without any compensating arrangement, with

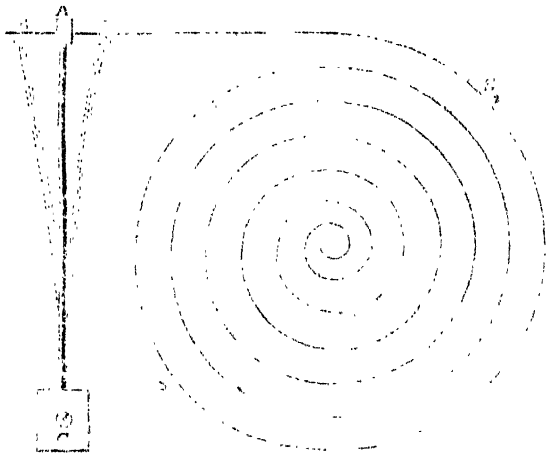

FIG. 19.

a balance-spring of steel, to go right at a temperature of 32 deg., when we raise the temperature to 100 deg. it will lose 6 minutes 25 seconds a day, whereas a clock with an ordinary steel rod pendulum would barely lose 20 seconds for the same change. This great difference is owing to the alteration in elasticity of the balance-spring (the effect really being the same as if, with reference to the pendulum, we could reduce the force of gravity).

Different materials are in this respect differently affected. Whereas a chronometer with a spring of steel will lose 6 minutes 25 seconds a day for 68 deg. rise in temperature, one with a gold spring would lose 8 minutes 4 seconds; a palladium spring would lose 2 minutes 31 seconds; a glass<sup>2</sup> spring would lose 40 seconds. (On account of the large amount of compensation required, quite a different plan has to be employed to that made use of in clocks.)

Suppose I take two thin strips of brass and steel, and fasten them rigidly together (the best plan is to pour the melted brass upon the steel), what will happen when there is any change of temperature? Imagine the temperature to rise, both expand, but the brass more than the steel, and how it manages this, being rigidly fastened to it, is

by Mr. H. Dent Gardner, at the Loan Collection, South ded from vol. xiv. p. 375.  
as the invention of the late Fredk. Dent.

by bending round the steel into a curve, of which *it* (the brass) is upon the *outside*.

Fig. 19 represents the first form of compensation applied to watches. CA is our compound bar (the steel, shaded black, being nearest the spiral), the extremity of which carries two pins applied to the balance-spring as the ordinary regulator.

When the temperature rises the brass expands and bends round the steel, shortening the balance-spring, and thus compensating for its loss of elasticity due to the rise in temperature. The reverse action takes place when the temperature falls.

The plan adopted now-a-days is the compensation-balance (see Fig. 20). The rims, R<sub>1</sub>R<sub>2</sub>, are formed of two strips of brass and steel, the brass being upon the outside. When the temperature rises, the brass expands more, and bends in the rims, carrying the weights w towards the axis of motion a sufficient distance to compensate for the loss of time due to the loss of the spring's elasticity.

As you see, the action of the compensation may be readily increased by shifting the weights nearer to the ends of the rims.

Where a chronometer is exposed to very wide ranges of temperature, there is another error (called the secondary

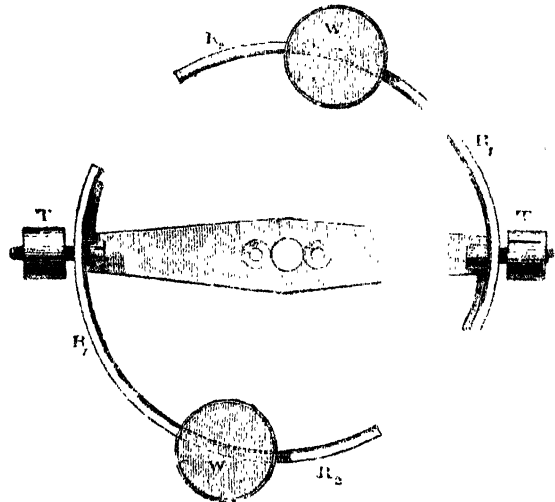

FIG. 20.

error) introduced. If, for example, we take a chronometer with such a balance as just described, and so adjust the compensation-weights that it shall go right at a temperature of 66 deg. and 32 deg., we shall find that when we expose the chronometer to a temperature of 100 deg. it will lose about four seconds a day; and we cannot correct it, for if we advance the compensation-weights along the rims to increase their action in the heat, we shall also increase it in the cold, and then the chronometer will lose in that direction. The best we could do would be so to adjust the weights as to make the chronometer lose two seconds a day in the heat, and two seconds a day in the cold.

The cause of this error is that the time of the swing of a balance depends not directly upon the distance of its weights from the axis of motion, but upon the square of that distance; and it therefore requires a greater amount of motion inwards to produce the same effect as any given motion outwards.

The following is one of the plans adopted for the correction of this error (see Fig. 21):—

FB is a flat bar composed of brass and steel fastened together, the brass being beneath. LL are two loops also formed of brass and steel, the brass being inside. The compensation weights, WW, are mounted upon



two rods, RR, fastened upright upon the extremities of the loops.

When the temperature rises, the flat bar bends upwards, and tilts in the loops and the weights at their extremities. But at the same time the loops open a little, and as they are pointed towards the axis of motion, AA, advance the compensation weights a little further in upon their own account. Thus the action of the main bar is increased in the heat. In the cold, the main bar bends downwards, and tilts out the weights, but in this case the loops close, and as they are now pointed away from the axis of motion, by doing so, *bring back* the weights a little. Thus the action of the balance is reduced in the cold. The secondary error is in this manner corrected.

Balance-springs have this very important property, that you are able to isochronise them, that is, so adjust them that the balance shall perform long and short arcs of vibration in the same time. The rule for doing this is simple, though exceedingly difficult of execution upon account of the minuteness of the operation; if the chronometer gains in the short vibrations, you shorten the spring, and if it gains in the long vibrations, you lengthen it. The best plan is to leave it gaining a trifle in the short vibrations, for the reason I pointed out to you when discussing the circular error in pendulums. A chronometer gaining 3 or 4 seconds a day in the short vibrations will also be compensated against changes in atmospheric pressure.

The best watches are always timed in positions. There is of course much more friction when the pivots are roll-

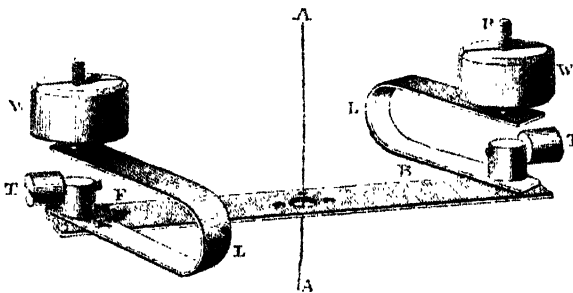

FIG. 21.

ing upon their sides than when turning upon their ends; gaining in the short vibrations tends to correct variation due to this. In general, timing in positions is a work of the very greatest difficulty, and perfect accuracy can only be obtained when the balance-spring weight of the balance and mainspring are in exact adjustment.

A very curious property sometimes exhibited by chronometers is to gain upon their rates, that is to say, if the average daily rate of the chronometer were during the first month 1 second a day fast, during the second it would be  $1\frac{1}{2}$  seconds, and during the third month 2 seconds.

This arises from the balance-spring having been left at too high a temper after hardening. On the other hand, if the temper were left too low the chronometer would lose upon its rate. Glass springs exhibit the tendency to gain upon their rates to a remarkable degree.

#### Watch Escapements.

It would never do to have watch balances vibrating so small an arc as clock pendulums; the least we can do with is  $200^\circ$ , that is, 100 times as much. If you will remember the various clock escapements described, you will see that not one of them is suitable to fulfil such conditions, and something quite different had to be devised.

The form most generally employed is Mudge's detached lever, which is more in favour to-day than it ever was. PP are the pallets (see Fig. 22) mounted along with a lever, LL, upon a spindle, S. During the greater part of

the swing of the balance, the lever and pallets are lying against either of the banking pins, BB. There is a notch, N, in the lever and a pin, I, to correspond upon the disc, R, which moves around along with the balance in the direction shown by the arrow. By-and-by the pin upon the disc will catch the notch in the lever and unlock the escape-wheel, a tooth of which is now being held against the dead face, D, of the pallet; the tooth will immediately slide along the slant, and deliver its impulse, which will be transmitted to the balance through the connection of the pin and disc R. The lever whilst resting against either of the banking pins is held in position by a little "draw" upon the dead faces of the pallets, that is, they are slanted back, so that the pressure of the wheel teeth thrusts them away from it. There is also a safety disc, O, underneath the unlocking one, and a safety tongue in the lever, which, in the event of the watch getting a shake prevents its falling over to the opposite side of the balance-spindle to that where the unlocking pin is then situated.

People are continually "improving" this escapement, generally by making some slight alteration in the pins, but the broad principle and details always remain the same, as I have described them to you.

Another form of escapement very much used in foreign watches is the horizontal, invented by the same Graham

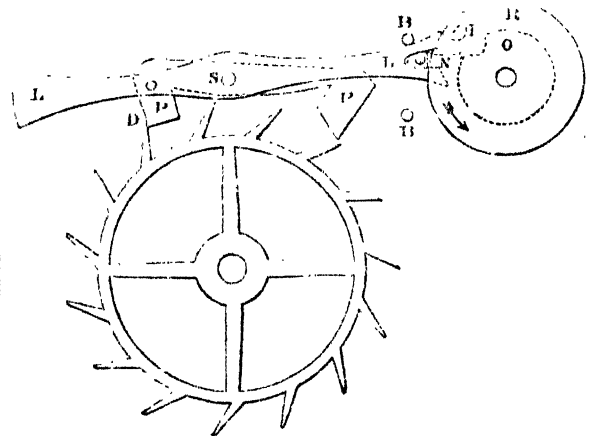

FIG. 22.

already referred to; but as it does not possess qualifications for accurate time measurement, I shall not describe it.

Our last escapement is that universally employed in chronometers (see Fig. 23); its original conception is apparently due to Earnshaw, though it was modified and greatly improved by Earnshaw. SS is the escape-wheel, which is now being held by the detent, D.  $R_1, R_2$  are two discs, the smaller being situated in the plane of the detent, and the larger in the plane of the escape-wheel; both of them move upon the same spindle with the balance. The balance is now turning in the direction of the arrow; by-and-by the finger,  $P_2$ , upon the smaller roller will come round and lift away the detent, and the wheel will be free. The tooth, T, will then drop upon the impulse pallet,  $P_1$ , and deliver impulse to the balance. Meanwhile, the finger,  $P_2$ , gets clear of the detent, which it allows to fall just in time to receive the succeeding tooth of the escape-wheel.

The balance now passes on to the limit of its excursion, and returns; but in returning the finger does not interfere with the detent for the detent, D, is actually too short to reach it. Just now the finger really unlocked the detent by means of the little spring, Y Y, which is fastened some distance down the detent, the little spring being supported by the horn or extremity of the detent; but when the finger returns, it merely lifts out the spring, as there is upon this side no horn or extremity to support it.

*Distribution of Time by Electricity—Chronographs.*

To those acquainted with the difficulties in the way of communicating a uniform impulse to the pendulum through the medium of a train of wheel-work, it has, always been a favourite idea directly to maintain the swing of the pendulum by means of an electric current. but, unfortunately, the thing has not hitherto proved feasible; apparently it must be taken for granted that the action of an electric current cannot be *constantly* maintained.

But although electricity is of little service for keeping clocks going, it has been very successfully employed in controlling them. It is, of course, very much more economical to have inferior clocks than good ones, and what is done in this case is to use one good clock for the purpose of controlling a quantity of bad ones. The nature of the apparatus is in general this: our first good clock and all the others are placed in the circuit of a galvanic battery, and what our first good clock does is to close the circuit and transmit a current at every beat of its pendulum. The passage of an electric current around a coil of copper wire (as you no doubt know) converts it for so long as it passes into a magnet, and this current so transmitted by the clock is employed for such a purpose, and the magnets so formed are constructed to operate upon the pendulums of the controlled clocks and accelerate them if they are

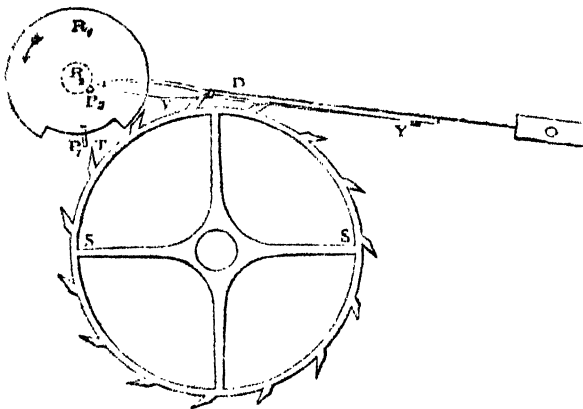

FIG. 247

lagging, or resist them if they should be moving too quickly.

Electricity is also employed for the purpose of correcting the time of a clock, say once a day. In this case the clock which is to be corrected is kept at a slight gaining rate. Upon the axis of its escape-wheel is a little finger which revolves with it. At a few seconds before, say 1 o'clock, the controlling clock, by the transmission of a current, brings down an arm in front of the finger and stops the controlled clock for just so many seconds as it is in advance of the controlling clock; at 1 o'clock the arm is raised again, and the controlled and controlling clock start off approximately together.

Such a controlling clock as is used to transmit a current, say once a day, is also employed for the purpose of dropping time-balls and discharging guns. The time-ball itself is generally composed of wicker-work covered with canvas, and is wound up by hand to its position a few minutes before the transmission of the current, and held by a hook or detent. Upon the arrival of the current the detent (by what arrangement it is unnecessary to describe) is withdrawn, and the time-ball falls.

To discharge a time-gun, the current usually passes through a very fine platinum wire, which it makes red-hot. Both with time-balls and guns, and wherever it has heavy work to perform, the current from the clock is employed to close another and much more power-

ful circuit, the latter being that which operates upon the mechanism.

Instruments employed for the purpose of registering the passage of short intervals of time are called chronographs. These in the main consist of a cylinder covered around with paper revolving at a uniform rate. The rotation of those employed in observatories is generally controlled by what is called a conical pendulum, that is, a pendulum swinging round in the surface of a cone. Such pendulums are much more sensitive to any slight change in the pressure of the clock-train than ordinary oscillating pendulums, and require to be controlled by special apparatus. The pendulum used at Greenwich is so contrived, that when it endeavours to move faster (in doing so, of course swinging out further) it dips little spades into an annular trough of glycerine, and its velocity by this means is checked.

The operation of the apparatus is the following:—A pin upon the pendulum of the normal sidereal clock presses two weak springs together at every vibration, and so transmits a current. This current, by making an electro-magnet, brings down a striker upon the paper of the revolving cylinder. By an arrangement similar to a screw-cutting lathe, the frame carrying this striker just as the cylinder rotates, travels alongside of it, and the clock-beats are consequently indicated upon the cylinder in the form of a spiral of successive pricks. The mechanism attached to the clock is arranged so as to pass no current at the termination of each minute (the sixtieth second), and consequently a blank is left upon the cylinder, by which anybody can tell when the minute happened. Upon the same frame alongside the first striker is a second, which can be brought down by the observer at any one of the instruments, by touching a button at his side. His observation is consequently registered upon the barrel alongside the clock-beat, and you have no difficulty in determining its precise time of occurrence to the tenth or one-hundredth of a second.

Similar instruments are employed for determining the velocity of projectiles, but in these the cylinder travels at a much higher velocity, and other means of controlling it are made use of.

*THE ARCTIC EXPEDITION*

IT will of course be some time ere all the results obtained by the Expedition which has just returned from its year's sojourn on the edge of the ice-blocked Polar Sea can be presented to the public. Enough, however, is known to lead us to believe that abundant additions of the highest importance to our knowledge of the physics and natural history of the Arctic Regions have been made; and meantime we are able to exhibit in a map the main additions which have been made to Arctic geography.

The *Alert* and *Discovery*, under Captains Hayes and Stephenson, left England in May, 1875. *Godhavn* was left on July 15, and all seems to have gone well till July 30, when, after leaving Port Foulke, the ice was met off Cape Sabine, 78° 41' N., from which point the ships had a constant struggle with the pack to the north end of Robeson Channel. So close was the ice that occasion the water channel by which the ships advanced very soon closed behind them, rendering it as difficult to return as to proceed north. On August 25, after many hairbreadth escapes, a well-sheltered harbour was reached on the west side of Hall's Basin, north of Lady Franklin Sound, in lat. 81° 44' N. Here the *Discovery* was secured for the winter, a few miles north of Polaris Bay, which was in sight on the opposite side of the channel.

The *Alert*, pushing onward, rounded the north-east point of "Grant Land," but instead of finding a continuous coast-line leading 100 miles further towards the north, as everyone had expected, found herself on the border of what was evidently a very extensive sea, with

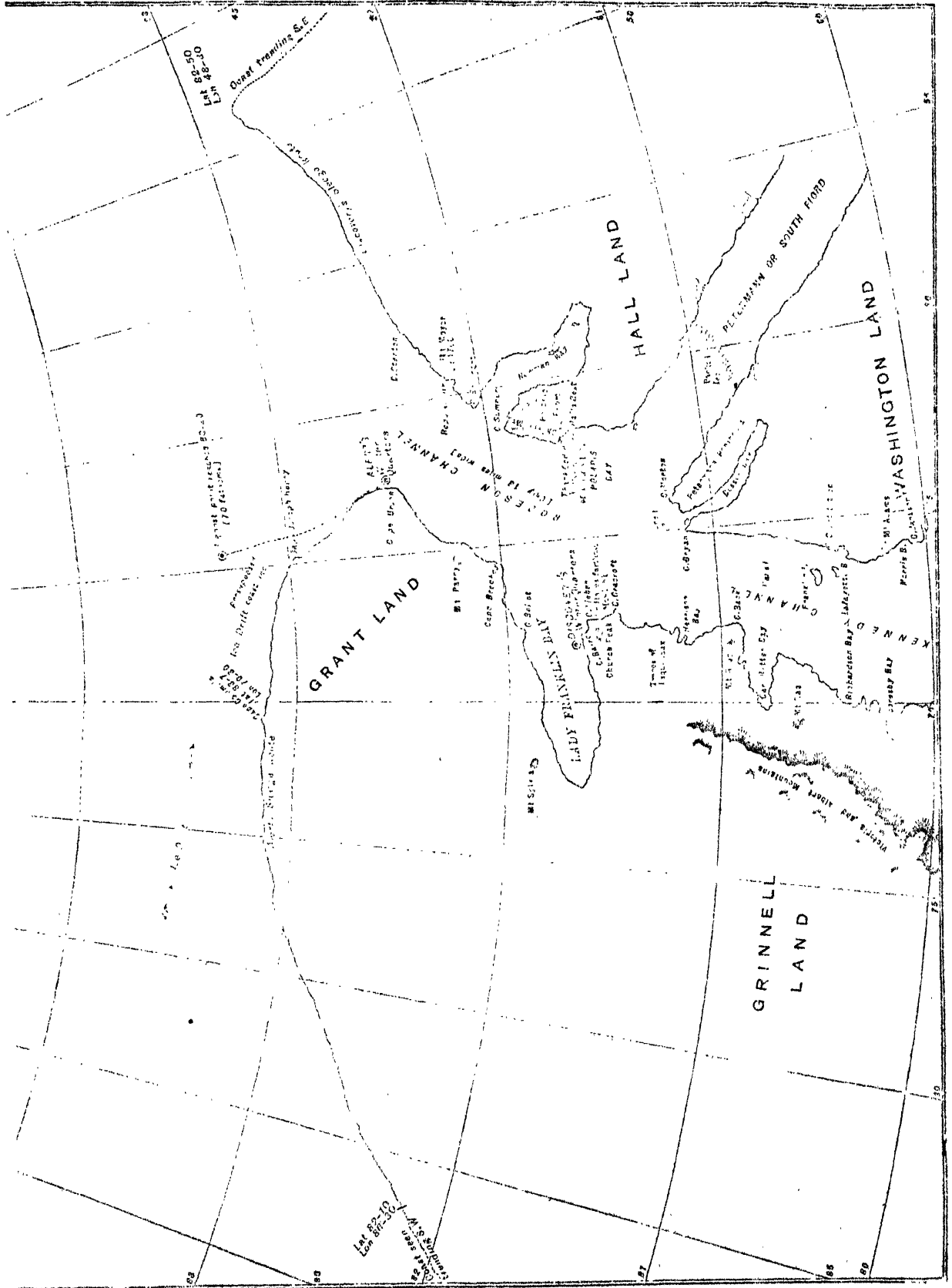

impenetrable ice on every side. No harbour being obtainable, the ship was secured as far north as possible, inside a sheltering barrier of grounded ice, close to the land, and there she passed the winter; during her stay of eleven months no navigable channel of water permitting further advance to the northward ever presented itself. We believe that had an accident not happened to the screw of the *Alert* she would have endeavoured to push still further north; but the current round the corner of the land was so great she could not make headway. It was fortunate that the accident happened, for had she gone much further she would probably have got so jammed in the frightful ice-masses that it would have been impossible to get her out again. In lieu of finding an "open Polar sea," the ice was of most unusual age and thickness, resembling in a marked degree, both in appearance and formation, low floating icebergs rather than ordinary salt-water ice. It has now been termed the "Sea of Ancient Ice"—the Palæocrystic Sea; and a stranded mass of ice broken away from an ice-floe has been named a floe-berg. Whereas ordinary ice is usually from 2 feet to 10 feet in thickness, that in the Polar Sea, in consequence of having so few outlets by which to escape to the southward in any appreciable quantity, gradually increases in age and thickness until it measures from 80 feet to 120 feet, floating with its surface at the lowest part 15 feet above the water-line. In some places the ice is spoken of as reaching a thickness of from 150 to 200 feet, and the general impression among the officers of the expedition seems to have been that the ice of this "Palæocrystic Sea" is the accumulation of many years, if not of centuries, that the sea is never free of it and never open, and that progress to the Pole through it or over it is impossible with our present resources. It is interesting to note that the Aurora Borealis was not distinct in these latitudes, the latitude being supposed to be too high; this is consistent with the observations of the *Polaris* expedition, Dr. Bessels rarely finding the colours brilliant enough to give a spectrum.

When it was seen that further advance with the ships was impossible, all the energies of officers and men were directed to sledge-work. Sledge-parties were sent out northward, eastward, and westward, depôts having been established at intervals in the two former directions last autumn ready for the parties to be sent out during the spring of this year.

Although the two ships were only seventy miles from each other, it was impossible for any communication to pass between them till last March, when a party from the *Alert* succeeded in reaching the *Discovery* and relieving those on board the latter of any doubt as to the fate of their fellows. Owing to the high latitude of both ships the winter was unusually long and dark, the sun having been absent 142 days, and the cold was more intense than had ever been experienced by any previous expedition. All the old and a few new expedients were resorted to to relieve the unimaginable monotony of such a position, and apparently with great success. The lowest temperature observed was 104° below freezing, Fahr., at least 20° below the minimum observed by the *Polaris* expedition, and the mean temperature for thirteen consecutive days was 91° of frost; the mercury was frozen forty-seven days during the winter.

As soon as the sun appeared in the spring of this year active preparations were made for sledge-exploration, and by the beginning of April each ship was left with only half-a-dozen officers and men whose duties kept them on board. After that date sledges were continually arriving and departing, carrying forward provisions to be placed in depôt, ready for the return of the advanced parties.

Capt. Stephenson, besides looking after his own division, visited the *Alert*, and also made two trips across Hall's Basin to Greenland, and Capt. Nares started off like the rest, with Capt. Feilden, naturalist to the Expedi-

tion, immediately all the provision depôts were complete along the line of route, and the safety of the travellers insured. When at Polaris Bay Capt. Stephenson hoisted the American ensign and fired a salute as a brass tablet, which he and Capt. Nares had prepared in England, was fixed on Hall's grave. The plate bore the following inscription:—"Sacred to the memory of Captain C. F. Hall, of the U.S. ship *Polaris*, who sacrificed his life in the advancement of science on November 8, 1871. This tablet has been erected by the British Polar Expedition of 1875, who, following in his footsteps, have profited by his experience."

A party, headed by Commander Markham and Lieut. Parr, made a most gallant and determined attempt to push northwards by means of sledges. They were absent 72 days from the ship; and on May 12 succeeded in planting the British flag in lat. 83° 20' 26" N., within about 400 miles of the Pole. From this position there was no appearance of land to the northward, but, curiously enough, the depth of water was found to be only 70 fathoms. Owing to the extraordinary nature of the pressed-up ice, a roadway had to be formed by pickaxes for nearly half the distance travelled before any advance could be safely made, even with light loads; this rendered it always necessary to drag the sledge loads forward by instalments, and therefore to journey over the same road several times. The advance was consequently very slow, and only averaged about 1½ mile daily—in fact, much the same rate attained by Sir Edward Parry in his somewhat similar attempt during the summer of 1827. Although the distance made good was only seventy-three miles from the ship, 276 miles were travelled over to accomplish it. It is quite impossible for any body of men ever to excel the praiseworthy perseverance displayed by this gallant party in their arduous struggle over the roughest and most monotonous road imaginable. Their journey, considering the ever-recurring difficulties, has eclipsed all former ones.

The result of their severe labour is held to prove the impracticability of travelling over the Polar Sea to any great distance from land, and also that Baron von Wrangell was perfectly correct in his expressed opinion that before the North Pole can be reached it is first necessary to discover a continuous coast line leading towards it.

In addition to the despatch of the northern travellers, the coast line to the westward of the *Alert's* position was traced for a distance of 220 miles by a party under the command of Lieut. Aldrich; the extreme position reached was in lat. 82° 10' N., long. 86° 30' W., the coast line being continuous from the *Alert's* winter quarters. The most northern land, Cape Columbia, is in lat. 83° 7' N., long. 70° 30' W. The coast of Greenland was explored by travelling parties from the *Discovery*, under the command of Lieutenants Beaumont and Rawson; they succeeded in reaching a position in lat. 82° 18' N., long. 50° 40' W., seventy miles north-east of Repulse Harbour. The land extended as far as lat. 82° 54' N., long. 48° 33' W., but very misty weather prevented its character being determined with exactness. The coast is much cut up into fjords and land was seen to the north-east, probably reaching to 83°. Lieut. Archer, with a party from the *Discovery*, explored Lady Franklin Sound, proving that it terminates at a distance of sixty-five miles from the mouth, with lofty mountains and glacier-filled valleys to the westward. Lieut. Fulford and Dr. Coppinger explored Petermann Fjord, finding it blocked up with a low glacier, which extends across from shore to shore. With the exception of Hayes Sound the coast line of Smith Sound has now been explored from north to south. President Land, marked in recent maps in about 84° N., is proved to have no existence, though Lieut. Aldrich, when engaged in pioneering the way for the main party, which was led by Commander Markham, advanced three miles beyond Sir Edward Parry's most northern position,

and, from a mountain 2,000 feet high, sighted land towards the west-north-west, extending to lat.  $83^{\circ} 7'$ .

Ancient Eskimo remains were traced on the west side of Smith Sound up to lat.  $81^{\circ} 52' N$ . From that position the wanderers had evidently crossed the channel at its narrowest part to Greenland. The most diligent search was made further north, but no trace of them discovered.

Six musk oxen were shot at the *Alert's* winter quarters, and three half way between her position and that of the *Discovery*, while fifty-four were shot near Discovery Bay. The ermine was seen, and owls were found on the Greenland shore opposite the *Discovery's* quarters, the young on their appearance being mostly devoured by wolves. The remaining items in the *Alert's* game list at her northern station show seven hares and ninety birds of different kinds, the latter shot only in July. The birds certainly do not migrate beyond Cape Joseph Henry, lat.  $82^{\circ} 50' N$ . Very few besides those accounted for by the sportsmen passed the *Alert*. Very few seals were seen north of Cape Union, and no bears, dovekies, or looms, it is stated, ever reach the Polar Sea. Water animals were notably absent, and it is surmised that those that do visit the Arctic Sea come from the south. Among other birds visiting the country, but not advancing beyond the point mentioned, are the knots. Although no nests or eggs were found, the young in all stages of growth were obtained. Amongst the flora described by the parties from the *Alert*, were the saxifrage, sorrel, and dwarf oak, and late in the summer a few poppies were met with.

In the neighbourhood of the *Discovery's* winter quarters a seam of coal of good quality and readily worked, was discovered by Mr. Hart, naturalist; but, unfortunately, not before the present summer, otherwise it might have been of service during the winter, when the allowance of that article on board was necessarily kept as low as possible. Capt. Feilden obtained some fine fossil corals at the extreme northern hills. Very large collections of natural history subjects have been made by the naturalists, assisted by one and all of the officers and crew. The dredge and trawl were used on several occasions with great success. The observations on the physics and meteorology of the Arctic Regions are likely to prove of the greatest value when published. It will be remembered that during the stay of the *Polaris* in the north, the prevailing wind was from the north-east; during the present expedition scarcely any easterly wind was noticed at all, the prevailing wind, like the prevailing current, coming from the west.

All the *Polaris's* cairns were visited. At the boat depôt in Newman's Bay a box chronometer by Negus, New York, was found to be in perfect order after an exposure of four winters; it has since been keeping excellent time on board of the *Discovery*. Some wheat sent out in the *Polaris* in order to ascertain whether it would deteriorate when exposed to extreme cold, has been grown successfully under a glass shade by Dr. Belgrave Ninnis.

A magnificent series of photographs has been brought home, a selection of which will no doubt be published, and afford some idea of the strange scenery to be seen in these inhospitable regions.

Such is a brief summary of the results obtained by this latest Arctic expedition, but at what expense of hard work and suffering it is difficult for those who read the narrative to realise. The labour which had to be undergone would have been trying enough to perfectly healthy men, but unfortunately the dreaded scourge of Arctic explorers, scurvy, broke out among them. No expedition could have been better provisioned, but in spite of every precaution all the sledge parties suffered most severely. Notwithstanding this, every one worked determinedly and cheerfully. Only three seamen, however, died of scurvy, and only one death was the result of frost-bite, that of Niels Christian Petersen, the interpreter of the expedition.

The ice in the Polar Sea remained firm until July 20, when there was a movement, increasing with each tide. On the 31st the *Alert* succeeded in leaving her winter quarters, and, after many struggles with the ice, joined company with the *Discovery* on August 12. Lady Franklin Bay remained closed until the 20th, when, a chance occurring, both ships were pushed into the ice, and succeeded in crossing. After this date the same kind of battle and slow progress took place daily between the ships and the ice, as during the passage north every inch gained being of importance as the ice closed in the rear. As the season advanced, or rather slipped away, many were the fluctuations in the social barometers as hopes and fears rose and fell, for it was not until September 9, the very last of the season, that the mouth of Hayes Sound was crossed, and the expedition again rejoiced in "open water."

The *Alert* reached Valentia on the 27th ult., and both ships arrived at Queenstown on the 29th. On Monday they left for Portsmouth, where they arrived on Wednesday morning. "It goes without saying" that everywhere officers and men have had the heartiest welcome, though no heartier than they deserve.

#### OUR ASTRONOMICAL COLUMN

$\mu$  DORADUS.—This star, which was called a fifth magnitude by Lacaille at the end of 1751, and a sixth by Brisbane, was observed by Moesta from February, 1860, to January, 1861, of 8<sup>h</sup> 9<sup>m</sup>. or 9<sup>m</sup>. only. Perhaps one of our southern readers will put upon record the actual magnitude of this star, the period of which, as Moesta remarked, would appear to be one of considerable length. Position for 1877<sup>o</sup> in R.A. 5<sup>h</sup>. 5<sup>m</sup>. 52<sup>s</sup>., N.P.D.,  $151^{\circ} 58'$ .

SOUTHERN DOUBLE-STARS.—(1)  $\alpha$  Centauri.—Measures of the angle of position and distance of this star, taken in the course of the ensuing year or two, will materially contribute towards defining within narrow limits the elements of the orbit. Even in Powell's last orbit, which was founded upon measures to January, 1870, the peri-astron passage (1874<sup>2</sup>) is certainly too early, though each successive calculation of elements from Jacob's first has assigned a later date; it probably occurred in

(2)  $\gamma$  Eridani also deserves close attention from the astrometer in the other hemisphere. There must be a great change in angle since the epoch of the last-published measures. The position (1877<sup>o</sup>) is in R.A. 1<sup>h</sup>. 35<sup>m</sup>. 7<sup>s</sup>., N.P.D.  $146^{\circ} 49'$ .

THE INTRA-MERCURIAL PLANET QUESTION.—If in the general formula obtained by M. Leverrier, and given in last week's NATURE, we put  $k = -1$ , the solution, which gives for the sidereal period as referred to the node  $27^{\circ} 964$  days semi-axis major  $0.180$ , and synodical period  $30.282$  days, accords with Stark's observation on October 9, 1819, one of the most definite upon record, besides representing, as well as the solution with  $k = 0$ , the five data upon which M. Leverrier has relied in deducing the formula. In this case we have—

$$v = 285^{\circ} 76' + 12^{\circ} 873724j - 10^{\circ} 8 \cos v.$$

Stark's observation was published in his "Meteorologisches Jahrbuch," 1820. Under date, October 9, 1819, he says:—"At the same time there appeared, at a distance of  $12' 28''$  from the southern limb of the sun, and  $4' 58''$  from the eastern limb, a black, well-defined nuclear spot, which was perfectly round and of the size of Mercury. At 4<sup>h</sup>. 37<sup>m</sup>. this nuclear spot was no longer present, and I found also later on the 9<sup>th</sup>, as well as on the 12<sup>th</sup>, when the sun next came out, no trace of this spot." The observation was probably made about Augsburg, which was one of Stark's usual hours for the sun's disk—corresponding to October 8, at 23<sup>h</sup>. 11<sup>m</sup>. wick time. For this time the above formula gives  $v =$

and the earth's heliocentric longitude being  $15^{\circ}3'$ , the inferior conjunction of the assumed intra-Mercurial body with the sun would have occurred on the morning of Stark's observation.

**THE FOURTH COMET OF 1857.**—The best determined period of revolution of a comet, exceeding in length the period of the comet which appears to be associated with the August stream of meteors, is that of the fourth comet of 1857, discovered by Prof. C. H. F. Peters at Albany, U.S., on July 18, by Dien, at Paris, on the 27th, and by Habicht at Gotha, and Donati at Florence on the 30th of the same month. It was observed with the great refractor at the observatory of Harvard College till October 21. These dates include an interval of from about one month before to two months after the perihelion passage, or an arc on the orbit of  $145^{\circ}$ . A very complete discussion of the observations was made by Dr. Axel Möller, whose masterly investigations relating to the motion of Faye's comet have led to such accurate prediction of its apparent track in the heavens at recent returns; the period he assigns is 234.7 years. A similarly rigorous calculation led Dr. Hans Lind to a revolution of 243.05 years, and there are ellipses of nearly the same length of period by other computers.

If we examine the path of this comet through the planetary system we soon discover that it passes near to the orbit of Venus. Employing the elements of Axel Möller, a strict calculation shows that in heliocentric ecliptical longitude  $24^{\circ}54'$ , the distance between the two orbits is less than  $0.023$  of the earth's mean distance from the sun. It may therefore be reasonably concluded that it is to an actual near approach of the comet to Venus about this point that the present form of orbit is due. The comet's perihelion distance is  $0.747$ , the aphelion distance  $75.35$ .

### BIOLOGICAL NOTES

**POCK-LYMPH.**—The efficacy of pock-lymph has been attributed by several observers to the presence of small organisms of the nature of *Micococcus*. M. Hiller has recently studied this subject (*Centralblatt für d. Med. Wiss.*), and from 6,840 separate inoculations, he finds that the degree of activity of the lymph and the proportion of micrococci present do not correspond; on the one hand, the development of the organisms was often at its greatest when the action of the lymph was falling off, and on the other, lymph was often active, though no bacteria were perceptible in it. Fresh diluted lymph having been put in vertical tubes in a freezing mixture, and slowly thawed after freezing, the upper half gave on inoculation, 41.4 per cent. positive results, the lower half, 63.8 per cent. It appears from this that the poison is associated with the solid constituents more than with the liquid. Boiled lymph was, without exception, inoperative. The addition of 1 to 4 per cent. carbolic acid merely weakened the contagiousness of pock-lymph, while addition of glycerine left it unaltered. Strong dilutions weakened the action, while condensations exalted it; with evaporation, the percentage of favourable cases was increased about a half. In coagulated parts produced in the lymph, the active element was present in great quantity. Perfectly dried lymph is also active in high degree; hence we may infer that the communication of pox may occur by means of the crust and scurf of pustules which are rubbed off and float in the air. Inoculation with the blood of persons that were successfully inoculated proved inoperative; so also were the fresh contents of the bladders, seven days after inoculation. It is inferred that the cow-pox ferment is not contained in the blood, or not in the active state; and that very probably, also, the blood is not itself the seat of fermentation and reproduction of the poison.

**ALGOID SWARM-SPORES.**—If vessels of water containing algæ are placed in a room where they are lighted only on one

side, swarm-spores are generally found to collect at the side turned towards the window, more rarely on the opposite side. If they are present in considerable number, they often become arranged in peculiar cloudy forms; network, rays, tree-like branched figures, &c. The phenomenon has been frequently studied, and has been always regarded as an action of light, causing the living swarm-spores to move towards it or withdraw from it. After a long investigation of the phenomena, M. Sachs has come to a different conclusion. He considers that these groupings of zoospores are not phenomena of life, inasmuch as quite a similar process is found to occur with emulsions of oil in alcohol diluted with water; also that the light either does not at all participate in the action, or does so only indirectly, for all the phenomena may be reproduced in darkness. The accumulation of spores and the cloud-like figures are rather due to currents produced by differences of temperature in the water. M. Sachs's experiments are described in *Flora*, 1876, No. 16.

**DISEASES GERMINATED IN HOSPITALS.**—Several observers have remarked on the presence of globules of pus and microscopic algæ in the air and on the walls of hospitals. Some interesting facts of this order have recently been communicated to the French Société de Biologie, by M. Nepveu of the laboratory of La Pitié. A square metre of the wall of a surgery-ward, having been washed, after two years without washing, the liquid pressed from the sponge (about 30 gr.) was examined immediately after. It was somewhat dark throughout and contained micrococcus in very great quantity (fifty to sixty in the field of the microscope), some micro-bacteria, a small number of epithelial cells, a few globules of pus, some red globules, and lastly a few irregular dark masses and ovoid bodies of unknown nature. The experiment was made with all necessary precautions; the sponge employed was new, and carefully washed in water that was newly distilled. Facts like those referred to make it easy to comprehend how the germs of a large number of diseases occur in the air of hospitals, and how the latter may readily become centres of infection. The same conditions, though in less degree, may sometimes be met with in private life.

**MARINE MOSSES.**—M. Gisard lately showed to an audience at the Congress of learned societies at the Sorbonne, specimens of marine mosses growing on a madrepora placed in an aquarium, since January, 1872. They produce every year, in spring, phenomena of fructification, consisting of urns of a superb nacreous colour, growing at the ends of beautiful green filaments, then becoming detached and rising to the surface of the water. He cited the following fact as showing the vitality of certain marine plants. On May 13, 1875, a parcel of algæ which had been taken from an aquarium and dried several months in the sun, was placed in sea-water, and developed a magnificent green plant of ribbon form. In February and March, 1876, there were formed on the border of the ribbon sparse filaments carrying rounded urns of variegated colour, which became detached, and rose to the surface, giving rise to green plants.

**NOTES FROM ST. PETERSBURG.**—At the last meeting, October 18, of the Zoological Section of the St. Petersburg Society of Naturalists, Prof. Wagner gave some information as to his recent researches made in the Solovetsky Bay of the White Sea. The special aim of them was to throw some light on the causes which determine the use in certain organisms, as for instance the hydroids, of two different modes of reproduction, sometimes by gemmation, and sometimes with the help of special organs. Without coming to any decided conclusions (the researches having to be continued) M. Wagner pointed out, as one possible cause of this difference, the influence of different nutrition which generally so greatly influences the reproductive functions. M.

Cherniafsky, who has been many years engaged in the study of the fauna of the Black Sea, and now studies especially the influence of the media on organic forms, reported upon his numerous collections of animals from various depths, and traced in them the slow variations which animals of the same species undergo at different depths, and the appearance of new species with the increase of depth; the labours of M. Cherniafsky promise to be of great interest when published in full.

COLOURS OF ANIMALS.—At the last meeting of the St. Petersburg Entomologists' Society, October 16, M. Porchinsky reported upon some results on the exploration of a scientific party engaged last summer upon the exploration of the Caucasus. The southern limit of the region explored was the Steppe of Erivan, a plain covered with sand, with some patches of variously coloured clays appearing in the low hills. A remarkable feature of the animal inhabitants of the Steppe, insects and reptiles, and especially of the lizards, is the most perfect coincidence of their colouring with the colouring of the Steppe. The same thing was observed also in the Steppe of Elizabethpol. Interesting collections of the fauna made by the party were produced at the meeting.

### NOTES

DR. CARL JELINEK, the eminent and accomplished meteorologist, died at Vienna on October 19, after a protracted illness.

THE death is announced, on the 16th ult., of Dr. von Waltershausen, Professor of Mineralogy and Geology at Göttingen, where he was born in 1809. While young he travelled much, especially in Sicily and Iceland, making large mineralogical collections, which he presented to the university. He is specially known for his researches in connection with volcanic phenomena. During his later years he was engaged in a large work on the topography and orography of Etna.

PROF. H. J. S. SMITH'S valedictory address to the London Mathematical Society, on the 9th inst., will touch upon various points affecting the present state and prospects of pure mathematics.

THE popular German poet and mineralogist, Prof. von Kobell, has just celebrated, in Munich, the fiftieth anniversary of the day on which he was appointed extraordinary professor of mineralogy in that city.

DR. RÖNTGEN has been appointed extraordinary Professor of Physics in Strasburg University.

DR. CARPENTER, F.R.S., Secretary to the Gilchrist trust, has, for the special benefit of the Primary Teachers of the Metropolitan, arranged for a course of lectures to be given by Dr. Richardson, F.R.S., at St. Thomas Charterhouse Schools, on Human Physiology, and its application to daily life. The course will be opened on Friday, November 3, by Dr. Carpenter, delivering an address on a Sound Mind in a Sound Body.

WILLIAM CLARKE MILLER, B.A. Lond., vice-principal of Huddersfield College, has been elected Registrar of the General Medical Council of Education in the place of Dr. Erasmus Hawkins, resigned. The new Registrar has been long known as an able mathematician.

It is stated by the *Medical Press and Circular* that the Goldsmith's Company has voted a sum of 1,000*l.* to the Chemical Society to aid in the formation of the fund to be devoted to the promotion of original research in the science of chemistry.

M. WADDINGTON, the intelligent Minister of Public Instruction in France, has come to a most liberal decision on behalf of the Paris Observatory. According to the standing financial rules

used in France, no adjudicator of works executed in the public interest is entitled to be paid except when his task has been completed and received. As an exception, M. Leverrier is authorised to pay in advance to the opticians and philosophical instrument makers a sum amounting to one-third of the total value

instrument, which has been so delayed by the red-tapeism of the Finance Department, is almost finished, and observations will very shortly be inaugurated in the new pavilion which has been built on an improved scheme for its reception.

M. FEIL, the glass-worker of Paris, has just finished the casting of the crown-glass lens for the great Vienna refractor. The diameter is 28 inches and the weight 112 pounds. It will be sent immediately to Mr. Howard Grubb, of Dublin, who already possesses the flint lens.

THE course of lectures at the Sorbonne for candidates for the licence and pupils of the Normal Schools was opened a few days since. In former years the lecturers were confined to merely elementary subjects relating to mechanics, classics, astronomy, differential and integral calculus. But this year M. Bonnet lectures on the recent discoveries in high geometry, and M. Puiseux on a subject which has been largely discussed by men of science in England, the figure that the earth must have taken owing to its fluidity.

WITH exception of the schools of Paris, which rank among the first in the world, most of the faculties of sciences and letters in France (says M. Grad in *La Nature*) have only five professors. Now there were a hundred and thirty-five at the University of Berlin, seventy at the University of Königsberg, against three hundred and forty-eight in all the faculties of the fifteen academical divisions of France in 1870. The faculty of sciences and that of letters of Strasburg, more favoured than others, had then thirteen professors, against thirty-six in the faculty of philosophy and sciences of the present University. The University at present has a total of eighty professors (but among the five faculties of theology, law, medicine, philosophy, and natural and mathematical sciences. This year Prussia devotes to the maintenance of its nine universities 6,577,397 marks, of which 4,820,841 marks are furnished from the State Treasury. With regard to population, the expenditure per head of inhabitants is 0.70 fr. in Alsace-Lorraine, 0.12 fr. in France, 0.33 fr. in Prussia.

A COMMITTEE appointed by the Russian Government at the St. Petersburg Medical Academy to investigate various proposed antiseptics and disinfectants, have arrived at the following conclusions:—1. Carbolic acid is the most efficient means against the development of ammoniacal gas, putrescence, and development of lower organisms in organic matter under decomposition, and it is therefore the best antiseptic. 2. Vitriol, salts of zinc, and charcoal, are the best means for deodorising matter under putrefaction. 3. The powders of Prof. Kitary, besides the properties they share in common with other carbolic disinfectants, deserve attention because of the isolated state of phenol in them and their contents of quick-lime, which absorbs moisture—the principal condition of each kind of putrefaction—as also some part of the gases. 4. Chloride of lime and permanganate of potash quickly destroys the lower organisms in putrid liquids. 5. The disinfectants certainly retard the putrid processes in organic bodies, but their influence is only temporary, as a means of purifying the air in dwellings their influence is very small if not nil, because of the very small degree of concentration of their ingredients that can be used without injuring the health of inhabitants. 6. For uninhabited buildings the best disinfectants are nitrous acid and chlorine.

REFERRING to our recent correspondence on "Antedated Books," a correspondent calls attention to another evil practice that has of late years crept into the publishing trade, namely, that of publishing books without any date at all. Our correspondent mentions two firms that sin extensively in this respect; but there are several others, especially in what is known as the "number trade," who of *malice prepense* publish undated books. Such books are generally of small literary or scientific value, but circulate among a class who are generally unable to test their value. Of course the purpose of issuing undated books is evident; works half a century old may be palmed off on the unknowing as the genuine product of the current year.

We understand that Dr. A. Wojeikoff, of St. Petersburg, has arrived at Singapore from Batavia on his way to Japan, on what may be truly characterised as a meteorological tour, at his own expense, over the whole civilised world. The tour was begun upwards of seven years ago, when the greater part of Europe was visited, and after a return to and brief residence in Russia, was again resumed through the United States, extending as far as Manitoba, and thence southwards through South America, and onwards to the East India Islands. Those who have had the pleasure of meeting him know that this tour means a large amount of meteorological work, in the prosecution of which he has made prolonged sojourns in different regions with the view of familiarising himself practically with their meteorology and with the steps which have been taken towards its investigation. The training which this able meteorologist is giving himself well deserves our warmest commendation.

As being somewhat analogous to the above, it may be notified that Dr. Hamberg, meteorological assistant to Prof. H. Hildebrandsson, of Upsal University, is at present engaged on a year's tour through Europe for the purpose of familiarising himself with the systems of meteorological research pursued in different countries, funds for the purpose having been provided by the Upsal University. This is real professional education, and deserves to be carried out more extensively and in a more Catholic spirit than has yet been done by our British Universities.

We have received from Prof. Dove the *Monatliche Mittel für Druck, Temperatur, Feuchtigheit, und Niederschläge und fünfjährige Wärmemittel* for 1875. In addition to the usual meteorological results, this admirable annual serial gives the five-day means of temperature for the year and their departure from the means of the twenty years ending 1867, and the same for ten Austrian, thirteen Swiss, and twenty-four Italian stations, thus presenting in a clear manner the temperature conditions of Germany, and their relations to those of immediately surrounding regions during 1875. The results of the observations made at the Forest-stations of Bavaria and additional rain returns are also given, together with a most valuable *résumé* of the monthly amounts of rainfall observed at all stations in Germany during the past five years, and monthly and annual averages of rainfall calculated from all the past observations at each place as are available. The latitude, longitude, and height of the Austrian, Swiss, and Italian stations are stated, and we very earnestly hope that, with next issue, Prof. Dove will be able to give the data for his stations in Germany, the want of which is felt to be a serious omission in nearly all discussions of German meteorology.

In a paper in this month's Petermann's *Mittheilungen* Prof. H. Fritz treats of the Geographical Distribution of Hail. He refers to our comparative ignorance of the origin and peculiarities of the appearance of hail, of the want of long series of observations on the subject, and in those that do exist of the frequent confounding of hail and graupel—the balls of true hail having an icy structure, whereas the balls of graupel are only small

pellets of snow. The latter he shows falls in all latitudes and at all heights; while hail is mainly confined to middle latitudes. In high latitudes and in tropical valleys, hail is a rare phenomenon. Prof. Fritz brings together for comparison observations on the subject made in various quarters of the globe, the statistics being, as might be expected, fullest in the case of Europe. The following are some of his conclusions from these data:—He infers that hail occurs whenever the moisture of the atmosphere is precipitated in very great quantity as rain or snow, and that hail phenomena correspond to the amount of this excess of precipitation. With increase in latitude and in height the fall of graupel increases and that of hail decreases, while hailstones of large size are most frequent towards the equator. But since in the low lands of the tropics hail is little known, the regions of the most frequent and especially most destructive hailstorms belong to the middle latitudes, while in high and low latitudes hail-falls of large stones are exceptional. It appears then that no region in which an excessive rainfall occurs is secure against hailstorms, if only the height of fall is sufficient to allow of the formation of hail. In high latitudes and in high table-lands the vertical distances to the atmospheric strata with temperature below zero are small, and therefore more snow and graupel will fall than hail, while in middle and low latitudes this distance, especially in summer, is great enough to allow of the formation of large hailstones. North and south of the zone of calms the hail-fall becomes more frequent reaches its maximum between 40° and 60° of latitude. The currents of the atmosphere and the formation of the land-masses have also an influence on the distribution of hail. A satisfactory solution of the hail question can, however, only be obtained by complete series of observations, the details for each station being given separately, and the distinction between true hail and graupel being attended to.

THE German Society for Arctic Exploration (Bremen) has just heard from Drs. Finsch and Brehm. They speak of the most difficult part of their journey from the Ob to the Kara Sea through a hitherto quite unknown region, which they performed partly in boat, partly by reindeer, and partly on foot, over the Tundras. The knowledge obtained by the expedition in this region is an important contribution to the geography of West Siberia. The collections with reference to the ethnology of the Samoyeds and Ostiaks are especially valuable, as also the specimens of birds and fishes. The travellers expected to be home by the beginning of this month.

PROF. JAMES ORTON, of Vassar College, U.S., has nearly completed his preparations for the exploration of the river Beni, a little known tributary of the Madeira River, the largest affluent of the Amazon. Prof. Orton sums up the special objects of the survey as follows: 1. To solve some of the most interesting and important geographical problems of the day. 2. To search for the traces of the ancient military roads, probably built by the Inca Yupanqui when he invaded that region. 3. To open up the trade of the eastern slope of the Andes with the United States. In Prof. Orton's opinion, the search for the source of the Nile, while of not greater interest than that of the Beni, is of very much less commercial value.

In a paper on "The Climate Controversy," published in the two last numbers of the *Geological Magazine*, Mr. Searles V. Wood, jun., discusses the possible cause of the latest changes of climate experienced by the earth. The aim of Mr. Wood is less to advocate some special solution of the question than to insist on the difficulties which beset all the theories hitherto offered as a solution, and which are (1) a decrease in the original heat of our planet; (2) changes in the obliquity of the ecliptic; (3) the combined effect of the precession of the equinoxes and of the eccentricity of the earth's orbit; (4) changes in distribution



of land and water; (5) changes in the position of the earth's axis; (6) a variation in the amount of heat radiated by the sun; and (7) various temperatures of those regions of space through which the solar system has moved. Discussing each of them, Mr. Wood deals at greater length with the theory advocated by Mr. Croll, arriving at the conclusion that, although the influence of geographical conditions and currents is a powerful agent in modifying climate, nevertheless the cause of the Glacial period must have been a cosmical one; that the cold of this period seems to have fallen upon the earth while its axis was in its present position; and that nothing has yet been found to raise a doubt as to the glaciation of the northern and southern hemispheres having been synchronous. Mr. Wood inclines to admit that it is to the sixth suggested cause, a diminution in the heat emitted by the sun, that the probabilities incline. The discussion of the geological facts connected with the latest changes of climate is the main attraction of the paper of Mr. Wood.

CAPT. ALLEN YOUNG'S Arctic ship *Pandora* is back again, all well. It will be remembered Capt. Young went out to endeavour to communicate with the Arctic expedition, which he met on its road home.

Two shocks of earthquake were felt at Irkutsk and its neighbourhood, on August 31 at 10 P.M., and on September 4 at 1.30 A.M. Both extended over a large region, and the last was rather strong at Irkutsk.

Two earthquakes are reported as having occurred in Germany on October 14, the one near Kehl at 11 A.M., and the other at Schopfheim between 8.30 and 9 P.M. The former extended over Strasburg, Kehl, Kork, Auerheim, Zierolsbosen, Leutesheim, Linz, Diersheim, Rhein-Bischofsheim; the direction was apparently in a south-west-north-east direction. There were three or four shocks lasting about four seconds. The other earthquake was to the north of Schopfheim, at Neuenweg and Gresgen, and was of shorter duration than the former; the direction was apparently north-south.

THE African explorer, Eduard Mohr, writes to Dr. Nachtigal, under date August 28, of his arrival at St. Paul de Loanda. Within eight days he was to proceed to Malange, on the eastern limit of Angola, which he was to make his base of operations for an exploring journey to the northern interior.

IN the Geological Section of the Helvetic Society of Sciences, besides many interesting smaller communications, the following larger contributions to geological science were made:—The results of a thorough exploration of the earlier geological history of the Black Forest and of the Vosges, by Prof. Sandberger; the results of explorations in the Argovian Jura, by Prof. Muhlberg; the results of explorations by M. Mesch in the Bernese Alps, accompanied by a map of the mass of the Faulhorn and of its neighbourhood; a map on the scale of 1:250,000 of the glacial deposits of Switzerland, with full particulars as to the former extension of glaciers, their depths, slopes, &c., made by Prof. Favre; and a very detailed map, on a scale of 1:5,000, of the glacier of the Rhone, with all its moraines, moulins, crevices, &c., constructed by M. Gosser, at the charge of the Swiss Alpine Club.

AT the same meeting Prof. Sandberger presented his work "Land- und Süsswasser-Conchylien der Vorwelt." The terrestrial and fresh-water molluscs are described here in these geological succession, beginning from the oldest formations. Being very abundant in the Tertiary deposits, they have, as is known, much contributed to settle the classification of these deposits.

AT the *conversazione* of the Chester Society of Natural Science held last month, Mr. Cross exhibited some specimens of *Dioscorea rotundifolia* which had been grown in Mr. Siddall's

fern case, and which presented characters differing greatly from those of the typical plant. The axis had elongated considerably and bore a number of alternate leaves, quite green, with aborted tentacles, and several of them showing buds produced on the mid-rib. Some of the old leaves of the original plants placed in the case for preservation also exhibited the phenomenon last named.

WE have received from Dr. C. A. MacMunn an account of the method he proposes for measuring and comparing different spectra with the spectrum microscope. In order to overcome the difficulties due to the difference in the dispersion of different prisms, he proposes to look upon the distance between the Fraunhofer lines *B* and *E* as equal to 100, and to express the position of all bands in relation to this scale. We, however, think that it is very desirable not to multiply the already too numerous arbitrary scales of this kind, and would strongly advise him and all others who are studying this subject, to express their results in terms of wave lengths, since, as Mr. Sorby has argued, that system alone has a true physical basis.

THE Bethnal Green Museum is becoming just now a great centre of attraction to the multitudes from the numerous interesting collections illustrative of art and science now deposited together. The former speak to the eye for themselves, although the Secretary of the Department has taken care to provide admirable historical and descriptive cheap catalogues. But the scientific and industrial collections require more carefully prepared aids for study, and these are now being furnished by the Department in illustrated manuals, published at a cheap price, written by eminent authors, and on these no expense has been spared to make them thoroughly practical and useful treatises upon the subjects on which they treat. Messrs. Chapman and Hall, we are informed will publish immediately for the Council of Education and Department of Science, three of these works—“Food, its Chemical Constituents and Uses,” by Mr. A. W. Chunt, F.C.S., Professor at the Royal Agricultural College, Cirencester; “Economic Entomology,” by Mr. Andrew Murray, F.L.S., and “Animal Products, their Preparation, Commerce, and Uses,” by Mr. P. L. Simmonds.

THE additions to the Zoological Society's Gardens during the past week include a Cape Hyrax (*Hyrax capensis*) from South Africa, presented by Mr. J. M. Thornton; an Ocelot (*Felis pardalis*) from Honduras, presented by Mr. H. Fielding; two Norwegian Lemmings (*Lemmus norvegicus*) from Norway, presented by Mr. W. Duppa Crotch; a Common HANGNEST (*Literus vulgaris*) from South America, presented by Mr. J. T. Levett; an African Cobra (*Naja haje*) from South Africa, presented by the Rev. G. H. R. Fisk; a Vervet Monkey (*Cercopithecus talandii*) from South Africa, deposited; two Indian Cobras (*Naja tripudians*) from India, received in exchange; a Merin (*Hypotrichus cesalon*), European, purchased.

### SEXUAL SELECTION IN RELATION TO MONKEYS

IN the discussion on Sexual Selection in my “Descent of Man,” no case interested and perplexed me so much as the brightly-coloured hinder ends and adjoining parts of certain monkeys. As these parts are more brightly coloured in one sex than the other, and as they become more brilliant during the season of love, I concluded that the colours had been gained as a sexual attraction. I was well aware that I thus laid myself open to ridicule; though in fact it is not more surprising that a monkey should display his bright-red hinder end than that a peacock should display his magnificent tail. I had, however, at that time no evidence of monkeys exhibiting this part of their bodies during their courtship; and such display in the case of bird affords the best evidence that the ornaments of the males are of service to them by attracting or exciting the females. I have lately

read an article by Joh. von Fischer, of Gotha, published in *Der Zoologische Garten*, April, 1865, on the expression of monkeys under various emotions, which is well worthy of study by any one interested in the subject, and which shows that the author is a careful and acute observer. In this article there is an account of the behaviour of a young male mandrill when he first beheld himself in a looking-glass, and it is added, that after a time he turned round and presented his red hinder end to the glass. Accordingly I wrote to Herr J. von Fischer to ask what he supposed was the meaning of this strange action, and he has sent me two long letters full of new and curious details, which will, I hope, be hereafter published. He says that he was himself at first perplexed by the above action, and was thus led carefully to observe several individuals of various other species of monkeys, which he has long kept in his house. He finds that not only the mandrill (*Cynocephalus mormon*) but the drill (*C. leucophaeus*) and three other kinds of baboons (*C. hamadryas*, *sphinx*, and *babouin*), also *Cynopithecus niger*, and *Macacus rhesus* and *nemestrinus*, turn this part of their bodies, which in all these species is more or less brightly coloured, to him when they are pleased, and to other persons as a sort of greeting. He took pains to cure a *Macacus rhesus*, which he had kept for five years, of this indecorous habit, and at last succeeded. These monkeys are particularly apt to act in this manner, grinning at the same time, when first introduced to a new monkey, but often also to their old monkey friends; and after this mutual display they begin to play together. The young mandrill ceased spontaneously after a time to act in this manner towards his master, von Fischer, but continued to do so towards persons who were strangers and to new monkeys. A young *Cynopithecus niger* never acted, excepting on one occasion, in this way towards his master, but frequently towards strangers, and continues to do so up to the present time. From these facts von Fischer concludes that the monkeys which behaved in this manner before a looking-glass (viz., the mandrill, drill, *Cynopithecus niger*, *Macacus rhesus*, and *nemestrinus*) acted as if their reflection were a new acquaintance. The mandrill and drill, which have their hinder ends especially ornamented, display it even whilst quite young, more frequently and more ostentatiously than do the other kinds. Next in order comes *Cynocephalus hamadryas*, whilst the other species act in this manner seldomer. The individuals, however, of the same species, vary in this respect, and some which were very shy never displayed their hinder ends. It deserves especial attention that von Fischer has never seen any species purposely exhibit the hinder part of its body, if not at all coloured. This remark applies to many individuals of *Macacus cynomolgus* and *Cercopithecus radiatus* (which is closely allied to *M. rhesus*), to three species of *Cercopithecus* and several American monkeys. The habit of turning the hinder ends as a greeting to an old friend or new acquaintance, which seems to us so odd, is not really more so than the habits of many savages, for instance that of rubbing their bellies with their hands, or rubbing noses together. The habit with the mandrill and drill seems to be instinctive or inherited, as it was followed by very young animals; but it is modified or guided, like so many other instincts, by observation, for von Fischer says that they take pains to make their display fully, and if made before two observers, they turn to him who seems to pay the most attention.

With respect to the origin of the habit, von Fischer remarks that his monkeys like to have their naked hinder ends patted or stroked, and that they then grunt with pleasure. They often also turn this part of their bodies to other monkeys to have bits of dirt picked off, and so no doubt it would be with respect to thorns. But the habit with adult animals is connected to a certain extent with sexual feelings, for von Fischer watched through a glass door a female *Cynopithecus niger*, and she during several days, "umdrehte und dem Männchen mit gurgelnden Tönen die stark geröthete Sitzfläche zeigte, was ich früher nie an diesem Thier bemerkt hatte. Beim Anblick dieses Gegenstandes erregte sich das Männchen sichtlich, denn es polterte heftig an den Stäben, ebenfalls gurgelnde Laute ausstossend." As all the monkeys which have the hinder parts of their bodies more or less bright coloured live, according to von Fischer, in open rocky places, he thinks that these colours serve to render one sex conspicuous at a distance to the other; but as monkeys are such gregarious animals, I should have thought that there was no need for the sexes to recognise each other at a distance. It seems to me more probable that the bright colours, whether on the face or hinder end, or, as in the mandrill, on both, serve as a sexual ornament and

attraction. Anyhow, as we now know that monkeys have the habit of turning their hinder ends towards other monkeys, it ceases to be at all surprising that it should have been this part of their bodies which has been more or less decorated. The fact that it is only the monkeys thus characterised which, as far as at present known, act in this manner as a greeting towards other monkeys, renders it doubtful whether the habit was first acquired from some independent cause, and that afterwards the parts in question were coloured as a sexual ornament; or whether the colouring and the habit of turning round were first acquired through variation and sexual selection, and that afterwards the habit was retained as a sign of pleasure or as a greeting, through the principle of inherited association. This principle apparently comes into play on many occasions: thus it is generally admitted that the songs of birds serve mainly as an attraction during the season of love, and that the *leks*, or great congregations of the black grouse, are connected with their courtship; but the habit of singing has been retained by some birds when they feel happy, for instance by the common robin, and the habit of congregating has been retained by the black grouse, during other seasons of the year.

I beg leave to refer to one other point in relation to sexual selection. It has been objected that this form of selection, as far as the ornaments of the males are concerned, implies that all the females within the same district must possess and exercise exactly the same taste. It should, however, be observed in the first place, that although the range of variation of a species may be very large, it is by no means indefinite. I have elsewhere given a good instance of this fact in the pigeon, of which there are at least a hundred varieties differing widely in their colours, and at least a score of varieties of the fowl differing in the same manner; but the range of colour in these two species is extremely distinct. Therefore the females of natural species cannot have an unlimited scope for their taste. In the second place, I presume that no supporter of the principle of sexual selection believes that the females select particular points of beauty in the males; they are merely excited or attracted in a greater degree by one male than by another, and this seems often to depend, especially with birds, on brilliant colouring. Even man, excepting perhaps an artist, does not analyse the slight differences in the features of the woman whom he may admire, on which her beauty depends. The male mandrill has not only the hinder end of his body, but his face gorgeously coloured and marked with oblique ridges, a yellow beard, and other ornaments. We may infer from what we see of the variation of animals under domestication, that the above several ornaments of the mandrill were gradually acquired by one individual varying a little in one way, and another individual in another way. The males which were the handsomest or the most attractive in any manner to the females would pair oftener, and would leave rather more offspring than other males. The offspring of the former, although variously intercrossed, would either inherit the peculiarities of their fathers, or transmit an increased tendency to vary in the same manner. Consequently the whole body of males inhabiting the same country, would tend from the effects of constant intercrossing to become modified almost uniformly, but sometimes a little more in one character and sometimes in another, though at an extremely slow rate; all ultimately being thus rendered more attractive to the females. The process is like that which I have called unconscious selection by man, and of which I have given several instances. In one country the inhabitants value a fleet or light dog or horse, and in another country a heavier and more powerful one; in neither country is there any selection of the individual animals with lighter or stronger bodies and limbs; nevertheless after a considerable lapse of time the individuals are found to have been modified in the desired manner almost uniformly, though differently in each country. In two absolutely distinct countries inhabited by the same species, the individuals of which can never during long ages have intermigrated and intercrossed, and where, moreover, the variations will probably not have been identically the same, sexual selection might cause the males to differ. Nor does the belief appear to me altogether fanciful that two sets of females, surrounded by a very different environment, would be apt to acquire somewhat different tastes with respect to form, sound, or colour. However this may be, I have given in my "Descent of Man" instances of closely-allied birds inhabiting distinct countries, of which the young and the females cannot be distinguished, whilst the adult males differ considerably, and this may be attributed with much probability to the action of sexual selection.

## SCIENTIFIC SERIALS

THE *Bulletin de l'Academie Impériale des Sciences de St. Pétersbourg*, t. xxii., No. 1, contains the following papers of scientific interest:—On the absorption of carbonic acid by sulphuric acid and its mixtures with water, by J. Setchenow.—On tartronic acid, by N. Menshutkin.—On ethyl- and methylsuccinimid, by the same.—On the geological age of the North-Caucasian Jura coal sandstones, and on natural saltpetre occurring in the same in the valley of Kuban, by H. Abich.—On diethyl-methylacetic acid, a new isomeric variety of cœnanthylic acid, by M. E. Idanow.—On the formation of buds in *Equisetum*, by Prof. A. Famintzin.—Observations made at the astronomical observatory of the Academie des Sciences de St. Petersburg, by A. Sawitch.

*Journal de Physique*, September.—M. André here investigates the subject of diffraction in optical instruments and its influence on astronomical observations. He shows that the diameter of Venus and Mercury during transit must always be less than in ordinary conditions of observation, and less by day than by night, with an instrument of the same aperture; also that it is less, the smaller the aperture of the instrument, the variation being equal to the difference of constants of instrumental diffraction of the instruments employed.—It is known that sulphur affects two incompatible crystalline forms, the right octahedron with rectangular base, and the symmetrical oblique prism. M. Gernez specifies the circumstances in which they are produced without intervention of any solvent.—M. Igoroff gives a description, with figure, of his differential electro-actinometer, an instrument for determining the co-efficients of absorption of ultra-violet rays by different substances.—M. Lecoq de Boisbaudran describes the physical properties of gallium. *Inter alia*, even a few degrees under its point of fusion + 29°·5, it is hard and remarkably tenacious for a metal so fusible; it can be cut, however, with a knife. It crystallises with great facility. The spectrum got by passing the spark in a saline solution, has two violet lines, the brighter with wave length 4170, the other 4031. In gas flame the former is hardly observable. The density is 4·7; the equivalent, not yet quite fixed, seems to be near the number deduced from the position of gallium between iodine and aluminium.

*Sitzungsberichte der naturwissenschaftl. Gesellsch. Isis in Dresden*, July to December, 1875.—In this number will be found an interesting account of the Auckland Islands, by M. Hermann Krone, of the German Transit Expedition. The copper-bearing strata of Lake Superior, a potato exhibition at Altenburg, in October, Dr. Dohrn's zoological station at Naples, and an instance of lightning with a clear sky, are among other subjects treated; there are also a few archaeological papers.

## SOCIETIES AND ACADEMIES

## PARIS

Academy of Sciences, October 23.—Vice-Admiral Paris in the chair.—The following papers were read:—Theorems relating to systems of three segments forming a constant length, by M. Chasles.—Remarks on a critique of Dr. Boué on the theory of trombes, by M. Faye. The gyration of the base of a trombe is generally too rapid to be perceived; but on reaching the ground or the sea, a quantity of dust or of water-droplets is raised by the escaping air, and passes obliquely before the trombe, with a perceptible slow movement. The spectator may by mistake attribute this motion to the trombe itself, and conclude that the trombe pumps the water (e.g.) up to the clouds. The trombe's motion is really a descending gyratory one.—(On the order of appearance of the first vessels in the aerial organs of *Anagallis arvensis*, by M. Trécul.—Report to the Academy on the works of M. Francis Garnier, naval lieutenant. M. Garnier died about three years ago. His travels in China have had important results. The Minister of Public Instruction, on the recommendation of the Academy, has appointed an annual pension of 1,200 francs to be given to his widow.—Note on electric effluves, by M. Boillot. To obtain the dark effluves the conducting tubes for the electricity should be sufficiently apart to prevent any phosphorescent glow in the darkness. M. Boillot describes some modifications of his apparatus.—On determination of the depth of the sea by means of the bathometer, and without use of a sounding line, by Dr. C. W. Siemens.—On the industrial applications of phosphuret of copper and phosphorised bronze, by MM. de Ruolz, Montchal, and De Fontenay. Of two bells presented to the Academy, one made with phosphuret of copper in proportion of  $\frac{1}{100}$  gave sounds much superior in acuteness, intensity, and timbre, to those

of the other bell, which was of an ordinary bronze (78 copper, 22 tin). Its composition was also more homogeneous. By reducing the proportion of phosphorus to a few thousandths, red copper may be cast in sand without its physical properties being sensibly altered as regards industrial use. A bronze alloy with the proportion of  $\frac{1}{1000}$  of phosphorus, sustains friction well, and can be indefinitely recast without appreciable loss industrially.—On the cure of hypertrophic elongation of the neck of the uterus by igneous utero-vaginal myotomy, by M. Abeille.—On the industrial preparation of nitro-glycerine, by MM. Boutmy and Faucher. (This note was in a sealed packet, deposited in August, 1872.) In the ordinary manufacture the reaction liberates much heat, which tends to decompose the nitro-glycerine formed. The authors first make sulpho-glyceric acid treating glycerine at 30° with three times its weight of sulphuric acid at 66°; and sulpho-nitric acid by mixing equal weights of sulphuric acid at 66° and nitric acid at 48°. Then these two acids are united, giving a mixture like this: glycerine, 100; nitric acid, 280; sulphuric acid, 600. The rise of temperature is then limited to 10° or 15°. The reaction is finished in about twenty-four hours. The nitro-glycerine forms in a distinct layer above the acids, from which it can be separated by decantation.—Report on experiments made, in several communes of Charente, with a view to destruction of phylloxera, by M. Boutin. To succeed well with sulpho-carbonate of potassium, alone or with water, or with coal-tarred sulphur carbonate, the operations should be done in October, November, or even December (if not too cold), then again from March till the end of May.—On a general proposition of the theory of conics, by M. Halphen.—On the effects of eddies observed in water-courses, by M. Bouquet de la Grye. If there be poured into a glass vessel first a dense liquid like aniline, then water, then oil, and the upper liquid be put in rotation with paddles, a central depression forms at the surface of the oil; a cone of the liquid descends in the centre, while a protuberance of niline rises from the bottom. A similar action of the eddies in rivers accounts for the raising and removal of sand, and the form assumed by the river's bed. And the movement of liquid threads in a river-bend may be compared to that in the vessel, taking as centre the successive points of the convex bank, and as border the concave part. There are vortices with horizontal axes also. The author thinks that by suitable dams, &c., the *vis viva* of the water might be utilised for deepening the channel.—On the laws of vibratory motion of tuning-forks, by M. Mercadier. The duration of the period of vibratory motion, increases or diminishes with the amplitude. This variation, even for considerable amplitudes of 1 cm., is very small, and extends only to the fourth figure. If a certain limit, which may be fixed at 4 min., be not exceeded, the duration of the period may be regarded as constant.—On the electrical apparatus of the torpedo, by M. Rouget. A histological description

## CONTENTS

	PAGE
THE ARCTIC EXPEDITION . . . . .	1
SCHIMPERK'S "MOSSES OF EUROPE" . . . . .	2
OUR BOOK SHELF:—	
Rutherford's "Outlines of Practical Histology" . . . . .	4
Dale's "Study of the Rhatic Strata of the Val di Ledro in the Southern Tyrol" . . . . .	4
LETTERS TO THE EDITOR:—	
"Geographical Distribution of Animals."—V. BALL . . . . .	5
European Polygalas.—ALFRED W. BENNETT, F.L.S. . . . .	5
The Solidity of the Earth.—W. MATTHEW WILLIAMS . . . . .	5
Are We Drying Up?—JOSEPH JOHN MURPHY . . . . .	6
Antedon rosaceus ( <i>Comatula rosacea</i> ).—W. K. HUGHES, F.L.S. . . . .	7
Caterpillars.—I. A. OSBORNE . . . . .	7
Electro-Capillary Phenomena.—DR. P. HIGGS . . . . .	7
THE CAPERLAITZIE IN NORTHUMBERLAND. By W. TOPLEY . . . . .	7
NEWTON ON FORCE. By P. T. MAIN . . . . .	8
PRINCIPLES OF TIME-MEASURING APPARATUS, IV. By H. DENT . . . . .	9
GARDNER ( <i>With Illustrations</i> ) . . . . .	9
THE RESULTS OF THE ARCTIC EXPEDITION ( <i>With Map</i> ) . . . . .	16
OUR ASTRONOMICAL COLUMN:—	
Doradus . . . . .	14
Southern Double-Stars . . . . .	14
The Intra-Mercurial Planet Question . . . . .	14
The Fourth Comet of 1857 . . . . .	15
BIOLOGICAL NOTES:—	
Pock-Lymph . . . . .	15
Algod swarm-Spores . . . . .	15
Diseases Germinated in Hospitals . . . . .	15
Marine Mosses . . . . .	15
Notes from St. Petersburg . . . . .	15
Colours of Animals . . . . .	16
NOTES	
SEXUAL SELECTION IN RELATION TO MONKEYS. By CHARLES DARWIN, F.R.S. . . . .	18
SCIENTIFIC SERIALS . . . . .	20
SOCIETIES AND ACADEMIES . . . . .	20

THURSDAY, NOVEMBER 9, 1876

## FUNGUS DISEASE OF INDIA

*The Fungus Disease of India: a Report of Observations.*  
By F. R. Lewis, M.B., and D. D. Cunningham, M.B.  
(Calcutta: Government Printing Office, 1875.)

FEW questions are more perplexing than the relations of fungi to different diseases to which the animal world is subject. On the one hand the most exaggerated and ill-founded theories have been put forth, which have tended to cause the most senseless alarm, while on the other hand their agency has been altogether denied, or if at all allowed, restricted to subjects already in a depressed state of health, and therefore as merely availing themselves of a fitting nidus for their development. The truth probably lies between the two extremes, and if the analogy of the vegetable kingdom be allowed to have any weight, it is difficult, after what we know of the propagation of the potato-murrain by means of zoospores in perfectly healthy individuals, to deny the possibility of infection without a previous morbid state. The advocates, indeed, of these views, at once cut off all argument by the assertion that the potato-plant, by reason of long propagation by means of tubers, has become essentially unhealthy, but the same might be asserted of members of the animal kingdom subject to disease, as indeed is the case with that to which silkworms fall victims, by reason of inoculation with the spores of *Botrytis bassiana*. The real point, however, is whether even in unhealthy subjects, fungi merely find a proper nidus for their growth, or whether they may induce disease in these subjects, and no question in pathology can be conceived of greater importance. It at least seems quite certain that a gangrenous state of wounds may arise from the access of fungoid germs from the air, and that proper means to prevent their access, or to destroy their vitality, are effectual.

The work, therefore, which bears the title given above, is of unusual interest, relating as it does to one of the most formidable maladies to which the human frame is subject, and it demands very patient observation, as the authors have not only paid the greatest attention to questions of the kind, having had a special preparation for such investigations before entering upon their study, but, what is unfortunately of too great rarity amongst persons who have written on such subjects, are thoroughly acquainted with the nature of that part of the vegetable kingdom which is called in question.

It is not necessary here to describe the peculiar features of the disease, which would take us far beyond our limits, farther than to state that it appears under three different forms, in one of which black sclerotoid bodies of various sizes, from a grain of sand to a small walnut, excavate hollows in the bones, or are ejected with various sanious matters from the wounds, and it is to this form that the observations have a special relation. In the article in the *Intellectual Observer*, Nov. 1862, by the writer of this notice, which was founded on observations communicated by Dr. H. J. Carter, it is stated that the figure *d*, p. 256, represents the natural state of the red fungus, *Chionophye Cuvieri*, springing from particles of the black fungus

scattered over rice paste. It should seem, however, that there is some doubt about this as our authors deny that the *Chionophye*<sup>1</sup> has ever been raised from the black fungus. It is at least certain that all attempts of our authors to raise it from the Sclerotoid mass have failed, and it is supposed that the *Chionophye* was an accidental growth from macerated specimens of fragments of either the black or pink form of the disease. It is doubtful whether any great weight can be laid on the pink colour. Nothing is more common in this country than for pink spots to occur on paste or decaying fungi, and these pink gelatinous specks are capable of propagation, as is also the case with the bright blue specks which occur in similar situations, as I have myself proved, and of which I preserve specimens. The so-called blood-rain belongs to the same category. Unfortunately it has not yet been proved that these bodies are capable of development into higher forms. The real point is whether these sclerotoid bodies are really of a fungoid nature at all, a point which is worthy of mature consideration.

And here our authors very properly call attention to the fungoid forms which appear in the myeline of Virchow. The observations are so important that it is well to give them textually:—A development of myeline is especially prone to occur where portions of the fatty matter, roe-like masses, &c., freshly removed from an alcoholic preparation, are subjected to the action of liquor potassæ. The multifarious and highly complex forms of tubes, filaments, globules, and cysts, which may frequently be observed to become developed, shooting out and, as it were, growing from the globules and aggregations of fatty matter, are wonderful, and such that they could hardly be believed to owe their origin to any such process or material, were not their development distinctly traceable through all its stages.

“From the extremely organised nature of their appearance they are, as the accompanying figure will show, peculiarly liable to be mistaken for fungal growths, especially by those who are unused to the practical study of such bodies and to the various appearances presented by complex oily bodies, and it is necessary that very great caution should be exercised in the interpretations of such phenomena.”

This is clearly of the utmost importance, and cannot be too thoughtfully considered. The calcospherites of Prof. Harting, the concretions of Mr. Raines, and the curious specimens of dentine exhibited at Norwich, in 1868, so similar to cellular tissue as to deceive the most instructed who were not acquainted with their origin, belong to the same class of bodies.

We are not surprised, then, after these considerations, the futile attempts to raise the *Chionophye* from the Sclerotoid bodies, and the mode of origin of the fungus in other cases, that our authors have arrived at the conclusion that the Fungus-foot of India is not due to any fungus growth.

The roe-like bodies which occur in the pale variety of the disease are shown to be fat in various modified forms; the pink particles were determined to be pigmented concretions, while the black masses consist of degenerated tissues mixed to a greater or less extent with black pig-

<sup>1</sup> The genus *Chionophye*, it should be observed, does not grow on snow, but on wheat, or other vegetables that have been buried under snow.

ment and fungoid filaments. These fungoid filaments would not be coaxed by any treatment into the development of fruit, and their nature, therefore, must still remain doubtful.

Our authors conclude that it is more reasonable to infer that localised spots in the tissues undergo a degenerative change into a substance peculiarly adapted to the development of filamentous growths, the origin of which, in situations where no spore could penetrate, must remain matter of perplexity.

M. J. BERKELEY

### THE ADMINISTRATION OF PATENT LAWS IN ENGLAND

*Abstract of Reported Cases relating to Letters Patent for Inventions.* By T. M. Goodeve, M.A. Barrister-at-Law, and Lecturer on Applied Mechanics at the Royal School of Mines. (London: Henry Sweet, 1876.)

THE subject of the Patent Laws of this country which is now upon its trial, is one which largely affects the interests of scientific men in almost every branch of research, for in a great majority of cases a patent is the only channel through which the inventor of a good thing, which may confer inestimable benefits upon mankind, has any chance of being remunerated.

There is, at the present time, great diversity of opinion upon the question whether the Patent Laws should exist at all or be abolished, and there is also a diversity of opinion among men of science whether a scientific invention designed for scientific purposes ought to be patented, or freely given to the world. It is universally admitted, however, that some mode of rewarding the individual whose ingenuity and perseverance have enabled him to discover a new invention ought to be in existence; but, until some better system than that of patents is established the laws must be dealt with as they are. With regard to purely scientific inventions it is impossible to draw a hard and fast line between those useful alone to science and others upon which large commercial industries may be built. It often happens in the course of scientific research that an idea is struck upon, which, while aiding the immediate inquiry, is at the same time the solution of some great commercial problem, out of which fortunes may be made. The history of the science of Chemistry alone abounds with innumerable instances of the truth of this, and assuredly the original inventor ought to share in benefits derived from what could not have existed apart from his discovery.

The principle of patents is in itself good, because it provides that the reward of the inventor is regulated by and is proportionate to the utility of the thing invented, and to the amount of benefit derived from it by the community and, at the same time, that reward is at the expense of that portion of the public who use the invention, and not, as in alternative schemes, at the cost of the public at large. The carrying of that principle into practice, however, is beset with so many difficulties, and the administration of the laws relating to it is so very defective, that a patent which is worth anything, can only be maintained at the cost of endless litigation, which often swamps all possible profits, and with a few exceptions lands the inventor in a large sum out of pocket.

Much of this would be saved if inventors had a more accurate knowledge of the Patent Laws, and knew something of the principles upon which they are administered in the tribunals of the land. Many a patent is taken out for an invention which is legally disqualified from being the subject-matter of a patent, and every day letters of patent are being granted for things which have been invented and patented over and over again. They are never refused on this ground, and the mischief is not discovered until the expenses of an action at law have been incurred.

Prof. Goodeve's work, though not a treatise on the Law of Patents, gives to the reader a remarkably clear insight into that law and its administration, by enabling him to understand the reasons which must guide a court or jury in their decisions upon patent cases.

From the vast medley of reported cases scattered throughout the archives of the Courts, the author has made a selection of abstracts chosen with great judgment on account of the characteristic nature of the principles involved, and, by the omission of all matter extraneous to those principles, has put forward the real points at issue in a very prominent and instructive manner. In each case the essential pleadings are given, and the inventions are described as nearly as possible in the language of the specification. The claims are stated, with the evidence adduced in their support at the trial, and both the direction of the judge and the finding of the jury are given in a clear and condensed form.

Many of the cases quoted in Prof. Goodeve's book involve points of high scientific interest; and, apart from its obvious value as a work of legal reference, it will be found to be a useful handbook to the inventor, and not without some considerable interest to the general scientific reader.

C. W. C.

### LETTERS TO THE EDITOR

*[The Editor does not hold himself responsible for opinions expressed by his correspondents. Neither can he undertake to return, or to correspond with the writers of, rejected manuscripts. No notice is taken of anonymous communications.]*

#### Sumner's Method at Sea

IN NATURE for August 24 you were good review, in very favourable terms, Sir William recently published book of tables for facilitating Sumner's Method of navigation. Since then you republished an attack on that method by the Astronomer Royal, which he made in the form of a letter to Prof. Stokes, after Sir William Thomson had communicated to the Royal Society the plan upon which his tables are based. Will you allow me, as one who took an active part in preparing Sir W. Thomson's book for publication, and who has had a good deal of practical experience of his method, to endeavour to reply shortly to the criticisms of the Astronomer Royal?

In publishing Sir G. B. Airy's letter, Prof. Stokes appended a note which was really a complete answer to the objections brought forward, and this was further enforced by remarks made by Sir W. Thomson in a second communication to the Royal Society (*Proc.*, June, 1871). As, however, the subject was but briefly treated in these communications, and the Astronomer Royal's letter has been republished at his own request, it may not perhaps be useless to go into the question in somewhat greater detail.

After stating the geometrical conditions under which the Sumner line, or *locus* of the ship's position is obtained from a single observation of altitude and time, the Astronomer Royal points out the very obvious truth that the accuracy of the position of the line depends on the accuracy with which Greenwich time can be

reckoned from the ship's chronometers; that the Sumner line will have been drawn east or west of its true position according as the chronometer is slow or fast. He then adds:—

"And the question now presents itself, which uncertainty is the greater—the uncertainty of latitude, which it is the real object of this problem to remedy? or the uncertainty of the chromometric longitude, which must be used in attempting to find the remedy? I do not doubt the reply of every practical navigator, that the chromometric longitude is far more uncertain than the latitude; and if it be so, the whole method falls to the ground."

Now this passage can only mean that Sumner's Method, while correcting one uncertainty which exists in the ordinary plan of working out rights, introduces another and a greater uncertainty, and so does more harm than good. Unless it means this, the question which uncertainty is the greater is completely beside the point. The statement, however, is wrong in both particulars. Sumner's Method does not remove uncertainty as to latitude, it only limits and defines that uncertainty to the extent which the data allow, and it introduces no new uncertainty whatever. Every other method of working out an observation of altitude and chronometer time gives results which are uncertain as to longitude for just the same reason and to just the same extent as are these given by Sumner.

The ordinary usage, for which Sir W. Thomson desires to substitute Sumner's Method, and with which he contrasts it in showing the superiority of the latter, is to estimate, by dead-reckoning or otherwise, the latitude, and then to compound this information with that derivable from the observation so as to obtain a knowledge of the longitude, and thus be able to say that the ship is at such and such a point. Now this operation is mathematically equivalent to drawing separately the Sumner line for the observation, and an east and west line through the estimated latitude, and then taking as the position of the ship the point in which these two lines meet. The result obtained is precisely the same in both cases, but the second plan has the great advantage that each piece of information is exhibited on the chart independently of the other, so that either may be made use of before the other is acquired. As Prof. Stokes says, "it is hard to suppose that the mere substitution of a graphical for a purely numerical process could lead a navigator to forget that he is dependent upon his chronometer."

That Sumner's Method supplies a means of exhibiting for each observation "*precisely what that observation gives, neither more nor less*" (to use Prof. Stokes' words), is its chief though not its only claim to adoption. The ordinary practice of navigators produces, indeed, results which have a greater show of precision, but the show is fallacious, for the data are not there to warrant it; in Prof. Huxley's forcible phrase, it is a grinding of wheat-flour from pease-pods. The question in a word is this: Shall we prefer the ordinary usage, which quietly ignores two causes of uncertainty, to a method which, while it necessarily leaves one of these still untouched, keeps the other constantly in view, and limits it as far as the case admits? J. A. EWING

### Sea Fisheries and the British Association

PROF. NEWTON has kindly sent me a copy of his address to the Biological Section of the British Association at their recent meeting at Glasgow. It contains much interesting matter, and like the addresses delivered by others to the same body in former years, was no doubt listened to with the respect due to the scientific attainments of the author.

It is with very great regret, therefore, that I feel it necessary to dispute the accuracy of some of Prof. Newton's ideas, and to point out that my friend made a very important mistake when, towards the close of his address, he spoke of "the falling off in our sea fisheries," and of the Royal Commission of 1863, to which I was secretary, having been appointed "to seek a remedy for it." It was not ascertained then that there was any falling off in our sea fisheries, nor is such known to be the case at the present time. I say this advisedly, because Prof. Newton was evidently not speaking of unsuccessful fishing in any one year owing to that frequent cause of failure—bad weather—but of a general decrease in the supply of sea fish. The Royal Sea Fisheries Commission to which he refers, was appointed in 1863, in consequence of the clamour of the line fishermen of Sunderland and of the adjacent coasts against the North Sea trawlers, who, it was alleged, were doing their best to ruin the fisheries by the wholesale destruction of spawn and young fish; but who, it appeared, after full inquiry had been made by the Commission, had committed the great crime of landing large

quantities of fish in the local markets, and of underselling the local fishermen. The object of the gentleman who represented the complainants of the Sunderland fishermen to Parliament was specially to inquire into the effects of beam-trawling, and the Commission when at work was popularly known as the "Trawling Commission;" but the Government, finding a great deal of interest taken in the fisheries generally, thought it desirable to extend the inquiry into the state of all the sea fisheries around the United Kingdom, and it consequently became the most comprehensive investigation of the subject that had ever been made.

The following were the points the Commissioners were instructed to inquire into, as stated in the Commission:—

"1. Whether the supply of fish from the sea fisheries is increasing, stationary, or diminishing.

"2. Whether any of the methods of catching fish in use involves a wasteful destruction of fish or spawn, and, if so, whether it is probable that any legislative restriction upon such a method of fishing would result in an increase in the supply of fish.

"3. Whether any existing legislative restrictions operate injuriously upon any of such fisheries."

The conclusion arrived at on the first point by the Commissioners—and I would call Prof. Newton's special attention to it—is thus stated in their report:—

"The total supply of fish obtained upon the coasts of the United Kingdom has not diminished of late years, but has increased; and it admits of further augmentation to an extent the limits of which are not indicated by any evidence we have been able to obtain."

It is desirable to call attention to the important fact that the above conclusion arrived at by the Commissioners was not based on newspaper reports—the common foundation of the frequent alarms about the sea fisheries—but on careful and laborious examination of the fishermen in their own towns and villages, of fishmongers, fishing boat builders, market and railway returns, and every kind of evidence that could be obtained which bore on the question of the supply of sea fish, and the condition of those persons who were dependent on it for their livelihood.

On the second point of the inquiry the conclusion was that any legislative restrictions on the methods of fishing would result in a decrease in the supply of fish.

And on the third point, the Commissioners stated that they found the existing regulations complicated, confused, and unsatisfactory; many regulations, even of late date, were never enforced; many would be extremely injurious to the interests of the fishermen and of the community if they were enforced; and with respect to these and others, the highest legal authorities were unable to decide where, and in what precise sense, they were operative.

As Prof. Newton started under the false impression that the Commissioners were appointed in order to seek some remedy for a falling off in our sea fisheries, it is not, perhaps, surprising that he did not clearly apprehend the meaning of their conclusions, although I should have thought that anyone reading them with ordinary care could hardly fail to do so. He says: "That Commission reported in effect that there was nothing to be done with our sea fisheries but to leave them alone." There is a despairing tone about this which would be very depressing if an examination of the Report did not result in showing that the Commissioners deprecated any interference with our sea fisheries for the simple reason that their produce was not falling off, but was increasing. They recommended, however, the removal of all vexatious and useless restrictions, and they advised a strict enforcement of such regulations as would prevent the interference in particular cases of one kind of fishing with another kind, and as would conduce generally to the maintenance of order on the fishing grounds.

Such are the facts of the case; and I cannot help thinking that if Prof. Newton had given a little more attention to the subject before he delivered his address to the British Association, he would scarcely have expressed himself in the terms in which he did on that occasion. Such statements and opinions from a person in his position, and addressed to a body like the British Association, can hardly fail to have considerable weight with those who heard or read about them; but more practical mischief is likely to result when they are repeated to the fishermen themselves, by keeping them in a continual state of apprehension lest the Government should interfere with their work. Such was the very general fear around the coast when the last Commission began its work, and one of my most difficult and constant duties in connection with the Commission was to satisfy the fishermen that the desire of the Government was to promote the success

of the fisheries by every means in their power, and to impose no restrictions or regulations upon them which were not clearly consistent with that object. I have neither time nor inclination again to deal with all the old arguments which year after year have been brought forward to show that our sea fisheries are being ruined. It is not quite two years since I entered at some length into the subject in my work on "Deep-sea Fishing and Fishing-boats," and the question is not one that can be discussed in a few lines, or even pages. But I may ask Prof. Newton how he reconciles his belief in a falling-off in the supply of sea fish with the recent considerable enlargement of Billingsgate Market, the continued immense fish traffic on the railways, and the large additions which have been made, and are now being made, to the capital invested in fishing-boats and gear? Brixham alone has added twelve new large trawlers, costing nearly 1,200*l.* each, to her fleet in the present year; and the shipwrights there were hard at work on several more for other stations when I visited the place last month. Prof. Newton rightly calls science to the aid of the sea fisheries, for there is still an immense deal to be learnt about the economy of fishes which may help the fishermen in their work. He makes no reference, however, to the important discoveries which have already been made by Professors Sars and Malm on the coast of Norway. The investigations of the former naturalist especially, carried on for several years, have resulted in showing that there need be little fear of disturbing the "spawning beds" of most of our edible sea fishes, as the spawn of almost all those in chief request is not deposited on the bottom, but floats during the whole process of development.

I will not enter into the question of destroying the balance of nature, on which Prof. Newton laid so much stress in his observations at Glasgow, because I believe we are all too ignorant of the conditions affecting it to be able to do more than theorise on the subject; but I would ask my friend, assuming he is correct in his belief that our sea fisheries are falling off, whether he has considered the probable effect on them and on the balance of nature, of the tens of thousands of additional gulls, guillemots, &c., which I hope will result from our sea birds being undisturbed during the breeding season, under the Sea Birds' Protection Act, of which he was such an earnest advocate?

I do not know on what evidence he grounds his belief in the decline of our sea fisheries; but I have no hesitation in saying, as the result of my inquiries during the last few years, that the average annual produce of those fisheries has considerably increased since the Royal Commissioners were engaged in inquiring into their general condition. Bad weather has had an important effect in some years in interrupting the fishermen's work; but fluctuations from such causes have continually occurred, and they will undoubtedly happen again.

E. W. H. HOLDSWORTH

#### Mr. Wallace and his Reviewers

I DID not intend to take any public notice of reviews or criticisms of my book on "Geographical Distribution"; Mr. Gill's letter, however, calls for a few remarks. I have first to thank him for pointing out the errors of a previous critic, and also for a list of *errata* in the account of North American freshwater fishes. He very truly remarks, that had I been acquainted with ichthyology and its literature these errors might have been avoided; but he has overlooked the fact that I have twice stated (vol. i., p. 101, and vol. ii., p. 168) that the part of my work relating to fishes is, practically, a summary of Dr. Günther's Catalogue. The labour of going through such an extensive work for the purpose of extracting and tabulating summaries of the geographical materials it contains, was very great, and no doubt I have made some errors. Most of those indicated by Mr. Gill depend, however, either on differences of classification and nomenclature, or on additions to North American ichthyology since the date of Dr. Günther's work, and are therefore due to the plan of this part of my book, and not to oversight. Although possessing a tolerable acquaintance with the literature of ornithology, I had found the task of collating and combining the latest information into a uniform system of classification and nomenclature to be one which severely taxed whatever knowledge and literary ability I possessed. To have attempted to do the same thing in a class of animals which I had never studied would, I felt sure, have resulted in great confusion, and have been far less satisfactory and reliable than the course I have adopted. Had I been able to find any work giving a general account of the fishes of temperate North America, I

should gladly have availed myself of it, but I do not gather from Mr. Gill's letter that any such work exists; and notwithstanding the great imperfection of the results (in the eyes of a specialist) as regards the fishes of the United States, I still think I exercised a wise discretion in confining myself to the vast mass of materials, classified on a uniform system, which Dr. Günther's Catalogue affords.

I may here add, that the "24 peculiar genera" mentioned by me are in addition to the "5 peculiar family types"—making together the "29 peculiar genera" referred to in the succeeding paragraph—so that the contradiction alluded to by Mr. Gill is only apparent.

ALFRED R. WALLACE

Dorking, October 30

#### Self-fertilisation of Plants

IN NATURE, vol. xiv. p. 475. I find an abstract of Mr. Meehan's paper on the "self-fertilisation" of *Browallia elata*. When I first saw this paper in the *Proceedings* of the Philadelphia Academy of Natural Sciences, I suspected that the observation was incomplete and the inference hasty. It is therein stated that the densely bearded connectives of the upper anthers completely close the tube of the corolla with a bearded mass; that "no insect can thrust its proboscis into the tube except through this mass; and if it has foreign pollen adherent to it, it will be cleaned off by the beard; for here, moreover, the very act of penetration will thrust the anthers forward on to the pistil [meaning stigma], and aid in rupturing the pollen-sacs [opening the anther cells?] and securing self-fertilisation." My dissection of the flower showed that the orifice of the tube was clearly pervious on the (morphologically) anterior side by a chink, which is nearly divided by a crust of the tube into two orifices, one exactly before each anther-cell; a hog's bristle, slightly moistened, on being thrust down these passages in a freshly open flower, and then withdrawn, was found to have the inserted part well supplied with adherent pollen, so that it was *not* "cleaned off by the beard," nor was it cleaned off by introduction into the orifice of a second flower.

As to self-fertilisation being brought about by the thrusting of the overhanging anthers down upon the stigma, this seems to be effectually prevented by the lodgment of these anthers in a pair of cup-like concavities at the back of the stigma, so as to keep them quite away from the actual stigmatic surface. It is obvious that if insects ever self-fertilise *Browallia* it is by carrying down upon their tongue or proboscis some pollen from the upper anthers; but in this operation, passing from flower to flower, they are quite as likely to cross-fertilise them. The blossoms are freely visited by *Hymenoptera* and *Lepidoptera* of various sorts. It is quite probable that the other cases of "self-fertilisation" brought forward by Mr. Meehan may equally bear a different interpretation from his own.

ASA GRAY

Cambridge, Mass., U.S.A.

#### Nitrite of Amyl

MR. GEORGE ARYARCH, of Cincinnati, asks of me through the columns of NATURE two questions concerning the nitrite of amyl, which I may briefly answer as follows:—(1) Nitrite of amyl has been used, and with considerable success, in the treatment of epilepsy, but its application can only be entrusted to a regular practitioner of medicine who understands its mode of action. (2) It has not as yet been proved to be of service in the treatment of paralysis.

B. W. RICHARDSON

#### CAPT. NARES'S REPORT<sup>1</sup>

H.M.S. *Alert*, at Valentia,  
October 27, 1876.

SIR,—I have the honour to report in detail the proceedings of the Expedition since leaving Upernivik on July 22, 1875, as follows:—

The *Alert* and *Discovery*, one ship in tow of the other, left Upernivik, from which port I last had the honour of addressing you, on July 22, 1875.

A dense fog prevailing at sea I steamed to the northward, between the islands and the main land, experiencing clear and calm weather until arriving near Kangitok

<sup>1</sup> Communicated by the Lords Commissioners of the Admiralty.

Island, when the fog, stealing in from the sea, gradually obtained the mastery, and completely enveloped us. The numerous picturesque rocky islands and reefs in this sheltered labyrinthine passage are so incorrectly represented in the public charts that a pilot is at present a necessity. The one who accompanied us, an Esquimaux, informed me that many of the likely-looking channels are bridged across with sunken reefs, and from the many rocks we saw lying just awash directly in our passage, I have reason to believe his statement.

The large discharging Upernivik Glacier having only one outlet leading direct to the sea, its numerous icebergs of all sizes are collected in great numbers by the eddy tides and currents among the islets situated to the southward, and tend to keep the channels completely closed until late in the season; but when once open in July by some of the bergs grounding on rocks, and others, by their height above the flotation line, affording certain evidence of deep water, they assist rather than impede navigation during calm weather. On the morning of the 23rd, after an anxious night, passed with a dense fog and a strong tidal current in a narrow channel, in which we could obtain no bottom with 100 fathoms of line at a cable's length of the shore, and with the *Discovery* in tow, during a momentary clearance of the atmosphere, two Esquimaux in their kyacks were observed close to us. After consulting with them through Christian Petersen, Danish and Esquimaux interpreter, they volunteered to conduct us to an anchorage. On following them to the position they denoted, and obtaining no bottom with the hand-lead line at the main chains, I felt the bow of the ship glide slowly up on the ground. Through the fog we could then see that the land was within fifty yards of us. The Esquimaux had evidently not considered that our ships required a greater depth of water to float in than their own frail canoes. As it was nearly low water, and the tide still falling, I allowed the ship to remain quiet where she was, the *Discovery* still hanging to us by her towing hawser, and took advantage of the enforced delay by landing the ships' companies to wash their clothes.

The fog lifted slightly as the day advanced, and as the tide rose the ship floated without having incurred any strain or damage whatever. I then proceeded to sea, discharging the pilot, who was not to blame for our mishap, off the north shore of Kangitok, the outlying island of the group, after passing which the channel presents no difficulties.

Thinking that probably a distorted account of our getting on shore might reach Europe, at the last moment I wrote a hasty pencil letter to Capt. Evans, hydrographer, merely to point out how very unimportant the slight detention had been.

By 4 P.M. we had passed the Brown Islands with a sea perfectly clear of ice before and around us. Having given much study and consideration to the question, and a high and very steady barometer following a south-east wind, denoting that the calm settled weather we had lately enjoyed was likely to continue, I decided to force my way through the middle ice of Baffin's Bay instead of proceeding by the ordinary route round Melville Bay. Accordingly both ships proceeded at full speed to the westward, racing in company for Cape York, with only about a dozen icebergs in sight ahead, floating quietly on a calmly mirrored sea to dispute our passage. As we passed out from the land the fog gradually dissolved and revealed a magnificent and unique panorama of the ice-capped mountains of Greenland which give birth to the Upernivik Glacier, fronted by innumerable icebergs, and, at a long distance in advance, by the group of scattered black islets among which we had passed the previous night, and of which Kangitok is the northernmost.

At 1.30 A.M. of the 24th we ran into the pack at a distance of seventy miles from Kangitok. It consisted of open-sailing ice from one to three feet, and occasionally

four feet in thickness. The floes were at first not larger than 250 yards in diameter, and very rotten, dividing readily, and opening a channel when accidentally struck by the ship. The reflection in the sky near the horizon denoted that while the ice was very open to the southward of us, it was apparently closer packed to the northward. About 6 A.M., when we had run thirty miles through the ice, it gradually became closer, and the floes larger, estimated as measuring one mile in diameter, and necessitated a discriminating choice to be made of the best channels. For fourteen hours, during which time we ran sixty miles, the ice continued in much the same state, never close enough to suggest the probability of a barrier occurring, and yet keeping the look-out in the "Crow's Nest" fully employed. After 8 P.M. the channels of water became decidedly broader and more numerous, so I gradually altered course to the northward, steering directly for Cape York, the ice becoming more and more open as we advanced.

At 9.30 A.M. of July 25 we sighted the high land north of Cape York, and at 11 o'clock, much to the astonishment of the ice quartermasters, who continually declared, "It will ne'er be credited in Peterhead," we were fairly in the "north water," and able again to think about economising coal, having come through the middle ice in thirty-four hours without a check; but it is my duty to add, with not a few scratches along the water-line.

In consequence of our having made a successful voyage through the middle it should not be too hastily concluded that a similar passage can always be commanded. The middle pack is justly dreaded by the most experienced ice navigators. Large icebergs and surface-ice, floating in water at various depths, when affected either by wind or an ocean current, move at different rates; hence, when in motion, as one passes the other, the lighter surface-ice, incapable of controlling its course, is readily torn in pieces by the heavy massive iceberg; therefore, a ship once entrapped in pack ice among icebergs, unless she has water space to allow her to move out of the way, is constantly in danger of being carried forcibly against a berg. On such occasions man is powerless, for he can take no possible means to save his vessel. Before steam-vessels were used for ice navigation the masters of sailing ships, being unable to take full advantage of a favourable calm, very wisely seldom ventured to force their way through the middle ice, and chose, in preference, the chance of delay in making the safer passage through Melville Bay, where, by securing their vessel in dock in the fixed land ice, they ran less danger of being nipped whilst forcibly detained by the channels through the ice remaining closed.

At the latter end of July with an open season, indicated by the main pack not being met with nearer than fifty miles from the land, in about latitude  $73^{\circ} 20'$  and a continuous calm, to allow the northerly running current on the Greenland shore and the southerly running one on the western side of Baffin's Bay to open up the ice, I believe a passage can always be made by a steam-vessel; but, unless this favourable combination of circumstances is met with, so far as the scanty knowledge we at present possess enables us to judge, the passage must still be said to be doubtful.

Soon after sighting land and getting clear of the drift ice, the *Discovery* parted company to communicate with the natives at Cape York, while the *Alert* proceeded towards the Carey Islands. A vast collection of icebergs, many of them aground, were thickly crowded together off the Cape, and in lines parallel with the coast trending towards Conical Rock and Cape Atholl. In the offing they were less numerous, which I attribute to the southerly current which we experienced the following day on our passage to the Carey Islands, catching up and carrying with it to the southward those that drift out from the main body to the westward beyond the influence of the north-running current on the Greenland coast.



During the stay of the *Discovery* at Cape York the natives were communicated with through Christian Petersen, interpreter, and Hans the Esquimaux, but as the brother of the latter was absent on a hunting excursion for an uncertain period, Capt. Stephenson wisely gave up the hope of obtaining his services for the benefit of the expedition, and pushed on for the Carey Islands, where he joined company with the *Alert*; the two ships arriving there at midnight on July 26.

A depôt of 3,600 rations and a boat were landed on the south-east point of the south-east island, and a record deposited in a conspicuous cairn on the summit. The "Expedition" then proceeded, steaming with as much economy of coal as possible, northward through a calm sea, with bright clear weather. With the exception of the many scattered icebergs there was no ice in sight from the summit of Carey Islands. Passing between Hakluyt and Northumberland Islands, the ships were becom of Cape Robertson, by 8 P.M. of July 27. Ice apparently fast to the shore, completely closed Inglefield Gull, east of Cape Acland, but both entrances to the gulf were clear. At 8 A.M. of July 28, five days and a half from leaving the anchorage of Upernivik, I had the satisfaction of seeing the "Expedition" at anchor near Port Foulke, with the entrance of Smith's Sound perfectly clear of ice, and none coming to the southward with a fresh northerly wind.

While Capt. Stephenson explored the head of Foulke Fiord to ascertain its suitability as a station for winter quarters for any relief vessel coming to our assistance, Commander Markham and myself proceeded in a boat to Littleton Island and Life Boat Cove, the scene of the wreck of the *Polaris*. The cache mentioned by Dr. Emil Bessels and Mr. Bryant of the "United States North Pole Expedition" as the depository of certain instruments and boxes of books was very readily discovered, but contained nothing. Articles of clothing and numerous small caches containing seal and walrus meat were scattered about all over the small peninsulas in the neighbourhood of the late winter quarters, and near the ruins of the house, but apart from each other and without any protection, were found four or five boxes, each covered with heavy stones to prevent the winds moving them, and having the lids secured on by a rope. Besides one thermometer, unfortunately not a self-registering one, they contained scraps of skin clothing, old mitts, carpenter's tools, files, needles, and many small articles of the greatest use to the Esquimaux, but apparently they had not been disturbed since the abandonment of the station. A few books were found in the different boxes, and a copy of the log, or the actual log itself, from the departure of the vessel from the United States up to May 20 the following year. No pendulum, transit instrument, or chronometer was found. Three skin boats left on the shore, weighted down with stones, were in fair order. The smallest one was taken for conveyance to Cape Sabine.

On returning to the *Alert* we landed at Littleton Island, and on the south-west brow erected a cairn, and deposited a notice containing a short account of the movements and prospects of the expedition up to that time. There was no ice in sight from a high station on Littleton Island; but the sportsmen roaming over the higher grounds on the mainland reported on their return that they had distinguished an "ice-blink" to the northward.

Port Foulke is at present the best known station for winter quarters in the Arctic regions. A warm ocean current, combined with the prevailing northerly winds, acting at the narrow entrance of Smith's Sound, keeps the ice constantly breaking away during the winter, causes an early spring and a prolific seal and walrus fishery. The moisture and warmth imparted to the atmosphere by the uncovered water moderates the seasons to such an extent that the land is more richly vegetated, and therefore attracts to the neighbourhood and supports Arctic life in greater abundance than other less favoured locali-

ties. In addition to this great advantage—of obtaining an ample supply of fresh meat—connected as its waters are with the "north water" off Cape York, it can readily be communicated with every summer without more than the usual risks attending Arctic navigation.

On the morning of the 29th the two ships sailed across the strait for Cape Isabella, with fine weather; but as we approached the western shore a snow storm worked its way over the land from the interior, and reached us just as we arrived at the Cape. As the weather was so thick that no one on board the ships, except those employed in establishing the cairn and small depôt of provisions, could see its position, and there being therefore no reason for delaying the *Discovery*, Capt. Stephenson proceeded. The cairn was built on the summit of the outer easternmost spur of the Cape, at an elevation of about 700 feet from the water. On the boat returning on board at 5 P.M., I steamed to the northward for Cape Sabine, the wind having died away, but the weather continuing misty with snow. By 8 P.M., when we were fifteen miles north of Cape Isabella, ice was sighted between us and the shore, and necessitated our keeping well out from the land.

Early in the morning of July 30, having run our distance for Cape Sabine I stopped steaming, and at 5 A.M., the mist clearing off, I observed the *Discovery* near the land apparently beset with a close pack five or six miles broad; no ice in sight to seaward. As I did not wish the two ships to separate, and the calm weather being favourable, I bored through the pack, which, although apparently close, opened sufficiently to admit of the slow progress of the ship until we gained the land in company with the *Discovery*, and secured the ships in a convenient harbour, named after Lieut. Payer, the successful and energetic Arctic traveller, two miles to the southward of Cape Sabine. A depôt of 240 rations was established on the southernmost of the islets in a convenient position for travelling parties, a cairn being built on the summit of the highest and outer one, and a notice of our movements deposited there.

The pack in the offing consisted of floes from 5 to 6 feet thick, with occasionally much older and heavier floes 10 to 12 feet thick intermixed with it, but all was very much decayed and honeycombed; still it could not be treated with the same impunity as the ice in the middle passage through Baffin's Bay.

I may here draw attention to the deceptive impressions inexperienced people naturally receive when from a lofty look-out station they observe a sea unbordered by ice. The distance from Littleton Island to Cape Sabine is only twenty-five miles. On a clear evening, from an altitude of 700 feet, with the land and horizon distinctly visible, no ice was in sight from the first-named place, and the prospects of the expedition as to attaining a higher latitude without trouble appeared to be precisely the same as when I looked over a boundless sea from the summit of one of the Carey Islands 100 miles to the southward, and yet the ships were twenty-four hours afterwards locked up by ice in a harbour near Cape Sabine. From Littleton Island the inexperienced observer would conclude that there was an open Polar Sea; from our present position he would as certainly conclude that his farther progress was for ever stayed, and that the sooner he looked for winter quarters the better.

The ships were detained at Payer Harbour for three days watching for an opening in the ice, getting under weigh whenever there appeared the slightest chance of proceeding onwards, but on each occasion being unable to pass Cape Sabine, were forced to return. Their resting-place proved to be an excellent station, well protected against the entrance of heavy floes, possessing a lofty look-out, and deep navigable channels to the north and south through which to proceed to sea immediately the ice opened with a favourable westerly wind. Being ad-

vantageously situated near a prominent Cape, where the tidal currents run with increased velocity, it is however subject to squally winds; but in icy seas during the summer, when awaiting the opening of the ice, they are rather an advantage than otherwise, striving as they do with the sea currents, which is to be the chief worker in removing the impediments to a vessel's advance.

Early in the morning of August 4, after several hours of light south-westerly winds, the main pack, while remaining perfectly close and impenetrable to the northward, moved off from the land to a sufficient distance to enable the ships to pass to the westward round Cape Sabine. In the hope of finding a passage on the western side of the island, of which Capes Victoria and Albert are the prominent eastern points, sail was immediately made, and we succeeded, with only one short detention, in advancing twenty miles along the southern shores of Hayes Sound, and securing the ships in a snug harbour. In the neighbourhood the sportsmen discovered a richly vegetated valley with numerous traces of musk-oxen and other game. Two glaciers coming from nearly opposite directions, which, instead of uniting in their downward direction, abut the one against the other, and maintain a constant warfare for the mastery, a never-ending grapple for victory, suggested the name of Twin Glacier Valley for the locality.

The ice in the sound was one season old, and decaying so swiftly that if not drifted away it would in a week's time present no impediment to the advance of a steam vessel. On August 5 the strong tides and a south-westerly wind opened a channel to the north-west, and we gained a few miles in advance; but not wishing to expend much coal, were finally stopped in the light pack. After remaining sufficiently long to determine that the flood tide still came from the eastward, although the ebb or east running tide was apparently the stronger of the two, I pushed the ship through the pack towards the shore, and with Capt. Stephenson ascended a hill 1,500 feet high. From this station, the appearance of the land giving no prospect of a channel to the northward, and, moreover, the westerly wind having set in in strength, which we expected would open a passage to the eastward of Cape Albert, we decided to bear up and return to the entrance of the Sound; accordingly the ships made a quick run under sail to Cape Albert, arriving off which the wind died away leaving the ice loosely packed. A clear space of water being visible along the shore of the mainland to the northward, and the coast between Cape Victoria and Cape Albert affording no protection, I ran the two ships into the pack under steam, with the hope of forcing our way through, but before midnight they were hopelessly beset; and the floe, to which the ships were secured at a distance of 100 yards apart, drifting rapidly towards an iceberg. Both ships were at once prepared for a severe nip, the rudders and screws being unshipped. At first the *Discovery* was apparently in the most dangerous position, but the floe in which we were scaled up by wheeling round, while it relieved Capt. Stephenson from any immediate apprehension, brought the *Alert* directly in the path of the advancing mass, which was steadily tearing its way through the intermediate surface ice. When only 100 yards distant the iceberg, by turning slightly, presented a broader front to the approaching ice, which then accumulated in advance of it to such an extent as to fill up the angle, and form, as it were, a point or bow of pressed-up ice, sufficiently strong to itself divide and split up the floe, and act as a buffer in advance of the berg; and this it did in our case most successfully, our floe breaking up into numerous pieces. The ship herself escaped with a very light nip, and, sliding past the side without accident, was finally secured in the water space left in the wake of the iceberg by the faster drift of the surface ice.

The next twenty-four hours were spent in a constant

struggle towards the shore through the pack, which fortunately consisted of ice seldom more than 4 feet in thickness, with occasional pieces up to 12 feet thick, formed by the over-riding and piling up of ordinary floes, and then cemented together by a winter's frost; the worn down round-topped ice hummocks on these were from 6 to 8 feet above the water-line. The icebergs, evidently derived from inferior glaciers, were from 20 to 40 feet in height above water, and 100 yards in diameter.

Owing to the unsteady wind and the variable tidal currents we were unable to remain for long in any one pool of water—either the iceberg turned round and carried us with it to the exposed side, before we could change the position of the hawsers by which we were secured; or the pack ice, which was readily acted upon by the wind, drifting back the opposite way with any change, closed up the water space. Securing the ships in a dock in rotten ice in the presence of so many icebergs, was not advisable, and also would have carried the ships deeper into the pack to the southward. There was, therefore no alternative before me but to get up full steam and dodge about as best we could, taking instant advantage of every change in our favour. The ships were seldom separated for long, and now as on all other occasions, they mutually assisted each other. The *Discovery* was handled by Capt. Stephenson and her officers in the most masterly and daring manner, combined with great judgment, qualities essential in arctic navigation. She, as well as the *Alert*, ran not a few hairbreadth escapes. Once in particular when in following us through a closing channel between an iceberg and heavy floe-piece, before getting quite past the danger she was caught and nipped against the berg, and had it not been for a fortunate tongue of projecting ice would certainly have had all her boats on the exposed side ground away from her. Fortunately, the moving ice pushed her clear, much in the same manner as it had done the *Alert* the previous day.

Having less beam than the *Alert*, and a finer bow, with the very great advantage of an overhanging stem, the *Discovery* is better adapted for forcing her way through a pack. It will be difficult ever to efface from my mind the determined manner in which, when the bluff-bowed leading ship had become imbedded in the ice, which by her impetus against it had accumulated round and sunk under her bows, and a great quantity by floating to the surface again in her wake, had helplessly inclosed her abaft, the *Discovery* was handled, when advancing to our rescue; having backed some distance astera, for the double purpose of allowing the *débris* ice from a former blow to float away and for the vessel to attain distance sufficient for the accumulation of momentum with which to strike a second, coming ahead at her utmost speed she would force her way into the ice burying her bows in it as far aft as the foremast, the commanding officer on the bowsprit, carefully conning the ship to an inch, for had the ice not been struck fairly it would have caused her to cannon off it against ourselves with much havoc to the two. From the moment of the first impact the overhanging stem necessarily caused the ship's bow to rise 3 or 4 feet as she advanced from 12 to 20 feet into the solid floe and imbedded herself before the force of the blow was expended, and as the ship's way was stopped, the overhanging weight, by settling down, crushed the ice down still further ahead. Frequently on these occasions her jib-boom was within touching distance of the *Alert's* boats! But after a little experience had been gained, such confidence had we in each other that there was not the slightest swerving in any one. Floes up to 4 feet in thickness, and in a soft state, that is melting, not freezing, may be charged with advantage, thicker or harder ice had better be left alone. It speaks well for our chronometers, and the manner in which they are secured, that their rates were little effected by the frequent concussions on this and on many after occasions.

By 8 A.M. on the morning of the 8th we had succeeded in reaching the land water off Cape Victoria, having sustained no more serious damage during this severe trial than sprung rudder heads, consequent on the frequent necessity of going full speed astern; all heartily glad to be out of the pack ice. The two islands marked on the chart, on the authority of Dr. Hayes, as existing in the entrance of Hayes Sound are, as originally represented by the present Admiral Inglefield, in reality joined; the three capes named by the latter, north of Cape Sabine, are very prominent headlands, and readily sighted from a ship's deck from any position north of Littleton Island. There is no sign of an inlet along the very slightly indented coast line between his Cape Camperdown and Cape Albert. His Princess Marie Bay is the inlet north of the land in the middle of the sound, but whether that be an island or a peninsula remains to be determined; and his Cape Victoria is evidently one of the headlands on the present Grinnell Land.

It is necessarily an unthankful office to find fault with our predecessors; but navigators cannot be too careful how they remove from the chart names given by the original discoverers, merely because during a gale of wind a bearing or an estimated distance is a trifle wrong; and when the corrector or improver is also himself considerably wrong, and in fact produces a more unreliable chart than the first one, he deserves blame. The names given to the headlands undoubtedly discovered by Admiral Inglefield should not have been altered by Doctors Kane and Hayes, each of whom published very misleading delineations of the same coast.

It is as yet uncertain whether Hayes Sound is a channel or not. The flood tide coming from the eastward, the apparent continuity of the western hills, and the absence of berg pieces or heavy ice high up the sound, would lead to the supposition that it was closed; but considering the general configuration of the neighbouring land and the fact that the ebb or east running tidal current was stronger than that during the flood—but this the westerly wind might have occasioned—and the numerous Esquimaux remains which are usually found in channels, there seems no reason why we may not reasonably expect the existence of a narrow opening leading to a western sea. The very decayed state of the ice would be the natural result either from strong tidal currents in a long fiord or the increased strength of the ebb tide occasioned by an inlet set from the Polar Sea.

On passing what is called on the chart Cape Victoria, Commander Markham landed to ascertain the state of the ice, but a very thick fog and snowstorm coming on he was obliged to return. The ships were secured to the floe in Princess Marie opening which consisted of the last season's ice which had not cleared out: it was very much decayed but sufficiently strong to prevent our forcing our way through it—and in fact when pressing in with the flood tide it became so compact that at one time the ship was in danger of being driven on shore. At high water it opened and we succeeded in crossing the bay and securing the ships to the land ice in Franklin Pierce Bay on the southern shore of Grinnell Land.

On the morning of August 9, after depositing a record in a small cairn erected on a spur of the limestone hills, 200 feet above the sea, on the west side of the bay, one and a half miles east from Cape Harrison, we gained three miles of easting; but, being unable to round Cape Prescott, were compelled to make the ships fast to an extensive floe extending from that cape to Norman Lockyer Island, which stopped all further progress. Franklin Pierce Bay, which is about three miles broad and two and a half deep, and in which we found an unbroken smooth floe of one season's ice, is protected from any heavy pressure by Norman Lockyer Island and the Walrus Shoal, situated one mile further to the eastward; it is therefore a fit position for winter quarters. But, as far as we could

judge during our short stay, there is very little game procurable in the neighbourhood. The shoal was so named in consequence of the numerous ancient remains of Esquimaux found on the island, who, by the number of bones found lying about, had evidently subsisted principally on these animals. At present this neighbourhood may be considered as the northern limit of their migration, only a very few having been seen farther to the north. The comparatively sluggish tidal motion at the entrance denotes that the coast lies out of the main run of the stream, and if so, Princess Marie opening will probably prove to be merely a deep inlet. In the extended basin of Smith's Sound the southerly current and the tidal streams run in a direct line between Cape Frazer and Cape Isabella, producing eddies and accumulating the ice in any open water space on either side of that course.

August being proverbially a calm month in the Arctic seas, and the western mountains protecting the coast from winds blowing off the shore, the ice is inclined to hug the land, and, except during strong westerly winds, a large amount of patience must be exercised by any one striving to advance to the northward. The pack in the offing in the main channel consisted principally of old floes which did not clear out of the sound during the previous season, mixed with light one-season ice, formed in Kennedy Channel and its numerous bays, and in Hall's Basin. Amongst these were scattered numerous icebergs discharged from the Humboldt Glacier, and the few smaller ones on the eastern shores, and here and there a heavy blue-topped hummocky floe of ancient ice from the Arctic basin, but of unknown thickness. By the scarcity of these the main drift of the northern ice is apparently in some other direction.

During the fortnight we were delayed in this neighbourhood, in the middle of August and the height of the Arctic summer, a constant watch was kept on the pack, and as often as possible from high elevations, from which we were able to distinguish even the eastern shore, with its glacier and heavy barrier of fringing icebergs. Although small openings were seen occasionally, I am satisfied that north of Cape Sabine it was at no time navigable to the smallest extent, and that any vessel which endeavoured to force a passage through the middle ice here, where it is drifting steadily towards an ever narrowing opening, as many have succeeded in doing the more open sea of Baffin's Bay, would decidedly be beset in the pack and be carried with it to the southward.

We were delayed near Walrus Shoal for three days, unable to move more than a mile in any direction, until August 12, when, during a calm, the ice set off shore with the ebb tide, and allowed us without much trouble to steam past Cape Hawks, and between it and Washington Irving (or Sphinx) Island—a very conspicuous landmark—but here the ice prevented any further movement, the flood tide closing in the channel by which we had advanced. A large depot of 3,600 rations of provisions was landed on the northern side of Cape Schott, and a notice of our progress deposited in a cairn on the summit of Washington Irving Island. Two cairns were found there, but they contained no documents, and were much too old to have been built by Dr. Hayes in 1866, the only time any traveller has journeyed past the position.

On the western shore of Dobbin Bay there is no shelter obtainable, and the tides run with much greater rapidity than off the coast farther to the westward. During the next ebb tide, August 13, after blasting a passage through a neck of ice, I succeeded in conducting the ships to the eastern shore, and docking them in an extensive floe four miles north-west of Cape Hilgard. A mile north of our position was an island, having a channel half a mile broad between it and the eastern shore of the bay, named Prince Imperial Island. The land ice which had not broken out this season extended from the island in a

westerly direction across the bay. Several small icebergs were frozen in at the head of the bay, where there are some large discharging glaciers named after the Empress Eugénie. The land, as far as our explorations went, was very bare of game, and not well vegetated. A floe of last season's ice was observed in the bay, between Cape Hilgard and Cape Louis Napoleon, but off each of those headlands the piled-up ice foot denoted very heavy recent pressure from the eastward.

On the evening of August 15, after considerable labour, we succeeded in blasting and clearing away a barrier which separated the ships from a water channel leading beyond Cape Louis Napoleon, but so narrow was the channel that, notwithstanding the extreme care of Capt. Stephenson, the *Discovery* took the ground for a few minutes whilst steaming between the ice and the shallow shore. By 8 A.M. of the 16th we had advanced to within five miles of Cape Frazer, but here we again met with a block. Calm weather and spring tides caused much and constant movement in the ice, the main tendency being to drift to the southward at the rate of about five miles a day.

The character of the pack had changed considerably, few icebergs were seen that were not aground, and the floes consisted principally of old hummocky pieces pressed together, of from 12 to 20 feet in thickness, the surface being studded over with worn-down hummocks of a blue bottle-glass colour, which denotes great age. In such ice it was impossible to cut into dock on account of the time it would occupy, even had we been provided with saws of sufficient length. Our only possible safety lay in keeping close in shore of grounded icebergs, but in doing so the two ships were obliged to separate. The *Alert* securing to one, and the *Discovery* forcing herself in between three smaller ones farther in shore.

On the two following days, during which the ice continued to drift to the southward and westward, the constant movement of the heavy floes, nipping together with great force, like the closing of a gigantic pair of scissors, between which, if once caught, the ships would have been instantaneously crushed, caused much anxiety, and necessitated constant watchfulness and much labour on the part of the officers and crew; and all were much distressed at losing three or four miles of the ground previously gained. The rudders and screws were constantly being shipped and unshipped, the midship boats were obliged to be turned inboard, on account of the ice touching their keels, and steam, when not in use, was always kept ready at twenty minutes' notice. Beyond wrenching the rudder-head, no serious damage occurred. On the 19th, the highest spring tide, the ice near us became more open; and from a high station on Mount Joy I saw that we could at least regain our lost station, and might get further north. Knowing that this was our last chance during the present tides, and until the strong westerly winds set in, and the pack having opened for the first time, I risked boring my way into the pack for two miles, and by doing so entered a channel round Cape Frazer which had long been considered as one of the most difficult milestones to pass on our passage north. By 9 P.M., after a few hours' delay during the flood tide which brought the ice inshore again, we were fairly in Kennedy Channel, secured to a floe off Cape John Barrow; only two days later in the year than when the *Resolute* was blown out of winter-quarters at Melville Island, in 1853, and with a fortnight of the navigable season still before us. Between Scoresby Bay and Dolbin Bay there is no protection obtainable except inside grounded icebergs; none of the shallow bays are deep enough to shelter a ship from the pressure of heavy ice.

Soon after midnight the ice moved off shore, opening a passage, and again allowed us to proceed, the water spaces becoming more frequent and larger as we advanced northward. Passing the mouth of a large bay

about ten miles deep, after making a very tortuous course through the ice and many narrow escapes of being driven to the southward again in the pack, we reached what we supposed to be Cape Collinson, the second of two capes to the north of the large bay, which must be intended to be represented on the chart as Scoresby Bay. But as Cape Frazer is placed eight miles and Scoresby Bay twenty miles too far north, and the rest of the western land very incorrectly delineated on the charts, it is difficult to say where we arrived, and yet for the present it is necessary for me to describe the advance of the expedition by reference to the published charts. I shall therefore continue to do so with an occasional necessary reference to our correct latitude.

Between Cape Collinson and Cape McClintock, the north point of Scoresby Bay, is a slight indentation in the coast from half to three-quarters of a mile in depth, but affording no protection. North of Cape Collinson the land trends slightly to the westward, and about three miles north of the Cape turns sharp to the west, forming Richardson Bay, which is much deeper than represented, probably four miles broad and six deep. A heavy iceberg firmly aground two miles from the land in the shallow bay north of Cape Collinson, which had evidently never moved this season, prevented a compact floe from floating off shore. The same iceberg caught all the ice that streamed down the west coast and round Richardson Bay, guiding it out towards the south-east, away from Cape Collinson, off which, and between it and the iceberg, was navigable water. In this pool the two ships were secured, watching for an opportunity to get north, and during the forced delay employing our energies in trying, by blasting, to unlock the land ice from the berg, and let it drift south, with the hope of releasing the ice to the northward; but perhaps it is fortunate we did not succeed, as by doing so, if the ice in the offing had not opened at the same time, our principal protection might have been lost, the iceberg itself being too small to form a pool under its lee sufficiently large for both ships, even had it been for one. A depot of provisions was landed at Cape Collinson for our future travellers bound to the southward along the coast. The current was observed to run with greater rapidity to the southward than in the broader part of Smith's Sound. During each flood-tide about five miles of ice drifted past us; for four hours of the ebb it remained stationary; thus about ten miles of ice drifted south daily, adding to the accumulation in the basin of Smith's Sound, unless, as is probable, it is carried as quickly into Baffin's Bay through the southern entrance. On the north side of each point on this shore the ice had piled up a wall-like barrier from 20 to 30 feet high, but elsewhere there was not much display of pressure.

On the morning of August 21, the water channels in the middle of the straits looking very inviting, we made a start at the top of high water, but were led by the ice so much out from the land that I returned to our friendly protecting floe and iceberg until the next tide, first endeavouring to clear the nip of one against the other by ramming; but finding that it would cost too much in coal and shake of the ship to clear it completely, and too much powder to blast it away, I gave up the attempt, after consultation with Capt. Stephenson, and considering that the constant open channels in the offing denoted more water farther off. The two ships started again at 9 P.M., just before low water, and after a troublesome passage through about three miles of close heavy floe pieces, we passed into open leads of water, extending to the north-east up the straits. A bitter northerly wind, accompanied with mist and snow, freshening at the same time, carried the ice with great rapidity to the southward, and obliged us to beat to windward under steam and fore and aft sails, tacking frequently to avoid the heaviest streams of ice. After this snowstorm the land remained covered with snow for the season.

By noon of the 22nd, after buffeting against a strong breeze, we succeeded in weathering the northern headland of the largest bay on the west coast, named on the latest charts Carl Ritter Bay, but agreeing by latitude and relative position with the neighbouring land on the north part of Richardson Bay. In this part of the channel there was very little ice, but three or four miles further north a heavy pack extended across towards Crozier Island, and obliged us to proceed in that direction. In the evening, the wind lulling, I took in the fore and aft sails, and steered through the most open channels to the northward, passing to the westward of Franklin Island, and at midnight we were abeam of Hans Island, with perfectly clear water between us and the eastern land; but streams of ice prevented our approaching the western shore. No deep inlet answering to the Carl Ritter Bay of the charts exists in its given latitude. Steaming to the northward, I endeavoured to close the western shore south of Cape Cracroft, but the ice prevented our doing so, and forced me to bear up to the eastward for Cape Bryant, passing which I found the pack extending across from Cape Morton and Joe Island to Cape Lieber, with a south-westerly wind constantly adding to it by driving more ice to the northward through Kennedy Channel. The *Discovery* then landed a depôt of 240 rations at Cape Morton for use of any travelling party exploring Petermann Fiord, and the ships beat back to Bessels Bay, in the entrance of which we obtained a sheltered anchorage to the north of Hannah Island.

On the 24th, the south-west wind still continuing, which I knew would open the ice on the western shore of Hall's Basin, I ascended Cape Morton. At an altitude of 2,000 feet it was perfectly calm, with a clear sky. The prominent capes of the channel were clearly visible—Cape Union seventy miles distant, and Cape Sumner fifty miles, the one locking in beyond the other to within five degrees. All the west coast of Kennedy Channel, up to Cape Lieber and Lady Franklin Sound, was clear of ice, with navigable water through the ice streams in the middle of the channel far to the northward. From Joe Island to the north, and east to Polaris Bay, the ice was clearly packed, but between Cape Lupton and Beechey was more open. Hurrying to the boat the ships were signalled to get under way, and we ran quickly to the northward across the channel under sail. Five miles north of Cape Lieber the pack obliged me to enter Lady Franklin Sound, on the northern shore of which an indentation in the land gave promise of protection. On a nearer approach we discovered a large and well-protected harbour inside an island immediately west of Cape Bellot, against which the pack ice of the channel rested. Here the ships were secured close to the shore on the morning of August 25.

On entering the harbour we had the satisfaction of sighting a herd of nine musk-oxen, all of which were killed; our joy at the good luck of the sportsmen and ourselves being greatly increased by the news that the vegetation was considerably richer than that of any part of the coast visited by us north of Port Foulke, the Elysium of the Arctic regions. Finding that the harbour was suitable in every way for winter quarters, and the abundance of the spare Arctic vegetation in the neighbourhood giving every promise of game being procurable I here decided to leave the *Discovery*, and to push forward with the *Alert* alone.

Owing to our high northern position, although the sun was still above the horizon at midnight, its altitude at noon was too low to affect the temperature much, consequently, after August 20 the temperature of the air remained steadily below freezing point for the winter, and the young ice was forming at midday much earlier than it does in more southern latitudes. Notwithstanding this, Arctic navigation depends so much upon the wind, that I considered that the transient Arctic season of twenty days' duration was still at its height. The ice in Robeson

Channel was well broken up, moving up and down the strait with the change of tide, and only waiting for a wind to open a passage along shore.

Having strengthened my crew by embarking Lieut. Wyatt Rawson and seven men belonging to the *Discovery*, forming one travelling sledge party, on the morning of August 26 the two ships forming the expedition, the officers and crews of which had worked so harmoniously and successfully together, separated; those embarking in one, if the published charts and the statements of our predecessors proved correct, having the cheering feelings of in all human probability successfully completing the chief task assigned us, but the others, although elated at the prospects of their comrades and partaking generally in the inspiring feelings, having a desperate fight to conquer the sensation of being left behind to play what they could not but consider a secondary part in the general programme.

On arriving at the entrance of the harbour the main pack was found to have closed in against the shore and completely filled up Lady Franklin Sound, some small floes streaming rapidly into Discovery Bay. In endeavouring to keep the ship clear of these, she touched the ground at the top of high water and hung there for half an hour, when, fortunately, by lowering the boats and lightening the ship a little, she floated again without damage. During the afternoon, at low water, the pack, which, apparently uninfluenced by wind, had been moving to the southward the whole day, but fastest during the flood tide, drifted slightly off the land. Immediate advantage was taken of the welcome opening which enabled us to proceed north, but on reaching Point Murchison, the pack extending completely across the strait, prevented all further progress; there was therefore nothing for it but to return to "Discovery Harbour," where the ship was again secured at the entrance ready to advance at the first opportunity.

On the 27th we experienced very light north-east winds. The ice in the channel continued to move to the southward, except during the height of the ebb tide, when it was either stationary or set slowly northward, but not sufficiently so to open a navigable passage, although just before high water it appeared so ready to move that I was induced to recall the skating parties to the ship and keep the steam up. On the 28th the ice was decidedly more open, and we were just about to move at 11 A.M., the commencement of the north running tide, when a thick fog enveloped us, and, hiding everything at more than twenty yards distance, effectually prevented our moving. Later in the afternoon it cleared off, but it was now low water, and on trying to move the ship I found that, although afloat, she was within a basin, surrounded on all sides by a raised embankment of mud, so, with the tantalising prospect of an open channel before us, we were forced to remain until the rising water enabled the lightened ship to pass over the obstacle. Hoisting up the boats and signalling a final "good-bye" to the *Discovery*, we succeeded in advancing to within a mile of Cape Beechey, fifteen miles north-east of Discovery Bay, when, in a tussle with a heavy floe-piece, the rudder-head—which had been badly sprung some days before—became so injured that the rudder was nearly useless; at the same time the pack was sighted pressing tight in against the cape on the northern side; I therefore secured the ship inside some grounded ice and shifted the rudder. While waiting at this part of the coast the sportsmen were fortunate enough to capture three more musk-oxen, a very welcome addition to our supply of fresh meat.

On the 29th the pack remained closed in to the northward of Cape Beechey until noon, when, at about the time of high water, from the summit of the cape, I observed it opening. The ship was immediately signalled to advance, and, picking up my boat on the way, we succeeded in reaching Lincoln Bay, but not without having to run an

exciting and rather anxious neck-and-neck race with a heavy floe, which setting in towards the beetling precipitous cliffs of Cape Frederick VII., forming the south point of the bay, threatened to prevent our progress. At the entrance of Lincoln Bay, which otherwise is much exposed, some very heavy floe-bergs were aground on a bank, and they must to a great extent keep heavy ice from forcing its way into the bay during a south-easterly wind, in which direction the bay is perfectly open. The head of the bay, which appeared from the distance to be well vegetated, was filled with pack ice consisting of numerous small floe pieces less than a quarter of a mile in diameter, intermixed with "rubble," or "boulder" ice, now all cemented so firmly together with this season's frost that we had great difficulty in clearing away a dock for the ship.

On the 30th a depôt of provisions of 1,000 rations, for the use of travelling parties, was landed on the north shore of the bay. Soon after high water, the ice having opened out considerably, we proceeded to the northward; but, in doing so, some large floe pieces of unusually heavy ice obliged me, much to my regret, to stand out some three miles from the land, thereby risking the ship being beset in the pack which I was most anxious and careful to avoid happening. On all occasions of viewing the ice in Robeson Channel, since it was first seen from Cape Morton, I had invariably noticed lanes of water stretching south-east and north-west across the channel from about Cape Lupton on the Greenland shore, to Cape Frederick VII. on the west side, due probably to this being the narrowest part or neck of the channel, and the ice jamming across the narrowing space north and south of it, according to the direction of pressure. Consequently, when at 3 P.M. the ice prevented any farther advance, observing many pools of water near us, and having two hours of the north-running tide favoured by a light air still due, instead of returning to the safety of Lincoln Bay, I waited at the edge of the pack, in the hope of its opening. But in this I was disappointed, for at 4 P.M., having just sufficient warning to enable me to pick out the safest-looking place near us, that is, to get as far away as possible from the heavy ice, it completely encircled the ship, and she was hopelessly beset in a very heavy pack, consisting of old floes of 80 feet in thickness, and from one to four miles in diameter, the intervals between them filled with broken-up ice of all sizes, from the blue-ice rounded hummocks which were sufficiently high above the water-line to lift the quarter boats bodily as they passed underneath, whilst grinding their way along the ship's side, down to the smaller pieces which the previous nipping together of the heavy floes had rounded and polished like the boulders and pebbles in a rapid river. Intermixed with the pack, fortunately for us, was a vast collection of soft pats of sludge-ice formed during the last snowfall: this, if squeezed together before it is properly hardened into ice, forms into plate-like masses with raised edges, each piece, whenever moved, assisting to round its neighbour.

Since meeting the ice off Cape Sabine I had noticed a gradual but considerable change taking place in the appearance and formation of the floes. The heaviest that we first encountered were not more than eight or ten feet in thickness. Off Cape Frazer were a few more ancient pieces, estimated at the time as being twenty feet thick, but we now know that that was far short of the correct measure. But up to the present time, when the main pack consisted of heavy ice, I had failed to realize that, instead of approaching a region favoured with open water and a warm climate, we were gradually nearing a sea where the ice was of a totally different formation to what we had ever before experienced, and that few Arctic navigators had met, and only one battled with successfully; that in reality we must be approaching the same sea which gives birth to the ice met with on the coast of America by Collinson and McClure, and which the latter

in 1851, succeeded in navigating through in a sailing vessel for upwards of 100 miles, during his memorable and perilous passage along the north-west coast of Banks Land, from Prince Alfred Cape to the Bay of Mercy, but there sealed up his ship for ever; which Sir Edward Parry met with in the same channel in 1820, but with the more difficult task before him of navigating against stream and prevailing wind, was forced to own conquered even him and his experienced companions; which, passing onwards to the eastward down McClintock Channel, beset, and never afterwards released, the *Erebus* and *Terror* under Sir John Franklin and Captain Crozier; and which, intermixed with light Spitzbergen ice, is constantly streaming to the southward along the eastern shore of Greenland, and there destroyed the *Hansa* of the German Arctic Expedition.

As our only hope of pushing north against the general set of the current, to say nothing of the extreme hazard of remaining in such a pack, consisted in regaining the shore, both boilers were lighted and full steam kept ready, in order to take immediate advantage of any opportunity that might occur. During the night, at the top of high water, the pack, which previously had been drifting in a compact body to the southward, eased a little near the edge of the large and deep floating floes, in consequence of a difference in the force of the surface and under-current; but before we were able to clear away a space of water at the stern sufficiently large to enable the rudder to be shipped, the ice closed, and obliged us to dismantle again. At the full height of the ebb current the pack again tried its best to open, but with the same result.

Fully expecting a change at low water, with much labour a working space was cleared under the stern, but owing to the spare rudder being very badly balanced we nearly lost our opportunity. At last, with the same momentary slacking of the ice pressure as occurred at the top of high water, with a greater pressure of steam than had been exerted even during the official steam trial, the ship commenced to move; when, by advancing and retreating, a water space was gradually formed in which the ship could gain momentum, and at last we pushed our way bodily into ice not quite so close, and succeeded most providentially in reaching the shore in Lincoln Bay. Had we been delayed another five minutes the ship would have been caught in the pack during the heavy gale which set in from the south-west the same evening, and continued for two days; and which, in fact, by forcing the pack to the north-east, out of the Robeson Channel, enabled the ship to pass Cape Union without any trouble.

During the late struggle, as well as on many previous occasions, it was noticeable how futile the efforts of the crew were to clear away the ice on the bow or quarter which impeded the movement of the ship, compared to the enormous power exerted by the ship when able to ram her way between the pieces even at ordinary speed. Thus steamers are enabled to penetrate through a broken-up pack which the old voyagers, with their sailing vessels, necessarily deemed impassable. At the same time there is a limit to the risks which are advisable to be run; no ship has yet been built which could withstand a real nip between two pieces of heavy ice.

On the afternoon of August 31, shortly after the ship was secured in her former position to the firm ice in Lincoln Bay, the wind gradually freshened from the south-west, blowing slightly off the land, accompanied with a snow-storm and a threatening appearance of the weather. So far as we could distinguish through the snow, the main pack was driven by the gale to the northward up the channel, but knowing that it would take some hours to produce a navigable passage past Cape Union, I waited until the morning of September 1, when with steam at hand ready if requisite, we passed up the straits, running before a strong gale  $9\frac{1}{2}$  knots an hour, between

the western shore and the pack, which was driving quickly to the northward, at about three miles distance from the land. By noon, having carried Her Majesty's ship into latitude  $82^{\circ} 24' N.$ , a higher latitude than any vessel had ever before attained, the ensign was hoisted at the peak. On hauling to the westward at the northern entrance of Robeson Channel, we lost the wind under the lee of the land, and were obliged to furl sails and proceed under steam; at the same time the breadth of the navigable water channel was much contracted, until off Cape Sheridan the ice was observed to be touching the shore.

In Robeson Channel proper, except where the cliffs rise precipitously from the sea, and afford no ledge or step on which the ice can lodge, the shore line is fronted at a few paces distance by a nearly continuous ragged-topped ice wall from fifteen to thirty-five feet high. It is broken only opposite the larger ravines, where the soil carried down by the summer flood has, by accumulating, shallowed the water sufficiently to catch up the drifting ice as it passes, and form a line of more isolated ice hummocks. Here the continuity of the ice wall is occasionally broken. But on leaving Robeson Channel, immediately the land trends to the westward, the coast line loses its steep character, and the heavy ice is stranded at a distance of 100 to 200 yards from the shore, forming a fringe of detached masses of ice from 20 feet to upwards of 60 feet in height above water, aground in from eight to twelve fathoms water, and except where the coast is shallow extending close into the beach line. The average measurement of the ice in thickness as it floated is 80 feet, and it always breaks from the salt water floe of which it originally formed a part in pieces of slightly greater dimensions in horizontal measurements. On finding the ice close in at Cape Sheridan, having made good 25 miles of northing since leaving Lincoln Bay in the morning, my only alternative was to secure the ship inside this protecting barrier of ice, where she was accordingly placed during the afternoon, and a depôt of provisions of 2,000 rations established for the use of travelling parties. The weather remained thick until the evening, when I obtained a good view from a station about 300 feet above the sea level. The coast line continued to the north-west for about thirty miles, forming a large bay bounded by the United States' range of mountains—Mounts Marie and Julia and Cape Joseph Henry, named by the late Capt. Hall, are so conspicuous that it was impossible to mistake their identity although more than thirty degrees out in bearing on the chart. No land was to be seen to the northward although our wishes leading to the thought, we still hoped that the heavy clouds in that direction might hide it from our view. But considering the character and movement of the ice I was reluctantly forced to admit that it gave convincing proof that none existed within a reasonable distance, and that we had arrived on the shore of the Arctic Ocean finding it exactly the opposite to an "Open Polar Sea." The pack ice extended close in to Cape Sheridan and the shore to the westward of it, a pool of water being noticed on the east or lee side of each projecting point in the bay which the intervening ice effectually prevented our thinking of reaching. To the eastward the channel by which we had advanced was completely blocked by the return of the ice, and the ship, although fairly protected, was thoroughly embayed by the pack. The last snowfall had covered the land completely to a depth of from 6 to 12 inches and the low sloping hills formed anything but a cheering landscape.

During the night the wind again freshened considerably from the south-west, and in a squall carried away the hawsers by which we were secured and obliged me to let go a bower anchor; this falling on gravel did not bring the ship up until she had drifted half a cable's length outside the barrier of "floe-bergs" from which the pack was slowly retreating towards the north-east. The gale continued all night and drove the pack two miles off shore,

but its constant motion to the eastward kept it tight in against Point Sheridan and cut us off from all chance of advancing. I was much struck at the time by the pertinacity with which the pack kept its ground during this severe gale, and could not help fearing that there would be little chance of its opening out sufficiently to allow us to advance much farther this year; but knowing well the occasional inexplicable uncertainty in its movements we still hoped for the best.

On the morning of September 2 the wind suddenly shifted from south-west to north-west, bringing the pack rapidly in towards the land, and causing the ship to swing broadside on to the heavy stranded ice; fortunately, the barometer having indicated the probability of a change occurring, steam had been kept ready, and after a considerable amount of manœuvring the anchor was weighed. Our protected dock was so small, and the entrance to it so narrow and encumbered with ice, that it was with extreme difficulty, much labour, and no trifling expense in broken hawsers, that the ship was hauled in stern foremost, with the united force of the wind and flood tide pressing at right angles to the course. It was a nice question whether the ice or the ship would be in first, and my anxiety was much relieved when, as the whole northern pack reached the outside of our friendly floebergs, I saw the ship's bow swing clear inside into safety, and the pack, instead of doing us an injury, considerably strengthen our protecting outwork by forcing new pieces on shore; at the same time, we could not help foreseeing that by so doing our chance of advancing when we wished was proportionately lessened. The danger we had so narrowly escaped from was forcibly represented to us all, as the pack, with irresistible force, swept past us to the eastward at the rate of a mile an hour, and constantly added to the accumulated masses outside.

The projecting point of a heavy floe would first ground in from ten to twelve fathoms of water; then the outer mass, continuing its course, unable to stop its progress, would tear itself away from its cast-off portion. The pressure, however, still continuing, the severed piece was forced, and frequently by the parent mass itself, up the steeply inclined shore, rising slowly and majestically out of the water 10 or 12 feet above its old line of flotation, and remaining usually nearly upright. The motion was entirely different to that produced when two ordinary floes some 4 or 6 feet thick met together; then, the broken edges of the two pieces of ice, each striving for the mastery, are readily upheaved and continually fall over with a noisy crash. Here, the enormous pressure, raising pieces, frequently 30,000 tons in weight, in comparative silence, displays itself with becoming solemnity and grandeur. What occurs when two 80-foot floes meet we cannot say; but the result, as far as a ship is concerned, floating as the ice does higher out of the water than herself, would be much the same as the closing together of the two sides of a dry dock on the confined vessel.

For the next three days we experienced light westerly winds; the ice remained close in to the coast, moving generally to the south-eastward, but occasionally stopping and closing up towards the north-west during the ebb tide. During the flood, pools of water, half a mile long by a quarter broad, frequently formed on the south-east side of the larger floes, but they were always completely isolated from each other by several miles of heavy ice. Although a few large floes could be distinguished in the offing, the pack within five miles of the land usually consisted of floes of less than a mile in diameter, with a very large proportion of rubble ice evidently broken off the large floes as they forced their way past the points of land to the north-west of us, the whole forming as rough a road for sledge travelling as could well be imagined.

At this period, although all regular navigation was evidently at an end, I was naturally most anxious to move the ship from her exposed position before the setting in

of winter, but the quickly advancing season warned me that no movement should be made without a reasonable probability of attaining a sheltered position. Accordingly, Commander Albert Hastings Markham and Lieut. Pelham Aldrich started on September 5 to look at a bay seen from our hill station about eight miles distant from us to the westward. They reported that it was a well-sheltered harbour, thickly coated with this season's ice, but that the continuous wall formed by the grounded floe-bergs across the entrance to it would effectually prevent our entering.

After this report, with the temperature remaining steady between  $+20^{\circ}$  and  $+10^{\circ}$ , and the barrier of grounded ice, which, although protecting, effectually imprisoned us, having increased in breadth to seaward for 200 yards, each heavy piece being compactly cemented in amongst its neighbours by the lighter broken up rubble ice, which was carried in by the tidal current, and frozen into position by the low temperature, I decided to commence landing such provisions and stores as were hampering the decks of the ship, and which would not be required during the winter, should we fortunately be able to move into safer quarters.

On September 6, 7, and 8, we experienced a heavy fall of snow, which, bearing down the young ice by its accumulated weight, allowed the water to percolate upwards, and render the floe very wet and unfavourable for travelling on. But not expecting any decided movement of the ice during the neap tides, and having secured the ship with a bower anchor and cable to the shore, and landed an ample depôt for the support of any travelling party in the event of accident to the ship, which at the time did not appear improbable, Lieut. Pelham Aldrich, accompanied by Capt. Feilden, R.A., and Dr. Edward L. Moss, started on a pioneering journey towards the north, and Lieut. Wyatt Rawson towards the south. The latter returned after two days' absence, having found the cape three miles from the ship, forming the entrance to Robeson Channel, impassable by land, on account of the steepness of the cliffs; and by sea, in consequence of the continual movement of the broken pack, which prevented him venturing on it, even with a boat. Lieut. Aldrich's party returned after an absence of four days. He had succeeded in establishing a depôt of provisions, and exploring the coast line for a distance of twenty miles to the north-west. The travelling was found to be unusually heavy, owing to the very rough state of the ice, and the deep snow, with its sticky wet foundation of sludge; indeed, so bad was it that although only laden with half weights, all three sledges broke down. The young ice in the few patches met with was too weak and treacherous to admit of heavy sledges journeying over it; one sledge broke through, and was only recovered with much difficulty.

On September 10 a westerly wind blowing off shore, force 4, combined with the ebb tide, opened for the first time since our arrival here, a narrow channel between the grounded ice and the pack extending for half a mile beyond Cape Sheridan, but trending out to seaward. On the 11th, the same wind continuing, the channel widened out until it was a mile broad, and extended for six miles to the westward, ending two miles distant from the shore. As this offered an opportunity of advancing a large depôt of travelling provisions and boats by water, Commander Markham started with a strong party, having first to launch the boats across the heavier barrier of ice within which the ship was sealed up, apparently frozen in for the season.

The sky being fairly clear, this was the first day on which we were able to pronounce decidedly concerning the northern land reported to exist by the *Polaris*. After a constant watch, and carefully noting the movement of the darkened patches, I was now with much reluctance forced to admit that no land existed to the northward for

a very considerable distance. As seen through the light haze the dark reflection of the sky above the detached pools of water in the offing, in strong contrast by the side of the light reflected from the close ice, which in a great measure is similar to the bright glare reflected from a large sand flat, creates a very decided appearance of land when there is a mirage; indeed, sufficiently so as to deceive many of us when so anxiously expecting and hoping to see it. We, therefore, cease to wonder at the casual look-out men from the *Polaris* being mistaken, but the more experienced on board should not have allowed themselves to be so readily misled.

During the 13th and 14th the wind from the south-west gradually freshened, until on the latter day it was blowing a very strong gale, force 10 in the squalls, and evidently extending over the whole extent of Kennedy Channel; for the swell from the open water which it had produced on the weather shore extended round Cape Rawson, and reaching our position broke up all the light ice formed this season, and drove it out to sea, the large grounded floe-bergs alone remaining, with clear passages between them, through which we could have readily passed if requisite; but the main pack to the westward, although the channel leading to seaward had extended to between ten and twelve miles distance from us, still remained fast to the shore at a distance of about six miles from the ship.

The ship was secured by a bower cable, stern to the shore, one side resting against a large floe-berg, and bumping slightly against it with the swell. During the evening it was blowing furiously, with a blinding snow-drift, and whilst I was thinking of the uncomfortable state of the travellers in the tents in such a gale, I observed Commander Markham arrive abreast the ship. Although we were within 120 yards of the shore, it was only by double manning the oars of the cutter that during an opportune lull I was able to establish a hauling line between the ship and the shore, and so communicate with him; when it appeared that, having one man disabled from exhaustion, he had decided to push on for the ship to obtain assistance. With the help of the fresh men forming the cutter's crew, Capt. Markham and myself had the satisfaction of seeing the sledge party all on board before midnight, and the frozen man's life saved; but the sledge crew, who had so gallantly faced the storm, were all much exhausted, and in fact did not recover themselves for several days.

On the morning of the 15th the wind lulled considerably, and the remainder of Commander Markham's party, under the command of Lieut. Parr, returned, having passed anything but a pleasant time in their tents during the gale. On ascending our look-out hill I observed that the ice to the westward between the land and the channel in the pack had drifted to seaward, leaving a clear road by which we could advance to a place of shelter. Making a signal to the ship, steam was immediately got ready and the rudder shipped, but on lowering the screw we found it impossible to enter the shaft. Whilst raising it again to clear away the ice, a very thick snowstorm came on with a blinding mist, which, hiding everything from view, prevented our moving. Before midnight the storm was blowing as furiously as ever.

On the morning of the 16th, the gale still keeping the main pack clear of the shore, the weather cleared again, and another attempt was made to ship the screw, but without success, on account of the accumulated ice. While endeavouring to clear it the wind gradually shifted round to the north-west, and we had the mortification of seeing the pack rapidly nearing the land. By 2 P.M. it had reached the shore ice, and effectually closed us in for the winter. It never left the shore to the north-westward of our position afterwards, although a large space of clear water remained to the eastward between us and Robeson Channel, so long as the wind lasted from the eastward.



I may here add that on examining the coast-line afterwards, both during the autumn and the following spring, I am firmly persuaded that our forced detention during the late gale was most providential. There was no bay on the coast open enough to receive the ship, and the ice at the entrance of each was far too thick for us to cut or force our way through before the main pack had closed in.

Off the open coast where we were forced to pass our winter, the heavy nature of the ice constituted our safety; grounding in twelve fathoms, it was impossible that it could hurt the ship. At first I was rather anxious lest any lighter ice might be forced in, and that then the ship might be driven by it on shore, but as time advanced and nothing but ice of the same thick character made its appearance, I became more reconciled to our position. It ultimately proved to be the best sheltered position on the coast from which a ready means of retreat was likely to be offered. In all other parts, the beach, either by being too steep, allowed the heavy ice to force its way close up on to the shore, or where shallower, left a sufficiently large space of water in which smaller and more dangerous ice-blocks were able to drift about before they grounded in about the same depth of water as that in which the ship floated.

During the following week preparations were made for the autumn sledging, each man being fully employed fitting his travelling clothing and preparing the equipment of the sledges. As soon as the shore ice was sufficiently strong, Commander A. H. Markham, with Lieutenants A. A. C. Parr and W. H. May under his orders, started on September 25 with three sledges to establish a dépôt of provisions as far in advance to the north-westward as possible. Lieut. P. Aldrich left four days previously with two lightly-equipped dog sledges to pioneer the road round Cape Joseph Henry for the larger party. He returned on board on October 5, after an absence of thirteen days, having been accompanied by Adam Ayles, A.B. On September 27, from the summit of a mountain 2,000 feet high, situated in lat.  $82^{\circ} 48' N.$ , somewhat further north than the most northern latitude attained by our gallant predecessor, Sir Edward Parry, in his celebrated boat journey towards the North Pole, he discovered land extending to the north-westward for a distance of sixty miles to lat.  $83^{\circ} 7'$ , with lofty mountains in the interior to the southward. No land was sighted to the northward.

On October 14, two days after the sun had left us for its long winter's absence, Commander Markham's party returned after a journey of nineteen days, having, with very severe labour, succeeded in placing a dépôt of provisions in lat.  $82^{\circ} 44' N.$ , and in tracing the coast-line nearly two miles further north, thus reaching the exact latitude attained by Sir Edward Parry. Being anxious to inform Capt. Stephenson of our position, and the good prospects before his travelling parties in the following spring in exploring the north-west coast of Greenland, I despatched Lieut. Rawson again to attempt to open communication between the two vessels, although I had grave doubts of his succeeding. He was absent from October 2 to October 12, returning unsuccessful on the latter day, having found his road again stopped by unsafe ice within a distance of nine miles of the ship. The broken masses of pressed-up ice resting against the cliffs, in many places more than 30 feet high, and the accumulated deep snow-drifts in the valleys caused very laborious and slow travelling.

During these autumn sledging journeys, with the temperature ranging between  $15^{\circ}$  above and  $22^{\circ}$  below zero, the heavy labour, hardships, and discomforts inseparable from Arctic travelling, caused by the wet soft snow, weak ice, and water spaces, which obliged the sledges to be dragged over the hills, combined with constant strong winds and misty weather, were, if anything, much greater

than those usually experienced. Out of the northern party of twenty-one men and three officers, no less than seven men and one officer returned to the ship badly frostbitten, three of these so severely as to render amputation necessary, the patients being confined to their beds for the greater part of the winter.

The sledges with their cargoes on four occasions broke through the ice, and individual men frequently; but these, becoming wet through, were made to change their clothing, and so escaped any bad consequences. The frost-bites are to be attributed entirely to the wet sludgy state of some of the ice that had to be crossed. It so happened that heavy snow fell on twelve consecutive days, forming a layer of lightly compressed snow at least 2 feet thick, which in the snow-drifts collected into ridges more than double that depth. The thin ice, not being sufficiently strong to support this additional weight, became borne down and allowed the water to ooze through. This being protected from the cold temperature of the air by its blanket-like covering, remained unfrozen, although the temperature was upwards of  $40^{\circ}$  below the freezing-point; consequently whenever the travellers, inexperienced as they were at the time, were forced to drag their sledges over a road of this nature, their feet became wet and afterwards frost-bitten a considerable time before they discovered it (when the tent was pitched in the evening), by which time the mischief had attained such an advanced stage as to defy all restoration of the circulation. The tent equipment became so saturated with frozen moisture that on arrival on board it weighed more than double what it did when dry before starting; and so anxious were all to escape another sleepless night in the stifflly frozen blanket bags, that on the last day a forced march was made by the northern party through the heavy snow to the ship, in which the powers of endurance of all engaged were tried to the utmost. All the travellers returned in wonderful spirits and full of pluck. Nothing could exceed the determined perseverance with which each obstacle to the advance of the party was overcome, or the cheerfulness with which each made light of the numerous unavoidable hardships they had undergone. The sledges proved to be too rigid; the uprights breaking necessitated frequent stoppages for repairs; but by taking out the metal pins connecting them to the upper bearers, and depending upon the hide lashings, they afterwards stood the unusually heavy work admirably.

On no one day while the northern party were travelling this season could they have obtained snow of sufficient consistency to enable them to build snow houses for shelter by night. Lieut. Rawson, finding harder snow in the southern ravines, was able to construct a snow house on one occasion. The advantageous results of the autumn travelling, in addition to the advance of provisions for future use, were, first, a considerable gain in experience in Arctic sledging, and secondly, by our greater good fortune in finding continuous land over or near which to travel, we succeeded in wresting from Sir Edward Parry and his companions their gallantly-achieved distinction of having advanced the British flag to the highest northern latitude. I have grouped the names of himself and his followers together on the chart in the latitude to which they attained in 1827. On the return of the travelling parties, the sun having bidden us farewell, preparations were made for the winter; the ship was house over, all the provisions and stores which could withstand the weather, and for which room could not be found below hatches, were deposited on shore, and the habitable deck cleared as much as possible. By carefully covering over the engine-room hatches with a thick layer of snow, the cold, throughout the winter, was kept from penetrating downwards into the lower part of the ship. The temperature of the holds and engine-room, without the use of fires, always remaining above  $+28^{\circ}5$ , the temperature the surrounding water, and the fire-pumps which had

their suction pipes more than six feet below the water-line, remained serviceable to the last.

The long Arctic winter, with its unparalleled intensity and duration of darkness produced by an absence of sunlight for 142 days, was passed by each individual on board with much cheerfulness and contentment. Owing to the sameness in the daily routine, which, when looking into futurity, is thought to entail a long duration of dreary monotony, the time, in reality, passed with great rapidity, and in January, when the first glimmering increase in the midday twilight began to lengthen sensibly day by day, the want of light was scarcely noticed by any one; and not until the sun actually returned on March 1 did we in any way realise the intense darkness we must have experienced for so long a period. The manifold ordinary duties of the ship—to which were added the constant repair of the snow embankment, which, in consequence of our being frozen in close to a stranded piece of ice, was thrown down every spring tide—kept the ship's company fully employed, and gave them plenty of exercise during the day. On five evenings in the week a school, formed on the lower deck under Commander Markham and several of the officers, was well attended, each Thursday being devoted to lectures, songs in character, and readings, with occasional theatrical representations; the whole so admirably arranged and conducted by Commander Markham as to keep up the pleased interest of all for the whole period. The ventilation of the ship received the unceasing attention of Dr. Thomas Colan and myself, and owing to the large extra space amidships, left little or nothing to be desired in that respect. The health of the officers and crew, with only one exception, was most excellent, and the habitable deck as dry as is possible in these regions, in a ship without an extraordinary expenditure of coal.

With the arrival of the new year preparations for the spring travelling campaign commenced, the dogs being exercised daily under the superintendence of Mr. George Le Clere Egerton, Sub-Lieutenant, as soon as there was sufficient light. The pack in the offing remained in motion until the first week in November, when it gradually settled itself into position for the winter, the last pool of water being seen on the 16th of the month off Cape Rawson at the entrance to Robeson Channel. No movement, whatever occurred in the ice during the winter, except the formation of a tidal crack outside the grounded ice, which opened 2 or 3 feet during the spring tides. Although we had frequent evidence of strong winds prevailing in Robeson Channel, the weather at our winter quarters was remarkably calm; indeed we may be said to have wintered on the border of a Pacific Sea. The prevailing wind was from the westward; we never experienced any easterly winds; it always blew off the land. Had it not been for the intervening calms, the persistent westerly winds might have been well called a trade wind. On only two days were we prevented by the wind and accompanying snow-drift from taking exercise outside the ship. This quiet state of the atmosphere was productive of the severest cold ever experienced in the Arctic regions.

Early in March, during a long continuance of cold weather, the *Alert* registered a minimum of 73.7 below zero; the *Discovery*, at the same time, 70.5 below zero. In 1850 the *North Star*, at Wolsenholme Sound, in lat. 76° 30' N., recorded 69.5 below zero. The *Alert's* minimum temperature for twenty-four hours was 70.31 below zero, the *Discovery's* minimum temperature for twenty-four hours was 67.0 below zero; Dr. Kane's, at Rensselaer Harbour, in lat. 78° 37' N. in 1854, 58.01 below zero. Previously the longest continuance of cold weather recorded, that by Sir Edward Belcher at Northumberland Sound, in lat. 76° 52' N., in 1853, was a mean temperature for ten consecutive days of 48.9 below zero. The *Discovery* experienced a mean temperature for seven consecutive days of 58.17

ditto. The *Alert* experienced a mean temperature for thirteen days of 58.9 ditto; and for five days and nine hours of 66.29. During February mercury remained frozen for fifteen consecutive days; a south-westerly gale, lasting four days, then brought warmer weather; immediately the wind fell cold weather returned, and the mercury remained frozen for a further period of fifteen days.

After the heavy snow-fall in the autumn previously alluded to, very little fell, and much trouble was experienced in obtaining sufficient for embanking the ship, it being necessary to drag some from the shore for that purpose. Owing to the small quantity which fell during the winter, estimated at from 6 to 8 inches, the summits of the coast hills were uncovered by the wind and remained so until May and the early part of June, when we again experienced a heavy snow-fall, estimated at a mean thickness of 1 foot. In the valleys and on the shores having an eastern aspect, the snow which fell remained light, and, unless snow-shoes were used, caused very heavy travelling. In the unprotected valleys and on the weather coasts the snow was sufficiently compact to afford fair travelling, much the same as that experienced in southern latitudes, where the more variable winds harden the snow everywhere.

Light flashes of aurora were occasionally seen on various bearings, but most commonly passing through the zenith. None were of sufficient brilliancy to call for notice. The phenomena may be said to have been insignificant in the extreme, and, as far as we could discover, were totally unconnected with any magnetic or electric disturbance.

During the winter Commander Albert H. Markham and Lieut. George A. Giffard employed themselves with much diligence and perseverance at the magnetic observatory, situated on shore, in a series of large and lofty snow houses, which were connected together with a covered snow gallery. Weekly observations were made with Barrow's dip circle for determining the inclination, and by means of Lloyd's needles for the total (relative) force. Occasionally these observations were repeated on the same day. The absolute horizontal intensity was obtained once every three weeks, and a series of hourly differential observations were obtained with the portable declination magnetometer on several consecutive days in the months of December, January, and February. At various places between Disco and the *Alert's* winter quarters, whenever opportunities offered, observations for inclination and total force were taken with Mr. Fox's instrument, observations for determining the absolute declination were also taken when opportunities occurred.

Lieut. Pelham Aldrich superintended the meteorological observations, also observations with Sir C. Wheatstone's polariscope, and Lieut. Alfred A. C. Parr, notwithstanding the severe season, obtained a good series of astronomical observations, also observations with the spectroscope and Sir William Thomson's portable electrometer.

I have not hitherto alluded to the services of Capt. Feilden, Paymaster, R.A., Naturalist to the Expedition, preferring that the report on the numerous scientific subjects to which he has directed his attention should emanate from himself; I will merely state here that not one moment has been lost by this indefatigable collector and observer. He has, moreover, by his genial disposition and ready help on all occasions, won the friendship of all, and I feel confident that their Lordships will highly appreciate his valuable services. I am only doing him justice when I state that he has been to this expedition what Sabine was to that under the command of Sir Edward Parry.

Dr. Edward Moss, a highly skilled and talented observer, in addition to his medical duties, kept himself fully employed in many branches of natural science; his investigations embraced studies of the floe-bergs and floes,



principally chlorine estimations, specific gravity estimations by Buchanan's method, and microscopy of dust strata; the chlorine and specific gravity estimations, and the microscopy of winter sea water; examination of air precipitates; estimation of carbonic acid and watery vapour in air; some experiments on the brittleness of iron at low temperatures.

The vicinity of our winter quarters proved to be unfavoured by game. On our first arrival a few ducks were seen and five shot, and during the winter and spring three hares were shot in the neighbourhood of the ship. This completes our list up to the end of May. In March, a wolf suddenly made his appearance, and the same day the tracks of three musk-oxen or reindeer were seen within two miles of the ship, but they had evidently only paid us a flying visit. In July six musk-oxen were shot, the only ones seen in our neighbourhood. The travelling parties were only slightly more fortunate in obtaining game. In June a few ptarmigan, ducks, and geese were shot and used by the sick. In July and August they obtained a ration of fresh meat daily. In March and the beginning of April about two dozen ptarmigan passed the ship, flying towards the north-west in pairs; finding no vegetation uncovered by snow in our neighbourhood, they flew on seeking better feeding grounds; they were nearly all shot subsequently by the outlying parties near Cape Joseph Henry. In the middle of May snow-buntings and knots arrived. A number of the young of the latter were killed in July, but no nests or eggs were found. Early in June ducks and geese passed in small flocks of about a dozen, flying towards the north-west, but owing to a heavy fall of snow, lasting three days, which covered the land more completely than at any other time during our stay, at east half the number returned to the southward, not pleased with their prospects so far north. Two dozen small trout were caught during the autumn and summer in lakes from which they could not possibly escape to the sea.

The total game list for the neighbourhood of the *Alert's* winter quarters, is as follows:—

	Musk-oxen.	Hares.	Geese.	King Ducks.	Eider Ducks.	Long-tailed Ducks.	Ptarmigan.	Walrus.	Seals.	Foxes.
In Winter Quarters ...	6	7	67	12	—	9	—	—	1	3
By Short Service Sledging Parties ...	—	13	3	5	—	—	10	—	—	—
Total ... ..	6	20	70	17	—	9	10	—	1	3

On March 1 the sun returned after its long absence. The sledging season being now near at hand, I prepared orders for Capt. Stephenson to employ the whole force at his disposal in exploration of the neighbouring shore and the north coast of Greenland, instead of sending a party to communicate with Smith's Sound, as I considered that a sledge party employed on that duty this season would be performing unnecessary work, and that in the event of their Lordships communicating with Littleton Island, and finding that I had not visited it, they would understand that the expedition was well placed or exploration far north, and that all was going on satisfactorily.

March 4 was the day fixed for the dog-sledge to start to open communication with the *Discovery*, should the weather be favourable, but the severe cold which we then experienced prevented their starting. The temperature remained unusually low until the 12th, when it rose to -35°, and the weather being fine and settled, Mr.

George Le Clerc Egerton, Sub-Lieutenant, started in charge of the dog-sledge, accompanied by Lieut. Wyatt Rawson, belonging to the *Discovery*, whom I wished to consult with Capt. Stephenson concerning the exploration of the Greenland coast, and Christian Petersen, interpreter. As I knew that this journey was sure to entail very severe labour, Frederick, the Esquimaux dog-driver, not being a strong man, was left on board. Four days afterwards, the temperature having risen considerably in the interval, with a strong wind from the southward, the party returned in consequence of the severe illness of Petersen. He was taken ill on the second march with cramp in the stomach; and afterwards nothing could keep him warm. The tent being very cold, the two officers burrowed out a snow hut, and succeeded in raising the temperature inside to +7°, but the patient still remained in an unsatisfactory condition, and it was only by depriving themselves of all their own warm clothing, and at the expense of the heat of their own bodies, that they succeeded, after great persistence, in restoring the circulation in his extremities to some extent. The following day, Petersen being no better, they wisely determined to return with him immediately to the ship. During this journey of sixteen miles, both Mr. Egerton and Lieut. Rawson behaved most heroically, and, although frequently very seriously frost-bitten themselves, succeeded in keeping life in the invalid until they arrived on board. He was badly frost-bitten in the feet, both of which had subsequently to be amputated. Notwithstanding the professional ability and incessant watchful care of Dr. Thomas Colan, he never recovered from the severe shock his system had received on this occasion, and eventually expired from exhaustion three months afterwards. He leaves a wife and family living in Copenhagen, who trust will receive a pension.

On March 20, with fine weather and a temperature of 30° below zero, Mr. Egerton and Lieut. Rawson, having partially recovered from their most praiseworthy exertions when attending Petersen, again started for the *Discovery*, accompanied by two seamen, which they succeeded in reaching on the sixth day, after a very hard scramble over the rough ice in Robeson Channel, and along the steep snow slopes formed at the foot of the precipitous coast cliffs. No water was met with beyond that formed in the tidal crack, close to the shore. The temperature throughout the journey ranged from -42° to -24°. During the latter part of March the sledge crews were fully employed preparing their provisions, and equipping the sledges for the spring journeys. Long walks were taken for exercise, and a depot of provisions was placed a few miles to the southward for the use of the Greenland division.

On April 3 the seven sledges and crews, numbering fifty-three officers and men, started on their journeys with as bright prospects before them as any former Arctic travellers—everyone in apparently the best possible health, and, while knowing the severe labour and hardships they would have to undergo, all cheerful, and determined to do their utmost. A finer body of picked men than the crews of the three extended sledge parties was never previously collected together.

Commander Albert H. Markham, seconded by Lieut. Alfred A. C. Parr, with two boats equipped for an absence of seventy days, was to force his way to the northward over the ice, starting off from the land near Cape Joseph Henry.

Three sledge crews, under the respective commands of Dr. Edward Moss, who in addition to his duties as Medical Officer to the division, volunteered to assume executive charge, and Mr. George White, Engineer, also a volunteer, accompanied them as far as their provisions would allow. Lieut. Pelham Aldrich, assisted by a sledge crew under the command of Lieut. George A. Giffard, was to explore the shores of Grant Land towards the north and

west, along the coast line he had discovered in the previous autumn.

In regard to the first of these two journeys, that undertaken over the ice towards the north, it is my duty to its Commander and his followers to state that, knowing the extremely rough road over which they would be obliged to travel, I had little hope that they would reach a high latitude, for their daily progress with light or heavy sledges must necessarily be very slow. I thought it best, nevertheless, to make the experiment, to prove whether or not the Pole could be reached by a direct course over the ice without continuous land along which to travel. Having such willing and determined leaders as Commander Markham and Lieut. Parr, and the pick of the ship's company, who themselves were all chosen men out of numbers at hand, I sent them forth with full confidence that whatever was possible they would perform.

In organising this party, nothing was known of the movements of the Polar ice. I was even in doubt whether it was not always in motion in the offing, consequently I decided that boats must be carried of sufficient capacity for navigation, and not merely for ferrying purposes. This necessitated very heavy weights being dragged. It was also necessary that the party should carry a heavy load of provisions, for, owing to our clear weather and lofty look-out station, we had previously ascertained that no land existed within a distance of fifty miles of Cape Joseph Henry.

When a sledge party have to drag a boat even with only a few days' provisions, and over a smooth floe, double trips are necessary over the same road daily, in the same manner as Sir Edward Parry was compelled to journey in 1827, consequently, the utmost limit that could be transported in this way with two trips on level ice was chosen, and this provided the party for an absence from the land for sixty-three days. The plan usually resorted to of reducing the weights carried by the advance party by providing a chain of supporting sledges is not applicable when each assisting sledge requires a boat capable of carrying its crew.

On the day following the departure of our travelling parties, Mr. Egerton and Lieut. Rawson returned from the *Discovery* after a rough journey, with a temperature ranging between 44° and 15° below zero, but all in good health and spirits, and beyond sore noses and tips of fingers from frost-bites, were none the worse for their cold journey.

The news from the *Discovery* was most cheering with the exception that, although they had succeeded in obtaining upwards of thirty musk-oxen, one man was in the sick list with a bad attack of scurvy. With this exception the crew of the *Discovery* had passed a very comfortable winter, plenty of cheerful work leading to and inducing constant employment of mind and body, coupled with a fair share of mirthful relaxation and a frequent meal of fresh meat. I refer you, Sir, to Capt. Stephenson's full report for a detail of his proceedings. His crew were preparing for the exploration of Lady Franklin Sound and the coast of Greenland.

On April 8 the first supporting sledge returned from Commander Markham's and Lieut. Aldrich's parties. As usual on the first starting several of the travellers were much distressed by the severe and unaccustomed work, and the cold weather preventing sleep at night, but were gradually improving. One man who had been ailing slightly during the last month was sent back, and one of the crew of the supporting sledge returned with a frost-bite, the only serious case during the season, although the travellers, on two days out of the six that this party were away, experienced a temperature of - 46°.

On April 10 Lieut. Wyatt Rawson and Sub-Lieut. George Le Clerc Egerton, having somewhat recovered after their cold journey to the *Discovery*, equipped with sledges, started to ascertain the nature of the ice in

Robeson Channel, and to mark a convenient road across it for the heavier exploring sledges coming north from the *Discovery* under the command of Lieut. Lewis A. Beaumont.

On April 24 the second division of the supporting sledges returned, reporting the main parties to have settled steadily down to their work, and with the exception of one marine suffering from debility who was sent back, all were in good health and capital spirits. The temperature had fortunately risen to about - 26 degrees. The very cold weather had tried the party much, and there had been numerous light cases of frost-bites, which but for the presence and care of Dr. Moss might have proved serious. The appearance of the ice within six miles of the land was anything but cheering to the northern party, but they looked forward with hope that the floes would get larger and less broken up as they advanced. Each sledge carried extra tea in lieu of the usual midday allowance of spirits. Both men and officers were unanimous in favour of the change, and willingly put up with the misery of standing still in the cold with cold feet during the long halt needed for the purpose of boiling the water, and all agreed that they worked better after the tea lunch than during the forenoon.

On the 16th Lieut. Lewis A. Beaumont and Dr. Richard W. Copping arrived from the *Discovery*, having been ten days performing a travelling distance of seventy-six miles with light sledges, so broken up and difficult was the nature of the ice in Robeson Channel. They brought news that the ice was continuous and afforded fair travelling across Hall's Basin, and that the depôt of provisions at Polaris Bay was in good condition and fit for use. These circumstances enabled me to arrange for Lieut. Beaumont to proceed with lightly laden sledges along the Greenland coast to the eastward, and after completing his journey to fall back on the *Polaris* depôt before June 15, by which time two boats would be carried across the straits from the *Discovery*, ready for his retreat should the ice have broken up.

On the 18th Lieut. Rawson and Mr. Egerton returned, having succeeded in crossing the channel without finding more than the usual difficulties amongst the heavy hummocks, which they had now become so accustomed to. They had landed on the Greenland coast north of the position marked as Repulse Harbour, which proves to be only a slight indentation in the coast line, having a freshwater lake inshore of it, which from an inland view might readily be mistaken for a harbour.

On April 20 Lieut. Beaumont, accompanied by Lieut. Rawson and Dr. Copping, started for his Greenland exploration, the few days' rest having materially benefited his men, who may be said to have started from the *Discovery* unexperienced in Arctic sledging, that ship having had no autumn travelling in consequence of the ice remaining in motion until a very late period of the season.

On April 23 Capt. Stephenson and Mr. Thomas Mitchell, assistant-paymaster in charge, arrived from the *Discovery*, and I had the advantage of consulting with the former unreservedly concerning the prospects of our numerous travellers then scattered over the neighbouring shores, the two ships remaining tenanted only by officers and a few invalids. Arrangements were made for the exploration of Petermann's Fiord, and should the season prove favourable, for the examination of the ice-cap south of Bessels Bay. On April 30 Capt. Stephenson returned to the *Discovery*.

Until the latter end of May sledge parties were continually arriving or departing, carrying forward depôts of provisions for the use of the distant parties on their return. In carrying out these duties I was much indebted to Dr. Edward L. Moss, who again volunteered to command a party, and I the more readily availed myself of his services knowing that it would afford him a chance of continuing his scientific studies. Mr. James

engineer, also assisted me materially as commander of a sledge party.

On May 3 Lieut. Giffard returned with news from Lieut. Pelham Aldrich up to April 25, his twenty-second day out from the ship. He reported that all his crew were well and cheerful, but that the soft snow was causing very heavy and slow travelling.

Up to this time all had gone well with the expedition. The two ships had advanced as far north as was possible; they were admirably placed for exploration and other purposes; and the sledge crews, formed of men in full health and strength, had obtained a fair start on their journeys under as favourable circumstances as possible. On May 3 Dr. Thomas Colan reported that five men had scorbutic symptoms; however, as each case had some predisposing cause, I was not alarmed until on the 8th the three ice quartermasters and two able seamen returning from sledge service were attacked, and by June 8 fourteen of the crew of the *Alert* and three men belonging to the *Discovery* who happened to be on board, forming the majority of the number of men then present, had been or were under the doctor's care for the same wasting disorder. Capt. Stephenson also reported that four more of his crew had been attacked.

Although many of the sledge crews formerly employed on Arctic research had been attacked by this disease some had totally escaped; therefore, considering the ample equipment and carefully prepared provisions with which the *Alert* and *Discovery* were provided, its outbreak was most inexplicable and unlooked-for. It was, however, most encouraging to learn from the report of former expeditions how transient the attacks had usually proved, and how readily the patients recovered with rest, the advance of summer, and a change to a more generous diet.

On May 9, by the return of Lieut. May and Mr. Egerton from Greenland, whither they had carried supplies and succeeded in discovering a practicable overland route immediately east of Cape Brevort fit for the use of the returning sledges should the ice break up, I received news of Lieut. Beaumont's party up to May 4, when he was within two miles of Cape Stanton. From their place of crossing the Straits they found that the coast line for nearly the entire distance to Cape Stanton was formed either by precipitous cliffs or very steep snow slopes, the bases of which receive the direct and unchecked pressure of the northern pack as it drifts from the north-westward and strikes against that part of the coast nearly at right angles. The floe-bergs, at their maximum sizes, were pressed high up one over the other against the steep shore; the chaos outside was something indescribable, and the travelling the worst that can possibly be imagined, seven days being occupied in moving forward only twenty miles. Being quite uncertain when such a road might become impassable by the ice breaking up in May as it did in 1872, a depot of provisions, sufficient for a return journey by land, was wisely left, but Lieut. Beaumont's journey was thus shortened considerably.

As nearly every south-westerly wind we experienced at Floeberg Beach changed its direction to north-west before it blew itself out, the coast of Greenland north of Cape Brevort must necessarily be a very wild one as regards ice-pressure, and a most uncertain coast for navigation. A vessel once caught in the pack-ice off that shore, if not crushed at once, runs a great risk of being carried by it to the eastward round the northern coast, as pointed out by Admiral Sir George Back, Kt., F.R.S.

During the first week in May the temperature rising to zero enabled me to remove the snow from over the skylights and bull's-eyes and let in light between decks, but owing to there being no skylight over the lower deck it still remained very dark. I would here remark, Sir, how very important it is that Arctic ships should, if possible, be fitted with a large skylight above the ship's company's living deck.

On May 24 Lieut. Giffard returned on board, after depositing Lieut. Pelham Aldrich's last depôt of provisions, he and his crew having performed their important work well and expeditiously; but I am sorry to add that he brought Dr. Colan two more invalids. The attack occurring on his outward journey, as it was of vital importance that he pushed on, Lieut. Giffard was necessarily obliged to leave them in a snow hut for five days, one man taking care of the other as best he could until the party returned. Lieut. Giffard acted with great judgment, decision, and consideration on this occasion, and the two invalids recovered before the ship broke out of winter quarters.

On June 1 Mr. Crawford Conybeare arrived with news from the *Discovery* up to May 22. Lieut. Archer had completed his examination of the opening in the land west of Lady Franklin Sound, proving it to be a deep fiord terminating in mountainous land, with glacier-covered valleys in the interior.

Lieut. Reginald B. Fulford, with the men returned from Lieut. Archer's party, then transported two boats across Hall's Basin to assist Lieut. Beaumont in his return later in the season. Capt. Stephenson, accompanied by Mr. Henry C. Hart, naturalist, overtook this party on the 12th at Polaris Bay. On the following day, the American flag being hoisted, a brass tablet prepared in England was erected at the foot of Capt. Hall's grave with due solemnity. It bore the following inscription:—

"Sacred  
to the Memory of  
CAPTAIN C. F. HALL,  
of the U.S. Ship *Polaris*,  
who sacrificed his Life  
in the advancement of Science,  
on the 8th November, 1871.

"This Tablet has been erected by the British Polar Expedition of 1875, who, following in his footsteps, have profited by his experience."

Dr. Coppinger, when returning from assisting Lieutenant Beaumont, had visited Capt. Hall's Cairn at Cape Brevort, and the boat depôt in Newman's Bay, and conveyed the few articles of any value to the *Discovery*. The boat itself, with the exception of one hole easily repairable, was in a servicable condition. Capt. Stephenson returned to the *Discovery* on May 18, leaving Lieut. Fulford and Dr. Coppinger on the Greenland shore to explore Petermann Fiord. Mr. Crawford Conybeare having reported that the travelling along shore in Robeson Channel was fast becoming impracticable in consequence of the ice being in motion near the shore, his party were kept on board the *Alert*.

On the evening of June 8, Lieut. A. A. C. Parr arrived on board, most unexpectedly, with the distressing intelligence that nearly the whole of the crew belonging to the northern division of sledges were attacked with scurvy, and in want of immediate assistance. Commander Markham, and the few men who were able to keep on their feet, had succeeded in conveying the invalids to the neighbourhood of Cape Joseph Henry, thirty miles distant from the ship, but each day was rapidly adding to the intensity of the disease, and, while lessening the powers of those still able to work, adding to the number of the sick, and consequently, alarmingly increasing the weight which had to be dragged on the sledges. Under these circumstances, Lieut. Parr, with his usual brave determination, and knowing exactly his own powers, nobly volunteered to bring me the news, and so obtain relief for his companions. Starting with only an alpenstock, and a small allowance of provisions, he completed his long solitary walk, over a very rough icy road, deeply covered with newly fallen snow, within twenty-four hours.

Arrangements were immediately made to proceed to

Commander Markham's assistance ; and with the help of the officers, who at once all volunteered to drag the sledges, I was able by midnight to proceed with two strong parties, Messrs. Egerton, Conybear, Wootton, and White, the officers who could be best spared from the ship, taking their places at the drag ropes, Lieut. W. H. May and Dr. E. Moss pushing on ahead with the dog-sledge laden with appropriate medical stores.

By making a forced march the two latter, with James Self, A.B., reached Commander Markham's camp within fifty hours of the departure of Lieut. Parr, although they were, I deeply regret to state, unfortunately too late to save the life of George Porter, Gunner R.M.A., who only a few hours previously had expired and been buried in the floe. Their arrival had a most exhilarating effect on the stricken party, who were gallantly continuing their journey as best they could. Early on the following day the relief party joined them, when the hope and trust which had never deserted these determined men was quickened to the utmost, even the invalids losing the depression of spirits always induced by the insidious disease that had attacked them, and which in their case was much intensified by the recent loss of their comrade. Early on the morning of the 14th, owing to the skill and incessant attention of Dr. E. Moss and the assistance of the dog sledge conducted by Lieut. May and James Self, A.B., who, with a most praiseworthy disregard of their own rest, were constantly on the move, Commander Markham and I had the satisfaction of reaching the ship without further loss of life ; and after a general expression of thanksgiving to God for his watchful care over the lives of the survivors, of placing them under the skilful charge of Dr. T. Colan, Fleet-Surgeon.

Of the original seventeen members composing the party, only five—the two officers and three of the men, John Radmore, chief carpenter's mate, Thomas Joliffe, first-class petty officer, and William Maskell, A.B.—were able to drag the sledges alongside. Three others, Edward Laurence, captain fore-castle, George Winston, A.B., and Daniel Harley, captain foretop, manfully kept on their feet to the last, submitting to extreme pain and fatigue rather than, by riding on the sledge, increase the weight their enfeebled companions had to drag, and were just able to walk on board the ship without assistance. The remaining eight, after a long struggle, had been forced to succumb to the disease, and were carried on the sledges. Out of the whole number, the two officers alone escaped the attack of scurvy. After a few days' rest and attention, John Radmore, chief carpenter's mate, returned to his duty, and three of the others were able to attend on their sick comrades : but Thomas Joliffe, who had most manfully resisted the disease while actively employed, when his legs became cramped from resting on his return on board, was one of the most lingering cases. These men gradually recovered, and were all out of the sick list before the ship was free of the ice during the passage home.

In journeying to the northward, the route, after leaving the coast, seldom lay over smooth ice ; the somewhat level floes or fields, although standing at a mean height of 6 feet above the neighbouring ice, were small, usually less than a mile across. Their surfaces were thickly studded over with rounded blue-topped ice humps, of a mean height above the general level of from 10 to 20 feet, lying sometimes in ranges, but more frequently separated at a distance of from 100 to 200 yards apart, the depressions between being filled with snow deeply scored into ridges by the wind, the whole composition being well comparable to a suddenly frozen oceanic sea. Separating these floes, as it were, by a broadened-out hedge, lay a vast collection of *débris* of the previous summers, broken up pack-ice, which had been re-frozen during the winter into one chaotic rugged mass of angular blocks of various heights up to 40 and 50 feet, and every possible shape, leaving

little, if any, choice of a road over, through, or round about them. Among these was a continuous series of steep sided snow drifts sloping down from the highest altitude of the pressed-up ice until lost in the general level at a distance of about 100 yards. The prevailing wind during the previous winter having been from the westward, and the sledges' course being due north, these "sastrugi," instead of rendering the road smoother, as they frequently do in travelling along a coast line, when advantage can be taken of their long smooth tops, had to be encountered nearly at right angles. The whole formed the roughest line of way imaginable, without the slightest prospect of ever improving. The journey was consequently an incessant battle to overcome ever recurring obstacles, each hard-won success stimulating them for the next struggle. A passage had always to be cut through the squeezed-up ice with pickaxes, an extra one being carried for the purpose, and an incline picked out of the perpendicular side of the high floes or roadway built up, before the sledges, generally one at a time, could be brought on. Instead of advancing with a steady walk, the usual means of progression, more than half of each day, was expended by the whole party facing the sledge and pulling it forward a few feet at a time. Under these circumstances, the distance attained, short as it may be considered by some, was truly marvellous.

The excellent conduct of the crews and the spirit displayed by them, combined with the work performed, indicated in a striking manner the sense of confidence in the leaders which they enjoyed, and points unmistakably to the watchful care taken of themselves and to the general good guidance of the party.

No two officers could have conducted this arduous journey with greater ability or courage than Commander Albert H. Markham and his very able second in command, Lieut. A. C. Chase Parr, and I trust that their Lordships will notice their services by some mark of approval. The services of Thomas Rawlings and Edward Laurence, 1st class petty officers, filling the highly important positions of captains of the sledges, was beyond all praise. In addition to their general cheerfulness and good humour, to their care and skill must be attributed the safe return of the sledges, on which the lives of the party depended, uninjured, and in as serviceable a state as when they left the ship, notwithstanding the heavy nature of the road, which on all former occasions not only repulsed the travellers altogether, but drove them back with broken-up equipment. To such men as these, and the sledge crews generally, it is difficult to find any reward which can in the least compensate them for the manner in which they have manfully met the extreme privations and continuous labour necessarily undergone. During this memorable journey to penetrate towards the north over the heavy Polar oceanic ice, without the assistance of continuous land along which to travel, in which has been displayed in its highest state the pluck and courageous determination of the British seaman to steadily persevere, day after day, against apparently insurmountable difficulties, their spirits rising as the oppositions increased, Commander Markham and Lieut. Parr and their brave associates succeeded in advancing the National Flag to lat. 83° 20' 26" N., leaving a distance of 400 miles still to be travelled over before the North Pole is reached.

In order to attain this position, although a direct distance of only seventy-three miles from the ship was accomplished, the total distance travelled was 276 miles on the outward, and 245 miles on the homeward journey. Their severe labour and exertions which certainly can never be surpassed, coupled with the experience gained by Sir Edward Parry in the summer of 1827, proves that a lengthened journey over the Polar pack ice with a sledge party provided with a navigable boat is, in consequence of the rough nature of the road over which the party has to travel, impracticable at any season of the year ; and

further, as the sledges were necessarily advanced each stage singly, we are enabled to estimate the exact rate of progression which may be expected should anyone consider it desirable to push forward with light sledges without any additional means of returning later in the season in the event of the ice breaking up in his rear. The maximum rate of advance in this way was at the rate of  $2\frac{1}{2}$  miles a day, the mean being at the rate of  $1\frac{1}{2}$  miles a day.

It may be necessary here to state that the much to be deplored outbreak of scurvy, which certainly shortened the journey to the extent of some ten or twenty miles, in no way affects the conclusions to be derived from it. When the first two men who were attacked complained of sore legs, the disorder so commonly experienced by travellers in all countries, and particularly those employed to drag Arctic sledges, the loss of their services at the drag ropes was fully balanced by one of the two boats being left behind, thus, the daily distance accomplished during the first twenty-five days of the outward journey was not materially altered, and it was only during the latter fourteen days, that owing to the gradual breakdown of three more of the crew, the rate of advance was necessarily much retarded. The previous rate, however, had been so slow that the party gallantly continued their advance to the utmost limit of their provisions, confident that with the help of the manual labour of the officers, who from the first took their places at the drag ropes and pickaxes and worked as hard as the men, they could readily return to the land along the road on which they had expended so much labour in somewhat levelling during their outward journey.

The scurvy by this time having with very few exceptions, attacked the whole ship's company, I was somewhat anxious concerning the health of Lieut. Aldrich's men returning from their western journey; particularly when I observed that the cairn erected over his depot of provisions, thirty miles to the north-west, remained untouched on the day appointed for his arrival there; accordingly I sent Lieut. May with the dog sledge, and three strong men to meet him. On June 20 the two parties joined company at the depot and signalled their arrival to the ship. Lieut. Aldrich had crossed the land only just in time, for on the following day a gale of wind from the southward commenced bringing warmer weather, and the thaw set in with such rapidity that the snow valleys on the land were rendered impassable for sledges for the remainder of the season. Lieut. May met the party on the very last day, when most of them were able to travel, having succeeded in reaching, after a very severe journey most courageously borne, the same position to which Commander Markham's party had returned without assistance; but there the same blight that attacked the northern party, and against which the western division had long been struggling, gained on them so quickly that, with the exception of Lieut. Aldrich and Adam Ayles (P. O., 2nd class), the whole crew were placed *hors de combat*, James Doidge (1st class P.O.) and David Mitchell (A.B.) still gallantly struggling along by the side of the sledge, the other four invalids, having held out until the last moment, were obliged to be carried. Under these circumstances the arrival of Lieut. May with relief was most providential. With their assistance Lieut. Aldrich succeeded in reaching the *Alert* on the morning of the 26th, when, after again publicly returning thanks to Almighty God for his watchful care over the lives of the party, they were placed under Dr. Colan's charge, the officer being the only one not attacked by scurvy.

Notwithstanding a bad start, owing to the necessity of crossing the land with heavily laden sledges, Lieut. Aldrich with great energy succeeded in exploring the coast line to the westward for a distance of 220 miles from the position of the *Alert*. Trending first to the north-westward for ninety miles to Cape Columbia, the

extreme northern cape in lat.  $83^{\circ} 7' N.$ , and long.  $70^{\circ} 30' W.$ , the coast extends to the west for sixty miles to long.  $79^{\circ} 0' W.$  and then gradually trends round to the southward to lat.  $82^{\circ} 16' N.$  and long.  $85^{\circ} 33' W.$ , the extreme position attained. No land or appearance of land was seen at any time to the northward or westward, and owing to the continued heavy nature of the ice, I conclude that no land can possibly exist within an attainable distance from this coast. Although most of the party suffered more or less during the outward journey, the attack was supposed to be merely transient, and it was not until they were returning home when the scorbutic symptoms of sore gums first made their appearance, that the real nature of the disease was in the least suspected. To these men equal praise is due as to their comrades employed in the northern division for the endurance and intrepidity with which each individual performed his respective duty. Crippled nearly as badly, they if possible suffered more severely; for being so distant from relief none could be carried without imperilling all, and each was obliged to remain toiling at the drag ropes making forced marches.

It is to Lieut. Aldrich's judicious care and energy during the long and anxious homeward march, seconded by the spirited example of Joseph Good, acting chief boatswain's mate, captain of the sledge, himself one of the most enfeebled of the party, that they owe their lives. Lieut. Aldrich's services on this, as on all other occasions during the three years he has been under my command, calls for my unqualified admiration; he is a talented and zealous officer, and in every way deserving of their Lordships' consideration.

Again, Sir, I have to bring to your notice the valuable services of Lieut. May and James Self, A.B.; the thaw having set in, it was principally due to their incessant labour that the party arrived on board before the rapidly advancing disease had further developed itself.

With regard to the outbreak of scurvy, which attacked the crew of the *Discovery* as well as ourselves, when the sledge crews started early in April, a finer body of men in apparently perfect health it would have been difficult to pick anywhere, and I trusted that, owing to the excellent condition of our provisions, we were secure from any attack, but I must now conclude that disease was even then lurking among us, and that the heavy labour of sledge travelling intensified and brought it out, as has been the case in nearly all former journeys when the travellers have been unable to procure large supplies of game, and were unprovided with lime juice. It attacked first the weakly men, afterwards the strong men who were predisposed for it, and most severely of all those who were employed on the longest and most trying journeys. Had there been no sledging work I believe that the disease would not have betrayed its presence amongst us, and had the officers been called upon *from the first* to perform as severe daily labour as their men I think that they would have been equally attacked.

On July 9, fifteen days after the return of the last sledge party, thirty-six of the crew of the ship had been, and twenty-four were, under treatment for scurvy. This large number of patients, most of them requiring constant and special attention, necessarily taxed to the utmost the services of Dr. Thomas Colan, Fleet Surgeon, and his able second, Dr. Ed. Moss, Surgeon. Nothing could exceed their indefatigable patience and care. The deprivation of necessary rest and exercise cheerfully submitted to by Dr. Colan, upon whom the chief responsibility fell, considerably impaired his own health, following as it did so closely on his long anxious watch by the bedside of Neil Petersen.

In order to preserve the continuity of the narrative, I will here report the result of Lieut. Beaumont's exploration on the Greenland coast, but which I only learnt some time afterwards.



On August 6, while the *Alert* was imprisoned by the ice twenty miles north of Discovery Harbour, during her passage down Robeson Channel, Lieut. Rawson and two men arrived with letters from Capt. Stephenson containing the distressing intelligence that scurvy had attacked the Greenland Division of sledges with as much severity as it had visited the travellers from the *Alert*, and that Lieut. Beaumont was then at Polaris Bay recruiting his men. I must refer you, Sir, to Capt. Stephenson's letters and to Lieut. Lewis A. Beaumont's report for a full detail of the proceeding of this party, but I may here mention the chief points. I have already reported their movements up to May 5, when Dr. Coppinger left them; Lieut. Beaumont with two sledge crews journeying to the north-eastward along the north coast of Greenland, all apparently in good health. A very few days after, James J. Hand, A.B., who had passed the winter on board of the *Alert*, showed symptoms of scurvy. As soon as the nature of the disease was decided, Lieut. Beaumont determined to send Lieut. Rawson with three men and the invalid back to Polaris Bay, and to continue the exploration with reduced numbers. Lieut. Wyatt Rawson parted company on his return on May 11; but owing to two more of his crew breaking down, leaving only himself and one man strong enough to drag the sledge on which lay the principal sufferer, and to look after the other two, he only succeeded in reaching the depôt on June 3, James J. Hand unhappily dying from the extreme fatigue a few hours after the arrival of the party at Polaris Bay. Out of the other men forming the sledge crew, who had all passed the winter on board the *Alert*, only one of them—Elijah Ryner, Gunner, R.M.A.—escaped the insidious disease; George Bryant, 1st class petty officer and captain of the sledge, and Michael Regan, A.B., were both attacked, the former, although in a very bad state, manfully refused to the last to be carried on the sledge, knowing that his extra weight would endanger the lives of all.

I cannot praise Lieut. Rawson's conduct on this occasion too highly; it is entirely due to his genial but firm command of his party, inspiring as he did his crippled band, who relied with the utmost confidence on him, that they succeeded in reaching the depôt. His return being totally unexpected, no relief was thought of, nor, indeed, were there any men to send. On June 7 Lieut. Fulford and Dr. Coppinger, with Hans and the dog-sledge, returned to Polaris Bay depôt from the exploration of Petermann Fiord; and, with the help of some fresh seal meat and the professional skill and care of Dr. Coppinger, the malady was checked and the sick men gradually regained strength.

Lieut. Beaumont, continuing his journey on May 21, succeeded in reaching lat.  $82^{\circ} 18' N.$ , long.  $50^{\circ} 40' W.$ , discovered land, apparently an island, but, owing to the nature of the ice, probably a continuation of the Greenland coast, extending to lat.  $82^{\circ} 54' N.$ , long.  $48^{\circ} 33' W.$  By this time two more of the crew showed symptoms of scurvy, and soon after the return journey was commenced the whole party were attacked, until at last Lieut. Beaumont, Alexander Gray, sergeant-quartermaster captain of the sledge, and Frank Jones, stoker, were alone able to drag, the other four men having to be carried forward on the sledge in detachments, which necessitated always double and most frequently treble journeys over the rough and disheartening icy road; nevertheless, the gallant band struggled manfully onwards, thankful if they made one mile a day, but never losing heart; but Lieut. Beaumont's anxiety being intense lest relief should arrive too late to save the lives of the worst cases. Not arriving at Polaris Bay on the day expected, Lieut. Wyatt Rawson and Dr. Richard W. Coppinger, with Hans and the dog-sledge, started on June 22 to look for them, the two parties providentially meeting in Newman's Bay, twenty miles from the depôt. The following day Frank Jones

three officers and Alexander Gray to drag the four invalids, the dogs carrying on the provisions and equipage. On the 27th Alexander Gray was obliged to give in, and the officers had to drag the sledge by themselves, Gray and Jones hobbling along as best they could. On the 28th, being within a day's march of the depôt with the dogs, the two worst cases were sent on in charge of Dr. Coppinger, and arrived at the end of the march, but I regret to state that Charles W. Paul, A.B., who joined the expedition from the *Valorous* at Disco, at the last moment, died shortly after their arrival. The remainder of the party, helped by Hans and the dogs, arrived at the depôt on July 1, and it being impossible to cross the strait and return to the *Discovery* before the invalids were recruited, at once settled themselves down for a month's stay, those able to get about shooting game for the sufferers with such success that they obtained a daily ration of fresh meat. It was entirely due, under Providence, to the timely assistance dispatched by Lieut. Rawson, who, as senior officer at Polaris Bay, when there was not time to cross Hall's Basin and inform Capt. Stephenson of his apprehensions, acted promptly on his own authority and went to the relief of Lieut. Beaumont's party, that more casualties did not occur.

After such details it is scarcely necessary for me to allude to the services of Lieut. Beaumont. The command of the Greenland sledges, entailing as it did the crossing and recrossing of Robeson Channel—which in 1872 remained in motion all the season—required even greater care and judgment than is always necessary in the leader of an Arctic sledge party. My confidence in Lieut. Beaumont, as expressed in my original orders to him, was fully borne out by his careful conduct of the party throughout this trying and most harassing march. He is a most judicious, determined, and intelligent leader, and as such I bring his services to the notice of their Lordships.

Capt. Stephenson by personal inspection having satisfied himself that the resources of the Polaris depôt were sufficient and appropriate for the subsistence of the men detached to the Greenland shore, although naturally anxious at their non-arrival on board the *Discovery*, was not alarmed for their safety. On July 12 Lieut. Fulford, with two men and the dog-sledge, were dispatched across Hall's Basin to Discovery Bay, and arrived there on the third day, having found the ice in motion on the west side of the channel, and experiencing much difficulty in effecting a landing. On the receipt of the news Capt. Stephenson instantly started with a relief party, carrying medical comforts, and arrived at Polaris Bay on the 19th. On the following day the ice was in motion on both sides of the channel. On the 29th Capt. Stephenson, with Lieut. Rawson, Hans, and four able men, with two invalids who could walk, started with the dingy for Discovery Bay, and after a very wet journey they landed on the west shore on August 2, Lieut. Beaumont and Dr. Coppinger, with five strong men, being left for a few days longer in order to give the other two invalids further time to recruit. The whole party ultimately re-crossed the Strait, and arrived at Discovery Bay on August 14, having been absent from their ship 120 days, several of the party who had wintered on board of the *Alert* having been absent since August 26 the previous year.

Great praise is due to Dr. Richard W. Coppinger for his skilful treatment of the disease; living as he and the party did for from six to eight weeks in tents on an Arctic shore without extra resources or medicines, except at the last, it is much to his credit that on their arrival on board the *Discovery* all the patients were able to perform their ship duties. All speak in the highest terms of Hans the Esquimaux, who was untiring in his exertions with the dog-sledge, and in procuring game—it was owing to his patient skill in shooting seal that Dr. Coppinger was able to regulate the diet somewhat to his satisfaction. Lieut. Reginald B. Fulford, and Dr. Richard W. Cop-

pingers cleared up all doubt about the nature of Petermann Fiord, having reached at a distance of nineteen miles from the entrance, the precipitous cliff of a glacier which stretched across the Fiord.

On considering the result of the spring sledging operations, I concluded that, owing to the absence of land trending to the northward and the Polar pack not being navigable, no ship could be carried north on either side of Smith's Sound beyond the position we had already attained; and also that from any maintainable position in Smith's Sound it was impossible to advance nearer the pole by sledges. The only object, therefore, to be gained by the Expedition remaining in the vicinity for another season, would be to extend the exploration of the shores of Grant Land to the south-westward, and Greenland to the north-east or eastward, but as with the whole resources of the expedition I could not hope to advance more than about fifty miles beyond the positions already attained on those coasts, and moreover, although the crew were rapidly recovering from the disease which had attacked them, they would certainly be unfit for employment on extended sledge parties next year, I decided that the Expedition should return to England as soon as the ice broke up and released the ship. It was with the very greatest regret I felt it my duty to give up the very interesting further examination of the northern coast of Greenland.

Although pools of water formed along the tidal crack in the ice early in June, the thaw did not regularly set in before the last week of the month. On July 1 water in the ravines commenced to run, after that date the thaw was very rapid both on shore and on the ice, but no decided motion took place before the 20th. On the 23rd, with a strong south-west wind, the pack was driven a mile away from the shore, but, as in the autumn, no navigable channel made to seaward or along the land to the westward of Cape Sheridan. On the 26th a record was left in a cairn erected on shore detailing the work performed by the expedition, and of my intention to proceed to the southward. On the 31st, after considerable labour to clear away a passage through the barrier of floe-bergs which had so well protected us during the winter, we succeeded during a strong south west wind, which drove the pack out to sea, in rounding Cape Rawson and entering Robeson Channel on our return voyage. After a ten miles run along shore, through a fairly open channel between the pack and the cliffy ice foot bordering the coast, we were stopped by a heavy floe one-and-a-half miles in diameter nipping against the land four miles north of Cape Union, and there being no other protection attainable, the ship was secured in a small indentation among a group of grounded floe-bergs lining the shore off a shallow part of the coast. The ice in the offing drifted north and south with the tides in a nearly compact mass, that near the shore alone being loose, but in no way navigable.

Early in the morning of August 1, the heavy floe which had stopped us the previous day commenced to move, and was soon travelling to the northward with the whole strength of the tide at the rate of one-and-a-half miles an hour, scraping along the ice foot as it advanced towards the ship in a rather alarming manner. Steam being fortunately ready we cast off, and succeeded in passing between it and the shore, as after a severe wrench against a projecting point close ahead of us, a channel was opened by its rebound, as it coach-wheeled round the north point of the floe, turned in towards the land close to the position which we had vacated a few moments before.

The difference between an ordinary floe and Polar Sea ice was here exemplified completely; the former composed of ice about 6 feet in thickness, on meeting with an obstruction is torn in pieces as it presses past it; the latter being some 80 or 100 feet thick, quietly lifts any impediment away out of its course, and takes no further

notice of it. Such was the case on this occasion: the Polar floe, which we only escaped by a few yards, on nipping against the heavy breastwork of isolated floe-bergs lining the coast, some of them 40 feet high and many thousand tons in weight, which had lately formed our protection from the smaller ice pieces, tilted them over one after another, and forced them higher up the land-slope, like a giant at play, without receiving the slightest harm itself, not a piece breaking away. It was most providential, that by its twisting round the *Alert* was enabled to escape out of the trap in which she was inclosed.

Steering onward, so close to the shore ice-cliff—from 20 to 40 feet high, and having ten to twenty fathoms water alongside it—that the quarter-boats touched on several occasions, we reached within two miles of Cape Union, but in consequence of the pack remaining close in at the cape, both during the flood and ebb tides, the ship was again brought to a stop. Fortunately we were able to secure her abreast of a large water-course, the stream of which had been powerful enough to undermine the ice-cliff to such an extent as to allow fifty yards of it to break away and float off to sea; this left just sufficient space in which to secure the ship alongside the beach in such a manner that in the event of a nip taking place she would merely be forced on the shore before the floe itself grounded. Here we were delayed for twenty-four hours with the boats from the exposed side lowered down and moored in-shore for safety.

At half flood, the south-running tide, a narrow lead of water formed round the cape; steam was got up immediately, but owing to delay in shipping the rudder consequent on the tide running towards the bow carrying it under the ship's bottom, the ice closed in again before I could get round; it also cut us off from our friendly little haven, and I was therefore obliged to secure the ship during the north-running tide in a slight indentation in the high cliffy ice-foot. Fortunately being within half-a-mile of Cape Union, the run of the ice, as it passed to the northward round the Cape, kept at about twenty yards from the land until after it had passed our position; only the lighter ice pieces scraping their way along the ship's side.

As we would be exposed to the whole pressure of the ice during the south-going tide, at 4 P.M., low water, it being calm and no prospect of a westerly wind to open a navigable passage, I cast off and bored a short distance into the pack with the purpose of allowing the ship to drift round the Cape with the flood or south-going tide. The ice carried her with it about a quarter of a mile distant from the land, with no navigable water in sight, the whole pack moving steadily together without nipping to any great extent. As we passed we noticed that the front of the ice-foot was perfectly smooth, and would afford no protection whatever if we were obliged to leave the pack. As the tide slackened we succeeded with great trouble in steaming out of the pack just as the ice commenced to set to the northward with great rapidity. As it remained slack for some twenty yards from the beach, we were able to proceed slowly to the southward, close to the ice-foot; the midship boats being turned in-board, but the quarter-boats which could not be protected, being in constant peril of a squeeze. The water channel widened considerably as we approached Lincoln Bay, and we crossed it without any trouble, and arrived within five miles of Cape Beechey before the tide turned, to run south again, when I secured the ship alongside a heavy polar floe-piece, with the hope of again drifting south; but finding that the lighter pieces of ice were drifting faster and gradually inclosing us, I was obliged to cast off, and with much trouble succeeded in reaching the north side of Cape Beechey, before the north running tide made at noon, August 3. After two hours waiting, there being plenty of water space to the northward, a channel opened and allowed us to get round the Cape. Here the cliffy ice-foot comes to an end with the precipi-

tous land. South of the Cape the land slopes down to the shore line, and is fronted by a breast-work of broken off floe-bergs similar, but somewhat smaller, than those lining the shore of the Polar Sea; among these the ship was secured in three fathoms water within twenty yards of the shore, a mile south of the Cape, and considering our much more exposed position during the winter, I thought the ship secure.

During August 4 the weather was overcast with snow squalls from the south-west, with a low barometer but not much wind. As the ice had closed in and locked the ship up completely, the sportsmen visited the lakes where three musk-oxen had been shot the previous summer. A number of geese were found all unable to fly; the old ones moulting were nearly featherless, and the young ones not yet having grown theirs; consequently fifty-seven were captured, a very welcome supply for the invalids, of whom we had ten still remaining. The ice remaining close, and being only twenty miles from the *Discovery*, Mr. Egerton, with a seaman for a companion, was sent to her on August 5 with orders for her to prepare for sea. They had a rough and troublesome walk over the hills, but arrived the same evening.

During our detention in this position, the pack in the offing drifted up and down the strait with the tide, the wind having the effect of increasing the speed of the current, and the duration of its flow both towards the north and the south. Although the ice generally was of a considerably lighter character than that in the Polar Sea, or at the northern entrance of Robeson Channel, a number of heavy Polar floes passed us, driven to the southward by the northerly wind, and set into Lady Franklin Sound and Archer Fiord rather than down Kennedy Channel. In fact, that Sound may be considered as a pocket receiving all the heavy ice driven south through Robeson Channel, and retaining it until the prevailing westerly winds carry it to the northward again, and clear out the Sound ready to be re-filled when the north wind returns. It is only during seasons when northerly winds prevail considerably over the westerly ones, that the heavy Polar ice is carried south in large quantities into Smith's Sound and Baffin's Bay.

On August 6 the wind increased considerably from the north until it blew a gale. During the height of the flood or south-going tide a succession of heavy floe pieces passed us drifting down the strait, toying with our barrier of outlying protections, and turning one large one completely topsy-turvy. It was firmly aground in twelve fathoms water on an off-lying shoal some 200 yards from the main line of the floe-bergs, and on this and the previous days had been of great service in keeping the line of the drifting pack at a safe distance from us; but on this occasion the point of a large floe which was drifting south close in shore brought the weight of the whole pack on the doomed mass. As it received the pressure the floe-berg was reared up in the air to its full height of at least 60 feet above water, and turning a complete somersault, fell over on its back with a tremendous splash, breaking into a number of pieces with a great commotion and raising a wave sufficiently to roll the ship considerably. Our protecting floe-berg carried away, the ice moved in, forcing the lighter floe-bergs one after the other, as they became exposed farther in-shore, and at last nipped the ship slightly. This evening Lieut. Rawson and two seamen arrived from the *Discovery* with news of the Greenland division of sledges. On the morning of August 7, with the wind blowing slightly off the land, the ice eased off shore, and cleared the nip round the ship, but did not allow me to move to a more sheltered position. In the afternoon, a temporary opening occurring, steam was raised and the rudder shipped, but owing to some of the ropes fouling, the latter was not ready before the ice closed in and imprisoned us again. During the night the wind increased considerably, and with the south

running tide the ice was being carried past us at the rate of two miles an hour. Owing to several heavy pieces grounding outside our line of barrier ice, the inner edge of the pack was guided more towards our position, and at last two heavy pieces wedged themselves against the ship, the inner one grounding alongside the ship after forcing her very close to the shore, and nipping her to such an extent that the ship was raised bodily 3 feet. As the tide rose the lighter ice in-shore gradually forced its way under the ship's bottom and relieved the pressure somewhat; so that after four hours she was only raised about 6 inches above her usual draught of water.

As there was now no hope of releasing the ship, except by cutting down the heavy piece of ice which was aground outside us, all hands were set to work with pickaxes to lighten it. On August 10, after three days' work, the ice having been sufficiently reduced, floated at the top of high water, and released the ship; the main pack moving off shore at the same time, we advanced five miles, and on the following day, after much trouble, succeeded in joining company with the *Discovery*. Sending all my sick men to the *Discovery*, the *Alert* was secured at the entrance of the harbour ready to start for Polaris Bay to relieve Lieut. Beaumont immediately the ice permitted me to cross; but his arrival on August 14, as before stated, fortunately rendered this passage unnecessary. The *Discovery* having embarked her coals and provisions, both ships were now ready to continue their voyage to the southward, but although water was observed in Kennedy Channel, the whole of Lady Franklin Sound remained filled with the ice brought to the southward by the late northerly gale. While waiting, ready to start, each of the ships tailed on shore at nearly low water, but floated again without damage.

We were delayed here with calm weather and consequent little motion in the ice until August 20, when, a chance offering, we pushed our way through the pack, which, gradually opening as we advanced, led us into comparatively open water off Cape Lieber, where a strong south-westerly wind had been blowing for several days but had not been able to force its way across the ice in Hall's Basin. As we neared Cape Lawrence, the ice, which had been getting closer as we advanced south, became so close that we must either return north, run into the pack, or secure the ships to some of the grounded floe-bergs or icebergs. I chose the latter, and entering the bay immediately south of the cape, we followed the coast until we found ourselves in a large inner basin perfectly land-locked, and I made the ship fast with perfect confidence, although with the spring flood-tide the ice was floating sluggishly in and gradually filling up the bay. It happened, unfortunately, that at the very top of high-water a rather insignificant-looking piece of ice pressed against the ship, when the floe-berg in-shore of us, and against which the ship was resting, having floated with the spring tide, allowed itself to be pressed in-shore, and suddenly we found the ship aground forward with deep water under the stern. Before any means could be taken to release her from this position the tide had fallen 14 feet at low water, leaving the fore foot and keel bare as far aft as the fore channels, the ship lying over on her bilge at an angle of twenty-two degrees. As the tide rose, the ship was lightened, the cables hauled aft, and the anchors lowered on to suitable pieces of ice. One of these was then hauled astern to a proper position, when by blowing up the ice the anchor was laid out with great ease. At high water the ship was hauled off without having received any injury. On August 22 a south-west wind opened a passage again, of which immediate advantage was taken, and we proceeded to the southward as far as Cape Collinson with only the ordinary troubles in ice navigation, during thick snow-storms, misty weather, and strong head winds. Off the cape, owing to the *Alert* being obliged to back astern to escape a nip, the two

ships fouled for a few moments, and the *Discovery* lost a boat's davit, but by smart and skilful management saved the boat. I may here add that such has been the skill displayed by the officers of the watches of the *Alert* and *Discovery*, although the two ships have frequently been necessarily within touching distance of each other, and of the ice-cliffs and bergs, this is the only accident of consequence which occurred during the voyage. The ice closing in ahead, the two ships were made fast inside some grounded icebergs in Joiner Bay, one mile north of Cape McClintock.

In Rawlings Bay, south of Cape Lawrence, icebergs are found for the first time on coming from the northward. All to the northward may be considered as floe bergs. Few even of the initiated can distinguish one from the other, so like are they; and certainly any stranger would be deceived, the floe-bergs being frequently larger than the icebergs. The ice-foot is also totally different, being formed by the pressure of lighter ice, it does not project into such deep water; consequently, whereas we could secure the ship alongside the ice-foot in Robeson Channel with confidence of her not grounding, in Kennedy Channel and all parts to the South of it there is only one fathom water alongside the icy cliff at low water.

Starting again in the evening, as an increasing south-west wind gradually opened the ice to the southward, we crossed Scoresby Bay, which, extending from fifteen to twenty miles in a south-west direction, was perfectly clear of ice, the fresh breeze blowing down it raising a sea which caused the ships to pitch slightly, and materially stopped their speed through the water. Approaching Cape Frazer, the wind was blowing a whole gale, and I was forced to expend much coal in reaching Maury Bay immediately north of it, and in which the two ships were anchored among a lot of grounded ice, but the squalls off the land rendered it anything but a safe or comfortable position. We were delayed three days rounding Cape Frazer and Cape Hayes, the turning point of the channel, and consequently a troublesome piece of navigation. On the 25th, after twice being driven back into Maury Bay, we succeeded in securing the ships inside some grounded icebergs near Cape Louis Napoleon, the same in all probability that sheltered us when bound to the northward the previous spring.

Much has been said concerning the expected difficulty of passing Cape Frazer, on account of the two flood tides, one coming south from the Polar Sea, and the other north from the Atlantic, being supposed to meet there, and by so doing collect a quantity of ice in the neighbourhood. Were ice navigation dependent on tidal currents alone, then at the position of slack water, where there is a minimum ebb and flow, a vast quantity of ice might be collected by the two flood tides, but on the other hand there would be an equal chance of the two tides carrying it away in opposite directions; however, as wind is of far greater importance than tidal movement, the case need not be considered. The two tides do meet at Cape Frazer, the actual position varying a few miles north or south according to the prevailing wind, and also the ice is certainly accumulated immediately about and south of the cape in great abundance. But this is owing to the ending of Kennedy Channel, and the strait widening considerably at that place into Smith's Sound proper. While many causes tend to keep narrow channels clear, enlarged seas with narrow outlets are naturally encumbered with ice.

I found no greater danger or trouble in passing Cape Frazer than in navigating elsewhere, except from what is caused by that cape being the turning point of the coast line, where no one wind blowing up or down the strait is able to clear away the ice on the north and south sides of the cape at the same time. Struggling slowly and patiently along, gaining about one mile a day by moving forward from the protection of one stranded iceberg to that of

another, as slight movements in the ice during the calm weather allowed, and although obliged to enter the pack occasionally, always keeping as near the shore as prudent, we rounded Cape Louis Napoleon, and on the 29th arrived at Prince Imperial Island, in Dobbin Bay, everyone heartily thankful to be out of the pack, clear of the straggling icebergs, and for the ships to be secured to fixed ice once more.

During the previous week we had experienced much misty weather with a heavy fall of snow, measuring five inches, which changed the whole aspect of the land by reclothing the richly-tinted stratified mountains with their winter garb, from which they had only been free for a short seven weeks; afterwards the snow only melted slightly in the low-lying valleys. A northerly wind now set in, not strong enough to effect the movements of the ice materially, but sufficiently so to clear the atmosphere and lower the temperature considerably below freezing-point; after this date the young sea-ice formed continually day and night. As the mist cleared away it disclosed a fine panorama of lofty snow-clad mountains with glacier-filled valleys intervening; one large one extending to the shore discharges numerous icebergs into Dobbin Bay. This, the largest discharging glacier on the west shore of Smith Sound, was named after the Empress Eugenie, who, besides taking a personal interest in the expedition by her thoughtful present of a number of homely but most useful articles, added considerably to the comfort and amusement of each individual.

On September 1 we crossed Dobbin Bay and succeeded in securing the ships to an iceberg aground only a quarter of a mile from the depot of provisions left by us the previous spring a few miles north of Cape Hawkes, but such was the thickness of the newly-formed ice that boat work was nearly out of the question; by working in the crack opened by the ebb tide some of the provisions were embarked, but there is still a boat and a large quantity of biscuit left on shore there. The same reason prevented landing on Washington Irving Island and visiting our own cairn until the third day, when the spring tide having opened a water passage I found that our notice had not been visited since we left it. The two old cairns erected by former travellers were again visited; the lichens which had spread from stone to stone proving that they are undoubtedly of very ancient date. They were probably erected to mark the farthest north point reached by one of our enterprising and gallant predecessors who never returned home.

On September 3 a lane of water opening along shore to the westward of Cape Hawkes, every exertion was made to reach it, but owing to the newly made ice, which by cementing together a number of loose pieces of old ice formed a barrier between us and the water, we only succeeded, after long perseverance, in ramming our way through it at a large expenditure of coal. After rounding the Cape, the pack by drifting away from the land has left unfrozen water and numerous detached small floes which forced us to make a very serpentine course, and occasionally to pass within thirty yards of the low ice rest on the shore, fortunately always finding deep water. The outer pack, consisting of heavy ice, was closely cemented together by this year's frost; it contained fewer icebergs than we observed last year.

We succeeded in reaching Allman Bay, half-way between Cape Hawkes and Franklin Pierce Bay, but here the water ended, and the new ice was so strong that I thought it better to wait for the chance of an opening instead of forcing our way through it with full steam. On the following day, no sign of an opening occurring, and wishing to get to a more sheltered position on the western side of the bay, the *Discovery* being better adapted for the work than the *Alert*, led the way under full steam forcing a canal through the ice, which was 1 to 3 inches thick. She was several

times completely stopped, until with all hands running from side to side on the upper deck and rolling the ship, she cleared herself and obtained headway again. At the head of Allman Bay we found a long valley leading down from the lofty hills far back in the interior filled with a gigantic glacier, probably extending eastward nearly to Gobbin Bay. It was named after Mr. Evans, the President of the Geological Society. In the Bay the temperature of the surface water was 32°, whereas since the frost had set in we had not met with any above 30. On testing it was found to be nearly fresh, which fully accounted for the increased thickness of the newly formed ice. We afterwards found the same phenomenon in the neighbourhood of each glacier stream that we passed, proving that the water under the glaciers being cut off from the increasing cold remains unfrozen, and running after the temperature of the air is considerably below freezing point.

The ice prevented our further movement until September 6. Early on the 7th, after one halt to allow the ice to open, we reached Norman Lockyer Island, with water channels for a third of the way across Princess Marie Bay. The season was now getting so late that one false step would probably entail our passing another winter in these seas without any adequate result being derived; therefore before attempting to cross the bay I walked to the summit of the island with Capt. Stephenson, and from there we had the cheering prospect of seeing a large space of open water some twenty miles distant from us which we knew would extend to the entrance of Smith's Sound, with only a few troublesome-looking nips between us and it. Making a signal to the ships we hurried on board, and with the exception of one nip which cost us an hour to clear away with all hands on the ice, and the *Discovery* charging at it repeatedly with full steam, we succeeded in getting two-thirds of the distance across the Bay; but there we were stopped by three extensive Paleocrystic floes which tozzled in between some grounded bergs, and Cape Victoria prevented the ice from drifting out of Princess Marie Bay. The open water was now in sight from the mast-head, but the supply of coal was getting so low that if we did not succeed in releasing the ships the allowance for the second winter would have to be much reduced. On the 9th, as the ice moved at the change of tides, we advanced about a mile. On the morning of the 10th, observing that the heavy ice was likely to pass clear of the icebergs which imprisoned it, steam was got up ready, and five minutes after the channel was opened we passed through and found ourselves clear of Cape Victoria.

After this there was only one serious obstacle to our advance. Owing to the very calm weather the new ice had now frozen so strong that full steam was always necessary, particularly so wherever we had to force our way through ice where scattered pieces of old ice had been re-frozen closely together. At our last barrier of this kind, after the *Alert* had repeatedly charged the nip with full steam and considerable speed on, with no result, the *Discovery* ranged up alongside, and there being a narrow piece of heavy ice which would prevent the two ships actually touching, we made a charge together, and succeeded in forcing the barrier and gaining the open water beyond. From here the water channel permitted me to make a clear run for Cape Sabine, the ice opening as we advanced until none was in sight from the mast-head. On passing the entrance of Hayes Sound a considerable quantity of ice was observed some distance inside it.

In comparing the voyage of the *Polaris* and that of the *Alert* and *Discovery*, I believe that a vessel might have passed up the channel with equal fortune as the *Polaris* without encountering ice during the south-west gale we experienced in the middle of September, 1875. The heavy sea which on that occasion was produced in Robeson Channel indicated that there was a considerable stretch of clear water to the southward. The difficulty would be

the choice of a starting point so late in the season after the frost has set in. If carefully navigated, a vessel, although kept ready to make a start, ought by that time to be secured in a sheltered position fit for winter quarters; and, therefore, would most probably be unable to reach the channel of open water when it formed. If incautious, she would be as helpless in the pack. The best starting points are Port Foulke and Port Payer, at the entrance of Smith's Sound. The *Polaris*'s quick passage north was entirely due to her leaving the entrance of Smith Sound at an opportune moment late in the season; had she left at any other time she would have experienced the same trouble in getting north in 1871 as in returning south the following year. There was as much in the channel in 1871 as in 1872—75—76. To the latitude of *Polaris* or *Discovery* Bay, if no accident happens to the ship, the passage may probably be made with perseverance most years by starting early in the season, but it will at all times be a most dangerous one.

In Robeson Channel the difficulties are greatly increased, and the passage may be said to depend as much on a fortunate combination of circumstances as on skilful navigation. The present expedition was 25 days in going and returning between Cape Sabine and *Discovery* Bay, the distance being 250 miles; 7 days in proceeding from *Discovery* Bay to the Arctic Sea, and 12 days in returning, the distance being 76 miles.

Sail was only used once on the passage north, the distance run being 20 miles, it was never used during the passage south. It is, therefore, totally out of the question a sailing vessel ever making the voyage; nevertheless, as full steam was only necessary on two occasions, a powerful steamer is not necessary. When the ice is decidedly closing no power at present available is of the slightest use; when it is opening, easy speed generally carries the ship along as fast as the ice clears away in advance of her; it is rarely that a quick dash forward is necessary.

In a very exceptional season a ship might be carried nearer towards Cape Joseph Henry than Floeberg Beach on the west shore, and probably into Newman Bay on the east shore of the entrance to Robeson Channel; but from the experiences we have gained I most confidently report that no vessel will ever round the promontory of Cape Joseph Henry, or pass beyond Cape Brevoort in navigable water.

Every observation indicates that the last few years have been mild at the settlements on the west coast of Greenland, and open seasons with regard to the ice in Baffin's Bay; little or none having been met with north of Cape York in July and August. The settlement at the Whale Fish Islands has been temporarily withdrawn, owing to the thin state of the ice rendering the fishing dangerous; and the temperature of the water as we proceeded south, through Baffin's Bay, was so high that navigation could scarcely be interrupted off Disco before the end of the year; indeed, the Inspector intended to be absent in an open boat in the month of November. With a maximum body of water the ice formed on it in one winter will be considerably lighter or thinner than it would be, had a quantity of ice been left floating about on its surface ready to be re-frozen thicker, and cemented with the new ice into one floe during the coming winter. Thus, one open season certainly leads to another; and unless fortuitous circumstances occur, such as continuous south-west gales, during the summer months, the season of 1877 must be a very open one in Baffin's Bay. North of Smith's Sound the season is probably entirely different to that of Baffin's Bay, for the same northerly winds that carry the ice to the southward towards Davis Straits, must fill up Smith's Sound with heavy Polar ice and produce a cold season. Southerly winds which keep the ice north in the Bay would as certainly clear out the channels to the northward, empty the ice into the Polar Sea, and produce a milder season than usual.

From Hayes Sound to Cape Beechey, in lat.  $81^{\circ} 52' N.$ , where Robeson Channel is only thirteen miles across, numerous Esquimaux remains stud the whole line of the west shore of Smith's Sound. To the southward of Cape Beechey the coast line affords fair travelling, to the northward the precipitous cliffs cut off all further advance, except during the depth of winter, when the ice in the channel is stationary. A very careful examination was made of the coast north of Cape Union, and I can report with confidence that Esquimaux have never had a permanent settlement on that shore. All the facts collected by our numerous observers lead me to conclude that the wanderers crossed Robeson Channel from Cape Beechey to Cape Lupton, where the *Polaris* Expedition discovered their traces.

The few pieces of drift wood, all of the fir or pine species, that have been obtained on the shores of the Polar Sea have evidently drifted to the position in which they were found from the westward. One piece was obtained lying on the surface of the sea ice itself, two miles distant from the land, the rest were found on the shore at different heights above the sea level up to 150 feet; the former was perfectly fresh with the bark on; the latter in all stages of decay, usually imbedded in the mud of dry ancient lakes evidently formed by the rising of the land, and of very great age. Besides these evidences of the rising of the land, the clearly defined smoothing of the ice at all the prominent capes, from the present ice level up to 300 and 400 feet until the marks are lost in the gradually decomposing rocks, caused by the pressure of the bordering ice-foot and the grounding ice as it is forced against the land by the drifting pack, and the numerous sea-shell beds and mud deposits at high elevations were most noticeable.

At Flosberg Beach the salt-water ice formed during the winter attained its maximum thickness of  $75\frac{1}{2}$  inches early in June. In a fresh-water lake at the same date the ice was  $79\frac{1}{2}$  inches thick, with 12 feet depth of water at a temperature of  $32^{\circ}$  below it. This proves decidedly that the deep lakes do not freeze to the bottom during the winter. The lowest temperature registered by a thermometer buried 2 feet in the ground beyond the influence of any sudden variation was 13 degrees below zero; 59 degrees warmer than the air at the time. It rose gradually as the summer advanced, and at the end of July had risen to  $29.5^{\circ}$ . By that time the ravines had nearly stopped running, and the weather was becoming gradually colder. The sun's rays were most powerful on June 13 and 21, when a thermometer, with a blackened bulb in vacuo, registered  $+128$  and  $+129$  degrees, the temperature of the earth's surface at the time being  $+27$  and of the air  $+34$  degrees.

The coldest temperature of the sea-water during the winter was  $28.25^{\circ}$ , the same at all depths. On several occasions the Casella reversible thermometer showed that the temperature of the surface water, south of Robeson Channel, was colder than that of the underlying stratum, the difference amounting on one occasion to  $1\frac{1}{2}$  degrees Fahrenheit.

At Floeberg Beach the time of high water full and change, 10h. 44m.; spring rise, 3ft. 0in.; neap rise, 11h. 73m.; neap range, 0ft. 5in.

As I had deposited a notice of our proceedings at Norman Lockyer Island and intended calling at Cape Isabella I ran past our station near Cape Sabine without visiting it; observing that the cairn was intact and appeared to be in the same state as we left it. Payer Harbour and the neighbourhood was clear of ice.

We arrived off Cape Isabella on September 9, the weather still remaining calm. On landing, a small mail of letters and newspapers which had been left by the *Pandora* was found at the depot, the dates informing us that the visit was made this year, but beyond a notice that if possible a duplicate box of newspapers

would be landed at Cape Sabine, we found no record of her previous or intended movements. Concluding that the remainder of our mail was left at Disco, and being short of coal, and the weather very calm, I pushed on towards the Carey Islands, without losing time by visiting Littleton Island on the opposite side of the strait. A southerly wind springing up, the ships were put under sail. Beating to the southward, we fetched into Whale Sound on the 11th without meeting any ice since leaving Smith's Sound. The wind having freshened into a gale I anchored in Bardin Bay on the evening of the 12th, where we observed some Esquimaux on shore, but the weather continuing very bad, I, unfortunately for them, put off communicating until the following day. On the same night the wind shifted suddenly and forced us to get under weigh, when the misty weather and a dark night prevented my landing at their settlement. The rock a-wash off Cape Powlet, the east point of the entrance on which the Esquimaux village stands, is very dangerous. There is no good anchorage obtainable outside of Tyndall Glacier; we were obliged to anchor in twenty-three fathoms in a position exposed to the northward, the *Discovery* making fast astern of the *Alert*.

During the 13th and 14th we worked to the southward towards Wolstenholm Island with calm and light airs from the west, which prevented my reaching the Carey Islands except at a large expenditure of our rapidly diminishing stock of coal; the heavy swell left from the late southerly gale would also have prevented our landing; accordingly our letters, left there the previous year by the *Pandora*, were obliged to be sacrificed.

From Wolstenholm Sound a south-easterly wind enabled us to fetch across to Cape Byam Martin at the entrance of Lancaster Sound, where we arrived on the 16th, having seen no field ice, and the temperature of the sea-water ranging from 31 to 34 degrees. Steaming to the eastward on the 18th, we met another south-east wind, which carried us into the south part of Melville Bay, and we proceeded south along the Greenland shore. I preferred recrossing Baffin's Bay rather than by standing to the southward risk getting in-shore of the middle ice on the west side. On the 20th Cape Shackleton was sighted, and on the 25th we arrived at Disco, having had persistent head winds since we left the entrance of Smith's Sound on the 10th. Only one light stream of ice was fallen in with all this part of the voyage. Here Mr. Krarup Smith, Inspector of North Greenland, most considerately allowed us to take 30 tons of coal out of his small store, and informed me that there were 20 tons more at my disposal if I would visit Egedesminde; and in order to give the Expedition the full benefit of his presence in obtaining supplies, Mr. Krarup Smith accompanied the ship to that port. Nothing could exceed his kindness to us during our stay. Finding that several of the inhabitants of Egedesminde were attacked with scurvy, I made the Governor a present of lime-juice for general use. From Mr. Smith we learnt that all our letters, with the exception of the few left at Cape Isabella, had been deposited at Littleton Island. Only a few letters were received at Cape Isabella, therefore a large mail of private and official correspondence has been lost.

After coaling and preparing the ships for sea we left Egedesminde on October 2. On October 4 the two ships recrossed the Arctic Circle, exactly fifteen months from the time of crossing it on the outward voyage. Experiencing contrary winds, slow progress was made to the southward. As the weather became warmer and damper a few men were attacked with rheumatism and colds. On the 12th, during a very severe gale, in which the ships were hove to under a close-reefed main topsail and storm staysail, the *Alert's* rudder head, sprung when the ship was in the ice, worked adrift from the irons with which it had been repaired, the lower part of the rudder being sound. As I had neglected to have the rudder

pendants shackled on before leaving port, it was with no little difficulty that make-shift rudder pendants were improvised; but by their means the ship has been steered across the Atlantic, the sails being trimmed to bring as little strain as possible on the rudder. The *Discovery* was lost sight of during a heavy gale on the 19th. During the passage, southerly winds prevailed. The spare rudder, itself badly sprung, has been repaired, and is in serviceable condition; when it is shifted the *Alert* will be ready to proceed to Portsmouth. Captain Stephenson, before parting company, was ordered to rendezvous at Queenstown.

In conclusion, it is my pleasing duty to inform you for the information of their Lordships, that one and all under my command have done their duty well and nobly, the utmost cordiality prevailing throughout the members of the Expedition from first to last. Capt. Stephenson has been a most valuable colleague, and I am much indebted to him for his friendly advice, and ready help on all occasions.

The executive officers have each been mentioned in the detailed reports of Capt. Stephenson and myself; their conduct when taxed to the utmost, under difficult and most distressing circumstances, is beyond all praise. Much as the attack of scurvy which visited us is to be regretted, it proved how valuable were the services of Fleet-Surgeon Thomas Colan, M.D., and Staff-Surgeon Belgrave Ninnis, M.D., who were so ably assisted by Surgeons Edward Lawton Moss, M.D., and Richard William Coppinger, M.D. These officers are each of great talent and high character, and have fully borne out the confidence imposed in them by the Medical Director-General; any reward that it is in the power of their Lordships to bestow on these gentlemen could not be given to more careful or zealous officers.

Lieuts. Lewis Anthony Beaumont and William Henry May, who voluntarily undertook the navigating duties in their respective ships, have performed that work most ably.

Lieuts. May and Robert Hugh Archer have charted the coast line from the entrance of Smith's Sound to the northward with great exactness; these officers have earned their Lordships' commendation.

The Expedition is much indebted to Mr. Thomas Mitchell, Assistant Paymaster-in-charge; the departure of the Assistant Paymaster of the *Alert* has much increased his work, as the only officer of his rank in the Expedition. In order the more readily to assist me, he performed a sledge journey in the early season from the *Discovery* to the *Alert*, and has since then divided his time between the two ships. He is a steady and trustworthy officer, and as such I recommend him for promotion. Mr. Mitchell and Mr. George White, Engineer, have made a most valuable collection of photographs of subjects connected with Arctic life and scenes.

The Engineers of the two ships have always most zealously assisted, like everyone else, in the general work, and fully occupied their spare time for the benefit of the Expedition.

Messrs. James Wootton and Daniel Cartmel deserve great praise for the invariable excellent order in which the engines under their charge have been kept, and for the careful economy of the coal supply, a vital point in Arctic exploration. Messrs. George White and Matthew Richard Miller are each careful and talented officers. I most confidently recommend the claims of these four gentlemen, who were voluntarily employed with the support sledges, to the favourable consideration of their Lordships.

The two ships' companies have conducted themselves in the most praiseworthy manner throughout; they are specially commendable for their resolute perseverance during the trying sledge journeys which have been already reported. Their good conduct and zeal entitles them to

the most favourable consideration of their Lordships. A list of men specially deserving of and fit for advancement to higher rates will shortly be forwarded.

#### OUR ASTRONOMICAL COLUMN

THE NOVEMBER METEORS.—The earth will arrive at the descending node of the first comet of 1866 (Tempel), in the track of which the meteors of the November period are found to travel, early on the evening of the 13th inst. The comet itself is approaching the point of nearest approximation to the orbit of Uranus, which planet, however, is always far removed from the comet during the present revolution. The distance from the earth on November 13 is 19.06, and from the sun 18.11, the mean distance of the earth from the sun being taken as unity; and were we able to reach the comet with our telescopes it would then be found rather more than one degree to the west of Antares. The obvious existence of more than one point of excessive condensation in this stream of meteors, necessitates a strict watch at each return of the earth to the nodal point, if we are to arrive at a clear knowledge of the law of distribution along the orbit, and as was remarked by M. Leverrier, "cela permettra de comprendre ces questions dans une théorie plus précise."

HERSCHEL'S FIRST GLIMPSE OF URANUS.—Herschel's first observation for position of this planet on the night of discovery, March 13, 1781, was made at 10h. 30m. M.T. at Bath, when he found it 2' 48" distant from a star which he calls  $\alpha$ . For those who are curious in such matters it may be stated that the tabular place of Uranus at this time is in right ascension 5h. 35m. 48.28s., and north polar distance 66° 27' 3", whence it appears that Herschel's first comparison was made with the star Argelander  $\gamma$ . + 24°, No. 1067, estimated 9.5m.; the difference of one minute of arc, between the observed distance and that computed on reducing the star to March, 1781, being probably due to error of position in the "Durchmusterung." The log-distance of Uranus from the earth was 1'2774.

THE TRANSIT OF VENUS, 1882.—Prof. Bruhns has circulated the results of a new calculation of the circumstances of this transit, made from Leverrier's tables of sun and planet, on the method adopted by Hansen for the transit of 1874. These results, allowing for small differences in the semi-diameters employed, are quite in accordance with those previously published by Hind, Puisseux, &c. Prof. Bruhns hopes to issue a chart of the limiting curves in this transit, founded upon this new computation, before the end of the present year.

MR. KNOBEL'S CATALOGUE OF THE LITERATURE OF SIDEREAL ASTRONOMY.—One of those exceedingly useful, but monotonous and laborious performances which exhibit the real zeal of the worker, occupies a large portion of the supplementary number of the "Monthly Notices" of the Royal Astronomical Society. It consists of a list of references to books, papers, &c., bearing upon the following subjects connected with stellar astronomy:—1. Double Stars, and the investigation of the orbits of Binary Systems; 2. Variable Stars; 3. Red Stars; 4. Nebule and Clusters; 5. Proper Motions; 6. Parallaxes of Stars; 7. Stellar Spectra; and, in the formation of this list, Mr. E. B. Knobel has had the advantage of the valuable library of the Royal Society, which is known to be remarkably rich in scientific transactions, &c., in addition to the library of the Royal Astronomical Society, to which numerous and important additions have been made of late years. In such a work it might not perhaps be difficult for any one who has interested himself in a particular branch of sidereal astronomy to suggest some addition which he would like to have seen incorporated. For instance, if a calculator of double-star orbits be looking up measures of  $\alpha$  Centauri, he will find no reference to the valuable measures by Mr. E. B. Powell, at Madras, under his name.

Mr. Knobel's statement that with one exception he has "personally examined every paper or book to which reference is made," will afford an idea of the expenditure of time and trouble involved in the production of his catalogue. By the way, the one exception refers to the "Sidereal Messenger," issued by the late Prof. O. M. Mitchell, while director of the Observatory at Cincinnati, which Mr. Knobel says is "not in the British Museum nor the libraries of the Royal Society and the Royal Astronomical Society." The writer is able to testify to a circumstance from his own experience, which may throw some light on the rarity of this periodical in our scientific libraries. He was one of a favoured few in this country to whom Prof. Mitchell sent the "Sidereal Messenger." It arrived through the post in one or more numbers at a time, but the postal arrangements with the United States not being then on the liberal footing of the present day, and Prof. Mitchell unluckily enveloping his journal in a stiff cover, heavy letter-postage was demanded for the successive deliveries. The demand increased on each occasion, until the presentation of one, which would have left but small change out of a sovereign, closed the writer's knowledge of the "Sidereal Messenger," and he has some recollection that the present Plumian Professor of Astronomy informed him at the time that his own receipt of the paper terminated about the same epoch, and for a similar reason. If this be a mistake, perhaps the periodical to its termination may be found in the library of the Cambridge Observatory. No. 4 contains the author's early measures of the companion of Anares, which he detected at Cincinnati, in 1845, with measures of  $\eta$  Coronæ and one or two other double stars of no particular interest. The "Sidereal Messenger" was not continued for any length of time.

#### METEOROLOGICAL NOTES

CLIMATE OF MANITOBA.—In the *Journal* of the Austrian Meteorological Society for October 1, there appears a valuable paper on this subject by Dr. A. Wojekoff, based on observations made for a period of about five years at Winnipeg, the capital of this province of Canada. The results, a monthly *résumé* of which accompanies the paper, show a mean atmospheric pressure about three-tenths of an inch less in summer than in winter, and in consequence of the position of Manitoba with reference to the diminished pressure in the interior of the continent at this season, N. and N.W. winds prevail there 19 per cent. less, and N.E. E., S., and W. winds 26 per cent. more in summer than in winter. Leaving out September, the rainfall of which appears to be exceptional, May and June are the two rainiest months, and next to these come April and July, the rainfall of Winnipeg being in these respects closely analogous to that of the prairie region of the Western States. The rainfall for the year is only 22 inches. The greatest amount of cloud and the greatest relative humidity occur in November. The mean annual temperature is  $34^{\circ}$ , the coldest month January, being  $0^{\circ}5$ , and the warmest July,  $66^{\circ}7$ . The winter temperature is thus as cold as that of Archangel, but the summer temperature as warm as that of Paris. The high summer temperature and generous rainfall from April to July, the rainfall rising from 1.85 inches in April to 3.58 inches in June, mark the climate of Manitoba as admirably suited for the successful cultivation of wheat, barley, potatoes, turnips and other agricultural products of temperate regions. Dr. Wojekoff draws an interesting comparison between the climates of the prairies of Manitoba and Minnesota on the one hand, and the Steppes of Western Siberia on the other, and shows that the seasonal distribution of temperature of Winnipeg is all but identical with that of Ischim, and that of St. Paul with Saratow. An important climatic difference must, however, be kept in view, viz., the summer rains are several weeks earlier in Manitoba than in Siberia.

SIROCCO AT PAU.—In the same number M. Piche, Secretary of the Meteorological Commission of the Lower Pyrenees, communicates a short notice of a sirocco which occurred in that part of France on September 1, 1874, during which the temperature rose at Biarritz to  $101^{\circ}3$ , and the humidity fell to 38, the humidity falling still lower, or to 33, at Eaux-Bonnes. The extraordinary heat and dryness of the sirocco, which came from the south and south-east are attributed by M. Piche to the course it had pursued, that course being from Africa, across the Pyrenees, and thence down on Pau, this wind being thus quite analogous to the föhn of the Alps. The sirocco of the Lower Pyrenees being merely the in-draught towards a low atmospheric pressure accompanying a great storm which is advancing from the west, it follows that as soon as the wind veers to W. or to N.W., and consequently no longer crosses the Pyrenees before reaching Pau, it may be expected that the air will become instantly saturated with moisture, and rain begin to fall. This is just what takes place, and the connection between the sirocco and Atlantic storms is well recognised, and finds expression in the weather-prognostic current at Pau, "The drier the air the nearer the rain."

THE NORWEGIAN ATLANTIC EXPEDITION.—Prof. Mohr communicates to the *Bulletin International* an interesting note on the Norwegian scientific cruise of last summer. The hourly meteorological observations will not only be discussed with a view to ascertain the diurnal periods during the summer months, but also be compared with simultaneous observations made on land with the view of tracing the connection which subsists between the weather and its changes on sea and land respectively. In addition to the observations usually made on board the navy of Norway, the humidity of the air, the evaporation from seawater, the velocity of the wind, and the rainfall were observed. The zoological collection is rich and varied, many of the species found are new to science, and will necessitate the establishment of new genera. A valuable collection has been made of specimens of the sea-bottom taken at each sounding, of seawater from the bottom and the surface, and of the rocks and minerals of Farö and Westmanna Island. The stormy character of the weather prevented magnetic observations being made on board, but such observations were very carefully made at Husö, in Sognefiord, Reykjavik, and Namöos in Norway. The expense of the cruise, inclusive of the instruments and apparatus, has been 165,000 francs—an expenditure which can only be regarded as liberal for such a country as Norway—and it is intimated to be the intention of the Norwegian Government to resume the prosecution of the researches in the next two years, extending them in the direction of Jan Magen and Spitzbergen.

BAROMETERS OF SOUTHERN RUSSIA.—M. Moritz, the eminent director of the Tiflis Observatory, makes an important communication to the *Bulletin International* of October 26, regarding the barometers of the stations in the south of Prussia. Prof. Wild, in the *Annals* of the Central Physical Observatory of St. Petersburg for 1874, states that the barometer at Tiflis is  $0.028$  inch lower than that at Nicolaieff. The determination of the true difference of the readings of these two barometers is of more importance than appears at first sight, because the barometers of all the Russian stations on the borders of the Black Sea have their errors determined by that of the barometer at Nicolaieff, or as it is technically phrased, are controlled by it, whereas all the barometers of the Caucasian Stations are controlled by that of Tiflis. Now these southern Russian Stations, taken as a whole, can supply data, unique of its kind, towards the solution of such questions of general meteorology as concerns the influence of large sheets of water and lofty mountain ranges on the state of the atmosphere and its movements, if only we be quite certain that the barometric readings at the numerous stations over the region are comparable with each other. During the past summer M. Moritz has made a careful comparison of the Tiflis



and Nicolaieff barometers, by means of two barometers which he carried from Tiflis to Nicolaieff, and back again to Tiflis, with the result that the difference between the two barometers by which so many barometers are controlled, is only a tenth part of the difference as given by Prof. Wild, or the difference instead of being 0.028 inch, is only 0.003 inch. The comparison of station barometers is a laborious and delicate operation. If the instrument be a Board of Trade barometer, having an air-trap, any air lodged in it renders the comparison worthless; if not furnished with an air-trap, any air admitted into the tube vitiates the comparison; and if care be not taken in hanging the barometers or in timing the observations so as to secure that each attached thermometer truly gives the temperature of the whole instrument with its contained mercury, the comparison is not satisfactory.

**THE FALL OF TEMPERATURE IN END OF OCTOBER.**—The weather maps of Europe of October 27 and following days show remarkable changes in the distribution of the atmospheric pressure and changes of temperature consequent thereon. On the 27th pressures were much higher in the east than in the west of the continent, accompanied with south winds and temperatures considerably above the average of the season in Great Britain; in other words the meteorological conditions were analogous to those described in a recent number of NATURE (vol. xiv. p. 536), as characterising the warm weather from October 4 to 7. On the 28th, however, barometers began to fall in the extreme north of Norway. This depression and a general lowering of the barometer was propagated southwards over Eastern Europe, while at the same time barometers rose to a considerable height over Western Europe. The necessary result, as regards the British Islands, of this altered distribution of pressure was a change of wind from south to north and a fall of temperature from about 5° above the average on October 27 and 28, to about 5° below it on October 31 and November 1. In addition to the interest of this illustration from its bearing on the importance of a knowledge of the weather in the extreme north of Europe in connection with weather forecasts for Great Britain, it is also interesting as a type of those meteorological conditions to which some of our severe winter weather is due. Indeed, some of our severest winter storms of wind and snow have occurred with barometric depressions which have advanced from the Arctic Sea southwards over Europe; and they are peculiarly severe in these islands when the centre of the depression takes a course more to westward than that of last week, or when it passes to the south-eastward over the North Sea or over Denmark.

#### NOTES

We publish this week the complete Report of Capt. Nares on the Arctic Expedition, along with a new map showing in detail the various geographical discoveries made by the expedition, our map of last week being necessarily very general. We congratulate the Admiralty on the rapidity of the publication, and are glad to be able thus to place on permanent record the general report of the Commander of the expedition, both as to its work and its results. As we said last week, these results will be fully appreciated only when the various scientific reports are published. Of course various schemes have been proposed to accomplish the minor object in attempting to attain which our fearless men were baffled—the attainment of the Pole. A correspondent writes to us suggesting the use of a balloon to be inflated at the coal-bed in Discovery Bay, and crossing right over the Pole, about 1,000 miles, obtain a bird's-eye view of what is below. A correspondent in one of the daily papers advocates the use of steam, and that something like a tramway should be made to the Pole, the floe-bergs being tunnelled if necessary. Another of our correspondents endeavours to show that the ice-masses met with must have been pushed

over from the Siberian coast, though this seems somewhat inconsistent with the fact of the destruction of the Behring Strait whaling fleet by ice. But what do all these groping ideas point to but the adoption of Weyprecht's scheme, advocated by the German Government, and curiously enough only now finding its way into the daily papers, as something before quite unknown here, though we published it in detail a year ago. If we are not mistaken we shall have to thank both the successes and the failures of this expedition for opening up a new era in Arctic exploration. The following promotions for services rendered in connection with the Arctic Expedition have been made:—Commander A. H. Markham to be Captain; Lieutenants Pelham Aldrich, L. A. Beaumont, and A. A. C. Parr to be Commanders; Sub-Lieutenant C. J. M. Conybeare to be Lieutenant; Staff-Surgeon B. Ninnis, M.D., to be Fleet Surgeon; Surgeons E. L. Moss, M.D., and R. W. Coppinger, M.D., to be Staff Surgeons; Engineers D. Cartmel and James Wootton, to be Chief Engineers; Assistant Paymaster Thomas Mitchell to be Paymaster.

As we announced last week, Capt. Allen Young has returned with the *Pandora*. He was so beset with ice in about 78° N., that he was able to accomplish little, though he managed to deposit the letters and despatches which he took out for the expedition. Capt. Young found some Eskimo at the high latitude of 77° 12' N., who conducted themselves very well. They offered Capt. Young's party everything they had, and when asked what they would like to receive, the chief went off to the ship and selected a 15-foot ash oar and some gimlets. He wanted the oar for spear shafts, and the gimlets to bore ivory and bone in order to cut it. Some other useful presents were given them, and they gave in exchange some narwhal's horns, specimens of their pot stone cooking kettles, and of the iron pyrites used for striking fire. Capt. Adams, the well-known master of the whaler *Arctic*, has brought home with him to Dundee an Eskimo "Chief" named Alnack, thirty-eight years old, who has for years begged to be taken to England. His object in coming to Dundee is that he may get during the winter, knowledge that might be of much importance to the tribe of which he is chief. We hope he will take more kindly to our climate and habits than previous Eskimo visitors.

The following is the award of medals for the present year by the Council of the Royal Society:—The Copley Medal to Prof. Claude Bernard, For. Mem. R.S., for his numerous contributions to the science of physiology; a Royal Medal to Mr. William Froude, F.R.S., for his researches, both theoretical and experimental, on the behaviour of ships, their oscillations, their resistance, and their propulsion; a Royal Medal to Sir C. Wyville Thomson, F.R.S., for his successful direction of the scientific investigations carried on by H.M.S. *Challenger*; the Rumford Medal to Mr. Pierre Jules César Janssen, For. Mem. R.S., for his numerous and important researches in the radiation and absorption of light, carried on chiefly by means of the spectroscope. The medals will be presented at the anniversary meeting of the Society on the 30th inst. It is hoped that the two eminent Frenchmen named in the foregoing list will be able to appear in person on the day appointed.

The store-houses, workshops, and studies of zoology of the Jardin des Plantes, Paris, have been recently removed to a new and most commodious building in the rue Buffon, where there is ample space for scientific work of every kind. Plans have likewise been made for the erection of a large new building in front of the "Galerie," in order to give more space for the exhibition of the general collection of zoology.

RUSSIAN newspapers announce the death of M. Chekanoffsky, who, exiled in Siberia, has spent more than ten years in the

geological exploration of the country, and recently returned from his travels on the Olenek and the shores of the Polar Sea, to St. Petersburg, where he was engaged at the Academy in the description of his immense collections. He was found on October 10 dead in his room, and it is supposed that he poisoned himself.

THE Academy of Geneva, whose foundation goes back to the sixteenth century, to the time of Calvin and Beza, has for more than three centuries maintained a renown and a value far exceeding the dimensions of the small republic which glories in its prosperity. Five years ago, in consequence of the erection of large buildings for its use and of concomitant legislative decisions, it assumed the title of University, the National Council having decreed the creation of a Faculty of Medicine as an addition to those of ancient standing. Until now this new faculty existed only on paper, the buildings intended to receive it not having been erected. They have been recently finished; the professors have been chosen from the native medical men, to whom have been added some eminent foreigners—Professors Schiff, of Florence, Zahn, of Strasburg, and Laskowski, of Paris. An inaugural ceremony took place on October 26, when addresses were given by the President of the Council of State, the Rector of the University, and the Dean of the new Faculty. There are already fifty students, and the organisation of the new classes has been made on a scale entirely satisfactory.

THE *Norddeutsche Allgemeine Zeitung* states that Capt. Kielsen, of the *John Maria*, Tromsøe, has reached  $81\frac{1}{4}^{\circ}$  N. lat. between Novaya Zemlya and Spitzbergen, and found the sea free of ice. He discovered an island with a mountain 500 feet high, which he called White Island. He supposes that the ice-wall round the Pole was, at least this year, at a higher latitude, and that the Gulf Stream generally follows this direction.

THE following statistics with regard to the number of students attending German universities during the summer term of this year are taken from the just published *University Calendar for 1876-7*. Berlin—number of students, matriculated and unmatriculated—3,666, of teachers 193. The corresponding numbers in Leipzig were 2,803 and 155; Munich, 1,158 and 114; Breslau, 1,142 and 108; Göttingen, 1,059 and 119; Tübingen, 1,025 and 86; Würzburg, 990 and 66; Halle, 902 and 96; Heidelberg, 795 and 110; Bonn, 785 and 100; Strasburg, 700 and 94; Königsberg, 611 and 82; Greifswald, 507 and 60; Jena, 503 and 77; Marburg, 445 and 69; Erlangen, 422 and 55; Münster, 415 and 29; Giessen, 343 and 59; Freiburg, 290 and 54; Kiel, 223 and 65; and Rostock, 141 and 36. Of universities outside the German Empire, Vienna had 3,581 students and 247 teachers; Dorpat, 844 and 65; Graz, 804 and 88; Innsbruck, 570 and 67; Zürich, 355 and 78; Bern, 351 and 74; and Basel, 239 and 64.

It is proposed by the Council of the Trades' Guild of Learning, in conjunction with the Committee of the National Health Society, to organise a course of twenty lectures on the "Laws of Health," to be delivered by W. H. Corfield, Professor of Hygiene and Public Health in University College, London, in the large room of the Society of Arts, John Street, Adelphi, W.C., on consecutive Saturdays, commencing November 11, at 8.30 P.M., excepting the following dates:—December 1 (Friday), February 1 (Thursday), March 1 (Thursday). There will be an interval of four weeks at Christmas, and three weeks at Easter. Certificates will be awarded to those who satisfy the examiner and who have attended not less than fifteen lectures out of twenty.

MR. MCMANN writes that on p. 18, vol. xv, in our notice of his method of comparing spectrum maps, K should have been G. The distance between B and G is not assumed equal to 100, he states, but is assumed equal to 1, and is divided into 100 equal parts.

IN a letter addressed to Dr. Andrews, Prof. Wartmann, of Geneva, states, with reference to the communication on Radiometers to NATURE of Oct. 19, that Prof. Frankland reproduces precisely the conclusions which Prof. Wartmann gave at one of the conferences at South Kensington in the month of last May. The results were published in No. 222. (June 15) of the *Archives des Sciences Physiques et Naturelles*. In the first note which Prof. Wartmann published (*Archives*, No. 219, March 15) he said (p. 315) that by making two calorific sources act simultaneously on the opposite faces of the same disc, we obtain an equilibrium when the intensity of the pressures is in the inverse ratio of the absorbing power of each face. The experiments, which he made in spring, during very favourable nights, on the nullity of the action of the lunar light, completed the demonstration. It is the calorific radiation which is the cause of the movements of the radiometer.

AT the recent meeting of the German Association of Naturalists and Physicians, Dr. Hermes described some interesting characteristics of the young gorilla in the Berlin aquarium. He nods and claps his hands to visitors; wakes up like a man and stretches himself. His keeper must always be beside him and eat with him. He eats what his keeper eats; they share dinner and supper. The keeper must remain by him till he goes to sleep, his sleep lasting eight hours. His easy life has increased his weight in a few months from thirty-one to thirty-seven pounds. For some weeks he had inflammation of the lungs, when his old friend Dr. Falkenstein was fetched, who treated him with quinine and Ems water, which made him better. When Dr. Hermes left the gorilla on the previous Sunday the latter showed the doctor his tongue, clapped his hands, and squeezed the hand of the doctor as an indication, the latter believed, of his recovery. In fact the gorilla is now one of the most popular inhabitants of the Prussian capital. For Pungu, as the gorilla is called, a large glass palace has been erected in the Berlin Aquarium in connection with the palm-house.

THE *Kölnische Zeitung* of November 4, reports on the discovery of an ancient burial ground, during some excavations made near Rauschenburg on the Cologne-Minden Railway. It appears that a number of antiquities were found, and while the vases amongst them, as well as a number of objects found in these vases are of undoubtedly Roman origin, it is doubted that the people buried there, and whose skeletons were found, were of Roman nationality. It is believed at present that they were Teutons of the third or fourth century who lived in friendly intercourse with the neighbouring Romans, and had obtained from them the objects mentioned. A definite opinion would be premature until the whole of the ground is excavated, and a scientific investigation has been made of all that is found. Amongst the objects discovered recently, we may mention a well-preserved vase of *terra sigillata*. On its floor there is still a small remainder of the linen containing the bone-ashes; the vase is 20 cm. broad, and 12 cm. high; it shows an ornament which is of decidedly Roman origin. Amongst the bone ashes in its interior there were two bronze nails, several molten pieces of bronze, and remains of a beautifully ornamented ivory comb. Another vase, quite full of bone ashes, and roughly worked of coarse clay, consists of two parts almost equal, of which the lower one is 25 cm. broad, and 16 cm. high, while the upper one is 27 cm. broad, and 18 cm. high. Amongst the bone ashes it contained were found several molten pieces of bronze, the remains of a burnt ivory comb, and a piece of some handsome ornamental object made of bone. Round this urn several smaller vessels were placed; they were of ordinary gray clay, two of them of somewhat finer black clay. One of them was empty, another one contained ten little pieces of clay, about 3 cm. thick, and perforated, all of different shapes, they had very likely been worn as beads on a string round the neck. There was also a little tablet of bronze in this vessel. One of

the black vessels seems to have served for incense, the other one may have served the same purpose, but being shaped like a three-armed Roman lamp, it is probable that it served as support for three lamps. Of the different pieces of undoubtedly Roman vases that were found besides the above, one shows the figure of a hare, and another that of a running hound—both in relief.

A WISH, which was expressed last year at the International Geographical Congress held at Paris, will be realised in January next. From that date a monthly geographical review will be published there, at the Librairie of Ernest Thoinin, and edited by Ludovic Drapeyron, Professor at the Lycée Charlemagne, and member of the Academie. This *Revue Geographique* will contain reports of all work done in connection with geography; the investigation of the various methods now employed in teaching geography, as well as topography, will form some of the principal subjects of the *Revue*. Besides theoretical original papers, it will publish the latest reports of the different travels of discovery going on in various parts of our globe, criticism on new geographical works, biographies of celebrated geographers, &c. The *Revue Geographique* is not to be the organ of petty party spirit, but of all those who see in geographical science one of the principal means of breaking the reign of empty rhetorics and scholastica. Besides geographers and geologists, the editor invites for co-operation the representatives of all historic sciences in the widest sense of the term—palaontologists and ethnographers, as well as archæologists—all those, therefore, who by the application of geography in historic research, wish to open new fields for social science in general.

THE University of Zurich has announced that in future, like the German universities, it will grant the doctor's degree only after an oral and written examination.

MR. BRYCE M. WRIGHT, of Great Russell Street, has procured one of the finest and most complete specimens known of the Plesiosaurus from the Lias of Whitby, which is open to the inspection of the public until the 12th inst. The neck is 6½ feet long, and the entire animal nearly 17 feet. The whole of the vertebrae from the head to the tip of the tail are complete without the slightest break, which gives some idea of the entirety and preservation of the animal. It was procured from the cliff in which it was found in about twenty pieces, but after three weeks' incessant work Mr. Bryce Wright has mounted it in such a manner that one could scarcely believe a bone had been disturbed. Mr. Bryce Wright, has, we believe, secured this specimen for a foreign institution.

THE additions to the Zoological Society's Gardens during the past week include a Puma (*Felis concolor*) from Santa Fé, presented by Miss Brassey; two Wild Swine (*Sus scrofa*) from Cuba, presented by Mr. J. Alfonso de Aldama; a Persian Gazelle (*Gazella subgutturosa*) from Persia, presented by Mr. T. Fowler; two Senegal Touracous (*Corythæix persa*) from West Africa, a Sun Bittern (*Eurypyga helias*) from South America, a Scarlet Ibis (*Ibis rubra*) from Para, a Ring-necked Parrakeet (*Falconis torquata*) from India, two Black Tortoises (*Testudo carbonaria*), a Common Boa (*Boa constrictor*) from Panama, a Sulphur-breasted Toucan (*Ramphastos carinatus*) from Cartagena, deposited; and an Andean Goose (*Dernicla melanoptera*) from Chili, purchased.

## SOCIETIES AND ACADEMIES

### PARIS

Academy of Sciences, October 30.—Vice-Admiral Paris in the chair.—The following papers were read:—Letter of Mr. Hind communicated by M. Leverrier, on the intra-Mercurial planet.—Study of the organs of reproduction in epheniera, by M. Joly.—On a new electric lamp devised by M. Sabloschhoff, by M. Denayrouse. The carbons are fixed parallel, and the short interval between them is occupied by an insulating substance which disappears along with them (as the wax of a candle

used, sand, glass, mortar, lac, &c. The simplest and cheapest is a sand of pounded glass.—On the distribution of magnets on the surface of magnets, by MM. Treve and Dutassier. The more a steel is carburetted, the more is the magnetism condensed towards its extremities; the less carburetted, the more magnetism spread out equally over its surface. The authors are having a series of steels prepared by hardening with cold water and they seek to formulate a simple law establishing the relation between the coercitive force and the proportion of carbon.—C the deterioration of vineyards of Côte-d'Or, by M. du Mense.—M. Wery submitted an apparatus for ventilating apartments and mines, or increasing the draught of chimneys.—On the rotatory polarisation of quartz, by MM. Soret and Sarasin. They extend their observations to the ultra-violet rays not refrangible than the line N, and also make more precise measurements. The results are tabulated.—On the laws of vibrator motion of diapasons, by M. Mercadier. The number of vibrations of a prismatic diapason is proportional to its thickness an inversely as the square of its length. The isochronism of vibrations is not absolutely rigorous; the duration of the period depends on the amplitude and the temperature. In using a diapason a chronograph or interrupter, the instrument will not give results quite identical unless you operate at the same temperature and give the vibrations the same amplitude. If (as is generally the case) one does not need complete identity and large amplitudes, then provided an amplitude of 2 to 3 mm. be not exceeded, and one operate at temperatures little different, one is certain to have the same number of periods per second to nearly 0.0001.—Chemical reactions of gallium, by M. Lecoq de Boisbaudran. *Inter alia*, further experiment confirms the opinion that oxide of gallium is more soluble than alumina in ammonia. Carbonate of soda only precipitates indium after gallium. Chloride of gallium is very soluble and deliquescent. A slightly acid solution of it dried at a mild heat, gives needles or crystalline lamellæ, which act strongly on polarised light. Sulphate of gallium is not deliquescent.—On terephthalaldehyde, by M. Grimaux.—On the simultaneous formation of two trioxanthraquinone: and the synthesis of a new isomer of purpurine, by M. Rosenstiehl.—On the electric apparatus of the torpedo (third part), by M. Rouget. In the electric discs, besides ramifications of nerve fibres and the reticulated nervous plate, one finds only vessel and cell-elements, fibrillæ and membranes belonging all to the connective tissues. M. Rouget offers a theory as to the mechanism by which the nervous elements produce electrical effects.—On the phenomena of division of the cellular nucleus, by M. Balbiani.—Variations of the electric state of muscles in tetanus produced by passage of a continuous current, studied by means of the induced contraction, by MM. Moral and Toussaint. In such tetanus the induced contractions (shocks, isolated or associated into a tetanus of short duration) are to be regarded as accidents, though the comparison of the two traces (inducer and induced) indicates but imperfectly the cause of these accidents. The electric state of the muscle is sensibly uniform during the whole duration of the contraction.—On some parts relating to nutrition of the embryo in the egg of the hen. The blastoderm derives its elements from the yolk, whereas at the beginning of incubation, and at least till the time of complete closure of the amnion, the embryo is developed at the coat of the albumen.—On the influence of poisoning by the bulbous agaric on glycaemia by M. Oré.—On the employment of picric acid in treatment of wounds, by M. Curie.

## CONTENTS

	PAGE
FUNGUS DISEASE IN INDIA. By Rev. M. J. HERKLEY	2
THE ADMINISTRATION OF PATENT LAWS IN ENGLAND	2
LETTERS TO THE EDITOR:—	
Sumner's Method at Sea.—J. A. EWING	2
Sea-Fisheries and the British Association.—E. W. H. HOLDSWORTH	2
Mr. Wallace and his Reviewers.—ALFRED R. WALLACE	2
Self-fertilisation of Plants.—Prof ASA GRAY	2
Nitrite of Amyl.—Dr. B. W. RICHARDSON, F.R.S.	2
CAPTAIN NARES'S REPORT ( <i>With Map</i> )	2
OUR ASTRONOMICAL COLUMN:—	
The November Meteors	4
Herzberg's first Glimpse of Uranus	4
The Transit of Venus, 1882	4
Mr. Knobel's Catalogue of the Literature of Sidereal Astronomy	4
METEOLOGICAL NOTES:—	
Climate of Manitoba	4
Climate at Pau	4
The Norwegian Atlantic Expedition	4
Barometers of Southern Russia	4
The Fall of Temperature in End of October	4
NOTES	4

THURSDAY, NOVEMBER 16, 1876

## FOSTER'S "ELEMENTARY PHYSIOLOGY"

*A Course of Elementary Practical Physiology.* By M. Foster, M.D., F.R.S., Fellow of and Prælector in Trinity College, Cambridge, assisted by J. N. Langley, B.A., St. John's College, Cambridge. (London: Macmillan and Co., 1876.)

In this little book Dr. Foster gives us the results of his experience in teaching physiology practically to students. As may be readily understood, such teaching is attended with much greater difficulties than those encountered in the experimental teaching of chemistry or of physics—difficulties which arise partly out of the complexity of the phenomena to be demonstrated, partly from the circumstance that experiments in which living processes are concerned cannot be repeated so frequently as would be desirable. Dr. Foster has himself been remarkably successful in overcoming these difficulties. The evidence of that success is to be found in the number of men whose names are already known as efficient workers in physiology, who owe to his teaching their first introduction to scientific research. On this ground, even more than on that of his long experience as a teacher, his opinion on the question of method is more worthy of attention than that of any other person. The book is entitled "A Handbook of Practical Physiology." Our readers are probably not aware that during the last half-dozen years that term has acquired a special meaning. Under the term Practical Physiology all students of medicine are now required by the examining Boards to go through a course of laboratory instruction, for which accordingly arrangements are made in all medical schools. In very many instances the instruction is purely technical and anatomical. All that is attempted is to teach the student "how to work with the microscope," which means for the most part how to prepare tissues for microscopical examination. The acquirement of this art, although, it need not be said, of great value to the physiologist, is not the end and purpose of physiological teaching. The physiologist interests himself only in what is living, and when he uses the microscope, concerns himself with the anatomical structure of a part or organ, only in relation to its living properties.

The handbook contains no description of the microscope, and the subject of microscopical manipulation is dealt with in an appendix. In this respect it differs from most previously published works on histology. Nevertheless it is as good an introduction to that subject as the beginner in animal physiology can take in hand. The plan of study laid down is anatomical, but in carrying it out, the principle is acted upon that it is desirable from the first to give meaning and interest to the otherwise dry details of anatomy, by combining the study of the function of every part with that of its structure. Histological work, says Dr. Foster in his preface, "unless it be salted with the salt either of physiological or of morphological ideas, is apt to degenerate into a learned trifling of the very worst description." To avoid this evil, of which the feebleness of English microscopy is the best evidence, Dr. Foster encourages the student, as soon as he has

learnt the anatomy and histology of a part, to pass at once to its physiology, "so that by learning what is known concerning its action, he may form an opinion of the real importance of its structural details."

Let us now see how the principle is carried out. The book comprises twenty-nine lessons. The first is entitled, "Dissection of a Rabbit and of a Dog." The purpose of this introductory lesson is to make the student acquainted with the general construction of the body of the mammalian animal as a whole, a sort of knowledge which students of human anatomy are often strangely wanting in. Then follow two lessons on the blood. In the first, the student learns all that relates to the structural elements of the circulating fluid; but even here the instruction given is of such a nature that he cannot fail to be impressed, provided that he is capable of being impressed by observation, with the fact that he has to do, not with dead forms, but with living organisms. In the second lesson on the blood, the chemical constituents of the *liquor sanguinis* are dealt with, particularly those which are concerned in the process of coagulation. Here necessarily, the microscope and scalpel are for the moment replaced by methods and instruments borrowed from the chemical laboratory, but they are resumed in lessons four and five for the study of cartilage, bone, teeth, and the connective tissues. In the next series of lessons on contractile tissues, structure and function are again mixed. The student, as soon as he knows what cilia and muscular fibres are like, at once proceeds to find out for himself, though according to a prescribed order, how they work. He familiarises himself in succession with the effects of the voltaic current, of single induction shocks, and faradization on living muscle, then proceeds to the more minute examination of the mechanical phenomena of muscular contraction, and finally, as in the previous study of the blood, investigates the same phenomena in their chemical relations.

In the same style and on the same principle each successive subject is dealt with. "The animal body is regarded," to quote the author's words, "as a collection of fundamental tissues, each having a conspicuous property or properties."

Each lesson has appended to it a list of subjects for demonstration by the teacher, these consisting either of microscopical structures requiring very high powers for their exhibition, or of experiments which the student would be unable to perform for himself. Among these last only such are comprised as are in their nature painless.

There can be no doubt that the book is admirably adapted for its immediate purpose, namely, for the instruction of natural science students at Cambridge. In order to judge of its general utility the question must be asked whether it is adapted to the requirements of the much larger class of students who learn physiology with a view to the study of medicine.

The answer to this question must depend on the class of medical students contemplated. Students of medicine may be divided into three categories, the first comprising those who come up with the avowed intention of acquiring no more than the minimum of cram exacted of them by the Examining Boards, and who at the end of their time are as incompetent for practice as they are destitute of knowledge. The second, and by far the largest class,

made up of men who, while they desire to acquire by assiduous reading as much so-called medical science as is thought necessary for them to possess, rightly regard it as their principal duty to devote their energies during their brief period of study to the attainment of skill and experience in the arts of medicine and surgery. But besides these, there is a smaller class of men who not only have time for real study, but possess the necessary previous education in which their fellows are in general so deplorably wanting, and whose motive for work is something higher than that of preparing themselves for examination.

To medical students of this last class the lessons are perfectly adapted. Nor can we conceive that a better course could be followed by a young man intending to fit himself for the higher career of the medical profession, than that laid down by Dr. Foster, namely, that he should at a very early period, *i.e.*, while he is still engaged in the study of the more exact branches of natural science, first work through the course of elementary biology laid down for him in the well-known lessons of Professor Huxley; then that he should devote a considerable proportion of his time during a subsequent year to becoming conversant with the structures and processes peculiar to the bodies of the higher animals, under the guidance of a teacher who must be a real physiologist—all this being accomplished before he begins his proper medical studies, *i.e.*, before he begins to study the details of human descriptive anatomy.

Strange as it may seem, it is not yet sufficiently recognised by those who are concerned in medical education that the men on whom the community depends for enlightenment on the great questions of the preservation of health and the prevention of disease, ought to be practically familiar with all that is known concerning living processes. The remark is frequently made that even to the consulting physician or to the officer of health, physiology and pathology are of relatively little value. Surely this must be a mistake. It may be readily admitted that the ordinary practitioner needs only familiarity with the characteristics of human ailments and the prescribed methods of treatment and skill in the handling of sick people, and may well content himself with as much of the elements of scientific knowledge as he can learn from manuals and lectures; but surely the education of those who are intended to be advisers of the public in relation to health and disease should have some more solid foundation. There can be no question that these men ought to be prepared for their higher functions and responsibilities by such a course of preliminary work in physiology as will enable them, if so be that nature has fitted them for it, to enter with some hope of success on those most difficult of all biological investigations which relate to the nature and causes of diseases.

#### BRITISH MANUFACTURING INDUSTRIES

*British Manufacturing Industries.* Edited by G. Phillips Bevan, F.G.S. "Salt, Preservation of Food, Bread, and Biscuits," by J. J. Manley, M.A.; "Sugar Refining," by C. Haughton Gill; "Butter and Cheese," by Morgan Evans; "Brewing, Distilling," by T. A. Pooley, B.Sc., F.C.S. (London: Edward Stanford, 1876.)

THE preface states that in these volumes, of which the present is one, "the facts are gathered together and

racy and a freedom from superficiality; and though they do not lay claim to being a technical guide to each industry, the names of the contributors are a sufficient guarantee that they are a reliable and standard work of reference."

This editorial explanation fairly describes the scope of the articles contributed by their respective writers to this volume; since, while not pretending to be a technical guide to each industry, they must prove of great value to all desiring to obtain a *general* knowledge of the processes described. The common fault of encyclopædias of this kind is to devote much space to detailed explanations of manufacturing processes and of the machinery employed. To the ordinary reader all such elaborate details are useless, since his object is to obtain information upon the general principles upon which the various processes are based; and to the manufacturer practically engaged in any process they are equally useless, since no matter how carefully written, they can teach him nothing, because, as a matter of course, he is in advance of the processes described with so much detail.

The first article is an interesting account of "Salt," where found, and how manufactured from the crude quantity. Some valuable statistics are given as to the quantity produced in and exported from England.

The next article on the "Preservation of Food" by the same contributor deals with a subject of increasing importance. Though there has been an important increase, of late years, in the amount of green crops, and in land laid down to grass in the United Kingdom, yet the consumption of beef and mutton has so spread among the working classes, as to render the increased production vastly inadequate to the ever-increasing demand. It has become in consequence a matter of the highest importance to discover means by which animal food may be imported from America, Australia, and other countries where it is abundant.

The chief processes hitherto employed for the preservation of meat are classified by the author under the heads of Drying, Action of Cold, Chemical Reagents, and Exclusion of Air. The drying process has certainly not proved a success. "Charqui," so much praised a few years since, is but a poor substitute for fresh animal food.

The value of ice in preserving meat in cold countries is so well established, that it naturally presents itself as a convenient agent. Hitherto, however, as regards great distances, it has failed. This has arisen from two causes: in the first place the temperature of melting ice is not low enough to prevent change even on ship board; this difficulty will doubtless be overcome by the employment of machines, by which a temperature lower than 0° C. can be maintained at sea. Another difficulty has arisen from the fact that meat kept at the temperature of melting ice is very prone to change so soon as removed from the ice-tanks to be distributed throughout the country. Doubtless in time these and other difficulties will be removed, and our large cities, at least, be supplied with regular arrivals of fresh uncooked meat from South America and our colonies.

The use of chemical reagents has hitherto proved inefficient, but we cannot agree with Mr. Manley "that it is hardly likely that the use of chemicals will solve the question of meat preservation." A patent has lately been  
by which oxygen-absorbing reagents are so suc-

cessfully applied as to give some hope that this or some other chemical process will aid us in this important question.

The author gives some useful details and statistics regarding the "tinned meat" process. This well-known method depends upon the exclusion of air by the substitution of steam, and in the consequent destruction of organic germs. So far as mere preservation is concerned, it has undoubtedly proved a great success, and has already been of some benefit to us; but the long cooking process hitherto employed to expel the air has so destroyed the texture of the meat as to have rendered its use unpopular in spite of the efforts of enthusiasts to force the over-cooked product upon an unwilling public. So soon as the very primitive plan of heating the tins in a bath of chloride of calcium for three or four hours be replaced by one exhausting the air and replacing it by steam at a high temperature successively, and occupying no more than half an hour, then will the tinned meat process prove a real success, and possess many advantages over all others. Mr. Manley has done good service by his description of what has been attempted, and though he suggests but little himself, he may induce some of his readers to experiment upon a matter of such national importance.

The paper on "Sugar Refining" is one of the best contributions in the series, written by one not only an able chemist but also a thoroughly practical sugar refiner. As a clear, accurate, and scientific exposition of an important industry it serves as an example of what such contributions should be. Its only fault is that it is somewhat too brief. After the usual historical account of the industry, the author explains the more important properties of sugar, and shows how these are made use of in the various stages of extraction and purification from the cane and the beet. The author has not considered it within his province to refer to the serious injury to our sugar manufacturers by the heavy export premiums paid by the French nation on all high class products exported to this country. Doubtless so soon as the French financiers have completely extinguished the manufacture of loaf and other high class sugars in England, they will then remove the export premiums, being full well assured that the memory of the ruined English sugar refiners will for a long time at least deter our capitalists from competing with French refineries. Though the "beet" produces one-third of the total amount of sugar grown, and has proved of such value to agriculture on the Continent, yet hitherto the growth of beets for sugar manufacturing purposes has not proved a success in our own country. Nor indeed is it likely to prove remunerative so long as it pays better to grow beef and mutton. In concluding this brief notice we cannot refrain from once more praising the author's valuable—though brief—contribution.

Mr. Evans contributes a short article on dairy produce. He gives some interesting information upon the factory system of cheese-making introduced with so much success into England within the last few years. It is to be regretted that Mr. Evans has given no information upon the mode of preparing the French, Italian, and Swiss cheeses so much appreciated by connoisseurs.

The article on "Brewing and Distilling" is a useful

contribution on two important industries, by one evidently well acquainted with them. Some valuable statistics are given, showing the vast development which has taken place in the production of alcoholic beverages in the United Kingdom. According to the author, on March 31, 1873, there were 31,010 brewers, 144,425 dealers and retailers of beer. The income derived from beer in 1873 amounted to 8,027,408*l.*, a sum which fully explains the hesitation of the present Government to please the agricultural interest by the removal of the malt-tax. In addition to these thirty thousand brewers, of whom, however, only some three thousand are licensed common brewers—there are, it appears, 318 distillers and rectifiers, producing 30,644,750 gallons of spirit, yielding a revenue of 14,895,769*l.*; the number of licences issued in 1875 to persons dealing in and retailing spirits was 138,845. The author calculates that in the brewing and distilling industries, and in those originated and sustained by them, there is a capital of two hundred millions invested. Without following Sir Wilfrid Lawson in all his statements, one cannot but view an annual consumption of twenty-eight to thirty millions of gallons of spirit as a most serious feature in our social life.

Those interested in this matter and desirous of obtaining a general knowledge of the technical processes, will with advantage consult Mr. Pooley's articles. In concluding this notice of the volume before us we must congratulate the publisher and the editor on their success in obtaining the aid of writers so well acquainted with their respective subjects.

#### LETTERS TO THE EDITOR

*[The Editor does not hold himself responsible for opinions expressed by his correspondents. Neither can he undertake to return, or to correspond with the writers of, rejected manuscripts. No notice is taken of anonymous communications.]*

##### Sea Fisheries

MR. HOLDSWORTH, at the close of his animalversations (*NATURE*, vol. xv. p. 23) on the address I recently delivered in the Biological Section of the British Association at Glasgow, says that he does not know on what evidence I grounded my belief in the decline of our sea-fisheries. I am therefore anxious to state that the evidence to which I trusted in what I then said was mainly, if not entirely, that collected by the Royal Commission of which he was the hard-working secretary. The kindness of my good friend in giving me private notice of his intention to make his comments public enables me the more promptly to furnish a reply to them, and for so doing he has my best thanks.

I do not pretend to have read through the whole of the 1,500 and odd somewhat closely-printed folio pages which form the two "Blue-books" embodying the labours of that Commission. But soon after they appeared—about ten years ago—I looked into them sufficiently, as I thought, to give me a fair notion of their contents. Whether that notion was mistaken your readers will be better able to judge by the time I have done. When I wrote my address I had not these books by me. I have since refreshed my memory by consulting them. I find that deep as was the impression left by my first examination of them it is now still deeper, and were I to write my address over again I should express myself in far stronger terms.

The second and most bulky volume of these blue-books contains the "Minutes of Evidence" taken before the Sea Fisheries Commission, and reports the 61,831 questions and answers put by or given to the Commissioners. At first the attempt to find the particular needles one may be seeking in this immense bottle of hay seems hopeless. But fortunately the volume (as most blue-books are) is furnished with a copious index, extending to 29

pages folio, and by help of this I beg leave to submit to Mr. Holdsworth and your readers the following results.

The Commissioners took evidence at eighty-six places (Billingsgate and London counting separately), which, for convenience's sake, I will call "stations." Now it appears that of these eighty-six stations evidence was offered at twenty-two, showing an *increase* in the supply of fish generally, and evidence showing a *decrease* at forty-three, or exactly half of the whole number. But at thirteen of these stations the evidence was conflicting. Deducting, therefore, that number from each side, we have thirty stations where the evidence was solely for the decrease and only nine for the increase, or a clear majority of twenty-one stations for the former. It also appears (unless my arithmetic is at fault) that of the answers given to the Commissioners at these several places 250 showed an increase, and 605 a decrease. If, then, my opinion on this subject is so erroneous as Mr. Holdsworth asserts, it is one entertained by a good many people who know more of fishery matters than I do.

If, further, we analyse the evidence as to various kinds of fishes the results will not be very different. These will be best stated in a tabular form.

Kind of fish	No. of Stations showing				
	Decrease	Conflict	Increase	Total	Percentage
Brean	—	—	2	2	—
Brill	—	—	2	2	—
Cod and Ling	9	—	42	51	—
Dogfish	—	—	2	2	—
Haddock	12	—	40	52	38
Hake	1	—	13	14	12
Halibut	—	—	2	2	—
Herring	24	—	41	65	17
Ling	1	—	8	9	7
Mackarel	4	—	11	15	7
Megrim	—	—	1	1	—
Pitchard	3	—	1	4	—
Plaice	3	—	2	5	—
Pollack	—	—	3	3	—
Skate	—	3	—	3	—
Smelt	—	—	2	2	—
Sole	6	—	15	21	9
	3	—	6	9	3
	7	—	9	16	2
	6	1	11	18	4

Thus out of these *twenty* kinds, *sixteen* show a positive decrease at more or fewer stations, and among them are some of the most important of our "food fishes"—cod and ling, haddock, hake, herring, mackarel, sole, sprat, and whiting.

Now I can imagine *three* objections being raised to the obvious inference from this table:—

*First*: that the witnesses for the decrease were untrustworthy.

*Secondly*: that the Irish stations are included among those showing decrease, and Irish fisheries are said to be languishing from causes which do not concern the present matter.

*Thirdly*: that even the non-Irish stations showing decrease are comparatively small and unimportant.

1. Without imputing any want of veracity to the witnesses for the decrease it is obvious that, as all fishermen have a pretty hard time of it, the proportion among them with a despairing turn of mind may be greater than among men who follow other callings, and that this may unconsciously tinge their testimony. So far, however, as my own experience goes, which is perhaps a very little way, I have found that the grumblers among fishermen commonly assign some specific cause for their complaints—be that cause real or imaginary. If so-and-so were or were not the case, they say, they would get on very well. Their assignment of any cause is purely a matter of opinion with them. Their statements as to the increase or decrease of fishes relate to a matter of fact within their own knowledge.

2. The proportion of Irish to non-Irish stations among those which show decrease is by no means excessive. Here it is:—

out of 13; herring, 10 out of 41; mackarel, 2 out of 11; sole, 1 out of 15; sprat, 1 out of 6; whiting, 1 out of 11. If the Irish stations were wholly disregarded the general deduction would not be materially affected.

3. Any one who has ever tried to learn the facts attending the process of extinction of animals, will soon find that the premonitory symptoms of approaching extirpation may be for a long time hardly recognisable at places where the particular species concerned is most abundant. It is first cut short on its borders, and scarcity begins and is most readily perceived at its outlying localities. Hence it is exactly in accordance with what always, or almost always happens, that the smaller and least important fisheries should first show signs of decline, if such decline is going on, as the above figures seem to prove. It may be years before the great trawling-grounds on various parts of the coast, or the Dogger Bank and the Silver Pit show unmistakable signs of exhaustion, but where is the take of fish inshore increasing or even stationary?

Having thus furnished the main grounds of my belief—for I do not wish to rely on the Report of the Committee of the House of Commons in 1833 (though that declared the Channel fisheries to have been in a declining state since 1815) further than to show it is a belief of long standing and held by practical men—I must proceed to make some other remarks on Mr. Holdsworth's indictment. First of all let me admit that he is of course literally accurate in his statement of the particular objects for which the Royal Commission of 1863 was appointed. But, as he also rightly remarks, its inquiry was extended, and indeed no one can glance at its blue-books without seeing that the inquiry covered far more ground than ever was scraped by a trawl. As I read the Instructions to the Commissioners, they were wide enough to permit any sort of inquiry into British Fisheries—even the seeking of a remedy for any decline in them if such was found to exist. But since my friend takes refuge behind the literal wording of the Queen's Commission, I may do the same with regard to the expressions used in my address. No doubt had I had the blue-books by me when I was writing I should have been more explicit in separating the Commission in which he acted as secretary from others that had preceded it. But, as it is, my words, reprinted in your own columns (*NATURE*, vol. xiv. pp. 440, 441), show that I spoke of it as something distinct from them, and so it truly was, for as Mr. Holdsworth himself says, it was "the most comprehensive investigation of the subject that had ever been made," and the evidence it collected is one of the most valuable contributions to applied zoology with which I am acquainted.

Next there comes up another point. It is quite compatible with an increased supply of fish that there may be an actual decrease in the *stock* of fishes, and it seems to me that my critic hardly sees the danger of confounding these two very different things. That the supply of fish to our markets has of late enormously increased may be indubitable—the question really is whether there are still in our seas as many fishes as there used to be. The evidence I have above analysed shows, I think, that there are not, and the recommendations of the Commissioners of 1863 are certainly not such as would increase the number.

Mr. Holdsworth asserts that "practical mischief is likely to result" from my opinions becoming known to fishermen. I wish he had been a little more careful to explain wherein the danger lies. Unless it be that the next Sea-Fisheries Commissioners may find their inquiries suddenly stopped by a well-placed torpedo, I am at a loss to imagine the risk. As, however, their permanent brethren of the Rivers Commission continue to pursue their duties without any such unpleasant consequences, I think the possible mischief must be over-rated. Mischief may arise, though, from the utterance of smooth sayings, and very great mischief too; but, if it does, it will not attach to those that utter the note of warning. My friend refers to his "Deep-sea Fishing and Fishing-boats," an excellent work in many respects, which fully deserves all that was said in its praise in your columns when it appeared (*NATURE*, vol. xi., p. 421), and perhaps more, for the reviewer did declare that the author's "inferences and his facts are very much at variance," which was perhaps going rather too far. I have carefully read it, but I fall to find there any new facts—new, I mean, since the publication of the blue-books before-mentioned—that bear out his views of the matter. On the contrary, I have met with several admissions which I think point in the opposite direction. Thus I read of Yarmouth (p. 111):—"The mackarel 'voyages,' however, have been so unprofitable during the last few years that there is little inducement to invest very largely in new gear for that fishery."

A little further on, of Lowestoft (p. 122):—"Recent experience, however, does not support this statement" [that the summer fish are often as abundant as they ever were before the spring-fishery came into fashion], "as with a more or less successful series of spring fisheries, the summer herrings have been exceedingly scarce for the last seven years." Now neither Yarmouth nor Lowestoft are very small or unimportant stations. It would look, then, as if scarcity has begun to appear there. Again (pp. 214, 215), Mr. Holdsworth tells a very good story of the disappearance of herrings from the Guernsey waters; but he does not contradict the statement that there has been no herring-fishery there since the year 1830. Furthermore he says (pp. 266, 267):—"Turbot or 'bratt' nets are successfully worked by the Staithes fishermen, although, according to their report, the catches are not nearly as large as they were formerly. This is the general statement along this coast. . . . It is a remarkable circumstance that nearly thirty years ago turbot became so scarce near North Sunderland, close to Holy Island, that the turbot-nets were given up. At that time trawling in the North Sea was only just beginning from Hull and that part of the coast; and the trawlers have never worked near the place where the decrease of turbot was said to have been greater than even at Staithes. It is evident, then, that we have a good deal to learn about what attracts or drives away the fish to or from any particular locality."

To this last remark I cordially agree, for in my address I said that the consideration of our fisheries is "fraught with unusual difficulties." But while we are satisfying ourselves on this and similar points, I cannot regard with the same complacency as Mr. Holdsworth the increasing outlay of capital in improved boats and fresh fishing-gear, the growing fish-traffic on the railways, or the glories of an enlarged and renovated Billingsgate, arising amid the pious ejaculations of its frequenters. Is that the only market which is to be unaffected by inflation? I derive little comfort in allowing my fancy to run riot over the marble slabs of Cheapside, Bond Street, and Arabella Row, teeming at present with every finny delicacy, and still less when I meet the humble barrow of the East-end costermonger, with its as plenteous and more odorific load. The question is, how long will that abundance last? Incalculably great as the stock of fishes in our seas may be, it must be subject to the same laws as the stock of every other animal. Directly the draughts upon it exceed its natural increase, it must dwindle. The time when that shall happen seems from the evidence before me to be imminent.

Some of Mr. Holdsworth's remarks appear to me irrelevant. I said nothing in my address about "spawning-beds," and therefore to have mentioned the discoveries of Prof. Sars and Herr Malm would have been little to the purpose. But if my friend meant to hint that I did not know that the spawn of some fishes floats in the water during its development, I will content myself by observing that my acquaintance with Scandinavian naturalists and their works began in the year 1855. His reference to the Sea Birds' Preservation Bill also seems to be wide of the mark. But I am sure ornithologists will be thankful to him for information that will show how many of the birds named in that Act commonly prey upon the sea-fishes that come to our markets, and which kinds they take. Perhaps he will also explain why the fishermen of our coasts were so strongly in favour of its being passed. Of the precise direction my efforts took towards that end Mr. Holdsworth, I think, cannot be aware.

J. NEWTON

Magdalene College, Cambridge, November 3

P.S.—If the remarks I made in my address be well founded, they of course have a general bearing, and will apply to all cases of "over-fishing." Since I wrote the above I have received from my kind friend, Prof. Baird, the United States' Commissioner of Tides and Fisheries, his reports from 1871 to 1875. Therein I find the decrease of the Sea-Fisheries on the Atlantic coast of the United States treated as a fact beyond denial, and "over-fishing" unquestionably assigned as the chief cause of that decrease.

A. N.

November 14

#### The Foundation of Zoological Stations in Heligoland and Kiel

WILL you kindly permit me to say a few words in answer to the letter by which my friend Mr. Balfour expressed his view on the proposed foundation of zoological stations at Heligoland and Kiel.

Mr. Balfour has certainly not been well informed, when he believes the promoters of the future stations in Heligoland and Kiel had intended "to put aside claims of the zoological station at Naples in favour of the two new institutions." In the first place it is expressly stated in their Report that the committee are far from wishing to take away the least support from the Naples establishment. Besides, according to information which reached me some time ago, one of the most competent and influential members of the committee has only consented to act, if it is expressly stated in the memorandum to be handed over to Government, "that, should the empire limit its annual contributions to zoological stations to 1,000*l.* or 1,200*l.* (a sum asked at present for the zoological station at Naples), this sum ought to go *undivided* to the Naples establishment as the one of much greater importance. The foundation of the two northern stations ought in consequence to be deferred to later times."

Nothing more than this could be desired, and certainly the proposition once made, nothing more could be expected, and had Mr. Balfour been acquainted with the whole of the facts, I am satisfied he would never have applied the terms "unwise and ungenerous" to the proposition. He is, however, certainly right in maintaining that the Naples station has been the means of proving both the value and sea-ability of such institutions, and perhaps nobody, besides myself, knows better than Mr. Balfour, how great and how numerous were the obstacles which had to be overcome. This and the fact that Mr. Balfour assisted me most generously and most vigorously during the whole of my struggle, entitles him fully to disapprove of what he thinks might possibly have a detrimental influence on the fate of the Naples establishment. With regard to this apprehension I may be permitted to state that there is well founded hope that the Naples station will soon be free from such embarrassments as are the consequence of insufficient means, and that I always expected and desired a series of zoological stations to spring up which should not only follow but even rival the original one started by myself. The sudden appearance of zoological stations on the Normandy coast, at Trieste, Sebastopol, the foundation of the late Anderson School of Natural History in the United States, the proposition to create two stations at Heligoland and Kiel, and another plan to erect a station on the White Sea, brought before the Association of Russian Naturalists in Warsaw, furnish indubitable proofs that my belief was well founded. It may be that too little circumspection has been used in founding or planning several of these institutions; nevertheless their great number and rapid augmentation justify me in giving to my establishment such dimensions and so distinct an international character as to carry it as far beyond competition as possible.

I hope to be able to enter more fully into the development of the Naples station in the Second Annual Report, which I think will be ready next spring. It will show that till now the station has not only not suffered from competition but has been increasing very considerably the range of its activity and influence on the progress of biology.

ANTON DOHRN

Berlin, November 5

#### The Deep-sea Manganiferous Muds

IN the very interesting Address delivered by Sir C. Wyville Thomson, at Glasgow, on the *Challenger* expedition, while referring to the "red clay" deposit so general over the deepest parts of the Atlantic and North Pacific, the remarkable fact is mentioned that the clay contains numerous nodules of peroxide of manganese, which in some places are found in great quantity.<sup>1</sup> The Address goes on to say:—"This is a phenomenon which we are as yet unable to explain, and I do not know that there is any analogous instance in any of the older formations" (*NATURE*, vol. xiv., p. 494).

It is possible that this can be accounted for in the same manner as the formation of the "red clay" itself, assuming that the explanation given by Sir C. Wyville Thomson is the correct one, as there can be but little reason to doubt. It is true that exception has been taken to it by Dr. Carpenter, who considers the "red clay" to be "a *post-mortem* deposit in the chambers of the foraminifera."<sup>2</sup> It does not clearly appear, however, where such a *post-mortem* pseudomorphic deposit could come from in this case, while, were that opinion correct, then the *Globigerina* ooze

<sup>1</sup> See also "Report to Hydrographer of the Admiralty on the Cruise of H.M.S. *Challenger*." Prof. Wyville Thomson, F.R.S., *Proc. Roy. Soc.*, vol. xxiv., p. 39.

<sup>2</sup> "Remarks on Prof. Wyville Thomson's Preliminary Notes on the Nature of the Sea-bottom," &c. *Proc. Roy. Soc.*, vol. xxiii., p. 244.



itself ought also to form a pseudomorphic deposit of the same kind.

Accepting, then, Sir Wyville Thomson's theory, the manganese deposit might be accounted for as follows:—

Manganese occurs in sea-water in very small quantities, sufficient, nevertheless, for detection. Forchhammer has detected it together with iron and silica; as also have Figuer and Mialhe.<sup>1</sup> It is, besides, almost invariably found in the waters of some springs, according to Prof. T. Sterry Hunt,<sup>2</sup> and spring-water sooner or later finds its way to the ocean. Again, it is found in the ashes of plants,<sup>3</sup> and it is therefore not unlikely that it may be secreted by other organisms, such as foraminifera, molluscs, &c.—in fact, Bischof found in the outer scale of oyster-shells 0.61 per cent. of ferric oxide, with some oxide of manganese<sup>4</sup>—and as its carbonate is isomorphous with that of lime and iron, it is perfectly probable that these should be found associated together, as indeed they usually are. Supposing, then, *Globigerina* shells to consist of carbonate of lime, with small traces of carbonate of iron, carbonate of manganese, peroxide of iron, and silicate of alumina, the following changes might take place while the shell was passing through water charged with carbonic acid gas and oxygen.

All the carbonates would first be dissolved. Then the carbonates of iron and manganese would be oxidised, as they readily part with carbonic acid in presence of oxygen, and the liberated carbonic acid would, no doubt, act on a fresh portion of the mixed carbonates. The silicate of alumina and peroxide of iron already in the shell<sup>5</sup> would not be affected. Thus there would be a continual deposition of silicate of alumina, peroxide of iron, and peroxide of manganese, very likely both hydrated. It is taken for granted here that the red clay is merely a silicate of alumina coloured by peroxide of iron, and not a double silicate of iron and alumina. It does not seem quite clear which is really meant in any of the reports. Alumina is found in small traces in river- and sea-water, perhaps in many cases as the silicate, which is soluble in minute proportions. Or it might originally exist as sulphate, in that state enter into the structure of marine organisms, and subsequently undergo alteration to silicate. Alumina has been found in small quantities in plants, but how combined is not yet known.

I believe the principal deposits of manganese ores are found in connection with limestone or dolomitic rocks, probably for the most part originally disseminated through them in small proportions, and subsequently concentrated in particular localities by the action of infiltrating water, and the nearest approach to the phenomenon described by Sir Wyville Thomson appears to be met with in the associated limestone, dolomite, iron ore, and nodular manganese ore of the Lahn district, as recorded by Bischof.<sup>6</sup> At the place where the iron and manganese beds are worked, there are several clay beds, varying from a few feet to several fathoms in thickness. These Bischof considers are the result of the continuous action of water containing carbonic acid, the argillaceous limestone being converted into clay. The manganese and iron ores lie beneath the clay beds, and it is most likely that these minerals were extracted from the argillaceous limestone at the same time as the carbonate of lime, having doubtless existed in small quantities as carbonates in the organisms forming the mass. In fact the lower clay beds still contain some manganese. There is thus considerable analogy between the two cases, the difference being that these old limestones having been formed in mass, in not very deep water, were not liable to be dissolved—immediately on the death of the organisms whose skeletons they were—by the action of sea-water, that part being played, ages afterwards, by atmospheric water. The result has been mainly the same, however, viz., the production of clay from the limestone, together with nodular manganese. Possibly had the corals, &c., forming that limestone had the opportunity of falling slowly, and each isolated, through

a sufficient depth of sea-water, the result would have been a manganeseiferous mud, similar to these deep-sea clays.

As to the nodular structure of the manganese oxide, it is of course referable to the same mysterious molecular attraction which determines the segregation of all the carbonate of iron in the case of clay-ironstone in fire-clays and shales, and silica, as in chalk flints.

Since the above was written, the last number of the *Proceedings of the Royal Society* (vol. xxiv. No. 170), with Preliminary Reports on the Cruise of the *Challenger*, by Sir C. Wyville Thomson and colleagues, has come to hand. These reports contain a full description of the manganeseiferous muds, but no theory as to the origin of the manganese is as yet put forward.

EDWARD T. HARDMAN,

Kilkenny

II.M. Geological Survey, Ireland

#### Mr. Wallace on the Distribution of Passerine Birds

IN Mr. Wallace's recently-published work on Geographical Distribution, in more than one place the results arrived at from an inspection of his elaborate tables of genera and families do not agree with the numbers he uses in considering the general bearing of the facts adduced. Thus in his "General Remarks on the Distribution of the Passeres," vol. ii. pp. 299-302, he says (*i.e.* p. 300): "The families that are confined to single regions are not very numerous, except in the case of the Neotropical region, which has *five*, the Australian has only *three*, the Oriental one, Ethiopian one, and the other regions have no peculiar families." Adopting his tables of the families of the Passeres, I find the numbers should be really as follows:—

Neotropical	7	...	Fams. Nos. 39 <sup>a</sup> , 40, 41, 42, 44, 45, 46.
Australian	5	...	" " 21, 22, 25, 49, 50.
Oriental	3	...	" " 11, 12, 43.

The Nearctic region should also be mentioned as possessing one peculiar family, *i.e.* *Chamaeidae*. The statement that none of the troid Passerine families are exclusively American must also be modified to meet this fact. There are three families (*i.e.* *Paictidae*, *Pittidae*, *Eurylamidae*), instead of *two*, of the Formicoroid Passeres in the Old World, of which the *Pittidae* can hardly be said to have only a "very restricted distribution."

The Australian genus *Struthidea*, of doubtful position, seems omitted altogether.

W. A. FORBES

Cambridge, Oct. 30

#### Antedon Rosaceus (*Comatula rosacea*)

THERE are one or two rather hasty conclusions in the letters you have recently published upon the feather-star, which I will take the liberty of pointing out. My friend, Major Lang, arguing from his experience in Torbay, says: "It is evident that the habitat of *Comatula* is strictly defined, viz., in comparatively deep water, and amongst rocks." Last year, however, I took it in Salcombe Estuary, in shallow water, and not among rocks, but among the *Zostera marina*, to which numbers of the young stalked form were sticking. The well-known marine zoologist, Mr. Hincks, tells me that he took both the adult and stalked forms in great abundance in the same locality more than twenty years ago.

The President of the Birmingham Natural History and Microscopical Society, in commenting upon Major Lang's letter and other notices of the capture of the feather-star, says, "It is a most remarkable circumstance, therefore, that in the space of about three years, the species should have become numerous to the extent alluded to by Major Lang, more than a hundred being taken in one haul of the dredge." But this rapid increase in the numbers of the species since 1873 is imaginary, for dredgings in the two previous years had yielded the adult form by bucketful from the neighbourhood of the Thatcher Rock.

In regard to the name, one can only wish for a scientific dictator to restore Lamarck's happily appropriate designation *Comatula*, in place of the earlier name, *Antedon*, the meaning and pronunciation of which are alike difficult to determine. It would be interesting to learn from political economists, in what category of labour, productive or unproductive, those investigations should be reckoned, which end in displacing some name universally received and understood in favour of one forgotten and obsolete. Justice to the ancient observer is pleaded as a chief reason for these revivals. But it is a poor renown to have helped to increase the ever-growing burden of scientific nomenclature.

Torquay, Nov. 6

THOMAS R. R. STERBING

<sup>1</sup> Bischof, "Chem. Geo.," vol. i., pp. 99-108.

<sup>2</sup> "Chem. and Geo. Essays," p. 143.

<sup>3</sup> Fownes' "Man. of Chem.," p. 469; also Watts' "Chem. Dict."

<sup>4</sup> *Op. cit.*, vol. i., p. 198.

<sup>5</sup> It may be that there is a trace of uncombined ferric oxide already in these shells, since the *Globigerina* ooze, when treated with very dilute acid, leaves a red sediment like the "red clay" (see "The Cruise of the *Challenger*," *NATURE*, vol. xiv. p. 95). Sir Wyville hesitates to claim for the silicate of alumina and peroxide of iron that they exist in that form in the shells, rather supposing them to be products of alteration. But the latter is certainly found in some shells and in red corals. It has been shown by Prof. A. H. Church that the red chalk of Hunstanton, treated with very weak acid, yields a residue closely resembling the deep-sea "red clay."—*Chem. News*, xxxi. p. 199.

<sup>6</sup> *Op. cit.*, vol. iii. p. 193.

If you can afford the space I shall be glad to add a few words to the recent communications of Major Lang and Mr. Hughes to NATURE on the occurrence of *Antedon rosaceus* in Torbay.

I do not think *Antedon* has been more abundant than usual during the present year in this locality. An entry in an old note-book reminds me that a chance haul near the Thatcher Rock on July 11, 1871, brought up "plenty of feather stars," and since then during the six years I have dredged in Torbay, *Antedon* has been a very ordinary capture whilst dredging for other objects of interest.

The haul under Berry Head on July 25, alluded to by Major Lang, was undoubtedly an unusually prolific one, but had it not been for the fortunate discovery by Major Lang of the pedunculate form, the mere occurrence of an abundance of the adult feather stars would have made no impression on my mind and no notice would have been taken of it.

Remembering that the Birmingham Natural History Society had taken the young, I mentioned the fact to Major Lang, adding that I had never seen them myself. Next morning I was gratified to hear that on examining at his leisure the proceeds of the haul he had found them in quantity.

This successful result induced me to revisit the spot near the Thatcher after an interval of six years, and there, as I fully expected, *Antedon*, both adult and immature, was abundant. With this experience to guide me, I have since tried a third locality, when, though the adults were less numerous, the pedunculate young, and every stage of growth up to about an inch in diameter, appeared to me to be even more numerous than at Berry Head or the Thatcher.

In conclusion, I beg to say that it will give me pleasure to afford the fullest information in my power to any naturalist desirous of dredging in Torbay. It has often been a source of regret to me to see strangers wasting their time in dredging in spots where, as my old boatman used to say, they could not expect to meet with anything "of any consequence."

ARTHUR ROOPE HUNT

Southwood, Torquay, November 6

As the localities of *Antedon rosaceus* seem to be exciting interest, I may notice that I dredged the adult state in June, 1875, in Bressay Sound, sheltered in about 10 fathoms water, and in June, 1876, abundantly between Mount St. Edgecumbe and Duke Island, Plymouth, in about the same depth of water, in each case on a rocky bottom.

PHILIP B. MASON

Burton-on-Trent, November 8

#### Meteor

ON November 6 I observed a large meteor of a red colour. It commenced near the zenith and took a sinuous course about west-south-west, dividing into two portions after it had travelled about 40°, one portion disappearing about 10° above the horizon nearly due west, the other taking a north-west direction, and disappearing somewhat higher; it was not very bright, but seemed to be a large one. I should like to hear if anyone else has seen it; the time was between 8 and 9 P.M.

Clithero, Lancashire

T. NOSTRO

#### THE MUSICAL ASSOCIATION<sup>1</sup>

THE third annual session of this Society opened on Monday, November 6, with a paper of considerable interest from Alexander J. Ellis, Esq., F.R.S., "On the Sensitiveness of the Human Ear for Pitch and Change of Pitch of Notes in Music."

It appears from the Annual Report, just issued, that the Association numbers 170 members, and is in a sound financial position. It may therefore be considered to have passed its period of infancy, and should now be permanently reckoned among the learned confederations of the metropolis.

It is not altogether uninteresting to look back at its origin and to point out the fulfilment of the especial objects for which it was established.

The first conception appears to have emanated from Mr. William Spottiswoode, Dr. Stainer, and a few other

<sup>1</sup> Report and Proceedings of the Musical Association for 1874-5 and 1875-6.

gentlemen, representing about equally the scientific and artistic sides of music, who circulated a letter among their friends, and in a private meeting held at the house of the Treasurer of the Royal Society, laid the foundations of its future organisation. The original title chosen for the new society explained at more length its peculiar objects than that which it now bears; it was "Society for the Investigation and Discussion of Subjects connected with the Art and Science of Music."

The double function herein indicated has hitherto been steadily and rigorously carried out. Indeed the Council for 1876-7, numbering among its members eminent musicians such as the two professors of Oxford and Cambridge, Messrs. Hullah, Osborne, Goldschmidt, and Dr. Stainer, is supplemented on the side of Science and Literature by the familiar names of Mr. Spottiswoode, Prof. Tyndall, Dr. Pole, Mr. W. Chappell, and Mr. George Grove.

The contributions recorded in the two annual volumes of "Proceedings" are strictly in concordance with the initial programme; they cannot be better summed up than in the words of Mr. Spottiswoode's letter above-named, advocating "the formation of a society similar in the main features of its organisation to existing learned societies. Its periodical meetings might be devoted partly to the reading of papers upon the history, the principles, and the criticism of music, partly to the illustration of such papers by actual performance, and partly to the exhibition and discussion of experiments relating to theory and construction of musical instruments, or to the principles and combination of musical sounds."

In the first year Mr. Hullah, Dr. Stainer, and Mr. Sedley Taylor, spoke on musical notation and nomenclature; Mr. Bosanquet and Mr. Ellis furnished valuable illustrations of true and tempered intonation; Mr. Charles E. Stephens criticised Dr. Day's theory of harmony; Mr. Baillie Hamilton and the writer described their respective improvements in musical instruments.

During the second session there were two papers of great value, mainly historical, from Sir F. Ouseley, "On the History of Ecclesiastical Music in Western Europe;" and from Prof. W. G. Adams "On Wheatstone's Musical Inventions," two "On Notation," by Dr. Pole and Prof. Monk; two mathematical and physiological, by Lord Rayleigh, "On Our Perception of the Direction of a Source of Sound," and Mr. Lennox Browne "On the Management of the Voice;" two mechanical and instrumental, by Mr. de Pontigny, "On Kettledrums," and by the writer "On Standards of Musical Pitch;" one critical, perhaps even polemical, by the active secretary of the Association, Mr. C. K. Salaman, "On Musical Criticism."

Several of the above communications, especially Mr. Bosanquet's two exhaustive papers "On Temperament," call for full analysis; but the general status and purpose of the Association itself are so far novel as to deserve preliminary attention. Music, of all æsthetical subjects, is that which is most deeply marked by its bisection into art and science; much of the art, little of the science is ancient; for Euclid, Pythagoras, and even Galileo carry us only a short distance into the laws of harmony. But it is peculiar to music that instruments accidentally invented, slowly improved, fabricated simply for performance, and intended solely to charm the ear, have at a later period furnished the tools and apparatus of scientific analysis. The violins of Gaspar di Salo and Stradivarius, have for centuries illustrated the laws of harmonic sounds, and even as early as the time of Tartini, furnished the *Terzo Suono*, which figures so boldly in modern acoustics.

As the instruments themselves fulfil a double purpose, so are their votaries divided into two very distinct classes, those namely of artists and theorists. The essential value of Mr. Spottiswoode's proposal lay in the appreciation of this schism, and of the means towards healing it. The

artistic world of music, great as the individual acquirements of some members as executants may be, is essentially a world of handicraftsmen; practising indeed a very subtle art, but led entirely, according to Aristotle's definition, by rules, and not by laws.

The function of the scientific man is to expand these technical rules of art into the conscious and explained laws of science. How nobly this duty has been performed by Chladni, by Savart, by Wheatstone, and above all by Helmholtz, few artists are aware; nor indeed has there been hitherto any easy mode for their obtaining such information. They have been somewhat in the habit of sneering at the theorist as a "mathematician;" nor is it very remarkable that the other party, like the Dublin fishwife whom O'Connell called a parallelopipedon, should retaliate with even more opprobrious epithets. Hence old threadbare jokes about "catgut-scraping," Lord Chesterfield's contempt of musicians, and the like, which culminate in the epigram on Handel and Buononcini. This century is beginning to recognise that varying styles of musical art are not a mere question of "Tweedledum and Tweedledee," and that the "fiddler," though in an utilitarian point of view unnecessary to the maintenance of life, is highly conducive to education and civilisation. If artists are to maintain the improved position of later years it must be by cordially fraternising with the man of science, for thus only can their art hope to acquire the dignity and generalisation which are the prerogatives of *ἐπιστήμη*.

It is to be noticed that this view of the case appears to have been taken by many of our best professional musicians; for the list of members which heads either volume of these "Proceedings" is far more remarkable for individual eminence of the names than for their multitude. It is to be hoped that such a conviction will continue to extend. The number of points in which music is conterminous with pure science is considerable, and is daily increasing. Music, moreover, is among the most powerful means we have for cultivating that delicacy of the senses on which all accurate observation depends. It has, as yet, been too apt to fall into the hands of a sect or clique, whose disposition is naturally exclusive, and whose objects have often been the reverse of elevated. But with the great advance which has of late years taken place in general musical knowledge throughout England, and by the fostering care of societies like the present there is ground for anticipation that the science of music may rise to the esteem and consideration as an educator and humaniser which it once held in the writings of Plato, and in the palmiest days of old Greek thought.

W. H. STONE

#### ON THE RESISTANCE OF THE AIR TO THE MOTION OF PROJECTILES

THE experiments made by Hutton to determine the resistance of the air to the motion of shot were carried out by firing small spherical balls into the receiver of a gun-pendulum. As little confidence could be felt in applying his results to the large service shot at present in use, on the formation of the Advanced Class of Royal Artillery Officers, Woolwich, in 1864, it was thought desirable that a systematic course of experiments should be made with *elongated* shot, and upon a much larger scale. Afterwards, similar experiments were made with *round* shot.

The method of experimenting pursued by Hutton appeared to have been carried to its useful limits, and although a large ballistic pendulum had been constructed for Government, it was practically useless. The chronograph used in the experiments above referred to was invented and constructed for that purpose by the Rev. F. Bashforth, at that time Professor of Applied Mathematics to the Advanced Class, and Official Referee to the Ord-

nance Select Committee. This instrument is now in the Loan Exhibition, South Kensington.

A complete collection of the "Reports on Experiments made with the Bashforth chronograph, 1865-1870" (marked 84, B, 1941), has been published by Government, at the nominal price of one shilling.<sup>1</sup> It will therefore be sufficient here to state that the first set of experiments was made to test the new chronograph, in which the velocity of the shot varied from about 1,150 f.s. to 1,060 f.s. The resistance of the air was found to vary as the *cube* of the velocity. The next experiments were made with *elongated* shot of equal diameters and different forms of head. The velocities here varied from 1,500 f.s. to 1,090 f.s., and the law of resistance still appeared to be the *cubic*. Lastly, a course of experiments was made with *elongated* and *spherical* projectiles (solid and hollow) of 3, 5, 7, and 9 inches in diameter. The velocities of the elongated shot varied from 800 f.s. to 1,750 f.s., and those of the spherical from 800 f.s. to 2,400 f.s. At a given velocity the resistance of the air varied as the square of the diameter. But when the coefficient of resistance was obtained by dividing the numbers expressing the resistances by the cube of the corresponding velocity, the result was not now constant through these great variations of velocity. This coefficient was found to increase rapidly from 900 f.s. up to 1,050 f.s., and from 1,100 f.s. to 1,300 f.s. it was nearly constant, and for higher velocities it gradually decreased with the increase of velocity. The published reports give a full account of every round fired. Unfortunately it has not hitherto been found possible to express the coefficient of resistance by a simple function of the velocity. Mr. Bashforth has made use of the cubic law in his treatise on the motion of projectiles (1873). The trajectory is divided into arcs, and each arc is supposed to be described, while the coefficient of resistance retains its mean value for that arc.

In a tract on the remaining velocities, &c., of several service shot (1871),<sup>2</sup> Mr. Bashforth stated: "For ogival-headed elongated shot, the resistance of the air may be said to vary roughly as the *sixth* power of the velocity for velocities 900-1,100 f.s.; to vary as the *third* power for velocities, 1,100-1,350 f.s.; and to vary as the *second* power for velocities above 1,350 f.s."

General Mayevski, Professor of Ballistics to the Academy of Artillery, St. Petersburg, published a work on Ballistics in Russian, in 1870, at the expense of the State. A translation of the more interesting chapters of this work was published in French by the author, in 1872.<sup>3</sup> In the preface to the latter work he states that "Les résultats des expériences faites par M. Bashforth en Angleterre sur les projectiles oblongs ont été déduits des données insérées dans les *Proceedings of the Royal Artillery Institution, Woolwich*, 1868. Les expériences de St. Pétersbourg sur la résistance de l'air au mouvement des projectiles sphériques et oblongs ont été faites par nous en 1865 et 1869, et leurs résultats sont pour la première fois publiés dans notre traité. Afin que les expressions de la résistance représentent, avec une approximation suffisante, les résultats de nos expériences et ceux des expériences anglaises, faites avec des appareils perfectionnés, et que ces expressions permettent en même temps une intégration facile, quoique par approximation, des équations différentielles du mouvement, nous avons admis pour les projectiles sphériques, dans les limites des vitesses de 530<sup>m</sup> à 376<sup>m</sup> (1739-1230 f.s.) la résistance de l'air proportionnelle au carré de la vitesse, et nous avons exprimé, à partir de la vitesse de 376<sup>m</sup> (1230 f.s.) jusqu'aux petites vitesses, la résistance de l'air par un binôme dont le premier terme est proportionnel à la deuxième puissance de la vitesse, et le second à la quatrième puissance de la vitesse; pour les projectiles oblongs, quand leur axe de figure coïncide avec la direction du mouvement, nous

<sup>1</sup> W. Clowes and Son; Allen; Mitchell; Longmans and Co.

<sup>2</sup> London: Epon.

<sup>3</sup> Paris: Gauthier-Villars.

avons admis, dans les limites des vitesses de 510<sup>ms</sup> à 360<sup>ms</sup> (1673-1180 f.s.) la résistance de l'air proportionnelle au carré de la vitesse; dans les limites des vitesses de 360<sup>ms</sup> à 280<sup>ms</sup> (1180-920 f.s.) nous l'avons admise proportionnelle à la sixième puissance de la vitesse, et nous avons exprimé, à partir de la vitesse de 280<sup>ms</sup> (920 f.s.) jusqu'aux petites vitesses, la résistance de l'air par un binôme dont le premier terme est proportionnel à la deuxième puissance de la vitesse et le second à la quatrième puissance de la vitesse," &c. (pp. vi., vii.). So that Mr. Bashforth employs one single law, the cubic, and makes his coefficient vary to suit the velocity, while General Mayevski varies his law of resistance according to the velocity. But in neither case does the law of resistance admit of direct integration. Mr. Bashforth supplies this defect by extensive tables calculated by quadratures, and ranting the cubic law, the results are exact. General integrations are approximations, and require ... bles also. But there is no dispute as to the of resistance encountered by elongated shot in g through the air. For General Mayevski observes; "Aussi pour compléter les données se rapportant aux projectiles de forts calibres, nous avons profité des tableaux des vitesses décroissantes déduites par M. Bashforth de ses expériences faites en 1868 au moyen de son chronographe; ces tableaux comprennent les vitesses de 518<sup>ms</sup> à 283<sup>ms</sup> (1700-930 f.s.), qui correspondent aux trajets de 305 en 305 mètres des projectiles oblongs de 178<sup>mm</sup>, 203<sup>mm</sup>, et 229<sup>mm</sup> (7, 8, and 9 inches), et qui sont obtenues pour le cas où le mouvement des projectiles peut être considéré comme rectiligne. Nous avons calculé d'après les résultats insérés dans ces tableaux les valeurs de la résistance correspondantes à différentes vitesses" (p. 38).

Projectiles Oblongs.

Bouches à feu.	Vitesses	Valeurs	Bouches à feu.	Vitesses	Valeurs
					de p'.
C. de 4 <sup>l</sup>		0'0151	C. de 203 <sup>mm</sup>		0'0338
C. de 203 <sup>mm</sup>		0'0137	C. de 203 <sup>mm</sup>		0'0327
C. de 4 <sup>l</sup>	239		C. de 229 <sup>mm</sup>	334	0'0332
C. de 12 <sup>l</sup>			C. de 4 <sup>l</sup>	337	0'0341
C. de 24 <sup>l</sup>		0'0160	C. de 178 <sup>mm</sup>	340	
C. de 203 <sup>mm</sup>		0'0163	C. de 203 <sup>mm</sup>	345	
C. de 203 <sup>mm</sup>			de 2	355	
C. de 229 <sup>mm</sup> angl.			C.		0'0322
C. de 203 <sup>mm</sup> angl.		0'0230	C. de 203 <sup>mm</sup>		
C. de 178 <sup>mm</sup> angl.		0'0218	C. de 203 <sup>mm</sup> angl.	360	
C. de 1	304	0'0221	C. de 4 <sup>l</sup>	401	0'0450
C. de 4 <sup>l</sup>	307	0'0158	C. de 203 <sup>mm</sup>	409	0'0430
C. de 229 <sup>mm</sup> angl.	316	0'0305	C. de 203 <sup>mm</sup> angl.		0'0433
C. de 4 <sup>l</sup>	317				0'0427
C. de 203 <sup>mm</sup>	319	0'0174	C. de 203 <sup>mm</sup> angl.		0'0449
C. de 203 <sup>mm</sup> angl.	320	0'0277	C. de 203 <sup>mm</sup> angl.		0'0446
C. de 24 <sup>l</sup>	320		C. de 178 <sup>mm</sup>		
C. de 178 <sup>mm</sup> angl.					

It ought to be stated that Hutton's results for spherical shot are very good indeed for velocities above 1200 f.s., while Didion's results, intended to correct Hutton's, were not quite so good. They both failed for lower velocities. It would be interesting to have the resistance of the air to projectiles determined for velocities below 900 f.s. But very considerable difficulties would be met with if the experiments were conducted in the usual manner, for the chronograph is most effective when there is a rapid variation of velocity. In the middle of the range the screens would have to be raised to a considerable height. It would be found difficult to fire shots through them all. If the shot were fired at low initial velocities from the ordinary rifled gun, there might be considerable doubts the steadiness of the shot.

It must be made to the collection of scientific memoirs on ballistics by the Comte de St. Robert published in 1872,<sup>1</sup> although they do not supply any new experimental data.

<sup>1</sup> Turin: Vincent Bora.

As it is found impossible to integrate the equations of motion of shot for the simple laws of resistance, of square cube, &c., it appears almost hopeless to search for an expression of the complicated law now known to hold good through a considerable range of velocities. These results would serve as tests of any theory of the resistance of the air; and if any theoretical investigations did satisfy these conditions, then we should have an expression for the resistance of the air to the shot, but it is almost certain that it would be too complicated to be of practical use. B.

A LOCAL MUSEUM

THE population of the parish of Morton, 1871, was 2,099—the chief village, Thornhill, containing about one half of the population of the parish. The parish is situated on both banks of the Nith in the North of Dumfriesshire, Scotland. Yet sparse as is the population, and remote from the great commercial centres as is the district, it is supplied with a museum which well might grace a place of far more wealth and consequence. The building was erected by Thomas B. Grierson, and the collections in the museum were formed by him. The Duke of Buccleuch granted the land on which to build, together with stone. The memorial stone was laid with masonic honours in June 1869. The building, which was from the design of a local architect, is an oblong, consisting of a ground floor and gallery. The gallery is very appropriately supported by six oaks, as brought from the forest, being among the last of the natural woods of Nithsdale.

The débris excavated for the foundation has been well utilised by forming a large mound in the surrounding garden, which is faced on all sides by an excellent collection of the minerals and curious stones of the district, and forms a suitable habitat for hardy plants. The garden contains a great variety of flowering plants, of shrubs, trees, and cryptogamous vegetation, and is laid out with considerable art. Large objects, which do not suffer waste by atmospheric causes, such as stone crosses and querns, are placed at intervals in the walks. Great prominence has been given in the collections inside the building to objects which illustrate the history of the country. These include some valuable relics belonging to the Covenanters of the seventeenth century, and to the poet Burns. The collections illustrative of the unpolished and polished stone-period are very valuable. Some beautifully wrought cells and stone-hammers have been yielded by this part of Nithsdale. The bronze and iron collections are very fair. Among the quadrupeds is a skull of the ancient ox which roamed wild less than a century ago in Drumlanrig Parks, and which belong to the same variety as those at Chillingham and Hamilton Palace, which are supposed to be the sole survivors of the ancient Caledonian Urus. Among fish there is an interesting collection, which was the gift of the late Mr. Shaw, illustrative of the natural history of the salmon, and which shows that animal in its various different stages. The late Mr. Shaw threw great light on the development of the salmon, and destroyed some popular delusions concerning it. He was a keeper in the district under the Duke of Buccleuch. The abnormal form of animals are very various, many opportunities having occurred to fill the cases devoted to these from the pastoral and agricultural district around. In the collection of fossils due prominence is given to those belonging to the strata of the south of Scotland, and the industrial departments contain specimens of the manufactures of the country. The museum is free to the public on Saturday, and open for a small sum during the week. School children are admitted along with their teachers gratuitously on application. The proprietor, Dr. Grierson, is most indefatigable in his attentions and explanations to all willing to learn from his collection of objects. The

number of persons who have been admitted for the first time since the museum was opened, July 1872, is about 4,000. There is a society in connection with the museum which meets monthly, having for its object original research. Papers have been contributed, amongst others, by Dr. Grierson, Dr. Sharp of the London Entomo-

logical Society, and Mr. Shaw, schoolmaster. Dr. Sharp gave an exhaustive account of the Colorado beetle, and Mr. Shaw illustrated, by means of large diagrams, Darwin, Lubbock, and Müller's discoveries on the fertilisation of flowers by insects.

J. SHAW  
Tynron, Thornhill

### THE AUSTRIAN ARCTIC EXPEDITION<sup>1</sup>

NO doubt most of our readers have some acquaintance with the story of the memorable Austro-Hungarian Arctic Expedition in the *Tegetthoff* under the leadership of Lieutenants Payer and Weyprecht. We have at various times since the return of the expedition, upwards of two years ago, given details of the adventures of the party

and of the results obtained; in vol. x. p. 524, we published a map showing the geographical discoveries which had been made. In the work named below all who have heard anything of the expedition or who take an interest in Arctic exploration will be glad to have a complete history of its doings from the artistic and graphic pen of one of its commanders, Lieut. Payer. We venture to think that Payer's narrative is likely to take its place



The Austrian Flag Planted at Cape Fligely.

among the classics of Arctic exploration; the skill with which he has told the story of an expedition so full of strange and unexpected events, the enthusiasm and interest which mark every page, its pathos and humour, the value of the information it contains, and the attraction of its numerous illustrations, are sure to make it a permanent favourite with old and young, and constitute it an authority on Arctic matters generally.

The *Tegetthoff*, a screw steamer, expressly built for the purpose of this expedition, of 220 tons burden, fitted out for two years and a half, left Bremerhaven June 13, 1872, and Tromsøe about a month later, for the purpose of exploring the Arctic Seas in the Novaya Zemlya region. The vessel was equipped mainly at the expense of the

<sup>1</sup> "New Lands within the Arctic Circle. Narrative of the Discoveries of the Austrian Ship *Tegetthoff* in the Years 1872-1874." By Julius Payer, one of the Commanders of the Expedition. Maps and numerous Illustrations. Two vols. (London: Macmillan and Co., 1876.)

Austrian Count Wilczek, and, including officers and men had only twenty-four souls on board. The ultimate destination of the expedition was not rigidly defined; they might make their exit by Behring Straits, or winter on the Siberian coast, or on any lands which they might be fortunate enough to discover. The first ice was met with in about 74° N., near the coast of Spitzbergen, and it remained with the ship more or less till the end. Only the year before, in a preliminary reconnaissance in a small sailing vessel, the *Ishjörn*, by Count Wilczek, the sea between Spitzbergen and Novaya Zemlya was found to be almost free of ice, and with a properly-equipped steam vessel there seemed to be no obstacle to pushing northwards indefinitely. In 1872 things were a very different aspect. The ice was entered in 74° N., and it requires careful navigation to reach Cape Nassau, near which the *Tegetthoff* was overtaken by Count Wilczek in the

*Isbjörn*, who had thoughtfully followed to establish a depot for the exploring ship in the north of Novaya Zemlya. The two ships parted company on August 20, and a few hours after the *Tegetthoff* was beset by the ice in lat.  $76^{\circ} 22'$  N., long.  $63^{\circ} 3'$  E., and she never afterwards got out. Completely at the mercy of the moving ice-field, the ship drifted slowly in a general north-east direction during the winter, till somewhat north of  $79^{\circ}$  she turned westward in the middle of February, 1873. Though generally westward, the course was somewhat erratic. During the spring and summer of 1873, every effort was of course made to free the ship from her helpless position, in which apparently nothing could be done to carry out the object of the expedition. To be imprisoned thus for another winter appeared utterly intolerable, but all the efforts made failed, and by August everyone felt resigned

to the inevitable. In August the ship took a turn towards the north, and on the 30th of that month the whole aspect of things suddenly brightened for the ice-bound explorers by the unmistakable sight of new lands. When in  $79^{\circ} 43'$  N. and  $59^{\circ} 33'$  E., new life was awakened in every breast by the sight of the mountains and glaciers of what is now known as Kaiser Franz-Josef's Land. Thus, then, when hope was lowest, the expedition drifted into success. It was too late that season to explore the new-found land, and it can easily be imagined how impatient all were for the advent of spring, to enable them to commence to gather the fruits of their lucky find. Lieut. Payer strongly advocates autumn as the best season for sledging, but as they could not run the risk of another winter in the ice, the sledge journeys were commenced early in March, and by the beginning of May Lieut. Payer had made



The Aurora during the Ice Pressure.

three separate expeditions into Franz-Josef Land. In the first expedition, a short one, he explored Wilczek Island, the most southerly, and the south part of Hall Island. In the second journey he went right northwards, 160 miles, as far as he could go with sledges, to Cape Fligely,  $82^{\circ} 5'$ , making several subsidiary trips right and left of Austria Sound, on which he travelled, and which separates the two main divisions of Franz-Josef Land into Wilczek Land and Zichy Land. Finally a third short expedition was made to the north-west to M'Clintock Island, and on May 20, 1874, all necessary preparations having been made, the good ship *Tegetthoff* was abandoned. No other course was open to the commanders, if they did not want to run the risk of perishing along with their greatly enfeebled crew. By sledging and boating, a painful, wearisome, and slow progress southwards was made, so slow that in two months they

were only nine miles from the ship, with a rapidly diminishing stock of provisions, though tobacco and water seem to have been the greatest wants; Payer says you could not have then done a man a greater favour than ask him to a pipe and a glass of water. Fortunately the open water was met with in about  $78^{\circ}$  N., and with little difficulty the wearied party rowed and sailed southwards along the west coast of Novaya Zemlya, until finally rescued, on August 24, by a Russian fishing-vessel at Cape Britwin. On September 3, all except poor Krisch, the engineer, who died of consumption and was buried on Wilczek Island, reached Vardö, not much the worse of their extraordinary experiences.

This bald outline of the course of the expedition can give one no idea of the intense interest which the detailed narrative assumes in the pages of Lieut. Payer. With the hand of a true artist, with pen and pencil, he sketches

the life of the apparently forlorn party from day to day, with such clearness, and force, and sympathy that the reader becomes familiar with the peculiarities of each individual, and feels towards him in the end like an old acquaintance. The ways and characteristics of the very dogs, Jubinal and Sumbu and Pekel, and the rest, are sketched in a manner that would delight the heart of the author of "Rab and his Friends." While the work only pretends to be a general account of the expedition, it contains much of scientific value. Most of the scientific results yet remain to be published, though from time to time papers by Weyprecht, Höfer, and others appear in Petermann's *Mittheilungen*, containing elaborate discussions of the various scientific observations; we published some account also of the scientific results in three articles in NATURE, vol. xi. p. 366, *et seq.* Of Franz-Josef Land itself the author, by drawings, descriptions, and map, conveys a satisfactory idea. It is evidently an archipelago of about the size of Spitzbergen, stretching from about 80° to at least 83° N. lat., but how far from east to west is not ascertained. Running north and south, on each side of Austria Sound, are two main stretches of land, Wilczek and Zichy Lands, broken up, the latter especially, by many deep fiords, and with many islands in the channel between them. Payer got as far north as Cape Fligely, in 82° 5' N., and from that saw land stretching northwards to 83°, Petermann Land, and another coast-line far to the west, King Oscar Land. The land, as might be expected, is a barren one, with mountains 2,000 to 5,000 feet high, and glaciers of such size, as argues that the country must have very considerable breadth. In many parts, and as far north as Payer went, animal life, bears and seals, and thousands of Arctic birds in great variety, abound; during the whole time of the expedition's sojourn fresh meat of some kind was seldom lacking. At Cape Fligely open water was met with, but it was only an extensive ice-hole or "polynia;" the idea of an "open Polar Sea" Lieut. Payer does not for one moment entertain. Distinct recent traces of foxes and even of hares were seen in some places, but no actual specimens were met with. Under the summer-sun, Lieut. Payer is of opinion, numerous streams will rush down the mountain sides, and some of the valleys be clothed with verdure. But for most of the year there is nothing but barrenness and ice and snow; the land is, of course, uninhabitable, and no trace of human beings was discovered. The islands are evidently volcanic, and reminded Lieut. Payer geologically of the rocks of North-east Greenland. Brown coal was found and coarse-grained dolerite abounds. But for details as to the appearance, the geology, the fauna, and flora, and other characteristics of Franz-Josef Land, we must refer the reader to the work itself. It would certainly be interesting to know more of this discovery, and perhaps means may yet be found to gratify a justifiable curiosity. The discovery of this group of islands greatly favours the theory of those who maintain that the Arctic basin is mainly an archipelago, and after all, our own expedition has found nothing that seriously weakens the theory.

From a scientific point of view the first chapter is probably one of the most important in the work. Lieut. Payer has evidently made a thorough study of ice in all its phases, both by means of direct observation (and both in the Novaya Zemlya seas and on East Greenland he has had ample opportunities for this) and by extensive reading of the works of previous explorers. In this first chapter are given the results of this investigation, the characteristics of ice of all kinds—field-ice, pack-ice, hummocks, icebergs, and other forms—in a more systematic and thorough manner than we remember to have seen before. Many popular delusions he demolishes, and writes with an accuracy and fulness that must be satisfactory to those who have had no opportunity of studying ice-forms for themselves. Icebergs, he tells us, with long,

illustrations, have no real existence. It is only fragments of field-ice, raised up by pressure, exposed to the action of waves and the process of evaporation, which are transformed into fantastic shapes. Icebergs are of a pyramidal or tabular shape, and in time they are usually rounded off into irregular cones. Altogether this chapter on ice is exceedingly instructive. The masses or thickness of floe-ice depends, he shows, not on age alone, but on several influences, pressure being one; so that the enormously thick ice met with by our own expedition does not need to be regarded as a remnant of the last glacial epoch, but due probably to unusual pressure, and the heaping of one mass upon another.

The year 1871, we have said, was in the Spitzbergen seas a great contrast to 1872, while 1874 again was as open as 1871. One of the most interesting, and in some ways instructive passages in the work, is where Lieut. Payer describes the fearful pressure to which the ship was subjected as she drifted northwards. For months these poor men had nightly to rush from their bunks on to deck ready to abandon the ship, which they expected to see every moment crushed to splinters. Payer's descriptions of the appearance and the agonising noises accompanying the ice-pressure are most impressive. The ice was comparatively smooth when first the ship entered it, but shortly the party were startled, when forced to rush on deck by the dreadful sounds which awakened them, by seeing the whole field crushed together, broken up, the pieces piled on the top of each other and lying at all sorts of angles, not unlike, indeed, the description given by Capt. Nares of the "Palæocrystic ice." Is not this, possibly, one more proof that the sea to the north of Robeson Channel was in an exceptional condition last spring? That we are almost entirely ignorant of the laws that regulate the movements of the ice in these regions is evident; no two successive years are alike, and the condition of one part cannot be inferred from that of another. In that very June, 1872, when the *Tegetthoff* was beset so far south on the Novaya Zemlya side, the *Polaris* pushed north with ease to 82° 16' by the Smith Sound route, and could have gone further; and this year, when our own ships have had a life-and-death struggle with palæocrystic ice, whalers have been cruising and making easy discoveries between 81° and 82° N., on the Spitzbergen side. If any satisfactory results are to be obtained concerning these Arctic regions, is it not evident that the only means to obtain them is by the establishment of permanent stations all round? This is the conclusion to which Lieut. Weyprecht, one of the commanders of this expedition, has been driven. By the by, we would recommend Payer's description of the results of ice-pressure to geologists who desire to have a forcible illustration of the results of pressure in changing the configuration of a surface.

In these introductory chapters the author gives many valuable directions as to the equipment and conduct of Arctic expeditions, and, it may not be amiss to state, expresses his complete approval of M'Clintock's method of constructing and fitting sledges. We recently referred to the suggestion of the use that might be made of ballooning in Arctic exploration; Lieut. Payer thinks that valuable results might be obtained by means of a captive balloon. As to the Gulf Stream, he gives little ground for believing that it extends much beyond Spitzbergen; indeed he thinks that the wind was the main cause of the drift of the ship; though Baron von Wüllersdorf, who has discussed some of the results of the expedition, thinks it probable that there exists a sea-current in the seas between Novaya Zemlya and Franz-Josef Land; that at any rate its existence cannot positively be denied, although the prevailing winds may produce similar phenomena. He also thinks there is a great probability that the ocean stretches far to the north and east beyond the eastern end of Novaya Zemlya.

The crew of this expedition was a mixed one—German.

Slavonic, Italian, Norwegian, and English being spoken, though all orders were given in Italian. It was well selected, and the ships equipped according to the most approved directions, but still scurvy broke out, though apparently not to so serious an extent as in the case of the *Alert* and *Discovery*. Fresh meat was abundant, and everything known to prevent or counteract the disease, but it broke out in both winters, the men improving during spring. Payer is distinctly of opinion that a judicious use of alcohol is a preventive, but evidently the real cause of this scourge of Arctic explorers has yet to be found out. The lowest temperature met with was a little over 40° R., though the general temperature was much milder. No one suffered seriously from frost bites, though they were common. The single death was due to consumption.

The conduct of the expedition by its two leaders, and the behaviour of officers and men, were all that could be wished. Observations in meteorology and magnetism, on the Aurora (of which there were many magnificent displays), geology, biology, and other departments of science were regularly and carefully made, and will no doubt gradually find their way into the general body of scientific knowledge and deductions. Unfortunately, many of the specimens, geological and zoological, had to be left behind with the ship. On the whole, this expedition is one of the most satisfactory in its conduct and results of all that have gone out to gather knowledge in these inhospitable regions, and Lieut. Payer has written its story in a style not surpassed in fascinating interest and scientific value by any of those old narratives that are still the delight of all who love to read of the adventures of daring men. The translator has had a hard task before him in putting the narrative into English dress, but he has succeeded, we think, completely; while retaining an unmistakable German flavour, the English version is thoroughly idiomatic and readable.

OUR ASTRONOMICAL COLUMN

THE NINEVEH SOLAR ECLIPSE OF B.C. 763.—In the Rev. A. H. Sayce's notice of the discoveries of the late Mr. George Smith amongst the Assyrian inscriptions in the British Museum (NATURE, vol. xiv. p. 421), reference is made to a solar eclipse in the month Sivan, which has been fixed to the year B.C. 763, June 15 (not in May, as printed in the notice quoted). The following are elements of this important eclipse—which has so direct a bearing upon the Assyrian chronology of the period—deduced upon the same system of calculation adopted for other ancient eclipses previously alluded to in this column:—

Greenwich Mean Time of Conjunction in R.A., B.C. 763, June 14, at 19h. 9m. 25s.

R.A.	...	...	...	73	9	43
Moon's hourly motion in R.A.	...	...	...	39	56	
Sun's	...	...	...	2	34	
Moon's declination	...	...	...	23	10	10 N.
Sun's	...	...	...	22	53	4 N.
Moon's hourly motion in decl.	...	...	...	0	54	N.
Sun's	...	...	...	0	17	N.
Moon's horizontal "parallax"	...	...	...	60	9	
Sun's	...	...	...	0	9	
Moon's true semi-diameter	...	...	...	16	24	
Sun's	...	...	...	15	25	

The sidereal time at Greenwich noon was 4h. 57m. 47s., and the equation of time 8m. 4s. additive to mean time. Hence the middle of the eclipse fell at 19h. 8m. 52s., and the following would be points in the line of central and total phase:—

Longitude	...	35	14	E.	Latitude	...	30	59	N.
"	...	40	2	"	"	...	32	58	"
"	...	43	35	E.	"	...	34	19	N.

Sir George Airy places the Pyramid of Nimrud in long. 3° 20' 8" E., and lat. 36° 6' 1". Calculating directly for this

point from the preceding elements we find a very large partial eclipse—

Beginning June 15 at 7 52 A.M., local M.T.  
Ending " " 10 23 " " "

Greatest phase at 9h. 8m. A.M., magnitude of eclipse 0.987.

The breadth of the zone of totality in the longitude of Nimrud measured upon the meridian was 2° 5', whence it appears that this point is distant by calculation about 50' outside the northern limit, but at this remote period a very small alteration in the value of the moon's secular acceleration employed would suffice to bring Nimrud within the total eclipse, and it has been inferred that the eclipse was probably total at the station of the Assyrian Court, from the circumstance of the inscription referring to the phenomenon being underlined in the Assyrian Canon or register of annual archons at Nineveh, although there is no interruption in the official order of the Eponymes.

The discovery of the record of this eclipse was first announced by Sir Henry Rawlinson, in May, 1867.

THE COMET OF 1652.—This comet, which was observed for about three weeks only, is stated by Hevelius and Comiers to have equalled the moon in apparent magnitude, a fact pointing to a near approach to the earth. At present we have only the elements given by Halley in his "Synopsis Astronomiæ Cometice," which were calculated upon the observations of Hevelius, extending from December 20, 1652, to the 8th of the following month, published in the scarce volume of his "Machina Cœlestis." From this orbit the following positions and distances result:—

reb. G.M.T.	R.A.	Decl.	Distance from the Earth.
1652, Dec. 12	124 43	- 59 18	0.2275
16	96 19	43 42	0.1515
18	81 52	27 2	0.1308
20	69 50	- 6 2	0.1314
1653, Jan. 8	33 28	+ 48 50	0.5627

So that the comet's least distance from the earth was about 0.13 of the earth's mean distance from the sun, and the real diameter of the cometic nebulosity rather less than 110,000 miles.

THE BRIGHTNESS OF JUPITER'S SATELLITES.—In connection with a recent reference in this column to M. Prosper Henry's direct comparison of the brightness of Jupiter's satellites with that of Uranus, it may be mentioned that Dr. Engelmann of Leipsic, in his memoir "Über die Helligkeitverhältnisse der Jupiterstrabanten," taking the star 132 Tauri as 5.3 in magnitude found the respective magnitudes of the satellites

I. .... m. 5.52 II. .... m. 5.70 III. .... m. 5.32 IV. .... m. 6.28

While a reduction of light-comparisons by Prof. Auwers between November, 1858, and May, 1860, gave

I. .... m. 6.43 II. .... m. 6.59 III. .... m. 5.87 IV. .... m. 6.76

BIOLOGICAL NOTES

THE PROGRESS OF EMBRYOLOGY.—The value of Dr. Dohrn's Zoological Station at Naples has never been more conclusively demonstrated than by the publication, in a recent number (July, 1876) of the *Archiv für mikroskopische Anatomie*, of a series of researches by Dr. Bobretzky, of Kiev, on the development of certain forms of Gastropods. The systematic search for embryonic forms which is carried on under Dr. Dohrn's superintendence has enabled Dr. Bobretzky to publish a memoir of great value, illustrated by a hundred figures. His skill and success have been previously attested by his excellent researches on the development of the crustacean genera, *Astacus*, *Palæmon*, and *Oniscus*; and he has now passed with equal good fortune into the Gastropod group, dealing with



the genera *Nassa*, *Natica*, and *Fusus*. These investigations are of special interest because, according to Prof. Ray Lankester, they are the first in which the method of cutting sections has been employed in the examination of these minute eggs and embryos. To have carried the conquests of embryology to such an extent is no slight achievement. Histologists are well aware that the estimate formed of structures by viewing them as transparent objects is liable to be erroneous, even in favourable circumstances; much more so when the objects have an appreciable thickness and are more or less opaque. In all cases it is desirable to obtain, if possible, confirmatory evidence by means of sections cut through hardened specimens; but the labour and manipulative skill required are much greater than in viewing bodies as transparent objects. At the same time Dr. Bobretzky's results convey an instructive warning to those who are tempted to generalise. Nothing is more common, or more detrimental, than for a series of generalisations to be founded on a new set of observations more or less limited in their range. By the continual discovery of fresh variations in the mode in which the ova of aquatic animals are segmented, and acquire their embryonic layers, it is to be hoped that students are being led to see that nothing but summaries of observed facts are of real value at present. Dr. Bobretzky seems to have made it evident that in the genus *Nassa* the three primary embryonic layers are all established during the segmentation of the ovum, and as a direct result of that process; and this is certainly a surprise. Again, a definite relation has been made out in certain cases between the orifice of the earliest invagination of cells and the permanent mouth of the animal. It is to be regretted, however, that Dr. Bobretzky throws doubt on Prof. Lankester's observations on some genera of fresh-water Gastropods, in which facts of a different character were discovered. However, the latter investigator has been stimulated to examine the development of the common *Paludina vivipara* anew, and has published an account of it in the *Quarterly Journal of Microscopical Science* for October last; his previous assertions appear to be very definitely confirmed, notwithstanding that the method of sections has not been adopted: the embryos, it may be stated, are amongst the most transparent in the Gastropod class. Although it must be a disappointment to ardent theorists to find that they are so far from a satisfactory goal, it may encourage young workers when it is seen that the field for independent investigation is practically unlimited, even in embryology. In invertebrates, at least, it appears that the development of every genus should be studied, and that new facts bearing on evolution, on the distribution of life, on the influence of external conditions, on the warping, so to speak, of the direct process of development by temporary influences acting during embryonic life, will reward all diligent work in this fruitful field.

**NEW SPECIES OF ECHIDNA.**—A very remarkable zoological discovery is announced from Genoa. Among the collections recently received by the Marquis G. Doria for the Museo Civico of that city from Mr. Bruyn, of Ternate, is a specimen of a new and large species of *Echidna* from the Arfak Mountains of New Guinea. As the only two Ornithodelphs hitherto known are exclusively confined to Australia, it is difficult to over-estimate the importance, as regards geographical zoology, of the existence of a third member of this peculiar group of mammals in the adjoining land of New Guinea.

**SPHENODON GUENTHERI.**—At a recent meeting of the Wellington Philosophical Society (New Zealand) Dr. Buller described a second species of Lizard (if Dr. Günther will allow us to call it so) of the genus *Sphenodon* (sive *Hatteria*). *Sphenodon guentheri*, as Dr. Buller proposes to designate this new form, "after the greatest of living herpetologists," is from the Brother Islands, whilst the original *S. punctatus* appear to be confined

**A NEW FISH.**—Dr. W. Peters has lately communicated to the Royal Academy of Science of Berlin the description of a new fish of the order *Leptocardii*. Of this most peculiar group of "Invertebrated Vertebrates," but one genus—the *Amphioxus branchiostoma*—has yet been recognised, though several more or less doubtful species of the genus from various parts of the world have been described. Dr. Peters has received from Australia several examples of a well-marked, though closely-allied, form, which he names *Epigomethys cultellus*, and which differs from *Branchiostoma* in having a high dorsal fin and in wanting the caudal and anal fins. These minute rarities were dredged up near Peale Island, in Moreton Bay, in eight fathoms water.

**A NEW PERIPATUS.**—A paper on *Peripatus*, by Capt. F. W. Hutton, Director of the Otago Museum, which will be found to be a valuable supplement to that by Mr. H. Moseley, in the *Transactions of the Royal Society*, has been published in the current number of the *Annals and Magazine of Natural History*. The author describes a new species, which he names *Peripatus nova-Zealandia*, peculiar in being hermaphrodite. These strange animals, between 1 and 2 inches in length, are found in the West Indies, Chili, the Cape of Good Hope, and New Zealand. They have relations with worms and with the tracheate Articulata, and habits much like those of the wood-louse.

**THE PERSIAN DEER.**—In the same number of the same journal, Dr. N. Severtzoff has also an interesting communication on the affinities of the Persian Deer (*Cervus maral*), in which he shows that this species is identical with the Wapiti (*C. canadensis*) of Canada, that from the warmer locality changing colour in the summer, that from the colder not doing so. The author very reasonably suggests that the name *C. wapiti* or *C. maral* would be preferable to *C. canadensis*, now the distribution of the species has been shown to be so general.

**FISHES OF THE ARALO-CASPIO-EUXINE BASIN.**—The results arrived at by Prof. Kessler, after many years' study of the fishes of the Aralo-Caspio-Euxine region (which includes these three interior seas with their affluents) are as follows:—The number of described species is about 280, out of which 80 are marine, 100 fresh-water, and 40 brackish water species; 20 inhabit various waters, and 40 are migratory. 150 species belong exclusively to the region, and 10 have spread out into neighbouring regions at comparatively recent times. Out of the 120 other species, about 25 have a wide range of distribution, about 80 have migrated into the Black Sea from the Mediterranean, and about 15 fresh-water species have penetrated into the Aralo-Caspio-Euxine region from the north. Out of the 160 species limited exclusively to this region, 45 were found in the Black Sea, 54 in the Caspian, and 26 in Lake Aral. There are but 6 species which inhabit simultaneously the three basins of the three interior seas, 4 species which are common to the Caspian and Aral basins, and 25 to those of the Black Sea and the Caspian. The most characteristic families of fishes in the region are the *Gobioidae* and the *Acipenseridae*, the former being represented by less than 50 species, out of which 40 do not extend over other regions; the genus *Benthophilus* of this family, which numbers here six or seven species, has no representatives abroad; and the genus *Scaphirynchus*, represented in the Amu and Syrdarya by three species, is known to have but one more species inhabiting the Mississippi.

**DEVELOPMENT OF THE MAMMA.**—Among the important histological investigations which have appeared quite recently in one by Mr. C. Creighton, M.B., in the current number of the *Journal of Anatomy and Physiology*, on the development of the mamma, and of the mammary function, in which the view generally received that the mamma is a complex extension downwards of the ectoderm or surface of the skin, is combated in favour of the

account originally given by Goodsir, that the essential secreting structure of the breast develops from a matrix tissue at numerous scattered centres, which are the same from which the surrounding fat originates, and that the ducts arise out of the same matrix tissue by direct aggregation of the embryonic cells along predetermined lines. It is shown that in neither genus of Monotremata does the mamma possess a duct-system, it simply being a follicular gland. In the Cetacea these follicles open into a median unbranched simple duct. In the Marsupials and all other animals the ducts are branched, which causes the organ to be racemose. It may be noted that it was during the prosecution of this investigation that Mr. Creighton was led to the correct determination of the nature of the coagulation-appearances found in mucus and other albuminous fluids.

## NOTES

WE regret to announce the death, at Stuttgart, on the 5th inst., of the celebrated traveller and zoologist, Theodor von Heuglin. He was only fifty-two years of age, having been born in 1824, at Hirschlanden, near Leonberg, in Suabia. Von Heuglin had received a comprehensive education and had well prepared himself for his greater travels, by numerous visits to different European countries and by wide study. In 1850 he made a protracted stay in Egypt in order to study oriental languages, manners, and customs. After some visits to the interior of Arabia as well as the east coast of the Red Sea, he became secretary to Dr. Reitz, the Austrian Consul at Khartoum, and in that capacity visited the Upper Nile districts and Abyssinia. When Dr. Reitz had succumbed to the climate, von Heuglin returned to Khartoum, and succeeded him in the consulate. As consul he visited the White Nile, and eventually returned to Germany in 1856. Here he published his excellent "Travels in North-East Africa" (Gotha: Justus Perthe, 1857), which had been preceded (in 1855) by his "Systematic Review of the Birds of Africa." He again paid a visit to the Red Sea, and in 1860 took the lead of the expedition which was to find Vogel's traces, proceeding from the east; Steudner, Kieselbach, Hansal, Schubert, and Munzinger were members of this expedition, which, although acquiring valuable information about the Gallas districts, failed in its principal object. In 1862 von Heuglin returned to Khartoum with Steudner, and in 1863 made a fresh attempt to trace the course of the White Nile. The results of these travels were published in Petermann's *Mittheilungen* (1860-64). His merits were particularly great in ornithology; his drawings are true to nature, his descriptions exact, detailed, and extremely attractive. Also in Arctic regions von Heuglin gave proof of great intelligence and courage; he was almost more successful as an Arctic explorer in 1870 and 1871 than as an African traveller. His work on northern landscapes and animals (published by Westermann, at Brunswick) is one of the most attractive and handsomest records of travels yet published, and is highly esteemed by all who are interested in Arctic exploits. His death was a sadly unexpected one, a slight cough developed into inflammation of the lungs, to which he succumbed in the course of a few days.

WE deeply regret that we have to record the death of Mr. T. Heathcote G. Wyndham. Few among the younger men devoting their life to the pursuit of scientific knowledge and to the teaching of science have formed for themselves a higher ideal of the training a man of science should impose on himself before venturing on original work, or on giving instruction to others. As a commoner of Oriel he took a first class in natural science in 1866, was Burdett-Coutts Scholar in 1867, and was afterwards elected Fellow of Merton. He undertook at Merton the duty of a lecturer in natural science, and the thoughtful care he took in his teaching was not only gratefully spoken of by many of the undergraduates, but frequently referred to in conversation by

those who knew him. The branch of natural science which seemed gradually to have presented itself more prominently to his mind for his own especial study was the chemical side of mineralogy. But although for years he fitted himself for this work in all ways he thought requisite, sparing no pains in acquiring collateral knowledge that might bear on his subject, and though he had done original research which many other men would from time to time have thrown off in isolated papers, he held back from appearing in print. A paper on Iodocrase and Garnet and one on Vesuvius are, so far as we know, all he published. But there is a prospect that some of his work will be preserved, as in conjunction with Mr. Gurney he had in hand a small work on chemical mineralogy. Although he had not yet achieved work to make his name marked in the world of science, yet those who knew him lament the loss of a scholar and a gentleman, and the lament is in no way softened by the unhappy circumstances attending his death.

THE published results of the exploration of Lake Titicaca by Messrs. Alexander Agassiz and S. W. Garman, has just reached us. The expedition was undertaken during the early months of last year. Mr. Agassiz writes on the hydrography of the lake, describing the peculiarly uniform temperature at all depths, the potability of the water, the scarcity of the fish—six species only—and its 'previous' greater extent. Mr. J. A. Allen gives a list of the mammals and birds collected, with field-notes by Mr. Garman. Of mammals only ten species were obtained, none new, four being Llamas. Of birds sixty-nine species were collected, including a new *Falcinellus* (*ridgwayi*), and a Gallinule (*Gallinula garmani*) closely resembling *G. galeata*. It is noted that many of the species had been but a short time before obtained by Messrs. Bartlett, Whitely, Hauxwell, and Jelski, and described by Messrs. Sclater and Salvin, Cabanis and others. Mr. W. Faxon describes the Crustacea, all excepting a species of *Cypris*, belonging to one amphipodous genus *Allorchestes*, of which seven new fresh-water species are added to the one or two already known. Mr. Agassiz gives a valuable hydrographical map of the lake, and records the presence of corals closely allied to genera living in the West Indies at the height of 2,900 feet above the level of the sea.

MESSRS. CHURCHILL have just published a third edition of Mr. Sutton's "Systematic Handbook of Volumetric Analysis," in which the author has embodied "all such novelties and modifications as experiment have proved to be worthy of notice."

WE have to announce with great regret the death of another martyr to science. In a letter, dated September 15, the Rev. S. McFarlane writes from Somerset, Cape York: "We have just heard of the massacre of Dr. James and his partner, a Swede, at Yule Island by the natives of New Guinea. They had gone in their large boat to the east side of Hall Sound to shoot birds of Paradise, when they were attacked by three canoes, and both white men were killed. The native crew managed to get away in the boat, and brought the sad news here." Dr. James was a young American who had been collecting objects of natural history in Yule Island and on the opposite shores of New Guinea. His first collections arrived in this country about a fortnight ago, having been sent over by his friend, Dr. Alfred Roberts, of Sydney, to whose liberality the expedition was greatly indebted. The excellent way in which the specimens are preserved and the careful notes given by the collector show that Dr. James was enthusiastic in his work, and it is melancholy to think that so promising a scientific career has been thus prematurely cut short. A description of the collection of birds formed by the late traveller will be given by Mr. Bowdler Sharpe at an early meeting of the Linnean Society, in continuation of the articles on the

avifauna of New Guinea, commenced during the last session of the Society.

THE Forty-seventh Session of the Royal Geographical Society was opened on Monday evening by the delivery of the presidential address by Sir Rutherford Alcock. He referred to the satisfactory state of the Society, which now numbers 3,199 members, and to the valuable work it had done since its foundation for the cause of geographical research. He also referred with complete satisfaction to the work accomplished by the Arctic expedition, the leaders of which had done the only thing that could have been done under the circumstances. Sir Rutherford then spoke of the work of Cameron in Africa, the *Challenger* Expedition, Russian Exploration, the Oriental Congress, and on various other topics. He referred to the fact that geography and exploration have now assumed a much more scientific aspect than ever they had before; no traveller can gain distinction by mere topographical detail and descriptive power; his exploration must be conducted on a thoroughly scientific basis. To spread a knowledge of this aspect of geography, lectures are to be given during the winter by General Strachey on the general subject of "Geography in its Scientific Aspect," Dr. Carpenter on "The Physical Geography of the Ocean," and Mr. Wallace on "The Influence of Geographical Conditions on the Comparative Antiquity of Continents, as indicated by the Distribution of Living and Extinct Animals." After the President's address, Sir R. Douglas Forsyth read a paper on "The Buried Cities of the Gobi Desert."

THE Lords of the Admiralty have addressed a letter to the Commander-in-Chief at Portsmouth, in which they request Admiral Elliott to express to Capt. Nares their lordships' warm approval of the conduct of all engaged in the Arctic Expedition. While they deeply commiserate the sufferings of the officers and men, and deplore the loss of life, they cannot but feel that their bearing and conduct have been in all respects worthy of British seamen. Their lordships approve the sound judgment displayed by Capt. Nares in at once, on the return of his sledge parties, determining to endeavour to extricate the ships and return to England, and they observe that his skill and energy in carrying out this determination, ably seconded as he was by Capt. Stephenson, were of the highest order. Capt. Nares proudly records that to uphold British honour and Christian duty to the death was the pre-eminent determination of all under his command.

A SPECIAL Arctic meeting will be held under the auspices of the Royal Geographical Society at St. James's Hall on December 12, when papers on the various results of the English Arctic Expedition will be read by Captains Nares, Markham, and Feilden.

AMERICAN observatories have been very diligent in the search for the supposed "Intra-Mercurial Planet," no less than nine having given their whole time to the search on October 2, 3, 10, and 11, viz., those of Dartmouth College, Harvard College, Cincinnati, Glasgow (Mo.), Washington, Albany, the Coast Survey in San Francisco, Ann Arbor, and the Observatory of Dr. Peters, besides others that have made no report. It is exceedingly creditable to the United States that they contain so many observatories, many of them national ones, in which astronomical observations are so diligently pursued.

THE Free Spanish University we referred to in vol. xiv. p. 132, has been opened in Madrid, under the name of Free Institution of Education, for Government will not allow the assumption of the title University. Only 1,000 guineas have been subscribed, many of the shareholders being well-known Englishmen, among them Prof. Tyndall. The Institution is held at present in one storey of a large house, and has already seventy-three students, besides eight or nine ladies; the fees are very low.

We hope this attempt to establish a university where unrestricted instruction can be given, will prosper, and that the professors, all men of high standing, will soon be able to have a building of their own.

THE library of the late Adolphe Brongniart is to be sold by auction in Paris on December 4, and following days. The classified catalogue, arranged by M. Deyrolle, occupies 240 pp. 8vo. Copies may be obtained through M. Deyrolle, 23, Rue de la Monnaie.

THE *Kölnische Zeitung* of November 9 reports on a meeting of the Rhenish section of the German and Austrian Alpenverein, held at Cologne on November 4. It appears that the Verein, the head-quarters of which are at Frankfurt-on-the-Maine, consists of sixty sections and numbers over 6,000 members. During 1875 over 2,000*l.* were expended for the construction of huts and roads in the Alps, and the Verein now owns about twenty-four houses in different parts of the mountains; it has also appointed a special commission for the supervision of guides and huts. Altogether the Verein is thriving, and we may look for important scientific results from its labours.

IT is stated that M. Gessi has discovered a large branch of the Nile, 200 yards wide, with a good current, diverging from the White Nile, 100 miles south of Duffle. It is stated by the natives that it runs in an unobstructed stream into the Nile again, and, if so, water communication may possibly be established between Lake Albert Nyanza and Khartoum. Col. Gordon has discovered a large lake fifty miles in length between Urondogam and Mrooli, a little north of Victoria Nyanza (in 1° N. lat.), from which issues the main branch of the Nile, called Victoria Nile, running from the Victoria to the Albert Lake, together with a branch river which must either join the Sobat river or the Asua river.

THE Italian geographical journal, *Cosmos*, for October contains a continuation of the papers on New Guinea, which it has made a speciality. The present contribution consists of further letters from Dr. Beccari and extracts from the *Challenger* reports.

TO the November number of Petermann's *Mittheilungen*, Lieut. Weyprecht contributes No. 7 of his "Bilder aus dem hohen Norden," under the title of "The Walrus-Hunter." He describes in a graphic and interesting manner the yearly quest of the walrus-fishers in the Spitzbergen Seas, which is becoming more and more difficult and dangerous on account of the increasing scarcity of the animal.

THE Geographical Society of Paris has received news from the Brazza-Marche expedition, now exploring the Ogowe, the large stream which falls into the South Atlantic in the French African settlement of Gaboon. It was discovered by the explorers that, after running north to the first degree of S. lat., the Ogowe turns abruptly southwards into quite unexplored regions. MM. Brazza and Marche had lost almost all their goods destined to conciliate the African tribes and to pay for their labour. But the Society sent to them a large number of small objects which will enable them to proceed towards the sources of the river. It is supposed that, owing to the immense volume of its water, it is an outlet for some of the large lakes of the yet untroubled region.

A TELEGRAM from Calcutta states that the district of Backergunge was ravaged by a cyclone on the 1st inst. Thousands of native houses were destroyed. The town of Dowlutkhan was submerged by a storm-wave, which swept away all the buildings of the place. Five thousand persons are believed to have perished. Backergunge is a British district in the Bengal presidency, near the mouth of the Ganges, lying between lat. 22° 2'—23° 13', long. 89° 49'—91°, and has an area of about 3,794

square miles. A severe cyclone has also been experienced at Chittagong.

THE *Kölnische Zeitung* of November 11 reports on a disastrous gale and snowstorm which raged with terrific force in the neighbourhood of Stockholm on the 5th inst. Over fifty vessels stranded near Kalmar, and all railway lines to the south and to Norway were completely snowed up, and traffic upon them interrupted. The latter had not yet been resumed on the 8th inst.

A MAGNIFICENT bolide was observed on Sunday night, November 5, at nine o'clock, at Clercy (Aube), in France. Numerous sparks were visible and an explosion was heard, although very feeble, owing to the immense distance at which it had taken place.

THE French Minister of the Interior has authorised the Municipal Council of Lyons to dedicate a bust to Ampère, the inventor of electro-magnets. This memorial will be placed in the museum where are gathered the memorials of the illustrious men who were born in the city.

THE transit-room in which the Bischofsheim instrument is to be placed is being fitted up at the Paris Observatory. The work is almost finished. M. Leverrier has asked the Minister of Public Instruction to appoint an administrative commission in order to better regulate the part which the Observatory is to take in the 1878 Exhibition.

THE new number of the *Ibis*, now in the press, will conclude the third series and the eighteenth volume of this ornithological periodical, which has been carried on by the British Ornithologists' Union with the greatest energy since its institution as the organ of that body in 1859. A fourth series, under the joint editorship of Messrs. Salvin and Sclater, will be commenced next year.

COUNT T. SALVADORI, of the Royal Zoological Museum of Turin, is engaged on a general account of the birds of the Papuan and Molluccan Islands, based principally on the large collections recently formed by the Italian naturalists Beccari and D'Albertis in those countries. The work will be published, when completed, in the *Annals* of the Museo Civico di Storia Naturale of Genoa, to which institution the above-named collections have been transmitted.

ON Thursday and Friday last week the Haggerstone Entomological Society held its annual exhibition at its place of meeting, No. 10, Brownlow Street, Dalston. It was only in 1857 that a few working men interested in insect-collecting discussed, in West Wickham Wood, the desirability of an east-end club for mutual assistance. A club was formed and now numbers a hundred members. The subscription is but a penny a-week, but with this a reference library has been accumulated. The type cabinet for the collections consists of forty drawers, in which there are now some 15,000 specimens, and the library and collection together are insured for 200*l*. All through the year the society meets every Thursday, and many points of practical importance (some of them bearing on "the theory of evolution" put to the test by breeding) have been discussed. Among the ways in which members of the society have done valuable work may be mentioned the preservation of the avenue of elms in Victoria Park from insect ravages by a knowledge of exactly how to proceed in dealing with the foe. Although this and several such societies do not obtrude themselves on the scientific world, they still, besides exercising a good effect on the members, often do work of sterling value.

WE understand that it is proposed at University College to give a larger development than before to the practical work of students in connection with the classes of mathematics, physics,

and engineering in their workroom especially adapted to the purpose, and placed under the direction of a special teacher, M. Paul Robin. Various models to illustrate the theorems of modern and higher geometry, of kinematics and mechanics, so difficult to understand theoretically,—such models as are so largely represented in the South Kensington Exhibition collection—will be made in a simple manner by the students themselves, side by side with their theoretical studies. The best models, and such as require more time and accuracy for their construction, will be preserved in a small educational collection. It would hardly be possible to insist too strongly on the usefulness, or rather on the absolute necessity of such work for the successful study of science. It is only when the student has not only seen and handled various practical illustrations and applications of the theorems of geometry and mechanics he is studying, but when he has himself constructed them—however roughly approximate they may be—that the mathematical truths will be permanently impressed on his mind. Only thus can he become so familiar with them, that they will be a basis for acquiring further notions, and a source of further mental activity. We wish, therefore, complete success to this new enterprise of University College.

SHORTLY after the appearance of Prof. Tyndall's work on Glaciers, the Bologna Professor, Bianconi, observed that, while Tyndall's experiments certainly prove that rapid changes of form in ice are due to crushing and to regelation, they do not prove at all that ice is devoid of a small degree of plasticity, which degree might be sufficient to explain the plasticity of glaciers. He undertook, therefore, a series of experiments (described and published in 1871 in the *Mém.* of the Acad. of Bologna, 3rd ser. vol. i.) on planks and bars of ice submitted to bending and torsion. The bending of ice-planks having been afterwards the subject of researches of Messrs. Mathews, Moseley, Tyndall, and Heim, it will suffice to say that Prof. Bianconi, making his experiments at higher temperatures (from +1° to +5° Cels.), observed a still greater plasticity of the ice than that obtained by the experiments made in England and Germany at lower temperatures. These experiments proved that slow changes of form of the ice may go on without any crushing and regelation, and that ice enjoys a certain degree of plasticity notwithstanding its brittleness; the ice-plank can, indeed, be shattered to pieces, during its bending, by the slightest shock. Now, Prof. Bianconi gives in the *Journal de Physique* for October the results of his further experiments on ice, much like those of Heim, or, yet more, those of M. Tresca on the puncheoning of metals. Granite pebbles and iron plates are slowly pressed into ice at the same temperatures, and not only do they penetrate into it as they would penetrate into a fluid or semi-fluid, but also the particles of ice are laterally repulsed from beneath the intruding body, and form around it a rising fringe. Moreover, when a flat piece of iron is pressed into the ice, the fringe rising around it expands laterally upon the borders of the piece, and tends thus, as in fluids, to fill up the cavity made by the body driven in. These experiments tend thus greatly to illustrate the plasticity of ice; but it would be very desirable that M. Bianconi, if he continues his researches, should accompany them by some measurements (as has already been done by M. Heim) in order to obtain numerical values of the plasticity of ice under various circumstances.

AT the Warsaw meeting of Russian naturalists Prof. Mendeleëff described the results of researches he has pursued during 1875 and 1876 for the verification of Mariotte's law. His former researches had proved that the decrease of volume of the permanent gases proceeds at a slower rate than the increase of pressure exerted on them, if the pressure is less or much greater than the mean pressure of the atmosphere. The experiments of Regnault, made with air, nitrogen, &c., at pressures higher than

that of the atmosphere proved, however, directly the contrary, and a series of measurements undertaken some years ago by Prof. Mendeléeff to verify those of Regnault, gave the same results. Suspecting that there might be some cause of error affecting in the same way both series of experiments, Prof. Mendeléeff and M. Bogussky constructed special apparatus eliminating all possible causes of errors and allowing the most perfect accuracy of measurements. With these they made a new series of researches, at pressures varying from 700 to 2,200 millimetres. These researches confirmed again the conclusions of Regnault, showing only numerical differences in the values obtained, and proving, for instance for the air, that its deviations from Mariotte's law are even less than appeared before. But the most important result of the researches is that the divergences from Mariotte's law shown by the air being negative at pressures above the mean atmosphere, as was observed by Regnault, proved to be positive (decrease of volume slower than the increase of pressure) at pressures below it. We must then conclude that the air experiences a change of compressibility at a certain pressure about the mean of that of the atmosphere; and this conclusion is supported by the circumstance that such a change was noticed also in the carbonic and sulphurous acid gases, but at pressures far lower than is the case for air. Only for hydrogen the divergence is of the positive kind at all pressures. Altogether we must conclude that the deviations from Mariotte's law are far more complicated than has been suspected.

At the same meeting Prof. Czechovicz demonstrated the influence exercised by various sources of electricity on certain spectra, chlorine, oxide of carbon, &c. The inductive apparatus of Ruhmkorf gives a spectrum differing from that produced by the Holtz electric machine, not only by the number of rays, but also by their position and aspects. Prof. Czechovicz proposes therefore to make for comparative researches a selection of such rays as maintain the same aspect and occupy the same position whatever source of electricity be used; such lines will not be numerous.

At the same meeting Prof. Grewingck presented the drawing of his geological map of the Baltic provinces, prepared for a second edition. It embodies the results of all acquisitions made in this department during the last fifteen years, and will soon be published.

The Warsaw Zoological Museum having received during recent years valuable additions from America, Africa, and Eastern Siberia, presented by Count Branicky, is now very rich in the department of higher animals. It counts 514 species of mammals, 3,216 of birds, and 400 of reptiles and amphibians.

The Natural Science Club at Cambridge held several successful meetings during the two months' residence in the Long Vacation. The following papers were read:—"Hæckel's Gastric Theory," by Mr. Marshall (St. John's); "Fermentation," by Mr. Stodart (St. Peter's); "Some Salts of Chromium," by Mr. Houghton (St. John's); "The Relation between the Fore and Hind Limbs of Vertebrates," by Mr. Phillips (St. John's); "Growth," by Mr. Buxton (Trinity); "Theories of Heredity," by Mr. Sedgwick (Trinity); "Owen's Vertebrate Theory of the Skull," by Mr. Humphry (Trinity); many of which were followed by interesting discussions and remarks.

A GERMAN paper describes a dreadful fight between two Polar bears, male and female, in the Cologne Zoological Gardens. After a fierce struggle the female became exhausted, and was dragged by the male into the water basin in the den, and held down till life was quite extinct. He then pulled her out and dragged the body for a considerable time round the den.

From a correspondence in the *Times* we learn that the statue of Faraday, subscribed for years ago, and entrusted to Foley to execute, was left by that sculptor in the clay at his death. Since then, Mr. Burch, the principal pupil of Foley, has been entrusted with the founding and completion of the work.

The second edition of Brehm's well-known "Thierleben" is about to be published in 100 parts, with entirely revised text and with almost entirely new illustrations taken from life.

At the meeting of the Mathematical Society, on November 9, the changes were made which we intimated in vol. xiv. p. 58r.

PART 5 of the second series of the great work, in quarto, upon the butterflies of America, with coloured drawings and descriptions, has just been published by Mr. Edwards, through Hurd and Houghton, New York, and sustains the reputation of its predecessors by the artistic elegance and superiority of its illustrations. These consist of five plates, executed by Miss Peart in her best style, giving, for the most part, not only the different sexes and varieties of the adult insects, but likewise the eggs, larvæ, and chrysalides, and the favourite plants upon which they feed. No new species are represented, although several of those included are of great rarity.

The *City Press* states that some of the Livery Companies have a scheme in embryo for combining to form a College of Technical Instruction in a building to be erected on the Thames Embankment.

The Board for superintending non-collegiate students give notice that an examination in physical science for the award of an exhibition of 50*l.* a year, granted by the Worshipful Company of Clothworkers, and tenable for three years by a non-collegiate student, will be held in the Censor's rooms, 31, Trumpington Street, Cambridge, commencing on Thursday morning, December 14, 1876, at 9 o'clock. Fuller information as to the subjects of examination and the conditions of tenure of the exhibition may be obtained from the Censor, Rev. R. B. Somerset, Cambridge.

A CAUCASIAN Society of Naturalists has been recently opened at Tiflis.

The publishing house of Triebner in Strasburg are issuing translations of Macmillan's Science Primers, under the superintendence of the Professors of the University. There have already appeared Roscoe's Chemistry and Balfour Stewart's Physics, the former by Prof. Rose, and the latter by Prof. Warburg, Lockyer's Astronomy, by Prof. Winnecke, and Geikie's Physical Geography, by Prof. Oscar Schmidt, are in the press.

The *Augsburger Allgemeine Zeitung* of November 5 gives some interesting details of the North-Dutch canal, which was opened officially by the King of Holland on the 1st inst., and which connects the city of Amsterdam directly with the German Ocean. It appears that the canal is 25 kilometres in length, that at its broadest part it measures 120 metres across its surface by 68 metres at its narrowest part. In the middle the depth averages 6 metres, but during the next two years the depth is to be made uniform all over the area of the canal, and to be increased to 8.20 metres, so that even the largest vessels can come close to the quays on both sides of the canal. Its name is to be Ymuiden, viz., mouth of the Y; at the spot where it reaches the sea two enormous moles or dykes have been constructed, reaching 1,600 metres into the sea, and forming a spacious port of refuge for ships during stormy weather; their extreme ends are no less than 1,200 metres apart. The total cost of the canal, which was borne by the Dutch Government as well as by the city of Amsterdam, amounted to more than twenty-six millions of florins, and it is expected that about seventeen millions more will be wanted for the construction of quays, warehouses, &c.; yet the

undertaking cannot fail to be a success, owing to its incalculable importance with reference to the commerce of Amsterdam.

THE following experiment has recently been employed by M. Merget to demonstrate the phenomena of gas-synthesis in plants: Two glass cylindrical vessels of 300 cc. capacity are placed with their open ends in a large vessel of water. The one is filled with hydrogen, the other with oxygen, their interiors are brought into communication by means of a branch which is long enough to reach from one end to the other. The level of the water is seen gradually to rise in each cylinder, and both gases finally disappear, without, however (as other experiments show), condensation or displacement being produced. At the beginning of the experiment there is nearly equality in the volumes which disappear, since a part of the oxygen serves to form carbonic acid; but in proportion as the water level rises in the two cylinders, and the projecting parts of the branch become shorter, the disappearing volume of hydrogen becomes more and more nearly double that of the oxygen. If a similar experiment be made with hydrogen and nitrogen in the two vessels, the disappearing volume of the gas is to that of the latter as three to one. Operating with hydrogen and carbonic oxide, both gases always disappear, but in very variable proportions. The most common was one volume hydrogen to one volume carbonic oxide, but the ratios of 4 : 1 and 5 : 1 were also sometimes met with. M. Merget finds in these variations the indication of a formation of hydrates of carbon, and of various carburets of hydrogen.

It is pretty generally supposed that crystallised nitroglycerine is considerably more sensitive to shocks and blows than the liquid substance, though there is nowhere evidence of this; and not only is practical experience against it, but from the theoretical standpoint it seems very improbable, for by reason of the positive melting heat of crystallised nitroglycerine, a considerable amount of heat must be employed to change its aggregate state before an explosion can occur. For decision of this question M. Beckerhinn (of the Vienna Academy) recently used a fall-machine furnished with a block of wrought iron 2.130 kilogrammes in weight, having at its lower end a hardened steel point of 7.068 sq. mm. A flat anvil of Bessemer steel was employed as support for the nitroglycerine, which was placed on it in a thin layer, and the weight dropped upon it from different heights. It was found that the mean height of fall with which explosion of the liquid occurred was 0.78 metres, whereas the frozen nitroglycerine did not explode till a fall-height of 2.13 m. was reached, showing that the frozen substance is considerably less sensitive to impact. M. Beckerhinn has determined some constants of the solid material. The average melting heat (from three experiments) appeared to be 33.54 heat-units. The density was found = 1.735 (the determinations were made at a temperature of + 10° C., which is near the melting-point of nitroglycerine); that of the liquid material was 1.599, whence it appears that in crystallising of nitroglycerine there is a contraction of about  $\frac{1}{11}$  of the original volume.

AMONG the various works presented at the last Congress of Orientalists we notice a very useful catalogue, "Bibliographia Caucasica and Transcaucasica," by M. Miansaroff, the first volume of which recently appeared in St. Petersburg. It is the result of fifteen years' labour by the author and of careful research furnished by him in the chief libraries of Russia, Germany, Italy, and Turkey. The work is divided into three parts, devoted respectively to the Earth, to Man, and to the Mutual Influences of Nature and Man. The first two form the first volume (800 pages + 4to), which contains more than 5,000 titles of books and smaller papers on the Caucasus and Transcaucasus which have appeared in Europe and Asia since A.D. 1565. They are systematically arranged under the heads of geodesy, cartography, physical

geography and geographical descriptions of localities, geology, botany and zoology, mineral springs, climate, medicine, &c. Whatever be the imperfections of this work, or of the classification adopted in it, it will nevertheless prove most useful for all engaged in the study of Caucasus.

DR. KING'S report of the Royal Botanical Gardens, Calcutta, for the year 1875-76 has just reached us. In the acclimatisation of valuable economic plants in India, the Calcutta reports have become of late years the official record, and the present report by no means lacks interest on this score, though it is unsatisfactory to find that Dr. King's opinion is still against the possibility of either india-rubber or vanilla becoming staple products of Bengal. With regard to rubber plants both of the Para and Madagascar kinds, he says that during the year it has become more apparent than ever, that neither of these valuable plants can be grown for commercial purposes in the climate of Bengal. In the gardens as well as in the warm tropical valleys of the Sikkim Himalayas both kinds failed. Dr. King suggests that a suitable home may be found for them further north than Tenasserim, Ceylon, or perhaps Malabar. Vanilla, of which a number of plants were put out in the garden under shading similar to that used for protecting the pepper plants, has not made satisfactory growth, which it is suggested may have been due to over-shading, and a further experiment has been made by planting many of them under the shade of mango trees. The finest old vanilla plants in the garden are described as growing against a north wall; this year one of these plants was laden with pods, but an unusually high temperature caused these to drop prematurely. A better report is given of the ipecacuanha; numbers of plants have been sent from Calcutta to Ceylon, to the Neilgherries and to Burmah, and the quality of those grown in India is said to be equal to the best native Brazilian growth. A good deal of attention has been directed lately to the bamboo as a source of paper-making material, and it has been thought that it might be cultivated with profit in India for this special purpose, the young tender shoots being reduced to a rough kind of paper-stock for convenience for transmission to England. Dr. King points out that if the old stem would answer the purpose there is plenty of material in India, and a large revenue would accrue, but the young shoots are only produced at a certain season; nevertheless, experiments are being made with a view to utilise the bamboo for this purpose. In the distribution of plants and seeds, we learn that no less than 23,106 plants, and 6,343 parcels of seeds, were sent out during the year. It is satisfactory to know that amongst Dr. King's other multitudinous duties he has found time to prepare a "Manual of Cinchona Cultivation," and to edit other works on Indian botany. We also learn that Mr. Kurz's "Forest Flora of Burmah" is passing through the press.

PART 3 of vol. i. of the *Proceedings* of the West London Scientific Association has been published, and contains several interesting papers and accounts of excursions.

THE October part of the *Journal* of the Franklin Institute contains an interesting history of the steam-engine in America.

MESSRS. WILLIAMS AND NORGATE send us the following German scientific works:—"Bildern aus Aquarium," by Dr. Hess, of Hanover; and "Grundriss der Zoologie," by Dr. Gustav von Hayek.

THE additions to the Zoological Society's Gardens during the past week include two Esquimaux dogs (*Canis familiaris*) from the Arctic region, presented by Capt. Allen Young, S.S. *Pandora*; four Viscachas (*Lagostomus trichodactylus*) from Buenos Ayres, presented by Mr. C. F. Woodgate; two Banded Ichneumon (*Ichneumon fasciatus*) from West Africa, presented by Mr. W. N. Bakewell; three Chirping Squirrels (*Tamias striatus*)

from North America, presented by Mr. F. W. Stockwell; a Peregrine Falcon (*Falco peregrinus*), European, presented by Mr. Chilton Newburn; a Green Monkey (*Cercopithecus callitrichus*) from West Africa, presented by Miss Ridsdan; three American Red Foxes (*Canis fulvus*), a Golden Eagle (*Aquila chrysaetos*) from North America, six Clapperton's Francolins (*Francolinus clappertoni*) from West Africa, deposited.

## SOCIETIES AND ACADEMIES

### LONDON

**Chemical Society, Nov. 2.**—Prof. Abel, F.R.S., president, in the chair.—The President announced that the Goldsmith's Company had contributed 1,000*l.* to the recently-instituted research fund of the Society.—Mr. Lupton then read a paper on the oxides of potassium, after which communications were read on certain bismuth compounds (Part III.), by M. M. P. Muir.—On phospho- and arseno-cyanogen, by W. R. Hodgkinson.—A secondary oxidised product found during the reduction of stannic ethide to stannous ethide, by W. R. Hodgkinson and G. C. Matthews; and a preliminary notice on pigmentum nigrum, the black colouring matter contained in hair and feathers, by W. R. Hodgkinson and H. C. Sorby. This black colouring matter is left on digesting the coloured hair or feathers with dilute sulphuric acid, but is present only in very small quantity.

**Zoological Society, November 7.**—Prof. Newton, F.R.S., V.P., in the chair.—The Secretary read a report on the additions that had been made to the Society's Menagerie during the months of June, July, August, and September, 1876.—A letter was read from Dr. Otto Finsch, relating to the supposed existence of the Wild Camel (*Camelus bactrianus*) in Central Asia.—A letter was read from Mr. E. Pierson Ramsay, giving a description of the habits of some *Ceratodi* living in the Australian Museum, Sydney, which he had lately received from Queensland.—Mr. W. K. Parker read a memoir on the structure and development of the skull in the sharks and rays.—Prof. A. Newton made a correction of some of the statements in Canon Tristram's "Note on the Discovery of the Roebuck in Palestine." (*P.Z.S.*, 1876, p. 421).—Lieutenant-Colonel Beddome gave the description of a new species of Indian Snake from Manantwaddy, in the Wyand Hills, which he proposed to name *Platyplecturus heustonii*.—Dr. G. E. Dobson, communicated a monograph of the Bats of the group *Molassi*.—Dr. A. Gunther, F.R.S., read a report on some of the recent additions to the collection of mammalia in the British Museum, amongst the more remarkable of which was a new form of Porcupine, from Borneo, proposed to be called *Trichys lipura*, and a new Marmoset, obtained by Mr. T. K. Salmon, near Medellin, U.S. of Columbia, to which the name *Hapale leucopus* was given.

**Royal Microscopical Society, Nov. 1.**—H. C. Sorby, F.R.S., president, in the chair.—A paper by Dr. G. W. Royston Pigott on a new refractometer was read by the President and illustrated by drawings and by the instrument removed for the occasion from the Loan Collection at South Kensington.—A paper by the Rev. W. H. Dallinger, on experiments with sterile putrescible fluids exposed alternately to an optically pure atmosphere and to one charged with known organic germs, was read by the Secretary.—A paper by Mr. F. H. Wenham, on the measurement of the angle of aperture in object glasses, was read by Mr. Ingpen.

### PARIS

**Academy of Sciences, November 6.**—Vice-Admiral Paris in the chair.—The following papers were read:—On an experiment which should be made with a view to the destruction of phylloxera, by M. Em. Blanchard. He advises a general adoption of the method of coating the vines and stakes in winter with coal tar, so as to destroy the eggs lodged in the fissures or under the bark.—Reply to M. Balbiani with regard to migration and egg-laying of phylloxera, by M. Lichtenstein. It is the nutriment and not the interior conformation of the insect that produces the fecundity. M. Lichtenstein does not accept the theory of degenerescence or exhaustion of the females.—Letter to M. Dumas on the products of the winter egg of *Phyllosera vastatrix*, by M. Boiteau.—M. Mouillefert presented some photographs showing the efficacy of treating phylloxerised vines with sulphocarbonate of potassium.—On the efficacy of iodides against saturnine intoxication, by M. Faure. He considers that a work-

man taking 5 to 10 centigrammes of iodide of iron or of potassium daily will have satisfactory results, and not be forced to interrupt his work.—On the results obtained by illumination of photographers' studios with violet light, by M. Scotellari. Violet light acts more rapidly than white or blue, and so requires shorter exposure. Some persons are very impressionable to ordinary light, but not to violet rays. The photographs got with violet rays are better modelled, and have a better finish.—M. Farret communicated results he has obtained in organisation of exercises for remedying Daltonism. These have been established in several schools, and he hopes to introduce them into the army and navy, railways, &c.—Researches on the production of electro-chemical deposits of aluminium, magnesium, cadmium, bismuth, antimony, and palladium, by M. Bertrand.—On a new dynamo-magnetic phenomenon, by MM. Trève and Durassier. A horseshoe magnet of any length is covered on one face with a varnish, or, better, a plate of glass. A cylinder of soft iron is laid on its neutral part. It commences to move towards the poles, and reaches them in a time which is naturally a function of the weight of the cylinder and of the coercitive force of the magnet. Thus the magnetic attraction is exerted over the whole extent of the magnet. A new mode is afforded of estimating the magnetic force by the mechanical work which it has effected. The product of the movable weight by the space traversed, divided by the time, will be the rigorous measure of this force. Determining the force, e.g., for three large and three small magnets, identical in form and weight, containing respectively 0.250, 0.500, and 1 per cent. of carbon, the authors think it perhaps possible to define the unit of magnetic force, or *magnetic*, and to establish its equivalence in kilogrammetres. The phenomenon also helps them to determine the magnetic conductivity of steels in relation to their proportions of carbon.—Examination of wine for fuchsine, by M. Bouillon. He employs hydrate of baryta in excess. It decomposes perfectly the salts of rosaniline, precipitates the colouring matter of the wine, and furnishes, by filtration, liquids of amebrous colour, which do not give persistent emulsions with ether.—Contributions to the anatomy and histology of the Echinida, by M. Fredericq. The nerves and muscles are described. The latter are formed of very thin cylindrical fibres, quite smooth and homogeneous throughout their length. Using various reagents, he could not detect the least trace of transversal striation. The fibres have a fibrillar structure, often with elongated nuclei applied on their surface, but they are without an enveloping membrane. They are birefringent, and are strongly impregnated with colouring matter and osmic acid. The muscles contract strongly under electric excitation, but not so suddenly as striated muscles.—Observation of a bolide, on the night of November 5, 1876, by M. Meunier. A fire-ball, the size of one's fist, was observed near a of Ursa Major; and behind, its trajectory south to north was traceable as a luminous line, commencing near Capella. The flash was bluish, and appeared brighter than moonlight.

## CONTENTS

	PAGE
FOSTER'S "ELEMENTARY PHYSIOLOGY" . . . . .	53
BRITISH MANUFACTURING INDUSTRIES . . . . .	54
LETTERS TO THE EDITOR:—	
Sea Fisheries.—Prof. ALFRED NEWTON, F.R.S.	55
The Foundation of Zoological Stations in Heligoland and Kiel.—	
Dr. ANTON DOHRN . . . . .	57
The Deep-sea Manganiferous Muds.—EDWARD T. HARDMAN . . . . .	57
Mr. Wallace on the Distribution of Passerine Birds.—W. A. FORBES . . . . .	58
Antedon rosaceus (Comatula rosacea)—THOMAS R. R. STREBBING; ARTHUR ROOPE HUNT; PHILIP B. MASON . . . . .	58
Meteor.—T. NOSTRO . . . . .	59
THE MUSICAL ASSOCIATION. By Dr. W. H. STONE . . . . .	59
ON THE RESISTANCE OF THE AIR TO THE MOTION OF PROJECTILES . . . . .	60
A LOCAL MUSEUM. By J. SMAW . . . . .	61
THE AUSTRIAN ARCTIC EXPEDITION (With Illustrations) . . . . .	62
OUR ASTRONOMICAL COLUMN:—	
The Nineveh Solar Eclipse of B.C. 763 . . . . .	65
The Comet of 1852 . . . . .	65
The Brightness of Jupiter's Satellites . . . . .	65
BIOLOGICAL NOTES:—	
The Progress of Embryology . . . . .	65
New Species of Echinida . . . . .	66
Sphondonium Guentheri . . . . .	66
A New Fish . . . . .	66
A New Peripatus . . . . .	66
The Persian Deer . . . . .	66
Fishes of the Aralo-Caspio-Euxine Basin . . . . .	66
Development of the Mammary . . . . .	66
NOTES . . . . .	67
SOCIETIES AND ACADEMIES . . . . .	71

THURSDAY, NOVEMBER 23, 1876

## FERRIER ON THE BRAIN

*The Functions of the Brain.* By David Ferrier, M.D., F.R.S. With numerous Illustrations. (London: Smith, Elder, and Co., 1876.)

## I.

THIS is in many respects an important work. Full of experimental facts and theoretical suggestions, clearly and forcibly written, it is important as a contribution to our knowledge (and our ignorance) of the functions of the brain. The reader must not misunderstand my parenthesis as an epigram. That we are ignorant of brain-function is undoubted; and this ignorance is sustained and fortified by the "false persuasion of knowledge" which prevents search in other directions. Such false persuasion of knowledge will be deepened by Dr. Ferrier's work—all the more because of its merits, if the conclusions maintained there are erroneous, and the conceptions which determine them are unphysiological; and on both points I am inclined to judge affirmatively. There is something seductive in the precision of his statements and the unhesitating confidence with which only one side of a question is presented. The reader is easily led captive by a writer who has no hesitation. Add to this the many difficulties which stand in the way of controlling by experiment the experimental data, and the indisposition of most men to undertake the labour of verification, and we may foresee that physicians and psychologists will eagerly accept this work as an authoritative storehouse of material for their speculations. They will see how its "facts" harmonise with their own pet errors. They will interpret clinical observations or psychological facts by its conclusions. Already we have seen various theories invoking the Hitzig-Ferrier views; and when nerve-cells of a larger size than usual are found in a particular region of the cortex they are straightway declared to be motor-cells, because the region is said by Hitzig and Ferrier to be motor, while the existence of these cells is adduced in confirmation of the hypothesis respecting the region!

In view of the too-probable precipitation in adopting the conclusions of this work, we cannot do better than emphasize the warning with which the author closes his Introduction:—

"We are still only on the threshold of the inquiry, and it may be questioned whether the time has even yet arrived for an attempt to explain the mechanism of the brain and its functions. To thoughtful minds the time may seem as far off as ever."

The volume opens with an elementary sketch of the structure of the brain and cord, followed by a short chapter on the reflex functions of the cord, with passing reference to Pflüger's view of its sensory functions, and to Goltz's experiments against that view. Then follows a chapter on the medulla oblongata as a respiratory and vaso-motor centre; and one on the general relations of the mesencephalon and the cerebellum. After full, yet brief accounts of what is taught respecting the effects of removing the cerebrum, the mechanism of equilibration, the muscular sense, the function of the semicircular canals, vertigo, co-ordination of locomotion, and finally the mechanism of emotional expression, we are brought to the main topic of the book—the functions of the cerebrum

and basal ganglia. Let a word, in passing, be also given to the excellent chapter in which the psychological aspect of the cerebrum is treated.

Rich as the work is in facts and suggestions, it is so deficient in the indispensable correctives of counterfactuals and arguments, that the reader must be cautioned against accepting any position unless elsewhere verified. Partly because, from long occupation with his subject, Dr. Ferrier has become unable to see it in any other light than that of his own hypothesis, and therefore doffs aside all counter-facts and counter-arguments as not really significant; partly, perhaps, because his memory has let slip what must have entered into his knowledge; from one cause or another there is a disregard of counter-evidence, which, in a second edition, I should seriously urge him to rectify. Let me cite examples.

In arguing against the sensory functions of the spinal cord, the experiment which he urges as decisive is Goltz's well-known experiment on the insensibility of the brainless frog to pain. I formerly (*NATURE*, vol. ix. p. 84) pointed out the defect in logic, which concludes from the fact that under certain conditions a brainless animal is insensible to pain (equally to be said of animals with brains), therefore it is altogether without sensibility. Pain and sensation are so far from being equivalent terms that not only are the great mass of our sensations without pain, but some cannot even be exaggerated into pain. Dr. Ferrier probably did not read the article in which I answered Goltz; but did he also overlook the article in the *Journal of Anatomy* for November, 1873, or the same article in the *Studies in the Physiological Laboratory of Cambridge*, Part I, where Prof. Michael Foster showed by decisive experiments that the facts observed by Goltz had another interpretation? Again, is it possible that Dr. Ferrier has never been made to hesitate in assigning the optic thalami and corpora striata respectively as the integration of sensory and motor centres, by the observations and experiments which show that sensibility sometimes persists after total destruction of the optic thalami, and that paralysis does not always follow destruction of the corpora striata? One such observation would be decisive against these localisations. But Dr. Ferrier neither disproves the facts nor suffers them to disturb his views of the functions of these ganglia. Finally, there is an experiment by Dr. Burdon Sanderson which, as I shall presently show, cuts the very ground from under Dr. Ferrier's feet—yet this he does not even mention. He probably overlooked its significance; at any rate he leaves his readers without the advantage of knowing that there is such a fact.

That this disregard arises from no unfairness, but simply from the onesidedness which comes from preoccupation with certain views, is evident in the way he equally disregards his own counter-evidence. A notable instance is the first assigning the occipital lobes as centres of organic sensations on the faith of observed absence of such sensations when the lobes were removed, and then citing a case of complete recovery of such sensation five days afterwards, and instead of recognising this as decisive against his hypothesis, still persisting in maintaining it.

Thus much on what may be called the "personal equation." Another and more serious source of the misleading effects of the book seems to me its following the



increasingly popular but thoroughly unphysiological conception of Localisation. Were not the current notions respecting organ and function very chaotic, and were not the indispensable artifice of analysis mistaken for more than an artifice which demanded rectification by synthesis, we should marvel to witness so many eminent investigators cheering each other on in the wild-goose chase of a function localised in a cerebral convolution. I will not, however, dwell on this point here, because it is one which would require a long discussion. It is only mentioned as a general caveat, and as leading up to the main question of cerebral excitation.

In 1870 Hitzig and Fritsch startled the scientific world by announcing that the universally accredited notion of the brain not being excitable was an error. The most eminent experimenters had declared that mechanical, chemical, and electrical stimuli were utterly powerless to excite the grey matter; and many a writer pointed to the paradox of the chief organ of sensation being *insensible*. We may here note another example of the common confusion of sensibility with pain; the brain was said to be "insensible" because no cutting, burning, pricking, or galvanising of it yielded evidence of pain; whether other evidence of sensibility might have been present was not asked. The utmost the experiments could prove was that the brain was not excitable by these abnormal means, though excitable by the very different normal means of peripheral stimulus. And even this conclusion Hitzig and Fritsch upset, by demonstrating that there were certain regions of the cortical substance which were excitable by electricity, as proved by the movements following such excitation; and the other "non-excitable regions" they inferred to be also excitable, though in another way, namely, by the production of sensations (*Vorstellungen*).

This was an epoch-making discovery. Experimenters in Germany, Italy, England, Switzerland, France, and America, quickly verified it, although differing among each other both as to the particular facts, and their interpretation. Among these followers the chief place must be assigned to Dr. Ferrier, both for the extent and the precision of his results; accordingly the names of Hitzig and Ferrier are usually coupled in speaking of the new hypothesis that various motor centres are located in particular spots of the cerebral cortex.

Although I have called it an epoch-making discovery, because I believe it will open a new track for the anatomical and physiological interpretation of the nervous mechanism, which will one day enable us to follow the whole pathway of stimulation, instead of—as at present—leaving us with the vague conception that "somehow" the cerebrum determines movements by setting the motor apparatus in action, I do not think that the hypothesis of motor centres in the cerebrum is tenable; nay, more, I do not think that Hitzig and Ferrier have proved the grey substance to be excitable. It is one thing to admit that the brain is excitable, another to admit that the excitation so effected is effected by calling into activity the special property of the grey substance. We do not consider the fauces to be the centre of vomiting, although tickling the fauces will be followed by retching. We do not consider the centre of laughter to be located in the sole of the foot, because tickling the sole causes laughter. Something more is needed; and it is precisely this om-

thing more which the Hitzig-Ferrier hypothesis has yet to find, namely, the anatomical connection of the so-called centre with the motor apparatus.

Has any proof been adduced that the electrical stimulus first acts on the cortex, and then—by the stimulation there produced—on the white substance, which in turn acts on the motor ganglia? None that withstands criticism. Knowing as we do that if the cortex be removed, or destroyed, the electrical stimulus nevertheless on reaching the white substance determines the same movements which had previously been determined when the stimulus was applied to the cortex, we may fairly ask: What proof is there that the current does not pass through the cortex (as through any other conducting medium) without exciting its activity? That it does simply pass through the cortex is probable on two grounds: (1) only the electrical current causes an excitation; mechanical and chemical stimuli have no such effects, because they cannot pass through the cortex to reach the white substance; (2) it is a well-known law that the propagation of neurility, unlike that of electricity, takes place only at insensible distances: if the nerve be divided, and the two cut surfaces be brought into the closest possible contact, there is still no propagation of the excitation from one surface to the other; whereas electricity passes freely across the cut surfaces. Now here Dr. Burdon Sanderson's decisive experiment, formerly referred to, comes, as I said, to cut the very ground from under the Hitzig-Ferrier hypothesis. "If that part of the surface of the hemisphere which comprises the active spots is severed from the deeper parts by a nearly horizontal incision made with a thin-bladed knife, and the instrument is at once withdrawn without dislocation of the severed part, and the excitation of the active spots thereupon repeated, the result is the same as when the surface of the uninjured organ is acted upon" (*Proceedings of the Royal Society*, No. 153). Here the interruption caused by the incision, while it must have completely prevented the propagation of neural excitation, did not prevent the propagation of the electrical current. Clearly therefore the simple passage through the cortex will explain all the effects of electrical stimulation. Clearly therefore some other proof is needed before we can assign the motor effects to an excitation of the cortex. The arguments of Dr. Ferrier (pp. 135-6) are all set at nought by Dr. Sanderson's experiment; and on the physiological and histological views now adopted I do not see how Dr. Sanderson's experiment can be brought into agreement with the motor centre hypothesis.

Nevertheless, although I say that the preliminary fact of excitation of the cortex is not proved by Hitzig and Ferrier, I do not myself doubt that fact, although my reasons will sound so paradoxical that I must wait for another article to give them expression.

GEORGE HENRY LEWES

(To be continued.)

#### GREEK AND LATIN PHILOLOGY

*Baur's Philological Introduction to Greek and Latin for Students.* Translated from the German by C. Kegan Paul and E. D. Stone. (London: King and Co., 1876.)

WITH the publication of Jacob Grimm's "German Grammar" the comparative study of language entered upon a new period of existence. Bopp and the

other great founders of Comparative Philology had been too busily engaged in laying the foundations of the science, in determining its main laws and principles, and in classifying whole groups or families of speech, to devote themselves to the minute and special investigation of single languages, and trace therein the application and action of the laws they had formulated. But a time came when the work of the pioneer was finished, and when it was necessary for special scholars to elaborate the details of the new science and to strengthen or modify its conclusions by a patient examination of individual dialects. The old-fashioned "philology" which had professed to analyse the forms of a language, as preserved in its literature, had proceeded upon a wrong method and had accordingly arrived at wrong results; its area of comparison was too narrow and limited, its procedure was capricious and at haphazard, and its doctrines were based rather upon individual taste than upon inductive reasoning. When it was discovered, however, that language is as much subject to the action of invariable laws as the bodily frame of man, that every sound in the words we utter is due to conditions which can be accurately gauged and determined, the "philology" of the last century underwent a complete change. It stands to the modern science of language in much the same relation as alchemy stands to chemistry. The general laws of language which had been obtained by a careful and far-reaching comparison of phenomena, were applied to explain and illuminate the facts presented by special languages, and these in their turn served to confirm or modify the generalisations already made.

Latin and Greek were naturally among the first to benefit by the new method of treatment. Thanks to the labours of scholars like Curtius and Corssen, the languages of ancient Greece and Rome have been placed in their true position, and probed, as it were, to their very roots. Their grammatical forms have been explained and simplified, their words have been traced back to an epoch when they were the common heritage of the Aryan race, and their phonetic characteristics have been made to yield fresh testimony to the truth that the place and nature of every consonant and vowel is the result of the working of undeviating laws. What, perhaps, is of still greater importance, is the line that has been drawn between the literary and the linguistic value of the two classical tongues. For purely philological purposes they are of less interest than many a savage jargon, the name of which is almost unknown, and certainly than those spoken languages of modern Europe whose life and growth can be watched like that of the living organism, and whose phonology can be studied at first hand. The more or less artificial dialect of a literary class stands outside the ever-moving current of living speech; in proportion as it is impressed with the individualism of particular writers, it becomes unsuitable for scientific treatment. The greater the literary perfection of a language, the less is its importance to the mere glottologist. The value of Latin and Greek, and more especially of Latin, lies rather in the literature they enshrine than in the linguistic features they present.

No language, however, can be wholly valueless or uninteresting to the student of human speech, and Latin and Greek, from the minuteness with which they have

been studied, and the number and variety of monuments they have left behind them, have a special claim upon his attention when revived and illuminated by scientific philology. The laws which have been ascertained by the observation of living utterance have been applied to explain the letter-changes of the classical tongues, and the comparison of their grammatical forms with those of the cognate languages has done much towards throwing light on the history of Aryan flexion and the vicissitudes through which it has passed. The innermost structure of the dead languages of Greece and Rome has been laid bare, and, though there is much which will to the last resist analysis, the old mystery which enveloped the paradigms and "rules" of our school grammars has been dispelled for ever. Dr. Baur's attempt to convey the results of a scientific investigation of Greek and Latin in the shortest possible form is highly successful, and those who are unable to read German ought to be grateful for the translation of the work. The book is essentially a useful one, and we hope it will be extensively read in our schools and universities. As the author confines himself very strictly to the two classical languages, the teacher need have no fear of the pupil's mind being confused by a reference to less-known tongues. Indeed the book suffers from a neglect of Sanskrit, with which Dr. Baur does not seem to be acquainted. He has compiled the work, however, with German care and thoroughness, though, as is inevitable in a work of the kind, exception might be taken to some of his statements.

Thus no distinction is made between primitive Aryan *kw* and *k*, and the two sounds are accordingly confounded together in Greek and Latin words. *Quies*, for instance, can have no connection with the Greek *κῆμα*, *κομή*, the English *home*, the Sanskrit 'si, but must go back to a different root. So again it is very questionable whether the characteristic *r* of the Latin passive is really the reflexive pronoun *se*. In Old Bulgarian, it is true, we have *divlya se*, *diviši se*, "I admire myself," "thou admirest thyself," and in Lithuanian *dvyjū-s* "I admire myself," but the Old Irish characteristic of the passive is also *r*, and in Old Irish *r* cannot be derived from an earlier *s*.

A. H. SAYCE

#### OUR BOOK SHELF

*A Monograph of the Geometrid Moths or Phalaenida of the United States* (Tenth Report of the United States Geological Survey of the Territories). By A. S. Packard, Jun., M.D. (Washington, 1876.)

THIS is without question the most valuable contribution to the study of the Geometrid Moths which has ever come under our notice. The size of the work, the paper, and the classification of the introductory chapters are all that can be desired; as for the plates they are simply perfect, no pains having been spared to render them accurate even in the most minute details.<sup>1</sup>

After the Introduction, a chapter is devoted to the History of the Family from the time of Linnæus, a work demanding no little research, and which consequently must claim for the author the gratitude of all succeeding generations of lepidopterists: the only point in which we disagree with Dr. Packard is as regards the prominence which he gives to the "Tentamen" of Hübner, the value

<sup>1</sup> To the eye of an amateur the plates would appear overcrowded, but to the working entomologist this must be one of their greatest merits.

of which document will always be a disputed point with entomologists, inasmuch as (although twice quoted by its author in his subsequent works) it is more than doubtful whether it ever was actually published.

The succeeding chapters are devoted to the differential characters of the family, to structural details, habits, development, secondary sexual characters, origin of the genera and species, and mimicry; then follow concise descriptions of the genera and species, with comparative and other valuable notes, descriptions of preparatory stages, &c.

It is a subject for congratulation, the importance of which none but the working lepidopterist can fully appreciate, that Dr. Packard has devoted six of the plates to the delineation of wing structure; most of the *generic* errors in Mr. Walker's lists must be attributed to his entire neglect of the characters offered by neuration; attention to this is sometimes the only means by which species, otherwise wholly similar, can be distinguished. The structure of the thorax, although of much importance, can rarely be attended to, as the destruction of the specimens is necessary before it can be detected; but in the examination of the wing-veins nothing is needed but a bottle of benzine, a brush, and a pocket lens, to reveal all that is required *without injury* to the insect.

In conclusion we heartily congratulate Dr. Packard on having produced a work in every respect worthy of himself and the Academy of which he is an officer.

A. G. B.

### LETTERS TO THE EDITOR

[The Editor does not hold himself responsible for opinions expressed by his correspondents. Neither can he undertake to return, or to correspond with the writers of, rejected manuscripts. No notice is taken of anonymous communications.]

#### Prof. Balfour Stewart on Meteorological Research

It occurs to me to make the following remarks with reference to Prof. Balfour Stewart's proposal in NATURE, vol. xiv. p. 388.

I cannot see any objection either to the nomination of the council which is suggested, or to its constitution, provided each existing society is duly represented by a member who can, when circumstances seem to require it, attend and vote at any meeting of the Council in London. I quite agree with the Professor in thinking that the time has now come when our country should resolutely grapple with the data which have accumulated in past years and with those that are now being obtained. It is only by a thorough discussion of meteorological data that the importance of certain principles can be detected, and the necessity for altering the modes of observing can be demonstrated.

I do not see that the appointment of the proposed council should interfere prejudicially with the working of the different societies. While it is the duty of such societies to procure the facts, it seems to me essential in order to secure uniformity in instrumental observation, without which all deductions or generalisations from the data may be worse than useless, that a council of control should be appointed in order to lay down rules for regulating all observers. I would not give an arbitrary power to that council to compel every society to adopt their views, because I have a great aversion to centralisation in matters of science, for in some cases the branches may be more in the right than the head; but in the event of a society declining to comply with the rules issued by the council, that society should not receive Government aid excepting for work that is done in terms of the rules. I take it for granted, however, that the council would give due weight to the arguments which were adduced from time to time by the representatives of the different societies. I am further of opinion that the different bodies should not only be allowed but encouraged by Government aid to prosecute independently in their own way, any special subject which they may choose to take up.

I hold so very strongly the absolute necessity of uniformity in instrumental observation, that I should be disposed to recommend each society to adopt almost any change in the forms of instruments, in the kind of exposure, in the hours of observation, in the form of protecting boxes, or in any other matter which might be recommended by the proposed council, provided such

changes were practicable, and were agreed to once for all by the other societies in this country, and by foreign nations.

I think it right to add that I am only stating my own individual convictions, and do not in any way profess to represent the opinions of the Council of the Society of which I am the honorary secretary, although I have no reason to suppose that they would take a different view.

THOMAS STEVENSON

Edinburgh, November 18

### Ocean Currents

In the report published in NATURE (vol. xiv. p. 492) of an address given at the Glasgow meeting of the British Association, September 11, by Sir C. Wyville Thomson, and revised by the author, the following passage occurs:—

"We have come to the conclusion that this great mass of water is moving from the Southern Sea, and there seems to me to be very little doubt—although this matter will be required to be gone into carefully—that the reason why this water is moving from the Southern Sea in a body in this way, is that there is a greater amount of evaporation in the North Atlantic and over the northern hemisphere generally, than there is of precipitation, whereas it seems almost obvious that in the southern hemisphere in the huge band of barometric low pressure round the south pole, the precipitation is in excess of the evaporation."

Now I quite feel that I am guilty of very great presumption in challenging in any way the theories of so great an authority as Sir C. W. Thomson, and my only excuse for the remarks I am about to make is that there are some points that I and many other seamen would like to have cleared up before we entertain such an hypothesis.

1. Have the investigations of the *Challenger* sufficiently proved that there is no compensating or return current from the North Atlantic to the South Atlantic Ocean? Especially, is it quite certain that a stream of water from the Arctic regions does not set southerly along the West Coast of Africa, *i.e.*, south of the equator?

2. Allowing that the precipitation in the Antarctic regions is greatly in excess of that in the Arctic regions, is the precipitation in the north torrid and north temperate zones less than the precipitation in the south torrid and south temperate zones?

3. Looking to the much larger distribution of land in the northern hemisphere, is it likely that the evaporation there is in excess of the evaporation in the southern hemisphere?

4. Even supposing the evaporation in the northern hemisphere to be in excess of that in the southern hemisphere, can it be shown that this vapour is carried to the Antarctic regions for condensation, or can the excess of precipitation in the Antarctic regions be accounted for in a more probable manner?

In answer to the first question I can only say that I am not able to gather from the reports of the ocean soundings and temperatures of H.M.S. *Challenger*, published by the Admiralty,<sup>1</sup> that it has been at all proved that there is no compensating stream of Arctic or other water.

In answer to the second question, I have never heard it disputed, and my experience as a seaman leads me to doubt the possibility of reasonably disputing, that the rainfall in the north temperate and north torrid zones is not only not less, but that it is far in excess of the rainfall in the south torrid and south temperate zones. Maury (and no matter to what extent we may differ from his theories, we must give due weight to his data) says that the total amount of rain in the north temperate zone is half as much again as in the south temperate zone.

With reference to the third question, whether the evaporation in the northern hemisphere is in excess of that in the southern hemisphere, I think the onus of proof rests with those who start the theory, but in my present state of ignorance on this subject I must confess that it is to my mind quite inconceivable. There are, with few exceptions, no large rivers in the southern hemisphere, and surely the discharge into the sea of the large rivers in the northern hemisphere must be regarded as the return to the ocean of the excess of precipitation over evaporation in the regions which they drain.

There remains the fourth question, and before trying to answer this I should like briefly to state what I think is the general or accepted belief up to the present time with reference to atmospheric currents or circulation. The trade winds are supposed to be currents from the poles which, starting from the Polar

<sup>1</sup> Plate VI, Report No. 7 would appear to indicate that Arctic water does cross the equator.

regions as upper currents, descend to the surface of the globe on the equatorial side of 30° of lat. in both hemispheres, they then travel onwards towards the belt of equatorial calms, when they meet and ascend into the upper regions of the atmosphere, whence they travel back towards the poles as upper currents, until they arrive at the calm belts of Cancer and of Capricorn, on the polar sides of which they once more descend to the surface, and are then known as the westerly winds of the temperate zones. Owing to the rotatory motion of the earth, it is impossible for these westerly winds to blow direct towards the poles, but it is clear that if you surround the Polar regions with a belt of westerly winds, that no matter what the direction of the wind may be in the Polar regions, it must, if a surface wind, be supplied by this zone; and that the winds experienced in the Polar regions are winds travelling on the surface, and are drawn from this belt of warm winds, is, I think, proved by the following extract from an account of the wintering of the *Hecla*, Capt. (Sir Edward) Parry, at Melville Island, in the year 1819-20:—

"A gale of wind, from whatever quarter it might blow, was almost invariably found to raise the thermometer several degrees, even when it came from the north, as much as 14°. An east, south-east, or east-south-east wind causes the thermometer to rise 40°."

From this extract it is evident, as might be supposed, that any current of air from this zone or belt of warm westerly winds raised the thermometer considerably, but that the wind that proceeded the more directly from the ocean and had the least land to traverse was the warmest.

Maury, without attempting to prove his case, and indeed throwing the onus of proof on those who ventured to disagree with him, considers that the south-east trade winds of the southern hemisphere become the south-west winds of the north temperate zone, and *vice versa*; that the north-east trades of the northern hemisphere become the north-west winds of the south temperate zone. I do not say that this is not the case, but if you admit that the north-east and south-east trade winds meet in the belt of equatorial calms and there ascend, it appears to be more reasonable to suppose that their currents intermingle and that their mixed volume is then drawn off north and south as required to restore the equilibrium of the atmosphere. And there is a very strong argument against Maury's hypothesis, viz., that as the south-east trades of the southern hemisphere are stronger and extend over a greater surface than the north-east trades of the northern hemisphere, and as also the north-west winds of the southern hemisphere are stronger and more continuous than the south-west winds of the northern hemisphere, it is illogical to suppose that the stronger polar current, *i.e.*, the south-east trade, feeds the weaker equatorial current, *i.e.*, the south-west winds of the north temperate zone; it would be more reasonable to suppose the reverse to be the case.

This entire theory of atmospheric currents is antagonistic to the presumption that a larger body of vapour is carried from the northern to the southern hemisphere.

Owing to the scarcity of land, and especially of very high land in the south temperate zone, not only is the precipitation less, but the vapour-carrying winds, *i.e.*, the westerly winds, are far more constant in their direction and force than are the westerly winds of the northern hemisphere. (The proportion of westerly winds to any others in the temperate zone in the North Atlantic is two to one, while throughout the south temperate zone they are so constant as to have been christened by Maury the north-west trades.)

If you once admit that these westerly winds are equatorial currents flowing towards the poles (a fact susceptible of undoubted proof), it is easy enough to account for the low barometer in the Antarctic regions, as also the larger amount of precipitation there as compared with the precipitation in the Arctic regions.

1. Because the westerly winds being much stronger and more continuous in the southern than in the northern hemisphere, the ascension of the air in the South Polar regions must be greater than in the North Polar regions.

2. Because, owing to the westerly winds of the south temperate zone parting with less of their moisture (as previously accounted for) than the corresponding winds of the north temperate zone, and also to their being stronger and more continuous, it is evident that when they meet with Antarctic cold and their vapour is condensed, the precipitation must be greater, which also involves the giving out of a much larger

amount of latent heat and the consequent greater expansion and ascension of the atmosphere in the South Polar regions.

It is, I believe, universally acknowledged that all winds must blow from a high to a low barometer, *i.e.*, from a zone of high pressure to a zone of low pressure (not directly, but in a direction modified by the earth's rotatory motion). I may therefore fairly argue that the zones of low pressure at both the equator and the poles proceed from the same causes, *i.e.*, from precipitation, and from the ascension of the atmosphere, and that the lower barometer in the South Polar regions fairly accounts for the greater strength and continuity of the westerly winds of the south temperate zone, and that without these constant inequalities of pressure we should have neither trades nor westerly winds.

I have purposely from want of space avoided speaking otherwise than generally of the effect of the land on atmospheric currents, nor is it directly pertinent to my present argument.

The hypothesis of atmospheric circulation which I have very briefly sketched is in many of its features susceptible of absolute proof, more especially in the following points, viz. —

1. That the trade-winds descend to the surface of the ocean on the equatorial sides of the calms of Cancer and of Capricorn.
2. That the trade-winds ascend in the belt of equatorial calms.
3. That currents flow from the equator in the upper regions of the atmosphere in an opposite direction to that of the trade-winds on the surface of the ocean.
4. That these upper currents, flowing from the equator, descend again to the surface of the ocean on the polar sides of the calms of Cancer and of Capricorn.
5. That these equatorial currents, subsequent to their descent on the polar sides of the calms of Cancer and of Capricorn, are known as the westerly winds of the temperate zones.

And with reference to my supposition that these westerly winds ascend in the Polar regions, one strong evidence in favour of this is, that if, as I say, the ascension of the atmosphere is greater in the South Polar than in the North Polar regions, the counter or return current towards the equator must also be greater, which is the fact.

The onus lies on the promoters of the new hypothesis either to reconcile their views with the existing theory of atmospheric circulation or to supply us with a better theory, and one which shall agree equally well with well-established facts.

October 27

DIGBY MURRAY

#### Definiteness and Accuracy

IN my lecture on *Force* (ante, Sept. 21), I take for granted that the scientific use of the word is that with which all are familiar in the expression "the parallelogram of forces." Hence Newton's term for *force* is *vis impressa* (Thomson and Tait's *Nat. Phil.*, § 217); though, where there is no room for mistake, he often employs the single word *vis*.

One of the main objects of my lecture was to protest against the absurd custom of translating the word *vis* in every case by the scientific word *force*. It is not easy to get an unobjectionable single word for the purpose, for most of the available words have already a semi-scientific sense attached to them. The word *power* is very flexible in its meaning, and would have been suitable had it not been already seized by the engineers. Thus (Thomson and Tait, § 216) *vis insita* is rendered *innate power*. And, giving the word as wide an application as Newton gives to *vis*, we might render *vis viva* as *active power*, which is not far from *actual* or *kinetic energy*. But this is merely a suggestion.

In *Foggenlorff's Annalen* (No. 7 of this year) Prof. Zöllner translates the scientific term, "the perpetual motion," by "die beharrliche Bewegung," and thus, to his own satisfaction at least, proves me to be ignorant alike of the proper meaning of the Latin *perpetuum mobile* and of the first law of motion!

In another journal I have lately been held up to scorn, not in the main for any real or imputed fault of mine, but because my would-be critic (Mr. R. A. Proctor) happens not to know the scientific meaning of "absolute" measure!!

I could give many more telling instances, great and small, but I have given enough to show how needful was my contention for definiteness and accuracy.

P. G. TAIT

College, Edinburgh, November 11

### On the Internal Fluidity of the Earth

THE question of the solidification of the crust of the earth from the fluid interior nucleus, as referred to by Mr. Mathieu Williams, in *NATURE*, vol. xv. p. 5, is one which has been long since fully discussed in my papers in the *Philosophical Transactions*, the *Atlantis*, vol. i., and in a paper of which an abstract appears in the Report of the British Association for 1856. As far as I am aware, no person has controverted my conclusions as to the process of solidification of the earth. The results are, in the main, somewhat similar to those so admirably illustrated and enforced by Mr. Robert Mallet, and also such as Mr. Williams upholds in this journal.

In articles 6 and 7 of my "Researches in Terrestrial Physics," Part I, this subject is discussed as a problem of fluid equilibrium, and the conclusion is there deduced that the fluid interior mass of the earth must consist of spheroidal strata of equal density, the density of each stratum increasing from the surface to the centre of the nucleus. The mode in which this arrangement of the fluid matter would favour the formation of a solid crust is pointed out. In Part 2 Section III., the probable law of density of these fluid strata is discussed. In Section IV. the shape of these strata is investigated, and also that of the inner surface of the shell or crust. It is shown independently of the law of density that the least ellipticity of this inner surface of the crust cannot be less than the ellipticity of its outer surface. A similar result was soon afterwards enunciated by Plana in a paper in the *Astronomische Nachrichten*. In the same section the theory of a solid nucleus in the earth originally proposed by Poisson, is examined and shown to be incompatible with physical laws.

Owing to the pointed manner in which Sir William Thomson invited discussion in a previous number of *NATURE*, I ventured to controvert his views as to the rigidity of the earth in a paper inserted at p. 288, vol. v. of this journal. Never at any time have I had even a doubt as to the untenable character of Sir William Thomson's views regarding the solidity of the earth.

In again reiterating this opinion in *NATURE*, vol. ix. p. 103, a reference to my paper was given, in which vol. vii. p. 288, is misprinted for vol. v. p. 288.

In his address at Glasgow Sir William Thomson, while maintaining his opinion as to the earth's solidity, appears to have seen the weakness of some of his former arguments by calling on his hearers (*NATURE*, vol. xiv. p. 428) to erase whole paragraphs of his paper on the Rigidity of the Earth, in the *Philosophical Transactions*. At the same passage of his address he refers to a hint from Prof. Newcomb, that viscosity might suffice to render precession and nutation, the same as if the earth were rigid. "This," he says, "I would not for a moment admit, any more than when it was first put forward by Delaunay." The *Comptes Rendus* of the Academy of Sciences of Paris for March 6, 1871, contains a paper in which my priority on this point is clearly established. In *NATURE*, vol. iii. p. 420, the following statement occurs:—"Paris Academy of Sciences, March 13.—M. Delaunay read a declaration stating that he acknowledged that Mr. Hennessy had used the same arguments as himself against Mr. Hopkins' theory relative to the fluidity of the interior parts of the earth."

I am willing to believe that Sir William Thomson had neither seen the *Comptes Rendus* nor the paragraph in *NATURE* just quoted, but it is to be regretted that a presidential address should contain an erroneous statement on a point of recent scientific history, especially when the error could be avoided by a glance at the most widely known scientific publications.

All through the portion of his address which refers to the earth's structure Sir William Thomson assumes that the views of Mr. Hopkins are established and admitted. A reference to some of the past volumes of this journal alone shows the inadmissibility of such an assumption. At pp. 45 and 182 of vol. iv. and elsewhere Mr. Hopkins' views are distinctly controverted on mechanical, physical, and geological grounds.

It appears that in the discussion on my paper in the Academy of Sciences of Paris, in which some of the most eminent mathematicians and geologists of France took part, not one of them adopted Mr. Hopkins' "Discovery of the earth's solidity." As far as I am aware, this "discovery" is not adopted anywhere on the continent of Europe. I have studied with as much care and attention as I could give to them, the mathematical and physical researches of Mr. Hopkins and Sir William Thomson relative to this subject, and for reasons already partly unfolded in this journal at vol. v. p. 288 and vol. iv. p. 182, I continue to firmly

adhere to the almost diametrically opposite conclusions long since enunciated in the publications referred to at the outset of this communication.

HENRY HENNESSY

Royal College of Science, Dublin

### The Age of the Rocks of Charnwood Forest

I SEE that in Mr. Woodward's "Geology of England and Wales," recently published, the rocks of Charnwood Forest, in Leicestershire, are (with some hesitation) referred to the "Laurentian" series, Prof. Ansted and Dr. Holl being quoted as authorities. The reviewer in the recent number of the *Saturday Review* adopts the same opinion; at the same time it is proper to add that Mr. Woodward states in another place (p. 31) that the Charnwood Forest rocks "may be of Cambrian age," so that the reader is left to take his choice.

For my part I confess to being at a loss to understand on what grounds these old rocks can be referred to any other than the Cambrian period. The evidence in any case is small, but what there is points to this conclusion.

In the first place it ought to be remembered that the age of these rocks was first indicated by Prof. Sedgwick, whose opinion on such a question should not be disregarded unless on very substantial grounds. Sedgwick's opinion of their age was founded almost entirely on lithological grounds, and no one was better qualified to recognise the representatives of the Welsh Cambrians, though rising up isolated amongst much newer formations in the heart of England. Prof. Jukes, in his description of the geology of Charnwood Forest, appended to Porter's "History," adopted the same view, in which the officers of the Geological Survey, including the present Director-General, who made a personal examination of the forest rocks, concurred (see "Geology of the Leicestershire Coal Field," Mem. Geol. Survey, 1860). I am not aware that they have changed their views owing to what has been since written on the subject.

As regards the determination of the age of these rocks, if it is impossible to prove them to be of Cambrian age, there are very good grounds for concluding they are not of "Laurentian" age, assuming that term to refer to the fundamental gneiss of the north-west Highlands and Isles of Scotland. These rocks consist, according to the description of Murchison, of coarsely crystalline gneiss, full of granite veins. They are everywhere intensely metamorphosed. Now, this is far from being the case with the Charnwood Forest rocks. Generally they are no more metamorphosed than are the Cambrian beds of the Longmynd, or of Llanberis. True "gneiss" is very exceptional, and metamorphic action is quite local, and is chiefly confined to one district. Any argument, therefore, drawn from lithological resemblance to the rocks of the typical district entirely fails; and I cannot admit that the occurrence of rocks (syenite, &c.) resembling those of the Malvern Hills, is of any force in this question, as it is very far from having been proved that the Malvern Rocks are of Laurentian age.

As regards evidence founded on organic remains, it is of the most meagre kind, but whatever the obscure markings on the slates of Charnwood may really be, they are certainly not those of *ebouon*. From whatever side, therefore, the question is viewed, there appears to be no good ground for departing from the view regarding the age of these rocks originally adopted by Sedgwick.

EDWARD HULL

Geological Survey Office, Dublin, November 3

### Mind and Matter

MR. SPALDING in his critique on Maudsley's "Physiology of Mind" (*NATURE*, vol. xiv. p. 541), while admitting that "the dependence of consciousness on nervous organisation, seemed," by the science of nerve physiology, "to be fairly established," stated that the difficulty of conceiving *how* consciousness stood related to the material organism, was a difficulty which had not yet been overcome.

Might not this problem be solved somewhat thus:—It is as easy to predicate subjectivity (or susceptibility to consciousness) of one entity called matter, as of another entity called soul or spirit. It is no more difficult to conceive of matter being subjective than of spirit being subjective.

Again, energy accompanies matter in all its forms, and yet

how it is related to the entity called matter, is no less mysterious than how subjectivity may be a property of matter. Energy moreover may be divided, Why may not subjectivity? Energy exists in isolated as well as in grouped and combined forms, Why may it not be so with subjectivity? Energy exists in a potential form when opposing forces neutralise each other—that condition of matter we call rest. May not subjectivity exist in a potential form when opposite kinds of subjective states tend to establish themselves in the same material mass—so constituting that condition of matter which we call unconsciousness? Energy is only kinetic or active, that is, only shows itself in the form best realised by us when one force has of all the others the ascendancy, or is the expression of their united tendencies. May it not be so of subjectivity that it only develops into its active and best recognised form when one kind of subjective state has the ascendancy, or is the expression of the united subjective states? Thus, as energy potential is rest, so subjectivity potential is unconsciousness. As kinetic energy is motion, so active subjectivity is consciousness.

In this way while all matter is subjective or susceptible of consciousness, this subjectivity seems to exist in the potential form only in all but organisms possessed of a nervous system. In the active nerve fibre the subjectivity of matter appears alone to be active or conscious, while the complex organisation of the nervous systems of the higher animals alone permits of matter rising to the powers of mind by harmoniously combining many subjective states so as to build them up into perception, understanding, memory, imagination, reason, invention, and judgment.

WM. S. DUNCAN

Stafford, November 9

#### Meteor

I OBSERVED from a high point overlooking the Weald, on the night of November 6, about the time Mr. Nostro mentions, a large meteor fall from a point a little below the zenith in the northern sky. It burst twice, emitting bluish sparks in doing so, once shortly before it disappeared, and the second time on its disappearing. Could it have been the same meteor seen from different positions?

I could not be positive to a point or two as to its exact magnetic bearing, but I do not think I am far wrong in saying it fell almost due north from where I observed it.

CECIL H. SP. PERCEVAL

Pulborough, November 18

### THE PRESENT STATE OF MATHEMATICAL SCIENCE

AT the meeting of the Mathematical Society on November 9, Prof. H. J. S. Smith gave an address on this subject, in which he excluded all reference to applied mathematics. "I shall regard it," he said, "as a fortunate circumstance if my successor when he, in his turn, is looking round for a subject for his own presidential address, should be attracted by a domain on which I must myself decline to enter, but of which he, better perhaps than anyone among us, is fitted to give us a clear and comprehensive view." He professed to offer only fragmentary remarks, "hoping that even such fragmentary remarks may not be without their use if they serve to remind us of the vastness of our science, and yet of its unity; of its unceasing development, rapid at the present time, promising to be still more rapid in the immediate future, and yet deriving strength and vitality from roots which strike far back into the past, so that the organic continuity of its gigantic growth has been preserved throughout. In every science there is a time and place for general contemplations, as well as time for minute investigations. And it is a rule of sound philosophy that neither of these shall be neglected in its proper season ('itaque alternandæ sunt istæ contemplationes,' says Lord Bacon, 'et vicissim sumendæ ut intellectus reddatur simul penetrans et capax')."

Touching upon a charge brought against the *Proceedings* of the Society that its memoirs "have shown and

still continue to show a certain partiality in favour of one or two great branches of mathematical science to the comparative neglect and possible disparagement of others," it might be rejoined "with great plausibility that ours is not a blamable partiality but a well-grounded preference. So great (we might contend) have been the triumphs achieved in recent times by that combination of the newer algebra with the direct contemplation of space which constitutes the modern geometry—so large has been the portion of these triumphs, which is due to the genius of a few great English mathematicians—so vast and so inviting has been the field thus thrown open to research, that we do well to press along towards a country which has, we might say, been 'prospected' for us, and in which we know beforehand we cannot fail to find something that will repay our trouble, rather than adventure ourselves into regions where, soon after the first step, we should have no beaten tracks to guide us to the lucky spots, and in which (at the best) the daily earnings of the treasure-seeker are but small, and do not always make a great show, even after long years of work. Such regions, however, there are in the realm of pure mathematics, and it cannot be for the interest of science that they should be altogether neglected by the rising generation of English mathematicians. I propose, therefore, in the first instance, to direct your attention to some few of these comparatively neglected spots."

The foremost place is assigned, by Prof. Smith, to the Theory of Numbers. "Of all branches of mathematical knowledge this is the most remote from all practical application, and yet, perhaps more than any other, it has kindled an extraordinary enthusiasm in the minds of the greatest mathematicians. We have the examples of Fermat, of Euler, of Lagrange, Legendre, of Gauss, Cauchy, Jacobi, Lejeune Dirichlet, Eisenstein, without mentioning the names of others who have passed away, and of some who are still living. But, somehow, the practical genius of the English mathematician has in general given a different direction to his pursuits; and it would sometimes seem as if we measured the importance of the subject by what we find of it in our best treatises of algebra, or as if we accepted the denunciations of Auguste Comte, and regarded the votaries of the higher arithmetic as reprobate of positive science, as moving in a vicious circle of metaphysical ideas, and as guilty of a great crime against humanity in the pursuit of knowledge beyond the limits of the useful. . . . I would rather ask you to listen to what is recorded of the great master of this branch of science."

Gauss (we are told by his biographer) held mathematics to be the queen of the sciences, and arithmetic to be the queen of mathematics—"She sometimes condescends to render services to astronomy and other natural sciences (so spoke the great astronomer and physicist); but under all circumstances the first place is her due." A citation was also made from Jacobi's *Life of Göpel*: "Many of those who have natural vocation for pure mathematical contemplation find themselves in the first instance attracted by the higher parts of the theory of numbers."

Three great departments of arithmetic were instanced: The arithmetical theory of homogeneous forms (or quantities)—"It is a memorable fact that some of the greatest conceptions of modern algebra had their origin in connection with arithmetic, and not with geometry or even with the theory of equations." In the "*Disquisitiones Arithmeticæ*" are given for the first time the characteristic properties of an invariant and a contravariant (for ternary quadratic forms). "But the progress of modern algebra and of modern geometry has far outstripped the progress of arithmetic; and one great problem which arithmeticians have now before them is to endeavour to turn to account for their own science the great results which have been obtained in the sister sciences. How

difficult this problem may prove is, perhaps, best attested by the little advance that has been made towards its solution." As an example, the researches of Cayley, Bachmann, and Hermite on the algebraical problem of the automorphies of a quadratic form, containing any number of indeterminates, were alluded to. Omitting many other points which were brought out, we can only mention the second department of arithmetic, the theory of congruences. In connection with this division, Prof. Smith also dwelt in detail upon the subject of complex numbers. "The last part of arithmetical theory to which I would wish to direct the attention of some of the younger mathematicians of this country is the determination of the mean values, or the asymptotic values of arithmetical functions. This is a field of inquiry which presents enormous difficulties of its own; it is certainly one in which the investigator will not find himself incommoded or crowded out by the number of his fellow-workers. 'Nemo est fere mathematicorum,' said Euler, in the last century; 'qui non magnam temporis partem inutiliter consumpsit in investigatione numerorum primorum;' but I do not think that (as a rule) the mathematicians of the present day have any reason to reproach themselves on this score." The speaker then pointed out what had been done in this direction since the days of Euler. "I do not know that the great achievements of such men as Tchebychef and Riemann can fairly be cited to encourage other and less highly gifted inquirers, but at least they may serve to show two things—first, that nature has fixed no impenetrable barrier to the further advancement of mathematical science in this direction; and secondly, that the boundary of our present knowledge lies so near us that at any rate the inquirer has no very long journey to take before he finds himself in the unknown land. It is this peculiarity, perhaps, which gives such perpetual freshness to the higher arithmetic. It is one of the oldest branches—perhaps the very oldest branch—of human knowledge, but yet its truest truths lie close to some of its most abstruse secrets. I do not know that any more striking example of this could be furnished than by the theorem of M. Tchebychef. To understand his demonstration requires only such algebra and arithmetic as are at the command of many a schoolboy; and the method itself might have been invented by a schoolboy with the genius of Pascal or of M. Tchebychef."

Passing on to other branches of analysis, Jacobi's method of approximation ("a natural extension of the theory of continued fractions"), Lejeune Dirichlet's researches on complex units and his great generalisation of the theory of the Pellian equation, Liouville's treatment of irrational quantities, Lambert's proofs that neither  $\pi$  nor  $\pi^2$  nor  $e$  are rational with M. Hermite's extensions, who, though he has proved that  $e$  is a transcendental irrational, declines entering on a similar investigation for the number  $\pi$ , but leaves this to others, adding, "Nul ne sera plus heureux que moi de leur succès, mais, croyez m'en, il ne laissera pas que de leur en coûter quelques efforts"—all came in for a notice.

Another class of questions mentioned were those which relate to the transcendental or algebraic character of developments in the form of infinite series, products, or continued fractions. The theorem of Eisenstein and M. Hermite's recent investigation of it, lately communicated to the Society, "are amply sufficient to awaken the expectation of great future discoveries in this almost unexplored field of inquiry."

Amongst important objects for mathematicians to set before them were named the advancement of the integral calculus ("confessedly all important in the applications of mathematics to physics"). In this connection the theory of differential equations and of singular solutions came in for a detailed notice, as also did the subject of elliptic functions.

Towards the close of the address, Prof. Smith said "I am convinced that nothing so hinders the progress of mathematical science in England as the want of advanced treatises on mathematical subjects. We yield the palm to no European nation for the number and excellence of our text-books of the second grade; I mean of such text-books as are intended to guide the student as far as the requirements of our University examinations in honours are concerned. But we want works suitable for the requirements of the student when his examinations are over—works which will carry him to the frontiers of knowledge in certain directions, which will direct him to the problems which he ought to select as the objects of his own researches, and which will free his mind from the narrow views which he is apt to contract while getting up work with a view to passing an examination, or, a little later in his life, in preparing others for examination. Can we doubt that much of the preference for geometrical and algebraical speculation which we notice among our younger mathematicians is due to the admirable works of Dr. Salmon; and can we also doubt that if other parts of mathematical science had been equally fortunate in finding an expositor, we should observe a wider interest in, and a juster appreciation of, the progress which has been achieved?"

There are, of course, other works besides those of Prof. Cayley and Dr. Salmon to which I might refer; there is, for example, the work of Boole, on Differential Equations; and there are the great historical treatises of Mr. Todhunter so suggestive of research, and so full of its spirit; we have also a recent work by the same author on the functions of Laplace, Lamé, and Bessel. But the field is not nearly covered. . . . There are at least three treatises which we sadly need, one on definite integrals, one on the theory of functions in the sense in which that phrase is understood by the school of Cauchy and of Riemann, and one (though he should be a bold man who would undertake the task) on the hyperelliptic and Abelian integrals.

Geometry, and some other subjects, were hardly more than mentioned.

"Verum hæc ipse equidem spatiis exclusus iniquis  
Prætereo, atque aliis post memoranda relinquo."

"In these days, when so much is said of original research, and of the advancement of scientific knowledge, I feel that it is the business of our Society to see that, so far as our own country is concerned, mathematical science should still be in the vanguard of progress. I should not wish to use words which may seem to reach too far, but I often find the conviction forced upon me that the increase of mathematical knowledge is a necessary condition for the advancement of science, and, if so, a no less necessary condition for the improvement of mankind. I should tremble for the intellectual strength of any nation of men whose education was not based on a solid foundation of mathematical learning, and whose scientific conceptions, or in other words, whose notions of the world and of the things in it, were not braced and girt together with a strong framework of mathematical reasoning. It is something to know what proof is, and what it is not; and where can this be better learned than in a science which has never had to take one footstep backward, and which is the same at all times and in all places. . . . I shall be more than satisfied if anything that may have fallen from me may induce any one of us to think more highly than he has hitherto done of the first and greatest of the sciences, and more hopefully of the part which he himself may bear in its advancement."

The address, delivered in the author's effective style, was frequently applauded by an appreciative group of members. On the proposal of Prof. Cayley it was resolved (with the author's consent) that the address should be printed in the *Proceedings*.

THE AUSTRIAN ARCTIC EXPEDITION<sup>1</sup>

IN addition to the points referred to in our article of last week, there are several others touched on in Lieut. Payer's work, which, in view of some of the results of our own expedition, it may not be unprofitable to dwell upon. Indeed a comparison between the observations and deductions of so keen and accomplished an observer as Payer and those of Capt. Nares's party, when these have been fully published, might, we think, lead to a distinct advance of our knowledge of the Arctic basin. And here we may be allowed to say that when so experienced and cautious an Arctic explorer as Payer expresses a decided conviction, as we understand he has done, that Capt. Nares acted in the only way possible under the circumstances, and no expedition could have been better conducted, surely it is a strong proof that our expedition was essentially successful.

The translator in his Preliminary Notice refers to the experiences of the Austrian expedition as compared with those of the English expedition, and finds in many points a striking similarity between them. We have already referred to the tedious journey of the *Tegetthoff* party over the piled-up ice after they abandoned the ship, when they were able to make only nine miles in two months, suggesting inevitably the now well-known and ever-memorable experiences of Capt. Markham and his party. To all appearance this retreat of the Austrians was over a part of the same field which held the *Tegetthoff* in its grip, and which those on board saw in the very process of changing from a level floe to mountains of ice, as Payer calls them. It seems to be inferred by some that the ice of such enormous thickness met with by Markham was the result of the freezing of layer on layer through a long succession of years, since the last glacial epoch as it has been put—only of course a violent figure of speech. This notion we believe to be open to question.

"The thickness which ice acquires in the course of a winter," Payer says, in his instructive chapter on "The Frozen Ocean," "when its formation is not disturbed, is about eight feet. In the Gulf of Boothia, Sir John Ross found the greatest thickness about the end of May; it was then 10 feet on the sea and 11 feet on the lakes. In his winter harbour in Melville Island Parry met with ice 7 or 7½ feet thick; and Wrangel gives the thickness of a floe on the Siberian coast, which had been formed in the course of a winter, at 9½ feet. According to the observations of Hayes the ice measured 9 feet 2 inches in thickness in Port Foulke. He estimates it, however, by implication, far higher in Smith's Sound: 'I have never seen,' he says, 'an ice-table formed by direct freezing which exceeded the depth of eighteen feet.' The rate at which ice is formed decreases as the thickness of the floe increases, and it ceases to be formed as soon as the floe becomes a non-conductor of the temperature of the air by the increase of its mass, or when the driving of the ice-tables one over the other, or the enormous and constantly accumulating covering of snow places limits to the penetration of the cold. While therefore the thickness which ice in free formation attains is comparatively small, fields of ice from 30 to 40 feet high are met with in the Arctic Seas; but these are the result of the forcing of ice-tables one over the other by pressure, and are designated by the name of 'old ice,' which differs from young ice by its greater density, and has a still greater affinity with the ice of the glacier when it exhibits coloured veins."

It seems evident, then, that the palæocrystic ice, like the ice in which the *Tegetthoff* was beset, is not the result of direct freezing of layer on layer, but to a great extent the result of pressure, by which a wide field may be broken up, and the pieces so piled over each other as to

form impassable mountains and valleys. How this is accomplished may be learned from the impressive description of Lieut. Payer:—

"A dreadful day was the 13th of October—a Sunday; it was decisive of the fate of the expedition. . . . In the morning of that day, as we sat at breakfast, our floe burst across immediately under the ship. Rushing on deck, we discovered that we were surrounded and squeezed by the ice; the after part of the ship was already nipped and pressed, and the rudder, which was the first to encounter its assault, shook and groaned; but as its great weight did not admit of its being shipped, we were content to lash it firmly. We next sprang on the ice, the tossing tremulous motion of which literally filled the air with noises as of shrieks and howls, and we quickly got on board all the materials which were lying on the floe, and bound the fissures of the ice hastily together by ice-anchors and cables, filling them up with snow, in the hope that frost would complete our work, though we felt that a single heave might shatter our labours. But, just as in the risings of a people, the wave of revolt spreads on every side, so now the ice arose against us. Mountains threateningly reared themselves from out the level fields of ice and the low groan which issued from its depths grew into a deep rumbling sound, and at last rose into a furious howl as of myriads of voices. Noise and confusion reigned supreme, and step by step destruction drew nigh in the crashing together of the fields of ice. Our floe was now crushed, and its blocks piled up into mountains, drove hither and thither. Here they towered fathoms high above the ship, and forced the protecting timbers of massive oak, as if in mockery of their purpose, against the hull of the vessel; there masses of ice fell down as into an abyss under the ship, to be engulfed in the rushing waters, so that the quantity of ice beneath the ship was continually increased, and at last it began to raise her quite above the level of the sea."

It can easily be imagined that were ice which had been subjected to such a process to get jammed permanently into any position, it would become a formidable barrier to all passage over or beyond it. But the question arises—Does such mountainous ice never break up? Are these areas in the Arctic basin eternally covered with such ice, or is there a perpetual movement going on all over the Polar region? That the palæocrystic ice is not a fixture in the position in which our expedition found it we endeavoured to show in a previous article; if the observations of Hall and his party are to be trusted, and we believe they are perfectly reliable, the southern latitude of the formidable barrier must change considerably. That there is an open Polar Sea we do not think there is the least ground for believing. So far as we have seen, its only serious advocate is Dr. Hayes, one of its surviving "discoverers," and it is not to be at all wondered at that he should cling fondly to his pet theory. It is to be regretted that he did not wait for Capt. Nares's report, ere he rushed to an attack of the conduct and results of the English expedition; he might then have spoken more coolly and courteously. At Cape Fligely Lieut. Payer came upon a large stretch of open water which one less well-informed and with less of a scientific training might at once have eagerly taken for the border of an "open Polar Sea." Not so Lieut. Payer, who has no faith in such a dream; he took his open water for what it undoubtedly was seen to be on careful inspection, a polynia, or water-hole. Here is his opinion on the question. After referring to the experiences of previous explorers he says:—

"Those propitious ice-years amount, therefore, to nothing more than a greater recession of the outer ice-barrier—trifling when compared with the mighty whole—or to an increased navigability of certain coast waters, or to a local loosening of the inner polar ice-net. In reality the whole Arctic Sea, with its countless ice-fields and floes, and its

<sup>1</sup> "New Lands within the Arctic Circle. Narrative of the Discoveries of the Austrian Ship *Tegetthoff* in the Years 1872-1874." By Julius Payer, one of the Commanders of the Expedition. Maps and numerous Illustrations. Two vols. (London: Macmillan and Co., 1874.) Continued from p. 65.



web of fine interlacing water-ways, is nothing but a net constantly in motion from local, terrestrial, or cosmical causes. All the changes and phenomena of this mighty network lead us to infer the existence of frozen seas up to the Pole itself; and according to my own experience

gained in three expeditions I consider *that the states of the ice between 82° and 90° N.L. will not essentially differ from those which have been observed south of latitude 82°; I incline rather to the belief that they will be found worse instead of better.*"

Noon on December 21, 1873

This is almost prophetic of the results obtained by the English expedition, and is one more proof of the accuracy of their observations. Still that there are one or more bodies of open water in the polar basin, bodies which are never permanently frozen over seems evident from even the comparatively little information we have.

Hall saw only water and easily penetrable ice where our sailors were baffled by the impenetrable ancient ice. This simply shows that there is a constant shifting of the southern ice border, but that its position and that of whatever open water exists within the basin itself will ever be so favourable as to enable a ship to navigate to the Pole is to us quite incredible. That the polar ice, like all other phenomena, is subject to some laws in its movements, we must believe; what these are we as yet know not, but that



Icebergs at the Base of the Middendorf Glacier.

The ice seems to be in almost constant motion within the basin except in the immediate vicinity of coasts, and in order that this may happen there must be open spaces somewhere. The southern edge of the Novaya Zemlya ice varied in the years 1871-2-4 by about 300 miles, and



The View from Cape Tyrol. Collinson Fiord—Wiener Neustadt Island

they have some connection with the sun-spot period, is most likely. These and other points can only be satisfactorily settled by an international ring of Arctic observatories.

As to the future of the polar question, Payer believes that the days of large expeditions are past, and that until we are able to devise some aerial method of reaching or crossing the polar area, we ought to content ourselves

with completing our knowledge of what has been discovered, and carrying on observations on the plan proposed by Lieut. Weyprecht. Still that there will be attempts to penetrate farther northwards we think is very likely; and should any other nation surpass the latitude attained by Markham's party, or even find the secret of the pole itself, the English nation will not grudge it the honour. Ballooning has, since the return of our expedition, been frequently advocated as a means of polar exploration, and it may be interesting to mention that more than twenty years ago Parry used balloons as a means of scattering messages while his ship was frozen up.

The meteorological observations of the Austrian expedition are likely to be of the greatest value when fully published. Some data are given in the appendix, and a few extracts in the text from Admiral von Wüllerstorff-Urbair's analysis of them.

The observations made use of by Admiral v. Wüllerstorff-Urbair are those of the winds, including both direction and force, and such of the astronomical observations as served to fix the positions of the ship while it drifted in the ice from Novaya Zemlya to Franz Josef Land. The results were published in two charts in Petermann's *Mittheilungen* in 1875, which show the positions of the ship from August 24, 1872, to November 1, 1873, and the mean direction of the wind at the same times. They are deeply interesting from the light they seem to cast on the air and sea currents over this portion of the Arctic Sea. Speaking generally, during the first half of the course, or from October to the beginning of February, westerly and southerly winds prevailed and, during the latter half easterly and northerly winds; these winds being, it may be remarked, in accordance with the mean distribution of atmospheric pressure for the different regions and months respectively. The ice-drift followed approximately a similar course, subject apparently, however, to deflections which may be supposed to be due to the coasts of Novaya Zemlya and Franz-Josef Land, and to powerful ice-drifts from the Kara Sea and from the sea to eastward of Franz-Josef Land. From the investigation so far as carried out, it is concluded that in the sea lying between Novaya Zemlya and Franz-Josef Land the existence of a sea-current is probable, the prevailing winds being also in accordance with this supposition, and that a great expanse of sea to the north and north-east of Novaya Zemlya is also probable.

We look forward with much interest to the publication of the detailed account of the meteorological work of this expedition for the elucidation of several questions, such as the remarkable changes in the course of the ice-drift in the end of 1872 and beginning of 1873, viewed in connection with the weather of Northern Europe at the time. Thus, at Archangel the barometer rose on November 4 to 30.476 inches, fell on the 8th to 29.118 inches, and on the following day the temperature rose to 33°·8; immediately after this the wind shifted from S.W. to N.E., temperature fell to -13°·0 on the 11th, and the barometer rose to

30.717 inches on the 13th. The great deviation in the course of the ice-drift, which extended from November 9, 1872, to February 2, 1873, began with this rise of the barometer, shift of the wind, and fall of the temperature at Archangel. Again, during January, 1873, the mean height of the barometer was 30.027 inches at Archangel; 29.826 inches at Kem, on the west coast



Parhelia on the Coast of Novaya Zemlya.

of the White Sea; 29.838 inches at Vardö and 29.770 inches at Alten, both in the extreme north of Norway; 29.229 inches at Thorshavn, Farö; and 29.131 inches at Stykkisholm, Iceland. In connection with the remarkably disturbed state of the atmosphere in this arctic and



Ice Pressure in the Polar Night.

sub-arctic region, as indicated by these figures, it is to be remarked that it was just during this time that the most remarkable deviation from the general course of the ice-drift took place. On January 2 the course suddenly changed from a north-north-westerly direction to a direction almost due east, which was steadily maintained until February 2, when it again suddenly changed

to a north-north-westerly direction, the ship having drifted between these dates from 66° 50' to 73° 20' long. E.

No more powerful argument, we think, could be adduced than these facts for the establishment of a series of Arctic observatories; the influence of the changing Arctic conditions on the climate of Europe is unmistakable, and a knowledge of what these conditions are, and what laws they are subject to, would undoubtedly be of great practical value.

The chapter on the aurora is very interesting; it contains the valuable observations by Lieut. Weyprecht, which we published in NATURE, vol. xi., p. 368. Contrary to the experience of our own expedition and others in high latitudes on the American side, the auroras seen by the *Tegethoff* were remarkably brilliant. No sound of any kind was observed to accompany the phenomenon.

Lieut. Payer's work, though professing to be only a popular narrative of the expedition, contains, it will be seen, much of great scientific interest, and we repeat that in the discussion of the results of our own expedition, his observations and conclusions will be found of real value.

#### OUR INSECT FOES

THE receipt of the eighth Annual Report on the noxious, beneficial, and other insects of the State of Missouri, and the conferences on insect destruction in connection with the Paris Insect Exhibition recently held, bring again prominently forward the question—what are we to do to cope with our insect foes? Mr. Riley, the State entomologist for Missouri, in his report, gives account of five noxious insects—the Colorado Potato-beetle (*Doryphora 10-lineata*, Say), the Canker Worms (*Paleacrita vernata*) and (*Anisopleryx pomataria*), the genus *Paleacrita* being a new one; the Army Worm (*Leucania unipuncta*, Han.), the Rocky Mountain Locust (*Caloptenus snyderi*, Tho.), and the Grape Phylloxera. In each case an account is given of the estimated amount of damage done, and the proposed methods for attacking the enemy, as well as the life history, so far as is known, of the insect itself. While the damage by Colorado Beetle during 1875 was less than usual, owing to the excessive wet drowning the broods, and the Army Worm did comparatively little damage, the devastation caused by the locust was unusually heavy. Mr. Riley gives separately the accounts of different counties of the State.

One or two quotations will serve to indicate the gravity of the question, what is the remedy to be adopted? For example, in the account of Jackson County—"All kinds of growing crops disappeared before the black dead line of their advance. . . . With all the crops of wheat, rye, oats, flax, clover, corn, gardens, and pastures consumed in defiance of every human effort to stay the general devastation, the fields being as bare as the public roads, the outlook was gloomy beyond description. Many gave up in despair and left the county." So great was the destitution that relief meetings were held, the story of suffering being that many were reduced to a scanty supply of bread. "Take again Buchanan County (written June 7): "The crops are all destroyed now, together with meadows and pastures." Again, Bates County: "all our crops and pastures eaten off until they are as bare as in mid-winter." St. Clair County: "The terrible sights of the cruel war are now being outdone by the cruelest of sights—starvation." And so on with a large proportion of the counties. Some counties were so fortunate as to escape with small damage. The total loss to the State for the year is set down at \$15,000,000. A day of supplication to Almighty God, with fasting, was ordered on June 3 by the Governor. Mr. Riley, however, repudiates the idea that this calamity was a divine visitation, and quotes from a speech he made in the previous May, in which he said, "When I suggested last

winter that a law should be passed offering a bounty for the eggs, the idea was ridiculed, but the people see now how wise such a course would have been. A few thousand dollars appropriated by the legislature for the purpose would have been the means of averting the present injury" (p. 93). The accounts given from some States describe the air as thick with locusts on the wing, so that darkness as of twilight was produced. We fortunately in England do not suffer from the locust, but we may learn a lesson as to what is the course considered necessary for coping with insect ravages. Nothing short of an Act of Congress to enforce the action to be taken seems to be regarded as of any real use. Although districts have previously suffered to the verge of starvation, we find Mr. Riley saying (p. 132), "It is very evident that if anything can be done at all in averting this evil, it must be done by national means. The advantage of having the matter properly investigated by the national government has been repeatedly urged by many prominent persons in the west best competent to judge." Societies have recently passed resolutions, the resolutions have led to a memorial, and the memorial to the introduction of two bills into Congress. The one proposed the appointment of a commission of three by the Commissioner of Agriculture, who are to report on the best means of preventing incursions of the locusts. The other proposed that the Secretary of the Interior shall appoint a board of three entomologists on the nomination of the National Academy of Sciences. They were to report on noxious insects generally, and "as soon, also, as the information gathered shall enable them, the commissioners shall compile practical instructions for the suppression of the different insects referred to." The amendments to both these bills were finally adopted in this form:—"That it shall be the duty of the Commissioner of Agriculture to investigate and gather information relative to those insects, &c. . . . and to make public from time to time such information and practical instructions for the suppression of the different insects." This, Mr. Riley remarks, is what people outside the senate were in the habit of supposing to be his duty. The chief practical suggestion Mr. Riley has to make is that State aid should be given for bounties of so many cents a bushel for the young insects while hatching. It will be some time, however, before we shall know what the Commissioner of Agriculture proposes to have done. Dr. Leconte, in his address before the American Association for the Advancement of Science at Detroit last year, urged the need for a law to compel farmers to destroy insects on their lands at a particular time.

Let us now turn to what has been done in France. We have already in a note, a few weeks ago, mentioned the way in which it is sought, through the elementary schools, to spread a knowledge of practical entomology. It remains now to refer to the attempts at legislation. As far back as 1732 a law was passed ordering farmers and landowners to destroy the caterpillars on their lands under a penalty of fifty livres. This 1732 law was renewed by prescriptions in 1777 and 1787. During the revolution, fines were abolished and rewards for destruction were substituted. It was found this plan was of no practical use. In 1796 the law known as that of 26 Ventose, an. iv. was passed. It enacted that the destruction of caterpillars should be effected by the owners or tenants of land, and that if they neglected to do it the adjoints were to have it down and recover the expense from the negligent owner or tenant. The public lands were to be done at public cost, and the *Commissaires du Directoire Exécutif* were to visit the districts to see that all been carried out. The penalty fixed was not less than three nor more than ten days labour, in addition to repaying the expenses incurred by the employment of workmen. This law, made in 1796, is still the law for France, though practically it is not put in force. The local officials were found to hesitate in the performance

of the duties laid down for them, those even who were disposed to carry them out saw how useless it was for one district to be cleared while adjoining districts remained as practically breeding grounds for the pests. That a workable law is wanted has been shown by the attempts in 1839, 1849, 1851, and 1872, to introduce a bill that shall repeal the old law and substitute one that could be worked. The first two attempts fell through in consequence of dissolutions, the *coup d'état* interfered with that of 1851, but the proposal of 1872 was considered in March, 1873, passed a first reading December, 1874, a second on January 5, 1875; while the amendments were under discussion, however, M. Ducuing, the proposer, died. Last May a *projet de loi*, based on M. Ducuing's proposal, and somewhat modified in accordance with the discussion on the amendments, was introduced by MM. de la Sicoitière, Grivart, and the Comte de Bouillé. They propose the law to apply to all harmful insects, the duty of destruction being imposed on the landowners and tenants. The time of the year to be selected for the destruction is to be made known by the prefect who will have scientific advice; the maires and commissionaires are to see that the law is carried out; in cases of neglect they are to have the work done, and recover the cost from those who should have done it. Special provisions are made for public lands, lands bordering on roads and railways. The fines are to range from 10 to 25 francs for a first offence. The articles that refer to the protection of birds that eat insects are not applicable to the wants of England as we already have legislation on that subject. But for years the want of some definite action to cope with "our insect foes" has been over and over again the subject of articles, speeches, and letters to the public press. The experience of France and America is that farmers must be compelled to look to their own interests. The department of practical entomology under the direction of the Committee of Council on Education is designed to give information regarding England's insect pests, but the question remains—How is the knowledge to be applied for the practical good of the country?

In connection with this important subject, the following extract from a Memorandum of the Canadian Minister of Agriculture, in reference to a despatch of the Secretary of State for the Colonies, on the subject of the Colorado Beetle is interesting:—

"The remedies which necessity has taught on this side of the Atlantic are such as to require for their application the joint effort of the community at large, kept alive to its interests and duties by the authorities, and men of devotedness to the common welfare. These remedies are (1) Searching for and crushing every potato-beetle wherever found; (2) Frequent visits to the potato-fields, and searching for the eggs deposited on the under-side of the leaves of the potato-vine; and (3) Watching for the presence of the larvæ on the buds and on the leaves of the plant, in order to destroy them by means of Paris green, the only substance yet discovered to be effectually operative on a large scale for the destruction of the insect in its larva state. By these means, and by these means only, the invaded American States, and the Western part of Canada, have been able to secure potato-crops in a measure commensurate with the care and energy bestowed, and by similar means only can the invasion be retarded and lessened in its effects. No measure has been taken in Canada, for reasons given, to prevent the falling or creeping of individual insects on board ships loading in Dominion seaports. There is, however, almost a certainty that the environs of Montreal will be invaded next year, and with that prospect in view, general orders may be given to public officers and employes of the ports to look for and destroy any beetles which might be observed on the wharves, on sheds, on packages of goods to be embarked, or on board ships. A general appeal might also be made to all persons having to deal with the shipping

for assistance in the execution of such preventive measures. The undersigned respectfully recommends the adoption of such precautions, beyond which he does not see that there is anything within the power of the Canadian Government to do."

#### CARL JELINEK

DR. CARL JELINEK was born at Brünn, in Moravia, on October 23, 1822. He entered the University of Vienna in 1839 as a student of law, but soon thereafter his attention was turned more exclusively to the mathematical and physical sciences. In 1843 he assisted in the work of the Vienna Observatory, and in 1847 was appointed assistant in the observatory of Prague. It was while assisting in the work of the Vienna Observatory, then under the direction of Kreil, that his interest in exact observations in the fields of meteorology and magnetism was awakened—an interest deep and strong, which soon merged in a life-sacrifice to the furtherance of these sciences.

It is not necessary here to dwell upon his connection with the events of 1848 further than to say that the high moral qualities for which he was in after life so remarkable were even then conspicuous, and that the knowledge he then acquired of men and affairs was an invaluable training for the successful discharge of the duties of the public offices he afterwards filled.

His first important contribution to science was a paper published in 1850 on the construction of self-registering meteorological instruments, an important department of practical science to which he continued to make contributions down to the last. Indeed the last published number of the *Journal* of the Austrian Meteorological Society opens with the last of a series of articles by him on this subject. He was appointed in 1852 Professor of the higher mathematics in the Polytechnic School at Prague. Eleven years afterwards, or in 1863, he returned to Vienna as successor to Kreil, the first director of the Central Institute for Meteorology and Magnetism at Vienna. In this new sphere his remarkable powers of administration and organisation had full scope. The influence of this calm, eager, untiring, and clear-sighted worker and administrator was immediately felt. A new spirit was infused into the machinery of the institute, its resources were increased, connections were formed on all sides with the similar institutes and societies of other countries, and its annual publications were enlarged and improved; and in the course of time not the least important change was effected by the erection of new buildings for the Meteorological Institute on the Hohe Warte—an open commanding position on the outskirts of Vienna—thoroughly equipped with all the instruments required for meteorological and magnetical observation of the most improved construction, and placed in positions which indicate a clear perception of the problems to be investigated and the methods by which the observational data for their solution might be obtained.

On June 14, 1864, he was elected a corresponding, and on August 3, 1866, a full member of the Imperial Academy of Sciences at Vienna. In 1864 he became a member of the Unterrichtsath, and from 1870 to 1873 acted as secretary of the High Schools for technology and the schools for industry and commerce, and brought to bear on the discharge of these duties the matured results of science, a strong will, and an eagerness and activity that never flagged, which were productive of the best results to the interests of the department he served. His public services were recognised when he retired from the education department in 1873, by having conferred on him the title and rank of Hofrath and the distinction of Knight of the order of the Iron Crown.

It is, however, in meteorology that he appears as an

original investigator endowed with an extraordinary capacity for work. In these respects meteorology is perhaps the sternest of the sciences in exacting from those of its votaries who make any permanent contribution to its literature not only keen scientific insight, but also courage to encounter for years, if need be, the constant drudgery of calculations before the end sought can be attained.

That Dr. Jelinek published scarcely any important work on meteorology from 1850 to 1865 need excite no surprise if we keep in view the great and important works on Austrian meteorology which appeared in quick succession from his pen between the years 1865 and 1870. The papers here referred to, about ten in number, several being really voluminous productions, are all of them rich in well-digested tabular matter, which, in relation to the subjects discussed, is of the most satisfying character. The paper on the five-day mean temperatures at Austrian stations from 1848 to 1863 contains 130 closely-printed quarto pages of tables. Among the subjects discussed in these papers are the mean annual and monthly distribution of atmospheric pressure and thunderstorms, and the annual, monthly, five-day, daily, and hourly distribution of temperature over the Austrian Empire; the temperature of Vienna for the ninety years from 1775 to 1864 thus supplying data calculated to throw light on not a few cosmical questions; the cold weather which occurs in May, and the storms of November and December, 1866. An important result of this work is that over the whole of Austria a closely approximate statement can be given as to how far the temperature as observed at any hour of any day of the year is above or below the average. In addition to the above, he wrote his admirable and well-known "Anleitung zu Meteorologischer Beobachtungen," which has already in the present year reached its third edition, and in 1866 established and edited, jointly with Dr. Hann, the *Journal* of the Austrian Meteorological Society, which is published fortnightly, and which, from its liberal and catholic spirit, and the position in science it has attained, stands alone among meteorological publications. In 1865 he succeeded in introducing telegraphic weather reports in Austria. Dr. Jelinek was also Secretary of the Meteorological Society of Austria, and the important services he rendered in connection with the Meteorological Congresses at Leipsig and Vienna are well known.

Thus the Austrian Meteorological Institute, under Dr. Jelinek's management, has not merely made observations and published results, but it has also discharged the functions of a discussing body of a high order. The domain of meteorology in which Dr. Jelinek takes the highest position is that which is concerned with the discussion of averages, taking the term in its widest significance. It is here where his scientific insight appears to the best advantage. We may refer in illustration to the judicious use he makes of the method of differentiation in the discussion of such problems as the normal atmospheric pressure in Austria during the months of the year. He does not commit the mistake of taking different terms of years for different places, according as observations at each place were available, but by the application of the method of differentiation he practically takes the same terms of months and years for all places. In all his writings there is evinced the greatest care to avoid giving expression to any view or speculation unless he had taken the trouble of collecting together all available information that lay in his power bearing on the point in

He died, after a lingering illness, on October 19, being thus prematurely cut off at the comparatively early age of our—a man of singularly noble and spotless character, ever on the alert, if we may use the expression, to discover and recognise real work wherever it appeared, and ever ready to offer his help to workers in science, even though he could do so only at the expense of much

personal trouble and fatigue. His beneficence was characteristic of the man, being absolutely without ostentation, and his kindly acts were performed as if his left hand knew not what his right was

### OUR ASTRONOMICAL COLUMN

**DISTANCES OF THE STARS.**—We shall here endeavour to present at one view the most reliable results of investigations relating to stellar parallax up to the present time. In making the selection parallaxes less than a tenth of a second of arc are omitted except in the case of the pole-star, for which independent researches have given values closely approximating to this amount. In estimating the "light-years," we adopt Struve's determination of the time occupied by light in traversing the mean distance of the earth from the sun, viz., 8m. 17.78s. (According to Leverrier's last value for the solar parallax, and Clarke's diameter of the earth's equator, this would assign for the velocity of light, 185,360 miles per second, at which rate of travelling it would arrive at the planet Neptune in 4h. 10m., or the breadth of the planetary spaces as at present known would be traversed in less than 8½ hours.) By "light-years" is of course to be understood the interval which light would require to pass from the star to the earth at the distances respectively assigned.

The authorities are, for  $\alpha$  Centauri, Henderson's value as corrected by Peters, and that of Moesta, the mean; for  $\beta$  Centauri, Auwers's mean of his own result and that of Otto Struve; Lalande 21185, Winnecke;  $\beta$  Centauri, Sir Thomas Maclear;  $\mu$  Cassiopeæ, Otto Struve; Groombridge 34, Auwers; Capella, Otto Struve; Lalande 21258, Krüger; Oeltzen 17415, Krüger;  $\sigma$  Draconis, Brünnow; Sirius, Gylden from Maclear's observations at the Cape of Good Hope;  $\alpha$  Lyrae, Brünnow's mean;  $\gamma$  Ophiuchi,  $\eta$  Cassiopeæ, Otto Struve; Procyon, Auwers; Groombridge 1830, a mean of results of Brünnow, Schlüter, Wichmann, and Otto Struve; and for Polaris, Peters.

Name of Star and Magnitude.	Annual Parallax.	Distance in Solar Distances.	Light-years.
$\alpha$ Centauri (1 and 4) ...	0.928	222,300	3.5
$\beta$ Centauri (5½ and 6) ...	0.553	373,300	5.9
Lalande 21185 (7½) ...	0.501	411,700	6.5
$\beta$ Centauri (1) ...	0.470	439,100	6.9
$\mu$ Cassiopeæ (5½) ...	0.342	603,100	9.5
Groombridge 34 (8½) ...	0.307	671,900	10.6
Capella (1) ...	0.305	676,300	10.7
Lalande 21258 (8½) ...	0.271	761,400	12.0
Oeltzen 17415 (8½) ...	0.247	835,100	13.2
$\sigma$ Draconis (5) ...	0.246	838,500	13.2
Sirius (1) ...	0.193	1,069,000	16.9
$\alpha$ Lyrae (1) ...	0.180	1,146,000	18.0
$\gamma$ Ophiuchi (4½) ...	0.162	1,273,000	20.1
$\eta$ Cassiopeæ (4½ and 7) ...	0.154	1,339,000	21.1
Procyon (1) ...	0.123	1,677,000	26.5
Groombridge 1830 (6½) ...	0.118	1,748,000	27.6
Polaris (2) ...	0.091	2,267,000	35.7

In the third column is given the distance of the star from the earth, in mean distances of the earth from the sun, as is usual; it will be seen how greatly the alteration, even of a single unit in the last decimal place of the annual parallax in the preceding column, affects these numbers.

So far as our present knowledge extends, light, travelling at upwards of 185,000 miles per second requires 3½ years to pass from the nearest fixed star to the earth, and it does not reach us from our well-known northern polar star in less than thirty-five years.

**THE TOTAL SOLAR ECLIPSES OF 1239, JUNE 3, AND 1241, OCTOBER 6.**—Prof. Celoria has published an important memoir on these eclipses, in the *Transactions* of the Royal Institute of Sciences at Milan, vol. xiii. He refers to a note xii., p. 167, in which, when remarking on his first compu-

tation of the eclipse of 1239, it was suggested that this phenomenon might deserve further examination in connection with the eclipse of 1241, which had been already calculated by Hansen. The present memoir contains a very careful and complete discussion of the two eclipses, employing Leverrier's tables for the sun, and Hansen's lunar tables, except that the last values for the terms involving the square of the time, given by Hansen in "Darlegung der theoretischen Berechnung der in den Mondtafeln angewandten Störungen," Part 2, are substituted for the values adopted in the tables. The position of the belt of totality in the eclipse of 1241, in its passage across Germany, is very well defined by the statements of contemporary writers, taken chiefly from the great work of Pertz, "Monumenta Germaniæ Historica;" Prof. Schiaparelli had been similarly successful in laying down the actual track of totality across Italy in the eclipse of 1239, from the Records in Muratori's collection of Italian writers. In both cases totality is assumed to have taken place, when there is distinct mention of stars having appeared, which is about the only criterion that has value at these distant times. We shall probably revert to the subject of Prof. Celorai's able memoir.

### NOTES

MANY geologists who have visited the Philadelphia Exhibition and seen the geological collections there have been impressed with the importance of having as nearly complete a collection as possible on exhibition, of geological specimens, maps, and sections, in accordance with a previously arranged plan. The International Exhibition to be held at Paris in 1878 will furnish such an occasion, and it is proposed to invite to that end governmental geological surveys, learned societies and private individuals throughout the world, to send to Paris such collections as will make the geological department of that exhibition as complete as possible. In order to take advantage of the collections which may thus be brought together, it is moreover proposed to convoke an International Geological Congress, to be held at Paris at some time during the Exhibition of 1878, and to make that Congress an occasion for considering many disputed problems in geology. In accordance with this plan it is proposed that the Geological department of the International Exhibition of 1878 shall embrace:—1. Collections of crystalline rocks, both crystalline schists and massive or eruptive rocks, including the so-called contact-formations and the results of the local alteration of uncrystalline sediments by eruptive masses. 2. Collections illustrating the fauna and the flora of the Palæozoic and more recent periods. 3. Collections of geological maps, and also of sections and models, especially such as serve to illustrate the laws of mountain structure. In pursuance of the above plan the American Association for the Advancement of Science during its annual meeting at Buffalo, appointed a Committee to carry out this scheme, to which were added the names of Prof. Huxley, Dr. Otto Torell, and Dr. E. H. von Baumhauer. Prof. James Hall was elected chairman, and Dr. T. Sterry Hunt, secretary. It was then resolved to prepare a circular to be printed in English, French, and German, and distributed to geologists throughout the world, asking their co-operation in this great work of an International Geological Exhibition and an International Geological Congress to be held at Paris in 1878; the precise date of the Congress to be subsequently fixed. All those interested in this project are invited to communicate with any one of the following members of the Committee:—Prof. T. H. Huxley, London, England; Dr. Otto Torell, Stockholm, Sweden; Dr. E. H. von Baumhauer, Harlem, Holland; Dr. F. Sterry Hunt, Boston, Mass., U.S.A.

AT a recent meeting of the Literary and Philosophical Society of Manchester, Prof. Osborne Reynolds, in justly

animadverting on the large type sensation headings in which some newspapers announced what, in their perversity or ignorance, they called the "failure" of the Arctic expedition, showed that in truth the expedition had been one of the finest achievements ever accomplished. Looked at boldly, it comes to this. Since Hudson's time, more than 200 years ago, Arctic navigators had succeeded in penetrating about sixty or seventy miles of the 540 to be passed before the Pole could be reached. Whereas Capt. Nares has, in one year, carried the British flag some sixty miles nearer, so that nearly one half, and this by far the most difficult half, of the entire results of all expeditions since Hudson's time has been accomplished by the last. And this is not all. Capt. Nares seems to have pursued the journey to its end, at least by that route; and in coming back can say that he did not leave a single uncertainty behind him. So far, therefore, from having been a failure, this has been the most successful expedition ever sent out.

It is expected that the French Government will ask our Admiralty to establish an Arctic department in the Exhibition of 1878, in which all the relics of English Arctic exploration will be collected and exhibited, as well as all the Parliamentary papers and publications relating to the subject.

M. CHEVREUL was entertained at dinner the other day at the Café Corazza, in the Palais Royal, by eighty savants in celebration of the fiftieth anniversary of his professorship and membership of the Academy of Sciences. M. Chevreul, now the oldest member of the Academy of Sciences, is ninety years old, and enjoys perfect health and mental vigour. The most notable instances of academical longevity have been Fontanelle, one of the perpetual secretaries, who died in 1742, aged close on 100 years; M. Biot, who lived ninety-two years, and preserved to the end of his days his mental powers; M. Mathieu, who died March 5, 1875, was also a nonagenarian, and the *Annuaire du Bureau des Longitudes* for 1875 was edited by him. He had succeeded in 1817 Messier, an astronomer, who was an Academician during more than forty years, so that the same seat had only two occupants in a whole century.

A SERIES of lectures is now being given by eminent men of science, explanatory of the instruments in the Loan Collection of Scientific Apparatus at South Kensington. The lectures are free, and working men are invited to attend. The lectures at present arranged for are as follows:—Saturday, November 25, Prof. W. Leith Adams, F.R.S., on "Extinct Animals," as represented by magic lantern slides and specimens in the loan collection. Saturday, December 2, J. S. Gardner on "The Collection of Fossil Leaves." Saturday, December 9, J. Norman Lockyer, F.R.S., on "The Spectroscopes in the Collection." Saturday, December 16, Prof. Huxley, F.R.S., on "The Systematic Teaching of Biology." The lectures will be delivered in the Lecture Theatre of the South Kensington Museum at eight o'clock P.M.

PROF. HUGHES read a paper before the Cambridge Philosophical Society last Monday, in which he criticised the evidence offered to support the view that man existed on the earth during or before the glacial period. He first reviewed several of the older cases which had been put forward, and tried to show that the evidence was always incomplete, or that its trustworthy character disappeared on closer examination. Coming to the two more recent and important instances of human remains or implements being found beneath glacial beds or in beds older than the glacial, Prof. Hughes gave his opinions from personal inspection and acquaintance with the localities. The human fibula found under glacial till in Victoria Cave, Settle, with *Elephas antiquus*, *Rhinoceros leptorhinus*, &c., had been regarded as decisive. Mr. Tiddeman (NATURE, vol. xiv. p.

506) says, "The Settle till is undoubtedly of the age of the ice-sheet." Prof. Hughes said that although the boulder clay at the mouth of the cave had got rather underneath the brow of the hill, yet from intimate knowledge of the physical nature and conditions of the district, which he had himself mapped, he saw no impossibility in the idea of the boulder clay having tumbled from the cliff above during the process of wearing back. Very often the upper limestone was so dissolved as to form pockets into which the boulder clay was let down, and then when an escarpment was disintegrated, he could quite conceive how such a pocket was thrown obliquely against the mouth of the cave in post-glacial times. This had ponded back the water that came into the cave, and necessarily produced a stratified deposit, in which the remains in question were found. With regard to the evidence brought forward by Mr. Skerchley, of the occurrence of palæolithic implements in brick earth beneath the chalky boulder-clay at Thetford, near Brandon, he had visited the locality, and his opinion was that in each case there was a missing link in the proof that the clay beneath which the implements were found was identical with clay at no great distance which was indubitable boulder-clay. In fact, there were many indications of the opposite. Local conditions in denudation, solution of chalk, formation of the valleys, &c., were abundantly present to mask the true state of things. The proof in this case was certainly not cogent; and it must be cogent to be accepted.

We are glad to be able to confirm the report which appeared in our columns a short time ago that the Goldsmiths' Company had promised to contribute 1,000*l.* to the Chemical Society's Research Fund. This sum has now been handed over to the society and raises the amount of the fund already received to 3,050*l.*, a sum which we hope will be still further largely increased.

In a communication to the St. Petersburg Society of Naturalists, Prof. Fr. Schmidt sketches the Tertiary formations on the northern shores of the Pacific as follows:—The formation consists of two stages. The Lower is a continental Miocene deposit with coal-seams and numerous plants, the complete description of which will soon appear by Dr. Oswald Heer. This deposit has a very wide extent, having been found in the middle parts of the Amoor basin, on the Sakhalin, in Kamtchatka, Alaska, and on Vancouver Island; and nearly the same rich flora which it contains can be traced as far as the Mackenzie River, Greenland, and Spitzbergen. An immense continent between North-eastern Asia and North-western America must thus have existed at this epoch, and its flora shows the prevalence of a far warmer climate than now, probably like that which the middle parts of the United States now enjoy. The Upper Tertiary stage is a marine Pliocene deposit with numerous remains of molluscs, and it was observed on the Sakhalin Island (but wanting at the same time on the closely-adjacent Siberian continent), in Kamtchatka, on the Aleutian Islands, in Oregon, U.S., and in California. Notwithstanding their varied lithological characteristics, these deposits contain a remarkably uniform fauna. The number of species already described by Prof. Schmidt, on the basis of large collections made during the last thirty years, is eighty, out of which eighteen have no living representatives, six inhabit only the Polar Sea and the Northern Atlantic, and the remaining fifty-six still inhabit the Northern Pacific. Out of the eighteen extinct forms six were already found in the Tertiary of Oregon and California, and one of them (*Nucula ermani*, Girard) will probably prove to be the same as the *N. cobboldie*, Sow., of the English Crag. Generally, during the Pliocene epoch, the faunas of the northern parts of the Pacific and the Atlantic were far more alike than now, and it must be supposed that the connection between both oceans through the Polar Sea was far closer than now, a supposition supported also by the close likeness of

some forms inhabiting the Pacific and the Atlantic shores of Northern America. Their close likeness, which appears so strange when we learn that they do not now inhabit the Polar Sea, is perfectly explained when we find them in a fossil state in the Pliocene deposits of the far north, as was the case with the *Pholas crispata* and the *Pectenculus pilosus*, which were found fossil, the former on the Northern Dwina and Jenissei, and the second on the Kadiak Island. The fossil fauna of the Arctic regions thus explains the present distribution of forms. Prof. Schmidt expresses the wish that the Pliocene deposits of these regions were thoroughly explored as soon as possible.

At the meeting of October 21 of the Geological Section of the St. Petersburg Society of Naturalists, Prof. Friedrich Schmidt made an interesting communication on the Post-Glacial Period in Esthonia. Starting from the supposition—which he supports in common with Swedish and Finnish geologists—that Esthonia was covered during the Glacial period with an ice-sheet which concealed it with Scandinavia, Finland, Northern Russia, reaching probably the southern slope of the Waldai plateau, Prof. Schmidt proved that after the melting of the ice the country was covered with numerous immense lakes. The land was then submerged by the sea, but only to a small extent, as notwithstanding many years' careful researches, formations with marine fossils have not been found in Esthonia further than 30 kilometres distant from the Gulf of Finland, nor on levels higher than 60 feet above the sea. They are Post-Glacial, containing a fauna which, with very few exceptions, inhabits now the Baltic. After the submergence the land rose to its present height, but this elevation was probably accomplished during pre-historic times. At least, M. Schmidt states, contrary to the assertions of M.M. Baer, Hofmann, and others as to the present rising of all the islands of the Gulf of Finland, there was not in Esthonia evidences of the rising of the land during the last four centuries which could be accepted as unmistakable. It may be remarked that the conclusions of Prof. Schmidt as to the small submergence of Esthonia, however contradictory of current opinions are also supported by the circumstance that marine formations were not found in Eastern Sweden above a level of 100–120 feet; and that in Finland the traces of marine clays (with *Cordium edule* and *Tellina balthica*) totally disappear at a level higher than 62 feet. These negative evidences have some weight, both countries having been well explored along some parts of their coasts.

At the meeting of the Literary and Philosophical Society of Manchester, on October 17, Mr. Baxendell drew attention to the paper "On the Protection of Buildings from Lightning," read by Prof. J. Clerk Maxwell at the late meeting of the British Association at Glasgow, and stated that the system of protection recommended by the professor, and which he appears to have regarded as new, was suggested, and its adoption strongly advocated, nearly forty years ago by the late Mr. Sturgeon, whose many valuable contributions to electrical and magnetical science seem to have been strangely overlooked by recent investigators and writers. The paper in which the system was first described was read before the London Electrical Society on March 7, 1838, and an abstract of it was published in the second volume of the "Annals of Electricity." There is, however, one important difference between the two systems. Mr. Sturgeon considered it necessary that the copper sheathing or covering of a protected room or powder magazine should be well connected with the ground; but Prof. Maxwell is reported to have stated that "there would be no need of any earth connection. They might even place a layer of asphalt between the copper floor and the ground, so as to insulate the building." It is obvious, however, Mr. Baxendell states, that if the magazine were struck by lightning, a disruptive discharge through the layer of asphalt would in all probability take place, which might rupture the copper sheath-

ing, and thus ignite the contents of the magazine; but by the adoption of Mr. Sturgeon's plan an accident of this kind could not occur.

HER Majesty has commanded that instructions be given to the Master of the Mint to prepare a die and cast a sufficient number of medals commemorative of the Arctic Expedition. These are to be distributed amongst the officers and crews of the *Alert*, the *Discovery*, and the *Pandora*. The Lord Mayor, Sir Thomas White, is to give a dinner to the crews of the *Alert* and *Discovery* at the Mansion House, on the evening of December 5. The Lord Mayor intends to invite the officers of the expedition to a banquet a few days later, probably December 8. The inhabitants of Portsmouth intend to entertain the crews of the *Alert*, *Discovery*, and *Pandora* at a dinner on the 30th inst.

MR. R. J. FRISWELL has resigned the honorary secretaryship of the Photographic Society.

THE Ethnographical Museum of Berlin has lately received several valuable additions, viz., the objects acquired by Dr. Lenz during the German-African Expedition. They represent tribes from the West Coast of Africa hitherto little known, and consist of various wooden weapons, domestic implements and musical instruments. Very shortly the excellent collections of the celebrated African traveller, Dr. Nachtigal, are also to be exhibited at the museum. Some of these come from tribes which Dr. Nachtigal was the first European to see. Much inconvenience is felt at the museum through want of space, and particularly so with reference to some American curiosities sent for exhibition by Prof. Bastian.

ST. JOHN'S COLLEGE, Cambridge, offers for competition an exhibition of 50% per annum, for proficiency in Natural Science. The examination will commence on Saturday, April 7, and will be in chemistry, including practical work in the laboratory; Physics, viz., Electricity, Heat, and Light; and in Physiology. Candidates will also have the option of being examined in Geology, Comparative Anatomy, and Botany, provided they give notice of the subjects in which they desire to be examined four weeks prior to the examination. No candidate will be examined in more than three of these six subjects, whereof one at least must be chosen from the former group. It is the wish of the master and seniors that excellence in some one department should be specially regarded by the candidates. Names should be sent to one of the tutors at least fourteen days before the examination.

A CHAIR of Physical Astronomy has been created in the Faculty of Sciences at Lyons.

How rapidly an interest in prehistoric researches is spreading among the educated classes in Germany is seen in the progress of the Anthropological Society of Munich. It was constituted in 1870 as a branch of the German Anthropological Society, founded only three weeks before it. It began with thirty-five members and now numbers 300.

THE present efforts of the German Anthropological Society are directed towards the preliminary preparations for an Anthropological and Primitive History of Germany; by means of a territorial division of labour, extremely important data have already been obtained. Contributions on particular points are appearing in the *Correspondenzblatt* of the German Anthropological Society, the *Archiv für Anthropologie*, and the Berlin *Zeitschrift für Ethnographie*. Meantime, at the Anthropological Meeting held in Munich last year, a plan was formed by a number of Anthropologists, in reference to the astonishing richness of the prehistoric discoveries in Bavaria, for the advancement of German Anthropology, by the establishment of an organ for the publication of the complete results which have been obtained in reference to Bavaria. The accomplishment of this scheme has now commenced with the publication of a part of the *Beiträge zur*

*Anthropologie und Urgeschichte Bayerns*, an organ of the Munich Society of Anthropology. This part contains a monograph on the "Lake Dwellings in the Würm See," by S. v. Schab, who has thoroughly explained this prehistoric dwelling-place, and collected and arranged the rich finds. The most important of the latter are shown in seventeen lithographic plates, partly coloured, with maps, plans, &c.

THE *Daily News* Alexandria correspondent sends to that paper, November 21, some particulars of the life and work of an African explorer who has been quietly doing good service for many years. This is Signor Pinggia, who went to Tunis first in 1851 as a gardener, and there and in Alexandria saved money (or years, with which he went up to Khartoum. From then until now he has made several important journeys; to the country of the "Kicks," the territory of the Niarn-Niams, where he became a great favourite, and stayed more than two years, the Bogos territory on the borders of Abyssinia with the Marquis Antinori, into Cerada, south-east of Lake Tzana, which he explored minutely. Latterly, after accompanying Gessi for some distance, he has been in the districts of Mro-lli and Mtesa, and made a thorough exploration of the Lake Caechii. From all his journeys he has brought back large collections of objects of all kinds, which, it is believed, are now for sale.

THE *Moniteur de l'Algérie* states that from November 8 a violent sirocco, or wind from the desert, was felt in Algeria for several days. This accounts for the unusual elevation of temperature in Algeria.

THE exhibition of fossils, paintings, plants, and other objects illustrative of the mountain limestone in the Manchester Aquarium, was closed on Monday, having been open to the public a little more than a week. The exhibition has been in every way successful.

FURTHER details received regarding the cyclone of October 31 prove it to have been one of the most terrible calamities on record. Estimates based on official returns from each police section put the loss of life in the districts of Backergunge, Noakhally, and Chittagong at not less than 215,000. Three large islands—Dakhin Shahabzapore, Hattiah, and Sundeep—and numerous small islands were entirely submerged by the storm wave, and also the mainland for some five or six miles inland. These islands are all situated in or near the estuary of the Meghna, a river formed by the confluence of the Ganges and Brahmapootra rivers. Up to 11 P.M. on the night of the catastrophe there were no signs of danger, but before midnight the storm wave swept over the islands to a depth in places of 20 feet, surprising the people in their beds. The country is perfectly flat, and, therefore, trees were the only secure range. Almost every one perished who failed in reaching trees. A strange fact about the disaster is that in Dakhin Shahabzapore and Hattiah most of the damage was done by the storm wave from the north sweeping down the Meghna. Several theories, the *Times* Calcutta correspondent states, have been started to account for this. One is that the cyclone, forming in the bay, struck the shore first near Chittagong, and went north for some distance, and then turned southward again. Another is that the wind blew back the waters of the Meghna, which rebounded with terrific force when the pressure relaxed. A third supposition is that there were two parallel storms with a centre of calm between them. The first or third theory seems most probable, as in Sundeep and Chittagong the destruction came from the south.

MR. HENRY MEEGGS, the well-known American railroad contractor and engineer, whose efforts in connection with the establishment of railroads in Peru are so well known and appreciated, has recently furnished the means to M. Bar, a



French ethnologist, for carrying on some explorations in the vicinity of Tiahuanuco, in Bolivia, a region which abounds in objects of archaeological interest. Mr. Meiggs has arranged that a full series of these objects shall be presented to the U.S. National Museum.

A VALUABLE entomological collection has been presented to the Oxford University Museum by Mrs. Tylden, the relict of the late Rev. W. Tylden, formerly of Balliol College. The collection numbers 23,518 specimens, arranged in cabinets.

PROF. PALMIERI, Director of the Observatory on Mount Vesuvius, has been made an Italian Senator.

A DESPATCH received at Rome from Aden, November 19, states that the Italian African Expedition has arrived in Shoa.

THE Government Resident at Somerset has telegraphed to the Colonial Secretary that Messrs. D'Albertis, Hargrave, and party have returned safely from their expedition to the Fly River. They ascended the country a distance of 350 miles above the spot reached by the expedition party of last year. They were unable to communicate in any way with the natives who were very numerous and hostile.

A SIXTH edition of Prof. Page's well-known "Advanced Text-Book of Geology" has been published. The work has been enlarged "to embrace whatever is new and important in the science, to afford space for additional illustration, and to combine, as far as possible, the principles with the deductions of geology."

WE have on our table the following books:—Preliminary "Report on the Forests of Pegu," by Sulpice Kurz (Calcutta). "The Aquarium," J. E. Taylor (Hardwicke and Bogue). "Spiritualism and Animal Magnetism," Dr. Zerffi (Hardwicke and Bogue). "The Theory of Colour," Dr. W. von Bezold (Trübner). "The Art of Retouching," Burrows and Colton (Marion). "Science in Sport made Philosophy in Earnest," by Robert Routledge (George Routledge and Sons). The ninth edition of "Kirke's Physiology," edited by Morratt Baker (John Murray). "Between the Danube and the Black Sea," H. C. Barkley, C.E. (John Murray). The fourth edition of Wanklyn's "Water Analysis" (Trübner). "Demonstrations of Microscopic Analysis," Harley and Brown (Longmans). "Mushrooms and Toadstools," Worthington G. Smith (Hardwicke and Bogue). "Geological Observations," Charles Darwin, F.R.S. (Smith, Elder, and Co.). "Lessons in Electricity," John Tyndall, F.R.S. (Longmans). "Our Birds of Prey," The Raptores of Canada, H. G. Vennor (Sampson Low and Co.).

THE additions to the Zoological Society's Gardens during the past week include two Prussian Carp (*Carassius vulgaris*), European, presented by Lord Arthur Russell, F.Z.S.; a Bubaline Antelope (*Alcelaphus bubalinus*), an Addax Antelope (*Addax nasomaculatus*) from North Africa, a Buff-breasted Partridge (*Philopachus ventralis*) from West Africa, four Brazilian Cormorants (*Phalacrocorax brasiliensis*) from Brazil, purchased; a Macaque Monkey (*Macacus cynomolgus*) from India, a Chilean Sea Eagle (*Geranoetus agnia*) from South America, deposited; a Hairy-rumped Agouti (*Dasyprocta prymnolopha*), born in the Gardens.

### SCIENTIFIC SERIALS

*Schriften der physikalisch-ökonomischen Gesellschaft zu Königsberg* (1875, 1 and 2).—These parts, amongst a number of smaller papers and notes, contain the following more important treatises:—On the determinations of temperature in the soil at different depths at the station at Königsberg, by Prof. E. Dorn.—Observations on the genera of *Nematode*, by C. G. A. Brischke and Prof. Dr. G. Zaddach. This paper occupies more than half of Part 1.—On the temperature in the interior of animal bodies, by Dr. Adamkiewicz.—On a new species of Algae, *Marismopodium Reitenbockii*, Casp., by Prof. Caspary.—On the different forms

of the stigmatic disc of *Nuphar luteum*, Sm., by the same.—On the latest investigations made by M. Lassautz on earthquakes, by O. Tyachler.—On the so-called "Moosbrüche," specially on the "Zehlaubbruch," near Tapiaw, by Herr Stiemer.—On the courses of rivers, &c., in the North German plains during the Diluvial period, by Prof. Berendt.—On one of Euler's geometrical problems, by Dr. Saalschütz.—On the courses of rivers in the province of Prussia, by Herr Stiemer.—On the Colorado beetle, by Dr. Schiefferdecker.—On reflectors, by Dr. Berthold.—On Gore's rotating ball, by Herr Momber.—On the artificial production of colours from the white of eggs, by Dr. Adamkiewicz.—On Phylloxera, by Dr. Benecke.—On the oscillations of *terra firma*, by Dr. A. Jentzsch.—New list of Prussian beetles (fourth paper), by Dr. Lentz. The author makes the total of different species to the number of 3,216!—On old Prussian "Kjökken Möddings" at the coast of the "Frische Haff," by Prof. Berendt.—On the conception of value in the different theories of the same, by Adolf Samter.—On the power of accommodation amongst plants and insects, by Dr. G. Czwalina.—On an erratic block-limestone found near Tilsit, by Dr. Friederich.—On salicylic acid, by Prof. Samuel.—Archæological researches on the "Kurische Nehrung," by O. Tischler.—On an alleged proof of the early existence of man in Europe, by Dr. Jentzsch.—On an unusually large fungus, *Agaricus suffruticosus*, by Prof. Caspary.—The Appendix contains the report sent by the Society to the Provincial Landtag on its geognostical researches in the province of Prussia.—The parts further contain a memoir of the late Prof. Argelander, of Bonn, by Dr. Luther.

### SOCIETIES AND ACADEMIES

#### LONDON

Mathematical Society, November 9.—Prof. H. J. S. Smith, F.R.S., president, in the chair.—Mr. J. W. L. Glaisher communicated a note on certain identical differential relations.—Mr. Tucker read parts of papers by Mr. Spottiswoode on curves having four-point contact with a triply-infinite pencil of curves, and by Mr. E. B. Elliott on some classes of multiple definite integrals.—In a paper published in the *Mathematische Annalen* (vol. iii. p. 459) Brill has investigated the case of curves having three-point contact with a doubly infinite pencil of curves; and in the same journal (vol. x. p. 221) H. Krey, of Kiel, has applied a method, similar to that of Brill, to the next step in the problem proposed in Mr. Spottiswoode's paper. He does not, however, appear to have succeeded in completely eliminating the differentials which occur in the process; and in that respect his solution is incomplete. Some formulae used in Mr. Spottiswoode's paper on the contact of curves and surfaces, and in particular in that on the sextatic points of a plain curve (*Phil. Trans.*, 1865, p. 657), prove to be directly applicable to the question. An application of them to Brill's problem will be found in a paper in the *Comptes Rendus* (1876).

Astronomical Society, November 10.—Mr. Huggins, president, in the chair.—The Astronomer-Royal gave a short account of the proceedings of the Royal Observatory during the recess, describing the lunar and physical observations which had been assiduously prosecuted and the state of the calculations for his new lunar theory.—A paper by Prof. Langley, of the Allegheny Observatory, Pennsylvania, on the measurements of the direct effects of sun-spots on terrestrial climates was read. Prof. Langley has made experiments to determine the difference in the amount of heat radiated from the centre of a sun-spot and from an equal area of penumbra and photosphere. Combining these results with the amount of the sun-spot area given as existing during a period of maximum of sun-spot frequency in the tables of Messrs. De la Rue, Stewart, and Lowy, he calculated that the mean terrestrial temperature due to solar radiation at a period of sun-spot minimum would be something between three-tenths and one-twentieth of 1° C. greater than at a period of sun-spot maximum. The Astronomer-Royal pointed out that the observations of underground temperature made at the observatories at Paris, Edinburgh, and Greenwich showed differences in the mean annual temperature of the surface soil which amounted to as much as 6° F. An examination of the temperatures at different depths showed that the differences of surface temperature had their cause in something external to the earth, but he had not found that the differences of mean surface temperature coincided with the variations in the amount of the English serial crop as given by the Board of Trade returns or with the periods of sun-spots maxima. Mr. De la Rue said that it did not follow that the

amount of solar radiation would necessarily vary inversely as the sun-spot area, for at a period of maximum sun-spot area it was possible that the radiation from the photosphere might be increased to such an extent as wholly to counteract the difference caused by the decrease in the apparent area of the photosphere. He further remarked that the numbers given in his papers in conjunction with Messrs. Balfour Stewart and Loewy must not now be relied upon, as some serious errors had been discovered which he was now endeavouring to put straight by a re-investigation of the whole subject.—Mr. Penrose read a paper entitled "An Endeavour to simplify the Method of making the Correction for the Spheroidal Figure of the Earth in Lunar Observations, and particularly with Reference to its Effect upon the Lunar Distance."—Mr. Christie described some observations which he had made with a polarising photometer upon the relative brightness of different parts of the disc of Venus. He had found that when the disc of Venus was gibbous, the last part of the disc to disappear, as its brightness was decreased by rotating his photometer, was a sausage-shaped patch, the convex edge of which was found to be distinctly within the limb of the planet. He thought that his observations supported Mr. Brett's theory as to specula reflection from the surface of Venus.

Linnean Society, November 2.—Prof. Allman, president, in the chair.—In exhibiting a live specimen of the Norwegian Lemming, the survivor of seven at starting, Mr. Duppa Crotch called attention to charts he had made showing the nature of the ground traversed in two instances in which he himself had witnessed the westerly migration of this singular little rodent.—Mr. G. Bentham, vice-president, read a paper on the distribution of the Monocotyledonous order into primary groups, more especially in reference to the Australian flora, with notes on some points of terminology.—Dr. Francis Day drew attention to examinations he had made on some Irish sticklebacks (*Gasterosteus*). These had led him to doubt the conclusions arrived by M. Sauvage (*Nouv. Archiv. d. Mus.*, 1874), as to the propriety of dividing the family into subgenera and some seventeen species. Dr. Day has noticed such abnormal variations in the presence and absence of ventral fin and spines in specimens of the three-spined and ten-spined sticklebacks as cause him to believe these appendages to be a very imperfect diagnostic and specific character. Nay more, as certain other Acantopterygians have been generically divided by such features, it is questionable whether further observations may lead to considerable necessary revision of the families. He is of opinion, moreover, that the spinal armature of at least the *Gasterosteus* has an increment in the ratio of their proximity and access to a maritime habitat.—Mr. H. W. Bates communicated a paper by Mr. D. Sharp on the respiratory function of the Carnivorous Water Beetles (*Dytiscidae*). Experiments made by the author on numerous species show that there are wide differences in the length of time they spend submerged and on the surface for breathing exposure. For example, the *Pelobius Hermannii* remains under water in a ratio of 375 to 1 of air exposure; whereas *Dytiscus marginalis*, a more highly developed form, has a corresponding ratio of about 12 to 1. Most specimens of the group are more active by night than by day. The *P. Hermannii* and *Hydrovatus clypealis* he regards as much less developed, and adapted for moving through the water than our indigenous water-beetles; and therefore, along with the American Amphizoa, appear to him to represent the most rudimentary and primitive of existing forms of the Dytiscidae.—Prof. Dickie gave a supplemental notice of Marine Algae obtained in the *Challenger* Expedition. Of some fifty species one only is new.—A description of *Thaumantis pseudaliris* and *Amesia pexifascia*, two new Lepidopterous forms from Malacca, by Mr. A. Butler, was taken as read.—The same author also had a communication on the genus *Eupychia*, a revision, with the addition of twelve new species being made; a case of these butterflies was exhibited in illustration of his paper.—A second communication, by Mr. D. Sharp, referred to new species of beetles (*Scarabaeidae*) from Central America; these had been captured by Mr. Bell, chiefly in the neighbourhood of Chontales.—Mr. A. Peckover exhibited and made a few remarks on two skins of the young of the Madagascar insectivore, *Hemicentetes nigriceps*, Günth., and on a series of insects from the same island, collected by Mr. A. Kingdon, near Antananarivo.—Mr. E. D. Crespiigny showed a specimen of the Umbelliferous plant, *Tordylium maximum*, L., obtained near Tilbury Fort, a locality where it had disappeared for a considerable length of time.

Chemical Society, November 16.—Prof. Abel, F.R.S., president, in the chair.—A paper on barwood, by the late Prof.

Anderson, was read by the Secretary, describing the method of preparing *baphuin* from it, and also some of the ducts obtained by the action of various reagents.—The second communication was on the alkaloids of the aconites, Part I. on the crystallisable alkaloids contained in *Aconitum napellus*, by Dr. C. R. A. Wright. The author finds that the alkaloids from *A. ferox*, which he calls *pseudanacotinine*,  $C_{35}H_{49}NO_{11}$ , differs both in properties and in composition from *aconitine*,  $C_{23}H_{35}NO_{12}$ , the crystalline alkaloid of *A. napella*. In one instance, however, he obtained from the root of the latter a perfectly distinct bitter crystalline alkaloid, *picroconinone*, possessing scarcely any toxic power; whether this is an alteration product of aconitine or not remains at present undetermined.—Mr. G. S. Johnson then read a paper on potassium triiodide, a crystalline compound obtained on saturating a saturated solution of potassium iodide with iodine, and slowly evaporating the solution over sulphuric acid. It forms prismatic or tabular crystals having an appearance very similar to that of iodine.—The last communication was by Mr. T. S. D. Humpidge, on the coal-gas of the metropolis. He has carefully analysed and determined the illuminating power of different samples, and comes to the conclusion that the gas at present supplied is but little if any better than it was twenty-five years ago, the actual increase in illuminating power being due to the use of improved burners.

Physical Society, Nov. 4.—Prof. G. C. Foster, president, in the chair.—The following candidates were elected members of the society:—Warren de La Rue, D.C.L., F.R.S., and W. H. Preece.—Dr. Guthrie read two letters which he had received from Dr. Forel, in continuation of a communication which he made to the Society on May 27 last, in reference to the "Seiches" or periodic oscillations which take place in the Swiss lakes, and on which he has recently made an elaborate series of observations. Since his communication he has found in a pamphlet by Dr. J. R. Mérian, published in 1828, a formula which is strictly applicable to the phenomena under consideration. If  $t$  be the duration of half an oscillation,  $h$  the depth of the lake, and  $l$  its

length,  $t = \sqrt{\frac{\pi l}{g}} \left\{ \frac{\pi h}{l} + e^{-\frac{\pi h}{l}} \right\}^{\frac{1}{2}}$ . Considering that pro-

bably this formula will be applicable to lakes of irregular depth if  $h$  be the mean depth, he has applied it to several lakes, and the following are some of his results. In the case of transverse seiches on Lake Lemman, the formula gives 216 metres as a mean depth, and 334 metres is the greatest known depth. With a longitudinal oscillation, the mean depth is found to be 130 metres. In the case of Lake Wallenstadt, the formula having shown the mean depth to be somewhat greater than the generally accepted greatest depth, Prof. Forel took a number of fresh soundings, and found a great basin of comparatively even bottom and of such a depth as to render probable the mean depth given by the formula.—Mr. O. J. Lodge suggested that the formula would be rendered more simple by using the hyperbolic function. It would then become

$t = \pi \sqrt{\frac{l}{g}} \text{Coth}^{\frac{1}{2}} \frac{\pi h}{l}$ . Mr. Lodge also indicated the curve

which this equation represents.—Dr. Stone exhibited some diffraction gratings on glass and metal, ruled for him by Mr. W. Clark, of Windsor Terrace, Lower Norwood. The majority of them were close spirals about 1,000 to the inch, which, when held between the eye and a distant lime-light, exhibited circular spectra of great brilliancy. The slight difference between the spiral and true circles appeared to exercise no appreciable effect on the result. The metal gratings were of linear form, 1,000 lines to the inch, intended for use by reflection in a spectroscope. The spectra thus obtained were of much greater brilliancy than those ordinarily obtained by refraction, and presented obvious advantages for examining the ultra-violet rays. He explained the mechanical difficulties which had been surmounted in their manufacture together with the manner in which the diamond cutters are prepared. The metals hitherto employed, namely, cast-steel and German silver, are objectionable, and Dr. Stone proposes, on the suggestion of Prof. McLeod, to employ speculum metal, and will report the result of the experiments more fully at a subsequent meeting.—Dr. Guthrie then briefly described some experiments which he has made to determine the effect of a crystalloid on a colloid when in the presence of water. Mr. Graham, in his classical researches, made numerous experiments with a salt on one side of

a colloid membrane and water on the other, and Dr. Guthrie thought it might be well to determine what action, if any, takes place when a salt is added to a solution of a colloid such as size. Two or three lumps of rock salt were added to a jelly of size, and the whole hermetically sealed in a glass tube. The colloid parted with its water readily, a saturated solution of the salt was obtained, and the size became perfectly white and opaque, having undergone a structural change. Experiments were also made employing a more hygrometric salt, such as chloride of calcium.—Mr. W. C. Roberts pointed out that a jelly containing 5 per cent. of silicic acid readily parts with water to sulphuric acid, and dries into a hard glass like hydrate of silica. He asked whether this might be considered as analogous to the action of salt on size, or whether the strong affinity between the acid and water removed it to another class of action. Dr. Guthrie thought it might be possible to establish the existence of a point at which the jelly did not give up its water to the hygrometric substance. He also pointed out the analogy between a jelly and a mass of small bags filled with liquid.

Entomological Society, November 1.—Prof. Westwood, president, in the chair.—Mr. F. Smith exhibited some remarkable specimens of thorns from Natal and Brazil, which had been taken possession of by certain species of *Cryptoceridae* for the construction of their nests. Some of the thorns were as much as 3 inches in length.—Prof. Westwood mentioned an instance of the hairs of a larva of *Lasiocampa rubi* having caused considerable irritation of the skin, and that the irritation was complained of by his correspondent for a week afterwards.—The Professor exhibited a singular Coleopterous larva from Zanzibar, of a flattened, ovate form and a steel-blue colour, with two points at the extremity of the body, and with long, clavate antennae. The head bore some resemblance to that of the dipterous genus *Diopsis*. He also exhibited a specimen of the butterfly, *Hesperia sylvanus*, received from the Rev. Mr. Higgins, of Liverpool, having the pollinaria, apparently of an Orchid, attached to the base of the tongue. Also an Orchid bulb purchased by Mr. Hewitson with a collection of roots from Ecuador, which was found to contain nine living specimens of coekroaches, comprising six different species, viz., *Blatta orientalis*, *Americana*, *ciurea*, *Maderæ*, and two others unknown to him, some being of considerable size.—Mr. Dunning read a "Note on *Acentropus*," in which he remarked on Heer Ritsema's Second Supplement to his Historical Review of the genus, published in the *Transactions of the Entomological Society of the Netherlands*, in which that author tried to prove that two distinct species existed, of which one (*A. nucus*, Oliv. = *A. Garnonsii*, Curt.) has a female with rudimentary wings, and the other (*A. latipennis*, Möschl. = *Zancle Hansoni*, Ste.) has a female with normally developed wings; whereas, Mr. Dunning argued that the facts, as stated by Heer Ritsema, did not in any way prove the duality, but were quite consistent with the unity of the species.

Institution of Civil Engineers, November 14.—Mr. George Robert Stephenson, president, in the chair.—The paper read was on the Japan lights, by Mr. R. H. Brunton.

#### PARIS

Academy of Sciences, November 13.—Vice-Admiral Paris in the chair.—The following papers were read:—Theorems relative to systems of three segments making a constant length, by M. Charles.—Note on the recent progress of phylloxera in the departments of the two Charentes, by M. Bouilland.—Continuation of observations of eclipses of Jupiter's satellites at the Observatory of Toulouse, by M. Tisserand. For eclipses of the first satellite little seemed to be gained by using larger instruments; for those of the second and third the difference was greater.—M. Milne-Edwards presented the first part of tome xii. of his work on comparative physiology and anatomy of men and animals. It treats of audition and sight.—Report on a memoir of M. Fouqué, "Mineralogical and geological researches on the lavas and dykes of Thera" (i.e. island of Santorin group). These lavas contain two, and often three triclinic feldspars (some say volcanic rocks never contain more than one); albite predominates among the small crystals; labradorite or anorthite among the large. These anorthite lavas (hitherto thought exceptional) form forty-one of the dykes of Thera. M. Fouqué shows, from experiments, that a lava fused and suddenly cooled is quite as crystalline as when it has solidified slowly; crystals are formed before ejection from the ground. Contrary to M. Tschermak, who would eliminate from the catalogue of mineralogical species all triclinic feldspars except albite and anorthite, M. Fouqué shows reason for retain-

ing oligoclase and labradorite. Tridymite, a variety of crystallised silicon, is found in the lavas in form of thin hexagonal imbricated plates; M. Fouqué regards it as a posterior formation to the other elements, and as having arisen at a high temperature under the influence of imprisoned droplets of water, when the surrounding rock was liquid or viscous. The report speaks highly of the value of this memoir.—Researches on the brachistochrome of a heavy body, with regard to passive resistances, by M. Haton de la Goupillière.—On the characteristics of systems of conics and surfaces of the second order, by M. Halphen.—M. François recommended, against phylloxera, the vitriolic water from the mines of pyrites of Sainbel.—Observations relative to the general theory of trombes, by M. Virlet d'Aoust. He describes some dust whirlwinds observed on the Mexican plateau.—Determination, by the method of analytic correspondence, of the envelope-surface of a surface whose equation contains  $n$  parametres connected together only by  $n-2$  relations, by M. Salter.—Influence of temperature on magnetisation, by M. Gaugain. The value of the temporary variation varies considerably from one bar to another. To determine the influence of temperature this should be kept invariable throughout an experiment; the author describes how he accomplished this. With a bar susceptible of considerable temporary variation, the magnetism developed at 300° is weaker than at ordinary temperature, but in the opposite case it is stronger.—On the hydrates of sulphate of copper, by M. Magnier de la Source.—On margaric chloride and its derivatives, by M. Villiers.—Researches on quercite, by M. Prunier. He considers quercite to form a transition between the fatty series and the aromatic series.—On angelic acid, by M. Demarcay. He verifies his former experimental results against some contradiction of them by M. Fittig in the Berlin Chemical Society.—Physiological experiments on the functions of the nervous system of Echinida, by M. Fredericq. The cords described as the nervous system are the means by which harmony of movements is established. Facts seem also to favour the existence of a nervous plexus situated in the thickness of the external tegument.—On the mobile state of *Podophrya fixa*, by M. Maupas. This, he says, hardly merits its name; it is more mobile and vagabond than known Acinetinians, and is an intermediate type between suctorial infusoria and ciliated infusoria, properly so called. He describes in detail the changes which take place in it during its mobile period.—On the existence of asparagine in sweet almonds, by M. Portes.—On the influence of leaves and floral branches on the nature and quantity of sugar contained in the scape of agave, by M. Balland. Both leaves and flowers have an incontestable rôle in the formation of sugar.—On a meteoric iron very rich in nickel, found in the province of Santa Catharina (Brazil), by MM. Guignet and Ozorio de Almeida; iron 64 per cent., nickel 36. It appears to belong to the terrestrial rocks. M. Daubrée remarked that a careful examination of all that region was very desirable.—Chemical composition of the water of the Bay of Rio de Janeiro, by MM. Guignet and Teller. It contains considerable quantities of silica and alumina (9.5 and 7.5 gr. respectively, per cubic metre). This is from decomposition of the gneiss and granite rocks under friction of the water.

#### CONTENTS

	Page
FERRIER ON THE BRAIN, I. By GEORGE HENRY LEWIS . . . . .	73
GREEK AND LATIN PHILOLOGY. By Rev. A. H. SAYCE . . . . .	74
OUR BOOK SHELF:—	
Packard's "Monograph of the Geometrid Moths or Phalaenidae of the United States" . . . . .	75
LETTERS TO THE EDITOR:—	
Prof. Balfour Stewart on Meteorological Research.—THOMAS STEVENSON, C.E. . . . .	76
Ocean Currents.—CAPT. DIGBY MURRAY . . . . .	77
Definiteness and Accuracy.—Prof. P. G. TAIT . . . . .	76
On the Internal Fluidity of the Earth.—Prof. HENRY HENNESSY, F.R.S. . . . .	78
The Age of the Rocks of Charnwood Forest.—Prof. EDWARD HULL, F.R.S. . . . .	78
Mind and Matter.—WM. S. DUNCAN . . . . .	78
Meteor.—Cecil H. SP. PERCIVAL . . . . .	79
THE PRESENT STATE OF MATHEMATICAL SCIENCE. By Prof. H. SMITH, F.R.S. . . . .	79
THE AUSTRIAN ARCTIC EXPEDITION ( <i>With Illustrations</i> ). . . . .	81
OUR INSECT FORK . . . . .	84
CARL JEJLINEK . . . . .	85
OUR ASTRONOMICAL COLUMN:—	
The Distances of the Stars . . . . .	86
The Total Solar Eclipses of 1839, June 3, and 1841, October 6 . . . . .	86
NOTES . . . . .	87
SCIENTIFIC SERIALS . . . . .	90
SOCIETIES AND ACADEMIES . . . . .	90

ERRATUM.—P. 57, col. 1. line 23 from bottom, for "Tides" read "Fish."

THURSDAY, NOVEMBER 30,

## FERRIER ON THE BRAIN

*The Functions of the Brain.* By David Ferrier, M.D., F.R.S. With numerous Illustrations. (London: Smith, Elder, and Co., 1876.)

## II.

SINCE it is certain that the movement of a limb may be occasioned by an idea, an emotion, or a sensation, and also by the reflex of an external stimulation; since, moreover, it is certain that such a movement may be arrested by an idea or emotion; and since there is good ground for the hypothesis that the cerebral hemispheres are, if not the sole agents, at any rate indispensable accessories in the production of ideas and emotions, we have every right to conclude that the hemispheres play a part in the normal production of many movements; and that ideas and cerebral processes are the subjective and objective aspects of one and the same effect. But experiment proves that many, if not all, these movements can be executed in the absence of the hemispheres, therefore the hemispheres are not *indispensable* but *accessory* factors. This leads to the question, What part do they play? And this again to the questions, Are all cerebral processes or only some of them, ideas emotions, and sensations, the others being simply molecular movements which propagate their excitation to centres of muscular innervation?

I understand the Hitzig-Ferrier view to be this: One set of cerebral processes, having their centres or terminal stations in a limited region of the cortex, are sensational, emotional, and ideal; another set, having also all their centres or terminal stations in a limited region of the cortex, are motor. I am not quite sure that this representation is exact, for in both writers there is absence of explicit definition. But this much at least may be taken as exact, that they profess to have discovered limited areas of sensory and motor stimulation, and within these areas limited spots for particular sensations and particular movements. The interpretation must, of course, rest on a basis of fact, yet the facts observed may be accepted without forcing acceptance of the interpretation. There is general agreement on the facts with great want of agreement as to the conclusions. I have already suggested that the discoveries of Hitzig and Ferrier are of great importance; but only as finger-posts for anatomists seeking the pathways of stimulation, not as inductive stations for deductive inferences. All we can say at present is that electrical stimulation of certain spots is followed by certain movements; but *how* the stimulation reaches the motor nerves is as dark as before.

Thus far, therefore, the part played by the cerebral process is only recognisable as an incitation; it certainly does not effect the movements, it only incites the motor organs. And *thus far* it is on a level with *peripheral* incitations, such as the incitation of laughter by tickling the sole of the foot; or of vomiting by tickling the fauces. Laughter is a function of a complex apparatus, and this apparatus may be stimulated in very different ways from very different starting-points—an idea, a sight, or a touch. Vomiting, again, follows from a blow on the head, acidity in the stomach, a disgusting sight, a smell, or a tickling

of the throat. No one considers the sole of the foot and the fauces to be centres or terminal stations for the functions of laughter and vomiting. Why, then, when we see movements of the limbs, the eyes, or the tail following stimulation of the cerebral cortex, are we to conclude these movements to have their centres in the cortex? The foot may be removed or the sole rendered insensible, yet still laughter will be stimulated by ideas, sights, &c., as before. In like manner the spot of the cerebral cortex may be removed or destroyed, yet still the limbs will move as before. Nay, not only the cortical spots, but the whole hemisphere may be removed, and still the limbs will move as before.

For anatomical purposes we make a wide distinction between grey matter and white, and a still wider distinction between central and peripheral nerve-substance. Physiologically such distinctions are, I conceive, erroneous, the whole nervous system being one. But the distinction between a centre—*i.e.*, a place *to* which stimulations are carried, and *from* which motor impulses issue—and a peripheral region where stimulations begin or end—is both a physiological and an anatomical division usefully maintained. According to this definition of a centre, we may doubt whether the cortex of the cerebrum has any claim to be called a centre, or group of centres, *whether, in fact, it is not a peripheral region*, the processes of stimulation in it being of the same order as the processes of stimulation in the skin, or mucous membranes, *i.e.*, simply those of peripheral incitation.

This is the paradox to which allusion was made at the close of my former article. As it would occupy too much space for development here, and as I have worked it out in a volume now at press, I merely suggest it for speculative readers, and pass on to Dr. Ferrier's book.

First as to his facts. It has been urged against his localisations that he has employed a too powerful current. On this subject I have no right to an opinion, but incline to accept his reply as satisfactory; though one must not overlook the fact remarked by Carville and Duret, that very different movements may be occasioned by the stimulation of one and the same spot according to intensity of the current—a fact analogous to what is observed in stimulations of the skin. It has been urged by Hitzig, and also by Braun (Eckhard's "Beiträge," vii., 133, 137), that in Dr. Ferrier's experiments the same movements follow stimulation of different spots, even when these spots are situated in the different regions recognised as excitable and non-excitable. The objection is not only triumphantly answered by Dr. Ferrier, but is answered by the introduction of an idea which is of great significance:—"The mere fact," he says, "that movements result from stimulation of a given part of the hemisphere does not necessarily imply that the same is a motor centre in the proper sense of the term. It will afterwards be shown that the movements which result from stimulation of the regions in question are expressive of sensation, and that the character of the movements furnishes an important index to the nature of the sensation" (p. 147; compare also p. 163).

As an answer to his critics this seems conclusive. But does it not throw a serious difficulty in the way of his hypothesis? If, as he luminously suggests elsewhere,

"the sensations accompanying muscular action being repeated as often as the muscular action itself, the organic nexus between the motor and tactile centres becomes so welded, that this sensori-motor cohesion enters like a compound chemical radical as a simple factor into every association which motor centres can form with other motor centres and with sensory centres in general" (p. 268); then surely this, while it satisfactorily accounts for the motions following excitation of sensory regions, leaves unexplained the facts of other such excitations *not* being followed by motions (comp. p. 231), and raises the question whether all motions are not due to sensory excitation? On the first point let us ask why the optic thalami—said by him to be sensory centres—do not respond by motor manifestations when stimulated? He regards this "as sufficient of itself to dispose at once of the views of those who would attribute motor functions to these ganglia. The fact that lesions of the optic thalami cause paralysis of motion proves nothing regarding the real functional significance of these ganglia" (p. 239). Agreed; but then why does he not equally conclude that absence of paralysis of motion, when the corpora striata are destroyed, disproves the motor function he assigns to these ganglia, especially since direct stimulation of these ganglia does not produce motions?

Then, again, if sensorial excitations produce movements by playing upon the motor centres, why not adopt the view which regards all cerebral excitation as sensorial? The hypothesis of motor centres in the cortex would thus be resolved into the fact that particular sensations excite particular movements; and the localisation of spots on the cortex would be no more than analogous localisations on the skin—the sensation excited by tickling the sole of the foot, causing different movements from those caused by the same stimulus applied to the heel or instep.

Dr. Ferrier has explicitly declared that "there is no reason to suppose that one part of the brain is excitable and another not. The question is how the stimulation manifests itself" (p. 130). This is in accordance with what I have maintained, namely, that *neural processes* are uniform in character, the diversity of their results—sensation, motion, or secretion—depending on anatomical connections. *In itself*, a neural process is no more a sensation than it is a secretion. To determine a motor centre, therefore, we must look beyond the cortex, and detect its anatomical relations to the motor apparatus. Do Dr. Ferrier's experiments prove that the area of the cortex, assigned by him as the motor area, has such anatomical relations to the motor apparatus, and the sensorial area such relations to the sensory organs, that we can speak of their activities as motor and sensorial functions? In other words, are the cortical areas to be regarded as playing the part of central functions or only of peripheral incitations?

He has argued his view with such force of fact and suggestion that I have little doubt of his carrying most readers with him; and because I dissent from his view I must occupy all my remaining space by endeavouring to weaken the effect of his argumentation. He considers that the indications naturally suggested by the observed facts of electrical stimulation are proved by the observed effects of disease and extirpation. Stimulation of particular spots is followed by definite movements; destruction of

those spots is followed by paralysis of those movements. The reader is led captive by what seems irresistible logic. The evidence seems decisive. How if the evidence should be illusory? That it is illusory may be shown, I think, under three heads:—

*First Head.*—The Italian physiologists Lussana and Le-moigne have specially called the attention of experimenters to the fact that very many recorded contradictions result from the not distinguishing between the first and second experimental periods, namely, the effects observable soon after the operation, and the effects which are observable when the disturbance has settled down, and the organism has recovered something like its normal state ("Fisiologia dei Centri Nervosi," 1871). The first period comprises what may be called the effects of Disturbance of Function; the second period the effects of Removal of Function. The distinction, so fruitfully introduced by Dr. Hughlings Jackson, of discharging lesions and destroying lesions falls under the same conception. I will only add that neither the effects of Disturbance nor the effects of Removal are to be taken as conclusive evidence that the function disturbed or removed is the function of the organ operated on; but that whenever a function persists, or reappears, after the destruction of an organ, this is absolutely conclusive against its being the function of that organ.

This premised, I must suggest that Dr. Ferrier's experiments cannot be considered as conclusive, because he was unable to keep the animals alive long enough to allow the effects of Disturbance to subside, so as to leave only the effects of Removal to be estimated. And this is the more to be emphasised because in some instances the animals did survive long enough to show some subsidence of the disturbance and *some reappearance of the lost functions*. Now the reappearance of a function after the destruction of an organ admits of but two interpretations—either the function was arrested as an effect of the disturbance, or its organ was destroyed, and *another* organ had vicariously taken its place. This second interpretation is much in vogue, and has received the name of the law of Substitution. The notion that a function can be driven from organ to organ, "like a sparrow driven from one branch to another," as Goltz picturesquely says, is surely raising Hypothesis to the *n*th power? Dr. Ferrier without adopting the first of the two interpretations, argues against the second with his usual force; replacing it by one which is physiologically more consistent, namely, that "there is no direct establishment of new centres in place of those which have been lost, but that those which remain may indirectly without assuming new functions make up for the loss, to some extent at least." In these cases "the path from impression to action is not as in the ordinary course of volition through the cortical motor centres to the corpus striatum, and thence downwards to the motor nuclei and motor nerves, but through the basal ganglia directly." This fails to meet the case when, for example, the function of vision on one side disappears after removal of its assigned cortical centre, and nevertheless reappears. We cannot get the ear to do the work of the eye; and if touch does indirectly make up for loss of sight, it is by a slow process of acquisition; whereas the animal recovers its lost *sight*, and that in the course of a few days.

But restricting the explanation to movements, is it not a relinquishment of the hypothesis of voluntary motor centres? Is it not an invocation of the hypothesis of peripheral incitation? Observe this, moreover: Dr. Ferrier restricts his explanation to the movements which have been automatically organised in the corpora striata. All actions not become automatic are impossible after removal of the cortical centres. "It may confidently be asserted," he says, "and perhaps it may one day be resolved by experiment, that any special tricks of movement which a dog may have learnt would be effectually paralysed by removal of the cortical centres." Well, since this was written, experiment *has* decided the point. By an ingenious method of washing away cerebral substance, Goltz has been able to greatly diminish the disastrous effects of operation, and thus preserved the animals for weeks, in the course of which he observed an *almost* complete restitution of the lost functions. One of the striking cases recorded by him (Pflüger's *Archiv*, xiii. 31) is that of a dog who had been taught to "give the paw" on command. When the surface of the left hemisphere had been washed away there was at first a complete destruction of the power to give the right paw; and the dog when urgently called upon to give it, looked wistful, and ended by stretching out the left paw. Had the dog died within six days after the operation this might have been cited as proof of the destruction of a voluntary centre; but the dog lived, and on the eighth day began to give the right paw when asked, and a month afterwards gave it as readily as before the operation.

*Second Head.*—Under this head we may consider the evidence adduced for the existence of definitely circumscribed areas, and definite spots within those areas. Dr. Ferrier's pages are very instructive on this point, but not, I think, competent to force his conclusion when they are confronted with Goltz's experiments, which show that the paralysis of sensation and motion cannot reasonably be assigned to the destruction of particular spots, because the paralysis is dependent solely on the *amount* of substance washed away, and not at all on the *localities*. Add to which the fact just insisted on, that the paralysis is temporary. Dr. Ferrier believes that his experiments prove the distinct localisation of motor centres. For example, he produces inflammation and suppuration in one place, and observes spasms followed by paralysis of motion in the whole of one side of the body. This is urged in proof of motion being affected without affection of sensation. On examination, however, it seems to me only to prove the effects of disturbance; and this the more decisively, because he admits than when instead of an *irritating suppuration* there is *extirpation* of the centre, the paralysis quickly disappears. "In these experiments," he adds, "the power of movement alone was destroyed, sensation remaining acute and unimpaired." This is very ambiguous. Sensation *elsewhere*—on the other side of the body—was unimpaired; but so was power of movement *there*. In the paralysed limbs there was no sensation.

Let us now turn to a sensational centre: and we will select that of Vision, because the experiments are here most striking. Destruction of the "angular gyrus" on one side causes blindness in the opposite eye. But this is temporary, and begins to subside the next day (165). One would imagine that in presence of such

observations, the fact of blindness would be attributed to Disturbance, not Removal of Function; and the recovery of vision to the subsidence of the disturbance. Dr. Ferrier interprets the recovery as due to the compensatory action of the centre in the other hemisphere (p. 169). But this is to invoke the Law of Substitution (which he has successfully refuted), and leaves unexplained why the compensatory action did not manifest itself from the first. The experiments of Goltz seem to me conclusive as to the observed blindness being merely the effect of disturbance; not only does the vision gradually return, but is proved not to depend on the compensatory action of the intact centre, because it reappears even in an animal deprived of the other eye. That is to say a dog, with only one eye, had almost the whole of one hemisphere washed away, so that on the one side it had no optical apparatus, on the other no visual cortical centre—yet it showed unmistakable evidence of being able to see. Observe the dilemma: either there is a complete decussation of the optic nerves, so that each hemisphere is the sole centre for one of the eyes; or the decussation is partial, so that each hemisphere is a centre for both eyes. In the first case destruction of the one hemisphere should produce absolute and permanent blindness in one eye—and this is disproved by experiment. In the second case destruction of one hemisphere should produce partial blindness in both eyes—and this also is disproved by experiment. Or, finally, the visual centres are *not* in the hemispheres, so that destruction of the hemispheres is not destruction of vision—and *this* is what experiment proved.

*Third Head.*—I must be very brief on this point—namely, that very various effects ensue on excitation of one and the same spot. If we regard the cortex as a peripheral surface of excitation there is nothing mysterious in the various effects produced by reflexes from it—as from the skin; but if we regard it as a collection of distinct sensory and motor centres, there is great difficulty in reconciling the results of observation. For example, the so-called voluntary centres for movements of the limbs and tail are found by Bochefontaine to be centres of salivary secretion. In his memoir in the *Archives de Physiologie* (1876, No. 2, p. 169), the last-named experimenter sums up the results of his observations thus—that the hypothesis of cortical voluntary centres would lead to the conclusion that the same spot was the centre for voluntary movements in a limb, and involuntary contractions of the bladder and spleen, as well as dilatation of the pupil.

My space is exhausted, and I have not been able to do more than criticise the main topic of Dr. Ferrier's book—and this not with the fulness which its importance demands. But if I have shown grounds for regarding the hypothesis of voluntary centres in the cortex as at any rate far from *proved*, and in doing so have had to adopt an antagonistic attitude throughout my review, I should not be just to him, nor to my own feelings of gratitude, if I did not, in concluding, express a high sense of the value of his work, full as it is of suggestions, and rich in facts, which no counter-facts can set aside. It will long remain a storehouse to which all students must go for material. It may be the starting-point of a new anatomy of the brain.

GEORGE HENRY LEWES

## SHELF

*British Manufacturing Industries.*—Edited by G. Phillips Bevan, F.G.S. "Jewellery," by George Wallis; "Gold Working," by Rev. C. Boutell; "Watches and Clocks," by F. J. Britten; "Musical Instruments," by E. F. Rimbault, LL.D.; "Cutlery," by F. Callis. (London: Stanford, 1876.)

THIS little volume (which is intended for popular reading) is comprised of several short essays, by different writers, upon the separate subjects indicated. Each essay contains a fairly good account of the history and general trade position of its subjects, but so far as their mechanical construction and the manufacturing operations involved therein are concerned, all are more or less disappointing. No doubt this is in great measure to be attributed to the nearly entire absence of diagrams, the essay on watches and clocks alone being illustrated, and that but scantily. Naturally some subjects suffer more than others. In jewellery, gold working, and cutlery the forms produced are familiar, the tools employed are simple, and what is the method of shaping and fitting together the various portions can easily be imagined. But with musical instruments and watches and clocks the case is different; people, *à priori*, are unacquainted with the apparatus or mechanism made use of, and a free reference to diagrams or figures becomes indispensable. In the essays upon jewellery and gold working, especially in the latter, their aspects and bearings as branches and developments of art are particularly dwelt upon. Cutlery, of course, is treated as an industry, so are watches and clocks. We are afraid the last-mentioned essay is not very carefully written, the writer, amongst other things, actually forgetting to tell us that there is any connection between the length of a pendulum and the time of its swing. And what he can be thinking of to describe Huyghens as a "French clock-maker of eminence," who "about 1650 showed great skill and ingenuity in arranging pendulums to clocks, so as to describe a cycloid," we do not know. The essay upon musical instruments (considering its not being illustrated) is much more intelligible than it might have been.

The book is neatly bound and printed, but will require considerable alteration and extension before it becomes what from its title we expected to find it.

*An Introduction to the Osteology of the Mammalia.* By Prof. W. H. Flower, F.R.S. 2nd Edition. (London: Co., 1876.)

PROF. FLOWER'S valuable "Osteology of the Mammalia" holds so high a position among scientific manuals that the appearance of a second edition requires but a passing notice from us. The author is himself so continually adding to our knowledge of the anatomy of the higher Vertebrata, at the same time keeping fully *au courant* with the investigations of both British and foreign zoologists, that there are several minor additions which he has had to make after an interval of six years, since the appearance of the volume originally. Amongst the most important of these, we notice the record of the conical form of the odontoid process of the axis vertebra in the Chevrotains (*Tragulina*), the introduction of a summary of Prof. Parker's study of the development of the skull of the pig, the account of the hyoid bones of the Ant-eater, of the large pectineal process in Phylorhine Bats, and of the peculiarly ankylosed tarsus in the Muntjacs. In the first edition the typography and the printing of the woodcuts was too black throughout; in the new one this defect has been entirely removed, both the type and the figures being all that can be desired. There is a new outline diagram of special interest introduced to illustrate the mutual relations of the various elements of what may be termed the typical mammalian skull. This re-

places a plan drawn out for a similar purpose in which the names of the bones were distributed over a page in such a way as to indicate their relative positions. In the new diagram the employment of outlines to the bones renders the exact situation much more distinct and enables the commencing student to carry away with him a much more precise idea of the exact neighbourhood of each part of each bone than was possible from the older plan. We welcome with much pleasure this new edition of the "Osteology of the Mammalia."

## LETTERS TO THE EDITOR

[The Editor does not hold himself responsible for opinions expressed by his correspondents. Neither can he undertake to return, or to correspond with the writers of, rejected manuscripts. No notice is taken of anonymous communications.]

## On the word "Force"

PROF. TAIT in his lecture on *Force* said that this word must be used in a certain definite sense and in this sense only. In order to claim Newton's authority for the one definite sense to which he would confine the word, he has to assume, not only that Newton translated *force* by *vis impressa*, but that he—an Englishman writing in Latin—used *vis insita*, *vis motrix*, &c., without any English equivalents. Until good evidence for these assumptions—improbable as they are on the face of them—is brought forward, Prof. Tait cannot claim the authority of Newton in *his favour*.

In the communication I made to NATURE (vol. xv. p. 8) I contended that the authority of Newton was *against* the restriction of the word to this one sense, on the assumption that the equivalent of Newton's word *vis* is *force*. To those who demur to this assumption I propose the questions: (1) Is it likely that Newton had in his mind no English equivalents for *vis insita*, *vis gravitatis*, *vis centrifuga*? (2) If *force* is not English for *vis*, what English word had Newton in his mind? Until some new light is thrown on these questions I maintain that Newton's authority is claimed for the restriction of *force* to the sense of *vis* on, to say the least, insufficient grounds; and that the obvious interpretation of Newton's words is dead against it.

I have, I hope, in a previous communication done justice to Prof. Tait's zeal for definiteness and accuracy; and with him I feel that supreme virtues these are in a scientific man. But I contend that the wide sense of the word *force*—which I attribute to Newton—is not loose and inaccurate; it is simply general and comprehensive; each of the narrower uses, as in *vis impressa*, *vis insita*, is not more accurate but more special: these special senses are not inconsistent, though they are not identical; they are neither inconsistent with each other nor with the use of the word *force* in its widest sense. Some English mathematicians wish to have this valuable word all to themselves for a special technical sense; Newton claims no such monopoly, nor is it claimed by all foreign mathematicians, nor conceded by metaphysicians; nor is the claim to this monopoly likely to be conceded until a better title to it has been shown.

Cambridge, November 24

P. T. MAIN

## Peripatus N. Zealandiæ

In the November number of the *Annals and Magazine of Natural History* is a paper by Capt. Hutton on *Peripatus N. Zealandiæ*, in which the author comes to the astounding results that this species is hermaphrodite, and that its horny jaws are not foot jaws but homologous with those of annelids such as Eunice. If such were in reality the case much of my results concerning *Peripatus capensis* (*Phil. Trans. R. Soc.*, 1874, vol. clxiv. Part 2) would lose its value, and since I believe *Peripatus* to be a most important form, and a representative of the ancestral stock of all tracheates, in fact of the Protracheata of Prof. Haeckel, I hasten to write a few words in reply.

I obtained specimens of *Peripatus N. Zealandiæ* at Wellington from Mr. W. T. L. Travers, who has done so much for science in New Zealand, and who most kindly assisted me and my late colleague, R. von Willemöes-Suhm, in many ways, and who first pointed out *P. N. Zealandiæ* to Capt. Hutton also. I had further at least fifty specimens of *Peripatus* collected for me and brought to me alive. I examined these and made notes, but have been prevented by other work from

them hitherto. *P. N. Zealandia* is not hermaphrodite. I examined several males, which differ in no essential points in their structure from those of *P. capensis*. Like those of *P. capensis*, they are less numerous than the females, and Capt. Hutton has been unlucky enough not to meet with any amongst the twenty specimens examined by him. The jaws of *P. N. Zealandia* are further, I believe, developed just as are those of *P. capensis*. At least I saw that the earliest stages corresponded, and recognised the first pair of members of the embryo in *P. N. Zealandia* in the stage in which they are not yet turned inwards to become foot jaws. I have prepared a more extended answer to Capt. Hutton's paper with an account of my own observations on *P. N. Zealandia* for the *Ann. and Mag. of Nat. Hist.*, but as this cannot probably be published immediately, I should be much obliged if you would insert this reply in NATURE.

H. N. MOSELEY,  
Naturalist to H.M.S. Challenger

### The Age of the Rocks of Charnwood Forest

It is no doubt to be regretted that Mr. Woodward, misled by insufficient authority, should have introduced, in his excellent work on the geology of England and Wales, still further confusion into the maltreated old rocks of Charnwood Forest, but I doubt whether their age is quite so certain as Prof. Hull seems to think. I fully agree with him that there is not a particle of evidence for their Laurentian age, and that their syenites and hornblende granites cannot be correlated with the hornblende gneiss of the Malverns, but I must demur to his grouping them with the Cambrian rocks of the Longmynd or of Llanberis. The authority of Prof. Sedgwick is great, but it must be remembered that the term Cambrian with him included far more than in the nomenclature of the Geological Survey, and I am not aware that he ever committed himself to the Charnwood rocks being equivalent to his Lower Cambrians. Except a slight lithological resemblance of some Charnwood rocks to those of Harlech and Llanberis, and a still slighter to Longmynd rocks, there is really nothing in favour of this special correlation. One point, however, there is which may give some clue to their age, which does not seem to have been much noticed hitherto, probably because the facts have been strangely overlooked in the Geological Survey description of the district. It is that beds of coarse volcanic agglomerate and ash abound among the Charnwood series. Further, the resemblance of the rocks as a whole (when not unusually metamorphosed) is very close to the "green slate and porphyry series" (or Borrowdale rock) of the Lake District. Compared with the Welsh rocks, they are far more like those of Cader-Idris than of Llanberis. With these there is scarce any lithological resemblance, but if I mixed my Charnwood collection with those from the other two localities, especially the former, I should have great difficulty in separating many specimens. It seems then to me far more likely that this great volcanic activity in the Charnwood district should have corresponded in time with that in the Lake District or with some part of that in Wales, than that it should have happened in the age of the Harlech, Llanberis, and Longmynd groups, where we have no evidence of any volcanic disturbance. The argument may be summed up thus, as it seems to me:—The Charnwood rocks are old, so are both the competing groups; they are unfossiliferous, so are both; they are cleaved, so are both; they contain evidence of great volcanic action, so do the Borrowdale series, and not the Welsh Lower Cambrians. One point for the former. The general correspondence of their strike with that of the Borrowdale series under Ingleborough may also perhaps count for something.

T. G. BONNEY

St. John's College, Cambridge, November 25

THOUGH the discussion of the age of the rocks of Charnwood Forest is not likely in the present state of our knowledge to lead to any useful result, there are still a few points in Prof. Hull's letter on the subject which seem to call for remark. In the first place the late Prof. Jukes was by no means so strongly in favour of the Cambrian age of these rocks as Prof. Hull states. Prof. Jukes' words, in Potter's (not Porter's) "History of Charnwood Forest" are as follows:—"It is therefore uncertain whether they (the rocks of Charnwood) belong to the Devonian, Silurian, or Cambrian systems, the probability only being in favour of the latter." Secondly, the Cambrian of Sedgwick includes a great deal more than the Cambrian of the Geological Survey, and therefore there is not the perfect unanimity between these two

authorities that Prof. Hull's remarks would lead us to believe. Thirdly, if lithological resemblance is to go for anything, it may be used directly against the Cambrian age of the rocks. On the western side of the forest we find sheets of crystalline rock and beds of highly altered conglomerates and breccias, which have a suggestive likeness to the lava flows and ash beds of the green slate and porphyry series of the Lake District. I don't say the resemblance proves anything, but it is worth quite as much as the similarity between the slates on the east side of the forest and the slates of Llanberis. Mr. Bonney has also called attention to the fact that the strike of the Charnwood Forest rocks is the same as that of the Volcanic Series in the Lake Country, when that group is last seen. Again, it is far from certain that the rocks of Charnwood Forest are all of the same age. I recollect seeing many years ago some sections (of which I am afraid I have kept no record) that seemed to show that some of the bosses of Dioritic rock near Markfield were older than the slates that surrounded them. If this be so, perhaps these crystalline hills may be the projecting points of a nucleus of similar rock that underlies the whole area, and which may be Laurentian in age. The rocks are not gneiss, but I know of no reason why the equivalents of the rocks of the Hebrides must be gneiss all the world over; they are, however, rich in hornblende, and so are the Hebridian rocks. With all these possibilities before us, I am afraid it will be hard to arrive at that enviable state of security which Prof. Hull seems to have been in when he penned his letter.

A. H. GREEN

I AM pleased to find in NATURE, vol. xv., p. 78, a letter from Prof. Hull, with reference to the age of our Charnwood Forest rocks. He writes against their assignment by Mr. J. B. Woodward, in his "Geology of England and Wales," to the Laurentian period (see p. 24).

But, in fact, as Prof. Hull himself points out, we also find on p. 30 a statement that part of the series may belong to the Cambrian epoch.

It would appear that as Mr. Woodward is not personally acquainted with the region, he has endeavoured to give the views of the various authors whom he knows to have written on the subject, and as these are conflicting, and based upon little personal work, it is no wonder that he has been led astray.

I do not think sufficient importance has been attached to the study of this isolated outcrop of old rocks. We can trace its continuation to the south and south-east for a considerable distance, and I would venture to suggest the possibility of a flexure or spur in this direction connecting with the old palæozoic ridge for which we have lately been fishing in the Wealden. In my "Geology of Leicestershire and Rutland," which will shortly be published, there will be found some fine photographs of the principal quarries and natural outcrops of the Charnwood rocks; and I have there given the reasons which induce me on the whole to refer the main mass of the rocks to neither Laurentian nor Cambrian, but to the Silurian period. The evidence is but scanty however, but a balance of probabilities at the best. As to Sedgwick's determination of the region, we must remember that much that he then called Cambrian has since been assigned to Lower Silurian.

WM. JEROME HARRISON

Town Museum, Leicester, November 24

### Minimum Thermometers

SOME time ago a correspondence appeared in NATURE (vol. vi. pp. 122, 142, 221) on the subject of moisture deposited in minimum thermometers exposed on the grass. As I was at the time much annoyed with this myself I took up every hint I could get in the matter, though I must confess with indifferent success. I tried for a long time india-rubber packing, with sealing-wax, &c., of varying coats, as advised, but still moisture insinuated itself.

At last I bethought myself of a cork packing. I cut a piece of cork so as to fit tightly round the neck of the thermometer tube, then inserted the tube and packing into the glass case—the cork packing being about a quarter of an inch long. The exposed end of the cork I covered with two or three coats of asphalt, as used on microscopic slides. At first a slight bubbling was seen through the asphalt, but soon disappeared, and a fine uniform surface at last set in. The thermometer has now been in use for several months, and not the least trace of moisture has ever been seen within the cases, although moisture has been abundant, especially for the last three months. The process is simple enough, and I venture to send it to you, hoping that it



may answer the purpose for others as it has now for some time answered mine.

THOMAS FAWCETT

Blencowe School, Cumberland, November 6

### Electric Motor Pendulum

THE following very simple apparatus may I think be of use in any laboratory or other place where at times it is necessary to have a pendulum beating seconds in order to give the time for any experiments needing it.

It consists of a Siemens' galvanoscope, A, to which is attached the pendulum; the needle N, preferably with platinum contacts, works between two platinum wires, B and C, with a small amount of play; these platinum wires are insulated from one another by being fastened into a piece of ebonite, which works on a pivot D. The needle is connected by its support to one end of the coil of the galvanoscope, the other end being to earth. To the wires, B and C, are connected the opposite poles of a small battery, the centre of the battery being to earth.

The action of the instrument is as follows:—On slightly oscillating the pendulum the needle N makes contact between B say, and the coil, the magnet being so arranged that the needle then deflects towards B, thus carrying with it the movable contact wires until the pendulum reaches its limit of oscillation, when it

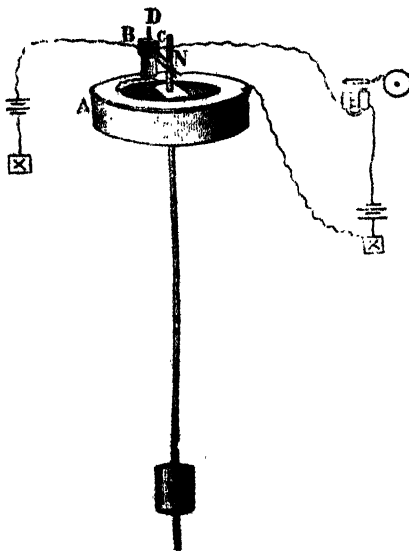

falls, breaks contact with B and makes contact with C, which thus tends to pull the needle over to C, and so on; in this way the pendulum receives at each oscillation the impulse necessary to overcome the forces tending to stop it; and thus will keep oscillating as long as the battery supplies the motive power. For small arcs the beat is not affected by variation in battery power.

In the circuit of the battery we can introduce an electromagnet which at each contact of the pendulum on one side will make a stroke on a bell, or indeed by a detent will move by a small train of wheels the hands of a clock. If the pendulum is made to beat half seconds, then the contact being made alternately on each side, the bell stroke would beat seconds. We could of course introduce any number of arrangements of this sort at any intervals along the circuit, and so move any number of clocks at different positions in a large establishment, only one pendulum being requisite to control the whole set.

P. HIGGS

### PROF. YOUNG ON THE SOLAR SPECTRUM

THE paper of Prof. C. A. Young read at the last meeting of the American Association for the Advancement of Science describing his recent measures of the displacement of the D and other absorption lines at the receding and approaching limbs of the sun, has a double interest.

By careful measures to which all the necessary corrections have been rigorously applied, obtained by using a diffraction grating in combination with a prism, Prof. Young deduces from observation of the D lines a value of  $142 \pm 0.035$  miles per second for the surface velocity of rotation at the sun's equator. Direct observation of the motion of spots gives 1.25 miles per second, and the author thinks that the difference of these two values being so many times larger than the probable error of the spectroscopic method, the result of which agrees so well with Vogel's result, indicates that a portion of the displacement observed is produced by the difference in the angular velocity of rotation of the solar atmosphere which causes the absorption lines and the underlying luminous surface, and the sign of the difference would indicate that the atmosphere is swept forward with the greater velocity of the two.

This conclusion is itself one of great interest, but for many persons the fact that it is based on the acceptance of Doppler's theory will be a source of satisfaction as indicating that the recent disputes as to its soundness are beginning to be considered settled and in its favour, as at any rate a near approximation to the truth.

One of its first assailants, on mathematical grounds, was Prof. Petzval. But, as was pointed out by Mach in a "Contribution to Doppler's Theory," published at Prague, in 1874, his main argument fell beside the mark, while the only one which touched it went to prove that for comparatively small velocities of translation in the source of sound or light, compared to the velocity of wave transmission, Doppler's theory was a correct approximation.

More recently Van der Willigen's mathematical objections have been apparently fairly disposed of by Mr. Christie, while the discrepancy that Father Secchi has lately pointed out between the measures of displacement of spectral lines in the case of certain stars as observed by Mr. Huggins on the one hand and at Greenwich on the other, does not really affect Doppler's theory at all, but only the degree of certainty with which it can be applied to the determination of stellar motion. But the facts are not as Father Secchi represents them. He points out, in a list of thirteen stars, that the displacement in the case of some five stars as observed by Huggins is in the opposite direction to that observed at Greenwich. But the Greenwich observations that he takes are some early tentative observations. We have taken the trouble to refer to the most recent Greenwich measures, and find that of the five disagreements insisted on only one holds.

### INDIAN GEOLOGY

THERE seems to be a very pretty quarrel just now—and one urged with the usual absence of acrimony in scientific controversies—as to the age or ages of an important group of rocks in Her Majesty's Indian empire.

For years it has been known that while a large mass of the rocks forming the Peninsula of India are unfossiliferous, there is also in that country an extensive series of beds the predominant, and frequently the only, fossils of which are vegetable remains. These beds were often spoken of as the Plant-beds of India. Among the flora certain forms which used to be called *Palaosamia*, now *Psilophyllum*, were pretty generally distributed, while the genera *Schisonoura* and *Glossopteris* were found in lower portions of the series.

On the evidence of the first-named fossils and several others, a Jurassic age was assigned to the containing beds, while the identity of the *Glossopteris* with Australian forms involved these Indian beds in the dispute as to whether the coal-rocks of that country were likewise Jurassic or really carboniferous.

One portion of the Indian plant beds contained a limited terrestrial fauna which on high authority (Hux-

ley) was considered probably Triassic. And another portion of this plant series (in Kutch) was found associated with a marine fauna ranging from the age of the Bath Oolite up to the Tithonian of Continental geologists.

On the whole question, the Triassic fossils, though their suggestiveness was admitted, were not considered sufficient to have much influence, and to the upper part of the plant-beds a Jurassic age was assigned, while the lower portion, apparently on the evidence of the *Glossopteris*, was thought to be Palæozoic, an opinion, however, which does not appear to have been universally received.

In this state, or one very similar, Dr. Feistmantel found the subject upon commencing his examination of the Indian fossil plants, aided by the separation of the series into several groups on stratigraphical grounds by the officers of the Geological Survey.

His examination has led to results so far as yet published, which will be found in two papers among the *Records* of the Geological Survey (vol. ix., parts 2, 3).

From these it appears he considers the Kutch flora to represent a period in the Jurassic epoch somewhat earlier than that indicated by the associated marine fauna, so far as this has been examined, which is one of the points in debate, and that five of the upper divisions of the Indian plant beds (or Gondwana series) are Jurassic, while he contends that the remaining three of its lower groups are neither Jurassic nor Carboniferous, but Triassic.

In a paper immediately following Dr. Feistmantel's second contribution to the *Records* of the Indian Survey, Mr. W. T. Blanford discusses the whole question, and arrives at the conclusion that the evidence connecting the lower Indian plant beds with the Australian carboniferous rocks is about equal to that for their being of the same age as the Trias of Europe—pointing out that the land faunas and floras of Palæozoic and Mesozoic times differed from each other in different parts of the globe, at least as much as they do at present, and far more than the fauna of the sea. Also that the evidence founded upon fossil plants of the age of rocks in distant regions must be received with great caution, being certainly in some cases opposed to that furnished by the [contemporaneous] marine fauna.

In a coming volume of the "*Palæontologia Indica*," Dr. Feistmantel will no doubt state his views and their reasons as fully as possible; meantime, enough has been said to show the interesting, yet rather difficult, nature of the subject, for more detail regarding which the papers just mentioned may be referred to.

### THE RIVER CLYDE

THE profession of Civil Engineering, as defined by Telford, which definition is incorporated into the Charter of the Institution of Civil Engineers, is "the art of directing the great sources of power in Nature for the use and convenience of man," and there are few more striking examples of what science may do for commerce, or of what man may accomplish by working hand-in-hand with Nature than is the proud position of the River Clyde at the present day, as compared to what it was one hundred years ago, or even as late as the year 1840.

To many of those who attended the recent meeting of the British Association, and who have fresh in their memory the geography of the City of Glasgow, with which most indissolubly be connected the princely hospitality of its inhabitants, it may be interesting to know that the noble river which has made Glasgow the mighty city that it is, from whose shores some of the largest ironclads of our fleet have been launched is a water highway, almost as much the work of man as is the Suez Canal itself.

One hundred years ago the Clyde was little more than a picturesque mountain-stream, so shallow, that at a place

called Dumbuck Ford, twelve miles below Glasgow Bridge, passengers could traverse it on foot. Now, vessels drawing twenty-three feet of water can ride safely in the heart of the city at low water, and the largest ocean-going steamers can come up the river at all times of the tide.

This wonderful change has been brought about by a succession of engineering operations, in all of which Nature has been coaxed, by artificial means, into doing the largest share of the work; and the operations of man, great as they have been, have been directed solely to assist that work, and to remove obstacles which stood in its way. The names of the engineers under whose directions these improvements have been made, alone show that the highest scientific skill has been brought to bear upon the development of the water-way to the City of Glasgow; for, within the last 100 years, among the engineers who have been employed by the Clyde trustees, either to carry out improvements, or to prepare reports in connection therewith, will be found the names of Smeaton, Golborne, Watt, Sir John Rennie, Telford, Stevenson, Walker, Scott Russell, and Bateman; but the largest engineering operations have been left for Mr. Deas, the present engineer of the Clyde navigation to carry out, for since the year 1872 greater progress has been made than during any previous equal period. In that time no less than 1,505 lineal yards of quays have been added, slip and graving-docks have been constructed, large cranes erected, and very considerable progress towards completion has been made in the celebrated Stobcross Docks of which we shall speak further on.

The exceptional construction of these docks, necessitated by the local peculiarities of the geological strata, formed the subject of a valuable paper read before the British Association by Mr. James Deas, C.E., under whose directions they are being constructed, and who has recently published a most interesting work upon the Clyde,<sup>1</sup> illustrated with maps, sections, and tidal diagrams, and from which many of the data contained in this article have been derived, and to which we would refer those of our readers who wish for further investigation.

It is just a hundred and eight years ago since John Golborne, of Chester, visited the Clyde and made his first report, in which he pointed out that the shores of the river "in most places being much softer than the bottom, the current has operated there, because it could not penetrate the bed of the river, and has by those means gained in breadth what is wanting in depth;" and, he added, "I shall proceed on these principles of assisting Nature when she cannot do her own work, by removing the stones and hard gravel from the bottom of the river where it is shallow, and by contracting the channel where it is worn too wide."

Golborne, carrying these principles into practice, erected a number of rubble jetties so as to contract the channel, giving to the stream greater rapidity, and consequently greater scouring power, and by a system of dredging in the deeper shallows, and horse-ploughing in those which were exposed at low water, he loosened the hard crust forming the bed of the river, exposing to the action of the current the softer material below, which was speedily scoured away, and in less than eight years the depth of water at Dumbuck Ford was increased from 2 feet to 14 feet. Golborne was followed by Rennie, who, in 1799, recommended the shortening of some of the jetties, the lengthening of others, and the construction of new ones, so as to direct the channel in its proper course with the least obstruction to the water; and to insure this he recommended building rubble walls from point to point of the jetties, so as to avoid the formation of shoals between them. These suggestions were carried out by the Clyde

<sup>1</sup> "The River Clyde; an Historical Description of the Rise and Progress of the Harbour of Glasgow." By James Deas, M.Inst.C.E. (Glasgow: James Maclehose, 1876).

mistakes in transmission can be traced to the station and person where they occur.

The Recorder consists of a powerful electro-magnet, between the poles of which a coil of fine insulated wire is delicately suspended, so as to be able to move round a vertical axis. The current from the cable is made to pass through this coil of wire. When a current passes through a coil suspended between the poles of a magnet, the coil tends to take up a position with its plane at right

into a metal box containing ink, and the other end hangs down nearly touching a paper ribbon. The motion of the coil is thus transmitted to the glass siphon. The metal box containing the ink is insulated and is electrified by means of an electrostatic induction machine while the paper is connected with the earth. The ink being electrified, is drawn from the point of the siphon and spurted out in small drops on the paper. When no current is passing they form a straight line on the paper as it is

drawn past the end of the siphon; but when a current passes through the coil, it being deflected, draws the siphon to one side, and the line on the paper is no longer straight, but indicates the deflections of the coil. The well-known Morse alphabet is used with the recorder. A deflection of the siphon-point to one side corresponds to a dot, and one to the opposite side to a dash.

Fig. 1 shows a front view of the Recorder. B is the electrostatic induction machine, called the mouse-mill, which is driven by an electro-magnet inside the box D. The mouse-mill serves two purposes. It generates electricity, which is communicated to the box K, containing the ink, by means of the rod P, and it draws the paper along, past the siphon point. M M are the electro-magnets and S is the coil of wire suspended between them; *t* is the siphon, one end of which dips into the ink-box K, and the other end is almost touching the paper *c*. The paper passes under the spring *a* which keeps it stretched, over the roller *b*, then vertically down, past the siphon point, to the driving drum *z*. The battery used for the electro-magnet M M and for the mouse-mill is of the form of Daniell's battery known as the Tray battery. It is fully described in NATURE, vol. vi. p. 32.

Fig. 2 is an enlarged view of the signal coil and siphon. Fig. 3 shows a front view of the suspension of the coil. S is the coil suspended by a silk fibre passing round the pulley *r*. From the coil hang two weights, which can slide up and down the guides *x*. The coil surrounds a stationary piece of soft iron placed there for the purpose of increasing the intensity of the magnetic field. A silk fibre *v* connects one corner of the coil with one end of a vertical lever U. The other end of the lever is connected to the siphon *t* by means of another silk fibre, and the motion of the coil is thus communicated to the siphon.

In consequence of the electrostatic capacity of submarine cables, a retardation occurs in the transmission of signals, so that when a current enters at one end of a cable, a certain time elapses before any effect can be de-

tected by the most delicate instrument at the other end. Fig. 4, Curve I., represents the strength of the current, received at the remote end of a cable, as it gradually increases, when the end operated upon is connected to one pole of a battery and kept permanently so. The vertical ordinates represent the strength of the current. The horizontal ordinates represent intervals of time reckoned from the first application of the battery in terms of an arbitrary unit, *a*. This unit of time, *a*, may be defined as follows:—Suppose a cable electrified so that

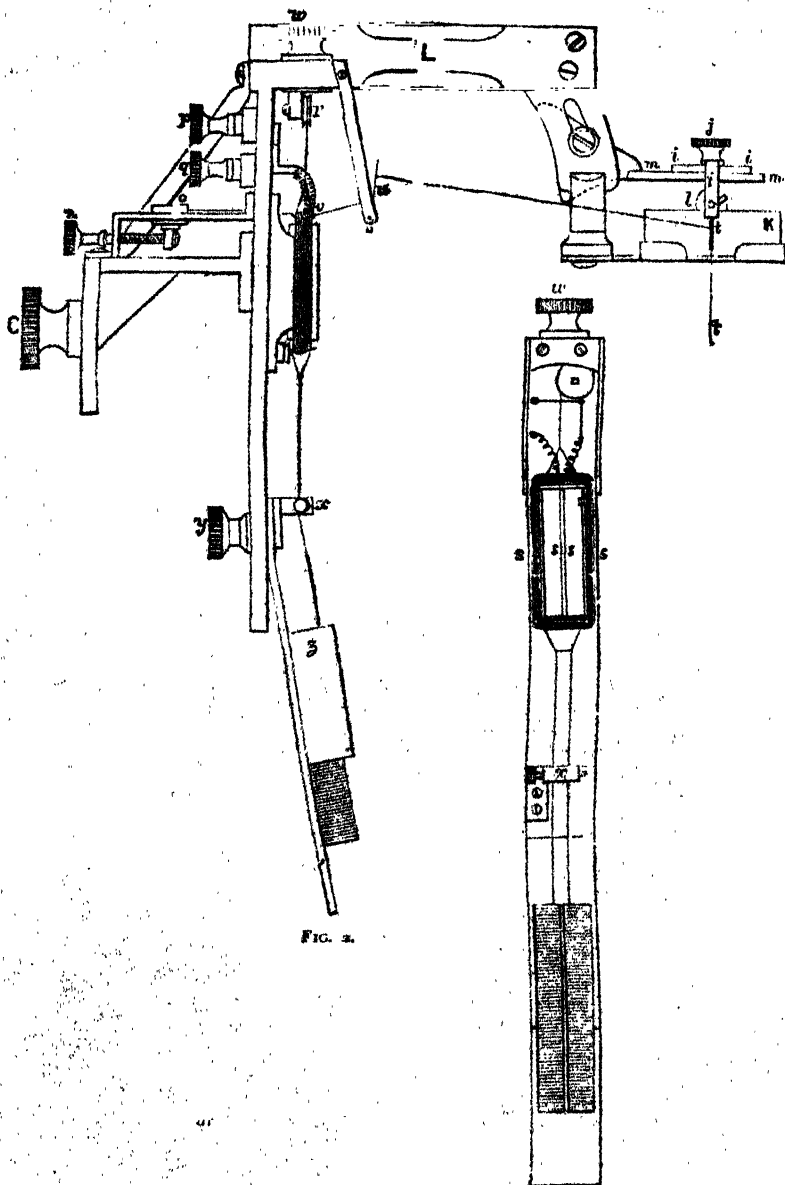

FIG. 2.

FIG. 3.

angles to the line joining the poles. There are two weights suspended from the bottom of the coil, which, when no current is passing, keep the plane of the coil in the line joining the poles of the magnet. When a positive current is passing, the coil tends to turn round a vertical axis in one direction, and when a negative current is passing, it tends to turn round in the opposite direction.

The coil is connected by means of silk fibres with a very fine glass siphon, suspended so that one end dips

the electrification along the cable may be represented by a harmonic curve, with single maximum in the middle and zero at each end. Now let both ends be connected to earth. Then the time that the harmonic electrification takes to subside to three-fourths of its initial value is denoted by  $a$ . Curve I. coincides so nearly with the line, OX, at first, as to indicate that there is no sensible current until the interval of time corresponding to  $a$  has elapsed; although, strictly speaking, the commencement of effect at the remote end is instantaneous. After the interval,  $a$ , the current rapidly increases in strength. When an interval of time equal to  $5a$  has elapsed from the first application of the battery, the current will be about half its ultimate strength. After  $10a$ , the current will have attained to nearly its full strength, that the further increase will be scarcely sensible. Theoretically the full strength is not reached until an infinite time has elapsed.

strip of paper in right and left holes, which correspond to the dot and dash of the Morse alphabet, and a central

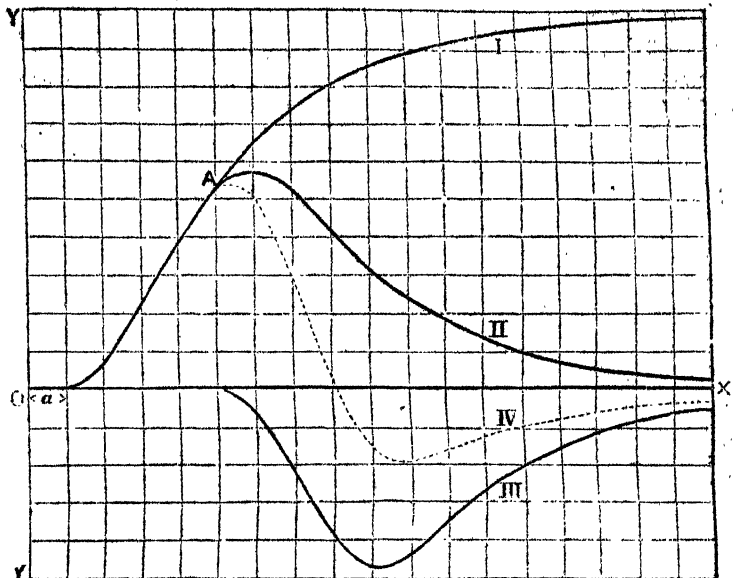

FIG. 4.

Fig. 4, Curve II., shows the effect at the remote end of applying a battery during a time equal to  $4a$ , and then putting the cable to earth. It will be observed that a current gradually diminishing in strength continues to flow out of the cable for a considerable time after the battery has been disconnected. It is this after-effect which interferes so seriously with the working of submarine cables.

The Automatic Curb Sender was designed by Sir William Thomson and Prof. Fleeming Jenkin for the purpose of diminishing the effects of the retardation due to the electrostatic capacity of submarine cables. This was accomplished by making each signal consist of two currents, the second being of opposite name to the first and of a shorter duration. The latter, or curbing current, hastens the neutralisation of the cable after the first current has passed, and tends to do away with the effects of the first current. For example, let one end of the cable be connected to one pole of a battery for an interval of time equal to  $4a$ , and then let it be connected to the opposite pole for a time  $3a$ . The effect at the remote end of this latter current, if it had occurred alone, would be represented by Curve III. of Fig. 4. The joint effect of the two currents is represented by Curve IV., whose ordinates are the algebraic sum of the ordinates of Curves II. and III. The quick return of Curve IV. to the zero line OX, as compared with Curve II., shows the advantage of curb sending.

row of holes is punched for the purpose of carrying the paper through the machine. The paper is then put into

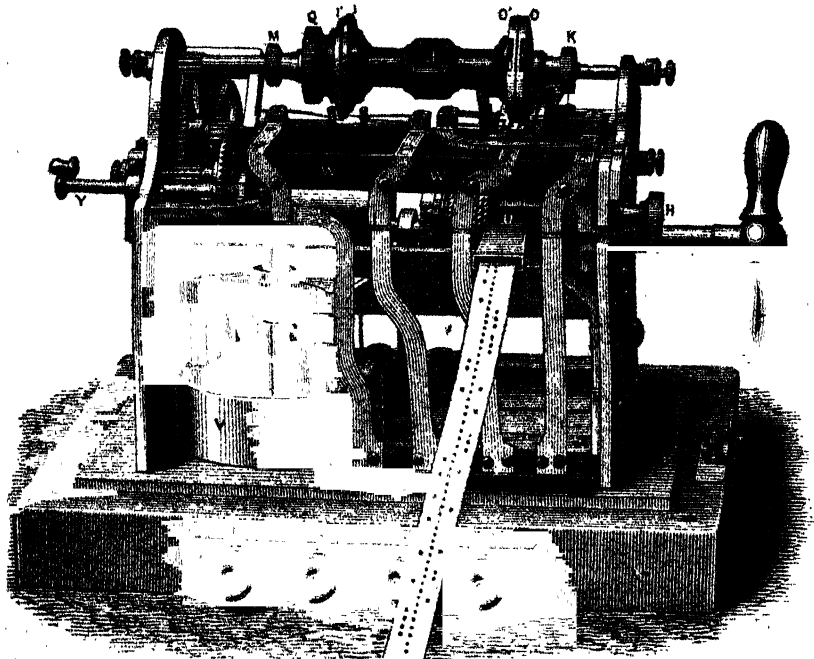

FIG. 5.

The curve traced out by the point of the siphon represents the curve of arrival, and the effect of curb sending is to give a sharp outline to the signals and to bring the point of the siphon back or nearly back to the zero line between each signal. It is necessary for the success of curb sending that the spaces for the signal and curb currents should be perfectly correct, and this can only be effected by means of automatic mechanism.

the machine and drawn along at a uniform speed by means of clock-work. The paper passes through the

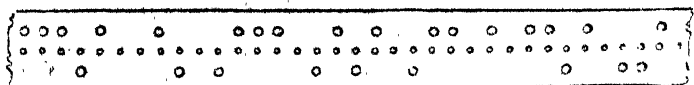

FIG. 6.

Fig. 5 is an engraving from a photograph of the automatic sender. The message to be sent is punched on a tube U and underneath two prickers placed so as to correspond to the right and left holes in the paper. When

a right or left hole passes, the corresponding pricker falls into the hole, and in doing so lifts a spring through the opening *l* or *l'* into the rim of the revolving wheel *o* *o'*. The spring being caught in the rim of the wheel is obliged to remain there until the wheel makes one complete revolution, and the opening in the rim returns to free it. The wheel makes one revolution while one space passes the pricker. When the spring is lifted into the rim of the wheel it makes connection between the battery and another set of springs. The latter set of springs are acted on by a double cam, *11*, which is connected with the same shaft as *o* *o'*, and revolves with it. During one revolution this double cam by means of the second set of springs sends first one current from the battery into the cable, and immediately afterwards a second current of the opposite name and of rather shorter duration. The first current is the signal and the second is the curb current. If a left-hand hole in the punched paper passes, and the corresponding pricker falls into it, a positive current will be sent first, followed by a negative current, but if a right-hand hole passes, the first current will be negative, followed by a positive one.

Fig. 6 shows the appearance of the punched paper when it is prepared for the Automatic Sender. The specimen represents the signal "understand" and the first seven letters of the alphabet.

#### ON THE CONDITIONS OF THE ANTARCTIC.

MY principal object in this evening's lecture is to direct your attention to some of the peculiarities in the physical conditions of the Antarctic regions, and to put you in a better position to contrast these with the more generally known phenomena of the Arctic; and it seems specially appropriate to allow our thoughts to travel for an hour towards that other fortress of the Ice King, a fortress apparently even more hopelessly impregnable, now while the pulse of the nation is still throbbing in sympathy with the brave little band who have just added another chapter to a long and terrible record of daring and self-sacrifice, and have succeeded in the face of almost unparalleled hardships in once more planting the Union-Jack nearest to the North Pole. The propriety is all the greater seeing that Capt. Nares, the gallant leader of the northern explorers, is also the last of the few navigators who have crossed the Antarctic Circle.

I will first of all then give you a brief sketch of our Antarctic experiences in the *Challenger*, and then go on to consider what may be the most probable explanation of some of the most striking of the appearances which we observed.

After spending about a month at Kerguelen Island, making meteorological and other observations, and selecting a suitable spot for the observation of the transit of Venus by the English astronomical party in the following season, the *Challenger* left Christmas Harbour on January 31, 1874, and on February 6 we reached the desolate little group of the Heard Islands, and on the 7th continued our course southwards.

Early on the morning of the 11th a large iceberg was observed bearing south-south-east about six miles off. The berg was table-shaped, the top perfectly flat and covered with a dazzling layer of snow. The perpendicular ice-cliffs bounding it were of a delicate pale blue, apparently perfectly clear, with some caves and slight recesses, where the blue was of a deeper shade. The height of the berg above the sea was 219 feet, and its extreme length by angular measurement was 2,202 feet; so that, supposing it to be symmetrical in shape, the contour of the visible portion being continued downwards, its depth below the

water may probably have been about 1,500 to 1,800 feet. In the afternoon Lord George Campbell observed during his watch a large piece come off the side, dashing up the spray, and we afterwards saw a quantity of fragments floating off.

The 12th was misty, with a breeze force = 3-4 from the north-west by west. Many icebergs came in sight from time to time and quickly became obscured in the mist. The position of the ship at noon was lat. 62° 38' S., long. 80° 4' E.

Towards evening we passed close to a very beautiful iceberg. One part of it was rounded and irregular in form, putting us in mind of the outline of the Sphinx, and another portion, separated from the first by a fissure, the sea dashing through between them, was like a fragment of a colossal cornice. As the sun sank the ice took a most lovely pink or mauve tint, and when we came close up to the berg it showed out veined in a wonderful way with lines of deep cobalt blue. The ice was perfectly pure and clear. The bergs which we were passing at this time seemed to be breaking up very rapidly; some large fragments had been detached from this one shortly before we reached it, for a quantity of debris was floating at a little distance. The pieces washing about in the water very soon lose their edges and angles, and get rounded, and shortly disappear.

The 13th was a fine day, with a light wind from the north-north-east and occasional snow showers. There were some large tabular icebergs along the southern horizon. In the afternoon we passed close to a beautiful berg, very irregular in form, all the curves and shadows of a most splendid blue. The lower portion of the side of the iceberg next us formed a long steep slope into the water, and up this slope the surf ran with every heave of the swell, taking in its course the glorious blue of the ice and ending at the top of the glacier in a line of glittering foam.

The evening fell grey and slightly misty, with a number of icebergs looming through the mist. One or two of us were standing on the bridge about midnight looking at what seemed to be a low bank of white fog coming down upon us, when all at once a universal grating and rasping sound and sensation seemed to pervade the ship, and looking over the side we found that instead of sailing in open water we had passed into the edge of the pack, and as far as the eye could reach to the eastward the sea was closely covered with blocks of ice of all sizes up to six or seven feet in length among which the ship ground her way. A cold-looking moon struggled faintly through the cloud and mist and showed the pack vaguely for a mile or so ahead, covered with a light fog through which we could just see several icebergs looming right ahead of us and on either bow, and the masses of ice becoming larger and forming a closer pack as we passed onwards from the outer edge.

It was a wonderful and in a certain sense a beautiful sight, but one which would certainly require for its full enjoyment very fine weather such as we had, or a specially strengthened ship.

The necessary orders were given, and we veered round and slowly passed out of the pack and into open water; and we hung about beyond the line of wash-ice for the short Antarctic night.

On the following morning there were icebergs all round us, some of them of very fine forms. One which we saw all day on the port quarter was gable-shaped with a glorious blue Gothic arch in the centre, and a separate spire over 200 feet high. It was like a gorgeous floating cathedral built of sapphire set in frosted silver.

All day the pack could be seen from the deck stretching away to the east and south as far as the eye could reach, a mass of rugged glittering blocks one piled on the top of another. The ice-blink, a beautiful and characteristic phenomenon, was very marked above the pack—a clear

\* The sphinx-shaped iceberg by Sir C. Wyville Thomson, F.R.S., delivered in the City Hall, London, on November 23, under the arrangements of the British Association for the Advancement of Science.

band of white reflection rising some  $12^{\circ}$  above the horizon, and frequently bounded above by a dark-rolled cloud.

The 15th was clear and calm, with a light wind from the south-east. There were innumerable icebergs in all directions, some with their blue cliffs entirely visible from the bridge, and the blue waves lapping about their base, and springing up into fissures and recesses in jets of dazzling foam; some only rising above the horizon and slowly developing their varied outlines, and for a time deluding us into the idea that they were low-sloping gently from the water, and that it might be possible to land upon them. All the very large bergs, and some of them were one or two miles in length, were table-topped, evidently retaining their original position.

About 10 o'clock in the evening our attention was called by the officer of the watch to a very beautiful effect of light. There had been a fine crimson sunset, and now a dark curtain of cloud had sunk almost to the water's edge, leaving between it and the sea a long open line of the most vivid flame-colour, broken here and there by an iceberg, which, according to its position, took a rosy glow from the sky, or merely interrupted it with its cold grey outline.

During the forenoon of February 16 we passed on under sail through a splendid double chain of icebergs, most of them table-topped, and showing little evidence of change of form; and all day, on the southern horizon, berg after berg rose solemnly out of the water, at first a white line only, the blue bounding-cliff growing in height as we ran southwards. Shortly after noon we crossed the Antarctic circle, and a little later we reached our most southern point, lat.  $66^{\circ} 40' S.$ ; long.  $78^{\circ} 22' E.$  exactly fourteen hundred miles from the South Pole.

As the season was advancing, and as there was no special object in our going further south—a proceeding which would have been attended with great risk to an unprotected ship, since, while the temperature of the surface-water ranged between  $-1^{\circ} 67$  and  $-2^{\circ} 0 C.$  ( $29^{\circ}$  and  $28^{\circ} 4 F.$ ), very close to the freezing-point of sea-water, the temperature of the air fell to  $-4^{\circ} 44 C.$  ( $24 F.$ ), and once or twice the water began to show that sludgy appearance which we know sets so rapidly, converting in a few hours an open pack into a doubtfully penetrable barrier—Capt. Nares decided upon following the edge of the pack to the north-eastward, towards the position of Wilkes' "Termination Land."

From our most southern point the sea was tolerably clear of ice for at least twenty miles in a south-westerly direction. The whole of the horizon to the south-east was closed by a chain of very uniform and symmetrical flat-topped bergs, all about 200 feet high above the water, one upwards of three miles in length, and several between one and two miles.

During the next week we were making our way slowly to the north-east, along the edge of the pack, sometimes dipping into it a little way, or crossing outlying loose patches.

The pieces of ice on which we were bumping every now and then were 10 to 20 feet in length, rising from 1 to 2 feet out of the water. Most of them were covered with a smooth layer of lately fallen snow, which had apparently not even got splashed with the water which was lapping round the blocks, it was so pure and white.

When the ship struck a block, the ice was usually driven aside unbroken; but the crust of snow was shattered and fell into the water. At the line where the water broke against the ice-blocks, they were all more or less honeycombed and worn-looking, and along this line many of them were of a dirty-yellow colour, probably from the washing of diatoms and crustaceans into the spongy ice. The temperature of the air averaged about  $-4^{\circ} 7 C.$  ( $23^{\circ} 5 F.$ ) in the shade; and that of the surface of the sea  $-2^{\circ} 78$  ( $27^{\circ} F.$ ); every overhanging ledge of an iceberg was fringed with delicate new icicles, and the

"gummy" look of the surface, threatening the formation of young ice, was very evident. The sea was usually a splendid deep blue.

The weather changed during the night of the 23rd, and at daylight on the morning of the 24th the wind was rising fast with a cloudy sky and frequent snow-showers. We were very anxious to get a haul of the dredge in this position, and Capt. Nares had it put over in the hope of getting it up before the weather became too boisterous. The wind and sea rose so fast, however, that it was found necessary to shorten the operation. The dredge was got in safely, but, as we anticipated, it was empty, and had probably never reached the bottom. During the forenoon the weather got rapidly worse. The snow became continuous, and was so thick—blinding clouds of singularly beautiful wheel-like crystals, which stung the face as if they were red hot—that we could scarcely see the length of the ship. We tried to get under the lee of an iceberg; but while reefing an eddy caught the ship and dragged her towards the berg, which she fouled, carrying away her jibboom. At three P.M. things were nearly as bad as they could be. The wind was blowing from the south-east by east, with a hurricane force, in the squalls; the sea was running very high; the temperature had fallen to  $-6^{\circ} 11 C.$  ( $21^{\circ} F.$ ); we were surrounded with icebergs, which we could not see for the sheets of blinding snow, but we could hear the dull boom of the surf dashing upon them. When the gale was at its height we saw the loom of an iceberg on the lee-bow, and we were drifting directly upon it. As there was no time to steam ahead, Capt. Nares went full-speed astern with the four boilers, and set the reefed main topsail aback, and under this sail the ship fortunately gathered stern-way, keeping broadside to the wind, and we drifted past the berg. Towards evening the wind fell a little, and we moved about all night between two bergs, whose position we knew, keeping as much as possible under their lee till daylight.

On the morning of the 25th this storm, which was one of the most trying and critical episodes in the whole voyage, was entirely over, and the air was calm and clear. We pushed a couple of miles into the pack to the north-east. We were now about fifteen miles from the position of Termination Land on the chart sent by Lieut. Wilkes to Capt. Ross. The sky was clear to the southward and eastward, the direction of the supposed land, but there was nothing which could be taken even for an "appearance of land." A sounding taken close to the edge of the pack had given a depth of 1,300 fathoms, and there was no trace of land *débris* on any of the icebergs. We were forced to conclude that Lieut. Wilkes had been in error, and that there was no land in this position. We now ran on steadily in a north-easterly direction towards Cape Otway, and on March 4 we passed a low irregular iceberg, the last we saw during our southern cruise of 1874. We sighted Cape Otway on March 16, and on the 17th we anchored off Sandridge Pier, in Hobson's Bay.

In these high southern latitudes, at all events at the point where we crossed the Antarctic circle, it seems that originally all the icebergs are tabular, the surface perfectly level and parallel with the surface of the sea, a cliff on an average 200 feet high bounding the berg. The top is covered with a layer of the whitest snow; now and then a small flock of petrels take up their quarters upon it, and trample and soil some few square yards, but after their departure one of the frequent snow showers restores it in a few minutes to its virgin whiteness. The upper part of the cliff is of a pale blue, which gradually deepens towards the base. When looked at closely, the face of the cliff is seen to be traversed by a delicate ruling of faint blue lines, the lines more distant above, and becoming gradually closer. The distance between the well-marked lines near the top of the berg may be a foot, or even more; while near the surface of the water it is not more than 2 or 3 inches, and the spaces between

the blue lines have lost their dead whiteness and have become hyaline or bluish. The blue lines are very unequal in their strength and in their depth of colouring; sometimes a group of very dark lines gives a marked character to a part of a berg. Between the stronger blue lines near the top of the cliff a system of closer bands may be observed, marking the division of the ice by still finer planes of lamination, but these are blended and lost in the narrower spaces towards the water-line. The blue lines are the sections of sheets of clear ice; the

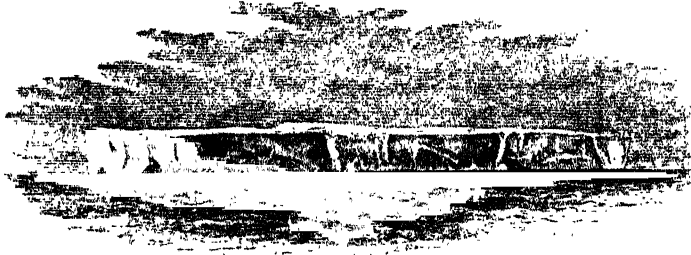

FIG. 1.—February 11, 1874. Lat.  $60^{\circ} 52' S.$ , Long.  $80^{\circ} 20' E.$

white intervening bands are the sections of layers of ice where the particles are not in such close contact—ice probably containing some air.

The stratification in all the icebergs which we saw, was, I believe, originally horizontal and conformable, or very nearly so. In very many of them the strata had become inclined at various angles, or vertical, or reversed; in many they were traversed by faults, or twisted or contorted or displaced, but I never saw a single instance of deviation from the horizontal and symmetrical stratification which could in any way be referred to original structure; which could not, in fact, be at once accounted for by changes which we had an opportunity of observing taking place in the icebergs.

I think there can be no reasonable doubt from their shape, and from their remarkable uniformity of character,



FIG. 2.—February 23, 1874. Lat.  $64^{\circ} 15' S.$ , Long.  $93^{\circ} 24' E.$

that these great table-topped icebergs which we saw all around us, and closing in our southern and eastern horizon at the southernmost point of our voyage, and breaking down and melting a little further to the north, are prismatic blocks riven from the edge of the great Antarctic ice-sheet, portions of whose vertical cliff were seen by Ross in January, 1841, and in February, 1842, in lat.  $78^{\circ} 4'$  and lat.  $77^{\circ} 49' S.$  to the southward of New Zealand, and by Lieut. Commandant Ringgold in the U.S. ship

lat.  $65^{\circ} 49' S.$  There is unfortunately great difficulty in determining when the wall of ice to which the term "ice-barrier" was restricted by Capt. Ross was seen by Lieut. Wilkes or any of his party, since Lieut. Wilkes applies the term indiscriminately to the solid ice-walls and to the masses of moving pack by which his progress was from time to time interrupted. The wall is satisfactorily described at one or two points only.

I believe that the stratification of those portions of the icebergs which were visible to us is due entirely to successive accumulations of snow upon a nearly level surface. The spaces between the transverse blue lines on the bergs may possibly represent approximately the snow accumulation of successive seasons. The direct radiant heat of the sun is very great in these latitudes, and during summer the immediate surface of the snow is frequently melted in the middle of the day, the water percolating down among the snow beneath and freezing again at night, or when it has trickled down into the shade. This process repeated every clear day for the two or three months of summer might well convert a very considerable belt of snow into

ice more or less compact. That the process does go on we had ample evidence in the icicles fringing the snow which was lying upon flat pieces of the pack, which dropped rapidly in the sun even when the thermometer in the shade was several degrees below the freezing point.

The finer laminations may probably indicate the more feeble results of the same process after successive snow-falls. As I have already said there was not, so far as we could see, in any iceberg the slightest trace of structure stamped upon the ice in passing down a valley, or during its progress over *roches moutonnées* or any other form of uneven land; the only structure except the parallel stratification which we ever observed which could be regarded as bearing upon the mode of original formation of the ice-mass was an occasional local thinning out of some of the layers and thickening of others, just such an appearance as might be expected to result from the occasional drifting of large beds of snow before they have time to become consolidated.

We certainly never saw any trace of gravel or stones or any foreign matter necessarily derived from land on an iceberg; several showed vertical or irregular fissures filled with discoloured ice or snow, but when looked at closely the discoloration proved usually to be very slight, and the effect at a distance was chiefly due to the foreign material filling the fissure reflecting light less perfectly than the general surface of the berg. In one or two distant bergs there seemed to be thick horizontal beds of ice deeply coloured brown or bottle-green, but this was also, I believe, chiefly an effect of light.

In the pack, which is made up of fragments of all sizes of berg-ice mixed with masses of salt-water ice, the berg-ice is almost always either white with pale-blue streaks, blue with a white opalescence, or rarely deep blue, or still more rarely black from absolute transparency; it is seldom soiled in any way. It is so occasionally; on the 10th we passed, not far from our turning-point, a piece of berg-ice with a small flock of penguins upon it. The birds had evidently been there for some time for the snow on the surface of the ice was trampled into a dirty brownish mud; another fall of snow would have converted this layer into a discoloured vein in the block.

C. WYVILLE THOMSON

OUR ASTRONOMICAL COLUMN

CHANGE OF COLOUR IN A STAR.—Dr. Klein of Cologne first directed attention to a periodical change of colour in the star  $\alpha$  Ursæ Majoris, from yellow to an intense fiery red, and estimated the duration of the period to be about five weeks. In a communication to the *Astronomische Nachrichten*, he gives observations by Herr Weber from August 22, 1876, to October 24, which support his inference. Thus on September 5 and October 10 the star was considered "stark feuerroth" and "feuerroth, tief," while on August 22 and October 24, it was noted "weissgelb" and "gelb, schwach blaulich" respectively: from September 5 to October 10 is a period of thirty-five days, confirming the earlier estimation by Dr. Klein. Herr Weber observed with a Steinheil achromatic of  $2\frac{3}{4}$  inches aperture, and  $3\frac{1}{2}$  feet focal length with a power of 90. Probably since the suspicion of a regular change of colour was made known, the star has engaged the attention of other amateurs, who may be able to add something to the evidence pro or con.

NEW DOUBLE STARS.—Mr. Ormond Stone, Director of the Observatory, Cincinnati, has circulated a list of fifty double stars, varying in distance from  $0\cdot8$  to  $8\cdot0$ , which are assumed to be new, and which have been recently found by Mr. Howe with the eleven-inch refractor; the whole are included between  $8^\circ$  and  $40^\circ$  south declination. Positions are given for 1880, with estimated angles and distances, and the magnitudes of the components. Since the number of rapidly-revolving double-stars is probably much greater than at present known, it appears very desirable that micrometrical measures of objects newly discovered should be at once placed upon record, in place of merely estimated angles, which form no satisfactory starting-points for the calculation of orbits.

THE BINARY STAR  $\eta$  CASSIOPEÆ.—Dr. Gruber, of Buda-Pesth, has investigated elements of this binary, from normal position-angles formed with the aid of Duner's orbit. His figures agree as nearly as can be expected in such a case with those obtained by the careful calculation of Doberck. With the value of annual parallax obtained by O. Struve, viz.,  $0\cdot154$ , we find—

	Gruber.	Doberck.
Mass of the system ... ..	4 <sup>6</sup> 32	5 <sup>2</sup> 56
Semi-axis major .. .. .	56 <sup>0</sup> 97	63 <sup>8</sup> 31

The sun's mass is taken for unity, and the semi-axis major is expressed in mean distances of the earth from the sun. Dr. Gruber's period is  $195\frac{1}{4}$  years.

In the only two cases which we are at present able to compare with that of  $\eta$  Cassiopeæ we have for a Centauri, mass of system = 2.2 sun-masses, while for  $\gamma$  Ophiuchi the similar value is 3.1.

THE MASS OF NEPTUNE.—It is understood that M. Leverrier, from his final researches on the motion of Uranus, obtains a sensibly larger value for the mass of Neptune than has been assigned by Prof. Newcomb, and one approximating to that which was inferred many years since from Mr. Lassell's direct measures of the distances of the satellite.

THE NAUTICAL ALMANAC FOR 1880 has been published during the last week. The ephemeris of the planet Saturn, which since the appearance of the almanac in its improved form has hitherto been founded upon Bouvard's Tables, is computed from heliocentric plans communicated by M. Leverrier in advance of the publication of his new tables in vol. xii. of the *Annales* of the Observatory of Paris; the number of standard stars has been increased from 149 to 197, and in extending Damoiseau's Tables of Jupiter's satellites, certain corrections supplied by Prof. Adams have been introduced.

The impression of the *Nautical Almanac* now considerably

METEOROLOGICAL NOTES

ACCELERATED TRANSMISSION OF WEATHER MAPS.—The *New York Herald* of November 7 publishes a map of the weather of that morning, exhibiting the lines of atmospheric pressures and of the temperatures over the United States. The meteorological charting which was finished at the Central Office in Washington at 10 A.M. was immediately transmitted from Washington in *fac-simile* by telegraph to Philadelphia, where it was received at 10.30 A.M. It was shortly thereafter published in the supplement of the *New York Herald* of the same day, being the first occasion on which such telegraphic charting had appeared in any newspaper. The fact of telegraphing and printing such charts solves one of the greatest difficulties of exchanges of Weather Reports. It may now be regarded as only a question of time when the more important newspapers of our British large towns will be in a position to present their readers every morning with a chart of the weather as existing only two or three hours before going to press; and indeed it will not be till this result be effected that the practical utility of weather warnings will be properly developed, owing to our close proximity to the Atlantic and the rate at which our weather-changes pass to the eastward.

GREAT STORM OF WIND AT SYDNEY.—Mr. Russell, the Government astronomer at Sydney, reports that during a heavy storm of wind which occurred in that part of Australia on Sunday, September 10, the wind, in a gust lasting one or two minutes, attained the extraordinary rate of velocity of 153 miles per hour, as ascertained by Robinson's cup anemometer; and that during the twelve minutes, from 12.18 to 12.30 A.M. 22½ miles of wind passed the Observatory, being at the rate of 112 miles per hour. This extraordinary recorded velocity may be regarded as a new contribution to meteorological observation, and we look with much interest to the description which will doubtless be given of the method by which it was determined. It scarcely admits of a doubt that the maximum velocity or force of the wind that occurs in great storms is frequently much understated.

THE TEMPERATURE OF THE NORTHERN PART OF THE ATLANTIC.—An important contribution to the physics of the North Atlantic appears in the November number of *Petermann's Geogr. Mittheilungen*, in a paper by Prof. Mohn on the temperature of the sea between Norway, Scotland, Iceland, and Spitzbergen. The material employed in the discussion consists of the observations collected by the Norwegian Meteorological Institute from the lighthouses on the coast of Norway and from Norwegian ships, and the observations published by the Scottish Meteorological Society from their stations in Scotland, Farø, and Iceland—the observing stations, exclusive of the ships, numbering twenty-two. At places where observations only for two or three years are available, they are reduced to the longer period of the nearest station by the process of differentiation, with the result that virtually the averages are all good and fairly comparable with each other. The results are represented on seven charts, well executed in colours, showing by six distinct shades, as well as by isothermal lines, the distribution of temperature over this portion of the Atlantic for each set of two months and for the year, and the changes in the positions of the same temperatures from season to season. The outstanding feature of the charts is a strong-marked warm thermal axis, taking a north-easterly direction about 150 miles to westward of Scotland and Norway, extending even beyond the North Cape. Along this line of warm water temperatures are considerably higher than elsewhere in the same latitude. On the July-August chart, however, the warm axis approaches much nearer to the coast of Norway, and extends only from off the Naze to about lat.  $66^\circ$ . From June to September the North Sea is coldest on the Scottish coast and warmest



In other words, during the hottest months the influence of the heated land is powerfully felt, but during the other two-thirds of the year the peculiar distribution of the temperature is determined by the strong south-westerly winds and current of the Atlantic. This influence of the Atlantic on the temperature of Western Europe is enormous, the thermic anomaly for January being estimated by Prof. Mohn to be  $10^{\circ}8$  in the interior of Norway,  $25^{\circ}2$  in Scotland,  $32^{\circ}4$  in the north-west of Iceland, while in Lofoten it amounts to  $41^{\circ}4$ . In May-June and in a slight degree in July-August, a large extent of cold water appears as if thrust out from the Arctic Sea west of Jan Mayen to the south-eastwards as far as Farø, deflecting and crowding together the whole of the isothermals over this region in a most remarkable manner. This is a point which well deserves the most careful investigation, not merely from its evident importance to the fisheries of this part of the Atlantic, but also from its meteorological significance, it being in May and June that atmospheric pressure reaches its annual maximum, northerly and easterly winds their greatest predominance, the weather becomes brightest and clearest, and the rainfall sinks to its annual minimum over the extreme north-west of Europe. An instructive comparison is also made between the temperature of the sea and that of the air, and a valuable discussion is added of the observations made at different depths of the sea between Iceland and Norway; but for these and other interesting points we must refer to the paper itself.

#### BIOLOGICAL NOTES

**NEW FRESH-WATER RHIZOPODS.**—For many years the small group known as Actinophrys, first accurately described by Ehrenberg, remained somewhat isolated, distinguished among unicellular forms by its nearly constant spherical form, and the persistence of its straight radiating processes or "pseudopodia." But in recent years a whole series of organisms has been described, and has attained sufficient prominence to constitute, with Actinophrys, an order denominated Heliozoa. Many interesting papers have appeared in the *Archiv für mikroskopische Anatomie* on these organisms, contributed by E. Hertwig, Lesser, Cienkowski, Greeff, and others; and in our own country Mr. W. Archer has been the most active and successful student of the Heliozoa, his papers having been principally published in the *Quarterly Journal of Microscopical Science*. From these one derives an idea of these animalcules as being the most complex of the free forms which possess pseudopodia, and are at the same time unicellular; they are neither multicellular and differentiated like the Radiolaria, nor organised like the ciliated Infusoria. While a few forms, as Actinophrys, are quite devoid of skeleton, most of them possess certain hard parts, consisting, it may be, of a single solid and globular piece, but in other cases of very minute rod-shaped spicules, sometimes siliceous, sometimes easily soluble. These are either disposed so as to invest the main body of the organism more or less closely, or radially, projecting as spines. When food is taken, these minute hard parts can be pushed aside to allow access to the central body-mass; and the same occurs when indigestible material is thrust out. Locomotion is usually very slow; most Heliozoans move by balancing themselves on the tips of their pseudopodia, and thus very gradually rolling onwards. Multiplication of the organisms is effected by division, either simple, or occurring after encystation. Some forms are remarkable for containing a great abundance of chlorophyll granules.

**RE-ARRANGEMENT OF THE ORDERS OF ENDOGENS.**—At a recent meeting of the Linnean Society of London, Mr. Bentham proposed an entirely new arrangement of the orders of Endogens, which he believes to be more in accordance with their genetic

present in use. He proposes to classify Endogens under four series, viz., 1. **EPIGYNÆ**; flowers with a double usually petaloid perianth; ovary usually inferior syncarpous. 2. **CORONARIÆ**; flowers with a double usually petaloid perianth; ovary superior, almost always syncarpous. 3. **NUDIFLORÆ**; flowers usually achlamydeous, or with a dry perianth; ovary mostly apocarpous; and 4. **GLUMALES**; perianth replaced by membranous scales (pales or lodicules); ovary always uniovular. The orders are arranged thus in the four series:—in the first, Hydrocharidæ, Scitamineæ (including Musacæ, Cannacæ, &c.), Orchidæ, Burmanniaceæ, Iridæ, Amaryllidæ (including Hæmodoracæ), Taccacæ, Dioscoridæ, and Bromeliacæ (?); to the second, Roxburghiaceæ, Liliacæ (including Melanthaceæ, Smilacæ, &c.), Pontederiacæ, Phillydracæ, Xyridæ, Commelynacæ, Juncæ, and Palmæ; to the third, Pandanæ, Aroidæ, Typhacæ, Lemnaceæ, Naiades (including Juncaginæ), and Alismacæ (?); and to the fourth, Eriocaulæ, Centrolepidæ, Restiacæ, Cyperacæ, and Graminæ.

**THE SENSATION OF SOUND.**—At a recent meeting of the Vienna Academy a paper was communicated by Dr. Isidor Hein "On the Relations between Perceptions of Touch and of Hearing." His conclusions are these:—1. The sound produced by striking a solid body is always accompanied by a sensation of touch, which, like the sound, differs according to the nature of the body. If the sound is different in different parts of a body, there goes along with the variation of the sound, a variation in the touch-sensation; and if the surface be divided into several sections according to differences in sound, a congruent division may be made on the basis of touch. 2. On bringing a struck body towards a reflecting wall, the sound and touch-perceptions show similar variations. 3. To the touch-perception in question correspond vibratory motions of the exterior body, produced even with the weakest striking, whereas sound only begins to be perceived with impacts of a certain intensity. 4. The sense of touch is capable of perceiving vibrations and comparing the differences of these. It brings hereby to consciousness, a special quality of touch-sensation, which is to be distinguished from sensation of pressure. 5. This distinguishing power of the organ of touch, not sufficiently appreciated hitherto, offers practical medicine a peculiar mode of investigation, which greatly enlarges the doctrine of the physical symptoms of the human organism, and for which the author suggests the (German) name of "Erschutterungs-palpation."

**THE ABSORPTION OF ORGANIC MATTER BY PLANTS.**—In a communication from Prof. Calderon, of the Institute of Las Palmas, Canary Isles, he contests the ordinary view that the nitrogen of the tissues of plants is derived entirely from the nitrates and ammoniacal salts absorbed through the roots. He does not, however, adopt the old theory that the source is the free nitrogen of the atmosphere, but rather the nitrogenous organic matter which is always floating in the air. The nutrition of plants he divides into three classes: *microphagous*, the absorption of dead organic matter in various stages of decomposition; *plasmophagous*, the assimilation of living organic matter without elimination, or distinction of any kind between useful and useless substances, such as the nutrition of parasites; and *biophagous*, the absorption of living organisms, such as that known in the case of insectivorous plants. A further illustration of the latter kind of nutrition is, according to Prof. Calderon, furnished by all plants provided with viscid hairs or a glutinous excretion, the object of which is the detention and destruction of small insects. To prove the importance of the nitrogenous substances floating in the air to the life of plants, he deprived air of all organic matter in the mode described by Prof. Tyndall, and subjected lichens to the access only of this filtered air and of distilled water, when he found all their physiological func-

## NOTES

THE Kew Committee have appointed Mr. G. N. Whipple, B.Sc., Superintendent of the Observatory. Mr. Whipple's connection with the establishment is of nearly nineteen years standing, he having entered it in January, 1858.

DR. PETERMANN has sent us a map in which he has embodied the discoveries of the English Arctic Expedition. He appears still to maintain his well-known hypothesis of the continuation of the north coast of Greenland towards and beyond the North Pole. He draws the line of the visible horizon of the English Expedition at about fifty nautical miles north of Grant Land, its furthest north point being the 84th deg. of lat., and remarks that north of this line may be either land or sea. Of course no one can contradict this. He has, however, restored President's Land in rather a remarkable position, identifying it apparently with Beaumont's Cape Britannia, to the north of Beaumont's furthest point on the north coast of Greenland. The map will be found a very useful one in studying the route of the expedition, especially as compared with that of the *Polaris*.

CAPT. NARES and the other Arctic officers have been entertained by the Greenwich cadets and by the Royal Naval Club at Portsmouth. Capt. Nares stated that when the whole story of the efforts of the expedition is published, it will be seen that better work could not have been done.

THE constituents of fodder-remains of rhinoceroses and mammoths in Northern Siberia have been examined by several observers, and the conclusion arrived at that these animals lived in the places where their frozen bodies have been found, on plants which are still to be met with in Northern Siberia. New ground for this opinion has been furnished by M. Schmalhausen to the St. Petersburg Academy, who has examined microscopically the constituents of a mass of dark-brown matter extracted from hollows in the teeth of a rhinoceros in the Irkutski Museum. That this was truly the remains of fodder of the animal seemed clear from the appearance and the macerated character of the vegetable substance, of which only the woody and cuticular parts showed a more or less distinct structure. The greater portion of the piece consisted of leaf-remains, with here and there a fragment of stem. For the most part the stem and leaf-fragments were those of monocotyledonous plants, probably of Gramineæ; there were also, in less quantity, leaf-fragments of dicotyledonous plants. Besides leaf-shreds of Coniferæ, there were woody pieces which indicated the existence of *Picea* (*Obovata*?), *Abies* (*Sibirica*?), *Larix* (*Sibirica*?), *Gnetaceæ*, *Betulaceæ*, and *Salicinææ*. If it is scarcely possible to determine certainly the species of a plant merely from some of the wood received in the state indicated, and from the structure of the leaf epidermis, it yet seems unquestionable that these remains must be referred to northern plants and to such as are still partly found in the high north.

MR. COXWELL writing to the *Daily News* in reference to Arctic ballooning, maintains that the ordinary practice of ballooning would be quite unsuitable for the conditions found in the Arctic regions.

M. MORITZ, director of the Tiflis Observatory, makes an interesting communication on the results of an examination of the magnetic instruments there last July by Prof. Smirnof, of Kasan, who has been engaged during the last six years travelling through to determine the elements of terrestrial magnetism. The instruments employed by Prof. Smirnof, which cost 300 roubles, were all verified at Kew, and are furnished with microscopes and all the other accessories of the English system. The compass has three needles (No. 4, No. 3, and No. 16), four inches in length, and the mean of the readings of the three needles is the true

structed according to the old method of Gambey, which are now generally looked upon as inferior instruments. They cost respectively only 165 and 40 roubles. The results of a very careful comparison are these:—Assuming the mean of the indications of the three Kew needles as the true inclination the errors of the instruments were, Kew No. 4,  $-0^{\circ}25'$ ; No. 3,  $+2^{\circ}45'$ ; and No. 16,  $-2^{\circ}22'$ ; the error of the large Gambey being  $+0^{\circ}30'$ , and of the small Gambey  $-0^{\circ}09'$ . M. Moritz remarks that the microscope and detached circle on which the readings are made, and which add so greatly to the price of the English compass, appear to add nothing to the precision with which the inclination is determined, facilities for minute readings of the compass being made counting but little, it being the form of the pivots of the physical axis of the needle which stamps its character on the instrument.

"ON Some Insect Deformities," by Dr. Hermann A. Hagen, is the title of No. 9, vol. ii., of the *Memoirs* of the Museum of Comparative Zoology, Harvard College, Cambridge, U.S.

WE have received from Herr Schmitt, publisher, Zürich, Dr. Hermann Berge's "Beiträge zur Entwicklungsgeschichte von *Bryophyllum Calycinum*," and Dr. Gustav Schoch's "Die Schweizerischen Orthopteren."

THE following German publications have been sent us by Messrs. Williams and Norgate:—"Ueber die Zugstrassen der Vögel," by J. A. Palmén, of Helsingfors; "Grundzüge der Mikrophotographie," by Max Hauer; "Sammlung wissenschaftlicher Vorträge von Prof. Wilhelm Förster;" "Die Darwin'schen Theorien und ihre Stellung zur Philosophie, Religion, und Moral," by Rudolf Schmid.

THE Goldsmiths' Company, whose donation to the Chemical Society we noted last week, have voted 500*l.* in aid of the fund for extending Edinburgh University buildings. It is stated that this Company spends annually 6,000*l.* for educational purposes alone. We wish the other City Companies would follow such a good example.

THE following were elected office-bearers of the Royal Society of Edinburgh on Monday last:—President, Sir William Thomson; Vice-Presidents, Rev. Dr. Lindsay Alexander, Bishop Cotterill, Sir Alexander Grant, Prof. Kelland, Lord Neaves, and David Stevenson; General Secretary, Prof. Ballour; Secretaries to Ordinary Meetings, Professors Tait and Turner; Treasurer, David Smith; Curator of Library and Museum, Prof. MacLagan; Members of Council, Prof. Crum Brown, Dr. James Bryce, Alexander Buchan, Dr. Matthews Duncan, Dr. A. Fleming, Dr. T. Harvey, D. Milne Home, Prof. McKendrick, Dr. C. Morehead, Sir C. Wyville Thomson, Dr. R. H. Traquair, and Dr. Robert Wyld.

THE next meeting of the French Association for the Advancement of Science will take place, as we have already intimated, at Havre in the end of August, 1877, under the presidency of Dr. Broca. A local committee has been already formed at Havre under the presidency of M. Mazurier, the mayor. At the first meeting M. Gariel, the secretary of the committee, suggested many useful and interesting experiments to be made in the Seine or the sea. Special efforts will be made to procure a large attendance of English savants and members of the British Association. It is reported that a special deputation will be sent to the Dublin meeting of the British Association. The place of meeting for 1878 has not yet been determined upon, but it will probably be Versailles or Paris.

THE *Times* of Monday contains a journal kept by the Rev. Mr. Lawes during a voyage from Port Moresby to China Straits,

At Hood's Bay they sailed up a considerable river, and near the coast found a large village, regularly laid out in streets and squares, scrupulously clean, with gardens and carefully cultivated flowers. Canoes of large size and excellent make they saw being hewed out with stone hatchets. At a lagoon at Cape Rodney a regular lake village was found, the lagoon leading up to a considerable river. Near Table Point a large canoe "manned" by at least twenty-one women, came alongside; it is reported at Port Moresby, and all along the coast, that there is a village of women somewhere near Amazon Bay.

At the last meeting of the French Geographical Society, the president, M. Malte Brun, intimated that the Council General of the Seine had voted a sum of 2,000 francs to assist M. Largeau in his exploration of the Sahara. M. Largeau left on November 19 for Algiers, whence he will proceed to Constantine, Tuggurth, and Central Sahara. The subscription on his behalf is proceeding. The Geographical Council of Lyons has voted a small subsidy of 12*l.*, and the Municipal Council of Lyons will send him, within a very few days, a considerable donation. M. Melidin, a rich landed gentleman, has offered to the Society to maintain during one year any traveller approved by the Society. The offer was accepted with thanks. On December 20 the general secretary will deliver a lecture on "The Progress of Geography during 1876," and on the following day the annual banquet will take place at the Grand Hotel.

At the Geographical Society on Monday night papers were read on the results of Col. Gordon's expedition in Central Africa, from General Stone, the Rev. E. J. Davis, and Signor Gessi-Sir Rutherford Alcock announced the death of an African missionary, Mr. Redman, who, by his explorations, had materially helped subsequent travellers, and who first suggested that there was a great system of lakes in Central Africa.

A GREAT extension of the medical department of the University of Heidelberg has been in progress for some time. Large additions to the Medical School and the Hospital attached to it have been made, and when completed, as it will be shortly, this institution will be one of the most complete in Europe. Every provision has been made for scientific investigation in connection with the healing art in all its departments.

THE *Archiv für Anthropologie* (ix. 173) contains a paper by Herr L. Lindenschmidt, in which he pronounces his conviction that the drawings upon the fossil bones found in the Thayingen Cave are spurious and the result of intentional deception. These drawings, which represent a bear, a fox, and a stag, were generally admired in scientific circles in 1874 (when they were found) as being amongst the most perfect specimens of the kind; they also led to the supposition of the highly-civilised state of the ancient cave inhabitants. Herr Lindenschmidt produces evidence to the effect that precisely the same drawings are contained in a little work by Leutemann, "Die Thiergärten und Menagerien mit Ihren Insassen," which was published in 1868, *i.e.* six years before the discovery of the cave near Thayingen. As the work in question had a very wide circulation in Germany the inference drawn is obvious.

A NOTICE in the *Ostsee Zeitung* accounts for the frequent deficiencies in the aroma of foreign cigars by announcing that from Guben whole waggon-loads of dried cherry-leaves are weekly exported for the manufacture of "tobacco."

A SUCCESSFUL *soirée* of the Manchester Scientific Students' Association was held last Friday, when Prof. Williamson gave an address on Insectivorous Plants.

A VERY fine new university building has been erected at Kiel, one marked peculiarity of which is that it has no "carcer," or prison, which hitherto, it seems, has been an invariable appendage to German universities.

THERE met in Berlin, a few days ago, a German Government Commission whose business it is to look after the moors and marshes of Germany. They resolved to establish an experimental station at Bremen, to be opened on April 1 next year, drew up a plan for obtaining statistics and a topography of moors, and made arrangements for the complete canalisation of the moors in the Duchy of Bremen. The labours of the Commission will include the whole of Germany.

THE directors of the Swedish Government railways have turned their special attention to the frequent occurrence of colour-blindness amongst their engine-drivers and other officials. Prof. Holmgren has lately examined the whole staff of the Upsala-Gefle Railway, and amongst the 266 persons examined has found no less than eighteen who suffered from this defect, and who therefore were utterly useless and unfit for railway service. This investigation proves that cases of colour-blindness are far more frequent than is generally supposed, and that our railway companies would do well to follow the example of the Swedish State railways.

THE *Kölnische Zeitung* of the 14th inst. declares that the recent sudden cold was a perfectly abnormal meteorological phenomenon, and all the more so since it did not only visit a part but nearly the whole of Europe. Reports of heavy snowstorms have come from the whole of North Germany, Austria, Servia, and Roumania, and the temperature had fallen below freezing in all these countries as well as in Western France, Italy as far south as Rome, and the whole of European Turkey. In Hungary the cold reached 13° C. Violent gales were raging in the Black Sea, the Adriatic, and the Baltic. In another article, dated from the Teutoburg forest, the paper reports that the whole of that district is snowed up, and a valuable crop of vegetables, beetroot, &c., has been destroyed by the cold.

A MONS. MÉNIER, of Bordeaux, has invented a new contrivance for the steering of balloons. The mechanism is placed behind the car, and by a clever arrangement of network acts upon a belt which encircles the body of the balloon, extending about four or five degrees above and below a horizontal plane through its centre—its equator, so to say. The rudder is plane, and can be used as a sail. The balloons are said to move obliquely upwards and downwards and also sideways, according to the position of the rudder. The sideway motion is very likely facilitated by changing the position of ballast. One circumstance, which may be of special practical use, is that a balloon provided with this new apparatus, when falling to the ground, can be made to touch the earth's surface very obliquely and thus avoid any sudden shock, and at the same time facilitate a safe anchoring.

HERR EDWARD TREWENDT, publisher, Breslau, has issued the prospectus of a New Encyclopædia of the Natural Sciences, which will include all departments of science. The first part will appear on January 1, 1878.

MORE than 18,000 francs have been already collected for the erection of Arago's statue at Perpignan.

THE additions to the Zoological Society's Gardens during the past week include a Bonnet Monkey (*Macacus radiatus*) from India, presented by Mr. E. F. Mathews; a Slender-billed Cockatoo (*Licmetis tenuirostris*) from South Australia, presented by Mr. Stevens; a Gannet (*Sula bassana*), European, presented by Mr. R. H. W. Leach; a Peregrine Falcon (*Falco peregrinus*), captured at sea, presented by Mr. A. Whyte; a Guivet Monkey (*Cercopithecus griseo-viridis*) from Nubia, an Indian Leopard (*Felis pardus*) from India, a Hooded Crane (*Grus monachus*) from Japan, a Globose Curassow (*Crax globicera*) from Central America, deposited; an Indian Muntjac (*Cervulus muntjac*), a Japanese Deer (*Cervus sika*), born in the Gardens.

## SCIENTIFIC SERIALS

*Morphologisches Jahrbuch*, vol. ii. Part 2.—On the structure of the toes of Batrachia, &c., by Dr. F. Leydig (32 pages).—On the valvular apparatus in the conus arteriosus of Selachians and Ganoids, by Dr. Stöhr.—Contribution to the anatomy and histology of Asteroids and Ophiuroids, by Wichard Lange (46 pages, 3 plates).

REICHERT and Du Bois Reymond's *Archiv*, September, 1876.—Studies on animal heat, Part 3 (conclusion), by Dr. A. Adamkiewicz.—Contribution to the theory of the growth of bone, by Dr. L. Lotze.—On the negative variation of the muscular current during contraction, Part 3 (conclusion), by Du Bois Reymond.

*Archiv für mikroskopische Anatomie*, vol. xiii. Part 1, July, 1876.—Rhizopod studies, No. vi., by F. E. Schulze.—On the anatomy and histology of the Coccidae, by E. L. Mark.—Studies of the development of Gastropods, by N. Bobretzky (75 pages), with 6 plates illustrating the development of *Nassa mutabilis*, *Natica*, and *Fusus*.—On the hypothesis of discharge and the motor end plates, by W. Krause.

*Bulletin de l'Académie Impériale des Sciences de St. Pétersbourg*, t. xxii., No. 2.—This part contains the following papers of interest:—Diagnoses plantarum novarum Japoniae et Mandshuriae, decas xx. (continued from last vol.), by C. J. Maximovicz.—On the plants of the bear period found in the deposits of the Ogour river, a tributary to the Jenissei, in Siberia, by J. Schmalhausen.—Preliminary communication by the same, on a microscopical examination of the food-remains of Siberian fossil rhinoceros, viz., *Rhinoceros antiquitatis seu tichorinus*.—On the supposed satellite of Procyon (*a Canis min.*), by O. Struve. The other contents are only of archaeological and philological interest.

## SOCIETIES AND ACADEMIES

## LONDON

Linnean Society, November 16.—Prof. Allman, president, in the chair.—Messrs. J. C. Onian, R. H. Peck, and D. G. Rutherford were duly elected fellows.—Mr. H. N. Moseley, of H.M.S. *Challenger*, read a paper on the flora of Marion Island. This island possesses considerable interest from its isolation and being within the Antarctic drift. It is about 1,000 miles from the African Continent, 450 from the Crozets, 1,200 from the desolate Kerguelen Island, above 2,000 from Tristan D'Acunha, and 4,500 from the Falklands, to which, nevertheless, its flora appears related. It is of volcanic origin and snowclad. The rocks at half-tide are covered with *Darvula utilis*, above high tide *Tillea moschata* is found in abundance, and beyond the beach a swampy peaty soil covers the rocks, where there is a thick growth of herbage; this is principally composed of species of *Acena*, *Azorella*, and *Pestuca*, the first of these three being the most abundant plant on the island, though the latter grass is by no means scarce. The cabbage-like plant *Pringlea antiscorbutica* is less profuse than at Kerguelen's Land. Some of the ranunculus group are met with at water pools near the sea; four kinds of ferns were obtained, *Lomaria Alpina* being the most numerous. Lichens are scarce, but mosses in plenty form yellow patches, which stand out conspicuously midst the green vegetation, which rises to an altitude of probably 2,000 feet. From the occurrence of *Pringlea* on Marion Island, the Crozets, and Kerguelen Island, and the existence of fossil tree-trunks on the two latter, the author surmises an ancient land connection between them.—A memoir on the birds collected by Prof. Steere (U.S. Michigan) in the Philippine Archipelago was read by Mr. R. Bowdler Sharpe, and copious coloured drawings of the new and rare forms exhibited and commented on. Although it is but lately that Lord Tweeddale's (President Zool. Soc.) remarkable monograph on the Philippine birds was published, with immense additions to the avifauna, yet Steere's collection has yielded over sixty hitherto unknown species. Many novelties may therefore still be expected as further exploration proceeds. The recorded species of birds from the Philippines at the present now amount to 285.—A letter containing observations on the American Grasshopper (*Caloptenus femur-rubrum*), with remarks on the same by Mr. Frederick Smith, was noticed.—Mr. Moseley exhibited some insular floral collections in illustration of his paper and of the various parts touched at by the *Challenger*. He also called attention to a series of volumes and pamphlets, &c., on natural history obtained by him in Japan.

Zoological Society, November 21.—Prof. Flower, F.R.S., vice-president, in the chair. The Secretary read a report on the additions that had been made to the Society's Menagerie during the month of October.—Mr. Slater exhibited and made remarks on the skin of a young rhinoceros (*R. sondaicus*), belonging to Mr. W. Jarrach, which had been captured in the Sunderbunds, near Calcutta, in May last.—The Secretary exhibited on behalf of Mr. Andrew Anderson, a coloured drawing of a specimen of *Emys hamiltoni*, lately captured at Futteghurh (Ganges). The occurrence of this *Emys*, chiefly confined to Lower Bengal, so far west as Futteghurh, was considered as of much interest.—A letter was read from Count T. Salvadori, containing remarks on some of the birds mentioned by Signor D'Alberis, as seen by him during his first excursion up the Fly River.—A communication was read from Mr. G. B. Sowerby, jun., containing descriptions of six new species of shells, from the collections of the Marchioness Paulucci and Dr. Prevost.—Mr. Edward R. Alston read a paper containing the descriptions of two new species of *Hesperomys* from Central America, which he proposed to call respectively *Hesperomys teguina* and *H. coxsi*.—A paper was read by Prof. Garrod, F.R.S., on the Chinese Deer, named *Lophotragus michianus*, by Mr. Swinhoe, in which he showed that the species so called was identical with *Elaphodus cephalophus* (A. Milne Edwards), obtained by Père David in Moupin. The close affinity between the genera *Elaphodus* and *Cervulus* was demonstrated, the latter differing little more than in the possession of frontal cutaneous glands not found in the former.—Mr. Arthur G. Butler read a paper containing descriptions of new species of Lepidoptera, from New Guinea, with a notice of a new genus.—A communication was read from Dr. J. S. Bowerbank, being the eighth of his series of "Contributions to a General History of the Spongiadæ."

Meteorological Society, November 15.—Mr. H. S. Eaton, M.A., president, in the chair.—Messrs. R. A. Allison, John Evans, F.R.S., Dr. W. Marcet, F.R.S., Rev. T. G. P. Pope, and Mr. G. Washington were elected fellows.—The following papers were read:—Results of meteorological observations made at Rossinière, Canton Vaud, Switzerland, during 1874 and 1875, by Mr. William Marriott. Rossinière is situated in a valley running north-east and south-west, about three quarters of a mile broad, the mountains on the north being 3,000 to 4,000 feet above the valley of the Sarine, and those on the south, 1,000 to 3,000 feet. The valley is shut in at either end by a gorge, that on the east being about one mile, and that on the west about two miles distant. The observations were all taken by Col. M. F. Ward, F.R.A.S. The mean temperature, as deduced from the mean of the maximum and minimum readings, was 43°·4 for 1874, and 43°·5 for 1875. The monthly means ranged from 20°·0 for December, 1874, and 20°·5 for December, 1875, to 64°·9 for July, 1874. The highest temperature in 1874 was 80° on July 3, and 1875, 85° on August 18; the lowest in 1874 was -4° on December 24, and in 1875 -7° on January 1. Owing to the situation of Rossinière, the prevailing winds are those from north-east and south-west. In the winter months the air is for the most part calm, and it is owing to this absence of wind that the intense cold is not so severely felt as it would otherwise be. The total rainfall for 1874 was 54·282 inches, and for 1875, 55·870 inches. The months of greatest rainfall are July and November, and those of the least February and March. Thunderstorms occur frequently from May to August, as many as five being sometimes recorded in one day. The number of thunderstorms observed in 1874 was forty-five, and in 1875, forty-three. No thunder was heard or lightning seen in the months of December to March.—The climate of Fiji, by Mr. R. C. Holmes. This paper contains the results of meteorological observations taken at Delanasau, Bay of Islands, north coast of the province of Bua, Fiji, during the five years ending 1875. The average annual mean temperature is 79°·1. The highest temperature recorded was 97°·7 on January 12, 1871, and the lowest 58°·5 on August 20, 1875, the extreme range in the five years being 39°·2. The average annual rainfall is 124·15 inches, and the number of rainy days 170. The greatest fall in 24 hours was 14·95 inches, which occurred on March 19, 1871. After describing somewhat fully the chief characteristics of the months and seasons, hurricanes and storms, earthquakes, waterspouts, &c., the author concludes with the question, "Is the climate of Fiji a healthy one?" In reply he says that, considered as a tropical country, an affirmative answer may be given without hesitation. Those fatal diseases so common in tropical countries, fevers of various kinds, cholera, and liver complaints, are almost unknown. This is owing partly to the geographical

position of the group, lying in the region of the trade winds, so that it enjoys almost perpetual breezes, calms being rare, and the islands so small that the sea-breeze from all directions can penetrate into every corner.—Notes on some remarkable errors in thermometers recorded at Sydney Observatory, 1876, by Mr. H. C. Russell, F.R.A.S. For upwards of five years the same hygrometer has been in use at the Observatory; the dry bulb is small, only 0.3 inches in diameter, and the instrument up to February 26 had always given very satisfactory readings, tested by those of a standard which hangs only 3 inches from it; the difference in the readings was usually 0.2 to 0.3. On that day the maximum shade temperature rose to 96.4 about noon; at 3 P.M. the dry-bulb and standard read 83.7, and at 9 P.M., 68.9 and 69.0. Next morning they read 69.6 and 69.8; as this was Sunday, they were not read again until 9 A.M. on the 28th, when the dry bulb read 87.3, and the standard 64.9, showing a difference of 22.4. It was at once thought that the glass had cracked and let in the air, but as no crack could be seen after careful examination, it was determined to continue the readings. The author had always found before that if a thermometer cracks in the bulb, the mercury rises till the tube is full, and he expected it would be so in this case, though he could see no crack. The result, however, was that the difference steadily decreased, at first at the rate of 1° each day, and in thirty-five days the difference had fallen to less than 0.5, or almost to its normal condition. Between April 7 and 17, it rose again, then fell; on May 3, and again on the 7th, sudden rises took place, since then the difference has been diminishing, except a slight rise on May 21 and 22. When very closely examined with the microscope, a very small piece of coloured glass is to be seen in the bulb, as if lead had been reduced by the blowpipe, and on one side of the bulb a mark is visible, as if there was a minute quantity of water between the mercury and the glass at one spot.

PARIS

Academy of Sciences, November 20.—Vice-Admiral Paris in the chair.—The following papers were read:—Meridian observations of small planets made at the Greenwich and Paris observatories during the third trimestre of 1876, communicated by M. Leverrier.—Tables of the planet Uranus, based on comparison of theory with observations, by M. Leverrier.—On the physical and chemical properties of ruthenium, by MM. H. Sainte-Claire Deville and Debray.—New researches on the chemical phenomena produced by electricity of tension, by M. Berthelot. He studies the relations of the reactions to sign and tension of the electricity.—On the composition of some phosphites, by M. Wurtz. Phosphite of calcium, neutral and acid phosphites of barium.—On the quantity of rainfall at Rome during fifty years, 1825 to 1874, by P. Secchi. The yearly maximum is in the end of October and beginning of November. No relation was perceptible between the quantity of rain and the sun-spots. The great rain-periods at Rome coincide with floods of the lake of Fucino, 100 kilos. distant.—Organisation of a new meteorological observatory on Monte-Cavo; meteorological observations near Rome, by P. Secchi.—On the modifications of oleomargaric acid produced by light and heat, by M. Cloëz.—On the phenomenon of the black drop, by M. André.—On a series of experiments with regard to the flow of water made at the reservoir of Furens, by M. Græff.—On exchange of gases in the tympanic cavity; physiological considerations and therapeutical applications, by M. Löwenberg. In cases of obstruction of the Eustachian tube, causing deafness, the volume of gas in the tympanic cavity is diminished, and the membrane presses inward. The author says this diminution must be due, not to absorption, but to exchange by diffusion, and he suggests as remedies—(1) the insufflation of air that has been inspired and expired four or five times; (2) the insufflation of hydrogen.—New observations on the cure of typhoid fever by parasiticide phenicated medication (phenic acid and phenate of ammonia, in draughts, and subcutaneous injection in large doses), by M. Doclat.—The theory of systems of land-elevation, à propos of the system of Mont Seny, by M. Vezian.—Researches on the structure and the vitality of eggs of phylloxera, by M. Balbiani.—Remarks on M. Bouillaud's observations regarding the effects produced by sulpho-carbonates, by M. Mouillefert.—Experiments on treatment of phylloxerised vines by phenic acid and alkaline phenates, by M. Rommier.—On the practical conditions of employment of insecticides to oppose phylloxera, by M. Delachanal.—Results obtained from the use of sulpho-car-

the employment of pyrites in treatment of vines affected with oidium, by M. François.—On the gaseous movement in the radiometer, by M. Salet.—Experiments on the immersed radiometer, by M. de Fonvielle.—Absorbent powers of bodies for heat, by M. Aymonnet. The atomic absorbent power appears to be constant (1) for all simple bodies dissolved in the same medium; (2) for all simple bodies forming part of compounds of like chemical composition.—On a process of determination of alkaline sulphates, by M. Jean.—On the causes of error involved in the application of the law of mixtures of vapours, in the determination of their density, by MM. Troost and Hautefeuille.—On the saccharine matter contained in the petals of flowers, by M. Boussingault. This is considerable, amounting in some eighteen cases examined to an average of 4.88 per cent. in the undried flower.—On a process of testing wines for fuchsine, by M. Fordos.—On the investigation of rosolic acid in presence of fuchsine, by MM. Gayot and Bidaux.—New researches on the action of non-arsenical fuchsine introduced into the stomach and the blood, by MM. Feltz and Ritter.—On the action of iron in anemia, by M. Hayem. It causes the globules to become charged with a larger amount of colouring matter, and this, not merely in the curable anæmic, but even in cachexia; where, the organism being exhausted, the production of red globules is almost entirely stopped.—Experiments on the pneumogastric and on nerves supposed to be inhibitory, by M. On-mus.—Researches on the urea of the blood, by M. Bernard.—On the power possessed by certain Acarians, with or without a mouth, of living without food during whole phases of their existence, and even their whole life, by M. Megnin.—On crystals of oxydulated iron presenting a singular deformation, by M. Friedel.—On the figures which are formed in superposed liquids, when a movement of rotation is imparted to them, by M. Bouquet de la Grye. These show some analogies to sun-spots. M. Faye added a few comments.—On some peculiarities of lightning, by M. Renon. Beaded lightning; purple or violet flashes; lightning in a near cloud without thunder; sound of thunder heard at 40 kilom. distance.—Observations of falling stars during the nights of November 12, 13, and 14, 1876, at Clermont Ferrand, by M. Gruy.—On the present state of volcanic phenomena of Carvasséra, by M. de Cigalla.

VIENNA

Imperial Academy of Sciences, October 12, 26.—The following among other papers were read:—The nerves of hair-covered skin, by M. Arnstein.—The germination of plant spores in its relation to light, by M. Leitgeb.—On spontaneous variations of blood-pressure, by M. Mayer.—On the action of chloroform and ether on breathing and circulation, by M. Knoll.—On some remarkable phenomena in Geissler tubes, by MM. Reilinger and Urbanitzky.

CONTENTS

	PAGE
FERRIER ON THE BRAIN, II. By GEORGE HENRY LEWIS. . . . .	93
OUR BOOK SHELF:—	
"British Manufacturing Industries" . . . . .	96
Prof. Flower's "Introduction to the Osteology of the Mammalia" . . . . .	50
LETTERS TO THE EDITOR:—	
On the Word "Force."—P. T. MAIN . . . . .	95
Peripatus N. Zealandic.—H. N. MOSLEY . . . . .	96
The Age of the Rocks of Charmwood Forest.—REV. T. G. BONNEY; Prof. A. H. GREEN; WM. JEROME HARRISON . . . . .	97
Minimum Thermometers.—THOMAS FAWCETT . . . . .	97
Electric Motor, Pendulum.—DR. P. HIGGS (With Illustration) . . . . .	98
PROF. YOUNG ON THE SOLAR SPECTRUM . . . . .	98
INDIAN GEOLOGY . . . . .	99
THE RIVER CLYDE . . . . .	98
RESEARCHES ON THE RADIOMETER. By Prof. PAUL VOLPICELLI . . . . .	101
THE SIPHON RECORDER AND AUTOMATIC CURVE SENDER (With Illustrations) . . . . .	101
ON THE CONDITIONS OF THE ANTARCTIC. By Sir C. WYVILLE THOMSON, F.R.S. (With Illustrations) . . . . .	104
OUR ASTRONOMICAL COLUMN:—	
Change of Colour in a Star . . . . .	107
New Double Stars . . . . .	107
The Binary Star $\alpha$ Cassiopeæ . . . . .	107
The Mass of Neptune . . . . .	107
The Nautical Almanac for 1880 . . . . .	107
METEOROLOGICAL NOTES:—	
Accelerated Transmission of Weather Maps . . . . .	107
Great Storm of Wind at Sydney . . . . .	107
The Temperature of the Northern Part of the Atlantic . . . . .	107
BIOLOGICAL NOTES:—	
New Fresh-water Rhizopods . . . . .	108
Rearrangement of the Orders of Endogens . . . . .	108
The Sensation of Sound . . . . .	108
The Absorption of Organic Matter by Plants . . . . .	108
NOTES . . . . .	109
SCIENTIFIC SERIALS . . . . .	111
SCIENTIFIC AND ACADEMIC . . . . .	111

THURSDAY, DECEMBER 7, 1876

## THE YORKSHIRE LIAS

*The Yorkshire Lias.* By Ralph Tate and J. F. Blake.  
(London: Van Voorst, 1876.)

IT might at first sight seem a piece of presumption in one whose palæontological attainments are of the slenderest, and who knows no more of the Yorkshire Lias than has been picked up during a few days ramble along the coast, to attempt a criticism of a work conspicuous for elaborate palæontological research and rich in descriptive detail of the most minute and local character. But in forming an estimate of the work of a specialist the absence of minute special knowledge is in many cases far from being a disadvantage; the specialist always runs some risk of becoming engrossed with details, of looking upon them as the end and not as a means to something higher, of being "unable to see the wood for the trees," and, as long as this risk exists, there is always a fair prospect that the remarks of an outsider, however inferior he may be in special attainments to the man whose work he is reviewing, may add something in breadth of view, and may suggest questions that have been overlooked in the task of collecting minute particulars. It is with this feeling that we attempt to give an account of the work before us, and to discuss some problems which its perusal has suggested to us; and we make the attempt all the more readily, because the authors have by no means in the multiplicity of their details lost sight of the broad questions which underlie and spring from them.

The opening chapter on the "General Range of Liassic Strata on the Continent and British Isles" would have been better for rather more copious references. The authors quoted may be well known to the mass of professional geologists, but if this book comes, as we feel sure it will, into the hands of workers of a more amateur class, mainly occupied with the geology of their own neighbourhood, but at the same time anxious to understand its relation to that of corresponding districts abroad, many of its readers will certainly be glad of directions where to find the papers of geologists not familiar to the world at large, and whose names they perhaps now meet with for the first time. This indifference to references is a growing and a very serious evil; take, for instance, such a book as Marcou's "Explication de la Carte Géologique de la Terre;" to attempt to give in 200 pages a complete account of the geology of the globe would be a hopeless task, but an outline no longer than this, abundantly furnished with references, would be a work whose value it would be difficult to overestimate; unluckily M. Marcou has fallen into the prevalent carelessness in this respect, and for every reference he has given, ought to have supplied fifty.

Chapter II. gives an account of the literature of the Yorkshire Lias; the abstracts of the various papers and works on the subject are admirable for point and conciseness, and the criticisms fair and just. In Chapter III. the range and general character of the Lias in Yorkshire are clearly sketched out.

The fourth chapter lands us in one of those disputes, unavoidable possibly in the present state of geological nomenclature, which have far too much the look of fight-

ing about mere words to be altogether satisfactory. The point at issue is, where should the line be drawn between the Lias and the Inferior Oolite? In some cases the demarcation between the two formations is both lithologically and palæontologically so sharp as to leave no room for hesitation; but some sections show a group of beds in which fossils that occur in the Upper Lias are found side by side with others generally looked upon as characteristic of the Inferior Oolite. Here, then, was a fine battle-ground for the systematists, and here, accordingly, as in other analogous cases, much good ink and paper has been—shall we dare to say—wasted in discussing whether the problematical strata ought to be called Liassic or Oolitic. Dr. Wright maintains the first view, and the authors of the work before us lean to the second, the question being argued by both disputants on purely palæontological grounds; it turns partly upon the correct naming of certain Ammonites, hard to discriminate from one another, and possibly so closely allied that they ought to be looked upon as varieties rather than distinct species; it involves many points on which there is great difference of opinion, such as whether we ought to look mainly to the Cephalopoda or to the Conchifera in determining the relationship of the group; and after carefully considering what has been said on both sides, it certainly seems that it is one of those cases where the impartial bystander would find it so hard to make up his mind that he would be sorely tempted to resort to the unscientific method of "tossing up" to help him to a decision. Fortunately there is a better way out of the difficulty; we are not tied down, as the manner in which the question has been handled would seem to imply, to a single alternative. It is an easy thing to say that there shall be a Liassic group and an Oolitic group, and that of the rocks about the junction, what won't go into one shall be forced into the other, and by adopting this principle neat tables of strata may be constructed. But if, as the group under consideration proves was the case, there was not a clean sweep of the Liassic forms of life before any Oolitic forms came in, but that to a certain extent the replacement was gradual, then wherever the record of the change in the least degree approaches completeness, beds will occur which contain a mixture of Liassic and Oolitic species, and consequently cannot be placed consistently under either of these heads. It is unfortunate for the symmetry of our classification that it is so, but being so, we must bear the evil as best we may. Perhaps the best way is to let each man *call* the beds in dispute Lias or Oolite as his fancy prompts him, but to be careful to bear in mind that the meaning they carry with them is this—that, when they occur, we have been lucky enough to have preserved a record, which at other spots either never existed or has been destroyed, of the rate at which changes in life that took place between two indistinctly outlined periods of the earth's history were brought about.

It would not, of course, be fair to blame Messrs. Tate and Blake, when they are writing a monograph on the Lias, for explaining what they mean by that term; but it would possibly have been more philosophical if they had looked upon their upper boundary as purely conventional, and noticed the beds above that line as of interest because they show a gradual passage from the life of the period

with which they are specially concerned to the life of the period which followed it.

A dispute of a similar nature arises when we come to the boundary between the Lower and the Middle Lias. The tabulated lists of fossils given by our authors show in the Yorkshire area a marked palæontological break between the zones of *Ammonites oxynotus* and *A. Jamesani*, and a similar break has been observed at a corresponding horizon both elsewhere in England and on the Continent. Here then German and a large number of English geologists draw the line. But a difficulty arises when we attempt to construct maps according to this classification; unfortunately the marked change in life is not accompanied by a corresponding change in the character of the rocks; the beds above and below the palæontological line are lithologically so much alike that it would be impossible to separate them on a map by the ordinary methods of geological surveying. Somewhat higher in the series, however, a change in lithological character, marked and sudden enough to allow of its being traced with considerable accuracy, does occur, and the field geologist, finding that he can separate on his map the rocks above and below this line, naturally draws a boundary here. Hence it arises that the subdivisions drawn on maps, such as those of the Geological Survey, do not coincide with those established from palæontological considerations. And no harm would follow from this if the lithological line always kept the same place in the series; we should merely have to bear in mind that the boundary laid down on the map was adopted out of sheer necessity, because it was the only line that could be traced, that it did not coincide with any great change in life; but that the palæontological break occurred at a certain distance below it. But in the case before us the hard sandstones and ironstones of the Middle Lias are notoriously irregular and uncertain, and if we make the Middle Lias begin where rocks like these—which can be separated on a map from the clays—first make their appearance, we shall place in the Lower Lias at Banbury beds which we call Middle Lias at Frodingham. In such a case, when the map-maker is driven to neglect or set at defiance palæontological boundaries, the right thing would seem to be that he should call his sub-divisions by names different from those used by the palæontologist; on the Survey maps, for instance, it would be better to drop the terms Lower, Middle, and Upper Lias, and speak merely of Lias Clays, Sandstones, and Ironstones, leaving it to the palæontologist to decide to which of the three sub-divisions the strata distinguished on the map ought in each locality to be assigned. It should be added, however, that Mr. Judd has something to say even from a palæontological point of view for the classification of the Geological Survey;<sup>1</sup> though it must be confessed that his words sound somewhat as if he were dutifully trying to make the best case for a line which his official position rather than his own convictions led him to adopt.

For the painstaking zeal with which the authors have in succeeding chapters worked out the palæontology of the different minor sub-divisions, and described the localities where each may be studied, and for their long and elaborate descriptions and figures of the fossils the thanks

of all geologists, and specially of those interested in the district, will be gratefully rendered; and as they have thought it necessary to defend the minute and detailed character of their work, a word may be added on this head. It is somewhat unfortunate that a special term, "zones," has been applied to those lesser sub-divisions, which in common with the majority of palæontologists they have sought to establish. It leads to the notion that a "zone" is something different from a "formation," and to a vague fear that the zone-maker is introducing some new and presumably unsafe method into geological classification. But if, as the evidence seems to show, each zone is characterised not indeed by fossils entirely peculiar to itself, but by certain assemblages of fossils which are not met with in any other zone, then the principle on which zones are established is identically the same with that which determines the larger sub-divisions, and the only difference between a zone and a formation is that the one requires more care and labour to detect and define it than the other. As our authors remark, we are quite in the dark as to the causes that brought about the change from the fauna of one zone to that of the succeeding zone; but just the same remark applies in many cases to the more marked differences between the fauna of successive formations. If, then, the palæontological facts on which zones are based can be securely established, the existence of these minor sub-divisions is a fact which geologists cannot refuse to recognise; but it is just here that the rub occurs. The intolerable complexity and uncertainty of palæontological nomenclature, the utter want of agreement on points of the first importance between many leading palæontologists, the strong tendency which so often exists to a multiplication of species in order to justify existing sub-divisions or even to increase their number, have raised suspicions and distrust in palæontological grouping, unfounded perhaps, but for which palæontologists have only themselves to thank. What can, for instance, be more monstrous than the idea that the time at which it lived ought to be taken into account in the definition of a species? An idea which, according to one of our authors, only a limited number of palæontologists are prepared to repudiate. If you have two creatures exactly alike in every respect, what reason can there be for calling them by different names because one is alive now and the other died ages ago? The idea is closely akin to the old superstition that the volcanic rocks of the earlier periods must have been different from those of the present day, and that if no real difference can be detected between them, they at least ought to be called by different names. Such a notion is now scouted by the most advanced petrologists, and when palæontologists follow in their steps, they may be assured that the objections which some geologists have urged against their smaller and less easily recognised sub-divisions will no longer be heard.

We cannot help thinking that the authors have laid rather too much stress on the littoral character of the Lias in the northern part of the North Riding. They lean to the conclusion that the Lias never extended much further towards the north-west than the points where we now last see it in that direction; in fact one or two of their expressions seem to hint that the Lias of the North Riding was deposited in a basin of its own. This can

<sup>1</sup> "The Geology of Rutland" (Memoirs of the Geological Survey), p. 45.

hardly be admitted; the persistence over large areas of the different palæontological zones of this formation shows that the Liassic sea formed one great life province, and that however it may have been broken up by projecting headlands or insular masses of land, there was free communication between all its parts. That the water was shallower in some places than others is likely enough, and variations in depth would seem to be sufficient to account for the changes which occur in the lithological character of the Lias in North Yorkshire without invoking the neighbourhood of an extensive shore line. A very interesting fact is the decided unconformity between the Lias and the Inferior Oolite east of Easingwold; the upheaval to which it is due was only the forerunner of the still more important movements which a little later on drove back the sea and established estuarine and terrestrial conditions over a large part of the North Riding.

It is not necessary that a scientific work should be a model in point of style, but it is a matter for regret when scientific writers neglect the graces of composition, and it is certainly a blot on the work before us that the writing is occasionally obscure, and that instances of somewhat slipshod English are not uncommon in it.

If we stop here it is not for want of more to say; a book as rich in matter as this would furnish texts for many another lengthy disquisition. We may fairly congratulate the authors on having produced a monograph which will take a high place among standard works on local geology, and may be recommended as a model for writings of a similar kind. We wish every natural geological district in our island was likely to be worked out with the same amount of patient labour and faithful description as Messrs. Tate and Blake have bestowed on the Yorkshire Lias. A. H. G.

OUR BOOK SHELF

*Die Fauna der Clavulina Szabói Schichten.* Von Max. von Hantken. I. Theil: Foraminiferen. Mit 16 Tafeln. (Buda-Pesth, 1875.)

EVERY visitor to the Loan Exhibition of Scientific Apparatus at South Kensington must have noticed in the Geological Department some beautiful series of preparations of Foraminifera and Bryozoa from Hungary. These have been sent by Dr. von Hantken, the Director of the Hungarian Geological Survey, who has greatly distinguished himself by the remarkable skill with which he has studied these minute fossil organisms. One of these series of fossils, which English geologists have now such a valuable opportunity of studying, illustrates the remarkably rich Foraminiferal fauna of the zone of Clavulina Szabó in Eastern Europe, a fauna which is very admirably described in the work before us. This memoir is a reprint of a portion of the fourth volume of the "Mittheilungen aus dem Jahrbuche der kön. ungar. geologischen Anstalt," which is published in both the Hungarian and German languages.

The Clavulina Szabó Schichten are a series of clays, marls, and marly limestones, sometimes glauconitic, which are situated at the junction of the Eocene and Oligocene formations, and appear to have a wide distribution in Western Hungary. These strata are very remarkable for the wonderful richness of their fauna, especially in Foraminifera, Bryozoa, Echinoderms, and Mollusca, while in certain portions of the formation great numbers of fish-remains have also been found. No less than 213 species of Foraminifera have been described by Dr. von Hantken as occurring in these beds, and their distribution in the Eocene and Neocene strata of Eastern Europe, as

well as in the strata which most nearly correspond in geological age with the zone of Clavulina Szabó in Germany and Italy respectively, are shown by the author in a very useful table. The lithographic plates with which this monograph is illustrated are beautifully executed, and reflect the highest credit on the present condition of the art of book-illustration in Hungary. Although the dimensions of each of the forms described is given with great exactness in the definition of the species, we think it is unfortunate that the extent to which each figure is magnified is not also indicated either on the plates themselves or in the descriptions which accompany them. J. W. J.

*Elements of Algebra for Middle-Class Schools and Training Colleges.* By Edward Atkins, B.Sc. (Collins's School Series, 1876.)

THIS is a handy book, covering the ground usually occupied by similar treatises on the subject. It is a fairly independent work, keeping near the beaten track as regards results arrived at, but giving these results in many cases by new modes of proof. The chief additional features of interest are in some articles on "Imaginary Quantities," "Properties of Numbers," and "Determinants." We do not like the use of the expression, "It is easily found," and so on, in a few passages, and we must point out that there are a great many mistakes, not merely typographical ones. These are faults which can easily be rectified in a second edition. Care also should be taken to correct the numerous wrong references.

LETTERS TO THE EDITOR

[The Editor does not hold himself responsible for opinions expressed by his correspondents. Neither can he undertake to return, or to correspond with the writers of, rejected manuscripts. No notice is taken of anonymous communications.]

Carl Jelinek

ALLOW me to correct a little inadvertency in the necrology of Carl Jelinek (NATURE, vol. xv. p. 85). In line 8 from commencement "Prague" should be read instead of "Vienna," as the former and not the latter observatory was then under the direction of Kreil. Jelinek passed four years (1843-1847) as assistant in the Vienna observatory, then under my direction, and published in that period a valuable memoir on hygrometrical observations made at Vienna in the years 1829-1845, besides several astronomical observations and computations in the *Astronomische Nachrichten*, and in the *Annals of the Vienna observatory*. CH. DE LITTROW

Vienna, November 29

Ancient Solar Eclipses

IN NATURE, vol. xv. p. 65, is given the result of calculation of the solar eclipse of June 14, B.C. 763.

As soon as notice of the probability of this eclipse was given by Sir Henry Rawlinson (in May 1867), I asked the assistance of Mr. Hind for its computation. Mr. Hind most kindly acceded at once to my request, and sent to me on June 19, 1867, the following results, which he permits me now to offer to NATURE. They were transmitted to Sir Henry Rawlinson on June 20, 1867, and to Mr. George Smith on October 17, 1867.

SOLAR ECLIPSE, - 762, JUNE 14-15.

Path of Totality, according to the Lunar Tables of Hansen and the Solar Tables of Le Verrier.

Greenwich Mean Solar Time, B.C. 763.	Northern Limit.		Central Line.		Southern Limit.	
	Long.	Lat.	Long.	Lat.	Long.	Lat.
June 14, 18 54	35 23	37 52	30 3	37 7	36 44	36 20
19 0	38 29	38 53	39 6	38 4	39 43	37 14
19 6	41 33	39 46	42 7	38 54	42 39	38 3
19 12	44 35	40 31	45 4	39 28	45 34	38 46
19 18	47 34	41 9	47 59	40 14	48 23	39 21
19 24	50 32	41 40	50 52	40 45	51 12	39 49



The path of the shadow defined by these numbers differs sensibly from that given in *NATURE*, vol. xv. p. 65. It passes to the north of Nimrud instead of the south.

With the permission of Mr. Hind, I also transmit the following list of solar eclipses, computed by him, of which the results are preserved in the manuscripts of the Royal Observatory:—

- 885, July 24 ...	- 533, Aug. 31 ...	A.D. 671, Dec. 6
- 884, July 13 ...	- 480, April 18 ...	647, Oct. 12
- 769, May 4-5 ...	- 479, Oct. 1-2 ...	840, May 5
- 762, June 14 ...	- 477, Feb. 16-17 ...	1133, Aug. 1
(above) ...	- 509, Aug. 14 ...	1140, March 20
- 688, Jan. 10 ...	- 189, March 13 ...	1173, June 11
- 609, Sept. 29 ...	- 187, July 16 ...	1241, Oct. 6
- 602, May 17 ...	- 103, July 18 ...	1433, June 17
- 584, May 28 ...	- 50, March 6 ...	1521, April 6-7
- 556, May 19 ...	A.D. 29, Nov. 23 ...	1567, April 8
- 548, June 18 ...	113, May 31 ...	1598, March 6
- 546, Oct. 22 ...	237, April 12 ...	1652, April 7
- 534, March 17 ...	418, July 12 ...	

G. B. AIRY

Royal Observatory, Greenwich, December 5

#### Negretti's Reversible Thermometer and the Arctic Expedition

CAPT. NARES presents his compliments to the editor of *NATURE*, and requests him to correct a mistake which Capt. Nares inadvertently made in his official report to the Admiralty concerning the late Arctic expedition, and which has been reprinted in *NATURE*.

In obtaining some deep-sea temperatures, which proved the existence of a sub-stratum of water warmer than that at the surface, the instruments used were the reversible thermometers of Negretti and Zambra, not Casella's. The Casella thermometer was used on other occasions, but not at the time referred to.

H. M. S. *Alert*, Portsmouth, November 30

#### The Arctic Expedition

Two or three considerations have led me to believe that possibly the recent Arctic Expedition has not been so fortunate as might have been wished, and that the same amount of foresight, courage, and energy, expended on a similar expedition another year might be attended with much more satisfactory results.

The considerations referred to are these:—

Fifty years ago Sir Edward Parry traversed a distance of some hundreds of miles in sledges upon what he at first supposed to be the main pack; but on finding that as fast as he travelled northwards he was drifting to the south, he concluded what he had mistaken for the main pack, was after all only a loose floe of immense extent.

Now in 1872, on the return of the American expedition, we were all given to understand that an open Polar Sea existed where instead is now found a sea of ancient ice. All testimony concurred in pointing to this open sea. The climate was warmer than further south; birds were seen flying north; a creeping herbage flourished, and bright flowers were not absent. Musk oxen, rabbits, and lemmings also abounded. Now these *Polaris* explorers were neither mendacious nor stupid; and it seems to me that it is rather premature to set down their inference from all they observed as a mistake.

Now, sir, my theory, true or false, new or old, is this:—This Palæocrycic Sea is really a vast floating island of ice; say 500 miles in diameter. Just like the ice in a pail or on a pond, it melts in the hot weather at the edges, and then, disengaged from the land, it floats hither or thither, according to the direction of the prevalent winds or currents. If this theory be correct, it accounts for Parry's disappointing journey, for the inferences based on the *Polaris* observations, and for the otherwise unaccountable fact that the ice encountered by the recent explorers is undoubtedly ancient. The fact that the vast floe showed no signs of drifting away last summer only shows that the wind was unfavourable, or that this northernmost Greenland coast, when once the ice is stranded, does not easily relinquish its grasp. Possibly if a *Hecla* had attempted in 1876 what was impracticable in 1827, or if an *Alert* had tried in 1827 what has just proved a failure, both enterprises would have succeeded.

Next time two opposite routes must be undertaken simultaneously, of which one will fail and the other succeed.

WORDSWORTH DOWNINGTHORPE  
17, Porchester Terrace, W.

#### The Age of the Rocks of Charnwood Forest

IN reference to the letters which have appeared in *NATURE* (vol. xv. p. 97) allow me to say, in the first place, that I neither attacked, nor intended to attack, any discredit to Mr. Woodward's very useful manual for the statements it contains in reference to the age of the Charnwood Forest Rocks. On the other hand, I am gratified to find that so competent an observer as the Rev. T. G. Bonney concurs with me in the view "that there is not a particle of evidence for their Laurentian age." This was the special point of my letter; and I fail to see that Prof. Green's hypothetical inferences from certain sections at Markfield (of which he fears that he has kept no record) are of much value in the question. Prof. Green, however, admits that the great mass of these rocks give no evidence of Laurentian age.

As regards what may be the respective limits of "Cambrian" and "Silurian" rocks that is another question. I am quite aware that Sedgwick claimed formations as "Cambrian" which are not so recognised by the Geological Survey, nor by the majority of authors, continental as well as British; for example, M. Barrande. To which of the series of formations belonging to the Cambrian system of Sedgwick the forest rocks are to be referred I am not prepared to say; but I think it must be allowed that the negative evidence founded on the absence of fossils ought to have some weight in favour of the view that they are referable to the horizon of the "Cambrians" of the Geological Survey rather than to that of the Llandeilo or Caradoc beds.

Mr. Bonney's comparison of the forest rocks with those of the volcanic series of the Lake District is very suggestive; nor is the correspondence of the strike of the beds in both districts without its weight, where every circumstance ought to be taken into consideration in question of such uncertainty. It would also be very desirable if some general understanding could be arrived at regarding the respective limits of the Cambrian and Silurian systems. There are scarcely two authors who adopt the same view on this subject. Theoretically it may be a matter of small consequence; but practically it gives rise to confusion amongst geologists and amongst students of geology. As this is the age of "conferences" why should not a conference of Palæozoic geologists meet and lay down a frontier line for the two kingdoms, which would last, perhaps, for a generation, and until the "instinct of nationality" crops up and brings on another conflict between the inhabitants of Cambria and Siluria, and their allies respectively?

EDWARD HULL

Geological Survey Office, Dublin, December 4

#### "Towering" of Grouse, Partridges, &c.

MOST of your readers doubtless know what is meant by the towering of game-birds; but, for the sake of those who do not, I will begin by describing the facts. When a partridge, for instance, is hit while on the wing by a few pellets of shot—perhaps only by one or two—the flight may continue for a variable distance; but, if the bird is a "towerer," a slight irregularity soon begins to show itself, after which the flight rapidly becomes more and more laboured, till eventually the bird ceases its onward motion altogether. The direction of the flight now changes from the horizontal to the perpendicular, and with a rapid fluttering sort of action the bird rises to a variable height, when all motion suddenly ceases, the animal falls like a stone, and the sportsman then knows that when he finds his partridge it will be lying dead on the exact spot where he "marked it down."

Before proceeding to state the cause of these curious movements, I should like to draw more prominent attention to the facts, first, that the time after receiving the wound during which horizontal flight continues is variable; second, that the limits of variation are tolerably definite, a bird never towering until it has flown some distance after being shot, and never flying any very great distance before towering; and third, that the height to which the bird rises is also variable, this height being sometimes only 1 or 2 feet, and at other times 40 or 50.

Now I suppose there is not a sportsman in the country who has not witnessed these phenomena scores and scores of times, and I dare say there is scarcely one of that numerous body who, if asked to assign the cause of these phenomena, would hesitate for a moment in his reply. From the time he first saw a bird tower, he has probably satisfied himself that the current hypothesis is the only one that can explain the curious facts; and if his interrogator should venture to doubt that cerebral injury is this cause, he would probably point to a drop of blood in the beak as a final answer to such scepticism. This drop of blood has doubtless always seemed to him such a complete verification of the current hypothesis, that he has probably never waited to ask himself the following questions:—1. Why is towering so common? The head of a partridge or grouse is a small object, and therefore not likely to be often hit. Moreover, common sense may show that if towering is due to cerebral injury, such injury must be of a very local and definite character as regards the brain: some particular part of that organ must be injured to the exclusion of all other parts, or else the effect would be instant death. This consideration would lead us to expect that towering, if it is due to cerebral injury, should be of exceedingly rare occurrence. 2. Why does a bird always fly some considerable distance before towering? If the action is due to cerebral injury, we should expect the former to ensue immediately upon the infliction of the latter. 3. Why is the distance which a bird flies before towering so variable? 4. Why is the height to which it does tower so variable? 5. Why is it that birds tower most frequently when shot from behind? 6. Why is it that we never see the hole in the skull through which the pellet has passed?

In view of these difficulties besetting the ordinary hypothesis, and in the hope of ascertaining the exact seat of cerebral injury if this hypothesis were the true one, I have last year and this year dissected a number of partridges which I had observed to tower, and in every case I found the cause of death to be the same, viz., pulmonary hæmorrhage. In all my specimens the lungs were gorged with extravasated blood. It thus becomes impossible to doubt that we have here the true cause of towering; and, as is always the case with true causes, examination will show that it is sufficient to explain all the effects. Towering is common, because the lungs expose a large area to receive the shot, and an area which is especially liable to be crossed by a single pellet from a bad marksman when, as is most usual, the bird is shot from behind. The bird always flies a considerable distance after being hit, because it takes time for the blood to pour into the spongy texture of the lungs from the open ends of the severed blood-vessels. The distance flown is variable, because it depends on the size and number of the severed blood-vessels—i.e., the rapidity of the bleeding—which of course is also variable. The height to which the bird towers is variable, because depending on the same cause. The drop of blood in the beak comes from the bleeding lungs through the wind-pipe—the latter organ in most of my dissections having been found full of clotted blood. Lastly, we do not find any indications, either externally or internally, of cerebral injury, for the simple reason that no such injury has taken place.

Any one who is not a physiologist may here ask, Why does pulmonary hæmorrhage give rise to such very peculiar movements as those that occur in towering? The answer must certainly be, that in these towering movements—which, be it remembered, only take place immediately before death—we have to do with the characteristically convulsive movements which in all animals mark the last stages of asphyxia. That in birds these movements should show themselves mainly in the wings, might, I think, be reasonably expected, seeing that the pectorals are the principal muscles in the body—and all sportsmen are aware how the particular birds in question exhibit violent fluttering motions of their wings when dying from any violent cause, just as rabbits, under similar circumstances, exhibit violent galloping motions of their principal muscle-masses in the hind legs. But why the convulsive movements of asphyxia should show themselves in these birds in the form of upward flight, is a question which I cannot answer. It seems, however, to be a question of some interest to the physiologist, and if worked out might possibly tend to elucidate that obscure subject, the mechanism of flight. Of course to investigate the phenomena of towering, asphyxia of birds would require to be produced in the laboratory; and here I must leave the matter in other hands, for although I have a licence to suffocate as many birds as I can in the pursuit of sport, I have no licence to suffocate a single bird in the pursuit of science.

And, in conclusion, may I suggest that those sportsmen who annually conduct their experiments on asphyxia by the thousand, should endeavour to glean from them one result of some little value to science? It would be of interest to know what birds tower and what birds do not. So far as my own observation extends, the peculiarity in question seems to be confined to members of the grouse genus, nearly all the endemic species of which I have observed to tower. But, excepting those species, I have never known any other bird to do so. By publishing this notice in your columns, therefore, I hope to obtain information from any of your readers who may have observed the well-known phenomena in birds of other genera. GEORGE J. ROMANES

### Squirrels

ON the lawn before the window near which I am writing is erected a tripod of three lofty poles, at the summit of which is suspended a basket containing nuts and walnuts. The squirrels, of which there are many in the shrubberies and adjoining plantations, ascend these poles, extract a nut from the basket, and quickly make their way down and across the lawn, in various parts of which they bury their nuts, scratching a hole in the green turf, putting in a nut, filling up the hole, and, lastly, with much energy, patting the loose materials with their feet till the filling-up is made firm and solid. This morning for a considerable time only one squirrel was at work, giving me a better opportunity of observing the mode of operation. His journeys were made in all directions, and varied from 5 feet to nearly 100 yards, never, so far as I could observe, going twice to the same place or even nearly so. The squirrels, I am told, forget the spots where they hide the nuts, and in the following spring the lawn, which is very spacious, is dotted with the young plants of nuts and walnuts. As the colours of flowers attracting bees and moths promote fertilisation, so the racy flavour of a nut, irresistible to a squirrel, contributes to the distribution of its kind.

Turvey Abbey, November

HENRY H. HIGGINS

### Mr. Harris's Challenge to Mathematicians

IN an advertisement in *NATURE* (vol. xv., p. xxxviii.) Mr. Harris (Kuklos) challenges mathematicians "to examine and disprove if they can" his published demonstration of the value of  $\pi$ . Presumably he reads this publication; if so, we would direct his attention to an article on "Cyclometers and some other Paradoxers" in vol. xii., p. 560, vol. xiii., p. 28. The part which is concerned with his approximation will be found on p. 29. Reasoning, however, which we venture to think will satisfy mathematicians, may not, we fear, convince Mr. Harris.

THE WRITER OF THE ARTICLE

December 4

### A ZOOLOGICAL STATION ON THE NORTH SEA

REFERENCE was made in *NATURE* (vol. xiv. p. 535) to the resolutions passed at the recent meeting of the Association of German Naturalists and Physicians at Hamburg, as to the establishment of zoologico-botanical stations on the German coast. The distinguished names of those appointed to draw up a memorandum, which is to be presented to the Imperial Chancellor, the Bundesrath, and the Governments of the several States of the Empire, will no doubt be of the greatest service in securing success to a scheme so universally approved of by all students of biology.

The following is a brief sketch of similar endeavours made in Holland a year ago and of the results arrived at during the summer of 1876:—The Netherlands Zoological Association, at a meeting held in November, 1875, recognised the necessity of founding an establishment on the Dutch coast, where anatomical and microscopical investigations of the fauna and flora of the North Sea might be carried on at leisure, and which could at the same time be made serviceable for physical, chemical, and meteorological

logical observations on this part of the German Ocean. A committee, consisting of Prof. Hoffmann, Drs. Hoek and Hubrecht was appointed to take the necessary steps towards the realisation of this scheme, and to provide temporary accommodation during the summer months of 1876, where members of the Association might engage in these pursuits. In February, 1876, the Committee was obliged to report that no suitable accommodation was to be found in those localities on the Dutch coast, where the erection of a zoological station might prove a success, and that the funds of the Association would not suffice to carry out the scheme on the scale to which an institution like this ought to aim at from the beginning. The committee proposed to raise the necessary funds by a public subscription as well as by the issue of shares of 10 guilders each, paying no interest, but terminating within a fixed number of years. The Association might thus obtain a building of its own, which, if it were made of wood, might be transportable from one locality on the coast to another

according to season and varying abundance of the material for study. This proposal was agreed to, and within a few weeks about 400*l.* were raised, a sum more than sufficient to commence with.

Accordingly a wooden shed similar to those which had served the Dutch astronomical party for the observation of the transit of Venus in Réunion was constructed. It has four windows on each side with corresponding working tables and a small room adjoining, where the vessels containing marine animals may be kept in darkness, and where an apparatus for oxygenising the sea-water is to be kept in constant working order. This embryo zoological station, more resembling a block-house in the back woods than Dohrn's well-known institution, is, however, fitted out with all the requisites for histological and microscopical research prescribed by the different methods of investigation of the present day. Next to the numerous chemical desiderata a store of glass and crockeryware is kept in readiness, a stock of standard works and other

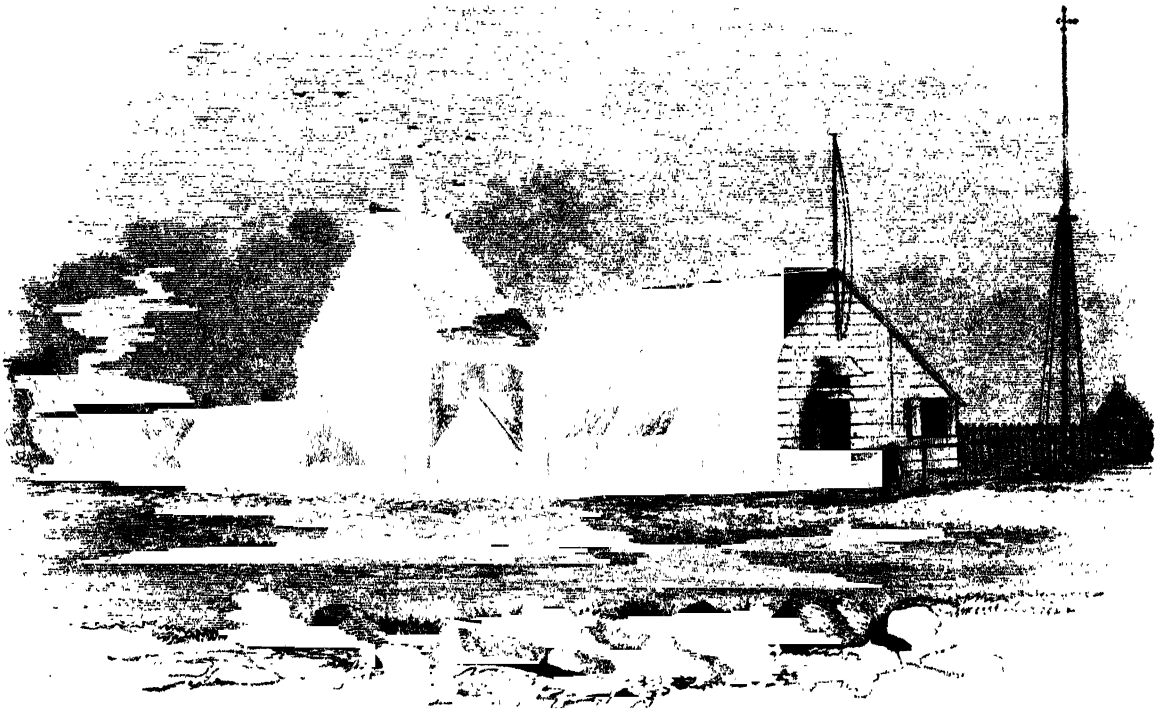

ical Station, 1876.

books which may in any way prove useful is selected from the library of the Association; in short, everything provided for, microscopes and steel instruments only excepted. A set of dredges, towing nets, cross-bars with hempen swabs for scraping the bottom (Marion, Lacaze Duthiers), pelagic nets, &c., complete the inventory, and have to serve for the daily renewal of those marine forms which would be the objects of investigation in the station itself.

In the first week of July all this was transported to Helder, the northern seaport opposite to the Island of Texel, and erected on the top of the great dyke which there protects the Low Countries behind from inroads of the sea. Regular dredging parties were organised, the work being carried on partly in sailing vessels hired for the occasion, partly by means of a small steamer belonging to the Navy, which the Minister of the Marine placed at the disposal of the Zoological Association. The work was carried on for eight weeks; towards the end of

August, when continual bad weather set in, the station was closed, taken down, and transported back to Leyden, in order to be erected again on another point of the coast next summer.

During those two months ten members of the Association availed themselves of the opportunity of studying the marine fauna of that part of the Dutch coast, and in many branches interesting results have been arrived at which will in time be published in the Annual Reports of the Association. The shifting sands, which everywhere form the bottom round the coasts of Holland as well as the total absence of rocks and cliffs may explain the deficiency of many sessile forms which form so conspicuous a part of the fauna of the French and British coasts. Crustaceans and Annelids were numerically, perhaps, the best represented; next came the sponges, the Polyzoa, and different species of Molluscs and Echinoderms. Not met with, neither were Holothurians.

they were represented by the composite Botryllidæ, which could be had in immense numbers in some of the shallower parts at the entrance of the Zuyder Zee, mostly attached to blades of the Zostera. The stones employed in the construction of the great dyke, which are partly lying loose, were of importance, as they usually covered over the haunts of numerous Crustaceans, Nemerteans, &c. A no less rich harvest was got from the driftwood now and then met with, and from the wooden palings serving in the construction of the wharfs, &c., in the harbour, which were submerged at high tide.

Altogether this first summer of the Dutch Zoological Station gave ample proof of its practicability. It would perhaps be a good idea to act conjointly in future with the German men of science, and to add a third permanent station to those proposed in the German Committee's Report (Kiel and Heligoland), say at Flushing. If, then, one other station were to be erected on the English or Scotch coast (St. Andrew's Bay?), a conjoint attack could be made on the mysteries still hidden in that part of the ocean which is inclosed by our neighbouring coasts. The healthy competition which would arise out of this division of the work to be done, can only be favourable to the common end—an accurate knowledge of the natural history of our own seas, and a constant opportunity of studying their animal and vegetable productions in the fresh state.

**SENSITIVE FLAME APPARATUS FOR ORDINARY GAS PRESSURE, AND SOME OBSERVATIONS THEREON**

A GLASS or metallic tube, about 5 inches long, and  $\frac{1}{4}$  in diameter, is closed at one end with a perforated cork, through this cork slides a piece of  $\frac{1}{8}$  inch tubing, about 6 inches long. One end of this is either drawn out to a jet, or closed in the blow-pipe flame to reduce its diameter to about  $\frac{1}{16}$  inch, and the other end is connected to a gas supply. (Fig. 1.)

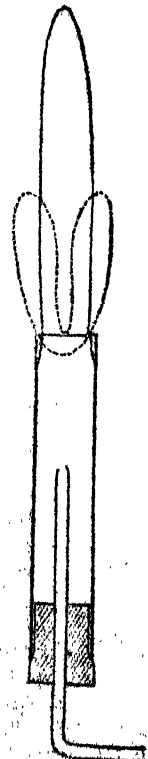

The outer tube is held in a suitable support, and the inner tube is pushed through the cork till it nearly reaches the mouth of the outer one, and a light then applied. It now gives a long steady flame.

*Experiment I.*—Lower the inner tube till the flame is on the point of roaring. It will now be found very sensitive to noise. Snapping the fingers at a distance of eight or ten yards will cause it to contract fully  $\frac{1}{4}$  of its height. The most suitable flame for this is about 6 inches high.

*Experiment II.*—Adjust the gas to give a flame of about  $4\frac{1}{2}$  inches high, and gradually raise the inner tube. A point will be reached at which the flame becomes sensitive, not to noise, but note; and it will be found to respond to a certain note by dividing into two portions, and while this note is produced it will continue divided. It is difficult to keep the exact note by whistling with the mouth, and therefore a glass whistle with paper slider should be used, or, better still, a singing tube with adjustment.

*Experiment III.*—Arrange two singing tubes to give the responding note. The flame divides. Now make one tube a little sharper than the other, so as to beat slowly. The apex of the flame alternately recede and coalesce.

*Experiment IV.*—Using the whistle; blow it so hard

as to produce higher octaves of the responding note. The flame will be unaffected, as though in perfect silence.

The dimensions of the instrument are open to great variation, and also the size of the flame. For lecture work, a flame  $1\frac{1}{2}$  or 2 feet would be more suitable, though less sensitive, and neither dividing nor shortening so perfectly as the sizes given above. It will act effectively with any pressure of gas, from  $\frac{1}{16}$  inch (of water) upwards, and the sliding jet makes it equally sensitive with a large or small gas supply.

**Observations on the Escape of Gas from Contracted Openings, and on a Differential Pressure Indicator.**

Glass tubes of about  $\frac{1}{4}$  in. bore are joined as shown in Fig. 2. At D the tube is slightly bent so as to retain a little drop of water. The gas enters at C, and then divides into two channels, one towards B, the other towards A.

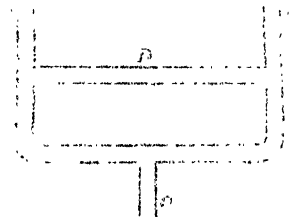

FIG. 2.

If one of the exits be contracted, say B, then the water moves towards A. Certain precautions have to be observed, the conditional arrangements of which need not be mentioned here.

*Experiment I.*—Connect to each, A and B, a tapering jet, and C with the gas supply. Get the water stationary. Now light, say, B, the water will move towards A, showing that the exit of the gas is retarded by being ignited.

This is rather a remarkable result, seeing that the gas is hotter, and therefore more mobile, and also that the heat must enlarge the aperture. Now light A, and the water will return to zero.

*Experiment II.*—Connect B with a sensitive flame apparatus, A remaining as before, light and adjust to zero. Now sound the responding note and the water moves towards A, showing that the outflow of gas is retarded by a certain note. Now adjust the sensitive flame for noise, and rapidly snap the fingers or stamp the foot, and the water will still move towards A.

*Experiment III.*—Arrange as in II., then extinguish the sensitive flame and readjust to zero. Produce the responding note, and the same movement of the water will be observed. This shows that an issuing jet is affected in the same manner by a sound, whether ignited or otherwise.

*Experiment IV.*—Fix the sensitive flame apparatus adjusted for note under a large jar open at both ends. A large stoppered gas jar answers very well. Fix three balls of spongy platinum, a, b, and c, upon a piece of thin platinum wire so that the point of the quiescent flame just reaches b, and the points of the responding flame reach a and c respectively. Now extinguish the flame without turning off the gas. The issuing gas will cause the ignition of b. Now sound the responding note, and b will cool, and a and c will be ignited. This confirms the previous observations, and forms a rather pretty lecture experiment. The object of the gas jar is merely to protect from air currents.

R. H. RIDOUT

## ON THE CONDITIONS OF THE ANTARCTIC

## II.

ALTHOUGH no land *débris* of any kind was observed by us on the icebergs, there cannot be the slightest doubt that such is carried by them all over the region and distributed on the bottom. The samples brought up by the sounding instrument consist almost entirely of comminuted clays and sands, and the dredge always contained in considerable quantity, about the meridian of  $80^{\circ}$  E., chiefly basaltic pebbles, and, further to the eastward, pebbles and larger fragments of metamorphic rocks, granite, gneiss, mica-slate, hornblende-slate, clay-slate, and chlorite-slate.

While the evidence may be said to be conclusive that these icebergs have their origin on land, it seems to me that the presumption is greatly in favour of the land at their breeding-place having been comparatively low and flat, and bordered for a considerable distance by shoal water. Although the white ice which forms the exposed portion of the flat-topped southern icebergs is very hard, its specific weight is considerably below that of absolutely compact ice. Allowing for this difference, and supposing that one-seventh part of the ice is raised above the water, supposing also that the berg is symmetrical in form, which, from its appearance and probable mode of origin is likely to be the case; before it has been subjected to the action of the sea, the submerged portion would be 1,200 feet in depth, the berg would float in water 200 fathoms deep, and the average thickness of the land ice-cap would be 1,400 feet. From the comparatively small number of icebergs at the point where we crossed the Antarctic circle, and so far as we could judge from our own observations and the previous observations of others, for a considerable distance to the west of the meridian of  $80^{\circ}$  E., we were led to believe that the place of their formation, the land and the belt of shallow water girding it, was at a very considerable distance from us.

Although in the present state of our knowledge it would be rash to form any very definite opinion as to the conditions of the region included within the parallel of  $70^{\circ}$  S., still there are some indications which have a certain weight. We have no evidence that this space which includes an area of about 4,500,000 square miles, nearly double that of Australia, is continuous land. The presumption would seem rather to be that it is, at all events, greatly broken up, a large portion of it probably consisting of groups of low islands united and combined by an extension of the ice-sheet. One thing we know, that the precipitation throughout the area is very great, and that it is always in the form of snow, the thermometer never rising, even in the height of summer, above the zero of the centigrade.

Various patches of Antarctic land are now known with certainty, most of them between the parallels of  $65^{\circ}$  and  $70^{\circ}$  S.; most of these are comparatively low, their height, including the thickness of their ice-covering, rarely exceeding 2,000 to 3,000 feet. The exceptions to this rule are Ross's magnificent volcanic chain, stretching from Balleny Island to a latitude of  $78^{\circ}$  S., and rising to a height of 15,000 feet; and a group of land between  $55^{\circ}$  and  $95^{\circ}$  west longitude, including Peter the Great Island and Alexander Land, discovered by Bellingshausen in 1821; Graham Land and Adelaide Island, by Biscoe, in 1833; and Louis Philippe Land, by D'Urville, in 1838.

The remaining Antarctic land, including Adélie Land,

discovered independently by Dumont D'Urville, and Lieut. Wilkes, in 1840, in long.  $140^{\circ} 2' 30''$ , lat.  $66^{\circ} 45' S$ ; Claire Land, discovered by the same navigators about  $3^{\circ}$  farther to the westward; Sabrina Land, discovered by Balleny, in 1839; and Kemp Land and Enderby Land, discovered by Biscoe, in 1833, nowhere rise to any great height. If we were justified in adding the "strong appearances of land" reported by Lieut. Wilkes, which would virtually connect Ringgold's Knoll not far from the Balleny Islands, with a point in long.  $106^{\circ} 18' 42''$  E., lat.  $65^{\circ} 59' 40''$  S., by a continuous coast-line of moderate height, the extent of land of this character would be considerably increased.

The geological structure of the Antarctic Land is almost unknown. South Victoria is actively volcanic and consists doubtless of the ordinary volcanic products. D'Urville's party landed on Adélie Land and found rocks of gneiss. Wilkes reports having landed on an iceberg, long.  $106^{\circ} 18' 42''$ , and finding "imbedded in it in places boulders, stones, gravel, sand, and mud or clay. The larger specimens were of red sandstone and basalt." At the same place Lieut. Ringgold found that "the icebergs near at the time presented signs of having been detached from land, being discoloured by sand and mud." From one iceberg he procured several pieces of granite and of red clay which had been frozen in. Beyond these obser-



FIG. 3.—February 25, 1874. Lat.  $63^{\circ} 49' S$ , Long.  $94^{\circ} 51' E$ .

ations, and our own on the nature of the pebbles brought up by the dredge, we have no information.

That the area within the parallel of  $70^{\circ}$  S. is continuously solid, that is to say, that it is either continuous land or dismembered land fused into the continental form by a continuous ice-sheet, I think there can be little doubt. The local cases of abnormal distribution of temperature which produce such remarkable conditions of climate even within the North Polar Sea exist in the southern hemisphere only to a very slight degree; and we know by the absence of any well-defined local Antarctic return-currents comparable with the Labrador current, or the current round the south of Spitzbergen, that the function of such currents as the Gulf Stream in ameliorating the northern climate, and breaking up the ice, and producing a circulation even in the highest northern latitudes, is not in any way represented in the south.

In favour of the view that the area in question is broken up, and not continuous land, two considerations appear to me to be very suggestive. If we look at an ice-chart we find that the sea is comparatively free from icebergs, and that the deepest notches occur in the "Antarctic continent" at three points, each a little to the eastward of south of the great land-masses, and I have little doubt that the explanation of this fact lately suggested by Dr. Neumayer is the correct one. The great equatorial current impinging upon the eastern coasts of the continents bifurcates upon

<sup>1</sup> The substance of a lecture by Sir C. Wyville Thomson, F.R.S., delivered at the City Hall, Glasgow, on November 23, under the arrangements of the Glasgow Science Lecture Association. Continued from p. 104.

each, and both branches acquiring a slight but decided easterly set by their excess of initial velocity, pass northwards and southwards directed for a time by the land coasts. But the fate of the southern is very different from that of the northern branches. Instead of accumulating and "banking down" in the confined gulfs, the Atlantic, the Pacific, and the Indian Oceans, they at once pass into the waste of the "water hemisphere," and are almost merged in the great drift current which sweeps round the world occupying a belt from 600 to 1,000 miles broad in the southern sea. But while the greater portions of the Brazilian current, the East Australian current, and the southern branch of the Agulhas current are thus merged they are not entirely lost; for at their points of junction with the drift current of the westerlies the whole belt of warm water is slightly deflected to the southward, and it is opposite these points of junction that we have the comparatively open sea and the penetrable notches in the southern pack.

Thus Ross, in 1841 and 1842, after forcing his way through the moving pack, which he found sufficiently open to allow of his doing so, passed between the meridians of  $170^{\circ}$  E., and  $170^{\circ}$  W., to the latitude of  $78^{\circ} 11'$  S. Weddell in 1823, and Ross in 1843, reached the parallels of  $74^{\circ} 14'$  and  $71^{\circ} 30'$  S. respectively, between the meridians of  $15^{\circ}$  and  $30^{\circ}$  W. The case of the Brazilian current is, however, a little more complicated than that of the others, for there is high and extensive land between the meridians of  $55^{\circ}$  and  $65^{\circ}$  W., in  $65^{\circ}$  south latitude, and the warm current already led far to the southward by the south-American coast appears to bifurcate upon Graham Land, and to produce another bight, in  $90^{\circ}$  west longitude, a little to the west of the southern point of the South American Continent. In this bight, Cook, in 1771, and Bellingshausen in 1821, pushed nearly to the 70th parallel of south latitude.

The opening caused by the deflection of the southern branch of the Agulhas current towards Kerguelen and the Heard Islands, has not yet been fully explored, but what has been already done in that direction seems to be in striking confirmation of this view. We had indeed arrived independently at the same conclusion before reading Dr. Neumayer's paper. At the point where we crossed the Antarctic Circle (Long.  $78^{\circ} 0'$  E.), and for some distance to the westward there were few icebergs, and the sea was almost clear to the south-west. It was Capt. Nares' opinion that had it been considered desirable and had the attempt been made earlier in the season, it would have been easy for us to have pushed southwards in that direction—how far we had no means of ascertaining—but the pack was moving about round us, and for the reasons already given we believed the barrier to be at a considerable distance.

But we not only observed the effect of the influx of warmer water; we were able to detect its presence by the thermometer. Referring to the results of a serial temperature-sounding of February 14, with a surface-temperature of  $-1^{\circ} 2$  C., between 300 and 400 fathoms there is a band rising to more than half a degree above the freezing-point. That this warm layer is coming from the north there is ample proof. We traced its continuity with a band at the same depth gradually increasing in warmth, to the northward; and it is clear that its heat can be derived from no other source, and that it must be continually receiving new supplies, for it is overlaid by a band of colder water tending to mix with it by convection.

It is of course possible that the three warm currents may, by coincidence, be directed towards three notches already existing in a continental mass of land; but such a coincidence would be remarkable, and there is certainly a suggestion of the alternative, that the "continent" may consist to so great an extent of ice as to be liable to have its outline affected by warm currents.

The second consideration is that during summer, the

only time when these regions have been as yet visited, the greater part of the outline of the area representing the Antarctic continent has been found to consist of moving ice-pack. The prevailing winds within the Antarctic Circle are from the south-east, and as a rule the pack and the icebergs are moving to the westward, and fanning out from a centre. Almost all the navigators who have passed the belt of pack have received the impression that there was open water within, that, in fact, by that time, late in the summer, the pack of the year had been drifted a considerable distance from its nucleus—the land or the continuous ice-sheet. If this be so it would at all events indicate that the "Antarctic continent" does not extend nearly so far from the Pole as it has been supposed to do.

I conceive then that the upper part of one of these tabular icebergs, including by far the greater part of its bulk and culminating in the portion exposed above the surface of the sea, was formed by the piling up of successive layers of snow during the period, amounting perhaps to centuries, during which the ice-cap was slowly forcing itself over the low land and out to sea, over a long extent of gentle slope, until it reached a depth considerably beyond 200 fathoms. The lower specific weight of the ice then caused an upward strain which at length overcame the cohesion of the mass, and portions were rent off and floated away. If this be the true history of the formation of these icebergs, the absence of all land debris on the portion exposed above the surface of the sea is readily understood. If any such exist it must be confined to the lower part of the berg, to that part which has moved upon the floor of the ice-sheet.

The icebergs, when they are first dispersed, float in from 200 to 250 fathoms; when, therefore, they have been drifted to latitudes of  $65^{\circ}$  or  $64^{\circ}$  S., the bottom of the berg just reaches the layer at which the temperature of the water is distinctly rising, and is rapidly melted, and the mud and pebbles with which it is more or less charged are precipitated. That this precipitation takes place all over the area where the icebergs are breaking up, constantly and to a considerable extent, is evident from the fact that the matter brought up by the sounding-instrument and the dredge is almost entirely composed of such deposits from ice; for diatoms, *Globigerina*, and radiolarians are present on the surface in large numbers, and unless the deposit from the ice were abundant, it would soon be covered and masked by a layer of the exuviae of surface organisms.

There is one point in connection with the structure of icebergs which is of great interest, but with regard to which I do not feel in a position to form a definite judgment. It lies, however, especially within the province of a distinguished professor in the University of Glasgow, Dr. James Thomson, and I hope he will find leisure to bring that knowledge and experience to bear upon it which have already thrown so much light upon some of the more obscure phenomena of ice. I have mentioned the gradual diminution in thickness of the strata of ice in a berg from the top of the berg downwards. The regularity of this diminution leaves it almost without a doubt that the layers observed are in the same category, and that therefore the diminution is due to subsequent pressure or other action upon a series of beds which were at the time of their deposition pretty nearly equally thick. About 60 or 80 feet from the top of an iceberg the strata of ice a foot or so in thickness, although of a white colour, and thus indicating that they contain a quantity of air, and that the particles of ice are not in close apposition, are still very hard, and the specific gravity of the ice is not very much lower than that of layers not more than 3 inches thick nearer the water-line of the berg. Now it seems to me that this reduction cannot be due to compression alone, and that a portion of the substance of these lower layers must have been removed.

It is not easy to see why the temperature of the earth's crust under a widely extended and practically permanent ice-sheet of great thickness should ever fall below the freezing-point; and it is matter of observation that at all seasons of the year vast rivers of muddy water flow into the frozen sea from beneath the great glaciers which are the issues of the ice-sheet of Greenland. Ice is a very bad conductor, so that the cold of winter cannot penetrate

to any great depth into the mass. The normal temperature of the crust of the earth at any point where it is uninfluenced by cyclical changes is, at all events, above the freezing-point; so that the temperature of the floor of the ice-sheet would certainly have no tendency to fall below that of the stream which was passing over it. The pressure upon the deeper beds of the ice must be enormous; at the bottom of an ice-sheet 1,400 feet in thick-

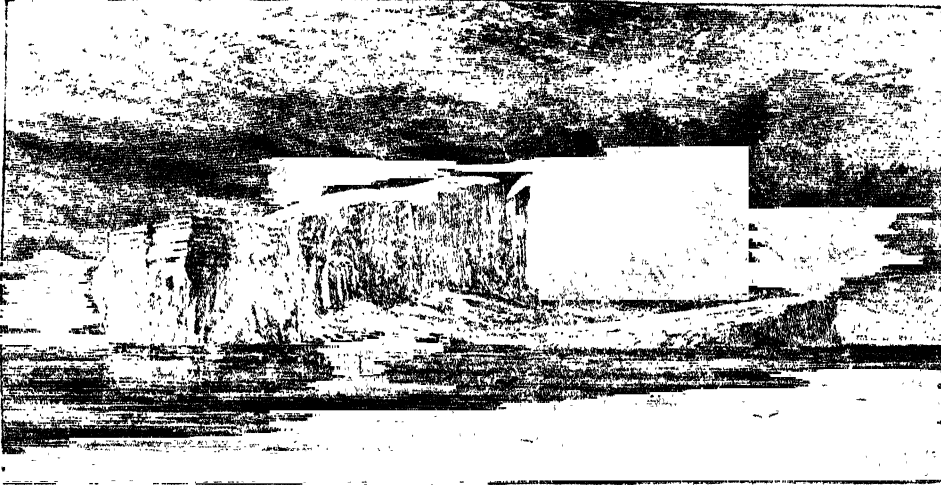

FIG. 4.—Iceberg passed on February 21, 1874. Lat.  $63^{\circ} 37'$ , Long.  $89^{\circ} 6'$  E.

ness it cannot be much less than a quarter of a ton on the square inch. It seems therefore probable that under the pressure to which the body of ice is subjected a constant system of melting and regelation may be taking place, the water passing down by gravitation from layer to layer until it reaches the floor of the ice-sheet, and finally working out channels for itself between the ice and the land whether the latter be sub-aërial or submerged.

I should think it probable that this process or some modification of it may be the provision by which the indefinite accumulation of ice over the vast nearly level regions of the "Antarctic continent" is prevented, and the uniformity in the thickness of the ice-sheet maintained; that in fact ice at the temperature at which it is in contact with the surface of the earth's crust within the Antarctic regions cannot support a column of itself more than 1,400 feet high without melting.

When the icebergs are drifted in the summer a little to the northward—in the meridian of  $80^{\circ}$  E. to the parallel of  $64^{\circ}$  S.—they begin to disintegrate very rapidly. The water at the surface of the sea rises to zero and slightly above it, and dashing against the windward side of the berg, partly by its mechanical action, but more by the constant and rapid renewal of the warm water, it wears a deep groove in the face of the cliff. When the groove has cut in so far that cohesion will no longer maintain the weight of unsupported ice, which seems usually to be the case when it is 10 to 15 feet deep, a mass of the cliff falls down, and the weight of the berg being reduced on that side it tilts up more or less and assumes an inclined position; the stratification thus becomes inclined, although it still remains conformable with the plane of the top of the iceberg.

The sea now washes up on the low portion which has been exposed by the tilting of the berg, which it soon

reduces to a beautiful curved slope to the bottom of the new cliff, and the process is repeated until by repeated falls of the face of the cliff one side of the berg is so much lightened, that the preponderating weight of the opposite side raises the newly exposed portion out of the water; giving the berg a double outline and the veining a high inclination.

We frequently saw table-topped icebergs with the upper surface very irregular; when that is the case evidence



FIG. 5.—February 25, 1874. Lat.  $63^{\circ} 49'$  S, Long.  $94^{\circ} 51'$  E.

may usually be found from the colour, the closeness of the veining, and other appearances, that it is not the original surface of the iceberg which is now presented to us, but a second surface produced by the cutting away by the sea of an entire story, as it were, of the berg; which although it had no doubt at one time during the process been greatly inclined, had recovered its equilibrium on the whole of the upper layer having been more or less symmetrically removed. Fig. 3 is a view of an iceberg in which the whole of the upper tier seems to be breaking

up and disintegrating under the influence of the air and waves; it is fissured through and through, a large portion has already fallen away, exposing terraces of blue ice previously submerged, and the sea around is cumbered with the fragments. It is easy to see how almost any eccentricity of form may be produced by the irregular action of the waves upon the different sides of an iceberg tilted to different inclinations.

When an accidental hollow or other irregularity on the surface of an iceberg directs the action of the surf on any special point, a cave is speedily formed, and the effect constantly increasing with the deepening of the cavity, the ice is often honeycombed with caverns which penetrate far into the solid berg, and add wonderfully to its beauty by their lovely colouring in shades of cobalt blue, varying with every play of shade and light. The caves are, however, very fatal to the iceberg. From the ice not being thoroughly rigid, whenever the support is taken away from beneath, the layers above bend and give way; vertical fissures are produced which become filled with a breccia of ice and snow, often discoloured by sea-birds; the ice, instead of showing its original uniform horizontal stratification, is distorted into all sorts of anticlinals and synclinals; and fragment after fragment crashes down into the sea.

Fig. 2 gives an idea of the form of a beautiful vaulted berg. The sea was washing through and through it; and as we passed close by, we sat gazing, entranced, at the marvellous beauty of the colouring of the vaults of ice, and the waves, and the snowy spray illuminated by a red setting sun; but our gorgeous iceberg was evidently doomed to speedy destruction. Some glittering pinnacles were the only remains of the buttresses of former arches, and a quantity of *débris* floating round it showed that the whole fabric was undergoing rapid change.

Some few of the bergs which we saw were tilted up to an angle of upwards of 50°, and in various ways—by the inclination of the bergs, by the denudation of successive layers by the action of the sea, and by “dislocations of strata.” I believe we saw at various times sections of icebergs to the depth of perhaps 400 feet. All such sections gave simply a continuation of the same phenomenon which we observed in the portion of the berg normally exposed, a gradual approximation of the lines of stratification and deepening of the blue colour.

Sometimes we saw small bergs which were very irregular in form, with all marked prominences rounded off, perfectly clear, and of a deep sapphire blue. These I conceive to be masses of ice from near the base of a berg, which, from extreme shifting of its centre of weight, has turned right over, and exposed the ice near the bottom, in which, by melting and regelation under great pressure, all structure has been lost.

The curious question naturally arises, Shall we ever be able to reach the South Pole? With our present methods and appliances I should think that the answer must be an unhesitating negative. Except possibly somewhere in the region where Ross penetrated, in 1842, to the parallel of 78° to the south of New Zealand, or about Graham Land, where Capt. Dallman, in 1873, continued the explorations of Capt. Biscoe, there seems to be no accessible lead of land; and Ross's southernmost point is upwards of 700, and Graham Land 1,200 miles from the pole. The remainder of the outline of the Antarctic continent appears to be a perpendicular cliff 200 to 250 feet in height, without shelter, and with a heavy pack broken up and kept in motion by frequent gales moving outside it during the greater part of the year, and bounding a vast expanse of glacier surface, a great part of it subject probably to high winds and to almost incessant falls of snow.

We have now learned that the North Pole, if not actually inaccessible, is much more difficult of access than we imagined, even with the long roll before us of the

gallant men who have strained through many years the resources of human skill and bravery to the utmost in fruitless attempts to attain the barren issue; and we can only anticipate disasters multiplied a hundred-fold should the South Pole ever become a goal of rivalry among the nations.

C. WYVILLE THOMSON.

### NORDENSKJÖLD'S EXPEDITION TO THE JENISSEI<sup>1</sup>

THE expedition, of whose plan, equipment, and composition we have already given some account, left Tromsø in the steamer *Ymer*, on July 25 this year, and on the 30th entered Matotschkin Scharr, where they obtained some specimens of Novaya Zemlya salmon. An easy passage was made to the east side, where, during a stay of twenty-four hours, the naturalists did some collecting, dredging, &c. Leaving the Scharr on the 31st, the Kara Sea was at first found quite open, but after a few hours it became so blocked with loose ice in all directions that the *Ymer* was compelled to turn back, and was anchored on the inner side of the promontory which projects from the southern side of the sound, nearly half way between the entrance and Gubin Bay.

Here the sea is rich in varying animal forms, the land bleak and poverty-stricken. The mountains for the most part consist of black clay-slates, probably early Silurian, and grey dolomite beds, in which search was made for fossils in vain. On the other hand, the clay-slate is in many places full of quartz veins with numerous cavities, whose crystalline contents gave occasion to the unfortunate Tschirakin's statement that he had found here a block of stone set full with the most brilliant, beautiful, and valuable precious stones, for which, after his death, he was vehemently censured by his chief, Rosamylov, who sought in vain for the supposed treasure.

In one respect this part of Novaya Zemlya is of great geological interest; for here are to be seen no fewer than six clearly-marked beaches, situated at different heights one above the other, and showing that the land hereabouts has been elevated during the very latest geological period at least 500 feet. With the exception of certain parts of Greenland, where a considerable sinking of the land has taken place during recent centuries, a similar raising of the land has been observed in most other Arctic regions, and this raising of the land has without doubt played a very important part in the great geological changes which have occurred on the surface of the earth since the close of the Tertiary period. For the Swedish observer the phenomenon besides has quite a special interest, inasmuch as attention was first called to it in Sweden more than a century ago, and it then gave occasion to an impassioned discussion between those holding different opinions, which is well known in the history of science.

Matotschkin is surrounded by high, bold mountain ridges and summits, which continue to occupy the interior of the island for more than thirty English miles south of the sound. Farther south the mountain tops disappear completely from the interior, and the land passes into a level high-lying plain, nearly free of snow during summer and sloping gently towards the east coast and the Kara Gate, till it terminates most frequently with a precipitous face towards the sea.

A broad ice-free belt of water having in the meantime been formed along the east coast of Novaya Zemlya, the expedition took advantage of it, and sailed along shore. The greater part of the ice-fields were, however, now quite rotten, and it was clear that they would completely melt away during the remaining part of the summer.

Partly by ice, partly by fog, the *Ymer* was prevented making right across the sea, and it was not till the 12th that the ice-belt was so broken up that they could steam on round White Island, past the Gulf of Obi to the mouth of the Jenissei.

We sighted land here on the 15th, Dr. Nordenskjöld goes on to state, thus exactly a year after the rocks at Dickson's Harbour were first seen from the *Prüven*. This was some hours sooner than the dead reckoning promised, which at first was ascribed to the influence of an easterly current in the parts of the Kara Sea we had just traversed. When we came nearer, however, I was surprised to see before me a plain which was unbroken by any “berg-åser,” though I knew, from last year's observation, that

<sup>1</sup> Abstract of Prof. Nordenskjöld's Report in the *Göteborgs Handels- och Sjöfartstidning*, October 24.



an "is." which was certainly low, but yet perfectly developed, runs over the tundra towards Jewremow Kamen; neither could we discover any of the rocky islands which surround Dickson's Harbour. In the meantime we continued our course up the river along the bank, and after the lapse of four or five hours we obtained a quite unexpected explanation of the circumstances described. For it appeared that the mouth of Jenissei, which is ten Swedish miles (60') wide, is divided into two by an island about five Swedish miles (30') long, which was thought to have been unknown both to Russian cartographers and to the natives. That it has not been before observed clearly depends on its not being visible from the river bank along which the few boats that have traversed this part of the river are believed to have always kept. The navigable water on both sides is deep and free from shallows. This large new island ought clearly to be advantageous for navigation in those regions, as it will form a welcome protection against north-westerly winds and sea for the vessels that may be in the mouth of the river. I mean to name it Sibiriakoff's Is'an', after the zealous and generous supporter of all this year's Siberian expeditions.

Sailing up the river the *Ymer* reached Mesenkin, which had been appointed the meeting-place with Dr. Théel's party. Here, where the Mesenkin falls into the Jenissei, Dr. Théel expected to obtain some specimens of mammoth skins, which, it was reported, had been washed out of the tundra near this place. Dr. Théel's party, not, however, having arrived at Mesenkin when the *Ymer* reached it, Nordenskjöld himself made an excursion to the locality already spoken of, where the mammoth hide was found. No complete hide was found here, but he succeeded in digging two large and a number of small pieces out of a newly-formed sand-bank at the confluence of the Mesenkin with the Jenissei. The excavations showed that the mammoth remains in question had been newly brought down by the spring floods to the place where they were found from some point situated higher up in the river valley of the Mesenkin, and that the place where the mammoth was originally imbedded in the frozen tundra is to be sought for in this direction.

On August 17 the *Ymer* proceeded up the river, but the water became so shallow, and the navigation by a steamer of such draught as the *Ymer* so dangerous, that Dr. Nordenskjöld resolved to return to Mesenkin. He left his merchandise at Korepowskoj simowic, near Mesenkin, to be taken away next summer by the river steamer. After landing the goods another vain attempt was made to steam up the river, and the *Ymer* was again anchored, this time between Orlowskoj and Gostinoj. The following days were devoted to excursions which yielded interesting information regarding the geology of the tundra, and a very rich collection of the sub-fossil shells, which are found in the sand of the tundra.

By the word *tundra* are denoted, as is well known, the plains of immense extent in Russia and Siberia lying between the boundary of the forest region and the Polar Sea. The ground, at least in the northern parts of the Siberian tundra, is continually frozen to no great depth, but during the summer bears a vegetation of low bushes, mosses, and grass, which yields summer pasture to numerous herds of reindeer, partly wild, partly tame, which wander about on them.

To the eastward of the Jenissei the tundra forms a level or slightly rolling plain, which toward the river has a sloping bank 50 to 100 feet high. In the interior of the country the plain is not interrupted by any very considerable heights, but on the other hand it is intersected at a number of places by deep river valleys, whose steep sides offer fine sections of the earthy layers. It is apparent, on a merely cursory examination, that these for the most part consist of enormous masses of sand and mud washed down by the Siberian rivers. The tundra, however, is by no means a common delta formation. Numerous marine shells imbedded in the sand show that the tundra plain formerly lay under the surface of the sea, and that therefore a considerable elevation of the land must have taken place during the latest geological period. For all the shells imbedded in the tundra sand belong to existing types, the most of which have been dredged up by us from the bottom of the Kara Sea, and which we again find in the post-glacial beds at Uddevalia and Christiana Fjord, and the cray formation of England. All this shows that the tundra has been formed under climatic circumstances very similar to the present, which is further confirmed by the geognostic formation of the beds. It has therefore long been difficult of explanation by the geologist that just in these sand-beds there are found in great abundance remains of the

for the present flourish only in a tropical or sub-tropical climate.<sup>1</sup> The evident contradiction which is apparent here has indeed obtained an explanation through the researches of the Petersburg academicians, Middendorff, Schmidt, and Brandt. But there remains here much to clear up, and collections from these regions have, besides, a peculiar interest, from the remarkable circumstance that here in the frozen earth of the tundra there are found not only skeletons, but also flesh, hides, hair, and intestines of animal types which died out many hundred thousand years ago. I therefore, Dr. Nordenskjöld goes on to say, of course, gladly availed myself of the opportunities which offered themselves in making excursions in the neighbourhood of the places where the vessel was anchored. Among the results of our search may be mentioned large pieces of mammoth hide, found along with some few pieces of bone, at the confluence of Mesenkin with the Jenissei; a skull of the musk ox, remarkable for its size, found together with mammoth bones in another tundra valley south of Orlowskoj; a very rich collection of sub-fossil shells, found principally between Orlowskoj and Gostinoj. In addition, various interesting observations concerning the geological formation of the tundra, &c., were made.

During their stay on the Jenissei there was often a dense mist with rain prevailing, but otherwise they were favoured, as a table of observations shows, with warm and summer-like weather. The ground was quite free of snow, and at several places, especially in the tundra valleys, adorned with a variegated carpet of flowers. According to the statement of the inhabitants, however, the former part of the summer in these regions had not been fine, and the preceding winter had been exceedingly severe. The temperature of the water of the river at the surface was almost constantly + 12° to 13° C., and even at a depth of nine fathoms the deep-water thermometer marked + 11° C.

As it had been arranged that Théel's party, which, as our readers know, had come overland, should in no case stay so long on the northern part of the Jenissei as to run the risk of missing the last river steamer to Jenisseisk, which this year was to leave Saostrowskoj about September 7, Nordenskjöld resolved to set out on the return journey on September 1. This he did, as Théel's party had not turned up.

The sea, he continues, was at first completely free of ice, and first when we came quite close to the east coast of Novaya Zemlya in 75° N. lat., a very compact belt of worn ice was fallen in with, which stretched along the coast towards Matotschkin. The course was now set along the ice towards the south to 74° 40' N. lat., where the edge of the ice took a westerly direction, which allowed us, without the inconvenience of being hindered by ice, to steam right westwards towards Matotschkin. A perceptible swell now gave indication of ice-free water. If the course from Dickson's Harbour had been set close past White Island towards Matotschkin we certainly would not have met with a single ice-floe. Even in the northerly way I chose our advance was scarcely hindered by ice but by a nearly constant fog, which compelled us to lie still at night. In this way Dr. Stuxberg, the zoologist of the expedition, obtained a welcome opportunity for dredging and swabbing in the deep channel along the east coast of Novaya Zemlya.

Of all the expeditions which have gone to Novaya Zemlya and the sea surrounding it, there are only three which, before the last two Swedish ones, concerned themselves with zoological, botanical, and geological researches and the collections pertaining to them. These are von Baer's expedition in 1837, Heuglin's in 1871, and the Austro-Hungarian in 1872-74.

As far as zoology is concerned, von Baer brought home from his journey about seventy species of invertebrate animals, Heuglin increased our knowledge of the number of species within some groups, and the Austro-Hungarian expedition within others. But all those collections were from the south-western, western, and northern coasts of Novaya Zemlya. Of the nature of the animal life in the Kara Sea all actual knowledge was wanting till last summer. There was also a current tradition among zoologists, grounded on the knowledge of the immense mass of fresh water which the Obi and the Jenissei yearly carry down, partly also on something at first loosely uttered in literature, which afterwards took the form of axiomatic certainty, that the Kara Sea is exceedingly poor in animals.

The Swedish expedition of 1875 has already dissipated these misconceptions, having brought home from Novaya Zemlya and

<sup>1</sup> The mammoth, for instance, is looked upon as the progenitor of the now living Indian elephant, but a progenitor considerably larger than his descendant, and provided with an abundant covering of hair.

the west coast of Waygata Island a collection many times richer in species than its predecessors. But in any case it was impossible that the collections which were made during a single summer could be taken as giving so complete an idea of animal life in these regions, as is necessary not only for comparison with the existing fauna of other arctic countries, but also for a complete clearing up of its relation to the fauna in the deposits of the Siberian tundra. It was on this account that I made provision for Dr. Stuxberg accompanying this summer's expedition to Jenissej, and carrying on the zoological work. His researches were rewarded with great success, as appears from the short sketch annexed, communicated by him:—

"During the voyages of 1875 and 1876 to Jenissei and back dredging has been carried on at fifty places in all and at different depths from the beach to a depth of 200 fathoms, and rich and comprehensive animal collections have thus been made. A large proportion of species occur locally, and in quite incredible numbers. Others again are found nearly at every dredging, but in far smaller numbers. The occurrence of the latter is more uniform, consequently distinctive of the territory of the fauna in its entirety. To these belong first of all two species of the genus *Idothea* (*Id. sabinei* and *Id. entomon*), both well-developed, and it may with reason be said that this genus is characteristic of the Kara Sea; it is the province of the *Idotheæ*. To the animal forms again which are local in their occurrence belong various species of Mollusca, Hydromedusæ, and Bryozoa, but chiefly all the representatives of the Echinodermata are known to exist here. The abundance of these is sometimes quite surprising, and, what is more singular, where a species occurs in any great quantity, it lives nearly alone, and to the exclusion of all others. This, for instance, is the case with species of the genera *Cribella*, *Stichaster*, *Ctenodiscus*, &c., which here are found in large and well-developed types. Not seldom the swab brought up at the same time hundreds of the same species. Of the beautiful Crinoid *Alcoto Eschrichtii* there were obtained many choice specimens.

"But rich as is the Kara Sea in asterids and ophiurids, it is proportionately poor in echini. These have been sought for everywhere without success, except possibly close to the east coast of Novaya Zemlya. This circumstance is the more extraordinary as along the whole of the west coast a species of the family *Echinus* is one of the animal forms that are most abundant and occur most frequently.

"In two respects the zoological work of this summer has been exceedingly profitable for our museums. It has in the first place added something new in all the groups to the very rich collections made during last summer; it has, for instance, increased the collection of crustacea by 20 per cent. new species, and of echinodermata a large number of types has by oft-repeated swabbing been obtained in an extraordinary collection of specimens. Further, the swab has brought up from the bottom of the Kara Sea two animals specially remarkable and important in a systematic respect. The first was brought up by the swab during last year's expedition, not far from the eastern mouth of Matotschkin Scharr. Then it was found in only a few specimens, now we have collected a considerable number. It is a hitherto unknown holothurioid, differing greatly from most others of the same group by its quite complete bilateral symmetry, but from all by its habitus and anatomical structure, and being singular in its kind inasmuch as it combines characters from diverse classes of animals. It has lately been exhaustively described and delineated in detail by its first discoverer, Dr. Thelcl. The other remarkable animal is one of the greatest rarities within the animal world. It is an *Umbellularia*<sup>1</sup> of about a foot and a half in length. It

<sup>1</sup> Two specimens of the family *Umbellularia*, the first of which we have any knowledge, are said to have been found on the coast of Greenland before the middle of last century. After a description first given by Ellis and Mylius, the animal was registered by Linnæus in his "Systema Naturæ," in the year 1758, under the name *Urs. encrinurus*. What has become of the original specimen is unknown. The enigmatical animal type, as it appeared from the descriptions, has been the subject of many interpretations, till Dr. J. Lindahl, during the Swedish expedition to Greenland in 1871, succeeded in dredging up two specimens of it in Baffin's Bay, and accurately described its interior structure in the *Transactions* of the Academy of Sciences. Individuals of the same genus have since been found, first by the English *Challenger* Expedition in 1873, between Portugal and Madeira, by the same expedition between Prince Edward's Island and Kerguelen's Land, and possibly at other places in the Antarctic Ocean; afterwards by the Austro-Hungarian expedition in 1873, between Novaya Zemlya and Franz Josef Land (the specimen was lost when the *Tegelthoff* was abandoned); again during the present summer by the Norwegian Atlantic expedition off the west coast of Norway, and finally by us in the Kara Sea. It is thus an animal type which is widely distributed, but of extremely rare occurrence.

was found in 150 fathoms south of Cape Middendorff, and north of the 75th degree of N. lat.

"From the collections made during the Swedish expeditions it appears that the Kara Sea, far from being so poor as has been supposed, is, on the contrary, distinguished by an animal life rich both in individuals and in types when compared with that which Spitzbergen, Greenland, Iceland, and the Arctic regions of North America have to show. It appears, also, that a nearly uniform marine fauna is found around the pole along the whole coast of Siberia and the polar archipelago of North America. The immense mass of fresh-water which the great rivers of Siberia carry down, does not in any degree determine the composition of the animal life on the bottom of its Arctic Ocean.

"Before the various groups have been worked out by specialists it is difficult to state for certain the number of the lower animal types of the Kara Sea, but it may be put approximately at nearly 500 species, a considerable number, indeed, for a sea that previously was believed to be as poor in species as the Baltic. Such, with the addition of about a hundred species of insects from Novaya Zemlya, whence previously only seven were known, and an extended knowledge of the vertebrate world, is the main zoological result of the researches of the last two Swedish expeditions in these regions."

The *Ymer* made a safe return voyage through Matotschkin Scharr, and on September 18 anchored at Hammerfest. Dr. Nordenskjöld concludes:—

"My stay at Hammerfest and Tromsø I turned to account in collecting information from the numerous walrus-hunters there about the state of the ice in the Arctic regions, and especially in the Kara Sea. I have succeeded in this way in bringing together very abundant materials for a solution, founded on actual observations, of the problem in navigation which lies before us here, and I shall, by and by, make a full statement of the conclusions at which I have thus arrived. Here: I will only say that it is my conviction, which is also shared by the walrus-hunters whom I have consulted, that a regular sea-communication between Siberia and Northern Europe during a short season of the year ought not to be attended with greater risks and dangers than seamen encounter on many other waters now yearly visited by thousands of vessels."

#### OUR ASTRONOMICAL COLUMN

TELESCOPIC METEORS.—In his "Histoire de l'Astronomie pour l'Année VIII.," Lalande, referring to Schröter's observations, states, "il a vu plusieurs fois dans son telescope des petites étoiles qui filent comme un petit trait de lumière très-faible, qui dure 2 ou 3," and by way of explanation goes on to say that this proves the extension of hydrogen and oxygen many leagues in the depth of the atmosphere; meteors or globes of fire which excite astonishment when they are a distance of some hundred *toises*, become shooting stars when they are distant a league, and telescopic stars at three or four leagues, an opinion hardly favoured by later research.

When occupied in comet-sweeping, or general observation in a dark and pretty large field, it has very often occurred to the writer to meet with objects of the class mentioned by Lalande. A striking instance was afforded one very fine April morning about twenty-seven years since (the exact date, though upon record is not at hand at this moment), when a number of telescopic meteors as bright as stars of the eleventh magnitude passed slowly through the field at intervals of a minute or more, the instrument during the time of observation being directed to different parts of the constellation Sagittarius and lower region of Ophiuchus; the course of these meteors was nearly uniform. Their motion was generally so slow that when caught they could be followed to extinction on moving the instrument. On other occasions he had noticed similar slow-moving meteors, though in less number, and hence was under the impression that there was nothing unusual in the occurrence. But in the summer of 1850, happening to mention the observations of frequent faint slow-moving telescopic meteors to Sir John Herschel, that eminent observer, notwithstanding his long experience in both

hemispheres, expressed surprise at the phenomenon, and stated that he did not recollect to have remarked anything of the kind. In 1852 Schmidt published the results of his observations of telescopic meteors between 1844-51, "Resultate aus zehnjährigen Beobachtungen über Sternschnuppen," p. 165; most of those seen by him were as bright as stars of between the eighth and tenth magnitudes, and generally moved very slowly. Schmidt during these observations was for the most part using a "comet-seeker," the same with which he formed the chart for Hour V. of R. A. in the Berlin series; the writer was invariably observing with the comet-eye-piece on a 7-inch refractor giving a power of about 45.

Perhaps some of the astronomical readers of NATURE may be able to put upon record the dates of other appearances of telescopic meteors in some numbers and with a general uniformity of direction.

Lalande appears to make his reference to Schröter's observation of telescopic meteors with the intention of illustrating the acuteness of vision of the Lilienthal astronomer. Indeed, in the preceding sentence he makes the following extraordinary statement with regard to Schröter:—"Il a une vue privilégiée pour l'astronomie; il voit Mercure en plein jour à la vue simple."

THE COMET OF THE BAYEUX TAPESTRY.—There can now remain very little doubt that the grand comet which astonished Europe in the year of the Norman Conquest leading to a multitude of records in the annals of the time, and forming, with its astonished beholders, the subject of embroidery on the celebrated Bayeux tapestry, was the famous body which now bears universally the name of our countryman Halley. Allowing for the peculiar character of Chinese observations of comets, the account they have left us of its track amongst the stars from the beginning of April to the end of the first week in June, 1066, is well represented by elements not differing more from the actual elements of Halley's comet than accumulated effect of perturbation in eight centuries may well explain. If it is assumed that Halley's comet arrived at its least distance from the sun on March 18, its position when discovered by the Chinese in the morning sky on April 2, would be as they record in their sidereal division "Shih," two degrees south of the equator, and distant from the earth rather less than eight-tenths of the earth's mean distance from the sun. Between this date and June 8, or sixty-seven days after discovery, which is the duration of visibility assigned, the comet would make a grand sweep across the sky from the constellation Pegasus into Sextans between Leo and Hydra, or as the Chinese express it, "through fourteen sidereal divisions from Shih to Chang." The imposing aspect of the comet described in European chronicles and confirmed by the Chinese Annals, wherein it is compared in brilliancy to Venus, and by exaggeration, no doubt, even to the moon, is fully explained by the circumstances under which Halley's comet must have been observed if in perihelion on March 18. When last seen in China it had receded to  $\frac{1}{4}$  times the earth's distance from the sun.

### METEOROLOGICAL NOTES

RECENT STORMS.—We have already referred to the great cyclone of October 31, which will long be remembered as one of the most appalling catastrophes that has occurred in the history of the human race. The storm-wave advanced over Chittagong from south to north, but most of the damage was done along the shores of the Meghna by a storm-wave which swept seawards from north to south. The details of this and the other features of this great cyclone will be looked forward to with intense interest.—We have also given some account of the storm of wind of almost unexampled violence which broke over Sydney at 9.50 P.M. of Sunday, September 10, and continued with un-

good reasons for the belief that the maximum velocity or force of the wind in great storms is frequently understated, it is desirable that the fullest details of the observations from which the velocity of the wind at the rate of 153 miles an hour has been deduced be published in the monthly publication of the Observatory.—A hurricane of great severity and followed by most disastrous results swept over Central America on October 3 and 4. The town of Managua, on the south side of the lake of the same name, and west of Lake Nicaragua, was inundated on the 4th, and 400 houses were blown down by the hurricane. As the flood rose the inhabitants had to betake themselves to the tops of the houses, and many were drowned by the houses falling. The hurricane then passed eastward over Lake Nicaragua and descended over Blewfield, situated on the Mosquito Gulf, and overturned upwards of 300 houses in that town. It was in all probability the same cyclone which was encountered at the same date by the Panama Transit and Pacific Mail Steamer *Costa Rica* about 300 miles to the south-east, near Parita, on the Gulf of Panama, where it was accompanied with a frightful sea-running wind shifting all round the compass and blowing with such a force that the *Costa Rica* had its hurricane deck blown away and the head of the mainmast, maintopmast, and gaff carried off. Later, or from October 17 to 21, Capt. Bremner, of the steamship *Chilian*, reports the severest hurricane he ever experienced at Cayuan's Island, to the west of Jamaica, where 170 houses were destroyed and much damage done to fruit trees and other crops.—The list of heavy storms and hurricanes might be increased by including the severe storms reported as having recently occurred in Behning's Strait, wrecking a dozen of whalers, the great gale near Chefoo, in which H.M.S. *Lapwing* was lost, the terrible storms in Madeira and Portugal, commencing on November 11, and the storms of the British Islands a fortnight since, as well as during the present week, with their attendant floods, which in certain districts attained to a height and a destructiveness unknown for many years. The last two months have thus been noteworthy for the violence of the storms of wind which have been let loose, as it were, over all quarters of the globe, thus offering in their salient weather characteristics a marked contrast to the characteristics of the weather little more than a year ago, when we were called to record disastrous inundations occurring in almost all parts of the globe. During the past two months the weather has not only been characterised by the extreme violence of the wind but also by equally unprecedented and violent alternations of abnormally warm and cold, and dry and wet tracks of weather—the connection between which is no doubt a more deeply rooted one than that of mere coincidence.

METEOROLOGICAL OBSERVATORY ON MONTE CAVO.—We are interested to learn, from a letter which appears in *Comptes Rendus*, that P. Secchi has succeeded in establishing a meteorological observatory on the summit of Monte Cavo. This is the highest of the volcanic group in Latium. Its summit rises 953 metres above the sea-level and about 900 metres above the Roman Campagna. The meteorological instruments are placed in the convent, and the monks are charged to make observations. These instruments are a Fortin barometer, a psychrometric thermometer, a maximum and minimum thermometrograph, a pluviometer, and a weather vane. An anemometrograph will soon be added. The isolation of the mountain, which rises about 200 metres above the surrounding volcanic cones, renders it peculiarly well suited for researches in meteorology. In view of the importance of the institution the Government has agreed to defray the expense of installation. The observations are only begun two months; they show, among other things, that the temperature of Monte Cavo is often higher than that of Rome, and that the variations of temperature are less than on the plain. There is another observatory at the base of the cone, at Grotta Ferrata, in a mountain there also; its elevation is about 220 metres, and it

serves for investigating the phenomena of the agricultural region, the most interesting of the environs of Rome, along with another station placed at Velletri, on the other side of the volcanic group.

### BIOLOGICAL NOTES

**THE PRIMARY ELEMENTS OF THE SKULL.**—At a recent meeting of the Cambridge Philosophical Society Mr. Bettany brought forward some of the ideas resulting from Prof. Parker's most recent researches, which will be embodied in a forthcoming work on the "Morphology of the Skull," by Messrs. Parker and Bettany. A fundamental point in researches of this kind appears to be the question what are axial and appendicular elements in the skull. For some years past Profs. Huxley and Parker have regarded the primary rods or *trabeculae* occupying the base of the forepart of the skull as being the foremost of the series of facial or visceral arches (mandibular, branchial, and the like). In several types, although these *trabeculae* lie in the true base of the cranium, they are at an early stage more or less parallel with the visceral arches; and certain nerve-relations appeared to show a close similarity between them. But Mr. Parker now believes their facial nature cannot be maintained. They arise in tissue immediately beneath the brain cavity as the vertebræ arise beneath the spinal canal; the temporary flexure of the fore-part of the skull does not make this tissue other than axial. Every relation of the *trabeculae* proper is to the nervous centres, and cartilaginous growths continuous with them bound the cranium laterally just like the lateral occipital or vertebral regions. Mr. Bettany also directed attention to the nasal, pre-nasal, and antorbital regions of the skull as probably showing rudiments of true appendicular parts in the anterior regions of the head. In the discussion which followed, Prof. Humphry cordially welcomed this rehabilitation of the *trabeculae*, having never been able to agree with Prof. Huxley that they were facial in their origin. He could not doubt that the bones formed in them, the basisphenoid and presphenoid, were axial in character. He thought that further research would but demonstrate more clearly the vertebral or segmental theory of the skull.—Mr. Balfour thought research was not yet sufficiently advanced for a true estimate of the skull to be formed. Although the *trabeculae* might be morphological continuations of the basal cartilages in the hinder part of the skull, yet the greater part of the vertebræ and part of the base of the skull, arose from an unpaired cartilaginous mass surrounding the notochord, while no such element existed in the anterior part of the skull. It appeared very possible that the lateral parts of the cranial floor behind were really equivalent to the base of the cartilages which formed the vertebral arches, and thus the *trabeculae* might similarly be regarded as only the basal parts of the continuous lateral wall of the skull.

**THE ANATOMY OF THE GORILLA.**—Dr. H. Bolau, director of the Zoological Gardens at Hamburg, has recently had the fortunate opportunity of dissecting three gorillas preserved in spirit, with the viscera intact. His results are just published in the "Abhandlungen aus dem Gebiete der Naturwissenschaften," and they add much to our zoological information. The brain is figured by photography from three aspects, Dr. Ad. Pausch describing the convolutions. In all the specimens the liver exhibited the lateral fissures or incisions which are not found in man, the orang, the chimpanzee, or the gibbon, but in all the lower monkeys. This agrees with the descriptions given by Professors Huxley and Flower of the specimen in the Museum of the College of Surgeons; and serves to separate off the gorilla from the rest of the anthropoid apes. The caudate lobe is minute, and the spigelian lobelet of fair size. As in man only among the primates, valvulae conniventes, the transverse folds of the mucous membrane of the small intestine, so large in

the Sumatran rhinoceros, are present, although they are not large. We hope to be able to enter more fully into the results arrived at by Dr. Bolau next week.

**THE WINDPIPE IN MANUCODIA.**—For a long time it has been known that in the Paradise Bird, *Manucodia*, the windpipe, instead of running straight from the neck into the chest, takes a turn forming a spiral over the front of the breast under the skin before it divides to enter the lungs. M. P. Pavesi has just read an interesting paper on the subject, published in the *Annali del Mus. Civ. di St. Nat. di Genova*, in which he shows that in the three species of the genus examined by him this superficial spiral is only developed in the adult *M. heraudrenii*, in the female of which an irregular and crooked loop only exists; whilst in *M. chalybea* it is only in the male that any superficial loop is found, this being straight and longitudinal, like that in many of the Guans and Curassows of South America. In *M. atra* there is no loop in either sex. M. Pavesi also demonstrates that different specimens of the same species differ slightly in detail.

### NOTES

WE announce with sincere regret the death, on Tuesday morning, from malarial fever, of Mr. David Forbes, F.R.S., the well-known Foreign Secretary of the Iron and Steel Institute. Mr. Forbes was only forty-nine years of age. We hope to give a memoir next week.

WE regret to announce the death of Mr. Louis A. Lucas, the African traveller, at the early age of twenty-five. He reached the equatorial provinces in the month of June last, but his escort proving too weak to allow him to penetrate further into the interior, he returned to Khartoum, *en route* for Suez, intending to reorganise his expedition, and proceed by way of Zanzibar to the Congo. After repeated attacks of fever, he left Khartoum on October 26, but died on the Red Sea, near Jeddah, on his way back, having abandoned all idea of further exploration.

CAPT. NARES has been made a K.C.B. There can only be one opinion that by his conduct both of the *Challenger* and Arctic Expedition he has well earned such an honour. The *Alert* and *Discovery* have been paid off, and the crews were entertained at the Mansion House on Tuesday evening.

COL. GORDON has arrived in Cairo, after an absence in equatorial Africa of three years.

A NAINSHIRE African Association has been formed in connection with the International African Association instituted by the King of Belgium.

THE just published *Cosmos* of Guido Cora is mainly devoted to Africa. One paper describes the explorations of Antinori, Beccari, and Issel in the region of the Red Sea about the Straits of Babelmandeb, and another contains letters from various members of the Italian Expedition to Equatorial Africa. There is also an address on Italian Travellers in Africa, by Signor F. Bonola, given to the Egyptian Geographical Society.

ACCORDING to Behm and Wagner's just published Yearly Review of the Population of the Earth, the total population of the globe amounts to 1,423,917,000. Of this number Europe claims 309,178,300; Asia, 824,548,500; Africa, 199,921,600; Australia and Polynesia, 4,748,600; and America, 85,519,800. The average density of population of the whole globe is about 28 inhabitants to one square mile of land surface. The density is of course greatest in Europe, where it is 82 per square mile; in Asia, 48; in Africa, 18; in America, 5½; and in Australia and Polynesia, about 1½. The publication is accompanied by two maps, one showing density of population in India, and the other recent changes in the boundaries of various districts and countries.

MR. A' COURT SMITH writes to us from Gurnet Bay that he has recently found two celts about a mile to the westward of the one referred to in NATURE, vol. xi. p. 466. They are both of dark flint, one is very rough, and though apparently used, seems unfinished. The other is curved, and chipped very evenly, the flat surface still showing the weathering of the old flint.

WE are glad to see that the North of England Institute of Mining Engineers has at last been incorporated by Royal Charter. This institute was founded in 1852, and has done good work in its own important department.

MR. HERBERT SPENCER'S new volume, the sixth of the Synthetic Philosophy, comprising the first of his "Principles of Sociology," is now ready and in the hands of the binder.

IT is intended to issue from the press of the University of Dublin a series of works, chiefly educational, by members of that University. It is expected that the earliest volumes of the series will be the following:—"Lectures on Physical Geography," by Rev. Samuel Haughton, M.D., F.R.S., Professor of Geology; a treatise on "The Morphology of the Vertebrate Animals," by Alexander Macalister, M.D., Professor of Zoology and Comparative Anatomy; and the first portion of a complete edition of the "Letters of Cicero," with a Commentary, by Robert Y. Tyrrel, A.M., Professor of Latin.

A BELGIAN Geographical Society has been established, with M. Liagre as president. Judging from its rules, it is founded on a comprehensive basis, and is likely to do good work. It will publish a journal.

A NEW Geographical Society has been founded in Denmark. The Society proposes to organise lectures, and has invited Prof. Nordenskjöld to speak on the Kara Sea and Jenissei, and Prof. Bergren on New Zealand, where he stayed during a number of years. The Society will issue a geographical magazine.

THE deep boring at Rheinfelden, on the Swiss shore of the Rhine, as seen from a report of Prof. Desor, was stopped at a depth of 1,422 feet, after having pierced 200 feet of granite and diorite, and without meeting with the coal-measures which were expected. It was carried out on the system which has already proved successful in the 2,200-foot boring in Bohemia, *i.e.*, by the process of cutting out of the rock a cylinder by means of a diamond crown. The diameter of the bore, which was, until a depth of 660 feet, only 5 centimetres, was afterwards enlarged to 12, being thus the largest diameter used until now in this kind of boring. In a more or less coarse sandstone the boring advanced at an average rate of 15 metres (49 feet) in twelve hours, and proved altogether most successful. A complete collection of cylinders, cut out of the rocks pierced, which are mostly dyas, is now deposited at the Museum of Aarau.

MESSRS. BICKERS AND SON have just published a new edition of Mr. J. E. Harting's "White's Selborne," containing in an appendix the ten letters from Gilbert White to Robert Marsham which first appeared, with notes by Mr. Harting, in the *Transactions of the Norfolk and Norwich Naturalists' Society*. A detailed notice of these letters will be found in NATURE, vol. xii. p. 481. They possess great interest, and add materially to the value of Mr. Harting's beautiful edition of "The Natural History and Antiquities of Selborne."

MR. R. E. BARTLETT, of Chelmsford, has sent us an interesting relic of Mr. Robert Marsham, F.R.S., a well-known observer and recorder of natural phenomena of last century. It is a table containing indications of spring, observed by Marsham at Stratton, Norfolk, read before the Royal Society in 1789. The indications consist of observations on birds, insects, flowers, trees, &c., as to the times when first they appeared, or sang, or leafed, &c. The observations extend over from thirty to sixty years, and are neatly and clearly arranged.

A BED of pink coral has been discovered by the captain of the U.S. steamer, *Gettysburg*, on her passage from Fayal to Gibraltar, in lat. 36° 30' N., long. 11° 38' W. The least depth found was 30 fathoms, but the captain has no doubt that the coral comes to the surface at some point near the anchorage. Twenty miles west of the bank a depth of 16,500 feet was found. Between this and Cape St. Vincent, 12,000 feet. The bank is rich in valuable coral of light pink shades. Full details of the discovery have been sent by the commander of the *Gettysburg* to the Navy Department, Washington, by mail.

TELEGRAMS have been received from Bahia (Brazil) stating that the *Frigorifique* had crossed the Atlantic successfully with the methylic ether refrigerating apparatus, which worked admirably through the torrid climate of the equator, meat brought from Europe having been found excellent by the Brazilians. More details are sent by letter.

THE French scientific papers publish a letter signed by MM. Jacquet, Hovelacque, Mortillet, and others, engaging to give by will their brain, or any part of their body, to the laboratory of the Anthropological Society, so that experiments may be made and useful observations collected. A special club or society has been established for that purpose.

WE have received a highly satisfactory Report for 1875-6, of the Dundee Free Library, perhaps one of the best managed institutions of the kind in the kingdom, thanks to its able librarian and curator, Mr. Maclauchlan. An unusually large proportion of the books consulted and lent were scientific, a decided increase being attributed to the University Science Classes in connection with St. Andrews University. In connection with the library a fine museum is being gradually collected, Arctic fauna and flora, as might be expected, being largely represented. We have also received the Twentieth Annual Report on the Sheffield Free Public Libraries and Museum. The libraries are evidently largely taken advantage of, and a very large proportion of the books in demand belong to the department of Arts and Sciences. The Sheffield Museum, which was established some twelve months ago as a Free Public Museum, has lately received the very fine collection of antiquities known as the Bateman Collection, formed by the late William and Thomas Bateman of Derbyshire, and previously stored in Lomerdale House, near Bake-well, where it was almost entirely hidden away, and known by little more than the printed catalogue of it compiled by Mr. Thomas Bateman, and published in 1855. The collection consists chiefly of British antiquities ranging from the Celtic to the Old English period, and is especially rich in Celtic and Roman remains. It also contains many Etruscan, Greek, and Egyptian antiquities of considerable rarity and interest. The public of Sheffield and lovers of antiquities generally, are indebted to Mr. W. T. Bateman of Middleton Hall, Derbyshire, for the opportunity of inspecting and studying this interesting and instructive collection.

AT the meeting of the Mathematical Society of November 9 Prof. Smith was chairman only in the early part of the meeting; before the reading of the papers, the new president, Lord Rayleigh, took the chair.

THE distribution of prizes and certificates obtained by the students of the Science and Art Classes of the Belfast Working Men's Institutes took place on November 28. These classes are attended by hundreds of persons of the very kind to whom they are likely to do most good, and yearly carry off a large percentage of the prizes of the department. Dr. Andrews distributed the prizes and gave a short address.

THE inauguration of the French National School of Agriculture took place at the Conservatoire des Arts et Métiers on Wednesday, December 6. There are about fifty pupils, all of

them taking the course of lectures for the first year of instruction. Amphitheatres and classrooms have been prepared for them in one of the courts of the establishment.

At a recent meeting of the United States National Academy, Prof. Henry communicated some additional facts obtained in his long-continued and elaborate researches concerning sound in relation to fog-signals. His principal investigation, this year had reference to the divergence of sound, especially as to the phenomenon known as the Ocean Echo. To test the explanation given by Prof. Tyndall, requiring reflection from the air, the trumpet of a siren was turned directly to the zenith. The blast was exceedingly intense, but no echo was heard from the prolongation of the axis of the trumpet, *i.e.*, from the zenith. A loud echo was, however, heard from the whole circumference of the horizon, half of which was on land, the other half on water. This was repeated many times, and always with the same result. In one case a small cloud passed directly across the zenith, from which a few drops of rain fell into the mouth of the trumpet; still no sound was heard from the zenith, although sound continued to be heard from around the horizon. In this case, on account of the divergence of sound, portions of waves in every direction must have descended to the horizon; and as some of these must have reached the plane of the ocean on a path curving inward towards the source of sound, they would, when they reached the ear of the observer in the vicinity of the source, seem as if coming from a point in the horizon, and hence would give rise to the phenomenon of the ocean echo. Rays of sound at different distances from the ear would be reflected from the surface of the ocean, and thus give rise to a prolonged echo. This is in accordance with the fact observed during last summer, that a blast of five seconds' duration gave an echo that was prolonged twenty seconds. That could only be produced by ordinary reflection from a series of surfaces placed at different distances, an arrangement of the material of the atmosphere which (on the doctrine of probabilities) would not be of frequent occurrence.

In an address at the Manchester Literary and Philosophical Society, Prof. Boyd Dawkins made some forcible remarks on the position of museums in Britain. After speaking of the necessity of museums and laboratories to the student of nature, and of the few good museums in this country, he said:—"From my experience of those abroad, I turn to those of our own country, with feelings of envy and regret. Here a museum is frequently a large sort of advertising bazaar, or a receptacle for miscellaneous curiosities unfitted for a private house, or it is composed of an accumulation of objects valuable in themselves but valueless for all practical purposes, because they are crowded together, or crowded away for want of room. They are generally undermanned, starved for want of funds, largely dependent on casual benevolence, or a burden on the scant resources of the various societies. On the Continent, in America, and in Australia, they are as a rule well officered, well arranged, and not dependent on private resources for their sustenance. That our museums should be allowed to be such a striking contrast to those of our neighbours and kinsmen is a most singular oversight in the richest, and, as we sometimes fancy ourselves to be, the most practical people in the world. With regard to the arrangement of subordinate parts in a museum, that which is now being carried out in the new Imperial Museum, at Vienna, under Dr. Hochsletter, seems to me the best; to form one lineal series, inorganic objects forming the base, then Palæontological specimens, illustrating the life which has been, and leading up to the illustrations of the life which is now on the earth, Botany, Zoology, anatomy, and the like. When this is completed, the Museum at Vienna will present a more perfect and complete history of the knowledge of the earth and its inhabitants than has as yet been

presented. In the City of Lyons, which in its commercial aspects resembles Manchester, the collections are lodged in a magnificent building—the Palais des Beaux Arts—supported by the municipality, and are being largely increased by the contributions of local naturalists, who have banded themselves together for that purpose under the title of 'Les Amis des Sciences Naturelles.' There is one point in which the British Government may learn a lesson from the German. When I was in Berlin this autumn I had the pleasure of meeting gentlemen who had been sent by the latter to make collections in the Americas, in India, and in the China seas; and I saw a valuable collection made by German cruisers in the Pacific. Why should not our ships of war, which are to be found in every sea, have orders also to bring home collections from distant stations, and why should not we send out travellers with the same object? With our navy and our wandering instincts, we ought rapidly to outstrip any rivals, and that at a comparatively small expenditure of money."

THE Manchester Literary and Philosophical Society possesses a select and valuable library; a catalogue of this, by Mr. Nicholson, hon. librarian, has just been published.

WE have received the winter programmes of five Cumberland Scientific and Literary Societies. They appear to us satisfactory, and creditable to the intelligence and culture of the Cumberland folk. The towns to which these societies belong are Workington, Whitehaven, Maryport, Cockermouth, and Keswick, and in some of them, besides lectures by well-known men, and papers by members, regular science classes are to be held during the winter. These and other societies, as we intimated some time since, are formed with the Cumberland Association for the Advancement of Literature and Science, Part I. of the *Transactions* of which is to hand, and contains some papers worth perusing.

A MAGNIFICENT work on the Yellowstone National Park is about to be published by Prang and Co., Boston, U.S. The description is to be by Prof. Hayden, and will be accompanied by a fine series of chromo-lithographic reproductions of water-colour sketches taken by the artist to the expedition of 1871, Mr. Thos. Moran. The work will be published simultaneously in English, French, and German.

In 1866 the students at the six Russian Universities—St. Petersburg, Moscow, Kasan, Kharkoff, and Odessa—numbered 3,591; in 1871 they were 5,301; but in 1873-1874 there was a large diminution, and in 1875-1876 they were only 4,492. It appears that, generally speaking, Russian students have no resources of their own, and are obliged to give lessons to support themselves. At Moscow many of them are said to be in a miserable condition, principally amongst medical students. Three or four students lodging in the same miserable room is a usual occurrence. From 1870 to 1873 the University registers show that 3,224 students left, having finished their course of studies, but no less than 2,911 were obliged to desist without having taken their degree. A good many scholarships of the amount of from 19% to 38% yearly (which amount it is proposed now to raise to 45%) were founded by Government, and yet more by private persons and institutions; but the number of them is yet far below the number of students who have no other means of subsistence than miserably paid lessons. After all, the Russian students are not worse off than many of the students at the Scottish Universities. A few years ago at St. Andrews it was no uncommon thing for students to cover all the expenses of a six months' session, including 10% for fees, with from 16% to 20%; they would simply have stared had they been spoken of as miserably off.

THE additions to the Zoological Society's Gardens during the past week include a Bonnet Monkey (*Macacus radiatus*) from

India, presented by Mrs. Aspiwall; a Macaque Monkey (*Macacus cynomolgus*) from India, presented by Mr. Richard Schott y Larios; a Duyker Bok (*Cephalophus mergens*) from Natal, presented by Mr. J. D. Witherspoon; a Hairy-rumped Agouti (*Dasyprocta prymnolopha*) from South America, presented by Mrs. Booth; a Spring Bok (*Gasella euc chore*) from South Africa, purchased; a White-throated Capuchin (*Cibus hypoleucus*) from Central America, three Rough-legged Buzzards (*Archibuteo lagopus*), European, deposited; a Long-nosed Crocodile (*Crocodilus cataphractus*) from West Africa.

### SCIENTIFIC SERIALS

*Verhandlungen der k. k. zoologisch-botanischen Gesellschaft in Wien*, vol. xxv. The following papers are published in this volume: On some new species of *Mycetophilidae* from the neighbourhood of Sandez (Galizia), by Dr. A. Grzegorzek.—On the structure of the muscular cells and on the general structure of *Mnestra parasites*, Krohn, by Prof. C. Claus.—On some new and some insufficiently known species of *Cecidomyiidae* of the Vienna district, by Dr. Franz Löw.—On the relations of the African and Indo-Malayan bird-fauna, with some general remarks on the geographical distribution of mammals, by A. von Pelzeln.—On Hungarian fungi (third treatise: *fungi hypogaei*), by Prof. A. Haszlsinsky.—Description of new and insufficiently known *Phryganidae* and *Oestridae*, by Dr. Fr. Brauer.—Mycological notes, by S. Schulzer von Muggenburger.—*Hemiptera Heteroptera Austriaca*, MM. Maji.—Augusti, 1870, a J. A. Palmén collecta, by O. M. Reuter.—On some new *Lepidoptera* of the South American fauna, by Dr. O. Staudinger.—Second note on the Aracnida-order of *Territularia* Thorrell (*Mygalidae* Autor.), by Dr. Anton Ausserer. This is one of the most elaborate papers in the volume. On North-American moths, specially *microlepidoptera*, by Prof. P. C. Zeller; this is equally elaborate.—Notes on Adriatic echinoids, by Dr. E. von Martenszeller.—On the vegetation-formations of the Taurian peninsula and its climatic conditions, by Dr. A. Kehlmann.—Researches on the *Diptera*-fauna of Austria, by Josef Palm.—On the ornithological fauna of Moravia, by F. von Dalberg.—On the occurrence of *Salix babylonica*, L., androgyna et masculina in Austria, by J. E. Hübner.—Lichenological excursions in the Tyrol, by F. Arnold.—On some species of *Salix* new in the "Wechsel" district (Lower Austria), by F. Woloszczak.—Researches on land-*Isopoda*, by C. von Vogl.—On some species of *Spermophilus*, by Ernst Schauer.—On the fungi-flora of Bohemia, by F. von Thümen.—On the occurrence of short-eared *Arvicole* near Vienna, by Prof. L. H. Jettles.—On thermal constants and the power of accommodation in the vegetable kingdom, by Prof. H. Hoffmann.—Remarks on some ferns from the island of Celebes, by M. Kuhn.—Botanical excursions in Italy, by Dr. C. von Marchesetti.—Researches on some parasites infecting the hop plant, producing mildew and "kupferbrand" (copper-burn), by Wilh. Voss.—Second paper, containing additional remarks on the *Cecidomyiidae* of the Vienna district, by Dr. Franz Löw.—Researches on *Folidiadae*, by Dr. R. Bergh.—New researches on *Phyllidiadae*, by the same.—European *Encyrtidae*, considered biologically and systematically, by Dr. G. Mayr (this paper occupies some hundred pages).—*Muscorum* species nova, by J. Juratzka.—*Symbolae ad pteridographiam et Characeas Hungaricæ præcipue Banatus*, by Dr. V. de Borbás.—On some *Lepidoptera*, by A. F. Rogenhofer.—Researches made upon leaf galls and their causes on *Vitis vinifera*, by G. von Haimhoffen.—Six years' observations on the first appearances both in the animal and vegetable kingdoms at New Cologne near Milwaukee (North America), by Th. A. Bruhin.—On the flora of Lower Austria (second paper), by J. Wiesbaur.

*Poggendorff's Annalen der Physik und Chemie*, No. 9, 1876.—This contains the following papers:—Experimental researches on liquid-friction in salt solutions, by M. Sprung.—On the summer rain season of Germany, by M. Hellmann.—Observation of the retardation in the progress of the induction current by means of tuning-fork apparatus, by M. v. Ettingshausen.—On the passage of strong induction currents through liquids, by M. Herwig.—Contributions to electro-dynamics, by M. Wand.—On the dependence of the electric conductivity of selenium on heat and light; the photography of tones, by M. Stein.—On the dependence of the specific heat of mercury on the temperature, by M. Winkelmann.—An interesting aerostatic experiment, by

M. Reauleaux.—On the theory of double refraction, by M. v. Lang.

The *Naturforscher* for October, 1876, contains the following papers of interest:—On the specific power of substances in solution, to turn the plane of polarisation, by H. Landolt.—On the uneven surface of meteorites, by M. Daubrée.—On the nature of milk globules and the formation of butter, by F. Soxhlet.—On some phenomena in the combustion of gases, by Herr Horstmann.—Note on the germ-leaf theory in botany, by Herr Famintzin.—On the action of carbon bisulphide as a means for conserving animal and vegetable substances, by Phil. Zöller.—On the absorption of carbonic acid by saline solutions, by J. Setschenow.—On the explosion-limits of mixtures of combustible gases with oxygen or atmospheric air, by A. Wagner.—On the first appearance of the plants now living during geological periods, by Herr de Saporta.—On the deep-sea temperatures in the South Pacific and the circulation of waters from ocean to ocean; speculative remarks based upon the results of the *Gaselle* Expedition sent out by the German Government, by Herr von Schleinitz.—On the chemical composition of leaves, according to the age and species of trees, by P. Fliche and L. Grandeaun.—Hypothesis on the nature of the soft aggregate state of matter, by L. Pfaundler.

### SOCIETIES AND ACADEMIES

#### LONDON

Geological Society, November 8.—Prof. P. Martin Duncan, F.R.S., president, in the chair.—Melville Atwood, San Francisco, and R. W. Moore, Whitehaven, were elected Fellows of the Society.—The following communications were read:—A short notice of a new exposure of rhaetics near Nottingham, in a letter from E. Wilson, F.G.S., dated November 3, 1876.—Note on the Red Crag, by W. Whitaker, F.G.S.—On the Kessingland Cliff Section, and the relation of the forest-bed to the Chillesford Clay, with some remarks on the so-called terrestrial surface at the base of the Norwich Crag, by F. W. Harmer, F.G.S.—Observations on the geology of East Anglia, &c., by S. V. Wood, jun., F.G.S., and F. W. Harmer, F.G.S., &c. The subjects discussed in this paper were threefold, viz.:—(1) The unfossiliferous sands of the Red Crag. (2) The unconformity between the Lower and Middle Glacial deposits. (3) The mode in which the Upper and Middle Glacial were accumulated. The views of the authors under the first head were similar to and confirmatory of those advanced in the previous paper by Mr. Whitaker; but they pointed out that the Red Crag, which these sands, in an altered form, represent, could not belong to the Chillesford division of that formation, by reason of the casts of shells which had been preserved not comprising any of the more characteristic Chillesford species, and of their including among them forms confined to the older portions of the Red Crag. They also pointed out that the Chillesford Clay had been removed over all the area occupied by these sands by denudation prior to the deposition of the Middle Glacial, which rests upon these sands wherever they occur. The removal of the Chillesford Clay, the authors consider, was due in part, if not in all, to the great denudation between the Lower and Middle Glacial, which gave rise to the unconformity discussed under the second head. This unconformity they illustrate by lines of section traversing most of the river valleys of Central and East Norfolk and Suffolk. These show that such valleys were excavated after the deposit of the Contorted Drift, and out of that formation and the beds underlying it. They also show that the Middle and Upper Glacial have been bedded into these valleys, as well as spread (the middle only partially, but the upper more uniformly) over the high grounds formed of contorted drift out of which they were excavated, and thus generally concealing that deposit, which manifests itself only in the form of occasional protrusions through these later formations, but which they consider constitutes, though thus concealed, the main mass of the two counties. The authors also describe a glacial bed as occurring at various localities in the bottom of some of these valleys, and which in one case they have traced under the Middle Glacial. This they regard as having been formed in the interval between the denudation of the valleys and their subsequent submergence beneath the Middle Glacial sea; and inasmuch as such valley-bed invariably rests on the chalk in a highly glaciated condition, they attribute its formation more probably than otherwise to the action of glaciers occupying the valleys during an inter-glacial interval of dry land. They also suggest that if this was so it is probable that that the forest and mammaliferous bed

of Kessingland, instead of being coeval with the pre-glacial one of the Cromer coast, may belong to this inter-glacial interval—that is to say, to the earliest part of it, before the glaciers accumulated in the valleys, and when the climate was more temperate, any similar deposits in these inter-glacial valleys having been for the most part subsequently ploughed out by the action of the glaciers. In discussing the subject under the third head the authors point out the many perplexing features which are connected with the position and distribution of the Middle Glacial formation; and while they admit that as to one or two of these the theory which they offer affords no explanation, they suggest that the theory of this formation's origin which best meets the case is as follows, viz.:—As the country became re-submerged, and as the valley glaciers retreated before the advancing sea, the land-ice of the mountain districts of North Britain accumulated and descended into the low grounds, so that by the time East Anglia had become re-submerged to the extent of between 300 and 400 feet, one branch of this ice had reached the borders of the counties of Norfolk, Suffolk, Essex, Herts, and Bedford, ploughing out and destroying any lower glacial beds that had been deposited over the intervening counties upon which it rested, and over which we ought otherwise, having regard to the depth of the earlier submergence under which they were accumulated, to find them, but do not. The Middle Glacial formation, consisting of sand and gravel, they attribute principally to the action of currents washing out and distributing the morainic material, which was extruded on the sea-bottom by this land-ice; that ice itself, by keeping out the sea over all the country on which it rested, which was then below the sea-level, preventing the deposit of the Middle Glacial in those parts. The termination of this current action was accompanied by increased submergence and by a gradual retreat of the land-ice northwards to the mountain districts, until Britain was left in the condition of a snow-capped archipelago, from which eventually the snow disappeared and the land emerged. To the moraine extruded from the base of this ice and into deep water they refer the origin of the Upper Glacial Clay, the moraine material remaining partly in the position in which the ice left it, and partly lifted by the bergs which became detached from the ice. Such part of it as was lifted was dropped over the sea-bottom at no great distance from its point of extrusion, and in that way the marine shells occurring in a seam of sand in the midst of this clay at Dimlington and Bridlington on the Yorkshire coast became imbedded, the mollusca which had established themselves on the surface of this moraine material having been thus smothered under a lifted mass of the same, which was dropped from a berg. The authors point out that precisely in the same way in which the Middle Glacial is found stretching out southwards and eastwards beyond the Upper Glacial Clay in Suffolk and in Herts, and is succeeded by such clay both vertically and horizontally, so does the earlier-formed part of the Upper Glacial Clay, or that with chalk *débris*, stretch southwards beyond the later-formed part, or that destitute of such *débris*, and is succeeded by it, both vertically and horizontally. This, they consider, shows that the Middle and Upper Glacial deposits, which constitute an unbroken succession, were due to the gradually receding position of the land-ice during their accumulation, the sequence being terminated with the Moel Tryfaen and Macclesfield Gravels, which were accumulated during the disconnection and gradual disappearance of the ice, and while the land still continued deeply submerged.

Anthropological Institute, November 14.—Col. A. Lane Fox, F.R.S., president, in the chair.—The president read a paper on the Black Burgh Tumulus, Dyke Road, Brighton, explored by him in 1872. This tumulus, about two miles from another opened in 1856, which contained the amber cup, bronze dagger, &c., now in the Brighton Museum, was found to contain towards the centre a layer of charcoal 1' 10" below the surface, and extending to a radius of 20 feet. This, on being microscopically examined, was found to be oak charcoal. Portions of ribs of goat or sheep, notched apparently with a flint saw, were found, a piece of British pottery, and in the centre of the tumulus, in an oblong grave 8 feet by 12 feet, was found a skeleton in a crouching position, six feet below the surface, and crushed flat by the superincumbent earth, the face towards the south-east. These remains Prof. Flower ascribes to a female of about 5' 6" in length, about two feet from the feet lay a fine bronze dagger 4" in length, with the rivets for attaching it to its handle. A curious food-cup with peculiar ornamentation on one side, and also two small discs of metal, apparently rivet-heads, together with a

quantity of small flat beads, originally strung together, were found. These objects belong to the time of interment. Two flint scrapers were also found near the body. The chief peculiarities of this find are the presence of a dagger with a female skeleton and the curiously-ornamented food-cup. The president then read a paper on the exploration, in 1875, of the ditch and tumulus in Seaford Camp. In the ditch at 1 foot below the present surface were found one or two pieces of mediæval pottery, then Romano-British at about 3 feet, and below this chalk rubble evidently filled in, till the original bottom at 7 feet was found. The tumulus inside the rampart was examined, and a large flint scraper and a piece of British pottery were found at 2 feet. Below, at a depth of 3 feet 5 inches, five flint saws and more British pottery were found, also fragments of a flint hammer and a polished flint celt, originally 5 inches long, but broken into three pieces; one of the edges was chipped to make a new edge. The flint hammer was formed from a sea-worn flint pebble. The flint celt had evidently been fractured three or four times at the place of interment. Scrapers and fragments of pottery and a broken but well-shaped barbed arrow-head were also found. No trace of bone was found.—Mr. F. G. H. Price, F.G.S., then read a paper on excavations in the Romano-British cemetery at Seaford, Sussex, by himself and Mr. John E. Price, F.S.A. The authors described the cemetery and the cuttings they made in it. The surface soil, extending to a depth of about 3 feet, contained large quantities of flint scrapers, flakes, and fragments of pottery. Several urns were met with at a depth of 3 feet 6 inches from the surface, which contained, in addition to the usual calcined bones, thin iron nails with large heads, flint flakes, and bronze fibulæ. The objects found in the above excavations were exhibited, and a discussion on the three papers took place, in which the president and others joined. Maps and sections illustrated the papers.—Photographs of a so-called horned man from Akim were exhibited by Mr. Hay per Mr. Francis Galton, F.R.S.

Physical Society, November 18.—Prof. G. C. Foster, president, in the chair.—The following candidates were elected members of the Society:—Major W. Malcolm, R.E., Prof. J. M. Purser, Dr. W. Francis, Mr. G. Johnstone Stoney, and Mr. D. MacAlpin.—Mr. Tylor read a paper on the cohesion and capillary action of films of water under various conditions. The author endeavours to eliminate the action of all forces except that of gravity by immersing his "valves" in water. The models which he exhibited consisted of glass tubes about 3 inches in diameter and 6 inches high, filled with water and containing each a piston, which, on being raised, was capable of lifting by cohesion a heavy mass of metal, the nature of the surfaces in contact differing in the several instruments. From experiments with them he concludes that the time during which a heavy valve can be supported depends upon the size of the surface of contact, the difference of pressure within and without the moving parts, and the smoothness of the valve. On the contrary, dry bodies, such as Whitworth's surface planes, will adhere for an indefinite period. Mr. Tylor considers that the supporting of a body in water is due to a difference of pressure in the water itself, and he adduced Giffard's injector as showing that such differences can take place. He has also studied the form assumed by a drop of water at a tap, and considers that when a fly walks on a ceiling its weight acts in the same manner as the heavy valves in the models exhibited.—Prof. Shelley exhibited some of Sir Joseph Whitworth's surface planes and gauges, and showed their bearing on the subject.—Dr. Stone then projected on to the screen the spectra produced by the diffraction gratings, which he exhibited at the last meeting of the Society. When received on a screen at a distance of about 25 feet they showed bright bands in the red and violet, after transmission through a strong solution of permanganate of potash. Mr. Clarke has since ruled for him gratings on the backs of right-angled prisms, and Dr. Stone has cemented, by means of glycerine, or oil of cassia, gratings on glass and steel on such prisms. The lines were two thousand and three thousand to the inch.

Institution of Civil Engineers, November 21.—Mr. George Robert Stephenson, president, in the chair.—The paper read was on the fracture of railway tires, by Mr. W. W. Beaumont, Assoc. Inst. C.E.

Victoria (Philosophical) Institute, December 4.—Mr. C. Brooke, F.R.S., in the chair.—It was stated that the Society now numbered 713 members.—A paper on the Egyptian myth of Ra, by Mr. W. R. Cooper, was read.



CAMBRIDGE

Philosophical Society, November 6, 1876.—Mr. J. W. L. Glaisher made a communication to the Society on a formula of Cauchy's for the evaluation of a class of definite integrals.—Prof. Hughes exhibited three series of specimens in illustration of the mode of (1) formation, (2) weathering, and (3) fracture of flint, the first two being selected chiefly with a view to the last. He produced proofs that the supposed faulted and re-cemented flints were generally only flint that had irregularly replaced jointed chalk, the formation of the flint being arrested by the joints. In the case of the banded flints he exhibited and distinguished two kinds—one in which infiltration had taken place all round the outside, often a good test of the drift origin of certain fragments; and the other in which a difference of texture, due generally to some included organism, had determined and limited the areas over which infiltration had produced bands of colour. He pointed out that these differently coloured included portions, whether banded or not, affected the fracture, as they also depended upon the texture of the flint, but that the bands themselves had little or no influence upon the fracture. He then drew attention to a series of specimens which showed that when flint or other material of a similar texture was struck by any object such as a round-headed hammer, so that the blow was symmetrically distributed over a small area, a bruise was produced which on weathering flaked off all round a small cone having an angle at its apex of about 110°, and that when the whole had flaked away a smooth basin was left. But if, and only if, the blow was sufficiently intense to break the flint up, this cone was found to truncate a larger cone whose apex had an angle of about 30°. He pointed out that modifications of this double cone structure explained the "rings" and "bulb of percussion" which were appealed to as evidence of the direction of blows on which arguments were founded as to the origin of some stone implements.

PARIS

Academy of Sciences, November 27.—Vice-Admiral Paris in the chair.—The following papers were read:—On the crystals of magnetic oxide of iron formed during the roasting of a spathic ore, by M. Boussingault.—On various works of hydraulics, executed by the ancients in the environs of Rome, by P. Secchi. He notices, shortly, an inverted siphon aqueduct at Alatri, a complete system of drainage there, mode of supplying purified rain-water to the town of Segni, filtration through porous soils, mode of cooling the *acqua tepida*, and of removing carbonate of lime from water. P. Secchi has found the spring which furnished the *acqua tepida*: its temperature is 17° to 18° C. in winter, and it cannot have been over 18° when the ancients used it; this shows the extreme slowness of cooling in the interior of the globe.—On a remarkable fall of hail observed at Grotta Ferrata, by P. Secchi. The hail cloud appeared like an immense ball of cotton or wool, and it advanced with a whirling movement from south-east to north-west. The first rain drops were very large, at least 1 cubic centimetre. The hailstones which followed were formed of groups of crystals like those of quartz gathered round an irregular mass of ice. These groups weighed 40 to 60 grammes; certain blocks at Marino, 300 grammes. Round grains, with concentric layers, were very few. P. Secchi thinks electricity not the cause but the effect of hail.—On the composition of gun-cotton, by Prof. Abel. This refers to a note by MM. Champion and Pellet.—On a new electric repulsion and its application to the theory of comets, by MM. Reilinger and Urbanitzky. Operating with air, oxygen, hydrogen, nitrogen, &c., in Geissler tubes, they got, under pressures of 2 to 8 mm., the usual attraction in the luminous column when the finger, or any conductor was brought near; but, pursuing the rarefaction further, a repulsion. Using a tube like an electric egg, the nebulous light was like the tail of a comet, and the repulsion was very strong, and manifest at a great distance.—On the portative force of horse-shoe magnets; extract from memoir by M. van der Willigen. To saturate his magnets he places them vertically with their poles on those of a Ruhmkorff coil, the circuit of which he opens and closes several times; and the magnetism in the magnets then reaches its maximum, even supersaturation. After the last opening, he slides the magnet carefully towards the edges of the polar planes of the electro-magnets. Then he puts the well-cleaned support before the magnet, inclining the latter slowly. Immediately the support has joined the magnet, the latter can be removed without effort; its portative force is then nearly a third greater than the permanent portative force of M.

von Wetteren's best magnets. This state of supersaturation he makes the starting-point of his researches.—Researches on the vitality of the eggs of phylloxera (second paper), by M. Balbiani. He examines the action of alkaline sulphocarbonates, sulphide of carbon, and empyreumatic products.—Treatment of phylloxerised vines, by M. Boiteau.—On a question of ballistics, by M. Astier.—On the determination of groups formed of a finite number of linear substitutions, by M. Jordan.—On the application of methods of mathematical physics to the study of bodies terminated by cyclides, by M. Darboux.—Construction for a point of the curve of intersection of two surfaces with the centre of the osculating sphere of this curve, by M. Mannheim.—Explanation of actions at a distance; gravitation, electric actions, by M. Picart. He explains all phenomena by matter in motion.—Crystals of gallium, by M. Lecoq de Boisbaudran. These are octahedra truncated at the base; the angles indicate a clino-rhombic form.—Note on the determination of sugars by means of titrated liquors, by M. Perrot.—Second note on testing for fuchsine in wines, by M. Fordos.—Researches on the real origin of nerves of general sensibility in the medulla oblongata and the spinal chord, by M. Pierret.—On the physiological action of temperatures below zero, on silk-worm grains, by M. Daclaux. To the limit, at least, of -10°, the effects produced on the grain by lowering the temperature are comparable in their nature, and differ only in their intensity; this intensity does not increase or decrease regularly with the temperature, but presents a maximum for a certain point of the thermometric scale. This physiological zero of the grain is probably a little above the ordinary zero.—On the structure of the optical system in crustaceans, by M. Chatin.—Synoptic table showing the distribution of fossil molluscs in the Tertiary layers of the Paris valley, by M. Meunier.—On a crystallised silicate of baryta obtained artificially, by M. Pisani.—On the study of the barometer, by M. Wickenheimer. 1. The mean of barometric observations, made at any hour for all the days of the month, gives a constant number, whatever the hour. 2. The barometric height passes two maxima and two minima daily. 3. The annual barometric mean is constant for all hours of the day.—Observation of descending trombes, made at the Cape of Antibes, November 21, 1876, by M. Ferreri.

CONTENTS

PAGE

THE YORKSHIRE LIAS . . . . .	113
OUR BOOK SHELF:—	
Max. von Hantken's "Die Fauna der Clavulina Szabó's Schichten"	115
Atkins's "Elements of Algebra for Middle-Class Schools and Training Colleges"	115
LETTERS TO THE EDITOR:—	
Carl Jelinek.—Dr. CH. DE LITTRON . . . . .	115
Ancient Solar Eclipses.—Sir G. B. AIRY, F.R.S. . . . .	115
Negretti's Reversible Thermometer and the Arctic Expedition.—Sir G. S. NARES . . . . .	116
The Arctic Expedition.—WORDSWORTH DONNISTHORPE . . . . .	116
The Age of the Rocks of Charnwood Forest.—Prof. EDWARD HULL, F.R.S. . . . .	116
"Towering" of Grouse, Partridges, &c.—GEORGE J. ROMANES . . . . .	116
Squirrels.—HENRY H. HIGGINS . . . . .	117
Mr. Harris's Challenge to Mathematicians.—THE WRITER OF THE ARTICLE . . . . .	117
A ZOOLOGICAL STATION ON THE NORTH SEA (With Illustration) . . . . .	117
SENSITIVE FLAME APPARATUS FOR ORDINARY GAS PRESSURE, AND SOME OBSERVATIONS THEREON. By R. H. RIDOUT (With Illustrations) . . . . .	119
ON THE CONDITIONS OF THE ANTARCTIC, II. By Sir C. WYVILLE THOMSON, F.R.S. (With Illustrations) . . . . .	120
NORDENSKJÖLD'S EXPEDITION TO THE JENISSEI . . . . .	123
OUR ASTRONOMICAL COLUMN:—	
Telescopic Meteors . . . . .	125
The Comet of the Bayeux Tapestry . . . . .	126
METEOROLOGICAL NOTES:—	
Recent Storms . . . . .	126
Meteorological Observatory in Monte Cavo . . . . .	126
BIOLOGICAL NOTES:—	
The Primary Elements of the Skull . . . . .	127
The Anatomy of the Gorilla . . . . .	127
The Widgeon in Massachusetts . . . . .	127
NOTES . . . . .	127
SCIENTIFIC SERIALS . . . . .	129
SOCIETIES AND ACADEMIES . . . . .	129

THURSDAY, DECEMBER 14, 1876

## MCLENNAN'S STUDIES IN ANCIENT HISTORY

*Studies in Ancient History, Comprising a Reprint of Primitive Marriage.* By John Ferguson McLennan, M.A., LL.D., Advocate. (London: Quaritch, 1876.)

THE learned and ingenious author of "Primitive Marriage" has in this volume republished that excellent work, appending to it his paper on "Kinship in Ancient Greece," which originally appeared in the *Fortnightly Review*, and some essays, in which he discusses Bachofen's "Das Mutterrecht," Morgan's work on Relationships, Sir Henry Maine's views on the constitution of the Ancient Irish Family, and the chapter on Marriage in my "Origin of Civilisation."

Bachofen supposes that in the first stage of the development of the family marriage was unknown; and his theory is that at length the women, being by nature nobler and more sensitive than the men, and impelled moreover by strong religious aspirations, combined to put an end to this system, and to introduce marriage. For this an appeal to force became necessary and was successful. The result of the victory, moreover, was that the women claimed and established a superiority over the men; they were the heads of the family; after them the children were named; through them the rights of succession were traced, and they even exercised a political as well as a domestic supremacy. At length, however, men reasserted their original supremacy; they reconquered the first place in the family and the state, established their right to the inheritance of property, and to confer their names upon their children. Mr. McLennan considers that Bachofen's "methods and results are equally unscientific;" he points out that the system of inheritance through females is really no evidence of female superiority, but arises partly from marriage not being monogamous, or such as permitted the certainty of fatherhood, and partly also, he considers, from the fact of women not yet living in their husbands' houses. At the same time he fully concedes to Bachofen the honour of being the first to point out that a system of kinship through mothers only had generally preceded that through the male line.

Nor is Mr. McLennan more disposed to accept the theory of Mr. Morgan, which indeed he characterises as a "wild dream, not to say nightmare, of early institutions." Mr. McLennan supposes that in Mr. Morgan's opinion his tribal organisation was an institution intentionally designed to prevent the intermarriage of near relations. In support of this he quotes the passage in which Mr. Morgan says: "It is to be inferred that the tribal organisation was designed to work out a reformation with respect to the intermarriage of brothers and sisters."

From this and other passages a previous writer in this journal, and I myself, had supposed that Mr. Morgan regarded the steps in his system of development as arbitrary and intentional.

Nor do I even now see how we could have arrived at any other conclusion. Mr. Morgan has, however, explained that this is not his theory, and I am not therefore sure whether either Mr. McLennan or I thoroughly under-

stand his view. The solution which he has given, however, of the origin of the family in Mr. McLennan's opinion—"failing to explain the phenomena must sink below the level of reasonable guessing, to which level indeed it must have sunk even had it explained the phenomena, if by any other set of mere conjectures the phenomena could be equally well explained."

Mr. McLennan himself considers that the earliest form of marriage (if indeed it can be so called) was that still prevalent amongst the Nairs of Malabar, in which one wife was married to several husbands not necessarily related to one another. Under this system the idea of relationship naturally took the form of kinship through females. Family property went ultimately to the daughters of their sisters; a man's heirs being in the first place his brothers, and subsequently his sister's children. From the Nair system was, in Mr. McLennan's opinion, gradually developed (in many cases through an intermediate form anciently prevalent in Britain) the Thibetan species of polyandry, in which the sons of a house took one wife between them. This change eventually introduced kinship through males. It involved the breaking up of the primitive form of the family, and led in time to the transference of the government from the mother to the father. After this the practice of monandry arose, the younger brothers making separate marriages, and thus Thibetan polyandry died out, leaving behind it the Levirate, that is to say, the obligation of brothers to marry in turn the widow of a brother deceased, a custom which the Old Testament has rendered familiar to us. The Levirate next died out, and thus the family slowly assumed the form to which we are accustomed. It will thus be seen that the keystone of Mr. McLennan's system is the practice of polyandry, which, indeed, under his theory is a necessary stage of the development of the family relationship. I cannot, however, regard polyandry as having been a general and necessary stage in human development. I have therefore suggested that individual marriage rose out of capture. That just as a warrior converted to his own use the animals which he captured, and made slaves of the men, so he made a wife of any woman whom he admired, the capture giving him a right which the other men of the tribe did not share. This view, indeed, seems so natural that I wonder it had not been before suggested; and I observe that one or two recent writers have treated it as a recognised and well-known fact, whereas it cannot at present claim to be more than an individual theory which none of the authorities on such a question, such as Mr. Darwin, and Mr. McLennan himself, have as yet accepted. Mr. McLennan, indeed, denies that my views are "in the least degree probable," and if such a question could be decided by authority, I should at once bow to his decision. Such, however, is not the case, and I will only say that, before my work was published, I had foreseen and weighed as carefully as I was able, the objections which Mr. McLennan has now brought forward; and that I then thought, and still think, that I have satisfactorily replied to them. The fundamental objection which Mr. McLennan urges I did not indeed expect him to allege. Like Bachofen, I commence with a time when marriage did not exist. Mr. McLennan, however, replies: "Sir John Lubbock has not only failed to show that the initial stage of his scheme was

existed, but has failed also to make it in any the least degree probable that it ever existed" (p. 449).

I will, in reply, content myself here with quoting one authority only for the existence of my first stage, an authority for whom I have the highest respect, namely, Mr. McLennan himself:—"I conceive," he says, "that marriage was at first unknown;" in fact, the initial state in his system is practically the same as in mine; the differences between our views lie in the subsequent stages.

In his last essay Mr. McLennan discusses Sir Henry Maine's views on the Ancient Irish Family. The question is very complex, and those who have not Sir Henry's work by their side for reference will not find this chapter very easy to follow.

The Irish family "was anciently divided into four groups known as the 'geilfine,' 'deirbfine,' 'iarfine,' and 'indfine' divisions. . . . Within the family seventeen members were organised in four divisions, of which the junior class, known as the 'geilfine' divisions, consisted of five persons; the 'deirbfine' the second in order, the 'iarfine' the third in order, and the 'indfine' the senior of all, consisted respectively of four persons. . . . If any person was born into the 'geilfine' division, its eldest member was promoted into the 'deirbfine,' the eldest member of the 'deirbfine' passed into the 'iarfine,' the eldest member of the 'iarfine' moved into the 'indfine,' and the eldest member of the 'indfine' passed out of the organisation altogether."

A complete family therefore would be composed as follows:—

Indfine.	Iarfine.	Deirbfine.	Geilfine.	
A <sub>1</sub>	A <sub>2</sub>	A <sub>3</sub>	A <sub>4</sub>	Fathers and brothers. Sons and first cousins. Grandsons and second cousins. Great-grandsons and third cousins. Great-great-grandsons.
B <sub>1</sub>	B <sub>2</sub>	B <sub>3</sub>	B <sub>4</sub>	
C <sub>1</sub>	C <sub>2</sub>	C <sub>3</sub>	C <sub>4</sub>	
D <sub>1</sub>	D <sub>2</sub>	D <sub>3</sub>	D <sub>4</sub>	
			E <sub>4</sub>	

On many points, however, Mr. McLennan dissents from the views of Sir H. Maine.

Sir Henry Maine, for instance, says, "The Brehon writers speak of its (the geilfine division) consisting of a father, son, grandson, great-grandson, and great-great-grandson, which is a conceivable case of geilfine relationship, though it can scarcely be a common one." Mr. McLennan, on the contrary, thinks that "it was, actually or constructively, the only one—when the division was full—i.e., when all its possible members were in being."

Again, Sir Henry Maine considers this strange arrangement to be "a monument of that power of the father which is the first and greatest landmark in the course of legal history."

Mr. McLennan entirely dissents from this, and indeed after discussing Sir Henry Maine's views with ingenuity and erudition, he concludes that the objections he has brought forward "are fatal to Sir Henry Maine's account of the system. He has failed to throw light either on its purposes or its principles. He has made no single feature of it clear in the light of Roman law, and, after all his ingenious reasonings, has left its main features as mysterious as he found them."

Whatever conclusions on these subjects may ultimately be arrived at, everyone who reads Mr. McLennan's book must feel that he brings to the inquiry an immense

amount of learning, and has stated his views with great ingenuity. All students of early history will hope that he may have leisure and health to pursue his studies.

JOHN LUBBOCK

OUR BOOK SHELF

*Science in Sport made Philosophy in Earnest.* Edited by R. Routledge, B.Sc., F.C.S. (London: Routledge and Sons, 1877.)

THE title of this book at once recalls Dr. Paris' "Philosophy in Sport made Science in Earnest." The author, however, tells us in his preface, that the reason he has adopted so similar a title is that his original design was to re-edit Dr. Paris's well-known, but now antiquated, book; finding, however, that mere patchwork would not bring the book into harmony with the present state of science, he determined to treat the subject afresh, and the volume before us is the result of that determination. The inversion of the title is, we think, wise, though some will object to the use of the word philosophy in the sense meant by the author, and will contend that the term physics should have been employed. The graver question is whether, under any circumstances, science should be taught by sugar-sticks. Our own opinion is decidedly against all books of this kind, and there can be little doubt intelligent children prefer not being trapped into the study of any subject, but like work openly and honestly put before them. Such books as the original editions of Mrs. Marcet's "Conversations in Chemistry," or the altogether admirable "Chapters on Sound," and other little books by Miss C. A. Martineau, are the best kind of reading to put into the hands of children who wish to learn the rudiments of natural knowledge. Nevertheless, Mr. Routledge has done his work extremely well. Those who like science and a story running together, will here find a trustworthy, clear, and accurate introduction to the study of physics. W. F. B.

*Mushrooms and Toadstools.* By Worthington G. Smith. (London: Hardwicke and Bogue.)

THIS is a reprint in a separate form of the descriptions illustrative of two large sheets of figures of edible and poisonous fungi, with the addition of two key-plates. Not having been written and designed for separate publication, it is consequently not so complete as it might otherwise have been, and we doubt whether by itself it will prove of much service in the discrimination of good and bad fungi. Mr. Worthington Smith may be accepted as a safe and trustworthy guide, having himself suffered on one or two occasions from reckless indulgence in doubtful species; he is desirous of sparing others like sufferings, and approaches the subject fortified by experience. In conjunction with the plates this key is admirably suited to fulfil its purpose; as a separate work, we doubt whether the author himself would feel wholly satisfied. If this reprint leads to a wider acquaintance with the diagrams, which ought to find a place in every schoolroom, its reproduction in this form will fully justify the step which the publishers have taken. M. C. C.

*Between the Danube and the Black Sea; or, Five Years in Bulgaria.* By Henry C. Barkley, C.E. (London: John Murray, 1876.)

THIS book has not been written to take advantage of the interest in Bulgaria excited by the present crisis. Mr. Barkley really spent twelve years in Turkey—the first five commencing shortly after the Crimean war, and the other seven at a subsequent period. He was employed as an engineer in connection with a Bulgarian railway, and had ample opportunities of becoming well acquainted with the country and the people. These opportunities he took good advantage of, and in the volume before us has recorded his impressions and adventures in simple and

interesting style. It is a valuable feature that Mr. Barkley's sojourn in Turkey was not made during recent events, and his narrative is not written with a view to advocate one side or the other in the present unhappy conflict. He saw the Bulgarians in what may be called their normal condition, and had no reason to be prejudiced for or against any section of them. He saw much to condemn and a good deal to praise both in Christians and Mohammedans, but little that was praiseworthy in Turkish officials, "from the Governor-General to the hangman." The work contains much information on the Bulgarians, their characters and ways, and will be found both interesting and instructive.

*The District of Bakarganj; its History and Statistics.*  
By H. Beveridge, B.C.S. (London: Trübner and Co., 1876.)

THE publication of this work is somewhat opportune, for under the reformed, if not improved, spelling of the title, our readers will no doubt recognise the district of Backergunge, which, with other districts at the mouth of the Hooghly, was recently overwhelmed by one of the most disastrous cyclone-waves on record. Mr. Beveridge is magistrate and collector of the district, and as such has had a good opportunity of becoming acquainted with it. He has evidently also read a great deal on the subject, and the result is a work which ought to take a good place as a local history. Mr. Beveridge describes the physical features of the district, its antiquities and early history, the pergunnahs and sunderbunds, treats of Government estates, land tenures, the inhabitants, productions, and manufactures. The second part refers to the several departments of the administration, education, &c. This district, from its low-lying position at the top of the Bay of Bengal, has been peculiarly subject to the inrush of the wave which accompanies cyclones. Until the recent catastrophe the great event in the history of the district was an inundation, evidently caused by a cyclone-wave, which occurred in June, 1822. According to contemporary account, 100,000 persons lost their lives, and as many cattle; but this must pale before the recent catastrophe, and henceforth October 31, 1876, will be the black-letter day in Bakarganj. Mr. Beveridge's book will be found to contain a great deal of really valuable information, and if every district in India were treated in a similar manner, we should possess a library of information of the greatest value. The volume contains a good map of the district.

#### LETTERS TO THE EDITOR

[The Editor does not hold himself responsible for opinions expressed by his correspondents. Neither can he undertake to return, or to correspond with the writers of, rejected manuscripts. No notice is taken of anonymous communications.]

##### Sea Fisheries

PROF. NEWTON has sent you a long reply to my criticism of his Address to the British Association; and although it is exceedingly inconvenient to me, as I believe it is also to him, to continue the discussion at the present time, I must ask you for space; as soon as you can spare it, to point out as briefly as I can, how little progress my friend has yet made in his subject. He was good enough to show me his reply before he sent it to you, and I then told him I should have to meet him on every point in it. Nevertheless he sent it for publication, and as the subject appears to me to be one on which the public should not be misled, I am compelled to ask space for some comments upon it.

The Minutes of Evidence given before the Commission, consisting of 61,831 questions and answers rather frighten him, and he turns to the Index for help. Without a careful study of the evidence the Index is practically useless for my friend's purpose, as I told him. And some knowledge of the habits of sea-fish will be exceedingly valuable in enabling it to be understood. The Index is not a *præcis*. There is intrinsic evidence in Prof. Newton's reply that he framed it, I think I may say solely from the Index, and not from the evidence; his tables of increase and decrease,

and calculations of the number of questions and answers relating to each, are obviously so, and the value of his arguments may be judged of accordingly. To show what his tables are worth I will take two or three entries in them for examination. "Bream" is the first, and that fish is said to have increased. This is the only entry relating to bream in the whole Index. Bream are common fish on very many parts of our coast; they often congregate in large numbers, sometimes on one part, sometimes on another; they happened to have been unusually numerous off Hastings just before the Commissioners were there, and the fishermen accordingly recorded the increase. But there is not the slightest reason for believing bream were then more abundant than usual on our coasts generally than the reverse. "Brill" has two entries, both in the decrease column. In one case the evidence is that of fishermen in Start Bay, who used the sean nets within half a mile of the beach, and who were furious against the Brixham trawlers for sometimes working in the Bay; the said trawlers, up to that time, and for the twelve years since, finding no falling off in the supply of brill. The other case was at Liverpool, where brill was mentioned, among other fish, by the Inspector of the Fish Market, as having diminished. He made the remarkable statement that not 1 per cent. of sea-fish of all kinds was brought to the market in 1864 compared with what had been taken there twenty years before. As the number of fishing-boats had increased during that interval, and the price of fish was, if anything, rather less, owing to the large supplies sent by railway from the east coast direct to the fishmongers' shops, and not going into the market, it is very clear that if the fishermen were getting a living from the 1 per cent. in 1864, they must have been making at least 100 times as much money twenty years before, which is an absurdity. "Cod and ling" come next. Here my friend had better look to his arithmetic. There is no doubt that cod, and haddock especially had fallen off at many of the inshore fishing grounds. They are both species which have fluctuated very much in numbers in many places, the haddock in particular making its appearance in abundance for a season or two, and then becoming very scarce; or they have left places where they were abundant for years together, and again unexpectedly returned. The last report I had from the north-east coast of England, just three years ago, was that the line fishermen were doing well, and their only complaint was of the scarcity of mussels for bait. But it was along this coast that the great outcry against the trawlers arose in 1863, which led to the issue of the Sea Fisheries Commission; and a great deal of the evidence given there was such as might have been expected under the circumstances.

It will be difficult to treat the next entry seriously, but I will try to do so. In a table professing to show the increase or decrease of the fishes with which our markets are supplied, he notes one particular kind as having decreased, and he counts the two instances as helping to prove that our sea fisheries are on the high road to ruin. Those persons who have even but a very slight acquaintance with sea fishing will be rather surprised to hear that the fish whose end is approaching is nothing less than the "dogfish!" one whose utter extermination would gladden the hearts of the fishermen from the Shetlands to the Land's End, and from Dingle to Dover. Hordes of these predatory and mischievous fishes roam round the coasts of the British Islands; sometimes they swarm in one place, sometimes in another. In the herring season the destruction they have caused to both fish and nets has been such that the fishing where they were has been almost entirely stopped for nights together, and the long-liners also suffer severely from them. They are said to have seriously interrupted the Yarmouth herring fishery this year; and the official report for 1875 from the coastguard at Killibegs, in Ireland, states that the dogfish had so much increased that Donegal Bay had, on several occasions, been apparently cleared of fish by them, and that the nets were constantly full of them. It may be well said that happy is the country whose dogfish are decreasing! Would that I could believe they were becoming scarce in our own!

Prof. Newton has evidently been taken in by a heading in the Index, thus—"Dogfish, consumption of." The explanation is as amusing as it is simple. In Morecambe Bay some of the fishermen catch the dogfish, and after skinning it and removing the head and tail, send it under the name of "Darwen Salmon" to the Blackburn and Preston weavers, who are the only persons who will buy it. This is the only case I ever heard of in which the hated dogfish was not knocked on the head and thrown overboard whenever there was a chance of doing so.

Had I space at command I could enlarge on these tables, but

I think I have said enough to show how much dependence can be placed on them.

We now come to the "process of extinction of animals." Here my ingenious friend should be on safe ground. His argument is, as I understand it, that a species first becomes scarce on the borders of the locality or area where it is found in most abundance. Let me apply this rule to the herring. That fish is only met with when it shows tolerably near the coast—on what I presume he would call the "borders." Can he tell us where the herrings go after what is called the herring season, when they disappear—where the great herring centre is? Fishermen have a vague way of answering this question by saying that they go into deep water, which strictly means somewhere out of sight. Has Prof. Newton evolved more than that from his inner consciousness in his study at Cambridge? That he had given five minutes' attention to the practical study of the habits of the herring—to its life-history, before he gave his Address to the British Association at Glasgow, I venture to doubt very much. The apparent abundance of any fish depends very much on the success of the fishery for it; but many things may and do interfere with that success. It is only within the last very few years that evidence, apparently of great importance, has been obtained, pointing to a relation of the temperature of the sea to the depth at which the herrings swim, and consequently to the chances of their coming within reach of the floating drift-nets, or otherwise. No one can say, with any confidence, why fish are taken abundantly by drift-net or line in one week, or even day, and very few in the next. It may appear very well for Prof. Newton to talk of the consideration of our sea-fisheries being "fraught with unusual difficulties," but he disposes of the question as if it were one of no difficulty, by saying, in his Address, that "it is highly necessary to impose some limitation upon them"—the sea-fisheries. This implies, as plainly as can be, that, notwithstanding the "unusual difficulties," he has quite made up his mind on the subject.

Again, he says, "I have found that the grumblers among the fishermen commonly assign some specific cause for their complaints, be that cause real or imaginary. Their assignment of any cause is purely a matter of opinion with them." Is not Prof. Newton aware that very many of the fishermen who gave evidence before the Commissioners stated these matters of opinion simply as matters of fact? The history of the trawling question is quite sufficient to prove this. He then says, "Their statements [those of the fishermen] as to the increase or decrease of fishes relate to a matter of fact within their knowledge." Does he know the meaning of "conflicting evidence," for which he gives a separate column in his tables? If one fisherman says fishes are increasing in a district and another says they are decreasing, are they both to be considered as speaking of a matter of fact within their knowledge?

In the matter of the extent of the inquiry under the Sea Fisheries Commission, I must keep my friend to the point. My stated objection to Prof. Newton's address was that in it he clearly spoke of a decline as a fact, and of the Sea Fisheries Commissioners being unable to find any remedy for it—"There was nothing to be done with our Sea Fisheries but to leave things alone." No possible refuge under the expressions in his Address will prevent this meaning being obvious.

I now come to this statement:—"It is quite compatible with an increased supply of fish that there may be an actual decrease in the stock of fishes." It may be so; but as, at all events, in the important drift-net and line-fisheries, the capture of the fish depends entirely on their chancing to come in the way of the nets or baits, and there is no hunting them down as there is with game on land, the probability of such a case does not appear to be very great. Of course, Prof. Newton will admit that the converse proposition is equally sound—that a decreased supply of fish may be compatible with an increased stock in the sea. There may be millions of herrings in the British seas without our fishermen finding them out; in fact, there must be, for it is only during a certain season in each year that the fishermen meet with them, and, as they will themselves admit, "luck" has then a great deal to do with it.

The "practical mischief likely to result" from such agitation as his Address might stir up is this—the fishermen may fear some new regulation for the size of mesh they use in particular fisheries, and be afraid to order new nets of the old pattern when they are urgently wanted, as was the case in 1863; for a mile and a quarter of herring nets, or two miles and a half of mackerel nets, are very much more costly articles than the comparatively small nets used for salmon-fishing in the rivers. The

salmon fishers, as it is, are sufficiently bothered with inquiries and alterations of bye-laws.

Prof. Newton can find no new facts in my book on "Deep-Sea Fishing," supporting my belief that our sea fisheries are not falling off; but I may mention that I have shown from official returns that since the Commissioners reported, there has been a vast increase in the number of the most important class of fishing-boats, used respectively for the trawl, drift, and line-fisheries; and I believe most people will consider that when, for years in succession, more money is invested by the fishermen generally in boats and gear—by the persons who Prof. Newton says know more about fishing matters than he does—and the general supply to the markets does not fall off, but the contrary, there is not much evidence of the stock of fishes in the sea becoming exhausted. That the fisheries at particular places have fluctuated is well known, and if we knew more about what affects the movements of fish, this might perhaps be explained.

The reason why the fishermen were so much in favour of the Sea Birds' Preservation Act was simply because the congregation of sea birds over the shoals of fish often told the fishermen when their fishing was likely to be successful. Prof. Newton, I believe, was anxious to prevent certain species of sea-bird having the protection of the Act, but, unless I am greatly mistaken, he was strongly in favour of the general principle of the Bill. What particular species of fish is devoured by any particular species of protected sea-bird does not affect my argument; but I may suggest that the protected gulls are surface-feeders, and mackerel, herrings, pilchards, and sprats, besides plenty of young fishes of other species, are commonly considered as surface-swimmers. The collection of gulls over the shoals of fish is spoken of by the fishermen on many parts of our coast as one of the "appearances of fish."

The last point to be considered is Prof. Baird's Report on the American Sea Fisheries. Prof. Newton says the decrease of these fisheries on the Atlantic coast of America is therein treated as a fact beyond denial. He is quite correct here; but he adds that "overfishing" is unquestionably assigned as the chief cause of that decrease.

I have Prof. Baird's Report for 1872 and 1873 now before me. I must content myself with a few extracts from it. Among other fishes he mentions, Prof. Baird gives a good notice of the alewife or fresh-water herring, and speaks of how valuable it has been in attracting the deep-sea fishes to the shores; he points out how the alewife has diminished, owing to the dams in the rivers preventing the alewives proceeding up to their spawning grounds some way from the sea, this fish having much the same habits as the salmon and the shad. As a consequence the myriads of young fish which used formerly to come down to the sea are now not to be met with at the mouths of the rivers. He goes on to say, at page 12:—"It would, therefore, appear that while the river fisheries have been depreciated or destroyed by means of dams or exhaustive fishing, the codfish have disappeared in equal ratio. *This is not, however, for the same reason, as they are taken only by the line, at a rate more than compensated by the natural fecundity of the fish.*" (The italics are mine.) At p. 60 Prof. Baird says, after speaking of the value of the alewife as food for salmon, trout, and other freshwater fishes: "It is in another still more important connection that we should consider the alewife. It is well known that within the last thirty or forty years the fisheries of cod, haddock, and hake along our coast have measurably diminished, and in some places ceased entirely. . . . Various causes have been assigned for this condition of things, and among others, the alleged diminution of the sea-herring. After a careful consideration of the subject, however, I am strongly inclined to believe that it is due to the diminution, and in many instances to the extermination of the alewives" (or freshwater herring). . . . "We know that the alewife is particularly attractive as a bait, especially for cod and mackerel. . . . The coincidence, at least, in the erection of the dams and the enormous diminution in the number of alewives, and the decadence of the in-shore cod-fishery, is certainly very remarkable. It is probable, also, that the mackerel fisheries have suffered in the same way, as these fish find in the young menhaden and alewives an attractive bait."

Unless Prof. Baird has in a later report expressed an entire change of opinion, I think I am justified in believing that Prof. Newton is as unable to comprehend the question of the American sea-fisheries as he is that of our own.

My friend has told me in his usual good-humoured manner that neither of us will ever convince the other, and I am cer-

tainly indisposed to throw away any more time on this discussion; but I may remind those who are interested in it that the question really lies between Prof. Newton and the Royal Commissioners. On the one hand, Prof. Newton, with no practical acquaintance with the subject, knowing nothing of the witnesses or of the circumstances under which they gave their evidence, but taking the Index to the evidence as his sole guide, so completely satisfied himself that the Commissioners had arrived at an erroneous conclusion in believing our sea-fisheries were flourishing that he brought their delinquencies before the British Association. On the other hand, Prof. Huxley (who somehow has obtained the character of thoroughly working out any subject he takes up, so far as he has the means of doing so) and the other Commissioners themselves visited the several fishery stations, ascertained beforehand the nature of the disputes and complaints among the fishermen, and examined and cross-examined the various witnesses. They spent many days separately and together in considering the evidence on the several subjects of their report, and unanimously agreed to this among other conclusions:—

"The total supply of fish obtained upon the coasts of the United Kingdom has not diminished of late years, but has increased; and it admits of further augmentation to an extent the limits of which are not indicated by any evidence we have been able to obtain."

E. W. H. HOLDSWORTH

Athenæum Club, November 25

### Examinations in Science

MAY I beg you will introduce to the notice of your readers a grievance urgently in need of a remedy? The grievance is considerable; the remedy simple; and if scientific men will not make it their concern, nobody else will.

A short time ago, when the competitive examination controversy waxed warm, I ventured to enter somewhat fully into the present haphazard system of awarding marks to candidates who competed for posts in the public service. My object then was twofold:—(a) to bring facts and figures to bear against the erroneous statements of a few theorists who unfortunately were able to command a great deal of public attention; (b) to get fair play for all examinees. My object now, however, is to warn those who advocate the advancement of scientific instruction, that the present faulty method of conducting public examinations (in some quarters at least) tends far more to the depression than to the encouragement of scientific study. Destitute myself of scientific knowledge, and bound to no particular curriculum of instruction, I am obviously not writing from the point of view of a partisan; and if I have joined in the lament of scientific men that insufficient consideration is given in most schools to the teaching of science, it is simply because there are good grounds for the conviction that the higher education of this country is too one-sided.

The point I wish to raise is not whether the grammar and philosophy of science contribute to the training and stimulating of the youthful mind in a greater or less proportion than the grammar and ornaments of the Latin and Greek languages; nor whether so-called technical instruction is being properly administered or injudiciously shelved; but I am asking whether scientific teaching, so however little it be, is adequately encouraged by scientific men in the persons of their public examinees?

Judging from the issues of certain examinations, the candidates for which are drawn from the leading schools, I am satisfied that it is not.

By dint only of considerable pressure are candidates induced nowadays to carry on their school course in science for an additional year or two, so general is the conviction among them that they are merely gambling for marks and that the object of much honest labour will not be attained. In fact, for the particular purposes they have in view, they run the double risk of wasting their time and burning their fingers.

It may, of course, be urged that the ends of science are not furthered by youths who aspire to touch only a modest limit in view of qualifying for public employment; but surely as much may be said of almost every other branch of study. And if this is really the opinion entertained by science examinees, it would be better at once to expunge all scientific subjects from the Government programmes.

But candidates and teachers are concerned only with the rules and regulations that are actually current, and that wiser men have made; and their grievance is that there is a greater element of uncer-

tainty in the awards issued for science than for any other subject. Instead of estimating the various science subjects as fractional parts of a wide and comprehensive programme, and of dispensing marks on a fixed and definite plan whereby a given quota of proficiency shall be made to carry the same relative weight as a given quota of proficiency in other branches, it would seem that examinees, who, by the way, are constantly being changed, regard their own branch as a distinct entity—set up their own standard of excellence for the nonce—and distribute basket after basket of ducks' eggs among all who fail to reach a very advanced qualifying minimum, forgetting perhaps that meanwhile the classical candidate is receiving his modest or substantial reward according to the character of his work. The position indeed would be pretty much the same as if a classical examiner should announce that no candidate would be entitled to a single mark who did not write a faultless copy of Greek verses! I am prepared to show that this ideal standard has varied to the extent of 50 per cent. in two successive years; nay, more, that science candidates have suffered a loss of 50 per cent. in their marks after an additional year's reading under the best teaching that money can purchase. A case occurred some months ago of a youth who, having won the Huxley and Balfour prizes in Edinburgh, entered his name for an open competitive examination in London. He obtained 64 out of 1,000 marks in his two branches of science, at a moment when from 500 to 600 marks out of a total of 1,500 were being showered upon the classical men. At this particular ordeal "Chemistry" chanced to receive decent recognition, but as this youth's tastes happened to run in another direction he was ignominiously defeated.

Any number of such cases may be enumerated, but perhaps I have said enough to prove that a real grievance does exist.

The remedy is obvious: either to induce the authorities to strike out the words "Natural Science" from their list of subjects, or to arrange for the formation of a committee of science examinees who will devise some plan for fixing, as nearly as possible, a uniform standard, and for distributing marks on equitable principles, after consultation with the classical, mathematical, and other examinees. In default of this I do not hesitate to say that examinees will continue to be trifled with at the most important crisis of their lives; for at these public examinations it is no longer a question whether they gain a scholarship or improve their position at school—it is a question of their future career.

I have yet to state the main point. Setting aside the fact of hardship and injustice, it may be asked how far the present independent and very summary system of dealing with batches of schoolboys can possibly cripple the cause of the technicians who are anxious to press forward the teaching of science. My reply is that science candidates, heartsick with disappointment, will fall out of the ranks and will induce others not to enter them; the belief will rapidly gain ground in the schools that science is "a mistake;" and there is abundant reason for supposing that many a schoolmaster will be only too willing to endorse this opinion. I contend that our public examinees wield the thong that lashes the schools into action, and that we are only just beginning to get fair play for what are called "modern" subjects, but that unless our science examinees apportion their marks in a more just and consistent manner they will simply drive all science candidates "bag and baggage" out of the field. In other words, they will virtually be paying a premium to the schoolmasters for neglecting to carry out the very objects they are clamouring for.

W. BAPTISTE SCOOLES

Garrick Chambers, Garrick Street,  
December 12

### The Rocks of Charnwood Forest

MAY I be allowed a short space in reply to Prof. Hull's courteous reference to my letter on the Charnwood rocks, for I fear that I have failed to make two points in that sufficiently clear? One was, that as the Borrowdale series of the Lake District and the (Lower) Cambrian series of North Wales are equally azoic, no correspondence in time with the latter could be inferred for the azoic Charnwood rocks. The argument from absence of fossils surely tells as much one way as the other; indeed, having regard to the similar petrological conditions of the Borrowdale and Charnwood rocks, I think it is slightly in favour of their correspondence. The other point was, that as Prof. Sedgwick's term Cambrian included the Cambrian and Lower Silurian of the survey, his authority could not be quoted in favour of the (Lower) Cambrian age of the Charnwood rocks any more than of their correspondence with the Borrowdale series, unless it could be

shown (I am not aware that it can) that he had definitely correlated them with (Lower) Cambrian beds. T. G. BONNEY  
St. John's College, Cambridge, December 11

#### Self-Fertilisation in Flowers

DR. MÜLLER (*NATURE*, vol. xiv. p. 571) and Prof. Asa Gray (vol. xv. p. 24) reflect on your abstract of my verbal remarks (vol. xiv. p. 475) on *Browallia* in a way not particularly complimentary to me. Prof. Gray admits having read the full report, and yet fails to notice that "February 8," is there given as the date of my remarks. Had he not overlooked this, he would not have wondered that I did not see "Hymenoptera and Lepidoptera of various sorts" visiting them. As reported in the *Proceedings* of the Society, I exhibited fresh specimens in fruit at the meeting of that date, which is about mid-winter with us, when these insects are at rest. The plants were of course grown under glass, and when I say "*Browallia* is not visited by insects, yet seeds abundantly," I am referring naturally to the experience I am describing. If one be justified in taking an unguarded expression, or even a whole sentence, without any regard to the subject matter of its connection, we might have as many "theories" in science as there are sects in religion, all founded on isolated "texts" in Scripture. It is remarkable that in a paper in which Prof. Gray is commenting on hasty observations, in another he should have overlooked a fact like this. I do not say *Browallia* is never visited by insects, but I do say that they do not visit them *under such circumstances as I was describing*.

Of the fact there is no doubt, of the interpretation there may be many opinions; and no one respects an opinion by Prof. Gray, when he carefully considers it, more highly than I. Yet I would respectfully submit, that even though an insect were as careful to avoid the "brush" which almost closes the throat, though it were able to be as careful in finding the chink as Dr. Gray was in his manipulations with the hog's bristle, the obstruction of the mouth in the way it is cannot surely be claimed as an arrangement in favour of cross-fertilisation.

Dr. Müller seems to believe that I do not know that "many flowers have recourse to self-fertilisation when not visited by insects." If he will examine the *Proceedings* of the Am. Association for 1875, p. 247, he will find that I have given him the credit of the observation, and the fact itself such consideration I thought it in justice entitled to. The impression which Dr. Müller's expression warrants, that he has not had the opportunity of reading the numerous observations I have placed on record during the last few years, in relation to this and kindred topics, fully excuses him in my mind for his sharp comments.

THOMAS MEEHAM

Germantown, Philadelphia, Nov. 21

#### On Supersaturated Solutions

IN a paper communicated to the Royal Society last May I described some experiments to show that the open air and the air of ordinary rooms do not generally contain crystals of the various salts which form supersaturated solutions. It has been remarked to me that I did not give the strength of the solutions, so that doubt might arise as to whether the results would hold good for very strong solutions:—The following experiments set that question at rest. I made a very strong solution of sodium sulphate which threw down abundance of anhydrous salt on boiling. When cold a good half inch of anhydrous salt remained at the bottom of the test-tube. Took this into my garden, which is near Bristol. Took up some of the solution in a clean pipette and put drops on the leaves of peonies, which were very dusty, on geraniums, on moss, on the stone coping of Bath oolite, and on the painted woodwork of the railings and garden door. Not a single drop crystallised. Made a drop set quite solid by dropping in earth with the fingers. N.B.—I had been at work with the salt for some time and crystals were probably adhering to my finger. Earth not touched inactive. The drops sank into the moss slowly, remaining quite liquid. Those on the stone were soon absorbed and dried up on the surface; fresh drops put on these remained liquid. Smear a drop repeatedly with the finger which had been cleansed; inactive, as fresh drops remained liquid on it. Drop on flower-pot, inactive, smeared with finger; when dry inactive to fresh drops. These and other drops on the flower-pot slowly formed a film of 7-atom salt. Stirred the solution with a dry twig picked off the ground, inactive. The drops on the leaves all slowly evaporated, giving the 7-atom salt. Finally, made some of the drops and the original

solution crystallise, to prove that they were really supersaturated. These experiments were made both in sun and shade. Weather dry. The test-tube was left open the whole time.

On another occasion I took a flask of sodium sulphate containing a large quantity of the 7-atom salt into the garden in the evening. Put drops on a flower-pot; one only crystallised. Put a lump of dry earth into one drop, and added more solution; did not crystallise. Made a little mud pie by breaking this up with the pipette, inactive; pipette repeatedly inactive in the solution after touching this. Brought a crystal to the earth; crystallised at once all through the mass.

Clifton College

J. G. GRENFELL

#### KARL ERNST VON BAER

SCIENCE has sustained a great loss by the death of Dr. Karl Ernst von Baer, the eminent biologist; he died at Dorpat on November 29, in his eighty-fifth year. Von Baer was born in Esthonia on February 29, 1792, and while yet at the gymnasium became an earnest student of botany. He studied medicine at Dorpat in 1810-14, whence he proceeded to Vienna for the study of clinical medicine, to Würzburg, where he gave special attention to comparative anatomy, and to Berlin, where he studied magnetism, electricity, crystallography, and geology. In 1817 he went to Königsberg as prosector to Prof. Burdach, and two years later he became professor of zoology at the same university. In 1826 he succeeded Burdach in the chair of anatomy, accepted an invitation in 1829 from the St. Petersburg Academy, but returned to Königsberg the following year. A few years later, in 1834 he was again invited to St. Petersburg, where he became one of the most active members not only of the Academy, but also of the Geographical and Economical Societies. Von Baer's writings, marked by philosophic depth, are, on account of their orderly and clear exposition, as attractive as they are generally intelligible. The subject of the origin and development of organic bodies, which had special attractions for him, he did much to clear up. The foundation of his eminence he laid in Königsberg, where he published in 1827 his "*Briefe über die Entstehung des Eies*," which was soon followed by the important works "*Entwicklungsgeschichte der Thiere*," and "*Geschichte der Entwicklung der Fische*." These works, which are yet of great value, have earned for their author the title of Father of Comparative Embryology.

In the summer of 1837 von Baer made a journey of exploration from Archangel to Novaya Zemlya, and his report is still one of the most valuable sources of information upon that island. In 1851 his attention was attracted to the immense Russian fisheries and the irrational methods used. During 1851-6 he investigated the fisheries of Lake Peipus, the Gulf of Finland, and the Caspian Sea, publishing the results of his investigations in a great work in 1859. The name of Baer is connected with more than one improvement in the fisheries, and some important additions were made to the trade, thanks to his efforts. His remarkable work, "*Kaspische Studien*," has had no rival. It would be impossible to enumerate the various subjects upon which he has thrown clear light in his writings. The laws of excavation of river-beds, the navigability of the Arctic seas, the steppes and forests of Southern Russia, the Glacial period, the Siberian mammoths, the potato disease, were at various times treated by him, and in each department von Baer opened out new and extensive fields of inquiry. His acquirements in zoology, comparative anatomy, embryology, physiology, and anthropology are well known; moreover ethnography, the early history of mankind, archaeology, and the science of language will count him among their most eminent students. In his later years, besides various anthropological papers, he published an autobiography (which appeared soon after the fiftieth anniversary—1864—of his scientific career), his "*Reden*," and "*Kleine Aufsätze vermischten Inhalts*."

(1864-75). The very valuable publication he undertook along with M. Helmersen, "Beiträge zur Kenntniss des russischen Reichs" numbers twenty-six volumes, and continued to appear until within the last few years. Von Baer continued to work up to the very last, and he has left behind him a large quantity of manuscripts and unfinished works.

Von Baer was undoubtedly one of the most accomplished investigators of the present century. Haeckel speaks of him thus:—"If among living scientific investigators there is one who justly enjoys universal honour and respect it is Karl Ernst Baer; and if classical and in the best sense natural philosophical writers will admire a Coryphæus of to-day, an unsurpassed example of exact observation and philosophic reflexion, let them go to the 'Entwicklungsgeschichte' of this head master of our science." Helmersen speaks of the late biologist as follows in the *Sz. Petersburg Zeitung*:—"With Baer departs a man such as is rarely met with in any century, a genial man of science and research, endowed with a penetrating critical intellect, with unusual faculty of observation, with perseverance and energy in work. The earth and its inhabitants were the great field of his research, and he brought to his work not only a deep philosophic training, but also an equipment of the profoundest knowledge in several departments of natural science which few of the great spirits of our time have possessed. This great, comprehensive, but profound knowledge, which he to the day of his death continued to increase and turn to use, combined with the determination to trace things to their ultimate grounds and by means of keen and unprejudiced, clearly arranged, and thoughtful observations to discover the truths and the laws of nature, stamp all his works with a monumental character which they will preserve for all time. The widely-known name of Baer is written in large letters in the book of science and its history."

We hear that a subscription will be opened among all the scientific bodies of which von Baer was a member for the founding of a scholarship in his name, or for any other scientific purpose worthy of the name of the great natural philosopher.

#### DAVID FORBES

AT the comparatively early age of forty-eight the busy life of Mr. David Forbes has been brought to a close. Like his distinguished brother Edward, he has been unexpectedly cut off before much of the immense mass of knowledge he had acquired has been put in a form to be of use to others. He was always looking forward to a time of less active occupation, when he might devote his principal attention to putting on record the results of his many years' investigations. What there may be in the piles of manuscript he has left that will be available for use, there has not yet been time to ascertain. For the last five years the most important papers he wrote were the half-yearly reports for the Iron and Steel Institute, but among his earlier papers there will be recollected "The Relation of Silurian and Metamorphic Rocks in the South of Norway," and "The Geology of Bolivia and South Peru." Alluding to his connection with the Iron and Steel Institute, the organ of that society has just written:—"In his capacity of Foreign Secretary he has, almost from the foundation of the institute, rendered most essential service, and has in no inconsiderable degree contributed to that rapid prosperity which has characterised its operations. His exhaustive reports on the foreign iron and steel industries which appeared in the *Journal* were most valuable, as they embraced everything going on in connection with the iron trade all over the world. The wonderful linguistic accomplishments of Mr. Forbes enabled him to deal easily with the publications of all

countries where iron and steel is made. His name was so well known abroad that the leading people connected with the technological features of ironmaking most readily furnished full details of what was going on in each country; and through his influence mainly the institute speedily assumed a recognised position abroad."

Mr. Forbes joined the Geological Society in 1853, and since February, 1871, has been one of the secretaries. He was also a Fellow of the Chemical Society. In June, 1856, he was elected a Fellow of the Royal Society. He had travelled extensively in many parts of the world. All the family of the Max Forbeses have been great travellers. Dr. Wilson, in his memoir of Edward Forbes, has mentioned many of his relatives who died out of Europe. Mr. David Forbes, as a consulting engineer, had an extensive practice, and was often summoned abroad. His death occurred at his house on Tuesday, December 5, and on Monday, the 11th, his remains were laid in the Kensal Green Cemetery, in the presence of the Presidents of the Geological and Chemical Societies and many scientific friends.

#### THE GLACIATION OF THE SHETLAND ISLES

IN the *Geological Magazine* for May and June, 1870, my colleague, Dr. Croil, first pointed out that the Scotch and Scandinavian ice-sheets probably united on the floor of the North Sea, and thence moved northwards towards the Atlantic. He was led to this conclusion by a consideration of the peculiar direction of the striae in Caithness, in Shetland, and the Faroe Isles, as well as by the occurrence of marine shells in the boulder clay of the northern parts of Caithness. He showed that the enormous *mer de glace* which pressed out on all sides from Scandinavia forced its way close to the Scotch coastline, and in virtue of its greater size produced a slight deflection of the Scotch ice, causing it to over-ride portions of the main land. He stated that in all likelihood both the Shetland and the Faroe Isles were over-topped by the Scandinavian ice in its onward march towards the Atlantic.

During a recent traverse in Shetland I obtained evidence which tends to strengthen this remarkable theory. In the north island of Unst, the direction of the striae, the boulders on the surface, and the stones in the till, clearly indicate that this island was glaciated by a mass of ice moving from east to west. The proofs of continental glaciation, which are comparatively clear in the north, are obscured in a great measure in the main island by the effects of a local ice-sheet. The nature of the boulder clay, as well as the trend of the striae in various localities, show that the movement of this local sheet was influenced by the general features of the country. In addition to these markings, however, others were found which could not have been produced by ice shedding off the land in the ordinary way. These cross the island, regardless of its physical features, and are often at right angles to the newer set. Lastly, the wide distribution of morainic matter with groups of moraines indicate the gradual disappearance of the local ice-sheet and the presence of small glaciers, where the ground presented favourable conditions for their development.

The islands are dotted over with small lochs; the most of these lie in peat or drift, while others occupy true rock basins. The singular absence of marine terraces ought not to escape notice, as bearing on the recent geological history of these islands, since the lochs or sea-lochs are admirably adapted for their preservation.

These observations will be described in detail in a forthcoming paper before the Geological Society.

JOHN HORNE  
Geological Survey of Scotland, Nairn, N.B.,  
November 29



## PRIMEVAL SWITZERLAND.

THE veteran Swiss professor, Dr. Oswald Heer, is not more distinguished for his ability and indefatigable industry in original research than he is for his brilliant powers of popular exposition. His admirable work, "The Primeval World of Switzerland," of which both German and French editions have already appeared, has been so favourably received, alike by the scientific and the general public, that we are happy to be able to announce the publication of it in the form of an English translation, adorned with the whole of those numerous and excellent illustrations which contributed so greatly to the value of the book as it was originally issued. A work like the present, in which accuracy of scientific detail is in no degree sacrificed to its main design—that, namely, of producing a succession of lively descriptions leading up to clearly-enunciated generalisations—must be largely dependent not only on the literary skill of its translator, but on his competence for dealing in an intelligent manner with the various branches of natural history treated of; and when we state that the interpreter of Prof. Heer's views to English students is so erudite a naturalist as Mr. W. S. Dallas, the Assistant Secretary of the Geological Society, we have said enough to predispose our readers in favour of the present translation. Nor does a careful perusal of the work serve to disappoint the high expectations we have been naturally led to entertain with regard to it, for both editor and translator have evidently performed their respective tasks in a most skilful and conscientious manner. Neither in respect of accuracy or of elegance do we notice any very serious failures; under the former category, indeed, we only feel called upon to draw attention to a little confusion which exists in some parts of the work with respect to the English and German measures; and, under the latter, to what appears to us to be the rather awkward adoption of the third person, which, however suitable for abstracts or reviews of the writings of an author, seems somewhat out of place when employed in a full translation of one of his works.

To that numerous section of our countrymen who regard "the playground of Europe" as a place only for fashionable lounging or purposeless climbing, Prof. Heer's work may well be commended as opening up new, and to many perhaps, unsuspected sources of enjoyment during their holiday tours. Those who will take the trouble to master the contents of these two pleasantly written volumes—a task demanding no great preparation of preliminary studies—will be in a position to appreciate and follow with ever increasing interest the discussion of those numerous important geological problems, to the solution of which no country in the world affords more important materials than Switzerland. Aided by the carefully arranged collections of rocks and fossils which exist in the museums of all the larger Swiss towns, the tourist would find the means of enabling himself to vividly realise and almost live among the wonders of long past geological periods; and by personal contact with the actual evidences of geological change, his scientific knowledge and convictions would acquire a reality and solidity, which no amount of work in the library could ever com-

"The Primeval World of Switzerland." With 560 Illustrations. By Prof. Heer, of the University of Zurich. Edited by James Heywood, M.A., of the Statistical Society. Two vols. 8vo. (London: and Co., 1876.)

municate to them. Those who will adopt this plan will soon find aroused within their minds an interest and enthusiasm, which will prevent them from ever finding their holiday tour dull; and will be amply rewarded thereby for the necessary preliminary labour. Phlegmatic, indeed, must be the individual who does not find his pulses stirred as he follows in the work before us the life-like delineation by word-painting of the characteristics of ancient worlds, or who does not find the desire awakened in his mind to witness for himself some of the phenomena here described; for even the most indifferent reader can-

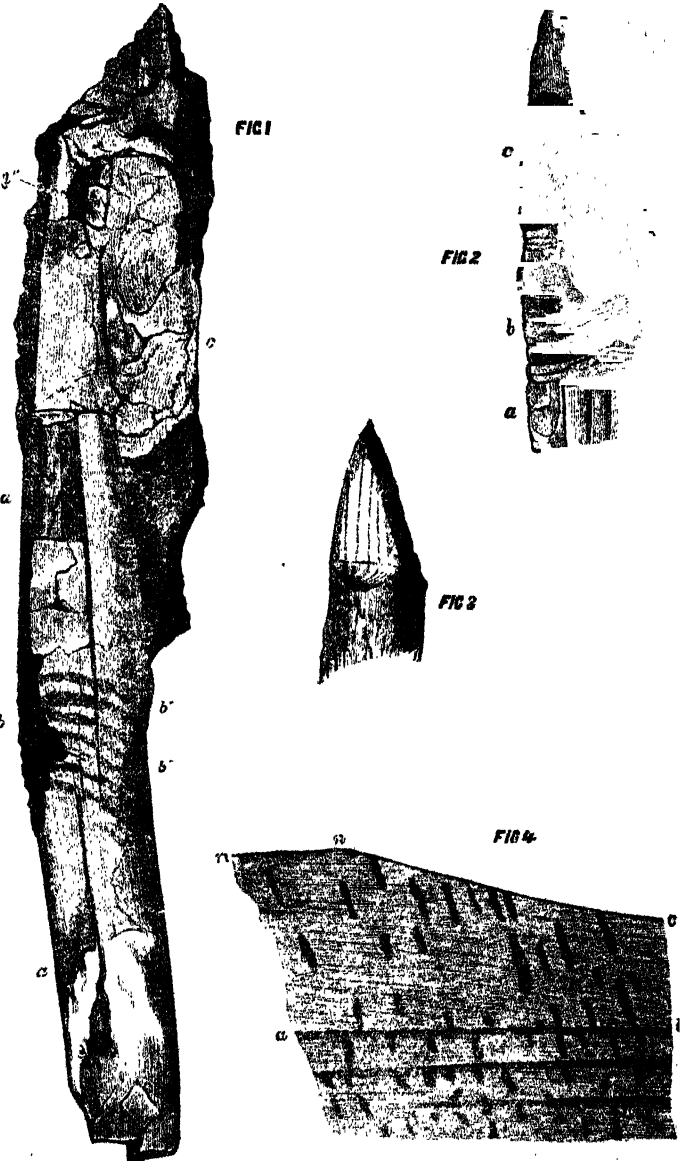

Rods of fir-wood exhibiting marks of cutting and binding, from the lignites of Wetzikon.

not fail to catch a portion of the enthusiasm which everywhere glows in Prof. Heer's eloquent pages. But such feelings are only a very feeble echo indeed of the pleasures experienced by the student who has the courage to enter himself within the veil, and to look upon nature and her mysteries face to face.

We should, however, be doing Prof. Heer an if we referred to his book as being only a popular to the geology of Switzerland. To the man of

the work will be no less valuable than to the tourist and general reader, for in it he will find an authoritative *résumé* of the results of multifarious studies by one of the most eminent of living palæophytologists; results which otherwise he would be compelled to search for in numerous scattered papers and bulky monographs. Just such a sketch of the general geology of Switzerland as is contained in the work before us, is indeed especially welcomed at the present time, from the fact that Studer's admirable "Geologie der Schweiz," is so far behind date. The main features of the Carboniferous, Saliferous, Lias, Jurassic, and Cretaceous formations as displayed in Switzerland, are all very clearly described in Prof. Heer's book; but it is of course in respect to the Miocene—to the eluci-

dation of the characters of the fauna and flora of which his own admirable researches have been more especially devoted—that our author's detailed observations and inferences are possessed of the greatest value and interest. Prof. Heer's general conclusions on such subjects as the physical evolution of our globe, the changes of climate during former geological periods, and the doctrine of descent and Darwinism, are also worthy of the most serious attention.

We shall not here stop to discuss how far the identification of species of plants, by their leaves alone, is safe or defensible on the part of the palæophytologist. Some botanists, especially in this country, have adopted very extreme views with regard to the work of Heer and others;

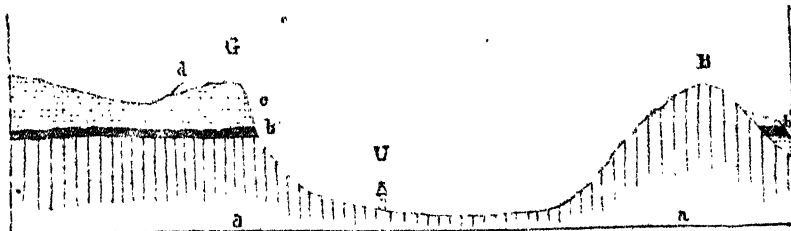

5.—Ideal Section of the valley of Uznach (the vertical scale is to the horizontal as 8 : 1). G, Gubel; U, Uznach; B, Lower Buchberg.

demanding that fossil plants, like recent ones, should only be named after an opportunity has been found for studying

Opinions, too, may differ as to the propriety and value of those rather fanciful delineations of scenery in the

demand from malacologists that no conclusions should be based on the shelly coverings of molluscs, or from comparative anatomists, that we should reject all identifications based on portions of the skeleton of the vertebrates. It is surely better to make the best of the imperfect materials which we possess—guarding ourselves meanwhile at every point with cautious reservations—rather than to reject it altogether because of its lack of completeness.

is disarmed by the fact that, while a means of arresting the interest of the general reader has been supplied by these rather questionable "landscapes," the real wants of the student have by no means been lost sight of, but are very liberally provided for in numerous other plates and woodcuts of truly scientific character and accuracy.

No time, perhaps, could possibly be chosen as more opportune for the appearance of this work than the pre-

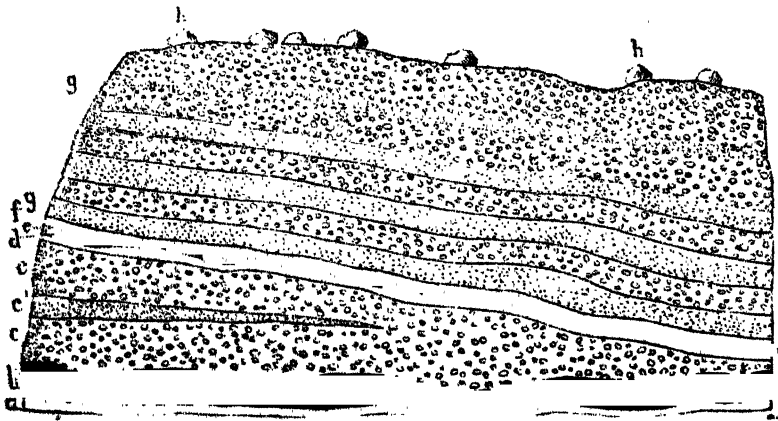

6.—Section of the paper-coal or lignite deposit and pebble-beds, at Düren.

sent, for attention has recently been very generally drawn to the discovery of certain articles of human workmanship in Switzerland which seem to throw far back the date of the appearance of man upon the globe, and to make him contemporaneous with a portion at least of the Glacial period of that country. The editor of this work has, we think, acted most judiciously in appealing to Dr. Heer's book, which contains ample details concerning the characters and relations of the which have yielded these interesting relics, a translation of Prof. Rüttimeyer's memoir in the *Archiv* for 1875, which describes the objects and we cannot more appropriately close this

article than by a brief reference to the facts of the case, as detailed in the work before us, illustrating them by several woodcuts borrowed from the same source.

That the relics in question are of artificial origin, there can be scarcely the smallest room for doubt. They consist of a number of rods lying side by side in a block of lignite from Wetzikon, in the Canton of Zurich; these rods are of fir-wood, they are converted into true lignite perfectly similar to the surrounding matrix, and are flattened and crushed like the remains of plants, constituting the mass. Careful examination of them shows that the point of one of these rods has been artificially cut (Fig. 1, a" and Fig. 3), and that it has been bound round with

some flexible material (Fig 1, *b, d*). A second rod exhibits its longitudinally fibrous woody body bound round transversely with a different bark (Fig. 2, *b*). Prof. Schwendauer, who has made a microscopical examination of these interesting rods, confirms the fact of their having been subjected to artificial treatment. He supplies in Fig. 4 an enlarged view, showing how the artificially-produced section cuts across the structure of the wood. We can hardly doubt that we have here portions of a piece of the rude basket-work, the construction of which is among the earliest practised of the arts of savage peoples.

With regard to the mode of occurrence of the Wetzikon lignite deposit, in which these singular remains were found, two woodcuts, which we transfer from Dr. Heer's book, will suffice to make the matter perfectly clear. The first is an ideal section across the Valley of Uznach, which shows the lignites in question (*b*) resting on upturned Miocene strata (*a*) and covered by beds of pebbles (*c*) and erratic blocks (*d*). From this section it appears that a vast amount of denudation has taken place since the formation of the beds of lignite and their being covered up by deposits showing signs of glacial origin, for the outcrop of the lignites occurs at a height of 100 yards above the bottom of the valley. The second section shows the nature of the stratified materials, sand, loam, and pebble-beds (*c, d, f, g*) with which the lignites (*b, e*) are interstratified and covered—a number of erratic blocks (*h*), evidently derived from the Alps, surmounting the whole mass.

That these lignites of Wetzikon with their relics of human workmanship are of great antiquity there is the plainest proof; that they are, however, of more recent date than the principal mass of the glacially-derived materials occurring in the great Swiss valley is rendered clear by their undoubted superposition to these deposits, which is seen at a number of different points; but that moraine matter and erratic blocks have been deposited *above* them, either by glaciers or icebergs, there seems to be no room for doubting. We would venture to suggest, in conclusion, however, that the greatest possible caution ought to be exercised in attempting to correlate these Alpine deposits with the glacial beds of our own country.

J. W. J.

THE BRAIN OF THE GORILLA

THE anatomy of the brain of the gorilla has been hitherto absolutely unknown. From the valuable photographs published by Dr. Bolau in his recent memoir on the anatomy of the gorilla, which was referred to in last week's issue of this journal (p. 127), I am enabled to give a brief account of its external anatomy, to reproduce the illustrations of its form, and to compare it with the brain of man and the other anthropomorpha. There are three views of the brain, the upper, the outer, and the inner surfaces, figures of which are here given, and a careful description of the sulci, by Dr. Ad. Pansch, is appended.

When seen from above the brain presents a broad ovoid figure, the greatest transverse diameter opposite the supra-marginal convolutions, and very nearly two-thirds of its length from the anterior extremity; the frontal lobes are broad, and show a remarkable approximation to the square form of the human brain. In the lateral view it has moderate depth, the arching of the upper surface is but slight, and the highest point would seem to be about midway between the centre of its length and the broadest part. The dimensions are given, length = 100 mm., breadth = 87 mm., and the depth = 70 mm.; but the last certainly includes the cerebellum, for which an allowance of one-fifth may very properly be made, which will reduce the depth to 56. In the orang the three propor-

tions are respectively 100, 78, and 50; in the chimpanzee 100, 84, and 66; in the bushwoman 100, 77, and 62. The breadth of the gorilla's brain here is notable, but in connection with this it may be pointed out that the bushwoman has as great a relative breadth of brain as the European, in whom the numbers are 100, 77, and 69, and

Fig. 1.

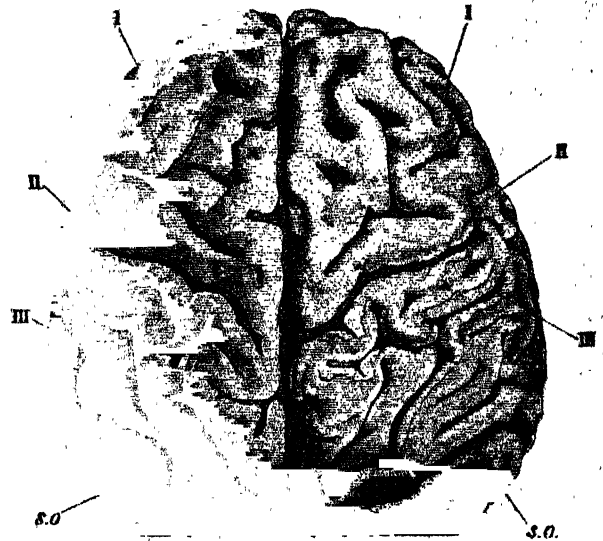

Upper view of the brain of the Gorilla. i. Sulcus, pre-central; ii. Fissure of Rolando; iii. Intra-parietal sulcus; s.o. External perpendicular fissure.

that the great and more valuable contrast is to be found in the depth; in the case of the orang (from Dr. Rolleston's paper) it would seem that it must be too low, probably from the flattening that follows removal of the brain from its natural cavity.

Hence conclusions drawn from the shape of the brain

Fig. 2.

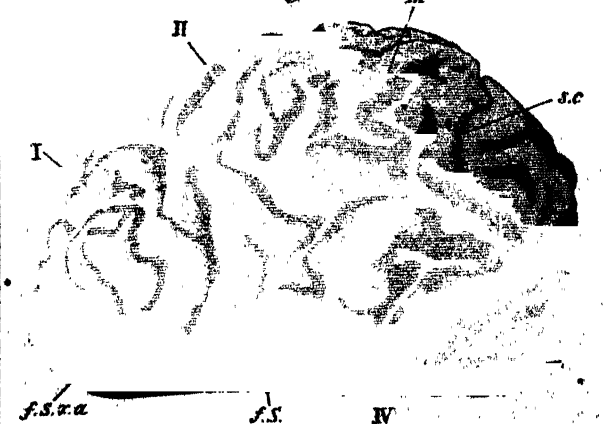

Outer surface of the brain of the Gorilla. i. ii. iii. s.o. as before; iv. Parallel fissure; f.s. Sylvian fissure, posterior branch; f.s.p.a. Ant. branch of the same.

itself are from this very circumstance liable to error, and for this purpose casts of the interior of the cranium are the only reliable guides. Referring to those in the Hunterian Museum, that of the gorilla as compared with man is seen to be characterised by want of height, flatness of the vertex, and narrowed frontal lobes; compared with

the orang, in the latter the frontal lobes are more compressed, giving a pointed form to the frontal extremity, and the occipital lobes are larger and more rounded, so that the figure is pear-shaped rather than ovoid; but the vault is decidedly more lofty and better arched; also the orbital concavity is less marked in the orang, so that any deficiency in the lateral development of the frontal lobes might very well be compensated by their downward extension. The chimpanzee and gorilla, however, exhibit a very great resemblance in shape and proportions, though the former has somewhat more compressed frontal lobes, a greater development of the occipital region, and apparently greater width, so that the cast looks more globular than that of the gorilla.

The *corpus callosum* is of good length, but rather thin; its proportion, taking the length of the brain as 100, is 41, and its average thickness appears about one-twelfth of that; in the chimpanzee the length is 39 and the thickness one-eleventh; in the orang, 44; and in man, 40; thickness, one-thirteenth.

The convolutions are strongly marked; in a general view they are slightly more subdivided than in the chimpanzee, but in complexity and asymmetry the orang exceeds the gorilla to about the same extent.

*Outer Surface of the Hemisphere.*—The posterior branch of the Sylvian fissure extends upwards and ends in the usual bifurcation, nearly at the junction of the middle and posterior thirds of the hemisphere, and almost half of the height from the lower margin; judged by this, the fissure is more oblique than in man, less so than in either orang or chimpanzee. The short anterior limb is very faintly marked in front of the insula, but its ending is distinct, bifurcated, on the outer side of the frontal lobe. The insula has its fore part uncovered in the bottom of the fissure. The external parieto-occipital fissure travels over the outer surface to within a very short distance of the lower margin of the hemisphere; its hinder margin, prolonged forwards, gives rise to a convex operculum in about its lower two-thirds, very much resembling that of the chimpanzee, although somewhat more sinuous. The fissure of Rolando is very oblique, the lower end is remarkably forward, being actually in front of the tip of the temporo-sphenoidal lobe (probably part of this is due to the position of the brain), and the upper end reaches the longitudinal fissure behind the centre of the hemisphere; the angle formed by the two fissures is very little more than a right-angle, 95°.

The length of the hemisphere being 100, the distances in a horizontal line from the anterior extremity to the upper end of the fissure of Rolando, *i.e.*, the extreme length of frontal lobe, being *a*, thence to the parieto-occipital fissure, length of parietal lobe, *b*, and from that to the hinder extremity, occipital lobe, *c*, we get—

	<i>a</i>	<i>b</i>	<i>c</i>
Gorilla ...	57	29	14
Chimpanzee ...	49	28	23
Orang ...	52	27	21
Bushwoman ...	65	17.5	17.5
European ...	57	23	30

The length of the frontal and the smallness of the occipital lobes are especially noteworthy.

The convolutions of the frontal lobe present their typical arrangement: the ascending frontal is very simple, following in easy curves the fissure of Rolando, and marked only by one slight indentation opposite the superior frontal sulcus; it is bounded in front for the lower half by the præ-central sulcus (Ecker) from which the distinct and strongly-bent inferior frontal sulcus runs forwards to the tip of the lobe. The superior frontal sulcus has its characteristic T shape, the top of the T being placed vertically in front of the upper half of the foregoing convolution, and the second limb sent forwards almost straight for about two-thirds of the distance to the

anterior extremity between the upper and middle frontal convolutions. Of the three horizontal gyri, the upper springs by a narrow root from the ascending frontal close to the margin, and shows plainly the indications of the longitudinal division into two; the middle is much narrower, connected to the ascending by a pedicle between the præ-central and superior frontal sulci; and the inferior frontal is well developed, arching over the anterior limb of the Sylvian fissure, and considerably folded. Compared with the chimpanzee, the upper is narrow, the middle and lower larger and more subdivided. The orang throughout the whole lobe exhibits a greater richness of convolution.

The convolutions of the parietal lobe are very definitely and strictly marked off, and at the same time they are decidedly the most developed of the whole brain, far exceeding the chimpanzee, and not inferior to the orang. The intra-parietal sulcus, springing from the Sylvian fissure near its hinder end, runs forwards and then upwards, round the front of the supra-marginal lobule, parallel to the fissure of Rolando, as far as the centre of that, when it turns backwards at an obtuse angle, continues, approaching slightly the longitudinal fissure, and debouches into the external parieto-occipital fissure; from the angle which it forms, the customary prolongation, giving off two or three smaller branches, is sent upwards

Fig. 3.

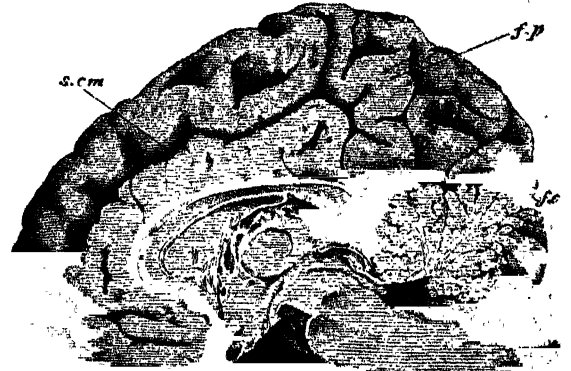

Inner surface of the brain of the Gorilla. *f.p.* internal parieto-occipital fissure; *f.c.* Calcarine fissure; *s.c.m.* Callosal sulcus.

in continuation of the ascending portion, and dividing the ascending parietal convolution from the parietal lobule almost completely; the interruption to this fissure about its bend which is seen so often in human brains I have observed only in the orang. The ascending parietal convolution is much more developed than the ascending frontal, and it presents a marked indication of a longitudinal fission; the lower end has the usual triangular expansion split into two (superior marginal convolution of Gratiolet). The parietal lobule is large and divided into an outer and an inner portion, the latter showing further subdivisions, in this condition approaching more to the human brain than either orang or chimpanzee. The supra-marginal lobule is more developed than in either chimpanzee or orang, and divided into three portions by a triradiate sulcus, but its proportion and the amplitude of its gyri are much inferior to the human brain. The angular convolution springs from the upper end of the supra-marginal lobule by a narrow bent piece; the descending branch here differs from the chimpanzee and orang in being cut off from the middle temporo-sphenoidal convolution and running backwards into the middle occipital convolution, constituting the anterior boundary of the external parieto-occipital fissure.

The occipital lobe is by no means richly convoluted,

the three gyri are marked off, the upper being broad and the lower narrow.

The temporo-sphenoidal lobe presents nothing remarkable; the parallel fissure is continuous and simple, running up behind into the angular convolution, where it is cleft, one branch extending downwards parallel to the lower part of the external parieto-occipital fissure, and cutting off the middle temporo-sphenoidal gyrus from the descending ramus of the angular and the second annectent convolutions. The upper convolution is simple, the middle is broader and more folded, the inferior is separated by a well-marked sulcus from the middle.

The first external annectent gyrus is seen issuing from under cover of the operculum, and passing forwards and inwards to the parietal lobule; this is an approach to the orang, in which the gyrus is normally superficial, and an advance on the chimpanzee, in which it occurs only at times. The second does not appear at all; the third is to be recognised nearer the lower margin of the hemisphere and below the lower end of the external parieto-occipital fissure, but the extension of the parallel fissure separates it superficially from the middle temporo-sphenoidal convolution; below this the small fourth appears, uniting the lower occipital and third temporo-sphenoidal convolutions.

*Inner Surface of the Hemisphere.*—The calloso-marginal fissure pursues its usual course and turns upwards opposite the hinder end of the corpus callosum, sending a branch backwards between the convolution and the quadrate lobule; it is interrupted opposite the anterior extremity of the corpus callosum by a small gyrus, a very frequent condition in human brains; from it a few small indentations pass up into the marginal convolution. The callosal convolution is simple: at the fore part there is a hint of the longitudinal division which obtains here sometimes in man, and it is more broken up when it passes under and is joined by the quadrilateral lobule. The marginal convolution is larger and more divided, but both of these are simpler than in the orang. The quadrate lobule is divided into about four small gyri, and is much larger than in the orang, where the calloso-marginal fissure opens into the surface very near the parieto-occipital, and the lobule is almost obliterated. The internal parieto-occipital fissure does not join the calcarine below, so that a distinct inferior internal annectent convolution is present, and at the upper end the upper internal annectent convolution can be seen coming out of the fissure and joining the upper posterior angle of the quadrate lobule. The calcarine fissure is usual, so also is the fissure of the hippocampus. The occipital lobule is divided into three gyri transversely by two furrows running the upper from the parieto-occipital, and the lower from the calcarine fissures nearly across; this is in marked contrast with the arrangement of the human brain where the gyri run from apex to base, being subject, however, to great variety. The gyri on the under surface of the occipital and temporo-sphenoidal lobes cannot be seen.

The resemblance between this brain and the chimpanzee's is striking both in its shape and the arrangement of the convolutions, so much so that Gratiolet's description of the latter would serve also for many parts of the gorilla's brain. The chief points of difference between the two are mainly in favour of the gorilla, e.g., the greater length and breadth of the frontal lobe, a greater development of the middle and lower frontal and of the parietal convolutions, especially of the supra-marginal lobule and the appearance of the first external annectent gyrus. On the other hand the chimpanzee appears to have some advantage in the important point of greater vertical height. On the whole, the comparison seems to indicate a development of the chimpanzee type of brain and to give it a higher rank than that.

In one particular character it approaches the orang, the

partial appearance of the annectent convolution, but the differences in shape, the more perfect operculum, the lesser complication of the frontal and occipital convolutions and the greater symmetry far outweigh the resemblances and denote its proper position as with the chimpanzee, although somewhat nearer the orang than that.

Gratiolet placed the gorilla with the baboons by reason of its elliptical form and the supposed want of development of the frontal and great excess of the occipital lobes; but we see now that of all the anthropomorpha the gorilla is characterised by the most extensive frontal lobe and smallest occipital; in addition to which the richness of the convolutions and the breadth of the frontal region also separate it farther from the baboons than the chimpanzee.

It is certainly open to great doubt whether this diminution of the occipital lobe is at all an ascensive step in the cerebral conformation, in fact, the comparison of the respective proportions in the bushwoman and the European points distinctly in the opposite direction; and it is to be noticed that the great relative length of the frontal lobe is entirely due to this dwarfing of the occipital, for the proportion of the frontal to the parietal is no greater in the gorilla than in the others; and the highest type is to be sought rather in the co-ordinate development of all the lobes and not in the predominance of any one; so that regarded by this standard the gorilla's brain shows one marked feature of inferiority.

It should be remarked that Dr. Pansch, whose judgment must carry great weight, is disposed to regard the divergences from the chimpanzee as sufficient to establish a distinct type of brain in the gorilla.

In the comparisons above instituted, the brain of the bushwoman so carefully and elaborately described by Mr. Marshall in the *Philosophical Transactions* for 1854, that of the chimpanzee described with photographs by the same author in the *Natural History Review* for 1861, and that of the orang in the same journal by Prof. Rolleston have been taken as standards, supplemented by reference to the specimens in the Hunterian Museum.

G. D. THANE

#### MUSEUM SPECIMENS FOR TEACHING PURPOSES<sup>1</sup>

It is now generally admitted that a thorough and practically useful knowledge of the form and other properties of natural bodies can only be acquired by an examination of such bodies themselves. The difference between knowing a thing by description only and knowing it from personal acquaintance need scarcely be insisted on.

All teaching, therefore, of the physical properties, especially the form, texture, colour, and relation to one another of the component parts of any natural object, whether organised or inorganic, should be illustrated by reference to the object itself. The more completely the student is enabled to examine it, the more thorough will his knowledge of it be.

In the Department of Biology, which is that to which my remarks must now be limited, very much valuable and practical teaching can certainly be given without the possession of a museum or a single permanent preparation. The common and easily accessible animals and plants furnish materials for study and demonstration, which, when done with, can be thrown away and replaced as occasion requires. But it is often desirable to preserve specimens for a considerable time or permanently, either on account of their intrinsic rarity, causing difficulties in procuring them when needed, or on account of the labour and skill which may have been expended upon their proper display, and which it is not desirable to have wasted.

Hence the necessity for museums as most important adjuncts in connection with all establishments for teaching biology.

<sup>1</sup> Lecture at the Loan Collection of Scientific Apparatus, South Kensington, July 26, 1876, by Prof. W. H. Flower, F.R.S., Conservator of the Museum of the Royal College of Surgeons of England.

It has been suggested to me on this occasion to give a few hints as to the class of objects best adapted for display in such a museum, and the best method of preserving them, especially illustrated by the specimens contributed to the Loan Collection, and having been a collector of specimens and a curator of some kind of museum all my life, at all events since I was nine years old, I do not speak without some experience. As the time at my disposal will be limited, I shall say nothing of the preparation and preservation of specimens intended for microscopical investigation and demonstration, as that is a special branch of the subject, on which there are numerous excellent treatises, and which is considered in other lectures of the present course. I shall therefore confine myself to objects visible to the unassisted eye, and mainly to those derived from the animal kingdom, as having come most fully within the scope of my own experience.

Whether it has arisen from a mistaken impression that museum specimens are scarcely legitimate objects for this exhibition, or whether from the too general neglect on the part of those in charge of collections, of expenditure of labour, ingenuity, skill, and taste, in effecting improvements in arranging, displaying, and preserving the objects under their care, this department of the Exhibition is, on the whole, not very satisfactorily represented, and, compared with some others, puts in rather an insignificant appearance. And yet properly preserved and displayed specimens are essentially "scientific apparatus;" the preparing of such specimens is a most valuable aid to the cultivation of biology, and it is to be regretted that such an opportunity as that now presented of comparing the merits of different processes and of different materials used in the art, has not been more fully taken advantage of.

In considering the subject of museum specimens, it will be convenient to treat, first, of the methods of preservation in a dry state, afterwards of the methods of preserving animals or parts of animals in some kind of fluid, and lastly, to speak of the reproduction, by means of casts and models, of such objects as cannot be conveniently preserved in other ways.

The first method is applicable only to certain parts or tissues of the animal body; either those like the bones of vertebrates, shells of molluscs, chitinous integuments of articulata, &c., which are in their natural condition so hard and dry, that they undergo no material change when completely deprived of all the water contained in their substance, or those like skins, hollow viscera, &c., which may be kept in shape until they are dry by filling them with some stuffing material, or distending them with air. Attempts have frequently been made to preserve soft and fleshy tissues, as the muscles, in a dry state, but by all the processes hitherto adopted they eventually lose so much of their form and substance as to be of little value as representations of actual and natural objects. Such parts of the body, and the whole of the soft-bodied invertebrates, can only be successfully preserved in a fluid medium.

The best known and most generally practised method of preservation in a dry state is that intended to give an exact idea of the whole animal when living, by means of its skin, and the various tegumentary appendages, as fur, feathers, scales, horns, &c., attached to it, removed from the body, and then mounted by means of internal supports and puddings, or "stuffed," as it is familiarly called. The art of preserving animals in this manner is called "taxidermy." Although an art of really great importance for the study of natural history, and one essential, in fact, to its proper diffusion among the masses, it is almost unrepresented in the present collection, the only exceptions being among the "Apparatus for Instruction in Physical Science, contributed by the Committee of the Pedagogical Museum of Russia." The examples sent by this committee, though extremely interesting as illustrations of an admirable system of practical school teaching, and quite equal to the average level seen in most public museums, are of no especial merit as works of art, or as showing improvement over the ordinary methods. That this level should be so low is extremely to be regretted; but as long as curators of museums are contented to fill their cases with wretched and repulsive caricatures of mammals and birds, out of all natural proportion, shrunk here and bloated there, and in impossible attitudes, it will be difficult to get it raised. There may be seen occasionally, especially in continental museums and in private collections, where amateurs of artistic taste and good knowledge of natural history have devoted themselves to the subject, examples enough to show that an animal can be converted after death, by a proper application of

perfect in form, proportions, and attitude, and almost, if not quite as valuable for conveying information on these points as the living creature itself.

The injurious effect of a low standard of perfection in one branch of art upon another is curiously seen in the drawings of birds often introduced into pictures by some of our most accomplished artists. I could point out in the present Royal Academy exhibition several examples of birds introduced into landscapes, and therefore evidently intended to be representations of living and moving creatures, carefully copied from miserable specimens of "stuffing" of the lowest order. The fact is that taxidermy is an art, resembling that of the painter, or rather the sculptor; it requires natural genius as well as great cultivation. One of the obstacles to its improvement seems to be that few people have knowledge enough of the subject to judge of the execution of the taxidermist as they do of the painter or sculptor. And yet to curators of natural history museums this knowledge should be indispensable. But then they must give up the conventional low standard of payment for "bird stuffing" which now prevails. The artist should be able to devote far more time to the manipulation of each subject than at present, and, moreover, be able to compensate himself for the time he must spend in the study of the anatomy of the dead, and of the form, attitudes, and manners of the living. I have often thought that if a Landseer or a Wolf could have devoted himself to taxidermy, what glorious specimens we should have, and how different then would be the effect of a visit to the "bird gallery" of one of our great museums to that which it now produces. How much of nature would then be learned while admiring the art! And why should this not be? Simply because no one, at least no one in charge of a public museum, thinks of paying for a stuffed bird more than some ridiculously inadequate sum. It may be said that our natural history museums have not funds for such a purpose. If so it is of course a subject to be regretted, and ought to be remedied; but it is not exactly the case. A few really good specimens are far better than an infinity of bad ones. Let the same amount of money, judiciously laid out on skill and labour, now expended on a hundred specimens be concentrated on ten, and a far more valuable and instructive museum will be produced. The remaining specimens for completing the series for advanced students of the subject, should be kept as skins in drawers, in which state they are in every respect preferable to badly-stuffed specimens. They can be handled or examined without damage, and they do not mislead or disgust.

Next to the skin, the part of vertebrate animals most commonly preserved is the skeleton, the bones being, in fact, the most imperishable and easily preserved of all the tissues. The facilities, therefore for the study of osteology are very great, and it has especial importance in comparison with that of any other system, inasmuch as large numbers of animals, all in fact of those not at present existing on the earth, can be known to us by little else than the form of their bones.

These remarks, however, only apply to the skeleton in its ossified state, when the bone-tissue is so strongly impregnated with salts of lime, as to resemble, in its properties, rather a mineral than an animal substance. Many of the most important problems of anatomy relating to the skeleton, either the adult skeleton of the lower vertebrates, or the developing skeleton of higher forms, can only be worked out on fresh specimens or wet preparations. The ossified bones, which alone constitute what is popularly called the skeleton, can be studied best from dried specimens.

An osteological collection for teaching purposes should contain a certain number of mounted skeletons of the most characteristic types of vertebrate animals; *i.e.*, skeletons with all the bones joined together in their natural relations, and placed in such an attitude as the animal ordinarily assumes when alive.

In this way the student acquires a general idea of the construction of the framework of the body, the proportions and relative positions of the various parts. But in such skeletons much that is important to know is inaccessible to examination. One bone more or less overlies and hides another, and the articular ends, or those parts that come in contact with each other at the joints, are entirely concealed. Although general comparisons of form and proportion can be made with other skeletons, detailed comparisons of bone with bone are impossible. This applies more especially to skeletons articulated upon the plan almost universally adopted until the last few years, in which all the parts are immovably fixed to each other. It is to a large extent obviated by the method I shall refer to presently, but still, for the complete study of osteology, it is very desirable

indeed essential, to have at hand separate parts of skeletons, or individual bones, which may be kept in boxes, drawers, cases, or in any way found to be most convenient. Entire skeletons with the bones separated occupy very little space in boxes, and the characteristic parts may be selected and mounted in the way I shall presently indicate.

Everyone in charge of a biological museum, however small, should be familiar with the mode of preparing skeletons. I only indicate the outlines of the process, for in this, as in every other part of the work of making anatomical preparations, a few practical lessons from a person already an adept, and a little experience and observation will do more than any description. When the principles are known, the details can be carried out with such modifications and improvements for each individual case, as the skill and ingenuity of the operator can suggest. With regard to museum specimens generally, the question is frequently asked how such or such a preparation is made, and an answer is expected in a few words, which will enable the questioner to do the same himself. This is much as if a novice who had never handled a brush were to ask an artist how he had painted his picture and expect that a few simple directions would put him on a level with the master. Preparation-making is an art which can only be acquired by labour and perseverance, superadded to some natural qualifications not possessed in an equal degree by all.

To return to the bones, as in many respects the simplest kind of preparations. There is a popular notion that skeletons are made by putting animals into ant-hills. So I have been told over and over again ever since I was a child. I must, however, say that I have never actually seen, or even heard of a skeleton really made in this way, though ants, doubtless, especially in hot countries, will make short work of the flesh of an animal's body, leaving at least all the larger bones untouched. But we must adopt some safer and more universally applicable method of proceeding. Another common idea is that some "chemical" substance is used to dissolve the soft parts, and I am often asked "What acid do you use for this purpose?" when a little reflection would have shown that the bones would be the first parts to disappear under the influence of such a menstruum. Pure water is the only thing required in preparing bones and skeletons in the great majority of cases, and in the proper use of the water the art of "macera-ting," as it is called, chiefly consists.

This process is nothing more or less than placing bones in water and leaving them undisturbed until putrefaction of all the flesh and blood remaining on and around them and within the hollows and small cavities of their interior, takes place, and these soft parts entirely lose their form and structure and become converted into liquids and gases mingled with the water or escaped from its surface; so that when the bones are removed and well washed, nothing remains but the comparatively indestructible true osseous tissue, which, when dried, is hard, clean, and without smell.

Maceration consists, then, essentially in the destruction of the soft tissues by putrefaction, and certain circumstances are essential or favourable to the success of the process. In the first place, the water should not be too abundant in proportion to the amount of animal matter to be destroyed. Then it should never be changed or disturbed until the process is completed. The surface should be exposed to the air, and the loss from evaporation supplied from time to time. The temperature should be uniform and elevated. Cold checks the process; freezing arrests it altogether. If the heat is too great the bones are often greasy and discoloured, as when they are prepared by boiling. It is to the fact that the process varies in rapidity according to so many circumstances that the chief practical difficulty, which is to know when it is completed, is due. If the bones are taken out too soon, unless they are returned immediately to the same water, a check takes place in their preparation. To estimate the necessary time is a matter acquired only by practice and knowledge of the surrounding circumstances. Much will depend upon the size of the bones, small bones macerating much more rapidly than large ones; also upon their condition, if fresh, they macerate far more quickly than if they have been previously dried (as is the case with skeletons sent from abroad in a rough state), or if they have been kept in spirit or any other

They are then removed to clean water, frequently changed for several days, well washed with a brush if necessary, and dried, if possible, in the sun.

The process of maceration is necessarily attended with disagreeable smells. As long as it continues the surface of the water slowly emits gases; but the worst is when the water is stirred up by pouring it off to remove the bones. Hence it should be carried on in the open air, or what is far better, in a building isolated for the purpose, and in which the temperature may be kept uniform. When maceration has to be conducted among dwellings, it is necessary to be very careful not to disturb the vessels, and to put some disinfectant, as chloride of lime, into them the day before the contents are taken out. This will obviate most of the usual disagreeable effects, and if not used in too great a quantity, will not cause any material damage to the bones. But chloride of lime, when used too freely, is a dangerous agent; it destroys the gelatinous portion of the osseous tissue (which of course is not removed in maceration) and leaves the bones white, chalky, and friable. After proper maceration no chemical bleaching is required. Exposure to sunlight or alternate sun and rain for some months is generally good, especially for large solid bones, though this may be carried too far, as the intensely white, cracked, porous and fragile condition of osseous fragments which have been lying long on moors or hill-sides, shows. Bones are not naturally of a pure white colour, but have a delicate yellowish or creamy tint like that of ivory.

Several substitutes for the process of maceration in water are occasionally adopted under special circumstances.

1. Boiling. This process has the advantage of rapidity, but is seldom resorted to except when absolutely necessary (as in the case of the celebrated skeleton of the "Irish giant" in the Hunterian Museum), as the fatty matter in the medullary cavity is melted and pervades the whole osseous tissue, and gives the bones discoloured and greasy, as may be seen in some of those that have been cooked for the table.

2. Burying in the ground may be resorted to when there are no conveniences for maceration, but it is even a slower process. The effect upon the bones is the same, but they are nearly always stained brown by the colouring matter in the soil, and the small ones are apt to get lost.

3. It has lately occurred to me, following out a suggestion of Mr. Seymour Haden's in his excellent letters, entitled "Earth to Earth," relating to the best mode of disposing of the dead, to clean bones by burying them in a basket of charcoal, and though the experiments are not quite complete, they promise excellent results, especially as all the disagreeable odour of maceration is entirely obviated, and the process may even be carried on in inhabited rooms without any inconvenience.

(To be continued.)

#### OUR ASTRONOMICAL COLUMN

A NEW STAR IN CYGNUS.—On November 24, at 5h. 41m. P.M., the director of the Observatory at Athens, Prof. Schmidt, remarked a star of the third magnitude not far from  $\rho$  Cygni, which was not visible on November 20, the last clear evening previous. Its position from observations with the refractor was found to be in R.A. 21h. 36m. 50.5s., N.P.D. 47° 40' 34" for the beginning of the present year. At midnight its light was more intense than that of  $\eta$  Pegasi, which is rated a third magnitude by Argelander, and very yellow.

Direct intimation of this discovery was given by Prof. Schmidt to M. Leverrier, and the Paris *Bulletin International* of December 6 contains the few particulars concerning this star which the generally unfavourable weather up to that date had permitted to be put upon record. M. Paul Henry estimated it of the fifth magnitude, so that as in the cases of the similar suddenly-visible stars of 1848 and 1866, it would appear to have remained but a very short time at a maximum. He considered the colour "greenish, almost blue" by comparison with Lalande 42,304, not far distant. M. Cornu examined it on December 2 with a spectroscope applied to the great equatorial, though only during a short break; the spectrum was chiefly formed of bright lines and consequently proceeded probably from a vapour or incandescent gas. On the same evening, but under conditions equally unfavourable, M. Cazin made similar observations with a spectroscope on the 9-inch Foucault equatorial, and with the

When the bones are to be removed, the water must be carefully poured off through a hair sieve, and all the solid matter which remains at the bottom of the jar must be carefully searched for any of the smaller bones which might otherwise be lost.

same result. On December 5 M. Cornu succeeded in making several measures, though still much interrupted by clouds; the *Bulletin* states:—"Il a constaté la présence des trois lignes de l'hydrogène, C, F et  $\lambda = 434$  (échelle des longueurs d'onde); la raie D, du sodium, la raie b du magnésium et deux autres  $\lambda = 535$  et  $\lambda = 503$ . La première paraît coïncider avec la raie 1474 (échelle de Kirchhoff) ou  $\lambda = 532$  observée pendant les éclipses dans la couronne solaire; ce qui ferait peut-être penser que la raie notée comme correspondant au sodium pourrait être celle de l'élément solaire appelé hélium."

There is a slight confusion about the declination of this star, which, according to the lithographed *Bulletin*, M. Paul Henry made three minutes less than Prof. Schmidt, while the declination, as reduced by the latter to 1855°0, differs more than a minute from his declination for 1876°0, correctly carried back.

The nearest catalogue star is one  $9^{\circ}2' m. = +42^{\circ}$ , No. 4, 184, in the sixth volume of the Bonn Observations,  $\Delta\alpha = -24'6s.$ ,  $\Delta\delta = +4'3''$ , according to Prof. Schmidt's place. We find no star in the position of the new one, in the *Durchmusterung*, nor in Lalande, d'Agelet, Bode, Bessel, &c., nor Harding's Atlas.

The remarkable star of 1866 (T Coronæ Borealis) descended to the limit of unaided vision in ten days from its discovery by Mr. J. Birmingham, of Millbrook, Tuam, on the night of May 12, when it appears to have become suddenly visible as a star of the second magnitude: it is now a little over the eleventh magnitude in Bessel's scale extended.

The similar object of 1848, detected by Mr. Hind on the morning of April 28, then of the sixth magnitude, and certainly less than the ninth on April 4 and 5, attained its maximum about May 7, and at that time was a little brighter than 20 Ophiuchi, rated a fifth magnitude by Argelander. The maximum brilliancy assigned to this star in Schönfeld's last catalogue is one magnitude too low. It continued visible without the telescope to the end of May. Last summer it was not over the thirteenth magnitude.

[By observations at Mr. Bishop's observatory, Twickenham, on the 12th inst., the position of the new star for 1876°0 is in R.A. 21h. 36m. 50<sup>s</sup>.35s. N.P.D.  $47^{\circ}43'4''$ ; Prof. Schmidt's declination is in error. The star was of the seventh magnitude and colourless; the sky, however, very indifferent.]

THE OPPOSITION OF MARS, 1877.—In addition to the stars observed by Bessel, which are mapped on the Astronomer-Royal's Chart in the *Monthly Notices* of the Royal Astronomical Society, the following lie near the path of the planet at this opposition:—

1. An uncatalogued star of the ninth magnitude, the place of which for 1877°0 is in R.A. 23h. 19m. 55<sup>s</sup>.3s., N.P.D.  $101^{\circ}21'49''$ ; the planet in conjunction with this star, August 25<sup>d</sup>.292, G.M.T.  $5^{\circ}14'$  north.

2. Lalande, 45504 —  $7\frac{1}{2}$  mag.; mean place, 1877°0, in R.A. 23h. 8m. 56<sup>s</sup>.1s., N.P.D.  $102^{\circ}14'0''$ ; the planet in conjunction with this star, September 5<sup>d</sup>.224,  $3^{\circ}10'$  north.

On September 6<sup>d</sup>.415 Mars will be in conjunction with, and  $2'15''$ , north of the tenth magnitude, the mean place of which is in R.A. 23h. 7m. 46<sup>s</sup>.4s., N.P.D.  $102^{\circ}18'6''$ .

There is every reason to expect that this favourable opposition of Mars will be very completely observed with the view to another determination of the solar parallax.

#### NOTES

FOR the erection of a monument to Linnæus 36,000 crowns have been received. The monument will be erected in Stockholm, and will be unveiled on January 10, 1878, the hundredth anniversary of the death of the great naturalist.

THE inauguration of the Liebig monument in the new promenade at Darmstadt, will shortly take place. Pupils, friends,

and admirers of Liebig are invited to be present on the occasion.

M. DE LESSEPS presented to the Academy of Sciences at its last sitting, the final report of Capt. Roudaire, who has returned from Tunis after having completed his survey of the Algero-Tunisian depression. The project is now quite complete and ready for execution. All the trigonometrical measurements have been taken, and the preliminary steps for making an inland sea have been considered. A commission, of which M. de Lesseps is a member, and will most probably be the referee, was appointed by the President, Admiral Paris. The opposition offered by some influential members of the Academy is now considered as being quite at an end.

FROM the *Tour du Monde* we learn that an American company proposes to introduce fur seals from Alaska into Lake Superior. The temperature of the lake is considered to be sufficiently cold for the purpose, and the company hopes to obtain from Congress and the Canadian Parliament an Act protecting the creatures from slaughter for twenty years, after which time it is supposed that they will be sufficiently acclimatised and numerous to form subjects of sport.

NEWS has been received from Gen. Nansauty, the adventurous observer who has located himself near the top of the Pic du Midi for the purpose of taking meteorological observations during the winter. He and his companions have been made comfortable and secure, the only thing wanting being a telegraph to connect the Pic du Midi with Toulouse as Puy-de-Dôme has been with Clermont. This will very likely be the work of next year. Up to the end of last week the weather was very mild and almost no snow had been observed.

AT the Arctic meeting of the Geographical Society on Tuesday night, honoured by the presence of the Prince of Wales, Sir George Nares and the other officers of the Expedition met with a deservedly enthusiastic reception. Addresses were given by Sir George Nares and Captains Stephenson and Markham, in which details were given of the work of the Expedition. Sir G. Nares gave a clear account of the currents of the Atlantic and Pacific in their bearing on the condition of the ice in the Arctic regions. We may now consider the Polar basin, he stated, as a locked-up bay continuing out of the narrowed North Atlantic Channel, with a warm stream of water constantly pouring into it between Spitzbergen and Norway, and a cold icy one as constantly running out between Spitzbergen and Greenland, and also through the very narrow straits between Greenland and America; the first conveying an enormous source of heat towards the north, the latter causing the intense cold of Canada and that on the east coast of Greenland and North America. In the Polar Sea, near the inflow of the warm water, we should naturally expect to meet the lightest ice and an early season; near the outlets the heaviest ice. And such is found to be the case. Heavy ice has been traced all the way from Behring Straits eastward to Bank's Land, and from there, west of Prince Patrick Island, to Ireland's Eye, from which point it is lost; for the sledging parties under Admirals Richards and Osborn, journeying along the north shores of the Parry Islands, found light ice. It is therefore concluded with certainty that some protecting land exists to the northward. From the *Alert's* winter quarters the heavy Polar ice was traced by Aldrich for one-third of the distance towards Ireland's Eye, leaving 400 miles still unknown; to the eastward, Beaumont proved that it extends for 100 miles, leaving about 500 miles still unexplored between his farthest and the farthest of the Greenland Arctic Expedition under Koldewey. We have now a distinct knowledge of the nature of the ice in the Polar Sea. Whether that sea extends to the Pole or across the Pole, we cannot, according to Sir George Nares, be absolutely certain, but by reasoning, we may safely predict that a very



broad opening exists north of Cape Columbia, and Sir G. Nares firmly believes that it extends at least as far as the Pole. During winter there appears to be a compact mass of ice in the Polar region, the thinner portions of which are melted by summer heat, leaving open lanes or pools of water, giving sufficient scope for the broken-up permanent ice-mass to drive backwards and forwards according to the wind or current, its main course being towards the channels of outlet, by which a small portion escapes. By the end of September the increasing frost cements together the struggling masses, and young ice forms on the open spaces to about seven feet thick. Thus the pack covering the Polar Sea is a collection of separate pieces of ice, movable among each other during the summer like the pebbles and boulders in a river bed, each piece grinding against its neighbour as the whole body jostles its way along, slowly pressing forwards towards the outlet between Spitzbergen and Greenland. Sir George Nares showed that by calculation an extremely small proportion of the Polar ice can escape by the various channels, and that much of what remains may easily be at least 100 years old. Many other valuable observations were made on Polar questions by Sir George, and Captains Stephenson and Markham read interesting papers on "Arctic Winter Experiences" and "Sledge Travelling."

DR. PETERMANN has sent us a long letter on the English Arctic Expedition, which he has addressed to the President of the Geographical Society. Dr. Petermann says he has made himself acquainted with the history of every Arctic and Antarctic expedition that has ever been undertaken, and it appears to him "there never was a more able and heroic expedition than that of Capt. Nares. Capt. Nares's expedition may be said to have

as it were, a great portion, say one-third, of the Arctic region from Smith Sound to Behring Strait, the of the Paleocystic Sea, our knowledge is entirely due to British enterprise and perseverance." Petermann thinks Sir George Nares has exploded the fallacy of the continuous navigability of the Smith Sound route, and that it required the greatest moral courage to return with results diametrically opposed to what was expected. He thinks that had he been able to stay another winter and gone round to East Greenland, he would also have "finished" the Pole. Petermann thinks it has been a triumph of seamanship that the commander has been able to bring back the two ships safe and sound, and that if our "enlightened and liberal Government remains true to the English way of doing things, in a complete way, and not by half-measures, it is to be hoped that these vessels will once more be sent out by a more promising route." He then refers to the six routes to the pole, advocating the Novaya Zemlya and the East Greenland routes. He believes there is a great open sea all along Northern Siberia, and states that Prof. Nordenskjöld intends in 1878 to sail right across from Norway to Behring Strait. Petermann believes that a high latitude could easily be obtained along the west coast of Franz-Josef Land, and maintains that no proper attempt has been made since Parry's journey in 1827 to push north beyond Spitzbergen. But of all the routes that by East Greenland is the one which he advocates most strongly. He maintains that throughout the summer the East Greenland coast is almost free of ice, and even in winter there is a strong outward drift. He firmly believes that an expedition like that which has just returned, would have no difficulty in sailing direct north, crossing the pole, and coming out at

These views are based on the observations of the captain, David Gray, and on the known drift of the

The well-established current by the Smith route brings down much ice, but much more of the ice must escape by the wide opening between East Greenland and Spitzbergen. The ice-drift must leave an open space behind, and there is therefore good reason to believe that in the Polar

region will be found an open sea. Petermann is convinced that Sir G. Nares, with the *Alert* and *Discovery*, could steam right to the pole by this route, probably in one season. He thinks it possible, moreover, that East Greenland and Franz-Josef Land may approach each other towards the pole, and still maintains the prolongation of Greenland across to Behring Strait, in, however, it appears to us, a somewhat modified and less objectionable form. He considers the central region to be divided into two nearly equal areas of land or islands, the one extending from the shore of East Greenland in about 20° W. long. over Baffin's Bay, Parry Island, and Point Barrow, Behring Strait, and Cape Yakan, in about 176° E. long.; the other half thence all along the Siberian Coast, over Franz-Josef Land, Spitzbergen, to East Greenland. These two regions are in all respects distinct. In the two former, or western, the land prevails, in the latter, sea. "It is not at all unlikely," Petermann states, "that Eskimos will yet be found right under the North Pole." A Swedish and a Dutch expedition have, he assures us, been decided on. He has no hope of anything being done, meantime, to carry out Weyprecht's scheme. The mass of data collected by various expeditions has not yet been half worked out. He still maintains: "It might be done, and England ought to do it." We have endeavoured to give the drift of Dr. Petermann's letter, without comment.

DR. PETERMANN has sent us Nos. 123-5, of his valuable series of papers, "Geographie und Erforschung der Polar Regionen." In these he discusses the results of Nordenskjöld's recent expedition, of the Siberian expedition of Finsch, Brehm, and Ziel, and those of the English expedition. As prefatory to an abstract of Nares's report, he describes and discusses some of the observations of previous expeditions, all tending to show the impracticability of the Smith Sound route, and the probability of an open Polar Sea. The papers are accompanied by three maps illustrating the observations and theories referred to, and whatever may be thought of the latter, are a valuable contribution to the polar question.

M. W. DE FONVILLE writes to us protesting against any scheme of Arctic exploration by means of balloons in the present state of the aeronautical art. No such scheme is practicable without some certain means of directing a balloon and insuring its progress in any direction independently of air-currents; and as no method of steering and propulsion has yet been invented that merits consideration, discussion of the subject on existing bases is totally unscientific.

THE German Arctic Exploration Society has received a telegram from the Ob Expedition dated Jenisseik, the 5th instant, announcing that Captain Wiggins has found a good harbour in the Podarala Bay, where he remained several weeks; he also discovered a large island north of the mouth of the Ob, and a new land route to the Jenissei. He found the water way up the Jenissei to Nurjaha good.

ABOUT two years ago the Registrar-General discontinued the practice of sending, free of charge, to the London Medical Officers of Health, copies of the returns of deaths made by the local registrars. Among the three vestries that still protest against this change for what is public property, is that of St. George's, Hanover Square. For the last two years, therefore, the Medical Officer of Health for St. George's, Dr. Corfield, been without the returns for his district, as stated in his fourth annual report, just issued. It is his fourth annual report, just issued. It is the year, according to the Registrar-General's returns, out ninety-three deaths from six to the sanitary inspector. "We states, "of seven deaths occurred, or what precautions

he spread of the diseases by means of infected bedding, clothing, &c. This shows, I think, quite clearly, that it is necessary that in some way or another I should be supplied with the mortality returns, and especially with details of the deaths from infectious diseases. As regards the cases which do not prove fatal, there is at present no official way of obtaining information about them." Dr. Corfield has stated so clearly the ill effects of the present arrangement as to show that there is evidently urgent need for an alteration.

At the Hamburg meeting of the German Naturalists, Prof. Virchow gave an address on the present position of anthropology. In introducing his subject he pointed out that anthropology, although one of the youngest of the sciences, already occupies an advanced position as many of the older branches of study; and also that the races possessed of least ability are also those lowest in the scale of culture. To judge of the capacity for culture from the signs of it which exist is only admissible in the case of people who are surrounded by great intellectual activity, but not in the case of entirely isolated people. Thus the Australian Papuas by no means stand so low as has hitherto been believed. On this fact Virchow founds an important doctrine, which opposes the idea that such people must necessarily fade away when they come into contact with civilisation. Virchow thinks that the extinction of such races is rather to be ascribed to the barbarousness of Europeans and to the incapacity of the latter to educate the former. There is yet no evidence that uncivilised races must become extinct, which indeed is contradicted by the history of Europeans themselves. If the civilised people of the present day be considered as the product of a higher development, we cannot regard the possibility of such a development as a cause of the extinction of such people as are now on the same platform of culture which we ourselves once occupied. In relation to this Virchow spoke of the value of a systematic observation, of collections of skulls, weapons, clothing, also of evidences of intellectual activity, religious ideas, language, &c., and urged the important services that might be rendered in this respect by captains both in the navy and in the merchant service. No time is to be lost; every day is of value, since many of the lower races are rapidly becoming extinct. Virchow showed the utility of such observations by reference to the German peoples, of whose anthropology we as yet know almost nothing. Osteological remains, to be of any scientific value, should be seen in the place where they are found. Virchow spoke of the value of the statistics recently taken as to the colour of the hair, eyes, and skin of German children, to which we have already referred.

The Siberian explorers, Brehm and Finsch, have arrived at St. Petersburg, after a most successful journey.

The following extracts of a letter from Dr. Miklucho Maclay, dated July 3, Maclay Coast (New Guinea), appear in the *Globe*, November 28:—"I landed on June 28; the natives received me in a very friendly way, and were not at all astonished to see me amongst them again; they said they had been long awaiting my arrival, as I had said when leaving them I would soon return. Since the departure of the *Isumrud* on December, 1872, no ship had visited the shore. Three or four months after that time there was an earthquake on the island, which destroyed many villages in the highlands. Talking with my old acquaintances, I was astonished to hear how many Russian words they had retained since my first stay; they pronounce the words perfectly, and have introduced them in common use. Hundreds of natives from the neighbouring settlements helped in building me a house. I have brought for the natives various seeds of useful plants and of fruit-trees, and I hope they will grow as well as the Indian corn I left here in 1872. I expect soon to make some excursions in the highlands." The captain of the *Sax Bird*, who transmitted this letter, adds

that Dr. Maclay was perfectly well on board the ship during the cruise and on his landing.

THE Omsk correspondent of the Irkutsk newspaper *Siberia*, writes under date September 27, that M. Potanin's expedition in Mongolia (*NATURE*, vol. xiv., p. 534) has been stopped by the Chinese authorities at Tootly, a short way beyond the Chinese frontier. Arriving at Tootly, the members of the expedition expressed their wish to make a visit to the Governor of the place. Being told that he resided in a convent some miles from the town, they proceeded thither, but on their arrival they were informed that the Governor was not at home, and that the visit must be made next morning. On going next morning to the convent they were met at the doors by a hostile crowd, which soon began to throw stones at them, seriously injuring two persons. The authorities then appeared and took the members of the expedition into custody, but released them next day, announcing that they could not answer for their safety if they insisted on proceeding further.

SOME very important geological discoveries have been made by Prof. Hartt and his assistants in Brazil. Working over again the region explored by Prof. Theodore B. Comstock in 1870, and by Messrs. Hartt and Derby in 1871, they have extended the Devonian down 1,000 feet below the beds discovered by Messrs. Smith and Comstock. The lower beds are Oriskany, with the characteristic North American fossils, as well as some others (seventy-five species in all) which have undoubted Devonian affinities. Carboniferous beds were also discovered to the northward, making a complete section from the base of the Devonian to recent beds in the lower Amazonian Valley.

PROF. TYNDALL has accepted the office of President of the Midland Institute for 1877.

THE professors of the new School of Anthropology established in Paris under the patronage of the Faculty of Medicine and the Municipal Council, intend to organise excursions. The first of these was made last Sunday to the St. Germain Museum of National Antiquities, of which M. Mortillet is the sub-director. He explained to a large number of visitors the arrangement of the collections and the scientific value attached to the several curiosities which are exhibited.

M. LEVERRIER has organised meteorological warnings for St. Cloud, Clichy, Boulogne, and Levallois Perret, and will gradually extend them to the suburban districts. He will give a lecture at Boulogne to the several delegates of Communes for the purpose of teaching them the use of the meteorological maps published daily by the Observatory.

ON the 16th of next month, at the scientific meeting of the Zoological Society, we are informed that Captain Feilden, Naturalist to the Arctic Expedition, will exhibit the birds obtained by him in the regions he has so recently traversed.

AT the last meeting of the French Geographical Society, it was intimated that M. Jules Trebeau had been sent to explore French Guiana, which although a part of the territory of a civilised nation is almost untraced by explorers. M. Trebeau will proceed by the river Maroni, up to its source, with a party of three French and ten negroes, and will return by the Oyapok or Amazon, according to circumstances.

"NIPPON and its Antiquities" is the title of a pamphlet by Mr. W. C. Borlase, in which from personal investigation during a stay of some weeks in Japan, and the study of the best works on the subject, the author gives an interesting summary of what is known of the ethnology, mythology, and religions of the Japanese. The pamphlet is published by Brendon and Son, Plymouth.

IN a paper in the *Cleveland* (U.S.) *Herald*, November 14, entitled "Archæological Frauds," Col. Whittlesey examines some of the recent so-called prehistoric finds in some parts of the United States, and comes to the conclusion that most of them are extremely suspicious; among these is the well-known Grave Creek inscription.

THE New York Aquarium, some account of which we gave recently, is publishing a fortnightly journal. Of course it is essentially popular, but, while keeping an eye to the success of the aquarium, it gives considerable information concerning its inhabitants.

WE have received from New South Wales several papers which show that there is a creditable amount of activity in connection with science in that colony. We recently published a brief account of two meetings of the Royal Society of the colony, and from the rules, list of members, and other documents in connection with that body, which have been sent us, we have hopes that it will become an important centre of scientific influence and culture. We believe that the recent development of the Society is greatly due to the energy of the hon. secretary, Prof. Liversidge. "New South Wales; its Progress and Resources," is the title of a paper prepared by the authority of the Commissioners for the Philadelphia Exhibition, and giving, in brief space, an interesting account of the rapid progress of the colony. Along with this is a mineral map of New South Wales, showing the localities of the principal minerals, the back being utilised for the tabulation of some important statistics. As text to this map is a long and valuable paper by Prof. Liversidge giving a complete account of the minerals of the colony. Finally, we have by the same gentleman, a "Report of the Sugar-Cane Disease in the May River District, Queensland."

WE noticed some time ago the opening of Mr. Rooke Pennington's local museum at Castleton, in Derbyshire. We are informed that the result has been a great impetus to scientific study in that and the neighbouring Peak villages, and that a course of lectures has been arranged in connection with the museum. The first lecture will be delivered by Mr. Ralph Betley, F.G.S., who will take as a subject "Water." Mr. C. E. De Rance will give the second.

A VERY valuable and interesting collection of silver ores from Chili and Bolivia was sold by auction the other day by Mr. Stevens at his sale rooms in King Street, Covent Garden. Some of the specimens realised very high prices, one piece of red silver about the size of an orange being bought by Mr. H. Ludlam for 200*l.*, another about a quarter the size, with very perfect crystals, was secured by Mr. Bryce M. Wright, the mineralogist, for 100 guineas, and the remainder, comprising about 100 small specimens, were sold at proportionate prices; we believe Mr. Wright bought nearly a third of the collection, which was probably one of the finest ever brought to England.

THIS year Dr. Hermann Müller was accompanied to the Alps by one of his pupils, Ed. Gaffron, who collected, prepared, and carefully mounted fine specimens of all those Alpine flowers which Dr. Müller has observed and described, or will describe, in *NATURE*, in his articles on the Fertilisation of Flowers by Insects. Twenty complete collections have been made, and the young collector is anxious to sell them in order to raise funds to accompany Dr. Müller next summer. No doubt a number of our readers will desire to possess such a collection, which may be obtained by writing to Eduard Gaffron, Realschule, Lippstadt. The price, we believe, of a single collection is fifteen shillings.

THE additions to the Zoological Society's Gardens during the past week include a Patas Monkey (*Cercopithecus ruber*) from West Africa, presented by Mr. J. W. Feather; an Australian

Crane (*Grus australasiana*) from Australia, presented by Mr. H. Roberts; two Crested Guinea Fowls (*Numida cristata*) from West Africa, presented by Mr. Daniel R. Ratcliff; two King Parrakeets (*Aprosmictus scapularis*) from New South Wales, presented by Miss E. Rigby; a Short-eared Owl (*Otus brachyotus*), European, presented by Mr. W. R. Stanley; a Snowy Owl (*Nyctea nivea*), European, presented by Mr. John Kendall; a Brown Capuchin (*Cebus fatuellus*) from South-east Brazil; a Kinkajou (*Cercoptes caudivolutus*) from South America, a Royal Python (*Python regius*), a West African Python (*Python sebez*) from West Africa, deposited.

## SOCIETIES AND ACADEMIES

### LONDON

Linnean Society, December 7.—Mr. G. Bentham, vice-president, in the chair.—Mr. Francis Day read Part I. of the "Geographical Distribution of the Fresh-water Fishes of India." This contribution aims towards solving the vexed question of whether the fauna of Hindostan is mostly African or Malayan. The author first separates the true fresh-water species from those which enter rivers from the sea for breeding or predacious purposes. Out of nine families of Spiny-rayed fish (Acanthopterygians), only two are likewise found in the African region, but one of these is in Madagascar, which is doubtfully African; the other is also found in the Malay Archipelago, which possesses representatives of eight out of nine families. Each of the forty-five known species is then followed out, and the author considers that the Indian and Malayan fauna (of the group in question) are essentially identical, whereas the species are scarcely represented in Africa. The fresh-water fishes of Ceylon, the Andamans and Nicobars, he believes, are also strictly Indian, whilst as these fishes cannot be spread except by line of fresh-water communication, it thus appears highly probable that these islands were at one period connected to the continent of India. Moreover, certain forms exist in Malabar which are absent from the rest of India, but reappear in the regions of Chittagong or Siam.—Mr. J. G. Baker gave the substance of an exhaustive memoir on a general systematic arrangement of the Iridaceæ (the Iris family). Nearly all the Iridaceæ inhabit temperate regions, and may be grown successfully in the open air in this country. Some are among our most familiar garden genera—for instance, the Crocus, the Iris, and the Gladiolus. Altogether about 700 species and sixty-five genera are now recognised. In his present classification the structure of the perianth mainly guides the author to adopt three primary divisions—(1) Ixiaceæ, (2) Iridaceæ, and (3) Gladiolaceæ, the above common garden plants serving respectively as typical examples of these groups. The three divisions in question are again subdivided into—(a) Those having *bulbs with free stamens*; (b) Those having *bulbs with monadelphous stamens*; (c) Those *wanting bulbs, but with free stamens*; (d) Those also *devoid of bulbs with monadelphous stamens*. As regards distribution, 312 genera are found at the Cape; in Europe and North Africa, 94; Temperate Asia, 89; Tropical America, 82; Tropical Africa, 56; South America, 34; Australia, 31; and Polynesia, 1.—The Rev. W. A. Leighton communicated a description of eleven new British Lichens, seven of these belonging to the genus *Leccidea*, one to *Odontotrema*, and three to *Verrucaria*.—The Chairman passed some remarks on a folio treatise concerning the structure and culture of the quinine-bearing trees (*Cinchona*) in our East Indian Plantations, by I. E. Howard, F.R.S.—Mr. T. Christy exhibited specimens of the so-called Black Coral (*Antipathes*) from the Philippines, referring to its commercial value.—Thirteen gentlemen were elected Fellows of the Society.

Zoological Society, December 5.—Dr. E. Hamilton, vice-president, in the chair.—A letter was read from Count T. Salvadori, announcing that a new species of Paradise-bird, of the genus *Drepanornis*, had been discovered near the most inland point of Geelvink Bay, New Guinea.—A communication was read from Mr. Andrew Anderson, containing some corrections of and additions to previous papers on the Raptorial Birds of North Western India.—Mr. Francis Day read a paper on the fishes collected by the Yarkand Mission, in 1873, to which the late Dr. Stolcizka was attached as naturalist. The paper gave an outline sketch of the fresh-water fishes of Hindustan, Afghanistan, Western Turkestan, Yarkand, Tibet, and Cashmere. The author showed that the principal fishes of Yarkand belong to a

local group of carps, termed "Hill Barbels, or *Schinthoracina*," by McClelland: that this group is almost restricted to cold and elevated regions, spreading to the most eastern portion of Western Turkestan, Afghanistan, and along the western slopes of the Himalayas to China; and that these forms are entirely distinct from the carps of the plains to the south of the Himalayas.—A communication was read from Mr. Martin Jacoby giving the descriptions of new genera and species of Phytophagous Coleoptera.—A communication was read from Dr. A. Günther, F.R.S., containing the description of a new species of lizard from Asia Minor, which he proposed to name *Zootoca danfordi* after Mr. C. G. Danford, its discoverer.—Dr. Günther communicated a paper by Mr. W. Ferguson, of Colombo, containing the description of a new species of snake of the genus *Aspidura* from Ceylon, for which the name of *A. guentheri* was proposed.

Geological Society, November 22.—Prof. P. Martin Duncan, F.R.S., president, in the chair.—The following communications were read:—On the pre-Cambrian (or Dimetian) rocks of St. David's, by Henry Hicks, F.G.S. Referring to the ridge of pre-Cambrian rocks, which he described in a former paper as running down the St. David's promontory, and as previously supposed to consist of intrusive syenite and felstone, the author stated that he had now found it to be composed exclusively of altered sedimentary rocks of earlier date than the Cambrian deposits, the conglomerates at the base of which are chiefly made up of pebbles derived from these rocks. Recent investigations had led him to the conclusion that the main ridge was composed of two distinct and decidedly unconformable formations, the older of which, composed of quartzites and altered shales and limestones, constituting the centre of the ridge, has a north-west and south-east strike, and dips at a very high angle; whilst the newer series, consisting of altered shales, and having at its base a conglomerate composed of pebbles of the older rock, has a strike nearly at right angles to that of the latter. For the former he proposed the name of Dimetian, and for the latter that of Pebidian. The author indicated the points of resemblance between these pre-Cambrian rocks and the Laurentian of Canada, the Malvern rocks, and others in Scotland and elsewhere, but thought it safer at present to abstain from attempting any definite correlation of them. The exposure of the older, or Dimetian series, led the author to ascribe to those rocks a thickness of at least 15,000 feet; the upper, or Pebidian rocks, which flank both sides of the old ridge through a great portion of its length, are apparently of considerably less thickness, but they are in most parts more or less concealed by Cambrian deposits overlying them unconformably. Running nearly parallel with Ramsey Sound is another large mass of the author's Pebidian rocks, and at the south-western extremity of Ramsay Island they compose a bold hill almost 400 feet high, and on the east side of this a fault, with a downthrow of at least 14,000 feet, has brought the Arenig beds into contact with the pre-Cambrian rocks.—On the fossil vertebrates of Spain, by Prof. Salvador Calderon, communicated by the President.

Anthropological Institute, November 28.—Col. A. Lane Fox, F.R.S., president, in the chair.—An Indian hammock from the city of Mexico, weapons from Perak and British Guiana and a Bosjesman's skull were exhibited.—The President, by permission of Messrs. Bollin and Feuardent, exhibited some terra cotta figures from Tanagra, Bœotia, and read some notes thereon. Mr. Hyde Clarke and others joined in the discussion.—Papers on the Laplanders, by A. von Humboldt von Horck, and on the tribes of British Guiana, by the Rev. D. Harper, were also read.

Royal Microscopical Society, December 6.—H. C. Sorby, F.R.S., president, in the chair.—The President exhibited a *fac-simile* of Jansen's microscope, made by permission of the Dutch Government from the original, exhibited at the South Kensington Loan Collection.—A paper by the Rev. W. H. Dallinger was read by the Secretary, on *Navicula crassinervis*, *N. rhomboides* and *Frustulia saxonica*, as test objects, in which, after referring at some length to the recent discussion upon the subject of their identity or difference, he expressed his belief that they were all specimens of *Rhomboides*, differing only as to size; and in support of his opinion, a number of very beautifully executed drawings were exhibited to the meeting, showing the microscopical appearance of the diatoms in question under a magnifying power of 800 diameters.

Institution of Civil Engineers, November 28.—Mr. George Robert Stephenson, president, in the chair.—The paper read was on the chalk water system, by Mr. J. Lucas.

## CAMBRIDGE

Philosophical Society, November 20.—Mr. O. Fisher read a communication on the effect of convective currents on the distribution of heat in a bore-hole. This paper was supplementary to one read by the author on November 29, 1875. The temperatures obtained in the boring at Speremberg, near Berlin, which attained a depth of upwards of 4,000 feet, were reduced to a mean law by Prof. Mohr, of Bonn, and had been already shown by the author to conform closely to those expressed by a parabolic curve, having its axis horizontal, and its vertex at a depth of 5,171 feet expressed by the equation—

$$v = -\frac{251}{10^6}x^2 + 0.012982x + 7.1817,$$

$v$  being the temperature expressed in Reaumur's scale, and  $x$  the depth. An elaborate account of the observations taken in the Speremberg boring has been given by Dunker in a paper entitled "Ueber die Benutzung tiefer Bohrlöcher zur Ermittlung der Temperatur des Erdkörpers, und die deshalb in dem Bohrloche zu Speremberg auf Steinsalz angestellten Beobachtungen." The temperature curve within the earth's crust being believed to be a straight line expressing an increase of 1° Fahr. for 60 feet of descent, it was shown that the departure from this law in a large bore-hole (in the present case a foot in diameter) might be accounted for by vertical currents. At the surface of the water its temperature, from radiation and evaporation, will nearly coincide with that of the upper bed of rock. As we descend, the tendency will be for the currents to warm the water in the upper part of the bore-hole above the normal temperature of the rock, and to cool it in the lower part below the temperature of the rock. At a certain depth the temperatures of the water and rock would be the same. By Dunker's table this appears to have occurred at the depth of about 200 feet. A diagram representing graphically the effects mentioned will appear, accompanied by the proper explanations, in the forthcoming number of the Society's *Proceedings*.—Prof. Hughes then gave a criticism of the evidence for pre-glacial man, which we have already noted.

## MANCHESTER

Literary and Philosophical Society, October 31.—Rev. William Gaskell, M.A., in the chair.—Remarks on the general affections of the barometer noticed by Mr. J. A. Broun, by Prof. B. Stewart, LL.D., F.R.S. Mr. J. A. Broun has found as an experimental fact that simultaneous variations of the barometric pressure occur at such distant portions of the globe as to lead to the inference that the whole globe is thus affected, from which Mr. Broun infers that some other force besides gravity is concerned in these phenomena. We know as a matter of fact that there are causes at work which give rise to electrical separation, although we may not know the precise nature of these causes. Thus evaporation goes on from the surface of the sea and of the land. Changes take place in the amount of aqueous vapour held by the air, and also probably in the molecular state of this aqueous vapour. But although we may not be able to point to the specific actions which produce electrical separation, we know that such separation implies a one-sidedness or heterogeneity; and since gravity will presumably act differently on the two things, we may probably suppose that one of the constituents which have caused this electrical separation may have a tendency to mount upwards in the atmosphere, while the other may have a tendency to move downwards. For instance, if evaporation from the surface of the earth or sea be one cause of this electrical separation, we might imagine the land or sea to become electrified in one way, while the vapour electrified in the other direction might mount in the air, owing to its being specifically lighter. In fine, whatever be the cause of the electrical separation, we may presumably suppose that the one constituent will either remain below or find its way downwards, while the other, carrying with it its peculiar electricity, will mount upwards. Now, may not the earth be regarded as a Leyden jar, the sea and earth forming one coating, and the upper, rarer, and hence electrically conducting strata of air forming the other coating; and will not the tendency of the action above named be to charge the upper coating with one kind of electricity and the under with another? Such a process would, of course, be continually going on, while on the other hand the earth, regarded as a Leyden jar, would, by means of thunderstorms, and possibly by other means, be continually discharging itself. Next, let us suppose that by some extensive local circumstances a greater than usual electrical separation and charging of the earth jar has

been going on. The effect of this local cause would, however, not be local, but would contribute to increase the charge of the earth as a whole—as one jar in fact, so that the earth as a whole might, for a short period, be increasing its charge—the local charging causes being in excess of the local discharges. Next, would not this excessive charge appear to increase the barometric pressure of the air over the whole earth? On the other hand we may imagine the discharging influences to be sometimes in excess of the charging causes, and then the electrical separation of the earth jar would diminish, and the barometric pressure of the air appear to diminish also. These remarks are put forward not as a formal theory, but rather with the view of inviting discussion. In considering a fact such as that brought forward by Mr. Broun, we must first endeavour to explain it by the operation of some known cause. I have therefore introduced a force which we know to exist, and a mode of operation which is not at first sight improbable. It may be thought that electrical separation can hardly be great enough to produce a sensible barometrical difference. Let this be proved, and a point will be gained by the dismissal of what seems at first sight a possible hypothesis. Meanwhile—to bring these remarks to a practical issue—might it not be well to examine the records of atmospheric electricity corresponding to the dates of Mr. Broun's observations with the view of ascertaining whether Mr. Broun's results are in any way connected with the electrical state of the earth's envelopes?

GENEVA

Physical and Natural History Society, October 5.—Prof. Plantamour communicated to the Society the continuation of his investigations into the climate of Geneva, dealing especially with winds, cloudiness, and rain. As to winds, he has obtained for the last fifteen years a confirmation of the previous results, viz., that the local winds at Geneva play an important part in consequence of the action of the lake; the land breeze at the lake giving a south wind, prevails in the warm season, especially during the morning and evening hours. Generally the south wind prevails from April to October, while the *bise*, or north wind, prevails from November to March. With regard to cloudiness, M. Plantamour has established that the daily variation changes in a notable manner with the season. In winter the minimum of nebulosity occurs at 4 P.M., while in summer it is the afternoon hours that are most overcast. In winter it is the night cold which is the principal cause of clouds; in summer the afternoon heat. December is the most cloudy month; July and August are the clearest months, with difference from one year to another. Examining next the period of fifty years from 1826 to 1875, in reference to the quantity of rainfall, M. Plantamour arranges the years into very dry, dry, wet, and very wet, according to the proportion of rain which they have given, as compared with the mean. It follows from this classification that years of different qualities succeed each other in an order entirely irregular; that a year may be followed as likely by a similar as by a different or very different year in point of humidity. However, there are series of years in which the rainy prevail, and others in which the dry prevail. Thus, from 1826 to 1837, there were eight dry years and four wet; from 1838 to 1856, fourteen wet years and five dry years; from 1857 to 1865, six dry years and three wet. Still there is no regularity, no periodicity, in the return of these dry and wet epochs, nothing especially which we may connect with the eleven-year period of sun-spots.

PARIS

Academy of Sciences, December 4.—Vice-Admiral Paris in the chair.—The following papers were read:—On a note of P. Sechi relative to the formation of hail, by M. Faye. He is surprised at P. Sechi giving out as new the idea of trombes with vertical axes blowing down cold air from the upper regions. He urges the sun-spot analogy.—Indices of a new genus of marine mammifer, fossil in the Saint-Ouen liocene deposits, by M. Gerard. The peculiarities of some of the fragments (chiefly a calcaneum and metatarsal or metacarpal bones) are described. The animal seems to have been like *Macrotarhius* and *Macrotarhius* in some respects, unlike in others. M. Gerard names the genus *Panasternum*, and the species *P. panasternum*, in allusion to the wrinkles on many of its bones.—Preparation of alcohol by means of sugar contained in the leaves of beets, by G. Dumas. He calculates that 30 kilogrammes of leaves of the leaves may yield 0.100 litre of absolute alcohol.

the leaves of 1 hectare about 173 litres. At the moment of removal the leaves contained nearly 350 kilogrammes of sugar per hectare.—M. de Lessens, presenting a brochure on Africa and the Geographical Conference at Brussels, explained the scheme of the King of Belgium of an international association for opening and civilizing Central Africa.—On the employment of iodids of potassium in lead colic and paralysis, according to M. Melsens' method, by M. Jacobs. The patient takes 1 gramme a day, and increases the dose by 1 gramme up to 6, 8, 10, 12, or 15 grammes, then returning gradually to the initial dose. The more iodide he can bear the sooner is he cured.—Researches on the devitrification of vitreous rocks, by M. Meunier. M. Levy's facts do not seem to him to furnish any argument against the production of crystalline rocks at expense of vitreous rocks, by way of devitrification.—Results obtained by the decortication of vine stocks, by M. Sabaté.—Report on the experiments made by the Paris-Lyons-Mediterranean Company for combating phylloxera, by M. Marion. They commend sulphide of carbon and sulpho-carbonates, which should be applied when the products of the winter eggs have descended to the roots, i.e., about July. The old phylloxera of the roots is thus treated as well.—Scale of platinumised iridium (4 m.) of the International Geodesic Association, by M. Matthey. Observations on this communication, by M. H. Sainte-Claire Deville, also by MM. Tresca and Dumas. M. Tresca remarked on the high density, about 21.50. If it contained only 10 per cent. of iridium,  $\frac{1}{1000}$  of rhodium, and  $\frac{1}{1000}$  of ruthenium, the manufacture of metals of platinum must have been greatly improved since 1872.—Observation of a new star in the constellation of Cygnus, by M. Schmidt, director of the Athens Observatory.—Observations of the planet (169) Zella, discovered at the Observatory of Paris, Sept. 28, 1876, by MM. Henry.—On the application of the methods of mathematical physics to the study of bodies terminated by cyclides, by M. Darboux.—New method for studying calorific spectra, by M. Aymonnet. With a constant heat-source, one may, even with a pretty large aperture of thermopile, find approximately the quantities of heat in spectral parts smaller than the aperture. Thus, suppose the pile is 1 mm. In aperture, you advance it (say) two-tenths of a millimetre at a time, noting each time the portion of spectrum 'passed' from and the 'new part' embraced. This is the principle of the method; by which M. Aymonnet gets some interesting results. The minima present a remarkable periodicity, and are displaced when the temperature of the source varies or a liquid screen is interposed.—Productions of carbonate of soda by the action of chloride of sodium in solution on carbonates of lime and magnesia, in presence of vegetable matter, by M. Pichard.—Researches on sensation compared with motion, by M. Richet. He formulates this general law as applicable both to muscles and to sensitive nerve centres: the number of excitations necessary to produce a perception or a motion is inversely proportional to the intensity and frequency of these excitations.—Experimental researches on the cardiac, vascular and respiratory effects of painful affections, by M. Franck. The immediate effect on the heart is always a stoppage or retardation of the beats.—On the form and reciprocal relations of the cellular elements of loose connective tissue, by M. Renaut.—Habits of fishes; the gottami and its nest, by M. Carbonnier.

CONTENTS

PAGE

McLennan's Studies in Ancient History. By Sir John Lubbock, Bart., F.R.S.	133
OUR BOOK SHELF—	
Science in Sport made Philosophy in Earnest	134
Smith's "Mushrooms and Toadstools"	134
Burley's "Between the Danube and the Black Sea for Five Years in Bulgaria"	134
Beveridge's "District of Bakarganj; its History and Statistics"	135
LETTERS TO THE EDITOR—	
Ed. Fisher's "W. H. Hoobworth"	135
Emmanouil's Science—W. BERTIN'S SCOWS	137
The Rocks of Charwood Forest—REV. J. G. BOWNEY	137
Self-Fertilization in Flowers—THOMAS MERRILL	138
On Superheated Solutions—J. G. BOWNEY	138
KARL ERNST VON BAER	139
RAVENS FOWNS WITH THE SHETLAND ISLES. By JOHN HORNE	139
THE GLACIATION OF THE SHETLAND ISLES. By JOHN HORNE	139
PRINCEVAL SWITZERLAND (17th Century)	140
THE DEATH OF THE GORILLA. By G. D. DUMAS (With Illustrations)	140
MUSINGS (Continued) FOR A MUSEUM—EUROPEAN. By Prof. W. H. B. STURTON	144
OUR ASTRONOMICAL COLUMN—	
A New Star in Cygnus	145
The Opposition of Mars, 1877	147
NOTES	147
SCIENTIES AND ACADEMIES	150

THURSDAY, DECEMBER 21, 1876

## GRAHAM'S RESEARCHES

*Chemical and Physical Researches.* By Thomas Graham, D.C.L., F.R.S. Collected and printed for presentation only. (Edinburgh, 1876.)

IT is but seldom that science owes a work like this to private munificence. All, therefore, to whom Mr. Graham's memory is dear will be specially grateful to Mr. James Young for choosing, as the second monument he has raised to his friend, the publication of this splendid volume.

It is fortunate also that its compilation has been undertaken by Dr. Angus Smith, who has done more than collect the scattered writings, for he has added an analysis of the contents of the volume which cannot fail to be of use, and reminds us, in a careful preface, of Graham's claim to a place in "that chain of eminent thinkers which has been represented by such as Leucippus, Lucretius, Newton, Higgins, and Dalton." As the work is printed for private circulation only, it may be well to give a brief summary of this preface which is headed "Graham and other Atomists."

A sketch is first given of the nature of Indian and Greek thought as regards atoms, and, passing to Leucippus, Dr. Smith points out that "in the mind of this early Greek, the action of the atom as one substance taking various forms by combinations unlimited, was enough to account for all the phenomena of the world." Leucippus told us that all was motion. "Graham conceived the idea that the diversity in the motion was the only basis of the diversity of the material, or that an atom constituted an element of a special kind," according to the velocity or nature of its movements. After Leucippus few men seem to have devoted much attention to the subject until modern times. A quotation from Lange gives the position assumed by Democritus, "The difference of substances arises from the difference in the number, size, shape, and arrangement of the atoms. The atoms have no internal conditions; they act by pressure and percussion only."

Dr. Smith considers that the views of Lucretius deserve attention, as he was the only full expositor of the theory of atoms to the ancients. To Lucretius atoms are "solid and eternal, with some unalterable motion." "They are made of parts, which parts cannot exist by themselves." "Motion is to him everything that can be found in life and thought, which are only the clashing of atoms." This theory allows of any shape of molecules, even hooked ones, which, as Dr. Smith somewhat dryly adds, "are spoken of as explaining combination both in Lucretius and more modern writers." Space will not permit Newton's words to be given at length, but he held that the primitive particles of which matter is composed are incomparably hard and incapable of wear, for otherwise "water and earth composed of old worn particles, would not be of the same nature and texture now with water and earth composed of entire particles in the beginning." He is thus forced to the conclusion that "the changes of corporeal things are to be placed only in

the various separations and new associations and motions of these permanent particles."

A sketch is then given of the next important stage, namely, the motion of gaseous molecules, beginning with Daniel Bernoulli, and passing to Davy, Rumford, and Herapath—to whom, by the by, Graham asserted in 1863 the merit of reviving Bernoulli's hypothesis in modern times is fairly due. As is well known, the theory of gases now generally received makes them consist of small bodies continually impinging on one another, and on the walls of the inclosing vessel, their elasticity increasing with the temperature, and the pressure of the gas being due to the impact of the particles against any surface presented to them, an hypothesis which Joule investigated experimentally.

Now, as Dr. Smith shows, "it was the object of Graham's life to find out what the movement of an atom was. . . . He avoided picturing the most primitive motion in all its character, but he seems to indicate one of revolution, as he brings in the similarity to the orbit of a planet," and he advances still further, "when he adopts the theory of one kind of matter, each atom being distinguished by the extent of its motion," there being an initial impulse for each kind. "These atoms are believed to be congregate . . . and equal volumes can coalesce and form a new atomic group." Indeed the whole force of Graham's intellect was patiently and persistently devoted to this study of molecular movement, and as Dr. Smith claims him to be as "strict an anatomist as perhaps can be found," it may be interesting to gather from his writings some of the passages in which his views are expressed.

His earliest paper, on the Absorption of Gases by Liquids, was published in Thomson's "Annals of Philosophy," in 1826. In it he considers that "gases may owe their absorption in liquids to their capability of being liquefied," and that when gases appear to be absorbed by liquids, they are simply reduced to that liquid inelastic form, which otherwise (by cold or pressure) they might be made to assume; their detention in the absorbing liquid is owing to that mutual affinity between liquids which is so common. In his last paper in the *Phil. Trans.*, published forty years afterwards, he refers to the liquefaction of gas in colloids in much the same terms, for he alludes to the "general assumption of liquidity by gases when absorbed by actual liquids or by soft colloids," and he states that those gases penetrate (india-rubber) most readily which are easily liquefied by pressure, that gases undergo liquefaction when absorbed by liquids and such colloid substances as india-rubber, and finally, that the complete suspension of the gaseous function during the transit through india-rubber cannot be kept too much in view.

The *Quarterly Journal of Science*, 1829, pp. 74-83, contains his first paper on the diffusion of gases. In it he states that the diffusiveness of gases is inversely as some function of their density, apparently the square-root of the density; he also considers it conceivable that orifices of excessive minuteness may be altogether impassable by gases of low diffusive power, but defers these theoretical considerations to a future paper. This promise was fulfilled by a paper in 1831, the object of which was to establish the following law of the diffusion of gases. "The diffusion or spontaneous intermixture of two gases

in contact is effected by an interchange in position of indefinitely minute volumes of the gases, which volumes are not necessarily of equal magnitude, being in the case of each gas inversely proportional to the square root of the density of that gas." He speaks of diffusion "being effected by a force of the highest intensity," and insists that diffusion takes place between the *ultimate particles of gases*, and not between sensible masses. In a later paper, *Phil. Trans.*, 1863, he states that molecules only of gas can pass the pores of graphite, "and they may be supposed to pass wholly unimpeded by friction." He showed that a gas may pass into a vacuum in four ways, first by effusion, a movement which affects *masses* of gas only, second, by diffusion which affects *molecules*, third, by transpiration through capillary tubes, "the transpiration ratios forming a class of phenomena remarkably isolated from all else at present known of gases," and lastly by a previous absorption in the walls of the septum which divides the gas from the vacuous space, as was so beautifully shown in the papers published in the years 1866-69. In one of these, in considering the passage of gas through metallic septa, he recognises "an intermolecular porosity due entirely to dilatation at a high temperature," and thus apparently hoped to ascertain the ultimate size of molecules, for he says that this "species of porosity, if it exists, might well be expected to throw light on the distances of solid molecules at elevated temperatures."

His views are very clearly defined in a paper published in 1863 entitled "Speculative Ideas respecting the Constitution of Matter." He is of opinion that the various kinds of matter now recognised as different elementary substances may possess one and the same ultimate or atomic molecule existing in different conditions of movement. Were this ultimate atom at rest, the uniformity of matter would be perfect; but it always possesses motion, due to a primordial impulse, and, as differences in the amount of this motion occasion differences of volume, matter only differs in being lighter or denser matter. The gaseous molecule is composed of a group of the preceding inferior atoms following similar laws and is thus a reproduction of the inferior atom on a higher scale. Chemical combination consists in equal volumes of the different forms of matter coalescing and forming a new atomic molecule, and is therefore directly an affair of weight; and the combining weights differ because the densities, atomic and molecular, differ. Graham is further careful to point out that liquefaction and solidification probably only involve a restriction of the range of the atomic movement.

In this brief sketch it has not been possible to touch on his views as to states of matter, such, for instance, as the "colloidal condition which intervenes between the liquid and crystalline states," or to the more purely chemical portion of his work, of which his theory of polybasic acids is probably the most remarkable.

Widely as the value of Graham's work was recognised during his lifetime, there is no doubt that the appreciation of it is increasing, and cannot fail to be stimulated by Mr. Young's liberality, which has set forth the researches in such a manner as to impress us with their coherence and strength.

W. CHANDLER ROBERTS

### THE ANDES AND THE AMAZON

*The Andes and the Amazon; or, Across the Continent of South America.* By James Orton, A.M., Professor of Natural History in Vassar College, U.S., &c. Third Edition, Revised and Enlarged, containing Notes of a Second Journey. Maps and Illustrations. (New York: Harper Brothers, 1876.)

AS is indicated in the title this work contains accounts of two separate journeys, to a considerable extent over the same ground, the first undertaken in 1867, the second in 1873. A narrative of the former was published several years ago both in America and in England, we believe; the second half of the volume is quite new and is essentially supplementary to the former. The results of the journey of 1867 are given in the form of a personal narrative, those of 1873 are arranged systematically in a number of chapters on the various features of the Amazon and its surroundings. The main scientific results of both expeditions have been described in the *Proceedings* of various scientific societies and in scientific journals in America and in England, and the present volume is therefore perfectly free from any details that would prove unattractive to the general reader.

In the journey of 1867 Prof. Orton and party landed at Guayaquil in Ecuador, mounted the Andes to Quito, proceeded by Papallacta, Baeza, and Archidona, still among the Andes, to the Napo river. Floating down this river they reached the Amazon, took steamer at Pebas, and enjoyed a splendid sail to the mouth of the river at Pará. In the second journey, that of 1873, Prof. Orton landed at Pará and sailed up the great river to Yurimaguas, thence over the Andes to the Pacific Coast and down to Lima, with a side-excursion to Lake Titicaca by way of Arequipa.

Prof. Orton tells his story in most attractive style. He is in danger sometimes, no doubt, of degenerating into the florid, but from beginning to end of his large volume he never ceases to be attractive, amusing, and instructive. He writes on people and things in the wonderful region of the Amazon with great piquancy, genuine humour, and full knowledge; he frequently becomes absolutely eloquent, if not poetic. Few features of the towns and the country through which he passed have escaped his attention. In describing his first journey, he lingers at Quito for several chapters, describing the city, giving hints and comments on its history, touching off the appearance and character of its easy-going people, giving an account of the country of which it is the capital, Ecuador, the flora and fauna and primeval inhabitants of the Valley of Quito, rising thence to an eloquent dramatic sketch, à la Hugh Miller, of the geological history of South America, the rise of the Andes, and the creation of the Amazon, devotes two interesting chapters to the volcanoes of Ecuador and its earthquakes, and before leaving, gives several details about a few of the Indian tribes in "the Province of the Orient." So on his way down the Napo and the Amazon, he paints vividly and picturesquely the scenery, the people, the animals, the plants, and the geology of one of the most interesting regions in the world. He chats pleasantly and piquantly of all he comes across, never gives the reader a chance of feeling wearied, and leaves him, if he has been a faithful

listener, with a fuller and clearer knowledge of the Amazon and its tributaries, its basin, its products, its people, its cities, and fragments of towns, its industries, and its probable future, than he could get from reading many other books. The second part especially, containing the results of the journey of 1873 systematically arranged, will be found extremely handy and valuable by anyone who desires in brief space a general view of the physical geography, natural history, ethnology, industrial resources, commerce, prospects, and scenery of the vast Amazonian region. Prof. Orton has evidently supplemented his personal knowledge of the region by an extensive study of the contributions of others who have written on the subject, so that while the classical works of Bates and others, as well as the special papers of Prof. Orton himself, will be resorted to by those who desire to make a thorough study of the Amazonian basin, we know of no single work containing a fuller, more brilliantly written, and at the same time more trustworthy general account of the basin of the Amazon and its many wonders. The following extract on the density of population in the Amazonian valley will give our readers some idea of the style of the work :—

"The valley of the Amazons is probably the most thinly-peopled region on the globe, save the great deserts and the polar zones. There are not 40,000 souls along the banks of the rivers in the whole province of Amazonas and the Lower Marañon. Many of the towns marked on the maps do not exist, or are represented by a solitary palm-hut. The visible population is almost confined to the circumference of the valley; as at Pará, near the mouth of the river; at Moyobamba and Taramoto, on the oriental side of the Andes; and at Trinidad, Santa Cruz, Cochabamba, and La Paz, on the head-waters of the Madeira. The great basin is filled with a continuous, dark, primeval forest, rarely disturbed by the hand of man, and into which daylight seldom enters. Yet imagination peoples this pathless wilderness with uncounted swarms of savages. There are, it is true, numerous clans (we can hardly call them tribes) of Indians, distinct in language, and often hostile toward each other. But many of these so-called tribes, though dignified with separate names, are insignificant in numbers, barely mustering a hundred; while the Mundurucú, the largest known tribe in the valley, does not exceed 8,000—men, women, and children. Nor are there any remains of ancient walls to indicate a bygone civilisation, or even shell-heaps in memory of a more primitive race.

"Until the close of the Tertiary age the waters prevailed over this heart of the continent; and since then vegetation has had the mastery, leaving little chance for animal life. And until there is a decided change in the physical geography of the valley, a large part of it must remain unfit for permanent settlement, on account of the annual floods; for a rise of 40 feet in the river drives the inhabitants from their summer resorts on the margin of the streams to the higher *terra firma* within the forest. In this way nomadic habits are engendered or perpetuated, and poverty is almost inevitable, for half the year (flood-time) it is hard work to get a living. Furthermore, this regular inundation of the country and the lack of grassy campos (except on the Lower Amazons and the Beni region) prevent the raising of domesticated animals, which, if it does not lie at the foundation of agriculture, certainly does aid in the transition from the savage to a semi-civilised state. In this respect the natives of Central Asia and Africa, as well as the maize-eating tribes of the Andes, have an advantage over the mandioca-eating Indians on the Amazons."

While minute criticism might find many statements

and hypotheses in Prof. Orton's work to challenge; while some of his chapters may be considered by the lover of severity of style as intolerably florid; while in short anyone who has a mind to might find something to object to, we are sure that all into whose hands the work may fall will agree that few more attractive and at the same time more instructive works of travel have been written. Prof. Orton seems to anticipate that ere long the Amazon will become a highway for tourists, as it well might—even now it has a considerable service of steamers—and therefore gives many hints, directions, and statements of expense that render his work valuable as a guide-book. Not the least attractive feature are the many well-executed illustrations of places, people, scenery, and animal and plant life that enrich the volume. Two large maps, one of the Marañon and its tributaries and the other of Equatorial America, add to the value of the work, which will doubtless be brought within reach of the English reading public by some enterprising publisher.

#### OUR BOOK SHELF

*The Secret of the Circle, its Area Ascertained.* By Alick Carrick. Second Edition. (H. Sotheran and Co., 1876.)

*The Impossible Problem.* By James Alexander Smith. Printed for the Author's Use. (Shaw and Sons, 1876.)

THE only difference we have been able to detect between this edition and its predecessor are that the last lines of pp. 34 to 38 of the first edition are the first lines of pp. 35 to 39 of the second edition, with the corresponding changes of the other lines of the several pages, that a date has been omitted on p. 39, and fig. 2 on p. 41 slightly modified. With our copy we were favoured with a number of *The Welshman* (Sept. 29, 1876) containing a very long notice of it, supplied to the editor of the paper by an enthusiastic admirer of the work. An extract or two will sufficiently illustrate the article. "Don't let the reader run away with the idea that this is a prelude to any long, complicated calculations, understandable only by the initiated. As simple as truth itself, when ascertained, the solution of this problem is as easy and capable of absolute proof as any ordinary sum in addition and subtraction." "This beautiful problem and mystery that has tempted, attracted, and defeated the skill of thousands of the most subtle and far-seeing minds for thousands of years is found, when looked at in the right way, to be as easy and as simple as the alphabet." "It will not suffice for mathematicians to endeavour to show by any fallible and inadequate system of computation now in vogue that this result cannot be. The reader can judge for himself."

We in our former notice pointed out what we considered defective in Mr. Carrick's proof. The work is a posthumous one, hence it is that the second edition has experienced no revision at the author's hands.

Mr. Smith, in his pamphlet (8 pp.), arrives at the same result as Mr. Carrick, viz., that  $\pi = 3\frac{1}{2}$ , or the area of the circle equals  $\frac{3}{8}$  of the square of the diameter +  $\frac{1}{8}$  of that square. The roads pursued are different.

Though we cannot agree with Mr. Smith, we have read his work with some interest, for there are some neat little pieces of simple construction in it. His equations on p. 5 may be put into the more general form :—

$$w = (3 + \rho) x, \quad y = (\frac{3}{2} + \rho) x, \quad z = (\frac{3}{2} + 2\rho) x;$$

We have not been able to see if other values would satisfy his equations besides the one he has selected, which leads him to draw the conclusion he does.



*Concise Instructions in the Art of Retouching.* By Burrows and Colton. (London: Marion and Co, 22 and 23, Soho Square, 1876.)

FOR some years past a conviction has been growing amongst the better class of professional photographers that their art alone, even under the most perfect conditions, is unable to produce an artistically perfect portrait, a proposition, by the way, for which the true artist has all along contended in the face of the constant assertion of the converse by fanatical advocates of "sun-painting" *pur et simple*. The victory having at last rested with the artists, a number of books on retouching have been published, each professing to give the true method of at once producing artistic pictures.

We are glad to see that in the present little work the authors disclaim any such intention, but, on the contrary, proceed solely to instruct their pupils in the work before them, which we may here inform the uninitiated is no less a one than that of restoring, so to speak, on a photographic negative those injuries to a face which may have been caused by imperfect lighting and defects, such as dust, &c., in the film; or disease or physical injury to the face itself. In fact, the art of the re-toucher is to convey to a photograph a certain amount of that idealisation always manifest in the works of the painter, the want of which is the unknown cause so often producing a feeling of dissatisfaction even with the best of photographs.

To carry out their aim, the authors give two very good lithographs of the muscles of the face and head, with two more of the same model covered with the flesh. Two negatives on a flexible film (apparently taken by Warneke's process) are also added as examples of the work to be done. The descriptive matter is concisely put, and is clear and to the point. We have little doubt that the book will be of service to many amateur and professional portrait photographers.

R. J. F.

### LETTERS TO THE EDITOR

[The Editor does not hold himself responsible for opinions expressed by his correspondents. Neither can he undertake to return, or to correspond with the writers of, No notice is taken of anonymous communications.]

#### Sea Fisheries

I HAD hoped that Mr. Holdsworth, in the rejoinder which he told me he was preparing to my former letter (*NATURE*, vol. xv. p. 55) would have confined himself to defending the assertions he had before made, or at most to rebutting the evidence I had adduced in reply to them. In this case I should have gladly left the matters at issue between him and me to the judgment of the public. Unfortunately he has thought it needful for the sake of the cause he adopts to introduce some new assumptions and charges, conveyed in language of a rather vigorous kind, so that out of regard to the good opinion of your readers, I am driven to trespass on their forbearance and yours. But in doing so I try to be as brief as possible, and however much my friend may have exceeded the limits of a rejoinder, not to follow his example.

All will fully agree with Mr. Holdsworth that an "index is not a *præcis*," but few will deny that an index is a valuable aid to mastering the contents of a book. If he says that this particular index is a bad one, I must leave him to settle with the maker of it. If it is neither bad nor good it may be misleading unless the user of it looks pretty carefully into the text. But if it is good, it gives the reader the best of all help in acquainting himself with the huge volume, and by its help nobody need fear dangerous mistakes. It does not seem to me that I have done so. The errors which my friend asserts I have made are, if errors at all, very trivial, and as one tells for, and the other against, his views, they may be safely paired off to the detriment of neither side. As to the figures set in the last column of my table, against "Cod and Ling," they ought to have been "33" instead of "38"—a mistake in copying or printing which escaped my observation till now. I freely give Mr. Holdsworth the benefit of it. The next two paragraphs of his letter have afforded me some merriment, though chastened by

the thought that he must have a very low opinion of me if he seriously supposes I am ignorant of the notorious reputation of the dog-fish. Whether "predatory fishes," however, are necessarily "mischievous," so that the two epithets should be closely linked together, as though one was the consequence of the other, is upon which I shall not enter. But surely it is obvious that the prevalence of predatory fishes is more or less a measure of the prevalence of their prey, and as the blind man judged of the value of the field by asking how many thistles grew on it, so may we judge of the abundance or scarcity of other fishes by the abundance or scarcity of the dog-fish. Might I here apply to Mr. Holdsworth an expression of his own to myself, and say that, from these paragraphs, I am justified in believing him unable to comprehend one of the simplest relations of animal life?

As to herrings, I pretend to no greater knowledge of their natural history than other people do. I do not see why I should be accounted more ignorant, or attempting to conceal that ignorance, by any mysterious evolutionary process from my inner consciousness or elsewhere. The herring is admittedly not ubiquitous in the sea, *i.e.*, it has, like other animals, its more or less definite range. It therefore has "borders," though even Mr. Holdsworth cannot lay them down exactly. My friend is pleased "to doubt very much" whether I "had given five minutes' attention to the practical study of the habits of the herring—to its life-history" before I wrote my Glasgow address. That rather depends on what may be called "practical study." Has Mr. Holdsworth ever heard of a "water-telescope"—an instrument of which I can find no mention in his book—or has he ever looked through one? If, when the days get a little longer and the steamers are running conveniently, he will cross to Norway and follow the coast to the Lofoden Islands (perhaps he need not even go so far), he will possibly appreciate the value of these remarks, and will be doing what I did more than twenty years ago.

The next five paragraphs of Mr. Holdsworth's rejoinder seem to contain very fair comments on what I had urged, and, though I do not thereby assent to them, I may say that had the rest been of a piece with them I should not now be troubling you. I must, however, express my disappointment that in what follows no definite information is given as to the sea-fishes which are so often said to be devoured by sea-birds. Here is room for almost any amount of new and interesting observations, whether those observations affect his argument or not. He, not I, introduced the topic, for reasons I suppose known to himself, but not to be guessed at by me. He now seems to consider it, as I did, irrelevant.

Then as to Prof. Baird's reports. Far be it from me to find fault with my friend for fishing out the two passages which, as he thinks, tell in his favour. But these relate to two particular kinds of fishes—the alewife and the cod—the former mainly as furnishing food to the latter, and I never said that to over-fishing *only* was the diminution in every case due. The decrease of the cod is ascribed by Prof. Baird to the decrease of the alewife, and this, he says, is caused by the erection in the tidal rivers of impassable dams or of weirs by means of which every fish ascending the river to spawn was caught. Surely this was "over-fishing." In the first of his reports this question is considered far more generally and closely than in the second, from which Mr. Holdsworth's extracts are taken, yet there is nothing in the latter really to contradict the conclusions arrived at in the former. Hence I infer that they are still upheld by their author, and their nature may be seen by the following citations from his "General Summary of Results" (Part I., pp. 38, 39):—

"I. The alleged decrease in the number of food-fishes in these waters within the last few years has been fully substantiated.

"II. The shore-fishes have been decreasing during the past twenty years, gradually at first, but much more abruptly from about the year 1865, the reduction by the year 1874 being so great as entirely to prevent any successful summer-fishing with the hook and line, and leaving to the traps and pounds the burden of supplying the markets. This statement applies also, but perhaps to a certain extent, to the blue-fish. The decrease in their numbers first manifested itself about ten years ago, and is going on quite rapidly at present.

"III. This period of decrease represents the time during which the traps and pounds have been well established, their operations

\* The mackerel and the mackarel are indeed mentioned, but incidentally and with some uncertainty.

increasing year by year, and their catch, especially in the early spring, being always very great.

"VI. The decrease of the fish may be considered as due to the combined action of the fish-pounds or weirs, and the blue-fish, the former destroying a very large percentage of the spawning fish before they have deposited their eggs, and the latter devouring immense numbers of young fish after they have passed the ordinary perils of immaturity."

As Prof. Baird goes on to remark that there are no measures at command for destroying the blue-fish, even if that were desirable, and as the blue-fish was once far more abundant than it is at present, while other fishes were also more numerous, I cannot see that I made any mistake in stating that "over-fishing" was unquestionably assigned as "the chief cause" of the decrease in American sea-fisheries.

Lastly, Mr. Holdsworth says that the question lies between the late Royal Commissioners and myself. It was under this belief, holding him as their secretary to be their mouthpiece, that I took some trouble to reply to his first letter. Had any one not in that position challenged my remarks I should, perhaps, have not felt myself bound to give my reasons for the faith that is in me. He asserts that I have "no practical acquaintance with the subject." Possibly he considers that qualification limited to those who have been named in a Fishery Commission. In such case I certainly have none. He further charges me with using the Index to the Evidence as my "sole guide." Here I must venture to contradict him. I have used that Index, indeed, but much as Norwegian fishermen use the "water-telescope"—to look into the teeming depths of evidence below, unobstructed by the surface ripple of a Report.

To sum up. Your readers are aware that I originally treated of the Fisheries question as part of a much wider subject on which I felt constrained to speak my mind at a fitting opportunity. I have yet to learn that the Report of a Royal Commission is beyond the reach of fair and cool criticism, or that it is obligatory on all men to accept that Report as a revelation from supreme intelligence. My criticism of this Report was, I venture to think, not unfair, and it was not made in hasty warmth. Some ten years had passed since I adopted the opinions I hold, and the time had come when, as I thought, I could not help uttering them, nor does it seem to me that an unfitting occasion was offered by a meeting of the British Association. The decision of the question whether there is and has been "over-fishing" or not is hardly helped by the reiteration of the passage with which my friend ends his rejoinder.

Magdalene College, Cambridge, ALFRED NEWTON  
December 15, 1876

### Ocean Currents

AGREING in the main with Mr. Digby Murray's argument on the subject of ocean currents in NATURE (vol. xv. p. 76), I am the more disposed to criticise some of the statements with which it concludes, as put forward too strongly, to say the least.

I would ask for the "absolute proof" which Mr. Digby Murray supposes to exist, that (1) the upper current return-trades "flowing from the equator descend again to the surface of the ocean on the polar sides of the calms of Cancer and Capricorn," and (2) "that these equatorial currents, subsequent to their descent on the polar sides of the calms of Cancer and Capricorn, are known as the westerly winds of the temperate zones." That these statements represent the prevailing opinion on the subject I readily admit, but I have ever looked in vain for any convincing arguments in their favour.

As regards the hypothesis that the trades cross one another in the region of equatorial calms, I may perhaps be permitted to quote some remarks of my own, made two years ago (*Symons' Met. Mag.*, vol. x. p. 37), since subsequent study has tended to confirm the doubts which I then expressed:—

"Maury's hypothesis, that the surface trade-wind of one hemisphere becomes the upper-current return-trade of the other ('Physical Geography of the Sea,' sec. 122 to 139) was in all probability originally suggested by the well-known fact that over the southern portion of the N.E. trade a S.E. upper-current prevails, and over the northern portion of the S.E. trade a N.E. upper-current, though he lays most stress on the arguments which he draws from the greater rainfall of the northern hemisphere (sec. 169 to 186), and from Ehrenberg's examination of the African air-dust (sec. 266 to 296).

"A seaman on approaching the doldrums, commonly notices a current overhead blowing at an angle of about 90° with the surface-trade; he is aware that this upper-current coincides in direction with the trade on the other side of the doldrums, and that in the calm belt itself, there is an upward motion of the atmosphere. It is, therefore, not unnatural that he should conclude that the upper-current which he observes is a poleward extension of the opposite trade in the higher regions of the atmosphere. It may also, I think, be admitted that the rapid and suddenly shifting cloud-currents, often observed over the region of the doldrums, are somewhat in keeping with Maury's idea of 'curdles,' or alternate strips of air.

"I would suggest that this hypothesis (which many subsequent writers have been surprisingly ready to adopt) may, perhaps, be subjected to a crucial test, if an answer can be given to the following query:—When the south-east trade draws so far to the north as to be deflected into a south-west surface wind, what is the prevalent direction of the upper-current over the southern portion of the north-east trade? If it runs from south-west it will be difficult to resist the conclusion that Maury is right; if from south-east it will appear probable that the upper-current is (principally at least) the north-east trade, deflected in the first part of its return course towards the north-west, just as it is in the subsequent part towards the north-east.

"Perhaps some meteorologist can give a definite answer to this question. The published data for its solution appear rather scanty; but, so far as my own limited information goes, the observations are generally rather adverse to Maury's theory."

I would now ask what proof exists that the upper currents from the polar depressions and those from the equatorial depression cross one another in the calms of Cancer and Capricorn so as subsequently to become the trades and anti-trades respectively? Since these upper-currents are understood to meet at the belts of tropical calms and there to descend, it is surely "more reasonable to suppose that their currents intermingle and that their mixed volume is then drawn off north and south, as required to restore the equilibrium of the atmosphere." These are Mr. Digby Murray's words in reference to the equatorial calms, and I fail to see why they will not apply to the calms of Cancer and Capricorn.

The whole question of the cause of the prevailing south-west and north-west winds of the north and south temperate zones, and the relation which these bear to the polar areas of barometric depression, may be regarded as fairly solved by the researches of Mr. Ferrel, Prof. J. Thomson, and others. As regards the great intensity of the Antarctic, as compared with the Arctic depression, and the superior force of the westerlies on its border, there is surely *prima facie* ground for believing that these are mainly due to superior evaporation in the water-hemisphere generally. (I say "mainly," because it seems probable that the comparative absence of surface-friction experienced by the atmospheric currents in that hemisphere tends to intensify the Antarctic depression.) That the evaporation from the warm surface-water of the North Atlantic is in excess of that from the relatively cold surface-water of the South Atlantic, may be readily admitted; but the Atlantic represents, after all, only a small portion of the surface of the globe. Will anyone maintain that the evaporation from the whole continent of Asia is equal to that which takes place from the corresponding area of the South Indian Ocean?

W. CLEMENT LEY

### Solar Physics at the Present Time

HAVING now read the *Astronomical Register's* more extended account of the November meeting of the Royal Astronomical Society, I found it very confirmatory of NATURE's shorter, but more quickly produced, summary of November 23, especially in what was said in the discussion upon Prof. Langley's (United States) paper on Sun-spots and Terrestrial Climate. Will you kindly allow me to remark:—

I am extremely glad that Sir G. B. Airy is now finding from the deep-soil thermometer observations at Greenwich that, whatever may be the interior temperature of the earth, and the terrific manifestations of it in some special volcanic localities abroad, yet all the remarkable changes and occasional abnormal elevations of temperature in the Greenwich soil *come from without*; for, Sir, that is precisely one of the earliest conclusions which I deduced for the Edinburgh soil, from the longer series of similar deep-soil thermometers there, and which I had the honour

of communicating to the Royal Society of London six years ago.

2. I am also very glad that Prof. Langley has proved by his most refined and crucial observations on the direct radiating powers of spot, penumbra and photosphere surface, combined with the continuous register of the amount each day of the spotted portion of the sun, that sun-spots have no sensible power in themselves for producing any notable change on terrestrial climate; because, Sir, in that paper of six years ago, and still in the hands of the Royal Society, I deduced that sun-spots were consequences, rather than causes, of the great periodical waves of heat which come upon the earth from without; and I proved that conclusion three times over, or for three successive cycles of the eleven-year sun-spot period.

3. As we are now on the commencement of another of those cycles, I must regret that the chief speakers seemed to intimate that almost all their idea of further investigation into the origin of those mysterious heat-waves received by the earth from without and apparently from the sun, centred in causing to be made more sun-spot observations; for, Sir, not only did it sound very much like proposing to lock the stable-door as soon as it should be announced that the horse is no longer therein, but there are further features accompanying those occasional great heat-waves, showing that they must originate in something much more intense, violent, and complicated than those comparatively harmless little phenomena, the dark spots. PIAZZI SMYTH, Edinburgh, December 5 Astronomer Royal for Scotland

Radiant Points of Shooting Stars

BETWEEN October 13 and November 28, watching for forty-nine hours, I observed 367 shooting stars, 306 of which were well seen and their paths registered. On going carefully over them some thirty-five radiant points are shown, about twenty-five of which are good positions, while the remainder are open to more or less doubt. The following are the twelve principal ones:—

Dates.	Position of Radiant Point.		No. of Meteors.	Notes.
	in	at		
		R.A. Decl.		
1. Oct. 21-Nov. 20 ...	Taurus ...	60 + 19	25	Many fine meteors, mean of three showers.
2. Sept. 17-Nov. 8 ...	Pisces ...	15 + 11	17	Mean of two showers, very slow meteors.
3. Sept. 20-Oct. 25 ...	Musca ...	46 + 26	19	Small rapid meteors.
4. Oct. 13-Nov. 23 ...	Lynx ...	125 + 47	17	White rapid meteors, mean of two showers.
5. Sept. 18-Nov. 8 ...	Cassiopeia ...	75 + 52	20	Small meteors, mean of two showers.
6. Oct. 25-Nov. 8 ...	Gemini ...	110 + 19	11	Mean of two showers, very swift meteors.
7. Nov. 20-28 ...	Leo Minor ...	155 + 36	21	A fine A.M. shower.
8. Nov. 20-28 ...	Ursa Major ...	208 + 43	12	Just before sunrise, small, short meteors.
9. Nov. 7-8 ...	Camelopardus ...	69 + 66	10	An evening shower.
10. Sept. 17-Nov. 20 ...	Lacerta ...	345 + 43	10	White rapid meteors, mean of two showers.
11. Nov. 22-28 ...	Auriga ...	78 + 43	9	White rapid meteors.
12. Oct. 17-25 ...	Orion ...	88 + 17	8	A well-known Oct. shower.

Several of these positions are the mean of two showers, one seen in October the other in November, and evidently identical. No. 7 in the list is possibly new, and was a very active shower from near Leo; the meteors were rapid and white, leaving phosphorescent streaks. No. 8 is quite new, and three other radiants found on the mornings between November 19 and 28 are new. They are:—

- 1. Near  $\gamma$  Leonis ... R.A. Decl. 170 + 4 ... 6 meteors, very swift.
- 2. In Sextans ... 153 S 1 ... 6 meteors.
- 3.  $\alpha$  Bootis ... 212 + 18 ... 7 meteors.

The positions given are in most cases very accurate, and each of them represents a well-marked shower. The new radiants are visible preceding sunrise, and this may account for their having previously escaped detection.

Generally the meteors of October-November were very small. The magnitudes of the 306 registered were:—

x or =	1st mag.	2nd mag.	3rd mag.	4th mag.	5th mag.	6th mag.	Total.
19	...	49	...	61	...	107	...
						65	...
						5	= 306.

I have lately found meteors very much more frequent after midnight than before it. In November, 13 $\frac{1}{2}$  hours watching, P.M., gave 79, while 12 hours watching, A.M., gave 133. Thus I have noted about double the number in the mornings than in the evenings. I found a similar difference in October, though have made no special comparisons to find if it has also been shown in the other months of the year. I usually find meteors show a progressive increase in numbers as the night advances, being at a minimum early in the evening hours and at a maximum just before the morning twilight.

Ashleydown, Bristol

WILLIAM F. DENNING

The Atlantic Ridge and Distribution of Fossil Plants

IT has occurred to me that the discovery of the narrow belt of suboceanic highlands extending in a sinuous course down the length of the Atlantic, as shown in the *Challenger* chart, removes a difficulty that has been present to students of fossil botany. When the area was land these hills would probably form a ridge sufficiently high to have a temperature cool enough to explain the migration across the tropics of plants living in a temperate or even cooler climate. M.

Antedon Rosaceus (Comatula Rosacea)

THE letters of your correspondents with reference to the above, seem to me to fail to prove that there is any public recorded instance of its capture in the stalked (brachial) form at Torquay before the instance noted by the Birmingham Natural History and Microscopical Society in 1873. Of course if Prof. Allman took a specimen in the pre-brachial stage there in 1863, and Mr. Gosse the adult animal in 1864, the stalked form (brachial) must have been there as well, but was probably overlooked.

As to the change of name to which Mr. Thomas R. R. Stebbing objects, I certainly think that Dr. Carpenter, in his monograph before referred to, has deduced ample reasons for the substitution of *Antedon* for *Comatula*, "on the grounds of priority, in accordance with the rules of zoological nomenclature, and in concurrence with the views of Dr. J. E. Gray, Sir Wyville Thomson, and the Rev. A. Merle Norman."

Birmingham, December 10

W. R. HUGHES

"Towering" of Birds.

My experience goes to show that the towering action, although most frequent in the gallinaceous birds, is by no means confined to them. In the first case which came under my notice the bird was the common godwit. It was feeding on the border of a marsh, and I being very young at the time, committed the un-sportsmanlike act of firing at it on the ground. Immediately on being hit the bird rose perpendicularly to a height of about 30 feet, then turned over on its back and fell dead almost on the spot from which it started.

Since then I have seen the same movement in the dunlin and some other species of *Tringa*, in the sandpiper, the whimbrel, and, if I recollect rightly, in the lapwing plover, but in no other birds, excepting of course those mentioned by Mr. Romanes.

I have never seen a towering shore bird, after being struck, fly any considerable distance before towering, and those which have towered directly on being hit have always received a slight wound at the base of the brain, but there is little doubt that pulmonary hemorrhage is the principal cause of this curious action.

December 12

F. W. MILLET

THE SPECTRUM OF THE NEW STAR<sup>1</sup>

NOTWITHSTANDING the bad weather and the feeble light (4th to 5th mag.), I have been able to investigate pretty completely the spectrum of the light

<sup>1</sup> Sur le spectre de l'étoile nouvelle de la constellation du Cygne. Note by M. A. Cornu, read at the Paris Academy of Sciences, December 11.

of this new star with the Eastern Equatorial of the Paris Observatory. On the first evening of observation I was only able to establish the presence of bright lines in the spectrum, two days after the atmospheric conditions enabled me to make a more thorough examination, and to take measurements as exact as the feeble light of the star permits. The following is the result of the spectroscopic investigations:—

The spectrum of the star is composed of a certain number of bright lines standing detached on a sort of luminous background, almost completely interrupted between the green and the blue, so that at first sight the spectrum appears to consist of two separate parts. In order to study it qualitatively, I made use of a spectroscopic eye-piece, specially constructed, which utilises the greatest portion of the light, and allows us to vary its concentration. For the measurements I employed a Duboscq direct-vision spectroscope, fitted with a scale visible by means of lateral reflection. The accompanying sketch gives an idea of the appearance of the spectrum, and represents the position of lines measured according to the readings of the auxiliary scale, in the most complete series of measurements.

I have only noticed bright lines; the dark lines, if they exist, must be very fine and must have escaped me on account of the very feeble light of the star. The order  $\alpha\beta\gamma\dots\theta$  is that of their intensity, taking into account the visibility of the colour. The following figures are the divisions of the scale which define their position:—

$\alpha$	$\delta$	$\gamma$	$\beta$	$\zeta$	$\eta$	$\theta$	$\epsilon$
30	44	60	66	73	81	100	113

The flame of a spirit lamp, observed immediately after, gave the line D at the division 42; but a slight obliquity

of the slit relatively to the lines of the scale, introduces a constant difference of one to two divisions in the direction of the re-establishment of the coincidence with the line  $\delta$ .

The sky being covered soon after that measurement, I left the spectroscope in position without touching it, and next morning I compared the position of the Fraunhofer lines visible with the light of the clouds:—

C	D	$\delta$ (mean)	F	G
31	43.5	65.3	79.5	116

This is the spectroscope which I employed to observe the spectrum of the Aurora Borealis of February 4, 1872. The relative distance of the lines C, D, F, was the same, 21, 33, 69. There may easily be deduced from these data the correspondence of the divisions of the auxiliary scale with the scale of wave-lengths. The following are the results calculated for the bright lines observed, as also a table of bright lines of various elements expressed in millionths of a millimetre:—

Observ.	$\alpha$	$\delta$	$\gamma$	$\beta$	$\zeta$	$\eta$	$\theta$	$\epsilon$
Hydrogen ...	661	588	531	517	500	483	451	435
Hydrogen ...	656(C)	—	—	—	—	—	486(F)	434
Sodium ...	—	589(D)	—	—	—	—	—	—
Magnesium...	—	—	—	517( $\delta$ mean)	—	—	—	—
Line in Solar Corona ...	—	—	532	—	—	—	—	—
Line in Chromosphere...	—	587	—	—	—	—	—	447

This comparison shows that if we take into account the small apparent displacement caused by the obliquity of the slit (which makes all the numbers a little too large), and the inevitable uncertainty presented by measurements of such feeble lights, it may be admitted that the lines  $\alpha$ ,  $\eta$ ,  $\epsilon$ , coincide with that of hydrogen,  $\delta$  with that of

sodium, and  $\beta$  with the triple line  $\delta$  of magnesium. The feeble dispersing power of the spectroscope used did not enable me to distinguish whether the bright line was single, double, or triple, for any of the three cases may occur (*Comptes Rendus*, t. lxxiii., p. 332).

But the most curious coincidence, which I give here with much reserve, but which it will be interesting ultimately to verify, is the coincidence of the line  $\gamma$ , very bright in the spectrum of the star, with the green line  $\lambda = 532$  (1474 of Kirchhoff's scale), observed in the spectrum of the solar corona and in the chromosphere; the feeble band  $\theta$  corresponds also to a band  $\lambda = 447$  of the chromosphere; one is thus led to think that the line  $\delta$  corresponds rather to the bright line of the chromosphere  $\lambda = 587$  (helium), than to that of sodium, 589. If this interpretation be accurate, the bright lines of the spectrum of the star comprehend exclusively the brightest and most frequent lines of the chromosphere. The following, in fact, according to Young's Catalogue of the Chromospheric Lines (*Phil. Mag.*, November, 1871), is a list of the brightest lines and their relative

frequency	100	587	532	517( $\delta$ )	486(F)	447	434
	100	100	75	15	100	75	100

All the other bright lines have a relative frequency lower than 10, with the exception of the fourth bright line of hydrogen  $\lambda = 410$  ( $\beta$ ), to the extreme violet, whose frequency is represented by 100. I believe, moreover, that this line without always being able to measure it.

To sum up, the light of the star appears to possess exactly the same composition as that of the solar envelope known as the chromosphere. Notwithstanding

the great temptation there exists to draw from this fact inductions relative to the physical condition of this new star, its temperature, the chemical reactions of which it may be the seat, I shall abstain from all comment and all hypothesis on this subject; I believe the facts necessary to arrive at a useful conclusion are wanting, or at least at a conclusion capable of verification. Whatever attractions these hypotheses may have, it is necessary not to forget that they are unscientific, and that, far from serving science, they greatly tend to trammel her.

### JUST INTONATION

DR. STONE'S lectures on "Sound and Music," just published, lead one to expect that notwithstanding the formidable appearance of some of the key-boards exhibited at South Kensington, the cause of scientific music and of just intonation in particular will be materially advanced by the Loan Exhibition.

Certainly we may look for something practicable and little short of perfect in the "Natural Finger-board" of Mr. Colin Brown, the Euing Lecturer on Music in the Andersonian University, Glasgow. As supplementary to the descriptions given by Dr. Stone and by Mr. Brown himself, I trust the following remarks will help to elucidate the construction of the instrument, and to make still more obvious its simplicity and "naturalness."

The vibration numbers of the diatonic scale being represented by—

$$2, \frac{9}{8}, \frac{5}{4}, \frac{4}{3}, \frac{3}{2}, \frac{5}{3}, \frac{15}{8}, 2,$$

if we build the scale upon the dominant  $\frac{3}{2}$  the vibration numbers will be—

$$1, \frac{9}{8}, \frac{5}{4}, \frac{45}{32}, \frac{3}{2}, \frac{27}{16}, \frac{15}{8}, 2,$$

and if we built it upon the subdominant  $\frac{4}{3}$  the vibration numbers will be—

$$1, \frac{10}{9}, \frac{5}{4}, \frac{4}{3}, \frac{3}{2}, \frac{5}{3}, \frac{16}{9}, 2.$$

Or, more generally, if C, D, E, F, G, A, B, 2C, be taken to represent the vibration numbers of the so-named notes in the scale of C, then the vibration numbers of the scales on G and F will be—

$$\begin{aligned} &C, D, E, aF, G, \beta A, B, 2C, \\ &C, \frac{1}{\beta}D, E, \frac{1}{\alpha}F, G, A, \frac{1}{\alpha}B, 2C, \end{aligned}$$

where

$$\alpha = \frac{135}{128} \quad \beta = \frac{81}{80}$$

$\alpha$  and  $\beta$  being respectively the chromatic semitone and the comma. Here the law of the formation of the relative scales is so obvious that they can be written down successively at sight.

Now let the fifteen scales be written down from C to C $\sharp$  in the one direction, and to C $\flat$  in the other, when it will be immediately apparent that the symbols are arranged in groups of threes and fours, and if we draw straight lines horizontal and vertical so as to enclose these groups each in a rectangle, we have at once the properly so-called "Natural Fingerboard," the rectangles being the digitals, of which the larger are white and the smaller coloured

Major Keys	a $\beta$ C	a $\beta$ D	a $\beta$ E	a $\beta$ F	a $\beta$ G	$\circ$ a $\beta$ A	a $\beta$ B	2a $\beta$ C
C $\sharp$	a $\beta$ C	a $\beta$ D	a $\beta$ E	a $\beta$ F	a $\beta$ G	$\circ$ a $\beta$ A	a $\beta$ B	2a $\beta$ C
F $\sharp$	a $\beta$ C	$\circ$ aD	a $\beta$ E	a $\beta$ F	a $\beta$ G	a $\beta$ A	$\beta$ B	2a $\beta$ C
B	a $\beta$ C	aD	$\beta$ E	a $\beta$ F	$\circ$ aG	a $\beta$ A	$\beta$ B	2a $\beta$ C
E	$\circ$ aC	aD	$\beta$ E	a $\beta$ F	aG	$\beta$ A	$\beta$ B	$\circ$ 2aC
A	aC	D	$\beta$ E	$\circ$ aF	aG	$\beta$ A	$\beta$ B	2aC
D	aC	D	$\beta$ E	aF	G	$\beta$ A	$\circ$ B	2aC
G	C	D	$\circ$ E	aF	G	$\beta$ A	B	2C
C	C	D	E	F	G	$\circ$ A	B	2C
F	C	$\circ$ $\frac{1}{\beta}$ D	E	F	G	A	$\frac{1}{\alpha}$ B	2C
B $\flat$	C	$\frac{1}{\beta}$ D	$\frac{1}{\alpha}$ E	F	$\circ$ $\frac{1}{\beta}$ G	A	$\frac{1}{\alpha}$ B	2C
E $\flat$	$\circ$ $\frac{1}{\beta}$ C	$\frac{1}{\beta}$ D	$\frac{1}{\alpha}$ E	F	$\frac{1}{\beta}$ G	$\frac{1}{\alpha}$ A	$\frac{1}{\alpha}$ B	$\circ$ $\frac{2}{\beta}$ C
A $\flat$	$\frac{1}{\beta}$ C	$\frac{1}{\alpha\beta}$ D	$\frac{1}{\alpha}$ E	$\circ$ $\frac{1}{\beta}$ F	$\frac{1}{\beta}$ G	$\frac{1}{\alpha}$ A	$\frac{1}{\alpha}$ B	$\frac{2}{\beta}$ C
D $\flat$	$\frac{1}{\beta}$ C	$\frac{1}{\alpha\beta}$ D	$\frac{1}{\alpha}$ E	$\frac{1}{\beta}$ F	$\frac{1}{\alpha\beta}$ G	$\frac{1}{\alpha}$ A	$\circ$ $\frac{1}{\alpha\beta}$ B	$\frac{2}{\beta}$ C
G $\flat$	$\frac{1}{\alpha\beta}$ C	$\frac{1}{\alpha\beta}$ D	$\circ$ $\frac{1}{\alpha\beta}$ E	$\frac{1}{\beta}$ F	$\frac{1}{\alpha\beta}$ G	$\frac{1}{\alpha}$ A	$\frac{1}{\alpha\beta}$ B	$\frac{2}{\alpha\beta}$ C
C $\flat$	$\frac{1}{\alpha\beta}$ C	$\frac{1}{\alpha\beta}$ D	$\frac{1}{\alpha\beta}$ E	$\frac{1}{\alpha\beta}$ F	$\frac{1}{\alpha\beta}$ G	$\circ$ $\frac{1}{\alpha\beta}$ A	$\frac{1}{\alpha\beta}$ B	$\frac{2}{\alpha\beta}$ C

Here all the scales are true and adjacent according to their relationship, the fingering obviously the same for all. The relative minors are provided for by a round

digital in the corner of each coloured digital, bearing to it the vibration ratio of 15 : 16.

The intervals on the board as seen above express themselves: moving from flat towards sharp keys the interval from a white to a coloured digital is  $\alpha$ , and from coloured to white  $\beta$ .

Between digitals related as  $\alpha$ G (G $\sharp$ ) and  $\frac{1}{\alpha}$ A (A $\flat$ ), that is, between every pair similarly related in mutual azimuth (to borrow a term) and distance, the schisma occurs. The keyboard gives us the value of the schisma by inspection; we may either take the route—

$$\frac{1}{\alpha}A \text{ to } A = \alpha : A \text{ to } G = \frac{9}{10} : G \text{ to } \alpha G = \alpha,$$

giving schisma =  $\frac{9}{10}\alpha^2$ . Or thus—

$$\frac{1}{\alpha}A \text{ to } A = \alpha : A \text{ to } \beta A = \beta : \beta A \text{ to } \alpha G = \frac{15}{16},$$

giving schisma =  $\frac{15}{16}\alpha\beta$ . This expression shows that the

schisma also exists between any round digital, and the coloured digital next below. Or we may get an entirely numerical value thus:—Since from white to white is 8 : 9, then from  $\frac{1}{\alpha\beta}$ D diagonally to  $\beta$ A is (8 : 9) $^4$  and from  $\beta$ A back horizontally to  $\alpha$ C, a minor sixth, is 8 : 5, the interval of  $\alpha$ C and  $\frac{1}{\alpha\beta}$ D is

$$\text{Schisma} = \frac{5}{8} \left( \frac{9}{8} \right)^4.$$

Again, the "comma of Pythagoras" being the excess of twelve fifths over seven octaves is expressed by—

$$\left( \frac{3}{2} \right)^{12} \frac{1}{2^7} = \left( \frac{9}{8} \right)^6 \frac{1}{2}.$$

that is, it is the excess of six major tones over one octave.

The keyboard shows this immediately; from  $\frac{1}{\alpha\beta}$ D diagonally to 2a $\beta$ C is six major tones, thence back horizontally to a $\beta$ C is one octave, therefore a $\beta$ C differs from  $\frac{1}{\alpha\beta}$ D by the "comma of Pythagoras." And every pair of white digitals (or coloured, as aD and  $\frac{1}{\alpha\beta}$ E) similarly related in azimuth and distance have the same interval. Obviously, by mere inspection of the board, the "comma of Pythagoras" is equal to comma + schisma. In fact this keyboard will well repay a very careful study.

Turning to the practical aspect of the subject, the harmonium on this principle must be considered "un fait accompli," judging by the highly appreciative interest shown by the South Kensington audience, who remained long after the close of the lecture to listen to the instrument which was exhibited, and played on.

When we count the number of wires that would be necessary for a piano, the prospect would be somewhat alarming, did we not remember that on account of the number of harmonics and sub-harmonics, or combination tones that would be called into play, probably one wire to each digital instead of two or three would suffice.

The original account of this key-board is given in the second of two small pamphlets entitled "Music in Common Things," by Mr. Colin Brown. In these the numerical basis of the diatonic scale as derived from harmonics is laid down with remarkable perspicuity, and amongst other things the reader will see, for the first time probably, that although the fourth and sixth of the scale are wanting as harmonics to the tonic, yet they come out in the diatonic scale as harmonics to the fourth of the scale. Indeed the seven notes of the scale come out successively as harmonics to Fa in the fifth and sixth octaves.

A. R. C.

ANATOMY OF THE TEETH<sup>1</sup>

TO the histologist, the zoologist, and the human anatomist the teeth are organs of considerable interest, from the points of view of their minute structure, their development, together with their variations, as well as from the diseases to which they are subject; and yet our literature has been deficient in a work on "Dental Anatomy, Human and Comparative." Text-books, such as Quain and Sharpey's "Anatomy," give us full information with reference to their structure, form, and development in man, whilst in Owen's superb monograph on "Odontography," as in his "Anatomy of Vertebrated Animals," their zoological aspect is treated of in detail. Mr. Charles S. Tomes has filled the deficiency in the volume under consideration, in a manner so satisfactory that we feel assured that his work will take a high place among Messrs. Churchill's valuable "Manuals."

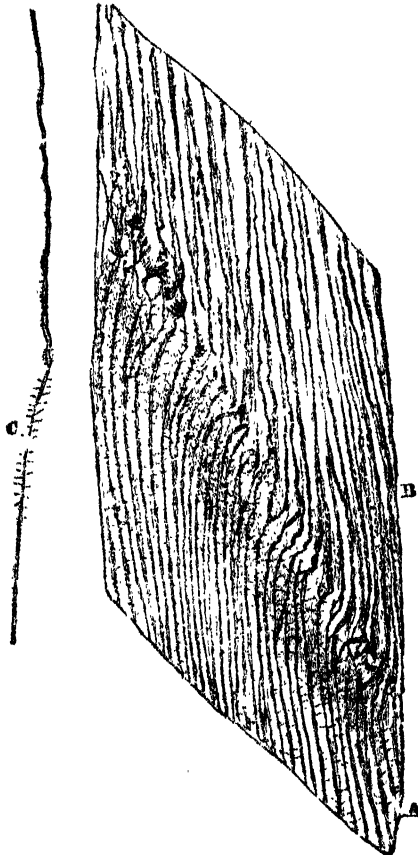

FIG. 1.

For some years past Mr. Tomes, following his father's footsteps, has been carefully investigating the structure and development of the teeth, not so much in man as in the lower vertebrata; and his results have been published in the *Proceedings of the Odontological Society*, the *Quarterly Journal of Microscopical Science*, the *Transactions of the Royal Society*, and elsewhere. In the work before us these results, many of them of considerable importance, are incorporated in the sections to which they refer, the book itself being an excellent epitome of our present knowledge of the development and structure of the teeth in man and the lower animals.

It is evident to all that a thorough acquaintance with comparative odontology cannot be obtained by anyone not familiar with the structure and development of the

<sup>1</sup> "A Manual of Dental Anatomy, Human and Comparative." By C. S. Tomes, M.A. J. and A. Churchill, 1876.

teeth. In the same way the facilities for investigating histological and embryological odontology are much enhanced by a knowledge of the comparative anatomy of the organs studied, as is the human dentition, although we would be among the last to make it a *sine quâ non* that our dentist should be thoroughly informed on this large view of the subject. It is, therefore, on these accounts that Mr. Tomes's Manual will appeal to more than one class of student.

The work commences with an account of the teeth of

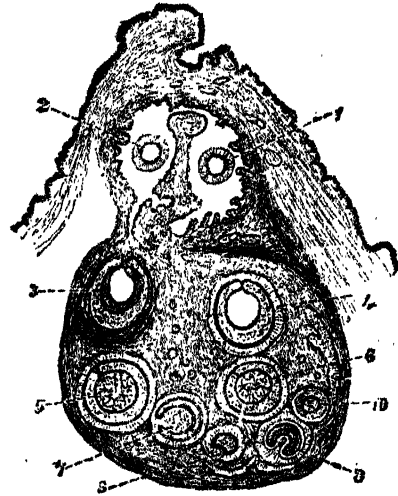

FIG. 2.

man and of the bones with which they are associated, "as being the standard with which the student is likely, consciously or unconsciously, to compare those other forms with which he afterwards becomes acquainted." The dental tissues are next described, followed by the development and eruption of the teeth, the last two hundred pages being devoted to the zoological aspect of the subject.

The human teeth have been studied so thoroughly that Mr. Tomes has nothing special to tell us with reference

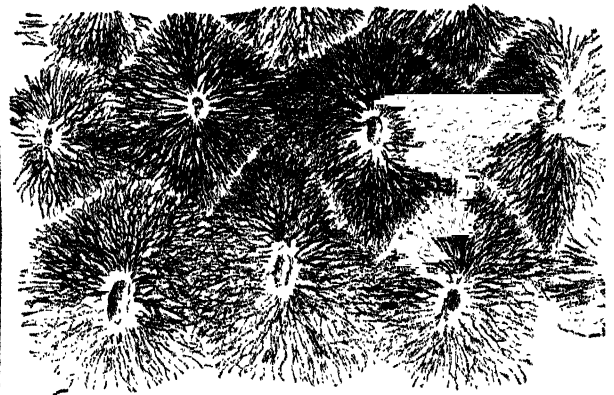

FIG. 3.

to them. As to their arrangement, his experience confirms the fact that, from the parabolic curve in which they are arranged in the typical human jaws, tending to squarish in the lowest races, "a deviation in the opposite direction is daily becoming more common in the most highly civilized races, resulting in a contour to which in extreme cases the name of V-shaped maxilla is applied."

On the subject of the histology of the dental tissues we notice several interesting points. With reference to the presence of enamel in the lower vertebrata, we are told

on the density and thickness of the cloud below the point from which the drops started.

The author's object is to suggest that this is the actual way in which raindrops and hailstones are formed. He was first led to this conclusion from observing closely the structure of ordinary hailstones. Although to the casual observer hailstones may appear to have no particular shape except that of more or less imperfect spheres, on closer inspection they are seen all to partake more or less of a conical form with a rounded base like the sector of a sphere. In texture they have the appearance of an aggregation of minute particles of ice fitting closely together, but without any crystallisation such as that seen in the snow-flake, although the surface of the cone is striated, the striae radiating from the vertex. Such a form and texture as this is exactly what would result if the stones were formed in the manner described above. When a particle which ultimately formed the vertex of the cone, started on its downward descent and encountered other particles on its lower face, they would adhere to it, however slightly. The mass, therefore, would grow in thickness downwards; and as some of the particles would strike the face so close to the edge that they would overhang, the lower face would continually grow broader, and a conical form be given to the mass above.

When found on the ground the hailstones are generally imperfect; and besides such bruises as may be accounted for by the fall, many of them appear to have been imperfect before reaching the ground. Such deformities, however, may be easily accounted for.



FIG. 4.—Imitation in Plaster of Paris.

mation caused by the presence of the smaller stone, the effect of the impact may be to impart a rotary motion to the stone, so that now it will no longer continue to grow in the same manner as before. Hence we have causes for almost any irregularities of form in the ordinary hailstone.

It appears from the numerous accounts which have been published that occasionally hailstones are found whose form is altogether different from that described above. These, however, are exceptional, and to whatever causes they may owe their peculiarities these causes cannot affect the stones to which reference is here made.

Again, on careful examination it is seen that the ordinary hailstones are denser and firmer towards their bases or spherical sides than near the vertex of the cone, which latter often appears to have broken off in the descent. This also is exactly what would result from the manner of formation described above. When the particle first starts it will be moving slowly, and the force with which the particles impinge upon it will be slight, and, consequently, its texture loose; as, however, it grows in size and its velocity increases, it will strike the particles it overtakes with greater force, and so drive them into a more compact mass. If the velocity were sufficient, the particles would strike with sufficient force to adhere as solid ice, and this appears to be the

The larger stones fall faster than those which are smaller, and consequently may overtake them in their



FIG. 3.—Imitation in Plaster of Paris.

descent; and then the smaller stones will stick to the larger and at once deform them. But besides the defor-

case when the stones become large, as large as a walnut, for instance.

An idea of the effect of the suspended particles on being overtaken by the stone, may be formed from the action of the particles of sand in Mr. Tilghman's sand-blast, used for cutting glass. The two cases are essentially the same, the only difference being that the hailstone is moving through the air, whereas in the case of the sand-blast, the object which corresponds to the stone is fixed, and the sand is blown against it.

By this sand-blast the finest particles of sand are made to indent the hardest material, such as quartz or hard steel; so that the actual intensity of the pressure between the surface of the particles of sand and that of the object they strike, must be enormous. And yet the velocity of the blast is not so much greater than that at which a good-sized hailstone descends. It is easy to conceive, therefore, that the force of the impact of the suspended particles of ice if not much below the temperature of freezing on a large hailstone, would drive them together so as to form solid ice. For the effect of squeezing two particles of ice together, is to cause them to thaw at the surface of contact, and as soon as the pressure is relieved they freeze again, and hence their adhesion.

It is then shown that hailstones, such as those described, can neither be formed by the freezing of rain-drops, nor by

the condensation of vapour on a nucleus of ice; and that it is impossible that the particles of ice can have been drawn together by electrical attraction—their conical shape, and the increase in their density towards their thicker sides clearly showing that the particles have aggregated from one direction, and with an increasing force as the size of the stone has increased.

The possibility of making artificial stones is thus considered:—If a stream of frozen fog were driven against any small object, then the frozen particles should accumulate on the object in a mass resembling a hailstone. Not seeing his way to obtain such a stream of frozen fog, the author thought it might be worth while to try the effect of blowing very finely powdered plaster of Paris. He therefore introduced a stream of this material into a jet of steam, issuing freely into the air (which he hoped would assist the powdered plaster sufficiently to cause it to set firmly into whatever form it collected). The jet was directed against a splinter of wood.

In this way masses of plaster very closely resembling hailstones were obtained. They were all more or less conical, with their bases facing the jet. But as might be expected, the angles of the cones were all smaller than those of the hailstones. Two of these figures are shown in the sketches annexed:

The striæ were strongly marked, and exactly resembled those of the hailstone. The bases also were rounded. They were somewhat steeper than those of the hailstone; but this was clearly due to the want of sufficient cohesive power on the part of the plaster. It was not sufficiently wet. Owing to this cause also it was not possible to preserve the lumps when they were formed, as the least shake caused them to tumble in pieces.

Similar masses were also obtained by blowing the vapour of naphthaline, but these were also very fragile. Whereupon it is remarked:—At ordinary temperatures the powdered naphthaline does not adhere like ice when pressed into a lump. No doubt at very low temperatures ice would behave in the same way, that is to say, the particles would not adhere from the force of impact. Hence it would seem probable that for hailstones to be formed, the temperature of the cloud must not be much below freezing-point.

That the effect of the temperature of the cloud exercises great influence on the character of the hailstones cannot be doubted. And if, as has been suggested by M. L. Dufour, the particles will sometimes remain fluid, even when the temperature is as low as 0° F., it is clear that as they are swept up by a falling stone, they may freeze into homogeneous ice either in a laminated or crystalline form.

The author then proceeds to show that raindrops are probably formed in the same way as hailstones; that although the raindrops have no structural peculiarities like the hailstones, the aggregation of the particles of water by the descent of the drop through the cloud is the only explanation which will account for them. He shows that, as Mr. Baxendell had previously pointed out, the amount of vapour which a cold drop could condense before it becomes as warm as the vapour would be inappreciable when compared with the size of the drop, and since, in order that there might be condensation, the air must be warmer than the drop, the drop could not part with its heat to the air. He also shows that during the time of descent of a large drop, the heat lost by radiation would not account for the condensation of sufficient vapour to make any appreciable difference in the size of the drop. Whereas if we suppose all the vapour which a body of saturated air at 65° F. would contain over and above what it would contain at 32° to be changed into a fog or cloud; then if a particle, after commencing to descend, aggregated to itself all the water suspended in the volume of air through which it swept, the diameter of the drop after passing through 2,000 feet would be more

than an eighth of an inch, and after passing through 4,000 feet a quarter of an inch, and so on. So that in passing through 8,000 feet of such cloud, it would acquire a diameter of half an inch.

The fact that raindrops never attain the size of large hailstones is explained as being due to the mobility in the case of large drops of the surface tension of the water, by which alone the drop retains its form, to withstand the disturbing force of the air rushing past; when the drop reaches a certain size, therefore, it is blown in pieces like the water from a fountain.

The origin of drops and stones is then discussed—why some of the particles in a cloud should be larger than the others, as it is necessary for them to be in order that they may commence a more rapid descent. A cloud does not always rain; and hence it would seem that in their normal condition the particles of a cloud are all of the same size and have no internal motion, and that the variation of size is due to some irregularity or disturbance in the cloud.

Such irregularity would result when a cloud is cooling by radiation from its upper surface. The particles on the top of the cloud being more exposed would radiate faster than those below them and hence they would condense more vapour and grow more rapidly in size. They would therefore descend and leave other particles to form the top of the cloud. In this way we should have in embryo a continuous succession of drops.

Eddies in the cloud also form another possible cause of the origin of drops and stones.

#### D'ALBERTIS'S EXPEDITION UP THE FLY RIVER, NEW GUINEA

RECENT letters from Sydney announce the successful results of Signor L. M. D'Albertis's expedition up the Fly River, and that he was shortly expected back in Sydney.

The following letter from him to Dr. George Bennett has been published in the Sydney newspapers of October 13:—

“DEAR DOCTOR,—I have written a letter to the Committee, necessarily very brief, as I have but little time and a very scanty supply of paper. I am satisfied with the collection I have made, not for the number, but for the quality. I have four species of birds of paradise (*Paradisæa*), the *P. raggiana*, the *P. apoda*, the twelve-wired bird of paradise (*Seleucidés alba*), the king bird of paradise (*Cincinurus regius*), and the rifle bird (*Epimachus magnificus*). I got a perfect adult specimen of a cassowary, which I think is *Casuarus bicarunculatus*; also the *Dasyptilus pacqueti*, a new genus of *Ptilotis*, and a splendid new species of *Gracula*, and several other small but very interesting birds. I have seen many birds which are not included in the avifauna of New Guinea, as the *Pelecanus conspicillatus*, the Jabiru (*Mycteria australis*) and the pygmy goose (*Nettion pulchellus*). Among my fishes I have some fine and large species. Of reptiles I have very few except a water snake, which I hope will be something extraordinarily new. Among my insects I have some fine Coleoptera, but the season was not very favourable for them. I expect to have about five hundred species of dried plants and between twenty and thirty of living plants, collected far in the interior, many of which I did not get afterwards. I hope Mr. C. Moore will be satisfied, as I have some fine crotons and palms among them, also some ferns with variegated leaves, orchids, and several other plants with variegated or spotted foliage, &c., from the very centre of New Guinea. I hope Mr. Moore has sent to Somerset some Wardian cases, so that the plants may not be destroyed by the sea breezes during the passage to Sydney. I much regret that I cannot send you any specimens, but I have not a box to pack them



in; the few boxes I have are filled with earth and living plants. My ethnological collections are very extensive indeed; I have literally cleared all the houses, and I have the best collection of the stone implements of New Guinea ever seen, of every kind and description. I have also the ornaments used when dancing and when engaged in war, paddles for their canoes, &c., &c. I procured dresses of various patterns, some petticoats made of human hair, others of grass, both of the natural colour and dyed; stone implements, finished and unfinished; painted and carved skulls, stuffed human heads, arrows pointed with bone, artistically worked, and the cement used in fixing the points. I am very anxious to show you everything, and see your surprise at the beauty of my collection, as you can so well appreciate it. I hope my plan of the Fly River will be correct. I have noted mile by mile, and every day I landed I recorded the nature of the soil, &c. I hope the Government, Committee, and subscribers to the Expedition will be satisfied with the confidence they placed in me, and, more so, when I have time to publish my notes *in extenso*. I have investigated science in all its various branches, more especially anthropology. The presence of the great bird of paradise (*Paradisæa apoda*, Linn.) in the centre of New Guinea, but at the same time in almost the same latitude as Aru Island, is of the greatest importance after what Lesson has asserted, and which has been denied by Wallace. I have got specimens in every stage of plumage, and of both sexes, and I have no doubt it is the *P. apoda*, and not the *P. papuana*. It is, nevertheless, much smaller than all the specimens I have seen in the British Museum, and in the collections of Mr. Beccari and Mr. Cockerell, and if with this distinction, when compared, any other difference may be perceptible, then it will probably prove to be a new species. For the present I believe it to be the *Paradisæa apoda*. I have two beautiful male birds in full plumage, and also of the *P. raggiana*. I hope the Committee will be pleased with the short report I have sent, but at the same time must ask them to suspend their judgment of all that I have done until they receive a more extended and minuter account of the expedition from me." [Mr. D'Alberty concludes his letter with a few lines addressed to Mrs. Bennett, in which he says]: "I am in good health and spirits, and remember your kindness, for I bought bananas, when I was starving, with the red worsted ribbons adorned with pearl shells you gave me to traffic with the natives. I also enjoyed the large plum cake for a month, and finished it in the true centre of New Guinea, and wished I had another. The flag was the admiration of the natives of Moatta, and I bore in remembrance the ladies who presented it to me."

P. L. S.

#### OUR ASTRONOMICAL COLUMN

**THE NEW STAR IN CYGNUS.**—It is stated by Prof. Littrow (*Bulletin International*, December 12) that this star, which on December 1 appeared of about the same brightness as at the time of discovery on November 24, was of the fourth magnitude on December 2, and two days later had descended to the fifth.

Comparisons with neighbouring stars, using the magnitudes of the "Durchmusterung" on December 13, showed that the estimate we gave last week was somewhat too low, being doubtless influenced by the unfavourable conditions on the previous night; the star was found to be 5.8–6.0, but as before, without trace of colour.

The following position for 1876 0 will be rather closer than the one given last week, R.A. 21h. 36m. 50.41s., N.P.D. 47° 43' 21" 5, to which correspond annual precession in R.A. + 2.361s., in N.P.D. – 16".27. We give M. Cornu's spectroscopic results in another column.

**REMARKABLE STAR SPECTRUM.**—D'Arrest, writing in No. 1206 of the *Bulletin International*, refers to the spectrum of the star XX. 1206. of

Weisse's second catalogue from Bessel's zone observations; he says "sein Spectrum ist das merkwürdigste unter einigen tausenden, die ich bislang untersucht habe," and thinks the star may eventually prove to be variable. Has this object been examined by any British spectroscopist? It was observed by Bessel as an eighth magnitude, October 26, 1823, and his position reduced to 1877 0 is in R.A. 20h. 43m. 24.2s., N.P.D. 67° 27' 36".

**THE MINOR PLANET, No. 169.**—This last discovered member of the group of small planets which was detected at Paris on September 28, has been named "Zelia." M. Leverrier's *Bulletin* of December 12, contains ample materials for the determination of its orbit.

**NEWCOMB'S CORRECTIONS TO HANSEN'S LUNAR TABLES.**—Part III. of papers published by the United States Commission on the transit of Venus, just received, contains an important investigation, by Prof. Newcomb, of the corrections required by Hansen's lunar tables, for the purpose of rendering the lunar ephemeris available for accurate determination of the longitudes of stations not telegraphically connected with well-ascertained positions.

Remarking that determinations of longitudes from moon culminations have been found by experience to be subject to constant errors which there is difficulty in allowing for, Prof. Newcomb refers to its having been a part of the policy of the American Commission to depend rather upon occultations. An occultation of a star is a sudden phenomenon, and the time at which it occurs can be fixed by observation within a small fraction of a second; wherefore, if the ephemeris of the moon is exact and her figure a perfect circle, the longitude could be determined from such observations with a similar degree of precision. The inequalities of the lunar contour form a source of error that it is impossible to avoid, but may be considered to be eliminated from the mean of a large number of observations, and the star's position admitting of being fixed by the meridian instruments with any required exactness, there remain only the errors of the lunar ephemeris to be diminished as far as practicable, and it is the object of Prof. Newcomb's paper to reduce these errors to a minimum.

The material principally relied upon is the series of meridian observations of the moon at Greenwich and Washington from 1862 to 1874, but in order to verify the most striking and unexpected result of the investigation, the comparison of Hansen's tables with the Greenwich observations during the twelve years 1847–1858 has also been utilised. The result alluded to is the irregularity in the moon's longitude represented by

$$1''50 \sin(56^{\circ}8 + 13^{\circ}12413t)$$

where  $t$  is reckoned in days from Greenwich mean noon of 1850, January 0. The period of this inequality is 27.4304 days.

Prof. Newcomb remarks that "it would perhaps be premature to introduce so purely empirical a term as this into lunar tables for permanent use," but in the particular case to which his researches apply, where it is requisite to obtain the corrections of the tables with all possible accuracy for a limited period only, he considers the evidence in favour of the existence of the inequality sufficiently strong to justify its introduction. He further observes that the only apparent cause for this term is "the attraction of some one of the planets."

Prof. Newcomb finds some support to a correction of the tabular longitude of node, as already suggested by Hansen in the *Darlegung* in connection with his discussion of ancient eclipses. The entire corrections to the moon's longitude given by his investigation are given at p. 37, supplemented by auxiliary tables for facilitating the calculation of the corrections required by the tables as published, the arguments in which extend from 1850 to 1890.

It will be remembered that Prof. Newcomb communicated his principal result to the Royal Astronomical Society last summer (see "Monthly Notices," vol. xxxvi. p. 358).

PROF. FÖRSTER'S SCIENTIFIC LECTURES.—Under the title *Sammlung wissenschaftlicher Vorträge*, there has lately appeared a series of seven lectures on astronomical subjects by the director of the Royal Observatory at Berlin. It includes an address on "The Astronomy of Antiquity and the Middle Ages in Relation to Modern Development," notices of Copernicus and Kepler and their works, &c.

### CHEMICAL NOTES

VARIATIONS IN THE CRITICAL POINT OF CARBON DIOXIDE IN MINERALS, AND DEDUCTIONS FROM THESE AND OTHER FACTS.—Mr. W. N. Hartley has continued his experiments on this subject, and gives in a paper read lately before the Chemical Society further conclusions as to the existence of the expansible fluids in mineral cavities. He concludes it to be carbon dioxide from the spectrum produced by the electric spark in a tube containing such gas as was liberated by the decomposition of the minerals; the turbidity produced by crushing quartz under baryta water (Vogelsang and Geissler, 1869); the rate of expansion of the liquid in sapphire compared with that of carbon dioxide (Sorby and Butler, 1869) and the determinations of the critical point made by himself in 1875-76. To determine the critical point he uses small thermometers made specially for the purpose, one having a range from  $-20$  to  $140^{\circ}$  F., the other graduated to register tenths of a degree from  $25^{\circ}$  to  $33^{\circ}$  C. The following table shows all the variations noticed in the critical point of carbon dioxide existing in various minerals:—

	Critical point.
Topaz ... ..	$28^{\circ}$ C.
Topaz ... ..	$28^{\circ}$ C. and $26^{\circ}5$
Topaz ... ..	$27^{\circ}55$
Tourmaline ... ..	$27^{\circ}27$
Tourmaline ... ..	$26^{\circ}9$
Sapphire ... ..	between $30^{\circ}5$ and $31^{\circ}$
Sapphire ... ..	between $25^{\circ}5$ and $26^{\circ}$
Sapphire ... ..	$29^{\circ}5$
Rock crystal ... ..	$30^{\circ}95$
Rock crystal ... ..	$30^{\circ}95$
Rock crystal ... ..	$32^{\circ}5$
Rock crystal ... ..	$33^{\circ}7$
Rock crystal ... ..	$39^{\circ}$
Rock crystal ... ..	$30^{\circ}95$
Beryl ... ..	$30^{\circ}92$

He discusses, from his conclusions, certain ideas with regard to the formation of diamonds, and believes that it is difficult to suppose that they are entirely formed by a process in which unoxidised forms of carbon are intermediate products, otherwise they would occur not unfrequently in the neighbourhood of coal formations. The theory that diamonds are produced by reducing agents on carbon dioxide very highly compressed and acted on at temperatures much above its critical point, introduces a condition of things highly suggestive of further speculation, and of experiments subject to conditions under which no chemical reactions have ever been made in the laboratory.

THERMO-CHEMICAL RESEARCHES.—Julius Thomsen has found in some recent investigations that gold presents allotropic modifications according to the nature of the solutions from which it is obtained, and the reagent with which it is precipitated. The modifications he has examined are gold precipitated from solution of the chloride and bromide respectively by sulphurous acid, and that precipitated from the sub-chloride, sub-bromide, and sub-iodide. These modifications differ in the amount of heat evolved by each in similar reactions. As the energy shown by the gold precipitated from solution of the chloride by sulphurous acid is less than in the other cases, this amount is taken as the

standard. The energy of the gold precipitated from the bromide is greater by  $3^{\cdot}200$  heat units, and that precipitated from the sub-chloride, sub-iodide, or sub-bromide by  $4^{\cdot}700$  heat units per atom.

THEINE IN TEA.—As the amount of theine varies in various kinds of tea (according to different analyses) from one to six per cent., the question naturally arises whether the quality of tea does not depend upon the amount of theine it contains. Some time ago M. Claus arrived at the conclusion that the inferior kinds of tea contain altogether more theine than the higher, pointing out especially that the cheapest, the so-called brick-tea used in Mongolia and Siberia, and prepared from all kinds of refuse as dead leaves, stalks, &c., contains far more theine ( $3^{\cdot}3$  to  $3^{\cdot}6$  per cent.) than the higher qualities ( $1^{\cdot}0$  to  $1^{\cdot}3$  per cent.). M. Markovnikoff, of Moscow, now arrives at different results. Having made a series of analyses of one kind of tea by the various analytical methods used until now, for ascertaining their comparative values, he proves the deficiency of most of these methods. Ether, for instance, extracts but one-third of the whole amount of theine, and benzole, one-fourth. Using, then, a more perfect method, and analysing six kinds of tea, selected from the highest and from the lowest qualities, he arrives at the result that the amount of theine in them varies but very little, from  $2^{\cdot}08$  to  $2^{\cdot}44$ , and that it regularly increases, with one exception, with the quality of tea, whilst the amount of ash given by each kind regularly decreases from  $6^{\cdot}1$  to  $5^{\cdot}7$  per cent. The differences being, however, very small, M. Markovnikoff supposes that the quality of tea does not depend, or depends very little, upon the amount of theine, and far more upon the quantity of tannic acid and aromatic oils it contains, but that on the whole the teas made from younger leaves contain more theine than those made from older leaves.

INFLUENCE OF PRESSURE ON COMBUSTION.—Some interesting observations have been recently made by M. Wartha, on the influence of pressure on combustion. He observed the burning of six stearine candles in free air, and in an iron case under a pressure of  $1^{\cdot}95$  atmospheres. They burned under this pressure with a flame 9 to 12 cm. long, and gave much smoke; their luminous power diminished, while the flame assumed a yellowish-red colour. The decrease of weight after one hour of burning was found to be less than in burning in free air. This last result is opposed to the observations of Frankland, who has affirmed that the consumption of the burning material of a candle, or the like, is not perceptibly dependent on the pressure of the medium in which the combustion occurs. It is supposed that the difference of pressure in Frankland's experiments (on Mont Blanc and at Chamounix) was not sufficiently great to give a distinct difference in consumption of the burning matter. M. Wartha further put a candle to burn under an air-pump receiver, with special apertures, and, with increasing rarefaction, the flame was seen to enlarge, and its luminous power to diminish. At a pressure of 90 mm., the greatest rarefaction produced, the luminous power was quite gone, and the flame, which had now assumed threefold size, appeared to consist of three parts, an inner bluish-green cone with a violet sheath, and a weakly violet mantle. The diminution of the luminous power in this case M. Wartha explains by the fact that under less pressure less of the products of combustion are separated in the form of soot.

### BIOLOGICAL NOTES

THE AMERICAN BISON.—An important quarto memoir on the living and extinct Bisons of America, from the pen of Mr. J. A. Allen, has just been issued from the University Press of Cambridge, Massachusetts. It is illustrated by twelve plates and a map of North America, in which the distribution of the bison

at different dates is indicated by various colours. The material for the account of the fossil forams, namely, *Bison latifrons* and *B. antiquus*, was obtained by Mr. N. S. Shaler, the Director of the Kentucky Geological Survey during 1868 and 1869, at Big Bone Lick. Independent of its scientific interest the description of the chase and rapid diminution of the existing animal will be found well worthy of perusal.

**COLORATION OF WATER BY SALPÆ.**—Coral reefs, as is well known, give a greenish appearance to the surrounding water when they do not lie far below the surface of the sea. The captains of merchant-vessels are accustomed to report the observation of such spots in the ocean when they are not marked on the charts. It has, however, frequently occurred, that subsequent navigators are entirely unable to find at such points any trace of hidden reefs. Baron von Schleinitz, commander of the German vessel *Gazelle*, in the report on his late exploring expedition, mentions that he encountered ten such places in the meridian 177° E. and 31° S. The lead was sunk to distances varying from 400 to 600 feet, at all these places, without reaching bottom. The green water presented an appearance as if an oily liquid was constantly rising to the surface, and a quantity of it was secured for examination. Investigation showed the cause of the phenomenon to be the presence of a great number of small, transparent, spherical salpæ. These were joined together in double rows of seven each, and by simultaneous expansion and contraction maintained a regular and comparatively rapid motion.

**THE EVOLUTION OF THE CAMELIDÆ.**—Prof. Cope traces an acceleration of the process of ossification of the cannon bones in Camelidæ, by which the three constituent metapodials become united at earlier and earlier periods of life. In the oldest genus, *Poëbrotherium*, these bones are permanently distinct; they are long distinct in *Procamelus*; and in *Auchenia* the bones are united before birth. There has been a concurrent reduction of the incisor teeth. In the Soup Fork genus *Protolabis* the three superior incisors persisted throughout life. In *Procamelus occidentalis* the second of these teeth persisted without being protruded till nearly adult age; the first incisor was very small, and, with its alveolus, was early removed. In the existing Camelidæ the second incisor disappears in the same way. In ruminants other than Camelidæ the third or external incisor has undergone the same process, while in the Bovidæ the canines have also been atrophied.

**SELF-FERTILISATION OF PLANTS.**—Mr. Thomas Meehan, continuing his observation on this subject, has found that the flower of *Campanula pulcherrima*, when confined in fine gauze bags, seeded perfectly; the method of this self-fertilisation he has not discovered. He has observed the self-fertilisation of chicory, which has rather large white pollen grains. The whole process takes about two hours. About six o'clock in the morning the pistil with closed stigmatic lobes elongates, pushing through the mass of pollen, and carrying quantities with it. About an hour after the stigmatic lobes expand, and the pollen falls into the cleft and on to the stigmatic surface. The flowers close entirely by nine or ten o'clock of the same day. No doubt pollen-eating insects visited the flowers, but when these were carefully excluded, all the flowers had pollen on their stigmatic surfaces, nevertheless. (*Proc. Acad. Nat. Sci., Philadelphia, 1876, p. 142.*)

**AN UNUSUAL CASE OF NATURAL SELECTION.**—The usual causes for the origin and increase of secondary sexual characters do not exist among gasteropods; there is no struggling between the males for possession of the females. Mr. E. S. Morse has described (*Proc. Boston Soc. Nat. Hist., 1876, p. 284*) a curious case in which in a limited area the shells of the males of *Buccinum undatum* scarcely equalled half the length of the

female shells, and there was no doubt about their maturity. The rocky ledge on which they lived was at all times washed by impetuous currents, and the specimens of *Buccinum* were always found hid in nooks and concealed in cracks and crevices. Only the smallest males could work their way into such constricted quarters to the females; thus a diminution of the normal size of the male had arisen from a singular secondary sexual cause.

**GELATINE IN RELATION TO NUTRITION.**—Proceeding from the supposition that the processes of digestion are merely decompositions under the influence of water, which furnishes smaller and more diffusible molecules, that are afterwards compounded into the constituents of the body, M. Hermann recently (*Naturforscher*) proposed the question whether it might not be possible to employ gelatine for synthesis of albumen in the system (its decomposition products being very similar to those of albumen), merely adding tyrosin to it, the products of albumen-decomposition which are wanting. He accordingly requested M. Escher to make certain experiments on the subject. For a number of days the same food, containing gelatine but no albumen, was given to animals, and their weight and urine were determined. Then, for a similar number of days, the same amount of food was given, with a small quantity of tyrosin added, and weight and urine again determined. If the above supposition were correct, the body-weight should diminish during the first period, and the excreted urine correspond to the gelatine taken, plus some albumen of the body; in the period in which tyrosin was given, the body-weight should decrease less quickly or not at all, or even increase, and the urine be diminished so much as would correspond to the quantity of gelatine retained in the body together with tyrosin, like albumen. The experiments (nine series of them) made on pigs and dogs gave the following results:—1. Gelatine and tyrosin are absorbed in the intestine; they do not appear again in the excrement. 2. In food containing no albumen, gelatine alone cannot sustain the animal organism; the weight diminishes. 3. The same holds for tyrosin in food that is without albumen. 4. In food without albumen, gelatine and tyrosin may together sustain the organism; the weight of this remains stationary, or even increases. 5. The addition of tyrosin to food containing gelatine, but no albumen, diminishes the excretion of urine, so that less nitrogen is excreted than taken.

#### NOTES

NEXT month a new mineralogical journal will appear in Germany to be called *Zeitschrift für Krystallographie und Mineralogie*. The editor is Dr. Groth, Professor of Mineralogy in the University of Strassburg. The most eminent German and foreign mineralogists have promised their co-operation.

THE *Nation* states that the Trustees of the Johns Hopkins University are prepared, if convinced of the want of such a periodical, to assist in the publication of an American *Journal of Pure and Applied Mathematics*. A circular to elicit an expression of views on this subject has been issued under the signatures of Professors J. J. Sylvester, Simon Newcomb, Henry A. Rowland, and William E. Story.

MESSRS. MACMILLAN AND CO. are about to publish the first volume of a "Treatise on Chemistry" by Prof. Roscoe and Dr. Schorlemmer. The aim of the authors in this work has been to furnish a concise but at the same time complete treatise, which they hope will serve as a standard for the use of those who desire to obtain a more extended knowledge than can be derived from the various excellent smaller manuals that exist. The authors endeavour to give as complete and accurate an account as possible of purely chemical phenomena, and a clear description of the chief chemical processes. In the case of each element and of the chief compounds a short historical statement of the

growth of our knowledge is prefixed to the description of their chemical properties, while in all cases of importance references to original memoirs are given. Special care has been bestowed upon the illustrations.

THE following are the arrangements for the Friday evening lectures at the Royal Institution:—January 19, Prof. Tyndall, LL.D., F.R.S., M.R.I.; January 26, Prof. Huxley, LL.D., F.R.S.; February 2, Prof. Osborne Reynolds, "Vortex Motion;" February 9, Francis Galton, F.R.S., M.R.I., "Typical Laws of Heredity;" February 16, Prof. F. Guthrie, F.R.S., "Solid Water;" February 23, J. F. Moulton; March 2, Sir John Lubbock, Bt., M.P., F.R.S., M.R.I., "Ants;" March 9, Frederick J. Bramwell, F.R.S., M.R.I.; March 16; March 23, Prof. Gladstone, Ph.D., F.R.S., M.R.I.

M. LEVERRIER is setting up, at the door of the Paris Observatory, a public clock for the use of clock-makers, who have been in the habit of calling at a special room to see a chronometer regulated for their use. He has also issued a circular announcing that every commune which purchases a public aneroid barometer, places it for inspection in a public building, and enters into an engagement to send regularly weather telegrams, will receive warnings, either directly from the Observatory, or through a departmental office established in each chief centre.

A LARGE aneroid barometer has been placed in the most prominent part of the Paris Halles for the use of the country people who come daily to sell their garden produce. The dial is 1 metre 50 in diameter, and is lighted at night.

AT the last meeting of the Netherlands Zoological Association (held on Saturday, November 18, in the Zoological Garden of Rotterdam) the Committee of the Transportable Zoological Station (see NATURE, vol. xv., p. 118) presented their first annual report, which was received with enthusiasm by the members of the Association, and will be printed in its *Bulletin*. Next year Flushing will see the station erected in its neighbourhood. With the addition of a fourth member, the Committee of the past year was re-elected for the year 1877, and consists now of Prof. Hoffmann (Leiden University), Dr. Hock (Assistant at the Leiden Zoological Laboratory), Dr. Hubrecht (Conservator Leiden Natural History Museum), and Dr. Horst (Assistant at the Utrecht Zoological Laboratory).

NO less than twenty-nine medical men have been elected members of the French Chamber of Deputies, and seven members of the Senate. One of these, Dr. Henry Liouville, suggested the establishment of an extra Parliamentary Conference of all his colleagues. The idea was carried into execution, and the conference of medical legislators has produced much useful work. Various important bills have been already prepared and presented to the Chamber of Deputies by these medical members. The object of the Conference is merely to deliberate upon medical matters, all political subjects being excluded. Members of all parties are admitted if they belong to the medical profession. The meetings of the Medical Conference are held weekly at the residence of Dr. Henry Liouville.

A PARISIAN optician recently commenced to observe daily the exact times at which a radiometer in his shop began and ceased to rotate. The results are published daily in the *Temps*, and although different radiometers cannot well be compared with each other, these results are already interesting. Since December 1, when the first notice was published, the radiometer stopped twice entirely during the daytime—on the 8th, during a thunderstorm, which lasted from 1.30 to 3 P.M., and on the 13th, from 10 to 10.45 A.M., during an obscuration produced by fogs. The exact time of the first move varies from 8.15 to 10.25 A.M. accord-

ing to the purity of the atmosphere. The time of stopping is far less irregular, having varied only from 3.30 to 4 P.M.

THE hall in which the Academy of Sciences meets seems to be one of the worst ventilated rooms in Paris. If the windows are closed the members are stifled with heat and foul air, and many of the members have a horror of open windows. An illustrious physiologist is specially remarkable for his aversion to a current of fresh air. At a recent sitting the following colloquy on this subject occurred:—"M. Bouley: Nous sommes plongés dans un air irrespirable; ce n'est pas tenable; et, au lieu du gaz, je désire qu'on nous rende les anciennes bougies. M. Leverrier: J'ai réclamé l'éclairage par le gaz; mais j'avais réclamé aussi un autre mode d'aération. Or, rien n'a été changé sous ce rapport. Cependant nous avons le général Morin, et en huit jours des appareils convenables de ventilation seraient installés, si l'on voulait. M. Morin: Ah! en huit jours! Il y a dix ans que leur installation est décidée en principe!!! M. Leverrier: L'état actuel est vraiment honteux! Il n'y a pas de salle aussi mal ventilée que la *salle de l'Institut!*" If M. Leverrier would enter the meeting-room in the magnificent new buildings of the Royal Society during a meeting of that learned body, perhaps he would be inclined to modify his statement. It is a curious commentary on the progress of science that in Paris and London the most unscientifically constructed buildings are those in which the leaders of science carry on their deliberations.

BARON VON HOFMANN, president of the Oriental Museum in Vienna, has received a letter from the Austro-Hungarian Consul at Khartoum giving some details of the travels of Enjin Effendi (Dr. Schnitzer). He has visited Uganda, Usoga, and Unyora, and stayed for some time with King Mtesa, whom he speaks of as a most wonderful man, with a considerable proportion of Abyssinian blood in his veins. This mixture of Abyssinian and negro blood Dr. Schnitzer is inclined to think accounts for the varied traits of character which travellers tell us Mtesa exhibits. He speaks of him as a man of high intelligence, but like all negroes, a child with tiger instincts; his liking for Christianity may possibly be an outcome of his Abyssinian blood. Dr. Schnitzer states that if he gets safely to the end of his journey through Nasiadi, Magango, over the lake to Duffla and Lado, he will set about the arrangement for publication of his well-filled diaries. Dr. Noll of Frankfort will publish the zoological results of his travels.

A COMMISSION for the investigation of the possibility of making a canal across the Isthmus of Darien, left St. Nazaire last month. If their report is favourable it is stated that the work will be commenced next year.

A SPECIAL society for sending a scientific and commercial expedition to the unexplored parts of Asia is about to be formed at St. Petersburg.

MR. WILLIAM JOLLY, H.M. Inspector, has reprinted the paper he read at the B.A. Glasgow Meeting, on Physical Education and Hygiene in Schools. Kempster and Co., London, are the publishers.

IN the last session of the Berlin Anthropological Society Prof. Virchow presented a communication from Dr. MacLay on the results of his journey through the Malay peninsula. In his zigzag course through the mountainous region he repeatedly encountered savage tribes, displaying many points of resemblance with the Nigritos of the Philippine Islands. Two very interesting physical peculiarities of these savages attracted the traveller's attention. The first was the unusually prominent development of the so-called third eye-lid, a feature by no means uncommon among many families of animals; and the second, a remarkable inclination sideways of the three outer toes. This

latter peculiarity has been noticed in several members of the ape family. In the course of his trip Dr. Maclay reached what he regarded as the highest mountain of the peninsula. At its foot he found the most numerous remains of the prehistoric Milanese inhabitants, and encountered the dreaded "Bru," an ape above the human size. His accounts possess a special interest, as they supply the first accurate description of what are probably the only continental representatives of the insular tribes of the Malay Archipelago. Prof. Virchow exhibited also a bronze three-wheel vehicle, excavated near the River Spree, which was ornamented with oxen heads and birds. Among a large number of anthropological objects shown to the Society were a collection of outlines of the feet of negroes on the Loango coast, showing in the most striking manner, by comparison, with the feet of Europeans, the crippling effects of modern costume.

THE South African Exhibition is to be opened at Cape Town on March 15, 1877. We believe that Messrs. R. S. Newall and Co., the well-known lightning-conductor manufacturers, have received the contract for supplying their copper-rope lightning-conductors to the buildings.

A MEETING was recently held in Birmingham of the Council in connection with the projected aquarium for that town. We are glad to see that the arrangements for carrying the scheme into execution are well forward, and a Committee was appointed at the meeting to make all necessary preliminary arrangements. The proposed plan of the aquarium seems to us all that could be desired, and we are glad to see that Mr. Hughes, and other speakers at the above meeting, showed a laudable desire to make the institution serve important educational purposes; we hope, at least, that it will not degenerate into a second-rate music-hall and miscellaneous rendezvous.

THE French government established many years ago at Athens a school to which pupils are sent yearly at its expense, to study, *in situ*, Greek archaeology. M. Jules Simon, when Minister of Public Instruction, established a similar school at Rome, for Italian archaeology. Both have been highly successful. The number of works sent to France by them has been so great that it was stated at the last sitting of the Academy des Inscriptions et Belles Lettres, that M. Waddington has determined to issue a special periodical to be called *Annals of Archaeology* in order to publish the contributions of the Fellows of the schools and of other French archaeologists.

A CORRESPONDENT writes that on Wednesday, about ten minutes to 5 P.M., while at Blackwater, near Yorktown, Hants, he suddenly saw, not sixty yards off, what appeared to be a small ball of fire falling from the heavens. It was of a pale yellow colour at first, changing to a lovely bluish green; then, as it approached nearer to the earth, it became brilliant red, with a tail of fire of the colour already mentioned; and finally, when about a yard from the ground, it seemed to go out. There was no explosion, no hissing sound. There were thin clouds in the sky at the time, but no wind; and very few stars had come out. It shortly became too dark to ascertain if any body had actually seen it, or if the exploding carbon, or whatever it may have been, had left any mark on the grass, which was partly under water. Several friends had noticed an aëroliote proceeding from north to south in the direction of our correspondent's post, about the time when he saw the fire-ball fall.

THE intensity, colour, and polarisation of the diffuse light of the sky in different parts has recently been a subject of study by J. Wild, of the St. Petersburg Academy, who has endeavoured to measure it with a somewhat complicated instrument devised by him and named a "uranophotometer." Referring to the Academy's *Bulletin* for the account of this instrument, we may here give briefly the results at which M. Wild has arrived:—

Proceeding from the sun in a vertical circle northwards, it is

found that the colour of the light gradually changes from the red end of the spectrum towards the violet, and at about 80° distance from the sun, it reaches about midway between the Fraunhofer lines C and D (corresponding to a wave-length of 0.000628 mm.); from there on to the horizon the colour gradually goes back towards the red end of the spectrum. Thus, in St. Petersburg at the time of equinox, the sun having about 60° zenith distance, the colour tone of the diffuse light at 80° angular distance (in a vertical circle) is mostly pure blue, and passes on either side into green. 2. The saturation of the colour appears to reach its maximum at 90° distance from the sun; where also the degree of polarisation is a maximum. On either side of this maximum the degree both of polarisation and of saturation of colour decreases pretty regularly. 3. The intensity of the diffuse reflected light of the sky appears, on the other hand, to be at its least at about 80° distance from the sun, and from there it increases less quickly towards the horizon than towards the sun. Thus, while at 140° distance from the sun the intensity is about five times greater than at 80°, at 20° distance it is over seven times greater. Southwards from the sun the intensity is considerably greater than northwards for the same distance. Thus, at 20° distance southwards it is nearly twice as great as the same distance northwards. These researches are being further prosecuted by the author.

THE "photography of tones" has been accomplished by Dr. Stein in a way which he describes in *Poggendorff's Annalen* (No. 9, 1876). One variety of his method consists in fixing a tuning-fork horizontally with its branches in vertical planes; there is a hole bored through the upper branch and a horizontal beam of light of somewhat larger section than the hole is directed on this from a heliostat. Part of the beam passes through to a sensitised plate in a case, which plate is made to move rapidly in a horizontal direction by means of a spring, or the like. Thus the luminous circle (on the plate) which, when the fork is vibrated and the plate at rest, gives a vertical line, gives a horizontal sinusoidal line when the plate is put in motion. The rate of motion of the plate being fixed, there will be a different number of undulations in a given space for each fork of different pitch. The curve has some interesting features; thus, it is much brighter at the bends than at the intermediate parts, the motion having been slower at the points of turning. The gradual retardation and acceleration are clearly shown. Dr. Stein finds it possible to photograph all ordinary musical tones, and even those vibrations which are above the upper limit of audition. He applies his method to strings also; fixing on these, with light supports, small square discs of blackened mica with a hole for admission of the light. Several cords in a row may have their periods photographed together on the same plate, the mica discs rising one above another.

THE additions to the Zoological Society's Gardens during the past week include a Sykes's Monkey (*Cercopithecus abogularis*) from West Africa, presented by Mr. R. Payne; a Vervet Monkey (*Cercopithecus lalandii*) from South Africa, presented by Mr. Thos. Mash; a Rhesus Monkey (*Macacus erythreus*) from India, presented by Mr. J. H. Ivory; a Hoffmann's Sloth (*Cholepus hoffmanni*) from Panama, presented by Mr. L. R. Dickinson; a Silver-backed Fox (*Canis chama*) from South Africa, presented by Mr. Richard Ladd; a Common Paradoxure (*Paradoxurus typus*) from Bengal, presented by Dr. J. B. Wilson; a Black-headed Gull (*Larus ridibundus*), European, presented by Mr. James Smart; two Jardine's Parrots (*Psecephalus gularis*) from West Africa, two Indian Robins (*Geocichla citrina*), two Red-crowned Jay Thrushes (*Garrulax ruficeps*), a Hornfield's Mountain Thrush (*Mycophonus horsfieldi*) from India, purchased; a Red Coati (*Nasua nasica*) from South America, seven Double-spurred Francolines (*Francolinus bicoloratus*) from West Africa, deposited.

## SCIENTIFIC SERIALS

*Memoria della Società degli Spettroscopisti Italiani*, for September, 1876, contains a paper on the absorption spectrum of the colouring matters of several molluscs, by Antonio and Giovanni De-Negri. The authors show that the colouring matter of the *Elytia viridis* gives the same absorption spectrum as chlorophyll, and that the colouring matter of other molluscs is identical vegetable colouring matters, or their derivatives.—A table of the solar spots and faculae observed at Palermo in August and September. On at least half the days there was an absence of spots. The spectroscopic image of the sun's limb as seen at Rome in January and February, 1875, accompanies this number.—Prof. Serpieri continues his paper on the observations of the zodiacal light, by G. Jones.

October.—This number contains a very quaint drawing of the sun taken from Kircher's "Mundus Subterraneus." It represents a spherical body covered with flames, bright spots of light, and puffs of smoke giving the appearance somewhat of facula, spots, and prominences.—Spectroscopic and direct observations of the sun made at Palermo in August and September last, by Prof. Tacchini. He remarks that the height of the chromosphere, about 12", seems greater than is usual at the minimum sunspot period where hitherto a diminution has been noticed, the eruptions were smaller in number. Prof. Serpieri continues his paper in this number.

*Poggendorff's Annalen der Physik und Chemie*, No. 10, 1876.—On the heat conduction of gases and vapours, and the dependence of their specific heat on temperature, by M. Winkelmann.—On the absolute changes of phase in reflection of light, and on the theory of reflection, by M. Wernicke.—The electric conductivity of chlorhydric, bromhydric, and iodhydric acid, and of sulphuric, phosphoric, oxalic, pyrotartaric, and acetic acid in aqueous solutions, by M. Kohlrausch.—On the transverse vibrations of liquid films, by M. Melde.—On the photography of the less refrangible parts of the solar spectrum, by MM. Vogel and Lohse.—On the number of electric materials, by M. Neumann.—On anhydride sulphuric acid and a new hydrate of sulphuric acid, by M. Weber.—Remarks on M. v. Oettingen's paper on temperature and adiabata, by M. Clausius.—On the smallest deflection in the prism, by M. Lommel.—On the momentary illumination in observation of light wave streaks, by M. Mach.—On a radiometer experiment, by M. Krüss.—Safety arrangement for hydrogen-making apparatus for avoidance of oxyhydrogen explosions on mixture of the gas, by M. Rosenfeld.

## SOCIETIES AND ACADEMIES

## LONDON

Royal Society, December 14.—"Note on the Photographic Spectra of Stars." By William Huggins, D.C.L., LL.D., F.R.S.

In the year 1863 Dr. Miller and myself obtained the photograph of the spectrum of Sirius,

"On January 27, 1863, and on March 3 of the same year, when the spectrum of this star (Sirius) was caused to fall upon a sensitive collodion surface, an intense spectrum of the more refrangible part was obtained. From want of accurate adjustment of the focus, or from the motion of the star not being exactly compensated by the clock movement, or from atmospheric tremor, the spectrum, though tolerably defined at the edges, presented no indications of lines. Our other investigations have hitherto prevented us from continuing these experiments further; but we have not abandoned our intention of pursuing them."<sup>1</sup>

I have recently resumed these experiments by the aid of the 18-inch speculum belonging to the Royal Society's telescope in my possession. Considerable delay has arisen from the necessity, for these observations, of a more uniform motion of the driving clock. For this purpose Mr. Howard Grubb has successfully applied to the clock the control of a seconds pendulum in electric connection with a sidereal clock. This system works quite satisfactorily.

The prisms employed are made of Iceland spar, and the lenses of quartz. After an extensive trial of different photographic processes, preference has been given to dry plates.

The apparatus is so arranged that a solar or electric spectrum can be taken on the same plate, for the purpose of comparison,

<sup>1</sup> *Phil. Trans.* 1864, p. 428.

with the spectrum of the star. Spectra have been obtained of Sirius, Vega, Venus, the moon, &c.

I do not purpose in this preliminary notice to describe in detail the arrangements of the special apparatus which has been constructed, nor to offer in their present incomplete state to the Royal Society the results of the experiments. Still I venture to hope that even in this early stage of the inquiry the enlarged copy of the spectrum of Vega (a Lyræ) which accompanies this note, may not be regarded as altogether unworthy of attention.

After exposure to the light of Vega the dry plate was allowed to remain in the instrument until the following morning, when a solar spectrum was taken upon it through the half of the slit which had remained closed when the instrument was directed to the star.

The photograph shows seven strong lines all of them slightly shaded at the sides. The two lines which are least refrangible coincide with two known lines of hydrogen in the solar spectrum.

It is expected, by means of an apparatus now in the course of construction, to obtain also any finer line which may be present in the spectrum of this star, as well as to extend the photographic method to stars which are less bright.

I need not now refer to the many important questions in connection with which photographic observations of stars may be of value.

Anthropological Institute, December 11.—Col. Lane-Fox, president, in the chair.—The following new members were announced:—Rev. A. H. Sayce, G. Tippets, and T. F. Peacock. The following paper, by H. H. Howorth, was read:—On the ethnology of the Germans; Part I., The Saxons of Lower Saxony. The author contended that the Saxons north of the Elbe were immigrants, and of the same race as those south of that river, and that the Saxons were not indigenous to Hanover or Westphalia, but colonists or invaders. This he proved by the topography of those districts and by the names of men, things, &c. He pointed out also the strong differences between the old Saxons and the Saxons who invaded England. He referred to Spruner's Historical Atlas for the definition of the ancient limits of the Saxon peoples.—In the discussion which followed Mr. Hyde Clarke opposed the author's views, and considered that in these matters we had no better authorities than those heretofore accepted.—A paper on the Javanese, by M. Kiehl, who had resided there for some time, was also read, and interesting accounts of the religion, customs, agriculture, &c., of the Javanese were given. Mr. Campbell also spoke on the subject.

Physical Society, December 2.—Prof. G. C. Foster, president, in the chair.—The following candidate was elected a member of the Society:—G. Waldemar von Tunzelmann.—M. Janssen made a brief communication, in French, with reference to a method which he has proposed to the Académie des Sciences for ascertaining whether planets really exist between Mercury and the Sun. After mentioning the importance of photography from an astronomical point of view he explained his reasons for hoping that a series of solar photographs, taken regularly at intervals of about two hours at a number of places on the earth's surface would enable us to determine this question. As it is necessary that such observations be made at several places and in several countries, M. Janssen hopes that other countries besides France, will ere long arrange to have such a series of observations taken, and he considers that in a few years the circumsolar regions would thus be explored with a certainty which could not possibly be attained by any other method. He exhibited some of the original photographs taken in Japan of the transit of Venus, and explained the advantage of placing a grating in the focus of the camera, in order to eliminate distortion.—Mr. Crookes showed the spectrum of a small specimen of chloride of gallium which he had received from its discoverer, M. Lecoq de Boisbaudran. The discovery of this metal is of peculiar interest, as M. Mendelief had previously, from theoretical considerations asserted it to exist, and had also correctly given some of its chemical and physical properties. The most prominent line in the spectrum was a bright line in the blue somewhat more refrangible than that of indium.—Mr. Lodge briefly described a model which he has designed to illustrate flow of electricity, &c., and he showed how similar considerations can be applied in the case of thermo-electric currents. The model in its simplest form consists of an endless cord passing over four pulleys, and on one side of the square thus formed it passes through a series of

buttons held in their positions by rigid rods or elastic strings, according as they represent layers of a conducting or non-conducting substance. When considered in connection with thermo-electricity, the buttons are assumed to oscillate on the cord, and if they move in one direction with greater velocity than in the other, the cord will tend to move in the former direction. Now at a junction of copper and iron an unsymmetrical oscillation of the molecules must ensue, and the cord, or electric current, will advance when two junctions are at different temperatures. Mr. Lodge showed experimentally that for a given difference of temperature the maximum thermo-electric current is obtained when one of the junctions is at 280° C.; and beyond this point the amount of deflection decreases. This fact led Sir W. Thomson to discover the convection of heat by electricity; that is, if we have a circuit composed of copper and iron and one of the junctions be at the above temperature, the current in passing from hot to cold in the iron, or from cold to hot in the copper, absorbs heat. This fact was experimentally illustrated by Mr. Lodge. A strip of tin plate was symmetrically bent so as to nearly touch the two faces of a thermopile and is heated at the bend by steam passing through a brass tube on one side (not end) of the thermopile and kept cold by a current of water on the other side. As the arrangement is symmetrical no current is found to pass through the thermopile, but when a powerful voltaic current passes through the strip of metal, a distinct deflection of the needle is observed in accordance with the above law.

PHILADELPHIA

Academy of Natural Sciences, June.—Prof. Cope's fourth contribution to the history of the existing Cetacea, describes new species of *Globiocephalus*, *Phocæna*, and *Lagenorhynchus*. He also described (July 25) a new fossil genus of *Camelidae*, *Protolabis*, with three upper incisors on each side.

PARIS

Academy of Sciences, December 11.—Vice-Admiral Paris in the chair.—The following papers were read:—Theorems relating to couples of segments making a constant length, taken the one on a tangent of a curve, and the other on a normal of another curve, the two curves being of any order and class, by M. Chastel.—On the composition of glass and crystal among the ancients, by M. Peligot. He proves by quotation and chemical analysis that the glass of the ancients differed importantly in composition from the ordinary glass of to-day; the proportion of lime was much smaller (our good glasses contain 12 to 15 per cent. of the weight of it). Further, no test or analysis proves that the true crystal, the English *flint glass*, was known to the ancients. The honour of its invention belongs to us.—General method of analysis of the tissue of plants, by M. Fremy. He finds the principal tissues of plants, after exhaustion by neutral solvents, to be formed by organic association of (1) celluloses (cellulose, paracellulose, metacellulose); (2) vasculose; (3) cutose, (4) pectose, (5) pectate of lime, (6) azotised substances, (7) various mineral matters. He indicates the reagent for each.—On a polymer of oxide of ethylene, by M. Wurtz.—Results obtained on phylloxerised vines by their treatment with sulpho-carbonates, manures, and compression of the ground, by M. Marès.—M. de Lesseps presented a report by M. Roudaire on the results of his exploration of the Tunisian Chotts. An extract from an Arabic manuscript found at Nafta shows that the sea at one time reached to that place. M. Roudaire points out the advantages of the new project.—On the laws of impulse (*entrainement*) in plants, by M. Baillon.—A new chapter added to the history of hybrid *Agilops*, by M. Godron.—Researches on the structure, the modes of formation, and some points relative to the functions of the urns in *Nepenthes distillatoria*, by M. Faivre. The urn is a special formation, *sui generis*, belonging histologically to the foliaceous type, derived from the peduncle, which itself is a continuation of the median nerve of the foliar lamina. The complex liquid of the urns proceeds from the plant itself; and liquid poured into the urns is partly absorbed.—On the caries of horns, by M. Brame.—Researches on the vitality of the eggs of phylloxera (third communication), by M. Balbiani. The upper limit of temperature, at which the eggs are rendered sterile, is 45°. (The experiments were made with hot water.) The eggs and insects brought out of the ground die quickly on being exposed in a dry place. The eggs by reason of the chitine of their outer envelope present much greater resistance to destructive agents than the individuals fully developed; and the germs or embryos is less surely affected by large doses of poisonous vapour acting

tinuously.—On some processes indicated by Florentinus, for preservation of the vines and for the manufacture of wines, by M. Pualet.—On the geometric construction of the pressures which are borne by several plane elements which cross at the same point of a body, by M. Boussinesq.—Note on the integration of the equation—

$(x dy - y dx)(a + bx + cy) - dy(a' + b'x + c'y) + dx(a'' + b''x + c''y) = 0$ , by M. Allégret.—On the spectrum of the new star of the constellation of Cygnus, by M. Cornu. [See separate article.]—Note on the correction of variations in the working of astronomical pendulums arising from differences of atmospheric pressure, by M. Redier. Above the bob is fixed an aneroid barometric case, and a mass connected with the flexible wall of this rises or falls, thus compensating the effects of the pressure.—Note on the theory of the radiometer; extract from letter of Mr. Crookes to M. du Moncel.—Liberation of ammonia observed after rupture of certain bars of steel, by M. Barré. This was verified with red litmus and yellow turmeric paper; which applied to the moistened fracture, changed to blue and brown respectively. Bubbles of gas rose from the moistened surface during a quarter of an hour. The effect is got in Bessemer steels, and in steels obtained from the Siemens furnace. M. Daubrée remarked that M. Fremy had observed the liberation of ammonia from steels in the cold state in presence of steam. M. Boussingault had discovered nitrogen in all the meteoric irons he had examined, and M. Cloëz had found ammonia in the state of chlorhydrate and carbonate, in the meteorites of Orgueil. He thinks the gaseous bubbles indicated also the presence of a gas less soluble in water than ammonia.—Researches on the urea of the blood, by M. Picard. There are in arterial blood two different substances, both decomposed by Milon's reagent; the one, very destructible, disappears almost completely in the capillaries; the other is fixed, resistant, and exists in venous blood in the same quantity as in arterial (it is probably the urea of the blood)—On the fixed cells of tendons, and their lateral protoplasmic expansions, by M. Renant.—On a dust shower at Boulogne on October 19, and on the mode of formation of earthy rains in general. The dust was mostly of *débris* of various microscopic algae, with grains of silica and lime; it was probably raised from the beach. He thinks the organic matter in such showers is not, as often supposed, derived from the air.—The height of the quaternary glacier of La Pique, at Bagnères-de-Luchon, by M. Piatte.

CONTENTS

	PAGE
GRAHAM'S RESEARCHES. BY W. CHANDLER ROBERTS, F.R.S.	153
THE ANDS AND THE AMAZON	154
OUR BOOK SHELF:—	
Carrick's "Secret of the Circle, its Area Ascertained"	155
Smith's "Impossible Problem"	155
Burrows and Cotton's "Concise Instructions in the Art of Re-touching"	156
LETTERS TO THE EDITOR:—	
Sea Fisheries.—Prof. ALFRED NEWTON, F.R.S.	156
Ocean Currents.—REV. W. CLEMENT LEWY	157
Solar Physics at the Present Time.—Prof. PIAZZI SMYTH	157
Radiant Points of Shooting Stars.—WILLIAM F. DRUMMING	158
The Atlantic Ridge and Distribution of Fossil Plants.—M. ANTONIO ROSACEA (Comatula Rosacea).—W. R. HUGHES, F.R.S.	158
" Towering " of Birds.—F. W. MILLETT	158
THE SPECTRUM OF THE NEW STAR. BY Prof. A. CORNU (With Illustrations)	158
JUST INTONATION	159
ANATOMY OF THE TEETH (With Illustrations)	161
FORMATION OF RAINDROPS AND HAILSTONES. BY Prof. OSBORNE REYNOLDS, M.A. (With Illustrations)	163
D'ALBERTI'S EXPEDITION UP THE FLY RIVER, NEW GUINEA	165
OUR ASTRONOMICAL COLUMN:—	
The New Star in Cygnus	166
Remarkable Star Spectrum	166
The Minor Planet, No. 169	166
Newcomb's Corrections to Hansen's Lunar Tables	166
Prof. Förster's Scientific Lectures	167
CHEMICAL NOTES:—	
Variations in the Critical Point of Carbon Dioxide in Miocene, and Deductions From these and other Facts	167
Thermo-Chemical Researches	167
Theorie des Ton	167
Influence of Pressure on Combustion	167
BIOLOGICAL NOTES:—	
The American Bisons	167
Coloration of Water by Salts	168
The Evolution of the Cameline	168
Self-Fertilisation of Plants	168
An Unusual Case of Natural Selection	168
Gelatine in Relation to Nutrition	168
NEWS	168
SCIENTIFIC SERIALS	171

THURSDAY, DECEMBER 28, 1876

## DR. SCHLIEMANN'S DISCOVERIES AT MYCENÆ

OF all the archaeological discoveries which this nineteenth century has witnessed, that which Dr. Schliemann has just reported from Mycenæ will certainly be regarded as among the most important. Indeed, as throwing a light on those early days of Greece, the glories of which are reflected in the Homeric poems, it will stand pre-eminent, and cast even the researches made by the same ardent explorer at Hissarlik into the shade. There was in that case always some degree of uncertainty, and even his most sincere admirers and sympathisers could not but feel that among the successively disinterred cities it was doubtful which, if indeed any, was the Troy of the Iliad, and whether "the treasure of Priam" was in reality that of the unburied father of Hector.

At Mycenæ, on the contrary, the claim of the ruins which bear that name to be regarded as the representatives of the ancient city founded by Perseus, the massive walls of which were built by the Cyclopes, appears to be indisputable. It is true that Strabo relates that not a vestige of the town had survived to his time, but the account of Pausanias fully identifies the spot where modern geographers place Mycenæ as having been in his days the traditional site of the city.

"In returning to Tretus, on the way to Argos, the ruins of Mycenæ are," he says, "seen on the left, nor is there anything recorded of greater antiquity in the whole of Argolis. When Inachus was king he called the river which flows by after his name, and consecrated it to Juno. In the ruins of Mycenæ is the fountain called Perseia. There are also the underground buildings of Atreus and his sons, in which were kept their treasures. There is, too, the tomb of Atreus and of all those whom Ægistheus slew at the banquet after their return with Agamemnon from Troy. As to the tomb of Cassandra, it is disputed by the Lacedæmonians who live about Amychi. But there is the tomb of Atreus himself and of the charioteer Eurymedon, and that in which Teledamus and Pelops lie together (who were the twin sons of Cassandra, and were slaughtered as infants by Ægistheus at their parents' tomb), and the grave of Electra. But Clytemnestra and Ægistheus were buried a little without the walls as they were not thought worthy to be interred within, where Agamemnon himself, and those who were slain with him, lie."

Such was the legend 1,700 years ago, and making all allowance for the reconstruction of history or legend to which local guides are so prone, there is enough to show that a strong tradition remained upon the spot of an early race of kings whose deeds were famous in the then remote days when the Iliad was composed.

Even now the gate with the lions still stands in the Cyclopean walls, the subterranean buildings and various sepulchres still exist, and the tradition of the treasures of Atreus and his sons appear not to have been without a good foundation. Who were the occupants of the tombs now rifled by Dr. Schliemann must of course be conjectured, but he seems to have brought to light more than

one of the kings of the golden city, more than one βασιλῆα πολύχρυσου Μυκῆνης.

Until we receive photographs of the various objects discovered in the tombs it is idle to speculate upon their forms, which are of course but vaguely described in a hurried account such as that furnished to the *Times* by Dr. Schliemann. Though many of them appear to be novel in character and the general contents of the graves rich beyond all comparison, yet the results of the excavations do not as yet appear to be at all out of harmony with what might have been predicated of the contents of a royal tomb belonging to what prehistoric archaeologists would term the close of the Bronze period of Greece—a country where notoriously much allowance must be made for Egyptian influences. The bronze knife, the curious bronze dagger, the bronze swords and lances, the former having scabbards ornamented with gold, the gold-covered buttons, which from the description would seem to be not unlike those found by Sir R. Colt Home in some of our Wiltshire barrows, the long flakes or knives of obsidian, the style of ornamentation of the gold with impressed circles and spiral lines, are all in keeping with such a period. But though in general harmony with what might have been expected, there are, as already observed, also important and special features of novelty in the discovery.

The unprecedented abundance of the gold ornaments, the masks, the great diadems—which possibly may throw some light on the Scandinavian bronze ornaments which go by that name, and also on the Irish gold "minds" and the golden crosses in the form of laurel leaves—the silver sceptres with the crystal balls, the engraved gems, the vases, the great gold pin with the female figure crowned with flowers—possibly the Juno Antheia worshipped in the city of Argos—in fact the whole find will attract the attention of both classical and prehistoric antiquaries.

The pottery discovered appears also to be of peculiar fabric and material, and will no doubt contribute much to our knowledge of ancient fictile art. As all the originals will go to enrich the already important Museum of National Antiquities at Athens, it will be mainly from photographs and drawings that these wonderful objects will be known in this country. Let us in passing express a hope that the photographic and artistic representations of the Mycenæ treasure may be more satisfactory than those which constitute Dr. Schliemann's Hissarlik Album.

With regard to the antiquity to be assigned to these interments, it will be well to bear in mind that they lay at a considerable depth below the slabs first discovered by Dr. Schliemann, the ground beneath which he originally regarded as virgin and undisturbed; that above these slabs lay a great thickness of *débris*, probably accumulated at a time when the city was inhabited, and yet that Mycenæ was destroyed by the Dorians of Argos, about B.C. 468, at a period so early in Greek history that no authenticated coins of the city are known. It seems to have been from the depth at which the interment lay that they escaped the researches of former excavators, including Lord Elgin, upon the site. The reputed tomb of Theseus, which was rifled by Cimon the Athenian the year after the destruction of Mycenæ, must have lain nearer the surface, but the bronze spear and sword which were found in it, and which were brought with the



bones in triumph from Scyros to Athens, point to its having belonged to much the same period. The spear of Achilles in the temple of Minerva at Phaselis, and the sword of Memnon in the temple of Esculapius at Miodia, were also of bronze, of which metal, as Pausanias observes, all the weapons of the heroic age were made. Had Augustus but known of the buried treasures of Mycenæ when he was collecting the *Arena Heroum* for his museum at Caprea, the researches of Dr. Schliemann might have been in vain.

As it is, he is to be congratulated not only on the extent and importance of his discoveries, but also on his investigation having brought to light those horned Juno idols which he anticipated finding. His theory of some of the owl-like figures from Hissarlik bearing reference to the name of *πλαυκῶπις Ἀθήνη* has met with more ridicule than it deserved, and if the discovery of these horned figures of *βοῶπις πόρνια Ἥρη* should be substantiated, Dr. Schliemann will be fairly entitled to claim the victory over his adversaries. Under any circumstances both he and his no less enterprising helpmeet deserve the most cordial thanks of all scholars and antiquaries.

J. E.

#### PESCHEL'S "RACES OF MAN"

*The Races of Man and their Geographical Distribution.*

From the German of Oscar Peschel. (London: Henry S. King and Co., 1876.)

THIS book appears from the preface to be founded on General A. von Roon's "Ethnology as an Introduction to Political Geography," though it is substantially a new work intended to form a complete manual of ethnology. The actual title is somewhat misleading, as no special prominence is given to problems of geographical distribution, while languages, myths, and mere tribal distinctions, are treated with great and somewhat bewildering detail. The perusal of a work like the present, which, with great labour attempts to bring together in a compact form, all the existing information as to the physical and mental characteristics of the various races of mankind, impresses one painfully with the still chaotic state of the infant science of anthropology. With an overwhelming mass of detail as to secondary and often unimportant characters, we find a frequent want of exact knowledge as to the chief physical and mental characteristics of the several races and sub-races.

Language, myths, habits, clothing, ornaments, weapons, are described in detail, while we are left without any sufficient information as to the stature, bodily proportions, features, and broad mental characteristics of many important groups of men. The reason is obvious. The former class of facts can be readily obtained by passing travellers; while the latter require the systematic observation of an intelligent resident and more or less skilled anthropologist, and can only be arrived at by means of careful measurements and long-continued observations. It is not sufficiently considered that in almost every part of the world there is more or less intermixture of races, brought about by various causes—as slavery, war, trade, and accidental migrations. Hence in many cases the passing traveller is altogether deceived as to the characters of the race, and any observations he may make

are of little value. It is only by a long residence among a people, by travelling through the whole district they inhabit, and by a more or less accurate knowledge of the surrounding tribes with whom they may be intermixed, that the observer is enabled to disentangle the complexities they present, and determine with some approach to accuracy the limits of variation of the pure or typical race. Unfortunately this has yet been done in comparatively few cases; but anthropologists are now becoming impressed with its importance, and we may soon hope to obtain a body of trustworthy materials, which may enable us to determine, with more confidence than is yet possible, the characters and the affinities of many of the best marked races of mankind.

We will now give a sketch of the mode in which the subject is dealt with in the present work, and point out some of the more striking merits and defects it possesses. The first and larger portion of the book treats of the various physical and mental characteristics of mankind, the latter portion being devoted to a systematic review of the races and tribal divisions. The introductory chapter treats of man's place in nature, origin, and antiquity; and while adopting the developmental theory as regards animals, argues with more or less force, against the Darwinian theory of the animal origin of man and especially against the influence of sexual selection. The hypothetical continent—Lemuria—is suggested as the most probable birthplace of the human race, and it is explained that this locality is "far more orthodox than it might at the first glance appear, for we here find ourselves in the neighbourhood of the four enigmatic rivers of the scriptural Eden—the Nile, the Euphrates, the Tigris, and the Indus." The unity of mankind as constituting a single *species*, is strongly urged, while the evidences of his antiquity are briefly but forcibly set forth. We are glad to see due weight given to Horner's borings in the Nile valley, which we have always thought have been unduly depreciated. It is well remarked that the suggestion of the piece of pottery found at a depth of 39 feet having fallen into an ancient well or tank, is altogether groundless, because this is only one out of a large number of fragments of bricks and pottery found at various depths over an extensive area, and there is certainly no reason why the one found at the greatest depth should have fallen into a well rather than any or all of the others. It seems not to have been considered, by those who have advanced this view, that a well at Memphis, close to the Nile, could not have been very deep, and that if it had been it would probably have been in use for many centuries, and would have become the receptacle, not of a solitary fragment of pottery, but of a whole collection of utensils, ornaments, and domestic implements, such as invariably fall into wells in the course of time. Moreover, a well 40 feet deep in the soft alluvium of the Nile must certainly have been lined with stone or brickwork, and have been protected at the top by some inclosure solid enough to have resisted the muddy inundation water, and it would almost certainly have been covered over to keep out sand and dust in the dry season. It would therefore be almost impossible to bore on the site of an ancient well without knowing it; so that no more hasty and unsound suggestion to avoid a supposed difficulty was ever made than this "well theory," and yet, strange to say, it has been almost uni-

versally adopted as fatal to all calculations founded on these careful borings. It seems to be thought that although we must have facts to establish a theory, we need only have suppositions to overthrow them.

The next chapter—on the Physical Characters of the Races of Mankind—treats pretty fully of the brain and cranium, and also of the hair, but far less satisfactorily (owing to absence of material) of other physical characters; and the conclusion arrived at is “that neither the shape of the skull nor any other portion of the skeleton has afforded distinguishing marks of the human races; that the colour of the skin likewise displays only various gradations of darkness, and that the hair alone comes to the aid of our systematic attempts, and even this not always, and never with sufficient decisiveness.”

The next chapter treats of Linguistic Characters. While speaking favourably of the imitative and interjectional theory of language, its powers are unnecessarily “limited to events connected with the production of sounds, for no such representation is possible of that which is perceived by sight or the sense of touch.” It has, however, been often shown that roots derived from sounds or emotions may soon be applied by metaphor, analogy, or contrast, to a wide variety of meanings; and it may perhaps be something more than a coincidence, that the languages which possess the smallest number of primitive sounds—the Polynesian—belong to an area where from the total absence of mammalia and paucity of birds and insects the variety of natural sounds is extremely small. The chapter which treats of Social and Religious Development is very voluminous, occupying considerably more than one-third of the whole work, while more than seventy pages are occupied with an account of the various religions, a large part of which is modern history and has the smallest possible connection with ethnology. This chapter is full of facts intermingled with a good deal of more or less doubtful philosophy. We may call attention, however, to the view that cannibalism is not a character of the lowest state of savagery, but is “more frequently encountered exactly among those nations and groups of nations which are distinguished from their neighbours by their abilities and more mature social condition.” The ancient Mexicans, the Fijians, the Battas of Sumatra, as well as the Fans, Niamnians, and Monbuttos of Central Africa are adduced as examples, and as likewise proving that it is not the absence of animal food that has led to the formation of the habit. On the question of the first discovery of fire there is much wasted argument, founded on the erroneous assumption that to obtain fire by friction is a most laborious operation and always requires the combined labour of two persons (p. 143). On the contrary, either by the hand-drill or by rubbing it is effected with great rapidity by one individual, and there is really no reason why it might not have been independently discovered in different parts of the world.

One of the best passages in this part of the work is that which treats of the influence of commerce on the migrations of nations (pp. 210-214). Humboldt has remarked that had not Columbus altered his course a few days before sighting America he would have landed in Florida, and the Spaniards would have peopled the United States instead of Central America, and the New World would now have had quite different ethnographical fea-

tures. This was a very crude and unphilosophical remark of Humboldt's, for, as our author shows, the portion of America to be colonised by Spaniards was almost wholly determined by the presence of the precious metals. Wherever these were not found they marked on their charts as “worthless territories,” and had they first discovered the present United States they would certainly have at once abandoned them. Agricultural colonies were not possible at that early period, and the first settlements of the French and English literally perished of starvation. Tobacco as a valuable article of commerce first made Virginia flourish. The demand for codfish in France caused Canada to become a French colony. The Russians have settled wherever furs were obtainable. Spices caused the Portuguese and Dutch to settle in the far East, while in modern times the attraction of gold has led to the peopling of California with Anglo-Americans. This interesting discussion is summed up with the remark:—

“We thus see how much we owe to the rare and precious products of the animal, vegetable, and mineral kingdoms, as the means by which human culture was spread, and as the baits which attracted national migrations, and we perceive that the regions which were fortunate enough to possess such treasures were the first to be drawn into the sphere of a higher culture; the direction in which civilisation has moved has frequently been prescribed by this influence.”

In the last part of the work, devoted to a detailed exposition of the races of mankind, we have a somewhat peculiar primary division into seven groups. The first includes the inhabitants of Tasmania and Australia; the second, the Papuans of New Guinea and the adjacent islands; the third, the Mongoloid nations, including the Malayo-Polynesians and native Americans; the fourth, the Dravida of Western India; the fifth, the Hottentots and Bushmen; the sixth, the Negroes; and the last, the Mediterranean nations, answering to the Caucasians or Indo-Europeans of other ethnologists. The Tasmanians are said to have “exactly resembled the Australians in all points, except that the growth of the hair was more Papuan in character.” The supposed resemblance of Australians to the aboriginal inhabitants of Central India is set aside as entirely without foundation, while they are said to be decidedly nearest of kin to the Papuans. These latter are associated with the Negritos and the Andaman Islanders. Notwithstanding that a wide-spread relationship between Papuan and Polynesian languages is affirmed (p. 342), yet the Polynesians are associated with the Malays as a Mongoloid sub-race, the Malayo-Polynesians, an association which the present writer holds to be radically erroneous. The American tribes are treated as a single homogeneous group which entered the continent from the north-west, and little weight is given to the great differences of mental and physical character which exist and which are certainly greater than can be explained by a comparatively modern origin from a single stock. Very much yet remains to be done in determining the successive waves of migration which have flowed into the American continent, and we hardly think our author is justified in ranking the American aborigines as far higher than the negroes, on the ground that the former have, *quite independently*, reached a much higher civilisation. Throughout all this portion of the book a vast

mass of information is given as to the tribal divisions, habits, languages, and migrations of the several groups; but these details often obscure those broader features of physical and mental peculiarity which are of most importance in arriving at correct conclusions as to the primary divisions of mankind and the true affinities of the various races.

It is impossible here to notice the many interesting questions which arise as we peruse the mass of facts and opinions set forth in such a work as this. Although unequal in treatment, and in many respects imperfect, it exhibits much labour and research, and treats in more or less detail every branch of the great and rapidly-developing science of anthropology; and it forms on the whole as good a manual of the subject as we are at present likely to obtain from a single author. It is to be hoped that when another English edition is required some well-instructed anthropologist may revise and edit the work, so as to modify (by means of footnotes or otherwise) the unusual treatment of many questions of which our author gives a more or less one-sided exposition.<sup>1</sup>

ALFRED R. WALLACE

#### OUR BOOK SHELF

*Ostriches and Ostrich Farming.* By Messrs. De Mosenthal and Harting. 8vo. pp. i-xvii, 1-246. (London: Trübner and Co., 1876.)

If ornithologists have regretted the apparent retirement of Mr. Harting for the last few years from the field of scientific research, they will find on consulting the present volume that his devotion during that time to popular science has not impaired his powers, but has perhaps tended to increase the gift which he always possessed in a high degree, of being able to present to his readers the details of science in interesting and attractive language. We have been induced to make the above remarks, inasmuch as no one would suspect that under the above title is comprised a very complete monograph of the *Struthionidae* from the pen of Mr. Harting, but such is really the case, for, out of a volume of some 250 pages, three-fourths are occupied with the history of the ostrich and its kindred. This portion of the work is entirely written by Mr. Harting, and, like everything he undertakes, is executed with thorough conscientiousness. The true *Ostriches* (*Struthio*), the Rheas (*Rhea*), the Emu (*Dromæus*), the Cassowaries (*Casuarus*), and the *Apteryges* are all passed in review, and a complete monographic account given of each; the history of the ostrich and its distribution in times past and present being very exhaustively compiled. We can heartily commend the

<sup>1</sup> The translation is from the second edition, yet there are a considerable number of errors and oversights, some of which it may be useful to point out. First we must notice that the copious table of contents is rendered quite useless by the absence of a single reference to the pages at which the several chapters and sections begin or end. Among errors of fact we notice (at p. 2) that the *Hylobates* is said to "stand far nearer to man than the other three highest apes;" at p. 20, that the Dutch are not acclimatised in the East; at p. 117, that the Malays always use the word *stone* in counting as "three *stones* chickens," the fact being that *stone* or *seed* is used for inanimate objects only, *tail* for living things, as "three *tails* chickens," &c.; at p. 204 "the Sunda, Banda, and Molucca Islands," are said to have formerly been bound together Asia and Australia, but by subsidence have become "groups of islands in a shallow sea;" and again, at p. 205, the Gulf of Mexico and Caribbean Seas are both said to be *shallow*, and to show a former connection with the continent; p. 343, Papuans are said to smelt iron ore; this I think is quite erroneous, though on the coast they work iron brought them by the Malays and traders; at p. 344 the Papuans are said to cultivate *peas*, and to possess "only seedless varieties of the bread fruit," the exact contrary being the fact; at p. 413 guinea-fowls are put as natives of the New World, and "prairie dogs" as domestic animals; at p. 414 the "ounce" is put for the "jaguar;" at p. 493 ("*Crax*" guinea-fowls," are said to be bred for food. Of oversights or mistranslations we notice at p. 8, lines 10-11, figures which are quite unintelligible; p. 266, line 1, "allows too long" is a bad translation; p. 268, line 2, "outbreak of the pestilence" refers to the mummy disease.—A. E. W.

illustrations in this volume, very good full-page drawings of the principal *Struthionidae* forms, having been designed by Mr. T. W. Wood, while the Zoological Society has allowed the woodcuts which have illustrated Dr. Selater's various memoirs on the *Struthionidae* to be utilised, so that a very complete monograph of these birds is the result.

Mr. De Mosenthal's portion of the work is confined to the practical "Ostrich Farming," and seems to be extremely well worked out, giving a history of the development of the pursuit from its first commencement. The author's personal experience has been confined to South Africa, where ostrich-farming has acquired its chief importance, but the statistics of the exportation of feathers from the other parts of Africa show that at present the greatest trade is done through Egypt, the annual value of the exports from this country being 250,000*l.* The Cape comes next with exports to the value of 20,000*l.* less, while from Barbary the value is 100,000*l.* annually, from Mogador 20,000*l.*, and Senegal 3,000*l.* The whole of the process of the artificial incubation of the eggs is described with minuteness, and altogether the contribution is most entertaining and instructive. The volume concludes with an appendix giving consular and other reports, all of which supply important statistics and interesting historical matter bearing on the subject.

*Die Darwin'sche Theorien und ihre Stellung zur Philosophie, Religion und Moral.* Von Rudolf Schmid, Stadtpfarrer in Friedrichshafen. (Stuttgart, 1876.)

A GLANCE through this book will not satisfy the reader that the great problems of modern thought are to be settled even by the well-meant essays of a well-read pastor. It is one of the "reconciliations" of science and religion, so common in England, but less so in Germany, where people are in general unwilling to check views on scientific questions by their relation to theology. The author impresses on his readers that the theory of universal law is compatible with the Christian doctrine of miracles, and that the Darwinian hypothesis of development may really receive strong support from the doctrine of human development in a future state. But his arguments prove little or nothing one way or the other. Next, turning to the Creation, we find him placidly remarking that the order of its stages is given differently in Genesis and again in Job, his inference being that neither order is "binding on us." The six days, in his opinion, are not natural days, nor are they geological periods, for neither would this fit with the geological evidence; he therefore concludes that they are "divine days," whatever that may mean. Such reading ought to suggest to religious minds the serious question whether disbelief can do so much harm as the habit of perverting and mystifying belief. We may hope that when theologians have become more familiar with the theory of evolution as manifested in the development of religious ideas themselves, their reconciliation of man's religious tendencies with his scientific knowledge may be placed on a higher basis than in such attempts as this, of which the weakness is only made more conspicuous by its good intention. E. B. T.

#### LETTERS TO THE EDITOR

[The Editor does not hold himself responsible for opinions expressed by his correspondents. Neither can he undertake to return, or to correspond with the writers of, rejected manuscripts. No notice is taken of anonymous communications.]

##### Sea Fisheries

As an enthusiastic amateur sea-fisher some twenty years ago on the Canadian coast of what the Americans call the "herring-pond," perhaps you will allow me to make a remark or two on Mr. Holdsworth's letter in NATURE, vol. xv, p. 135. Long absence from that happy hunting-ground has not precluded my

memory, for I often in imagination fight again my battles with halibut and skate, lobster and cod, and the words "sea fisheries" have not altogether lost their charm; but I confess I wholly overlooked Prof. Newton's interesting letter on the subject, and turned back the file of NATURE and read the letter in connection with Mr. Holdsworth's. The theory of the former appears to me to be the correct one; the Atlantic sea fishery is being gradually played out.

I doubt whether we can anywhere along its extensive coast now meet with "shoals" of mackerel or "schools" of herring several miles in breadth, forming a mass of so compact a nature that small vessels had almost as much difficulty in getting through them as Sir George Nares had in getting through the so-called palaeocystic ice, or hear of single hauls of 1,000 barrels! And yet such was possible not twenty-five years ago.

The great mischief is done, certainly in America, by trawling. This must be evident if one will but consider the *modus operandi*, by which the female fish are captured just before they have deposited their spawn, a few thousand fish so taken representing the non-existence of many millions. The subject has received the most serious attention of the Canadian Government, and has by it been brought under the notice of the United States and French authorities.

Mr. Holdsworth appears very much amused to find that Prof. Newton has discovered a use for dogfish over and above his own instance, in which it served as "salmon" for the Preston weavers. But as we have never heard that the fishermen of Morecambe Bay were charged with feloniously administering a poison to the said weavers, we must conclude that dogfish is a wholesome, but perhaps not a toothsome, article of food.

Mr. Holdsworth says that with this exception he has never heard of a case in which "the hated dogfish was not knocked on the head and thrown overboard whenever there was a chance of so doing." I can tell him one. Along the American coast the dogfish is certainly knocked on the head, but the fishermen there know its value too well to throw it overboard; they keep it, and it yields an oil; and of the many millions of gallons of "fish-oil" in the returns, "dog-oil" forms no inconsiderable portion.

There can be no doubt that the American fishermen, if they had had their say in creation, would have vetoed dogfish; but as they had not, they came to the conclusion that there was doubtless some wise purpose even in that creature: a thorn in the flesh to try their tempers and their nets, but one which they forced to bear fruit.

If it is true that the nets of the Donegal fishermen in 1875 were constantly full of dogfish, and they driven to their wits' end, I hope some Donegal reader of NATURE will kindly read them this letter; it may be the means of opening up a glorious future for Ireland. Perhaps too some Lancashire reader will give the Morecambe Bay fishermen a hint, in case the Blackburn weaver should hereafter have a surfeit of "salmon," and those practical jokers' occupation be gone.

May I in conclusion be allowed to dissent from Prof. Baird's plural of "alewife?" He calls it "alewives." There is nothing of the meaning of *wife* in the word. This species of herring, which usually goes by the name of *gaspereau*, is also called *alewife*, which is a corruption of the Indian word for a fish, *alooof*. The plural, I think, should be "alewives." B. G. JENKINS  
Dulwich, December 18

### Sense of Hearing in Birds and Insects

I do not know whether ornithologists are acquainted with the peculiar manner in which curlews frequently obtain their food on sandy flats which have been left bare by the tide. The birds force their long bills into the wet sand as far as the nostrils, and then again withdraw it, leaving a small hole, which, when probed, is found to be only just large enough to have taken in the bill. The animal, therefore, can only have made a single prolonged push without adding any lateral or exploring movements of the bill, as birds which feed in mud may be observed to do. Now it cannot be supposed that curlews adopt this mode of feeding without obtaining from it some degree of profit. Neither can it be supposed that they make their thrusts into the sand at random; for, their bills being so pointed and slender, the birds would usually require to make a vast number of ineffectual thrusts before they happened to hit upon a worm or other edible object. The question therefore is, How do the birds know the precise spots where their victims lie buried in the sand? That this knowledge is not derived by sight I am quite sure, for I have repeatedly observed innumerable curlew marks of the kind described occur-

ring on tracts of sand which, in virtue of their high level, presented a perfectly smooth and uniform surface. I can therefore only suppose that the birds are guided in their probrings by their sense of hearing. Doubtless it is difficult to believe that this sense is so delicate and precise as to enable the curlew to perceive so exceedingly slight a sound as that which must be caused by the movement, say, of a small worm at a distance of ten or twelve inches from the surface of the sand, and at the same time to localise the exact spot beneath the surface from which so slight a sound proceeds. I cannot see, however, that any other explanation is open, and perhaps the one now offered may not seem so incredible if we remember the case of the thrush. No one, I think, can observe this bird feeding and doubt that it finds its worms and grubs almost exclusively by the sense of hearing. And if the distance which it runs between successive pauses for listening represents—as we cannot but suppose it must—the diameter of the circle within which this bird is able to hear the movements of a worm, I think that the hypothesis I have just advanced with regard to the curlew ceases to be improbable.

It seems worth while to add a few words with respect to the sense of hearing in insects. So far as I am aware, the occurrence of such a sense in this class has never been actually proved, although on *à priori* grounds there can scarcely be any doubt concerning the fact of some insects being able to hear; seeing that in so many species stridulation and other sounds are made during the season of courtship. In the case of moths, however, I believe that sounds are never emitted—except, of course, the death-rattle. It therefore becomes interesting to observe that an auditory sense is certainly present in these insects. Several kinds of moth have the habit of gently, though very rapidly, vibrating their wings, while they themselves are at rest on a flower or other surface. If, while this vibrating movement of the wings is going on, the observer makes a sudden shrill note with a violin or file, &c., the vibrating movement immediately ceases, and sometimes the whole body of the insect gives a sudden start. These marked indications of hearing I found invariably to follow a note with a high pitch, but not a note with a low one.

GEORGE J. ROMANES

### "Towering" of Birds

I HAVE read Mr. Romanes' communication on the "towering" of grouse and partridges with much interest. As he requests further information, may I be permitted to contribute the following:—I once observed a pheasant which, after being shot, flew apparently untouched for about one hundred yards, then towered ten or fifteen yards, and fell dead. As a rule birds that have towered are picked up dead, as Mr. Romanes states; but such is not invariably the case. A correspondence took place in the *Field* some weeks since in answer to the question: "Do towered birds ever rise again," and several replies were elicited in the affirmative. The conclusion warranted by that correspondence seemed to be that towering arises from at least two distinct kinds of injury. In the first, the common form, the bird is struck in the *back*, and is always found precisely where marked down. It seems to me that in this kind of towering the *perpendicular* flight may be attributed to a cause perhaps other than, or at all events additional to, *pulmonary* hæmorrhage. I consider that hæmorrhage is a necessary factor, and Mr. Romanes makes but a very strong case in favour of its being into the lungs. That the movements of the wings are convulsive, and the explanation of the towering, I am not inclined to dispute, but I think it has yet to be proved that the convulsive flapping of wings (the directing power of the brain being in abeyance) always produces perpendicular and never merely erratic flight. Every towering bird acts in a precisely similar way. Are we to take it for granted that in asphyxia it is only certain sets of muscles, and these always in the same and to an equal degree, that are spasmodically affected? I have noticed that a towering bird very often has his legs hanging straight down (I do not allude to those cases where they are palpably mutilated), and it strikes me as being likely that paralysis of the legs and lower part of the back may have something to do with the flight being upward. A man who has paraplegia always complains that he cannot move his legs because they are so heavy. This sensation would doubtless be felt by a bird paralysed behind, and this, in addition to the loss of its steering apparatus and the co-operating contractions of the posterior muscles, would produce a loss of balance with much the same effect as though the after parts had really become disproportionately heavy. I have no desire to be

dogmatic, but merely offer this as a possible assisting factor in some cases.

In towering from the second kind of injury, the bird can and sometimes does fly away from the place where it fell, and, after retrieving, concordant testimony shows lesion in the neighbourhood of the eye, whence blindness has been assumed to be the cause. The fact that this very rarely occurs, perfectly agrees with the objection that the smallness of the head is adverse to the theory of cerebral injury being the invariable cause. It has further been noticed that these birds seldom move until they are touched. Whether, attention having been drawn to this subject, future observers will detect a difference in the towering of birds that may, and those that cannot, rise again, is hard to say, but I hope, in the interests of science, all pertinent observations will be communicated and admitted into the columns of NATURE.

Faringdon, Berks, December 11 J. HOPKINS WALTERS

#### The Tasmanians

I SEE it stated in NATURE, vol. xiv. p. 242 (which has just reached us), that M. Castelneau, French Consul at Sydney, states in a letter "to the Geographical Society of Paris, read at its last sitting, that the only four Tasmanians living were presented at the last levée held by the Governor of Tasmania."

I cannot imagine how M. Castelneau can have allowed himself to propagate such an error. It is quite true that four Tasmanian aborigines were presented at a governor's levée, but the presentation occurred just ten years ago, and all the four have long since been gathered to their fathers.

In reference to the last paragraph in your note, I regret to say that we really "have seen the last of them." The sole survivor of this singular race, a female, by name Trucanini, died a few months ago at the age of seventy or thereabouts. The "penultimate" aborigine was King Billy, who preceded Trucanini to the grave three years ago. W. W. STONEY  
Hobart Town, October 21

#### Algoiid Swarm-spores

IN a note on algoiid swarm spores, published in NATURE, vol. xv. p. 15, reference is made to the new investigations of M. Sacy, who considers the motion and accumulation of spore as due to currents produced by differences of temperature in the water, and not at all to the action of the light causing the living swarm-spores to move. I do not know the experiments by which this result has been reached; but the following seems to me a confirmation of the new theory.

At a distance of about 5 feet from the window of my room is placed a cylindrical glass vessel of 1 foot in diameter, and containing only some sphagna and microscopical crustacea. This aquarium has been kept unshaken for four years.

Now a great quantity of green alga is collected on the side opposite to the window, while the side turned towards the light is covered with a considerable number of little particles of an amorphous matter, arranged in pretty regular cloudy forms, containing nothing but debris of plants or animals, and a few desmidsia.

These particles, which cannot be considered as living matter, arise from the light mud which covers the sand at the bottom of the aquarium. The right and left sides of the vessel remain quite clean.

I should much like to know if any of your readers have observed similar facts. E. RODIER

29, rue Saubat, Bordeaux, December 17

#### Meteor

I SAW the meteor spoken of by your correspondent (ante, p. 170) at Blackwater on Wednesday the 13th inst. at 4.45 P.M. as I was passing down St. James's Square. It was apparently of somewhat greater magnitude than the planet Jupiter, and passed from north to south, till it disappeared behind the houses.

Your correspondent will find two notices of the same meteor in the Times of the 15th inst. P. L. SCLATER

#### ON THE RELATION BETWEEN FLOWERS AND INSECTS<sup>1</sup>

THE habit possessed by our honey-bee of feeding itself from flowers, and its corresponding faculty of deciding amongst different species and divining the situa-

<sup>1</sup> Abstract of an article in the *Bienen Zeitung* by Dr. H. Müller.

tion of the honey, is, in the first instance, derived from the common parents of all the Hymenoptera. It probably even comes from such remote ancestors as the leaf-cutting wasp, from them passes to the gall-flies, the ichneumons, and the hunting-wasps, from which latter it goes to the allied species of ants and bees. We may see all these families of Hymenoptera feeding on the honey and pollen of flowers, and manifesting a certain, if not always very obvious, intelligence in choosing the flower to be visited.

The various families of wasps differ amongst each other as to their ingenuity in finding the honey, but it is in the bees that we first arrive at the more complex use of the food, i.e., not merely for the insect itself, but also for its young, combined with such intelligence in its discovery, as proves that the most highly developed form of insect is the one which profits by the honey lying most concealed. The following observations may throw some light on the foregoing statements:—

I come to the conclusion that the Hymenoptera enumerated have a certain degree of intelligence, at least with regard to honey that is in sight, from never having seen leaf-cutting wasps or ichneumons, and still less hunting-wasps or bees, seek honey so long in flowers where it does not exist as is the case with some species of beetles, which feed frequently or exclusively on the nourishment derived from flowers.

However, even very highly-organised insects are at times misled, and Dr. Müller cites one case in which *Melampyrum arvense* was surrounded by a crowd of ichneumons, bees, &c., seeking the honey in vain, the only one which succeeded in obtaining it being *Bombus hortorum*, which has the longest proboscis of all our humble-bees.

It cannot be said either of the leaf-cutting wasps or of the gall-flies that they attain a high degree of intelligence in finding concealed honey, and to these we may add the ichneumons which are frequently found on plants with the honey easily seen (*Umbelliferae*, *Listera*, *Ruta*, &c.), much more rarely on those where it is partially concealed (*Cruciferae*, *Spiræa*, *Salix*), and quite as an exception on those in which it is completely hidden (*Gypsophila*, *Malva*, *Mentha*.)

When once a family of Hymenoptera has attained to the point of intelligence of providing food for its young and placing it along with the eggs, we see it develop greater dexterity in its search for honey. In comparing, for instance, the statistics of the visits of the leaf-cutting wasp and the hunting-wasp, we find that even the most developed leaf-cutting wasp only attempts to rob those flowers whose simple form renders the honey easy of access. Even those of *Bryonia* and *Roseda* seem unattainable by them. On the contrary, we see the hunting-wasps attack not only these, but also flowers specially adapted to the movements of the fossorial Hymenoptera, for example, *Echium*, the Labiatae, and the Papilionaceae, and also the pendent bells of *Symphoricarpos*, which only allow ingress to the honey from below. It must be deduced from the above statements that flowers and the insects which visit them are adapted to each other, and have gone through corresponding degrees of development at each period of the world's history. For example, if my view of the origin of the Hymenoptera is correct, there has been a time when species with an ovipositor were the only Hymenoptera; and when only regular, open, turned-up flowers of as low a form as *Salix* existed, while *Roseda*, *Echium*, the Labiatae, the Papilionaceae, &c., &c., have been developed at a later period after the species of Hymenoptera had developed to the point of preparing a place for their young.

We may therefore see how through the transition of hunting-wasps to the habits of bees, and farther within the bee-like family, dexterity in acquiring the food has increased. The species perhaps most nearly allied to the ancestors of the bee—*Prosopea*—is, as to its organisation,

on the same footing with the hunting-wasp, and, as to the length of its tongue, is even but little more highly developed. The assiduity with which it visits the flowers, its practice in seeking those where the honey is concealed, its well-established habit of feeding its young entirely on food derived from flowers; all place it above the average of its ancestral species. Even, however, among these ancestral species—the hunting-wasps—are certain kinds whose love for flowers has far surpassed their power of rearing a family, and these, favoured by their large size and length of tongue, have attained still greater dexterity in getting at concealed honey than *Prosopis*.

Out of eighty-five visits to flowers by different species, there were of *Prosopis* :—

On flowers with the honey apparent, 19 = 22·4 per cent.

On flowers with the honey somewhat concealed, but still fairly apparent, 19 = 22·4 per cent.

On flowers with the honey concealed, but easily reached through the formation of the mouth, 28 = 32·9 per cent.

On flowers with the honey entirely concealed, which are specially adapted to the burrowing Hymenoptera, 8 = 9·4 per cent.

On flowers without honey, or at least only having pollen as far as *Prosopis* is concerned, 11 = 12·9 per cent.

Some of the hunting-wasps appear to show even more intelligence than *Prosopis* in the search for honey, and this will appear still more forcibly if we leave out the flowers which only yield pollen, when the total result is for the wasps 35·3 per cent., for the *Prosopis* 48·6 per cent.

The following table will show at a glance how far the hunting-wasps are above the leaf-cutting wasps, how far the former are surpassed by *Prosopis*, and how far the hunting-wasps, most eager for flowers, again surpass the *Prosopis*.

	a	b	a+b	c	d	c+d	e	f
Leaf-cutting wasps ... ..	69·2	16·3	85·4	13·0	0	13·0	0	1·6
Majority of wasps indifferent to flowers ... ..	55·3	17·8	93·1	24·0	1·0	25·0	1·9	—
Principal hunting wasps ... ..	44·7	19·0	63·7	30·0	4·8	34·8	1·5	—
<i>Prosopis</i> ... ..	22·4	22·4	44·8	32·9	9·4	42·3	12·9	—
The wasps most eager for flowers ... ..	10·8	23·1	33·9	49·2	16·9	66·1	—	—

If we look down the perpendicular lines of this table from top to bottom we shall see the frequency of the visits to the flowers with the honey apparent (*a*) even if we add the visits to the flowers with the partially seen honey (*a* + *b*) steadily decline, though the visits to the flowers with partially concealed honey (*b*) steadily increase. In still more rapid ratio the frequency of the visits to the honey entirely concealed, increases (*c* + *d*), both in the case of those flowers whose honey is easily attainable through the simple form of the corolla (*c*), and those specially adapted to the burrowing Hymenoptera (*d*).

With regard to the flowers yielding only pollen (*e*), the *Prosopis* shows a remarkable advance on the other Hymenoptera, probably caused by the great need the young fed from flowers have of the pollen.

The results of a careful series of observations, prolonged over a course of five summers, brings us to the following conclusions :—

1. The *Tenthredos* stand, as regards the rearing of their young and in their general intelligence, as well as in their capacity of finding and acquiring concealed honey, the lowest of all the Hymenoptera we have considered. They visit flowers with the honey altogether apparent much more frequently than those with the honey wholly or partially concealed, and the latter only in the case of those with a low and simple organisation.

2. The hunting-wasps, which, as has been previously shown, stand decidedly above the *Tenthredos*, show also a decidedly higher power of finding honey. Even when the most intelligent and flower-loving families are excluded, a high percentage among the hunting-wasps is found visiting flowers with concealed honey, and a lower visiting flowers where the honey is apparent; they even seek some flowers whose formation shows them to be adapted to the fossorial Hymenoptera. All this progress

appears still more remarkable when we compare the whole group of *Tenthredos* with the whole group of hunting-wasps.

3. *Prosopis*, the least highly-developed bee, and one which does not stand higher than the hunting-wasps, either in general capacity or in care for its young, is yet compelled, through the greater requirements of the latter and their need of pollen, to visit both flowers with concealed honey and flowers which only produce pollen.

4. Certain species of hunting-wasps stand above the *Prosopis*, both in size and in the length of the proboscis; these, however, only seek food from flowers for themselves, and not for their young.

We may now hope through the following steps to obtain some idea how the honey-bee has acquired its peculiar capacity for finding concealed honey.

All our European bees, except *Prosopis* and the parasitic species, have their hairy covering specially adapted to collect pollen. This apparatus forms a characteristic by which they are divided into two families, namely, those which collect the pollen with a brush on the lower side of the body, and those which collect it with the pencil-like hairs of the hind legs.

In the former family there are various degrees of development in the pollen-collecting apparatus, difficult alike to describe or distinguish; and as the relationship of these species to the honey-bee is but remote, we may content ourselves with glancing at this group as a whole.

The second group, on the contrary, offers a steady series of degrees of development which we may now compare with each other and with *Prosopis*.

Passing over the first step—sphécodes, we come to *Andrena* and *Halictus*, whose size and length of proboscis places them distinctly above *Prosopis*. Their visits to flowers rise from 7·4 per cent. in the case of flowers with the honey altogether apparent, to 51·6 per cent. to the flowers of complex form and with the honey entirely concealed.

The genera *Eucera*, *Anthophora*, and *Saropoda* reach the highest point of intelligence as regards flowers of all our native bees, the length of their proboscis varying from ten to 21 mm., one of the humble-bees (*Bombus hortorum*) being the only one that can in this respect compare with them.

The three above-mentioned genera, out of fifty-six visits to flowers, paid none to those with the honey apparent, but 91·1 per cent. to those with either concealed honey of complex form, or with both characteristics united.

There is no further example of increased development of the proboscis in this family, but they have attained a further step in the transformation of the thigh brushes into pollen-baskets, and above all in the establishing the community of life and of labour which distinguishes the humble hive bees. From observations made on the latter, however, it appears that increased development shows a certain return to the flowers containing more visible honey, the honey bee, out of 520 visits observed, going to such flowers at the rate of 0·8 per cent., the hive-bee, 194 visits being observed, at the rate of 3·1 per cent.

The following table is fuller than the previous one :—

	a	b	a+b	c	d	c+d	e	f	g
<i>Tenthredos</i> ... ..	69·2	16·3	85·4	13·0	0	13·0	0	—	1·6
Hunting-wasps ... ..	44·7	19·0	63·7	30·0	4·8	34·8	1·5	—	—
Solitary bees ... ..	22·6	22·6	45·2	33·3	7·1	40·4	11·9	2·4	0
<i>Prosopis</i> ... ..	7·4	26·5	33·9	40·2	11·4	51·6	9·6	2·0	2·9
<i>Andrena</i> and <i>Halictus</i> ... ..	0	9·6	9·6	65·4	17·3	82·7	5·8	0	1·9
<i>Cissa</i> ... ..	0	5·4	5·4	5·4	85·7	91·1	3·5	0	—
<i>Panurgus</i> , <i>Dasypoda</i> ... ..	0	5·4	5·4	5·4	85·7	91·1	3·5	0	—
<i>Rhopalites</i> ... ..	0	5·4	5·4	5·4	85·7	91·1	3·5	0	—
<i>Halictoides</i> ... ..	0	5·4	5·4	5·4	85·7	91·1	3·5	0	—
<i>Eucera</i> <i>Anthophora</i> ... ..	0	5·4	5·4	5·4	85·7	91·1	3·5	0	—
<i>Saropoda</i> ... ..	0	5·4	5·4	5·4	85·7	91·1	3·5	0	—
<i>Chalcidodoma</i> ... ..	0	5·4	5·4	5·4	85·7	91·1	3·5	0	—
<i>Dip. vis</i> , <i>Megachile</i> ... ..	0	5·4	5·4	5·4	85·7	91·1	3·5	0	—
Social bees ... ..	0·8	8·3	9·1	26·3	35·6	61·9	4·0	4·8	0·2
<i>Bombus apis</i> ... ..	3·2	15·5	18·6	25·3	34·5	59·8	13·4	7·2	1·0

Explanation of Table—

a, flowers with honey apparent; b, partially apparent; c, honey concealed but easily reached; d, concealed but adapted to a short proboscis; e, flowers only possessing pollen; f, needless attempts to get honey by making a hole, as on *Dasytris*; g, flowers without honey.

The visits to the flowers with partially apparent honey steadily diminishes from the *Tentaredos* to *Andrena* and *Halictus*, but so that the diminution of the visits entirely refers to the flowers with the honey apparent, while, on the contrary, the flowers with honey partially hidden are visited with still greater frequency.

In the case of some solitary bees, the disinclination to flowers with the honey apparent has reached to their total abandonment.

The transition to social life brings the development in the second group, of which we have been treating, to an end, as, in proportion as the number of individuals in a community increases, the necessity for food forces them to seek honey where they can, and it is indeed touching to see the unwearied diligence with which the hive-bee will collect almost imperceptible drops of honey from even the smallest flowers.

The perfection which the family of bees, viewed as a whole, has attained, beginning with *Prosopis*, and rising to the most perfect of the solitary bees belonging to the group which collect pollen on their hind legs, consist:—

1. In the increasing development of the pollen-bearing apparatus.

2. In the prolongation of the lower part of the mouth.

3. In the increasing size of the individuals.

The first is seen best in the humble and hive-bees; the third is very marked in the humble-bee, while the length of the proboscis reaches its furthest point in *Anthophora*. The hive-bee has a more perfect pollen apparatus than the humble-bee, but is inferior to the latter in size and length of proboscis, and only succeeds in obtaining more honey through its more populous communities.

It is well known that as a rule every hive-bee occupied in seeking food from flowers specially devotes itself to a particular species, passing by others, however rich in pollen or honey. The advantages of this arrangement are obvious, much fewer visits being made in vain to flowers already plundered, and much greater dexterity being attained in the case of flowers with complex forms.

Two questions remain to be decided—

1. Does each individual bee collect pollen and honey from a single plant only (to which it has become adapted by instinct, *i.e.*, by inherited custom)?

2. Does the hive-bee possess a greater degree of intelligence in deciding among the different species of plants than the humble-bee and other lower forms?

The first question must be met with a decided negative; the second, as far as observation has yet gone, cannot be answered with certainty. It would scarcely be of advantage to the bee-community, whose object is the exploitation of as many flowers as possible, if its instincts as to special tribes were hereditary.

It is, on the contrary, to be observed in the hive-bee that each bee makes various essays before deciding on any special tribe of flowers. For example, we have seen a hive-bee in vain attempt to obtain the honey of *Iris pseudacorus*, and then fly to *Ranunculus acris*, which it sucked at for some time. Another more than once bored through the spur of *Orchis latifolia*, loading its head with two little clubs of pollen, and then flying to the flowers of *Lychnis flos-cuculi*.

A third, wandering over a field full of weeds, visited one after another *Veronica hederifolia*, *Lithospermum arvense*, *Sisymbrium thalictroides*, and *Viola tricolor*.

These and similar facts show that there can be no question of inherited preferences for certain plants in individual bees, and that the fact of each bee being devoted to certain plants is only to be ascribed to the subordination of the interests of the individual to that of the state. The humble-bee approaches the hive-bee in the peculiarity of keeping to certain species, as well as in the number and keeping of its community. However, though chiefly confined to the plants accessible to it alone, as for example, *Lamium album*, *Sec.*, there are

fairly numerous cases in which the humble-bee goes to other plants, and its baskets are often found full of very varied kinds of pollen.

Even in solitary bees, the special preference for special kinds of flowers is a frequent habit. For example, *Andrena halleriana* is found on *Scabiosa arvensis*, *Cistis melanura* on *Lythrum salicaria*, &c.; but this preference evinced by some solitary bees for a single species of flower sufficing all their needs is radically different from the practised and exhaustive pillage of all flowers by a bee community, in which special individuals are told off to gain the produce, however small, of special families of plants. At first I believed I could answer the other question propounded above, *i.e.*, whether the hive-bee promises a higher degree of intelligence in distinguishing different genera of plants than the humming-bee and other lower forms, in the affirmative, on the ground of the following observations:—In a field grown over with weeds I saw one of our more intelligent humble-bees, *Bombus agrorum*, visit without distinction the little whitish flowers of *Viola tricolor* var. *arvensis*, and those of *Lithospermum arvense*, the same size and colour, but evidently differing in form, while avoiding all other plants. I had, indeed, seen the hive-bee mistake the flowers of *Ranunculus arvensis* for those of *R. bulbosus*, those of *Trifolium repens* for those of *Trifolium fragiferum* many times, but had then never seen it make so great a mistake as that I have recorded of the humble-bee. From this I concluded that the hive-bee is more practised in distinguishing various species than the humble-bee. As, however, I later saw the hive-bee go from the blue violet to a hyacinth of the same colour, and back again, I felt convinced that the grounds of my conclusion were somewhat defective, and I can only leave the decision of this question to further observations. As far as my own experience is concerned, I am inclined to believe that the hive-bee, as well as all other bees which we see preferring special families of plants, are much more led by colour and size than by any clear apprehension of the form of the flowers.

A. J. G. D.

#### AN ACCOUNT OF DUPLEX TELEGRAPHY

THE introduction of the duplex system of working not only upon land-lines, but on sub-marine cables, is without doubt the most important advance recently made in electric telegraphy.

Duplex telegraphy may be defined as the art of telegraphing in opposite directions simultaneously along one line wire.

It is claimed by M. Zantedeschi in papers read before the Academy of Sciences, Paris, in 1855, that as early as 1829 he had suggested and demonstrated the possibility of working "duplex;" but until the year 1853 there do not appear to have been any noteworthy attempts made to effect it practically. In that year, Dr. Gintl, a director of Austrian telegraphs, described a system of duplex telegraphy to the Academy of Sciences, Vienna, and practically tested it on the land-lines between Vienna and Prague.

The principle underlying this and all other systems is that the outgoing currents at a station shall not sensibly affect the receiving instrument there, while, at the same time, the latter is free to be affected by the incoming currents, so to speak, from the other station. That is to say, no signals are made at a station by its own sending currents, unless when these are interfered with by the sending currents of the other station.

Gintl's plan was as shown in Fig. 1. The receiving instrument, R, was wound by two separate wires, one long and thin, the other short and thick. The long wire, shown by a full line, was connected at one end to the line L, and the short wire, shown by a dotted line, was connected at one end to a local, or, as it was called, a "com-

compensating" circuit. Both of these wires were connected at their other ends to a signalling key or sending instrument,  $K$ , having duplicate points. Two batteries,  $B$  and  $B'$ , one large and the other small, were also connected to this key in such a manner that on making contact the current from the larger battery  $B$  passed through the long coil of the instrument into the line, while at the same instant the current from the smaller battery  $B'$ , passed through the short coil and compensating circuit. These two currents were so adjusted as to balance each other in their effects on the indicator of the receiving instrument, and no signal was therefore made by the outgoing or signalling current from the battery  $B$ . Such was Gintl's arrangement at both stations,  $s$  and  $s'$ . Confining our attention to any one of these stations, say  $s$ , we see that as long as only  $s$  is sending, the receiving instrument at that station is unaffected, but when  $s'$  is also sending at the same time, the currents in the line from  $s'$  must interfere with the currents in the line from  $s$ , either aiding or opposing these according to the poles of the battery which are applied, and thereby disturbing the balance of currents on the receiving instrument at  $s$ , causing it to make signals. And we see also that these signals are entirely under the control of  $s'$ —that when  $s'$  applies his battery to the line,  $s$ 's instrument will make a signal, and that when  $s$  applies his battery to the line,  $s'$ 's instrument will make a signal, or that when either put "earth" to the line, that corresponding "spaces" will be recorded. The currents do not cross each other in the line, as was sometimes thought, but they interfere with each other in such a way as to disturb the electric balance which independently exists at either end.

One objection, however, to this plan of Gintl's was that the lever of the key during sending interrupted the line circuit when it was between the earth and battery contacts; and another more serious objection lay in maintaining the equivalence of the two currents, as the smaller battery working through the shorter circuit lost power more rapidly than the signalling battery.

Gintl, however, in the following year (1854) obtained better success with a Bain's chemical printing instrument. Here he made the two currents oppose each other upon the chemically prepared paper and no stain was produced by the outgoing current. The sending current from the other station neutralised to a certain extent the outgoing current and the local current then overmastering it stained the paper and produced signals.

Early in 1854, while Gintl was still engaged in experimenting with the Bain's instrument, a great improvement was effected on his plan by Herr Carl Frischen, a telegraph engineer of Hanover. Frischen dispensed with the second battery  $B'$  and split up the signalling current itself, causing one part to pass round one coil of the receiving instrument into the line and the other part to pass round the other coil of the instrument into the local or compensating circuit. Instead of making the two wires of the instrument dissimilar, like Gintl, he made them both alike, so that the instrument was practically wound by equal wires in opposite directions and thereby rendered differential. He inserted into the compensating circuit a rheostat or set of resistance coils whose resistance could be adjusted to equal the electric resistance of the line. His arrangement at either station is shown in Fig. 2. Here  $R_1$  is the differentially wound receiving instrument,  $B$  is the battery, and  $R$  is the rheostat or artificial line as it was called, because of its being intended to imitate the actual line.  $K$  and  $E$  are as before, the sending key and earth plates respectively. In the act of sending a message, on making contact between the key and battery at  $a$  the current flowing into the apparatus divides itself at the point  $b$ , and part passes through the right coil of the instrument into the line, while part passes through the left coil into the local circuit. But the resistance of the local circuit being made equal to

that of the line and the two coils of the instrument being electrically equal one half of the current will flow through one coil and the other half through the other coil. The coils being oppositely wound these currents will neutralise each other in their effect on the indicator or needle of the instrument and no signal will be produced as long as they flow freely. We have seen, however, that the sending at the remote station may either oppose or assist that part of the current entering the line. Thus the balance is disturbed and signals will be made on the receiving instrument of one kind or another according as the line current or the local current overbalance each other.

In sending by this method of Frischen's the line circuit is never completely interrupted, but it will be observed that according to the position of the key the line is either applied "to earth" direct or through the battery, or through the resistance  $R$ , and this leads to a troublesome variation in the signals.

Friscchen's method was re-invented a few months subsequently by Messrs. Siemens and Halske of Berlin, who patented it in England, where, however, they were forestalled by a week by Mr. Stirling Newall, of Gateshead, whose patent bears date October 30, 1854. Newall describes substantially the method of Frischen-Siemens, and in 1855-56, successful experiments were made under his patent on the Manchester and Altringham line; but when he came to make trials upon the longer line between Birmingham and London, the static charge and discharge of the line was found to make false signals. Condensers or accumulators of electricity were applied to correct this disturbance with promising results, but the expense of constructing large condensers was objected to and their use was prematurely abandoned.

At this time there was a great deal of activity in the direction of duplex working displayed both at home and abroad. Besides the names mentioned, Messrs. W. H. Preece, Highton, De Sauty, and others in this country, Edlund, Bosscha, Kramer, in Germany, and Farmer, in America, were all more or less engaged in the work. In 1856 a good many lines were worked on the duplex principle in Prussia, but the time was not yet ripe for its successful introduction, and it gradually fell into disuse again. Some desultory activity was still shown here and there, however, showing that the idea had not been lost sight of. In 1862 Mr. William Hinckling Burnett patented a method of working two or even three distinct systems of telegraphy by the use of currents of different degrees of force, and in 1863 M. Maron, of Berlin, appears to have first placed the receiving instrument in the diagonal of a Wheatstone's balance. This has been called the Wheatstone bridge method in the recent revival of duplex, and it may be shown as follows, Fig. 3.

Here  $r$  and  $r'$  are two of the branch resistances of a Wheatstone's balance; the line and artificial line, or rheostat,  $R$ , forming the other two branches. The receiving instrument,  $R_1$ , is inserted in the "bridge" wire. In sending, the current from the battery  $B$  splits at  $b$ , and part passes by  $r$  into the actual line, while part passes by  $r'$  into the artificial line. If  $r$  be equal to  $r'$ , and the actual line be equal to the artificial line, the current will divide itself equally, and the potentials, or, as it may be called, the electric levels, at  $c$  and  $d$ , will be equal, and there will be no tendency for a current to flow through the cross channel or "bridge wire," and the receiving instrument will not, therefore, be affected. When, however, the line currents are interfered with by the sending currents of the distant station, this balance will be disturbed, currents will flow through the "bridge wire,"  $cd$ , and the receiving instrument will signalise. The resistance,  $w$ , may with some slight advantage be made equal to the battery resistance. It will be seen that in the balance method, as in the differential method, the principle consists in dividing the signalling current between two circuits whose electrical properties are practically the same.



and so placing the indicator between these as to cause them to neutralise each other's effect upon it.

The credit of reviving the lagging interest in duplex telegraphy appears to be due to Mr. Joseph Barker Stearns, of the Western Union Telegraph Company, United States, who, in 1868, experimented on the New York to Boston line, and subsequently achieved considerable practical success on the overland lines of the company with which he was connected. In 1872 Stearns came to England and patented his system, which practically embraced the differential and Wheatstone balance

methods, as described, with the addition of a novel sending key and a condenser attached to the rheostat or artificial line.

With the differential method his arrangement is as shown in Fig. 4, where K is the new sending key, and C is the condenser. The advantage of Stearns's key is that the manipulating lever, *a* (which is permanently connected to the battery B), makes contact with the lever *b* (which is permanently connected to the receiving instrument), before *b* is disconnected from the earth wire *w*, so that, in sending, the line may always be "to earth,"

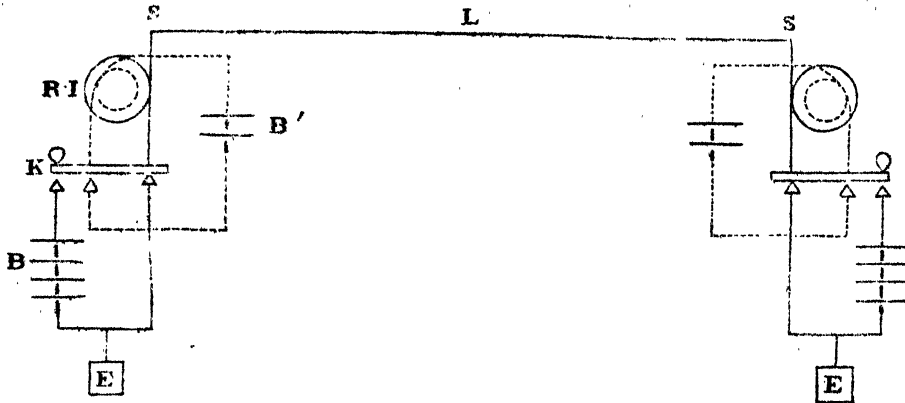

FIG. 1.

either through the battery B, or the earth wire *w*. Thus the evils of both Gintl's and Frischen-Siemens's methods are obviated, inasmuch as the line circuit is not only never interrupted, but the resistance of the earth connection may be kept the same by keeping *w* equal to the resistance of the battery. In order to prevent the wasting of the battery while it is short-circuited for a moment through the key, the resistance, *w'*, may be added to the battery resistance, and *w* then made equal to both.

The condenser was applied, as in the experiments made under Newall's patent, to correct the effects of the static induction of the line upon the instrument. Condensers or accumulators had been in common telegraphic use for producing induction since Bagg's patent in 1858 and

flows back again out of the line to earth. Thus two sudden jerks or "kicks," as they are called, are produced on the electric balance, and false signals are thereby made. When, however, a condenser or other inductive apparatus is added to the artificial line, so as to give it induction, too, the charge and discharge "kicks" of the artificial line may be made to counterbalance those of the actual line. In short, it is clear that if the electrical properties of the artificial and of the actual line in induction, resistance, and insulation are approximately equal, a duplex balance can be effected between them.

Stearns's key and earth connections were subsequently

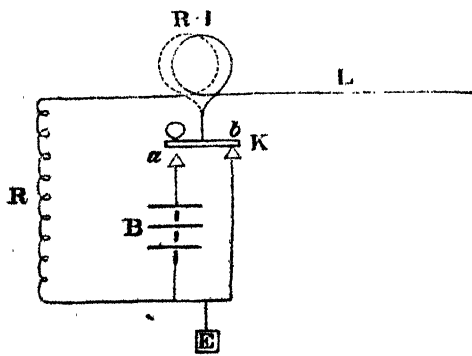

FIG. 2.

Varley's in 1860, and it is obvious that the sudden inductive charge and discharge of the line could be counterfeited by attaching a condenser or other inductive apparatus to the artificial line. This inductive effect is in general only sensible on land-lines upwards of 300 miles long. The induction between the wire and earth is then sufficient to maintain a sensible static charge on the wire, independently of the signalling currents, so that on working the sending key, and thus charging the line, the sudden static charge is for a moment added to the signalling current or dynamic charge; and, on the other hand, when the key is made to earth the line, this static charge

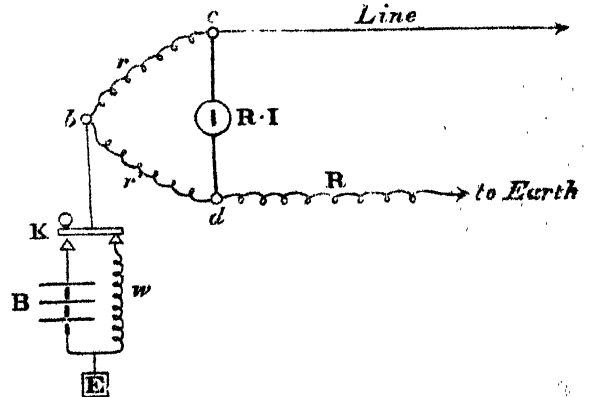

FIG. 3.

in the same year (1872) re-invented by Herr J. F. Naes, of Rotterdam.

In 1873 Mr. George Kift Winter, Telegraph Engineer of the Madras Railway of Arcunum, British India, patented in England a method of duplex (by opposed batteries, a principle which it appears had been previously applied by Mr. Moses G. Farmer, of New York, in 1858. Winter's method consisted in keeping the batteries at both ends of the line continually applied to it, so that their like poles opposed each other and a standing balance was maintained on the receiving instrument at either station,

which could be disturbed by the operator at the other station. This arrangement is shown in Fig. 5.

Here, as will be seen, the batteries are equal and are constantly connected to the line, so that their like poles oppose each other through the differential coils of the receiving instrument and the line. Thus the balance is maintained. But when at station S, for instance, contact is made with earth by the keys K, the battery B will be cut off from the line, and the current from station S', no longer opposed, will make a signal on the instrument there. Winter's method was tried with some success in India. Up to this time experiments had been for the most part confined to land-lines.

Attention now began to be turned to submarine cables, and Winter proposed the use of secondary batteries, made of plates of one metal (as lead) immersed in a single fluid (as sulphuric acid), in order to provide the large electric induction necessary to the artificial line, or by application in some particular way to the receiving instrument, so as to counterfeit the induction "kicks."

Stearns, also, in the same year, took out further patents principally for the purpose of extending his system to cable work. For example, he patented combinations of

condensers and resistance coils to represent an artificial

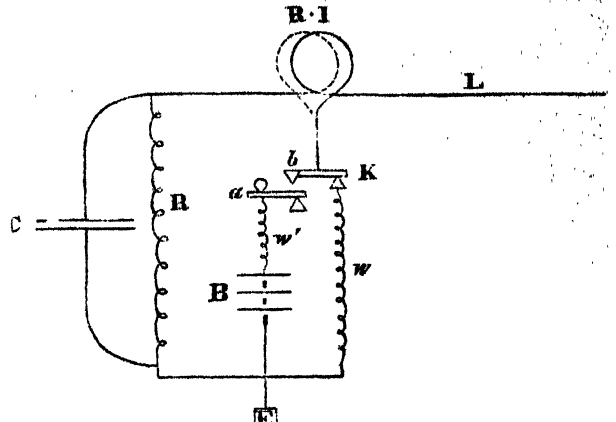

FIG. 4.

cable. This, however, had been done as early as 1852

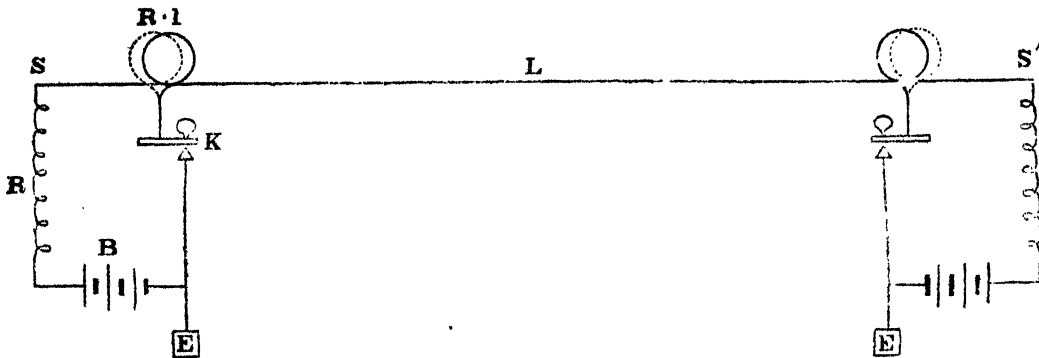

FIG. 5.

by Varley, for the purpose of making an imitation cable for use as a "test" circuit. Varley distributed his condensers along his resistance circuit in the manner shown in Fig. 6, so as to approximate to the uniform distribution of resistance and capacity in a submarine cable; but Stearns confined himself to attaching his condensers all at one point of his rheostat, and modifying their charges in various ways by means of resistance coils. Stearns also proposed various additional arrangements for superimposing "kicks" on the receiving instrument which should counterbalance the inductive "kicks" known to be very violent and difficult to obviate on submarine cables. He also describes a method of constructing his condensers in the form of a submarine cable;

and, apparently for the purpose of economising material, he further proposes to employ Gintl's original plan of two

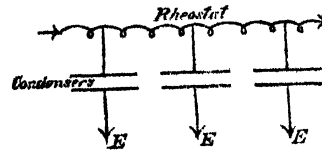

FIG. 6.

batteries; but in this case the stronger battery would be used to charge the artificial line, so that, with less capacity

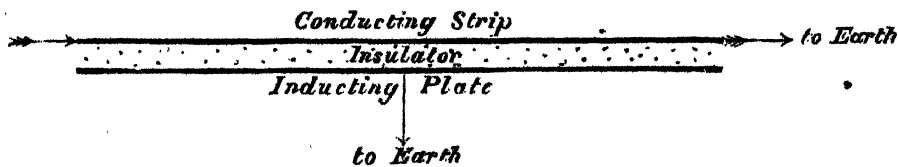

FIG. 7.

than the actual line, its inductive "kick" might be made equivalent to that of the latter. In fact, Stearns and Winter appear, naturally enough, to have striven rather to effect the duplex balance by some device or by an artificial line approximately similar, instead of aiming at one approximately equal to the actual cable.

In 1874 Mr. Louis Schwendler, of Calcutta, patented a system founded on the Wheatstone balance principle, and applicable to submarine cables by the use of resistance coils and condensers, or of a cable itself as an artificial

line; but Schwendler's system is only novel for the ratios between the resistances of the balance which it lays down. The best results are said to be given when the resistances  $r$ ,  $R$  and  $w$ , Fig. 3, are each one-half of the resistance of the line, and  $r$  is made equal to one-sixth of the resistance of the line.

The first successful trials in submarine duplex that we hear of are mentioned in the *Journal of the Society of Telegraph Engineers* for 1874. From this it appears that Messrs. De Sauty and Harwood, both of the Eastern

Telegraph Company (which had been encouraging experiments), had succeeded in effecting a balance, in 1873, on the Gibraltar-Lisbon cable by the use of the Wheatstone balance method, and Varley's artificial line. Also, in a letter to the *Telegraphic Journal* for 1874, by Mr. B. Smith, of the Eastern Telegraph Company, we learn that he had succeeded in effecting a balance on one of the Company's cables between Malta and Alexandria in July, 1873, so that he could receive messages while sending a distance of 911 nautical miles. In September of the same year Mr. Smith also reported good success on the Malta-Gibraltar cable, a distance of 1,121 nautical miles. We are not aware, however, that these methods have been in practical working for any length of time.

In 1874 Mr. John Muirhead, of the firm of Messrs. Warden, Muirhead, and Clark, telegraph engineers, Westminster, took out a patent for a new form of condenser, or inductive-resistance, so made as to imitate a submarine cable, and ostensibly for the purpose of duplex telegraphy. The inductive resistance is formed by taking two strips of tinfoil and laying one over the other separated by an insulator. One strip forms the conducting circuit of the artificial line, the other forms the outer, or inductive coating, and is connected to earth. The current is passed through the conducting strip and exposed throughout its entire length to the induction of the other strip or sheet in the same way that the current in the conductor of the cable is subjected to the induction of the earth throughout its length. The principle of Muirhead's artificial line is shown in Fig. 7, where the arrows represent the local current passing along the conducting strip while being at the same time retarded by the induction of the other strip, or inducting plate, which is connected to earth.

This artificial, or model cable, can be made to have the same resistance, capacity, and even leakage, per knot, that the actual cable has, so that it can be made practically equal in its electrical properties to the actual cable. It may be employed either with the differential or Wheatstone balance methods. In either case the local current passes through the conducting strip to earth, experiencing the same resistance and retardation that the signalling current experiences in the cable. It therefore balances the signalling current in its effects on the instrument. Its advantage over Varley's "artificial line" consists in the closer equivalence to an actual cable that it admits of. Subsequent patents of Mr. Muirhead describe various adjustments to be used in connection with the artificial line for the purpose of refining upon the balance.

In July, 1875, this system, which is hitherto the most successful of all in submarine duplex, was first tried on the Marseilles-Bona (Algeria) cable, a length of 448 nautical miles. In the spring of this year it was established for permanent working on the Marseilles-Malta cables of the Eastern Company, a length of 826 nautical miles, and also on the Suez-Aden cable, a length of 1,461 nautical miles, but in an electrical sense, one of the longest of existing cables. These are the first practical successes in submarine duplex telegraphy, and they also prove the feasibility of working cables of any length by this advantageous method.

## MUSEUM SPECIMENS FOR TEACHING PURPOSES<sup>1</sup>

### II.

**ARTICULATED** or mounted skeletons are divided into two classes: 1. Natural; 2. Artificial. The two processes may, however, be more or less combined in certain cases.

Natural skeletons are not macerated. The bones are merely

<sup>1</sup> Lecture at the Loan Collection of Scientific Apparatus, South Kensington, July 26, 1876, by Prof. W. H. Flower, F.R.S., Conservator of the Museum of the Royal College of Surgeons of England. Continued from p. 140.

cleaned by the hand, assisted by scalpel, scissors, and brush; the subject being placed in water during the intervals of the operation, to get it free from blood, and to soften the parts removed. Everything having been taken away, except the bones and the ligaments which unite them, the skeleton is fixed in the required attitude by external supports, and allowed to dry. This process is commonly adopted with very small mammals, birds, reptiles, and especially fish. It has the advantage of involving less labour and skill in articulation, and of affording a trustworthy record of the number and relations of the bones, especially the vertebrae, about which, in an artificially articulated skeleton, unless prepared by very competent hands, there always may be doubt. On the other hand, such skeletons are far less useful for the study of the details of their structure, they not only cannot be taken to pieces, but the extremities of the bones are actually concealed by the dried ligaments. The latter, moreover, often become brittle with time; and in the case of the smaller specimens, will break unless handled with great care. In such cases it is often advisable to strengthen them with isinglass, or when more support is required, some strands of cotton-wool steeped in melted isinglass or glue make excellent artificial ligaments.

2. Artificial skeletons are those in which the bones have all been separated and completely cleaned by maceration, or one of the processes substituted for it, and then joined together again by wire. The reconstruction of such skeletons is technically called "articulating." To perform it properly some knowledge is required of osteology, so that the bones may be placed correctly, which of course is of the utmost importance, and also some mechanical skill in drilling the holes in the bones, and in adapting and fitting the wires and metal supports, and several instruments are required, not needed in the preparation of natural skeletons, such as drills, pliers, wire-cutters, files, &c.

The best wire is iron-tinned, which does not rust, and is now sold at most ironmongers. For very fine work, iron wire plated with silver, and for still more delicate operations, especially in fishes' skeletons, thin silver wire may be used. Copper wire is too soft and flexible for almost all articulating work, and is apt to give a green stain to bones which contain any grease, and so should be avoided. Brass tubing of various sizes is now extensively used in articulating, and for larger animals, iron supports, which will have to be made by the blacksmith specially for each subject.

However great the knowledge of the articulator, it is always best to take precautions before macerating an animal, that there should be no mistakes in arranging the bones properly, especially in the case of rare and little-known specimens. The skin and the greater part of the soft parts having been removed, and the bones roughly prepared as for a natural skeleton, should then be divided into several parts. The sternum with the costal cartilages should be removed by cutting through the latter at the junction with the ribs, and cleaned in water without macerating, and then allowed to dry in their natural form on a block of wood, cut to the requisite shape and size. If this part goes into the macerating vessel, the cartilages will be lost, and the thorax can then only be restored in an imperfect manner. The limbs should be separated, and if each is macerated in a separate vessel, much trouble will be saved in sorting the small bones of the feet. If there is any doubt about articulating them correctly, it is best to take them out before they have actually separated, and clean them off and articulate them at once, at all events drilling the holes for the wires while they are still in natural apposition. The vertebrae may be allowed to come apart and macerate together, as there is never any difficulty in placing them in their natural sequence. The hyoid bones should be sought for in the throat, and cleaned and preserved separately, and small sesamoid bones about the feet and behind the knee-joint in most animals, so commonly lost in museum specimens, should be looked for and preserved, as well as the rudimentary clavicles of the carnivora and the pelvic bones of the whales and porpoises. When the relations of any bone to another, especially of the sesamoids above spoken of, or the chevron bones under the caudal vertebrae, are likely to be lost in maceration, they should always be observed, and either notes or drawings made of them, or they should be marked with fine holes, made with an Archimedes drill (an essential instrument to the articulator). By making two holes on different bones opposite to one another before the bones are separated, or several holes arranged in patterns, most important records can be preserved, and such small holes do not damage the bones, as they can be filled up afterwards with putty, or trans-maker's composition.

The perfection of a skeleton, an object always to be aimed at, it greatly depend upon the attention paid to all the small equations just named, and others which will suggest themselves in the course of the process.

In skeletons, as ordinarily articulated, the principal object aims to be to preserve the general appearance of the framework of the animal and to make the whole firm and strong, at the same time showing as little as possible of the supports necessary to hold it together. Every bone, even to the skull and lower jaw, is immovably fixed, and strong wires, or irons, according to its size, are made to traverse the interior of the limb bones, fixed into the stand below, and connected with the main support, which runs along the centre of the bodies of the vertebrae from head to tail.

Such skeletons are little better for the detailed study of zoology than are natural skeletons, and they are inferior, inasmuch as there is no guarantee against errors on the part of the lecturer, unless he be of known knowledge and experience.

The improvements in articulating skeletons that I am about to bring before your notice were commenced about twelve years ago, and are mainly due to the ingenuity and skill of the veteran fabricator to the Museum of the Royal College of Surgeons, my mesake, Mr. James Flower, who has successfully put into practice various ideas and suggestions which have occurred to me during the time of my conservatorship.

The object aimed at is to mount a skeleton which will give a perfect idea of the form and proportions of the animal and show the bones in their relative position, and at the same time allow every part of each bone to be separately examined. Any portion which is required for examination must be made capable of being moved without disturbing the rest of the skeleton. The skull, the lower jaw, the different vertebrae, the pelvis, the limb bones must be all separable.

Such a skeleton of course cannot be supported on its own limbs, like one of the old kind, as the bones of all the extremities may be removed one by one if necessary, leaving the trunk *in situ*. It will also be somewhat less firm and stable, and must be treated with care, as in fact a delicate and somewhat complicated instrument would be.

The details by which this principle is carried out vary greatly, and must be adapted to every different animal, and may probably yet still further modified and improved. The illustration sent to the Exhibition is a very fair example. It is a skeleton of a Malay anteater or pangolin (No. 3,812). The two principal mechanical arrangements adopted are simple enough.

They are, first, the use of brass tubes, into which wires of corresponding size are made to slide. This is the best method of connecting two parts, which have to be separated at pleasure. When necessary the tubes and wires may be flattened to prevent them rattling. The principal supports are made of tubes fixed into the wooden stand below, and into the upper end of which a short wire fixed in the bone to be supported slides. These tubes can readily be riveted to each other so as to make a branched support when required.

The second mechanical contrivance consists in the use of twisted or plaited wires as a means of movable connection between bones which need not be completely separated, but only rest upon each other as by a hinge. For instance, the principal uses of the limbs are connected by a strand of wires, twisted together like a rope, passing on one side of the joint. Each end is inserted in a hole drilled in the bone, and fixed by means of small wedges of wood or metal. These joints are so stiff as to maintain in any position in which they are placed, and yet are perfectly flexible and durable. The vertebrae are connected, by being fixed by wires, on to a plaited band, passed along the anterior surface of their bodies, where nothing of importance is needed by it. Since this skeleton was mounted it has, however, been found better in many cases to run the plaited wire through the canal, so that it is perfectly out of sight. Though stiffness in the mountings of a skeleton is certainly a desideratum, it is better to have any number of external supports to the bones, than either to fix immovably or to mutilate them, as was often done in the old plan, in order to allow of the introduction of the concealed supports.

The ribs, sternum, and sternal ribs are usually mounted in one solid piece, separable from the vertebral column, so that the tincture ends of all the ribs can be easily examined. In some cases it is found better to string the vertebrae upon a stiff rod, several pieces of rods, connected by sliding joints, from which they can be removed in succession. In fact, as before said, the articulations of these processes are numerous, but they can best

be appreciated by examining a few mounted specimens, and may be further developed by the suggestions of experience.

In addition to the complete mounted skeleton, museums will be expected to have separated portions of the bony structures exhibited in a manner that the student can study them. The skull especially must be treated in this way. For many years skulls of various animals have been prepared at Paris "*d la Beauclère*," and there are some good examples in the Exhibition contributed by Tramond, including an entire human skeleton (No. 3,913, also 3,915 and 3,918, skulls of man and turtle).<sup>1</sup>

All the bones are separated and fixed by brass bands and wires, at short intervals from each other, so as to allow of their complete form being examined.

The sliding joints formed of brass tubing will be found a great improvement in such specimens, as it allows the complete removal of any portion required for more particular examination. An example will be seen in the skull of a sheep (No. 3,819), contributed by Mr. E. T. Newton, of the Museum of Practical Geology.

A single bone is best mounted by driving a sharpened wire into its lower surface, which wire slides into a tube of corresponding diameter fixed in the wooden stand; in this way all the series of separate bones in the Museum of the College of Surgeons are mounted. The stands are made of turned wood, circular, polished, and black. All the brass work in them and the mounted skeletons is coated with a layer of black japan varnish.

I must not omit to mention a method of mounting skeletons devised and recommended by Prof. Huxley, the details of which have been developed by Mr. Newton from processes initiated at the College of Surgeons. There is an example in the Exhibition in the skeleton of a dog, No. 39042. Each of the bones of the skeleton is mounted separately with wire and tubing, as in the single bone just spoken of, but they are arranged on a single flat board in definite order, the vertebrae in succession along the middle, and the limbs on each side, each bone being near its actual position of the body. Skeletons so prepared can be arranged one above the other in a cabinet, each board running on ledges in the sides of the cabinet like drawers. They are very convenient for study and demonstration, especially for advanced students; but they are not so suitable for public museums or for elementary teaching, as they convey no idea of the general appearance, form, and proportions of the animal from which they are prepared.

Certain portions of the skeleton, especially of the lower vertebrae, are never ossified, but remain permanently in a cartilaginous condition, and when dried, shrivel and contract into small shapeless masses. But it would be often desirable, in a dry skeleton, to keep them if possible, if only to preserve the positions and relations of the surrounding bones. For instance, the axial portions of the skeleton of many fishes' heads are entirely cartilaginous, and so are the carpal bones of the crocodile. Such parts ought to be modelled either in soft wood or in the composition of whitening, resin, and linseed oil used by the picture-framemakers, which is soft and plastic when recently made, but sets to an almost stony hardness. Specimens of the application of such modelling may be seen in the Museum of the College of Surgeons.

Besides the skin, and the skeleton, many other parts of the body are frequently preserved in a dry state in museums. When bottles and spirits were very dear this method was much more attended to than at present, and it was extensively used for injected preparations, showing the course of the blood-vessels, and even dissections of muscles and nerves, as well as for the hollow viscera, such as the stomach, cæcum, &c., which were inflated, dried, and then varnished. There are many objections to such preparations. All soft and fleshy parts, when dried, contract so much as to give little idea of their appearance in the recent state, and in doing so disturb the relations of the parts in contact with them. Inflated organs, which look very well for a time, are apt to collapse, and they are all liable to decay and to perish from the attacks of insects. To guard against this it is absolutely necessary that the preparations should be thoroughly soaked in alcoholic solution of corrosive sublimate, or some other such poison, before the drying process commences. In Italy, especially in the Museum of Comparative Anatomy at Pisa, I have seen beautiful and very instructive specimens of viscera preserved in a

<sup>1</sup> I should also call attention to a beautiful human skeleton by the same exhibitor, for the purpose of pointing out a dislocation (No. 3,914), in which the principal bones are connected by coiled spring wire. This method has long been used on a partial scale, as for attaching the lower jaw to the skull, but is not so convenient as the one described above, as the elasticity of the spring is always an impediment to the free examination of the bones.

dried state, and it is to be regretted that none have found their way into this Exhibition, as they might have stimulated us to endeavour to do something to improve the art, which in most of our anatomical museums is now almost obsolete.

The methods of preserving the hard parts of invertebrate animals, such as insects, molluscs, and coral animals, in a dry state, are so generally understood, and so fully described in many special treatises,<sup>1</sup> that there is no occasion to detain you with them at present. The best illustration in the present collection of this branch of the subject is the very valuable and instructive preparation of the Exoskeleton of the common lobster (No. 3904) prepared by Mr. E. T. Newton, and exhibited by Prof. Huxley, which is a model of a class of preparations which might be largely employed in teaching zoology. I may also call attention to a small series of preparations contributed by Prof. H. Landolt, of Münster (No. 3878), which purport to show something of the life history and habits of several species of insects, an idea which might be more fully carried out in biological museums, and to the typical collections of the shells of molluscs exhibited by Mr. R. Damon (Nos. 3808 to 3811).

(To be continued.)

### OUR ASTRONOMICAL COLUMN

**THE NEW STAR IN CYGNUS.**—On the evening of December 13 this star, as regards brightness, was about midway between 75 Cygni and Bessel's star, Weisse XXI. 1004, the *Durchmusterung* magnitudes of which are 5.2 and 6.5 respectively, giving for the new star a magnitude of about 5.8 to 6.0, as stated last week. On December 20 it was not more than 0.25m. brighter than Bessel's star, indeed at moments it was difficult to say which was the brighter of the two; its present rate of decline is therefore slower than during the first ten days after the discovery. In the foggy sky of December 20, there was a yellowish tinge in its light, not perceptible in Bessel's star. A further careful search through our star-catalogues has failed to reveal any previous observation of a star in this position. It falls in one of the two zones, the re-observation of which has been undertaken at Bonn.

**THE BINARY STAR 6 $\beta$  ERIDANI.**—It may be hoped that some one of our southern observers is putting upon record measures of this double star, of which, so far as we know, none have been published since those of Mr. Eyre B. Powell at Madras, at the beginning of 1861, when the angle of position was 253°, and the distance 4".9. Altering the node in Capt. Jacob's second orbit to 109° 40', and assuming the peri-astron passage to have occurred 1817.64, with a period of revolution of 117.48 years, the measures from 1835 to 1861 are very closely represented, without change in inclination, distance of peri-astron from node, or semi-axis major. Dunlop's measures in December, 1825, which are of doubtful interpretation, would, with Jacob's corrections, differ 6½" from the computed angle. Later measures than those of 1861 are required for a decision on the true form of orbit.  $\alpha$  Centauri and  $\delta$  5114 (R.A. 19h. 17m. 50s., N.P.D. 144° 34' for 1876) are equally to be recommended to the close attention of the southern astronomer.

When a systematic remeasurement of the double stars of Sir John Herschel's Cape catalogue, which are out of reach in these latitudes, is undertaken (and we know of no more desirable or more interesting work in the miscellaneous astronomy of the other hemisphere), a large accession to the list of binaries may be anticipated. Perhaps M. O. Struve has not—in 24 Comae Berenicensis—detected the most rapid of the revolving double stars, which it may remain for a southern observer to bring to light.

**PERIODICAL COMETS IN 1877.**—Of the known comets of short period, only one—that of D'Arrest—has been predicted for the ensuing year, though if the elements of De Vico's comet of 1844 have not undergone a violent change since that appear-

ance, it may be expected to be in perihelion also within the next twelve months.

D'Arrest's comet will arrive at its least distance from the sun on May 10, but will not be nearest to the earth until October; its positions when observations should be most feasible, are not favourable for observers in the northern hemisphere. M. Leveau's elaborate ephemeris affords every possible assistance towards its detection. At its last visit in 1870 this comet was excessively faint, and was not observed at more than four or five of the numerous European Observatories.

Surely there must soon be an end of the dearth of discoveries of new comets which has prevailed since the beginning of December, 1874.

**ANCIENT SOLAR ECLIPSES.**—In NATURE (vol. xv., p. 116), Sir George Airy notes a difference in the path of the shadow in the total eclipse of B.C. 763, June 14, given in this column (p. 65) from that defined by a direct calculation from Hansen's Tables. In explanation of this difference it should be stated that our elements of the eclipse of B.C. 763, as also (with one exception) for other eclipses to which we have from time to time referred, are obtained by the use of Damoiseau's Lunar Tables of 1824, with the main arguments, and one or two of the principal equations adapted to the elements resulting from Sir George Airy's laborious discussion of the observations of the moon at the Royal Observatory, Greenwich, from 1750 to 1830, combined with M. Leverrier's Solar Tables, and the introduction of Hansen's last values of the terms in longitude, anomaly and node depending on the square of centuries.

### METEOROLOGICAL NOTES

**THE STORM OF MARCH 12, 1876.**—We turned with considerable interest to the account of this storm, which passed over the south of England on March 12, as published in the *Journal* of the English Meteorological Society for July. The interest was all the greater, seeing that the account was drawn up, at the request of the Council of that Society, by Mr. Scott, assisted by Messrs. Gaster and Whipple, that descriptions of the same storm had been previously published by Prof. Quetelst, Dr. Neumayer, and the late M. C. Sainte-Claire Deville, and that another paper on the same subject was intimated by Dr. Buys Ballot. The widespread interest which this storm has called forth is seen at once on looking at the nine weather maps and tables of Mr. Scott's paper, which show it to be one of the most remarkable storms of recent years, whether regard be paid to the rapid rate of its propagation eastwards, estimated by Dr. Neumayer at seventy-seven miles per hour over part of its course; to the rate of the barometric fluctuation, almost unprecedented in these islands, the barometer at Kew having risen 0.407 inch during the two hours from 2 to 4 P.M.; or to the violent contrasts of temperature and weather on the two sides of the storm at comparatively short distances apart. To illustrate the subject with greater fulness a woodcut is given showing the automatic registrations of the different meteorological instruments at Kew, and tables of pressure and temperature for every ten minutes during the most interesting phase of the storm. To these curves a noteworthy and novel feature is added in the form of a curve showing the electrical changes from positive to negative, and vice versa, at the time. The hourly readings of their self-recording instruments for March were moreover published shortly after by the Meteorological Office. On turning to these two barometric records taken from the same instrument at Kew, referring to the same time, and published by the same authorities, and comparing them together, we meet with nothing but confusion. Of the whole of the eleven instances on which readings are printed in the two reports for the same instants of time, no two agree, the eleven differences being in order, +0.006, -0.022, -0.008

<sup>1</sup> The most recent being "Notes on Collecting and Preserving Natural History Objects," edited by J. E. Taylor, Ph.D., and published by Har-

-0.040, -0.020, -0.001, -0.040, -0.004, -0.012, -0.027, and +0.003 inch. Whether or not the readings in the paper be reduced to sea-level, no information being given on this point, the whole observations of at least one of these two records are entirely wrong. In explanation of discrepancies previously pointed out, it was stated by the office that the original photographs may not admit of a precision closer than 0.020 inch. In this case, however, such an explanation is out of the question. Equally loose and inaccurate are the descriptions of the Kew curves, even though the main design of this costly system of registration is to furnish data for exact comparisons being instituted among the different meteorological elements. Thus it is stated that the electricity, having been strongly negative, returned again to positive between 6 and 8 A.M., whereas the change occurred all but instantaneously about 6.45 A.M.; that simultaneously with the time of maximum temperature, about 12.20 P.M., the wind, which had been west "suddenly became north," whereas the change was not of such a character as to be described by the words simultaneous and sudden, seeing that about fifteen minutes elapsed as the wind veered from west to north; that "the barometer rose rapidly until 4 P.M., at an average rate of about 0.005 per minute," whereas this rapid rate of increase of pressure was spread over no more than the fifty minutes from 2 to 2.50 P.M. It is needless to remark that the data of this singular storm thus put before us are worse than useless and it may be also stated that a number of the barometric observations at Kew, as published in the *Hourly Readings* for March, are of such a character as to render a verification by comparison with the originals very desirable.

DIURNAL BAROMETRIC RANGE AT LOW AND HIGH LEVELS.—We have recently received from Mr. W. W. Rundell, a paper on this important subject, published about two years ago in the *Journal of the Meteorological Society of London*, based on observations made under the direction of Gen. Myer during May, 1872, on Mount Washington, New Hampshire, at heights of 2,639 and 6,285 above the sea, hourly from 6 A.M. to 6 P.M., and at 9 and 12 P.M., and at Portland, Maine, 54 feet above the sea and near the coast, at 7 and 8 A.M., and at 2, 5, 9, and 12 P.M. The means of atmospheric pressure, temperature, and humidity, are given for the different hours of observation, to which are added interpolated values for the hours of the day for which no observations were made, by drawing a fair curve passing through the observed values plotted off on a moderately large scale. These various averages are laid down in sets of curves accompanying the paper. The point of interest raised by such a discussion consists in the presentation of these three vital meteorological elements at three stations not far apart from each other, but very differently situated as regards height above the sea, and the probability that some light may thereby be thrown on one of the most difficult problems in physics. On examining the curves the attention is at once arrested by the remarkable character of the curve of the diurnal barometric range at Portland, which represents the morning maximum as occurring at 6 A.M., and the afternoon minimum at 2 P.M. Deductions of a somewhat large nature are drawn from the times of occurrence of these and others of the maxima and minima of the paper tending to show that they stand to each other in certain definite relations. Since, however, the facts of observation afford no instance of the morning maximum occurring in May at such places as Portland at 6 A.M., and the afternoon minimum at 2 P.M., we were led to calculate afresh the averages from Gen. Myer's figures with the result that the averages of the six hours of observations published in the paper are all in error in amounts varying from +0.027 inch to -0.004 inch. The fresh averages, it may be remarked, give an amplitude of range and time of occurrence of the extremes accordant with what has been observed in latitudes and situations similar to that of Port-

land in May. It is obviously premature to discuss the various points raised until the necessary data be put in order before us, and the interpolated values for the unobserved hours be laid down on a method based on a wide knowledge of observed values for the same hours at places similarly circumstanced.

THE CLIMATE OF GENEVA.—A large work on this subject has just been published by Prof. Plantamour, in which are discussed with clearness, precision, and great fulness, the observations made at the observatory during the past fifty years, on temperature, pressure, moisture, rainfall, winds, clouds, and thunderstorms. The hourly averages of the different elements of each month for each year and for groups of years are given, as well as the averages for each day of the year, and the average or sums of the pentades and months for the long periods during which the observations have been made. There is thus amassed in a handy form in one volume of 263 pp. 4to., data for the elucidation of the climate of this part of Switzerland, as well as for larger inquiries which fall to be dealt with by comparative meteorology, and for the investigation of many cosmical questions. Among the specialties of the climate of Geneva, the most interesting, perhaps, are those which arise from its position with reference to its lake. The variations in the direction and force of the wind during the day show land and lake breezes of a strongly marked character—the breeze from the lake prevailing at those hours of the day when the temperature of the land is in excess of that of the lake, and the land-breeze during the rest of the day. In December, when the land at no hour of the day is warmer than the lake, no breeze from the lake prevails. In January, however, the breeze from the lake begins slightly to prevail, and in an increasing degree in succeeding months, forming a marked feature in the climate of the town during the greater part of the year, and leaving its impress in nearly all directions on the different meteorological elements. During the winter months, when no breeze from the lake prevails, or but a feeble one, the vapour curves show only one daily minimum, occurring about sunrise, and one maximum about 2 P.M.; whereas during the other months, from March to October, there occur two daily minima, one about or shortly before sunrise, and the other from 2 to 4 P.M., and two maxima, one from 8 to 11 A.M., and the other from 6 to 10 P.M., according to season. Equally marked are the curves of the hourly variations of cloud, the maximum during the winter months occurring about sunrise and the minimum about sunset. During the warm months, however, there are two daily maxima and minima—the first maximum occurring about or shortly after sunrise, and the second, which is by far the larger of the two, about 6 P.M., and the two minima shortly after midnight and from 9 to 11 A.M. These variations in the moisture of the air of Geneva are attributed by Plantamour to the condensation and evaporation which take place at the surface of the earth, and to the ascending and descending aerial currents consequent on the diurnal march of the temperature. These are undoubtedly true causes concerned in bringing about diurnal hygrometric changes, but they are insufficient to explain the strongly-marked double maxima and minima observed at Geneva. This will be evident by a simple reference to the hygrometric curves for such places as Valentia, Toronto, and Oxford, which either exhibit no second maximum at all, or if they do, so faintly marked as to form no outstanding feature of the curves. The explanation, in all probability, of this peculiarity of the Geneva hygrometric curves is to be found in the relative size of Lake Geneva which is just large enough to occasion a strong breeze during the day from the lake *all round its shores*. On the setting in of the breeze, the air having been some time previously resting on the surface of the lake is therefore moist, and while this continues the first daily maximum is reached. As, however, the breeze continues, the air finding it must necessarily, owing to the same

parative smallness of the lake come from higher strata of the atmosphere, and since this air has been, but a brief time in contact with the surface of the water the lake breeze becomes constantly drier till the afternoon minimum from 2 to 4 P.M. The breeze thereafter diminishes in force, the air consequently becomes moister till the greater maximum is attained about the time of the day when the breeze from the lake falls to a calm. This special feature of the climate of Geneva well deserves the closest investigation, particularly in its relations to the curves of temperature, pressure, and clouds. Among the other points discussed may be mentioned an examination of Deville's cold and warm periods of the year by the long series of the Geneva Observations; a comparison of the temperature of the water of the Rhone, as it issues from the lake, with that of the air, showing the mean annual temperature of the water to be  $3^{\circ}7$  higher than that of the air, a point of some importance in connection with questions affecting oceanic circulation; the distribution through the year of strong northerly and southerly winds, and the variations, regular and irregular, in the amount and duration of the rainfall.

CLIMATE OF LUND.—A paper of considerable value has been published by H. A. V. Tidblom, in *Lunds Universitets Arsskrift*, tom. xii., on the meteorological observations made at the observatory at Lund from 1741 to 1870. The observations, which are very fully discussed, embrace the temperature, winds, rain, snow, thunderstorms, and auroras, and their great value lies in the long period, viz. 130 years, over which they extend. The highest observed temperature during the 118 years ending 1870 was  $94^{\circ}1$ , and the lowest  $-13^{\circ}9$ , both occurring in 1845. Northerly and easterly winds prevail in winter and spring, north-westerly in summer, and south-westerly in autumn—these winds being of special interest from their relation to the prevailing winds in the south of Norway in the corresponding seasons. Hail falls on an average 5 days in the year, snow 37 days, and rain 122 days. March is the month of smallest and least frequent, and August of greatest and most frequent rainfall. Thunderstorms reach the maximum in the last half of July and first half of August, very few occurring from the middle of October to the middle of April. The greatest number of auroras occur in April and September, and the variations through the different years are very great, a remarkable maximum period occurring from 1776 to 1790, since which latter date the number has been singularly few.

WEATHER SUMMARY.—M. H. Tarry's *Histoire de l'Atmosphère* for July and August, 1876, has been received. The publication, which recently began to be published in *Les Mondes*, aims at giving a summary and discussion of the meteorological elements of the northern hemisphere, which it is possible to collect within a month or two of their occurrence. It is thus calculated to be a useful supplement to the weather maps of Europe and America, and to the International Meteorological Observations of the United States, and as such it deserves the active support of the meteorologists of different countries.

INFLUENCE OF FORESTS ON OZONE.—In a note by M. L. Fautrat in the *Bulletin Hebdomadaire*, No. 475, of the Scientific Association of France, it is shown from observations made at Halatte and Ermenonville, that less ozone was observed in forests, particularly forests of pine, than in the open country, and more ozone at a height of 46 feet above the ground than near the surface.

#### NOTES

THE Loan Collection of Scientific Apparatus is to be finally closed on the 30th inst.

THE Danish Geographical Society enters upon its existence under royal auspices. In accordance with the invitation of the

King of Denmark, the first public session was held in the royal palace at Copenhagen, on December 22, accompanied by appropriate festivities. The King has accepted the position of Protector of the Society, while the Crown Prince is active president.

THE veteran chemist, Prof. F. Wöhler, has been elected president of the German Chemical Society for the coming year.

A TELEGRAM received by M. Sidoroff from Capt. Wiggins, and communicated by the former to the *St. Petersburg papers*, announces that on December 13 Capt. Wiggins and his shipmaster, M. Svanenberg, left Krasnoiarisk on their way to St. Petersburg.

OUR readers may remember that at the International Conference on the means for exploring Central Africa thoroughly and systematically, held at Brussels last September under the presidency of the King of Belgium, invitations were issued to the different countries represented to form local committees for the furtherance of this object. The German National Committee was formed last week under the presidency of Prince Henry VII. of Reuss, and embraces many of the most distinguished names in the empire. A committee has already been intrusted with the duty of preparing the statutes for a permanent association, the German Society for African Exploration, which is to be under the patronage of the Crown Prince, and expects to enter vigorously and energetically upon its chosen field.

THE *Daily News* correspondent at Rome writes that the Marquis Antinori has sent to the Italian Geographical Society a long account of the journey of the Italian African Expedition of which he is leader. The expedition has, after many hardships and delays, reached Shoa, the king of which has received the members in his capital, Liocé, with the greatest hospitality. The Marquis has taken steps to make Shoa a scientific *entrepôt*, as a basis of operations for exploring the equatorial lakes. When the letter left the Marquis was preparing an extended scientific report of his journey to be forwarded to the Italian Society by a courier.

IN the last session of the Berlin division of the German and Austrian *Alpen-Verein*, Dr. Scholle delivered an elaborate address on the orography of the Bernese Alps. He regards them as distinguished from the mountains of other alpine regions by the following peculiarities:—The valleys are unusually deeply cut. The mountains inclosing these valleys are remarkable for their relative as well as their absolute heights, and the horizontal projection of their tops lies always at but a short distance from the bottom of the valleys. Finally, the topmost points of the mountains are generally visible from the valleys, and their commanding appearance imparts to the landscape its most picturesque and magnificent features.

THE *Bulletin* of the French Geographical Society for November contains a paper by Dr. Jules Carret on the Displacement of the Polar Axis, in which he gives a summary of arguments in favour of displacement which will appear at length in a work about to be published by him.

THE following particulars are given by Prof. Desor in the last number of the *Bulletin* of the Society of Natural Sciences at Neuchâtel, as to the burial-ground of the inhabitants of the lake-dwellings discovered last winter on the shores of the Lake of Neuchâtel at Auvernier. The burial-place is about 100 feet distant from the well-known lake-dwellings of this locality, at the foot of a hill, and it was shut up by some 7 feet of earth washed by rains from the slopes of the hill. It has a quadrilateral form (1.6 metre long and 1.12 broad), and is built of flat granitic stones covered with two large flag-stones of gneiss, these last necessarily having been cut artificially. The burial-place thus belongs to that class of dolmens which are known in England as "stone-cists," and it establishes therefore a new link between the true dolmens and the lake-dwellings. Ambiguously

watching the excavation, Prof. Desor ascertained that he had really to do with a grave (that of a family, or of a clan), not merely with a receptacle of bones, the relative positions of bones proving that complete corpses were deposited in the grave, probably in a sitting position. The number of individuals buried must have been from fifteen to twenty. It was very difficult to obtain well-preserved skulls, the bones being much deteriorated and the excavations not having been made with the desirable accuracy; but some better preserved skulls show a close likeness to those found in other lake-dwellings, and especially to the skull of this kind described by MM. Rutimeyer and His in their "Cranicologie Helvétique;" they belong to the mesaticephalous (semi-long) form known as the "Sion group," which form is also the true Helvetic. This form, which has been found in the stone age, continues to appear throughout the bronze and stone ages, constantly increasing in size, and showing a more and more developed, higher and broader, forehead; and it differs from the present Helvetic form not in kind but only by the degree of its development. The implements found in the grave are stone and bone implements belonging to the age of polished stone. But along with them were also found bronze implements (a perforated disc, a ring, and a pin), which thus establish the long missing link between the lake-dwellings of the stone age and those of the bronze age, both of which have representatives at Auvernier. The importance of the Auvernier grave is thus very great, as it gives new proofs in support of the alleged unity and continuity of races of prehistoric man during the stone age and that of the bronze. Some bronze implements implying a somewhat higher degree of culture, together with a bead of yellow amber and a skull, were found in the neighbourhood of the grave, on a somewhat higher level; they belong probably to a more recent period. It is proposed by the Neuchâtel Society to undertake further excavations in the same locality.

THE earthquakes which were felt in the Canton of Neuchâtel last spring (from April 2 to May 16) are the subject of two interesting communications by Prof. Desor and Dr. Tribolet, published in the last number of the *Bulletin* of the Neuchâtel Society of Natural Sciences (vol. x, part iii.). Dr. Tribolet, in addition to particulars of the earthquakes of this year, gives also a list of those known to have been felt in the canton since 1313. From this list we see that earthquakes were especially numerous during the seventeenth century, comparatively rare during the eighteenth, and totally wanting during the first half of this century, until 1852, when they begin anew to be frequent, twenty-four shocks having been felt from that year to the end of 1875. The earthquakes of last spring began with a strong one on April 2, at 5.55 A.M.; a second shock followed on April 30, and then, until May 16, no less than eleven shocks were felt in the canton at short intervals. The region of the shocks was generally limited, only two of them having been felt beyond the frontiers of the canton. As to their causes, Professors Desor and Studer, and Dr. Tribolet come unanimously to the conclusion that they have nothing to do with volcanic causes; but that the rocks of the Jura, forming a varied series of harder and softer strata, the latter mostly undermined by subterraneous streams and numerous caverns, it is very probable that the earthquakes are due to the crumbling of undermined strata, the seat of these crumbling being probably at a depth of about 1,400 feet, where friable dolomites and siliciferous marls are covered with hard muschelkalk. The exceptionally abundant rains of last spring must have contributed to the saturation of rocks with water.

PROF. LIVERSIDGE, of the University of Sydney, has published a report on the disease known as "rust" which has been causing great havoc among the sugar-canes in Queensland. This disease appears to have been first observed in the colony in 1870. Though most of the varieties of cane seem to have been more or

less affected, the Bourbon was the one upon which the disease was first noticed, and this kind has since suffered more than any other; soil and climate have also assisted its progress in a marked degree; thus it is said to have been almost exclusively confined to dry, porous, sandy soil, and to have been more virulent after unusually wet and cold seasons. The juice obtained from diseased canes shows a lower density than that obtained from healthy ones, and the sugar is more difficult to make. With regard to his microscopical examination of the diseased canes, Prof. Liversidge says he failed to detect anything which could possibly be considered as the cause of the disease; though the canes were affected by minute fungoid growths, they were not sufficient to account for the actual disease, and were, undoubtedly the consequence and not the cause. Red spots are found on all the plants, healthy as well as unhealthy, but more abundantly on the latter. It is to the presence of these red spots that the name of *rust* has been applied generally to the disease in Queensland. The fungoid growths are said to bear a very strong resemblance to a large group of very common microscopic fungi—the *Urediacæ*, to which order they are said probably to belong. Notwithstanding the prevalence of these fungoid bodies, and after a minute examination and analysis of various soils, the author of the report arrives at the conclusion that the disease has not been due to any one cause but rather to a combination of numerous complex, and more or less obscure causes, which are attributed to the system of cultivation adopted by the planters, the land being exhausted without a proper return being made to it.

IMPORTANT results have been obtained by parties of the United States Geographical Survey west of the hundredth meridian, under Lieut. George M. Wheeler, corps of engineers, in geology and natural history, Mr. H. W. Henshaw, the zoologist of the California Section, having made large collections of the vertebrate fauna, including every family of birds occurring in the West. The streams explored in Nevada and California were found to abound in fishes of the genus *Catostomus*, and among the specimens collected it is not improbable some species may be found that are new to science. In the reptilian collection are several snakes belonging to the genus *Eutania*, and a new species of lizard. In entomology the *Orthoptera* and *Coleoptera* are largely represented, including some rare species from the Alpine mountain region. Careful investigations were made in geology by Mr. A. R. Conkling, and the collections made taxed the facilities for transportation, the rocks gathered being chiefly igneous and metamorphic, including syenite, granite, basalt, &c. The predominating rock in the region thus far examined by the California scientific expedition is grey syenitic granite, containing numerous crystals of black hornblende. Several mines were explored and described in detail. In palæontology there were few collections, fossiliferous formations being rare. From the sandstone quarries in Ormsby County several specimens of the genus *Uro* were obtained, these tertiary fossils being the only representatives of extinct fauna observed.

WE have received a paper, "On the Larger Divisions of the Carboniferous System in Northumberland," by Mr. G. A. Lebour, being a reprint from the *Proceedings* of the North of England Institute of Mining and Mechanical Engineers, vol. xxv. Discussing the stratigraphical characters of the different members of the Carboniferous series, the author advocates a new subdivision of it into two stages, an Upper and a Lower, instead of the three adopted now; the blending together under a common name of "Bernerian" of the Yoredale Rocks, the Scar Limestone series, and the Calcareous and Carbonaceous groups which are incapable of natural division, and the additions of the Tuedian and of the so-called Upper Old Red to the Lower Carboniferous beds. A plate showing the stratigraphical changes undergone by the Carboniferous series from Derbyshire



to Berwickshire, on which the views of Mr. Lebour are based, accompanies the paper.

The General Council of Hautes-Alpes has decided to organise a special meteorological service for the purpose of carrying out the system of weather-warnings for agriculture for that department analogous to what have been established in other departments of France. The height and other physical peculiarities of the department make this a valuable addition to this system of warnings which is being gradually established over France with marked success.

A MEMOIR on the Ophite of Pando, in the province of Santander, by Don Francisco Quiroga y Rodriguez, which has just been published in the *Anales de la Soc. Esp. de Hist. Natural.*, is of considerable interest to petrographers, as it discusses the microscopic structure and mineralogical constitution of a rock of decidedly peculiar character, and at the same time enables us to realise the points of resemblance and difference between it and the similar rocks of the Pyrenees, described by Prof. Zirkel, and those of the province of Cadiz, concerning which Mr. Macpherson has recently given us such very interesting details. The rock in question is suspected to be of Triassic age, and among other features of interest presented by it we may mention the existence in it of a mineral which appears to possess characters intermediate between those of augite and diopside.

THE following further Saturday evening lectures have been arranged for in connection with the South Kensington Loan Collection of Scientific Apparatus. We do not yet know whether the closing of the Collection will interfere with their delivery:—December 30.—Prof. W. F. Barrett, on "Some of the Practical Applications of Electricity as Illustrated by Instruments in the Loan Collection." January 6.—Alexander J. Ellis, F.R.S., on "The Nature of Chords in Music, illustrated by Appunn's Apparatus." January 13.—Dr. B. W. Richardson, F.R.S., on "Stephen Gray and the Discovery of Electric Conduction." January 20.—Prof. Garrod, on "The Instruments exhibited by M. Marey, specially with reference to the Flight of Birds and Insects." January 27.—W. Chandler Roberts, F.R.S., on "The Means adopted for securing the Accuracy of the Coinage." February 3.—Prof. Osborne Reynolds, on "Vortex Motion." It is intimated that the Collection will be closed after Saturday, the 30th inst.

We are glad to see that an effort is being made to give the people of Hertford some knowledge of science, of the value of which they seem somewhat ignorant. Mr. Percy Smith and Mr. Vincent Elsdon have commenced a course of experimental lectures on Chemistry and Physics, which, to judge from the syllabus, is likely to prove both interesting and instructive to those who are wise enough to attend.

THE curious phenomenon of a ball being supported in air by a strong air current directed obliquely  $35^{\circ}$  to  $40^{\circ}$  from the vertical, has lately been exhibited in Philadelphia. Various explanations of it have been attempted by engineers and others. M. Renleaux (in *Poggendorff's Annalen*), rejecting previous explanations, offers the following:—The pretty thin air current, on reaching the ball, is deflected on all sides, and therefore more or less rarefied in its interior. Accordingly the atmosphere presses the ball in the direction of the greatest rarefaction, or the mean force of the rarefactions, towards the orifice. The weight of the ball acts vertically downwards. Equilibrium occurs between the obliquely-acting force of the current and the two forces just named, when the mean force of the latter is parallel to the action of the current. This can only take place when the ball has its centre under the axis of the current. There is then a pair of forces which put the ball in rotation. If the finger or a rod be brought to the place of supposed minimum pressure on the ball, the latter is forthwith driven off (as the

FROM a recent report on the cultivation of the vine in Madeira we are told that the *Phylloxera vastatrix* has partially attacked and destroyed many plants in some districts, but the evil has been discouraged the renewal and extension of plantations. The improved method of treating Madeira wines have rendered them more agreeable to the prevailing taste of consumers, and the demand for them is steadily increasing in every market. In Teneriffe many landowners have likewise turned their attention again to the cultivation of vines, and the wines of the island are thus increasing annually in quantity. The *Oidium* is gradually dying out, and where it still appears is successfully checked by sulphuring. The *Phylloxera* has as yet not appeared in any of the vineyards.

FROM the Annual Report on the Brisbane Botanic Garden we gather some valuable and interesting facts relating to the acclimatisation of economic plants. Of the three most extensively cultivated tropical plants—sugar, coffee, and tea, we learn that at present forty varieties of sugar-cane are grown in the garden, and that there is such a large and continuous demand for plants of such varieties as are known to be not yet subject to disease, that the director has recommended the setting apart from the Botanic Garden of a piece of ground to be used as a nursery for sugar and other plants of commercial value. It is satisfactory to know that with regard to coffee the plants of the ordinary kind (*Coffea arabica*) in the experimental plantation are all healthy, and show not the slightest sign of disease either from the *Hemileia vastatrix*, or any other cause. The northern districts, especially the sheltered ridges of the Hubert and Endeavour rivers are said to be the most suitable to the profitable cultivation of coffee, and some thirty acres of land on the Lower Hubert is to be put under this cultivation during the ensuing season. Of the Liberian kind (*Coffea liberica*) some seed have been sent from England, and these are growing into perfectly healthy plants, some of which, indeed, have been already distributed. Though the tea plantation is reported to be in a flourishing condition and numbers of plants have been distributed, the cultivation of tea, it is said, does not attract the attention it deserves owing to the high price of skilled labour required in the preparation of tea as a commercial article. Among other plants of interest introduced to the Garden may be mentioned the Paraguay tea (*Ilex paraguayensis*), which seems to be thoroughly well adapted to the climate of Queensland. Mr. Hill reports that the demand for it has of late very largely increased. The Balsam of Tolu (*Myroxylon toluifera*), the new tanning plant (*Balsamocarpon brevifolium*), the Sumatra rubber plant (*Urceola elastica*), and the Siam Gamboge (*Garcinia morella* var. *pedicellata*), all seem to be doing well. The consideration of the introduction of foreign grasses and other plants as well for fodder purposes as for renovating old pastures, has occupied some attention in Queensland, and the result is that many of our well known meadow-grasses as well as the *Trifolium Medicago*, and *Melilot*s have established a similar reputation in the new to that which obtains in the old. The only unsatisfactory part of Mr. Hill's report is that in which he tells us of the destruction and probable extermination of indigenous plants. Thus, in certain districts within the Colony, some trees formerly plentiful have almost disappeared, or are but rarely found. The Queensland Nut (*Macadamia ternstroemia*) is an instance, in districts abounding with it some years ago, it is now difficult to find even a single specimen. This has been caused in consequence of numbers of them having been cut down chiefly by South Sea Islanders for the purpose of more easily obtaining the fruit at the expense of the destruction of the tree. A similar fate seems to await the *Cycas* which is found between Port Denison and Cooktown, and the flour obtained from its seeds forms one of the principal articles of food in certain seasons, of the aborigines of that part of the Colony. During the visit of the North-East Coast Expedition of 1873,

quantities of it were found in the deserted camps, and unless preventive measures are promptly taken, from the wholesale destruction now going on, it will speedily share the fate of the *Macanassa*.

At the two meetings of the St. Petersburg Chemical Society, September 28 and October 19, many papers of interest were read. We notice among them a valuable report of M. Bogusky on his researches into the velocity of chemical reactions and on its dependence upon the degree of concentration of the solutions; a paper of M. Alekseeff on the mutual solubility of soluble liquids, the conclusions of which were, however, warmly criticised; a paper of Prof. Butleroff on the di-isobutylene, classing this body among the homologues of the ethylene series; and of M. Kovalefsky on the amount of mechanical power disengaged during chemical reactions, those of the sulphates of copper and zinc having been begun with in the course of researches undertaken by the author.

MR. THOMAS SOUTHWELL, of the Norfolk and Norwich Naturalists' Society, writes with reference to our notice of Mr. Marsham's "Indications of Spring" (NATURE, vol. xv. p. 128), that this remarkable series of observations commenced in the year 1736, is still continued by the Marsham family. In 1789 Robert Marsham communicated his observations to the Royal Society, they were read on April 2 and printed *in extenso*, in the *Philosophical Transactions* of that year. Robert Marsham died in 1797, and the observations were continued by his son Robert to the year 1810. From that time till 1836, no record was kept, but in the latter year a third Robert Marsham resumed them, by whom, and his son, the present Rev. H. P. Marsham, they have been continued to the present time.

THE experienced Arctic cruiser, Mr. Lamont, writes to the *Times* of Tuesday in reference to Dr. Petermann's recent letter to the Geographical Society, expressing his decided conviction, founded on his own extensive experience and that of many other practical Arctic men, that all round the North as round the South Pole, there lies an eternal mass of ice a thousand miles in diameter, and perhaps miles thick in the centre. He does not believe that either "ship, sledge, man, beast, bird, or balloon, will ever get across it."

THE additions to the Zoological Society's Gardens during the past week include two Bonnet Monkeys (*Macacus radiatus*) from India, presented by Mr. Peter Varwell and Mrs. Leopold Evans; a Chinese Eyebrowed Thrush (*Leucodipteron canorum*) from China, presented by Mrs. Arabin; a Short-eared Owl (*Otus brachyotus*), European, presented by Mr. Josh. Lee; three Golden Orioles (*Oriolus galbula*), a Redwing (*Turdus iliacus*) European, presented by Mrs. A. H. Jamrach; a Dunlin (*Tringa cinclus*), European, presented by Mr. F. Cresswell; a Snowy Owl (*Nictaea nivalis*) from Lancaster Sound; a King Parrakeet (*Aprosmictus scapularis*) from New South Wales; a Greater Sulphur-Crested Cockatoo (*Cacatua galerita*), from Australia, deposited.

### SCIENTIFIC SERIALS

*Poggendorff's Annalen der Physik und Chemie*, No. 11, 1876. —On the nature of elastic reaction, by M. Braun. —On the gliding of gas on glass walls, by M. Warburg. —Report on experiments of Dr. Root of Boston, on penetration of platinum by electrolytic gases, by M. Helmholtz. —Researches on the heat phenomena in the galvanic battery, and on electromotive forces, by M. Edlund. —Electro-magnetic properties of unclosed electric currents, by M. Schiller. —On the reply of M. Schlösser and the asserted preferability of ebonite for the discs of influence-machines, by M. Holtz. —Observation on the division, among two acids, of the positive metal in a galvanic battery, by M. Fuchs. —On phenomena of motion in electrified surfaces of mercury, by M. Herwig. —On the galvanic behaviour of gold, and a new kind of Nobili rings, by M. Schiel.

THE *Naturforscher* (November, 1876). —From this number we note the following papers of interest: —On the transparency of the water of Lake Lemán, by F. A. Forel. —On the meteoric iron of Neustaundorf, near Pirna (Saxony), by F. E. Geinitz. —On the absorption of albumen by the leaves of *Dionea muscipula*, by A. Fraustadt. —On the simultaneous occurrence of sugar and oxalate of lime in plants, by G. Kraus. —On electrical dust figures in space, by E. Lommel. —On some experiments with plants in coloured light, by G. Kraus. —On the dependence of the co-efficient of interior friction of gases from temperature, by A. von Obermayer. —On ascending air-currents, by Herr Crompton. —On microscopical inclosures in South African diamonds, by E. Cohen. —On the deterioration of air through artificial light, by Friedrich Erismann. —On the mechanics of breathing and the circulation of matter in the animal body, by E. Pfüger. —On the chemical composition of beech-leaves and fir-needles in different states of development, by L. Dulk.

*Morphologisches Jahrbuch*, vol. ii. part 3. —On the skin and dermal sense-organs of Urodela, by F. Leydig, with four plates. —On the metamorphosis of Echiurus, by W. Salensky, one plate, giving four stages of development. —On the exoskeleton of fishes, part 1; a long and valuable paper, by O. Hertwig, with six plates, dealing with the exoskeleton of Siluroids and Accipenseroids. —Prof. Gegenbaur has another contribution on the morphology of the limbs of vertebrates. —R. Wiedersheim discusses "the most ancient forms of the carpus and tarsus found in existing amphibia."

*Zeitschrift für wissenschaftliche Zoologie*, vol. xxvii. Part 3. —On the development of the lower jaw in Mammalia, by Dr. J. Brock; a histological memoir. —An account of the anatomy of *Rhynchelmis limosella*, with four plates, by Franz Vejdovskí. —On the organisation and minute structure of the Daphniæ and other Cladocera, by Dr. C. Claus, with four plates. —Description of a new hydroid polyp related to Allman's family Pennaridae, by F. E. Schulze.

THE *Journal de Physique* for November, 1876, contains papers on illumination of transparent and opaque bodies, by M. Lallemand; application of very thin layers of gold to cathetometers and other instruments of measurement, by M. Govi. —On the distribution of magnetism in cylindrical bars, by M. Routy. —On the physical properties of gallium, by M. Lecoq de Boisbaudran.

### SOCIETIES AND ACADEMIES LONDON

Mathematical Society, December 14. —Lord Rayleigh, F.R.S., president, in the chair. —Mr. R. F. Davis, B.A., and Mr. H. Weston Eve, M.A., head-master of University College School, were elected members. —Prof. H. J. S. Smith, F.R.S., read a paper on the conditions of perpendicularity in a parallelo-pedal system (the subject was of interest to crystallographers as well as to mathematicians). —Mr. Glaisher, F.R.S., gave an account of a paper by Prof. Cayley, F.R.S., on the condition for the existence of a surface cutting at right angles a given set of lines. "In a congruency or doubly infinite system of right lines, the direction-cosines  $\alpha, \beta, \gamma$  of the line through any point  $x, y, z$ , are expressible as functions of  $x, y, z$ , and it was shown by Sir W. R. Hamilton in a very elegant manner that in order to the existence of a surface (or what is the same thing, a set of parallel surfaces) cutting the lines at right angles,  $\alpha dx + \beta dy + \gamma dz$  must be an exact differential; when this is so, writing

$$V = \int (\alpha dx + \beta dy + \gamma dz) \text{ [we have } V = \zeta, \text{ the equation of}$$

the system of parallel surfaces, each cutting the given lines at right angles." The author obtains his results from the analytical equations of a congruency, viz.,  $x = mz + p$ ,  $y = nx + q$ , where  $m, n, p, q$  are functions of two parameters, and  $m, n$ , are given functions of  $p, q$ . The condition he gets for the existence of the set of surfaces is—

$$(1 + n^2) \frac{dm}{dy} - (1 + m^2) \frac{dn}{dx} + mn \left( \frac{dm}{dx} - \frac{dn}{dy} \right) = 0.$$

He verifies his results in the case of the ellipsoid. —Prof. Clifford, F.R.S., communicated two notes on the orthogonal transformation, and additions to former papers on transformation of elliptic functions. —Mr. Tucker read portions of papers by Mr. F. W. Frankland (New Zealand), on the simplest continuous manifoldness of two dimensions and of finite extent, (communicated by Mr. Spottiswoode, F.R.S.). —On the theory

of electric images and its application to the case of two charged spherical conductors placed opposite one another, Mr. W. D. Niven.—On viscous fluids, and Quaternary forms of some general propositions in fluid motion, Mr. J. G. Butcher (communicated by Mr. G. H. Darwin). An easy method of finding the invariant equation expressing any poristic relation between two conics, Prof. Wolstenhölme.

**Geological Society, December 6.**—Prof. P. Martin Duncan, F.R.S., president, in the chair.—Thomas Collinson, P. Lindsay Galloway, the Rev. George Middleton, S. H. Needham, Maskeil Wm. Peace, Nathaniel Francis Roberts, and John Stirling, were elected Fellows of the Society.—The President announced the sad loss the Society had sustained in the death of Mr. David Forbes, F.R.S., one of its secretaries, which took place on the morning of Tuesday, December 5. On this account the only paper read was on the intrusive character of the Whin Sill of Northumberland, by Mr. W. Topley, F.G.S., Assoc. Inst. C.E., Geological Survey of England and Wales, and Mr. G. A. Lebour, F.G.S., Lecturer on Geological Surveying at the University of Durham College of Science, Newcastle-on-Tyne. The Carboniferous Limestone series of the north of England contains a bed (or beds) of basalt, known as the "Whin Sill," regarding the nature of which opinion has long been divided. Some writers regard it as truly interbedded and contemporaneous; others look upon it as intrusive, and as having been forced laterally between the planes of bedding. The latter opinion is that held by the authors. Amongst the practical miners of the north of England there are very few who will admit any doubt that the Whin lies evenly, and at one constant horizon, amongst the strata. Clear cases to the contrary are looked upon as merely local variations, possibly due to successive eruptions of submarine lava. The work of the Geological Survey has shown that the Whin Sill lies at different horizons in different places: sometimes it even lies above the Great Limestone itself. In other words, the Whin Sill, which is supposed to mark the base of the Yoredale series, sometimes lies above the limestone which forms the top of that series. With the disappearance of the supposed base-line of the Yoredales goes also any good reason for drawing a line here at all. The authors traced the Whin Sill through Northumberland, as far north as Dunstanborough Castle, showing the varying positions at which it occurs in the Limestone series, and noting points of interest in some of the sections. The Whin shifts its position amongst the strata to the extent of 1,000 feet or more. It frequently comes up in bosses through the bedded rocks, and bakes the beds above it quite as much as those below, especially when those beds consist of shale. As to the age of the Whin Sill, nothing definite can be said.

EDINBURGH

**Royal Society, December 18.**—Sir William Thomson, president, in the chair.—The following communications were read:—On the roots of the equation  $\rho\phi\rho = c$ , by Gustav Plarr, communicated by Prof. Tait.—Applications of the theorem that two closed plane curves cut one another an even number of times, by Prof. Tait.—On the distribution of volcanic debris over the floor of the ocean—its character, source, and some of the products of its disintegration and decomposition, by Mr. John Murray, communicated by Sir C. Wyville Thomson.—On new and little-known fossil fishes from the Edinburgh district, No. 1., by Dr. R. H. Traquair.—Notes on the Ruff (*Machates pugnas*), by Prof. Dana.

MANCHESTER

**Literary and Philosophical Society, November 6.**—Charles Bailey in the chair.—Wealden fossils from Columbia, South America, by John Plant, F.G.S.—The raised beaches of County Antrim, their molluscan fauna, and flint implements, by Mark Stirrup, F.G.S.

November 14.—E. W. Binney, F.R.S., F.G.S., president, in the chair.—Notice of a passage in Clement of Alexandria on the origin of certain arts and customs, and their introduction into Greece, by William E. A. Axon, M.R.S.L., &c.

BOSTON

**Natural History Society.**—Mr. S. H. Scudder's contributions on the orthoptera continue to be among the most important papers published by this society. His "century" of new forms has reached its tenth decade. His latest published paper is

Descriptions of new Generic Forms, and an Alphabetical Synonymic list of the described Species." This extends over fifty pages, and will be of great use to entomologists.—W. H. Niles has contributed a paper on the geological agency of lateral pressure, exhibited by certain movements of rocks, referring especially to observations in sandstone quarries at Berea, Ohio, and in limestone quarries at Lemont, Illinois.

VIENNA

**Imperial Academy of Sciences, October 19, November 16, 23.**—The following are some of the papers read:—Researches on the contractility of the capillaries, by M. Stricker.—On the integration of linear differential equations of the second order through simple quadratures, by M. Winkler.—On the discriminants of the Jacobi covariants of three ternary quadratic forms, by M. Igel.—On the fresh-water fishes of South-Eastern Brazil, by M. Steindachner.—On the absorption spectrum of hypermanganate of potash, and its use in analytical chemistry, by M. Brücke.—On the magnetic observations of the Austro-Hungarian Polar Expedition, 1872-74, by M. Weyprecht.—On the action of bromine on succinimide, and a new way of forming fumaric acid, by M. Kisielinski.—On the velocity of propagation of sound-waves from explosion, by M. Mach.—Three papers by M. Velten (sealed packet). 1. On the transference of material particles by the electric current; 2. On the polar and magnetic behaviour of plant-cells; 3. On the magnetic behaviour of portions of the cell contents.—On the heat-conductivity of ebonite, by the Secretary.

GENEVA

**Physical and Natural History Society, November 2.**—M. Lucien de la Rive gave an account of his researches on the specular reflection of surfaces covered with hairs, these being considered as cylinders with circular base. The condition necessary for a cylinder to present an edge of specular reflection is that the axis of the cylinder be found in the plane normal to the bisectrice of the angle of the luminous and visual rays. It results that it is only possible to have a luminous angle by starting from a certain inclination of the visual ray. This principle is proved mathematically. It is applied to bodies of various forms, and explains the apparently abnormal play of light on children's heads, for example, and on any surface covered with hair. (*Vide Archives des Sciences Physiques et Naturelles*, t. lvii, p. 219, Nov. 1876).

CONTENTS

PAGE

DR. SCHLEMMANN'S DISCOVERIES AT MYCENÆ . . . . .	173
PESCHEL'S "RACES OF MAN." By Prof. ALFRED R. WALLACE, F.R.S. . . . .	174
OUR BOOK SHELF:—	
De Mosenthal and Harting's "Ostriches and Ostrich Farming" . . . . .	176
Rudolf Schmid's "Darwin'sche Theorien und ihre Stellung zur Philosophie, Religion und Moral" . . . . .	176
LETTERS TO THE EDITOR:—	
Sea Fisheries.—B. G. JENKINS . . . . .	176
Sense of Hearing in Birds and Insects.—Rev. GEORGE J. ROMANES, F.R.S. . . . .	177
"Towering" of Birds.—J. HOPKINS WALTERS . . . . .	177
The Tasmanians.—W. W. SPICER . . . . .	178
Algold Swarth-spores.—E. ROBIER . . . . .	178
Meteor.—Dr. P. L. SCLATER, F.R.S. . . . .	178
ON THE RELATION BETWEEN FLOWERS AND INSECTS . . . . .	178
AN ACCOUNT OF DUPLEX TELEGRAPHY ( <i>With Illustrations</i> ). . . . .	180
MUSEUM SPECIMENS FOR TEACHING PURPOSES, II. By Prof. W. H. FLOWER, F.R.S. . . . .	184
OUR ASTRONOMICAL COLUMN:—	
The New Star in Cygnus . . . . .	186
The Binary Star $\epsilon$ Eridani . . . . .	186
Periodical Comets in 1877 . . . . .	186
Ancient Solar Eclipses . . . . .	186
METEOROLOGICAL NOTES:—	
The Storm of March 12, 1876 . . . . .	186
Diurnal Barometric Ranges at Low and High Levels . . . . .	187
The Climate of Geneva . . . . .	187
Climate of Lund . . . . .	187
Weather Summary . . . . .	187
Influence of Forests on Climate . . . . .	187
NETS . . . . .	187
SCIENTIFIC SERIALS . . . . .	187

THURSDAY, JANUARY 4, 1877

## THE FARADAY LECTURE FOR 1875

*The Life Work of Liebig in Experimental and Philosophic Chemistry.* By A. W. Hofmann, F.R.S., &c. Delivered before the Chemical Society of London. (London: Macmillan and Co.)

**I**N this volume we have given us a sketch of the labours of Liebig in the domain of Pure and Applied Chemistry, and also an account of his manifold investigations in the direction of its Application to Agriculture and Physiology.

Prof. Hofmann has been induced to take the works of this great chemist as the theme for the Faraday lecture, not only from its being a subject in itself rich in most interesting matter, but, that from Liebig's studies on the relation and mutual bearing of the facts discussed by him, he was led to the conception of general laws elucidating chemical phenomena; thus standing beside Faraday as a fit representative of our century to future generations. Notwithstanding the great reputation Liebig now possesses, Prof. Hofmann seems to think that at the present time, we being almost contemporaneous with this great chemist, are not in a position to give to his works such appreciation as will be yielded them in the future; on this point Prof. Hofmann says:—

"As those who wander in a mountain chain cannot appreciate the sky-reaching grandeur of its lofty peaks as well as those who remotely from the plains beneath contemplate its snow-crowned summits, so we, the contemporaries of Faraday and Liebig cannot perceive the full dignity of their commanding forms—the philosophic pinnacles of this century—as they will hereafter appear to distant generations of posterity. In these days Faraday and Liebig will be looked up to with such reverence as it is ours to offer to the mighty spirits of the past—to such giant figures as those of Galileo, Kepler, Newton, and Lavoisier. And as that bright constellation shines on us from the misty darkness of the past, so will the names of Faraday and Liebig—stars of co-equal lustre—throw forward their bright beams on our successors through the far-reaching vista of ages yet to come."

Although expressing himself at the outset embarrassed by the richness of the subject, and consequently the difficulty of making any proper classification or selection of the many interesting investigations and discoveries to be discussed, Prof. Hofmann must be congratulated on the very successful result which has crowned his endeavours.

Commencing with a short review of the general work of Liebig with regard to the elaboration of apparatus and analytical methods for chemical research, Prof. Hofmann proceeds to speak of the great power Liebig had in imparting knowledge to others, and his influence over the mind of his pupils. He next draws attention to the resemblance between the labours of Liebig and Faraday in abstract science, and the abundant results they have produced in their applications to the useful arts.

In the field of agricultural chemistry, in his investigation of the laws regulating the growth of plants, we learn from Prof. Hofmann that Liebig first penetrated the doubt and uncertainty which had previously existed, establishing with certainty the relation which exists between the growing plant and soil and air in which

it lives. Standing as a monument of his most exhaustive researches on this point, we have his two works: "Chemistry in its Application to Agriculture and Physiology," and "The Natural Laws of Husbandry," this latter work constituting the first perfect treatise on the philosophy of agriculture which had appeared up to that time. To Liebig is also due the knowledge we now possess, that for proper vegetable growth the plant must be supplied through the land with those constituents which are found in its ash; and, as a sequence following from this, the fact, that should the soil become deprived of such constituents, it will be unfit for further plant growth till the proper saline ingredients are returned to it. With the knowledge acquired on such points he was naturally led to the production of artificial manures as a means for the fertilisation of land impoverished and exhausted by the crops grown upon it.

Passing from Liebig's labours in agricultural chemistry to those in the higher branch of biology, we find his discoveries producing no less perfect and important results. Although many isolated researches, as those of Chevreul, Berzelius, Gmelin, and Tiedeman, had been already conducted on certain constituents of the animal economy, still we owe to Liebig the collection of these widespread attempts into a "focus" for the elucidation of the phenomena of animal life. Of Liebig's chemico-biological work perhaps the best instances we can refer to are his "Investigations into the Origin of Animal Heat," his "Theory with regard to the Nutrition of Animals," and his "Doctrine of the Origin and Function of Fat in the Animal Economy." In the first of these inquiries he reviews the ideas of Lavoisier and Laplace, and the experiments of Dulong and Despretz, pointing out the errors of experiment the two latter investigators had fallen into, and from his own minute calculations proving the sensible heat of the animal body to be explained by the processes of combustion carried on within the organism. From his inquiries into the chemical nature of food, Liebig was led to his theory that the vegetable stands in a position intermediate between the mineral and the animal. The animal being unable to assimilate inorganic compounds, the vegetable acts as a means for transforming the mineral molecules into those of a higher order fit for the proper maintenance of the animal organism. The facts necessary for the support of his theory are to be found in the identity in composition of the nitrogenous principles, animal and vegetable, albumin, casein, and fibrin; a fact previously pointed out by Mulder, but exactly determined through analysis either by Liebig, or his pupils.

In the views promulgated by Liebig that it is in the animal organism, through the transformation of starch, sugar, &c., that the chief formation of fat takes place, he was led into a long and animated controversy with Dumas and Boussingault; but in this, as in other of his discussions, experiment has decided in favour of Liebig. Although the experiments of his opponents proved the existence of fat in vegetables, it was nevertheless in quantities quite insufficient to account for the amount found in animals when fed artificially on vegetable food alone. Like his investigations in agricultural chemistry, Liebig's discoveries in the biological branch yielded their proportion of practical applications, and from his investigations of the composition and nutrition of the animal body arose

the methods now used for the preparation of condensed food and for its preservation without decomposition.

On examining the purely scientific work of Liebig brought before our notice by Prof. Hofmann, the reader is at once struck by the varied nature of the researches. In his experiments on the cyanogen group, resulting from his examination of the fulminates, we are led back to some of the earliest stages of Liebig's scientific career. In this investigation, published at the age of nineteen and detailing experiments extending over two years, we have accurate proof given us of the very early age at which he had recognised the natural tendency of his mind. His experiments proving the fulminates to be isomeric with the cyanates brought him in contact with Wöhler, already working on the same ground, this friendship being soon destined to exercise a most important influence upon organic chemistry.

Liebig's investigations upon alcohol and its derivatives are interesting, not only from the fact that it was from his earlier experiments on this body proceeded the discovery of chloral and chloroform, but also that in his endeavours to elucidate the constitution of alcohol he was led into a long protracted discussion with Dumas and Boullay, a discussion resulting in the victory of Liebig. It would be impossible here to give a detailed notice of the remaining investigations of Liebig touched on by Prof. Hofmann in his discourse; it will be sufficient for us to mention Liebig's researches on the group of benzoic compounds, his discoveries in uric acid and its derivatives, executed in conjunction with Wöhler, and his elaborate work on the constitution of the organic acids.

Many as Liebig's experimental researches were he still found time for literary labour. It would be almost sufficient to mention the work founded by him, in conjunction with his friends, Wöhler and Hermann Kopp, as early as 1832, a work then and now known as "Liebig's Annalen," a most invaluable collection of recent experimental discovery. Of his other larger works two more may be mentioned, his "Dictionary of Pure and Applied Chemistry," begun conjointly with Poggendorff and Wöhler, and his "Handbook of Organic Chemistry," a treatise translated into French and English by Gerhardt and Gregory respectively.

Examining the whole "Life Work of Liebig" as put before us in this admirable discourse of Prof. Hofmann, the reader must be at once struck with the enormous amount of work which it is almost impossible to believe could have been accomplished by one man during a lifetime. The number of his papers published in the records of the Royal Society alone is, we are told by Prof. Hofmann, 317, of which 283 are by Liebig himself, the remainder published in conjunction with other chemists. It is worthy of remark, however, that from the number and ability of the pupils he drew around him, Liebig was able to trust certain of his researches to their care, invariably, however, giving his assistants all credit for any ideas or discoveries of their own.

If Liebig was followed ardently by his pupils it was because he possessed the rare gift of inspiring them not only with admiration but with love. With the spirit which was equally characteristic of Faraday's genius, Liebig endeavoured to lead his followers beyond mere single spheres of thought to the conception of laws regu-

lating wide ranges of phenomena, tending in their results to the material welfare of mankind.

We feel sure that this interesting account of the work of one so distinguished and widely known as Justus Liebig, will be read with great pleasure not only by chemists but by all who are interested in the progress of natural science.

JOHN M. THOMSON

#### HUNTING-GROUNDS OF THE GREAT WEST

*The Hunting-Grounds of the Great West, a Description of the Plains, Game, and Indians of the Great North-American Desert.* By Richard Irving Dodge, Lieut.-Col. U.S.A. With an Introduction by William Blackmore. (London: Chatto and Windus.)

MR. WILLIAM BLACKMORE, well known to anthropologists in connection with the Blackmore Museum at Salisbury, hunted buffalo on the great plains of the Far West with Col. Dodge. The American colonel's camp-fire stories seemed to his English companion well worth preserving, and thus the present volume came to be written, and dedicated to Mr. Blackmore, who has prefaced it with an introduction on the Indian tribes of North America and the causes of their extinction. No doubt Mr. Blackmore was right in encouraging his friend to write his book, which contains much curious information not got up out of other books, but drawn direct from life in the Indian country, and told well in barrack-room fashion. The bold picturesque illustrations by Grisct suit the contents well, and the volume in its red and gold binding might have been recommended as a gift-book, had the author had the discretion and good taste to exclude certain stories as to the relations of the sexes among Indian tribes, as well as several pages of revolting details respecting the fate of those who fall as captives into the hands of such tribes as the Comanches, which ought not to have found a place in it.

In pointing out that these contents must in great measure remove the book from popular circulation, we do not say that they should not have been printed somewhere, though a smart *ad captandum* volume was not the proper place. In fact they form part of a general description of Indian society, which students of the development of law and morals may read with considerable advantage. The necessary growth of some rule of female propriety in societies where the women are the absolute chattels of the men, is illustrated with remarkable clearness among the Cheyennes (see p. 301, &c.), and all the more plainly by contrast with the habits of their husbands, who, being no one's property, own no social restraint whatever. Again, however brutal the individuals of any tribe may be, there must be a social contract observed or the whole society would collapse. This also is well shown among the Cheyennes, by the fact that women obtain absolute protection by a merely symbolic form, which, if any man failed to respect, he would certainly be killed (p. 303). Again, the existing marriage law of the Cheyennes (p. 300) furnishes an instructive commentary on the story of King Gunther's marriage with Brynhild in the Nibelungen Lied, which is possibly a relic of Germanic custom in remote barbaric times. These are a few among many points in which modern savage society throws light on the

ancient manners of nations now in the front ranks of culture.

The state of the savage mind as contrasted with that of the civilised man is well brought out in the following remarks by Col. Dodge as to what will and what will not astonish an Indian:—

"The Indian has actual and common experience of many articles of civilised manufacture, the simplest of which is as entirely beyond his comprehension as the most complicated. He would be a simple exclamation-point did he show surprise at everything new to him, or which he does not understand. He goes to the other extreme, and rarely shows or feels surprise at anything. He visits the States, looks unmoved at the steamboat and locomotive. People call it stoicism. They forget that to his ignorance the production of a glass bottle is as inscrutable as the sound of the thunder. A piece of gaudy calico is a marvel; a common mirror a miracle. He knows nothing of the comparative difficulties of invention and manufacture, and to him the mechanism of a locomotive is not in any way more matter of surprise than that of the wheelbarrow. When things in their own daily experience are performed in what to them is a remarkable way, they do express the most profound astonishment. I have seen several hundreds of Indians, eager and excited, following from one telegraph pole to another a repairer, whose legs were encased in climbing boots. When he walked easily, foot over foot, up the pole, their surprise and delight found vent in the most vociferous expressions of applause and admiration. A white lady mounted on a side-saddle, in what to the Indian women would be almost an impossible position, would excite more surprise and admiration than would a Howe's printing press in full operation" (p. 309).

Both Mr. Blackmore and Col. Dodge lament over the wanton destruction of the buffalo in the hunting-grounds of the Far West, where they are killed by tens of thousands merely for the value of their hides. On the Arkansas River, where the hunters had formed a line of camps, and shot the buffalo night and morning when they came down to drink, Mr. Blackmore found their putrid carcasses in a continuous line along the banks (p. xvii.). He reckons that in three years as many buffalo have been thus wastefully slaughtered as there are cattle in Holland and Belgium, and the map prefixed to the book shows the insignificant patches to which the buffalo ground, in 1830 extending across the whole middle of the continent, had shrunk by 1876. How recklessly the extermination was carried on may be judged from the description, at p. 137, of the "great buffalo-skinner's" method of using a waggon and horses to take the hide off the carcass at one pull, the ordinary method of careful flaying being found too slow. The destruction of the buffalo, driving the tribes of hunting Indians to starvation and revolt, has done much to hasten the extinction of this doomed race. But it is not the only cause of their destruction so swiftly going on. Every one who reads the details here given as to how the Indians carry on their war against the white settlers, must see that the whites will inevitably pursue the policy of killing them down till only a helpless remnant survives. But every candid reader will agree with Mr. Blackmore and Col. Dodge that it is the ill-treatment of the settlers, and the faithless disregard of Indian treaties by the American Government, that have made the warrior tribes into human wolves. It is evident that a humane while firm policy might have given the Indian tribes at least some generations of existence and well-being.

We English have much to reproach ourselves with as to the treatment of indigenous tribes, but in Canada these have not fared quite so ill as in the United States. Indeed, Mr. Blackmore shows by American testimony that the comparatively prosperous condition of the Indian tribes in the British possessions is due to our more just and kindly management of them. But their prospects look hopeless enough in such districts as Idaho, in United States territory, where the legislature could put forth the following proclamation of reward to men who go "Indian hunting":—"That for every buck scalp be paid \$100, and for every squaw \$50, and \$25 for everything in the shape of an Indian under ten years of age."

Col. Dodge's chapter on "Travel" contains an interesting description of the branching ravines which intersect the table-land of the western plains, where valley-systems, with their numberless tributaries, often approach one another so as to be only separated by narrow "divides." Such a region presents interesting problems of valley-excitation to the geologist, but extraordinary difficulties to the path-finder, who, though his destination may be but a few miles off in the straight line, has to find and follow the divide, often in a circuitous track of as many leagues, that he may avoid a score of deep ravines which cut the ground between. Going up divides is easy enough, for they all must reach the principal, or summit, divide; but in going down, the one practicable divide has to be selected from hundreds which at the top look just as practicable to the waggoner, but only lead him, with his loaded wains, down upon the tongue of land in the fork of two steep ravines, where he must turn back and try again. Where there are buffalo, their trail marks the proper route, but otherwise the intricate maze can hardly be threaded except with the aid of an Indian guide or a perfect map. An account of these valleys, with a sketch like the author's, should find its way into every book on physical geography.

#### OUR BOOK SHELF

*The Combined Note-book and Lecture Notes for the Use of Chemical Students.* By Thomas Eltoft, F.C.S., &c. (London: Simpkin, Marshall, and Co., 1876.)

MR. ELTOFT is, we see from his title-page, engaged in teaching chemistry to two very large evening classes and also to the matriculation class at St. Bartholomew's Hospital, he has therefore very considerable experience as to the kind of instruction required by students going up for examination either to the University of London matriculation examinations, or to those of the Science and Art Department. His knowledge of the wants of the students has no doubt led him to the production of the "Note-book" we have before us; and we do not doubt that the system here followed will save the student much trouble otherwise incurred in wading through his own notes, so often ill arranged, and missing the salient points of the lecture.

The first twelve pages of the book following the index are occupied with a mass of useful memoranda, as we should prefer to call them, such as notes on formulæ, atomic weights, nomenclature, use of numbers, brackets, and signs, &c., in formulæ; the construction of constitutional formulæ, the base saturating power of acids, the density of gases, calculation of formulæ from analyses, and that tremendous crux with the ordinary student, the crith.

Of course the book is not intended for regular science

students such as attend the Royal College of Chemistry and other science schools, but rather for those who take up chemistry either as a branch of general education or as an evening study, and for this purpose it seems to be well fitted; at the same time there is the danger of cram to be guarded against. The author evidently feels this and has endeavoured to provide against it in a somewhat original manner. Pages 102-121 are divided into double columns, the left hand one on each page containing the preparation or reaction formulæ of one of the non-metallic elements and their more simple compounds; the right hand column is left blank, and the student is requested to note the conditions under which each substance is prepared either from the lecture or from a text-book. This device would if conscientiously carried out by the teacher, probably prevent cram of a certain sort, and compel the student to know a little more than the mere formula of a reaction or preparation. At the same time we must confess that we must still regard this knowledge as only another form of cram which is infinite in its varieties and made to suit the idiosyncrasies of each individual examiner, and which will exist as long as any form of knowledge continues to be looked on as something to "pass" an examination in; and as long as examiners continue to look only to a set of answers given on a certain day in a certain time to a particular set of questions, and not to the general character and capacity of the student. We therefore think that Mr. Eltoft will meet with failure in his well-meant effort; we trust, however, that he will continue to persevere.

The rest of the book is divided into double pages, meant for notes on particular elements, the pages being divided according to a scheme in which specific gravity, in the state of solid, liquid, or gas, colour, melting-point, and boiling-point, are successively considered. Another space is reserved for the description of the experiment, a third for sketches of apparatus, and a fourth for tests for the identification of the body. These pages will no doubt teach the student to systematise his notes to a very considerable extent and indicate to him a detailed method of observation.

In conclusion, we note that Mr. Eltoft, in his short preface, expressly states that his "note-book" is "not in any way supposed to take the place of a text-book, but to act as an adjunct to it." We regard it in this light as an honest effort to assist the large class of students for whom it is intended, and we hope that the author will watch the effect of the book on the classes he is teaching, look on his present effort as experimental, and come forward again with the aid of his increased experience to still further improve his work.

R. J. FRISWELL

### LETTERS TO THE EDITOR

[The Editor does not hold himself responsible for opinions expressed by his correspondents. Neither can he undertake to return, or to correspond with the writers of, rejected manuscripts. No notice is taken of anonymous communications.]

#### Solar Physics at the Present Time

IN reference to Prof. C. P. Smyth's letter in NATURE, vol. xv. p. 157, I think it my duty to state that Prof. Smyth's remark on the priority of his exhibited results of observations of deep-sunk thermometers (as bearing on the question of transmission of waves of temperature into or from the interior of the earth) is perfectly correct.

It was only in the last summer that, having occasion to inspect some parts of Prof. Smyth's printed "Observations," I became acquainted with the extensive series of diagrams illustrating this matter. I have not yet been able to refer to his cited paper in the "Philosophical Transactions." G. B. AIRY

Royal Observatory, Greenwich, S.E.,  
1877, January 1

#### Just Intonation, &c.

UNDER this heading your correspondent "A. R. C.," while explaining Mr. Colin Brown's "natural finger-board," writes thus:—"The vibration numbers of the diatonic scale being represented by—

$$1, \frac{9}{8}, \frac{5}{4}, \frac{4}{3}, \frac{3}{2}, \frac{5}{3}, \frac{15}{8}, 2.$$

If we build upon the dominant  $\frac{3}{2}$ , the vibration numbers will be—

$$1, \frac{9}{8}, \frac{5}{4}, \frac{45}{32}, \frac{3}{2}, \frac{27}{16}, \frac{15}{8}, 2,$$

and if we build upon the subdominant  $\frac{4}{3}$  the vibration numbers will be—

$$1, \frac{10}{9}, \frac{5}{4}, \frac{4}{3}, \frac{3}{2}, \frac{5}{3}, \frac{16}{9}, 2."$$

Unless "A. R. C." proposes some new system of tuning, I submit that he is in error in the first steps of his two examples. The dominant of C is G, and from G to A is a minor, and not a major, tone. Also the subdominant to C is F, and from F to G is a major, and not a minor, tone. I do not pursue the analysis, not desiring to criticise oversights, but to draw attention to a not uncommon misconception of the figures in the above scale, and to the general adoption of a miscalculation as to the so-called "Comma of Pythagoras."

An eminent mathematician, not long deceased, derived our diatonic scale from the one note F, by the following process:—"F A C—C E G—G B D," thus taking the common chords of three different keys. Had he followed out his system of adding on a new scale from the Fifth of the preceding, he would have gone the round of the keys, and have derived them all from F, which would have been the *redu. tio ad absurdum*.

Nothing can be clearer than the history of the scale, and it carries with it conviction of its truth. The octave was formed out of two Greek conjoined tetrachords, such as B C D E and E F G A, the E being common to both. Then the lower A was added at the bottom, to complete the octave, and it was called "the added note" (*proslambanomenos*) because it did not form part of any tetrachord. The reduction from the eight notes of the two tetrachords to seven is attributed to a superstition in favour of the number seven. Thus came our A B C D E F G A—a minor scale with a minor Seventh—and from it came our truer major scale, by commencing on the third note, C, but carrying with it all the imperfections of the double root of the original. No improvement has been made in the scale since the days when Archytas, the friend of Plato, introduced the consonant major Third, and Eratosthenes the minor Third. Our present scale is therefore absolutely anterior to the Christian era; the ratios of its intervals given by Greek authors prove the identity irresistibly. Let us then look to the figures which represent our scale as "A. R. C." has justly given them. The large 1 and 2 refer to C as the fundamental note and its octave. The 3 to 2, the 5 to 4, the 9 to 8, and the 15 to 8 represent octaves of the key-note (2, 4, or 8); but the 4 to 3 (the interval of a Fourth) and the 5 to 3 (the interval of a major Sixth) refer to C only as the so-called "Twelfth" above F, and not to C as the octave. If we play either of these two notes, F or A, with C, we cannot use C as a consonant bass. We must take F, and thus we have the old tetrachord system, with its double root, running in our present scale. In all keys the tonic and the subdominant are both necessary basses. F and A belong exclusively to F; but B and D have no relation to F, not being aliquot parts of the F string. They belong to the scale of C, but more intimately to that of G. The F string exceeds the length of the C string by 3 to 2, because its sound is that of a Fifth below C; therefore any attempts to bring the sounds of our scale to a common denominator are fallacious, the first law of Proportion being that "Ratio can subsist only between quantities of the same kind." Thus the "24, 27, 30, 32, 36, 40, 45, 48," cannot be accepted, because the 32 intended for the 4 to 3 of the scale, and the 40 for 5 to 3, represent other intervals. The 4 to 3 of C is the Fourth from C down to G, and the 5 to 3 of C is the major Sixth from E down to G. The 32 and 40 are not applicable to the interval of a Fourth from F down to C, nor to the major Sixth from A down to C.

And now as to the so-called "comma of Pythagoras," a strange name for the interval of 531441 to 524288! Can the modest inventor, who has concealed his own name, have supposed that the Greeks had musical instruments so very far

beyond the compass of our seven or eight octave grand pianofortes? This interval is simply the excess of the twelfth power of 3 over the nineteenth power of 2. As powers of 3 are Twelfths, in music—octaves with Fifths, and not merely Fifths—and as octaves are powers of 2, this comma represents B sharp as topping C in its nineteenth octave. Happily any nineteenth octave is beyond our powers of hearing, even if we adopt a No. 1 with only one vibration in a second of time. We may therefore dismiss so disagreeable a sound to the so-called "Music of the Spheres," in compliment to Pythagoras, who is supposed to have been acquainted with music of that kind.

We are too generally prone to rely upon the labours of our predecessors, and hence this peculiar comma has been received without examination, as the overlapping of twelve Fifths over seven octaves, as stated by "A. R. C." After having traced what it really is, wishing to find the author of the miscalculation, I took up a newly-acquired copy of Koch's "Musikalisches Lexicon," which, although written in the last century, is still reputed as a work of authority, and has been re-edited by Arrey von Dommer (8vo, Heidelberg, 1865). I found a more curious mistake: instead of twelve Fifths, it is there stated to be twelve Fourths or Fifths; and Koch's way of proving it is by multiplying the ratios, not as fractions, but as whole numbers. For example, a Fifth and a Fourth we know to make one octave, but Koch multiplies 3 times 3 = 9 in one column, and 4 times 2 = 8 in the other (p. 24). As the twelve threes are in one column, he arrives by multiplication at the twelfth power of 3, and as the fours and twos are in the other column, he arrives at the nineteenth power of 2. It is desirable that this should be known as a caution against too-ready acquiescence in Koch's calculations.

WM. CHAPPELL

#### On "*Comatula* (*Antedon*) *Rosacea*," and the Family "*Comatulidæ*"

MAY I be allowed to point out to Mr. Stebbing that *Comatula* and *Antedon* are not precisely equivalent names, but that the genus *Antedon* represents only one of some five or six different types, to all of which "Lamarck's happily appropriate designation *Comatula*" is equally applicable; and that this is now generally used as a sort of family name, and only when strict scientific accuracy is not very important, as a generic name.

Johannes Müller, who laid the foundation of nearly the whole of our present knowledge of the zoology and morphology of the family, was the first to recognise that Lamarck's designation, *Comatula* included more than one type; in his well-known memoir, "Ueber die Gattung *Comatula*, Lamarck, und ihre Arten," he indicated two distinct varieties of *Comatula*, the one represented by the ordinary *Comatula rosacea*, with a central or subcentral mouth, and symmetrically distributed ambulacral furrows; and another, which he first recognised in the ordinary *Comatula solaris*, Lamarck, to which he gave the name *Actinometra*: in this type the mouth is marginal, and the furrows of the ten arms open at equal intervals into a circular furrow running round the edge of the disc, the centre of which is occupied by the anal tube. The first of these types is that to which de Fremenville's name of *Antedon* is now usually applied. Müller, however, seems never to have been acquainted with this name, and adopted Leach's genus *Alecto*, which was constituted three years subsequently to *Antedon*; while *Comatula* did not appear till a year later. Recent observations have, however, shown that *Alecto*, as used by Müller, really includes many forms that are true *Actinometra*, and the name has passed gradually into disuse, in its original application to the Crinoids; this was all the more necessary, as the name has been generally received as designating a genus established by Lamouroux in 1821, for a section of the Polyzoa.

Müller was in the habit of using a sort of trinomial nomenclature in his descriptions of the species of *Comatula*; thus, *Comatula (Alecto) europæa*, and *Comatula (Actinometra) solaris*; it will probably be advisable to continue this practice, and it is therefore somewhat unfortunate that Mr. Norman<sup>1</sup> should have transposed *Antedon* into a masculine name, for de Fremenville, who first proposed it, used it as a feminine one, and described his first and only species as *Antedon gorgonia*, which is probably the same as *Comatula carinata*, Lam. Pourtales has already adopted *Antedon* as a feminine name, and we should probably do well to follow his example, especially if we employ Müller's very convenient system of trinomial nomenclature, for it is far simpler to

<sup>1</sup> On the Genera and Species of British Echinodermata, Ann. Mag., N. S., vol. 1866.

write *Comatula (Antedon) rosacea*, than *Comatula rosacea = Antedon rosaceus*.

Besides these two types *Antedon* and *Actinometra*, there is, as Müller pointed out, another division of the *Comatula* represented by the recent *Comaster* of Agassiz and the fossil *Solanocrinus* of the Wurtemberg Jurakalk; these are distinguished from the ordinary *Comatula* by the fact that five small basals appear externally between the first radials. The five small ossicles lying between the second radials of *Antedon Dübeneri*, Böhlische, are possibly also external basals. It is unfortunate that Böhlische was unable to make a further examination of this species, and so determine this very interesting point.

Müller considered *Solanocrinus*, or at any rate *S. costatus* and *S. scrobiculatus* as generically identical with *Comaster*, and pointed out that the differences in the form of the "knopf," or centro-dorsal basin, which is elongated and more or less fusiform in *Solanocrinus*, and hemispherical in *Comaster*, could not be regarded as of generic value, for similar differences occur among different species of the recent *Comatula*; e.g., between *C. Eschrichtii*, Müll. and *C. phalangium*, Müll. I have recently found that such differences may occur within the limits of the same species. Thus, of the two specimens of *Comatula (Antedon) macrocnema* in the Paris museum, one has a hemispherical centro-dorsal basin, just like that of *Comatula (Antedon) Eschrichtii*, while in the other it is a short pentagonal or nearly circular column, on which the cirrhi are disposed in four alternating rows, precisely as in *Solanocrinus*. Götte, who has recently made some most beautiful observations upon the embryology of *Comatula*, opposes the view first suggested by Sir Wyville Thomson, and since adopted and strengthened by Dr. Carpenter, that the centro-dorsal basin represents a coalesced series of the nodal or cirrus-bearing stem-joints in the stalked Crinoids, but its condition in *Solanocrinus* and *Antedon macrocnema* seems to show unmistakably that Sir Wyville Thomson's determination of its homologies is the correct one, especially when it is remembered that, as Goldfuss says, young specimens of *Solanocrinus* are not uncommon, in which the articular surfaces of the segments composing the elongated "knopf" are visible, although in the adult animal they become so closely united as to be inseparable.<sup>1</sup>

Unfortunately we do not know the position of the mouth in *Comaster*, the only specimen yet known having been dissected by Goldfuss, who says little or nothing about the ventral surface; but in *Phanogenia*, a new genus of the free Crinoids established by Lovén, it is central, as in *Antedon*.

These four types, *Antedon*, *Actinometra*, *Comaster*, and *Phanogenia*, all currently regarded as belonging to Lamarck's genus, *Comatula*, differ very considerably from one another in many points, perhaps the most characteristic of which is the condition of the basals in the adult animal.

In *Antedon*, as shown by Dr. Carpenter, the primitive basals of the Pentacrinoid larva undergo a very remarkable metamorphosis into the small and relatively insignificant "rosette;" this is almost entirely inclosed within the circlet of first radials, with which it becomes more or less fused in the adult animal, and by which it is so concealed as very readily to escape notice; so that all the older investigators either denied the existence of basals at all, or like Goldfuss, mistook the first radials for basals. I have recently found that in *Actinometra solaris* (Müller's typical species), and in several other species of the genus, the basals are relatively very large, and take the shape, not of a "rosette," but of a five-pointed star, the rays of which lie on the dorsal aspect of the five sutures of the first radials with one another, while its centre is simply an open and very delicate calcareous network, more or less connected with that proceeding from the inner surface of the radial circlet. These basals are readily exposed by the removal of the flattened centro-dorsal basin, the ventral aspect of which exhibits five stellate interradial depressions, into which the basals fit, but they never extend outwards so far as to be visible externally.

This last condition, of external basals, occurs, however, in *Comaster*, and in the Jurassic *Solanocrinus*. The centro-dorsal basin of *Comaster* is hemispherical, and round its ventral margin lie five small triangular basals, not in contact with one another, but so widely separated that the first radials lying between them

<sup>1</sup> Further, in the singularly minute *Comatula althææ* found by Philipp between the valves of a fossil *Isocardia* cor from the Sicilian Tertiaries, the centro-dorsal, which he calls the "welch stück," is elongated, egg-shaped, and visibly composite, bearing at least two, and very probably several more, alternating rows of cirrhi just like that of *Antedon macrocnema*. I have little doubt but that this species was a true *Antedon*, and an ancestor of our recent *Antedon rosacea* which is now so common in the Mediterranean.



articulate directly with the centrodorsal basin, while their infero-lateral angles are truncated so as to make room for the inter-vening basals.

The basals of *Phanogenia* appear to be in a condition intermediate between that of *Antedon* and *Actinometra*. Lovén describes them as internal and concealed, forming a small rosette with a central pentagonal opening, and marked on its ventral face by five sinuses, which receive processes from the sutures of the first radials.

We have thus a very interesting series of transitions from *Antedon* to *Pentacrinus*; firstly through *Phanogenia* and *Actinometra* to *Comaster*; thence to *Solanocrinus costatus*, in which the basals resemble those of *Comaster*, but the centrodorsal basin is elongated and visibly composite; and finally to *S. jegeri*, Goldfuss, in which the basals are so wide that they are completely in contact with one another all round, precisely as in *Pentacrinus*; this genus then only differs as far as the stem and basals are concerned, from *S. jegeri*, by the fact that its nodal cirrus-bearing stem-segments are not fused together, but separated from one another by more or fewer of the internodal ones which do not bear cirrhi.

*Solanocrinus* thus constitutes, as already pointed out by Goldfuss, a very interesting intermediate form between the stalked *Pentacrini* and the ordinary free-living *Comatulæ*, which are only stalked in their young stages.

Besides the above-mentioned four generic types, or rather five, if Pictet be right in erecting *S. jegeri* into a separate genus, Lamarck's name *Comatula* also includes the beautiful little five-armed *Ophiocrinus* from the Philippines; unfortunately we do not yet know either the condition of its basals or the anatomy of its soft parts, and can therefore form no opinion as to its relations to the other members of the family.

As these five or six types are all equally entitled to the name *Comatula*, it becomes necessary in any systematic work on the family to give them distinct generic or sub-generic names, especially as in one or two cases the same specific name has been given to two or more types. Thus the *Comatula multiradiata*, Goldfuss, is a *Comaster*, while the *C. multiradiata* of Lamarck is an *Actinometra*; and again the *C. armata* of Pourtales is an *Antedon*, while *C. armata*, Semper, is an *Actinometra*.

For ordinary dredging work, however, on the British coasts, where *Antedon* is the only representative of the family, it is not so necessary to discard a common and better known name in favour of one which, although scientifically correct, and considerably older, has only recently come into general use, especially when, as Mr. Stebbing remarks, its meaning and pronunciation are alike difficult to determine; and though the designation *Comatula rosacea* may, scientifically regarded, be a somewhat loose one, it is now so well known that the use of it is not likely to lead to any serious mistakes in synonymy among working naturalists.

P. HERBERT CARPENTER

Würzburg, Bavaria

WITH reference to the names *Antedon* and *Comatula*, will you allow me to say that the former has been applied to a genus of lamellicorn beetles since the year 1832? *Comatula* has been in use from nearly the beginning of the present century, and it is not only found in the works of Fleming, Forbes, Sars, Owen, G. H. Lewes ("Seaside Studies"), Carus, and others, but it must be a familiar word to many who have seen the splendid tank of those crinoids in the Naples aquarium. And now that we are bidden to change it "on the grounds of priority," may we inquire if the "grounds" of long custom (in this case more than sixty years) are to be invariably set aside? Dr. J. E. Gray, who had a sort of mania for change, tried in 1848 "to restore de Fremenville's name of *Antedon*. He went a step further, and, after Pennant, adopted Linck's specific name (so far as Linck had any idea of specific names, for they were unknown in his day) of "decameros," so that the advocates of absolute priority will have to take "*Antedon decameros*" as the designation of *Comatula rosacea*.

In Gemminger and von Harold's "Catalogus Coleopterorum," *Antedon* is derived from ἀντι and δόν, and consequently spelt *Antodon*; I do not see its application in either case.

I should be glad to see the "rules of zoological nomenclature" (Mr. Hughes means, I presume, those of the British Association) better observed if it led to the exclusion of such barbarisms as *Butekopf*, *Gatyghol*, *Sing-sing*, *Nabiroup*, and others, which many of the readers of NATURE will probably be astonished to find in our modern scientific nomenclature. May

we inquire if such a description as that of the celebrated "*Hister australis*," viz., "nigro-cyanus, nitidus, subtus ater," which would apply to hundreds of species of *Histeridae*, is entitled to claim the protection of the law of priority? I think we may sometimes fall back with advantage on the law of common sense, or that, at any rate, it may be allowed to supplement the law of priority.

FRANCIS P. PASCOE

December 23, 1876

### Sea Fisheries

MY chief reason for again intruding on you is for the purpose of supplying some omissions in Prof. Newton's quotations from Prof. Baird's first Report. In this Prof. Baird speaks of the destructive agency of the blue-fish. He states that about a million and a quarter of these fishes are caught annually on the New England coast, but that any one who has watched the blue-fish there must feel convinced that not one in a hundred of these fishes is caught; he allows twenty fish of other kinds as being devoured or mangled by each blue-fish daily, and then goes into a calculation of the thousands of millions of fish which must be destroyed by the blue-fish. I am writing this from memory, but I believe I am correct. Prof. Baird then says (I give this *verbatim*), p. 23:—"Indeed I am quite inclined to assign to the blue-fish the very first position among the injurious influences that have affected the supply of fish on the coast. Yet, with all this destruction by the blue-fish, it is probable that there would not have been so great a decrease of fish as at present but for the concurrent action of man."

This, the other cause of decrease, on which Prof. Baird lays great stress, is the numerous traps and pounds along the coast; but in Clause XII. of the same summary from which Prof. Newton quoted, I find the following:—

"As there is reason to believe that scup, and to a less degree other shore-fish, as well as blue-fish, have several times disappeared at intervals to a greater or less extent, within the historic period of New England, we cannot be certain that the use of traps and pounds within the last ten years has actually produced the scarcity complained of. The fact, however, that these engines do destroy the spawning fish in so great numbers renders it very probable that they exercise a decided influence."

Prof. Newton does not speak with his usual scientific precision when he refers only to the cod, and doubtfully to the mackerel, having decreased owing to the scarcity of the alewives—"cod, haddock, and hake" being mentioned in the same paragraph. Nor does it seem to me quite worthy of my friend, in discussing the probabilities of overfishing in the sea, to try to prove his case by bringing forward an instance of overfishing in the rivers leading to a smaller supply of food at a certain season for purely sea fish on the coast, and therefore a decrease in those sea fish.

Dogfish are "predatory and mischievous;" they plunder the nets, and they tear the nets in pieces.

Athenæum Club, December 29 E. W. H. HOLDSWORTH

[Pressure upon our space has necessitated a curtailment of this letter. This correspondence must now cease.—ED.]

### The "Sidereal Messenger"

IN NATURE (vol. xv. p. 49), in a notice of Mr. Knobel's "Catalogue of the Literature of Sidereal Astronomy," attention is called to the rarity of the *Sidereal Messenger*. We have, in the library of this Observatory, only one copy of that periodical. I hope, however, soon to be in possession of a few copies of vol. I. If so I shall take pleasure in sending one of them to the Royal Astronomical Society. All of Prof. Mitchell's measures of double stars (about 300) are now in the hands of the printer and will be published before the close of the year.

OSMOND STONE

Cin. Obs., September 12

### South Polar Depression of the Barometer

MR. CLEMENT LEY, writing in NATURE (vol. xv. p. 157), thinks that the great depression of the barometer throughout the region round the South Pole as compared with that round the North Pole, is "mainly due to superior evaporation in the water hemisphere generally." This seems an inadequate cause, for evaporation must be small in the very low temperatures which appear to be constant at all seasons in high southern latitudes. I am convinced that the cause of the barometric depression round the South Pole is the centrifugal force of the west winds which revolve round the Pole, forming, in Maury's words, "an everlasting cyclone on a great scale." A similar cyclone is formed

round the North Pole also, but less perfectly, and consequently the North Polar barometric depression, though decided, is much less than the South Polar. The reason of this difference I believe to be, that the North Polar cyclone is broken up by local air-currents due to the unequal heating of land and sea—a cause which scarcely exists in the South Polar regions, where almost all is sea or snow-covered land. JOSEPH JOHN MURPHY

#### "Towering" of Birds

In connection with Mr. Romanes' valuable letter on this subject, the following note may be interesting. Rooks, I am informed, are sometimes killed by means of a paper cone containing birdlime, which is placed in a locality where these birds congregate. The rook inserts his bill and head into the cone; after a little time he rises vertically into the air and then falls dead. My informant—a traveller and sportsman of much experience—considered the upward motion to be due to the obstruction of sight, but the fact, I doubt not, will bear the same explanation as the towering in the case of a wounded grouse.

ARTHUR SUTHERLAND

If it is of any importance to the question I may state that I have seen the following birds "tower":—common snipe, field-fare, wood-pigeon, pheasant, partridge, common Australian duck (*Anas superciliosa*), large Australian white cockatoo, Australian Nankeen night heron, and Australian piping crow. I have shot many thousands of Australian duck, and towering has occurred among them pretty frequently. In one case, the notes of which I have, the duck began to rise almost immediately, and rose to a great height. I was indoctrinated in the cerebral injury hypothesis, but I soon found that this was untenable, for I made a habit of plucking and examining the heads of all towering birds which I could recover, and there were some among them with no wound whatever on the head. One such instance would have been sufficient to dispose of the hypothesis; but I was unable to substitute another for it. The explanation given by Mr. Romanes meets the conditions as far as they have come under my observations. A. N.

#### THE SOCIETY OF TELEGRAPH ENGINEERS

THE Annual General Meeting of this Society was held at The Institution of Civil Engineers, 25, Great George Street, Westminster, on the evening of Wednesday, the 13th instant.

The Report submitted by the President and Council showed that during the past year the number of Foreign Members, Members, and Associates had gone on increasing until the total of all classes now exceeded 800. Many valuable papers, it was stated, have been sent in, or promised, for discussion during the current session, almost every available evening being already taken up. The result of the ballot for the President, Vice-Presidents, and Council for the ensuing year, was announced, Prof. Abel, F.R.S., being elected President.

A *Conversazione* was held at Willis's Rooms on the evening of Monday the 19th inst., when about 600 were present. Amongst these were to be found almost all the prominent members of the telegraphic profession, as well as most of the representatives of the leading cable companies and men whose names are known in connection with electrical or telegraphic engineering. A magnificent display of apparatus had been got together, including everything in the shape of a novelty which had been introduced in connection with this branch of science during the past year. Many interesting experiments were shown, and for the more especial gratification of the non-scientific portion of the assembly, Mr. Apps and Mr. Browning of the Strand exhibited respectively their attractive vacuum tubes and microscopical objects.

Prominent amongst the features of the evening were the experiments designed and personally exhibited by Mr. Robert Sabine. These may be divided into three classes—(1) Showing the circulation of mercury under the influence of oxidation and deoxidation; (2) Measuring time to the infinitesimal portion of a second; (3) Showing the potential at various points and the speed of waves of elec-

tricity through submarine cables. Full descriptions of these experiments—now publicly shown for the first time—have been contributed by Mr. Sabine to the recent numbers of the *Philosophical Magazine*. It was on the first-named that Sir Charles Wheatstone was engaged at the time of his death in Paris, and, based upon the results which he obtained, he had constructed a form of mercury "relay" constituting one of the most delicate portions of receiving telegraphic apparatus that could possibly be devised. The duration of impact, when an anvil is smartly struck with a hammer, was measured by means of the arrangement in connection with the second series of experiments. A condenser is charged from a potential of one volt, and then discharged through a Thomson's reflecting galvanometer, the deflection on the scale being noted. The condenser is again charged; a hammer in connection with one side of it is then brought on to the anvil which is in connection with the other side; during the moment of impact partial discharge takes place, the amount of current escaping being known when that which remains is next measured through the galvanometer. All the factors being thus known, the question of the time during which the hammer and anvil were in contact becomes a matter of simple mathematical calculation. The third series, owing to the difficulty of obtaining a sufficient length of Muirhead's artificial cable, was scarcely so successful as the other two, but yet sufficient was done to show the principle involved.

Prof. Dewar's electrometer, by means of which the electromotive force of the most minute fraction of any galvanic cell may be measured, and which is based upon the oxidation and deoxidation of mercury, was also shown.

Amongst the apparatus Sir William Thomson's new form of marine compass proved to be a centre of attraction. The adjusting "spider"—the most recent addition—was absent, but yet enough was exhibited to show that the mariner might to a great extent now render himself independent of solar observations. Eight small magnetic needles are employed, and the friction of the various parts is reduced to a minimum. Two soft iron balls are placed, one on each side of the compass, and adjusting rods are employed in addition to them. The liquid gyrostator, already described in NATURE, was also amongst Sir William Thompson's collection.

Hanging around the walls of the room were carefully executed diagrams, showing what are perhaps the most valuable observations of earth-currents that have ever been made. They were exhibited and are now presented to the Society by Mr. H. Saunders, of the Eastern Telegraph Company. Availing himself of a broken cable between Suez and Aden, Mr. Saunders succeeded in obtaining simultaneous observations at both stations, and saw that they are graphically represented; the coincidence between the two is striking to a degree. It is to be hoped that so interesting a record as this may be brought prominently forward in the form of a paper, and so elicit a discussion upon a subject which, although occupying the attention of many, still remains one of the most obscure problems in connection with electrical science. Closely allied to these were the specimens of the movements of the declination and horizontal magnetic force and of the earth-currents as observed at Greenwich and sent up specially for the evening by the Astronomer-Royal. They comprised the observations for a calm and a disturbed day, and served to show very clearly the correspondence which exists between magnetic and galvanic disturbances.

A form of grapnel designed by Mr. Andrew Jamieson, assistant to Mr. Saunders, did not fail to attract considerable attention. The toes, instead of being rigid, are hinged on to a spring which yields under a pressure of two tons, and thus serves to release the toes from any rocks or foreign matter with which it may be brought into contact, whilst a hold is still retained of the cable.

A telephone—showing clearly the principle of the apparatus—was exhibited by the Messrs. Wray, and musical notes were accurately transmitted by means of it through about 120 feet of wire. The battery employed for the purpose was the thermopile, designed by themselves, which was also shown. Although at first sight very similar to the well-known form of Clamond, the thermopile of Messrs. Wray has several modifications which are undoubted improvements. The extreme brittleness so fatal to many of Clamond's bars is here got rid of by the introduction, for a distance of about two inches, into the alloy, of a tongue which really is only a continuation of the sheet-iron. At first sight one would be inclined to think that this would tend to lower the electro-motive force of the couple, but the reverse is stated to be the case. The asbestos rings are replaced by a framework composed of circular plates of earthenware supported on three tie rods which serve to give stability to the structure and remove from each ring of bars the superincumbent weight of all the others over it. But perhaps the main improvement effected is the method of heating the bars; instead of allowing the flammers to impinge directly on their ends, or admitting the products of combustion near them, an earthenware cylinder forms the centre of the pile. Around it and abutting hard upon it the bars are placed, and from a perforated chimney within the gas issues, and burning in blue jets, speedily raises the cylinder to a red heat, which is transmitted through to the ends of the bars.

#### THE PHYLLOXERA AND INSECTICIDES

SOME time ago we published in our columns a short account of the results of the investigations of various scientific men in France into the nature of the Phylloxera—that terrible scourge which is committing such widespread ravages among the French vineyards. Latterly we have received some reports communicated to the French Academy of Sciences dealing with the attempts which have been made during the last three or four years to arrest the mischief done by the insect, and ultimately to destroy it altogether, by means of some potent drug. It is obvious that the remedy to be employed must possess two qualities at starting, viz., it must destroy the insect and it must not damage to any great extent the vine. But, further, it is not sufficient that when put in close contact with the roots of a plant—as in a pot—it should prove fatal to the insect, it is necessary, if the remedy is to be of real practical value, that it should reach and destroy the Phylloxera on all the parts attacked by it in vines which are planted out in the open air. This is a real difficulty to overcome, as the remedy, be it in the form of solution or of vapour, cannot easily permeate the soil, sometimes clayey, sometimes sandy, on which the vine is growing, so as to reach and act upon the smaller root branches whose nutrition the Phylloxera diverts into itself.

M. Mouillefert, a professor at the School of Agriculture at Grignon, was the gentleman delegated by the Academy of Sciences to make the necessary experiments for the purpose of determining what agent was the most practically applicable to the destruction of the Phylloxera, and the account of the numerous substances employed by him with varying results fills no less than 200 pages of a memoir presented to the Academy of Sciences. It is not our intention here to do more than give a brief résumé of the results at which he arrived.

He divides the substances used by him into seven groups, the first of which was composed of manures of various kinds, such as guano, superphosphates, farm-muck, &c.; the second of neutral substances, as water, soot, and sand; the third of alkalis, as ammonia and soda; the fourth of saline products, amongst which were the sulphates of iron, copper, zinc, potassium, and am-

monia, alum, and sea-salt; the fifth of vegetable essences and products, as decoctions of hemp, datura, absinthe, valerian and tobacco; the sixth of empyreumatic products; and the seventh of sulphur compounds. It was only with some of the substances contained in this last group that really satisfactory results were obtained, and it is to M. Dumas, the permanent secretary of the French Academy of Sciences, that the credit is due for suggesting the employment of the alkaline sulpho-carbonates of potassium and sodium and those of barium and calcium. All the other classes of remedies mentioned above were either without effect on the Phylloxera, or, in destroying it, also destroyed or damaged the vine.

The sulpho-carbonates, which were carefully studied by the great Swedish chemist Berzelius, are obtained by combining the alkaline mono-sulphides with the bi-sulphide of carbon, are either liquid or solid, and emit a powerful odour of sulphuretted hydrogen and bi-sulphide of carbon.

The alkaline sulpho-carbonates in the solid state are of a beautiful reddish yellow colour and deliquescent, but are not easily obtainable in that condition; the sulpho-carbonate of barium can be easily procured, however, in a solid state, and presents the appearance of a yellow powder, but little soluble in water. The sulpho-carbonates decompose under the influence of carbonic acid, forming a carbonate, and evolving sulphuretted hydrogen and bi-sulphide of carbon. These two latter substances are gradually liberated and, as they have a very powerful effect on the Phylloxera, one can understand that the sulpho-carbonate, placed in the ground, may prove, by its slow decomposition, a powerful insecticide. In the case of the sulpho-carbonate of potassium, over and above its toxic effect, it has a direct invigorating influence upon the vine, as the carbonate of potassium is an excellent manure.

The employment of the sulpho-carbonates as a means for the destruction of the Phylloxera was suggested to M. Dumas by the clearly-recognised need that there was of some substance that would evaporate less quickly than the bi-sulphide of carbon; he saw that it was desirable to apply the insecticides in some combination which would fix them and only allow them to evaporate gradually, so that their action might continue long enough in any one place to infect with their vapours all the surrounding soil.

But the task of eradicating the Phylloxera has by no means been accomplished by the mere discovery of the value for the purpose of these substances; there is the further difficulty of applying them to the vine in cultivation. One thing seems very certain, that in order to render the sulpho-carbonates practically efficacious in killing the insect, it is necessary to use water as the vehicle by which they may be brought to all the underground parts of the plant, and that the best time of year for their application is the winter or early spring, when the earth is still moist and the quantity of water necessary to be brought on to the ground by artificial means is consequently less. Mixed with lime in the proportion of 2 to 1, these sulpho-carbonates give a powder which can be spread over the ground before the heavy rains, that is, between October and March, and which will probably prove itself very efficacious.

The conclusion at which M. Mouillefert arrives at the end of his report is that the efficacy of the sulpho-carbonates is proved, and all that is necessary is to bring to perfection their employment in agriculture, which can only be accomplished by the intelligence and practical knowledge of the vine-grower who is well able to discover the economic processes of culture which are conducive to their successful application.

He ends by saying that "Science has accomplished its mission, and it remains for Agriculture to fulfil its part" in the eradication of the Phylloxera from the vineyards of France.

## CAMBRIDGE (U.S.) OBSERVATORY

IN two previous articles (*NATURE*, vol. x. pp. 186, 206) I gave a sketch of the history of some of the principal observatories of the United States. Those which we then referred to are all more or less connected with the work of education. We shall now give some details of an observatory which has been enabled to make marked advances in independent research outside of its educational service; we refer to that of Cambridge, Massachusetts.

A look into the earlier annals of the observatory of Harvard repays the inquirer at the outset by revealing the interest in astronomical pursuits which was felt in the old Bay State many years before the founding of an observatory was practicable in the United States. In 1761 the *Province* sloop was fitted out at the public expense to convey a Harvard professor, Winthrop, to Newfoundland, to observe the transit of Venus of that year; and in the troublous times of 1780 the old "Board of War" fitted out the *Lincoln* galley to convey Prof. Williams and a party of students to Penobscot, to observe a solar eclipse. At so early a day was New England disposed to encourage scientific observations.

In 1805, Mr. John Lowell, of Boston, was consulting with Delambre in Paris on astronomical observatories, and forwarding his information to the Hollis professor, Webber, who even then indulged the hope of seeing an observatory founded. But it was only in 1839 that an observatory was erected on the Dana estate, and the



FIG. 1.—Cambridge Observatory.

observations which had been authorised by the United States Government to be made in connection with Lieut. Wilkes's exploring expedition were conducted by Prof. Bond until the year 1842.

A new issue now arose. The sudden appearance of the splendid comet of 1843 was, happily, the occasion of final success in the founding of the present institution. Cambridge was immediately appealed to for information about this strange comet. But the observers had no parallactic instruments or micrometers of the least value for its observation. While they were endeavouring to obtain data to compute the comet's orbit, a meeting of citizens was held, under the sanction of the American Academy, to take measures for procuring a first-class equatorial; the needed amount of \$20,000 for the instrument was contributed in Boston, Salem, New Bedford, and Nantucket. The equatorial was ordered from Merz and Mähler, of Munich, and Harvard determined to erect a new observatory. The location selected was 80 ft. above tide-water, and 50 ft. above the plain where the soil was found favourable for the stability of piers for the instruments. In 1844 the buildings were occupied, and an equatorial of 44 in. focal length and 2½ in. aperture, and a transit instrument loaned by the United States, were temporarily mounted for observations until the arrival of the great refractor. This was placed in position June 24, 1847. Among the earlier objects on which systematic observations were made with the new instrument were the nebulae of Andromeda and Orion. "These nebulae," said Prof. Bond, "were regarded as strongholds of the

nebular theory; that is, the idea first suggested by the elder Herschel of masses of matter in process of condensation into systems." Orion's nebula had not yielded to either of the Herschels, armed even with their excellent reflectors, nor had it shown the slightest trace of resolvability under Lord Rosse's 3 ft. reflector. Bond announced, on Sept. 27, 1847, that the Cambridge refractor, set upon the trapezium under a power of 200, resolved this part of it into bright points of light, with a number of separate stars too great to be counted. With a power of 600, "Struve's Companion" was distinctly separated from its primary, and other stars were seen as double.

Within a few years yet more brilliant discoveries followed. Among them the inner ring of Saturn and its eighth satellite, the coincidence of which latter discovery on the same day (Sept. 19, 1848) at Cambridge and in England in no wise detracted from the honour due to each discoverer. It required, in those times, weeks before the discovery, indeed, could be mutually made known.

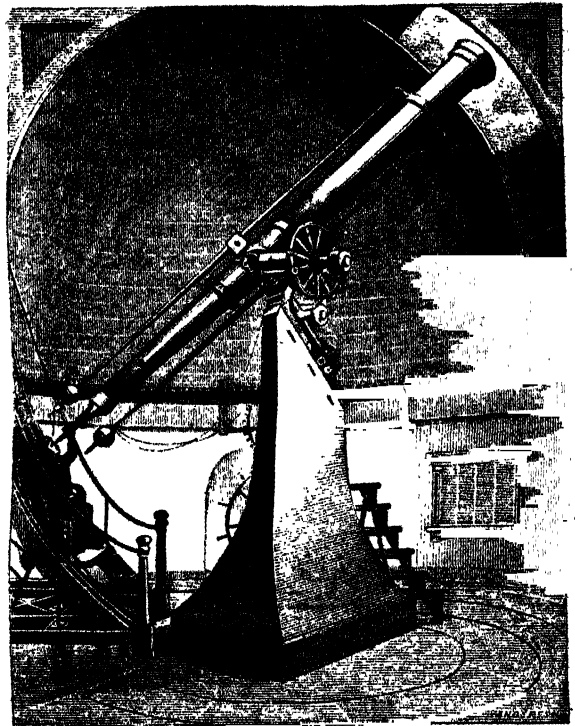

FIG. 2.—Cambridge Equatorial.

In 1850 Prof. W. C. Bond, with his sons, invented the spring governor, which gave an equable rotatory motion to the revolving cylinder of the chronograph. The observatory having been placed in 1849 on a permanent endowment by a legacy of \$100,000 from Mr. E. B. Phillips, a young graduate of Harvard, and a fund for printing its results having been also provided by will of the Hon. Josiah Quincy, jun., the reports of the first systematic zone observations appeared in 1855 as Part II. of vol. i. of the "Annals." This zone catalogue comprises 5,500 stars situated between the equator and 0° 20' north declination. The second volume, published in 1857, embraced chiefly observations of the planet Saturn made during a period of ten years. The second part of this vol. ii. is a zone-catalogue of 4,484 more stars in the same zones as those observed before 1854. It was not printed until the year 1867. The splendid vol. iii., published in 1862, is a quarto of 372 pages, with fifty-one plates almost entirely illustrative of the great comet of the Italian astronomer Donati, which appeared in such different forms in America from those seen in England.

The Great Nebula of Orion was the other chief object of the observatory up to the death, in 1849, of Prof. W. C. Bond, the father, and thence to the death of the son, Prof. G. P. Bond, in 1865. The observations of this constellation form the latest as yet published volume of the "Annals," issued, in 1867, under the supervision of Prof. T. H. Safford, then director of Dearborn Observatory, but formerly in charge at Harvard as assistant in the observatory. For Mr. G. P. Bond's work, and especially for his observations on Donati's comet, he received a gold medal from the Royal Astronomical Society in 1865.<sup>1</sup>

Since the year 1866, in which the present director, Prof. Joseph Winlock, took charge of the observatory, its work has been yet further most successfully extended into new fields of research, by his own labours, and those of his able assistants, Messrs. Searle, Rogers, and Peirce. Besides what is known as routine work of all observatories,

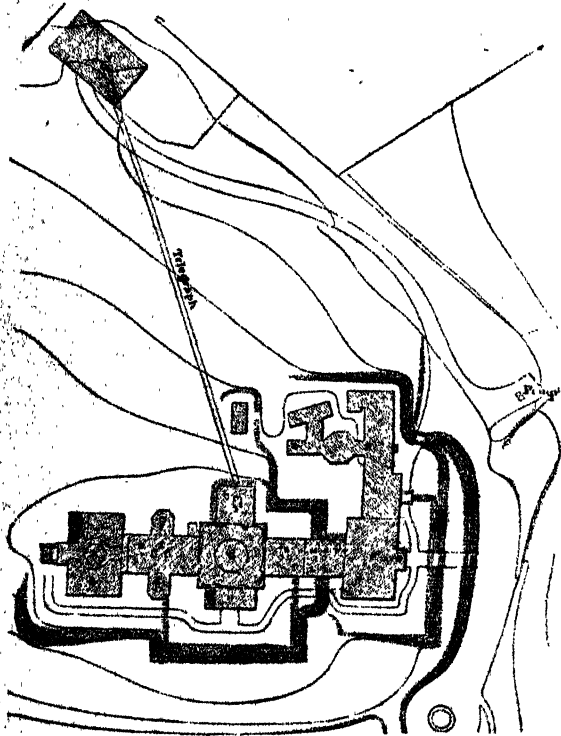

FIG. 3.—Ground plan of Cambridge Observatory. A, west equatorial; B, library; C, computing-room; D, west transit; E, new piers for new transit circle; F, collimator piers; G, east equatorial; H, grand entrance and stairs to east equatorial; I, prime vertical room and north clock; K, east transit; L, south clock; M, east clock; N, Chronograph; O, anemometer register; P, director's house; Q, front door; R, magnetic observatory; S, rain-gauge; T, anemometer.

spectroscopic observations of the sun and of stars and nebulae, and the most careful photographs of the sun, have been frequent. Five hundred drawings of the sun were made between January 1872 and November 1873, and 500 careful drawings of solar prominences in the year 1873. To this work is to be added a great deal of labour given to the determination of longitude differences, and the observations, by Prof. Winlock, of the solar eclipse of 1869, at Shelbyville, Kentucky, and that of 1870, at Jerez, in Spain. The general reader, as well as the astronomer, cannot fail to be interested in the beautiful pictorial representations of these and of other astronomical phenomena which have been issued by subscription recently from Harvard.

<sup>1</sup> Mr. Bond was the first American, we believe, to be thus honoured with the gold medal of a foreign scientific society. Prof. Watson, of Ann Arbor, and more recently Prof. Simon Newcomb, of the United States Naval Observatory, have been the recipients of like honours; the former from the Imperial Academy at Paris, the latter last year, from the Royal Astronomical Society of London.

The great equatorial, made in 1847 by Mers and Mähler, of Munich, has an object-glass of 15 in. in diameter, and a focal length of 22 ft. 6 in. The power of its eye-piece ranges from 100 to 2,000; the hour-circle is 18 in. in diameter. The movable portion of the well-balanced instrument is estimated at three tons. Its original cost was about \$20,000. The sidereal motion given to this telescope is now secured by clockwork from Alvan Clark, which is spoken of by the observers as the only known "driving-clock working with perfect steadiness." The telescope rests on a central granite pier, in constructing which 500 tons of granite were used. It is 40 ft. high, and rests on a wide foundation of grouting 26 ft. below the ground surface. Upon the top of the pier is laid a circular cap-stone 10 ft. in diameter, on which is the granite block, 10 ft. high, bearing the metallic bed-plate. This instrument is in the central "Sears Tower."

The meridian circle was mounted in the west transit-

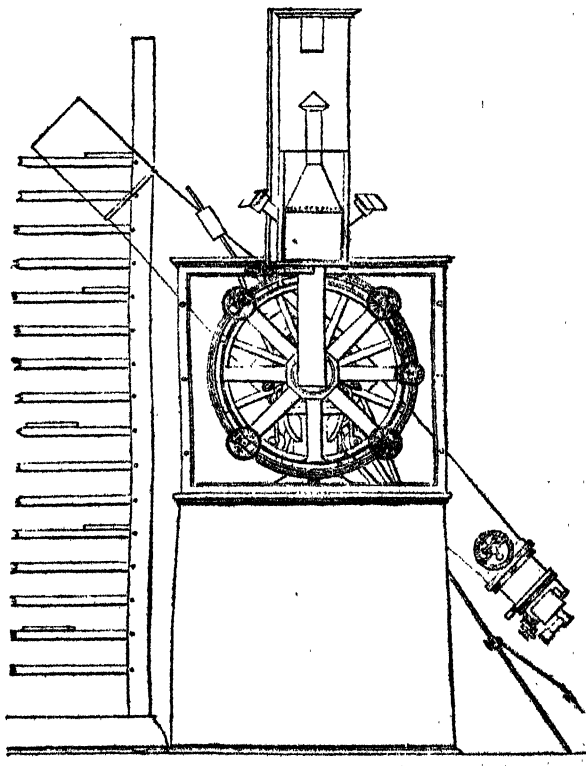

FIG. 4.—Cambridge Meridian Circle.

room in 1870. It has modifications, introduced by Prof. Winlock, not usually found in transit instruments, chiefly that the graduated circles are directly above the piers, the bearings of the pivots being carried by iron standards; the axis friction rollers rest on rods rising from the base of the piers and counterpoised below the floor. The pivot circles and reading microscopes are protected by glass casing; the object-glasses of the transit and of each of its collimators, made by Clark, are each 8 in.

In the west dome is another Clark equatorial, made in 1870, with an object-glass of 5½ in. In the east wing is the transit circle made in Prof. Bond's directorship, by Simms, of London. Its focal length is 65 in., its object-glass 4½ in.; its circles are 4 ft. in diameter, read by eight microscopes to single seconds. Cambridge possesses a number of more modern instruments, constructed to meet the wants of astronomical investigations at this day.

The spectroscopes, photometers, and photographic apparatus are peculiar in form and power. The spectro-

scope used with the west equatorial in solar observations powerfully disperses the rays of light, which are carried twice through a train of prisms. In photographing the sun a lens of long focus is used, the light being thrown upon it by movable plane mirrors. This plan of Prof. Winlock's was adopted by the astronomers who went out under the U.S. Government to observe the Transit of Venus in December, 1875.

The photometer, or light measurer, made by Zöllner, has been used for three years by Assistant Prof. C. S.

Peirce. The design is the accurate measurement of the magnitudes of all stars in Argelander's Uranometria between  $40^{\circ}$  and  $50^{\circ}$  north declination, determining these magnitudes on a scale of uniform ratios of light, so that the probable error of one observation shall not exceed the tenth of a single magnitude. The great object of this is, that throughout Europe and the northern part of the United States there will be constantly enough of accurately determined stars near the zenith to serve as comparisons for any star visible to the naked eye whose mag-

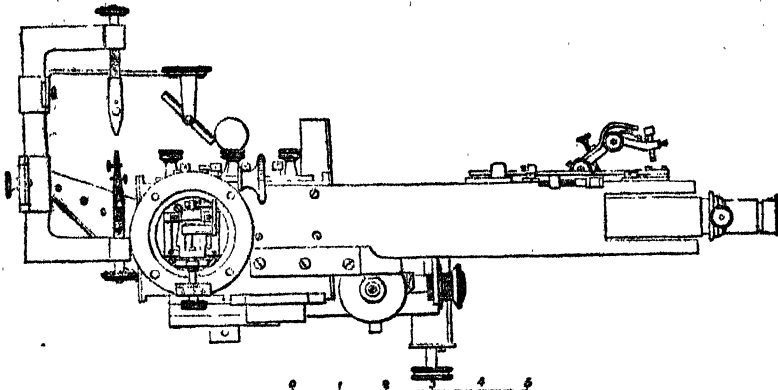

FIG. 5.—Cambridge Star Spectroscope.

nitude is to be estimated. The secondary object is the prosecution of inquiries with regard to the distribution of the stars in space, their magnitudes and variability.

The true time is daily given from this observatory to the State-house and other places in Boston, and by means of the telegraph lines to the whole of the New England States. It is received directly at noon each day without the intervention of any operator; the various lines being merely switched into the time line, the same click is heard at the same moment over the Eastern States.

Much more, however, than this is done for securing accuracy of time at any hour of the day. If anyone wishes to learn not only what the true time is, but whether his own watch is a good timekeeper, he may readily do so by a visit to the State-house in Boston. The arrangement for this, introduced by Prof. Winlock, is as follows:—The observatory clock is put in circuit at one end of a telegraph line, connected with which, at the State-house and other points, is an ordinary telegraph sounder. When the clock breaks the circuit by every second swing of the pendulum, a click of the armature of the sounder is heard at each of these points. The clock being so arranged that at every fifty-eighth second the break ceases, and at every even five minutes twelve breaks cease (no clicks being then heard), any person can, by listening to the sounder, compare his own watch with the standard clock. He can tell whether his watch is fast or slow by watching when the sounder ceases, the first click after the short pause being always the beginning of the minute, and the first click after the long pause the beginning of an even five minutes, as shown by the face of the clock in the distant observatory.

This standard motor clock is of course regulated with extreme care. It is customary, for the government of its rate of motion, to use shot of different sizes, which, according to the size, produce a change in the rate of the pendulum varying between  $0.05$  and  $0.10$  of a second per day. These are used as the astronomical correction for clock error may require. The time given by the standard clock thus regulated is that of the meridian near the State-house, sixteen seconds east of the observatory. Prof. Winlock considers that the use of the telegraph sounder gives a more satisfactory accuracy of time than can be given by other clocks which are put within the circuit and

controlled, as is usual, by the standard clock; for in their case a variation in the strength of the electric current introduces an error in the beats of the pendulum, but the telegraph sounder must give the time with entire accuracy.

With so much before one at Cambridge of which interesting note could be made, one can do no more than attempt to trace its early and munificent endowment, its

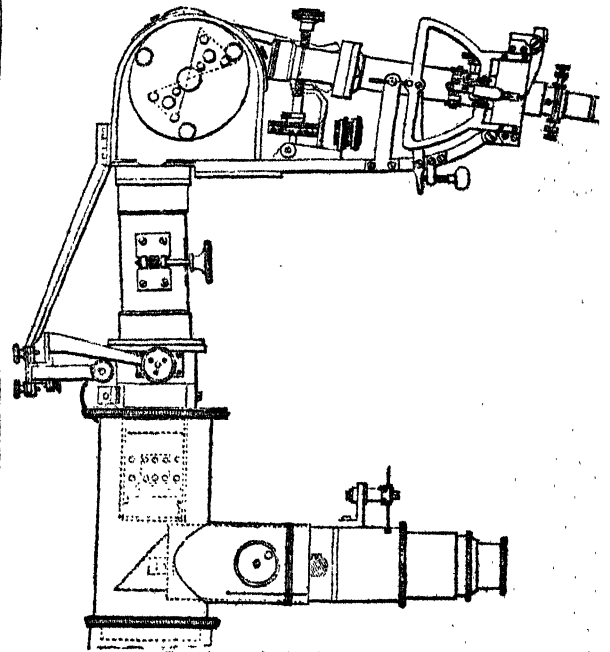

FIG. 6.—Cambridge Spectroscope.

earliest discoveries under its first labourers, and the steady and recently very rapid advances not only in the highest objects of an observatory—exactness throughout extended series of observations—but in the exercise of professional skill in the invention and manufacture of the best appliances of the day for carrying on these investigations.

## MUSEUM SPECIMENS FOR TEACHING PURPOSES<sup>1</sup>

### III.

I NOW pass to the second great division of museum preparations, those that are preserved in a fluid medium; the only way in which the greater part of the structure of most animals, both vertebrate and invertebrate, can be kept from change and decomposition.

The first question for consideration is the best preservative medium. The one which has been most extensively used in all countries is alcohol. Various substitutes, as solutions of common salt, alum, bichloride of mercury, or arsenic, have been proposed and tried, (chiefly on account of the expense of alcohol, and other slight disadvantages, but after a few trials these have generally been given up. At all events, the experience of alcohol in all the large museums of this country, has been so satisfactory compared to that of other media, that it is now alone used. The objection of expense which was caused by the high duty, has been in a great measure obviated by the permission to use "methylated" spirit, duty free, though some disadvantages have been thereby entailed.<sup>2</sup>

There seems little doubt but that a mixture of alcohol and water (commonly known as "spirits of wine," or when spoken of in relation to anatomical purposes, as "spirit" only) of the proper strength will preserve an animal substance for an indefinite length of time. There are specimens in the exhibition, (No. 3878 a), belonging to the Museum of Anatomy of the Academy of Science at St. Petersburg, prepared by the celebrated Dutch anatomist Ruysch, and bought from him by the Czar Peter the Great, in 1717, still in a perfect state of preservation. We have now in the Museum of the College of Surgeons many thousand preparations put up in the last century by John Hunter, and which appear to have undergone no changes beyond those which took place during the first few weeks of immersion in spirit, and which may be described as a certain amount of hardening and contraction of the tissues by coagulation of the albumen contained in them, and discharge of much of the natural colour.

The extent to which these changes take place depends very much upon the method with which the specimen is treated in the first instance. Sometimes it is desirable to harden the structure rapidly, as in preparations of hollow viscera, when the form alone is essential, in others, where preservation of the general appearance and the texture of the tissue is more requisite, and where further dissection is likely to be required, it is best to keep it as much as possible of the natural softness. The first condition is produced by immersing the preparation, when placed in the position in which it is to remain, in alcohol of the greatest strength, which afterwards may be diminished; the latter by beginning with a weak solution and gradually increasing the strength up to that finally used for permanent preservation.

The strength of the alcohol is estimated by its specific gravity, ascertained by the instrument called the hydrometer. But we do not speak of the actual specific gravity of physicists, but follow the conventional standard of the spirit-trade, the starting-point being taken at what is called "proof" at a temperature of 60° F., and the scale divided into degrees or "per-centages" above and below proof. By 1 per cent., or 1 degree under proof, is meant proof spirit with one-hundredth part (by bulk) of water. Spirit 10 per cent. under proof is a spirit consisting of 90 parts of proof spirit and 10 of water. On the other hand, by 10 per cent. over proof is meant that 100 parts (by bulk) of such spirit will require 10 parts of water to bring it to proof.

The "rectified spirit," as commonly sold, is about 60 or 65 per cent. above proof. This is only used for hardening preparations.

For ordinary use in the museum, proof spirit is strong enough, though to be quite on the safe side we generally use 10 per cent. over proof, diluting the rectified spirit with distilled water till it is reduced to the requisite strength, as ascertained by the

hydrometer. This is the strength commonly used for all kinds of preparations, though it might be varied with advantage in some cases.

In estimating the preservative power of spirit, consideration should be given to the bulk of the specimen, and especially the amount of water contained in its tissues, as compared with the quantity of spirit used. For instance, if a large solid mass of animal substance is placed in a jar little larger than sufficient to contain it, filled up with proof spirit, the amount of fluid contained in the specimen will so dilute the spirit that decomposition, especially of the interior of the specimen, to which the spirit cannot penetrate, will not be prevented, whereas a smaller specimen placed in the same jar of spirit will be preserved perfectly. Many collectors of objects of natural history do not attend sufficiently to these considerations, and hence the specimens become spoiled, much to their disappointment or to that of their consignees. The way to obviate this is not to use stronger spirit, as that would harden the exterior of the specimen, and prevent the spirit penetrating to the centre, but to use greater bulk of spirit, and especially to change it, after a day or two, pouring away the old diluted spirit, and substituting fresh, repeating the process if necessary more than once.

When a specimen has once been thoroughly saturated with spirit, and its tissues hardened, a strength much below proof will be sufficient to preserve it. The nature of the specimen must also be taken into consideration. For instance, nerve tissue, as in the brains of animals, requires stronger spirit for its preservation than ligamentous or fibrous tissues. Much will also depend upon the freshness of the specimen. If decomposition has already set in before it is placed in spirit, it will require much stronger spirit, and more frequent renewals than if it is fresh.

With most preparations it is desirable to cleanse them well before mounting them in spirit. They should be left a few hours or days (according to the temperature) in water frequently renewed, and the blood should be washed out of the large vessels, by means of a stream of water directed through them. This will save to a large extent the discoloration of the spirit into which they are placed. When removed from the water they should be allowed to drain, and be gently dried with a cloth before placing in the spirit, but no part of them must on any account, at any time during the process of preparation, be allowed to become actually dry, otherwise dark stains which are quite irremovable will be produced. This precaution is most essential when they have been once in spirit, and are removed for examination or further dissection, as evaporation of the alcohol, and consequent desiccation of the preparation, takes place much more rapidly than that of water.

In most cases it will be requisite to change the spirit once or oftener, before all the soluble colouring matter is given off from the preparation, and it can be permanently mounted. The discoloured spirit need not be wasted, as it can be perfectly restored by passing through the still.

To succeed in making a good anatomical preparation, much patience, neatness of hand, knowledge of the subject illustrated, and some artistic talent are required. No pains should be spared to make it tell the lesson it is intended to convey in the most attractive and pleasing manner. Everything should be displayed as definitely and clearly as in a drawing, and there should be no appearance of negligence or want of finish in any part.

When an elaborate dissection is required, it must, at least in all its later stages, be carried on while the specimen is under spirit, fixed in a flat dish or basin. The small fragments of connective tissue which have to be removed then float out from between the fibres of the muscles and the vessels which are to be preserved and exhibited, and they are carefully snipped off with fine curved scissors. A dissection which looks clean and highly finished as long as it is in air, when placed in fluid, becomes at once cloudy and obscure, from the floating up of these little particles. Hollow viscera, as hearts or stomachs, are distended by injecting their interior with strong spirit, tying or plugging the apertures by which it could escape, and placing them for several days in a vessel with the same fluid. If all the requisite precautions are taken, they will then preserve their form, and the interior of their cavities can be exhibited, by cutting openings or "windows" through different parts of their walls. If from any cause a cavity cannot be made to contain spirit, it may be stuffed with cotton-wool or horse-hair during hardening. The preparation, when laid aside to harden, if not suspended, should be placed in a bed of cotton wool adapted to its form, otherwise it will become irremediably flattened on the side on which it rests.

<sup>1</sup> Lecture at the Loan Collection of Scientific Apparatus, South Kensington, July 26, 1876, by Prof. W. H. Flower, F.R.S., Conservator of the Museum of the Royal College of Surgeons of England. Continued from p. 198.

<sup>2</sup> Methylated spirit is decidedly inferior in transparency and in absence of colour to pure spirit, and even if bright when first used, is apt to become turbid after a time. In a large establishment this can be to a great extent remedied by passing the discoloured spirit through a still, but it would be very desirable to consider whether some other method could not be devised by which alcohol could be used for scientific purposes, without the necessity of paying the present heavy duty of sixteen shillings and sixpence a gallon.

Preparations are usually mounted in glass jars, open at the top, and with a foot below, and either circular or oval, *i.e.* flattened on two opposed sides. The form is selected according to that of the preparation. The ovals show off some preparations to greater advantage than round bottles, but have the disadvantage of being more expensive and being (especially when of large size) liable to crack spontaneously, and apparently without provocation, but probably in consequence of some alteration of temperature affecting the unequal tension of the outer and inner surface of the glass at the bent ends.\*

The fine silk threads by which the preparation is to be suspended are brought over the edges of the jar, and passed beneath an ordinary thread tied round the groove, then returned and secured across the top of the jar. As threads fastened in this way occasionally are the means of causing leakage of the spirit, with which of course they are always saturated, some prefer to tie them to a piece of wood, or whalebone, fixed across the mouth of the jar. The only disadvantage of this is that it entails some additional trouble, and a reduction of the number of points of suspension which may be made use of in the other method.

There are two methods generally adopted for closing the upper end of the jars after the preparation is mounted in it. The oldest, and still very generally used, is by means of successive layers of bladder, tin foil, thin sheet lead, bladder again, and finally black varnish. The bladder must be macerated until it is partially decomposed, and then it will adhere firmly to the glass. This necessity makes the process a disagreeable and dirty one. The object of the tin foil is to protect the lead from the oxidation which always takes place when the vapour of spirit comes in contact with it through the first layer of bladder, tin not being so acted upon. A layer of tin only would answer as well as the tin and lead, but if thick enough for the requisite strength, would be more expensive and less easily worked round the edges of the glass. The thin sheet of tin is gummed to the surface of the lead, and then they are cut together to the requisite size, and treated as one, the tin being of course placed downwards. The edges are firmly pressed down round the lip at the top of the bottle and into the groove, with pieces of box-wood shaped for the purpose. Much of the success in closing the bottle depends upon the care with which this is done. Then the second layer of bladder is put on, and tied firmly with twine, round the groove at the top of the bottle. When thoroughly dry the twine is removed, and the edges of the bladder neatly trimmed with a knife; it is afterwards coated with one or two layers of black paint and a layer of black japan varnish.

Bottles closed in this way often keep in the spirit for many years without any material alteration in its level, but there is generally a slight evaporation, so that they have to be watched, and whenever the spirit gets so low that the safety of the preparation is endangered, the old cover must be cut off, and the specimen remounted and closed in by the same process.

A more expeditious and cleaner process, which has also the advantage of admitting light to the top of the preparation and allowing it to be seen from above, is by the use of glass covers. The top of the bottle is ground smooth, and a cover of glass of thickness suited to the size of the bottle cut to fit it. Many practical difficulties have been encountered in carrying out this process, but they have been mostly surmounted by experiment and perseverance, and it probably will in time entirely supersede the bladder and lead plan.

One cause of difficulty was the frequent breakage of bottles so fastened; upon changes of temperature; in the other plan, the top, being somewhat flexible, yields with the varying state of expansion of the contents of the jar, but the glass top is perfectly rigid, and if the pressure is too great must either separate from the bottle or break. This occurs chiefly in large bottles where the bulk of spirit is great, and consequently its expansive power out of proportion to the strength of the glass. This can be obviated to a great extent by not filling the bottle completely, as then the layer of air at the top, being far more compressible than the spirit, acts as a sort of buffer between the bottle and the glass; but in large bottles we generally take the further precaution of a small safety-valve; a hole drilled through the cover, with a loosely fitting stopper to check too

The greatest desideratum in putting up wet preparations is a durable glass jar with flat sides, so that the distortion of the object caused by the refraction through the curved surface of the glass may be avoided. Built up jars do very well for small objects, but they are very expensive, and generally fail when tried on a large scale. The subject still offers a good field for experiment.

great evaporation, or the ingress of dirt. Through this hole the jar can be filled up with spirit, when required, without the necessity of disturbing the preparation, as in the old process.

A second difficulty with glass-covered jars was to find a cement to fix the top, at the same time easy of application and not dissolved or weakened by the spirit. Isinglass dissolved in strong acetic acid, pure gutta percha, a mixture of pitch and gutta percha, and other substances, have been successively used in the Museum of the College of Surgeons, but finally we have given them all up for a composition sold as "Rock marine glue."<sup>1</sup> It is applied in a melted state, the edges of the glass cover being also heated. A small gas jet fixed on a flexible tube greatly facilitates this process.

The suspending threads can either be fixed to a glass rod placed across the top of the bottle just below the glass cover, the ends of which are let into notches cut for the purpose on opposite sides of the inside of the upper rim of the jar, or they can be brought out between the top of the jar and the glass cover, embedded in the cement, and secured by a string tied round the top of the bottle till the cement is hard, when they can be cut off close to the outer edge of the cover, and the securing string removed. The preparation is then finished by neatly painting the edge of the covering glass and cement, and the neck of the bottle for a short distance below, with two or three coats of black varnish.

For displaying different parts of the preparation, especially canals or cavities, black and white hogs' bristles and variously coloured glass rods are used. Delicate preparations, which cannot be kept in position if simply suspended, are fastened by stitches to thin transparent plates of mica, or to opaque coloured slabs of wax, or cardboard. Black or blue are the colours generally preferred, as in greatest contrast to the usual colour of preparations, as shown in the beautiful series of dissections illustrating the anatomy of the frog (3,904 c) contributed by Prof. Huxley.

I have said nothing yet about injecting preparations, a process necessary in order to display the course and distribution of blood-vessels. There are two kinds of injections, fine and coarse; the former fills the capillary vessels, and for preparations intended to be seen with the naked eye, gives a bluish of the colour used to the tissue, and is chiefly valuable as indicating the relative amount of vascularity of contiguous tissues. For microscopical investigations it is invaluable, and the methods employed and the materials used are fully detailed in all works devoted to microscopical manipulation. Coarse injection is intended only to show the vessels visible to the eye, and not to enter into the capillaries. Size, so generally used as a basis for fine injections, is not so satisfactory in this case, as if in any bulk it contracts in the spirit. The best material (introduced by Dr. J. B. Pettigrew, F.R.S., when Assistant in the Museum of the College of Surgeons) is fine plaster of Paris, coloured with vermilion or ultramarine, according as the tint of red or blue is required. It is mixed with water, as in taking casts, though of rather a more fluid consistence, and of course must be injected immediately, or it will set in the syringe. It has the great advantage of being used cold. It is rather brittle when set, and the vessels should be handled with care, but it may be made more tenacious by the addition of some glue or isinglass to the water with which the plaster is mixed.

The distinction between two different kinds of tissue is sometimes well shown by staining the preparation. Some good examples are exhibited by the Anatomical Museum of the University of Oxford. The head of a sturgeon (Nos. 3,837 and 3,838, prepared by Mr. Robertson) has been immersed for a short time in a solution of carmine, and the cartilage and connective tissue has received the colour, while the bones retain their natural white hue. The distinction between them, which otherwise would scarcely be perceptible in the bottle, is thus very clearly brought out.

The third and last great division of museum specimens for teaching purposes, illustrated by this exhibition, is that which comprises models and casts of natural objects, and under the same heading drawings and diagrams may be included.

As a general rule, models should never be used for teaching if actual specimens can be obtained and exhibited; but there are numerous cases in which the object is of so perishable a nature, that it cannot be preserved efficiently by any of the methods above described. Many objects are so scarce that it is quite out of the power of most museums to possess any representations of them, except as copies of the originals.

<sup>1</sup> It is bought from Rockhill and Co., 10, Blackfriars Road.



There are also others so small, that for lectures and demonstrations an enlarged model is of very great assistance.

What may be done in teaching natural history by means of models and coloured casts is admirably shown in Mr. Frank Buckland's museum in this building, where may be seen accurate representation of many of the species of Cetacea and larger fish of our seas, giving a more complete idea of their size, form, and colour, than has ever been produced by any other method. The reduced models of animals and men of various races exhibited by the Committee of the Pedagogical Museum of Russia are also interesting, and must be useful aids to school teaching. By what other means, for instance, could the singular form of such an animal as the Greenland right-whale be brought before a class of pupils? I would also call attention to the well-known anatomical models of Dr. Auzoux, of Paris (which by the way are not very fully represented in the present exhibition by Nos. 3,829 *a* to *d*); to the models illustrating the development of the trout, by Dr. A. Ziegler, of Freiburg (No. 3,839); to the enlarged models of blood corpuscles of different animals for illustrating their form and size, by Prof. H. Wolcker, of Halle (No. 3,893); to the models of Radiolaria in *papier mâché*, by V. Fric, of Prague (No. 3,865); to the numerous anatomical models of Strembitsky in the Russian collection, of Rammé and Todtmann, of Hamburg (Nos. 3,868-3,877); and of Tramond, of Paris (Nos. 3,923-3,925); to the casts of different parts of the human body dissected, by Steger and Honikel, of Leipzig (Nos. 3,840-3,842); and to the models by various exhibitors illustrating the structure of flowers and seeds.

With reference to such models, the importance of accuracy of execution cannot be too strongly insisted upon. With a cast of course there is not much chance of error, but for the accuracy of a model, especially when on a different scale from the original, we are entirely dependent upon the artist's skill and care. The only fault to be found with most of those in the exhibition is that they are rather too rough in execution to be pleasing to the eye, but it has been in most cases an object to produce them at such a low price, as would not be compatible with fine workmanship.

Although I have only been able in the time allotted to glance briefly at the various branches of the subject which I have been requested to expound, I trust that some suggestions have been given in this lecture which will be found of use to those who have the care of collections, and that I have succeeded in showing that the art of preparing, preserving, and displaying specimens in museums is one which deserves to be more fully cultivated than it has hitherto, as a most important adjunct to the diffusion of biological knowledge.

OUR ASTRONOMICAL COLUMN

THE NEW STAR IN CYGNUS.—Prof. Schmidt has published details of his observations of this star from November 24, the date of discovery, to December 15, and has also put upon record the dates, between November 1 and 20, when he had examined the constellation Cygnus, with the view to show that a star as bright as the fifth magnitude could not have escaped his notice, and therefore that the rise of the new one to the third magnitude must have been very rapid, as also appears to have been the case with T Coronæ in 1866. On the evening of its discovery the star was strong golden yellow, and writing on December 9, Herr Schmidt states it had always been of a deep yellow, but at no time exhibited the redness of its neighbour, 75 Cygni. The following are the magnitudes on different nights as determined at Athens by careful comparisons with  $\rho$ ,  $\pi^2$ ,  $\tau$ ,  $\zeta$  and  $\phi$  Cygni, and  $\eta$  Pegasi:—

	m.	m.	m.
Nov. 24	3.0	Dec. 2	5.4
25	3.1	3	5.6
26	3.1	4	5.8
27	3.2	5	5.9
28	3.8	7	6.3
29	4.7	8	6.5
30	5.0	9	6.6
Dec. 1	5.2	10	6.5

On the evening of December 31 the new star was about 7m. and very decidedly orange. It has but slowly diminished during the last three weeks.

NEW VARIABLE STAR IN CETUS.—Mr. J. E. Gore, writing from Umballa, Punjab, on November 28, draws attention to a

star entered on Harding's atlas as a sixth magnitude, about 14° distant from 59  $\nu$  Ceti, and 13' s.p. Lalande 5590. On November 18, this star was only 8m., considerably fainter than a 7m. star shown by Harding, closely preceding  $\nu$ .

This star is not in any of the catalogues, nor in Schjellerup's list in No. viii. of the publications of the *Astronomische Gesellschaft*. Reading off from Harding and reducing to 1877° its position is in R. A. 1h. 50m. 13s., N.P.D. 110° 59'.

DE VICO'S COMET OF SHORT PERIOD.—It was remarked in this column last week, that unless the orbit of De Vico's comet of 1844 has undergone some violent perturbation, a perihelion passage may be expected to occur during the year just commenced. It appears, however, that the chances of detecting the comet, should it arrive at its least distance from the sun during the first three months of the year are very small indeed, and hence, unfortunately if the comet is not found between July and December, it cannot be inferred with any degree of certainty that it has not passed its perihelion within the twelvemonth. The following places are calculated from Prof. Briinnow's last orbit for 1844, reduced to the equinox of 1872, supposing the arrival at perihelion to fall either on the date mentioned or thirty days before or after it.  $\Delta$  is the comet's distance from the earth.

Time from Perihelion.	January 1°.			February 1°.		
	R.A.	Decl.	$\Delta$	R.A.	Decl.	$\Delta$
- 30 days	302°1	- 21°8	2'13	316°4	- 18°3	2'23
0 "	317°9	- 18°1	1'85	331°6	- 13°4	2'10
+ 30 "	335°1	- 12°3	1'58	347°0	- 7°2	1'94

Time from Perihelion.	March 1°.			April 1°.		
	R.A.	Decl.	$\Delta$	R.A.	Decl.	$\Delta$
- 30 days	329°2	- 14°2	2'17	342°2	- 9°5	1'97
0 "	344°1	- 8°5	2'18	357°1	- 3°0	2'12
+ 30 "	358°6	- 2°1	2'16	11°1	+ 3°4	2'24

THE TOTAL SOLAR ECLIPSE OF STIKLASTAD, 1030, AUGUST 31.—The circumstances under which this eclipse occurred are given by Prof. Hansteen, of Christiania, in *Ergänzungs-Heft zu den Astronomische Nachrichten*, p. 42, with elements computed from the tables of Burckhardt and Carlini. Sir George Airy has also published elements of the eclipse, resulting from Hansen's calculations from his Solar and Lunar Tables, as an addendum to the paper on the eclipses of Agathocles, &c., in vol. 26 of the Royal Astronomical Society's *Memoirs*, having previously drawn attention to the circumstance that the eclipse of Stiklastad, from the narrowness of the belt of totality and its having been total at a well-defined point, might, in combination with the eclipse at Larissa, B.C. 557, May 19, be of much value in throwing light upon corrections possibly required for the lunar tables.

The following elements of this eclipse are founded upon the same system of calculation for the moon's places, to which we lately referred as having been applied to the Nineveh eclipse of B.C. 763, with the sun's place from Sir George Airy's paper:—  
G.M.T. of conjunction in R.A., 1030, Aug. 31, at 1h. 20m. 40s.

R.A.	164	20	54.7
Moon's hourly motion in R.A.	33	14.8	
Sun's " " " "	2	15.3	
Moon's declination " " "	7	37	23.3 N.
Sun's " " " "	6	43	1.6 N.
Moon's hourly motion in decl.	10	20.8	S.
Sun's " " " "	0	46.0	S.
Moon's horizontal parallax	58	18.1	
Sun's " " " "	9	9.0	
Moon's true semi-diameter	15	53.2	
Sun's " " " "	15	56.5	

Points on the central line would fall in long.  $10^{\circ} 22' E.$ , lat.  $54^{\circ} 5' N.$ , and in long.  $14^{\circ} 31' E.$ , lat.  $51^{\circ} 41' N.$  Hansteen gives for the position of Stiklastad  $11^{\circ} 35' E.$ , and  $63^{\circ} 48' N.$ , which by the above elements would be only  $10'$  outside the northern limit of totality. On making a direct calculation for the longitude of Stiklastad, we find that the duration of totality could not have exceeded twenty seconds on the central line.

METEORS OF DECEMBER 11.—MM. Perrotin and Jean, at the Observatory of Toulouse, observed a considerable number of meteors on the night of December 11; between 11h. and 13h. 106 were counted, the majority of which, according to M. Perrotin, radiated from a point in about R.A.  $115^{\circ}$ , N.P.D.  $57^{\circ}$ , near Castor and Pollux, though closer to the former star than to the latter. The trajectories were very short, so that it was difficult to refer them to a chart. The sky was overcast on the following night.

### NOTES

WITH reference to the closing of the Loan Collection, a circular has been issued by the Lords of the Committee of Council on Education, stating that, although in consequence of the funds at their disposal for the Collection being exhausted, they have found it necessary to close the Exhibition, arrangements are being made for the safe custody of all objects which may be left on loan to the Museum, pending the decision by Her Majesty's Government on the offer made by the Royal Commissioners for the Exhibition of 1851, of a building for the establishment of a permanent Science Museum. The Lords of the Committee of Council on Education also inquire whether exhibitors are willing to leave the objects contributed till this question be settled. The closing of the Exhibition will not interfere with the delivery of the Free Saturday Evening Lectures.

ACCORDING to the will of Dr. C. A. Bressa, dated September 4, 1845, the testator left all his property to the Royal Academy of Sciences of Turin, the net interest to be given every two years as a prize for the most important discovery made or work published during the previous four years on natural and experimental philosophy, natural history, mathematics, chemistry, physiology, and pathology, as well as geology, history, geography, and statistics. This is to be given alternately to a person of any nation and to an Italian. Signora C. A. Dupêché had a life interest in the property, and it was not until July last that the legacy became free from all claims, and the first prize will be given in 1879, open to all, and of the value of 480*l.* In accordance with the spirit of Dr. Bressa's will, the Academy will choose the best work or discovery, whether or not it be presented by the author.

WE are informed that the valuable collection of fossils from the Red Crag made by the Rev. H. Cahnham, of Waldringfield, including, among the most important, the remains of *Halithrium* described by Prof. W. H. Flower, teeth of *Alastodon*, &c., has been purchased by Sir Richard Wallace, and most liberally presented by him to the Ipswich Museum.

THE Dutch Society of Sciences at Harlem has offered a gold medal for the best answer to the following question:—What are the meteorological and magnetical periodic changes which may be considered to be in a well-established relation with the period of the solar spots? The answers must have a motto and be accompanied with a sealed letter containing the name of the author. They should be sent before January 1, 1878, to the Secretary, Prof. von Baumhauer, Harlem.

RUSSIAN newspapers announce that the Helsingfors professor, Dr. Ahlquist, a well-known explorer among the tribes of North-western Siberia, will start, next spring, for further ethnological explorations among the Voguls and Ostyacks of the Obi and

Irtysk. He will be accompanied by two assistants, the Senate of Finland having allowed a sum for the travelling expenses of the explorers.

AT a recent meeting of the Manchester Literary and Philosophical Society a letter was read from Mr. Joseph Sidebotham in which he calls attention to the fact of the growing use of the aniline colours for tinting photographs. He finds they are being extensively used in paintings and water-colour drawings, and the colours regularly sold for that purpose. Anyone who knows the speedy alteration by light of nearly all of these colours will protest against their use, and a statement of this with the authority of some of our chemists would probably have the effect of causing them to be discontinued by all artists who care to think that their works should last more than a single year.

ON the night of the Arlesey railway accident there were six Indian elephant's on their way by train from Huddersfield to London. Two were large and the others quite young. The tarpaulin over the trucks in which they travelled was blown away in the gale, and the animals were thus exposed to the snow and sleet and cold wind of that night. They were also delayed long on the road in consequence of the accident. One of our contributors who saw them "unloaded" at King's Cross, and noticed that they walked very stiffly at first, has inquired of Mr. Harrington, their keeper, whether the cold journey has affected them. He has written in reply that they seem perfectly well, and he cannot see that the unusual exposure has had any effect on them. None of the animals have been more than a few years in England. As Mr. Harrington's letter is written nine days after the journey, no effects of chill are likely now to show themselves. The Indian (and perhaps the African) elephant may be better able to withstand sudden climatical changes than is generally supposed.

OUR Samoan Correspondent, the Rev. S. J. Whitmee, announces the publication of a new Dictionary of the Samoan language by himself and the Rev. G. Pratt. Mr. Whitmee is on his way to England, where he will probably arrive in spring. Intending subscribers—and we hope there will be a considerable number in this country—should address Mr. Whitmee at the Mission House, Blomfield Street, Finsbury, E.C. The price, it is hoped, will not exceed 10*s.*

WE have received reprints of the letters which M. Poliakoff has written during his recent journey for the zoological exploration of the Obi and Irtysk. They contain many valuable observations on the physical characters of the country visited, on its fauna, on the migrations of fishes up and down the Obi, and on the fisheries, on the migrations of birds, together with a variety of interesting occasional observations. We may hope therefore that the report on this journey will be a valuable addition to the zoo-geography of Western Siberia.

M. POLIAKOFF gives the following particulars confirming the law of Baer as to the deviation to the right of rivers running north and south. The bed of the Irtysk being cut in loose deposits, these deposits are constantly undermined by water on the right bank. Each spring a strip of the bank from 30 to 50 feet broad is destroyed by the waters. Sometimes it happens that a strip from 70 to 140 feet broad and about 150 yards long falls suddenly into the river. The course is then barred for a short time, and a great wave propagated up and down the stream, destroys the fishing-boats which happen to be at work within a distance of about ten miles from the spot. Large quantities of fishes are also found, after such a catastrophe, on the shores, suffocated in the muddy waters. The destruction of the right bank going on constantly, year after year, the villages are also constantly advancing to the east; one of them, Demiansk, has thus travelled about a mile in the course of 240 years. The left shore shows, therefore, a low tract

of land covered with ponds and marshes, and yearly overflowed, whilst the right shore faces the water with abrupt crags from 70 to 150 feet high. The same thing is also observed on the Obi. The hills of Bégologie, a short way below the mouth of the Irtysh, have now the main bed of the river to their right, while some time ago it was on their left, there being now on the latter side only a secondary arm. These arms of the Obi—remains of its former beds—form on the left flat shore a series of elongated ponds and channels, connected with the main body of the river by a labyrinth of smaller water-courses.

IN the article in last week's number on Dr. Schliemann's Discoveries, *Amyclo* was misspelt *Anychi*, Sir R. Colt Hoare's name was given as *Home*: *Arena* should be *Arma* Heroum, *Mianedia* should be *Nicomedia*, and *Caprea*, *Caprea*.

THE first number of a new quarterly scientific journal, devoted to zoology, botany, geology, and mineralogy, will be published at Buda-Pest this month. It will be in German, though its first title is "Természertajzi Füzelek" ("Naturhistorische Hefte"). Prof. Otto Herman is the principal editor.

THE death is announced of the Rev. Barnard Smith, the author of many well-known educational works in arithmetic and algebra.

A WELL-DESERVED pension of 50*l.* a-year has been bestowed upon Mr. Thomas Edwards, the "Scottish Naturalist," whose life Mr. Smiles has written.

DR. PETERMANN has been informed that the Portuguese Government has granted a subsidy of 20,000*l.* in aid of the proposed great scientific expedition for the exploration of Central Africa. The expedition is already organised and will start without delay, commencing its operations by proceeding up the Congo.

THE *New York Herald* of December 2 and 11, contains letters on our Arctic Expedition, by Dr. Hayes.

IN the last report of the Berlin *Akademie der Wissenschaften*, J. Bernstein describes an exceedingly simple and ingenious apparatus for determining the position of the nodal point of the eye of a living person. Experiments with his right eye gave 7.21–7.38 mm. as the distance of the rear nodal point from the vertex of the cornea.

THE Royal Museum at Berlin has received a valuable donation of about 8,000 ethnographical objects from Dr. Jagor. They are the results of extensive journeys through East Turkestan, Burmah, and portions of India, and afford a most complete picture of the domestic and military life of the widely diversified tribes inhabiting the less known parts of these countries.

THE gorilla in the Berlin Aquarium which excited so much interest among German naturalists, has lately recovered from a serious illness, and is now more than ever demonstrative and humanlike in his movements. With the approach of winter a soft silky fur has made its appearance. The weight of this young gorilla has increased from thirty-three to forty-three pounds during his six months' residence in Europe, a fact which would seem to show that confinement is, after all, not so unendurable for him as was supposed.

A SERIES of new rooms has been opened at the *Musée d'Artillerie* of Paris, in which a set of guns is arranged showing the various models used since the artillery was introduced for the first time in warfare 600 years ago.

THE *Annuaire du Bureau des Longitudes* is publishing for the first time two interesting tables—first, the situation of the several radiant points of falling stars, second, the catalogue of all variable stars, with a calendar of their variations during the year 1877.

MR. M'LACHLAN gives a few details in the *Entomologist's Monthly Magazine* concerning Capt. Feilden's collection of the insects of the Arctic expedition, which he has seen. The greater number of the insects were collected near Discovery Bay in 81° 42' N. latitude; some of the *Lepidoptera* are even from 82° 45'. The most interesting fact is the occurrence of five or six species of butterflies within a few hundred miles of the North Pole, especially when taken into consideration with the fact that Iceland and the large islands of the Spitzbergen group, although in lower latitudes, have apparently no butterflies. In *Lepidoptera* Mr. M'Lachlan observed four examples (2 ♂, 2 ♀) of the genus *Colias*, possibly two species (? *Boothii* and *Hecla*). Apparently three species of *Argynnis* or *Melitæa* (or both). A *Chrysophanus* apparently identical with *phleas*. In the *Noctuidæ*, only one individual—an *Acronycta*. In the *Geometridæ*, one *Amphidasis* or *Biston*, and several Cheimatioboid forms with apterous females. Of the *Crambites*, one *Phycis*, perhaps our *fusca*. The *Hymenoptera* are represented by a *Bombus*, and one of the *Ichneumonidæ* of considerable size. In the *Diptera* there is one large fly, probably belonging to the *Tachinidæ*, and perhaps parasitic on the larvæ of some of the *Lepidoptera*. One species of *Tipulidæ*; and a considerable number of *Culicidæ*, and of what looks like a *Simulium*, which, however, do not appear to have annoyed the members of the expedition in these high latitudes. Of *Coleoptera*, *Hemiptera*, and *Neuroptera*, Mr. M'Lachlan saw none; but the bird-lice are naturally well represented.

THE second International Congress of Americanists, organised for the Study of American Antiquities, will be held at Luxembourg on September 10–13, when all English students and savans will be cordially welcomed. Information and tickets may be obtained from Mr. Francis A. Allen, 15, Fitzwilliam Road, Clapham, S.W., one of the delegates for England.

THE December session of the *Deutsche Geologische Gesellschaft* was devoted to a long address from Herr Lohsen upon the Rammelsberg, in the neighbourhood of Goslar. The peculiar deposits of ore in this mountain he regarded as belonging to a much later epoch than that in which the surrounding slate was formed, while he explained the lens-shaped form of the cavities in which the deposits are formed as due to the enormous pressure of the overlying strata of sandstone.

THE recent death of Mr. James Drummond, of Comrie, deprives us of a local geologist. He had devoted much time and attention to the Comrie earthquakes, on which he had published many articles and a little book. His views were generally in disaccord with those of the observers appointed by the British Association, against whom he held out manfully.

THE large number of fossil plants brought home from Greenland and Spitzbergen by the two Swedish expeditions of 1870 and 1872 have been carefully examined by Dr. Oswald Heer, and they appear to throw important light on the geological development of the plant world. An account of his study of the remains from the chalk period appears in a recent number of the *Naturforscher*, and in the summary of his results Dr. Heer points out that the facts are against a gradual imperceptible transformation of plant types; from the upper chalk the dicotyledons appear suddenly in great variety, without any transition, whereas other forms at this period wholly disappear from the scene. Further, these researches make it very probable that a whole series of genera have had their origin in the Arctic zone, and have thence "radiated" southwards. Lastly, Dr. Heer shows that the facts at present known of plant palæontology do not point to any alternation of climate or repeated ice-periods in these regions (a view which has also been developed by Prof. Nordenskiöld).

DR. LAUREN LINDSEY has sent us a well drawn up programme

of a subject for essays, to be substituted for the ordinary subjects set in schools. The subject is the Moral Education of the Lower Animals, and is intended to train the observing powers of the young, as well also to discover how far animals are capable of moral training.

AT a recent meeting of the Belgian Academy, M. Dupont announced the discovery of numerous vestiges of the age of polished stone in the neighbourhoods of Hastière-sur-Meuse. No less than fifteen burial caverns were discovered in the locality. Five of them have already yielded about fifty-five human skeletons and thirty-five sufficiently well-preserved skulls. Sixteen dwelling-places of the people who inhabited at that period the plateaux, are already explored, and have produced numerous flint weapons. These discoveries promise to throw much light on the pre-historic ethnography of the country.

THE Pennsylvania Company, which was formed some time ago in order to convey the petroleum obtained in Pennsylvania from the wells to the seaports on the Atlantic, now intends to construct a tube of 4 in. diameter and of some 300 miles in length, connecting the wells with the sea. The practical possibility of the plan is proved by works, which, for a distance of 250 miles, are already in action and use. Baltimore was the first city with which these new canals were connected. The oil is forced through the pipes at a pressure of 900 lbs. on the square inch, and at intervals of fifteen miles large steam pumps, of 10-horse power, assist the motion of the stream. At Baltimore the canal ends in enormous tanks, and these are in direct communication with the refining works. The cost of the new canal and accessories is calculated at 1,250,000 dollars.

IN a note in the *Bulletin* of the Belgian Academy (vol. xlii., Nos. 9 and 10) Dr. Putzeys gives the results of his experiments on new anaesthetics belonging to the alcoholic series, viz., the bromides of ethyl, propyl, and amyl. Inhaled by frogs, rabbits, cats, and dogs, they were proved to possess the same properties as chloroform. The interest of the result is increased by the circumstance that many compounds of bromine from the fat series do not possess the same anaesthetic properties as the corresponding compounds of chlorine.

THE July number of the *Ivestia* of the Russian Geographical Society gives an interesting report by Col. Bolsheff on that part of the Pacific shores of Russian Manchuria which lies between the 45° and 52° north lat., a country the interior of which remained very little known until now. Almost the whole of the land is covered with mountains, outliers of the Sikhotaalin, a ridge reaching in its highest point 5,173 feet, and abruptly falling to the sea with hills about 800 feet high. The high valleys, which sometimes have a breadth of seven miles, seem to be well suited for agricultural settlements. In the northern parts of the country, lead, silver, iron, copper, and gold, were discovered, this last seeming to occur in considerable abundance. The population is very thin, numbering but 550 souls, Chinese and Tazes, who carry on agriculture, and Gilyaks and Tunguses, living miserably by hunting and fishing. The settled Chinese and Tazes are also engaged in the collection of sea-weeds and sea-worms purchased in China, the Tazes being almost reduced to slavery by the Chinese. Various collections, especially botanical and entomological ones, were brought in by M. Bolsheff, and will be deposited at the Russian Geographical Society.

M. LIPPICH, of the Vienna Academy, has recently been investigating the influence of the mean distance of absorbent particles upon absorption. As such an influence must be especially prominent when the substances afford well-defined absorption bands, and, with considerable density, show strong colours, he chose for his experiments the nitrate of didymium oxide, which has these properties in high degree. A

pretty concentrated aqueous solution of this salt in a vessel 1 cm. thick was spectroscopically compared with a solution having concentration only 0.1, 0.05 . . . of the first. The solutions were in tubes of 10, 20 cm. . . length severally. A Steinheil spectroscope was used, and the light sources were two gas lamps so regulated that both spectra showed the same brightness on the parts that were free from absorption. Even with the concentration-ratio 1:10, there were marked differences in the absorption bands. The very characteristic bands in yellow and yellow-green were, for the more concentrated solution, considerably broadened towards the red end of the spectrum, while the sharp limit towards the violet was the same for both solutions. The much narrower bands in the green showed quite a similar behaviour. In the other parts differences were observed with difficulty. Besides this difference in the breadth of the absorption bands, there were others in the distribution of the bright parts.

PROF. BERNARDIN, the indefatigable *conservateur* of the Commercial and Industrial Museum at Melle, near Ghent, has just published another of his useful lists under the title of *Classification de 250 de Fécules*. The arrangement is on a scientific system, the plants being classed under their natural orders, commencing with the Cryptogams and proceeding with the higher developed plants. The scientific name of the plant is placed first under each order and is in italics so as easily to catch the eye. The lists previously compiled by Prof. Bernardin are *Classification des Huiles Végétales*, *Nomenclature de 550 Fibres Textiles*, *Classification de 250 Matières Tannantes*, *Classification de 100 Caoutchoucs et Gutta-perchas*, and *Classification de 40 Savons Végétaux*. These lists, when brought together, will prove serviceable to all those interested in the application of plants.

THE phenomenon of fluorescence, according to M. Lallemand (*Journal de Physique*) is much more general than has been commonly supposed; he knows of only two substances in which it is *nil*, viz., rock-salt and quartz. If it has not been remarked in the majority of liquids, and even of transparent solids which possess it, this is because all the spectral rays are capable of producing it, and the fluorescence, instead of being produced with a maximum of brightness and a proper colour at the surface of incidence, is manifested throughout the mass of the body traversed by the light and without a very pronounced proper colour. M. Lallemand distinguishes two kinds of fluorescence—one called *isochromatic*, or of equal colour, in which each simple ray excites an identical vibratory movement; this kind is produced by all the luminous rays of the spectrum in sulphide of carbon, benzine, alcohol, ether, &c., and in water itself in a slight degree; the other is that long observed in sulphate of quinine, and which is therefore called *quinic* or *hypochromatic* fluorescence. Each luminous ray here produces a fluorescence of less refrangibility, with this peculiarity, that a simple light produces often a complex fluorescence, containing rays of various refrangibilities, but always inferior to that of the exciting ray. It is generally the most refrangible and the chemical rays which develop quinic fluorescence of various intensities. A body may possess both kind of fluorescence at once, but the two parts of the spectra corresponding to them may be very unequal. In glass and crystal, e.g., the red, yellow, and green rays develop a weak isochromatic fluorescence, the others produce quinic fluorescence.

M. GIFFARD, the celebrated aeronaut, and inventor of the *injecteur*, is constructing, at Forges-de-la-Seine, a small steam-boat for service from Pont Royal to the Exhibition (1878) Pier, distance only three miles. The steamer will realise the extraordinary velocity of forty-five miles per hour, and run the distance in four or five minutes. The length of the steamer will be thirty metres, and transverse section three and a half metres.

THE additions to the Zoological Society's Gardens during the past week include six Greek Partridges (*Caccabis saxatilis*) from Persia, Naran River, two Black-headed Partridges (*Caccabis melanoccephala*), a Hey's Partridge (*Caccabis heyi*) from Hedyar, near Mecca, presented by Mr. F. M. Burke, Commander S.S. *Arctot*; a Yellow-lored Amazon (*Chrysolis xantholora*) from Central America, purchased.

### SCIENTIFIC SERIALS

*Poggendorff's Annalen der Physik und Chemie*, Ergänzung Band viii., Stück 1.—On the electric conductivity of water and some other bad conductors, by M. Kohlrausch.—The mica-combination of Reusch, and the optical rotatory power of crystals, by M. Sohncke.—On determination of the constants for absorption of light in metallic silver, by M. Wernicke.—The interference of refracted light, by M. Lommel.—The fundamental principles of Edlund's electro-dynamics, by M. Chwolson.—Volumetric chemical studies, by M. Ostwald.—On the influence of the funnel-valve on electric spark discharges in air, by M. Holtz.—On an electrical fly-wheel like that of the radiometer, by M. Holtz.—Steam-jet air-pump, by M. Teclu.

*Journal de Physique*, December.—Measurement of the calorific intensity of the solar radiations and of their absorption by the terrestrial atmosphere, by M. Crova.—On various theories given to explain the movements of Crookes's radiometer (second paper), by M. Lippmann.—On the illumination of transparent and opaque bodies (concluded), by M. Lallemand.

THE *Jahrbuch der k.k. geologischen Reichsanstalt zu Wien* (vol. xxvi. part 2), to which are added Dr. Gust. Tschermak's *Mineralogische Mittheilungen* (vol. vi., part 2), contain the following papers:—Geological survey of the Dutch East Indian Archipelago, by Dr. Schneider.—The saline springs of Galicia, by Mich. Kelb.—Report on the volcanic events during the year 1875, by Dr. C. W. C. Fuchs. Of this we publish a detailed account in our "Notes."—On the green slates of Lower Silesia, by Ernst Kalkowsky.—On beryl from Eisvold, in Norway, by M. Websky.—Chemical analysis of the iodiferous saline springs of Darkau, by E. Ludwig.—On the volcanic formations of the Galapagos Islands, by F. A. Gooch.—On a perfect combination of pyrites and hematite crystals, by Dr. C. Hintze.—On some minerals from North-western Silesia, by F. Nenimar.

### SOCIETIES AND ACADEMIES

#### LONDON

**Chemical Society**, December 18, 1876.—Prof. Abel, F.R.S., president, in the chair.—Prof. W. N. Hartley made a communication entitled "a further study of fluid cavities," in which he described the results of his examination of a large number of topaz and of rock sections, mostly granites and porphyries. The fluid contained in the cavities was almost invariably water, but it was very remarkable that the cavities often took the form of the crystals in which they were contained, and nearly always arranged themselves symmetrically with regard to the faces of the crystal.—A paper by Dr. H. E. Armstrong, F.R.S., on thymoquinone, one on high melting points with special reference to those of metallic salts, part 2, and another on the determination of urea, by Mr. G. Turner, followed this, after which Dr. G. Bischof called attention to the rapid corrosion of the so-called "compo" pipe employed by gas-fitters when used to convey water, especially when exposed alternately to the action of air and water.

**Meteorological Society**, December 20, 1876.—Mr. H. S. Eaton, M.A., president, in the chair.—Rev. C. C. Chevallier, T. Gordon, and Rev. T. H. Quelch were elected Fellows of the Society.—The following papers were read:—On observations with the psychrometer, by Dr. R. Rubenson (translated from the Swedish, and abridged by Dr. W. Doberck). This paper contains an account of the instructions issued to the Swedish observers in order to obtain trustworthy results from the psychrometer, or dry and wet bulb hygrometer. These instructions, however, do not differ from those followed by English observers at the present time.—Contributions to hygrometry: The wet bulb thermometer, by William Marriott, F.M.S. This paper contains the results of observations made with several wet bulbs in different positions and under different conditions, which were carried on in order to determine what a wet bulb thermometer should be. Ten thermometers were used as wet bulbs and three

as dry bulbs. With three wet bulbs the water receptacles were placed at different angles; but it was found that the readings were not affected by the position of the water receptacle. Others were used with different thicknesses of muslin and conducting threads; but it was shown that the thermometers with the thinnest muslins always gave the lowest readings. Three pairs of dry and wet bulbs were used, one with a closed water reservoir six inches from the dry bulb, the other two having open reservoirs which were respectively three inches and one inch from the dry bulbs. It was found that the dry bulbs of the two latter read lower than the former in fine dry weather, but when the air was damp and during rain they generally read higher. The wet bulbs of the latter read a little higher than the former; this was mostly the case in damp weather. In conclusion, the author submitted for adoption certain regulations for the management of the dry and wet bulb thermometers, in order to secure comparable results.—Visibility, by the Hon. Ralph Abercromby, F.M.S. Visibility, or unusual clearness and nearness of distant objects, is a very trustworthy prognostic of rain in this and many other countries. The usual explanation that much moisture increases the transparency of the atmosphere is not borne out by observation. In this country great nearness occurs on a clear, brisk day, when hard masses of cloud shade the glare of the sky from crossing direct light sent from distant objects, and make clearness so great as to give the impression of nearness. The kind of rain which immediately follows nearness is in short sharp showers, but unsettled weather often follows later. The synoptic conditions of nearness in this country are either straight isobars or the edge of anticyclones, neither of which are associated with settled weather.—Description of a meteorographic model, a letter from the late Commodore M. F. Maury, Hon. Mem. M.S., to Capt. H. Toynebe, F.R.A.S.

**Physical Society**, December 16, 1876.—Prof. G. C. Foster, president, in the chair.—The following candidate was elected a member of the Society:—Mr. W. Baily, M.A.—Mr. Crookes described some of the most recent results he has obtained in his experiments on the radiometer, and exhibited many beautiful forms of the apparatus, most of which have been devised with a view to decide on the correct theory of the instrument. We shall refer to the subject of the paper in an early number.—Prof. Dewar exhibited a simple electrometer which he has designed, founded on the discovery of Leiman that the capillary constant is not really independent of the temperature or condition of the surface, but is a function of the electromotive force. If a capillary tube be immersed in mercury, and dilute sulphuric acid be placed in the tube above the mercury, and a current from a Daniell's cell be so passed through the liquids that the mercury forms the negative pole, the column will be depressed to an extent dependent on the diameter of the tube. In making an electrometer, Prof. Dewar has increased the sensitiveness by connecting two vessels of mercury by means of a horizontal glass tube filled with the metal, except that it contains a bubble of dilute acid. The tube must have an internal diameter of two millimetres, and it is essential that it be perfectly clean, uniform in diameter, and horizontal. The instruments exhibited were constructed by Messrs. Tisley and Spiller, and Prof. Dewar showed that it is possible by means of them to measure an electromotive force equal to 1/1000th of a Daniell's cell; force capable of decomposing water must be measured by causing two currents to act against each other. The index bubble is brought to zero by uniting the mercury cups by a wire. The apparatus is very convenient, as it requires no preparation and is extremely simple in its action. He then showed an instrument arranged by Mr. Tisley for producing a current by the dropping of mercury from a small orifice into dilute sulphuric acid; if the vessel containing the mercury and the acid be connected by a wire, current is found to traverse it. He then exhibited a manometer suitable for measuring very slight variations of pressure, and illustrated the use of it for proving Laplace's law that the internal pressure multiplied by the diameter of a soap-bubble is constant. It consists of a U-tube, one arm of which is about 15 inches long, and is bent horizontally and levelled with great care. The shorter arm be connected with a tube on which a bubble has been blown and the diameter of the bubble be varied, the position of the extremity of the alcohol column will be found to vary in accordance with the above law.

**Entomological Society**, December 6, 1876.—Sir Sidney Smith Saunders, C.M.G., vice-president, in the chair.—Prof. Eduard Grube, Director of the Zoological Museum of the University of Breslau, and Dr. Katter of Patzau, in the Island of

Rügen, were elected foreign members.—Mr. M'Lachlan (on behalf of Mr. W. Denison Roebuck, of Leeds) exhibited some oecysts, a swarm of which had passed over Yorkshire during autumn. He believed that they belonged to the *Pachytylus lineasens*, an insect which was supposed to breed in some parts of Northern Europe.—Mr. W. C. Boyd exhibited living larvae of *Brachycentrus subnubilus* in their quadrilateral cases, having been reared from the eggs. They were of a much larger size than those previously exhibited by him at the meeting of November, 1873, being more than half an inch long.—Mr. S. Stevens (on behalf of Mr. Edwin Birchall) exhibited a specimen of *Cirrhodia xanthopeloides*, var. *unicolor*, *Agrotis lucerna*, var. *latens*, and what appeared to be a small variety of *Zygana filipendule* with the pupa case and cocoon. They were all taken by Mr. Birchall in the Isle of Man.—Mr. Meldola referred to a request made by Mr. Riley, of St. Louis, Missouri, that entomologists should supply him with cocoons of the parasite *Microgaster glomeratus*, which were much wanted in America to destroy the numerous broods of *Pirris rapae* which had been imported into that country. Mr. M'Lachlan had at a subsequent meeting stated that *M. glomeratus* was parasitic on *P. brassicae*, but doubted whether it ever attacked *P. rapae*; and Mr. Meldola now exhibited the insects he had found parasitic on these two species, that on *P. rapae* being *Pteromalus imbutus* (one of the *Chalcididae*), while on *P. brassicae* he had observed *Microgaster glomeratus* and a dipterous species *Tachina augusta*. Specimens of all of these were exhibited.—Mr. Smith remarked that he had received a nest of *Osmia muraria*, sent to him from Switzerland, in which he had found in one of the cells a yellow larva, which ultimately proved to be that of a beetle belonging to the *Chrysididae* (*Trichodes abvarius*).—Sir Sidney Saunders exhibited a large box of insects of all orders, which had been collected in Corfu by Mr. Whitfield.—Mr. C. O. Waterhouse remarked on the "Catalogue Coleopterorum" of Gemminger and v. Harold, the concluding portion of which was now published. The total number of generic names given is 11,618, of which 7,364 are adopted genera, and 4,254 appear as synonyms. The total number of species recorded is 77,008. Dejean's first Catalogue, published in 1821, gave 6,692 species, while that of 1837 (the 3rd edition) gave 22,399 species, of which, however, only a portion were then described. Taking into consideration the number of species described during the publication of the Munich Catalogue, the number of described species at the present date could not be less than 80,000. Thus, since 1821, the known species of Coleoptera had increased twelvefold.—Sir Sidney Saunders exhibited several larvae of *Meloidae* in their first stage, received from M. Jules Lichtenstein, of Montpellier, including (1) the primary larval form of *Sitaris colletes* found on *Colletes succinea*, feeding on ivy blossoms; (2) the same larval stage of *Mylabris melanura* obtained from the egg, and furnished with triple tarsal appendages like other larvae of *Meloidae* in their primary form; (3) the exuviae of the primary form of *Meloe cicutricosus* (from the egg), and also the second stage of the same larva, still bearing legs; (4) the primary larva of *Meloe proscarabaeus* (?) differing from the foregoing in the structure of the antennae, taken on an *Andrena*; (5) the corresponding larval stage of *Meloe autumnalis* (?), also differing as aforesaid, taken on *Scolia hirta*.—Mr. C. O. Waterhouse read descriptions of twenty new species of Coleoptera from various localities.

Geologists' Association, December 1.—Mr. William Carruthers, F.R.S., president, in the chair.—On the comparative ages of the English and Scottish coal-fields, illustrated by the geology of the Lothians and Fifeshire, and the structure and age of Arthur's Seat, Andrew Taylor, F.C.S. The author, after alluding to the early interest evoked by the geological problems which a study of Arthur's Seat suggests, proposed to bring forward some local sections bearing on the question of its age. A section, beginning with the Burdiehouse limestone quarries at East Calder, deals with upwards of 1,700 feet of strata. This area had undergone much disturbance; the trap-sheets were shown to fill the crevices, consequent on the subsidence, both in the main lines of shrinkage and in the parallel ones; nor does this shrinkage and contemporaneous emission of volcanic matter terminate in the lower strata. The structure of the Torbane hill mineral basin proves this. Another section was described at North Queensferry, through what was originally supposed to have been a compact mass of intrusive dolerite. During the earlier operations no igneous rock was touched; it was only towards the close of the work that the narrow plug became visible. The superposition of the beds cut through is—3. Sandstone, 2. Shale, 1. Freshwater (Burdiehouse) lime-

stone. The freshwater limestone was found only in the plug of the tunnel, standing almost vertically, and having a white crystalline character. Below it occurred a bed of ozokerite, three inches thick. The shale near the plug lost its fissile laminated character, assuming a somewhat columnar form. Whilst the dolerite on the hill is visibly crystalline, at the plug it presents a compact aphanitic mass. We have here, as elsewhere, the association of ozokerite and bitumen with limestone.

## PARIS

Academy of Sciences, December 18, 1876.—Vice-Admiral Paris in the chair. The following papers were read:—Note on the integration of total differential equations, by M. Bertrand.—Theorems concerning couples of segments taken the one on one tangent of a curve, and the other on an oblique of another curve, and making together a constant length, the curves being of any order and class, by M. Chasles.—On the secular displacements of the plane of the orbit of the eighth satellite of Saturn (Japhet), by M. Tisserand. If we consider on the sphere great circles representing the orbit of Saturn and his ring, and draw through their intersection two great circles suitably chosen, the orbit of the satellite will form with these two latter circles a triangle of constant surface.—Microscopic study of the volcanic rocks of Nossi-Bé, by M. Velain.—Method of methodic compression and immobilisation, by M. Chassagny. A solid inextensible envelope with a caoutchouc bag under it incloses the region to be compressed (e.g. a limb), and the bag is injected with air or water.—On a particular class of left unicursal curves of the fourth order, by M. Appel.—Manometer for measuring high pressures, by M. Caillaet (already noticed in connection with the *Journal de Physique*).—Researches on mannite with regard to its optical properties, by MM. Müntz and Aubin. Mannite, of whatever origin, presents the same optical properties.—On the keel of least resistance, by M. Bécquic.—Various notes on Phylloxera.—Calculation of three observations of the new star of Cygnus, by M. Schmidt.—Preliminary note on photographs of stellar spectra, by Dr. Huggins. He submitted a copy of the photographed spectrum of Vega ( $\alpha$  Lyrae), in which are seven broad lines, two of them coinciding with the two lines of hydrogen in the solar spectrum.—Observations on the explanation of the phenomenon of the black drop at the moment of exterior contact of Venus and the sun, by M. van de Sande Backhuysen.—Second note on the theory of the radiometer, by Mr. Crookes.—On an arrangement for reproducing Foucault's experiment (stoppage of a turning disc under the action of an electro-magnet), with the aid of the syren, by M. Bourbouze. The copper disc is fixed on the axis of the syren, and when the magnet is made the sound suddenly stops.—Practical method of testing an element of a battery, by M. Leclanché. He states some interesting effects of variation of temperature on a Daniell element.—Note on the presence of sugar in the leaves of beets, by M. Corenwinder.—Note on a rapid means of determination of lime in presence of magnesia, and on the application of magnesia to the defecation of saccharine juices, by MM. Bernard and Eilmann.—On the fall of cold/fair which produced the disastrous frost in the middle of April, 1876, by M. Barral. This he considers strongly in favour of M. Faye's theory.—Absorption, by a meadow, of the fertilising principles contained in a liquid charged with manure and employed in watering, by M. Leplay.—On the quantity of rain that fell and was collected during the heaviest showers, from 1860 to 1876, by M. Berigny. The average of water which fell in ten to forty-five minutes, in the heaviest showers, was 0.51 mm. per minute, which would give 1.53 cc. for thirty minutes (an exceptional case occurred on August 2, 1866, when a shower furnished, in ten minutes, 11.62 mm. of water, equivalent to 1.16 mm. per minute).—Relations between the optical elements of Arthropoda and those of certain worms, by M. Chatin.—On the beds of fossil bones of Pargny Filain and of Dezanne.—M. Decharme described an experiment with coloured rings. Directing a current of vapour of bromine, iodine, or sulphhydrate of ammonia against a metallic plate, he obtains, by chemical process, coloured rings similar to the thermal rings he got with a jet of flame.

## BERLIN

German Chemical Society, November 13, 1876.—A. W. Hofmann, president, in the chair.—O. Pettersson has determined the atomic volumes of isomorphous mixtures of selenates and sulphates, notably of the alums, containing both acids.—A. Horst-

mann published researches on the tension of dissociation, proving that the presence of one of the constituents of a substance liable to dissociation diminishes this tension.—V. Meyer described a simple apparatus to show the increase in weight by the combustion of a candle.—Friedrich Müller described simple apparatus for the lecture-room to determine the density of gases and the quantity of water formed by the combustion of hydrogen. The same chemist has determined the temperatures to which solutions of different salts are raised by a current of steam.—C. Hensgen has treated the sulphates of potassium, sodium, and lithium with hydrochloric acid gas at high temperatures, transforming them into chlorides. Sulphate of copper absorbs under similar circumstances 2HCl; heated in a current of air, this (molecular?) compound yields chlorine and water, and reproduces sulphate of copper. These experiments are interesting with regard to Deacon's process.—H. Iobst has found in coto-bark a new base, called by him para-cotoin.—C. Böttinger has treated racemic acid, C<sub>2</sub>H<sub>3</sub>O<sub>3</sub> with hydrocyanic and hydrochloric acids, transforming it into lactic acid as well as into a new acid of the formula C<sub>2</sub>H<sub>3</sub>O<sub>3</sub>, or C<sub>2</sub>H<sub>3</sub>O<sub>7</sub>.—C. Vogel showed absorption-bands produced by magnesia and alumina in solutions of purpurine; by their means traces of these substances can be recognised in the presence of large quantities of organic substances, as in milk, urine, tartaric acid, &c.—C. A. Martius reported on the Chemical Exhibition at Philadelphia.

November 27, 1876.—A. W. Hofmann, president, in the chair.—E. Baumann described phenylsulphate of potassium, obtained by the reaction

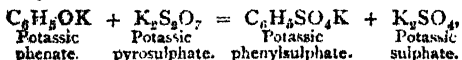

a well-defined crystalline salt easily decomposed into phenol and sulphuric acid. Conjointly with E. Herter Mr. Baumann proved the transformation of phenoles into phenolsulphates by the digestion in warm-blooded animals.—A. Atterburg described chlorides obtained from  $\alpha$  and  $\beta$  dinitronaphthalenes, and expounded the probable reasons of their isomerism.—W. Thörner reported on some derivatives of phenyl-toluy-ketone.—T. Hunats described citrate of methyl C<sub>2</sub>H<sub>5</sub>(OH)(CO<sub>2</sub>CH<sub>3</sub>)<sub>3</sub>, acetyl-citrate of methyl C<sub>2</sub>H<sub>5</sub>(OC<sub>2</sub>H<sub>3</sub>O)(CO<sub>2</sub>CH<sub>3</sub>)<sub>3</sub>, the product of the action of PCI<sub>5</sub> on the former, viz., C<sub>2</sub>H<sub>5</sub>Cl(CO<sub>2</sub>CH<sub>3</sub>)<sub>3</sub>, monochloro-tricarballylate of methyl; and experiments trying in vain to produce ethyl-citrate of ethyl.—H. Willgerodt stated that  $\alpha$ -dinitrochlorobenzol yields with acetamide (and alcohol) ortho-para-nitraniline (and acetic ether). With urea it yields another dinitraniline.—L. F. Nilson described double nitrides of platinum with K, Na, Li, Rb, Ag, Ca, Sr, Ba, Pb, Mg, Mn, Co, Ni, Fe, Zn, Hg, Be, Al, Cr, In, Y, Er, Ce, La, and Di.—C. Liebermann proved frangulic acid to be identical with emodin C<sub>14</sub>H<sub>8</sub>O<sub>4</sub> + 1½H<sub>2</sub>O. The same chemist showed glass tubes profoundly attacked and rendered non-transparent by water at 200°.—A. Michael and Th. Norton, by treating resorcine with terchloride of iodine, have obtained teriodo-resorcine.

December 11, 1876.—A. W. Hofmann, president, in the chair.—E. Berglund, who obtained imido-sulphonate of ammonium, NH<sub>2</sub>(SO<sub>2</sub>ONH<sub>2</sub>)<sub>2</sub>, by treating chlorosulphuric acid, ClSO<sub>2</sub>OH, with ammonia, has found that by boiling the same with baryta, it yields the barium salt of amido-sulphonic acid, NH<sub>2</sub>SO<sub>2</sub>OH.—S. Stein described levers, thermometers, and circular measures of rock crystal.—W. Thörner described an apparatus for distilling in vacuo, permitting the change of the receiver without taking the apparatus to pieces.—H. Landolt published interesting details of a projecting apparatus used by him for lecture-purposes.—F. v. Lepel communicated his observations on spectroscopic reactions of magnesium salts.—E. Glatzel described titanic sulphates derived from TiO<sub>2</sub> and Ti<sub>2</sub>O<sub>3</sub>.—E. Erlenmeyer has observed that an acid phosphate of lime, CaH<sub>2</sub>(PO<sub>4</sub>)<sub>2</sub>H<sub>2</sub>O, when treated with less water than is necessary for its solution, is decomposed into insoluble dicalcium phosphate, CaHPO<sub>4</sub> + (H<sub>2</sub>O)<sub>2</sub>, and free phosphoric acid. The same chemist recommends the following easy method for preparing cyanides, viz., to fuse ferrocyanide of potassium with sodium—

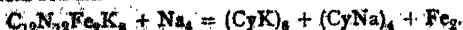

The same chemist, by oxidising normal oxycaproic acid, C<sub>6</sub>H<sub>11</sub>O<sub>2</sub>, obtained normal valerianic acid.—E. Fischer has transformed diphenylamine into diphenyl-nitrosamine, and the latter into (C<sub>6</sub>H<sub>5</sub>)<sub>2</sub>N-NH<sub>2</sub>, diphenyl-hydrazine, isomeric with hydrazobenzol, but not transformable into benzidine.—C. Böttinger confirmed former observations that citraconic acid and its

isomers treated with nascent hydrogen yield the same pyruvic acid.—A. Laubenheimer reported on orthodinitrochlorobenzol, one of the NO<sub>2</sub> groups having been replaced by NH<sub>2</sub>, it yielded, by treatment with nitrite of ethyl, paranitrochlorobenzol.—H. Limpricht published detailed researches on various bromobenzol-phenonic acids.—G. Krämer to purify methyl alcohol transform it into formiate. The impurity found in the pure alcohol of commerce is dimethyl-acetal. Conjointly with Grotzky he has found in impure methyl alcohol: acetone, dimethyl acetal, allylic alcohol, methyl-ethyl-ketone, higher ketones and oil which with chloride of zinc yielded cymol and xylol.—H. Bulk published simple contrivances to replace the ordinary suction-pump and separating funnel.—C. Liebermann and O. Burg have made researches on braziline, to which they give the formula C<sub>10</sub>H<sub>14</sub>O<sub>2</sub> + H<sub>2</sub>O; the formula of haematoxyline being C<sub>16</sub>H<sub>14</sub>O<sub>6</sub>. Braziline, when oxidised, yields the colouring matter brasiline, C<sub>16</sub>H<sub>12</sub>O<sub>6</sub>.—A. Frank gave a warning against the use of glass for sealed tubes, that yield more than 1 per cent. of soluble matter to water. He also mentioned that wine bottles are now in use that yield alkali to the wine, thereby spoiling their taste.

VIENNA

I. R. Geological Institution, November 26, 1876.—The Director, M. F. v. Hauer, referred briefly to M. F. Fötterle, vice-director of the institution, who died last summer; he then welcomed M. R. Drasche, who has recently returned from his travels in the Philippine Islands, Japan, and North America. The following papers were read:—Dr. Stache on the old eruptive rocks from the region of the Ortler Mountains; these bear a strong resemblance to modern andesites, and he showed their distribution on a large-scale map. The name of Ortlerite was proposed for one sort of these rocks, with a dioritic dark-coloured cement, a more basic nature, and of an older geological period; for the newer one, with a light-coloured trachytic and more acidic cement, the name of Guldenite was adopted. Many specimens which he presented contain various enclosures of other crystalline rocks.—Dr. E. Majsišovic presented the detailed geological map of South-Eastern Tyrol and the province of Belluno. The mapping was performed in the years 1874-1876, under the direction of the reporter, assisted by Dr. Hörnes and Dr. Dölter, since appointed professors at the University of Graz.—Dr. Tietze, on the country of Krasnowodsk, on the eastern coast of the Caspian Sea, which he had visited on his return from Persia. He stated that the supposition of a reappearance of the Persian-Armenic salt-beds in these parts, was erroneous. The large gypsum beds in Kubadagh belong to the mesozoic formations, and might be contemporaneous with the Jurassic gypsum-beds of Daghestan. The hills of Krasnowodsk may be regarded as a continuation of the Caucasian Mountains, and form the northern part of an anticline, whose southern part is partly formed by the Turcomanic Balkan.—Dr. Koch, on the occurrence of ice-crystals in loose gravel which he had observed at the Arlberg.—Dr. Drasche mentioned a similar occurrence that he had noticed during his travels in high mountainous regions of the tropical zone.

	PAGE
THE FARADAY LECTURE FOR 1875. BY JOHN M. THOMSON . . .	192
HUNTING-GROUNDS OF THE GREAT WEST . . .	194
OUR BOOK SHELF.—	
Elftoft's "Combined Note-book and Lecture Notes for the Use of Chemical Students . . ."	195
LETTERS TO THE EDITOR.—	
Solar Physics at the Present Time.—SIR G. B. AIRY, K.C.B., F.R.S.	196
Just Intonation, &c.—WM. CHAPPELL, F.S.A.	198
On "Comatulæ (Antedon) Rosacea," and the Family "Comatulidæ."—	
P. HERBERT CARPENTER; FRANCIS P. PARSONS	197
a FISHERIES.—E. W. H. HOLDSWORTH	198
"Stardial Messenger."—GEMOND STONE	198
Polar Depression of the Barometer.—JOSEPH JOHN	199
of Birds.—DR. ARTHUR SUTHERLAND; A. N.	199
THE TELEGRAPH ENGINEERS	199
THE LARVAE AND INSECTICIDES	200
CAMBRIDGE OBSERVATORY (With Illustrations)	20
MUSEUM AND PAPERS FOR TEACHING PURPOSES, III. BY PROF. W. H.	
FLOWER, &c.	20
OUR ASTRONOMICAL COLUMN:—	
The New Star in Cygnus . . .	20
New Variable Star in Cetus . . .	20
De Vico's Comet of Short Period . . .	20
The Total Solar Eclipse of Sukkadee, 1876, August 21	20
Meteor of December 11 . . .	20
NOTES.—	
SCIENTIFIC SERIALS	21
SOCIETIES AND ACADEMIES	21

THURSDAY, JANUARY 11, 1877

## FERMENTATION

*Études sur la Bière.* Par M. L. Pasteur. (Paris : Gauthier-Villars).

## I.

IN a recent notice of an article on Brewing contributed by Mr. Pooley to Stanford's "British Manufacturing Industries," some statistics were quoted showing the gigantic development which the production of beer has acquired in the United Kingdom. The amount of beer manufactured in the British Islands, vast though it be, forms yet but a small portion of that made throughout the world. Probably no industry—saving agriculture—employs so large an amount of capital as that of brewing and the various industries supported by it. Important though this old and at present vastly extended industry be, it is yet one which, until ve recently, scientific methods of investigation had done but little to add to our knowledge of the complex phenomena underlying the apparently simple art, and therefore even less in preventing the serious losses constantly occurring even with the most careful manufacturer.

The valuable contribution to our knowledge of the biological aspect of fermentation, which M. Pasteur has just given to the world, is a worthy sequel to the classical researches described by the illustrious chemist in the papers read before the French Academy during the last fifteen years, and summarised by him in a popular form in his "Études sur le Vin," and "Études sur le Vinaigre." These important works, containing the results of long years of laborious and brilliant research, have done much to remove the charge brought against science, and have indeed become to the brewer and wine-grower as the brightening sky to the mariner groping his way in fog and uncertainty to his haven. The grateful recognition of twenty years fruitful labour is due alike from practical and scientific men to the illustrious investigator of the Biology of Fermentation, and he certainly will not deem it the less hearty and sincere if occasional exception here or elsewhere be taken to some of his propositions.

Before considering Fermentation and the recent views promulgated by Pasteur and others regarding the interesting and complex phenomena grouped under this term, it will be useful to discuss the changes produced in the malting and mashing processes of the brewer as necessary precursors to the greater change produced in Fermentation properly so-called. Let us, then, examine the change brought about by the action of water and heat on the grain of any of our common cereals—barley, for example; if this be ground and digested for a few hours at a temperature of 60° C. with five or six times its weight of water, it will be found that the whole, or nearly the whole—this depending upon the comparative activity of the albuminous matters present—of the insoluble starch will be changed into products soluble in water. By the agency of the albuminous ferments or alterative agents water will be assimilated and dextrine and Glucose and products of transformation intermediate between these will be obtained.

This reaction is general, and applies not only to the grain of our common cereals, but also to other stored-up

amylaceous vegetable products. While, however, the agency of heat and moisture suffice to bring about this remarkable change, it yet requires too much time, and the products formed are not well adapted to the brewer's wants. Various albumenoid bodies, such as the ptyalin in the saliva, and those in the secretions from the pancreas and intestinal canal in the animal economy intensify the action of the soluble albumenoids in ordinary bread-stuffs, and hence produce a greater hydration, and therefore solution, in a given time. Now the object of malting is to convert some of the inert albumenoids into these more active agents of change, and thus the maltster avails himself of a property existing throughout all vegetable tissues, whereby previously stored-up insoluble amylaceous matter is converted, through the joint agency of moisture, heat, and albumenoid ferments, into soluble sugars, and used along with soluble albumenoid matters for the production of new tissues.

To produce an increase in the albumenoid ferments in barley—the grain chiefly employed in England—the maltster first steeps the grain in water for a period varying from fifty to seventy hours according as the skin is thin or thick, that is, more or less pervious to water. So soon as the desired amount of water has been absorbed, it is removed from the cistern and spread out on the floor of the malt-house, the temperature best suited for the production of sound malt being about 15° C. The germination of the grain commences and is allowed to proceed, with occasional turnings, until the plumule of the young growing plant has advanced far enough up the back of the grain to satisfy the objects which the brewer may have in view. Thus, if a full and somewhat dextrinous ale be required, the plumule is barely allowed to grow to the bend, or *bridge*, of the grain, whereas, if a dry alcoholic ale be required, the growth is allowed to proceed further. According to the growth of the plumule, so does the production of active ferment vary. This point being obtained, the malt is placed on the floor of a kiln, whereby further growth is stopped. Without dwelling with too much detail on this malting, or germinating, process, it will be useful to consider here some of the changes produced. In the first place, by the absorption of water the grain swells and the albumenoid ferments previously existing in the grain are made soluble, and these, by the aid of moisture and heat, begin to act on the starch. Meanwhile, a portion of the insoluble albuminous bodies are rendered soluble, and aid in this conversion of starch, and at the same time, in conjunction with the transformation products of starch, serve to build up the cell structures of the growing plumule and rootlets. Throughout the germinating process carbonic acid and heat are evolved precisely as in the subsequent process of the conversion of sugar into alcohol. The analogy does not, however, rest here, because alcohol is also produced in small quantities. If the growing grain be shut in an air-tight vessel, it will be found that as the growth of the young plant is stopped, the amount of alcohol becomes largely increased, attended at the same time by the production of a large quantity of gas, the chief constituent being carbonic acid. This production of alcohol by vegetable cells has already been noticed in the case of fruits by Lechartier and also by Pasteur. The enormous volume of carbonic acid gas produced without the intervention of *free oxygen* is a fact



of great interest to which we must again refer when considering the action of yeast upon sugar.

In this germinating process we have an example of the way in which insoluble matter stored up, whether in the seed or in the tissues of a plant, becomes digested and used for the production of fresh tissues. This property is not limited to vegetable organisms; in animals, also, we find stored-up matter, fatty or amylaceous, acted upon by albumenoid ferments, and being thus rendered soluble, become available for the building up of fresh structures, or for the production of heat by their oxidation in the system. It would lead us too far to discuss here the manner and the agents by which albuminous food, such as flesh meat, cheese, &c., are made soluble in the human economy. Suffice it here to state that the means by which nature produces the desired end of solution in animal and vegetable alike, are moisture, heat, and albumenoid ferments.

The following analyses by Oudemans show the changes produced in the malting process and in the subsequent drying on the kiln :—

	Barley.		Malt.	
	Air dried.	Air dried.	Kiln dried (pale).	Kiln dried (amber).
Torrefaction products	0.0	0.0	7.8	14.0
Dextrine	5.6	8.0	6.6	10.2
Starch	67.0	58.1	58.6	47.6
Sugar	0.0	0.5	0.7	0.9
Cellulose	9.6	14.4	10.8	11.5
Albuminous Substances	12.1	13.6	10.4	10.5
Fatty	2.6	2.2	2.4	2.6
Ash, &c.	3.1	3.2	2.7	2.7
Total	100.0	100.0	100.0	100.0

These analyses, though made some years since, and differing in some points from our existing knowledge, are yet sufficient for our present purpose. We see that the air-dried malt, when compared with the barley from which it was made, is poorer in starch, and richer in woody fibre.

Again, as regards the changes in the albuminous bodies, still quoting Oudemans, we find—

	Barley.	Malt.
Gluten, soluble in alcohol	0.28	0.34
Albuminous substances coagulable by heat	0.28	0.45
"    "    not coagulable	1.55	2.08
Insoluble albumen	7.59	6.23
Total	9.70	9.10

We notice that there has been a loss of some of the albuminous matters in the germinating process, but at the same time an increase in the soluble or active agents of change, to obtain which the malting process is followed. Let us now examine the changes which the malt undergoes when placed in the brewer's mash tun and submitted to the action of heat and water. In England the amount of water employed varies with the nature of the beer to be

made, it may be taken, however, as being about twice the weight of the malt, and the temperature of the mixture of malt and water varies from 63° C. to 67° C. In the course of half-an-hour the insoluble starch is converted into soluble sugars and dextrine. The infusion thus obtained is, however, too dextrinous in character for the production of dry alcoholic ales, but as the process continues, more and more water is assimilated, and finally an infusion is obtained rich in alcohol-yielding sugars.

Many theoretical explanations have been given, and will doubtless yet be given, as to the action and the products formed. We are indebted to the admirable and suggestive researches of O'Sullivan for the first clear exposition of what takes place, or rather of one of the changes which occur. He formulates the reaction thus :—



and he states that this is the final action of soluble ferments on starch. This equation, however, expresses only what takes place when a small quantity of malt acts on starch paste at a temperature of only 40° C. to 45° C. We must rather assume the probability of several changes, of which that formulated by O'Sullivan is one. Thus if the amount of starch be large in comparison to the active albumenoid ferments, and if the water and time of infusion be lessened, we obtain a solution having a reducing power on Fehling's liquid equal to 33 per cent. of glucose. On the other hand, if the conditions be reversed, that is, if we increase the time, the amount of ferment, and the water, we obtain an infusion having a reducing power equal to 66 per cent. of glucose.

Here, however, the action ceases, and the so-called diastase of malt is unable to carry on the hydration beyond the point last-mentioned, where we obtain a solution which reduces Fehling's liquid to the extent of two-thirds of the reduction obtained when the starch is fully hydrated by weak mineral acids.

Formulating the reactions according to the Fehling reducing products obtained we should have—

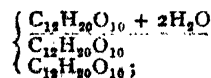

this product having a 33.33 per cent. reducing action. On the other hand, where we continue the action of diastase for a longer period and with more water, we have—

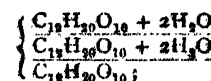

this product having a 66.66 per cent. reducing power, and being apparently the final action of diastase on starch. When the hydration of the starch is effected by dilute acid we obtain—

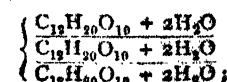

that is, dextrose having the full reducing action.

O'Sullivan's dextrine-maltose reaction might similarly be thus expressed—

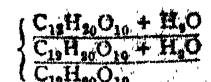

and giving a product having a 44.44 per cent. reducing

action. If this be a correct expression it follows that there are two other possible cases where one and three molecules of water are assimilated. Cane-sugar and lactose are isomeric with O'Sullivan's maltose, and are all dextro-rotatory. These three sugars of the formula  $C_{12}H_{22}O_{11}$  are all further hydrated by the action of diastase, yeast water, and dilute acids.

Though ignorant of the molecular weights of starch we may yet safely assume in the expression  $(C_6H_{10}O_5)_n$  that the value of  $n$  must be large, and that a molecule of such complexity will yield in addition to dextrine several sugars isomeric with sucrose and with dextrose, and it may be others of greater hydration. In the brewer's mash tun the hydration products vary according to the malt employed and the extent to which the malting process is pushed before the kiln drying action, the more of the active ferment formed the greater the hydration in a given time. The amount of water is an important factor in the hydration process; the greater this is within certain limits the greater the hydration; and lastly, the products vary with the amount of time given to the mashing or hydration fermentation.

Thus we may briefly sum up the changes produced by the statement that the infusion products of starch will be more dextrinous, *i.e.*, least altered according as we lessen the time, the amount of water, and the growth of the plumules in the malting process; and on the other hand the infusion products will be richer in Glucose (dextrose), and therefore attenuate lower in the subsequent fermentation process, according as we increase the amount of water, the time of infusion, and the growth of the plumule. The variations in these directions introduced in the mashing process in English breweries are within a narrow range, and the products formed have a reducing action on Fehling's liquid, varying from 50 per cent. to 55 per cent. of the total hydration possible by the aid of mineral acids.

The use of unmalted grain is prohibited in England, whereas cane-sugar and Glucose (made by the action of dilute acid on grain) are allowed. The variations in the direction of dextrine-increase were until recently very limited, but on the other hand those in the direction of alcohol-yielding sugars are without limit.

Messrs. O'Sullivan and Valentin, in a communication to the Society of Arts (March 17, 1876), have recently shown how the action of dilute sulphuric acid may be so regulated as to obtain O'Sullivan's dextrine-maltose reaction already described.

The hydration by the agency of very dilute sulphuric acid is carried on until the liquid has a rotatory power of  $+171^\circ$ , indicating two parts of maltose (rotatory power  $+150^\circ$ ) and one part of dextrine (rotatory power according to O'Sullivan  $+213^\circ$ ), *i.e.*,

$$\frac{2 \times 150 + 213}{3} = +171^\circ.$$

So soon as the polariscope indicates O'Sullivan's reaction to be complete, the further hydration is stopped by the addition of chalk. Should the mixture of dextrine and maltose thus made prove to yield a stable and good-keeping beer, they will have contributed greatly to counteract the evil tendency of recent legislation by which beer more and more alcoholic has been manufactured.

Having briefly examined the hydration of starch by

albumenoid alterative ferments in the brewer's mash-tun, we have now to consider the breaking up of the still complex saccharine products of the reaction into bodies of simpler structure, such as alcohol and carbonic acid, which result from the fermentation process properly so called. Though it is with alcoholic fermentation, with its characteristic boiling or disengagement of carbonic acid gas, that we have chiefly to do, at the same time other products of the decomposition of saccharine bodies, such as acetic, lactic, and butyric acids, must necessarily be considered before we can obtain a correct insight into the phenomena which present themselves in the manufacture of beer.

Let us then follow the products formed by the hydration of starch already studied.

The wort, as the brewer terms the liquid containing the infusion products of the mash tun, is drawn off from the insoluble matters of the malt, and is then boiled in another vessel along with hops; the amount of this valuable agent of preservation employed depending upon the strength of the wort, the nature of the product desired, and the length of time it has to be kept before being consumed.

By mere boiling, some of the albuminous bodies are rendered insoluble, a further portion is precipitated by the tannin of the hops, and the resulting liquid, being thus deprived of some of the albuminous food materials, is found to be less liable to subsequent destructive changes. The hops at the same time yield a pleasant bitter principle, and essential oils which play no slight part in the preservation of the manufactured beer. Now, unlike the juice of the grape, the infusion of malt is so rich in albuminous matters, that every expedient is adopted to diminish these aids to destruction; hence the process of boiling, the use of tannin, and the employment in the infusion process of hard water containing salts of lime. To its water Burton chiefly owes its reputation for good ale. The boiled wort, when cooled, is placed in fermenting vessels, and yeast is added. This addition of yeast is almost universal; at the same time it must be noted that in the production of *Faro* and *Lambick* the Belgian brewer adds no ferment; a similar practice was at one time rather common in England, and is even now occasionally to be found in Wiltshire. In thus adding no ferment, the brewer follows the invariable practice of the wine-maker, who leaves the must or pressed juice to spontaneous fermentation; the wine-grower may reasonably reckon upon a definite decomposition of his must, but the brewer who follows this method can foretell but little of the result. We shall presently see why the wine-grower's must and the brewer's wort comport themselves so differently under apparently the same conditions. The spontaneous fermentation of malt wort, even now so little practised, is doomed to be altogether discontinued within but a few years.

The English brewer, having cooled his wort to a temperature varying from  $14^\circ$  C. to  $18^\circ$  C., and having added yeast, the fermentation commences, the heat, unless checked, rapidly rises, and the yeast greatly increases in quantity, the larger portion of which rises to the surface of the liquid. Hence this is termed *top* or *surface* fermentation, in order to distinguish it from the *Bavarian* process, in which the yeast sinks to the bottom of the

liquid. The temperature of the German *bottom* fermentation varies from 5° C. to 7° C., a temperature that can only be maintained by the employment of large quantities of ice.

The *bottom* and *top* yeasts are probably distinct species. M. Pasteur, however, seems to be in error in stating (p. 190) that the *bottom* yeast may be distinguished by being less spherical than top yeast. It is true that in London and Edinburgh yeast the cells will be found usually round; hard water, however, such as that at Burton, or artificially made so, yields yeast in which the cells are distinctly ovoid in appearance, resembling very closely Bavarian *bottom* yeast. M. Pasteur further states (pp. 188 and 192) that the *bottom* yeast yields a beer of finer flavour, and hence argues the replacement of ales produced by top fermentation by those made on the Bavarian system. Here surely he must be thinking rather of the inferior products of the surface fermentation in France and Germany than of those of England and Scotland. His assertions (pp. 12-17) that by *bottom* fermentation store beers can be produced, whereas those produced by top fermentation must be consumed at once and cannot be transported are certainly strange to an Englishman.

So far from these unfavourable comparisons being true in all cases, the exact opposite is generally the case. Bavarian and other *bottom* fermentation beers are in fact those which can neither be preserved nor transported without the liberal employment of ice; even that sent from Vienna to London must be kept cold artificially in order to avoid rapid destruction. As regards flavour, there are many who think a glass of Burton pale ale or of good old college rent ale to be superior to any Bavarian beer. The chief cause of the decline in the production of top fermentation beers on the Continent has been the want of attention in the fermentation process, whereas the English brewer, especially the brewer of high-class ales, has been unremitting in his attention to the temperature in fermentation and to the perfect cleansing of the ale. Now where such attention is given it is not difficult to obtain ales which will keep a few years. While objecting to our English produce being so hastily depreciated by M. Pasteur, our brewers will be the first to avail themselves of his biological researches in order to render their produce more stable and better flavoured, without having recourse to the general adoption of the vastly more costly system of *bottom* fermentation.

Let us now leave this question of the respective value and future development of the two systems of fermentation, and assume that by either the one process or the other we have obtained our glass of beer. The question now naturally presents itself to us, as to others before us, to what is fermentation due? Pasteur's answer to this I propose to discuss next week.

CHARLES GRAHAM

#### OUR BOOK SHELF

*Manual of the Vertebrates of the Northern United States.*  
By David S. Jordan, M.D. (Chicago: Jansen, McClurg, and Co., 1876.)

This useful work contains a short diagnostic account of the whole of the vertebrated animals of the Northern United States, and has been written, as the author tells

us, to give collectors and students who are not specialists a ready means of identifying the families, genera, and species described. The mammals as well as the birds of North America have been so ably and elaborately treated of by Prof. Baird, Dr. Coues, and others, that those who are studying these branches of zoology will not find this smaller volume of special service, nevertheless we are not acquainted with any work having a range of treatment which includes the reptilia, amphibia, and fishes with the two other classes. The sub-kingdom, as well as each class and order, are concisely defined, and the most modern arrangement is adopted, based upon the best authorities, the relative importance of the characterising features being clearly brought forward. The system of employing artificial keys so useful in botanical determinations, and so successfully employed by Dr. Coues in ornithology, is employed throughout the book, and will, no doubt, be found to work well. A glossary of the principal technical terms used in the body of the book is also appended. As an example of the manner in which the different species are described, we will take that of one of the species of Fly-catchers: "*Empidonax acadicus* (Gm.), Baird. SMALL GREEN-CRESTED FLY-CATCHER.—Clear olive-green; wing bands buffy; whitish becoming yellowish below; yellowish ring about eyes; bill pale below; primaries nearly an inch longer than secondaries; second, third, and fourth primaries nearly equal, and much longer than first and fifth; first much longer than sixth; L. 6; W. 3; T. 2½; Ts. ¾; Tcl. ½; E.U.S. frequent." To naturalists on this side the Atlantic the work will be found a valuable one of reference on account of its inclusiveness, and a glance through it makes us feel how useful a similar one on the British vertebrate fauna would prove to students and collectors.

*The Emigrant and Sportsman in Canada.* By John J. Rowan. (London: Stanford, 1876.)

THIS is a capital book in many respects. Mr. Rowan is himself an old Canadian settler and knows the country well in various aspects. He tells the plain truth as to the suitability of Canada as a field for emigration, and the intending emigrant could not get a better guide as to the resources of the country, and the kind of settlers for which it is adapted. Mr. Rowan is a keen sportsman and has a fair knowledge of zoology. His descriptions of hunting life in Canada are thoroughly interesting and abound with fresh information on the many animals which are still to be found there. Mr. Rowan is a good observer, and some of the information which he gives regarding the animals with whose habits he is familiar may be new even to naturalists. He describes, at considerable length, especially, the habits of the beaver as observed by himself, and adduces some facts to show that previous popular statements with regard to this animal must be to some extent modified. The volume will be found of interest not only to the emigrant, the sportsman, and the naturalist, but to all who love good hunting and trapping stories well told. Its principal defect is the want of an index.

#### LETTERS TO THE EDITOR

[The Editor does not hold himself responsible for opinions expressed by his correspondents. Neither can he undertake to return, or to correspond with the writers of, rejected manuscripts. No notice is taken of anonymous communications.]

#### On a Mode of Investigating Storms and Cyclones

I SCARCELY know anything more interesting in connection with the investigation of cyclones and of our storms than the theoretical investigations of Reye, Mohr and Goldberg, and the practical ones of Mr. Clement Ley. Mr. Ley's papers in the *Journal of the Scottish Meteorological Society*, iv. 60, 149, 328, have especially attracted my attention. We have to study the

form of the craters, as I might call them, of the barometric depressions, and their steepness in different directions.

The following note has some connection with this inquiry, and I beg you, if you think it suitable, to give it a place in your esteemed journal:—

In 1874 I proposed to lay, as well as it can be done, a plane or planes, having such a slope as would represent the barometric height at some two distant places, and to indicate (in geodetic terms) the fall and strike, or the inclination on the horizon and the azimuth of the projection of the perpendicular on such a plane, and I still recommend it. In the Netherlands, where my area is small (see Jour. Scot. Met. Soc., iv. 25) it is always easy to find such a plane, and of course its perpendicular. Now I have inquired whether the projection of that perpendicular moved round the horizon generally in a direct way (with the sun) in the same manner as M. Dove has found that the direction of the wind does, and which I demonstrated in *Pogg. Ann.*, lxxviii. 417, 553, to be the case thirteen times per annum in our latitude.

On examination I find that in 1874 and 1875 the projection has gone round the horizon in a direct way ten times more than the opposite way; further, that it often goes back when the direction of the projection lies to the south-east, but that when it has veered to be to the north-west it veers forward surely and quickly enough in a direct way to the east, which is in accordance with the fact that when we have a depression over Ireland or Scotland it then moves in the direction of Norway and Finland. I don't think it superfluous to call the attention of others to this research, and I propose to calculate the results for other years in this respect, which is easily done by means of the Netherlands' *Annales*, and thus find thrice a day the direction and size of the steepest gradient.

Utrecht, December 23, 1876

BUYS BALLOT

#### Mind and Matter

THE problem, "How consciousness stands related to the material organism," has been attempted to be solved by Mr. Duncan, under the head of "Mind and Matter" (*NATURE*, vol. xv., p. 78). Now that a more exact scientific examination has reconciled so many differences on this question, a return to the old *à priori* method of mere logic is still perfectly legitimate, provided the logic is sound.

Admitting that consciousness is related to matter, and without contending, for the present, that it may not be a state of matter (under certain restrictions of the term), I will content myself with pointing out what seem to be fallacies in this "solution." "It is as easy," says Mr. Duncan, "to predicate subjectivity (susceptibility to consciousness) of one entity called matter as of another entity called soul or spirit. It is no more difficult to conceive of matter being subjective than of spirit being subjective." Let us see if this is or is not *petitio principii*. It was the difficulty, real or apparent, of ascribing certain attributes (mental) to matter, that demanded the supposition of some support other than material. So that when we say that spirit is alone susceptible to consciousness, we merely express that matter is not thus susceptible. Therefore, to affirm that the one may be as susceptible to consciousness as the other is to assume, *in limine*, that matter may be susceptible to consciousness, the very probability which has to be established.

Mr. Duncan next asserts that "How energy is related to matter in all its forms, is no less mysterious than how subjectivity may be a property of matter." Now every opponent of materialism admits that how energy is related to matter is a mystery, and avows that he cannot conceive of consciousness as a property of matter; but the difficulty of understanding the *how*, even if we grant it equal in both cases, cannot establish any parity of probability as to the facts; for while we know as a fact that energy is related to matter, we do not know as a fact that subjectivity (susceptibility to consciousness) is a property of matter. And even if we put the argument more exactly, and affirm that we know that subjectivity, like energy, is related to matter, still nothing in point is gained, seeing that while we know all matter in relation to energy, it is only a certain form of matter (the human) which we know to be related to subjectivity; for if we surmise this of a dog, we cannot know it till he tell us.

The next position, "Energy may be divided. Why not subjectivity?" would seem to demand nothing less than absolute proof, since subjectivity, or the state of the Ego, appears indivisible in virtue of its essential unity. Yet no support is advanced except the foregoing assertion, which we have seen is a mere assumption on the side of materialism, and which we shall next

see contains an admission all but fatal to the cause it advocates. When Mr. Duncan says, "How energy is related to matter is no less mysterious than how subjectivity may be a property of matter," he admits that we cannot understand either, while he believes the first because it is a fact. But why should we believe the last? Because we cannot understand it, and because it is not a fact? Will he admit that we have advanced any proof of an oyster being an astronomer, when we have affirmed that this would be no more mysterious than the relation of energy to matter? Yet his three remaining arguments go on this ground: they assume that the probability of subjectivity being a property of matter equals the fact of energy being related to matter.

Rugby

J. L. TUPPER

#### Solar Physics at the Present Time

AT the conclusion of his letter of the 1st inst. (*NATURE*, vol. xv. p. 196), Sir G. B. Airy alludes to a paper of mine as being cited by me (in my last letter to *NATURE*) as being "in the 'Philosophical Transactions.'"

The paper referred to *ought*, with little doubt, to have appeared there, but it did not, and I was most careful to avoid implying that it had; my words being with regard to it (see your pages 157 and 158):—

1st, "which I had the honour of communicating to the Royal Society of London six years ago;" and

2nd, "that paper of six years ago, and still in the hands of the Royal Society;"

nor is there any mention of the "Philosophical Transactions" throughout.

PIAZZI SMYTH,

Edinburgh, January 5

Astronomer Royal for Scotland

#### Towering of Birds

SNIPES frequently tower—also pigeons. I saw a mallard that flew nearly half a mile, towered, and, fell dead. Teal also tower, but their towering is different to the ordinary, as they are as often alive as dead when they fall. I have also remarked this in widgeons, and once in a partridge. In the latter case birds fell right and left, the second a towerer. It was in heavy turnips that had been planted when mangel had missed. The towerer fell on an isolated mangel; when picked up, he was at least ten yards from the mangel and still alive. Some years ago there was a discussion on this subject in *Land and Water* or the *Field*, and I think it was shown it was due to pulmonary hæmorrhage. At least I was quite aware of the cause, and that head or spine injuries had nothing to do with it.

Ovoca, Ireland

G. H. KINAHAN

#### Rooks Building at Christmas

ON Christmas morning I saw a few rooks engaged in building in a clump of elms near my house. Four nests are now in progress, though the gale of December 30 made the rooks desist from their work. During the ten years (about) that I have watched their proceedings, I think I have never seen these birds begin building till February.

I may add that our well-watered lands and woods are being visited with wild duck, teal, peewits, and gulls in great numbers.

Valentines, Ilford, Essex

C. M. INGLEBY

#### Are We Drying Up?

THE above question has been asked in the Columns of *NATURE*. As a small contribution towards an answer, it may be stated that at this place the two last years, 1875 and 1876, have been the two wettest in a series of twenty-four years.

In 1875, the rainfall was 44.05 inches.

In 1876 " " " 42.42 " "

The average of twenty-four years has been 33.11 inches.

Clifton, January 7

GEORGE F. BURDER

#### Radiant Points of Shooting Stars

IN December, from observations of 163 shooting stars seen in 20½ hours' watching, chiefly in the evenings, I amply confirmed several of the positions of radiant points as given in my note (*NATURE*, vol. xv., p. 158), and observed that several of the showers there mentioned were actively continued. The centres, as I gave them, of two of these require revision, as the additional meteors seen in December indicate the radiant with

greater precision than the few I had noted in November. The new radiant in Sextans, I now deduce at R. A. 148°, Decl. 2° N., and that at  $\gamma$  Leonis, as near Crater R. A. 165°, Decl. 6° S. The meteors from these new showers are very rapid and white, usually leaving bright streaks for 2 or 3 secs. in their path.

Ashley Down, Bristol, January 2 W. F. DENNING

### ALEXANDER BAIN

IT is with much regret that we announce the death of Mr. Alexander Bain, which took place at Glasgow on January 2. To many of our readers his name is perhaps unknown, and yet the inventions of Mr. Bain, made when telegraphy was in its infancy, were of the very highest importance. They were perhaps made too soon. Mr. Bain himself never reaped the benefit of them, and would have died in great poverty had it not been for a pension of 80*l.* a year obtained for him from Mr. Gladstone chiefly through the exertions of Mr. C. W. Siemens, Sir William Thomson, and the Society of Telegraph Engineers.

One of the most important services of Mr. Bain to telegraphy was the reinvention of the method of making use of "bodies of natural waters" "to complete the electric circuit by laying a single insulated wire between the given stations, having at each end a metallic brush immersed in the water." In 1838 Steinheil discovered the use of the earth for completing a circuit instead of a return wire, but does not appear to have taken steps to bring his discovery into notice, or to remove the prejudices with which a discovery so startling would naturally be met. Mr. Bain seems to have established the principle for himself, and he published it in a patent of 1841, by Wright and Bain, for "Improvements in applying electricity to control railway engines and carriages, to mark time, to give signals, and to print intelligence at different places." It is impossible to say how large a part of the completeness of our present telegraphic system, particularly of our submarine telegraphic system, is due to this great discovery of Steinheil and Bain.

An early invention by Mr. Bain, was that of the electro-chemical telegraph. This was patented in 1846. Paper chemically prepared is drawn under a metallic style which rubs upon it. As long as there is no current passing in the line the paper comes away from the style unmarked, but each signal sent through the line passes by the style to the prepared paper and leaves a mark. Combinations of dots and dashes, as in the Morse system, formed Mr. Bain's alphabet.

At first the signals were sent by hand by a simple contact key, but Mr. Bain soon found his system capable of receiving signals at far higher speed than that of the fastest hand sending. He was thus led to the invention of automatic methods of transmitting signals of which one is the basis of the most important method at present in use. A slip of paper is perforated with holes arranged in groups, forming the letters required in accordance with the code of signals. This slip is passed between a metallic roller and a contact point. As long as the contact point is separated from the roller by the paper slip, no current passes in the line. But when one of the perforated holes comes under the contact point, the point falls in and makes contact with the metallic roller. The circuit is thus closed, and a signal is sent.

This apparatus was tried before Committees of the Institute and of the Legislative Assembly at Paris. Through a line between Paris and Lille, a message of 282 words was sent. The time taken was fifty-two seconds! The fastest automatic receiving by mechanical instruments of the most refined modern construction, such, for example, as the instruments of Wheatstone, does not commonly reach 200 words per minute. We hear from Sir William Thomson, in his recent address to the British Association, that he saw in America "Edison's Automatic Tele-

graph delivering 1,057 words in 57 seconds—this done by the electro-chemical method of Bain." That Mr. Bain's method was not received in England cannot but be regarded as a great misfortune.

These were, perhaps, Mr. Bain's principal inventions, but there are others of such importance that they well deserve notice. Several of his patents relate to the keeping of time by clocks controlled or driven electrically by a standard clock. Jones' system, now so largely used in England, is based upon the system of Bain. He invented the earth battery in 1843, or rather reinvented it, as Gauss and Steinheil had previously obtained a current, after the discovery by Steinheil of using the earth for a return wire, making one of the earth plates of zinc and the other of copper. In 1844 he patented ingenious apparatus for registering the progress of ships and for taking soundings. Vanes caused to rotate by the motion of the "log" or "sounding fly," through the water were employed, and an electrical method of observing the result on board was employed. The same patent describes apparatus for giving warning when the temperature of the hold of a ship rises above a certain point. An electric circuit was employed, which was closed by the expansion by heat of mercury contained in a tube. The current passing in the circuit traversed coils which formed an electro-magnet. A pointer or alarm connected with the magnet gave the required warning. This method is now very commonly employed for fire alarms; and modifications of it have been proposed for giving warning of over-heating in the bearings of machinery.

He had also an electric method of playing a keyed instrument at a distance on more than one organ or piano at a time; and he applied his perforated paper to the automatic playing of a wind instrument, such as an organ. For this purpose the paper, properly punched, was drawn between the openings of the wind chest and the openings of the notes to be played upon. Whenever and as long as there was a punched hole of the paper between the wind chest and the pipe the note of the pipe sounded. When there was a blank space between the wind chest and pipe the pipe was silent.

In his later years Mr. Bain's inventions have been inconsiderable. Some years ago he was stricken down with paralysis. He died at the age of sixty-six, on the second day of this year, in the Home for Incurables, Broomhill, near Glasgow.

### PHOTOGRAPHS OF THE SPECTRA OF VENUS AND $\alpha$ LYRÆ

SINCE the spring of 1872 I have been making photographs of the spectra of the stars, planets, and moon, and particularly among the stars, of  $\alpha$  Lyrae and  $\alpha$  Aquilæ, with my 28-inch reflector and 12-inch refractor. In the photograph of  $\alpha$  Lyrae, bands or broad lines are visible in the violet and ultra-violet region, unlike anything in the solar spectrum. The research is difficult, and consumes time, because long exposures are necessary to impress the sensitive plate, and the atmosphere is rarely in the best condition. The image of a star or planet must be kept motionless for from ten to twenty minutes, and hence the driving-clock of the telescope is severely taxed.

During last summer I obtained some good results, and in October took photographs of the spectrum of Venus which show a large number of lines. I am now studying these pictures, and have submitted them to the inspection of several of my scientific friends, among others, Professors Barker Langley, Morton, and Silliman. There seems to be in the case of Venus a weakening of the spectrum towards H and above that line of the same character as that I have photographically observed to take place in the spectrum of the sun near sunset.

New York, December, 1876

HENRY DRAPER

ON THE STUDY OF BIOLOGY<sup>1</sup>

IT is my duty to-night to speak about the study of Biology, and while it may be that there are many among you who are quite familiar with that study, yet as a lecturer of some standing, it would, I know by experience, be very bad policy on my part to suppose such to be extensively the case. On the contrary, I must imagine that there are many of you who would like to know what Biology is; that there will be others who have that amount of information, but would nevertheless gladly learn why it should be worth their while to study Biology; and yet others, again, to whom these two points are clear, but who desire to learn how they had best study it, and finally when they had best study it; and I shall address myself to the endeavour to give you some answer to these four questions—what Biology is, why it should be studied, how it should be studied, and when it should be studied.

In the first place, in respect to what Biology is, there are, I believe, some persons who imagine that the term "Biology" is simply a new-fangled denomination, a neologism in short, for what used to be known under the title of "Natural History," but I shall try to show you, on the contrary, that the word is the expression of the growth of science during the last 200 years, and came into existence half a century ago.

At the revival of learning, knowledge was divided into two kinds—the knowledge of nature and the knowledge of man; for it was the current idea then (and a great deal of that ancient conception still remains) that there was a sort of essential antithesis, not to say antagonism, between nature and man; and that the two had not very much to do with one another, except that the one was oftentimes exceedingly troublesome to the other. Though it is one of the salient merits of our great philosophers of the seventeenth century, that they recognise but one scientific method, applicable alike to man and to nature, we find this notion of the existence of a broad distinction between nature and man in the writings of Bacon and Hobbes of Malmesbury; and I have brought with me that famous work which is now so little known, greatly as it deserves to be studied, "The Leviathan," in order that I may put to you in the wonderfully terse and clear language of Thomas Hobbes, what was his view of the matter. He says:—

"The register of knowledge of fact is called history. Whereof there be two sorts, one called natural history; which is the history of such facts or effects of nature as have no dependence on man's will; such as are the histories of metals, plants, animals, regions, and the like. The other is civil history; which is the history of the voluntary actions of men in commonwealths."

So that all history of fact was divided into these two great groups of natural and of civil history. The Royal Society was in course of foundation about the time that Hobbes was writing this book, which was published in 1651, and that Society is termed a "Society for the Advancement of Natural Knowledge," which is nearly the same thing as a "Society for the Advancement of Natural History." As time went on, and the various branches of human knowledge became more distinctly developed and separated from one another, it was found that some were much more susceptible of precise mathematical treatment than others. The publication of the "Principia" of Newton, which probably gave a greater stimulus to physical science than any work ever published before, or which is likely to be published hereafter, showed that precise mathematical methods were applicable to those branches of science such as astronomy, and what we now call physics, which occupy a very large portion of the domain of what the older writers understood by natural history. And inasmuch as the partly deductive and partly

experimental methods of treatment to which Newton and others subjected these branches of human knowledge, showed that the phenomena of nature which belonged to them were susceptible of explanation, and thereby came within the reach of what was called "philosophy" in those days; so much of this kind of knowledge as was not included under astronomy came to be spoken of as "natural philosophy"—a term which Bacon had employed in a much wider sense. Time went on, and yet other branches of science developed themselves. Chemistry took a definite shape, and as all these sciences, such as astronomy, natural philosophy, and chemistry, were susceptible either of mathematical treatment or of experimental treatment, or of both, a great distinction was drawn between the experimental branches of what had previously been called natural history and the observational branches—those in which experiment was (or appeared to be) of doubtful use, and where, at that time, mathematical methods were inapplicable. Under these circumstances the old name of "Natural History" stuck by the residuum, by those phenomena which were not, at that time, susceptible of mathematical or experimental treatment; that is to say, those phenomena of nature which come now under the general heads of physical geography, geology, mineralogy, the history of plants, and the history of animals. It was in this sense that the term was understood by the great writers of the middle of the last century—Buffon and Linnæus—by Buffon in his great work, the "Histoire Naturelle Générale," and by Linnæus in his splendid achievement, the "Systema Naturæ." The subjects they deal with are spoken of as "Natural History," and they called themselves and were called "Naturalists." But you will observe that this was not the original meaning of these terms; but that they had, by this time, acquired a signification widely different from that which they possessed primitively.

The sense in which "Natural History" was used at the time I am now speaking of has, to a certain extent, endured to the present day. There are now in existence, in some of our northern universities, chairs of "Civil and Natural History," in which "Natural History" is used to indicate exactly what Hobbes and Bacon meant by that term. There are others in which the unhappy incumbent of the chair of Natural History is, or was, still supposed to cover the whole ground of geology and mineralogy, zoology, perhaps even botany in his lectures. But as science made the marvellous progress which it did make at the latter end of the last and the beginning of the present century, thinking men began to discern that under this title of "Natural History" there were included very heterogeneous constituents—that, for example, geology and mineralogy were, in many respects, widely different from botany and zoology; that a man might obtain an extensive knowledge of the structure and functions of plants and animals without having need to enter upon the study of geology and mineralogy, and *vice versa*; and, further, as knowledge advanced, it became clear that there was a great analogy, a very close alliance, between those two sciences of botany and zoology which deal with living beings, while they are much more widely separated from all other studies. It is due to Buffon to remark that he clearly recognised this great fact. He says: "ces deux genres d'êtres organisés [les animaux et les végétaux] ont beaucoup plus de propriétés communes que de différences réelles." Therefore, it is not wonderful that, at the beginning of the present century, and oddly enough in two different countries, and so far as I know, without any intercommunication, two famous men clearly conceived the notion of uniting the sciences which deal with living matter into one whole, and of dealing with them as one discipline. In fact I may say there were three men to whom this idea occurred contemporaneously, although there were but two who carried it into effect, and only one who worked it out completely. The persons to

<sup>1</sup> A lecture by Prof. Huxley, delivered at the South Kensington Museum on Saturday, December 15, 1876.

whom I refer were the eminent physiologist Bichat, the great naturalist Lamarck, in France; and a distinguished German, Treviranus. Bichat<sup>1</sup> assumed the existence of a special group of "physiological" sciences. Lamarck, in a work published in 1801,<sup>2</sup> for the first time made use of the name "Biologie" from the two Greek words which signify a discourse upon life and living things. About the same time, it occurred to Treviranus that all those sciences which deal with living matter are essentially and fundamentally one, and ought to be treated as a whole, and, in the year 1802, he published the first volume of what he also called "Biologie." Treviranus's great merit consists in this, that he worked out his idea, and wrote the very remarkable book to which I refer. It consists of six volumes, and occupied its author for twenty years—from 1802 to 1822.

That is the origin of the term "Biology," and that is how it has come about that all clear thinkers and lovers of consistent nomenclature have substituted for the old confusing name of "Natural History," which has conveyed so many meanings, the term "Biology" which denotes the whole of the sciences which deal with living things, whether they be animals or whether they be plants. Some little time ago—in the course of this year, I think—I was favoured by a learned classic, Dr. Field of Norwich, with a disquisition, in which he endeavoured to prove that, from a philological point of view, neither Treviranus nor Lamarck had any right to coin this new word "Biology" for their purpose; that, in fact, the Greek word "Bios" had relation only to human life and human affairs, and that a different word was employed when they wished to speak of the life of animals and plants. So Dr. Field tells us we are all wrong in using the term biology, and that we ought to employ another, only unluckily he is not quite sure about the propriety of that which he proposes as a substitute. It is a somewhat hard one—zootocology. I am sorry we are wrong, because we are likely to continue so. In these matters we must have some sort of "Statute of Limitations." When a name has been employed for half-a-century, persons of authority have been using it, and its sense has become well understood, I am afraid that people will go on using it, whatever the weight of philological objection.

Now that we have arrived at the origin of this word "Biology," the next point to consider is: What ground does it cover? I have said that in its strict technical sense it covers all the phenomena that are exhibited by living things, as distinguished from those which are not living; but while that is all very well so long as we confine ourselves to the lower animals and to plants, it lands us in a very considerable difficulty when we reach the higher forms of living things. For whatever view we may entertain about the nature of man, one thing is perfectly certain, that he is a living creature. Hence, if our definition is to be interpreted strictly, we must include man and all his ways and works under the head of Biology; in which case we should find that psychology, politics, and political economy, would be absorbed into the province of Biology. In fact, civil history would be merged in natural history. In strict logic it may be hard to object to this course, because no one can doubt that the rudiments and outlines of our own mental phenomena are traceable among the lower animals. They have their economy and their polity, and if, as is always admitted, the polity of bees and the commonwealth of wolves fall within the purview of the biologist proper, it becomes hard to say why we should not include therein human affairs, which in so many cases resemble those of the bees in

zealous getting, and are not without a certain parity in the proceedings of the wolves. The real fact is that we biologists are a self-sacrificing people; and inasmuch as, on a moderate estimate, there are about a quarter of a million different species of animals and plants to know about already, we feel that we have more than sufficient territory. There has been a sort of practical convention by which we give up to a different branch of science what Bacon and Hobbes would have called "Civil History." That branch of science has constituted itself under the head of Sociology. I may use phraseology which at present will be well understood and say that we have allowed that province of Biology to become autonomous; but I should like you to recollect that that is a sacrifice, and that you should not be surprised if it occasionally happens that you see a biologist trespassing upon questions of philosophy or politics; or meddling with human education; because, after all, that is a part of his kingdom which he has only voluntarily forsaken.

Having now defined the meaning of the word Biology, and having indicated the general scope of Biological Science, I turn to my second question, which is—Why should we study Biology? Possibly the time may come when that will seem a very odd question. That we, living creatures, should not feel a certain amount of interest in what it is that constitutes our life will eventually, under altered ideas of the fittest objects of human inquiry, seem to be a singular phenomenon; but at present, judging by the practice of teachers and educators, this would seem to be a matter that does not concern us at all. I propose to put before you a few considerations which I dare say many of you will be familiar with already, but which will suffice to show—not fully, because to demonstrate this point fully would take a great many lectures—that there are some very good and substantial reasons why it may be advisable that we should know something about this branch of human learning. I myself entirely agree with another sentiment of the philosopher of Malmesbury, "that the scope of all speculation is the performance of some action or thing to be done," and I have not any very great respect for, or interest in, mere knowing as such. I judge of the value of human pursuits by their bearing upon human interests; in other words, by their utility, but I should like that we should quite clearly understand what it is that we mean by this word "utility." Now in an Englishman's mouth it generally means that by which we get pudding or praise, or both. I have no doubt that is one meaning of the word utility, but it by no means includes all I mean by utility. I think that knowledge of every kind is useful in proportion as it tends to give people right ideas, which are essential to the foundation of right practice, and to remove wrong ideas, which are the no less essential foundations and fertile mothers of every description of error in practice. And inasmuch as, whatever practical people may say, this world is, after all, absolutely governed by ideas, and very often by the wildest and most hypothetical ideas, it is a matter of the very greatest importance that our theories of things, and even of things that seem a long way apart from our daily lives, should be as far as possible true, and as far as possible removed from error. It is not only in the coarser practical sense of the word "utility," but in this higher and broader sense that I measure the value of the study of biology by its utility, and I shall try to point out to you that you will feel the need of some knowledge of biology at a great many turns of this present nineteenth century life of ours. For example, most of us lay great and very just stress, upon the conception which is entertained of the position of man in this universe and his relation to the rest of nature. We have almost all of us been told, and most of us hold by the tradition, that man occupies an isolated and peculiar position in nature; that though he is in the world he is not of the world; that his relations to things

<sup>1</sup> See the distinction between the "sciences physiques" and the "sciences physiologiques" in the "Anatomie Générale," 1801.

<sup>2</sup> "Hydrogéologie," an. 5. (1801)

<sup>3</sup> "The term *Biology*, which means exactly what we wish to express, the *Science of Life*, has often been used and has of late become not uncommon among good writers."—Whewell, "Philosophy of the Inductive Sciences," vol. 1. p. 244 (edition of 1847).

about him are of a remote character, that his origin is recent, his duration likely to be short, and that he is the great central figure round which other things in this world revolve. But this is not what the biologist tells us. At the present moment you will be kind enough to separate me from them, because it is in no way essential to my argument just now that I should advocate their views. Don't suppose that I am saying this for the purpose of escaping the responsibility of their beliefs, because at other times and in other places I do not think that point has been left doubtful; but I want clearly to point out to you that for my present argument they may all be wrong; nevertheless, my argument will hold good. The biologist tells us that all this is an entire mistake. They turn to the physical organisation of man. They examine his whole structure, his bony frame, and all that clothes it. They resolve him into the finest particles into which the microscope will enable them to break him up. They consider the performance of his various functions and activities, and they look at the manner in which he occurs on the surface of the world. Then they turn to other animals and taking the first handy domestic animal—say a dog—they profess to be able to demonstrate that the analysis of the dog leads them, in gross, to precisely the same results as the analysis of the man; that they find almost identically the same bones, having the same relations; that they can name the muscles of the dog by the names of the muscles of the man, and the nerves of the dog by those of the nerves of the man, and that such structures and organs of sense as we find in the man such also we find in the dog; they analyse the brain and spinal cord, and they find that the nomenclature which fits the one answers for the other. They carry their microscopic inquiries in the case of the dog as far as they can, and they find that his body is resolvable into the same elements as those of the man. Moreover, they trace back the dog's and the man's development, and they find that, at a certain stage of their existence, the two creatures are not distinguishable the one from the other; they find that the dog and his kind have a certain distribution over the surface of the world comparable in its way to the distribution of the human species. What is true of the dog they tell us is true of all the higher animals; and they assert that for the whole of these creatures they can lay down a common plan, and regard the man and the dog, and the horse and the ox as minor modifications of one great fundamental unity. Moreover, the investigations of the last three-quarters of a century have proved, they tell us, that similar inquiries carried out through all the different kinds of animals which are met with in nature will lead us, not in one straight series, but by many roads, step by step, gradation by gradation, from man, at the summit, to specks of animated jelly at the bottom of the series; so that the idea of Leibnitz and of Bonnet, that animals form a great scale of being, in which there are a series of gradations from the most complicated form to the lowest and simplest; that idea, though not exactly in the form in which it was propounded by those philosophers, turns out to be substantially correct. More than this, when biologists pursue their investigations into the vegetable world, they find that they can, in the same way, follow out the structure of the plant from the most gigantic and complicated trees down, through a similar series of gradations, until they arrive at specks of animated jelly, which they are puzzled to distinguish from those specks which they reached by the animal road.

Thus, biologists have arrived at the conclusion that a fundamental uniformity of structure pervades the animal and vegetable worlds, and that plants and animals differ from one another simply as modifications of the same great general plan.

Again, they tell us the same story in regard to the study of function. They admit the large and important interval which, at the present time, separates the manifesta-

tions of the mental faculties observable in the higher forms of mankind, and even in the lower forms, such as we know them, mentally from those exhibited by other animals; but, at the same time, they tell us that the foundations or rudiments of almost all the faculties of man are to be met with in the lower animals; that there is a unity of mental faculty as well as of bodily structure, and that, here also, the difference is a difference of degree and not of kind. I said "almost all," for a reason. Among the many distinctions which have been drawn between the lower creatures and ourselves, there is one which is hardly ever insisted on,<sup>1</sup> but which may be very fitly spoken of in a place so largely devoted to art as that in which we are assembled. It is this, that while among various kinds of animals it is possible to discover traces of all the other faculties of man, especially the faculty of mimicry, yet that particular form of mimicry which shows itself in the imitation of form either by modelling or by drawing is not to be met with. As far as I know, there is no sculpture or modelling, and decidedly no painting or drawing, of animal origin. I mention the fact, in order that such comfort may be derived therefrom as artists may feel inclined to take.

If what the biologists tell us is true, it will be needful for us to get rid of our erroneous conceptions of man and of his place in nature, and substitute right ones for them. But it is impossible to form any judgment as to whether the biologists are right or wrong unless we are able to appreciate the nature of the arguments which they have to offer.

One would almost think that this was a self-evident proposition. I wonder what a scholar would say to the man who should undertake to criticise a difficult passage in a Greek play but who obviously had not acquainted himself with the rudiments of Greek grammar. And yet before giving positive opinions about these high questions of Biology people not only don't seem to think it necessary to be acquainted with the grammar of the subject, but they have not even mastered the alphabet. You find criticism and denunciation showered about by persons who not only have not attempted to go through the discipline necessary to enable them to be judges, but have not even reached that stage of emergence from ignorance in which the knowledge that such a discipline is necessary dawns upon the mind. I have had to watch with some attention—in fact I have been favoured with a good deal of it myself—the sort of criticism with which biologists and biological teachings are visited. I am told every now and then that there is a "brilliant article"<sup>2</sup> in so-and-so, in which we are all demolished. I used to read these things once, but I am getting old now, and I have ceased to attend very much to this cry of "wolf." When one does read any of these productions, what one finds generally, on the face of it, is that the brilliant critic is devoid of even the elements of biological knowledge, and that his brilliancy is like the light given out by the crackling of thorns under a pot of which Solomon speaks. So far as I recollect Solomon makes use of that image for purposes of comparison; but I won't proceed further into that matter.

Two things must be obvious: in the first place, that every man who has the interests of truth at heart must earnestly desire that every well-founded and just criticism that can be made should be made; but that, in the second place, it is essential to anybody's being able to benefit by criticism that the critic should know what he is talking about and be in a position to form a mental image of the facts symbolised by the words he uses. If not, it is as obvious in the case of a biological argument as it is in that

<sup>1</sup> I think that Prof. Allman was the first to draw attention to it.  
<sup>2</sup> Galileo was troubled by a sort of people whom he called "paper philosophers," because they fancied that the true reading of nature was to be detected by the collation of texts. The race is not extinct, but, as of old, brings forth its "winds of doctrine" by which the weathercock heads among us are much exercised.



of a historical or philological discussion, that such criticism is a mere waste of time on the part of its author, and wholly undeserving of attention on the part of those who are criticised. Take it then as an illustration of the importance of biological study, that thereby alone are men able to form something like a rational conception of what constitutes valuable criticism of the teachings of biologists.<sup>1</sup>

Next, I may mention another bearing of biological knowledge—a more practical one in the ordinary sense of the word. Consider the theory of infectious disease. Surely that is of interest to all of us. Now the theory of infectious disease is rapidly being elucidated by biological study. It is possible to produce from among the lower animals cases of devastating diseases which have all the appearance of our infectious diseases, and which are certainly and unmistakably caused by living organisms. This fact renders it possible, at any rate, that that doctrine of the causation of infectious disease which is known under the name of "the germ theory" may be well-founded; and if so it must needs lead to the most important practical measures in dealing with those most terrible visitations. It may be well that the general as well as the professional public should have a sufficient knowledge of biological truths to be able to take a rational interest in the discussion of such problems, and to see, what I think they may hope to see, that, to those who possess a sufficient elementary knowledge of Biology, they are not all quite open questions.

Let me mention another important practical illustration of the value of biological study. Within the last forty years the theory of agriculture has been revolutionised. The researches of Liebig, and those of our own Lawes and Gilbert, have had a bearing upon that branch of industry the importance of which cannot be over-estimated; but the whole of these new views have grown out of the better explanation of certain processes which go on in plants, and which of course form a part of the subject-matter of Biology.

I might go on multiplying these examples, but I see that the clock won't wait for me, and I must therefore pass to the third question to which I referred:—Granted that Biology is something worth studying, what is the best way of studying it? Here I must point out that, since Biology is a physical science, the method of studying it must needs be analogous to that which is followed in the other physical sciences. It has now long been recognised that if a man wishes to be a chemist it is not only necessary that he should read chemical books and attend chemical lectures, but that he should actually for himself perform the fundamental experiments in the laboratory, and know exactly what the words which he finds in his books and hears from his teachers, mean. If he does not do that he may read till the crack of doom, but he will never know much about chemistry. That is what every chemist will tell you, and the physicist will do the same for his branch of science. The great changes and improvements in physical and chemical scientific education which have taken place of late have all resulted from the combination of practical teaching with the reading of books and with the hearing of lectures. The same thing is true in Biology. Nobody

<sup>1</sup> Some critics do not even take the trouble to read. I have recently been adorned with much solemnity, to state publicly why I have "changed" my opinion as to the value of the palæontological evidence of the occurrence of evolution.

To this my reply is, Why should I when that statement was made seven years ago? An address delivered from the Presidential Chair of the Geological Society in 1870 may be said to be a public document, inasmuch as it not only appeared in the *Journal* of that learned body, but was re-published in 1873 in a volume of "Critiques and Addresses," to which my name is attached. Therein will be found a pretty full statement of my reasons for enunciating two propositions: (1) that "when we turn to the higher Vertebrata, the results of recent investigations, however we may sift and criticise them, seem to me to leave a clear balance in favour of the evolution of living forms out from another;" and (2) that the case of the horse is one which "will stand rigorous criticism."

That I do not see clearly in what way I can be said to have changed my opinion, except in the way of intensifying it, when in consequence of the accumulation of similar evidence since 1870, I recently spoke of the denial of evolution as not worth serious consideration.

will ever know anything about Biology except in a dilettante "paper-philosopher" way, who contents himself with reading books on botany, zoology, and the like; and the reason of this is simple and easy to understand. It is that all language is merely symbolical of the things of which it treats; the more complicated the things, the more bare is the symbol, and the more its verbal definition requires to be supplemented by the information derived directly from the handling, and the seeing, and the touching of the thing symbolised:—that is really what is at the bottom of the whole matter. It is plain common sense, as all truth, in the long run is only common sense clarified. If you want a man to be a tea merchant, you don't tell him to read books about China or about tea, but you put him into a tea-merchant's office where he has the handling, the smelling, and the tasting of tea. Without the sort of knowledge which can be gained only in this practical way his exploits as a tea merchant will soon come to a bankrupt termination. The "paper-philosophers" are under the delusion that physical science can be mastered as literary accomplishments are acquired, but unfortunately it is not so. You may read any quantity of books, and you may be almost as ignorant as you were at starting, if you don't have, at the back of your minds, the change for words in definite images which can only be acquired through the operation of your observing faculties on the phenomena of nature.

It may be said:—"That is all very well, but you told us just now that there are probably something like a quarter of a million different kinds of living and extinct animals and plants, and a human life could not suffice for the examination of one-fiftieth part of all these." That is true, but then comes the great convenience of the way things are arranged; which is, that although there are these immense numbers of different kinds of living things in existence, yet they are built up, after all, upon marvellously few plans.

There are, I suppose, about 100,000 species of insects, if not more, and yet anybody who knows one insect—if a properly chosen one—will be able to have a very fair conception of the structure of the whole. I do not mean to say he will know that structure thoroughly or as well as it is desirable he should know it, but he will have enough real knowledge to enable him to understand what he reads, to have genuine images in his mind of those structures which become so variously modified in all the forms of insects he has not seen. In fact, there are such things as types of form among animals and vegetables, and for the purpose of getting a definite knowledge of what constitutes the leading modifications of animal and plant life it is not needful to examine more than a comparatively small number of animals and plants.

Let me tell you what we do in the biological laboratory in the building adjacent to this. There I lecture to a class of students daily for about four-and-a-half months, and my class have, of course, their text-books; but the essential part of the whole teaching, and that which I regard as really the most important part of it, is a laboratory for practical work, which is simply a room with all the materials arranged for ordinary dissection. We have tables properly arranged in regard to light, microscopes, and dissecting instruments, and we work through the structure of a certain number of animals and plants. As, for example, among the plants, we take a yeast plant, a *Protococcus*, a common mould, a *Chara*, a fern, and some flowering plant; among animals we examine such things as an amœba, a *Vorticella*, and a fresh-water polype. We dissect a star-fish, an earth-worm, a snail, a squid and a fresh-water mussel. We examine a lobster and a cray-fish, and a black beetle. We go on to a common skate, a cod-fish, a frog, a tortoise, a pigeon, and a rabbit, and that takes us about all the time we have to give. The purpose of this course is not to make skilled dissectors, but to give every student a clear

and definite conception, by means of sense-images, of the characteristic structure of each of the leading modifications of the animal kingdom; and that is perfectly possible, by going no further than the length of that list of forms which I have enumerated. If a man knows the structure of the animals I have mentioned, he has a clear and exact, however limited, apprehension of the essential features of the organisation of all those great divisions of the animal and vegetable kingdoms to which the forms I have mentioned severally belong. And it then becomes possible for him to read with profit, because every time he meets with the name of a structure, he has a definite image in his mind of what the name means in the particular creature he is reading about, and therefore the reading is not mere reading. It is not mere repetition of words; but every term employed in the description, we will say, of a horse or of an elephant, will call up the image of the things he had seen in the rabbit, and he is able to form a distinct conception of that which he has not seen as a modification of that which he has seen.

I find this system to yield excellent results; and I have no hesitation whatever in saying, that any one who has gone through such a course, attentively, is in a better position to form a conception of the great truths of Biology, especially of morphology (which is what we chiefly deal with), than if he had merely read all the books on that topic put together.

The connection of this discourse with the Loan Collection of Scientific Apparatus arises out of the exhibition in that collection of certain aids to our laboratory work. Such of you as have visited that very interesting collection may have noticed a series of diagrams and of preparations illustrating the structure of a frog. Those diagrams and preparations have been made for the use of the students in the biological laboratory. Similar diagrams and preparations illustrating the structure of all the other forms of life we examine, are either made or in course of preparation. Thus the student has before him, first, a picture of the structure he ought to see, secondly, the structure itself worked out; and if with these aids, and such needful explanations and practical hints as a demonstrator can supply, he cannot make out the facts for himself in the materials supplied to him, he had better take to some other pursuit than that of biological science.

I should have been glad to have said a few words about the use of museums in the study of Biology, but I see that my time is becoming short, and I have yet another question to answer. Nevertheless I must, at the risk of wearying you, say a word or two upon the important subject of museums. Without doubt there are no helps to the study of Biology, or rather to some branches of it, which are, or may be, more important than natural history museums; but, in order to take this place in regard to Biology, they must be museums of the future. The museums of the present do not do by any means so much for us as they might do. I do not wish to particularise, but I dare say many of you seeking knowledge, or in the laudable desire to employ a holiday usefully, have visited some great natural history museum. You have walked through a quarter of a mile of animals more or less well stuffed, with their long names written out underneath them, and, unless your experience is very different from that of most people, the upshot of it all is that you leave that splendid pile with sore feet, a bad headache, and a general idea that the animal kingdom is a "mighty maze without a plan." I do not think that a museum which brings about this result does all that may be reasonably expected of such an institution. What is needed in a collection of natural history is that it should be made as accessible and as useful as possible, on the one hand to the general public, and on the other to scientific workers. That need is not met by constructing a sort of happy

hunting-ground of miles of glass cases, and, under the pretence of exhibiting everything, putting the maximum amount of obstacle in the way of those who wish properly to see anything.

What the public want is easy and unhindered access to such a collection as they can understand and appreciate; and what the men of science want is similar access to the materials of science. To this end the vast mass of objects of natural history should be divided into two parts—one open to the public, the other to men of science, every day. The former division should exemplify all the more important and interesting forms of life. Explanatory tablets should be attached to them, and catalogues containing clearly-written popular expositions of the general significance of the objects exhibited should be provided. The latter should contain, packed into a comparatively small space, in rooms adapted for working purposes, the objects of purely scientific interest. For example, we will say I am an ornithologist. I go to examine a collection of birds. It is a positive nuisance to have them stuffed. It is not only sheer waste, but I have to reckon with the ideas of the bird-stuffer, while, if I have the skin and nobody has interfered with it I can form my own judgment as to what the bird was like. For ornithological purposes what is needed is not glass cases full of stuffed birds on perches, but convenient drawers into each of which a great quantity of skins will go. They occupy no great space and do not require any expenditure beyond their original cost. But for the purpose of the public, who want to learn indeed, but do not seek for minute and technical knowledge, the case is different. What one of the general public walking into a collection of birds desires to see is not all the birds that can be got together. He does not want to compare a hundred species of the sparrow tribe side by side; but he wishes to know what a bird is, and what are the great modifications of bird structure, and to be able to get at that knowledge easily. What will best serve his purpose is a comparatively small number of birds carefully selected, and artistically, as well as accurately, set up; with their different ages, their nests, their young, their eggs, and their skeletons side by side; and in accordance with the admirable plan which is pursued in this museum, a tablet, telling the spectator in legible characters what they are and what they mean. For the instruction and recreation of the public such a typical collection would be of far greater value than any many-acred imitation of Noah's ark.

Lastly comes the question as to when biological study may best be pursued. I do not see any valid reason why it should not be made, to a certain extent, a part of ordinary school training. I have long advocated this view, and I am perfectly certain that it can be carried out with ease, and not only with ease, but with very considerable profit to those who are taught; but then such instruction must be adapted to the minds and needs of the scholars. They used to have a very odd way of teaching the classical languages when I was a boy. The first task set you was to learn the rules of the Latin grammar in the Latin language—that being the language you were going to learn! I thought then that this was an odd way of learning a language, but did not venture to rebel against the judgment of my superiors. Now, perhaps, I am not so modest as I was then, and I allow myself to think that it was a very absurd fashion. But it would be no less absurd if we were to set about teaching Biology by putting into the hands of boys a series of definitions of the classes and orders of the animal kingdom, and making them repeat them by heart. That is a very favourite method of teaching, so that I sometimes fancy the spirit of the old classical system has entered into the new scientific system, in which case I would much rather that any pretence at scientific teaching were abolished altogether. What really has to

be done is to get into the young mind some notion of what animal and vegetable life is. You have to consider in this matter practical convenience as well as other things. There are difficulties in the way of a lot of boys making messes with slugs and snails; it might not work in practice. But there is a very convenient and handy animal which everybody has at hand, and that is himself; and it is a very easy and simple matter to obtain common plants. Hence the broader facts of anatomy and physiology can be taught to young people in a very real fashion by dealing with the broad facts of human structure. Such viscera as they cannot very well examine in themselves, such as hearts, lungs, and livers, may be obtained from the nearest butcher's shop. In respect to teaching something about the biology of plants, there is no practical difficulty, because almost any of the common plants will do, and plants do not make a mess—at least they do not make an unpleasant mess; so that, in my judgment, the best form of Biology for teaching to very young people is elementary human physiology on the one hand, and the elements of botany on the other; beyond that I do not think it will be feasible to advance for some time to come. But then I see no reason why in secondary schools, and in the Science Classes which are under the control of the Science and Art Department—and which I may say, in passing, have, in my judgment, done so very much for the diffusion of a knowledge over the country—I think that in those cases we may go further, and we may hope to see instruction in the elements of Biology carried out, not perhaps to the same extent, but still upon somewhat the same principle as we do here. There is no difficulty, when you have to deal with students of the ages of 15 or 16, in practising a little dissection and getting a notion, at any rate, of the four or five great modifications of the animal form, and the like is true in regard to plants.

While, lastly, to all those who are studying biological science with a view to their own edification merely, or with the intention of becoming zoologists or botanists; to all those who intend to pursue physiology—and especially to those who propose to employ the working years of their lives in the practice of medicine—I say that there is no training so fitted, or which may be of such important service to them, as the thorough discipline in practical biological work which I have sketched out as being pursued in the laboratory hard by.

I may add that, beyond all these different classes of persons who may profit by the study of Biology, there is yet one other. I remember, a number of years ago, that a gentleman who was a vehement opponent of Mr. Darwin's views and had written some terrible articles against them, applied to me to know what was the best way in which he could acquaint himself with the strongest arguments in favour of evolution. I wrote back, in all good faith and simplicity, recommending him to go through a course of comparative anatomy and physiology, and then to study development. I am sorry to say he was very much displeased, as people often are with good advice. Notwithstanding this discouraging result, I venture, as a parting word, to repeat the suggestion, and to say to all the more or less acute lay and clerical "paper-philosophers"<sup>1</sup> who venture into the regions of biological controversy—Get a little sound, thorough, practical, elementary instruction in biology.

T. H. HUXLEY

<sup>1</sup> Writers of this stamp are fond of talking about the Baconian method. I beg them therefore to lay to heart these two weighty sayings of the herald of Modern Science:—

"*Syllogismus ex propositionibus constat, propositiones ex verbis, verba notatione tessere sunt. Itaque si notiones ipsae (id quod basis rei est) confusae sint et temere a rebus abstractae, nihil in eis quae superstruuntur est firmitudinis.*"—"Novum Organum," ii. 17.

"*Hic autem videri nonnulli ex modernis summa levitate ita indulerunt, ut in primo capitulo Gesnerus et in libro Job et aliis scripturis sacris, philo-sophiam naturalem fundere conati sint; inter vitiosas querentes mortua.*"—"Ibid." 6c.

## EXPERIMENTS WITH THE RADIOMETER

I.

ABSTRACTS of my earlier papers on "Repulsion Resulting from Radiation" having appeared in NATURE, it has been suggested that an account of my later researches, which place the subject in such a different light, may also prove of interest.

It has already been shown that if the air is expelled from a large bulb containing a suspended bar of pith, and a lighted candle is placed about 2 inches from the globe, the pith bar commences to oscillate to and fro, the swing gradually increasing in amplitude until the dead centre is passed over, when several complete revolutions are made. The torsion of the suspended fibre now offers resistance to the revolutions, and the bar commences to turn in the opposite direction. It has been found, however, that very little movement takes place until the vacuum is so good as to be almost beyond the powers of an ordinary air-pump to produce, and that, as the vacuum gets more nearly absolute, so the force increases in power. The most obvious explanation therefore is, that the repulsive action is due to radiation; but at a very early stage of my investigation I found that the best vacuum I had succeeded in producing might contain enough matter to offer resistance to motion, and in describing an experiment in a paper sent to the Royal Society on February 5, 1876, I said that the impression conveyed to my mind was that the torsion beam was swinging in a viscous fluid, and the repulsion caused by radiation was indirectly due to a difference of thermometric heat between the black and white surfaces of the moving body, and that it might be due to a secondary action on the residual gas.

I have recently succeeded in producing such a complete exhaustion that I have not only reached the point of maximum effect, but gone so far beyond it that repulsion nearly ceases, and the results I have thus obtained seem to show conclusively that the true explanation of the action of the radiometer is that given by Mr. Johnstone Stoney, according to which the repulsion is due to the internal movements of the molecules of the residual gas. When the mean length of path between successive collisions of the molecules is small compared with the dimensions of the vessel, the molecules, rebounding from the heated surface, and therefore moving with an extra velocity, help to keep back the more slowly moving molecules which are advancing towards the heated surface; it thus happens that though the individual kicks against the heated surface are increased in strength in consequence of the heating, yet the number of molecules struck is diminished in the same proportion, so that there is equilibrium on the two sides of the discs, even though the temperature of the faces are unequal. But when the exhaustion is carried to so high a point that the molecules are sufficiently few, and the mean length of path between their successive collisions is comparable with the dimensions of the vessel, the swiftly-moving, rebounding molecules spend their forces in part or in whole on the sides of the vessel; and the onward crowding, more slowly-moving molecules are not kept back as before, so that the number which strike the warmer face approaches to, and in the limit equals, the number which strike the back cooler face; and as the individual impacts are stronger on the warmer than on the cooler face, pressure is produced, causing the warmer face to retreat.

Before referring at length to the experiments which led to my adopting the above theory, I will describe some effects of dark heat, &c., on the radiometer. In a paper I sent to the Royal Society on January 5, 1876, and which is now being published in the *Philosophical Transactions* of the Royal Society, about seventeen pages are occupied with the description of my experiments with various forms of this instrument. In the present paper I propose only to refer to a few typical experiments made during the year 1875.

To show the action of dark heat on the radiometer, a candle was placed at such a distance from the instrument that the arms would make one revolution a minute. A small glass flask of boiling water was then placed half-an-inch from the bulb. The revolutions instantly stopped, two of the arms setting equidistant from the hot-water flask. The flask of water was removed. As the portion of the bulb which had been heated by the hot water cooled, the white surface gradually crept nearer and nearer to it, the superior repulsion of the candle on the black discs urging the arms round, and acting in opposition to the repulsion of the hot glass to the white disc. At last the force of the light drove the white disc with difficulty past the hot spot of glass. Rotation then commenced, but for some revolutions there appeared to be a difficulty in the white discs passing the spot of glass which had been warmed by the hot water; and the flask of boiling water being replaced in its position half-an-inch from the bulb of the radiometer, the rotation immediately stopped.

The instrument having become cool, the candle was again placed in position, so that it produced one revolution in a minute. The finger was then pressed against the side of the bulb, and as the spot of glass got warm, the white surface experienced more and more difficulty in getting past it, until at last one refused to pass, and the arms came to rest.

The instrument was again allowed to cool, and the revolutions recommenced at the usual speed (the laboratory in which this was tried was somewhat cold). I then came from a warm room, and stood a foot from the radiometer, watching it. In about a minute the radiant heat from my body had warmed the side of the bulb nearest to me sufficiently to cause an appreciable difficulty in the movement, and soon the revolutions stopped. The same effect has been observed if the radiometer is brought into a very warm room and placed near a cold window. If the daylight is feeble, the instrument not very sensitive, or an observer stands near the instrument, an appreciable sticking is observed as the white discs come near that part of the bulb which is the warmest.

These experiments show that many precautions are necessary to guard against the interfering action of unequal heating of the radiometer when it is being used for accurate measurements.

Having found such an antagonistic action of dark heat, I tried the action of ice. This is equivalent to warming the opposite side of the instrument. A lump of ice was brought within half an inch of the bulb on the opposite side to the candle. The revolutions got slower, until at last the movement stopped altogether, one arm pointing direct to the ice, and being apparently held there by a powerful attractive force. Bringing the candle nearer caused the arms to oscillate a little, and when it was almost close to the bulb the force of the light overcame the action of the ice, and the arms revolved again, but irregularly, and with jerks, the discs moving quickly to the ice and leaving it with difficulty. In this action of ice no preference was noticed for either the black or white surface.

A very delicate radiometer, in 2-inch bulb, was placed in a sufficient light to allow it to be seen distinctly, but not enough to cause it to move. I then came out of a warm room and stood near it. In a few seconds it began to move slowly round in the negative direction, *i.e.* the black discs advanced instead of retreated. On moving away from the instrument the rotation gradually stopped. I again approached it, and held one hand an inch from the bulb. Rotation soon commenced, but still in the reverse way. These experiments were frequently repeated and always with the same results.

When the instrument was at rest I came quickly to it, and gently breathed on the bulb. There was a slight movement in the normal direction, but this stopped

directly, and the arms then revolved the reverse way for more than a minute, performing three or four complete revolutions.

A glass shade four inches in diameter was held over a gas-flame till the air inside was warm, and the inner surface dim with steam. It was then inverted over the radiometer. Rotation commenced the reverse way, and kept up for several minutes. The glass shade was then dried inside, and heated uniformly before a fire until it had a temperature of about 50° C. It was then inverted over the radiometer. Reverse rotation instantly commenced, and kept up with some vigour for more than five minutes, diminishing in speed until the shade had cooled down to the temperature of the surrounding air.

The same experiment was repeated, and whilst the arms were in full negative rotation, a lighted candle was slowly brought near it. When three feet off the negative rotation slackened. When the candle was about two feet off the arms became still, and when nearer than two feet the instrument rotated normally, the antagonism between the action of the hot shade and the lighted candle was perfect; by moving the candle to and fro it was easy to cause the radiometer to move in one direction or the other, or to become still.

I now tried the action of a radiometer the moving parts of which were made of a good conductor of heat, such as a metal, instead of pith, which is a bad conductor of heat. I selected thin rolled brass as the material wherewith to make the arms and discs of a radiometer. The parts were all fastened together with hard solder, and no cement or organic matter was used, so that if necessary the instrument could be submitted to a high temperature without injury. The moving portion weighed 13·1 grains. One side of the discs was silvered and polished, the other side being coated with lampblack. The apparatus was exhausted with a charcoal reservoir attached. A candle  $1\frac{1}{2}$  inch from the bulb caused it to revolve about once a second, the black surface being repelled in the normal manner.

Standing in a rather dark cold room, it was covered with a warm glass shade, and it immediately began to revolve the negative way, but very slowly. A few drops of ether poured on the bulb caused the arms to move rather rapidly the normal way. A hot shade put over whilst it was thus moving caused it to stop and then begin moving the reverse way. A small non-luminous gas flame was held vertically beneath the apparatus, so that hot air should ascend and wrap round the bulb on all sides. The arms now revolved the reverse way.

The brass radiometer being somewhat heavy, one was made of aluminium, the moving parts being hard soldered as before. A siphon-gauge was attached, and the apparatus connected direct on to the pump by a spiral, no charcoal tube being used. One side of the wings was bright aluminium, and the other was lampblack. When exhausted the arms revolved very quickly to a candle a few inches off, the black being repelled. On removing the candle the arms stopped and immediately commenced revolving the reverse way, keeping up rotation for more than ten minutes, and being little inferior in speed to what it was when the candle shone on it. The whole of the bulb was heated with a Bunsen burner; whilst it was getting hot the aluminium arms revolved rapidly in the normal direction, but as soon as the source of heat was removed and cooling commenced, rotation set up in the reverse way, and continued with great energy till the whole thing was cold. It appeared as if the reverse movement during the cooling was equal in energy to the normal movement as it was being heated.

A little ether was poured on the bulb of a very sensitive pith radiometer as it was standing still in a faint light. The evaporation of the ether caused a chilling of the instrument and a rapid abstraction of heat from the arms. They commenced to move in the normal direction and

increased quickly in speed until they revolved at a rate of one in four seconds. This movement kept up for several minutes, and as it slackened it could at any time be revived by a few drops of ether on the bulb. When in rapid movement a hot glass shade was placed over the radiometer the movement slackened, the arms quickly came to rest and immediately revolved in the reverse direction, acquiring a speed of about two revolutions a minute, and keeping up this reverse movement for more than ten minutes.

I again set the instrument in rapid rotation by dropping ether on the top of the bulb and applied the tip of one finger to the side of the bulb for ten seconds. The rotation stopped, and I could not start it again for some minutes, although I dropped ether on the bulb, several times in the interval. When the radiometer had once more acquired the temperature of the air I dropped ether on the bulb, not in the centre, but so that the ether wetted only half of the bulb. The arm which was nearest to the part most chilled by the ether rushed towards that part and remained, as it were, fixed opposite to it, refusing to move away, although I tried to equalise the temperature by dropping ether on the other parts of the bulb, and to drive it round by bringing a candle near. Not until the candle came within six inches of the bulb did the arms begin to rotate, which they then did with a rush, as if suddenly relieved from a state of tension.

I have referred to a sufficient number of experiments to show that a metal radiometer rotates in a negative direction on being exposed to the action of dark heat, the black advancing and continuing to do so until the temperature has become uniform throughout. On removing the source of heat, the fly commences to revolve with rapidity the positive way, the black this time retreating as it would if light shone on it.

To determine whether at temperatures between 250° and 100° the repellent action of radiant heat was about equal on black and on white surfaces, I used a radiometer having pith discs blackened on one side. A tube was sealed into one side of the bulb, and having two stout platinum wires passing along it, sealed their whole length in glass to prevent leakage of air into the interior of the apparatus. At the ends of the wires a spiral of fine platinum wire was fastened, and the other ends terminated in loops outside. The bulb was perfectly exhausted, and the following experiments were tried:—

A resistance-coil was so adjusted that a battery would keep the platinum spiral at a bright red heat. The arms of the radiometer, which were before quite still, moved rapidly until two of the discs were one on each side of the hot spiral, the black disc being further off than the white disc. The resistance was then gradually increased, and as the temperature of the spiral diminished, the black disc gradually approached the spiral, until, when the temperature was just at the point of visible redness in a dark room, the black and white discs were practically equidistant from the spiral. On diminishing the resistance, the same phenomena took place in inverse order.

The resistance was again adjusted to give a bright red spiral, and the contact key kept pressed down. A lighted match was momentarily brought near the bulb, so as to start a movement. Rotation of the arms commenced, and kept up, with some energy, at the rate of about one revolution in five seconds, equal to that given by a candle eight inches off. There was some little hesitation, as the white side came up to the spiral, but this was scarcely noticed when the speed had become steady. The resistance was now slightly increased. The speed became slower as the temperature of the spiral diminished, and the hesitation, as the white approached the spiral, became more apparent. The resistance was further increased, with the effect of making rotation still slower, bringing the temperature of the spiral down to just visible redness in the dark. The speed of rotation again

slackened; at each approach of the white surface to the spiral it appeared to stop, hesitate, and then get past with a rush. Thus it went on for a few revolutions, until one white disc, a little nearer, perhaps, than the others, was not able to pass, and the arms, after a few oscillations, came to rest, the black and the white surfaces being, as near as I could judge, equidistant from the hot spiral.

I now tried to ascertain whether, at temperatures lower than 100° C., the white would be repelled most.

The resistance of the coil was increased again, and the position of the arms in respect to the spiral noticed. When so much resistance was offered to the passage of the current that the spiral would only be just warm, I fancied the white was further from it than the black, but the observation was not satisfactory at higher temperatures; up to visible redness the repulsion was equal for each. Breathing on the bulb sent the arms rapidly round the reverse way.

The battery was disconnected from the instrument, and one end of a wire was attached to one of the platinum loops, the other end of the wire being connected to the prime conductor of a frictional electrical machine. A few turns of the handle sent the arms flying about wildly; first in the positive and then in the negative direction, till finally one pointed steadily to the platinum spiral, and refused to move. When the candle was quite close it overcame the interference, and the discs revolved in an irregular jerky manner. In three or four days the electrical disturbance was sufficiently diminished to enable me to proceed with my experiments, but I could detect the influence for weeks after.

One pole of a small induction-coil capable of giving half-inch sparks in air, was fastened to the platinum loops, the other pole being held by an insulating handle. The loose pole was then brought near the bulb. The nearest disc rushed round to it and followed it a little, then it stuck as if the glass were electrified. By gently moving the loose pole round I could get the arms to rotate in either direction, and they would keep on for five minutes or more when once started. These movements appear all to be explained by the known laws of static electricity, the rotations being of the "electrical fly" kind.

I obtained rotation in a radiometer without having the surfaces of the discs differently coloured. One having the pith discs lamp-black on both sides, and weighing 1·25 grain, was exhausted with a charcoal tube attached. On a candle being brought near it, the arms moved until two of the discs were equidistant from the flame, and no amount of initial impulse in either direction would set it in rotation. A piece of ice caused it to move until one disc pointed to the ice, when it also stopped, but by shading the candle with a screen, so that the light shone on only one half of the tube, rapid rotation commenced, which, by altering the position of the screen to the other side, was instantly stopped, and changed into as rapid rotation in the opposite direction.

To enable me to exhibit the movement of a radiometer to a large audience I have made an instrument, the discs of which are of thin glass, silvered and polished on one side, and coated with lampblack on the other. Owing to its great weight the movement is somewhat slow, but in the sun, or, with a strong light shining on the instrument, it is very striking, as it shows discs of light chasing each other round the room.

To communicate motion from the interior of the bulb to the outside, a radiometer was made which would carry round a magnet. Outside the bulb of this instrument I suspended, in a vertical position, a smaller magnet having the south pole at the top and the north pole at the bottom; this oscillates to and fro with every revolution of the radiometer, and making contact at the bottom, carries an electric current from a battery to a Morse instrument through which a ribbon of paper is drawn by clockwork.

so that at each revolution of the radiometer a record is printed on the strip of paper by dots; close together if the radiometer revolves quickly, farther apart if it goes slower.

The power of the earth on the magnet is too great to allow the radiometer to start without some initial impetus; there should therefore be an astatic combination inside the bulb, but for a single experiment it may be set going by placing a few coils of insulated copper wire outside the bulb and depressing the battery key for an instant. An electric current is thus passed through the coils of wire, and the interior magnet is immediately deflected from its north-south position; the impetus thus gained enables the light to keep up the rotation.

For the purpose of measuring the amount of force exerted by radiation I constructed a torsion balance capable of indicating the millionth of a grain. A light beam having two square inches of pith at one end is balanced on a fine fibre of glass<sup>1</sup> stretched horizontally in a tube, one end of the fibre being connected with a torsion handle passing through the tube, and indicating angular movements on a graduated circle. The beam is cemented to the torsion fibre, and the whole is enclosed in glass and connected with the mercury pump by a spiral tube and exhausted as perfectly as possible. A flat oblong piece of soft iron weighing accurately 0.01 grain is put into the cross tube under the pith surface. This weight can be picked up by a horse-shoe magnet outside the tube and dropped on any part of the pith. A mark is made at the exact centre of the pith surface, and by moving the magnet about it is easy to place the iron weight accurately on this mark. A ray of light from a lamp reflected from a mirror in the centre of the beam to a millimetre scale four feet off shows the slightest movement. When the reflected ray points to zero, a turn of the torsion handle in one direction or the other will raise or depress the pith end of the beam, and thus cause the index ray to travel along the scale to the right or to the left. If a small weight is placed on one end so as to depress it, and the torsion handle is then turned, the tendency of the glass fibre to untwist itself will ultimately balance the downward pressure of the weight, and will again bring the index ray to zero. It was found that when the weight of the 1-100th of a grain was placed on the pith surface the torsion handle had to be turned twenty-seven revolutions and 353°, or 10073° before the beam became horizontal. The downward pressure of the 1-100th of a grain was therefore equivalent to the force of torsion of the glass thread when twisted through 10073°.

I then found out the degree of delicacy of the balance. 1° of torsion gave a very decided movement of the index ray, a torsion of 10073° balancing the 1-100th of a grain, while 10074° overbalanced it. The balance will therefore turn to the 99-100,000,000th of a grain.

Weighed in this balance, the mechanical force of a candle 12 inches off was found to be 0.000444 grain; of a candle 6 inches off 0.001772 grain. At half the distance the weight of radiation should be four times, or 0.007088 grain; the difference between theory and experiment being only four millionths of a grain is a sufficient proof that the indications of this instrument follow rigidly the law of inverse squares. An examination of the differences between the separate observations and the mean shows that my estimate of the sensitiveness of this balance is not excessive, and that in practice it will safely indicate the millionth of a grain.

I performed an experiment at the meeting of the Royal Society on March 30 last to demonstrate the movement of the glass case of the radiometer. I made use of a large radiometer in a 4-inch bulb with ten arms, eight of

<sup>1</sup> The torsion of fibre must be selected with great care. Ten threads were drawn out before the blowpipe and suspended from a horizontal beam. Weights were then gradually hung on to the lower ends. Only two were found strong enough. The one selected stood 450 grams without breaking, its diameter being less than 1/1000 inch.

which were brass, and the other two a long watch-spring magnet. The discs were of pith blackened on one side.

The instrument was floated in a vessel of water, four candles being placed round it to set the arms in rotation. A mark was put on the glass envelope to enable a slight movement to be seen.

A powerful magnet was now brought near the moving arms, which immediately stopped, and at the same time the glass envelope commenced to revolve in the opposite direction to that in which the arms had been revolving. The movement kept up as long as the candles were burning, and the speed was one revolution in two minutes. On the magnet being removed the arms obeyed the force of radiation from the candles and revolved rapidly, whilst the glass envelope quickly came to rest. The candles were then blown out, and as soon as the whole instrument had come to rest, a bar-magnet was moved alternately from one side to the other of the radiometer, so as to cause the vanes to rotate as if they had been under the influence of a candle. The glass envelope moved about one revolution in three minutes in the same direction as the arms, and on reversing the direction of movement of arms, the glass envelope changed direction also. This I consider is proof that the internal friction, either of the steel point on the glass socket or the vanes against the residual air, or of both these causes combined, is considerable. Moving the vanes round by the exterior magnet carries the whole envelope round in opposition to the friction of the water against the glass.

In another communication I propose to give the results of my experiments on the influence of the residual gas on the movement of the radiometer, and also refer to other results which I have recently obtained.

WILLIAM CROOKES

#### ON A NEW ASTRONOMICAL CLOCK<sup>1</sup>

THE object of this communication was to explain to members of the Association and give them an opportunity of seeing in my house in the University a clock which had been described in a communication to the Royal Society, in 1869, entitled "On a New Astronomical Clock and a Pendulum Governor for Uniform Motion." The following description is taken from the *Proceedings* of the Royal Society for 1869, except a few alterations and additions, and except the drawings, which have not been hitherto published:—

It seems strange that the dead-beat escapement should still hold its place in the astronomical clock, when its geometrical transformation, the cylinder escapement of the same inventor, Graham, only survives in Geneva watches of the cheaper class. For better portable time-keepers it has been altered, through the vicious rack-and-pinion movement, into the superlatively good detached lever. If it is possible to make astronomical clocks go better than at present by merely giving them a better escapement, it is quite certain that one on the same principle as the detached lever, or as Earnshaw's ship-chronometer escapement, would improve their time-keeping.

But the irregularities hitherto tolerated in astronomical clocks may be due more to the faultiness of the steel and mercury compensation pendulum, with its loosely attached glass jar, and of the mode in which it is hung, and to instability of the supporting clock-case or framework, than to imperfection of the escapement and the greatness of the arc of vibration which it requires; therefore it would be wrong to expect confidently much improvement in the time-keeping merely from improvement of the escapement. I have therefore endeavoured to improve both the compensation for change

<sup>1</sup> "On a New Form of Astronomical Clock with Free Pendulum and Independently Governed Uniform Motion for Escapement Wheel." By Prof. Sir William Thomson, F.R.S. (Communicated to Section A of the British Association, Thursday, September 7, 1876.)

of temperature in the pendulum, and the mode of its support, in a clock which I have recently made with an escapement on a new principle, in which the simplicity of the dead-beat escapement of Graham is retained, while its great defect, the stopping of the whole train of wheels by pressure of a tooth upon a surface moving with the pendulum, is remedied.

Imagine the escapement-wheel of a common dead-beat clock to be mounted on a collar fitting easily upon a shaft, instead of being rigidly attached to it. Let friction be properly applied between the shaft and the collar, so that the wheel shall be carried round by the shaft unless resisted by a force exceeding some small definite amount; and let a governor giving uniform motion be applied to the train of wheel-work connected with this shaft, and so adjusted that, when the escapement-wheel is unresisted, it will move faster by a small percentage than it must move to keep time properly. Now let the escapement wheel, thus mounted and carried round, act upon the escapement, just as it does in the ordinary clock. It will keep the pendulum vibrating, and will,

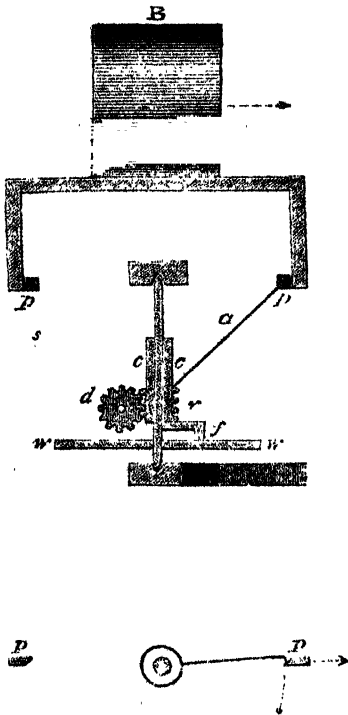

just as in the ordinary clock, be held back every time it touches the escapement during the interval required to set it right again from having gone too fast during the preceding interval of motion. But in the ordinary clock the interval of rest is considerable, generally greater than the interval of motion. In the new clock it is equal to a small fraction of the interval of motion:  $\frac{1}{100}$  in the clock as now working, but to be reduced probably to something much smaller yet. The simplest appliance to count the turns of this escapement-wheel (a worm, for instance, working upon a wheel with thirty teeth, carrying a hand round, which will correspond to the seconds' hand of the clock) completes the instrument; for minute and hour-hands are a superfluity in an astronomical clock.

In various trials which I have made since the year 1865, when this plan of escapement first occurred to me, I have used several different forms, all answering to the preceding description, although differing widely in their geometrical and mechanical characters. In all of them the escapement-wheel is reduced to a single tooth or arm,

to diminish as much as possible the moment of inertia of the mass stopped by the pendulum. This arm revolves in the period of the pendulum (two seconds for a one second's pendulum), or in some odd multiple of it. Thus the pendulum may execute one or more complete periods of vibration without being touched by the escapement. In all my trials the pallets have been attached to the bottom of the pendulum, projecting below it, in order that satisfactory action with a very small arc of vibration (not more on each side than  $\frac{1}{100}$  of the radius, or 1 centimetre for the seconds' pendulum) may be secured.

In the clock in my house the seconds' pendulum of the fine movement, vibrates with great constancy through half a millimetre, that is to say, through an arc of  $\frac{1}{100}$  of the radian, on each side of the vertical. This, I believe, is the smallest range that has hitherto been realised in any seconds' pendulum of an astronomical or other clock.

In the drawing *s* represents the vertical escapement shaft, round which is fitted loosely the collar *c*, carrying the worm *v*. The small wheel, *a*, is worked by *v*, and carries round the seconds' hand of the clock. *a* represents a piece of fine steel wire, being the single arm to which the teeth of the escapement-wheel are reduced in the clock described in this paper; *p* the pallets attached to bars projecting downwards from the bob, *B*, of the pendulum; *f*, a foot bearing the weight of the collar-worm and escapement tooth. The bar connecting *f* with the collar is of such a length as to give a proper moment to the frictional force by which the collar is carried round. The shaft *s* carries a wheel, represented in section by *w*, which is driven by a train of wheel-work (not shown in the drawing) from the governor. This wheel is made to go  $\frac{1}{100}$  per cent. faster than once round in two seconds, while the pendulum prevents the collar from going round more than once in two seconds.

My trials were rendered practically abortive from 1865 until a few months ago by the difficulty of obtaining a satisfactory governor for the uniform motion of the escapement-shaft; this difficulty is quite overcome in the pendulum governor, which I now proceed to describe.

Imagine a pendulum with single-tooth escapement mounted on a collar loose on the escapement shaft just as described above—the shaft being vertical in this case also. A square-threaded screw is cut on the upper quarter of the length of the shaft, this being the part of it on which the escapement-collar works; and a pin fixed to the collar projects inwards to the furrow of the screw, so that, if the collar is turned relatively to the shaft, it will be carried along, as the nut of a screw, but with less friction than an ordinary nut. Below the screw and long nut-collar, three-quarters of the length of the escapement-shaft is surrounded by a tube which, by wheel-work, is carried round about 5 per cent. faster than the central shaft. This outer shaft, by means of friction produced by the pressure of proper springs, carries the nut collar round along with it, except when the escapement-tooth is stopped by either of the pallets attached to the pendulum. A stiff cross-piece (like the head of a T), projecting each way from the top of the tubular shaft, carries, hanging down from it, the governing masses of a centrifugal friction governor. These masses are drawn towards the axis by springs, the inner ends of which are acted on by the nut collar, so that the lower or the higher the latter is in its range, the springs pull the masses inwards with less or more force. A fixed metal ring coaxial with the main shaft holds the governing masses in when their centrifugal forces exceed the forces of the springs, and resists the motion by forces of friction increasing approximately in simple proportion to the excess of the speed above that which just balances the forces of the springs. As long as the escapement-tooth is unresisted, the nut collar is carried round with the quickest motion of the outer tubular shaft, and so it screws upwards, increasing the force of the springs. Once every semiperiod of the pendulum it is held back by either

pallet, and the nut-collar screws *down* as much as it rose during the preceding interval of freedom when the action is regular; and the central or main escapement-shaft turns in the same period as the tooth, being the period of the pendulum. If through increase or diminution of the driving-power, or diminution or increase of the coefficient of friction between the governing masses and the ring on which they press, the shaft tends to turn faster or slower, the nut collar works its way down or up the screw, until the governor is again regulated, and gives the same speed in the altered circumstances. It is easy to arrange that a large amount of regulating power shall be implied in a single turn of the nut collar relatively to the central shaft, and yet that the periodic application and removal of about  $\frac{1}{10}$  of this amount in the half period of the pendulum shall cause but a *very small* periodic variation in the speed. The latter important condition is secured by the great moment of inertia of the governing masses themselves round the main shaft. My communication to the Royal Society ended as follows:—

"I hope after a few months' trial, to be able to present a satisfactory report of the performance of the clock now completed according to the principles explained above. As many of the details of execution may become modified after practical trial, it is unnecessary that I should describe them minutely at present. Its general appearance, and the arrangement of its characteristic parts, may be understood from the photograph now laid before the Society."

I am sorry to say that the hope here expressed has not hitherto been realised. Year after year passed producing only more or less of radical reform in various mechanical details of the governor and of the fine movement, until about six months ago, when, for the first time, I had all except the pendulums in approximately satisfactory condition. By that time I had discovered that my choice of zinc and platinum for the temperature compensation, and lead for the weight of the pendulums, was a mistake. I had fallen into it about ten years ago through being informed that in Russia the gridiron pendulum had been reverted to because of the difficulty of getting equality of temperature throughout the length of the pendulum; and without stopping to perceive that the right way to deal with this difficulty was to face it and take means of securing practical equality of temperature throughout the length of the pendulum (which it is obvious may be done by simple enough appliances), I devised a pendulum in which the compensation is produced by a stiff tube of zinc and a platinum wire placed nearly parallel each to the other throughout the length of the pendulum. The two pendulums of the clock shown to the British Association were constructed on this plan. Now it is clear that the materials chosen for compensation should, of all those not otherwise objectionable, be those of greatest and of least expansibility. Therefore, certainly, glass or platinum ought to be one of the materials, and the steel of the ordinary astronomical mercury pendulum is a mistake. Mercury ought to be the other (its cubic expansion being six times the linear expansion of zinc) unless the capillary uncertainty of the mercury surface lead to irregular changes in the rate of the pendulum. The weight of the pendulum ought to be of material of the greatest specific gravity attainable; at all events unless the whole is to be mounted in an air-tight case; because one of the chief errors of the best existing pendulums is that depending on the variations of barometric pressure. The expense of platinum puts it out of the question for the weight of the pendulum, even although the use of mercury for the temperature compensation did not also give mercury for the weight. Thus even though as good compensation could be got by zinc and platinum as by any other means, mercury ought on account of its superior specific gravity (nearly three times that of lead) to be preferred to lead for the weight of the pendulum.

I have accordingly now made several pendulums (for tide-gauges) with no other material in the moving part than glass and mercury, and with rounded knife edges of agate for the fixed support; and I am on the point of making four more for two new clocks which I am having made on the plan which forms the subject of this communication. I have had no opportunity hitherto of testing the performance of any of these pendulums, but their action seems very promising of good results, and the only untoward circumstance which has hitherto appeared in connection with them has been breakages of the glass in two attempts to have one carried safely to Genoa for a tide-gauge made by Mr. White, to an order for the Italian Government.

As to the accuracy of my new clock, it is enough to look at the pendulum vibrating with perfect steadiness, from month to month, through a range of half a centimetre on each side of its middle position, with its pallets only touched during  $\frac{1}{100}$  of the time by the escapement-tooth, to feel certain that, if the best ordinary astronomical clock owes any of its irregularities to variations of range of its pendulum or to impulses and friction of its escapement-wheel, the new clock must, when tried with an equally good pendulum, prove more regular. I hope soon to have it tried with a better pendulum than that of any astronomical clock hitherto made, and if it then shows irregularities amounting to  $\frac{1}{10}$  of those of the best astronomical clocks, the next step must be to inclose it in an air-tight case kept at constant temperature, day and night, summer and winter.

#### ON THE TROPICAL FORESTS OF HAMPSHIRE<sup>1</sup>

ENGLAND at the present time has a climate far from tropical, but at the time to which this lecture refers the palm and spice plants flourished here; and hence the climate then may rightly be spoken of as actually tropical.

The data on which this inference is based are the fossil leaves which are found in the clays of the south of Hampshire. Out of the many thousands of such leaves obtained by me during summer holidays for many years past, some selected specimens were exhibited in a cabinet in the Loan Collection of Scientific Instruments. Other collections of leaves from this spot and from Alum Bay have been made, and may be seen in the British Museum. It is the district immediately along the line east and west of Bournemouth which has been specially examined, and it is in the lower Bagshot beds, which are, comparatively speaking, amongst the youngest of the geological scale, that the leaves referred to have been found.

These Bagshot beds need not detain us; but as I have referred to them as amongst the youngest in the geological scale, I may mention that above them we have the Bracklesham beds, full of marine forms; the Barton beds, also full of marine forms, but telling a tale of a different sea; the Headon, Bembridge, and Hempstead series, with many repetitions of marine and fresh-water conditions, indicating long lapses of time. There is, too, the whole Miocene period, of which we have no trace in this district, but which we believe from continental evidence was of vast duration. Then, too, there followed periods of immense length, during which England underwent its latest glacial epoch; after that, the time during which the gravels were formed. While, therefore, we speak of these beds as almost the youngest of our series, they belong to periods of an incalculably remote past.

It is from the cliffs principally, and from the deep cuttings of the recently constructed railway from Bournemouth to Parkstone, that our knowledge is mainly derived. There are, in addition, the diggings carried on

<sup>1</sup> Lecture in connection with the Loan Collection of Scientific Apparatus, given at the South Kensington Museum, December 4, 1876, by J. Sarsley Gardner, F.G.S.



for commercial purposes. Great interest attaches to these somewhat monotonous-looking cliffs, as it is from them that has been unearthed the marvellously rich flora which I shall briefly describe further on. Let us commence by visiting the diggings near Wareham. We see that they are situated on a wild moorland with hillocks, under the high range of chalk downs, in a gap in which stand the massive ruins of Corfe Castle. Very bleak and barren the scenery looks in high winds and driving showers, and the latter are of unusually common occurrence, the clouds being caught and held by the high downs. The moorland stretches far to the sea and enwraps Poole Harbour, continuing as far as the eye can reach, beyond Bournemouth to the tower of the fine old abbey of Christchurch and to the New Forest, being here and there clothed with extensive pine plantations. But in fine weather it has a charm of its own and is especially lovely when the yellow furze and purple heather are in full bloom. Even the actual diggings themselves are most picturesque, especially those now abandoned, as there we find little deep blue lakes surrounded by many-coloured cliffs fifty feet in height, in which bright yellows, magentas, and crimson predominate. I do not apply the word blue to the small lakes poetically, for they are of an intense blue, finer in colour than the famed blue of the waters of some of the Swiss lakes. The heath is, in some patches, of a magenta colour, where a crimson clay patch forms the soil. If we examine these cliffs and banks we find them composed of clays dark or white, or red and white mottled, of layers of coarse grey grit and of sands of every shade of red and yellow, white, and variegated. Often the sands have angular lumps of clay imbedded in them. The quarrying is mostly done in open pits, the clay being dug out perpendicularly with a long and narrow spade. Some of the deeper seams are mined, and a considerable depth is reached in Mr. Pike's workings, and at Branksea it is worked under the sea-level. These pipeclays are exported to all parts of the world wherever good pottery is made.

Overlying the pipeclays we find another series of deposits, which are not here quarried for use, but looked upon as refuse; but near Bournemouth they are dug into in many places for the brick earth contained in them. They are easily distinguished by the darker colour and more sandy nature of the clays. These drab clay basins are of smaller extent and are full of remains of decayed leaves, and have actual seams of coal in them, which is burnt by the villagers. We now cross Poole Harbour, at high tide a magnificent sheet of water, the distant hills, behind which the sun sets, giving it the appearance of an Italian lake, and glance at Branksea Island as we pass—the owner of which, however, will not allow us to land. In the sheltered bay of Studland we can see but little of the cliffs, as they are now mostly overgrown to the very beach. We are struck, however, by the coloured sands which forcibly remind those of us who are familiar with them of the still more brilliant hues of the sands at Alum Bay.

Being ferried across the inlet of Poole Harbour and walking along the beach towards Bournemouth, we find the coast for the first mile composed of hills of blown sand, beyond which the cliffs we have been viewing from a distance rapidly rise. These cliffs are themselves of rather monotonous appearance, being devoid of the brilliant colouring so conspicuous at Alum and Studland Bays, but they are crowned for the greater part of their length with pine woods. Their colour varies from buff to white and from white to slate colour. We notice apparently endless successions of clays, sands, and grits deposited at different angles and without any single bed being traceable for more than a few yards. The cliffs, preserving the same characters for a distance of four miles, extend to near Boscombe, where we notice a change in their composition. The clays are black and still more sandy, the upper parts of the cliffs are far less steep and seem

composed of loose white sands and shingle with a thick capping of gravel.

At length still further east these beds disappear beneath the sea in consequence of the general dip of the strata. The sand beds which follow, where they cap the cliffs, are recognised from a great distance by their greater slope from the cliff shorewards, for they are so loosely composed that every wind blows the sand away in clouds and leaves the shingle to rattle down on to the beach. So loose is this material that that part of the coast line which had cliffs composed of this sand has now but an insignificant height; all the sand has been blown away by wind and wasted by rain, until the shingle has been left dropping lower and lower, and the stones which neither wind nor rain could affect, have come closer and closer together. This is the cause of the land connecting Hengistbury Head being much lower than any other in the neighbourhood. The shingly beds are ancient sea beaches, and the slope of them to the ancient sea can still be seen in places. So long have they been exposed that the flint pebbles in them are sometimes almost decomposed, the familiar white coating to the flints being an inch or more thick. This shingle, which is composed of rounded pebbles, that tell the tale of a long rolling on the old sea beach, is now the source of the pebbles on the present beach, and the round condition of the pebbles on the present beach on this part of the coast is not as on the shore further towards Poole, or as at Brighton, the result of present wave action, although the existing sea has undoubtedly reduced the pebbles in size. They cannot be confounded with the later angular river gravels which everywhere cover this area.

At the peninsula of Hengistbury Head, about six miles beyond Bournemouth, the cliffs again rise, being at first composed of black, chocolate-coloured, and white sands with pebbles, and farther on of green clayey sands containing nodules of large irregularly-shaped concretions of sandy, argillaceous ironstone disposed in layers, until lately worked for iron and shipped to the smelting furnaces of South Wales. Beyond Christchurch Harbour we have cliffs of white sand which, according to my views, close the series.

Inland the country has a barren appearance except in the plantations, and the scattered brick pits afford no additional information of use to us in our present researches. There is but little of interest to the tourist except on the very edges of the district where the archaeologist will be interested in the Minsters of Christchurch, with its associated ruins, Wimborne, and the ruins of Corfe Castle.

No order of arrangement is at first apparent in these beds, but by going backwards and forwards over the ground attentively there is, it seems to me, a very well-marked and recognisable sequence. I will now tell you what I take to be this sequence. It has never been submitted to geologists before, and it is possible, as is often the case with new work, that there may be some objections raised to it.

#### FRESHWATER. MARINE

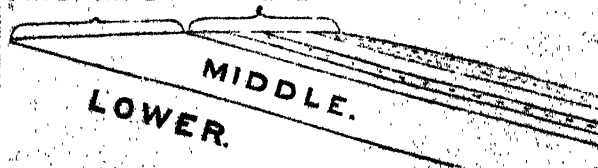

FIG. 1.

I would refer to the diagram (Fig. 1) where I have expressed my reading of this district. This lower fresh-water series is seen in the neighbourhood of Corfe and forms part of the cliffs at Studland. It is characterised by abundance of pipeclays, and has a thickness of 200 feet or more. The middle fresh-water series, also met with near Corfe



FIG. 2.—The Valley of the Bourne restored to represent the conditions which are supposed to have existed during the deposition of the Lower Bagshot Formation. From a drawing used in illustration of Mr. Gardner's Lecture.

and at Studland, forms the whole thickness of the cliffs between Poole Harbour and Bournemouth. We thus have a magnificent section four miles long and 100 feet in height. Branksea Island is also formed of this series. Their entire thickness cannot yet be accurately stated, but may be put down at some 300 feet. They are characterised by the fact that the clays contained in them are usually brick-earth.

The next series above is a marine series and is some 400 or 500 feet thick. The base beds are dark sands and clays, succeeded by pebble beds and sands, then more sandy clays with pebbles, and ending with a thick deposit of white sands. This marine portion of the series occupies the cliffs between Boscombe and High Cliff.

Plain as this order of deposition appears, we have collateral proof that this interpretation is right, for at Alum Bay there is a complete section of the whole of these beds although somewhat thinned out, upheaved vertically, that is, turned completely on end, so that we can examine them in detail in the space of a few hundred yards, like passing in review volumes on a book-shelf. We see in succession the lower pipe-clays, the brilliant sands, the darker clays, sands, pebble-beds, one after the other, so tilted up and so placed that those who know nothing of the depression and elevation of areas can with difficulty be brought to believe that they have all been deposited horizontally.

In giving you the history of the deposition of these beds, I shall have to speak of a sinking area, and before doing so let me remind you that in Lyell's "Geology," a book in everyone's hands, many instances are recorded, of sinking areas in historic times, from our knowledge of which we feel justified in supposing that there were sinking areas in geological times.

The thick pipeclays and quartzose grits which we find at the bottom of the series can without the slightest hesitation be referred to the result of the wearing away of granite rock, for wherever granite is worn away by water, there we find white clays and similar quartz grits. We need not go further than Cornwall to see still finer clays, which have been produced in quite recent times from granite by the agency of water. The beds of this district included in the Tertiaries, first laid down over the chalk, were those now called London clay (a marine deposit), and when the streams which brought down our Bagshot beds first spread out their deposits, they spread over the London clay, except, perhaps, in those places where they first cut away the London clay, so that some of these Bagshots were possibly laid down on the chalk. The water in this case came from the west, and as here we are nearer the hills, which were the source of the clay, we find the grits coarser and the clays thicker.

At Studland the grits are not so coarse, and at Alum Bay, a long way east, the sands are very fine, so that anyone, knowing the district could tell which of these specimens came from either place.

Each clay-patch represents a small lake, first scooped by the running water out of the beds just previously deposited, and then filled in by sediment. The mode of action is this:—The weather disintegrates the exposed surfaces of the distant granite rocks, and the loosened particles are carried by rain into streamlets, which convey them on to the river. The river, tearing and tumbling along, grinds the rocks which have fallen into its bed into round boulders, until in flood times the water is white with finely-divided granite. This grit being hurried along by the rush, is spread far and wide over the valley whenever the stream bursts its banks, which sometimes torrents very often do, while the finer particles are still held and carried on until a lake or pool is met with, where the speed is checked; these fine particles are then dropped, and the water becomes quite clear. This deposition of fine clay goes on for ages, until the lake becomes filled up, the water gets diverted into

another channel, and what was a lake becomes dry land; the river at the next flood spreads over the valley, covers in common with the surrounding ground what was the lake again and again with thick grits. Such is the origin of the large basins containing the clays which serve now to make your pipes and your crockery. You have only to recognise that the valley in which this takes place was slowly sinking, and there is no limit to the thickness of sands and clays which might be thrown down on any one spot, and in this way can be explained the sudden changes from grit to clay, which would else be a puzzle to us. The size of these old lakes is very well seen now wherever a clay basin has been quarried away, for the clay is quarried away for use whilst the sand is left. Some of them are represented by the beautiful blue pools I told you about, and are seen, therefore, to have been about one-quarter to one-third of a mile round, whilst their depths have varied from 30 to 60 feet. Mr. Lawrence Pike informs me that other clay basins are of larger extent, being  $\frac{1}{2}$  of a mile in diameter. Their greatest length is in the direction of the valley. These clays extend under the surface, eastward, for they are worked at Branksea under the sea-level, at Parkstone, and near Bourne. At Alum Bay they are tilted up, and are full of beautiful fossil leaves.

This next series of beds above, which I have told you are of a different character, mark a great change in the conditions of the land. The clay patches are of smaller extent, being the filling in of mere ponds or puddles, which acted on a smaller scale, as the lakes of which we have just spoken. The change indicated by these beds is one from the valley in which the previous contained beds were deposited, to a broad low-lying tract in proximity to the sea. We infer that we can trace how this tract became gradually lowered and lowered down to the sea-level.

The belief in the gradual lowering of the land in this area is borne out by the fact that in the cliffs near Poole, which are slightly lower in position than those farther east, we get only leaves of evergreens and forest trees, whilst as we work our way east so as to meet with beds on a higher level or, which is the same thing, of more recent age, we get a mixture of ferns and other plants, which require much moisture, whilst farther east still we get assemblages of plants that could only have lived in absolute swamps.

Low as the land appears to have become we have no evidence whatever, throughout the whole thickness of this part of the series, amounting to 300 feet at least, with an exception which I will tell you about directly, that it was low enough to be inundated by the sea, as the few shells that have been found are of fresh-water kinds. The exception alluded to is the occurrence of logs of wood bored by the ship-worm or teredd. All the ship-worms generally known to us live only in salt water, and are so delicately organised that the slightest mixture of fresh water instantly kills them. This isolated fact for some time presented a grave difficulty, but happening to read Mr. Gwyn Jeffreys' interesting account of the habits of this creature, I not only found that he relates the occurrence of similarly bored wood 300 miles up the River Gambia, but distinctly states that there is a species which lives in fresh water. Therefore this supposed marine indication may be on his authority removed, and, supposing this theory should be verified and universally accepted, we may safely infer that these middle beds are of fresh-water origin.

We now come to the third series of beds. A still continued sinking of the area brought this swampy condition so low that the sea was no longer kept out, but, bursting through, formed great salt-water lagoons teeming with life; for we suddenly find crowds of marine forms imbedded in what was formerly black mud, such as we might find now in the existing Poole Harbour here.

In this series of marine beds we have at the bottom lagoon beds, as I call them, which may represent a similar state of things to what we see at Christchurch, or Poole, or Weymouth, or any place where we have mud banks left dry or even shallow, between each returning tide. We still find here leaves of trees, many of them doubtless overhanging the lagoons, which have so slowly decayed, that they are overgrown with zoophytes; crowds of oysters are met with; we find the remains of shore-crabs, which from our knowledge of existing species, we infer, overran the muddy shore; the callianassa, a prawn-like creature, which bored through the mud; snipets, arcas, corbulars, and many other shell-bearing molluscs, passing their lives, dying, and becoming buried in the sediments of the sheltered lagoons. This lagoon condition went on until the gradual sinking has permitted the ever-encroaching surf to break over the lagoon barrier, to rush in, and in time overwhelm them with rolled shingle and sea-sand. We still trace the lagoon condition for a mile or so east, where it is represented by cigar-ash coloured sands, impregnated with salt, and coloured with this dark tint of carbonaceous matter. These sands contain very perfect remains of branches of a coniferous



BRANCH OF CONIFER

FIG. 3.—*Taxodium.*

tree resembling the genus *Dacrydium* and large pieces of cactus. It should be mentioned that this is the earliest cactus known, and that the spines are found to be still flexible. The sands are in other places crowded with fruits something like those met with at Sheppey. Unfortunately the salt contained in them effloresces and splits all these specimens into fragments.

I may just tell you that at Hengistbury Head we have deeper sea deposits, with sharks' teeth and bones. At Highcliff, Barton, we have relics of a sea swarming with life, myriads of fossil shells may be collected on the cliffs, whilst still further on at Hordwell, we have beds showing that the land arose again, affording suitable conditions for the growth of luxuriant palms, and was the haunt of the alligator, turtle, and other reptiles which are now confined to tropical countries.

Fig. 2 is a view of the Valley of the Bourne at the time referred to above; a description will be given in the next article. (To be continued.)

#### GEOGRAPHICAL CURIOSITIES

**D**URING the meeting of the International Geographical Congress at Paris in 1875, the National Library opened an exhibition supplementary to that which was held in the Tuileries. Although very rich in documents and modern geographical works, the great national institution did not wish to show simply a duplicate of the collections exhibited at the Tuileries, and it therefore brought out only ancient and rare objects which the rules of the establishment wisely forbid to leave the building. Thus it showed to the public neither its great topographical maps, such as those of Cassini, van der Maelen, &c., nor its recent atlases, its numerous geological maps, its hydrographic charts of the French, English, and other Admiralty Departments. But, thanks to M. Leopold Delisle,

Administrator-General of the National Library, and to M. E. Cortambert, Librarian of the Section of Maps and Plans, there was exhibited in the magnificent Mazarin Gallery a collection unique of its kind, and to which the Departments of Printed Books, Manuscripts, and Engravings contributed. The objects exhibited belonged generally to Group IV., devoted to Historical Geography and the History of Geography, and comprised, besides ancient and modern works and MSS. treating of geography and its history, ancient maps and globes, instruments used by ancient geographers, astrolabes, sundials, &c.

The success of the exhibition in the Mazarin Gallery inspired the Administration of the Library with the happy idea of transforming this temporary exhibition into a permanent institution. This has been established in the ground-floor of what is known as the "Salle des Globes," and in the two rooms which look out upon the great court of the Rue Richelieu, has been recently opened to the public who are admitted on Tuesdays from 10 to 4.

Although the limited space at disposal in these apartments has not permitted the transference of all the objects exhibited in the Mazarin Gallery, and although the Departments of Manuscripts and Printed Books have kept possession of some of the valuable documents lent on the occasion of the Geographical Congress, the exhibition is nevertheless of the greatest interest on account of the rarity of the objects which it contains. Space forbids us to give a complete list of the many objects exhibited, though we are able, through the courtesy of the editor of *La Nature*, to give illustrations and descriptions of a few of the curiosities. There are nearly 500 objects altogether, and those who desire a complete descriptive catalogue of them should procure No. 178 of the French journal just referred to.

On entering the first room of the exhibition the visitor is at once struck with the large dimensions of the two great globes of Coronelli, made, in 1683, by order of the Cardinal D'Estrees, who presented them to King Louis XIV. One of the most curious objects shown in this room is a map of the world, probably of the ninth or tenth century. It is a copy of one which appeared in a Commentary on the Apocalypse written by Beatus, a benedictine of the monastery of Valcovado in Leon, who lived in the eighth century. The original of which the one exhibited (Fig. 1) is a copy, belongs to the library of Turin. It shows strikingly the wonderful notions which these old monks had of the universe, and especially of the earth in which they dreamed their uneventful lives away. Four winds, represented by the grotesque figures seated upon the skin or leathern bottles, and holding shells in their mouths, indicate not the four cardinal points, but the collateral points, where the sun rises and sets at the summer and winter solstices. The orientation of the map, as was for long the custom in the middle ages, places the east at the top, the west below, the north on the left, and the south on the right. A circular ocean, the old river Oceanos of Homer, surrounds the world. If we examine the interior of this strange *mappemonde*, Europe will be seen on the left, Africa on the right, and Asia at the top. The Mediterranean is represented by a very regular parallelogram, extending from east to west. A not less regular branch of this sea occupies the place of the Archipelago, the Black Sea and the Sea of Azov, and bounds Europe on the east, the north-east point of the continent being indicated by the words *Hic Caput Europe* (Europæ). Islands uniformly square are spread over the Mediterranean; we may recognise under strange names, Corcyra, Cyprus, Samos, Sicily, Corsica; the name *Tassis*, which may also be noticed, designates, no doubt, the City of Tarsus, which the author evidently regards as an island.

In the surrounding ocean appear other islands not less fantastical. On the east the island of Crisa and Aigue

(for Argire), in allusion to the region of gold and silver of the ancients, in trans-Gangetic India; on the north-east the Island of Thulé, which recalls the famous Thulé; Britannia; then the Island of Scotia, which, however, is not Scotland, as many might be apt to think, but the original home of the Scots, Ireland; for it was not till about the twelfth century that the name was fairly transferred to North Britain.

The orography of Europe is shown, partly in enormous cones, partly in elongated masses, five principal chains, of which only one is named, the Mountains of Gaul (*Montes Galliarum*), without doubt, the Pyrenees. The hydrography is wretchedly meagre. The largest river is

correctly set down as the Danube (*Danubu*), but what a curious course is given to it! The second in extent is the Tagus, under the name of *Tavus*, which in utter contempt of geography, discharges itself into the Mediterranean. What considerable river is that which flows towards the east under the name of *Eusis*, a name still applied in Asia to a large river situated almost opposite to this one? Perhaps it may be meant for the Pontus Euxinus itself, the Black Sea; for to mistake a sea for a river was not an uncommon thing with these old geographers.

The political geography is of a higher kind than the physical geography. To speak only of Gaul we find mention made of Aquitaine, Toulouse, Gallia Lugdunensis,

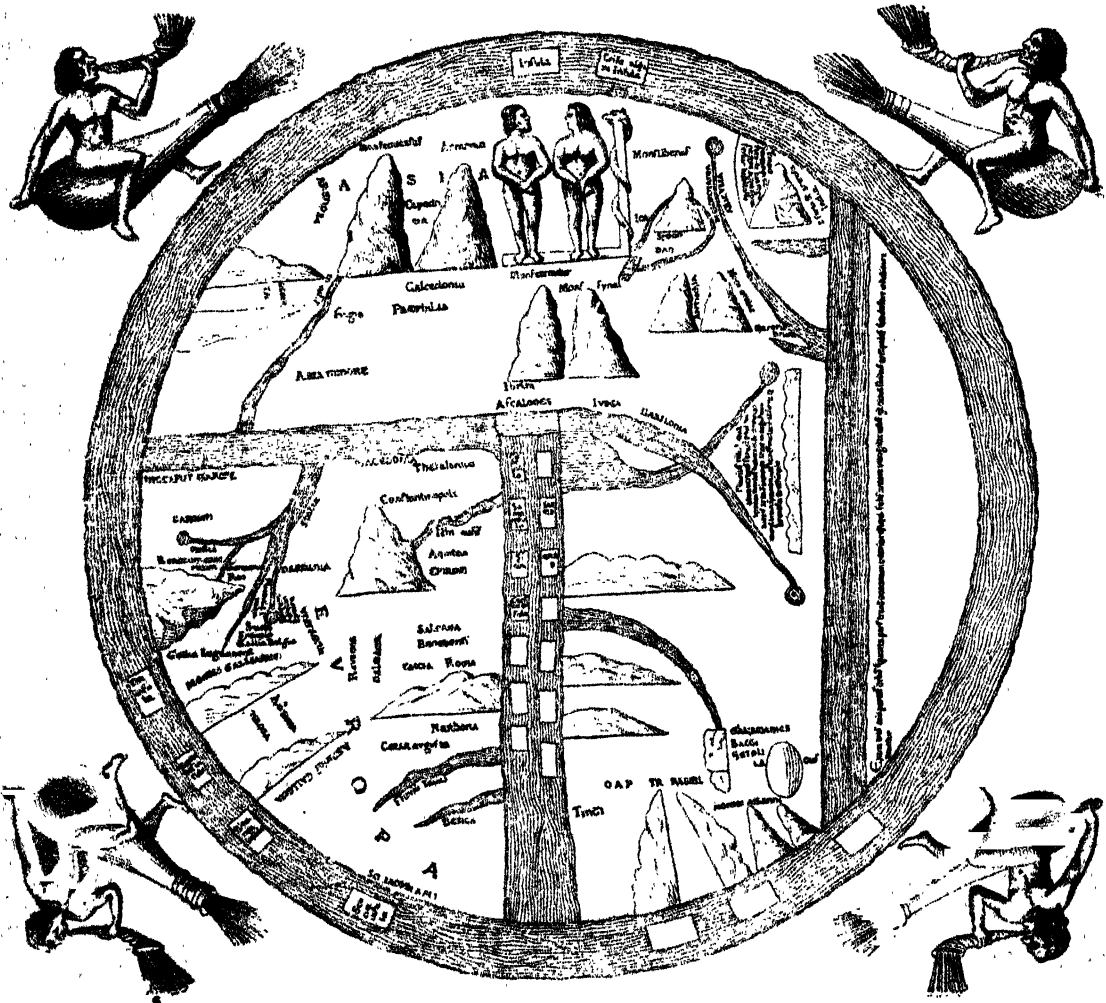

FIG. 1.—Map of the world contained in Beatus's Commentary on the Apocalypse (10th c.).

and Gallia Belgia; we also find *Francia*, which, however, does not stand for France but for Franconia.

In Asia, on the spot, no doubt, where Paradise was supposed to have been placed, appear Adam and Eve, in a grotesque position, and near them the serpent, who, however, has nothing tempting about him. Ten conical mountains surround this curious scene, without names except Libanus, the Caucasus, Carmel, and Sinai. Only three rivers flow in this vast space: first the Jordan, which encompasses Mount Lebanon in a very strange way; the Euphrates, which, though it bears no name, may be divined by the name Mesopotamia written on its

banks; and then the Eusis, that mysterious Eusis to which we referred above.

The countries and the towns are more abundantly treated, though scattered pretty much at hazard. Jerusalem holds the first place, under the abbreviation, Iherim; Judea, Ascalon, Sidon, Antioch, Asia Minor, Phrygia, Mesopotamia, &c., are represented in situations more or less inexact.

In Africa, what strikes one at first is the Nile, the enormous Nile, divided near its sources into two branches, each issuing from a lake; it falls into the sea by a mouth larger than that of the Mediterranean itself. A note in-

serted between its sources tells of the gold which is mixed with the sand of the river, a vast lake which it traverses, and the sandy deserts of Ethiopia, through which it flows. The only other river seen in Africa is one without a name, which descends from the country of the Garamantes and falls into the Mediterranean; it is probably the Bagradas—the Medjerda of the present day. The mountains of Africa are but poorly shown. After Mount Atlas (*Montes Atlantici*), which is neither in its place nor very markedly brought out, there may be noticed three mountains which abut in the Mediterranean, and two steep and sharp-pointed mountains designated by the scarcely legible

century shows a marked progress on that which we have just described.

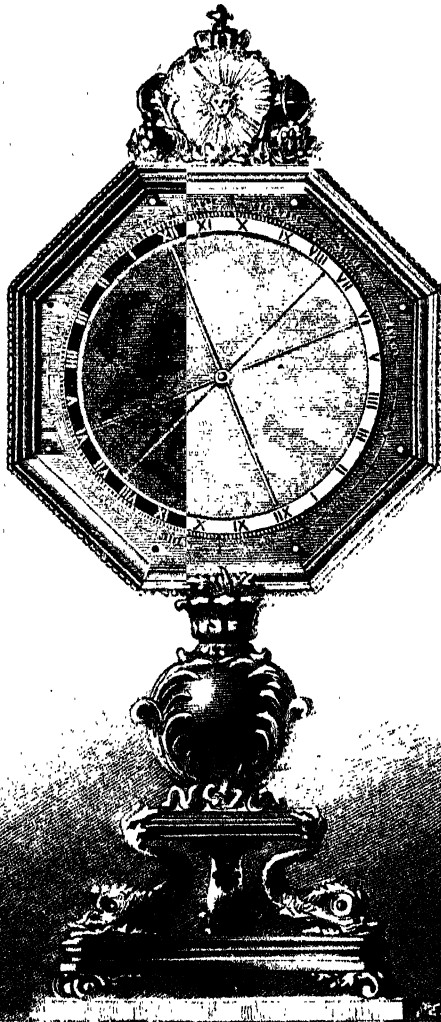

FIG. 2.—Copper cosmographic apparatus.

words, *duo Alpes Contra Arasibi*; this should perhaps be read *Contraria sibi*, i.e., two mountains opposite each other, forming, as it were, two walls between which is a narrow passage. But where exactly are they?

A note inserted in the south of the map tells us that, independently of the three points of the known world, there is beyond the ocean a fourth part which is unknown to us on account of the heat of the sun, and on the confines of which, it is fabled, adds the author, that there are Antipodes.<sup>1</sup>

A reproduction of this map belonging to the 11th

<sup>1</sup> For the above details we are mainly indebted to an article recently published by M. E. Cortambert.

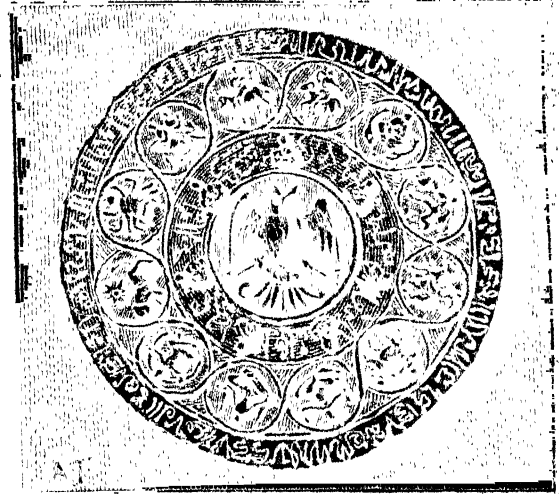

FIG. 3.—Arab zodiac (one-fifth size of original).

The room in which this map is exhibited contains many equally curious objects, some of them of great rarity and

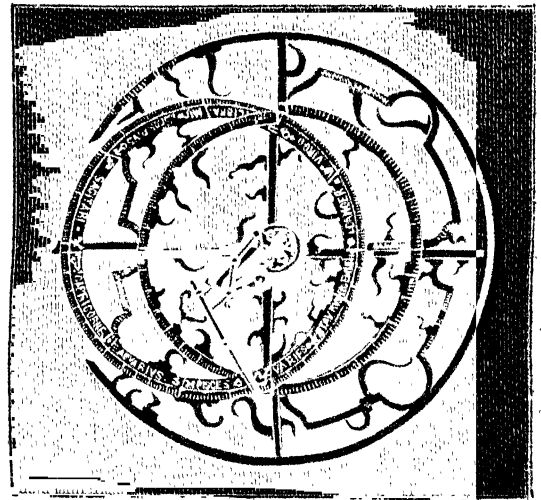

FIG. 4.—French astrolabe (one-fifth size of original).

value. Among these we may mention a copper cosmographic apparatus (Fig. 2) by Thuret, of date 1725. On

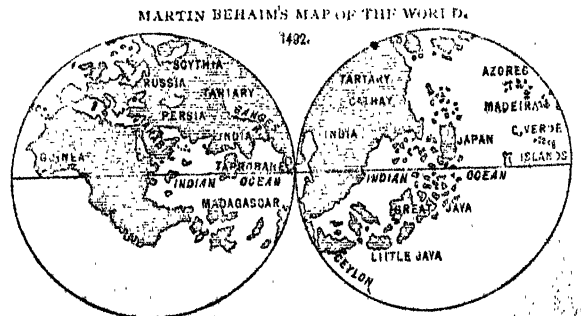

FIG. 5.—Martin Behaim's map of the world.

one face are represented the northern constellations and the signs of the zodiac, as well as the correspondence of

these signs with hours and days; on the other side is shown the movement of the planets around the sun. It is worked by means of a clockwork mechanism in the interior, and is made to indicate the days, months, and years. In other rooms are shown the curious Arab zodiac represented in Fig. 3, and a French astro-labe (Fig. 4) made by François Chassignet, and of date

Rome, 1622. Another interesting object is a facsimile map of the world, painted on parchment by order of Henri II. (1547-1559). Some critics, among others M. D'Anezac, date it as far back as the time of François I. (1515-47). In Fig. 6 we have reproduced a portion of South America after this curious document. Among other objects is a facsimile of the well-known

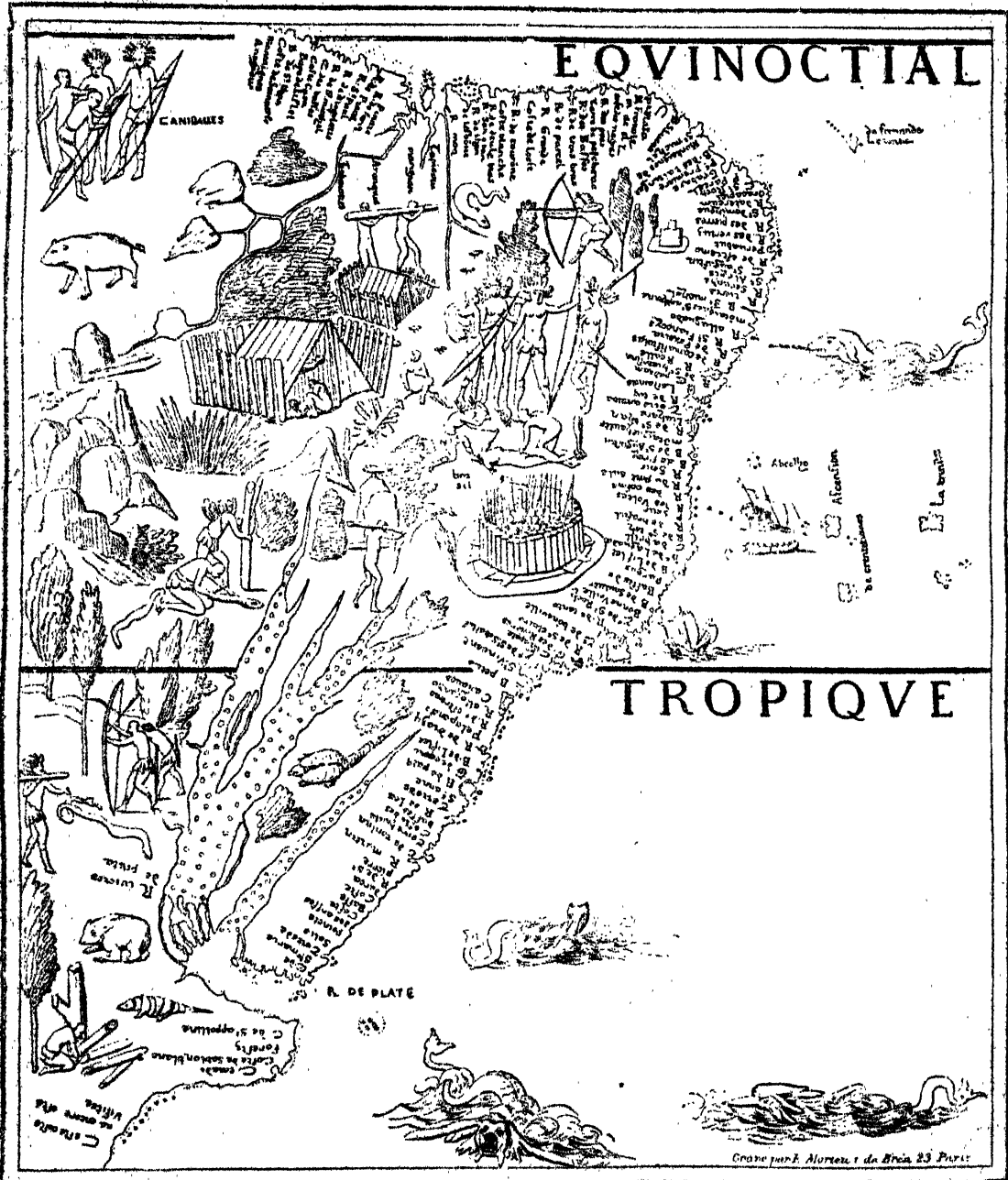

FIG. 6.—North-east region of South America (16th c.).

globe of Martin Behaim, of date 1492, the original of which is at Nuremberg. This globe is extremely curious, specially on account of the lacuna in the region where America should be, that continent not having been discovered when the globe was made. An idea of the contents of this globe may be obtained from the illustration, Fig. 5. There is also the only known copy of the cele-

brated map of the world of Sebastian Cabot, of date 1544. A valuable legend in Latin and Spanish informs us, among other things, that John and Sebastian Cabot landed on the new continent in 1494.

Such are a few of the objects exhibited in this extremely interesting and instructive collection. No doubt many of our readers will be glad to know of its existence, and

those who take an interest in the progress of geography will doubtless think with us that such an exhibition adds more to the many attractions of Paris; now that the Loan Collection is closed, nothing at all approaching it exists in London.

### TEMPERATURES AND OCEAN CURRENTS IN THE SOUTH PACIFIC

[In the *Annalen der Hydrographie und maritimen Meteorologie* (Jahrg. iv., 1876, Heft 6, p. 219), Herr von Schleinitz, a member of the recent expedition in the German corvette *Gazelle*, states his views on ocean temperatures and currents; these are somewhat different from those expressed by Sir C. Wyville Thomson (Proc. Roy. Soc., vol. xxiv.), which are based on the data obtained during the *Challenger* expedition. The *Gazelle*, after leaving Auckland (New Zealand), pursued a course almost due north as far as the Fiji Islands; thence she proceeded to the Samoan Islands, situated at a short distance north-east of Fiji. After a brief excursion to the Tonga group and back, the *Gazelle* (from long.  $72^{\circ} 18' 5''$  W., and lat.  $14^{\circ} 28' 1''$  S.) sailed some 2,500 nautical miles in a south-south-east direction (to long.  $41^{\circ} 11' 4''$  W., and lat.  $45^{\circ} 33' 6''$  S.), after which she took a line easterly, and later on, a south-easterly course, to Magellan's Straits (long.  $80^{\circ} 30' 3''$  W., lat.  $51^{\circ} 41' 6''$  S.). The observations of temperature on the long cruise between the Samoan Islands and the Magellan's Straits are of special interest, as the course taken by the *Gazelle* lies to the south of that pursued by the *Challenger*.

On the first part of the course described, which has a direction nearly coinciding with the meridian, eight series of observations of temperature were made. The bottom profile of this part shows a peculiar absence of elevations, which is all the more remarkable when compared with any similar profile of the same length in the Atlantic.

The conclusion arrived at by Herr von Schleinitz, and based on the results of his observations is, that in the Pacific the arctic deep-sea current crosses the equator in a southerly direction and meets the antarctic current only between lat.  $30^{\circ}$  and  $36^{\circ}$  S. This is just the reverse of what takes place in the Atlantic, as it seems highly probable from the observations of both the *Challenger* and the *Gazelle* expeditions, that in the Atlantic the antarctic deep-sea current passes the equator, running northward of it some to a considerable distance.

Herr von Schleinitz concludes from these latter observations, that if the antarctic deep current enters the North Atlantic, even as a current of limited breadth, it must nevertheless carry enormous quantities of water from the South Atlantic to the North Atlantic, as it is certain that the current has a depth of more than 1,000 fathoms on an average. He then asks the question, What becomes of this mass of water? There is no strong surface current of existence which carries it back to the South Atlantic; even the current caused by the south-east trade winds runs more towards the Gulf Stream than towards the Brazilian coast current. There seems only one hypothesis possible, viz., that a great part of the water flows through the Arctic Sea and Behring's Strait into the North Pacific, and that may be the cause of the preponderance of the arctic current of this ocean over its antarctic one.

The natural conclusion drawn from this is that the South Pacific, in order to complete the whole circle, gives a great part of its waters to the South Atlantic, and as a proof of this it might be pointed out that the ice limit does not approach the equator so much anywhere as it does in the South Atlantic.

The following facts may also be mentioned as in favour of the hypothesis of a certain regular circulation taking place in the manner described. A comparison of the air-isotherms as well as the sea-isotherms both of the Atlantic and Pacific Oceans shows that (1) the South Atlantic is

colder than the North Atlantic; (2) the North Atlantic is warmer than the North Pacific; (3) the South Pacific is warmer than the South Atlantic.

The higher temperature of the North Atlantic Ocean has hitherto been generally explained by the influence of the Gulf Stream. But a similar current exists in the North Pacific, and yet this is colder. There is no doubt that the Gulf Stream has a warming effect on some European coasts, but it is very probable that considering its comparatively small breadth of about 100 nautical miles, and shallow depth of only 100 fathoms, the stream is far too insignificant to be able to exercise a perceptible influence upon the climate of the whole North Atlantic and of the coasts surrounding this ocean.

On the other hand it does not seem to have been sufficiently appreciated hitherto, that a very large part of the North Atlantic is filled by water, which has crossed the equator, even if at a considerable depth. However trifling the rise in the temperature of this water, as caused by the passage over the equator, may be, when compared to the general temperature of the South Atlantic, it is nevertheless a fact that there is an important amount of heat, which the South Atlantic loses and the North Atlantic gains, on account of the very large extension of the current. Nor can it be objected with regard to this, that the mean temperature of that mass of water is probably below the mean temperature of air in the North Atlantic, because there is no question of absolute heat, but only of difference of temperatures between the North and South Atlantic.

The excess of water in the North Atlantic, which is not carried back into the South Atlantic by the surface-currents, and which passes through the Arctic Ocean (where it loses the heat it possessed) into the North Pacific, causes a decrease of temperature in the latter, and, proceeding southward, i.e., again crossing the equator and thus absorbing heat, produces an increase of temperature in the South Pacific. Finally, the South Pacific gives back to the South Atlantic a part of that water at a very low temperature, which originally flowed from the latter into the North Atlantic perceptibly heated, on account of its passage through the tropics.

This circulation, however, is not to be understood as if the lowest strata of all the oceans took part in it; on the contrary, there are doubtless only single currents in the lower strata which follow it, while others may flow in an opposite direction. Further observations will throw light on these hypotheses; those made up to the present are yet insufficient and at times even contradictory. At the same time it must not be overlooked that a constant exchange of water between the lower and upper strata, i.e., currents flowing in a vertical direction, are proved to exist beyond doubt, particularly in certain zones.

In conclusion Herr von Schleinitz considers the oceanic system of currents to be evidently a very complicated and at present obscure one, upon which the observations made on board the *Challenger* and the *Gazelle* throw but a very faint light.

The second part of the course pursued by the *Gazelle*, as described above, did not differ sufficiently in latitude, and therefore could not furnish any data which would be useful or decisive on the subject in question. However, the observations which were made give results in complete accordance with the hypothesis referred to above.

### ON THE MEANS OF PROTECTION IN FLOWERS AGAINST UNWELCOME VISITORS

THE phenomena relating to this subject, which have important bearings on the doctrine of selection, have recently been discussed by M. Kerner in an interesting monograph communicated to the *Festschrift* published on occasion of the twenty-fifth anniversary of the Zoo-



logico-Botanical Society, in Vienna. The following is a brief outline of this paper:—

M. Kerner, first of all, thinks it unwarrantable to divide the characters found in plants into *physiological*, which bring their possessors a certain advantage, and *morphological*, which are of no advantage. While, no doubt, profitless and even disadvantageous formations occur in plants, it is yet certain that such individuals are soon extinguished and suppressed by others which bear advantageous characters. Most of the so-called morphological characters have rather a certain biological significance, and it is only from the lack of observations regarding them that the material for their comprehension is so defective.

Hitherto study has mostly been directed to the relations between the forms of flowers and those of the animals visiting them. M. Kerner gives an account of those manifold forms hitherto regarded as only of morphological significance, but the use of which is to guard flowers against uninvited guests and against all injurious influence, and attacks to which they may be exposed; these forms therefore are of essential biological value.

How numerous are these enemies and uninvited guests will appear from the following brief sketch:—First, there are the large grazing animals, such as the ruminants, solipedia, &c. Then there are snails, especially the voracious Helicidæ, which, indeed, are seldom found in the flowers, not because they despise them, but because they are kept from them by a group of stiff bristles and prickles underneath the flowers. The same holds for soft insects, especially many larvæ of caterpillars. The wingless aphides are, specially among soft insects, to be noted as unwelcome guests of flowers. They are found extremely seldom in flowers, being warded off by suitable means, but if they are carried into the flower they immediately force their proboscis into the sappy tissue. The insects with a firm chitinous skeleton, again, easily pass over the bristles and prickles; only their posterior feelers are sensitive to contact with sharp points. Among animals of this class those are injurious to flowers which, in consequence of their too small size do not, in passing through to the nectar at the bottom of the flower, brush against either the anthers or the stigma. They take away the nectar without effecting fertilisation. But even when the chitinous insects are of the proper size they are unwelcome to flowers if they are wingless, for in that case they are a comparatively long time in reaching the flower of another individual of the same species, and the pollen with which they are laden is exposed to so many hazards, that fertilisation by these insects is extremely improbable.

Now the means of protection against access of these numerous animals are very various, as we shall presently see.

We may first notice the protection afforded by the leaves, which produce the building materials of the flowers and are necessary to their growth. They afford protection through certain alkaloids and other compounds contained in the cell-gap, and also through a hard leather-like consistence and thorny processes by which a portion of the leaves are protected from injury by grazing animals.

The means of protection in the flowers consist, first of all, in the production of matters which are repugnant to some animals; such are alcohols, resins, and etheric oils, to which a number of the unwelcome guests have such a dislike that they will rather endure the sharpest hunger than eat these plants.

A second kind of protection consists in prevention of approach to the flowers by isolation of these with water, as is the case in the Bromeliaceæ. Generally the foliage leaves have funnel-like forms in which the atmospheric precipitates, rain and dew collect and so form an insurmountable barrier to the passage of creeping, wingless insects, while the access of the flying insects which

affect fertilisation is not prevented. The water-plants are also defended against unwelcome guests which might otherwise creep to them; and it is very remarkable that in water plants with projecting flowers, other means of protection against creeping animals are wanting; they are only developed when the isolating layer of water, from some cause or other, disappears. Very instructive in this relation is the behaviour of *Polygonum amphibium*. To the flowers of the plants growing in water, creeping insects cannot come, the flowers being surrounded with water. When, however, the water has run off and the plant is on dry ground, there develop on the leaves and stalks gland-hairs, which secrete a sticky matter, rendering the flower-bearing axis all smeary, so that access is equally forbidden to the creeping insects. If, now, a plant of *Polygonum* bearing these gland-hairs be put in the water again, the trichome-tufts with their sticky material disappear, and the surface appears once more smooth and even.

Such a formation of sticky matters is developed in very many plants as a sure protection against unwelcome visitants. These sticky matters appear on the most different parts of plants, under the flower, and ward off especially creeping, but also unwelcome flying animals from the flowers. The variety of the glandular forms yielding sticky matter is very great, and their occurrence is very widespread.

While these sticky matters are effective against creeping animals which have a pretty firm chitinous coat, and especially against ants, they are ineffective against the soft creeping animals, e.g., the snails, which secrete slime on the sticky parts of the plants, enabling them to pass over these. Against such enemies the plants are armed with the most various thorns, prickles, and sharp teeth, which mostly have their points directed downwards, but may have the most diverse positions and forms. Quite peculiarly interesting are those prickles and needles, which serve the purpose not so much of keeping off unwelcome visitants as of showing to the insects which visit the flowers the right way for effecting fertilisation; whereas if the same insects visited the plants and removed the nectar by another way, fertilisation would not be accomplished.

The means of protection thus far described are all on the path which the unwelcome guest must traverse if he would reach the flower. There are other means of defence, however, within the flower itself. These, indeed, cannot be regarded as absolute, for they may be overcome by unwelcome visitors. They consist of hair-like formations, which are united in large numbers, into grating-like groups, rendering access impossible to one animal, while to another, which is furnished with a longer, thin proboscis, or can drive with greater force against the grating, they yield the desired food. These soft hair formations, which have the most various modifications towards the end in question, also often serve to point the way by which welcome visitors may reach the nectar.

Where all the formations that have been mentioned are wanting, protection is still afforded by bends, enlargements, and collocations of particular parts of plants, which are so diverse that it is difficult to indicate them cursorily. In general they may be divided into two groups, one of which comprises those formations by which the nectar is completely covered, whereas in the other the entrance is merely narrowed so that an opening remains by which the animals may introduce their sucking organs. The most different parts of the flower share in these formations, producing a very great variety of forms.

A last means of protection of flowers is represented in those numerous cases in which the flowers open only in the evening, and thereby are guarded against the visit of insects which swarm during the day. Further, there is the diversion of injurious insects, due to the fact of the nectaries being sometimes situated in other parts of the

plants, and mostly in the foliage leaves, so that creeping insects satisfy here their need of food, and do not trouble themselves about reaching the flowers higher up, and thus these remain protected from their visits.

"From the foregoing observations," says M. Kerner, "it will sufficiently appear that the relations of plant-form to that of animals living at the expense of plants are far more manifold than has hitherto been supposed, and that especially numerous formations in foliage-leaves and stem are so far of biological significance that by them protection is afforded to the flowers against the prejudicial visits of certain animals. Where the attacking animals are absent this defence is also, naturally, useless, and therefore all these formations are properly to be regarded as means of protection only for those plant-stocks which occur in their original region—in the region where the species to which they belong has arisen. In another place they are perhaps not means of defence; indeed they may even be of disadvantage, or their formation there is at least something superfluous, not in the economy of the plant, and as a matter of course, these disadvantageous, because not economically organised plants, when they come under conditions which are not in harmony with their form, are driven out of the field by competitors that are more advantageously organised.

"If, for example, a plant species comes, in course of its migrations, into a region in which it is exposed to other attacks, or if the external relations in the place where the species arose (and with which it was formerly in agreement) are altered, it may become more and more rare, and gradually quite die out. Among these changes of external relations, however, are to be understood not merely changes of climate; a not less important part is played by the changes which occur in the animal world in a particular region. Apart altogether from changes in the extent of distribution of animals, the animals vary as well as the plants, and individual varieties, which occur with new characters that are advantageous relatively to given external conditions, may become the starting point of new species. What is of advantage, however, to the animals which attack the plants, constitutes, as a rule, a disadvantage for the attacked plant, and it is therefore not only possible, but in course of time it has actually often happened that in consequence of the multiplication of an advantageously organised animal form in a certain region, some plants in this same region having their flowering function destroyed, and their formation of seeds hindered, have disappeared gradually from the scene.

"While, on the one hand, the dying out of certain species with altered external relations, is at once explained by changes in the attacks of animals, the same relations, on the other hand, afford an explanation of the phenomenon, that under similar external conditions, plant species, which, with reference to other characters, are classed under the most different genera and families, do yet in certain formations agree with each other. Only the advantageous forms can maintain themselves, and only those individual varieties which appear with characters that are advantageous with reference to the conditions presented by the locality and position become the starting-points of new species. Since, however, the creation of new species in this way may occur in the most different plant-families, it is explicable that we find, e.g., in one floral region, very many species of the most different stocks guarded with prickles, in another floral region such species furnished pre-eminently with flowers very rich in nectar, and that often even the character of the whole vegetation is determined by the preponderance of plants with like formations. Owing to the fact that the variety of the means of protection, as well as of the means of attraction is very great, and that through formations of the most different kind the same result can be reached, this conformity is again, of course, greatly limited. Indeed, precisely by this circumstance that, against the same prejudicial attacks, very different forma-

tions may serve as equally good means of defence, is the phenomenon explained that frequently several species of a family occur beside one another, without entering into competition in this relation, because the species, each after its own fashion, possess equal advantages."

#### THE ACTION OF THE WINDS IN DETERMINING THE FORM OF THE EARTH<sup>1</sup>

IN view of the most recent discoveries in the region of physics, especially with regard to the nature and properties of forces, it became necessary *eo ipso* for dynamical geology to give up as unsatisfactory the division of geological forces into "igneous" and "aqueous," and to substitute a division of them into "primary" and "secondary"; of which the former explain all the motions which we observe on and in the earth, according to their origin and nature; while the others—one might call them "agencies" to distinguish them from the first—would teach us what and how great changes in the figure of the earth's surface are produced by the bodies so moved, through reciprocal action on each other. Sensible of this inevitable reform in dynamic geology, the author of an essay entitled "The Action of the Winds on the Configuration of the Earth," sought to call attention to the gaps hitherto existing in physical geography, and especially to show what a mighty and yet hitherto very little observed agent the wind is, considered as one of these secondary geological forces. In the following paper the author offers to the readers of NATURE a *résumé* of his memoir.

It is at once evident and conformable to nature that the winds are to be regarded, in the first instance, as a proof of the unequal insolation at different points of the earth's surface, but, in their direction and variation, they are immediately influenced now by the position of the sun, now by the earth's rotation and the distribution of the solid and the liquid; that the winds are, on the one hand, a product of these geophysical actions, and, on the other, become a special factor, of which not only the meteorologist, but also, in front rank, the geologist, is called on to take account. Since, that is to say, it is purely the winds which determine the condition of moisture of the atmosphere, and have to perform the *role* of distribution of rain over the entire surface of the earth, but at the same time, in their constant circulation from the equator to the poles and from the poles to the equator, represent an imposing motive force, it is obvious that to be able to prove and establish more fully their geological *role*, one must consider them in this twofold relation; on the one hand as a climatic-meteoric, on the other as a mechanical agent. Accordingly the essay referred to treats, in its first part, of the climatic-meteoric, in the second, of the mechanical action of the winds; while the third part comprehends those actions of the winds which they perform indirectly either in meteorological or in mechanical relation.

More particularly the *First Part* is concerned with the characteristics of the two principal wind systems, the polar and equatorial currents, and with their reaction on those continents and mountain-chains, by which, in their typical course—as is manifest on oceans and neighbouring coasts, especially west coasts, of continents—they are variously disturbed. The equatorial currents here appear as properly the distributors of precipitation, and therefore as the principal factors by which the transporting power of flowing water, or generally the levelling action of water on the earth's surface, is produced. The polar currents, on the other hand, discover a tendency to act contrary to the work of the equatorial currents, that is, to restore the precipitated water in vapour form to the atmosphere, and generally to further evaporation. In view, however, of the fact that not all the water, which by action of the winds is precipitated on the solid land, returns to the ocean or the atmosphere, these two air-currents together appear to be similarly empowered to empty entirely, some time, the immense water-basin of the earth from which they continually procure anew their freight of water, and meanwhile to continuously lower the sea-level, through by a very small quantity, and therefore to take a prominent part in the so-called secular elevation of continents.

These two air-currents, indeed, are not everywhere and always true to the character just given. On the contrary, when they have to accomplish a great work, and especially when a polar current has to rise over a lofty mountain, or an equatorial current

<sup>1</sup> Abstract, by Dr. Francis Czerny, of a memoir of his in the 4th supplementary number of Petermann's *Mittheilungen*.

has to traverse an extended surface of dry land, the former, as a rule, even appears as a rainy wind, while the latter, if its course have been long enough, appears as a dry wind; and if the mountain range be high enough, which the latter is required to rise over, this may, when it has reached the other side, even stream down as a hot, withering wind, the fohn of Continental writers, on the thirsty regions. If, then, we find in coast districts a greater yearly rainfall than further inwards, or if, on the wind side of the hills, we find lower snow-lines and further-reaching terminal moraines of the glaciers than on the lee side; or lastly, if we find successively regions of forests, of steppes, and of wastes, we may easily recognise therein each time an expression of the power of the winds, which, according as they are abundantly or poorly laden with aqueous vapour, or even quite dry, call forth this variety of geophysical phenomena.

The ever-moving atmosphere has therefore the most heterogeneous actions. While it feeds the glaciers and rivers, it causes at the same time a backward prolongation of these to the common source of the water—to the ocean, so as, with its moist breath, to produce everywhere simultaneously a formation of humus, and awake all into life; and again, where it is otherwise—where it appears as by nature a dry wind, or has been deprived of its freight of water, it brings with it drought and death. In the deserts the flora and fauna, then, have an extremely poor existence; the rivers no longer flow in a regular course; they have already been long in retreat, or are still only intermittent in their flow; the lakes also, when they are to be found in deserts, continually lose, through the constant evaporation, an abundance of water, although they may long have ceased to have an outlet to the neighbouring sea. In many deserts you do not meet with a single brook or pond; instead of such, you find only dried-up wadis and depressions, while the extensive stretches of waste, covered with salt incrustations and efflorescences, as also the scattered remains of dead animal species of past times, give evidence that these waste and withered regions formerly wore quite a different physiognomy; indeed, as the fossils and deposits of gypsum and salt testify, must even have been flooded with enormous inland seas. Now, probably (next to solar heat), it was above all, the winds, especially the dry winds, which, acting for a long period of time in the earth's history, dissolved these seas into aqueous vapour, carried them away, and so transformed the former lake bottom, now laid bare, into a waste.

*Second Part.*—But the winds are not only an expression for the general circulation of the air and aqueous vapour of the ocean; they are also a moving agent *quand même* not to be underestimated, since, in their progress, they communicate their own motion to all bodies which are not heavy enough to withstand them. Now, according as, in this way, solid or liquid bodies (especially the waters of the ocean) are put in motion, the mechanical action of the winds is to be considered from two distinct standpoints; first, its action on the solid land, and second, on the water, and through this again upon the solid land.

In the first case, it is the conditions of the strata that are continually altered under the action of the winds. It is at one time the snow, at another the salt-dust, at another the vegetable and animal remains, the ashes thrown out in volcanic eruptions, masses of dust and *débris*, or lastly, sand, that are whirled about, raised, carried miles away, and again deposited. The so-called wind-bedding characterises in every case the formations so produced, or in course of production. We shall cite here only two of the most remarkable examples of this kind of power in winds. One is the extensive Chinese Loess formation, which, according to von Richthofen's researches, appears to be quite a wind-formation; the other is the progressive dune-formation and dune-shifting on flat sandy coasts. Closer investigations (in this connection) of the conditions under which dunes are generally formed, examinations of their form, slope, and strike, and further, some materials furnished in the narratives of travel of Rohlf's and Dr. Tietze, have enabled the author to form a new theory as to the origin of sandy wastes, but especially to show that, as a rule, they are simply dune-formations on the shores of the former inland lake which has disappeared through evaporation. Some examples of sand scratches, sand cuttings, and the devastations wrought by hurricanes, illustrate the further mechanical action of the winds on the dry land.

Passing to the mechanical action of winds on water, we have, above all, to consider drift-currents (wind-drifts) and the motion of wind-waves. But while the former manifest themselves as

powerful factors of transport, the wind-waves are besides characterised by a not unimportant effect in the direction of depth, but more especially by their now land-forming, now land-shattering surge. In this way the waters appear also as the most powerful medium through which the action of the winds is exerted on the solid land. In fact it is the capricious wind-wave that destroys and carries away whole stretches of coast in order to raise somewhere else and lay dry whole areas out of the oceanic depths (sand bars, sandbanks, flat coasts, delta formations, &c.). It is the wind-wave that ever renders active the principle of constant transformation in opposition to that of stability, and seeks to alter the contours of the dry land. Not without reason, then, does El. Reclus remark:—"It is by the movement of the atmosphere that we have to explain the form of continents." (*C'est par les mouvements de l'atmosphère, qu'il faut expliquer la forme des continents.*)

*Third Part.*—The winds, finally, produce, in an indirect way, many geological phenomena. According as their influence and determine the air-pressure, they cause now a perceptible swelling out, now a sinking of some large water surface, as has been observed on the oceans as well as on the North American and the Swiss lakes. Through this influence of air-pressure the winds further appear to affect volcanoes now favourably, now preventively—since also the lava masses in the crater (according to P. Scrope's representation) must be sensitive to atmospheric pressure; in high pressure finding a greater resistance, and in low pressure rising and breaking out more easily. The firedamp explosions also appear to be favoured by barometric depression. Similarly a certain connection can be demonstrated between the air-pressure and earthquakes.

Still more evidently are winds seen to exert an influence on earthquakes and volcanic phenomena, when regarded as rain-winds. With a large access of atmospheric water are connected both subterranean deluges and overturnings, and an abundant formation of steam in the heart of volcanoes; these circumstances immediately give rise to earth-tremblings, or violent volcanic outbursts and exhalations of steam.

If the hypothesis of T. R. Mayer, that the trade-winds are the principal cause of terrestrial magnetism, be correct, we must also, finally, ascribe to the winds an important part in the production of electricity. Lyon, Duveyrier, and Rohlf's have observed that the dry desert wind is uncommonly rich in electricity.

The author, indeed, has, in the course of his researches, given attention especially to the action of the winds in the most recent geological periods, and must in the meantime leave to specialists the more definite answering of the question how far the traces of action of winds also in the older periods of the earth's history can be followed. It is certain, however, that since in historical geology we have to do with a land flora and fauna, and with the (wrongly) so-called ocean precipitate, and so with the building up of sedimentary layers, we have so many undoubted proofs of the existence of rain and rivers, and accordingly of that of winds. Even when the earth was still a ball of glowing gas—and consequently a sort of sun to the moon's inhabitants, we can conceive the wind already acting as a geological agent—with the proviso, indeed, that the theory (of Faye and Keye) which regards the sun-spots as cyclone-like phenomena, or Secchi's view that the temperature of the sun at the sun's equator is higher than beyond the 30th degree of latitude, be verified.

#### UNDERGROUND TEMPERATURE<sup>1</sup>

A REMARKABLE series of observations have recently been taken in a boring at Sperenberg, near Berlin. The bore was carried to the depth of 4,052 Rhenish (or 4,172 English) feet, and was entirely in rock salt with the exception of the first 283 feet, which were in gypsum with some anhydrite. The observations were taken under the direction of Herr Eduard Dunker, of Halle-an-der-Saale, and are described by him in a paper occupying thirty-two closely printed quarto pages (206-238) of the *Zeitschrift für Berg-Hütten-und-Salinen-Wesen* (xx. Band, 2 und 3 Lieferung, Berlin, 1872).

<sup>1</sup> Ninth Report of the British Association Committee, consisting of Prof. Everett, Sir W. Thomson, F.R.S., Prof. J. Clerk Maxwell, F.R.S., G. J. Symonds, F.R.S., Prof. Ramsay, F.R.S., Prof. A. G. Nikie, F.R.S., James Glaisher, F.R.S., George Maw, F.G.S., W. Feagally, F.R.S., Prof. Hull, F.R.S., Prof. Ansted, F.R.S., Prof. Frostwich, F.R.S., Dr. C. Le Neve Foster, Prof. A. S. Herschel, G. A. Lebour, F.G.S., and A. B. Wynne, appointed for the purpose of investigating the Rate of Increase of Underground Temperature downwards in various Localities of Dry Land, and under Water. Drawn up by Prof. Everett, Secretary.

The instrument employed for measuring the temperatures was the earth-thermometer of Magnus, which gives its indications by the overflowing of mercury, which takes place when the instrument is exposed to a higher temperature than that at which it was set. To take the reading, it is immersed in water a little colder than the temperature to be measured; the temperature of this water is noted by means of a normal thermometer, and at the same time the number of degrees that are empty in the earth-thermometer is noted. From these data the maximum temperature to which the instrument has been exposed can be deduced, subject to a correction for pressure, which is not very large, because the same pressure acts upon the interior as upon the exterior of the thermometer.

In the following column (as in the original paper) temperatures are expressed in the Réaumur scale, and depths in Rhenish feet, the Rhenish foot being 1.029722 English foot.

Observations were first taken at intervals not exceeding 100 feet, from the depth of 100 feet to that of 4042 feet, the temperature observed at the former depth being 11.0, and at the latter 38.5; but all these observations, though forming in themselves a smooth series, were afterwards rejected, on the ground that they were vitiated by circulation of water and consequent convection of heat.

It has often been supposed that though this source of error may affect the middle and upper parts of a bore, it cannot affect the bottom; but the Sprenberg observations seem to prove that no such exemption exists. When the bore had attained a depth of nearly 3,390 feet, with a diameter of 12 inches 2 lines at the bottom, an advance bore of only 6 inches diameter was driven 74 feet further. A thermometer was then lowered half-way down this advance bore, and a plug was driven into the mouth of this advance bore so as to isolate the water contained in it from the rest of the water above. After twenty-eight hours the slug was drawn and the thermometer showed a temperature of 16.6. On the following day the temperature was observed at the same depth without a plug, and found to be 33.6. Another observation with the plug was then taken, the thermometer (a fresh instrument) being left twenty-four hours in its position. It registered 36.5, and again, without plugging, it gave on the same day 33.9. It thus appears that the effect of convection was to render the temperature in the advance bore 3° R. too low.

Apparatus was then employed for isolating any portion of a bore by means of two plugs at a suitable distance apart with the thermometer between them. This operation was found much more difficult than that above described, but in several instances it gave results which were deemed quite satisfactory; while in other instances the apparatus broke, or the plugging was found imperfect. The deepest of the successful observations by this method was at 2,100 feet, and the shallowest was at 700 feet. The first 444 feet of the bore was lined with iron tubes, between which the water had the opportunity of circulating even when the innermost tube was plugged, hence the observations taken in this part were rejected.

All the successful observations are given in the third column of the following table, subject to a correction for pressure; and, for the sake of showing the error due to convection in the ordinary mode of observing, the temperatures observed at the same depths when no plugs were used, are given in the second column:—

Depth in feet.	Temperature Réaumur.		Difference.
	Without plugging.	With plugging.	
700	16.08	17.06	0.98
900	17.18	18.5	1.32
1,100	19.08	20.8	0.72
1,300	20.38	21.1	0.72
1,500	22.08	22.8	0.72
1,700	22.9	24.1	1.2
1,900	24.8	25.8	1.0
2,100	26.8	27.1	0.3
3,390	34.1	36.15	2.05

These temperatures are not corrected for pressure, but they are corrected for rise of zero in the normal thermometer; and this last circumstance explains the difference of 0.4 between the

temperature 36.15 here given and 36.55, which is the mean of the above-mentioned observations at the depth of 3,390 feet.

Another proof of the injurious effect of convection was obtained by comparing the observed temperatures (without plugging) in the first 400 feet of the great bore, designated Bore I., with the temperatures observed at the same depths during the sinking of another bore, designated Bore II., near it; the observations in this latter being always taken at the bottom. The following were the results:—

Depth Feet.	Temperatures.	
	Bore I.	Bore II.
100	11.0	9.0
200	11.6	10.4
300	12.3	11.5
400	13.6	12.5

The temperature at the depth of 100 feet in the great bore thus appears to have been raised about 2° R. by convection.

The following is a table of the successful observations, corrected for pressure:—

Depth in Rhenish feet.	Temperature Réaumur.
700	17.275
900	18.780
1,100	21.147
1,300	21.510
1,500	23.277
1,700	24.741
1,900	26.504
2,100	28.668
3,390	37.238

Assuming, with Herr Dunker, the mean temperature of the surface to be 7.18, which is the mean annual temperature of the air at Berlin, we have the following increments of temperature with depth:—

Depths in Rhenish feet.	Increment of depth.	Increment of temperature.	Increase per 100 feet deg. Réau.	Increase per 100 feet deg. Fahr.
0 to 700	700	10.095	1.442	3.24
700 to 900	200	1.505	.752	1.69
900 to 1,100	200	2.367	1.184	2.66
1,100 to 1,300	200	0.363	.182	.41
1,300 to 1,500	200	1.767	.884	1.99
1,500 to 1,700	200	1.464	.732	1.65
1,700 to 1,900	200	1.763	.882	1.98
1,900 to 2,100	200	2.164	1.082	2.43
2,100 to 3,390	1,290	8.570	.664	1.49
0 to 3,390	3,390	30.058	.887	2.00

The mean rate of increase found by comparing the temperatures at the surface and 3,390 feet is exactly 1° Fahr. for 50 Rhenish or 51.5 English feet.

The numbers in the last two columns exhibit upon the whole a diminution with increase of depth; in other words, the temperature increases less rapidly as we go deeper down. As regards the first 700 feet, which exhibit a decidedly more rapid rate than the rest, it must be remembered that nearly half of this distance was in a different material from the rest of the bore, being in gypsum with some anhydrite, while all the rest was in rock salt. Prof. Herschel has found, in recent experiments not yet published, that the conductivity of rock salt is exceedingly high; and theory shows that the rates of increase, in superimposed strata, should be inversely as their conductivities. We may, therefore, fairly attribute the rapid increase in the first 700 feet

to the relatively small conductivity of the portion (283 feet) which is not rock salt. The slow rate of increase observed in the long interval between the depths of 2,100 and 3,390 feet is not so easily accounted for; we can only conjecture that this and the other inequalities which the above table presents, for depths exceeding 700 feet, are due to fissures or other inequalities in the rock which have not been put in evidence.

With the view of summing up his results in small compass, Herr Dunker has assumed the empirical formula—

$$t = 7.18 + ax + bx^2,$$

$t$  denoting the temperature (Réaumur) at the depth  $x$  (Rhenish feet); and has computed the most probable values of  $a$  and  $b$ , by the method of least squares. He finds

$$a = .0129857 \quad b = -.00000125791,$$

the negative sign of  $b$  indicating that the increase of temperature becomes slower as the depth increases.

A paper by Prof. Mohr, of Bonn, as represented by an abstract published in NATURE (vol. xii. p. 545), has attracted attention from the boldness of its reasoning in reference to the Spereberg observations. Prof. Mohr, however, does not quote the observations themselves, but only the temperatures calculated by the above formula, which he designates, in his original paper (*Neues Jahrbuch für Mineralogie, &c.*, 1875, Heft 4), "the results deduced from the observations by the method of least squares." In the abstract in NATURE they are simply termed "the results of the thermometric investigation of the Spereberg boring," a designation which is still more misleading.

Attention is called to the circumstance that the successive increments of temperature for successive equal increments of depth, form an exact arithmetical progression, as if this were a remarkable fact of observation, whereas it is merely the result of the particular mode of reduction which was adopted, being a mathematical consequence of the assumed formula  $t = 7.18 + ax + bx^2$ . The method of least squares is not responsible for this formula, but merely serves, after this formula has been assumed for convenience, to give the best values of  $a$  and  $b$ .

Herr Dunker, in his own paper, lays no stress upon the formula, and gives a caution against extending it to depths much greater than those to which the observations extend. Writing to Prof. Everett under date April, 1876, he requests that in the summary of his results to be given in the present Report, the formula should either be suppressed or accompanied by the statement that its author reserves a different deduction.

The following are the differences between the temperatures computed by the formula and the observed temperatures:—

Depth.	Difference (computed minus observed).
700	- 1.621
900	- 0.931
1,100	- 1.204
1,300	+ 0.427
1,500	+ 0.553
1,700	+ 0.882
1,900	+ 0.811
2,100	+ 0.238
3,390	+ 0.482

The necessity of adopting some means to prevent the circulation of water in bores, has for some time been forcing itself upon the attention of your Committee. Many of the observations taken by their observers have contained such palpable evidence of convection as to render them manifestly useless for the purpose intended; and in the light of the Spereberg experiments it is difficult to place much reliance on any observations taken in deep bores without plugging. The selection of a suitable form of plug is now occupying the careful attention of your Committee.

Herr Dunker's paper gives a very full account of the different kinds of plug employed at Spereberg.

For stopping the mouth of the advance-bore the plug had a tapering shape, and was of hard wood, strengthened by two iron rings, one at each end, and covered with a layer of tow 5 lines thick, outside of which was thick and strong linen, nailed above and below to the wood, through a leather strap. It was lowered into its place by means of the iron rods used for boring; and, when in position, was pressed home by a portion of the weight

of the rods. The plug carried the thermometer suspended from it. Its extraction was commenced by means of a screw on the beam of the boring machine, in order to avoid a sudden jerk, which might have broken the thermometer. The force which was found necessary for thus starting the plug, as well as the impression observed upon it when withdrawn, showed that it had fitted tight. To insure a good fit, the top of the advance-bore had been brought to a suitable shape, and its inequalities removed, by means of a revolving cutting-tool. Herr Dunker remarks that this plan is adapted to a soft material like rock-salt, but that in ordinary hard rock it would be better to make the bottom of the main bore flat, and to close the advance-bore by an elastic disc pressed over it. The method of observation by advance-bores can only be employed during the sinking of the bore, a time when it is difficult to avoid error arising from the heat generated in boring. The expense of making an advance-bore at each depth at which an observation is required is also an objection to its use.

Another kind of plug devised by Herr Dunker, and largely used in the observations, consisted of a bag of very stout india-rubber (9 millimetres thick) filled with water, and capable of being pressed between two wooden discs, one above and the other below it, so as to make it bulge out in the middle and fit tightly against the sides of the bore. On the suggestion of bore-inspector Zobel, the pressure was applied and removed by means of screwing. Two steel springs fastened to the upper disc, and appearing, in Herr Dunker's diagram, very like the two halves of a circular hoop distorted into an oval by pressing against its walls, prevented the upper disc from turning, but offered little resistance to its rising or falling. The lower disc, on the contrary, was permitted to turn. Both discs were carried by the iron boring-rods. Rotation of these in one direction screwed the discs nearer together, and rotation in the other direction brought them further apart. The india-rubber bag could thus be made to swell out and plug the bore when it was at the desired depth, and could be reduced to its original size for raising or lowering. In order to prevent the boring-rods from becoming unscrewed one from another, when rotated backwards, it was necessary to fasten them together by clamps, a rather tedious operation in working at great depths.

In taking observations at other points than the bottom, two of these plugs were employed, one above and the other below the thermometer.

In some of the experiments, the apparatus was modified by using linen bags filled with wet clay, instead of indian-rubber bags filled with water; and, instead of screwing, direct pressure was employed, the lower disk being supported by rods extending to the bottom of the bore, while the upper disk could be made to bear the whole or a portion of the weight of the rods above it. Some successful observations were obtained with both kinds of bag; but the water-bags were preferred, as returning more easily to their original size when the pressure was removed, and consequently being less liable to injury in extraction. In some observations since taken in another place (Sudenberg), Herr Dunker states (in the private letter above referred to) that indian-rubber bags, filled with water, and pressed, not by screwing, but by the weight of the rods, were employed with much satisfaction.

All the methods of plugging employed by Herr Dunker involved the use of the iron rods belonging to the boring apparatus, and therefore would be inapplicable (except at great expense, after the operation of boring is finished and the apparatus removed.

It seems desirable to contrive, if possible, some plug that can be let down and raised by a wire. In the first report of your Committee, it was suggested that two bags of sand, one above and the other below the thermometer, should be used for this purpose. Bags of sand, however, would be liable to rub off pieces from the sides of the bore, and thus to become jammed in drawing up. Mr. Lebour has devised a plug which will be of small diameter during the processes of lowering and raising, but can be rendered large and made to fit the bore, when at the proper depth, by letting down upon it a sliding weight suspended by a second wire. Sir W. Thomson suggests that a series of indian rubber disks, at a considerable distance apart, will probably be found effectual.

Mr. Boot has continued his observations in the bore which he is making at Swinderby, near Scarle (Lincoln). It has now been carried to the depth of 2,000 feet, and is in earthy limestone & calcareous shale, of carboniferous age. Its diameter in the lower part is only  $3\frac{1}{2}$  inches. In April last the temperature 78° F., was observed at 1,950 feet; and more recently 79°

was observed at 2,000 feet; the water, in each case, having been undisturbed for a month. Supposing these results not to be vitiated by convection, and assuming the mean temperature at the surface to be 50°, we have an increase of 29° in 2,000 feet, which is at the rate of 1° in 69 feet.

Mr. Symons has taken a series of observations at the depth of 1,000 feet in the Kentish Town well, with the view of determining whether the temperature changes. The instrument employed is a very large and delicate Phillips' maximum thermometer. The following is a list of the observations:—

Date of lowering.	Depth indicated. Feet.	Thermometer set at.	Date of raising.	Depth indicated. Feet.	Temperature. Fahr.
1874 —	1000	64.50	May 8	1007	66.82
„ May 8	1000	63.80	July 2	1009	(reading) lost.
„ July 2	1000	63.20	July 28	1005	67.40
„ July 28	1000	65.10	Sept. 8	1004	67.51
„ Sept. 8	1000	65.30	Sept. 29	1004	67.43
„ Sept. 29	1000	65.81	Oct. 30	1006	67.68
„ Oct. 30	1000	63.40	Dec. 3	1006	67.52
„ Dec. 3	1000	63.80	Jan. 7	1009	67.63
1875 Jan. 7	1000	63.75	Feb. 1	1006	67.56
„ Feb. 1	1000	63.90	March 3	1005	67.58
„ March 3	1000	63.90	May 3	1006	67.62
„ May 3	1000	63.95	June 1	1005	67.49
„ June 1	1000	63.00	July 7	1005	67.53
„ July 7	1000	63.87	Aug. 3	1004	67.58
„ Aug. 3	1000	63.87	Sept. 10	1004	67.58
„ Sept. 10	1000	64.00	Oct. 2	1003	67.58
„ Oct. 2	1000	63.90	Oct. 19	1004	67.62
„ Oct. 19	1000	63.80	Nov. 1	1005	67.62
„ Nov. 1	1000	63.70	Dec. 1		Wire broke.

The "depth indicated" is shown by a measuring wheel or pulley, over which the wire runs by which the thermometer is raised and lowered, as described, with a diagram, in the Report for 1869. The above table shows that there is always some stretching, real or apparent, in the interval between lowering the thermometer and raising it again. Recent observations by means of a fixed mark on the wire, have shown that the change is not, in the main, a permanent elongation, but an alternation of length. It is probably due in part to the greater tension which the wire is under in raising than in lowering, a circumstance which will cause a temporary difference of length variable with the rapidity of winding up; also in part to the circumstance that the wire is warmer when it has just left the water than when it is about to be let down. Some portion of the irregularity observed may be due to variations of temperature in that part of the well (210 feet) which contains air. The observations taken as a whole, show that any variations of temperature which occur in this well at the depth of 1,000 feet, are so small as to be comparable with the almost inevitable errors of observation. The observations will be continued at intervals of six months, with additional precautions, and with an excessively slow (specially constructed) non-registering thermometer, in addition to the maximum thermometer hitherto employed.

Through the kindness of the eminent geologist, M. Delesse, of the Ecole Normale at Paris, observations have been obtained from the coal-mines of Anzin, in the north of France. They were taken under the direction of M. Marstilly, chief engineer of these mines. Maximum thermometers of the protected Negretti pattern, were inserted in holes bored horizontally to the depth of 6 or 7 of a metre in the sides of shafts which were in process of sinking, and in which there was but little circulation of air. A quarter of an hour was allowed to elapse in each case, after the boring of the hole, before the thermometer was inserted, and the hole plugged. Four different shafts were tried. Those designated as Nos. I., II., III., were in the mine Chabaud La Tour; and No. IV. was in the mine Renard.

In Shaft I. observations were taken at eight different depths, commencing with the temperature 56½° F. at the depth of 38½ metres, and ending with 67½° F. at 200½ metres.

In Shaft II. there were observations at four depths, commencing with 55° at 87½ m., and ending with 63½° at 185 m.

In Shaft III. there were observations at three depths, commencing with 56° at 87½ m., and ending with 62½° at 144 m.

These three shafts, all belonging to the same mine, were very wet, and the temperature of the air in them was 11° or 12° C. (52° or 54° F.).

In Shaft IV., which was very dry and had an air temperature of about 15° C. (59° F.), observations were taken at 6 depths, commencing with 70½° F. at 21½ m., and ending with 84° F. at 134½ m.

The mean rates of increase deduced from these observations are:—

In Shaft I.,	1° F. in 14.4 m.,	or in 47.2 feet.
„ II.,	„ 11.5 m.,	„ 37.7 „
„ III.,	„ 8.65 m.,	„ 28.4 „
„ IV.,	„ 8.57 m.,	„ 28.1 „

The observer mentions that in Shaft II. there was at the depth of 90 m. a seam of coal in which heat was generated by oxidation; but no such remark is made with respect to any of the other shafts, although it is obvious that some disturbing cause has rendered the temperatures in Shaft IV. abnormally high. Possibly the heat generated in boring the holes for the thermometers in this shaft (which was dry) has vitiated the observations, the instruments employed being maximum thermometers. Two of the slow non-registering thermometers mentioned in last year's Report have been sent to M. Delesse, to be used for verification.

The slow-action thermometers are constructed on the following plan:—The bulb is cylindrical and very strong, and is surrounded by stearine or tallow, which fills up the space between it and a strong glass shield in which the thermometer is inclosed. The shield is not hermetically sealed (not being intended for protection against pressure), but is stopped at the bottom with a cork, so that the thermometer can be taken out and put in again if desired. Stearine and tallow were selected, after trials of several substances, including paraffin-wax, bees-wax, glue, plaster of Paris, pounded glass, and cotton wool. The thermometers are inclosed in copper cases lined with india-rubber. When placed, without these cases, in water differing 10° from their own temperature, they take nearly half a minute to alter by one-tenth of a degree.

In concluding this Report, your Committee desire to express their regret at the losses which they have sustained by the deaths of Prof. Phillips, Sir Charles Lyell, and Col. Strange, of whose valuable services they have been deprived within the last three years.

OUR ASTRONOMICAL COLUMN

THE ROTATION OF SATURN ON HIS AXIS.—On December 7 Prof. Hall, of the Naval Observatory at Washington, observed a very white spot on the disc of Saturn, just below the ring. At 6h. 18m., Washington mean time, the spot was central, and it was watched from 22h. 40m. sidereal time, to 0h. 10m., as it moved across the disc. It was small, very well defined, and from 2" to 3" in diameter. A rough ephemeris of its motion was sent to various observers in the U.S., and the observations which have been received are as below. The second column gives the time when the spot was central.

	Washington M.T. h. m.	Place.	Observer.	o - c
1876, Dec. 7	6 18	Washington	Hall	...
10	6 11	Cambridge	A. G. Clark	... - 8m
—	6 3	Hartford	D. W. Edgecomb	... 0
—	6 4	Foughkeepsie	M. Mitchell	... - 1
—	...	Albany	L. Boss	... ..
13	5 47	Washington	Hall	... .. 0
—	5 50	„	Eastman	... .. 3
—	5 38	Cambridge	A. G. Clark	... .. + 9

The column o - c gives the residuals when a rotation-time of 10h. 15m. is assumed. At Albany, on December 10, the spot was seen, but not until after passing the centre.

[It will be remarked that the time of rotation, supported by the above observations of a very definite spot, is in close agreement with the result obtained by Sir W. Herschel from noting the successive appearances of a belt during the winter of 1793-94,

viz. 10h. 16m. 0<sup>th</sup>. Doubt has been occasionally expressed with regard to Sir W. Herschel's rotation-period from the uncertainty attaching to such observations, and the interesting confirmation of it just arrived at by the American observers will therefore be the more welcome. The Herschelian rotation for the planet globe of Saturn has been sometimes confounded with a rotation not depending upon observations, but calculated on Kepler's law for a satellite at an apparent mean distance equal to the semi-diameter of the middle of the ring; thus, Baily, in his "Astronomical Tables and Formulæ"—which were widely quoted for many years—has 10h. 29m. 17s. for time of rotation both of the globe and the ring.]

**THE NEBULA IN THE PLEIADES.**—Mr. Maxwell Hall, of Jamaica, communicates some observations of this nebula made on October 20, 1876, with a 4-inch Cooke equatorial, and power 55. "The nebula was 'bright,' according to Sir John Herschel's scale, and extended in a parabolical form at least 40' from Merope, which was at the focus, while the axis of the figure was nearly S. of that star."

The difficulty of seeing with very large instruments a very faint nebulosity in close proximity to a bright star is strikingly illustrated by a remark made by Mr. Dreyer, observing with Lord Rosse; he states—"The Merope-nebula is never perceived with Lord Rosse's telescopes." So also D'Arrest sought for it in vain with the Copenhagen refractor, subsequently referring it to the class of which we are writing, which may be invisible in a great telescope but seen without difficulty in the finder. Vols. lviii. and lix. of *Astronomische Nachrichten* may be consulted for the earlier discussions as to the variability of this object.

**VARIABLE STARS.**—Prof. Schönfeld has published in *Vierteljahrsschrift der astronomischen Gesellschaft*, xi. Jahrgang, Heft 4, an ephemeris of the maxima and minima of most of the variable stars for 1877, including Algol,  $\lambda$  Tauri, S Cancri,  $\beta$  Libræ, and U Coronæ Borealis, which have short periods. The max. of  $\chi$  Cygni is dated February 6, and the min. on September 15; Mira Ceti, min. on July 23, max. on November 10.

Schmidt's star in Cygnus was red on January 7, and about equal in brightness to the star + 41° No. 4243 in the "Durchmusterung," but the difference of only 0<sup>th</sup>.5m. between the catalogue brightness of this star and that of + 42° No. 4204, certainly did not represent their relative intensity of light on this evening. The variable might be estimated at 7<sup>th</sup>.2m. by reference to the latter star.

**METEORS OF JANUARY 7.**—In the early part of this night a number of meteors were remarked near London, with unusually slow motion, particularly in the cases of several which equalled Jupiter in brightness. One at 10h. 32m. G.M.T. starting from near  $\lambda$  and  $\mu$  Ursæ Majoris, appeared to receive a sudden check, and was stationary for two seconds 3° below a Canum Venaticorum, where it was nearly extinguished, but a faint portion left a train for several degrees further. It was not easy to judge of the radiant point owing to continual interruption from passing clouds, but it would probably be somewhere about the stars in Ursæ Major above-named. Much lightning on this evening. The zodiacal light well seen as far as the principal stars of Aries.

**THE MELBOURNE OBSERVATORY.**—The Eleventh Report of the Board of Visitors of the Melbourne Observatory, with Mr. Ellery's Annual Report for the year ended 1876, June 20, has been received. In addition to the large reflectors, the Observatory now possesses an 8-inch equatorial, both instruments in excellent working order. With respect to the former, Mr. Ellery remarks that, although at present the mirrors retain their high reflecting polish exceedingly well, it is not to be overlooked that the time must arrive when they will require to be re-

polished, and in anticipation of this eventuality, which may occur sooner than is now looked for, he intends to devote time during the ensuing year to practice in grinding and polishing large surfaces. Out of about 150 nights during the year to which the report applies, which were more or less fit for observing with the reflector, forty were solely occupied with visitors. The astronomical work accomplished includes the examination, measurement, and sketching of seventy of the nebulae and clusters of Sir John Herschel's southern work, of which the greater number have been drawn and described in a manner suitable for publication. Mr. Ellery adds:—"The result of these observations indicates that several of the nebulae are considerably changed, while others appear so completely altered as to be scarcely recognisable, save by their position with respect to adjacent stars. The nebula about  $\eta$  Argus have been compared with a drawing made in March, 1875, but no decided changes were detected. The weather was so far unfavourable at Melbourne for certain classes of observations that out of ninety conjunctions of Saturn's satellites only ten could be observed. No material change in the regular work of the Observatory is contemplated during the year following the conclusion of the report. Observations with the transit-circle would be continued assiduously as in previous years, the Government Astronomer regarding this as the fundamental work of the establishment, which has already given it a reputation in the world, and he quotes in proof of this the opinion expressed by Sir George Airy, that the Melbourne Observatory had produced "the best catalogue of stars of the southern hemisphere ever published." The revision of Sir John Herschel's figured nebulae will also be continued, with occasional planetary work, as drawings of Mars and Jupiter, observations of conjunctions of Saturn's satellites, &c.

The early publication of results obtained with the great reflector is strongly urged by Mr. Ellery, and all astronomers will concur in his representations upon this point. Difficulties, no doubt, must exist in giving such results to the astronomical world in a perfectly satisfactory manner; nevertheless, Mr. Ellery thinks if a plan be proposed is approved, these difficulties may be surmounted, and all the completed work with the reflector may be forthwith published. We can only express the hope that work of such great interest, and which may so greatly add to the reputation of the Melbourne Observatory, will soon be in the hands of the public. The importance of early publications of astronomical work in these days can hardly be exaggerated.

#### METEOROLOGICAL NOTES

**NEW DAILY WEATHER MAP.**—We hail with the greatest satisfaction the appearance, on New Year's Day, of the first number of a daily international weather-map issued by the Austrian Meteorological Institute. It embraces nearly the whole of Europe, and supplies a want not met by any existing weather-maps, in representing the weather of Central and part of Southern Europe, with a satisfactory fulness such as the meteorology of this important region demands in the development of this branch of the science. In addition to the invaluable material this publication will lay before us from day to day relating to thunderstorms, the summer rains, and the falls of hail and snow of Central Europe, it will also furnish data absolutely indispensable in investigating the causes which determine the course and the rate of progress of the storms of North-western Europe. Indeed, in this respect, and consequently in the prognosis of British storms, the Austrian empire is, of all countries which lie eastwards of Great Britain, second in importance only to Lapland and the north of Scandinavia.

**LOW TEMPERATURES.**—During recent weeks some remarkably low temperatures have been recorded in various countries. During a heavy storm which occurred on December 17 over

all Canada and the north of the United States, and which was attended with considerable damage, the temperature fell at Ottawa to  $-30^{\circ}\text{O}$ . What makes this temperature noteworthy is that at the same time the wind continued to blow with great violence, the low temperature being thus not confined to a few feet of the surface, but that of the aërial current passing over Ottawa at the time. On January 4 the temperature fell at Hernösand, in Sweden, and also in Lapland to  $-31^{\circ}\cdot 2$ . An anticyclone of limited extent, with the characteristic calms and light winds, overspread this region at the time, and it is to be noted that the space of excessively low temperature embraced an area virtually coincident with, and equally as limited as, that of the anticyclone. Still lower temperatures are reported from the interior of Russia. The *Golos* gives the following information as to the unusually low temperatures which prevailed in Northern Russia before Christmas. The thermometer of the Physical Observatory at St. Petersburg (in town) showed on the 22nd, at 9 A.M.,  $-37^{\circ}\cdot 8$  Cels., and in the Botanical Garden (in the suburbs), between 7 and 9 A.M., the following temperatures were observed:—  $-38^{\circ}\cdot 1$  on the 20th,  $-39^{\circ}\cdot 4$  on the 21st, and  $-41^{\circ}\cdot 9$  on the 22nd ( $-43^{\circ}\cdot 4$  Fahr.) On the last-named day the mercury was frozen, and the readings were made from a spirit thermometer. So low a temperature as on the 22nd was never observed before at St. Petersburg in December, during the 123 years that regular meteorological observations have been made; and even during the coldest month, January, such low temperatures were observed before only four times, namely,  $-38^{\circ}$  on January 26, 1868;  $-41^{\circ}$  in 1760;  $-38^{\circ}\cdot 7$  in 1772; and  $-39^{\circ}\cdot 0$  in 1814. The region of low temperatures occupied a very large tract of land, and the cold advanced from the north-east, as was also the case during the unusual cold of 1868. On the 22nd there was observed in the morning,  $-40^{\circ}\cdot 4$  at Vologda,  $-40^{\circ}\cdot 5$  at Kuopio, in Finland,  $-39^{\circ}\cdot 9$  at Bielozersk,  $-39^{\circ}$  in Moscow ( $-40^{\circ}$  in the higher parts of the town), &c. Very low temperatures might have been predicted for some days before, as already on the 20th the cold reached  $-44^{\circ}$  Cels. ( $-47^{\circ}$  Fahr.) in Vologda, and the barometer continued to rise in the whole of Northern Europe, whilst a minimum of pressure traversed the middle parts of Europe and Southern Russia, with comparatively high temperatures and cyclonic winds, which in the north and on the shores of the Baltic blew from the east and the north.

#### NOTES

A WEALTHY Copenhagen brewer, J. C. Jacobsen, has given the sum of a million of crowns for the promotion of mathematics, natural science, the science of language, history, and philosophy.

As we intimated some time since, the Swedish University of Upsala, founded September 21, 1477, will this year celebrate its 400th anniversary. Great preparations are being made for the event. The University is not only the oldest but the richest in Scandinavia; besides many rich gifts from Gustavus Vasa, it received, among other things, from Gustavus Adolphus, 360 farms, which now yield an annual rent of 200,000 crowns. The funds for maintenance and salaries amounted, in 1870, to 1,758,587 crowns, and the yearly Government grant to 300,000 crowns. The teaching staff consists of thirty-five professors, twenty-seven adjuncts, and fifty docents; the number of matriculated students amounts to about 1,500.

THE Royal Cabinet of Natural History at Stuttgart has just been enriched with an exceedingly rare and valuable palæontological specimen, which is probably without its like in the geological museums of the world. It consists of a group of twenty-four fossil lizards from the sandstone strata of Stuben. The

inclosing stone has been with great care entirely removed, showing a strangely intertwined mass, possibly as met by sudden death, but more probably a collection of dead bodies gathered together by the action of the waves. They cover a space of about two square yards, and the individual specimens possess an average length of thirty-two inches. These fossils can be classed with no existing species, but appear rather to possess a combination of diverse characteristics, which at a later stage of development became distinctive features of quite different types. Prominent among the peculiarities are the bones of the extremities, resembling those of existing lizards; the head, which can almost be called a bird's head, and the massive scaly armour, consisting of sixty to seventy successive rings.

We notice with great pleasure that decided steps are about to be taken to reform the curriculum in Exeter Grammar School. It is intended, as soon as arrangements can be completed, that the younger boys shall be taught divinity, English, including history and geography, French, Latin, arithmetic, and the other elements of mathematics, drawing, and some elementary natural science. At a certain point in the school Greek will be added, in accordance with the provisions of the Scheme and the resolution of the Governors; or in lieu of the study of Greek more time will be devoted to mathematics, English, modern languages, and natural science. German will be taught to any boys sufficiently advanced in other subjects to make it desirable. Thus, it is hoped, boys will be adequately prepared for the Universities, for the Public Service, for professional or commercial life. The principle of this new scheme is excellent, and should it be faithfully carried out, Exeter Grammar School ought to become one of the most efficient and complete schools in the country. We hope that the school will receive every encouragement in this laudable effort to provide a complete course of instruction.

THE Vilna Observatory is reported to have been totally destroyed by a fire on December 28. The *Vilensky Vestnik* says that the combined efforts of the town and railway fire brigades, of the troops, and of the students of a college in the neighbourhood, did not succeed in overcoming the fire and rescuing the great refractor and photo-heliograph. Only books and instruments of smaller value were saved. This is a great loss to science, as the Observatory had done, during the last few years, very valuable work, and some of the beautiful photographs of the sun was exhibited at the South Kensington Loan Collection.

MR. F. B. MEEK, the eminent palæontologist, and for several years a member of the United States Geological and Geographical Survey of the Territories, under Prof. F. V. Hayden, died at Washington, D.C., December 21, aged fifty-nine years. He had just completed the great work of his life, the Cretaceous and Tertiary Invertebrate Fossils of the Upper Missouri Country, in one large quarto volume.

IN the last Session of the Berlin *Anthropologische Gesellschaft*, Prof. Virchow stated that the intrepid young traveller, Herr v. Horn von der Horck, is at present in the camps of the warlike Sioux Indians, busily engaged in obtaining plaster casts for craniological studies. The printed record of v. d. Horck's journey of last summer to the Polar Sea, has just appeared in Germany, and contains much of value written in a very sprightly style. During the first half of the journey zoological and geographical ends were kept in view. On the return trip through Lapland to the Gulf of Bothnia, the expedition assumed an almost exclusively anthropological character. Enormous collections of bones and more especially of skulls were made, and a large number of masks were obtained from the present inhabitants of Lapland. So extensive and complete are these results, that Prof. Virchow regards them as more valuable for the study of Scandinavian craniology than the combined collections of



European museums outside of the Scandinavian countries themselves. The principal geographical result of the journey was the establishment of the fact that a continuous water communication exists between the Polar Sea and the Gulf of Bothnia. On the summit of the watershed between these bodies of water, the lake Wawolo Lampli lies at a height of 800-900 feet above the level of the sea. Two rivers flow from this, one to the north, emptying into the Ivalle, and the other to the south, emptying into the Kitital. Frequent cascades and rapids render this waterway useless for purposes of navigation.

PROF. PALMIERI—the *Times* correspondent at Rome telegraphs on January 7—writing from the Observatory on Mount Vesuvius, says that for the last two days the instruments have shown evident signs of agitation. The smoke from the mountain is issuing with greater force and increased volume. In the interior of the last month, opened on December 18, 1865, the fire is no longer visible, in consequence of an immense amount of material having fallen into it, through the giving way of a portion of the crater of 1872. An extraordinary eruptive force will, therefore, be necessary either to make a way through the enormous accumulation of sand and scoræ or to open some new mouth, whether on the summit or the side of the volcano. In the meantime, the cone is manifest, but it cannot be stated when it will reach a point sufficient to overcome the resistance.

M. FAYE has been appointed president of the *Bureau des Longitudes* for 1877, and Dr. Janssen vice-president.

A SUBSCRIPTION has been opened at Rouen for the erection of a statue to M. Pouchet, the naturalist, who was the director of the Botanic Gardens of that city, and who died ten years ago. M. Pouchet, as a correspondent of the Academy of Sciences, published many papers in defence of spontaneous generation against M. Pasteur. His works are referred to by Haeckel and Bastian.

AN Admiralty Committee of Inquiry has been appointed in connection with the outbreak of scurvy in the Arctic expedition.

AT the meeting of the Geographical Society on Monday, Mr. Robert Michell read a paper on "The Russian Expedition to the Alai and Pamir." The expedition resulted in much interesting information, which was mentioned in detail, as to the physical features of the country. The president, in winding up the discussion, observed that the regions visited by the expedition and described in the paper were, perhaps, the least known in Central Asia. They contained vast and confused ranges of mountains, some of the peaks of which were among the highest in the world. He trusted that when further expeditions of the kind were organised, steps would be taken by our government to secure that at least two Englishmen of requisite scientific attainment should be allowed to accompany them.

A RECENT thorough survey of the Kasbek-glacier of the Caucasus, has proved that since 1863 it has increased, *i.e.*, its lower extremity has advanced down the valley, by 826 feet.

THE *Medicinisch-etiologische Verein* of Berlin decided, in the session of January 4, to call together during the present year an etiological congress. The following four subjects are announced as the principal topics for the coming conference:—1. Methods of etiological investigation. 2. Causes of epidemic disease dependent upon mankind. 3. The natural conditions of epidemic diseases. 4. On the *Contagium vivum*.

AT the January session of the Vienna *Zoologisch-botanische Gesellschaft* papers were read by Herr J. Mann "On the Lepidopterous Fauna of the Dolomite Region," and by Prof. Jetteltes "On *Tritrema Polymorpha*."

DR. BREHM, the enterprising Siberian explorer, is at present

delivering in the principal German cities, a course of six lectures on the results of his last tour through Northern Asia.

PROF. KLEIN, one of the most promising among the younger German mineralogists, has accepted a call to the professorship of crystallography at the University of Halle.

AUSTRIA follows Germany and other countries in accepting the invitation of the King of Belgium, and an *Africanische Gesellschaft* has been organised at Vienna.

THE German Imperial Sanitary Department commences, with the beginning of the present year, the publication of a weekly periodical devoted to sanitary statistics and all subjects connected with the preservation of the public health. Prompt official reports of the mortality in all cities numbering over 150,000 inhabitants, will form a leading feature.

THE Municipal Council of Paris, determined to spare no efforts in order to prevent fresh inundations, have voted the funds for boring a new sewer, or rather a tunnel, which will be utilised for discharging a portion of the Seine, below Paris.

The plan for the rebuilding of the *École de Médecine* is now ready to be presented to the Municipal Council of Paris. When all the works are completed the total surface covered will be 8,000 square yards; it does not now exceed 3,000. The expense will be 4,300,000 francs.

AN interesting article, by Mr. E. A. Barber, with some curious illustrations, on "The Rock Inscriptions of the Ancient Pueblos of the Colorado, Utah, New Mexico, and Arizona," will be found in the *American Naturalist* for December.

IN an article in the *Révue Scientifique* of January 6, M. H. Le Chatelier shows that there is no geological evidence for the existence of a great inland sea in North Africa, though there was probably in the district of the Tunisian Chotts, at one time, a small isolated salt lake. All the phenomena of the region of the Chotts and of the Sahara may be explained by the action of existing forces, which might at some future time cause a thin layer of salt water to reaccumulate over a small extent of surface.

WITH reference to our note (*NATURE*, vol. xv. p. 167), on Mr. Allen's work on the North American Bisons, which we stated was issued by the University Press, Cambridge, U.S., we are informed that this "University Press" has no relation with the University. It is simply a name denoting its position near the University grounds to distinguish it from another large printing establishment known as the "Riverside Press," also at Cambridge. The memoir noticed formed a part of the "Memoirs" issued by the "Museum of Comparative Zoology," which have taken the place of the former "Illustrated Catalogues," the title having been changed so as to enlarge the scope of the 4to. publications of the old numbers of the Catalogue collected into volumes to form the first volumes of the Memoirs.

ON December 20, the *Bremer Verein für die deutsche Nordpolfahrt*, changed its name to that of *Bremer geographische Gesellschaft*. The question of Polar exploration has assumed such dimensions that a private society cannot hope to accomplish much unaided in this direction. The society will henceforth devote its energies to the solution of geographical problems in other parts of the world. Its occasional communications are also to be replaced by a regular periodical appearing quarterly, under the editorial supervision of Dr. Moriz Lindeman. A special feature of the new society will consist in frequent courses of lectures from the most famous of recent explorers; Brehm, Güsefeldt, and Baron von Schleinitz, are announced as first on the list.

LATE letters from Sydney report the arrival of the Rev. G. Brown, who has been spending the last year in Polynesia, passing from one island to another in the mission brig *John Wesley*. Many interesting discoveries were made in the islands of New Britain and New Ireland. The inhabitants of both islands are

cannibals, but indulge in the custom in order to show their complete mastery over their enemies, and not from a preference for human flesh. New Britain was coasted entirely and crossed several times. The interior is hilly, the loftiest point being 2,500 feet high. It is well populated, and the natives expressed the usual surprise at seeing white men for the first time. The tribe at Blanchi Bay informed the travellers of another tribe at some distance from the coast, who were provided with caudal appendages of an exceedingly remarkable character, and promised to obtain a specimen before the next visit of the brig. At another place, the wealthier families among the natives were accustomed to confine their daughters for several years before the attainment of puberty in tabooed houses, not allowing them to put foot upon the ground during the whole period. A superior tribe was encountered at Spacious Bay, with lighter complexions and straighter hair than their neighbours. Both sexes wore partial clothing. Large collections were brought back illustrating most fully the geology, the fauna, and the rich tropical flora of the islands.

M. CLEMENT GANNEAU, who has recently been in London to study the Semitic monuments in the British Museum, writes to the *Times* animadverting on the complete want of system in their arrangement. The Semitic remains are scattered among other collections in such a way as to make their examination a work of the greatest difficulty, whereas were they properly classified and arranged by themselves they would form a Semitic Room without a rival.

THE Geographical Society of St. Petersburg has received a telegram from Prjevalsky announcing that he has crossed the Thian Shan, and, on October 14, was fifty versts from Karashar. The country he was then in is a desert.

M. WADDINGTON, French Minister of Public Instruction, is busy fitting up a large pedagogical museum, which will be located in the hotel of the Ministry, and be open to the inspection of any scientific men interested in the progress of pedagogy.

THE first portion of the German *Jahresbericht über die Fortschritte der Chemie*, for 1875, containing 480 pages, about one-third of the complete work, has just been issued. General and physical chemistry receives 150 pages, inorganic chemistry, 80 pages, while the remainder of the number is devoted to organic chemistry, which will also occupy the greater portion of the second number. Prof. Fittica, of Marburg, assumes, with the volume for 1875, the chief editorial supervision, and is assisted by the following able corps:—K. Birnbaum, C. Böttinger, C. Hell, H. Klinger, A. Lauberheimer, E. Ludwig, A. Michaelis, A. Naumann, F. Nies, H. Solikowski, Z. H. Skraup, and K. Zöprritz. Complete sets of the *Jahresbericht* are difficult to obtain now as seven years' numbers are out of print. A perfect set from 1847 to the present date, with the two registers, costs from 500 to 600 marks in Germany. The editor requests from the authors of chemical articles separate copies of their communications in order to lighten the labour of classification and compilation.

We have received vol. 1. of the *Proceedings of the Davenport (Iowa, U.S.) Academy of Natural Sciences*. This Academy had a very small beginning in 1867, but is now in a flourishing condition. The volume contains the proceedings from 1867 to 1876, and includes some papers of real value, especially on mound exploration. The number of scientific societies in the U.S. issuing publications containing papers of genuine scientific importance is now large, and constantly increasing.

THE artificial lighting of rooms affects the human system, on the one hand, through the change produced in the composition of the air by gases of combustion, and on the other through rise of temperature. These influences have lately been examined by M. Eriemann (*Zeitschrift für Biologie*). In a part of the laboratory 10 cubic metres' capacity, inclosed by wooden and glass

walls, various materials were burnt eight hours, viz., stearine candles (six at a time), rape oil, petrolum, and ordinary gas, and the air was drawn off at different heights and analysed. The results do not pretend to absolute exactness, but a comparison of them is interesting. The tables first show that under all circumstances, and with all sorts of artificial lighting, the air of an inclosed space contains more carbonic acid and organic carbon-containing substances than in absence of such illumination; still, in these experiments the carbonic acid was never greater than 0.6 or 0.7 per 1,000, while the proportion of other carbon compounds was very variable, so that the amount of carbonic acid gives no exact criterion for the vitiation of the air. The CO<sub>2</sub> actually found in the air was only a very small fraction of that produced by the combustion; by far the greatest part must have been carried away by the natural ventilation. In comparing the four materials, the proportion of CO<sub>2</sub> and other carbon compounds was reduced to a light strength of six normal candles. It appeared that the petroleum, with lamp of good construction, communicates to the atmosphere, not only less CO<sub>2</sub>, but (what is much more important) fewer products of imperfect combustion than the other lighting materials; and, further, that stearine candles, with the same light-strength, vitiate the air most. As to temperature, that of the lower layers of air, up to a height of 1.5 metres, rose very little during the eight hours, about 2° to 3° on an average, while the upper layers increased considerably in temperature, especially just under the ceiling; this increase, in the case of ordinary gas, rape oil, and petrolum, was 10.5° to 10.8°, in that of candles only 4°. If, however, we take into account the photometric light-effect of the flames during the experiment, it is found that, with equal light-strength, rape oil and gas raise the temperature considerably more than petrolum, and the action of the latter, indeed, came to about that of the candles.

THE additions to the Zoological Gardens during the past week include an American Black Bear (*Ursus americanus*) from North America, presented by Mr. W. Stead; a Common Partridge (*Perdix cinerea*), European, presented by Mr. H. Laver; a Razor-bill (*Alca torda*), European, presented by Mr. W. Thompson; two Common Swans (*Cygnus olor*), a Common Cross-bill (*Loxia curvirostra*), European, purchased.

#### SOCIETIES AND ACADEMIES LONDON

Zoological Society, January 2.—Prof. Newton, F.R.S., vice-president, in the chair.—Prof. Newton exhibited and made remarks on a specimen of a variety of the guillemot (*Alca trolle*) with yellow bill and legs, which had been lately shot by Mr. J. M. Pike on the south coast of England.—Prof. Garrod, F.R.S., read a paper on the osteology and visceral anatomy of the Ruminantia, in which many facts concerning the anatomy of the Cervidae and the Cavicornia were brought forward, especially with reference to the shape of the liver and the structure of the generative organs in these animals. Among the most important of these was the observation that the uterine mucous membrane of the musk-deer (*Moschus moschiferus*) presents no indications of the presence of cotyledons, the contrary being the case in all other ruminants. Prof. Garrod likewise made a suggestion as to a proposed method of expressing the relations of species by means of formulae.—A paper by Messrs. Sclater and Salvin was read containing the descriptions of eight new species of South American birds, namely (1), *Euphonia finschi*; (2), *Phœnicus crissalis*; (3), *Octhaeca leucometopa*; (4), *Octhaeca arenacea*; (5), *Chloroneryx dignus*; (6), *Celaus subflavus*; (7), *Chamaepeta buckleyi*; (8), *Craz erythragantha*.—Mr. R. Bowdler Sharpe read a paper on some new species of warblers from Madagascar, which had been recently added to the collection in the British Museum, and were proposed to be called *Apalis cerviniventris*, *Baeocera flaviventris*, and *Dramacoceros brunneus*, the last-named being a new genus from Madagascar.—A communication was read from Mr. G. S. Brady, containing notes on fresh-water mites which had been obtained from lakes and ponds in England and Ireland.

Royal Microscopical Society, January 3.—Charles Brooke, F.R.S., vice-president, in the chair.—Dr. Wallich read a paper

on the development, reproduction, and surface markings of diatoms, illustrating the subject by drawings.—An interesting paper was read by Mr. Stephenson descriptive of some very curious diffraction experiments, by Prof. Abbe, from which it appears that the use of "diffraction gratings" in connection with stops of various kinds placed above the back combination of the objective were competent to produce precisely the same appearances as were observed in certain well-known test objects.—Some mercury globules mounted in balsam were exhibited under the micro-polariscope, by Mr. Stephenson for Mr. Slack, producing some very curious and interesting optical effects.

MANCHESTER

Literary and Philosophical Society, November 28, 1876.—Edward Schunck, F.R.S., vice-president, in the chair.—The Radiometer. Mr. Harry Grimshaw, F.C.S., communicated the following summary of an extract from the "Panorama of Science and Art," published by Nuttall, Fisher, and Dixon, 1813, 2 vols.:—"After alluding to Boerhaave's experiment on the influence of the 'burning glass' on the motion of the 'compass,' the extract goes on to describe a radiometer constructed by Mitchell, which seems to have been constructed as follows:—A thin plate of copper one inch square was attached to one end of a fine 'harpisichord' wire ten inches long. This was balanced on an agate suspension, and the little copper plate was counterpoised by a grain of shot at the other extremity of the wire. As a result of experiments with the instrument, it was found that the influence of the rays of the sun focussed by a concave mirror two feet in diameter, caused a revolution of one-millionth of an inch in a second. The instrument was protected by some sort of glass shade. The same motion was produced in a vacuum."—Note on a manganese ore from New South Wales, and on a specimen of native silver from New Zealand, by M. M. Pattison Muir, F.R.S.E.

December 12, 1876.—E. W. Binney, F.R.S., president, in the chair.—The lowest amounts of atmospheric pressure during the last sixteen years as observed by Thomas Mackereth, F.R.A.S., F.M.S.—On a mineral water from Humphrey Head, near Grangeover-Sands, North Lancashire, by Joseph Barnes and Harry Grimshaw, F.C.S.—On ternary differential equations, by Sir James Cockle, F.R.S., Corresponding Member of the Society.

December 26, 1876.—E. W. Binney, F.R.S., president, in the chair.—Notice of the "Almanacke for XII Yere," printed by Wynkyn de Worde in 1508, by William E. A. Axon, M.R.S.L.—A notice of some organic remains from the Manx schists, by E. W. Binney, F.R.S., president.—On changes in the rates of mortality from different diseases during the twenty years 1854-73, by Joseph Baxendell, F.R.A.S.

PARIS

Academy of Sciences, December 27, 1876.—Vice-Admiral Paris in the chair.—The following papers were read:—On the analysis of pyrogenic gases, by M. Berthelot.—On some derivatives of diadol, by M. Wurtz.—Note by M. Chevreul on his more recent works. One is a *résumé* of the history of matter from the atomists and Greek Academicians down to Lavoisier. Another relates to experiments meant to show the difference of absolute black from material black.—On the secular displacements of the orbit of the eighth satellite of Saturn (Japhet), by M. Tisserand.—Researches on the velocity of the wind, made at the observatory of the Roman College, by P. Secchi. He gives a table of observations from 1862 to 1876, with Robinson's anemometer and a meteorograph. The general daily mean for the whole year is 197.5 km. It differs little from month to month, but the horary distribution is very different in the summer and the winter months. The velocity is greatest in March, least in September. But P. Secchi does not take his figures as representing the absolute velocity of wind in the country, as the College is in a low part of the city; observations on Monte Cayo will be better. He adds tables of mean hourly velocity in the different months.—On the project of an irrigation canal from the Rhone, by M. de Lesseps. The canal (schemed by M. Dumont) is estimated to cost 110 million francs; the irrigable surface (in five departments) might produce annually 450,000 tons of hay and support at least 100,000 additional head of large cattle. The scheme would also permit of submersion of the vines. It could be completed in four years.—M. Faye presented the *Annuaire du Bureau des Longitudes* for 1877, and noted improvements in it.—New measurement of the meridian of France, by M. Perrier. The operations now extend, in a continuous system, from the frontier of the Pyrenees

to the Department of Loiret; there are thirty-nine stations.—On the absorbent power of wood charcoal for sulphide of carbon, and on the employment of sulphocarbonic charcoal for the destruction of phylloxera, by M. Laureau. M. Kvassey announced that the vines of Hungary are greatly threatened by Phylloxera.—Study on the reduction of a system of forces, of constant amount and direction, acting on determinate points of a solid body, when this body changes its orientation in space, by M. Darboux.—New theorems in higher arithmetic, by M. Lucas.—Enumeration of various theorems on numbers, by M. Proth.—Third note on the theory of the radiometer, by Mr. Crookes.—Researches on the coefficient of capillary flow, by M. Guerout. This coefficient is found to be smaller, in the same series, the more of carbon the substances contain. The author proved this before for monoatomic alcohols and homologous derivatives of benzene; it is here extended to fatty acids and ethers from the same alcohol, and others formed by union of the same organic acid with different alcohols of the fatty series. The coefficient for ethers is much higher than that of the alcohols or acids producing them; the introduction of an organic radical into the molecule of an alcohol raises its fluidity considerably. The determination of this coefficient establishes a sort of classification among isomeric bodies.—Practical study on gluten and on its determination in the dry state, by M. Lailier.—Researches on the physiological properties and the mode of elimination of bromhydric ether, by M. Rabuteau. This agent has properties intermediate between those of chloroform, bromoform, and ether.—Formation of the heart in the chicken, by M. Dareste.—On a *Balanoptera borealis* caught at Biarritz in 1874, by M. Fischer. This is the rarest of European species; only five examples have been known.—On a new globular state of quartz entirely crystallised in only one crystallographic direction, by M. Michel Levy. It is probable that the silica of this globular quartz was isolated in the paste before the end of the movement of effusion which produced the fluidity. The example furnishes a new combination of the colloid and crystalline states of silica.—Note on organic powders of the air, by M. Marié-Davy. The meteorological observatory of Montsouris has been charged by the Municipal Council of Paris to make a regular study of the dust of the air, the ground, and the water in various quarters of Paris, commencing with the new year. The author describes some preliminary observations relating to a recent epidemic.—On a maximum of falling stars, already indicated, in the month of December, by M. Chapelas.

CONTENTS

	PAGE
FERMENTATION, I. By CHARLES GRAHAM . . . . .	213
OUR BOOK SHELF:—	
Jordan's "Manual of the Vertebrates of the Northern United States" . . . . .	216
Rowan's "Emigrant and Sportsman in Canada" . . . . .	216
LETTERS TO THE EDITOR:—	
On a mode of Investigating Storms and Cyclones.—Dr. Buys	216
DALLON	
Mind and Matter.—J. L. TUPPER . . . . .	217
Solar Physics at the Present Time.—Prof. PIAZZI SMYTH . . . . .	217
Towering of Birds.—G. H. KIMAHAN . . . . .	217
Rooks Building at Christmas.—C. M. INGLEBY . . . . .	217
Are We Drying Up?—GEORGE F. BURDER . . . . .	218
Radiant Points of Shooting Stars.—W. F. DENNING . . . . .	218
ALEXANDER BAIN	
PHOTOGRAPHS OF THE SPECTRA OF VENUS AND A LYRA. By Prof.	
HENRY DRAPER, M.D. . . . .	218
ON THE STUDY OF BIOLOGY. By Prof. HUXLEY, F.R.S. . . . .	219
EXPERIMENTS WITH THE RADIOMETER, I. By WILLIAM CROOKES, F.R.S. . . . .	224
ON A NEW ASTRONOMICAL CLOCK. By SIR WILLIAM THOMSON, F.R.S. (With Illustration) . . . . .	227
ON THE TROPICAL FORESTS OF HAMPSHIRE. By J. STARKIE GARDNER, F.G.S. (With Illustrations) . . . . .	229
GEOGRAPHICAL CURIOSITIES (With Illustrations) . . . . .	233
TEMPERATURES AND OCEAN CURRENTS IN THE SOUTH PACIFIC. By	
HERF VON SCHLRINITZ . . . . .	237
ON THE MEANS OF PROTECTION IN FLOWERS AGAINST UNWELCOME VISITORS. By M. KERNER . . . . .	237
THE ACTION OF THE WINDS IN DETERMINING THE FORM OF THE EARTH. By Dr. FRANCIS CZERNY . . . . .	239
REPORT OF THE UNDERGROUND TEMPERATURE COMMITTEE OF THE BRITISH ASSOCIATION . . . . .	240
OUR ASTRONOMICAL COLUMN:—	
The Rotation of Saturn on his AXIS . . . . .	243
The Nebula in the Pleiades . . . . .	244
Variable Stars . . . . .	244
Meteors of January 7 . . . . .	244
The Melbourne Observatory . . . . .	244
METEOROLOGICAL NOTES:—	
New Daily Weather Map . . . . .	244
Low Temperatures . . . . .	244
NOTES . . . . .	245
SOCIETIES AND ACADEMIES . . . . .	247

THURSDAY, JANUARY 18, 1877

FERMENTATION<sup>1</sup>

II.

*Études sur la Bière.* Par M. L. Pasteur. (Paris : Gauthier-Villars.)

**W**HAT is fermentation? Such is the important question of which we have now to seek the solution. It is necessarily impossible within the scope of a brief article to enter into an examination of the numerous theories propounded, yet a few words of explanation are needed in order that we may the more clearly understand what it is that Pasteur has done, and what is the real bearing of his answer to the question not only on fermentation, but on many a disease which flesh is heir to.

According to Willis and Stahl, to whom we are indebted for the first philosophical attempt at explanation, fermentation was due to a peculiar motion communicated from a decaying body to another substance, by which a similar degrading action was set up, so that complex molecules became less complex. This idea was subsequently taken up and developed by Gay-Lussac, Liebig, and others, who maintained that the decomposition of albuminous bodies produced the molecular disturbance by which sugar was broken up into alcohol and carbonic acid. Thus the molecular disturbance produced by decay of nitrogenous matter in a fitting liquid gave rise to lactic and butyric acids and other products.

The contact theory of Berzelius and Mitscherlich belonged to a period in the history of chemistry when catalysis was constantly employed to explain the unknown, and need not here be further alluded to.

Cagniard de Latour, in 1837, first proved that yeast is composed of living cells; this was confirmed by the almost contemporaneous observations of Schwann and Kützing, and subsequently by Turpin and others. The subject, however, remained in much obscurity until Pasteur commenced his investigations on the nature of ferments; these have been carried on for a period of twenty years, the results obtained being communicated to the French Academy in 1862 and subsequent years and are now, in so far as they concern the brewer, summed up in the important work before us. The theory of molecular disturbance produced by putrefaction, so energetically maintained by Liebig, may be considered vanquished on all points. M. Pasteur, from his researches, has proved incontestably the two following propositions:—

1. *Every diseased alteration in the quality of beer coincides with the development of microscopic organisms foreign to the nature of beer, properly so called.*
2. *The absence of alteration of beer wort and of beer coincides with the absence of foreign organisms.*

The first proposition M. Pasteur has amply proved from hundreds of examinations of beer undergoing diseased action; in no one case did he find the sediment of such beer to consist solely of the globular or ovoid alcoholic yeast cells, but of a more or less intermixture with the various ferments of disease already described by him with great minuteness in his "*Études sur le Vin.*" His second proposition is a necessary corollary of the first.

We cannot do better than follow our author in some of his researches by which he has demonstrated the truth of these propositions. M. Pasteur, by boiling animal and vegetable infusions—it is not necessary in all cases to use so high a temperature—and then, by cooling them under rigid precautions against the introduction of germs from the air, has shown that they are then unacted upon by oxygen, at least that no putrefaction or fermentation ensues.

The temperature to which a liquid must be heated in order to ensure against subsequent decomposition varies with its nature. Thus while 50° C. is sufficient to destroy the germs in vinegar, malt infusion must be heated to 90° C., and milk to 110° C., and others require even higher temperatures. Blood and urine heated in Pasteur's flasks and cooled under conditions precluding the entrance of germs from the air undergo no alteration even when kept for weeks at a temperature of 20° C. in contact with pure air. Mere oxidation therefore is not the cause of fermentation and putrescence. It is unnecessary to refer to the exceptions taken by many experimentalists to Pasteur's conclusions, the great experimental skill required and the rigid precautions to be taken to secure success amply explain why others less habile than Pasteur have obtained conflicting evidence. Two of the ablest of his opponents, Doctors Brefeld and Traube, have recently retracted their previous objections to Pasteur's results, and now unhesitatingly adopt his views on Fermentation. Allusion has already been made to the fact that the brewer occasionally, and the wine grower invariably, leaves the saccharine liquid to spontaneous fermentation; it is many years since Pasteur first demonstrated that the dust on the skin of the grape contained the small organisms necessary for vinous fermentation, and that when these were destroyed or removed no fermentation took place. Thus the juice heated in a Pasteur flask with the usual precautions against the admission of germ-laden air did not undergo fermentation when freely exposed to germ-free air, but did so readily when a portion of the dust of the skin was added. If this dust, however, was removed by a few drops of water and then boiled previously to being added to the must no fermentation took place. Hence the dust on the skin contained the ferments, and M. Pasteur has demonstrated their nature and their distinguishing features.

In the case of boiling beer wort there are necessarily no living organisms, and therefore, as Pasteur has shown, there is no change when the wort is allowed to cool in a vessel to which only pure air has access. If, however, the cooled wort be exposed to air, ferments of various kinds, e.g., *Saccharomyces cerevisiæ* (though rarely), *Saccharomyces pastorianus*, and *apiculatus*, and other alcoholic ferments, fall into the liquid; at the same time, however, attended by more or less of the lactic and butyric ferments and other organisms of disease. In a brewery where other fermentations are proceeding, doubtless the number of alcoholic ferments will be greater and the injurious bacteria less than in other localities; still in any case the beer when finished must be very inferior, owing to the large quantities of acetic, lactic, and butyric acids, and other products of putrefactive change. M. Pasteur, having satisfactorily demonstrated that alcoholic fermentation was due to the action of certain organisms

<sup>1</sup> Continued from p. 245

living and reproducing in a saccharine liquid, the question arose whether the common *Penicillium glaucus* and the *Aspergillus glaucus* could be transformed into the true alcoholic ferments of beer or of wine, and the still wider question of the conversion of one ferment into another; a question of vital importance to the brewer, since, if this theory of the conversion of one kind of ferment into another were proved to be true, the hope of obtaining greater power over the results of his process would be dashed to the ground, or at any rate such power would only be obtained in the distant future. In his researches upon this question, M. Pasteur availed himself of the liquid proposed by his pupil, M. Raulin (p. 89), e.g. :-

Water ... ..	1,500 parts.
Cane sugar ... ..	70 "
Tartaric acid ... ..	4 "
Nitrate of ammonia ... ..	4 "
Phosphate of ammonia ... ..	0.6 "

We must refer the reader to M. Pasteur's book for the full directions of procedure and the precautions to be taken in order to avoid the introduction of mixed organisms. No one can read this portion of his work without being greatly impressed by the author's wonderful ability in detecting and overcoming difficulties and thereby removing sources of error which have led so many to erroneous conclusions. We may briefly sum up this part of his work by stating that in no case where such necessary precautions were taken did he ever find that the penicillium changed to alcoholic yeast or to a mycoderma, or that yeast gave rise to vibrios, or that mycoderma aceti became yeast. M. Pasteur himself at one time thought he had detected the conversion of the mycoderma vini into a true alcoholic ferment; in this, however, he now finds he was in error, and that more rigorous precautions fail to support his original supposition.

In his experiments with mycoderma aceti and mycoderma vini carried out with his usual marvellous ingenuity and attention to details, he has shown that these organisms in contact with the air burn up the sugar of the liquid upon which they rest; and so far from alcohol being produced in quantities that may be detected, the mycoderma vini completely burns up any alcohol previously existing in the liquid. When submerged in the liquid, though life is far less active, they continue to exist for a time, undergoing structural changes, obtaining the necessary oxygen from the sugar, and producing alcohol, as in the case of the penicillium glaucus and aspergillus glaucus under similar conditions of submersion. We must admit, with Pasteur, that the production of alcohol and carbonic acid from sugar, in other words, alcoholic fermentation, is a chemical act attending the life of cells the moment they are removed from the influence of free oxygen, and are submerged in a saccharine liquid capable of yielding oxygen and heat by its decomposition. This alcohol-producing character becomes, therefore, not the isolated property of this or that organism, but a general function of a living cell, when removed from the air and compelled to obtain the necessary oxygen by the decomposition of its food. The duration of life and the production of alcohol will vary with the power of the cell to reproduce its kind under these submerged conditions. I have already referred to

the production of alcohol and carbonic acid when growing malt is placed in an air-tight vessel. Under such circumstances alcohol and a large amount of carbonic acid are for a long time produced, ultimately the moist mass becomes increasingly acid, the production of alcohol ceasing and acetic and other acids being formed attended with a strong ethereal odour. When first noticed by the writer in the year 1873 he was unaware of M. Pasteur's previous conclusions as to the action of vegetable cells. Messrs. Lechartier and Bellamy in 1874 published their valuable researches, upon which they had been engaged for some time, and they proved incontestably that the cells of fruits possessed the power, when removed from free oxygen, of obtaining this gas by the decomposition of sugar; alcohol and carbonic acid gas being produced, though not in the ratio found in true alcoholic fermentation. We thus learn from our author's researches, amply confirmed by those of Lechartier and Bellamy, that active living cells, when removed from the influence of free oxygen, and when placed under conditions where they must obtain it from saccharine materials, for a time continue to exist, producing alcohol and carbonic acid. Those, such as the cells of fruits and grain, which cannot reproduce under these conditions, soon die, and the amount of alcohol produced is but small; on the other hand those cells which can reproduce by germination become true ferments, and their action only ceases when the original reproductive energy due to their previous aerial condition also ceases. Thus when the *muco* *racemosus* was submerged in a saccharine liquid it was found that the alcoholic fermentation was at first active and then finally ceased, the cells being deformed in contour, full of granulations, and to all appearance dead. The introduction of a little pure air, however, reinvigorated the apparently dead organism, and again—for a time—alcoholic fermentation was produced. Free oxygen therefore endows these simple cell-plants with an energy which enables them for a time, longer or shorter, to exist without it by obtaining the necessary oxygen from their food. I have said for a time, because the *muco* *racemosus*, or the mycoderma submerged in a liquid soon lose their activity and cease to act, the true yeast ferments under the same conditions being enabled for a much longer period to reproduce and carry on their vital functions; even with these, however, Pasteur has proved the necessity of periodical aëration so as again to place them under their normal aerial condition, a fact long known to those English brewers who employ the method of *rousing* to stimulate the activity of the yeast. Pasteur's investigations on fermentation have convincingly proved—at least to most minds—the intenable of a *peculiar motion* and also of *spontaneous generation* as being the true cause of these interesting phenomena.

In addition to a continued life without free oxygen which the yeast cell manifests, there is another feature—exceptional in character—which it possesses, and that is, that its growth is not commensurate with the sugar decomposed. For a given weight of yeast formed one may have ten, twenty, or one hundred times its weight of sugar decomposed. It may be of interest to quote here two experiments—out of many—bearing on this question and also on the influence of dissolved oxygen in a

saccharine liquid. M. Pasteur took two flasks partially filled with a liquid containing in each case 150 grammes of sugar; the one (a) was almost completely deprived of air, the other (b) contained air. A mere trace of yeast (species, *Saccharomyces pastorianus*) was added to each. The fermentation in a was sluggish, and after nineteen days, when the experiment was closed, there was still a slight evolution of carbonic acid gas; in b the fermentation was active, and ceased entirely on the ninth day. The weight of yeast formed was determined in both cases, as also that of the sugar left undecomposed; these were the results:—

a. Weight of yeast formed	...	1.368 grammes.
Sugar undecomposed	...	4.600 "
b. Weight of yeast formed	...	1.970 "
Sugar undecomposed	...	nil.

In b, therefore, though the liquid was far from being saturated with air, the decomposition of the sugar was completed in eight days, whereas in a, even at the end of nineteen days, there was still some sugar left. The weight of yeast formed was as 1 to 76 of sugar decomposed in b, and only as 1 to 89 in a. In another experiment on a sugar solution completely deprived of air, the whole of the sugar was not decomposed even at the end of three months, the yeast produced was deformed in appearance, and the ratio of yeast to alcohol produced was as 1 to 176. Reversing the experiment so as to obtain a thorough and constant saturation of the liquid with air, the ratio of yeast formed to the alcohol was as high as 1 to 4. In this latter case the yeast acted more as a mycoderm or as a mould than as a true ferment. We may sum up the bearing of the facts elucidated by Pasteur, by the statement that, within given limits defined in Pasteur's experiments, the production of yeast is directly, and that of alcohol inversely, as the consumption of free oxygen.

M. Pasteur having demonstrated that the alterations in the yeast, in the wort, and in the beer, are due to the action of microscopic organisms other than the true yeast cells, and that these ferments of disease are killed at a high temperature, it follows that if a boiling wort be cooled under conditions which preclude the entrance of these germs, and if fermented with pure yeast, a beer will be obtained which, so long as not exposed to germ-laden air, must remain unchanged for an indefinite time. M. Pasteur has conferred an additional favour on the practical man by designing an apparatus by which these conditions may be secured, and has carried on his process of fermentation on a large experimental scale in several French breweries with much success so far as flavour and soundness of product are concerned. The general adoption of new and costly appliances must necessarily be slow. Nor is it essential that his suggestions should be in all cases carried out in their entirety. The intelligent brewer who thoroughly masters the key to sound and unsound fermentation will be enabled to secure the one and avoid the other without replacing costly appliances by others vastly more so. To do this, however, the microscope must be in daily use in order to cultivate a purer and purer yeast crop, and his technical processes of skimming and cleansing must be more and more directed by this invaluable instrument. The selection and preservation of yeast, the cultivation of it and the gradual elimination of diseased ferments will henceforth be the object of well-guided

efforts, and not of mere chance, as heretofore. The technical reader will do well to read and re-read the work before us; as he becomes master of its method of investigation and of the results obtained, so will he master many of the difficulties of his art.

Some suggestions are given (p. 224, *et seq.*) on the purification of yeast of interest to the brewer as well as to the experimentalist. It would lengthen this notice too much to give the details of the process; it will suffice here to state that the author recommends the use of a weak solution of sugar rendered slightly acid with tartaric acid. In some cases he employs in addition a trace of carbolic acid. Such a liquid destroys some true yeast; it is, however, far more injurious to the ferments of disease. It should not be forgotten that aeration, while injurious to most ferments of disease (*mycoderma vini* and *aceti*, of course, excepted), is a great stimulant to the *Saccharomyces*; hence this method may be adopted either alone or in conjunction with others suggested by him. Those interested in this matter, and especially the brewer, will do well to study carefully the work itself, they will find on this subject, as well as on many others, not alluded to here, much invaluable and suggestive information.

In concluding our brief examination of Pasteur's biological researches on fermentation, a few words on the products formed will not be out of place.

Numerous attempts have from time to time been made to express by a chemical equation the decomposition of glucose sugar by the yeast cell. Until the discovery of succinic acid by Schmidt, and of glycerine by Pasteur, the attempts made were far from being satisfactory. According to Pasteur 100 parts of cane-sugar corresponding to 105.26 parts of grape-sugar give when fermented—

Alcohol	...	...	...	...	51.51
Carbonic acid	...	...	...	...	49.42
Succinic acid	...	...	...	...	0.67
Glycerin	...	...	...	...	3.06
Matters united with ferments	...	...	...	...	1.00
					105.26

Therefore ninety-five parts of cane-sugar are broken up into carbonic acid and alcohol, one part is assimilated by the yeast, and four parts are converted into succinic acid and glycerin.

Monoyer has proposed the following equation to represent the decomposition of these four parts of sugar, *e.g.*,

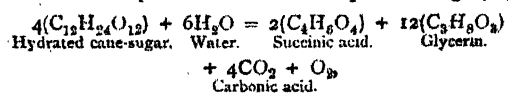

the liberated oxygen supporting the life of the plant. It is impossible at present, however, to formulate the reactions which occur, because they vary according to the temperature, pressure, species of yeast employed, and to the nature of the saccharine liquid. M. Pasteur himself has pointed out that the proportions of succinic acid and glycerin vary in different experiments.

Mr. Horace Brown in some admirable and suggestive experiments on the influence of pressure on the products of fermentation (*Fourn. Chem. Soc.*, 1872, p. 570), has shown that in alcoholic fermentation in addition to carbonic acid there is always formed a small quantity of nitrogen, hydrogen, and a hydrocarbon of the marsh

gas series; the nitrogen being evolved from the albuminous matter of the wort. By diminishing the pressure the amount of evolved hydrogen increased, and with this an increase in the amount of acetic acid and aldehyde. These products, though very small compared with the alcohol and carbonic acid, the chief resultants of ferment action are yet sufficient to account for the ethereal odour of a fermenting tun. Pasteur had previously noticed the production of minute quantities of volatile acids. On electrolysing a weak aqueous solution of invert sugar, Brown obtained carbonic acid, hydrogen, and oxygen, and at the same time an appreciable quantity of aldehyde and acetic acid, together with a small quantity of formic acid. It may be that water is decomposed in fermentation in small quantities precisely as occurs in ordinary vegetation; though highly probable, we have, however, no definite facts in support of the assumption. Our present knowledge of the chemistry of fermentation is somewhat vague and general, and much remains to be done before we shall be enabled by purely physical means to decompose sugar so as to produce the results brought about by the yeast cell.

As we progress in knowledge, so does our power to imitate the products of life-action increase, and assuredly the time will arrive when alcohol will be produced by simple physical or chemical means. For many a year to come, however, we must continue to depend upon the wonderful organisms known as yeast. Their life history and action on liquids have been elucidated by the genius and patient toil of Pasteur, and he has enabled us to select such ferments as are required to produce the result desired, and hence we are no longer the sport of chance.

The brewer and wine-maker are not alone in the debt due to the illustrious Frenchman whose work we have briefly examined; we are all interested in the far wider field of germ action opened out by him, whereby many a disease of man hitherto as dark and unexplained as was fermentation, will be brought under the illuminating light of his teaching.

He who has thus shown us the key whereby we may open the locked-up secrets of nature may rest assured of the gratitude of his fellow-men, given with the greater earnestness and respectful sympathy from the knowledge that our guide has impaired health and sight in his labours for others.

France has given many a great name to the roll of fame, but none more noble or more worthily inscribed thereon than that of Pasteur. CHARLES GRAHAM

### GAYLEY'S\* ELLIPTIC FUNCTIONS

*Elementary Treatise on Elliptic Functions.* By Arthur Cayley. (Cambridge: Deighton, Bell, and Co.)

THIS is a book thoroughly worthy of the great name of its author. It is difficult to know which to admire most, the grasp of the subject, the extreme simplicity of its exposition, or the neatness of its notation. It will, we think, at once take its proper place as the leading text-book on the subject.

In regard to notation, it seems to us to be thoroughly good throughout, not only in respect of the adoption of Gudermann's suggestion of the very short forms  $sn$ ,  $cn$ ,  $dn$ , for the sine, cosine, and elliptic radical of the ampli-

tude of the function of the first kind, but throughout. In particular, we note an important typographical simplification in the suppression of the common denominator in long series of fractional formulae, the denominator being given once for all, and its existence in each separate formula merely indicated by the sign of division ( $\div$ ). This is a simplification, some equivalent of which we ourselves, and probably most of those who have worked at elliptic functions, have used in our private papers; but it is a new thing, and a very good thing, to see it introduced in a systematic form in a printed book.

Another very useful feature belonging to mechanical arrangement is, that the first chapter contains a general outline of the whole theory, so that its perusal enables the reader to see at a glance the plan and intention of the work. He is thus enabled at once to bring intelligent attention to bear upon his reading, instead of being distracted by the wonder as to what it is all driving at.

The intention of the work is, firstly, the direct discussion and comparison of the three forms of elliptic integral, and of the doubly periodic functions which are regarded as the direct quantities of which these integrals are inverse functions. Then the auxiliary functions  $Z$ ,  $H$ , and  $\Theta$  are taken up in an elementary form, and after this the transformation of the elliptic functions, by division or multiplication of the primary integral, with the corresponding change of modulus and amplitude. These are very fully and clearly discussed. In particular, the connection between the transformation of the radical in the elliptic integrals, and the formulae of multiplication, is clearly brought out. Legendre had left this as a very puzzling, although necessary, inference, which he scarcely stopped to discuss. After this comes a discussion of the  $g$  functions, with a further discussion of the functions  $H$  and  $\Theta$ , and then some miscellaneous developments.

The work is strictly confined to elliptic functions and their auxiliaries. The more general theories of Abel and Boole find no place in it, nor is there any general discussion of single and double periodicity such as forms the foundation of the work of Messrs. Briet and Bouquet. There are but few examples of the computation of particular values of the elliptic functions, and no account of general methods of computation, either of isolated values, or of tables, or of the arithmetic connected with them; nor are ultra-elliptic functions touched upon. The geometrical applications or illustrations of the elliptic integrals and functions are but meagre, and no mechanical applications are given.

The arithmetical work is quite rightly omitted. That will find a much better place in the hand-book or introduction which will doubtless accompany or follow the great tables of elliptic functions now being printed for the British Association. There is, however, one point which we think it an omission to notice, and that is the solution of the addition equation by means of auxiliary angles. (See Legendre, "Traité des Fonctions Ell." vol. i., p. 22; or Verhulst, § 19, p. 40.) It is no defect, again, that the mechanical applications are omitted. These are better studied as they arise, as a part of mechanics rather than of analysis. But as regards geometry, we think there has been done either too much or too little. For instance, we have the usual theory of the representation of the arcs of the ellipse and hyperbola

by those functions, and we have a long disquisition on the geometrical representation of the elliptic integral of the first kind by an algebraic curve; while there is no mention of the late John Riddle's discovery, that the arcs of the curves by which circles on the sphere are represented in Mercator's projection are directly given by, and absolutely co-extensive with, the elliptic integrals of the first kind, the amplitude being simply the longitude on the sphere. We think this quite as simple and as important as the discussion of the lemniscata. If we are to go into geometry at all, it might be as well also to make some allusion to Dr. Booth's discussion of the spherical conics, and to Mr. Roberts's integration of the Cartesians.

Then, again, we have an account of Jacobi's geometrical theorem in its original form, depending upon a family of circles having the same radical axis, while the corresponding theorem, depending upon circles having two inverse points in common, given by Chasles (see his "Géométrie Supérieure," cap. xxxi., p. 533), which much more directly represents both amplitudes and moduli, is not mentioned explicitly, although it is involved in the geometrical exposition given of Landen's theorem.

We have also been unable to find any account of Jacobi's reduction of the integral of the third kind to the form—

$$\int \alpha \phi. \beta \phi : \Delta \phi$$

The transformations of the functions are worked out with great completeness, the results being tabulated in some rather formidable-looking, but really very convenient, schedules. This part of the work is carried almost to an extreme.

On the whole the book is one of the most important contributions to mathematical literature which has appeared for a long time. It is well done, and covers ground that was previously but ill occupied. It is clearly printed, and the fact that the proof-sheets have been revised by Mr. J. W. L. Glaisher is a guarantee for the correctness of detail. C. W. MERRIFIELD

OUR BOOK SHELF

*Instruction in Photography.* By Capt. Abney, R.E., F.R.S., &c., Instructor in Chemistry and Photography at the School of Military Engineering, Chatham. Third Edition. (London: Piper and Carter, Gough Square, Fleet Street, E.C., 1876.)

We are very glad to find that Capt. Abney did not carry out the intention which he mentions in the preface of not producing another edition of his well-known "Instruction in Photography." That the little volume is widely known and appreciated is shown by the fact of its having reached a third edition, and we can only say that it well deserves its success. A photographer of the author's well-known skill and repute could not fail to be able to instruct others in his art, but when in addition he has gained large experience by continued practical teaching in such a school as that at Chatham his lessons become additionally valuable.

Capt. Abney does not enter much into theory, though he gives very good and simple accounts, illustrated by chemical equations, of the principal changes occurring during the processes described. We observe that he announces the forthcoming publication of a "Photography" among Messrs. Longmans' Text-books of Science, in which he proposes to deal more fully with the theoretical part of the subject. We shall look forward to this

with considerable interest; meanwhile, for practical instruction in the art this little book distances all competitors. R. J. F.

LETTERS TO THE EDITOR

[The Editor does not hold himself responsible for opinions expressed by his correspondents. Neither can he undertake to return, or to correspond with the writers of, rejected manuscripts. No notice is taken of anonymous communications.]

Just Intonation

THE errors and oversights—in my paper in NATURE, (vol. xv. p. 159)—with which Mr. Chappell charges me, are imaginary. To make the matter clearer, the vibration numbers of a diatonic scale started from  $\frac{3}{2}$  as a tonic are—

$$\frac{3}{2}, \frac{27}{16}, \frac{15}{8}, 2, \frac{9}{4}, \frac{5}{2}, \frac{45}{16}, 3.$$

In order to keep to the same part of the keyboard, let the last five notes be depressed one octave, and we get this series:—

$$1, \frac{9}{8}, \frac{5}{4}, \frac{45}{32}, \frac{3}{2}, \frac{27}{16}, \frac{15}{8}, 2,$$

where  $\frac{3}{2}$  is the tonic, and 1 or 2 the subdominant. A similar

explanation applies to the scale starting from  $\frac{4}{3}$  as tonic. With respect to the "comma of Pythagoras," I am not aware of any "generally adopted miscalculation." Who was the real discoverer of that interval is a matter of no consequence; but in a system such as the Pythagorean, which was tuned by true fifths, it would have been not only a very natural but an essential inquiry, "What definite number of fifths corresponds with another number of octaves?" This, without at all necessitating the supposition of the existence among the Greeks of instruments of an immense range in octaves, would be but an easy arithmetical calculation resulting necessarily in the conclusion that there was no exact coincidence between fifths and octaves, but that twelve fifths differed by a very small quantity from seven octaves. This small difference is therefore very aptly termed the Pythagorean comma. Now in the equal temperament system twelve fifths just coincide with seven octaves, so that the despised comma of Pythagoras is really a measure of the error of the equal temperament fifth. In fact, putting P for the comma in question—

$$P = \left(\frac{3}{2}\right)^{12} 2^{-7} = 2^{1/4} = \frac{3}{2} P^{-1/4}$$

so that if 2N be the vibration number of the lower tone of an E T fifth, that of the upper tone will be  $3NP^{-1/4}$ , which is in error by  $3N(1 - P^{-1/4})$  vibrations, giving rise to a number of

$$\text{Beats} = 6N(1 - P^{-1/4})$$

per second in the E T fifth. Not, however, that it is necessary to allude to Pythagoras or seven octaves to get those beats.

The grounds upon which Mr. Chappell declines to accept 24, 27, 30, 32, 36, 40, 45, 48, as representing the vibration numbers of the diatonic scale are not very clear, certainly; and repudiating these, he can of course have no sympathy with Colin Brown's keyboard.

To revert shortly to this, the subject of my previous communication,—in his new and very interesting work on "Temperament," Mr. Bosanquet has given a description of Colin Brown's keyboard, but in so peculiar a manner that it is really difficult to recognise the instrument at all, and neither its elegance nor simplicity are brought out as I think they should be.

A. R. CLARKE

Ordnance Survey, Southampton, January 9

South Polar Depression of the Barometer

I THINK it probable that on this subject Mr. Murphy's views and my own might have appeared more in harmony if we had neither of us expressed them with so much brevity. In my letter on Ocean Currents in NATURE, vol. xv. p. 157, I was incidentally led to speak of the barometric depression found the South as greater than that round the North Pole. In speaking



of this superiority as "mainly due to superior evaporation in the water hemisphere generally," it did not occur to me that I could be misunderstood to mean that the excessive depression in high south latitudes is due to excessive evaporation taking place *within those latitudes*, an idea which, with Mr. Murphy, I regard as absurd.

The large areas of depression which the American meteorologists have termed the "Polar Cyclones" appear, on examination, to be themselves aggregates of those local depressions, or cyclones, which have penetrated either into the Arctic or Antarctic regions, and have there, either partially or wholly, coalesced. Local depressions starting from the edges of the great areas of excessive evaporation seem to be governed in their course by the distribution of relative humidity, and to be determined towards those districts in which precipitation is most in excess of evaporation. Consequently their forward development is, as a general rule—a rule to which there are in the northern hemisphere many important exceptions—somewhat towards the poles. As they advance between converging longitudes they commonly expand, and therefore become united, while the influence of the earth's rotation deflects their circulating currents further away from the points of lowest pressure. Mr. Murphy's view that the imperfection of the Arctic as compared with the Antarctic depression, is due to the amount of land in the northern hemisphere, and the local air-currents produced thereby, is not in opposition to my argument. Undoubtedly over Greenland the anticyclonic circulations predominate (except in the summer quarter) over the cyclonic. It is not improbable that somewhat analogous irregularities of pressure dependent on the distribution of land and sea may exist in high south latitudes. But I still think that it is to the middle latitudes of the two hemispheres that we must look in order to find the chief cause of the contrast between the Antarctic and Arctic depressions, for it is in the middle latitudes that the majority of the local depressions originate. In the southern hemisphere those latitudes are almost entirely occupied by surfaces in which evaporation is excessive. In the northern they are represented to a large extent by areas of relatively slight evaporation and predominant precipitation.

The correlation of wind and pressure-distribution is of a kind which can hardly be stated at the same time briefly and correctly. But if it is necessary to be concise, it seems more natural in every case to regard the distribution of pressure as the primary cause of the wind than to say "the cause of the depression round the Pole is the centrifugal force of the west winds."

Lutterworth, January 9

W. CLEMENT LEY

#### Sense of Hearing, &c., in Birds and Insects

MR. ROMANES (*NATURE*, vol. xv., p. 177) is not quite correct in supposing that the Death's Head is the only species of *Lepidoptera* known to "stridulate." Possibly the phenomenon is far more general than is commonly believed, although only few instances of its occurrence have been observed. In the current number of the *Entomologist's Monthly Magazine*, Mr. Swinton details the method in which a sound is believed to be produced by *Vanessa io* and *V. urticae*, viz., by friction of a nervure of the hind-wings against a "fled" nervure in the fore-wings. *Chelonia pudica*, one of the tiger-moths, has long been known to produce a sound (cf. Solter, *Annales Soc. Entomol. de France*, 1837). In 1864, Guenée (*Ann. Soc. Fr.*, pp. 398-401) notices that the genus *Setina* possesses a tympaniform organ on each side of the breast, analogous to that found in the *Chelonia*, and in the same volume he is followed by Laboulbène, who gives an elaborate anatomical description of the organ in *Chelonia*, with figures (pl. 10). Another tiger-moth (*Euprepia matronula*) is said to stridulate (cf. Czerny, *Verhand. zool.-bot. Vereins in Wien*, 1859); and the existence of the phenomenon is (at least) suspected in members of other groups of *Lepidoptera*.

Without being able to prove it, I suspect that birds obtain a knowledge of the whereabouts of worms and subterranean larvae by sight, and not by sound. In the case of the thrush, I think the excrement rejected to the surface guides the bird to the right spot. The starling during breeding-time feeds almost exclusively on the larvae of *Tipula*. Here, again, I think it is sight, and not sound that aids the bird. True, in this case there is no rejected excrement on the surface, but there is something that may be equally significant to the eye of the bird, viz., the withered condition of the plants of grass, &c., telling a tale of the mischief that is going on below. Furthermore, it is not possible that if the movements of the larvae below the surface cause sufficient sound to be heard above the surface, the move-

ments of the bird should act as a warning, and cause the larva to cease feeding? The withered plant tells its own tale; if only flagging, but yet with some amount of vitality in it, the chances are that a larva is still at work at its roots; if entirely dead, then the larva has departed for another plant.

Confessedly in the case of the curlew and allied birds, the matter becomes very difficult of explanation, owing to the depth below the surface at which the food is found. But do these marine and other worms always keep at the depth to which the bird is obliged to penetrate in order to obtain them? *Solen* is believed to remain near the surface until warned that an enemy is near, when it descends with rapidity. The worm might also be ordinarily near the surface, and the slight movement thereon caused by its endeavours to bury itself deeper might result in its destruction. I throw this out as a suggestion, because it is hard to believe that sound produced by the movements of an annelid could be transmitted through nearly a foot of sand. There is yet another difficulty. In the case of the curlew the sound would have to travel nearly a foot above the surface before it reached the auditory organs of the bird.

Lewisham

ROBERT M'LACHLAN

#### THE "CHALLENGER" COLLECTIONS

THE following "Preamble" to a list of observing stations, printed for the use of the naturalists engaged in preparing the account of the voyage, contains so much likely to interest naturalists generally that we think it useful to publish it in *NATURE*:—

The special object of the *Challenger* Exploring Expedition was to investigate the physical and biological conditions of the great ocean basins; and with this object in view, during an absence from England of three years and a half, and at intervals as nearly uniform as circumstances would permit, throughout a course of 68,890 miles, 362 observing stations were established.

The following list of these stations has been compiled for the use of those naturalists who have consented to assist in the working out of the scientific results of the expedition, with a view to their being published in an official account of the voyage. Interesting observations were made on land as opportunity occurred during the short periods of the *Challenger's* stay in port, and during her short visits to remote islands; but these observations were necessarily desultory and incomplete, and it has been decided to omit their consideration from the present work, and to publish such as may appear of sufficient value in the transactions of learned societies. The Official Report will thus consist strictly of an account of the additions which have been made to the knowledge of the physical and biological conditions of the ocean by the expedition.

At each station the following observations were made, so far as circumstances would permit. The position of the station having been ascertained—

1. The exact depth was determined.
2. A sample of the bottom averaging from 1 oz. to 1 lb. in weight was recovered by means of the sounding instrument, which was provided with a tube and disengaging weights.
3. A sample of the bottom water was procured for physical and chemical examination.
4. The bottom temperature was determined by a registering thermometer.
5. At most stations a fair sample of the bottom fauna was procured by means of the dredge or trawl.
6. At most stations the fauna of the surface and of intermediate depths was examined by the use of the tow-net variously adjusted.
7. At most stations a series of temperature observations were made at different depths from the surface to the bottom.
8. At many stations samples of sea-water were obtained from different depths.
9. In all cases atmospheric and other meteorological conditions were carefully observed and noted.

10. The surface current was determined as far as possible.

11. At a few stations an attempt was made to ascertain the direction and rate of movement of water at different depths.

The numerical results of observations yielding such are now available in the logs, in the various reports of the Admiralty, and in the note-books and official journals of the naval and civilian scientific officers attached to the expedition.

The samples of the bottom procured by the sounding-instrument were carefully preserved in tubes or in stoppered bottles, either dry; or wet, with the addition of alcohol.

The samples of bottom and intermediate waters were determined as to their specific weight; in some samples the amount of carbonic acid, and in others the amount of chlorine, was determined; in others the contained gases were boiled out and sealed in tubes for future examination; and a large number of samples were reserved in stoppered bottles for analysis.

The mud and minerals and inorganic concretions brought up by the dredge or trawl were preserved in large quantity in boxes or jars for examination and analysis.

The collection of invertebrate animals is of great extent; and from most of the species being undescribed, and from the great peculiarity of the distribution of the fauna of the deep sea, it will perhaps yield the most generally interesting results.

The invertebrate animals from the deep-sea stations were, with few exceptions, placed in jars of rectified spirit, closed with stoppers smeared with a mixture of tallow and wax, covered over with bladder, and the tops painted with a black varnish. The animals of different groups were in many cases roughly selected at each dredging, and put into different jars; but frequently, in order to save jars and spirit, it was necessary to put the whole result of one dredging into one or two jars, the animals of all groups mixed. Each jar was marked outside with the locality and the number of the station; and the station number, written with a black pencil on a slip of parchment, was placed *within* each jar. The collection on its arrival in this country was thus arranged geographically. It came home in most excellent order.

To insure accuracy so far as possible, the observing stations have been numbered from 1 to 354, and a number corresponding to the station is on every sample of every description, and on every record of the result of observations for every station; and the same number is carried through the whole series of journals and other books kept by the members of the Civilian Scientific Staff.

It is now our object, in preparing a scientific account of the voyage, to describe these investigations, and to give their results in detail; and to develop, as far as possible, the bearings of these results upon one another, and upon the broad problems of physical geography and hydrography.

For this purpose it is necessary that the various numerical results should be reduced and tabulated; that the samples of soundings should be examined chemically and microscopically; that the samples of water and of air should be analysed; and that the animals procured by the dredge should be most carefully catalogued as to localities, and the forms new to science described.

The data for the physical and chemical work are in few hands, and these chiefly at head-quarters. It is especially for the assistance of the naturalists dealing with the deep-sea fauna that these notes are drawn up.

Prof. Agassiz, Mr. Murray, and I have now gone over the whole of the collection of marine invertebrate animals in spirit, and we have separated the zoological groups from one another for each station, and re-arranged the

collection in zoological order. Each jar, therefore, now contains animals of one group only (*e.g.* Ophiurids or Alcyonarians), to be described by one person. Each jar has within it a station number, which refers to the specimens which are loose in the jar; but in many cases, to save space, and to lessen the number of large jars, there are in the same jar several packets done up in muslin, each packet containing animals of the same zoological group from another station, and each packet having within it its own station number.

The jars will be placed in the hands of the naturalists who undertake the description of the different groups in their present condition; and in order to secure uniformity and the safety of the collection, they are requested--

1. To go carefully over the whole collection intrusted to them, and to select a first series, including all unique specimens and a sufficient number of specimens of those of which there are several duplicates, to illustrate their geographical distribution; and to associate with each species a particular number, by which number that species may be always referred to afterwards—at all events, until it has been described and named. This is the collection which is to be described and figured, and it is ultimately to be placed as a collection of types in the British Museum. It will usually be desirable, for the purposes of description and illustration, to put the specimens of the first series into rectified spirit in clear glass bottles; and I will arrange in each case how the bottles are to be provided and the expense defrayed. This collection must be retained by the describer until the description of the whole is finished.

2. To select at the same time a second set, consisting of a complete series of duplicates, numbered to correspond with the numbers attached to the first series species for species, and to pack them either in separate bottles or in packets in muslin, a number of packets together in one store bottle. This set to be returned to me for reference.

3. To pack up again all the duplicates from the different stations, each species from each locality either in a separate bottle or in a muslin packet, with the station number and the number corresponding with the type specimen of the species along with it. It will greatly facilitate matters if this general duplicate collection is returned to me along with the first series of duplicates, whenever the collection has been gone over, and the first series for description selected out.

4. For easy reference, each naturalist who undertakes the working out of a group will be provided with a large number of small vellum labels, marked thus:—

Ast.	---	(Asteridea.)
St	---	(Station.)

and he need simply enter, *with a dark pencil*, the number which he has associated with the particular species, and the number of the station where the specimens were found; and put the label *into* the bottle or the muslin bag, as the case may be.

Special arrangements must be made in every individual case as to publication, but it is the general intention that the account of the voyage shall be in a series of volumes quarto, of the size of the *Philosophical Transactions* of the Royal Society. It will probably consist of—

1. Two volumes, containing—(1) such a general account of the voyage, and such hydrographic details, illustrated by charts and sections, as may be necessary for the clear comprehension of the scientific observations; and (2) a full discussion of the general results of the voyage, physical and biological. To these volumes will be appended tables of the routine observations in meteorology, &c., made during the voyage.

2. A volume containing an account of the physical and chemical observations and investigations, with a special discussion thereon. To this volume will be appended tables of analysis, tables of specific gravities, reports on the microscopical examination of minerals, &c.

3. A series of volumes, probably not less than six in number, containing a detailed account of the fauna, and plates illustrating the undescribed or imperfectly known forms.

In case of plates being required, the space available for figures on each plate is not more than 11 by 8½ inches (= 28 by 12½ centimetres). It is intended that the plates shall be, generally speaking, in lithograph; but if any form of engraving seem preferable in any case, a special arrangement may be made. Woodcuts will be given where required.

I undertake the editing of the work, and all manuscripts and proofs of plates are to be sent to me.

All packages and letters to be addressed—

Professor Sir Wyville Thomson, F.R.S.,  
University,  
Edinburgh.

and marked "Challenger."

The intention at present is that the preparation of all the volumes shall go on simultaneously, and it is earnestly desired that the different parts may be done as speedily as is consistent with the utmost care and accuracy. Authors are invited to enter into any anatomical or other details which may be desirable for the full illustration of the groups in their hands; and their full consideration is particularly requested of all questions bearing upon geographical distribution, and upon the relation of the deep-sea fauna to the fauna of the later geological periods.

Authors will be at full liberty to publish abstracts of the results of their work during its progress, in the proceedings of Scientific Societies; but such communications should be made through me or with my knowledge, and "by permission of the Lords Commissioners of the Treasury."

I am directed to report to Government and to furnish my accounts at certain intervals; and in order that I may be able to do so, authors are requested to report progress and to render accounts and vouchers for any expenses which they may have incurred, to me quarterly; on or before the 1st of March, of June, of September, and of December.

In the following list of stations—

1. The number is given by which each particular station is referred to throughout. The first eight stations, to which Roman numerals are attached, are to be considered in a certain sense preliminary; the regular series commences with Station I (*bis*) on the 15th of February, 1873, and is indicated by Arabic numbers up to 354.

2. The date is given.

3. The exact position of the ship at noon of the day on which the observations were made.

4. The depth in fathoms (= 6 English feet).

5. An abbreviation, as it is given on the chart, indicating the nature of the bottom:—

r. (rock) indicates hard ground, where nothing was brought up by the sounding instrument, there being at the same time evidence that the tube had reached the bottom.

m. (mud), a material varying in colour, but derived chiefly from the disintegration of the land.

gl. oz. (Globigerina ooze), a white or greyish deposit formed in a great measure of the shells, entire or broken, of foraminifera belonging to the genera *Globigerina*, *Orbulina*, *Palmulina*, and *Hastigerina*, usually with a quantity of amorphous calcareous or earthy matter, and many coccoliths.

di. oz. (diatom ooze) indicates a deposit formed to a

great extent of the frustules of diatoms which have sunk from the surface.

rad. oz. (radiolarian ooze) indicates a deposit composed mainly of the skeletons of *Polycystina* and other Radiolarians.

r. cl. (red clay) indicates a deposit, very widely extended in deep water, of red, reddish, or grey aluminous mud, such as would be produced by the decomposition of a felspathic mineral. This deposit varies considerably in character; it seems to be derived from several sources, but one of the most important of these appears to be the decomposition of pumice and other volcanic products. The "red clay" often contains concretionary nodules, consisting chiefly of the oxides of manganese and iron.

gr. oz. (grey ooze), and gr. m. (grey mud), usually indicate an intermediate condition between *Globigerina* ooze and red clay, or in some cases a fine-grained grey deposit, formed in deep water, chiefly of land *Albris*.

The positions of the stations are shown on the accompanying chart.

C. WYVILLE THOMSON  
Edinburgh, January 2

#### PROF. AGASSIZ ON THE "CHALLENGER" COLLECTIONS

PROF. AGASSIZ, who has come to this country for the express purpose of examining the *Challenger* Collection, has kindly sent us the following notes on what he has already seen:—

I have seen a great many alcoholic collections of marine animals made by direction of different government expeditions, and in no case have I seen one in a better state of preservation, or where greater care had been taken to insure the accuracy of the locality. Those who work up the material will have the double advantage of working on admirably-preserved collections, and of being absolutely certain of the exact locality of their specimens. Sir Wyville Thomson has already called attention, in his Preliminary Reports to the Royal Society and his Lecture before the British Association at Glasgow, to many of the most interesting things collected, and he has also alluded to the amount of the material brought together. I may perhaps give a better idea of the magnitude of the collections by stating that if a single individual, having the knowledge of the eighteen or twenty specialists into whose hands the collections are to be placed, were to work them up, he would most certainly require from seventy to seventy-five years of hard work to bring out the results which the careful study of the different departments ought to yield.

We may assume that the work of the *Challenger* has probably accomplished for the depths of the ocean in general what the American and English expeditions of 1866-1869 did for the North Atlantic, for it certainly is remarkable how much these expeditions, working over a comparatively limited area, contributed to the knowledge of the deep-sea fauna, and how little of novelty has been added by the subsequent and more extended work of the *Challenger* over the same ground. Judging from these premises, we may fairly say that hereafter, while any new expedition will undoubtedly clear up many of the points left doubtful by the *Challenger*, and may carry out special lines of investigation only partly sketched out, yet we can hardly expect them to do more than fill out the grand outlines laid down by the great English expedition.

To attain the best possible results it is of the utmost importance that the collections brought home should be placed in the hands of specialists who are thorough masters of their respective departments. The scientific public will therefore bear with the greatest satisfaction that the Government has left the collections in the hands of Sir Wyville Thomson, who is to direct the publications until the whole of this invaluable material is thoroughly worked out.

REMARKS ON THE NEW MONOTREME FROM NEW GUINEA

A FEW weeks ago we announced to our readers the remarkable news of the existence of a mammal of the order Monotremata in New Guinea. The receipt of a separate copy of the description of this animal, just published by Dr. W. Peters and the Marquis G. Doria,<sup>1</sup> enable us to give a few more particulars of what must be universally regarded as one of the most important zoological discoveries of the period.

Mr. Bruijn, of Ternate, to whom science is indebted for our first acquaintance with this novelty, gives the following details of its discovery in a letter to the Italian naturalist, Dr. Beccari:—

"Two years running my native collectors have brought me word that, according to the Papuan mountaineers, there are a good many mammals in New Guinea, but that they are only hunted there when they are required for food. At first I did not place much confidence in these stories, because I know the little value of the reports of the hunters and the natives in general. Nevertheless, I have always told them to look carefully for mammals. The last time they set out I told them, in order to stimulate their zeal, that I knew that a certain animal existed in New Guinea of which I showed them a figure, and that I wished to have it at any price, hoping that in searching for it they would, perhaps, find other new or little-known species. The figure which I showed to Joseph and the other hunters was that of an *Echidna*.

"This year (1876) my men ascended a peak of the Arfaks called Mickirbo, and halted at a spot about the same height above the sea-level as Pjobjeda. Here Saleh entered a hut where a piece of a skull of a mammal was offered to him, which he at once thought belonged to the animal which I required. He accepted it and forthwith commenced interrogating the Papuan who had given it to him. The latter told him that the skull belonged to an animal with four legs, with a tail, as large as a dog, and with long harsh fur; he added that these animals were not uncommon on Mount Arfak, and concealed themselves in small caves, and that the Papuans hunted them with dogs, being very fond of their flesh. The skull in question belonged to an animal that had been killed about a month before. Acting upon this information, Saleh set to work to hunt for this animal, but without success. It was only after he had descended from the mountains that a second skull was brought to him, which was still stinking from the fragments of rotten muscles attached to it."

One of these two crania reached the Museo Civico di Genova, in November last, and constitutes the material upon which Messrs. Peters and Doria, who are engaged on a joint memoir upon the Mammals and Reptiles of New Guinea, have founded their *Tachyglossus*<sup>2</sup> *bruijnii*.

It will be observed that this skull, of which a figure is given herewith (Fig. 1), copied from that of Messrs. Peters and Doria, wants the greater part of its posterior

portion, and also the lower jaw. But it is quite perfect enough to enable one to see at a glance that the species must be quite distinct from the Australian *Tachyglossus hystrix* and *T. setosus*. In the first place the size of the skull is much greater, and the rostrum of the new species is longer by one half, measuring in total length about 6.4 inches, instead of 4.2 inches, as in the Australian animal,<sup>3</sup> of which a skull is represented (Fig. 2) for comparison. Again, in the Papuan species, the rostrum is

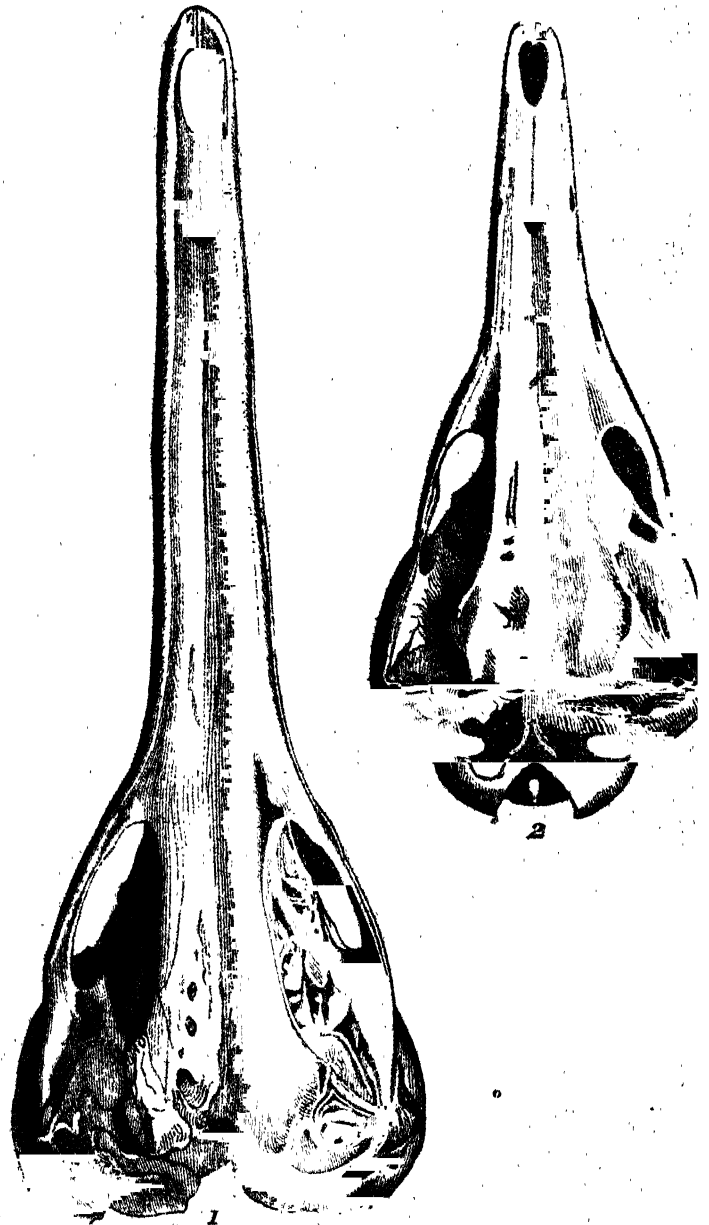

FIG. 1.—Skull of *Tachyglossus* of New Guinea. FIG. 2.—Skull of *Tachyglossus* of Australia.

curved downwards throughout its length, which is not the case in the Australian forms. Other minor differences are pointed out by Messrs. Peters and Doria in their excellent description, which we need not repeat here. It is quite sufficient to compare the outlines of the two skulls together to convince oneself that the newly-discovered

<sup>1</sup> W. Peters e G. Doria: "Descrizione di una nuova specie di *Tachyglossus* proveniente dalla Nuova Guinea settentrionale." *Ann. Mus. Civ. di Nat. di Genova*, vol. ix. (December 3, 1876)  
<sup>2</sup> The "Spiny Ant-eater" of Australia is usually called *Echidna* in scientific nomenclature, but Messrs. Peters and Doria reject this term in favour of *Tachyglossus* of Illiger, because *Echidna* was previously applied by Foster in 1779 to a genus of fishes.

<sup>3</sup> It is not known to which of the two Australian species this skull belongs but they are closely allied, and as regards size there is little if any difference between them.

animal must belong to a much larger and quite distinct species, of which we trust it will not be long before perfect examples are received in Europe.

The significance of the discovery of a species of *Tachyglossus* in New Guinea will be appreciated when we consider that hitherto the Monotremes or Ornithodelphs, which, according to the most recent authorities, constitute not merely a distinct order, but even a separate sub-class of mammals, have been supposed to be at present exclusively restricted to Australia. The two only known genera of Monotremes are *Tachyglossus* (sive *Echidna*) and *Ornithorhynchus*. Of the latter the single known species is peculiar to South-Eastern Australia, of the former, the two species are found, one in South-Eastern Australia, and the other in Tasmania. The whole of the north and west of the Australian continent is, so far as we are at present informed, without any representative of this remarkable group. Looking at these facts, the discovery of a species of Monotreme in New Guinea becomes still more significant, and leads us to expect that when the mountain-ranges of Queensland have been further explored, some representative of the order may still be found lingering in this district, and uniting the newly-discovered area of distribution with that previously known.

Finally we may remark that the fundamental unity of the Papuan and Australian fauna was already sufficiently obvious by the existence amongst mammals of *Macropus* and amongst birds of such peculiar genera as *Orthonyx* and *Climacteris* in New Guinea. The discovery of *Tachyglossus bruijnii* is another confirmation of the correctness of this view, as regards zoology, though, as regards the flora of New Guinea, facts, we believe, point rather in another direction. P. L. S.

## ON THE TROPICAL FORESTS OF HAMPSHIRE<sup>1</sup>

### II.

It has been mentioned that in some of the clays remains of leaves, fruits, and flowers are met with, and I will now proceed to tell you something about them. There are some enlarged drawings here on the wall which I should tell you are not all enlarged to equal scale, and there are trays of specimens on the table.

These leaves are found in various conditions of preservation. In most cases the impression only of the leaves in the clay is met with, but in some cases they are so well preserved that the actual substance has been retained although chemical changes have altered its composition, and it will peel off and blow away. In some of the clays the masses of leaves are so decayed that they cannot be recognised, and are not worth our collecting.

Where the preservation is good we can readily distinguish the various original textures of the leaves by comparing their general aspect and colour both among themselves and with existing forms. For instance, those which are thick, such as evergreens, thin, as convolvulus, hard, such as oak, or soft, such as lilac, or even velvety, such as the common phlox, can all be recognised. Their colours, in most of the beds, vary from buff to brown, but I need hardly tell you that in no case have we any of the green colouring of the leaves preserved. Whilst these various shades of dark buffs and browns are in many cases the result of chemical change that has taken place after the leaf was covered up, yet I believe that in many cases this change had occurred, at least partially, before the covering up, just as we saw a few weeks ago the changed colours of the fallen leaves of autumn.

In the darker clays the remains are black and com-

pletely carbonised; where this is so the finer venation is indistinct and the remains difficult to save, so that we may discard them unless the outline of the leaf is of unusual form. The darker browns, I take it, indicate hard and evergreen leaves; for instance, the laurel-like leaves are always of a deep colour, whilst both the thin and the succulent leaves are always of light colour, as in the leaves which we suppose to be fig, some species of smilax, &c.

No other colours have been met with with one remarkable exception; fragments of a reed-like aspect are found of a deep violet, staining the surrounding clay mauve for a considerable distance.

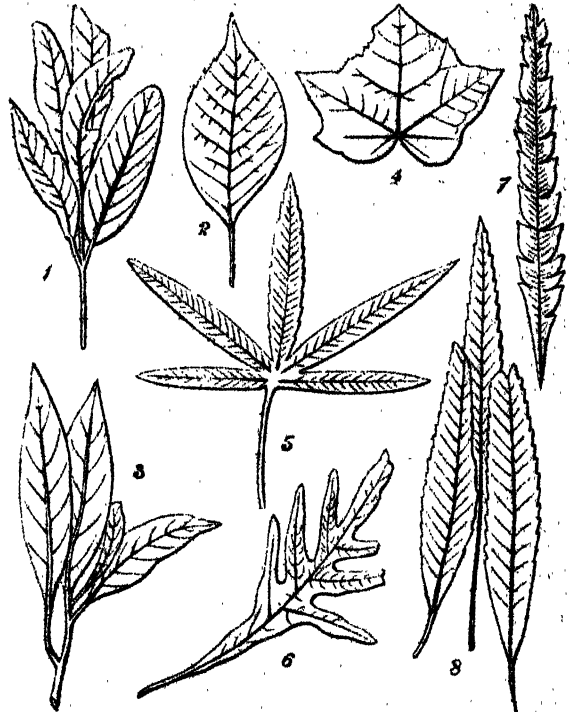

FIG. 4.—LEAVES OF DICOTYLEDONS, FROM THE LOWER BAGSHOT BEDS. 1 and 2, Fagus; 3, Laurus; 4, Acer; 5, Aialia (?); 6, Stenocarpus; 7, Dryandra; 8, Quercus.

I next call attention to the shapes of these leaves; the most cursory examination shows that the differences in shape are very great. Here are drawings of palmate leaves, leaves resembling in general shape the beech, the sub-tropical *Dryandra*, which, though unfamiliar, have been probably seen by most of you in the warmed houses at Kew; laurel-like leaves, a tropical kind of oak, maple, smilax, aralia, yew, palms, and a fern. These have been selected to show the great diversity in the shapes which existed.

Most people are familiar with the process of skeletonising leaves—that is, the removal of the green part, and the preservation of what is called the skeleton. I have here a large case of leaves so prepared by Mrs. J. E. Gardner, and which may be examined at the close of the lecture.

I would next draw attention to some leaves of trees which are well known as now growing in England. In these a continuation of the leaf-stalk can clearly be distinguished running through the leaf, which is commonly called the mid-rib. [The mid-ribs in two diagrams were coloured red.] Those running from the primary ribs are called secondary ribs (coloured blue). There are, again, running from these many smaller portions, which are called the network of the skeleton. In some, as, for example, the plane-tree, there are three primary ribs; in a few leaves

<sup>1</sup> Lecture in connection with the Loan Collection of Scientific Apparatus, given at the South Kensington Museum, December 2, 1896, by J. Starkie Gardner, F.G.S. Continued from p. 253.

there are more. In some, these principal ribs are very strong, and form prominent features; in others, as in the convolvulus, they are but slight. Some of these secondary ribs run straight to the margin, and in other cases they are curved. Again, in some they run right out to the extremity of the margin, as in the elm; and in others they are curved back, as in the fig. These are things to be noticed, which it will be seen are of consequence.

I wish now to refer to the character of the margins of the leaves. Here is a drawing of a fig leaf in which a perfectly smooth margin will be observed; whilst the elm is saw-like, or serrated, as botanists call it. In the dryandra the margin is deeply notched, whilst in a strange-looking form (*Stenocarpus*) the edge is markedly lobed; in the case of some palmate leaves the edge is smooth, as in the passion-flower, or serrated, as in the fossil aralia. Those who have paid any attention to leaf form, have no doubt observed that leaves, even from the same plant, differ in some of these characters. This constitutes one of the greatest difficulties which presents itself to the botanist, in the endeavour to decide by comparisons to what plants the fossil remains probably belonged. Still, there are numbers of specimens with which we have to deal presenting forms so unmistakably alike that we are able to group them together; and even putting on one side many fossil forms about which we must feel considerable hesitation, there still remain a vast number about which we can feel little hesitation as to the value of the comparisons.

It is worth while to point out that when we compare these leaves with the existing flora and contrast in like manner the plants of the coal period with the existing vegetation, we see that there is a much closer resemblance between these plants and the present plants than there is in the case of coal plants. That is, that in these forms we have a nearer approach to the existing state of things than there was in the coal period, a matter which, in viewing the evolution of plant life, cannot be overlooked, whatever may be the value to be set on such evidence. Those who know anything of the plants of the coal period are aware that we find there gigantic forms of which we have only dwarf representatives at the present time. The principal of these forms are gigantic horse-tails or Equisitaceæ, great lycopods, as the *Lepidodendron* and *Sigillaria*, and tree-ferns, all very unlike the representatives of these groups now living. Here, however, the resemblances to the existing vegetation is close, not only in the arrangement of the ribs, but the size of the leaves, and also in those cases where we have groups of leaves joined by twigs, the method of attachment is similar.

To determine to what kind of plants each of these leaves belongs is a matter of considerable difficulty and requires an extensive knowledge of the plants now living on the earth. Although we have collections of growing plants from different parts of the world in various conservatories, such as at Kew, it is on the dried specimens brought home by travellers, or sent from abroad, that we mainly have to depend. How frequently leaves closely resembling each other but belonging to plants of widely different kinds are met with, the careful student of botany knows well. It requires a comparison by a skilled eye of the most minute details to arrive at conclusions on which any reliance may be placed.

The work of comparison of this immense number of leaves is necessarily a work of considerable time, and is still in progress, but some conclusions have already been arrived at. I call your attention to a large group of growing plants, from the conservatory of Mrs. J. E. Gardner, which illustrate the kind of foliage existing in England in the Eocene time. Those who have paid attention to this subject will not doubt that these are palms; these are unmistakable ferns; botanists are agreed that this form is undoubtedly referable to the

group to which *this* dryandra belongs; this may with almost certainly be referred to the beech tribe; this doubtless belongs to the same tribe as the pea; this is an aralia; this an acer or maple; this a laurel, and this a yew. Specimens of elm, acacia, chestnut, great aroids, as well as hundreds of other forms, have been obtained, some of the comparisons of which have already been determined, and some few are of forms which appear to have no living analogies whatever. There are also countless fruits, many of which can be recognised as like those now existing; a few flowers too have been met with. These fruits are of great assistance in telling us what plants were living at the time, as they are compared with greater certainty than the leaves can be.

I have mentioned the cabinets in the Loan Collection; close by is a cabinet which contains the collection made by Baron von Ettingshausen, and although time does not permit me to do more than allude to them, I would just mention that collections of an approximately similar geological age have been made from Switzerland, Italy, Greenland, and Austria, so that taking together all these localities we get a fair notion of what was the vegetation of the period which geologists call Eocene. You must remember geology is a study only of this century. Interest, at first small, spreads now over all Europe, and gradually records of past vegetations of different ages are being brought to light and compared.

I would say a word or two by way of explanation of the origin of the different colours of the sands and clays which have been mentioned. The yellows, buffs, and reds, which form the prevailing colours of the lower series, owe their origin to iron in various chemical conditions. The granite from which they were derived contains sufficient iron to account for iron being in solution in the streams by which they were deposited. The different colours of the different oxides of iron are here shown. The anhydrous sesquioxide is of a deep tinge: the hydrous sesquioxide gives a yellow colour. [A successful experiment was then made with a large glass jar of rain-water with dissolved grey granite held in suspension. To show the amount of iron present in the granite, a little ammonia was added, which changed it to a dark colour. The green oxide thus obtained would, on evaporation of the water, take another degree of oxygen and change to a bright red sesquioxide. This red oxide was produced in a second jar, and shown to be the same as the colouring matter of the red clays.] De la Beche, in his researches in theoretical geology, alludes to the fact that pipe-clays of similar colours are now being deposited in some of the lakes of North America.

Whilst some of the dark colouring of the darker clays is due to iron, that of some of the middle clays may be due to the fact that, whilst these beds were being deposited, the source of the stream was coming from a district farther north, cutting perhaps across the Somersetshire and Gloucestershire coal-field.

The question may perhaps have presented itself to your minds—how is it possible that the tropical forms of which we have spoken, such as the palm, aroids, cactus, &c., could have grown alongside of the apparently temperate forms, such as the oak, elm, beech, and others. Time does not allow that I should go at any length into the explanation of this; but I may just remind you that in the long geological record of the beds found in England, there are to the geologist unmistakable indications of many changes in climate. Further, astronomers, having calculated the path of the revolution of the earth in ages past, tell us that in successive periods, each consisting of about 26,000 years, each hemisphere, northern and southern, has been successively subject to repeated cyclical changes in temperature. There have been for the area which is now England many alternations of long periods of heat and cold. Whenever the area became warmer, the descendants of semi-tropical forms would gradually

creep further and further north, whilst the descendants of cold-loving plants would retreat from the advancing temperature. *Vice versa*, whenever the area became gradually colder, the heat-loving plants would, from one generation to another, retreat further and further south, whilst the cold-loving plants would return to the area from which their ancestors had been driven out. In each case there would be some lingering remnants of the retreating vegetation (though perhaps existing with diminished vigour), growing alongside of the earliest arrivals of the incoming vegetation. Such is a possible explanation of our finding these plant remains comingled together. It must, too, be borne in mind that it is not so much the mean temperature of a whole year which affects the possibility of plants growing in any locality, as the fact of what are the extremes of summer and winter temperature. For example, one place may have a mean winter temperature of 50°, and a summer one of 70°; while another place might have a mean winter temperature of 20°, and a summer one of 100°, and yet both have a mean annual temperature of 60°. In Cornwall the maiden-hair fern grows in sheltered localities, because the winter tempera-

result only in disappointment; either the clay turns out to be too sandy, and the impressions valueless; or it contains nothing; or it is found, accessible. But supposing well-rewarded the search, a secure footing has first to be cut with a light pickaxe; then the sands or clays overlying the leaf-bed have to be removed by spade and pick—real navy's work this—then to get out blocks large enough to contain the palm-leaf shown in this drawing, which is only enlarged twice, the leaf-bed has to be undermined to a depth of five or six feet, a difficult operation requiring patience, and the then hanging mass of clay has to be cut off with the pick, being too plastic to break away by its own weight. When nearly cut through, it gradually breaks away, and falls gently on to the platform prepared for it underneath. The blocks thus obtained are sometimes too large for three or four men to tilt over. The method is then to leave them to dry, as when wet the clay will not split to disclose the leaves. It is then, I can assure you, that I esteem myself fortunate if some too curious excursionist, or enthusiastic townsman, does not arrive during my absence with a hammer to break the blocks up. So great has been the curiosity excited, that fossilizers have so far forgotten their sense of justice as to get up at day-break to appropriate the result of my work had not the faithful coast-guardsmen, with a keener sense of justice, been near.

Wet weather of course puts a stop to operations, and buries the working in mud and sand, sometimes two or three feet deep even in a single night. When the workings are as far off from your headquarters as at Poole Harbour, and the specimens heavy, a boat is necessary to convey them home. The most enjoyable moments are, perhaps, those occupied in splitting the blocks, as one then shares what I should suppose to be the excitement of gold-workers, except that gold-finding must be more monotonous, as in this case no one can say what sort of treasure may reward us next. Anyhow, it is a recreation strongly to be recommended to those who like healthy exercise, freedom, and the sea.

[A large and heavy block of matrix was then split, in illustration of this part of the lecture, and a layer showing hundreds of leaves, exposed for the first time to view.]

I have now endeavoured to give you as accurately as I can, the absolute facts as far as we can learn them, respecting the conditions under which these beds were deposited, the sources from which the material was derived, and so far as we can tell, by comparison with existing vegetation, what were the trees of which these leaves are the records, and also the climatal conditions under which they grew. We may now, in conclusion, allow our imagination to come into play, a scientific use of the imagination, I hope it is, while we picture to ourselves the appearance of this area during the time these beds were being formed. The changing force of the streams and their directions varying from time to time would, as we have already said, frequently undo the work of accumulation which had been previously done.

We have reason to believe that there was here a width of valley closed in to the north by the chalk hills which are still represented by the chalk range of North Hampshire and Wiltshire, and on the south and east by accumulations forming the lagoon barrier of which I have spoken. The course of the stream was from west to east. To the east was the sea, to the west was the valley of the stream, about some of the conditions of which, necessarily uncertain, in consequence of the changes from upheaval and denudation, which have extensively modified that district. When the streams were from the valley swollen they moved along at a rapid rate away previously deposited beds and also coarse quartz grit and blocks.

were not so violent then there were doubtless frequently

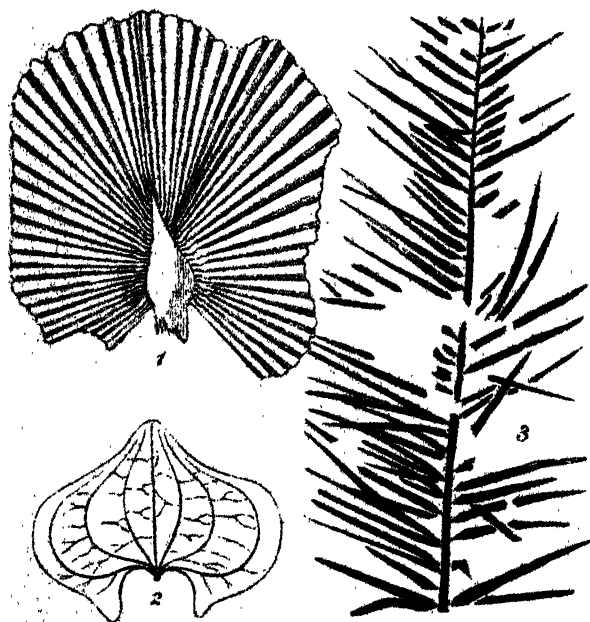

PL. MONOCOTYLEDONS, FROM THE LOWER BAGSHOT BEDS.  
1, Fan Palm; 2, Smilax; 3, Feather Palm.

ture never sinks to the point that would cause its destruction. Again, at that most charming spot in the west of Ireland, Glengariff, the arbutus still forms an abundant underwood; and the Irish filmy fern flourished in many favoured spots until quite recently, when the modern, too comfortable Eccles Hotel has retained tourists in the district, who have ruthlessly carried off, as reminiscences of a pleasant holiday, this which was one of the most attractive features to the botanists.

These facts, which seem so simple when laid out in diagrams, are the results of long-continued and careful work; but you may take my word for it, having enjoyed the during my holidays for many summers, that fossils is a fine, healthy and active exercise. this particular district, let me tell you some of mees. Fossils are not to be obtained here without hard work; the steep and crumbling cliffs have to be climbed, and most diligent search has to be made for indications of them. Fifty times, perhaps, the cliff may be laboriously scaled to examine what appears from the beach to be a promising-looking patch of clay, to

repeated scenes such as I will now attempt to describe to you. In this ideal picture I have endeavoured to depict what I consider to have been the state of things. Here we have the valley of the river some six or seven miles broad. The streams reduced to streamlets meandering through dried and barren sand-banks. Among them are more elevated patches—*islands*, if we may use the term—*islands* standing up from the general expanse of sand, and in some cases actual islands in the sense that they were surrounded by water. Here and there pools of water, some almost stagnant, others fed by minute streamlets.

Looking at the scene from a southern standpoint we should see to the north the distant chalk range. Whilst along the shore of the opposite bank of the valley we could with some difficulty detect the various forms of vegetation, which we should see with greater clearness in the more immediate foreground. In this valley a singular stillness must have prevailed, as no trace of animal life whatever has been found, except a feather and a few insect wings blown in from the southern bank.

Of the following at least we are pretty sure, and of numerous others we can be almost sure, but there are indications of very many besides, the relationships of which are at present but imperfectly defined.

Here we should see the graceful fan-palm and the feather palms, adding softness to the view by their elegantly-curved and drooping leaves, laurel and dwarfed oak, stately beeches, clumps of feathery acacia, trellised and festooned with smilax; the trailing aroid, with its large and glossy foliage and an undergrowth of *Mimosa* and of cypress in the swamper ground, and variations in colour caused by the foliage of cinnamon and fig, and the ground clothed with ferns and sedges. On the barren sands of the distant valley are growing clumps of giant and weird-looking cactus. It is not difficult to picture to ourselves the view. (See Fig. 2.)

All this beauty is gone. We have nothing but these records of what must have been a view of great loveliness, which only the toil of the geologist can even faintly reproduce.

"The hills are shadows, and they flow  
From form to form, and nothing stands;  
They melt like mist, the solid lands,  
Like clouds they shape themselves and go.

"There rolls the deep where grew the tree.  
O Earth, what changes hast thou seen!  
There where the long street roars, hath been  
The stillness of the central sea."

#### THE REPORT ON THE AUSTRIAN "NOVARA" EXPEDITION

A FEW days ago Admiral v. Wüllerstorff Urbair, late Commander-in-Chief of the Austrian *Novara* Exploring Expedition, had an audience of the Emperor to present to his Majesty this final report on the scientific results of this great exploring cruise round the world. It has required about seventeen years' serious labour, and has cost nearly 13,000*l.* sterling to complete this important scientific work, embracing 18 vols. 4to. and 3 vols. 8vo., and containing the anthropological, botanical, geological, zoological, physico-nautical, statistico-commercial, medical, and descriptive parts.

The narrative of the expedition, written by Dr. Karl von Scherzer (an author also well known in England, and at present attached to the Austro-Hungarian Embassy in London), has met with such a success that five editions have been published and more than 20,000 copies sold.

The most interesting of the purely scientific publications is the geological part, by Dr. Hochstetter, which gives the most complete description of the geology of New Zealand, the author having been the first naturalist who thoroughly explored these antipodean islands, and he has

carefully examined and described its gold and coal deposits. The statistico-commercial part, by Dr. Karl von Scherzer, has become quite a standard book on the Continent.

The price of the complete series being very high (39*l.* florins, or nearly 40*l.* sterling), the Emperor has given permission that a considerable number of copies of this most valuable publication should be given away to public institutions and libraries in the empire, as well as in foreign countries, and as the *Novara* has met with a particularly kind reception in the British colonies, the libraries of these have been considered first in the list of recipients of this great national work, which is a monument of scientific investigation.

#### THE CYCLONE WAVE IN BENGAL

AN interesting correspondence on this subject has appeared in the *Times* during the last few days, evincing generally on the part of the correspondents an earnest effort to arouse the public mind to a sense of the necessity of something being done towards mitigating the calamitous results of such occurrences in the future. The subject being one that must sooner or later be faced, it is beside the question to point to the destructive flooding of the Thames as a proof that the Government of India does not differ greatly in such matters from similar authorities at home.

As regards the meteorology of this important question, three lines of inquiry stand prominently out as calling for special and extended investigation. The first of these is a thorough discussion of the storms of the Bay of Bengal, or a continuation of the work under this head which has been ably begun by Mr. Blanford and Mr. Willson. The second line of inquiry is the cause or causes which originate the cyclone wave and determine the course it takes—a subject on which we cannot be said to have any information at present, all that is or can be said being little more than unsatisfactory conjectures. To carry out these inquiries with the fulness and with the detail required to ensure a successful handling of the subject additional stations must be established and the taking of meteorological observations must be more extensively and frequently done than is now the practice on board the ships which navigate the Bay.

The third line of inquiry is the systematic inauguration of a meteorological survey of the Bay of Bengal and its shores, with a more strict reference to its storms, by having first-class meteorological stations established at Trincomalee, Madras, Vizagapatam, False Point, Saugor Island, Chittagong, Akyab, Cape Negrais, the Andaman and the Nicobar Islands, these stations having a full equipment of instruments, including in each case a continuously registering barometer and anemometer. With these instruments the law of the diurnal oscillation of the barometer and of the changes in the direction and velocity of the wind, including the variations with season, would become known, and any deviation therefrom which may happen to occur, could be telegraphed at once to the head office at Calcutta. It may be regarded as absolutely certain, that no long time would elapse before the nature of the disturbing force, cyclonic or otherwise, revealed by the anomalous readings of the barometer and anemometer would come to be correctly interpreted; and with the aid of frequent telegrams from the whole circuit of stations, so well interpreted that the superintendent at Calcutta would have no difficulty in localising the cyclone, its track and rate of progress would be so certainly known that warning could be sent to the coasts threatened by it.

This system of storm warnings must not be confounded with that practised in Great Britain, in which no refined system of observations is called into play, and in which no accurate knowledge of mean periodic changes is required. What is chiefly required in this country is a



vigilant outlook for what may be called the grosser changes of atmospheric pressure and of the wind, and a very moderate knowledge of meteorology for their interpretation. So clearly is this the case that notwithstanding the great advances made by meteorology in recent years no progress has been made in this country in issuing warnings of the approach of storms, since the number of fresh gales (8 of Beaufort-scale) of which warnings have been sent are still somewhat under the percentage of success attained by Fitzroy in 1864.

But in India it is different. Any system of storm-warnings there, to be successful, must be based on a refined system of observation carried on at a considerable number of stations in such positions as we have pointed out—those positions being selected with special reference to this inquiry.

### OUR ASTRONOMICAL COLUMN

AN OBSERVATORY ON ETNA.—Prof. Tacchini sends us a note read before the Accademia Gioenia on September 22, 1876, entitled, "Della convenienza ed utilità di erigere sull' Etna una Stazione Astronomico-Meteorologica," in which after describing his experiences during a brief ascent on September 15-16, he expresses his views with regard to the establishment and most desirable fitting of an observatory on the mountain to be mainly devoted to spectroscopic and meteorological observations.

Prof. Tacchini ascended on the morning of September 15 from Catania to the station occupied by a party of the English and American expeditions on the occasion of the total solar eclipse of December, 1870, and found there a diminution of temperature of 33° Centigrade. He had taken with him a Dollond-telescope of 3½ inches aperture, a spectroscope of strong dispersion by Tauber, a small spectroscope of Janssen, an aneroid barometer, thermometers, and a polariscope. At 10h. 30m. A.M., on the 16th, a few detached clouds only being present, he remarked that the blue of the sky was much deeper than at Palermo or Catania. The solar light had a special character, it seemed whiter and more tranquil, as though due to artificial illumination by magnesium. Viewing the sun rapidly with the naked eye, it was seen as a black disc surrounded by an aureola of limited extent, projected on the blue ground of the sky. On interposing an opaque body before the disc the aureola was seen better but always limited, and the pure blue sky terminated the same, which extended to rather more than half the solar radius; with the naked eye it was difficult to judge if the aureola was of equal breadth all round the disc, and the only thing well marked was the difference from the view obtained at the level of the sea; while the sky is ordinarily whitish about the sun, on Etna it remained blue, and the aureola acquired a better-defined contour. With a helioscope the aureola was much better seen, and its border appeared irregular, and as though it were rather more extended at four points, which, at noon, corresponded to the extremities of the vertical and horizontal diameters of the disc. At 3 P.M., after interruption from clouds which in passing rapidly at short intervals produced a striking effect by the formation of a stupendous series of coloured rings round the sun containing all the gradations of colour in the spectrum, a phenomenon new to Prof. Tacchini, the Tauber-spectroscope was applied to the telescope for examination of the solar spectrum, and the observer expresses his surprise at the fine definition of the lines and the extraordinary distinctness of the whole; the chromosphere was bright.

In the evening at 10h., the spectacle of the starlit sky was novel and enchanting. Sirius appeared to rival Venus, the finer constellations acquired an altogether special aspect, and the appearance of the Via Lactea was astounding. The image of the planet Saturn was admirable, and the peculiarities of the ring

and belts were seen to much greater advantage than at Palermo, shortly before leaving. Venus afforded remarkable proof of the rare quality of the sky of Etna. The planet shone with a powerful light, which cast shadows during the ascent of the mountain; it scintillated frequently like a star. The telescope showed, on the northern part of the phase, an oblong space, less illuminated than the rest of the disc, which Prof. Tacchini says was "sicuramente una macchia del pianeta."

Spectroscopic observations were renewed on the following morning, when the sun had attained an altitude of 10°. The chromosphere was "magnificent;" the inversion of the magnesium and of 1474 was immediately evident, which was not seen at Palermo with the same telescope.

With regard to the proposed observatory which Prof. Tacchini is desirous should be an accomplished fact before the meeting of the scientific bodies at Rome, in September next, he proposes that it should be erected at the *Casina degli Inglesi*, and should be named after Bellini, and that it should belong to the University of Catania. He suggests that it ought to be provided with a refractor of first-rate quality and of at least 16 centim. (about 6.3 inches) aperture, and he advises that while the meteorological instruments, which should be adapted to the requirements of the day, as indicated by the London Congress, would remain constantly at the Bellini Observatory, a duplicate mounting might be provided for the refractor at some spot within the University of Catania, with its proper dome, the other being fixed on Etna, so that while from June to the end of September astronomical observations could be carried on upon the mountain, during the winter they might be made at Catania, where the sky is a very good one; the astronomer would thus have only the object-glass with its tube to transport to and fro. Prof. Tacchini further suggests that accommodation for visitors should be provided, with the view to increasing their numbers, and that a certain payment should be made by them, to go towards the maintenance of the Observatory and its custodian.

We wish every success to the scheme thus energetically brought before the Italian authorities by Prof. Tacchini, and have no hesitation in predicting important gains to science from its adoption.

THE NEW STAR OF 1604.—The vicinity of this star's place deserves to be closely watched, as it appears by no means improbable that the object may be identified amongst the telescopic stars actually visible, by small fluctuations of brightness, which there are grounds for supposing to have been the case with the so-called new stars of Tycho Brahe and Anselmi.

The best position of Nova 1604, is no doubt that deduced by Prof. Schönfeld from the observations of David Fabricius, found in the *libere mutuz* in Fritsch's edition of Kepler's works. Fabricius measured the distance of the new star from  $\zeta$ ,  $\eta$ ,  $\epsilon$  Ophiuchi,  $\alpha$  Aquile, and  $\alpha$  Scorpii, and the discussion of these measures leads to the following place for 1605.0, R.A. 236° 45' 43" or 17h. 7m. 2.9s., N.P.D. 111° 4' 42", with probable errors of  $\pm 2.0s.$  and  $\pm 0.65'$ ; this position brought up to 1877.0 is R.A. 17h. 23m. 16s., N.P.D. 111° 22' 4". The nearest catalogued star is one of 8.9 mag. observed in Argelander's Southern Zones, No. 16872 of Oeltzen's reductions. Kepler's star precedes, according to Schönfeld's calculation, 25.7m., and is N. about 0.8'. There is a star 12' 13 mag. preceding Argelander's star 15.0s. and 1.6' to the south, suspiciously close to the recorded place, since the probable errors are no safe guide in such a case as this. Chacornac on Chart No. 52, has a tenth magnitude in about R.A. 17h. 21m. 50s., N.P.D. 111° 22' for 1855, which is no low visible or was not last summer. But the locality requires a stricter and more systematic examination, which may be suggested to some one of our astronomical readers, who possess adequate optical power, when this region of the sky is favourably situated for observation.

## METEOROLOGICAL NOTES

**STORMS AND FLOODS OF THE PAST SIX WEEKS.**—An examination of the Daily Weather Maps published in different countries of Europe for this period is very instructive. The most common course taken by the winter storms of north-western Europe is an easterly or north-easterly one, and the tracks of their centres lie somewhere between Faro and Iceland. Hence the winter climate of the British Isles is characterised by south-westerly winds, and the relatively high temperature and humidity which they bring with them from the Atlantic. This state of things is occasionally varied by the centre of the storm passing in its easterly course across England, along the Channel, or over a track even still further south, resulting in easterly and northerly winds at places situated to the north of the centre track, with the probable accompaniments of sleet, snow, or hail, low temperatures, chill drizzling rains, and heavy seas. Since, however, the storm-centres usually soon pass on to eastward, the easterly winds accompanying them are generally not of long continuance. But during these past six weeks, notably from December 1 to 7, 16 to 24, and 31 to January 7, the cyclonic centres have had their course in the south, or to the south, of the British Islands, and consequently easterly and northerly winds have prevailed, particularly in the north of Great Britain. The cyclonic centres, instead of advancing, as ordinarily happens, to eastward, oscillated backwards and forwards—to eastward and then to westward, to north-westward, and then to south-eastward—being thus continually for days together in the south of the British Islands, and hence the persistency of the easterly winds for several days in succession in the north. Finally, since steep gradients prevailed frequently and for considerable periods from North Britain to Norway, the easterly winds acquired a violence, as well as a persistency, almost unprecedented, strewing the coasts with wrecks, and raising high tempestuous seas, which, particularly when conjoined with the high tides in the beginning of January, damaged harbours and other property to an extent fortunately of rare occurrence in these islands. As frequently happens, gradients were also steep and winds violent over the Channel and the south of England. The snow and rainfalls were also excessive, and blocking up of railways and river floodings, with the inconveniences and disasters attending them, were experienced in all parts except the north-west of Great Britain. At many places the rainfall of December was the heaviest ever recorded. The intimate bearing of the weather of Scandinavia and Lapland on that of Great Britain, and its great scientific importance in forecasting British weather—a point we have on various occasions insisted on in this journal—were several times conspicuously illustrated during the singular weather of these six weeks.

**PHYSICS OF THE ATLANTIC OCEAN.**—Dr. Buys Ballot has made a valuable contribution to the physics of the Atlantic Ocean in a paper just published on its mean monthly atmospheric pressure. The author wisely groups the observations for each degree of latitude along the outward and homeward bound routes of the Dutch ships on board which the observations were made. The extent and laboriousness of the work will be understood from the fact that for the North Atlantic alone, 175,003 observations have been discussed for the outward, and 163,418 for the homeward bound route. We shall take an early opportunity of reverting to the subject of this paper; in the meantime we content ourselves with heartily recommending the paper more particularly to seamen, from its great utility in navigation, seeing that it gives them the average barometric pressure each month for each degree along this great highway of commerce, which, when intelligently interpreted by the wind which happens to prevail at the time, puts them in possession of information, the importance of which it is impossible to over-estimate.

**WEATHER MAPS OF GERMANY.**—The Weather Maps of the *Deutsche Seewarte*, in the numbers for January, already received, give on a large scale the barometric curve and the hourly direction and force of the wind for the twenty-four hours previous, as recorded by the self-registering instruments at Hamburg. The value of such data in the study of the daily changes of the weather it is unnecessary to point out. This Office has also begun to publish monthly *résumés* of the weather of the Continent, of which those for January and February, 1876, have appeared, containing short papers by various well-known meteorologists, referring to the weather of the month; and the averages and extremes for the month are briefly but lucidly discussed for all the stations in Germany, and for many other stations in the countries adjoining. A valuable chart is given showing the tracks from day to day of all the European storms of the month.

**THUNDERSTORMS IN CENTRAL EUROPE.**—It was recently shown by M. von Bezold that there is a double maximum in the frequency of summer thunderstorms in particular regions of central Europe. The results of further researches by others seem to point in many cases to a similar behaviour in hydrometeors generally. Thus a double periodicity in hailfall has been demonstrated by M. Prettner for Kärnthen and M. Fournet for the Rhone Valley. And more recently still (*Pogg. Ann.*), Dr. Hellman, having studied the rainfall in North Germany, is led to the following conclusions:—1. There is a double maximum in both the frequency and quantity of rain in the summer months in North Germany. 2. The first maximum falls, in the case of quantity of rain, in the beginning of the second half of June; that for frequency of rain in the beginning of June; the second maximum for both cases in the middle of August. 3. The first maximum is more intense in the case of frequency of rain, and weaker in the case of quantity. Dr. Hellmann offers an explanation of these phenomena, for which, however, we must refer to the original.

**SUNSPOTS AND WEATHER.**—Prof. Fritz, of Zurich, has shown from a comparison of annual meteorological statistics, that the years distinguished by a maximum of solar spots coincide very closely with those years marked by exceptionally severe hailstorms, and an unusual average height of the great rivers. This law is shown to be in accordance with observations made during the past century in all latitudes, the special periods occurring at intervals of eleven years.

## BIOLOGICAL NOTES

**CHEMICAL CHANGES OBSERVED DURING PROGRESS OF THE POTATO DISEASE.**—The Rev. J. H. Jellett details the results of a series of experiments made to ascertain (1) whether there be any development of sugar during the progress of the disease, and if so of what kind? (2) whether there be any perceptible change in the quantity of nitrogen? It would appear that the first stage of the disease in the tuber is marked by an increase in the quantity of the nitrogen, which seems to attain its greatest value before the stage of discoloration of the tuber. The same stage of the disease is also marked by the development of sugar, both glucose and sucrose. In the second stage of the disease, marked by a great increase in the discoloured part of the tuber, the part which remains apparently sound shows no increase of nitrogen, but a very considerable increase in the quantity of sugar, while in the discoloured part there is a diminution both in the percentage of nitrogen and of sugar. It will be remarked that the development of the sugar continues for a considerable time after the nitrogen has attained its maximum value. Mr. Jellett has no doubt that the whole of this sugar is formed by the conversion of the potato starch, though he is not aware that there is any known method by which starch can be made to pass into sucrose; possibly this effect may

be produced by the presence of the fungus. (*Proc. R. Irish Acad.*, Vol. ii., Series ii. Science, January, 1877.)

**COMMENSALISM AMONG CATERPILLARS.**—The following extract from a letter from Fritz Müller, dated Itajahy, Brazil, October 22, has been sent us by his brother, Dr. Hermann Müller, of Lippstadt:—"I have lately become acquainted with an interesting case of commensalism in two caterpillars, of which I inclose a photograph taken by my friend, Scheidemantel. The larger caterpillar, with red head, protected by long branching stinging-hairs or thorns, lives on mulberry and other trees. Like other caterpillars protected from enemies by odour, stinging-hairs, or otherwise, it sits on the upper side of the leaves, and is light-coloured, the head red, the hairs white. Across its back, between its thorns, there sits a small blackish caterpillar, protecting itself by the thorns of the large com-

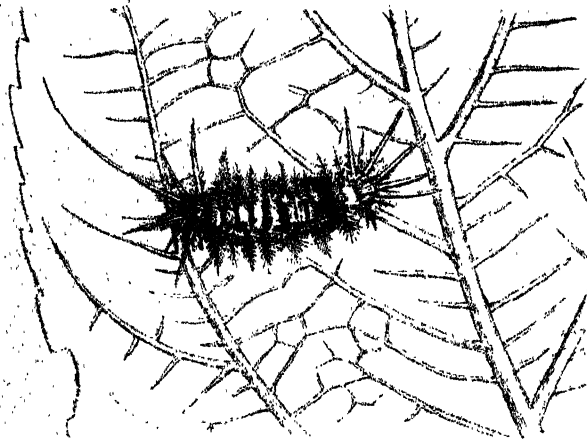

panion. I took off the small caterpillar from the large one, but it soon occupied again the same place. In order to take a photograph of it, the larger caterpillar was anaesthetised with ether; it recovered again somewhat, but after two days it died. The smaller caterpillar has now left its place and taken refuge on another caterpillar in the same box; on this it sits somewhat further forward, on the base of the abdomen. In its former host, the place where the small caterpillar sat looks pale, as if it had been scoured. The small caterpillar from above eats small holes in the leaf on which the larger one is sitting. As far as I know, no similar case has hitherto been observed."

**BLISTERING BEETLES AS A CURE FOR HYDROPHOBIA.**—M. de Saucy, père, laid before a late meeting of the Entomological Society of France the *débris* of two species of beetles belonging to the *Meloidæ* (*Melœ tucius* and *Mylabris tenebrosa*) which had been sent to him from Gabès, in Tunis, by M. de Chevarier, and which constituted the medicine in use by the people of Amerna as a cure for hydrophobia. It is known under the name of *Dermona*, and is mentioned in several Arabian works on medicine. A portion about the weight of a grain of corn is given to be suffered. The medical formula directs that it should be taken in some meat soup by the person bitten between the 21st and 27th day after the bite; if taken before or after these dates it will not effect a cure. The natives of Amerna seem to have great faith in this cure, and preserve the dried beetles as a treasure. It might be worth while to try a series of experiments on the use of the vesicating beetles in this terrible malady. But it should not be forgotten that so long ago as 1750, Linnæus, in his dissertation, "*De Materia Medica in Regno Animalium*," suggested the employment in such cases of the common blistering beetle, and in 1836, when M. L. Fairmaire laid before the Entomological Society of France a brochure by M. Saint Hombourg on the treatment of hydrophobia by the administration of a

species of *Melœ*, many of the members then present mentioned that this remedy was known for a very long time in Germany. (*Ann. Soc. Ent. France*, 27 Dec., 1875, *Bulletin*, p. cxliii.)

**CARBONIFEROUS AMPHIBIA IN NOVA SCOTIA.**—In the Carboniferous era many of the Sigillarian trees became partly embedded, and as they decayed their inner bark and woody axes crumbled away, leaving open holes on the surface of the ground into which were swept by water, or fell accidentally, the animals of the period together with vegetable *débris*. In this way successive layers of deposit, within the trunks of the trees, became stored with skeletons of Amphibian animals, snails, &c., which they have retained in an admirable state of preservation. Dr. J. W. Dawson, whose former investigations on this subject are well known by all palæontologists, has recently examined a fresh tree-stump about 2 feet high and 18 inches in diameter. In its interior were found no less than thirteen skeletons, more or less complete, belonging to six species, including *Hylerpeton dawsoni*, *Dendropteron acadianum*, *D. oweni*, a new species of *Hylerpeton* and *Hylonomus lyelli*. In the last part of the *American Journal of Science and Art*, Dr. Dawson has described these remains.

**ACTION OF THE BRAIN.**—At a recent *séance* of the French Academy, MM. Giacomini and Mosso presented the photograph of a woman who, from a syphilitic affection of the cranial walls, had lost a great part of the frontal and the two parietal bones. The movements of the brain of this woman (who is now completely cured) had been studied by the graphic method, one of M. Marey's tambours having been applied at the cranial aperture, and some remarkable results were obtained. The traces, which will appear in the *Archivio delle Scienze mediche*, prove that there are in the brain of man, even during the most absolute repose, three different kinds of movement:—1. *Pulsations*, which are produced at each contraction of the heart; 2. *Oscillations*, which correspond to the movements of the respiration; 3. *Undulations*, which are the largest curves, and are due to movements of the vessels during attention, cerebral activity, sleep, and other causes unknown; they might be called *spontaneous* movements of the vessels. The authors studied the relations between the movements of the brain, the heart contractions, the changes of volume of the forearm and the respiratory movements, by applying simultaneously with the arrangement just described, a pneumograph to the chest, and one of M. Mosso's plethysmographs to the forearm. The form of the brain-pulsation differs considerably from the tracing obtained from the fore-arm, or by means of a sphygmograph applied to an artery. During profound sleep, with snoring, there is considerable increase in the height of the cerebral pulsations, and the respiratory oscillations and the undulations are much more pronounced. Certain causes produce the same change of volume in the brain and in the extremities; others produce variations which are simultaneously in opposition in the brain and in the different parts of the body. The authors describe the effects of compressing the carotid and the jugular, the influence of bodily movements and intellectual labour, which are always reflected in a change of volume of the brain and therefore of its pulsations, and a number of interesting facts are elicited.

**PAPUAN PLANTS.**—So much still remains to be learned regarding the natural productions of New Guinea, that Baron von Mueller's *Descriptive Notes on Papuan Plants*, will contain much that is new to all botanists. Three successive papers have now been published under this title, the material being chiefly derived from the explorations of Macfarlane, Goldie, and D'Albertis. Von Mueller hopes that one or other of these energetic discoverers will shortly reach the hitherto unknown Alpine heights, which are likely to yield rich stores of endemic species.

**NEST-BUILDING FISH.**—The habits of those few fishes which build nests for their progeny are very curious, and indicate a highly-developed instinct. One of these, the Gourami (*Aphyronemus affinis*), has lately been studied by M. Carbonnier in his private aquarium. The male animal constructs a nest of froth of considerable size, 15 to 18 centimetres horizontal diameter and 20 to 12 centimetres height. He prepares the bubbles in the air (which he sucks in and then expels), strengthening them with mucous matter from his mouth, and brings them into the nest. Sometimes the buccal secretion will fill him, whereupon he goes to the bottom in search of some conferva, which he sucks and bites for a little, in order to stimulate the act of secretion. The nest got ready, the female is induced to enter. Not less curious is the way in which the male brings the eggs from the bottom into the nest. He seems unable to bring them up in his mouth; instead of this, he first takes in an abundant supply of air, then descending, he places himself under the eggs, and all at once, by a violent contraction of the muscles in the interior of the mouth and pharynx, he forces out the air he had accumulated, by his gills. This air, finely divided or pulverised, in some sort, by the lamellæ and rings of the gills, escapes in the form of two jets of veritable mucous powder, which envelops the eggs and raises them to the surface. In this manœuvre, M. Carbonnier says, the Gourami quite disappeared in a kind of air-mist, and when this had dissipated, he reappeared with a multitude of air-bubbles like little pearls, clinging all over his body.

**BEAVER IN SIBERIA.**—The beaver which, some centuries ago, was so numerous in Russia and Western Siberia, and which was supposed to have totally disappeared from both countries, continues to exist on the rivulet Pelyin. M. Poliakoff has procured from an ostyack on the Obi five skins of these animals killed last year, and he has engaged a hunter to procure this winter complete specimens for the Museum of the St. Petersburg Academy. No farther back than a century ago the beaver was common on one of the affluents of the Irtysh, Bobrofska, but it is now totally disappeared from the locality, the last colony existing probably on the Pelyin.

### NOTES

THE first volume of "China," by the well-known geologist Baron von Richthofen, has just appeared. The Berlin Academy of Sciences has granted a generous sum to defray the expense of publishing this costly work.

WE have pleasure in announcing that a new Natural History journal is about to be started, which is intended to form a bond of union among the various schools belonging to the Society of friends in this country, both those for boys and girls. Some of the oldest societies of the kind in the country are in connection with these schools, especially the one at York, to which reference has more than once been made in these columns. The journal is intended to be specially devoted to young beginners; the main object being to awaken a personal interest in natural history pursuits, and to induce tyros to make and record observations. By this means it is hoped to promote a genuine study in place of the indiscriminate collecting now so much in vogue. Other cognate subjects will also be taken up as space permits, such as chemistry, carpentry, &c. It is intended to publish the first number on February 15; communications, which are warmly invited, should be addressed to J. E. Clark, B.Sc., 20, Bootham, York.

UNDER the title of the "Indian Miscellany," a work is announced by Mr. J. Munsell, of Albany, New York, on the history, the inventions, languages, religions, traditions, and superstitions of the American aborigines; with descriptions of their domestic life, manners, customs, traits, governments, wars,

treaties, amusements, exploits, &c.; together with sketches of travel and exploration in the Indian country, incidents of border warfare, journals of military expeditions, narratives of captivity, anecdotes of pioneer adventure, missionary relations, &c.

M. ED. BECQUEREL has been elected president of the French Physical Society, which seems, like its English sister society, to be doing excellent work.

THE Council of the Geographical Society of Paris has appointed M. Levasseur president for 1877. MM. Daubrée and Quatrefages have been appointed vice-presidents, and M. Maunoir has been continued general secretary.

IT is stated on good authority that the measurement of the photographs taken by the French parties during the transit of Venus is not progressing favourably. More than 1,000 plates are to be investigated micrographically, and at the present moment only forty-seven have been disposed of. Unforeseen difficulties are said to have arisen.

IN 1828 M. Janson de Sailly, a French barrister who had married a sister of the celebrated Berryer, left by will his fortune to the French University, under the condition of creating a high school in the Quartier des Champs Elysées, to be named Janson College. The will was accepted by the Government, but the heirs tried to get it cancelled, and a law-suit was instituted, which was ended only in December, 1876. The Janson College will be inaugurated in 1878. The legacy is quite adequate to carry out the purpose of the testator, who was proprietor of the greatest part of a large estate.

GERMAN educational statistics show that in Saxony one out of 1,194 of the total male population is in actual attendance upon a university, while in Prussia the proportion is 1 to 1,328.

THE next annual meeting of the *Deutsche geologische Gesellschaft* takes place at Vienna, in September of this year.

THE Council of the Society of Arts have made arrangements for the delivery of six lectures on various scientific subjects, which will take the place of the usual papers and discussions, on six Wednesday evenings during the session. The following gentlemen have each consented to deliver one of the lectures:—Sir John Lubbock, Bart., F.R.S., Mr. E. J. Reed, C.B., M.P., Prof. W. K. Clifford, M.A., F.R.S., Prof. Alexander Kennedy, C.E., Dr. B. W. Richardson, F.R.S., Mr. James Baillie Hamilton.

THE Bremen Geographical Society has received a report from Capt. Wiggins dated Jenissei, November 25, in which he gives more fully the results of his late voyage to Siberia. The Podaratta Bay was found to be exceedingly shallow, and the river itself could not be ascended by craft drawing over two feet of water. Special stress is laid upon the discovery of the channel for sea-going vessels up the picturesque Jenissei as far as Kureika. Numerous observations of the temperature of the air and water, the specific gravity of the latter, &c., were taken during the progress of the voyage. These all tend to show that the Gulf Stream and equatorial currents exert a decided influence much farther to the east than was hitherto supposed, as they pass through the straits of Jugor and Waigat into the Karian Sea.

THE adherence of air round a current of some fluid or liquid when this is forced through the air, has been utilised in various ways, as in water bellows, the blast pipe of locomotives, Sprengel's air-pump, the Bunsen burner, &c. Prof. Teclu, of Vienna, has recently described, in *Poggendorff's Annalen*, a simple arrangement, in which a jet of steam is used to do the work of an air-pump. A small steam boiler containing 15 litres of water, and heated to something over one atmosphere, is heated over a gas furnace. It has a safety-valve, which also serves for admission of water when necessary. From above rises a brass steam pipe

consisting of two similar parts, each of which is a tube narrowing upwards; the terminal aperture of the lower tube (a) is situated just where the contraction of the upper tube (b) terminates, leaving a small annular aperture. Two lateral tubes proceed from the wide portion of the upper tube, one to the vessel to be exhausted, the other to a manometer. It will be seen that the steam issuing from the boiler exerts suction on the air in the connected vessels.

At a meeting of the Edinburgh Botanical Society, held on January 11, Mr. M'Nab made a second communication on the scarcity of holly berries at Christmas. He has learned from correspondents in various parts of the kingdom that the scarcity of holly berries has been very general. The only places where the supply of berries has been abundant are in the Highlands, in such districts as the Trossachs, and in the vicinity of Loch Katrine and Loch Ard. At Ranelagh, near Dublin, few berries were to be obtained, but several of the trees were covered with clusters of white and cream-coloured flowers, and it is of interest to note that all the flowers, both open and past, of the specimens received by Mr. M'Nab from Ranelagh, were hermaphrodite.

At a meeting of the Glasgow Philosophical Society, held on Wednesday, January 10, it was agreed, on the motion of Sir William Thomson, to petition both houses of Parliament for the amendment of the Patent Laws, the objects aimed at being the reduction of the stamp duty on patents, an extension of the time for which patents were granted, and the abolition in connection with the notice to proceed.

At the second meeting of the Edinburgh Naturalists' Field Club, which was held on Friday last, a lecture on "Foraminifera," copiously illustrated by diagrams and microscopical preparations, was delivered by Mr. D'Arcy W. Thompson, a pupil of the present seventh class of the Edinburgh Academy. Science lectures by schoolboys are a much rarer occurrence than science lectures to them.

In a note to the Roman Academy on the rate of oratorical utterance, M. Mariotti recalls an observation made by Gibbon that a facile English orator pronounced 7,200 words in an hour, *i.e.*, 120 in a minute, and two in a second. Though it might seem possible to investigate the velocity of the Greek and Roman orators, knowing that the judicial orations in Athens were recited in a space of time determined by the clepsydra, yet their methods render conjecture somewhat vague. Thus, *e.g.*, it is said that Caius Gracchus, when speaking in the forum, had a servant concealed behind him, who, with an ivory instrument, signalled to him at the proper moments to raise or to lower his voice. Nowadays, when parliamentary discussions, as has been said, are little more than animated conversations, accurate observations may be made by means of stenography on the rate of speaking of various orators. M. Mariotti gives some such data from the Sub-Alpine and Italian Parliaments. De Foresta pronounced sixty words in a minute; Massimo d'Azeglio, 90; Gioberti, 100; Ratazzi, 150; Mameli, 180; Cordova, the quickest, was able to pronounce as many as 210. The very rapid orators, M. Mariotti says, are rather admired than effective, such as Macaulay in England, and Cordova in Italy. The mind of the hearer is not allowed sufficient time to take in the meaning. It is possible, speaking rapidly in the Italian tongue, to pronounce 300 words in a minute. Comparative observations on the subject in parliaments of different countries, would afford important data regarding various tongues, and suggest interesting psychological considerations. From observations in the Parliament of Athens, it might be possible to conjecture the velocity of the ancient Greek orators. In this way stenography might render valuable services to philology and philosophy.

We notice in the January number of the *Geological Magazine*

a paper by Mr. James Durham on "The 'Kames' in the Neighbourhood of Newport, Fife, N.B.," accompanied by a sketch-map of the locality. Unhappily, the paper is written much in the same style as too many papers on kames have already been written, and we find in it, as is too often the case, more generalisations than thorough descriptions of the interior structure of these interesting formations, and not even a single detailed section. It gives us an opportunity, however, of observing that only thorough explorations of the structure of those kames the interior of which is rendered accessible by adequate cuttings, together with detailed studies of the directions, positions, and forms of the kames, discussed in connection with the topography of the locality and its neighbourhood, can help us to settle the question as to the origin of kames, so much debated hitherto without arriving at any definitive result. As to the conclusions of the author, *viz.*, that "the kames" owe their present forms to the same denuding agencies as are at present in operation, we must object that, even if the author had proved his statement with reference to the Newport kames, he was by no means entitled to generalise from it; there are hundreds of kames and thousands of totally identical gravelly mounds and ridges the shapes of which have nothing to do with denuding agencies.

THE first number of the *Veröffentlichungen des kaiserlichen deutschen Gesundheitsamtes*, appeared last week. It gives the mortality statistics of about 150 German cities and a large number of foreign cities, and supplies a most valuable picture of the progress of epidemics as well as the general statistics of disease, and the working of all sanitary regulations at home and abroad. A graphic representation of the meteorology of the past week is also added.

VERY high floods, second only to those of 1872, are reported, by Russian newspapers, from the shores of the Amoor. After unusually heavy rains, which fell almost without interruption from the middle of July until the end of August, the waters of the great river rose so as to menace even Blagovieshensk, built on a comparatively high bank, and overflowed the villages and fields of the Upper and Middle Amoor. A very heavy gale visited also the Lower Amoor on the night of September 18 and 19. Some barges were destroyed, a steamer was much damaged, and some houses on the shore at Khabarofka were washed away.

THE rain which fell at St. Jaen, in the Côtes-du-Nord, on the night of December 29-30, 1876, was observed to be tinged red. A bottle filled with the water has been sent to Dinant to be analysed microscopically and chemically.

THE French Government is selling by auction the last four balloons which were constructed during the siege for escaping from Paris. These balloons are considered unfit for service, and others will be constructed by the balloon committee, a credit of 200,000 francs having been placed in the budget of 1877 for military ballooning.

NEWS has been received from the *Frigorific*, which has arrived with its cargo of meat at La Plata, where experiments have been continued on the largest scale. The success is complete.

THE Paris-Lyons-Mediterranean Railway Company have ordered sixty locomotives to be constructed, which are intended to travel from Paris to Marseilles (1,820 kilometres) in twelve hours. The Northern Railway has established comparative experiments on the Westinghouse continuous brakes and electric brakes. The old hand-brakes are to be superseded at any one by the Northern Railway.

PROF. MACH, of the Vienna Academy, has recently made some experiments on the velocity of propagation of sound-waves from explosion. He finds that in course of the motion this velocity diminishes, and soon approximates to the ordinary velocity.

of sound. In one experiment, by means of a fall-apparatus with double hammers, two percussion caps were exploded (at a determinate interval) at the two ends of a tube. From the displacement of the interference-band on the inner smoked surface of the tube, the velocities were found to be more than 700 metres over a stretch of 50 centimetres. With weaker explosions or longer stretches, the velocities were less. Again, a pistol-ball, whose velocity was determined, liberated at two stations, at a measurable interval of time, two electric discharges. From the displacement of the interference-band, the velocity appeared to be about 400 metres. Several other experiments are described in Prof. Mach's paper.

MR. FREDERICK A. OBER has recently sailed from America or Martinique to commence an exploration of the West India islands, under the patronage of the Smithsonian Institution. Mr. Ober proposes to begin at Martinique, and to collect the vertebrates on all the Leeward Islands, visiting each one in succession, and proceeding east and south by the Windward Islands to the Spanish Main. The work will probably occupy several years, and with it will be combined the taking of photographic views of the scenery and inhabitants. It is believed that, should Mr. Ober be as successful as he anticipates, a critical investigation of his collections by specialists will not only bring to light species long ago described and not met with for many years, but will include some new to science, and at the same time elucidate many interesting problems in physical and zoological geography.

MR. JOHN MURRAY has the following new works in the press:—"Scepticism in Geology, and the Reasons for it," by Verifier; "The Cradle of the Blue Nile," an account of a journey through the mountains of Abyssinia and the plains of Soudan, and a residence at the court of King John of Ethiopia, by E. A. De Cosson, F.R.G.S.; "Pioneering in South Brazil," a narrative of three years of forest and prairie life in Paraná, by G. P. Bigg Wither. These two last books will both be accompanied by maps and illustrations.

We have the following books on our table:—"Winds of Doctrine," by Ch. Elam (Smith, Elder, and Co.); "Thebes and its Five Greater Temples," by Capt. Abney, F.R.S. (Sampson Low and Co.); "Animal Physiology," by Prof. McKendrick Chambers; "The Two Americas," by Sir R. Lambart Price Sampson Low and Co.; "The Discoveries of Prince Henry the Navigator," by R. H. Major (Sampson Low and Co.); "Darwiniana," by Prof. Asa Gray (Trübner); "Across the Vatna Jokull," by W. L. Watts (Longmans); Dr. Dobell's "Reports on Diseases of the Chest," vol. ii., 1876 (Smith, Elder, and Co.).

THE additions to the Zoological Society's Gardens during the last week include two Secretary Vultures (*Serpentarius reptiliivorus*) from South Africa, presented by Capt. Larmer, of s.s. *African*; two Crowned Partridges (*Rollulus cristatus*) from Malacca, presented by Mr. Barclay Field; three Chukar Partridges (*Caccabis chukar*) from North-West India, presented by Capt. Newton Paul; two Caroline Coueures (*Conurus carolinensis*) from North America, presented by Mr. L. Delves Broughton; a Wood Owl (*Syrnium flaco*), European, presented by Mrs. A. O. Faulkner.

### SCIENTIFIC SERIALS

THE *American Journal of Science and Arts*, December, 1876.—Experiments on the nature of the force involved in Crookes's radiometer, by O. N. Rood.—Experiments on the sympathetic resonance of tuning-forks, by Robert Spice.—Types of orographic structure, by J. W. Powell.—On the ethers of uric acid, by H. B. Hill.—Notice of a meteorite from Madison Co., N.C., by E. S. Burton.—On a recent discovery of carboniferous Batrachians in Nova Scotia, by J. W. Dawson.—On the association of crystals of quartz and calcite in parallel position, as observed on a specimen from the Yellowstone Park, by Edward S. Dana.—Principal characters of the American Pterodactyls, by O. C. Marsh.

### SOCIETIES AND ACADEMIES

#### LONDON

Mathematical Society, January 11.—Mr. S. Roberts, treasurer, in the chair.—Mr. G. W. von Tunzelmann was elected a member.—The following communications were made to the Society:—Determinant conditions for curves, or surfaces, of the same order, having all their intersections common, by Mr. J. Hammond.—Numerical values of the first twelve powers of  $\pi$ , of their reciprocals, and of certain other related quantities, by Mr. J. W. L. Glaisher, F.R.S.—On some general classes of multiple definite integrals, by Mr. E. B. Elliott.—On the partial differential  $s + Pp + Qq + Z = 0$ , by Prof. H. W. Lloyd Tanner.—Determination of the axes of a conic in tri-linear co-ordinates, by Mr. J. J. Walker.—On some elliptic-function properties, by Prof. H. J. S. Smith, F.R.S.

Linnean Society, December 21, 1876.—Prof. Allman, president, in the chair.—Mr. Thomas Christy and Mr. Robert Drane were balloted for and duly elected Fellows of the Society.—The butterflies of Malacca, formed the subject of a paper by Mr. A. G. Butler. Of 258 species now registered from Malacca thirty-six are endemic; of the remainder sixty-five also belong to Assam or Nepal, thirty-eight to Moulmein, thirty-three to Ceylon, ninety-four to Penang, forty-six to Singapore, 112 to Borneo, forty-one to Sumatra, eighty-seven to Java, thirty-nine to Siam, twenty-six to China, two to New Hebrides, and six to Australia. Thus the Malaccan butterflies preponderate towards those of the Indian region. For several reasons, however, the so-called Penang fauna must be accepted with considerable qualifications.—A communication was read from Mr. J. K. Jackson on the commercial uses of a species of cane termed "Whangee." This was shown to be a species of *Phyllostachys*, possibly *P. nigra*, and supposed to be from China. That common in the trade he considers not to be the stem proper but the rhizome; pale-coloured, as introduced, plants of the kind in question grown in England produce a black cane, hence bleaching must be resorted to with the commercial sort.—*Craniorhinus waldeni* is the name of a new Hornbill from the Island of Panay (Philippines), described by Mr. R. B. Sharpe. It is allied to *C. cassidix*. The new species was found by Prof. Steere in a virgin forest in the mountainous range of the island.—An extract of a letter from Dr. J. Anderson, of Calcutta, was read. It mentioned some curious facts in connection with the Hornbills *Hydrocissa albivestris* and *Aceros subruficollis*. These birds greedily devour, head foremost, the smaller kinds of the feathered tribe, and before doing so break all the bones of the bodies and toss the bird about.—The Secretary read some morphological notes on certain species of *Thunbergia*, by Mr. Marcus Hartog. He states that microscopical sections of *T. laurifolia* reveal axillary buds inside the sixth and eighth pair of bracts, the basal elevations becoming pedicel and bractlets, and inside these, by repetition, sister buds arise. The flowers are thus axillary buds formed in succession from the axis outwards and are as independent as if they had arisen side by side.—Dr. Buchanan White brought forward a paper on the male genital armature in the European Rhopalocera. His researches yield evidence that as in some other orders of the Insecta the appreciable structural variations of the organs in question afford good characters whereby to distinguish not only genera, but species, of the above limited group of Lepidoptera.—Prof. Flower communicated a memoir on the morphology of mammalian *Ossicula auditus*, by Mr. A. G. H. Doran. While dealing with these diminutive bones *in extenso*, the author more particularly confined his summary to those of the Insectivora, Cheiroptera, Cetacea, Sirenia, Edentata, Marsupialia, and Monotremata. In the first of these groups the ossicula present no positive or marked characteristic. Among the bats there is a resemblance to what obtains in the shrews, except in the genus *Pteropus*, where the malleus is of a lower type. Of whales, *Balaena* has the most generalised type; the dolphins have relatively stout stapedial crura and other marked features; *Platanista* has slightly modified ossicula. Those of Sirenia are distinguished by weight and outline. Certain of the Edentata (armadillos) differ among themselves, and so do the sloths and ant-eaters, as far as concerns their internal ear-bones. Marsupials possess ossicula of a low grade still descending in the Monotremata. The general conclusion arrived at is that even by the so-to-say subsidiary differentiation of the auditory ossicles doubtful affinities in some cases receive a certain interpretation.—*Actemorphia croca* is the name given to a new genus and spe-

cies of crustacean described by Mr. E. J. Miers. It was dredged at seven fathoms, and came up along with a number of *Canceroidae*, &c., and which it resembles much, though structurally undoubtedly belonging to the family *Leucosidae*.—Mr. H. N. Moseley tendered a paper descriptive of two new and remarkable forms of deep-sea Ascidians obtained by him during the *Challenger* expedition. The first of these aberrant forms was trawled in the North Pacific, from a depth of 2,900 fathoms. This *Hybithius calypsoides*, of cup-like shape, is probably allied to *Bolittaria*, but differs, among other things, in possessing a series of cartilaginous plates developed with symmetrical arrangement on its otherwise soft test. The second Ascidian, named by the author, *Oterocampus bythius*, was got from 1,070 fathoms. Star-shaped or of eight-rayed form, its gill-sac is nearly horizontal, and gill-network absent; muscular prolongations of the tunic run into the curious conical protuberances of the test; nucleus contracted and small like that of *Salpa*. This unique specimen, so far as our present knowledge goes, is presumed to be without living allies.

Anthropological Institute, January 9.—Col. A. Lane Fox, president, in the chair.—Mr. Henry Hyde Clarke exhibited a handsome feather dress from the Amazon.—Mr. Moseley, naturalist to the *Challenger* expedition, then read a long and most interesting account of the inhabitants of the Admiralty Islands. He considered that in their arts, as shown in the ornamentation of their weapons, &c., they resembled the natives of New Guinea, while in a peculiar note in their chants or singing he noticed a strong Fijian resemblance; their manner of halting the stone implements differed from that in other groups, the stone being fixed in a slot in the wood. Obsidian spear and knife heads were shown, the mounting of the obsidian flakes in the spear heads being effected with a strong gum and twine. The lecturer described most fully the customs, dress, and manners of the natives, and gave some thirty-five words of the language. The whole was illustrated with maps, sketches, and numerous objects. The president and Prof. Rolleston took part in the discussion.—Mr. J. P. Harrison then read the report on recent excavations at Cissbury Camp. The pit that has been excavated immediately adjoins the one cleared out by Mr. E. Willett in 1874, and is of nearly the same size. There are two platforms, one above the other, in a kind of apse on the highest, or eastern side of the pit. Galleries radiate in all directions, excepting towards the west, where, under a mass of chalk rock which projects into the pit some six feet, there is a small chamber. Outside of it a quantity of charcoal and smoked chalk indicated that a fire had been made on the floor of the pit. Lines in different combinations were found at the entrances of two of the galleries and also on loose blocks of chalk; some of them may, perhaps, possess a definite meaning, but the majority were most probably idle marks.

PARIS

Academy of Sciences, January 3.—M. Peligot in the chair. The following papers were read:—Observations on a reclamation recently presented by M. Faye, with regard to whirlwinds produced in the atmosphere, by P. Secchi. The supposition of descending currents in whirlwinds is very old; we find it in *Lucretius* and the ancient physicists. Besides trombes with descending pressure, there are many which exert suction. M. Faye replied, denying the latter fact, maintaining the novelty of his ideas, &c.—Practical processes for the destruction of *Phylloxera*, by M. Boiteau. He describes an apparatus, a perforator with automatic distribution, employed in applying the insecticide liquid.—The programme of a prize founded by the late Dr. Bressa, was announced from the President of the Turin Academy of Sciences. It is 12,000 francs, and to be awarded every two years to Italian and foreign savants alternately, for the most brilliant and useful discovery or most remarkable work in the physical and experimental sciences, natural history, pure and applied mathematics, physiology, and pathology, not excluding geology, history, geography, and statistics. First award, in 1879, to a savant of any nationality.—The cyclic or logarithmic periods of the quadratrix of an algebraic curve of degree  $m$  are the products by  $2\pi\sqrt{-1}$  of the roots of an algebraic equation of degree  $m$ , which may always be obtained, and the coefficients of which are rational fractions of those of the equation of the curve proposed. Theorem by M. Maximilien Marie.—On the cause of motion in the radiometer, by M.M. Berthelot and Garbe. In a suspended radiometer, according to the initial con-

ditions, the movement of the vessel may be *nil*, positive, or negative, and thus may be explained various errors of observation. From the equation  $I\omega + I'\omega' = \text{const.}$  (where  $I, I'$  are the moments of inertia of vessel and vane-system,  $\omega, \omega'$  their angular velocities), the authors draw several consequences which are verified by experiment.—On the flow of mercury by capillary tubes, by M. Villari. The quantity which flows in a second is proportional to the pressure under which the flow occurs, and to the fourth power of the radius of the tubes, and inversely proportional to the length of the tubes, if a certain minimum length have been passed which is smaller the narrower the tubes, and the less the pressure. For tubes with elliptic section, the minimum length under which these laws are no longer verified is smaller than for circular tubes whose radius is equal to the mean radius of the elliptical section. The quantity of flowing mercury, lastly, depends on a certain constant, which depends on the form of aperture of the tube and the nature of the sides.—On an experiment similar to that of singing flames, by M. Montecat. Into a long vertical metallic tube is lowered a metallic basket with glowing charcoal. When this has reached the lower part, the air-current produces a sound. On raising the charcoal towards the middle, the sounds increase, diminish, and cease; on continuing the movement they recur, but at the double octave of the first, and they cease as the charcoal nears the orifice. M. Jamin recalled M. Kastner's pyrophone.—On the rotatory power of mannite and its derivatives, by M. Bouchardat. Contrary to M.M. Mintz and Aubin, who supposed mannite to be a substance with indifferent rotatory power, it is shown to possess a real levorotatory power near  $-0^\circ 15'$ .—Researches on Melezitose, by M. Villiers.—Remarks on its communication and on the constitution of the isomeric sugars of cane sugar, by M. Berthelot. The union of two molecules of the same glucose, regarded in turn as aldehyde and as alcohol, produces three distinct types of isomeric saccharoses. Of these three types, mixed ether, mixed aldehyde, and ether aldehyde, the first and third alone are capable of reproducing their generators by simple hydration, under the influence of acids or ferments.—Graphic study of the movements of the brain in man, by M.M. Giacomini and Mosso.—On the alterations of quaternary deposits by atmospheric agents, by M. Vanden Broeck. Such alterations in the Paris valley permit of assimilating the red diluvium to the grey, a simple *facies* of modification of the same layer.—M. Virlet d'Acoust described a lunar halo observed by him at Paris on the 30th ult.

CONTENTS

	PAGE
FERMENTATION, II. By CHARLES GRAHAM	249
CAVLEY'S ELLIPTIC FUNCTIONS. By C. W. MERRIFIELD, F.R.S.	252
OUR BOOK SHELF:—	
Abney's "Instruction in Photography"	253
LETTERS TO THE EDITOR:—	
Just Intonation.—Lieut.-Col. A. R. CLARKE, R.E.	253
South Polar Depression of the Barometer.—Rev. W. CLEMENT LEV	253
Sense of Hearing, &c., in Birds and Insects.—ROBERT M'LAURIAN, F.R.S.	254
THE "CHALLENGER" COLLECTIONS. By Prof. Sir C. WYVILLE THOMSON, F.R.S.	251
PROF. AGASSIZ ON THE "CHALLENGER" COLLECTIONS	256
REMARKS ON THE NEW MONOTREME FROM NEW GUINEA ( <i>With Illustrations</i> )	257
ON THE TROPICAL FORESTS OF HAMPSHIRE, II. By J. STARKIE GARDNER, F.G.S. ( <i>With Illustrations</i> )	258
THE REPORT ON THE AUSTRIAN "NOVARA" EXPEDITION	261
THE CYCLONE WAVE IN BENGAL	261
OUR ASTRONOMICAL COLUMN:—	
An Observatory on Etna	261
The New Star of 1864	261
METEOROLOGICAL NOTES:—	
Storms and Floods of the Past Six Weeks	265
Physics of the Atlantic Ocean	265
Weather Maps of Germany	265
Thunderstorms in Central Europe	265
Sunspots and Washer	265
BIOLOGICAL NOTES:—	
Chemical Changes Observed during Progress of the Potato Disease	261
Commensalism among Caterpillars ( <i>With Illustrations</i> )	261
Blistering Beetles as a Cause for H. drophobica	261
Caprosaurus asaphidis in Nova Scotia	261
Action of the Brain	261
Papuan Plants	261
Beet-building Fish	261
Beaver in Siberia	261
NOTES	
SCIENTIFIC SERIALS	261
SOCIETIES AND ASSOCIATIONS	261

THURSDAY, JANUARY 25, 1877

## THE ENCYCLOPÆDIA BRITANNICA

*Encyclopædia Britannica*. Ninth Edition. Vol. V.  
(Edinburgh: A. and C. Black, 1876.)

THE article of greatest scientific interest in this volume is, of course, that on Chemistry. We can conceive of few literary tasks more trying to a duly qualified and conscientious writer than to attempt to give a comprehensive and well-balanced account of the rise, progress, and present position of a science like chemistry within an encyclopædia article of such compass as even the most compliant of editors would tolerate. And we must confess at the outset that it was with some feeling of sympathy for its authors, engendered by this reflection, that we commenced the examination of their essay—a feeling, however, which quickly altered its complexion as the consciousness grew upon us that in everything which is essential it may fairly compare with any one of its predecessors. And than this, no higher praise, we think, is possible.

The article divides itself, naturally, into three parts. In the first part, which we owe to Mr. F. H. Butler, is traced the origin and growth of chemistry. Its only fault is its exceeding brevity; it is hardly to be expected that within the space of some six or seven pages we can have a picture as lively or as complete as we find in the works of Hoefer or of Hermann Kopp. Of the birth of chemistry very little is said, and only the slightest reference is made to its association with the Greeks, Arabians, and Egyptians. With the rise of the Spagyrist with Paracelsus, who taught that the true use of chemistry is not to make gold but medicines, we seem to perceive the first attempts at a rational pursuit of the study, but the crooked manner in which the sect sought to advance its doctrine of the threefold constitution of matter was too much for the patience even of the gentle Robert Boyle, who had scant mercy for "the sooty empiricks, having their eyes darkened and their brains troubled with the smoke of their furnaces," who were "wont to endeavour to evince their salt, sulphur, and mercury (to which they gave the canting title of hypostatical principles) to be the true principles of things." The growth of Iatro-Chemistry until its final overthrow by Hoffmann so late as the beginning of the eighteenth century is concisely and carefully worked out, and the relations of its doctrines to those of Becher and Stahl are made apparent. Indeed the largest portion of this section of the article is devoted to the Phlogistic period, and the theory itself is set in a proper light. It has been too much the fashion to decry the services of Stahl's great conception, and people have marvelled that men of insight and logical minds—such men as Bergmann, Macquer, Scheele, or Cavendish—could have been hoodwinked by such a doctrine. But the theory was perfectly consistent in the outset, and it was only by the very excellence with which it served the purpose of a great theory that it fell. We are glad to find, too, that the services of Black and Cavendish as the real founders of quantitative chemistry meet with a just appreciation. The labours of Lavoisier are estimated with equal impartiality.

For, as Liebig declares, although "Lavoisier discovered no new body, no new property, no natural phenomenon previously unknown . . . his immortal glory consisted in this—that he infused into the body of the science a new spirit; but"—he is careful to add—"the members of that body were already in existence and rightly joined together." It may be worth while noting that the date of Lavoisier's famous memoir "On the Nature of the Principle which Combines with the Metals during their Calcination and which Augments their Weight," is given as 1755, at which time if, as some authorities declare, he was born in 1745 (our author says 1743), the great chemist would be of the tender age of ten years; the careful reader would doubtless marvel at so remarkable an instance of precocity did he not discover from the context that the memoir must be antedated by at least twenty years. That *clarté* which was the distinguishing feature of Lavoisier's mind is reflected in his "Traité de Chimie," with an outline of which Mr. Butler fitly closes his account of this stirring epoch. It is instructive to trace the progress of our knowledge of the elementary bodies from the date of the publication of that work. Excluding light and caloric, Lavoisier recognised some thirty simple substances; since his time the number of the elements has doubled itself, but it is remarkable to observe how slow, with all our appliances, is the rate of discovery in these degenerate days. Gallium, the latest on the list, was brought to light in 1875. If we divide the lapsed portion of the present century into periods of twenty-five years, we find that the times of discovery distribute themselves as follows:—

1800-1825	...	...	...	22	New elements.
1825-1850	...	...	...	10	" "
1850-1875	...	...	...	5	" "

And yet, if we may credit M. Mendelejeff and his Laws of Periodicity, we have nothing like our proper complement of elements. Obviously, therefore, if the present rate of increase is to be maintained, the occupation of the chemist will not be gone for some time to come; ages must elapse before even the alphabet of his science is constructed; and by the time that Macaulay's Richard Quongti goes to complete his studies at the University of Tombuctoo, attracted by the high scientific character of Prof. Quashaboo, the learned professor will doubtless be engaged on the article "Chemistry," to occupy an entire volume of the 101st edition of the "Britannica," which will still be published by the eminent firm of Black.

Mr. Butler repeats the common statement, that the atomic theory first suggested itself to Dalton during his investigations on light carburetted hydrogen, and olefiant gas; the matter is probably of little moment, but as an historical fact it may be noted that the germ of his great work is to be found in his "Experimental Inquiry into the Proportion of the Several Gases Contained in the Atmosphere," read before the Literary and Philosophical Society of Manchester in November, 1802. In this paper Dalton states that one of the component gases—the oxygen—has the power of combining chemically, in two different proportions, with nitric oxide, to form two distinct compounds; and that the quantities by weight of oxygen which thus combine are in the ratio of one to two. It was this circumstance which first aroused Dalton's attention to the fact that one chemical element



can combine with another in two different but definite proportions by weight. The study of the hydrocarbons and of carbon monoxide and dioxide was not taken up until two years later. (See Roscoe's "John Dalton and his Atomic Theory," Science Lectures, 1874.)

It has probably been from considerations of space that Mr. Butler has been unable to do more than glance, in the briefest possible manner, at the progress of modern theory, and we fear that in one or two instances, his reader may complain that in the effort to be concise he has become obscure. The idea of the polyatomicity of the elements is dismissed in a single line. The doctrine of *materia prima* has played such an important part in the past, and if we may judge from the signs of the times, is destined to play a still more important part in the future, that it is surely an omission of some moment to neglect all mention of Prout's hypothesis, of Dumas's extension of it, of its unquestionable influence upon the French school, and of the labours of Stas in connection with it. It is to be regretted too that so little is said of the rise of what may be termed the physical side of chemistry; of, for example, the influence of Dulong and Petit's law, of the law of Avogadro, of Mitscherlich's law of isomorphism, and that no direct reference is made to modern notions of the constitution of matter. It is true that certain of these matters are mentioned in subsequent sections of the general article, but they have their proper place in a historical account of the growth of the science. Lastly, the value of this portion of the article would have been greatly augmented by some reference to the bibliography of chemical history; Mr. Butler will excite the interest and curiosity of many students by his well-written and thoroughly readable sketch; he would have increased their gratitude by informing them how they might satisfy their craving for further knowledge.

The second, and by far the largest, portion of the article (it occupies nearly two-thirds of the whole) treats of Inorganic Chemistry, and is the work of Prof. Armstrong. In its main features it differs considerably from the ordinary run of descriptive treatises, although we question whether any one of them exhibits a more complete *coup d'œil* of the present position of this branch of the science. No space is wasted on mere *technics* (if we may employ a word which is sanctioned by Worcester), and it would be almost impossible for one ignorant of the science to employ it as a *vade mecum*. It is characterised by the manner in which broad and comprehensive principles are grasped and illustrated; entire groups are contrasted or compared, marched up and down as it were, like the skilful handling of battalions. Nevertheless, whilst we cannot but admire the fearless manner of his evolutions, we are afraid that Dr. Armstrong's love and zeal for system and generalisation occasionally allure him upon tender ground. The article is, presumably, not specially written for chemists, although we have no hesitation in affirming that every chemist who reads it will do so with pleasure, and therefore hypotheses such as that Epsom salts may be regarded as the normal magnesium salt of dihydrated sulphuric acid,  $H_2SO_6$ , crystallised with five molecules of water; or that the true formula of potassium perchlorate is  $K_2Cl_2O_8$ ; or that the molecule of selenium dioxide is probably not represented by the formula  $SeO_2$ ; or that the so-called hydrogen disulphide has

presumably the composition  $H_2S_2$ ; which are not the common property of the science, however ingenious and suggestive they may be, as these undoubtedly are, do not, we submit, come within the scope of a treatise which should primarily be a register of facts for the use of general readers. We allow that Dr. Armstrong is generally very cautious in his mode of stating these and similar conjectures, and possibly a very careful reader, whilst admitting their relevancy, would regard them in their proper light of tentative hypotheses; but all readers are not careful; the beaten path, we are told, is the safe path; and although scientific preachers, unlike other preachers, may with impunity be as heterodox as they please among themselves, it may be doubted how far it is expedient to preach any other than perfectly safe doctrine to the laity. This is really the only piece of adverse criticism we have to offer. When facts are known they are stated, and with remarkable perspicacity. As instances of careful and judicious compilation we may refer to the sections on ozone, hydrogen dioxide, and the organo-silicon compounds. A commendable feature is the recognition of the great importance of what we have before termed the physical side of chemistry; and in this respect Dr. Armstrong's treatise is unique: we have no hesitation in asserting that everything of value which recent investigation in the domain of chemical physics has brought to light is carefully interwoven in the proper place. The results of the thermo-chemical work of Thomsen and others; of the work of Troost and Hautefeuille and Brodie on dissociation phenomena; of the researches of Berthelot and others on the state of salts in solution; and of numerous other works scarcely less important, are duly set forth, and in such relation as to enforce their value and applicability. Indeed, in one or two cases we have the results of work which has not yet been fully published, as in the account of the action of nitric acid upon the various metals. It appears that with the exception of silver all the metals give with this acid a mixture, in varying proportions, of free nitrogen and nitrogen dioxide and monoxide. If, however, we compare the behaviour of the acid in the case of the three closely-related metals, magnesium, zinc, and cadmium, the reducing action of the evolved hydrogen is found to be greatest with the magnesium, and least with the cadmium, which result Dr. Armstrong connects with the fact that in the solution of these metals, the greatest amount of heat is evolved by magnesium and the least by cadmium. But that the comparative reducing power of the hydrogen evolved by the action of the three metals stands in no direct relation to the heat developed on solution, appears to be evident from the circumstance that in the case of the deoxidation of solutions of vanadium pentoxide by the action of these metals, the very reverse obtains: magnesium added to the solution of the pentoxide forms the trioxide, and the liquid becomes green; under no conditions, apparently, is this metal able to bring about a lower degree of oxidation; on the other hand, zinc and cadmium carry the deoxidation a stage further, and a lavender-coloured solution of the dioxide is obtained. And it would further appear from experiments which are in progress by the writer of this notice, that the amount of hydrogen which is effective in the work of reduction, as measured by its power of deoxidising ferric sulphate, amounts, in the case of mag-

to about twenty-two per cent. of that which is evolved; whereas in the case of magnesium, under circumstances as similar as possible, it is only about eight per cent. This, indeed, is but a portion of the broad problem of the connection between the conditions of a chemical change and its amount, one side of which, as Dr. Armstrong shows us, has already been attacked by Messrs. Harcourt and Esson. We may add, in this connection, that it would have conduced to clearness if, in the concise account of the work of these chemists, the term "thiosulphate" had been substituted for that of "hyposulphite," since we have the existence of Schützenberger's acid duly stated a few pages further on, and it, in accordance with Henry Watts's suggestion, is called hyposulphurous acid.

Of the remaining portion of the article, namely, that on organic chemistry, we have but little space to speak. In one respect Mr. Meldola has had the most difficult share of the work, for it is no light task to be obliged to concentrate the essence of modern organic chemistry within less than forty pages. The general arrangement of this section bears considerable resemblance to that of Prof. Schorlemmer's excellent Manual of the Carbon Compounds, and although it, of necessity, cannot be attractive to the general reader, we can congratulate Mr. Meldola on having produced a compilation which will be highly serviceable to chemists.

T. E. T.

#### PACKARD'S LIFE-HISTORIES OF ANIMALS

*Life-Histories of Animals, including Man; or, Outlines of Comparative Embryology.* By A. S. Packard, jun. (New York: Holt and Co.)

IN the rapidly-shifting condition of our knowledge of the development of all kinds of animals, it is a most difficult thing to produce a satisfactory treatise on Comparative Embryology. None the less such a work is much needed by our university students, and the little book which Dr. Packard has put together may be recommended to them as containing a great deal of the latest information on the subject, well illustrated by diagrams derived from a number of widely-scattered German, French, English, and American periodicals.

At first sight Dr. Packard's book appears considerably better than it really is. The student needs to be cautioned in using it, since it combines with much that is excellent a surprising amount of inaccuracy, and is sadly deficient in critical power. Dr. Packard is a student of German zoological journals, and is too ready to attach a large measure of importance to German work because it is German. Moreover, though he has himself engaged in researches on the embryology of the King Crab and of Insects, he has clearly not worked over a wide field in the subject, and consequently is not able to bring a trained experience to bear on the discrimination of the sound and the unsound observations and speculations of recent writers.

Amongst the good points of the book (to take some of these to begin with) we have a figure supplied by Dr. Brants of his *Protobathybius Robesonii*; the account and figures of various Monads from James Clark, Dallinger, and Drysdale; the text and figures relating to the

*Dentalium*; figures relating to the development of Arthropods from the works of Bobretzky, Kowalewsky, and Ganin; Morse's figures of developing Terebratulina; Agassiz's Tornaria and Balanoglossus; Wyman's embryonic skates; whilst good figures of larval Ascidians are also given.

Whilst insisting on the service which the book will render to the young student, we shall now point to some of its shortcomings. In the first place it is somewhat misleading to call attention in the title of the book to the two pages which are devoted to man. The Vertebrata altogether, are not treated with the same proportion of attention, relatively to our knowledge of them, as are the lower groups of animals.

It may be pointed out that whilst giving a large number of very useful citations of recent embryological works, Dr. Packard is not uniformly careful to ascribe the use of the terms and genealogical hypotheses which he employs to their rightful authors. In his chapter on the life-history of the Mollusca, he makes use of the terms Trochosphere and Veliger which I introduced into embryological nomenclature in my paper on the Development of the Pond Snail (*Quart. Journ. Micros. Science*, 1874), which he cites at the end of the chapter; he does not, however, ascribe either the terms or the views connected with them to their author. I am induced to mention this omission specially, since Prof. Semper of Würzburg, in his last publication—a heavy octavo discussing the relationship between Vertebrates and Annelids—has made a leading feature of the Trochosphere, appropriating the name as applied by me and the doctrine connected with it, without the slightest acknowledgment. The impropriety of Semper's proceeding is the greater since he makes no mere passing allusion to the Trochosphere, but puts forward a "Trochosphere-theory" which is intended to eclipse the "Gastrula-theory" of Haeckel.

A few points amongst those which we have noted as blemishes may be conveniently cited in order of pages.

Page 3.—We read "Bathybius was first discovered by Prof. Wyville Thomson in 1869, in dredging at a depth of 2,435 fathoms at the mouth of the Bay of Biscay." It was not, but was described and named by Huxley in 1868. Thomson appears to have seen it in 1869, in a living state under the microscope, to judge from his description quoted by Packard. Presumably this was not the sulphate of lime with which Bathybius has since been identified by the same authority.

Pages 24 and 25.—Urella should be, Uvella.

Page 54.—"We have by tearing apart a species of Sycandra (or Sycon) perhaps *S. ciliata*, which grows on a Ptilota, found the planula much as figured by Haeckel, Metschnikoff, and Carter, and anyone can with patience and care observe the life-history of the marine sponges." It would have been more satisfactory if Dr. Packard had told us whether the planulae he saw were like the figures of Haeckel or those of Metschnikoff; they certainly could not have been like both. It is a mistake to dismiss one of the most difficult problems which is now baffling embryologists with the assurance that "anyone can with patience and care" solve it.

Page 96.—"Sprat" for young oysters should be "spat." See also observation on the young oyster, and his erro-

neous interpretations, are quoted with simple faith by Dr. Packard; so, too, are the same author's observations on Gasteropod development.

Page 105.—A serious error is here revived as to the identity of the velum of the Gasteropod larva, and the wings of such Pteropods as *Styliola*. The older observations of Gegenbaur, and the later ones of Fol, have shown that the velum co-exists with, and is quite distinct from, the expanded wing-like foot-lobes of the Pteropods.

Page 117.—The mode of development of Grenacher's Cephalopod is not, as stated by Dr. Packard, "totally different" from that of the common cuttle-fishes. It differs only in the somewhat smaller size of the nutritive yolk. The marginal cilia have no significance.

Page 120.—"Peripatus has been proved by the researches of Mr. Moseley to be a tracheate insect, for in the young genuine tracheæ exist, though they disappear in the adult, or at least have not been discovered." We should have expected to find Dr. Packard less inaccurate in what relates to the Arthropods. The above is altogether misleading; what Mr. Moseley found was that the adult *Peripatus* is richly supplied with tracheæ. He did not find tracheæ in the embryos, but he found still more important evidence of Arthropod character, namely, the presence of a pair of foot-jaws, the first post-oral pair of appendages becoming modified in the course of development, so as to function as mandibles.

Page 207.—Amphioxus is said to possess "primitive kidneys like the segmental organs of Worms." Of all the varied attempts to fix upon renal organs in Amphioxus there are none which quite warrant this statement. The fact is that nothing corresponding to the segmental organs of Worms has ever been described in Amphioxus, excepting the "pigmented canals." Though sometimes one epithelial area and sometimes another is declared for the time to be "renal," functionally if not morphologically, the truth is that no renal organs at all are known to exist in Amphioxus.

Notes like the preceding might be multiplied were it worth while. Though such inaccuracy of statement does somewhat lessen the value of Dr. Packard's book, it is nevertheless one which is really welcome, and serves very well the main purpose for which it was designed, viz., that of conducting the commencing student over the recent literature of that young giant, Comparative Embryology.

E. RAY LANKESTER

#### OUR BOOK SHELF

*Descriptive Catalogue of a Collection of the Economic Minerals of Canada, and Notes on a Stratigraphical Collection of Rocks. Exhibited at the Philadelphia International Exhibition. (Montreal, 1876.)*

THE geological survey of Canada, under the direction of Mr. Selwyn, F.R.S., has placed in the Philadelphia Exhibition a collection of minerals and rock specimens of much interest, as they very fairly represent the geological productions of the Dominion, as far as the operations of the survey have extended. The descriptive catalogue of these "exhibits" (we regret the use of this new-fangled Americanism in a Canadian work) has been ably drawn up by the Geological Corps of Canada under the following heads:—1. Metals and their ores. 2.

Materials used in the production of heat and light. 3. Minerals applicable to certain chemical manufactures, and their products. 4. Mineral manures. 5. Mineral pigments and detergents. 6. Salt, brines, and mineral waters. 7. Materials applicable to common and decorative construction. 8. Refractory materials, pottery-clays, and pottery. 9. Materials for grinding and polishing. 10. Minerals applicable to the fine arts and to jewellery. 11. Miscellaneous minerals. This catalogue is sufficiently comprehensive, while the arrangement is well adapted for easy reference.

Along with the descriptions of the specimens under each head we frequently find a condensed account of the origin and progress of various industrial pursuits. Thus under the head of Class 2, "Materials used in the production of heat and light," we have short notices of the more important collieries in the eastern provinces of Canada, together with observations on the origin of the petroleum springs of Ontario. The region in which the petroleum beds occur is situated in the western part of Ontario, around the town of Petrolia, occupying about eleven square miles of level ground, covered to a depth of about 100 feet with bluish clay. The oil is tapped by borings, which penetrate a series of bluish dolomites, shales, and marls to a depth of 380 feet under the clay, when a productive stratum is struck, and the oil, accompanied by sulphurous saline water, flows into the bore-hole, or well. The strata penetrated in boring the oil-wells, belong apparently to the "Hamilton," "Chemung," and "Portage" groups, representing according to Sir W. Logan, the upper portion of our Devonian beds,<sup>1</sup> but the petroleum itself is believed to originate in the lime-stones of the "Corniferous" formation which lie underneath; the strata occur in the form of a flattened dome. Another source of petroleum is the "Trenton" group, much lower down in the geological series, and referable to the Lower Silurian period. The geological position of the petroleum beds, as well as cases of actual observation, all go to show that the source of the mineral oil is animal, not vegetable. The limestones of the Corniferous, Gaspé, and Trenton groups are more or less coralline, and from the observations which Sir W. Logan records, it would appear that the oil is derived from the decomposition of the animal matter which originally filled the cells of the coral-rock. In such a position the oil has been observed, where these palæozoic limestones crop out at the surface, and where the limestone is overlaid by sandstone, as in the United States, or by shales or other materials, as in Canada. The animal oil has saturated these latter to such a degree that they have become underground reservoirs which can be made available by artificial means.

The notes by Mr. Selwyn on the collection of rock-specimens suggest several points on which we should like to dwell, did space permit. We shall only, however, refer to the remarkable case of metamorphic action to which he calls attention; namely, that to the south-east of the Valley of the St. Lawrence the formations are highly metamorphosed, their representatives to the north of that river being in their unaltered condition. This change takes place along a great line of dislocation ranging from Lake Champlain to Quebec and Gaspé, as described by Dr. Sterry Hunt. The change in the condition of these beds, none of which are probably older than the Devonian period, is so great, that the hand-specimens are undistinguishable from others collected in Eastern Canada or Ontario of undoubted Laurentian age. That metamorphic rocks may be of any geological period is a fact of which students of geology should be reminded; for we have recently had evidence before us, that some of the rising generation of geologists are still instructed in the exceedingly erroneous view that there is a "metamorphic system" of rocks forming the base of the general series.

E. H.

<sup>1</sup>Geology of Canada, p. 20.

LETTERS TO THE EDITOR

[The Editor does not hold himself responsible for opinions expressed by his correspondents. Neither can he undertake to return, or to correspond with the writers of, rejected manuscripts. No notice is taken of anonymous communications.]

Holly Berries and Rare Birds

WITH reference to the statement which has been made by Mr. McNab of the Botanic Gardens in Edinburgh, corroborated by Mr. Darwin and others in England, that holly berries are, this season, extremely scarce, it may be interesting to note that so far as this district is concerned, the holly is, on the contrary, unusually rich in fruit. For many years I have never seen so abundant a crop, and I suspect this will be found to be the case all over the West Highlands.

We have had a most unusual winter, from its extreme mildness, skies almost continually densely overcast, and the persistence of east wind. The rainfall for 1876 was not much in excess of our average—fifty-three inches. We have had little snow, and only one severe gale of wind. But the barometer has been frequently very low, in sympathy with the destructive gales both to the north and to the south of us.

I don't know whether it is due to any of those circumstances of climate that we have had two very rare birds—the great grey shrike, and the greater spotted woodpecker.

The shrike was seen here about twelve years ago, on one occasion; and a specimen of the woodpecker was killed about fifty years ago. About the time when the shrike was seen here on the last occasion, several specimens were shot in different parts of the low country; but this winter I have seen no case mentioned of the bird being observed.

ARGYLL

Inveraray, January 20

On the Southern Tendency of Peninsulas

THE attention of those interested in physical geography has long been attracted to the remarkable fact that almost all the great peninsulas of the earth trend southwards, and that the majority, at any rate, have an island, or group of islands, at their southern extremity. Thus Mrs. Somerville, calling attention to this, says:—"The tendency of the land to assume a peninsular form is very remarkable, and it is still more so that almost all the peninsulas trend to the south, circumstances that depend on some unknown cause which seems to have acted very extensively. The continents of South America, Africa, and Greenland, are peninsulas on a gigantic scale, all directed to the south; the peninsula of India, the Indo-Chinese peninsula; those of Korea, Kamtschatka, Florida, California, and Alaska, in North America; as well as the European peninsulas of Norway and Sweden, Spain and Portugal, Italy and Greece, observe the same direction. . . ."

"Many of the peninsulas have an island, or group of islands at their extremity, as South America, which is terminated by the group of Tierra del Fuego; India has Ceylon; Malacca has Sumatra and Banca; the southern extremity of Australia ends in Tasmania, or Van Diemen's Land; a chain of islands runs from the end of the peninsula of Alaska; Greenland has a group of islands at its extremity; and Sicily lies close to the southern termination of Italy."

Now may we not correlate this with the remarkable preponderance of ocean in the southern hemisphere, which M. Adhemar has suggested to be due to the alteration of the centre of gravity of the earth, caused by the great southern cupola of ice? However that may be, the preponderance of water in the south is very remarkable. Taking each parallel as unity, the proportion of sea is as follows:—

60° North	0.353	10° South	0.786
50° "	0.407	20° "	0.777
40° "	0.527	30° "	0.791
30° "	0.536	40° "	0.951
20° "	0.677	50° "	0.972
10° "	0.710	60° "	1.000
0° "	0.771		

Without at the present moment entering upon any discussion as to the cause which has produced this remarkable result, the fact at any rate seems to throw some light on the southern direction of promontories, for which, as far as I am aware, no cause has yet been suggested. For let us suppose three tracts of land, each trending north and south, each with a central backbone, but one with a general slope southwards, one with a northward

slope, and the third without any. The first will, of course, form a peninsula pointing southwards, because as we proceed southwards, less and less of the surface will project above the water, until nothing but the central ridge remains. The second tract, however, would also assume the same form, because, though by the hypothesis the land does not sink, still the gradual preponderance of water would produce the same effect.

If, moreover, the central mountain ridge, as is so generally the case, presents a series of detached summits, the last of such elevations which rises above the water level will necessarily form an island, situated, with reference to the land, like those mentioned by Mrs. Somerville.

Lastly, in the third case, the gradual diminution of water would tend to neutralise the effect of the slope, and if the two were equal, the land would form, not a pointed peninsula, but an oblong tract.

If there is anything in the above suggestions it will throw some light on the southern trend of peninsulas by bringing them under the general law to which is due the remarkable preponderance of ocean in the southern hemisphere.

JOHN LUBBOCK

Down, Kent

Basking Shark

IN looking over some old numbers of NATURE, which I had not been able to read, owing to my absence from Florence, I came across Dr. E. Perceval Wright's interesting article on the basking shark, *Selache maxima* (NATURE, vol. xiv. p. 313), which I read with much pleasure, and on which I would beg to offer a few observations, which I hope will not be considered as coming too late.

First and foremost, Dr. Wright in justly lamenting the absence of information on a most strange and singular form of Elasmobranch fish, far from being rare on the British coasts, entirely omits to mention the exhaustive and most important memoir on the genus *Selache*, published by Prof. P. Pavesi, of Pavia, in the *Annali del Museo Civico di Storia Naturale di Genova*, edited with so much ability, and mostly at his own private expense, by my friend, the Marquis G. Doria. In Italy we usually take much pains to be au jour of foreign scientific literature, and we are striving to do our best to form a good scientific literature of our own, therefore we may be excused if we feel anxious that it should be more generally known and appreciated abroad. Doria's *Annali* include most important zoological papers, and form already eight big volumes, which have cost the editor no small amount of pains and money; and it is most desirable that they should not escape the notice of working zoologists out of Italy. Indeed I may refer to some of the leading English zoologists, and more especially to my friend Dr. P. L. Sclater, to corroborate my assertion.

Prof. Pavesi's paper, "Contribuzione alla Storia Naturale del genere *Selache*," is continued in the sixth volume of Doria's *Annali*, published in 1874; and had Prof. Wright read it, he would have discovered that the very conflicting opinions on *Selache*, *Polyprosopus*, and *Pseudotriakis* had been most carefully examined, discussed, and sifted, that all the anatomical and zoological labours of well known and little known savants on the subject had been carefully analysed and critically studied by Prof. Pavesi, who in illustrating in a very lucid and minute manner the zoological affinities and anatomical peculiarities of a fine specimen of *Selache* captured at Lerici, near Spezia, on April 25, 1871, has succeeded in solving the Gordian knot which confused the true relations of the three genera above cited, and refers those strange Selacoids to two forms: *Selache maxima* (Gunn) and *S. rostrata* (Macri). To the latter species, characterised by a most singular snout, is to be referred the Lerici specimens, now in the Museum of the University of Genoa; one captured near Reggio (Calabria) in May, 1795, and described by Macri as *Squalus rostratus*; and lastly, the basking sharks, captured on the Western British coasts, and described in an incomplete manner as *Polyprosopus* by Couch, and as *Squalus* or *Cetorhinus rostratus* by Cornish.

Prof. Pavesi has largely illustrated the anatomy of *S. rostrata* in his memoir, especially the skeleton of the Lerici specimen which is preserved entire in the Genoa Museum; he also describes and figures the strange baleen-like fringes which adorn the branchial arches.

HENRY J. GIGLIOLI

Florence

[We have also received a communication from Rev. M. Harvey, of St. John's, Newfoundland, mentioning that a spe-

carcasses of the basking shark had been captured entangled in some salmon nets off the south shore of Conception Bay in August, 1876. Mr. Harvey thinks that the shark was probably feeding on caplin, as the Bay was full of shoals of this little fish. The teeth in his dried specimen were about a quarter of an inch in length, though probably in the fresh state they hardly projected beyond the gums. For other details we would refer Mr. Harvey to Prof. Pavesi's memoir quoted above, with the hope that he may still further continue his interesting investigation of the fauna of Newfoundland.—E.D.]

### The "Challenger" Collections

It is a rather remarkable proof of the increased interest taken in natural science, that no one worth listening to has ventured to make a remark in disparagement of the *Challenger* expedition, or to utter a growl at the liberal support accorded to it from the national fund. This goes far to show that extensive classes of the community are able in various degrees to appreciate the objects and results of the expedition. One of these results is the collection of specimens in natural history. It is on the final details of this collection that I wish to offer a suggestion. Within my own recollection it would have been difficult to name half-a-dozen public museums in Great Britain and Ireland where a series of objects, such as could be formed out of the duplicates in the *Challenger* collection, would be sure of meeting with a suitable reception. The number now would probably exceed a score, exclusive of museums in public colleges and schools; at a rough estimate the total number may be put down as at least forty. The supporters of these museums, as public tax-payers, have willingly contributed towards the expenses of the late noble and successful expedition; but it is not alone on this ground that I would respectfully urge a recognition of their claim to share in the treasure trove, but rather on the ground of the impulse that might be given to the study of natural science, and to the cordial support of plans for further expeditions of a like character.

For reasons which will be obvious on reflection, it would be a great saving of time and trouble to those engaged in the arrangement of the specimens if public museums were invited to send in, on or before a certain fixed day, to some central board, an expression of their desire to participate in the benefit of the *Challenger* collections, at the same time stating the grounds of their claim, and the department in natural science in which they would prefer to receive contributions. The examination and determination of these applications must be a work of time, therefore the sooner the plan is set on foot the better. Monographs will probably be published, and museums will purchase them; but they cannot buy the specimens, and the value of the monographs to any institution will be increased tenfold by the possession of authenticated specimens of some of the species described. Of course there are universities and other centres of scientific teaching which must come first; but I respectfully and earnestly protest against drawing the line of exclusion too stringently. There is now a great national opportunity for encouraging in a substantial way the instruction given in lectures and science classes, which often languishes for want of illustrations. I know of stores of natural history treasures. If only they had been dispensed in wisely apportioned nuclei, how valuable, by this time, might have been the collections accumulated round them. If selection amongst the claimants be impossible, might not series be made up for loan or sale? It will be unworthy of the way in which the *Challenger* work has been done, if even a single Rhizopod shall find its resting-place in a dust-hole.

HENRY H. HIGGINS

### Traces of Pre-Glacial Man in America

IN NATURE, vol. xv. p. 87, you have given an outline of a paper by Prof. Hughes, read before the Cambridge Philosophical Society, "in which he criticised the evidence offered to support the view that man existed on the earth during or before the glacial period." As concerning the question of the antiquity of man in North America, I would first call attention to the remarks on this subject by the late Prof. Jeffries Wyman, the most cautious and careful of archaeologists, who writes: "The ancient remains found in California, brought to the notice of the scientific world by Prof. J. D. Whitney, and referred by him to

the Tertiary period, &c," to which is added a footnote, that "the ample evidence collected by Prof. Whitney, but not yet published, substantiates the opinion given above with regard to age. The omission of the Calaveras skull would not weaken the evidence as to the existence of man in the Tertiary period in California." Inasmuch as the Glacial period occurred at the close of the Tertiary period, if Prof. Whitney's discoveries are conclusive, as to this side of the Atlantic, does it not follow that man must have existed, certainly in Asia, prior to the glacial epoch? We are assured by all ethnologists, that man migrated from Asia to America, and now we are offered proofs of his American sojourn, of a date preceding the occurrence of glacial conditions. Speaking of the Eskimo, Dr. Peschel remarks: "The identity of their language with that of the Namollo, their skill on the sea, their domestication of the dog, their use of the sledge, the Mongolian type of their faces, their capability for higher civilisation, are sufficient reasons for answering the question, whether a migration took place from Asia to America, or conversely from America to Asia, in favour of the former alternative; yet such a migration from Asia, by way of Behring's Straits, must have occurred at a much later period than the first colonisation of the New World from the Old one." Again, in speaking of the Red Indians, he remarks: "It is not impossible that the first migrations took place at a time when what is now the channel of Behring's Straits was occupied by an isthmus. The climate of those northern shores must then have been much milder than at the present day, for no currents from the Frozen Ocean could have penetrated into the Pacific." This reference to a milder climate must necessarily refer to the genial warmth of Pliocene times; for scarcely under other circumstances can we find time enough to explain the various phases of lost civilisations, especially in South America. Whether or not the supposed traces of glacial and pre-glacial man in Europe be really such—if the archaeology of North America has, so far, been correctly interpreted—then, unless they have been totally destroyed, unquestionable traces of such early man will be ultimately discovered; but if such "finds" should never gladden English archaeologists, the earnest workers in America have rendered it certainly true that in Asia, and doubtless in Europe, man did exist during the closing epoch of the Tertiary period, if there is, indeed, no error in the supposition that our American aborigines migrated from the Old World.

CHAS. C. ABBOTT

Trenton, N.J., U.S.A., December 16, 1876

### Glacial Drift in California

In a recent letter from my brother residing in California, he describes a curious moraine or drift formation, which may, perhaps, be as new to some of your readers as it was to myself. His description, with a few verbal alterations, is as follows:—

"The plains for a distance of from five to twenty miles from the foot of the Sierra Nevada are covered with what are locally termed 'hog-wallows.' The surface thus designated may be represented on a small scale by covering the bottom of a large flat dish with eggs distributed so that their longer axes shall lie at various angles with one another, and then filling the dish with fine sand to a little more than half the height of the eggs. The surface of the sand and of those parts of the eggs which rise above it, gives a fair representation of the 'hog-wallow' land. The mounds, which are represented by the eggs, vary from two to five feet in height, and from ten to thirty feet in diameter, some being nearly circular, some oval, while others are more irregular in shape. Those nearest the foot-hills are the largest, and they gradually diminish in size as they extend out into the plain. They are composed of gravel and boulders of irregular sizes, generally covered with a surface-soil, but sometimes bare. These tracts, which are very extensive in some parts of the State, have been till lately unexplained; but it is now generally admitted that they are due to the retreat of the broad foot of the glacier, leaving behind it a layer of debris or moraine-matter, which has become arranged in its present form by the innumerable hills that issued from the retiring sheet of ice. A living glacier has lately been discovered far up in the Sierra Nevada, near the head waters of the San Joaquin River."

Perhaps some of your geological readers may know if any similar formations occur elsewhere; and may favour us with their views as to whether so extensive and uniform a deposit could be due to a retreating glacier alone, or would not rather require the agency

<sup>1</sup> "Fresh Water Shell-remains of Florida." Fourth Memoir of Peabody Academy, Salem, Mass., U.S.A., December 1874, p. 45.

<sup>2</sup> "Races of Man," by Dr. Oscar Peschel. New York, 1876, p. 260.

<sup>3</sup> *Ibid.*, p. 400.

of a temporary submergence to spread out the debris with such uniformity. During the retreat of the waters, pluvial action might perhaps wash away the softened soil in the regular manner described.

ALFRED R. WALLACE

The Number of Species of Insects

PROF. HUXLEY is very much within the mark when he estimates the species of insects at "about 100,000, if not more." Were I to estimate the number of described species at 200,000, I believe the figures would also fall short of the truth, even allowing a liberal margin for synonyms. In one order alone (*Coloptera*) it is estimated that 80,000 species have been described.

I could enlarge upon the bearing these figures have upon theories on the geographical distribution of animals, but content myself with the remark that the groups of insects selected by writers on the subject are those in which colour is most prominent and structure least differentiated.

Lewisham, January 12

R. McLACHLAN

[WE sent the above to Prof. Huxley, who has appended the following note.—"It was not my object to give an accurate estimate of the total number of species of insects. Gerstaecker, in the new edition of Broun's 'Thier-reich,' gives 200,000 as the total number of species of *Arthropoda*; but I dare say that Mr. McLachlan has good grounds for the claim he puts in for insects alone.

"T. H. HUXLEY"—ED.]

Meteor

PRECISELY at 6 P.M., on the 19th inst., I saw a splendid meteor traverse the sky from a point about midway between Orion's belt and the Pleiades to a point directly under the moon, and about 10° above the horizon. It was pure white and dazzling, lasted about five seconds, emitted no sparks, except at the moment of disappearance, and was about half the size of the moon at the time.

R. M. BARRINGTON

Bray, Co. Wicklow, January 21

Diurnal Barometric Range at Low and High Levels

YOUR notice under this head (vol. xv. p. 187) of my paper on the daily inequalities of the barometer at Mount Washington and Portland, Maine, has hit a blot of which I was unconscious until now. Had I been more than a student writing one of his first essays in meteorology, I should probably, like yourself, have suspected something wrong in the Portland curve. The morning maximum and the afternoon minimum, as you point out, occur very much earlier than is usual.

Differences varying from +0.027 inch to -0.004 inch between your averages of General Myer's figures and those given in my paper did not surprise me, as mine were intended to represent the temperature of 60° F., while you have probably taken the observations either as already reduced to 32°, or have yourself reduced them to this temperature. My own impression is and was that the printed observations are not corrected for temperature, and in order to make the comparison with as little change as possible in the original figures for the three stations I brought each to something near a mean temperature for the three attached thermometers. Unfortunately, and here comes the blot, I now find that, by some mischance, in taking out the differences for Portland the external temperatures were taken instead of those by the attached thermometer. I exceedingly regret this, and shall as early as practicable make the required correction.

Fortunately this error does not affect the purport of my paper or the suggestions which I offer in it towards the explanation of the long-veiled question of the cause or causes of the daily inequality of the barometer.

An acquaintance with the variations of the daily barometric curves, which depend on change of season and difference of locality, would undoubtedly be of assistance in drawing these curves when the observations for only a few hours are given, but the six hours for which the Portland figures are given are so well distributed as to leave little uncertainty as to the general form of the curve in this case. I should not, however, be satisfied with any curve for the Portland observations which, when analysed by the usual formula and reconstructed from the co-efficients thus obtained, did not reproduce the original observations, and also the interpolated values for the other hours, within a limit of error of 0.001 inch. Unless your curve can stand this test I shall not be satisfied with your deductions as to the epochs of maximum and minimum values. Having had much experience in drawing

such curves, I venture to assert that the Portland observations, whether taken as they are printed or after a correction for temperature, will still give the morning maximum and afternoon minimum of the barometer much earlier than is usually the case in this country. If my paper draws attention to any singularity of this kind it will mitigate the disappointment caused by the mistake in the temperature correction.

I append the times of maxima and minima for Portland, May, 1872, as corrected; also similar data for five years at the Naval Observatory, Washington, U.S., and for Oxford, England.

Times of Daily Maxima and Minima of the Barometer for the Month of May.

	First Min.	First Max.	Second Min.	Second Max.
Portland, Maine:—	b. m.	h. m.	h. m.	h. m.
1872 ... ..	1 30	7 30	15 30	21 20
Washington, U.S.:—				
1862 ... ..	1 30	9 0	17 30	22 40
1863 ... ..	1 30	8 20	17 30	22 40
1864 ... ..	1 20	10 10	17 0	22 0
1865 ... ..	1 50	9 0	16 0	22 30
1866 ... ..	1 20	8 30	17 0	21 30
Mean for five years ... ..	1 30	9 0	17 0	22 16
Mean from calculation as given by Prof. J. R. Eastman ... ..	2 0	8 0	16 50	22 20
Mean for sixteen years at Oxford, England ... ..	3 55	7 55	16 25	22 45

Liverpool, January 5

W. W. RUNDELL

Former Climates

IT appears to be established that a climate favourable to the growth of coal plants and coral builders has prevailed in latitudes where the sun now shines for about seven months out of twelve.

Without inquiring how it came about that a warm sea once washed polar coasts, it would be interesting to learn whether the plants and animals concerned in the production of coal forests and coral reefs can flourish under these conditions of light supply.

Holmwood, Putney Hill

D. PIDGEON

Tape-worms of Rabbits

HAVING had occasion to dissect a number of wild rabbits, I have been surprised to find that the majority of them are infested with a large species of tape-worm. Can any of your readers inform me whether the life-history of this parasite has ever been made out? The case appears to be a remarkable one, because the host cannot here be suspected of ever taking animal food. Unless, therefore, we suppose that the tape-worm of a rabbit differs from other tape-worms in not passing through a hydatid stage, it becomes difficult to explain the very general occurrence of this species.

GEORGE J. ROMANES

POLARISCOPE OBJECTS

THE following is an interesting combination:—When the polariser and analyser are crossed, insert a concave plate of quartz cut parallel to the axis, with its axis inclined at 45° to that of the polariser, add to this a quartz wedge cut also parallel to the axis, having its axis placed perpendicular to that of the concave plate. The coloured circles, shown by the concave plate alone, will be seen to be displaced in the direction of the thicker edge, to a distance dependent upon the angle of the wedge. Also, as the wedge is made to slide in or out, the circles will be seen to expand or contract, according as the thicker or thinner part of it is presented to the field of view.

The explanation of this is to be found in the fact that a combination of two crystalline plates is optically equivalent to a single plate, whenever the axes of the plates are either parallel or perpendicular to one another. This follows immediately from a comparison of the mathematical expressions for the intensity of the light at any

part of the field in the two cases. The expressions will be found in Verdet (*Oeuvres*, tome vi. p. 110), who further remarks that, if the two sections are parallel, the addition of the second is equivalent to an augmentation, or a diminution of the thickness, according as the two plates are both positive or both negative, or are one attractive and one repulsive. If the principal axes of the plates are perpendicular, the addition of the second plate is equivalent to a diminution of the thickness when the plates are of the same sign, and to an augmentation of thickness when they are of opposite signs.

When, as in the case proposed, the second plate is a wedge, the effect of the combination will be the same as if the flat side of the concave plate were cut away wedge-wise, but in direction opposite to that of the actual wedge. Optically, then, the bottom of the concavity will be thrown towards the side on which the combination is optically thinnest; *i.e.*, on which the actual wedge is thinnest.

The sliding of the wedge will not alter the displacement of the centre, which is dependent on the angle, and not on the thickness of the wedge, but it will alter the total thickness of the compound plate, and consequently the diameter of the circles.

In addition to the above, I may mention another piece devised and constructed for me by Mr. C. D. Ahrens. This consists of two quartz cones, one hollow, the other solid, fitting into one another; one cone is of right-handed, the other of left-handed, quartz, and the axis of each is parallel to that of the crystal. The polarisation figure due to this combination is of course a series of concentric circles, which expand or contract when the analyser is turned in one direction or in the other.

If the field of view be examined at various distances from the centre, it will be found that there is a distance, *viz.*, where the right and left-handed cones compensate one another, at which there is no colour, but only an alternation of light and darkness. In the immediate neighbourhood of this the red and orange assume the brown and drab hues due to low illumination, in accordance with Helmholtz's experiments; beyond this the colours are more brilliant; while at still greater distances, where the thickness of one cone much exceeds that of the other, the colours become more pale.

Combe Bank;

W. SPOTTISWOODE

### MUSEUMS

THE subject of Museum management and arrangement having lately been commented upon by Prof. Flower in a lecture delivered at South Kensington Museum, and printed in *NATURE* of December 14, 28, *et seq.*, and also by Prof. Boyd Dawkins in an address to the Manchester Literary and Philosophical Society, noticed in *NATURE* of December 7, it may not be an inopportune time to suggest to those who have the management of these institutions the desirability of their mutual co-operation in order to develop them to their fullest extent. The great progress which has been made during the past few years in the establishment of museums in the various provincial towns of this country is highly creditable to those who have assisted in the movement, and the influence which they might have, if properly utilised and developed, on the education and intellectual progression of the people, gives them a forcible claim to national and individual support.

There is no doubt that the present financial support given to museums is totally inadequate to maintain them in an efficient state, and we hope to see this remedied to some extent in the next session of Parliament, by the adoption of Mr. A. J. Mundella's Bill for Increasing the Library and Museum Rate, the penny rate not realising sufficient money, except in large and wealthy towns, to serve the purpose for which it is intended. Mr. Mun-

della's Bill gives the power to levy a rate, not exceeding 2d. in the pound, for the purpose of establishing and maintaining free libraries and museums, and in those towns where there is no museum, but only a library or libraries, the rate not to exceed 1½d. in the pound. This slight increase would not press heavily on any section of the ratepayers, while it would enable many of our libraries and museums which are now languishing for want of funds to go on in their wide sphere of usefulness with increased vigour and zeal.

The important conference of the mayors of towns and chairmen of museum committees, which was held in Birmingham on the 5th instant, to discuss and urge the claims of museums and galleries of art to some of the surplus funds remaining from the International Exhibition of 1851, and also to the duplicates which are stored away in Government collections, is a step in the right direction, and we hope that it will be productive of good results.

With the more general diffusion of education among the great masses of the people which it is hoped will result from the passing of the recent elementary education acts, the class of readers and students will be greatly enlarged, and we might naturally look for something being done by the Government to meet the increased demand for books and objects of study which is likely to follow; and we see no reason why museums themselves should not be occasionally converted into schoolrooms where teachers could bring their zoological, geological, and other natural science classes, and find well-arranged material for illustrating their lessons. Of course we take it for granted that these sciences will eventually be taught in all elementary schools under Government control.

With regard to the preservation and arrangement of specimens in museums, those who had the pleasure of listening to Prof. Flower's lecture cannot have failed to carry away some useful suggestions, and his remarks, together with those of Prof. Boyd Dawkins on the neglected and unsatisfactory state of many of our museum collections, are well worth the consideration of those in charge of them. What ought fairly to be the aim and scope of a provincial museum is a question which each town must to a great extent answer for itself, as it must depend on the resources of the neighbourhood and on the facilities possessed for obtaining certain classes of objects; and curators would do wisely to content themselves with doing only what can be done thoroughly and well, be it ever so little, and not to accept objects simply with the view of filling empty cases. We are well aware that curators are not always responsible for the incongruities which get into a museum, and if the refusal of objects were always left with them, we should not have museums sinking into advertising establishments or mere curiosity shops. We do not, however, intend now to go into this subject, but in order that all the important matters connected with the work of museums may receive full and careful consideration, we would suggest that an association be formed, to consist of curators and others engaged in the arrangement of museums. Such an association need not in any way interfere with those now existing, as there is a sufficiently wide field for discussion and action included in the work and development of museums without treading on the ground occupied by other associations. By holding periodical meetings and constantly changing the place of meeting from town to town, the various museums of the kingdom could be inspected, and their contents and plan of arrangement discussed and criticised. Friendly communications would thus be opened among all museums, and exchanges could be arranged to their general advantage. Much might be said as to the necessity and work for such an association, but we content ourselves, for the present, with suggesting it, and now leave the matter to be taken up by those most intimately concerned.

E. H.

ACROSS AFRICA!

OUR readers are no doubt already familiar with the main results of Commander Cameron's remarkable march across the continent of Africa; many details concerning it have appeared through various channels. These, however, have only been sufficient to whet the appetite of all who take an interest in African exploration for the complete narrative; this we find quite as interesting and informing as we had reason to believe it would be. Commander Cameron has not attempted to produce a highly polished summary of the copious notes he seems to have taken by the way; he takes the reader along with him step by step and day by day over the long and to him often tedious route he had to travel, and in the end the reader finds he has become possessed of a substantial amount of new information concerning one of the most important sections of one of the most interesting continents.

Commander Cameron's story is so well known that to summarise it here would merely be to repeat what we have already given on various occasions. The primary object of the expedition which he commanded, it will be remembered, was to seek and succour the great Livingstone, whom Stanley had just discovered, after the explorer had been hidden in the centre of Africa for five or six years. Cameron as leader, with Dr. Dillon, Lieut. Murphy, and poor young Moffat, who had sold his all to enable him to find and help his uncle, set out from Bagamoyo with a large following, early in 1873. They had only got as far as Unyanyembé in October when they were sadly surprised by the bearers of Livingstone's remains, the great traveller having died in the previous May on the south of Lake Bangweolo, almost on the same day as his enthusiastic nephew perished on the threshold of his search for his uncle. Under the new circumstances Lieut. Murphy decided to return, Dillon was compelled by the state of his health to accompany him, and Cameron resolved to proceed alone to take up and continue the work of his immortal predecessor. By doing so, he rightly believed he was carrying out the spirit of his instructions. Dillon's sad end, a few days after he left Cameron, is already known to all.

Cameron's route may be divided into four sections. First, from the coast to Ujiji; second, the survey of Lake Tanganyika; third, his journey to Nyangwé, on the banks of the broad Luialaba; and fourth, from Nyangwé, south and west, to the west coast. The first part of this route is already to a considerable extent familiar to those who have read the narratives of Burton, Speke, and Stanley. Nevertheless, it will be found that Commander Cameron has added considerably to our knowledge of its appearance, its products, and its people. The admirable series of levels which he was able to take from first to last, and the results of which are condensed in the section that accompanies his interesting map, shows that the ground rises till about the thirty-fourth degree west, when it slowly slopes to the centre of the continent, which is a wide hollow or basin, rising very gradually towards the western coast, on which side the descent is very steep. The country between the coast is varied in character, sometimes level, and sometimes very hilly, frequently swampy and liable to be inundated by

the overflow of the numerous rivers which water it, but very often well wooded, thickly populated, and fertile. It is cut up into a number of states inhabited by various small tribes independent of each other, the appearance, manners, and customs of which are frequently referred to by Commander Cameron. Of the Wanyamwezi, especially, he has much to say, for at Unyanyembé, in their territory, he was detained for many weeks by fever, and indeed did not reach Ujiji till February, 1874, after innumerable troubles caused by his scratch lot of followers,



Heads of Men of Manyéma.

and being fleeced at every hand by the chiefs through whose villages he had to pass.

Cameron was well-received and well-treated by the Arab traders at Kawelé, the capital of Ujiji, and here he fortunately secured Livingstone's papers. After measuring a short base-line, he set out on March 13 to circumnavigate the southern half of Lake Tanganyika. Our readers will remember that Burton and Speke were able

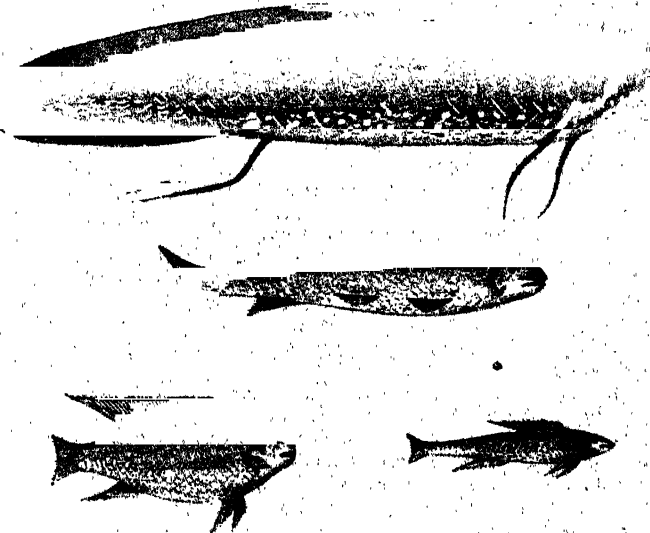

Tanganyika Fishes.

to survey a comparatively small portion of the lake in the neighbourhood of Ujiji, while Livingstone and Stanley coasted the east side of the northern part, and a portion of the north-west coast. Cameron has, therefore, by his survey been able to add considerably to our knowledge of this interesting lake. He sailed along the eastern side of the southern half, crossed to the west just before reach-

\* "Across Africa." By Versey Lowest Cameron, C.B., D.C.L., Commander R.N.'s vols. (London: Daldy, Dobson, and Co., 1877.)



ing the end of the lake, passed up the west side, examined the Lukuga, and returned to Ujiji on May 9. His work contains a great deal of information as to the result of this survey, and he has been able to lay down, we have no doubt with considerable accuracy, the contour of the shores. These are mostly high and rocky, covered with trees and other vegetation, often fringed with dense reeds, and cut up by a multitude of streams. Animal life of all kinds, quadrupeds, birds, insects, fishes, abounds

of the Victoria Nyanza. To Cameron geographers are greatly indebted for the large additions he has made to a knowledge of Lake Tanganyika.

About a fortnight after his return from this survey—which, we ought to say, was carried out amidst insurmountable difficulties caused by the timidity and inefficiency of his crews—Cameron crossed the lake to make for Nyangwé in the hope of obtaining boats to take him down the Lualaba. He passed over pretty much the same route as did Livingstone, whose memory he still found alive among the people. The two main districts in this route are Ugubha and Manyema, and the people are among the most interesting with whom Cameron came in contact. In Ugubha copper is largely worked, and shaped into curious cross-bars, and in Manyema iron ore is found and largely smelted in elaborately and ingeniously-constructed furnaces. The people of Manyema are in many respects peculiar, and although undoubted cannibals, superior to the tribes around them. Cameron believes them to be a superior intrusive race, the lower classes being aborigines. They live in well-built houses, arranged in neat villages, and are of fine physique. They seem well deserving of further study.

At Nyangwé Cameron was well treated by an old Arab who had been kind to Livingstone but to his great disappointment he failed in obtaining boats to carry out his cherished purpose. He was assured by many people, both here and in his journey southwards, that the Lualaba a fine broad stream at Nyangwé, flowed westwards into a large lake, Sankorra, to which men came in large boats capable of holding 200 people, for the purpose of trading. From the interesting data collected by Cameron we must say that he has good reason for connecting the Lualaba with the Congo, and regarding the latter as the great drainer of all the region to the west and north-west of Tanganyika. The Lualaba is in the very lowest part of the great Central African basin, is a river of very large volume, which, in the upper part of its course receives various affluents, and it is difficult to conceive what other south-west African river except the Congo could carry off all this drainage. Still there is an extensive region, from about 5° N. to 10° S. waiting to be explored, and until this is done we think it premature and unnecessary to maintain any positive theory on the subject. The solution cannot now be far off with so many expeditions either on the field or about to be sent out. The data obtained by Commander Cameron are of great value, and will form an important guide to subsequent explorers.

In company with an Arab trader, Cameron proceeded southwards in the hope of being able to work his way north to Lake Sankorra. This, too, alas, he was grievously disappointed his designs being thwarted on every hand by the caprices of bearded chiefs and brutal slave-hunters, and the cowardly fears of his own men. The greater part of the ground from Nyangwé to the coast region, south and west, over which Cameron now travelled, is quite new, never having been before explored by an European, so far as is known. Much of the season's volume, on this account, possesses novel interest. Most of the country is fertile, well watered, and well wooded. Innumerable streams were crossed, and so level is the watershed between the streams going east and those going west, that during floods, which seem to be frequent, the courses must sometimes be changed. About 200 miles

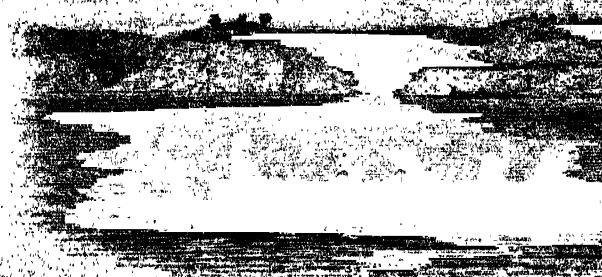

Nyangwé from the River.

around and in the lake, the scenery of which Cameron describes as of surpassing beauty. The western shores are well peopled by a fairly industrious population, but many portions of the east coast have been devastated by slave-hunters, evidences of whose destructive raids were seen all along Cameron's route. With regard to the river Lukuga, which Cameron believes to be the outlet of Lake Tanganyika, and an affluent of the Lualaba, he has some interesting notes. He believes he traced a distinct cur-

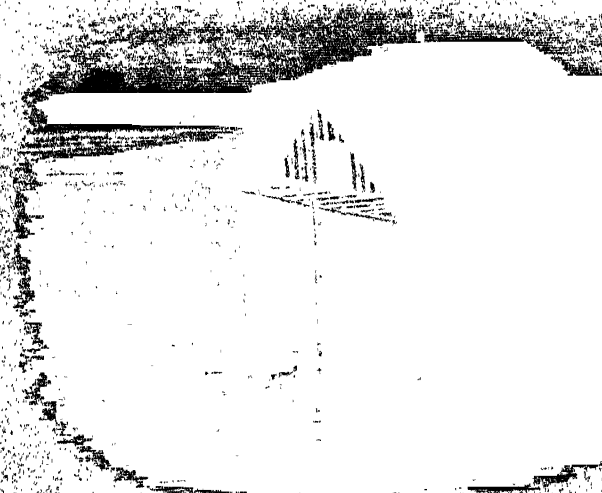

Hut in Lake Maloja.

rent westwards, and sailed up several miles until stopped by a dense barrier of vegetation which crossed from side to side. As we said when referring to this point previously, we do not think much is to be gained by discussing the question in its present shape. It is not as if no further data were to be obtained, the question is one capable of demonstration by the attainment of additional information, and we hope that Mr. Stanley will be able to set it at rest as satisfactorily as he has settled the contour

south of Nyangwé, Cameron came to Kilemba, the headquarters of Kasongo, the chief of the extensive district of Uvua, and where is the principal station of the remarkable Arab trader, Jumab Americani. This individual has extensive trading connections over Central Africa, is a man of considerable intelligence, and was able to give Cameron much geographical information which he had gathered during his widespread journeys. Cameron was compelled to remain at Kilemba for about eight months, and had it not been for the ever-to-be-remembered kindness of this humane and generous Arab trader, his life must have been intolerable, even if he had been able to preserve it. The treatment of Cameron by this remarkable man is beyond all praise. Cameron found at Kilemba a black slave-hunter from the Portuguese settlements, than whom probably a more barbarous blackguard does not exist. The cruelties practised by this man and

the chief Kasongo are almost incredible and painful to read of. The whole country here is being rapidly devastated by these slave-hunters from the west coast, and until their headish practices are put a stop to, the country can never be opened up either to exploration or legitimate traffic.

While staying here Cameron visited an interesting little lake, Mohrya, studded with houses built on high piles. He also heard of a people who dwell in caves in this region; we believe that Livingstone refers to this in his "Last Journals." Cameron also paid a visit to a Lake Kassali, a short distance south of Kilemba, and which contains many floating islands; but he was not permitted to reach the shores. He has collected much interesting information about the people among whom he was compelled to sojourn, and collected many notes from various sources concerning the geography of the region. But the capricious restrictions under which

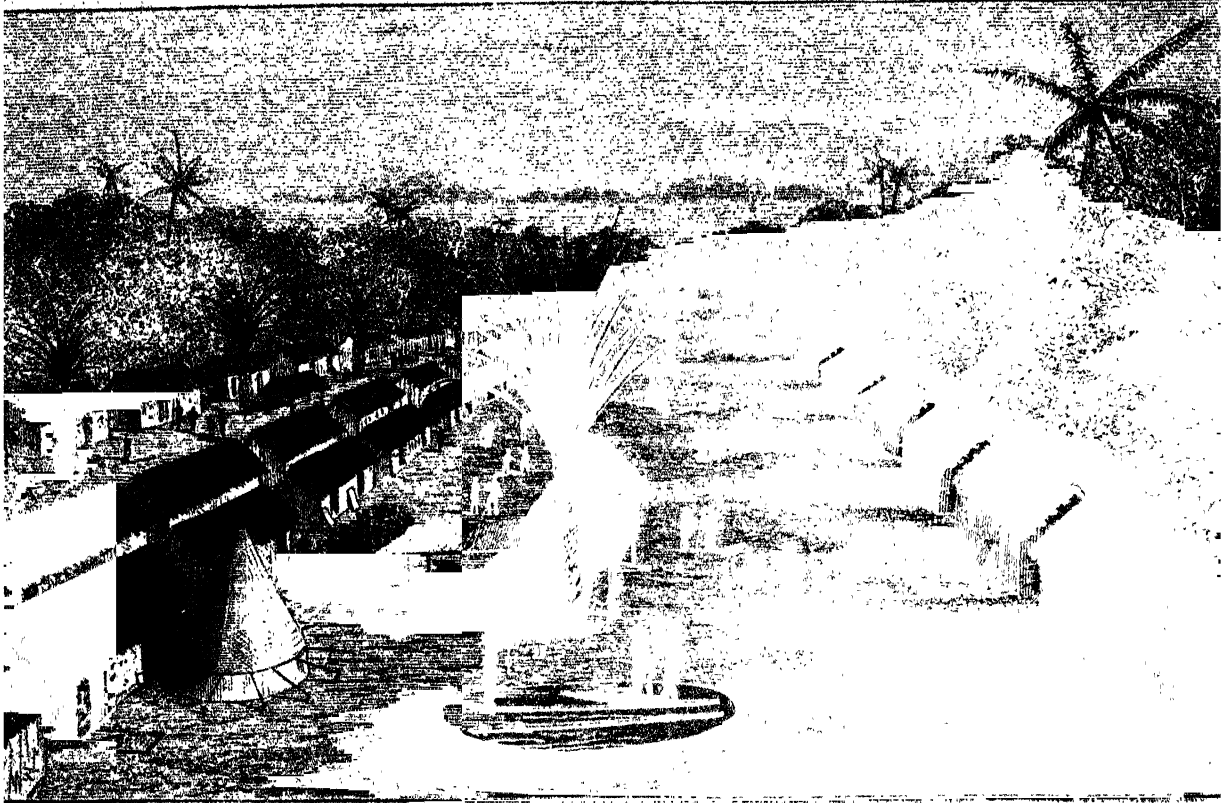

Village in Masyoema.

he was placed compelled him to lead a life of comparative idleness, so that when Kendele, the brutal slave-hunter, whose pleasure he was compelled to await, was ready to march with his ill-gotten human booty, the wearied traveller was heartily glad. This was in June, 1875, and starved and nearly dead with scurvy he reached Beaguella in November.

Of the value of Commander Cameron's work we think there can be but one opinion. Every page is interesting,

and he has been able to add materially to our knowledge of the hydrography, the geology, the people, and products of the important part of Africa he traversed. The general results he discusses in two concluding chapters, and botanists will be pleased to find in an appendix an enumeration of the plants collected in this region about Lake Tanganyika, drawn up by Mr. Oliver. The flora of the region, Mr. Oliver states, may be taken as belonging to the basin of the Congo.

### THE TROPICAL FORESTS OF HAMPSHIRE<sup>1</sup>

111.

WE have in the series of beds, the aspect and formation of which I have endeavoured to describe, a total thickness of perhaps somewhere about 1,000 feet. We

<sup>1</sup> Continued from p. 266. This concluding article is the substance of a paper read by Mr. J. S. Gardner, F.G.S., at the Geologists' Association, January 2.

read in Lyell's "Geology" and other works that river and delta deposits are accumulated with comparatively great rapidity, as in the case of the Rhone delta above Geneva, which has advanced one-and-a-half miles in historical times. Throughout the Bournemouth district we have in the great and sudden deposits of coarse grit evidence of quick deposition. We also find leaves folded over with half an inch of sediment between the folds, and leaves sun-cracked

and divided with that or more difference in level between the segments, which also shows extreme rapidity of deposition; and although we have proof that we in some cases see the actual soil in which some of the smaller plants grew, still penetrated by their roots, there is no evidence of its having been long occupied, or that it indicates more than a rapid fern growth between recurring floods. We have further, in the fine state of preservation of some of the leaves, which have been doubtless buried before decay set in, and in the breaking up and redeposition of beds, evidence of rapid accumulation; yet we must not hastily conclude that the time required for the formation of these deposits was, even geologically speaking, short. We over and over again see beds, one above another, which have been cut through and carried away after they had become consolidated, that is, after the muds had become so hard that they have resisted the dissolving power of water and been rolled and redeposited as pebbles and boulders.

The same spots may have been again and again silted up and denuded before the beds finally remaining were covered up, the same material has been rearranged by different currents perhaps a great number of times, whilst the constant unconformability of the strata may indicate periods of rest or great lapses of time. All our facts as to the depression of areas tend to show that it is an extremely slow and imperceptible process—slower still when the general depression is intermittent. We have further a totally different kind of evidence, which to my mind is still stronger, of the vast ages that rolled away during the deposition of these beds. This is the significant fact that the entire marine fauna was completely changed. By this I mean that we have in the London clay a fauna that migrated away, a fauna familiar to us and characterised by great nautili and other shells, crustacea, &c., peculiar to it. In the succeeding Bracklesham beds we have another totally distinct fauna, so that the duration of the land period was sufficiently long for the fauna of the London clay sea to be entirely changed before the return of the sea whose fauna we have recorded in the Bracklesham beds. In the Barton beds which overlie the Bournemouth deposits, we have again an extensive fauna, most distinctly characterised and widely separated from that of either of the preceding beds just mentioned.

In many cases it is recognised that variations in fauna are dependent upon the depth of the sea, but such cannot be the case in this instance since we get species belonging to the same genera, so closely resembling each other, that we cannot but infer that they lived under similar conditions. And when we come to see, as we do, that this applies to all the groups, the inference drawn from one individual group accumulates to an evidence which presents itself as at any rate approaching certainty. The well known case of the difference in the fauna of the Red Sea and the Mediterranean, which are separated by so narrow a strip of land, has been often referred to as a possible explanation of how different fossil faunas occurring close together may have existed contemporaneously, and do not imply any lapse of time during which changes of climate occurred; but although in many cases it is impossible when a purely hypothetical theory is brought forward to bring an argument to disprove it, yet in this case there is no evidence whatever in its favour, and what little evidence there is bearing on the question, is directly opposed to it; therefore the other seems the more reasonable explanation. The great changes in the flora which I shall mention to you, although principally due perhaps to the great change of level of which we have other indications, may also indicate long lapse of time, long enough as I have said for the marine fauna of Bracklesham to develop, to disappear, and to give place to that of Barton.

These deposits, which have been neglected by geologists, are of extreme importance as being one of the few records we have of land surface. The rocks in which organic remains are found are aqueous rocks, principally marine;

the remains of aquatic animals are more numerous than are those of terrestrial animals, and are, for the same reason, far more numerous than those of plants. Such facts as these give great interest to series of land remains of so complete a nature. We can form an idea of how incomplete our terrestrial records are when we consider that whilst upwards of 4,400 plants are growing in Great Britain, about 700 only are known fossil, whilst 513 testaceous mollusca now inhabit Great Britain, and 4,500 were known fossil as far back as 1862.

The Bournemouth flora seems to consist principally of trees or hard-wooded shrubs, comparatively few remains of the herbaceous vegetation being preserved.

Parasitic fungi are abundant. Ferns, extremely rare in the lower part of the series, become abundant, as far as the remains go, almost to the exclusion of other vegetation, towards the close of the middle period. The prevailing group seems that of *Acrostichum*, of which several species are present. We can also determine, with almost certainty, the presence of *Angiopteris*, *Anemia*, *Nephrodium*, *Gleichenia*, *Lygodium*, and there are, besides these, several undetermined forms.

Of Conifers we have *Cupressus* and *Taxodium*, determined by De la Harpe, with the addition of *Dacrydium* and indications of *Pinus*; Cycads have disappeared.

Of Monocotyledons we have indications of reeds and rushes; *Pandanus* is represented by its fruit, *Nipadites*; palms are very abundant, especially in the lowermost beds of Corie, the middle beds of Studland, and the upper middle beds of Bournemouth. Massolongho has determined *Chamoecyparites*, in addition to which many fan and feather palms exist, belonging to *Flabellaria*, *Sabal*, *Phœnicites*, and a genus new to the Eocene, *Iriartea*. A gigantic aroid is also very abundant, and the *Smilacæ* occur in all the fossiliferous beds throughout, and are represented by five or six species.

The Dicotyledons are, however, most abundant, and it is probable that a vast number of species will be determined from these beds. De la Harpe's list included in 1856:—

*Apetalæ*.—*Populus*, *Ulmus*, *Laurus*, *Quercus*, and *Artocarpidium*, to which Massolongho added *Daphnogene*. To these we may now add *Carpinus*, *Fagus*, *Castanea*, *Salix*, *Platanus*, *Ficus*, *Celtis*, numerous *Proteaceæ*, *Cinamomum*.

*Polypetalæ*.—*Elaeodendron*, *Rhamnus*, *Prunus*, *Juglans*, *Cluyta*, have been already noticed by De la Harpe. We will add, *vide* Massolongho, *Ceratopetalum*, and as new to the Bournemouth flora, *Acer*, *Dodonæa*, *Celastrus*, *Eucalyptus*, and a number of *Leguminosæ*.

*Monopetalæ*.—De la Harpe has determined *Diospyros*; to this may perhaps be added *Porana*.

*Cactus* and *Stenocarpus* have been previously mentioned, and have never previously been found fossil.

In addition to these we have probably represented almost every genus described from continental Eocene floras, but it is premature, for the reasons already stated, to go further into this question at present. The forms I have mentioned will, however, give you a general idea of the composition of the flora.

It will have been gathered from the anniversary addresses of our president, Mr. Carruthers, that the remains of plants are, if possible, of more interest and importance than those of marine animals, as whilst we have already some idea of the succession and development of animal life, especially of the more purely marine orders of crustacea, mollusca, echinodermata, &c., we know very little of the history and development of plant life. Mr. Carruthers laid stress on the somewhat sudden occurrence of dicotyledons as being unfavourable to the hypothesis of evolution in descent. I concur with him fully, that it is difficult to realise that the absence of dicotyledons can be due to any cause but their absence from the then existing vegetation, yet there are certain causes

ending to make their preservation difficult, which may perhaps be taken into account.

Some kinds of coniferous plants resist decay, when immersed in water, more completely than do almost any dicotyledons; and this resistance may, owing to their resinous nature, be very greatly increased when the immersion is in sea-water. This supposition is borne out by a fact I have noticed, that in some Eocene beds, such as the marine beds at Bournemouth, the Bembridge marls, the Bracklesham beds, coniferous remains preponderate, whilst from the two latter places I have never seen remains of dicotyledons at all, although there is evidence in these cases that dicotyledons were abundant on all surrounding land areas. This may partly account for their complete absence in marine cretaceous rocks in England, where, as in the gault, &c., foliage, fruit, resinous stems in the form of amber, remains of coniferae, are preserved. The foreign cretaceous rocks, in which an abundance of dicotyledons is met with, are principally of fresh-water origin.

It should be borne in mind that our Chalk period contains a deep sea fauna, and we have no record in England as to what were the prevailing contemporaneous shallow water forms of life in other regions. I have great doubts, however, as to the correct position of many of the foreign so-called cretaceous beds. Those of America, from which most of the list of dicotyledons of this period is derived, appear to me, from the character of their fauna, to be either Lower Eocene, or at most filling in the gap between our chalk and London clay. Most of the shells have a marvellously Eocene-like aspect, and I take it that the presence of an ammonite, and some few other forms of shells, which in England do not range above the Chalk, would not be taken as conclusive evidence of the antiquity of the bed, as although migrated from our seas, they may very well have lived on in other regions. It is inconsistent to assume that no ammonite lived on in any part of the world to a more recent period than that of our chalk; the finding of pleurotomaria and other supposed extinct cretaceous shells in Australian waters, should not be forgotten. The same doubts apply to many of the European leaf deposits; many of these are isolated patches, and their age has been inferred rather from the character of the leaves than from their stratigraphical position. The age of many of the so-called Eocene leaf-beds is admitted now to be extremely doubtful.

What little evidence we may expect to find in these beds seems to me likely to be in favour of the theory of evolution by descent, although until the flora has been worked out, it is premature to offer an opinion. By far the greater number of the plants belong to the lowest division of the dicotyledons, the *apetalae*, a minority are *olypetalous*, whilst none can, as far as I know, with certainty be assigned to the highest (according to Haeckel) group, the *monopetalae*.

Prof. Ettingshausen has traced the gradual development of some of the Miocene forms into existing species, notably that of *Castanea atava* to *Castanea vespa*; when he was here last summer and saw my collection, he especially picked out the castanea from Bournemouth as verifying the history of this genus a step further back, and linking it with the oak—as it possesses an oak-like character of venation. I would merely add that many botanists who have studied fossil plants, as Unger, Champer, and others, are profoundly impressed with the amount of botanical evidence that has already been brought forward in support of the theory of evolution.

#### OUR ASTRONOMICAL COLUMN

RED STAR IN CANIS.—No. 4 of Sir John Herschel's list of stars at p. 448 of his *Cape Observations* is placed by him in R.A. 1h. 19m. 47s., N.P.D. 123° 26' 1" for 1830, with the

remark "most beautiful orange red. Two observations," and he estimated it 6m. Dunlop in his catalogue of 253 double and triple stars in vol. iii. of the *Memoirs of the Royal Astronomical Society*, gives the position of a highly-coloured object thus: for 1827, R.A. 1h. 19m. 43s., N.P.D. 123° 31', and calls it "a very singular star of the seventh magnitude, of an uncommon red purple colour, very dusky, and ill-defined;" he made three observations upon it, and notes that it had a small star preceding and another following it. We may presume that these stars are identical, with an error of position on the part of one or other observer, most probably on Dunlop's, whose catalogue contains a number of errors; and it may also be supposed that this is the star spectroscopically examined by Secchi, which he calls No. 11 of Schellerup's catalogue of red stars, but places in 35° 17' S. declination (A.N. 1737), perhaps through a misprint. In this state of uncertainty as to the star's true place, meridional observation appears very desirable. So far we believe it is not to be found in any catalogue, founded on such observations; it does not occur in the zones published in the Washington volumes 1869-71, a most valuable series, nor in those of Prof. Ragona in the *Giornale Astronomico e Meteorologico del R. Osservatorio di Palermo*, vols. i. and ii., neither is it found in the southern catalogues of the Cape, Madras, or Melbourne Observatories. Sir John Herschel's place reduced to 1877° is R.A. 1h. 21m. 19° 0s., N.P.D. 123° 11' 16". Secchi says of the star he examined, "couleur rose; spectre à zones discontinues."

VARIABLE STARS.—There is considerable probability that Lalande 12863-5 should be added to the list of variable stars. His estimates of magnitude are 6½ and 8½; it is 6 on Harding's Atlas and in Argelander, 6·7 in Heis, 7·3 in the *Durchmusterung*, but does not occur in Piazz, Bessel, or Santini. Piazz has a star of the ninth magnitude about 1¼° distant (VI. 190), which, oddly enough, he places in the Lynx. The position of Lalande's star for the beginning of 1877 is in R.A. 6h. 35m. 23s., N.P.D. 83° 32' 3".

Will some one of our southern readers record the actual magnitude of  $\mu$  Doradus? At present we have the following estimates indicating a long period of variation. La Caille 5m. about 1751, Brisbane 6m. about 1825, Jacob 9·5m. in 1850 and 9·2m. in 1855; while Moesta states that between February, 1860, and January, 1861, he had always found it 8¼m. or 9m. The law of variation may be similar to that of 34 Cygni, P Cygni of Schönfeld, the so-called Nova of 1600.

A FIFTH COMET IN 1851.—In a small tract entitled "Ragguagli Popolari sulle Comete Periodiche," by Prof. Ragona, published at Palermo, in 1855, there is reference to a comet stated to have been discovered at Rome by Prof. Calandrelli, director of the Pontifical Observatory, in the morning twilight on November 30, 1851, which both the discoverer and the writer of the tract considered to be the short-period comet of Brorsen, due in perihelion in the autumn of that year. By comparison with B.A.C. 4798, the following position resulted:—

1851, November 29, at 17h. 32m., M.T. at Rome.

Right Ascension, 14h. 21m. 38s. Declination, + 1° 47' 2". This position Prof. Ragona compares with the elements of Brorsen's comet according to Dr. van Galen, and found the differences between calculation and observation + 35' 27" in R.A., and + 11' 1" in declination. But notwithstanding this approximation, it is certain it was not the periodical comet of Brorsen that was observed by Calandrelli, Dr. van Galen's prediction having been vitiated by a serious error of calculation, so that, instead of arriving at perihelion on November 10, the date assigned by him in *Ast. Nach.*, No. 782, the comet passed that point in its orbit about September 25, and consequently on November 30 was far removed from the position of the body observed by Calandrelli, which was therefore a new comet.

It is stated that Calandrelli published an account of his observations in the Roman journals in December, which was transferred to the official journal of Palermo on the 11th of the same month. Perhaps a reference to the Italian journals might bring to light a further observation or observations; the comet is said to have been bright, but the weather about the date of discovery was unsettled, and for several days previously had prevented observations of any kind.

**BELTS ON JUPITER.**—In connection with the supposed periodicity in the appearance of marked colour on the belts of this planet, the observations of Gruithuisen, of Munich, in the years 1836-40 possess interest. They are found in his *Astronomische Jahrbuch*, 1839, p. 76, 1840, p. 99, and 1841, p. 101. He first noticed the colour on April 23, 1836, at 9<sup>h</sup>., when, observing with a 30-inch refractor of 2 $\frac{1}{4}$  inches aperture, and power 150, the single central belt then visible had a brown tint throughout, and he states that, hardly believing his own vision, he called a person who was at hand, and on asking him what colour the belts presented, he replied "the colour of rust." With a 5-foot telescope, power 120, the brown tint was not distinguished. On subsequent occasions he found that with the highest powers of the telescope the belt appeared of a bright reddish brown, while with the lower powers it was merely of a dark shade, and hence concluded that the intensity of light was disadvantageous to discerning the colour. In addition to the brown tint of the central belt, it was remarked that the planet near its north pole had a bluish-grey tint in May, 1836; a few months later Dr. Albert, a pupil of Bessel, observing with a 30-inch telescope, found the polar region "quite blue." The length of Gruithuisen's descriptive remarks prevents their being transferred to this column, but we refer to the observations, as his annual volumes are not often met with here, and the fact of such observations having been made forty years since may not be generally known. That these tints should have been conspicuous with such small optical aid is worthy of note.

**THE INTRA-MERCURIAL PLANET.**—In M. Leverrier's last communication to the Paris Academy on the planet assumed to exist within the orbit of Mercury, it was mentioned that, with the elements adopted, or very similar ones, a solar conjunction would occur on March 22, and a transit over the sun's disc was possible, though uncertain. A close examination of the disc is therefore to be recommended on March 22 and 23, and there is reason to believe that observers in widely-differing longitudes are prepared to undertake it. If no transit should then occur, eight or nine years may elapse before one is possible at the spring node.

### CHEMICAL NOTES

**ATOMIC WEIGHTS OF CAESIUM AND RUBIDIUM.**—M. Godeffroy gives an account in Liebig's *Annalen* of some determinations he has made on the above subject. To obtain pure material he employs Redtenbacher's method for the separation of the caesium, rubidium, and potassium, by preparing their respective alums, separating these by fractional crystallisation, and finally converting them into pure chlorides of the metals. The determination of chlorine in the non-dilutescent caesium chloride, gave, as the mean of four closely-agreeing experiments, the atomic weight of caesium as equal to 132.557, the atomic weights of chlorine and silver being taken as 35.46 and 107.94 respectively; from analogous experiments the author finds the atomic weight of rubidium to be equal to 85.476.

#### THE SPECIFIC HEAT OF GASES.—

vii. E. Wiedemann gives a most judicious communication on this matter, in which he criticises the of Regnault on the same subject, and describes a new method of

the specific heats of gases introduced by Regnault. Comparing the author's results with those of Regnault it is found that the method employed by the former is not inferior in accuracy to that of Regnault, and also that a great economy of material may be effected by using Wiedemann's process; this economy giving the experiments greater range in a comparatively shorter time. The following tables give a synopsis of the results and numerous tables given in Wiedemann's paper:—

#### Specific Heats of Equal

	II.	III.	IV.
Air	0.2389		
Carbon monoxide	0.3410		
Carbon dioxide	0.2426		
Ethylene	0.1952		
Nitrous oxide	0.3364	0.5015	49.08
Ammonia	0.1983	0.2212	23.15
	0.5009	0.5317	0.5629

#### Heats of Equal Volumes.

	V.	VI.	VII.	VIII.	
		100°	200°	Specific weight.	$\frac{P}{P'V}$
Air	0.2389	—	—	I	1.00215
Hydrogen	0.2359	—	—	0.0692	—
Carbon monoxide	0.2346	—	—	0.907	1.00293
Carbon dioxide	0.2985	0.3316	0.3650	1.529	1.00722
Ethylene	0.3254	0.4052	0.4851	0.9677	—
Nitrous oxide	0.3014	0.3302	0.3712	1.5241	1.00651
Ammonia	0.2952	0.3134	0.3318	0.5894	1.01881

Columns I., II., III., contain the true specific heats at the temperatures indicated; column IV. the difference of specific heat at 0° and 200° expressed in percentage of the specific heat at 0°. Columns V., VI., VII., represent the true specific heats in reference to the unit of volume, the specific heat of the unit volume of air being taken as 0.2389; column IX. gives Regnault's proportions of the products of the volumes V and V', and the pressures P and P', when P is at the pressure of one, and P' at the pressure of two atmospheres. Herr Wiedemann thinks that the specific heat determined in these experiments seems to be composed of two parts, the heat caused by work expended on the expansion of the gases in overcoming outside pressure, and secondly, the heat employed in the internal work of the gas itself. He also thinks that attempts to determine the separate parts of the heat of molecular motion, of which the specific heat is composed in constant volumes—of the heat of atoms according to Naumann—and also the attempt to establish simple relations between the two to be still premature, as the alteration of the specific heat with the temperature would cause these effects to have different relations between different temperatures. The author thinks that the alteration of specific heat of the gases with the temperature cannot be explained by the deviation of such gases from the perfect gaseous condition. As an illustration of this he cites the case of ammonia gas, which, although more remote from the state of a perfect gas than nitrous oxide or carbon dioxide, still possesses smaller variations of its heat with change of temperature than either of these latter gases.

**ANTIMONY PENTACHLORIDE ON CERTAIN ORGANIC SUBSTANCES.**—The action of this re-agent on some organic substances has lately been investigated by C. W. who obtained. When chloroform and antimony pentachloride are mixed, chloroform becomes converted into carbon tetrachloride. Ethyle

omide is attacked by antimony pentachloride, the whole of the bromine being liberated and ethyle chloride formed. The action of antimony pentachloride on ethene bromide differs according to the quantities employed. With the same number of molecules of the two substances the chief product is ethylene chlorobromide, whilst with two molecules of pentachloride to one of ethene bromide the product is ethene chloride. Ethene bromide is not acted on when similarly heated with phosphorous pentachloride. The product of the reaction of acetic acid with antimony pentachloride is monochloroacetic acid, accompanied by another substance with a higher boiling point. When salicylic acid is gradually added to antimony pentachloride, monochloro- and dichloro-salicylic acids are produced along with other products; monochloro-salicylic acid is found in small quantities only. Dichloro-salicylic acid on being boiled with potash for a considerable length of time exchanges its chlorine for hydroxyl, yielding gallic acid accompanied with pyro-gallic and oxy-salicylic acids. When paroxybenzoic acid is acted on by two or four molecules of antimony pentachloride the mono- and dichlorinated acids are found respectively. From these reactions it is evident that the action of antimony pentachloride differs from that of its analogue, phosphorous pentachloride, since it simply parts with its chlorine, which replaces hydrogen in the acid radical, instead of replacing the hydroxyl group by chlorine, as is generally the case when phosphorous pentachloride acts upon organic substances.

**ACTION OF CHLORINE ON PEROXYDES.**—MM. Spring and Arisqueta continue (*Bull. Acad. de Belg.*, xlii p. 565) their researches into the action of chlorine on peroxydes of metals, for the purpose of elucidating the very important question whether the atomicity of certain bodies is variable (as supposed by Kolbe and Blomstrand), *i.e.*, whether whilst one atom of a body in a molecule is, say, tri-atomic and possesses basic properties, another atom of the same body may be pent-atomic and partake of the properties of an acid, or whether the atomicity remains invariable, as supposed by Kékulé and the authors of the paper. Former researches induced M. Spring to conclude that the atoms of chlorine possess constantly the same properties in all their compounds with oxygen, which would be contrary to the alleged varying atomicity. Now, studying the action of chlorine upon the peroxyde of silver, the authors prove, by a very delicate experiment, that its result is the formation of a peroxyde of chlorine, a body prevised by the theory, but unknown until now, and they conclude, therefore, that the structure of peroxydes of silver and of chlorine is identical, which identity gives a new argument in support of the invariability of the atomicity of chlorine and silver.

**BORON AND ITS SPECIFIC HEAT.**—Boron occurs, it is known, in two different forms, in the amorphous state, and in crystals. M. Hampe has recently found (*Liebig's Annalen der Chemie*) that both the black and the honey-yellow crystals are not pure boron, but compounds of the element; the black crystals consisting of aluminium and bromine in the proportions  $AlB_{12}$ , and the yellow crystals of aluminium, carbon, and boron,  $C_2Al_2B_4$ . Boron has hitherto been numbered among the few elements which show a departure from Dulong and Petit's general law of the constancy of specific heat into atomic weight, and M. Weber sought the reason for this departure in the case of boron, as in those of carbon and silicon, in the fact that the specific heat varies with the temperatures, but at high temperatures reaches a value which establishes an agreement with Dulong and Petit's law. The determination of the specific heat of boron, however, as also M. Weber's experiments, were made with crystals of boron. Now, since, according to M. Hampe, these crystals are not pure boron, but compounds of it, the whole question as to the validity of Dulong and Petit's law for the pure element boron remains an open one. All the attempts made by M. Hampe to produce pure crystallised boron had been with-

out success. He is engaged in further investigating whether the amorphous boron can be produced in absolute purity.

**HEATED AIR.**—Dr. Kayser, of Nuremberg, has lately conducted a number of experiments upon the effects of heating ordinary air, with especial reference to the warming of dwellings. The results appear in the last report of the Munich Industrial Museum, and may briefly be summed up as follows:—Air previously free from carbon monoxide was invariably found to contain this gas after heating. The tests were performed with chromic acid, and also with cuprous chloride. In order to test the products of the decomposition of the dust present in the air, about sixty litres of air, which had been heated, were drawn through an ordinary apparatus for determining carbonic acid, which contained absolute alcohol. The liquid assumed a yellowish brown colour, and flakey masses were suspended in it. The flakes were found to consist chiefly of carbon. After filtration and evaporation of the solution, a brown residue was obtained. This was insoluble in water, intensely acrid, and possessed a resinous, empyreumatic odour. The estimations of carbonic acid and water before and after heating showed no difference worthy of mention.

NOTES

CONTRIBUTIONS are being collected in Stockholm for the establishment of a scientific college. The *Dagblatt* states that steps will be taken at once to fill the chairs in philology, the natural sciences, history, &c.

BARON VON RICHTHOFEN, for a long series of years president of the Berlin Geographical Society, has accepted a call to the Chair of Geography in the University of Bonn.

THE large collections brought back by the German exploring expedition in the *Gazelle* under the command of Baron v. Schleinitz have been formed into a separate museum in Berlin. The ethnographical section is especially rich and valuable, embracing many objects brought from islands where the natives are rapidly disappearing.

THE Society for African Exploration at Berlin has been amalgamated with the newly-formed German branch of the international societies, under the leadership of the King of Belgium. During the three years of its existence it has been exceedingly active, and has expended the following sums:—Dr. Güssfeldt's Loango expedition, 9,200*l.*; expedition of Homeyer, Lux, and Pogge to the Cassandje, 1,000*l.*; Dr. Lenz's journey to the Ogowe, 1,000*l.*; various stations and shorter excursions, 2,500*l.* It has at present over 5,000*l.* in its treasury. The first session of the newly-formed *Deutsche afrikanische Gesellschaft*, was held in Berlin on January 16. The society confines its field of operations to Central Africa, proposing to open up this region "to civilisation, travel, and commerce, by the establishment of permanent stations and the maintenance of exploring parties." The energies of the society will also be directed to the repression of slavery. A letter was read from the Crown Prince of Germany, expressing his desire to take an active part in furthering the objects of the Society. A request for pecuniary assistance from the Government has already been presented to the Chancellor of the Empire.

THE Berlin *Afrikanische Gesellschaft* has received telegraphic news from Dr. v. Pogge, the African explorer, who landed last week in Lisbon, stating that he had succeeded in penetrating to the long-sought-for country of King Muata Yambo in Central Africa. A detailed report is awaited with interest in geographical circles.

DR. O. LENZ, the African traveller, has been forced to return to Europe with a shattered constitution. For a number of years

he has indefatigably pursued his researches in equatorial Africa, having led, during this period, the three German exploring expeditions into the Ogowé and Gaboon region.

THE Council of the Italian Geographical Society have agreed to present Sir George Nares with its gold medal.

AT the last meeting of the Paris Geographical Society the Abbé Darvad gave an address, the object of which was to prove that the Portuguese crossed Central Africa in the fifteenth and sixteenth centuries, from the Congo to Mozambique.

THE Norwegian geologist, K. Pettersen, is planning a new expedition to Spitzbergen during the coming summer, which shall aim at a thorough geological survey of the island. A petition has been presented to the Norwegian Government requesting a grant for the undertaking.

AT the meeting of the Royal Geographical Society on Monday, Dr. Mullens read a paper on "Later Explorations in Madagascar," giving an account of five journeys of unusual importance, and over entirely new ground, by English missionaries in Madagascar during the last two years.

ON January 13 the Sumatra Expedition of the Dutch Geographical Society embarked at Nieuwediep for the east. A corps of leading scientific men have been gathered together for this expedition, and interesting as well as valuable results are expected from their researches. A great portion of their time will be devoted to the exploration of the as yet unvisited Diambi region, which is represented by the natives as abounding in useful woods and minerals. The Dutch Government has displayed a lively interest in the undertaking, and has placed at the service of the expedition a steamer completely fitted out for a two years' cruise. If favourable reports are brought back it is intended to send colonies to the above-mentioned district.

ON January 10 to the St. Petersburg Academy of Sciences celebrated its 150th annual anniversary in an extraordinary gathering, at which the Emperor and royal family were present. Count Lütke, the president, reviewed the past activity of the Academy in a short address. The great medals of merit were assigned this year to Profs. Reilstein and von Bunge. The Emperor of Germany and M. Lesseps were among the list of those elected as honorary members. Among the fourteen leading scientific men elected as corresponding members, were Profs. Frankland, Newton, and Wright, England; Prof. Kirchhoff, of Berlin; Prof. Fiorelli, of Naples; Profs. Berthelot, Egger, and Decaisne, of Paris.

ON January 12, Prof. Wilhelm F. B. Hofmeister, one of the leading German botanists, died at the age of fifty-two. Although a self-taught botanist, he attracted attention at an early age by his publications on embryology and the physiology of plants, and was elected member of several royal academies. In 1863 he was called to the ordinary professorship of botany in Heidelberg, and in 1873 accepted a call to Tübingen, where he was active until the time of his death. But a short time since he received from Holland the great medal of Boerhaave—worth 75*l.*—in recognition of his botanical investigations. Among Prof. Hofmeister's principal works are "Die Entwicklung des Embryo der Phanerogamen. Eine Reihe mikroskopischer Untersuchungen," "Vergleichen der Untersuchung der Keimung, Entfaltung und Fruchtbildung höheren Kryptogamen, und der Samenbildung der Coniferen," and an extensive handbook of physiological botany, published in conjunction with de Bary, Irmsch, and Sachs.

WE regret to record the death, on the 11th inst., of Mr. Alfred Smee, F.R.S., F.C.S., F.R.C.S., F.L.S., &c. Mr. Smee was born June 18, 1818. He was educated at St. Paul's School, and afterwards at King's College and St. Bartholemew's

Hospital, and was elected Fellow of the Royal Society at the early age of twenty-one. As an eminent and well-qualified medical man he held many offices, including that of Surgeon to the Bank of England. To scientific men he is best known as the inventor of the battery known as Smee's Battery, and which for certain purposes is still more useful than any other form of battery. For this he got the Gold Medal of the Society of Arts in 1840. He was author of numerous works, of which we note the following:—"Elements of Electro-Metallurgy," "Sources of Physical Science," "Elements of Electro-Biology," "On the Monogenesis of Physical Forces," "Lecture on Electro-Metallurgy," "My Garden," "The Mind of Man."

THE French *Official* publishes the regulations for the appointment of professors of hydrography by the Government. There are to be three classes of them. The third class is to be recruited by competitive examination from officers of the national navy and captains of the mercantile navy. They are to be appointed by the President of the Republic, according to the award given by the jury of admission. The jury is to be composed of an admiral or vice-admiral president, two examiners from the marine department, a hydrographical engineer, and a professor of hydrography.

THE credit asked by the French Government for public instruction in 1878 is 52,000,000 francs. In 1877 it was 49,000,000, and in 1876 only 39,000,000.

THE electric light is becoming common in Paris in connection with works that have to be carried on during the night. A large lamp fed by a six-horse power has been established in the Avenue de l'Opéra, and others are employed in the Trocadero in connection with the building of the Exhibition Palace. The gramme machine and screw regulator are employed.

THE first number is issued of an important publication, *The Wild Flowers of America*, by Dr. G. L. Goodale, Professor in Harvard University, with coloured illustrations by Isaac Sprague. The present number consists of figures of five species, in four plates, and the plates are accompanied by a botanical description together with some gossip about folk-lore, popular names, &c. The paucity of figures of even the commoner American plants will render the work very welcome to botanists. The name of the artist is a sufficient guarantee of the faithfulness of the drawing, and the colouring appears to us to be successful.

CAPT. H. W. HOWGATE, Acting Signal Officer, U.S.N., suggests the following method of attaining the North Pole:—To be able to take advantage of the occasional breaking-up of the ice-barrier with the greatest certainty and with the least expenditure of time, money, and human life, it is essential that the exploring party be on the ground at the very time the ice gives way and opens the gateway to the long-sought prize. This can only be done by colonising a few hardy, resolute, and experienced men at some point near the borders of the Polar Sea, and the most favourable one for the purpose appears to be that where the *Discovery* wintered last year. Such a party should consist of at least twenty men, and should be provided with provisions and other necessary supplies for three years, at the end of which period they should be visited, and, if still unsuccessful in accomplishing the object, revictualled and again left to their work. It is stated that an effort will be made to induce the U.S. Government to adopt this plan.

BEHN's last *Geographischer Jahresbericht* shows a total of thirty-six geographical societies in existence at present.

DURING the middle of January the South of Norway has been visited with the severest snowstorm experienced since 1818. In some of the villages snow covers the roofs of the houses to the depth of sixteen feet, and dwellings have been unable to sup-

port the overlying weight. Communication is dependent upon the use of snow-shoes.

THE Prussian Universities granted during the past year 500 doctor's diplomas upon the basis of a thesis and oral examination. Göttingen bestowed 139, Berlin, 90. Twenty honorary degrees were granted during the same period.

M. FIZEAU has been elected Vice-President of the French Academy of Sciences for the coming year, from the section of the mathematical sciences; the President is M. Peligot. Of the Academy's *Mémoires*, tome xxxix., in course of publication, is reserved for works of M. Chevreul, on dyeing, on an error of reasoning frequent in sciences which are concerned with the concrete, science in relation to grammar, history of opinions on the chemical nature of bodies of chemical and living species, &c. The Academy is also publishing a number of documents on the Transit of Venus. Tomes xxiii., xxiv., and xxv. of *Mémoires des Savants Etrangers* contain memoirs on the theory of running waters, a system of irrigation, the succinic series, the carboniferous flora of the department of the Loire, the transformation and equivalence of chemical forces, the transparence of flames, vision of scintillating lights and nocturnal transparence of the atmosphere, the Phylloxera, &c.

THE *Bulletin de la Fédération des Sociétés d'Horticulture de Belgique* for 1875 is just published, and illustrates the great activity with which this branch of science is pursued in the little kingdom. Besides the official papers connected with the federation, and reports from twenty-five associated societies, the volume contains the "Correspondance botanique" for that year, a list of botanists and horticulturists holding official positions throughout the world, a sketch of the life of Mathias de l'Obel (Lobelius), by E. Morren, and several other papers by the same writer.

MR. THOMAS COMBER reprints from the *Transactions* of the Historic Society of Lancashire and Cheshire, a useful paper entitled "Geographical Statistics of the Extra-British European Flora," containing a considerable mass of information which will be valuable to anyone interested in the subject of the distribution of continental species, and the causes of the range which they now enjoy.

HUNGARY is developing no small degree of activity in matters of scientific interest. The president of the Royal Society for Natural Sciences at Pesth reported in the annual Session of January 17, that the present membership amounts to 4,650. Five subjects for prize treatises were announced, one of which was on the chemical resources and industries of the kingdom.

THE phenomenon of the "black drop" has recently been made the subject of experimental study by M. Ch. André, who has communicated his results to the French Academy. Without stopping to describe his artificial transit, we may state that he had a battery communicating with the planet Venus, the other with the limb of the sun; and at the moment of geometrical contact a current was produced, which was registered on a Breguet chronograph. On the same instrument was inscribed parallelly the hour given by a Winnerl pendulum, and the mark produced by the observer pressing down a Morse key. The conclusions of M. André are, shortly, as follows: The black drop is not an accidental fact, but one that is necessary and characteristic of the phenomenon. With sufficiently strong light, the bridge is always produced at the moment of geometric contact, however perfect the telescope. It may be made to disappear entirely in the retinal image, either by increasing sufficiently the absorbent power of the dark glass used, or by placing before the objective a screen formed of a large number of very narrow rings separated by dark rings of the same width, also by diminishing the intensity of the luminous source. In each case

the transit is produced in a geometric manner. All these facts accord with the theory of diffraction rightly interpreted. The ligament is not a real obstacle to observation of the transit. There is a *simultaneous phase* for all telescopes, whatever their apertures, which corresponds to geometric contact, and after a suitable education one may observe with an error equal at the most to 0.75s. for internal contact of ingress, and 1.50s. for internal contact of egress. The total error, then, may be reduced to 2.5s. Now to have the solar parallax to a hundredth of second of arc, it is sufficient not to commit, in the duration of transit, an error above five seconds of time; hence the observation of the transit of Venus may furnish this parallax to nearly five-thousandths of a second of arc.

A PAIR of Kœnig Ut<sup>4</sup> forks will show the phenomenon of sympathetic resonance at much greater distance than a pair of Ut<sup>3</sup> forks. The common explanation is that as double the number of impulses are delivered in a second, double the energy is conveyed to the distant fork. This is questioned by Mr. Robert Spice (*American Journal of Science and Arts*), in view of the law of forces radiating from a centre. At twenty feet, in fact, the intensity of resonance of Ut<sup>4</sup> forks is undoubtedly greater than the intensity of Ut<sup>3</sup> forks at six feet. With Ut<sup>3</sup> forks of bell-metal he got, at forty feet, a greater result than that obtained with the steel Ut<sup>4</sup> forks of Kœnig. The hypothesis he offers is this: *The intensity of sympathetic resonance of forks on their cases increases with the angular deviation or motion of the prongs.* By means of an electro-chemical registering apparatus Mr. Spice finds that when a fork (between Ut<sup>3</sup> and Ut<sup>4</sup>) is in vibration, its stem or handle alternately rises and falls in accord with the period of the fork, through about  $\frac{1}{8}$  inch. In sympathetic resonance the case gives the stem this up-and-down motion, which is conveyed to the prongs and sets them in motion, as a hand might start a pendulum suspended from it (by moving laterally, say, one inch each way). This motion of  $\frac{1}{8}$  inch may be looked on as a constant. If we decrease the length of the fork without altering the constant, we thereby allow of a greater initial angle, the result of which is the same as shortening the pendulum cord. Thus we are in a position to explain the department of the bell-metal forks. The velocity of sound in bell-metal is much less than in steel; hence, retaining similar thicknesses in both cases, an Ut<sup>3</sup> fork in bell-metal would be shorter than an Ut<sup>3</sup> fork in steel. Therefore, though we retain the vibration number, we gain advantage from the shortness of the fork, and hence from the increase of angular motion of the prongs.

THE applicability to liquids of Kirchoff's law as to the subdivision of galvanic currents in bifurcating metallic conductors having been doubted, Prof. Lenz has recently (*Bull. de l'Ac. de St. Pétersb.*, vol. xxii., No. 3) made a series of experiments with solutions of sulphates of copper and zinc and of nitrate of silver. He arrives at the conclusion that the subdivision of galvanic currents in liquids follows exactly the same laws as their subdivision in metallic conductors.

IN a paper "On Evolution in Geology," in the January number of the *Geological Magazine*, Mr. W. J. Sollas, starting from the ground that the energy of the earth and the sun is a continually diminishing quantity, and must at the beginning of geological history have been far in excess of its present amount, briefly discusses the influence of this greater quantity of energy on geological changes. He arrives at the conclusion that all main factors of geological changes, viz., the denudation, reproduction, and the elevation and depression of strata, must have notably and rapidly decreased in intensity; and, alluding to the opposition met with from geologists by Sir W. Thomson's views, he insists on the mistake of attempting to check the results as to the age of the world, obtained by the physicist with these de-



duced by the geologist," which last are based on the rate of changes produced now, during a period of diminished energy of all main geological factors.

THE Chair of Botany at Aberdeen, we learn from the *Gardener's Chronicle*, is likely to be vacant shortly. Among the candidates are mentioned the names of Dr. J. E. Balfour, Rev. Dr. Brown, Dr. W. R. M'Nab, and Dr. Traill.

MR. C. P. OGILVIE, who has been studying the art of aquarium management at the Royal Aquarium, Westminster, has been appointed Curator and Resident Naturalist to the aquarium recently completed at Great Yarmouth, Norfolk.

THE distance between Paris and Marseilles is 863 kilometres, not 1,820, as stated in our note on p. 266 last week.

THE additions to the Zoological Society's Gardens during the past week include a Malbrouck Monkey (*Cercopithecus cynosurus*) from East Africa, presented by Mr. L. C. Brown; a Macaque Monkey (*Macacus cynomolgus*) from India, presented by Mrs. Cecil Long; a Pig-tailed Monkey (*Macacus nemestrinus*) from Java, presented by the crew of H.M.S. *Dwarf*; a Bay Lynx (*Felis rufa*) from North America, presented by Mr. W. Otho N. Shaw; two Teguxin Lizards (*Telus teguxin*) from South America, presented by Mr. A. Stradling; an Ocelot (*Felis pardalis*), an Azara's Fox (*Canis azara*) from South America, a Talpaupa Tinamou (*Crypturus talpaupa*), two Talpacoti Ground Doves (*Chamapelia talpacoti*), two Scaly Doves (*Scardafella squamosa*) from Brazil, a Chopi Starling (*Aphobus chopi*), a Chilean Sea Eagle (*Geranoaëtus aguiua*) from Pernanibuco, deposited; two Ring-tailed Lemurs (*Lemur catta*) from Madagascar, purchased.

### SCIENTIFIC SERIALS

THE *American Journal of Science and Arts*, January. — Contributions to meteorology, being results derived from an examination of the observations of the United States Signal Service, and from other sources, by Elias Loomis. — On some points in connection with vegetation, by J. H. Gilbert. — Observations on a property of the retina first noticed by Tait, by Ogden N. Rood. — On grains of metallic iron in Dolerites from New Hampshire, by George W. Hawes. — On certain phenomena of binocular vision, by Francis E. Nipher. — Notes on the Vespertine strata of Virginia and West Virginia, by William M. Fontaine. — On the production of transparent metallic films by the electrical discharge in exhausted tubes, by Arthur W. Wright.

THE *Verhandlungen des naturhistorischen Vereins der preussischen Rheinlande und Westfalens* (Jahrg. 33, Part 1.) contain the following papers of interest: — Geological, Mineralogical, and Anthropological Section: On some new discoveries in the Jurassic formation west of the river Weser, by W. Treukner. — On a diseased ox's rib from the calcareous tuff-stone in the vicinity of the Toenistein saline spring (Rhenish Prussia), by Prof. Schaaflhausen. — On some bronze implements found near the Weser river, by the same. — On a petrified piece of wood with the image of a human face, by the same. — On the so-called periclinal combinations of Albite by Prof. vom Rath. — On Skrodite-crystals, on plagioclase, and on Brookite crystals, by the same. — On a pine cone found near Dormagen, on the Rhine, together with Roman coins and antiquities, by Prof. Schaaflhausen. — On Capellini's researches on pliocene man in Tuscany, by the same. — On some stone implements recently found, by the same. — On geological researches made at Nagyag and Vöröpaták, in Transylvania, by Prof. vom Rath. — On olivine from Dockweiler and on crystallised slakes, by Dr. Mohr. — Physical Section: On Mallet's theory of volcanic force, by Prof. A. von Länala. — On a further simplification of the electro-dynamic fundamental law, by Prof. Clausius. — On anomalous dispersion of light, by Prof. Ketteler. — On the effects of a stroke of lightning, by Herr Gieseler. — Zoological and Anatomical Section: Synoptical review of the genera and species of *Stilpnoida*, by A. Förster. — On the respiration of *Linnæa*, by Prof. Troschel. — On a specimen of *Pedicularis capitata* with extremely

large system of tracheæ, by Dr. Bertkau. — On Darvete's investigations on the reproduction of eels, by Prof. Troschel. — On the *Cephalopoda* of the German upper chalk, by Dr. Schütler. — On the spermatogenesis of *Amphibia*, by Prof. von la Valette St. George. — Botanical Section: On the influence of interior and exterior causes upon new formations in plants, by Prof. Vöchting. — On the fruit of *Raphia laudigera*, by the same. — On some phenomena observed in the botanical garden of Poppelsdorf, near Bonn, during the summer of 1875, by Herr Körnicka.

### SOCIETIES AND ACADEMIES

#### LONDON

Royal Astronomical Society, January 12. — Mr. William Huggins, D.C.L., president, in the chair. — Mr. Robert John Baillie, Mr. Henry Vere Barclay, the Rev. Daniel Dutton, Mr. Samuel Haywood, Dr. Louis Stomeyer Little, Mr. Richard Pearce, Commander William James Lloyd Wharton, R.N., H.M. surveying ship *Fawn*, and Mr. Jesse Young, were elected Fellows of the Society. — A paper by Mr. Marth giving an ephemeris for the satellites of Uranus for the year 1877, was read. This is one of a series of papers which Mr. Marth has presented to the Society giving ephemerides useful for physical observations of the major planets and their satellites. It was remarked by the president that these ephemerides involve much labour in their construction, and the astronomical world is greatly indebted to Mr. Marth for their production. — A paper by Prof. Harkness on the theory of the horizontal photoheliograph was read. The instrument consists of a heliostat and a long focussed object-glass, in the principal focus of which the negatives are taken; the distortion produced by secondary magnifiers is thus avoided, and very accurate means are adopted for determining the shrinkage of the collodion film upon the plate and the accurate orientation of the photograph. — Mr. Wentworth Fock read a paper on an improved eye-piece for viewing the sun. His method is to use a small glass prism as a reflector which is placed within the image of the sun, so that only a portion of the rays from a part of the disc are reflected into the eye-piece at any one time; the effects of heating are thus reduced to a minimum, and for viewing small areas of the sun the eye-piece is preferable to that suggested by Mr. Dawes in which the light of the whole image is reflected and the small area to be observed is viewed through a diaphragm which is exposed to the heating effects of the reflected rays. — A paper by Mr. Knott was presented to the society; it contains a catalogue which he has been some years in preparing, and gives a very large number of micrometrical measures of double stars which have been made with a very fine eight-inch refracting telescope formerly the property of Mr. Dawes.

Chemical Society, January 18. — Prof. Odling, F.R.S., vice-president, in the chair. — The secretary read a paper by Dr. Jäger on some derivatives of dithymylchloroethane, a substance produced on adding a mixture of sulphuric and acetic acids to a mixture of thymol and chloral. By heating this compound with zinc dust it yields dithymylethane and dithymylethene. — Mr. Kingzett then read a preliminary notice by Dr. Heike and himself on some new reactions in organic chemistry and their ultimate bearings, showing that the colour reaction known as the "Pettenkofer reaction" produced by the action of sulphuric acid on sugar and cholic acid extended to many other substances, some of which did not require the admixture of sugar to produce the colour. This was followed by a paper on dinitro-orecin and dinitro-orecin, by Dr. J. Stenhouse and Mr. C. E. Groves, in which the methods of preparation and properties of these compounds were fully described. — The last communication, by Mr. T. Carnelley, was on high melting points with special reference to those of metallic salts, Part 3. — The meeting was then adjourned until Thursday, February 1.

Zoological Society, January 16. — Prof. Newton, F.R.S., vice-president, in the chair. — Capt. H. W. Feilden, exhibited and made remarks on some of the birds collected by him in the Arctic regions during the recent North Polar Expedition. Sixteen species were enumerated as having been met with on the shores of the Polar Basin, and north of 82° N. lat., but some of these only occurred as stragglers. — The Rev. Canon Tristram exhibited and made remarks on a specimen of a rare terrestrial Dormouse (*Elomys melanurus*), obtained by him in Southern Palestine, where it is found in desert places. — Mr. P. L. Schaller, F.R.S., exhibited and called attention to a collection of man-

mals, birds, reptiles, fishes, and insects, which had been made by the Rev. George Brown during his recent residence in Duke of York Island, and during excursions to the neighbouring islands of New Britain and New Ireland.—Prof. A. H. Garrod read a note on a variety of the domestic swine in the Society's collection, and pointed out that the presence of rudiments of a supplementary digit between the third and fourth digit might be the cause of the consolidation of the hoof, observable in this variety.—A communication was read from Mr. Henry Durnford containing notices of the habits of some small mammals obtained in the neighbourhood of Buenos Ayres.—A communication was read from Mr. Gerard Krefft, containing notes on a young living Cassowary (*Casuarus australis*), which had been obtained from North Australia, and was destined for the Society's collection.—A communication was read from Mr. G. French Angas, containing a description of a new species of *Helix*, from South Australia, which he proposed to call *Helix (Rhadada) koorringensis*.—A second paper by Mr. Angas contained the description of two genera and twenty species of marine shells, from different localities on the coast of New South Wales.

**Geological Society, December 20.**—Prof. P. Martin Duncan, F.R.S., president, in the chair.—Bartholomew Parker Bidder, Robert William Cheadle, David Grieve, Player Isaac, James Love, Kerry Nicholls, William Ridley, William Joseph Spratling, and George Blake Walker were elected Fellows of the Society.—The President announced that the late Dr. Barlow had left to the Society by will the sum of 500*l.*, to be invested and to constitute a fund under the title of the Jameson-Barlow Fund, the proceeds to be applied annually, or at intervals of two or more years, at the discretion of the Council, in such manner as shall seem to them best for the advancement of the study of geology. Dr. Barlow also left to the Society, under certain restrictions, his collections of geological specimens, and a selection of books from his library. The President further announced the donation to the Society, by the Earl of Enniskillen, of the drawings made by Mr. Dinkel, from Sir Phillip de Malpas Grey-Egerton's collection, for the illustration of Prof. Agassiz's great work on Fossil Fishes, presented in accordance with the promise made by his Lordship at the meeting of May 24.—The following communications were read:—On *Phareospongia strahani*, a fossil Holorhaphidote Sponge from the Cambridge Coprolite Bed, by W. J. Sollas, F.G.S.—On the remains of a large Crustacean, probably indicative of a new species of *Eurypterus*, or allied genus (*Eurypterus? stevensoni*) from the Lower Carboniferous series (Cement-stone group) of Berwickshire, by Robert Etheridge, jun., F.G.S., Palaeontologist to the Geological Survey of Scotland. The fragmentary Crustacean remains described in this paper are referred by the author to a large species of *Eurypterus*. They are from a rather lower horizon in the Lower Carboniferous than that from which *Eurypterus scouleri*, Hibbert, was obtained. The animal was probably twice the size of *E. scouleri*. The remains consist of large scale-like markings and marginal spines which once covered the surface and bordered the head and the hinder edges of the body segments of a gigantic Crustacean, agreeing in general characters with the same parts in *E. scouleri*, but differing in points of detail. For the species, supposing it to be distinct, the author proposes the name of *E. stevensoni*.—On the Silurian Grits near Corwen, North Wales, by Prof. T. McKenny Hughes, F.G.S. The author commenced with a description of sections near Corwen, in North Wales, from which he made out that the grits close to Corwen were not the Denbigh grits, but a lower variable series, passing in places into conglomerate and sandstone with subordinate limestone and shale. The series, under the name of "The Corwen Beds," he described in detail, having traced them round the hills south of Corwen, also near Bryngorlan, south of the Vale of Clwyd, on Cymybrain, and south of Llangollen. He had noticed in places a kind of double cleavage affecting the lower series, but not the upper, and also fragments of cleaved mudstone included in the upper, from which he inferred a disturbance of the older rocks previous to the deposition of the newer. He exhibited a selection of fossils, and said that immediately below the Corwen beds there were none but Bala fossils. In the Corwen beds all the few fossils found were common to the Llandovery rocks, some of them, as *Meristella crassa* and *Parvaia crenulata*, being peculiar to that formation. In the flaggy slates above the Pale Slatess he had found Graptolites and Orthoceratites of the same species as those found in the Denbigh Flags. He considered that the Corwen Beds were on the horizon of the May Hill or Llandovery group, and should be taken as the base of the Silurian, thus including in the Pale Slatess of Tarnon Shale a thick series which intervened between the Corwen Beds and the flaggy slates of Penyglog.—On mineral veins, by W. Morgan, communicated by Warington W. Smyth, F.R.S.

lurian, thus including in the Pale Slatess of Tarnon Shale a thick series which intervened between the Corwen Beds and the flaggy slates of Penyglog.—On mineral veins, by W. Morgan, communicated by Warington W. Smyth, F.R.S.

**Meteorological Society, January 17.**—Annual General Meeting.—Mr. H. S. Eaton, president, in the chair.—The Council in their Report to the Fellows expressed their satisfaction at the progress that had been made by the Society during the year. The first point on which they thought there was reason for congratulation was the publication in their journal of the daily observations taken at Hawes and Strathfield Turgiss and of the monthly abstracts of the observations at thirteen other stations. The increase in the number of Fellows was considered worthy of special reference, as it is an indication not only of the vitality of the Society but also of the advance which meteorology is now making amongst the professional and general public. They also referred with much satisfaction to the enlargement of the Quarterly Journal as well as to the printing of the Catalogue of the Library and of the List of Fellows, which have both been issued during the year. They drew special attention to the report of Mr. Symons on the new stations which have been inspected and brought into relation with the Society. The financial position, notwithstanding the large outlays during the year, was very good. The report also contained the very interesting discussion by the Rev. T. A. Preston, of the observations on natural periodical phenomena.—The following gentlemen were elected Officers and Council for the ensuing year:—President, Henry Storks Eaton, M.A. Vice-Presidents: James Park Harrison, M.A., John Knox Laughton, F.R.A.S., Robert James Mann, F.R.A.S., Charles Vincent Walket, F.R.S. Treasurer, Henry Perigal, F.R.A.S. Trustees: Sir Antonio Brady, F.G.S., Stephen William Silver, F.R.G.S. Secretaries: George James Symons, John W. Tripe, M.D. Foreign Secretary, Robert H. Scott, F.R.S. Council: Percy Bicknell, Arthur Brewin, F.R.A.S., Charles Brooke, F.R.S., Edward Ernest Dymond, John Evans, F.R.S., Rogers Field, Assoc. Inst. C.E., Charles Greaves, M. Inst. C.E., William Carpenter Nash, Rev. Thomas Arthur Preston, M.A., William Sowerby, F.L.S., Capt. Henry Toynebe, F.R.A.S., George Mathews Whipple, F.R.A.S.

## PARIS

**Academy of Sciences, January 8.**—M. Peligot in the chair.—The following papers were read:—Exploration of the Gulf of the two Syrtes, between Sfax and Benghazi, by M. Mouchez. This was in the early part of last year. The author sketches the character of the coast, and refers to difficulties he had with the natives, who are very hostile to Frenchmen; but receive Englishmen with ovation, for defending the Sultan. They had some curious very old arms. The great recent development of the Alfa trade on the Algerian coast is notable, and the fact that while 75 per cent. comes to England and 18 per cent. to Spain, only 4 per cent. comes to France. M. Mouchez regrets this small consumption by his country.—Theorems relating to series of triangles of the same perimeter satisfying four other conditions, by M. Chasles.—Does ozone combine with free nitrogen in presence of alkalies to form nitrous compounds and nitrate? by M. Berthelot. He verifies Schönbein's observations on the formation of nitrous compounds during slow oxidation of phosphorus in contact with air, but he had not observed oxidation of free nitrogen by ozone in presence of alkalies. He points out some sources of error in Schönbein's experiments.—Note on the alteration of urine, *à propos* of recent communications of Dr. Bastian, by MM. Pasteur and Joubert. Dr. Bastian had said that M. Pasteur in repeating his experiment had exceeded the point of saturation of the urine (with solid potash). MM. Pasteur and Joubert have re-examined the point, in careful experiment, and produced exact neutralisation; though they consider this not indispensable for fertilisation. Dr. Bastian would have got quite different results from what he described, had he used KO, HO, which alone can properly be called *potash*.—Observations on the interior structure of one of the masses of native iron of Ovikak, by M. Daubrée. In its section it presented the aspect of a loop of iron from a refining hearth, the scorie of which had been very incompletely expelled by compression with the hammer or rolling mill.—Note on the fall of a meteorite which took place on August 16, 1875, at Feid Chair, in the circle of La Calle, province of Constantine, by M. Daubrée. It fell about midday; a noise was heard like a thunderpeal, and there was a train of blackish smoke with brilliant light in the middle of it. The mass, which weighed 380 grammes, rebounded

to about 30 metres further on, making a hole. It is of the most common type of sporadicities. — M. van Tieghem was elected member in the section of Botany, in place of the late M. Brongniart. — Report on a memoir of M. Haton de la Goupillière, entitled "Resarches on the Brachistochrone of a Heavy Body with regard to Passive Resistances." — Determination of the polar distance in magnets, by M. Benoit. — Experiments on the coagulation of fibrine, by M. Schmidt. This is essentially a process of fermentation; soluble albuminoid substances are changed by the action of a specific ferment and in presence of a small quantity of neutral salts of alkaline metals, into insoluble bodies. The ferment does not pre-exist; it is formed when the liquids are brought into abnormal conditions. The places of its formation are the white corpuscles of the blood, the lymph, chyle, and pus, and the cells of certain tissues, which undergo decomposition, the liquid then receiving from them a new quantity of fibrinoplastic substance. Meanwhile all the fibrinogen substance disappears as such, while the fibrinoplastic substance in excess, with the ferment becomes a constituent part of the serum. A temperature of zero retards considerably the formation of the ferment; concentrated neutral salts of alkaline metals hinder it almost entirely. They also paralyse the action of the ferment in the liquids. — On the spontaneous disappearance of a disease which for seven years attacked the vines in the island of Cyprus, by M. Dubreuil. It seems to have been *oidium*; its disappearance is attributed to the growing of abundance of sumach among the vines. — On the construction of open manometers, for measuring high pressures, by M. Cailletet. In his apparatus a metallic tube (70m. long 2mm. inner diameter) is soldered into a reservoir of mercury at the foot of a hill side. At the free end above is adapted a wide glass tube. When the mercury is compressed in the reservoir it rises to the glass tube. This upper part is movable by reason of the flexibility of the metallic tube, and may be shifted between stakes fixed on the slope. The pressure developed is measured by the difference of levels of the mercury in the glass tube and the reservoir. — Effects of heat on voltaic circuits completed by an electrolyte, by M. Helleisen. In one arrangement two test tubes are connected by a tube near the top and fitted with saturated solution of sulphate of copper; a copper plate is inserted in the upper part in one, another in the lower part in the other; and the former is heated with a spirit lamp. A considerable current is had. — Action of sulphate of lime on alkaline sulphates, by M. Ditte. — On the camphor of patchouli, by M. de Montgolfier. — Note on the life and survival of spermatozooids within the mammalian egg, by M. Campana.

January 15. — M. Fizeau in the chair. — The following papers were read: — Exploration of the Great Syrtes, by M. Mouchez. He describes this coast as in great part an utter desert of sand, without tree or dwelling; and the beach strewn with wreck of vessels whose surviving crews were probably massacred. Careful survey was made of some 250 leagues of coast line, also observation of the tide (total amplitude at Syzygies about 1'5m.), the strange atmospheric refractions preceding and following the sirocco, the declination of the needle, and natural history. — Note on the question of the nature and the contagion of the disease called typhoid fever, by M. Bouillaud. M. Pasteur referred to his researches in which he had proved the disease of silkworms to be both contagious and infectious in the highest degree and not at all epidemic, in the ordinary sense. The same would probably hold good for typhoid fever. M. Chevreul also made some remarks. — Spectroscopic study of the new star observed by M. Schmidt, by P. Secchi. His observations chiefly confirm those by M. Cornu. — On the application of photography to observation of the transit of Venus, by M. Angot. This treats of the measurement of direct parallactic effect; which can be measured (1) by the angle of position; and (2) by the distance of the centres of the two stars. In the former it is difficult in practice to get with sufficient exactness a fixed direction as origin for the angles of position. The American expeditions have come nearest solving the problem, and their results will aid to a judgment on the method. In the second method, the determination of the angular value of the images is a difficulty; M. Angot shows how it may be met. A third method, based on the fact, that for objects uniformly illuminated, with straight borders and dimensions far above the zone of diffraction, the increase of the image of a luminous object is equal to the diminution of that of a dark object in like circumstances, seems at first irrefragable, but, in practice, leads to much error, because (1) the diameter of Venus is far from being large with reference to the extent of the diffracted zone; and (2) the luminous intensity of different parts of the sun is not uniform. — Experiments on the

coagulation of fibrine, by M. Schmidt. He distinguishes *pro-plastic* liquids, which do not contain ferments but contain substances generative of coagulation; *plastic* liquids, which coagulate spontaneously and contain ferment and which are generators of fibrine; and *fibrinogenous* liquids, serosities which contain the substance fibrinogen. — Second note relative to the effects produced by Phylloxera on the roots of various American and indigenous stocks, by M. Foey. — Effects of dilute sulphocarbonates on vines, by M. Maistre. — On the simultaneous determination of annual constants of aberration and of parallax, by M. Trepied. Observations of declination will give at once and with the same weight, the special constants of aberration and parallax for each of the stars, and these determinations, made at two stations suitably chosen will enable us to appreciate the influence of the absolute movement of translation of the solar system on the phenomenon of aberration. — On the relations which necessarily exist between the periods of the quadratrix of the most general algebraic curve of degree  $n$ , and, *à fortiori*, of a particular curve in its degree, by M. Marie. — The phenomena of the radiometer explained by means of pyro-electricity, by M. de Fonvielle. Pyro-electric phenomena occur not only at the surface of certain crystals when subjected to a variation of temperature, but any non-conducting body submitted to the action of luminous rays is heated, then electrified more or less according to its nature and the intensity of the action. M. Fonvielle thinks all the phenomena hitherto observed in the radiometer may be thus explained. — Note on a new derivative of albuminoid matter, by M. Schützenberger. — On the optical properties of Mannite, by MM. Müntz and Aubin. — Action of chlorochromic acid on organic matters, by M. Etard. — Chemical studies on mistletoe (*Viscum album*, Linn.), by MM. Grandeau and Bouton: 1. The composition of the stem differs essentially from that of the species of trees on which it grows. 2. The composition varies with the species. 3. Mistletoe contains much more potash and phosphoric acid than its supporting trees, and much less lime. 4. It seems to live on the tree like a plant on the soil; it takes from the yellow parts gorged with nutritive juices, the incombustible matters necessary for its organisation. — On testing of wines for fuchsine and other similar colouring matters, by M. Béchamp. — On the passage of plasma through living unperforated membranes, by M. Cornu. It passes in a manner contrary apparently to the laws of endosmosis. — On the winter of 1877, by M. Renou. — M. Archereau presented prepared carbons for the electric light, said to increase the stability and illuminating power. They consist of carbon agglomerated and compressed, mixed with magnesia.

## CONTENTS

	PAGE
THE ENCYCLOPEDIA BRITANNICA	269
PACKARI'S LIFE-HISTORIES OF ANIMALS. By Prof. E. RAY LAN- KESTER, F.R.S.	271
OUR BOOK SHELF:— "Economic Minerals of Canada"	272
LETTERS TO THE EDITOR:— Holy Berries and Rare Birds.—The DUKE OF ARGYLL On the Southern Tendency of Peninsulas.—Sir JOHN LUBBOCK, F.R.S.	273
Basking Shark.—Prof. HENRY J. GIUGLIOLI	273
The "Challenger" Collections.—HENRY H. HIGGINS	274
Traces of Pre-Glacial Man in America.—Dr. CHAS. C. ABBOTT	274
Glacial Drift in California.—ALFRED R. WALLACE	274
The Number of Species of Insects.—R. MCLACHLAN; Prof. T. H. HUXLEY, F.R.S.	275
Meteor.—M. M. BARRINGTON	275
Digital Barometric Range at Low and High Levels.—W. W. RUNDLELL	275
Former Climaxes.—D. PIDGRON	275
Tape-worms of Rabbits.—GEORGE J. ROMANUS	275
POLARICOPIC OBJECTS. By W. SPOTTISWOODE, F.R.S.	275
MUSEUMS	276
"ACROSS AFRICA" (With Illustrations)	277
THE TROPICAL FORESTS OF HAMPSHIRE, III. By J. STARKIE GARDNER, F.G.S.	279
OUR ASTRONOMICAL COLUMN:— Red Star in Cetus	281
Variable Stars	281
A Fifth Comet in 1851	281
Coloured Belts on Jupiter	282
The Intra-Mercurial Planet	282
CHEMICAL NOTES:— Atomic Weights of Caesium and Rubidium	282
On the Specific Heat of Gases	282
Action of Antimony Pentachloride on certain Organic Substances	282
Action of chlorine on Peroxydide	283
Boron and its Specific Heat	283
Heated Air	283
NEWS	283
SCIENTIFIC BELLAS	286
SOCIETIES AND ASSOCIATIONS	286

THURSDAY, FEBRUARY 1, 1877

## DARWIN'S "GEOLOGICAL OBSERVATIONS"

*Geological Observations on the Volcanic Islands and Parts of South America visited during the Voyage of H.M.S. "Beagle."* By Charles Darwin, M.A., F.R.S. Second Edition, with Maps and Illustrations. (London: Smith, Elder, and Co., 1876.)

MR. DARWIN'S important contributions to biological observation and theory have during the last seventeen years attracted so much public attention, that there is some danger—one from which, however, all geologists will claim exemption—of his valuable labours in almost every department of geological research being to some extent lost sight of. Long, however, before the publication of the "Origin of Species," its author had achieved a foremost place in the ranks of the cultivators of geological science; nor must it be forgotten that the great work itself is as much a contribution to geology as to biology. Students of Mr. Darwin's earlier geological writings must all have been impressed by the powers of minute observation, the acumen in testing, and the skill in grouping data, and the boldness and originality in generalisation which distinguish their author; for these characteristics are no less conspicuously displayed in the theory of Coral Reefs than in that of Natural Selection.

In December, 1831, Mr. Darwin sailed from England in H.M. surveying vessel the *Beagle*, having accepted an invitation from the late Capt. FitzRoy to act as volunteer naturalist to the expedition then being despatched to complete the survey of the coast of South America. After an absence of nearly five years—during which many of the islands in the Atlantic were examined, large portions of both the east and west coasts of South America fully explored, several inland traverses of that continent made, the Falkland and Galapagos Islands carefully studied, and more rapid visits paid to Tahiti, New Zealand, Australia, Tasmania, the Cape of Good Hope, and a number of the coral islands in the Indian Ocean—the expedition returned to this country in August, 1836. Not a few important scientific discoveries will be associated with the names of the vessels of the United States Exploring Expedition, with the *Novara*, the *Challenger*, and many another surveying ship that might be mentioned; but it will be long indeed, we suspect, ere any vessel attains such a proud position in the annals of science as was won by the little ten-gun brig which bore our naturalist in his now famous "Voyage Round the World." Wherever in future the sciences of biology and geology shall be cultivated, there will the name of the *Beagle* become a household word.

The ten years which followed his return to England would appear to have been mainly devoted by Mr. Darwin to the publication of the numerous and important results obtained during the voyage. Besides editing the treatises of Prof. Owen, Mr. Waterhouse, Mr. Gould, the Rev. L. Jenyns, and Mr. Bell on the different groups of vertebrate animals, of which specimens were brought home, he wrote two very important works, one addressed to general readers—the "Naturalist's Voyage Round the World"—and the other of a more purely scientific character—the "Geology of the Voyage of the *Beagle*."

Before the publication of the "Origin of Species" had made the author's name so widely famous as it is at present, the works which we have named above, with the several memoirs communicated by their author to the *Transactions* and *Journal* of the Geological Society, had become universal favourites with the students of various branches of natural science; and this, no less on account of the rich store of novel observations which they contained, than for the originality and suggestiveness of their deductions from those observations. And since the appearance of their author's *magnum opus*, we confess that these earlier writings have for ourselves acquired a strange fascination. Again and again have we perused them, only to detect valuable observations and striking suggestions before missed, and to encounter fresh traces of the germs of ideas, that, after twenty-eight years of earnest thought and study, were developed into the theory of descent with modification, which is now exercising so important an influence on the progress of the natural sciences. At the commencement of the present notice we ventured to claim for geology at least a moiety of the advantages which have flowed from the publication of the "Origin of Species;" and, on the other hand, we feel that we are putting forward no undue demands on behalf of the same science, in declaring that the theory of Natural Selection must be regarded in at least as great a degree the prize of geological observation as the reward of biological research.

Such being the case, these "Geological Observations" are well worthy to take their place in the long series of the author's contributions to the doctrine of descent, side by side with those more widely known works on different departments of zoology and botany which have been published subsequently to the "Origin of Species." Two years ago the first part of the "Geology of the Voyage of the *Beagle*"—a work which has long been out of print, and has become extremely scarce—was republished; and naturalists and geologists were alike gratified by the appearance of this revised and enlarged edition of the well-known memoir on Coral Reefs. The work now before us is a re-issue of the remaining portions of the "Geology of the Voyage of the *Beagle*," and will be equally welcome to a large section of the scientific public.

The districts described in the present work, as Mr. Darwin justly observes in his preface to the new edition, "have been so rarely visited by men of science" that very little "could be corrected or added from observations subsequently made." And on the other hand attempts to modernize the terminology could scarcely fail to detract from the minute accuracy of observations, which were clearly either recorded upon the actual spot where they were made, or at all events while the memory of them was still fresh and vivid in the mind of the author. We think, therefore, that a wise discretion has been exercised in allowing the descriptions and discussions of phenomena to remain in precisely the same form as when they were originally drawn up; though we must confess to a feeling of disappointment at the absence of notes from the author's pen, indicating how far in his own view some of these original conclusions have been strengthened or modified by his later studies and researches.

We can only permit ourselves to recall a few of the more important among the valuable contents of this book

to the memories of our readers—and in doing so we shall dwell more particularly on such as, through recent discoveries or controversies, have acquired especial interest at the present day.

Every explorer who, since the publication of the "Observations on Volcanic Islands," has been called upon to investigate districts containing extinct volcanos, has been greatly aided by the valuable store of facts and suggestions contained in that work. We very much doubt, however, whether some of the interesting questions discussed in it—and we more especially refer to those relating to the nature and origin of the banded structure in lavas, with the light which these are calculated to throw on the difficult problem of the cause of foliation in rocks—have received that amount of attention from geologists, of which they are certainly deserving.

The proofs of the long-continued elevation of the shores of South America for thousands of miles, and to the height of many hundreds of feet, yet unattended with marked disturbances of the strata, the gradual disappearance of every trace of organism in rocks which once abounded with them, the survival of a most remarkable fauna of gigantic vertebrates to post-tertiary times, and its seemingly sudden extinction at a very recent period—these are some among the many interesting facts described in the second part of the work which are of especial value to geologists seeking to interpret the records of the past. Mr. Darwin's observation of an admixture of Jurassic and Cretaceous types of life in the same deposits in South America have acquired fresh significance now that the United States geologists have shown that ammonites range up into the tertiary strata, and that Dr. Waagen has described ammonites, goniatites, and ceratites, occurring in India, in the same bed with several carboniferous species of brachiopods. Now, too, that so much has been done by Dana, Le Conte, and others, in determining the mode of origin of the Rocky Mountains, and the part played by the volcanic outbursts which occurred simultaneously with the mountain-forming movements, Mr. Darwin's clear descriptions of the sections noticed by him in his traverses of the chain of the Andes will be referred to with fresh interest by geologists: and the comparison of phenomena displayed in distant parts of the same great chain is highly suggestive. But space fails us to refer to even a tithe of the points of interest which we have noted in our reperusal of this valuable work.

A striking characteristic of all Mr. Darwin's writings, and one which is very eminently displayed in the work before us, is his scientific candour. Like his teacher and friend, the late Sir Charles Lyell, he never forgets in his discussions to look at all sides of the questions before him, and to give the fullest expression and weight, alike to the difficulties which he himself detects, and to arguments which opponents may have advanced. With superficial readers this peculiarity in the writings of Lyell and Darwin has apparently very unjustly detracted from their merits; and we are sometimes amused by finding critics boldly parading as their own, objections which it is perfectly clear that only the candour of the authors has permitted them to rehearse, but which their own knowledge has not sufficed to enable them to understand or to make adequate use of.

Perhaps at no period in the history of the science have the great facts of geology suffered so much distortion from the works of pseudo-scientific writers—through which media alone science is too often, alas! transmitted to the general public—than at present. These writers selecting a few isolated and imperfectly understood facts, in bold defiance or lamentable ignorance of a thousand unmistakable and clearly established principles, proceed to build up the most elaborate hypotheses. We cannot therefore help regarding the republication of Mr. Darwin's "Geological Observations" as a most opportune event. The able geologist, De la Beche, many years ago wrote a charming little book entitled "How to Observe in Geology." To those anxious to learn this most important art at the present time, we would recommend as a model—since example is better than precept—the work now before us. The careful study of the clear and minute descriptions of geological phenomena, and the following step by step of the fair and cautious discussion of facts and arguments contained in this book can scarcely fail indeed to teach the reader something which is even more valuable than "how to observe," namely, how to reason in geology.

JOHN W. JUDD

#### TWO "CHALLENGER" BOOKS

*Log Letters from the "Challenger."* By Lord George Campbell. (London: Macmillan and Co., 1876.)

*The Cruise of Her Majesty's Ship "Challenger."* By W. J. J. Spry, R.N. With Map and Illustrations. (London: Sampson Low and Co., 1876.)

IT was to be expected that with so carefully-selected and intelligent a staff, both naval and civilian, on board, the cruise of the *Challenger* would be productive of something more than the official literature. It will have been seen from the "Preamble" which we recently published (*antea*, p. 254) that it must necessarily take a long time to arrange the abundant scientific results that have been obtained, and the complete official accounts may not be in the hands of the public for years. The Report on the Austrian *Novara* Expedition has taken seventeen years' serious labour to complete; but we hope to be in possession of the *Challenger* Reports in a much less space of time. Meantime many readers will be glad to have in a handy form a general account of the work which the expedition has done, and some details concerning the incidents of the long cruise and the many places which the ship visited. From either of the books before us such information may be obtained.

There is a wide difference, however, between the characters of the two works. Lord Campbell's is by no means an attractive book at first sight. It is a big, plain, heavy-looking volume, with a large page well filled with type, enormous paragraphs of sometimes half-a-dozen pages in length, and with not a single picture. One is apt to sigh at first at being compelled to read it, but after perusing a few sentences the reader "puts on the garment of praise for the spirit of heaviness," and finds the real difficulty to be to stop. Lord Campbell's pages bear all the marks of being genuine letters, written with no thought of a public before him, and only for the entertainment of those to whom they were sent. He has evidently not "got up" his subject at all, the information he conveys being almost

entirely the results of his own observation. And a thoroughly good and most original observer he is, with a faculty of telling what he has seen in such a way as keeps the reader in a constant state of exhilaration. Lord Campbell makes no pretence at instruction, nevertheless in his own characteristic and irresistibly amusing way, he conveys a vast amount of information concerning all the places visited by the *Challenger*, and tells not a little of the results of the soundings and dredgings carried out by the "scientifics," as he calls the civilian staff. But apart from the genuine entertainment to be had from the work, its great value will be the observations made by the author on the various peoples among whom he sojourned for a longer or shorter period. Even well-informed ethnologists, we should think, will be able to obtain not a little important information from the work on the present condition, for example, of the inhabitants of many of the Pacific islands, such as those of the Friendly, Fiji, and Sandwich Islands, New Guinea, Admiralty Islands, &c. A very large space is devoted to Japan, and many shrewd remarks made on the present condition and future prospects of the Japanese. There are many interesting notes besides, on the physical aspect and natural history of most of the places visited, and in almost all cases it will be found that some new feature has been brought out. Even of such well-worn subjects as Teneriffe, the Azores, Cape de Verde Islands, Australia, New Zealand, Tahiti, the South American littoral, Lord Campbell manages to say something unexpectedly original. In a concluding chapter he gives an instructive summary of the *Challenger's* work and how she did it. We can only, in our space, speak in the most general way of the nature of the contents of this work. A more entertaining, a more genuinely bracing book, it would be difficult to find, and the reader who goes carefully to the end of it will have added considerably to his knowledge of the earth's surface. It is a great pity that a work so full of varied information should have been published without either an analytical table of contents or an index. A map would also have been a great help to the reader.

Mr. Spry professes simply to give a plain, straightforward narrative of the cruise, of some of the chief results obtained by sounding and dredging, with notes on the places and people visited, partly the result of his own observation and partly of reading. The book is nicely got-up, well printed, and contains a large number of interesting and well-executed illustrations, not only of people and places, but of the implements used in carrying out the work of the *Challenger*. He gives a very clear account of the various apparatus used, their construction and uses, which we commend to the perusal of the uninitiated reader who wants to know how such work as that of the *Challenger* is performed. Mr. Spry gives the curious story of the brothers Stoltenhoff, who were found living alone on Inaccessible Island, at considerable length, in the words of the elder brother. The work contains a really large amount of valuable information, and as no two men observe alike, we commend those who desire to have complete information about the cruise of the *Challenger*, to read both books. While Mr. Spry sometimes unnecessarily introduces information obtained from books, his work is, on the whole, thoroughly readable,

and certainly instructive. Altogether, these preliminary "snacks" augur well for the great official feast which is being prepared for us.

#### OUR BOOK SHELF

*The Year-Book of Facts in Science and Arts for 1876.*  
Edited by James Mason. (London: Ward, Lock, and Tyler, 1877.)

THE "Year-Book of Facts" so long associated with the name of the late indefatigable Mr. Timbs seems to have taken a new lease of life under the present editor, who begins his duties with the volume before us. Some useful changes have been made; thus, there is a marked improvement in the arrangement and character of the contents, and the period covered by this year-book now extends from the autumn of one year to the autumn of the following, and not January to December as heretofore. The longer time thus given for preparation has been well used by Mr. Mason, who certainly has produced a volume far in advance of any of its predecessors. It is hardly necessary for us to say much about this well-known year-book, which does not pretend to be more than a popular digest of scientific scraps; and in no sense supplies the need, to which we have alluded in previous notices, of a carefully-prepared record of scientific progress—the nearest approach to which in the English language is the American "Annual Record of Science and Industry," edited by Mr. Baird. The present editor of the book before us has done his work, so far as it goes, in a comprehensive and careful manner. One or two serious omissions we notice, notably the important discovery made by Dr. Ker, and announced at the last meeting of the British Association, of the rotation of the plane of polarisation by reflection from a polished magnetic pole, certainly one of the most novel physical facts of the past year.

#### LETTERS TO THE EDITOR

[The Editor does not hold himself responsible for opinions expressed by his correspondents. Neither can he undertake to return, or to correspond with the writers of, rejected manuscripts. No notice is taken of anonymous communications.]

##### Just Intonation

YOUR esteemed correspondent, Col. A. R. Clarke, declines to admit any error or oversight in his communication to NATURE under the signature of "A. R. C.," on December 21, 1876. I regret to be of a different opinion. The first error which I pointed out ought to be palpable enough to a mathematician who is acquainted with the ratios of a scale, and therefore I treated it as an oversight. Col. Clarke gives 27 to 16, instead of 5 to 3, as the ratio for A in our present diatonic scale. By his enlargement of the interval he would unknowingly convert the well-known consonance of a major Third between F and A into a Pythagorean ditone. Evidently the Colonel is not aware that F and A are notes *interposed* in the scale of C, that harmonically they belong to F, and require F as a consonant bass. All this has been explained in a pamphlet in print. I would therefore suggest to Col. Clarke an investment of sixpence in the purchase of a "Review of Helmholtz's New Musical Theories," published by Novello, Ewer, and Co., No. 1, Berners Street. To prove all the unadmitted charges would be too long for NATURE, and Col. Clarke will find most of them touched upon in that pamphlet as well as other current errors. In the meantime it is not difficult to tell that Col. Clarke derived his ratio from the harmonic scale of C, and not from that of F (which would have been right), or from the work of any modern mathematician.

It is because F and A are harmonically derived from F that our scale cannot be reduced to a common denominator. The F string exceeds the length of the C string by half, the ratio being 3 to 2, and one of the first rules of proportion is that

"ratio can exist only between quantities of the same kind." When mathematicians employ the figures of 4 to 3 in the scale of C, the interval they really obtain is from C down to G (not from F down to C, as they have supposed), and when 5 to 3, they have the major Sixth from E down to G, and not the one from A down to C.

Music is a much more simple science than most men suppose. All that a mathematician requires is a set of harmonic scales, with powers of 2 and 3, before him. The scales include all ratios, and all consonances with their proportions of accompanying dissonances. They are scales of aliquot parts, and those aliquot parts are the corresponding multiples of vibrations. Time spent upon calculating temperament is but thrown away, because no mathematician's figures will be adopted in practice. Practical musicians will continue to tune by listening to the beats, as they have ever done, and perhaps all other musicians before them. The recommendation to eschew temperament may be even worthy of consideration in another point of view. Mathematicians have not given sufficient attention to the musical side of the question. Have we not, of late years, heard much of proposals to divide the octave into "twelve equal semitones"? Are we to imagine that this is a mathematician's idea of "equal temperament"? If music were but geometry, it would be an admirable arrangement: twelve equal semitones, like twelve equal inches in a foot. But, unfortunately, a musical scale is the very reverse of a geometrical one, and there are no two intervals alike in it. As it rises, the dimensions become less at every step, in ratio and in length. For instance, the ratio of C to C sharp is 16 to 17, that of G to G sharp (G being the half-way in point of vibrations) is 24 to 25, and from B to octave C is 30 to 32, but only because we omit B sharp, otherwise it would be 31 to 32. Fancy two such extremes "tempered" to the middle note! Only one of the twelve would fit into a musical scale, and there would be eleven discordant semitones out of the twelve. The discord would not be confined to one key only, but would be the same in every key. The so-called "diatonic semitones" are really tones. E is the seventh to F, which requires F as a bass, and B is the seventh to C in the scale of C. Are these to be changed into chromatic semitones?

The diminished attraction of music, some persons even disliking it, is mainly, if not wholly due to tempered tones. The first point to be considered by mathematicians who temper scales is the meaning of the two words, "consonance" and "dissonance." The charm of music depends upon "coincident," and "non-coincident" vibration.

In justice to Col. A. R. Clarke, let me add that I find only the first error to be his own, and am still disposed to attribute it to oversight in referring to a wrong scale. All the others are after precedent, and every source might be pointed out, although he is disposed chivalrously enough to defend those upon whom he relied. My excuse for writing at all is that NATURE is a purely scientific journal, and that I share with others an earnest wish to uphold it as a fair representative of English thought. Articles such as those of Col. Clarke and my own would be distasteful to any but scientific readers. As to the "comma of Pythagoras," it is not worth discussing. In spite of his chivalry, Col. Clarke knows as well as I do, that such an array of figures, representing vibrations, as 524, 288, cannot arise in less than nineteen octaves.

WM. CHAPPELL

Stratford Lodge, Oatlands Park, Surrey

### The Nebula of Orion

IN NATURE, vol. xv. p. 201, in an account of the American Cambridge Observatory, it is stated that the nebula of Orion had not shown the slightest trace of resolvability under Lord Rosse's 3-feet reflector.

The authority for this statement is, I suppose, Nichol's "Thoughts on the System of the World," where, p. 52, it is said that in 1844-5, the 3-feet did not contain the vestige of a star in the nebula.

On the occasion there referred to the speculum must have been in bad order, for the resolution of parts of the nebula is quite within the reach of the instrument in its normal condition. In proof of this I may refer to Lord Oxmantown's paper on the Nebula of Orion, *Phil. Trans.*, 1861, and to an extract from my own note-books of an earlier date, February, 1848:—"With the 3-feet saw the nebula of Orion resolved as far up as the little bay and C 1 Oriolite—powers 351 and 320—best with the latter which is a single lens."

I may add that Nichol also states, p. 55, that he had received from Lord Rosse, March 19, 1846 intelligence "that all about the trapezium is a mass of stars (in the six feet); the rest of the nebula also abounding with stars, and exhibiting the characteristics of resolvability strongly marked."

Observatory, Armagh, January 19

T. R. ROBINSON

### Basking Shark

MY notice of Prof. Steenstrup's paper was written in the autumn of 1875, to accompany an electrotype of the woodcut in that paper of the baleen-like fringes of the basking shark, sent to me for NATURE from Copenhagen.

At the time I was quite ignorant that my friend and former master, Dr. Allman, had written on the subject, nor could the keenest bibliographer have known much of the contents of his memoir, as the only reference to it in the Fourth Annual Report of the Dublin Natural History Society for 1841-42, is "Two [papers] have been read on Ichthyology; that on the basking shark (*Selachus maximus*) by Mr. Allman, caused him to notice the value of the fisheries of our southern coasts, abounding in large fishes and cetacea, whose capture would prove highly profitable to our fishermen from the quantity of oil they would yield." In June, 1876, on the arrival of the specimen in Dublin from Bofin, I had a woodcut made of a branchial arch with the fringe attached, and added a brief account of the specimen now in the Dublin Museum. About that time Dr. Allman told me that notes of his paper had been published in the *Saunders's News Letter*, but that he had forgotten the date. Guided by the notice in the Dublin Natural History Society's Report, I searched the files of that paper for the years 1841 and 1842 without success, but I fully purposed to mention what Dr. Allman had told me, from memory, of his researches, when I should get a proof of my manuscript. Unfortunately, from press of matter, my notes were not published until many weeks after they were sent, and the proof reached me during long vacation, when I completely forgot to do as I had intended. I regret this exceedingly, and hope Dr. Allman will accept my apology. I cannot, however regret, that it has induced Dr. Allman to publish an abstract of his paper (NATURE, vol. xiv. p. 368), and perhaps he may still further furnish us with the date of its original publication.

In answer to the note of Prof. Eurico Giglioli, which has called my attention again to this subject, I have simply to state that finding no notice in the Zoological Records for 1873 or for 1874 (this latter published May, 1876) of any papers on Selache, I concluded, as it now appears wrongly, that nothing had been written during these years on the subject. This was my misfortune, perhaps my fault; but regarding Italy as the mother country of all the sciences, being well aware of the advances she has made in biological researches during the last twenty years, and having gone each year, while one of the zoological recorders, to Florence to work out the Italian literature of the preceding year, I cannot accuse myself of any intentional neglect of the labours of Italian biologists. It is to be hoped that Prof. Giglioli will favour us with an abstract of Prof. Pavesi's memoir, especially of the reasons that induce Prof. Pavesi to assert that our Bofin shark is *S. rostrata* and not *S. maxima*, for to me it appears that our seas may possess both these species.

It may also be mentioned that no reference to Prof. Pavesi's memoir will be found in the account of the Pelerin appended to Prof. Lütken's "Fishes of Greenland," prepared for the use of the British North Polar Expedition, 1875.

E. PERCIVAL WRIGHT

### Sense of Hearing in Insects and Birds. "Towering" of Birds

I AM glad to learn from Mr. McLachlan that stridulation is known to occur in several species of *Lepidoptera*; for this shows that the sense of hearing in these insects is probably of general occurrence. With regard to the sense of hearing in birds, I did not say in my previous letter that thrushes, &c., were guided to their food *exclusively* by this sense; indeed it would be a very anomalous thing if animals which possess so keen a sense of sight are not in the habit of using it, as Mr. McLachlan suggests, in any profitable way they can. But that thrushes trust *very largely* to their sense of hearing in their search for food—especially in certain conditions of the ground—no one, I think, who has observed the process can doubt. The bird runs rapidly some twelve to twenty feet in a straight line; it then stops

suddenly, elevates its head, and remains motionless in a listening attitude; after pausing thus for a few seconds, it again runs to about the same distance as before, again stops to listen, and so on. These successive excursions are usually made in the same direction; but every now and then, during the process of listening, the thrush apparently hears a sound proceeding from some point within the circle which it has last entered; immediately the course of progression is deflected at an angle from the continuous straight line in which all the previous excursions were made, and, either with a single rush or after one or two brief pauses to make quite sure of the exact spot, the bird may nearly always be seen to find a worm.

I may take this opportunity of thanking your various correspondents for the information which they have supplied with regard to the towering of birds. Some of the letters mention ducks, teals, and widgeons as birds which occasionally tower. May I ask the writers of these letters whether the action in these cases resembled that of *trunc* towering in the case of partridges and grouse? I ask this because one of the numerous letters by which my communication to NATURE has been answered in the *Field*, states that birds of this build never tower; and on this supposed fact the writer constructs a theory as to the mechanism of towering in general. All the correspondence taken together cannot leave any doubt that there are at least two kinds of towering:—viz. (1) The common kind which I described, and the cause of which is certainly pulmonary hæmorrhage; and (2) a very rare kind which I have never myself witnessed, and the immediate cause of which appears to be cerebral injury. In the case of the second, or rare kind of towering, all the correspondents are agreed that the bird is not dead when found, and that it may even fly away again when disturbed. Never having had an opportunity of observing such a case, of course any hypothesis by which I may try to explain the cause of the rare kind of towering is of no further value than a conjecture; but I may remark that both kinds of towering may possibly be due to the same cause, if the parts of the brain which are injured when the second kind of towering ensues, are the parts whose injury Brown-Sequard found to be attended in the case of mammals, with bleeding of the lungs. At any rate, it would be worth while for any sportsman who may have the opportunity, to dissect a bird which he has seen to exhibit the second kind of towering, in order to ascertain whether, in such cases also, some degree of pulmonary hæmorrhage may not have taken place.

GEORGE J. ROMANES

In Mr. G. J. Romanes' interesting remarks (NATURE, vol. xv., p. 177) on the sense of hearing in insects, he says:—"In the case of moths, however, I believe that sounds are never emitted, except of course the Death's-head."

As I trust that insects will continue to have a place in his observations, may I be allowed to call Mr. Romanes' attention to the following species of Lepidoptera which are known to produce sounds:—

1. *Vanessa*, several species.—The sound produced—which has been compared to the friction of sand-paper—has been noticed by several observers, viz., Rev. J. Greene (*Proc. Ent. Soc. of London*, New Series, ii., p. xcvi.), Mr. Hewitson (*l.c.* iv., p. ii.), and Mr. A. H. Swinton (*Entomologist's Monthly Magazine*, xliii., p. 169, January, 1877), who describes the apparatus by which the noise is produced. On the under surface of the upper wing one of the nervures is roughened like a file, and upon this a raised nervure on the upper surface of the underwing plays; there is also a circular embossed patch of the wing-membrane destitute of scales, which Mr. Swinton thinks serves to "impress the musical tremours." The object of this stridulation, Mr. Swinton suggests, may be classed with those phenomena of rivalry and love so conspicuous in the *Orthoptera*, &c., but at the same time it is produced when the insects are disturbed, and possibly also when the sexes are coquetting in mid-air. Moreover, the development of the mechanism is greatest in the female, contrary to the usual rule. For my own part, I incline to think that the object of the sound is rather the intimidation of possible enemies than a sexual love-call. Both Mr. Greene's and Mr. Hewitson's cases occurred when insects that were hibernating were disturbed, and the sound was renewed whenever the disturbance was repeated. These butterflies hibernate in dark holes and corners, and the sound may be intended to suggest to the disturber the hiss of a snake or the note of an angry wasp or bee. As the perpetuation of the species depends for the most part on the female, she is provided with a stronger

apparatus. If the sound is produced when the sexes are coquetting, it may be the butterfly expression of a playful "Get along with you."

2. The well-known case of *Acherontia* (the "Death's-head Moth").—The sound here also is probably for intimidation, and not a love-call. I cannot at present call to mind any observations on any disparity of the sound in the sexes.

3. *Setina*, several species, and

4. *Chelonia pudica*.

The sound emitted by these insects—which is compared to the ticking of a watch—is described by M. A. Guenée (*Ann. Soc. Ent. Fr.*, 4<sup>e</sup> ser., vol. iv. 1864; translated in *Ent. Month. Mag.*, i. 223) who says that it is produced by two tympaniform vesicles situated in the pectoral region, and is much more developed in the male than in the female. This, M. Guenée remarks, is rather curious, for, as the females of *Setina* can scarcely fly, it would seem that, if the organ of sound is to produce a love call, it is the female, and not the male that should have it most strongly developed. M. Guenée consequently expresses himself unable to give any plausible reason to account for the object of the sound.

A reason has occurred to me and I here give it for what it may be worth. We know that the females of several Lepidoptera (especially wingless females) have the power of emitting a scent which attracts the males, often from considerable distances. When the male of *Setina* is hunting for the female and making probably his drums vibrate loudly, the sound reaching the concealed female may excite her to give out an increased odour, and thereby more surely attract the male. In short the drums are organs of excitation.

5. *Hylophila prasinana*.—This species Mr. Swinton (*Entom. Monthly Mag.*, vii. 231) has noticed to emit a wittering sound, which he thinks is produced by a structure between the thorax and abdomen.

I have been fortunate enough to have also had an opportunity of hearing the sound produced by this species (*Scottish Naturalist*, i. 213). The sound resembles a continuous squeaking and was heard on more than one occasion, and was audible at a distance of ten feet or upwards. All the specimens that I caught in the act of squeaking were males, so that I cannot say whether the other sex squeaks or not. The sound is emitted whilst the insect flies about the bushes, and the object of it is probably the same as I have suggested above in the case of *Setina*. The emission of the sound is quite voluntary on the part of the moth, as specimens taken in the act of squeaking and made to fly afterwards did not then give out any sound. Careful dissection revealed no structure that appeared capable of producing the noise except a tympaniform plate situated at the base of the hind body.

6. *H. quercana*.—According to Mr. Swinton (*l.c.*, viii. 70) this species can make a "membranous sound," which he thinks is produced by the wing catching a little horny lateral thoracic plate.

There may be other recorded instances of sound-producing Lepidoptera, but I cannot at present recall any to mind. It is probable moreover that more species than are generally supposed emit some kind of a sound. It is therefore much to be regretted that the many collectors of Lepidoptera—whose sole aim seems to be the amassing of large collections and whose lack of anything beyond the mere desire to accumulate specimens, has made entomology a bye-word amongst the sciences—would not spend some of their misplaced energy in really studying the objects of their attention.

Mr. Romanes' observation of the sensible appreciation moths have for high-pitched notes suggests a question. Does the shrill squeaking of bats convey an intimation to moths of the approach of one of their greatest enemies?

It is to be noted moreover that in the majority of cases the sounds emitted by moths, and indeed all insects, themselves, are high pitched.

F. BUCHANAN WHITE

Perth, January 12

P.S.—Since the above was written I see that my friend Mr. McLachlan has pointed out (NATURE, vol. xv. p. 254) another record of a sound-producing moth—*Euprepia matronula*.

THE perusal of Mr. McLachlan's letter on "Sense of Hearing &c., in Birds and Insects" has recalled to my memory another instance of a Lepidopterous insect which possesses the property of emitting a marked sound when on the wing. This is a common Brazilian butterfly (*Ageronia ferrenia*), and attention



was long ago directed to its habits in this respect by Mr. Darwin in his delightful "Naturalist's Voyage" (p. 33). He there mentions that when watching a male and female of this species in flight, he "distinctly heard a chinking noise, similar to that produced by a mothed wheel passing under a spring catch."

This curious observation I had numerous opportunities of verifying in the course of three visits to Rio Janeiro in 1866, 1867, and 1869.

ROBERT O. CUNNINGHAM

Queen's College, Belfast, January 19

I HAVE noticed that, when moles are burrowing, the worms near make their way to the surface. I have also observed that starlings gather round and under cows in pasture-fields. Their doing so I have been in the habit of ascribing to the tread and grazing-work of the cows producing tremors in the ground, which worms may mistake for mole-work, and therefore crowd to the surface; and I have offered the same explanation for the method of hunting pursued by blackbirds and thrushes. They have practically found out that (earth-tremors induced by) small hopping-runs make "the poor inhabitants below" seek safety above, and that thus the hunters most readily secure a breakfast. I am not acquainted with the habits of those hunters.

Cambuslang

HENRY MUIRHEAD

### Galton's Whistles

WITHIN the last few days I have had the opportunity of making observations with Galton's whistle upon a large number of people and upon some cats, and I have come to some conclusions which are curious and suggestive, even though they may not be absolutely exact. Thus, on the whistle a line is marked which is the usual limit of human hearing, and which represents, I should say, a number of vibrations somewhere between 41,000 and 42,000 per second. Out of many hundreds of persons examined I have only met with one instance, a young man, in which I was satisfied that a note higher than this was heard. As a rule the compass of the ear of women is markedly higher than it is in men, and age seems to lower it sooner in men than in women. Is this a result of the female animal always having the more intimate protection of the young as her work, the young having notes of higher pitch than the adult? The fact is at least suggestive.

Very few of the persons experimented upon seemed to have the compass of one ear exactly the same as that of the other, the right ear usually hearing a higher note than the left, and this is more marked in men than in women.

The sense of direction of the sound in the human ear seems to be lost at a very much lower point than appreciation of the note, but this is not the case with cats; for until the instrument ceases to produce a note altogether, or at least one within their compass, they turn their faces to the source of it the moment it is produced. These facts are also suggestive. The cat still depends to a large extent for its food supply on the appreciation of high notes, and quite as much on the appreciation of the direction from which they come. The power of hearing a note of a pitch beyond the limits of our sense of direction is suggestive that that sense has been blunted by disuse; and it would be extremely interesting to know if the compass of direction is higher in savage than in civilised peoples. From facts known concerning their other senses, I should say it is likely to be higher.

This difference in the two compasses is further indicative that the appreciation of direction is the work of a separate organ, and Dr. Crum Brown's experiments suggest the semicircular canals, or the utricle or sacculle in association with them, as the seat of this sense. If, as Dr. Brown seems to have shown, the semicircular canals are the organs of the general sense of position and direction, it would not be a far-fetched idea, that the utricle has to do with the sense of the direction of sound and that the canals are additions to it. An analogous relation of the cochlea to the sacculle is suggested by the mere facts of anatomy. If it be, as Helmholtz believes, that the cochlea is the organ for the appreciation of pitch, the relations of the three divisions of the organ of hearing are to be easily understood, and these relations offer, at first sight, a singularly strong evolutionary argument. There is, first, the organ for the perception of sound vibrations, having a comparatively limited compass. To this is added an organ for the appreciation of the direction of the sounds, and another for the appreciation

of highly pitched notes; and a part of the first of these becomes so modified as to be capable of interpreting position and direction generally, independently of sound. The facts of the development of the ear support such a view, and we may conclude that the sense of direction is more important than the appreciation of high notes; for the semi-circular canals appear, or at least one exists, in the Myxine, whilst a very rudimentary cochlea does not appear till we get high up in the fishes.

Birmingham

LAWSON TAIT

### Atmospheric Currents

MR. CLEMENT LEY (in vol. xv. p. 157 of NATURE) asks me for the absolute proof which I suppose to exist (1) that the upper current return trades "flowing from the equator descend again to the surface of the ocean on the polar sides of the calms of Cancer and of Capricorn," and (2) that "these equatorial currents subsequent to their descent on the polar sides of Cancer and of Capricorn are known as the westerly winds of the temperate zones"; (3) he further asks "what proof exists that the upper currents from the polar depressions and those from the equatorial depressions cross one another in the calms of Cancer and of Capricorn so as subsequently to become the trades and anti-trades respectively," and suggests that it is more reasonable to suppose that their currents intermingle, and that their mixed volume is then drawn off north and south, as required, to restore the equilibrium of the atmosphere, as suggested by myself with reference to the equatorial calms. Mr. Clement Ley's three questions may, I think, be fairly answered as one, all depending upon the same proof.

The correctness of my assertions with reference to the atmospheric currents flowing from the equator can be referred to the one crucial test, viz., Are the atmospheric currents which descend to the surface of the ocean on the equatorial and on the polar sides of the two zones of high pressure, similar in their constituents (i.e., when they first become established as winds on the surface of the ocean)? is their degree of electricity the same? is their degree of saturation the same? If these questions could be answered in the affirmative it would show that Mr. Ley's supposition with reference to the mixed volume of the upper currents was possible, but if, on the other hand, they are answered in the negative, Mr. Ley can hardly hold, I think, that I have put my statements forward too strongly.

Though I believe that the north-east and south-east trades meeting at the belt of equatorial calms are thrown upwards from the surface of the ocean, and in ascending do mix their volumes, the conditions of atmospheric currents meeting many thousand feet above the sea-level are entirely different, as they have not the ocean as a *point d'appui*, and there is no more difficulty in accounting for their currents passing one another and the heavier under-running the lighter, than there is for the Labrador, augmented by the East Greenland current, meeting and under-running the Gulf Stream.

At Tenerife, and other mountainous regions, in the latitudes of the trades, observations have been made with reference to the height of the trade winds, and of the neutral strata intervening between them and the upper current, as also of the height of the lower portion of the equatorial return current, which flows at heights varying from 12,000 feet upwards above the sea-level.

Prof. C. P. Smyth, H.M. Astronomer for Scotland, in his very interesting work, "Teneriffe," gives us some very important data with reference to these currents, showing—

1. The extreme dryness of the north-east wind.
2. Its very moderate electricity.
3. The greater saturation of the south-west wind.
4. The descent of the south-west upper current.
5. The chemical difference between the two currents.

Though there is much that I might quote with advantage, I shall content myself with the following four paragraphs—

Page 110. "If we must live in a wind by all means let it be the south-west, and not the north-east, that effete unwholesome and used-up polar stream. As to the chemical and sanitary qualities of the two winds there could be no comparison between them."

Page 176. "And so indeed we found before we had finished with our expedition, when the south-west wind descended to the very surface of the sea."

Page 184. "In short, whatever the north-east wind did, its electricity was always moderate."

Page 202. "The trade wind is undoubtedly a poor one for

bringing water, but its position in Teneriffe during summer is favourable for making it deposit any which may be present."

I think from these extracts, which are supported by other passages in Prof. Sm. h's work, I am quite justified in arguing that the trades and counter-trades are not similar in their constituents, that their degrees of electricity and of saturation are not the same, and that therefore it is not reasonable to suppose that their upper currents intermingle at the belts of tropical calms, and that their mixed volume descends and is then drawn off north and south as required, to restore the equilibrium of the atmosphere.

As these opposite currents flowing in the northern hemisphere from the north-east and the south-west (approximately) do not intermingle, and their mixed volume does not descend in the calms of Cancer it must necessarily follow that the south-west or return equatorial current, does descend to the surface of the ocean on the polar side of the calms of Cancer, and equally that the north-east upper current does descend on the equatorial side.

I have by no means exhausted what I have to say on this subject, but Mr. Ley will doubtless understand that I am unable to treat it at greater length in your columns. The same line of argument would have enabled me to answer Mr. Ley's questions separately had space permitted.

DIGBY MURRAY

### Mind and Matter

PERMIT me to correct a mistake on the part of Mr. Tupper (NATURE, vol. xv. p. 217), who, though starting with a correct notion that my letter (NATURE, vol. xv. p. 78) was intended to solve a problem, immediately fell into the error of regarding it as intended to prove an alleged fact.

The fact alleged, that consciousness depends on nervous organisation I assumed to be a fact, and undertook to indicate how the dependence might be conceived, or regarded, to exist.

First, I alleged that the hypothesis of matter being as susceptible of consciousness as spirit, was quite conceivable, as a hypothesis, whether or not it should be proved afterwards to be a wrong hypothesis.

Second, the connection of two so dissimilar entities as matter and subjectivity had not the objection of being anomalous or unique; for energy and matter were equally dissimilar and yet invariably united. The parity of mystery was not intended to establish "parity of probability as to the facts," but merely parity of conceivability. For it is surely some help to our entertaining a new conception if we can point to an existing similar conception.

Third, if such a mysterious entity as energy could be divided and combined (using the words in a loose sense) why should there be a difficulty in conceiving of the division and combination of subjectivity. By this I meant that as division of matter involved division of energy, as to amount, so division of matter might be conceived involving division of subjectivity, as to amount: so with combination.

Thus far, however, I had only cleared away difficulties "real or apparent" in the way of our conceiving the relation of consciousness to matter from the "materialistic" stand-point.

The essential part of my solution which indicated roughly the *modus* of the connection between matter and consciousness and which dealt with the great difficulty of the question—How to account for the two aspects of matter, the unconscious and conscious?—has not been touched by Mr. Tupper. This portion he excused himself from examining because he regarded it as based on the assumption that "the probability of subjectivity being a property of matter equals the fact of energy being related to matter," whereas it is based on the fact, or alleged fact, or assumption, that "the dependence of consciousness on nervous organisation seemed by the science of nerve-physiology to be fairly established." To mistake allegations of the conceivability of a notion for assumptions or intended proofs that the notion is true, as has been done by Mr. Tupper, is surely not equivalent to pointing out fallacies in the solution of a problem.

Will he admit that, if a "pointer" could "tell us" he scented a fox and immediately thereafter follow the scent of a hare, such would be an admirable analogy of how to practise "sound logic by the old *a priori* method?"

Stanford, January 17

W. S. DUNCAN

### Pre-Glacial Man in America

DR. ASSORT, in his interesting letter on the traces of pre-glacial man in America, supposes that it may be correct that the

American aborigines migrated from the Old World. This may be the case with the Red Indians, but we know that they drove out an earlier people—the mound-builders. However, both mound-builders and Red Indians were certainly post-glacial in their occupation of the northern parts of America, and the oldest traces of their existence may not date back to an earlier time than a late stage of the Neolithic period in Europe.

Paleolithic man in America holds the same relative position to these later peoples as he does in the Old World, and we have so far obtained no evidence to show whether he occupied Europe or America first. The position of his remains in the auriferous drift of California is the same as in that of Siberia; in the loess of the Mississippi as in that of the Danube and the Rhine; in the caves of Brazil along with extinct mammalia as in those of Europe; and in the lowland gravels of Virginia as in those of France and England.

The question of the post or pre glacial age of paleolithic man depends in America as it does in Europe on that of the age of the deposits in which they are found, and this is at present a matter of inquiry and discussion which might be set at rest, as I have pointed out in the *Quarterly Journal of Science* for July of last year, by a thorough examination of the brick clays at Hoxne where paleolithic implements were first found in England.

Cornwall House, Ealing, January 27

THOMAS BELT

### Holly Berries

REPORTS of the scarcity and abundance of holly berries have appeared in NATURE from the south-east of England and west of Scotland respectively. It may be interesting to note the condition of the holly crop at a point somewhere about midway between these two places. In North Staffordshire and Derbyshire the holly berries are by no means scarce. They are not as plentiful as they were last year, but there is a fair average crop.

I have seldom seen such crops of them as I saw in several places in South Wales about a month ago. It may be also worth adding that the most teeming bush I saw was at a place in Cardiganshire, which was as far as I could learn—and I made diligent inquiries—between four and five miles from the nearest hive of bees. I questioned closely several children on the spot who were intelligent enough to give me a minute description of most of the common birds and insects; not one of them had ever seen a bee.

D. EDWARDS

Denstone College, Staffordshire

### The Meteor of January 7

AMONG the "Notes" in NATURE, vol. xv., p. 244, there is a description of a large meteor, of which I was fortunate enough to secure a good observation; but on comparing the apparent path, as observed by myself, with that recorded in the paragraph, I find the latter somewhat imperfect; the apparent path, as seen from near London, seems to have been curtailed both at beginning and at end of flight; probably the observer in question could further amplify his remarks, or some other correspondent send an observation. The following is an abstract from my note-book:—

"Birmingham, January 7, 10:31 P.M. G.M.T.—Meteor pear-shaped, deep yellow merging into ruby-red towards the tail; commenced as a luminous point near  $\eta$  Hydra, gradually increased in size, motion very slow and unsteady, appeared to force its way with difficulty, and slight undulation. Near  $\alpha$  Leonis it attained the apparent size of Venus, the forward hemisphere now showing signs of internal commotion by the projection of ebullition prominences, which were swept back towards the tail, then 8° long, and vaporous. The latter portion of its flight was intercepted by houses, but on emergence it burst with a flash below  $\beta$  Leonis at A.R. 182°, D.N. 16°. Length of path, 52°; time of flight, five to six seconds; radiant point (in Fluvius Eridanus), No. 96 Tupman, or No. 164 of the B. A. Catalogue.

W. H. WOOD

Balsall Heath Road, Moseley Road, Birmingham

### Spectrum of New Star

THE spectrum of the new star in Cygnus is changeable, and is now very unlike Cornu's representation of it in a recent number of NATURE (vol. xv., p. 158). Your readers may not be aware that it is easy to see several of the bright lines without a powerful instrument, though not to measure them accurately. As observed with a Browning's "miniature spectroscope" attached to a 4-inch refractor, the brightest line is now about at

wave-length 503, and is probably that described by Cornu as sixth in order of brightness, at wave-length 500. At the end of last month the brightest line was about 484, probably the F hydrogen line. Since December 27 the new star has always appeared to me orange. Has not this star received any name yet? Sunderland, January 26 T. W. BACKHOUSE

### KÜHNE'S RESEARCHES ON PHOTO-CHEMICAL PROCESSES IN THE RETINA

ON January 5, Dr. W. Kühne, Professor of Physiology in the University of Heidelberg, read before the Naturhistorisch-Medicinisches Verein, of Heidelberg, a paper entitled "Zur Photo-chemie der Netzhaut," so full of interest to the physicist and physiologist, that I think an abstract of it will be acceptable to the readers of NATURE.

A short time since, Boll (a pupil of Max Schultz and Du Bois-Reymond, who now occupies the chair of Physiology in Rome) communicated to the Berlin Academy the remarkable fact that the external layer of the retina, *i.e.*, the layer of rods and cones, possesses in all living animals a purple colour. During life, according to Boll, the peculiar colour of the retina is perpetually being destroyed by the light which penetrates the eye; darkness, however, restores the colour, which vanishes for ever almost immediately after death.

The wonderfully suggestive nature of Boll's discovery led Kühne to repeat his observations; in doing so, whilst he has confirmed the fundamental statement of Boll, he has ascertained a number of new facts of great interest.

Kühne's observations were made on the retinae of frogs and rabbits. In the first place, implicitly relying upon the statements of Boll, he examined, as soon as possible after death, the retinae of animals which had been kept for some time in darkness. He soon found that the beautiful purple colour persists after death if the retina be not exposed to light; that the bleaching takes place so slowly in gas-light, that by its aid the retina can be prepared and the changes in its tint deliberately watched; that when illuminated with monochromatic sodium light the purple colour does not disappear in from twenty-four to twenty-eight hours, even though decomposition have set in.

These first observations of Kühne on the vision-purple (*Schpürpur*), as he terms it, whilst they showed that the disappearance of the colour is not, as Boll had asserted, a necessary concomitant of death, removed many of the difficulties which stood in the way of a careful investigation. Carrying out his preparations in a dark chamber illuminated by a sodium flame, Kühne was able to discover the conditions necessary to the destruction of the vision-purple as well as some facts relating to its restoration or renewal.

As long as the purple retina is kept in the dark or is illuminated only by yellow rays, it may be dried upon a glass plate without the tint changing; the colour is not destroyed by strong solution of ammonia, by saturated solution of common salt, or by maceration in glycerine for twenty-four hours. On the other hand, a temperature of 100° C. destroys the colour, and alcohol, glacial acetic acid, and strong solution of sodium hydrate produce the same effect.

Kühne's next observations were directed to the discovery of the influence of light of different colour upon the vision-purple. It would appear that the more refrangible rays of the spectrum have the greatest action, and that the red rays are as inactive as the yellow.

Kühne now found the incorrectness of Boll's assertion that the retina of the living eye exposed to ordinary daylight does not exhibit the vision-purple, for on preparing the eyes of animals which had just been exposed to light, as rapidly as possible in the chamber illuminated by sodium light, he discovered that the retina was of a beautiful purple. It was only when eyes were exposed for a considerable time to the direct action of the sun's rays that a fading of the purple colour was perceived.

A most suggestive experiment now threw some light upon the circumstances which retard the decolorisation, and which restore the vision-purple. The two recently extirpated eyes of a frog were taken; from one the retina was removed, whilst an equatorial section was made through the other eye, so as to expose the retina and still leave it *in situ*. Both preparations were exposed to diffuse daylight, until the isolated retina had

lost its purple colour. On now taking the other preparation into the yellow chamber and removing the retina, it was found that its colour yet remained: it was dark red, but was bleached when exposed in its naked condition to daylight.

This experiment was confirmed by others, in which the effect of strong sunlight was substituted for that of diffuse daylight.

But the most curious results of Prof. Kühne's experiments have reference to the restoration of the vision-purple. If an equatorial section be made through a recently extirpated eye, and a flap of retina be lifted up from the underlying choroid and exposed to light, the purple colour of the flap will be destroyed, whilst the colour of the rest of the retina persists. If, however, the bleached portion of the flap be carefully replaced, so that it is again in contact with the inner surface of the choroid, complete restoration of the vision-purple occurs. This restoration is a function of the living choroid, probably of the living retinal epithelium (*i.e.* of the hexagonal pigment cells, which used formerly to be described as a part of the choroid), and it appears to be independent of the black pigment which the retinal epithelium normally contains. As it is absolutely dependent upon the life of the structures which overlie the layer of rods and cones, it is natural that it should be observed to occur for a longer time after somatic death in the frog than in the rabbit.

Kühne's researches, though suggested by the interesting observation of Boll, have not only corrected many errors which that observer had committed, but have led to the discovery of facts which add immensely to the importance of the newly-observed vision-purple.

They have shown that the living retina contains a substance which under the influence of light undergoes chemical changes, which vary in intensity according to the intensity and character of the luminous rays, and they point to the existence of structures in connection with the retina which as long as they are alive are able to provide fresh stores of substance sensitive to light.<sup>1</sup>

Since the above account of Kühne's researches was written, he has published in the *Centralblatt der medicinischen Wissenschaften* (January, 1877, No. 3) a short paper, dated January 15, in which he announces the startling confirmation to his previous researches afforded by his having been able to obtain actual images on the retina which corresponded with objects which had been looked at during life (1).

The discoveries of Boll and Kühne must, as the latter remarks, have led to the thought that after all there might be some truth in the stories which we all have heard of images of things seen in death being left imprinted upon the eye. After his first researches Kühne endeavoured over and over again to observe on the retina of rabbits bleached spots corresponding to the images of external objects, but his endeavours failed. As Kühne remarks, and as all readers who have understood his experiments will allow, in order to obtain a permanent photograph, or, as he terms it, *optogramme*, the effect of the light would have to be so prolonged or so intense as to destroy the balance between the destruction of the vision-purple and the power of the retinal epithelium to restore it.

Kühne took a coloured rabbit and fixed its head and one of its eye-balls at a distance of a metre-and-a-half from an opening thirty centimetres square, in a window-shutter. The head was covered for five minutes by a black cloth and then exposed for three minutes to a somewhat clouded midday-sky. The head was then instantly decapitated, the eye-ball which had been exposed was rapidly extirpated by the aid of yellow light, then opened, and instantly plunged in 5 per cent. solution of alum. Two minutes after death the second eye-ball, without removal from the head, was subjected to exactly the same processes as the first, *viz.*, to a similar exposure to the same object, then extirpation, &c.

On the following morning the milk-white and now toughened retinae of both eyes were carefully isolated, separated from the optic nerve, and turned; they then exhibited in a beautiful rose-red ground, a nearly square sharp image with sharply-defined edges; the image in the first eye was somewhat roseate in hue and less sharply defined than that in the second, which was perfectly white. The size of the images was somewhat greater than one square millimetre.

Prof. Reussner was amongst the witnesses of this beautiful experiment.

ARTHUR GANONG

<sup>1</sup> I have repeated all the more important observations of Kühne with the exception of *Rana temporaria*, and with those of two rabbits, of which one was an albino, and can entirely confirm all his interesting facts. In ordinary daylight, the purple-red colour of the frog's retina, and its subsequent decoloration, may be most satisfactorily demonstrated. The use of the dark chamber illuminated by sodium is, however, useful in cases where

<sup>1</sup> This account of Boll's researches is taken from Kühne's paper. The latest number of the *Monatsschrift der Berlin Academy* which has just reached Manchester includes the Proceedings for September and November, does not contain Boll's communication, which is of later date

ON THE PRECESSIONAL MOTION OF A LIQUID

THE formulas expressing this motion were laid before the meeting and briefly explained, but the analytical treatment of them was reserved for a more mathematical paper to be communicated to the Section on Saturday. The chief object of the present communication was to illustrate experimentally a conclusion from this theory which had been announced by the author in his opening address to the Section, to the effect, that, if the period of the precession of an oblate spheroidal rigid shell full of liquid is a much greater multiple of the rotational period of the liquid than any diameter of the spheroid is of the difference between the greatest and least diameters, the precessional effect of a given couple acting on the shell is approximately the same as if the whole were a solid rotating with the same rotational velocity. The experiment consisted in showing a liquid gyrost, in which an oblate spheroid of thin sheet copper filled with water was substituted for the solid fly-wheel of the ordinary gyrost. In the instrument actually exhibited, the equatorial diameter of the liquid shell exceeded the polar axis by about one-tenth of either.

Supposing the rotational speed to be thirty turns per second, the effect of any motive which, if acting on a rotating solid of the same mass and dimensions, would produce a precession having its period a considerable multiple of  $\frac{1}{2}$  of a second, must, according to the theory, produce very approximately the same precession in the thin shell filled with liquid as in the rotating solid. Accordingly the main precessional phenomena of the liquid gyrost were not noticeably different from those of ordinary solid gyrostats which were shown in action for the sake of comparison. It is probable that careful observation without measurement might show very sensible differences between the performances of the liquid and the solid gyrost in the way of nutational tremors produced by striking the case of the instrument with the fist.

No attempt at measurement either of speeds or forces was included in the communication, and the author merely showed the liquid gyrost as a rough general illustration, which he hoped might be regarded as an interesting illustration of that very interesting result of mathematical hydro-kinetics the quasi-rigidity produced in a frictionless liquid by rotation.

P.S.—Since the communication of this paper to the Association, and the delivery of my opening address which preceded it on the same day, I have received from Prof. Henry No. 240 of the Smithsonian Contributions to Knowledge, of date October, 1871, entitled "Problems of Rotatory Motion presented by the Gyroscope, the Precession of the Equinoxes and the Pendulum," by Brevet Major-Gen. J. G. Barnard, Col. of Engineers, U.S.A., in which I find a dissent, from the portion of my previously-published statements which I had taken the occasion of my address to correct, expressed in the following terms:—

"I do not concur with Sir William Thomson, in the opinions quoted in note p. 38, from Thomson and Tait, and expressed in his letter to Mr. G. Poulett Scrope (NATURE, Feb. 1, 1872). So far as regards fluidity, or imperfect rigidity, within an infinitely rigid envelope, I do not think the rate of precession would be affected."

Elsewhere in the same paper Gen. Barnard speaks of "the practical rigidity conferred by rotation." Thus he has anticipated my correction of the statements contained in my paper on the Rigidity of the Earth, so far as regards the effect of interior fluidity on the precessional motion of a perfectly rigid ellipsoidal shell filled with fluid.

I regret to see that the other error of that paper, which I corrected in my opening address, had not been corrected.

Communicated to Section A of the British Association, Thursday, September 7, 1876.

by Gen. Barnard, and that the plausible reasoning which had led me to it had also seemed to him convincing. For myself, I can only say that I took the very earliest opportunity to correct the errors after I found them to be errors, and that I deeply regret any mischief they may have done in the meantime.

Addendum.—Solid and Liquid Gyrostats.—The solid gyrost has been regularly shown for many years in the

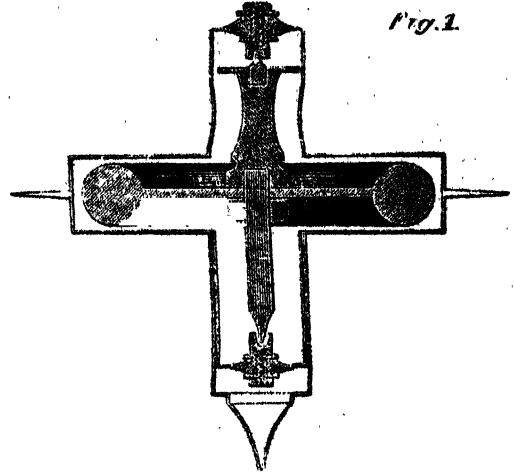

Fig. 1.

Natural Philosophy Class of the University of Glasgow as a mechanical illustration of the dynamics of rotating solids, and it has also been exhibited in London and Edinburgh at conversations of the Royal Societies and of the Society of Telegraph Engineers, but no account of it has yet been published. The following brief description and drawing may therefore even now be acceptable to readers of NATURE:—

The solid gyrost consists essentially of a massive fly-wheel possessing great moment of inertia, pivoted on the two ends of its axis in bearings attached to an outer case which completely incloses it. Fig. 1 represents a section

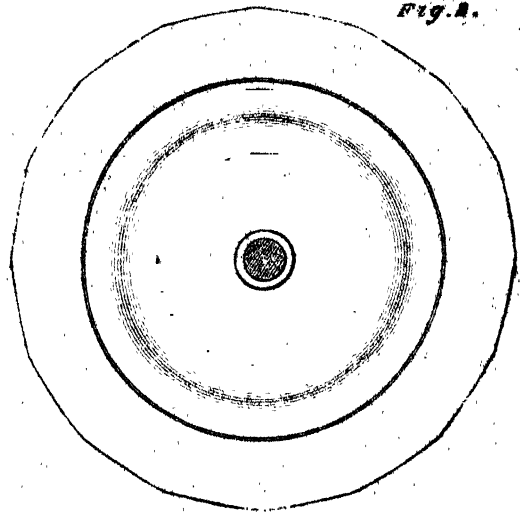
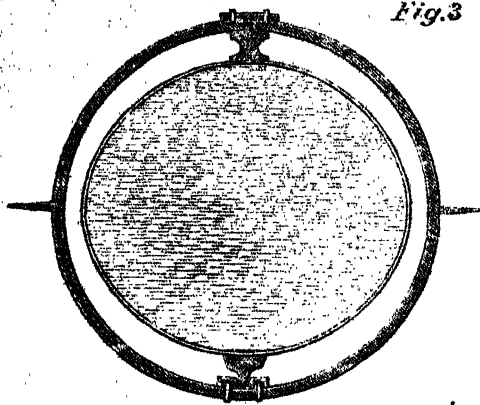

Fig. 2.

by a plane through the axis of the fly-wheel, and Fig. 2 a section by a plane at right-angles to the axis and cutting through the case just above the fly-wheel. The containing case is fitted with a thin projecting edge in the plane of the fly-wheel, which is called the bearing edge. Its boundary forms a regular curvilinear polygon of sixteen sides with its centre at the centre of the fly-wheel. Each side of the polygon is a small arc of a circle of radius

greater than the distance of the corners from the centre. The friction of the fly-wheel would, if the bearing-edge were circular, cause the case to roll along on it like a hoop, and it is to prevent this effect that the curved polygonal form described above and represented in the drawing is given to the bearing-edge.

To spin the solid gyrostat a piece of stout cord about forty feet long and a place where a clear run of about



sixty feet can be obtained are convenient. The gyrostat having been placed with the axis of its fly-wheel vertical, the cord is passed in through an aperture in the case, two-and-a-half times round the bobbin-shaped part of the shaft, and out again at an aperture on the opposite side. Having taken care that the slack cord is placed clear of all obstacles and that it is free from kinks, the operator holds the gyrostat steady so that its case is prevented from turning, while an assistant pulls the cord through by running, at a gradually increasing pace, away from the instrument, while holding the end of the cord in his hand. Sufficient tension is applied to the entering cord to prevent it from slipping round on the shaft. In this way a very great angular

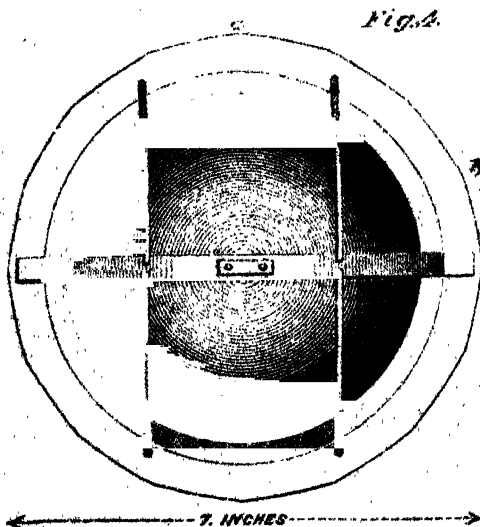

velocity is communicated to the fly-wheel, sufficient, indeed, to keep it spinning for upwards of twenty minutes.

If when the gyrostat has been spun it be set on its bearing edge with the centre of gravity exactly over the bearing point, on a smooth horizontal plane such as a piece of plate-glass lying on a table, it will continue apparently stationary and in stable equilibrium. If while it is in this position a couple round a horizontal axis in the

plane of the fly-wheel be applied to the case, no deflection of this plane from the vertical is produced, but it rotates slowly round a vertical axis. If a heavy blow with the fist be given to the side of the case, it is met by what seems to the senses the resistance of a very stiff-elastic body, and, for a few seconds after the blow, the gyrostat is in a state of violent tremor, which, however, subsides rapidly. As the rotational velocity gradually diminishes the rapidity of the tremors produced by a blow also diminishes. It is very curious to notice the tottering condition, and slow, seemingly palsied, tremulousness of the gyrostat, when the fly-wheel has nearly ceased to spin.

In the liquid gyrostat the fly-wheel is replaced by an oblate spheroid, made of thin sheet copper, and filled with water. The ellipticity of this shell in the instrument exhibited is  $\frac{1}{10}$ , that is to say, the equatorial diameter exceeds the polar by that fraction of either. It is pivoted on the two ends of its polar axis in bearings fixed in a circular ring of brass surrounding the spheroid. This circle of brass is rigidly connected with the curved polygonal-bearing edge which lies in the equatorial plane of the instrument, thus forming a frame-work for the support of the axis of the spheroidal shell. In Fig. 3 a section is represented through the axis to show the ellipticity, and Fig. 4 gives a view of the gyrostat as seen from a point in the prolongation of the axis. To prevent accident to the shell when the gyrostat falls down at the end of its spin cage bars are fitted round it in such a way that no plane can touch the shell.

The method of spinning the liquid gyrostat is similar to that described for the solid gyrostat, differing only in the use of a very much longer cord and of a large wheel for the purpose of pulling it. The cord is first wound on a bobbin, free to rotate round a fixed pin. The end of it is then passed two-and-a-half times round the little pulley shown in the annexed sectional drawing, and thence to a point in the circumference of the large wheel to which it is fixed. An assistant then turns the wheel with gradually increasing velocity, while the frame of the gyrostat is firmly held, and the requisite tension applied to the entering cord to prevent it from slipping round the pulley.

WILLIAM THOMSON

## REMARKABLE PLANTS

### I.—THE COMPASS-PLANT.

"Look at this delicate plant that lifts its head from the meadow.  
See how its leaves all point to the north, as true as the magnet;  
It is the compass-plant that the finger of God has suspended  
Here on its fragile stalk, to direct the traveller's journey  
Over the sea-like, pathless, limitless waste of the desert."

LONGFELLOW'S *Evangelist*.

IT has long been known that there grows on the prairie-lands of the south-western part of the United States of America, especially Texas and Oregon, a plant which has the peculiar property of turning its leaves towards the north, and which hence serves as a magnet to the traveller when no other means is available of ascertaining the points of the compass. It is probable however, from Longfellow's description of it as a "delicate plant" on a "fragile stalk," that he never saw it growing. The Compass-plant is a member of the enormous natural order Compositæ, known to botanists as *Silphium laciniatum*. It is described as a stout perennial plant from three to six feet in height, with ovate, deeply pinnatifid leaves and large yellow heads of unisexual flowers, the ray-florets strap-shaped and female, the disc-florets tubular and male. It is also known as the pilot-weed, polar-plant, rosin-weed, and turpentine-weed, the two last names being derived from the abundant resin exuded by the stem; and is occasionally to be seen in English gardens.

The "polarity" of the leaves of this singular plant has long been familiar to hunters and other denizens of the prairie, who, "when lost on the prairies in dark night

easily get their bearings by feeling the direction of the leaves." But the first occasion on which it was brought under the notice of scientific men appears to have been in communications addressed to the National Institute at Washington in August, 1842, and January, 1843, by General Alvord. The accuracy of his statement having been questioned, the General presented another communication at the second meeting of the American Association for the Advancement of Science, held at Cambridge, Mass., in August, 1849, in which he confirms his own observations by those of other officers, all agreeing in the conclusion that the radical leaves of the plant really present their edges north and south, while their faces are turned east and west, the leaves on the developed stems of the flowering plant, however, taking rather an intermediate position between their normal or symmetrical arrangement and their peculiar meridional position. For the following particulars respecting the phenomena exhibited by the compass-plant we are indebted mainly to a paper by Mr. W. F. Whitney, read before the Harvard Natural History Society and printed in the *American*



The Compass-plant (*Silphium laciniatum*).

*Naturalist* for March, 1871, and to some subsequent notes by Prof. Asa Gray and Mr. Thos. Meehan.

The cause of the ordinary position of the leaves of most plants, one surface being directed towards the sky and the other towards the earth, is generally believed to be a difference in the sensitiveness to light of the two surfaces, the epidermal tissue of the upper being generally denser and less pervious to light than that of the under surface. It is possible also that something may be due to the fact that the under surface of the leaf is almost always more copiously furnished with stomates or "breathing-pores," as they are often inaccurately termed, minute orifices, which serve to promote a diffusion of gases between the external air and the intercellular cavities within the tissue, and especially an abundant exhalation of aqueous vapour. A microscopical examination of the leaves of the compass-plant shows that the structure of the epidermal tissue of the two surfaces is similar, and also that the number of stomates in each corresponds, affording in this respect a contrast to other allied species of the genus *Silphium*, which do not exhibit the phenomenon of polarity, and in whose leaves the

stomates were found to be from two to three times as numerous on the under as on the upper surface. If, therefore, the object to be gained is an equal sensitiveness to light, it is obvious that the two surfaces will receive an equal mean amount of light during the twenty-four hours, if they face the east and the west, rather than if they face the north and the south, or the earth and the sky. An attempt has also been made to explain the phenomenon of polarity by currents of electricity induced by the peculiar chemical composition of the substances secreted by the stem and the leaves, but not with much success.

In a recent communication to the Academy of Natural Sciences at Philadelphia, Mr. Meehan says that those who affirm that the leaves are directed to the north and those who say that there is no such tendency, are both right. He watched a plant in his own garden, and observed the unmistakable northern tendency in the leaves when they first came up, and until they were large and heavy, when winds and rain bore them in different directions, and they evidently had not the power of regaining the points lost. It would appear, therefore, to depend on the season when the observation is made whether the leaves are seen to bear northwards or not.

The same observer records also the following facts with regard to the flowers of the compass-plant. The expansion of the ray-florets in August was observed to begin at daybreak, 4 A.M.; forty minutes afterwards the florets of the disc began to open, and the whole of the corollas were expanded in about three-quarters of an hour, after which there was no further growth in the corollas. The stamens and pistils were gradually protruded beyond the corolla, and the lengthening of the stamens ceased at 6 A.M. After 6.20 no further growth was noticed in the flowers. Later on they were visited by insects, causing the detachment of the florets of the disc, and the scattering of the pollen on to the ray-florets which were thus fertilised. There appear, in fact, to be three phases of growth, with a slight rest between each the pistil taking the most time, then the stamens, and the corolla the least; but the whole growth of the day is included within two hours.

The geographical range of the plant is stated to be from Texas on the south to Iowa on the north, and from Southern Michigan on the east to 300 or 400 miles west of Missouri and Arkansas. Its chief habitat is rich prairie land. Our illustration is taken partly from the plate in Jacquin's "Eclogæ," the only good drawing of the plant published, assisted by comparison with dried specimens in the Kew Herbarium. A. W. B.

## EXPERIMENTS WITH THE RADIOMETER<sup>1</sup>

### II.

HAVING ascertained that the action of the radiometer was due to the internal movement of the molecules of the residual gas, it became important to obtain as much information as possible respecting the physical properties of this residue.

In the apparatus constructed for this purpose a vertical plate is suspended by a glass fibre, which it twists in opposite directions alternately, instead of continuously rotating in one direction, as in the ordinary radiometer. Attached to this apparatus there is:—*a*, a sprengel pump; *b*, an arrangement for producing a chemical vacuum; *c*, a lamp with scale, on which to observe the luminous index reflected from a mirror; *d*, a standard candle at a fixed distance; and *e*, a small vacuum tube, with the internal ends of the platinum wires close together. I can therefore take observations of—

1. The logarithmic decrement of the arc of oscillation when under no influence of radiation.

<sup>1</sup> Continued from p. 287.

2. The successive swings and final deflection when a candle shines on one end of the blackened bar.

3. The appearance of the induction spark between the platinum wires.

1 measures the viscosity of the gas; 2 enables me to calculate the force of radiation of the candle; and 3 enables me to form an idea of the progress of the vacuum according as the interior of the tube becomes uniformly luminous, striated, luminous at the poles only, or black and non-conducting. The movement is started by rotating the whole apparatus through a small angle, and the observation consists in noting the successive amplitudes of vibration when the instrument is left to itself, a mirror and spot of light being employed for this purpose. The amplitudes form a decreasing series, with a regular logarithmic decrement. Up to the point at which the vacuum is apparently equal to a Torricellian vacuum, the logarithmic decrement is nearly constant; but as the exhaustion proceeds beyond this point, it becomes smaller, and the force of repulsion approaches a maximum; when the logarithmic decrement is about one fourth of what it was at the commencement, the force of repulsion begins to diminish, and at much higher exhaustions it nearly ceases.

I have experimented with different gases in the apparatus, and by means of a McLeod gauge attached to a mercury-pump, I have been able to measure the atmospheric pressure at any desired state of exhaustion. From the results of the measurements of the force of repulsion and of the viscosity of the residual gas, I have plotted the observations in curves, which show how the viscosity of the residual gas is related to the force of repulsion exerted by radiation.

I have supposed my scale to be 1,000 metres long, and to represent one atmosphere. Each millimetre, therefore, stands for the millionth of an atmosphere.

When the residual gas is air, the viscosity, measured by the logarithmic decrement of the arc of oscillation, is practically constant up to an exhaustion of 250 millionths of an atmosphere, or 0.19 millim. of mercury, having only diminished from 0.126 at the normal pressure of the atmosphere, to 0.112. It now begins to fall off and at 0.1 of a millionth of an atmosphere the logarithmic decrement has fallen to about 0.01. Simultaneously with this decrease in the viscosity, the force of repulsion exerted on a black surface by a standard light varies. It increases very slowly till the exhaustion has risen to about 70 millionths of an atmosphere; at about 40 millionths the force is at its maximum; and it then sinks very rapidly till at 0.1 millionth of an atmosphere it is less than one-tenth of its maximum.

When the residual gas is oxygen the logarithmic decrement is 0.126 at the atmospheric pressure, and at 2 millionths of an atmosphere it is 0.02. The force of repulsion in oxygen increases very steadily up to an exhaustion of about 40 millionths of an atmosphere; it is at its maximum at about 30 millionths, and thence declines very rapidly.

It is not necessary to get so high an exhaustion with hydrogen as with other gases to obtain considerable repulsion. The viscosity at the normal pressure is measured by a logarithmic decrement of 0.063; at 50 millionths it is 0.046, when it rapidly sinks. The force of repulsion is very great in a hydrogen vacuum being, in comparison with the maximum in an air vacuum as 70 to 41.

Carbonic acid has a viscosity of about 0.01 at the normal pressure, being between air and hydrogen, but nearer the former. The force of repulsion does not rise very high and soon falls off.

A long series of observations have been taken, at different degrees of exhaustion, on the conductivity of the residual gas to the spark from an induction coil. Working with air I find that at a pressure of about 40 millionths of an atmosphere, when the repulsive force is near its

maximum, a spark, whose striking distance at the normal pressure is half an inch, will illuminate a tube having terminals 3 millimetres apart. When I push the exhaustion further the 1/2-inch spark ceases to pass, but a 1-inch spark will still illuminate the tube. As I get nearer to a vacuum more power is required to drive the spark through the tube, but, at the highest exhaustions, I can still get traces of conductivity when an induction coil, actuated with five Grove's cells, and capable of giving a 6-inch spark, is used.

When so powerful a spark is employed it sometimes happens that the glass is perforated, thus causing a very slight leakage of air into the apparatus. The logarithmic decrement now slowly rises, the repulsive force of the candle increases to its maximum and then slowly diminishes to zero, the logarithmic decrement continuing to rise till it shows that the internal and external pressure are identical.

In preparing experimental radiometers I prefer to exhaust direct to one or two millionths of an atmosphere. By keeping the apparatus during the exhaustion in a hot air-bath heated to about 300° C. for some hours, the occluded gases are driven off from the interior surface of the glass and the fly of the radiometer. The whole is then allowed to cool, and attenuated air from the air-trap is put in in small quantities at a time, until the McLeod gauge shows that the best exhaustion for sensitiveness is reached; if necessary, this point is also ascertained by testing with a candle. In this manner, employing hydrogen instead of air for the gaseous residue, and using roasted mica vanes at an angle with the axis, I can get very considerably increased sensitiveness in radiometers. I am still unable, however, to get them to move in moon-light, while my sensitive torsion balance does easily.

I have tried many experiments with the view of putting the theory I have referred to in my former paper (*NATURE*, vol. xv. p. 224) to a decisive test. The repulsive force being due to a molecular disturbance causing a reaction between the fly and the glass case of a radiometer, it follows that, other things being equal, the fly should revolve faster in a small bulb than in a large one. I therefore constructed a double radiometer which shows this fact in a very satisfactory manner. It consists of two bulbs, one large and the other small, blown together so as to have a wide passage between them. In the centre of each bulb is a cup, held in its place by a glass rod, and in the bulbs is a small four-armed fly with roasted mica discs blacked on one side. The fly can be balanced on either cup. In the smaller bulb there is about a quarter of an inch between the vanes and the glass, whilst in the larger cup there is a space of half an inch. The mean of several experiments shows that in the small bulb the fly rotates about 50 per cent. faster than in the large bulb when exposed to the same source of light.

One of the arms of another radiometer was furnished with roasted mica discs blacked on alternate sides. The other arm was furnished with clear mica discs. The two arms were pivoted independently of each other, and one of them was furnished with a minute fragment of iron, so that by means of a magnet I could bring the arms in contact, the black surface of the mica then having a clear plate of mica in front of it. On bringing a lighted candle near the instrument and allowing it to shine through the clear plate, on the blackened mica, the clear plate is at once driven away, till the arm sets at right angles to the other.

Two currents of force, acting in opposite directions, can exist in the same bulb. I have prepared a double radiometer in which two flies are pivoted one over the other, and having their blackened sides turned in opposite directions. On bringing a lighted candle near the flies rotate in opposite directions.

Experiment shows that the molecular disturbance

which constitutes the force can be reflected from a plane surface in such a manner as to change its direction. A two-disc radiometer was made having flat opaque mica discs blacked on one side. In front of the black surface of the mica and about a millimetre off, is fixed a larger disc of thin clear mica. On bringing a candle near, the molecular pressure streaming from the black surface is caught by the clear plate and thrown back again, causing pressure behind instead of in front, and the result is rapid rotation in the negative direction, the black side now moving towards the light.

The above actions can be explained on the "evaporation and condensation" theory, as well as by that of molecular movement. I therefore devised the following test to decide between these two theories. A radiometer has its four discs cut of very clear and thin plates of mica and these are mounted in a somewhat large bulb. At the side of the bulb in a vertical plane, a plate of mica, blacked on one side, is fastened in such a position that each clear vane in rotating shall pass it, leaving a space between of about a millimetre. If a candle is brought near, and by means of a shade the light is allowed to fall only on the clear vanes, no motion is produced; but if the light shines on the black plate the fly instantly rotates as if a wind were issuing from this surface, and keeps on moving as long as the light is near. This could not happen on the evaporation and condensation theory, as this requires that the light should shine intermittently on the black surface in order to keep up continuous movement.

The experiments with the double radiometer of different sizes showed that the nearer the absorbing surface was to the glass the greater was the pressure produced. To test this point in a more accurate manner a torsion balance was fitted up with a glass suspending fibre and a reflecting mirror. At one end of the beam is a disc of roasted mica blacked on one side. In front of this black surface, and parallel to it, is a plate of clear mica so arranged that its distance from the black surface can be altered as desired at any degree of exhaustion without interfering with the vacuum. This apparatus has proved that when light falls on the black surface molecular pressure is set up, whatever be the degree of exhaustion. A large series of observations have been taken with it with the result of not only supplying important data for future consideration, but of clearing up many anomalies which were noticed, and of correcting many errors into which I was led at earlier stages of the research. Among the latter may be mentioned the speculations in which I indulged as to the pressure of sunlight on the earth.

I now tried similar experiments to the above, using the best conductors of heat instead of the worst. A radiometer, the fly of which is made of metallic plates perfectly flat and lamblackened on one side, is much less sensitive to light than one of mica or pith; but, as I proved in a paper sent to the Royal Society in January last year, it is more sensitive to dark heat, which indeed causes the black face of a metal radiometer rapidly to rotate in a negative direction, the black continuing to advance until the temperature has become uniform throughout; but as soon as the source of heat is removed the fly commences to revolve with rapidity the positive way, the black retreating as it would if light shone on it.

Experiments with discs of aluminium, mounted diamond-wise and turned up and folded at different angles, show that shape has even a stronger influence than colour. A convex bright surface is strongly repelled, whilst a concave black surface is not only not repelled by radiation, but is actually attracted.

Carefully-shaped cups of gold, aluminium, and other metals, have been tried, as well as cones of the same materials. If a two-disc, cup-shaped radiometer, facing opposite ways and both sides bright, is exposed to a standard candle 33 inches off, the fly rotates continuously

at the rate of one revolution in 3.77 seconds. A screen placed in front of the concave side so as to let the light shine only on the convex surface, the latter is repelled, causing continuous rotation at the rate of one revolution in 7.5 seconds. When the convex side is screened off so as to let the light strike only on the concave side, continuous rotation is produced at the rate of one revolution in 6.95 seconds, the concave side being attracted.

These experiments show that the repulsive action of radiation on the convex side is about equal to the attractive action gradation on the concave side, and that the double speed with which the fly moves when no screen is interposed is the sum of the attractive and repulsive actions.

With a two-disc, cup-shaped aluminium radiometer as above, lamblackened on the concave surfaces, the action of light is reversed, rotation taking place, the bright convex side being repelled and the black concave attracted. When the light shines only on the bright convex side no movement is produced, but when it shines only on the black concave side this is attracted, producing rotation.

Light shining on a cup-shaped radiometer similar to the above, but having the convex side black and the concave bright, causes it to rotate rapidly, the convex black being repelled. No movement is produced on letting the light shine on the bright concave surface, but good rotation is produced when only the black convex surface is illuminated.

With a cup-shaped radiometer like the above, but blacked on both sides, a candle causes rapid rotation, the convex side being repelled. On shading off the light from the concave side the rotation continues, but much more slowly; on shading off the convex side the concave is strongly attracted, causing rotation.

Radiometers have also been made with cups and cones of plain mica, roasted mica, pith, paper, &c., and they have been made either plain or blacked on one or both surfaces. These have also been balanced against each other, and against metal plates, cups, and cones. The results are of considerable interest but too complicated to explain without numerous diagrams. The broad facts are contained in the above selections from my experiments.

Some of the phenomena produced by the action of light on the cup-shaped vanes of a radiometer may be explained on the assumption that the molecular pressure acts chiefly in a direction normal to the surface of the vanes. A convex surface would therefore cause greater pressure to be exerted between itself and the inner surface of glass than could a concave surface. But it is not easy to see how such an hypothesis can explain the behaviour of those instruments where the action of the bright convex surface more than overcomes the superior absorptive and radiating power of the concave black surface; and the explanation appears to fail to account for the powerful attraction which a lighted candle is seen to exert on the concave surfaces in other instruments.

These experiments, interpreted by the light of the dynamical theory given in my last communication, explain very clearly how it was that I obtained such strong actions in my earlier experiments when using white pith, and employing the finger as a source of heat; and how it happened that I did not discover for some time that dark heat and the luminous rays were essentially different in their actions on black and white surfaces. Rays of high intensity pass through the glass bulb without warming it; they then, falling on the white surface, are simply reflected off again; but, falling on the black surface, they are absorbed, and raising its temperature, produce the molecular disturbance which causes motion. Rays of low intensity, however, do not pass through the glass to any great extent, but being absorbed, raise its temperature. This warmed spot of glass now becomes the repelling body through the intervention of the mole-



cules rebounding from it with a greater velocity than that at which they struck it. The molecular pressure, therefore, in this case streams from the inner surface of the warm spot of glass on which the heat rays have fallen, and repels whatever happens to be in front of it, quite irrespective of the colour of its surface.

WILLIAM CROOKES

### THE SPONTANEOUS GENERATION QUESTION

TWO contributions have recently been made to this subject through the Royal Society by Dr. W. Roberts and Prof. Tyndall. Dr. Roberts's communication is as follows<sup>1</sup> :—

In a recent communication to the Royal Society, Dr. Bastian<sup>2</sup> brought forward some experiments to show that while an acid urine usually remains barren after being boiled a few minutes, the same urine becomes fertile when similarly treated, if previously neutralised or rendered alkaline by liquor potassæ, especially if it be afterwards maintained at a temperature of 115° F. or 122° F. In this respect urine only conforms to the general rule observed by myself and formulated in my previous communication to the Society<sup>3</sup>—that “slightly alkaline liquids were always more difficult to sterilise (by heat) than slightly acid liquids.”

This difference came out strongest in my own experiments in the case of hay-infusion—the acid infusion invariably remaining barren after a few minutes' boiling, and the neutralised infusion invariably becoming fertile after a similar boiling. Accordingly I utilised hay-infusion to determine the cause of the difference in question. It could evidently only be due to one of two things—either (1) the change of reaction enabled germs pre-existing in the infusion to survive the ebullition; or (2) the addition of the alkali exercised a positive influence in exciting a *de novo* generation of organisms. To decide which of these two interpretations was the true one, an experiment was contrived in which the liquor potassæ could be added to the infusion, not before, but after it had been boiled, and thereby rendered permanently sterile. When added in this way, I found that liquor potassæ had not any power to excite germination. The infusions invariably remained barren when the alkali was added to them after they had been sterilised. I therefore concluded that the effect of the change of reaction consisted simply in enabling pre-existing germs to survive a brief ebullition. Dr. Bastian, in repeating his experiment in the case of urine, arrived at an opposite conclusion: he found that whether the alkali was added before or after ebullition he obtained the same result—the urine in both cases became fertile; and he concluded that the alkali had a positive power of promoting the origin of organisms in the urine.

This experiment, if properly performed, is obviously a crucial one, and it is recognised as such by Dr. Bastian. But two conditions are essential to the validity of the experiment. In the first place it must be ascertained beyond doubt that the boiled acid fluid has been really deprived of its germs—in other words, that the ebullition has been sufficiently prolonged to render it permanently barren; and secondly, that in adding the liquor potassæ due care is taken that no new germs are introduced at the same time. In repeating my experiment, Dr. Bastian appears to have departed from my procedure in two points, and he has thus possibly laid himself open to the two sources of fallacy just mentioned. In my own experiments, the acid infusion, after it had been boiled, was set aside in a warm place for a fortnight in order to test its sterility; and the liquor potassæ was not added to it until the lapse of time had satisfied me that it had been rendered permanently barren. In Dr. Bastian's experiments the liquor potassæ was added as soon as the vessels had cooled, so that he had no certainty that their contents would not have germinated without the addition of the alkali.<sup>4</sup> In the second place, instead of heating the tubes containing the liquor potassæ (as I had done) to 150° F., and thus ensuring the destruction of all germs contained in the air imprisoned therein

with the alkali, he contented himself with subjecting them for an inconsiderable period to the heat of boiling water.

Seeing these two possible sources of fallacy, I determined to repeat Dr. Bastian's experiments with urine, but taking care to avoid these defects. I proceeded as follows:—

A flask with a longish neck was charged with an ounce of normal acid urine. The due quantity of liquor potassæ requisite to exactly neutralise this (as ascertained by previous trials) was enclosed in a sealed glass tube drawn to a capillary portion at one end. The tube was then heated in oil up to 280° F., and maintained at that temperature for fifteen minutes. The tube was then introduced into the body of the flask. The neck of the flask was next drawn to a narrow orifice; then the urine was boiled for five minutes, and the orifice sealed in ebullition. Ten such flasks were charged and treated in the same manner. They were then set aside in a warm place (from 70° F. to 80° F.) for a fortnight. At the end of this time the contents of the flasks were found perfectly transparent; the urine was therefore assumed to be permanently sterilised. The liquor potassæ was then liberated by shaking the tubes against the sides of the flasks and thus breaking their capillary points. The previously acid and barren urine was thus neutralised. The flasks were then placed in an incubator and maintained at a constant temperature of 115° F. At the end of two days it was found that the urine in each flask had deposited a sediment of earthy phosphates, but the supernatant liquor was perfectly transparent. The flasks were again placed in the incubator and maintained at a constant temperature of 122° F. for three days. At the end of this period they were withdrawn and opened for examination. Not one of them showed the slightest evidence of living organisms; the supernatant liquor was perfectly transparent, and no Microphytes could be detected under the microscope. The precipitated phosphate in some of the flasks presented a granular appearance, which might, by the unwary, be mistaken for Micrococci, but any such illusion was at once dissipated by adding a drop of hydrochloric acid, which instantly dissolved the phosphate and restored the perfect transparency of the urine. This acid has no effect on the turbidity caused by Microphytes.

These experiments therefore negative the conclusion that liquor potassæ, or a temperature of 115° F. to 122° F., or both conditions combined, have the power of exciting the generation of organisms in sterilised urine.

The effect of elevated temperature was also tested in another way. I had by me twenty-nine preparations of fermentible liquids which had remained over from my previous experiments in 1873-74. These consisted of

- 15 alkalis hay-infusions,
- 5 pieces of boiled egg-albumen in water,
- 1 piece of turp in water,
- 2 diluted ascitic fluid,
- 1 blood with water,
- 1 albuminous urine,
- 4 pieces of meat or fish in water.

These had all been sterilised by the heat of boiling water two or three years ago, and were contained in large bulbs with long necks. Ten of the hay-infusions were hermetically sealed; the rest were all open to the air, under the protection of a plug of cotton-wool. All possessed perfectly transparent supernatant liquors, and showed no signs of containing organisms, nor of having undergone any fermentive or putrefactive changes.

These twenty-nine preparations were introduced into the incubator, and maintained at a constant temperature of 115° F. for two days, and then at a temperature of 122° F. for three days. At the end of this period not one of them showed any signs of fertility. The supernatant liquid in each bulb was quite transparent, and some of them, which were opened for microscopic examination, showed no traces of living organisms.

I can, however, fully confirm the statement of Dr. Bastian, that Bacteria, or certain kinds of them, grow and multiply freely in (unsterilised) urine, both acid and neutralised, when exposed to a temperature of 115° F. to 122° F.

The following is Prof. Tyndall's paper<sup>5</sup> :—

The communication “On the Influence of Liquor Potassæ and an Elevated Temperature on the Origin and Growth of Microphytes,” which, at Dr. Roberts's request, I have had the pleasure of presenting to the Royal Society, causes me to say earlier than I should otherwise have done, that the subject which has occu-

<sup>1</sup> “Note on the Influence of Liquor Potassæ and an Elevated Temperature on the Origin and Growth of Microphytes,” by W. Roberts, M.D. Communicated by Prof. Tyndall, F.R.S., December 21, 1876.

<sup>2</sup> “Experimental Illustrations of the Physico-Chemical Theory of Fermentation,” &c., read before the Royal Society, June 15, 1876.

<sup>3</sup> “Strictures on Biogenesis,” Phil. Trans. vol. lxxv. p. 427.

<sup>4</sup> It is not sufficient to rely in such a case on a central flask or retort. Each flask or retort should have its own individual sterility tested, because it is practically impossible to apply the heat exactly in the same degree in any two cases.

<sup>5</sup> “Note on the Decrement of Alkalisied Urine,” by Prof. Tyndall, F.R.S. Communicated December 21, 1876.

pied Dr. Roberts's attention has also occupied mine, and that my results are identical with his.

In some of the experiments the procedure described by Dr. Roberts was accurately pursued save in one particular, which has reference to temperature. Small tubes with their ends finely drawn out were charged with a definite amount of caustic potash, and subjected for a quarter of an hour to a temperature of 220° Fahr. They were then introduced into flasks containing measured quantities of urine. The urine being boiled for five minutes, the flasks were hermetically sealed during ebullition. They were subsequently permitted to remain in a warm place sufficiently long to prove that the urine had been perfectly sterilised by the boiling. The flasks were then rudely shaken so as to break the capillary ends of the potash tubes and permit the liquor potassic to mingle with the acid liquid. The urine thus neutralised was subsequently exposed to a constant temperature of 122° Fahr., which is pronounced by Dr. Bastian to be specially potent as regards the generation of organisms.

I have not found this to be the case, for ten flasks prepared as above described towards the end of last September, remained perfectly sterile for more than two months. I have no doubt that they would have remained so indefinitely.

Three retorts, moreover, similar to those employed by Dr. Bastian, and provided with potash tubes, had fresh urine boiled in them on September 29, the retorts being sealed during ebullition. Several days subsequently the potash tubes were broken and the urine neutralised. Subjected for more than two months to a temperature of 122° Fahr. they failed to show any signs of life.

These results are quite in accordance with those obtained by Dr. Roberts. His potash tubes, however, were exposed to a temperature of 280° Fahr., while mine were subjected to a temperature of 220° only.

With regard to the raising of the potash to a temperature higher than that of boiling water, M. Pasteur is in advance both of Dr. Roberts and myself. In a communication to the French Academy, on July 16 last, M. Pasteur showed that when due care is taken to add nothing but potash (heated to redness if solid, or to 110° C. if liquid) to sterilized urine, no life is ever developed as a consequence of the alkalisation.<sup>1</sup>

M. Pasteur has quite recently favoured me with sketches of the simple, but effectual apparatus, by means of which he has tested the conclusions of Dr. Bastian. Since his return from his vacation at Arbois, he has carefully gone over this ground with results, he reports to me, not favourable to Dr. Bastian's views.

I may add that I have by no means confined myself to the thirteen samples of urine here referred to. The experiments have already extended to 105 instances, not one of which shows the least countenance to the doctrine of spontaneous generation.

It gives me pleasure to refer to the skill and fidelity with which here, as in other cases, Mr. Cottrell has carried out my directions.

OUR ASTRONOMICAL COLUMN

THE NEW STAR IN CYGNUS.—In No. 2,115 of the *Astronomische Nachrichten*, Prof. Schmidt publishes the results of his observations on the intensity of light exhibited by this star between November 24, the date of its discovery, and December 15, when it was last perceptible to the naked eye. Having laid down his estimates of magnitude graphically on a large scale, he reads off therefrom the magnitude for every sixth hour, the differences showing a marked uniformity except about November 28, when the diminution of brightness was much more rapid. The magnitudes at midnight are as follow:—

	m		m		m
Nov. 24	2.07	Dec. 1	5.27	Dec. 8	6.44
" 25	3.03	" 2	5.47	" 9	6.55
" 26	3.14	" 3	5.65	" 10	6.64
" 27	3.38	" 4	5.81	" 11	6.71
" 28	4.06	" 5	6.00	" 12	6.79
" 29	4.74	" 6	6.16	" 13	6.86
" 30	5.06	" 7	6.32	" 14	6.92

In the forty-eight hours following November 27<sup>d</sup> 18<sup>th</sup>, there was a diminution to the extent of nearly 1<sup>m</sup>. It is remarked that

<sup>1</sup>Fast alkaline liquids are more difficult to sterilise than acid ones was announced by Pasteur more than fourteen years ago. See *Annales de Chimie*, 1862, vol. lxxv. p. 6.

on the night of discovery its brightness was such as to render its near neighbour, 75 Cygni, invisible, while on December 14 and 15, 75 Cygni (6.4<sup>m</sup>.) in its turn nearly obliterated the new one; at 10 P.M. on the latter date it was only by great exertion of the eye that a trace of the star could be discerned. Prof. Schmidt did not remark any decided change of colour: it was at no time decidedly of an orange tint, but less ruddy than  $\gamma$ ,  $\epsilon$ , and  $\zeta$  Cygni, yet of a full yellow, 5.6 to 5.8 on his scale.

The curve resulting from the Athens observations accompanies Prof. Schmidt's description, and for comparison with it similar curves are added to show the law of diminution to the limit of unassisted vision, in the cases of the so-called new stars of 1848 (Hind, April 27) and 1866 (Birmingham, May 12). The descent was slowest in the former case and quickest in the latter, but the curve for the star of 1848 appears to be drawn from a small number of observations. Prof. Schmidt assigns for the interval between discovery and disappearance to the unaided vision, twenty-five days in 1848, nine days in 1866, and twenty-one days in 1876; the writer is able to state that the star of 1848 was just perceptible without the telescope as late as May 27, four days after the termination of Prof. Schmidt's observations and thirty days after its discovery, and there was a decided check in the star's descent between May 1 and 6; on May 1 it was a little less than 20 Ophiuchi, and on May 6, certainly a little brighter than that star. On April 29 it was so nearly equal to  $\nu$  Serpentis that close attention was necessary to decide which was the brighter;  $\nu$  was found to be in a very trifling degree superior.

VARIABLE COMPONENTS OF DOUBLE STARS.—A suspicion of variability in the small companion of  $\delta$  Cygni has been entertained by several observers, Prof. Secchi, among others, having remarked that the star has appeared single at times when the atmospheric circumstances would not afford an explanation. But the case of 72 Ophiuchi, No. 342 of the "Pulkova Catalogue" of 1850, is a much more suspicious one. The discoverer, M. Otto Struve, says, "I have very often looked at this star, and have many times noted it single. Yet on three occasions I have seen it double, always in about the same direction, and at a distance of 1".5. I do not know how to explain these discordances, except on the supposition that the satellite is very variable." Secchi found the star single at the epochs 1856.53 and 1857.71; at 1857.57 a doubtful companion was noted in the direction 345°.9, but at the epoch 1859.61 he records it "certainly double, and well separated," the measures giving the position 3°75, and distance 0".608. This star does not occur in the more recent revision of the Pulkova list, by the Baron Dembowski.

To such cases may be added those of a Herculis and  $\beta$  Cygni, where the companions do not vary to such an extent as to cause the objects at times to appear single.

THE BINARY STAR  $\gamma$  CENTAURI.—While awaiting further measures of this fine double star, it may be remarked that admitting the measures of Sir John Herschel in 1835-36, to require an alteration of 180°, in order to render them comparable with those of Capt. Jacob and Mr. Powell, the latest published angle measured by the latter observer in 1860, indicates a motion in a retrograde direction of upwards of 160° between 1835-85 and 1860-68, the distance having increased about 0".4. The star will be in all probability one of comparatively short period, and, as such, deserves attention at the hands of southern observers. The alteration of 180° in Sir John Herschel's measures is quite justified by the near equality of the stars.

THE MINOR PLANETS.—M. Perrotin, of the Observatory at Toulouse, met with a small planet on January 10, in a region of the sky where it is probable that Nos. 77 and 120, Frigga and Medusa, are at present situated, and the same planet was detected some ten days later by Prof. Palisa at

Clinton, U.S. On January 13, M. Borrelly, at Marseilles, also found a small planet distinct from that of Perrotin and Peters. It is remarked in M. Leverrier's *Bulletin*, that the first of these planets is unlikely to be Frigga, since the rough ephemeris in the *Berliner Jahrbuch* gives a contrary motion in declination. The object found by M. Borrelly, however, presents indications of identity, though a considerable correction of the elements of Frigga, brought up to 1874, December, by Dr. Poyal, would be required. If we employ these elements it will be found that with  $\Delta M = -3^{\circ} 17' 67$ , the computed and observed longitudes of Borrelly's planet on January 13 will agree, but there is an outstanding difference of  $+1^{\circ} 39'$  between the latitudes. The comparisons with the observation on this date and one on January 15, are as follow:—

	Long.	Lat.
	c-o	c-o
January 13 ...	0'0	+ 1° 39' 1
"   15 ...	- 4'4	+ 1° 36' 9

### NOTES

THE eminent physicist, Prof. J. C. Poggendorff, for many years professor in the Berlin University and editor of *Poggendorff's Annalen*, has died in Berlin, in his 81st year. We hope to be able to give a memoir of Prof. Poggendorff next week.

THE eminent Belgian botanist, Prof. Belyneck, died at Namur in December.

THE first four names in the Cambridge Mathematical Tripos list, are Messrs. Donald McAlister, St. John's, Frederick M. de M. Gibbons, of Gonville and Caius College, R. C. Rowe and Mr. James Parker Smith, both of Trinity College. The Senior Wrangler, who was born at Perth in May, 1854, has had a most distinguished career as a student.

THE Society of German Naturalists and Physicians holds its annual session at Munich, February 18, and celebrates at the same time its fiftieth anniversary.

THE Council of the Royal Dublin Society have elected William Archer, F.R.S., Secretary for Foreign Correspondence to the Royal Irish Academy, as head of their Library Department, and the members of the Society, as well as the literary and scientific public in Dublin are to be congratulated on the occasion.

THE Russian Archæological Society holds its Annual Congress at Kasan, July 31.

ACCORDING to a Report of the French Minister of Public Instruction, the salaries of the Inspectors-General of Public Instruction, the Professors of the Collège de France, and the Professors of the Museum of Natural History, have been raised 50,000 francs, and of the Professors of the School of Living Oriental Languages, to 7,500 francs.

In 1855 Napoleon III. proposed a prize of 50,000 francs for the most important improvement made in the use of voltaic electricity during the previous ten years. The prize was last awarded to M. Ruhmkorff, who, it is known, is a German physician established in Paris. M. Waddington has recently appointed a jury to award the prize for the third time. Any improvement in any industry using voltaic electricity comes within the competition, consequently the sphere is a very wide one. Regulations will shortly be issued.

PROF. NORDENSKJÖLD proposes to take command of an expedition next year which will examine the Siberian coast from the mouth of the Jenisei to Behring Straits. The return journey will be by way of China, India, and the Suez Canal.

THE remarkable entomological collections of the late Dr. Breyer are to be purchased for the Royal Museum for Natural History of Brussels, for the very low price of 2400. They contain above 21,000 specimens of insects, classified by the late eminent entomologist.

WE observe that the following honorary members have been elected by the New York Academy of Sciences:—In this country, Mr. G. Bentham and Prof. Boyd Dawkins; on the Continent, Profs. Brandt, De Candolle, Milne-Edwards, Hoffmann, M. de Verneuil, and Herr von Siebold.

WE have lately alluded to the very large ethnographical additions made to the Berlin Museum by Dr. Lenz, Dr. Bastian, and Dr. Jagor. A still more valuable collection has lately been presented by Dr. Nächtigal, and is now in process of arrangement. It embraces a vast variety of objects gathered amidst widely-diversified tribes by this well-known traveller during his last extensive tour through Africa, and affords a rare opportunity for comparative ethnographical study.

A CREDIT of 15,668 $\frac{1}{2}$  has been requested from the Belgian Chamber of Representatives by the Minister of the Interior, for the astronomical and meteorological observatory of Brussels. Besides the construction of new astronomical and magnetical instruments, this sum will be used for the enlargement of observations upon the periodical phenomena of vegetation. Special arrangements will be made for carrying on the observations in the garden of the observatory, on plants especially selected for the purpose from the double point of view of the botanical geography of the present time, and of the study of former climates of the earth.

THE Belgian Chamber of Representatives passed, on January 26, a resolution of great importance to geologists, allowing the necessary sums for the publication, first, of the beautiful coloured maps of the soils and sub-soils of Belgium, prepared about thirty years ago by André Dumont, on the scale of 1:160,000, and which are long ago out of print; and second, of the MSS. of Dumont, with his numerous geological sketches and drawings, and of the numerous notes he took during his travels in Belgium. The MSS., which were purchased by Government, are already arranged for publication, and their appearance, as well as that of the maps, is expected about the end of this year.

THE Belgian Geological Society is engaged in the elaboration of a scheme for the preparation and publication of a detailed geological map of Belgium, on a large scale. The idea of such a publication being already approved by the government, the point under discussion now is the best means of engraving the work, and the Society proposes to entrust the task to two special committees, geological and cartographical; both committees will be placed under a common directorship.

AT the session of the Berlin Anthropological Society on January 20 Prof. Virchow gave an extended account of a large collection of diluvial remains found in the neighbourhood of Weimar. They consisted of the bones of such animals as the elephant, rhinoceros, arctic bear, deer, wild swine, &c. Apart from their palæontological value, they are extremely important from an anthropological point of view, as among the bones are several flints, remains of fires, and peculiarly divided fragments of bone, all indicating the presence of man in company with the animals mentioned. Dr. C. Jung described the superstitious observances and use of charms and amulets among the aborigines of Australia. The bones of animals which have been eaten, or the bones of dead relatives are regarded with peculiar reverence by almost all of the tribes. There was also a discussion on the supposed Phœnician inscription lately found on a block of stone

in North Russia, Dr. Wettstein declaring it impossible to connect it with known Phœnician characters.

IN the January session of the Swedish Anthropological Society H. Torell gave the results of an interesting comparative study of the Esquimaux and Japanese. The anatomical and ethnographical resemblances are so striking that they give additional strength to the theory of the settlement of America from Asia by the way of Behring's Straits.

H. V. SCHLAGINTWEIT-SAKUNLUNSKY publishes, in connection with his report on the botany of the Himalayas, presented before the Berlin Academy of Sciences, an interesting comparison between the snow limits of the great Asiatic mountain chain and those of the Swiss Alps. The Himalaya range shows a snow limit at the height of 16,600 feet on the northern side, and 16,200 feet on the southern side. That of the Kuenlun range varies from 15,100 feet on the northern side, to 15,800 on the southern. The snow limit of the Alps shows an average height of 9,000 feet, 8,900 feet on the northern side, and 9,200 feet on the southern.

IN the last session of the Austrian Meteorological Society, Prof. A. von Obermayer read a paper on the nature of fogs, strongly advocating the theory regarding them as minute drops of water, the specific gravity of which is overcome by the friction between the particles of air, according to Stokes's hypothesis.

IN a communication in the *Daily News* of January 25, in reference to the Cairo Geographical Society, by the Alexandria Correspondent of that paper, some interesting details are given of papers read on the Eastern Sudan and on Darfur.

THE use of rock crystal for normal scientific apparatus has recently been advocated by S. Stein, of Bonn, in a communication to the German Chemical Society. For scale-beams and scale-pans it is especially adapted, as it is entirely unaffected at ordinary temperatures by acids, bases, or the gases and moisture present in the atmosphere, while possessing nearly the same specific gravity as aluminium—2.65—and being comparatively unelastic. It is equally practicable for standards of measure, longitudinal as well as circular. Discs to be used for telescopes, theodolites, quadrants, &c., if cut at right angles to the chief axis, show an almost absolute unchangeability of form. The smallness of the coefficient of expansion renders it also eminently well fitted for normal thermometers, where accuracy and not cost is the chief requisite.

COMMANDER CAMERON having been invited by the Geographical Society of Paris to deliver a lecture on his journey across Africa did so at an extraordinary meeting held by the Society in the large hall of the Sorbonne, on January 26. The place, although fitted to accommodate 2,000 people, was crowded to inconvenience. On Saturday a banquet was given to Commander Cameron by the Fellows of the Geographical Society, about 200 being present. The President of the Republic was represented by his first aide-de-camp, the Marquis D'Abzac, and the Minister of Public Instruction by his general secretary, M. Watteville, who delivered to Commander Cameron the University gold palms and diploma. The knife and fork used by Livingstone in his African travels, and which had been purchased by MM. Rambaud, the large French traders established in Zanzibar, and presented to the Geographical Society of Paris, were used by Cameron. A magnificent album of the portraits of all the persons present at the banquet will be sent to Commander Cameron. MM. Hachette and Co. are preparing a magnificent French edition of Cameron's work.

AT the session of the Berlin Academy of Sciences on January 25, Prof. Dr. Bois-Reymond gave a report of the investigations

carried on in connection with the Humboldt foundation intrusted to the Academy. At present two travellers are supported by the funds—Dr. Hildebrandt, who is studying the snowy regions of the Kilimanjaro Mountains in Eastern Africa, and Dr. C. Sachs, engaged in researches in Brazil on the nature of the electricity of the electric eel.

A PIECE of burnt stone resembling a piece of partially burnt slate coal, with white sparkling specks on it, fell at Ecclefechan on the evening of the 2nd January. Two men, walking on the Glasgow road, heard a noise behind them, and on turning round they found the stone referred to embedded in the ground to the extent of half-an-inch or more. One of them attempted to lift it but got his hand burnt. The stone, which measures about four inches by two, and weighs nine ounces, took twenty minutes to cool. A volume of smoke proceeded from it.

A FEW years since, M. Delacour, sub-director of the Danish Meteorological Institute, invented the so-called phono-telegraphic system. Since then he has carried on an extensive series of experiments, the cost of which has been defrayed by the Danish Government, with the view of perfecting the new system. The results of his investigations were displayed a few days since to a company of electricians and members of the Danish Parliament. As is already known this system is based upon the application of vibrating currents, tuning-forks of the same number of vibrations per second being brought within the influence of current at both ends of the wire. M. Delacour made use on the above occasion of twelve different pairs of tuning-forks, all of which were connected at the same time with a single telegraphic wire. He was then able to send simultaneously twelve messages by means of the tuning-forks as well as one by the ordinary method, and most satisfactorily solved the problem with regard to the use of a single wire for the forwarding of numerous messages at the same time.

PROF. ANTON KERNER, author of the "Means of Protection in Flowers against Unwelcome Visitors" (*NATURE*, vol. xv. p. 237), has lately received from Charles Darwin the following characteristic epistle:—"Allow me to express to you my heartiest thanks for the pleasure experienced in reading your work. You have opened up an entirely new field of research, and explained many things which were previously enigmas to me. I find that I have fallen into many mistakes, in the preparation of my last book, when touching upon the subject which you have considered so fully."

THE last number of the *Jahrbuch der k. k. geologischen Reichsanstalt* (vol. xxvi. No. 3) contains a very valuable elaborate paper by K. M. Paul—"Grundzüge der Geologie der Bukowina"—with a map on a scale of 1 : 280,000, reduced from that of the Geological Survey, and embodying the results of the survey, made during the last four years, together with the data furnished by former explorations. The southern, hilly corner of the Duchy is occupied by an island of crystalline rocks, bordered on one side by a zone of mesozoic limestone (Dyas and Trias). A broad zone of the so-called Carpathian sandstones (Neocomian, Gault, and Upper Chalk, and probably Eocene) follows, as is generally the case at the northern slope of the Carpathians, and crosses the land in a north-western direction. Further to the north-east we see a broad district covered with Neogene formations (Lower and Upper Mediterranean, and Garmathian stages), diluvial deposits, and loess, which district meets with the Galician plains to the west, and the Podolian to the north.

THE geological structure, and especially the volcanoes of the southern parts of Luzon (Philippines) are the subject of an interesting note by Dr. Drasche, being a preliminary report upon his recent travels in the interior of the island, which appeared in Tcherniak's *Mineral. Mitth.*, 1876, Heft 3. The note is

accompanied by a map on the scale of 1 : 1,000,000, constructed after that of M. Jäger ("Reise in den Philippinen") and by some views and geological sections. The volcanoes of the Taal district, the Majajal, the Monte Labo, and Sierra Corasi, the Ysarog, Bahi, and Mayon, or Aibay, were visited by the author, and are shortly described. Among other interesting observations we notice the very steep slopes ( $32^\circ$ ) on which lava-floods may flow sometimes without being interrupted for distances of more than 300 feet, observed on the Mayon. The height of this last being 2,374 metres (7,787 feet), Dr. Drasche points out the error in the index of volcanoes, given in the late Mr. Poulett Scrope's work, where the height of the Mayon is given as 3,200 English feet. Another error of the Index is that an active volcano is reported to exist on "the little island Mindoro," whilst on this rather large island (250 square geographical miles) there are no volcanoes at all, neither active nor extinct.

IN a communication to the Vienna Academy on the nature of gas molecules, M. Boltzmann abandons the notion that they behave like aggregates of material points (the atoms). He considers that in estimating the impact action of the molecules, we may almost regard the whole aggregate, which we denote as an individual gas molecule, and which may consist of different substances, perhaps even ether atoms, as rigid. It is found that then the ratio of the heat-capacities of the gas must be  $1\frac{1}{2}$ , when the gas molecules have ball-form. The ratio of the heat-capacities will be  $1\frac{1}{4}$  if the molecules have the form of rigid bodies of rotation, but which are not balls; and  $1\frac{1}{3}$  if they are of any other form of rigid bodies. These numbers at least seem to agree so far with those found experimentally, that one cannot say that experiment furnishes a contradiction of the theory thus modified. It is further shown that the values experimentally got for the heat-capacity, under this view, are in satisfactory agreement with the heat-capacities of solid bodies. Of course the gas molecules cannot be absolutely rigid bodies; this is already disproved by spectral analysis, but it may be that the vibrations producing gas spectra are merely brief shiverings during the shock of two molecules, comparable to the sound perceived on the shock of two ivory balls.

THE current opinion as to the Ural range not bearing any traces of former glaciers, is now contradicted by M. Poliakov. This explorer, who has had during the last ten years many opportunities of making a close acquaintance with glacial formations in Southern Finland, in the basin of Lake Onego, and on the Valdai plateau, reports that, while the lower parts of the Ural ridge are connected under large alluvial deposits, its upper parts, especially east of the water-parting, exhibit unmistakable morainic deposits with scratched boulders. The rocks bear also, sometimes, true glacial striae running from north-west to south-east, and certainly such striae would be found more numerous, were the localities more thoroughly explored than M. Poliakov could do as he crossed the ridge on his way to the Obi. A lower secondary ridge, the last crossed by the highway before Ekaterinburg, exhibits also many *trinites* of immense boulders running in parallel directions, such as are found in Finland, Erithonia, and northern Russia. Further east, on the shores of the Obi (near to the mouth of the Irtysh), the lowest parts of the loose deposits, which are roughly stratified sands, contain a good deal of well-polished and striated boulders of glacial origin. These observations make it very desirable that the Ural were thoroughly explored by a geologist well acquainted with glacial formations.

THE Göttingen Academy announces the following subject for prize competition in the physical class till November, 1878.—The question what special actions (if such there be) breathing in pure oxygen gas of the ordinary density of atmospheric air has on the animal organism, has not hitherto been answered by

researches with sufficient agreement. Further researches, therefore, are desired, both on homeothermic and, as far as practicable, on poikilothermic animals; in these should be shown, quite specially, along with the phenomena externally observable in all animals, the nature of the change of blood and material (excretion of carbonic acid, nature of urine). In the view of certain data, the purity of the oxygen from all foreign matters occurs in its preparation must be carefully looked to, while a mixture of atmospheric nitrogen within narrow limits, hardly to be avoided would not essentially vitiate the results. In the mathematic class of the same Academy, new researches are desired on the nature of the unpolarised light-ray, calculated to bring the idea regarding natural light from any source, near to those which theory connects with the different kinds of polarised light.

WE have received the Fourth Report of the New Cro Microscopical and Natural History Society, which, we are glad to see, continues to prosper. It contains an address by the president, Dr. F. T. Taylor, on "Spontaneous Generation."

FROM the Seventh Annual Report of the Wolverhampton Free Library Committee, we are glad to learn that a Naturalists' and Archaeological Department has been established in connection with that institution.

IN 1875 a Bedfordshire Natural History Society was formed and it has just issued its first Abstract of Proceedings. It has made a very fair beginning both as to numbers and as to the quality of the papers read. We hope it will receive more encouragement from residents in the county than it appears to have done, and that it will work diligently at local natural history. One of the papers, accompanied by a map, is "On the Botanical Division of Bedfordshire," by Mr. W. Hillhouse, F.L.S.

AMONG the papers in the *Proceedings* of the Belfast Natural History and Philosophical Society for 1875-6, is one by Mr. J. J. Murphy on the Glacial Climate and the Polar Ice-cap. Mr. R. Lloyd Patterson has a concluding note on some of the swimming birds of Belfast Lough.

THE additions to the Zoological Society's Gardens during the past week include two Vervet Monkeys (*Cercopithecus islandi* from South Africa, presented by Mr. T. G. Butler; two Arctic Foxes (*Canis lagopus*) from the Arctic Regions, presented by Sir Thomas Erskine, Bart, F.Z.S.; a Ring-Necked Parrakee (*Palaeornis torquata*) from India, presented by Miss Smith; three Silky Marmosets (*Midas rosalia*) from Brazil, purchased.

## SOCIETIES AND ACADEMIES

### LONDON

Royal Society, December 21, 1876.—"On the Rotation of the Plane of Polarisation of Light, by Reflection from the Pole of a Magnet," by George Francis Fitzgerald, M.A. Communicated by G. Johnstone Stoney, F.R.S.

At the last meeting of the British Association, the Rev. J. Ker described a delicate and very remarkable experiment, from which it appeared that when plane polarised light is reflected from the polished surface of the end of a powerful magnet, the plane of polarisation is rotated. Mr. Geo. F. Fitzgerald has recently communicated to the Royal Society an explanation of this curious phenomenon, of which the following is an abstract:—

It is known from Faraday's and Verdet's experiments that when plane polarised light is transmitted through transparent diamagnetic or ferro-magnetic media, while under the influence of a powerful magnet, the plane of polarisation will be rotated, so that the plane of polarisation of the emergent beam will differ from that of the incident light. This action is most powerful when the direction of transmission coincides with the direction of the stream of magnetic influence, and in general the rotation is in opposite directions in diamagnetic and in ferro-magnetic media. Now, if we regard the incident light as formed of the two circularly polarised beams which are equivalent to it, we learn from Faraday's and Verdet's experiments that one of these beams is

started more than the other in passing through the medium, or, in other words, that they have different refractive indices. And of course if a powerful iron magnet were transparent, we might expect to find a much more powerful action of this kind upon transmitted light. Iron, however, is not transparent, so that the effect on transmitted light cannot be observed. But any effect which this difference between the refractive indices can produce upon reflected light may be made the subject of experiment, and Mr. Fitzgerald has shown that the observation made by Mr. Ker is an effect of this kind.

To show this, Mr. Fitzgerald splits the incident plane polarised light into its two equivalent beams of circularly polarised light. These circularly polarised beams are one right-handed and the other left-handed, and, before incidence, are equal in intensity to one another. If, however, their indices of refraction in the magnet are very different, as Faraday's and Verdet's experiments lead us to suppose, their intensities after reflection will be sensibly unequal, and their phases also will in general be unequally affected. Hence their united effect after reflection is to produce in general an elliptically-polarised beam, the major axis of which is inclined to the plane of original polarisation, thus producing that appearance of a slight change of the plane of polarisation which was observed by Mr. Ker.

Mr. Fitzgerald has repeated Mr. Ker's experiment, and ascertained that the reflected light is, in fact, elliptically polarised, as indicated by the theory. He has also found that when the polished pole of the magnet is gilt the observed effect disappears. This is a further confirmation of the theory, since gold is diamagnetic, and therefore too feeble to produce an appreciable effect, if the effect is due to the cause which Mr. Fitzgerald has pointed out.

January 11.—“On some Phenomena connected with Vision,” by B. Thompson Lowne, F.R.C.S., Arris and Gale Lecturer at the Royal College of Surgeons, &c., communicated by Prof. Stokes.

The author arrives at the conclusion that the intensities of the sensations produced by various illuminations of a white surface vary as the square roots of the intensities of illumination, by comparing the shadows, cast in Lambert's well-known experiment, with ruled shades, as those of engravings and wood-cuts, taking the amount of reserved white in the latter to indicate directly the intensities of the sensations produced by them. He considers the number of rods and cones stimulated on a given area of the retina as the measure of sensation, and proportional to the reserved white.

He further finds, by a repetition of the experiment of MM. Delboeuf and Plateau, that the grey ring seen on a rotating disc with a black or white sector, disappears when the sector is sufficiently narrow and the rotation sufficiently rapid, and that the rate of rotation necessary to produce this result with the same disc and sector varies as the square root of the intensity of the illumination of the disc.

Lastly, he proposes a modification of Fechner's formula, which only requires a change of Fechner's convention that the liminal increment of sensation is constant. The author proposes to consider that  $\frac{\Delta x}{\sqrt{x}} \propto \Delta S$ . The formula then becomes, in accordance with his experiments,  $2K \int \frac{dx}{\sqrt{x}} = K\sqrt{x} = S$ , which he regards as a physiological instead of a psychical one.

Anthropological Institute, January 23.—Col. Lane Fox, F.R.S., president, in the chair.—A new member was announced.—Col. Fox then read his report to the Anthropometric Committee of the British Association on the Second Royal Surrey Militia. The measurements, which comprised the profession, race, origin, age, height, weight, chest measurement, colour of hair and eyes, and strength of arm, &c., of 459 individuals afforded some interesting facts concerning what might be called a fairly representative number of men from within a radius of twenty miles round Guildford. It appeared that the colour of the hair was in 391 cases brown or dark brown, and in only two cases black, and in two cases red, one of the latter being Irish. As to eyes, 311 were grey, light blue, or blue, 133 brown or dark brown. Col. Fox proposed some modifications of the existing tests of strength of arm and sight; suggesting that in the first test should be the same as in drawing a bow, neither hand being in any way supported, and the pull being from an object not fixed. From a table of twenty comparative cases the average of strength showed in the case of pulling from a fixed

point, 165.55 lbs., while the same men pulling with the one hand against the other only 81.95 lbs. From the general results Col. Fox considered that the muscular strength, vital capacity, &c., of our reserve and regular forces would show very favourably in comparison with those of the ordinary population, and so dispose of some of the frequent alarms given by the “man in the street” as to the deterioration of our forces in physique.—Mr. Street, President of the Philological Society, read a very interesting paper on the development of language, and Mr. E. B. Tylor and the President and others took part in the discussion.—Papers by Mr. Knowles, of Ballycally, Ireland, on the classification of arrow-heads, and on the “Portstewart find,” were also read, and numerous objects illustrating the papers were exhibited.

Physical Society, January 20.—Prof. G. C. Foster, president, in the chair.—The following candidate was elected a member of the Society: Mr. A. G. Greenhill, M.A.—Dr. Huggins exhibited an enlarged view of a photograph, half an inch in length, of the spectrum of the star  $\alpha$  Lyrae, which he has recently taken in a manner similar to that in which the spectrum of Sirius has already been obtained. The first results were very unsatisfactory, in consequence of the clockwork being insufficient for maintaining the image of the star on the slit for a length of time. Mr. Grubb has, however, devised a secondary control apparatus, the employment of which renders it impossible for the error to exceed one-tenth of a second. In the spectroscopy employed the prism was of Iceland spar, and the lenses of quartz. Dry plates were employed, and the necessary breadth was secured by slightly changing the position of the image instead of by the use of a cylindrical lens. Dr. Huggins has also been engaged in taking a series of photographs of the moon, and hopes to obtain some information in regard to the question of a lunar atmosphere of small extent. In the spectrum of a Lyrae a line occurs corresponding with  $H_1$  in the solar spectrum, and several more refrangible ones which he is at present unable to explain.—Mr. Lockyer considered the results which Mr. Huggins is obtaining to be of extreme importance, and he pointed out how he hopes a large series of photographs of stellar spectra will afford valuable information in regard to the constitution of certain substances now supposed to be elementary, such as calcium. Some time ago he communicated a paper to the Royal Society on the spectrum of this metal, and he considers that it is not a simple substance, but that the H lines are due to two elementary substances of which it is composed, and this supposition is confirmed by the fact that in the photographs exhibited by Dr. Huggins only one of the H lines is present, that is, only one of the constituents of the metal calcium is present in the star  $\alpha$  Lyrae.—Mr. W. C. Roberts read a paper on the artificial production of columnar structure. He gave an account of the several theories which have hitherto been given as accounting for this phenomenon and that of cross-jointing, as observed in the Giant's Causeway, and he dwelt specially on the views of Mr. R. Mallet and Prof. James Thomson. He found as the result of experiment, that when certain masses of clay and sand are heated to about  $1300^\circ$  C. they contract to about the same amount as a basalt does in passing from the molten to the solid state, and that beautiful columnar forms are produced. He had hoped, by accumulating a number of specimens, to have been able to establish a relation between the strains at the point of rupture and the dimensions of the hexagons, but in the small masses employed the strains were so numerous that it was impossible to apportion their influences. He had, however, obtained a number of specimens which possessed much interest.—Mr. Locky referred to a very fine columnar cliff in the island of Beznass, in Valencia Harbour, which he has examined in the hope of finding cross-joints, but, although some breaks exist, there are none at all comparable to those in the north of Ireland.—Prof. Guthrie showed an arrangement he has recently devised, in the hope of making the mercurial as sensitive as the water barometer. It consists of an ordinary siphon barometer in which the two vertical tubes are united by means of a long uniform horizontal tube having a diameter considerably less than that of the main tubes. The instrument is filled in the same manner as the ordinary siphon barometer, except that a bubble of air or dilute acid is left in the narrow tube. For a given rise of pressure the absolute amount of mercury which passes from the shorter to the longer tube depends upon their diameters, and as these are great in comparison with the tube uniting them, the motion of the bubble will be considerable in comparison with that of the surface of

languages, very probably, as Mr. Douse suggests, through the medium of *ky*. But in spite of his arguments to the contrary, *kw* still seems to me a harder sound than simple *k*, so that even if we accept his own test of the principle of least effort, the latter sound should be derived from the former, and not the converse.<sup>1</sup> He confesses himself, moreover, that his theory fails to explain the equivalence of the Sanskrit *živ* and the European reduplicated root *gwi-gwi* "to live" (as in the Latin *vivere* and our *quick*), an equivalence which can only be accounted for by supposing that in this particular instance the Indian dialect has preserved the labial semi-vowel of the original root. Equally instructive is the equivalence of the Greek *γαστήρ*, and the Latin *venter* (for *gventer*), which Mr. Douse does not notice, as it shows that Greek could sporadically deal with the guttural in the same way that Indian and Litho-Slavic habitually did. I can see no reason why these dialects should not have sibilated *k* pure, very possibly through an intermediate *ky*, at the same time that *kw* was being reduced to simple *k*. I have heard *kyind* and *conker* from the same lips. To the instance of words with primitive *ghw* given by Mr. Douse, may be added *ελαχός*, Lat. *levis* (for *legvis*), and *βραχός*, Lat. *brevis* (for *brevis*).

The excellence of Mr. Douse's book has led me to dwell upon the points which seem to me open to objection, and I have left myself no space to draw attention to the many striking suggestions and new points of view scattered through the volume. I cannot, however, quite pass over the note in which he maintains the existence of bivalent roots (*aka, ata, &c.*), and acutely suggests that the Greek *ἐπέ* and *ἐκείνος* imply dissyllabic roots as much as the archaic Latin *enos* or the Sanskrit *ana*, Lat. *vile* (for *onulus*). Mr. Douse has materially helped forward the solution of the problem of Grimm's Law, and if his theory is not secure from attack in every particular, in its main outlines it will doubtless prove correct. At all events the chronological hypothesis which derives the phonetic systems of the Indo-European languages from one another can never again be upheld.

A. H. SAYCE

### STEELE'S "EQUINE ANATOMY"

*Outlines of Equine Anatomy.* By J. H. Steele, M.R.C.V.S. (London: Longmans and Co., 1876.)

**A**LTHOUGH this manual is intended, as we are informed on the title-page, for the use of veterinary students in the dissecting-room, we think it quite possible that it may have a larger sphere of usefulness.

As long as the study of zoology and comparative anatomy was confined to those who had entered on the medical profession, the human frame formed an excellent standard with which every mammalian animal might be compared in all its parts. Of late, however, since biology has been introduced into general education, those who have taken to it in earnest have not been long in finding that without a pretty thorough knowledge of the details of what may be termed the typical vertebrate structure they are on all sides beset with difficulties; they make errors in nomenclature, they cannot appreciate the significance of bony processes, and are unable to generalise with safety.

<sup>1</sup> Mr. Rhy's reminds me that in the Keltic languages at any rate *kw* (*gwi*) proved to have passed into simple *k*.

Whether it is possible that the requisite amount of detail will be mastered by those who are not stimulated by the severity of rigid examinations on the way to a professional career is a question which we will not discuss upon the present occasion; nevertheless, those teachers who are anxious that their pupils should have a reliable work on the anatomy of some one of the lower animals cannot do better than recommend the one at present under notice. The ass is an animal the expense of whose carcase is not excessive. Its size is sufficient for the easy investigation of all its important parts, and its structure is normal enough to form the basis for a competent knowledge of all the essential parts of the mammalian organisation. It is superior to the dog or the cat, because both are as a rule too small for the satisfactory demonstration of many of the more delicate systems, such as the vascular and nervous, except by those who have already had considerable experience in dissecting. Another advantage is that the requirements of the veterinary colleges have led to the production of such works, and there are more elaborate ones, such as that of Chauveau, the translation of which by Mr. George Fleming we reviewed some time ago (*NATURE*, vol. viii. p. 158), to fall back upon where greater detail is called for. On the other hand, a treatise on the anatomy of the dog would with great difficulty repay any author for the time and labour required in its production.

Mr. Steele's work commences with a chapter on the methods and terms employed. The osteology of the horse is then considered in detail, each bone being fully described. This is followed by a section on arthrology, in which the nature and action of each joint is explained. The fourth part of the volume is devoted to special anatomy, which is treated in the same way as is human anatomy in dissecting manuals generally. Appended are tables of nerves and vessels. The style in which the whole subject is treated is not inferior to that adopted in the best works on anthropotomy, at the same time that the language is clear and concise. We do not quite know why fascia should be spelt "faschia" throughout.

In his account of the liver, Mr. Steele reproduces an error found in most works on the subject. This we cannot correct better than by quoting the accurate description given by Prof. Flower in his Hunterian Lectures before the College of Surgeons in 1872.<sup>1</sup> There we learn that "The liver is tolerably symmetrical in its general arrangement, being divided nearly equally into segments by a well-marked umbilical fissure. Each segment is again divided by lateral fissures, which do not extend quite to the posterior border of the organ. Of the central lobes thus cut off, the right is rather [decidedly] the larger, and has two fissures in its free border dividing it into lobules. . . . The two lateral lobes are subtriangular in form. The spigelian is represented by a flat surface between the portal fissure and the posterior [the vertebral] border, not distinctly marked off from the left lateral by a fissure of the ductus venosus, as this vessel is buried deep in the hepatic substance; but the caudate is distinct and tongue-shaped, its free apex reaching nearly to the border of the right lateral lobe. In most works on the anatomy of the horse (as those of Gurlt and Leisering) [to which

<sup>1</sup> *Medical Times and Gazette*, August 21, 1872, p. 219.

we may add Chauveau and Steele] this has been confounded with the spigelian lobe of man."

In conclusion, we are sure that all teachers of anatomy will agree that, in an educational point of view, Mr. Steele's volume is a most valuable addition to the literature of the subject on which he treats.

#### OUR BOOK SHELF

*Dutch Guiana.* By W. G. Palgrave. (London: Macmillan and Co., 1876.)

*Canoe and Camp Life in British Guiana.* By C. Barrington Brown, Assoc.R.S.M. (London: Stanford, 1876.)

THESE two works deal with a small portion of a region of considerable interest from various scientific points of view, but of which we as yet know comparatively little; indeed much of the region included under the name Guiana is a *terra incognita*, and presents a fine field for an enterprising explorer. Mr. Palgrave, whose long silence since the publication of his classical work on Arabia many have wondered at and regretted, spent only a fortnight in Dutch Guiana, and this volume testifies made a diligent use of his time. The work is more connected with the historical, social, and commercial aspects of the Dutch colony than with the strictly scientific, but contains much valuable information about a country of which even the Dutch themselves, we suspect, know little. Mr. Palgrave has gathered many facts about the colony from various quarters, and ingeniously weaves these into his pleasant narrative, so that a reader who gets to the end of the little volume will have a very fair idea of its history, present condition, and future prospects. In a graphic and popular way he describes the journeys he made up the rivers near the coast, and conveys a fair idea of the productions, the people, and the aspect of the district visited. To the ethnological reader, one of the most interesting chapters is that on the Bush Negroes. Scattered all over the colony to the number, Mr. Palgrave thinks, of about 30,000, are various tribes of independent negroes, descendants of former slaves, who rose against their Dutch masters, fought for and obtained their freedom and liberty to settle pretty much where they chose, and have lived peaceably beside their former masters ever since. These Bush Negroes are descended mostly from Africans of the same type, but are now divided into three main tribes, and several subordinate branches, with chiefs and sub-chiefs, each tribe named from the place at which its treaty of peace and freedom was signed, as Aucan, Saramaccan, and Moe-singa. The interesting point is that "the grouping, once made, perpetuated, and in the course of years it has produced in each instance a distinct type, till what was at first merely nominal and accidental has become permanent and real." Mr. Palgrave's work is one of great interest from beginning to end. It contains a clear map and a plan of Paramaribo.

Mr. Brown is a much better surveyor and explorer than he is a book-maker. As Government Surveyor of British Guiana, he has visited nearly every corner of it—the tracings of his routes on the map forming a regular network of blue lines—and during his journeys has collected a vast amount of valuable information about its physical aspect, geology, fauna, flora, and people. The reports on the physical features and descriptive geology of the colony have, he says, been already published by the Treasury Commissioners, and in the present volume he professes to give only a popular narrative of his travels. But the volume is something more than this, as almost every page contains notes on the fauna and flora and geological features, as well as natives that came under his observation. All these notes are put down miscellaneous in the order of time, amid the notes of the

incidents that occurred during the journeys, so that it is difficult for one interested in the natural history of the country to ferret out and classify the observations. Mr. Brown would have done great service both to the general and the scientific reader, had he gathered these notes together and arranged them in an appendix, or even if he had taken care to see that his work was provided with a carefully compiled index. In another edition we hope the latter want will be supplied, as I will certainly add much to the value of the work, which notwithstanding the defects in plan we have mentioned is an important contribution to the information we already possess about British Guiana. Mr. Brown, I may be remembered, was the discoverer of the magnificent Kaieteur Fall, on the river Potaro, a tributary of the Essequibo, an account of which we gave in *NATURE* shortly after its discovery in 1870 (vol. iii. p. 108). The excellent map and well-executed illustrations add much to the interest and value of Mr. Brown's work.

*The Royal School of Mines' Magazine.* (London: Wyman and Sons, 81, Great Queen Street, Lincoln's Inn Fields, W.C.)

THIS magazine, the first number of which we have just received, is to be issued three times a year, under the auspices of the students of the Royal School of Mines, and is to be devoted to articles on travel, athletics, football, and to other matters connected with the school. The present number contains several articles, by former students, on travel, an article on football, together with a record of matches played by the Royal School of Mines' Football Club, during the session 1875-76. It also contains a list of papers on mining and metallurgy; results of Royal School of Mines for 1875-76; a report of the annual dinner of the club; besides two original poems, both of which are good.

We confess we are a little disappointed that greater attention has not been paid to scientific subjects; we have no doubt, however, that this will be rectified in the future, and we heartily recommend the magazine to all interested in the Royal School of Mines. J. McD. C.

#### LETTERS TO THE EDITOR

[The Editor does not hold himself responsible for opinions expressed by his correspondents. Neither can he undertake to return or to correspond with the writers of, rejected manuscripts. No notice is taken of anonymous communications.]

##### Storm Waves of Cyclones

I BEG to submit the following suggestion, to explain in a general way by the accompanying diagram the view that might be taken of the rise and great height of storm waves of cyclone at sea, such as occurred in the Bay of Bengal, and inundated and devastated extensive tracts of the coasts and islands on October 31 and November 1, 1876.

It is generally observed that when the winds blow into a re-entering angle of any sea-walls or quays, that the surge of the wave rises higher in it than against the plane sea wall, and frequently it shoots up the corner in a kind of spouting form. Again, the tides in estuaries and friths, having bell-shaped mouths facing the ocean, and contracted inner ends receiving a river, rise to very extraordinary heights, as in those of the Severn and Thames, where disastrous floods have just occurred.

These heights are much increased when the winds blow into them, as westerly into the Severn estuary, and easterly into the Thames mouth, as during the recent gales. The ordinary rise on the south coast of England of the tides is generally only about ten feet, but at Bristol they may rise to thirty or forty feet, which, in fact, would be greater than the height of any storm-wave in a cyclone in India. Now if the course of the revolving winds in a storm mass be considered as a spiral from the outside to the inside, like a coiled watch-spring, then the section of each spiral turn may be considered as decreasing from the outside to the centre inside. This will therefore resemble a long re-entering angle or estuary tube twisted upon itself as a



bellix, and therefore if the water be driven in at the large end and up to the small end of the spiral, it should considerably increase in height as it went along and move with greater rapidity.

When arrived at the extremity of the spiral, it may be considered to remain there for some time and spread itself out laterally in bulk at the high level as long as the violence of the storm lasted. But when the force of the wind began to diminish, this impeded aqueous mass would more or less suddenly subside,

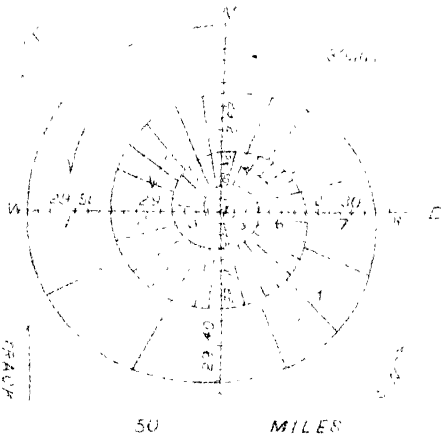

Cyclone—Horizontal Plan.

and rush down on all sides to seek its natural level. This might occur at sea, and be evidenced by the long swell or rollers frequently seen, or might be translated by progressive motion to launch its tremendous weight on the land, and inundate it. This, it may be conjectured, could only be effected over lands about the level of the sea, over which the base of the funnel of the cyclone would advance, carrying the inclosed mass of water with it for part of the area of the revolving circle, which would so far be still able to draw its supplies from the sea on the coast yet included in its motion. As soon, however, as the southern or equatorial limb of the circle had so far progressed as to leave the sea behind it, then the friction of the earth would prevent the inclosed mass of water following the cyclone, which had been already cut off from its aqueous communication, and it would be left behind to expand over and deluge the country lying under its level.

In speculating on the dimensions of the Bengal storm-wave we may assume, from the statements in the newspapers, that it was a disc of fifty miles in diameter and twenty feet deep, when viewed

The means for counteracting the disastrous effects of the storm or cyclone-wave in the Delta of the Ganges on life and property would probably be found in the erection of mounds, as proposed by a writer in the *Times*. As this tract of country would be destitute of stone or rock, and be composed chiefly of mud and sand, it would be requisite to convert this into bricks first, as the mud-mounds would not stand the impact of the storm-waves even in this country.

The design for the construction of these mounds would probably be most suitable after the model of the celebrated *Tower of Babel*, projected by the post-Diluvial inhabitants of Mesopotamia for a like purpose of self-preservation from inundation.

VORTEX

#### "Polar Cyclones"—Etna Observatory

IN reply to Mr. Clement Ley's letter in *NATURE*, vol. xv p. 253, I fear I cannot at all agree with him as to the cause of the polar depressions of the barometer. He says: "The 'polar cyclones' appear to be themselves aggregates of those local depressions, or cyclones, which have penetrated into the Arctic or Antarctic regions, and have there partially or wholly coalesced." Now, let us test the question in this way:—Suppose the surface of our planet were all land, so that there was no watery vapour in the atmosphere; there would be no cyclonic storms, for they are due to what Espy truly calls steam power;—would the polar depressions of the barometer be observed as they are in our actual atmosphere? Mr. Clement Ley's reasoning seems to require him to say that they would not; I have no doubt that they would. The causes which produce the west winds of the middle latitudes (Maury's "counter-trades") would act as in our actual atmosphere, and their centrifugal force, in rotating round the poles, would produce a space of shallow atmosphere at and around each pole, exactly like the depression at the centre of a vortex of water, which would show itself, as at present, by a depression of the barometer.

I see in *NATURE* of the same date that it is proposed to form a meteorological observatory on Etna. I hope the opportunity may be taken of obtaining what is one of the greatest desiderata in the present state of meteorology—I mean a set of comparative observations of the barometer taken at two neighbouring stations, one at the sea-level, and the other at a great height. One such set, continuous or taken at short intervals, extending over a few years, and accompanied by observations of temperature and wind (the latter by self-registering anemometers), would probably give more information on the physics of barometric waves than could be obtained by any amount of observations, all taken at the sea-level. I have urged this in *NATURE* before, but it is so important I hope I may do so again.

JOSEPH JOHN MURPHY

Old Forge, Duamurry, Co. Antrim, January 20

#### The Boomerang

REFERRING to my letter on the "Boomerang" which you were so good as to publish in *NATURE* vol. xiv. p. 248, I may, perhaps, be permitted to add a few more statements on the same subject. Concerning the use of the boomerang by the North Gippsland aboriginal natives, I have no more to add, but I have acquired some information in respect to its use among the blackfellows of South Australia, which may be of interest.

My informant is Mr. James, now a senior constable in the Victorian police, but formerly, and when I first became acquainted with him, managing a large cattle station at Blanchewater, on the borders of the so-called Lake Torrens Basin. Mr. James has had great experience among the blacks of that district during many years both before and after the time I first met with him

during my second expedition into Central Australia.

I quote Mr. James's statements to me just as I noted them:—

"Among the blacks about Blanchewater the boomerang is made for killing game. It is principally thrown among flocks of ducks, pigeons, and water-hens. It is not used often for fighting nor for killing kangaroo. They might use it in a row when short of weapons, and if their adversaries were not more than twenty or thirty yards distant. The blacks did no

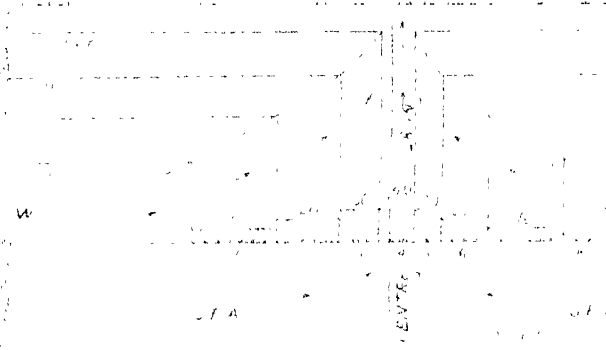

Cyclone—Vertical Section.

as a frustrum of a cylinder, which might also represent, when in a state of gyration, a cone of the same diameter and forty feet high in the centre. The contents of this space would amount to about, in bulk, 1,094,785,668,000 cubic feet, representing a weight of 70,339,979,169,000 lbs of sea-water, which would have flooded over a perfectly level district of a disc of about 700 miles in diameter, or 39,270 square feet in area to the depth of one foot horizontally.

generally like to use them except for killing small game, as they often broke, and they have told me that their boomerangs were not 'strong enough' to kill a man. For fighting they have no throwing weapons—no throwing-sticks for their spears, but throw them by the hand, and only do so in extremity, for the spear is too valuable a weapon. It is only used as a pike; and they obtain their spears by barter from some tribe to the north. In ordinary fighting they use a weapon like a boomerang from 4 to 5 feet in length. It is held in both hands and blows are struck with the convex edge. They were not warded off when I saw it used, but the blows were struck indiscriminately—a sort of free fight. These weapons are made by themselves of boxwood.

"In throwing the boomerang I have seen it usually held nearly parallel with the horizon. When thus thrown it would rise and return towards the thrower, but the blackfellows always told me that although they could ensure its returning near them they could not tell exactly where it would come to. They could tell the direction but not the distance. If the boomerang strikes anything its course ceases.

"Some years ago the blackfellows living in the mountains just south of Blanchewater had no boomerangs and no spears. Their weapons were yamaticks and stones. They had no shields. Boomerangs, spears, and shields were acquired by them from the Blanchewater blacks, in return for which they bartered Wallaby rugs; at that time the Blanchewater and Deerie blacks had absolutely no clothing.

"This system of barter is said to have been instituted by a Hill blackfellow named Pompey, who, in 1856, was concerned in the spearing of two men at Angepina. He escaped and went north to the Deerie blacks, having first stayed some time with the Blanchewater blacks, who understood both languages, being a border tribe. He took up to the Deerie blacks some flour, sugar, tobacco, and for some time settled at Kopparamanna. He endeavoured to raise a confederacy to drive the white settlers out of the Flinders Range, and is said at that time to have instituted the system of barter.

"I knew this Pompey in 1857, when he sent another blackfellow, named Blanchewater Charley, to offer his services as 'nauto shepherd.' When Pompey then came in he told me much of the above concerning himself, which was also current among the tribes. He was a very shrewd fellow, and thus became a leader among them. He was afterwards shot for killing station-blacks. The national weapons of the Blanchewater blacks are stones. These are thrown of the size of the fist, and are perhaps thrown as far as a hundred yards, and with precision for forty yards; and in throwing, a rotatory motion is imparted to the stone. At about forty to fifty yards they can hit a small mark, such as a bottle, almost without fail. In fighting at close quarters they ward off spear blows by means of a short stick held in the hand, and if possible, in cases where the spear has been thrown, clutching it in passing with the other. They do not use a shield for stopping spears, but against stones, which, as I have said, are the national weapons."

Although much of the above cannot be said to be strictly belonging to the "boomerang," I have preferred to give Mr James's statements in full as given to me.

Much that he says corroborates the statements I have made in the letter referred to.

It is much to be regretted that no one else than myself among your readers in Australia has recorded their observations on the "boomerang," in reply to your correspondent's request.

Bairnsdale, Gippsland, Victoria A. W. HOWITT

#### Longmynd Rocks

MR. H. B. WOODWARD, in his "Geology of England and Wales," p. 23, states that, near Shrewsbury, the Longmynd Rocks are overlaid conformably by the Lingula Flags. I should be glad to see the evidence upon which this conclusion is based. So far as I have examined the district, the facts do not sustain Mr. Woodward's view. Arenig fossils are found at the very head of the ravines which cut back nearly to the quartzite of the Stiper Stones. The beds under the quartzite are similar in lithological character to the Arenig shales above, and I have not heard of the lower shales yielding Lingula flag fossils. At the base of the escarpment is the fault which separates the Stiper Stones rocks from the Longmynd beds. I believe the Stiper Stones beds are Arenig, in the absence of proof to the contrary. The quartzose band of the Stiper Stones may represent the arenaceous bed adopted by the Geological Survey as the base of the Arenig.

CHARLES CALLAWAY

Wellington, Salop, January 15

#### The Measurement of the Height of Clouds

It has always been a matter of some interest to obtain measures of the height of clouds, independently of observations made from balloons on mountains.

During last July and August I made a series of measures of cloud-altitudes—the first, I believe, of their kind—by photographing the clouds simultaneously from different stations.

The details of the process would occupy too much space to be inserted here, but I have reason to believe that the results obtained are not as much as three per cent. in error. The cirrus clouds which I measured varied in height from 22,000 to 25,000 feet; massive cumuli from 6,000 to 7,000 feet. I did not get any good examples of cirro-cumulus or stratus. Rain-clouds appeared at all altitudes up to 4,000 feet. I hope to resume the measures at some future time.

ARNULPH MALLOCH

Terling Place, Witham

#### Mimetic Habit of Bats

In September, 1875, whilst paddling in a dory (dug out boat) through a narrow and dark creek leading from Belize River, Honduras, to Reid's lagoon, we disturbed a number of small bats which were clinging to the trunks and branches of the mangroves overhanging the water. These bats were about six inches in expanse and of a grey colour so exactly corresponding with that of the trees on which they settled as to be with difficulty distinguishable even at a distance of only a few feet. They invariably clung to the trunk or bough with wings expanded, and were never, so far as I noticed, suspended from the branches.

I saw the same species in Black Creek of the same river in February last year clinging to the trees in a similar manner, and conclude it is the natural position of the animal when at rest. I send this note as I do not recollect having anywhere seen this curious mimetic resemblance and peculiar habit remarked upon.

101, Grove Street, Liverpool, January 22 S. ARCHER

#### THE SPONTANEOUS GENERATION QUESTION

THE following paper on this subject was read at the Paris Academy of Sciences on January 8<sup>th</sup>—

The Academy has perhaps not forgotten that at the *si-mnce* of July 10 last, Dr. Bastian announced the discovery by him of the physico-chemical conditions necessary and sufficient for the spontaneous generation of certain varieties of microscopic objects of the genus *Bacteria*. The experiment which, according to Dr. Bastian, realises these conditions is very simple; it consists in exactly neutralising by liquor potassæ urine deprived of every organic germ and exposing the mixture to a temperature of fifty degrees. In those conditions certain varieties of bacteria promptly appeared.

Dr. Bastian has no doubt as to the bearing of his conclusions. To all who are attentive to medical movements it is evident that the debate relative to spontaneous generation has been removed into the domain of the etiology of contagious diseases.

I immediately repeated the experiment, and I proved, among other things, that it is sufficient to determine the saturation of the urine by solid potash instead of potash in aqueous solution (which does not modify whatever be the physico-chemical conditions to which it is subjected) for the mixture to remain perfectly sterile. I hence concluded that the interpretation given by Dr. Bastian to his experiment was totally inadmissible.

Dr. Bastian replied (*Comptes Rendus*, July 31 and August 21); he did not at all dispute the legitimacy of my reasoning, but he affirmed that I reproduced his experiment badly and exceeded the exact point of neutralisation of the urine. Such is, according to him, the cause of the sterility of the liquid in my hands.

The question is then limited to the point: Have I done anything else but replace the liquor potassæ by melted potash, and specially, have I exceeded the point of saturation of the urine, and is there anything amiss in so doing?

I have examined the debate reduced to these terms, along with M. Joubert, with all the attention of which we are both of us capable, and we are able to declare to the Academy, on the basis of new experiments, that the exact neutralisation of the urine by solid potash, which we had melted, left the urine sterile. We add, although that may not be indispensable, that there is no obstacle to the fertilisation of urine, in the experi-

<sup>1</sup> Continued from p. 303.

<sup>2</sup> Note on the Alteration of Urine in reference to Recent Communications of Dr. Bastian, by MM. Pasteur and Joubert.

ment of Dr. Bastian, in exceeding the point of saturation, even sensibly.<sup>1</sup>

The conclusion of my reply of July 17 last is then unassailable, consequently it is not accurate that Dr. Bastian has found the physico-chemical conditions for the spontaneous generation of bacteria.

We have examined experimentally, with not less attention, all the other points treated by Dr. Bastian in his papers of July 31 and August 21, subsequent to his original note of July 10. We are prepared to discuss them, but as they might distract attention from the main point of the debate we shall return to them later if convenient. One thing is of importance at the present moment, to know if Dr. Bastian is still convinced that urine, exactly neutralised by potash, yields microscopic organisms.

What we have said on the influence of solid potash may be repeated for liquor potassæ after it has been raised to 110°. But we wish to reply to-day to Dr. Bastian solely by the facts relative to solid potash, which suffice by themselves alone to condemn the conclusions which he has deduced from his experiments.

The reader will doubtless remark that in the preceding abstract we have scrupulously avoided introducing the word *germ* and opposing a doctrine to a doctrine. We have to do with a fact: Yes or no, does urine which has been boiled so as to be sterile, and better still, fresh, natural urine, just from the bladder, not having been submitted to any preliminary boiling—does this at 50° yield organisms after having been neutralised by potash? Dr. Bastian says yes, and this is his pretended great discovery. We say no, and we demonstrate by proving that Dr. Bastian would have obtained a result absolutely contrary to that which he published if he had made use of the substance KO<sub>2</sub>H<sub>2</sub>O, which alone, in cases when it is pure or only associated with mineral matters in small quantity, has the exclusive right of being called potash.

The following reply to the above by Dr. Bastian was read at the Paris Academy, January 22<sup>2</sup>:—

At the *séance* of the Academy of January 8 [M. Pasteur, in conjunction with M. Joubert, contributed another "Note sur l'Altération de l'Urine," in reply to the last communication which I had the honour of submitting to the Academy at its *séance* of August 21 of last year.

It may, perhaps, be permitted to me to state that an account of my researches on the fermentation of urine, much fuller than what has appeared in the *Comptes Rendus*, is now to be found in the *Proceedings* of the Royal Society No. 172, 1876; and to this paper I would particularly call the attention of all those who are interested in the question of the mode of origin of Bacteria and other related problems.

I have found, as stated in an earlier communication to the Academy, that previously sterile urine, when exactly neutralised by boiled liquor potassæ (of the British Pharmacopœia) will rapidly ferment and swarm with Bacteria, if the mixed fluids are maintained at a temperature of 50° C. M. Pasteur, after repeating my experiments with certain variations, said (*Compt. Rend.*, July 17, p. 178): "Je m'empresse de déclarer que les expériences de M. le Dr. Bastian sont, en effet, très-exactes; elles donnent le plus souvent les résultats qu'il indique." He then explains why he differs from me as regards the interpretation of these experimental results. It is somewhat confusing, therefore, to find M. Pasteur now saying in his most recent communication: "une seule chose importe en ce moment, c'est de savoir si le Dr. Bastian est toujours convaincu que l'urine neutralisée exactement par la potasse donne des organismes microscopiques?" My reply is simple. M. Pasteur has implied (*loc. cit.* p. 179) that solid potash heated only to 100° C. does lead to such an effect; I, however, have made no experiments with solid potash, though, in operating with the boiled liquor potassæ already named, I have many times obtained the result indicated, and am quite prepared to demonstrate to others the fact of the occurrence of fermentation in urine under these conditions.

In using solid potash M. Pasteur departed from the conditions of my experiments in a way which was wholly needless. It will be found much more convenient for others to repeat them exactly. Seeing that a strong solution of potash in suitable quantity can be easily heated in a closed glass tube to the temperature which

<sup>1</sup> It is not useless to say here that, contrary to what is generally admitted, urea in aqueous solution or in urine is decomposed at 100° C. and even at temperatures much lower. The product of decomposition is carbonate of ammonium.

<sup>2</sup> On the Fermentation of Urine: Reply to M. Pasteur. By Prof. H. C. Bastian.

M. Pasteur desires (110° C.), there is absolutely no reason for substituting solid potash as he has done. The liquor potassæ used by me has always been procured from Mr. Wm. Martindale, of 10, New Cavendish Street, London.

In his "Note" of July 17, the interpretation given by M. Pasteur of my results was that the liquor potassæ used by me immediately after it had been heated to 100° C. induced fermentation in the urine because it contained living germs not killed at this temperature of 100° C., but which would have been killed had the potash solution been heated to 110° C. M. Pasteur has strangely understood my meaning if he thinks, as he now intimates, that I have not contested the legitimacy of his reasoning. I am very far from regarding it as "irreproachable," and that for reasons which I have previously given. If, however, I have not been able to make myself understood it will be well for me to repeat the reasons on account of which I still absolutely reject M. Pasteur's interpretation. They are these:—(1) It is to me incredible that a fluid so caustic as the strong liquor potassæ which I have employed could contain living germs after it has been raised to 100° C., and it is not too much to ask that he who makes such an assertion should prove it; (2) that liquor potassæ (when added in proper quantity to the urine) is just as efficacious after it has been heated to 110° C. as when it has only been heated to 100°; (3) the decisive proof that liquor potassæ previously heated to 100° does not induce fermentation in sterile urine by reason of its containing living germs, is to be found in the fact that the addition of one or two drops of it only (when much more would be required for neutralisation), subsequently leaves the urine as barren as if no solution of potash had been added; whilst if the liquor potassæ really induced fermentation in the cases mentioned above (2) because of its containing living germs, then one or two drops of it would always suffice to infect any quantity of sterile urine to which they may have been added.

In his last communication to the Academy, M. Pasteur says:—"La question se trouve donc limitée à la connaissance de ce point:—Ai-je fait autre chose que de remplacer la potasse en solution par de la potasse fondue, et notablement, ai-je dépassé le point de saturation de l'urine, et y a-t-il quelque inconvénient à le faire?" To these three questions I reply as follows:—(1) Yes, too much potash was also added; (2) Yes, in those experiments in which you obtained negative results, you expressly state that potash was added in quantity sufficient to render the fluid "alkaline" *Compt. Rend.* t. lxxxiii. pp. 179 and 377; (3) Yes, according to my experience, any amount of potash beyond what is sufficient to neutralise the urine in its unboiled state is decidedly prejudicial to the inducement of fermentation, and I have especially cautioned experimentalists on this subject (see *Proceedings* of Royal Society, No. 172, pp. 152 *note* 1, and 155).

I would also call M. Pasteur's attention to the fact that in his last communication to the Academy, as printed in the *Compt. Rend.* for January 8, on the two occasions on which he professes to describe my experiment, he does it inaccurately. Thus, on p. 65, lines 2 and 3, and also on p. 66, in the sixth line from the termination of his note, he omits to mention the important fact that the added liquor potassæ was previously boiled.

Further discussion between M. Pasteur and myself seems to me in the present phase of the question to be almost useless. Certainly, no good can come from our alternate enunciation of opposite experimental results, when precisely the same methods have not been had recourse to. For my own part I am perfectly ready to reproduce before competent witnesses the results of which I have above spoken; or, failing this opportunity, I shall also be content patiently to await the ultimate decision of other properly informed fellow investigators, both here and on the Continent, as to the correctness of the facts which I have had the honour of announcing to the Academy.

#### JOHANN CHRISTIAN POGGENDORFF

SCIENCE has lost one of her most diligent and devoted servants by the death of Prof. Dr. J. C. Poggendorff, in Berlin, on January 24. He was born in Hamburg on December 29, 1796. The early deaths of both parents forced him at a comparatively tender age to engage in the rougher conflicts of life; a circumstance which, however, contributed in a great measure to the rapid development and maturity of his

mental powers. At the age of sixteen he entered the establishment of a pharmaceutical chemist, and was actively engaged for eight years in this occupation. His hours of leisure were devoted to scientific study, and his aspirations gradually rose above the narrow limits in which he was confined. These longings were gratified in 1820, when he was enabled to enter the University of Berlin as a student of physics. With restless energy Poggendorff entered upon his chosen field and quickly gave evidences of more than ordinary talent. In 1821 Oken's *Isis* contained his first paper, "Physico-chemical Investigations upon the Magnetism of the Voltaic Pile." In this article he describes his discovery of the electro-magnetic multiplier or galvanometer, formed by carrying a wire several times round a magnetic needle in a vertical plane; an apparatus which with Schweigger's later improvements, is in universal use. Other articles on closely-allied subjects appeared at this period in Gilbert's *Annalen*. The abilities of the young physicist were soon recognised, and he received from the Royal Academy of Sciences at Berlin the post of "observer," which enabled him to continue his scientific investigations. The leading savants of the day—G. Rose, H. Rose, v. Buch, Alexander v. Humboldt, Mitscherlich, and others—gave him also a warm welcome into the circle of their friendship.

In 1824 Poggendorff conceived the plan of issuing a new physico-chemical journal on a more extensive basis than any other hitherto existing in Germany. The above-mentioned investigators, as well as Berzelius, Arfredson, Bonsdorff, and other prominent foreign chemists and physicists promised a hearty co-operation in the new enterprise. Before the completion of the preparations, the death of Prof. L. W. Gilbert, of Leipzig, who for twenty-five years had issued Gilbert's *Annalen der Physik*, left that periodical without an editor. Poggendorff entered at once into negotiations with the publisher. The result was that he edited the seventy-sixth and closing volume of Gilbert's series, and then issued the first number of the *Annalen der Physik und Chemie*. This was the decisive step of Poggendorff's life. Although but four years had elapsed since the commencement of his university studies, he brought to the new undertaking a breadth of knowledge, a keenness of discrimination, and a true love and enthusiasm for his work which, united with the warm co-operation of leading investigators, gave the *Annalen* at once a prominent position among scientific periodicals. The somewhat exacting duties of the new position did not prevent the continuance of his researches. In 1827 he invented the magnetometer for the measurement of minute magnetic variations. At this time, also, papers appeared from him on the vibrations of light, on the aurora borealis, on the law of diffusion of gases, on the decomposition of chemical compounds, on the relations between the elements of ternary compounds, &c., all of which evidenced a comprehensive grasp of the varied departments of chemistry and physics. In 1834 he received the degree of Ph.D. from the University of Berlin, and in 1844 the degree of M.D. from the University of Königsberg. In 1834 he was elected to the position of extraordinary professor of physics at Berlin, in which relation he continued to the time of his death. The Royal Academy of Sciences at Berlin elected him to membership in 1839, and the most important of his subsequent researches were published in the *Transactions of the Academy*. These were confined almost exclusively to galvanism and electricity, and form altogether one of the most valuable and extensive contributions which has been made to our knowledge in this department. His labours were chiefly directed to the study of electro-chemical and thermo-electric phenomena, methods of measuring the intensity of the galvanic current, the laws of galvanic polarisation, the resistance of various conducting mediums, &c., as well as the invention of numerous pieces of apparatus applicable in this branch

of physics. In 1837 Prof. Poggendorff was actively engaged with Liebig in the preparation of the first volume of the well-known "Handwörterbuch der Chemie," but was unable to continue his co-operation in the succeeding volumes. A series of biographical sketches, "Lebenslinien zur Geschichte der exacten Wissenschaften," appeared from his pen in 1853, and were followed in 1863 by a compendious "Biographisch-literarisches Handwörterbuch zur Geschichte der exacten Wissenschaften." This book of about 3,000 pages includes the biographies and fragments of works and papers of the scientific men of all nations and all times, and involved an immense amount of time in the preparation.

Valuable as were the experimental results and encyclopaedic labours of Prof. Poggendorff, they assume a subordinate position by the side of the great life-work on which his energies were chiefly expended. In the long series of over 160 volumes of the *Annalen der Physik und Chemie*, he has left behind him the most enduring monument to his zeal and devotion in the cause of science. His rare combination of talents, his fine critical powers, his unflinching industry, and his long period of service render his scientific editorial career strikingly similar to that of the recently-deceased founder and editor of the *Revue des deux Mondes* in the world of politics and letters. The translation of the articles of foreign investigators forming no small part of his editorial labours. The seventy-six contributions of Faraday alone occupy between two and three volumes, those of Brewster and Regnault require each over a volume. It has been calculated that about one-fifth of the total number of volumes of the *Annalen* would be occupied alone with the editor's translations. The original plan of making the *Annalen* a complete record of all advances made in both chemistry and physics gradually became impossible, as the opportunities and incitements for original research increased. With the appearance of the various chemical serials in Germany, the department of chemistry became less and less prominent, until the *Annalen* has assumed an almost purely physical character.

Ever watchful to detect and recognise merit in fellow-labourers, he stood upon peculiarly intimate and friendly relations with a large proportion of his extensive staff of contributors. Their feelings of love and respect found opportunity for expression three years ago, when many of them gathered to celebrate the fiftieth anniversary of the foundation of the journal. The occasion was very fittingly observed by the presentation to the aged editor of a jubilee volume of the *Annalen*, compiled under the direction of the contributors, and containing special articles from a number of leading physicists. The hope then expressed that it might be followed by many more volumes under his editorship was not destined to be fulfilled. He had reached his eighty-first year with unimpaired possession of mental and physical powers, when death suddenly removed him from his sphere of earnest, useful activity, after a brief and painless illness. A large assembly of men famous in literature and science, gathered at the burial ceremonies, to pay the last tribute to the memory of their departed friend. It is not alone in science that Poggendorff will be missed. His kindly, genial, appreciative disposition endeared him in the hearts of men from all classes of society; and the generous hospitality of his home will not easily be forgotten by those who have learned to know him in the midst of the family circle.

T. H. N.

#### THE NEW STAR IN CYGNUS

THE following three letters are published in the *Astronomische Nachrichten*, Nos. 2115, 2116:—  
On December 3 I received the news of the discovery of the new star in Cygnus, but the unfavourable weather did not allow me to search for it till the 5th.

The star on that day, when the sky cleared up for a few hours, was of magnitude, 4.5; it appears then to have decreased considerably in brightness, for Schmidt estimated the star on November 24, at magnitude 3. The colour of the star is not remarkable—yellowish-red; the spectrum is one of the most interesting that I know. It is the coloured band crossed by numerous (from eight to ten) dark bands, and besides there are several bright lines visible.

I have prepared an accurate drawing of the spectrum, which exactly agrees with a drawing made shortly before by Dr. Lohse. At the very first sight the spectrum of the new star appeared to me entirely different from those of the reddest stars, and a later accurate comparison with the drawing has enabled me to discover no satisfactory connection either with the so frequently met with band spectrum III.a, or with the rare class III.β (Secchi's type, III. and IV. respectively). Of the bright lines there was one specially conspicuous in the farthest red, as also one on the boundary of the green and blue, and two lines in the blue. In the yellow and green appeared some very bright stripes (? bands), which I, however, cannot consider proper bright lines (of which the specimen of glowing gas consists), but of which I believe there are places in the spectrum, which, by contrast with the neighbouring dark absorption bands, stand out conspicuously. In the case of the very marked band spectra of Class III.a, one has very often, and especially with a disturbed sky, the impression that there are bright lines in the spectrum, while with favourable atmospheric conditions, it is clearly perceived that regions of the spectrum deficient in lines in the neighbourhood of dark bands produce that impression.

The observations were made by means of a small spectroscope formerly described by me. With a larger Browning instrument some measurements were later attempted, and one of the bright lines undoubtedly recognised as the second hydrogen line F. The lines in the blue gave the wave-lengths 474 and 470 mill. m.m. Bright places in the spectrum (very possibly bright lines) were further observed with 512 and 498 mill. m.m. wave-lengths. We did not manage to measure the red lines.

In further characterising the spectrum, I might state that the blue and violet, in comparison with other stars which showed a band spectrum, was very well seen, and that, at all events, in consequence of the proportionally small general absorption which this part of the spectrum undergoes, the colour of the star differs little from the mean star colour.

On December 8 I succeeded in confirming and completing the observations herewith sent. I estimated the star at magnitude 5—perhaps it was even less. By means of the small spectroscope several measurements were obtained of bright lines and stripes (? bands) of the spectrum; especially was it possible to observe very accurately the position of the red lines, and to identify them with the red hydrogen line C. The following further measurements were made:—

Wave-lengths.	
587-589	Bright lines.
469-470	
526-528 (E)	
513-514	Bright stripes, very possibly bright lines.
507-509	
497-499	
485-486 (F)	Bright line.

The state of the atmosphere was bad, and very often the observations were interrupted by clouds for a long time. The double numbers for the wave-length should indicate the limits within which the particular line lies according to the measurements. It is hereby evident that besides the hydrogen lines C and F the line D<sub>3</sub> (wave-length 487.5) appears bright in the spectrum of the star. The magnesium line (δ) I have not been able

to see bright, but I have repeatedly measured a bright stripe, somewhat more broken than δ, which very possibly is identical with a bright line which, under special circumstances, stands out as the brightest line in the spectrum of the hydrocarbons. A line appeared to me to shine out temporarily in the violet, apparently the third hydrogen line in the neighbourhood of G.

I hope to be able, ere the star becomes too weak for spectroscopic research, to obtain some more accurate measurements in the positions of the bright lines.

I may in conclusion add the remark that in the constellation Cygnus there are three stars,<sup>1</sup> whose spectra are without parallel; we have therefore, in a tolerably circumscribed space of the sky, including Schmidt's new star, four objects which give a spectrum entirely differing from the many hundred stars examined hitherto.

H. VOGEL

Since the receipt of the first account of Dr. Schmidt's Nova the weather here has generally been of the most unfavourable character, and it was not until January 2 that the new star could be examined with the 15-inch refractor of this observatory. On the evening of that day the Nova was of about the seventh magnitude and of a decided red colour. The spectrum, as shown in a spectroscope of Dr. Vogel's construction, was of surprising brilliancy, and consisted of a faint continuous spectrum interrupted by five bright lines. The positions of these lines determined in parts of the scale of the instrument, and afterwards reduced to wave-lengths by comparing the spectra of moonlight and various elements are as follows:—

No.	W. L.	Mill. m.m.	Description
1	655		Intense bright red.
2	581		Middle of a rather bright band in the yellow, fading off rapidly on both sides.
3	504		Bright, well-defined line.
4	486		" "
5	456		Faint line in the violet.

It is remarkable that four of these wave-lengths agree closely with those of bright lines previously observed. Nos. 1 and 4 are obviously the C and F lines of the hydrogen spectrum. No. 3 coincides almost exactly with the brightest line of gaseous nebulae, and lastly, No. 2 corresponds very nearly with one of the bright lines in the spectra of the three remarkable stars in the Swan, pointed out by Messrs. Wolf and Rayet, and subsequently observed by Dr. Vogel (see *Berichte d. Königl. Sächs. Ges. der Wiss. Math. Phys. Cl.*, 1873, p. 556 ff.). As yet it has been impossible to confirm the above results, but considering the great interest of the subject I venture to lay this imperfect account before the readers of the *Astronomische Nachrichten*.

RALPH COPELAND

Lord Lindsay's Observatory, Dunecht, January 8

Yesterday night I observed the star of M. Schmidt; it was about the seventh or eighth magnitude, of a colour tending to greenish, but yellower than on the preceding day. The spectrum is formed of two strong lines, of which one corresponds to hydrogen and the other to magnesium. The sodium was still more marked and bright. There was besides another line in the violet, probably also hydrogen. The red of this gas is very weak and does not bear measurement. Besides these four very beautiful lines there were a number of small lines between D and the magnesium, but the space where are the two bright lines of magnesium and the F and the H is almost devoid of light. After these two bright lines towards the violet there is a dark gap, and then follows a group of very fine lines. So that the description given by M. Cornu is correct: only the bright lines are not bordered by nebulosity, but are as perfectly defined as the bright lines of nebulae.

Rome, January 9

P. A. SECCHI

<sup>1</sup> R.D. No. 4002, 40013 + 25'; 2956 + 36'; by Wolf and Rayet discovered, by me accurately examined. Communicated to the *R. Sächs. Gesellsch. der Wiss.*, December 12, 1873.

From flowers so simple as those of *G. lutea*, which openly offer their honey to all flying insects, but, in spite of their extraordinary conspicuousness, are incapable of securing cross-fertilisation by the various visitors, the genus *Gentiana* advances to such species as exclude from the honey the majority of the less industrious visitors, and at the same time compel the most industrious of the larger *Apidae*, chiefly the humble-bees, to effect cross-fertilisation, whenever they fly from flower to flower. By what modifications of structure this improvement has been effected, may at once be seen in Fig. 96, which represents a flower of *Gentiana punctata*, longitudinally bisected from above to near the base. The petals, in *G. lutea*, nearly completely separated, are here united, and form an obliquely upright bell, wide enough to inclose the whole body of any humble-bee. The pistil, just as in *G. lutea*, stands exactly in the centre of the flower, and is terminated by two reflexed branches of the stigma, but the filaments, diverging in *G. lutea*, here incline together, so that the anthers, developing some time after the stigma, and dehiscing extrorsely, closely surround the pistil somewhat beneath the stigma. The honey being secreted, as in *G. lutea*, by an annular swelling at the base of the pistil (*n*, Fig. 97), every humble-bee is induced to creep towards the base of the bell-shaped corolla, and, when doing so, first touches the stigma and dusts it with pollen of previously-visited flowers, thus effecting cross-fertilisation; then with the same portion of its hairy body it touches the anthers and charges itself with fresh pollen. The exclusion of the majority of use-

actually observed to be visited and cross-fertilized by humble-bees, namely, *G. acaulis*, by Ricci ("Atti della Soc. Ital. di Sc. Nat.," xiv, 3, 1871), *G. pueraminantha* (H. Müller, "Befruchtung," p. 333), and *G. excisa*, by myself.

3. *Alpine Species of Gentiana, adapted at the same time to Apidae and to Lepidoptera.*—Whilst in the foregoing

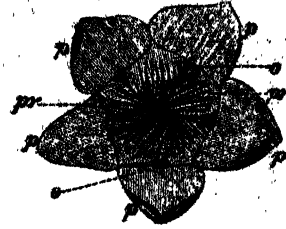

FIG. 103.

FIGS. 103-105.—*Gentiana nana*, Wulf.—FIG. 103.—Flower seen from above (*g*: *g*). FIG. 104.—The same flower bisected longitudinally. FIG. 105.—A piece of the corolla, with petals, protecting hairs, stamens, and nectaries (*g*: *g*).

group Diptera and other useless visitors are prevented from gaining the honey by the base of the corolla being constricted and by the filaments dividing the interstice between the corolla and the ovary into narrow channels, in the present group (*G. tenella*, Fig. 98-102; *G. nana*, Fig. 103-105) the same effect has been attained by the entrance to the tubular corolla being barred by hairs (see Fig. 98, 99, 102-105), between which only four or five small openings (*o*, Figs. 99, 103) are to be seen. The corolla, in the previous group wide enough to inclose the whole body of a humble-bee, is here so narrow that any proboscis attempting to reach the honey will graze the stigma and the anthers, and, when passing from flower to flower, will effect cross-fertilisation. But only *Apidae* will be enabled to thrust their proboscides between the protecting hairs, and only *Lepidoptera* have proboscides slender enough to penetrate the small openings. Thus, in these flowers the visits of *Lepidoptera* are useful for the cross-fertilisation of the plant, while in the foregoing group they are useless.

Most probably the present group is not descended from the foregoing; besides the narrowness of the corolla and



FIG. 100. FIG. 101. FIG. 102.

less visitors from the honey is effected by the base of the corolla being constricted, and the base of the filaments united with it (as far as *ch*, Fig. 96); the narrow interstice between the ovary and the corolla being thus divided by the filaments into as many narrow channels as there are petals and filaments (in *G. punctata* commonly seven, in *G. acaulis*, *excisa*, and others five). By these narrow channels humble-bees may easily pass their proboscides as far as the honey, whereas saw-flies, flies, and most beetles are unable to reach the honey.

Thus the variety of visitors has been greatly diminished; but the humble-bees, for which alone the honey is reserved, are hence induced to make more eager and frequent visits; and, as by these visits not fortuitously, as in *G. lutea*, but regularly pollen is brought from one flower to the stigma of another, cross-fertilisation in the species of this group is far more certain than in *G. lutea*; and the possibility of self-fertilisation, indeed, seems to have been lost.

Of twenty-six species of *Gentiana* inhabiting Germany and Switzerland, eleven belong to the present group, which must almost necessarily be cross-fertilised by humble-bees; namely, besides the three above-mentioned species inhabiting the plain and lower mountain region, the following eight Alpine ones: *G. punctata*, *purpurea*, *pannonica*, *acutepalata*, *Fritschii*, *frigida*, *acaulis*, and *excisa*. But hitherto only three of these eleven species have been

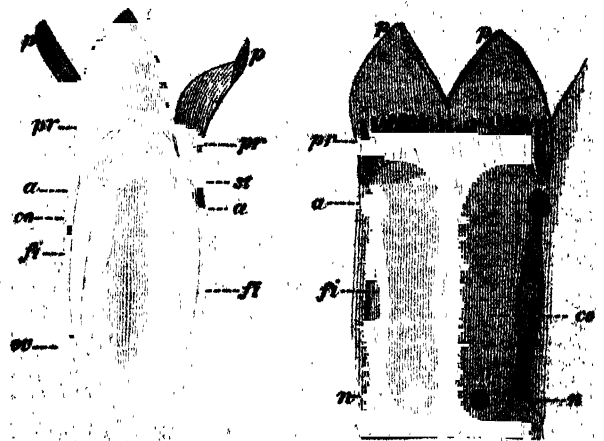

FIG. 104. FIG. 105.

the protecting hairs, the position of the nectaries is so peculiar to this group, that it is rather to be considered

I found, in the Alps, *G. excisa* visited and cross-fertilized by *Andrena*, *Lepidoptera*, *P.*, and *B. meridiana* Coen. Once, in the Albulan Pass, July 25 1876, I saw a male, *Pieris hochmanni*, creeping into a flower and sucking its honey, but without touching stigma or anthers. Also some small *Andrena* and other specimens of a small species, *Andrena subulnensis*, Rottg. (see 60) be registered as useless guests.

as a separate branch, diverging from the common stem of the genus *Gentiana*, even before *G. lutea*. For whilst in all other species of *Gentiana* the honey is secreted by an annular swelling of the base of the pistil, in this group the nectaries are situated at the base of the corolla itself, between the filaments (*n*, Figs. 101, 105). As hitherto *G. tenella* and *G. nana* have been distinguished only by somewhat fluctuating characteristics, it may be of especial interest that in *G. tenella* I have found each interstice between two filaments to contain two nectaries (*n*, Fig. 101), in *G. nana* only a single one (*n*, Fig. 105).

To the same group belong *G. campestris*, *germanica*, *amarilla*, and *obtusifolia*, two of which have been directly observed by myself to be visited both by Lepidoptera and butterflies. For instance, near Pontresina and in the Val del Fain, August 6-8, 1876, I saw *G. campestris* repeatedly visited by *Bombus mendax*, Gerst. ♀, but also by butterflies (*Argynnis pales*, *Hesperia serratula*, *Colias phacellone*, *Lycana argus*).

The fourth group of Alpine species of *Gentiana* exclusively adapted to cross-fertilisation by Lepidoptera, will be treated of in my next article.

Lippstadt

HERMANN MÜLLER

(To be continued.)

DEEP SEA MUDS<sup>1</sup>

DURING the present session I propose to lay before the Society several papers on subjects connected with the deposits which were found at the bottom of the oceans and seas visited by H.M.S. *Challenger* in the years 1872, 1873, 1874, 1875, and 1876.

*Instruments in use for obtaining information of the deposits.*

It will be convenient to introduce this first communication with a brief description of the instruments and methods employed on board H.M.S. *Challenger* with the view of obtaining information and specimens of these ocean deposits. The instrument in most frequent use was the tube or cylinder forming part of the sounding apparatus.

During the first six months of the cruise this cylinder was one having less than an inch bore, and was so arranged with respect to the weights or sinkers that it projected about six inches beneath them. The lower end of the cylinder was fitted with a common butterfly valve. This arrangement gave us a very small sample of the bottom.

In July, 1873, this small cylinder was replaced by one having a two-inch bore, and it was also made to project fully eighteen inches below the weights. This was a great improvement, as it gave a much greater quantity of the bottom in most soundings.

The tube was, in the clays, frequently forced nearly two feet into the bottom. On its return to the ship, the butterfly valves were removed, and a roll of the clay or mud, sometimes eighteen inches in length, could be forced from it. In this way we learned that the deeper layers were very frequently different from those occupying the surface.

In the organic oozes—as the Globigerina, Pteropod, Radiolarian, and Diatom oozes—the tube did not usually penetrate the bottom over six or seven inches, these deposits offering more resistance than the clays and muds. Occasionally the tube came up without anything in it, but the outside was marked with streaks of the black oxide of manganese. In about thirteen out of nearly four hundred soundings we did not get any information of a reliable nature about the deposit.

The dredge in use was a heavy modification of Ball's naturalist's dredge, and the trawl was the ordinary beam trawl of the fishermen.

Both of these instruments had generally a bag of canvas or other coarse cloth sewed into the bottom of the netting, to prevent the soft clay or ooze from being entirely washed out. In this way we, at many stations, got, along with animals, a large quantity of ooze, clay, stones, or manganese nodules.

When trawling or dredging the ship often shifted her position a mile or two, but we could not tell whether the dredge or trawl

had been working over all that distance, or had merely taken a dip into the deposits. This should be remembered when comparing the captures in one locality with those of another.

Altogether there is much uncertainty about the behaviour of the trawl and dredge in deep water. It occasionally happened that when the greatest care was taken, and when it was believed that the trawl had been dragging for some hours, it came up without anything in it, or any evidence upon it or in the attached tow-nets to show that it had been on the bottom.

During the last year of the cruise a tow-net was attached to the dredging line just below the weights, which last were placed a few hundred fathoms in front of the trawl or dredge. Tow-nets were also attached to the trawl and dredge. These nets frequently came up nearly full of mud, and almost always contained minute things and fragments from the surface layers of the bottom.

At times the water-bottle attached to the sounding line came up with clay or ooze in it, or had some of the deposit adhering to its under-surface.

These then were the means and methods employed for getting information concerning ocean deposits, and collectively they have furnished us with a large amount of material. A careful examination of the specimens procured has already much increased our knowledge of the nature and distribution of ocean deposits, of the sources of the materials of which they are built up, and of the chemical processes taking place in the deep waters and on the floor of the ocean.

*The Volcanic débris in Ocean Deposits and some of the Products of its Disintegration and Decomposition.*

In a preliminary report to Prof. Wyville Thomson, which has been published in the *Proceedings* of the Royal Society of London, I pointed out the wide-spread distribution of volcanic débris in ocean deposits, and its probable influence in the formation of deep sea clays, and manganese nodules or depositions. In this paper I propose to treat of these subjects in more detail, and to give some of the results of observations which have been made since the above report was written.

*Pumice-Stones.*

The form of volcanic débris most frequently met with in ocean deposits is pumice stone.

Specimens of these stones, varying from the size of a pea to that of a foot-ball, have been taken in dredging at eighty of our stations. I have placed the position of these stations on a map, from which it will be seen that they occur all along our route.

Near volcanic centres the dredge has frequently brought them up in great numbers, as off the Azores in the Atlantic, off New Zealand and the Kermadec Islands, at several places among the Philippine Islands, off the coast of Japan, and elsewhere. As a rule, they are not numerous in shore deposits when these are distant from volcanic regions. In deposits far from land they are most abundant in deep sea clays, from which the shells and skeletons of surface organisms have been all or nearly all removed.

In the North Pacific the trawl brought up bushels of them from depths of 2,300 and 2,900 fathoms. Perhaps in no single instance have we trawled successfully on any of our deep sea clays without getting numbers of these stones. If there be an exception it is in the North Atlantic. But here it is to be remembered that while we were investigating the conditions of the North Atlantic, our attention had not yet been directed to the importance of detecting the presence of pumice, and we have not preserved such large samples of the North Atlantic deposits as those of other regions.

On the whole, pumice-stones are more numerous in the Pacific than in the Atlantic deposits.

In the Globigerina and other organic oozes, they are abundant or otherwise, according as the deposit is near or far removed from volcanoes. In these oozes they never occur so abundantly as in the clays. They are more or less masked and covered up by the accumulated remains of foraminifera, diatoms, or other surface organisms. In like manner they are obscured in shore deposits by river and coast detritus. Besides those specimens, which are sufficiently large to be examined by the hand, we detected with the microscope minute particles of feldspar in all our ocean deposits.

An inspection of the specimens which I have placed on the table will show that the majority of these pumice stones have a rolled appearance. Some of them have undergone much decom-

<sup>1</sup> On the Distribution of Volcanic Débris over the Floor of the Ocean; and on the Nature, Origin, and some of the Products of its Disintegration and Decomposition, by Mr. John Murray. Read at the Royal Society, Edinburgh.

position, while others are little altered. Some are coated with the peroxide of manganese, or have streaks of this substance running through them. They are the most frequent nucleus of the manganese nodules, to which I shall presently refer. Some specimens which were dredged from a depth of over three miles, will, when dried, float for weeks in a basin of water; others, which have undergone partial decomposition, sink at once.

They present a great variety of texture and composition. They are white, grey, green, or black in colour. They are highly vesicular, or rather compact and fibrous. There would appear to be every gradation from common feldspathic to dark green pyroxenic kinds.

We find in them crystals of sanidin, augite, hornblende, olivine, quartz, lucite, magnetite, and titaniferous iron. Magnetic iron ore was found in all the specimens examined, either in crystals or in the form of dust. The other minerals vary in kind and abundance in the different specimens. The same crystals which we find in the pumice occur in all the kinds of ocean deposits.

#### *Sources of the Pumice-Stones.*

The pumice-stones which we find at the bottom of the sea have most likely all been formed in the air. Some of them may have fallen upon the sea; but the great majority seem to have fallen on land, and been subsequently washed and floated out to sea by rains and rivers. After floating about for a longer or shorter time they have become water-logged and have sunk to the bottom. Both in the North Atlantic and Pacific small pieces of pumice were several times taken on the surface of the ocean by means of the tow-net. Over the surface of some of these serpulae and algae were growing, and crystals of sanidin projected, or were imbedded in the feldspar. During our visit to Ascension there was a very heavy fall of rain, such as had not been experienced by the inhabitants for many years. For several days after many pieces of scorix, cinders, and the like were noticed floating about on the surface of the sea near the island. Such fragments may be transported to great distances by currents.

On the shores of Bermuda, where the rock is composed of blown calcareous sand, we picked up fragments of travelled volcanic rocks. The same observation was made by General Nelson at the Bahamas. Mr. Darwin noticed pieces of pumice on the shore of Patagonia, and Prof. L. Agassiz and his companions noticed them on the reefs of Brazil. During a recent eruption in Iceland, the ferry of a river is said to have been blocked for several days by the large quantity of pumice floating down the river and out to sea. All the pumice which we find need not be of quite recent origin. Mr. Bates informs me that great quantities of pumice are continually being floated down the Amazon. These come from near the foot of the Andes, where the head-waters cut their way through fields of pumice-stones. In the province of Wellington, New Zealand, two of the rivers run through areas covered with pumice, and during floods bear great quantities out to sea.

Prof. Alex. Agassiz has kindly furnished me with the following note:—

"The river Chile, which flows through Arequipa, Peru, has cut its way for some thirty miles through the extensive deposits of volcanic ashes which form the base of the extinct volcano, Misti. Some of the gorges are even 500 feet in depth, forming regular cañons. The whole length of the river bottom is covered by well-rolled pieces of pumice from the size of a walnut to that of a man's head. In the dry season (winter) there is but little water flowing, but in the summer, or rainy season, the river, which has a very considerable fall (7,000 feet in a distance of about ninety miles), drives down annually a large mass of these rolled pumice-stones to the Pacific. The volcanic ashes are not recent. There is no tradition among the Indians of any eruption within historic times."

Capt. Evans, the present hydrographer to the navy, informs me that he frequently picked up pumice on the Great Barrier Reef of Australia.

#### *Volcanic Ashes.*

Near volcanic centres, and sometimes at great distances from land, we find much volcanic matter in a very fine state of division at the bottom of the sea. This consists of minute particles of feldspar, hornblende, augite, olivine, magnetite, and other volcanic minerals. In the South Pacific, many hundred miles from land, and from a depth of 2,300 fathoms, the trawl brought up a number of pieces of tufa entirely composed of these comminuted fragments. These particles appear to me to have been

carried to the areas, where we find them, by winds, in the form of what is known as volcanic dust or ashes. Sir Rawson Rawson sent to Sir Wyville Thomson a packet of the volcanic ashes which fell on the island of Barbadoes, after an eruption in 1812 on the island of St. Vincent, W.I., one hundred and sixty miles distant. I have examined this, and find it made up of fragments of the same character as those in the tufa to which I have just referred, some of the particles being perhaps a little larger. We have sometimes found this ash in considerable abundance mixed up with the shells in a globigerina ooze. In the deposits for hundreds of miles about the Sandwich Islands there are many fragments of pyroxenic lava, which I believe have been borne by the winds, either as ashes, or in the form of Pele's hair.

At Honolulu we were informed that threads of Pele's hair were picked up in the gardens there after an eruption of Kilauea, one hundred and eighty miles from the volcano. This Pele's hair bears along with it small crystals of olivine.

#### *Obsidian and Lava Fragments.*

Small pieces of obsidian and of feldspathic and basaltic lavas were frequently found in deposits near volcanic islands.

At two stations in the South Pacific, many hundred miles from land, we dredged pieces of this nature of considerable size larger than ordinary marbles. It is difficult to account for the transference of these fragments to the places where they were found. It is, however, in this region, and this alone, that it may be necessary to bring in a submarine eruption to account for the condition of things at the bottom.

A consideration of these observations, and the specimens which are laid on the table, will, I think, justify the conclusion that volcanic materials, either in the form of pumice-stones, ashes, or other fragments, are universally distributed in ocean deposits.

They have been found abundantly or otherwise in our dredgings, according as these have been near or far from volcanoes, or as there has been much or little river and coast detritus, or few or many remains of surface organisms in the deposits.

#### *Some of the Products of the Decomposition of Volcanic Debris.*

Clay.—Pure clay, as is well known, is a product of the decomposition of feldspar, and the clay which we find in ocean deposits appears to have had a similar origin.

In the deposits far from land the greater part of the clay originates, I believe, from the decomposition of the feldspar of fragmental volcanic material, which we have seen to be so universally distributed.

Pumice-stone is largely made up of feldspar, and from its areolar structure is peculiarly liable to decomposition. Being permeated by sea-water holding carbonic acid in solution, a part of the silica and the alkalis are carried away, water is taken up, and a hydrated silicate of alumina or clay results.

Like most clays our ocean clays contain many impurities, these last being as varied as the sources whence the materials of the deposits are derived.

Let us briefly enumerate the sources of these materials.

We have (1) the matters derived from the wear of coasts, and those brought to the sea by rivers, either in a state of suspension or solution. The material in suspension appears to be almost entirely deposited within two hundred miles of the land.

Where great rivers enter the sea, and where we have strong currents, as in the North Atlantic, some of the fine detritus may be carried to a greater distance, but its amount can never be very large. In oceans affected with floating ice we have land debris carried to a greater distance than above stated; for instance, we can detect such materials in the deposits of the North Atlantic as far south as the 40th parallel N., and in the South Pacific as far north as the 40th parallel S.

Some of the substances in solution, as carbonate of lime and silica, are extracted by animals and plants to form their shells and skeletons; these last, falling to the bottom, form a globigerina, a pteropod, a radiolarian, or a diatom ooze. We have also the bones of mammals and fish mixed up in different kinds of deposits. These, as well as animal and vegetable tissues, generally are a source of phosphates, fluorides, some oxides of iron, and possibly of other inorganic material.

Sir Wyville Thomson, early in the cruise, suggested that much of the inorganic material in deposits is derived from the source to which I have just alluded. Our subsequent observations have, I think, shown that originally Sir Wyville gave too much



importance to this as a source of the materials in our deep deposits.

2. We have the dust of deserts, which is carried great distances by the winds, and which, falling upon the ocean, sinks to the bottom and adds to the depositions taking place. In the trade-wind regions of the North Atlantic we have a very red-coloured clay, in deep water, which is largely made up of dust from the Sahara. Such dust frequently falls in this region as what is called blood-rain.

3. We have the loose volcanic materials, which have been shown to be universally distributed as floating pumice, or as ashes carried by the wind.

This short review shows that the clay in shore deposits is chiefly derived from river and coast detritus. As we pass beyond about one hundred and fifty miles from the shores of a continent the character of the clayey matter changes. It loses its usual blue colour, and becomes reddish or brown, and particles of mica and rounded pieces of quartz give place to pumice, crystals of sanidin, augite, olivine, &c. All this goes, I think, to show that in deposits far from land the clay is chiefly derived from volcanic debris, though in the region of the North Atlantic trade-winds much of it may be derived from the feldspar in the dust of the Sahara.

The pumice which floats about on the surface of the sea must be continually weathering, and the clay which results and the crystals which it contains will fall to the bottom, mingling with the deposit which is in course of formation. In our purest globigerina ooze this clay and these crystals are present. If a few of the shells, say thirty foraminifera, are taken from such a deposit, and carefully washed, and then dissolved away with weak acid, a residue remains, which is red-brown or grey in colour, according to the region from which the ooze came. If the same number of shells be collected from the surface and dissolved away in the same manner, no perceptible residue is observed. The clayey matter would therefore seem to have infiltrated into the shells soon after they fell to the bottom.

I have already mentioned several instances of pumice-stones having been found on coral-reefs. Many more instances could be given. These stones, undergoing disintegration in these positions, add clay, crystals of augite, hornblende, magnetic iron ore, &c., to the limestones which the coral animals are building up.

I have found these crystals in the limestones and red earth of Bermuda, and in a specimen of the limestone from Jamaica.

This observation, it appears to me, points out that the red earth of Bermuda, Bahamas, Jamaica, and some other limestones, may originally have been largely derived from fragmental volcanic materials, which were carried to the limestone while yet in the course of formation. There are also small particles of the peroxide of manganese in the red earth of Bermuda.

(To be continued.)

## CHEMISTRY AND TELEGRAPHY<sup>1</sup>

DISCLAIMING at the outset any pretensions which could be advanced in his behalf for the honour conferred upon him, Prof. Abel assumed that his advancement to the position of president was intended more as a recognition of the special importance of chemical science in its application to telegraphy. Proceeding upon this assumption he made chemical science the basis of his address, and went on to show the principal directions in which it bears importantly upon the work of the telegraph engineer.

No stronger evidence of the value attaching to a combination of chemical with electrical research need be sought for than that which is to be found in the labours of the late Dr. Matthiessen. His investigations into the causes of the differences in the resistance of various kinds of commercial copper were followed by most important results.

The series of experiments so carefully conducted by him showed the influence which the principal metalloids and metals known to be naturally associated with copper exerted upon the conducting power of the pure metal, and he afterwards determined the conducting power of important varieties of commercial copper, and thus rendered it possible to assign to their real causes the enormous differences in the value of various kinds of commercial copper as conductors of electricity. For instance, amongst the many facts established by Matthiessen's experiments was the im-

portant one that by no combination of any other metal or alloy was it possible to increase the conducting power of pure copper, but that, on the contrary, a most prejudicial effect was exerted upon it by the presence of some of the non-metallic elements—notably oxygen and arsenic—which are almost invariably to be found as impurities in the copper of commerce. It was these non-metallic impurities he found rather than the presence of any of the other metals which chiefly impaired the conductivity of copper, although both iron and tin exercised a deleterious influence. Thus, fixing the conductivity of pure galvano-plastic copper at 100, the addition of merely traces of arsenic reduced it to 60; while an addition of 5 per cent. brought it as low as 6.5; the existence, again, of 1.3 per cent. of tin in pure copper reduced its conductivity to 50.4, and with only 0.48 per cent. of iron present the conductivity fell to 36.

Specially interesting were the experiments made by Matthiessen to ascertain the cause of the good effects which had long before his day been observed to be produced upon the working qualities of refined copper by the addition of minute quantities of lead. The existence of 0.25 per cent. of lead in copper renders it so rotten that it cannot be drawn into wire; the presence of even so minute a trace as 0.1 per cent. unfits it for wire-drawing. Some special action must therefore take place during the melting of copper which would serve to account for the toughening and softening effects obtained by the addition of a small quantity of lead. The fact that the copper when subjected afterwards to a most careful analysis shows nothing but the merest traces of lead, would indicate that during the process of melting, the lead combines with and removes from the copper some impurity which would otherwise materially affect its toughness and ductility. The well-known affinity of lead for oxygen, combined with the fact that the presence of oxygen in copper beyond some narrow limit was known to affect its quality prejudicially, afforded good reasons for supposing that this impurity could be nothing else than oxygen, and this view, which was further supported by the beneficial influence of lead when employed in casting operations with copper and gun metal, received the strongest confirmation of its correctness from Matthiessen's experiments. Thus, the addition of 0.1 per cent. of lead to a sample of copper (the two being fused together in a current of carbonic acid), raised its conductivity from 87.25 to 93, and the amount of lead remaining in the metal after that was too minute to be detected. So with tin, the alloying of 1.3 per cent. of which with copper reduced, as has been already stated, its conductivity to 50.4; yet on melting the sample fused in contact with air with 0.1 per cent. of tin raised its conductivity to 94.55.

It was these investigations of Matthiessen which indicated to the wire manufacturer whence he could obtain or how best fulfil the conditions for the purity of a quality of copper, which would meet the requirements of a conductor whose size might be laid down by the telegraph engineer, whilst his researches into the preparation of alloys brought the most valuable aid to the B.A. Committee of 1861, in their determination of the standards of electrical resistance.

But it is not only in facilitating the selection of suitable materials for conductors, as well as in raising their quality as such that chemical science has brought important aid to the telegraph engineer; it has been most usefully applied in the investigation and determination of the materials most suitable as the dielectrics of telegraph cables, and it is in this direction that telegraphy may look in the future for the most valuable results from the labours of the chemist. Dr. Miller's investigations (instituted at the desire of the Submarine Telegraph Committee) into the causes of the decay of gutta-percha and india-rubber, confirmed the results which Hoffman had already communicated in 1860 to the Chemical Society and which Mr. Spiller had obtained some years afterwards. But Miller examines more in detail than either of his predecessors has done, into the changes which these gums undergo, and firmly established the fact that the alterations in their structure, resulting in the gradual destruction of their insulating powers, was due entirely to atmospheric influence, accelerated by the exposure of the material to light. He further pointed out that intermittent exposure to moisture, especially if solar light has access, rapidly destroys gutta-percha, whilst if kept continually immersed in water it remains unchanged for an indefinite period. He also showed that commercial gutta-percha contained, previous to any special exposure to oxidising influences, as much as 15 per cent. of resinous matter and a considerable amount of water (2.5 per cent.) mechanically diffused through it. Considerable improvements had doubtless been made since that date in the mechanical processes for preparing gutta-percha, but these

<sup>1</sup> Abstract of Address at the opening meeting of the Society of Telegraph Engineers, January 24, by the President, Prof. Abel, F.R.S.

do not appear to have been attended with similar improvements in the quality of the material as indicated by its chemical composition, for the highest quality of sheet gutta-percha which Prof. Abel himself had been able to find contained 12.7 per cent. of resinous matter and 5 per cent. of water. Much greater pains are no doubt taken to consolidate the material and express the water from the gutta-percha coatings of wire than in the manufacture of sheet gutta-percha. Nevertheless, that a considerable amount of inclosed water still remains is evidenced by the fact that in two samples of covered wire, submitted by the same manufacturers as lately as September and November last, the one contained 1.86 per cent., and the latter 3.97 per cent. of water. Little doubt now remains that the processes of "mastication" (to which gutta-percha is subjected for the removal of certain impurities and the production of a mechanically homogeneous material) favours oxidation, so that the destruction of some of the most valuable qualities of gutta-percha as an insulator depend upon the degree of completeness to which the mechanical impurities have been removed. An examination of old gutta-percha seems to show that, provided the material has been reduced to a compact condition, oxidation due to exposure to the air and light proceeds but slowly.

Dr. Miller also points out that mastication promoted the oxidation of india-rubber, and further experience has established the similarity of the two gums in this respect. The application of vulcanising to india-rubber was hailed as a most important step in submarine telegraphy; but although many chemists have made this same process of vulcanising a subject for study and investigation, it remains imperfectly understood even to the present day. The wire manufacturer had no difficulty in meeting the most important objection urged against the application of the vulcanising process (viz., the injury done to the conductor by the chemical action of the sulphur in the dielectric upon it) by availing himself of the fact that tin would not be equally affected, and so protecting the copper by the simple process of tinning. Still the tendency to an alteration, either in the chemical or mechanical structure of vulcanised india-rubber, exhibited by it when kept submerged in water, has developed serious elements of uncertainty in cables prepared by the vulcanising processes. Prof. Abel then proceeded to give some interesting illustrations drawn from his own personal experience of the uncertainty of our existing knowledge regarding the chemical and other conditions to be fulfilled in the application of vulcanising processes to the preparation of telegraph cables.

A number of half-mile lengths, for instance, of vulcanised telegraph cable—some for field service, others for firing broad-ides on board ship—were found, after a period varying from eighteen months to three years, to have undergone considerable deterioration; the dielectric in some instances had become so porous that even the variations in the hygroscopic condition of the atmosphere on board ship, where the wires were placed between decks, caused decided differences in the results obtained with a particular battery power; and this alteration was not distributed uniformly over a length, the porosity in some instances extending along a few feet only, the adjacent portions being in very good condition; an inspection of a large quantity of the same sort of cable which had remained untouched in store showed precisely similar results.

The uncertainty attaching to this is still further illustrated by the fact that in armoured cables with multiple cores of this description some of the cores remain comparatively good, whilst the insulation of others had fallen off to a very great extent.

Scarcely less conflicting is the experience gained with cables prepared according to Hooper's system. This system consists in maintaining the inner portion of the india-rubber surrounding the conductor in an unvulcanised condition by means of a "separator," which contains a preparation of a metal possessing the power of arresting the passage of the sulphur beyond it during and subsequent to the application of the vulcanising process.

The deterioration due to the alteration of the india-rubber being caused by oxidation, the question naturally arises as to how the oxygen finds access to it? It must evidently find access to the interior of the dielectric through the substance of the cable—a view which is more than confirmed by the researches of Graham. That eminent chemist showed that solid india-rubber absorbed oxygen to an extent which showed the gas to be twice as soluble in it as in water at the ordinary temperature, and the comparatively greater priority of vulcanised india-rubber would be his absorption. The oxidation of unvulcanised india-rubber, being once established, the tendency to the absorption of oxygen by the external vulcanised india-rubber, and to its passage through

the latter, must be promoted by the increased tendency to chemical change of and continual assimilation of oxygen by the inner portion, which thus acts like the vacuum by which Graham caused air very rich in oxygen to filter through a stout vulcanised india-rubber tube.

The efforts made from time to time to improve the insulation of cables, served until lately to clear the ground for future experiments, but of late important success seems to have been achieved in a direction where different experimenters (including Prof. Abel himself) had failed—that direction is towards paraffin, "a substance which during the last thirty years had passed from the obscure position of a chemical curiosity to the foremost rank amongst important chemical products." In 1875 Mr. Field, F.R.S., working in conjunction with Mr. Talling, the mineralogist, produced by means of a solvent, or by masticating the substances together, a black ozokerit-product with india-rubber, which appeared quite free from the brittleness which Matthiessen, who also had been at work here, failed to get rid of. This preparation in point of insulation and inductive capacity compares very favourably with india-rubber and gutta-percha, and would seem likely to prove very valuable for telegraphic purposes in the future.

Prof. Abel could only allude to the importance of chemical science in the proper management of batteries, a subject which, after the valuable paper read before the Society by Mr. Sive-wright, "On Batteries and their Employment in Telegraphy," and the instructive discussions which it elicited, needed only to be named. Amongst other matters of importance where the telegraph engineer might derive great benefit from the fruits of applied chemistry, were the decay and preservation of telegraph poles, the preservation of fibrous materials used in constructing submarine cables, the production of points and the protection of cables against the deposition of vegetable or animal growth.

Prof. Abel then concluded his address by a final illustration of the manner in which the practical electrician may unexpectedly be brought face to face with problems which can be solved by a knowledge of chemistry and by that alone. Lieut.-Col. Stotherd, R.E., having pointed out certain defects in the permanency and difficulties connected with the testing of Abel's "phosphide" fuse, he (Prof. Abel) constructed another form of high tension fuse specially designed for submarine mining. The poles of this new fuse were 0.05 of an inch apart, in an insulating column consisting of Portland cement with sufficient sulphur to allow of its being melted and cast in a mould. Fuses manufactured in this way were supplied to different military stations, and after a time it was found that the average resistance of the fuses being 15,000 ohms, that of many of them had fallen as low as 300 or 400 ohms, and one or two had gone down even below 50 ohms. The cause of this at first sight inexplicable change in the stability of the fuse was traced by Mr. E. O. Brown to the existence in many of the cement pillars of very minute hair-line cracks or fissures extending sometimes right across the space between the inclosed small copper wires. The sulphur in the cement and the copper wire in presence of the air which had penetrated with the ever-concomitant moisture had set up a galvanic action which had formed one or more complete bridges, thereby short-circuiting the copper poles. Chemical knowledge, which unravelled this mystery at once, provided the remedy; platinum, upon which sulphur and air were powerless, replaced the copper, and the permanence of the fuse was secured.

A hearty vote of thanks to Prof. Abel was carried by acclamation, and it was decided that the address should be printed and circulated amongst the members.

#### SCHOLARSHIPS AND EXHIBITIONS FOR NATURAL SCIENCE AT CAMBRIDGE, 1877

THE following is a list of the Scholarships and Exhibitions for proficiency in Natural Science to be offered at the several Colleges and for Non-Collegiate Students in Cambridge during the present year:—

*Trinity College.*—One or more Foundation Scholarships of 100*l.*, and one Exhibition of 50*l.* The examination for these will commence in the first week of April.

*St. John's College.*—One of the value of 50*l.* per annum. There is a separate examination in Natural Science at the time of the annual College examination at the end of the academical year, in May; and Exhibitions and Foundation Scholarships ranging in value up to 100*l.* will be awarded to students who

show an amount of knowledge equivalent to that which in Classics or Mathematics usually gains an Exhibition or Scholarship in the College.

**King's College.**—On Wednesday, April 4, 1877, and following lays an Exhibition in Natural Science will be offered for competition. The Exhibition is worth about 90% a year, and is renewable for three years, but not with any other Exhibition or Scholarship of the College.

**Christ's College.**—One or more in value from 30% to 70%, according to the number and merits of the candidates, tenable for three-and-a-half years, and for three years longer by those who reside during that period at the College.

**Gonville and Caius College.**—One of the value of 60% per annum. The examination begins on the last Tuesday in the Lent term. College examinations are held annually in the Easter term for Medical and Natural Science Students who have passed the University previous examination, in Anatomy, Physiology, Physics, Chemistry, &c., at which prizes and Scholarships of the value of from 60% to 20% are awarded to members of the College of the first, second, and third year, on precisely the same conditions as those for other branches of learning. Examinations are also held, as vacancies occur, in Botany and Comparative Anatomy in its most general sense (including Zootomy and Comparative Physiology), for two Shuttleworth Scholarships, each of the value of 60% per annum, and tenable for three years. The successful candidates for the Tancred Medical Studentships are required to enter at this College; these studentships are five in number, and the annual value of each is 100% information respecting these may be obtained from B. J. L. Frere, Esq., 28, Lincoln's Inn Fields, London.

**Clare College.**—One of the value of 60% per annum, tenable for two years at least. The examination will be held on March 20.

**Downing College.**—One or more of the value of 60% per annum. The examination will be on or about April 9.

**Sidney College.**—One of the value of 60%. The examination will be on March 20.

**Emmanuel College.**—One Foundation Scholarship of 70%, tenable till the holder is of standing for the degree of B.A., and our Minor Scholarships (two of 70%, and two of 50%), tenable for two years, will be awarded. The examination will take place on March 20.

**Non-Collegiate Students.**—An Exhibition each year is given by the Clothworkers' Company, value 50% per annum, tenable for three years. Examination about Christmas, open to Non-Collegiate Students who have commenced residence in the October term, and to any who have not commenced residence. Information to be obtained from the Rev. R. B. Somerset, Cambridge.

The subjects, it may be stated generally, are Chemistry, Physics, Geology and Mineralogy, Botany, Comparative Anatomy and Zoology, and Physiology; but for detailed information application must be made to the tutors of the respective Colleges.

Although several subjects for examination are in each instance given, this is rather to afford the option of one or more to the candidates, than to induce them to present a superficial knowledge of several. Indeed, it is expressly stated by some of the Colleges that good clear knowledge of one or two subjects will be more esteemed than a general knowledge of several. In some instances, as at Caius College, each candidate is required to furnish beforehand a list of the subjects in which he desires to be examined.

There is no restriction on the ground of religious denominations in the case of these or any of the Scholarships or Exhibitions in the Colleges or in the University.

Some of the Colleges do not restrict themselves to the number of 15 Scholarships here mentioned, but will give additional Scholarships if candidates of superior merits present themselves; and other Colleges than those here mentioned, though they do not offer Scholarships, are in the habit of rewarding deserving students of Natural Science.

It may be added that Trinity College will give a Fellowship in Natural Science, once, at least, in three years, and that such Fellowship will be given in the present year. The examination will take place at the end of September, and will be open to all Bachelors of Arts, Law, and Medicine of the University, not more than three years' standing from their first degree. Application should be made to the Rev. Count's Trotter, Tutor of Trinity. Most of the Colleges are understood to be willing to award Fellowships for merit in Natural Science equivalent to that for which they are in the habit of giving them for Classics and Mathematics.

OUR ASTRONOMICAL COLUMN

**THE COMET OF 1812.**—In view of the approaching return of the comet discovered by Pons on July 20, 1812, which beyond doubt, at the time of its visibility, was moving in an elliptic orbit with a period of about seventy years, it is not without interest to inquire into the particular circumstances of its track in the heavens, and distance from the earth and sun, under different assumptions, with regard to the time of the next perihelion passage. The case is a very different one to that of Halley's comet (which has a period only five or six years longer than that of the comet in question) at its last appearance in 1835, or even at the previous one in 1759. The semi-axis major of Halley's comet was already known with considerable precision, from this body having been observed at several returns to perihelion since the year 1456, and in 1835 an exceedingly close prediction of the date of the comet's arrival at its least distance from the sun was made, it is true, after most laborious calculation. Pons' comet of 1812 is not thus situated. So far, no previous appearance has been recognised, and we are, therefore, dependent entirely upon the observations made in 1812 for the determination of the length of the revolution, and hence of the epoch of its next return. Within what limits these observations admit of the period being assigned, has not perhaps as yet been fully examined, but it appears probable they will be wider than in the case of another comet of similar length of revolution, that discovered by Olbers on March 6, 1815, the perturbations of which were calculated for the present revolution by Bessel, who fixes the return to February, 1887, though the prediction may be materially in error.

From the great inclination of the orbit of Pons' comet to the plane of the earth's annual path, it is perhaps possible that with a fairly accurate prediction of its position, it might be detected with very powerful telescopes, no matter at what time of the year the perihelion passage falls, but such prediction being impracticable, it is desirable, as we have already remarked, to trace out the apparent path of the comet amongst the stars, on different hypotheses as to date of arrival at perihelion. At present we shall confine our remarks to the more favourable conditions under which it is possible for the comet to appear.

The nearest approach of the comet's orbit to that of the earth (O185) occurs near the passage of the descending node, about 93 days before the arrival at perihelion, and the longitude of the descending node being in 73° 56' for 1880, we may assume the perihelion passage to take place on December 15<sup>o</sup>. In this case the comet would have the following track:—

	R.A.	N.P.D.	Distance from earth.
Nov. 5 ...	223° 8'	32° 9'	0.787
" 15 ...	228° 4'	38° 3'	0.551
" 25 ...	236° 3'	52° 7'	0.316
Dec. 5 ...	252° 5'	110° 1'	0.185
" 15 ...	283° 0'	157° 0'	0.356
" 25 ...	311° 4'	164° 8'	0.629

If the perihelion passage be taken eight days later, when the earth and comet would have about the same heliocentric longitude, with the latter body in perihelion, we shall have:—

	R.A.	N.P.D.	Distance from earth.
Oct. 24 ...	231° 3'	29° 6'	1.181
Nov. 13 ...	241° 8'	34° 7'	0.760
" 23 ...	251° 4'	40° 1'	0.529
Dec. 3 ...	267° 8'	56° 4'	0.308
" 13 ...	293° 9'	110° 7'	0.223
" 23 ...	320° 9'	146° 2'	0.396
Jan. 2 ...	336° 9'	155° 8'	0.656

Under such conditions it appears very improbable that the comet could escape observation. At its discovery in 1812 it was a diffused telescopic nebula, but towards the end of August it became visible to the unaided eye, and about the time of

nearest approach to the earth in the middle of September it exhibited a tail  $2\frac{1}{2}^{\circ}$  in length, according to Baron de Zach; at this period, though near perihelion, its distance from the earth was 1.26. We may conclude that should the comet arrive at its least distance from the sun about the close of the year, its recovery will be almost certain.

In a future note we shall examine the conditions attending perihelion passage at other seasons.

The appearance immediately preceding that of 1812 probably occurred about the year 1742. The calculated comet of that year had very different elements, and the same remark applies to the two comets of 1743. Struyck mentions a second comet in 1742, recorded in the journals of several Dutch navigators. On the morning of April 14, the ship being (at noon) in latitude  $35^{\circ} 36' S.$ , and longitude  $42^{\circ} E.$ , the comet was in the E.  $\frac{1}{4}$  S.E., with a tail  $30^{\circ}$  in length; the time is not given. From this rough indication it may perhaps be inferred that its place was somewhere amongst the stars of Pisces, or bordering ones in Aries; in too small a right ascension to admit of its identity with the comet of 1812. And as already stated, an examination of earlier cometary records is not attended with more success.

During the actual revolution there may be very sensible perturbations due to the attraction of the planet Uranus.

**THE ZODIACAL LIGHT.**—This phenomenon was conspicuous in the neighbourhood of London on the evening of the 4th inst. At 6h. 35m. the light was very much stronger than that of the Via Lactea in the brightest part above the horizon, and totally different in colour, being a pale yellow in the more elevated portion, with a ruddy tinge nearer the horizon. It was not distinctly traceable much beyond  $\zeta$  Piscium; the axis of the light passed through about R.A.  $352^{\circ}$ , N.P.D.  $100^{\circ}$ .

### BIOLOGICAL NOTES

**AMOUNT OF WATER IN TREES.**—Farmers and gardeners have often observed, and the fact is referred to by Lindley, that during cold weather the branches of certain trees are sometimes so much bent down as to obstruct passage below the tree, but that with the advent of mild weather they return to their former positions. In investigating these phenomena, Prof. Geleznov observed that they depend not only upon temperature, but also upon the humidity of the air; and he undertook, therefore, a series of researches to ascertain the amount of water contained in different parts of the branches under various atmospheric conditions. The first part of these researches (not yet published) proved (1) that the amount of water increases in each branch from its base to its summit; (2) that the bark of the larch throughout the year contains more water than the wood; and (3) that in Coniferæ the upper part, *i.e.*, the part above the pith of a horizontal branch, contains always more water than the lower part, whilst in other trees, as, for instance, the birch, the conditions are reversed; altogether, that Coniferæ and Dicotyledones seem to possess opposite properties, as regards the distribution of water in the tree. Further researches, published now in full (*Bull. Ac. de St. Pétersb.*, vol. xxii., No. 3), introduced new elements into the inquiry, namely, the varying amount of water in the bark and the wood. It appears from these researches that humidity of the wood and dryness of bark have a constant relation; that in certain trees (fir and maple) the wood remains throughout the year drier than the bark, while in others (birch and aspen) this is the case only during a part of the year, the conditions being reversed at other times. The relations between the humidity of the bark and that of the wood are so constant, that a useful classification could be based on them. It appears, further, that the smallest amount of water contained by the branches of certain trees, as, for instance, the

fir, is observed during the season when the vegetation is in fullest vigour, and that this circumstance, as well as some other important facts, is in close relation with the development of leaves. Altogether the researches, which are yet far from being completed, promise to disclose, and probably explain, a variety of very interesting facts.

**THE EEL.**—In the last session of the Rhenish and Westphalian Natural History Society, O. Melsheimer reported the results of observations on the habits of the eel, conducted through a series of years. The statement that the eel subsists on vegetable nourishment, probably originating from Albertus Magnus, is shown to be utterly false. Examinations of the contents of the stomach of numerous individuals show that the food of the eel is exclusively animal. It seems to be especially fond of the river lamprey (*Petromyzon fluviatilis*). The periodical movements—down stream in August and September, and up stream in April—are brought in connection with the spawning, which takes place in the sea. The bluish-black and the yellowish-green varieties are perfectly alike in their habits.

**HONEYDEW IN PLANTS.**—Prof. Dr. H. Hoffmann, of Giesesen, has recently published the results of his observations on the formation of honeydew upon the leaves of plants, and has come to the conclusion that it is not to be attributed to the *Aphis*, or other insects. A healthy specimen of *Camellia japonica*,  $1\frac{1}{2}$  feet in height, without blossoms, which afforded an instance of the phenomenon, was found to be entirely free from insects. The so-called honeydew consisted of a sticky colourless liquid, which possessed a sweetish taste, and contained, principally, gum. This gradually appeared on the surface of the leaves, slowly forming drops on the under-side, which dropped down to be continually replaced. The separation of the liquid continued vigorously for some time, even after the removal of the leaves from the plant. Although showing that the appearance of the dew is not attributable to insects, Prof. Hoffmann was unable to ascertain the real method of formation. On the upper side he was able to trace the origin of spots of a clear slightly sweet liquid on the leaves of an ivy, to the presence of *Coccus sp.* This insect, as well as *Coccus abietis* and *pini*, seems to possess the power of forcibly ejecting, *per anum*, a sweetish secretion, which causes them to be sought after by bees.

**RELATION OF BODY-CHANGE TO TEMPERATURE.**—From exact experiments on frogs (measuring the consumption of oxygen and production of carbonic acid at different temperatures), M. Schulz arrives at the conclusion that the exchange of materials in these animals is directly dependent on the temperature (*Pflüger's Archiv*). It is specially notable, in M. Schulz's tables, that at  $12^{\circ}$  body-temperature the frog exhales so little carbonic acid that it was hardly certain whether it produced any (the amount was 0.0084 gr. per kilo. and hour). At  $33^{\circ}$  to  $35^{\circ}$ , on the other hand, the frog shows an exchange of material which comes up to that of man, and at  $37^{\circ}$  it would probably exceed this considerably, if the organism of the cold-blooded animal permitted of so rapid a replacement as the strong consumption would require. The upper limit of temperature for the frog is therefore somewhere about  $35^{\circ} C.$

### NOTES

THE city of Brunswick is making preparations to celebrate the 100th birthday of Carl Friedrich Gauss, the mathematician and astronomer, who was born there April 30, 1777. A statue is to be erected to Gauss, and it is hoped that the foundation stone will be laid on the celebration day. Contributions are requested by the Committee to be sent to the Brunswick Bank.

FROM a circular recently issued by the general committee intrusted with the duty of collecting subscriptions for the erection of a statue to Liebig, it appears that the sum total contributed up to January 1, 1877, amounts to over 7,000*l.*, after the deduction of necessary expenses. Russia contributed over one-half of the receipts acknowledged in this third and last report. Since the decision to provide Giessen as well as Munich with a statue, the authorities of the former place have selected a fitting locality for the memorial, and laid it out in a tasteful manner.

We greatly regret to hear of the death of Capt. J. E. Davis, in his sixty-first year. Capt. Davis had only recently retired from the Hydrographical Department, to which he had rendered important services. He was also well known as an authority on polar matters, having himself seen service in the Antarctic regions. Capt. Davis had much to do in connection with the fitting out of the *Challenger* Expedition, and had himself made important contributions to hydrography.

LETTERS from Athens report the death of Prof. J. Papadakis, the Rector of the University, after a long period of suffering. He occupied the chair of mathematics and astronomy during a long series of years, and was a leading spirit not only in scientific circles, but also in the general society of Athens.

THE question of the erection of a great polytechnic school in Berlin is to be brought before the German Parliament. The estimated cost is eleven million marks.

THE philosophical faculty of Zürich University has conferred the degree of Doctor in Philosophy on a lady.

IN our notice last week of "Two *Challenger* Books," it was inadvertently implied that Lord George Campbell's "Log Letters from the *Challenger*," did not contain a map. That work has a map and an excellent one, taken, in fact, from the *Proceedings* of the Royal Society. Not only does it show the course of the ship, but the depths and dates of the various soundings, and by means of different colours, the varied deposits found on the ocean bed. The map adds greatly to the scientific value of the work.

M. BECQUEREL will take for the subject of his lectures at the Paris Museum, Light and its Effects. The course of lectures will begin after Easter, and include the subject of the radiometer. Neither of the two Becquerels, for M. Leon Becquerel is his father's assistant, has ever given his opinion on the radiometer, and their joint verdict is expected with not a little curiosity.

NINE Lectures on the Osteology of Birds will be delivered in the theatre of the Royal College of Surgeons, on Mondays, Wednesdays, and Fridays, at 4 P.M., commencing on Friday, February 16, 1877, by Prof. W. K. Parker, F.R.S.

A NEW mercury rheostat, which Jacobi devised shortly before his death, is described by M. Chwolson (*Bull. Ac. de St. Petersb.*, vol. xxii. p. 409), and its advantages and disadvantages are thoroughly discussed and illustrated by the results of some measurements. Owing to the very great precision of the new instrument, it appears to be especially useful for the measurement of very small resistances. The author concludes that this rheostat leaves far behind all former ones, and that the instrument itself, or at least its principles, will probably play an important part in future galvanometric researches.

THE Smith's prizes, Cambridge, have been adjudged as follows:—First prize, Donald MacAlister, B.A., St. John's College; second prize divided between Richard Charles Rowe, B.A., of Trinity, and James Parker Smith, B.A., of Trinity. Mr. MacAlister was senior wrangler, and Mr. Rowe and Mr. J. P. Smith third and fourth wranglers in this year's tripos.

AT a meeting of the Council of the Yorkshire College of Science, held February 2, it was resolved, "That the question of an extension of the curriculum in the direction of literature is now ripe for action on the part of the College," and a committee was appointed to confer with a delegation from the University Extension Committee, in order that a scheme might be brought before the Board of Governors. This is a step in the right direction.

THE United States Government have awarded Capt. Allen 800 dollars, and Capts. Adams, Soutar, and Walker, 300 dollars, for their kindness to the crew of the Arctic ship *Polaris*.

THE *Journal* of the Anthropological Institute will in future appear on the 1st of February, May, August, and November.

THERE will be an examination at King's College, Cambridge, on April 4 and following days, for an exhibition in natural science. The exhibition is worth about 90*l.* a year, tenable for three years, but not with any other exhibition or any scholarship of the college. Candidates must be under twenty years of age, unless already members of the college. The examination will be in physics, chemistry, and either comparative anatomy or botany, in addition to elementary classical and mathematical papers. Candidates must give a fortnight's notice of their intention to compete, sending in to the tutor certificates of character, and naming the particular subjects in which they wish to be examined.

THE following College Lectures in the Natural Sciences will be given at Cambridge during Lent Term:—Gonville and Caius College: "On the Physiology of Digestion, Absorption, and Sanguification," by Dr. Bradbury; "On Non-metallic Elements," by Mr. Apjohn. Christ's College: "On Vegetable Histology," by Mr. Vines. St. John's College: "On Chemistry," by Mr. Main; instruction in Practical Chemistry will also be given; "On Physical Geology," by Mr. Bonney; "On Palæontology," by Mr. Bonney; in the course of the term some demonstrations in Microscopic Lithology will be given; elementary course in Geology postponed to next term. Trinity College: "On Electricity," by Mr. Trotter; "Elementary Physics," by Mr. Trotter; "An Elementary Course of Practical Morphology," by Mr. Balfour; "Practical Physiology and Histology," by the Trinity Prelector in Physiology (Dr. Michael Foster), at the New Museums. Sidney Sussex College: "On Vegetable Histology and Physiology," by Mr. Hicks. Downing College: "On Chemistry," by Mr. Lewis; "On Comparative Anatomy and Physiology," by Mr. Saunders.

THE Bessemer Medal of the Iron and Steel Institute has been awarded to Dr. Percy, F.R.S.

THE King of Greece has conferred upon Mr. Edward Stanford the knighthood of the Royal Order of the Saviour for the services rendered by him to geographical science.

A BILL has been proposed to the U.S. Congress for the equipment of several Arctic expeditions.

THE sad news has been received from the African West Coast, that Baron Barth committed suicide, under an attack of fever, at Loanda, on December 7, 1876, and Dr. Mohr died at Malange on November 26, 1876, where he had only recently arrived. Baron Barth was making a botanical and geological survey of Portuguese Africa on account of the Portuguese government. Dr. Mohr will be known to our readers as the author of an interesting narrative of his journey to the Victoria Falls of the Zambesi; he was sent out by the German African Society to carry on the work of exploration from the Portuguese colony from which so many German explorers have had to return.

A FRENCH expedition under MM. Brazza and Marche is

exploring the Ogowe, a large stream to the north of the Congo. News has been received by the Geographical Society of Paris from these explorers, said to be important, and will be made public at the next sitting.

THE recent discussion of the budget in the Belgian House of Representatives brought out some interesting information as to the state of primary instruction in the country. The general yearly expenses of the State for educational purposes being, in the average of many years, about 480,000*l.* (6 per cent. of the whole of the budget), from two-fifths to one-half of this sum was devoted to primary instruction. The ordinary allotments of the State for this subject were, during the years 1872 to 1876, from 188,000*l.* to 244,000*l.*; but the part taken by the communes in primary instruction is very limited. When compared for instance, with Germany, the share of these expenses which falls on the State, is as much as about 38 per cent. of the whole of the expenses of the country. The number of normal schools for primary instruction was thirty-nine, for a population of 5,250,000 souls, *i.e.*, one normal school for every 141,970 inhabitants. But the instruction, and yet more the inspection, remain still mostly in the hands of the Catholic clergy, and the general results of the efforts made by the State, though showing some improvement during the last ten years, are by no means satisfactory. Steps are being taken to introduce the teaching of natural science into primary schools. Thus, M. Couvreur ably advocated in the House the foundation of a central and some local pedagogical museums, on the plan of that of St. Petersburg, which museums would be permanent exhibitions of recent improvements made in Europe and America in the elementary teaching of natural science; he also recommended institutions where the value of the various methods and apparatus could be submitted to experiment and discussion. Such a museum is to be opened before long by the city of Brussels. The Ministry also recommends to teachers to give to their scholars some elementary notions in natural science, applied to agriculture.

THE first number of Petermann's *Mittheilungen* for 1877 contains several papers of much value. There is the first instalment of a paper on the ethnology of Russia, in which this question is gone into with the usual thoroughness, accuracy, and detail of this journal; it is accompanied by a carefully-constructed map, embracing the whole of Russia in Europe and Asia, as well as some of the neighbouring territories. Dr. Loesche describes the results of a journey by himself and Dr. Falkenstein, in 1875, up the Killoo or Kuilu river, in Loango; he gives some important notes on the natural history of the district. E. Tessier gives a *résumé* of M. J. Dupuis' travels in South China, and Dr. A. Mühy discusses the geographical conditions of some European storms. In a short paper we are informed that Clemens Denhardt has been making preparations for some time for an exploring expedition into Central Africa, the particular region which he intends to occupy being that bounded by the Indian Ocean, the east and south of the Abyssinian Mountains, the Nile and its tributaries, the great lakes, Kilimanjaro and the River Dana—a region still almost entirely unknown. A feature of great interest and the highest importance has been commenced in this number, *viz.*, a monthly summary of geographical work in the various regions of the globe, by Dr. Behm. The first instalment embraces the last three months of 1876, and its regular continuance will make the *Mittheilungen* almost all that could be desired as a geographical journal.

M. FOUQUÉ has been appointed professor to the College of France, in room of the late M. Charles St. Claire-Deville, whose pupil and assistant he was.

AT the next meeting of the Society of Telegraph Engineers, to be held on the evening of Wednesday the 14th inst., Mr.

W. H. Preece will read a paper on "Shunts and their Applications to Electrometric and Telegraphic Purposes."

WE have received the first number of a new monthly popular Norwegian scientific journal named after our own, *Naturen*. The editor is Hans H. Reusch, and among the list of contributors is the well-known name of Prof. Sars.

PROF. DE BARY, of Strassburg, has declined the offer of the Botanical Chair in Tübingen rendered vacant by the death of Prof. Hofmeister.

DR. HENRY MUIRHEAD, of Cambuslang, has offered to the University of Glasgow the sum of 2,100*l.* as an endowment for a Demonstrator of Physiology in connection with the Chair of the Institutes of Medicine. The object of the endowment is the promotion of medical science by the training of young men of suitable capacity to become teachers and investigators of physiology, and as this training is best attained by actual work in the laboratory and by practical experience in the art of teaching, the demonstrator will be regarded as a teaching assistant to the professor, while he will also be encouraged to pursue independent original investigation, and will be aided by the use of all the laboratory appliances.

THE third edition of "L'Homme Fossile en Europe," by the late H. Le Hon, being out of print, a fourth edition, just appeared in Brussels, will be the more welcomed as it contains besides a short biography of the author, numerous additions by M. Ed. Dupont, referring to the recent discoveries in this department, and bringing this most valuable work to the present level of our knowledge as to the origin of man.

WE are glad to see that a second edition of Dr. Frank Clowes's "Elementary Treatise on Practical Chemistry" (J. and A. Churchill) has been published, with some useful additions. We noticed the first edition in vol. xi. p. 107.

IN the *South Australian Register*, of November 28, 1876, is an interesting lecture by the Rev. S. J. Whitmee, on the Ethnology and Philology of Polynesia. He contends that over all Polynesia there are two distinct types of people, a brown race connected with the Malays, and a black, or negro race, connected with the Papuans. There is also a third and very much mixed race, to which Mr. Whitmee could not venture to give a name or assign an origin.

WE have received a separate reprint from the *Philosophical Magazine*, of Capt. Abney's paper "On the Alkaline Development of the Photographic Image."

PROF. DIETERICH, of Berlin, sought to show in a public lecture, delivered a few days since, that the theories of Darwin were by no means novel, having been essentially published by learned Arabs in the tenth century.

WE have received several numbers of the *Bulletin* of the Torrey Botanical Club of New York, containing interesting papers which relate chiefly to botanical subjects of local interest.

THE additions to the Zoological Society's Gardens during the past week include a Pig-tailed Monkey (*Macacus nemestrinus*) from Java, presented by Dr. Broadbent; a Brazilian Tree Porcupine (*Cercolabes prehensilis*) from Trinidad, presented by Mr. Eliot S. Currey; three Amherst Pheasants (*Thaumalea amherstii*) from China, presented by Dr. A. P. Reid; a Yellow-fronted Amazon (*Chrysotis ochrocephala*) from U. S. Columbia, presented by Mr. F. A. B. Geneste; three Rhomb-marked Snakes (*Psammophylax rhombatus*) from South Africa, presented by the Rev. P. H. R. Fisk; an Ocelot (*Felis pardalis*) from South America, three Andean Geese (*Bernicla melanoptera*) from Peru, purchased; two Double-striped Thickknees (*Edicnemus bistrriatus*) from Central America, purchased.

## SOCIETIES AND ACADEMIES

LONDON

Royal Society, January 25.—“Description of the Living and Extinct Races of Gigantic Land Tortoises, Parts iii. and iv. The Races of the Aldabra Group and Mascarene Islands” (conclusion), by Dr. Albert Günther, F.R.S.

In continuation of, and concluding, the researches into the history of the Gigantic Land-Tortoises, read before the Royal Society on June 20, 1874, and published in the 165th volume of the “Philosophical Transactions,” the author treats in Parts iii. and iv. of the Tortoises of the Aldabra Group and Mascarenes.

By the addition of the valuable materials obtained by one of the naturalists of the Transit of Venus Expedition to Rodriguez, and by the Hon. Edward Newton in Mauritius, as well as by the aid of supplementary information received from other sources, the author has been enabled to show in the present parts of his paper that the round-headed division of Tortoises is confined to Aldabra and never extended to the Mascarenes proper; and that the Tortoises from the latter islands can be externally, though not osteologically, distinguished as a whole from the Galapagos Tortoises, as will be seen from the following synopsis:—

Nuchal plate absent. Frontal portion of the skull flat. Fourth cervical vertebra biconvex. Pelvis with broad symphyseal bridge.

A. Gular plate double; sternum of moderate extent ... GALAPAGOS TORTOISES.

B. Gular plate single; sternum short ... MASCARENE TORTOISES.

a. Carapace thin, thickened towards the margins; centre of the last vertebral plate raised into a hump, which is separated from the penultimate vertebral by a transverse depression: *Tortoises of Mauritius* (*T. triseriata*, *T. inepta*, *T. indica*, *T. leptocnemis*).

b. The entire carapace extremely thin and fragile, all the bones very slender: *Tortoise of Rodriguez* (*T. vosmaeri*).

II. Nuchal plate present. Frontal portion of the skull convex. Third cervical vertebra biconvex. Pelvis with narrow symphyseal bridge. Gular plate double. Carapace thick. ALDABRA TORTOISES (*T. elephantina*, *T. daudini*, *T. ponderosa*, *T. hololissa*).

Linnean Society, January 18.—Prof. Allman, president, in the chair.—Three new Fellows were elected, viz., Dr. W. Miller Ord, Thos. Routledge, and S. D. Titmas.—An interesting and scientific memento of the ill-fated *Polaris* Expedition was exhibited by Mr. R. Irwin Lynch. This consisted of a pot of growing wheat which had been sown from the grain left in *Polaris* Bay, 81° 38' N., by the American Expedition. Capt. Sir George Nares, in a letter to Dr. Hooker, says that the grain in question had been exposed to the winter frosts, 1872-76; notwithstanding the intense cold it had been subjected to, the above sample grown at Kew gave 64 per cent. as capable of germination. A grain of maize, among the wheat, which also sprouted, possessed even greater interest, inasmuch as being a truly tropical plant.—The amphibious and migratory fishes of India formed the subject of a paper by Dr. Francis Day. He first instanced many forms which respire air direct, and live for long periods after their removal from water, and are but little affected by a bandage being placed round their gills, preventing the use of that organ. The *Saccobranchus* was shown to have a distinctly amphibious circulation, venous blood being sent by the pulmonary artery to the respiratory sac, and arterial blood being returned from it to the aorta. He questioned the accuracy of the swim-bladder of fishes, being the homologue of the respiratory bladder of amphibia, and observed that in the *Saccobranchus* both a respiratory sac and a swim-bladder co-existed; the one along the muscles of the back, the other more or less inclosed in bone but possessing a pneumatic duct.—Mr. G. J. Romanes read a second notice on varieties and monstrous forms of *Medusæ*. He expressed surprise that among the jelly fish—at least the naked-eyed group, with their lowly grade of organisation and proneness to exhibit the phenomena of gemination—examples of monstrous and misshapen forms are comparatively rare. In those cases met with, especially in *Aurelia aurita*, the deviations from the normal type nearly always occur in a multiplication or in an abortion or suppression of *entire segments*. This affects the segments of the umbrella in a symmetrical manner, whilst the ovaries and manubrium, to a certain extent, may or may not be implicated.

Chemical Society, February 1.—Prof. Abel, F.R.S., president, in the chair.—Dr. H. E. Armstrong read a paper on Kekulé's and Ladenburg's benzene symbols, in which he discussed the relative value of the two symbols as a means of expressing the known reactions of benzene and its derivatives, expressly pointing out how Ladenburg's prism symbol was more in accordance with our knowledge of the quinones; but that up to the present time, although it might be considered proved that in benzene six carbon atoms were linked together in a closed chain, we had no evidence to show the manner in which the atoms were united. Subsequently Mr. W. H. Perkin read a paper on the formation of coumarine and of cinnamic, and of other analogous acids from the aromatic aldehydes. These acids, of which twenty are described in the paper, were obtained by the action of a metallic salt and acid anhydride, such as sodic acetate and acetic anhydride on an aromatic aldehyde; the latter part of the paper contained an account of the acids obtained from coumarin.

Anthropological Institute, January 30.—Annual meeting.—Col. A. Lane Fox, F.R.S., president, in the chair.—The Treasurer presented his Report, which showed that the finances of the Society were in a satisfactory condition. The President delivered his anniversary address. It gave a short *résumé* of the papers that had been read during the past year. From the Report of the Council it appeared that there had been an increase of members in 1876 over deaths and retirements. The following Officers and Council were elected to serve for 1877:—President, John Evans, F.R.S. Vice-presidents: Prof. George Busk, F.R.S., Hyde Clarke, Col. Lane Fox, F.R.S., A. W. Franks, F.R.S., Francis Galton, F.R.S., E. Burnet Tylor, F.R.S. Directors and Hon. Secs.: E. W. Brabrook, F.S.A., Capt. Harold Dillon, F.S.A. Treasurer, J. Park-Harrison, M.A. Council: J. Beddoe, F.R.S., J. Barnard Davis, F.R.S., W. Boyd Dawkins, F.R.S., W. L. Distant, Robert Dunn, F.R.C.S., Charles Harrison, F.S.A., H. H. Howorth, F.S.A., Prof. T. McK. Hughes, F.G.S., Prof. Huxley, F.R.S., A. L. Lewis, Sir John Lubbock, Bart, M.P., F.R.S., R. Biddulph Martin, F. G. H. Price, F.R.G.S., J. E. Price, F.S.A., Prof. Rolleston, F.R.S., F. W. Rudler, F.G.S., C. R. Des Ruffières, F.R.S.L., Lord Arthur Russell, M.P., Rev. Prof. Sayce, M.R.A.S., M. J. Walhouse, F.R.A.S.

Victoria Institute, January 5.—Dr. C. Brooke, F.R.S., in the chair. Mr. David Howard, F.C.S., read a paper upon the structure of geological formations as an evidence of design. After which, a paper by Principal Dawson, F.R.S., on the recent discovery of numerous flint agricultural implements in America was read.

Institution of Civil Engineers, January 30.—Mr. George Robert Stephenson, president, in the chair.—The paper read was on the combustion of refuse vegetable substances for raising steam, by Mr. John Head, Assoc. Inst. C.E.

BERLIN

German Chemical Society, January 15.—A. W. Hofmann, vice-president, in the chair. E. Mulder wishes to substitute the following expression,  $M = d$ , for the usual expression of the law of Avogadro,  $M = 2d$ , by accepting as the atomic weight of hydrogen not 1, but 0.5.—I. Boguski and N. Kagander, in continuing their researches on the quantity of carbonic acid evolved in a given time by the action on marble of acids of different strength, arrives at the conclusion: that the velocities of the evolution of carbonic acid are inversely proportional to the molecular weights of the acids employed.—A. Christomanos recommended several modifications of the usual methods of analysis of chrom-iron-ore.—A. Basarow described for lecture purposes a miniature torpedo, containing only three grams of gunpowder, and sufficing to throw up water from a pail to the height of twenty or thirty feet.—F. Frerichs proposed, for organic analysis, to heat the compound in sealed tubes with oxide of mercury, and to determine the volumes of  $\text{CO}_2$  and of  $\text{O}$ .—C. Göttig has found that the ordinary method of forming aldehydes from acids by distilling their calcium-salts with formiate of lime, holds good for the production of ethyl-salicylic aldehyde, but not of salicylic aldehyde.—A. Ladenburg has observed slight differences in the two bodies,  $\text{N}(\text{C}_2\text{H}_5)_3 \cdot \text{C}_7\text{H}_7\text{I}$  (iodo-benzyl-tri-ethylamine) and  $\text{N}(\text{C}_2\text{H}_5)_2 \cdot \text{C}_7\text{H}_7 \cdot \text{C}_2\text{H}_5\text{I}$  (iodo-ethyl-diethyl-benzylamine), the former, treated with  $\text{HI}$  yielding iodide of benzyl, while the second does not yield, this product. He thinks, therefore, that these two compounds are isomeric, that nitrogen is triatomic, and  $\text{NH}_2$ ,  $\text{HCl}$  a molecular combina-





THURSDAY, FEBRUARY 15, 1877

## DARWIN ON FERTILISATION

*The Effects of Cross- and Self-Fertilisation in the Vegetable Kingdom.* By Charles Darwin, M.A., F.R.S., &c. (London: John Murray, 1876.)

FEW as are the students of vegetable physiology in this country, it is very far from a mere boast to say that, with Mr. Darwin's aid, we have no reason to shrink from comparing English work in this subject with that done abroad. Mr. Darwin has sometimes lamented that he is not a botanist, yet it would be difficult to name any scientific man with an accepted claim to that description who could point to more valuable botanical work than his studies of heterostyled plants, the fertilisation of orchids, and the habits of climbing and insectivorous plants. As to the present volume, there is no risk whatever in stating that it at once takes and will always retain a classical position in botanical literature. And when one considers that these are not the only things which have come during late years from the same apparently inexhaustible treasury, and when one remembers also that the great student who has filled it has throughout struggled with difficulties which would have effectually quenched the energy of most men, one may allow oneself to wonder whether Mr. Darwin's own scientific activity is not itself a more than remarkable biological problem.

There can be no doubt that the publication of the present work is extremely opportune. An enormous body of observations, of which a great part have been brought together by Dr. Hermann Müller, have solidly confirmed the well-known induction stated by Mr. Darwin in 1862, that "nature abhors perpetual self-fertilisation." Most persons who have studied the subject have been satisfied that the facts safely covered the conclusion that the varied adaptive contrivances in flowers really had for their object the prevention of self- and the promotion of cross-fertilisation, even if nature chose to preserve an impregnable silence as to the reason of her abhorrence of the former process. There have not, however, been wanting those who have attempted to explain away the significance of all that had been stated. Not seeing the mischief of self-fertilisation, they have hastily assumed that it had none, and thence have arrived at the conclusion that the cause of the adaptive modification of flowers must be sought for elsewhere.

At any one period the area of knowledge is always bounded by a wall too high to see over, and against which it is easy but not profitable to bruise one's head. It is difficult to say whether it requires more genius to scale the wall at one dash or to pass out by the doors which are everywhere provided for those with eyes to see them. And though no one would have the rashness to suggest that there was anything defective in Mr. Darwin's scientific vision, yet there is some comfort to be derived from the fact that he gives from his own experience a most instructive instance of the real difficulty that even the greatest of investigators may feel in emancipating himself from the limits which prepossession—conscious or unconscious—constantly opposes to

the progress of research. Without, of course, having a shadow of doubt that nature had some need to satisfy in so laboriously struggling to prevent self-fertilisation in plants, Mr. Darwin was content to suppose that it might be injurious in the long run, in some way difficult, at present—if ever—to be analysed, and, to use his own words:—

"That it would be necessary, at the sacrifice of too much time, to self-fertilise and intercross plants during several successive generations in order to arrive at any result. I ought [he continues] to have reflected that such elaborate provisions favouring cross-fertilisation, as we see in innumerable plants, would not have been acquired for the sake of gaining a distant and slight advantage, or of avoiding a distant and slight evil" (p. 8).

In fact an observation almost accidental led the way to the remarkable discoveries recorded in the present volume. Of these an article in the *Academy* (August 28, 1875) by Mr. George Darwin gave, I believe, the first intimation, and raised in the highest degree our expectations. "My father," he stated, "has now been carrying on experiments for about nine years on the crossing of plants, and his results appear to him absolutely conclusive as to the advantages of cross-fertilisation to plants." Mr. Darwin informs us that he was led to the investigation by the manifest contrast presented by "two large beds of self-fertilised and crossed seedlings from the same plant of *Linaria vulgaris*" (p. 9), in which he found to his surprise that "the crossed plants when fully grown were plainly taller and more vigorous than the self-fertilised ones." His "attention was now thoroughly aroused," and two-thirds of the present volume are devoted to the very extended course of experimentation, the results of which Mr. Darwin puts forward in confirmation of the conclusion which his first and accidental observation suggested. These results deserve and will receive the most careful study at the hands of botanists, but it would be scarcely useful within the limits of this notice to examine them in any detail. They appear, however, to me, to demonstrate completely the advantage which cross-fertilised plants obtain in all that concerns their struggle for life—in increase of size, of bulk (as measured by weight), and of fertility, as well as in precocity of flowering and capacity of resisting adverse external influences.

The remainder of the volume is, however, occupied with general discussions, upon which it may be interesting to make some remarks. The process of gamogenesis essentially consists in "the physical admixture of protoplasm derived from two sources." Mr. Darwin's investigations have left no room for even a shadow of a doubt that the object of nature in bringing about this result is to secure for the starting-point of the new organism a protoplasmic mass made up of elements which have been independently individualised or differentiated by exposure to different external conditions. Mr. Herbert Spencer explains this by the need which the manifestation of life involves for continually disturbing the condition of molecular equilibrium to which all things in nature gradually tend. But as Mr. Darwin hints, this mode of explanation scarcely does more than restate the empirical facts which we may now sum up by saying that for gamogenesis to give the best result a certain mean differentiation—vary-

ing much for different organisms—in the sexual elements which take part in it is necessary. And in so far as Mr. Spencer's theory suggests an analogy to chemical change, it is perhaps leading us away from the direction of real explanation altogether.

The use of the phrase "mean differentiation" perhaps conveniently expresses Mr. Darwin's ingenious and most probable correlation of the facts of hybridisation with those of self-fertilisation.

"It is an extraordinary fact that with many species, flowers fertilised with their own pollen are either absolutely, or in some degree, sterile; if fertilised with pollen from another flower on the same plant they are sometimes, though rarely, a little more fertile; if fertilised with pollen from another individual or variety of the same species, they are fully fertile; but if with pollen from a distinct species, they are sterile in all possible degrees until utter sterility is reached. We thus have a long series with absolute sterility at the two ends; at one end due to the sexual elements not having been sufficiently differentiated, and at the other end to their having been differentiated in too great a degree, or in some peculiar manner" (pp. 455, 456).

In this mode of regarding phenomena which at first hardly seem to have anything in common, and embracing them under a single "expression," there is a neatness quite mathematical. Mr. Darwin admits, however, with characteristic frankness that in thus breaking down the fundamental difference between species and varieties, he traverses a prejudice which "it will take many years to remove" (p. 467).

But it is possible to go even further and regard gamogenesis and agamogenesis themselves as particular cases of a generalised process. Every organism, whether sexually produced or not, may be regarded as an aggregate of cells derived from a single mass of protoplasm which has undergone repeated division. Fertilisation, as Prof. Huxley has remarked,<sup>1</sup> is only "one of the many conditions which may determine or affect that process." And this remark probably supplies the explanation of the undoubted fact that amongst flowering plants as in every other part of the vegetable kingdom, there is every gradation between plants which are simply incapable of self-fertilisation and therefore would die out if they were not perpetually crossed, and others in which self-fertilisation is the rule.

"Some few plants, for instance, *Ophrys apifera*, have almost certainly been propagated in a state of nature for thousands of generations without having once been intercrossed; and whether they would profit by a cross with a fresh stock is not known. But such cases ought not to make us doubt that, as a general rule, crossing is beneficial, any more than the existence of plants which in a state of nature are propagated exclusively by rhizomes, stolons, &c. (their flowers never producing seeds), should make us doubt that seminal generation must have some great advantage, as it is the common plan followed by nature" (p. 439).

Still there is room for believing that nature may be able to give more or less freely to plants, but in some other way, those benefits which gamogenesis, especially in its more differentiated forms, undoubtedly confers. It may be one of nature's favourite expedients, and yet not the only one. It is highly important to bear this in mind and to keep clearly in view what it is exactly that Mr. Darwin has done. He has explored, and in a manner

which had never been attempted, much less accomplished before, the precise utility of cross-fertilisation, and has consequently given enormously increased force to all arguments drawn from the adaptive arrangements that promote it by demonstrating their extreme urgency. But he has not tied nature's hands to doing her work with this implement alone, and therefore he is not open to the objection which some persons will probably urge, that cross-fertilisation cannot be so important, seeing that many plants get on apparently very well without it. This is, indeed, as if one were to argue that the printing-press cannot have had the influence attributed to it, seeing that there have been those who expressed their meaning excellently well with the help of the fore-finger and some sandy soil.

The evidence which Mr. Darwin has collected leads almost irresistibly to the conclusion that the benefit derived from gamogenesis does not depend upon any mysterious property inherent in the process itself, but that "change" is to be regarded as at the bottom of the benefit derived from it; intercrossing, in fact, ceases to be beneficial if the plants crossed have been for many generations exposed to the same conditions. The advantage is, in fact, of the same kind as that which all organisms seem to derive from "an occasional and slight change in the conditions of life." "But the offspring from a cross between organisms which have been exposed to different conditions [and therefore differentiated] profit in an incomparably higher degree than do young or old beings from a mere change in their conditions" (pp. 454, 455) and the reason is that "the blending together of the sexual elements of two differentiated beings will affect the whole constitution at a very early period of life, whilst the organisation is highly flexible." But as change may be of the most variable amount, the corresponding differentiation may be equally variable. In some cases it must be exceedingly small; amongst the *Conjugata*, for example, in *Rhynchonema*, two adjacent cells of a filament unite by small lateral processes which bridge over the intervening septum. And the bridge being very narrow, one cell is forced to become the recipient of the contents of the other and the sexual differentiation of the two conjugating cells is thereby established. In *Vaucheria*, where the protoplasm is continuous through the whole vegetative portion of the filamentous organism, the sexual organs are formed by small adjacent processes which are merely parted off from the common protoplasm of the filament which bears them. This must also be an extremely closed case of self-fertilisation, but as fertilisation is effected by motile antherozoids, there is a remote possibility of an occasional cross. The hermaphrodite condition in such cases may easily be conceived to have been developed from a stage in which conjugation alone obtains.

It would not be difficult to show that all through the vegetable kingdom the hermaphrodite condition precedes the dioecious. Thus in ferns where the sexual organs are developments of epidermal processes on the peculiar intermediate generation known as the prothallium, there is almost every condition which is met with in flowering plants. The female organs (archegonia), however, require more than one layer of cells for their ultimate development, and are consequently matured later than the male organs (antheridia). Hence ferns tend to be proterandrous and therefore functionally dioecious; and as it fre-

<sup>1</sup> "Encyclopædia Britannica," Art. Biology, p. 667.

quently happens that the young prothallium gets arrested in its development without reaching the stage in which archegonia are produced, such prothallia will be exclusively male by arrest of development. It can hardly be doubted that in an analogous manner male flowers have arisen in diclinous flowering plants. In *Osmunda* amongst ferns the complete dioecious condition is reached. There can, in fact, be no doubt that ferns are habitually cross-fertilised, and there is also good reason to believe that they are even hybridised. It is further noteworthy that whilst in *Osmunda* there is an agamic reproduction of the prothallial generation, in a few rare cases, as pointed out first by Dr. Farlow, the process of gamogenesis is wholly in abeyance and the prothallium gives rise to the spore-bearing stage agamogenetically. One might remark here that the probable absence of true gamogenesis amongst the larger fungi might be compared with this abnormal occurrence in ferns. But another explanation suggests itself. Amongst the *Myxomycetes* the continuous masses of protoplasm which constitute the plant in its active state, segregate into spores which eventually set free zoospores. These swim about to again coalesce into a plasmodium. Sachs has suggested that this coalescence is of a sexual character, and in fact a kind of multi-conjugation; and no doubt the zoospores, in their motile condition, will undergo a certain amount—inconceivably minute it may be—of differentiation, due to slight differences in exposure to external conditions such as heat and light, and thus the end of a more regular sexual process may be attained. In the higher fungi there is nothing exactly comparable with this unless we compare with the fusion of zoospores in the *Myxomycetes* the habitual inoculation and intergrafting of the mycelial threads, the result of which must be to bring about an intermixture of somewhat differentiated protoplasm.

Perhaps, therefore, on a review of Mr. Darwin's remarks on the subject of hermaphroditism (pp. 409, 410), one may demur to his conclusion that the monoecious condition "is probably the first step towards hermaphroditism." It seems not improbable that precisely the converse may be the more true. Mr. Darwin thinks "that as plants became more highly developed and affixed to the ground they would be compelled to become anemophilous in order to intercross. Therefore all plants which have not since been greatly modified would tend still to be both diclinous and anemophilous." But it does not appear that it is intended to limit this statement to flowering plants; yet it would certainly require some modification amongst *Pteridophyta* for example. As we have seen, ferns, at any rate, are not diclinous, nor are they anemophilous, yet they escape all the evil results possibly attending the hermaphrodite condition. The fact is that as long as plants possess motile antherozoids, and their sexual processes take place not in mid-air, but on damp soil, there is no need for the intervention of agencies like the wind or insects to bring about cross-fertilisation. The natural locomotive powers possessed by the antherozoids are sufficient to secure that. The difficulty began when the very limited mobility of the pollen tube was substituted for the amazing activity of the antherozoid. And it will throw a great deal of light on the question as to whether the primordial flower was diclinous or not if one considers the manner in which it probably originated.

In the first place, it must be remembered that the processes which take place in a "flower" are, in a vascular cryptogam, spread over two distinct generations. The drama which once had two acts is now compressed into one. Bearing this in mind, we shall find little difficulty in seeing in the sporangiferous cone or spike of *Selaginella* the homologue of the flower. For, like that, it is composed essentially of an axis bearing modified lateral appendages, some of which, in this case the upper ones, produce male structures—microspores—and the lower—female ones—macrospores. These bodies fall to the ground, and those from adjacent plants are more or less commingled by the wind before sexual interaction begins to take place. Now, comparing a flower, we find that it also consists of an axis with modified lateral appendages, and if we call the embryo-sac a macrospore and the pollen-grain a microspore, as we are thoroughly justified in doing, then the only important difference between a "*Selaginella*-fructification" and a "flower" is that the position on the axis of microspore- and macrospore-producing structures is inverted.

How, then, do we proceed from one to the other? Simply by prolonging the period during which microspores and macrospores remain attached to the parent plant. Instead of fertilisation being effected on soil moist enough to allow the antherozoids to move, suppose it take place on the parent plant in a comparatively dry atmosphere. Antherozoids are no longer set free by the microspore, which simply puts out processes (of which those from the microspore of *Salvinia*—forming the very rudimentary male prothallia—are a kind of foreshadowing) towards the female organs developed from the macrospore. And there is precedent, for example, amongst the *Saprolegninae*, for such a reversion to a mode of fertilisation resembling conjugation (which fertilisation by a pollen tube really is) from a phase of motile antherozoids.

There is a probability, then, that a flower originated by the retention of macrospores (more especially) within the structures of some plant-form not distantly related to *Selaginella*—such a flower would be extremely inconspicuous, destitute of colour—these modifications being only subsequently acquired—and, what is more important, hermaphroditic. Diclinous flowers would arise simply by the arrest of development of either the male or female organs, and this arrest would be only one of the several modes by which nature determines the cross-fertilisation which we now know to be beneficial, and therefore likely to be secured by the self-adjusting process of natural selection. This view, by which flowers are regarded as originally hermaphroditic, instead of, as Mr. Darwin suggests, monoecious, further supplies a very simple explanation of the otherwise almost inexplicable nature of cleistogone flowers. These being inconspicuous and self-fertilising—are probably survivals of the original type.

I am happy to be able to support what I have urged by the following passages from Mr. Bentham's presidential address to the Linnean Society in 1873. Criticising Strasburger's views as to the pedigree of phanerogams (which derived them from the diclinous Conifers), he remarks that if we accept them,

"We must suppose that races, after having once secured the advantages of a total separation of the two

sexes and undergone modifications suited to their separate requirements, have again returned to their primitive state of sexual proximity, and commenced a totally different series of modifications destined to counteract the evil effects of that proximity. A much more simple hypothesis would be that Conifers separated from the parent stock before the development of floral envelopes, the higher *Dicotyledons* before the separation of the sexes."

The anemophilous fertilisation of the arboresecent plants of cool countries is perhaps rather a climatic adaptation than a survival of a primitive condition, while the cases, of which many have been recorded, in which diclinous plants have produced hermaphrodite flowers—such as the papaw and pitcher-plant in the Glasnevin Botanic Garden described by Dr. Moore—would be easily explicable as the results of atavism, *i.e.*, of reversion to a former hermaphrodite condition. On the other hand Mr. Darwin's suggestion (p. 410) that "if very simple male and female flowers on the same stock each consisting of a single stamen or pistil, were brought close together and surrounded by a common envelope, in nearly the same manner as with the florets of the *Compositæ*, we should have an hermaphrodite flower," offers very considerable morphological difficulties. As a further argument that the flower originates like the fructification of *Selaginella*, by the sexual specialisation of adjacent lateral appendages, one may point out that the early stages in the development of macrospores and microspores are indistinguishable, while in flowering plants there is a reminiscence of this in the case of ovules occasionally being polleniferous.

Difficult as it is to resist discussing the suggestions which everywhere present themselves in this most interesting book, the limits of a review compel me to stop. I will merely point out that here; as in so many cases, investigations undertaken from a purely scientific point of view are not without their practical utility. The precise conditions which Mr. Darwin has ascertained as sufficient to fix in a fleeting variety any particular quality, will be of the last importance in the hands of cultivators.

Just two centuries before the date of this book Sir Thomas Millington, at Oxford (1676), laid the foundation of this branch of investigation by assigning to pollen on theoretical grounds its hitherto unknown function. This it only remained for Bobart, in the Oxford Physick Garden, to experimentally verify (1681). Science is the property of no nation, nevertheless one may feel some pride that the first and the last of the capital discoveries that have been made in respect to plant fertilisation belong to Englishmen.

W. T. THISELTON DYER

#### OUR BOOK SHELF

*Bulletin des Sciences Mathématiques et Astronomiques.*  
Tome dixième. Mars-Juin, 1876. (Paris: Gauthier-Villars.)

WE have no mathematical publication in this country covering quite the same ground as this admirable *Bulletin*. Indeed we hardly think such a journal could survive the issue of half-a-dozen numbers here. The late Mr. T. T. Wilkinson, in an interesting series of notices of "Mathematical Periodicals," points out that such periodicals have "formed a distinguishing feature in our scientific literature for upwards of a century and a half," and quotes a remark of Prof. Playfair (*Edinb. Rev.*, vol. xi.) to the effect that "a certain degree of mathematical science, and, indeed, no inconsiderable degree, is, perhaps, more

widely diffused in England than in any other country of the world." These observations have reference principally to such journals as the *Lady's and Gentleman's Diary*.

A very limited circulation, we fear, rewards the editors of the *Quarterly Journal of Mathematics* and the *Messenger of Mathematics*. Nor do we think the state of things would be greatly altered if such a publication as the one before us were started here. The division is mostly a triple one—a review, or reviews, of new mathematical works, followed by an analysis of the contents of current mathematical publications, occasionally supplemented by an original paper.

In the March number we have a long account of Dr. Lindemann's edition of Clebsch's "Vorlesungen über Geometrie" (ersten Bandes erster Theil), a review of Rear-Admiral Sands's "Astronomical and Meteorological Observations" (1871, 1872), an analysis of Dr. Günther's "Lehrbuch der Determinanten—Theorie für Studierende." We have also in this and the other numbers descriptions of the contents of Bellavitis' *Rivista di Giornali*, Catalan and Mansion's *Nouvelle Correspondance Mathématique*, *Mathematische Annalen*, *Giornale di Matematiche*, *Monatsberichte*, and like periodicals. Just noticing the interesting discovery that the Gaussian logarithms (logarithmes d'addition et de soustraction) were first treated of by Leonelli (Avril No., p. 164), his work having been translated into German in 1806, and Gauss having published his table in Zach's *Monatliche Correspondenz* in 1812, we pass on to two notices of mathematical histories. M. E. Hoefler's "Histoire des Mathématiques, depuis leurs Origines jusqu'au Commencement du XIX<sup>e</sup> Siècle" (Mars No.), comes in for strong condemnation. At the end of the critique we read "nous terminerons cette analyse en exprimant le désir de voir bientôt paraître dans notre langue un ouvrage sur l'histoire des mathématiques, écrit par un mathématicien avec tout le soin que réclame une tâche aussi difficile, et s'adressant, non à tout le monde, mais à ceux qui ont intérêt à connaître cette histoire et que leurs études mettent à même de la comprendre." The importance of Hankel's "Zur Geschichte der Mathematik im Alterthum und Mittelalter" in the eyes of the editor may be gathered from the fact that the notice of it takes up thirty-four pages out of the forty-eight. Judging by the extracts and comments the work is one of much research, originality, and interest. "Tel est le résumé bien incomplet du remarquable volume dont nous avons cherché à rendre compte. Nous espérons que ce que nous venons de dire suffira pour engager tous ceux qui s'intéressent à la science à lire le livre de Hankel, et pour en faire désirer une traduction dans notre langue." Is it too much to hope that now we have living amongst us a mathematician whose "great historical treatises are so suggestive of research and so full of its spirit" this country will produce a work to rival M. Hankel's? If it is too much to expect then we hope some one will do for us what the writer in the *Bulletin* desires for his own country.

#### LETTERS TO THE EDITOR

[The Editor does not hold himself responsible for opinions expressed by his correspondents. Neither can he undertake to return, or to correspond with the writers of, rejected manuscripts. No notice is taken of anonymous communications.]

#### The Obsidian Cutlers of Melos

DURING a tour in Greece in the past summer I obtained a small number of stone implements chiefly from the Island of Kythera (cerigo) and the Isthmus of Corinth, consisting of a few corn-crushers or pounders, and some celts. The latter are particularly clumsy and very thick in section, and are usually a beach or torrent pebble of suitable form ground to a cutting edge, and sometimes roughened by pecking at the other extremity, as if to afford a firmer grasp for the hand. Their shape

makes them unsuitable for insertion into a handle except where the implement is small, and here the roughening is absent. I also obtained a large number of the obsidian cores and flakes from the Island of Melos, which are familiar to most collectors. It is on these latter objects that I shall make some observations.

On examining a series of these flakes I found a small number of them which presented a singular wavy pattern down the back ridge, which has evidently been produced by alternate pressure, or a series of taps administered by some small instrument like a punch.<sup>1</sup> I have since procured some more cores and flakes with the view of examining the question more carefully, and have been fortunate in securing some interesting evidence from them. Out of a total of 230 obsidian flakes examined I have found 39 which have this marking with more or less distinctness. In many cases the working is extremely rude, the alternate chipping wide, straggling, and uneven, and the depth of the depression and general character of the fracture such as to suggest considerable violence in the blows which produced it. In other cases the chipping is flatter and shallower, but still not very even. But in a very few choice specimens the chipping is so even and regular as to produce a pattern not unworthy of the manufactures of some of the "crimped" Danish daggers.

On examining a series of small cores I was delighted to find on a few of them traces which leave no doubt that this curious marking was produced *before* the flake was detached from the core. In addition to the beautiful parallel fluting for which the Greek cores are remarkable, I have found one ridge in some of the cores (in 22 out of 125) worked up into the serrated edge and ready for the blow which should have detached the flake. I have only had the good fortune to find in one instance a flake still *in situ* on its core whose chipping will compare with the best specimens in my possession of detached flakes. Indeed on some of the cores the working is so rude as to form merely a jagged and irregular line instead of the beautifully clean ridge of the ordinary flaking; and without the evidence of the other flakes and cores, I should not have been able to interpret the intention of these ruder specimens.

There is another form of working to be observed on a certain number of the obsidian flakes. They have in many cases, by a series of very delicate and flat chippings, had their back ridge so modified or removed as to present a blade-like surface. In some cases this extends over the whole of the back of the flake, in others (where it has been a double-ridged flake) the chipping is merely enough to remove one ridge, making a blade like one of our own dinner knives, thinner at the cutting edge than on the blunt back. The intention in this case is very evident, being merely to increase the cutting powers of the flake by removing all impediments. Here again the chipping was effected while the flake was still *in situ*. I have two or three cores with one side flattened by the removal of several ridges, and awaiting conversion into a knife-blade by a blow which never descended.

The use, however, of the flakes with the serrated back ridge, is more questionable. It is, I think, not possible to suppose that the working in this case was put there as a mere piece of ornamental cutlery, although the similar crimping on the Danish daggers was certainly so. In the best Melian flakes the working is certainly highly ornamental, but such specimens are somewhat exceptional, and in the majority of instances the working cannot be considered ornamental at all, and evidently does not aim at nicety and symmetry. Hence we may reasonably conclude that the purpose of the working was utility in the first instance, and ornament only incidentally. I think there is little doubt that these serrated flakes were manufactured to serve the double purpose of a knife and a saw (rasp, or file), and they would be by no means inefficient tools in experienced hands.

I am not aware that attention has been called to these peculiarities of the Greek obsidian flakes—or indeed that they have been hitherto observed at all; and I have therefore thought it worth while to offer some account of this interesting instance of obsidian manufacture. I am not aware that any similarly worked flakes have been discovered in Mexico; and I should be much interested if any of your readers could correct me on this point.

It is worth remarking that there are several qualities of Greek obsidian. The blackest and most beautiful is glossy and lustrous, but will by no means compare with the obsidian of Mexico in these particulars. Greek obsidian has nearly always an undertone of opaque green. There is, however, a quality which is a dull leaden grey, slightly lustrous only, and less vitreous in its

<sup>1</sup> Mr. John Evans, to whom I showed one of these, is of opinion that the marking has been produced in the second of the two ways suggested, viz., by blows administered by a small set or punch.

composition. It breaks with the same fracture as the more lustrous qualities.

When the flake is trimmed very fine, it is frequently transparent, and if held to a strong light presents a beautiful grey and black "brindled" texture.

The Greek cores are all of small size, the longest which I have seen being just under three inches; but I have one flake which measures  $3\frac{1}{2}$ , and a few which vary between that and three inches. One most exceptional specimen, however, which is quite unlike any of the others, and is weathered on both sides, measures  $4\frac{1}{2}$  inches by  $1\frac{1}{2}$  broad, has a rough central ridge, a large bulb of percussion, and is in sectional thickness  $\frac{1}{2}$  inch. I have some shorter fragments approaching the same character.

It will not have escaped the notice of many readers that Dr. Schliemann found a number of obsidian "blades" (flakes, no doubt) in one of the last opened of his tombs at Mykenae, together with twenty-five arrow-heads of flint. Future discoveries in Greece will furnish additional proofs of the general use of this material in early times, and I have little doubt that Melos served as the "Sheffield" of Greece, in the obsidian trade. I had myself the fortune to pick up a small fragment of the substance amongst the ruins of Tiryns.

I have placed the series of flakes, cores, &c., in Charterhouse Museum, where they can be seen by anyone who is interested in them.

GERALD S. DAVIES

Charterhouse, Godalming

#### Ocean and Atmospheric Currents

In a clever article in the *Quarterly Review*, on the geographical and scientific results of the Arctic expedition, which I have read with great interest, the following passage occurs:—"The polar streams flow southward as surface-currents as long as they remain under the influence of northerly winds. When they reach the region of south-westerly winds they disappear under the warm waters of the Gulf Stream. And this is for the simple reason that in each instance the stream, as Sir George Nares says, will take the line of least resistance. In the case of a stream going before the wind, this will be on the surface; when going against the wind, the line of least resistance will be some distance below it."

It is certainly very clever of ocean currents to dip below the surface, when they meet with a foul wind, but that they do so requires proof, especially as the warm current in the North Atlantic, bound presumably from the equatorial to the North Polar regions, makes a detour all along the north coast of South America, deflected by the north-east trade when it might apparently have accomplished its purpose so much more directly by the simple expedient of dipping beneath the surface. I would beg to suggest that the disappearance of the polar streams under the warm waters of the Gulf Stream, as indicated by the writer in the *Quarterly*, is to be accounted for in a far simpler manner, viz., because owing to the high temperature of the Gulf Stream in the latitude where this particular phenomenon takes place, it is lighter than the fresher but far colder water of the polar stream.

While I regret to differ from Sir Geo. Nares, backed by so great an authority as Mr. Croll, I must question the possibility of wind piling up water to any great extent either on the surface of the open ocean, or even in more confined water, of either great or uniform depth, as the water will, under those circumstances, re-establish its equilibrium by running off below the surface.

We know that in both the polar and equatorial basins, we have large volumes of water constantly running in at the bottom, or in case some of my readers may disagree with me, with reference to the polar basins, I will put it more guardedly, and say at some distance below the surface; these currents must displace on the surface a body of water exactly equal to their own volume, and this body of water must necessarily run off in that direction in which it meets the least resistance. For the sake of brevity I leave out the consideration of evaporation and precipitation, which bear a very small proportion to the large volume of these currents.

I have in a previous paper pointed out that "Heavier water flowing continuously from a higher level (*i.e.*, in the case of the ocean from the surface) into the bottom of any basin of lighter water must displace and raise a body of water equal to its own volume. The lighter water will just as surely be lifted and buoyed upwards by the heavier water as a ship, a piece of cork, or any other substance having a less specific gravity than water, and when

this lighter water is raised above the level of its own basin it will naturally flow off in the direction in which it meets the least resistance."

To conclude, I argue that while the wind undoubtedly influences the direction taken by ocean currents, difference of gravity, and not wind, is the principal promoter of them. The perfect agreement between the two systems of ocean and atmospheric currents alluded to in the *Quarterly* is, in my opinion, to be accounted for from similar causes producing similar effects.

How can the winds influence ocean currents running for thousands of miles below the surface, or how can they influence the direction of the lower strata of surface currents ranging say from 50 to 600 feet in depth, the latter being the depth of the Gulf Stream off Hatteras?

DIGBY MURRAY

January 25

MR. DIGBY MURRAY (vol. xv. p. 294), in common with a great number of meteorologists, maintains that the surface-trades have come, as upper-currents, from the Arctic and Antarctic regions, and that the prevailing westerlies of the extra-tropical regions have come, as upper-currents, from the equator, without intermingling their volume in the district of the tropical calms.

He argues that this *must* be the case, because the surface-trades on the interior borders of the tropical calms differ from the westerlies on the exterior borders in their degrees of electricity, and of saturation, and in other particulars.

I regard this argument as incontestably sound, provided always that no objection can be taken to the assumption on which it rests. That assumption may thus, as I conceive, be fairly stated: "Atmospheric currents differing greatly in character must have travelled from widely distant regions of the globe."

This premise is plausible, and the objection which I have to offer to it rests upon a fact which is, unfortunately, obscure, and which has received very little attention.

Some light is frequently thrown on the more general and permanent atmospheric circulation of our globe by the analogy of the local and temporary systems of circulation which we examine in our own latitudes. Now the *most local* currents often differ very remarkably in character according to the direction in which they move: e.g., the easterly winds felt on the south border of a small anticyclone, if pursued for a very limited distance into the district in which they begin to travel from the south, are often found to have undergone complete change in their electrical conditions, in the aspect of the clouds which they carry, in their humidity, in their amount of ozone, and finally even in their effects on the animal frame. Still more extraordinary are the alterations often noticeable in the different segments of very local cyclonic circulations. In the case of the smallest secondary depressions I have, very frequently indeed, been struck by the wonderful alteration in the several atmospheric conditions, and especially by the reversal of the electrical conditions, which immediately attends the springing up of a northerly breeze, when the barometric minimum has passed to the east. This breeze, in many of these examples, occupies a very short as well as very narrow belt, and is only of a few hours' duration. What is more important, it is usually of *very limited depth*. The synchronous upper-current observations at which I have been for some years at work, prove that in many instances of very local depressions the cirrus travels from southerly or westerly points for many hundred miles on all sides of the small depression, as well as immediately over it, in some cases very slightly affected, in others absolutely unaffected, by the limited circulation at the earth's surface.

Until therefore it can be shown (in contradiction to what is indicated by this fact) that our most local currents, if differing in character, have travelled to us at a great elevation from very high and very low latitudes respectively, I cannot hitherto regard Mr. Digby Murray's reasoning as furnishing an "absolute proof" of the soundness of his position.

From Mr. Murphy's criticisms on my former argument I do not retire, as Mr. Digby Murray may possibly complain that I have done from my discussion with himself, behind a veil of cirrus, after the convenient fashion of the Homeric heroes. But as I have already stated, my agreement with his view that "the imperfection of the Arctic as compared with the Antarctic depression is due to the amount of land in the northern hemisphere" (though differing from him as to the nature of the relation between the cause and the effect), it is perhaps hardly necessary for me to say that from his proposition in *NATURE* (vol. xv.

p. 312) I am bound to dissent. I do not think that on Mr. Murphy's hypothetical globe, possessed of an atmosphere containing no aqueous vapour, the currents would "act as in our actual atmosphere," or in a manner at all analogous to that which he describes. On this point I am afraid we must agree to differ for the present.

W. CLEMENT LAY

February 7

#### Auroric Lights

HAVE the auroric lights been studied in regard to their relations with changes in the weather? From casual observations made during the last twenty years it would appear that there are at least two distinct kinds of light so classed. One is brilliant and transparent, of a white, yellowish, bluish, or yellowish-red colour: while the other is semi-opaque and of a bloody red colour. The latter generally seems to be considered in Ireland a forerunner of bad weather, or, to quote a Connemara shepherd, "Them bloody lights are bad." The first kind generally appear as intermittent pencils of light, that suddenly appear and suddenly disappear. Usually they proceed or radiate from some place near the north of the horizon; but I have often seen them break from a point in the heavens, this point not being stationary but jumping about within certain limits. The brilliant aurora of September, 1870, was one of the latter class, except that the centre of dispersion was not a point, but an irregular figure, sometimes with three sides, but changing to four and five-sided. It began as rays near the north horizon and proceeded up into the heavens in a south-south-east direction. Sometimes, however, these lights occur as suddenly flashing clouds of light, like those of July 16 last, which were of a white colour; but at other times I have seen them of blue and reddish yellow. If this class of lights are watched into daylight they appear somewhat like faint rays of a rising sun. One morning while travelling in West Galway, in the twilight, they were very brilliant, and quite frightened the driver of the car, who thought the sun was going to rise to the north instead of at the east.

The second, or bloody-red light, usually occurs in clouds floating in one direction up into the heavens, but often depressed over a portion of the sky. I have never seen them coming from the eastward, and only on a few occasions from the southward, they generally proceeding from the west, north-west, or north. If both kinds of light occur at the same time, the second, while passing over the first, dim them. If the second class are watched into daylight they appear as dirty misty clouds that suddenly form and disappear without your being able to say where they came from or where they went to, or as a queer hazy mist over a portion of the sky that suddenly appears and disappears, or as misty rays proceeding from a point in the horizon. Generally when these clouds occur there is a bank of black clouds to the westward.

This season has been very prolific in auroric light, as there have been few nights since the 1st of October last in which they did not appear, sometimes, however, very faint. Generally they were lights of the second class, but on a few occasions there were a few rays of the first associated with them; on wet nights they made the rain-clouds or mist of a reddish purplish colour; tints of which could be seen in some of the excessively dark nights we had in November. On many occasions they were late in the night, being very common and brilliant during the "dark days" of December a few hours before dawn (about five o'clock). I have watched them carefully this season to see if we had a chance of fine weather, but each time we had a fine clear day they appeared also and the weather broke again. Last week I only saw white lights of the first class, very faint on two nights, but the weather has not cleared yet. It has, however, become seasonable, as we have had showers of sleet and snow, while previously it was like spring weather, the trees all budding out, innumerable birds singing morning and evening, and flies and wasps flying about.

G. HENRY KINAHAN

Ovoca, January 27

#### On the Sense of Hearing in Birds

THE sense of hearing is doubtless of much assistance in discovering the food of such birds as the scansores—to wit, woodpeckers, creepers, wrynecks and the like, which feed on insects.

On one occasion, in a Canadian forest, whilst seated close to a rotting pine trunk, I heard distinct scratchings in the interior, as if mice were nibbling the wood, and on splitting open the trunk, numerous large white larva of *Hylemyia* "woodworms" were found busily employed in making their tunnellings throughout the soft substance of the decayed wood.

Now, while these sounds were audible to human ears, it may be fairly believed that they would have been readily detected by the woodpecker, which may be often observed to halt suddenly on its way up a pine trunk. This trait in the mode of climbing is noticeable more or less in all the insectivorous climbers, and appears to me to be caused partly by the bird listening for the sounds produced by insects either in the bark or in the wood. I noticed this particularly in the case of the great black woodpecker (*P. pileatus*) or "log-cock," as it is named in Canada. It would suddenly stop on its way up a tree trunk, and after remaining perfectly motionless for a short time, commence to attack the bark and wood with great vehemence. Every one who has travelled in North American forests will have observed now the excavations made by woodpeckers are often confined to one side of a tree, or to particular situations. And not only on decayed parts, but, as in the case of the extremely tough cedar (*T. occidentalis*), where openings of several inches in circumference have been made through several inches of perfectly fresh wood in order to reach the decaying central layers where wood-eating beetles deposit their eggs and the animal is matured. Admitting that it may have been induced to dig out the insect by tracing the external opening inwards, still in the case of the larvæ the wandering from its birth-place, and the sounds consequent on the tunnelling process, would assuredly be heard by a bird whose ears had been trained to such delicate noises through the necessities of its mode of life. I can therefore well believe that auscultation is of great service to such birds, and also to nocturnal species in discovering their prey.

A. LEITH ADAMS  
Royal College of Science, Stephen's Green, Dublin

Tapeworm in Rabbits

I WOULD suggest that the tapeworm referred to by Mr. G. J. Romanes is like the *Bothriocephalus* of man—perhaps a species of the same genus. This is not supposed to have a cystic state, but to be developed from a ciliated embryo taken into the system on raw or badly-cooked vegetables, which have been watered by sewage from cesspools, in which the eggs will remain alive for months.

In the same way the eggs of the rabbit's tape-worm probably remain in the animal's droppings till set free in rain as ciliated embryos. As the rabbit feeds on the vegetation watered by such rain, there is no difficulty in understanding how the embryos would reach his alimentary canal.

R. D. TURNER

Meteor of January 7, 10.31 P.M.

THE fine meteor mentioned in NATURE, vol. xv. p. 244, and also seen by Mr. W. H. Wood, p. 295, was observed by many other persons; and as your correspondent asks for another observation of it, the following may be useful:—"J. L. M'C.," writing from Putney Hill, London, says: "As near as I could judge, it appeared between the stars Castor and Pollux ( $\alpha$  and  $\beta$  Gemorum), and its course lay almost due north-east, passing over the stars  $\lambda$  and  $\psi$  Ursæ Majoris, and disappearing a little beyond the latter star. It was of great brightness, left a tail of fire in its wake about two degrees in length, and was visible some ten seconds." This account, compared with the other two referred to, stands as follows:—

Place.	Meteor.		Ended R.A. Decl.	Length of path.	Duration in seconds.	
	Began R.A. Decl.					
London	153 + 43	...	200 + 31	39	...	Very slow.
W. H. Wood, Birmingham	130 + 5	...	182 + 16	52	...	
J. L. M'C., Putney Hill, London	113 + 31	...	170 + 46	46	10	

From these paths the radiant point comes out near  $\gamma$  Eridani, R.A. 58°, Decl. S., 12°, and I can confirm this position from other meteors seen in January, including one as bright as Venus, on the 4th, 8.51 P.M., which exhibited the same slow, halting motion as that noted in regard to the fine one seen on the 7th. I have read other accounts of the latter, but they are mostly vague. At Bermondsey it was seen at 10.30, and described as large and remarkably brilliant, closely resembling in size and colour the meteor which appeared on September 24, 1876. It was of a bluish colour, left a long tail or streak of light in its wake, and its course in the heavens was from south-west to north-east. At 10.37 on the same evening a very large, brilliant meteor was seen at Lower Clapton, and this, no doubt, refers to the same object.

Mr. Barrington (NATURE, vol. xv. p. 275) notes another bright meteor, at 6 P.M., on January 19, but its apparent path shows it to have been different to the one seen by a correspondent at Wolverhampton, at 6.27, January 19, who writes that he witnessed a meteor of "unusual magnitude and brilliancy. It moved almost perpendicularly, in a southerly direction, very slowly, the time occupied in its passage being about seven or eight seconds."

Ashley Down, Bristol  
W. F. DENNING

THE UNITED STATES GEOGRAPHICAL AND GEOLOGICAL SURVEY OF THE WESTERN TERRITORIES UNDER DR. F. V. HAYDEN  
Explorations in 1876.

WE have been furnished with some early notes upon the results of the work of Dr. Hayden's survey during the past year, from which we make the following extracts:—

"For reasons beyond the control of the geologist in charge, the various parties composing the United States Geological and Geographical Survey of the Territories did not commence their field-work until August. Owing to the evidences of hostility among the northern tribes of Indians, it was deemed most prudent to confine the labours of the survey to the completion of the Atlas of Colorado. Therefore the work of the season of 1876 was a continuation of the labours of the three preceding years, westward, finishing the entire mountainous portion of Colorado, with a belt of fifteen miles in width of northern New Mexico, and a belt twenty-five miles in breadth of Eastern Utah. Six sheets of the Physical Atlas are now nearly ready to be issued from the press. Each sheet embraces an area of over 11,500 square miles, or a total of 70,000 square miles. The maps are constructed on a scale of four miles to one inch, with contours of two hundred feet, which will form the basis on which will be represented the geology, mines, grass, and timber lands, and all lands that can be rendered available for agriculture by irrigation. The areas of exploration of the past season are located in the interior of the continent, far remote from settlements, and among the hostile bands of Ute Indians that attacked two of the parties the previous year."

The force was divided by Dr. Hayden into four parties. The first, for primary triangulation, under Mr. A. D. Wilson, with Mr. Holmes as artist and geologist, accomplished the survey of an area of about 1,000 square miles. The second, or Grand River party, under Mr. Garnett as topographer, and Dr. Peale as geologist, surveyed about 3,500 square miles. The third, or White River Division, with Mr. Chittenden as topographer, and Dr. Endlich as geologist, spent forty-eight days in absolute field-work, and reports a surveyed area of 3,800 square miles, in the accomplishment of which 1,000 miles of traverse were made, while forty-one main topographical stations and sixteen auxiliary ones were established. The fourth, or Yampah party, conducted by Mr. Bechler, topographer, assisted by Dr. White, geologist, surveyed about 3,000 square miles. Thus, during the two months of last autumn, these active explorers surveyed about 11,300 square miles of territory (that is more than the whole of the southern or lowland part of Scotland) with sufficient accuracy and detail to permit of the construction of a general map on this scale of four miles to an inch, and with contour lines at successive elevations of 200 feet to mark the main topographical features. Fortunately the geological structure is of extreme simplicity, otherwise such rapid and useful work would be impossible. Dr. Hayden and his associates are doing good service by making known in this way the main features of those vast territories, leaving the details to be worked out at a later time.

Among the most interesting geological results obtained last year are some additional particulars regarding the brackish water-beds lying at the base of the tertiary rocks of these western territories. Three new species of





THE UPPER COLORADO<sup>1</sup>

AMONG the most eminent services rendered by American geologists to the cause of science, there can be little hesitation in placing the labours of Lieut. Ives and Dr. Newberry as given to the world in their well-known Report on the Colorado country of the West. By pen and pencil they brought vividly before the eye and the imagination the structure and scenery of a region so singular and so stupendous in its memorials of slow prolonged subaerial erosion as not only to throw every other known district of the kind far into the shade, but to furnish proofs of the potency of river-excavation, which even the keenest advocates for the power of rain and rivers at first hesitated to believe. Since that Report appeared, however, additional and confirmatory illustrations of the same marvellous scenery have been published by other observers, notably by Hayden and Powell. The gorges of the Colorado, with walls sometimes more than a mile high and running for nearly five hundred miles across the tableland, are now more or less familiar, from descriptions and sketches, to the geologists of all countries. They are admitted, too, to be due, as Dr. Newberry first contended, to the gradual erosive action of the rivers by which they are traversed. The whole of this Colorado basin or plateau is justly regarded as the most magnificent example on the face of the globe of how much the land may have its features altered by the agency of running water.

In the present Report Dr. Newberry gives the results of a second exploration to the Colorado, but to a more northern or higher tract than that embraced in his previous journey. The Expedition took place as far back as 1859, and this Report was written and sent to the authorities by the beginning of May, 1860. At that time, however, the Civil War was impending, by which not only this publication but many others of importance were arrested. The recent surveys of the Department of the Interior and the Bureau of Engineers having called renewed attention to the Colorado region, Col. Macomb and Dr. Newberry have succeeded, at last, in inducing the authorities to print and circulate their account of the observations made by them seventeen years ago. It is a welcome contribution to the literature of the subject. Dr. Newberry, by his summary and his narrative of detail, combined with his clever lithographic sketches, presents us with so vivid a picture of the landscapes through which he has wandered and of the geological structure which has given them their character, that nothing further can be desired save a personal visit to the marvels themselves under his experienced guidance. Four of the most characteristic views are here reproduced as woodcuts.

Westwards from the Rocky Mountain ranges to the head of the Gulf of California the basin of the Colorado stretches as a vast plateau, broken by the transverse gorge of the Great Cañon, at the bottom of which, from 3,000 to 6,000 feet below the level of the plain, the river wanders to and fro for nearly 500 miles. The plateau is further marked by a succession of terraces ending in steep walls sometimes 1,000 feet or more in height, and by occasional isolated mountain areas which rise above the general level like islands from the sea. These various inequalities, however, when seen from any of the eminences bordering the plateau are almost lost in the vast sweep of the level plain. On all sides the table-land is surrounded with mountain-ranges which seem on the whole to have a meridional direction, so that the table-land itself would appear to be a tract which has somehow escaped plication during the movements by which the encircling ridges were formed. The isolated mountains

<sup>1</sup> Geological Report, by J. S. Newberry, M.D., of the United States Exploring Expedition under Captain J. N. Macomb, from Santa Fé, New Mexico, to the Junction of the Grand and Green Rivers of the Great Colorado of the West. (Washington, 1876.)

on this plain, however, indicate the same north and south trend, are composed like these bounding ridges, and may be referred to the same series and to a similar mode of origin.

In that upper part of the Colorado plateau now described by Dr. Newberry we recognise the same geological formations as well as the same striking features of colour which have given its name to the chief river. The oldest rocks belong to the Carboniferous system. Thence up to strata believed to represent the earlier Tertiary series of Europe there is a continuous conformable development of stratified deposits. These strata spread out in horizontal sheets over the plateau. On the eastern and western margins they have been heaved up along the flanks of the mountain ridges, and here and there, where an isolated axis of elevation or a dislocation occurs on the plain, they have likewise been upturned. But for the most part they retain their horizontality, so that the lower formations are not seen, except where they have been cut into at the bottoms of the cañons. The Carboniferous limestones contain such characteristic brachiopods as *Productus semireticulatus*, *P. scabriculus*, *P. punctatus*, *Spirifer*, and *Athyris*. The earliest records of that region, therefore, are those of a sea-floor, which must have stretched eastwards across what is now the range of the Rocky Mountains towards the land which then lay over the site of the Eastern States. The thickening out of the marine limestones towards the west establishes this point in the ancient physical geography of the American continent. Above the Carboniferous limestones and shales lie a conformable series of bright red, green, and yellow sandstones, shales, and marls, which are regarded by Dr. Newberry as Triassic, and perhaps partly Jurassic, and which pass conformably upward into massive yellow and grey sandstones and green shales, which are placed on the horizon of the Lower Cretaceous rocks. These latter strata, containing many cycads and ferns, with other traces of terrestrial conditions, form the surface over an enormous area of the table-land. As they approach the broader valleys they end off in a steep cliff or bluff like a sea-wall, often cut along the edges into numerous detached tables, pinnacles, and quaintly-shaped outliers. The red strata underneath form the platform out of which the deep gorges have been eroded and their bright colours running in parallel stripes along the walls of the cañons and the faces of the isolated fragments and pillars give an extraordinary character to the fantastic forms into which the rocks have been worn.

The want of any evidence of disturbance from palæozoic up into older Tertiary time is dwelt upon by Dr. Newberry in this Report as showing the simplicity of the structure of this part of the continent. The facts which he brings forward help to make our ideas still clearer of the stages by which the present physiography of America has been reached. He demonstrates the truth of his previous conclusion that the region of the Colorado is one of vast erosion, and he gives some interesting indications of the extent of this denudation. He shows that the great plain with its surface of firm Lower Cretaceous sandstone was once covered by a continuous sheet of soft Middle and Upper Cretaceous shales, of which scattered mounds and millions of loose fossils are strewn over the plain, and which rise along its margin into an upper plateau overlooking the great tableland and presenting a steep escarpment towards it. These overlying strata are at least 2,000 feet thick. There cannot be any doubt, therefore, that previous to the erosion of the profound gorges the tableland was buried under 2,000 feet of soft strata, all of which have been removed except these fragmentary relics. Dr. Newberry satisfactorily disproves the notion that this denudation could have been effected by any violent current like those waves of translation which used to be called in to account for the existence and distribution of the glacial drift and erratic blocks. No one can read his

pages without a conviction that he correctly regards the whole erosion of the Colorado region as one vast continuous process in which air, rain, frosts, and rivers have been the main agents.



FIG. 1.—The Needles, looking South-westerly.



FIG. 2.—Lower San Juan, looking West.

The observations contained in this Report upon the structure of the isolated ridges which now and then disturb the horizontality of the stratified formations of the great plain are of considerable interest and importance. They

show that the elevation of these ridges did not take place until after the deposition of the older Tertiary rocks, and that this elevation was not merely due to the protrusion of hypogene masses, but was part of a general and prolonged

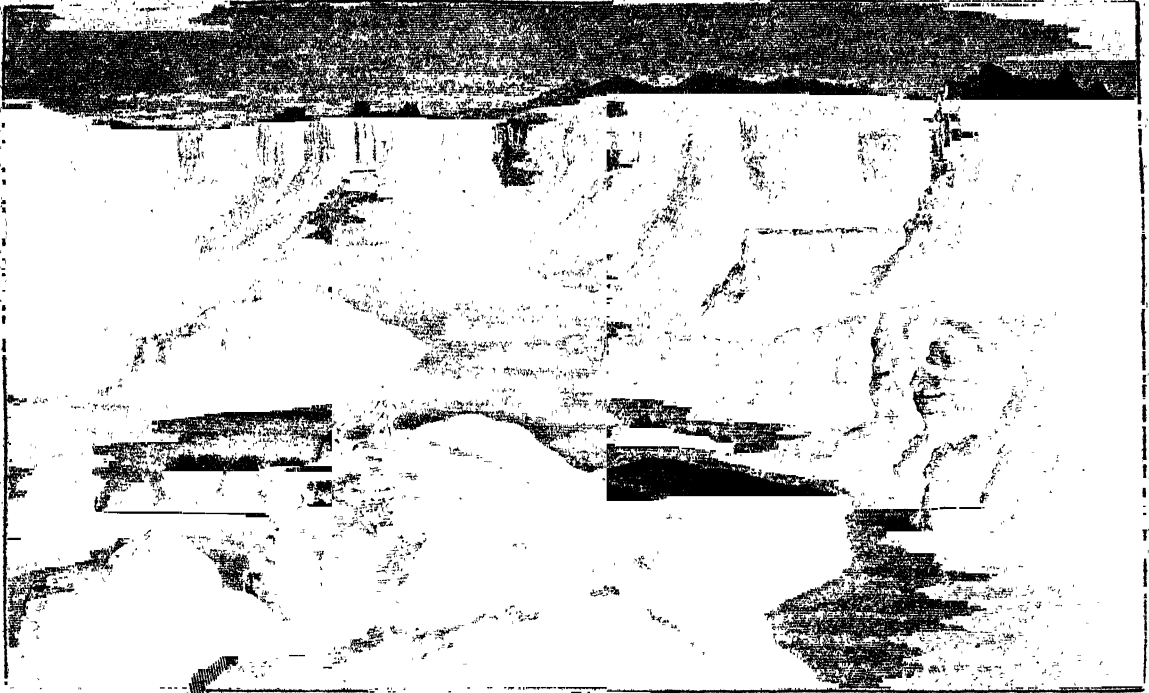

FIG. 3.—Head of Labyrinth Creek, looking South-easterly.

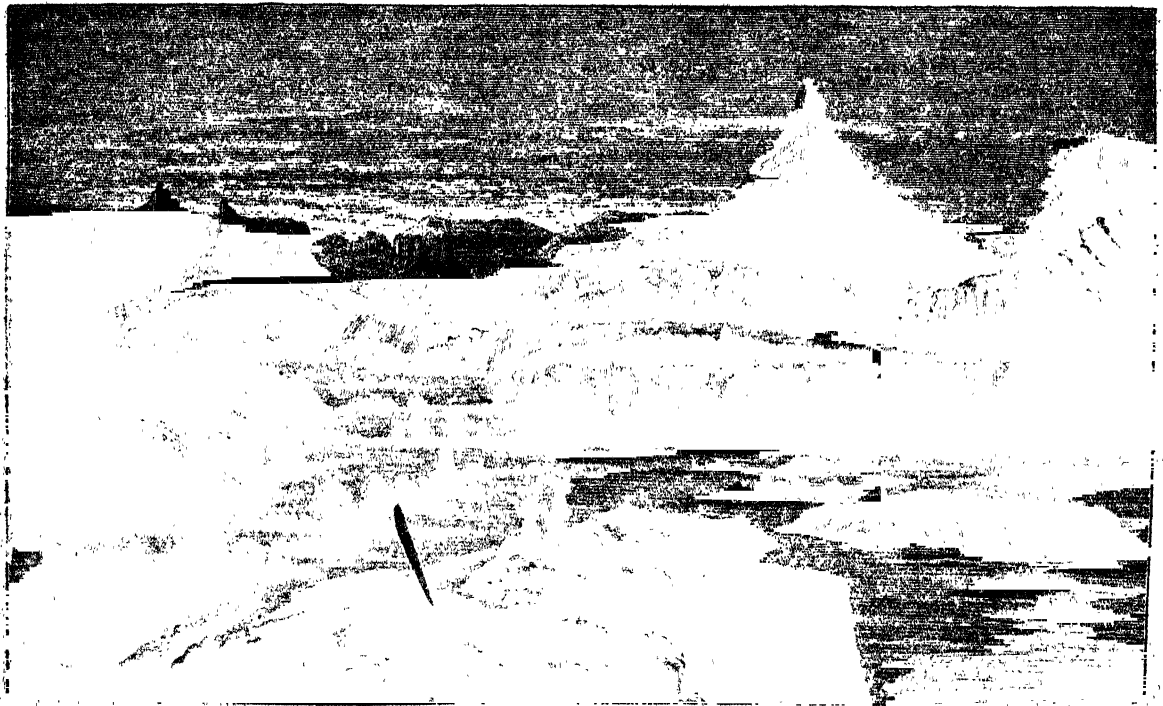

FIG. 4.—Head of Cañon, Colorado. Erosion of Triassic Series.

movement of pliation by which the present axis of the North American continent was determined. The whole of the sedimentary formations of the plain are found bent up against the granitic nucleus, which, like a wedge, has

been driven through them. No proof of any such movement or of any volcanic action older in date than the Eocene, or Upper Cretaceous rocks, was obtained in this Expedition. So that we have here, apparently, an area where any subterranean movements which occurred never disturbed the conformable succession of deposits during that vast section of geological time from the Carboniferous (or even from the Silurian) up to the Eocene period. Whether the traces of terrestrial surfaces indicated by the plants and lignite beds of the Lower Cretaceous series, occurring as they do with marine strata below and above them, are to be regarded as marking oscillations of the crust, or as due merely to the gradual up-filling of the old sea-basin and its conversion into lagoons and terrestrial surfaces which were subsequently gently submerged again beneath the Middle and Upper Cretaceous seas, may be a question for discussion. It would seem that coincident with or subsequent to the pre-Miocene upheaval, volcanic action began in the Western States. Dr. Newberry gives a drawing and a description of a singular basaltic rock called the Needles (Fig. 1) rising to a height of 1,700 feet above the Cretaceous floor of one of the tributary valleys of the San Juan, and regards this mass as having been intruded among the strata and as now left visible owing to its superior hardness, while the surrounding and overlying softer rocks have been washed away. But in his former Report in conjunction with Lieut. Ives, he showed the existence of a group of large extinct volcanoes in the San Francisco mountain group in Arizona, lying on the south side of the Colorado basin. The lava-streams are yet so fresh there that he supposes that the last eruption can hardly have taken place more than a comparatively few years ago. Considerably further to the east in New Mexico, San Mateo rises as another important extinct volcanic cone 11,000 or 12,000 feet high, whose most recent lavas are so fresh that "it is difficult to believe that they have been exposed to the action of the atmosphere even for so much as a hundred years." Dr. Newberry remarks that similar but smaller volcanic vents equally recent in appearance, but equally inactive now, are scattered over the entire area of the central tablelands from Mexico far up into the British possessions.

The author, who is an accomplished palæontologist as well as an active and gifted geologist, has added a valuable Appendix, in which he gives descriptions of the Carboniferous and Triassic fossils obtained by him in the course of the Expedition, and to which Mr. F. B. Meek<sup>1</sup> contributes an account of the Cretaceous fossils collected. It should be added, that besides the lithographic sketches the Report is enriched by some excellent plates of fossils.

ARCHIBALD GEIKIE

## DEEP SEA MUDS\*

### II.

#### *Peroxide of Manganese.*

**P**EROXIDE of manganese occurs widely in ocean deposits, either as nodules, incrustations, or as depositions on the bottom itself. It has been found most frequently in the nodular form in the deep sea clays far from land. It also occurs in the organic ooze, when these contain much volcanic debris, or are near volcanic centres.

In shallow water, near some volcanic islands, it covers shells and pieces of coral or pumice with a light brown incrustation.

\* Since this article was written, the announcement of Mr. Meek's death has reached this country. A more disastrous blow could not have been inflicted upon the progress of palæontology in the United States. It is much to be desired that amid the universal regret with which the death of this able palæontologist is received, some record shall be published of the services he has done. His numerous papers are scattered through so many publications (for he seems to have been ever at the call of any one who needed his assistance), that probably a comparatively small number even of palæontologists are aware of them all.

\* On the Distribution of Volcanic Débris over the Floor of the Ocean; its Character, Source, and some of the Products of its Disintegration and Decomposition, by Mr. John Murray. Read at the Royal Society, Edinburgh. Continued from p. 337.

It has been met with very sparingly, if at all, in shore deposits removed from volcanic centres.

In my preliminary report above referred to, I stated that further investigation might show that manganese nodules and depositions abound in these regions where we have much of the debris of augitic or heavy lavas.

A re-examination of specimens since our return confirms this view. Wherever we have pumice containing much magnetite, olivine, augite, or hornblende, and these apparently undergoing decomposition and alteration, or where we have evidence of great showers of volcanic ash, there we find the manganese in greatest abundance. This correspondence between the distribution of the manganese and volcanic debris appears to me very significant of the origin of the former. I regard the manganese, as we find it, as one of the secondary products arising from the decomposition of volcanic minerals.

Manganese is as frequent as iron in lavas, being usually associated with it though in very much smaller amount. In magnetite and in some varieties of augite and hornblende the protoxide of iron is at times partially replaced by that of manganese.

In the manganese of these minerals and in the carbonic acid and oxygen of ocean waters we have the requisite conditions for the decomposition of the minerals, the solution of the manganese, and its subsequent deposition as a peroxide.

The carbonic acid converts the silicates of the protoxides of manganese, and the protoxides of manganese into carbonate of manganese, and thus prepares the way for oxidation by the oxygen of the water.

It is probable that the action of the carbonic acid is not apparent, and that the manganese is at once deposited as a high oxide if not as the peroxide. This theory is essentially the same as that which Bischof gives for manganese ores generally. I have laid a series of these manganese depositions on the table. An inspection of these and their localities will show that in the clays and ooze the depositions are nodular in form. If a section be made of one of these, a number of concentric layers will be observed arranged around a central nucleus—the same as in a urinary calculus. When the peroxide of manganese is removed by strong hydrochloric acid, there remains a clayey skeleton which still more strongly resembles a urinary calculus.

This skeleton contains crystals of olivine, quartz, augite, magnetite, or any other materials which were contained in the clay from which the nodule was taken. In the process of its deposition around a nucleus, the peroxide of manganese has inclosed and incorporated in the nodule the clay and crystals and other materials in which the nucleus was imbedded. The clayey skeleton thus varies with the clay or ooze in which it was formed. Those from a fine clay usually adhere well together; those from a globigerina ooze have an areolar appearance; those from a clay with many fine sandy particles usually fall to pieces. Mr. Buchanan informs me that the purest portions of these nodules, that is those portions made up of closely-packed concentric layers, contain from 30 to 34 per cent. of the peroxide.

Taking the nodule as a whole, it will of course contain very much less than this. The nucleus varies in each nodule, and that part of a nodule which is made up of concentric layers will vary with each locality and with the depth from which it comes. We may expect, therefore, that analysis will show considerable variations in the amount of alumina, silica, and metals, lime, &c., in the nodules from different stations. At some places in the Pacific the nodules show periods of deposition very distinctly. We have first a very compact nodule which may have a shark's tooth for a nucleus, and which appears to have been formed slowly. Then there would seem to have been a shower of ashes. After a time manganese was again deposited, inclosing in the nodule a layer of these ashes. The most frequent nucleus in the nodules is a piece of pumice or other volcanic fragment.

In deep sea clays, far from land, sharks' teeth, ear-bones of whales, and fragments of other bones are very often the nucleus around which the manganese is deposited. In one instance a piece of siliceous sponge forms the nucleus. In a globigerina ooze a portion of the deposit has apparently formed the nucleus. In these we have perfect casts of the foraminifera, but all the carbonate of lime has been removed. The volcanic fragments which have formed the nuclei of nodules appear frequently to have undergone peculiar alterations. For instance, obsidian is usually surrounded by beautiful agate bands.

When we found the bottom composed almost entirely of volcanic ashes, or so hard from other reasons that the sounding tube did not penetrate it, the manganese was deposited in layers over

the bottom itself. Large pieces of this nature were taken several

The escape of carbonic acid through the floor of the ocean near volcanic islands may in these regions greatly accelerate the processes which end in the deposition of the peroxide of manganese, and account for the great abundance of it in some such localities where we found it.

*Native Iron and Cosmic Dust.*

While examining the deposits during the cruise I frequently observed among the magnetic particles from our deep sea clays small round black-coloured particles which were attracted by and I found it difficult to account for the origin of these.

On our return home I entered into a more careful examination of the magnetic particles. By means of a magnet carefully covered with paper I extracted these particles from the deposits, from the pumice-stones, and from the manganese nodules of many regions. The great majority of these magnetic particles are magnetic iron ore and titaniferous iron, either in the form of crystals or as fine dust. In the clays and in the manganese nodules from stations far from land and in deep water there were again noticed many small round spheres among the magnetic particles.

On mentioning this to Prof. Geikie he suggested that I should try the method employed by Prof. Andrews, of Belfast, for detecting minute particles of native iron.

This process consists in moistening the magnetic particles, which have been extracted by means of the magnet, with an acid solution of sulphate of copper, when copper is at once deposited on any native particles which may be present. In this way I have detected native iron in many of our deposits, in the powdered portions of manganese nodules, and in pumice-stones.

Prof. Andrews tells me that there can be little doubt that the particles on which copper is deposited are native iron, as he has found that it is not deposited on nickel, and the chances of cobalt being present are very slight. Prof. Andrews warned me on the extreme precautions necessary in conducting these observations, that no iron from a hammer or other instrument should get at the specimen under observation.

It is true that all specimens of our deposits have been obtained by means of dredges and iron gear, and some of these particles may be from this source.

Many of the particles must have another origin. I have taken two of our manganese nodules, and washing them carefully, taking care to let no iron instrument come near them, have broken them by rapping them together. Then taking only the interior parts of these nodules I have pulverised them in a porcelain mortar. The magnetic particles were afterwards extracted

by a magnet covered with paper. Now, on a glass slide under the microscope, and adding the sulphate of copper solution, there was in a few moments a deposit of copper on several small perfect spherules, varying in size from the  $\frac{1}{100}$  to the  $\frac{1}{200}$  of an inch in diameter. I have placed some of these spherules under the microscope and now show them to the Society. It will be noticed that on one the copper is not deposited all over the sphere, but in ramified spider-like lines. On the cut surface of a meteorite, from Prof. Sir Wyville Thomson's collection, which I also exhibit, the copper is precipitated in precisely the same manner as on the little sphere on the manganese nodule. Besides the spherules on which the copper is deposited, there are others generally of a larger size and dark colour. These are, so far as microscopic examination shows, quite like the particles on the mammillated outer surface of this Cape meteorite, also from Sir Wyville's collection.

These spherules have hitherto only been noticed in those deposits in deep water far from land, and where for many reasons we believe the rate of formation of deposits to be very slow.

They occur also only in those manganese nodules which come from the same deep sea clays or deposits far from land.

The particles of native iron found in pumice-stones are not numerous, and never take the form of spherules so far as observed. Some of these particles of native iron may then come from the dredge. Other particles come from the pumice and the volcanic materials. Prof. Andrews long since showed that minute particles of native iron existed in basalt and other rocks. And lastly, the spherules of which I have been speaking, appear to have a cosmic origin.

The reason for these spherules occurring only in deposits far from land and in deep water, may be more apparent by reference to the annexed diagram, which might represent a section from the west coast of South America out into the Pacific 500 miles. Along the shores of the continent, as at *a*, we have an accumulation of river and coast detritus. At *b* in depths from 1,400 to 2,200 fathoms we have a globigerina ooze mostly made up of surface shells. At *c*, in a depth of 2,300 to 3,000 fathoms, all the surface shells are removed from the bottom. No coast detritus reaches this area, and we find in the deposit pumice stones, some volcanic ashes, manganese nodules, sharks' teeth, and ear-bones of whales. It is only in areas like this that we find sharks' teeth and ear-bones of cetaceans in any numbers. Some of them from the same haul are deeply surrounded with manganese deposit, and contain little animal matter, while others have no deposit on them, and seem quite recent. These, and other facts which might be mentioned, all argue for an exceedingly slow rate of deposition. Now it is in these same areas that the spherules of native iron and other magnetic spherules are found, both in the deposits and in the manganese nodules from them.

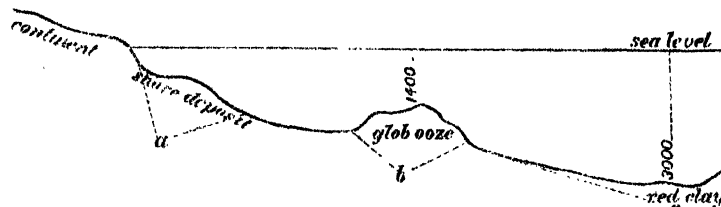

Finding them in this situation favours the idea that they are of cosmic origin, for in such places they are least likely to be covered up or washed away. It is certainly difficult to understand why the spherules on which the copper is precipitated have not become oxidised. If nickel be present in them, this may retard oxidation to some extent.

The manganese depositions in our ocean deposits are very different in structure and composition from any of the ores of I have had an opportunity of examining, and the deep sea far from land have not, so far as I know, any equivalents in the geological series of rocks.

All the subjects treated of in this paper are still under investigation, and at some future time I hope to present a much more detailed account.

These observations seem to me to give ground for the following

volcanic debris, either in the form of pumice or ejected fragments, are universally distributed in sea deposits.

pumice stones are continually being carried

into the sea by rivers and rains, and are constantly floating on the surface of the ocean far from land.

Third.—That the clayey matter in deposits far from land is principally derived from the decomposition of the feldspar in fragmental volcanic rocks, though in the trade wind region of the North Atlantic the dust of the Sahara contributes much material for clay.

—That the red earth of Bermuda, Bahamas, Jamaica, and other limestone countries, is most probably originally derived from the decomposition of pumice stone, while these limestones were in the process of formation.

Fifth.—That the peroxide of manganese is probably a secondary product of the decomposition of the volcanic rocks and minerals present in the areas where the nodules of manganese are found.

Sixth.—That there are many minute particles of native iron in deposits far from land; that some of these particles are little spherules; that these last, as well as some other spherules which are magnetic, have probably a cosmic origin.

the peroxide of manganese depositions in the



W. Jordan of Karlsruhe, giving the detailed results of the researches of the expedition into the physical geography and meteorology of this region during the winter of 1873-74. Though the observations extended only over a comparatively brief period, yet from their evidently high quality, the ability with which they have been discussed, and the physical characteristics of the region, the results thereby obtained form an exceedingly valuable contribution to meteorology. The results of the two-hourly observations show, as regards the daily maxima and minima of atmospheric pressure that the forenoon maximum and afternoon minimum are very greatly in excess of the others, and that the difference between them indicates an amplitude of range in accordance with that given for this region in Buchan's recently published charts of diurnal barometric range. The temperature has a daily range of  $24^{\circ}5$ , the maximum occurring about 3 P.M., and the minimum a little before 6 A.M. The lowest observed temperature was  $23^{\circ}$  in the earlier part of February. The minimum of vapour tension occurs about 6 A.M., and the maximum about 11 A.M. While the mean relative humidity at Cairo in winter is 65, it is only 51 in the desert, falling to 35, the minimum at 2 P.M., the dryness of the climate being thus very great. A humidity of only 17 was observed at Sandheim on February 12, at 2 P.M. Rain fell from February 1 to 4, thunder was heard on the second, and during next night  $0\cdot48$  inch of rain fell, soaking the sand of the desert to a depth of about five inches—an amount of rain of rare occurrence in the district. The prevailing winds are north-westerly, those having the highest percentages being W. 16, N.W. 34, and N. 27, or 77 per cent. Warm springs occur in several of the oases, the highest observed being at Dachel, the temperature of which ranged from  $92^{\circ}3$  to  $96^{\circ}8$ , or about  $15^{\circ}$  above the annual mean temperature of the locality. The magnetic declination was observed on January 1, at ten places variously situated between  $25^{\circ}11'$ , and  $29^{\circ}12'$  lat. N., and  $25^{\circ}31'$  and  $32^{\circ}34'$  long. E. of Greenwich, the results of which, when compared with the observations of declination made in 1819-20 by Cailliaud indicates an annual variation of  $6\cdot4$ , being closely approximate to that of Central Europe.

HEIGHT OF THE SEINE AT PARIS DURING 1876.—In the *Bulletin International* of the Paris Observatory for January 13, the height of the Seine is given for each day of 1876, as observed at Pont de la Tournelle and Pont Royal. The zero of the scale at Pont de la Tournelle is the lowest point to which the river fell during the great drought of 1719. The highest flood hitherto recorded measured 27 feet in 1658, and the greatest dryness  $3\cdot28$  feet below the zero of the scale on September 29, 1865. During 1876 the greatest flood was 21 feet on January 17, the greatest dryness  $0\cdot89$  foot, and the mean for the year  $3\cdot15$  feet, being  $0\cdot82$  foot below the mean calculated by Delalande.

OSCILLATIONS OF TIDES.—The meteorological *Bulletin* of the Brussels Observatory for January 26 calls the attention of meteorologists and physicists to a remarkable perturbation in the state of the sea, shown by the *maregraphe* of Ostende. "The low-tide level on January 25," the *Bulletin* says, "was by thirty-five centimetres lower than it should have been, and the high-tide level in the evening was lower by sixty centimetres, as if the tide were stopped in the last part of its ascending motion. These depressions of the sea-level took place under quite the same circumstances of wind at Ostend, as those which were observed during an elevation of the level, on January 2. The local direction of the wind, in the report, cannot be the cause of these oscillations, and the true cause remains thus unknown, and well deserving the full attention of meteorologists and physicists."

HURRICANE OF JANUARY 31, IN BELGIUM AND HOLLAND.—The hurricane which, accompanied by an unusually high tide, visited the shores of the North Sea during the night of January 30-31, is reported to have done very great damage. The

height reached by the tide at Ostend was  $7\cdot5$  metres above the mean level of the sea, and the height of the waves during the hurricane was about 12 metres (40 feet), the mareograph showing fluctuations from  $19\cdot5$  to  $1\cdot5$  metres above zero. The tide thus exceeded by about 4 feet the highest tides remembered at Ostend. The embankment of the town was destroyed for a length of more than 700 feet, and stones 14 feet long were thrown by the waves to distances of about 40 feet. Large parts of the town were inundated. At Antwerp the tide which swept along the Scheldt was higher by 1 foot than the highest tides remembered. The shores of the river were therefore inundated, as well as some of the polders, which appear now as immense lakes. The streets of Antwerp were covered with water 1 metre deep; Mechlin, Termonde, and many other places, were also flooded. In Holland the ravages were not less. Rotterdam was inundated, the Maas reaching a level only 6 centimetres lower than that reached in 1825. Various other places in Holland suffered. Numerous accounts received at the Brussels Observatory from various points of the kingdom will enable the path of the hurricane to be traced with great accuracy. It is worthy of notice that it took one hour and a half to go from Ostend to Brussels.

WEATHER NOTES.—Letters received from the United States on Saturday last state that the weather on the Atlantic seaboard has been intensely cold; temperatures from  $-35^{\circ}$  to  $-40^{\circ}$  have been recorded. At Baltimore, on the 26th ult., the temperature was the lowest known for many years, and the ice extended fully sixty miles down Chesapeake Bay, effectually blocking the harbour. Several steamers were compelled to put back, being unable to force their way through the ice-fields. Seventy vessels were locked in the ice twelve miles down the bay and the crews were in great distress. Very heavy snow-storms are reported from the west of the State of New York, by which railway travelling was all but stopped. Australian letters report exceedingly intense heat in Victoria during the month of December, the temperature in the shade rising on the 15th to  $110^{\circ}7$  at the Melbourne Observatory, and at some places in the interior,  $116^{\circ}0$  was recorded.

INTERNATIONAL WEATHER MAPS.—We have the greatest pleasure in noting that the system of simultaneous observations of atmospheric changes for the construction of the valuable weather maps issued under the direction of Gen. Myer, of Washington, U.S., which is already carried practically around the northern hemisphere on land, has recently received a large and important expansion. A general order was issued by the Navy Department, on December 25, to the commandants of naval stations and commanding officers of vessels of war, directing meteorological observations to be taken, recorded, and forwarded to the Bureau of Navigation, a particular officer being designated as responsible for the duty. The observations are to be of such a character as to be suitable for the preparation of synoptic charts, and to embrace, whenever practicable, at least atmospheric pressure, temperature, wind, rain, wet-bulb thermometer, sea-swell, and weather daily, on board every vessel in commission, and at every naval station of the United States at 7.35 A.M. Washington mean time ( $0\cdot43$  P.M. Greenwich mean time). The Secretary of the Navy enjoins the greatest care and promptitude in the taking and recording of these observations, which thus form part of the system of international meteorological observations taken simultaneously, upon which the United States have entered. We very earnestly hope that the navies and the mercantile vessels of all civilised countries will soon join in carrying out this magnificent scheme of observations originated by the Americans in 1873, and since then further developed and carried on by them with the highest ability and success.

## NOTES

ACCORDING to arrangements made since the death of Prof. J. C. Poggendorff, the *Annalen der Physik und Chemie* will in future be edited by Prof. Dr. G. Wiedemann, of Leipzig, assisted by Prof. Helmholtz and the Physical Society of Berlin. Prof. Wiedemann possesses admirable qualities for the new position, and under his supervision this well-known scientific journal will at least lose none of its former valuable features. The first number of the *Beiblätter*, the newly-founded adjunct to the *Annalen*, has already been issued. It will not only offer a review of contemporary physical research, but will seek to replace the supplementary volumes of the *Annalen*.

THE Council of the Royal Society of Edinburgh has awarded the Macdougall-Brisbane Gold Medal to Mr. Buchan for his paper on the diurnal oscillation of the barometer, as forming one of an important series of contributions by him to the advancement of meteorological science.

THE great Von Baer medal, worth over 1,000 roubles, and bestowed but once in three years, has been given by the St. Petersburg Academy of Sciences, to Dr. A. Götze, Professor of Zoology at Strasburg, in recognition of his remarkable work "Die Entwicklungsgeschichte der Unke."

A MEDAL to commemorate the part taken by the Institute of France in the observation of the transit of Venus has been struck at the national mint. It bears the representation of a female passing before the car of Apollo, with the motto in Latin, "Quo distent spatia, sidera juncta docent." Each member of the Institute has received a silver medal, as well as the heads of the mission; the assistants received a bronze one. A medal has been cast in gold and presented to M. Dumas, the President of the Transit Commission. The expenses were defrayed by subscription among the members of the Institute.

DR. STRAUDBERG, the president of the Swedish Academy of Sciences, died suddenly in Stockholm on February 5.

THE Norwegian Government proposes to send out a vessel during this year for the purpose of deep-sea exploration in the Atlantic. A credit of 103,000 kronen has been sought from the national Parliament to cover the expense of the expedition.

BARON BARTH, whose sad end at Loanda we mentioned last week, belonged to one of the oldest families of the Bavarian nobility. Although but thirty-one at the time of his death, he had already won a name by valuable researches on the nature of the Swiss glaciers, and by geological investigations in various parts of Europe.

FOR a number of years the University of Jena has been unable from lack of funds to meet the demands of modern university education, by the increase of professorships, establishment of scientific collections, &c. So severe has been the check upon the growth of the institution, that its friends have finally set on foot energetic measures to obtain a large increase in the annual grants from the various grand ducal governments upon which it depends for support. Saxe-Weimar has already promised an addition of 40,000 marks, and it is probable that this historic university will soon be relieved from its embarrassments.

WE regret to announce the death of the eminent surgeon, Sir William Ferguson, Bart., on Saturday last, in his sixty-ninth year.

WORK is about to be commenced on the new buildings for the University of Strasburg. They will be situated to the north-east of the City, with which they will be connected by a broad promenade, and will provide accommodation for about 1,500 students. The Government grant for the purpose amounts to

THE Hunterian Oration at the Royal College of Surgeons was delivered on Tuesday by Sir James Paget, in presence of the Prince of Wales, and a large and brilliant company. Sir James sketched the career, and pointed out the quantity, the wide range, and importance of the work done by Hunter.

AS Prof. Kirchoff refused the directorship of the Sun Observatory at Berlin, a Committee of Direction has been appointed, consisting of Professors Kirchhoff, Förster, and Awers.

AMONG the Bills to be brought before Parliament this session is one by Mr. Hardy "to make further provision respecting the Universities of Oxford and Cambridge, and the colleges therein."

ON Thursday last, Prof. Alexander Agassiz, who has been on a visit to this country for the purpose of investigating the results of the *Challenger* Expedition, embarked at Liverpool on board the White Star steamer *Britannic* on his return home. On the Wednesday evening he was entertained at dinner by the members of the Liverpool Art Club, and on Thursday, after visiting the Library and Museum of this town he was invited by the Mayor to lunch with the members of the library and museum committee at the town hall.

DR. N. V. KONKOLY, the director of the O. Gyalla Observatory in Hungary, is at present engaged in an extensive series of observations upon the spectra of the fixed stars. In the February session of the Hungarian Academy of Sciences he gave the results obtained with 160 stars. Vogel's division into three typical classes, white, yellow, and red, is followed. An interesting observation was made upon  $\beta$  Lyræ. The bright bands in its spectrum detected by Vogel in 1871 have now entirely disappeared, and were probably due to an astral protuberance. The same astronomer laid also before the Academy a carefully prepared record of all shooting stars observed in Hungary during the past six years. Their number amounts to about 2,000.

LORD NORTHBROOK has presented to Oxford University a valuable collection of skins of the game birds of India, collected for him by Mr. A. O. Hume, C.B., a distinguished Indian ornithologist. Lord Northbrook, in a letter to Dr. Acland, assures him that the collection is very perfect, if not unique.

A SINGULAR case has been tried at Paris. A manufacturer of gelatine complained that the water supplied by the new city waterworks was too good for him, and that he could not continue the manufacture of his gelatine. He claimed about 3,000*l.* damages, but his suit was dismissed with costs.

AT the next session of the French Association for the Advancement of Science, in August, the Geological Society of Normandy will organise an exhibition of all the geological and palæontological products of the five departments which compose that old province.

WE have received the first two numbers of a new monthly Italian journal, *Elektricità*. It is published at Florence.

WE regret that our space only admits of our acknowledging the receipt of the *Proceedings* of the Liverpool Literary and Philosophical Society for 1875-6. This volume, like many of its predecessors, contains a considerable number of papers of real value in various departments of science. Messrs. Longmans and Co., are the London publishers.

THE Report of the Committee of the East Kent Natural History Society contains some forcible remarks on the condition of provincial museums in the same direction as those of Prof. Boyd Dawkins, which we reported some weeks ago. It is shown that the rates now squandered in support of those miscellaneous and motley gatherings, and incoherent medleys vaguely called museums, would suffice for the formation and maintenance



case of museums worthily so named, and admirably adapted by judicious selection and arrangement to forward the education of our youth, and the direction of all classes of the people in the study of natural science. But, so far from promoting this worthy end, the managers of many provincial museums seem to understand nothing more than the establishment of unmeaning curiosity shops, better fitted to amaze the eyes and puzzle the brains of the groundlings, than to convey rational amusement and instruction to the people. Thus the study of the sciences of natural history is rather retarded than advanced, and the prevailing ignorance maintained and confirmed. Local museums should be adapted to the best mental culture. They ought to have a few good preparations, whether exotic or native, to exhibit plainly the general principles of nature, and systematic sets of many specimens to display particularly the natural history of the district; while the needless and grievous expense of room and money, caused by the acquisition and preservation of a gillimaufry of unsuitable objects, should be most strictly avoided. The rapid spread of knowledge, the report states, will soon convince the rate-paying public that their rates should be expended with at least some regard to the instruction of the rising generation. We sincerely hope so.

UNDER the heading, "Can Birds Count?" Mr. C. W. Wade, of Magdalen College, Oxford, writes as follows:—"I have often noticed that crows crowded on Sundays to a certain place, where, on the seventh day a friend of mine was in the habit of amusing himself by placing a quantity of broken biscuit on his window-sill; he had time for this only on the Sunday morning, and during the week no food was so presented. We noticed that on the Sundays a crowd of the birds came about the window, whereas on other days no special sign of excitement was visible among them. The opinion I formed of their power to count the days as they passed has been strengthened by hearing the following story." Mr. Wade then states that a gentleman much troubled by the depredation of crows built a shed at a distance from his house, where he took up position with gun and ammunition. After the first shot the crows would not return, so the gentleman took a friend with him to the shed and then sent him away, he himself remaining; but the crows kept out of range. Taking others with him up to the number of twelve, and sending them off separately, the result was the same. At thirteen, however, the crows seem to have lost count, and returned. To be fully credible the account ought to be first-hand, as it is not, and based on a regular series of experiments.

ANY information on the prospects of the future supplies to this country of Russian boxwood is a matter of some importance, therefore it is interesting, if not entirely satisfactory, to read in a recent report from Poti, the port from whence the bulk of the boxwood is shipped, that, though considerable quantities are still exported, it becomes annually worse in quality, and the supply for shipment at Poti must soon be exhausted. The export from the Abkassian forests is still prohibited by the Russian Government, but it is said that this restriction will shortly be removed. The writer of the report referred to describes a journey he made in 1873, through splendid forests of Normandy pine, birch, beech, oak, chestnut, walnut, and boxwood. With the opening of these forests it is estimated there will be a plentiful supply of prime boxwood for about fifteen years, after which that of inferior quality must be resorted to, as in Mingrelia. Boxwood, it seems, has also become quite recently an article of commerce from Taganrog to France and England; about 4,000 tons were shipped to these two countries during the year 1875, at a cost of from 8/ to 10/ per ton, free on board. This boxwood is drawn from Persian territory, on the southern coast of the Caspian Sea, across which it is conveyed to Astrachan, thence up the Volga to Tzaritzin, whence it passed over to Kalatch, on the Don, for Rostoff and Taganrog.

NO. 7, concluding vol. ii. series ii. (Science) of the *Proceedings of the Royal Irish Academy*, has just been published. It contains a report on Irish Hepaticæ, by Dr. David Moore; a revision of the species of *Abies* of Endlicher and Parlatore, and *Pseudotsuga* of Carrière and Bertrand, by Prof. M'Nab; contribution to the history of Dolomite, by Mr. E. Hardman; on Glucinum, by Prof. E. Reynolds; on the chemical changes in potato disease, by Rev. Prof. Jellett; on remains of *Cervus megaceros*, by G. Porte; on the detection and precipitation of phosphoric acid by ammonic molybdate, by A. N. M'Alpine; on the product of the squares of the differences of the roots of a cubic equation, by Prof. Young; and on a new genus and species of sponge, by Prof. E. P. Wright.

THE February session of the Berlin Geographical Society was devoted to detailed reports from the lately returned African explorers, Dr. Pogge and Dr. Lenz. The former described his journey from Angola to Mossambu, the chief town of the Watajombas, whose existence has hitherto been regarded as mythical. The difficulties of the route were few, and the climate in the interior healthful. Dr. Pogge's experience would seem to point out his route as one of the most desirable for future expeditions to use in attempting to reach the interior of the continent. Dr. Pogge stated his belief that the Casai or Casabi is the Upper Congo, and that the Lualaba flows into the Ogovai. A letter in Tuesday's *Times*, from an Angola paper, written by a Portuguese merchant, is of the same tenor. It states that a Portuguese, whose name is not given, has found the source of the Zaire, twenty days' march east from Malange, and one day's march from the capital of Dumbo Tembo. The river is known as Casai or Casabi till it crosses the country of Lunda, when it gets the name of Nzare. Livingstone, in a letter dated Cassangé, February 13, 1855, mentions the common belief there that the Casai and Quango join to the north of Cassangé, and form the Zaire or Congo. We seem to be getting near the solution of the problem. Dr. Lenz, at the same meeting, sketched rapidly the results of his three years' wanderings among the Oskebas of the Ogowai district, by whose assistance he was also able, although with the greatest difficulty, to penetrate to the Adooma land, and touch his farthest point to the east, Banjska. The interesting results of his anthropological and ethnological studies among the Oskebas, we hope to give more fully.

ON Monday evening, Gen. R. Strachey gave the first of a series of lectures on Scientific Geography at the Geographical Society. He traced the progress of Geographical Science, pointed out the wide field embraced by it at the present day, and showed its aims and its importance.

THE annual meeting of the American Geographical Society was held on January 16, Rev. H. W. Bellows, D.D., in the chair. The annual election of officers and members of the Council was held. Chief-Justice Daly was re-elected president, and delivered his annual address on the Geographical Work of the World for 1876. The address, of which an early copy has been forwarded to us, is one of great interest, and contains a comprehensive view of geographical work during 1876 in all departments and in all parts of the world. Mr. Daly criticises with some severity various statements as to previous explorers in the Report of Sir George Nares. He commends the plan proposed by Dr. Hayes some years ago, of carrying on polar exploration by establishing a station at Port Foulke, a plan substantially the same as that proposed by Capt. Howgate of the U.S. Signal Service, to which we referred in a recent number. Mr. Daly mentions the interesting fact that the first Geographical Society was probably that founded in Venice in 1688, under the name of "Society of Argonauts," followed a few years later by an association of the same kind established at Nuremberg. For English

readers one of the most valuable parts of this address is the account of the work of the various U.S. Surveys for 1876. We regret that space prevents us doing more than referring to this interesting address.

At the last session of the Berlin Academy a letter was read from Dr. J. M. Hildebrandt, travelling under the auspices of the Academy, who on December 10 was preparing to leave Mombassa, in Zanzibar, for an extensive expedition in the Kibuyin land. The chief aim of the undertaking will be to study the snowy regions of the lofty chain of mountains bordering on the coast-land. One of the first efforts will be directed to scaling the lofty summit of the Kenia.

*Die Natur* for February 12 contains a paper by Karl Emil Jung, "On the Family Conditions of the Australian Natives," in which he states some facts with regard to their marriage customs that deserve the attention of ethnologists.

No. 3 of the *Bulletin Trimestriel* of the Cairo Geographical Society contains a paper by Dr. Giussfeld on his exploration in West Africa, and a paper of great value by Col. Colston giving the results of his observations among the Bedouins of Sudan and Kordofan. Accompanying letters from Col. Gordon, which have been referred to by us already, are four maps of the course of the Nile in the region of the great lakes.

We have received a copy of a lecture on the English Arctic Expedition given at the Scientific Club, Vienna, by Dr. Chavanne, forming one of a series of cheap popular scientific lectures which are being published by A. Hartleben, of Vienna.

SEVEN weekly meetings of the Cambridge University Natural Science Club were held during the last (October) term, when the following papers were read:—"On Analogies between the Senses in Man," by J. Allen (St. John's); "The Pectoral and Pelvic Girdles," by T. W. Bridge, B.A. (Trinity); "The Probable Age of the Earth," by E. B. Sargant (Trinity); "Caves," by J. E. Marr (St. John's); "The General Anatomy and Functions of the Cerebrum," by O. A. Browne, B.A. (Trinity); "Fermentation," by A. Hill (Downing); "The Chemical Composition of the Albumenoids," by S. H. Vines, B.A. (Christ's). Seven meetings are arranged to take place during the present (Lent) term. There are nineteen members in residence.

PROF. OGDEN ROOD has called attention (*Am. Journ. of Sci. and Arts*) to some cases in his own experience, which, along with an experience described by Tait, seem to prove that our retinal apparatus for reception of waves of light of medium length is more liable to be strained by nervous shocks or by prolonged excitation, than that designed for reception of waves of greater or less length. Thus nervous derangement and prolonged excitation may produce temporary green colour blindness. The effects Prof. Rood observed were in recovering from effects of chloroform, exposure to bright white light out of doors (when white objects seemed at first purplish red), and convalescence from typhoid fever (when white objects appeared of a weak orange yellow).

THE works in connection with the Paris [Exhibition of 1878] are progressing with surprising activity. The buildings, which must be ready in the end of March by contract, will be completed before the appointed time.

IN the February Session of the Wurtemberg Anthropological Society, a somewhat novel communication was presented by Prof. v. Zech, the statistician of the Society. He instituted a careful comparison between the returns of the late parliamentary election and the anthropological statistics of the kingdom collected during the past year. The majorities of the government were invariably obtained in districts where light-coloured

hair and eyes predominate. The *Schwaben*, the Ultramontanes, formed a medium class with regard to complexion, &c., and were not recruited from among the black-haired and the black-eyed, who seemed on the contrary to be the champions of social democracy.

THE *American Naturalist* for February contains an Account of the Natural History of the Fanning Group of Islands, by Dr. T. H. Streets. These are four coral islands in the Pacific, stretching from 1° 57' N. to 5° 49' N., and from 157° 27' to 162° 11' W. They do not seem to have been yet grouped on any chart.

A SECOND edition, published to December 31, 1876, has been published of the "Catalogue of the Publications of the United States Geological and Geographical Survey of the Territories." Since 1867, forty-one publications have been issued, besides twenty-five maps. A considerable list of works in process of publication and in preparation is also given.

AT the meeting of the Brighton and Sussex Natural History Society, held on the 8th inst., an interesting paper by Miss Crane was read, "On Certain Genera of Living Fish and their Fossil Affinities." It is reported in full in the *Sussex Daily News* of February 10.

THE additions to the Zoological Society's Gardens during the past week include a Macaque Monkey (*Macacus cynomolgus*) from India, presented by Master R. Wallace; two Chinese Geese (*Anser cygnoides*) from China, presented by Mr. A. H. McEhursht; a Common Raven (*Corvus corax*), European, presented by Mrs. Nathan; a Common Magpie (*Pica caudata*), European, presented by Miss Jessie Bovill; a Rough-legged Buzzard (*Archibuteo lagopus*), European, presented by Mr. W. R. Paxton; a Common Marmoset (*Leopoldus jacchus*) from Brazil, a Common Paradoxure (*Paradoxurus typus*) from India, deposited; two Maned Geese (*Bernicla jubata*) from Australia, a Red-vented Cockatoo (*Cacatua philippinarum*) from the Philippine Isles, purchased.

### SCIENTIFIC SERIALS

IN the January number of the *Quarterly Journal of Microscopical Science* we find that Dr. Klein has superseded Dr. Payne, as one of the editors. Mr. H. N. Moseley has two valuable papers, the first on the colouring matter of various animals, and especially of deep sea forms dredged by H.M.S. *Challenger*, in which a large number of fresh hand-producing colours from sponges, Coelenterata, Echinoderms, Annulosa, and Mollusca are described with figures of their spectra. In the second, *Stylochus pelagicus*, a new species of Pelagic Planarian, is described, with notes on other pelagic species, together with the larval forms of Thysanozoon, and of a gymnostomatous Pteropod.—Dr. Klein, in a note on a method of preparing the cornea by the employment of caustic potash and lunar caustic.—Mr. Kidd describes Schiefferdecker's Microtome, and gives an epitome of a paper by Engelmann on "Contractility and Double Refraction."—Mr. Peek has an important paper on the minute structure of the gills of Lamellibranch molluscs, the investigation having been undertaken in the Histological Laboratory of Exeter College, Oxford, at the instigation of Prof. Lankester. The filamentary gills of *Arca* and *Mytilus* are shown to explain the nature of the more complicated organ in *Anodon*, the most simple type being filaments bent on themselves at their middle points, outwards for the outer gills, and inwards for the inner, so that in section they form a W.—The last paper is a *résumé*, by Mr. Archer, of recent contributions to our knowledge of freshwater Rhizopoda.

*Journal de Physique*, January.—On the phenomena of induction, by M. Mouton.—Chromatic polarisation of tufts in biaxial crystals, by M. Marc.—Note on the experiment of the Franklin portrait; a new glass breaker, by M. Barat.—On absorption of radiant heat by aqueous vapour, by M. Hagn.—Note on the employment and choice of spectacles designed to correct bad vision, by M. Dubois.

## SOCIETIES AND ACADEMIES

LONDON

**Mathematical Society, February 8.**—Mr. C. W. Merrifield, F.R.S., vice-president, in the chair.—The following communications were made to the Society:—On the area of the quadrangle formed by the four points of intersection of two conics, by C. Leudesdorf.—A certain series, by Mr. J. W. L.

Glaisher, F.R.S.—The differential equation  $\frac{dx}{\sqrt{X}} + \frac{dy}{\sqrt{Y}} = 0$ ,

by Prof. Cayley, F.R.S.—On the classification of loci, and a theorem in residuation, by Prof. Clifford, F.R.S.

**Zoological Society, February 6.**—Osbert Salvin, F.R.S., in the chair.—Mr. Sclater exhibited and made remarks on some unnoticed characters in the original and unique specimen of Comrie's Manucode (*Manucodia comriei*, P.Z.S., 1876, p. 459).—Mr. Howard Saunders exhibited a specimen of the Panay Sooty Tern (*Sterna anastheta*), which had been obtained on the English Coast, and was the first recorded occurrence of this bird in the British Islands.—Dr. A. Günther, F.R.S., read a memoir on the tortoises collected by Commander Cookson, R.N., during the visit of H.M.S. *Peterel* to the Galapagos Islands. The main results of Commander Cookson's visit consisted in giving us a knowledge of the tortoise of Abingdon Island (*Testudo abingdoni*) and of the tortoise of the north of Albemarle Island (*T. microphyes*).—A communication was read from Mr. Robert Collett containing an account of his observations on *Phylloscopus borealis*, as met with on the coast of the Varanger Fjord and adjacent parts of Finmark.—Mr. Sclater read a note on an apparently new species of spur-winged goose of the genus *Plectropterus*, proposed to be called *P. niger*, founded on two examples living in the Society's Gardens, which had been presented to the Society by Lieut.-Gen. A. V. Cunningham.—Prof. A. H. Garrod read a paper on the mechanism of the intervertebral substance and on some effects resulting from the erect position of man.—A communication was read from Sir Victor Brooke, containing notes on the small rutine deer of the Philippine Islands, and giving the description of a new species proposed to be called *Cervus nigricans*, of which a female example was recently living in the Society's Gardens.—A paper by Mr. O. Salvin and Mr. Ducane Godman was read giving the description of twelve new species and a new genus of butterflies from Central America.—Dr. Günther gave an account of the zoological collection made during the visit of H.M.S. *Peterel* to the Galapagos Islands, which had been worked out by himself and his assistants in the Zoological Department of the British Museum.—Mr. R. B. Sharpe communicated the description of a new species of pheasant of the genus *Lophophanes* and of a new species of *Pitta* from the Lawas River, North-west Borneo. Mr. Sharpe proposed to call the former *L. castaneicaudatus*, and the *Pitta*, *Pitta ussheri*.

**Geological Society, January 10.**—Prof. P. Martin Duncan, F.R.S., president, in the chair.—Frederick Tendron and David Thomas were elected Fellows, and Dr. J. F. Brandt, of St. Petersburg, Dr. C. W. Gumbel, of Munich, and Prof. Eduard Suess, of Vienna, Foreign Members of the Society.—On gigantic land-tortoises and a small fresh-water species from the ossiferous caverns of Malta, together with a list of the fossil fauna, and a note on Chelonian remains from the rock-cavities of Gibraltar, by A. Leith Adams, F.R.S., Professor of Zoology in the Royal College of Science, Dublin. The author described three distinct species of tortoises from the Maltese rock-cavities, one of which was of gigantic proportions, and equalled in size any of the living or extinct land Chelonians from the Indian or Pacific Islands. The characteristic peculiarity in the two larger species is a greater robustness of the long bones as compared with the denizens of the Mascarene and Galapagos Islands, with which he had been enabled to contrast them. The largest, on that account, he had named *T. robusta*; it rivalled the gigantic *Testudo cphippium* (Günther) in size, showing affinities to it in a few minor characters. A smaller species, *T. Sprattii*, and a small *Lutrenys*, not distinguishable, as far as the few remains extend, from the recent *L. europæa*, besides many fragments of shields of tortoises of various dimensions, had been obtained. These Chelonians were found in conjunction with the remains of the dwarf elephants and other members of the remarkable fauna, collected by Admiral Spratt and the author in the ossiferous rock-cavities of Zebbug, Mnajdra, Benghisa, &c. The paper contained a list of the animal remains hitherto recorded from the Maltese fissure caverns, including three species of dwarf elephants, two species of *Hippo-*

*potamus*, two gigantic species of *Myoxus*, a gigantic swan, and other animal remains; and further, a Note on some Chelonian remains from the rock-fissures of Gibraltar.—On the Corallian rocks of England," by the Rev. J. F. Blake, F.G.S., and W. H. Hudleston, F.G.S. The object of the paper was to describe the rock masses existing between the Oxford and Kimmeridge clays as exhibited throughout England. They occur in five distinct areas which were treated separately. Where best developed, as in Yorkshire and at Weymouth, the series is much more varied than the usual nomenclature indicates; in both instances a lower mass of limestone, distinct from that representing the "coral rag" of Central England, is present. In Yorkshire, especially, this limestone is of great importance, and is separated by a "middle calc. grit" from the upper limestone series. These upper limestones were also shown to be separable into two very distinct divisions, especially by their fauna, viz., the "coralline oolite" and "coral rag," which last term is here applied in a restricted sense only to true coral-bearing or inter-coralline beds. The upper beds, called "supra-coralline," were shown, where present, to be of great interest and importance—and their fauna was for the first time indicated—and the iron-ores of Abbotsbury and Westbury were proved to belong to this portion of the series. The fauna of the Corallian rocks was shown to be very markedly Oxfordian in the lower portions, and equally Kimmeridgian in the upper, while but a limited portion only could be said to have a fauna of its own. The whole series was deposited in lenticular masses of traceable size.

**Physical Society, February 3.**—Prof. G. C. Foster, president, in the chair.—The following candidate was elected a member of the Society:—Mr. J. Norman Lockyer, F.R.S.—Prof. Osborne Reynolds exhibited a number of experiments in relation to vortex motion in fluids. They have been gradually developed during the last few years, but are still in a very incomplete state, and he hopes that others will join him in the inquiry. Probably one reason why so little progress has been made in the determination of the elementary laws of fluid-motion is that mathematicians have been without experimental data on which to found their calculations. The well-known rings formed by puffs of smoke have been studied by many high authorities, but not with a view to their general bearing on this subject. Prof. Reynolds first showed smoke rings and their interference by means of the apparatus devised by Prof. Tait, and added that although the theory of smoke rings does not imply that vortex motion is peculiar to vapours, their existence in liquids was only pointed out by Mr. H. Deacon at a comparatively recent date. In studying the action of the screw-propeller, Prof. Reynolds noticed the systematic manner in which the form of a disc moved obliquely through water is retained by the track of air which it produces. If a flat disc be supported on a light frame and caused to move rapidly through water the motion ceases on withdrawing the hand suddenly; but if this be done gradually the motion continues. By passing a coloured liquid down a fine tube to the back of the disc, he found that a vortex ring is always formed, which passes to the rear of the disc, and the same effect is produced by dropping water from a height into water covered with a coloured liquid. In a trough about six feet long and at one end of which was a horizontal tube closed with sheet india-rubber, air rings were formed by introducing air into the tube and then striking the india-rubber externally by means of a flat board, and it was shown that a ring is capable of propelling a vane placed in its course, to the front of which it never advances. If the air be replaced by a coloured liquid the ring travels with considerable velocity and the motion of a solid body of the density of water is in no degree comparable. If a ring travels through a part of a liquid which has previously been coloured, it causes no motion of translation, and Prof. Reynolds concludes that no resistance is offered to their motion. Nevertheless the motion is gradually stopped, but the ring is constantly enlarging by gathering water as it travels, and its momentum remains nearly constant. After adverting to the methods adopted to ascertain the direction and velocity of motion, the initial form of the rings was shown to be a spheroid. A solid of this form, however, is very slow in its passage through water, and he considers this to be due to friction. He has succeeded in imitating the form of the ring by causing a disc, surrounded by pieces of ribbon, to move through water. Finally, Prof. Reynolds referred to Sir William Thomson's researches on the interference of two rings, and showed that the oscillating rings so produced can be formed in liquids or gases by employing an oval in place of a circular aperture.—The Annual General Meeting of the Society

was then held.—The president read the report of the Council, of which the following is a brief abstract:—The Council points with satisfaction to the number and interest of the papers read before the Society, and a brief summary is given of the more important. The Society has to regret the loss of three of its members, Mr. David Forbes, F.R.S., Mr. A. S. Hobson, and Mr. Arthur Pinn. The publication of a new edition of Prof. Everett's work and of a complete edition of Sir Charles Wheatstone's writings is announced, and the Council hopes shortly to undertake the translation of scientific papers from foreign sources to be published in its proceedings.—The following Officers and Council were elected for the ensuing year:—President, Prof. G. C. Foster, F.R.S. Vice-Presidents: Profs. W. G. Adams, F.R.S., and J. H. Gladstone, F.R.S., Mr. W. Spottiswoode, LL.D., F.R.S., Sir W. Thomson, LL.D., F.R.S., and Dr. W. H. Stone. Secretaries: Prof. A. W. Reinold and W. C. Roberts, F.R.S. Treasurer, Dr. E. Atkinson. Demonstrator, Prof. F. Guthrie, F.R.S. Other Members of Council: Prof. W. F. Barrett, Latimer Clark, Major Festing, W. Huggins, D.C.L., F.R.S., Prof. Kennedy, O. J. Lodge, Prof. H. MacLeod, Prof. B. Stewart, LL.D., F.R.S., Prof. Unwin, and E. O. W. Whitehouse.—The proceedings terminated with votes of thanks to the Lords of the Committee of Council on Education for the use of the Physical Laboratory at South Kensington and to the several officers of the Society.

Royal Microscopical Society, February 7.—Anniversary meeting.—H. C. Sorby, F.R.S., president, in the chair.—The president delivered the annual address, in which, after reference to the memory of those of their number deceased during the past year, he gave an interesting account of his recent researches into the composition and origin of the loose materials which form the sands and clays of this country, and also of those composing the sandstones and stratified rocks.—The result of the ballot for officers and council for the ensuing year was as follows:—President, Mr. H. C. Sorby. Vice-presidents: Dr. L. S. Beale, Sir John Lubbock, Bart., Rev. W. H. Dallinger, and Mr. H. Powell. Treasurer, Mr. John W. Stephenson. Hon. Secretaries: Mr. H. J. Slack and Mr. Chas. Stewart. Council: Dr. Robert Braithwaite, Dr. Lawson, Dr. Millar, Messrs. Bevington, Brooke, F. Crisp, Inppen, E. W. Jones, J. Joy, M'Intyre, Thos. Palmer, and F. H. Ward. Assistant Secretary, Mr. Walter W. Keeves.

Institution of Civil Engineers, February 6.—Mr. George Robert Stephenson, president, in the chair.—The paper read was on "The Sewage Question," by Mr. C. Norman Bazalgette.

## ROME

R. Accademia dei Lincei, January 7.—Second appendix to memoir on the construction, properties, and applications of a constant inductor, by M. Volpicelli.—On complete elliptic integrals, by Prof. Smith.—On the small oscillations of an entirely free rigid body, by M. Cerruti.—On the anatomy and physiology of the retina (continued), by M. Franz Boll.—On the spinal medulla and the electric lobe of the torpedo, by M. Reichenheim.—Geological studies on the group of the Gran Paradiso.—Rational catalogue of the rocks of Friuli, by M. Taramelli.

## PARIS

Academy of Sciences, February 5.—M. Peligot in the chair.—M. Duchartre presented the second and last part of the second edition of his "Éléments de Botanique." The following papers were read:—On the fundamental invariants of the binary form of the eighth degree, by Prof. Sylvester.—Preliminaries of a comparative study of living and fossil European oaks; definition of present races, by M. De Saporta.—On monochlorised oxide of methyl, by M. Friedel.—Composition and origin of diamantiferous sand of Du Toit's Pan, in South Africa, by M. Meunier. Geologists have assigned a deep origin, representing them as the residue of alteration of pyrogenous rocks emitted like lava. The author's analysis gives, besides minerals proper, a number of complex rocks which cannot have been formed at once in the state of mixture by the same causes. Each of them must have been removed from a special deposit, then carried to the point where mixture took place. These sands belong to the so-called vertical alluvia, and are related in formation to the Kaolinic sands in the environs of Paris.—On the preparation and use of the liquid for washing vines attacked by Phylloxera, by M. Bouteau.—MM. André and Augot expressed a

Mercury on May 5, 1878. They hope thus to render the study of the next Venus transit more fruitful.—Diathermancy of metals and of paper, by M. Aymonnet. They are not athermanous, as generally thought. They are more diathermanous for dark heat from metallic bodies raised to a temperature under 100° than for luminous calorific radiations or those near red. They have weaker absorbent powers than water. It is possible to find a mathematical relation between the absorbent power of a body and its coefficient of conductivity.—Note on the presence of ammonia in cast steel, by M. Regnard. Ingots of steel newly broken gave a distinct smell of ammonia, with perceptible noise in escape of the gas, and bubbles in soapy water if applied. The appearance of the fracture in all such cases was crystalline, varying slightly from periphery to centre; the liberation was greatest at centre. Soft steels in general did not give the phenomenon, nor did ingots previously annealed. Analysis of the gas showed it to be nearly pure hydrogen, with perhaps a few traces of acetylene.—On the active principle of *Strophantus hispidus*, or Ince, by MM. Hardy and Gallois. This is the plant used by the Pahomias in poisoning their arrows. The isolated body, called *ineine*, has not the same physiological properties as *Strophantine* (so-called by Fraser). Injected in considerable quantity under the skin of a frog's foot, it does not stop the heart's movements.—Immediate disorders produced by injections of pure fuchsine into the blood, by MM. Feltz and Ritter. The nervous disorders, like those of drunkenness, cannot, the authors now think, be due to embolic lesion (in the capillaries), but to direct impression of the nervous system by the fuchsine itself.—Structure and mineralogical composition of variolite of Durance, by M. Michel Levy. The globules of variolite are not petro-silicious. By its petrographic affinities it seems to be a compact term of the series of euphotides. It presents an interesting association of several varieties of amphibole and pyroxene; also a new example of spherulites entirely crystallised.—On the intestinal anguillule (*Anguillula intestinalis*), a new nematoid worm found by Dr. Normand in persons attacked by diarrhoea of Cochin China, by M. Ravay. It is distinct from, and much less abundant than, the *Anguillula stercoralis*.—On the minute phenomena of fecundation, by M. Fol. All the phenomena are reduced to two typical cases.—On *Filaria hematica* (Hæmatozoa), by MM. Galeb and Pourquier. The authors found filaria in the blood of the fetus of a bitch whose heart was teeming with them; the embryos doubtless passed through from mother to offspring. This explanation destroys the idea of verminous diathesis, and of spontaneous generation, called in to explain the genesis of such hæmatozoa. The authors also verify M. Davaine's view that the nematoid worms circulating in the vessels of certain dogs are larvæ of the hæmatic filaria.—Determination of ammonia in the air and in meteoric waters at Montsouris, by M. Levy.—On two new species of Ibis, from Cambodge, by M. Oustalet.—On a new sounding-line, by M. Tardieu.

## CONTENTS

	PAGE
DARWIN ON FERTILISATION. By Prof. W. T. THIBELTON DYER . . .	349
OUR BOOK SHELF:—	
" Bulletin des Sciences Mathématiques et Astronomiques " . . .	351
LETTERS TO THE EDITOR:—	
The Obsidian Cutlers of Melok.—Rev. GERALD S. DAVIES . . .	351
Ocean and Atmospheric Currents.—Capt. DIGBY MURRAY; Rev.	
W. CLEMENT LEY . . .	352
Auriferous Lights.—G. HENRY KINAHAN . . .	353
On the Sense of Hearing in Birds.—Prof. A. LEITH ADAMS . . .	354
Tapeworm in Rabbits.—R. D. TURNER . . .	355
Meteor of January 7, to 31 P.M.—W. F. DENNING . . .	352
THE UNITED STATES GEOGRAPHICAL AND GEOLOGICAL SURVEY OF	
THE WESTERN TERRITORIES UNDER DR. F. V. HAYDEN . . .	358
ALLOY OF PLATINUM AND IRIUM FOR A NEW METRIC STANDARD	
OF LENGTH. By W. CHANDLER ROBERTS, F.R.S. . . .	357
THE UPPER COLORADO. By Prof. ARCHIBALD GEIKIE ( <i>With Illustrations</i> ) . . .	351
DEEP SEA MUDS, II. By Mr. JOHN MURRAY ( <i>With Illustration</i> ) . . .	347
OUR ASTRONOMICAL COLUMN:—	
New Comet . . .	344
The Occultation of Regulus on February 25 . . .	341
The Solar Eclipse of 1877, April 9 . . .	349
New Minor Planet . . .	347
METEOROLOGICAL NOTES:—	
Meteorology of the Libyan Desert . . .	34
Height of the Seine at Paris during 1876 . . .	37
Oscillations of Tides . . .	34
Hurricanes of January 31, in Belgium and Holland . . .	34
Weather Notes . . .	34
International Weather Maps . . .	34
NOTES . . .	36
SCIENTIFIC REVIEWS . . .	34

THURSDAY, FEBRUARY 22, 1877

## A WORKING NATURALIST

*Life of a Scottish Naturalist: Thomas Edward, Associate of the Linnean Society.* By Samuel Smiles. Portrait and Illustrations by George Reid, A.R.S.A. (London: John Murray, 1876.)

It is rather a delicate thing and seldom advisable to publish a full and formal biography of a man with an account and attempted estimate of his work while he himself is still alive and in comparative vigour. There are many sound reasons, however, to justify Mr. Smiles in telling the wonderful story of the still living Thomas Edward, the Banff shoemaker and naturalist; not the least weighty of these is that it will bring to Edward some of that *kudos* and cash which he has earned long ago, and which it would have been well for himself and for science had they, or at least the latter, reached him years since.

Thomas Edward, born 1814, is the son of very humble but thoroughly respectable Scotch parents, who were able to bestow upon him the scantiest schooling. He was brought up in Aberdeen, where he was in rapid succession expelled from three schools on account of his intense in-born passion for "everything that hath life." He used to take all sorts of birds and beasts and creeping things to school with him, in his pockets, in boxes, or in bottles. Tom's specimens would often escape, and the scene may be imagined when some unconscious urchin realised that a snail, or a horse-leech, or a "Maggie-mony-feet" (centipede), was crawling up his bare legs. Poor Edward meant no harm, but it was too much to expect that an ordinary dame or dominie would, in that remote and unscientific age, at least, take the trouble to understand the boy's nature and tendencies and aspirations. The consequence was severe thrashings and expulsion.

When Edward left school finally he was only six years old, could read with difficulty, and could hardly be said to be able either to write or count. After serving for some time in a mill he was apprenticed to a shoemaker, Begg, "a low-class Cockney," Mr. Smiles calls him, and certainly a regular brute, who treated the poor boy and his birds and beasts in a most cruel fashion. However Edward managed with this man and a subsequent master to pick up a fair knowledge of the shoemaking trade, and after vainly trying to emigrate as a stowaway, removed to Banff when about twenty years old, where he has lived ever since working as a journeyman for wages, and devoting every moment of his leisure to the gratification of his passion for natural history. It is common enough for working men, and especially for shoemakers, to take an interest in certain animals, especially in birds; but Edward's fondness for animals was no fancy of this sort. From almost his infancy he was devoured with a passion for the observation and possession of animals of all kinds; to him no living creature was unclean or loathsome, and he feared to face or handle nothing from a centipede or an adder to a polecat. While yet a baby in his mother's arms he nearly put a premature end to his career by springing to clutch at a passing insect; and while being drilled as a militiaman in Aberdeen he made himself liable

to severe punishment by rushing like a madman from the ranks in chase of a passing butterfly.

As a journeyman shoemaker Edward had to work from six in the morning till nine at night. Shortly after settling in Banff he married, luckily for his love of nature, a prudent and considerate woman, who, instead of thwarting his eccentricities, did what she could to help him and enable him to indulge them. "Weel," she said once, when asked what she thought of his habits, "he took such an interest in beasts that I didna compleen. Shoemakers were then a very drucken set, but his beasts keepit him frae them. My man's been a sober man all his life; and he never negleckit his wark. Sae I let him be." "Wise woman!" justly adds Mr. Smiles. Shoemakers' wages in Banff were very low—only a few shillings a week. For many years Edward earned only about 10s. a week, and yet on this he managed to rear, without incurring debt, a thoroughly respectable and honest family of about a dozen children, who have repaid their parents' care by doing what they could to comfort their old age. Edward being a man who had a proper sense of his duty to his family, seldom thought of allowing his favourite pursuit to encroach on his long working hours. As his consuming passion must be satisfied, he took the only course legitimately open to him; he gave up his nights to it. As soon as he got home from work, unless indeed the weather was unusually bad, he shouldered his gun, equipped himself in his eight-pocket coat, four-pocket vest, double-storied hat, and other traps of a rude but efficient enough kind, and putting his supper of oatmeal cakes in his pocket, set out to watch and catch the denizens of the woods, heaths, air, and sea-shore of the region around Banff. He would prowl about as long as the light permitted, lie down for an hour or two in a hole, under the lee of a bush, inside some old ruin, or underneath a flat tombstone in some eerie churchyard, snatch an hour or two's sleep, and be up again with the first streak of dawn. Even when thus resting, however, he would frequently be kept awake watching the doings of any night animals that might be near him. Frequently also his rest was a very broken one. He might be awakened by a weasel or a pair of rats or some other inquisitive or hungry creature tugging at his coat-pockets or trying to make their way underneath his hat, always well filled with insects, birds, or eggs. He gives a most exciting description of a two hours' struggle with a pole-cat that attacked him while resting in darkness in the ruins of Boyne Castle. He was dreadfully lacerated by the claws of the animal, but this he did not mind, so long as he succeeded in keeping the skin of the pole-cat whole. Once he spent two days and a night, without sleep or food, in watching a Little Stint (*Tringa minuta*), which he sighted on the shore near Banff, and thought himself amply rewarded by being able at last to capture it. As might be expected, in his unconscious eagerness to follow out his pursuit, he met with frequent accidents, and was once or twice within very little of losing his life by falling down high precipices. All this, however, he took as "in the bond"—as no more than might be looked for by one in his circumstances persisting in gratifying a passion of the kind that consumed him.

When compelled to stay at home Edward occupied himself with the preparation of his collections and the

making of cases for holding them. In no long time every corner of his house was filled with cases, and he wisely determined to turn an honest penny by exhibiting his treasures. This he did on two or three occasions in Banff on fair days when the town was filled with country people. These exhibitions were so successful that he resolved, by the advice of his friends—it was all the help they ever gave him—to try a wider sphere, and he rented a room in Aberdeen, where he arranged his collection. Many of the groups of animals were most artistically put together, and as a mere sight, not to speak of its scientific value, the exhibition was well worth visiting. But it proved a complete failure; only a few people dropped in. It was a serious matter to Edward, for of course he had to leave his work and necessarily incur what were for him considerable liabilities. The prospect was so gloomy that he was driven to think of the last resort of despair, suicide. He went down to the mouth of the Dee, and had divested himself of his outer garments preparatory to taking a last plunge, when a strange bird hopping about on the sand caught his eye. His ruling passion asserted its sway, and off he set on a long and exciting chase to discover the nature of the bird; in this he failed, but the chase left him a more cheerful and a wiser man. He was compelled to sell his collection for about 20/, returned to Banff and resumed his work and gradually his old habits, and ere long had the pleasure of seeing another collection gradually accumulating. More than once afterwards had he to sell his collections, which he regarded as his savings' bank to fall back upon in time of need. But his ardour was never damped, and until prevented from wandering far by rheumatism and other results of his hard life, he never ceased adding to his store.

Edward's collections not only included quadrupeds, birds, and insects; plants of all kinds came in for a share of his attention, and, latterly, marine animals of all kinds; in the last field, especially, he did work of the highest value. Except one or two clergymen of similar tastes, the dreadfully respectable people in and about Banff took no notice of Edward, whom they seem rather to have shunned as eccentric, if not crazy. But gradually naturalists in various parts of England came to know of him, and thus he got into correspondence with well-known workers in various parts of England. One of his principal correspondents was Mr. Spence Bate, who, during the preparation of the "History of the British Sessile-eyed Crustacea," obtained important help from Edward. The latter collected for and sent Mr. Bate a very large number of specimens. Of 294 Crustaceans found in the Moray Firth, no fewer than twenty-six new species were added by Edward himself. A new Isopod which he discovered was named after himself *Praniza (Anceus) Edwardii*, and one of his most notable discoveries was one of the little fishes known as midges, which he sent to Mr. Couch, who pronounced it new to science, and named it Edward's Midge (*Couchia Edwardii*). By and by he was induced to send descriptions of his observations first to the local journal and latterly to such scientific journals as the *Linnean Society's Journal*, the *Zoologist*, *Naturalist*, and *Ibis*. No one reading Edward's accounts of his experiences would ever dream that their author had had no schooling after his sixth year, and had worked nearly all his life from 6 A.M. till 9 P.M. at a common handicraft. They

have been compared without any exaggeration to the classical descriptions of Wilson and Audubon.

How Edward, with no dredging apparatus whatever, but only with old pots, pans, rags, from seaweed cast ashore, from the inside of fishes obtained from the fishermen, and by other similar methods, collected his marine specimens, many of the greatest rarity, is well told in Mr. Smiles's narrative. It is quite amazing how much is yet to be learned about the commonest objects of our land and sea; and how much of new Edward managed to discover of the nature and habits of animals about which one would have thought no more was to be learned. In an appendix of forty-eight pages Mr. Smiles gives a descriptive list of a portion of the Fauna of Banffshire observed or found by Edward; had all that he has found been thus catalogued it would have filled the volume.

It is to the credit of the Linnean Society that years ago they conferred upon Edward the rare honour of Associate. Doubtless had the numerous correspondents whom he was so ready to help with specimens and the result of his observations known of his real condition, they would have done something to put him in a position in which he could have helped science with less hardship to himself. Here, surely, if ever there was one, was a fair case for the endowment of unremunerative research, and had the fund now being allotted been in existence even ten years ago, Edward would have had a prime claim upon it. How these things are managed in Norway may be learned from the following extract from a letter from Mr. A. Archer, Laurvig, Norway, to the *Times*, called forth by reading Edward's Life:—

"Some years ago there lived on the wild west coast of Norway a clergyman, with his wife, a large family, and a small income. He, too, employed every leisure hour in the study of nature, but being a graduate of Christiania University, and being obliged to take many a journey over the large fiords in visiting distant parts of his parish, he possessed two great advantages over Edward—a good education and larger opportunities of observation. He, too, had the seeing eye without which all opportunities are useless, and shortly it was known that science was being enriched with discoveries in zoology made by the hard-worked parish priest. The action of the Norwegian Storting was prompt. Though the great majority of that body are poor peasants, with little more education than they have picked up in the parish school, and though in all ordinary cases they hold the purse-strings with a grip that would have pleased Joseph Hume, they have the virtue of being liberal when good cause can be shown for it. At the request of the Governing Body of the Christiania University they created a new unattached Professorship of Zoology, endowed it with a salary of 333/, equal to 1,000/ in England; and, relieving the clergyman from his parish duties, which could be as well performed by another, appointed him to the professorship, but without requiring from him either residence or teaching. How the Professor, in these favourable circumstances, went on enriching science with his discoveries till his name became famous over the world, how he trained up his sons to follow in his footsteps, how two of them, though yet young men, are professors in Christiania University, one of them in his own favourite science, all this is known to the scientific men of Europe, nor should any of them read this, will they require to be told that the name of the clergyman was Sars. It would, of course, be absurd to ask the enlightened Parliament of Great Britain to take in the case of Edward a hint from the Norwegian Storting in the case of Sars, and the

Scotch Universities are, we all know, too poor to create unattached professorships and endow them, standing as they do rather in need of endowment. Is it equally absurd to ask if one of the wealthy English Universities would not consider it an honour to rank Edward among its professors, and assist him to publish the observations he may yet have time to make, or does it merely show gross ignorance of the spirit in which they are governed to suppose that either of them could so far depart from the usual routine? I suppose I am not the only countryman of Edward who, having lived here long enough to learn how poor Norway rears her great men, will regret—not so much on account of Thomas Edward, for his has been a great life and example, but in the cause of science—that his lines have not fallen in pleasanter places."

But Edward never complained of his lot, and had Mr. Smiles not written the present work, he would have had to stick to his stool to the end. All Edward ever wanted was some way of earning a living that would have enabled him to give more time and attention to his scientific pursuits, and no one will deny that it would have been immensely to the gain of science could his services have been devoted entirely to it, for he was too passionately fond of nature ever to have been spoiled by prosperity. But regrets are now useless; happily Edward is not beyond the reach of consolation and well-merited reward, and happily he is receiving them. He will be mentioned in the annals of science as an observer of the highest accuracy and originality, who gave up to a parish a genius fitted for an immensely wider sphere. The obvious moral of the work to those who have to spend most of their time in earning their daily bread, as well as to others, we need not point here. Mr. Smiles's work is one of the most interesting biographies ever written, and the illustrations gratuitously contributed by Mr. Reid are a great pleasure. Our readers by buying the book will not only become possessed of a rare treat, but will at the same time help to confer a substantial benefit upon Thomas Edward, the Scottish Naturalist.

#### BLAKE'S "ASTRONOMICAL MYTHS"

*Astronomical Myths. Based on Flammarion's "History of the Heavens."* By John F. Blake. (London: Macmillan and Co., 1877.)

IN the continual turmoil of daily life, when each one is looking forward to new methods and new discoveries, we seldom or never look back into the doings of our early predecessors, and even when we do we are somewhat inclined to pity their ignorance and their, to us, absurd notions. We ought rather to call to mind the difficulties under which the great men of old laboured, difficulties under which our present learners in astronomy would probably have been equally sorely tried. We must remember that we have all the sister sciences lending their aid, and that therefore the advance in astronomy should be made with constantly increasing strides.

The author of this work has put before us the labour of M. Flammarion in an English dress, and has added other matters—notably a chapter containing the researches of Mr. Halliburton on the Pleiades, to many the most interesting part of the book. We are carried back to the times when nations thought as the child did in the lines of Tom Hood, quoted by the author:—

"I remember, I remember, the fir trees straight and high,  
And how I thought their slender tops were close against the sky;

It was a childish fantasy, but now 'tis little joy,  
To know I'm further off from heaven than when I was a boy."

Mr. Blake commences by calling attention to the contemplation by our ancestors of the awe-inspiring phenomena of the heavens by night, the rising and setting of the sun, moon, and planets, the slow and silent motion of the constellations from east to west. To them the sky was a lofty canopy studded with stars, the earth a vast plain, the solid basis of the universe. Two distinct regions appeared to compose the whole system—the upper one, or the air, in which were the moving stars, and the firmament over all; and the lower one, the earth and the sea.

It is to be expected that in early times religious beliefs and rites were mixed up with and were derived from the motions and appearance of the heavenly bodies. The Druids appear to have seen or imagined that the moon was a body like the earth, having mountains, and, according to Plutarch, furrowed with several Mediterranean seas, which the Grecian philosophers compared to the Red and Caspian seas. This celestial earth was supposed by the western theologians to be the abode of departed souls, the place of immortality. The festivals were therefore ranged accordingly, and the Druids were represented as holding a crescent in their hands.

The origin of the names of the constellations has always been a source of speculation, and the chapter on this subject is well worth study. For the names of several of them there appears to be some show of reason, but others have been named from mere caprice, or in honour of some person or event. In the case of the "Locks of Berenice," the story goes that Berenice was the spouse and sister of Ptolemy Evergetes, and that she made a vow to cut off her locks and devote them to Venus if her husband returned victorious, and, to console the king, the astrologer placed her locks among the stars. The Great Bear, the *ἄρκτος μεγάλη* of the Greeks, the Okouari (bear) of the Iroquois may have been so called, as Aristotle observes, because the bear is the only animal that dared venture into the regions of the north. The Arabs called the bears the great and little coffins, and the Christian Arabs made the Great Bear the grave of Lazarus, and the three weepers Mary, Martha, and their maid.

The history of the signs of the zodiac is traced downwards in the several nations, and it is pointed out that the names may have originated in the rising of constellations at the times of certain important events, as Aquarius at the time of the inundation at Thebes, and the Bull at the time of ploughing, but this does not account for all. Further, we find how the precession of the equinoxes furnishes us with a means of fixing the date of the signs receiving their names; at that date the names of the signs of course corresponded to the zodiacal constellations, and if we find in any description that the equinox is said to be in the sign of the Bull we know that the method of naming dates back to some 3,000 years ago, for at that period the equinox happened in the constellation of the Bull. According to our present nomenclature the equinox happens in Aries, but really when the sun is in Pisces; our method therefore dates back to about 2,300 years ago when the equinox was in the constellation of

Aries, or more probably to the time of Hipparchus, when the equinox was exactly at the star  $\beta$  Arietis. It occurs to us that the worship of the Bull and Golden Calf was in vogue during the time that the equinox happened in the constellation of Taurus, that the Ram and Lamb were held in estimation at a later date when the equinox happened in the constellation of Aries.

The most prominent group of stars in the heavens—the Pleiades—has always been an object of attention, and we are glad to find an interesting chapter on this subject based on the careful work of Mr. Haliburton. The Pleiades, we learn, were observed for the purpose of dividing the year into two parts—one “the Pleiades above,” and the other “the Pleiades below.” During one half-year, while they were east of the sun, they would be visible at sunset and the reverse during the other half. The culmination of the Pleiades at midnight appears to have been with many nations the starting-point of the year, and here again the precession of the equinoxes has an interesting effect, since the tropical year is shorter than the sidereal. Thus the dates of the latter keep advancing on those of the former, and so long as dates were regulated by the stars all the countries would agree in the time of their festivals; but, as the author puts it, “as soon as a solar calendar was arranged, and it was found that at that time this position coincided with a certain day, say the Pleiades culminating at midnight on November 17, then some would keep on the date November 17 as the important day, even when the Pleiades no longer culminated at midnight then, and others would keep reckoning by the stars, and so have a different date.”

The instance given of the 17th November seems to be somewhat strange, for, on referring to our star maps, it appears that the Pleiades culminate now at midnight on or about the 14th November, and years ago the midnight culmination took place of course earlier in the year. It is, however, possible that judgment of the date of midnight culmination was in error.

Mr. Blake then goes on to point out that a new year's festival determined by the Pleiades is the most universal of customs. The Australians hold their new year's corroboree in November at the midnight culmination, and in India the year was determined by the Pleiades, and on the 17th day of November is celebrated the Hindoo Durga, the festival of the dead, and new year's commemoration. So also the Egyptians regulated their solar calendar that the day might be unchanged, and the commemoration of the dead took place on the 17th of their month Athyr, the same date at which the Mosaic account of the deluge makes the same commence. This, we agree with the author, is no chance coincidence.

We cannot think, however, that the explanation of the origin of November 17 is clear, for although some 4,000 years ago the equinoctial point was close to the Pleiades, there appears no particular reason that the day on which the equinox happened when near that group would be called November 17, and if it was so called how comes it that the midnight culmination happens now within three days of the same date, while our calendar has continually been changing with reference to sidereal events? If we assume that the commemorations of India and other places are kept on the day of midnight culmination of this group,

without inference to the calendar, then the events would happen now without much error on November 17, and will happen on December 17 some 2,200 years hence, and if we reckon back according to our calendar to a time—to some 4,000 years ago—the culmination and festivals would have happened on the autumnal (spring of the southern Hemisphere) equinox—September 21. We do not see from the text how the Egyptian and Mosaic dates of November 17, although perhaps connected together, can have any connection with the festivals of other nations kept on that date in modern times. The calendar might have been arranged to suit the sidereal year up to a comparatively late date, but our calendar has been fitted to the tropical year much too long to allow, at its commencement, the midnight culmination of the Pleiades to have happened anywhere near November 17.

In other words, the festivals depending on the midnight culmination of the Pleiades will necessarily be kept on or about the same day, and that day happens to be February 14, or, say November 17; now unless the calendar be a sidereal one, which it is not, this festival must have, in bygone years, happened earlier than November 17. It would seem, therefore, that some other event than the culmination of the Pleiades happened, by which the Mosaic and Egyptian date of November 17 was fixed.

The further account of the Pleiades and the relation to the passage in the Pyramid of Gizeh, as investigated by Piazzzi Smyth, is extremely interesting.

In the chapter on astronomical systems there is much worth reading, and the diagrams show the gradual advance of observation and order over imagination, and it seems curious to us at the present time that the ancients should have gone so far out of their way to describe the earth as a flat surface floating, with roots, on pillars, on the backs of elephants standing on a tortoise, as a portion of a cylinder, as cubical, or as having various other forms. The geography and cosmography are no less interesting, and a large number of diagrams of maps are given, many of which appear to have been made to suit the superstitious ideas of the fathers of the various churches rather than the results of observation.

The chapters on Eclipses and Comets, with the anecdotes of the consternation and awe produced by their appearance, give us a very correct idea of the all-supreme superstition of the middle and earlier ages; but even now among civilised nations there appears to be a large amount of superstition to be eradicated.

#### OUR BOOK SHELF

*Acoustics, Light, and Heat.* By William Lees, M.A., &c. Glasgow: Collins, Sons, and Co., 1877. (Collins's Advanced Science Series.)

THIS is a good specimen of a series of text-books, among which Dr. Guthrie's capital compendium of Magnetism and Electricity, and several other valuable works have appeared. It is stated, in a brief preface, to be founded on notes of the late Dr. W. S. Davis of Derby, who was to have undertaken its preparation, and to whom the first chapter, as well as the Appendix on the Doctrines of Energy, are due.

Text-books are far from easy to write in a satisfactory manner; by their very definition and nature they contain no novelty, except such as can be secured by clear treatment and lucid exposition of subjects already familiar.



They are, moreover, being issued in such numbers, under the present demand for popular education, that their very likeness to one another is fatiguing. They require also in their construction the rare faculty, whether intuitive or gained by long experience, of insight into a student's probable difficulties; for it seems desirable that they should rather aim at being employed as condensers and systematisers of knowledge already acquired generally from the study of larger and more diffuse treatises, than as independent works. It is in this respect that useful practical knowledge differs from "cram"; a distinction very real, though more difficult to define than to understand. The concentrated food offered by such compilations is less easy of digestion, and more readily expelled from the mental economy, than that which is more gradually administered and more completely assimilated.

The writer of the present manual has, for instance, only seventy pages to devote to Sound, one hundred and eighteen to Light, and ninety-one to Heat, exclusive of the Appendix. But it is remarkable how much he succeeds in compressing within these very restricted limits. The illustrative experiments are, as a rule, simple and well chosen, though occasionally trite, and even of doubtful accuracy; as is seen in the drawing of the periodic curve of a musical sound at p. 40, and that of dispersion of light on p. 135. On the other hand, the use of a long spiral steel spring to illustrate waves of compression and rarefaction, the description of the effects of Temperature on Sound-waves, and the chapters on Interference, Diffraction, and Polarisation of Light, especially in its Circular and Rotatory forms, are ingenious and easy to comprehend.

A few simple numerical examples are given of each important law, with their solutions, and the mode of working out; a method which probably tends more than any other to fix essential points on the memory of the student.

W. H. STONE

### LETTERS TO THE EDITOR

[The Editor does not hold himself responsible for opinions expressed by his correspondents. Neither can he undertake to return, or to correspond with the writers of, rejected manuscripts. No notice is taken of anonymous communications.]

#### Postulates and Axioms

A STRONG committee, appointed, or rather re-appointed, for the purpose, reported last year to the British Association upon the Syllabus drawn up by the Association for the Improvement of Geometrical Teaching. I have only just seen a copy of the report, and I wish to point out that it incidentally touches in a misleading fashion upon a matter which, though primarily of only historical interest, is really of theoretical importance too, if not (in the strictest sense) for the special purpose of the committee; I mean upon the different ways of distributing the fundamental assumptions under the two heads of postulate and axiom.

Let us stop for a moment at the historical point of view. It is well known that the received text of Euclid, which we may consider represented by David Gregory's edition (Oxford, 1703), misplaces the assumption about right angles, the assumption at the base of the theory of parallels, and the assumption that two straight lines do not inclose a space. That is to say, whereas in the correct text these are the 4th, 5th, and 6th postulates, the received text makes them the 10th, 11th, and 12th common notions, or, as we usually say, axioms.

Now, when the report speaks of Euclid in this connection, it means something nearly identical with the received text. Not quite, however; for, though the language is not clear in all respects, it clearly says thus much, that Euclid divided the axioms into general and specially geometrical. But this is not the case in either text; for in both texts the first seven common notions are general, the 8th geometrical, and the 9th general again, nor is the 5th distinguished from the rest by its grammatical form. But whether you follow the received text or depart from both, it is unhistorical to affirm of Euclid what is not true of the correct text.

Let us now consider the theoretical significance of the two dis-

tributions. The case is thus stated by De Morgan, under *Euclid's*, in Smith's "Dictionary of Greek and Roman Biography," p. 66b:—"The intention of Euclid seems to have been to distinguish between that which his reader must grant, or seek another system, whatever may be his opinion as to the propriety of the assumption, and that which there is no question *every one* will grant. The modern editor merely distinguishes the assumed *problem* (or construction) from the assumed *theorem*." This latter distinction is at least as old as Proclus; but to De Morgan it is Euclid's, at least as concerns right angles and parallels, that "seems most reasonable; for it is certain," he continues, "that the first two assumptions can have no claim to rank among common notions or to be placed in the same list with 'the whole is greater than its part.'" We need not pursue the modern editor's distinction further; but Euclid's acquires a more definite significance in relation to those generalised conceptions of space which, since De Morgan wrote these words, have almost passed into popular science. This in its generality is a difficult subject, but for the present purpose it is enough to regard plane geometry as a particular case of the geometry of points and lines on a given surface.

In this view the postulates specify the attributes of the plane which make plane geometry what it is. Thus the first three, whatever else they do, provide that the power of drawing diagrams shall not be restricted by boundries, and the fourth, "all right angles are equal," affirms that a complete rotation is the same in quantity at all points; thereby the first three exclude surfaces having such a singular locus as a cuspidal line, and the fourth excludes surfaces having such a point as the vertex of a cone. Again the fifth excludes anticlastic surfaces, and the sixth synclastic ones and any which, like the common cylinder, returns into itself. Nothing remains but the plane and such developable surfaces as the parabolic cylinder to which *mutatis mutandis* everything in plane geometry will equally apply.

The axioms, on the contrary, specify no property of any class of surfaces. This is crucially instanced in the one axiom (the 8th, that things congruent are equal) which does concern figures traced on surfaces of only a limited class. For this axiom merely says that if things coincide they are equal, not that figures in different places may be brought to coincide.

The question may be asked whether this last assumption ought not to be premised somewhere, that is, whether the method of superposition ought not to have been vindicated by expressly assuming that any plane figure may be laid down on any plane so as to coincide with a portion of it. The omission is an extremely curious fact—in Euclid, I mean, for it is not at all remarkable in his successors. On the one hand, express statement is superfluous in the sense that the assumption is implied in the last two postulates; for the fifth affirms that the "measure of curvature" of the plane is not negative, and the sixth that it is not positive, between them it is naught, and therefore constant; but this is the condition of superposableness. On the other hand, express statement is indispensable in the sense that the student cannot do without it, because the theory of measure of curvature does not belong to elementary geometry.

The fact is that Euclid has drawn the line with what is really remarkable accuracy, but is only seen to be so in virtue of principles not discerned, I believe, by any one before Gauss. Whatever may be the explanation of this phenomenon, to ignore it in speaking of Euclid's postulates and Euclid's axioms is to depart from history where adherence to history would be instructive in theory too.

It is of course another question whether this distinction of Euclid's ought to be preserved in books intended to supersede Euclid.

C. J. MONRO

Hadley, Barnet

#### Just Intonation

THAT Mr. Chappell misunderstands me is due partly to his confounding vibration numbers with their ratios. Thus  $\frac{2}{3}$  is the vibration number of the supertonic, where  $\frac{1}{3}$  is that of the tonic; while 524288 is not the vibration number of any musical sound, though the ratio  $524288 : 531441 = 2^{10} : 3^{11}$  expresses an interval that may be picked out fourteen times in each octave of Mr. Colin Brown's keyboard. A still more complex interval  $2^{22} : 3^{24}$  is found seven times in each octave.

I have followed Mr. Chappell's advice and purchased his six-penny pamphlet, and having read it with the care it deserves, I can only say I dissent from a great part of it, especially where

harmonics and the scale are treated of, and I am not surprised that its author cannot understand the numerical basis of Colin Brown's Just Intonation Harmonium.

The strict harmonic chords of the seven notes of the scale, including only sounds in the scale of C, and excluding all approximations, are these:

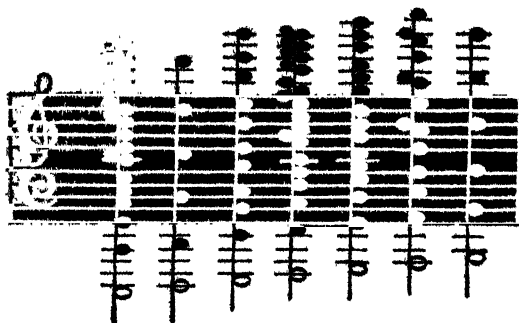

Here it will be observed that all the tones of the scale are harmonics of F and of that note only (a circumstance first pointed out by Colin Brown). I do not admit that F and A are notes *interposed* in the scale of C.

A. R. CLARKE  
Ordnance Survey Office, Southampton, February 8

#### Protective Mimicry among Bats

I HAVE read with much interest the remarks of Dr. S. Archer in NATURE, vol. xv. p. 313, on the habits of *Rynchonycteris naso*, Wied. (= *Proboscidea saxatilis* at *swalis*, Spix.), as they quite agree with notes on the same species made by me when travelling some years ago in British Guiana.

This is not, however, the first published notice of protective mimicry among bats. In my "Monograph of the Asiatic Chiroptera" (1876), I have referred to the peculiar markings of the wing and intermembral membranes in *Kerivoula picta*, *Vesperugo formosus*, and *V. Wetwutschii*, which are coloured on the same plan although these species are related in no other respects, and have stated that I believe these markings to be the result of "protective mimicry." Of one of the two first-named species, Mr. Swinhoe remarks:—"A species of *Kerivoula* allied to *K. picta* and *K. formosa*, was brought to me by a native. The body of this bat was of an orange brown; but the wings were painted with orange-yellow and black. It was caught, suspended head downwards, on a cluster of the round fruit of the Longan-tree (*Nephelium longanum*). Now this tree is an evergreen; and all the year through some portion of its foliage is undergoing decay, the particular leaves being, in such a stage, partially orange and black. This bat can, therefore, at all seasons, suspend from its branches, and elude its enemies by its resemblance to the leaf of the tree. It was in August when this specimen was brought to me. It had at that season found the fruit ripe and reddish-yellow, and had tried to escape observation in the semblance of its own tints to those of the fruit."<sup>1</sup>

A familiar instance of what appears to be "protective mimicry" occurs in the species of the genus *Pteropus* (Flying-foxes of European residents in India). These, the largest of all bats, measuring, on an average, nearly one foot in length with an expanse of wing of from four to five feet, are, from their large size, very conspicuous objects even when the wings are closed, and easily seen from the ground when hanging from lofty trees. With very few exceptions these bats have the fur of the back of the head and of the nape of the neck and shoulders of a more or less bright reddish or bright buff colour, contrasting strongly with the dark brown or black fur of the back. At first sight it might appear that this remarkable contrast of colour would render the animal more conspicuous to passing enemies, and consequently more subject to their attacks when hanging in a semi-jerid condition. But any one who has seen a colony of these bats suspended from the branches of a banyan tree, or from a silk cotton tree (*Eriodendron orientale*), must have been struck with their resemblance to large ripe fruits, and this is especially noticeable when they hang in clusters from the leaf-stalks of the cocoa-nut palm, where they may be easily mistaken for a bunch of ripe cocoa-nuts. Hanging close together, each with his head bent forwards on the chest, his body wrapped up in the ample folds of the large wings, and the back turned outwards, the

brightly coloured head and neck is presented to view, and resembles the extremity of a ripe cocoa-nut, with which this animal also closely corresponds in size.<sup>2</sup>

The much smaller species of *Cynopterus* and *Macroglossus* which feed on the fruit of guavas, plantains, and mangoes, resemble these fruits closely in the yellow colour of their fur and in their size, so that it is very difficult to detect one of these bats when suspended among the leaves of any of these trees.

The resemblances, however, between these frugivorous bats and the fruits of the trees on which they roost, may be accidental, and, in the present state of our knowledge, we would scarcely be justified in setting them down as the result of "protective mimicry," though there can be little doubt that, to whatever cause due, they aid in concealing these animals from the attacks of enemies.

I could adduce other instances of what appear to me to be cases of "protective mimicry" among bats, but my letter has already much exceeded the limits intended by me when I commenced it, and I must reserve my remarks on the peculiar position of *Rynchonycteris naso* when resting on a perpendicular plane surface for another communication.

G. E. DOUSON

#### Sense of Hearing in Birds and Insects

IN respect to "The Sense of Hearing in Birds," the habit of pattering with the feet while seeking food, which is common to many worm-eating birds, seems to preclude the idea that such birds at least depend to any great extent upon their powers of hearing. Gulls frequently tread or patter with their feet while seeking food. The object being clearly to discover, from some slight movement, the whereabouts of their hidden prey. Plovers doubtless with the same object, vibrate one foot rapidly with tremulous motion on the ground. Now the plover is essentially a worm-catching bird, more so even, probably, than the thrush. Light-footed, active yet stealthy in its movements, quick-sighted, and certainly quick of hearing, the plover, when feeding, runs a little way, like the thrush, then stops, with head erect, looking intently; listening it might well be thought *but for the tremulous motion of its feet*. The plover, at such time, trusts without doubt to sight and not to its sense of hearing.

It is true that the thrush has not this trick of pattering with the foot. It is true also that it has, while seeking food, very much the look of listening attentively. The largeness of its eye and comparatively small development of its ear in fine me, however, to believe with Mr. McLachlan (NATURE, vol. xv. p. 254), that the thrush also depends when feeding more on its power of sight than on its sense of hearing.

C. J. A. MEYER

#### THE ATMOSPHERE OF THE ROCKY

Mountains

ANYONE who observes with a large telescope soon becomes aware of the great obstacle atmospheric undulation offers to the pursuit of astronomy, particularly in the application of photography and the spectroscope. During two years when I photographed the moon on every moonlight night at my observatory, there were only three occasions on which the air was still enough to give good results, and even then there was unsteadiness. Out of 1,500 lunar negatives, only one or two were really fine pictures. A letter which the late Mr. Row wrote to me states that in seventeen years he had never met with a perfectly faultless night at the Cambridge Observatory.

Such facts naturally cause astronomers to consider whether it is not possible to diminish atmospheric disturbances, and have led to the celebrated expeditions of Prof. Pisazzi Smyth to the Peak of Teneriffe, and Mr. Lassell to Malta. Theoretically I would seem that the only complete solution is to ascend high mountain ranges or isolated peaks, and leave as much as possible of the air below the telescope.

Having had occasion during the months of August and September, 1876, to go on a hunting trip with two distinguished officers of the United States Army into the Rocky Mountains

<sup>1</sup> In a note to Sir James Emmerson Tennent's "Ceylon" Mr. Thwaiter remarks:—"These bats (*Pteropus medius*) take possession during the day of particular trees, upon which they hang like so much ripe fruit."

<sup>2</sup> "Astronomical Observations on the Atmosphere of the Rocky Mountains, made at Elevations of from 4,500 to 11,000 feet, in Utah, Wyoming Territory and Colorado." By Henry Draper, M.D., Professor of Astrophysics Chemistry and Physiology in the University of New York. Communicated by the author.

<sup>3</sup> Prof. Henry Draper's observatory is at Hastings-on-Hudson, near New York; latitude 40° 55' 25", longitude 73° 50' 25"; elevation above the sea, 200 feet.

and Wahsatch range, I thought it desirable to carry a telescope, with a view of ascertaining whether there would be sufficient inducement to return with my 18-inch achromatic or 28-inch reflector, and make a prolonged stay.

As it was not feasible to take an instrument of any great size, I contented myself with a small achromatic of unusual excellence. Though of only 1 1/4 inches aperture, it bears a power of 60 completely, and I think would carry 100. It was provided with a short brass tripod, holding an altitude and azimuth movement, giving both steadiness and smoothness of action. The eyepiece was capable of adjustment by a rack and pinion, and the object-glass was so arranged in its cell as to be free from injurious compression. This little lens stands the severe tests invented by Foucault, and in spite of its size is capable of doing good work.

In such observations on the atmosphere as those proposed during this trip, it is obvious that there are mainly two points to be considered: (1) freedom from tremor, and (2) transparency. A station combining both is most desirable, but a marked predominance of steadiness gives special advantages for celestial photography, while increase of transparency, even if accompanied by unsteadiness, is of value in eye observations. I had been led to suppose from conversations with Government officers and persons connected with the geological and geographical surveys of the territories, that the Wahsatch range, which is intermediately between the Sierra Nevada on the west and the true Rocky Mountains on the east, would offer the greatest advantages. This supposition turned out to be altogether incorrect, though it might have been argued that a high range flanked at a distance on either side by other higher ranges should have given the maximum chance for cloudless and still skies.

We first went to Salt Lake City, which, according to the Casella aneroid I carried, is at an elevation of 4,650 feet above the sea. It lies at the foot of the Wahsatch range. At eleven o'clock on the evening of arrival, August 25, I took some observations from the hotel after carefully centring the object-glass. Saturn looked about the same as on an ordinary night at my observatory. Capella, which was just clear of the house-tops across the street, twinkled as badly both to the naked eye and in the telescope as I have ever seen it at the sea-level. Lieut. Warren, of Camp Douglas [a military post near the city] said there had been a heavy rain the week previous, and the air was more moist than usual. The sun set among just such a bank of clouds as we are accustomed to see in New York. I was somewhat prepared for a tremulous condition in these high regions, because, the preceding night, having stopped for a few nights at Fort Steele, on the Union Pacific Railroad, I perceived that Antares twinkled very much, though we were nearly 7,000 feet above the sea.

However, in order to make a thorough trial it seemed best to ascend one of the high peaks of the Wahsatch, and accordingly the Red Butte was selected. The peak proved to be 7,350 feet high. Though it was quite clear when we started, clouds gathered in every direction as the sun went down, and at night-fall the sky was entirely overcast. Moreover, the wind blew so strongly that it was necessary to retire over the brow of the mountain, and eventually we returned to Camp Douglas. At this point, 5,250 feet above the sea, and about 600 feet higher than Salt Lake City, the telescope was set up to take advantage of some breaks in the clouds, through which the moon, Antares,  $\zeta$  Ursæ Majoris, and Jupiter appeared. With a power of only twenty the twinkling was surprisingly great; I do not remember ever to have seen it worse with my large instruments.

These results led to an examination into the meteorology of Salt Lake City, so as to find out the rainfall and its distribution and the percentage of cloudy days.

It appears that the average annual rainfall for the past five years is 18 1/2 inches. There is no perfectly dry month, the nearest approach being during the summer. The cloudy dry days are 194 per annum, the disposition being similar to the rainfall.

A former pupil of mine, and graduate of the University, Dr. Benedict, informed me the Mormons believed the rainfall had much increased since their community had settled in Utah, and this seems to be borne out by the statement that whereas formerly three gallons of Salt Lake water produced on evaporation one gallon of salt, it now takes four gallons to produce the same quantity.

For these reasons it is doubtful whether there would be enough advantage in bringing a large telescope to this region to make it worth while to encounter the labour and expense.

On August 30, having taken an escort, we moved south from Fort Steele, latitude 41° 48', longitude 107° 09', along the North fork of the Platte River, into the main range of the Rocky Mountains. During the fifteen days' expedition there were only two nights on which we saw clouds enough to prevent astronomical working, and only one thunderstorm of any moment took place in our immediate vicinity; about one quarter of an inch of rain fell. The sky was rarely perfectly free from clouds, and many local thunderstorms occurred about the higher peaks, but they seldom extended to the plateaus below.

September 1 and 2 our camp was 8,900 feet above the sea in the vicinity of mountains rising 10,000 and 11,000 feet. These peaks seemed to be nearer than they really were, for the transparency of the air causes estimates of distance to be deceptive. From the top of one I subsequently saw the Seminole Mountain, which was 150 miles distant; it did not appear to be fifty miles away. The night of September 1 was quite clear, with very little cloud, and the atmosphere remarkably tranquil. Antares, when near setting, hardly twinkled at all, and Arcturus in the telescope, exhibited four diffraction rings unbroken by flickering. The central disc was as hard and sharply defined as the pin-hole in the lamp-screen I am accustomed to use in testing specula and lenses. I looked for the companion of Polaris, but partly on account of the nearly full moon, and partly from the thickness of the diffraction-rings, I could not be sure of it. The moon was perfectly steady; with a power of sixty there was no trace of twinkling at the terminator. I tried to see Titan, the largest satellite of Saturn, but did not succeed. At the time it was not certain whether this failure was due to the position of Titan with relation to Saturn, or whether it arose from the blinding effulgence of the moon. Capella was perfectly steady, though there was a slow change of colour from bluish to reddish, occupying about a second.

The succeeding night, at nine o'clock, though the sky was mostly covered with cumulus clouds in motion southward, I was astonished to find the terminator of the moon absolutely free from twinkling and Arcturus down among the tops of the dead aspen trees as steady as possible. The four diffraction rings round the central disc were not perfectly circular, but that was the fault of the lens. Every defect of centring or of surface and any vein in the glass comes out even more clearly than in the workshop examinations, because, while the air is as steady, the light is far more intense.

I am certain, if a large telescope could be brought here and maintained against the furious winds, great results might be attained if there is much of this weather. But this particular place is difficult of access, and possibly no better than other situations on the line of the railroad. The sky is not as black as I had expected; it is rather of a light blue, though the full moon makes much difference.

On several other nights, in both lower and higher places, I made observations, but never saw the combination of steadiness and transparency again. On the plateaus at the foot of the mountains and away from the groves of quaking aspen trees and pines, the sun sends down scorching rays all day long on the alkali plains, where only sage plants are sparsely scattered, and even on horseback one can see the heated waves rising from the ground. The air is far from being moist, for the lips are apt to crack and bleed, and the mucous membrane of the nose is parched. When the sun sets the ground rapidly radiates, and we frequently had by morning one quarter of an inch of ice in our vessels of water standing outside the tents. These plateaus are on an average about 7,250 feet above the sea. The mere fact of broken ground and wooded surroundings does not, however, suffice to produce, even at this season, a tranquil air; for when we rode over the Rocky Mountains, along the margin of perpetual snow, to the head-waters of Snake River, and camped at Trout Lake, nearly 10,000 feet high, though the air was exceedingly transparent, it was very unsteady. I rose at 4 A.M. to see Venus, and her splendour was so great that it led to a most delusive estimate of her apparent size. Occasionally, during clear frosty weather in midwinter, a night of similar characteristics is seen at my observatory. On such an occasion I obtained, at the principal focus of the 15 1/2-inch reflector, a photograph of the moon near her third quarter in less than a second.

The officers of Fort Steele and the guides say it would be impossible to do any astronomical work in this region from the middle of October till the middle of May, that is, for seven months. The fierce winds, heavy falls of snow, and intense cold would be unbearable. Even in the beginning of September

we needed large camp-fires in the morning and evening. Our camp at Trout Lake could only be reached for six weeks in summer on account of the depth of snow in the fallen timber.

On the whole, it may be remarked of this mountain region, that the astronomical conditions, particularly for photographic researches, is unpromising. In only one place were steadiness and transparency combined, and only two nights out of fifteen at the best season of the year were exceptionally fine. The transparency was almost always much more marked than at the sea-level, but the tremulousness was as great, or even greater, than near New York. It is certain that during more than half the year no work of a delicate character could be done. At the end of August, in sheltered positions, and in good tents, we slept under half a dozen thicknesses of blanket, and only partially undressed. Such a degree of cold distracts the mind and numbs the body. Apparently, therefore, judging from present information, it would not be judicious to move a large telescope and physical observatory into these mountains with the hope of doing continuous work under the most favourable circumstances.

#### TESTIMONIAL TO MR. DARWIN

MR. DARWIN has received as a testimonial, on the occasion of his sixty-ninth birthday, an album, a magnificent folio, bound in velvet and silver, containing the photographs of 154 men of science in Germany. The list contains some of the best known and most highly honoured names in Europe. He has likewise received on the same occasion from Holland an album with the photographs of 217 distinguished professors and lovers of science in that country. These gifts are not only highly honourable to Mr. Darwin, but also to the senders as a proof of their generous sympathy with a foreigner; and they further show how widely the great principle of Evolution is now accepted by naturalists.

A German correspondent informs us that the German album bears on the handsome title-page the inscription "Dem Reformator der Naturgeschichte, Charles Darwin."

#### MICROSCOPICAL INVESTIGATION OF SANDS AND CLAYS<sup>1</sup>

THE anniversary address of the president, Mr. H. C. Sorby, F.R.S., at the Royal Microscopical Society on Wednesday, March 7, consisted mainly of an attempt to treat in a systematic manner the application of the microscope to the study of the mineral constituents of sands and clays. The various organisms found in such deposits have been much studied by Ehrenberg and other microscopists, and of late years much attention has been directed to the structure of igneous and other hard rocks, more or less allied to them, which can be cut into thin sections; but comparatively little attempt has been made to investigate the ultimate constitution of loose sands, muds, and clays.

The scope of this subject, as treated by the author, included the identification of the true mineral nature of the various particles, and the determination of the nature of the rock from which they were originally derived; the chief aim being to trace back the history of the material to the furthest possible extent.

After describing the manner in which the different kinds of deposits should be prepared, examined, and mounted as permanent objects, the author treated at some length on the conditions necessary for satisfactorily seeing the various particles with moderate or very high magnifying powers, and for observing their microscopic structure and optical characters. The particles of clay and the fluid-cavities in the grains of sand are often so minute as to task the power of the microscope to the fullest extent, and some indeed are so small that their perfect definition may perhaps be impossible by any means at our command. It was shown that the condi-

<sup>1</sup> Abstract by the author.

tions under which many of the objects are visible are such that with highly convergent light and object-glasses of large aperture no dark outline is possible, and therefore they are quite invisible, but become quite distinct when the aperture is reduced to a moderate and appropriate amount. For this reason object-glasses of comparatively small aperture are far the best, since the focal point being further from the front lens, very high powers can be used in cases which are beyond the reach of lenses of large aperture.

The author then went into much detail to show the character of the grains of quartz, mica, and other minerals derived from the decomposition or breaking up of various crystalline rocks, and showed that on the whole there are many characteristic differences between the material derived from granitic and schistose rocks—this difference consisting mainly in the form, internal structure, and optical characters of the various constituent grains; the general conclusion being that a careful study of sands, muds, and clays enables us to form a very satisfactory opinion as to whether they were derived mainly from granitic or schistose rocks, or from a mixture of the two in some approximately definite proportion. It was also shown that the shape of the particles as originally derived from their parent rock is sufficiently definite and characteristic to enable us to form a very good opinion respecting the amount of subsequent mechanical or other change.

Applying those principles to the study of particular typical cases, it was shown that the coarser grained British sandstones have been mainly derived from granite rocks, of a character somewhat intermediate between those of the Scotch Highlands and Scandinavia. Some of these sandstones consist of grains which have undergone scarcely any wearing, and are as angular as those derived directly from decomposed granite, and are thus totally unlike the blown sand of the deserts, which are worn into perfectly rounded grains.

The finer grained sands are no less angular than the coarse, and have not been derived from the wearing down of larger fragments, but have resulted from the separation of the small from the large grains by the action of currents. Though some fine-grained sandstones have been mainly derived from granitic rocks, yet, on the whole, the small particles of quartz have more commonly been derived from the breaking up of schistose rocks. Clays and shales consist to a great extent of particles identical in all their characters with those derived from the decomposition of feldspars and other minerals which undergo a similar change. As a general rule we meet with many grains of sand even in clays chiefly consisting of extremely minute granules, which can easily be explained by the remarkable manner in which such material, when suspended in water, collects into small compound grains, which subside at a rate quite independent of what would be the velocity of subsidence of the separate particles if they were detached.

The conclusions derived from a study of the characters of the separate grains are confirmed by the occurrence of what may be truly considered to be grains of granite or mica schist. We also in some cases meet with grains sufficiently large to show the characteristic structure of the still more complex rocks of which they are composed. Thin sections of some of the oldest slates in Wales are thus as it were a perfect museum of specimens of the rocks existing at a still earlier period, broken up and worn down into the sands which formed these very ancient slates.

In order to establish these various conclusions it would be necessary to enter into a large amount of detail, but perhaps what has been said may suffice to indicate the general line of inquiry, and to show that by making full use of every microscopic means, it is possible to learn many important facts from such very unpromising materials as sands and clays.

REMARKABLE PLANTS<sup>1</sup>

II.—SOME CURIOUS ORCHIDS.

**GENERAL Structure of the Flower of Orchids.**—The exotic representatives of the natural order Orchidaceæ have long been favourite objects of cultivation in our hot-houses, from the beautiful and often bizarre form assumed by their curious flowers. Great as is the variety in the size, colour, and form of the flower in the different genera, it is, nevertheless, more than in most natural orders, constructed always on one plan in its main features. Before describing some of the more remarkable forms, it will be necessary to give a general description of this type, and to define the more important of the technical terms used by botanists in relation to it. Both in this account and in the description which follows of particular species, we are largely indebted to Mr. Darwin's most interesting work<sup>2</sup> on orchids, of which a new edition has just appeared; the illustrations are also reproduced, by the kindness of the publisher, from the same work.

In all orchids the number of sepals and petals (which together form the perianth) is three each, the former being almost always nearly or quite as brightly coloured as the latter. One of the petals—really the upper one, but, in consequence of the twisting of the ovary, apparently the lower one—is nearly always larger than the others, and is so situated as to form a convenient stage for insects to settle on. It is called the lower lip or *labellum* (Fig. 1, *l*), and often assumes the most singular and fantastic shapes. It secretes nectar or honey, which is often contained in a longer or shorter spur-shaped prolongation or nectary (*n*) at its back, but sometimes in the tissue itself, which is then commonly gnawed by insects. There is only one fertile stamen (rarely two), which is confluent with the stigma, and forms with it the *column*. The anther (*a*) consists of two cells, which are usually very distinct, and often so widely separated as to appear like two anthers. The pollen is not, in most orchids, in the form of a fine granular powder, but coherent into two club-shaped masses, the pollen-masses or *pollinia* (*p*), one contained in each anther-cell; these are prolonged below into a kind of stalk termed the *caudicle* (*c*). The ovary is inferior (beneath the calyx), often presenting the appearance of a stalk to the flower, and consists of three carpels closely united together into a single cavity. The single stigma (*s*) is sessile upon the ovary, and is confluent with the stamen (*gynandrous*). Its upper part is modified into an extraordinary organ called the *rostellum* (*r*), which, when mature, consists partly or entirely of viscid matter. In many species the pollinia are firmly attached to a portion of the exterior membrane of the stigma, which, when insects visit the flower, is removed, together with the pollinia. This removable portion of the rostellum is called the *viscid disc* (*d*), or by some authors the "gland" or "retinaculum"; when large, the portion to which the pollinia is attached is called the *pedicel* (often confounded with the caudicle). The part of the rostellum which is left after the removal of the disc and viscid matter is called the *fovea*, or sometimes the "pouch" or "bur-sicula." In the present paper we propose to give an account of a few orchids, interesting from the remarkable mode in which fertilisation by insects is effected.

1. *Coryanthes macrantha*.—The genus *Coryanthes* belongs to the tribe Vandeeæ, which includes many of the most magnificent extra-British orchids. The extraordinary mode of fertilisation is certified by Dr. Crüger, director of the Botanic Gardens at Trinidad. The accompanying figure (Fig. 2) represents the flower of *C. speciosa*, an allied species, but will serve to show the relative position of the parts. It is very large, and hangs

downwards. The lower portion of the labellum (*l*) is converted into a kind of bucket (*b*). Two short appendages (*h*), which arise from the narrowed base of the labellum, stand directly over this bucket, and secrete so much limpid and slightly sweet fluid that it drops into the bucket; the quantity secreted by a single flower is said to be about an ounce, but it does not appear to attract insects. When the bucket is full, this fluid overflows at a channel which forms a kind of spout (*f*), closely over-arched by the end of the column, which bears the stigma and pollinia in such a position that an insect, forcing its way out of the bucket through this passage, would first brush with its back against the stigma, and afterwards against the viscid discs of the pollinia, and thus remove them. In *C. macrantha* the labellum is,



FIG. 1.—*Orchis mascula*. A, side view of flower, with greater part of perianth cut away; B, front view of flower; C, pollinium and viscid disc; D, caudicles with the viscid discs lying within the rostellum; E, section through rostellum; F, packets of pollen-grains; G, anther; H, rostellum; I, stigma; L, labellum; J, nectary; K, pollinium; L, caudicle of pollinium; M, viscid disc.

according to Dr. Crüger,<sup>1</sup> provided with crests, which are gnawed by bees, as is commonly the case with the labellum of the Vandeeæ. In this case the bees have been determined by Mr. F. Smith, of the British Museum, to belong to the genus *Englisma*. Dr. Crüger states that these bees may be seen in great numbers disputing with each other for a place on the edge of the "hypocyl" or basal part of the labellum. Partly by this contest, partly, perhaps, intoxicated by their food, they fall into the bucket, which is half full of the fluid already mentioned. They then crawl along in the water towards the anterior side of the bucket, where they arrive at the spout. But in order to extricate itself through this opening, the bee has to use considerable exertion, as the mouth of the

<sup>1</sup> *Journal of the London Society, Botany*, vol. viii., 1864, p. 120.  
<sup>2</sup> *The Various Contrivances by which Orchids are Fertilised by Insects*, by Charles Darwin, M.A., F.R.S., 2nd Edition, revised, with Illustrations, London: J. Murray, 1877.

"apical" or upper part of the labellum, fits closely to the column and is very stiff and elastic. The first bee which is immersed will have the pollinia glued to its back by their viscid disc. Having escaped through the passage with this appendage, the insect then returns nearly immediately to its feast, when it is generally precipitated a second time into the bucket, passes out through the same opening, and thus inserts the pollinia into the stigma as it forces its way out, thereby impregnating either the same or some other flowers. Dr. Crüger states that he has seen so many of the bees taking part in this operation that there is a continual procession of them through the passage. "There cannot be the least doubt," says Mr. Darwin, "that the fertilisation of the flower absolutely depends on insects crawling out through the passage formed by the extremity of the labellum and the over-

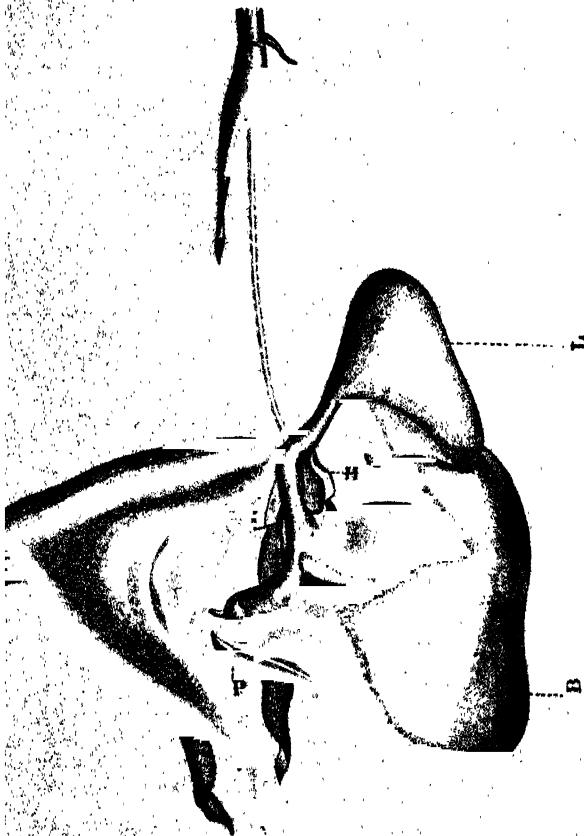

FIG. 1.—*Coryanthes spaciosa* (after Lindley). 1, labellum; 2, bucket of pollinia; a, fluid-secreting appendages; p, spout of bucket, over-arched by the end of the column bearing the anther and stigma.

arching column. If the large distal portion of the labellum or bucket had been dry the bees could easily have escaped by flying away. Therefore we must believe that the fluid is secreted by the appendages in such extraordinary quantity, and is collected in by the bucket, not as a palatable attraction for the bees, as these are known to gnaw the labellum, but for the sake of wetting their wings and thus compelling them to crawl out through the passage."

3. *Catasetum saccatum*.—The genus *Catasetum* belongs also to the sub-order Vandeeæ, and to a section of that order, the *Catasetidae*, distinguished from all other orchids by several very remarkable peculiarities. In the first place it stands almost alone among all genera of orchids in having unisexual flowers; and so greatly do the male and female flowers—which are usually borne on different plants—differ from one another, that they were long

regarded as belonging to different species, or even genera; while, to complicate the matter still further, some kinds have a third hermaphrodite form differing greatly from either of the others. Thus *Catasetum tridentatum* (male), *Monachanthus viridis* (female), and *Alyanthus barbatus* (hermaphrodite), are now known to be three forms of the same species. The second peculiarity of the male flowers of *Catasetum* is that they are provided with an extraordinary mechanical contrivance by means of which the pollinia are forcibly ejected on to the back of the insect, and thus carried to a female flower of the same species. There is no nectar in the male flower to attract insects; the ejection of the pollinia results from the accidental

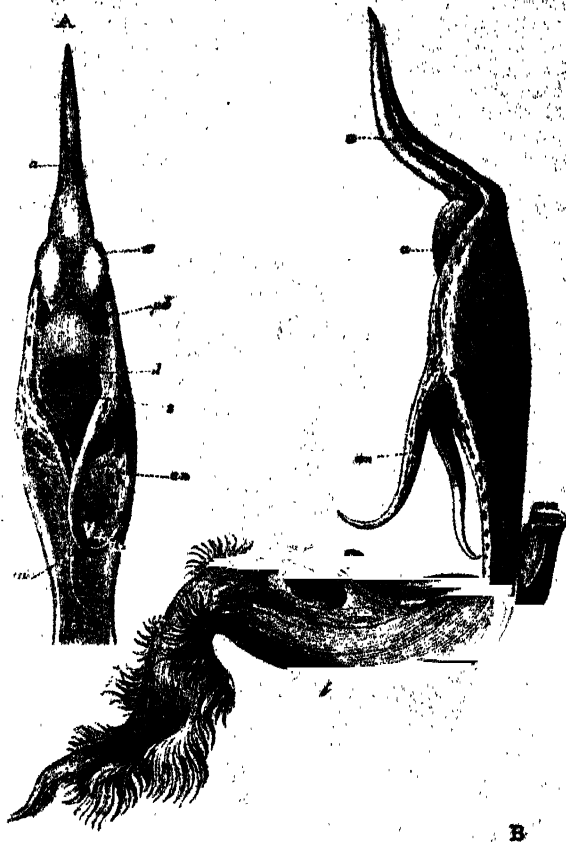

FIG. 2.—*Catasetum saccatum*. A, front view of column; a, side view of flower, with all the perianth except the labellum removed; a, anther; ad, antennæ; d, viscid disc; l, labellum; ad, pedicel of pollinifer; s, stigmatic chamber.

touching, by the wing of a passing insect or of one seated on the labellum for the purpose of gnawing it, of two long horns or antennæ, which occur in no other genus, and are placed in such a position that when touched by the insect the pollinia are projected on to its body, to which they adhere by their blunt and excessively adhesive point. The insect then flies away to a female plant and while standing in the same position as before on the flower, the pollen-bearing end of the pollinia is inserted into the stigmatic cavity, and a mass of pollen left on its viscid disc. Mr. Darwin has examined five species of *Catasetum*, and finds that this is the only possible way in which they can be fertilised.

In the accompanying Fig. 3 (A being a front, B a side

view of a flower, from which all the perianth except the labellum has been removed), *a* represents the anther containing the pollinia, and prolonged above into a long point, on the antennae, which are rigid, curved, hollow horns tapering to a point; but the two differ from one another in this respect, that the apex of the left-hand one bends upwards, while the right-hand one hangs down, and is apparently almost always paralysed and functionless; *l* is the labellum; *d* the disc of the pollinium, which is remarkably large and viscid; *pd* the pedicel of the pollinium; *s* the stigmatic chamber, which is of course functionless in the male flower. The action of the parts is thus described by Mr. Darwin:—When the left-hand antenna is touched, the edges of the upper membrane of the disc, which are continuously united with the surrounding surface, instantly rupture, and the disc is set free. The highly elastic pedicel then instantly flirts the heavy disc out of the stigmatic chamber with such force that the whole pollinium is ejected, bringing away with it the two balls of pollen, and tearing the loosely-attached spike-like anther from the top of the column. The pollinium is always ejected with its viscid disc foremost, and with such force that it is thrown to a distance of two or



FIG. 4. — *Mormodes ignea*. Lateral view of flower with one of the sepals and one of the petals removed. *a* anther, *pd*, pedicel of pollinium, *s*, stigma, *l*, labellum, *ls*, lateral sepal.

three feet. On one occasion Mr. Darwin touched the antenna of an allied species, *C. callosum*, while holding the flower at about a yard's distance from the window, when the pollinium hit the glass, and stuck by its adhesive disc to the smooth vertical surface. A series of experiments showed that even violent concussion of any other part of the flower except the antenna produced no effect whatever in disturbing the pollinia.

4. *Mormodes ignea*.—The genus *Mormodes* belongs also to the small family Catantopidae; the pollinia are again violently ejected, as in *Catantopum*; but the mode in which this is effected is somewhat different, and very curious. The appearance presented by the flower is represented in Fig. 4. The base of the column is bent backwards, at right angles to the ovary, then resumes an upright position, and is finally again bent near the summit. It is also twisted so that the anther, restellum, and the upper part of the stigma face one side of the flower, to the right or left, according to the position of the flower on the spike. In the drawing, *a* represents the

anther, which is elongated and triangular, but does not extend to the apex of the column. A group of spiral vessels runs up the column as far as the summit of the anther; they are then reflexed, and run some way down the anther-case. The point of reflexion forms a short thin hinge, by which the top of the anther-case is articulated to the column beneath its bent surface; and this hinge appears to be the sensitive portion of the structure, conveying any stimulus from a touch to the disc of the pollinia, and causing the ejection of the latter. *pd* is the pedicel of the pollinium, covering the rostellum; *st*, the stigmatic surface, which extends down to the base of the column, and is hollowed out into a deep cavity at its upper end; *l* is the very remarkable labellum, narrowed at the base into a nearly cylindrical foot-stalk, and its sides so much reflexed as almost to meet at the back, forming a folded crest at the summit of the flower. Near the summit it has a slight cavity, into which the summit of the column fits, fixing it in its place. The whole labellum is compared by Mr. Darwin to a cocked hat supported by a foot-stalk, and placed on the head of the column. *ls* are the two lower sepals, which hang down like wings; the upper sepal and one of the lateral petals have been cut off. By a number of experiments Mr. Darwin found that the minute hinge in the anther-case already described is the only portion of the flower that is sensitive to touch. When an insect lights on the folded crest of the labellum, the only convenient landing-place, he will lean over the front of the column in order to gnaw or suck the bases of the petals, which are filled with a sweet fluid. In so doing, he will disturb the summit of the column which fits into the cavity of the labellum; this will press on the hinge in the anther-case; the stimulus will then be conveyed to the pollinium-disc, and the pollinium will be violently ejected. Owing to the peculiar structure of the parts, guided by the hinge, which now serves a second function, the direction in which the pollinium flies is necessarily vertically upwards. If no object is in the way, it is projected perpendicularly up in the air, an inch or two above and close in front of the terminal part of the labellum, and would then alight on the folded crest of the labellum immediately above the column. But if the insect which has caused the disturbance remains in the same position, the pollinium will necessarily alight on his head, and will thus be carried off to fertilise another flower. The pollinium has, however, still the anther-cap attached to it; this drops off, as the pedicel dries on exposure to the air and gradually straightens itself from the almost hoop-shaped form which it bore when ejected; and when this has been done, the pollen-masses attached to the head of the insect are precisely in a position to strike against the stigmatic surface of the next flower visited.

Other instances, almost as extraordinary, could be cited of the special contrivances met with in species belonging to this order, to insure cross-fertilisation rather than self-fertilisation of the flowers. A. W. B.

THE MOVEMENT OF THE SOIL-CAP

AMID all their general tameness the Falkland Islands boast one natural phenomenon which is certainly exceptional, and at the same time very effective.

In the East Island most of the valleys are occupied by pale-grey glistening masses, from a few hundred yards to a mile or so in width, which look at a distance much like glaciers descending apparently from the adjacent ridges, and gradually increasing in volume, fed by tributary streams, until they reach the sea. Examined a little more closely, these are found to be vast accumulations of blocks of quartzite, irregular in form, but having a tendency to a rude diamond shape, from two to eight or ten or twenty feet long, and perhaps half as much in width, and of a thickness corresponding with that of the quartzite bands.

in the ridges above. The blocks are angular, like the fragments in a breccia, and they rest irregularly one upon the other, supported in all positions by the angles and edges of those beneath.

They are not weathered to any extent, though the edges and points are in most cases slightly rounded; and the surface, also perceptibly worn, but only by the action of the atmosphere, is smooth and polished; and a very thin, extremely hard, white lichen, which spreads over nearly the whole of them, gives them the effect of being covered with a thin layer of ice.

Far down below, under the stones, one can hear the stream of water gurgling which occupies the axis of the valley; and here and there, where a space between the blocks is unusually large and clear, a quivering reflection is sent back from a stray sunbeam.

At the mouth of the valley the section of the "stone river" exposed by the sea is like that of a stone drain on a huge scale, the stream running in a channel arched over by loose stone blocks, or finding its way through the spaces among them. There is scarcely any higher vegetation on the "stone river;" the surface of every block is slippery and clear, except where here and there a little peaty soil has lodged in a cranny, and you find a few trailing spikes of *Nassauvia serpens*, or a few heads of the graceful drooping chrysanthemum-like *Chabrea suarveolens*.

These "stone-rivers" are looked upon with great wonder by the shifting population of the Falklands, and they are shown to visitors with many strange speculations as to their mode of formation. Their origin seems, however, to be obvious and simple enough, and on that account their study is all the more instructive; for they form an extreme case of a phenomenon which is of wide occurrence, and whose consequences are, I believe, very much underrated.

There can be no doubt that the blocks of quartzite in the valleys are derived from the bands of quartzite in the ridges above, for they correspond with them in every respect; the difficulty is to account for their flowing down the valley, for the slope from the ridge to the valley is often not more than six to eight degrees, and the slope of the valley itself only two or three, in either case much too low to cause blocks of that form either to slide or to roll down.

The process appears to be this. The beds of quartzite are of very different hardness; some are soft, passing into a crumbling sandstone; while others are so hard as to yield but little to ordinary weathering. The softer bands are worn away in process of time, and the compact quartzites are left as long projecting ridges along the crests and flanks of the hill-ranges. When the process of the disintegration of the softer layers has gone on for some time the support of their adjacent beds is taken away from the denuded quartzites, and they give way in the direction of the joints, and the fragments fall over upon the gentle slope of the hillside. The vegetation soon covers the fallen fragments and usually near the sloping outcrop of the hard quartz, a slight inequality only in the surface of the turf indicates that the loose blocks are embedded beneath it. Once embedded in the vegetable soil a number of causes tend to make the whole soil-cap, heavy blocks included, creep down even the least slope. I will only mention one or two of these. There is constant contraction and expansion of the spongy vegetable mass going on, as it is saturated with water or comparatively dry; and while with the expansion the blocks slip infinitesimally down, the subsequent contraction cannot pull them up against their weight; the rain-water trickling down the slope is removing every movable particle from before them; the vegetable matter on which they are immediately resting is undergoing a perpetual process of interstitial decay and removal. In this way the blocks are gradually borne down the slope

in the soil-cap and piled in the valley below. The only other question is how the soil is afterwards removed and the blocks left bare. This, I have no doubt, is effected by the stream in the valley altering its course from time to time, and washing away the soil from beneath.

This is a process which, in some of the great "stone-rivers" in the Falkland Islands, must have taken an enormous length of time. I fear that the extreme glacialists will see in it a danger to the universal application of their beloved theory to all cases of scratching and grooving. I have known too much of the action of ice to have the slightest doubt of its power; but I say that ice had no hand whatever in the production of these grand "moraines" in the Falkland Islands.

In the West Highlands of Scotland, and in many other parts of the world, I have often noticed that when a hill of such a rock as clay-slate comes down with a gentle slope, the outcrop of the vertical or highly-inclined slates covered with a thick layer of vegetable soil or drift containing imbedded blocks and boulders derived from higher levels, the slates are frequently first slightly bent downwards, then abruptly curved and broken, and frequently the lines of the fragments of the fractured beds of slate can be traced for a yard or two in the soil-cap, gradually becoming parallel with its surface, and passing down in the direction of its line of descent. These movements are probably extremely slow. I well remember many years ago observing a case, somewhere in the west of Scotland, where a stream had exposed a fine section of the soil-cap with the lines of broken-down and crushed slate-beds carried far down the slope. The whole effect was so graphically one of vigorous and irresistible movement that I examined carefully some cottages and old trees in hope of finding some evidence of twisting or other irregular dislocation, but there appeared to be none such. The movement, if it were sufficiently rapid to make a sign during the life-time of a cottage or a tree, evidently pervaded the whole mass uniformly.

It seems to me almost self evident that wherever there is a slope, be it ever so gentle, the soil-cap must be in motion, be the motion ever so slow; and that it is dragging over the surface of the rock beneath the blocks and boulders which may be embedded in it, and frequently piling these in moraine-like masses, where the progress of the earth-glacier is partially arrested, as at the contracted mouth of a valley, when the water percolating through among them in time removes the intervening soil. As the avalanche is the catastrophe of ice-movement, so the land-slip is the catastrophe of the movement of the soil-cap.

As I have already said, I should be the last to undervalue the action of ice, or to doubt the abundant evidences of glacial action; but of this I feel convinced, that too little attention has been hitherto given to this parallel series of phenomena, which in many cases it will be found very difficult to discriminate; and that these phenomena must be carefully distinguished and eliminated before we can fully accept the grooving of rocks and the accumulation of moraines as complete evidence of a former existence of glacial conditions.

C. WYVILLE THOMSON

#### ON THE INFLUENCE OF GEOLOGICAL CHANGES ON THE EARTH'S AXIS OF ROTATION<sup>1</sup>

THE subject of the fixity or mobility of the earth's axis of rotation in that body, and the possibility of variations in the obliquity of the ecliptic has of late been attracting much attention. Sir W. Thomson referred shortly to it in his address at Glasgow last September,

<sup>1</sup> An account of a paper by G. H. Darwin, M.A., read before the Royal Society on November 15, 1896.



and Dr. Jules Carret has just published an ingenious book on the subject.<sup>1</sup>

The paper, of which the following is an abstract, is an attempt to investigate the results of the supposition that the earth is slowly changing its shape from internal causes. The first part is devoted to the mathematical consideration of the precession and nutations of a spheroid slowly undergoing such a change. It is shown that the obliquity of the ecliptic must have remained sensibly constant throughout geological history, and that even gigantic polar icecaps cannot have altered the position of the Arctic circle by so much as three inches; and this would be the most favourable redistribution of matter for producing that effect.

But a slow distortion of the earth would displace the principal axis of figure of the earth, and the axis of rotation would always sensibly follow the axis of figure. Thus the result would be a change in the geographical position of the poles, without any alteration of the diameters of the arctic circles, or in the width of the tropics.

For reasons, which cannot be given here, it is maintained that the earth would not be rigid enough to resist the effects of considerable departures from the figure of equilibrium, such as would arise from a wandering of the pole of figure from its initial position; and that readjustments to an approximate form of equilibrium would probably take place, at considerable intervals of time, impulsively by means of earthquakes. Such periodical adjustments would not sensibly modify the geographical path of the principal axis as due to terrestrial deformation.

The rest of the paper is given to the consideration of the kinematical question of the change in the geographical position of the pole, due to any distortion of the earth. It is assumed, in the first place, that the deformation is such that there is no change in the strata of equal density; and accordingly all suppositions as to the nature of the internal changes accompanying geological upheaval and subsidence are set aside. The forms of continents and depressions are investigated, which would cause the maximum deflection of the pole for elevations and depressions of given amounts.

In order to make numerical application to the case of the earth, some estimate is required of the extent to which it may have become distorted during any one geological period. From the consideration of certain facts, the author believes that from  $\frac{1}{10}$  to  $\frac{1}{20}$  of the whole earth's surface may have, from time to time, undergone a simultaneous rise or fall; and that the vertical rise or fall may be about 10,000 feet, or rather equivalent to about 10,000 feet, when allowance is made for the influx of the sea into depressed areas.

The first application given in this paper is to continents and seas of the most favourable shapes and positions. It may be here stated that if  $\frac{1}{20}$  of the earth's surface is elevated by 10,000 feet, the deflection of the pole is  $11\frac{1}{2}'$ ; if  $\frac{1}{10}$  of the whole surface,  $1^{\circ} 46\frac{1}{2}'$ ; if  $\frac{1}{5}$ ,  $3^{\circ} 17'$ ; and if  $\frac{1}{2}$ ,  $8^{\circ} 4\frac{1}{2}'$ .<sup>2</sup> In each case an equal area is supposed to fall simultaneously.

Other examples are also given for continents and seas which do not satisfy the maximum condition; in some the boundaries are abrupt cliffs, in others shelving.

The conclusion is arrived at that a single large geological change, such as those which obtain on the earth, is competent to produce an alteration in the position of the pole of from one to three degrees of latitude, on the hypothesis that there is no change in the law of internal density.

Various other hypotheses as to the nature of the internal changes accompanying the deformation of the earth are discussed.

1. It is shown that if upheaval and subsidence are due

<sup>1</sup> "Le Déplacement Polaire" Savoy, Paris, 1877.  
<sup>2</sup> The area of Africa is about '059, and of South America about '023 of the earth's surface.

to a shrinking of the earth as a whole, but to the shrinking being quicker than the mean in some regions and slower in others, the results are the same as those previously attained.

2. The increase of surface-matter due to the deposit of marine strata also gives the same results.

3. The hypothesis that upheaval and subsidence are due to intumescence or contraction immediately under the regions in question is considered. Under certain special assumptions, too long to recapitulate, it is shown that the previous results must be largely reduced. It appears that if the swelling or contracting stratum is tolerably thin and at all near the surface, the deflection of the pole is reduced to quite an insignificant amount. Even if the intumescence extends right down to the centre of the earth in a cone bounded by the elevated region, the results would be only about  $\frac{1}{3}$  of the former ones. Hence it appears that the earlier results can only be stated as the greatest possible for given superficial changes.

In conclusion it is pointed out that if the earth be quite rigid, no redistribution of matter in new continents could ever cause the deviation of the pole from its primitive position to exceed the limit of about  $3^{\circ}$ . But if the previously maintained view is correct, that the earth readjusts itself periodically to a new form of equilibrium, then there is a possibility of a cumulative effect; and the pole may have wandered some  $10^{\circ}$  or  $15^{\circ}$  from its primitive position, or have made a smaller excursion and returned to near its old place. No such cumulation is possible, however, with respect to the obliquity of the ecliptic.

It is suggested that possibly the glacial period may not have been really one of great cold, but that Europe and North America may have been then in a much higher latitude, and that on the pole retreating they were brought back again to the warmth. There seem to be, however, certain geological objections to this view.

THE NEW STAR IN CYGNUS<sup>1</sup>

ON January 9 the sky was unusually clear and the spectrum of Dr. Schmidt's Nova came out with amazing sharpness and brilliancy. In addition to the five bright lines seen on the 2nd, two others were detected, viz. —

	Mill mm	
No. 1a	W. L. 594	Very narrow line.
" 7	" 414±	Excessively faint, but still certainly and repeatedly seen.

Between wave-lengths 655 and 594 the spectrum was certainly banded, and, most probably, there were two additional faint maxima of brilliancy in that interval. The continuous spectrum attains a maximum in the region about W. L. 525, and extends, though possibly not without interruption, as far as the faint line No. 7. The star was estimated of seventh magnitude, and was of a red colour with a decided tinge of purple, reminding me forcibly of the varieties of red produced by the quartz-plate in Zollner's photometer. RALPH COPELAND  
 Lord Lindsay's Observatory, Dunecht, January 13

OUR ASTRONOMICAL COLUMN

THE NEW COMET.—The comet discovered by M. Borrelly, at Marseilles, on the morning of February 9, appears to have been found independently by Herr Pechule at the Observatory of Copenhagen on the following morning. During the past week it has been making a pretty near approach to the earth, and had the weather been more favourable in Europe, it would probably have been very generally observed.

The following elements of the orbit have been calculated by Mr. Hind from the first observation by M. Borrelly, one at

<sup>1</sup> *Astronomische Nachrichten*, No. 2, 117.

Kial on the 10th, and one made at the Imperial Observatory at Strasburg on the 15th, and communicated by Prof. Winnecke:—

Perihelion Passage, January 19 1807, Greenwich M.T.

Longitude of the perihelion ...  $200^{\circ} 5' 6''$  } Apparent  
 " ascending node 187 14 22 } Equinox, Feb. 10.  
 Inclination to the ecliptic ... 27 5 13  
 Logarithm of perihelion distance 9.907086  
 Heliocentric motion—retrograde.

According to this orbit the comet was distant from the earth, at the time of discovery, 0.45, the earth's mean distance from the sun being taken as unity. Its apparent path in the heavens about the perigee, and up to March 6, will be sufficiently defined by the following ephemeris:—

For Greenwich Midnight.			
	Right Ascension.	North Polar Distance.	Distance from the Earth.
February 13 ..	262 50	70 22	0.324
15 ....	266 21	57 2	0.292
17 ...	272 10	41 42	0.279
19 ...	283 10	26 48	0.288
21 ...	307 40	15 35	0.318
23 ...	359 21	11 52	0.303
25 .....	27 41	15 9	0.418
27 .....	42 51	19 43	0.479
March 6 ...	58 51	31 1	0.719

From the above figures it will be seen that the diurnal motion, about the middle of the present month, amounted to  $8^{\circ}$  in arc of great circle; the comet was nearest to the earth soon after midnight on the 17th. At the time of perihelion passage it would be situated about  $6^{\circ}$  to the east of Antares, distant from the earth 1.15.

There is a certain similarity, but by no means a striking one, between the elements of this comet and those of the comet of 1590, observed by Tycho Brahe, the orbit of which was first calculated by Halley, and, in 1846, after a new reduction of Tycho's observations, by Mr. Hind (*Ast. Nach.*, No. 584). It may be worthy of remark that shortly after the passage of the ascending node, the comet of 1590 approaches very near to the orbit of the planet Venus, the least distance not exceeding 0.04. Still the differences between the elements of the comets of 1590 and 1877, especially in the perihelion distance, are material.

THE "BERLINER ASTRONOMISCHES JAHRBUCH"—Under the active superintendence of Prof. Tietjen, the *Berliner Jahrbuch* continues the heavy labour involved in the preparation of ephemerides of the extensive group of small planets, a work which for many years past has been made its specialty. In the volume for 1879 now before us, we have the places for 1877 of 151 out of the 172 actually known members of the group, No. 164, Eva, being the latest discovery included in the list. Also the elements of their orbits and the opposition magnitudes, a very useful addition towards the identification of these minute bodies amongst the fainter stars. The portion of the volume devoted to the small planets extends to 106 pages. The judicious transfer of the ephemeris of the moon, derived from Hansen's Tables from our *Nautical Almanac*, which appears between one and two years earlier, to the pages of the *Berliner Jahrbuch*, after adaptation to the meridian of Berlin, whereby a most serious expenditure of time and labour is saved, has already been noted in this column; it is a step which no doubt assists materially in completing the peculiar work of the *Jahrbuch*.

The following are names which have been recently proposed, for discoveries made within the last few years: No. 139 *Jurua*, 149 *Matusa*, 150 *Nurua*, 155 *Scylla*, 160 *Una*, 161 *Athor*, 163 *Erigoni*, 164 *Eva*. No. 162 is not yet named.

Only four of these planets (in addition to two of the old members) attain 8 $\frac{1}{2}$ m. or upwards at their oppositions in 1877. Aridine, in opposition on July 24, approaches the earth within about 0.84 of the earth's mean distance from the sun, and 1.15,

which at her opposition on November 28, is calculated to be 6.8m. or on the limit of acute unaided vision, will be distant from us 0.86—affording an opportunity which may be utilized, for attempting direct measures of her diameter, though if we are not mistaken some pretty satisfactory measures were made at a favourable opposition a few years since, with a powerful refractor in this country. This planet when near the earth has a decidedly red light; at two oppositions within the last fifteen years it might be identified amongst the neighbouring stars by this circumstance alone.

## CHEMICAL NOTES

ABSORPTION OF LIGHT IN THE BLOOD.—In a number of cases of unintentional poisoning caused by carbon monoxide in Berlin during the past winter, oxygen has been used as an antidote. Dr. Baeblich, of Berlin, lately showed the desirability of the method by means of spectroscopic proof in a public lecture. As is well known, the spectrum of blood shows two well-defined bands between Fraunhofer's lines D and E. By the absorption of CO the position of these bands is very slightly changed in the direction of the red part of the spectrum. The difference is more strikingly shown by the addition of sulphide of ammonium. In the case of healthy blood the two bands of the spectrum disappear and are replaced by a single one situated midway between the positions of the former pair. Blood poisoned with CO shows no change in the bands by the same treatment. If oxygen is, however, added to it before the reduction with sulphide of ammonium, the characteristic spectrum of healthy blood is at once produced.

PHYSICAL PROPERTIES OF GALLIUM.—M. Lecoq de Bois baudran has introduced a new method for the extraction of this metal, and has investigated some of its physical properties. Its crystalline form is octahedral; the mean of six experiments gave as its melting point 30.15. Its specific gravity is 5.956; when fused it has a silver lustre, but on solidifying it shows a tinge of blue, losing its brilliancy. It is hardly acted on by nitric acid when diluted with an equal bulk of water.

POTASSIUM TRI-IODIDE.—Mr. G. S. Johnson has recently published an investigation on this body, which is prepared when a strong solution of potassium iodide is saturated with iodine, and the resulting liquid allowed to evaporate slowly over oil of vitriol. The crystals are sometimes long and isolated, sometimes appearing as hexagonal plates exhibiting a stepped arrangement like those of potassium iodide. They have a steel-blue lustre, are very deliquescent, fusing at about  $45^{\circ}$  C., and have a specific gravity of 3.498. When the temperature is raised above  $100^{\circ}$ , iodine is freely evolved from the crystals, a white mass of potassium iodide alone remaining. On analysis the crystals yielded 90.2 to 90.4 per cent. of iodine and 9.2 per cent. of potassium; the theoretical quantities required, supposing the body to be  $KI_3$ , are iodine 90.692 per cent. and potassium 9.307 per cent. An excess of water decomposes potassium tri-iodide, with precipitation of the most of the iodine; the crystals, however, may be dissolved in small quantities of water or alcohol, and re-crystallised over sulphuric acid.

SOLUTION OF GASES IN IRON, STEEL, AND MANGANESE.—MM. Troost and Hautefeuille have published in the *Ann. Chim. Phys.*, [5] vii., a reprint of their researches on this subject, previously published in other journals. When cast iron is fused in contact with silica or silicates, carbonic oxide is produced by the action of the iron carbide on silica; the iron thus becomes richer in silicon, the carbon diminishing. Melted cast iron seems to occlude considerable quantities of hydrogen, this inclusion being increased by the presence of manganese and diminished by the presence of silicon. Carbonic oxide is not taken up to any great

as extent as hydrogen by melted cast iron, its occlusion is almost entirely prevented by the presence of manganese. Gases are retained by pig iron after cooling, but can be extracted by heating the metal to 800°. Steel occludes less gas than cast iron, hydrogen predominating over carbonic oxide; on the other hand more carbonic oxide than hydrogen is occluded by soft iron. Finely divided iron free from gases decomposes water slowly at the ordinary temperature, rapidly at 100°, the decomposition being more rapid the finer the state of division of the iron.

### NOTES

THE golden Baer medal was awarded this year, by the St. Petersburg Academy of Sciences, to Prof. Bunge, for his various works upon the flora of Russia. The Lomonosoff premium, value 1,000 roubles, was awarded to Prof. Beilstein, of Kazan, for researches on the properties of bodies of the benzoil series.

M. ANDRÉ, the astronomer who was sent by the French Institute to New Caledonia to observe the transit of Venus, has been appointed director of the new observatory established at Lyons by M. Waddington.

AT the half-yearly General Meeting of the Scottish Meteorological Society, held yesterday, the Duke of Richmond was elected President. The following papers were read:—1. On methods of estimating ozone and other constituents of the atmosphere, by Mr. E. M. Dixon, B.Sc., Office of Health, Glasgow. 2. On the peculiarities of the weather of December and January last, by Mr. Buchan, Secretary. 3. Observations of rainfall at sea on board ship, by Dr. Black, Surgeon-Major.

THE Report of the Treasury Meteorological Commission appointed in the autumn of 1875 has now been published. The chief recommendations are that ocean meteorology be transferred from the Meteorological Office to the Admiralty, that the annual Parliamentary Grant be increased from 10,000*l.* to 14,500*l.*, and that, in addition to the above, some pecuniary assistance, the amount not being specified, be given to the Scottish Meteorological Society, on whose claims to Government support the Commission was specially instructed to report.

WE recently announced (p. 116) that the city of Brunswick was making preparations to celebrate the 100th anniversary of the birth of Carl Friedrich Gauss, the "prince" of mathematicians, who was born in that city on April 30, 1777. It is proposed to erect a monument in Brunswick to Gauss, and from the circular which has been sent us we learn that the Monument Committee consists of the principal officials of the city, civil, professional, and commercial. No doubt many English men of science might wish to contribute to this monument; contributions should be addressed to the Gauss Monument Fund, Brunswick Bank.

WE can do no more this week than refer to the fact that the Oxford and Cambridge Universities Bill passed the second reading on Monday, as might have been expected, practically without opposition. The Bill does not differ essentially from those introduced last year in reference to the two Universities.

THE fourth Congress of Russian Archæologists will be opened on August 12, at Kazan. All communications should be addressed to Count Oubaroff, at the Moscow Archæological Society.

WE are glad to hear that the founding of a Russian Anthropological Society at St. Petersburg may be considered as finally settled. Certainly many Russian scientific bodies have now special anthropological sections which, as for instance that of the Moscow Society of Friends of Natural Science, have done a good deal of valuable work, but it is also very desirable that the separate efforts of Russian anthropologists be more concentrated than they are at present.

THE Senatus Academicus of the University of St. Andrews have conferred the degree of LL.D. upon Dr. B. W. Richardson, F.R.S., and Dr. James Murie, F.L.S.

IN a small *brochure* recently published, Prof. Ragona, of the Royal Observatory of Modena, advocates the formation of an "Italian Meteorological Society." There are at present more than 100 meteorological stations throughout the peninsula, at various heights from the sea-level to 2,550 metres. Most are occupied also with magnetic observations; some are devoted almost exclusively to seismometry. The Minister of Agriculture, Industry, and Commerce publishes an *Italian Meteorological Bulletin*, and the Naval Minister sends out daily intimations of the state of the atmosphere throughout Europe, and of probabilities of weather. The proposed Society might hold an annual congress now in one city, now in another, and might, like the Austrian, receive a grant from Government.

DR. GABRIEL, of the University of Breslau, a well-known morphological investigator, has been sent by the Berlin Academy of Sciences to Naples to carry on for four months an extended series of observations on microscopic marine organisms. The necessary funds have been granted partly by the Academy and partly by the Prussian department of instruction.

THE Great Northern Railway Company have a bill now before Parliament for the construction of a line of railway from Shepreth to March, which will pass at a distance of not more than 1,700 feet from the Cambridge Observatory. From the experience of other observatories, and from the evidence of private letters, which Prof. Adams has received from several eminent astronomers, the Syndicate have strong reason to believe that the passage of trains, so near the Observatory, would very seriously affect the accuracy of the observations, or even cause their entire loss. The Syndicate therefore recommend, on good grounds, that the University should petition Parliament against the passing of the bill above referred to.

RUSSIA expended 345,000*l.* upon her seven universities during the past year.

OF the 13,356 new works issued in Germany during the past year, 848 were devoted to the natural sciences, 296 to geography and travel, and 190 to mathematics and astronomy.

IT is proposed to open before long a good aquarium at St. Petersburg. The institution is patronised by the Society of Acclimatisation, which will have, in connection with the aquarium, a garden for scientific experiments relative to the acclimatisation of plants.

THE immense number of wolves in Russia, to which reference was made some time ago, seems not to have been overrated. An official report of the *Zemstvo* of the Kerensk district (Penza Government), just published, estimates the ravages of wolves during the years 1874 and 1875 at 270 horses, 200 cows, 822 foals, 707 calves, 1,812 sheep, about 1,000 pigs, 3,616 geese and ducks, and 253 dogs.

WE recently announced the death of the eminent American palæontologist, Mr. F. B. Meek. He died within the walls of the Smithsonian Institution, where he had been permitted to occupy rooms for about eighteen years. He had been connected with the U.S. Geological and Geographical Survey of the Territories for the greater portion of the time since its first organisation in 1867. Mr. Meek was born in the city of Madison, Ind., December 10, 1817. From his earliest recollection he was interested in the Silurian fossils so abundant in the rocks of the neighbourhood of his home. He had then never heard of geology, but studied them with admiration and wonder as to their origin. Against his own wishes he entered into business, but during the financial crisis of 1847 he failed,

and lost all his property. During the years 1848 and 1849 he was an assistant of Dr. D. D. Owen in the U.S. Geological Survey of Iowa, Wisconsin, and Minnesota, after which he returned to Owensboro, Ky. In 1852 he became the assistant of Prof. James Hall, the eminent palæontologist, of Albany, N.Y. He remained there until 1858, with the exception of three summers, two of which he spent in the Missouri State Geological Survey. In the summer of 1853 he was sent by Prof. Hall with Dr. Hayden as his associate, to explore the "Bad Lands" of Dakota, and brought back very valuable collections. This was the commencement of that long series of successful explorations of all portions of the west which have continued up to the present time. While at Albany he was constantly engaged in the most important palæontological works, the results of which were published in the proceedings of the American learned societies. In 1858 he went to Washington, where he resided until the time of his death, leaving the city only for a few months at a time, while engaged as palæontologist for the State of Illinois, Ohio, or in field explorations in the far west in connection with the U.S. Geological Survey under the direction of Prof. Hayden. His publications, apart from the State reports referred to, were very numerous, and bore the stamp of the most faithful and conscientious research. They are regarded all over the world as authority on the subjects of which they treat, and in very few cases have his conclusions ever been questioned. They may be found in the *Proceedings of the Academy of Natural Sciences*, Philadelphia, *American Journal of Science*, New Haven, *Albany Institute, Smithsonian Contributions*, and various and important reports in the publication of the U.S. Geological Survey for the Territories with which he was so long connected. He was so modest and retiring that he was scarcely known outside of a very limited circle of friends. He was a member of the National Academy of Sciences, and many other prominent scientific associations in America and in Europe. Prof. J. D. Dana, writing the day after his death, says: "American palæontology has lost, as regards the Invertebrate Department, half its working force at a blow. He has gone before his work was done. But what he had finished was enough for half-a-dozen ordinary men; a marvellous pile, if we view only the aggregate of volumes and memoirs, but far more marvellous when we look within at the amount of laboured descriptions and careful comparisons, and at the almost numberless illustrations, mostly from his own exact and beautiful drawings."

ON Saturday, at the Society of Arts, Dr. Corfield, under the auspices of the Trades Guild of Learning, gives the next of the series of lectures on the Laws of Health. These lectures have been well attended and appreciated from the first. Prof. Huxley was chairman on the first occasion, Dean Stanley on the second, and at the lecture on February 10 Cardinal Manning presided. The Cardinal, after the lecture, heartily endorsed the statements of the lecturer; the lecture, he said, showed that the highest science came into the closest application in daily life. There are eight other lectures of the course.

THE educational and scientific institutions inaugurated by the Khedive of Egypt in his schemes of reform are among the first to feel the effects of the present chaotic condition of Egyptian finances. Not long since the free public schools of Cairo were all closed, and now the vice-regal Geographical Society is upon the point of dissolution. The Khedive had gathered together several men of talent and experience to form this Society, with the intention of instituting an active and energetic scheme of exploration in Central Africa. Their names and the bulletins which have appeared, gave every promise of early and valuable additions being made to the cause of African research. The long-continued withholding of financial support has, however, so entirely crippled its operations, that the Society has for some

time last contribution of Karl von Baer, written ten days before his death, appears in the last number of the *Archiv für Anthropologie*, and discusses the subject of the source of the tin used by the ancients in their bronzes. The fact that the proportions of nine parts of copper to one of tin are noticeable in almost all antique bronze articles, would seem to indicate that its use spread from a single centre. Taking a hint from Strabo's statement that tin was found among the Drangians, he caused inquiries to be set on foot by Russian Government officials in Khorassan, who reported that there are extensive deposits of tin there, as well as of other metals, which are mixed in a primitive manner. These v. Baer regards as the sources of the numerous bronzes found in the ruins of Babylon and Assyria, but did not think it probable that they supplied the tin required by Scandinavia and the countries surrounding the Mediterranean before the discovery of the Cornish mines. The latter was probably brought by Phœnicians from Banca, although no mention of such journeys is extant.

IN the February session of the Berlin Anthropological Society Prof. Virchow gave the results of a number of craniological measurements undertaken in Bulgaria. The general type is evidently not Slavonic but Finnish, and would seem to point to a distant emigration from among the Turco-finnish tribes of the Ural, to the region of the Danube. Two distinct subordinate types were noticed, one brachycephalic—pure Finnish; and the other macrocephalic, with retreating forehead, strikingly similar to that of the Australian negro. The Bulgarians gradually adopted the Slavonic language, and no trace of their original language, not even a manuscript, remains. Dr. Friedel exhibited at the same Session a large collection of stone hatchets lately found near Kopenick, in company with some peculiarly fashioned stone instruments, evidently used to prepare the hatchets, and possessing the same hardness as ordinary grind stones.

A TELEGRAM from Algiers announces that on the 16th inst Lieut. Say and others left Ouarghe with twenty-four men and fifty camels, intending to explore the Sahara, and establish commercial connections with Algerian producers.

M. KRANIZ, the Director-general of the Universal Exhibition of 1878 proposes to hold an international piscicultural exhibition. All who desire to exhibit must intimate their intention to the Secretary before May 1, 1877. The administration does not undertake to procure sea water.

M. QUATREFAGES has just published, through Baillière, a work on anthropology. He attacks the evolution theory.

MRS. FRANCES ELIZABETH HOGGAN, M.D. of Zurich, who has been for several years in practice in London, has just passed a successful examination in Dublin, and has received the Licence in Medicine and Midwifery of the King's and Queen's College of Physicians in Ireland, which of course secures for her official recognition in the United Kingdom. A paper by Doctor George and Mrs. Hoggan was recently read at the Royal Society on "Lymphatics of Muscles."

M. WADDINGTON intends to propose to the French parliament the establishment in four large provincial towns of universities according to the English system. The faculties at present in existence in a number of towns will not be suppressed, but they will be necessarily to some extent cast into the shade. A sharp discussion is anticipated in Parliament, many large towns competing for selection as the seats of these new universities.

THE third annual meeting of the Scientific Club was held at the Club House, Savile Row, on Thursday, the 15th inst. Major F. Dunlop, R.A., D.C.L., &c., Chairman of the Committee, presided at the chair. The report for 1876, which showed the rapid progress

made by the Club during the year, was unanimously adopted. The number of members, which is now over 600, is to be limited for the present to 700. Committee-men and auditors for 1877 were elected, and cordial votes of thanks to the Chairman, Committee, Auditors, and Secretary, concluded the meeting.

At the annual meeting of the shareholders of the Brighton Aquarium, Mr. Arthur Wm. Waters stated his belief that if arrangements were made so that a naturalist could go to Brighton and have a table in a quiet room with the most necessary apparatus and chemicals for his study, animals kept living, and fresh ones brought him as required by the sailors under the instruction of the scientific staff, there are many who would gladly avail themselves of the opportunity. The difficulties of a naturalist at present who may go down to the sea-side for a short time to undertake elaborate physiological studies are very great, and he thinks that many, including science students from the universities, would be willing to pay for the advantages which might thus be afforded. Mr. Francis Francis, who has just been appointed naturalist director, said that it was intended to do this; and even to hear of the intention will be a source of satisfaction to those who desire the present aquaria to be made more useful. We hope that if the directors have any suitable place they will not delay to utilise it, and that it may turn out to be a source of permanent advantage, for scientific research will continue when rinking and other such amusements have been replaced by more novel attractions.

THE most important paper in the February number of Petermann's *Mittheilungen* is a detailed discussion of the projects for a railway to Central Africa from the Mediterranean Coast, by Dr. G. Rohlf's. Dr. Rohlf's discusses the various schemes which have been proposed, speaks very unfavourably of that which would carry a line from Algeria southwards, and advocates strongly a line from the coast of Tripoli, especially from Braiga at the head of the Gulf of Sidra, to Lake Chad. He analyses all the difficulties and advantages of this route, and thus introduces much information on the region between these two points, as well as on the whole Saharan region. He proposes, as the only feasible plan, that the undertaking should be an international one.

IN the same number Dr. Behm continues his monthly summary of geographical news. He refers to a work by A. Kirchenbauer, "Die Irrfahrt des Odysseus als eine Umschiffung Afrika's erklart" (Berlin, Calvary), in which the author, by the application of astronomy and mathematical geography, endeavours to show that the Kernel of the Odyssey is a tradition belonging to the fifteenth century B.C., of a circumnavigation of Africa from the Red Sea to the Mediterranean. The Lotophagi were South Arabians, Polyphemus was a Galla, whose cave was at Cape Guardafui, Circe ruled in Rodriguez, the Cimmericians dwell in some South Polar land, and the Straits of Gibraltar were Scylla and Charybdis. Tans Ulysses was both the first African and first Polar explorer of whom we have any record. Dr. Behm states that the author discusses the subject with the greatest seriousness and acuteness.

THE December *Bulletin* of the French Geographical Society contains papers by Mr. J. B. Paquier, "On Russian and English Explorations in Central Asia;" by M. A. V. Parisot, "On the Region between Ouargla and El Golea;" by Abbé Durand, "On Portuguese India;" and by Abbé Desgodins, "On the Territory of Bafang." A letter from Dr. Emil Bessels, of the *Polaris* Expedition, accompanies a map exhibiting approximately the lines of equal tides in the North Atlantic, North Pacific, and Arctic Oceans, for the purpose of showing from what direction the tidal wave is propagated towards Polaris Bay.

*L'Exploration* for February 7 contains an interesting paper by M. Henry Bloune on the Colonial *Agrologie* of France.

CAPT. HOWGATE'S scheme of Polar exploration by means of a colony placed at Discovery Bay, to which we referred in a recent number, has been referred by the United States Congress to the Committee on Naval Affairs. It has received the support of the principal United States scientific societies, and already there have been many suitable volunteers. We should not be surprised, therefore, to hear that the grant has been made, and if men can be found suitable and willing to form such a colony, the experiment seems worth trying.

A SENSATION has been created in the geographical circles of Paris by the opinion expressed by Dr. Pogge at the Geographical Society of Berlin, that the Lualaba was flowing in the Ogoval. The Ogoval delta is part of the French Gaboon settlement. MM. Brazza, Marche, and others are engaged in exploring the river, which they have heard from natives flows out of a large lacustrine basin. It is feared the explorers cannot reach the end of their journey without receiving fresh reinforcements from home.

THE Geographical Society of Geneva voted at its last meeting its adhesion to the resolutions of the conference, for the exploration of Central Africa. A special Swiss committee, to form part of the Association, is to be appointed before long at Geneva.

M. BONNAT, the French African explorer, who has been up the Volta (Ashanti) as far as Salaga, states that from that place much-frequented routes strike off to Timbuctoo in the west, and Lake Tchad in the east, and that from these places trade caravans are constantly passing to and from Mexico and Tripoli. He bought European goods at Salaga, which entered Africa by the Mediterranean. M. Bonnat is organising a large expedition for the thorough exploration of the region from which he has just returned.

WE are glad to notice that science was well represented at the preliminary meeting last Saturday to make arrangements for the celebration of the 400th anniversary of the introduction of printing into England by Caxton. Science owes much to this art, and in recent years has to some extent repaid her debt by the vast improvements which have been introduced, based on the principles she has discovered.

FATHER SECCHI has compiled a very useful list of 444 coloured stars, which is published in the *Memorie della Società degli Spettroscopisti Italiani*. Many of them appear to be taken from Schiellerup's catalogues, from Lalande and Sir J. Herschel; to these have been added Mr. Birmingham's newly-discovered coloured stars. A note is added to each star, showing the colour and type of spectrum. The number of the star in Chambers's catalogue is given, when mentioned there, and the R. A. and Declination is given for the year 1870. We note that by far the greater number of stars are red, and the spectra of the third and fourth types prevail. This catalogue will prove useful, first, in detecting the variability of the stars, and secondly, the change of spectrum when variable. The following are representative stars of the types to which they belong:—1. Sirius,  $\alpha$  Lyræ, white stars; 2. Capella, Pollux, yellow stars; 3.  $\alpha$  Orionis,  $\beta$  Pegasi,  $\alpha$  Herculis, red-yellow stars; 4. Small blood-red stars.

WE notice in the fifteenth volume of the *Globe*, published by the Geographical Society of Geneva, a very interesting report by M. H. D. Saussure on the present state of cartography in Switzerland. The author not only gives a detailed report on the numerous Swiss cartographical works which were so much praised at the Paris Geographical Exhibition, but also sketches the history of cartography in his country, and skilfully discusses the relative values of different modes of representing on a map the various characters of land, and of dressing maps for various special purposes.

SOME fifty years ago Ampère stated his belief in the existence of molecular electric currents permanently flowing in bodies, and he applied this hypothesis to the explanation of the reciprocal action between movable conductors through which galvanic currents are passing and permanent magnets. According to Ampère a permanent magnet contains, in proportion to its strength, a larger or smaller number of molecular currents of the same direction, each of which behaves like a small molecular magnet. In pursuance of this theory, Herr Zoellner has lately made a series of investigations and has recorded the results of his experiments in a paper read before the Royal Saxon Society of Sciences at Leipzig during the past year. With regard to the constitution of material molecules Herr Zoellner expresses his opinion "that each material molecule of a body consists of a conglomeration of (Ampère's) molecular currents of any direction, with a certain quantity of freely movable electric particles, which, under the influence of electrostatic or electrodynamic induction forces, execute such motions or groupings as are determined by Weber's law of electric reciprocal action." It is but fair to state that Weber's views on this subject were identical, and he stated them as early as in 1851 in his explanation of diamagnetism. Zoellner makes a whole series of deductions from this theory, all of which agree with observed phenomena and laws found in various domains of physical science.

THE Rev. T. R. R. Stebbing sends us an interesting letter on the true origin and correct pronunciation of the name *Antedon*, which we regret we have not space to print in full. As the result of careful inquiry, Mr. Stebbing concludes that the name is undoubtedly feminine, that the middle syllable should be pronounced long, and that the aspirate which de Fréminville dropped ought to be restored to the spelling. "If, then, we were to adopt the compromise suggested in Mr. Herbert Carpenter's important letter (vol. xv. p. 197), we should have to write, instead of either *Comatula rosacea* or *Antedon rosacea*, the trinomial, *Comatula (antedon) rosacea*. To sanction such an innovation as Mr. Carpenter proposes, no doubt some general agreement would be required, and the same general agreement might be usefully employed in sanctioning a statute of limitations against the revival of obsolete names, and to insure the publication of new scientific names in one or other of a very limited number of chronicles. Some international science congress of the future may perhaps achieve the requisite legislation."

THE *Journal* of the Society of Arts for February 16 contains a useful paper by Dr. R. J. Mann, on "Recent Explorations of the Lake Systems of Central Africa."

WE notice an important German work, by the Bernese Professor, Dr. Emmert, on the diseases of the eye, occasioned by various professions, and especially by the vicious arrangements in schools. An inquiry made by the learned Professor in the cantons of Berne, Solothurn, and Neuchâtel proves that an increasing myopia is the fate of all scholars, and that at the age of twenty years there are very few of them who are not afflicted with this disease. Various hints by the author as to improved arrangements to be adopted in schools deserve the attention of school boards.

A RECENT subscriber will find an account of Siemens' Bathometer in NATURE, March 30, 1876 (vol. xiii. p. 431).

THE additions to the Zoological Society's Gardens during the past week include two Pennant's Parrakeets (*Platysercus pennanti*) from New South Wales, presented by Mr. E. Sargent; an Anaconda (*Eunectes murinus*), a Crested Curassow (*Craux alleator*), and two Green-billed Curassows (*C. viridirostris*) from South America; two Felina Dourocoulis (*Nyctipithecus felinus*) from South Brazil; two Carianis (*Carriama cristata*), from South America, purchased.

## SOCIETIES AND ACADEMIES

LONDON

Royal Astronomical Society, February 9.—Annual general meeting.—William Huggins, D.C.L., president, in the chair. The following gentlemen—A. Mason Worthington, B.A., John Sidney White, and George Francis Hardy, were elected fellows of the Society. The annual report of the society showed that the number of Fellows had been increased during the past year, and that the society's library had been enriched by several important presents of books and manuscripts. Ten minor planets have been discovered in the course of last year, six of them in America, and four in France. In solar physics Prof. Tacchini has made an interesting investigation as to the relative height of solar prominences at different times of the sun-spot period. Prof. Young has determined the rate of the solar rotation by means of the displacement of the dark lines in the spectrum of the sun's limb. He has also proved that the 1474 line is double, and that the two components are of unequal strength; the coronal line corresponds to the stronger of the two, whilst the other is one of the faint lines in the spectrum of iron. Mr. Huggins' photographs of the spectra of stars were also referred to, and a short account was given of the observations of the new star in Cygnus, which was discovered by Dr. Schmidt, at Athens, on November 24, 1876. Its spectrum gives several bright lines, amongst which are three of the hydrogen lines, C being the brightest of all, the sodium line D, or the chromosphere line near D, the magnesium lines  $\delta_1$  and the coronal line 1474. The reduction of the observations of the transit of Venus has been proceeding continuously at the Greenwich Observatory, under the direction of Capt. Tupman. All the observations with transit instruments at the various stations for local time and longitudes of Honolulu and Rodriguez by the observations of the moon in zenith distance have been completely reduced. An idea of the magnitude of the undertaking may be formed when it is stated that these two last calculations required the use of three millions of figures. The Report having been adopted, the Society proceeded to the election of Officers for the ensuing year, and the following gentlemen were elected: As President, William Huggins, F.R.S. As Vice-Presidents: J. C. Adams, F.R.S., Lowndean Professor of Astronomy, Cambridge; Sir G. B. Airy, K.C.B., F.R.S., Astronomer Royal; Arthur Cayley, F.R.S., Sadlerian Professor of Geometry, Cambridge; Edwin Dunkin, F.R.S. As Treasurer, Samuel Charles Whitbread, F.R.S. As Secretaries: J. W. Lee Glaisher, F.R.S.; A. Cowper Ranyard, M.A. As Foreign Secretary, Lord Lindsay, M.P. As Council: John Brett, Esq.; W. H. M. Christie, M.A. Warren De la Rue, F.R.S.; J. R. Hind, F.R.S., Superintendent of the *Nautical Almanac*; F. B. Kuobel; George Knott; William Lassell, F.R.S.; E. Neison; Capt. Wm. Noble; Rev. S. J. Perry, F.R.S.; Earl of Rosse, F.R.S.; Capt. G. L. Tupman, R.M.A.

Geological Society, January 24.—Prof. P. Martin Duncan, M.B., F.R.S., president, in the chair.—George Barrow, William Heerlein Lindley, and Joseph Samuel Martin, were elected Fellows of the Society.—The following communications were read:—Note on the question of the glacial or volcanic origin of the Talchir boulder-bed of India and the Karoo boulder-bed of South Africa, by H. F. Blanford, F.G.S. The author, referring to a doubt expressed by the President in a paper on Australian tertiary corals as to the glacial origin of the Talchir boulder-bed, indicated that the hypothesis of its formation by the action of local glaciers under present climatal conditions would require the elevation of the whole region to the extent of 14,000 or 15,000 feet, and the assumption that the denudation of this great mountain mass was so moderate that large tracts of the ancient surface are still preserved at levels now only a few hundred feet above the sea. This the author regarded as very improbable. He assumed that the President, rejecting the evidence adduced by various writers in favour of the glacial origin of the Talchir and Karoo boulder-beds, was inclined to fall back upon the notion of their being of volcanic origin, and quoted a letter from Mr. King, who had described the Talchir rocks of Kámáram as trappean, in which that gentleman stated that the rocks so interpreted by him prove to be dark green and brownish mudstone. He cited further evidence of like nature, and concluded that the description of a volcanic origin to these boulder-beds was probably in all cases due to similar misinterpretations.—On British cretaceous pelecypod gastropoda, by John Starkie Gardner, F.G.S. In this

paper the author commenced by a general statement as to the classification of the forms to be described in it, which he referred to the families Patellidæ, Fissurellidæ, Calyptræidæ, and Capulidæ. He noticed thirty species, which are mostly of rare occurrence, and nineteen of these were described as new. Four genera were indicated as new to the Cretaceous series, and one as new to the Cretaceous in England. The new species were *Achæa formosa* and *plana*, *Helcion Meyeri*, *Amisomyon vicis*, *Stærria calyptræiformis* and *depressa*, *Emarginula puncturella*, *diversaria*, *ancistræ*, *Meyeri*, and *unicostata*, *Puncturella antiqua*, *Calyptræa concentrica*, *Crepidula chamaeformis*, *Crucibulum giganteum*, *Pileopsis neocomiensis*, *dubius* and *Szeleyi*, and *Hippopoxa Dixoni*. Most of the Patellidæ were from the Neocomian, and the majority of the Fissurellidæ from the Upper Greenand; the species of the other two families were scattered through the series. The author referred to the indications of depth of deposit and other conditions furnished by these Mollusca, and also to the resemblance presented by many of them to certain bivalves common in the same rocks, which he regarded as a sort of mimicry.—Observations on remains of the mammoth and other mammals from Northern Spain, by A. Leith Adams, F.R.S.—The remains noticed in this paper were obtained by MM. O'Reilly and Sullivan in a cavern discovered at about twelve metres from the surface, in the valley of Udias, near Santander, by a boring made through limestone in search of calamine. They were found close to a mound of soil which had fallen down a funnel at one end of the cavity, and more or less buried in a bed of calamine which covered the floor. The cavern was evidently an enlarged joint or rock-fissure, into which the entire carcasses, or else the living animals, had been precipitated from time to time. The author had identified among these remains numerous portions, including teeth of *Elephas primigenius*, which is important as furnishing the first instance of the occurrence of that animal in Spain. He also recorded *Bos primigenius* and *Cervus elaphus* (?), and stated that MM. O'Reilly and Sullivan mention a long curved tooth which he thought might be a canine of Hippopotamus.

Chemical Society, February 15.—Dr. Gilbert, F.R.S., vice-president, in the chair.—Dr. Dupré, F.R.S., read a paper on the estimation of urea by means of hypobromite, in which he described a new form of apparatus and certain modifications in details to facilitate the working of Russell and West's process. The other communications were on a new carbometer for the estimation of carbonic anhydride, by Mr. S. T. Pruen and Dr. G. Jones, being a modification of Scheibler's "calometer."—On the influence exerted by ammonium sulphide in preventing the action of various solutions on copper, by Mr. F. W. Shaw and Dr. P. Carnelly.—An experimental inquiry as to the changes which occur in the composition of waters from wells near the sea, by Mr. W. H. Watson.—On the solvent action of various saline solutions upon lead, by Mr. M. M. P. Muir.—Derivatives of Di-sobulyl, by Mr. W. Carleton-Williams, and notes on madder-colouring matters, by Dr. E. Schunck and Dr. H. Roemer.

STOCKHOLM

Academy of Sciences, October 11, 1876.—Baron Fock gave an account of a report by O. Nylander, assistant at the Academy of Agriculture, of a journey he had undertaken with the Letterstedt grant for the purpose of studying the industries associated with agriculture.—Prof. Torell also gave an account of a report by Edward Erdman, the geologist, of a tour he had made, with Government assistance, in Central Europe in 1875.—Prof. Smith gave a short account of the expedition to North-western Russia and the region round the White Sea, undertaken by Lieut. H. Sandberg last summer.—Prof. Stål stated that the Vyder collections had been bought for the natural history department of the Riks Museum, through the liberal contributions of private persons, and gave a short account of their contents.—General-director Berlin communicated the result of the latest analyses by Valler of the mineral water at Forla, and Prof. Nordenskiöld gave a full and interesting narrative of his last expedition from Tromsø to Jenissei.—The following communications were received:—On the course of the alteration which a surface undergoes when it is bent, by Prof. Daug.—On compounds of cyanide of mercury with chlorides of the earthy metals, by J. E. Aalen.

November 8, 1876.—Herr Edlund communicated the results of his examination of the galvanic currents which are caused by the motion of fluid bodies.—Prof. Nordenskiöld exhibited pieces of a mammoth or fossil rhinoceros hide, found last summer near the confluence of the Mesenkin with the Jenissei, and several meteor-

ites which fell at Stålldalen, in Westmanland, on the 28th of last June, and gave an account of the nature of the meteorites in question.—Herr Gylden exhibited a calculating machine constructed by Engineer Pettersson for the purpose of adding, subtracting, multiplying, and dividing, and gave an account of a communication by Prof. T. N. Thiele, of Copenhagen, entitled, "Some geometrical propositions concerning a problem in theoretical astronomy."—The following papers were communicated: A new species of the family Portunidæ from the Scandinavian coast, by Docent Carl Bovallius; Communication from Upsala Chemical Laboratory, 20, on  $\gamma$  (gamma) dichloronaphthalene and bromo-chloronaphthalene, by Prof. P. T. Cleve; Remarks on Dr. Bioren de Haans Tables d'intégrales définies (Amsterdams, 1858), by Lektor Lindman, member of the Academy; and Researches on the cooling of bodies, by Prof. G. R. Dahlander.

BERLIN

German Chemical Society, January 29.—A. W. Hofmann, vice-president, in the chair.—W. Beetz claims priority for observing the disengagement of hydrogen at both poles of a battery (as lately described by Elsasser).—W. Bornemann published observations on the solubility of chloride of iodine, and R. Ulbricht some on the determination of water and of sugar in wine. The latter chemist gives warning of a fraud by which glass weights are sold instead of ones made from rock crystal.—R. Dyckerhoff has transformed monochloro-acetophenone,  $C_6H_5-CO-CH_2Cl$ , by the action of  $PCl_5$  into two chlorides:



—V. Meyer, T. Barbieri, and F. Forster by joint and elaborate researches refute the pretended observation of Linnemann and Zotta that normal butylamine and nitrous acid yield isobutylic alcohol. The reaction only yields normal primary butylic alcohol, normal butylene, and normal secondary butylic alcohol, but no isobutylic alcohol.—H. Wald has transformed paradinitrodiphenyl by the action of sodium-amalgam into paradinitro-azoxydiphenyl, a crystalline powder melting at 255°, and soluble

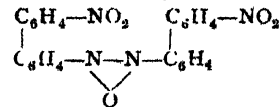

in aniline, but not in alcohol, ether, or chloroform, and yielding benzidine by further reduction with tin and hydrochloric acid. Isodinitrodiphenyl and sodium amalgam yield dinitro-azodiphenyl,  $(C_6H_4NO_2-C_6H_4N)_2$ , a yellow powder melting at 187°.—C. Kimich published researches on methazonic acid, the sodium-salt of which is engendered by the action of heat on nitromethan-sodium:—

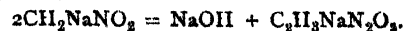

This salt with nitrate of diazobenzol yields red crystals of a mixed azo-compound,  $C_6H_5N_2 \cdot C_6H_3N_2O_3$  (azonitromethylphenyl), in which two atoms of hydrogen can be replaced by metals. Nitrate of diazotoluol gives a corresponding compound.—G. Burkhardt has transformed amidoterephthalic into oxytere-phthalic acid (with nitrous acid), a powder giving a crystallised barium salt and methylic ether. Hydrochloric acid transforms it into oxybenzoic (not salicylic) acid.—A. Baeyer has studied amidophthalic acid and its well-crystallised ethylic ether, which, with nitrous acid, yields an ill-defined oily oxyphthalic acid. The same chemist has transformed chloride of phthalyl into phthalic aldehyde by treating it with hydriodic acid and phosphorus. With potash it yields a new acid not yet investigated. The same chemist has transformed phenanthrenequinone,  $C_{14}H_8O_2$ , by boiling it with soda into diphenylglycolic acid,  $C_{14}H_{10}O_3$ :—

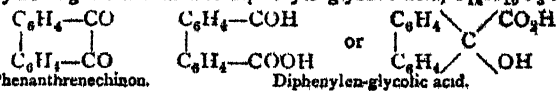

He rejects the former formula of the latter body, because it does not yield by oxidation diphenic acid.—G. Schultz, by passing oil of turpentine through red-hot tubes, has obtained benzol, toluol, xylo, naphthalene, phenanthrene, anthracene, and methylanthracene.—F. Hermann has studied the action of sodium on succinic ether. The product (probably impure succino-succinic ether) yields, treated with potash and with acetic acid, an acid of the composition

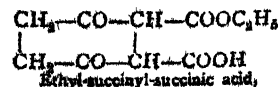

while with sulphuric acid it forms a black amorphous mass, which by distillation yields hydrochinone. The product of potash with bromine gives bromide  $C_6H_2Br_2O_2$ . Air and potash transform the ether into  $C_6H_2O_2(CO_2H)_2$ , chion dicarbonic acid, yellow hair-like crystals.—L. Schunck and H. Roemer, in order to discover traces of alizarine in Purpurine, expose the solution to the air until the latter is oxidised, when alizarine, remaining behind unaltered, can be recognised by its absorption-bands in the spectroscope. The same chemists have found that certain impure purpurines yield a precipitate with alum, which is decomposed by hydrochloric acid with greater difficulty than the purpurine compound. The compound thus obtained forms gold-brown needles fusing at  $231^\circ$  decomposed by heat into carbonic anhydride and purpuroxanthin, and corresponding to the formula of purpuroxanthincarbonic acid  $C_{12}H_{10}O_4COOH$ .—A. Kern published researches on the action of iodide of methyl on aniline, from which he concludes that only dimethyl-aniline and no monomethyl aniline is formed in this reaction.—R. Meyer has tried in vain to convert cuminol into cymol; and thinks that former assertions to the contrary depend upon the presence of preformed cymol in cuminol.—M. Murncke (of the firm of Warmbrunn and Quilitz, in Berlin) showed a model of a double aspirator, also a Bunsen burner with a tube to prolong it, and a modification of Fletcher's hot air blast.—G. Gabriel described phenylic and ethylic ethers of tribasic thioformic acid,  $CH(SR)_3$ , obtained by the action of chloroform on the sodium compounds of the corresponding mercaptans.—A. Klobukowsky showed a tube filled with oxide of iron for E. Kopp's method of determining chlorine, bromine, and iodine in organic compounds, and praised the simplicity of this method.—A. Czech and H. Schwelb have found that isocyanide of phenyl and formic acid are formed by the action of dichloroacetic acid on aniline.—A. W. Hofmann showed a new yellowish-red colouring substance called chrysoidine, and established the following remarkable analogies:—

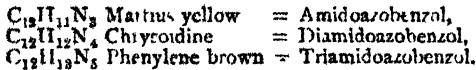

The first body is obtained by the action of nitrous acid on aniline; the third by the action of nitrous acid on phenylene diamine; the new colour (chrysoidine) by the action of phenylene diamine on newly-prepared diazobenzole in alcoholic solution.

VIENNA

Imperial Academy of Sciences, November 9, 1876.—On parthenogenesis of angiospermous plants, by M. Kerner.—On the shell-glands of Coelopoda, by M. Claus.—On a modification of Dumis' method of determination of vapour densities, by M. Habermann.—Researches on the origin of the lowest organisms, by M. Krasan.—On the action of secondary electric currents on nerves, by M. Heischl.

PARIS

Academy of Sciences, February 12.—M. Peligot in the chair.—The following papers were read:—Discovery of three small planets, 170, 171, and 172, and of a comet, at Toulouse and Marseilles, by MM. Tisserand and Stephan, communicated by M. Leverrier.—Researches on calorific spectra (continued), by M. Desains. With refracting apparatus of rock salt, the heat accompanying the luminous rays in the solar spectrum is about a third of the total heat; in the spectrum of incandescent platinum it is only a small fraction. Similar results are had with flint apparatus, and M. Desains was unable to make the difference disappear by sending the rays from the metal through layers of water, though this shortened the dark spectrum. But spectra from the electric lamp may be rendered much more like those obtained from the sun's rays. The heat in their luminous part seems to be about one-sixth of the total heat, and if the rays be sent through a layer of water of 3 to 4 cm., the calorific intensity of the dark part is considerably reduced, while the luminous heat is hardly affected; this latter being then about a third of the total heat as in the solar spectrum.—Preliminaries of a study of living and fossil European oaks, compared together, by M. De Saporta. The races most largely distributed in Europe, particularly *Quercus pedunculata*, *sessiflora*, and *pubescens*, are comparatively recent, though their type is old. In the south of France, at least, these have been preceded by other oaks, that have been partly eliminated, partly confined further southwards.—On a new catalogue of coloured stars, and on the spectrum of Schmidt's star, by P. Secchi. This work is based on Schjell-

erup's catalogue, published in 1866.—Observations on the comets *verdu* of the *stance* of February 5, 1877, by Gen. Morin. He expressed regret at the omission from *Comptes Rendus* of information given by MM. Wurtz, Pasteur, and Boussingault as certain falsifications of alimentary substances, and urged the importance of the subject, and of chemistry detecting such frauds. M. Pasteur stated that of fourteen cases of preserved peas bought at random in some of the principal quarters of Paris, ten contained copper, sometimes even about  $\frac{1}{1000}$  of the total weight of the preserves, excluding the liquid; which always contains some copper when the peas contain it, but less.—M. Lory was elected correspondent for the section of mineralogy, in place of the late M. Naumann.—On the application of photography to observation of the transit of Venus, by M. Angot. This relates to determination of the instant of contacts.—Practical formulae of velocities and pressures in arms, by M. Sarrau.—On a class of orthogonal systems, comprising isothermal systems as a particular case, by M. Darboux.—On nitrification by organised ferments, by MM. Schloesing and Mintz. He obtained nitrification by passing ammonia waters through a porous substance charged with organic matters, but there was no trace of nitrate from a filter made of pure sand. The active matter, after being subjected to action of chloroform, lost its nitrifying properties exactly as if these special ferments had been killed.—Note on certain alterations of glass, by M. de Luynes. Often, in moist air, fine parallel striae form on the surface, and scales come off, which are found to be of different composition from the glass. Alkalies are almost wholly absent in them, and they consist chiefly of earthy silicate; the proportion of silica rising to 78 per cent., while in normal glass it is only 68. The glass retains its transparency.—On phosphorescent organic bodies, by M. Rdziszewski. Hydrobenzamide, amarine, lophine, and the raw product of the action of alcoholic ammonia on benzile show phosphorescence in the dark when brought into contact with an alcoholic solution of caustic potash.—On the fermentation of urine; reply to M. Pasteur, by Prof. Bastian.—On the toxic properties of salts of copper, by M. Bergeron.—Method for recognising iodine in cod-liver oil and experiments on absorption of iodide of potassium by fatty animal matters, by M. Barral. He saponifies the fatty matter with potash, burns the soap, and dissolves in alcohol the residue of potassium formate. A goat received fifty centigrammes of iodide of potassium daily for eight days with its food. Butter prepared from its milk contained a good deal of iodine. The kid of a goat thus treated being killed, iodine was found in its fat and adipose tissue.—Researches on the history of respiration in fishes, by M. Jobert. He finds a peculiar respiratory system in the Callichthy;—On the transparency of the water of Lake Leman, by M. Forel. He explains the less transparency in summer than in winter, by a stratification of layers of different densities, due to heat on the surface; in winter there is uniform density, and powdery particles either sink to the bottom or rise to the surface.

CONTENTS

	Page
A WORKING NATURALIST . . . . .	34
BLAKE'S "ASTRONOMICAL MYTHS" . . . . .	35
OUR BOOK SHELF:—	
Less "ALUMINUM, Light, and Heat."—Dr. W. H. STONE . . . . .	37
LETTERS TO THE EDITOR:—	
Postulates and Axioms.—C. J. MONRO . . . . .	35
Just Intonation.—Lieut.-Col. A. R. CLARKE . . . . .	35
Protective Mimicry among Bats.—C. E. DOBSON . . . . .	35
Subs. of Hearing in Birds and Insects.—C. J. A. MEYER . . . . .	35
THE ATMOSPHERE OF THE ROCKY MOUNTAINS. By Prof. HENRY DEXTER . . . . .	35
TESTIMONIAL TO MR. DARWIN . . . . .	35
MICROSCOPICAL INVESTIGATION OF SANDS AND CLAYS. By H. C. SORBY, F.R.S. . . . .	35
REMARKABLE PLANTS. II.—SOME CURIOUS ORGANS ( <i>With Illustrations</i> ). . . . .	35
THE MOVEMENT OF THE SOIL CAP. By Sir C. WYVILL THOMSON, F.R.S. . . . .	35
ON THE INFLUENCE OF GEOLGICAL CHANGE ON THE EARTH'S AXIS OF ROTATION. By G. H. DARWIN, M.A. . . . .	35
THE NEW STAR IN CYGNUS. By RALPH COVELLAND . . . . .	35
OUR ASTRONOMICAL COLUMN:—	
The New Comet . . . . .	36
The "Berliner Astronomisches Jahrbuch" . . . . .	36
CHEMICAL NOTES:—	
Absorption of Light in the Blood . . . . .	36
Physical Properties of Gallium . . . . .	36
Potassium Tri-iodide . . . . .	36
Solution of Gases in Iron, Steel, and Manganese . . . . .	36
NOTES	
SOCIETIES AND ACADAMIES . . . . .	36



THURSDAY, MARCH 1, 1877

GOVERNMENT GRANTS IN AID OF  
SCIENCE

THE Civil Service Estimates for this year contain three different sums proposed to be granted by the government in aid of scientific research. As the circumstances connected with these grants do not appear to be generally well understood, it may be convenient to those engaged in the study of science to have a short explanation given to them on the subject.

The oldest and best known of these grants is that of 1,000*l.* which has been given to the Royal Society for the last twenty years, for the encouragement of scientific research. The distribution of this grant is regulated by a Committee of the Council and other Fellows of the Royal Society, usually denominated the "Government Grant Committee." The manner in which it is expended is given in the published *Proceedings* of the Royal Society every year. Last year, we observe, grants of 100*l.* were sanctioned to Mr. J. A. Broun, for "investigating the effects due to the sun's rotation and magnetism;" to Mr. J. N. Lockyer, to enable him "to continue his spectroscopic researches;" to Dr. Carpenter, in aid of his work on *Comatula* (or *Autedon*, as he prefers to call it); and to Sir W. Thomson and Prof. J. Thomson for the construction of an analysing machine suitable for performing certain calculations connected with the observation of tides. Other smaller sums were assigned to Dr. Stenhouse, Mr. G. J. Romanes, Mr. W. Crookes, and Prof. W. E. Adams, in aid of various researches in which these philosophers are respectively engaged.

Last year, as we stated on a former occasion, in consequence of the report of the Royal Commission on Science, the propriety of increasing the amount of this grant was considered by the Government. It was ultimately arranged that instead of making any alteration in the mode of distributing the grant of 1,000*l.*, which seemed to have answered its purpose very satisfactorily, a second grant of 4,000*l.* should be made, to be administered in a different manner. Instead of being given by the Treasury direct to the Royal Society, the new grant, in order to carry out another recommendation of the Duke of Devonshire's Commission, to the effect that the scientific work and votes should be placed under one Minister, was placed in the Privy Council Estimates, and will be distributed directly by the Lord President, according to a scheme prepared by the "Government Grant" Committee of the Royal Society, together with the presidents of fifteen other learned societies, who, for this object, are *ex officio* members of this Committee.

There are now, therefore, two different grants in aid of scientific research administered by the Royal Society: that of 1,000*l.* received direct from the Treasury appropriated mainly to the providing of instruments and other assistance necessary to scientific inquiries; that of 4,000*l.* applied to the aid of scientific investigators not only by providing instruments and assistance, but by making personal allowances or grants of money to the investigators for their services. As regards the last-named fund,

on the proposed distribution of which the Government Fund Committee is now occupied, we understand that the applications made for it for the present financial year (1876-77) have amounted to upwards of 14,000*l.* To three sub-committees (Physical, Chemical, and Biological) who have been for some time past engaged in investigating these applications, is assigned the pleasing task of reducing them to more moderate dimensions, and bringing them again before the whole Committee, which meets to-day, in order that they may be submitted to the Lord President of the Council for his final approval.

When it is possible to refer to the proceedings of the Committee without any breach of confidence, we shall state at length how the great question of the endowment of research has been aided, or the reverse, by the action of the Fund Committee. It is well known that there are many Fellows of the Royal Society whose positions as workers in science need not be too clearly defined, who view with mistrust the liberality of the Government. But we have the greatest confidence in the powerful Committee which has been formed, and believe that although it is possible mistakes may be made and endowments proposed which may perhaps have a different effect from that intended, that the proceedings of the Committee viewed as a whole will meet with the warmest approval of men of science, and that it will be acknowledged on all hands that an important step has been taken in the direction of increasing research in our country.

A third grant for scientific purposes, which has been made for some years by the Government, is not so generally well known amongst men of science, and as a change is to be made in its administration this year, it may be as well to give a few explanations on the subject. Commencing with the year 1871-72, as it appears from the Parliamentary return now before us, a sum of 2,000*l.* has been voted annually to the department of the Privy Council Office for "auxiliary scientific investigations." By reference to the same return, it will appear that in 1871-72 and the three succeeding financial years this sum, under the recommendation of Mr. John Simon, late Medical Officer of the Privy Council and Local Government Board, was divided pretty nearly equally between Dr. Sanderson and Dr. Thudichum, portions of the grant in each case being devoted to laboratory expenses and the payment of skilled assistants. The results of this expenditure have been various reports on such subjects as "Infective Inflammation," the "Chemical Changes in the Case of Typhus," and the "Pathology of "Sheep-pox," and other scientific investigations connected with questions of public health, which have been published as appendices to Mr. Simon's reports as Medical Officer of the Privy Council and Local Government Board. Mr. Simon having resigned his office last year, and there being no longer any medical officer attached to the Privy Council Office, the vote of 2,000*l.* has, we observe, in the Civil Service Estimates for the present year, been transferred to the Local Government Board, and will, we suppose, be administered in future by Mr. Sclater Booth, the President of the Board, under the advice of Dr. Sexton, who has succeeded Mr. Simon in his functions as principal medical officer of that department. Whether this transfer of the fund will involve any alteration in its disposal remains to be proved.

### THE LIFE OF SIR WILLIAM FAIRBAIRN

*The Life of Sir William Fairbairn, Bart., F.R.S., LL.D., D.C.L., &c.* Partly Written by Himself. Edited and Completed by William Pole, F.R.S., Member of Council of the Institution of Civil Engineers. (London: Longmans, 1877.)

THE art of Engineering is one by which above all others the influence of science upon the civilisation of the world has been proclaimed with the loudest voice. Astronomy may deal with far more tremendous mechanical problems and may have done more for establishing the exactness of scientific research. Chemistry may have done much for the amelioration of suffering, and have given to the world vast commercial enterprises. Geology and Metallurgy have told men where to find and how to use the wealth beneath their feet; and to Physics we owe the Electric Telegraph and a thousand things besides. But Engineering, combining all of them with much that is its own, goes out to the world and makes itself heard and known by every class. Millions who never heard of the *Nautical Almanac* see the feats of navigation and the power of ocean ships. The locomotive, diving under mountains or flying over valleys leaving civilisation in its track, preaches the power of steam to people who may never hear of the dynamical nature of heat. And the splendid machinery by which the commonest things of life are made testifies to the greatness and humanising influence of that art which, above every other, directs the great powers in Nature to the use and convenience of man.

To Engineering, civil and mechanical, this country, more perhaps than any other, owes its wealth and not a little of its fame; and the British public has always delighted to honour the veterans of the profession to which its country owes so much, more especially those who by great originality of mind, broad unprejudiced common sense, sound reasoning, and indomitable perseverance, triumphing over all opposition and difficulty, and abandoning the beaten paths of their fellow-men (whenever those paths led wide of their mark), have cut out for themselves new roads and made themselves pioneers in their profession, adding to it fresh lustre, and lifting themselves thereby from a humble position of life to a great and honoured place in the estimation of their fellow-men. Of such men as Brindley, Watt, Telford, Stephenson, Rennie, Maudslay, Nasmyth, Whitworth, and Fairbairn, this country may justly be proud, for with their names are mixed up, in no small degree, its prosperity and its fame.

The story of such eventful lives cannot but be full of interest and instruction; interesting as tales of the vicissitudes of fortune, the difficulties, trials, hardships, and triumphs inseparable from the life of a "self-made" man, and instructive in the highest degree, as putting upon record the history and development of those branches of human progress which played so important a part in the drama of their lives.

The career of Sir William Fairbairn, which extended over eighty-five years, was an exceptionally eventful one, and this biography before us possesses an especial interest from the fact of its being partly written by himself, and written, too, in so pleasant and animated a style as to carry the reader with him into all the scenes of his life,

and to show that he was as accomplished a writer as he was a mechanician. Indeed, he was a most prolific author, having given to the world some eighty publications, several being of the highest scientific character, and published in the *Philosophical Transactions*, as well as several large and important works upon engineering subjects.

William Fairbairn, like his friend, George Stephenson, raised himself from the humblest rank of life, being the son of a small farmer or "portioner" of Kelso, where he was born in the year 1789. When little over four years old he attended the parish school, where he learnt to read from some of the best poets and prose-writers, and in his own words, "if to these be added a course of Arithmetic as far as Practice and the Rule-of-Three, they will constitute the whole of my stock of knowledge up to my tenth year." He gives a lively description of the hard training which prevailed in Scotland at that period, and of the severity with which discipline was enforced in the Scottish schools. At the age of fifteen Fairbairn was apprenticed to a Mr. Robinson, a millwright at the Percy Main Colliery, near North Shields, and here he had a rough time of it. Surrounded by temptations of every kind, and with the lowest possible of companions to associate with, he sketched out for himself a weekly curriculum of study, in which literature, mathematics, and recreation were pretty evenly distributed. This he kept up with wonderful constancy, and in a short time was able to turn the tables upon those who ridiculed him, by proving the superiority which learning gave him.

It was also at this time that he made the acquaintance of George Stephenson, who had then charge of an engine at Willington Ballast Hill, only a mile or two from Percy Main Colliery. The two young men, who were nearly of the same age, and were both earnest in their love for mechanics, here formed a friendship which lasted through life. It is on record that in the summer evenings Fairbairn was accustomed to go over and see his friend, and would frequently attend to the Ballast Hill engine for a few hours, in order to enable Stephenson to take a two or three hours' turn at heaving ballast out of the collier vessels, by which he earned a small addition to his regular wages; and he often, in after life, alluded with pride and satisfaction to his early intimacy and close friendship with the great founder of the railway system.

At the age of twenty-one, Fairbairn, wishing to see more of the world, and being at this time of a roving disposition, went in search of other employment, which he obtained first at Newcastle, then at Bedlington. From here he went to London in the winter of 1811 with 2*l.* 7*s.* 6*d.* in his pocket, and immediately set out to look for work, which he failed to get, through the tyranny of the Millwright's Trades-union Society. For some time after this William Fairbairn was more or less a "rolling stone," travelling about the country picking up odd repairing jobs, and seldom remaining in one place for long.

We find him in Bath, Bristol, South Wales, Dublin, Liverpool, and Manchester, which he entered in the winter of 1813, when he was in his twenty-fourth year, and obtained employment with Mr. Adam Parkinson, with whom he remained two years; he was at this time earning thirty shillings per week, and this enabled him to fulfil in 1816 his engagement of marriage, which had

existed for five years. From this time he determined no longer to remain the servant of another, but by a bold effort to take an independent position.

The result of this determination was that he entered into a partnership with an old shopmate of the name of Lillie, and in a miserable shed which they hired for twelve shillings a week they set up a lathe which had to be turned by hand, and thus began a business which but a few years afterwards had a world-wide reputation.

The first order that came to the new firm was a somewhat important one—the taking down and renewal of the whole of the shafting in an extensive cotton-mill belonging to Messrs. Adam and George Murray. In carrying out this work, originality of mind and sound reasoning powers which Fairbairn brought to bear upon everything he undertook, came to his aid; he saw that the old system of mill-gearing was wrong in principle, that quick shafts and small drums would do the work with a great saving of power and space, and thus he revolutionised the whole system of mill-work, and the firm of Fairbairn and Lillie became the leading millwrights of the district. Orders poured in upon them from all sides, and they removed from the shed to a larger building, to which was afterwards added a cellar.

"I was," Mr. Fairbairn says, "designer, draughtsman, and book-keeper, and in order to meet all the requirements of the concern and keep Mr. Lillie's department in the shop constantly going, I had to rise with the sun in the summer and some hours before it in winter, in order to make the entries and post the books before breakfast. In the remainder of the day I had either to draw out the work or to ride fifteen or sixteen miles on a hired hack to consult with proprietors, take dimensions, and arrange the principle upon which the work was to be constructed."

Four or five years passed in this manner, and though the firm was always short of money it was daily increasing in prosperity; orders came in far beyond what they could execute, they kept adding to their stock of tools, and ultimately purchased a second-hand steam-engine by Boulton and Watt, bought a piece of ground, and erected a larger and more convenient workshop.

In the year 1824 Mr. Fairbairn designed and carried out the great Catrine Bank water-wheels in Ayrshire, in which he introduced so many improvements upon the old system of water power, that his firm for many years stood almost alone for such work, and received orders from all parts of the Continent until the principle which he had introduced became generally known. Thus the business increased, and in the year 1830 their stock-book showed a balance of nearly 40,000*l.*, and left them sufficient funds to increase their works, so as to be capable of employing 300 men. During this year William Fairbairn was elected a member of the Institution of Civil Engineers under the presidency of Thomas Telford.

The following two years were occupied in his celebrated experiments for the investigation of the properties of iron boats and the application of steam power to canal navigation, and it was in connection with this investigation that he made his first essay in engineering literature, "Remarks on Canal Navigation," which was published by Longmans in 1831.

These experiments led to the construction by his firm and from his designs, of the *Lord Dundas*, a small paddle-wheel vessel, built entirely of iron, and driven by a steam-

engine of 6-horse-power. This was the first iron steam-vessel, and the results of its trials were looked for with considerable excitement. Mr. Fairbairn gives a most interesting account of this little vessel and of her sea trip from Liverpool to Glasgow, a voyage not unattended with danger through the error of the compass due to the magnetic influence of the iron, of which the vessel was constructed; and no greater instance of the clearness of perception of this young engineer can be given than the fact that he not only detected at once the cause of the aberration of the vessel's course, but also corrected the compass error, compensating the ship's attraction by pieces of iron placed in the vicinity of the needle.

In the year 1832 a dissolution of partnership took place, and the Manchester works came into the sole possession of Mr. Fairbairn. Soon after this the subject of iron shipbuilding began to attract public attention, and he had many orders for vessels between 100 and 250 tons burden, which had to be built in Manchester, taken to pieces, and rebuilt at a seaport. To avoid this obvious inconvenience, and believing there was large business to be done in this branch of Engineering, Mr. Fairbairn bought a plot of land on the Thames, at Millwall, where, besides his Manchester business, he carried on for thirteen years large ship-building operations, having during that time built upwards of a hundred vessels, including several for the Royal Navy; but, with the exception of the first two years, the concern was a losing one, and it was ultimately wound up and sold at great loss. After passing through several hands it came into the possession of Mr. Scott Russell, and it was on this spot that the *Great Eastern* was built.

It was at these works that Fairbairn's celebrated experimental researches, in connection with Mr. Eaton Hodgkinson, upon the strength of cast-iron were carried on, and it was here that he conducted the experiments previous to the designing of the Britannia and Conway tubular bridges, and which led to his invention of the rectangular self-supporting tube, having cellular top and bottom sides. This is the essential principle of construction in those triumphant feats of engineering skill, and in connection with which his share of the merit is too often passed over.

This invention, for which a patent was taken out in his name with the concurrence of Mr. Stephenson, led to his being invited by the Chevalier Bunsen, at that time the Prussian Minister, to visit Berlin in order to confer with the authorities upon the erection at Cologne of a tubular bridge for the purpose of carrying the railway across the Rhine. This bridge, as far as he was concerned, was never built, but it led to a warm friendship between himself and Alexander von Humboldt, as well as with Bunsen, and the chapter relating to this connection will be of the greatest interest to the readers of this journal, containing, as it does, letters of Humboldt and Bunsen, and some very interesting letters of Sir William Fairbairn. Describing, in a letter to Dr. Robinson, of Armagh Observatory, his dining at the table of the King of Prussia where he made the acquaintance of Humboldt, he gives his impression of the great philosopher as follows:—

"I must, however, inform you that I was seated with feelings of pride and gratification beside a greater man than the King, and enjoyed the benefit of a conversation

similar to that I had the pleasure to listen to on the occasion of a recent visit to a highly valued friend of kindred mind and pursuits. I cannot express to you how much I valued the society of this amiable and distinguished man. At eighty years of age he possesses the mental energies of a man of forty, and retains what appears to me to be the desideratum of advancing years, a mind susceptible of impressions, with a power of discernment and retention which can only be looked for in the maturity of life. Such, however, is the mind of Humboldt, perfectly alive to every improvement and every development in the advancement of his favourite studies."

It is pleasant to compare this letter with one written by Humboldt to Bunsen, as showing that this cordial feeling was mutual between them; in it Baron Humboldt says:—

"I cannot be grateful enough to you for having made us acquainted with a man possessing so much knowledge, so highly esteemed by all, so amiable, and so modest;" and he adds: "The king was enchanted by the demeanour of the great man, and Mr. Fairbairn did not like less the frank and hearty demeanour of the King."

An interesting chapter of this interesting book is that devoted to the researches for the experimental determination of the influence of pressure in the process of solidification as bearing upon the solution of the question of the solidity or fluidity of the centre of the earth, and the thickness of the earth's crust. This inquiry was instigated by the late Mr. Hopkins, of Cambridge, and was carried on at Mr. Fairbairn's Works at Manchester, in conjunction with Mr. Thomson and Prof. (now Sir William) Thomson. As the experiments involved the submitting of various substances to enormous pressures—sometimes as great as 6,000 pounds upon the square inch—the mechanical fertility of Mr. Fairbairn's mind was of very great value to the investigation. The results of these experiments pointed to the conclusion that the least thickness that can be assigned to the solid envelope of the earth must be considerably greater than geologists have imagined it to be. This investigation was carried on three-and-twenty years ago, and it is interesting to notice that its result corroborates in a remarkable degree the conclusion which Sir William Thomson enunciated at the recent meeting of the British Association at Glasgow.

As a scientific man Sir William Fairbairn held a high position, he had an essentially analytical mind, seeing, by an intuitive reasoning characteristic of him, into the principles of things, separating essential from accidental results, and thereby directing his experiments to the best advantage. In 1850 he became a Fellow of the Royal Society, and two years after a Corresponding Member of the Institute of France. In 1861 he was the president of the Manchester Literary and Philosophical Society, which office he had held for five years. In 1860 he received one of the Royal medals of the Royal Society for his papers in the *Philosophical Transactions*, and the following year he held the office of President of the British Association, which met at Manchester. In consideration of this and of his services to engineering science he was offered the dignity of knighthood, which he refused. Eight years after, and when in the eightieth year of his age, he accepted a baronetcy which was offered him by Mr. Gladstone's Government. He survived this honour five years.

A more useful and eventful life than that of Sir William

Fairbairn rarely falls to the lot of a biographer to record. The work before us shows, however, that it has fallen into good hands. Dr. Pole is himself an engineer and a man of science; he was associated with Sir William Fairbairn in many of his works, and he possessed exceptional qualifications for telling the story of such a life. The interest—whether personal, historical, or scientific—is maintained throughout the book, and as an autobiography of great literary merit we would recommend it to our readers.

C. W. C.

#### GROTH'S "CRYSTALLOGRAPHY"

*Physikalische Krystallographie und Einleitung in die krystallographische Kenntniss der wichtigeren Substanzen.* Von P. Groth. Mit 557 Holzschnitten im Text, einer Buntdruck, und 2 lithographirten Tafeln. (Leipzig: Wilhelm Engelmann, 1876.)

PROF. GROTH has written a good book on a subject for which, if it attracts but few students in England, German universities will supply readers. It is a good book, as being written by a man whose work puts him in an authoritative position for writing it, while to anyone who is master of the small mathematical experience needed it is eminently readable, is to the point, and not too voluminous. It is moreover copiously and well illustrated. Of course, even as an Arabic chronicler of the events of his time, invariably commences his history with the origin of things, and the early traditions of mankind, so a German professor who writes on crystallographic optics, of necessity devotes a good many pages to a sketch of the fundamental laws of optics and the general principles of the undulatory theory. Our author, however, while doing so never loses sight of his purpose, and a few pages so occupied are probably intended to fill a void in the training of some of those for whom the book is intended.

Indeed for the student who wishes to obtain only so much knowledge of the principles of physical optics as is requisite for following the methods of the crystallographer, it would be difficult to find a more compendious and useful statement and illustration of those principles than in Prof. Groth's book, the exposition of them being so completely cleared of difficult mathematical language that the student might be led on to the possession of a fair insight into the optical characters of a crystal without any idea of the profound and splendid series of mathematical achievements by which the theory of light has been elaborated.

Prof. Groth has dealt in a similar if less complete way with the thermic properties of crystals. One might perhaps have expected a fuller treatment of the subjects of cohesion and cleavage, of the relations of crystals to magnetism, and of the results and the best methods of experimenting on pyroelectric crystals, in a treatise on the physical aspects of crystallography.

What is perhaps the best part of Prof. Groth's work is the description of the instruments used by the crystallographer, such as the "polarisation-instrument" as he calls that necessary companion which has been hitherto known, under its very usual form, as a Nörrenberg, or as a polariscope, or as a polarising microscope. This instrument has been reconstructed by our author in an

PROF. W. H. FLOWER, F.R.S., will commence his course of Hunterian Lectures at the Royal College of Surgeons in Lincoln's Inn Fields, on Friday, March 9. The lectures, nine in number, will be delivered on Mondays, Wednesdays, and Fridays, at four o'clock, the subject being "The Comparative Anatomy of Man." From the prospectus, we learn that after treating of the variations in the human external, dental, and osteological characters, Prof. Flower will discuss the methods of estimating the capacity of the skull, cranialometry, and the peculiarities of the brain. It is worthy of remark that anyone anxious to attend these lectures, if not connected with the College, will be allowed to do so upon application for a card of admission.

THE Association of German naturalists meets at Munich on September 18, and not in February, as stated in a recent number.

WE are glad to be able to state that a final settlement has been arranged between Mr. Floyd and the trustees of the late Mr. Lick's legacy on the one hand, and Mr. Lick, the son of the testator and the other relatives on the other. After a deduction of about 200,000 dollars the whole of the estates will be reserved for the ends proposed by Mr. Lick, the father. The sum so secured for scientific purposes amounts to a little less than three million of dollars.

THE French Society of Aerial Navigation has published a circular stating that owing to internal difficulties the meetings are suspended up to May 1. Another society was established by French aeronauts—who escaped from Paris by balloon during the siege—last April and is called the School of French Aeronauts. They confine themselves to practical ends, devoting themselves exclusively to the use of balloons for scientific purposes.

A NEW aeronautical periodical, *l'Aerosat*, has been published in Paris by M. Achille Rouland, secretary of the School of French Aeronauts. It is to appear three times a month, and to contain a summary of all aeronautic news.

*The Denstonian* is the name of a journal published as the organ of St. Chad's College, Denstone, Uttoxeter. It devotes some space to natural history.

"GEOLOGICAL Time" was the subject of the presidential address of Mr. T. Mellard Reade to the Liverpool Geological Society, and which has been published in a separate form.

NEWMAN'S *Entomologist* now appears as *The Entomologist*, and several new features have been added which will increase its scientific value.

A SPECIAL committee, intrusted with the elaboration of a scheme for the representation of Russian gardening at the Paris Exhibition of 1878, has been appointed by the Russian Society of Gardening.

By order of the Lord President of the Council, a letter, written by Mr. Andrew Murray, on Injurious Insects has been sent to the Secretaries of the Agricultural Societies of England, Scotland, and Ireland. Mr. Murray proposes a method of stamping out these insects which is worthy of being tried.

DR. PETERMANN has just published an index to his *Mittheilungen* for the period between 1865-1874. This will be of great value to geographers, and its value is much enhanced by two most ingeniously-constructed index-maps which show the various parts of the earth that have been mapped in the *Mittheilungen* during that period, and in a simple way indicate where the map will be found. Besides a general index-map there are maps of the various Continents and of the Arctic and Antarctic regions. By differently coloured lines the scale of the special map referred to is shown, as also its character, whether outline, topographical, physical, or geological.

A MEMORIAL to Lomonosoff, erected in the square of the University of Moscow, was unveiled on the anniversary-day of the University, January 24. The memorial, which was erected at the very moderate cost of 225*l.*, collected among professors and students of the Moscow University (founded by Lomonosoff in 1755), is very modest. It consists of a small bust placed on a high very plain pyramidal pedestal bearing the inscription: "To Lomonosoff—the Moscow University: year 1877." In an address by M. Solovieff, Professor of History, he briefly sketched the impulse given to science in Russia by Lomonosoff, and insisted especially on the importance of his works in the development of the history of his nation. No reference was made to the task performed by Russia's first physicist. We are glad to take this opportunity to say that it is a great pity that the Russian learned societies have not yet published a collection of the works of Lomonosoff, all the more as many of his writings, dispersed in rare old periodicals, are now totally unknown or forgotten. This neglect induces us to think that Russian men of science have not yet fully appreciated the depth and width of the physical conceptions of this remarkable physicist of the past century, who not only devoted his time to the study of the most important questions of astronomy, physics, and physical geography (as, for instance, the transit of Venus, the existence of ascending warm currents in the atmosphere), but also in a now forgotten, but able paper on the Arctic Seas, expressed himself very explicitly as to heat being but a mode of motion. We think, therefore, that a complete edition of Lomonosoff's works would be not only an addition to the glory of the science of the eighteenth century, but also a most interesting acquisition for all those who are interested in the history of science.

A PARTY of the Swiss Alpine Club have availed themselves of the prevailing mild weather to extend their yearly winter excursion in the mountains as far as the Col de Balme. They crossed the mountain-pass on January 21, and, after many pleasant adventures, reached the hotels of the Col, which were so deeply buried in snow that the way to the rooms had to be made through the windows of the first floor. Other parties, of French and Swiss excursionists, visited about the same time the renowned archæological ground lying in the Jura between Montbelliard and Porrentruy. The special aim of the excursions was to organise a scheme for a thorough exploration and a detailed survey of these localities to be undertaken next summer. If we take into account the immense number of caves, rocky *abris* (shelters), tumuli, grave-walls, open dwelling-places, and megalithic stones scattered over this part of the Jura, and the strange anomalies observed in the geographical distribution of these remains of prehistoric man (only caverns and rocky *abris* being known in the Swiss part of the Jura, whilst the French part abounds with all kinds of remains enumerated above), we cannot but hope that an exploration of these localities will result in valuable contributions to prehistoric archæology.

A NEW form of marine sounder has been described to the French Academy by M. Tardieu. It consists of a spherical envelope of caoutchouc, a few centimetres in thickness, communicating with an iron reservoir by means of a tube of small diameter fitted with a valve. The caoutchouc envelope being filled with mercury, any increase of the exterior pressure makes a certain quantity of mercury pass into the iron reservoir, whence, however, it cannot return. When the apparatus has been lowered in deep water, the weight of the mercury found in the reservoir enables one to determine the pressure to which it has been subjected, and therefore the depth.

M. FELIX PLATEAU read, at a recent meeting of the Belgian Academy, a paper giving an account of the journeys of a large number of Belgian naturalists during the last two centuries. This paper is now published separately (Hayez, Brussels), and contains much important information.

THE Russian Government having refused to enact a law by which all the *barogans*, or ancient and prehistoric grave-mounds, so numerous in Russia, would be proclaimed the property of the state, a private society is now in way of formation for the same purpose. The society proposes to enter into negotiations with proprietors of land for receiving from them grants of property on the *barogans*, and to undertake afterwards a series of systematical explorations of these mounds.

THE *Denton News* states that after a severe snowstorm on the night of December 22, 1876, the sun, next morning, rose clear, but the air was filled with particles of frost, the refraction from which caused the appearance of "mock suns" or "sun dogs." First, extending from the sun right and left was a circle entirely around the heavens. Along it were the "sun dogs" in their usual places, with extra ones in the north-west, south-east, and south-west, being directly opposite the sun and at right angles to that line. A very bright circle, like a continuous rainbow, surrounded the sun, at an angle twenty or thirty degrees from it, and crossing the horizontal circle at the most brilliant of the false suns. Another and similar circle, and of about the same diameter, occupied the zenith. Thus there was a complete circle around the horizon, and twenty to thirty-five degrees above it two complete rainbow circles of exceeding brightness and seven "mock suns" or "sun dogs." The spectacle lasted, with changing effects, for two hours or more.

AUSTRIAN census statistics show that cretinism is prevalent to a great extent in the more mountainous portions of the empire. The proportion in 10,000 inhabitants is 40 in the Salzburg district, 18·3 in Upper Austria, 17 in Styria, 10 in Silesia, 7·6 in Tyrol, &c. As yet no institution has been provided by the state for the reception of the unfortunate victims.

A SERIES of measurements of the calorific intensity of solar radiations and of their absorption by the terrestrial atmosphere, has been lately made by M. Crova. His mode of observation is described in the December number of the *Journal de Physique*. He has ascertained that the law of transmission of radiations may be represented by an expression of the form  $y = \frac{\rho}{(1+a)} b$ , in which  $y$  represents the calorific intensity of radiations which have traversed an atmospheric thickness equal to  $x$ ,  $\rho$  is the solar constant which, in the author's experiments, is represented by values generally superior to two units of heat received per minute on a square centimetre;  $a$  and  $b$  are two numerical constants determined by the position of tangents to the curve drawn at different points. The coefficient of transmissibility of the radiations through an atmospheric thickness equal to unity varied, in the circumstances in which M. Crova measured it, between about 0·940 and 0·800, according as the atmospheric thickness already traversed was more or less considerable.

MINERALOGISTS have often been troubled to distinguish with certainty between apatite and nephelin. A. Streng communicates in the last *Mineralogischen Mittheilungen*, a simple but secure method for overcoming this difficulty. If a drop of a concentrated solution of ammonium molybdate in nitric acid be placed on a thin section of an apatite crystal under a microscope, the observer notices quickly the formation of a circle of small yellow crystals of  $10M_2O_3 + PO_4(NH_4)_3$ , either in the form of regular octahedrons or of regular rhombic dodecahedrons. A second test is the following. If a drop of sulphuric acid be added to a section which is already partially dissolved in nitric acid, the formation of crystals of gypsum is easily noticed. Nephelin yields negative results in both cases; a positive test for its presence consists in the addition of a drop of hydrochloric acid to a thin section under the microscope. After the lapse of a few minutes the formation of numerous small colourless cubes of sodium chloride is quite perceptible. They result from the

decomposition of the silicate of sodium by hydrochloric acid, and the insolubility in the latter of the salt thereby formed.

THE *Bulletin* of the Belgian Academy of Science (vol. 42, Nos. 9 and 10) contains the second part of an interesting memoir by M. J. Plateau, "On Accidental or Subjective Colours." The author had advanced, in 1834, a theory for the explanation of the subjective colours, and especially insisted on the circumstance that, after having looked some time upon a coloured body, we mostly do not see the true complementary colour, but some other: the orange, for instance, instead of a pure yellow, after the blue; or a violet, instead of the blue, after the yellow. He explained it by supposing, firstly, that the retina, after having received the impression of some colour, comes immediately into such a condition as if it were influenced by the opposite colour, but that this subjective impression soon disappears, and reappears again, alternating with reappearing impressions of the primitive colour of the coloured body; and secondly, that similar phenomena take place also in space, *i.e.*, that the image of the coloured body on the retina is surrounded, firstly, by a narrow strip of the same colour as the body (which phenomenon we call irradiation), and then by a strip of opposite colour, around which, under some circumstances, may reappear a third strip, of the colour of the body looked upon. This theory having been much opposed since its appearance, especially in Germany and England, the author now discusses the various objections advanced against it; those relative to the first part of the theory were the subject of the first part of the memoir (*Bulletin*, vol. 39, 1875), and those relative to its second part are dealt with in this second memoir. The author begins his discussion with the objections against his theory of irradiation, dealing at great length with the opinions and objections of Helmholtz, and treating very skilfully the many difficulties of the whole question, among which the various myopia of the observers seems to be an important one. Further, the author criticises the theories of irradiation advanced until now (the imperfect accommodation of the eye, its spherical and chromatic aberration, and the diffraction at the borders of the pupil), and concludes that the fact that two neighbouring irradiations may mutually neutralise each other, would alone be sufficient to condemn all these theories. The memoir is to be continued.

A COMPARISON has recently been made by Dr. Buff between the indications of the thermomultiplier and the radiometer. The two instruments were placed side by side in the cone of light admitted through an aperture of a board from a gas lamp, which could easily be regulated and kept constant for some minutes. There was a glass disc in front of the thermopile. In the galvanometer the deflections of the needle were proportional to the deflecting force up to 21°. On tabulating deflections and numbers of rotations, it appears that their product is very nearly a constant number, warranting the inference that the velocity of rotation of the little wheel is inversely proportional to the heat action of the penetrating rays. This confirms the view that the turning of the radiometer is due to an action of heat rays which penetrate the glass. "If the radiometer," says Dr. Buff, "is incapable of measuring a mechanical force of light, it none the less wears its present name with full right. It is a special form of thermometer, only exclusively for heat rays of high refrangibility, whose heating force is proportional to the velocity of rotation of the wheel."

THE additions to the Zoological Society's Gardens during the past week include a Mauge's Dasyure (*Dasyurus maugei*) from Australia, presented by Mr. Robert S. Craig; a Slender-billed Cuckatoo (*Licmetis tenuirostris*) from Australia, presented by Mr. Bartle G. Goldsmid; a Chilian Sea Eagle (*Geranonotus aquia*) from South America, presented by Mr. C. Clifton; a Levallant's Amazon (*Chrysothris levallanti*) from Mexico, pre-

regions into the higher latitudes, and the polar air brings the less rotatory velocity of the polar regions into the lower latitudes. The latter constitute the trade-winds, which move more slowly than the earth's rotation, and consequently appear as an atmospheric current from the east; the former constitute the "counter-trades," which move more rapidly than the earth's rotation, and appear as an atmospheric current from the west.

The centrifugal force of the "counter-trades," as they circle round the poles, is the cause of the polar depression of the barometer.

The law of reaction makes it impossible for the earth's rotation to be either accelerated or retarded by the winds, and consequently the entire "torsional force" exerted by the winds on the earth must, at any given time, be equal in the easterly and westerly directions.

I have now described in outline what theory shows that the circulation of the atmosphere would be in the absence of watery vapour and in the presence of the sun's heat and the earth's rotation; and observation shows that such is the actual circulation on the large scale, and not taking account of local disturbances.

JOSEPH JOHN MURPHY

Old Forge, Dunmurry, Co. Antrim, February 23

### Halo round Shadow

It is not uncommon for an observer, when looking at his own shadow on rough ground or turbid water, to see its head surrounded by a halo, of which the brightest part is in contact with the shadow.

This phenomenon has often elicited notice, but as far as I am aware has not before now been explained, nor do those who have mentioned it seem to have observed that its appearance depended on the nature of the surface receiving the shadow.

The conditions necessary for the production of these halos are—

1. That the screen, as whatever the shadow is cast on may be called, should not be a continuous surface, but a number of small surfaces with intervals between them, each of these small surfaces of course casting its own shadow on whatever happens to be behind it.
  2. That the shadow should be at a considerable distance from the observer.
  3. That the light should not fall very obliquely on the screen.
- The first of these conditions only is essential, but the fulfilment of the last two makes the phenomenon more marked. Rough grass forms a good screen, especially if, as in the diagram, conditions 2 and 3 are fulfilled by the shadow being

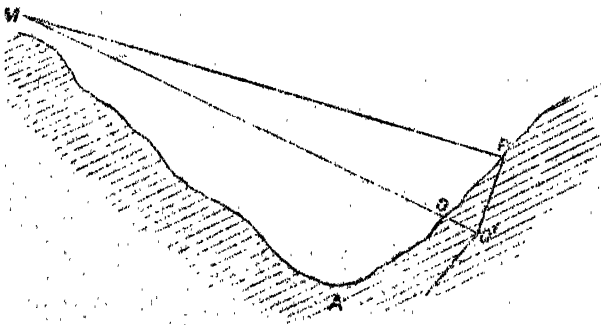

cast on one side of a valley, while the observer is standing on the other.

In the case of the shadow on turbid water, it must be remembered that it is not the surface of the water which forms the screen, but the particles suspended in it.

The general explanation of these halos is this—

From the observer's point of view the screen in the immediate neighbourhood of the shadow of the head is seen in nearly the same direction as it would be from the source of light. In this direction, therefore, each of the small surfaces of which the screen is made up will hide its own shadow; but this will be true of no other direction; and the effect on the whole will be that the screen will appear brighter close to the shadow of the observer's head than elsewhere.

To examine this rather more in detail, let M A O be a section

of the ground passing through the observer at M and his shadow at O. Let

$$\begin{aligned} O'P &= r \\ O'MP &= i \\ O'PM &= \text{a right angle.} \end{aligned}$$

Let  $w$  and  $w'$  be the projections on  $O'P$  of the average breadth of the sections of the small surfaces made by the plane M A S, and the average distance between them respectively, and let  $h$  be the average distance of each of the small surfaces from its own shadow.

Then the amount of light received from any space  $r d\theta$  ( $w + w'$ ) may, *ceteris paribus*, be taken without any great error as a measure of the brightness of the zone whose mean radius is  $r$ , and whose breadth is  $w + w'$  ( $d\theta$  being a small rotation of  $r$  about  $O'M$ ), and this will be proportional to  $w + w' - h \sin i$ . The decrease in brightness is proportional to  $h$  and  $\sin i$ , and will reach a maximum when  $h \sin i = w$ , if  $w < w'$ , or  $= w'$  if  $w > w'$ .

Outside the circle defined by this value of  $i$  the brightness will be sensibly constant, because the quantities of which  $w$ ,  $w'$  and  $h$  are the average values have all manner of actual values, even in a very small space.

These expressions are only approximate, but they serve, as well as the longer exact formulæ, to show the general laws of the phenomenon.

ARNULPH MALLOCK

### Meteor

THIS evening, at close upon twenty minutes past six, as I was walking in my garden towards the almost full moon (which was very bright), I observed a brilliant meteor pass from right to left over, and very near, the moon's disc. It was visible for a distance of about twice her diameter. From the amount of daylight, and the extreme brightness of the moon, I judge this meteor to be worth recording.

C. M. INGLEBY

Valentines, Ilford, February 26

### Tape-worm of Rabbits

So far as I am aware the only evidence in favour of the view that *Bothriocephali* present no hydatid stage is that which has been furnished by the researches of Knoch. To me it has always seemed that this evidence is insufficient fully to overcome the analogical probability that tape-worms of this genus resemble tape-worms of other genera in passing through a hydatid stage—and this notwithstanding the occurrence of a ciliated embryo. However, in my previous letter I ought no doubt to have alluded to the researches of Knoch, and should certainly have done so had my object in writing been other than it was, *i.e.*, merely to ascertain whether anyone had as yet taken the trouble to trace the life-history of the rabbit's tape-worm.

February 20

GEORGE J. ROMANES

### A PROBLEM IN THE NATURAL HISTORY OF THE SALMON.

MR. FRANK BUCKLAND, in giving evidence before the Parliamentary Committee, which during last session of Parliament inquired into the condition of our oyster fisheries, stated that "a salmon (*Salmo salar*) does not breed every year, but every three years!" On being asked by a member of the Committee if he had any proof of his averment, Mr. Buckland stated that, "he had a great idea of it," but was deficient in proof. Before examining this alleged fact in the life of the salmon, advanced by Mr. Buckland, it is proper that we should state briefly what induced him to make known his idea.

While illustrating the theory of oyster-spawning, and telling the Commissioners that all the individual oysters on a *scalp* would not be found exuding their young at the same time, however favourable for spawning the period might be, Mr. Buckland also enunciated his opinion as to the periods at which salmon spawn. That gentleman holds that only one of every six oysters on a *scalp* will be found in a procreant state during the same season; and, by way of clinching his illustration, he said, "you never get salmon always breeding the same year, they take time to recover themselves, and so forth." This latter state-

ment is rather obscure; but the interpretation undoubtedly is, that the same salmon does not breed every season. It would be instructive if Mr. Buckland were to state his ideas on this feature of the natural history of *Salmo salar* at greater length, giving at the same time a *précis* of the data on which he has formed his opinion; because the views hitherto entertained of the spawning of salmon have been mostly contrary to those promulgated by Mr. Buckland, the prevailing idea being that salmon spawn annually. Some persons, indeed, promulgated a theory of the salmon being able to spawn twice in the same year, doubtless founded on the fact of individuals having been known to go to, and return from, the sea within a few months. There is not, however, any exact proof of these facts. There are, also, one or two gentlemen of opinion that the fish in question only spawns every two years; but the opinion hitherto has been very general that salmon deposit their ova annually.

It is remarkable how ignorant we still are of the most important phases of salmon life, notwithstanding the active investigation of the last twenty years; and it is still more remarkable that some of the best informed salmon anglers, intelligent students of the natural history of the *Salar* group of fishes, should hold diametrically opposite opinions, both on this and other important points of salmon life. One gentleman, whose works on angling have a wide reputation, and whose knowledge of fish-life is extensive, tells us he has no doubt the same salmon spawns every year, which, he further says, "is the generally accepted opinion on our border rivers by anglers and fishermen of the professional caste." The same gentleman informs us that the late Mr. Robert Buist, superintendent of the River Tay Salmon Fisheries, was induced by experience to arrive at a similar conclusion. Mr. Buist, who took great interest in the Stormontfield salmon nursery, was usually present every season at the capture of the gravid fish, from which the required supply of ova to fill the breeding boxes was obtained. On one of these occasions a fine grilse was captured, in good condition for being artificially spawned; and, after being deprived of her ova, the fish was carefully marked, and restored to the river from whence she had been taken. "On the following year, at the same spot, the same fish, but now grown into a salmon, was retaken, full of ova, and again stripped, in order to aid in stocking the breeding boxes at Stormontfield." This incident Mr. Buist held to be decisive of two points in the natural history of the salmon; first, that a grilse becomes a salmon, and is not a distinct member of the *Salar* family, a point in salmon life which was at one time hotly discussed; and, second, that the same salmon spawn every year. Another gentleman, Mr. Brown, who at one time gave his personal aid in the salmon breeding experiments carried on at Stormontfield, relates, in his notice of the proceedings, that "one year we had a very fine male fish of 24 lbs., which we marked with a wire, and two years afterwards we spawned him from the same ford a few pounds heavier." This same fish may have visited the spawning ground also in the preceding year without being recaptured for spawning purposes.

Our angling authority says further, in his communication: "I have had many opportunities of examining spent and half-spent females—those in which what is vulgarly termed the *waim* was exhausted, a few particles of ova remaining, and those taken by me or others in a spawning state; and I invariably found new formations of ova, in the shape of two lobes, corresponding to what are found in the spring run or clean salmon, and often measuring two inches in length, according to the size of the female *hell*, or half-spawned *daggit*. This formation cannot be taken otherwise than as an index of what was to happen after the migration seawards had been accomplished, and the term of the salmon's stay in the salt water had expired—a term which may extend to six or eight

months, but has been ascertained in well-ordered rivers not to exceed that period."

None of the great naturalists, or fishers, who write on the natural history of fish—Jardine, Yarrell, or Couch—have thrown any light upon this phase of the life of the salmon. We search their works in vain to obtain information on this interesting point. The late Mr. Russel, in his book, "The Salmon," speaking at one place of the mysterious clean run fish of the early springtime, thinks "they must have passed the autumn or earlier winter in the sea; then they must have passed the winter without breeding, and thus we have the discouraging fact or hypothesis that the salmon is a fish which does not breed every year."

We have the authority of a gentleman residing in the north of Scotland, who is well versed in the economy of our salmon rivers, for stating that the salmon only spawns every two years. He says: "I have marked hundreds of *kelts* in the months of February, March, and April, returning downwards to the sea; I have marked them with different marks every season, so that there could be no mistake, and I have never seen one single instance of one being marked in spring return to spawn the autumn of the same year; but I have seen hundreds with the individual mark return next spring good, clean, fine full fish. I believe that all salmon spawn only once in two years till they get too old, when they become barren; but still they frequent the fresh water, I suppose from habit, although there is no sign of roe or milt, and I have seen and taken them off the *redds* along with fish which were in the act of depositing their spawn."

It would be tedious to run through the facts of the numerous controversies which have arisen as to the rate at which salmon grow. The experiment of marking large numbers of these fish has been often resorted to, and at different places. Mr. Young of Invershin, in his day a well-known authority on the natural history of the salmon, tells us that *spawned* grilse of four pounds weight were repeatedly marked; and after their journey to the sea it was found that these grilse had become beautiful salmon, varying from nine to fourteen pounds weight, "the majority" returning in about eight weeks. It is much to be regretted that Mr. Young was not more explicit in his statements, because it would have been most interesting to know when these fish returned, after an absence of only two months, if they were again ready to spawn. It is these records of quick journeys that have doubtless given rise to the theory of the Rev. Dugald Williamson, which is that salmon in the course of the year perform two migrations. At any rate, we are entitled to ask this question: What does a salmon, which is only away from its birthplace for eight weeks, do with itself during the other ten months of the year? The rate of growth indicated by Mr. Young is most astonishing, and had it not been corroborated by other observers, would have been considered doubtful. A fish marked many years ago by the Duke of Athole was found to have increased eleven pounds and a quarter in the short space of five weeks and two days! The rate of growth of the salmon is so assured, that smolts have been found to return from the sea as grilse in the same season during which they left for the salt water; but, curiously enough, none of the observers took note of what we now consider the only unsolved problem in connection with the growth of the salmon, namely, whether the same fish spawns annually, once in two years, or once in three years. Probably Mr. Buckland will make some additional statement on the subject. A Tay salmon fishery proprietor, whom we have consulted as to this problem in the life of the fish, will not, with all his experience, which has been very varied, and has extended over many years, venture to give an opinion, and "thinks that the question is almost beyond the reach of positive proof." It is therefore incumbent on her Majesty's Inspector of Salmon Fisheries to prove his case.



## THE SOUTH-AFRICAN MUSEUM

SINCE we last gave a notice of this institution we have learned, with much pleasure, that the Cape Government has made liberal provision for its more efficient administration and maintenance. There is none of the more important British Colonies which has of late made more rapid progress than the Cape in material prosperity, and it is most gratifying to find that the Molteno administration (the first ministry organised under the Parliamentary System of Government initiated in 1872) has not been oblivious of the claims of science during its four years' tenure of office. In the estimates for the financial year 1876-77, as passed by the Colonial Legislature, we find provision made for Botanical Gardens to the extent of 2,900*l.*; for Public Libraries, 2,600*l.*; for Museums, 1,300*l.*; while such items as "Geological Researches, 1,500*l.*;" "In aid of publishing Dr. Bleek's Bushman Researches, 200*l.*;" and "Meteorological Commission, 250*l.*," sufficiently prove that the duty of endowing research is practically recognised by the Cape authorities. The present able Governor, Sir Henry Barkley, F.R.S., is as well and widely known for his attachment to scientific pursuits as for his distinction in Colonial administration, and we think we cannot err in tracing to his judicious influence much of the enlightened action of his responsible advisers in their recommendations to the Parliament.

The South-African Museum is located in Cape Town, and is the public museum of the Colony. It was instituted in 1855 under the auspices of Sir George Grey, a governor distinguished for his energy and success in initiating measures for awakening and developing the intellectual life of the Colony. Many years before there had existed a South-African Museum in Cape Town, consisting of the combined collections formed by the Expedition for Exploring the Interior, under the superintendence of the celebrated zoologist, Sir Andrew Smith, and by M. Verreaux, but this museum was devoid of means for permanent maintenance, and after languishing for a while came to an untimely end for want of public support. Many of its finest specimens, however—and notably those of the magnificent larger mammals characteristic of the region which constituted its chief ornament—were fortunately secured for the British Museum, and still form an imposing feature of the national collection. The new, or present institution, was started by public subscription aided by an annual grant from the Government of 300*l.* Two trustees were appointed by the Governor, and a third elected annually by the subscribers; but in 1857 the collections already brought together were of sufficient importance to induce the passing of an "Act to Incorporate the South-African Museum," under which all the three trustees were to be appointed by the Governor, and to be vested with full powers for the entire management and control of the institution. Under this Act the Museum has continued to be and is still administered.

In happy contrast to the untoward fate of too many kindred institutions, the South-African Museum has from the first been most fortunate in the possession of trustees who were men of culture and of scientific attainments, and for fifteen years it enjoyed the further advantage of the services of Mr. E. L. Layard, C.M.G. (now H.M. Consul in New Caledonia), as its Curator.

The usual difficulties attended the acquisition of suitable premises for the Museum, but these were eventually obviated by the erection at the cost of the public of a building expressly designed for the purpose; and on April 5, 1860, the Museum was opened to the public in its new quarters.

As mentioned in our notice already referred to, the Cape Museum appears, notwithstanding the advantages stated, to have suffered from the chronic complaint of very inadequate funds. The system of support partly from the

Colonial Treasury, and partly from private subscriptions, seems to have failed, the subscribers lost by death or departure from the Colony not being as a rule replaced by others; and of late years the institution depended almost wholly on the government subsidy of 300*l.* With such limited means at their disposal, it was obviously out of the question for the Trustees to award an adequate remuneration to the Curator, and they had no alternative but to make shift with engaging the services of a gentleman willing to devote a part of his time to the Museum. This unsatisfactory state of things has now been remedied by the government on the recommendation of the Trustees, constituting the Curatorship a Civil Service appointment, with a suitable salary. We congratulate Mr. Trimen—who has been for four years endeavouring to satisfy simultaneously the rival claims on his attention of an ordinary public office, and of a museum of natural history—upon his appointment to the Curatorship on its improved basis, and we consider that great credit attaches to the Cape Government for effecting so desirable a reform. We must not omit to mention, moreover, that, under further legislative provision, a new gallery has just been erected in the Museum, and other much needed repairs and improvements in course of execution are approaching completion.

## ATLANTIC SOUNDINGS

THE recently-announced discovery by Commander Gorringe, of the United States sloop *Gettysburg*, of a bank of soundings bearing N. 85° W., and distant 130 miles from Cape St. Vincent, during the last voyage of the vessel across the Atlantic, taken in combination with previous soundings obtained in the same region of the North Atlantic, suggests the probable existence of a submarine ridge or plateau connecting the island of Madeira with the coast of Portugal, and the possible subaerial connection in prehistoric times of that island with the south-western extremity of Europe. The soundings obtained in January, 1873, by H.M.S. *Challenger*, and in July, 1874, by the German frigate *Gazelle*, furnish additional data, with the help of which the accompanying contour-chart has been constructed.

These soundings reveal the existence of a channel of an average depth of from 2,000 to 2,500 fathoms, extending in a north-easterly direction from its entrance between Madeira and the Canary Islands towards Cape St. Vincent. It is bounded on the west and north by the submarine ridge which unites Madeira with the Josephine bank and the recently-discovered Gettysburg bank, on the east by the coasts of Portugal and Morocco, and on the south by the submarine plateau which connects the Canary Islands with the African continent.

As shown in the chart, this channel is virtually an extension or branch of the still deeper channel which runs up between Madeira and the Azores. The island of Madeira, with the adjacent islands of the Desertas and Porto Santo, occupies the southern extremity of the dividing ridge, and marks the junction of the two channels. Confined by a comparatively steep bank on the west and a more gentle slope towards the African shore, this eastern branch seems to attain its greatest depth off Cape St. Vincent, after which it contracts into a narrower channel, less than 2,000 fathoms deep, and continuing northwards as far as the latitude of Cape Roca, it once more joins the vast abysses of the Atlantic. The Strait of Gibraltar is undoubtedly a recently-formed connecting-link between this basin and that of the Mediterranean.

Commander Gorringe, when about 150 miles from the Strait of Gibraltar, found that the soundings decreased from 2,700 fathoms to 1,600 fathoms in the distance of a few miles. The subsequent soundings, five miles apart, gave 900, 500, 400, and 100 fathoms, and eventually a depth of 32 fathoms was obtained, in which the vessel anchored. The bottom was found to consist of fine pink

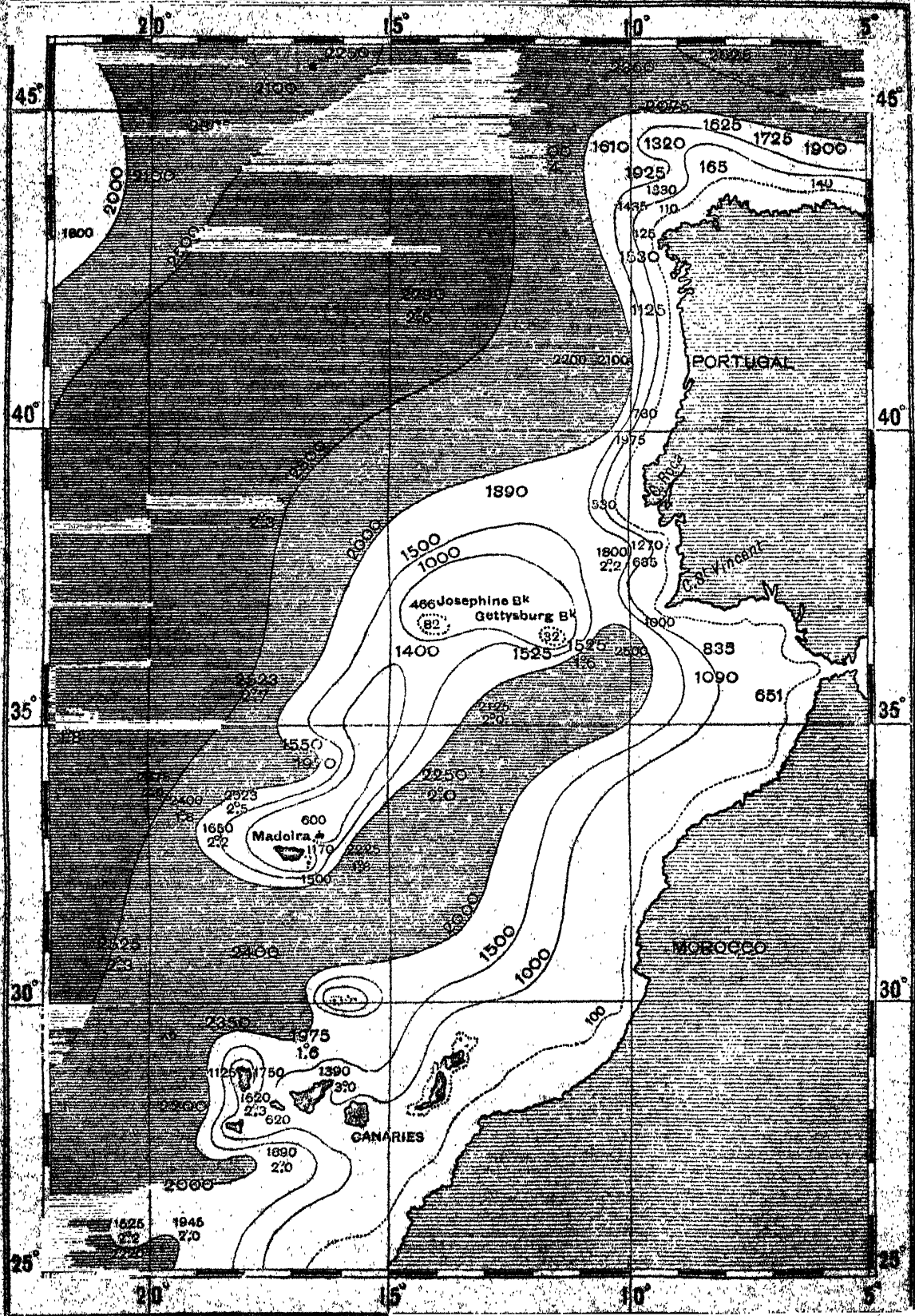

coral, and the position of the bank in lat. 36° 29' N., long. 11° 33' W. In other words, Commander Goringe, on his journey westward from the Strait, after passing over the northern extremity of the deep channel, sounded up the steep slope of the submarine plateau which connects Portugal with Madeira, and within a short distance of a sounding of 1,325 fathoms obtained by H.M.S. *Challenger* on January 30, 1873, in lat. 36° 23' N., long. 11° 18' W.

The sketch-map does not pretend to be more than an approximation founded upon the still limited number of soundings obtained up to this date, but the bottom-temperatures observed in this part of the North Atlantic tend to corroborate the views which I have ventured to express. They show that the submarine flow of cold water of antarctic origin, which has been traced as far north as the Bay of Biscay, also fills up the lower depths of the channel which stretches up towards Cape St. Vincent. On the other hand, the channel between the coast of Portugal and the Gettysburg Bank is occupied by the warm water of the Gulf Stream return-current, which, spreading itself out over the banks to westward, explains the presence of the live coral found by Commander Goringe.

JOHN JAMES WILD

HUMMOCKY MORAINE DRIFT

DURING his survey of the West Pacific slopes, Clarence King found and has since described, hummocks of moraine drift on the "dying-out glaciers," which are somewhat similar to the "hog-wallows;" and J. le Conte has described dying-out glaciers and moraine drifts of California. Abstracts of these descriptions will be found in the *American Journal of Science and Arts*, and the full description of the West Pacific



Paroled Erratic Blocks on Croagh-na-Cloosh.

slopes in Clarence King's report. In West Galway, Ireland, there are in places large tracts of drift sometimes like Clarence King's description, in others like the "hog-wallow;" that in the Memoirs of the Irish branch of the Geological Survey have been described as "rocky moraine drift." The accompanying sketch is of some of these drift hummocks on the north slope of Croagh-na-Cloosh, south of Oughterard.

G. H. KINAHAN

CONTRACTION OF THE LEAF OF "DIONEÆ MUSCIPULA"

IN the first section of this paper the authors give an account of the mechanical effects which ensue on exciting the sensitive hairs of the *Dioneæ* leaf. The following is a résumé of the principal conclusions at which the authors have arrived:—

1. The effect of paper on the Mechanical Effects and on the Electrical Discharge consequent on Excitation of the leaf of *Dioneæ muscipula*, by J.

If the sensitive hair of a vigorous leaf be touched with very great care by a camel-hair pencil, no visible effect on the leaf will be produced, and a similar gentle contact can be repeated several times before the leaf begins to answer to the excitation by any movement. Sooner or later, however, the marginal hairs bend inwards and the lobes slightly approach each other. The first effectual excitation is followed by an almost imperceptible movement; after this each successive approach of the lobes in nearly every case exceeds that of its predecessor. The interval which elapses between excitation and effect diminishes as the extent of the effect increases, both facts having the same meaning, namely that in the plant, as in certain cases well known to the animal physiologist, inadequate excitations, when repeated, exercise their influence by what has been termed "summation," and thus the last contraction, that by which the leaf closes, is the result of the summation of the excitation which immediately preceded it with all the previous excitations. After the leaf has closed it still contracts at each excitation, and attempts to clench itself with greater and greater force. The interval between an excitation and the resulting movement varies from two to ten seconds.

The authors next proceed to a consideration of the electrical condition of the leaf in an unexcited state, which has recently been made the subject of a minute investigation<sup>1</sup> by Prof. Munk, of Berlin, who has found—1. That if we conceive the external surface of the leaf divided into strips by parallel lines crossing the midrib nearly at right angles, and coinciding with the veining, any point of the external surface of each strip is negative to any point nearer the midrib. 2. That in comparing different points of the midrib with each other, there is one whose position is two-thirds of the distance from the near to the far end of the midrib, which is positive to the rest. 3. He has further stated that the potential of any point on the internal surface of the lobe is exactly equal to that of the corresponding and opposite point on the external surface. Of these three proportions the first two are confirmed, in the main, by the authors of the present paper; as regards normal leaves, however, they take exception to his conclusions on the two under-mentioned points—(a) That although there is a spot of greatest positivity on the midrib, more or less corresponding in position to that mentioned by Prof. Munk, yet its position is by no means so definite as Prof. Munk states, but varies in different leaves. (b) That the different points in his isoelectrical negative line are never found to be absolutely identical. From the third proposition the authors generally express their dissent. They, however, content themselves for the present with stating two general conclusions—1. That the part of the midrib which lies nearest the two central sensitive hairs is positive to every other part of the external surface of the leaf, but has usually the same potential as the petiole and other inactive parts of the plant. 2. That the external surface, so long as the leaf is in vigour, is always positive to the internal surface.

The method used in this research differs from that generally employed in previous investigations, relating to animal or plant electricity, in two important particulars:—1. In the adoption of Lippmann's electrometer<sup>2</sup> (which has already been used by Prof. Marcy in investigations on animal electricity) as the instrument for observing the electrical changes. 2. In the substitution of a constant for a variable potential as a standard of comparison with the potential under investigation.

In comparing the potentials of two points the following arrangement was usually adopted:—The pot containing the plant<sup>3</sup> had been previously kept plunged in water. Three non-polarisable electrodes were used, by one of them (the "fixed electrode") the damp surface of the pot is connected with the gas-pipes of the building, the other two ("movable electrodes") are in contact with the two points under observation. By means of a switch, either of these two movable electrodes can be brought into connection with one end of the electrometer, the other end being connected with earth.

When the whole of the outer surface of a leaf is covered with a mass of kaolin, moistened with salt-solution, and brought into connection with one end of the electrometer, the other end being connected by means of the fixed electrode with the petiole or pot, the effect of exciting a sensitive hair is to produce an

Burdon-Sanderson, M.D., F.R.S., Professor of Physiology in University College, and F. J. M. Page, B.Sc., F.C.S. Read before the Royal Society December 14, 1876.

<sup>1</sup> Reichert's and du Bois-Reymond's Archiv, 1876.  
<sup>2</sup> See the original paper, or Lippmann, *Pogg. Ann.*, 1873, 149, 146.  
<sup>3</sup> Most of the observations were made at Kew in the month of August, 1876, the plants being obtained from the Royal Gardens, through the kindness of the Director.

"excursion" indicating a change of potential in a negative direction at the movable contact amounting to 3.5 to 5.0 *mV* (De La Rue element).

If a similar plug is applied to the internal surface, so as to cover the whole of it, the result is the same but the extent of the excursion is somewhat less. Hence it may be generally stated that during the electrical disturbance the surface of the leaf becomes more negative as compared with any other surface of which the potential is constant, and that on the external surface the change is greater than on the internal. This electrical disturbance is limited to the leaf and ceases at the point dividing the petiole from the isthmus or bridge, by which it is united with the leaf on the petiole side of this point no sign of electrical disturbance is shown by the electrometer.

For various reasons the authors determined to direct their attention to the middle third of the leaf. The following were selected as representative points of contact:—(1) a point (*l*) on the internal surface of the leaf equidistant from the three sensitive hairs; (2) a point on the external surface (*o*) exactly opposite to *l*; (3) and (4) points on the internal (*im*) and external (*em*) surfaces of the midrib, where the line joining the points *l* on either lobe cuts the midrib; (5) the petiole (*p*); and (6) the bridge or isthmus (*b*) already mentioned. The letter *P* denotes the potential at any point, and *V* the variation of the potential during the electrical disturbance.

In four leaves the potentials and variations of the external surfaces of the midrib and lobe were severally in hundredths of a De La Rue coil:

<i>em P</i> as compared with <i>p P</i> ...	9	0	9	0
<i>im P</i> ...	16	0	0	16
<i>em V</i> ...	15.0	6.5	4.2	4.5
<i>im V</i> ...	2.0	6.5	4.0	4.0

The external variation is usually greater than the internal of a corresponding point, and the variation at *em* is usually greater than that at any other point; thus in six leaves—

<i>o V</i> =	-3.6	-4.0	-4.2	-4.0	-4.0	-4.5
<i>l V</i> =	-1.8	-1.7	-1.6	-1.8	-2.2	-2.2
<i>im V</i> =	-3.0	-3.5				
<i>em V</i> =	5.5					

When a leaf is excited at intervals of a minute or often by single shocks from a du Bois-Reymond's induction coil, which are of just sufficient intensity to produce a response, it invariably happens that after a time the electrical variation ceases. The variation can be reproduced either by (1) shifting the needle-points to a fresh spot, (2) by increasing the strength of the induction current, or (3) by allowing the leaf to rest for a longer interval. With relation to electrical stimuli, it is shown that the excitability of the leaf resembles that of the terminal organs of the higher animals, in this respect, viz. that relatively feeble stimuli, if applied at very short intervals and repeatedly, are competent to elicit a response.

If a leaf be excited at short intervals by faradisation, the excursions (makes and breaks) being continued each time until an excursion is produced, the combined effects of summation and gradually increasing exhaustion can be readily observed. At first the leaf responds after eight to ten excitations, but gradually the number of excitations required to awaken the leaves to action increases, the effect being postponed for longer and longer periods, until it finally fails to occur. When a leaf is excited at regular intervals by single shocks of such intensity as to be just beyond the limit of adequacy, the effects sometimes become rhythmical.

The time which intervenes between an excitation and the beginning of the electrical disturbance varies in different leaves, and is very much affected by variations of temperature. This time the authors have called the *period of electrical delay*.

As a mean of many experiments it was found that when the sensitive hairs was on the petiole and the movable electrode on the leaf, the delay was 0.295 second. If the movable electrode was at *l*, the delay varied according to the proximity of the sensitive hair touched to the point of application of the movable electrode. Thus if the movable electrode was at *o* and a

sensitive hair on the same lobe was touched, the delay was 0.227 sec. If a hair on the opposite lobe was touched, the delay was 0.403 sec, the disturbance having to make its way from the sensitive hair on the opposite lobe through and across the midrib and up to the electrode. It is obvious that by measuring the distance between the hair touched and the electrode we can ascertain, more or less exactly, the rate of the transmission of what may be called the "wave of negative variation" through the leaf. From many experiments, the stimulation being sometimes mechanical and sometimes electrical, it was found that the wave traveled a distance of about 8 mm in 0.18 sec., or at a rate of about 4.4 centims. per second. When the *period of delay at l* was compared with that at *o*, it was found that it was shorter at *o* than at *l*; e.g., in some experiments (the excitation being weak faradisation and the excursions being taken from *l* and *o* alternately), the following numbers were obtained:—

Inside	0.71	0.61	0.68	0.75	0.95	sec.
Outside	0.48	0.50	0.52	0.65	0.49	..

Finally, if either *o*, *l*, *em*, or *im* be compared with the bridge *b*, it will be found that the *period of delay at b* will be much greater than that at any of the other points;

thus <i>w</i>	0.26	0.24	0.12	0.18	sec.
bridge ( <i>b</i> )	0.87	0.65	0.85	0.83	..

In normally active leaves, in which the disturbance is first seen about a sixth of a second after mechanical stimulation, the excursion attains its maximum in about one second, and the whole disturbance is over in about two seconds after the excitation, so that the electrical disturbance is entirely over before the mechanical effect begins, and consequently occurs in a period which in muscle is called the period of latent stimulation.

All these periods are, however, very much modified by temperature, being shortened if the temperature is raised (within certain limits), and lengthened if the temperature falls.

The following is one of several tables given in the paper, illustrating the effect of temperature on the periods of delay, maximum and total duration of the electrical disturbance:—

	In leaf at ordinary temperature.	In warm chamber at 45° C.	Cooled by proximity of a block of ice.
To beginning of excursion	0.23	0.11	0.44
To maximum	1.40	0.79	1.68
To end	2.2	1.37	2.94

### THE SPONTANEOUS GENERATION QUESTION<sup>1</sup>

AT the meeting of the French Academy of Sciences on January 26, M. Pasteur read the following reply to Dr. Bastian:—

"Dr. Bastian, in reply to the communication which I made on January 2, along with M. Joubert, addressed to the Academy last Monday a long note, in which he still contrives, I think, to elude the main point of the debate. In our communication of January 2 there was one word of prime significance, *pure potash*, but, which is surprising, in the reply of three pages of Dr. Bastian there is not even allusion made to that condition of purity, which was everything.

I shall make a new attempt to recall the English *to what* to the criterion, from which he cannot escape, do what he will.

The discussion was raised by his statement, that a "solution of boiled potash seeded bacteria" to appear in sterile water at 90°, after it had been added to the latter is equally sufficient for exact neutralisation. Dr. Bastian concluded that he had thus discovered the physico-chemical conditions of the spontaneous generation of certain bacteria.

This is my reply to the learned London professor of pathological anatomy:—

"First, Dr. Bastian to obtain, in presence of competent judges, the result to which I have referred, with sterile water, on the sole condition that the solution of potash which he employs be pure, i.e. made with pure water and pure potash, both these ingredients

<sup>1</sup> It is interesting to know that the surface of a frog muscle, during the electrical disturbance which precedes contraction, becomes positive. (1) If a small number of needles in glass and bound together, were used as contact electrodes, the points of contact being three, through the splendour of the leaf.

matter. If Dr. Bastian wishes to use a solution of impure potash, I freely authorise him to take any in the English or any other Pharmacopœia, being diluted or concentrated, on the sole condition that that solution shall be raised beforehand to 110° for twenty minutes, or to 130° for five minutes.

This is clear enough, it seems to me, and Dr. Bastian will understand me this time.

The following reply to the above was read at the Academy on February 12:

At the *séance* of January 29, M. Pasteur, in reply to a communication which I had made at the previous *séance*, challenges me to cause sterile urine to ferment by the addition of a suitable quantity of *liquor potassæ*, "on the sole condition that this solution shall be raised beforehand to 110° for twenty minutes, or to 130° for five minutes."

In order that M. Pasteur may not attribute to me the least desire "to elude the main point of the debate," and also with the view of testifying the respect which I consider due to the opinions of so distinguished an investigator, I hastened at once to accept his challenge. During the last week I have repeated my experiments several times, and with a degree of precaution going much beyond the severity of the conditions prescribed by M. Pasteur.

I repeated them at first with liquor potassæ which had been previously raised to 110° C. for sixty minutes, and afterwards with liquor potassæ which had been raised, in the same manner, to 110° C. for twenty hours. The results have been altogether similar to those produced upon sterile urine by liquor potassæ, which has been raised only to 100°, when added in suitable quantity; that is to say, in twenty-four to forty-eight hours the urine was in full fermentation and swarmed with bacteria. The specimens of urine employed had a specific gravity ranging from 1,020-1,022, and they required about 3 per cent. of liquor potassæ for neutralisation.

If M. Pasteur has found himself unable to renounce his interpretation of my experiments on account of "la preuve manifeste," which I have cited in my last communication (p. 189 of the *Compt. Rend.*), I hope he will frankly accept the disproof of his views furnished by the experiments which I have now the honour of communicating to the Academy, and which have been made in acceptance of his own challenge. These experiments I hope in a short time to repeat before competent judges.

*Verbal Reply of M. Pasteur.*

I thank Dr. Bastian for having accepted the proposition which I made to him at the *séance* of the 29th of January. In consequence, I have the honour to beg the Academy to appoint a commission to report upon the fact which is under discussion between Dr. Bastian and myself.

I hope that Dr. Bastian will seek to induce the Royal Society of London, of which he is a member, to nominate a commission for the same purpose.

At the *séance* of February 19, it was announced that MM. Dumas, Milne-Edwards, and Boussingault have been appointed to constitute a commission charged to express an opinion on the act which is under discussion between Dr. Bastian and M. Pasteur.

OUR ASTRONOMICAL COLUMN

THE NEW COMET.—Elements of the new comet calculated by Dr. Hartwig of Strasburg from observations to February 15 are almost identical with those given in this column last week. Observations have been made at Berlin, Copenhagen, Leipsic, Lund, Paris, and Strasburg. On the 16th the comet appeared to the unaided vision a little brighter than the well-known cluster in Hercules, and in the telescope presented itself as a round nebula, ten minutes in diameter, with a small central nucleus: this apparent measure corresponds to a real diameter of 77,000 miles.

The following ephemeris for every second midnight, Greenwich time, may facilitate observations. The intensity of light is assumed, as usual, to be represented by the reciprocal of the product of the squares of the distances from the earth and sun: it will be remarked that on the last date, the degree of brightness is only one-sixth of that on the first date of the ephemeris:—

"On the Examination of Urine; reply to M. Pasteur." By M. H. Bastian.

		Right Ascension.	North Polar	Distance from	Intensity
		h. m.	Distance.	the Earth.	of Light.
March	3	3 39'5	27 12	0'613	2'06
	5	3 51'1	29 56	0'683	1'59
	7	3 59'5	32 11	0'754	1'25
	9	4 5'8	34 4	0'826	1'00
	11	4 11'0	35 38	0'898	0'81
	13	4 15'2	36 59	0'970	0'67
	15	4 18'9	38 8	1'042	0'56
	17	4 22'2	39 9	1'114	0'47
	19	4 25'1	40 1	1'185	0'39
	21	4 27'8	40 47	1'256	0'34

THE VARIABLE-STAR T CORONÆ BOREALIS.—In No. 2,116 of the *Astronomische Nachrichten*, Prof. Schmidt, of Athens, publishes numerous comparisons of the brightness of this star, the so-called *Nova* of 1866, with a neighbouring star which he satisfied himself is not variable, and finds that during the period 1866-1876 there have been fluctuations of brightness exhibiting a certain regularity, from which he deduces the most probable period 93.7 days. Prof. Schönfeld, at Bonn, has also noted these changes, and has determined the times of maxima at which the star varied from 7.8 m. to 9.0 m. T Coronæ therefore exhibits a similar phenomenon to that already remarked about  $\eta$  Argus, "Nova Ophiuchi, 1848," and the star which is almost precisely in the position of Tycho Brahe's famous object of 1572.

THE RADCLIFFE OBSERVATIONS, 1874.—With the marked regularity which distinguishes the publication of the Oxford observations, the Radcliffe observer has just circulated the thirty-fourth volume of the series, containing the observations made in 1874. The usual contents of the handsome octavo so punctually presented to us by the Rev. R. Main are too well known to require any detailed account here. The heliometer has been chiefly employed, as before, in the measurement of a selected list of double-stars, a number of which were also observed for position with the meridian circle. Observations of shooting-stars in the year 1876 are included in this volume, with the view of placing them early in the hands of those who are interested in the study of meteoric astronomy.

We believe we are correct in stating that the next volume will contain observations of the solar spots, commenced at the Radcliffe Observatory in 1875, and which will therefore be a new feature in the publication.

DUN ECHT OBSERVATORY PUBLICATIONS, VOL. I.—The difficulty of procuring Struve's great work, the "Mensuræ Micrometricæ," has suggested to Lord Lindsay the formation of a summary of the measures of double-stars contained in it in a convenient and portable form, which has been presented to the astronomical world, as the first volume of publications of the Dun Echt Observatory. The positions of the stars are brought up to 1875; in the text Struve's first epoch is given, the subsequent ones being added in foot-notes, or in the case of binaries and other stars frequently observed, in an appendix. The highest and lowest powers used in the measures, the magnitudes and colours of the components, and the page of the original work, where the measures are to be found, are included in the summary.

There can be no doubt that Lord Lindsay's volume will be welcomed by a large number of amateurs, who are interested in double-star astronomy, but to whom Struve's great work is difficult of access, to say nothing of its awkward size for frequent use, when obtained. The transcript and reduction of places from 1826 to 1875, appears to have been made with great care, as we are able to testify from a number of cases examined—including instances where the variation of precession has required to be taken into account. That equal care has been exercised in the correction of the press, is also apparent, and as an admirable specimen of astronomical typography, Lord Lindsay's summary of the "Mensuræ Micrometricæ" is probably unsurpassed.

From the absence of a publisher's name on the title-page, it is to be inferred that it has been Lord Lindsay's intention to circulate his volume privately amongst astronomers; and we know that this has been done to a most liberal extent: still there must be many persons, unknown to the author, who would gladly provide themselves with so unexpected and useful an addition to astronomical literature, and we would suggest whether it might not be desirable to place this volume, which appears to be intended as the precursor of a series, on sale to the astronomical public.

### NOTES

THE Italian Scientific Association, or Society of the Forty, has conferred on Sir William Thomson the prize instituted by Carlo Matteucci, for the Italian or foreigner, who, by his writings or discoveries, has contributed most to the advancement of science.

AT the annual meeting of the Geological Society, the Wollaston Gold Medal was presented to Mr. Robert Mallet, F.R.S., and the proceeds of the Wollaston Donation Fund, to Mr. R. Etheridge, jun., F.G.S.; the Murchison Medal to Rev. W. B. Clarke, F.R.S., Sydney, and the proceeds of the Murchison Geological Fund to the Rev. J. F. Blake, F.G.S.; the Lyell Medal and part of the Lyell Fund, to Dr. James Hector, F.R.S., New Zealand, and the balance of the Lyell Fund to Mr. W. Pengelly, F.R.S.; the Bigsby Medal to Prof. O. C. Marsh, F.G.S., Yale College, U.S.

THE total expenditure on the new building at South Kensington for the reception of the Natural History Collections now in the British Museum is stated in the new Civil Service Estimates to have been 206,472*l.* up to September 30 last. A further sum of 36,650*l.* is required to carry on the works up to the end of the present financial year. This amount has been already voted. The proposed vote for the present financial year 1877-78 is 70,000*l.*, leaving the amount of 81,878*l.* necessary to complete the building, the total estimate having been 395,000*l.* We may remark that it is not only in this country that a new Museum of Natural History is in progress. Both at Paris and at Berlin the present buildings for the National Museum are found to be too small, and large sums are to be appropriated to their reconstruction.

THE new Civil Service Estimates also contain an account of the proposed expenditure on the working out of the collections brought home by H.M.S. *Challenger*, which amounts altogether to 4,000*l.* Of this 1,560*l.* is to be devoted to "salaries," 800*l.* to "piece-work," 1,200*l.* to "plates," 240*l.* to "travelling expenses," and 200*l.* to "stores." The salary of the director is to be 500*l.* per annum, that of his chief assistant 400*l.*

IN the Civil Service Estimates for the present year under the head of "British Museum," it will be found that 800*l.* are asked for acquisitions in the Department of Mineralogy, 800*l.* for Fossils, 1,200*l.* for Zoological, and 400*l.* for Botanical specimens. At the same time it may be noted that the sum of 10,000*l.* is to be devoted to the purchase of printed books, although copies of all books published in the United Kingdom are furnished gratis to the Museum.

PROF. ALFRED NEWTON, F.R.S., has been elected to a Fellowship at Magdalene College, Cambridge.

THE death is announced, at the age of seventy-six years, of Admiral Wilkes, of the U.S. Navy. Probably our readers will better recognise him under the name of Commodore Wilkes, the commander of the well-known U.S. exploring expedition of 1838-42, the results of which were of great scientific importance. Wilkes was the author of a work on the Theory of Winds. He was the same Wilkes who, by his conduct in the Mason and

Shelley incident of the American civil war, nearly caused war between this country and the United States.

POGGENDORFF'S *Annalen* will be continued under the editorship of Prof. G. Wiedemann, in Leipzig, who is already the editor of the supplement (*Beiblätter*), and Prof. Helmholtz will join him in his new task. The old staff of contributors have declared their willingness to continue the publication of their researches in the *Annalen*.

AT the Royal Geographical Society on Monday, papers were read "On his recent journey to Lake Nyassa," by Mr. E. D. Young, R.N., and an "Examination of a route for wheeled vehicles between the east coast of Africa and Ugogo," by the Rev. Roger Price.

MR. L. HEILIGBRODT, of Bastrop, Texas, has been engaged since 1867 in making collections of the reptiles and insects of that district.

PROF. KUNDT has been chosen Rector of Strassburg University for this year.

PROF. SCHWENDENER, of Basel, has been called to the chair of the late Prof. Hofmeister, of Tübingen.

WE learn from Helsingfors that M. Henez has returned from his travels in Russian Lapland. He has been studying the little-known language of the Lapps on the Murmansk peninsula. Besides a collection of interesting ethnological data, he has brought with him a complete translation of the Gospel of St. Matthew, which, we believe, will be published by the English Bible Society in Russian type.

WE notice an interesting Russian monograph by M. Maléff—"Anthropological Sketch of the Bashkirs,"—which has appeared in Kazan. The author, who was sent to the Orenburg Government by the Kazan University, to collect skulls of Bashkirs, and spent some time among this people, gives a number of anthropological measurements of men, statistics as to births, and various interesting information on the present state of the Bashkirs, their rapid increase, their customs, religion, &c., and discusses their future prospects.

THE *Colos* announces that the Moscow Society for Promoting the Development of Russian Marine Trade will continue next year the exploration to the Gulf of the Obi, and also build some vessels for exporting, in 1878, various merchandises from the Obi into Europe, especially of ship-building wood to England. M. Dahl, a teacher at the Gammag Marine School in Livonia, with some of his pupils, will be intrusted with this task.

SOME difficulties have been met with in the advance of Potanin's expedition in Western Mongolia. When passing by the convent of Shara Sumsen the members of the expedition were assailed by the monks, and student Podnéeff and the interpreter received severe injuries. Nevertheless, Potanin continues to advance into the interior of the country.

THE occurrence of gold disseminated in small quantities through the older geological formations of Australia has been known for many years. But Mr. C. S. Wilkinson, of the Geological Survey of New South Wales, has observed what seems to be a new fact, that gold in sufficient quantity to be worth mining, occurs in a conglomerate belonging to the Coal-measures, and that the alluvial gold of the Old Tallawang diggings has been derived from the waste of these conglomerates. He justly points out that, apart from the scientific interest belonging to so venerable an auriferous alluvium, considerable commercial importance attaches to its discovery, seeing that the conglomerates may now become a new source of supply for the precious metal. At Clough's Gully the actual conglomerate is now being worked, and yields from 1 dwt. to 15 dwts. of gold per ton, and suggests sometimes weighing 5 ounces.

improved form, which gives a field nearly if not quite as large as that of the instrument of Nürtemberg and somewhat better definition near the edges; and, by the use of a scale engraved on a glass plate, approximate measurements of the angle of the optic axes of a crystal can be obtained when the apparent angle is not too great for the optic axes, or rather the "eyes" of the axes to be seen in the field of the instrument.

The application of the principle of von Kobell's stauroscope, enhanced in its sensitiveness by the use of the ingenious doubled calcite plate of Brezina, is also valuable for ensuring precision in determining the directions of the principal sections of a crystal, and is for example far more commodious than Descloiveaux's method of dividing a plate of an oblique crystal, cut parallel to the plane of symmetry, into two, and turning them after the manner of an artificial twin.

The crystallographic portion of Prof. Groth's work is good, especially so from the point of view of the student in the German universities, where the honoured name of Naumann still holds crystallographers by the spell of a notation which has the advantage of looking very simple, while in reality it is complex and incomplete, and for purposes of calculation, and indeed for other than a very superficial crystallographic representation of crystal forms—not of crystal faces—has next to no value.

Of course, Prof. Groth is too sound and excellent a crystallographer not to feel and to acknowledge as he does in his preface, the great superiority of the method of Prof. Miller for all the purposes which give crystallography its character as a science; and accordingly he introduces his readers to the system of Miller, co-ordinating the two methods of notation in his descriptions of crystalline forms.

Indeed, when he touches on the fundamental principles of crystallography in his section on the doctrine of zones, he discards at once the notation of his illustrious countryman, and handles the subject entirely in the language and method of Miller; a language and method which in fact are the result of an elegant development of the original principle of Weiss, and were first independently employed by the famous German mathematician, Grassmann. In point of fact every crystallographer now uses the Millerian formulae, and actually while using the notation of Naumann, prefers to translate it into the simpler symbols of Miller in order to deduce the determinants rather than employ the earlier modes of calculation.

Again, what crystallographer who has had to convert the notation of Naumann for the rhombohedral into that for the hexagonal system, but knows the complexity of the process, and must recognise the superficial character of that notation? Moreover, for a distinctive representation of hemi-symmetrical or tetarto-symmetrical forms in language or writing that carries a scientific meaning, the notation of Naumann is powerless.

But Prof. Groth is writing for a German public, and he has to write a book that will be read. It is to be hoped that his work will be widely read, so widely as that his intelligent countrymen may be prepared, when it reaches a second or at furthest a third edition, to accept the change to the Anglo-German notation and methods which Weiss, Neumann, Grassmann, Whewell, and Miller (five of the greatest names among European crystallographers), have elaborated.

There remains, however, a word to be said upon the examples selected by Prof. Groth to illustrate this part of his treatise. They are as interesting to the crystallographer as they are excellent from the point of view of illustrations; for the publication of several of them in this form serves to bring together valuable illustrations of the different kinds of merosymmetry, of which some are new, while others have to be sought for only in the memoirs in which they appeared.

It may have been the result of a practical estimate of the smallness of the number of Englishmen who would have been interested in seeing them, that prevented Herr Fuess, the optical-instrument-maker of Berlin, from sending to the Loan Exhibition a set of the instruments in the improvement of which he has been so largely guided by Prof. Groth. It was, however, a short-sighted view, for the students of this subject are increasing; the physical laboratories of Oxford and Cambridge, and some London teachers of physics, are, for instance, turning out students quite competent to handle and to appreciate such implements of research; and for all such students the instruments of Soleil and the other French makers represented in the Loan Collection naturally have the greater attraction due to proximity and to their having been for several months where they could be seen and handled by English teachers and their students.

N. S. M.

OUR BOOK SHELF

*La Digestion Végétale, Note sur le Rôle des Ferments dans la Nutrition des Plantes.* Par E. Morren. (Gand, 1876.)

THIS paper is brought forward by Prof. Morren as a supplement to his observations on carnivorous plants. Its main point is the statement that digestion is not a function exclusively of those plants termed "carnivorous," but is a process common to all living beings, vegetable as well as animal. Animal digestion is, he states, according to the most approved view, a process of fermentation consisting essentially in a transformation of colloids into crystalloids, this change being a necessary preliminary to absorption. In the same manner all plants digest; and the process is precisely analogous to that of animals, and is again essential before assimilation is possible. The ordinary vegetable ferment for the conversion of starch into glucose is diastase, which has been detected in barley; it occurs also in the tubers of the potato, near the "eyes." For the fermentation or digestion of nitrogenous substances, albuminoids, a different ferment is required, and this we have in pepsine, which has been detected by several observers in the viscid secretion of *Nepenthes*, *Drosera*, and other insectivorous plants. According to Masters, it occurs also in the nectaries of *Helleborus*; and a similar substance has long been known in the latex of *Carica Papaya*. Vegetable digestion is therefore as widely diffused and as various a phenomenon as animal digestion, and consists in the transformation of the raw insoluble food material into soluble crystalloids capable of assimilation. It takes place chiefly in the "reservoirs of reserve-material"—seeds, underground stems, roots, the bark, the pith. The nutrition of plants is made up of three successive processes:—elaboration, digestion, assimilation. The first consists in the production, out of its elements, of a carbo-hydrate, and can take place only under the influence of light. Digestion consists essentially in hydration—as in the conversion of starch into glucose—and is associated with an evolution

of carbonic acid. It is accompanied by a molecular change which renders the resulting product soluble and diffusible. Assimilation is simply the absorption by the living tissue of the substances thus prepared, one of the chief processes which accompanies it being the reversion, by loss of water, of the glucose to the condition of cellulose, a substance isomeric but not isomorphous with starch. Intussusception, therefore, is a process which can only succeed digestion. No essential difference can, in fact, be maintained between the manner in which animals and plants digest their food.

A. W. B.

## LETTERS TO THE EDITOR

[The Editor does not hold himself responsible for opinions expressed by his correspondents. Neither can he undertake to return, or to correspond with the writers of, rejected manuscripts. No notice is taken of anonymous communications.]

## Hygroscopic Seeds

I HAVE lately received an interesting letter from Fritz Müller, in St. Catherina, Brazil, on the subject of hygroscopic seeds. He tells me that in the highlands of the Uruguay he has succeeded in discovering more than a dozen grasses, as well as a species of geranium, whose awns are capable of hygroscopic torsion. He has been so kind as to send me specimens of the grass-seeds, and many of them appear to be as beautifully adapted as those of *Stipa*, *Avena*, &c. for penetrating the ground in the manner which I have elsewhere described.<sup>1</sup> The most curious among the specimens received are the seeds belonging to the genus *Aristida*. In one of these the awn is longitudinally divided into three fine tails, six or eight inches in length, each of which twists on its own axis when the seed is dried. These tails project in three directions, and more or less at right angles to the axis of the seed, and Fritz Müller states that they serve to hold it in an upright position with its lower end resting on the ground. The seed is pointed and barbed in the usual manner, and when it is made to rotate by the twisting of the awns, it evidently forms a most effectual boring-instrument, for Fritz Müller found many seeds which had penetrated the hard soil in which the parent plant was growing. Another species of *Aristida* is interesting to me, because it illustrates the explanation which I gave of the torsion of the awn of *Stipa*, namely, that each individual cell of which the awn is composed is capable of torsion, and their combined action results in the twisting of the whole awn. Now in this species of *Aristida*, each of the three tails into which the awn is divided is capable of torsion on its own axis, and as the seed dries they twist up into a perfect three-stranded rope, just as the component cells combine to produce the rope-like twist of the *Stipa* awn. And as the tails wind together and form the strands, the seed is made to rotate and thus bury itself in the ground.

Down, Beckenham, February 19 FRANCIS DARWIN

## Mind and Matter

BUT for illness I would have made an earlier reply to Mr. Duncan's courteously-expressed objections (*NATURE*, vol. xv, p. 295) to my analysis (*NATURE*, vol. xv, p. 217) of his very ingenious "solution" (*NATURE*, vol. xv, p. 78). A general "mistake," and an "essential omission," are the charges against me. The mistake is in "regarding what was intended to solve a problem as intended to prove an alleged fact." "The alleged fact," he adds, "that consciousness depends on nervous organisation, I assumed to be a fact, and undertook to indicate how the dependence might be conceived, or regarded, to exist." He says that I clearly understood this "at starting." Where now is it that I "fell into the error?" His first step towards "clearing away difficulties in the way of our concerning the relation of consciousness to matter," is to allege this fact: "It is no more difficult to conceive of matter being subjective than of spirit being subjective." This is a dogmatic statement about our powers of conceiving; no hint of help as to how we may conceive. We ordinarily conceive of "spirit"—the "ego," the "subject"—as susceptible to consciousness, or "subjective," because we (the ego) feel we are conscious; but is it "as easy" to conceive of a stone as susceptible to consciousness, i.e. subjective? To say it is, I called a *petitio prin-*

<sup>1</sup> *Trans. Linn. Soc.*, vol. i, part 3, p. 149, 1876.

*cipiti*, because it assumes that conceivability which has to be established. I used the word "probability" as involving conceivability; for can we intelligibly assume a probability without a conception of what that probability is? But Mr. Duncan contends that his position is "conceivable as a hypothesis, true or false." Unquestionably we may conceive some one stating any hypothesis—a stone feels, fire freezes—but to conceive one doing this is not to have a concept of any part of the operation as hypothesised, however we may attach a meaning to the terms as such. Again, if any hypothesis, true or false, is already conceivable, this fact cannot favour Mr. Duncan.

So far I have not been led "to mistake allegations of the conceivability of a notion for assumptions or intended proofs that the notion is true." To the next position, "How energy is related to matter, is no less mysterious than how subjectivity may be a property of matter," my objection was twofold: first, to the illogical form; second, to the argument itself. Mr. Duncan replies, "The parity of mystery was not intended to establish parity of probability as to facts, but merely parity of conceivability." Now what is conceivable in the known case? The fact of energy being related to matter. Next, what here is mysterious or inconceivable?—the manner how these are related. Finally, what is the parallel to establish? Mr. Duncan answers, "Not the parity of probability as to facts, but merely parity of conceivability." But the conceivability of how energy is related to matter equals zero, therefore, by parity of reasoning, the conceivability of how subjectivity is related to matter equals zero. I commented, therefore, on all that this argument supplied—a bare shadow of probability. My next objection to the position, "Energy may be divided, why not subjectivity?" is strictly categorical, and no flaw has been found in it, nor, intrinsically, in any of my objections, which have now been shown to apply to "conceivability." Of the omission, Mr. Duncan says:—"The essential part of my solution which indicated roughly the *modus* of the connection between matter and consciousness, and which dealt with the great difficulty of the question, How to account for the two aspects of matter, the conscious and the unconscious? has not been touched by Mr. Tupper." Because all this was based on the untenable ground that "subjectivity may be divided," I closed my analysis here; but will conclude with a few remarks on the ingenious and original parallels drawn by Mr. Duncan.

"As energy potential is rest, so subjectivity potential is unconsciousness. As kinetic energy is motion, so active subjectivity is consciousness." Now energy, both to the materialist and his opponent, is a hypothesis, not a phenomenon; and it is not legitimate to support one hypothesis by another.

Again, if subjectivity is defined "susceptibility to consciousness," some sub-definition of "susceptibility" is needed; for if non-innervated matter, as Mr. Duncan admits, is never conscious, then matter in this form being non-susceptible to consciousness, is by the definition non-subjective: a conclusion opposed to Mr. Duncan's "all matter is subjective or susceptible to consciousness," his qualification, that non-innervated matter is only "potentially subjective" not availing unless this term mean non-subjective, and leave us with the above contradiction. The expression "all forms of matter may, by innervation, be made susceptible," &c., would indeed carry the conclusion "all matter may be made subjective," but then subjectivity would be an accident, not a property of matter as defined by Mr. Duncan. Lastly, to the phenomenalist who would investigate, and not create, nature, matter, or a fancied common substance for the support of all phenomena, is perhaps the most unwarranted of all assumptions.

J. I. TUPPER

## Atmospheric Currents

NEW. CLEMENT LEY thinks (see his letter in *NATURE*, vol. xv p. 163) that if the earth's atmosphere contained no watery vapour, the great currents of atmospheric circulation would be quite unlike what they are. I think, on the contrary, it is as certain as the established truths of physical astronomy, that if there were no watery vapour the great currents, though not the storms and other temporary disturbances, would be nearly what they actually are.

All winds belonging to the great currents, though not local winds, form part of a system of circulation between the equatorial and the polar regions, which is caused by the difference of those regions in temperature. Equatorial air is constantly flowing towards the poles, and polar air towards the equator; the equatorial air brings the greater rotatory velocity of the equatorial



collected by Mrs. Mathews; a Common Kestrel (*Tinnunculus alaudinus*), European, presented by Mr. W. W. Hughes; a Rough-legged Buzzard (*Archibuteo lagopus*), European, presented by Lady Bumbury; a Passenger Owl (*Glaucidium passerinum*), European, presented by Mr. T. W. Evans; a Burriel Wild Sheep (*Ovis burriel*) from India; a Suricate (*Suricata senek*) from South Africa; two Beautiful Parakeets (*Prephodus pulcherrimus*) from Australia, deposited; a Common Rattlesnake (*Crotalus durissus*) from North America, purchased.

SCIENTIFIC SERIALS

*American Journal of Science and Arts*, February.—Astronomical observations on the atmosphere of the Rocky Mountains made at elevations of from 4,500 to 11,000 feet, in Utah and Wyoming Territories and Colorado, by Prof. Draper.—On disubstituted benzols, and their derivatives, by Dr. Austen (second paper).—On the orbit of the planet Urda (167), by C. H. F. Peters.—Principles of compensation in chronometers, by J. K. James, M.D.—Notes on the Vespertine strata of Virginia and West Virginia (concluded), by W. M. Fontaine.—On the chemical composition of the flesh of *Hippobosus americanus*, by R. H. Chittenden.—Notice of Darwin on the effects of cross- and self-fertilisation in the vegetable kingdom, by Asa Gray.—Note on *Microdus speciosus*, by S. W. Ford.—On water-courses upon Long Island, by Elias Lewis, jun.

*Poggendorff's Annalen der Physik und Chemie*, No. 12, 1876.—The ball supported on a jet of water, by M. Hagenbach.—On fluorescence, by M. Lommel.—Electromagnetic properties of unexcited electric currents (concluded), by M. Schüller.—The thermomultiplier as a meteorological instrument, by M. Buff.—On the temperature of the electrodes in induction sparks, by M. Herwig.—On an analogy of chromoxide to the oxides of the cerite metals, by M. Wernicke.—On the theory of condensers, by M. Aron.—On the ratio of cross-contraction to longitudinal dilatation in caoutchouc, by M. Rontgen.—On electrical figures in solid insulators, by M. Holtz.—On the work to be done in evacuation of a given space, by M. Koláček.—Contributions to history of natural sciences among the Arabians, by M. Wiedemann.—A historical note on Daniel Bernoulli's gas theory, by M. Berthold. [With this number is issued No. 1 of the *Beiblätter*. It contains twenty-five abstracts of various physical researches that have recently been published.]

THE *Naturforscher* (December, 1876) contains the following papers of interest:—On the action of capillary tubes upon mercury, by E. Villar.—On the influence of water upon the temperature of the soil, by E. Wollny.—On boron, by W. Haempé.—On the determination of the vapour-density of substances having a high boiling-point, by V. Meyer.—On the polarisation of carbon electrodes, by H. Dufour.—On the relation of the organ of sight to the absence or presence of light, by Herr Joseph.—On the age of cells and the protoplasmic currents, by Herr v. Vesque Füttingen.—On symbiotism (the cohabiting of different species of plants), by A. B. Frank.—On the periodic change in the colour of a Ursee Majoris, by H. J. Klein.—On the dependence of the respiration of plants upon temperature, by Adolf Meyer.—On the frequency of shooting-stars, by J. F. Schmidt.—On the influence of surrounding temperatures upon the circulation of matter in warm-blooded animals, by G. Colasanti.

From the *Verhandlungen des naturhistorischen Vereins der westfälischen Rheinlande und Westfalens* (32 Jahrg., Part 2) we note the following papers:—Section for geography, geology, mineralogy, and palaeontology: on the meteorites of the Natural History Museum of the University of Bonn, by Prof. vom Rath.—On the theoretical conclusions drawn from some observations made in a shaft of 4,000 feet depth at Spereberg, by Prof. von Leuzlich.—On some fossils from the Neanderthal, by Prof. Schaffhausen.—On the late volcanic eruption in Iceland and the lakes fallen in Sweden, by Prof. vom Rath.—On the cause of the ice-period, by Dr. Mohr.—On the occurrence of olivine in basalt, by Dr. Mohr.—On the most recent eruptions on the island of Vulcano and their products, by Prof. vom Rath.—On the systems of volcanic crevasses in Iceland, by Dr. Gurli.—On the investigation of Westphalian caves, by Prof. Schaffhausen.—On the occurrence of rock salt in the Kemper formation near Hagenow, by Dr. Gurli.—On remains of *Virebrata* from gravel deposits near Porta (Westphalia), by Herr Danning.—On fulgurites from the island of Sumatra, by Herr Danning.—On fossil fishes from Sumatra and

from Rinckhore, near Sanderhorst, by the same.—On the thermal sources of Oynhausen, by Herr Græff.—On the origin of and changes in Downs, with special reference to those of the German coasts of the North Sea, by Herr Borggreve.—On the geology of Eastern Transylvania, by Prof. vom Rath. Botanical Section: On dichogamy and the conditions regulating the production of blossoms in plants which bear fruit periodically, by Herr Borggreve.—On the formation of the primordial tube, by Herr Pfeifer.—On the production of high hydrostatical pressure through endosmotic action, by the same.—On the fruit of *Hesperis crepitans*, by Herr Andrac. Section for Anthropology, Geology, and Anatomy: On the palates of *Ptenoglossa*, by Prof. Troschel.—On a luminous beetle of the *Physodora* family from Java, by Herr Moknike.—On the fertilisation of the ova of *Arachnida*, by Herr Bertkau.—On a stone sarcophagus found near Sechtum (on the Cologne-Bonn railway), containing well-preserved red hair of reddish tint, by Prof. Schaffhausen.—On the various views of different naturalists on the reproduction of oels, by Prof. Troschel.—On the so-called *Cribellum* of L. Koch, by Herr Bertkau.—On some rare and remarkable *Arachnida* of the Rhenish fauna, by the same.—On stone implements and other objects found in the Klusenstein and Martin's Caves, by Prof. Schaffhausen. Section for Chemistry, Technology, Physics, and Astronomy: On the separation of ethyl-bases by means of oxalic ether, by Prof. Wallach.—On converting amides into bromides, by V. von Richter.—On indium, by the same.—On some experiments with hydrobenzoines, by Herr Zincke.—On an apparatus for measuring very small fractions of time, by Herr Gieveler.—On a new electro-dynamical law, by Prof. Clausius. Physiological Section: On the functions of the spinal cord, by Dr. Frensborg.—On the structure of the tissues of blood-vessels and the inflammation of veins, by Herr Koster.—On santonine poisoning, by Herr Binz.—On the influence of salicylic acid upon the bones, by Herr Koster. The remaining papers are of purely medical interest.

*Rendiconto Istituto Lombardo di Scienze e Lettere*. Rendiconto, December 28, 1876.—On some differential equations with algebraic integral, by M. Brioschi.—On the electric theory of the radiometer, by M. Ferrari.—On the anti-fermentative action of boric acid, and its application in therapeutics, by M. Poli.—On the *scerotium oryzae*, a new vegetable parasite which has devastated many rice-fields of Lombardy and the Novaresi during the past year, by M. Cattaneo.—Mildella, a new genus, type of new tribes of Polypodiaceæ.—Graeco-Indian studies, by M. Cantor. Relating to geometry, algebra, astronomy; &c.

*Morphologisches Jahrbuch*, vol. II. part 3.—On the structure of the skin and dermal sense-organs of Urodela (*Proteus*, *Melanopoma*, *Cryptobranchus*, *Salamandra*, *Triton*, *Salamandrina*), by F. Leydig, four plates.—On the metamorphosis of *Echidna*, by W. Salensky, four stages figured.—On the exoskeleton of fishes, by O. Hertwig. Part I, sixty-eight pages, six plates, relating to Siluroids and Accipenseroids. The placoid scales of Selachians, the dermal teeth of Siluroids, and the dermal scutes of Accipenseroids are shown to be homologous.—Contribution to the morphology of the limbs of vertebrates, by Prof. Gegenbaur.—The most ancient form of the carpus and tarsus of Amphibia, by R. Wiedersheim.

SOCIETIES AND ACADEMIES

LONDON

Royal Society, February 8.—“On the Transport of Solid and Liquid Particles in Sewer Gases.” By E. Frankland, F.R.S.

The suspension of vast aggregate quantities of solid and liquid particles in our atmosphere is the subject of daily remark. Cloud, fog, and smoke consist of such particles, and I have repeatedly seen at a distance of a few feet abundance of snow-crystals floating in the air, when the atmosphere was apparently perfectly clear and cloudless by placing the eye in shadow and then looking into the sunshine.

Prof. Tyndall has, I conceive, proved that a very large proportion of the suspended particles in the London atmosphere consists of water and other volatile liquid or solid matter by showing that the heat of boiling water is sufficient to dissipate them. That this is the true explanation of the disappearance of such particles by the application of a moderate degree of heat, and that it is not caused by the rarefied air from the heated body ascending and leaving behind the suspended matter, as suggested by Tyndall is, I think, conclusively proved by experiments in which

I found that suspended particles of sal ammoniac subsided in an atmosphere of hydrogen scarcely twice as fast as in atmospheric air.

Thus an atmosphere fourteen times as rare as that of London (and, as Prof. Stokes remarked, possessing only half the viscosity of air), still offers sufficient resistance to the subsidence of minute suspended particles to prevent them from falling more rapidly than one inch per minute. Such particles could not therefore be left behind by an ascending current of the slightly rarefied but more viscous air produced by an increase of temperature to 100° C.

In addition to these aqueous and other volatile particles which disappear by a gentle heat, there are also others which consist partly of organic and partly of mineral matters. But the organic seem greatly to preponderate in the air of towns, because such air becomes *apparently* perfectly clear after it has been ignited.

The processes of fermentation, putrefaction, and decay afford abundant evidence that zymotic and other living germs are present amongst the organic portion of the suspended matters, whilst many analyses of rain-water, made by myself and others, show that the salts of sea-water are amongst the mineral constituents floating in the atmosphere.

Of the zymotic matters, those which produce disease in man are obviously of the greatest importance. The outbreak of Asiatic cholera in Southampton in the year 1866, for instance, was traced by the late Prof. Parkes, F.R.S., to the dispersion of infected sewage through the air. The sewage became infected by the intestinal discharges from some cholera patients who landed from the Peninsular and Oriental Company's steamship *Poonah*.

In this case the dispersion was produced by the pumping of the infected sewage and its discharge, in a frothy condition, down an open channel eight or nine feet long. The effluvia disengaged from this seething stream was described as overpowering, and was bitterly complained of by the inhabitants of the adjacent clean and airy houses, amongst whom a virulent epidemic of Asiatic cholera broke out a few days after the sewage received the infected dejections. Nevertheless the discharge of the frothy liquid was kept up day and night for about a fortnight, and 107 persons perished. At length a closed iron pipe was substituted for the open conduit; from that day the number of cholera cases diminished, and within a week of the protection of the conduit the epidemic was virtually over.

In this example a potent cause of the suspension of the zymotic poison in the air was obvious, but in the many alleged instances of the propagation of typhoid fever by sewer gases, the condition of dispersion is not so evident. Does the flow of sewage in a properly constructed sewer produce sufficient agitation to disperse liquid particles through the air-space of the sewer? I endeavoured to answer this question by violently agitating a solution of lithic chloride in a glass cylinder three inches in diameter and thirty inches high, with a wooden rod, and ascertaining whether the atmosphere at the mouth of the cylinder became impregnated with the liquid, by testing it with the flame of a Bunsen burner; but no trace of lithium could be detected at the mouth of the jar, even after an agitation much in excess of what would ordinarily occur in a sewer.

There is, however, another kind of agitation to which sewage is subject that may produce a very different result—I allude to the development of gases during the processes of fermentation and putrefaction. It is well known that the bursting of minute bubbles of gas at the surface of an effervescing liquid causes the projection of visible liquid particles into the air to the height of several inches. Such visible particles are seen to fall back again immediately into the liquid; but it appeared to me not unlikely that other particles, too minute to be seen, might be simultaneously projected, and by reason of the smallness of their masses in relation to their sectional areas, might continue suspended in the air for a long time. To ascertain the fallacy or truth of this notion I made the following experiment:—

A quantity of a strong solution of lithic chloride was placed in a shallow basin and acidulated with hydrochloric acid; fragments of white marble were then added, and a paper tube five inches in diameter and five feet high was placed vertically above the basin. So long as the effervescence continued, abundance of particles of lithium were visible in a Bunsen flame held at the upper end of the tube. A tinfoil tube three inches in diameter and twelve feet long was now placed in such a position as to bring one of its open ends over the top of the paper tube. The tin tube was nearly horizontal but slightly inclined upwards from

the paper tube, so as to cause a gentle draught of air to pass through it, when it was slightly heated externally near its lower extremity. A Bunsen flame placed at the end of this tube furthest away from the effervescing liquid, showed that the suspended particles of solution of lithic chloride were not perceptibly less numerous than at the mouth of the paper tube; neither were they much diminished at the further end of the tin tube when the height of the paper tube was increased to nine and a half feet. There can, I think, be little doubt that these particles, which had thus been carried along by a gentle current of air for a distance of twenty-one feet, would be similarly conveyed to very much greater distances.

The following conclusions as to the behaviour of flowing sewage may be drawn from these experiments:—

1. The moderate agitation of a liquid does not cause the suspension of liquid particles capable of transport by the circumambient air, and therefore the flow of fresh sewage through a properly constructed sewer is not likely to be attended by the suspension of zymotic matters in the air of the sewer.

2. The breaking of minute gas-bubbles on the surface of a liquid consequent upon the generation of gas within the body of the liquid is a potent cause of the suspension of transportable liquid particles in the surrounding air, and therefore when, through the stagnation of sewage or constructive defects which allow of the retention of excrementitious matters for several days in the sewer, putrefaction sets in and causes the generation of gases, the suspension of zymotic matters in the air of the sewer is extremely likely to occur.

3. It is therefore of the greatest importance to the health of towns, villages, and even isolated houses, that foul liquids should pass freely and quickly through sewers and drain-pipes, so as to secure their discharge from the sewerage system before putrefaction sets in.

Linnean Society, February 1.—Mr. G. Bentham, F.R.S., vice-president, in the chair.—Messrs. G. Boulger, Alfred S. Heath, and William Meller, were elected Fellows of the Society.—Mr. A. W. Bennett exhibited, and made remarks on, certain specimens of insects illustrating mimicry; these had been captured in Syria by Mr. N. Godman.—An unusual form of double anemone, and some excessively large oak-leaves gathered near Croydon, were shown by Mr. S. Stevens, and they evoked discussion from the Chairman and other Fellows present.—Sir John Lubbock then proceeded with Part 4 of his contributions on the habits of ants, bees, and wasps. In this communication he illustrated by ingenious experiments his *modus operandi* of testing their faculties, dispositions, habits, &c., by something of a double F apparatus (F), whereby an interval of three-tenths of an inch, either by a drop from above or reaching upwards the distance from below, alone prevented ants from gaining access to a covered glass cell filled with larvae. They evidently had not the acumen to surmount the three-tenths of open space, although they had for hours before been traversing the route and carrying off larvae previous to the small gap being made. Industry was conspicuously shown by one specimen, which Sir John used to place in solitary confinement in a bottle for hours, and once for days, but the moment released it commenced its laborious larva-gathering propensities. It seems, from other experiments, that ants in difficulties within sight of their companions are by no means always assisted or relieved, other attractions, food and such like, possessing greater interest for them. On putting some specimens under the influence of chloroform, little or no notice was taken of those insensible by their companions, the tendency apparently being to let friends lie and throw over the edge of the board strangers thus chloroformed. It seems that to get ants properly intoxicated with spirit for experimental purposes is no easy matter, some recovering too quickly, and others remaining so thoroughly dead drunk as to come under the rank of impracticables; while between reeling friends and strangers the experimenter finds himself baffled. The sober ants are exceedingly puzzled at finding their friends in such a condition. As a general rule they picked up drunken friends and carried them to the nest, whilst they threw into the water and drowned strangers. In some instances confusion arose, for a few of the strangers were carried to the nest and friends tumbled into the water, but they did not return to the rescue of the friends, though strangers were afterwards expelled from the nest. Sir John expresses surprise that ants of one nest perfectly well know each other. Even after a year's separation old companions are recognised and amicably received, whereas strangers, particularly among the *Lasius niger*, are almost invariably attacked and destroyed, even when intro-

duced in the mixed company of old friends. Sight cannot be acute; for example, in experiments food was placed on a glass slip a few inches from the nest, the straight road to and from the nest being soon familiar to the ants; but when the food had been shifted only a short distance from its first position it was long ere it was discovered. Indeed they wandered from a few minutes to half an hour in the most extraordinary circuitous routes before finding out the direct road between the nest and food, and *vice versa*. Slavery in certain genera is a positive institution, the Amazon ants (*Polyergus rufescens*) absolutely requiring slave assistants to clean, to dress, and to feed them, else they will rather die than help themselves, though food be close at hand. A curious blind woodlouse (*Platyarthrus hoffmanseggii*) is allowed house room by the ants, it acts as a kind of scavenger, the ants taking little notice of the woodlice, and even migrate leaving them behind. Some new species of Diptera of the family Phoridae he finds to be parasitic on our house ants; and Mr. Vernal has recently described these interesting forms.—A paper on the aspects of the vegetation of Rodriguez was read by Mr. I. Bailey Balfour, who accompanied as botanist the Transit of Venus Expedition in 1874. It seems that, like the flora of St. Helena, that of Rodriguez has undergone great changes, partly by human and other agencies. It is insular, dry, and temperate rather than humid, and tropical in character. The facies is predominantly Asiatic, though forms of Mascarene type, and even Polynesian and American forms, are sparsely met with. The leaves of many plants Mr. Balfour observed exhibited heteromorphism of a marked kind, and this he described with some fulness, remarking that while as a whole in degree and kind variable, yet among species the leaf variation is pretty uniform.—The fungi of the *Challenger* Expedition (third notice), by the Rev. M. J. Berkeley, and on Steere's collection of tropical ferns, by Prof. Harrington, U.S., were papers announced and taken as read.

Zoological Society, February 20.—Prof. Flower, F.R.S., vice-president, in the chair.—Mr. Osbert Salvin, F.R.S., exhibited a series of drawings taken during Hunter's voyage to Australia in 1788–92, wherein Duke of York Island as it then existed was depicted, together with various objects of natural history.—A communication was read from Prof. Owen, C.B., containing an account of some additional evidence recently obtained of the former existence of extinct birds allied to the genus *Dromornis* in Australia.—Mr. Sclater read a paper on the birds collected by the Rev. George Brown on Duke of York Island and on the adjoining parts of New Ireland and New Britain. Eleven species were described as new to science, amongst which were a new Kingfisher proposed to be called *Tanyseptera nigricaps*, and a new Pigeon to which the name of *Macropygia browni* was assigned.—Dr. G. E. Dobson read a paper on a collection of Bats collected by the Rev. George Brown in Duke of York Island and the adjacent parts of New Ireland and New Britain. Amongst these four were considered to belong to undescribed species, and one of these to a new genus of the Frugivorous Bats, proposed to be called *Melonycteris*.—Mr. Edward R. Alston read a paper on the Rodents and Marsupials collected by the Rev. G. Brown in Duke of York Island, New Britain, and New Ireland. The species, six in number, were either identical with New Guinea forms or nearly allied. For the three new species the names of *Mus browni*, *Uromys rufescens*, and *Macropus lugens* were proposed.—Messrs. O. Salvin and F. Du Cane Godman read the descriptions of a collection of Lepidoptera made by the Rev. George Brown on Duke of York Island and its neighbourhood. The series of Butterflies contained twenty-six genera and forty species, while in that of the Moths eleven genera were represented by fourteen species.—Mr. E. J. Miers read a description of the Crustacea collected by the Rev. G. Brown on Duke of York Island. The collection, with one exception (*Lysiosquilla armaria*), belonged to the Decapoda, and contained in all forty-four specimens representing sixteen species. Although none of the species were new to science, several were interesting and little-known forms.—Dr. A. Günther, F.R.S., read a paper on a collection of Reptiles and Fishes made by the Rev. George Brown on Duke of York Island, New Ireland, and New Britain. Of nine lizards represented in the collection one was described as new, and of eleven snakes three were considered to be hitherto unknown. Amongst the latter was a new genus and species of Erycidae, proposed to be called *Erythopsis asper*.—Mr. H. W. Bates read a paper on the Coleoptera collected by Mr. George Brown on Duke of York Island, New Ireland, and New Britain. The collection comprised forty-four species, and contained some of the finest species of the New Guinea Fauna. Amongst these

were many examples of a new Longicorn, proposed to be called *Balocera browni*, after its discoverer.

Geological Society, February 7.—Prof. P. Martin Duncan, F.R.S., president, in the chair.—James Durham, Herbert William Harrison, William Hutchinson, H. M. Klaassen, Graeme Ogilvie, Joseph William Spencer, and Griffin W. Vyse were elected Fellows of the Society.—The following communications were read:—On the chemical and mineralogical changes which have taken place in certain eruptive rocks of North Wales, by John Arthur Phillips, F.G.S. In this paper the author described the felspathic rock of Penmaenmawr, which has been erupted through Silurian strata, and rises to a height of 1,553 feet above the level of the sea. The rock, which is composed of crystalline felspar with minute crystals of some hornblende mineral, is fine-grained and greenish grey, divided into beds by joints dipping north at an angle of about 45°, and again divided by double jointings, sometimes so developed as to render the rock distinctly columnar. At the eastern end of the mountain the stone is so close in texture as often almost to resemble chert. In the next two quarries westward the rock is coarser, and its jointing less regular. In the most westerly quarry the stone is generally fresher in appearance, closer in grain, and greener in colour. All these stones are probably modifications of the same original rock. From the chemical analysis of the rocks the author concludes that, supposing them all to have had originally the same composition as the unaltered rock in the most westerly quarry, that at the extreme east of the mountain has lost about 3 per cent of silica, and the others have received respectively an increase of 1.35 and 0.77 per cent. of silica.—On a new species of *Belemnitella* and *Salenia* from the Middle Tertiaries of South Australia, by Ralph Tate, F.G.S., Professor of Natural Science in the University of Adelaide. The author noticed the occurrence in deposits of supposed Miocene age in South Australia of a species of *Belemnitella* (*Belemnitella senescens*) and a *Salenia* (*S. tertiaria*). These fossils were obtained from Aldenga, twenty-six miles south of Adelaide, on the east coast of St. Vincent's Gulf, where the long series of sea-cliffs contains an assemblage of fossils identical with that of the Murray River beds. The *Salenia* is especially interesting on account of the discovery of a living species of the genus by the naturalists of the *Challenger*.—On *Mauisaurus gardneri* (Seeley), an Elasmosaurian from the base of the gault at Folkestone, by Harry Govier Seeley, F.L.S., F.G.S., Professor of Geography at King's College, London. The author described the skeleton of a great long-necked Saurian obtained by Mr. J. S. Gardner from the Gault of the cliff at Folkestone. The remains obtained included a tooth, a long series of vertebrae, some ribs, bones of the pectoral arch, the femur, and some phalanges, indicating a very large species, which the author referred, with some doubt, to the genus *Mauisaurus* of Dr. Hector, founded upon a Saurian from the Cretaceous formation of New Zealand. He gave it the name of *Mauisaurus gardneri* in honour of its discoverer. A small heap of pebbles was found in the neighbourhood of the ribs, and it was supposed that these had been contained in the stomach of the animal.

Anthropological Institute, February 13.—Mr. John Evans, F.R.S., president, in the chair.—Miss Buckland read a paper on primitive agriculture, in which the value of the study of the subject was explained, as determining migrations, &c., of nations in pre-historic times. It was observed that agriculture could only have been practised by peoples having settled habitats, and was probably carried on then, as often is the case now, by women; that agriculture was and is still unknown, to some of the lower races who confine themselves to the cultivation of indigenous roots and fruits, whilst the higher races cultivated the cereals. The origin of the cereals is still obscure, and maize, which has been considered indigenous to the New World, and unknown in Europe before the time of Columbus, was, in the opinion of Miss Buckland (based on the reports of recent travellers in Africa, Madagascar, New Guinea, China, &c.), cultivated by peoples which have never had intercourse with Europeans. In America, China, and Ancient Egypt there are traces of a time anterior to that of the cultivation of the cereals; and a similarity of myths, customs, &c., of China, Egypt, Peru, and Mexico leads to the conclusion that an allied pre-Aryan race introduced cereals into all these countries. In the discussion, Mr. Boyd Dawkins, the president, and others took part.—Mr. H. Hyde Clarke exhibited some weapons from the Amazon River, on which Mr. Franks and others remarked.—Lord Roschill exhibited a collection of very fine and large flint weapons, objects, &c., from Honduras.

The president, Mr. Blackmore, Mr. Franks, and others spoke on the subject.

Society of Telegraph Engineers, February 5.—Prof. Abel, F.R.S., in the chair.—The paper read was on shunts and their applications to electro-metric and telegraphic purposes, by Mr. W. H. Preece. Having briefly explained the laws of shunts, Mr. Preece referred to the use of shunts for measuring purposes as well as to their early employment in practical telegraphy. The author entered minutely into the question of electro-magnetic induction, and gave the results of the experimental investigations on the "extra" current upon which he has been recently engaged. The "extra" current which is received from a simple coil of insulated copper wire being selected as the *unit*, it was shown that by the insertion of a core as well as by varying the quantity of iron in the armature, the strength of the "extra" current might be increased no less than 2,238 times. The means which should be adopted in order to counteract the prejudicial effects of the extra currents upon the speed of working were then described at length, and the employment of electro-magnetic shunts in order to compensate for the static induction which proves so troublesome on long lines was also fully gone into.

Medical Microscopical Society, January 19.—Annual General Meeting.—Dr. J. F. Payne, president, in the chair.—The secretary's report for the year 1876 was read.—Twelve papers on important subjects were read during the year, of which four were illustrative of new forms of instruments applicable to medical histology.—The number of members in December, 1876, was 129.—The retiring President (Dr. Payne) then delivered his address, in the course of which he remarked that the Society was passing through a crisis, having outgrown its developmental stage, and that its sphere of usefulness was to be found rather among medical practitioners than among students, for whom it was first intended. After pointing out the special function of the Society to be the study of histology in its relation to medical practice and public health, the speaker passed in review the work done during the past year by the members of the Society.

Victoria (Philosophical) Institute, February 19.—Dr. C. Brooke, F.R.S., in the chair.—Mr. Morhead read a paper on comparative psychology.

BOSTON

Natural History Society.—Mr. Hyatt's important contribution on the life-history of the groups of Ammonites (*Proceedings*, December, 1876) develops and applies in detail to the *Siphonoceras* group (of which *A. amphyrus* is an important member), his doctrines as to the period in life at which specific peculiarities appear. He endeavours to prove that the species of a group inherit the characteristics of their ancestors at earlier and earlier periods, until they become present even in the very young forms. He further brings forward evidence of the inheritance of old-age or senile characters which forebode the extinction of the group. Thus the successive species of almost all large groups sooner or later inherit the senile features of their ancestors, so as to reproduce them at early stages. Further, there is a broad similarity between the senile characters in different groups.

PARIS

Academy of Sciences, February 19.—M. Feligot in the chair.—The following papers were read:—Meridian observations of small planets, at the Greenwich and Paris Observatories, during the fourth trimestre of 1876; communicated by M. Le Verrier.—The human species, by M. de Quatrefages. An outline of the views published in his new work on the subject.—Remarks of M. Chevreul on a recent note of M. Radziszewski relative to phosphorescence of organic bodies.—Properties common to canals, to conduct pipes, and to rivers with uniform flow (continued), by M. Boileau.—MM. Dumas, Milne-Edwards and Boussingault were appointed a Commission to give an opinion on the matter of discussion between Dr. Bastian and M. Pasteur.—On the air-jet in water, by M. de Romilly. When a steady jet is sent normally against the surface, and the tube gradually withdrawn, there is found a distance at which a siphon pocket, deeper than broad, is made at the surface, showing often a slow rotation, and giving a sound, which is strengthened if the same note be played on the violin. When a jet is sent upwards from an orifice near the bottom of a vessel of water, a spherical air-chamber forms about and under the

orifice, becoming the base of an ascending air-column, which base is more than triple the diameter of the orifice. The column suddenly contracts near the orifice, then gradually widens. The author describes some other effects.—On Kepler's problem, by M. de Gasparis.—On orthogonal systems comprising a family of surfaces of the second degree, by M. Darboux.—Memoir on the methods employed for determination of the curves of astronomical objectives, accompanied with tables for abridging the calculation, by M. Martin.—On a means of varying the focussing of a microscope without touching either the instrument, or the object, and without altering the direction of the line of vision, by M. Goni. This is based on the fact that the interposition between objective and object of a medium more refringent than air, with plane parallel sides at right-angles to the axis of the microscope, will cause an apparent elevation of the object represented by  $d = e \frac{n^2 - 1}{n}$ , where  $d$  is the

elevation produced,  $e$  the thickness of the medium, and  $n$  its index of refraction relatively to air or vacuum. He uses a vessel of liquid with glass bottom and varies the height of the surface either with a plunger or a communicating vessel.—New process of photomicrography, by M. Fayel. The upper end of the microscope catches in a wooden frame on colonnettes, the aperture of this corresponding with that of a dark chamber which can be placed or removed at will. In this chamber is a moveable plano-convex lens, and through it an image equal to that seen by the eye is thrown on sensitised glass.—On the microscope and the dark chamber, by M. Neyreneuf. This gives some theoretical results from examination of Dr. Fayel's method.—On the manufacture of carbon conductors for the electric lamp, by M. Carré. He reminded the Academy of his own experiments. Moistening carbon powder with syrups of gum, gelatine, &c., or fixed oils thickened with resins, he gets plastic and consistent pastes very suitable for making carbon points of. Even without other admixture, they give more light than the ordinary carbons, in the proportion of 1.25 to 1.—Study and determination of the principal colouring matters used to falsify wines, by M. Chanal.—On the action of alkaline sulphocyanates on chlorhydrates of alkalis of the fatty series, by M. De Clermont.—Action of electrolytic oxygen on glycol, by M. Renard.—On the discharge of the torpedo, studied with Lippmann's electrometer, by M. Marey. If the discharge of a torpedo, much weakened, be directed into the electrometer, the mercury moves in the positive direction, in a jerky way, progressing always more than it goes back. This shows a striking analogy to the phenomena of muscular contraction.—On the localisation of copper in the system, after ingestion of a salt of this metal, by M. Rabuteau. It would be rash to affirm poisoning with a salt of copper, because eight or even twelve centigrammes of the metal might be found in the liver. Salts of copper are less poisonous than hitherto supposed.—On the fish development of a star-fish, by M. Hol.—On the hair of vine shoots, applied to manufacture of paper, by M. Boutin.—On the reconciliation of moral liberty with scientific determinism, by M. Housineq.

CONTENTS

Table with 2 columns: Title and Page. Includes entries like 'GOVERNMENT GRANTS IN AID OF SCIENCE', 'THE LIFE OF SIR WILLIAM FAIRBAIRN', 'GROTH'S "CRYSTALLOGRAPHY"', 'OUR BOOK SHELF', 'LETTERS TO THE EDITOR', 'HYGROSCOPIC SEEDS', 'MIND AND MATTER', 'ATMOSPHERIC CURRENTS', 'HALO ROUND SHADOW', 'METEOR', 'TAPE-WORM IN RABBITS', 'A PROMISE IN THE NATURAL HISTORY OF THE SAHARA', 'THE SOUTH AFRICAN MUSEUM', 'ATLANTIC SOUNDINGS', 'HUNNOCKY MORAINÉ DRIFT', 'CONTRACTION OF THE LEAF OF "DIORGA MUSCIFLUA"', 'THE SPONTANEOUS GENERATION QUESTION', 'OUR ASTRONOMICAL COLUMN', 'THE NEW COMET', 'THE VARIABLE STAR I CORONA BOREALIS', 'THE RADECLIFF OBSERVATIONS, 1874', 'STAR BOLT OBSERVATORY PUBLICATIONS, VOL. I.', 'NOTES', 'SCIENTIFIC SERIALS', 'SCIENTIFIC AND ACADEMIC'.

THURSDAY, MARCH 8, 1877

## SCIENTIFIC WORTHIES

K.—HERMANN LUDWIG FERDINAND HELMHOLTZ

THE contributions made by Helmholtz to mathematics, physics, physiology, psychology, and æsthetics, are well known to all cultivators of these various subjects. Most of those who have risen to eminence in any one of these sciences have done so by devoting their whole attention to that science exclusively, so that it is only rarely that the cultivators of different branches can be of service to each other by contributing to one science the skill they have acquired by the study of another.

Hence the ordinary growth of human knowledge is by accumulation round a number of distinct centres. The time, however, must sooner or later arrive when two or more departments of knowledge can no longer remain independent of each other, but must be fused into a consistent whole. But though men of science may be profoundly convinced of the necessity of such a fusion, the operation itself is a most arduous one. For though the phenomena of nature are all consistent with each other, we have to deal not only with these, but with the hypotheses which have been invented to systematise them; and it by no means follows that because one set of observers have laboured with all sincerity to reduce to order one group of phenomena, the hypotheses which they have formed will be consistent with those by which a second set of observers have explained a different set of phenomena. Each science may appear tolerably consistent within itself, but before they can be combined into one, each must be stripped of the daubing of untempered mortar by which its parts have been prematurely made to cohere.

Hence the operation of fusing two sciences into one generally involves much criticism of established methods, and the explosion of many pieces of fancied knowledge which may have been long held in scientific reputation.

Most of those physical sciences which deal with things without life have either undergone this fusion or are in a fair state of preparation for it, and the form which each finally assumes is that of a branch of dynamics.

Many cultivators of the biological sciences have been impressed with the conviction that for an adequate study of their subject a thorough knowledge of dynamical science is essential. But the manner in which some of them have cut and pared at the facts in order to bring the phenomena within the range of their dynamics, has tended to throw discredit on all attempts to apply dynamical methods to biology.

We purpose to make a few remarks on a portion of the scientific work of Helmholtz, who is himself the most illustrious example not merely of extensive acquaintance with science combined with thoroughness, but of a thoroughness which of itself demands the mastery of many sciences, and in so doing makes its mark on each.

Hermann Ludwig Ferdinand Helmholtz was born August 31, 1821, at Potsdam, where his father, Ferdinand Helmholtz, was Professor of the Gymnasium. His mother, Caroline Penn, was of an emigrated English family. His father's means would not admit of his studying science otherwise than as a medical student. He

therefore became a military surgeon, and continued in that position till the end of 1848, when he was appointed Assistant of the Anatomical Museum of Berlin, and Teacher of Anatomy at the Academy of Arts. In the following year he went to Königsberg, in Prussia, as Professor of Physiology. In 1856 he became Professor of Anatomy and Physiology at the University of Bonn; in 1859, Professor of Physiology at the University of Heidelberg; and, in 1871, Professor of Natural Philosophy to the University of Berlin.

It was during his career as a military surgeon that he published his celebrated essay on "The Conservation of Energy."

The science of dynamics has been so long established, that it is hardly conceivable that any addition to its fundamental principles should yet remain to be made. But in the application of pure dynamics to actual bodies a great deal remains to be done. The great work for the men of science of the present age is to extend our knowledge of the motion of matter from those instances in which we can see and measure the motion to those in which our senses are unable to trace it. For this purpose we must avail ourselves of such principles of dynamics as are applicable to cases in which the precise nature of the motion cannot be directly observed, and we must also discover methods of observation by which effects which indicate the nature of the unseen motion may be measured. It is unnecessary here to refer to the labours of the different men of science who, each in his own way, have contributed by experiment, calculation, or speculation, to the establishment of the principle of the conservation of energy; but there can be no doubt that a very great impulse was communicated to this research by the publication in 1847, of Helmholtz's essay "Ueber die Erhaltung der Kraft," which we must now (and correctly, as a matter of science) translate *Conservation of Energy*, though in the translation which appeared in Taylor's "Scientific Memoirs," the word *Kraft* was translated *Force* in accordance with the ordinary literary usage of that time.

In this essay Helmholtz showed that if the forces acting between material bodies were equivalent to attractions or repulsions between the particles of these bodies, the intensity of which depends only on the distance, then the configuration and motion of any material system would be subject to a certain equation, which, when expressed in words, is the principle of the conservation of energy.

Whether this equation applies to actual material systems is a matter which experiment alone can decide; but the search for what was called the perpetual motion has been carried on for so long, and always in vain, that we may now appeal to the united experience of a large number of most ingenious men, any one of whom, if he had once discovered a violation of the principle, would have turned it to most profitable account.

Besides this, if the principle were in any degree incorrect, the ordinary processes of nature, carried on as they are incessantly and in all possible combinations, would be certain now and then to produce observable and even startling phenomena, arising from the accumulated effects of any slight divergence from the principle of conservation.

But the scientific importance of the principle of the conservation of energy does not depend merely on its accuracy as a statement of fact, nor even on the remarkable conclusions which may be deduced from it, but on the fertility of the methods founded on this principle.

Whether our work is to form a science by the colligation of known facts, or to seek for an explanation of obscure phenomena by devising a course of experiments, the principle of the conservation of energy is our unerring guide. It gives us a scheme by which we may arrange the facts of any physical science as instances of the transformation of energy from one form to another. It also indicates that in the study of any new phenomenon our first inquiry must be, How can this phenomenon be explained as a transformation of energy? What is the original form of the energy? What is its final form? and What are the conditions of the transformation?

To appreciate the full scientific value of Helmholtz's little essay on this subject, we should have to ask those to whom we owe the greatest discoveries in thermodynamics and other branches of modern physics, how many times they have read it over, and how often during their researches they felt the weighty statements of Helmholtz acting on their minds like an irresistible driving-power.

We come next to his researches on the eye and on vision, as they are given in his book on *Physiological Optics*. Every modern oculist will admit that the ophthalmoscope, the original form of which was invented by Helmholtz, has substituted observation for conjecture in the diagnosis of diseases of the inner parts of the eye, and has enabled operations on the eye to be made with greater certainty.

But though the ophthalmoscope is an indispensable aid to the oculist, a knowledge of optical principles is of still greater importance. Whatever optical information he had was formerly obtained from text-books, the only practical object of which seemed to be to explain the construction of telescopes. They were full of very inelegant mathematics, and most of the results were quite inapplicable to the eye.

The importance to the physiologist and the physician of a thorough knowledge of physical principles has often been insisted on, but unless the physical principles are presented in a form which can be directly applied to the complex structures of the living body, they are of very little use to him; but Helmholtz, Donders, and Listing, by the application to the eye of Gauss's theory of the cardinal points of an instrument, have made it possible to acquire a competent knowledge of the optical effects of the eye by a few direct observations.

But perhaps the most important service conferred on science by this great work consists in the way in which the study of the eye and vision is made to illustrate the conditions of sensation and of voluntary motion. In no department of research is the combined and concentrated light of all the sciences more necessary than in the investigation of sensation. The purely subjective school of psychologists used to assert that for the analysis of sensation no apparatus was required except what every man carries within himself; for, since a sensation can exist nowhere except in our own consciousness, the only possible method for the study of sensations must be an unbiased contemplation of our own frame of mind. Others

might study the conditions under which an impulse is propagated along a nerve, and might suppose that while doing so they were studying sensations, but though such a procedure leaves out of account the very essence of the phenomenon, and treats a fact of consciousness as if it were an electric current, the methods which it has suggested have been more fertile in results than the method of self-contemplation has ever been.

But the best results are obtained when we employ all the resources of physical science so as to vary the nature and intensity of the external stimulus, and then connect consciousness as to the variation of the resulting sensation. It was by this method that Johannes Müller established the great principle that the difference in the sensations due to different senses does not depend upon the actions which excite them, but upon the various nervous arrangements which receive them. Hence the sensation due to a particular nerve may vary in intensity, but not in quality, and therefore the analysis of the infinitely various states of sensation of which we are conscious must consist in ascertaining the number and nature of these simple sensations which, by entering into consciousness each in its own degree, constitute the actual state of feeling at any instant.

If, after this analysis of sensation itself, we should find by anatomy an apparatus of nerves arranged in natural groups corresponding in number to the elements of sensation, this would be a strong confirmation of the correctness of our analysis, and if we could devise the means of stimulating or deadening each particular nerve in our own bodies, we might even make the investigation physiologically complete.

The two great works of Helmholtz on "*Physiological Optics*" and on the "*Sensations of Tone*," form a splendid example of this method of analysis applied to the two kinds of sensation which furnish the largest proportion of the raw materials for thought.

In the first of these works the colour-sensation is investigated and shown to depend upon three variables or elementary sensations. Another investigation, in which exceedingly refined methods are employed, is that of the motions of the eyes. Each eye has six muscles by the combined action of which its angular position may be varied in each of its three components, namely, in altitude and azimuth as regards the optic axis, and rotation about that axis. There is no material connection between these muscles or their nerves which would cause the motion of one to be accompanied by the motion of any other, so that the three motions of one eye are mechanically independent of the three motions of the other eye. Yet it is well known that the motions of the axis of one eye are always accompanied by corresponding motions of the other. This takes place even when we cover one eye with the fingers. We feel the cornea of the shut eye rolling under our fingers as we roll the open eye up or down, or to the right; and indeed we are quite unable to move one eye without a corresponding motion of the other.

Now though the upward and downward motions are effected by corresponding muscles for both eyes, the motions to right and left are not so, being produced by the inner muscle of one eye along with the outer muscle of the other, and yet the combined motion is such that we can move our eyes quite freely without

during the whole motion the condition that the optic axes shall intersect at some point of the object whose motions we are following. Besides this, the motion of each eye about its optic axis is found to be connected in a remarkable way with the motion of the axis itself.

The mode in which Helmholtz discusses these phenomena, and illustrates the conditions of our command over the motions of our bodies, is well worth the attention of those who are conscious of no limitation of their power of moving in a given manner any organ which is capable of that kind of motion.

In his other great work on the "Sensation of Tone as a Physiological Basis for the Theory of Music," he illustrates the conditions under which our senses are trained in a yet clearer manner. We quote from Mr. Ellis's translation, p. 95:—

"Now practice and experience play a far greater part in the use of our senses than we are usually inclined to assume, and since, as just remarked, our sensations derived from the senses are primarily of importance only for enabling us to form a correct conception of the world without us, our practice in the observation of these sensations usually does not extend in the slightest degree beyond what is necessary for this purpose. We are certainly only far too much disposed to believe that we must be immediately conscious of all that we feel and of all that enters into our sensations. This natural belief, however, is founded only on the fact that we are always immediately conscious, without taking any special trouble, of everything necessary for the practical purpose of forming a correct acquaintance with external nature, because during our whole life we have been daily and hourly using our organs of sense and collecting results of experience for this precise object."

Want of space compels us to leave out of consideration that paper on Vortex Motion, in which he establishes principles in pure hydrodynamics which had escaped the penetrative power of all the mathematicians who preceded him, including Lagrange himself; and those papers on electrodynamics where he reduces to an intelligible and systematic form the laborious and intricate investigations of several independent theorists, so as to compare them with each other and with experiment.

But we must not dwell on isolated papers, each of which might have been taken for the work of a specialist, though few, if any, specialists could have treated them in so able a manner. We prefer to regard Helmholtz as the author of the two great books on Vision and Hearing, and now that we are no longer under the sway of that irresistible power which has been bearing us along through the depths of mathematics, anatomy, and music, we may venture to observe from a safe distance the whole figure of the intellectual giant as he sits on some lofty cliff watching the waves, great and small, as each pursues its independent course on the surface of the sea below.

"I must own," he says, "that whenever I attentively observe this spectacle, it awakens in me a peculiar kind of intellectual pleasure, because here is laid open before the bodily eye what, in the case of the waves of the invisible atmospheric ocean, can be rendered intelligible only to the eye of the understanding, and by the help of a long series of complicated propositions."—"Ton-empfindungen," p. 42).

Helmholtz is now in Berlin, directing the labours of the men of science in his splendid laboratory. Let us hope that soon, in his present position, he will again take a

comprehensive view of the waves and ripples of our intellectual progress, and give us from time to time his idea of the meaning of it all.

J. CLERK MAXWELL.

### THE UNIVERSITIES BILL

PEOPLE'S notions of "reform" differ very much according to their interest in or knowledge of the kind of thing to be reformed. At present there is much talk of university reform, but there is really no proposition before the public for reforming the universities. The Government Bill is simply intended to adjust certain parts of the machinery of the ancient corporations at Oxford and Cambridge and to oil the wheels which with the lapse of time have become rusty. There is no intention to make Oxford and Cambridge what they were three centuries ago—namely universities in the sense in which the word "university" is applied (excepting the cases of London and Durham) to every other institution claiming the title in civilised Europe. The historic process by which the endowed boarding-houses at Oxford and Cambridge known as colleges fell into the hands of the clerical party, and subsequently became possessed of the sole control of the university, suppressing the higher Faculties, with the exception of the Theological, and driving from the university all students but those who could afford to make a ruinous annual payment to the cooks, butlers, scouts, and tutors of one college or another in exchange for indifferent board and lodging and a "religious education" in a school-boy's horn-book, under the disciplinary system devised by the Jesuits, is *not* to be reversed. No re-constitution of the Faculties—the absolutely essential step in the reformation of decayed universities—is proposed, nor is the Bachelor-of-Arts curriculum to be relegated to its proper place—the preparatory schools. The colleges are still to have it all their own way, are to be allowed still to compete with one another in buying at the rate of 100*l.* a year the chances of distinction which a promising school-boy can give by entering his name on the college-books; they are still to pursue the fruitless task of training these youths so as to obtain for the college the largest possible number of "first classes" in an examination arranged and conducted by the colleges (whose representatives far outnumber the professoriate) in subjects and methods which the student should either have dropped at the threshold of the university or should pursue in a spirit and with a thoroughness incompatible with the conditions of these competitive examinations. Prize fellowships awarded by competitive examination are still to be the incentives to these mercenary studies on the part of the young men; the university professor, even though he may be multiplied by two, is still to occupy the ambiguous position which is at present his lot—by right the director of the studies connected with his chair, but, in fact, shorn of the privileges and functions of his office through the eager competition of colleges for examination honours and tutorial fees. Worst than all, the ridiculous "matriculation" examinations are *not* to be superseded by a thorough university matriculation examination—to the want of which the disgraceful inefficiency of school-teaching in all our public schools is due.

It is true that it is only within the last quarter of a century that the full supremacy of the Theological Faculty in Oxford has been attained by the practically complete effacement of the Medical Faculty, the Regius and Clinical chairs in which are now held by one professor, who appears to have acquiesced in the total cessation of medical study in Oxford. It is also true that within the same period the Faculty of Laws has made a partial re-appearance, and musters a few non-professional students, whilst under the stimulus afforded by competitive examination and prize fellowships, something more in quantity than, but still identical in kind with, the class-work taught at school to boys of from fifteen to eighteen years of age, is now sedulously driven into the undergraduate's brain by his college tutors and lecturers. It will also be adduced by the apologists of the present university régime, that over 80,000*l.* have been spent at Oxford on a palatial edifice for the encouragement of the long-neglected studies which are ranked as physical science. It should, however, be thoroughly understood that the sum in question has been primarily devoted to the production of an architectural monstrosity, the University Museums, which though pleasing to the æsthetic persons who invented it, does not provide the accommodation which the subjects require, nor even so much as could, in the absence of æsthetic muddling, have been obtained for a fourth part of the sum quoted with so much assurance.

The actual facts which are given below show what is the constitution of the University of Oxford in the way of professors, college-teachers, and students, and to what studies they respectively devote themselves. These figures entirely refute Mr. Lowe's recent statements to the effect that whilst the honour-man at Oxford has a good education, and the pass-man a very bad one—the pass-men far outnumber the honour-men. Clearly Mr. Lowe had not troubled himself to ascertain the facts before making his attack, which was intended to show the danger of allowing the Owens College to become a university. Mr. Lowe's conception of a university is limited by the model of that which he represents, and accordingly there is little comfort to be derived from his attacks on Oxford for those who believe in "the university" as it exists in the great German home of universities.

All that has been written and said within the last three months on the university question shows that there is a most serious ignorance among our public men of what universities are, what they can do, are doing, and how they do it, both in Great Britain and abroad. Only two members of the House of Commons, Dr. Lyon Playfair and Mr. Grant Duff, appear to have so much as an elementary acquaintance with the subject on which they are about to legislate. Even Mr. Goldwin Smith, who has returned to England full of wisdom gained in the Far West, expresses his belief in the college system because, ~~forsooth,~~ certain mushroom institutions in America which are defective as universities, have no colleges or boarding-houses. Had Mr. Goldwin Smith travelled east instead of west, he might have formed other and sounder conclusions after a study of German universities.

Under these circumstances, though it is a matter of profound concern, it is not surprising that the Government

Bill contemplates no change which will re-create Oxford and Cambridge as universities. They will remain each a congeries of finishing schools for the sons of the wealthier classes—where a man may learn, as Dr. Lyon Playfair has said—how to spend a thousand a-year, and to spend it with some discretion, but not how to earn a thousand a-year—how to make himself a useful member of society valuable at that rate.

To fit a man for a career in life, the task which is undertaken by every other university worthy of the name, is absolutely what Oxford and Cambridge refuse to do, and what legislators ought to force them to do. Poor men, or men of moderate means, can only afford to send their sons to an English university in order that they may become clergymen or schoolmasters, or on the chance that, as in the Chinese mandarin selection, they may, by submission to the tyranny of a competitive examination, win a prize fellowship.

Those who desire and see in the future a true university reformation—having nothing favourable to their views to expect from the action of the Commissioners appointed without definite instructions by the present Government Bill—have none the less much to fear and to combat. It is admitted on all hands that the powers of the Commissioners are very great, though they are not *definitely* instructed as to how they are to employ those powers. Practically it will come to this, that the Commissioners will simply empower the resident fellows of colleges to do what they have long wished and sketched out, namely, to marry and settle down permanently in the university as college lecturers and tutors. This boon will be granted to the colleges in exchange for an immediate ten and a prospective fifty thousand a year, which will go to paying for new university buildings and for some new (as well as additions to the stipends of some old) professorships.

The new professors will be in the same ignoble position as the old ones, since no change in the constitution of the government of the university is contemplated, and there is no reason to suppose that they will make the university more remarkable for research and less remarkable for apathy, than does the existing body. The clerical restriction on headships of colleges—*sinecures* varying in value from 1,000*l.* to 2,000*l.* a year—*may* be removed by the Commissioners, but is not necessarily to be so, nor is provision made for abolishing headships altogether. The nature of the duties of the college lecturers and tutors who will become a more formidable body than ever, when allowed to root themselves with family surroundings, will not be regulated by the Commissioners, nor the subjects which they shall teach. At the same time the non-resident fellows will have their term of tenure limited, and their influence in college government will be diminished, even if they are not altogether excluded from a share in it. The result of these changes will be greatly to strengthen the college system of preparing pupils for the examination race-course, and to render it more difficult than ever to remove the injurious antagonism which at present prevents any real co-operation among the colleges for the common good of the university. The cessation of this antagonism might have been effected once and for all by empowering the Commissioners to re-constitute the Faculties, and to combine in their equal



all college teachers and professors, to be organised into a series of consentaneous teaching bodies, one in each Faculty.

In sketching what seems a possible and satisfactory scheme for the university reform of the future, it is desirable first of all to ascertain what sum of money can be spent with advantage in a single locality like Oxford; and, secondly, what can be reasonably done with the surplus funds now administered through Oxford. It appears that about 400,000*l.* a year may be reckoned as the immediate prospective revenue of the colleges and university of Oxford. Of this, 150,000*l.* a year would nobly endow a reformed Oxford, leaving 250,000*l.* a year for other purposes. The University of Oxford is generally regarded as a *place*, whereas it is essentially a *corporation*. Whilst the University could not with benefit dispense more than 150,000*l.* a year within the city of Oxford, there is no reason why it should not have a series of institutions connected with it in London, or even in other great cities. The universities founded in this way by the surplus revenues of Oxford and Cambridge in London, Birmingham, Manchester, Leeds, and Bristol, should be equally endowed with the parent universities, and might form as do the German universities a series of co-operating institutions from one of which to another the student could pass as the special direction of his studies might determine, and the professorial positions in which (of graduated value) would furnish a ladder to be climbed by those who devote themselves to the professorial career.

Leaving the question aside, as to the ultimate disposal of surplus revenues, there is no doubt that with the introduction of a system of professorial teaching, combined with a rigid pass examination, and the removal of the baneful "competition for honours," Oxford could be maintained in external appearance much as it is with 150,000*l.* a year of endowment. The college buildings would remain as boarding-houses and would have to compete as such with the ordinary lodgings in the city. There would be a limited number (two or three in each college) of domestic "tutors" or house-masters to preserve order and give advice to the students resident in colleges, whilst the entire teaching would be performed by the greatly-increased professorial staff.

With or without the more radical points of this change, any Bill professing to reform Oxford and Cambridge ought to embrace the following provisions, or some at least of them; none of them are comprised in the Government measure.

1. The creation of new professorships and their arrangement with the old ones in Faculties (say Theology, Law, Medicine, Physical Science, and Literature), on as complete a scale as the most fully-developed German university presents—say Leipzig—where with a total revenue of 50,000*l.* a year the University has 115 professors as against 43 in Oxford.

2. The giving of the sole control of the curriculum of study in each Faculty to the official members of that Faculty, together with the sole right to appoint examiners and to elect to vacant professorships. The existing "Boards of Studies" might without difficulty be developed into the required Faculties.

3. The exclusion of all non-resident graduates and of

persons not officially recognised as teachers (members of Faculties) from participation in university government.

4. The imposition of a *thorough* matriculation examination (to embrace the elements of physical science and other modern studies) on all students seeking admission to the university; the subjects of examination and standard to be arranged and determined by a committee of the faculties in concert with other great national educational bodies.

5. The abolition of "college monopoly," and the introduction of free trade in the boarding and the teaching of undergraduates—firstly, by permitting an undergraduate (whether enjoying a college scholarship or not) to reside where he may find the cheapest and best accommodation either in or out of college; and secondly, by prohibiting any compulsory exaction from him of attendance on, or payment for, any teaching which he does not voluntarily select as the most likely to add to his knowledge, or to enable him to pass with credit the only examination he would have to undergo, viz., the "pass" examination of the faculty, admitting him to the degree of Bachelor or of Master.

6. The institution of a Doctor's degree to be given in the Faculty of Science, and in that of Literature after the degree of Bachelor, on presentation by the candidate of an original thesis to be approved by the Faculty, and to be published (publication being indispensable).

7. The annual assignment from surplus revenue of some thousands a year to each Faculty to be dispensed by them in special missions, explorations, travels, and researches.

8. The general control by the State Government of the finances and public acts of the university. The continual control of a richly-endowed corporation by the State is an indispensable safeguard.

9. The prohibition of the employment of any collegiate or university funds for any ecclesiastical purpose or for any other non-academic purposes.

10. The removal of all religious tests in connection with any office (professorial or other) held in the university or colleges, as well as the abolition of *all* compulsion in regard to religious observances such as are now exacted from undergraduates.

To make all or the major portion of the changes here advocated would be truly to change the character of our English universities. They would be restored to national uses as universities worthy of the name; they would cease to be the "Kindergarten" of the wealthy classes, to whom they belong by no right, and by whom they have long been appropriated and misused.

#### APPENDIX.

*Facts with regard to Teachers and Students in the University of Oxford, derived from the "University Calendar" of 1875.*

There are about 2,400 undergraduates, or persons *in statu pupillari*, on the College and University books; 400 of these graduate in each year, the average time spent in the University being over four years.

Of these 75 per cent. read for honours in the various schools or Faculties, whence it appears that there are about (probably less than) 1,800 students in Oxford reading for honours. Of these 1,800 it appears that 33

per cent. read for the school of Literæ Humaniores (Philosophy, Classical History, and Philology), 20 per cent. for the school of Modern History, 17 per cent. for the school of Theology, 15 per cent. for the school of Law, 7 per cent. for the school of Mathematics, and only 6.5 for the school of Physical Science.

Of the 2,400 undergraduates 24 per cent. hold college scholarships or exhibitions varying in value from 30*l.* to 100*l.* a year, exclusive of scholarships or exhibitions granted by external bodies.

There are at this moment 360 fellows of colleges, exclusive of heads and professors, of whom 140 (out of a total of 160 college lecturers and tutors) are resident and engaged in teaching. The average endowment of a fellowship is 250*l.*

There are thirty-seven University professors and six University readers or assistant professors, of whom nine give no definite courses and have no pupils. They are distributed in subjects thus: Theology, five; Medicine, two; Law, four, and a reader; Lit. Human. seven, and a reader; Mathematics, three; Physical Science, seven, and four readers; Modern History, three, and a reader; Fine Art and Modern Languages, seven.

Taking the total number of teachers, both collegiate and professorial, and the total number of honour-students, according to the subjects which they respectively teach and pursue (which subjects may be ascertained from the calendar), we find that in Literæ Humaniores the proportion of collegiate and professorial teachers to students is 1:5.5; in Mathematics, 1:6; in Physical Science, 1:7; in Modern History, 1:5; in Law, 1:15.5.

Estimating the average annual income of a college lecturer or tutor at 500*l.*, we find that 75,000*l.* is the sum required to pay at this rate for 150 such persons. This sum is exactly what the scholarship fund (40,000*l.*), plus 140 fellowships of 250*l.* each amounts to, so that, practically, the teaching in Oxford colleges is paid for, not by the parents of undergraduates, but by a portion of the collegiate endowments—to wit, the scholarship fund and two-fifths of the fellowship fund.

The statement recently made by Sir John Lubbock in the debate on the Universities Bill in the House of Commons, to the effect that Oxford practically has done nothing for the development of the study of physical science, is amply justified by the above figures; there are only seven professors and four readers of all the various physical sciences in Oxford; only one twenty-fourth of the undergraduate students in the place pursue the study of physical science; and of all the three hundred and sixty fellowships in the various colleges only five are held by persons (exclusive of professors) who have been elected to them in consideration of their attainments in physical science. In four more fellowships the application of mathematics to physics has been allowed to count in establishing a student's claim to such fellowship.

The public schools teach physical science to so few boys, and teach it so inefficiently, that there are quite as many scholarships for excellence in this subject offered to the matriculating students as there are worthy candidates. The fact that the public schools never teach physical science to all their pupils and only as a rule to the dullest

study on account of their failure in classics and mathematics, is simply due to the fact that neither the colleges nor the university introduce any branch of physical science into any one of their compulsory examinations. And this fact is further explained by the fact that the college lecturers and tutors, and even the heads of houses, are, with few exceptions, men who have been school-masters, or who hope to be so, and who are identified in every way with the pedagogic profession.

In fact, using the term without any offensive implication, the College authorities, together with the school-masters, form a "ring" whose interest it is to suppress a class of studies of which they are themselves ignorant. The university professoriate, which should act as a higher body, to control and stimulate the pedagogic class of teachers, is, as already mentioned, a nonentity. There is no such higher power—the "University" is ridden over rough shod by the "Academy for Young Gentlemen."

AN OXFORD MAN

### THE BASQUES

*Essai sur la Langue Basque.* Par F. Ribary. Traduit du Hongrois par J. Vinson. (Paris: F. Vieweg, 1877.)

*Basque Legends.* By W. Webster. (Griffith and Farren 1877.)

THE Etruscans perhaps excepted, there is no race that has had a greater attraction for the ethnologist and the student of language than the Basque. Defended by the mountain-fastnesses of the Pyrenees, with peculiar physiognomy, language, and manners, they seem to be the last waif and stray of a people and family of speech which have elsewhere disappeared. Whence did they come? and what is their kinship? are the two questions which have long been discussed warmly and to little purpose. Are we to regard them as the descendants of the ancient Iberi, and find their traces, with Wilhelm von Humboldt, in the local names of Spain, of Sicily, and of Southern Italy, or are we to bring them from Africa on the one side, or from America on the other, or finally let them drop from the clouds, or grow up spontaneously on their native soil? Certain it is that languages like Basque were spoken in the north of Spain under Roman rule; at least, the town called Gracchus, in honour of Tiberius Gracchus, is a genuine Basque compound of *viri* or *huri* "city," like Iria Flavia, "the Flavian burgh." Exclusive of emigrants in South America, the present Basque population amounts to about 800,000, of whom 660,000 are Spanish, and 140,000 French. Their language has little resemblance to any other known tongue, whether ancient or modern. Erro claimed for it the privilege of having been spoken in Paradise; and Larramendi proudly named his grammar (1729) "El Imposible Vencido"—"The Impossible Conquered." The native works upon the language, however, were all tainted with mysticism and want of scientific method, and it is only of late years that this interesting speech has been examined in the light of science and exact scholarship, and grammars composed which treat it in a rational way. Materials for the work have been prepared by the researches of Prince Lucien Bonaparte, who has accurately mapped out the several dialects of the language, and shown their individual characteristics and

peculiarities, and has actually discovered some fast-perishing dialects which had hitherto remained unknown. His magnificent work on the Basque verb has, it may be said, created the scientific philology of the language.

Basque, or Eskuara (probably meaning "mode of speaking"), as the Basques themselves call it, is an agglutinative tongue, postfixing, for the most part, the sounds which express the relations of grammar. The grammar would be simple were it not for the verb, at once the wonder of native writers and the despair of foreign linguists. The verb incorporates the pronouns, having a different form for "I have," "I have it," "I have it for you," &c., as well as (in some dialects) for addressing a woman, a man, a superior, and an equal. It possesses also three voices, two primary tenses, at least five moods, and more than one participle or infinitive. When analysed these forms turn out to be amalgamations of the verbal stem with various pronouns and modifying particles, but their origin is so obscured by phonetic decay, and their number is so immense, that we cannot much wonder if, according to the legend, the devil, having spent seven years at Burgos in the vain attempt to learn the language, was at last obliged to leave the Basques to their primitive simplicity and virtue. The eight principal dialects—Labourdin, Souletin, Eastern Bas-Navarra, Western Bas-Navarra, Northern Haut-Navarra, Southern Haut-Navarra, Guipuscoan, and Biscayan—differ a good deal from one another, and the three sub-dialects of Spanish Basque—Roncal, Aezcoan, and Salazarese, have yielded to Prince Bonaparte interesting archaic forms and words. It is unfortunate that our knowledge of Basque does not reach back further than 1545, when the first book in the language—the "Poems of Dechepare"—was printed, and a restoration of earlier grammatical forms must therefore rest solely upon a comparison of the existing dialects.

The grammar of the Hungarian professor, which M. Vinson has translated into French, is an extremely good one, and its value has been increased by the introduction he has prefixed to it, as well as by the notes he has added by way of supplement and correction, and by a very useful and almost exhaustive Basque bibliography he has appended at the end. These notes will form the subject of an article Prince Bonaparte is preparing for publication. Prof. Ribary's exposition of the intricacies of Basque grammar is singularly clear, and I know of no work from which the foreign student could gain a better insight into the machinery of the verb or a better key to its multitudinous forms. Certain of these are compared with corresponding forms in Magyar, Vogul, and Mordvinian, which, like the Basque, are able to incorporate the objective pronoun. The volume may be heartily recommended for both scientific and practical purposes.

While the Basque language has been attracting so much attention, the equally interesting and important folk-lore of the country has been almost wholly neglected. With the doubtful exception of Chaho, none of the Basque legends were "even noticed till within the last two years, when M. d'Abbadie read the legend of the Tartaro before the Société des Sciences et des Arts de Bayonne, and M. Cerquand his 'Légendes et Récits Populaires du Pays Basque,' before the sister society at Pau." Mr. Webster's book, therefore, is doubly welcome, inasmuch as it does of tales and legends written down

from the lips of the narrators, and literally translated into English with the co-operation of M. Vinson. Mr. Webster has divided the stories into (1) Legends of the Tartaro, (2) of the Heren-Suge, or Seven-headed Serpent, (3) animal tales, which are neither fables nor allegories, (4) legends of Basa-Jauna, Basa-Andre, and other Laminiak, or fairies, (5) tales of witchcraft, (6) Contes des Fées, and (7) religious legends. The Tartaro is a one-eyed Cyclops, and what is told about him will interest classical scholars. He lives in a cave among his flocks, and is blinded with a red-hot spit by the hero, who contrives to escape by the help of the unsuspecting sheep. In some versions the story of the talking ring is combined with that of the Cyclops, and in one form of the legend communicated to me by M. d'Abbadie, and alluded to by Mr. Webster, the hero is made to fight with a body without a soul. Grimm has quoted analogous stories to that of the Cyclops, among the Oghuzian Turks, Karelians, and others, and M. d'Abbadie heard an almost exactly similar one in Eastern Africa, while Mr. Moseley has pointed out to me that the Chinese also have their "one-eyed people who live to the east of Chuk Lung, and have one eye in the centre of the face." (See my "Principles of Comparative Philology," second edition, pp. 321-323, and for an account of a Mongolian Cyclops, Mr. Howorth, in the *Journal of the R.A.S.*, vii., 2 (1875), p. 232.) It is within the bounds of possibility that the Greek myth of the Cyclops may have been borrowed by the colonists in Sicily or the voyagers to Tartessus from some ancient Basque population. However this may be, the legends of the seven-headed serpent connect themselves very strikingly with Western Asia. Accadian mythology had much to tell of "a seven-headed serpent," the dragon of Chaos, which tempted man to sin and waged war with Merodach, the Chaldean Michael. The Indian Vritra has but three heads, like the Orthros, the Kerberos, the Ekhidna, and the Chimæra of the Greeks, but it is at least curious that Orthros, with his master Geryon, was localised at Cadiz in the later days of Greek mythology. Basa Jauna, again, "the wild man of the woods," with his wife Basa-Andre, though once represented as a kind of vampire, is usually described as a sort of Satyr, reminding us not only of the classical Pan, but of the far older Chaldean Hea-bani, the friend and councillor of the Babylonian Herakles. Basa-Andre, says Mr. Webster, "appears sometimes as a kind of mermaid, as a beautiful lady sitting in a cave and 'combing her locks with a comb of gold,' in remote mountain parts."

On the whole, however, there is very little that is native in these Basque legends, at least so far as their origin and texture are concerned. As Mr. Webster has noticed, the resemblance of many of them to the Keltic stories of the West Highlands is too minute to be the result of accident, while a large part of them is familiar to us in a French or even a German form. How the Basques could have borrowed Gaelic stories is at present not easy to explain; it is more probable, however, that this took place through maritime intercourse at a comparatively recent period than at some remote date when the ancestors of the Kelts and the Basques may be supposed to have lived in close proximity. The impression left upon the mind by the legends Mr. Webster has collected is that the Basques are neither imaginative nor original, and

this is borne out by what he tells us of their unreasoning "adherence to what they believe to be the text of these old tales. 'I don't understand it, but the history says so;' 'it is so;' 'the story says so;' was positively affirmed again and again." This conservatism accounts for the survival of so many pagan ideas and customs among the people, among which the legends themselves may be reckoned. The latter are believed like "the histories of the Bible, or the 'Lives of the Saints.' In fact, the problem of reconciling religion and science presents itself to the Basque mind in this strange guise—how to reconcile these narratives with those of the Bible and of the Church. The general solution is that they happened before the time of which the Bible speaks, or before Adam fell. They are *leçe zaharreko istorriak*—'histories of the ancient law'—by which is apparently meant the time before Christianity. 'This happened, sir, in the time when all animals and all things could speak,' was said again and again by the narrators at the commencement of their story;" a statement which curiously fits in with a similar belief among the Bushmen. Altogether Mr. Webster has produced a most interesting book, and we hope that the welcome given to it may induce him to make it but the first instalment of other researches among the folk lore of the Basques.

A. H. S. V. E.

#### OUR BOOK SHELF

*French Accent.* By A. H. Keane. (Asher and Co, 1877.)

THIS is an excellent and useful little pamphlet, in which the author claims to have discovered and formulated for the first time the laws which regulate French accentuation. Putting aside the tonic accent which usually falls on the last syllable of a word, and corresponds with the toned syllable of the Latin or Italic original, we have three accents: the acute, the grave, and the circumflex, which Mr. Keane terms respectively the euphonic, the grammatical, and the historical. The circumflex denotes the loss of a sound, as do also the acute when on initial *e*, and the grave when on final *e*. The grave is alone employed grammatically to indicate the grammatical changes of words, and Mr. Keane lays down the two rules that "e followed by grammatical *e* mute, one consonant intervening, takes the grave accent," and that "every unaccented *e* followed by one consonant not final is mute." Mr. Keane shows himself well acquainted with the latest philological researches into the French language, and both pupil and teacher will find great assistance from his attempt to introduce law and order into the nature and position of the French accents. However, he is not altogether the first in the field, and it must be remembered that the philological ignorance of those who have stereotyped the use of the accents has caused it to be somewhat arbitrary. The Neuschatel Bible of 1535 has no accents, and the first to employ them regularly, though somewhat capriciously, was Jacques Dubois, in the sixteenth century. In "An Introductory for to Learn French trewly," published by Du Guez, in London, probably about 1560, the accents are written below the line.

*Étude sur la Dégénérescence Physiologique des Peuples Civilisés.* Par M. Tschourloff. (Paris. Leroux, 1876.)

THIS is a careful and conscientious discussion of a class of statistics that have never been so carefully discussed before, and have in consequence been interpreted by different writers in very different senses. There are two

questions, both of which M. Tschourloff answers in the affirmative, but which perhaps he does not always separate as clearly as could be wished; the one is whether the French and other civilised nations are deteriorating in their *physique*, and the other whether their deterioration is due to the abstraction of able-bodied men to serve and perish in the army. He has no doubt as to the deterioration in France, Sweden, and Saxony; thus, in the latter country, the number of men too infirm to serve as conscripts has largely increased of late years; in 1832-36, one third of the men were rejected; in 1850-54, one-half. He quotes numerous medical authorities, whose opinions are printed in the article, "Recrutement," in the *Dictionnaire Médical*, to show the evil effects of industrial occupation on the health of factory workmen, and alludes to many other interesting facts of the same nature. But the bulk of the work is occupied in tracing the effects of the conscription on the French race. The statistical examination of the returns of the medical examiners is of a necessity very complex, allowances and corrections having to be made on many grounds. Even so apparently simple a problem as that of determining the amount of vigour abstracted from a population by the absence of a given fraction of them during a limited period, such as that of the great war, is in reality very complicated, and requires the free use of tables of mortality and of fecundity for different ages. The upshot of the author's inquiries is to show that the amount so abstracted is much greater than appears at first sight to be the case. He therefore ascribes a very seriously damaging effect to the vigour of a population by the carrying on of great wars. It is truly sad to read the statistical tables of the increase in France of a long series of such hereditary diseases as scrofula, hard lip, varicose veins, paralysis, madness, and skin maladies, due in large part to the propagation of the race by men who had been rejected as too infirm to serve in the army, and to so many of the healthy men having been destroyed or displaced. This treatise will become a standard work of reference, both in respect to its conclusions and to the statistical operations by which they have been attained.

F. G.

*The Northern Banner of India. A Popular Account of the Jummoo and Kashmir Territories.* By Frederic Drew. With Map and Illustrations. (London. Stanford, 1877.)

THIS is a popular edition of Mr. Drew's valuable work on Jummoo and Kashmir, noticed in NATURE, vol. xii. p. 550. That work was perhaps too formidable for the general reader to undertake, and Mr. Drew has therefore done well in selecting from it those parts likely to be of general interest. The selection has been judiciously made, and as the illustrations have been retained, and a map showing the races as well as the physical features, the work will be found of great value and interest by those who hesitate to undertake the larger volume. It deserves a wide circulation.

*The Two Americas: an Account of Sport and Travel.* By Major Sir Rose Lambert Price, Bart. With Illustrations. (London. Sampson Low, 1877.)

WE took up this book with little expectation of finding much in it either edifying or interesting, and have been most agreeably disappointed. The author, in one of Her Majesty's ships, touched at various places on the east and west coasts of South America, and although most of the ground has already been gone over, he has the faculty of seeing and describing the already known under new aspects. He also visited Mexico, California, and the Yosemite region. From beginning to end the narrative is thoroughly entertaining, and even those who are well read in American travel will find that Sir Rose Price is able to tell them much that is new.

LETTERS TO THE EDITOR

[The Editor does not hold himself responsible for opinions expressed by his correspondents. Neither can he undertake to return, or to correspond with the writers of, rejected manuscripts. No notice is taken of anonymous communications.]

Nebulous Star in the Pleiades

A SHORT paragraph in a recent number of NATURE (vol. xv., p. 244) on the nebulous star in the Pleiades appears to call for a few remarks. With reference to the supposed difficulty of seeing with very large instruments a faint nebulosity in close proximity to a bright star, I may say, that the words of my assistant, quoted in the paragraph referred to, viz., "The Merope nebula is never perceived with Lord Rosse's telescopes," are perhaps a little too strong.

The entries relative to this object are five in number. In February, 1871, "Examined under very favourable circumstances; no nebulosity seen." August, 1872, "Examined Merope for Tempel's nebula; not a trace of nebulosity visible." (Both the above with the 3-foot reflector.) October, 1872, "Tempel's variable nebula not found; sky clear." September, 1873, "Nothing seen; much false light in field." December, 1875, "Examined Merope in consequence of M. Tempel's letter (*Ast. Nach.*, No. 2,045); no nebulosity seen; only some little false light as around the other bright stars; sky very misty."

It may be expected *a priori* that imperfections of a certain class, such as dust and other opaque substances, will interfere more with the action of a speculum than of an object-glass in searching for faint nebulosity near a bright star, inasmuch as in the former they will throw back and disperse over the field light which would otherwise have contributed to form the image of the star; whereas in the latter they will cause a general darkening by intercepting a certain percentage of light from stars and sky alike. It may therefore still be possible that under peculiarly favourable atmospheric conditions, and with a speculum just repolished, we may still be able to detect the nebulosity, but it appears far more probable that we must look for an explanation of the difficulty of seeing the nebulosity to the comparative smallness of field of so large an instrument, which in general prevents the simultaneous comparison of the star under observation with neighbouring ones, and of a nebulous sky with an adjacent part free from nebulosity, so well as with a smaller telescope, and to the greater brilliancy of the image of the star while the nebulosity about it is only as bright as in the smaller telescope. From D'Arrest's remarks, quoted in NATURE, it appears that such objects are seen with much difficulty with a large refractor also. I have myself noticed, particularly in working with the six-foot reflector on the great nebula in Orion, that the fainter parts of the nebulosity, whether or not in the vicinity of bright stars, could best be seen with a finding eye-piece of 26' field, of too low magnifying power to utilise more than two-thirds of the diameter of the speculum, and with my eighteen-inch Newtonian, the very faint nebulosity on the preceding side of the nebula could be much better traced.

The absence of symmetry of the nebulosity round the star, as of that round  $\alpha$  Orionis, should, however, enable real nebulosity to be more easily distinguished from false light than in other cases. The more southern position of M. Tempel's observatory probably gave him some slight advantage.

It appears to be in the detection of minute stars and the examination of small details, where they exist, rather than in the search for faint diffused nebulosity, or nebulosity round stars that a large aperture gives so great an advantage. ROSSE

"The Movement of the Soil-cap"

UNDER the above heading Sir C. W. Thomson gives an interesting account of the "stone-rivers" of the Falkland Islands in a recent number of NATURE (vol. xv. p. 359), and attributes their origin to a general movement of the "soil-cap." Nothing can be clearer than his explanation of the mode in which the quartzites weather and break up on the hill-slopes, and one can quite understand how the resultant *débris* is gradually brought down into the valleys by the agents of change he refers to. But it is hard to see how these agents, after having got the *débris*

down into the valleys, can subsequently spread it out into wide sheets, reaching "from a few yards to a mile or so in width," and resembling at a distance glaciers that seem as if descending from the adjacent ridges. The stones, as Mr. Darwin tells us, "are not thrown together into irregular piles, but are spread out into level sheets or great streams." Sir C. W. Thomson is apparently of opinion that these great streams of stones move *en masse* down the valleys, as "earth-glaciers," and he refers to the occurrence in Scotland of certain phenomena which seem to him to indicate similar movements of the "soil-cap." Geologists who have worked much in hilly countries, will readily recognise the truth of his descriptions—indeed the appearances to which he calls attention are quite common in such districts as the Northern Highlands and Southern Uplands of Scotland. The soil and rock-rubbish which are found resting upon our hill-slopes, and the bending-over of the truncated ends of the underlying vertical or highly-inclined strata are of course the results of atmospheric action. Rain or thawing snow filters into joints and crevices, and insinuates itself between bedding-planes, and frost tends to force these apart—the loosened rock moving in the line of least resistance, that is, *down hill*. At the same time both solid rock and detached fragments "weather," and thus grit and soil gradually form, while in like manner this gradually-forming "soil-cap" being itself acted upon by frost, is forced in the same way to move down the slope, a movement which is of course aided by a *vis a tergo*, the weight of the descending mass. Partly in this way, and partly by the direct action of rain, which not only washes the particles down, carrying away surface after surface, but sometimes soaks the loose "soil-cap" to such a degree as to cause the entire accumulation to "flow," whole hill-sides become swathed in mantles of soil and *débris*. But it is difficult to believe that an experienced observer would be puzzled to discriminate between such rubbish-heaps and true glacial moraines. Arrived at the foot of the slope, the rock-rubbish accumulates there, unless there be some stream at hand to denude it, and to sweep its materials, in the form of gravel, sand, and mud, down the valley. There are many good grounds, however, for believing that much of that "surface-wash" of soil and rock-rubbish which cloaks our hill-slopes to a depth sometimes of many feet, dates back to a time when our climate was considerably colder than it is at present, and that, while it was accumulating, local glaciers occupied many of our mountain-valleys. Putting aside "screes" and *débris*-slopes generally, I must say I have never seen any indication of that movement *en masse* of the soil-cap upon which Sir Wyville insists; and I hardly think many geologists will agree with him that it is "almost self-evident that wherever there is a slope, be it ever so gentle, the soil-cap must be in motion, be the motion ever so slow; and that it is dragging over the surface of the rock beneath the blocks and boulders which may be embedded in it," &c. Soil, as we all know, is always travelling from higher to lower levels, but this movement consists for the most part in the mere sweeping downwards of its component particles by rain and surface-drainage. It is true that the expansive power of frost, and the action of vegetation as described by Sir Wyville, may force a certain proportion of a soil-cap *en masse* down a gentle slope, but these influences will affect only an inconsiderable stratum; and, besides, the movement thus caused will be so trifling that the mere surface-action of rain would suffice to carry away the whole soil, particle by particle, long before the power of frost could have moved it bodily more than an inch or two. In reading the accounts of the wonderful "streams of stones" in the Falkland Islands, one is strongly reminded of the great moving masses of *débris* in certain valleys of the Rocky Mountains, as described by Dr. Hayden, and to surmise that the stone-rivers of the Falkland Islands may possibly be of the same nature. Dr. Hayden tells us that entire valleys are "covered thickly with earth, filled with more or less worn rocks of every size, from that of a pea to several feet in diameter. The snow melting upon the crests of the mountains, saturates these superficial earths with water, and they slowly move down the gulch much like a glacier. This is another process of grinding the underlying rocks, smoothing, and grooving them." But he apparently finds no difficulty in distinguishing between such "earth-glaciers," and the moraines left by those gigantic ice-rivers, which, according to him, flowed down the valleys of the Rocky Mountains during the glacial period. Suppose now that owing to some change of climate these earth-glaciers were no longer to be saturated with water to such an extent as to cause them to flow *en masse*, it is evident that the loose soil of which they are partly composed

P.S.—Although the faint diffused nebulosity preceding the nebula in Orion can in general scarcely be detected by any gradations of light within the limits of the field, the general luminosity of the field increasing up to the nebula is strikingly apparent in the six-foot.

would then be gradually removed by the action of rain and running water, while the angular blocks and debris would remain for a very much longer time, until eventually they crumbled down and were carried away in the form of gravel, sand, and mud. As far as one can judge from descriptions, the "stone-rivers" of the Falkland Islands seem to present very much the appearance which such desiccated earth-glaciers might be expected to assume, after their finer materials have been abstracted. The possibility that considerable masses of loose materials, such as a "soil-cap," may have moved *en masse*, has before now attracted the attention of some observers. Mr. Robert Mallet contributed a paper on the subject a number of years ago to the Journal of the Dublin Geological Society (see vol. v.); and in the *Jahrbuch der k.k. geologischen Reichsanstalt*, vol. xxii. p. 309, will be found an article by Theodor Fuchs, treating of the same subject.

JAMES GEIKIE

Geol. Survey, Perth, N.B.

### Government Grants to Science

IN that part of the article in last week's NATURE on "Government Grants" which relates to the grant which has been for some years annually voted for pathological inquiries under the direction of Mr. Simon, a statement is made concerning myself, which I fear may convey a false impression as to the relation in which I stand to the Medical Department of the Privy Council.

Will you allow me to say that that relation is limited to the fact that the pathological investigations in question are conducted at the Brown Institution by my friend and colleague, Dr. Klein, who derives his commission directly from their lordships. I may take the opportunity of adding that the directors of the institution, of whom Mr. Simon is one, are as anxious as I am myself that its resources should be available, not only for this, but for all other purposes connected with the advancement of pathological science.

In former years, as your readers no doubt know, I have myself undertaken numerous investigations for the department, the last occasion occurring in 1875, but for some time past other and equally important duties have rendered this impossible.

March 5

J. BURDON-SANDERSON

### Tints and Polarisation of Moonlight in Eclipse

THE gradation of the coloured tints on the moon's surface during total eclipse was seen here most clearly last Tuesday. At the middle of the eclipse the surface seemed to be obscured by a dusky disc surrounded by a broad bright copper-coloured rim, of uniform width, following the outline of the moon's edge. Just before totality ceased the surface presented the appearance of a series of coloured crescents having the centres of their boundaries on the line joining the point where ordinary light would soon appear to the moon's centre.

The order of colour was bright sea-green at the edge, followed by a pale golden tint, then copper tints, deepening to a dusky red or peach-bloom.

The explanation of these effects of sunlight in its passage through the earth's atmosphere will be found in Herschel's *Astronomy*, §§ 421-4.

The sky generally was free from any but very transparent clouds, and the air keen and frosty with steady breeze.

Shortly before the middle of totality I examined the light from the moon's surface by means of a double image prism (made for solar eclipse work by Mr. Ladd) outside the eye-piece of a telescope with a  $\frac{3}{4}$  inch object-glass. On turning the prism round, with its front surface perpendicular to the axis of the telescope, the two images of the moon, in the parts where they did not overlap, appeared to brighten and darken alternately, interchanging intensities. The cycle was completed in course of revolution through  $180^\circ$ . This is conclusive as to the polarisation of the light received from the moon during total eclipse. I was unable to determine the character of the polarisation. There will be another total eclipse on August 23, for which I hope to be better prepared.

A. FREEMAN

St. John's College, Cambridge, March 1

### The Patenas or Grass Lands of the Mountain Region of Ceylon

EVERYONE who has travelled through the Central Province of Ceylon must have been struck by the occurrence, apparently

without sufficient cause, of tracts of grass-land varying from a few perches to hundreds, and sometimes thousands, of acres in extent, in the midst of otherwise interminable jungle. This land is exceedingly poor; almost without exception it is worthless to the coffee-planter for purposes of cultivation, and incapable of supporting any vegetation except its own acrid mana grass (*Andropogon schauinslandii*) and a few stunted specimens of *Coryza arbores* and *Embilica officinalis*. Yet on all sides of it will probably be found a rich forest vegetation that grows luxuriantly up to the very edge of the grass, where it terminates abruptly, without any dwarfed or stunted undergrowth on the border-line to show that the soil gradually changes from a fertile to a sterile character. Sir Emerson Tennant, in seeking for an explanation of this curious phenomenon, appears to have been completely baffled, for he suggests nothing beyond what is contained in a quotation from Humboldt in reference to the grassy plains of South America, where that great traveller speaks of the destructive custom of setting fire to the woods when the natives want to convert the soil into pasture. One reason, which seems to be quite conclusive against this explanation being applied to the grass-lands of Ceylon, is that cleared forest-land, however neglected and impoverished, does not run into grass such as is found on these Patenas, but into a dwarfish jungle called "chena," and then again, after a considerable period of time, into forest. Besides, it very frequently happens that these grass-lands are the very last pieces of ground that one would expect the natives to select out of the forest to bestow labour on in clearing and burning. Another and minor argument against this view is that the natives, whose traditions extend back for a considerable period of time, can give no account of the origin of Patena-lands, as no doubt they would be able to do if their ancestors and themselves were the cause of their existence. Other causes, therefore, than that of human agency must be sought for. One of these I believe I discovered during my residence in Ceylon, and I should be glad to learn whether any of the readers of NATURE have noticed the same in any part of the gneiss formation of Southern India, or indeed in any extensive gneiss formation within or without the Tropics. How far this particular cause operates in other instances than the one presently to be mentioned I am unable to say, but I am inclined to the belief that although it does not hold universally, it nevertheless holds pretty generally in the case of the larger patenas. It must be remembered that the mountain region of Ceylon is entirely a gneiss formation, very much dislocated during upheaval, and consisting at the present time of exceedingly deep valleys and precipitous mountain ranges. In this gneissic series occurs a band of half-formed quartzite several hundreds of feet in thickness, to which my attention was first attracted by noticing that below it, *i.e.*, where its debris accumulated, nothing but patena was to be found, whilst above, where the ordinary gneiss rocks were in a state of disintegration, the jungle and coffee was of a most luxuriant character. This band of quartzite stands out from the ordinary gneiss cliffs in the valley leading from Pussellawa to Ramboda, about twenty miles south of Kandy. It extends for about five miles in the form of a cliff, broken through here and there by ravines. Its upper surface, beginning at an elevation of 4,500 feet on the Helbodde coffee estate, dips under the main waterfall at Ramboda, and disappears under the ordinary gneiss at an elevation of about 3,000 feet above sea-level. This rock weathers very black, and is distinguishable at a distance of several miles from the ordinary gneiss above it and in its neighbourhood. It seems to disintegrate into little else than a quartz sand impregnated with iron and entirely incapable of supporting the usual forest vegetation with which the district, except in this particular spot, abounds. I have been informed that in the extensive patena district of Ouvah, which, roughly speaking, is a plain almost surrounded by mountains, a few miles south of the district just mentioned, and separated from it by the loftiest mass of mountains in the island, the same quartzite formation occurs, but not having had an opportunity of visiting and examining it, I am unable to say how far this information is to be relied on. When one remembers how very extensively the gneiss is broken up throughout the whole of this mountain region of the Kandyan province, it seems not improbable that other patenas, especially the larger ones, owe their origin to the cropping out of this quartzite band, although it is difficult, probably impossible in many cases, to determine that such is the case.

R. ABNEY

Oxford

**The Estimation of Urea by means of Hypobromite**

ALLOW me to correct a slight mistake into which your reporter has fallen, no doubt inadvertently.

Knop was the first to propose (in 1870) the use of a strongly alkaline solution of hypobromite for the estimation of urea in place of the hypochlorite previously employed by Davy. Every chemist who since 1870 has worked with the process has, as far as I am aware, retained the exact composition of Knop's hypobromite solution.

The modifications in details which I have proposed are therefore for the purpose of facilitating the working of Knop's process. This process is, I believe, the one best suited for general use. Certainly no other process as yet devised equals it in rapidity and ease of working, and few, if any, surpass it in accuracy. If, then, it should be deemed desirable to attach any names to this process, I would suggest that it be called the Knop-Davy process.

A DUIKÉ

Westminster Hospital, February 24

**Colinus Julia in Texas.—Venomous Snakes devouring each other**

IN Chapter xv of his "Geographical Distribution of Animals," Mr. Wallace mentions *Colinus* (belonging to the Nymphalidæ) as one of the South American forms, which do not pass north of Costa Rica or Nicaragua. I have taken, though only once during nine years, a female of *Colinus julia*, Hubner, here at Bastrop, on the Colorado, in about 30° N. latitude, but I believe this to be the first time where said species has been captured in temperate America.

I do not know whether the fact has been observed before, that one venomous snake will devour another belonging to even the same genus. Some time ago I captured, on the Guadalupe River, a large and very thick *Ancistrodon pu. naa* (Water Moccasin), one of the Crotalidæ, and upon opening it, found inside a large and quite well preserved specimen of *Ancistrodon contortrix* (Copperhead).

Although I have examined many venomous snakes since, I never found a similar case, and the stomachs contained only mice, frogs, &c.

I HERI BPODI

Bastrop, Texas, February 7

**Lowest Temperature**

THE temperature experienced during the night between February 28 and March 1 was so exceptional, that it may be thought worthy of a passing remark. The minimum reading at this observatory was 9° F., which is the lowest recorded during the last sixteen years; that of December 24, 1860, was, however, lower, being 6° 7". The lowest readings for February and March during the past twenty-eight years were respectively 10° on February 1, 1855, and 14° 5 on March 4, 1866.

Stonyhurst Observatory, March 2

S J PERKY

**Meteor**

I SAW the meteor described by Mr. Ingleby on February 26, about 6 20 P.M., Greenwich, from the railway platform at Gloucester. It was moving very slowly from right to left parallel with the horizon to the right of the moon, and a good deal below her, I should think two or three degrees at least. A bright track was left behind. The size must have been considerable for it was a very brilliant evening, and still almost daylight. No stars were visible in that part of the sky. I could not then see the position of Sirius, however. It was tolerably bright twenty minutes later. Gloucester is nearly due west of Ilford, and about 100 miles distant in a straight line.

Westbury-on-Severn, March 3

ALBERT J MOTR

**REPORT ON THE GOVERNMENT METEOROLOGICAL GRANT**

THE following is the Report to the Lords Commissioners of her Majesty's Treasury by the Committee appointed in November, 1875, to inquire into the conditions and mode of administration of the annual grant of 10,000*l.* in aid of meteorological observations. That Committee consisted of the following—Sir W. Stirling Maxwell, Chairman, Mr. T. Brassey, Mr. T. H. Farrer, Mr. Francis Galton, Mr. David Milne Home, Dr. J. D. Hooker, Mr. R. R. W. Lingee, C.B., and Lieut.-Gen.

Rd. Sirachey. We hope to make a few comments on the Report in our next number.

1. We have, in accordance with the Treasury Minute of November 2, 1875, made the inquiries therein mentioned. In doing so we have asked for the opinion of the President and Council of the Royal Society, who have favoured us with an elaborate report. We have also taken evidence from members and officers of the Committee which has hitherto administered the grant, and from many other persons whose opinions appeared to us to be important, either on account of their scientific eminence, their official position, or their practical knowledge and experience of the subjects in respect of which, and the classes to whom, meteorological knowledge is specially useful. To this report and evidence, which are contained in the Appendix to our Report, we desire to refer in support of the following conclusions—

2. The business of the Committee may be considered under two heads, viz—

- (1) The Meteorology of the Ocean
- (2) The Meteorology of the British Isles

And the business relating to the latter of these may again be subdivided as follows, viz—

- (a) That branch which by the use of the telegraph collects material for, and issues daily weather charts and storm warnings
- (b) That branch which collects, digests, and publishes meteorological statistics. This last branch depends on two sources of information, viz (1) on observations taken at a limited number of stations which are provided with self-recording instruments, and which furnish continuous observations, and (2) on observations taken by the eye at stated daily periods at more numerous intermediate stations.

3. All these divisions and sub-divisions of the business have produced results of value, and should be continued. For more specific information on these points we beg to refer to the evidence, and especially to the report of the President and Council of the Royal Society.

4. Ocean meteorology should, we think, be transferred to the Hydrographical Department of the Admiralty. The reasons for this are, first, that whilst this department is equally able with the present Committee to collect observations from merchant ships, it must be better able to collect similar observations from her Majesty's ships, and, secondly, that from its experience in chartography and in nautical wants, it is especially competent to put the results in a form useful to navigators.

5. In performing this new duty the Hydrographical Department should be in such relation with the office or department which manages land meteorology, as to insure that the observations taken at sea will be so made and digested as to be available for scientific purposes in connection with those made on land.

6. Every effort should be made to act in concert with other nations in ocean meteorology, so that labour may be economised, and the utmost possible use be made of all available materials.

7. In recommending the above transfer we assume that the orders of the Admiralty will be willing that the Hydrographical Department should undertake the duty; that that department will be organised and made in all respects adequate for the purpose; that the observations from merchant ships which have been hitherto successfully collected by the present Committee, and which are necessarily more numerous and more varied than any which can be obtained from the Royal Navy, will continue to be collected, and that the advancement of science, so far as the ocean is concerned, will be no less an object with the Hydrographical Department of the Admiralty than it has hitherto been with the present Committee.

8. As to land meteorology we have considered the alternative proposals of appointing one permanent head, as was the case before 1866, and of leaving matters to be managed by a Committee in the same manner in which they have since been managed. But we cannot recommend either of these proposals. As regards the first, although it may be desirable at some future time to create a permanent meteorological establishment on some such footing as that of the Astronomical Observatory at Greenwich, with an officer of scientific eminence at its head, we think that matters are scarcely ripe for such a step at present. As regards the second, it cannot be expected that the gentlemen who now constitute the Meteorological Committee, and who have by way of experiment given much valuable time to the work in its

initial stages, will continue to do so under the existing conditions.

9. We think, however, that the Royal Society should be invited to continue to recommend to the Government persons eminent in science to superintend the work, under the title of a Meteorological Council. They should be appointed for limited periods and should be eligible for re-appointment. They should be fewer in number than the present Committee, and the means should be provided of remunerating them in the shape of fees for attendance. They should have and exercise complete control and supervision over and be responsible for the business, expenditure, and staff, the chief officer of which would be more appropriately designated by the title of secretary than by his present title of director. The important duty of selecting a chairman, would rest with the Royal Society or with the members of the Council.

10. The present system of collecting daily information by telegraph and of issuing storm-warnings should continue. There is evidence that it is of real value to the seafaring population, and that it leads them to thought and observation on the subject of weather. The want of communication by telegraph on Sundays causes a serious defect in the system, which ought to be remedied.

11. An endeavour should be made to put into clear shape, and to issue, for public information, the maxims or principles upon which storm-warnings are in future to be given. This information should be revised from time to time so as to embody the latest results of experience.

12. The process of issuing daily weather-charts, with explanations, should continue, with such improvements as experience may from time to time suggest. The information thus given not only creates a general interest in the subject, but is of value to persons who are disposed to engage in the discussion of scientific meteorological problems.

13. A certain number of continuously self-recording stations should be retained. But it may deserve consideration by the Council whether some at any rate of the existing stations may not be discontinued, and others obtained on more eligible sites. Doubts have also been expressed whether in the present state of meteorological science the minute exactness of the observations now taken at these stations is of sufficient comparative value to justify the whole of the costs which they involve, when there are so many other objects of meteorological inquiry which call for increased expenditure.

14. The present system of supplementing self-recording observations by returns from eye-observers at intermediate stations should be continued. The positions of these latter stations should, however, be revised, and their number increased, especially in Ireland (where at present there are but few of them); so that the returns may exhibit a fair representation of the different climates and weather of the British Isles. Every possible endeavour should be made to secure the co-operation and assist the efforts of the different societies or other local bodies engaged in meteorology, and to further the adoption of uniform methods.

15. The evidence of the Astronomer-Royal and of other scientific witnesses contains some important observations on the form and extent in and to which the results of the observations should be published. This is a subject which deserves the careful attention of the Council with a view to saving all unnecessary expense on the one hand, and on the other to publishing the results in such a form as may render them most available for use by men of science.

16. There is evidence to show that the system adopted in the United States by which observations are taken over the large area of the North American continent and are communicated by telegraph to Washington, is of great value both for the immediate practical purposes of agriculture and navigation, and also as throwing light on the general movement of the atmosphere. The position and extent of the United Kingdom do not admit of any similar system of equal value. But it is desirable in the general interests of science as well as for practical purposes, that by means of co-operation between the different European nations synchronous observations should be made throughout Europe and the adjacent seas, so as to afford all possible facilities for synoptic charts of the weather in Europe. To this end this country should give all the help it can.

17. There is important evidence that the science of meteorology at the present moment stands in need of hypothesis and discussion at least as much as, if not more than, of observation. It is not easy to lay down any rule concerning the method by

which such investigations may be promoted. But we think that the Council should be at liberty to appropriate a part of their annual grant to the purposes of any special researches which they may think important, and in such cases it should rest with them to select the investigators, and fix the remuneration.

18. There is evidence of a connection between weather and health; but it does not appear that any special meteorological observations are wanted at present, or are likely to be wanted in future for this special purpose, other than the observations, which, under the scheme we have recommended, the Council should collect for general purposes.

19. Again, the importance of meteorological data to the agriculturist and dealer in agricultural produce is clearly established. But neither do their requirements demand other observations than should be included in the general returns and information obtained by the Meteorological Council.

20. As regards the forms in which the information thus collected can be made most available for sanitary and agricultural purposes, it appears desirable that the Meteorological Council should place themselves from time to time in communication with the Registrars General, and with such bodies as the Medical Council, and the Agricultural Societies of the United Kingdom.

21. The expense of the scheme we have suggested may be estimated as follows:—

The following return has been prepared by members of our Committee who are also members of the Meteorological Committee of the approximate present cost of the Meteorological Office:—

Director's office and general control	£ 2,500
Ocean meteorology, excluding supply of instruments	1,500
Land meteorology including self-recording observations and supply of instruments	3,500
Telegraphy and storm-warnings	2,500
Total	£10,000

The modifications that have been proposed would lead to certain additions to the necessary outlay, among which may be specified—

Remuneration of Council, say	£ 1,000
Special scientific researches	1,000
Extension of telegraphy on Sundays	500
New land stations	1,500
Inspection of stations	500
Total	£4,500
Deduct for ocean meteorology transferred to Admiralty	1,500
Net increase	£3,000

This sum being added to the present grant of 10,000*l.* would bring the whole sum to be placed at the disposal of the Council up to 13,000*l.* yearly. Assuming the expense of ocean meteorology transferred to the Admiralty to remain under the new arrangement at its old figure, 1,500*l.* the whole additional annual burden on the National Exchequer proposed in the above suggestions is 4,500*l.* or 14,500*l.*, instead of the existing grant of 10,000*l.*

22. With reference to the Scottish Meteorological Society, the representations of which have been specially referred for our consideration, we desire to offer the following remarks:—

It seems essential that any grant of public money for the purposes that have been indicated in our recommendations, should be applied under the immediate responsibility of the Council, and that no expenditure should be incurred which those purposes do not absolutely require. There is evidence to show that a large and trustworthy amount of co-operation may be obtained in all parts of the United Kingdom, from observers who do not require remuneration for their service, and it seems very important that such co-operation should be fostered to the utmost. Any system of payment for meteorological registers which was not very strictly limited, would necessarily involve the concession of payments to all observers, and might entail a very large outlay which has hitherto been avoided, and which there is reason to believe is not at present really called for.

We are of opinion, therefore, that only such payments should be made from the grant placed at the disposal of the Meteorological

\* See paragraph 16 of this Report.



logical Council to the Scottish Meteorological Society, as are necessary for obtaining observations at stations required for the purposes of the Council; for securing the proper inspection of stations the registers from which are required for the general purposes of the Council; for the needful compilation and check of such registers; and for meeting other charges directly arising from these services; or for special researches conducted by the Society with the approval of the Council; but that no grants should be made to ordinary observers, nor for any general purposes of the society which lie beyond the scope of the operations to be placed under the Council.

23 We think that the same principle should be applied to all similar local bodies interested in the study of Meteorology, so that, in fact, no payments should be made to them except for results sought for by the Council.

24. We have indicated above in very general terms the functions of the proposed Council, and we do not think it desirable to fetter their discretion by further details. We append, however, to this report a paper by a member of the present Committee of the Royal Society, who is also a member of our Committee, stating what, according to present experience, are, in his opinion, likely to be their duties.

25 The later stages of the inquiry in relation to the transfer of oceanic meteorology to the Admiralty have raised some serious questions of expense, which the Government will, doubtless, require time to consider. We think it only just to the Committee which has heretofore had the administration of the annual grant to report our opinion that very good and valuable work is being done by it, and that if funds were provided to admit of the more responsible and more extended action of the Council, as suggested in paragraphs 9 and 22 of our Report, and if, at least provisionally, some assistance were given to the Scotch Meteorological Society, the more immediate objects referred to our Committee would be met, and there need be no interruption of the Committee's operations pending the delay, if any, which may occur, whilst the feasibility of transferring oceanic meteorology to the Admiralty is being maturely considered by her Majesty's Government.

It is important in connection with this part of the subject to bear in mind the strong claims which the Superintendent and other members of the existing staff have to continued employment.

26. In recommending the above changes we feel bound to express our sense of the great value of the disinterested services which, at the cost of much time and labour have been rendered during so many years by the Committee appointed by the Royal Society.

27 We are aware that what we are proposing is still tentative only, and we recommend, in conclusion, that there shall be a further inquiry and report at the end of (say) five years.

### RESEARCHES ON THE SPECTRA OF METALLOIDS<sup>1</sup>

THIS paper was published by Mr. Thalen after Mr. Angstrom's death. Mr. Thalen states, in the introduction, that only the first sheet was printed during Mr. Angstrom's life, who in the remainder would have liked to alter some passages and add others. Yet we take it that such alterations only would have referred to matters of detail, and that as far as the general conclusions are concerned the paper represents fairly Mr. Angstrom's opinion on the important questions discussed therein. Mr. Thalen has made the measurements, while the experiments were made by him in conjunction with Mr. Angstrom.

After a few historical remarks the authors give the following judgment on the question of double spectra—

"We are far from denying that the lines of an incandescent gas may come out in greater number as the temperature, or perhaps only the quantity of radiating matter increases, or that some rays may increase much quicker than others in intensity. But it is certain that the assertion of various physicists that the lines originally seen may disappear altogether, and that in this way the spectrum may change completely in appearance is as unlikely from a theoretical point of view as it is contrary to experience. If such properties were real all spectroscopic researches would be rendered impossible as each element could play as far as its spectrum is concerned the parts of a Proteus.

"We do not deny that an elementary body may in certain cases give different spectra. The absorption spectrum of iodine, for instance, is quite different from its emission spectrum obtained by means of the electric spark. All bodies existing in different allotropic states will give different spectra corresponding to these different allotropic states provided that the allotropic states still exist at the temperature of incandescence.

"Oxygen, for instance, would present two different absorption spectra, one belonging to oxygen the other to ozone. But as ozone is destroyed at a high temperature, only one spectrum of incandescent oxygen can exist.

"Sulphur in the solid state exists in different allotropic states, and some observations lead us to believe that even as a gas it may exist in different states. Supposing this to be true, sulphur will give us several absorption spectra, while the possibility of a single or several emission spectra depends on the question whether the more complicated allotropic states support the temperature of incandescence.

"It is evident that the above cases do not form an exception to the general law which we have given, that an elementary body can only give one spectrum. In fact, if we suppose that the allotropic state is due to molecular constitution, it will possess from a spectroscopic point of view, all properties of a compound body, and in consequence it will be decomposed in the same manner by the disruptive discharge of electricity."

The paper then goes on to discuss the difference which is noticed in the electric spark, between the aureole and the spark itself. Messrs. Angstrom and Thalen sum up what they have said on the subject in the following words—

1 There are two kinds of electric discharge, one of tension, which takes place by explosion, or disruptively, the other of quantity, which takes place by conduction, or continuously.

2 By the disruptive discharge which always takes place when the tension is sufficiently great, the body is, as a rule, torn into its smallest particles, and thus decomposed into its elements if the body is compound. The phenomenon of incandescence which accompanies both the mechanical disruption and chemical decomposition, cannot be considered as a consequence of the augmentation of temperature, but we ought rather to say that the high temperature is an effect of the mechanical and chemical force which disintegrated the body. In addition to the decomposition produced directly by the disruptive discharge, we may have chemical actions, which are, however, of a secondary nature.

3 When the electricity is conducted by conduction we must distinguish between two actions. We have actions which are entirely due to heat, and which belong to the conductors themselves. They increase with the square of the intensity of the current. We have, secondly, actions which make themselves perceptible at the surface of bodies, and which are proportional to the intensity of the current. These latter actions are confined in elementary bodies to a variation in temperature, but if the body is compound they may consist in chemical effects, which we call electrolytic actions. These two phenomena, the Peltier effect and the phenomenon of electrolysis, must be considered as different manifestations of the same force, one or other of the actions takes place according as the body is simple or compound.

These laws, which are demonstrated to hold for solid and liquid bodies, must also be applied to gaseous bodies, where we must therefore expect electrolytic actions as well as chemical ones of a secondary nature.

Our authors then go on to discuss the spectra of carbon and their compounds. They begin again with a historical statement of the work done in this respect, and as this part of the paper does not contain anything new to those who are interested in the matter we pass to the question which they propose to solve: "How are we to explain all these different spectra of carbon compounds?" They draw attention to the fact that all these spectra have a common characteristic, as they consist of bands which can be resolved into fine lines. There is, however, one spectrum which must be attributed to carbon, while the authors attribute all other spectra to carbon compounds. This spectrum is a line spectrum. It is obtained from carbon poles by means of a powerful jar.<sup>1</sup>

If we allow a spark to pass between carbon electrodes, the lines are not seen in the middle of the field, but only close to the poles similar to the metallic lines. If the discharge pass through some carbon compound, one obtains not only these carbon lines, but also those of oxygen, hydrogen, or nitrogen, that

<sup>1</sup> Abstract from a paper in the "Nova Acta Regiæ Societatis Scientiarum Upsalensis," vol. ix., 1875, by A. J. Angstrom and F. R. Thalen.

<sup>2</sup> It is the apparatus marked by Watts No. IV.—4 S.

is, all lines belonging to the elements entering into the carbon compound.

Round the electrodes of carbon we observe during the disruptive discharge an aureole, which indicates a continuous discharge. The spectrum of the aureole depends on the nature of the medium in which the discharge passes; in nitrogen we find the blue and violet groups which characterise cyanogen; in hydrogen it is the spectrum of the hydrocarbons<sup>1</sup> which we observe; in oxygen we get the spectrum which a Geissler tube, filled with carbonic oxide, shows.

The shaded bands of cyanogen which are situated in the blue and violet part of the spectrum, are also seen if the spark passes the luminous part of a gas flame, or in the voltaic arc between the carbon electrodes of a powerful battery. In the spectrum of the voltaic arc, however, the brilliant lines of cyanogen are mixed with those of hydrocarbons, the splendour of which is still more magnificent.

After these observations we may consider it to be a demonstrated fact that the aureole gives respectively the spectra of cyanogen, hydrocarbon, oxide of carbon, or carbonic acid, according as the gas which surrounds the electrodes consists of nitrogen, hydrogen, or oxygen. The most natural supposition is, therefore, that the spectra belong really to the compound bodies, which is the more probable as the general appearance of these spectra suggests at once an origin of compound bodies rather than of elementary bodies.

It is well known that carbonic acid is decomposed by the electric current, and that the spectrum which is observed belongs exclusively to carbonic oxide, which is formed. One might therefore imagine that carbonic acid would not have any spectrum of its own. If, however, carbonic acid is formed, as, for instance, while cyanogen burns, it appears probable that lines belonging to carbonic acid can appear, and this opinion has been confirmed by an observation of Plücker. He has found that the shaded red bands of cyanogen burning in air or in oxygen become stronger and wider as the combustion becomes stronger. An experiment made by us with a spark passing in cyanogen gas, circulating in a glass tube and freed therefrom by degrees of every trace of oxygen, has taught us that these red bands only extended to the first band of hydrocarbon, and even vanished during some instants of the experiment. The probable cause of the appearance of the spectrum of hydrocarbon in this case must be looked for in the impossibility of drying the gas completely, if it is prepared with cyanide of mercury.

It seems to us that it is much more difficult to explain the appearance of the spectrum of hydrocarbons in the combustion of any compound of carbon and hydrogen, and also, according to Mr. Attfield, in the flame of carbon disulphide. Though this spectrum was considered by some observers to be due to carbon, we cannot accept this view, and for this reason: If we employ a condenser the spectrum of coal gas shows not only the spectrum in question, but also the lines of carbon and hydrogen. The appearance of the shaded bands, being similar to those of cyanogen, shows at once, as we have repeatedly said, that the body is compound.

The difficulty, it seems to us, must in great part disappear if we could show that the same chemical compound is always formed in the combustion of any hydrocarbon. M. Berthelot has shown this to be true. According to him acetylene is formed whenever an incomplete combustion of any hydrocarbon, ether, &c., takes place, and even if the electric spark passes between carbon electrodes in hydrogen gas. It is therefore very probable that the spectrum which is formed for all carbon compounds is due to acetylene.

As far as the observation of Mr. Attfield is concerned, that oxide of carbon gives the ordinary spectrum of the hydrocarbons, we must observe that this does not agree with our own experiments. In a Geissler's tube, containing carbonic acid or carbonic oxide, one can certainly find traces of the spectrum of hydrocarbon, as the gas is never altogether dry, but according to Plücker's observation, the particular spectrum of oxide of carbon has no resemblance to it.

To the left of the Fraunhofer line G one sees generally a very strong line which really belongs to carbon. We find here the same thing which we have mentioned speaking of the spectra of the metallic oxides, that often the spectrum of the oxide is mixed with some of the lines of the elementary body.

As a second example Messrs. Angstrom and Thalen take the

<sup>1</sup> Messrs. Angstrom and Thalen call Swan's spectrum of the candle the spectrum of hydrocarbons.

spectrum of nitrogen. The so-called line spectrum of nitrogen was first observed by Angstrom, while v. d. Willigen observed a different spectrum seen in the aureole when the discharge takes place in air. The two spectra which Plücker observed were therefore not new, though he gave a new way of obtaining them. The following is a translation of the author's remarks on the origin of the two spectra:—

As to the interpretation of these two spectra we think that they only depend on the way in which the electric discharge takes place, and belong to two different bodies. The spectrum of lines caused by the disruptive discharge must be attributed to nitrogen as it appears in Geissler's tubes under the same circumstances, which accompany the disruptive discharge, but the shaded bands belong doubtless to some combination of nitrogen formed by the discharge of quantity or by conduction.

In the aureole at the positive pole we find a great number of shaded bands in which we distinguish two different series, one situated in the least refrangible part of the spectrum, and another in the green, blue, and violet parts. The appearance of these two series is different and gives rise to the suspicion that they belong to two different bodies. Whether this be true or not it is certain that their intensity varies much according to circumstances and in different ways.

At the negative pole we observe a bluish violet sheet the spectrum of which, situated in the green, blue, and violet, does not change with the nature of the electrodes.

In Geissler's tubes, containing rarefied nitrogen, we find for the continuous discharge the same spectra as in the aureoles in the atmosphere. But the positive light, which is very intense, is not only seen near the pole but also in the capillary parts of the tube. At the negative pole the bluish violet sheet gets larger and more brilliant as the exhaustion proceeds.

We now ask which combinations of nitrogen can cause the spectra of the continuous discharge? As far as the negative light is concerned we are in complete ignorance on the subject. As to the gas which is found at the positive pole one can prove by means of a solution of sulphate of iron that nitrogen dioxide is formed. It is well known that the electric spark passing through air produces the red fumes which indicate the existence of nitrous acid. It follows that nitrogen combines under these circumstances with oxygen. The only question therefore is, where does the oxygen come from in a tube filled with nitrogen? We must remember that in making nitrogen we can never entirely get rid of air, or at least there will always be a trace of aqueous vapour present, as is shown by the hydrogen line C. This fact sufficiently explains the possibility of the presence of a compound of nitrogen and oxygen. As the luminous spectrum bears no resemblance to the absorption spectrum of nitrous acid fumes, we conclude that the dioxide of nitrogen causes the shaded bands at the positive pole or in the aureole, and in the capillary part of Geissler's tube containing nitrogen. Several experiments are mentioned which have been made by the authors. Those on the spectrum of carbon run as follows:—

1. Spark between carbon electrodes in oxygen with condenser. The lines of oxygen and carbon are seen.
2. Spark between platinum electrodes, 35 mm., apart in a current of carbonic acid. Two jars used as condenser. The revolving mirror showed that the spark was instantaneous. The lines of platinum, carbon, and oxygen, were seen.
3. Same as 2. Distance of electrodes 5 mm. The aureole gave the spectrum of carbonic acid.
4. Spark between aluminium electrodes 10 mm. apart, in a current of coal gas. The lines of hydrogen, carbon, and the bands of carburetted hydrogen are seen.
5. Spark without condenser in a current of cyanogen. The lines of hydrogen, nitrogen were seen, besides the bands of carburetted hydrogen, and some bands of cyanogen.

The experiments on the spectrum of nitrogen have been made with atmospheric air. A solution of sulphate iron was used to show the presence of dioxide of nitrogen. The appearance of Geissler's tubes at various pressures are given.

Exact measurements of all the spectra discussed in the paper are given, not only for the more intense lines or bands, but exact micrometer measurements of some of the band. The names of the authors are a sufficient guarantee of the accuracy of these measurements. Excellent plates with drawings of the spectra are added. A copy of the measurements will be found in the first number of the *Bibliothèque de Physique et de Chimie*.

SIR WILLIAM THOMSON ON NAVIGATION<sup>1</sup>

POPULAR lectures rarely contain much that deserves repetition or notice in a review. But when the lecturer is Sir William Thomson and his subject navigation, we may be sure that we shall hear something that we have not heard before, and that we should hear, if we wish to keep abreast of the advance of nautical science. When a reformer contents himself with merely making suggestions and leaving it to others to test them, his work is comparatively easy and its results are proportionally valueless. The suggestions of Sir W. Thomson have the very special merit that they are submitted to a practical test before he gives them utterance, and after he has done so he is far from considering his connection with them over. Every part of every crude idea or novel appliance is submitted to a searching process of natural selection which must cost the author as much labour as to watch it gives the onlooker pleasure, and those who see only the final survival of the fittest cannot form anything like a just conception of the time and pains which have been bestowed on the rejection of the less fit.

We cannot here find space to notice those parts of the lecture which are the reproduction of old and received truths, interesting though these are by virtue of their skillful dressing. We must pass on at once to mention one or two points which are either in themselves new, or which have as yet failed to secure the recognition they deserve.

The first important novelty we come to is the discovery by Mr. Hartnup, astronomer to the Harbour Board of Liverpool, of a system of rating chronometers, which gives an almost perfect means of compensating for change of rate due to change of temperature. It had long been known that no compensation balance could be made to keep time correctly through wide ranges of temperature:—

"Thus the best chronometers of the best makers in modern times are practically perfect only within a range of 5° or 10° Fahrenheit on each side of a certain temperature, infinitely near to which the compensation is perfect in the individual chronometer.

"The temperature for which the compensation is perfect, and the amount of deviation from perfection at temperatures differing from it are different in different chronometers. Mr. Hartnup finds that at the temperature for which the compensation is perfect, the chronometer goes faster than at any other temperature, and that the rate at any other temperature is calculated with marvellous accuracy (if the chronometer be a good one) by subtracting from the rate at that critical temperature the number obtained by multiplying the square of the difference of temperature by a certain constant coefficient."

Two chronometers recently carried from Liverpool to Calcutta, when rated on Mr. Hartnup's plan, gave a mean error of six seconds, while by the ordinary method the reckonings of Greenwich time from them differed by 4 minutes 35 seconds. The navigator could easily secure the advantages of Mr. Hartnup's system by noticing the temperature of his chronometer-case daily, and entering a few figures in a note-book. His work would be much facilitated if the thermometer used were graduated to squares of numbers of degrees from the temperature of maximum rate.

The lecturer discusses at considerable length various modifications of the pressure-log, the invention of Mr. J. R. Napier and Mr. Berthon, the principle of which is to measure the speed of the ship by observing to what height a column of water rises in a vertical tube, the

bottom end of which dips into the sea and faces forwards. It shows the ship's velocity through the water at any instant, instead, like all other logs, of telling the distance run during a known length of time. The latter piece of information is what is chiefly wanted for the purposes of ordinary navigation, but the former could not fail to be of immense use in the navy when ships are sailing in squadron. Even now, a rough approximation to a knowledge of velocity is got in the navy by the use of indicators showing the number of revolutions per minute made by the screw, and these satisfy very imperfectly the requirements of the case, as appears from the evidence given at the court martial on the loss of the *Vanguard*. The Admiral signalled to the squadron that his ship was about to go at thirty-three revolutions, which he afterwards explained to mean that he desired the squadron to go as nearly as possible at a speed of seven knots. Had each of the ships been provided with a pressure log, he might at once have given an order of whose meaning there could have been no possible doubt, and which it would have been perfectly easy for every ship to obey.

The taking of soundings to determine the depth is one of the most important of nautical operations. In surveys of the ocean's bed and for guidance in cable laying, soundings have to be made in great depths, often of several thousand fathoms. The trouble and time involved in taking a deep-sea sounding have been greatly reduced by Sir W. Thomson by the substitution of a single steel pianoforte wire for the hemp rope formerly used as a sounding line. The advantage of the wire is the comparatively small resistance it meets with in passing through the water. When hemp rope is used for sounding in deep water a weight of three or four hundred pounds must be attached to it, and even then it descends very slowly. When it reaches the bottom the weight is detached by a trigger and is therefore lost. When wire is used a weight of about thirty pounds suffices; it descends very much more rapidly, and there is nothing to prevent its recovery each time. For very small depths such as are met with in the immediate neighbourhood of land, the hand lead is convenient and sufficient, but there is a third class of soundings, those which are (or should be) made in depths of about twenty fathoms and upwards when a ship is approaching land. To be able to take "flying" soundings—that is, to find the depth without stopping the ship—in any depth from 20 to 150 fathoms, is a matter of the greatest possible importance in ordinary navigation. Sir W. Thomson has succeeded in making it easy to do this, by the aid of his pianoforte wire in combination with another apparatus which he described at the recent meeting of the British Association. This consists of a pressure gauge of very simple construction, which is attached close to the end of the sounding-line, and which, by registering the maximum pressure to which it has been subjected during immersion, registers the maximum depth it has attained. This indication is of course quite independent of the length of wire out, and is not affected by the fact that the ship is in motion. The pressure gauge consists of a small glass tube, of about  $\frac{1}{16}$  inch bore, open at the lower end, but closed at the top. As this descends, the water rises in the tube compressing the column of air. In order that a permanent record may be left of the maximum height to which the water rises, the interior of the tube is coated along its whole length with starch, in which red prussiate of potash has been dissolved, and just at the mouth of the tube are placed a few crystals of sulphate of iron, which are held in position by an outer guard tube. The water which rises in the tube carries with it a little sulphate of iron in solution, and so leaves a permanent record of its height by staining the tube with Prussian blue. The system of sounding by wire has now had abundant trial, and its success is thoroughly established. Its author was, no doubt, quite within the

<sup>1</sup> Navigation. A Lecture delivered under the auspices of the Glasgow Science Lectures Association. By Sir William Thomson, D.C.L., LL.D., F.R.S., Professor of Natural Philosophy in the University of Glasgow, and Fellow of St. Peter's College, Cambridge. (London and Glasgow; William Collins, Sons, and Company, 1876.)

limits of safe prophecy when he declared to the British Association in Glasgow that the old system of deep-sea sounding by hemp rope had done its last work on board the *Challenger*.

In proceeding to speak of astronomical navigation the author begins by giving a series of definitions which differ from those commonly given, by being based on no assumption as to the figure of the earth, so that they "designate in each case the thing found when the element in question is determined by actual observation." Thus the latitude of a place is defined as the altitude there of the celestial pole. After a flying shot at the British Statute mile, whose existence "is an evil of not inconsiderable moment to the British nation," he goes on to describe the various means of deducing a ship's place from observations of the heavenly bodies, giving the place of honour to Sumner's method, of the merits of which we had recent occasion to speak (*NATURE*, vol. xiv. p. 346).

To communicate information from ship to ship by signals is an object of first importance to the sailor. By day, in clear weather and with skilful men, the system of flag and semaphore signals at present in use in the navy is very complete and effective. By night, in clear weather, Capt. Colomb's method of flashing signals has been successfully used in the British navy for nearly twenty years, but its adoption has not been nearly so general as properly to meet the requirements of the case. On this point Sir W. Thomson says:—

"The essential characteristic of Capt. Colomb's method, on which its great success has depended, consists in the adoption of the Morse system of telegraphing by rapid succession of shorts and longs, 'dots' and 'dashes,' as they are called; and, I believe, its success would have been still greater, certainly its practice would have been by the present time much more familiar to every officer and man in the service than it is now, had not only the general principle of the Morse system but the actual Morse alphabet for letters and numerals been adopted by Capt. Colomb. A modification of Capt. Colomb's system, which many practical trials has convinced me is a great improvement, consists in the substitution of short and long eclipses for short and long flashes. In the system of short and long eclipses, the signal lamp is allowed to show its light uninterruptedly until the signal commences. Then groups of long and short eclipses are produced by a movable screen, worked by the sender of the message, and read off as letters, numerals, or code signals by the receiver or receivers. . . . Whenever the light of a lamp suffices, the eclipse method is decidedly surer, particularly at quick speeds of working, than the flash method, and it has besides the great advantage of showing the receivers exactly where to look for the signals when they come, by keeping the signal lamp always in view in the intervals between signals, instead of keeping it eclipsed in the intervals as in Colomb's method."

Is it too much to hope that before very long a knowledge of the Morse alphabet may form part of the elementary education of every boy and girl in the kingdom? Only then can the public be awakened to a sense of the many uses to which such a knowledge could be put.

But there is a third set of conditions where signalling is more necessary as well as more difficult than in either of the other two. In fogs, by day or night, visible signals have to be given up as useless, and audible ones take their place. We may utilise Colomb's code or the Morse alphabet by giving short and long blasts on a steam whistle or fog-horn.

"But here again a very great improvement is to be made. Use instead of the distinction between short and long the distinction between sounds of two different pitches, the higher for the 'dot,' the lower for the 'dash.' Whether in the steam whistle or the fog-horn a very sharp limitation of the duration of the signal is scarcely

attainable. There is, in fact, an indecision in the beginning and end of the sound, which renders *quick and sure* Morse signalling by longs and shorts impracticable, and entails a painful slowness, and a want of perfect sureness, especially when the sound is barely audible. Two fog-horns or two steam-whistles, tuned to two different notes, or when the distance is not too great, two notes of a bugle or cornet may be used to telegraph words and sentences with admirable smartness and sureness. Five words a minute are easily attainable. This method has the great advantage that, if the sounds can be heard at all, the distinction between the higher and the lower, or, as we may say for brevity, 'acute' and 'grave,' is unmistakable: whereas the distinction between long and short blasts is lost, or becomes uncertain, long before the sound is inaudible."

To produce powerful blasts of sound differing from each other in pitch the Americans have devised an instrument which is much more effective than the fog-horn or steam-whistle. By the irony of fate sirens are now enlisted in the service of humanity, and no longer lure sailors to destruction. The reform in their morals, however, has been fatal to their romantic charm, for now they are "driven at a uniform rate by clockwork, and the blast is supplied from a steam boiler." But is the change to be regretted when we hear that:—

"Short and long blasts of the siren might be advantageously substituted for short and long blasts of the steam whistle, but *much more advantageously* short blasts of two sirens on the same shaft, or on two shafts geared together, sounding different notes, acute note for the short, grave note for the long. The rapidity and the ready distinctiveness of character of the two notes will then be such that every officer and man will habitually recognise evolutions signals and signals for course and speed, just as in skirmishing every officer and private knows the bugle calls; and the signal-book will be no more needed on the bridge of a ship of war than on the saddle of a field officer. When the admiral desires to alter speed or course for the fleet, his order will be given to the whole fleet simultaneously, and very nearly as fast as he can speak it to his flag captain, and then instantly (without waiting to open signal-books) the other ships will, one after another in order, each in replying give the 'understand,' repeat the numbers expressing course and speed, and make her pennant. In as many quarter-minutes as there are ships under his command, the order will have been thus securely acknowledged by every one of them, and the admiral will sound his signal announcing that the order commences to take effect. Nothing short of this in quickness and sureness of ordering the movements of a fleet ought for a moment to be thought of as tolerable, when it is certain (as it assuredly is) that so much is readily attainable."

We have quoted this part of the *waure* at considerable length, for we have a strong conviction of its high practical value. The collision between the *Monarch* and the *Raleigh* in Besika Bay, which has happened since the lecture was published, serves to point Sir S. Peabody's moral. We are told that when the squadron, in three lines steadingly about five knots an hour, a signal was made to alter course, which "from some unexplained cause" was misunderstood by two of the ships—the *Triumph* and the *Invincible*. This brought the latter across the bows of the *Ma* the which then stopped and reversed engines, but the *Ma* the eastern of the *Monarch*, kept on her course, the *W* being a collision, which was fortunately much less in its consequences than the costly *Vanguard* experiment, of which this one did fair to be a repetition. That the signal was misunderstood, not by all the ships, and yet by two of them, seems to prove that much blame cannot be attached either to those who made it, or to those who read it; it is, in fact, the system that is at fault.

## TYCHO BRAHÉ

BY the kindness of Dr. Crompton, of Manchester, we are able to publish this week a copy from a photograph of what there is every reason to believe is a contemporary portrait of the great Danish astronomer, Tycho Brahé. This picture is on canvas, and is 3 feet  $3\frac{1}{2}$  inches high, and 2 feet  $6\frac{1}{2}$  inches wide. It represents a man of ruddy complexion, standing and looking forwards. He is bareheaded, has little hair, and that short, of a yellowish colour verging to red. He has very long moustaches and a short beard. In the right upper corner of the picture (that is, to Brahé's right) there is a curious emblematic design, consisting of a round tapering column springing from a square base, around which at its foot are waves. Over the monument is a canopy suspended by a strong chain, a few links only of which are visible, the top being lost in clouds, and the chain itself has flames playing round it. Two Æolic heads (one on each side) are represented as blowing towards the canopy and column. Lower down, and to the right and left of the column, are two hands (one on each side) holding each a jug from which water flows. Clouds and lightning surround the background, the wrists of the hands holding the jugs, and also the Æolic heads. Round the monument is a label not entirely decipherable with the words: "Stans (tectus?) in solido;" then follows an indistinct word and "igne e. tunda" (*sic*). "Igne et unda" was, no doubt intended. In the left upper corner, in large and distinct letters, is this inscription: "Effigies Tychonis Brahe, Otton. Da. anno 50 completo quo post diutinum in patria exilium libertati desideratæ divino provisu restitutus est."

Dr. Crompton thinks, correctly we believe, that the inscription referred to Brahé's departure from Denmark, and that the "exilium in patria" was an allusion to his residence on his island of Huenna, in his observatory, away from the court for twenty years. The emblematic picture evidently implies that nothing (not all the elements) could destroy the monument he had erected to his reputation by his observations, and that they would be protected by Providence.

The portrait then shows Brahé as he was in his fiftieth year, and Dr. Crompton thinks the tenor of the emblems and the inscription seem to be conclusive that the picture was painted after Brahé had left Denmark, most probably between the end of October and the 13th of December, 1597, and Dr. Crompton conjectures that the portrait may have been painted to be engraved for Brahé's "Mechanica."

In connection with this interesting portrait, it may not be inopportune to remind our readers of the main events in Tycho Brahé's life, and of the work on which his fame is grounded.

Tycho Brahé was born at Knudsthorp, an estate of his ancestors, near Helsingborg, in Sweden, on the Sound, December 14, 1546. Copernicus had been dead two years and a half, Galileo was not born till eighteen years after, and Kepler, with whom Tycho was latterly associated, was about twenty-five years his junior. Tycho's father, Otto Brahé was descended from an ancient Swedish family, and Tycho was the second eldest child, there being altogether five sons and four daughters in the family. Tycho, evidently much against his will, was destined for a military career. After the birth of another son, the father being in straitened circumstances, Tycho was adopted by his uncle, George Brahé. Until 1559 he appears to have been educated at home at his uncle's, learning reading and writing and Latin, with occasional instruction in poetry and belles-lettres. As it had now been decided that he should qualify himself for some political office in the kingdom of Denmark, Tycho, in April, 1559, was sent to the University of Copenhagen to prepare for the study of law. It seems to have been

while pursuing his studies at Copenhagen that Tycho's mind was first strongly attracted to the study of astronomy. An eclipse of the sun was to happen on August 21, 1560, and Tycho was so struck by the precision with which the various details of the phenomena had been predicted by the astrological almanacs of the time that he was fascinated by, and resolved to master, so wonderful a science as astronomy, more especially, it would seem, that phase of it then universally believed in and cultivated, astrology. The planetary motions seem first to have claimed his attention, and these he studied by means of the *Tabule Bergenses* of John Stadius.

In February, 1562, Tycho was sent to Leipsic, under care of a tutor, to study law. For this, however, he had not the smallest inclination, and devoted all his spare time, when not in presence of his tutor, or when the latter was asleep, and all his pocket-money, to becoming master of the science for which he had contracted a passionate devotion. By means of what books he could command, and with a celestial globe about the size of an orange, he studied the heavens nightly, and soon came to discover that the results obtained by himself differed greatly from those of Stadius. "From that moment," says Brewster, "he seems to have conceived the design of devoting his life to the accurate construction of tables, which he justly regarded as the basis of astronomy." For this purpose he set himself to get up a knowledge of mathematics.

So rapid was Tycho's progress in mastering the astronomy of the day, and so skilful already had he become as an observer, that by means of a simple pair of compasses he discovered that both the Alphonsine and Copernican Tables had erred considerably as to the time of the conjunction of Jupiter and Saturn, which took place in August, 1563. His first instrument seems to have been constructed at the time, a wooden radius, which he got a Leipsic artisan, Scultetus, to devise for him in the manner recommended by Homelius, the professor of mathematics in that city. With this instrument he continued his observations. On his uncle's death, Tycho returned to Denmark about May, 1565, to take possession of the fortune which had been left him. His continued devotion to astronomy greatly offended his friends and relations, who considered such a pursuit as degrading to a noble as trade used to be in this country, and still is in most continental countries. Tycho was so annoyed at the attitude of his friends, that he left Denmark after staying a short time at Wittenberg, took up his residence at Rostock, where he stayed during the years 1566-68, steadily pursuing his celestial observations. It was in a duel at this place that he lost his nose, which was so ingeniously replaced by a substitute of silver and gold, that few could have detected it to be artificial.

From Rostock Tycho proceeded to Augsburg, where with the help of the brothers Hainzel, he constructed a magnificent quadrant of fourteen cubits radius. It was made of beams of oak bound with iron bands, the arcs being covered with plates of brass, divided into 5,400 lines. To enable him to observe distances, a sextant on a similar scale was constructed, and a wooden globe six feet in diameter was begun; hitherto his only instrument was the simple radius made at Leipsic. With his new instruments he continued his observations at Augsburg, with renewed enthusiasm. Tycho returned to his native country in 1571, and found a warm friend in an uncle Steno Bille, who had always taken his nephew's part against the taunts of his other friends, and who assigned him a part of his own house as an observatory. It was while living thus that one of the most notable events in the life of this great astronomical observer occurred, his discovery, November 11, 1572, of a new star in the constellation of Cassiopeia. This wonderful body probably made its first appearance in the heavens on November 5, and continued visible for sixteen months, rapidly increasing in brightness till in the second month it surpassed that

of Jupiter, and was visible at noonday. It then slowly declined, and finally disappeared in March, 1574. It is curious that in the years 945 and 1264 something similar was observed in Cassiopeia, so that in fact the star observed by Tycho Brahe may be a variable one of long period, and if so may be expected to reappear about the year 1885. The colour of this star, moreover,

changed; it was at first white, then yellowish, then reddish; afterwards bluish, like Saturn, getting duller and duller as it decreased in apparent size. After much persuasion Tycho, in 1572, published an account of his observations on the new star in a work "De Nova Stella."

Tycho still further offended his relations by marrying a

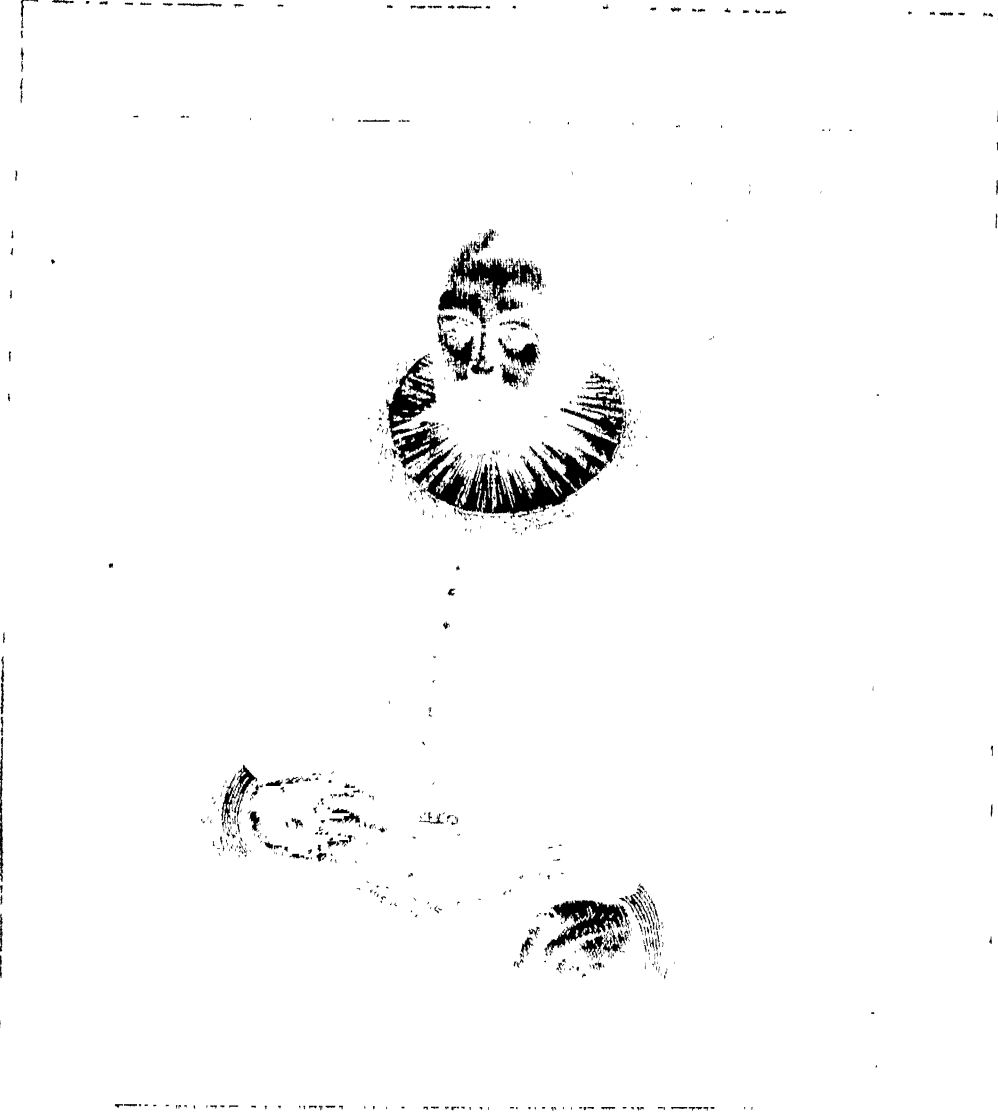

Portrait of Tycho Brahe (from original painting in possession of Dr. Compton, of Manchester).

peasant girl in 1573, and shortly after, at the request of the King of Denmark, delivered a course of lectures on astronomy both in its observational and astrological aspects, for in astrology he still continued to believe. After travelling in Germany and Switzerland in 1575, Tycho returned to Denmark and received from the King, Frederick II., an offer which ought to immortalise the name of that monarch. The King seems always really to have admired

the astronomer and estimated highly the pursuits to which he had devoted his life, and now realized it to be his duty, as head of the state, to put the man of science in the most favourable position to carry on researches which were then, as now, essentially unremunerative. In fact, in Frederick's treatment of Tycho Brahe we have an early and munificent, and in its results most successful, instance of the endowment of research.

The island of Huen lies in the Sound between Denmark and Sweden, about six miles from the latter and three from the former, and fourteen north-east from Copenhagen. It is somewhat rounded in form, six miles in circumference, and rises from the coast to its centre, where is formed a broad and level table-land. This island the King granted for life to Tycho Brahé, and on it erected a spacious observatory with every convenience for astronomical work and ample accommodation for Tycho's family and servants. A wide space around the

central building was inclosed by high substantial walls in the form of a quadrangle, each angle corresponding to one of the cardinal points, and the centre of each wall extending outwards in the form of a semicircle. At the north and south angles were erected turrets of which one was a printing-office and the other the residence of the servants.

This main building was carefully and elaborately planned. It was about 60 feet square, had on the north and south points two round towers for observations, with

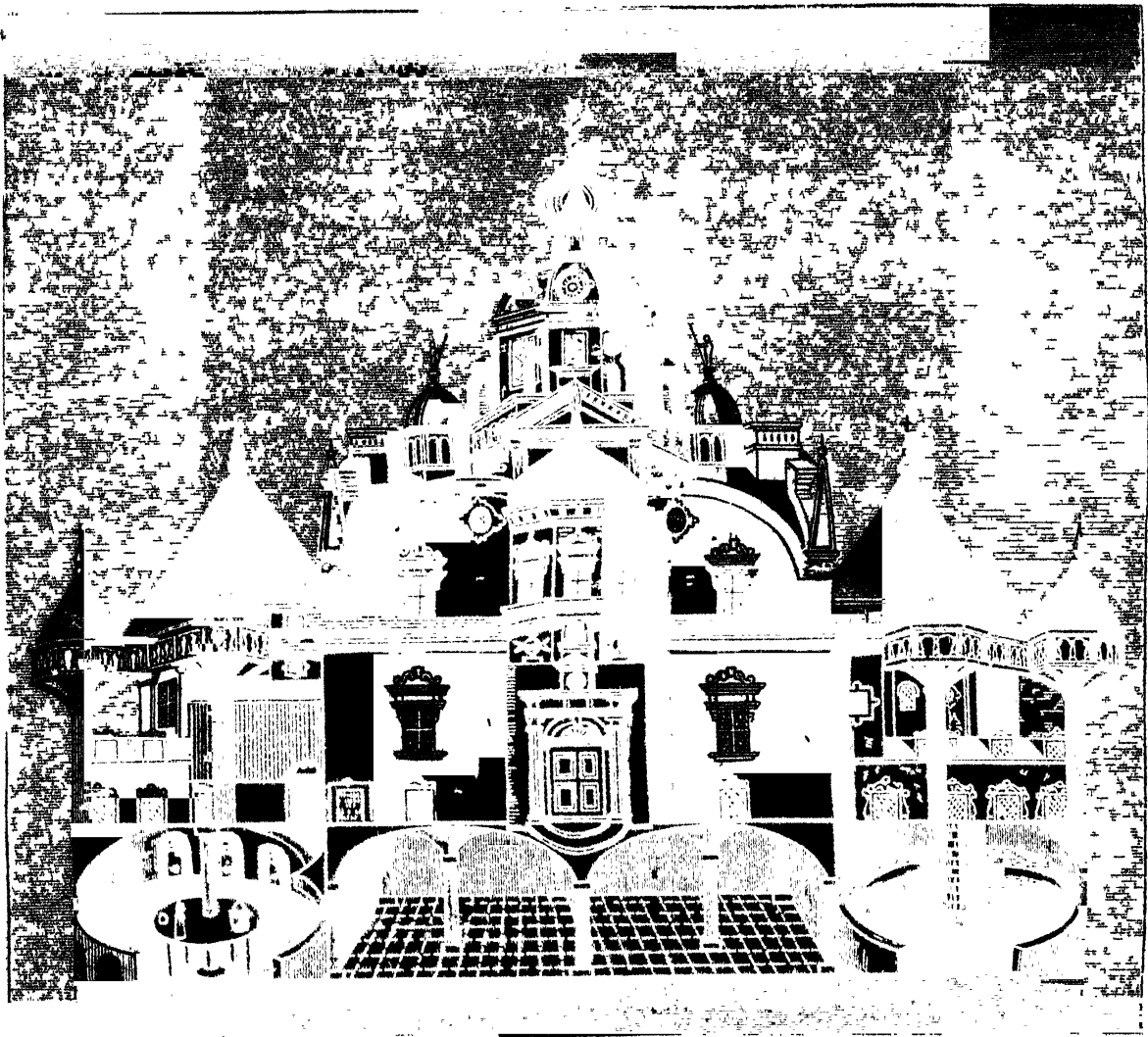

Tycho Brahé's Observatory on the Island of Huen

windows opening to any part of the heavens. Besides a museum and a library there was in a subterranean crypt a laboratory with sixteen furnaces, for we ought to say that Tycho devoted much of his time to the alchemical pursuits of the time, mainly, it would appear, in the hope of being able to find in his crucible the fortune he was prepared to spend on his astronomical pursuits. Tycho Brahé needs neither to be defended nor blamed for his belief in astrology and alchemy; it was a universal belief in his time, a belief only got rid of by slow degrees and the thradom of which no one man

could shake off while at its very height, least of all a man with so much reverence for established beliefs as was Tycho Brahé.

A well forty feet deep distributed water to the building by means of syphons. An instrumental workshop stood outside the rampart to the north, and a sort of farmhouse on the south. The foundation-stone of Uraniberg ("the City of the Heavens"), as Tycho called his establishment, was laid on August 6, 1576.

Large as was Uraniberg, it was found insufficient for the accommodation of all the astronomer's instruments,

and he therefore erected another, partly underground, for the sake of steadiness and solidity, on a hill a little to the south of the former; to this he gave the name of Sternberg ("City of the Stars"), which, by an underground passage, was connected with Uraniberg. Both buildings were in a handsome and regular style of architecture, as contemporary pictures testify, and cost the King of Denmark 100,000 rix dollars (20,000*l.*), and Tycho, it is said, an equal sum. Indeed, Tycho's expenses had so reduced his income, that the king gave him an annual pension of 2,000 dollars, an estate in Norway, and a canonry in the church of Rothschild worth 1,000 dollars per annum. Considering the difference between the value of money then and now, these sums for such a purpose may almost be considered munificent beyond example.

The magnificent set of instruments with which Tycho stocked the buildings were all made under his own superintendence, and according to his own designs, many of them having the merit of original inventions. For number, workmanship, and design, they were unequalled at the time. The following is a list of these instruments as given in Sir David Brewster's excellent memoir of Brahe, in "Martyrs of Science," on which the present notice is mainly based:—

*In the South and greater Observatory.*

1. A semicircle of solid iron covered with brass, four cubits radius.
  2. A sextant of the same materials and size.
  3. A quadrant of one and a half cubits radius, and an azimuth circle of three cubits.
  4. Ptolemy's parallactic rules, covered with brass, four cubits in the side.
  5. Another sextant.
  6. Another quadrant, like No. 3.
  7. Zodiacal armillaries of melted brass, and turned out of the solid, of three cubits in diameter.
- Near this observatory there was a large clock with one wheel two cubits in diameter, and two smaller ones which, like it, indicated hours, minutes, and seconds.

*In the South and lesser Observatory.*

8. An armillary sphere of brass, with a steel meridian, whose diameter was about four cubits.

*In the North Observatory.*

9. Brass parallactic rules, which revolved in azimuth above a brass horizon, twelve feet in diameter.
10. A half sextant, of four cubits radius.
11. A steel sextant.
12. Another half sextant with steel limb, four cubits radius.
13. The parallactic rules of Copernicus.
14. Equatorial armillaries.
15. A quadrant of a solid plate of brass, five cubits in radius, showing every ten seconds.
16. In the museum was the large globe made at Augsburg.

*In the Sternberg Observatory.*

17. In the central part, a large semicircle, with a brass limb, and three clocks, showing hours, minutes, and seconds.
18. Equatorial armillaries of seven cubits, with semi-armillaries of nine cubits.
19. A sextant of four cubits radius.
20. A geometrical square of iron, with an intercepted quadrant of five cubits, and divided into fifteen seconds.
21. A quadrant of four cubits radius, showing ten seconds, with an azimuth circle.
22. Zodiacal armillaries of brass, with steel meridians, three cubits in diameter.
23. A sextant of brass, kept together by screws, and capable of being taken to pieces for travelling with. Its radius was four cubits.
24. A movable armillary sphere, three cubits in diameter.
25. A quadrant of solid brass, one cubit radius, and divided into minutes by Nonian circles.
26. An astronomical radius of solid brass, three cubits long.
27. An astronomical ring of brass, a cubit in diameter.
28. A small brass astrolabe.

In the island of Huen Tycho resided and carried on his astronomical work for twenty-one years. The island itself was at the time fertile and well cultivated. The astronomer was virtually monarch of all he surveyed. He seems to have been loved by his subjects, and to have led a life of peaceful research and healthy contentment which any man of science of the present day might envy. Teaching was no condition of his tenure of the island and observatory, but his fame, which spread far and wide, attracted numbers of pupils eager to study under the great astronomer. Some of these were trained at the expense of the king, others were sent by different academies and cities, and several were maintained by the astronomer himself. Distinguished visitors were constantly arriving to do homage to the great man, and among these was our own James I., then, however, only James VI. of Scotland. This was in the year 1590, when the king was in Denmark to wed the Princess Anne. He spent eight days at Uraniberg, discussing various subjects with Tycho, and carefully examining all the instruments. He was so much surprised by what he saw and heard, that he granted the astronomer liberty to publish his works in England during seventy years.

Tycho Brahe might have peaceably ended his days in his pleasant island home, had his great patron Frederick II. lived; he died in April, 1588, and a new king, Christian IV., arose "who knew not Joseph," or at least cared

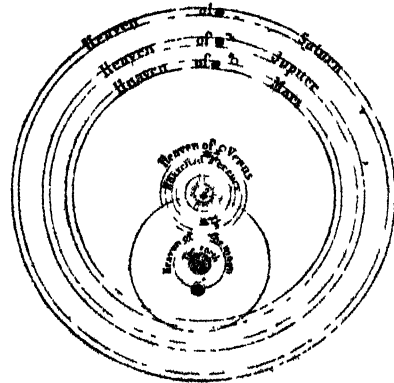

Tycho Brahe's System

nothing for him and his work. While Frederick reigned his courtiers of course, and many of them sincerely, professed to be passionately fond of astronomy; but as might be expected, Frederick's munificent kindness to Tycho made him many envious enemies. He continued to be tolerated for several years after the death of Frederick, but at last the young king's mind became so poisoned against Tycho by some of the courtiers, that he was deprived of his pension, his estate in Norway, and his canonry. With a wife, five sons, and four daughters, it was scarcely possible for him now to continue his work, but he stayed on till the spring of 1597, when he removed to Copenhagen. His persecution was brought to a crisis by a personal attack made on himself at the instigation of his chief enemy, the President of the Council, Walchendorp, in which one of his servants was injured. Tycho had the spirit to retaliate on his assailants, but almost broken-hearted he resolved to leave a country which had got tired of the glory of its greatest citizen, and which had nothing for him but persecution and insult. Fortunately he had many friends abroad among the nobles and princes of Europe. Among these was Count Henry Rantzau, who lived at the Castle of Wandesburg, near Hamburg, and who invited Tycho to take up his abode with him. Here then, with all his family, he went in the end of 1597, and here he wrote his "Astronomiæ instauratæ Mechanica," containing an account, with illustrations, of his various



instruments and their uses, and also of his chemical labours. This work also contains views and plans of his observatory at Huen, and in the British Museum is an original copy presented by Tycho to his friend, Dr. Thaddeus Haggencius ab Hayck, Chief Physician to the

instruments followed soon after. An annual pension of 3,000 crowns was bestowed upon him, and the castle of Benach given him for residence, though in the beginning of 1601 he removed into Prague, to the house of his late friend Curtius, which the Emperor had purchased and presented to the astronomer. It was at this period that Kepler, then about twenty-nine years of age, lived and worked with Tycho, who procured for him the post of imperial mathematician, for which, however, Kepler never seems to have received any income.

Notwithstanding the munificent treatment of Rudolph, Tycho's misfortunes in Denmark must have told seriously on his health, and his end was near. He had a serious attack on October 13, which so told on his weakened constitution, that although the immediate cause was removed, his strength failed him, and he expired on the

Tycho Brahe  
 Anno 1599.  
 January  
 Die 14.

Kingdom of Bohemia, and bearing the fine autograph which we here reproduce (one-half the size of the original). The work was printed at Wandesburg in 1598, and a copy, along with a MS. catalogue of 1,000

ARMILLÆ ZODIACALES.

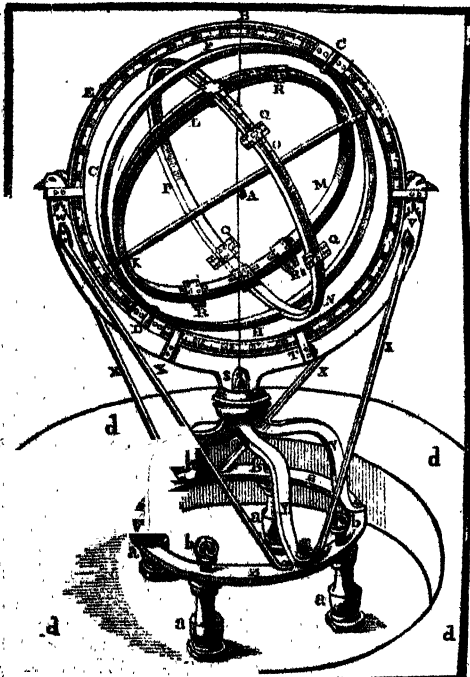

Ecliptic Astrolabe (Tycho Brahe) similar to that used by Hipparchus.

stars, was sent to the Emperor Rudolph II., a great lover of alchemy and astronomy. The result was an invitation to Tycho to go to Prague, with an assurance that he would receive the warmest welcome. Thither he went with his family in 1599, and most of his fine set of

QVADRANS MAXIMVS CHALIBEVS  
 QUADRATO INCLUSVS, ET  
 HORIZONTIAZIMUTHALICHALYBEO  
 INFISTENS.

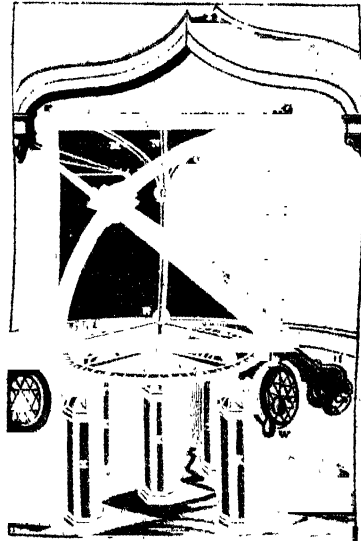

Alt-azimuth of Tycho Brahe.

24th of the same month, within two months of completing his fifty-fifth year.

As to Tycho Brahe's work, we cannot do better than give the following summary by Sir David Brewster:—

"As a practical astronomer, Tycho has not been surpassed by any observer of ancient or of modern times. The splendour and number of his instruments, the ingenuity which he exhibited in inventing new ones and in improving and adding to those which were formerly known, and his skill and assiduity as an observer, have given a character to his labours, and a value to his observations, which will be appreciated to the latest posterity. The appearance of the new star in 1572 led him to form a catalogue of 777 stars, vastly superior in accuracy to those of Hipparchus and Ulugh Beig. His improvements on the lunar theory were still more valuable. He discovered the important inequality called the variation, and likewise the annual inequality which depends on the position of the earth in its orbit. He discovered also,

the inequality in the inclination of the moon's orbit, and in the motion of her nodes. He determined with new accuracy the astronomical refractions from an altitude of  $25^\circ$  down to the horizon, where he found it to be  $34'$ ; and he made a vast collection of observations on the planets, which formed the groundwork of Kepler's discoveries, and the basis of the Rudolphine Tables."

### MINIATURE PHYSICAL GEOLOGY

THERE have appeared from time to time in the columns of NATURE, interesting and instructive letters on the subject of Miniature Physical Geology. May I be allowed to continue this subject, by pointing out a few lessons which may be learnt during spare half-hours on Ramsgate Sands.

Not far to the east of the harbour, there bubbles up a little stream, which, when the tide is low, flows for a considerable distance over the sands before it reaches the sea. Small as it is, this offers an excellent miniature example of a large river, and from it several things may be learnt. In the first place the river, when carefully watched, is seen repeatedly, and with more or less rapidity, to change its course. This is effected by the deflection, from some cause or other, of the main course of the stream against one bank; the result of which is that the bank is forced to recede, and, as it does so, it ceases to be a shelving slope, and becomes a tiny cliff of greater or less relative height. This bank continues to be rapidly undermined by the action of the stream, and the upper portions, now and again, topple over, with a little splash, into the water, in a manner with which those who have travelled on the Mississippi are well acquainted. In this way a bold curve is formed, which *increases in length down-stream*.

In the meanwhile, on the opposite shore of the river, sand is deposited, and, as the river cuts its way downwards, this portion is left high and dry.

But, ere long, the deep water channel shifts—often rapidly, and without apparent cause—and the miniature river tends to resume a straight course; it recedes from its bank cliffs, and soon a tract of comparatively level dry land separates these banks from the stream. After advancing, however, for a while in this direction, until it there forms a curve similar to the one described above, it once more swings in the direction of its former course, until, by a continuance of the same processes, a broad valley is formed, with beautifully-marked river terraces on either side, showing the length of swing of the river on each occasion that it oscillates to and fro.

In the midst of the stream sand islands are from time to time formed, partly by the deepening of the main channel on one side or the other; but, no sooner has the sand of which they are composed become dry, than the treacherous stream commences the destruction of that which itself had produced.

This is exactly what is continually taking place in the Delta areas of most great rivers. In the Pará branch of the Amazons a large island (Parraqueet Island) has, within the last quarter of a century, completely disappeared. The Ibla Nova has arisen, and is now covered with a luxuriant vegetation.

During the repeated changes in the course of our miniature river, it is possible to watch the deposition of a layer of coarse sand on the partially-eroded surface of a bed of finer material, and it is interesting and instructive to notice how great a body of the coarse material is dragged along the bottom. Even in the most sluggish of my miniature streams the sand-grains might be seen rolling over and over each other as they travelled seawards.

In the more muddy flats of Pegwell Bay, I, on one occasion, had an opportunity of witnessing the formation

of that which is known on the Mississippi as a "cut-off." The miniature stream bent round in a great loop, and as the flow of the water caused the concave banks to recede, the loop was gradually converted into a circle of water, and, the main stream flowing through the shortest course, left a "horse-shoe" lake, which was in time almost completely shut off from the miniature river.

Perhaps one of the most interesting of these spare half-hours may be spent in watching the formation of deltas. Numbers of these miniature rivers flow into pools, which are miniature seas or lakes. I have often seen one of the streams in the course of an hour fill up a considerable bay, and push its delta far out to sea. The grains of sand, when they come to rest in the pool, form a slope of very constant angle, which, by a number of measurements, I found to be  $40^\circ$  for coarse sand, and  $34^\circ$  for fine sand, the average angle being  $36^\circ$ . By watching the advance of the delta, the formation of false bedding may be seen in actual progress. But these pools, or miniature seas, which lie in depressions in the chalk, offer a field for the study of marine denudation. One may see, for instance, the waves advancing over a newly-formed delta, planing off the upper portion, and forming tiny cliffs of delta material, but leaving the deeper parts of the slope of the deposit intact.

Again, during gentle and steady breezes one may see the formation of drift-currents. I remember watching with interest such a current, which flowed between tiny chalk cliffs through the straits which separated two miniature seas; the most instructive point being that the finer grains of sand at the bottom of the straits, where the water was some 7 inches deep, were rolling over each other in such a manner as to prove the existence of an under-current setting *in the opposite direction* to that in which the surface-current was flowing.

There are many other lessons which may be learnt—such as the formation of fan-deposits (similar to those so plentiful in the Rhone valley and elsewhere in Switzerland), which are formed at the foot of the miniature chalk mountains that stand out from the sand; and the stoppage of the sand ripples, or miniature sand dunes, by the tiniest stream, reminding us of the way in which the Nile has preserved Egypt from total obliteration by this material; but I have already occupied enough of your space.

My object in drawing attention to such matters of ordinary observation is to induce students of physical geology to go out and observe these things for themselves. If, after a morning's study of Lyell's "Principles," the young geologist will devote an hour's careful observation to miniature physical geology, with sketch and note-book in hand, he will find that his conceptions have a reality and a solidity which could not have been evolved in the study at home, while at the same time he will find it more easy to follow, when he shall have the opportunity, the workings of nature on a grander scale.

C. LLOYD MORGAN

### TESTIMONIAL TO MR. DARWIN.—EVOLUTION IN THE NETHERLANDS

WE have great pleasure in printing the following correspondence:—

To the Editor of NATURE.

Utrecht, February 20, 1877

On the sixty-eighth birthday of your great countryman, Mr. Charles Darwin, an album with 217 photographs of his admirers in the Netherlands, among whom are eighty-one Doctors and twenty-one University Professors, was presented to him. To the album was joined a letter, of which you will find a copy here inclosed, with the answer of Mr. Darwin.

I suppose you will like to give to both letters a place in your very estimable journal, and therefore I have the honour to forward them to you.

P. HARTING,  
Professor, University, Utrecht.

Rotterdam, 6th February, 1877

SIR,—In the early part of the present century there resided in Amsterdam a physician, Dr. J. E. Doornik, who, in 1816, took his departure for Java, and passed the remainder of his life for the greater part in India. His name, though little known elsewhere than in the Netherlands, yet well deserves to be held in remembrance, since he occupies an honourable place among the pioneers of the theory of development. Among his numerous publications on natural philosophy, with a view to this, are worthy of mention his "Wijsgeerig-natuurkundig onderzoek aangaande den vorspronkelijken mensch en de vorspronkelijke stammen van dezelfde geslacht" ("Philosophic Researches concerning Original Man and the Origin of his Species"), and his treatise, "Over het begrip van levenskracht uit een geologisch oogpunt beschouwd" ("On the Idea of Vitality considered from a Geological Point of View"). The first already appeared in 1808; the latter, though written about the same time, was published in 1816, together with other papers more or less similar in tendency, under the title of "Wijsgeerig-natuurkundige verhandelingen" ("Treatises on the Philosophy of Natural History"). In these publications we recognise Doornik as a decided advocate of the theory that the various modifications in which life was revealed in consecutive times originated each from the other. He already occupies the point of vantage on which, shortly afterwards, Lamarck, with reference to the animal kingdom, and in his wake, Prévost and Lyell, with respect to the geological history of our globe, have taken their stand.

Yet the seeds scattered by Dr. Doornik did not take root in fertile soil. It is true that a Groningen professor, G. Bakker, combated at great length some of his arguments regarding the origin of man; it attracted but little public attention, and they soon passed into oblivion.

A generation had passed away ere the theory of evolution began to attract more attention in the Netherlands. The impulse was given by the appearance of the well-known work, "Vestiges of the Natural History of Creation," of which a Dutch translation was published in 1849 by Dr. T. H. van den Broek, Professor of Chemistry at the Military Medical College in Utrecht, with an introductory preface by the celebrated chemist, Prof. G. T. Mulder, as well known in England as elsewhere. This work excited a lively controversy, but its opponents were more numerous than its partisans. Remarkably enough, it found more favour with the general public, and especially with some theologians of liberal principles, than with the representatives of the natural sciences. The majority of zoologists and botanists of any celebrity in the Netherlands looked upon the writer's opinions as a chimera, and speculated on the weaker points rather than on the merits of the work. Notwithstanding, this presented no obstacle to a comparative success, and in 1854, even a third edition of the translation was published, enriched by the translator with numerous annotations.

Among the few Dutch savants to recognise the light which the theory of development spreads over creation, must be mentioned two Utrecht professors, viz., F. C. Donders and P. Harting. The former, in his inaugural address pronounced in 1848, "De Harmonie van het dierlijk leven, de openbaring van wetten" ("The Harmony of Animal Life, the Revelation of Laws"), expressed his opinion that, in the gradual change of form consequent upon change of circumstances, may lie the cause of the origin of differences which we are now wont to designate as species. The latter, in the winter of 1856, delivered a series of lectures before a mixed audience, on "The History of Creation," which he published the following year under the title of "Voorwereldlijke Schoppingen" ("Antemundane Creations"), with a diffuse supplement devoted to a critical consideration of the theory of development. Though herein he came to a standstill with a "non liquet," yet it cannot be denied that there glimmered through it his prepossession in favour of a theory which several years later his famed and learned colleague, J. van der Hoeven, Professor at Leyden, making a well-known French writer's words his own, was accustomed to signalise as an explanation, "de l'inconnu par l'inconnu." In 1862 your illustrious countryman, Sir Charles Lyell, was staying for a few days in Utrecht. In the course of conver-

sations with this distinguished savant on the theory of development, for which Lyell himself, at least in his writings, had shown himself no pleader, the learned of this country were first made observant of what had been and what was being done in that direction in England. He attracted attention to the treatise of Wallace in the Journal of the Linnean Society, and related how his friend Darwin had been occupied for years in an earnest study of this subject, and that ere long a work would appear from his pen, which, in his opinion, would make a considerable impression. From these conversations it was evident that Lyell himself was wavering. In the following edition of his "Principles of Geology," he declared himself, as we know, a partisan of the hypothesis of development, and Prof. Harting speedily followed in the same track. In his "Algemeene Dierkunde" ("General Zoology"), published in 1862, he was able to declare himself with full conviction a partisan of this hypothesis. Also another famous savant, Miquel, Professor of Botany at Utrecht, who had previously declared himself an opponent of the Theory of Development, became a convert to it in his later years, for although this is not expressed in his published writings, it was clearly manifest in his private conversation and in his lectures. To what must this conversion be attributed? With Harting and Miquel, as well as with Lyell and so many others in every country of Europe, this was the fruit produced by the study of your "Origin of Species," published in 1859, which first furnished one vast basis for the theory of development. That work, translated into Dutch by Dr. F. C. Winkler, now conservator of the Geological, Mineralogical, and Palaeontological collections in "Feyler's Foundation" at Haarlem excited great and general interest. It is true that a theory, striking so keenly and so deep at the roots of existing opinions and prejudices, could not be expected at once to meet with general approbation. Many even amongst naturalists offered vehement opposition. Prof. J. van der Hoeven, bred up as he was in the school of Cuvier, endeavoured to administer an antidote for what he regarded as a baneful poison by translating into our tongue Hopkins' well-known article in *Fraser's Magazine*. However, neither this production nor the professor's influence over his students could withstand the current, especially when, after his death, the German zoologist, Prof. Emil Selenka, now Professor of Zoology at Erlangen, was appointed at Leyden. A decided advocate of your theory, he awakened in the younger zoologists a lively enthusiasm, and founded a school in which the conviction survives that the theory of development is the key to the explanation of the History of Creation.

In Utrecht, Prof. Harting, with convictions more and more decided, was busy in the same direction; and Selenka's successor in Leyden, Prof. C. K. Hoffmann, did not remain in the rear. Other names, among which are Groningen and Amsterdam professors, might here be cited. By the translation of your "Descent of Man" and "The Expressions of the Emotions in Man and Animals," with copious explanatory notes and by various original papers and translations treating on your theory, Dr. Hartogh Heys van Zouteveen has also largely contributed to the more general spread of your opinions in the Netherlands.

To testify how generally they are held in esteem among the younger zoologists and botanists, and more and more obtain among professors of analogous branches in this country, we might refer to a multitude of less important papers and articles in the periodicals.

This, however, we deem superfluous, since by offering for your acceptance an album, containing the portraits of a number of professional and amateur naturalists in the Netherlands, we offer a convincing proof of our estimation of your indefatigable endeavours in the promotion of science and our admiration of you, Sir, as the cynosure in this untrodden path. We recognise with pleasure Dr. Hartogh Heys van Zouteveen as the primary mover of such a demonstration of our homage. The execution, however, devolved upon the directors of the "Nederland Zoological Society," who reasoned that, with the presentation of this unpretending mark of esteem, a few words on the History of the Theory of Development in the Netherlands would not be entirely unacceptable, the more so, since this historic sketch clearly shows that, albeit some ideas in that direction had already been suggested here, yet to you alone reverts the honour of having formed by your writings a school of zealous and convinced partisans of the theory of development.

Among the names in the accompanying list you will observe several professors of Natural History, Anatomy, and Physiology at the three Dutch Universities, the "Atheneum Illustré" of Amsterdam, and the Polytechnical Academy of Delft, the Con-

servators of the Zoological Museums, the Directors of the Zoological Gardens, and several lecturers on zoology and botany at the High Burghal Schools.

Accept, then, Sir, on your sixty-ninth birthday, this testimony of regard and esteem, not for any value it can have for you, but as a proof, which we are persuaded cannot but afford you some satisfaction, that the seeds by you so liberally strewn have also fallen on fertile soil in the Netherlands.

We are, Sir, &c.,  
The Directors of the Netherlands  
Zoological Society,

(Signed) President, A. A. VAN BEMMELFN  
Secretary, H. T. VETH

The following is Mr. Darwin's reply:—

Down, Beckenham, February 12

SIR,—I received yesterday the magnificent present of the album, together with your letter. I hope that you will endeavour to find some means to express to the 217 distinguished observers and lovers of natural science, who have sent me their photographs, my gratitude for their extreme kindness. I feel deeply gratified by this gift, and I do not think that any testimonial more honourable to me could have been imagined. I am well aware that my books could never have been written, and would not have made any impression on the public mind, had not an immense amount of material been collected by a long series of admirable observers, and it is to them that honour is chiefly due.

I suppose that every worker at science occasionally feels depressed, and doubts whether what he has published has been worth the labour which it has cost him; but for the remaining years of my life, whenever I want cheering, I will look at the portraits of my distinguished co-workers in the field of science, and remember their generous sympathy. When I die the album will be a most precious bequest to my children. I must further express my obligation for the very interesting history contained in your letter of the progress of opinion in the Netherlands, with respect to evolution, the whole of which is quite new to me. I must again thank all my kind friends from my heart for their ever-memorable testimonial, and

I remain, Sir,  
Your obliged and grateful servant,  
(Signed) CHARLES R. DARWIN

### THE NORWEGIAN NORTH-SEA EXPEDITION OF 1876\*

#### Zoological Researches

AMONG the various scientific objects of our expedition the examination of the biology of those parts of the ocean which we traversed was one of the most important. We had with this view equipped ourselves in the best way with all the apparatus required for the purpose (dredges, trawl-nets, swabs, sieves, &c.), chiefly after the newest English models, a considerable quantity of ropes of various kinds, and heavy iron weights to hold the apparatus to the bottom were also stowed away in the hold of the vessel. There was besides procured a large quantity of glass vessels of different sizes and kinds, from small test-tubes to cylinders a foot in diameter, and a considerable stock of spirits for preserving the specimens that might be collected.

That the zoological material that might be brought up with the apparatus we have named might be arranged and the preliminary examinations made, which would be of great importance for the later working out, we considered it indispensable that as many zoologists as possible should accompany the expedition; we also thought it right that a skilful artist should always be at hand. The zoological party consisted of Overlage Danielssen, Grosserer Friele, and myself, and as artist we were fortunate enough to engage Herr Schiertz, landscape-painter, whose practised pencil and keen, all-embracing faculty of observation were exceedingly useful to us. There is a series of masterly-coloured pictures from his hand which will be a true ornament to the zoological treatises, which in course of time will be published on the work of the expedition.

The zoological work was divided in this way:—Overlage Danielssen and Dr. Kovan undertook the Echinodermata, Gymnophora, and Corals; Grosserer Friele, the Mollusca; Dr.

Hansen, the Annelida; and I myself the other classes, the Crustacea, Pycnogonida, Polyzoa, Hydroida, Spongia, together with the lowest organisms standing on the boundary line between the animal and vegetable kingdoms (Foraminifera, Radiolaria, and Diatomacea), and that department of the researches which eventually concerns our salt-water fisheries. We have all been occupied for a considerable time in working out each his own portion of the collected material. But as this has been extraordinarily abundant, it has not been possible for any of us to bring his examination to a conclusion so that a detailed account of it can be given. As, besides, the more special results will be reserved for the collective work, which it is proposed to publish when the expeditions are concluded, it will be sufficient here to state some of the most important results of the expedition. It may also here be mentioned that these researches, carried on far out in the open sea from a comparatively small vessel, and at depths approaching 2,000 fathoms, are, even under the most favourable circumstances, attended with extraordinary difficulties, and occupy a comparatively long time. That we, notwithstanding the exceedingly unfavourable state of the weather during the expedition, were able to obtain such an abundance of zoological material, is due to the skilful and intelligent way in which the work was carried out by Laeut. Petersen, to whom Capt. Wille's command was given over.

During our expedition we had in all employed the dredge from the vessel sixteen times, the trawl-net twelve times, both these together twice, and the swabs but once; there were thus no fewer than thirty-one separate casts, and of these only a few were unsuccessful, while most of them gave very satisfactory results. A net was also employed for examining the marine animals occurring in the upper stratum. Boat dredgings were also undertaken in Sogne Fiord, at Husoe, at Thorshaven in the Fieroe Islands, and in the harbour at Keykjavik. Without entering on any detailed specification of the numerous animal forms thus brought from the depths of the sea, I will merely state that there are interesting species, new to science, of nearly all classes, of which complete descriptions and drawings will by-and-by be published.

The greatest depth reached during the expedition was about 2,000 fathoms, almost half-way between Norway and Iceland; there were several casts at depths of over 1,000 fathoms. The zoological researches were begun in Sogne Fiord, where the considerable depth of 650 fathoms was reached, the greatest depth which up to that time had been examined on our coasts. We found here the common deep-sea fauna known from earlier researches, viz., of Hardanger Fiord, and various rarities were collected; among others a well-preserved specimen of the remarkable family, *Bruisinga*, discovered by Aabjoernsen (*B. coronata*, G. D. Sars), several specimens of the *Priapuloides bicaudata*, Danielssen, and great numbers of the beautiful haired *Munida tenuimana*, G. D. Sars, of which previously only very few specimens had been found.

Our researches, however, first attained their peculiar interest when we reached the extended barrier that lies along our coast on the west, the uttermost limit of which forms the so-called Havbro. Here below 300 fathoms begins the yet little examined cold area, with a bottom-temperature of from 0° to 1·6° C., and the fauna now, in correspondence with this temperature, exhibits a very peculiar character, totally different from that on our south and west coasts. Seventeen of our casts were in the cold area, and we have thus some idea of the peculiar physical and biological conditions prevailing there.

Over the extensive depression which occupies the greater part of the expanse of sea between Norway on the one side, and the Fieroe Islands and Iceland on the other, the bottom below 1,000 fathoms appears everywhere to consist of a very peculiar, loose, but very adhesive, exceedingly light, nearly greyish white clay, which is very strongly calcareous, and, on being washed or passed through a sieve, appears to consist almost exclusively of shells of a little, low organism, belonging to the Foraminifera, *Biloculina*. We have therefore named this deep-sea clay *Biloculina* clay, to distinguish it from the kind of clay which occurs in the warm area at a great depth in the Atlantic Ocean, and which is called, after a very different Foraminifer, *Globigerina*. The *Biloculina* clay of the cold area contains a larger quantity of lime than the *Globigerina* clay of the Atlantic. It gives off, when treated with an acid, an uncommonly large quantity of gas, and when it is pressed and dried, it is converted in a short time into a very hard and compact sort of limestone. We have here a complete shell or limestone formation existing in existence, and the fauna occurring here also bears a considerable resemblance

its ancient origin and close alliance with the organic remains preserved in the fossiliferous strata from the close of the Secondary period. First of all may here be named a fine, probably new Crinoid, over a span long, which was here obtained in numerous living specimens, and which shows an unmistakable resemblance to a few of the oldest fossil forms of this, in our time, almost extinct animal group; next a very peculiar and interesting holothuroid animal, colossal chalk sponges, and large numbers of a new and very peculiar Pycnogonide, also a remarkable blood-red coloured Crangon (*Rake*) with integuments thin as paper (*Hymenocaris*), besides several lower crustacea, for the most part new; the mollusc commonly occurring here is that which is so characteristic of our older glacial clay, the *Siphonodonta* *vitreum*, M. Sara, which on our coast is first found living in the most northerly part of Finmark. The fauna in these great depths, though peculiarly interesting, both with reference to zoology and geology, appears however as a whole to be rather poor and without variety. The contrary is the case where the bottom begins to rise towards the sea banks. Here we find at a depth of 400 to 900 fathoms, but still within the cold area, an uncommonly abundant and varied animal life. Quite contrary to what we might be inclined to expect from the prevailing low temperature, so far is there from being any trace of hindering or preventing the development of animal life, in comparison with our coast fauna, that we find the rather as we go downwards an exceedingly remarkable luxuriance in the development of the fauna expressed both in the numerous and varied animal forms occurring here, and in the comparatively colossal dimensions which several of these here reach; indeed, one of the marine animals taken up here, belonging to the Umbellularia, had a length of quite eight feet. From the specimens which we got up with the help of dredges, trawl-nets, and swabs, we have been able, if only approximately, to form a sort of idea of the peculiar physiognomy which the sea-bottom here presents.

Forests of peculiar Cladorhiza, with tree-like branches, here deck the bottom for long stretches. Between the branches sit fast beautiful medusa heads (*Euryale*), and variegated *Jun-stjerne* (*Auteion*), and various crustacea, among them the marvellous object, *Arcturus Baffini*, known from the Polar Sea, and slow-moving Pycnogonida, partly of colossal size (up to a span between the extremities of the feet), creep along between their branches and with the help of their enormously-developed proboscis suck out their organic juices; a whole world of more delicate plant-like animals (*Polyzoa* and *Hydroids*) having at the same time fixed their dwellings on the branches and stems of the sponges when dead and deprived of their organic bark substance. In the open spaces between the sponge forests creep along beautiful purple sea-stars (*Astropecton*) and long-armed Ophiurids, together with numberless Annelids of various kinds, and round about swarm different sorts of Crustacea, long-tailed, bristly Decapoda (*Crangon*), finely-formed Mysida (*Eyrthroptis*, *Panerythroptis*, *Pseudomma*), masses of Amphipoda (*Anonyx*), and Isopoda (*Munnopsida*). Above all project, like high mast timber in a coppice, the predominating Umbellularia with their delicate straight stems and elegantly-curved crowns set full of fringes of polyps. The light of day does not, properly speaking, penetrate to these great depths, but as a compensation there is produced, by the animals themselves, a splendid illumination of the whole, inasmuch as almost all are strongly phosphorescent, or have the power to produce from their bodies an intense light, by turns bluish, greenish, and reddish.

So often as our bottom-scraper or trawl-net found bottom in that region which, after the animal type that was undoubtedly the most prominent and characteristic, we named the region of the Umbellularia, we were certain to have a rich zoological prize, and the day was indeed in most cases unfortunately quite too short for the proper examination and preservation of all those treasures fetched up from the depths of the sea.

Higher up, in a depth of 300 to 100 fathoms, and at a distance from the coast of from ten to twenty Norwegian miles (about 70 to 140 English), begins that extensive barrier which forms, as it were, the foundation on which our land rests, and by which the cold Polar Sea depths are shut off from it. This barrier begins in most cases with a hard, stony bottom, so that our dredgings were here attended with great difficulties. Numerous rolled stones, whose smooth rounded forms and worn edges clearly enough show that they had at one time been subjected to the powerful action of ice, lie here strewn on the sometimes very uneven bottom, consisting of solid rock, and prevent the dredges from acting properly, or fill up its mouth so that only incomplete specimens of the animal world living here can be

obtained. The fauna has here quite altered its character, and more resembles that common on our coasts; but it appears to be a rule that below this point at the border of the barrier it is considerably richer than that nearer the shore, a fact which also stands in full agreement with the long known great abundance of fish at these places.

When we finally survey what here can only in a general way be pointed out concerning the physical and biological relations of the tract of sea we traversed we may, both in a physiographic and a zoological respect, divide the depths of the sea surrounding our country into two regions differing greatly in character, namely, the warm and the cold areas. The first occupies the whole Skagerak and the North Sea, and farther north the sea along our coast to a distance of ten to twenty Norwegian miles, including herein all the fiords cutting deeply into the land, and stretches towards the north to the northernmost point of Finmark. The cold area commences where the bottom begins to sink from the sea-banks towards the great deeps lying beyond them, and towards the south reaches nearly to the latitude of Stadt, and towards the south-west extends in the form of a narrow wedge in between the Færoe and the Shetland Islands as far as the 60th degree of latitude. Towards the north the cold area extends to the Pole, which properly is its central point. We have examined it at one of the points where it extends farthest to the south, where it has shown itself to be everywhere very sharply and distinctly defined from the warm area. As we proceed farther north, the boundary between the two becomes less distinctly marked, inasmuch as the cold area little by little raises itself from the depths, until in the Polar Sea it finally rises to the surface, and thus also occupies the littoral region, the warm area being at the same time greatly diminished in extent. The close correspondence with the above-described peculiar physical conditions in the sea surrounding our country has been to a very considerable degree explained by the experience obtained during our expedition, and thus a very important contribution has been made to the meteorology of the sea in general. A fuller explanation of these purely physical phenomena is also of the greatest importance to us zoologists for the right understanding of the different biological conditions in the sea; but as such an explanation belongs properly to the physical-meteorological researches, I will not here enter farther upon it, but keep to the more purely zoological side of the matter.

With regard to the character of the fauna in the cold area, it is purely arctic or glacial without any southern mixture whatever; and we have already been able to identify several of our species with types before collected in the Polar Sea during the various North Polar expeditions fitted out in Sweden, Germany, England, and America. In higher latitudes those animal types, which in that part of the sea which we examined are only found below the 400 fathoms' line, live in comparatively shallow bands, indeed even in the upper stratum of the sea, which interesting fact appears still further to confirm the view held by several men of science that the distribution of animal life in the sea is mainly dependent on temperature, depth having only a comparatively limited influence upon it. The purely Arctic fauna which prevailed on our coasts during the Glacial period, and which has left behind its traces in the glacial clays and in the older glacial shell banks, has, under altered meteorological conditions, little by little drawn down to the depths, where the effect of these conditions was less sensible, while the places which it inhabited have been occupied by more southern, immigrating types. At great depths in our fiords which run far into the land, a remnant of the original Arctic fauna has been able to maintain itself. But this is clearly only a fortuitous circumstance, as clearly enough appears from the generally small size and stunted appearance of these animal types, and their complete extinction is probable. This we are now, after having acquired an accurate acquaintance with the temperature of the sea, able to explain on purely physical grounds. For even to those deep pools in our fiords the influence of the milder climatic conditions has at last reached, so that at depths of 650 fathoms there is a temperature of 6° C., which may be supposed to have a prejudicial influence on the growth of these types. On the other hand, the temperature of our sea-banks at a much smaller depth remains unchanged, such as it was in the Glacial period, both here and close to our coast, and therefore we find also here, even at a remarkably southern latitude, no impoverished and stunted, but as luxuriantly developed an Arctic or glacial fauna as high up in the north in the Polar Sea.

The very important light which from the side of meteorology may be thrown on several yet obscure phenomena in the deve-

agement and distribution of organic life as on the other hand the often considerable aid meteorological researches may obtain from purely biological facts, render it desirable that these two sciences, which may appear very different, do not become strangers to each other but mutually come into closer alliance with the object in view, to contribute to the scientific solution of the many yet unsolved physical and biological problems.

(To be continued.)

### OUR ASTRONOMICAL COLUMN

**THE BINARY STAR  $\xi$  BOOTIS.**—Dr. Doberck, of the Markree Observatory, has published elements of this revolving double-star, which appear to represent very satisfactorily the measures up to the present time, allowance being made for some obvious errors of observation. The orbit, which differs materially from those calculated upon shorter series of measures by Mädler, Herschel, and Hind, is as follows:—

Peri-astron passage, 1770'44.	Period, 127'97 years.
Node ... 12' 1'	Inclination ... 37° 53'
Node to peri-astron, on orbit ... 130° 54'	
Eccentricity ... .. 0'6781	
Semi-axis major ... 4''813	

At the epoch 1782'28 these elements give the position 24°1, distance 3''64; and for 1804'25, position 352°5, distance 6''53; for Dembowski's epoch 1870'87 the errors are + 0'3 and - 0'11. The following figures are deduced from Dr. Doberck's elements:—

1876'0, Pos. 283'7	Dist. 4''29	1892'0, Pos. 224'7	Dist. 2''35
1880'0, ,, 274'5	,, 3'84	1896'0, ,, 188'2	,, 1'82
1884'0, ,, 262'8	,, 3'36	1900'0, ,, 111'9	,, 1'31
1888'0, ,, 247'1	,, 2'86		

Dr. Doberck has now investigated elements of  $\sigma$  Corona Borealis,  $\tau$  and  $\lambda$  Ophiuchi,  $\mu^2$ , 44 and  $\xi$  Bootis,  $\gamma$  and  $\omega$  Leonis,  $\eta$  Cassiopea; and several other stars, thus greatly adding to our knowledge of the orbits of the binaries, his discussions being at the same time conducted in a very exhaustive manner, to date.

**VARIABLE STARS.**—In No. 2,119 of the *Astronomische Nachrichten* are observations of a number of variable stars, made in 1875 by Mr. Chandler of New York. There was a well-marked minimum of that irregular variable  $\alpha$  Hercules on August 21; the observations of W and X Sagittarii are worthy of note, as they support the results previously given by Prof. Schmidt, of Athens, and are stated to have been made without any "pre-occupation of mind in the observer," who had no previous knowledge of the character of the light variations. Schmidt's period for W, is 7'5933 days, and for X, 7'0119 days; another star in the same constellation, U Sagittarii of the last catalogue by Prof. Schönfeld, is assigned a period of 6'7452 days. The three stars were added to the variable star list by the indefatigable director of the Observatory at Athens, in the summer of 1866.

Mr. J. E. Gore (Umballa, Punjab) writes, suggesting the variability of Lalande 42360. The place in the catalogue depends upon an observation made August 7, 1793, when the star was rated 7m. Argelander ("Bonn Observations," vol. vii, p. 181) identifies this star with No. 42383 of the catalogue, observed as an 8m., September 29, 1791. Considering that there is an error in the record of the time of transit; the declinations closely agree.

**DAMOISEAU'S TABLES OF JUPITER'S SATELLITES.**—Independent extensions of these Tables, which run out in 1880, have been made in Europe and America. Prof. Coffin, superintendent of the American Ephemeris, notifies an extension to 1900, which has been carried into effect by Mr. D. P. Todd, we believe under the superintendence of Prof. Newcomb. The work will be sent to any library or astronomer possessing a copy of the

Tables, on application to the office at Washington. Before the time named it may be hoped that both as regards theory and observation, the laborious operation of forming new Tables may be justified by the certainty of obtaining results which will enable us to predict the phenomena of the satellites, with considerably greater accuracy than can be effected by the use of Damoiseau's Tables. And we may also express the hope that as regards systematic observations, the Astronomer-Royal's urgent recommendation will not be lost sight of.

**BESSEL'S TREATISES.**—Volume iii. of the reprint of the more important of the many papers by Bessel on astronomical and other subjects, which completes the work, was issued a short time since by Dr. Engelmann, and comprises geodesy, physics, and general astronomical subjects, as the libration of the moon, shooting-stars, the mass of Jupiter, and the theory of eclipses. Speaking of the work as a whole, it will prove a very valuable aid to the student of Astronomy, affording him without the labour and difficulty of consulting a number of publications, the means of acquainting himself with the principal memoirs of the illustrious Professor of Königsberg, who may be said to have revolutionised the practice of astronomy. Dr. Busch's "Verzeichniss sämmtlicher Werke, Abhandlungen, Aufsätze, und Bemerkungen, von F. W. Bessel," printed in vol. xxiv. of the Königsberg observations, and subsequently in a separate form, contains 385 articles, and we believe, with only one or two exceptions, Dr. Engelmann's three volumes will be found to contain all that are of more permanent interest and value.

### BIOLOGICAL NOTES

**THE ELECTRIC EEL.**—Since Humboldt's discovery of the electric eel and his observations of its peculiar properties, carried out unfortunately before the discovery of the voltaic pile, strange to say, no attempt has been made to study this remarkable reptile in its natural surroundings. In view of this fact, the Berlin Academy of Sciences sent the well-known histologist and physiologist Dr. Carl Sachs, last September, to the scene of Humboldt's former activities, well equipped with an ample supply of electro-physiological apparatus, and means for carrying out an extensive series of observations. In the last session of the Academy a letter dated December 7 was read from Dr. Sachs, in which he stated that he had safely performed the journey from Caraccas, over the Cordilleras, to the *Llanos*. The gymnotus had disappeared from the neighbourhood of Rastro, where Humboldt's investigations took place, but at a distance of a few miles from the city of Calabozo, a river was found fairly alive with the dreaded *Am. blador*. In the five days which had elapsed since the discovery of the locality, many valuable results had been afforded by the observations, and there was every prospect that the expedition would yield a large number of new and important additions to our knowledge of the electro-motive organs.

**EARLY DEVELOPMENT OF SPONGES.**—At a meeting, on February 8, of the Société Vaudoise des Sciences Naturelles, Prof. Forel spoke on an interesting occurrence of an early development of sponges in the Lake of Geneva, due to the unusually mild winter of this year. The fluviatile sponge of the lake consists of a horny skeleton with very fine siliceous spicules, covered with a sheet of soft, perforated animal matter. Usually, in autumn, this soft matter leaves the external ramifications and condenses under the form of small gemmules half a millimetre in diameter, in the deepest interior parts of the horny skeleton. There it remains until the spring, when it expands anew upon the ramifications, and covers them with a sheet of living animal matter. But this year M. Forel observed on February 2, besides many sponges in their habitual state, a colony of other sponges which had already reached their full summer development, differing only by a somewhat paler color

from the usual summer appearance. The occurrence is perfectly explained by the circumstance that the temperature of water in the Lake of Geneva was this year higher by two degrees than the average temperature for many years, which is 6°·3 Cels. for December and 4°·9 for January.

**A NEW SPONGE.**—Prof. E. Perceval Wright describes (*Proc. Irish Acad.*, vol. ii., ser. 2, part 7) a beautiful little sponge found growing on the fronds of some species of Red Seaweeds from the coast of Australia, of which we give the accompanying illustration. The largest specimens measure not three millimetres in height. The sponge consists of three distinct and well-marked portions: firstly, a small basal disk; secondly, an elevated stem, on the summit of which expands the third portion, or apicalium. The disk is button-shaped, flat, and is formed of an irregular horny framework, twice to three times as broad as the stem. The stem varies in height, and presents the appearance, in some cases, of a series of margined rings, some twenty in



*Kallispungia*.

number, fastened together one on the top of the other; in others the margins of the rings will be more prominent, and the bodies of the rings will be, as it were, more deeply sunk. In both these cases the horny framework is of a more or less evenly latticed character, the longitudinal lines of the lattice being very prominent. The head portion, in its natural state, probably presents a more or less spherical form, perhaps slightly flattened on the summit, with an indication of being divided into four nearly equal parts, the open space between these leading into the body-cavity of the sponge. In some of the specimens the head portion nearest to the stem seems to have been formed of a somewhat denser framework than the upper portion, so that while being pressed this upper portion has been fractured across. The framework here is of a densely-reticulated kind, in appearance reminding one of the reticulated network of the intracapsular sarcode in *Thalassolampe*, or of the tissues met with in some Echinoderms. This sponge has been called *Kallispungia archeri*. The wonderful mimetic resemblance which it bears to some Crinoid-forms can scarcely be overlooked. Leaving the texture and composition of the skeleton mass for the moment out of view, and simply looking at its outline—the circular disc-like base, the stem—the profile of which is absolutely the same, except as to size, as that of the pentacrinoid stage of *Antedon pacificus*, and the slightly cleft head, the resemblance is very great. So far as is known, this is a unique case among the sponges, and one is left to wonder what may be the tiny enemies from which *Kallispungia archeri*, by this complete disguise, conceals itself.

**WILD DOGS ON THE OBI.**—An interesting occurrence of dogs which have reverted to the wild state is reported by M. Poliakoff from the neighbourhoods of Soorgoot on the Obi, and Tobolsk. The size of these animals is somewhat larger than that of the dogs of the locality, but less than that of wolves; their habits being rather remarkable the inhabitants would not acknowledge them to be common dogs, and the hunters preserved by skins of the individuals they happened to kill, as rare samples

of unknown animals. M. Poliakoff could not, however, detect in the skins he describes any deviations from the common dog type, except the larger size, and perhaps a somewhat greater length of body, with comparatively shorter legs (at Tobolsk). But the habits of these animals are certainly wolf-like; they inhabit woods and live by hunting, which they carry on in companies. Ten individuals were thus well-known at Soorgoot as hunting in company the wild reindeer, and latterly they approached the settlements, causing a panic among the inhabitants by the ravages they made among cattle. They hunted always together, assailing their prey simultaneously. They are reported also to be far more voracious than wolves, and their habits, M. Poliakoff observes, resemble much those of the red highland wolf (*Canis alpinus*) of Eastern Siberia.

**THE WOODPECKER.**—At the session of the German Ornithological Society, on February 8, Prof. Altum gave an interesting address on the ordinary woodpecker, embodying a portion of the results of over seven years' observation. With regard to the question of how the woodpecker finds the trees inhabited by insects, he had noticed that it almost invariably resorted to such trees as bore the diseased look consequent upon the presence of insects, manifested by the smallness and fewness of the leaves, the absence of the usual fresh colour of the bark, &c. In some cases it is deceived, especially where new varieties of trees have been set out. When it has detected a hole bored in the bark by insects, it follows the course of the passage under the bark by a gentle tapping with its bill, until it reaches the place where the larvae are situated, when, by tearing off large portions of bark, its food is laid bare. Among the insects not eaten by the woodpecker are such as the *Ceromyx heros*, which bores too deep into the wood, or small insects such as the *Bastichida*, living in the bark of the pine tree, which is difficult to penetrate. The presence of the woodpecker is good for a forest, in so far as it destroys the insects upon the trees. It however injures the latter frequently by tearing off large pieces of bark, and indirectly by eating the useful wood-ants. The statement that woodpeckers made incisions in trees free from insects, for the purpose of sucking the sap, was disproved by Prof. Altum, on ground of repeated observations.

**SAGACITY OF A LOBSTER.**—A few days ago, at the Rothesay Aquarium, a tank containing flat fishes was emptied, and a flounder of eight inches in length was inadvertently left buried in the shingle, where it died. On refilling the tank it was tenanted by three lobsters (*Homarus marinus*), one of which is an aged veteran of unusual size, bearing an honourable array of barnacles; and he soon brought to light the hidden flounder, with which he retired to a corner. In a short time it was noticed that the flounder was *non est*. It was impossible the lobster could have eaten it all in the interim, and the handle of a net revealed the fact that, upon the approach of the two smaller lobsters the larger one had buried the flounder beneath a heap of shingle, on which he now mounted guard. Five times within two hours was the fish unearthed, and as often did the lobster shovel the gravel over it with his huge claws, each time ascending the pile and turning his bold defensive front to his companions.

**THE INFLUENCE OF TEMPERATURE ON THE NERVE AND MUSCLE-CURRENT.**—M. Steiner has proved (*Reichert's Archiv*) that the electromotive force of the nerve-current from 2° upwards, is greater the higher the temperature, that it reaches a maximum between 14° and 25°, and at higher temperatures decreases again. The force of the muscle-current is likewise, from 5° upwards, greater the higher the temperature; it has its maximum between 35° and 40°, and at higher temperatures becomes less again, till, when rigidity sets in, it is almost nil. Thus, for the nerve and muscle-current, as well as for other functions of

living organic forms, there is a *temperature optimum*; which is as distinctly marked when, by heating, we rise to it from lower temperatures, as when we descend to it by cooling from higher temperatures.

**FERTILISATION OF FLOWERS BY BIRDS.**—In an interesting article by Prof. Ass. Gray, in the *American Journal of Science and Arts*, on Darwin's recent work the writer notices what Darwin says about the fertilising of flowers by birds, chiefly humming-birds. The frequenting of the flowers of *Impatiens* is the only case cited from the United States; and Dr. Gray asks: "Can it be that there are no references in print to the most familiar fact that our humming-bird is very fond of sucking the blossoms of trumpet creeper (*Tecoma radicans*) and of honeysuckles? Both these are, in size and arrangement of parts, well adapted to be thus cross-fertilised."

**A NEW PARASITIC GREEN ALGA.**—Not very long since it was thought that the want of chlorophyll determined the parasitism of plants, and it is still true that the want of this green colouring substance serves to distinguish between fungi and algae. It is also true that the former need already-formed carbon compounds, but it is still thought that chlorophyll-bearing plants not only do not require to find these compounds ready formed, but that they are absolutely unable to assimilate them. It was therefore a fact of great interest when Prof. Cohn described some years since (1872) a perfectly new chlorophyllaceous alga ("Ueber parasitische Algen" in *Beit. zur Biol. der Pflanzen*, Bd. i. Heft 2; see also W. Archer, *Quart. Journ. Mic. Science*, N.S., vol. xiii.), which he found living as a bright emerald green parasite in the thallus of duck-weed gathered at Breslau. For this the genus *Chlorochytrium* was established, and *C. lemnae* was the only species until at a late meeting of the Dublin Microscopical Club, Prof. E. Perceval Wright exhibited and described a second species found growing and developing itself in the mucilaginous tubes of a species of *Schizonema*, collected on rocks at Howth, near Dublin, between high and low water-marks. There can be no question as to the parasite on the diatom being different from that on the duck-weed, while there is but little difficulty in placing it in Cohn's genus. Smaller in size its emerald lustre is scarcely if at all less than the fresh-water species, and like it its development has not been traced farther than the production of zoospores.

**FLORA OF TURKESTAN.**—We notice a very interesting communication on the Flora of Turkestan, made by Prof. Regel, the director of the St. Petersburg Botanical Garden, at the last meeting held on January 20, by the Russian Society of Gardening. The special aim of the communication being to advocate the introduction into European gardens of representatives of the flora of Turkestan, Prof. Regel described the numerous, original, and most beautiful species belonging to the *Compositae*, *Caryophyllae*, *Umbelliferae*, *Papilionaceae*, *Malvaceae*, and *Campanulaceae*, which grow in Turkestan, and which could rank among the best ornaments of our gardens by their variety and beautiful forms and colours. Most of these species are already cultivated with complete success in the St. Petersburg Botanical Garden, and they might be thus introduced in the gardens of Russia and Western Europe. Concluding his communication, Prof. Regel pointed out the remarkable circumstance that in Turkestan, even in hilly tracts, the *Ericaceae* are totally wanting, whilst they are so common in the highlands of the Alps, of the Caucasus, and even of the Altai.

#### NOTES

METEOROLOGISTS everywhere will learn with much satisfaction that Dr. Julius Hann, the eminent meteorologist, was appointed, February 20, successor to the late Dr. Feilich, as

Director of the Central-Anstalt für Meteorologie und Erdmagnetismus, Vienna.

FIFTY-SEVEN candidates for election into the Royal Society have offered themselves during the present session.

PROF. A. OFFENHEIM, of Berlin, has accepted the chair of chemistry in the newly-organised Philosophical Faculty at Münster.

PROF. PFEFFER, of Bonn, has accepted the ordinary professorship of Botany in the University of Basel.

THE Treasury have agreed to recommend votes from the Consolidated Fund for 80,000*l.* towards the new buildings devoted to the Science Schools of the University of Edinburgh, in four yearly instalments of 20,000*l.* each. This vote is to supplement a like amount subscribed by the public.

THE marble statue of Sir W. Fairbairn is in the hands of Mr. Gelfowski, who obtained the Commission in competition with other eminent sculptors. Besides the statue, which is to stand in the New Town Hall, Manchester, facing the entrance, a Fairbairn scholarship is founded in Owens College, Manchester, out of the funds subscribed. The statue is eight feet high, representing Sir W. Fairbairn standing with papers in his hand as if delivering an address to a scientific audience, the head bare and inclined slightly, and an admirable likeness in the features as well as in the thoughtful expression and quiet energy characteristic of the man.

THE University of Tübingen is making preparations to celebrate its 400th anniversary during the coming month of August. Various historical addresses are in course of preparation, and a work will be issued commemorative of the occasion.

A PUBLIC meeting of the Sanitary Institute of Great Britain will be held at the rooms of the Society of Arts, John Street, Adelphi, on Wednesday, March 14, at 3 P.M., to consider the report recently issued by the Committee appointed by the President of the Local Government Board upon the disposal of town sewage.

HIS Majesty, the Emperor of Brazil, observed the eclipse of the moon on the evening of the 27th, at the Arcetri Observatory. The Emperor took a very lively interest in the phenomenon and discussed with acuteness the hypothesis with which Prof. Tempel, the astronomer, and Prof. Ebert tried to explain the varying shades and colours in which the moon appeared during the different phases of obscuration. On Monday last his Majesty assisted at a meeting of the Anthropological Society, when Prof. Mantegazza made some interesting remarks on several Maori skulls, and Prof. Giglioli read an elaborate paper on the ethnology of Brazil.

THE general expenses of the seven Russian universities in 1876 were as follows:—The University of St. Petersburg, 43,500*l.*; of Moscow, 52,850*l.*; of Kieff, 38,375*l.*; of Kazan, 39,500*l.*; of Kharkof, 38,125*l.*; of Odessa, 25,375*l.*; and of Dorpat, 26,625*l.*

WE notice the following more important papers on natural science, among those published by professors of the Moscow University in 1876:—"Observations de Jupiter en 1876," "Profil spectroscopique du Soleil en 1876," and "Sur la Queue de la Comète de 1874," by Prof. Bredikhin, in the *Annales* of the Moscow Observatory; a paper, by Prof. Babukhin, "Ueber die Structur und Verhältnisse elektrischer und pseudo-elektrischer Organen," in the *Archiv für Anatomie und Physiologie*; "Théorie des Dérivées," and "On the Numerical Equations of the Second Degree," by Prof. Bagaieff, in the *Moscow Mathematical Review* (Russian); the papers of Prof. Markovnikoff on Thine (*NATURE*, vol. xv. p. 167). An interesting popular lecture on Unicorns,



and on the origin of the myths on them, was delivered at the last anniversary of the University by Prof. Usoff.

M. DUMAS has been nominated president of the Société d'Encouragement pour l'Industrie Nationale. At the last meeting of the Society M. Moutenat exhibited metallic tubes which emit sounds when burning coal is placed in the interior. The sound is modified when the place occupied by the coal has been changed. A copper tube into which metallic gauze has been introduced also emits musical sounds. M. Moutenat is preparing to build large tubes for the International Exhibition of 1878. He hopes the sounds may be heard at a great distance, and if successful he intends to propose this method instead of steam whistles for warning on the sea-coasts.

THE Bradford Scientific Association purpose holding a conversation and exhibition of scientific instruments and objects on the evenings of April 11 and 12. Exhibits will be arranged under various sections and sub-sections, and contributions will be welcomed.

FROM the Annual Report of the Geologists' Association we learn that the number of members on January 1 was 390.

VOL. I. Part 6, of the *Transactions* of Watford Natural History Society contain papers on the Hertfordshire Bourne, by Mr. John Evans, F.R.S.; on the Hertfordshire Ordnance Bench Marks, by Mr. John Hopkinson, F.L.S.; and on the Polarisation of Light, by Mr. J. N. Harford.

MR. RUDKIN has given notice of his intention to move, at the next meeting of the Court of Common Council, that it be referred to the Gresham Committee to confer with the Mercers' Company as to whether and how the Gresham College foundation can be utilised and extended in connection with the scheme which is now being prosecuted by the Livery Companies for establishing a Central Technical University, with affiliated colleges and institutes, not only in the metropolis and its suburbs, but in the chief centres of industrial life throughout the United Kingdom.

THE Russian Government announces the discovery of valuable silver deposits in several islands of the White Sea.

GRAF WALBURG, a member of Dr. Brehm's expedition to Siberia, is now studying the botanical and paleontological collections at Dorpat. He proposes to undertake this year another journey to Asia and to explore the Caucasus.

THE St. Petersburg papers announce the return of Lieut. Onatsevitsh, who has spent two years in the survey of the Northern Pacific shores of Siberia. After having observed the Transit of Venus, Lieut. Onatsevitsh engaged in a full and thorough survey of Behring's Strait, extending his soundings into the glacial ocean as far as the ice barrier over a surface of about sixteen square degrees. Further, having at his disposal fourteen chronometers, he has determined many longitudes, and has brought into connection the longitudes formerly determined in the north-east with those recently determined with great accuracy before the Transit of Venus in south-eastern Siberia. The work done by M. Onatsevitsh will be the subject of communications at the next meeting of the St. Petersburg Geographical Society.

THE map of the mouth of the Obi, prepared by M. Dahl (who made last summer a detailed survey and soundings when descending the river on board the schooner *Moscow*, built in Tiamen), will appear in the course of a month or two.

THE *Afrikanische Gesellschaft* of Berlin received a few days since news from Dr. von Bary, who at the end of December was on the point of leaving the city of Khat to penetrate into the mountain region of the Tianshan, in the central part of the Balkan. Hostilities had just ceased between the tribes inhabit-

ing this territory, and there was every probability of his successfully accomplishing the aims of the journey, viz., a careful geological study of this scarcely-known region.

IN the last session of the Berlin Geographical Society, the president, Dr. Bastian, announced that the well-known African traveller, Dr. Gustav Nachtigal, intended to undertake a new journey of exploration into the interior from the coast of equatorial Africa. This field, now rendered vacant by the death of Edward Mohr at Molange, has always been the favourite territory of the German explorers. Dr. Nachtigal's peculiar qualifications for the undertaking, as well as his six years' varied experience in the hardships of African travel, will lend an important character to this new attempt to penetrate into the unknown interior of the continent.

AT the meeting of the French Geographical Society M. Charles Velain read a paper on the volcanic lakes of the island of Nossi Bé, near Madagascar. The formation of the island is generally volcanic, the north and south parts being of ancient formation, while the central part is of much more recent origin. Besides a number of true volcanic craters, not very high, M. Velain found a great number of crater-lakes or circular troughs, level with the ground and filled with water. These troughs, M. Velain thinks, must have been formed by subterranean explosions, which did not last long enough to enable the lava to reach the surface. These lakes abound in fish, many of which are probably new species; it is impossible, however, to catch them, on account of the number of crocodiles that swarm on the banks.

ENGÄNZUNGSHFT No. 50 of Petermann's *Geographische Mittheilungen* contains the first part of a narrative of M. E. de Pruyssenaere's Travels in the Region of the White and the Blue Nile. M. de Pruyssenaere was a young and accomplished Belgian who spent most of the time between 1859 and 1864 in the exploration of the above region, and after much difficulty the editor of the narrative, K. Zöppritz, obtained possession of his journals and notes. Notwithstanding the length of time that has elapsed since M. de Pruyssenaere traversed the region, it will be found that his narrative adds considerably to our knowledge of it. He made many botanical notes, which, we believe, will be published at a future time. Accompanying the narrative is a map of the region, showing the traveller's routes, prepared from his astronomical and trigonometrical observations. M. de Pruyssenaere died in the midst of his travels in 1864, at the early age of thirty-eight years.

PROF. C. JARZ, of Vienna, formerly an artillery officer under the Emperor Maximilian of Mexico, has recently issued a short work on "Ocean Currents of the North Atlantic," with especial reference to the Gulf Stream, embodying much of individual observation. The rotation of the earth is excluded from among the causes producing these phenomena. His theory is essentially that each current has its own particular causes, and that a number of independent compensating forces occasion the character, speed, and direction of the currents.

THE last session of the Hungarian Natural History Society was devoted to a detailed account, by M. von Hantken, of the results of his extensive microscopic researches on the Hungarian limestone formations. The old Tertiary deposits near Ofen were found to consist almost entirely of organic remains, principally Algae, Foraminifera, and Bryozoa. The Algae form the chief part of several strata and belong to the genus *Lithothamnium*. Microscopic investigation showed a regular structure of successive layers of cells. In the interstices between the cells of the plants carbonate of lime was gradually deposited, and they were petrified entire. The presence of the remains of Foraminifera and Bryozoa showed a contemporaneous zoogenous and phylogenous growth of the rocks. As the *Lithothamnium* of the

present day grows only on the sea-shore, it is probable that these Hungarian limestone deposits are coast formations.

IN the February session of the Hungarian Geological Society, Prof. Krenner displayed a lately-discovered mineral from Nagyág, which consisted of pure telluride of gold. As is well known, gold does not occur in nature in combination with any member of the sulphur-group except tellurium. A mixture of the tellurides of silver and gold was found recently in California, but this is the first instance of the occurrence of the pure auric telluride in a crystalline state. In view of the fact that gold is the noblest metal, and tellurium one of the rarest elements, the new mineral has been called *Bunsenite*, in order to give a fitting expression of the gratitude of the great chemist's admirers in Hungary for the services rendered to mineralogy by his analytical methods.

A REMARKABLE piece of coral taken off the submarine cable near Port Darwin, is spoken of in a Melbourne paper. It is of the ordinary species, about five inches in height, six inches in diameter at the top, and about two inches at the base. It is perfectly formed, and the base bears the distinct impression of the cable and a few fibres of the coil rope used as a sheath for the telegraphic wire still adhering to it. As the cable has been laid only four years, it is evident that this specimen must have grown to its present height in that time, which seems to prove that the growth of coral is much more rapid than has been supposed.

It is well known that in many places springs of fresh water arise from the bottom of the sea. M. Toselli proposes to make use of them. Their water, brought through flexible tubes held at the surface by suitable buoys, would furnish ships with supplies of water they are often in need of. M. Toselli appears to have studied the question carefully, and provided for the preservation of his apparatus in the face of storms.

The rapid melting of snow in the mountain regions causes great inundations in south-eastern France and in Switzerland, and Swiss papers daily record the damages done by the floods. The greatest damage is caused by the Doubs, both in France and Switzerland. The Rhine at Basel rose on February 16 by 6.22 metres, reaching thus a level only 2.46 metres lower than during the great inundation of March 1, 1876. Prof. Fotel writes to the *Gazette* of Lausanne, that the level of the Lake of Geneva rose on February 15 and 16 at the rate of three millimetres hourly, or 155 millimetres in the course of two days, and he points out that more rapid risings were noticed only three times in the course of the last twenty-nine years (in 1856, and twice in 1876), when the level rose daily 73 to 82 millim. in twenty-four hours. The amount of water accumulated in the lake was thus as large as 42,000,000 cubic metres in the course of a day. The Lake of Zurich rose at the same time 40 centimetres in twenty-four hours; but its superficies being seven times less than that of the Lake of Geneva, the figure shows a far less accumulation of water; viz. of 26,000,000 cubic metres in the course of a day.

As one of the Memoirs of the Geological Survey, Mr. Whitaker has just published a paper on the Geology of the Eastern End of Essex (Walton Naze and Harwich). Longmans and Stanford are the publishers.

We are glad to hear that an ethnographical museum was opened at Helsingfors on January 24. The nucleus of the museum was formed from collections exhibited at the recent Helsingfors Exhibition. It contains a large number of clothed figures representing the varied ethnographical types of Finland and their yet more varied costumes, interiors of peasant's homes, samples of household furniture and tools, of hunting and fishing implements, of objects used by the yet numerous conjurers, pal-

lections of stone implements, &c. The importance of the museum will be well appreciated by all acquainted with the interest afforded by the ethnography of Finland.

THE French Anthropological Society has been authorised by M. Krantz to open an international exhibition in the central palace of the Trocadero. M. Quatrefages has been appointed Chairman of the Commission. Communications relating to the exhibition may be sent either to the Society in Paris or to M. Gabriel de Mortillet, at the Musée des Antiquités Nationales, St. Germain, Seine-et-Oise. The Anthropological Exhibition will be distributed into a number of sections, and several national committees might be established if necessary. Further details will soon be published for the guidance of intending exhibitors or visitors.

ON February 25 the city authorities of Vienna inaugurated a novel and remarkably interesting application of pneumatic tubes for the purpose of maintaining unison and regularity in widely-separated time-pieces. The inventor is the Austrian engineer and electrician, E. A. Mayrhofer, who, after vainly trying to solve the problem by means of electricity, finally hit upon the new system. From a central bureau in the city, connected with the Imperial Observatory, these pneumatic tubes extend in all directions, laid alongside the gas mains, and branching off to the public clocks. By means of a simple apparatus in the latter the authorities in this bureau are able to exhibit the true astronomical time on the clock dials in all parts of the city, a movement of the hands occurring once a minute. At present only the city clocks have been brought in connection with the new system, but it will rapidly be extended, until it embraces the time-pieces in all the schools, public institutions, hotels, &c., and in those private residences where it may be desired.

THE prospects of coffee-cultivation in Coorg seem to be somewhat gloomy, for we learn from a recent report that the plants have not only had to contend with the regular insect and fungoid diseases, but also with such an extremely dry season, that the drainage of the country became very low, and all the springs and wells nearly exhausted. Many of the coffee nurseries had to rely on hand watering from springs and rivulets, and thousands of seedling plants constantly withered and dried up. The greatest damage, however, seems to have been done by what is described as "the planter's old and implacable enemy, the *Xylocopa quadriceps*," commonly called the borer, the ravages of which are as destructive and extensive as ever; planters are often deceived as to the presence of this insect, the appearance of the trees even when attacked, failing to convey an idea other than health. The revelation at crop time, however, convinces the sceptic of the insidious approaches and devastations of the enemy, which can be overcome and subdued only by timely and resolute extermination of every bored coffee tree. The periodical increase of the insects is attributed by residents on or near the plantation to the prevalence of dry seasons. It spreads most in open coffee fields in warm localities, and least in moist and shady places where there is high cultivation. With regard to the *Henilda vastatrix*, or leaf disease, it seems to have considerably lessened, or, as the report says, disappeared. This is almost more than we can expect, and as much as we can hope for; nevertheless, it may be as the writer of the report says, that the disease is existing under another form, "And may reappear in those well-known orange-coloured spots, for like other fungi it undergoes certain transformations. It is singular that these orange-coloured spores are generally encircling the stomata of the lower epidermis of the leaves, and," the writer proceeds to say, "I have found them even on leaves of coffee seedlings, not one year old. It is difficult to conceive how these spores should have come there, whether from within or without. The walls of the cellular tissue around the spots being attacked are by an in-

insect disease. It seems equally difficult to say, whether the fungus is the cause or effect of the diseased leaf. As to remedies, these appear to be expected rather from climatic influences than from the sagacity of man, for all the propositions yet made may prove satisfactory in the laboratory, but are impracticable where any large area is to be operated upon."

THE subject of blight or disease affecting the plants in the tea plantations of India has been brought prominently under the notice of the Agri-Horticultural Society of India, a letter having been addressed to the society to the effect that the attacks of "blight and red spider having become of such a serious nature on many tea-gardens both in Assam and Cachar, but especially in the latter province, it is necessary that all possible information, with a view of mitigating the evil, should be obtained and made widely known." At a subsequent meeting of the society the line of action proposed, subject to the assistance of those interested in the matter, was to engage the services of an entomologist from England for the period of two years so that he might have time and opportunities to observe and carefully study the character of the several kinds of blight in their various localities, such observations to be published under the auspices of the society.

THE introduction of the Carob (*Ceratonia Siliqua*) into the Madras Presidency, a subject which occupied the attention of the Agri-Horticultural Society of Madras a few years since, has been again brought before the society. It is strongly recommended for cultivation in countries suffering from periodical droughts in consequence of its long roots penetrating a great depth into the earth, and because of the large quantity of mucilaginous saccharine matter contained in the pods, so that it might be largely used for feeding cattle, horses, pigs, &c. It is said, however, that although the seeds contain nitrogenous elements or flesh-making materials, they do not possess great nutritive properties, and the seeds being small and hard they are not easily masticated, and pass in their crude state undigested.

A PECULIAR request (according to the *Berliner Tageblatt*) has been made by the Society for Bird Protection to the General Postmaster in Berlin, viz., to make arrangements so that birds be not killed by the pneumatic post. The case is this: From the large air-compressing steam-engines proceed chimney-pipes to the roof, by which the required air is sucked in. The power of this suction-apparatus is so great, that both small and large birds, even pigeons, which happen to be flying over the tubes when the engine is in action, are helplessly drawn in and destroyed.

TAKING opportunity, lately, to observe with a Nicol's prism an uncommonly fine rainbow, which spanned the Oesthal in Baden Baden, M. Schiel found that with the prism in a certain position, the colours disappeared completely, and the prism was pretty dark. But on turning it through 90°, the bow appeared again in all its brilliancy. The rainbow is therefore perfectly polarised light. Several rainbows observed since have shown the same behaviour; but apparently only a very bright-coloured rainbow presents dark on the field of vision with the corresponding position of the prism.

THE additions to the Zoological Society's Gardens during the past week include a Macaque Monkey (*Macacus cynomolgus*) from India, presented by Mr. Thos. Dalby; a Galapagan Tortoise (*Testudo elephantopus*) from the Galapagos Isles, presented by Mr. W. H. Henderson; two Herring Gulls (*Larus argentatus*), European, deposited; a Common Nuthatch (*Sitta castea*), European, presented; a Red Kangaroo (*Macropus rufus*), born in the colonies.

## SCIENTIFIC SERIALS

*Poggendorff's Annalen der Physik und Chemie. Ergänzung Band VIII., Stück 2.*—Researches on the nature of the vowel "clang," by M. Aferbach.—On the interference of reflected light (concluded), by M. Lommel.—On the tension of liquid films, by M. Sondhaus.—On a fundamental law in dioptrics, by M. Most.—On the complementary colours of gypsum in polarised light, by M. v. Kobell.

*Memoria della Società degli Spettroscopisti Italiani, November, 1876.*—The paper by Prof. Young, of Dartmouth College, on the displacement of the lines in the solar spectrum caused by the sun's rotation appears here. Prof. Young used the spectra of the sixth and eighth orders obtained by a grating of 8,540 lines to the inch, a collimator of 2½ inches diameter, and 16 inches focal length attached to the 9¼ inch equatorial. The observations were made chiefly on the D lines and the Ni line between them giving a result of 1.42 mile a second; this exceeds the result from ordinary observations of spots by 0.34 mile, and the author considers it a fact that the solar atmosphere really sweeps on forward over the underlying surface.—Prof. Tacchini gives a history of his journey up Mount Etna for the purpose of making spectroscopic observations of the sun. The spectroscopic and direct observations of the sun made at Palermo in October last appear here, also the drawings of the chromosphere for May, 1875.

December, 1876.—Father Secchi gives his catalogue of 444 coloured stars with notes on the spectra of the same.—Mr. Huggins contributes a preliminary note on the photography of stellar spectra, together with a drawing of the spectrum of  $\alpha$  Lyra.—Observations of the lunar eclipse of September 3, 1876, by A. Dorna.—Observation of the Perseids made at Palermo in August, 1876, by Prof. Tacchini and G. de Lisa.

*Morphologisches Jahrbuch, vol. ii. part 4.*—On fossil vertebræ and teeth, by C. Hassé, dealing especially with fossil squatinas from the Jurassic and Cretaceous rocks.—On the development of the auriculo-ventricular valves of the heart, by A. C. Bernays.—On the segmentation of the ovum and formation of the blastoderm in Calyptraea, by A. Stecker.—On the primitive groove in the chick, by A. Rauber.—On the nasal cavities and nasal duct of Amphibia, by G. Born, seventy pages, three plates.

*Revue des Sciences Naturelles, vol. v., No. 3, December, 1876.*—Contributions to the natural history and anatomy of the Ephemeride, by N. and E. Joly, an important paper.—On parthenogenesis in *Bombyx mori*, by Carlo de Siebold.—On the histology of the egg, by A. Villot, dealing with theoretical views on the germinal vesicle and its history. There are also excellent reviews of recent French zoology, botany, and geology.

*Zeitschrift für wissenschaftliche Zoologie, vol. xxvii., part 4, 1876.*—On the anatomy of the Ophiuroid, *Ophiactis vivans*, by H. Simroth, seventy pages, five plates.—On the structure of the brain in Arthropods, a memoir describing the brains of *Apis mellifica*, *Gryllus campestris*, *Gryllotalpa vulgaris*, *Carabus viol.*, and *Astacus fluviatilis*, by M. J. Diel, of Innsbruck, thirty pages, three plates.—On the transformation of the Mexican Axolotl into Amblystoma, by Marie v. Chauvin.

*Reale Istituto Lombardo di Scienze e Lettere, Rendiconti, vol. 1., fasc. 1.*—On Arabic money in the numismatic cabinet of Milan, by M. Ghiron.—On the coordinates of points and of lines in a plane, and of points and planes in space, by M. Casorati.—On two meteorological instruments invented by Angelo Bellani, by M. Cantoni.—On special cases of anencephaly, with observations on their etiology, by M. Sangalli.—On *Helminthosporium vitis* (Lev), a parasite of the leaves of the vine, by M. Frotta.—On the phenomena which accompany the expansion of liquid drops, by M. Cintolesi.

*Journal de Physique, February.*—On a property of an electrified surface of water, and on the polarisation of the electrodes, by M. Lippmann.—On the phenomena of induction (concluded), by M. Mouton.—Comparative pitches of sounds given by various metals and alloys, by M. Decharme.—Experiments on M. Ch. Lottens, S.L.—The movements of the aerial column in anomalous tubes, by M. van Tricht, S.L.—The electric properties of sodium and potassium at different temperatures, by MM. Nœcker and Bellati.

## SOCIETIES AND ACADEMIES

## LONDON

Royal Society, February 8.—"On the Hindoo Division of the Octave, with some Additions to the Theory of the Higher Orders," by R. H. M. Bousquet, Fellow of St. John's College, Oxford. Communicated by Prof. Henry J. S. Smith, Savilian Professor of Geometry in the University of Oxford.

Attention has been recently directed to the remarkable division of the octave into 22 intervals, employed by the Hindoos. The paper commences with a slight account of the Hindoo scales as thus derived. It is then remarked that our best way to a real analysis of this music would be to study the system of 22 and compare the results with those actually obtained by Hindoo musicians. The methods, which have been employed in the writer's former paper on the subject, are then extended to the higher orders, which have not been before thoroughly discussed. The system of 22 is a system of the second order, and the nature and peculiarities of such systems, and of the system of 22 in particular, are discussed.

A classification of systems of the higher orders according to their mode of forming thirds is advanced. If the system be arranged in successive series of fifths, differing by one unit in pitch, then the system is said to be of class  $x$ , if the third of any note is in the series  $x$  units below that which contains the note itself.

The system of 22 is shown to be of the second order and first class.

A system of 34, also of the second order and first class, is pointed out as being of considerable excellence, even from a modern practical point of view.

It is shown that in systems of the second order and first class, modulation through a third cannot be regarded as equivalent to modulation through any number of fifths.

The notation is extended to systems of the  $n$ th order.

The subject of the transformations of the generalised key-board is then entered upon. It is remarked, in the first instance, that any form of arrangement whatever can be constructed by rearranging a supply of keys of the ordinary patterns.

The problem of inversion is then solved, and it is shown under what circumstances, by simply inverting the succession from end to end, a key-board can be obtained in which rise corresponds to fall of pitch, and *vice versa*.

The general transformation of the  $n$ th order is then investigated, and a rule is given by which the key-board of the  $n$ th order can be arranged with the ordinary keys.

This rule is then applied to the construction of the key-board of the second order, and a diagram is given of a portion of a key-board so arranged. Systems of the second order and first class, such as the systems of 22 and 34 above-mentioned, can be controlled with facility by means of this arrangement.

February 15.—On Crookes's force, by G. Johnstone Stoney, F.R.S., and Richard J. Moss, F.C.S.—This paper is a preliminary report of an experimental investigation of the theory of Crookes's radiometer proposed by Mr. Stoney in the *Philosophical Magazine* for March and April, 1876. The term "Crookes's force" is employed to designate the reaction which comes into play between the blackened disks of a radiometer and the walls of the exhausted chamber when a difference of temperature exists between them. The authors have sought to determine quantitatively the relation of the force to the tension of the residual gas, and the influence of variations in the distance between the reacting surfaces. For this purpose they employ an apparatus in which a blackened disk of pith can be placed at any required distance within twelve centimetres from a delicately suspended disk of thin microscope glass. The pith disk is heated by projecting on it the image of a uniformly illuminated aperture in a metallic screen. The relative magnitudes of the force are estimated by determining the distance to which the glass disk is repelled in a given time. It is sometimes difficult to distinguish between the effects of convection currents and those of Crookes's force. It is certain, however, that when the tension of the residual gas is as much as five millimetres of mercury there is a Crookes's reaction through a space of at least ten millimetres.

At distances of from twenty to eighty millimetres the very feeble force acting on the glass disk seemed to vary about inversely as the tension. It appeared to be nearly independent of the distance when the distance exceeded twenty millimetres.

*Proc. Roy. Soc. Lond.*, vol. 5, p. 220, and "An Elementary Treatise on Musical Intervals and Temperament" (Macmillan, 1876).

At distances of five, ten, and twenty millimetres, the force on the rotating disk made some approach to varying at each tenfold increase as the distance. But so far as may be judged from measures of such exceedingly feeble forces, there is a sensible deviation from this law at most of the tensions. Moreover the observations, taken as a whole, seem to suggest, in conformity with the dynamical theory, that the law changes with variations of density.

Linnean Society, February 15.—Prof. Allman, F.R.S., president, in the chair.—Messrs. W. Burns, E. L. Gardner, Prof. W. Harrington (of Michigan, University, U.S.), J. W. S. Meiklejohn, the Rev. J. Stobbs, and Sir Charles W. Strickland, Bart., were elected Fellows.—There was exhibited under the microscope by Mr. Arthur Lister the plasmodium of one of the lowly organised *Myxomycetæ*. This protoplasmic mass demonstrated the peculiar amoeboid movements, and the occasion gave rise to an animated discussion on its contested animal or vegetable nature.—Two botanical papers were read, the first on the rootstock of *Marattia fraxinea*, Sm., by Mr. John Buchanan; the second on the Algae collected at Rodriguez during the Venus Transit Expedition, 1874, by Prof. Dickie. The *Marattia* is chiefly found in the northern part of New Zealand. The Maspires use it as food, but do not cultivate it systematically. They say that when it is smashed, the pieces thrown on the ground spring up freely and thus it has increased. At Wellington, where transplanted, it grows luxuriantly when placed in rich damp soil. Mr. Buchanan has now studied its mode of growth; he considers the rootstock as resembling a scaly bulb more than a fern rhizome, and likens its propagation to that of the potato, though modified. Its growth is very slow, hence, probably, its scarcity. The fresh-water Algae of Rodriguez point in an Asiatic direction, none are African species, while some have rather a world-wide distribution.—The Secretary read a note on a new example of the Phyllocodiceæ (*Anailis rosea*), by Dr. W. C. McIntosh. This marine worm was obtained at St. Andrews. It is  $\frac{1}{2}$  inch long, with relatively broadish body, blunt snout, and small eyes. On head and body it is slashed and speckled with pink, which merges into a yellow band behind.—A communication was read on deep-sea anemones (Actinaria) dredged from on board the *Challenger*, with a description of certain Pelagic surface swimming species, by Mr. H. N. Moseley, late naturalist to the above expedition. The occurrence at great depths of representatives of ordinary shallow water forms of Actinia is of profound interest. A species of *Edwardsia*, from 600 fathoms, has undergone but trifling modification from the littoral form. The *Cerianthus*, from 2,750 fathoms, is dwarfed, but uncommonly like its shore brethren. Thus it appears one kind is found in shallow water at the Philippines under the full glare of the tropical sun, while another species of the same genus exists at three miles depth, where solar rays never penetrate, and the water keeps at freezing point. The fact of the deep-sea Anemones retaining vivid colouring in their dark watery abode is a point of special value as connected with certain other generalisations. The new genus *Corallinomorphus* likewise possesses interest both on account of being a nearly ally to certain of the simple discoid corals, and of its having the largest stinging cells (nematocysts) yet recorded.—An extract of a letter on the marsupial pouch of the Bandicoot, by Mr. R. D. Fitzgerald, was briefly adverted to by the Secretary.

Chemical Society, March 1.—Prof. Abel, F.R.S., president, in the chair. Prof. E. T. Thorpe delivered his lecture on "The theory of the Bunsen lamp." The speaker, after some preliminary remarks as to the great value of this instrument, both to the scientific chemist and also in the arts, gave a short description of the lamp and proceeded to show the principle on which it acted. The gas issuing from the jet draws in air through the holes in the side, and becomes mixed with it in the tube, the amount of air being about 2 to 2½ times the volume of the gas, and as it burns on an average 80 litres of gas per hour, as much as 250 litres of the mixed gases pass through the tube of the lamp in that space of time. After having sketched the progress of the mixture of gas and air up the tube, attention was directed to the flame itself, which is hollow, and contains a large internal space of the uninflamed gaseous mixture. As it has been found that a mixture of gas with less than 3½ times its volume of air will not burn, it is only, therefore, when it meets with an additional supply of oxygen from the surrounding air that combustion occurs. The composition of the gas in the tube and in various parts of the flame was then studied, and the probable causes of the want of luminosity in the flame stated. These are due

to the dilation of the gas by the nitrogen, the oxidation of luminiferous material, and the depression of temperature produced by the diluting gases, such as nitrogen, carbonic oxide, and aqueous vapour.

**Meteorological Society, February 21.**—Mr H. S. Eaton, M.A., president, in the chair.—William Adams, Thomas Black, Robert W. Munn, and R. Bowie Wallcott, M.D., were elected Fellows; and Mons. U. J. Leverrier, Director of the Observatoire National, Paris, an honorary member of the society.—The President gave an inaugural address. After referring to the various theories advanced to account for changes of climate, he observed that in drawing deductions from a long series of observations of the temperature of the air, it is important to ascertain whether the conditions of the surrounding district have altered, otherwise changes of reality due to local causes may be erroneously assigned to secular variation. The climate of London has thus been modified by the consumption of fuel and the vast population. He estimated that the heat developed from the present annual consumption of 5,000,000 tons of coal on the metropolitan registration area of 118 square miles, and from all other artificial sources, would suffice to raise the temperature of a stratum of air 100 feet in depth resting on that area 2° 5 every hour. The effect of the growth of the population of London from 900,000 at the commencement of the century to 3,500,000 at the present time, and of the still greater increase in the comparative consumption of coal was manifested by the rise in the average temperature of the air at the Royal Observatory, Greenwich, which place was year by year becoming more surrounded by a network of houses and population. For this reason Greenwich was not a suitable place for a Meteorological Observatory of the first order. Mr. Eaton subsequently referred to some of the practical difficulties experienced in pursuing the study of dynamical meteorology.—The following papers were then read.—Barometrical and thermometrical clocks for registering mean atmospheric pressure and temperature, by William F. Stanley; solar thermodiometer, and on an improvement in minimum thermometers for terrestrial radiation, by James J. Hicks.

**Anthropological Institute, February 27.**—Mr John Evans, F.R.S., president, in the chair.—Mr A. H. Keuhl, was elected a member.—Mr M. J. Walhouse read a paper on non-sepulchral rude stone monuments. Adverting to the extravagant Druidical and Draconian theories formerly connected with megalithic remains, he observed that perhaps at present speculation had gone to another extreme in refusing to see in them any purposes other than sepulchral. In this paper he adduced examples, many from his own observation of cairns, cromlechs, torlithons, stone-circles, and other megaliths, which he considered could not have been connected with burials, and he advocated the non-sepulchral intention of open-sided dolmens such as Kiscoty House, and those at Rollright and Drewsteignton, comparing them with similar structures now used in India as rude temples for sacred stones and images. The paper concluded with some observations on stone-worship, especially as now practised in India. Many existing instances were described, and passages quoted from classic authors, denoting its prevalence in antiquity. Some speculations were also brought forward as to the causes of rough stones having been so frequently taken for objects of worship. Col. A. Lane Fox, Mr. Hyde Clarke, the President, and others, took part in the discussion.

**Entomological Society, January 17.**—Anniversary Meeting.—Sir Sidney Smith Saunders, C.M.G., vice-president, in the chair.—An abstract of the treasurer's account and the Report of the Council for 1876 were read.—The following were elected members of council, viz., Prof. Westwood, Sir Sidney S. Saunders, and Messrs. H. W. Bates, Champion, Dunning, Grant, Meldola, Stainton, Weir, Douglas, E. Saunders, Rev. A. E. Eaton, and Rev. T. A. Marshall.—The following officers were elected, viz., Prof. Westwood, president, J. Jenner Weir, treasurer, Rev. T. A. Marshall, librarian, and Messrs. F. Grant and R. Meldola, secretaries.—The president, in consequence of an accident, was prevented from attending, and the delivery of his address was unavoidably postponed till the next meeting.

**February 7.**—Prof. Westwood, president, in the chair.—W. Denison Roebuck, of Leeds, was balloted for and elected a subscriber.—The president nominated Messrs. J. W. Douglas, J. W. Dunning, and H. T. Stainton as vice-presidents for the ensuing year.—The president delivered the address, postponed from the last meeting, on the progress of entomology during the past year.—Mr. F. Bond exhibited a specimen of the North American butterfly, *Gnathochorax*, taken in September last near Has-

sack's Gate, Sussex, being the third specimen taken in this country.—The president exhibited a specimen of the singular butterfly *Ephialtes Laiderdalii*, Atkinson, from Bhotan. He also read a letter which he had received from Baron v. Osten Sacken referring to his paper on the Dipterous genus *Systropus*, published in the last part of the *Transactions* of the Society, in which he had stated that a species in Natal (*S. crudelis*) had been bred from a cocoon resembling that of *Limacodes*, and pointing out that *Systropus mactr*, the common species in the United States, had been bred from the cocoon of *Limacodes hyalinus*, and was a remarkable instance of community of habit among insects of the same genus in far-distant regions.—The president read some remarks he had received from M. Ernest Olivier, of Moulins, respecting insects of the Dipterous genus *Bombylus*, frequenting the nests of a bee of the genus *Anthophora*, at Pompeii.—Mr. McLachlan exhibited a case of a Lepidopterous larva seen by Dr. Kirk, of Zanzibar, who had found it on a species of *Mimosa*. He considered it to be allied to *Psyche* and *Ophthalma*; and it was remarkable on account of its form, which bore a striking resemblance to that of a flattened *Hexis*. It appeared to be constructed of a substance resembling paper mache, with a smooth, whitish, external coating.—Mr. C. O. Waterhouse exhibited some remarkable varieties of British Lepidoptera, viz., *Chrysophanus phloxas*, *Polyommatus Adonis*, *P. Alexis*, and *Agrotis exclamatoris*.—Dr. Buchanan White forwarded an extract from the *Medical Examiner* of December 21 last, containing an account by Dr. Tilbury Fox of an extraordinary case of "Pruritus," which afflicted every member of a family and household, including even the dog and cat. A specimen of the insect causing it had been submitted to Dr. Cobbold, who had pronounced it to be a species of *Trombidium*, which was believed by Dr. Fox to have originated from certain plants in the garden, and that the cat and dog which appeared to have been the first affected, were agents in conveying the parasites to the human members.—The following papers were read, viz.—Notes on the African *Saturnia* in the collection of the Royal Dublin Society, by W. F. Kirby.—Descriptions of new genera and species of Phytophagous beetles belonging to the family *Cryptoccephalidae*, together with diagnoses and remarks on previously-described genera, by Joseph S. Baly.—Description of new species of Phytophagous beetles belonging to the family *Eumolpidae*, including a monograph of the genus *Eumolpus*, by Joseph S. Baly.

**Physical Society, February 17.**—Prof. W. G. Adams, vice-president, in the chair.—Mr. T. W. Philips, C.E., was elected a member of the society.—Prof. Guthrie exhibited, for Mr. C. J. Woodward, an apparatus he has devised for showing to an audience the interference of transverse waves. A light frame, capable of moving in a vertical plane, carries a horizontal strip of tin about two feet in length, cut in the form of the ordinary sine wave, and which supports, by means of a roller, a light wooden block carrying an ink recorder in front of a sheet of paper. This block slides in a vertical slot in a piece of wood, which can be moved horizontally, supported by a roller on another similar strip of tin fixed parallel to the first, and vertically below it. The movable frame rests on a castor attached to this block. If the relative positions of the waves be now varied, and the blocks moved along them, the path traced by the ink recorder will represent the wave due to their combination.—Mr. S. P. Thompson exhibited some galvanometers in the form of magic-lantern slides which he has arranged for exhibiting their indications to an audience. The instruments are, however, only capable of indicating comparatively powerful currents, and he hopes to succeed in arranging forms of greater sensitiveness. The index needle is usually formed of cardboard, and two small steel needles are attached to it parallel to its axis. It is pivoted lightly between glass plates, and influenced by the current traversing coils of wire placed beyond the circle in which it rotates. The best effects were obtained by means of two curved electro-magnets surrounding a small steel magnet, but this form is inapplicable to quantitative determinations, on account of the residual magnetism of the iron cores. A gold leaf electroscopium formed on this principle was capable of detecting very small charges of static electricity.—Mr. Wilson then showed an arrangement for exhibiting convection-currents in heated water. It consists of a small glass cell with parallel sides. In the base of the wood dividing the sides is cut a slight depression, to expose a brass tube which traverses it horizontally, and is open at one end, while the other is bent at right angles and connected with a flask containing water. The brass tube, where it is exposed in the cell, is surrounded with a jelly formed of gelatine containing some sulphur,

and the cell is filled with water and projected on the screen. When the tube is heated by boiling the water in the flask, the salt is liquefied, and the liberated colouring-matter rises in the water, showing the direction of the heated current.—Prof. Guthrie exhibited an arrangement he has been using, with a view to determine the vapour-tension of water, and explained the difficulties to which such a determination is liable, and the manner in which his apparatus has so far failed. It was shown that a crystal of alum or a saturated solution of salt, when introduced into the Torricellian vacuum, depresses the mercurial column less than pure water, whereas a solution of size, gum arabic, or any colloid, depresses it to precisely the same extent. It thus appears that water in its different states of combination has different vapour densities, and their determination requires an arrangement in which the several substances can be easily introduced into the Torricellian vacuum, and very slight changes of the level of the mercurial column can be ascertained. Prof. Guthrie has been employing a U-tube thirty-three inches long, one extremity of which is bent, and terminates in a capillary opening, and a bulb is formed at the U-bend. If the substance under examination be introduced at the open end after the apparatus has been filled with mercury, inverted and the superfluous metal escaped, the mercury expelled through the capillary opening will give a measure of the amount of the depression.—Prof. McCleod suggested a modification of this form of apparatus.—Prof. Guthrie then showed the manner in which electricity is distributed on non-conductors, such as the plate of an electrophorus, by placing it for a given time beneath a point connected with a charged Leyden jar, and subsequently sprinkling a mixture of sulphur and litharge over it. It was shown that the diameter of the circle formed below the point after the superfluous powder had been removed is not purely a function of the distance between the point and the plate, but is mainly influenced by the conductivity of the material, and further, that if the point be directed obliquely towards the plate, the circle formed is very slightly elliptical, but the ellipticity is in no degree proportionate to the obliquity of the point; and finally, he showed that if the non-conducting plate of an electrophorus be written upon with a metal and sprinkled with the above mixture of sulphur and litharge, the former or latter adheres according to the nature of the metal used, and he suggested that some such arrangement might be employed as a kind of electrical touch-stone for discriminating between certain metals.

## EDINBURGH

Royal Physical Society, February 21.—R. H. Traquair, M.D., president, in the chair.—A paper was read by Dr. Traquair, on the structure of the lower jaw in *Rhinodopsis* and *Rhinodus*. He stated that he had ascertained that the detached bone hitherto considered to be the premaxilla of *Rhinodopsis* was in reality the dentary element of the lower jaw. This bone shows one large lanian tooth at its anterior extremity, behind which the margin is set with a series of small teeth of uniform size. Complete specimens of the mandible of *Rhinodopsis* show, however, besides the large tooth in front, several others placed at intervals behind it, and internal to the range of small teeth. The question was, therefore, what had become of these other laminae in cases where the dentary bone was found detached. An explanation of this was afforded by an investigation into the structure of the lower jaw in the closely-allied *Rhinodus*. In this gigantic form the dentary element of the mandible is conformed just as in *Rhinodopsis*, bearing one large tooth in front, the rest of the margin being occupied only by smaller ones, the remaining lanian teeth being borne by separate internal dentary pieces articulated to the inner side of the dentary proper, and of course liable to be dispersed and lost in cases where the elements of the lower jaw had become detached from each other before their entombment as fossils. Analogous accessory bones bearing the large teeth of the lower jaw had previously been known to exist in the dendrodont fishes of the Old Red Sandstone. As regards the true premaxilla of *Rhinodopsis*, it was ascertained by Dr. Traquair to be a very small bone articulated to the front of the cranial shield as in other fossil fishes of the same group. Papers were read (1) on the ornithology of Yedo, by Colin A. McVean, and (2) on the occurrence of the Black Redstart (*Asiella naya*) in Shropshire, by J. A. Harvie Brown.

## BERLIN

German Chemical Society, February 12.—A. W. Hofmann, vice-president, in the chair.—A. Willner states that an observation lately published by F. Müller, that steam raises the temperature of saline solutions above 100°, was known before

the time of Gay-Lussac, and is in no way opposed to the fact that the steam evolved from saline solutions has the temperature of the latter, as observed by the late G. Magnus and himself.—C. Hesse, continuing his researches on the action of hydrochloric acid on sulphates, has observed the transformation of blue vitriol and of sulphate of magnesia into chlorides at a red heat.—M. Conrad and W. R. Hodgkinson have found that the action of sodium on acetate of benzyle gives benzyl-acetate of benzyl, that is hydrocinnamate (phenyl-propionate) of benzyl:—

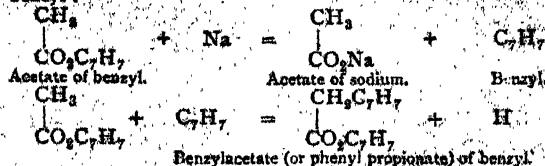

E. Chambon states that bromine transforms fuchsine into tetra-brominated rosaniline-bromhydrate  $\text{C}_{10}\text{H}_{10}\text{Br}_4\text{N}_2\text{H}_2\text{Br}$ , a fact already known through the researches of Caro and Gräbe.—T. Jobst and O. Hesse describe several constituents of coto bark: *paracotoin*  $\text{C}_{19}\text{H}_{18}\text{O}_8$ , transformed by barytes into *paracotoinic acid*  $\text{C}_{18}\text{H}_{14}\text{O}_7$ , and by potash into *paracumarhydrine*:—

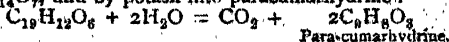

This losing water easily yields  $\text{C}_8\text{H}_8\text{O}_2$  paracumarin. They also describe hydrocotoin  $\text{C}_{22}\text{H}_{20}\text{O}_6$ , cotoin  $\text{C}_{27}\text{H}_{24}\text{O}_6$ , cotonetin  $\text{C}_{20}\text{H}_{18}\text{O}_6$ , oxyleucotin  $\text{C}_{21}\text{H}_{20}\text{O}_7$ , leucotin  $\text{C}_{21}\text{H}_{20}\text{O}_6$ .—H. Beckurts and K. Otto prefer sulphuric acid to alkali for transforming propionitril into propionic acid. They consider solid dichloropropionitril to be polymeric with the liquid substance. They likewise describe dichloropropionic acid and its transformation into monochloracrylic and pyrrocemic acid.—C. A. Martius gives a detailed description of the production and refining of petroleum in Pennsylvania.

February 26.—A. W. Hofmann, vice-president, in the chair.—A. Christomanos published the result of a great number of analyses of Greek chrome-iron-ore leading up to the formula of  $\text{R}_2\text{O}_3$  with varying amounts of  $\text{CaO}$ ,  $\text{MgO}$ ,  $\text{SiO}_2$ , &c. The proportion of  $\text{Cr}_2\text{O}_3$  and  $\text{FeO}$  varies between 1:2, 2:3, 1:1, and 3:2.—From researches by K. Heumaun, it appears that the greenish powder resulting from the action of nitrate of silver on ultramarine (discovered by Unger) is a mixture. The chief ingredient is yellow, but it has not been analysed.—J. H. Broese has determined the solubility of sulphate of lime in water at various temperatures and in solutions of various salts.—T. Moddermann published speculations on atomicity.—V. Meyer denied the correctness of Ladenburg's experiments and his conclusions as to the difference of  $\text{N}(\text{C}_2\text{H}_5)_2$ ,  $\text{C}_7\text{H}_7\text{I}$  and  $\text{N}(\text{C}_2\text{H}_5)_2$ ,  $\text{C}_7\text{H}_7$ ,  $\text{C}_2\text{H}_5\text{I}$ .—Br. Radziszewsky communicated that the following bodies show phosphorescence under the oxidising influence of alcoholic potash: paraldehyde, metaldehyde, aldehyde-ammonia: furfural, hydrocinnamide, hydrocuminamide, hydranisamide, anisidin; formic aldehyde. The author calls attention to the observation of Duchesne, that noctiluca miliaris acts on the skin like nettles, which have been proved to contain formic acid. He thinks that noctiluca may contain formic aldehyde.—R. Auschütz has found that chloride of acetyl transforms bibasic acids, viz., succinic, phthalic, and diphenyl-dicarboxylic acids into anhydrides, being itself transformed into acetic acid. The same chemist, conjointly with R. Schultz, has transformed phenanthrenchinone into diphenyl-dicarboxylic acid by the action of sodium amalgam by simultaneous reduction and oxidation:—

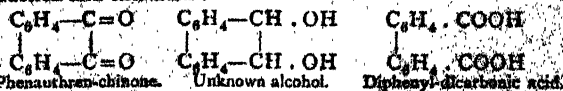

E. Hartwig published preliminary remarks on phthalic aldehyde.—H. Limpricht has found that hydrochloric acid transforms sulphonic acids into the corresponding hydrocarbons:—

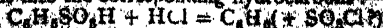

O. N. Witt, in a note on the history of chlorophyll, claims for himself the discovery of this colouring-matter, while he acknowledges that H. Caro has likewise prepared this substance by an independent discovery.—A. Baeyer has prepared from furfural,  $\text{C}_6\text{H}_7\text{O}.\text{COH}$ , and acetic anhydride, a new acid:—



a furfuryl-acrylic acid, yielding a green colouring-matter with phenol. With sulphuric anhydride a benzoin-like substance is obtained.

H. Schwartz has studied the bromides and chlorides of chlorinated anthracene and their action on potash.—Arno Belz, chemist to the large sugar-refinery of Messrs. Matthiessen and Wichers in Jersey City, has found in the residues of cane-sugar acetic acid, while citric acid is one of the regular ingredients of beet root.—A. W. Hofmann after showing a circular table of chemical reactions designed by Dennis Mommier in Geneva, returned to the statement of Kern that mono-methyl-aniline, formerly described by the speaker, does not exist, and read a paper by F. Hepp, who described mono-methyl-aniline obtained from sodium-aceto-methyl-aniline, with the same properties formerly described by himself. Hofmann has obtained the same body by the action of chloride of ethyl on aniline.

GENEVA

Physical and Natural History Society, December 7, 1876.—M. Théod. Turretini presented a specimen of a diphrograph, or writing machine for the blind, constructed at his workshop. The apparatus is the invention of M. Ernest Recordon, and prints at once for the blind according to one of the systems in use for them, and for the seeing in ordinary characters.—M. Th. Turretini explained the method devised by M. Raoul Pictet and himself, to obviate the opacity of the ice obtained by the machine of M. Pictet. The opacity of the ice thus manufactured results from the rapidity of the freezing of the water, which does not permit the air contained in the liquid to escape during its change of state. By retarding considerably this freezing the ice obtained is transparent. We may thus obtain an almost complete transparency by expelling from the freezing water the air which it contains by the preliminary action on the water of a paddle-wheel agitating the liquid.—Mr. Duby presented a paper relating to eighteen species and one genus of new mosses from Japan, the Philippines, and Mauritius. A considerable number of mosses from Mauritius are also met with in the Sunda Islands.—M. Hermann Fol gave an account of observations made by him on the fecundation of eggs, especially of the sea-machins. He has seen the zoosperm penetrate the vitellus and push a species of vesicule into the interior of the wall of the egg. Starred grooves show themselves soon after all over the vesicule. The latter then detaching itself from the wall begins to move, approaches a female nucleus, and combines with it so as to form only a single nucleus. At the two poles of this nucleus are formed two small masses of protoplasm, from which devolve starred grooves both in the interior and exterior of the nucleus. These polar masses enlarge, deviate more and more, then the cellular division takes place. In other animals the phenomenon is complicated, but may also be followed.

December 21, 1876.—Prof. Schiff gave a résumé of his researches on the electricity of the nerves for the purpose of examining the electric nature of the nervous agent, and determining whether the currents are produced in the nerves of living animals. He concludes, that the normal nerve when the animal is in a state of immobility does not present any current. When a current manifests itself it results from the alteration of the death of the nerve such as is produced by section, or better still from nervous activity, and the contraction which accompanies it.

VIENNA

Imperial Academy of Sciences, December 7, 1876.—The following, among other papers, were read.—Contributions to a knowledge of the Bryozoa of the Bohemian Chalk formation, second part treating of the Cyclostomata, by M. Novak.—Studies on the geological origin and the progressive development of the North Albanian coast land, by M. Koncicky.—New observations on Gessler tubes, by M. Roncky.—On the earthquake of Belluno on June 29, 1873, by M. Hofer.

December 14, 1876.—On the formation and integration of equations, which determine the molecular motion in gases, by M. Boltzmann.—On the nature of gas molecules, by the same.—On a remarkable property of periodic series, by M. Toepler.—On the methylic ether of resorcin, and on glycerolizin, by M. Habemann.—On grape sugar, by MM. König and Rosenfeld.

January 4, 1877.—On the origin of the posterior nerve-roots in the spinal cord of Ammocoetes (*Petromyzon planeri*), by M. Freud.—New methods for solution of indeterminate quadratic equations in whole numbers, by M. Kauerth.—On the amyloid substance in heart flesh, by M. Henschl.—On aperture widening muscles, by M. Exner.—Longitudinal muscle fibres in the wall of an animal tube; generally widen the tube when they contract.—Observations in November at the Meteorological Observatory, Vienna.

January 11.—On *Zonitoides Clausi*, a new parasite of snails.

idem, by M. Kurz.—On the influence of methodical drinking of hot water on the course of *Diabetes mellitus*, by M. Sommer.—Remarks on some problems of the mechanical theory of heat, by M. Baltzmann.—On a general mode of determination of the foci of contours of surfaces of the second degree, by M. Felt.—On the vessels of bones of the skull and the dura mater, by M. Langer.—Barometric observations in the western part of the Balkans and neighbouring regions, by M. Toula.

January 18.—On drainage and irrigation works in the valley of the Save, by the General Commando in Agram.—Astronomical and geodetic determinations of the Austro-Hungarian Polar Expedition, by M. Weyprecht.—On the theory of the Bessel functions, by M. Gegenbauer.—On the theory of the action of cylindrical spirals with variable number of windings, by M. Wallentin.—On a peculiar formation of isocyanophenyl, by MM. Cech and Schwebel.—On the arrangement, use, and accuracy of M. Roskiewicz's distance-measurer, by M. Schell.—On the development-history, and the structure of the seed-envelope in Phaseolus, by M. Haberlandt.

I. R. Geological Institute, December 5, 1876.—The following papers were read.—M. Karl v. Hauer on the analysis of the acid spring lately discovered at Ramsdorf, near Mährisch-Trubau in Moravia. The water contains a very small quantity of fixed ingredients, but the abundance of free carbonic acid is equal to the well known Giesshubel springs. 10,000 parts of water contain in weight 26 parts of free carbonic acid, so that the volume of the latter exceeds by far that of the former. The springs may therefore be considered of remarkable quality.—M. J. Gamper on diluvial vertebrates. At a little distance from the Klause at the Gahus Mountain near Gloggnitz, the author found a block of limestone covered by thin strata containing remains of vertebrate bones, in some places the layer formed a real breccia of bones. Among the remains he noted especially those of bats. The blocks formed a part of the inner wall of a cleft or cavern, like those often found in limestone mountains of this country. M. Gamper then referred to the occurrence of clay silicate near Steinbruck, and of arseno-pyrite in Joachimsthal.—M. Itache continued his communications on the eruptive rocks that he examined last summer in the mountainous regions of Upper Vintschgau, Ortler, and Vellin, mentioning particularly the various species of tonalites from Morignone, the Gabbro rocks from Isonale and Leprese, and some little known rocks containing many garnets. In the country of Soudal and Boladoie, light coloured pegmatites intersect in veins the dark coloured amphibolite and diorite rocks.—Dr. Tietze on the Elburs Mountains in Persia. He mentioned the relatively rare occurrence of old crystalline rocks in this mountain chain. The formations which may be determined by palaeontological evidence are the Devonian, the Carboniferous limestone, the Lias, the Upper Cretaceous, showing various facies partly abounding in fossils, the Nummulite formation, and the younger Tertiary. Other formations, containing no fossils, could only be judged by their position relative to those formations whose geological age was clearly to be determined. Almost certain is the occurrence of Trias and Upper Jura. The Lower and Middle Cretaceous are totally wanting. Only a few of the named formations extend over the whole country, therefore if two sections are made at some distance from each other, they give almost invariably a different result. M. Tietze gave also a short account of the older and younger eruptive rocks, of which these mountains are partly composed. The volcanic Demavend is not only the highest but also the youngest mountain of the whole chain, whose dimensions are given by the author as 90-100 miles in length, and at least fifteen miles in breadth.

January 23.—Dr. F. Tietze on the geological relations of the Demavend Mountain in Persia, whose height amounts to 20,000 feet. He distinguished an upper and a lower region, the former consisting of the cone heaped up by eruptions. The highest top of the cone, acting still as a solfatara, stands within the remains of an older crater-wall. The lower part is composed to a height of 9,000 feet of sedimentary rocks (Jurassic limestones, Carboniferous sandstones, and old limestone). It must be noted particularly that the position of these sedimentary strata shows exactly the same relations as those of rocks in other parts of the Elburs Mountains which are not in contact with volcanoes, a proof therefore that the outburst of the Demavend volcano exerted no influence upon the older rocks in its vicinity. The reporter mentioned the occurrence of streams consisting of lava-boulders on the Demavend, as they are found at present on the volcanoes of Java, then of columnar trachytes and of the lava streams keeping their original position, but

steeply inclined on the slopes of this volcano. He concludes by remarking that the Demavend shows probably a double axis, such as was stated for instance on the Aetna by Sartorius and Ch. Lyell.—M. C. Paul reports on his investigations in the Karpethian Mountains made in this year. In Silesia he studied the so-called hieroglyphs of the Upper Tschou slates, whose genesis is doubtful, but which are remarkable for their constantly keeping to a strictly limited level. He also gave a more exact division of Hohenegger's Iodula sandstone and fixed the position of the Irodek sandstone which Hohenegger had adjoined to the Lower Eocene (Nummulite group) as the highest division of the Eocene. In Western Galicia the gradual change of the petrographic facies of the Lower Karpethian sandstone (Neocomien) was studied. This formation consists in the northern zone of dislocation, chiefly of sandy and clayey strata, in the southern, which is called the penninic cliff-zone it shows a more lmy composition. In Przemyśl he visited the locality rendered important by Niedwiczky's discovery of ammonites. It was evident that the Neocomian ammonites were contained in a zone of those rocks called usually Ropauka beds, which had been from other reasons already denoted as Neocomien. In Eastern Galicia the Karpethian sandstones could be divided into their proper groups and marked on the map, conformable to the results obtained by the reporter in the adjacent Bucovina. The sediments of the Karpethian sandstone divide here into the lower period (Ropauka beds, Neocomian), the middle period (for the most part massy sandstones, probably middle Cretaceous), and the upper period, most certainly Eocene (to which belong sandstones containing Nummulites, the well-known fish-slates of Delatze, the Smilus slates, Schipoter beds, and the Magura sandstones of Czeruahora).

PARIS

Academy of Sciences, February 26.—M. Peligot in the chair.—M. Le Verrier reminded the Academy of the importance of watching on March 21, 22, and 23 for the possible transit of an intra-Mercurial planet across the sun. He also presented tome xiii. of *Annales de l'Observatoire de Paris*. This contains the theory of Uranus and Neptune, and M. Cornu's memoir on determination of the velocity of light between the Observatory and Monthéry (by Fizeau's method improved). He finds this velocity 300,400 kilometres per second of mean time; the deduced solar parallax is 8".88, 8".88, or 8".80, according as the number is combined with the equation of light given by Delambre (493".2), with Bradley's constant of aberration (20".25), or with that of Struve (20".445).—M. Debray was elected member for the section of chemistry in place of the late M. Balard (the other candidates being M. Cloez and M. Friedel).—Experiments on the origin and the nature of typhoid fever, by M. Guérin. He had in view the supposed direct influence of water-closets in producing the fever, and experimented on rabbits, injecting fecal matter, urine, blood, &c., from typhoid patients. He concludes (1) that such fecal matter contains, after issuing from the system, a toxic principle capable of causing death in a class of animals, in time varying from a few hours to a few days; (2) that the same holds for urine, blood, mesenteric liquid, and the detritus of mesenteric ganglions and of ulcerated intestinal mucus of typhoid subjects; (3) that these matters, after some months, are found to retain in large measure their original toxic principles; (4) that the fecal matters of healthy subjects or of those affected by other diseases have not the toxic principles which appear in excremential products of typhoid subjects.—On the effects of a jet of air in water, and on the suspension of water in air, by M. De Romilly. Among other experiments: Into a bell-jar, the mouth of which is closed with net, water is sucked up by means of a tube, with stopcock, entering the jar above. On closing the cock and raising the jar the liquid is retained, there being a meniscus at each mesh and a general meniscus. On inclining the jar the water flows out, but the smaller the mesh you may incline farther without escape of liquid. Using metallic net, one may place a lighted gas jet under the suspended liquid, which will bell (gently) without falling down. (In this case the jar should be connected with another larger, the mouth of which rests in water.)—On the functions of leaves in the phenomena of gaseous exchanges between plants and the atmosphere; rôle of stomates, by M. Merget. He shows that the leaf functions of absorption and exhalation are arrested when a layer of varnish is formed on the face bearing the stomates. Thus the leaf may be subjected to mercurial emanations without absorbing a trace of the metal, which can, of course, be easily detected by photographic processes. On the other hand, if an ammoniacal liquid be injected into the leaf, the liberation of the dissolved gas by

the face that has stomates is proved by the odour of this face, it white appearance when a rod dipped in hydrochloric acid is brought near, and its printing of paper sensitised with nitrate of mercury.—On ophthalmia, by M. Branc. He specifies twelve different categories and treatment.—New experiments to try for combating the phylloxera of the roots, by M. Rommer. He proposes salts or oxides of mercury, lead, copper, zinc, and others, dissolved in alkaline hyposulphites (potash or lime). Such compounds would not be acted on by the acids of the soil, like previous insecticides.—Determination of the lines of curvature of a class of surfaces, and particularly of the tetrahedral surfaces of Lamé, by M. Darboux.—Integrals of curves of which the developers by the plane and the developed by the plane are equal to each other, by M. Aoust.—Fourth note on the theory of the radiometer, by Mr. Crookes.—On the action of water on chlorides of iodine, by M. Schützenberger. If chlorides of iodine are not decomposed into hydrochloric acid, iodic acid, and free iodine, it is because the direction of the reaction is modified by the existence of a compound of hydrochloric acid and of protochloride of iodine stable in presence of water.—Formation of quinones by means of chlorochromic acid, by M. Etard.—On a saccharine matter extracted from leaves of walnut, by MM. Tanret and Villiers. The composition of the body is the same as that of *oselle*, but it has some special properties, and the authors name it (provisionally) *oselle*.—On the salts of the Algerian Chotts, by M. le Chatelier. They contain chloride of sodium and sulphate of soda; probably also carbonate of soda mixed with gypsum.—On three recent falls of meteoric stones in Indiana, Missouri, and Kentucky, by Mr. L. Smith.—Experiments on acute poisoning with sulphate of copper, by MM. Feltz and Ritter. These were made on frogs, pigeons, rabbits, and dogs. Sulphate of copper cannot be regarded as a harmless agent, though its introduction into the system does not, in the great majority of cases, cause death. No one would consent to swallow, in food or drink, the quantity that would prove fatal.—On the congestive and hæmorrhagic alterations of the brain and its meninges in birds, by M. Larcher.

CONTENTS

	PAGE
"SCIENTIFIC WORTHIES," X.—HEFEMANN LUDWIG FERDINAND HELMHOLTZ. By Prof. J. CLERK MAXWELL, F.R.S. ( <i>With Steel Engraving</i> )	189
THE UNIVERSITIES BILL	191
THE BANSQUES. By Rev. A. H. SAYE	304
OUR BOOK SHELF:—	
Keane's "French Accent"	396
Tschoniloff's "Étude sur la Dégénérescence Physiologique des Peuples Civilisés"	396
Drew's "Northern Barrier of India"	396
Sir Rose Lambert Price's "Two Americas; and an Account of Sport and Travel"	396
LETTERS TO THE EDITOR:—	
Nebulous Star in the Pleiades.—The EARL OF ROSS	397
"The Movement of the Soil cap"—JAMES GIBBS, F.R.S.	397
Government Grants to Science.—Prof. J. BURDON-SANDERSON, F.R.S.	398
Tints and Polarisation of Moonlight in Eclipse.—A. FREEMAN	398
The Patenas or Grass Lands of the Mountain Region of Ceylon.—Rev. R. ABBAY	398
The Estimation of Urea by means of Hypobromite.—Dr. A. DUPRÉ	399
Colonus Julia in Texas. Venomous Snakes devouring each other.—L. HPLIGHROD	399
Lowest Temperature.—Rev. S. J. PERRY, F.R.S.	399
Meteor.—ALBERT J. MOTI	399
REPORT ON THE GOVERNMENT METEOROLOGICAL GRANT	399
RESEARCHES ON THE SPECTRA OF METALLOIDS. By Dr. ARTHUR SCHUSTER	401
SIR WILLIAM THOMSON ON NAVIGATION	403
TYCHO BRAHE ( <i>With Illustrations</i> )	405
MINIATURE PHYSICAL GEOLOGY. By C. LLOYD MORGAN	410
TESTIMONIAL TO MR CHARLES DARWIN.—EVOLUTION IN THE NETHERLANDS	410
THE NORWEGIAN NORTH-SEA EXPEDITION OF 1876. By Prof. G. D. SARR	419
OUR ASTRONOMICAL COLUMN:—	
The Binary Star $\epsilon$ Bootis	414
Variable Stars	414
Damoiseau's Tables of Jupiter's Satellites	414
Beesell's Treatises	414
BIOLOGICAL NOTES:—	
The Electric Eel	414
Early Development of Sponges	414
A New Sponge ( <i>With Illustration</i> )	415
Wild Dogs on the Oh	415
The Woodpecker	415
Sagacity of a Lobster	415
The Influence of Temperature on the Nerve- and Muscle-Currents	415
Fertilisation of Flowers by Birds	415
A New Parasitic Green Alga	415
Flora of Turkestan	415
NOTES	415
SCIENTIFIC SERIALS	415
SOCIETIES AND ACADEMIES	415



THURSDAY, MARCH 15, 1877

## THE TREASURY REPORT ON METEOROLOGY.

WE gave in our last number the report of the Treasury Committee on the administration of the Government meteorological grant, and we shall now offer a few remarks on it and on the evidence upon which it has been founded, as contained in the Blue-book before us.<sup>1</sup> The expenditure is devoted to the meteorology of the ocean, that is, to the part of it traversed by our ships and to that of the British Isles.

As regards the former, though much valuable work, especially in the practical point of view, has been done, this work belongs distinctly to a government department of the Admiralty. It does not seem desirable that charts or the direction of seamen should be made out according to different methods by two institutions, supported by national money. It is then proposed by the committee that the charting work, together with the marine superintendent of the Meteorological Office, who has done his duty so well, should be transferred to the Hydrographic Department of the Admiralty, while the scientific part should be done in connection with investigations, including observations both over land and sea. This appears a most reasonable decision.

Though the second part of the business of the Meteorological Office is limited to a small surface, yet it is one with which we are more immediately concerned, and surrounded as we are by the sea, this part really involves all the modifications which surfaces of land and water may produce on the actions of meteorological causes. It seems to be supposed that observations on the ocean must present meteorological variations in a much simpler form, because the atmosphere rests on a surface which is at once more level, and at a more constant temperature than that of the land; but it seems not to have been remarked that the conditions under which the observations are made are much more complex. If we could imagine a search into the laws of continental meteorology founded on the observations made by some passengers in railway trains cross France, Germany, and Russia, the difficulty of piecing together observations of very various degrees of merit for the deduction of even accurate means would be at once evident; that of searching for laws would become still more so. It is no doubt desirable that the meteorological variations over water should be studied apart, but for this end an observatory placed on some small island in mid-ocean would be a more satisfactory way of obtaining the end in view. Whether this would aid in the search for the causes of phenomena met with under very different conditions in our latitudes is by no means certain.

The department of the Meteorological Office occupied with the meteorology of the British Isles, includes that of storm warnings; indeed this is, at present, the great practical work. There are numerous stations at which "eye" observations are made daily, and these are telegraphed to the central office in London. There are also even observatories having instruments which register

continuously the variations of the meteorological elements. The storm warnings are founded on the telegraphed observations; the registered observations have a different object. They can no doubt be employed after warnings have been issued to verify the observations and to satisfy any doubt that may have existed as to errors committed, but their chief object, in the first instance, is purely scientific.

It has long been seen that storm warnings are not founded upon laws that can be distinctly stated. Though observations made over a considerable tract of country are made use of, and a certain knowledge exists of relations between atmospheric pressure and winds, yet the warnings depend to some extent upon a practical experience which, like that of the shepherd and sailor, cannot easily be communicated to others.

The seven observatories were established to obtain good materials with which a scientific study might be founded and from which laws might be deduced giving increased probabilities of accurate prediction of the weather to-morrow from our knowledge of what it is to-day. This is not, however, the only use of the observatories. If all the scientific precautions have been taken with respect to them, they will in that case be to the meteorology of the country what carefully measured base lines are to its exact survey; each will give a point to which the observations made around it may be referred and corrected.

The great question before the Committee was how best to aid in making meteorology a science—a science from which practical results may be deduced. Millions of meteorological observations have been made and published; the seven observatories are producing continuous registers of the variations of barometric pressure, temperature, wind direction and force, &c. What is to be done with all these? Are we to go on piling Pelion on Ossa with the idea that heaps of observations will enable us to reach the mysteries they enclose? And can the Government be satisfied that they have done enough when they present the public with volumes of observation in something of the way in which Hamlet offered his friend the pipe—"Govern these ventages with your fingers and thumb, give it breath with your mouth, and it will discourse most eloquent music"?

The question then is how to get at the mysteries; or how to find a musician with breath enough to blow and skill enough to draw harmonious sounds from this giant pipe. We can only glance at parts of the testimony of the most distinguished witnesses.

When we remember that after a century of research by men of the greatest eminence—mathematicians, physicists, meteorologists—we cannot tell why the air presses heavier at ten o'clock than at four o'clock; we see that meteorological investigation includes some of the most difficult scientific problems. With this fact in view, some of the questions put to the witnesses would seem almost comical, did we not know that their object was to draw out something of value in the reply. Thus, with reference to finding a "man of genius to try and get something out of the observations which have been made" (1,012), the question (1,017) is put to Sir G. B. Airy: "But you would hardly think it a safe thing to select, for instance, a young man from Cambridge, and say to him: 'Now you must take up this subject?'" When we remember, also, that

<sup>1</sup> "Report of the Treasury Committee Appointed to Inquire into the Conditions and Mode of Administration of the Annual Grant in aid of Meteorological Observations; together with Minutes of Evidence, Appendix, and Index." (London, 1877.)

the Astronomer-Royal has directed a meteorological observatory nearly forty years, and that he now says meteorology is not a science (940), it is naught, and in short that he has not been able to make anything out of it, we can understand with what profound conviction he replied, "I do not think that would be a safe thing."

Sir William Thomson was also examined on this question, and he thinks (1720) "the best way would be to get some thoroughly able young man, well acquainted with mathematics and of good judgment to take up the whole subject of the harmonic analysis of the observations." No doubt the harmonic analysis has some advantages as representing mean values approximately by a series of simple oscillations occupying the whole, a half, a third, &c., of the time-period considered, which can be compared when the conditions vary; but it is only a first step, one which may be misused if it is supposed that each oscillation must represent the different periodic actions of the same or of different causes. Kaemtz employed this method forty years ago on every possible meteorological variation, but we cannot say that any important result was obtained by its means.

What has to be done was indicated by the Astronomer-Royal in answer to question 1,015; men (one man cannot undertake the work in all its directions) must be "seized upon" who have displayed "talent for things of that sort," who by long study have become saturated with the facts of the science and who have shown the capacity to devise new methods and to employ them with success. Such men, as Sir George Airy says, in answer to another question (991), should be asked to devote themselves to examining the observations already made, and to "turning them over in all conceivable ways." Such men, he says (1,015), are to be taken "on opportunity," that is to say, if they present themselves we should lay hold of them. But this is true for every occupation demanding special qualifications. It would seem sometimes as if the difficulties were exaggerated, and sometimes under estimated. If we had a Newton among us, he could do little till the meteorological apple has fallen, and the tree will require, we think, a good deal of shaking first. That the specialty of turning a thing "in all conceivable ways" is not very common, may be deduced from the evidence before the committee; but many look on meteorological investigation as a kind of lottery, where just because so many blanks have been drawn, every one has a better chance of getting a prize; and some very clever people think that the affair may be done by a machine.

There is also the very urgent reason for "turning over" the observations made at the seven observatories, that it is not possible to determine their value, nor how far they can be usefully employed for strict scientific investigation till this is done. Mr. Buchan, one of the few working meteorologists examined, says (1,530), that the eye-observations "secure an exactness and accuracy which photographic self-recording instruments do not possess." This, if true, is a very serious matter, and we shall have to return to it at another time.

The subject of observatories, the most important in connection with the progress of meteorology as a science, was also brought forward by the Committee. The question was put to the Astronomer-Royal (1,045); "Might I

ask what led your office to undertake the meteorological part of its work in 1840?—Because nobody else did." This answer must evidently be taken with reference to certain conditions. Had the Government been encouraged at the time to support a magnetical and meteorological observatory, paying a competent man to direct it, we can scarcely doubt that they would have done so. Sir G. Airy's reply means, we believe, that nobody was ready to undertake the duty for nothing but himself. We think it is much to be regretted that the director of the National Observatory, overcharged as he is with the duties connected directly with his office, should have been allowed to undertake scientific work, demanding so much care and devotion of time, which was really not at all in his specialty, however excellent the motives might have been which induced him to do so.

This is now well understood in other countries. In Paris there is now a magnetical and meteorological observatory with a distinct head; another observatory devoted to solar physics is rising; and similar arrangements have been made in Germany and Austria. It is the very essence of "penny wise, pound foolish" which can seek from one man to direct with success three or four observatories at the same time, when each of them will task the energies of the cleverest men in the different departments to make something good out of them.

The question is further put (1,050)—"In the former part of your evidence you spoke as if meteorology at present was scarcely in a scientific position at all, as too uncertain to be called a science at present?—It is not in a scientific condition at all, I think."

"1,051.—I want to connect that answer with the fact that in 1840 you undertook in this Government Department these particular inquiries; at that time you must have formed some idea that these studies were worth pursuing for national objects, and in a national establishment?—Observing the movement that was going on in other places, it was very desirable that Greenwich should be one of the stations in concert with them, but still I was so diffident about the success of it, that after three years, I think at the next meeting of the committee, or I forget by what name it was called, where the representatives of different nations attended, I earnestly urged them to cease. I did not see that there was any use in going on. I recommended them to do something like what I have spoken of to-day, to stop where they were, and try what they could extract from those observations that they had collected, before they proceeded further with them."

It has always been a tendency with the heads of great national scientific institutions to annex other scientific work than that for which the institutions were founded. We remember that the late Prof. Nichol described at the meeting of the British Association at Glasgow in 1840, the numerous works he was about to carry forward in different departments of astronomy; to all he added a magnetical and also a meteorological observatory, with special reference to important meteorological problems, which he proposed to take up. Photo-heliography and spectroscopy were not then in existence, or doubtless they also would have been included. The Astronomer-Royal then said (we do not remember the exact words, but they were to this effect): "Let me, as

an old observer, recommend Professor Nichol, as a young observer, to undertake less and he will do more."

We have much pleasure in finding that we agree so generally with Sir G. Airy's views. We do not think, however, that it was desirable to place a meteorological observatory in Greenwich Park. We have already said why we do not think it was necessary, or even advantageous to the sciences, that both magnetism and meteorology should be placed under the same direction as the National Astronomical Observatory. Indeed the Astronomer-Royal has allowed (in his evidence) for meteorology, what is well known to scientific men all over the world for magnetism, that his well-intentioned devotion to these subjects has not been repaid by the results he has obtained.

Sir G. Airy thinks the existence of the Kew Observatory unnecessary (1,028); that they can furnish observations "at Greenwich as good or better, but quite as good certainly" (995). We quite agree that Kew and Greenwich are not both necessary, but it will be seen that we would greatly prefer to see magnetism and meteorology relegated elsewhere (we do not admire the position of Kew). With reference to the comparative value of the observations made at the two observatories, it has always been to us a matter of surprise that with two observatories within a few miles of each other, no comprehensive, strictly accurate, and scientific comparisons of the observations, magnetical and meteorological, made in them, should have been made and published. We cannot tell how far they agree or disagree. One might at least have been used as an aid to the other; if there are differences, such a comparison would have led to a search for their causes, and errors might thus have been corrected. It would be a very disagreeable matter if, when compared, instruments at the two observatories should be found not to go together as well as Admiral Fitzroy's weather-glass and an aneroid barometer.

A great national observatory for the prosecution of a branch of science of so much practical importance as meteorology should not be merely observational, but also experimental. Let us take one of the simplest cases, one brought forward before the Committee: How should we place a thermometer? Sir G. Airy says (984). "The mere observation of getting the temperature of the air is one of the most difficult things I know. If you are on the north side of a building within some distance you get it too low; if you are on the south side you get it too high, and if you are close to the ground you get something different." This is all perfectly exact; and we may add, if you keep the thermometer in one place probably the sun will shine on the ground near it differently at different hours of the day and in different months of the year, so that there is a varying source of error in the same place. The Astronomer-Royal is also asked if he can estimate the probable difference between a thermometer at four feet and forty feet above the ground (987), but he cannot; and at what height a thermometer should be placed, but he replies only that four feet is the usual height.

We mention these questions to show that nearly everything has as yet to be placed on a scientific footing. We do not think four feet is a good height, and agree with the Astronomer-Royal that thermometers have been placed

too near the ground, where they have been affected by many local differences which would have been to a great extent avoided at a greater height. Of course observations may be made at any height from the soil when special questions are in view. Similar difficulties exist for other instruments, and it is certain that we are making masses of observations which might have been much more valuable to science had experiments of the class indicated been made in the first instance. In such an observatory, also, there is a whole series of physical experiments which could and should be performed, independently of those which should more properly be placed in the hands of specialists.

In the Report of the Committee, we find the following (Art. 8):—"As regards the first, although it may be desirable at some future time to create a permanent meteorological establishment on some such footing as that of the Astronomical Observatory at Greenwich, with an officer of scientific eminence at its head, we think that matters are scarcely ripe for such a step at present." We have been in some cases satisfied with the report, but here, if we understand the meaning of the word "ripe," we must differ. We believe that matters have been ripe any time the last forty years; but we hope to return to this subject on another occasion.

The Report of the Committee is all that could probably be expected with the evidence before it. There are at present two purely scientific works that should be carried forward. Something should be done with the observations of the seven observatories, and much should be done to encourage research in connection with meteorological questions generally. It should not be imagined that an investigation with reference to some very small variation can have no practical value, that is to say, that the practical results which may flow from it can be measured by the amount of the variation. Nor should it be supposed that any question which touches on atmospheric variations should be neglected, in this respect, because the relation may appear remote. The movements of the sun's envelopes, the spots, the protuberances; the moon's possible action on solar emanations may all appear unconnected with our calms or our storms, and may yet all have a relation to both.

To conclude, we object to a cumulation of duties on one head, by which things are not only not well done, but through which others are prevented from doing them well. We think centralisation hurtful to science, and we regret that 1,000*l.* a-year has not been granted to Scotland, by which a healthy rivalry would have been gained.

We have given most place to Sir G. Airy's testimony because his is really the most important, but we cannot help inquiring why so few directors of observatories and meteorologists were examined. Dr. Lloyd, who has directed a magnetical and meteorological observatory for many years; Prof. Balfour Stewart, once secretary to the Meteorological Committee and director of the Kew Observatory; Mr. J. A. Broun, who has directed observatories in Scotland and in India; the Rev. Mr. Main, director of the Radcliffe Observatory; Prof. Piazz Smyth, director of the Edinburgh Observatory; all of whom have been occupied with meteorological investigation, are all wanting, and they are all men who might have said something worth hearing on what should be done.

### MR. TROTTER ON UNIVERSITY REFORM

*On Some Questions of University Reform.* By Coutts Trotter, M.A., Senior Fellow and Tutor of Trinity College, Cambridge. (Cambridge, Deighton.)

**D**URING the short life of the Oxford and Cambridge Bills of last year, it was my lot to hear from many of my London friends many dismal, sometimes almost contemptuous, prophecies concerning the future of natural science at the old universities. For myself, in looking forward towards possible and probable changes, I always lay to heart the hackneyed consolation of the unsuccessful Liberal Orator, "Time is on our side." Whatever happens, science cannot lose much and may gain largely. How great a progress might with the least possible shock to conservative principles be effected by the help of men in whose minds a broad sympathetic love of learning is associated with a delicate appreciation of the present university feelings and habits, may be learnt by any one who will take the trouble to read Mr. Trotter's brief pamphlet.

There are men who in their so-called radical ways of thinking, exalt theoretical statements above practical suggestions, and thus are led to insist that all university reform is useless which is not based on the two abstract principles—1. That the interests of education are essentially opposed to those of learning. 2. That the interests of the colleges are essentially opposed to those of the university. Such men argue with great vehemence that it is hopeless to expect learning to flourish in a place like Cambridge, for instance, where education, so far from being neglected, as Mr. Lowe seems to think, is pushed with yearly increasing energy (they speak of it as being "rampant," and assert that the students, who have been long over-examined, are now in danger of being over-taught), and where a poor university, like an almost penniless king whose only subjects are a few wealthy barons, contends in vain with colleges which not only are at the present moment far richer and stronger than it, but must always tend to be so, since the feeling which binds a student to his university is akin to the mild emotion of patriotism, while his affection for his college is more like the family love of home.

To this class of reformers Mr. Trotter does not belong. How far he would agree with these abstract principles cannot be learnt from his pamphlet. He, perhaps, is one of those who think that abstract principles are like the timbers of a ship, which, through the very making of the vessel, come to the surface only after shipwreck. At any rate, he adopts what to many will seem the wise course of confining himself to the practical consideration of how, with the least possible dissipation of energy, education may be converted into learning, and how the university, which ought to be the seat of the latter, may be fortified without injuring that "college life" which is the natural instrument of the former, and which, to all who know it, has charms too great to be neglected by any wise reformer.

On these matters, all his remarks, coming as they do from one who, having a true love of learning, has for several years been prominently engaged in college and university business, seem to me worthy of very serious attention. I can readily imagine that his views will be condemned by two opposing parties. Many academic

conservatives will call them "revolutionary." Many academic and other radicals will stigmatise them as a compromise. They do indeed favour that dreadfully commonplace "middle way"; but they possess this notable characteristic—they are tentative and progressive. They may not at first convert the university into a palace of learning; but if adopted, may, without fear of strain, be expanded in proportion to the demands of knowledge and the wealth of the united corporations.

In the first of the three divisions of his pamphlet, Mr. Trotter deals with the relations of education and knowledge; and his leading idea is the multiplication of what, in general terms, may be called professorships, the duties of which shall be so light as to afford leisure for research, and the promotion to which shall be at least largely dependent on fruitfulness in advancing learning. He would make learning and education, what the pious founders thought they had provided for their being, co-partners in the wealth of the colleges; and would sweeten and lighten teaching with the spirit of research. In this he will doubtless fail to please those who press for the endowment of research "untrammelled by teaching duties;" but is not, after all, the difference between him and them one of detail only, and not of "abstract principle?" Putting aside certain tasks of continued observation, all investigators, or at least all with comparatively few exceptions, would be assisted rather than hampered in their inquiries by having from time to time to give expositions of their particular studies to an audience of some kind or other. And that is all which is really included under the duties of professor. How much or how little teaching ought to be demanded of this or that man must depend on the particular circumstances of each case; and the few instances where absolute dumbness is an essential to successful research, might without difficulty be provided for by special arrangements.

These professorships Mr. Trotter would divide into three classes.—(1) Ordinary Professorships, such as now exist; (2) Lectureships, somewhat corresponding to the present College Lectureships; and (3), what, in the absence of any more suitable word, he proposes to call Extraordinary Professorships. The first class he proposes to limit in number and exalt in dignity so that each professor should be considered as at least the nominal head of the particular study to which he is devoted. Although he does not expressly state it, Mr. Trotter evidently intends that the men holding these offices should be eminently men of research; and hence while their incomes would be ample, their official duties would be light. The extraordinary professors would form a more numerous class and would be appointed either for fruitfulness in research or for great teaching talent, or (and it is hoped frequently) for both. The emoluments and status of an extraordinary professorship ought to be such that a man might look to it as a post for life and not merely as a stepping-stone to something else. The third class of lectureships would be still more numerous, and serve in part at least as feeders to the other professorships. Though, for them, as for the other two classes, research would be a qualification at least on a level with didactic ability, the teaching duties of a lecturer would naturally be heavier than those of a professor. It may be urged, as Mr. Trotter himself feels, that extraordinary

professor is a very awkward title. Professor adjunct, or assistant professor is distinctly objectionable. It seems to me that there is much to be said in favour of calling the new professors by the simple title of professor, and of inventing for the higher and more select posts some such style as professor director, or professor rector; indeed, the duties of a member of this class would probably in many cases consist largely in a general guidance and supervision of the studies carried on in his own particular science.

His plans also provide assistants both for teaching and research, demonstrators, &c., and include the establishment of what he proposes to call "senior scholarships," *i.e.*, posts to be filled by able young men at the close of their student career for the purpose of enabling them to devote themselves free from all trammels, for two, three, or more of their best years, to learning research. This is, indeed, at present, perhaps the most crying want of the university, a want most imperfectly met or not met at all by fellowships as now administered.

The scheme by which Mr. Trotter proposes to unite the university and the colleges in the function of appointing and regulating this professoriate requires development; but it has the great merit of strengthening the hands of the various "boards of studies," and if adopted would soon grow into a natural and healthy form of government under which the hiring, by candidates for university posts, of special trains for the conveyance of their outlying voters, would become a grim and a grotesque reminiscence of the past. It must be remembered, however, that no artificial scheme will secure purity of election, unless the electors be thoroughly leavened with the leaven of loyalty to learning; and that such loyalty will only be found where research, rather than teaching, is regarded as the great aim of university life, where Leah is woo'd chiefly in the hope that Rachel may be won.

All these proposed changes, to say nothing of university laboratories, museums, &c., require money; and in the second part of his pamphlet Mr. Trotter discusses the methods by which the wealth of the colleges may be rendered available for university purposes. Here two plans present themselves. There is, first, what may be called the "social" plan. In this the colleges are supposed to undertake the care and protection of certain university posts or institutions, this college, for instance, supplying the funds, in the shape of fellowships or otherwise, for this professorship, or taking the charge of that laboratory. It may be regretted that Mr. Trotter has not entered more fully into the discussion of this plan, which is sure to find ardent supporters in the colleges. It offers the college a *quid pro quo*, and promises to strengthen rather than weaken "college life." The difficulties of the plan lie in the question of election. If the university elects, the college may have to receive into its bosom a man whom it detests, if the college elects, it may not unlikely choose the very man the university would seek to avoid. Such a scheme cannot be made to work satisfactorily even with the help of elaborate checks and counter-checks, unless the actions of both colleges and university are directed by thorough loyalty to learning.

The second plan is that of "taxation," or as a small but prominent party prefers to call it, "confiscation," by which the colleges are called upon to contribute, in proportion to their wealth, to the common university funds. And on this point Mr. Trotter's suggestion that the contributions "should be variable within limits, and fixed from time to time, in accordance with the wants of the university, by some competent authority representing the colleges," is worthy of consideration as an improvement on the older scheme of a fixed contribution in the form of a definite percentage tax on the collegiate divisible revenues. At the same time it is difficult to overlook the possible occurrence of bitter and frequent discussions as to what, at any given time, are to be considered the actual needs of the university.

The money which the colleges are in the one way or another to be called upon to devote to the university must come from the pockets of the scholars, or the fellows, or the heads of houses; and the third part of the pamphlet is devoted to a consideration of these three classes.

Concerning the fellows, Mr. Trotter, with a boldness which will undoubtedly prevent many Conservatives from recognising at first how moderate a compromise his whole plan of reform really is, writes as follows:—"On the whole, I am disposed, mainly for the reasons put forward by Mr. Sidgwick in the *Contemporary Review* (April, 1876), to advocate the abolition, or at any rate the restriction within very narrow limits, of the class of fellowships held purely as prizes." Such a proposal will be opposed tooth and nail by many both within and outside the university who have never attempted to answer Mr. Sidgwick's arguments; and Mr. Trotter himself states that he imagines "public opinion" is not at present prepared to support so extreme a measure.

In the matter of the scholars Mr. Trotter proposes no marked innovation, though he seems to think changes of some kind are desirable. To his general approval of present practices he will find few demurrers either within or outside the university; and yet the evil influences which the system of scholarships is secretly exercising on both education and learning are well worth consideration; *mutatis mutandis*, many of the arguments against prize fellowships might be well applied to prize scholarships.

The heads of houses form the last topic on which Mr. Trotter dwells, and those who know university life, whatever their opinions, must award to him the praise of having brought forward into open and plain-speaking discussion a subject on which, for many reasons, it is difficult for any fellow of a college to say his mind. That he boldly advocates the abolition of heads of houses is perhaps less important than that the question should be thoroughly considered. At the same time his arguments seem irresistible; he says all that can be said in favour of maintaining these ancient offices, but concludes that all the advantages they offer might be secured by other arrangements which would bring to the university at the least an annual income of 15,000*l.*, and yet eventually be felt by no college as a burden—by some, possibly, as a relief.

## LETTERS TO THE EDITOR

[The Editor does not hold himself responsible for opinions expressed by his correspondents. Neither can he undertake to return, or to correspond with the writers of, rejected manuscripts. No notice is taken of anonymous communications.]

## Science at Oxford

THE anonymous "Oxford Man" who so effectively reformed his *Alma Mater* on paper in the last number of *NATURE* can hardly be complimented on his successful and unfilial misrepresentations. It is not true that "of all the 360 fellowships in the various colleges only five are held by persons (exclusive of professors) who have been elected to them in consideration of their attainments in physical science." At the present moment no less than six fellowships are being held by *biologists*, viz., at Exeter, two; at Magdalen, two; at Pembroke, one; and at Ch. Ch., one; and two fellowships at Merton, one at Brasenose, one at C. C. C., and two at Ch. Ch., are tenable for physics or chemistry solely. It is true that one Merton fellowship and the one at Corpus is at the moment vacant, but this does not affect the question. Thus there are *twelve* instead of five fellowships in the hands of natural science honour men, and considering the few who graduate in the science school as compared with the vast crowds who in the aggregate go out in other schools, the number is by no means despicable. There is, moreover, the equivalent of a fellowship held by the Millard Lecturer in physics, who receives from Trinity an annual grant of 200*l.* This list of prizes takes no account of those fellowships in which "the application of mathematics to physics has been allowed to count in establishing a student's claim to such fellowship."

It is difficult to make out why the statistics of 1875 should have been selected by "an Oxford Man," to whom one would imagine the calendar for 1877 should be by no means inaccessible, and the conclusions to which consideration of these statistics has led him irresistibly suggest to those who know Oxford as it is, that "an Oxford Man's" survey is retrospective.

That the public schools pay so little heed to physical science is matter for regret, which is however tempered by the assurance that a change has been inaugurated in places, and the conviction grows daily stronger that the claims of natural truth are forcing a recognition in these centres of preliminary culture. At Eton, at Rugby, and at Clifton, science is no longer a bye-word and a play, but with masters to teach and willing boys to learn, biology and physics and chemistry are fast becoming realities where, not very long ago, they were but phantom names.

It is folly to hint of "introducing any branch of physical science into any one of the compulsory examinations." Such a course would effectually crush the growing taste for natural knowledge; it is only by leaving it an optional or alternative subject that the present prejudice against the study of science can be satisfactorily subdued.

Only ignorance of the Oxford of to-day could have led to the expression "even the heads of houses are with few exceptions men who have been schoolmasters, or who hope to be so." The Master of University, and the Dean of Christ Church can alone claim to have served in the capacity which has been asserted of the majority. The conclusion of the sentence quoted is ridiculous when applied to the senior members of the collegiate bodies.

The concluding paragraph of "an Oxford Man's" article is perhaps most glaringly indicative of sublime ignorance of the Oxford of to-day. Those whose interest, it is assumed, "it is to suppress a class of studies of which they are themselves ignorant," include many names honoured even in metropolitan centres of scientific culture; and it would better become all "Oxford men" who, *in absentia*, are prone to think of the University as they knew it, to assure themselves that things have remained *in statu quo*, than to censure in ignorance that a little careful inquiry would completely dispel.

CHARLES H. WADE

Magd. Coll., Oxford, March 12

## Just Intonation

OTHER occupations have prevented my replying sooner to Col. A. R. Clarke's amusing charge (vol. xv. p. 353), that it is I (instead of he himself) who "confound vibration numbers with their ratios." Three examples are included in his first letter: "The vibration numbers of the diatonic scale being represented by—

$$1, \frac{9}{8}, \frac{5}{4}, \frac{4}{3}, \frac{3}{2}, \frac{5}{3}, \frac{15}{8}, 2."$$

The figures are correct in this instance, but instead of being "vibration numbers," they represent only the *ratios* of vibration.

Then follows: "if we build the scale upon the dominant  $\frac{3}{2}$  the vibration numbers will be—

$$1, \frac{9}{8}, \frac{5}{4}, \frac{45}{32}, \frac{3}{2}, \frac{27}{16}, \frac{15}{8}, 2,"$$

and if we built upon the sub-dominant  $\frac{4}{3}$ , the vibration numbers will be—

$$1, \frac{10}{9}, \frac{5}{4}, \frac{4}{3}, \frac{3}{2}, \frac{5}{3}, \frac{16}{9}, 2."$$

Such ratios as these could not pass unchallenged in *NATURE*, therefore I drew the anonymous writer's attention to the second and third scales, only pointing to the first intervals in each, and as "oversights." It was reasonable to expect that he would submit the scales to some competent musical friend, who would correct them throughout. Instead of doing so, the Colonel announced himself, and had the courage to write, "the errors and oversights with which Mr. Chappell charges me are imaginary." Under the plea of "making the matter clearer," he changed the ratios (January 18), but still he could not set them right. Col. Clarke's third letter convinces me that he does not permit his figures to be called in question by any person. Perhaps, then, one illustration of the Colonel's system of making, or of transferring, ratios may interest the reader. I select his  $\frac{45}{32}$  because its source

may perhaps be pointed out. Mr. Colin Brown introduced that ratio as from F to B natural in the scale of F. The Colonel saw that F, G, A, and B *natural* were four consecutive long keys, and so also were G, A, B, and C, therefore the ratio of the one ought to do for the other. It was excellent geometry, because all the keys are of the same width; only, whether they were tones or semitones cannot have entered into the Colonel's calculation.

It may be assumed that Mr. Colin Brown did not construct any harmonic instrument of six octaves above F, in order to hear such a thorough dissonance among the quarter-tones as 45 vibrations sounding in cycles against 32, but that he had a sheet of paper before him, and added the intervals  $\frac{9}{8}$  to  $\frac{5}{4}$ .

$\frac{9}{8}$  was for the major tone from F to G, and the  $\frac{5}{4}$  for the major

Third from G to B. This  $\frac{9}{8}$  from F to G, might have assisted the Colonel to correct his sub-dominant scale.

Allow me to add a note which may be in time for Mr. George Grove's glossary. I now recollect that the so-called "Comma of Pythagoras" is claimed by Boethius, and, as his treatise was once a college text-book, it was in all probability from it that the moderns first applied the name "comma" to that most minute of intervals. It is a favourite plaything with mathematicians, but, being inaudible as a sound, whether as a difference, a ratio, or any other way, it may well be spared from books upon mundane music.

WM. CHAPPELL

Stratford Lodge, Oatlands Park, Surrey

## Typical Division of Stars.—Borrelly's Comet

EXCUSE me asking you to allow me to rectify a statement in *NATURE*, vol. xv. p. 344, col. 2. It is stated there that M. Kookoly has followed M. Vogel's typical division of stars. I beg to observe that this typical division has been proposed by myself since my first publication in 1866 (*Mémoire of the Société Italiana*, ser. iii. tom. i. p. 1) and *passim* in my first publications.

Again you say that M. Vogel discovered, in 1871, the bright lines of  $\beta$  Lyre. I beg you also to note that these lines were announced by myself in my first publication of the same year, 1866, and even printed in the special catalogue of spectral stars, published in Paris in 1867, and widely circulated (p. 21). I have also announced that these lines were invisible in after years.

I do not wonder at these omissions, since unfortunately the Italian language is very little understood out of our country.

Rome, February 24

P. R. SACCHI

P.S.—On the 15th of this month I obtained a sight of the spectrum of Borelly's Comet. It was composed of a bright line very large in the green, another *more* refrangible in the blue, and another *less* refrangible in the yellow (?) but this was narrow and faint. Their figure was approximately as follows:—



I could not determine them better. The lines, especially the central one, were pretty brilliant.

“Stone Rivers”

THE interesting account of the mode of formation of “Stone Rivers,” given in a late number by Sir C. Wyville Thomson, recalls to my mind some apparent moraines which I observed, and somewhat similarly explained, some years ago in the Hartz Mountains. In a paper read before the Geological Society of Dublin in 1872, I thus speak of them: “The first thing that one notices on entering this valley [the ‘Ockerthal’] from the north is that the bed of the stream is crowded with granite pebbles and boulders, which become of greater size as we proceed up the valley. The boulders are soon so large—many of them some tons in weight—and are situated so far up the slopes on each side, that the first idea is, we have here the morass of a former great glacier. I looked diligently for ice marks, but could see none; and I soon found that the causes which have the effect of scattering huge blocks of rock on the slopes and on the bed of the river are now at work and are slowly, but surely, altering the contour of the adjoining granitic mountains. . . . All over the sides and upon the summits of these mountains are scattered the most fantastic piles of immense boulders. Some of them are over thirty feet in height and form conspicuous objects in the landscape; others, again, are deep in the forest, away from pathways, and are not to be seen until one climbs quite up to them. . . . It is quite clear that the contiguous



A pile of granite rocks on a mountain overlooking Ockerthal.

surfaces of the blocks in these piles are undergoing a slow decomposition, that the joints are becoming gradually looser, and in consequence the cohesion of the component pieces less and less. Sooner or later the upper portions must either slip off or topple over, and roll down the mountain side. And this is not mere theory, for I hear that every now and then a boulder does fall and comes crushing down the hill until quietly deposited near the bottom: It would appear that while the surrounding rock has been decomposed and has fallen down in the manner indicated, these heaps have the longer resisted. But they are yet to follow in their turn; when the atmospheric agencies have

Notes on the Geology of the Hartz, by P. S. Abraham, M.A., F.S.G., in the *Transactions of the Geological Society of Ireland*, vol. xiii. Pt. 2, p. 24, 1872.

sufficiently done their work, gravity will come in and lower the whole.”

Instances of the turning over of the edges of slaty strata from the weight of the superincumbent mould and vegetation are common in the Hartz. I find in an old note-book the following entry:—“I was interested at seeing the upper slates on the left wall [of a quarry near Goslar] bent so much over that [their dip has become 75° to the north [the regular cleavage dip of the district is about 40° south]. Whether this is due to the weight of the ground above, to a landslip, or to the action of a glacier, I am not quite sure. I incline, however, to the first theory, for, although the slope of the hill is not high, the constant weight of the superincumbent earth and rubbish, bearing downwards for ages, would, it seems to me, be enough to cause such a result.”

Scientific Club

PHIN. S. ABRAHAM

The Measurement of the Height of Clouds

AMONG the various parallactic methods for determining cloud heights, one of which Mr. Malloch has put in practice (*NATURE*, vol. xv., p. 313), the use of the cloud shadow as a second station seems worthy of notice, as it requires very simple apparatus and observations.

On any partially cloudy day at the sea-side, an observer with a sextant may, from a cliff, easily determine cloud heights by the following elements:—A. Altitude of a given point of cloud above the horizon, allowing for dip. B. Depression of the shadow of the same point on the surface of the sea. C. Sun's altitude. D. Lineal elevation of observer above sea-level. The measurements should be taken when the cloud, the sun, and the observer all lie in a perpendicular plane; i.e., when the cloud shadow is seen on the sheen of light reflected from the wavelets; otherwise azimuth observations, and less simple calculations, must be applied. Full moonlight might also be used at night.

On practically trying this method in September, 1875, the time of day was selected when the sun was in the direction to or from which the wind was blowing; thus the cloud shadows slowly sailed along the sheen on the sea, and could be followed by successive timed observations for half-an-hour or more, so that their velocity, and any variation in their height, could be ascertained.

The results are of course most accurate when both clouds and sun are at considerable altitudes, and I believe that this method will give results quite as accurate as the photographic process. The rounded forms are the greatest trouble, and measurements of the centres of little isolated masses of cloud are the best. The height of the observer above the sea is of course easily obtained by the angular width of a base measured on the beach.

The same method might be employed with shadows on land, by using a theodolite and a map; and though it is only applicable to one or two classes of clouds, yet its simplicity may induce some of your sea-side readers to make such observations.

Bromley, Kent

W. M. FLINDERS PETRIE

The “Hog-Wallows” of California

My friend, Mr. Thomas Belt, F.G.S., has kindly sent me the following extract from a paper by Prof. Joseph Le Conte, in the *American Journal of Science* for 1874 (p. 366), in which an explanation is given of the above-named formation (*NATURE*, vol. xv. p. 274) and of similar mounds farther north. It will be seen that Prof. Le Conte refers them wholly to “surface-erosion,” but it is not clear whether he means “pluvial” or “aerial” erosion, or the two combined. More explanation seems required to account for the removal of the eroded matter over a surface thirty miles wide without producing any continuous ravines or other water channels:—

“*Prairie Mounds.*—The irregularly ramifying grassy glades or prairies already described as existing at the southern extremity of Puget Sound are studded over as thickly as possible with mounds about three to four feet high and thirty or forty feet in diameter at base.” . . .

“The whole country between the Dalles and the upper bridge of Des Chutes River, a distance of about thirty miles, is literally covered with these mounds.” . . . “The true key to their formation is given here, as it was not at Mound Prairie, by the great variety of forms, sizes, and degrees of regularity which they assume. They vary in size from scarcely detectable pimples to mounds five feet high and forty feet in diameter at base, and in form from circular through elliptic and long-elliptic to ordinary hill-side erosion-furrows and ridges.” . . .

"No one, I think, can ride over those thirty miles and observe closely without being convinced that these mounds are wholly the result of surface-erosion, acting under peculiar conditions. The conditions are a *treeless country* and a *drift soil* consisting of two layers, a fine and more movable one above and a coarser and less movable one below." . . . "The necessary condition, I believe, is the greater movableness of the surface soil compared with the sub-soil." . . . "Surface erosion cuts through the finer superficial layer into the pebble layer beneath, leaving, however, portions of the superficial layer as mounds."

"Similar less conspicuous mounds, under the name of 'Hog-wallows,' are well known to exist over wide areas in middle and southern California."

The words in italics are so in the original.

ALFRED R. WALLACE

### SCIENCE AT CAMBRIDGE, MASS.

THERE is marked activity in all scientific pursuits in and about Harvard University. The Agassiz Museum has at last had its management fully turned over to the University, the transfer being effected by permission from the State Legislature. At present the estimated worth of the property is \$322,000; the land and buildings being valued at \$100,000, and the collections at \$60,000; the rest being trust funds. By the transfer, Harvard will have the use of the collections for educational purposes, and the Peabody Museum of Archaeology will erect an edifice connected in plan with the Agassiz Museum. The Peabody trust provides for a Professorship of Anthropology, as well as for collections and a building. The Agassiz Museum is arranged so as to display types of the whole animal kingdom in their natural classification. Great facilities are already furnished to students and specialists, and these facilities will now be further increased. The force employed in the Museum is sufficient not only for the care of the specimens, but also to aid in new research.

There is a steady increase in the number of Harvard students in the scientific courses—physics, chemistry, natural history, botany, anatomy, and physiology. Text-books are little used in these courses; students are required to handle the things themselves, in the laboratories. "Summer schools" are conducted from June to September, in which teachers from the public schools become pupils. Chemistry has been taught in these summer schools for three years, geology and botany for two years, and zoology will be undertaken this year under Assistant-Professor Walter Faxon. Prof. Shaler's Summer School of Geology is the most widely-known of these enterprises. This year it will be conducted with headquarters successively in the Connecticut Valley, the Berkshire Hills of Massachusetts, and the Helderberg or the Catskill Mountains of New York. The class will be limited to fifty members. After the school closes, a trip will be made by those who can join in it to Cleveland, Nashville, Louisville, and the Mammoth Cave. Besides the Summer Schools, there is also organised a series of four courses of lectures to teachers, which include laboratory work. These are given on Saturdays from January to May. They embrace geology, physics, botany, and zoology, and have the services of Professors Shaler, Trowbridge, Goodale, and McCrady, and some assistant-professors of special repute. There are about forty members to a class.

The Boston Society of Natural History sustains a similar series of course-lectures to teachers during the winter months. The instruction is practical, as far as it can be made so by the illustrative specimens in the Society's collection. Prof. Shaler is also organising a system to furnish teachers with selected specimens and appropriate text-books and descriptions. It is expected that this new system will be the means of inducing teachers in the public schools to make further collections for their own use and to instruct their scholars. The Harvard Natural History Society is very actively engaged

in promoting scientific education, especially among beginners in such studies. Prizes are offered for the best essays of the students upon their actual observations in natural history and botany. A free course of six scientific lectures is furnished by this Society, the lecturers being eminent specialists in the University. Two scientific associations at Cambridge are also doing active work—the Nuttall Ornithological and the Cambridge Entomological Clubs. The latter is the larger of the two, and contains many members of eminence. It publishes a periodical, the *Psyche*. The Nuttall Club publishes a quarterly magazine, the *Bulletin*, edited by Prof. J. A. Allen. This list of scientific enterprises in and around Cambridge, Mass., is by no means exhaustive, but it will give a fair notion of the activity with which they are promoted at the present time. It is hoped that the present year will be marked by even greater effort than its predecessors.

### NATURAL HISTORY AND GEOLOGICAL RESULTS OF THE ARCTIC EXPEDITION

THE public will, we are sure, be glad to hear that though the Admiralty have declined to undertake or assist in the publication of the results of the late British Arctic Expedition, beyond matters purely hydrographical, the natural history and geological collections brought back by the expedition are being rapidly arranged and named. The whole of the numerous collection of fossils from the Silurian (Wenlock), Devonian, Carboniferous Limestone, and Miocene rocks of the coasts of the circumpolar sea have been examined by Mr. Etheridge, the palæontologist of the Geological Survey, and found to contain several new and interesting forms, which will be described in his forthcoming paper, at the Geological Society, on the Arctic fossils brought back by Capt. Feilden, R.A., and which will accompany a paper by that officer on the rocks and general geological facts observed by him in the Arctic area.

We especially rejoice to find that Capt. Feilden has brought back a large series of notes and portions of rocks glacially scratched and scored, scratched boulders and pebbles, which will throw much light upon the manner in which this country was glaciated during the Drift period. It will be seen that stones on a headland coast can receive the greatest possible amount of glaciation by the mere impinging of floe-bergs, driven by violent gales and currents, on the breaking up of the pack. On the much-vexed question of the parallel roads of Glen Roy, light also may possibly be thrown, for terraces fringe nearly every valley flanking the Arctic coast, formed by fresh water, dammed by pack ice. These rest on marine beds of boulder clay, with sea shells, which rise to heights of more than 500 feet above the present sea-level, and prove the recent elevation of the land, which movement is still going on; the marine beds outside the ice foot fringing the coast of to-day will doubtless ere long be elevated above the water-level, and be covered with the latest fluvial terrace behind the pack.

To those accustomed to the magnificent results brought to England by perfectly equipped expeditions like that of the *Challenger*, proceeding leisurely through seas teeming with the luxuriance of tropical life, the collections brought back by the Arctic Expedition may appear small; but we feel sure when the specimens are fully catalogued, and the difficulty realised of carrying heavy specimens of rocks and fossils when up to the arms in snow, and of securing insects with fingers numbed by a temperature of 50° below freezing, it will be felt that the naturalists of this expedition have made excellent use of their opportunities. We may mention that the extensive series of Miocene plants associated with the thirty-foot coal-bed of Lady Franklin's inlet will be described by Prof. O. Heer, the insects (recent) by Mr. McLachlan, and the fishes by Dr. Günther, of the British Museum.



THE PHYSIOLOGICAL ACTION OF LIGHT

... *Method of Experimenting.*—One of the chief difficulties in arriving at the exact relation between variation and the luminous and colour intensity of light, was the continually diminishing sensibility to the stimulus, owing to the abnormal conditions of the eye when removed from the head. When the experiment begins, the eye is remarkably sensitive to light, and a large variation of current is obtained; but the amount of this current is gradually falling, in consequence of the gradual change in the parts of the eye, owing to their loss of vitality and sensibility. In fact, the parts are dying—the blood is not circulating, and molecular and chemical changes are slowly occurring. In the case of the frog however, it is a fact that the retina retains its sensibility from three to four hours, and sometimes longer. After a lapse of two hours the frog's eye frequently remains in a tolerably stable condition, in which it does not lose sensibility rapidly. This condition may last for four

still circulating. A current is obtained; and all the effects I have just mentioned may be observed with ease. The animal remains in this condition, retaining its sensibility to the action of light, for as long a period, in the case of the frog, as forty-eight hours. These observations led to the discovery made recently, that there is no necessity for even exposing the surface of the brain. That is to say, the action of light can be traced, if needful, through the whole body. If, for example, we take a frog, place it in position, slightly abrade the skin on the surface of the head or back, or any part of the body, then adjust the electrodes, one in front of the cornea and the other upon the abraded skin, we obtain an electrical current which is affected by light in the usual way. But if the electrode in contact with the cornea be shifted to some other part of the body, a current may be obtained; but this current is not sensitive to light. In order to produce the specific action of light upon the eye, the retina must be included in the circuit. This discovery enabled us to perform many experiments without injuring the animal, except to the extent of abrading or removing a small portion of skin. It at once opened up the way for making observations upon warm-blooded animals (one of the chief difficulties in our earlier investigations). For example: give a rabbit or a guinea-pig a small dose of chinoline, and the animal remains prostrate and quiet. Then cut off a little of the hair from the surface of the head at the back of the neck, and abrade the skin so as to have a moist surface; bring the electrodes into position, placing one in contact with the abraded surface, and the other in contact with the surface of the cornea, and you will at once obtain the effect.

*Action of Light in Warm-blooded same as in Cold-blooded Animals.*—By the use of chinoline we were able to make experiments of the kind just described for a considerable time, without the necessity of maintaining artificial respiration. The result of those investigations upon warm-blooded animals has been to show that in these, as in the cold-blooded, light produces first an increase in the electric current on impact; continued light usually causes the electrical current to diminish; and on the removal of light, there is a second rise, as described in the case of the frog. In our earlier investigations, we always observed in the case of warm-blooded animals (when the eye had either been quite removed from the body or was receiving an inadequate supply of blood), that the action of light caused a negative variation, that is, a diminution in the electrical current. By improved methods, however, which have the effect of placing the eye in conditions more normal, we find that light causes a positive variation, that is, an increase; thus agreeing with what had hitherto been observed in the eye of the frog. This is a point worthy of notice. Du Bois-Reymond showed, even in the case of sensory nerves, that physiological action caused a negative variation. But it appears that in the case of the retina the action of the normal stimulus is to cause a positive, not a negative variation.

*Experiment with the Living Lobster.*—The action of light can be readily shown in this animal. Fix it loosely in a cloth, and lay it on the table in a slightly oblique position. With a small trephine remove a circular portion of the carapace, about three millimètres in diameter, and expose the moist tegumentary surface. Bring one electrode into contact with this surface, while the other touches the cornea. The usual effects of light may then be noted; but in the case of the lobster, the variation caused by the impact is greater than what we have noticed in any other animal, often amounting to one-tenth of the total amount of current. Another interesting experiment, comparable with that of the two eyes just described, may be made on the lobster by placing an electrode in contact with each cornea. The result frequently is apparently no current, but in reality the currents neutralise each other. Light falling on the one eye causes the

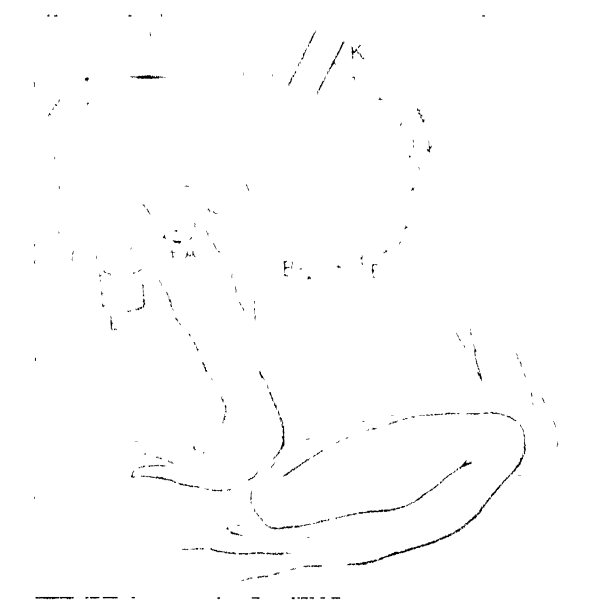

Diagram showing arrangement of apparatus in the experiment on eye of frog. A, Eye showing the electrode, & in contact with it. B, Skin removed, and subcutaneous tissue in contact with other electrode, & K. Key, G, Galvanometer. Arrows indicate direction of current. Cornea, positive. Back, negative.

or five hours. In order to get rid of the difficulty of death of the parts, various methods were tried in earlier experiments in the attempt to remove the eye as quickly as possible, and to make the observations rapidly. In the case of the warm-blooded animals this did not lead to good results, because the sensibility to light disappeared in a very few minutes. On several occasions the posterior aspect of the eye was exposed in the living anaesthetised warm-blooded animal, and on bringing one electrode into contact with the severed optic nerve while the other touched the cornea, the observations were tolerably constant. This method was troublesome and difficult.

These experiments are now made in a different way. By placing a frog, rabbit, or pigeon under the influence of chinoline, the animal remains motionless. A small portion of the surface of the cranium is then removed so as to expose a portion of the brain. One of the electrodes is brought into contact with the surface of the cornea, and the other with the surface of the brain. The blood is

say to the left, while if it fall on the other eye, the needle swerves to the right. When the eye of the lobster, removed from the body, was divided longitudinally into segments, each segment was found sensitive to light. The

experiments, viz, that sometimes, in the case of the eye of the frog, light produced an increase in the electrical current, and in other cases a diminution. This we could not at first account for. But we have been able to make out that the positive and negative variation, or the increase or diminution of the natural current on the action of light, depends upon the direction of the primary current, when the cornea and brain are in circuit. If the cornea be positive and the brain be negative, then light produces an *increase* of the electrical current. If, on the other hand, the cornea be negative and the brain positive, light then produces a *diminution* in the electrical current. It is thus conclusively shown that the current superadded, or if we may use the language, induced by the action of light, is always in the same direction; only in the one case it is added to, and in the other subtracted from, the primary current.

*The Use of Equal and Opposite Currents.*—Many experiments were performed in which equal and opposite currents were transmitted through the galvanometer at the same time. By the use of resistance coils, it was not difficult to balance the current from the eye; but, owing to the inconstancy of even a Daniell's cell in such experiments as these, it was impossible to avoid fluctuations which might possibly have been mistaken for those due to the action of light. This difficulty was got over by what was formerly called the *double eye experiment*, in which two similar eyes are placed in reversed positions on the electrodes, so that the current from the one neutralises that of the other. When this is accomplished, it is easy by means of a blackened box, having a shutter at each side, to allow light to fall on either the one eye or the other, and it is then shown that the galvanometer needle moves either to the right or left, according to the eye affected. Instead of removing the eyes from the head and balancing them as just described, it is a much better method to apply the two electrodes directly to the corneas in their natural position. By a little manipulation, it is possible to obtain two positions that seemingly give no electrical current. In these circumstances, light, allowed to fall on the one eye or the other, produces the effects above detailed.

Diagram showing arrangement of apparatus in experiment on living lobster. A, corneal surface, having electrode, E, in contact with it. B, portion of carapace removed so as to expose moist surface for electrode, K, key. G, galvanometer. Arrows indicate direction of current.

effect of light was then to increase the primary current, but no inductive action was observed on withdrawal. This observation is interesting as a confirmation of the views of physiologists regarding the mode of action of a compound eye.

*Mode of Experiment on Eye of Fish.*—An experiment upon the eye of a fish may be made in a very simple way, by a method adopted in Prof. Stricker's laboratory in Vienna. Take a fish and give it a very small dose of woorara. It soon becomes almost motionless, and sinks in some cases to the bottom of the vessel. The animal would soon die in consequence of paralysis of the movement of the gills necessary for respiration. But, if we take the animal out of the water, put it upon a glass plate, introduce a little bit of cork under each gill, and then by means of an india-rubber tube placed in the mouth, allow a little water to flow over the gills, the fish will live out of water for many hours. By this method may be made the experiment upon the eye of a fish with like results.

*Observation on Human Eye.*—Having succeeded in detecting the action of light on the retina of the living warm-blooded animal without any operative procedures, it appeared possible to apply a similar method to the eye of man. For this purpose, a small trough of clay or paraffin was constructed round the margin of the orbit, so as to contain a quantity of dilute salt solution, when the body was placed horizontally and the head properly secured. Into this solution the terminal of a non-polarisable electrode was introduced, and in order to complete the circuit the other electrode was connected with a large gutta-percha trough containing salt solution, into which one of the hands was inserted. By a laborious process of education it is possible to diminish largely the electrical variation due to the involuntary movements of the eye-ball, and by fixing the eye on one point with concentrated attention, another observer, watching the galvanometer, and altering the intensity of the light, can detect an electrical variation similar to what is seen in other animals. This method, however, is too exhausting and uncertain to permit of quantitative observations being made.

#### *of Variation in Direction of*

One phenomenon particularly attracted the attention of physiologists, and especially of those who first saw the

*Action of Polarised Light and Colours of Spectrum.*—The next point investigated was the action of polarised light and the various complementary colours. Early experiments, by passing light through solutions having various absorptive powers and by the direct coloured rays of the spectrum, &c., lead always to the same conclusion—namely, that the most luminous rays produce the greatest effect. For studying the action of polarised light, the simple contrivance of a black box, having a hole on one side of it, placed over the eye, may be employed. Opposite the hole two cylindrical tubes of brass, each carrying a Nicol's prism, were placed, and between the two prisms a thin plate of quartz is introduced, producing the various colours of polarised light on rotating one of the prisms. The general results were exactly the same as with the colours of the spectrum. In all cases, the impact of the yellow rays produced the greatest effect. It has also been ascertained by this method that the effect of the *impact* of light is much more regular than the effect of its removal. The results of one series of observations are given in the two following tables:—

#### *Action on Frog's Eye of Colours of Polarised Light.*

	Initial Effect.	Final Effect
Purple ... ..	rise of 3	rise of 14
Light blue ... ..		15
Red violet .. ..		20
Blue ... ..		15
Red ... ..		22
Orange red .. ..	10	
Green blue... ..	10	
Green ... ..		24

Rose

Action on Frog's Eye of Spectrum of Oxyhydrogen Flame.

	Initial Effect.	Final Effect.
Yellow, near orange ..	rise of 70 ...	rise of 10
Green yellow ... ..	" 25 ... ..	" 5
Green—low ... ..	" 15 ... ..	" 0
Green—high ... ..	" 15 ... ..	" 0
Green—higher ... ..	" 18 ... ..	" 8
Yellow green ... ..	" 85 ... ..	" 35
Yellow ... ..	" 80 ... ..	" 40

(To be continued)

SIR WILLIAM GROVE ON THE RADIOMETER<sup>1</sup>

SIR WILLIAM GROVE described some experiments he had recently made with a modification of Crookes's radiometer. After a few prefatory trials, such as covering one-half of the bulb with tinfoil and electrising it, which gave no notable results, he devised a method, shown in the accompanying sketch, by which he could electrise the whole of the internal system. Four aluminium vanes, each blackened on one side, had metallic arms and a metal point at their crossing that rested in a metal cup. The latter was united to a platinum wire that passed through a glass tube and was fused into it, the platinum wire protruding. Lastly, the glass tube was fused inside the apparatus and hermetically sealed, the end of the platinum wire being exposed. The vacuum in this apparatus was considered by Mr. Crookes<sup>2</sup> to be as perfect as in his radiometers generally, but Sir William Grove doubted that it was so. The following were the results:—

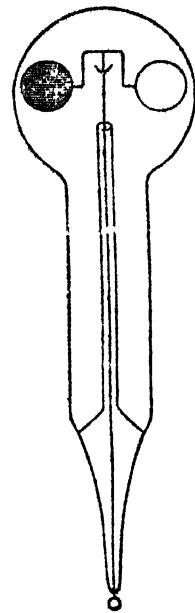

1. With the faint light of a lucifer match or of one or two candles, the vanes invariably turned the opposite way to the normal, the polished surface being repelled. With a dark heat, as from an iron shovel heated short of redness, they went the normal way. These effects continued for several days, but not permanently; the apparatus seemed to have leaked and to have become sluggish and irregular.

2. On electrising the protruding platinum wire with a rubbed rod of glass or sealing-wax, the vanes rotated sometimes one way and sometimes the other.

3. On connecting the negative pole of a Ruhmkorf's coil the results were uncertain, but the positive pole caused the vanes to rotate steadily, and its effect was even better than that from light or heat. In the dark the effect was very beautiful, as the dark vanes moved through a phosphorescent glow. The total results were considered by Sir William Grove to be somewhat negative, but they tended to show that all the effects were due to residual air. He suggested in explanation of

the last experiment, that more electricity would escape from the rough than from the polished faces of the vanes, as the former presented a vast number of points. Consequently the rough faces would produce more disturbance of the gas in front of them, and would themselves be more affected by the reaction than the plane faces. The polished surfaces being repelled by luminous heat is, however, very difficult of explanation.

In his second notice Sir William Grove described some further experiments he had made with Crookes's radiometers since the last meeting of the club. He did not now entertain much doubt that these movements are due to the effect of residual air. Mr. Crookes had kindly made a second instrument for him, and the one that he described at the last meeting, of which the vanes were metallic and in metallic connection with a platinum wire that protruded outside the apparatus, had been re-exhausted. Both now act normally, the black faces of the vanes being repelled by light and by heat. When the protruding wire is now electrised by a Ruhmkorf's coil the effects that were previously observed are altogether absent, there is not the slightest luminosity round the vanes, and the current does not pass. But although the current is now incapable of traversing the

small space of one-tenth of an inch that separates the vanes from the glass, induction acts across it just as well as before. This is shown by the readiness with which the vanes follow the movements of a piece of rubbed glass or sealing-wax held near the apparatus. It is therefore evident that the effects of attenuation of air upon discharge and upon induction are not the same. When attenuation has commenced and is increasing, the discharge passes more and more rapidly, until it becomes a glow, or according to the old theory of electricity, polarisation becomes more and more readily subverted; but a further attenuation stops the discharge entirely. On the other hand, induction continues, and appears to be in no way lessened by extreme attenuation. These results cannot be accounted for by the old theory that discharge is the consequence of subverted induction.

It farther appears that a radiometer is a most delicate electro-scope. By tilting it until the vanes touch the glass, the interior of the glass may be electrised, and it will then remain for days in that condition. He had performed this operation eight days ago, and the movements of the instrument by light or heat have been thereby wholly checked. Every endeavour has been made to discharge or neutralise the electricity on the glass surface, as, for example, by covering the exterior of the globe with tinfoil and connecting this with the platinum wire, nevertheless the glass remains charged, showing what a perfect insulator a good vacuum is.<sup>1</sup>

The above is a copy of the abstracts in the club book. They are now further published, as some partial notices of them have appeared in foreign journals. W. R. G.

THE NORWEGIAN NORTH SEA EXPEDITION, 1876<sup>2</sup>

II.

Researches relating to the Salt-water Fisheries.

BY the side of the more strictly scientific researches it was also our intention during the expedition, if opportunity offered, to give close attention to all the circumstances that might stand in any connection with or throw any light upon our most important salt-water fisheries. As I already during a series of years had been engaged in the study of our fisheries, the prosecution of these researches was committed to me.

For this reason there was added to our other equipment various fishing apparatus, as hooks and lines for deep-sea fishing, and several sorts of drag-nets with various sizes of mesh. The use of such implements could, as a matter of course, only be reckoned upon in good weather and with a pretty smooth sea, which we, however, had promised ourselves might occur at least now and then during our three months' excursion at the best season of the year. But the state of the weather was unfortunately so utterly unfavourable during our whole expedition that the employment of the apparatus we have referred to was not to be thought of. For the same reason the apparatus for measuring the velocity of the currents, exceedingly important in the first place for the physico-meteorological researches, but also for those with which we are now concerned, could not be brought into use. During the few fine days we had in the course of our expedition we were to near the coast for these researches to have any special interest.

Although the state of the weather thus laid insurmountable obstacles in the way of the researches referred to, I have, however, during our expedition, been able to establish certain facts which, in my opinion, are of no inconsiderable importance in this direction, and will be of great use in guiding us in the continued practical scientific researches concerning our fisheries. It is of these facts that I now proceed to give some details.

It is ascertained by our soundings that off our coast there are several fish-banks of whose existence there was no previous knowledge, and on which a profitable fishery with bank vessels may certainly be carried on during the summer months.

The so-called "Storegg" (great edge) off Romsdal's Amt has been from old times famous for its immeasurable richness in fish, and there has been an obscure tradition that it was not the only point where such fishing could be carried on to a large scale, but that there were to be found similar rich fish banks at many other points far out in the open sea, "were man only fortunate enough to fall upon them." The mystic account of the "Havbro" (sea

<sup>1</sup> I may state that the electricity did ultimately become dissipated, but not until several weeks had elapsed.—W. R. G.

<sup>2</sup> By Prof G. D. Sars From *Christians Dagbladet* of January 27. Continued from p. 414.

<sup>1</sup> Abstract of two communications by the Hon. Sir William Grove, F.R.S., to the Philosophical Club, May 18 and June 25, 1876.  
<sup>2</sup> Who kindly made it for me from my description.—W. R. G.

pier or jetty) has now been for the most part explained by the surveys set on foot during our expedition. The "Storegg" is nothing else than a piece of the edge of the extended barrier, which in the west forms the boundary line beyond which lie the cold polar sea-deeps. That so clear a knowledge of this edge within a very limited extent has been already obtained, without the least idea being formed as to its proper connection, naturally arises from the polar sea-deeps here running in closer to the coast than at any other point. A new piece of the continuation of this edge had already been found by soundings made from the steamer *Hansteen*, and we have now been able to establish its existence at several other points, and that both farther south and farther north it retires more and more from the coast to a distance of from twenty to thirty Norwegian (140 to 210 English) miles.

Although it may not be constant everywhere, it appears, however, to be the rule that at the bottom, at the farthest boundary of the barrier, before it slopes towards the great depths lying beyond it, it rises somewhat, and assumes simultaneously a hard stony character, as is the case, as is well known, at the Storegg. At the first sounding, when we went out from Husøe, we struck this edge at about twenty Norwegian (140 English) miles' distance from the coast (stations 16<sup>1</sup> and 17<sup>2</sup>). The bottom, which before had everywhere appeared to be soft, suddenly, at a depth of 221 fathoms, became hard and stony, and retained this character even after it had sloped about fifty fathoms down towards the deep sea lying beyond. That there was here a pretty abrupt descent is clear from the circumstance that we already at the next station reached far down into the cold area with a depth of 412 fathoms, and a bottom temperature of  $+1^{\circ}3$  C. Farther north, about the latitude of Trondhjem, we found at a depth of 190 fathoms, and likewise on the boundary line between the warm and cold area, a very similar edge with rocky bottom, which falls off with a pretty steep slope towards the west (Station 89<sup>3</sup>). Also on the opposite side of the tract of sea we traversed, we had occasion to observe a similar state of things. Off the Færoe Islands, and at a considerable distance from them, we were fortunate enough, though the weather was exceedingly unfavourable, to find the outer edge or opposite point of the extensive Færoe bank (Station 38<sup>4</sup>), whereby its extent and configuration could be to some extent determined, and the state of things here appears to be very similar to the Storegg.

By the carefully-planned soundings which were undertaken from Ramsen Fiord westwards, there could be established at a comparatively inconsiderable distance from the coast, the existence of a hitherto quite unknown, well-defined, steep bank of considerable extent, with a hard bottom, and a depth of only 62-93 fathoms (Stations 63,<sup>5</sup> 64,<sup>6</sup> 65<sup>7</sup>). Beyond this there was a very gentle and even descent towards the great depths, but we did not here meet with any true edge as at the Storegg. It may be added that in the outer part of Sogne Fiord (Sognfjorden), we found a pretty extensive plateau, with a hard stony bottom, and a slope both inwards and outwards (depth from 206 to 211 fathoms).

That all the points mentioned above are excellent fishing-grounds I have not a moment's doubt. Everywhere, where at a considerable distance from the coast, such banks with hard or stony bottom have been found, there have always on closer examination been found large quantities of fish, and although an attempt made by us by attaching to the lead a short line with hooks and bait was unsuccessful, there cannot be any negative conclusion drawn from this method of research, which was unfortunately, by reason of circumstances, very unsuitable for the purpose.

The kinds of fish which are found on the sea-banks are, as is well known, principally ling, torsk (*Brosmus vulgaris*), halibut, and cod, the so-called bank cod. I have already, in my reports to the department, clearly set it forth as my opinion that the so-called bank cod is not a different variety from the well-known winter cod, or *skred*, which in winter and all through the spring, visits our coast for the purpose of spawning. The earlier hypotheses concerning the migrations of the winter cod (*skreid*) from great distances in the sea, I have, after a close study of the nature of this fish, been obliged entirely to abandon, and the experience obtained during our expedition confirms me in this. It is my conviction that the winter cod, which is to be found along our

coasts during winter, and which is the object of some of our most important fisheries, is during the rest of the year distributed only over that tract of sea whose bottom forms the barrier against the polar sea-deeps lying beyond it, and that the outer boundary of this barrier (the so-called Havbro), with its well-developed animal life and favourable bottom, forms a suitable habitat for innumerable multitudes of this fish.

Very dissimilar are the circumstances with reference to the second of the varieties of fish most important for our fisheries—the herring. Here my earlier researches have led me just to the opposite conclusion. While the cod is evidently a genuine bottom fish, and as such dependent on the nature of the bottom and partly on the depth, the herring, on the contrary, in consequence of its whole nature, is a genuine pelagian fish, and its occurrence is therefore exceedingly independent of the depth or the nature of the bottom, but, on the contrary, dependent on the physical and biological conditions in the upper stratum of the sea. As these are very changeable, this species of fish may have been furnished with means to enable it speedily to seek out the most favourable tract of sea. The herring has also, as contrasted with the cod, obtained its elegantly-compressed, wedge-like form, whereby with the speed of an arrow it can shoot along through the water, and in a comparatively short time traverse long distances. Although I do not adopt the old ideas, according to which the spring herring comes as it were from the ice-covered sea about the North Pole, I am, however, inclined to believe that, not only when it visits the coast to spawn, but also during the rest of the year, it undertakes irregular migrations in the open sea. The distribution of the herring in the sea is dependent on the distribution of the small animals which form its food. These small animals are all pelagian, mainly small crustacea of the order Copepoda, which keep more or less near the surface of the sea, and are commonly known by our fishermen under the name of "aat." Only when the herring during winter resorts to the coast to deposit its spawn are its movements for the time independent of the occurrence of "aat." The whole other part of the year, on the contrary, the shoals range through the open sea, inasmuch as they prefer to betake themselves to that region of the sea where, at various seasons, there is the greatest abundance of "aat." The great mass of the herring shoals can thus very naturally, towards the approach of winter, or at the time when the development of the organs of generation drives them to resort to the coast in order to spawn, be found sometimes at a less, sometimes at a greater distance from their spawning places according as the sea in one direction or another has the greatest abundance in "aat." On this again mainly depends, I am convinced, the fluctuations in our spring herring fisheries. For as the spawning migration begins long before the roe or milt are ready to be deposited, the mass of herring, if at that point of time it finds itself close to the coast, will reach it so early that it will be obliged to remain there for a considerable time, during which it will naturally come to seek closer in towards the coast in the fiords and bays. In the contrary case, when the mass of herring at this point of time finds itself at a considerable distance from its spawning places, so long time will have passed before it reaches them that the spawning process will go on immediately after their arrival at the coast. The herring will then remain only a short time along the coast, and the spawning will then for the most part be carried on on the outermost banks, less accessible to the fishermen, in other words, the spring herring fishery will be very short or exceedingly unsuccessful.

This is, in short, the theory which I already, several years ago, in consequence of researches made by me along our coasts, was led to advance as in my view the only probable scientific explanation of the remarkable irregularities which in course of time are observable in our spring herring fisheries. I have, however, unfortunately this time only very few facts to support my theory with, and I cannot, therefore, be surprised if it has been received with mistrust, as merely a hypothesis. There are, indeed, a few reports from seamen of their having observed large herring shoals far out in the open sea, immediately before the beginning of the spring herring fishing, as there have been observed by others at various seasons of the year great masses of "aat" at different points in the sea, and we have information concerning this last phenomenon, partly also from trustworthy scientific men (Kroeyer), and that just from that region of the sea, which here most interests us; but these statements were, however, too few to form complete evidence that the open sea is in fact a suitable dwelling-place for the enormous masses of herring which at certain seasons of the year move towards the coast.

<sup>1</sup> Station 16, lat. 62° 23' 9", long. 2° 17' E. from Greenwich.

<sup>2</sup> Station 17, lat. 62° 33'; long. 2° 4' E. from Greenwich.

<sup>3</sup> Station 89, lat. 64° 1'; long. 6° 7' 5" E. from Greenwich.

<sup>4</sup> Station 38, lat. 62° 37'; long. 3° 47' W. from Greenwich.

<sup>5</sup> Station 63, 64° 41' 3" N. L., 9' E. from Greenwich.

<sup>6</sup> Station 64, 64° 42' N. L., 8° 50' E. from Greenwich.

<sup>7</sup> Station 65, 64° 42' 5" N. L., 8° 35' E. from Greenwich.

During our expedition I therefore considered it a very important object to examine closely the distribution of the "aat" in the tract of sea over which we sailed. For this purpose the sea was examined almost daily, often several times a day, by the help of a surface-net. The results of these examinations completely confirmed my previous view on this point. During the whole passage from Norway to the Færoe Islands, the sea was found everywhere filled with enormous masses of the so-called "red aat" (almost exclusively *Calanus finmarchicus*) which, as is well known, forms the food best liked by the herring, and, what deserves to be remarked, the quantity of this "aat" appears to increase with the distance from the coast, being greatest at a distance of about twenty Norwegian (140 English) miles. Besides the "red aat" we also observed farther out to sea, great quantities of another pretty blue sort of "aat" (*Pontella Patersonii*), which appears to belong more to the Atlantic Ocean, and which, to distinguish it from the other, might be called the "mackerel aat," as it probably forms the principal food of the mackerel at those seasons of the year when this fish is not in the neighbourhood of the coast. This "aat" also shows itself sometimes, particularly during great takes of herring in summer, among the "red aat" close to the coast. When we went northwards from the Færoe Islands toward Iceland, it was remarkable that the "aat" almost entirely disappeared from the sea. At the same time the sea had assumed a very different colour. While during the whole passage from Norway to the Færoe Islands it had been a deep blue, it was now a light, dirty, greyish-green. This peculiar circumstance, for which I cannot yet account, but in which a peculiar relation of the ocean currents certainly plays a considerable part, appears to stand in close connection with the occurrence of "aat," and will be the subject of careful researches during our next expedition. I had a very convenient opportunity of observing this phenomenon from my cabin, the light of which was almost on a level with the sea. When, by the pitching of the vessel, the glass was washed over, the whole cabin was clearly illuminated with a very beautiful, intense dark blue light, and I have often, when, after my work was ended, I was taking a little rest in my cabin, been greatly delighted with this phenomenon, which so strikingly reminded me of my stay in the south the preceding winter, and my ever-memorable visit to the blue grotto at Capri. Now, on the contrary, the illumination was quite different, namely, light greenish. This colour remained constant so long as we were in the navigable water near Iceland, and the sea was everywhere, as has been stated, almost completely free from "aat." The previously-observed state of things recurred first when we, on our return voyage, approached the coast of Norway. The water resumed its beautiful blue colour, and the sea swarmed with "aat." I cannot help supposing that the conditions observed during our expedition is not always the same, as several recent accounts state that the sea about Iceland is specially rich in "aat." It appears as if the constant westerly storm, which we had to put up with during our expedition, in combination with the strong up-going current, had had a disturbing action, and forced the mass of "aat" farther in towards the Norwegian coast. If this should in fact be the case, a supposition which in the mean time with the little experience we have yet had on the point can scarcely be supported with full evidence, there may be seen in this (if the above-mentioned theory of mine with reference to the migrations of the herring be accepted) a good omen of the improvement of the spring herring fishery in the near future. That the herring is where the herring food (the "aat") is, I consider a settled point. Although we unfortunately had no opportunity of directly establishing the presence of herring by the help of our nets, there were not wanting the best signs of it at the points where the "aat" was most numerous. Not a few whales (both *riidhval*, *Physalus antignorum*, and *staurkyrning*, *Orca gladiator*) were observed at such places, as well as large numbers of birds (chiefly kittiwakes), and, at a considerable distance from the coast at stations 75<sup>1</sup> and 76<sup>2</sup>, there were large brown spots in the sea, like extensive sea-weed fields, but which on a closer examination were found to be enormous masses of "aat" closely packed together, on which the fulmar petrels (*procellaria glacialis*), our constant companions during our excursion, feasted to their heart's delight. That these enormous "aat" masses could not be packed together here by pure accident is evident, and that the current alone should be able to do this here far out in

the open sea I cannot believe. I am rather of opinion that the herring shoals have driven this "aat," together in the same way as may often be observed in the case of coal-fish, and that there, under these brown spots on the sea, there were enormous shoals of herring (*sidebjerger*).

I am much disappointed that circumstances did not permit us to use our nets here. We might have been able in this way readily to establish the occurrence of the herring far out at sea. It is to be hoped in the mean time that in our next expedition we shall be more fortunate in the weather, and we shall then put this herring question in the first rank, the rather as we shall be then farther north or nearer the waters, which, in my opinion, are the proper home of spring herrings (*vaarsilden*) and the great herrings (*storsilden*).

#### OUR ASTRONOMICAL COLUMN

THE SUSPECTED INTRA-MERCURIAL PLANET.—M. Leverrier, in a circular addressed to astronomers, has again directed attention to the importance of close and frequent observations of the sun's disc, on March 21, 22, and 23, but especially on the intermediate date, with the view to detect the small planet, which he assumes to have been already observed in transit on six occasions, and which there would appear to be just a possibility, may be again projected upon the face of the sun at this time. In his reasoning upon this subject, M. Leverrier adopts for the place of the node, the value he had deduced from the well-known observations of Dr. Lescaubault on March 26, 1859, but the uncertainty attaching to the result renders it impossible to pronounce definitively on the occurrence of a transit in the present month.

The six observations to which reference is made above are those of Fritsch, at Quedlinburg, October 10, 1802; Stark, at Augsburg, October 9, 1819; Decuppi, at Rome, October 2, 1839; Sidebotham, at Manchester, March 12, 1849; Lescaubault, at Orgères, March 26, 1859; Lummis, at Manchester, March 20, 1862.

Attributing these observations to the passage of a single planet across the sun's disc, he found a formula for the heliocentric longitude at any time, in which an indeterminate entered, allowing of several solutions of the problem of finding the period of revolution, and hence the mean distance of the body from the sun. Two of the solutions appear to possess equal precision in the representation of the observations; in the first, the time of revolution is found to be 33<sup>o</sup>2 days, and the mean distance from the sun 0<sup>o</sup>201, that of the earth being taken as unity: in the second solution the length of the revolution is 27<sup>o</sup>96 days, and the mean distance 0<sup>o</sup>180. Whichever period we adopt, we find from M. Leverrier's formula that the suspected planet should be in conjunction with the sun on March 22, astronomical reckoning, for the meridian of Greenwich, though to decide definitively as to the passage or other wise of a planet across the sun's disc at this time, it will be necessary to examine it not only throughout the whole of the corresponding revolution of the earth upon her axis, but owing to uncertainty in the data for prediction, during the twenty-four hours preceding and following, or as already stated, on March 21, 22, and 23.

It is difficult to understand how six observers, without, as M. Leverrier remarks, any relation with each other, nor any knowledge of the periods under discussion, can have fallen by chance upon six exact epochs of a phenomenon explicable by the motion of a single planet. Though suspicion has attached in the minds of some astronomers to one or two of the observations to which we have referred, the fact pointed out by the illustrious French astronomer does appear very strongly confirmative of their reality. At any rate, the existence or otherwise of such a body may be decided by systematic examination of the sun's disc, near the calculated epochs of conjunction, within the assumed transit-limits; but it so happens that after the present month there is very little probability of a transit

<sup>1</sup> Station 75, lat. 64° 47' 30"; long. 7° 13' E. from Greenwich.

<sup>2</sup> Station 76, lat. 64° 47' 40"; long. 7° 3' 6" E. from Greenwich.

taking place either at the spring or autumn node for several years, and hence the greater necessity for continuous observation of the sun at the period named.

Extensive preparation has been made on the recommendation of M. Leverrier; the Astronomer-Royal availing himself of the telegraph, has notified observers at Madras, Melbourne, Sydney, and at Wellington and Canterbury, New Zealand, and we believe intends to organise a careful watch upon the sun's disc at the Royal Observatory, Greenwich. We know that a similar scrutiny will be carried into effect in American longitudes, so that it is not probable that a planet can present itself upon the sun on this occasion without being detected. Photography will be brought into requisition at more than one station. Where it is not available in the event of a planetary body being detected, it will be necessary to determine the differences of right ascension and declination from the sun's limbs at frequent intervals as long as the object is projected upon the disc; from such observations carefully made the position of the orbit will be very approximately determined, and we should be enabled to follow up the new member of the solar system.

**THE NEW OBSERVATORY AT KIEL.**—Prof. Peters has issued a brief description of the new observatory just erected a little to the north of Kiel, the present head-quarters of the *Astronomische Nachrichten*. The unfavourable position of the observatory at Altona, so long directed by Prof. Schumacher, and the desire to bring the establishment into nearer relation to the university at Kiel, led to successful negotiations about twelve years since for a suitable site near the town. The buildings were commenced in 1871 and are now completed. There is a free horizon and a considerably better climate than at Altona, and no interruption from surrounding buildings.

The instruments in the new observatory include Reichenbach's meridian circle, formerly at Altona, which was so far improved by Repsold, as described in the *Astronomische Nachrichten*, that it may be considered a new instrument. The Repsold equatorial, also at Altona, is mounted in one of the smaller towers, and in another, a parallactically-mounted comet-seeker, to which is attached a 4-foot refractor, its optical axis being parallel to that of the comet-seeker. Prof. Peters explains that the refractor being provided with a high power, may be useful in deciding whether any nebulosity caught up in the seeker is a comet, or a star-cluster.

About two months since, an equatorially mounted refractor by Steinheil of Munich, with an object-glass eight Paris inches in diameter, was added, of the performance of which Prof. Peters promises details at a future date. The meridian circle is at present employed in the observation of all stars to the ninth magnitude, within 10° from the pole, the same class of work, indeed, in which Schwed and Carrington so long occupied themselves.

The position of the new observatory at Kiel is in longitude  $oh. 35' 5'' E.$  of Greenwich, and latitude  $54^{\circ} 20' 29''.7$ .

Besides its connection with the Kiel University, the observatory is also in relation to the Danish Marine, and contains facilities for testing the rates of chronometers at different temperatures, and a time-ball, apparently very similar to the one at our Royal Observatory, which is dropped at noon, mean time at Kiel.

**65° OPHUCHI (FL.).**—Of this star Baily says, "Observed by Flamsteed on May 6, 1691, at 14h. 10m. 58s., and regularly reduced by him. . . . But no such star is now to be found. It is neither Piazzi xvii. 308, nor xvi. 251, as conjectured by that astronomer. Prof. Airy has been kind enough to look for this star, at my request, but has not been able to discover it." The place of this star, given in the British Catalogue, brought up to 1850, is—

R.A. ...	17h. 51m. 37 <sup>s</sup> .6s.	Precession + 3 <sup>s</sup> .50s.
N.P.D. ..	107° 59' 18"	,, + 0 <sup>s</sup> .732"

There is no star in this position in Argelander's southern zones nor in the zones observed at Washington; neither is there an star in these zones with which it can easily be identified, or admitting any probable error of observation. Did Flamsteed observe an object of the class which we are accustomed to term "new stars?" The Chinese annals record the appearance of an extraordinary star in the year 386, which remained stationary from April to July in the same "sideral-division" that 6 Ophiuchi would fall, and then disappeared. It may be worth while to watch any small stars near its position.

### BIOLOGICAL NOTES

**FLORA OF NEW GUINEA.**—Letters from Sydney of January 12 state that the Italian traveller, D'Albertis, had returned there from his last trip to New Guinea, and was engaged in preparing an account of his voyage up the Fly River. His fine collection of dried plants is in the hands of Baron von Mueller at Melbourne, who is describing many of the new plants in his "Papuan Flora." Among them is a grand *Hibiscus* which Baron von Mueller has named *Hibiscus albertisii*, its nearest affinity is with *Hibiscus tupiliflorus* of Hooker, of Guadaloupe and Dominica, in the West Indies. There is also a new *Mucuna*, which he has named *Mucuna bennetti*. D'Albertis describes this as one of the most beautiful of all the flowers seen in New Guinea; it is abundant on the banks of the Fly River and the pendulous masses of large red blossoms cover the loftiest trees from the base to the summit and form one of the most gorgeous sights it is possible to conceive. There was also a yellow flowering species of the same genus which was rare, and only met with in the interior of New Guinea, in lat. 6° south, on the banks of the Fly River. The flowers of this species were only seen on the tops of the trees, forming a dense mass of blossoms. There was likewise another species of *Mucuna* met with, bearing blue flowers. All these and a number of other novelties will duly appear in Baron von Mueller's forthcoming part of his "Papuan Flora."

**SALMO ARCTURUS.**—We are informed that the Salmon brought home by the Arctic Expedition from Grinnell Land is a new species of Charr, described by Dr. Gunther under the name of *Salmo arcturus*. It resembles in some points the Loch Kill Charr from Inverness-shire.

**PROF. OVSIANNIKOFF ON THE FUNCTIONS OF THE CEREBELLUM.**—In the seventh volume of the *Memoirs* of the St. Petersburg Society of Naturalists Prof. Ovsiannikoff communicates the results of experiments he has made in collaboration with M. Weliky on the physiological functions of the cerebellum. Preventing, by the tying of the carotid artery, the effusion of blood which usually accompanies the cutting out of the cerebellum, Prof. Ovsiannikoff proved by a series of experiments that the last operation does not at all paralyse the co-ordination of motion. A rabbit remained alive during two weeks after the upper half of the cerebellum was cut out, and did not show any traces of such paralysis, nor did it lose its faculty of co-ordinating its movements after all the cerebellum was cut out, and an effusion of blood produced this result. A long series of varied experiments made by M. Ovsiannikoff on rabbits, pigeons, fishes, and frogs, confirms this result, as well as some well known pathological cases reported by Brown-Sequard, Marc Combetta, and others.

**FAUNA OF LAKE GOKCHA.**—The seventh volume of the *Memoirs* of the St. Petersburg Society of Naturalists contains interesting information, by Prof. Kessler, on Lake Gokcha, lying in the Erivan government (Caucasus), at a height of 6,419 feet. It is surrounded with mountains from 9,000 to 12,000 feet high and occupies about 660 square miles. Altogether its average depth is from 150 to 250 feet, reaching only in one instance 1

361 feet. The lake has only a small and shallow outflow, the river Zanga, running into the Araks. The fauna of the lake and of its shores is varied. *Spongular*, not determined as yet, are very numerous. Among the *Vermes* the most common is the *Nephele vulgaris*, the *Crustacea* are represented by a variety of microscopical forms and by a species of *Gammarus*, this species being probably all but the only representative of that kind, as the dredging was not pursued to depths greater than 150 feet. The snails are remarkably numerous, and all belong to species common in European lakes (*Limnaeus stagnalis*, *L. oratus*, *L. varicularius*, and *Planorbis carinatus*), they differ only by their unusually fine and brittle shales. The common frog (a local variety) and the *Bufo viridis* are numerous. The number of fishes is immense, but they belong to only five species, of which three are new. These three, which occupy an intermediate position between the *Salmo fario* and the *S. trutta* and *S. laietanus*, will be described by Prof. Kessler under the names of *Salmo ischan*, *S. hegarium*, and *S. bolschai*. The fourth species of fishes is very nearly allied to the *Caboda fundulus*, Pall, a species most characteristic of Central Asian waters. The fifth is akin to the *Barbus cyri*, De Illipi, it inhabits mostly the short and cold rivers running from the mountains.

ANTS — Mr McCook has recently brought before the Academy of Natural Sciences of Philadelphia, an account of his investigations on *Formica rufa*. He finds that ants descending the tree paths, with abdomens swollen with honey dew, are arrested at the foot of the trees by workers from the ant hill. The descending ant places its mouth in contact with that of the food seeker, the two being reared on hind legs. Frequently two or three of its fellows are thus fed in succession by one ant, mostly complacently, but sometimes only on compulsion. Mr McCook made many experiments, which lead to the conclusion that there is complete amity between the ants of a large field, embracing some 1,600 hills, and many millions of creatures. Insects from hills widely separated always fraternised completely. A number of ants from various hills were placed in an artificial nest, and harmoniously built galleries and jointly cared for the cocoons.

NEW FORMS OF HALIPHYLSMA — The second half of the second volume of *Biologische Studien*, by Dr L. Haeckel, has just reached us. It contains an account of a wonderful family of minute forms belonging to the genera Haliphysma and Gastrophysema, and some supplementary remarks on the Gastræa theory. Six plates illustrative of the new forms accompany this part. The genus Haliphysma was established by Bowerbank for *H. tumonowiczi* and *H. ramulosum*. The species described as *H. chinoides* seems almost certainly to be that described in 1870, by Perceval Wright, as *Wallshii*, but the two new species described as *H. primordiale* and *H. globigerina*, the latter with a mosaic of Globigerina shells laid over it, are most extraordinary and interesting forms. The presence of a pore area in the tiny form figured in the previous note seems to point to its not having any close affinity to this new family of Haeckel.

### NOTES

PROF. SIR C WYVILLE THOMSON, F R S, has been appointed Rede Lecturer at Cambridge for the ensuing year. Sir Wyville Thomson will deliver a lecture in the latter term.

A BOTANICAL Congress assembles at Amsterdam on the 12th of April.

THE Iron and Steel Institute meets in London on March 20 and following days. On Wednesday, the 21st, at the rooms of the Institution of Civil Engineers, Dr. Siemens, F R S, will deliver his inaugural address, and the Bessemer Medal will be presented to Dr. Percy. A number of important practical papers are set down for reading.

CAPT. ALLEN YOUNG has presented to the Museum of the Royal College of Surgeons a collection of the skulls of Esquimaux obtained by himself and the surgeon of his vessel, Mr. Horner, during the last cruise of the *Pandora*. The honour of knighthood has been conferred upon Capt Young.

SIR JOHN LUBBOCK'S Ancient Monuments Preservation Bill was, we are glad to say, read a second time in the House of Commons on Wednesday week. We hope none of its important provisions will be impaired in the select committee to which it has been referred, but that it will be passed essentially as it stands.

THE *American Chemist* for December, 1876, contains an interesting Inaugural Address to the American Chemical Society on "Science in America," by Dr. J W Draper. The Address on a similar subject by Vice President C A Young, at the last meeting of the American Association for the Advancement of Science, has been printed separately. In both addresses the important work done by Americans in various departments of science is justly insisted upon, and the future of science in America spoken of in hopeful terms. Men of science in England, we are sure, will heartily endorse all that Professors Draper and Young claim on behalf of their countrymen as original workers in science, and there is every reason to believe that there is a bright future for science in America.

AS soon as the news that Mr Edward, the Scottish Naturalist, had resigned the curatorship of the Banff Museum spread over the country, he was pressed to accept various situations, among others one in Aberdeen and another in Durham, the latter in the University of that city. He has been obliged to decline all these offers owing to the state of his health. He had been solicited by the Meteorological Society of London to become one of their observers. This request he had owing to the same cause declined. The work is, however, congenial, and does not demand a change of residence, and we believe he has yielded to a second very pressing application.

THE Sedgwick Prize, founded in honour of the late Prof. Sedgwick, for an essay on a geological subject, has been adjudged to Alfred John Jukes Browne, B A, of St John's College, Cambridge. The subject of the essay is "The Post-tertiary deposits of Cambridgeshire, and their relation to deposits of the same period in the rest of East Anglia." The subject for the Sedgwick Prize to be awarded in 1880 is the best essay on "The Fossils and Palæontological Affinities of the Neocomian Beds of Upware, Wicken, and Brickhill." The prize is open to the competition of all graduates of the University of Cambridge who have resided sixty days during the twelvemonth preceding the day the essays must be sent in, that is, before October 1, 1880.

A PRELIMINARY meeting has been held in Paris by some influential followers of the Positive Philosophy for the purpose of establishing a course of lectures according to the system of Auguste Comte, as modified by Littré. Important resolutions were passed as to the teaching of the several sciences which, according to the theoretical view adopted by Comte, constitute the encyclopedic education. At the next meeting resolutions will be proposed for meeting the expenses of the institution and regulating its administration.

AN arrangement has been made with the Cassel publisher, Theodor Fischer, whereby the hitherto very expensive publication *Palaontographica*, will be published in yearly volumes at not more than forty-five shillings each.

THE Balloon Commission of the French Government, styling itself "Commission pour les Communications par Voie Aérienne," has become a standing institution, and includes within its province carrier pigeons as well as aeronauts and balloons.

IN the *Journal of the Society of Arts* for March 9 will be found an important and interesting lecture by Prof. A. B. W. Kennedy, C.E., on "The Growth and Present Position of the Science of Machines."

THE unification of the meridian has been advocated at Rome before the Italian Society of Geography, by M. Boutillier de Beaumont, the president of the Geneva Geographical Society. He proposes to adopt the Behring meridian which has been chosen by the American meteorological service for the universal daily observations. M. Boutillier de Beaumont proposes also to adopt the division into hours of fifteen degrees for angular divisions as well as for temporal minutes.

MANY of us will have read with interest Capt. Wiggins' account of his endeavours to establish sea-communication with the great rivers of North Siberia, as given in the last number of the *Geographical Magazine*. Capt. Wiggins has now just started on his return to the Yenisei, overland, to bring back his ship which he stowed away in October last at Kureika, on that river. He is accompanied by Mr. Seebohm, F.Z.S., a distinguished member of the British Ornithologists' Union, who has embraced this opportunity of visiting the nesting-haunts of some of our rarest and least-known European birds, and otherwise exploring an almost unknown country.

A "SOCIÉTÉ des Voyages d'études autour du Monde" has been constituted at Paris by the liberality of M. Bischofsheim and others. Its object is to organise a regular service of voyages round the world for the instruction of those who are able to afford the expense. The first departure is to take place from Marseilles in the end of May next. The voyage will occupy less than a full year. Opportunities will be given to cross South America from Monte Video to Valparaiso, and to visit the United States and India. The commander of the steamer will be M. Biard, a lieutenant in the National Navy and the promoter of the Society. Passengers may be registered up to April 10 next. A library, instruments for experiments, and a staff of competent teachers will be on board.

AMONG the papers in the January number of the *Bulletin* of the French Geographical Society are the following:—On a journey into the Sahara and to Rhadames, by M. Larcq; Across the Pampas, by M. D'Arville Charnay; on the French Expedition to the Ogové, by M. Savorgnan de Brazza; a letter from Dr. Halub on his travels in South Africa.

WE regret to notice that the Marquis de Compiègne, the French West African explorer, has died of a wound received in a duel at Cairo.

A GEOGRAPHICAL Society was established at Marseilles in the beginning of March. The president of the new Society is M. Rambaud, a merchant who is acting as representative of the Sultan of Zanzibar. Not less than 200 members subscribing 1*l.* were registered, and donations have been collected to the amount of 800*l.* A public library has been opened, a course of public lectures on geography established, and the Society is arranging a Museum of Raw Materials from every country.

THE *Daily Telegraph* announces the receipt of important letters from Mr. Stanley, under date Ujiji, August 7 and 13. Mr. Stanley has made a complete survey of Lake Tanganyika, apparently settled the questions of outlet and level, and made important discoveries at the north end of the lake. He also describes his discoveries at and about the Nyanzas, though it does not appear that he has succeeded in circumnavigating Albert Nyanza. Mr. Stanley intended to cross the country to Nyangwe, where he would determine his final course.

AT the meeting of the Royal Geographical Society on Monday the business consisted of the reading of papers "On the Distribution of Salt in the Ocean," by Mr. J. Y. Buchanan; "A Journey through Formosa," by Mr. H. J. Allen; and "A Trip into the Interior of Formosa," by Mr. T. L. Bullock. The first paper summarised experiments which had been made during the cruise of the *Challenger* on the specific gravity and saline strength of the ocean water at various depths. 1,800 samples had been obtained, and by the testing of them Mr. Buchanan had ascertained, first, that the specific gravity of sea-water was greater than that of fresh; and, second, that the variations in its specific gravity pretty exactly indicated the amount of salt held in solution. It had been found that the water was freshest at the equator and at the poles, and most impregnated with salt in the intermediate regions. The papers on Formosa were descriptive of the journeys through the island taken by the respective readers, and entered into details of the character of the inhabitants—Chinese, semi-barbarians, and aborigines.

ON March 26 Sir George Nares will read a paper on the "Geographical Results of the Arctic Expedition," at the Royal Geographical Society.

WE have received from a correspondent a very detailed account (illustrated by drawings) of the Kimberley diamond mine in South Africa. The conclusion as to the mode of origin of the diamonds to which his study of the district appears to have led our correspondent is as follows:—That they were formed in volcanic vents which have been opened in the midst of sedimentary rocks (sandstone and shale, with thin coaly seams), which vents probably existed at a considerable depth under the sea. As to the material which by its decomposition may have yielded the pure carbon in a condition ready for crystallisation, our correspondent suggests that it was probably some hydro-carbon derived from the coal by distillation.

WE notice the following details on the Jurassic flora of Eastern Siberia in a memoir by Dr. Oswald Heer, published in the *Memoirs* of the St. Petersburg Academy of Sciences. This formation occupies about 200 miles along the shores of the Amoor, between the villages Okloy and Vaganova, and border, probably, the south-western foot of the Stanovoy ridge. In the Irkutsk government it occupies a large space in the south-eastern corner of this province, where the district around the village Ust-Baley (on the Angara, forty miles to the north of Irkutsk) will be now, after the appearance of Oswald Heer's description, one of the most typical representatives of the Jurassic flora, by its beautifully preserved plants, insects, and fishes. All Siberian Jurassic plants belong to the period of the Brown Jura, and their nearest relations are the Jurassic deposits of Scarborough and of Cape Bogeman, in Spitzbergen. They mostly belong to new species; the most common of previously-known species being only the *Asplenium* (*Pecopteris*) *Whitkiense*, and the *Gingko* *Huttoni*. Three still existing kinds, *Asplenium*, *Thyrsopteris*, and *Dicksonia*, have their representatives among the East Siberian Jura. The most interesting group, by the variety of its forms, is the group of the Coniferæ (more than thirty species), and especially the group of the Salisburia. Altogether, the Siberian Jurassic flora occupies the first rank by the variety of species it affords (eighty-three species), the richest yet known flora, that of Yorkshire, numbering only seventy-three species.

A CORRESPONDENT writing from Knoxville, Tennessee, U.S., states that on two occasions he has witnessed true towering in wild ducks, one a call duck the other a summer duck. He adds to the list of towering birds already named the Virginia quail (*Ortyx virginianus*), and wild pigeon (*Cathartes migratoria*).



A PRACTICAL Society of Natural History has been recently established in Paris under the title of Société Parisienne. Its special aim is to procure young people the means to study nature by lectures and excursions.

FROM researches on the nature of the vowel "clang," in Prof. Helmholtz's physical laboratory, M. Auerbach (*Pogg. Ann.*) comes to the following conclusions, which appear to throw new light on some unsolved problems:—1. All clangs, especially the vowels of the human voice and speech, are to be defined as the consequence of the joint action of two moments, a relative and an absolute. 2. The relative moment is the mode of distribution of the whole intensity among the individual partial tones as determined by their ordinal number. The absolute is the dependence of the whole intensity on the absolute pitch of the partial tones, and the modification of the distribution, on change of the fundamental tone, therewith connected. 3. The difference of the vowels in the former relation is a result of the power of changing the form of the mouth-cavity. The differences of the absolute pitches characterising the various vowels, and of their influence, are a result of the power of changing the volume and size of the mouth-cavity. 4. The first partial tone is always the strongest in clang; it deserves, therefore, the name of fundamental tone. 5. The intensity of the partial tones as such decreases in general as their ordinal number increases; exceptions indicate the nearness of the boundary of the consonant region. 6. The intensity of the partial tones decreases more slowly the nearer the vowel clang is, therefore more quickly the duller this is. 7. The characteristic pitch is higher the clearer, and deeper the duller, the vowel clang. 8. The variations of the intensity, in consequence of the influence of the characteristic pitch, are greater the fuller the vowel is. Very slight variations indicate the nearness of the consonant region. 9. All the vowels admit of being sung within the whole range of the human voice; but the dull speak in very high, the clear in very deep, positions. 10. A little attention only is needed to perceive in a vowel clang the over-tones (often comparatively very strong) without artificial aids. They then sound very similar to the pure tuning-fork tones.

CONTINUING his researches on fluorescence, M. Lommel (*Pogg. Ann.*) arrives at the following conclusions:—1. There are two kinds of fluorescence. In one each excitant homogeneous ray falling within the limits of the fluorescence-spectrum excites not only rays of greater and equal, but also rays of shorter wave length; the latter so far as they belong to the region in question. In the second kind, each homogeneous ray excites only rays of greater or equal wave length. 2. There are substances which have only the first kind of fluorescence; each excitant ray excites the whole fluorescence spectrum. Hence they are not subject to Stokes's law. Such are naphthalin, red chlorophyll, and eosin. 3. There are substances which have only the second kind of fluorescence, and which therefore, throughout their fluorescence spectrum, obey Stokes's law. Such are most of the fluorescent substances hitherto examined. 4. There are substances which have both kinds of fluorescence, so that the first kind is proper to a certain portion of their fluorescence spectrum, and the second kind proper to their remaining parts. Hence these obey Stokes's law only in part. Such are chamaelin red, blue, and green.

THERE are several ways of decomposing water with only one electrode. One is this: let some water in a glass be brought in contact with a Wollaston electrode (*i.e.*, a fine platinum wire inclosed in glass and touching the water only by its extreme section), and connect the wire with the conductor of an electric machine in action. Fine bubbles of oxygen are liberated at the point. What becomes of the hydrogen? M. Lippmann replies

(*Journal de Physique*) that so long as the water continues charged the hydrogen remains in excess. On discharging the water it escapes at the platinum point, this being then the electrode of exit. But may it not be that the hydrogen is set at liberty within the liquid or at its surface while the corresponding oxygen is liberated (there being, according to this view, two electrodes, one the platinum point, the other diffuse and of large surface)? The objection, M. Lippmann says, cannot be refuted by direct experiment, but the impossibility of the hypothesis appears on considering the quantities of chemical and electrical work called forth during the experiment. He gives two demonstrations of this.

WE have received the first two numbers of a new Italian monthly periodical, *L'Elettricista*, the object of which is to give an account of the progress of the science of electricity. This publication is one of many signs that the countrymen of Galileo have made up their minds again to take an active part in scientific investigation, and especially not to forget that branch which owes so much to Volta. The papers do not lay claim to originality, but the first number especially is interesting, and if kept up on the same standard the periodical can do a great service in spreading modern ideas in Italy. We note especially the paper on absolute electrical units, by Naccari, and on some phenomena presented by electrified powders, by A. Ricco. The second number contains chiefly abstracts from foreign periodicals. Padre Secchi draws some conclusions from imaginary results, which he believes were obtained by Mr. Chrystal in his verification of Ohm's law.

IN a paper read the other day by M. Fulke, before the Wissenschaftlicher Club of Vienna, on German emigration to the United States, it was estimated that from 1820 to the present, nearly 10,000,000 must have emigrated, or a fourth of the entire population of the United States. M. Fulke lamented the extent of the movement, also the facility with which the Germans in America seemed to lay aside their customs and usages, and even their native tongue. In conclusion, he drew a parallel between the Germans in the United States, and the Germans in the whole of Austria. Here, too, the German element was about a fourth of the whole population, but what a contrast to the other case!

THE additions to the Zoological Society's Gardens during the past week include a Bonnet Monkey (*Macacus radiatus*) from India, presented by Mrs. Payton; a Rose Hill Parrakeet (*Platycercus caunus*) from Australia, presented by Mr. J. J. Chapman; a Rufous-vented Guan (*Penelope cristata*) from Central America, presented by Mr. Daniel Miron; two Hooded Crows (*Corvus cornix*), European, presented by Mr. F. Cresswell; a Macaque Monkey (*Macacus cynomolgus*) from India, deposited; a Two-Wattled Cassowary (*Casuarus bicarunculatus*) from the Aroo Islands, a Hooded Crane (*Grus monachus*) from Japan, a Hodgson's Barbet (*Megalenna hodgsoni*), two Striated Jay Thrushes (*Grammatoplia striata*), three Black-headed Sibilas (*Sibia capistrata*), three Brown-eared Bulbuls (*Hemixos flavala*), two Rufous-bellied Bulbuls (*Hyppipetes McLellandi*), a Red-headed Laughing Thrush (*Trochalopteron erythrocephalum*) from the Himalayas, purchased.

#### SCIENTIFIC SERIALS

FROM the *Naturforscher* (January, 1877) we note the following papers:—On radiation in space, by H. Buff.—On cave-insects, by L. Bedel and E. Simon.—On the germination of the fruits of mosses, by P. Magnus.—On the action of a di-electric body upon an electric one, by R. Felici.—On the preparation of pure alcohol yeast, by Moritz Traube.—On the limit between chalk and tertiary deposits in the Rocky Mountains (U.S.), by M. Delafontaine.—New researches on Bacteria, by E. v. M.—On the specific power of glycose (grape sugar) of turning the plane

of polarisation, by B. Tollens.—On the exhalation of carbon acid and the growth of plants, by L. Rischawi.—Researches on assimilation in plants, by A. Stutzer.—On the assimilation of water and lime salts by the leaves of plants, by J. Bohm.—On the phenomena of heat accompanying muscular action, by J. Nawalichin.—On the molecular volumes of sulphates and selenates, by Otto Pettersson.—Electro-dynamic theory of matter, by F. Zoellner.—Elements of the orbit of the double-star 24  $\eta$  Cassiopeise, by Ludwig Graber.—On the action of an electric discharge upon solid isolators, by W. Holtz.—On the external sexual differences upon our fresh-water fish, by V. Fatio.

THE *Memoirs of the St. Petersburg Society of Naturalists*, vol. vii., contains a series of valuable physiological contributions, the most important of which are:—On the comparative anatomy and metamorphology of the nervous system of the Hymenoptera, by E. K. Brandt.—On the influence of condensed air, oxygen, and carbonic acid on the nervous irritability of animals, by M. Tarkhanoff.—On changes in the eye produced by the section of the *nervus trigeminus* by M. Chistoserdoff.—On the psychomotor centres and on the bifurcation of electric currents in the cerebellum and corpora quadrigemina, by MM. Weliky and Shepvaloff.—On the influence of salicylic acid on the circulation of the blood, by MM. Dubler and Chistoserdoff.—The action of chinine and atropine on the hearts of frogs and rabbits, by Mille. Pantéléeff, and on the nucleus of the red globules of the blood, by A. F. Brandt.

## SOCIETIES AND ACADEMIES

### LONDON

Royal Astronomical Society, March 9.—Prof. Cayley, F.R.S., vice-president, in the chair.—The minutes of the previous meeting were read by Mr. Glaisher, F.R.S., the recently-elected secretary.—Two communications of immediate importance were made by the Astronomer-Royal. The first of these referred to the supposed intra-mercurial planet, and he expressed a wish that it should be published as widely as possible without delay in order that amateur astronomers might lose no opportunity of scrutinising the sun's disk during the latter half of the present month, but especially on the 22nd instant, from sunrise till sunset. He had been requested by M. Leverrier to make known that his computation of the elements of the supposed planet, from such reported observations as were available, pointed to March 22 as the day on which it might be expected to transit the sun's disk. He recommended that the disk should be continuously watched for several days before and after that date. The second communication of the Astronomer-Royal referred to the opportunity which will occur next autumn of determining the solar parallax by observations of Mars in opposition. He read an extract from a paper of his own published some years ago in the *Monthly Notices*, showing the great importance he attached to this method as compared with others, and pointing out that fifteen years from the present time must elapse before another nearly equal opportunity will occur of applying it. He dwelt with much emphasis on the ease and simplicity of the observations required and on their singularly inexpensive character. Lord Lindsay had offered to lend his heliometer, and Mr. Gill had offered his services gratuitously for an expedition to St. Helena or Ascension for the purpose, so that the money required would not exceed 500*l.* The Government would be asked to supply this sum, but if they refused, other means should be taken to raise the money, and if a subscription list became necessary, he would gladly contribute 20*l.* himself. Another Fellow, a member of the Council, then suggested that a part of the Carrington bequest might be available, and failing that, offered to contribute 100*l.* towards the expedition if it had to be carried out by private means.—Mr. Gill was called upon to explain the peculiar merits of this method of determining the solar parallax. It depended upon the difference of R.A. between Mars and certain stars measured early and late on the same day, which measures could be made by the heliometer with extreme accuracy.—Papers were presented by Prof. Zenger, C. Todd, A. T. Arcimis, S. W. Burnham, Dr. Robinson, A. de Gasparis, E. J. Stone, A. Marth, J. Tebbutt, Capt. Tupman, Prof. S. Newcomb, Capt. Abney, Sir G. B. Airy, T. W. Backhouse, Rev. S. J. Perry, Dr. Ball, Dr. Royston Piggott, Mr. Penrose, Mr. Knott, Mr. Nelson, and Mr. Kobel, some of which were read. Four new Fellows were elected.

Linnean Society, March 1.—Prof. Allmann, F.R.S., president, in the chair.—Messrs. R. Gillies, H. Goss, Dr. A.

Gunther, and M. Moggridge were elected Fellows, and Dr. M. C. Cooke an Associate of the Society. The embryo of *Diospyros embryopteris*, Pers., upon the fruit and seed of which species Gærtner founded his genus *Embryopteris*, was exhibited by Mr. W. P. Hiera. He explained how the immature fruit was gathered in India for the sake of the tannin contained, and hence the probability of Gærtner's having been misled as to the true structure of the seed and imperfect embryo, which Mr. Hiera now correctly describes.—Dr. Maxwell Masters brought before the meeting a series of specimens illustrative of what is commonly known as "Burs" or "Watch-knots." The examples exhibited were collected by Mr. Webster, gardener to the Duke of Richmond and Gordon. Some of these productions were illustrations of dimorphism or bud-variation, probably reappearance of latent ancestral characteristics or disjunction of parental forms usually amalgamated. Others doubtless owed their origin to some injury to the terminal bud, subsequent hypertrophy of the branches, and excessive development of adventitious buds. Injury apparently was frequently the result of insect puncture, as in the case of the birch, the "burs" on which had been lately discovered by Miss E. Omerod to be produced by a species of *Phytopus*, at other times it was the result of parasitic fungi or of injury consequent on frost, the wounds caused by birds, the action of wind, &c.—A most important communication on the flora of Morocco (*Spicilegium Floræ Maroccanæ*) was read by Mr. John Ball, F.R.S. (Pres. Alpine Club). By a sketch map he pointed out the peculiar physical features of the territory penetrated at several points by Dr. Hooker, Mr. G. Maw, and himself in 1871, and he mentioned how that Morocco, though within but a few days' sail of London, was in many respects a *terra incognita* to Europeans. Whilst the Sultan and population of Morocco generally are averse to the admission of Christians and strangers into their country, the hill tribes, derived from the warlike Berbers, are decidedly hostile and indeed dangerous to travel among. The flora, then, of this interesting region, is necessarily very imperfectly known. Mr. Ball gave a lucid historical account of what little had been done by earlier botanists, Zanoni 1675, Spotswood 1673, and Broussonnet 1790-9. The collections of the latter having been distributed to several European botanists, and here and there incidentally noticed by them; Cavanilles of Madrid temporarily secured to Spain a fair share of honour by his publications in the scarce periodical *Ann. d. Ciencias Nat.* M. Cosson has lately been working Broussonnet's material deposited in the Montpellier Museum. Schousboe, Danish Consul at Mogador, commenced 1801, but left unfinished a flora of Morocco. Jackson (1809) in his account of the Empire of Morocco, has noticed the curious Cactoid Euphorbias. P. Barker Webb in a short visit (1827) to Tangier and Tetuan, discovered a new genus of Cruciferae. Between 1840-1870 several Frenchmen touched at various points, and the "Pugillus Plantarum" of M. Boissier, contains merely a germ of future work.—The Rev. Mr. Lowe contributed to the Linnean Society, 1850, a list of plants observed by him at Mogador. But notwithstanding the preceding labours, a mere tithe of the flora has yet been worked out, and almost nothing satisfactorily. Mr. Ball, in 1851, attempted to reach the higher summits of the Lesser Atlas, but the disturbed condition of the district obliged him to desist. M. Balansa was likewise repulsed in 1867 (though fortunate in collecting numbers of new and remarkable species); but Mr. Maw was more successful in 1869. Messrs. Hooker, Maw, and Ball's routes in 1871 were then pointed out, and detailed but technical description of the plants collected, given. In giving a summary of results in a tabular form, Mr. Ball showed that the proportion of Compositae, leguminosae, and Liliaceae, is unusually large, whilst Gramineae, and Ranunculaceae is exceptionally small. Of Rosaceae there are 16, of Saxifrageae 5, of Primulaceae 7, of Gentianaceae 8, and of Cyperaceae only 28 species, thus showing the peculiarity that but a small proportion of these natural orders are present, which otherwise are so characteristic of the mountainous countries of the north temperate zone. It seems as if five temperate floras were represented as follows:—1, Mediterranean in general; 2, Peninsula; 3, Desert; 4, African mountain flora; 5, Macaronesian—to which may be added 6, Cosmopolite or widely-spread European species. The total number of phanerogamous plants now described are 1618 species, and among these many novelties.—Mr. J. G. Baker then read a paper on the Liliaceae, Iridiaceae, Ilyoxidaceae, and Hamoderaceae of the late Dr. Welwitsch's Angolan Herbarium, which, through the courtesy of the executors, he has been enabled to work out. Not only are there a large proportion of the species new to

science, but many genera are new though pertaining to Central African types already known. The excellent condition of the specimens, the care taken in selection of various stages and characters of the plants, and descriptions taken on the spot by Dr. Weiwitsch have rendered Mr. Baker's study very complete and satisfactory.—A technical descriptive paper by Mr. Charles Knight on the Lichens of New Zealand, was taken as read.—The Secretary also read a short notice of a new form of Ophiuridæ from the Philippines, by Mr. Edgar A. Smith. The distinctive characters of the specimen the author regards as subgeneric, and names it (*Ophiomastix*) *Acantharachna mirabilis*.

Zoological Society, March 6.—Dr. E. Hamilton, vice-president, in the chair.—Mr. E. W. H. Holdsworth exhibited and made remarks on a specimen of *Geocichla layardi*, from Ceylon.—Prof. Owen, C.B., communicated some notes made by Mr. G. F. Bennett, while exploring the burrows of the *Onithorhynchus paradoxus*, in Queensland, with comments on them.—A communication was read from Lieut.-Col. R. H. Beddome, containing the descriptions of three new snakes of the family Uropeltidæ, from Southern India.—M. A. G. Butler read the descriptions of some new species of Heterocerous Lepidoptera in the collection of the British Museum, from Madagascar and Borneo. Amongst the latter was the type of a new genus, proposed to be called *Mimuplax*.—Mr. G. French Angus read a paper in which he gave descriptions of a new species of *Bulimus* from Western Australia, and a *Paludimella* from Lake Eyre, South Australia; these he proposed to call respectively *Bulimus ponsonbyi*, and *Paludimella gilesi*.—A second paper by Mr. Angus contained the descriptions of one genus and twenty-five species of marine shells from New South Wales.—Mr. Angus also read a further list of additional species of marine mollusca to be included in the fauna of Port Jackson and the adjacent coasts of New South Wales, with remarks on their exact localities, &c., thus bringing up the number of species now ascertained to inhabit Port Jackson and the adjoining shores to a gross total of 693.—Mr. Phineas S. Abraham, M.A., B.Sc., read a paper containing a revision of the Anthobranchiate Nudibranchiate Mollusca. The paper comprised a general and historical introduction to this group of Nudibranchs, *i.e.*, those which bear the branchiæ upon the dorsal surface, more or less surrounding the arms, and allusion was made to all the principal work which had been done upon these animals. The second part consisted of definitions of the larger divisions and of the genera, with the enumeration, synonyma, references to and habitat of, as far as possible, every species hitherto published. In the last general list, *viz.*, that by H. and A. Adams, but 163 forms were mentioned; this list included 457. The third part contained descriptions of forty-one hitherto undescribed species belonging to the genera *Doris*, *Chromodoris*, *Hexabranchnus*, *Acanthodoris* and *Doridopsis*.—A communication was read from the Count Salvadori, containing notes on some birds mentioned by Dr. Cabanis and Mi. Reichenow, as collected in Papusia and in the Moluccas during the voyage of the *Gazelle*.

Geological Society, February 21.—Prof. P. Martin Duncan, F.R.S., president, in the chair.—Samuel Arthur Adamson, William Mason Cole, Thomas Floyd, William Stukeley Gresley, Edward Pritchard, Joseph Pryor, and John Gwillim Thomas were elected Fellows of the Society. The following communications were read:—On possible displacements of the earth's axis of figure produced by elevations and depressions of her surface, by the Rev. J. F. Twisden, M.A., Professor of Mathematics in the Staff College. Communicated by John Evans, F.R.S. The object of this paper is to discuss the question of the possibility of a displacement of the earth's axis of figure under the conditions indicated in a question (suggesting the possibility of a displacement of the axis of figure from the axis of rotation, amounting to 15° or 20°) put to mathematicians in a passage of the Anniversary Address delivered to the Society by its president, Mr. J. Evans, on February 18, 1876. The treatment of the question is kinematical; the forces by which the elevations and depressions might be effected do not come under discussion. In determining numerically the amount of the deviation from the formulas investigated, approximate numbers seem to be sufficiently exact for every useful purpose. The conclusions arrived at are as follows:—(1) The displacement of the earth's axis of figure from the axis of rotation that would be effected by the elevations and depressions suggested in the question above referred to would be less than 10' of angle. (2) A displacement of as much as 20° could be effected by the elevations and depressions of the kind suggested only if their heights

and depths exceeded by many times the height of the highest mountains. (3) Under no circumstances could a displacement of 20° be effected by a transfer of matter of less amount than about a sixth part of the whole equatorial bulge. (4) Even if a transfer of this quantity of matter were to take place, it need not produce any effect, or only a small effect, on the position of the axis of figure, *e.g.*, if it took place in a way resembling that suggested in the question, it would produce a displacement amounting to but a small part of 20°. (5) If, however, we suppose a deviation of the axis of figure from the axis of rotation amounting to as much as 20° to have been by any means brought about, the effect would be to cause a sort of tidal motion in the ocean, the greatest height of which would tend to be about twice the depth of the ocean. The author suggests as probable that the effect of this tendency would be to cause the ocean to sweep over the continents in much the same way that a rising tide sweeps over a low bank on a level shore. (6) The notion that a large deviation of the earth's axis of figure from its axis of revolution may be effected by elevations and accompanying depressions is at first sight an inviting way of bringing polar lands into lower latitudes, and thereby accounting for the more genial climate that is believed to have once prevailed in such countries as Greenland. The investigation by which the above results have been obtained seems to show that the desired explanation is not to be sought in the direction indicated by Mr. Evans's question. Whether there is any other agency by which a gradual displacement of the pole geographically could be effected is a question of far wider scope than that discussed in the present paper, and one which the author does not profess to determine.<sup>1</sup>—Note on a specimen of *Diploxylon*, from the coal-formation of Nova Scotia, by J. W. Dawson, F.R.S. The author described the occurrence in Coal-measure sandstone at the South Joggins of an erect stump of a Sigillarian tree 12 feet in length. It originated in a coaly seam 6 inches thick, and terminated below in spreading roots; below the coal-seam was an under-clay 3 feet 4 inches thick, separating it from an underlying seam of coarse coal. The stem, which tapered from about 2½ feet in diameter near the base to 1¼ foot at the broken end, was a sandstone cast, and exhibited an internal axis about 2 inches in diameter, consisting of a central pith cylinder, replaced by sandstone, about ¾ inch in diameter, and of two concentric coats of scalariform tissue, the inner one ⅓ inch in thickness, the outer constituting the remainder of the axis. The scalariform tissue of the latter was radially arranged, with the individual cells quadrangular in cross section. A few small radiating spaces partially filled with pyrites obscurely represented the medullary rays, which were but feebly developed; the radiating bundles, passing to the leaves, ran nearly horizontally, but their structure was very imperfectly preserved. The cross section, when weathered, showed about twenty concentric rings; but these under the microscope appeared rather to be bands of compressed tissue than true lines of growth. The thick inner bark was replaced by sandstone, and the outer bark represented by structureless coal. On a small portion of one of the roots the author traced the remains of stigmarioid markings. From the above characters the author identified this tree with *Diploxylon* of Corda, and stated that it was the first well-characterised example of this type of Sigillarians hitherto found in Nova Scotia. The author compared the structure of this stem with that of other Sigillarians, and remarked that it seemed to come within the limits of the genus *Sigillaria*, but to belong to a low type of that genus approaching *Lepidodendron* in structure; those of the type of *S. elegans*, Br., and *S. pumilosa*, Renault, being higher in organisation, and leading towards the still more elevated type described by him in 1870. He further discussed the supposed alliance of these trees with Gymnosperms, and the probability of the fruits known as *Trigonocarpa* being those of *Sigillaria*, and expressed the opinion that the known facts tend to show that there may be included in the genus *Sigillaria*, as originally founded, species widely differing in organisation, and of both Gymnospermous and Acrogenous rank.

Royal Microscopical Society, March 7.—H. C. Sorby, F.R.S., president, in the chair.—A letter received from Mr. Frederick Ebsworth, Australia, descriptive of a supposed new method of using the micrometer, which the author had found

<sup>1</sup> The first draught of the paper, of which the above is an account, was drawn up last August, and was shortly after sent to Mr. Evans. It was written independently of the wider view of the subject taken by Sir W. Thomson in his Address delivered at the last Meeting of the British Association, and by Mr. G. Darwin in his paper, of which an abstract has been published in No. 175 of the *Proceedings* of the Royal Society.

very useful in measuring the fineness of wool, was read by the Secretary.—A communication from the Rev. W. H. Dallinger, entitled "Additional Notes on the identity of *Navicula crassinervis*, *N. rhomboides*, and *Frustula saxonica*" was read by the Secretary, and some further observations on the subject were made by Mr. Ingpen, Mr. Slack, and Mr. Chas. Brooke.

CAMBRIDGE

Philosophical Society, February 26.—A communication was made to the society by Mr. Creighton on the order in which the secreting and the conducting parts of an acinous gland appear in the individual development and in the succession of animals.

PARIS

Academy of Sciences, March 5.—M. Peligot in the chair.—The following papers were read:—On the temperatures of combustion, by M. Berthelot. M. Bunsen's hypothesis, that the specific heat of the components and that of the products are constant quantities, independent of temperature and pressure, does not always apply; e.g., to gases formed with condensation. Still his measurements allow of calculating without any hypothesis on specific heats, two limits between which the temperature of combustion is necessarily comprised. That of carbonic oxide by oxygen at constant volume is between 4,000 and 2,600; by air, between 2,200 and 1,750. That of hydrogen by oxygen, between 3,800 and 2,400; by air, between 2,100 and 1,700.—Physical and mechanical action of incandescent gases after combustion of powder; application of these facts to certain characters of meteorites and bolides, by M. Daubrée.—Agreement of the laws of mechanics with the liberty of man in his action on matter, by M. de Saint-Venant.—Observations of solar protuberances during the second semester of 1876; rotations *lax*. to *lxxv*., by P. Secchi. Very few protuberances; average 5.4 (and even this exaggerated, including small jets), average height 40.8 seconds. Few protuberances over 68 seconds, general maximum between 40° and 50° latitude. The most notable point is the frequency of thin, very high and straight hydrogenic threads, sometimes one minute high; this indicates great calm. Metallic protuberances rare, and always preceding or accompanying spots. In December there was an important instance of a spot with apparent rotation; two nuclei in same penumbra, then separated by a bridge, which ere long was broken. The movement was in the direction of the hands of a watch, and the spot near the equator gained on that further north.—(Observations of the spectrum of Borrelly's comet, by P. Secchi. Three bright bands, a broad one in the green, a narrower in the blue, a third still more narrow and less refrangible, but difficult to define.—Report, in name of the Academy, on measures to be taken against Phylloxera, in regions uninvaded or threatened. The Commission advise interdiction of exportation and importation from phylloxerised regions, thorough destruction by fire of any vines attacked, and vigorous disinfection of ground and stocks in neighbourhood.—Dr. Bastian, in a letter, proposed to come to Paris and make his experiments before the Commission on spontaneous generation.—On the asymptotic lines of a surface of the fourth degree, by M. Rouché.—Demonstration, by the principle of correspondence, of a theorem on the contact of surfaces of an implex with an algebraic surface, by M. Fouret.—On the extension of the theorem of Fermat generalised, and of the *Canon Arithmeticus*, by M. Lucas.—On the mechanical theory of heat, by M. Levy.—Method of extracting platinum from chloroplatinates, by M. DuVillier. He utilises the property which salts of platinum have of being reduced in boiling by alkaline formiates in the presence of alkalies.—On the isomerism of rotatory power in the camphols, by M. de Montgolfier.—On a vat of aniline black, and on the transformation of aniline black into a fluorescent rose-colouring matter, by M. Goppelsroeder.—Researches on the acidity of the gastric juice of man, and observations on stomachic digestion, made with a gastric fistula, by M. Richey.—Action of hydrosulphite of soda on the hæmotosin of blood, by M. Cazeneuve. The change of colour might prove useful in legal medicine.—Experimental study on the rôle of the blood in transmission of vaccinal immunity, by M. Raymond. He inoculated children with blood from newly-vaccinated children. Neither was vaccination thus produced nor was there ulterior immunity. But, resorting to transfusion of blood from a vaccinated heifer to another heifer, he obtained immunity, in the latter, without any eruption.—On the maintenance of constant temperatures, by M. D'Arsonval. In his system are two concentric cylindro-conical vessels; the in-

terior, open above, being the cavity of the stove; the water bath is in the concentric space, and its dilatation acts on a caoutchouc membrane governing the passage of gas into the Schliessing regulator.—On "grisoumètres," or firedamp measuring apparatus, by M. Coquillon. Their principle is, that hydrogen or any of its compounds in the gaseous state is completely burnt in presence of oxygen and a palladium wire white hot.—On the unity of the forces in geology, by M. Hermite. Gravity may serve as the common measure of the forces which maintain the equilibrium of continents.—Chemical examination of turnerite, by M. Pisani.—Observation of a parhelion on February 5, by M. Soucaze.—On the treatment of cancerous affections by acetic acid and the acetates, by M. Curie.—Results of microseismic observations, by M. Bertelli.

VIENNA

Imperial Academy of Sciences, February 1.—On Peltier's experiment, by M. v. Waltenhofen.—On space-curves of the fourth order with a double point, by M. Weyr.—On the theory of electrodynamics, by M. Lippich.—On the theory of algebraic equations, by M. Igel.—New method of deduction of Taylor's series, by M. Zimels.—Report on the excavation of a bone deposit at Zeiselberg, by M. Wurmbrand.

February 8.—On collateral innervation, by M. Stricker.—Contributions to knowledge of hydrate of chloral, by M. Cech.—Researches on vaporisation, by M. Baumgartner.—On the condition of heat equilibrium of a system of bodies with reference to the force of gravity.—On the diffusion of vapours through liquid films, by M. Exner.—Observations during 1876 at the Central Institution for Meteorology and Terrestrial Magnetism.

ROME

R. Accademia dei Lincei, February 4.—Paleontological notes on the fossils of Genoa maris, by M. Issel.—Thirty years' experiments of Messrs. Lawes and Gilbert at Rothamsted, by M. Ronna.—On some palæozoic fossils of the Maritime Alps and the Ligurian Apennines, studied by Michelotti.—The tertiary formation of Reggio in Calabria, by M. Seguenza.—Monograph of tertiary nuculidæ found in the southern provinces of Italy, by M. Seguenza.—On the quaternary sea, by M. Moro.—On the existence of realgar and orpiment in the hills of Santa Severa in the province of Rome, by M. Sella.—On the modular equations of Prof. H. J. Stephen Smith, by M. Cremona.—On a new difficulty proposed against Melloni's theory, by M. Volpicelli.—Effect produced by the mass of Monte Mario on the vertical of the observatory on that hill, by M. Kella.—Experimental researches on electric discharges, by M. Righi.—On a class of finite and continuous functions which have only one derivative, by M. Dini.—On the degeneration of cut nerves, by M. Colasanti.—On the coloration proper of the retina and modifications of it, by M. Boll.—On the constitution of chlorammonium and aldehydes of ammonium, by M. Schiff.

CONTENTS

	PAGE
THE TREASURY REPORT ON METEOROLOGY . . . . .	425
MIR TROUTNER ON UNIVERSITY REFORM. By Dr. M. FOSTER, F.R.S.	428
LETTERS TO THE EDITOR:—	
SCIENCE AT OXFORD.—CHARLES H. WADE . . . . .	430
JUST INNOVATION.—WM. CHAPPELL . . . . .	430
TYPICAL DIVISION OF STARS.—BORRELLY'S COMET.—FATHER SECCHI (With Illustrations) . . . . .	430
"STONE RIVERS."—PHIN S. ABRAHAM (With Illustration)	431
THE MEASUREMENT OF THE HEIGHT OF CLOUDS.—W. M. FLINDERS PETRIE . . . . .	431
THE "HOG-WALLOW" OF CALIFORNIA.—ALFRED R. WALLACE . . . . .	431
SCIENCE AT CAMBRIDGE, MASS. . . . .	432
NATURAL HISTORY AND GEOLOGICAL RESULTS OF THE ARCTIC EXPEDITION . . . . .	432
THE PHYSIOLOGICAL ACTION OF LIGHT. By Prof DEWAR, F.R.S. (With Illustrations) . . . . .	433
SIR WILLIAM GROVE ON THE RADIOMETER. By the Hon Sir WM. GROVE, F.R.S. (With Illustration) . . . . .	435
THE NORWEGIAN NORTH-SEA EXPEDITION OF 1876, II. By Dr. G. D. SABS . . . . .	435
OUR ASTRONOMICAL COLUMN:—	
The Suspected Intra-Mercurial Planet . . . . .	437
The New Observatory at Kiel . . . . .	438
65 (Phipuchi) (Fl.) . . . . .	438
BIOLOGICAL NOTES:—	
Flora of New Guinea . . . . .	438
Salmo Arcturus . . . . .	438
Prof. Ovsiankoff on the Functions of the Cerebellum . . . . .	438
FAUNA OF LAKE GOKCHA . . . . .	438
ANTS . . . . .	438
New Forms of Halophysena . . . . .	431
NOTES . . . . .	435
SCIENTIFIC SERIALS . . . . .	441
SOCIETIES AND ACADEMIES . . . . .	444

THURSDAY, MARCH 22, 1877

**BRITISH MANUFACTURING INDUSTRIES**

*British Manufacturing Industries.* Edited by G. Phillips Bevan, F.G.S. "Hosiery and Lace," by the late W. Felkin, Nottingham; "Carpets," by Christopher Dresser, Ph. D.; "Dyeing and Bleaching," by T. Sims (second edition); "Pottery," by L. Arnoux, of Minton's Factory; "Glass and Silicates," by Prof. Darff, M.A.; "Furniture and Woodwork," by J. H. Pollen, M.A. (second edition). (London: Stanford, 1877.)

*Industrial Classes and Industrial Statistics* By G. Phillips Bevan, F.G.S. Vol. 1, "Mining, Metals, Chemicals, Ceramics, Glass, and Paper." Vol. 2, "Textiles and Clothing, Food, Sundry Industries." (London: Stanford, 1876-7.)

THE first edition of the first two volumes has been already noticed in these columns. The speedy issue of a second edition bears out the favourable opinion previously expressed with regard to them, and of this series of short comprehensive essays on British manufactures generally. There can be no doubt that any one wishing to take a general view of any of the subjects on which they treat will gain a good idea of their principles from a perusal of these volumes.

The latter two volumes, dealing as they do with the condition of the British industrial classes considered as *workers*, form an appropriate pendant to the "British Manufacturing Industries," in which the nature of the *work* which they perform has been already spoken of. Though, as Mr. Bevan says, the British workman "has from a political point of view . . . been frequently written and talked about—too much so, indeed, for his own good or for the good of the country—his social condition as dependent upon, or connected with, his special branch of labour," is comparatively seldom inquired into. This topic forms the subject of the present work.

In treating the subject one or more chapters are devoted to each of the divisions named above. A description of the character of the work in each department is given, together with the conditions whether healthy or otherwise, under which it is performed. This is supplemented by statistics as to the numbers employed in the various industries, the quantity of material manufactured, its value, the wages of the workman or workwoman, the effects of various industries on the rate of mortality, and some account of working class legislation and federation. The distribution of the various industries over the country is graphically shown by two maps in each volume.

The statistics are very full and complete, and being compiled mostly from official sources, may be taken as accurate and reliable. With regard to the introduction of this profusion of figures the author remarks that he has done so "in the hope of showing, how intimately allied is the development of our manufactures with the state of wages and the general condition of the working classes." There can be no doubt that Mr. Bevan's volumes clearly show that our English operatives are in better condition generally now than at any previous period, and this is so whatever be the standpoint from which they are regarded.

In reading the descriptions of the various handicrafts and under what conditions they are executed, one sees that there is much yet to be done in some branches to render the work still easier of execution and less unhealthy. Science has done much for the coal-miner; but more remains to be done in order that he may be better protected from sudden outbursts of fire-damp or choke-damp. It is evident from the quotation of Dr. Angus Smith's analyses of the air from metal mines, that some further legislative enactment is required to compel the more thorough ventilation of such mines. Blast-furnace workmen, it is true, do not work under very unhealthy or dangerous conditions; but there are one or two points in which there is room for improvement. For example, the "chargers" more particularly, are now and again rendered insensible by breathing escaping carbonic oxide, sometimes with fatal results; while once in a while, from the fall of the material in the furnace after "scaffolding," explosions occur in the "hearth" resulting in the forcible expulsion of the front or side of the furnace and of the molten metal, which occasionally envelops the workmen, who in some instances have been literally roasted to death. Possibly at some future period the dangers to health and life arising from these causes may be diminished or entirely obviated by the application of scientific principles.

The injurious effects and diseases resulting from the vapour of ordinary phosphorus and "phosphoric fumes" in match-making are fully pointed out (and the remedy in the use of red phosphorus), also those of oxide of zinc, sparks of metal and dust, poisonous gases, powdered glass and emery, and poisonous colours, in brass, needle, chemical, glass and emery paper, and paper-hanging manufactures. In the second volume the "sizing" of cotton goods, "singeing" of fabrics generally, "heckling" of flax, preparation of tobacco, use of "Scheele's green" and similar preparations in flower-making, and the closeness and general want of ventilation in workrooms, in dress-making, &c., are shown to result prejudicially to the health of the worker. Affections of the eyes from close work, as in watch and lace making, are not lost sight of. Neither are deformities resulting from working in constrained and unnatural positions.

In this connection it may perhaps reasonably be doubted—as the result of actual experience—whether "the effects of chlorine are transient and less serious" than follow from the inhalation of sulphuretted hydrogen. Weldon's chlorine-process is noted as an improvement on the old process, while Deacon's—which may fairly rank with it—is left unnoticed. On the same page a small matter needs correction; "mangan/te" and "permangan/te" should, of course, be manganate and permanganate. Mr. Bevan might be puzzled, perhaps, to show how tobacco acts as food, under which head he classes it.

A list is given of the legislative Acts hitherto passed affecting industries, which shows that the amelioration of the condition of the worker to its present improved state has not been an easy task. The trade societies are classed as trades unions, friendly societies, and co-operative societies; of the first the opinion is given that they are "at most a doubtful blessing," while the latter are considered as both useful and excellent.

The abundant statistics given cannot fail to be of great

service in many ways. The volumes altogether are very readable, and throughout the statements are usually reliable. Should a second edition be required it might possibly be improved by the addition of a "table of contents."

W. H. W.

### THE GERM THEORY

*The Germ Theory Applied to the Explanation of the Phenomena of Disease. "The Specific Fevers."* By T. MacLagan, M.D. (London: Macmillan and Co., 1876.)

IN his preface the author states that "one object which he has in view is to rescue the germ theory of disease from a false and misleading position, and to give to it its true and legitimate standing as a pathological question." The subject discussed is whether the propagation of germs in the system can produce specific fevers. He believes it can, and assumes that all contagia are living organisms, probably albuminous, reproducing their kind, living for a considerable period, speedily perishing when freely exposed to the atmosphere, and so minute as to elude the highest powers of the microscope.

If, however, the particles in sheep-pox, small-pox, and vaccine, be the infecting matter, they are easily seen by the microscope, and ought therefore to be found in the blood, but such is not the case.

Dr. MacLagan holds that "all microzymes are not contagia, but all contagia may be microzymes." The fact that the contagia fluids are most potent when fresh, and that their virulence diminishes as bacteria increase in them is explained by saying that disease-germs are more minute organisms than bacteria, and are the food on which bacteria live. According to this view, bacteria not only do not constitute infection, but destroy it.

Dr. MacLagan says "that the chief action of an organism on its environment is the consumption of nitrogen and water. A disease-germ is a parasite, and requires a special *nidus* as well as nitrogen and water; the parasite finds a *something* in its *nidus*—the second factor—the parasite being the first. Without this second factor no bad result follows the reception of the contagium." Different periods of incubation are accounted for by the varying amount of the second factor and the number of germs imbibed; incubation itself by germ-growth and reproduction; and the onset of the symptoms by the germs becoming mature.

The consumption of nitrogen by the contagium particles causes wasting of the tissues, *i.e.*, the organisms eat the albumen intended to nourish the body. They also drink largely of water from the liquor sanguinis, which, being rich in soda, explains why soda-salts are often absent from the excretions during fever. The same retention of soda-salts, however, often happens in acute pneumonia, which has no relation to infectious disease.

Increased elimination of urea is explained thus:—"The increased consumption of liquor sanguinis by the contagium particles leads to increased formation of retrogressive albumen and of urea." It seems by this that contagium particles have livers and kidneys, and excrete urea. Diminished excretion of urea is held as "due to consumption by the contagium particles of the water requisite to enable the kidneys to perform their excretory

function." What then, we ask, becomes of the water consumed by the contagium particles? Do their kidneys excrete urea in excess with limited water, while those of the patient are unable to do so? or do the contagium particles not consume water when the urea is increased as well as when it is diminished? In fever the quantity of water drunk by the patients is very great, but that, according to Dr. MacLagan, is because the quantity of contagium particles is also very great. We find, however, the same symptoms in symptomatic fevers, with no contagium particles present, and we have great difficulty in believing that ultra-microscopic organisms in a person's blood could consume several tumblerfuls of water in twenty-four hours.

The heat of specific fevers is partly ascribed to the propagation of the contagium causing increased consumption of tissue. But increase of living matter causes the disappearance of heat, not its production. Again, the author states that the fecundation of the organisms may be accompanied by an elevation of temperature analogous to that which occurs under similar circumstances in other organisms.

As regards treatment, at page 163 the following occurs: "If we were to bleed, to purge, to give antimony to, or even *simply to withhold food and water* from, all the cases of typhus and enteric fever which occur, there can be no doubt that we should find the mortality from those diseases greatly increased." Dr. MacLagan is right here, for by *simply withholding food and water*, there can be no doubt that he would greatly increase the mortality by starving his patients to death. He, however, believes that fever patients should be supplied with nitrogen and water to compensate for what the organisms consume.

The cessation of the fever and its specificity are attributed—the first, to the organisms, as parasites, requiring a special *nidus* which contains a suitable pabulum, and when the latter is exhausted the fever ceases; the second, to a local lesion in the *nidus*, which is the part where fecundation of the organism takes place. In small pox this *nidus* and lesion is in the skin, in typhoid in the bowels, and so on. It is well-known, however, that many medicines act on special parts of the body, and yet we do not think of calling them parasites which require a special *nidus*. The author gives many other plausible, and some very unusual explanations of febrile phenomena by means of the germ theory, all of which, we believe, are far more clearly and rationally explicable on the physico-chemical theory. The writing of this book must have cost Dr. MacLagan much trouble. We have read it very carefully, and commend the author's honesty in stating his views, but question if the work will go far in realising the object for which it was ostensibly written.

### OUR BOOK SHELF

*A Manual of Cinchona Cultivation in India.* By George King, M.B., F.L.S., Superintendent of the Royal Botanical Garden, Calcutta, and of Cinchona Cultivation in Bengal. (Calcutta, 1876.)

THIS manual is another contribution to the numerous books, papers, and articles that have appeared of late years on the subject of cinchona. Varied as these contributions have been, and valuable each one in itself, this manual brings together much that is useful, not only on

the scientific aspect of the subject, but also on the harvesting of the bark crop in India, as well as on the commercial value of the Indian cinchona plantations. The manual will probably find its largest circulation amongst owners of land who have embarked in the cultivation of cinchona as a commercial enterprise, or those who intend doing so, Chapter iv. being devoted entirely to cultivation: and this part of the subject is treated of very fully; the author giving the various details of suitability of climate, temperature, rainfall, elevation, soil, drainage, &c., together with the more practical operations of preparing the ground, sowing seeds, propagation, planting, and other matters of a similar character, which, from the nature of Dr. King's position as superintendent of the Government cinchona plantations, must be trustworthy, if not from his own practical experience, certainly from the fact of his being able to command the opinions of the best men in this important branch. The same may be said of Chapter v., on the "mode of harvesting the bark crop." Turning to Chapter vii. on the "local manufacture of a cinchona febrifuge," we come to what is interesting and important to the whole community, namely, some of the practical results of the cinchona introduction into India, in the production of a cheap but efficient febrifuge. This preparation, which Mr. Broughton, the Government quinologist calls amorphous quinine, consists of the total alkaloids of cinchona bark, in the form of a non-crystalline powder, mixed to some extent with the resin and red colouring matter so abundant in red bark. "This alkaloid," we are told, "has been accepted by the medical profession in the Madras Presidency, as a remedy in malarious fevers, scarcely, if at all, inferior to quinine." About 600 lbs. of this substance was produced in the Neilgherry factory up the end of the year 1872-73, but the process of manufacture was found too costly, and the factory was accordingly closed. A more simple process was commenced in Sikkim, by Mr. Wood, who arrived in India in 1873, and by this process at the present time, about a ton per week of dry red bark is being worked up. The bark, hitherto so utilised, has been chiefly derived from thinnings and prunings, undertaken from time to time in the interests of the trees. By the end of the current financial year (1875-76) about 32,000 ounces of alkaloid will have been turned out. Next year a much larger quantity will be yielded. It has been calculated that of this efficient febrifuge there can soon be yielded from three to four tons annually, at a cost of rather less than one rupee per ounce.

Some interesting appendices are attached to the Manual — one shows the stock of trees in the Neilgherry cinchona plantation, another the stock in the Sikkim plantations, another the meteorology of the same plantations, and the last one gives the opinions of medical men holding important positions in India, on the efficacy of the cinchona febrifuge. With the manual are also issued three extra pages, descriptive of the process at present used for manufacturing the above substance, by Mr. C. H. Wood, the Government quinologist.

J. R. J.

*Die Eugansen. Bau und Geschichte eines Vulkanes.*  
Von Dr. Ed. Reyer. (Wien, 1877.)

THIS is Dr. Reyer's first publication, and we gladly acknowledge it to be a very promising one. The subject, a minute geological treatise of the Euganean Mountains near Padua, illustrated by a well-drawn map, hardly calls for a lengthy notice on our part, but the little work is attractively written, and testifies to the complete mastery the author possesses over his subject. He minutely describes the structure of these mountains, then dwells upon the consequences he draws from this regarding their geological history, and raises before the eyes of the reader an interesting picture of times long past, and of forms long extinct. Dr. Reyer's language has the advantage of being clear and to the point, and free from all unnecessary

ornament. We have pleasure in recommending the book to our readers, and hope that it may soon be followed by another production from Dr. Reyer's pen.

*Die Erde und ihre Völker: ein geographisches Hausbuch.* Von Friedrich von Hellwald. Erster Band. Zweite Auflage. (Stuttgart: Spemann, 1877.)

THIS work has met with deserved popularity in Germany. Dr. Hellwald is known as one of the most accomplished living geographers, and is well fitted to undertake the compilation of a work like the present. It will, we believe, be completed in two volumes, the volume before us dealing with America and Africa. The author follows to some extent the method of Reclus in his *magnum opus*, though, of course, on a smaller scale. He takes the great divisions of the land and water one after another, and in a thoroughly interesting and clear style, summarises all that is known of them on the basis of the latest discoveries, and under a variety of well-selected heads. The work, so far as we have tested it, is up to the latest date, and we know of no more trustworthy, interesting, and handy compendium of geographical information. Some of the illustrations might bear improvement, especially in the case of North America, where, we think, a freer use might have been made of the magnificent illustrations in the U.S. Survey publications. On the whole, however, the work is a valuable "family book," as it is meant to be, and we should think would prove of considerable service to teachers of geography. We have no doubt that many would welcome an English edition of the work.

#### LETTERS TO THE EDITOR

[The Editor does not hold himself responsible for opinions expressed by his correspondents. Neither can he undertake to return, or to correspond with the writers of, rejected manuscripts. No notice is taken of anonymous communications.]

#### Science Fellowships at Oxford

YOUR correspondent, Mr. Charles Wade, is an undergraduate of Magdalen College, and makes the very natural mistake of supposing that fellowships once assigned to natural science are, like the class of college prizes with which he is more familiar, namely, the scholarships, regarded by the colleges giving them as in a certain sense appropriated for future vacancies, to the subject which has once been connected with them. This is not the case, and accordingly your readers will find that Mr. Wade's enumeration of twelve fellowships, as assigned to natural science at Oxford, is erroneous, whilst the statement of "an Oxford Man" that only five fellowships are at this moment held as rewards for proficiency in natural science, is correct. From Mr. Wade's list must be removed the three Lee's readerships at Christ Church, which are not of the nature of ordinary fellowships, but are special foundations and enumerated by "an Oxford Man" with the professorships. Of the nine remaining on Mr. Wade's list, one at Merton does not exist, nor does that at Corpus, nor that at Pembroke, whilst that at Brasenose was not offered purely and simply for physical science. Hence there are but five fellowships at Oxford now held for natural science, or six if we count that at Brasenose.

Since I have no reason to ingratiate myself either with those who defend or those who attack the abuses of Oxford, I shall not imitate Mr. Wade, but sign myself

SOCIUS

#### Spectra of Metalloids

IN a recent number of NATURE (vol. xv., p. 401) I gave a short abstract of a paper by Messrs. Angström and Thalen, on which I should like to make a few remarks. It is known that Plücker first drew attention to the fact that one body may have different spectra, and he seemed inclined to attribute these spectra to different allotropic states of the element. Later on, however, attempts were made to give another explanation of the phenomenon. It is against these attempts that Angström and Thalen chiefly protest in their paper. They use, however, the word element, in a different sense from that in which it is generally used. An elementary body, they say, can only have one spectrum. We are aware that bodies, as iodine and sulphur, can give two spectra, but then the band spectrum is due to an allotropic state, which, from a spectroscopic point of view, behaves

like a compound body. It would seem from this and other remarks, that, from a spectroscopic point of view at least, they consider an element to be not only a body which cannot be decomposed into two different bodies, but a body which cannot be resolved into any simpler molecular state. I have no objection against this if it is always clearly understood that our authors include allotropic states under the denomination of compounds. For instance, they lay great stress on the fact that a spectrum of fluted bands is always characteristic of a compound body. According to their definition of a compound this is perfectly correct, for no doubt the band spectrum belongs to a more complicated molecular state, but they cannot bring this argument forward as tending to show that Swan's spectrum of the candle belongs to a hydrocarbon, or that the fluted spectrum of nitrogen belongs to an oxide of nitrogen. The fact simply means that the molecule which gives these band spectra is to the molecule which gives the line spectra as the molecule which gives the absorption bands of iodine is to the molecule which gives the lines of iodine.

There is no doubt that we must be exceedingly careful, especially working with Geissler's tubes, not to ascribe to an element a spectrum which really belongs to a combination of that element with some other body present. The question what spectra an element really has must be settled in each individual case by careful experiments. Let us examine the two examples chosen by Messrs. Angström and Thalen. The first is carbon. Watta has already shown that the spectrum marked by him originally No. 2, really belongs to an oxide of carbon. The only spectrum under discussion is therefore Swan's spectrum of the candle. On this point Atfield's experiments are entirely conclusive. They have been amply confirmed by Watta and others. I take one case out of many. The flame of dry cyanogen gas shows the same spectrum brilliantly. The onus of the proof that a hydrocarbon can here be present lies entirely with those who make that assertion. Messrs. Thalen and Angström in the present paper assert that this spectrum is due to acetylene. In the year 1871 Prof. Angström published a paper, in which he tried to show that Wullner's second spectrum of hydrogen really belongs to acetylene. Other experimenters have confirmed this fact. In order to escape admitting that carbon has two spectra, Messrs. Angström and Thalen are forced therefore to assume that acetylene has two spectra.

The chief object of this letter is to say a few words on the spectrum of nitrogen. In the year 1872 I published a paper in which I gave an experiment tending to show that the band spectrum of nitrogen really belongs to an oxide of nitrogen. The experiment was this: Clean pieces of sodium were heated in a tube containing nitrogen; the band spectrum then disappeared, and another spectrum came out, which I then thought to be identical with the lines of nitrogen. The experiments were repeated by Stearns and Wullner; they also found that the bands disappeared, but the lines of nitrogen did not come out. I convinced myself that what I had seen was not the line spectrum of nitrogen, but the disappearance of the bands alone seemed to me to be an object of further investigation. Mr. Salet at last gave a full and correct explanation of the experiment. Nitrogen is absorbed by sodium under the influence of the electric spark, and the lines I had seen were the lines of sodium. As Mr. Salet has shown, my measurements agree better with the lines of sodium than with the lines of nitrogen. The bands of nitrogen remained if care was taken that the spark did not touch the sodium. If I have refrained hitherto from acknowledging the justice of Mr. Salet's conclusions, it is only due to the fact that I felt a natural curiosity to repeat his experiments; I have not yet been able to do so, but I have no doubt what the result would be. Mr. Salet's paper was only published after Prof. Angström's death, and I cannot help thinking that the professor would have considered his experiments conclusive against the assumption that the bands of nitrogen are due to an oxide of nitrogen. The only argument which Messrs. Angström and Thalen bring forward to support their theory is that in a tube containing rarefied air which showed the bands of nitrogen when the spark passed, nitric oxide was formed. But surely nitrous acid fumes are produced by sparks showing the line spectrum of nitrogen. Ozone is formed by sparks giving the lines of oxygen, yet we do not conclude that the line spectra of nitrogen and oxygen are due to nitrous acid and ozone.

If anyone still believes that an element can only have one spectrum at the temperature of the electric spark, I propose to him the following problem:—Let him take the three gases, carbonic acid, acetylene, and oxygen. If he investigates their

spectra carefully he will at least find ten different spectra (two of them I only discovered lately). Out of carbonic acid alone he can obtain six. Let him find a sufficient number of possible compounds to account for all these spectra. ARTHUR SCHUSTER.

### The Annual Parliamentary Grant for Meteorology

THE Meteorological Department of the Board of Trade was, as is well known, constituted by Government in 1856 with the object of collecting and discussing facts and observations too numerous to be collected and discussed by private persons. The Department continued for ten years under the sole direction of Admiral Fitzroy, who, by his self-denying exertions and enthusiasm, and a genius for developing meteorology in certain of its practical applications, gave a great and withal healthy impetus to a sound study of the laws of weather.

In consequence of the recommendations of a committee of inquiry appointed after Admiral Fitzroy's death to review the results of the labours of the department, its control was transferred to a Committee of the Royal Society, who, in return for an annual grant of 10,000*l.*, agreed to carry out the duties connected with the office. The Committee were left perfectly free in their method and in their choice of labour, the only condition attached to the grant being that an annual account be rendered to Parliament of the expenditure and of the results obtained in each year.

The support of the public was freely given to the Committee in the work they had undertaken, but in the course of a few years an opinion took root and gradually extended to the effect that the methods of inquiry adopted by the Committee and the work of the Meteorological Office were so seriously faulty as to call for inquiry. To some of these points attention was drawn in NATURE (vol. xii. p. 101), your criticism being limited to little more than the baldest statement of facts, which anyone could easily examine for himself, a criticism which, so far as we are aware, still remains unanswered.

Upwards of a year ago the Lords of H. M. Treasury, seeing that the Meteorological Committee had received nearly 100,000*l.*, considered that the time had arrived for an inquiry, the grant being so considerable that they did not think they could be justified in continuing it for any lengthened period without satisfying themselves that the results obtained were such as to warrant the application of so large a sum of public money. A Treasury Commission was accordingly appointed on November 2, 1875, to inquire into the work of the Meteorological Committee, particularly that portion of it referring to storm warnings; and, in the event of their deciding to recommend the continuance of the grant, to consider further upon what system it may be best administered. In connection with the latter part of the inquiry the Lords of the Treasury gave expression to their wish that the claims of the Scottish Meteorological Society for aid from the State should receive the consideration of the Commission. The Commission consisted of Sir W. Stirling Maxwell, Chairman, Mr. Brassey, M.P., Mr. Lingen, permanent Secretary of the Treasury, Mr. Farrer, permanent Secretary of the Board of Trade, Dr. Hooker, President of the Royal Society, Mr. F. Galton, and Gen. Strachey. Considering the many scientific questions of a strictly technical character which were to be dealt with, it is to be regretted that such names as Sir G. B. Airy and Prof. Balfour Stewart were not placed on the Commission; and it was perhaps unfortunate that Mr. Galton and Gen. Strachey were on it, seeing that they were also members of the Meteorological Committee whose work was to be inquired into by the Commission. The name of Mr. Milne Home, chairman of the Council of the Scottish Meteorological Society, was on November 29 added to the Commission.

On looking over the Report of the Commission, I am surprised to find an inattention to several important matters remitted to them by the Treasury. I do not find, for instance, that the methods adopted by the Meteorological Committee for the observation of the temperature of the British Isles, to which serious objection has been taken, and the character of the work of the office, to which also serious objections have been made, have been inquired into; and I find that the consideration of the claims of the Scottish Meteorological Society for aid from the State have been all but ignored in the Report of the Commission.

Passing on, however, to the recommendations of the Report we find that it recommends that the annual grant be increased from 10,000*l.* to 14,500*l.*; that, at least provisionally, some assistance be given to the Scottish Meteorological Society; that



ocean meteorology be transferred to the hydrographical department of the Admiralty; that the present system of collecting daily information by telegraph and of issuing storm-warnings be continued, an endeavour being made to put into clear shape, for the information of the public, the maxims or principles upon which storm-warnings in future are to be given; that the issuing of daily weather-charts be continued; that a certain number of continuously self-recording stations be retained; that the present system of supplementing self-recording observations by returns from eye-observers, that is, from ordinary meteorological stations, be continued; and, since the science of meteorology at present stands in need of hypothesis and discussion at least as much as, if not more than, of observation, that a part of the annual grant be appropriated to special researches, it resting with the Meteorological Council to select the investigators and fix the remuneration. Several of the recommendations are not put in the clearest shape in the Report, whilst others, such as those relating to the practical applications of the science, which concern the investigation of the relations of weather to health and agriculture, are so expressed as to suggest the idea that the nature of the problems involved in these large national questions has not been apprehended by the Commission, and consequently no provision is made in the Report for their proper investigation.

But by far the most important recommendations are those which refer to the constitution and action of the Meteorological Council, or new governing body, who are to be entrusted with the control of the grant, and the relation of the Council to the meteorological societies, which call for the gravest consideration. The services of the Meteorological Committee of the Royal Society are not to be continued, as suggested by some of its members when under examination before the Commission, the reason assigned being that it is not to be expected that they will continue to give much valuable time to the work under the existing conditions. It is proposed that the Royal Society be invited to recommend to the Government persons eminent in science who shall constitute the Meteorological Council, that they be fewer in number than the present Committee, and that they be remunerated in the shape of fees for attendance. This proposed reform as regards the body to be entrusted with the control of the grant in future is thus more nominal than real, and it is not improbable, looking at the phraseology of this part of the Report, that the Meteorological Council will be substantially the same as those who form the present Meteorological Committee, the only difference being that they will be fewer in number.

The value of the work of the meteorological societies is acknowledged, and it is recommended that co-operation with them be fostered to the utmost. The amount, however, of the assistance which the Commission recommends to be given to these societies out of the Parliamentary Grant, is indicated in these words of the Report (Art. 23):—"No payments should be made to them, except for results sought for by the Council." In other words, no assistance, whatever, is to be given to the meteorological societies out of the grant, because, these payments being only for services rendered to the Meteorological Council, cannot be regarded as grants to the societies, and they will neither aid them in conducting their own operations, nor remunerate them for the services which have long been rendered, and continue to be rendered, to Government Departments.

It is not in this way that foreign countries foster the prosecution of meteorology by their different nationalities. Thus, Hungary has its separate grant distinct from that of Austria proper; Norway has its grant distinct from Sweden; many of the Germanic States have their separate grants; and, as the readers of NATURE are aware, France is divided into meteorological departments, all of which are subsidised by the State, and their operations are aided, but not controlled, by the central office in Paris. In all cases, this division of work and responsibility is productive of greater economy and efficiency in carrying on meteorological research. Voluntary local effort is in this way evoked in a degree and to an extent not otherwise possible, and the healthful principle of competition and mutual criticism, so desirable in the present state of the science, is called into active play. Surely some provision ought therefore to be made by our own Government, to subsidise these societies, it being on all hands admitted that voluntary subscriptions alone are inadequate for their permanent efficient maintenance. In no other way can they be placed in a position to discharge the duty of a public department in collecting statistics for the elucidation of the climatology of a country in its details and practical applications.

In the estimated expense of the Meteorological Office on its

proposed new footing, I observe that 1,500*l.* is set down annually for "New Land Stations," and in the appended outline of "Duties of Future Council," they are to place themselves in postal and therefore direct communication with about 150 secondary stations in the United Kingdom. What does this mean? Is it intended quietly but surely to supersede, and in a few years supplant the meteorological societies—a course which the Report not only permits to be done if the Council be so minded, but also includes in the grant an annual sum of 1,500*l.* which may be so applied?

It cannot be supposed that any council, composed of persons eminent in science, could be formed at present, possessing the knowledge and technical training required to direct the conduct of the whole field of meteorological research, both physical and climatological. Certainly, keeping in mind the serious mistakes made under the *regime* of the Meteorological Committee, and the manner in which the work of the office has been conducted, to both of which attention may here again be drawn, no other result can reasonably be expected than that the programme, as sketched in the Report of the Commission, is seriously in fault. The fact that the work was not efficiently controlled, was no doubt one of the main reasons of appointing the Commission; and, therefore, virtually to reappoint the same controlling body, only under another name, armed with the means and powers as proposed by the Commission, could scarcely fail to result in work of a more or less unsatisfactory nature, and, besides, in an unnecessarily increased expenditure of public money.

It is difficult to see how this result can be obviated, except by remitting the whole question of local climatology, including its practical applications, to bodies located in each of the three kingdoms, these societies being at the same time intrusted with supplying the Registrar-General, as has been done in the past, and such bodies as the Medical Council and the agricultural societies of the United Kingdom, with the information they may require. If 1,000*l.* were given for this work to each of the societies referred to, and 1,500*l.* to the Admiralty for the work of ocean meteorology, there would still be 10,000*l.* for the central office in London, to be devoted to the issue of storm warnings and to the prosecution of the more purely physical researches of meteorology, of which the science at present stands so much in need, and which is so emphatically the proper work of the central office: and in this case it need scarcely be added that each of the societies would necessarily be represented on the Meteorological Council.

ZETA

#### Centralism in Spectroscopy

PERMIT me to repeat that happy remark of yours, and happy because so true and of wider application than the one meteorological case which called it forth, on p. 427; viz: "We think centralisation hurtful to science, and we regret that 1,000*l.* a-year has not been granted to Scotland, by which a healthy rivalry would have been gained."

In the Anniversary Report of the Royal Astronomical Society for last month will be seen a statement that the Royal Observatory, Greenwich, amongst a vast deal of other most undoubtedly admirable work, is also now having a large spectroscope constructed on a totally new plan. How many spectroscopes that observatory has had made for itself during the last twenty years I do not know! and I, for one single individual in the nation, do not grudge this new one if it should realise only a third part of the wonderful promises made for it.

In the same Anniversary Report there is also a statement that the Royal Observatory, Edinburgh, has been in want of a proper spectroscope for its special local observations for years and years past; and if at length there is one there now, almost good enough for the required purposes, it is because such a one has been recently made at the private expense of the Astronomer-Royal for Scotland, although his salary is less than that of many a clerk in London.

Of this, also, I am told there is no reason to complain, because I accepted the situation in its poverty-stricken condition, though when the nation itself was also poverty-stricken as compared with its present truly heaven-favoured financial condition. But what I do, merely as an individual, complain of is—that if the new Greenwich spectroscope is to be the *only one*: which the centralisation of the British Government in London allows to be built up at the expense of the whole nation, out of taxes levied in Ireland and Scotland as well as England, that it is being made on a principle which goes against the laws of Sir Isaac Newton and nature, and which, though it may give with "two-

or at most three half-prisms" more dispersion than was before obtained by "ten whole ones," does so at the cost of *all definition*, and will be certainly allowed at Greenwich, as well as everywhere else, to be a mistaken step in modern spectroscopy before another anniversary of the Royal Astronomical Society takes place.

Edinburgh, March 17

PIAZZI SMYTH,  
Astronomer-Royal for Scotland

### Greenwich as a Meteorological Observatory

IN NATURE (vol. xv. p. 421) there appeared a brief abstract of the presidential address of Mr. H. S. Eaton to the Meteorological Society of London on February 21. The increase of temperature at Greenwich in recent years is stated to be in reality due to local causes and not to secular variation, to which it has, as he thinks, been erroneously assigned. The effect of the growth of the population of London from 900,000 at the commencement of the century to 3,500,000 at the present time, and the still greater increase in the comparative consumption of coal, Mr. Eaton considers to be manifested by the rise in the average temperature of the air at the Royal Observatory, and for this reason it is concluded that Greenwich is not a suitable place for a meteorological observatory of the first order.

If the view enunciated by Mr. Eaton be correct, it is evident that the temperature of Greenwich during recent years has been in excess of that of surrounding districts. Is this view borne out by observation? Taking the figures for a number of places in the south-east of England whose mean temperatures have been calculated for the same thirteen years ending 1869, and adding the usual correction for height above the sea, we obtain the following results as their mean winter, mean summer, and mean annual temperatures; Greenwich, 40° 4, 63° 1, and 51° 1; Camden Town, London, 40° 4, 63° 3, and 51° 1; Royston, 40° 5, 62° 3, and 50° 8; Colchester, 39° 4, 62° 8, and 50° 6; Worthing, 41° 1, 61° 2, and 50° 7; Osborne, 42° 0, 62° 5, and 51° 8; Aldersholt, 40° 9, 62° 6, and 51° 2; and Oxford, 40° 6, 61° 3, and 50° 4. A simple inspection of these figures is sufficient to show that the consumption of fuel and the vast population of London cannot be said to have had an appreciable influence on the temperature as recorded at the Royal Observatory, and that if the Greenwich observations show a rise of temperature during recent years, the whole of the south-east of England has shared in that rise. This result deduced from observations is such as might have been expected when the position of the thermometers at Greenwich and the mode of escape of the artificially heated air by chimneys into the free atmosphere is taken into consideration. It follows, therefore, that, so far at least as regards the temperature observations, the conclusion drawn as to the future of our great national Observatory as a contributor to the higher meteorological researches is not supported by the facts of observation.

ALEXANDER BUCHAN

### Atmospheric Currents

I AM glad to have obtained from such exponents as Capt. Digby Murray and Mr. Murphy a clear statement of the old orthodox creed respecting the movements of the atmosphere.

The former, it is true, finds a difficulty in accepting Maury's belief that the currents cut one another in "curdles" in the equatorial calms, but none in adopting the same as regards the tropical calms, and his view may therefore, as I suppose, be taken as a modification of that which is graphically represented on Plate I. in the "Physical Geography of the Sea."

The question at issue between Capt. Digby Murray and myself amounts to this: Are rapid polar and equatorial upper currents observed over the region of tropical calms? Mr. Murphy's theoretical question appears to me to involve the inquiry—Is the force of the trades derived from the earth's rotation?

In tracing the course of the air particles along the route which he describes, the late Commodore Maury observes that this course is determined in certain particulars by "some reason which does not appear to have been very satisfactorily explained by philosophers." The latter do not as yet seem to have got rid of all the difficulties with which his theory is beset, which rather grow with its development.

I would beg the philosophers to look closely at the actual course of the atmospheric currents as shown by synoptic charts, not by charts of prevailing winds and mean pressures, which represent conditions never found at any one time in nature. The distinction between the "great currents" and the "temporary

than that between mean winds and actual winds; and to explain the mean winds on one principle and the actual winds on the opposite involves a fallacy.

Again and again we see a more or less irregular belt of high pressures, having central calms, extending across the North Atlantic. From the southern edge of this belt we may follow a particle of air in its course to and from the equatorial district of low pressure, also an irregular belt in the middle of which calms exist. The movement originates in the defect of pressure near the equator at the level occupied by the particle. Its velocity is governed by the steepness of the gradient; and its direction, in relation to the surfaces traversed, is affected by the increasing velocity of rotation of those surfaces. In the Doldrums it arrives at a district at which the gradient becomes zero and the horizontal movement has consequently disappeared; but a vertical movement has now been acquired from the difference in the tension of the particles above and beneath, a difference derived from solar heat. When the particle has arrived at a position in which this difference disappears the vertical movement vanishes, and a new horizontal movement commences owing to the defect of pressures on the polar side at the level then reached, and the direction of this movement is also affected in relation to the surfaces by their decreasing velocity of rotation. Where does the new movement terminate? Obviously in some district between the equator and the pole where horizontal pressures on all sides of the particle at its then level are equable, but where a vertical movement has been acquired, the particles near the earth's surface starting on their journey towards the equator. *The onus disputandi* lies with those who deny that such a district is presented by either of the belts of tropical calms.

We now look at the polar side of the calm belt of Cancer, and for this purpose we may take almost any, e.g., of Capt. Hoffmeyer's charts. We see in the majority of cases an aggregate of cyclonic circulations around local barometric minima, interfering and imperfect, and commonly becoming more so as they are propagated towards the pole. But we see no "polar depression" distinct from these, on which, as represented in the chart, we can lay the finger and say, "This is the result of centrifugal force; those are due to steam power." Within these systems an upward movement of the air occurs, owing to vapour condensation and the liberation of heat. Consequently towards these the particles of air near the earth's surface at the poleward edge of the tropical calms begin to travel, the earth's rotation deflecting their course in relation to the surfaces traversed. And from these, at a certain elevation, the particles return to the tropical calms for the same reason as that which determines the upper currents over the trades.

From the phenomena observed in the northern hemisphere I argue, *mutatis mutandis*, to those of the southern, and I expect the argument to be admitted by one who, like Mr. Murphy, attributes much less influence than I do to the work of water-vapour, and who even thinks that the mean movements of our atmosphere would be unaffected by the removal of all the water of our globe.

On some occasions pressure is high over all the North Atlantic on the polar side of the tropic, the anticyclones apparently extending nearly to the pole. In these cases we have no surface counter-trades over that district, yet the north-east trades continue to blow on the southward of the tropic as usual.

I repeat that all movements of the atmosphere originate in differences of pressure derived directly and indirectly from solar heat, and not in the force of the earth's rotation. And I must add that it seems to me very strange that any one while regarding the trades and their upper-currents as simply the effects of pressure differences in the lower latitudes, should maintain that the south-west and north-west winds of the temperate zones are simply the cause of the pressure differences in the higher latitudes. It would be just as logical to regard the south-west and north-west winds as due to pressure distribution, and the trades as the compensation for their eastward movement. W. CLEMENT LEY

March 10

### Electrical Phenomenon

LAST night I noticed a powerful development of electricity in a curious manner. I had thrown a piece of common, thick, white, unglazed paper upon a low fire which was tolerably full of ashes. When it was charred so as to be black and brittle, I happened to take it up and break bits off. To my astonishment they stuck firmly to my fingers. I broke off two pieces each an

each was capable of rotating (though with very great friction). When brought near each other they repelled each other forcibly. I experimented with these pieces for several minutes without perceiving any diminution in their electrification. Both sides of the paper seemed to be in the same condition. I then laid them down, and left the room to fetch a piece of sealing-wax to test the nature of the electricity. But by the time I returned, all trace of electricity was gone, and by no means could I repeat the experiment so as to get the slightest charge of electricity.

It is more than probable that the electricity was developed by the chemical action of combustion of the coals, and that the hot air rising up and brushing past the paper acted as a carrier of electricity of one kind to the paper, and of the opposite kind from it, until it acquired a very high potential. But it would be interesting to learn exactly in what manner this action takes place, and whether the electrification was positive or negative.

Andersonian College, Glasgow

GEORGE FORBES

Strange Star.—Meteor

ON going out last Saturday evening about 8.55 P.M. my attention was arrested by a large deep red star in Serpens which I had never seen before. Its magnitude was greater than Arcturus, though its deep colour made it seem less bright. About ten minutes afterwards I saw it increase and diminish in magnitude two or three times producing the effect similar to a "flashing" light on the coast, after which it suddenly disappeared.

On the same evening, at 9.56, I saw a very fine meteor of a bright pale blue colour with coruscations of ruby colour at the nucleus. Its course was from Gemini over Aldebaran, disappearing below Pleiades. Of a long pine-cone shape, duration about three seconds.

W. M.

Gunnersbury, March 19

SCIENCE IN GERMANY<sup>1</sup>

THIS book forms a continuation of the researches which in vol. i. treated of the season dimorphism as the result partly of exterior influences and partly of atavism. The present (second) volume comprises: (1) the origin of the markings upon caterpillars; (2) on the phyletic parallelism in metamorphous species; (3) on the transformation of the Mexican Axolotl into an Amblystoma; (4) on the mechanical conception of nature. The third treatise was published separately some time ago and was reviewed in NATURE; here we particularly wish to draw the attention of the lovers of natural science to the first paper. Weismann tries in the treatise in question to prove by his observations, and the deductions therefrom, that exterior influences and natural development or adaptation (Naturzuechtung) only can be the causes of the markings upon caterpillars. The observations referred to were made upon the caterpillars of several genera of *Sphingidae*, and relate to the history of their development.

I. *Charocampa*.—The caterpillars of *Ch. alpenor*, which have just left the ova, show no markings of any kind in this first stage, being of a uniform greenish colour; after the first change of skin (second stage) they show a bright longitudinal streak on each side, between the dorsal line and the line of breathing apertures (stigmata). To this first streak Weismann gives the name of "subdorsal streak." In the third stage eye-shaped spots form in the fourth and fifth segments, inside of these streaks, and these are completely developed in the following stages, i.e., after the subsequent changes of skin, while at the same time the subdorsal streak decreases and leaves only imperfect traces. In the fifth stage the greenish colour changes to a brownish one, and the horn at the tail of the caterpillar becomes shorter. In the sixth and last stage the other segments begin to show eye-spots, but these are not developed to perfection. *Ch. porcellus* shows the same form and development of the larva, with the only difference that most of the phenomena occur one stage earlier than with *Ch. alpenor*. This conformity and accord of both genera in the order in which the markings upon the caterpillars appear and are developed, lead to the conclusion that the markings were acquired in the same order during the progress of development (phylogeny) of these caterpillars; the oldest form (a) therefore showed no markings at all even when perfectly developed; the following form (b) had only the subdorsal streaks; then in form (c) the eye-spots occurred in the fourth and fifth segments, and finally in all segments (form d). It is probable further, that of the two genera of caterpillars now living, *Ch. alpenor*

<sup>1</sup>Weismann, "Studien zur Descendenztheorie" ("Researches on the Descent Theory"). Vol. II. On the last Causes of Transmutations.

is the original, i.e., older form, on account of its still showing the different stages of development in their completeness; the younger or more advanced form, viz., *Ch. porcellus*, proves that each new marking, acquired during the progress of development, appears first in the later stages and then gradually extends to the earlier stages. The whole of this view is well supported by the markings upon the complete form of the other species belonging to the genus *Charocampa*, of which the development of the larva is still unknown in its different stages. These other species may be divided into three groups, corresponding to forms b, c, and d of the phylogeny in such a manner that wherever the subdorsal streak remains in perfection, the eye-spots are not developed, and wherever these show themselves the subdorsal streak is decreasing. Form a (first group) is known in the full-grown caterpillars of three species (*Ch. syriaca*, *Daraspia myron*, and *D. charilus*); to the second group (form c) belong the above described *Ch. alpenor* and *Ch. porcellus*, together with several others; the last group (form d), which shows completely developed eye-spots on all segments, is even more numerously represented by *Ch. bisecta*, *oldenlandia*, *alecto*, *acteus*, *tersa*, and *celerio*. The species of the genus *Charocampa* which Weismann examined, therefore represent three phylogenetic stages of development, and it is interesting that the tropical species are the most advanced ones. It is probable, indeed, of one species, viz., *Ch. celerio*, that in Europe it shows form c in the markings of its caterpillars, while in India the larvæ of the same species have already attained form d.

II. In a similar way the author shows that markings upon the larvæ of the genus *Dellephila*, to which the well-known *D. euphorbie* (commonly called Sphinx) belongs, have passed through seven phylogenetic stages of development, viz., (1) caterpillars without markings; (2) with a subdorsal streak; (3) with a ring-shaped spot upon the last segment but one; (4) with similar but not altogether perfect spots upon all segments; (5) with eleven perfect ring-spots upon the subdorsal streak; (6) with these ring-spots but without the streak; (7) with a double row of ring-spots. Nowhere in the development any deviation from this order is noticed, and the living species of this genus form five groups, the markings of their full-grown caterpillars corresponding to the phylogenetic forms Nos. 3 to 7.

III. A somewhat smaller number of stages of development is apparent in the genera *Smerinthus*, *Macroglossa*, *Pteragon*, *Sphinx*, *Ancoryx*, which Weismann investigated less extensively than those mentioned before; however, he points out that upon their larvæ the simple subdorsal streak combines, in the course of development, with other longitudinal or oblique streaks, or becomes less distinct as the others increase in intensity.

Now Weismann considers that the remarkable conformities in the development of all the larva markings he investigated is the surest proof that we are dealing with a phenomenon of inheritance. Indeed three laws may be said to be established by these conformities, viz., (1) the development begins with the simple and progresses to the more complicated markings; (2) new markings first appear in the last stage of individual development; (3) these new markings then gradually pass backwards to the earlier stages and thus replace the older ones, causing them to disappear entirely. Weismann gives the following explanation of the phenomenon referred to in the second law:—Supposing that the respective markings are of use to the caterpillars, that therefore they are retained in subsequent generations by natural adaptation, this use can only be real if the caterpillars are big enough to resemble the different parts of the plants on which they feed, and thus escape being noticed by their enemies; and if a sufficient lapse of time is given for carrying this protection into effect. Both these conditions, however, are united in the last stage of development, where the caterpillars have attained the necessary size, and which is the longest of all stages. The use of the colour of caterpillars, and the markings upon them, is also perfectly evident. The younger ones are green as long as during the day they remain on the leaves of the plants they feed on; they do not then form a contrast with the colour of the leaves themselves. The older caterpillars remain green if the thick foliage of the plants protects them under all circumstances; if, however, the foliage is less dense, so that the caterpillars, as soon as they have grown bigger than the leaves, can be easily distinguished among them, they leave the green leaves in the day-time, and try to hide on the stems of the plants and among withered leaves; in that case, to complete the protection, their colour changes from green to brown. The biological value of the characteristic markings upon caterpillars, quite independently of their colour, may be recognised from the fact that

the caterpillars which live permanently in the dark, or those of the Microlepidoptera, just as little as those of the first stages of development of most butterflies, have no markings at all; their small size, or their habit of hiding themselves, sufficiently protect them from their enemies; they, therefore, need no markings to insure their safety. When the caterpillars are getting bigger the longitudinal streaks become useful, as through them they do not contrast so much with long-shaped leaves, fir-needles, or stems. The caterpillars with longitudinal streaks, such as those of *Satyrina*, *Pierida*, &c., almost without exception live on fir-trees, grass, or plants growing among grass. The oblique streaks in the segments of other green caterpillars imitate the lateral ribs of the large leaves upon which these species live. The eye- and ring-shaped spots form another means of protection. On the one hand, they may imitate the berries of the plants on which the caterpillars feed, and protect the latter, inasmuch as the berries are still unfit to be eaten at that particular time (*Deilephila hippophaes*). On the other hand, the spots, greatly resembling eyes, most decidedly act as means of frightening the enemies of the larvæ; this is particularly the case with the *Charocampa* species, as, whenever any danger threatens them they draw their foremost segments into the fourth and fifth ones, and the eye-spots upon these then glare on the puffed-up fore-part of the animal. Weismann has proved this experimentally, by throwing such caterpillars as food before birds, and then watching the expression of fear on the part of the latter. There are other caterpillars the markings upon which cannot possibly be looked upon as means of frightening their enemies, as their repulsive odour or taste alone suffice to ward off the insectivora. Wallace has shown that such insects bear their many coloured marking like a stamp of their unfitness for food, and already by this frighten off insectivorous animals. Weismann has proved by some experiments that lizards not only refuse certain caterpillars (*Smerinthus*, *Sphinx*, &c.) at all times, but are even diffident towards others which are marked in a similar manner although quite edible, and only eat them after minute examination.

It is certain that many of these useful markings were acquired by natural adaptation (Naturzuechtung), and it is quite beyond doubt that others have resulted from the internal laws guiding the formation or growth of caterpillars, *i. e.*, through correlation of the different parts of the insect, independently of all usefulness. This is proved by the retrograde movement of the markings acquired in later stages towards the earlier ones, where the markings can but be perfectly useless. The eye-spots, in the same way, first appear through natural adaptation near the head or the tail of the animal, and are then of use; but later on they spread over the other segments also, and here they only reappear, because in articula the general tendency exists to develop all segments in an equal manner. On the other hand the gradual disappearance of certain markings must be ascribed to natural adaptation, because under different conditions of life, more useful markings supplanted the existing ones, which had become useless. If the second phylogenetic form of the *Sphingida* caterpillars with single longitudinal streak, seems to indicate that the animals then lived on grass, these streaks became useless and even obnoxious when the caterpillars selected shrubs and trees for their food, and were then replaced by the more appropriate and useful eye-spots.

In short, as far as Weismann investigated the markings of caterpillars, particularly those of *Sphingida*, he could prove their development to be caused by external influences (natural adaptation and subsequent correlation), and could consequently reject the assumption of a special creative or form-shaping power.

#### D'ALBERTIS'S EXPEDITION UP THE FLY RIVER, NEW GUINEA

THE *Sydney Mail* of Saturday, January 20, contains a long account of the expedition of the Italian naturalist, D'Albertis, up the Fly River, New Guinea, translated from his diaries, and communicated by Dr. George Bennett. Signor D'Albertis left Sydney, April 20, 1876, in the mail-steamer, *Brisbane*, and reached Somerset, Cape York, on May 1, where the steam-launch *Neva*, which had been provided for the purpose of the expedition by the liberality of the good citizens of Sydney, was disembarked and equipped. On May 19,

after various small casualties, a start from Port Somerset was effected, and Katow, on the coast of New Guinea, reached on the second day. Hence the mouth of the Fly River, already well known to D'Albertis from his previous expedition in the *Ellangowan*, in 1876, was soon entered, and more or less progress was made every day. The land traversed appears to have been mostly low and swampy. On June 20, being on shore, Mr. D'Albertis ascended a hill 250 feet high, and from the summit saw some "very high mountains" in the north-east, fifty or sixty miles distant—probably part of the "great Charles Louis range." On June 28, after having been for some time aground, and only got off by an unusually heavy flood, it was determined to return and to try the western branch of the Fly River. The strong current and other adverse circumstances rendered it necessary to abandon this attempt likewise, after about a week's struggle, and the *Neva* returned to the coast, when the expedition passed several months amongst the islands, and finally returned to Somerset in November. The following is Mr. D'Albertis's summary of his discoveries:—

"After my long narrative I shall conclude with a few words expressing my regret at not having been able to do more. But it is often not the pioneer who shows the way that attains the most glory, but those who follow him; it is easy to hear of a road, but very difficult to find one out. I wish every success to any explorer of this part of New Guinea (should I not be able to return and complete my work), and I hope that the little I have done will be some guide and enable him to find his way more readily than I did mine, and to correct any errors I may have made. By this exploration we are now acquainted with a road into the interior of New Guinea, which is of the more importance, as it is so near to Somerset, where a line of large steamers calls twice every month. We have also found a passage from Moatta to the Fly River, shorter and safer than the one previously known, and a passage which, when properly surveyed, may be found navigable for larger ships. The richness of the land we visited, its vegetable, and probably mineral, products, the soil suitable for many of the most valuable plants, as coffee, sugar, cotton, india-rubber, sago, tobacco, nutmeg, &c., ought to attract the capital of the colony to open up the country. The Dutch from their part of New Guinea, although on a small scale, derive some trade. The part of New Guinea into which we penetrated, was in latitude 5° 30' S., and ran about 500 miles on the winding river, the course of which may be seen on the chart appended, and it almost forms a line of demarcation between that part of New Guinea claimed by the Dutch, and that remaining as yet unclaimed by any nation.

"About the Fly River, as far as I could judge, the natives appear less numerous than I have seen in other parts of New Guinea, and the land is cultivated in a smaller quantity, so that in this part of New Guinea the settler will not find the same difficulties which I have pointed out on former occasions when speaking of the south-eastern peninsula, where the natives are more numerous, and possess and cultivate all the best land. I have appended Baron von Mueller's report on my collection of dried plants;<sup>1</sup> and on the return of Prof. Liversidge to Sydney he will report on the small collection of minerals, &c., I submitted to him for examination. On a day not far distant I hope to give the ethnological report on the natives, their weapons, &c., also on the mammals and the birds collected, the latter consisting of about fifty species, many of which are new, or only recently described from specimens obtained during my first visit to the Fly River. I have also a rich collection of reptiles, fishes, both of salt and fresh water, some beetles, and some fresh water and land shells. I confidently expect that the voyage of the *Neva* will be remembered by those who take an interest in New Guinea, and by the scientific world."

<sup>1</sup> Some extracts from this were given in our last issue, p. 438.

THE PHYSIOLOGICAL ACTION  
II.

**DETERMINATION of Electro-motive Force.**—Soon after the first experiments were announced, certain physiologists said that although the results of the action of light which I have just described may be observed, to say there was a change in the electro-motive force, as stated in the earlier communications, was not correct. That the effect was due to an alteration in the electro-motive force had been proved, but experimental details were reserved for the second part of the investigations. At first Sir William Thomson's electrometer was used, but the amount of electric potential to be measured was too small to get good results. Another plan of determining the electro-motive force was adopted. This was the method introduced by Mr. Latimer Clarke, the eminent electrician, and described in his work on "Electrical Measurements." The instrument devised for this purpose is called by him a Potentiometer, and measures electro-motive forces by a comparison of resistances. Practically we found the Daniell's cell far too strong a battery to use as a standard of comparison. A thermo-electric junction of bismuth and copper was substituted for it. One end of the junction was constantly heated by a current of steam passing over it, the other being immersed in melting ice. The electro-motive force of this thermo-electric junction, as estimated many years ago by Regnault, is extremely constant, and is about the  $\frac{1}{175}$ th part of a Daniell's cell. By means of this arrangement the following results were obtained:—The electromotive force of the nerve-current dealt with in experiments on the eye and the brain of a frog varies from the  $\frac{1}{200}$ th to the  $\frac{1}{2000}$ th of a Daniell's cell. Light produced an alteration in the electro-motive force. This change was, in many instances, not more than the  $\frac{1}{10000}$ th of a Daniell's cell. But though small it was quite distinct, and proved that light produced a variation in the amount of the electro-motive force. By the same arrangement the gastrocnemius muscle of a well-fed frog gave  $\frac{1}{10}$ th of a Daniell; the same muscle from a lean frog which had been long kept, gave  $\frac{1}{30}$ th of a Daniell; and the sciatic nerve of the well-fed frog  $\frac{1}{200}$ th of a Daniell. Dr. Charles Bland Radcliffe states, in his "Dynamics of Nerve and Muscle," p. 16, that he obtained by means of Sir William Thomson's quadrant electrometer, from a muscle a positive charge equal to about the tenth of a Daniell's cell, a much greater amount than ascertained by the method I have just described.

The electro-motive force existing between cornea and posterior portion of the sclerotic in a frog amounts to  $\frac{1}{100}$ th part of a Daniell, and between the cornea and cross section of the brain is about four-fifths of the above.

**Effect of Temperature on the Eye of the Frog.**—From numerous experiments on the irritability of muscle induced by the excitation of nerve, it has been satisfactorily proved that a temperature of about 40° C. destroys the action of motor nerves in cold-blooded animals. Up to the present time we are acquainted with no observations as to the temperature at which a terminal sense organ becomes incapable of performing its functions. Having satisfactorily proved that the retina is the structure in the eye producing the electrical variation observed, it becomes evident that as long as this phenomenon can be detected the retina is still capable of discharging its normal functions. In order to investigate thoroughly the effect of an increasing temperature on the sensibility of the retina, a method of procedure was adopted of which the following may be taken as a general account:—A frog was killed, the two eyes removed rapidly from the body; the one eye was placed on electrodes and maintained at the ordinary temperature of 16° C., while the

other was placed on similar electrodes contained in the interior of a water bath having a glass front, the sides of the air chamber being lined with black cotton wool saturated with water. Into this chamber a delicate thermometer was inserted, and the currents coming from the two eyes were alternately transmitted to the galvanometer every five minutes by means of a commutator, the temperature and the electrical variation produced by the same amount of light being noted in each case. The general results are shown in the following table:—

Table showing Comparative Effect of Temperature on Sensibility of Frog's Eye.

Eye kept continuously at 16° C.		Eye at different Temperatures.		
Initial Effect	Final Effect.	Temperature.	Initial Effect	Final Effect.
55	28	16° C.	58	21
61	28	19° C.	55	16
53	27	21° C.	65	14
53	39	29° C.	97	5
53	45	29° C.	103	—4
60	45	37° C.	65	—3
60	50	38° C.	65	—4
53	41	43° C.	—	—5
60	40	43° C.	no effect.	no effect.

The initial amount of current was, however, increased on the whole by the action of the higher temperature, thus showing that the sensibility to light does not depend on the amount of current circulating through the galvanometer. It will be observed, on inspecting this table, that the eye maintained at the temperature of 16° C. remains tolerably constant in its initial action, although it gradually gets more sluggish, whereas the final effect steadily rises. On the other hand, in the case of the eye subjected to a higher temperature, the initial effect seems to have a maximum about 29° C., then gradually diminishes, and vanishes about 43° C., the final effect continuously falling and being actually reversed. To succeed in this experiment it is necessary to heat the electrodes which are to be used in the water bath up to 40° C., in order to be certain that no changes are induced in the electrodes themselves that might be mistaken for those above mentioned. An eye that had been placed in dilute salt solution along with lumps of ice was found to have the usual sensibility to light.

**Effect of Temperature on the Eye of Pigeon.**—Having succeeded in experimenting with a water-bath in the manner above described, it appeared interesting to ascertain if the eye of a warm-blooded animal would be benefited by being maintained at the normal temperature of the body. The head of a pigeon was placed in the water bath at a temperature of 40° C., the eyes were found sensitive to light, the action, however, being always a negative variation; but instead of vanishing quickly, as it does at the ordinary temperature, kept up its activity for at least an hour. For example, in one experiment, the electrodes being placed on the corneas so that the currents were balanced, sensibility was active for an hour and a quarter, but half an hour later it had almost disappeared. In this experiment the sensibility of the eye is shown by the large deflection produced by a single candle at different distances, thus:—

Distance of Candle from Eye.	Divisions of Galvanometer Scale
9 feet	—
6 feet	180
3 feet	230
1 foot	420

**Sensibility of the Optic Nerve.**—When the retina is entirely removed from the eye-ball, and the optic nerve is

Friday evening Lecture by Prof. James Dewar, M.A., at the Royal March 31, 1876. See NATURE, vol. viii. p. 204. Continued from

still adherent to the sclerotic, no effect of light can be detected. It now appeared possible to examine this question by repeating Donders's experiment of focussing an image on the optic disc in the uninjured eye, when no electrical disturbance ought to occur. This was done in the eye of the pigeon, but an image free from irradiation on the optic disc could not be produced, and consequently there was always an electrical effect observed.

*Exhaustion and Stimulation of the Retina.*—When the same light from a fixed position is allowed to act on the eye for successive intervals of time, say two minutes of light and two minutes of darkness, it gradually falls off in electrical sensibility. Thus, a candle at nine inches gives the following results when successively used as a stimulus :—

	Initial Effect.	Final Effect
1st experiment	259	254
2nd "	171	276
3rd "	140	282
4th "	122	274

These figures show a rapid fall of the initial effect. In these circumstances, it is evident that the image being

experiments may be made by throwing an image from a small silver mirror connected with a metronome. The rapid exhaustion of the eye may be most readily demonstrated by cutting off the anterior half of the eye, leaving the vitreous humour in contact with the retina, observing the effect of a candle, and then subjecting it to the action of a magnesium lamp. The sensibility will now be enormously diminished. The electrical variations resulting from the respective actions of a candle and a magnesium lamp placed at the same distance from the eye were as follows :—

	Initial Effect.	Final Effect.
Candle	38	78
Magnesium lamp	120	135

This experiment proves that an increase of 200 per cent. in the illuminating power of a source of light only triples the electrical effect. Thus the eye becomes less sensitive as the illumination increases.

*Chronometrical Observations.*—A series of experiments have been begun with the object of measuring the time required from the initial impact of light before electrical variation is produced. As the electrical variation has been shown to agree with our consciousness of luminous effects, it became an interesting point to ascertain whether the time occupied by the action of light upon the eye of the frog is similar to the time occupied in its action upon the eye of man. A good many years ago, Prof. Donders and his pupil, Schelske, performed a number of experiments by which they determined that the time required by the human being to observe light and to signal back the impression occupied about  $\frac{1}{10}$ th of a second. That is to say,  $\frac{1}{10}$ th of a second is occupied by the action of light on the eye, the transmission of nerve-current to the brain, the change induced in the brain during perception and volition, the time for the transmission of the nerve-current to the muscles, on signalling the result, and the time occupied by muscular contraction. The true period of latent stimulation in the case of man must therefore be a very small fraction of a second. In order to attempt a solution of this problem a chronograph made by Dr. König, of Paris, was employed. A diagram of the recording portion of the instrument is given above. The experimental arrangements were as follows: the galvanometer, the eye apparatus, and the chronograph being in separate rooms, one observer was stationed at the galvanometer for the purpose of signalling the moment the needle worked, which was recorded by one of the markers D in the diagram, the other marker being used to register the time of initial action.

The *first experiment* was to transmit at a known moment, through the eye circuit in the dark room, a quantity of current equal in amount to the electrical variation produced, when the eye was stimulated by a flash of light from a vacuum tube, and to record the difference of time between the origin of the current and the observer's signal from the galvanometer.

The *second experiment* was to flash a vacuum tube at a known moment in a room where the eye was placed, and to record as before the instant the galvanometer was effected. From the first observation we ascertain the minimum amount of time necessary to overcome the inertia of the instrument, the observer's personal equation, and the signalling under the conditions of the experiment. If this result is subtracted from the record of the second observation, the difference will represent the latent period of light stimulation. From a large number of experiments made on the eye of the frog we have found the latent period amounts to less than  $\frac{1}{10}$ th of a second, but its absolute value must be ascertained by some method not liable to the variations that are inevitable to the process described. Altogether the problem is one of great difficulty, but farther investigations are in progress.

J. D.

Diagram showing the recording portion of Regnault's Chronograph. A A, limbs of recording fork, worked by electro-magnets, G G, C, stilette on limb of recording tuning fork. B B, levers in connection with armatures of electro-magnets, F F, and bearing markers, D D, which, along with C, record on E, a strip of blackened paper passing over pulley

always localised on the same minute portion of the retina, only a few of the rods and cones of that structure are really exhausted. If the eye be allowed repose in the dark for a period of from half an hour to an hour, it will regain as much as triple the exhausted sensibility. But another mode of proving that only a minute portion of the retina was affected was to show that an alteration of position of the image by a slight movement of the luminous body was followed by a new electric variation. In order to vary and extend the action of a retinal image it is necessary to suspend a steady lamp by means of an indiarubber cord or spiral spring, so as to be able, by inducing vibrations in any direction, to stimulate in rapid succession different retinal areas. On oscillating a pendulum of this kind, an electrical variation is observed whenever the amplitude of the vibrations is increased, and by inducing a combination of vibrations, the electrical variation observed corresponds to what would be found if the luminous intensity were sixteen times as great as that of the stationary light. Similar

ASTRONOMICAL BIBLIOGRAPHIES

PROF. HOLDEN, of the Observatory of Washington, U.S., lately read to the Washington Philosophical Society a paper on "Special Astronomical Bibliographies," in which a careful comparison of one section of the "Reference Catalogue of Scientific Papers," by Mr. E. B. Knobel, F.R.A.S. (lately mentioned in these columns), was made with a MSS. catalogue on the same subject (nebulae and clusters) which Prof. Holden had compiled for his own use. Only one misprint was found (*op. cit.*, p. 377, for *Complex Rendus*, vol. 28, p. 537, read p. 573) and only one omission of a highly important paper, the "Siderum Nebulosorum Observationes, Havniensis" of D'Arrest. The list of works given by Mr. Knobel might be still further extended, but in its present state it is very accurate and extremely useful.

A list of bibliographical works available to the astronomer for consultation is given, which we extract :-

1. WEIDLER, "Bibliographia Astronomica," &c., 1755, 8vo.
2. SCHEIBEL, "Astronomische Bibliographie," &c., 1789-98, 8vo.
3. LALANDE, "Bibliographie Astronomique," &c., 1803, 4to.
4. REUSS, "Repertorium Commentationum," &c., vol. v. 1804, 4to.
5. YOUNG, "Natural Philosophy," vol. ii. pp. 87-520, 2 vols., 1807, 4to.
6. SOHNKE, "Bibliotheca Mathematica," &c., 1854, 8vo.
7. [SCHUMACHER], "Catalogue des Livres Composant la Bibliothèque de Feu," Prof. Schumacher, Part 1, 1855, 8vo.
8. STRUVE, "Catalogus Librorum in Bibl. Spec. Pulo-lovensis," 1858, 8vo.
9. ROYAL SOCIETY, "Catalogue of Scientific Papers," 6 vols., 1867-72, 4to.
10. DARBOUX et HOUEL, *Bulletin des Sciences*, &c., 8vo. (*serial*).
11. POGGENDORF, "Biog.-Liter. Handwörterbuch," 2 vols., 1863, 8vo.
12. R. WOLF, *Sonnenflecken-Literatur*, *Astr. Mit.*, 8vo. (*serial*).
13. R. WOLF, "Handbuch d. Mathematik," &c., 2 vols., 1872, 8vo.
14. CARL, "Die Principien d. astr. Instrumentenkunde," 1863, 8vo., p. 161 [Literature of Micrometers].
15. BELGIUM ACADEMY OF SCIENCES, "Bibliographie Académique," 1875, 8vo.
16. ST. PETERSBURG ACADEMY OF SCIENCES, "Tableau Général," &c., Part 1, 1874, 8vo.
17. ENGELMANN, "Literatur d. astronomische Nachrichten," &c., Bessel's *Abhandlungen*, 1876, 3 vols., 4to.
18. KNOBEL, "Reference Catalogue of Astronomical Papers and Researches." *Mon. Not. R.A.S.* 1876, Nov.
19. HOLDEN, "Index Catalogue of Works on Nebulae and Clusters of Stars, 1876," MS.

Almost any desired paper may be at once found by means of these works, and Nos. 3, 4, 8, 9, 11, 16, 17, and 18 are practically indispensable.

MENDELEEF'S RESEARCHES ON MARIOTTE'S LAW

IN compliance with your request I hasten to make known, through your esteemed journal, to the scientific public of England, the results of my researches on the Boyle-Mariotte Law. Special reasons which I have explained in the *Russian Journal of Artillery* (August, 1872), urged me to undertake new researches on this law. They are briefly as follows :-

1. It is impossible to admit in theory that under pressures infinitely great gases can be condensed into a volume infinitely small; or, in other words, that it is possible to introduce into a given volume an infinitely great mass of condensed gas. Although infinitely great pressures be practically unrealisable they are per-

fectly perceptible to the mind; as to an infinite condensation of matter it is quite inconceivable, otherwise we must admit the existence of an atomic substance without volume. The experiment of Cagniard-Latour developed and verified by MM. Wolf Drion, Andrews, and myself lead us to an inevitable conclusion, viz., that at a certain known temperature all gases and vapours can no longer be transformed under any pressure into liquid, but remain in the gaseous state, endowed with elasticity, but deprived of cohesion. At a lower temperature the gas may be transformed into liquid; but at a higher temperature it remains gas, whatever be the pressure. I gave to this temperature (*Lab. Ann.*, t. 119, p. 11) in 1860 the name of "temperature of absolute ebullition;" in 1872 Dr. Andrews gave it the name of "critical point."

Imagine a mass of gas at a temperature higher than this, and suppose that this mass is subjected to pressures always increasing; if the Boyle-Mariotte Law is accurate the volume ought to diminish in inverse proportion to the pressure. If we represent this same mass of gas at a temperature a little less than that of absolute ebullition, the gas transformed into liquid will cease to be compressed as before, as the Boyle-Mariotte Law requires. Consequently, there is no doubt that we ought to come to the paradoxical conclusion :- A gas can be more compressed than a liquid or solid. As there is reason to believe that oxygen at the ordinary temperature is hotter than at its temperature of absolute ebullition, the Boyle-Mariotte Law being admitted, under a pressure of 2,000 atmospheres, we ought to find a specific weight of oxygen greater than that of sulphuric acid, and the pressure being 10,000 atmospheres, its density would reach that of mercury. But it is impossible to admit this, judging from what we know of the relation which subsists between the atomic weight of the elements and their density in the free state, as well as in their combinations with other elements. It is sufficient to indicate that a very great density is the peculiar property of combinations, the elements of which are endowed with a considerable atomic weight. Consequently, it cannot be admitted that elements having so small an atomic weight as oxygen can be condensed to any very considerable degree, no matter in what state. We must then conclude, *a priori*, that under high pressures the Boyle-Mariotte Law is inapplicable.

2. The researches of Rumford, which date from last century, relating to the density of the combustion gases of powder; also the researches of M. Natterer, on the compressibility of gases like oxygen, the oxide of carbon, hydrogen, and air, made in the years 1850 *et seq.*, are completely in accordance with the conclusions stated above, and show that under high pressure gases are endowed with a positive compressibility analogous to that of solid or liquid bodies. I mean by positive compressibility that property by which bodies, in proportion to the increase of pressure, diminish in volume less rapidly than the pressures increase. In cases where the Boyle-Mariotte Law is found exact, the product  $p v$  of the pressure  $p$  into the volume  $v$  remains constant; and  $\frac{d(pv)}{dp} = 0$ . When the compressibility is positive this product  $p v$  increases together with the increase of the pressure, and consequently  $\frac{d(pv)}{dp} > 0$ .

3. At the same time MM. Despretz, Regnault, and many others, have conclusively demonstrated that gases like carbonic and sulphuric acid, which are transformed into liquids under considerable pressure, possess a negative compressibility, so that for them  $\frac{d(pv)}{dp} < 0$ . M. Regnault has found the same negative compressibility for air, nitrogen, and the oxide of carbon under pressures higher than that of the atmosphere as far as thirty. It necessarily follows that if the data of MM. Regnault and Natterer are correct, the negative compressibility of air becomes under a certain pressure above thirty atmospheres, equal to zero, and therefore positive.

When  $\frac{d(pv)}{dp} = 0$ , Mariotte's Law is verified. Consequently

there is a certain pressure above thirty atmospheres under which Mariotte's Law is applicable; under pressures below that point the compressibility is negative; under pressures above the same, it becomes positive and remains so to the end.

4. Although there is no doubt that the Boyle-Mariotte Law is not rigorously applicable even under moderate pressures, yet the prevailing doctrine, so rich in instruction on the nature of gases, which deduces all their properties from the *vis viva* which animates their molecules, admits the supposition that in the rarefaction of gases the distances between these molecules increase to

such an extent that their mutual attraction is destroyed; and in this case gases comply exactly with the Boyle-Mariotte Law. On this hypothesis the law becomes a limit towards which every gas tends in proportion as the distance between its molecules increases, and in proportion as their *vis viva* and the rapidity of their motion increase. That idea finds no support in fact. If it were accurate, then, at a certain high temperature, gases, especially those whose density is not great and whose particles are endowed with a very great rapidity of movement, ought to conform rigidly to the Boyle-Mariotte Law; but this is inconceivable, leading, in fact, to the paradox examined above. Moreover, the researches of M. Regnault on hydrogen, the lightest of gases, have shown the very opposite, hydrogen being positively compressible under pressures only a little higher than that of the atmosphere. It indubitably follows that in reference to the diminution of a mass of a gas filling a certain volume and the increase of the rate of movement of the molecules, we cannot expect a rigorous compliance with the Boyle-Mariotte Law. But we must make certain of finding positive errors, and the following are the grounds which urged me to have recourse to new experiments in reference to the application to gases of the law with which we are dealing.

These grounds were explained by me in 1872; since then similar ideas have been published by many others. Nevertheless, so far as I know, these ideas are far from having been generally adopted into science. It is evident that to combat an established opinion, a single *a priori* conclusion is insufficient; new researches are necessary, all the more that doubt may arise in the mind on the accuracy of the data of experiments, not only such as those of Rumford and M. Natterer, but even those which the celebrated experiments of M. Regnault have established. On examining critically the processes of the last-named eminent experimenter, we may not be able to discover any cause to explain the positive deviations which he has obtained for hydrogen, although it is possible to admit that the negative deviations depend on some defects in experimenting. New experiments and researches thus became indispensable; above all, for the purpose of verifying the data of MM. Regnault and Natterer, following methods not less precise than those which these observers employed. Thus it was specially necessary to experiment on the compressibility of gases under pressures less than that of the atmosphere, seeing that until 1872 there had been no accurate researches on this point.

I distributed as follows the work undertaken by me in 1872:—I commenced with pressures less than the pressure of the atmosphere, and I passed from that to pressures which exceeded those employed by M. Regnault. For the latter purpose I devised in 1872, and have now constructed, a compound manometer, containing alternate columns of mercury and of water, and permitting the measurement of exceedingly great pressures by means of a large number of very low columns of mercury. However, at present I shall not dwell upon this side of the researches, seeing that the experiments are still being carried on; I shall only endeavour to explain the main points of the practical processes, and the results obtained under small pressures. The first experimental researches made by me on the compressibility of air under pressures less than that of the atmosphere were made by means of very simple apparatus. Imagine a vessel A terminated above and below by tubes. The upper tube is always in communication with a syphon barometer, or, as I call it, a baro-manometer. In this apparatus the height of the column of mercury measures the elasticity of the gas in the vessel. It is easy to make the volume of gas in the baro-manometer remain the same all the time, notwithstanding the variety of pressures. To accomplish this it is only necessary to arrange so that we may at pleasure increase or diminish the quantity of mercury in the baro-manometer. The lower tube of A serves to introduce and to withdraw the requisite quantities of mercury. It is not necessary to see the height of the mercury in the vessel; the mercury here serves only to measure the volumes, and consequently, if we close the feeding-tube by means of a cock, and if by means of an emptying tube we allow all the mercury in the vessel to escape, we may ascertain the capacity of the whole reservoir; by emptying only a part of it we may ascertain the volume of the gas at each moment. Thus the weight of the mercury, directly observed by means of a balance, gives immediately, in all my researches, the volume occupied by the gas in each particular case. The first experiments made in 1873 on air, showed me that air under pressures lower than that of the atmosphere possesses a positive compressibility, and that the smaller the pressure the more are

the divergences presented by air from Boyle's Law increased. The first apparatus was constructed in a very simple manner; some errors might be suspected, and this is why I am not confident of the results obtained. I therefore constructed a second and a third apparatus, modifying successively not only the dimensions, but also the very construction of the details of the apparatus. I then arranged a fourth apparatus, by means of which, with Michel Kirpucheff, whose death is a sensible loss to Russian science, I made numerous observations. The report of these experiments was given by me in 1874 to the Russian Chemical Society, and printed in the *Bulletin* of the St. Petersburg Academy of Sciences. The experiments themselves are described in considerable detail in vol. i. chap. 9, of my work "On the Elasticity of Gases." It is impossible to describe in an article the great number of particulars which belong to these researches; we are limited to the more important details which I have introduced into this inquiry, as also into my subsequent investigations.

The normal metre and normal kilogramme which I employed were compared with the Paris standards at the Conservatoire des Arts et Métiers in concert with M. Tresca; their sub-divisions were then carefully verified.

I had to work a long time at the construction of the barometer, and I found out a new process for constructing this apparatus, which consists specially in terminating the end of the barometric chamber by a capillary tube bent downwards. By means of this tube it is possible to expel the last traces of gas which remain in the vacuum, and thus to show the experiment of obtaining an absolute vacuum, *i.e.*, to construct a barometer such that with the diminution of the volume of the chamber the indications do not vary. The construction of two barometers, with a common chamber and a single descending capillary tube affords an easy means of obtaining with the greatest precision the determination of the feeblest tensions in the barometric chamber. It is only necessary to direct the telescope of the cathetometer to the top of the column of mercury in one of the barometers when the mercury in the other is at its maximum height, and when the volume of the vacuum is very small; then pouring out the mercury contained in the other barometer, and thus diminishing the pressure which acts upon the vacuum, we may increase its capacity. Then the least quantity of gas contained in the vacuum will give an increase of height in the barometer observed. By constructing the barometer with the greatest care, and filling it with mercury distilled according to Weinhold's process, it is possible, as our numerous researches with M. Hemilian have proved, to obtain a perfect barometer requiring no correction for the tension of air which may remain in the vacuum. This result is obtained solely by means of the capillary tube referred to above. The process shows, moreover, the possibility of constructing barometers without boiling the mercury and without removing them from the position which they are ultimately to occupy. Here then is an undoubted improvement in the construction of an apparatus so important as the barometer, in a great number of physical researches.

Next a very long time and a great number of trials were necessary in order to attain the desired accuracy in measuring heights. I always employ the comparative method, consisting in placing beside the height to be measured a standard metre, well tried beforehand in all connections. My normal measures are generally in the form of tubes, in the inside of which is introduced water which enables me to appreciate at each moment the temperature of the measure, and if necessary even to change it. The telescopes of all my cathetometers are fitted with micrometer eye-pieces, carefully constructed by our engineer, M. Brauer, justly noted for his long residence at Pulkova, and for the construction of a great number of astronomical and magnetic apparatus. Besides the central cross-wire the micrometer eye-piece is fitted with one movable wire, or still better, with two movable wires. The fixed wires passing by the optical and geometrical centre of the telescope fitted with a level sensible to about 2-3" are directed towards a point of the object whose height is to be determined. Then both telescopes fastened to the same cathetometer, or better to two small separate cathetometers, are directed to the normal measure arranged at the side, and the double movable wire serves to determine the distance of the fixed wire from the nearest lines of the normal measure. This last is placed at such a distance from the column whose height is being determined, that the measure and the object may be distinctly visible without changing the position of the eye-piece. Every variation in the position of the eye-piece may derange the position of the optical



centre; this is why latterly I use exclusively cathetometric telescopes, in which the distance of the eye-piece from the objective cannot undergo any change. On the other hand, it is possible to move the lunette if the cathetometer itself is in the rest where it is fixed; which is not seldom necessary in practice. By using a considerable magnifier and an illuminator of the columns of mercury very carefully combined, it is possible to observe the columns with a precision carried to thousandths of a millimetre; so that the error in appreciating the height does not exceed 0.01 mm. Everyone who has worked with the ordinary cathetometers and who has used their scales for measuring heights, knows that the accuracy of the measurement by means of such apparatus never exceeds  $\frac{1}{5}$  mm., and that often he makes errors which reach tenths of a millimetre. It is sufficient to refer to the variations of temperature infallibly due to the presence of the observer. In the construction applied by me, these reasons, as well as many other causes of error, do not exist at all.

Although for the barometers and the baromanometers I always use tubes of large diameter, exceeding 17 and very often even 20 millimetres, nevertheless I have thought it proper to verify the capillary depression of the mercury depending on various diameters of the tube and various heights of the meniscus. A very extensive research has been made in my laboratory by Mlle. Goutkovsky, and the results which she has obtained have obliged me to change the data which we possess on the depression of mercury. I cite one example from many which are in my work on "The Barometric Levelling and on the Application of the *Sysstomer* to that purpose." The diameter of the tube being 8.606, and the height of the meniscus—

0.6	0.8	1.0	1.2	1.4	millimetre,
0.162	0.235	0.312	0.380	0.458	"

the depressions are— numbers differing from those generally adopted, according to which for a height of the meniscus 1.0, there ought to be a depression of 0.460 for the diameter 8.606.

DR. MENDELEEFF

(To be continued.)

OUR ASTRONOMICAL COLUMN

THE SUSPECTED INTRA-MERCURIAL PLANET.—M. Leverrier has issued an ephemeris of positions of the hypothetical planet, interior to Mercury, derived apparently from the two orbits to which reference was made last week as representing the observations upon which the general formula was founded, with equal precision, and if the planet should not be met with in transit across the sun's disc between March 21 and 23, use may be made of M. Leverrier's ephemeris to examine with large telescopes the positions of the greatest elongation westward in the two orbits. The differences of right ascension and declination from the sun about these times are thus given:—

	ORBIT I.		ORBIT II.	
	Diff R.A.	Diff. decl.	Diff R.A.	Diff decl.
	m.	m.	m.	m.
March 28 ...	- 38.4	- 2.6	- 38.8	- 2.6
29 ...	- 40.4	- 2.6	42.0	- 2.8
30 ...	- 40.4	- 2.8	- 44.8	- 2.9
31 ...	- 39.2	- 2.6	- 45.2	- 3.0

The observation of Decuppis at Rome in 1839, one of the five utilised by M. Leverrier, was communicated to the Paris Academy of Sciences on December 16 in the same year. It is thus noticed in the *Comptes Rendus* of that sitting: "M. Decuppis announced that on October 2, while continuing the observations which he has made upon the spots of the sun, saw a black spot, perfectly round, and with well-defined contour, which advanced upon the disc with rapid motion, so that it would have traversed the diameter in about six hours. M. Decuppis thinks that the appearances which he has observed can only be explained by admitting the existence of a new planet." The observation is reproduced here, as it appears to have escaped the notice of several writers who have recently entered upon this subject. Haase mentions it, but does not give particulars.

The observation by Mr. Joseph Sidebotham at Manchester,

on March 12, 1849, was communicated to the Literary and Philosophical Society of that city, April 1, 1873, and will be found in the *Proceedings*, vol. xii. p. 105. "A small circular black spot" was "watched in its progress across the disc for nearly half an hour," by Mr. Sidebotham and Mr. G. C. Lowe, also a member of the same society.

D'ARREST'S COMET.—If this comet is not detected before moonlight interferes in the mornings, it may probably be observed in the middle of the ensuing month, where the sky is very transparent down to the eastern horizon; it will then rise rather more than two hours before the sun, and the intensity of light will be greater than when it was last seen by Prof. Schmidt at Athens in December, 1870; still its distance from the earth will be considerable (1.7). When theoretically brightest, in May, observations may be made at the observatories of the southern hemisphere. At the Cape, Melbourne, and Sydney, the comet will rise more than four hours before the sun; the perihelion passage takes place on May 10. The following positions will sufficiently indicate its course about that time:—

	At Greenwich Noon.			N.P.D.	Distance from Earth.	
	h.	m.	s.			
May 2 ..	23	18	16	91	17.0	1.670
6 ..	23	32	13	90	31.9	1.659
10 ..	23	46	5	89	47.8	1.650
14 ..	23	59	51	89	4.8	1.642
18 ...	0	13	28	88	23.3	1.635
22 ...	0	26	56	87	43.6	1.629
26 ..	0	40	14	87	5.8	1.624

The intensity of light remains sensibly the same during this period. In August and September next observations may be practicable with very powerful instruments, as the comet moves from Taurus into Orion.

According to the elements of M. Leveau, who has continued the investigations on the motion of D'Arrest's comet, commenced on its first discovery in the summer of 1851 by M. Villarceau, the dimensions of the orbit in 1877 are as follow:—

Semi-axis major ..	3.5414
Semi-axis minor ..	2.7565
Semi-parameter ..	2.1456
Perihelion distance ..	1.3181
Aphelion distance ..	5.7647

The period of revolution in the ellipse of 1877 is 2434.2 days, or 6.664 years; it has been lengthened 104 days since 1851, by the effect of perturbation from the action of Jupiter, the principal disturbance of its motion having taken place in the spring of 1861, when the comet approached the planet within 0.36 of the earth's mean distance from the sun.

TOTAL SOLAR ECLIPSES.—It might be worth while to collect together and discuss the various notices of the total solar eclipses of 1386, January 1, and 1415, June 7, in the same manner that Prof. Schiaparelli and M. Celoria have done with the eclipses of 1239 and 1241. The eclipse of 1415 in particular was a very notable one from the large excess of the moon's augmented diameter over the diameter of the sun; as Baron de Zach states, "plusieurs historiens et presque tous les astronomes en ont parlé." Both eclipses were total at Montpellier, not a common occurrence at a particular place in an interval of only twenty-nine years.

METEOROLOGICAL NOTES

MEAN ATMOSPHERIC PRESSURE IN RUSSIA IN EUROPE.—A paper on this subject, by M. Rikatcheff, appeared some time ago in the *Repertorium fur Meteorologie*. The work is based on monthly averages for various months of years for thirty places in Russia, to which are added the averages for thirty-three places situated in other parts of Europe. A valuable part of the paper is that which gives the details of the observations at each place,

as regards the errors of the instruments employed and the heights above the sea, so far as known. The heights of places not yet determined trigonometrically are approximated to barometrically by a comparison with other stations whose heights are known. From these data the monthly and annual isobars for each millimetre (0.039 inch) are drawn on thirteen maps. It is to be regretted that so much work, characterised not only by general accuracy, but also by an attention to minute accuracy of detail in certain directions, can only be regarded as to a great extent thrown away, at least in so far as regards the inquiry in hand, viz., the representation of the facts of atmospheric pressure in Russia, as that pressure varies by latitude and season, in their relation to configuration of surface and the relative distribution of land and water. The author has failed to see that, in order to give a satisfactory solution of this problem, one of the first requisites is that the observations at the different stations be for the same terms of years, or be reduced to the same terms of years, by the process of differentiation. As regards the thirty Russian stations, the averages are for periods varying from seven to fifty years, and excepting Lugan and Catherinenburg, no two places are for the same terms of years. As regards the months the result of this method of discussion is great unsatisfactoriness. Thus at several places where the averages are only for a few years, they not unfrequently are very different from the isobars which have been drawn for the districts where they are situated. Still further, the anomalous directions of several of the isobars, such as the isobar of 750 millimetres for March, cannot be accounted for by the physical peculiarities of the region traversed by the anomalous portion of the curve; but an examination of the facts suggests that the anomaly is probably due to the simple circumstance that exceptionally high or low monthly means of particular years are included in the averages of some stations, whilst at other neighbouring stations observations were not made during these exceptional months. The annual isobars are necessarily more satisfactory. It may, however, be noted that if allowance be made for the correction for gravity, according to latitude, which has been employed, a correction which for several reasons is objectionable, the annual isobars for Russia are substantially the same as those published by Mr. Buchan, even though these were confessedly a first approximation, giving only the broad features of the distribution of atmospheric pressure over the globe. Much more is now required than this, seeing that the data since acquired would enable us to draw the isobars with a precision sufficient to show not merely their general change of position with season and latitude, but also the exact forms impressed on the curves by their position with reference to large masses of land and water. In solving this problem, what is required from Russia are tables of the monthly means of each year during which observations have been made at each station, corrected for instrumental errors now ascertained—tables, in short, similar to those published by Dr. Buys Ballot for many places in Europe, in the *Annals of the Dutch Meteorological Institute for 1870*.

**METEOROLOGY OF MAURITIUS**—The *Mauritius Meteorological Results and Meteorological Reports for 1874 and 1875*, have been received, which are deserving of special notice from the increased vigour and efficiency with which they show meteorological research to be prosecuted in that part of the globe. In addition to the usual elaborate summaries, the *Results for 1875* contain a noteworthy addition in the form of two Tables, one giving the hourly means of the atmospheric pressure of the months during 1875 deduced from the barograph curves, and the other the same means from the term-day observations made at the observatory from 1853 to 1871. Tables showing the hourly readings for each day were prepared but are not printed in the *Results*. If this be due to want of funds to meet the expense of publication it is to be hoped that the difficulty will be got over in next pub-

lication, on account of the great value of such hourly readings in many meteorological inquiries, but more particularly in connection with the gales and hurricanes of the Indian Ocean, which are so carefully detailed by Dr. Meldrum in the *Results*. The examination of these readings and the hourly observations of the wind could not fail to suggest conclusions of the utmost value in their bearings on systems of storm warnings for tropical countries such as we recently sketched in *NATURE* (vol. xv. p. 261) for the Bay of Bengal. In the *Annual Report for 1875*, it is stated in the course of a discussion on sunspots and rainfall, that since the photoheliograph has been in use at the Observatory the sunspots have been compared with the daily weather, and that, so far as the observations have gone, the results are in conformity with those for longer periods, both the rainfall and the velocity of the wind having been greater when the spots were most numerous. This increase of the velocity of the wind with an increase of sunspots is a point of first importance when viewed in connection with Mr. Lockyer's suggestion that increased sunspot area implies increased solar radiation, with Mr. Blanford's confirmation of this idea from an examination of the results of the solar radiation thermometers in India, and with the result arrived at by Mr. Clement Ley, showing that with like conditions of pressure the wind's velocity is greatest during those months of the year when temperature is highest.

**EXPLORING BALLOONS FOR METEOROLOGICAL PURPOSES.**—Since the beginning of February, M. Secretan, the optician of the Pont-neuf, in Paris, has been sending up regularly every day at noon small exploring balloons for the purpose of ascertaining the direction of the several streams of air and the height of clouds. The results are daily published in the *Petit Moniteur*. The balloons are given gratuitously by the *Grand Magasin du Louvre*, and are of india-rubber filled with pure hydrogen. The diameter is ninety centimetres. M. de Fonvielle finds by calculation and by several experiments, that the mean velocity of elevation is about four metres per second. Hence to obtain the altitude of the clouds it is sufficient to observe the balloon with an opera-glass, to count the number of seconds necessary to lose sight of it owing to the opacity of the clouds, and to multiply the number of seconds by four. It was found that the altitude of clouds varies from 400 to 800 metres, and prospects of fair weather are increased in proportion to the elevation of clouds. The clouds follow the direction of an aerial stream in which they are wholly immersed, and are not placed, as has been repeatedly stated, at the surface of separation. The direction of the air for the first 100 metres is almost always very uncertain and varies according to unknown causes. This shows that anemometers give a very poor idea not only of the velocity but also of the direction of prevailing winds, and that no real progress is to be expected in the knowledge of atmospheric calculation as long as meteorologists confine themselves to taking into account anemometrical observations. Very often two different streams of air are observed, the lower one extending from 100 to 200 or 300 metres; under these circumstances the weather seems to be particularly uncertain and unsettled. Meteorologists, we think, might make use of this method of observation with great advantage.

#### BIOLOGICAL NOTES

**A CHYTRIDIUM WITH TRUE REPRODUCTION.**—Botanists are indebted to Dr. L. Nowakowski for a memoir on *Polypogon rugulosus*, in which they will find recorded for the first time the whole life-history of one of the most interesting of the group of vegetable parasites known as Chytridia. First described in 1855 by Baji, who was a pupil at Breslau of the illustrious F. Cohn, this species has now had all the mysteries of its life cleared up by the researches of Nowakowski, studying at the same university and under the same master. The *Englece* on

which it is parasitic will be well known to microscopists as a group of flagellate Infusoria, at one time found as freely-swimming forms, and at another passing into a resting stage. It is at this period of their existence that the Polyphagus attacks them. The minute spores are furnished with four or more delicate filaments, which project from the body of the spores like rays. One or more of these soon comes into contact with a Euglena, bores through its integument, and penetrates into its protoplasmic contents; it now becomes a haustorium, increases in size, often sends off other filaments, which go on the search for other specimens of Euglenæ; in the meanwhile the body of the spore grows apace, and, if its haustoria be only fairly successful in catching Euglenæ, soon increases to considerable (microscopical) dimensions, and in course develops into a pro-sporangium. Next a little bladder-like projection is seen slowly forcing its way out from this latter, and at last becomes developed into a zoosporangium, from which in time issue the cloud of zoospores, and so after a well-known fashion the vegetative-development of this parasite is carried on. The presence of a true reproduction is, however, the great fact in the memoir. Among the individuals of Polyphagus developing in the inter-spaces of the dead Euglenæ will be found two forms; one larger than the other, and generally spherical in shape, is the female plant; the other, small and more or less club-shaped, is the male plant. From the former there is a tube-like prolongation which passes into a haustorium; from the latter there are several haustoria; these remain thread-like if they encounter no Euglenæ, or enlarge when they do. These two unicellular plants then conjugate, but after a somewhat strange and novel manner. The protoplasmic contents of the female plant project through an opening in the cell wall, forming slowly an oval mass (gonosphere), with the which a haustorium from a neighbouring male plant, coming into contact, there is a coningling of the contents of the two plants, and thereby a zygospore is produced; sometimes these have a quite smooth covering, at other times they are rough, with minute prickles. After a little rest the zygospore develops a zoosporangium, from which issue warm-spores, and the cycle is complete. As the result of these investigations, the author would place the Chytridia forms in the group of the Siphomycetes. It will be observed that though the whole contents of two cells go to form the zygospore, yet that the difference in the size of these cells is very marked, and that the behaviour of the gynocelial cell reminds one of what takes place in a oospore. (Cohn's *Beitrag zur Biol. der Pflanzen*, Bd. ii. Heft 2, 1876.)

CRYPTOGAMIC FLORA OF RUSSIA.—We notice the appearance of the first fasciculus of an important Russian work, by M. Iredinsky, being a Catalogue of Russian Cryptogams. The work will be divided into five parts: Vascular Cryptogams, Musci, Lichens, Fungi, Characeæ, and Algæ, each part to appear in several separate fascicules. The first fasciculus is a description of the Vascular Cryptogams of Southern Russia, Transcaucasia, and the neighbourhood of St. Petersburg. Much valuable material, collected by Russian botanists, is already in the hands of the author, and many members of the St. Petersburg Society of Naturalists have promised to supply him with much additional material for his valuable work.

ALGÆ OF THE GULF OF FINLAND.—At the last meeting, February 28, of the St. Petersburg Society of Naturalists, M. Gobi made an interesting communication on the Algæ of the Gulf of Finland. They are not numerous and have migrated from the Atlantic Ocean. Towards the east the red Algæ become rare, and all diminish in number and size. It must be observed also that the red Algæ of the Gulf of Finland have almost nothing in common with those of the White Sea, which circumstance is an argument against the existence of a former communication between the Baltic and the White Sea advocated by some

geologists, but more and more discountenanced by the latest explorations. Describing in detail the most important forms of red Algæ of the Gulf of Finland, M. Gobi exhibited a complete collection of them, together with a series of drawings and of microscopical plates from the same.

BOTANICAL GEOGRAPHY OF RUSSIA.—The seventh volume of the *Memoirs* of the St. Petersburg Society of Naturalists contains a most valuable contribution to the botanical geography of Russia, by M. Gobi, "On the Influence of the Valdai-plateau on the Geographical Distribution of Plants, with a Sketch of the Flora of the Western Part of Novgorod Government." The author begins with a detailed description of the orography of the region, of its geological structure, its soil and subsoil, its marshes, lakes, &c., and deals at length with the climate of the country. Further, after a review of former botanical works dealing with the same region, he gives a list of plants growing on the plateau (615 Phanerogams). The fourth chapter is devoted to a delineation of the main topographic-botanical subdivisions of the flora; and the fifth is a detailed discussion of the relations existing between the flora of the plateau and those of neighbouring tracts. After some general remarks the author traces here the boundaries of the regions occupied by about fifty plants, which boundary-lines run either across the plateau or along its slopes. The intrusion of these plants from the north, north-east, and south is graphically shown on three maps accompanying the paper.

#### NOTES

WE understand that the Council of the new University College, Bristol, intend shortly to appoint a Principal of the College. We presume that the claims of science will be well considered in the appointment, as the movement to which the college owes its origin took its rise in the desire to found a school of science for the West of England and South Wales. In the interests of the higher scientific and literary education, we hope that the Council may be successful in securing the services of an eminent man for so important a post.

At the monthly meeting of the Council of the University College of Wales, one of the governors present expressed his intention to give 200*l.* a year for three years, to be applied in such form as the Council may deem best in connection with the college for the encouragement of scientific agriculture.

THE President and Fellows of the Chemical Society dined together at Willis's Rooms on Tuesday evening, the company numbering about 200, and including some of the most distinguished names in science. Prof. Huxley, in responding to the toast of the Learned Societies, pointed out that most of the younger London scientific societies are offshoots, or "buds," of the Royal Society; the latter, he maintained, now more than at any other time, needed sympathy and support. Prof. Huxley alluded with some humour to the extraordinary claims put in by some applicants for a share of the government grant, one gentleman alone having asked for 3,000*l.* out of the 4,000*l.* Some of the applicants reminded him of the Irishman who requested government to give him an appointment in any capacity in Church, Army, Navy, or Civil Service, his sole qualifications, the applicant confessed, being an inexhaustible fund of animal spirits and a keen sense of humour.

AN influential meeting was held at the Mansion House on Tuesday in support of the erection of an Imperial Museum for India and the Colonies, to which scheme we have already referred in detail. The proposal met with the warm approval of the meeting, and it was resolved that steps should be taken to move in the matter, and have a building erected on the Thames Embankment, on the site of the now demolished Fife House.

THE *Morning Post* of March 15 contains an article on the present state of the Loan Collection of Scientific Apparatus, and

enumerates a number of collections that after the removal of foreign loans still remain to form the nucleus of a permanent museum. It points out that though the galleries have had to be closed in consequence of packing, the lectures have kept up the continuity of the scheme, and the apparatus forming the subject of the lectures have been brought into the lecture theatre as wanted. It adds, "There seems a fair probability that the nucleus of the permanent collection can be thrown open early in May."

THE obstacles hitherto presented to the medical education of women in England appear suddenly to have collapsed. The enabling Act of last session, introduced by the Right Hon. Russell Gurney, which permitted any licensing body to examine women for its diplomas, was first of all accepted by the Queen's University for Ireland and the Royal College of Physicians for Dublin. The example of these bodies has been speedily followed by the University of London. At a recent meeting the Senate reversed its decision of two years ago, and decided, by a majority of fourteen to eight, to admit women to its medical degrees. Among the majority are found the names of two of the most eminent medical men in London, who supported the motion on the ground that it was the duty of the University to give effect to the resolution arrived at by the Medical Council and by Parliament, that women should not be debarred from entering the profession. Since the matriculation examination is the sole avenue to all degrees in the University, this examination is now thrown open to women who present themselves with the intention of following it up by a course of medical studies. All these concessions to the friends of the medical education of women were, however, but barren victories as long as the hospitals closed their doors against the admission of female students to clinical instruction. Every hospital in London to which a medical school is already attached has refused this permission; and one chance only remained. The Royal Free Hospital in Gray's Inn Road is a general hospital containing the maximum number of beds required by any licensing body, and free from the difficulty of having already attached to it a school of male students. At the instance of the London School of Medicine for Women, the subject was last week brought before the Governing Body of this hospital, and a resolution was unanimously passed that, since they were the only body in London in a position to grant this privilege, it was their duty to throw open their hospital to female students. This decision, due mainly to the untiring exertions of the Treasurer to the London School of Medicine for Women in Henrietta Street, Brunswick Square, the Right Hon. J. Stansfeld, M.P., has only come just in time to prevent the breaking up of that institution. The executive committee of that school, at which regular courses of lectures in the whole curriculum of medical study have now been given for three years, had determined that, unless they could, before the close of this winter session, announce to the students that there was a prospect of solving the hospital difficulty in London, they must close the school in the summer, and recommend the students to go abroad for their clinical studies. The winter session closes next week, and it was only last Saturday that the announcement was made, in consequence of the decision of the Governing Body of the Royal Free Hospital, arrived at the preceding Wednesday. For the purpose of making the necessary arrangements, the Medical School for Women has entered into heavy engagements of a pecuniary nature, to enable them to fulfil which they will require the liberal support of the friends of the movement. With regard to the University of London, it is felt that the present position of admitting women to its medical degrees only, and to no others, is not one that can be permanently sustained; but any further extension of its privileges can only be effected by a new charter, or by an enabling Act similar to that of last session, applicable to all degrees.

PROF. GARROD completed on Tuesday his course of lec-

tures at the Royal Institution on "The Human Form, its Structure in Relation to its Contour." Although some of the lectures have consisted of anatomical details, illustrated with diagrams prepared for a medical school, the attendances have been large in comparison with those of other Royal Institution courses, and ladies have formed more than a half of the audiences. Prof. Garrod's object was to describe the parts of the structure of the body which affect the contour in such natural attitudes as are commonly portrayed in works of art. Several ingenious working models to illustrate the action of different parts of the body were devised especially for these lectures, and a colossal wooden model of a disarticulated human skeleton was also specially prepared.

M. WADDINGTON has appointed M. Maindron a Chevalier of the Legion of Honour for services rendered to science in the capacity of secretary of the French Transit of Venus Commission. A new volume will be issued very shortly by the French Academy.

TUNGSTATE of soda has been much talked about lately as valuable, when mixed with ordinary starch, for rendering muslin dresses unflammable. Prof. Gladstone and Dr. Alder Wright have both brought it before audiences at the Royal Institution, Dr. Wright showing its efficacy by having a muslin dress so prepared for one of his assistants to wear, in which he walked about over flames. In repeating the demonstration in the course of a lecture at South Kensington, on Saturday evening, it was fortunate that Dr. Wright had the dress placed on a dummy instead of being worn by an assistant, for no sooner was a light applied to it than it blazed up and was consumed. Why this happened could not be explained, as it is believed no mistake had been made in the preparation. No doubt the exact conditions under which the tungstate is reliable will be a subject for further investigation.

M. REDIER, barometer maker to the French Association for the Advancement of Science, has devised a barometer for warning miners when the atmospheric pressure is undergoing a sudden depression so that they may be on their guard against fire-damp explosion.

RURAL meteorology is progressing rapidly in France. No fewer than 500 parishes receive by telegraph daily warnings from the observatory. The telegrams summarising the readings taken at seven or eight o'clock in the morning (local time) from Constantinople to Valentia, arrive daily at two o'clock in each parish in connection with the observatory. The number of parishes is being daily increased.

EVERYONE knows that the aneroid barometer is composed of a metallic box exhausted of air and kept in a state of tension by an interior spring. A French optician has conceived the idea of substituting for the spring a weight attached to the exterior by a hook underneath.

IN a forcible article in the *Cape Argus*, for January 23, it is shown how much service could be done to farmers and others by giving them timely warning of approaching unfavourable weather. Such warning can only be based on extensive and carefully collected data, involving work which cannot be done for nothing. The *Argus*, therefore, reasonably urges that it is the duty of the Cape Parliament to provide the means of carrying on work that would undoubtedly benefit the whole colony.

SEVEN warnings have been sent to Europe by the Meteorological Office established by the *New York Herald*, since the end of February. Six of the predicted storms were felt in Paris, having crossed the Atlantic with a velocity somewhat less than had been anticipated.

A BRIGHT violet meteor was observed at St. Etienne on March 11 at two o'clock in the morning, in the southern part of

the horizon. It was travelling with great velocity from west to east. No detonation was heard.

It is stated that on the 5th instant a rather severe earthquake was felt in the districts of Hällsback, Lerback, Bodarne, and Sköllersha, in the county of Nerike, Sweden, a distance of about ten English miles. The shocks were strong enough to shake the houses and make china and even heavier objects tumble down. The earthquake was also felt in the Province of Ostergötland. It is stated also that the island of Mull has been visited by an earthquake, which, although it lasted only a minute, caused much commotion in the island.

THE Sedgwick Prize Essays must be sent in to the Registry on or before October 1, 1879, not as stated in last week's NATURE (p. 439) on or before October 1, 1880. The award is to be made in the Lent Term, 1880.

AT the meeting of the Swedish Academy on February 14, Prof. Nordenskjöld read a paper by Dr. Kjelman, on "The Algæ of the Kara Sea," from which it appears that the sea, contrary to current opinion, is full of algæ, which sometimes attain gigantic sizes. The professor exhibited also photographic views of glaciers of the interior of Greenland, taken in 1870, by M. Berggion. They are true representations of views of the glacial period now prevailing in Greenland.

THE *Stockholm Dagblad* states that recently Prof. Nordenskjöld and the companions of his last travel, Messrs. Kjelman Lundström, Tribom, Stucksberg, and Théel, as well as Mr Oscar Dickson, were entertained by the King of Sweden at dinner, where the question as to Prof. Nordenskjöld's expedition in 1878 was discussed. The king promised to place at Prof. Nordenskjöld's disposal the steamer *Sophia* on the same terms as in 1868, and the pecuniary means for the expedition are promised by Mr. Dickson. The expedition proposes to explore the Arctic Ocean east of the Yenisei as far as Behring's Strait. Some Russian naturalists have applied to Prof. Nordenskjöld to be permitted to take part in the explorations.

PROF. AHLQUIST and students Böhm and Bergroth started on February 24 from Helsingfors on their ethnographical journey to the mouth of the Obi (NATURE, vol. xv., p. 207).

AT the last meeting of the St. Petersburg Society of Naturalists the programme of a botanical excursion to the Fergana province and the Pamir plateau, to be undertaken this year by M. Smirnof, was discussed and agreed to.

WE regret to notice the death of Admiral Sir Edward Belcher whose name is so well known in connection with the Arctic exploration of about a generation ago. Sir Edward was in his seventy-ninth year, and began his naval career sixty-six years ago. He did a great amount of surveying work in various parts of the world. He had almost retired from active work when, in 1852, he was sent out in command of one of the expeditions in search of Sir John Franklin. Although the search was unsuccessful, and the vessel had to be abandoned in 1854, the work done by Sir Edward Belcher was sufficient to win for him a worthy place among Arctic heroes.

WE notice in the seventh volume of the *Memoirs* of the St. Petersburg Society of Naturalists a paper, by M. Alénitzin, on the existence, in the Aralo-Caspian region, of a rise of land in a direction from south-east to north-west, and on the causes of the change of bed of the Amu-darya. Combining some observations relative to the structure of the shores of lakes Aral and Balkhash, the author proves that the south-eastern shores of both lakes have, during the recent geological period, been rising; and he explains by his circumstance the rapid undermining by the Amu of its right bank, at the point where the river turned in former times sharply to the west. This undermining, assisted by a relative rising of

the upper parts of the river, resulted in an excavation of a bed directed to the north. Whatever may be thought of his theories the reader will find in M. Alénitzin's paper interesting information on the structure of the shores of both Central Asian interior seas.

THE same volume contains an interesting note, by Prof. Féofilaktoff, on the diluvial deposits in Kieff and Poltava governments, containing the general results arrived at by the author during his many years' explorations, the details of which will be found in the *Memoirs* of the Kharkof Society of Naturalists for 1874.

THE latest news received by the St. Petersburg Geographical Society from M. Potanin, announces that the expedition was stopped at Khoibo by the arrival of winter. The proposed further route of the expedition is across the great ridge which runs between the Altai and the Khangai, but the masses of snow which usually accumulated in the mountain-passes south of the Djabgan River made any further advance during winter impossible. Staying at Khoibo the expedition will make many important ethnographical observations, and collect information as to the trade of this place. As to Col. Prjevalsky, no news has been received from him, and probably will not for a long time. In November he was at Korleh, on his way to Iob-nor, entering thus on a country which has no communication with Russia. News may be expected only when he returns to Kuldsha, before undertaking his journey to Thibet.

THE secretary of the St. Petersburg Geographical Society announces the return to the capital of M. Wojeikoff from his meteorological journey round the world. The countries he visited last were India, Java, and Japan. The visit to Japan was especially interesting, as M. Wojeikoff made an excursion into a part of the interior never visited before by Europeans, and collected very valuable information as to the Ainos tribe. The observations made during the journey will be the subject of communications to the Geographical Society.

AT a sectional meeting of the Chester Society of Natural Science held last month Mr. J. D. Siddall read a paper on Foraminifera and other Microzoa in neighbouring limestone rocks, during the course of which he announced his discovery of Radiolarians, first, in the Halkin, and afterwards in the Minera limestones. Mr. Siddall had prepared several polished blocks to illustrate his lecture. Two of these showed specimens of beautifully preserved Radiolarians. Other members of this flourishing society have since obtained similar results by following his method of preparing these interesting microscopic objects. In some of the best pieces most of the types to be seen in thin slices of Barbadoes earth are represented, and in as great abundance. This discovery furnishes a capital example of the rewards which sooner or later follow patient scientific investigations. By this discovery Mr. Siddall has thrown back our knowledge of the distribution of Radiolarians in time from Mesozoic, if not from Tertiary, to Palæozoic formations.

THE additions to the Zoological Society's Gardens during the past week include two Orang-outangs (*Simia satyrus*) from Borneo, presented by Dr. R. Sim, F.Z.S.; a Green Monkey (*Cercopithecus callitrichus*) from West Africa, presented by Mr. J. Mason Allen; a Grivet Monkey (*Cercopithecus griseo-viridis*) from North-east Africa, presented by Mr. J. Walter Richardson; a Cape Hyrax (*Hyrax capensis*) from South Africa, a Chinese Blue Magpie (*Urocissa sinensis*) from China, a Red-capped Parrot (*Pionopsitta pileata*) from Brazil, three Red-eared Coureus (*Conurus cruentatus*) from South America, a Sarus Crane (*Grus antigone*) from North India, an Arabian Baboon (*Cynocephalus hamadryas*) from Arabia, purchased; an American Jabiru (*Mycteria americana*) from South America, deposited; a Common Badger (*Meles taxus*), born in the Gardens.

## IRON AND STEEL INSTITUTE

ADDRESS OF THE PRESIDENT, C. WILLIAM SIEMENS, D.C.L.,  
F.R.S.

THE Iron and Steel Institute opened its London Session on Tuesday, and yesterday Dr. C. W. Siemens gave his presidential address.

Dr. Siemens, after referring to the origin and progress of the Institute, touched upon several topics of interest to those connected with the iron and steel industries.

Speaking of Education, Dr. Siemens said:—Intimately connected with the interests of this institution, and with the prosperity of the iron trade, is the subject of technical education. It is not many years since practical knowledge was regarded as the one thing requisite in an iron smelter, whilst theoretical knowledge of the chemical and mechanical principles involved in the operations was viewed with considerable suspicion. The aversion to scientific reasoning upon metallurgical processes extended even to the authors who professed to enlighten us upon these subjects; and we find, in technological works of the early part of the present century, little more than eye-witness accounts of the processes pursued by the operating smelter, and no attempt to reconcile those operations with scientific facts. A great step in advance was made in this country by Dr. Percy, when, in 1864, he published his remarkable "Metallurgy of Iron and Steel." Here we find the gradual processes of iron smelting passed in review, and supported by chemical analyses of the fuel, ores, and fluxing materials employed, and of the metal, slags, and cinder produced in the operation. On the continent of Europe the researches of Ebelmann, and the technological writings of Karsten, Tunner, Gruner, Karl, Akermann, and others, have also contributed largely towards a more rational conception of the processes employed in iron smelting.

It must be conceded to the nations of the Continent of Europe that they were the first to recognise the necessity of technical education, and it has been chiefly in consequence of their increasing competition with the producers of this country, that the attention of the latter has been forcibly drawn to this subject. The only special educational establishment for the metallurgist of Great Britain is the School of Mines. This institution has unquestionably already produced most excellent results in furnishing us with young metallurgists, qualified to make good careers for themselves, and to advance the practical processes of iron making. But it is equally evident that that institution is still susceptible of great improvement, by adding to the branches of knowledge now taught at Jermyn Street, and I cannot help thinking that a step in the wrong direction has recently been made in separating geographically and administratively the instruction in pure chemistry from that in applied chemistry, geology, and mineralogy. If properly supported, the School of Mines might become one of the best and largest institutions of its kind, but it would be an error to suppose that, however successful it might be, it could be made to suffice for the requirements of the whole country. Other similar institutions will have to be opened in provincial centres, and we have an excellent example set us by the town of Manchester, which, in creating its Owens College, has laid the foundation for a technical university, capable of imparting useful knowledge to the technologist of the future.

Technical education is here spoken of in contradistinction to the purely classic and scientific education of the Universities, but it must not be supposed that I would advocate any attempt at comprising in its curriculum a practical working of the processes which the student would have to direct in after-life. This has been attempted at many of the polytechnic schools of the Continent with results decidedly unfavourable to the useful career of the student. The practice taught in such establishments is devoid of the commercial element, and must of necessity be an objectionable practice, engendering conceit in the mind of the student, which will stand in the way of the unbiassed application of his mind to real work. Let technical schools confine themselves to the teaching of those natural sciences which bear upon practice, but let practice itself be taught in the workshop and in the metallurgical works.

After referring to the question of Labour, Dr. Siemens spoke in some detail on that of Fuel. Fuel, in the widest acceptation of the word, may be said to comprise all potential force which we may call into requisition for effecting our purposes of heating and working the materials with which we have to deal, although in a more restricted sense it comprises only those carbonaceous

matters which, in their combustion, yield the heat necessary for working our furnaces, and for raising steam in our boilers.

The form of fuel which possesses the greatest interest for us, the iron smelters of Great Britain of the nineteenth century, is without doubt the accumulation of the solar energy of former ages which is embodied in the form of coal, and it behoves us to inquire what are the stores of this most convenient form of fuel.

Recent inquiry into the distribution of coal in this and other countries has proved that the stores of these invaluable deposits are greater than had at one time been supposed.

I have compiled a table of the coal areas and production of the globe, the figures in which are collected from various sources. It is far from being complete, but will serve us for purposes of comparison.

*The Coal Areas and Annual Coal Production of the Globe.*

	Area in Square Miles	Production in 1874 Tons
Great Britain	11,900	125,070,000
Germany	1,800	46,658,000
United States	192,000	50,000,000
France	1,800	17,060,000
Belgium	900	14,670,000
Austria	1,800	12,280,000
Russia	11,000	1,392,000
Nova Scotia	18,000	1,052,000
Spain	3,000	580,000
Other Countries	28,000	5,007,000
	270,200	274,262,000

This table shows that, roughly, the total area of the discovered coal fields of the world amounts to 270,000 square miles.

It also appears that the total coal deposits of Great Britain compare favourably with those of other European countries; but that both in the United States and in British North America, there exist deposits of extraordinary magnitude, which seem to promise a great future for the New World.

According to the report of the Coal Commissioners, published in 1871, there were then 90,207 million tons of coal available in Great Britain, at depths not greater than 4,000 feet, and in seams not less than 1 foot thick, besides a quantity of concealed coal estimated at 56,273 millions of tons, making a total of 146,480 millions. Since that period, there have been raised 600 millions of tons up to the close of 1875, leaving 145,880 millions of tons, which at the present rate of consumption of nearly 132 millions of tons annually, would last 1,100 years. Statistics show that during the last 20 years there has been a mean annual increase in output of about 34 millions of tons, and a calculation made at this rate of increase would give 250 years as the life of our coalfields.

In comparing however, the above rate of increase with that of population and manufactures, it will be found that the additional coal consumption has not nearly kept pace with the increased demand for the effects of heat, the difference being ascribable to the introduction of economical processes in the application of fuel. In the case of the production of power, the economy effected within the last 20 years exceeds 50 per cent., and a still greater saving has probably been realised in the production of iron and steel within the same period, as may be gathered from the fact that a ton of steel rails can now be produced from the ore with an expenditure not exceeding 50 cwt. of raw coal, whereas a ton of iron rails, 20 years ago, involved an expenditure exceeding 100 cwt. According to Dr. Percy, one large works consumed, in 1859, from 5 to 6 tons of coal per ton of rails. Statistics are unfortunately wanting to guide us respecting these important questions.

Considering the large margin for further improvement regarding almost every application of fuel which can be shown upon theoretical grounds to exist, it seems not unreasonable to conclude that the ratio of increase of population and of output of manufactured goods will be nearly balanced, for many years to come, by the further introduction of economical processes, and that our annual production of coal will remain substantially the same within that period, which under those circumstances will probably be a period of comparatively cheap coal.

The above-mentioned speculation leads to the further conclusion that our coal supply at a workable depth will last for a period far exceeding the shorter estimated period of 250 years, especially if we take into account the probability of fresh discoveries, of which we have had recent instances, particularly in

North Staffordshire, where a large area of coal and blackband ironstone is being opened up, under the auspices of his Grace the Duke of Sutherland, by our member, Mr. Homer.

Dr. Siemens then spoke of Anthracite and the large extent to which it was used in America, of Lignite and Peat, which may be looked on as coal in formation. After referring to natural gaseous fuel he went on to say:—

Although the use of natural gas is not likely to assume very large proportions owing to its rare occurrence, its application at Pittsburg has forcibly reminded me of a project I had occasion to put forward a good many years ago, namely to erect gas producers at the bottom of coal mines, and by the conversion of solid into gaseous fuel, to save entirely the labour of raising and carrying the latter to its destination. The gaseous fuel, in ascending from the bottom of the mine to the bank, would acquire in its ascent (owing to its temperature and low specific gravity), an onward pressure sufficient to propel it through pipes or culverts to a considerable distance, and it would be possible in this way to supply townships with heating gas, not only for use in factories, but, to a great extent, for domestic purposes also. In 1869, a company, in which I took a leading interest, was formed at Birmingham, under the sanction of the Town Council, to supply the town of Birmingham with heating gas at the rate of 6d. per 1,000 cubic feet, but their object was defeated by the existing gas companies, who opposed their bill in Parliament upon the ground that it would interfere with vested interests. I am still satisfied, however, that such a plan could be carried out with great advantage to the public; and although I am no longer specifically interested in the matter, I would gladly lend my aid to those who might be willing to realise the same.

With reference to water power, Dr. Siemens said:—The advantage of utilising water power applies chiefly to continental countries, with large elevated plateaus, such as Sweden and the United States of North America, and it is interesting to contemplate the magnitude of power which is now for the most part lost, but which may be, sooner or later, called into requisition.

Take the Falls of Niagara as a familiar example. The amount of water passing over this fall has been estimated at 100 millions of tons per hour, and its perpendicular descent may be taken at 150 feet, without counting the rapids, which represent a further fall of 150 feet, making a total of 300 feet between lake and lake. But the force represented by the principal fall alone amounts to 16,800,000 horse-power, an amount which, if it had to be produced by steam, would necessitate an expenditure of not less than 266,000,000 tons of coal per annum, taking the consumption of coal at 4 lbs. per horse-power per hour. In other words, all the coal raised throughout the world would barely suffice to produce the amount of power that continually runs to waste at this one great fall. It would not be difficult, indeed, to realise a large proportion of the power so wasted, by means of turbines and water-wheels erected on the shores of the deep river below the falls, supplying them from canals cut along the ledges. But it would be impossible to utilise the power on the spot, the district being devoid of mineral wealth, or other natural inducements for the establishment of factories. In order practically to render available the force of falling water at this and the thousands of other places under analogous conditions, we must devise a practicable means of carrying the power to a distance. Sir William Armstrong has taught us how to carry and utilise water power at a distance, if conveyed through high-pressure mains, and at Schaffhausen, in Switzerland, as well as at some other places on the Continent, it is conveyed by means of quick-working steel ropes passing over large pulleys. By these means, power may be carried to a distance of one or two miles without difficulty. Time will probably reveal to us effectual means of carrying power to great distances, but I cannot refrain from alluding to one which is, in my opinion, worthy of consideration, namely, the electrical conductor. Suppose water power to be employed to give motion to a dynamo-electrical machine—a very powerful electrical current is the result. This may be carried to a great distance, through a large metallic conductor, and there be made to impart motion to electro-magnetic engines to ignite the carbon points of electric lamps, or to effect the separation of metals from their combinations. A copper rod of 3 in. in diameter would be capable of transmitting 1,000 horse-power a distance of say 30 miles, an amount sufficient to supply one quarter of a million candle power which would suffice to illuminate a moderately sized town.

The use of electrical power has sometimes been suggested as

a substitute for steam power, but it should be borne in mind that so long as the electric power depends upon a galvanic battery, it must be much more costly than steam power, inasmuch as the combustible consumed in the battery is zinc, a substance necessarily much more expensive than coal; but this question assumes a totally different aspect if in the production of the electric current a natural force is used which could not otherwise be rendered available.

Dr. Siemens then went on to speak of the processes of manufacture, sketching briefly the history of the improvements in these processes, and concluded by referring to the various applications of steel. Speaking of the means of preserving iron and steel from rust, he referred to Prof. Barff's recently discovered process. This consists in exposing the metallic surfaces, while heated to redness, to the action of superheated steam, thus producing upon their surface the magnetic oxide of iron, which, unlike common rust, possesses the characteristic of permanency, and adheres closely to the metallic surface below. In this respect it is analogous to zinc oxide adhering to and protecting metallic zinc, with this further advantage in its favour, that the magnetic oxide is practically insoluble in sea water and other weak saline solutions.

Dr. Siemens concluded his valuable address by urging upon the Institute, now that it has attained to such importance, to obtain recognition in official quarters and to become possessed of a habitation in a central position, and in such a building as would serve the societies devoted to applied science in the same way that Burlington House does those devoted to pure science.

## SOCIETIES AND ACADEMIES

LONDON

Mathematical Society, March 8.—Mr. C. W. Merrifield, F.R.S., vice-president, in the chair.—The following communications were made:—On a new view of the Pascal hexagram, by Mr. T. Cottenil. In a system of co-planar points, the number of intersections of two chords is a multiple of 3. In the case of the hexagram the forty-five points thus derived are divided into four sets of triangles—(1) The three intersections of the chords joining four points form a triad self-conjugate to the conics through the four points. (2) Any three non-conterminous chords intersect in three points, forming a diagonal triangle. In each of these two cases, a derived point determines uniquely its corresponding triad, the number of triads being fifteen. (3) An inscribed triangle determines an opposite inscribed triangle; the three intersections of the pairs of sides supposed to correspond form a triangle, the intersections of two inscribed triangles, the nine intersections of the two triangles forming an ennead. (4) The three intersections of the opposite sides of a hexagon of the system form a Pascal triangle. The number of triangles in each of the two last cases is sixty; to each triangle of one set corresponding a triangle of the other, as well as a triad of the second set, the nine points forming three triads of the first set. Denoting, then, the primitive points by italics and fifteen of the derived points (no two of which are conjugate) by Greek letters, we obtain all the derived points by accenting once and twice the Greek letters to form self-conjugate triads. Tables are then formed in matrices of the nine chords joining the vertices of two opposite triangles and their eighteen intersections, found to consist of six triangles of each of the second and fourth sets. To these corresponds a matrix containing the nine intersections of the two triangles. In the case of a conic hexagram, the properties of the sixty points of intersection of chords with the tangents at the conic points are then examined.—On a class of integers expressible as the sum of two integral squares, by Mr. T. Muir. [The class of integers considered included those whose square root, when expressed as a continued fraction, has two middle terms in the cycle of partial denominators. A general expression was given for all such integers, and an equivalent expression in the form of the sum of two squares.]—Some properties of the double-theta functions, by Prof. Cayley, F.R.S. (founded on papers by Goepel and Rosenhain).—A property of an envelope, by Mr. J. J. Walker.

Chemical Society, March 15.—Prof. Abel, F.R.S., president, in the chair.—The secretary read a paper by Dr. W. A. Tilden and Mr. W. A. Shenstone, on isomeric nitroso terpenes, being a further contribution to Dr. Tilden's previous researches on these compounds. This was followed by a communication

entitled "Preparation of Copper-zinc Couples," by Dr J H Gladstone, and Mr A. Tribe, which was experimentally illustrated; it gave the details of the experiments made to ascertain the conditions for the preparation of a couple of maximum activity. The other papers were on chromium pig iron, by Mr F Riley; a note on gardenin, by Dr J Stenhouse and Mr C E. Groves; two papers by Mr M M P Mr entitled "Additional Note on a process for estimating Bismuth volumetrically," and "On certain Bismuth Compounds," Part IV, and a note by Dr. M. Simpson and Mr C. ( ) Keffe, on the determination of urea by means of hypobromite.

Victoria (Philosophical) Institute, February 5—Dr C. Brooke, FRS, in the chair—A paper was read by Prof. Brks, of Cambridge, on "The Bible and Modern Astronomy."

GENEVA

Physical and Natural History Society, January 15—M. Ernest Lavre read a paper on the question of the origin of the gravels which are found in the portion of the Alps under the glacial soil, and which are known as the old alluvium. This is formed in the vicinity of the ancient glacier, as is proved by the following facts. (1) The presence of glacial soil in two localities in the neighbourhood of Geneva, in the very interior of the alluvium, at several metres under the great glacial sheet, (2) the very different heights at which the alluvium is deposited in the interior of the same basin, (3) the fact that it is formed of the same elements, large pebbles and fossil sand at whatever distance it is observed from the foot of the Alps—the disappearance of these depôts begins the limit of the ancient glaciers—M. Philippe Plantamour has undertaken observations on the variations of the level of the Lake of Geneva, similar to those of Prof I. A. Forel at Morges. They confirm the theory of the perpetual oscillation to which the surface of the water is subject, as shown by Dr. Forel, and which lasts about an hour and a quarter in the longitudinal direction. The variations of level, or sea level, are much greater in the neighbourhood of Geneva, at the western extremity of the lake than at Morges, a little beyond the middle of its length towards the east, and they are in the opposite direction. A registering limnimeter, which is to be erected by M. Ph. Plantamour, will permit of following with a new facility the phases of the phenomenon, and of comparing them with those which occur at Morges.

PARIS

Academy of Sciences, March 12—M. Peligot in the chair—The following papers were read. Theorems relative to series of isoperimetric triangles which have on one side of constant size, and satisfy three other diverse conditions, by M. Charles—Influence of pressure on chemical phenomena, by M. Berthelot. He cites an experiment of Quincke's showing that the liberation of hydrogen from zinc and sulphuric acid is not stopped by pressure of the gas, but only retarded. It goes on so long as there is acid to saturate or zinc to dissolve—On a metallic iron found at Santa Catarina (Brazil), by M. Damour. This is supposed of meteoric origin. The small quantities of carbon (0.0020) and silicon (0.0001) in it are like those of the best qualities of iron obtained in industry, while the proportion of nickel (0.3397) considerably exceeds that of meteoric iron hitherto known. To this latter is doubtless due its resistance to oxidation in moist air and to the action of dilute sulphuric and hydrochloric acids. M. Boussingault stated he had had cast in his laboratory 62 per cent steel and 38 nickel. A polished face of the alloy did not rust in contact with air and water. Of the filings two or three grains took rust, merely showing the alloy was not entirely homogeneous. Alloys with 5, 10, or 15 per cent nickel oxidised rapidly—Observations on the native iron of Santa Catarina and on the pyrrhotine and magnetite associated with it, by M. Dauriac. The masses, when at a high temperature, seem to have been subjected to oxidising action of air or water, which action penetrated into the interior by very fine fissures—On the maintenance of constant temperatures; second note by M. D'Arsonval. He heats the apparatus by means of a thermo-siphon, and the size of the regulator is to proportion the activity of the circulation to the causes of loss. Thus the fire may be of any strength; it gives its heat to a liquid which distributes it as the regulator allows.—On the annual aberration and annual parallax of stars, by M. Kericuff. He corrects some mistakes in the formulæ made for these.—Applications of a theorem comprising the two principles of the mechanical theory of heat, by M. Levy.—On the periodicity of solar spots, by M. Wolf. In a brochure he

gives not only all the epochs of maxima and minima since the discovery of the spots, but, for a century and a quarter, by means of a relative number, the monthly energy of the phenomenon. He shows by curves the average course of the phenomena and anomalies, also the indices of a great period embracing sixteen small periods of eleven and a half years, or nearly 168 years—Measurements of the calorific intensity of the solar radiations received at the surface of the ground, by M. Crova. He calculates that on January 4, 1876, the heat received on a square centimetre at right angles to the direction of the sun's rays from sunrise to sunset, would be 535.0 cal., that on the surface of the ground 161.2 cal., for July 11, 1876, the corresponding numbers are 876.4 cal. and 574.1 cal. The heat received at right angles on January 4 is 0.610 of that on July 11, the heat received on the surface of the ground on January 4 is 0.281 of that on July 11—Metals which accompany iron, by M. Terrel. Their proportions are small they rarely amount to five thousandths, whereas, in native or meteoric iron, they may be ten per cent. They are chiefly manganese, nickel, cobalt, and chromium, while copper, vanadium, titanium and tungsten occur accidentally—Chemical study of mistletoe, (*Viscum album*, L.), by MM. Grindeau and Bouton. *Inula alba*, the composition of the stem is very near that of the leaves, and the composition of the mistletoe of different species is widely different. As to nutritive value, the mistletoe of the oak takes rank with meadow grass of good quality or red clover, the leaves of the mistletoe of the corn and pear trees have equal value with good hay or aftermath, while their branches may be compared to the straw of leguminous plants or the husks of cereals.—On the electrotonic state in the case of unipolar excitation of the nerves, by MM. Moit and Jousant. When the positive pole is applied to the nerve, the current is divergent, from the middle of the nerve it goes towards the two extremities. It thus in the two ends contrary to the proper current of the nerve; hence the negative phase of the electrotonic state. If the negative pole is applied, the battery current converges towards the middle, and is in the same direction with the proper current, which it increases (positive phase of the electrotonic state).—Acute poisoning by acetate of copper, by M. Feltz and Ritter. It is more active than sulphate. The disorders are more intense and long in fasting animals. One could not swallow the substance in food or drink without perceiving the taste. On the value of certain arguments of transformism, taken from the evolution of the dental follicle in mammals, by M. Palkiewicz. In these animals there is nothing at all like germs of canines and incisors, as Goodson affirmed.—On the unity of the forces in geology, by M. Hermite.—On the crevasses of the circuleous system, by M. Robert.

CONTENTS

	PAGE
BRITISH MANUFACTURED IRON RINGS	443
THE CEFM ILLUSTRATIONS	446
OUR BOOKSHELF—	
King's Manual of Cutch and Cultivation in India	448
Reyer. The Eugenic and Climatological Vilkanes	448
Vor Hellwald's Die Erde und ihre Völkern an geographischen	447
Hausbuch	447
LETTERS TO THE EDITOR—	
Science Fellowship at Oxford—SOCIETY	447
Spectra of Metals—Dr ARTHUR SCHUSTER	447
The Annual Publication of the Committee for Meteorology	447
Centralism in Spectroscopy—Prof PIAZZI SMITH	447
Greenwich and Meteorological Observatory—ALEXANDER BRICHAN	447
Atmospheric Currents—REV W CLEMENT IREY	447
Electrical Phenomenon—Prof GEORGE FORBES	447
Strange Star—Meteor—W M	447
SCIENCE IN GERMANY	447
DAHERITIS EXPEDITION IN THE PENINSULA NEW GUINEA	447
THE PHYSIOLOGICAL ACTION OF LIGHT II. By Prof DEWAR, F.R.S.	447
(With Illustrations)	447
ASTRONOMICAL BIBLIOGRAPHIES	447
MINORITIC'S RESEARCH ON MATHEMATICS LAW. By Prof Dr	447
MENDLER	447
OUR ASTRONOMICAL COLUMN—	
The Suspected Intra-Mercurial Planet	447
D'Arrest's Comet	447
Total Solar Eclipses	447
METEOROLOGICAL NOTES—	
Mean Atmospheric Pressure in Russia in Europe	447
Meteorology of Mauritius	447
Exploring Balloons for Meteorological Purposes	447
BIOLOGICAL NOTES—	
A Chytridium with True Reproduction	447
Cryptogamic Flora of Russia	447
Algae of the Gulf of Finland	447
Botanical Geography of Russia	447
NOTES	447
IRON AND STEEL INSTITUTE	447
SOCIETIES AND ACADEMIES	447



THURSDAY, MARCH 29, 1877

## PALMÉN ON THE MIGRATION OF BIRDS

*Ueber die Zugstrassen der Vögel.* Von J. A. Palmén, Docent der Zoologie an der Universität Helsingfors. Mit einer lithographirten Tafel. (Leipzig: Engelmann, 1876.)

GRANTING it to be true that truth never dies, it is undeniable that error is hard to kill. A notable instance of this last assertion is furnished by the infatuation which possesses so many people, otherwise, perhaps, not unreasoning, to believe that more or fewer of the birds which commonly frequent these islands in summer, pass the winter in a torpid state—"hibernate," as they are pleased to say. Vainly have travellers or residents on the shores of the Mediterranean, or in the interior of Africa, told us over and over again, how that as the hot weather comes to an end with us, our cuckoos, our swifts, our swallows—nay, almost all our summer birds come crowding southwards. As vainly have the same observers recorded the northward journeys of the same species, though under somewhat different conditions, on the approach of our spring. Of course, no one who merits the title of an ornithologist disregards the plain evidence thus afforded, or entertains a single doubt as to what it proves—however strongly he may recognise the fact that we know little of the paths taken by the migrants, and next to nothing of the faculty whereby they ordinarily reach their ancestral summer-home. But there are not a few persons enjoying among the vulgar of all classes the reputation of being ornithological authorities, and there are thousands of the general public, who still hanker after the ancient faith in "hibernation." It may be said that it is but lost labour to attempt to bring such people to reason, and so, possibly, it is. Still, the apparent gravity with which this absurd notion is from time to time propounded, renders it necessary that its folly should be as often exposed, lest the pertinacity with which it is urged gain for it adherents among those who think that, as they encounter no refutation of it, it may or must be true, and the testimony in its support unanswerable. As a rule, there seems to be an outbreak of the "hibernation" mania every two years or so. It nearly always presents the same essential features. Some one, who with the multitude passes for an ornithologist, sends to a newspaper a second or third-hand story of some nameless person who in some nameless place found a number of torpid swallows in the chink of a chalk-pit, or a drowsy land-rail in a haystack—or, on a log of wood being laid on the fire, of a cuckoo that woke from its slumber and, emerging from its retreat, sat on the hob, regardless of its singed plumage and cheerfully singing its accustomed song. Occasionally a brilliant imagination, and the desire of supplying some grateful novelty suggests a diversion of the details, and the swallows are dragged from a horse-pond in a casting-net, or have got themselves into an eclopot—or the cuckoo is discovered as the billets are being split. The story, which can be fairly compared with the tales of witches' imps, and of our dear old friend the antediluvian toad-in-a-hole, is repeated in many newspapers, and countless correspondents write letters to their respec-

tive "organs," citing parallel cases of which they have heard from their grandmothers, and wonder why "Professor" Darwin, Mr. Buckland, or the great "Doctor" Owen, do not favour the public with their views on the matter.

A delightful example of all this occurred not many weeks since, and one, moreover, marked by so much originality of conception as to reveal the hand of a master. A reverend gentleman published the evidence of a friend's friend, or that friend's friend's friend (there was a charming uncertainty on this point, and the final friend was of course nameless), who watched "a brood of young swallows too weakly to be able to follow their parents in their migration." (Here it is to be observed that the "hibernation" advocates of late years don't deny migration *in toto*, and that, as explained by the reverend storyteller, the "swallows must have been martins!") "So the old birds left them in their nests and plastered them up with mud." To cut the story short, it is enough to observe that the ingenious and considerate parents were (as they expected) rewarded, on their return next spring, by finding their offspring "none the worse for their six months' incarceration," and after this happy ending to the tale had been told, the sympathies of the British public were duly roused, and the "hibernation" mania was ready to run its usual course. On this occasion, however, its symptoms were more pronounced than usual, and a philosophical contemporary of ours, always prone to the analysis of conduct—perhaps also seeing in the story a fresh argument against experiments on live animals—hastened to record the story among the news of the week, though admitting that it was "not much in the way of evidence." This admission, however, was prefaced by the very curious statement that "It is at least quite conceivable that a creature which had been a hibernator generations ago, and which had since discovered the preferability of migration to a warmer climate, should yet be able to return to its old habit in case of need." This remark might be allowed to pass if it had only been proved that any bird, since birds ceased to be reptiles, ever had been a "hibernator." As that is not the case it may be sent instantly to the limbo of false hypotheses. Still the admission roused the remonstrances of a correspondent of the same journal, for he not only "was inclined to think" the story "authentic," but adduced in its support an agreeable variation of the fable. His gardener had assured him "that he had himself seen what he described, 'layers of young swallows in a hibernating state, when, taking up the flooring of some house in that parish [Thorpe Arch] during winter.' *O fortunatos nimium!* What sights bless the eyes of gardeners! Layers of young swallows under our boards or bricks! How were the rats and mice kept from feasting on their tender bodies? And then if one did happen to die before the day of release, how sweet would be that superimposed chamber! Inviting as the theme is, we must leave it to record the further progress of this maniacal outbreak.

The next portion of our history introduces us to a new world and to a family of birds never before accused of "hibernating." A second correspondent of the same journal, writing under the honoured initials "R. N.," spins a yarn, fit for the fo'castle (if there happen to be an audience of marines), and tells how humming-birds at

Port Montt (*sic*) pass the winter in hollow trees, and are often brought into the houses cold and stiff, perfectly dormant, and yet when revived by the warmth, able to fly about the room. They only need a refrigerating ship to be brought to, and "acclimatised" in, Ireland, or kept at the Crystal Palace. This is "R. N.'s" idea, not ours, but he makes it, we doubt not, in all sincerity. We now fully expect that the next bird charged with "hibernating" will be an ostrich. The phoenix, if he could be found, would certainly not be safe, but then he is dormant already. Even now it is perhaps not too late to injure the reputation of the dodo, and announce that a Rip van Winkle of the species has been "hibernating," like a tœtec, in some secluded rift of the rocks in Mauritius.

That truth will prevail in due time there can be no doubt, and these tales of "hibernation" will serve to amuse future generations, even as that marvellous and circumstantial account of the evolution of Bernacle-geese from shell-fishes now causes mirth to us—mirth mingled with regret at the stupid credulity of our quasi-scientific forefathers. Yet hardly so. It would be an injustice to the venerable Gerard to put on a par with him these story-tellers of to-day. The old herbalist had but little light, but what little light he had he did not neglect. Our contemporaries shut their eyes and ears to that which is before them. Their wilful ignorance is absolutely criminal, therefore shall they receive greater condemnation. If any of them is open to conviction, let him reflect on this single fact. The young cuckoo, when we last see it in autumn, is clad in a plumage of reddish-brown or liver-colour. When cuckoos reappear in spring, they are, almost without exception, in their proverbial "grey." It is obvious, then, either that the young birds have moulted in the meanwhile, or else they have perished in the process of "hibernation." This latter alternative would soon put an end to the species, and cannot for a moment be entertained. But as regards the former, every physiologist will agree that while an animal is torpid, all growth is suspended—yet on the "hibernation" theory, these young cuckoos must have put off their nestling feathers, and grown those characteristic of maturity, during the time when nearly all the animal functions are at rest. Therefore it simply stands that "hibernation" in the case of the cuckoo is an impossibility. The same, too, with swallows. It is known that they renew their feathers about Christmas. The plumage of the young swallow in its first autumn does not differ so strikingly from that of the adult, as it does in the cuckoo, but any one pretending to ornithological knowledge, must know that the swallow of the preceding year can be equally declared to have changed its feathers since the last autumn, and indeed the fact of this winter-moult has been observed in caged birds, and recorded many years since by Mr. James Pearson, whose account, verified by Sir John Trevelyan, was published by Bewick eighty years ago ("Land Birds," p. 249, Ed. 1797). Hence it follows that neither swallows nor cuckoos—thus moulting in the winter months—do, as has been asserted, "hibernate."

It is indeed somewhat humiliating to be at this day refuting an error which has been so often refuted before, but necessity knows no law, and the widely-spread fallacy creates the necessity. Furthermore, this protest against the sciolism of the age has led us away from our parti-

cular object, which is to notice the remarkably careful and painstaking work of Herr Palmén, originally published in Swedish in 1874, and now appearing in a German translation, which will have many more readers. This treatise does not indeed (as will be seen from its title) profess to treat of more than one branch of the migration question. Its scope is properly limited to a consideration of the routes taken by birds of passage in their migration; but on that account it is none the less a valuable contribution to the already extensive literature of the subject, and in this German version the author appends some remarks of more general interest. He seems to have availed himself of all the information, as to his main point, that he could collect, and the wonder, perhaps, is that, living in Finland, he has been able to amass so much. His work is weak, it must be confessed, in detail as to the migratory birds of our own islands, but, as we think, from no fault of his own, since most of those who delight to consider themselves "British Ornithologists" are content to stand on the ancient ways of their forefathers, and to disregard everything that happens beyond the "silver streak" as entirely as if it belonged to another planet. Thus we doubt much if he would have greatly gained by studying the various contributions to "British" ornithology that have appeared since 1856, when the last edition of Garrell's standard work was completed. We must, however, hold that Herr Palmén's assignment of routes to the migratory birds of North-Western Europe is almost purely conjectural. We do not say it is erroneous—far from that. There is much in it which will very likely be proved true whenever British ornithological observers shall be at the pains to observe to some purpose; but, at present, his views can, from the nature of the case, be only accepted provisionally. He has far different and more solid ground to go upon when he treats of the migratory birds of Eastern Europe, and especially of the Russian Empire—whether European or Asiatic, and every ornithologist owes Herr Palmén a debt of gratitude for the compendious abstract he gives from the mighty works of Pallas's successors, and notably from those of Dr. von Middendorff.

As regards the routes taken by the migratory birds of the Palearctic region, Herr Palmén's investigations have been so concisely summed up by a recent writer in the last edition of the "Encyclopædia Britannica" (iii. p. 768) that we take the liberty of here transcribing them as there given. These main routes are said to be *nine* in number:—

"The first (A—to use his notation), leaving the Siberian shores of the Polar Sea, Nova Zembla, and the North of Russia, passes down the west coast of Norway to the North Sea and the British Islands. The second (B), proceeding from Spitsbergen and the adjoining islands, follows much the same course, but is prolonged past France, Spain, and Portugal to the west coast of Africa. The third (C) starts from Northern Russia, and, threading the White Sea, and the great Lakes of Onega and Ladoga, skirts the Gulf of Finland and the southern part of the Baltic to Holstein and so to Holland, where it divides—one branch uniting with the second main route (B), while the other, running up the valley of the Rhine and crossing to that of the Rhone, splits up on reaching the Mediterranean, where one path passes down the western coast of Italy and Sicily, a second takes the line by Corsica and Sardinia, and a third follows the south coast of France and eastern coast of Spain—all three

paths ending in North Africa. The fourth (D), fifth (E), and sixth (F) main routes depart from the extreme north of Siberia. The fourth (D) ascending the river Ob, branches out near Tobolsk—one track, diverging to the Volga, descends that river and so passes to the Sea of Azov, the Black Sea, and thence by the Bosphorus and Ægean, to Egypt; another track makes for the Caspian by way of the Ural River and so leads to the Persian Gulf, while two more are lost sight of on the steppes. The fifth (E) mounts the Jenneisei to Lake Baikal and so passes into Mongolia. The sixth (F) ascends the Lena and striking the Upper Amoor reaches the Sea of Japan, where it coalesces with the seventh (G) and eighth (O) which run from the eastern portion of Siberia and Kamchatka. Besides these the ninth (X) starting from Greenland and Iceland, passes by the Færoes to the British Islands and so joining the second (B) and third (C), runs down the French coast."

All these routes are plainly laid down on the map which accompanies the work, and in the absence of more precise information, it will hardly be in the power of any British ornithologist to dispute them, though, as before stated, we must hold them to be in a great measure conjectural. In the following chapters the author shows how necessary it is to know the principal routes taken by birds in their migrations before we can understand or reason intelligibly on their movements, and of very great interest are his remarks on the Genetic Import of Regular and Irregular Lines of Travel, and on the So-called Migratory Instinct (chaps. ix. and x.), greatly amplified in the German version from the brief paragraphs which represent them in the Swedish original. They are, however, it must be confessed, somewhat verbose; but, for all that, they are well worth reading. Though Herr Palmén refers to an article which appeared in these columns some years ago (NATURE, vol. x. p. 415), he does not seem to be aware of the theory subsequently propounded by Mr. Wallace (vol. x. p. 459) as to the possible or probable origin of migratory habits, wherein is expressed, in far fewer words than his own, what appears to be essentially the same thing. For "Migratory Instinct" Herr Palmén substitutes "Experience" as the piloting power, and though there is much to be said in favour of this explanation in many cases, others there are in which it seems to break down utterly. How do the young cuckoos which stay in this country a month or six weeks after their parents (whom, let us remember, they have never known) have departed find their way to Africa? And how do the scores, hundreds, or thousands of rapacious and wading birds, whose elders do not accompany them, manage in their autumnal journeys to arrive more or less punctually at the spot which countless generations of their predecessors have reached before them? They have had no "experience," and though doubtless many perish by the way, a very large proportion year after year hit off exactly, and at the first intention, the ancestral landing-place. What, also, can "experience," which, after all, means only a knowledge of landmarks, do for the species which travel by night, as seems to be the habit of very many birds, or for those which, like at least two of the annual visitants to New Zealand, traverse a waste of waters? At present no solution of the mystery offers itself, at present such knowledge may be too wonderful for us; but, high as it is, our faith in the progress of science forbids us to say that we cannot attain unto it.

### OUR BOOK SHELF

*Dynamics; or, Theoretical Mechanics, in Accordance with the Syllabus of the Science and Art Department.* By J. T. Bottomley, M.A., F.R.S.E., F.C.S. (London and Glasgow: William Collins, Sons, and Co., 1877.)

THIS little text-book is issued by Messrs. Collins as one of their Elementary Science Series, and will prove useful to beginners, by rendering them familiar, at an early stage of their studies, with the more precise definitions and nomenclature which have been introduced by modern writers on dynamics. The distinction, for instance, between the centre of gravity and the centre of inertia is much more clearly pointed out than is usual in elementary works, and the statement that "there is only a limited number of classes of bodies that possess a centre of gravity" will probably be read by many with surprise. The measurement, composition, and resolution of velocities are treated of in the chapter preceding that on force, and the methods of measuring forces in terms either of gravitation units or absolute units are well and fully discussed. The definition of work given in the last chapter might, we think, be amended. As it stands at present it might lead the student to suppose that no work is done by an agent moving a body, unless the motion is created in opposition to a resisting force, though the language employed in some of the examples would be sufficient to correct such a supposition. Throughout the work the author assists the student to obtain "clear physical conceptions regarding the first principles of dynamics," by frequently directing his attention to the experimental proofs of the various laws he enunciates, and by hinting at the physical, rather than the mathematical, developments of his subject.

On these grounds, we have formed a very favourable opinion of Mr. Bottomley's work, and we have no doubt that it will meet with the success it deserves among a wider class of students than that for which it is specially designed.

A. R.

### LETTERS TO THE EDITOR

[The Editor does not hold himself responsible for opinions expressed by his correspondents. Neither can he undertake to return, or to correspond with the writers of, rejected manuscripts. No notice is taken of anonymous communications.]

#### Evolution and the Vegetable Kingdom

MR. CARRUTHERS has embodied in the *Contemporary Review* the substance of his Presidential addresses to the Geologists' Association, on which we would offer a few points for consideration.

Although not agreeing with Mr. Carruthers as to the inferences to be drawn from the present state of our knowledge of fossil vegetable remains, we cannot but admire the earnestness with which he makes a stand in what we regard as a losing cause. We set a high value on his researches in fossil botany, and his work is characterised by unvarying and careful exactitude. Whatever may be his theories, his reputation will rest on a solid basis of work. Palæontologists have to thank him for unvarying kindness and readiness to aid them in their researches, forming a marked exception to the treatment which botanists usually give the subject.

In discussing this question, we must keep well in mind the teaching of Sir Charles Lyell, first as to the insufficiency of the geological record, especially with regard to land-surfaces. Considering the denudation and the wasting action of the waves to which remnants of terrestrial conditions are exposed during the slow process of their submergence beneath the sea, and again during their gradual upheaval, it is surprising to us not that so few records are preserved, but that any vestiges whatever remain. Secondly, with regard to lapse of time, we must get the "chill of poverty out of our bones," and not misinterpret "the sign of successive events, and conclude that thousands of years were implied where the language of nature imports millions." Mr. Carruthers admits the imperfection of the geological record, although scarcely with sufficient emphasis, and compares its fragmentary condition to a tablet containing

the remains of an unknown inscription represented by only a few of its numerous letters, each of which occupies its proper relative position to the known and unknown letters of the inscription. This is hardly a happy simile as the relative ages of the beds and strata containing vegetable remains, scattered over the world, are certainly very far from settled, and their correlative sequence is in numerous instances still the subject of great discussion. The relative position of these letters is therefore at present but vaguely known.

Haeckel supposes "that the sub-marine forests of the primordial period were formed by the huge brown algae or fucoidae." In the 70,000 feet of sedimentary rocks, from the Laurentian to the Devonian, beds of carbon and graphite are abundant; the only known vegetation throughout that period is of algae. So far only Mr. Carruthers agrees with Haeckel; from this point his views diverge. During the period of the deposition of these 70,000 feet, time enough surely elapsed (if time only be required) for the evolution of vascular cryptogams from algae. In the Silurian had vegetation been equally fitted to resist decay, we should probably have had plant evolution indicated side by side with that of animals. Before leaving the subject of algae, we must differ from Mr. Carruthers, who says that if rich florae had existed, the limestones of the Llandovery rocks at Malvern would have preserved them. In these marine rocks at the most sea-weeds, could be expected, and limestone of whatever age do not usually preserve such traces; but we know that florae existed by the carbon and graphite before-mentioned.

Mr. Carruthers urges what he considers as fatal objections to the doctrine of evolution; his arguments may be briefly stated as follows:—

1. The simultaneous appearance of the three principal groups of vascular cryptogams, even in a more highly organised condition than their living representatives.

2. The early appearance of gymnosperms and the want of connecting links between these and the lycopods from which they are supposed to have been developed.

3. The early appearance of monocotyledons.

4. The sudden appearance of dicotyledons, not only in the lower form as *Apetala*, but also as *Dialypetala* and *Gamopetala*.

5. The persistence in specific character of *Salix polaris* from the glacial period until now and over a wide range.

Let us now see on what facts these objections are founded, and whether the facts are not open to other interpretations.

1. The evolution theory requires that lower groups have developed until the amount of organisation was reached required to enable them to fulfil the conditions under which they live, and to occupy vacant ground in the economy of nature. This required amount of development may be more or less quickly attained, and the development of the organism then remains almost stationary. Side by side with this development, other development goes on unceasingly, leading to the gradual evolution of entirely different and more highly organised forms. The cryptogams are paralleled amongst vertebrates by the early and specialised development of reptilia; amongst crustacea by trilobites, &c. In like way the tetrabranchiate cephalopods, the brachiopods, and numerous other mollusca, whose hard shells resisting decay, have enabled us to trace their life history, have come down to the present time, just as these vascular cryptogams have, not in their most complex and differentiated forms. We do not expect to find sustained progressive development in the lower animal and vegetable groups, and are not surprised at evidence of actual reversion.

2. On their first appearance "the Gymnosperms do not," Mr. Carruthers says, "present a generalised type, but a remarkable variety of genera and species, all as highly differentiated as any of the existing forms." Now if this is absolutely the case, and their first appearance in life is coincident with their first appearance in the fossil record, there is no doubt that they were specially created, and there is no need of further argument. But the point not yet proved is that the two are coincident. The occurrence of conifers in the Devonian is only known by wood with coniferous structure. The fruit and foliage, if known, might possibly afford an indication of the mode in which their course of evolution, as suggested by Haeckel, had taken place. Unger has described anomalous woods from Thuringian rocks of Devonian age. "Had these been of earlier age than Miller's Cromarty wood they might have been looked upon as one of the steps leading up to the true Coniferous structure." These may yet be looked on as steps, for the relative age of these Devonian rocks is still to be fixed. This occurrence of anomalous wood is at all events not to be overlooked, if, as is stated, the gymnosperms both structurally and

embryologically form the transition group from ferns to angiosperms. The occurrence of Coniferous wood in Devonian rocks rather shows how great are the gaps to be filled up, and that the evolution of the gymnosperms commenced at an earlier period than was supposed, during the formation of the great carbon layers of the older rocks, and side by side with the development of ferns and lycopods. The common ancestors of the spore-producing lycopod and the seed-bearing gymnosperm are to be sought in remoter times even than the Devonian. There is no evidence that the Devonian woods were those of the higher and dicocious conifers and that conifers first appeared in this form. Little is really known of the earlier coniferæ, but the cycads—the lowest form, and most nearly allied to ferns—were far more abundant formerly than at present. Schimper writes as follows:—"What form the prototype of our conifers took in carboniferous times is not satisfactorily settled, neither fruit nor foliage having been discovered which could be placed in any order with certainty. The few fragments placed in *Abietina* may belong to *Lepidodendron*." In the Permian rocks conifers are abundant.

3. Concerning the appearance of Monocotyledons at the base of the Trias, the first true monocotyledon, Mr. Carruthers states, is the stem and spike of an aroideous plant from the lowest carboniferous strata near Edinburgh.<sup>2</sup> Recently a number of additional specimens have come to light, but Mr. Etheridge, junior, who is referred to by Mr. Carruthers as having found them, does not we believe regard them to be monocotyledons at all; and in this view, although we have not examined them, we are inclined to concur, because it seems unlikely that so many spikes should be found without foliage. In the *Transactions of the Botanical Society of Edinburgh*, vol. xii. p. 152, Mr. Etheridge points out that the stem of *Pothocites* was branched, and what was thought by Paterson to be the remains of a deciduous spathe was one of a series of small enlargements which "occur along the course of the stem at regular intervals, jutting out one on each side opposite one another." This additional information throws still greater doubt on the correctness of the determination. At Bournemouth, where aroids are abundant, leaves only have been found without a single spike. This is not the first time monocotyledons have been supposed to be present in the Carboniferous; for example, Cordaites, a plant now acknowledged to be a gymnosperm—but whether a cycad or conifer is still, according to Schimper, a matter of doubt—was formerly supposed to be a palm, and subsequently a *Yucca* or *Dracæna*. The curious twisted bodies called *Spirangium* are assumed to be monocotyledons on very slender grounds, their affinities, according to high authorities, being completely unknown. Nevertheless we find Mr. Carruthers, referring to the Carboniferous, says:—"Including these fruits, there are probably eight species of monocotyledons in the later Palæozoic rocks." But excluding them there is but one, and that, as just shown, of an extremely doubtful nature. Monocotyledons occur doubtfully in the Trias as *Yuccites*, and in many forms in the Liass, agreeing so far with Haeckel's table of their pedigree. They gradually increase in number until the present day. Although we question the reality, we think the early appearance of a monocotyledon, even if it had occurred, would no more invalidate the theory of evolution than does the equally unlooked-for occurrence of mammalian remains in secondary rocks, invalidate the theory in reference to animal remains.

4. The next point Mr. Carruthers brings before us is the appearance of dicotyledon, and as their testimony for or against evolution is very important, this testimony deserves examination at some length. Mr. Carruthers regards, as the most fatal objection to the evolution theory, the supposed fact that representatives of all the three great groups appear simultaneously in the Upper Cretaceous rocks. Dicotyledons have been found as low down as the Neocomian, and their discovery in rocks of this age is quite recent. Still the evidence that this is their earliest appearance is purely negative, and no hypothesis is satisfactory which is based entirely on negative evidence. It is probable that dicotyledons may be found in yet earlier rocks—perhaps quite early, although playing an extremely subordinate part. The Wealden has yielded no monocotyledons, yet we know that they must have existed; may not then the earlier forms of dicotyledons also have existed? We may parallel the case of the mammals from the Purbeck. The Purbeck fauna was considered to show no trace of mammals until the examination of a particular

<sup>1</sup> *Pinus austriaca*, Lindley and Hutton, is "certainly a fragment of a Lepidodendroid fruit."—Carr., *Geol. Mag.*, vol. ix. p. 58.

<sup>2</sup> *Pothocites granitoides*, Paterson. *Trans. Bot. Soc. Edinb.*, vol. 4. p. 45. pl. 3. f. 1-3. Not mentioned by Haeckel or Schimper.

small area of the Purbeck beds revealed their presence in numbers; had this spot not been quarried it would have been supposed for years that mammalia had made their appearance in Eocene times. Some causes, tending to make the preservation of dicotyledons difficult, were discussed in NATURE, vol. xv. p. 281, and need not be further alluded to here. Mere localised patches of plant remains are not an unerring index of the character of a flora at any period. At Bournemouth there are patches just underlying the lowest marine beds, which are crowded with ferns only; other patches contain nothing but ferns, aroids, and gymnosperms. Had these patches been isolated, inferences of a most misleading character would have been drawn.

The upper Cretaceous floras are known to us principally from Aix-la-Chapelle and from America; but as in both these—in indeed in most cases—the supposed Cretaceous beds containing plant remains rest on palæozoic rocks, their relative age is a matter of uncertainty. M. Barrois fixes it as contemporaneous with his zone of Belemnites, but whether he is right in this supposition or not, the flora contains ferns and other plants which seem identical with those of the Bournemouth beds. In America, in the Dakota group, we have leaf beds 400 feet thick of the supposed age of our gray chalk, but the associated marine beds have, mixed with decidedly Cretaceous forms, shells approaching very closely those of our London clay. It seems more logical to determine the age of a rock by the incoming of new types than by the lingering of old, and the whole palæontological evidence shows that these beds are at most intermediate in age between our Eocene and Chalk, the enormous gap between which is probably filled up here by some 2,200 feet of strata. American geologists are not agreed as to their age. It would be out of place to discuss this subject at length, but enough is said to show that the relative ages of these floras is not definitely known, and that no series of arguments based on their relative sequence is, at present, entitled to any weight. M. Lesquereux finds evidence in support of evolution in the flora of Dakota, “in the remarkable disproportion of genera compared to species;” and in the sameness of the leaves, which are “mostly entire, coarsely veined, and coriaceous, the difficulty of separating them into distinct groups, by fixed characters, the numerous forms of leaf which, seen separately, represent different species, or even genera, and which, considered in series or groups, appear undividable into sections.” When, however, he theorises, we see that he makes use of the same arguments against evolution as those put forward by Mr. Carruthers. Von Ettingshausen, on the other hand, who has paid much attention to the subject, states that he is able to trace the ancestry of our present floras back to simple elements in Tertiary times, and these to still simpler and more united types in Cretaceous times. In his works a number of examples are given. The flora of Sezanne, whose age as Lower Eocene may be accepted, is closely analogous with that of Bournemouth.

Now let us examine the manner in which determinations of fossil leaves from these earlier rocks have been made, and see whether they are sufficiently reliable to entitle us to form any theories whatever as to the simultaneous appearance of the three divisions of Dicotyledons. Let us take the flora of Dakota.

Of *Polypetalæ* we have *Liriodendron*, founded on two fragments, and *Magnolia* on two fragments. These fragments are of simple leaves and possess no character whatever in themselves, upon which they can be determined. *Magnolia*, for instance, is determined from the similarity in form to leaves described as *Magnolia* by Heer in the Flora of Greenland, which themselves are supposed to be *Magnolia* because they resemble (not specifically) *Magnolias* from the Miocene of Europe. In *Menespermites*, the third genus, the name indicates that its affinities are vague, and we accordingly see that it had been formerly described as *Dumbeyopsis*, *Acer*, *Populus*. The *Gamopetalæ* are represented by three genera. Of these *Andromeda* is determined on two fragments and one indistinct leaf of simple lanceolate form; *Diospyros*, formerly described as *Quercus*, is determined from one simple and ovate leaf resembling *Laurus*, the other a round and simple leaf; while *Bumelia* is still more unsatisfactory, and has been previously thought to be either *Laurus* or *Quercus*. The determinations have been changed, as we see by the position of the plates and the figures on the plates, many times during the progress of the work, and it is not too much to say that all the determinations of leaves of *Polypetalæ* and *Gamopetalæ* from this flora are vague and unsatisfactory, and no one would be more ready to acknowledge this than Mr. Carruthers himself. We do not find fault so much with the determinations themselves, which are probably the best that could be made from such material, but we think it premature to base any theories upon

them as to the simultaneous appearance with the *Apetalæ* of the more highly organised Dicotyledons.

In the Eocene and Miocene we have, however, richer materials, and the variety and completeness of the fossil flora become conspicuous; the forms, as Lyell says, “were perfect, changing, but always becoming more and more like, generically and specifically, to those now living.” Von Ettingshausen has traced the direct descent of many living species back to the Miocene, sometimes two or more species to a common parent stock.

5. With regard to the persistence of *Salix polaris*, it appears to be simply a case of a plant becoming thoroughly adapted to certain conditions of life which were met with in England during the glacial period, and are present now in extreme northern regions. Why *Salix polaris* should have varied since glacial times more than mollusca and other animal life is not apparent. The intermediate forms which should connect willows and poplars have not been found, but as poplar-like leaves have been met with in lower cretaceous rocks, it is probable that the order of Salicaceæ is an extremely ancient one, and the single generalised form must be sought for in remoter times even than the Cretaceous.

Our general broad knowledge of the succession of plant life, as testified by the rocks, is too well known to need recapitulating here. Schimper enters in detail into its history. In the Silurian, Algae; in the Devonian ferns and Lycopods, reaching their apogee of development in the Carboniferous; and in the Permian the conifers first take an important position. The Triassic indicates a great gap, and may be considered the reign of gymnosperms, whilst the incoming of the phanerogams is placed beyond doubt. The Jurassic presents another hiatus, and but little is known of its flora.<sup>1</sup> Heer, however, infers, from the entomological fauna, that there were no leafy trees in the Lias. The oolitic rocks contain abundance of cycads. The Wealden and Neocomian vegetation has left us little more than gymnosperms and ferns. With the upper cretaceous period dicotyledons are abundant, but their incoming is traced to older rocks. The Eocene contains rich assemblages of dicotyledons, principally apetalous, and the Miocene, better known, a still greater variety. We see the same plan of development in the individual; and, as Prof. Huxley recently stated in a lecture at South Kensington, “we can trace living plants from the most gigantic and complicated tree, step by step down through many gradations to the lowest algae, the lichens, and on down to a piece of animal jelly.”

Thus we find on reviewing the evidence that has been brought forward, that other interpretations may be put upon the facts presented to us by Mr. Carruthers.

J. S. G.

In an article in this month's *Contemporary*, entitled “Evolution and the Vegetable Kingdom,” Mr. Carruthers refers incidentally to a question that deserves the careful consideration of all who accept the doctrine of evolution; viz., whether the earliest type of flower was hermaphrodite or unisexual. Alluding to the abundance and variety of palæozoic gymnosperms, as evidenced by the numerous fruits that have been discovered in the carboniferous measures, he lays stress on the fact that “they all belong to the Taxineous group of conifers . . . that the plants of this section are all dioecious, i.e. having the sexes on different plants. If the occurrence of the germ and sperm elements in different organs, and even in different individuals, is evidence, as it is held, of higher development in phanerogams, then it is important to notice the order of appearance of dioecious and monoecious groups in relation to those with hermaphrodite flowers. Advocates of evolution hold that dimorphic plants are now in a transition stage progressing towards a dioecious condition. The conifers attained to the highest known development as regards this element of their structure on their first appearance.”

If Mr. Darwin be regarded as an exponent of the views held by “advocates of evolution,” we find that he expresses himself very differently. From the following passages in his recently published work on “The Effects of Cross and Self-fertilisation in the Vegetable Kingdom,” he would seem to consider the primordial condition to be unisexual. “There is good reason to believe that the first plants which appeared on this earth were cryptogamic. . . . As soon as plants became phanerogamic and grew on the dry ground, if they were to intercross, it would be indispensable that the male fertilising element should be transported by some means through the air; and the wind is the

<sup>1</sup> An extensive Jurassic flora has been described by Heer in *Mém. de l'Acad. Imp. des Sciences de St. Petersbourg*, viii<sup>e</sup> série, tome xxii. No. 12, 1876.

simplest means of transport." . . . "Therefore the Coniferae and Cicadix, no doubt, were anemophilous, like the existing species of these groups." . . . "A remarkable fact with respect to anemophilous plants is that they are o'ten declinous." For reasons which he gives, Mr. Darwin considers that this "may be attributed to anemophilous plants having retained, in a greater degree than the entomophilous, a primordial condition, in which the sexes were separated and their mutual fertilisation effected by means of the wind." . . . "If this view is correct, plants must have been rendered hermaphrodites at a later though still very early period, and entomophilous at a yet later period, namely, after the development of winged insects." He subsequently points out, however, that "under changing conditions of life . . . some hermaphrodite plants, descended, as we must believe, from aboriginally declinous plants, have had their sexes again separated;" and he names as an example, *Lychnis ditroica*. It is only in the case of plants thus reverting that dimorphism can be held to be a transitional stage.

Prof. Thiselton Dyer, in his notice of Mr. Darwin's book in NATURE (vol. xv., p. 329), maintains an opposite view. "It would not be difficult to show that all through the vegetable kingdom the hermaphrodite condition precedes the dioecious." Demurring to Mr. Darwin's conclusion that the monoecious condition "is probably the first step towards hermaphroditism," he considers it "not improbable that precisely the converse may be more true." . . . "To throw light on the question whether the primordial plant was declinous or not," he discusses the manner in which it probably originated "from some plant-form not distantly related to Selaginella," and arrives at the conclusion that the first flower would probably be extremely inconspicuous, destitute of colour and hermaphrodite.

How would it be, however, if, instead of regarding the sporangiferous cone or spike of Selaginella as the homologue of a single flower, we compare it rather with the spike of Carex, say, for example, *C. pulicaris*? The spike in this species is, like the other, "composed essentially of an axis having modified lateral appendages." The glumes of the sedge correspond to the scales of the lycopod; in the axils of the upper are found the "male structures"—in Selaginella, sporangia containing microspores; in Carex, anthers containing pollen; in the axils of the lower are found the "female structures"—in Selaginella, sporangia containing macrospores; in Carex, ovaries containing each an ovule. There is then not even the difference that the position on the axis of the male and female structures is inverted. From *C. pulicaris*, with its single spike, the passage is easy to species that have several spikelets, each male at the top and female below; or to others that have the upper spikelets wholly male, the lower ones wholly female. The same arrangement of male and female elements is found in Typha and Sparganium, in most of the Araceæ, to which order belong the oldest fossil monocotyledons, and is preserved even in Sagittaria, although in the last the flowers are of a much higher type, being provided with petaloid perianths. So far as the comparison with Selaginella is concerned, does it not favour the production in the first place of unisexual flowers, at least as much as of hermaphrodite?

THOMAS COMBER

Newton le Willows

The Rocks of Charnwood Forest

SOME letters appeared in NATURE a few months ago upon the rocks of Charnwood Forest. In one of them it was suggested that the syenitic bosses of Markfield and Groby might be more ancient than the surrounding slates and grits. Some of your readers may therefore be interested in learning that we have now ascertained from unquestionable evidence in two places that the syenite is intrusive in these rocks, and, as we believe, in some of the highest and latest rocks of the series. We reserve the details of the sections and localities for a paper which we hope shortly to communicate to the Geological Society.

St. John's College, Cambridge,  
March 20

T. G. BONNEY  
E. HILL

Southern Double Stars

NOTING some queries in your November numbers (in the "Astronomical Column") respecting some southern stars, I inclose you some extracts from our occasional observations that refer to the objects named in those and some previous numbers:—

Southern Double Stars.—Measures with 8-inch Refractor.

	Pos.	Dist.	No. Obs.	Epoch.	
♂ Eridani	237.3	"	5 2	1877.03	Magnitudes 2.4-8-9½
* Centauri	50.6	"	3.9 3	1876.72	
γ Centauri	8.5 (7+180)	"	1.3 1	1876.63	
B A C 1972 = δ 3835	10.0	"	2.1 5	1876.98	
γ Argus 2nd *	214.8	"	42.5 2	1877.03	
" 3rd *	151.1	"	62.6 2		
" 4th *	141.3	"	94.3 2		

ROBT. L. J. ELLERY

Melbourne Observatory, January 22

Ship's Chronometers

WE have read with much pleasure your notice (vol. xv. p. 403) of Sir William Thomson's lecture on Navigation, and are prepared fully to endorse your remarks as to the value of Mr. Hartnup's system of rating ships' chronometers, by which account is taken of the change of rate due to change of temperature.

It is but fair to mention, however, that the principle upon which this system is founded was thoroughly investigated by experiments upon a large number of chronometers by M. Lieusous, of Paris, some thirty or forty years ago; acting upon his suggestions, and after independent investigation conducted in our chronometer manufactory some six years ago, we produced a table for the use of captains and others using ships' chronometers, which was fastened in the chronometer case, with a small thermometer in front of it, in such a way that the top or upper end of the column of mercury indicated, without any calculation whatever, the mean rate that should be given every day to the chronometer until some considerable change of temperature had taken place (say 3°), when the new position of the top of the mercury column again showed the new rate to be used in working the chronometer.

We did not introduce this plan to the navigating public generally, as we feared that sufficient trouble (small though it actually be) would not have been taken in the use of it, also for another reason, *i.e.*, nearly every chronometer that we have tested has been found to require a different daily coefficient for a change of temperature of ± 1°, and ships rarely remain sufficient time in port for us to determine this coefficient after allowing for the time necessary to clean the chronometer.

But, as our system of tabulation may be of interest to your readers and may possibly be available for other purposes, we give it you as briefly as possible.

From our experience (which agrees with that of Lieusous and of Hartnup) we find that the ordinary compensation balance without auxiliary, causes the chronometer to go at its fastest rate (or in other words to lose least) at a point of the thermometric scale somewhere between 55° and 70° F., usually at 60° or 65°, and that from 25° to 30° above or below that "fastest point" the chronometer loses or goes slower on its fastest rate by an amount that is determined by multiplying the square of the difference in temperature between the new point and the "fastest point" by the coefficient of temperature for a change of 1° above or below the "fastest point," *i.e.*, by the amount that a chronometer goes slower for having its temperature increased or diminished by 1°.

This is, however, only true so long as two conditions are adhered to; the first condition being that the "fastest point" (which can be moved at will by the chronometer maker), shall not be taken outside the limits of 55° to 70°, that is, the rule will apply from 30° to 95° but not beyond, even though the "fastest point" should be moved up to 80° or down to 40°; beyond these points a new law applies, and instead of squaring the difference of temperature and multiplying that quantity by the coefficient of temperature, this latter must be multiplied by the difference of temperature (always reckoned from the "fastest point" of the chronometer under trial) raised to a power between the square and the cube, or  $x^{\frac{5}{2}}$ , for which good reasons can be given.

This being explained, it will be easy to perceive the use of the

table or diagram as given below, in which T is a thermometer, C C and C' C' are curves drawn after testing the chronometer. For an ordinary voyage in which no extremes of temperature are expected, or which, if they occur, will be of short duration only, we should seal the diagram under the thermometer, so that the temperature line of 65° should coincide with and pass through the apex of the curve, and if the chronometer were neither gaining nor losing at 65° we should draw the curve as C C; if the chronometer were gaining five-tenths of a second per day we should draw the curve as C' C'.

Then the rate is always to be reckoned from the summit of the mercury horizontally till the line meets the curve; if this line should be to the left of the thermometer the time should be reckoned as plus (+) or gaining; if to the right, as minus (-) or losing.

Thus, for example, taking the line SA for a chronometer whose rate at 65° is 0' 0ths, this will give at 75° - 0' 5ths, or losing half a second daily; or for a chronometer whose rate at 65° (C' C') is fast 0' 5ths, at 75° it would be 0' 0ths for a chronometer whose daily coefficient gives a curve as here drawn.

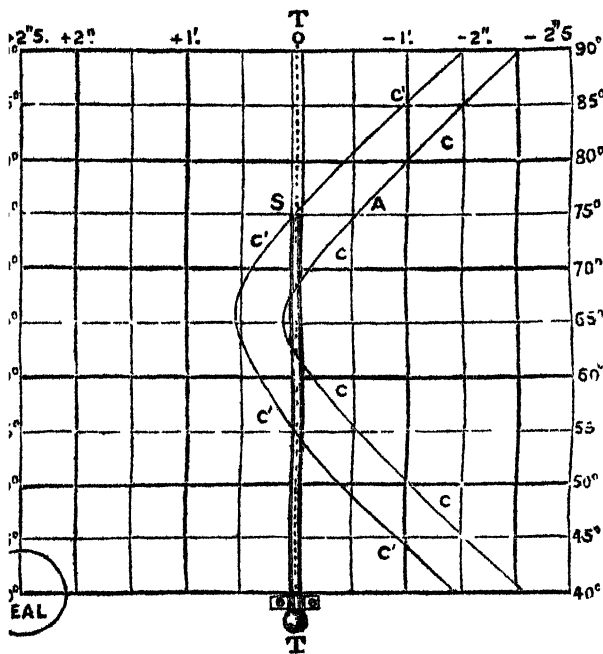

Of course in determining a daily rate, two or more observations of temperature should be taken, so as to give a mean temperature point from which to reckon the rate, as the day and night temperatures differ considerably.

Prof. Liensou, in his *brochure*, gives a rule for determining the amount which a new chronometer is likely to gain on its rate, owing to the hardness of the balance spring and other causes independent of temperature, but we do not find this latter so reliable as the temperature-correction method as detailed above.

Should this prove interesting to your readers, we may, with your permission, at some future time give a few reasons for the difference that is found to exist between the daily coefficients of temperature of different chronometers.

PARKINSON AND FRODSHAM

4, Change Alley, Cornhill, London, March 12

P.S.—The above system renders the auxiliary compensation unnecessary, and can therefore effect a saving of 4% to 5% on the cost of each instrument.

Lowest Temperature

THERE appears to be something almost abnormal in the climatic conditions to which the observatory at Stonyhurst is subject (vol. xv. p. 399). I remember going into a garden in the neighbourhood of Knaresborough, in Yorkshire, about eight o'clock on the morning of Christmas Day, 1860, and seeing what I suppose had never been seen in England outside a laboratory before that morning, viz., the mercury in a thermometer

standing at 8° F below zero, i.e., 40° F. of frost. At Stonyhurst on the same day the thermometer went down only to 6° 7 F., i.e., there were 25° 3 F. of frost.

Again, on March 1, 1877, the lowest temperature registered in the neighbourhood of Knaresborough was only, I believe, 18° F., whilst at Stonyhurst it was 9° 1 F. The differences, therefore, between the temperatures on the two days spoken of at these places, not fifty miles distant from each other, were respectively 2° 4 F. and 26° F., which are so wide apart as to suggest that Stonyhurst is subject to climatic conditions which do not prevail in the Vale of York. I may mention that the record in the *Times* of the temperature on the morning of March 1, was only 25° F., but in country districts in the south of England it was as low as 20° F. Great numbers of oaks, laurels, and other evergreens were killed in Yorkshire by the frost of 1860.

Oxford

R. ABBAY

Meteor

A FEW minutes before 10 o'clock on Saturday night I saw a very beautiful meteor towards the western horizon. The meteor passed obliquely downwards towards Orion's belt, moving slowly from right to left. When first seen it was a brilliant white body about 1/4th the apparent diameter of the moon. As it passed onwards it became bluish and pear-shaped with a bright track. Before its final disappearance between the belt and the pleiades it had a purplish hue. It was visible about four or five seconds, and during that period it traversed about ten or fifteen degrees.

Brighton, March 12

W. AINSLIE HOTLIS

I SAW the meteor at 9h. 56m. P.M. of Saturday, March 17, mentioned by your correspondent, "W. M." I was on the sea-shore at Rossall, near Fleetwood, and while looking out to sea, due west, I became aware of a sudden outburst of light on my left. On turning I saw the splendid meteor sailing rather slowly across the sky from a point about 3° north-west of the Hydre to a point in Monoceros, whose position I should estimate to be about R. A. = 7h 30m.; Decl. = 20° 0' south.

March 26

J. II.

DR. SCHLIEMANN ON MYCENÆ

LAST Thursday night will be always regarded as a memorable one in the history of the Society of Antiquaries, when Dr. Schliemann described to an unusually distinguished audience his own and his wife's explorations on the site of the Acropolis of ancient Mycenæ. Taking as his clue the well-known passage in which Pausanias (A.D. 176) speaks of the ruins and traditions of the famous Greek city, Dr. Schliemann was led to the belief that his scholarly predecessors had mistaken its drift. The passage in Pausanias runs thus:—

"Among other remains of the wall is the gate, on which stand lions. They (the wall and the gate) are said to be the work of the Cyclopes, who built the wall for Pæus in Tiryns. In the ruins of Mycenæ is the fountain called Perseia, and the subterranean buildings of Atreus and his children, in which they stored their treasures. There is a sepulchre of Atreus, with the tombs of Agamemnon's companions, who on their return from Ilium were killed at dinner by Ægisthus. The identity of the sepulchre of Cassandra is called in question by the Lacedæmonians of Amyklæ. There is the tomb of Agamemnon and that of his charioteer Eurymedon. Teledamos and Pelops were deposited in the same sepulchre, for it is said that Cassandra bore these twins, and that, when still little babies, they were slaughtered by Ægisthus, together with their parent. Hellanikos (B.C. 495-411) writes that Pylades, who was married to Electra by the consent of Orestes, had by her two sons, Medon and Strophios. Clytemnestra and Ægisthus were buried at a little distance from the wall, because they were thought unworthy to have their tombs inside of it, where Agamemnon reposed, and those who were slain with him."

Previous explorers had searched in vain for any of the relics here referred to, because they searched in the wrong place, mistaking the wall spoken of for that of the city,

whereas Dr. Schliemann's instinct led him to infer that Agamemnon and his companions were buried within the wall of the citadel. Following this clue he began three years ago to sink many shafts in different parts of the Acropolis, and met with such encouraging results near the Lions' Gate mentioned by Pausanias that he devoted his main attention to diggings in this quarter. There were, however, so many hindrances, that it was only in last July he was able to carry out his plans.

In the Acropolis Dr. Schliemann had entirely cleared the famous Lions' Gate, which he went on to describe, discussing also the old question of the symbolism of the lions surmounting the gateway, and of the altar surmounted by a column, on either side of which rest the fore paws of one of the two lions. One theory was that the column related to the solar worship of the Persians, another that the altar is a fire altar, guarded by the lions; a third that we have here a representation of Apollo Agyieus. Dr. Schliemann himself was of this last opinion, which, he thought, was borne out by the Phrygian descent of the Pelopidae. The lion-cult of the Phrygians was well known. Besides, among the jewels found in the tombs, and especially in the first tomb, this religious lion symbolism re-appeared. On two of the *repoussé* gold plates there found was seen a lion sacrificing a stag to Hera Boôtris, who was represented by a large cow's head, with open jaws, just in the act of devouring the sacrifice. On entering the Lions' Gate were seemingly the ancient dwellings of the doorkeepers, of whom some account was given. Further on, as at Troy, was quadrangular Cyclopean masonry, marking the site of a second gate of wood. Still further on were two small Cyclopean water-conduits; to the right of the entrance passage were two Cyclopean cisterns. A little further on came to light that large double parallel circle of closely-jointed, slanting slabs, which has become so famous during the last three months. Only about one-half of it rests on the rock, the other half rests on a 12-foot high Cyclopean wall, which has been expressly built to support it in the lower part of the Acropolis. The double circle had been originally covered with cross slabs, of which six are still *in situ*. Inside the double slabs was, first, a layer of stones for the purpose of holding the slabs in their position. The remaining space was filled up with pure earth mixed with long thin cockles, in the places where the original covering remains in its position, or with *débris* of houses mixed with countless fragments of archaic pottery wherever the covering was missing. This circumstance could leave no doubt that the cross slabs were removed long before the capture of Mycenæ by the Argives (B.C. 468). The entrance to the double circle was from the north side. In the western half of the circle Dr. Schliemann discovered three rows of tomb stelæ, nine in all, made of calcareous stone. All stood upright; four only which faced the west had sculptures in relief. One stelæ, precisely that beneath which was found the body with the golden plates representing the lion sacrificing the stag to Hera Boôtris, represents a hunting scene. The two next sculptured sepulchral slabs represent each a battle scene. The Mycænæ slabs, Dr. Schliemann said, were unique of their kind. The manner in which they fill up the spaces not covered by men and animals with a variety of beautiful spiral ornaments reminds us of the principles of the painting on the so-called Orientalising vases. But in the Mycænæan sculptures nowhere do we see a representation of plants so characteristic of ancient Greek ornamentation of this class. The whole is rather linear ornamentation, representing the forms of the bas-relief. Hereby we have an interesting reference to the epoch in Greek art preceding the time when that art was determined by Oriental influences, an epoch which may approximately be said to reach far back into the Second Millennium (B.C.).

Here then in the Acropolis of Mycenæ are tombs which are no myth, but an evident reality. Who were these great

personages entombed here, and what were the services rendered by them to Mycenæ which deserved such splendid funereal honours? It was argued at length that the inhabitants of these tombs could be none other than the very persons spoken of in the extract Dr. Schliemann had cited at the outset from Pausanias. Dr. Schliemann then proceeded to state the details of what he had found below the ruins of the Hellenic city. He spoke of the vast masses of splendidly archaic vases. Iron, he remarked, was found in the upper Hellenic city only, and no trace of it in the prehistoric strata. Glass was found now and then in the shape of white beads. Opal glass also occurred as beads or small ornaments. Sometimes wood was found in a perfect state of preservation, as in the board of a box (*υδροθηξ*), on which were carved in bas-relief beautiful spirals. Rock-crystal was frequent, for beads and also for vases. There were also beads of amethyst, onyx, agate, serpentine, and the like precious stones, with splendid intaglio ornamentation representing men or animals. When towards the middle of November he wished to close the excavations, Dr. Schliemann excavated the spots marked by the sepulchral slabs, and found below all of them immense rock-cut tombs, as well as other seemingly much older tombstones, and another very large sepulchre from which the tombstones had disappeared. These tombs and the treasures they contained, consisting of masses of jewels, golden diadems, crowns with foliage, large stars of leaves, girdles, shoulder-belts, breast-plates, &c., were described in detail. He argued that as 100 goldsmiths would need years to prepare such a mass of jewels, there must have been goldsmiths in Mycenæ from whom such jewels could have been bought ready-made. He spoke of the necklaces, too, and of the golden mask taken from one of the bodies, which must evidently be a portraiture of the deceased. Dr. Schliemann then proceeded to show that in a remote antiquity it was either the custom, or, at least, that it was nothing unusual that living persons wore masks. That also immortal gods wore masks was proved by the bust of Pallas Athenè, of which one copy was in the British Museum and two in Athens. It was also represented on the Couthian medals. The treasures of Mycenæ did not contain an object which represented a trace of Oriental or Egyptian influences, and they proved, therefore, that ages before the epoch of Pericles there existed here a flourishing school of domestic artists, the formation and development of which must have occupied a great number of centuries. They further proved that Homer had lived in Mycenæ's golden age, and at or near the time of the tragic event by which the inmates of the five sepulchres lost their lives, because shortly after that event Mycenæ sank by a sudden political catastrophe to the condition of a poor powerless provincial town, from which it had never again emerged. They had the certainty that Mycenæ's flourishing school of art disappeared, together with its wealth; but its artistical genius survived the destruction, and when, in later centuries, circumstances became again favourable for its development, it lifted a second time its head to the heavens.

No doubt Dr. Schliemann's theories will be subjected to much criticism when the full details and drawings appear in his forthcoming work. Of the value of the discoveries themselves there can be but one opinion. Those alone which have been made in the Acropolis of what many have been inclined hitherto to regard as a half mythical city are of themselves sufficient to entitle him to an important place in the field of scientific research. Both to the historian and ethnologist his researches must prove of the greatest value, and all who have been stirred with the recital of the deeds of the Homeric heroes will rejoice to have henceforth reasonable external evidence for regarding them as something more than myths.



FERTILISATION OF FLOWERS BY INSECTS.  
XVI.

*Alpine Species of Gentiana adapted to Lepidoptera.*  
**GENTIANA BAVARICA** (Fig. 106-108), *G. verna* (Fig. 109-111), *G. nivalis* (Fig. 112-114), of which I have examined living specimens in the Alps, and *G. imbricata*, *astiva*, *pumila*, and *utriculosa*, of which I have examined only dried specimens,<sup>2</sup> agree so completely in the structure of their flowers, and in their contrivances for cross-fertilisation by insects, that they all obviously belong to the same section of the genus *Gentiana*, and are adapted to the same group of visiting insects. They all possess a long narrow corolla (Fig. 106),<sup>3</sup> which contains in its lowermost portion the honey, secreted, as in our

dilated into a circular disc (cf. Fig. 106, 109, 112), and bordered at its margins with hair-like papillæ (Fig. 108), in all of them small openings are visible in the fully-opened flower between the margin of the stigma and the inclosing corolla (Fig. 109); but as soon as the corolla begins twisting (Fig. 110), these openings are concealed. In all of them the anthers surround the stigma, thus placing their pollen on the way to the honey (a, Fig. 106, 110, 114). They can all, therefore, be fertilised only by such insects as have a proboscis sufficiently long to reach the base of the corolla, and at the same time either sufficiently slender to enter through the small openings (Lepidoptera), or sufficiently strong forcibly to enlarge the entrance of the flower (humble-bees). Such an enlargement, indeed, would be possible by the expansion of the same folds between the petals (f. Fig. 106, 107, 109, 110, 112), by which the flower is enabled to twist, and to close, as soon as colder weather frightens away its natural fertilisers.

Now, looking about to discover what Lepidoptera and humble-bees might be the natural fertilisers of the present

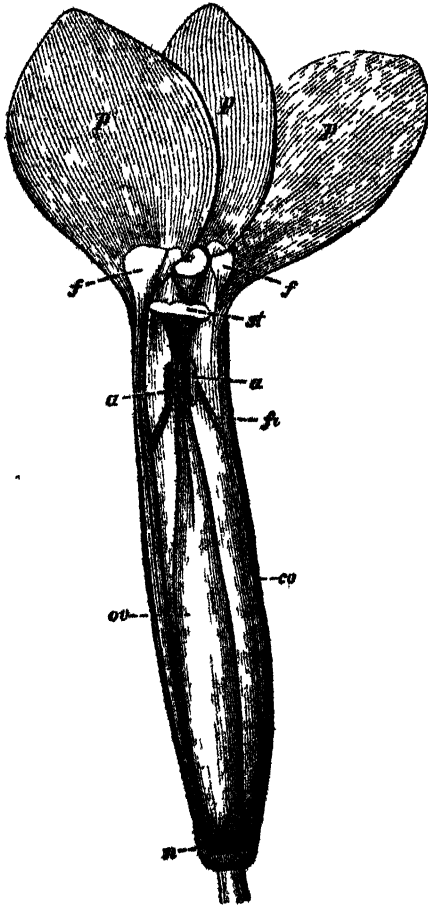

FIG. 106.

FIG. 106.—*Gentiana bavaria*. FIG. 106.—Lateral view of a flower which begins twisting and closing, the calyx and the anterior portion of the corolla having been removed (34: 1). FIG. 107.—The same flower viewed from above (34: 2). The margin of the circular stigma is already covered by the revolving corolla. FIG. 108.—The stigma seen from above (7: 5).<sup>4</sup>

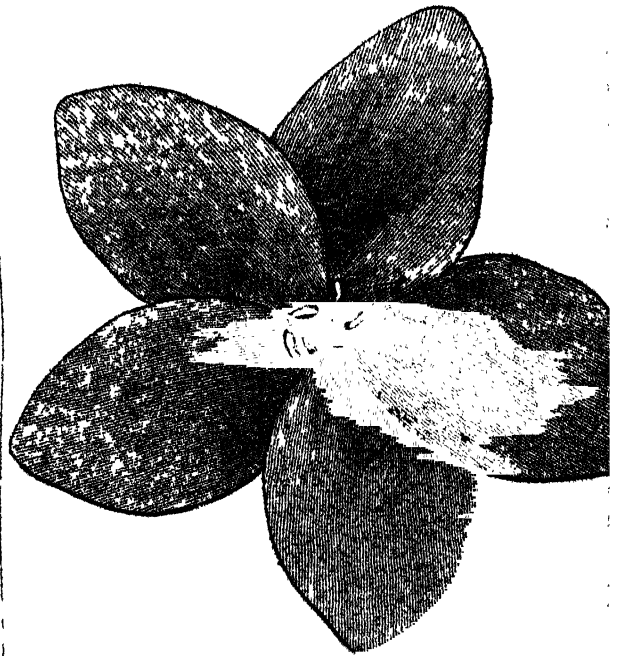

FIG. 107.

group, I was surprised at the fact that of all the 162 species of Lepidoptera which I had observed visiting flowers in the Alps, *Macroglossa stellatarum* alone has a proboscis sufficiently long (25-28 mm.) to reach the honey in all the species of *Gentiana* in question, and that of the Alpine humble-bees, even those provided with the longest proboscis of all, *Bombus hortorum* (18-21 mm.) and *B. opulentus*, Gerst. (22 mm.), are incapable of reaching the honey in all the above-named species, except by thrusting the whole of their head into the narrow corolla-tube. Moreover, direct observation seems to prove that humble-bees insert at the most their proboscis into these flowers, but never their whole head. For instance, in the Albuia Pass, July 28, 1876, I saw a humble-bee flying about for a long time in search of flowers; at length it hastily visited *Gentiana verna*, but having only once thrust its proboscis into a flower, it flew away out of my sight. Likewise near Pontresina, August 4, 1876, I saw *Gentiana nivalis* visited by *Bombus mendax*, Gerst. ♀, after having hastily tried one or two flowers in the same



FIG. 108.

two first groups, by an annular swelling at the base of the plate<sup>5</sup> (cf. Fig. 106, 111, 113). They all have the entrance to the corolla-tube closed by the bi-lobed stigma being

<sup>1</sup> Continued from p. 279.  
<sup>2</sup> For specimens of *G. pumila*, *astiva*, *fruticosa*, *Fretschl*, and *parviflora*, I am indebted to Prof. Ascherson of Berlin.  
<sup>3</sup> Only in *G. astiva* the corolla-tube seems to be considerably wider than in the other species.  
<sup>4</sup> The following explanation of the lettering applies to all the figures:—*a* = anthers, *cp* = corolla, *f* = filament, *n* = nectary, *o* = openings communicating to the honey, *ov* = ovary, *p* = petals, *s* = sepals, *st* = stigma, *f* = folds of the corolla by which its twisting is made possible.  
<sup>5</sup> I found the length of the corolla-tube, from the nectary to the stigma, in the species in question as follows: *G. astiva*, 26-28 mm.; *G. verna* and var. *macroglossa*, 23; *G. bavaria*, 21-22; *G. utriculosa*, 18-20; *G. pumila*, 15-18; *G. imbricata*, 25; *G. nivalis*, 23-25 mm.

manner, it passed over to *Trifolium nivale*, which it then sucked perseveringly. If from these observations we may infer that the forcible enlargement of the narrow corolla-tube of the species of *Gentiana* in question is too inconvenient for the humble bees, then the only insects capable of gaining the honey in all the species of the present group and capable of regularly visiting and cross-fertilising them, are *Macroglossa stellatarum*, and perhaps other Sphingidæ not yet observed by myself in the

is exclusively adapted to Lepidoptera, we ought embrace this opinion with due precaution; for visits of Lepidoptera, hitherto directly observed by comparison of the length of their proboscis with the length of the corolla-tube, prove to have been only fruitless attempts. On *G. nivalis* (corolla-tube 13-16 mm.), near Pontresina, August 4, 1876, I observed *Ceanothus satyrion*, Esp. (proboscis, 7 mm.), and *Argynnis*, Kbr. (10-11 mm.); on *G. verna* (corolla-tube, 23 mm.) in the Albula Pass, July 28, 1876, I found *Argynnis*, var. *Merope*, Prunn. (7 mm.), *Argynnis pales*, S. V. (9-10 mm.), and *Erebia lappona*, Esp. (8-9 mm.); on *G. bavarica* (20-22 mm.), Kerner<sup>1</sup> observed *Agrotis cuprea* (12 mm.), I myself, upon the Piz Umbrail, July 15, 1875, saw *Erebia lappona*, Esp. (8-9 mm.); in the Albula Pass, July 27, 1876, *E. lappona* and *Melitæa asteria* (5-6 mm.); in the Val del Fam, August 5, 1876, *Melitæa aurina*, var. *Merope*, Prunn. (7 mm.), all easily inserting their proboscis into the corolla tubes, but all apparently without any advantage to themselves, though, by their repeated fruitless attempts, some cross-fertilisation of the flowers may have been effected. No direct observation

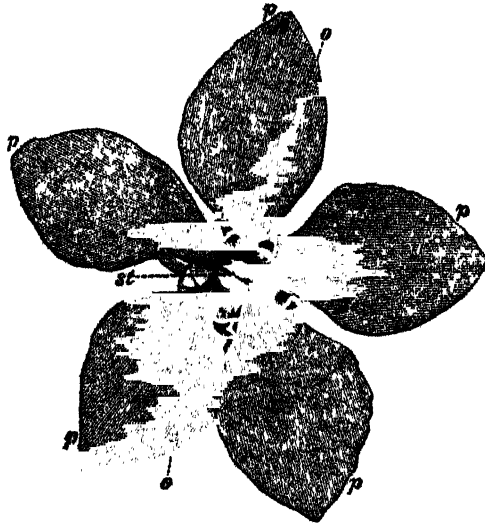

FIG. 100. 100-111—*Gentiana verna* (3½") FIG. 100—Flower, completely opened, seen from above. FIG. 110—Upper portion of the same flower, bisected longitudinally, showing the pistil and the anthers. FIG. 111—Lowermost portion of the same flower, showing the nectary

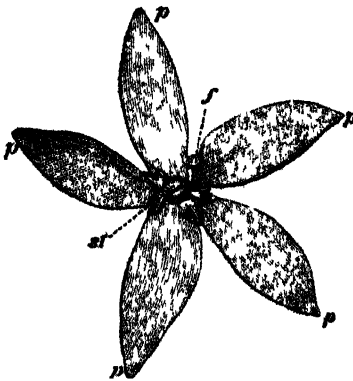

FIG. 112. FIG. 112—Flower seen from above. FIG. 113—Pistil FIG. 114—Upper portion of the flower bisected longitudinally, showing one of the anthers (a) in contact with the margins of the stigma

Alps. The smallest of the species in question, *G. nivalis* (13-16 mm.), *G. imbricata* (15 mm.), and *G. punula* (16-18 mm.), may also be fertilised by some moths<sup>1</sup> and by many butterflies<sup>2</sup> which will all easily insert their slender proboscis into one of the small openings at the base of the corolla-tube, then, withdrawing it smeared with pollen, will leave some pollen-grains on the margin of the stigmatic disc, and, when inserting the proboscis into another flower, will effect its cross-fertilisation by stripping off some of the pollen-grains from the hair-like papillæ at the margin of

of the true natural fertilisers of the species of *Gentiana* belonging to our fourth group has yet been made.

In former articles I have shown that frequently, of different species of the same genus, those possessing the most conspicuous flowers are adapted to cross-fertilisation by insects, whilst other species of the same genus, possessing less conspicuous flowers, have recourse to self-fertilisation, in case the visits of insects are wanting. This statement is also confirmed by the species of *Gentiana* in question. For in *G. verna* and *bavarica*, differing from *nivalis* not only by the considerably larger size of the separate flowers, but also by a number of flowers which stand close together, thus being easily seen from a great distance, the possibility of self-fertilisation is excluded by the position of the stigma and the anthers (as shown by Fig. 106 and 110); whereas in *Gentiana* flowers are much smaller and more another, one or some of the anthers contact with the margin of the stigma

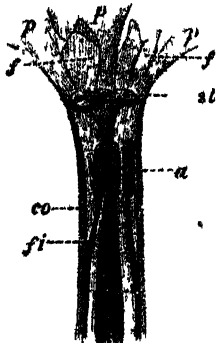

FIG. 110.



FIG. 111.

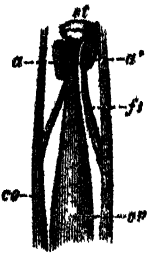

FIG. 112.

the stigmatic discs. Humble-bees, on the contrary, at all events, seem to be of very small or no importance as fertilisers of this group. If thus, by indirect inference, we are led to the conclusion that the present group

*Argynnis adippe*, 23-24; *A. aglaia*, 25-28; *A. niobe*, var. *oris*, 22-26; *A. paphia*, 22-24; (*Atlas phicomonæ*, 2) 25; *Erebia gam*

*and V. urtica*, 14-23 mm.

The most striking peculiarity of our fourth group of *Gentiana* is the sensibility of their flowers to the influence of the weather, which is apparently connected with the sensibility of their natural fertilisers to the same influence. The following observation clearly shows that different species differ widely in this sensibility, even when growing in the same locality. On the Piz Umbrail, July 16, 1874, I had collected some plants of *Gentiana bavarica*, var. *imbricata*, and of *G. verna*, and put them in my sleeping-room in the Quarta Cantoniera, upon a plate filled with water. The next morning, at half-past four o'clock, I found the flowers of *G. bavarica* already opened, those of *G. verna* still closed. I placed the plate outside the window, where the intensity of light was at least as great, but the temperature much lower, and all the opened flowers began twisting. After they had closed, I brought them back into the room, and they opened again. Repeating this trial from half-past four to half-past six o'clock, I saw them two or three times closing and opening again. *Gentiana verna*, standing upon the same plate, during this time, had not yet opened a single flower.

From this observation, the further prosecution of which was prevented by my departure, it is obvious (1) that the opening of the flowers of these species of *Gentiana* is caused

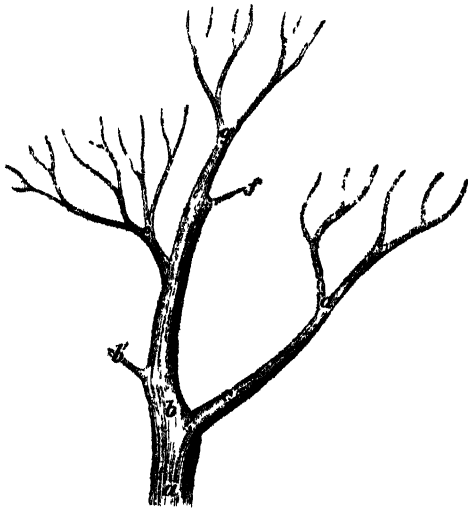

FIG. 115.—Pedigree of the species of *Gentiana* of Germany and Switzerland.

by heat, not by light; (2) that *G. verna* requires a higher temperature for opening than *G. bavarica*, var. *imbricata*. Possibly this is one of the causes which makes *G. verna* descend into sub-Alpine and low lands, whilst *G. bavarica* is confined to the Alpine region.

Comparing the present group with the foregoing ones, we need hardly doubt that it is most nearly allied to our second group, from which it differs only by the narrowness of the corolla, by the further development of the folds between the petals, and in connection with this by their greater sensibility, and by the lobes of the stigma being dilated. *Gentiana prostrata*, agreeing in every other respect with our fourth group, has as yet retained the two twisted stigma-branches, and therefore may be considered as a connecting species between the second group and the fourth, which is descended from it.

Summing up the above relations between the species of *Gentiana* of Germany and Switzerland, we obtain a pedigree like Fig. 115, in which the signification of the lettering is as follows:—

(a) Hypothetical ancestral form with fully open flowers, twisted stigma-branches, diverging stamens, and honey secreted at the base of the flower in the angle between the base of the pistil and the corolla. From this ancestral form we see two branches *b* and *c* descend; *b*

with the nectary confined to the base of the pistil, *c* with nectaries at the base of the corolla. From the branch *c* has developed the sub-genus *Entotricha* Fœrlich (*d*), containing six species:—*G. campestris*, *germanica*, *amarella*, *obtusifolia*, *tenella*, and *nana*, adapted both to Apidæ and to Lepidoptera. Of the branch *b* an original form, *G. lutea* (*b'*), has been preserved, accessible to insects of all orders, but from the same branch has descended the large sub-genus *Calanthe* Fœrlich (*e*), containing eleven species:—*G. punctata*, *pannonica*, *purpurea*, *cruciata*, *asclepiadea*, *Pneumonanthe*, *Friëlichii*, *frigida*, *acaulis*, *excisa*, and *ciliata*, all adapted to humble-bees. One branch of this sub-genus (*e*), by narrowing the corolla, perfecting the folds between the petals, dilating the stigma-branches, and thus adapting the flowers to Lepidoptera, has further developed the sub-genus *Cyclostigma* (*f*), containing seven species:—*G. bavarica*, *verna*, *æstiva*, *imbricata*, *pumila*, *utriculosa*, and *nivalis*. As a link between the ancestral sub-genus (*e*) and the derived subgenus *G.*, has been preserved *G. prostrata* (*f*).  
Lippstadt HERMANN MULLEK

RECENTLY PROPOSED IMPROVEMENTS IN MUSICAL INTONATION

THE harshness of the present system of tuning has been a source of constant complaint since it was first introduced, about a century and a half ago. But of late years several more or less practical attempts have been made to overcome this defect without interfering with the quality of our musical tones. Instruments with fixed tones, as the organ, piano, and harmonium, lead voices, and the inalterable quality of vocal tone has therefore to be constantly kept in view. The instruments exhibited in the Loan Collection of Scientific Apparatus at South Kensington are enough to show both the objects aimed at and the nature of the mechanical appliances by which it is hoped they may be more or less reached. It is difficult to give an intelligible account of them within the compass of an article, but Dr. Stone's two lectures<sup>1</sup> and Mr. Bosanquet's more recent work<sup>2</sup> will supply details and figures.

On examining musical tones generally,<sup>3</sup> we are led to the conclusion that the first requisite is to have a succession of notes forming perfect Octaves, Fifths, and major Thirds, that is, making numbers of vibrations which the air executes during the same length of time in the ratios 1 : 2, 2 : 3, and 4 : 5 respectively. An examination of prevailing systems of modulation, has shown<sup>4</sup> that a strict fulfilment of this condition would require 117 notes to the Octave—a mechanical impossibility on any instrument with fixed tones. Such a scheme must, however, be made the basis of subsequent work. Moreover if combinations with what is called the harmonic Seventh or 6 : 7 be admitted, then we should require very nearly to double the above number of separate notes. It follows, therefore, that we must either restrict our desires of modulation (which is not likely to happen) or be content to use more or less imperfect intervals, and the question turns upon the degree of endurable imperfection. It must be remembered that these apparently innumerable delicacies of sound present no real difficulty to the singer or violinist when he once knows the theory on which they have to be produced, for they are all generated by extremely simple intervals. The difficulty, indeed, is to avoid them, especially in part music, and to put up with alterations, apparently arbitrary and certainly neither

<sup>1</sup> "Sound and Music," by Dr. W. H. Stone, in the series of Science Lectures at South Kensington, 1876, pp. 40 (Macmillan)  
<sup>2</sup> "An Elementary Treatise on Musical Intervals and Temperament, with an Account of the Enharmonic Harmonium Exhibited in the Loan Collection of Scientific Instruments, South Kensington, 1876," also of an Enharmonic Organ Exhibited to the Musical Association on of London, May, 1878," pp. 94, 1876. (Macmillan.)  
<sup>3</sup> For reasons and details see Helmholtz's "Sensations of Tone."  
<sup>4</sup> See my translation of Helmholtz, pp. 669-679

easy to conceive nor to produce. No *temperament*, as such a makeshift intonation is called, could exist except by help of an instrument with fixed tones, and the most practised tuner finds it impossible to produce a satisfactory result, except by mechanical means.<sup>1</sup> How then could we expect a singer to produce at will any of the fifty or more schemes of tuning that have been invented, or even either of the only two that have been a success, the mean-tone and the equal temperaments?<sup>2</sup>

The Greek system of intonation, as we know from Euclid's "Section of the Canon," consisted of a series of perfect Fifths, and may for convenience be represented by F, C, G, D, A, E, B, where it will be found that each note is a Fifth higher than the preceding. It is therefore the simplest and most intelligible that can be imagined, and is in fact at the base of all music. Reduced to the same Octave and played as a major scale this gives C, D, E, F, G, A, B, C. This is perfectly singable, and produces excellent melodic effects. But if we attempt to play the usual major and minor chords of the scale with these notes, as F A C, C E G, G B D, D F A, A C E, E G B, the effect, as I know by frequent experience, is simply hideous, so that there is no difficulty in understanding why the Greeks called Thirds "dissonances" (*diaphona*), and had no harmony. Observing that in the series of Fifths E is the fourth Fifth above C, we may therefore say that the major Third cannot be identified with the fourth Fifth up, reduced to the same Octave.

On calculating out the ratio we find  $C : E = 4 : 5 \times \frac{81}{80}$ ,

whereas the real consonance requires 4 : 5. This would be produced by taking a note E<sub>1</sub>, as we may write it, which is flatter than E in the ratio of 80 : 81. The result of carrying this out to the extent of modern modulation is the series of 117 notes to the Octave already mentioned.

In the Loan Collection, one instrument, General Perronet Thompson's enharmonic organ, grappled with this problem to the extent of forty notes.<sup>3</sup> But its three finger-boards with occasional extraordinary shapes and colours to the finger keys (figured by Dr. Stone, *op. cit.*, p. 32) might well frighten the uninitiated. Yet General Thompson, himself unable to play, taught a blind organist how to use it, so that in a fortnight she could perform in public, and I have often heard the instrument played by others, who did not complain of any difficulty. Helmholtz (in my

translation, p. 636), who also heard it played, speaks of its chords as "extraordinarily harmonious," but the quality of tone (one stop of "metal principals") did not distinguish the consonances effectually at all times, and the compass of forty tones of course materially limited modulation except into tonic and relative minors, which were well provided for.

Mr. Colin Brown has also grappled with perfect tertian harmony, but has exhibited only a model of his keyboard, figured and described by himself in Dr. Stone's book (*ib.* pp. 42-45).<sup>4</sup> His scheme allowed of sufficient modulation into the dominant and sub-dominant major keys, and their first relative minors, but almost utterly ignored the tonic minor, and further minor modulation. As the instrument is an harmonium, the quality of tone is remarkably suitable for bringing out the effects of perfect Fifths and Thirds, and when proper music was selected, the result was most satisfactory. The keyboard is much simpler than General Thompson's, and has the great advantage of being the same in all keys. Such an instrument is of the highest value for lecture illustrations of harmony, and for training of vocalists in perfect intonation. As an independent instrument, its power of modulation is too limited, and the fingering usually simple enough, occasionally becomes very troublesome.<sup>5</sup>

These are the only instruments on which perfect tertian harmony was attempted. In the others some sort of compromise was come to. Mr. Guérout showed his modification of Helmholtz's double keyboard, each finger-key being cut in half, and the upper half giving, generally, a note flatter than the lower half by a comma.<sup>6</sup>

This is a most convenient instrument for scientific purposes, but from its very limited capacity not so well suited as even Mr. Colin Brown's for playing musical pieces. The fingering is also full of difficulty, having all the imperfections of the ordinary board, with many others super-added, and differs in every key.

We have seen that if we use the fourth Fifth up from any note, when reduced to the same Octave, as the major Third, it is too sharp by a comma, and unbearably dissonant, but if we use the eighth Fifth down, also reduced to the same Octave, the result is a note just  $\frac{1}{4}$  comma too flat, which is very much closer than the major Third in actual use (for that is  $\frac{1}{4}$  comma too sharp), and is not at all disagreeable, although not by any means as pleasant as the perfect major Third. Thus, going down eight perfect Fifths from C, we get in succession F, B $\flat$ , E $\flat$ , A $\flat$ , D $\flat$ , G $\flat$ , C $\flat$ , and F $\flat$ , and the proposal is to use F $\flat$  for E<sub>1</sub>. On the piano, and all instruments in the usual temperament, these are the same notes, but they are not so when thus tuned, and they are still strictly distinguished in our usual musical notation. Herr Georg Appunn, to whom we are indebted for various excellent acoustical apparatus, and especially for a tonometer (exhibited in the Loan Collection), which is self-verifying, and enables us to measure pitch with wonderful accuracy, likewise showed an harmonium, consisting of three rows of keys, the upper ones in the form of studs, with practically the usual fingering, consisting of thirty-six tones

<sup>1</sup> "Mr. Ellis has given a practical rule," [for producing the usual, intentionally equal, temperament], "which does not err in its results by much more than the hundredth part of a semitone" (Seldom as much as that.) "It is—make all the Fifths which lie entirely within the Octave of C" (middle C to the C above) least once per second; and make those which have their upper notes above C" beat three times in two seconds. Keeping the Fifth F—C to the last, it should beat once in between one and two seconds. See Ellis's "Helmholtz," p. 785. This is a perfectly practicable rule, and tuners ought to be instructed in the use of it. *There are few tuners who can produce a tolerable equal temperament.*—Bosanquet, *op. cit.*, p. 5.

<sup>2</sup> See my paper on Temperament (*Proc. Roy. Soc.*, vol. xiii., pp. 404-422), where more than fifty schemes are calculated and analysed. Mr. Bosanquet has a most interesting chapter on the history of the mean-tone temperament or old organ tuning, the only one known to Handel, and its complete realisation, without its former "wolves," by means of his own fingerboard, pp. 24-40. He rightly considers this temperament most suitable for the organ (p. 58) as the equal temperament is for the pianoforte. But then the voices of a choir might be led by the completed mean-tone system without much injury to the chords, which are shattered by the equal temperament.

<sup>3</sup> These are given by Mr. Bosanquet, *op. cit.*, p. 22, arranged according to his own finger-board, which completely does away with the errors of the original, but also expressed in his own notation, which implies a temperament which General Thompson well knew and repudiated. Hence I add them here in my own symmetrical arrangement (*Proc. Roy. Soc.*, December, 1874, vol. xxii., p. 49, called "the simplest" by Mr. Bosanquet, p. 50), in which the columns represent ascending Fifths, and the lines from left to right ascending major Thirds, and where the superior and inferior numbers indicate sharpening or flattening by a comma (this is here published for the first time).

General P. Thompson's Enharmonic System:—

c <sup>t</sup>	e				
f <sup>r</sup>	a	c <sub>2</sub> sh.			
b <sup>r</sup> sh.	d	f <sub>1</sub> sh.	a <sub>2</sub> sh.		
c <sup>r</sup> sh.	g	b <sub>2</sub>	d <sub>2</sub> sh.	f <sub>2</sub> sh.	
a <sup>r</sup> sh.	e	c <sub>3</sub>	g <sub>2</sub> sh.	b <sub>2</sub> sh.	
d <sup>r</sup> sh.	f	a <sub>3</sub>	c <sub>3</sub> sh.	e <sub>3</sub> sh.	
g <sup>r</sup> sh.	b <sup>r</sup> sh.	d <sub>3</sub>	f <sub>3</sub> sh.	a <sub>3</sub> sh.	
	c <sup>r</sup> sh.	g <sub>3</sub>	b <sub>3</sub>	d <sub>3</sub> sh.	
	a <sup>r</sup> sh.	e <sub>3</sub>	f <sub>3</sub> sh.	g <sub>3</sub> sh.	
		f <sub>4</sub>	a <sub>3</sub>	c <sub>4</sub> sh.	
		g <sub>4</sub>	b <sub>3</sub>	d <sub>4</sub> sh.	

<sup>4</sup> The notes used in the figure are comprised in the second, third, and fourth columns of the above scheme of General P. Thompson's, but carried further, the second column rising to D sh. and descending to F sh., the third rising to B sh., and descending to A sh., and the fourth rising to A<sub>3</sub> sh., and descending to G<sub>3</sub>, giving fifty-two notes in all; but the instrument performed on at Dr. Stone's lecture (July 25, 1876) had not so large a compass.

<sup>5</sup> "It is clear that this (Mr. C. Brown's) arrangement adapts itself with some facility to all music in which there is not much modulation, or in which the modulation is of a simple type. It is, however, easy to give instances which will at once involve the performer in difficulties." Bosanquet, *op. cit.* 48-9. Mr. Bosanquet, who is a practised organist, having studied the fingering, and played on the instrument at the Glasgow Meeting of the British Association, is well able to speak to its capabilities.

<sup>6</sup> Regarding one very slight alteration, the compass of twenty-four notes extended from B sh. to B in the second column of General Thompson's, from G<sub>2</sub> to G<sub>3</sub> sh. in the Third, and from F<sub>2</sub> sh. to H<sub>2</sub> sh. in the Fourth. With the exception of Two Fifths (G<sub>1</sub> sh. to E<sub>2</sub> sh., taken to be D<sub>1</sub> sh.; and B<sub>1</sub> sh. to G<sub>2</sub> sh., taken at F<sub>2</sub> sh.), which were too flat by  $\frac{1}{4}$  of a comma, as all Fifths ought to be on the piano, this gave a complete succession of dominant modulations, but only admitted of five minor keys.

forming thirty-five perfect Fifths, which, by the contrivance of using the eighth Fifth down as the major Third, into the place of which its finger-key is placed, gives very free play for modulation in all directions with perfect uniformity, although of course slightly imperfect intonation.<sup>1</sup>

To this system of perfect Fifths and major Thirds identified with eight Fifths down, we must attach all the other contrivances for reducing the number of notes necessary to tertian harmony, without seriously offending the ear. The practicability of arranging any number of dozens of such notes in the Octave, up to at least seven dozen, so that they should be entirely under the command of the performer, be fingered precisely in the same way in all keys, and have a style of fingering which is of about the same difficulty as that for three sharps or three flats on the piano, has been proved to demonstration by the "generalised keyboard" of M. Bosanquet, exhibited at the Loan Collection, for his enharmonic harmonium, and, up to four dozen finger keys to the Octave, to the Musical Association upon his enharmonic Organ. This keyboard is quite a triumph of ingenious construction, founded on rigorously scientific principles, for the practical solution of an apparently insoluble problem.

The modifications of the perfect Fifth system (to which Mr. Bosanquet seems much inclined, *op. cit.*, p. 57) depend on the discovery that fifty-three perfect Fifths exceed thirty-one Octaves by only about  $\frac{1}{100}$  of an equal semitone, or very nearly  $\frac{1}{10}$  of a comma. Helmholtz proposed to reduce every Fifth by  $\frac{1}{10}$  of a comma. This would make fifty three of the flattened Fifths to be about  $\frac{1}{10}$  of a semitone less than thirty one octaves, too large an interval for good ears not to perceive, being nearly half a comma, but then all his Fifths would be audibly perfect, and all his major Thirds absolutely perfect. Mr. Bosanquet endeavoured to tune a stop on his enharmonic organ in that way, but the effect with stopped pipes did not repay the immense trouble of tuning (*ibid.*), which cannot be truly effected without much mechanical assistance, and is therefore generally impracticable.

The great difficulty of tuning is also an objection which applies to M. Bosanquet's own proposal to divide the Octave absolutely into fifty three parts (see *op. cit.* p. 56). This would flatten the Fifth still less, but of course would also make the major Thirds nearly as flat as those in the system of perfect Fifths, from which his differ only by about  $\frac{1}{10}$  of a comma. It is not likely that Mr. Bosanquet has been able to tune to such a degree of accuracy. And as the object of the division of fifty-three is only to modulate *ad infinitum*, such accuracy is needless for general purposes, for which forty-eight perfect Fifths (or, as I believe, six sets of eight perfect Fifths, differing by perfect major Thirds from each other, and hence comparatively easy to tune by Fifths and check by Thirds), would fully suffice.<sup>2</sup>

<sup>1</sup> The notes may be considered to be those in Gen. Thompson's second column continued up to A<sub>7</sub> and down to A<sub>1</sub> (or A quadruple flat), the names being altered to those of the finger keys corresponding to those on the ordinary piano, so that no more sharps and flats are used than in ordinary notation. Unfortunately the bellows and some parts of the mechanism were injured in the carriage, and hence the full effect could not be appreciated. There were two extra rows of keys to bring out Herr Appunn's favourite minor Third, 16 to, which is slightly closer than that on the piano, and very effective in certain cases, but the fingering for these was new and difficult, and could not be considered practical.

<sup>2</sup> The first, with eighty-four notes to the Octave, is figured in Mr. Bosanquet's book (*op. cit.* p. 23), where it is fully described and also explained at length in my Helmholtz, pp. 692-696. In both books the builder's name and address are given, with his prices for compasses of 150 to seven dozen keys per Octave. Such instruments are indispensable for the scientific cultivation of music. It is also suited for mean-tone intonation.

<sup>3</sup> See the full explanations in my Helmholtz, pp. 656, 657, 783. Tuning by perfect intervals is the only system practicable without mechanical assistance. But even to tune the thirty-five Fifths of Appunn is impossible by ear alone. I find tuners have a difficulty with only eight notes, forming seven successive Fifths. But when the next eight notes are taken as major Thirds to these, all verified by forming Fifths with each other and producing correct differential tones with the original set, we may hope for some correctness. The only really satisfactory way of tuning is by calculating the pitch of each note, and then causing a set of forks, or Appunn reeds, to be constructed, each too flat by four vibrations, which can be done exactly by

The instruments exhibited in the Loan Exhibition and the others indicated in the preceding lines may, therefore, be said to have practically solved the difficulty of tertian harmony on instruments with fixed tones, and they have even approached to a solution for septimal harmony (which uses the harmonic Seventh; see Bosanquet, *op. cit.*, p. 41). Voices in part music, when unaccompanied, must sing in just tertian or even septimal harmony, but when accompanied they will inevitably follow the instrument. Violinists can do what they like, but are too much inclined to Greek intonation, which is all very well by itself, but which the performer should learn to modify by something better than a rule of finger, in double-stopped passages and part music. With the bass the comma stop may be made effective to a great extent, and Dr. Stone is trying what he can do with the oboe and clarinet (*op. cit.*, p. 35), so that there are some hopes of improving even the orchestra. Enough, at least, has been done on the instruments mentioned and in the practice and system of study of the Tonic Solfaists (Helmholtz, p. 640) to show that it is practically possible greatly to improve musical intonation.

ALEXANDER J. ELLIS

### ON PHOTO-CHEMICAL PROCESSES IN THE RETINA

IN an article which lately appeared in NATURE (vol. xv, p. 308), I gave an account of certain very remarkable discoveries made by Prof. Kuhne, of Heidelberg, which added additional interest to the startling announcement contained in a recent communication made by Prof. Boll, of Rome, to the Berlin Academy, to wit, that the external layer of the retina is, during life, of a purple colour, which disappears at death, but which is, during life, continually being bleached by the action of light. In my first communication I stated that the account of Boll's researches which I was able to give, was only quoted at second-hand from Kuhne's paper, as the number of the *Proceedings* of the Berlin Academy containing Boll's communication<sup>1</sup> had not yet reached Manchester. Having now had the opportunity of reading that communication, I am able to state that the summary of it contained in my first article was correct in every particular. As the paper is, however, one of peculiar importance I propose, with the concurrence of the Editor of NATURE, to insert a *verbatim* but annotated translation of it in next week's number of NATURE.

It is with great surprise that I have heard that the prominence given to Prof. Kuhne's researches on the "Vision-purple" in my article in NATURE has given some pain to Prof. Boll, who probably feels some disappointment in not having been allowed to remain in sole possession of the promising field of research upon which he had entered. It is with still greater surprise, however, that I have read the remarks which Dr. Warlomont, editor of the *Annales d'Oculistique*, has added to the literal translation of my article which he has published in that journal, and which follows a brief abstract of Boll's paper.

"Nous appelons toute l'attention de nos lecteurs sur les deux articles qu'ils viennent de lire, et qui signalent une découverte propre à révolutionner la physiologie de la rétine, à renverser quelques unes des idées reçues, à en affirmer beaucoup d'autres. Tout le mérite de la découverte de la coloration propre de la rétine appartient à M. le professeur Boll, avec toutes ses conséquences, dont M. Kuhne nous paraît s'être prématurément emparé. M.

Appunn's tonometer. After tuning a note roughly to one of these, harpen it till it beats four times in a second with the standard. Any temperament, even Helmholtz's, the best in existence, can thus be easily and perfectly realised note by note.

<sup>1</sup> Monatsbericht der königlichen preussischen Akademie der Wissenschaften zu Berlin, November, 1876. Gesammtsitzung, vom 23 November, 1876, S. 783-787.

<sup>2</sup> *Annales d'Oculistique*, tome XXVII, Janvier-Février 1877, pp. 78-81.

Boll avait évidemment entrevu toutes ces conséquences, et il eut été de bon goût, nous semble-t-il, de lui laisser le temps de les dérouler à l'aise. C'est donc sans droit que nous voyons déjà, dès à présent, la presse parler, à propos de ce fait, des 'découvertes de MM. Boll et Kuhne' et le nom de ce dernier associé à celui du *subinventeur*.

"Deux gémiers suivaient un trottoir; l'un d'eux sifflait un air, dont il n'était qu'à la moitié, quand le second se mit à la continuer; 'Une autre fois,' lui dit le premier le regardant très mécontent, 'tu voudras bien commencer toi-même.'"

If I quote the above sentences it is to show that they are as much opposed to truth as they are to the interests of science, or as they are repugnant to good taste. When a scientific man has published a discovery it is to the interest of the scientific world that all who will or can should be at liberty to repeat the experiments or observations which led to it; if other great discoveries are made by the new labourers it is to the interest of science that they be published.

In the particular case in point it would appear that Prof. Boll re-discovered (and, what is more, *appreciated the full value of*) a fact which had really been observed by some others (Leydig in 1857, and Max Schultze in 1866), but which had certainly not become part and parcel of the common stock of scientific knowledge, viz., that the rods of the retina are red, he observed that under the circumstances of his own experiments the colour faded at death, and arrived at the false conclusion that the colour was a function of the vital condition of the retina. He, however, observed the remarkable action of light in modifying the colour. "During life," he announced in his paper, "the peculiar colour of the retina is continually being destroyed by the light which penetrates the eye. Diffuse daylight causes the purple tint of the retina to pale. The more prolonged, dazzling action of the direct rays of the sun entirely destroys the colour of the retina. In darkness the intense purple colour is again restored. This objective alteration of the peripheral structures of the retina brought about by the rays of light undoubtedly occurs in the act of vision." This was the great discovery which Boll made, and with which his name will ever remain honourably connected. Although, however, he had been in full possession of the facts in the month of June of last year, when he demonstrated them to Professors Du Bois-Reymond and Helmholtz, and only published his paper in November, he did not succeed in making the discoveries with which, justly, the name of Kühne is now associated. Kühne showed that if the retinal purple is usually destroyed at death, the result is attributable to the action of light, persistence of the colour being by no means necessarily connected with the living condition of the retina. In his beautiful and far-seeing discovery of the true function of the retinal epithelium cells as restorers of the vision purple, he was fortunate enough to make a discovery which it would be very bold for any one—even for Prof. Boll—to say he would have made, had time and opportunities been granted. In saying that Boll had discovered everything referring to the vision purple, M. Warlomont shows that he has not appreciated the fact that two great discoveries have been made, the second supplementing the first, and actually needed in order that the significance of the first should be appreciated.

But I trust that the readers of NATURE do not think that I wish to depreciate the researches of Prof. Boll whilst I act as the champion of one who needs no champion, seeing that he illustrates in himself the truth of the adage, "le grand mérite est toujours probe."

Prof. Boll must reflect that great discoveries are rarely completed by one man, and that it is no shame, and should be no cause of sorrow, to the true man of science, if the conception which he has tried to develop and which he has almost raised to the position of a truth by

his own work, receives its final development through the strivings of a fellow-worker.

Abandoning the polemical discussion upon which I felt myself almost compelled to enter, I would give an account of the most recent results obtained by Kühne on the "Vision Purple," and published by him in the *Centralblatt für die medicinischen Wissenschaften* for March 17 (No. 11).

The purple colour of the retina is now shown to depend upon the presence of a substance which can be dissolved and separated in the solid form. The only solvent of the vision-purple as yet known is bile, or a pure glyko-cholate. The filtered, clear solution of the vision-purple is of a beautiful carmine-red, which, when exposed to light, rapidly assumes a chamois colour, and then becomes colourless. As long as it is at all red the solution absorbs all the rays of the spectrum, from yellowish-green to violet, allowing but little of the violet, but all the yellow, orange, and red rays to pass. Accordingly, bloodless retinæ spread out and placed in the spectrum, between green and violet appear grey or black.

Kühne has exposed retinæ in different parts of a spectrum (obtained by allowing the sun's rays between eleven and one o'clock to fall through a slit 0.3 mm. wide upon a flint glass prism) in which Fraunhofer's lines were shown in great number and with great distinctness, and he has ascertained that in the yellowish green and green regions the vision-purple is bleached most rapidly; the action is less in the bluish green, blue, indigo, and violet; it is still perceptible in the orange and yellow, but not in the red or ultra-violet regions.

March 24

ARIHUR GAMGEE

#### OUR ASTRONOMICAL COLUMN

THE CAPE ASTRONOMICAL RESULTS, 1871-1873.—Mr. Stone has just circulated the results of meridional observations of stars made at the Royal Observatory, Cape of Good Hope, in the years 1871-1873. His present object has been not so much to furnish extremely accurate places of principal southern stars as to supply reliable positions of stars down to the seventh magnitude within 15° of the South Pole, and it is considered that this volume contains all Lacaille's stars in this region of the sky, and very nearly all sevenths not observed by him. It is the "first published instalment of the materials collected for the projected Catalogue." The separate results for mean R. A. and N. P. D. are given, with catalogues of places for the commencement of each year, the whole number of stars observed being about 1,400. Bessel's reduction constants are appended. This form of publication is perhaps sufficiently ample in the present day, though Mr. Stone alludes to a desire expressed by some astronomers to see the Cape observations printed in detail in the same manner as the Greenwich observations, a plan hardly practicable with the limited staff at his disposal, and which would involve very slow progress of the work with the resources of the Cape press. We are inclined to think that Mr. Stone exercises a wise discretion in limiting his volume to its present form, and thus assuring its comparatively early distribution in the astronomical world. As it is the volume is not produced without a considerable expenditure of time in the routine work of the reductions by the director himself.

VARIABLE STARS.—Mr. J. E. Gore, of Umballa, writes with reference to several stars which may prove to be variable:—(1) Lalande 14088 (Canis Major); this star was observed by Lalande, March 2, 1798, but the magnitude was not registered. It is marked of the ninth magnitude only on Harding's Atlas, but at the beginning of February in the present year Mr. Gore found it a little brighter than the sixth magnitude Lalande 14105, closely south of it, and "decidedly reddish." Argelander observed this star on December 23, 1852, and rated it 6m. It is

as not entered it. There appears a strong suspicion of variability in this case. The star's position for 1877 is in R.A. h. 8m. 1rs., N.P.D.,  $112^{\circ} 27' 8''$ . (2) Harding has a star 6 m., little south—preceding 40 Leonis Minoris, where in February at Mr. Gore found only a star of about 10 m. The position at 1800, reading off from the Atlas, was in about R.A.  $157^{\circ} 14'$ , I.P.D.,  $63^{\circ} 28'$ . There is no star here in Lalande or Bessel, or in the *Durchmusterung*. (3) About  $1^{\circ} 20'$  south—following the 5 m. star 6 Canis Minoris, Harding has a 6 m. which on February 4 was only  $7\frac{1}{2}$  m., being less than Lalande 14720, but tighter than 14726; it was also less than the 7 m., about  $30'$  orth-preceding, which is underlined in the Atlas. This star appears to have been observed as an 8 m. by Bessel (Weisse, II., 780), and is called 8' m. in the *Durchmusterung*; Harding's place, however, requires a small correction in R.A. if Bessel's star is the one entered on his map.

BIELA'S COMET IN 1805.—Of the six observed returns of this comet that of 1805 was by far the most favourable for observation, and it approached very near to the earth as it sank below the horizon in Europe. At the beginning of December it exhibited a well defined planetary disc, according to Huth, surrounded by nebulousity  $20'$  in diameter; on the 8th Olbers found it very distinct to the naked eye, and it remained visible without the telescope after the moon had risen, though at a south declination of  $23^{\circ}$ ; the small well-defined nucleus which he had remarked in common with other observers he considered to be from twenty to thirty German miles in diameter. The comet was not observable in Europe after December 9, when it had reached  $35\frac{1}{2}^{\circ}$  S., but its after-course was a very favourable one for observation in the southern hemisphere, and, as Gauss remarked at the time, if observations from thence could have been obtained, it would have been practicable to determine at this appearance the true form of the comet's orbit, which, as is well known, greatly exercised the calculators of that day, and particularly Gauss and Bessel. The comet's apparent track in the southern heavens during the week subsequent to the cessation of observations in Europe was as follows, according to a computation from the definitive orbit in 1805, given by the late Prof. Hubbard:—

oh G.M.T.	R.A.	N.P.D.	Distance from earth
Dec. 9	350 9	122 26	0'03681
10	344 49	134 38	0'03698
11	337 14	145 49	0'03893
12	326 3	154 53	0'04245
14	288 36	164 36	0'05276
16	250 5	164 23	0'06570

While referring to Biela's comet, it may be noted that if the period of revolution had been so lengthened in 1872, as to delay the perihelion passage until December 27, and thus bring the comet, or what remains of it, into close proximity to the earth on the night of the great meteoric display a month previous, its return in 1879 will take place under nearly the same circumstances as in 1832, when this body was the object of so much interest.

NOTES

WE understand that the Fullerian Professorship of Chemistry at the Royal Institution is likely soon to be vacant by the resignation of Dr. Gladstone.

THE Council of the Yorkshire College of Science, Leeds, have arranged to purchase for 13,000l., the Beech Grove Hall Estate, comprising about three and a half acres, and situated a mile from the railway stations, and close to the Grammar School. The total donations to the College have now reached 42,456l.

It has been decided that of the statues of the two Humboldts which are to be erected in Berlin, that of Alexander will be given to Reinhold Begens to execute, and that of Wilhelm to M. P. Otto.

EVERY Thursday evening M. Leverrier receives at the Paris Observatory the provincial mayors who happen to be in Paris and explains to them the principles used by the International service for telegraphing its warnings all over France.

THE dreaded *Agmilicia vastatrix* which has hitherto been confined to the coffee plantations of Ceylon and Southern India has at last made its appearance in Sumatra, and in all probability will find its way before long to the neighbouring islands where coffee is grown.

THE Settle Cave Exploration Committee have issued a circular asking further contributions to enable them to carry on their important work. The valuable contributions already made, both to the historical and prehistoric ethnology of Britain are already well known, but there is good reason to believe discoveries even more interesting than any yet described remain to be made. The Committee are now working in beds of still earlier age than those hitherto explored, and hope by perseverance to throw some light upon the condition of Britain and its inhabitants during some of the most obscure ages of its geological history, the interest and value of the explorations increasing as the work is carried down into lower and earlier beds. Except at the entrance, the rocky floor of the cavern has not yet been found, and it is impossible to say what treasures to science and aids to the unwritten history of man still lie beneath the feet of the explorers. Though liberally assisted by a grant from the British Association, the Committee find themselves obliged to appeal to the public for further funds, without which this interesting work will speedily come to a premature end. We are sure that the wants of the Committee only require to be made known in order to be supplied. The sum required is, after all, very moderate, and we hope that many who read this will send what they can afford to the Hon. Treasurer, Mr. John Birkbeck, jun., Craven Bank, Settle, Yorkshire.

THE present French University will probably be divided into seven or eight local universities—Paris, Nancy, Lyons, Bordeaux, Lille, Marseilles, Montpellier or Toulouse. The competition between the two last has been so sharp that it has been suggested to divide between them the boon sought for. None of the existing Faculties in a large number of provincial towns will be suppressed, but will become affiliated to the nearest university. Each university will be governed by a special Senate or Council, and the Minister of Public Instruction will have authority over all of them. Fellowships will be created by the government, and will be distributed according to merit, after due examination.

ALL who have read Mr. Smiles's "Scottish Naturalist" must remember the crowning incident of Mr. Edward's exhibition of his collection in Aberdeen, when, in his despair at the total success of his venture, he rushed to drown his misery in the Dec. Mr. Edward was the chief actor in a very different scene in the same city on Wednesday week, when the proverbially hard-headed and close-fisted citizens of Bon Accord tried to make amends for their former almost fatal neglect, by presenting him publicly, through their Lord Provost, with an olive-wood casket containing 333 sovereigns. Mr. Edward, who seems to be taking his sudden eminence very quietly, thanked the subscribers in a short speech spoken in broad Doric and characterised by perfect naturalness and much humour—Scotch, perhaps, but not Highland, as some of the papers characterise it, for Aberdeen and Banff are as much "Highland" as Berwick and Newcastle. Mr. Edward made no allusion to his former treatment by the certainly not obtuse Aberdonians, who, after all, can't be blamed for not making it their business to discover and succour genius, though the gift of the "bit boxie," as Edward called it, looks very like as if meant to be a peace-offering.

THE papers read at the Iron and Steel Institute last week were all of a purely technical nature. The Bessemer Medal was

presented by the President to Dr. Percy, who, in his reply, hinted that he is at present engaged in a large new metallurgical work. The Institute unanimously approved of the President's proposal to endeavour to obtain for the applied science societies a common permanent home. The Institute holds its autumnal meeting in Newcastle in September next, Norway having been abandoned, mainly, we believe, on account of the death of the Foreign Secretary, Mr. David Forbes. The Institute of Naval Architects, which also met last week in London, intends, we believe, to have for the first time an autumnal session, Glasgow and the Clyde having been selected for a visit next August.

THE following are the probable arrangements after Easter at the Royal Institution for the Friday evenings—April 13, Dr. William Spottiswoode, Treas. R.S., Experiments with a Great Induction Coil; April 20, Mr. Frederick Pollock, M.A., Spinoza; April 27, Lieut.-Gen. Richard Strachey, R.E., F.R.S., The Physical Causes of Indian Famines; May 4, Rev. W. II. Dallinger, Researches on the Origin and Development of Minute and Low Forms of Life; May 11, Mr. D. Mackenzie Wallace, M.A., The Intellectual Movements and Secret Societies in Russia; May 18 [blank]; May 25, Mr. G. J. Romanes, The Evolution of Nerves and Nervo-Systems; June 1, Mr. Oscar Browning, The History of Education; June 8, Prof. Tyndall, F.R.S. The lecture arrangements are as follows:—Prof. J. II. Gladstone, F.R.S., Five Lectures on the Chemistry of the Heavenly Bodies, on Tuesdays, April 10 to May 15; Prof. Tyndall, F.R.S., Eight Lectures on Heat, on Thursdays, April 12 to May 31; Mr. Edward Dannreuther, Two Lectures on Chopin and Liszt, on Saturday, April 14, and Thursday, June 7; The Rev. A. II. Sayce, M.A., Three Lectures on Babylonian Literature, on Saturdays, April 21, 28, and May 5; Mr. Walter II. Pollock, M.A., Three Lectures on Modern French Poetry, on Saturdays, May 12, 19, 26; Mr. Charles T. Newton, C.B., Two Lectures on the Recent Discoveries at Mycenæ, on Saturdays, June 2 and 9.

THE first of the letters from Mr. Stanley, already referred to, is published in Monday's *Daily Telegraph*. It is dated Ujiji, August 7, 1876. Mr. Stanley has succeeded in circumnavigating Lake Tanganyika, exploring every indentation, and has made a material addition to our knowledge of this interesting body of water. As might have been expected, he has occasion to supplement and correct the observations of his predecessors. On the mistakes of the latter he dwells at quite unnecessary length, and discusses them in an aggravatingly apologetic tone, which becomes quite irritating, and does not in the least enhance the value of his own discoveries, which require no contrast to bring out their importance. The greater part of Mr. Stanley's letter is occupied with an account of his exploration of the Lukuga, Cameron's supposed outlet of the lake, but which Mr. Stanley maintains, on what appear solid grounds, to be merely a creek, the surface current of which is influenced by the wind. The most extraordinary result, however, of his examination of the lake and of the Lukuga, is that the former is rising with comparative rapidity—several feet since Cameron's visit—and that in the course of a very few years the Lukuga will develop into an effluent river, which will pass over the narrow mud-swamp that separates it from the river Luindi, flowing westwards to the Kamolondo River (it is not a lake), and thence to the Lualaba. Thus, what Cameron discovered, is not the present, but the future outlet of the Tanganyika, which hitherto Mr. Stanley maintains, has had no outlet. It must not be forgotten that this outlet has already been suggested by Livingstone; writing on October 8, 1871, about three years before Cameron's visit, he says, "It may be that the Loŋgumba is the outlet of Tanganyika; it becomes the Luasse farther down, and then the Luanio before it joins the Lualaba; the country slopes that way, but I was too ill to examine its source." The interest of geologists will cer-

tainly be excited, if not satisfied, by some references in Mr. Stanley's letter. He speaks of basalt and trap-rocks as occurring in the district, and of a large portion of the shores of the lake being composed of calcareous tufa; he also, somewhat more obscurely, refers to what he thinks may be volcanic cones; and states that considerable quantities of asphalt have been found floating on the waters of the lake. The theory which Mr. Stanley suggests as explaining the origin of this vast lake is of a sufficiently startling character. At no remote period, his hypothesis is, this part of Africa was a level table-land, westwards across which flowed the Malagarazi, and other rivers along a channel which is now occupied by the Lukuga and Luindi. But a great volcanic convulsion disturbed the region, sinking a deep hollow across the channel of the Malagarazi, which, with other streams, has ever since been filling up the bed. Mr. Stanley supposes he has come upon the lake when it has almost reached its highest level and is about to form an outlet by the Lukuga. Until more detailed and exact information reaches us concerning the structure of the country it would be premature to enter upon a discussion of this theory. Possibly Mr. Stanley's other letter, which will be published to-day, may enable geologists more fully to understand the conclusions at which the traveller appears to have arrived. In the north-west part of the lake, what Burton, Speke, and Stanley himself had thought to be an island, Ubwari, is really a peninsula. This is so indicated on Livingstone's map, with the remark that "a sandy spit connects Mozima Island and the shore."

ON Monday night Sir George Nares read a paper on some of the results and observations of the late Arctic Expedition. He discussed mainly the state of the ice and the limits of life in the most northern channels, and concluded by stating his conviction that unless the coast of Greenland extended beyond lat. 83° 20', the Pole would not be accessible by the Smith Sound route. In the discussion which followed it was evident that a marked change of opinion has followed the results of the late expedition as to the best route to the Pole, the general opinion being that the Smith Sound route must be abandoned and that by Spitzbergen tried. This must no doubt be gratifying to Dr. Petermann, who has so long advocated the latter route, though this change of opinion is not at all inconsistent with the idea that much valuable scientific information is still to be obtained in the Smith Sound region. Admiral Richards expressed his decided conviction that sledge travelling is at an end, although he does not venture on the opinion that ship would actually reach the Pole by the Spitzbergen route. Now that the Presidential excitement is over in America, we may hope to hear of preparations being made for the establishment of the proposed Polar Exploring Colony.

THE National French Committee for the Exploration and Civilisation of Southern Africa has held its inaugural meeting. M. De Lesseps was appointed president. Two delegates were appointed to represent the French Section in the large Committee presided over by the King of the Belgians. They are MM. D'Abbadie, Member of the Institute, and Grandidier, the French explorer of Madagascar.

A SECOND Italian expedition for the exploration of Africa, has arrived at Suez.

THE *Honolulu Gazette* of February 28, reports an extraordinary volcanic outbreak in Kealakeakana Bay, near the entrance to the harbour. The eruption occurred at 3 A.M. on the 24th, appearing like numerous red, green, and blue lights. In the afternoon the water was in a state of peculiar activity, boiling and broken, and heaving up blocks of red-hot lava. A severe shock of an earthquake was felt by the residents of Kamaekia during the night of the eruption.



MR. STANFORD has just published five more physical wall-maps of the series noticed by us some time since. One chief feature of these maps is their exhibition of the orography of the respective countries, and we still think it would be an improvement if the green could be dispensed with, as by the use of light and the blue of the water are indistinguishable. We are glad to know, however, that means are being taken to remedy this in future issues, which we think may easily be done by the use of various shades of brown, when this is done the maps will leave little to be desired. They are those of North and South America, Africa, Scotland, and Ireland. Each map is up to the latest date, and as physical maps, showing at the same time all the main natural and artificial features of the various countries, they must be quite a luxury to teachers and students, and to all who have to consult maps. Africa especially is thoroughly satisfactory, and the compiler has wisely obtained from following any theory as to the course of the fragmental rivers west of Tanganyika, unless indeed one may be led to infer that he believes Lake Chad to be the receptacle of much of the drainage attributed to the Congo and the Ogove, so, his theory, judging from the little that is known of the rivers themselves, and the various elevations of the region so clearly shown in the map, is quite as probable as any other.

M. LEVERRIER recently received a requisition from the Chamber of Commerce of Marseilles for the establishment of a special service for the Mediterranean coasts. M. Leverrier replied that the military government had established in Algeria a special meteorological service which pertinaciously refused to comply with the rules of the international service. Consequently it was impossible for him to take advantage of Algerian observations so long as the special rules of the Algerian Meteorological service were not altered, and without Algeria no reliable service could be established at Marseilles.

THE opening meeting for 1877 of the West Riding Consolidated Naturalists' Society will be held at Pontefract on Easter Monday, April 2.

WE have to record the death, on the 9th inst., of Dr. John Scott Bowerbank, F.R.S., so well known from his important investigations on sponges. Dr. Bowerbank, born in 1797, in London, commenced life as a distiller, but being attracted by biological studies, subsequently devoted himself to them. In 1833 his first paper appeared in the *Entomological Magazine*, on the circulation of the blood in insects, from which time numerous papers by him have appeared in the *Philosophical Magazine*, the *Microscopical Journal*, the *Annals of Natural History*, the *Philosophical Transactions* and the *Proceedings of the Zoological Society*, upon the geological and structural relations of the spongiæ, upon Pterodactyles, upon the structure of the shells of the Mollusca, and other less important points. Dr. Bowerbank was a Fellow of many learned societies, with the foundation of more than one of which he was intimately associated, including the Microscopical, the Ray, and the paleontological.

THE tomb of Croci Spinelli and Sivel, the two *Zenith* astronauts, will be inaugurated at Pore la Chaise on April 4.

THE Annual Congress of the *Société des Savantes* will, as usual, take place at Paris on April 3 and following days.

A WELL-ATTENDED *soirée* was given by the Northampton Naturalists' Society on Tuesday evening, March 6, in the Science and Art Rooms of the Grammar School. A large and valuable series of natural objects were displayed, many of which had been collected during the past year. Amongst those especially worthy of note were a splendid collection of eggs, exhibited by the Rev. G. Nicholson; of butterflies, A. Perry, Esq., of plants, by G. C. Druce, Esq.; and

of fossils, by W. Hull, Esq., and C. Jecks, Esq. The opening address was given by the Rev. R. Winterbotham, and short addresses were delivered in the course of the evening, by the Very Rev. Canon Scott, the Rev. W. F. Aveling, and B. Thompson, Esq. A beautiful collection of photographs was exhibited by R. G. Scriven, Esq., and H. Manfield, Esq., under the superintendence of the Rev. S. J. W. Sanders, and the attractions of the evening were still further enhanced by the exhibition of several excellent microscopes, and other scientific instruments, kindly lent by various gentlemen of the town and neighbourhood.

IN "The Stone Age in New Jersey," by Dr. C. C. Abbott (Washington, Government Printing Office), a valuable mass of facts on the various implements and weapons found in that state is collected and discussed, and illustrated by upwards of 220 cuts.

PART 4 of V. 11 of the *Proceedings* of the West London Scientific Association contains, among other interesting papers, one on Waves, by Prof. F. Guthrie, F.R.S.

AMONG other matters that came before the German Ornithological Society at a recent meeting, mention was made by M. Mutzel of an osprey which had lived eighty years in captivity on a farm near Neu Damm. M. Schulow took up the question whether in bad weather birds stop their migratory flight and return, or not. He affirmed that they either went on or remained for a time where they happened to be caught by the weather. M. von Schleinitz, of the *Gazelle*, stated that several individuals of *Chionis nivosus* had been brought from Kerguelen's Land to St. Paul's. It remains to be seen on later visits to St. Paul's whether the birds will still be found there.

M. DECHARME has been studying the comparative pitch of sounds given by various metals and alloys. Cylindrical bars of each metal were used, all of the same length and diameter (20 cm and 1 cm). The metals examined rank as follows in ascending series—Iron (fa, 690 vibrations), gold, antimony and silver (the same), tin, brass, zinc, copper, cast iron, iron, steel, aluminium (fa, 2,762 vibrations). From lead to aluminium there is thus an interval of two octaves. No simple relations, sufficiently exact, were perceived between the pitch of the sounds and the physical or chemical properties of the substances. M. Decharme's results differ considerably from those of Wertheim.

THE circumference (not the diameter) of the exploding balloons for meteorological purposes in Paris, referred to last week, is ninety centimetres. They have an ascensional force of about thirty grammes.

PROF. GARKOD illustrated his Royal Institution lectures by a colossal model of a disarticulated human skull, not skeleton, as we stated last week.

THE additions to the Zoological Society's Gardens during the past week include a Puma (*Felis concolor*) from South America, presented by Commander Stanhope Grove, R.N.; a Nisnas Monkey (*Cercopitheus pyrrhonotus*) from Nubia, presented by Mr. B. C. Simpson; a Burrhel Wild Sheep (*Ovis burrhell*) from the Himalayas, deposited; two Hairy Tree Potcupines (*Sphingurgurus villosus*), two White-fronted Guans (*Pendopus pumilus*) from Brazil, two Blue-bearded Jays (*Cyanocorax cyanopogon*) from Para, two Turkey Vultures (*Cathartes aura*) from America, two Upland Geese (*Bernicla magallanica*) from Patagonia, three West Indian Rails (*Aramides cayennensis*), a Common Boa (*Boa constrictor*) from South America, two Great Cyclodus Lizards (*Cyclodus gigas*), a Stump-tailed Lizard (*Trachydosaurus unguis*) from Australia, purchased; a Zebu (*Bos indicus*) born in the Gardens.

## SOCIETIES AND ACADEMIES

LONDON

Royal Society, January 18.—“Residual Charge of the Leyden Jar.—II. Dielectric Properties of Various Glasses,” by J. Hopkinson. Communicated by Prof. Sir William Thomson, F.R.S.

The experiments appear to verify the fundamental hypothesis, viz., that the effects on a dielectric of past and present electromotive forces are superposable. Ohm's law asserts the principle of superposition in bodies in which conduction is not complicated by residual charge. Conduction and residual charge may be treated as parts of the same phenomenon, an after effect as regards electric displacement, of electromotive force. The experiments appear to show that the principle of Ohm's law is true of the whole phenomenon of conduction through glass.

February 1.—“The Meteorology of the Bombay Presidency,” by Charles Chambers, F.R.S., Superintendent of the Colaba Observatory.

This work consists of four parts—the first dealing with registrations of meteorological phenomena at the Colaba Observatory during a period of twenty-seven years; the second with moderately full observations at five military stations in the Bombay Presidency during a period of nineteen years; and the third with large numbers of observations from civil hospitals and revenue stations, being those of selected registers extending over various periods from not less than a fortnight up to a number of years; in this part the phenomena treated are temperature of the air, winds, and rainfall only; and the extent of territory to which the observations refer includes the whole of the Presidency, Sind, and the western half of Rajputana. In the fourth part are discussed the general distribution (as regards both space and season) of temperature and rainfall, and the variations of the wind; first with respect simply to the physical geography of the country, and then in combination with certain theoretical views, the elucidation of which, by means of the dynamical theory of heat and the kinetic theory of gases, occupies much space.

February 15.—“On Stratified Discharges.—III. On a Rapid Contact-Breaker, and the Phenomena of the Flow.” By William Spottiswoode, M.A., F.R.S.

In a paper published in the *Proceedings* of the Royal Society, vol. xxiii. p. 455, I have described a form of contact-breaker designed for great rapidity and steadiness of action. It consisted of a steel rod which vibrated under the action of an electromagnet. As regards sharpness of break and steadiness of the strike, this instrument left little to be desired. But, as explained in the paper, an alteration in the current not only affected the steadiness directly, but also reacted on the break itself. In order to obviate this inconvenience, I devised another form of contact-breaker consisting of a wheel platinised at the edge, on which a platinum spring rests. In the circumference of the wheel a number (40 in the first instance) of slots were cut, and filled with ebonite plugs so as to interrupt the current. The breadth of the slots was about  $\frac{1}{64}$  inch, and that of the teeth about  $\frac{1}{16}$  inch. The wheel was connected with suitable driving gear, so as to give from 250 to 2,000 currents from the coil in each direction per second.

For some time the experiments were conducted with the platinum spring resting on the wheel; and the effects were varied by altering either the pressure of the spring or the velocity of the wheel; but it was found that actual metallic contact between the spring and wheel was not necessary, provided that a layer or cushion of conducting material were interposed. Such a layer was formed by a thin film of dilute sulphuric acid drawn out by a thread leading from a reservoir and resting on the wheel. The spring, which under these circumstances became unnecessary, was replaced by a point, the adjustment of whose distance from the wheel was simple. This arrangement gave excellent results, even when the number of currents per second was reduced in some cases to 250; added to which the unpleasant and disturbing noise of the friction was entirely avoided. Ultimately, however, I used a light wire in the place of the spring first mentioned.

With the contact-breaker here described effects similar to those produced by the rapidly-vibrating break were obtained. The strike were formed in a regular manner, and advanced or receded, or remained at rest, in a column usually unbroken so long as the velocity of the wheel was maintained without change.

With a view of ascertaining the nature of the distinction between the ordinary and the steady strike, careful observations were

made with the revolving mirror. It having been noticed that when the wheel-break moved slowly, ordinary or irregular strike were produced, and that when it moved rapidly, steady strike resulted, it seemed probable that the latter effect might be due to the short time of contact, and to the consequent absence of many of the features described in Part II. of these researches. This is, in fact, identical with the suggestion there made, that the fluttering appearance was due to the unequal duration of the strike themselves, and to the irregular positions of the points at which they are renewed at successive discharges of the coil. And such, in fact, proved to be the case; for as the speed of the wheel was increased, the duration of the discharges diminished; the image as seen in the mirror became narrower and simpler in its configuration, until, when the steady effect was produced, each discharge showed only a single column of strike of a width proportional to the apparent width of the slit. The proper motion, implied by the inclination of the individual strike to the vertical, was still perceptible, and was directed as usual towards the negative pole.

The phenomena of the flow may be considered to be due to the different positions taken up by the strike in successive discharges. If in each discharge the strike occupy positions in advance of those occupied in a previous discharge, the column will appear to advance; if the reverse be the case, they will appear to recede. If the positions remain unchanged, the column will appear stationary.

Experiments were instituted with a view of ascertaining the connection between the flow and resistance. Starting from a condition of current and break for which the strike were stationary, it was found that an increase of resistance, introduced generally in the primary circuit, produced a forward flow, i.e. from the positive towards the negative terminal, while under similar circumstances a decrease of resistance produced a backward flow. Furthermore, if after producing a forward flow the resistance be continually increased, the flow, after increasing in rapidity so as to become undistinguishable by the unassisted eye, gradually appears to become slower, and ultimately to reverse itself.

Another form of contact-breaker was also occasionally used. The principle upon which it was based was the sudden disruption of a thin film of conducting liquid by a discharge between the electrodes of a circuit.

As soon as the current passes, the fluid between the plate and point will be decomposed, and electrical continuity broken. This done, the fluid flows back again, and continuity is restored.

February 22.—“On a New Form of Tangential Equation,” by John Casey, LL.D., F.R.S., Professor of Higher Mathematics in the Catholic University of Ireland.

“Addition on the Bicircular (Quartic),” by A. Cayley, LL.D., F.R.S., Sadlerian Professor of Mathematics in the University of Cambridge.

Geological Society, March 7.—Prof. P. Martin Duncan, F.R.S., president, in the chair.—The Rev. Ebenezer Davies, William Davies, and Henry Davis Hoskold were elected Fellows, and George Garves Brush, Professor of Mineralogy in the Sheffield School of Science, Yale College, Newhaven, Connecticut, Prof. A. L. O. Descloizeaux, of Paris, Prof. E. Renzvier, of Lausanne, and Count Gaston de Saporta, of Aix en Provence, Foreign Correspondents of the Society.—The following communications were read:—On the vertebral column and pelvic bones of *Pliosaurus evansi* (Seeley), from the Oxford Clay of St. Neot's, in the Woodwardian Museum of the University of Cambridge, by Harry Govier Seeley, F.L.S., Professor of Geography in King's College, London. In this paper the author described some bones obtained by J. J. Evans in the lower part of the Oxford Clay at Eynsbury, near St. Neot's. They consisted of thirty-seven vertebrae, twenty-one of which are cervical, and apparently complete that series. These presented the characters of the cervical vertebrae of the typical Pliosaurus of the Kimmeridge Clay. The remains of the pelvis included a pubic bone showing a close correspondence in form with those of the Pliosaurus of the Kimmeridge Clay of Ely, and an ischium.

Supplementary notes on the fauna of the Cambridge Greensand, by A. J. Jukes-Browne, F.G.S. This paper was supplementary to one communicated to the Society by the author in 1875, in which he maintained that the Upper Greensand does not extend further in a northwesterly direction than West End Hill, near Cheddington, in Buckinghamshire, that the Cambridge Greensand is merely a nodule-bed at the base of the Chalk Mass, resting unconformably upon denuded Gault, to the upper part of which the greater portion of the fauna belongs, and that the

remainder of the fauna, belonging to the deposit itself, consists of species proper to the Chalk Marl rather than to the Upper Green-sand. The object of the paper was to indicate certain additions to, and corrections in, the list of fossils upon which these conclusions were supported. The following Gault species were indicated as not previously identified in the Cambridge Greensand:—*Nautilus vucatus*, Desh.; *N. inaequalis*, Sow.; *Turrillites elegans*, D'Orb.; (?) *T. emericianus*, D'Orb.; *Ornithopsis histocheila*, Gardn.; *Trachystoma angularis*, Seeley; *Turbo pictetanus*, D'Orb.; *Urosomaria regina*, Pict. and Roux; (?) *P. iteraiana*, Pict. and Roux; *Pecten raulinianus*, D'Orb.; *P. subacutus*, D'Orb.; and *Lima rauliniana*, D'Orb. The author described as new species—*Turrillites nobilis*, *Nautilus*, sp. nov., *Natica levistrata*, *Serita nodulosa*, and *Lima interlineata*, and noted several corrections in the nomenclature adopted in his former list.—On the beds between the Gault and Upper Chalk, near Folkestone, by G. Hilton Price, F.G.S. The author described the characters presented by the beds between the Gault and Upper Chalk near Folkestone, indicated the fossils contained in them and their range in this division of the Cretaceous series, and discussed the classification of the deposits and their equivalence with those recognised by other writers.

Anthropological Institute, March 13.—Mr. John Evans, F.R.S., president, in the chair. The President exhibited a hafted bronze celt, with its original wooden handle (which was covered with brass plates), found near Chiusec.—Mr. Biddulph Martin exhibited some pottery, shells, and other remains from a supposed kitchen midden at Smyrna, which, the president pointed out, was of comparatively modern date. Some flint arrow-heads, rapers, &c., from Ditchley, were exhibited by Capt. Dillon.—Mr. Hyde Clarke then read a paper on the Himalayan origin of the Magyar. The object of this paper was to show that languages of Nepal, &c., in the Himalayas, formerly called Subarvian, are to be classified as Ugrian, and include Finnish, Magyar, Lap, and Samoyed affinities. In connection with the extension of the Ugrian area and possible centre to High Asia, the author entered on the question of the origin of the Magyars. After referring to the Magyar, Khun, &c., in the Himalayas, he proposed as a solution that the attack on Pannonia had been made by Avar or Khunzag traders from the Caucasus speaking a Vasco-Kolarian language, and with a main body of Ugrians, the language of whom prevailed in the extinction of the former. The author dissented from the Ugrian classification of Accad and Etruscan, giving other prehistoric examples for the Accad words in Lenoimant, claimed by him and M. Sayous as Ugrian. Messrs. Bertin, Salyinos, Coes, the President, and others, took part in the discussion.—The Director then read the following papers by Mr. Hector McLean:—On the Scottish Highland language and people, and on the Anglising and Gaelicising of surnames.

Physical Society, March 3.—Prof. G. C. Foster, president, in the chair.—The following were elected members of the Society:—Mr. J. A. Fleming, Mr. P. le Neve Foster, and Mr. S. Hall.—Prof. Foster showed experimentally the polarisation of heat rays, employing two large Nicol's prisms of 2½ inch aperture, and thermopile surrounded by a double jacket and connected with Thomson galvanometer as arranged by Mr. Latimer Clark for showing very slight indications to an audience. When the principal sections of the prisms were at 90° to each other only a slight movement, doubtless due to an initial heating of one side of the pile, was observed; and the amount of the deflection was found to increase steadily up to about sixty divisions on the scale as the above angle was diminished. Prof. Foster exhibited the results of experiments made to determine the intensity of a source of heat by this means, and they were very concordant.—Mr. Latimer Clark then explained the arrangement of the galvanometer used. The image of an arrow head or other form of index projected by means of a limelight at the further end of the room traverses a telescopic object-glass about two feet distant from the lamp and falls on a square silvered plate of glass suspended from the needle of a Thomson galvanometer, which is rendered ready in the ordinary way by a platinum spade in water. The deflected image then traverses the whole length of the room and falls on a large scale placed in front of the audience, and, by such an arrangement, the instrument may be at any distance from the scale, and yet the image will not be unduly magnified. A method is employed for bringing the needle rapidly to rest. A thermo-electric couples are placed above the lamp chimney, and being kept constantly hot, and the terminals are united by wires which is coiled several times round the galvanometer;

the circuit is closed at the moment when this subsidiary current will tend to neutralise the motion of the needle.—Prof. Guthrie incidentally mentioned that the difficulty experienced in separating the fibres of a cocoon thread may be obviated by boiling the thread in carbonate of potash, when the natural resin is saponified and the fibres may be easily split.—Mr. Wilson then explained some difficulties he has met with in constructing a Holtz electrical machine, especially with reference to the windows and armatures, and he exhibited two machines which he recently made, from one of which a spark five or six inches in length can be obtained; this apparatus is so arranged that it can be taken entirely to pieces and packed in a very moderate-sized case. After carefully pointing out the difference between an ordinary machine and the Birch machine, he proceeded to consider the theory of the Holtz machine, and explained how he was led to construct an instrument in which there were no windows, the armatures being placed on the face of the fixed plate next to the moving plate, but the result was not satisfactory. He then made the larger machine provided with six fixed and six moving plates, and the windows were replaced by holes ½ inch in diameter traversed by short pieces of tape glued to the paper armatures. The initial charging of the armatures is effected by means of a disc of ebonite fixed to the main axis of the machine, which is lightly held by the fingers and caused to rotate. Electricity is thus generated and points projecting towards it and communicating with points in the neighbourhood of the armatures cause them to become charged; after this, electricity is generated with great rapidity.—Prof. MacLeod gave some details concerning the working of a large Holtz machine which he drives by a turbine. He finds that after it has been in action for nearly an hour a much greater force is required to work it, and he suggested a theory in explanation of this phenomenon. By keeping the machine dry under a glass shade reversing effects are entirely avoided as well as the necessity for varnishing the plates.

Entomological Society, March 7.—J. W. Dunning, F.L.S., vice-president, in the chair.—Mr. Douglas exhibited a specimen of the Longicorn Beetle, *Monohammus ulor*, brought to him alive, having been captured in a garden in the Camden Road; also a melanic variety of *Orthosa suspecta*, taken at Dunkeld.—Mr. Inudd exhibited some interesting varieties of British Lepidoptera taken near Bristol and in South Wales; amongst them were *Iycia na alexis*, *Sphinx ligustri*, and *Boarmia repandata*, the latter a black variety.—Mr. Champion exhibited specimens of *Cassiopeus rufipes*, a species new to Britain, taken by Mr. J. Dunsmore, near Paisley; also a British example of *Aphodius seroja* from the collection of Mr. Dunsmore, who unfortunately had no note of its locality.—The Secretary exhibited a specimen of an Isopod Crustacean which had been forwarded to him by Mr. J. M. Wills, surgeon, *City of Canterbury*, who stated that it was found occasionally parasitic on the flying fish, and generally close to the pectoral fins. Mr. Douglas read an extract from a letter from Dr. Sahilberg, who had recently returned from an excursion to the neighbourhood of the Yenisei River and the extreme north of Siberia, from whence he had brought a large number of insects, principally Coleoptera and Hemiptera. Amongst the Hemiptera were one *Aradus*, one *Calocoris*, two *Orthotylus*, one *Orthops*, one *Pachystoma*, one *Anthacoris*, one *Acomptocoris*, five *Sahlia*, and one *Corixa*, which appeared to be hitherto unknown. The species of *Sahlia* were from the extreme north, in Tundra territory.—The Secretary read a paper by Mr. W. L. Distant, on the geographical distribution of *Danaus archippus*, a North American butterfly which has recently been taken in the south of England.

Mineralogical Society, March 14.—Mr. H. C. Sorby, F.R.S., president, in the chair.—The following papers were read.—On a simple method for roughly determining the index of refraction of small portions of transparent minerals, by H. C. Sorby, F.R.S.—This can be effected by having a small graduated scale attached to the body of the microscope, by means of which the thickness of the crystal and the displacement of the focal point can be easily measured. From these data the index of refraction can be at once calculated with sufficient accuracy to make the result valuable in determinative mineralogy.—On a serpentine from Japan, by A. H. Church, M.A.—Notes on Vauquelinite from Scotland, and Cantonite or Harrisite from Cornwall, by Thomas Davies, F.G.S.—On an easily constructed form of reflecting goniometer, by S. B. Hannay, F.C.S.—On a peculiar form of quartz crystals from Australia, by Rev. J. M. Mello, F.G.S.—On certain black quartz crystals from Boscawell Down, Cornwall, by

J. H. Collins, F.G.S. The black colour is due to minute crystals of schorl.—On quartz including oxides of iron, by William Vivian.—On the magnetic constituents of minerals and rocks, by J. B. Hannay.—On the water contained in minerals, by J. B. Hannay.—On the Nordenskjöld iron masses from Greenland, by K. T. V. Steenstrup, translated by Mr. Rohde, one of the Danish expedition. The author contends that the iron is a natural constituent of the basalt, and not of meteoric origin.

Institution of Civil Engineers, March 13.—Mr. George Robert Stephenson, president, in the chair.—His Majesty the King of the Belgians was elected by acclamation an honorary member. The paper read was on the transmission of motive power to distant points, by Mr. H. Robinson, M. Inst. C.E.

MANCHESTER

Literary and Philosophical Society, December 4, 1876.—Charles Bailey in the chair.—Notes on a botanical excursion in the Aberdeenshire Islands in July, 1876, by Mr. Thomas Rogers.

December 26, 1876.—A notice of some organic remains from the schists of the Isle of Man, by E. W. Binney, president, F.R.S., &c.

January 9.—E. W. Binney, F.R.S., F.G.S., president, in the chair.—On the poisonous properties of yew-leaves, by James Bottomley, D.Sc.—On the luminous sulphides of M. Ed. Becquerel, by William Thomson, F.R.S.E.—On the types of compound statement involving four classes, by Prof. W. K. Clifford, M.A., F.R.S. Communicated by Prof. W. S. Jevons, M.A., F.R.S.

January 23.—Results of the monthly observations of the magnetic dip, horizontal force, and declination made at the magnetic observatory of the Owens College, from January, 1874, to December, 1876, inclusive, by Prof. Thomas H. Coie, M.A. Communicated by Prof. Balfour Stewart, LL.D., F.R.S.

GENEVA

Physical and Natural History Society, February 1.—M. Alphonse Favre presented a geological map of the Canton of Geneva on the scale of 1:100,000, intended to enlighten agriculturists on the management of the soil for their various crops.—Prof. Schiff described the researches he had made on the properties of nicotine as a poison, and on the part played by the liver in such poisoning.

February 15.—M. E. Renevier, professor at Lausanne, exhibited to the Society his geological map of Vaudoises Alps, on the scale of 1:100,000, as also several sections which complete it. It includes principally the mass of the Dablerets and the neighbouring spurs on the right bank of the Rhone.—Prof. Wartmann showed a small apparatus intended to prove the impulse which an induction spark in a rarefied gas is capable of giving in the direction of its length.—M. Raoul Pictet described various experiments made by himself, and proving the great facility with which sulphuric acid is diffused through caoutchouc.

PARIS

Academy of Sciences, March 19.—M. Peligot in the chair.—The following papers were read:—Observations of temperature at the Museum of Natural History, during 1876, with electric thermometers placed at depths of 1 metre to 36 metres under ground, as also in air and under grass-covered and bare ground, by MM. Becquerel. The results are nearly the same as were obtained before. General Morin, remarking that at only 10 to 12 metres depth he found a nearly constant temperature of 11°, suggested the use of underground air, drawn through pipes, to produce a constant temperature where it might be required (as for conservation of meat, &c.).—On the decomposition of bioxide of barium *in vacuo*, at the temperature of dark red, by M. Boussingault. The whole of the oxygen could be thus extracted. On removing the source of heat the bioxide was reconstituted. Bioxide of barium, then, cannot exist *in vacuo* at a dark red heat.—Physical and mechanical actions of incandescent and strongly compressed gases from combustion of powder. Application of the facts to certain characters of meteorites and bolides, by M. Daubrée. The facts of experiment seem to explain:—(1) the alveolar cavities or cupules in meteorites; (2) the peculiar clouds, smoke, or dust, which follow the disappearance of the incandescent mass; (3) the dust of cosmic origin which is thus expanded in our atmosphere, not only by combustion and volatilisation, but by pulverisation at a high temperature.—On the fundamental invariants of the binary form of the eighth degree, by Mr. Sylvester.—On the palæontological origin

of trees, shrubs, and bushes indigenous in the south of France, that are sensitive to cold in severe winters, by M. Martins. He considers them to be the survivors of the flora which covered those parts during the Tertiary period. We have here plants exotic as regards *time*, while other plants are exotic as regards *space*. At Montpellier and Marseilles the annual average of absolute minima of temperature are -9.23° and -5.95° respectively.—On the experiments made at Prévigny by the canton of Geneva, by M. Bouley. He had erroneously given the Swiss Federal Government the credit of the experiments.—M. Hebert was elected member in the section of Mineralogy in room of the late M. Ch. Sainte-Claire Deville.—On the phosphorescence of organic bodies, by Mr. Phipson. *Apropos* of a recent note, he calls attention to his memoir on noctilucline, the first organic body known to be phosphorescent by slow oxidation, like phosphorus in the mineral kingdom.—Propositions of algebra and geometry deduced from consideration of the cubic roots of unity, by M. Appell.—On the curvature of surfaces, by M. Serret.—On a problem comprising the theory of elimination, by M. Ventéjols.—On the suspension of water in a vessel closed below by a tissue with large meshes, by M. Plateau.—On a singular fact of production of heat, by M. Olivier.—On the reform of some processes of analysis used in the laboratories of agricultural stations and observatories of chemical meteorology; first part, Ammonimetry, by M. Houzeau. His method is to use stable vinous red litmus, which will reveal free ammonia in solution in water containing only 1/100000 and even 1/1000000 of its weight of that substance. The proportion is determined by pouring into the litmus-coloured liquor a weak titrated acid till disappearance of the original red.—On the preparation of crystallised acetate of magnesia, and on the fermentation of this salt, by M. Patrouillard.—On a simple mode of production of certain mono-, bi-, and tri-chlorised acids, by M. Demarçay.—Transformation of normal pyro-tartaric acid into dibromo-pyrotartaric and dibromo-succinic acids, by MM. Reboul and Bourgoin.—Action of chlorochromic acid on anthracene, by M. Haller.—On the constitution of pseudo purpurine; continuation of researches on the colouring matters of madder, by M. Rosenstiehl. Pseudo-purpurine is sufficiently unstable to produce by its partial destruction the other colouring matters in madder (alizarine excepted).—Experiments on muscular tonicity, by M. Carlet. A muscle generally contracts after section of a nerve, before final relaxation. This is due, the author says, to the increased excitability of the nerve. In rare cases, where the nerve is cut without excitation (at one of Bridge's "nodes" perhaps), relaxation begins at once. Elongation immediately after section is due to *rigidity* not *flexibility*, the extensor muscles being stronger than the flexors.—On the modifications in the egg of phanerozoous medusæ before fecundation, by M. Giard.—On the age of elevation of the Margeride, by M. Fabre.—On the formation of thunderstorms, by M. Zundel.—Clinical and therapeutical researches on epilepsy and hysteria, by M. Bouneville. From two analyses of portions of liver from an epileptic patient who had taken, in four months, forty-three grammes of ammoniacal sulphate of copper (and died of pulmonary tuberculosis 2½ months after cessation of the treatment), the total amount of copper in the liver was estimated at 236 milligrammes and 250 mm.

CONTENTS

	PAGE
PALMÉN ON THE MIGRATION OF BIRDS . . . . .	465
OUR BOOK SHELF:—	
Bottomley's "Dynamics; or, Theoretical Mechanics, in Accordance with the Syllabus of the Science and Art Department" . . . . .	467
LETTERS TO THE EDITOR:—	
Evolution and the Vegetable Kingdom.—J. S. G.; THOMAS COMBER . . . . .	467
The Rocks of Charnwood Forest.—REV. T. G. DONNAY; E. HILL . . . . .	470
Southern Double Stars.—ROBT. I. J. ELLERY . . . . .	470
Ship's Chronometers.—PARKINSON AND FRODSHAM ( <i>With Illustration</i> ) . . . . .	470
Lowest Temperature.—REV. R. ABBAY . . . . .	471
Meteor.—W. AINSLIE HOLLIS; J. H. . . . .	471
DR. SCHLEMMANN ON MYCENÆ . . . . .	471
FERTILISATION OF FLOWERS BY INSECTS, XVI. By DR. HERMANN MÜLLER ( <i>With Illustrations</i> ) . . . . .	473
RECENTLY PROPOSED IMPROVEMENTS IN MUSICAL INTONATION. By ALEXANDER J. ELLIS, F.R.S . . . . .	475
ON PHOTO-CHEMICAL PROCESSES IN THE RETINA. By Prof. ARTHUR GANGER, M.D., F.R.S . . . . .	477
OUR ASTRONOMICAL COLUMN:—	
The Cape Astronomical Results, 1871-1873 . . . . .	478
Variable Stars . . . . .	478
Biela's Comet in 1805 . . . . .	479
NOTES . . . . .	479
SOCIETIES AND ACADEMIES . . . . .	482

THURSDAY, APRIL 5, 1877

## THE GEOLOGICAL SURVEY OF OHIO

*Report of the Geological Survey of Ohio.* Vols. I. and II. Geology, and I. and II. Palæontology. (Columbus, Ohio: Nevins and Myers, State Printers, 1873-5.)

**I**N the reports of American Scientific Surveys we have become accustomed to find that the results are as new and interesting as the methods of working are original and ingenious. Few of the States are more richly endowed with the elements of prosperity and stability than Ohio, and yet she has but recently come into the field with her contribution to the knowledge of her own geological structure and natural history. It is gratifying to know that this contribution can well afford to be tried by the high standard attained by the reports already issued by many of the neighbouring States.

The survey just completed is technically the second but practically the first geological survey of Ohio, taking into consideration how long ago the former survey was disbanded, and how short was its term of life.

In 1836 the legislature appointed a committee consisting of Dr. Hildreth, Dr. Locke, Prof. Riddell, and Mr. Lapham, to report on the best method of obtaining a complete geological survey of the State, and to estimate the probable cost. In the summer of that year three of these gentlemen made reconnaissances, while the fourth analysed iron ores and limestones. A year after the appointment of the committee, the legislature, on its recommendation, created a geological corps, comprising a state geologist (Prof. W. W. Mather) and six assistants. During the summer of 1837, the State geologist and three assistants prosecuted geological explorations, two assistants being absorbed by zoology and topography. Next summer the survey was continued on a similar footing, but a financial panic having broken out, "the legislature of 1838-39 made no appropriation for the continuation of the geological survey, and it was at once suspended." In spite of the disadvantages under which this early survey laboured in being almost entirely without palæontological assistance, its two annual reports were much appreciated, and the short-sighted economy that led to its disbandment was soon regretted by the citizens of the State. Although several attempts were made, what with the defalcations of a State treasurer, the building of a costly state-house, and the great Civil War, Ohio was not financially in a position to re-establish a geological survey till the year 1869.

According to its constitution, this new survey was to be begun (and was begun) on June 1, 1869, and was to be finished in three years. It was required "to make a complete and thorough geological, agricultural, and mineralogical survey of each and every county in the State." To the chief geologist the act of legislature allowed three assistants, and a number (generally eight or nine) of temporary local assistants were employed and paid from a fund provided for "contingent expenses." One of the assistant geologists was to be a chemist. We can see in the organic law of the survey no provision for a palæontologist, and presume that the appointment of that officer was authorised by one of the subsequent Acts

of Appropriation. At any rate, Prof. J. S. Newberry, having been appointed chief geologist, conjoined with himself two assistants, a palæontologist and a chemist, and it can hardly be disputed that this was the best possible disposition of his forces, however desirable a large increase in the number of assistants might have been.

Such then is the scale on which a State, having an area of 39,904 square miles, plans its geological survey. Considering the number of working days in a year, the number of the field geologists, and the area of the State, many will not hesitate to decide that the character of a reconnaissance was stamped on the survey by its framers from the beginning. But it should not be forgotten that there are circumstances which render the geological mapping of Ohio exceptionally simple. The Palæozoic rocks which form its framework are so undisturbed, that over areas of sometimes thousands of square miles, only one formation makes its appearance at the surface, and outcrops are therefore little more than contour lines. We are accustomed in this country to think of "dip" as something visible to the naked eye, and measurable with a pocket clinometer; and as producing, by its relation to the contour of the ground, endless variety in our geological boundary-lines. In Ohio it appears that the method of ascertaining the degree of dip is to set up half a dozen or so of trigonometrical stations, several miles apart, and carefully take the levels of the outcrop at the several points. So far as we have noted in reading the Reports, there is not a dip in the whole state that would make an appreciably stiff railway gradient. Then we are informed by Prof. Newberry that "faults in which the displacement amounts to more than one foot are very rare in the Ohio Coal-field," and that the greatest known has a down-throw of 3 feet. In Europe the complications produced by faults frequently add the excitement of a puzzle to the labours of the field-geologist and just as often leave an irritating element of uncertainty to embitter the satisfaction with which he is apt to regard his finished work. Then again there are no igneous rocks in Ohio and no metamorphic rocks in the ordinary sense of the term. Indeed it may almost be said that over large tracts there are no rocks at all. Thus in one county, "consisting of twelve towns," *i. e.* 432 square miles—exactly the area, let us say for comparison's sake, of a whole sheet of the 1-inch Ordnance Map of Scotland—the rock is deeply covered with drift and is never seen, having been reached by boring at one point only, at a depth of 110 feet.

On the other hand, the very simplicity of the geology of the State makes it a typical region by which other lands may measure their geological scale, and on this account it becomes necessary to survey it with minuteness and care. If Ohio renders this service to the neighbouring states, each of these has already given an equivalent. As it happened, when the late survey was begun, Ohio was almost surrounded by a belt of states which had got ahead of her in the work, and whose completed labours greatly simplified her task, at the same time that they presented discrepancies which could only be reconciled on her neutral ground.

Although it was originally intended that the survey should be finished in three years, its field work lasted for five, the average annual cost being \$17,355.

We have now before us a portion of the final Reports of the Survey. These consist of two volumes of Geology, two of Palæontology, and two of Sheets of Vertical Sections (a sheet of Vertical Sections, by the way, is called a "Map" the American language). Besides these there have already been published three volumes of Annual Reports of Progress, two of them containing Accounts of the Geology of Counties, in substantially the same form as that followed in the Final Reports. A third volume of Geology, to comprise by far the most important counties in the coal-field, is ready for publication and "awaits the action of the Legislature." "The matter for the third volume," says Prof. Newberry, "has been, to a considerable extent, prepared since the appropriations for the salaries of the geological corps were discontinued. Much of it is, therefore, a gratuitous contribution with which the corps should be credited when a comparison is made between the value of their services and the compensation they have received." Materials for a third volume of Palæontology have been accumulated, but the chief geologist does not speak confidently of his chances of getting a grant to defray the cost of its publication. It would be a thousand pities that the State which has been at the expense of collecting this information should not secure the credit and advantages involved in its official publication. Otherwise, the materials will have to be hunted through the transactions of American and foreign societies, and will be as good as half lost.

A volume on Economic Geology is far advanced, but six months' time and from \$4,000 to \$5,000 are estimated as necessary to complete it. A volume on the Zoology and Botany of the State is also ready for publication at a trifling expense.

Lastly, "a general geological map of the State can be prepared at a cost not greater than \$1,500."

It will thus be seen that there still remain to be published some of the absolutely essential parts of the work of the survey. For scientific purposes the geological map stands first in point of necessity. It is not too much to say that it is chiefly by its general geological map that the survey will be known and judged abroad. It is indeed possible to construct a sort of geological map from the county and other sketch maps and information scattered through the volumes, and the writer has done so for his own satisfaction and as a means of mastering the Reports. But we can affirm with confidence that this is a labour that few will undertake, and which it would be much better that the officers of the Survey should perform once for all. The county maps, as will readily be understood from what has been said about the undisturbed condition of the rocks, are simplicity itself, being generally rectangles, crossed on an average by three boundary-lines inclosing four dabs of colour. But the general map will doubtless contain outcrops of coal and ironstone seams, the positions of oil and brine wells, fossil localities, and numerous other details, whose bearings can only be properly estimated when seen in the mass, or which it is the function of a geological survey to record, since for economic purposes the registration of all mining enterprises, whether failures or successes, is of permanent value. In her own interests we cannot doubt that the State will at once provide for the publication of the volume on Economic Geology, depending as

she does to a large extent at present, and as she is certain to do still more in the not very distant future, on mining industries.

If we may judge of the promised volumes on Palæontology, Zoology, and Botany from the results already before us, we are confident that their publication will place scientific workers in Europe as well as America under a debt of gratitude to Ohio, and we trust they will not be withheld.

It appears that when the first volume of the Final Report was ready, the Legislature ordered that the edition should consist of four times the number of copies estimated by the chief geologist as likely to meet the public demand. It is to be hoped that a similar spirit will induce them to complete the Survey's publications. A survey by four geologists, in three years, of a country one-third larger than Scotland, must soon have been felt to be impracticable, more especially if it was meant that the whole of the surveyor's labours, writing as well as field work, were to be compressed within the three years over which it was originally planned that their salaries were to be continued. A conscientious desire to finish their work having kept the officers of the survey in the field (doubtless with the approval of the legislature) for two years beyond the estimated time, the results of their zeal and skill ought not to be thrown away. There need be no hesitation in admitting Prof. Newberry's assertion, when he "claims" "that an honest and energetic use was made of the time and money expended on the Survey, and that its fruits will be worth much more than their cost to the people of Ohio."

We must refer the reader to the Reports themselves for the valuable information with which they are crowded. We can only notice briefly the leading scientific results, and some points of more than usual interest.

The rock-formations exposed in Ohio form an almost unbroken series, ranging from Lower Silurian to Carboniferous, inclusive. The principal feature in the geology of Ohio is undoubtedly the "Cincinnati axis," and to this the late Survey has justly devoted much attention. This great arch, passing through Cincinnati and the west end of Lake Erie, brings to light the oldest rocks of the State. It has hitherto been understood to be a minor flexure of the same date as the elevation of the Appalachian chain, to which it is, roughly speaking, parallel. But the investigations of the recent Survey have proved it to be much older. While the Appalachian chain does not appear to have been elevated until after the Carboniferous epoch, Prof. Orton has made the discovery that a large portion of the Cincinnati region was a land-surface, and suffered erosion towards the close of Lower Silurian times. The denudation of a synclinal arch and consequent exposure of deep-seated strata would not, of course, alone suffice to prove this; but the insular character of the Lower Silurian land of Cincinnati is rendered certain by the occurrence of pebbles derived from it in merates at the base of the Upper Silurian deposits, and by the manner in which calcareous strata of that age, as well as some Devonian limestones, thin out on approaching what must have been the shores of the island. It is not so clear whether the island was or was not entirely submerged in Devonian and Lower Carboniferous times. On the other hand, Prof. Newberry and his col-

leagues have satisfied themselves that during the deposition of the Upper Carboniferous or Productive Coal-measures, the Cincinnati land formed a barrier between the marshes of Ohio and Indiana; in other words, that the Alleghany and Illinois Coal-fields were never united, at least as far south as Alabama and Arkansas, where wide-spread tertiary deposits obscure all evidence bearing on the point.

"It is important," says Prof. Orton, "to mark the following fact distinctly, viz., that there is quite a broad tract at the summit of the fold in which the beds have but little dip. It is hard to speak of an axis without involving the idea of a line, but there is probably no part of this region of less than a score of miles that deserves, by way of excellence, the name of the Cincinnati axis. In other words, this fold has a broad and flat axis, rather than a linear one." The elevation has been so gentle and so gradual that direct visible evidence of unconformable succession is hardly to be expected.

No reader will fail to be struck by the important place accorded to chemical geology in the Reports. This portion of the work has been done mainly by Prof. Wormley, and adds greatly to the value of the survey as a whole. He has not confined his investigations to minerals of immediate economic importance, but has placed on record many analyses that must for a long time to come be drawn upon with advantage as the development of the resources of the State goes on. Especially as regards limestones and cement-stones and the amount of sulphur in the various coal-seams, very complete and useful information is given.

More than a score of counties "lie wholly within the limits of the productive coal-measures," and of nearly as many the geological surveyors pronounce without hesitation that "the soil will necessarily always be the source of their greatest material wealth." It sounds strange to hear already from such a rich agricultural district as Western Ohio the cry of exhaustion of the soil, but as all the surveyors without exception sound the note of warning against unskilful farming, it is evident that ere long science will have to be called in to assist nature if the productiveness of the State is to be maintained.

Although doubtless to be discussed more fully in the volume on economic geology, the coal and ironstone seams of the great coal-field, and the salt, oil, and gas industries receive much attention in the various county Reports. Prof. E. B. Andrews furnishes a chapter on coal which is full of interesting facts. Mr. M. C. Read gives a plan of a coal-mine in Trumbull County, which shows how very local was the formation of the seam. The coal thins out on every side, and presents the outline of a long winding swamp with branching creeks.

The importance of the ironstone beds in Ohio is well known. A black-band in Tuscarawas County locally attains, according to Prof. Newberry, a thickness of 12 feet.

The excitement caused by the discovery of the oil-wells of Pennsylvania and Ohio will yet be fresh in the memory of our readers. The conditions under which petroleum occurs are well illustrated in the Reports. There must be a mass of carbonaceous shales from whose organic contents the hydro-carbons are slowly distilled, and an overlying porous rock for the storage of the pro-

ducts—best of all a jointed sandstone with an impervious stratum for a roof—if dome-shaped so much the better. When these conditions are present the oil is ready for the fortunate landowner, and his luck is the greater if he happen to strike a joint where a quantity can collect. So well is this now understood that when a well shows symptoms of giving out, a torpedo is exploded in it to loosen up the rock and open out the way to neighbouring fissures. Carbonaceous shales, yielding oil, are met with at various horizons from the Huron (Devonian) upwards.

Carburetted hydrogen gas occurs under similar conditions and is now expressly bored for. The town of Fredonia, N.Y., has been lighted up with natural gas for more than forty years. In Knox County, Ohio, two wells were sunk to the Huron shale. "At a depth of about 600 feet, in each well, a fissure was struck from which gas issued in such volume as to throw out the boring tools and form a jet of water more than 100 feet in height. . .

One of these wells constantly ejects, at intervals of one minute, the water that fills it. It thus forms an intermittent fountain 120 feet in height. The Derrick set over this well has a height of 60 feet. In winter it becomes encased in ice, and forms a huge translucent chimney, through which, at regular intervals of one minute, a mingled current of gas and water rushes to twice its height. By cutting through this hollow cylinder at its base and igniting the gas in a paroxysm, it affords a magnificent spectacle, a fountain of mingled water and fire which brilliantly illuminates the icy chimney. No accurate measurement has been made of the gas escaping from these wells, but it is estimated to be sufficient to light a large city." Unfortunately there is no large city to light.

Geologists had a right to expect from Ohio an important contribution to their knowledge of the Glacial period, and Prof. Newberry and his colleagues have not disappointed them. The chief geologist sums up the results of the Survey in a masterly essay, and it is satisfactory to find that his views to a great extent corroborate the conclusions at which glacialists in Europe have arrived. Want of space compels us to allude to these in the briefest manner. The cold came on at a period when the land stood considerably higher than at present, as is proved by numerous river channels deeply buried beneath the drift. A wide-spread boulder clay or hard-pan, the product of a land ice-sheet radiating from the Canadian Mountains marks an early, and the greatest, development of the cold. A subsidence followed on the retreat of the ice-sheet, and a stratified clay was deposited over low-lying portions of the hard-pan. Then a forest covered a large portion of the glacial *débris*, and this furnishes remains of the mammoth, mastodon, and giant beaver. Another submergence covered the forest-bed with the loess of the Mississippi Valley, and icebergs strewed boulders from Canada over the State. Much of the older drift was reassorted and heaped up into kaims or eskars. Lastly, the sea gradually retired, occasionally pausing, and giving rise to terraces in the river valleys.

Intimately connected with the Glacial period were the hollowing out of the great lake-basins, and numerous important changes in the drainage-system of the continent. Taking Lake Erie as the simplest case, it is clear that its

basin was not excavated during the greatest extension of the ice-sheet, which, as shown by the striae on the higher ground, passed directly across the valley. But in the bottom of the valley the striae point up the lake, and this fact makes it probable that the excavation of the basin was the work of local ice, in other words, that it dates from a time when the valley-glaciers had ceased to coalesce. The islands near the upper end of the lake are wrought out of hard Corniferous sandstone and Water-lime exposed on the crown of the Cincinnati anticline. This hard barrier, Prof. Newberry believes, opposed an obstinate resistance to the passage of the glacier, and was consequently left in comparative relief.

The Ohio geologists without exception appear to be sub-aërialists, and indeed, the scenery of the State—such as it is—could hardly admit of any other explanation. It would not be easy to connect valleys of some hundreds of feet in depth with faults of less than a yard.

Of the palæontology of the Reports, we need only say that it is a remarkable proof of the enthusiasm, energy, and success of the late Prof. Meek and the naturalists who assisted him, several of them without any compensation. The publication of the Survey as a whole marks an epoch in culture as well as in material progress, in which all the well-wishers of the State must rejoice.

#### OUR BOOK SHELF

*History of Nepal.* Translated from the Parbatiya, by Munshi Sbero Shunker Singh and Pandit Shri Gunanand. With an Introductory Sketch of the Country and People of Nepal, by the Editor, Daniel Wright, M.A., M.D. (London, Cambridge Warehouse; Cambridge, Deighton, Bell, and Co., 1877.)

THE Cambridge University Press have done well in publishing this work. Such translations are valuable not only to the historian but also to the ethnologist; perhaps more so to the latter than the former, as the very myths with which a people are apt to adorn their own history may become, in the hands of a cunning ethnologist, a clue to their racial connections. Dr. Wright's Introduction is based on personal inquiry and observation, is written intelligently and candidly, and adds much to the value of the volume. The coloured lithographic plates are interesting.

#### LETTERS TO THE EDITOR

[The Editor does not hold himself responsible for opinions expressed by his correspondents. Neither can he undertake to return, or to correspond with the writers of, rejected manuscripts. No notice is taken of anonymous communications.]

##### The First Swallow at Menton

THE first swallow arrived here alone in the rain on Monday, March 19. It entered the best room of the *curé* by one of the windows which chanced to want a pane, and the good old man immediately removed a pane from the other window, by which the swallows have been in the habit of going in and out. I did not hear of the arrival of this summer resident until the 23rd, when I immediately paid it a visit. It is still solitary but not uncomfortable; it flits about the room from place to place, and from nest to nest, twittering very contentedly; and when a bright hour comes it flies out, where, sporting in the sun it soon makes a hearty meal. But it has arrived decidedly too soon, for it has found as yet mostly wet and rather cold days with snow-covered mountains for its immediate surrounding. Such, however, is the climate of this place, difficult to conceive by untravelled Englishmen, that I at this moment bask outside in the sun, soothed by the singing of birds, surrounded by flowers and butterflies, and the green trees with their golden fruits. I am in

the midst of summer, and yet I have but to turn my head, and there, close at hand, are the mountains white with snow.

The coldest weather we have had this winter began with this month. The only time I have seen ice was on the morning of March 1. (On the preceding night, I see by a letter to NATURE, vol. xv, p. 399, that the thermometer at the Stonyhurst Observatory went down to 9° F., the lowest temperature there recorded during the last sixteen years.) That morning, cheated by the serene stillness and the bright sunshine, I, before getting out of bed, resolved to make a journey to the sea-side—a distance of about three miles. A lunch was immediately packed up and the donkey of the *curé* borrowed for the occasion. As soon as I descended into the valley—Cabrolles, consisting of some dozen houses, all the dwellings of peasants, and hung on the mountain side like so many birds' cages or birds' nests on the back wall of a court, open only to the south, is 300 feet above the level of the sea, and enjoys a climate superior to that of the much vaunted Menton. I am, however; the first *étranger* who has ventured to brave the isolation, the inconvenience, and want of accommodation.—Well, as I have said, on descending into the valley, a change of temperature suggested that it would be preferable to have my Italian cloak around me, instead of carrying it before me on the donkey. Proceeding a little farther, I saw with astonishment large quantities of ice in the torrent, and in turns of the road looking northward, icicles, thick as my arm—which, however, is one of the thinnest—hanging from the rocks. Still I went forward quite irrationally, carried along solely by the force of the impetus with which I started, for, as I approached Menton, I had to make way in the face of a biting cold wind. But I would certainly have shivered over my cold lunch among the rocks or ruins at Cap Martin, had not my progress received a check at Menton, in the for the moment irritating discovery that the key of the provision-bag had been, I may now say providentially, lost. I accepted the hospitality of a kind English clergyman, who gave me a nice warm lunch, after which I slowly wound my way back to my mountain retreat, where I dwell almost as completely removed from the winter visitants of these shores as is the now lonely swallow from its companions, the summer visitants, which have not unwisely made a halt somewhere by the way.

After this long digression I must return for a moment to the swallows of Cabrolles. They live in the rooms with the people, attaching their nests generally to the beam which supports the ceiling. On their arrival, whether it be by night or by day, they enter at once and take possession of their old habitations. Madame Valetta, an old woman of seventy-three, has two or three times given me a graphic account of how, when she was a young woman and had her husband by her side, they were both frightened almost to death one night by something which from time to time gave a flap-flap against the glass of the window. Madame, however, summoned courage to urge her husband to get up and open the window, which, though "all of a shake," he did, when whish! very like a spirit, a weary swallow glided past him and was the same instant peacefully reposing in its nest.

DOUGLAS A. SPALDING  
Cabrolles, près de Menton, France,  
March 24

##### Coal Fields of Nova Scotia

IN his address to the Iron and Steel Institute (NATURE, vol. xv, p. 462), Dr. Siemens stated that the area of the Coal Fields of Nova Scotia was 18,000 square miles, and the production in 1874 1,052,000 tons. If Dr. Siemens will refer to Dr. Dawson's "Acadian Geology," the Reports of the "Canadian Government Geologists," and Brown's "Coal Fields and Coal Trade of Cape Breton," he will find that he has greatly overstated the area of the Nova Scotia Coal Fields. From these sources which I believe are perfectly reliable, I make out that the whole area of the Nova Scotia Coal Fields does not amount to 1,000 square miles, distributed over the following counties:—

	Square Miles.
Cumberland .. .. .	250
Pictou .. .. .	34
Cape Breton .. .. .	194
Victoria .. .. .	6
Inverness .. .. .	40
Richmond .. .. .	10



To this amount, however, must be added the portions of the Cape Breton and Inverness Coal Fields lying under the sea, which, supposing the seams can be worked a distance of five miles beyond high-water mark, will make the total area of the Nova Scotia Coal Fields 850 instead of 18,000 square miles.

The production in 1874 has also been greatly overstated in Dr. Siemens' Table, as I find by reference to the Government Inspector's Report for the year 1876, that the production in 1874 was only 749,127 tons. R. B.

[Dr. Siemens informs us that the difference referred to by our correspondent chiefly arises from the fact that in American reports Nova Scotia is made to include the maritime province of New Brunswick as well as Cape Breton Island, both of which contain large areas of coal-fields, although those fields are as yet very imperfectly developed. The figures given in the address were taken from Macfarlane's very elaborate work on the "Coal Regions of America." With reference to the coal production, this should be for the year 1873, and is also given on the authority of Macfarlane, who quotes from the Report of the Department of Mines.—ED.]

#### Greenwich as a Meteorological Observatory

A CAREFUL examination of the interesting communication by Mr. Alexander Buchan to the Scottish Meteorological Society, on "The Temperature of the British Islands," based on observations for the thirteen years ending 1869, fails to support his conclusion (NATURE, vol. xv., p. 450) that the proximity of London does not appreciably influence the temperature as recorded at the Royal Observatory, and that the temperature of Greenwich during recent years has not been in excess of that of surrounding districts. The evidence is quite the reverse. Extracting the figures, given by Mr. Buchan in the paper referred to, for all the stations within a radius of sixty miles of the metropolis, sixteen in number besides Greenwich, it appears that their mean is 50°·1, that of Greenwich being 50°·6. Allowing for elevation, the values are respectively 50°·68 and 51°·13. Omitting, however, several stations such as Camden Town, which, forming part of London, is clearly inadmissible for the comparison, and Maidstone and Canterbury, where observations were made on two years only of the thirteen, the temperature of the ten remaining stations is 50°·59. Thus, according to data furnished by Mr. Buchan himself, Greenwich is warmer than the south-east of England generally by more than half a degree (0°·54). It may be added that, from the same data, the temperature of the district under consideration north of the Thames is 50°·5, and south of the river 50°·8. H. S. EATON

#### Centralisation of Spectroscopy

IN his letter (NATURE, vol. xv. p. 449) Prof. Smyth makes a statement respecting the new "half-prism" spectroscope which I cannot help thinking must be founded on a misapprehension of the principle involved. This will, I trust, be made clear when my paper is published in the forthcoming number of the *Proceedings* of the Royal Society; but meanwhile, as Prof. Smyth appears disinclined to wait for a full explanation of the instrument, I shall be most happy to answer his objections when he informs me what particular "laws of Sir Isaac Newton and nature" are in opposition to the principle of this spectroscope.

Against Prof. Smyth's confident assertion that all definition is lost in this instrument, which he has never seen and of which he can only know by hearsay, I have only to set the statement that a small experimental spectroscope on the new plan, with two "half-prisms," is, as a matter of fact, decidedly superior in definition, as well as in brightness of spectrum, to the large Greenwich spectroscope, with ten large compound prisms, of which the excellence is sufficiently attested by the accordance of the results obtained for the sun's rotation by its means. This statement is based on a careful comparison of the sodium lines, and also of the  $\delta$  group in the solar spectrum, as seen with the two instruments,  $\delta_2$  and  $\delta_4$  with the finer lines in their neighbourhood being shown with remarkable distinctness in the new form of spectroscope, small though it is. In this assertion, I think, I shall be fully borne out by several astronomers to whom I have shown the action of the new spectroscope.

Though I am not in any way concerned with Prof. Smyth's argument in the earlier part of his letter, I may mention for his

information that "during the last twenty years" only *two* spectroscopes have been made for Greenwich Observatory (one of these having only a single prism of small dispersion), and that our second or powerful spectroscope was only made *three* years ago; whilst the Edinburgh Observatory has, for the past *four* years, possessed *three* spectroscopes which are almost precisely identical with those used with such effect by Dr. Huggins.

W. H. M. CHRISTIE

Royal Observatory, Greenwich, March 27

#### Morphology of "Selaginella"

BEFORE instituting a comparison it is generally prudent to ascertain that the things to be compared are comparable. I am afraid Mr. Comber, who has done me the honour of making some remarks on what I have said in the pages of NATURE on the primordial type of flowers, has neglected this precaution. If I understand him rightly, he suggests that the "spike" of *Selaginella* is the homologue of the spike of *Carex pulicaris*. He compares, then, the scales bearing macrosporangia of the former with the lower glumes bearing each an ovary of the latter.

Now in the first place, if he had studied the matter a little more (if he will allow me to say so), he would have seen that the ovule, and not the ovary, is the equivalent of the macrosporangium, and that the embryo sac, and not the ovule, is the equivalent of a macrospore. This leaves the ovary unaccounted for, and the homology hopelessly breaks down on that point.

But this is not all. Mr. Comber has omitted all notice of the singular structure, the perigynium, and also of the equally singular structure, the "seta," which it contains along with the ovary, and which happens to be particularly well represented in *Carex pulicaris*. If he will take the trouble to look at a short paper which I have published in the *Journal* of the Linnæan Society (Botany) vol. xiv., pp. 154-156, pl. xii., he will find that I have carefully discussed the morphology of the female flower of this very plant. I think I have succeeded in showing that far from being a simple racemose inflorescence it is a compound raceme or panicle reduced in a very peculiar manner. I am afraid, therefore, that Mr. Comber has been led away by resemblances of a very superficial character, and that the fact *Selaginella* has a "spike" and that *Carex* has a "spike," is a point of contact between the two about as significant as the existence of a river in both Macedon and Monmouth.

In fact, far from being plants of a primitive type, the *Cyrtocarpus* are generally regarded as reduced representatives of plants of much more fully developed character, the exact nature and relationship of which we have no materials for at present estimating. W. T. THISELTON DYER

#### Tungstate of Soda

WITH regard to your note (NATURE, vol. xv. p. 460) upon muslin rendered unflammable by tungstate of soda, will you allow me to say that when properly prepared the muslin is fairly unflammable. I say unflammable—not fireproof. There can be no doubt from experiments made in Prof. Gladstone's laboratory that muslin prepared with a sufficient quantity of the salt will not catch fire by ordinary means, but no one could reasonably expect it to stand an *auto de fe* such as that to which I saw Dr. Wright subject his dummy, and fortunately not his assistant, last Saturday fortnight. MATTHEW W. WILLIAMS

Chemical Laboratory, Royal Institution

#### Traquair's Monograph on British Carboniferous Ganoids

WILL you kindly permit me through the medium of your journal, to correct and apologise for a very awkward blunder which occurs in the first part of my monograph on British carboniferous ganoids, recently published by the Palæontographical Society? In the introduction I have advocated the retention of the *Dipnoi* as a distinct order of fishes, but at page 41, in a manner unaccountable to myself, for I certainly did not mean it, I have included them as a sub-order of the Ganoidel. That this "slip of the pen" was not detected in the revision of the proofs must have been due to an amount of carelessness of which I am justly ashamed. R. H. TRAQUAIR

Edinburgh, April 2

## ALEXANDER BRAUN

WE regret to announce the death of the well-known German botanist, Prof. Alexander Braun, which took place at Berlin, on March 29. He was born in Ratisbon, May 10, 1805, and after the completion of his university studies entered upon the duties of Professor of Botany in the University of Freiburg, in Baden. Here he published his first important book, "Vergleichende Untersuchung über die Ordnung der Schuppen an den Tannenzapfen," in which he formulated the theory with regard to the position of the leaves on plants now essentially recognised by botanists. In 1850 he accepted a call to the University of Giessen, and issued shortly after his most notable work, "Betrachtungen über die Erscheinung der Verjüngung in der Natur, insbesondere in der Lebens- und Bildungsgeschichte der Pflanze." The extensive series of observations, and the numerous valuable theoretical deductions recorded in this suggestive work, formed one of the most noteworthy contributions to vegetable morphology, and placed the author at once among the leading botanists of the day. In 1852 he removed to Berlin, where he had been appointed Professor of Botany and Director of the Botanical Gardens, positions which he occupied up to the time of his death. The unwearied activity of Braun during this period is evidenced by the large number and variety of the contributions made by him to botanical literature. Of these his investigations on cryptogamia assume the foremost rank, embracing papers on the families *Marsilia*, *Pilularia*, and *Selaginella*, African varieties of *Chara*, Movements of the Juices in the Cells of *Chara*, Vegetable Individuals in their relations to Species, Some New Diseases of Plants caused by Fungi, New Varieties of Single-celled Algae, &c.

Among his more prominent publications on phanerogamia should be mentioned the papers on parthenogenesis, polyembryony, and budding of *calebugyne*, and the oblique direction of woody fibre in its relations to twisted tree stems. His efforts in all investigations were chiefly directed to perfecting our knowledge of vegetable morphology, and by comparative studies in this region, to the establishment of well-defined laws with regard to the growth of plants, and the relationship between different varieties. Braun's theories on the latter subject led to the formation of a system, which, although not accepted in all points, is yet regarded by many botanists as the most perfect approach to a natural classification of plants which we at present possess. A contemporary botanist describes the leading feature of his character as consisting in an "earnest striving to bring all the widely diverse families of the vegetable kingdom, fossil as well as existing, within his grasp, and by means of thorough, comparative study to advance toward the true natural classification."

The merits of Prof. Braun were recognised by the bestowal of numerous German orders, and from the King of Prussia he received the title of "Geb.-Regierungs-Rath." He was a prominent member of the Berlin Academy of Sciences and the Botanical Society, occupying the presidency of the latter for a number of years. His papers appeared chiefly in the *Transactions* of these two societies; the classification of plants being given, however, in Ascherson's "Flora of the Province of Brandenburg," in 1864.

## THE LOAN COLLECTION OF SCIENTIFIC APPARATUS

THE last of the "present series" of free lectures in connection with the Loan Collection of Scientific Apparatus was given on Saturday, in the lecture theatre of the South Kensington Museum. Major Festing, R.E., took the chair, and the theatre was, as usual, crowded.

The lecture was given by Mr. W. Stephen Mitchell, M.A., on "The Challenger Soundings and the Lost Island of Atlantis." An abstract of this will shortly appear. At the end of the lecture Mr. Mitchell said he thought that as this was the last—at any rate of this series—it would be in accordance with the wish of the audience that a few words should be said by way of *résumé*, to mark the occasion. He regretted that his place was not occupied by some one eminent in science. When the Loan Collection of Scientific Apparatus was opened there were planned in connection with it conferences, demonstrations, lectures to science teachers, and the free evening lectures. The conferences lasted as planned during May and June, the lectures to science teachers were carried out as proposed, and the demonstrations were given till December 31. At that date, in consequence of packing the cases for returning the collections lent from abroad, which were lent for a definite period only, it was necessary to close the galleries to the public. The free lectures, however, had been continued, and the apparatus from the galleries had been brought into that theatre, as it had been found necessary, to illustrate the lectures. The lectures had thus kept up the continuity of the collection. He believed he was right in saying that from the outset the promoters of the Loan Collection had looked forward to the establishment of a permanent physical science museum somewhat in imitation of the Conservatoire des Arts et Métiers of Paris. Such a museum was recommended by the Royal Commission on Scientific Education, under the presidency of the Duke of Devonshire, and composed of some of the most distinguished men of science in this country. For a building to contain such a museum the commissioners of the Exhibition of 1851, under the presidency of the Prince of Wales, have voted 100,000*l.*, and offered it to the Government. A petition in favour of the establishment of such a museum had, since the opening of the collection, been signed by officers and fellows of learned societies, and presented to the Duke of Richmond and Gordon. At this last lecture of the series they would naturally ask what was likely to be done for the future. As he was in no way officially connected with the museum he was not in a position to give any certain information; but this much he could tell them, a number of instruments that would otherwise have been returned had been acquired by purchase, a number had been presented, a number were left on loan for an indefinite period, and many were left under certain conditions. The galleries at the present time contained a collection of fair size to commence a permanent collection. Here, as in considering the lost island of Atlantis, they must be careful to discriminate between facts and inferences to be drawn from facts. No announcement had been made by the Government as to its intentions. The present condition of the Collection, as he had stated it, was a fact, and they would draw for themselves inferences as to what this might mean. He had seen a statement that the permanent museum might be open in May, but he could not say how far this represented official intentions. The crowded audiences at the lectures in that theatre was, he said, a proof that they wished the Collection and the lectures in connection with it to continue.

Mr. F. S. Mosely moved, and Mr. J. Heywood, F.R.S., seconded the following resolution:—"We who form the audience at this, the last of the present series of lectures in connection with the Loan Collection of Scientific Apparatus, desire to thank the Board of the Science and Art Department for having arranged this series of lectures. We would wish to take this opportunity to express the hope that the Loan Collection of Scientific Apparatus may lead to a permanent collection of a similar nature. We beg the chairman to convey the terms of this resolution to the head of the department."

The motion was put to the meeting and carried unanimously with loud applause.

Major Festing said that, as representing the department, he was sorry he could give no more information than the lecturer had. The Government had not yet announced its intention as to what it would do in the matter. It had lately had many other matters on hand. With regard to the lectures, it was felt that it was hardly fair to continue to ask men of science to give their services gratuitously, and until some arrangement for fees could be made, he thought the lectures would probably remain in abeyance. It would give him pleasure to forward the resolution so unanimously carried to the head of his department as requested.

THE DEVELOPMENT OF BATRACHIANS WITHOUT METAMORPHOSIS

**M**ETAMORPHOSIS, or the transition of the animal through an intermediate stage between the ovum and the adult, has hitherto been considered by modern naturalists a special characteristic of the Batrachians amongst the Vertebrates, and as one of the main features which distinguish them from the true Reptiles, with which they were formerly united. It is, therefore, surprising to learn, as we do from a recent communication of Dr. Peters to the Royal Academy of Sciences of Berlin, that there are cases in which no such metamorphosis takes place, and the young frog is developed directly from the egg without showing any signs of what is usually called the "tadpole" stage.

Dr. Peters's noteworthy discovery is based upon observations made by Dr. Bello, Herr Klug, and Dr. J. Gundlach, in Porto Rico, on the development of a West Indian tree-frog—*Hylodes martinicensis*, which seems to be not uncommon in Porto Rico, and is there generally known by the vernacular term *Coqui*.

Five years ago Dr. Bello stated<sup>1</sup> that a tree-frog in Porto Rico called *Coqui* was remarkable from the fact that the young came out of the eggs in a perfect condition, and fit for life in the air. "In 1870," he says, "I observed in a garden an example of this species upon a lilaceous plant, on which about thirty eggs were clustered together in a cotton-wool-like mass; the mother kept close to them as if she intended to incubate. A few days afterwards I found the little frogs from two to three lines long just born, with all their four feet perfectly developed, springing about, and enjoying life in the air. In a few days they attained their full size. This garden is surrounded by walls six feet high, and there is no water in it. The so-called lily (which appears to be an introduced species of *Crinum*) always contains a little water in the receptacles, but is not a water-plant."

The translator of these observations rightly remarks that the exclusion of the animal out of the egg was not actually witnessed in this case, and that it was possible even in the short time which elapsed between when the eggs were seen and the young frogs appeared, some metamorphosis might have taken place, especially as the subsequent development seems to have been uncommonly quick.

These short observations of Dr. Bello appear to have attracted the less attention inasmuch as the development of tree-frogs from eggs placed in dry situations in frothy masses had been already observed and described in tropical countries. In 1867 Herr Hensel published some interesting observations on *Cystignathus mystacinus*, in the forests of Rio Grande do Sul,<sup>2</sup> and last year Dr. Peters laid before the Academy of Berlin the extraordinary discoveries of Buchholz concerning the egg-masses of *Chiromantis guineensis* laid upon trees in Guinea. Be-

sides this the development of *Alytes obstetricans* between the hind-legs of the male in the ordinary way, and, through Herr Weinland's brilliant investigations, the metamorphosis of the young in the dorsal sacs of the females of *Opisthodelphys* and *Nototrema*, were facts so generally known that it seemed highly improbable that any Batrachian should be developed without metamorphosis.

Under these circumstances it is of the greatest interest to be able to state that Dr. Bello's information has been fully corroborated by recent observations of Dr. Gundlach and by preparations which he has transmitted to Berlin.

"On May 24, 1876," Dr. Gundlach says, "I heard a singular call like that of a young bird, and went to see what it was. Between two large orange-blossoms I perceived a leaf frog, and on taking hold of it, found I had captured three males and a female of the *Coqui*. On putting them into a damp glass, one of the males quickly placed himself on the female and grasped around her. Not long afterwards she had laid from fifteen to twenty eggs, which, however, mostly soon disappeared—perhaps eaten.

"There were subsequently laid five eggs, round, with a transparent covering, which I removed and placed on some wet slime. The inner yolk, of a whitish or pale straw-colour, contracts a little, and then the tail is seen forming.



FIG. 1.—Egg of *Hylodes martinicensis*, twelve days old, lower surface. FIG. 2.—Young of *Hylodes* as it leaves the egg. c, tail. FIG. 3.—Adult male *Hylodes*, natural size.

In eight days this was quite clearly visible, as well as the eyes, and the red pulsating blood-vessels. Later on traces of the legs became manifest. I was now absent for some days, and when I returned, on June 6, found the eggs still, but on the next morning, the young were out, and had no trace left of the tail.

"Afterwards I found two leaves of a large *Amaryllid*, just like Dr. Bello, a batch of more than twenty eggs, upon which the mother was sitting. I cut off the leaf, along with the eggs—upon which the mother jumped off—and placed them in a glass with some damp earth at the bottom. About the fourteenth day, having returned from an excursion, I found, at 9 A.M., all the eggs hatched, and I remarked on the young ones a little white tail (see Fig. 2, c), which by the afternoon had altogether disappeared."

Dr. Gundlach's collection, as Dr. Peters tells us, contains four eggs of this frog, with embryos. They consist of a transparent vesicle of from 4.5 to 5.5 mill. in diameter, which is partly occupied by an opaque flaky white mass. The vesicle is filled with a transparent fluid, which allows one to see every part of the swimming embryo quite clearly. The embryo, as in the case of mammals, is curved together on the lower surface, so that the head approaches the lower extremities, which, as well as the anterior extremities, are drawn together under the belly and lie close to the body.

<sup>1</sup> "Zoologische Notizen aus Portorico," in "Der zool. Garten," 1871, p. 285.  
<sup>2</sup> Sitzb. d. Ges. Nat. Freunde zu Berlin 1867, p. 20, and Arch. Nat. zool. 1867, p. 129.

The tail is likewise curved up underneath, and lies with its broad surface towards the body, turning either towards the right or the left, and thickening part of the hinder extremities. In three examples the extremities are fully developed, and even show the characteristic discs on the tops of the toes. In the fourth example all four extremities present short stumps, and as yet show no traces of toes, whereas, as is well known, in the *Batrachia anura* generally the hinder extremities and the ends of the feet first appear. Neither of branchiæ nor of branchial slits is there any trace. On the other hand, in the last-mentioned example, the tail is remarkably larger, and has its broad surface closely adherent to the inner wall of the vesicle, and very full of vessels, so that there can be no doubt of its function as a breathing organ. As development progresses, the yolk-bag on the belly and the tail become gradually smaller, so that at last, when the little animal, being about 5 mill. long, bursts through the envelope, the tail is only 1·8 mill. in length, and after a few hours only 0·3 mill. long, and in the course of the same day becomes entirely absorbed. Examples of the same batch of ova, which were placed in spirit eight days after their birth, have a length of from 7·0 to 7·5 mill., whence we may conclude that their growth is not quicker than in other species of Batrachians.

The development of this frog, Dr. Peters observes (and probably of all the nearly allied species), without metamorphosis, without branchiæ, with contemporaneous evolution of the anterior and posterior extremities, as in the case of the higher vertebrates, and within a vesicle, like the amnion of these latter, if not strictly equivalent to it, is truly remarkable. But this kind of development is not quite unparalleled in the Batrachians, for it has long been known that the young of *Pipa americana* come forth from the eggs laid in the cells on their mother's back tailless and perfectly developed. In them, likewise, no one has yet detected branchiæ, and we also know from the observations of Camper, that the embryos at an earlier period are provided with a tail-like appendage, which in this case also, may be perhaps regarded as an organ of breathing, possibly corresponding to the yolk-placenta of the hag-fish. As regards this point, also, Laurenti says of the *Pipa*: "Pulli ex oculamentis dorsi prodeuntes, metamorphosi nulla?" (Syn. Rept., p. 25.)

It would be of the highest interest, Dr. Peters adds, to follow exactly this remarkable development on the spot. The development of the embryo of these Batrachians in a way very like that of the scaled Reptilia makes one suspect that an examination of the temporary embryonic structures of *Hylodes* and *Pipa* would result in showing remarkable differences from those of other Batrachians. The general conclusions which might be drawn from this discovery are so obvious, says Dr. Peters, in conclusion, that it would be superfluous to put them forward.

A subsequent communication of Dr. Peters to the Academy informs us that it had escaped his notice that M. Bavay, of Guadaloupe, had already published some observations on the development of *Hylodes martinicensis*.<sup>1</sup> According to his observations, on each side of the heart there is a branchia consisting of one simple gill-arch, which on the seventh day is no longer discernible. On the ninth day there is no longer a trace of a tail, and on the tenth day the little animal emerges from the egg. M. Bavay also observed the contemporaneous development of the four extremities, and hints at the function of the tail as an organ of breathing.

The observations of Dr. Gundlach, therefore, says Dr. Peters, differ in some respects from those of M. Bavay. It would be specially desirable, however, to ascertain whether the arched vessel on each side of the heart is really to be regarded as a gill-arch, or only as the incipient bend of the aorta.

### TYPICAL LAWS OF HEREDITY<sup>2</sup>

WE are far too apt to regard common events as matters of course, and to accept many things as obvious truths which are not obvious truths at all, but present problems of much interest. The problem to which I am about to direct attention is one of these.

Why is it when we compare two groups of persons selected at random from the same race, but belonging to different generations of it, we find them to be closely alike? Such statistical differences as there may be, are always to be ascribed to differences in the general conditions of their lives; with these I am not concerned at present, but so far as regards the processes of heredity alone, the resemblance of consecutive generations is a fact common to all forms of life.

In each generation there will be tall and short individuals, heavy and light, strong and weak, dark and pale, yet the proportions of the innumerable grades in which these several characteristics occur tends to be constant. The records of geological history afford striking evidences of this. Fossil remains of plants and animals may be dug out of strata at such different levels that thousands of generations must have intervened between the periods in which they lived, yet in large samples of such fossils we seek in vain for peculiarities which will distinguish one generation taken as a whole from another, the different sizes, marks and variations of every kind, occurring with equal frequency in both. The processes of heredity are found to be so wonderfully balanced and their equilibrium to be so stable, that they concur in maintaining a perfect statistical resemblance so long as the external conditions remain unaltered.

If there be any who are inclined to say there is no wonder in the matter, because each individual tends to leave his like behind him, and therefore each generation must resemble the one preceding, I can assure them that they utterly misunderstand the case. Individuals do *not* equally tend to leave their like behind them, as will be seen best from an extreme illustration.

Let us then consider the family history of widely different groups; say of 100 men, the most gigantic of their race and time, and the same number of medium men. Giants marry much more rarely than medium men, and when they do marry they have but few children. It is a matter of history that the more remarkable giants have left no issue at all. Consequently the offspring of the 100 giants would be much fewer in number than those of the medium men. Again these few would, on the average, be of lower stature than their fathers for two reasons. First, their breed is almost sure to be diluted by marriage. Secondly, the progeny of all exceptional individuals tends to "revert" towards mediocrity. Consequently the children of the giant group would not only be very few but they would also be comparatively short. Even of these the taller ones would be the least likely to live. It is by no means the tallest men who best survive hardships, their circulation is apt to be languid and their constitution consumptive.

It is obvious from this that the 100 giants will not leave behind them their quota in the next generation. The 100 medium men, on the other hand, being more fertile, breeding more truly to their like, being better fitted to survive hardships, &c., will leave more than their proportionate share of progeny. This being so, it might be expected that there would be fewer giants and more medium-sized men in the second generation than in the first. Yet, as a matter of fact, the giants and medium-sized men will, in the second generation, be found in the same proportions as before. The question, then, is this:—How is it that although each individual does *not* as a rule leave his like behind him, yet successive generations resemble each other with great exactitude in all their general features?

<sup>1</sup> Conn. Soc. Reg. Gotting. Cl. phys. in p. 135 (1786).  
<sup>2</sup> Ann. Sc. Nat. ser. 3, xvii., art. 16 (1873).

<sup>2</sup> Lecture delivered at the Royal Institution, Friday evening, February 2, by Francis Galton, F.R.S.

It has, I believe, become more generally known than formerly, that although the characteristics of height, weight, strength, and fleetness are different things, and though different species of plants and animals exhibit every kind of diversity, yet the differences in height, weight, and every other characteristic, are universally distributed in fair conformity with a single law.

The phenomena with which it deals are like those perspectives spoken of by Shakespeare which, when viewed awry, show nothing but confusion.

Our ordinary way of looking at individual differences is awry; thus we naturally but wrongly judge of differences in stature by differences in heights, measured from the ground, whereas on changing our point of view to that whence the law of deviation regards them, by taking the average height of the race, and not the ground, as the point of reference, all confusion disappears, and uniformity prevails.

It was to Quetelet that we were first indebted for a knowledge of the fact that the amount and frequency of deviation from the average among members of the same race, in respect to each and every characteristic, tends to conform to the mathematical law of deviation.

The diagram contains extracts from some of the tables,

Scale of Heights Metres	American soldiers, 25,878 observations		France (Hargravesvillers)		Belgium, Quetelet 20 years' observations.	
	Observed	Calculated.	Observed	Calculated.	Observed	Calculated
1'90	1	3				
1'90	7	5				
87	14	13		1	1	1
84	25	28		3	2	3
81	45	52	25	7	7	7
79	99	84		16	14	14
76	112	117	32	32	34	28
73	138	142	55	55	48	53
70	148	150	88	87	102	107
68	137	137	114	118	138	136
65	93	109	144	140	120	150
62	102	75	140	145	162	150
60	49	45	116	132	106	136
57	14	24		105	110	107
54	8	11		73		53
51	1	4		44		28
48		1		24		14
45			286	11	147	7
42				4		3
39				2		1
36				1		
	1000	1000	1000	1000	1000	1000

Degrees of Dynamometer.	Lifting power of Belgian Men.	
	Observed.	Calculated.
200	1	1
190		
180	9	10
170		
160	23	23
150		
140	32	32
130		
120	23	23
110		
100	12	10
90	1	1
	100	100

FIG. 1.

in them refer to the heights of Americans, French, and Belgians respectively, and the fourth to strength, to that of Belgians. In each series there are two parallel columns, one entitled "observed," and the other "calculated," and the close conformity between each of the pairs is very striking.

These Tables serve another purpose; they enable those who have not had experience of such statistics to appreciate the beautiful balance of the processes of heredity in ensuring the repetition of such finely graduated proportions as those they record.

The outline of my problem of this evening is, that since the characteristics of all plants and animals tend to conform to the law of deviation, let us suppose a typical case, in which the conformity shall be exact, and which shall admit of discussion as a mathematical problem, and find what the laws of heredity must then be to enable successive generations to maintain statistical identity.

by which he corroborates his assertion. Three of the series

I shall have to speak so much about the law of deviation, that it is absolutely necessary to tax your attention for a few minutes to explain the principle on which it is based, what it is that it professes to show, and what the two numbers are which enable long series to be calculated like those in the tables just referred to. The simplest way of explaining the law is to begin by showing it in action. For this purpose I will use an apparatus that I employed three years ago in this very theatre, to illustrate other points connected with the law of deviation. An extension of its performance will prove of great service to us to-night, but I will begin by working the instrument as I did on the previous occasion. The portion of it that then existed and to which I desire now to confine your attention, is shown in the lower part of Fig. 1, where, I wish you to notice the stream issuing from either of the divisions just above the dots, its dispersion among

them, and the little heap that it forms on the bottom line. This part of the apparatus is like a harrow with its spikes facing us; below these are vertical compartments; the whole is faced with a glass plate. I will pour pellets from any point above the spikes, they will fall against the spikes, tumble about among them, and after pursuing devious paths, each will finally sink to rest in the compartment that lies beneath the place whence it emerges from its troubles.

The courses of the pellets are extremely irregular, it is rarely that any two pursue the same path from beginning to end, yet notwithstanding this you will observe the regularity of the outline of the heap formed by the accumulation of pellets.



FIG. 2.

This outline is the geometrical representation of the curve of deviation. If the rows of spikes had been few, the deviation would have been slight, almost all the pellets would have lodged in a single compartment and would then have resembled a column; if they had been very numerous, they would have been scattered so widely that the part of the curve for a long distance to the right and left of the point whence they were dropped would have been of uniform width, like an horizontal bar. With intermediate numbers of rows of teeth, the curved contour of the heap would assume different shapes, all having a strong family resemblance. I have cut some of these out of cardboard; they are represented in the diagrams (Figs.

2 and 3). Theoretically speaking, every possible curve of deviation may be formed by an apparatus of this sort, by varying the length of the harrow and the number of pellets poured in. Or if I draw a curve on an elastic sheet of india-rubber, by stretching it laterally I produce the effects of increased dispersion; by stretching it vertically I produce that of increased numbers. The latter variation is shown by the successive curves in each of the diagrams, but it does not concern us to-night, as we are dealing with proportions, which are not affected by the size of the sample. To specify the variety of curve so far as dispersion is concerned, we must measure the amount of lateral stretch of the india-rubber sheet. The curve has no definite ends, so we have to select and define two points in its base, between which the stretch may be measured. One of these points is always taken directly below the place where the pellets were poured in. This is the point of no deviation, and represents the mean position of all the pellets, or the average of a race. It is marked as  $0^\circ$ . The other point is conveniently taken at the foot of the vertical line that divides either half of the symmetrical figure into two equal areas. I take a half curve in cardboard that I have again divided along this line, the weight of the two portions is equal. This distance is the value of  $1^\circ$  of deviation, appropriate to each curve.

FIG. 3

We extend the scale on either side of  $0^\circ$  to as many degrees as we like, and we reckon deviation as positive, or to be added to the average, on one side of the centre say to the right, and negative on the other, as shown in the diagrams. Owing to the construction, one quarter or 25 per cent. of the pellets will lie between  $0^\circ$  and  $1^\circ$ , and the law shows that 16 per cent. will lie between  $+1^\circ$  and  $+2^\circ$ , 6 per cent. between  $+2^\circ$  and  $+3^\circ$ , and so on. It is unnecessary to go more minutely into the figures, for it will be easily understood that a formula is capable of giving results to any minuteness and to any fraction of a degree.

Let us, for example, deal with the case of the American soldiers. I find, on referring to Gould's Book, that  $2^\circ$  of deviation was in their case 1'676 inches. The curve I hold in my hand has been drawn to that scale. I also find that their average height was 67'24 inches. I have here a standard marked with feet and inches. I apply the curve to the standard, and immediately we have a geometrical representation of the statistics of height of all those soldiers. The lengths of the ordinates show the proportion of men at and about their heights, and the area between any pairs of ordinates give the proportionate number of men between those limits.

It is indeed a strange fact that any one of us sitting quietly at his table could, on being told the two numbers just mentioned, draw out a curve on ruled paper, from which thousands of vertical lines might be chalked side by side on a wall, at the distance apart that is taken up by each man in a rank of American soldiers, and know that if the same number of these American soldiers taken indiscriminately had been sorted according to their heights and marched up to the wall, each man of them would find the chalked line which he found opposite to him to be exactly his own height. So far as I can judge from the run of the figures in the table, the error would never exceed a quarter of an inch, except at either extremity of the series.

The principle of the law of deviation is very simple. The important influences that acted upon each pellet were the same; namely, the position of the point whence it was dropped, and the force of gravity. So far as these are concerned, every pellet would have pursued an identical path. But in addition to these there were a host of petty disturbing influences, represented by the spikes among which the pellets tumbled in all sorts of ways. The theory of combination shows that the commonest case is that where a pellet falls equally often to the right of a spike as to the left of it, and therefore drops into the compartment vertically below the point where it entered the harrow. It also shows that the cases are very rare of runs of luck carrying the pellet much oftener to one side than the other. The law of deviation is purely numerical; it does not regard the fact whether the objects treated of are pellets in an apparatus like this, or shots at a target, or games of chance, or any other of the numerous groups of occurrences to which it is or may be applied.<sup>1</sup>

I have now done with my description of the law. I know it has been tedious, but it is an extremely difficult topic to handle on an occasion like this. I trust the application of it will prove of more interest.

(To be continued.)

#### ON THE STRUCTURE AND ORIGIN OF METEORITES<sup>2</sup>

THE study of meteorites is naturally divisible into several very distinct branches of inquiry. Thus in the first place we may regard them as shooting stars, and observe and discuss their radiant points and their relation to the solar system. This may be called the astronomical aspect of the question. Then, when solid masses fall to the ground, we may study their chemical composition as a whole, or that of the separate mineral constituents; and lastly, we may study their mechanical structure, and apply to this investigation the same methods which have yielded such important results in the case of terrestrial rocks. So much has been written on the astronomical, chemical, and mineralogical aspect of my subject by those far more competent than myself to deal with such questions, that I shall confine my remarks almost entirely to the mechanical structure of meteorites and meteoric irons, and more especially to my own observations, since they will, at all events, have the merit of greater originality and novelty. Time will, however, not permit me to enter into the detail even of this single department of my subject.

In treating this question it appeared to me very desirable to exhibit to you accurate reproductions of the natural objects, and I have therefore had prepared photographs of my original drawings, which we shall endeavour to show by means of the oxyhydrogen lime-light, and I shall modify my lecture to meet the requirements of the case,

<sup>1</sup> Quetelet, apparently from habit rather than theory, always adopted the binomial law of error, basing his tables on a binomial of high power. It is absolutely necessary to the theory of the present paper, to get rid of binomial limitations and to consider the law of deviation or error, in its exponential form.

<sup>2</sup> Abstract of lectures delivered by H. C. Sorby, F.R.S., &c., at the Museum, South Kensington, on March 30.

exhibiting and describing special examples, rather than attempt to give an account of meteorites in general. Moreover, since the time at my disposal is short, and their external characters may be studied to great advantage at the British Museum, I shall confine my remarks as much as possible to their minute internal structure, which can be seen only by examining properly prepared sections with more or less high magnifying powers.

By far the greater part of my observations were made about a dozen years ago. I prepared a number of sections of meteorites, meteoric irons, and other objects which might throw light on the subject, and my very best thanks are due to Prof. Maskelyne for having most kindly allowed me to thoroughly examine the very excellent series of thin sections, which had been prepared for him. During the last ten years my attention has been directed to very different subjects, and I have done little more than collect material for the further and more complete study of meteorites. When I have fully utilised this material I have no doubt that I shall be able to make the subject far more complete, and may find it necessary to modify some of my conclusions. I cannot but feel that very much more remains to be learned, and I should not have attempted to give an account of what I have so far done, if I had not been particularly asked to do so by Mr. Lockyer. At the same time I trust that I shall at all events succeed in showing that the microscopical method of study yields such well marked and important facts, that in some cases the examination of only a single specimen serves to decide between rival theories.

In examining with the naked eye an entire or broken meteorite we see that the original external outline is very irregular, and that it is covered by a crust, usually, but not invariably black, comparatively thin, and quite unlike the main mass inside. This crust is usually dull, but sometimes, as in the Stannern meteorite, bright and shining, like a coating of black varnish. On examining with a microscope a thin section of the meteorite, cut perpendicular to this crust, we see that it is a true black glass filled with small bubbles, and that the contrast between it and the main mass of the meteorite is as complete as possible, and the junction between them sharply defined, except when portions have been injected a short distance between the crystals. We thus have a most complete proof of the conclusion that the black crust was due to the true igneous fusion of the surface under conditions which had little or no influence at a greater depth than  $\frac{1}{16}$ th of an inch. In the case of meteorites of different chemical composition, the black crust has not retained a true glassy character, and is sometimes  $\frac{1}{8}$ th of an inch in thickness, consisting of two very distinct layers, the internal showing particles of iron which have been neither melted nor oxidised, and the external showing that they have been oxidised and the oxide melted up with the surrounding stony matter. Taking everything into consideration, the microscopical structure of the crust agrees perfectly well with the explanation usually adopted, but rejected by some authors, that it was formed by the fusion of the external surface, and was due to the very rapid heating which takes place when a body moving with planetary velocity rushes into the earth's atmosphere—a heating so rapid that the surface is melted before the heat has time to penetrate beyond a very short distance into the interior of the mass.

When we come to examine the structure of the original interior part of meteorites, as shown by fractured surfaces, we may often see with the naked eye that they are mottled in such a way as to have many of the characters of a brecciated rock, made up of fragments subsequently cemented together and consolidated. Mere rough fractures are, however, very misleading. A much more accurate opinion may be formed from the examination of a smooth flat surface. Facts thus observed led Reichenbach to conclude that meteorites had been formed by the

collecting together of the fragments previously separated from one another in comets, and an examination of thin transparent sections with high magnifying powers and improved methods of illumination, proves still more conclusively their brecciated structure. The facts are, however, very complex, and some are not easily explained. Leaving this question for the present, I will endeavour to point out what appears to be the very earliest history of the material, as recorded by the internal structure.

It is now nearly twenty years since I first showed that the manner of formation of minerals and rocks may be learned from their microscopical structure. I showed that when crystals are formed by deposition from water or from a mass of melted rock, they often catch up portions of this water or melted stone, which can now be seen as cavities containing fluid or glass. We may thus distinguish between crystalline minerals formed by purely aqueous or by purely igneous processes; for example, between minerals in veins and minerals in volcanic lavas. In studying meteorites it appeared to me desirable, in the first place, to ascertain whether the crystalline minerals found in them were originally formed by deposition from water or from a melted stony material analogous to the slags of our furnace or the lava of volcanoes. One of the most common of the minerals in meteorites is olivine, and when met with in volcanic lavas this mineral usually contains only a few and small glass cavities in comparison with those seen in such minerals as augite. The crystals in meteorites are, moreover, only small, and thus the difficulty of the question is considerably increased. However, by careful examination with high magnifying power, I found well-marked glass-cavities, with perfectly fixed bubbles, the inclosed glass being sometimes of brown colour and having deposited crystals. On the contrary I have never been able to detect any trace of fluid-cavities, with moving bubbles, and therefore it is very probable, if not absolutely certain, that the crystalline minerals were chiefly formed by an igneous process, like those in lava, and analogous volcanic rocks. These researches require a magnifying power of 400 or 600 linear.

Passing from the structure of the individual crystals to that of the aggregate, we find that in some cases we have a structure in every respect analogous to that of erupted lavas, though even then there are very curious differences in detail. By methods like those adopted by Daubrée, there ought to be no more difficulty in artificially imitating the structure of such meteorites than in imitating that of our ordinary volcanic rocks. It is, however, doubtful whether meteorites of any considerable size uniformly possess this structure. The best examples I have seen are only fragments inclosed in the general mass of the Petersburg meteorite, which, like many others, has exactly the same kind of structure as that of consolidated volcanic tuff or ashes. This is well shown by the Bialystock meteorite, which is a mass of broken crystals and more complex fragments scattered promiscuously through a finer-grained consolidated dust-like ash.

Passing from this group of meteorites, which are more or less analogous to some of our terrestrial volcanic rocks, we must now consider the more common varieties, which are chiefly composed of olivine and other allied minerals. The Mezö Madaras meteorite is an excellent illustration, since the outline of the fragments is well seen, on account of the surrounding consolidated fine material being of dark colour. In it we see more or less irregular spherical and very irregular fragments scattered promiscuously in a dark highly consolidated fine-grained base. By far the larger part of these particles do not either by their outline or internal structure furnish any positive information respecting the manner in which they were formed, but careful examination of this and other analogous meteorites, has enabled me to find that the

form and structure of many of the grains is totally unlike that of any I have ever seen in terrestrial rocks, and points to very special physical conditions. Thus some are almost spherical drops of *true glass* in the midst of which crystals have been formed, sometimes scattered promiscuously, and sometimes deposited on the external surface, radiating inwardly; they are, in fact, partially devitrified globules of glass, exactly similar to some artificial blow-pipe beads.

As is well known, glassy particles are sometimes given off from terrestrial volcanoes, but on entering the atmosphere they are immediately solidified and remain as mere fibres, like *Pele's hair*, or as more or less irregular laminae, like pumice dust. The nearest approach to the globules in meteorites is met with in some artificial products. By directing a strong blast of hot air or steam into melted glassy furnace slag, it is blown into spray, and usually gives rise to pear-shaped globules, each having a long hair-like tail, which is formed because the surrounding air is too cold to retain the slag in a state of perfect fluidity. Very often the fibres are the chief product. I have never observed any such fibres in meteorites. If the slag be hot enough, some spheres are formed without tails, analogous to those characteristic of meteorites. The formation of such alone could not apparently occur unless the spray were blown into an atmosphere heated up to near the point of fusion, so that the glass might remain fluid until collected into globules. The retention of a true vitreous condition in such fused stony material would depend on both the chemical composition and the rate of cooling, and its permanent retention would in any case be impossible if the original glassy globule were afterwards kept for a long time at a temperature somewhat under that of fusion. The combination of all these conditions may very well be looked upon as unusual, and we may thus explain why grains containing true glass are comparatively very rare; but though rare they point out what was the origin of many others. In by far the greater number of cases the general basis has been completely devitrified, and the larger crystals are surrounded by a fine-grained stony mass. Other grains occur with a fan-shaped arrangement of crystalline needles, which an uncautious, non-microscopical observer might confound with simple concretions. They have, however, a structure entirely different from any concretions met with in terrestrial rocks, as for example that of oolitic grains. In them we often see a well-marked nucleus, on which radiating crystals have been deposited equally on all sides, and the external form is manifestly due to the growth of these crystals. On the contrary the grains in meteorites now under consideration have an external form *independent of the crystals*, which do not radiate from the centre, but from one or more places on the surface. They have, indeed, a structure absolutely identical with that of some artificial blow-pipe beads which become crystalline on cooling. With a little care these can be made to crystallise from one point, and then the crystals shoot out from that point in a fan-shaped bundle, until the whole bead is altered. In this case we clearly see that the form of the bead was due to fusion, and existed prior to the formation of the crystals. The general structure of both these and the previously described spherical grains also shows that their rounded shape was not due to mechanical wearing. Moreover, melted globules with well-defined outline could not be formed in a mass of rock pressing against them on all sides, and I therefore argue that some at least of the constituent particles of meteorites were originally detached glassy globules, like drops of fiery rain.

Another remarkable character in the constituent particles of meteorites is that they are often mere fragments, although the entire body before being broken may originally have been only one-fortieth or one-fiftieth of an inch in diameter. It appears to me that thus to break such



minute particles when they were probably in a separate state, mechanical forces of great intensity would be required. By far the greater number of meteorites have a structure which indicates that this breaking up of the constituents was of very general occurrence.

Assuming then that the particles were originally detached like volcanic ashes, it is quite clear that they were subsequently collected together and consolidated. This more than anything else appears to me a very great difficulty in the way of our adopting Reichenbach's cometary theory. Volcanic ashes are massed together and consolidated into tuff, because they are collected on the ground by the gravitative force of the earth. It appears to me very difficult to understand how in the case of a comet there could be in any part a sufficiently strong gravitative force to collect the dispersed dust into hard stony masses like meteorites. If it were not for this apparent difficulty we might suppose that some of the facts here described were due to the heat of the sun, when comets approach so near to it that the conditions may be practically almost solar. Comets may and probably do contain many meteorites, but I think that their structure indicates that they were originally formed under conditions far more like those now existing at the surface of the sun than in comets.

The particles having been collected together, the compound mass has evidently often undergone considerable mechanical and crystalline changes. The fragments have sometimes been broken *in situ*, and "faulted;" and crystallisation has taken place, analogous to that met with in metamorphic rocks, which has more or less, and sometimes almost entirely, obliterated the original structure. The simplest explanation of this change is to suppose that after consolidation meteorites were variously heated to temperatures somewhat below their point of fusion. Those which have the structure of true lava may in some cases be portions which were actually remelted. We have also this striking fact, that meteoric masses of compound structure, themselves made up of fragments, have been again broken up into compound fragments, and these collected together and consolidated along with fresh material, to form the meteorites in their present condition. L'Aigle is a good example of this complex structure.

Another remarkable fact is the occurrence in some meteorites of many veins filled with material, in some respects so analogous to the black crust, that at one time I felt induced to believe that they were cracks, into which the crust had been injected. Akburfur is a good example of this, and seems to show that under whatever conditions the veins were found, they were injected not only with a black material, but also with iron and magnetic pyrites.

Taking, then, all the above facts into consideration, it appears to me that the conditions under which meteorites were formed must have been such that the temperature was high enough to fuse stony masses into glass; the particles could exist independently one of the other in an incandescent atmosphere, subject to violent mechanical disturbances; that the force of gravitation was great enough to collect these fine particles together into solid masses, and that these were in such a situation that they could be metamorphosed, further broken up into fragments, and again collected together. All these facts agree so admirably with what we know must now be taking place near the surface of the sun, that I cannot but think that, if we could only obtain specimens of the sun, we should find that their structure agreed very closely with that of meteorites. Considering also that the velocity with which the red flames have been seen to be thrown out from the sun is almost as great as that necessary to carry a solid body far out into planetary space, we cannot help wondering whether, after all, meteorites may not be portions of the sun recently detached from it by the violent disturbances which do most certainly now occur, or were carried off from it at some earlier period, when

these disturbances were more intense. At the same time, as pointed out by me many years ago, some of the facts I have described may indicate that meteorites are the residual cosmical matter, not collected into planets, formed when the conditions now met with only near the surface of the sun extended much further out from the centre of the solar system. The chief objection to any great extension of this hypothesis is that we may doubt whether the force of gravitation would be sufficient to explain some of the facts. In any case I think that one or other of these solar theories, which to some extent agree with the speculations of the late Mr. Brailey, would explain the remarkable and very special microscopical structure of meteorites far better than that which refers them to portions of a volcanic planet, subsequently broken up, as advocated by Meunier, unless indeed we may venture to conclude that the material might still retain its original structure, due to very different conditions, previous to its becoming part of a planet. At the same time so little is positively known respecting the original constitution of the solar system, that all these conclusions must to some extent be looked upon as only provisional.

I will now proceed to consider some facts connected with meteoric irons. The so-called Widmanstätt's figuring, seen when some of these irons are acted on by acids, is well known; but in my opinion the preparations are often very badly made. When properly prepared, the surface may be satisfactorily examined with a magnifying power of 200 linear, which is required to show the full detail. We may then see that the figuring is due to a very regular crystallisation, and to the separating out one from the other of different compounds of iron and nickel, and their phosphides. When meteoric iron showing this structure is artificially melted, the resulting product does not show the original structure, and it has therefore been contended that meteoric iron was never in a state of igneous fusion. In order to throw light on this question, I have paid very much attention to the microscopical structure of nearly all kinds of artificial irons and steels, by studying surfaces polished with very special care, so as to avoid any effect like burnishing, and then acting on them very carefully with extremely dilute nitric acid. In this manner most beautiful and instructive specimens may be obtained, showing a very great amount of detail, and requiring a magnifying power varying up to at least 200 linear. In illustration of my subject I will call attention to only a few leading types of structure. In the first case we have grey pig-iron, showing laminae of graphite promiscuously arranged in all positions, on the surface of which is a thin layer of what is probably iron uncombined with carbon, whilst the intermediate spaces are filled up with what are probably two different compounds of iron and carbon.

White chilled refined iron has an entirely different structure and more uniform crystallisation, the structure is very remarkable and beautiful, mainly due to the varying crystallisation of an intensely hard compound of iron and carbon, and the two other softer compounds met with in grey pig.

Malleable bar iron has an entirely different structure, and shows fibres of black slag, and a more or less uniform crystallisation of iron with a varying small amount of carbon.

Cast steel differs again very much from any of the previous. It shows a fine-grained structure, due to small radiating crystals, and no plates of graphite.

The difference between any of the above and meteoric iron is extremely great.

In the case of Bessemer metal we have a crystalline structure approaching in some places more nearly to that of meteoric iron. We see a sort of Widmanstätt's figuring, but it is due to the separation of free iron from a compound containing a little carbon, and not to a variation in the amount of nickel.

The nearest approach to the structure of meteoric iron

is met with in the central portion of thick bars of Swedish iron, kept for some weeks at a temperature below their melting point, but high enough to give rise to recrystallisation. We then get a complete separation of free iron from a compound containing some carbon, and a crystalline structure which, as far as mere form is concerned, most closely corresponds with that of meteoric iron, as may be at once seen on comparing them.

These facts clearly indicate that the Widmanstätt's figuring is the result of such a complete separation of the constituents and perfect crystallisation as can occur only when the process takes place slowly and gradually. They appear to me to show that meteoric iron was kept for a long time at a heat just below the point of fusion, and that we should be by no means justified in concluding that it was not previously melted. Similar principles are applicable in the case of the iron masses found in Disco, and it by no means follows that they are meteoric because they show the Widmanstätt's figuring. Difference in the rate of cooling would serve very well to explain the difference in the structure of some meteoric iron, which do not differ in chemical composition; but, as far as the general structure is concerned, I think that we are quite at liberty to conclude that all may have been melted, if this will better explain other phenomena. On this supposition we may account for the separation of the iron from the stony meteorites, since under conditions which brought into play only a moderate gravitative force, the melted iron would subside through the melted stone, as happens in our furnaces; whilst at the same time, as shown in my paper read at the meeting of the British Association in 1864, where the separating force of gravitation was small, they might remain mixed together, as in the Pallas iron, and others of that type.

In conclusion I would say that though from want of adequate material for investigation I feel that what I have so far done is very incomplete, yet I think that the facts I have described will, at all events, serve to prove that the method of study employed cannot fail to yield most valuable results, and to throw much light on many problems of great interest and importance in several different branches of science.

#### MENDELÉEFF'S RESEARCHES ON MARIOTTE'S LAW<sup>1</sup>

FROM researches on the depression of the mercury results the possibility of introducing a precise correction relative to the volume of gas contained between the surface of the mercury and the horizontal plane which touches the summit of the meniscus. In all my researches I introduce each time a correction relative to this volume.

The volume of the reservoir which contains the mercury and the gas under various pressures undergoes two kinds of variations; first, those which are due to the difference between the pressures which act on the two sides of the vessel, and second, those which depend on differences in the volume of mercury. The compressibility of the reservoirs employed in the researches has been always determined by experiment, and their change of volume produced by the introduction of mercury can be determined by surrounding the vessel filled with mercury by another filled with the same material. When the height in the two vessels is the same, the capacity of the vessel is that which exists at the time of equality of pressure on the external and internal surfaces of the vessel. If we empty a part of the external vessel the capacity of the vessel changes in the same manner as when we fill or when we empty the vessel. Experiments of this kind have shown the possibility of determining the changes of capacity depending on the quantity of mercury. The relative corrections have in each case been introduced into the calculations.

All the practical side of the subject—the desiccation of the gas, the complete abstraction of the remains of the gas from the apparatus, the hermetic junction of the parts of the apparatus by means of mastic and mercury stop-valves, the means of main-

trating the gases and the mercury at a constant temperature, the calibration of the tubes, and a number of other details have had to be elaborated more or less anew. All this will be found described in my work "On the Elasticity of Gases." I have published this work only in Russian, not having means sufficient to publish a translation of a work so voluminous, and desiring to conform to the custom existing among *savants* of all countries of describing their labours in their mother-tongue, in order to present to the scientific literature of the country where they live and work a gift in proportion to their powers.

My desire was to investigate the subject in its minutest details in order to eliminate every possibility of doubt as to the causes which determine the deviations observed from the Boyle-Mariotte Law. I know that that law is firmly established, and I believe it will remain so. Not less great is the certainty in the mind that rarefied gases approach the perfect state. That certainly I had also on commencing my experiments. It was necessary then to determine as completely as possible all the circumstances on which depend the facts contrary to the opinion generally held. This is why I have modified the apparatus, improved the methods, and employed in this work more than three years without interruption. Now so far as regards low pressures the work is finished, and I have obtained definitely certain proofs of the rigorous accuracy of my first observations.

The experiments which I have made with Kurpitschoff have proved that not only for air, but also for hydrogen, and even for carbonic acid, the deviations are positive when the gas is subjected to a very small pressure, it is found, moreover, that these deviations increase in proportion to the variation from the normal pressure. The same thing has been found in a new series of experiments undertaken by me with M. Hemilian. The experiments are described in one of my works on the "Elasticity of Gases," which I have just published. A brief extract on this subject is published in the *Ann. de Chimie et de Physique*, (October, 1876). I shall quote only the results obtained by us from the experiments made in 1875 and in the beginning of 1876.

Into a new apparatus we have introduced several further improvements, of which the chief are—(1) The barometer, the metre, and the reservoir, containing the gas and the mercury, have been placed in the same bath full of water, (2) We have succeeded in producing a complete vacuum in the barometric chamber, (3) The bath was maintained at an almost uniform temperature by means of an apparatus, and the small differences in the temperatures of the various layers have been determined by a differential thermometer, (4) The junction between the air reservoir and the barometer has been made, not only without the aid of a tap, but also without the use of mastic. Thus the gas was surrounded only by the glass and the mercury. We shall confine ourselves to a summary of the results of our experiments, made between 650 and 20 millimetres' pressure, with four gases—H<sub>2</sub>, air, CO, and SO.

1. If, starting with a certain small pressure, we arrive at pressures smaller still, we find for all gases positive deviations, viz,

$\frac{d(pv)}{dp} > 0$ , the gases, then, are in this case less compressed than Mariotte's Law requires. Similar deviations were also observed for hydrogen by M. Regnault between 1 and 30 atmospheres, and M. Nattelet for all gases between 100 and 3,000 atmospheres.

2. Under small pressures and for all gases, the value of the positive deviations,  $\frac{d(pv)}{dp}$ , the numerical quantity (or magnitude) increases when the initial pressure diminishes. Thus, for example, for hydrogen at 400 millimetres—

$$\frac{d(pv)}{dp} = + 0.000002,$$

and at 120 millimetres—

$$\frac{d(pv)}{dp} = + 0.000010$$

3. For gases like CO<sup>2</sup> and SO<sup>2</sup> we find near the atmospheric pressure, negative deviations,  $\frac{d(pv)}{dp} < 0$ , for CO<sup>2</sup>,  $p_0 = 635$ ,  $p_1 = 600$ ,  $p_0 v_0 = 10,000$ ,  $p_1 v_1 = 10,020$ , but, under less pressures still, the deviations become positive even for CO<sup>2</sup> and SO<sup>2</sup>. For example, for CO<sup>2</sup>,  $p_0 = 190$ ,  $p_1 = 64$ ,  $p_2 = 22$ ,  $p_0 v_0 = 10,000$ ,  $p_1 v_1 = 9,996$ ,  $p_2 v_2 = 9,983$ ; for SO<sup>2</sup>,  $p_0 = 190$ ,  $p_1 = 60$ ,  $p_2 = 22$ ,  $p_0 v_0 = 10,000$ ,  $p_1 v_1 = 10,010$ ,  $p_2 v_2 = 9,996$ .

4. The existence of positive and negative deviations for the

<sup>1</sup> To attain this end the gas-vessel and the branch of the barometer are soldered together by a capillary tube made of a single piece.

same gas, observed by means of the same apparatus, according to the amount of pressure, and the conformity in the various series of experiments, prove that the results obtained do not depend on any constant errors in the methods employed, but that they are really caused by the nature and the essential qualities of the gases investigated.

5. The variations from Mariotte's Law under very weak pressures being very small, it is necessary, in determining them, to make the reading of the pressures, the volumes, and the temperatures (absolute  $t = 273^\circ$ ) with a precision of two-thousandths of these total values; thus, e.g., if  $p_0 = 0.200$  m.,  $p_1 = 0.100$  m., and  $v_0 = 2,500$  gr.,  $v_1 = 5,000$  gr. of mercury ( $t = 20$ ), it will be necessary to determine the pressures with a precision of 0.01 mm., the volumes to 0.1 gr. of mercury, and the temperatures to 0.01 of a degree.

The results will be doubtful if the precision is less.<sup>1</sup> Thus it is found that under a certain small pressure gases present positive deviations from Mariotte's Law; even gases like sulphurous acid and carbonic acid, which under high pressures show considerable negative deviations. It is the same with air. M. Regnault commenced his researches with pressures which exceeded that of the atmosphere, and obtained negative deviations.

In 1874 I effected with all the care possible the determination of the deviations for air under pressures of from 650 to 2,000 millimetres, and towards the end of 1875 and in the beginning of 1876, in a special apparatus provided with compound manometers, I repeated the same experiments with M. Bogusski for pressures from 700 to 3,000 millimetres with air, hydrogen, and carbonic acid. These researches proved the rigorous accuracy of M. Regnault's conclusions. Air and carbonic acid were found to be subject under these pressures to negative deviations, greater for carbonic acid than for air; and hydrogen, for these same pressures, was found to present positive deviations. At present we are continuing the same kind of experiments for pressures of more than three metres.

Thus hydrogen, under all pressures, commencing with zero and ending with a pressure infinitely great, presents throughout positive deviations; at no pressure does it follow Boyle's Law rigorously, and it never presents negative deviations. Increased pressures always give a greater volume than what might be expected according to the variation of the pressures. Air under pressures less than 600 millimetres also presents positive deviations; but under pressures greater than that of the atmosphere its deviations become negative, and under pressures which exceed 100 atmospheres its compressibility again becomes positive. Consequently for this gas there are two pressures at which it follows Boyle's Law; the one is very nearly that of the atmosphere, the other lies between 30 and 100 atmospheres. These pressures, under which the changes of the sign of compressibility occur, will be different for carbonic acid; viz., under pressures less than that of the atmosphere the change of sign is found at nearly 200 millimetres, and for higher pressures it commences near that which corresponds to 70 metres of mercury, if we base our researches on this point on the observations of Dr. Andrews on the compressibility of carbonic acid gas for temperatures above  $31^\circ$ . For lower temperatures this point will probably correspond to the passage of carbonic acid into the liquid state. Consequently with a change of temperature the pressure at which the change of sign of compressibility occurs, changes also. For sulphurous acid the sign of compressibility under pressures lower than that of the atmosphere changes at about forty millimetres of pressure. But even this gas, so easily liquefiable, under low pressures, has always a positive compressibility. There is not then, and there cannot be, a gas which is rigorously subject to Mariotte's Law under small pressures.

The idea of an absolute gas belongs, then, to the number of fictions which find no confirmation in facts. We cannot, then, suppose that with the decrease of density or with the increase of the *vis viva* of gaseous molecules, gases approach a state in which they follow Boyle's Law. Then (the density diminishing, the velocity of the molecules increasing, that is to say, the pressure diminishing, the temperature increasing, and the molecular weight diminishing) they all tend towards another state characterised by the expression  $\frac{d(pv)}{dp} > 0$ ; i.e., they are assimilated to solid and liquid bodies, when the condensation reaches its limit. We

must believe that there is a limit of condensation and a limit of rarefaction. If we take, in fact, a mass of non-volatile liquid, and if we submit it to pressures infinitely great and infinitely small, we shall see it change volume; but in the two cases, we shall have finite volumes, capable of measurement, and even differing little for one and the same body. It is the same with gases, if we admit that for pressures approaching zero, gases contract according to the same law as that which we can deduce from our compression experiments under pressures less than that of the atmosphere, or as hydrogen contracts. Under great pressures, or under pressures excessively small, every gas resembles a solid or liquid body, and possesses two limits of compressibility. The volumes which correspond to these limits are very different, but there is always reason for believing that they exist.

Without launching into hypotheses to explain these limit volumes (such, e.g., as the supposition that molecules in themselves possess volume), I will confine myself to the question of the matter of celestial space. What is the luminous ether? One of two things—either an elastic independent matter, *sui generis*, or the gas of the atmospheres of celestial bodies, considerably rarefied. In the latter case it is necessary to admit the absence of limits in the atmospheres and a condensation of the ether greater and greater in proportion as we approach a celestial body (sun or planet). There are many arguments for and against both hypotheses. On the one hand, spectrum analysis leads us to conclude that the material of all heavenly bodies is identical; on the other hand, it proves the diversity of the composition of atmospheres. This is why we abstain from solving the question in its essence. But spectrum analysis does not speak less in favour of the former hypothesis, because it shows the diversity of composition of our terrestrial atmosphere from that of many of the other celestial bodies. In the researches on the resistance of celestial matter to the movement of the planets, there appears also to be a confirmation of the former of these two hypotheses, for neither planets nor comets show any diminution in the eccentricity of their orbits, which would be an inevitable consequence of motion in a rarefied medium, as has been observed in the case of Encke's comet. Exact investigations on the movement of that comet, repeated in recent times by M. von Asten, the Pulkowa astronomer, show clearly the advances towards the sun at perihelion, although in the beginning M. von Asten had not noticed them. But that comet at perihelion was found only at one-third of the distance which separates the sun from the earth, i.e., it was nearer to the sun than Mercury. It is possible that it passed near to the limits of the solar atmosphere. Faye's comet, as is known, does not present these same diversities, but its perihelic distance is about 1.68, that of Encke's comet being only about 0.33; it exceeds it then so much that their comparison would only serve to confirm the hypothesis of a solar atmosphere. If we admit a limit for the atmospheres, we must expect in gases, for small pressures, exactly that kind of variation from Boyle's Law which I observed in rarefied gases.

To prove that gases under very small pressures, as well as under very considerable pressures, vary from the Boyle-Mariotte Law is by no means the same as to deny the truth of that law; I feel that I ought to state this most explicitly. For a long time the law of gravitation could not be made to accord with the perturbations; latterly these perturbations have proved the best confirmation of the laws of gravitation. In the present case it may be the same. There are three laws for gases: that of Boyle and Mariotte,  $p v = \text{const.}$ ; that of Gay Lussac,  $v t = v_0 (1 + \alpha t)$ ; and that of Ampère and Gerland  $\frac{a v}{m} = \text{const.}$  ( $a$  being the molecular weight, and  $m$  the mass). Their ensemble is expressed for all gases in general by the equation—

$$a p v = 845 (273 + t) m,$$

where  $a$  is the atomic weight ( $H = 1$ ),  $p$  the pressure in kilograms per square metre,  $v$  the volume in cubic metres,  $m$  the weight in kilograms,  $t$  the centigrade temperature. This is, however, only a first approximation. In the second member of the equation there must be additional terms which express a function of  $p$  and of  $a$ , very small for the ordinary mean values of  $p$ , and which become of a sensible magnitude only when  $p$  is very small or very great. To find this function is a question of the future, and demands the labours of a great number of investigators. My aim is to be able to furnish some experimental data which will permit of judging of the form of that function. This work requires many new processes, measuring apparatus of a high

<sup>1</sup> It is by these causes that the want of conformity in the experiments of Silvestroni is sufficiently explained (Pogg. Ann., April and May, 1874; see also the Bull. de l'Acad. de Sc. de St. Pétersbourg, t. xix, p. 465, and Berichte der deutschen chem. Gesell., t. viii, p. 1,330; t. viii, pp. 576 and 742, and of M. Amagat (Comptes Rendus, April 27, 1876.)

degree of precision, many varied arrangements as well as experienced assistants. That idea has secured me the protection of His Imperial Highness the Grand Duke Constantine and the support of the Imperial Russian Technical Society.

I thus conclude this communication which I have the honour to send you. The researches on the co-efficients of dilatation of gases in their general features confirm the accuracy of the deductions drawn from the observations on compressibility. But that matter is in process of elaboration, and only a part of the researches has been completed. Consequently I abstain from expounding all the details of the subject. I shall only remark that the true coefficient of dilatation of air under constant pressure and with variable volume is found to be greater for pressures near to atmospheric pressure than the number generally accepted, notably from the researches which I have made with M. Kaiander, it is equal to 0.003683 if we take 100° C. as the temperature of boiling water under an atmospheric pressure of 760 mm. in latitude 45°.

If you do not find devoid of interest more ample details on this subject, as also on the determination of the weight of a litre of air, I shall have the greatest pleasure in explaining to the English public through your interesting journal the essential points of the researches made on this subject in my laboratory. St. Petersburg, January 1 DE MENDELKEF

OUR ASTRONOMICAL COLUMN

BINARY STARS.—From one of the very careful and complete investigations on the orbits of the revolving double stars, by which Dr. Doberck is so greatly contributing to our knowledge of the motions of these interesting objects, we have an orbit of  $\xi$  Scorpii which is probably a very near approximation to the true one.

We have called the star by what appears to be its correct designation,  $\xi$  Scorpii, but few stars have been subjected to more varied nomenclature than the one in question. In Dr. Doberck's paper, published in No. 2,121 of the *Astronomische Nachrichten*, in all probability through one of the typographical errors which have of late so much disfigured this periodical, the star is styled  $\zeta$  Libræ. It has been previously very commonly named  $\xi$  Libræ, and it is  $\zeta$  Libræ of Flamsteed; Secchi, in *Astron. Nach.*, No. 1,614, calls it  $\rho'$  Libræ, though we are ignorant upon what precedent.

Dr. Doberck's elements are those of a very nearly circular orbit, and it may be remembered that some thirty years since Madler gave elements for circular motion with a period of revolution of about 104 years. In *Astron. Nach.*, No. 1,683, Dr. Thiele gave the results of a very complete discussion of the measures up to 1856, in which he has assumed that Sir W. Herschel's angle on the night of his discovery of the duplicity of the star has been registered correctly, though a doubt has been entertained upon this point. He thus arrives at a highly eccentric elliptic orbit with a period of a little over forty-nine years. It should be remarked that from the near approach of the magnitudes of the components forming the double star  $\xi$  Scorpii (it is more correctly a triple star), an error of 180° in the measured angle of position is by no means an improbable one.

Dr. Doberck assumes that Sir W. Herschel's angle of 1782 requires this correction, and deduces an orbit in which the period of revolution is nearly twice that of Thiele, and which therefore approaches the period originally assigned by Madler. His elements are as follow:—

Peri-astron passage 1859.62.			
Node	... 12° 15'	Inclination	... 68° 42'
Node to peri-astron on orbit	... ..		... 89° 16'
Eccentricity	... ..		... 0.0768
Semi-axis major	... ..		... 1" 26
Revolution	... ..		... 95.90 years.

A full comparison with the measures up to the present time, appears in the *Astronomische Nachrichten*.

In the same number Dr. Doberck gives first elements of that exceedingly difficult object  $\gamma$  Coronæ Borealis, in which the

period of revolution is 95½ years, and the peri-astron passage 1843.7. The distance calculated from this orbit is still under two-tenths of a second, but it will increase, until towards the end of the first decade of the next century the components according to Dr. Doberck's calculation, will be separated by more than 0".8.

THE ANNULAR ECLIPSE OF THE SUN, 1737, MARCH 1.—Prof. Grant, in his "History of Physical Astronomy," mentions this eclipse as the first annular one of which we have any detailed account. This phase passed over Edinburgh, where it was observed by Maclaurin, the well-known mathematician, by Short the optician, Lord Aberdour, and others. The times were determined by Maclaurin by a pendulum clock of Graham's and he was also furnished with a meridian instrument by the same maker, with the aid of which the clock was rated by Short for "a long time before and after the eclipse." The clock used by Lord Aberdour, who was located in Edinburgh Castle, was compared with Maclaurin's at noon on the day of the eclipse and in addition signals were exchanged between the Castle and Maclaurin's station at the college. Both observers determined the duration of the annular phase to have been 5m. 48s.

The following elements of this eclipse have been deduced from a similar system of computation as regards the moon's place to that adopted for other eclipses to which reference has been made from time to time in this column, a system which gives result for the total solar eclipse of 1715 agreeing very closely with the observations of Flamsteed and Halley.

G.M.T. of conjunction in R.A., March 1, at 3h. 1m. 31s.

R.A.	... ..	342	35	32	0
Moon's hourly motion in R.A.	... ..	28	50	9	
Sun's " " " "	... ..	2	20	3	
Moon's declination " " "	... ..	6	44	0	1 S.
Sun's " " " "	... ..	7	24	5	7 S.
Moon's hourly motion in decl.	... ..	8	49	5	N.
Sun's " " " "	... ..	0	57	2	N.
Moon's horizontal parallax " "	... ..	54	19	1	
Sun's " " " "	... ..				90
Moon's true semi-diameter " "	... ..	14	48	0	
Sun's " " " "	... ..	16	7	7	

The equation of time was 12m. 40s. subtractive from mean time. The following were points upon the central line by the above elements:—

Long. 10 10 W.	Lat. 54 53 N.	Long. 4 11 W.	Lat. 56 35 N.
" 7 26 W.	" 55 42 N.	" 0 4 W.	" 57 36 N.

If reduction equations are founded upon a direct calculation for Edinburgh, there result for any place not far distant:—

$$\cos w = .876969 - [1.59617] \sin l + [1.22018] \cos l, \cos(L - 51^\circ 1' 4")$$

$$l = 2h 13m. 35.5s \mp [2.29350] \sin w + [3.49325] \sin l$$

$$- [3.89280] \cos l, \cos(L + 147^\circ 15' 5s)$$

where  $l$  is the geocentric latitude of the place,  $L$  its longitude from Greenwich + if E, - if W, and  $t$  is expressed in Greenwich mean time; the upper sign is to be used for beginning of annular phase, and the lower for the ending. The quantities within square brackets are logarithms.

The calculated duration of annularity at Edinburgh 5m. 46.6s., differing only 1.4% from the observations of Maclaurin and Lord Aberdour, but the middle of this phase is given later by 1m. 51s. At other places mentioned in Maclaurin's memoir on this eclipse, published in the *Philosophical Transactions*, the duration of the annulus was as follows:—At Alnwick 2m. 0s.; at Crosby, near Ayr, 5m. 54s.; at Montrose, 6m. 27s. and at St. Andrew's, 6m. 12s. At Aberdeen, which was very near the central line, the annulus was formed at 3h. 43m. 0 local mean time, and continued 6m. 30s. On the east coast of Scotland, where the duration of annulus was longest, it did not exceed 6m. 35. The eclipse is not given annular at Morpet (therein agreeing with the observation).

## NOTES

THE Swiney Lectures on Geology (free to the public) will be delivered this year at the Royal School of Mines, Jermyn Street, on Monday and Thursday evenings at eight P.M., commencing on Monday, April 9.

As we have already stated, the "Verein für die deutsche Nordpolarfahrt," of Bremen, has been converted into a Geographical Society (die geographische Gesellschaft in Bremen) with the object of promoting scientific exploring expeditions generally, and of publishing their results. Dr. Finsch, who was sent out by the Verein last year to the mouths of the Obi along with Dr. Brehm and Graf Waldburg-Zeil, is now busily engaged in working out the ethnographical and natural history collections made during the expedition and publishing their results. A paper of Dr. Finsch on the new buds discovered on this occasion has been received by the Zoological Society of London, and will be read at one of their next scientific meetings.

ON Friday, April 13, Mr. W. Spottiswoode will deliver a lecture at the Royal Institution on his great Induction Coil, described in the January number of the *Philosophical Magazine* and in the March number of the *Nineteenth Century*. The lecture will be illustrated with some new experiments on statitised discharges, which a coil of this enormous power has for the first time rendered practicable.

THE Leipzig publisher, Gunther, has issued the first part of a new journal, *Kosmos*, specially devoted to the furtherance of the development doctrine, under the editorship of Caspari, Jäger, and Krause, with the assistance of Darwin, Haeckel, and other eminent workers in the Darwinian field. We shall give a detailed notice of the first part in an early number.

PROF. SYLVESTER seems to have become quite naturalised in the United States, if we may judge from the fact that he was one of the speakers at the celebration of Washington's birthday at the Johns Hopkins University, where, as our readers know, he is Professor of Mathematics. Prof. Sylvester spoke of his work and of his satisfaction with his new relations, as also on some points of general interest. He maintains that it is a mistake to divorce teaching and research, illustrating the advantage of their union in his own case by the fact that in the act of teaching, important fields for research have been suggested to him. Recently, for example, at the University in Baltimore, the persistence of a student in his desire to study the new algebra has led Prof. Sylvester into "a research of fascinating interest," from which he hopes for great results. He has reason "to think that the taste for mathematical study, even in its most abstract form, is much more widely diffused than is generally supposed" in the United States. Prof. Sylvester, the *Nation* tells us, spoke at considerable length and with deep feeling on the estrangement between the two great branches of the Anglo-Saxon race caused by the exclusive, ecclesiastical policy of the English Universities in former years. "Their work it is that a separation deeper and a chasm more difficult to fill up has been created between the two most free and powerful nations in the world—England and America—than any due to political causes, present or past." Why is it, he inquired, that the flower of American youth do not resort for their mental impulse and higher education to Oxford and Cambridge, instead of to Berlin, Leipzig, Jena, or Heidelberg? "It is because there they are welcomed, to whatever religious communion they are attached or unattached, without question and without distinction. It is because there they can rest on the bosom of a common mother, who shows kindness to all and favour to none. . . I have been struck, almost from the first hour of my landing on these shores, by the manifestations I have everywhere witnessed of the close intellectual sympathy, which exists between America and

Germany. It is German books that are read, it is German authors who are quoted, German opinion on all matters of science and learning that is appealed to; and as regards community of work and intellectual ties, I do not think it at all extravagant to assert that Germany and America belong to one hemisphere, and we in England to another." If our universities are to blame for this state of things, they have much to answer for; and it is therefore some relief to know that the New York *Nation* accounts for it by the desire of Americans to acquire another language in the country where it is spoken, and to come in contact with a different order of mind, however little superior.

DR. KLEIN, extraordinary professor of mineralogy in the University of Heidelberg, has accepted an ordinary professorship in the University of Göttingen.

THE Clothworkers' and Merchant Tailors' Companies have each contributed one hundred guineas to the fund being raised by the Chemical Society for the promotion of chemical research.

THE trustees of the Johnson Memorial Prize for the encouragement of the study of astronomy and meteorology propose the following subject for an essay, "The History of the Successive Stages of our Knowledge of Nebulae, Nebulous Stars, and Star clusters, from the Time of Sir William Herschel." The prize is open to all members of the University of Oxford, and consists of a gold medal of the value of ten guineas, together with so much of the dividends for four years on 338/ Reduced Annuities as shall remain after the cost of the medal and other expenses have been defrayed. Candidates are to send their essays to the registrar of the University, under a sealed cover marked "Johnson Memorial Prize Essay," on or before March 31, 1879, each candidate concealing his name, distinguishing his essay by a motto, and sending at the same time his name sealed up under cover with the same motto written upon it.

ONE or more minor scholarships in natural science will be offered by Downing College, Cambridge, during the present year. The scholarships range in value from 40*l.* to 70*l.* per annum, and are tenable for two years, or until the holder is elected to a foundation scholarship. The examination will be held in Downing College on June 5 and the three following days. The subjects of examination will be (1) Chemistry, theoretical and practical; (2) Physics; (3) Comparative Anatomy; and (4) Physiology. All persons are eligible to these scholarships who have not commenced to reside in the University.

ON March 7, at Gjesvar, a Norwegian fishing station, near the North Cape, in 71° 12' N. lat., the most northerly telegraph station on the earth was opened.

THE *Conversations* of the Quekett Club takes place on the 13th inst., at University College, Gower Street.

THREE electric eels from the River Amazon have this week been added to the Westminster Aquarium. As they require to be kept at a temperature of between 70° and 80° F. it needed some ingenuity to bring them from Liverpool, where they were landed, to London. By placing the vessel containing them on foot-warmers and telegraphing on for changes of foot-warmers at different stations, the water on arriving at Westminster was found to be at 75°. The eels are lodged in a tank kept warm by a steam pipe passing under the shingle, and are at present by the alligators. These, by the by, are waking up wonderfully in activity, and the attendants have now to keep a sharp lookout when cleaning the tank.

WE are enabled to state that the increasing number of demands for space in the Paris International Exhibition has led M. Krantz reluctantly to give up the idea of authorising the con-

struction of the large Giffard Captive Balloon within the precincts of the Exhibition. The construction will take place at all events either on public ground lent by the Government or on some private vacant space at a small distance from the Champ de Mars. The preliminary technical arrangements have been made by M. Giffard. The length of the rope will be about 600 metres. It will be conical; the largest end close to the car will be 8 centimetres diameter, the smallest end only 6. The ascending force, when loaded with ballast, guide ropes, grapnels, and 50 passengers, will be 5 tons. The weight of the cable will be 2½ tons when fully expended. The ascending force of the hydrogen filling the envelope will be 23 tons. The diameter of the balloon will be 34 metres, the height 50 metres from the lower part of the car to the upper part of the valve, and the engine will be of 200-horse power.

THE supplementary number, 51, of Petermann's *Mittheilungen* contains the second half of the late E. De Fruyssenac's travels in the region of the White and Blue Nile. This part contains the special scientific results of the accomplished traveller—meteorological observations, barometrical altitude observations, river measurements, astronomical observations, triangulation of a part of the Jelfra, besides the southern half of the map, constructed by the editor, Herr Zoepfritz, and a plate of some of the implements, weapons, utensils, ornaments, &c., used by the inhabitants of the region traversed.

AT the meeting of the delegates of the French learned societies to be held at the Sorbonne, as we noticed last week, M. Allard, the director of the Puy-de-Dôme Observatory, will present a most interesting paper. A self-registering barometer has been kept in constant operation on the top of the Puy-de-Dôme, and another similar instrument was observed at Clermont-Ferrand during the same length of time. The difference of pressure has undergone most remarkable variations, which cannot be accounted for by the Laplace law for determining the altitudes by comparing barometers. The corrections of temperature will be shown to be quite insufficient.

THE Scientific Congress of France, a quite distinct organisation, established by the late M. de Caumont, will hold its forty-third session at Versailles, from May 17 to 27. A number of attractive excursions have been arranged with the help of the municipal authorities, and there will be a floral exhibition.

AT the meeting of the St. Petersburg Society for the Protection of Trade, March 21, the maps prepared last summer by M. Orloff during his journey to the Baydaraksky Gulf, were exhibited. The survey and levelling were made from the Irtysh, up the Shchuchya River, and along the Baydaraka River to the Baydaraksky Gulf. Both rivers are navigable during the three months—June, July, and August.

A TOMSK telegram received by M. Siderof on March 18, from M. Schwabenberg's expedition, announces the find, on the banks of the Obi, near to the Marinsky gold-washings, of a well-preserved mammoth with flesh and skin. The definitive excavation of the carcass was stopped until instructions should arrive from St. Petersburg.

DR. J. F. BRANSFORD, surgeon in the United States Navy, has been investigating the antiquities on the island of Omotepe, in Lake Nicaragua, collecting large numbers of vases of various kinds, burial urns, ornaments, and other objects for the National Museum at Washington. Among the more important points substantiated by him was the occurrence on the island of at least three successive and distinct bases of prehistoric civilisation, all of them anterior to the present epoch, these being bounded and defined by successive overflows of lava from the volcano. Very great intervals of time elapsed between the eruptions, as is shown in the accumulations of soil that took place on the fresh surface

of the lava from the decomposition of vegetable deposits. No estimate can be made of these eras, but they are believed to carry the period of the earliest overflows back to a very remote antiquity. The objects of these successive layers are very definite and easily recognisable by the practised eye, and highly important deductions in regard to the early civilisation of that region are expected from a critical investigation of the subject. Dr. Bransford has prepared an elaborate report on this subject for presentation to the Navy Department, but, before publishing it, he has obtained permission to revisit the country, and settle some still doubtful points.

A MALVERN correspondent writes that he and many other residents in that part of the country are desirous of having some legislative protection for the eggs of such birds as are mentioned in the Wild Birds' Preservation Act. He wishes to know if there is any society for looking to the interests of wild birds; if so he and others will be glad to subscribe. The Woolhope Field Club used to give rewards for the best collection of birds' eggs, but the rule was altered when the mischief of this course as regards ornithology became evident.

THOSE of our readers who were at the Glasgow meeting of the British Association last autumn will, no doubt, remember the interesting collection which was on view in the City Industrial Museum. The Report of the Museum for 1876 has just been issued, and we are pleased to see that under the management of its Curator, Mr. Paton, it is rapidly increasing in size and importance, and we have no doubt that ere long it will become, what so important a city as Glasgow ought to possess, a really valuable industrial collection arranged on a thoroughly scientific plan.

AT a recent meeting of the French Academy M. de Romilly called attention to some remarkable effects obtained by suspension of water sucked up into a bell jar closed below by a tissue with wide meshes; in one arrangement, the net being metallic the suspended water could even be boiled by heat applied below. M. Plateau has just pointed out that he described this phenomenon of suspension in 1867, in treating of the construction of aquatic arachnida.

*A propos* of the question (which has been disputed) whether toads eat bees, M. Brunet states, in *La Nature*, that going one day into his garden, just before a storm, he found the bees crowding into their hives. About fifty centimetres from the best hive there was a middle-sized toad, which every now and again rose on his fore-legs and made a dart with surprising quickness towards blades of grass. He was found to be devouring bees, which rested on the grass-blades, awaiting their chance to enter the hive. M. Brunet watched till twelve victims had been devoured; he expected the toad's voracity would soon be punished with a sting, but in vain. Objecting to further destruction, he seized the toad by one of his legs and carried him to a bed of cabbage thirty metres off, where he might do real service among the caterpillars, &c. Three days after this, on going out to the hives, he found the same toad (which was easily distinguishable) at its old work. M. Brunet let him swallow only three or four bees, then carried him fifty metres in another direction. Two days later the "wretch" was again found at his post, greedily devouring.

OUR correspondent, "J. H.," in describing the path of the meteor of March 17, as seen by him at Rosall, near Fleetwood, wrote a Hydre for a Hydre. The date of Mr. Ainslie Hollis's letter should have been March 19.

MR. ELLIS asks us to state that in his article on Musical Notation last week, p. 476, col. ii., lines four and five, the readings should be A<sub>1</sub> ♯, A<sub>2</sub> ♯♯, G<sub>2</sub>.

THE additions to the Zoological Society's Gardens during the past week include a Large-eared Brocket (*Cervus auritus*) from South America, presented by Mr. Charles Cooper; two Common Otters (*Lutra vulgaris*), European, presented by Mr. Augustus E. Foster; a Vulpine Phalanger (*Phalangista vulpinus*) from Australia, presented by Mr. Thos. Welsh; two Rufous Tinamous (*Rhynchotus rufescens*) from South America, presented by Mr. F. Searle Parker; eighteen Roach (*Leuciscus rutilus*), six Perch (*Perca fluviatilis*), six Tench (*Tinca vulgaris*), a Bream (*Abramis brama*), a Prussian Carp (*Carassius vulgaris*) from British fresh waters, presented by Mr. J. Smith; three Fire-tailed Finches (*Erythrura prasina*) from Sumatra, purchased; a Feline Dourocouli (*Nyctipithecus felinus*), a Kinkajou (*Cercoptes caudivolutus*), three Blue-shouldered Tanagers (*Tanagra cyanoptera*), an Adorned Terrapin (*Clemmys ornata*) from South America, deposited; a Great Kangaroo (*Macropus giganteus*), a Yellow-footed Rock Kangaroo (*Petrogale xanthropus*), a Collared Fruit Bat (*Cynonycteris collaris*), a Black Swan (*Cygnus atratus*) born in the Gardens.

## SOCIETIES AND ACADEMIES

## LONDON

Royal Society.—March 1.—“Note on the Electrolytic Conduction of some Organic Bodies,” by J. H. Gladstone, Ph.D., F.R.S., Fullerian Professor of Chemistry in the Royal Institution, and Alfred Tribe, F.C.S., Lecturer on Chemistry in Dulwich College.

Our results, preliminary as we considered them to be, show that the iodides of ethyl, isobutyl, and amyl, the bromides of ethyl and propylene, the acetate of ethyl, and chloroform are practically non-conductors to a battery-power of 100 cells Grove, and that alcohol is to some extent traversed by the current. They show also that when these liquid non-conductors are mixed with the feeble conductor, alcohol, the conductivity of the mixture is greater than that of alcohol alone, which offers at least a partial clue to the readiness with which such mixtures are decomposed by the copper-zinc couple.

The very considerable development of heat in these liquids, which conduct the electric current with great difficulty, is a circumstance worthy of notice. In these cases it is evident that it does not result from any chemical change, because the decomposition, if anything at all, is utterly insignificant in amount.

“On the Protrusion of Protoplasmic Filaments from the Glandular Hairs of the Common Teasel,” by Francis Darwin. Communicated by Charles Darwin, F.R.S.

The following is a summary of the results arrived at by Mr. Darwin:—Certain observations have been made on the protrusion of protoplasmic filaments, from leaf-glands on the teasel; and the only theory which seems at all capable of connecting these facts is the following. That the glands on the teasel were aboriginally (*i.e.*, in the ancestors of the Dipsacaceæ) mere resin excreting organs. That the protoplasm which comes forth was originally a necessary concomitant of the secreted matters, but that from coming in contact with nitrogenous fluids it became gradually adapted to retain its vitality and to take on itself an absorptive function. And that this power—originally developed in relation to the ammonia in rain and dew—was further developed in relation to the decaying fluid accumulating within the connate leaves of the plant.

March 8.—“On the Structure and Development of Vascular Dentine,” by Charles S. Tomes, M.A. Communicated by John Tomes, F.R.S.

March 15.—“On the Density of Solid Mercury,” by Prof. J. W. Mallet, University of Virginia. Communicated by Prof. Stokes, Sec. R.S.

The author gets 14° 1932 as the number representing the density of solid mercury at its fusing point as referred to water at 4° C. taken as unity. This result, which differs considerably from previous figures, he thinks, may be fairly accepted with confidence.

“The Automatic Action of the Sphincter Ani,” by W. R. Gowers, M.D., Assistant Physician to University College Hospital. Communicated by J. S. Burdon Sanderson, M.D., F.R.S.

“Description of the Process of Verifying Thermometers at the New Observatory,” by Francis Galton, F.R.S.

Linnean Society, March 15.—Prof. Allman, president, in the chair.—The Rev. A. Gardner Smith and Mr. A. Y. Stewart were elected Fellows.—The Secretary read a paper on the poisoned spears and arrows of the Samoa Islanders, by the Rev. Thos. Powell. The information thereon had been derived from the son of a native chief. According to his account, the weapons are pointed with human thigh and parietal bones, these being ground to a fine tapering point. A milky juice, the product of several kinds of trees—among others *Callophyllum inophyllum*—is used for dipping the arrow and the spear-heads into, and there is added a substance obtained from wasps' nests, besides some of the fluid of putrid Sea-cucumbers (*Holothuria*). A kind of kila is then prepared, where the weapons are smoked, after which they are inserted into the dried flower-stalk of a species of *Tacca*, to prevent bad effects from humidity; lastly, they are bundled together and laid by ready for use. The effects of the poison on the human system—*viz.*, convulsions and tetanus, and the reputed means of cure the author duly mentions. Mr. G. Busk, however, questions the active quality of the said poison; at least some experiments of his incline him to think that a local irritation may be set up rather than an immediate deadly influence of a virulent vegetable poison, such as is the “Woorali” of South America. On the other hand, Messrs. Nichols and Pratt corroborate Mr. Powell's statements.—Dr. A. Gunther gave a notice of two large extinct lizards formerly inhabiting the Mascarene Islands. The remains of the bones had been partly obtained by Mr. Edward Newton, already well known for his researches on the extinct Mascarene fauna, and partly by Mr. H. H. Slater, Naturalist to the Transit of Venus Expedition. Comparisons have led Dr. Gunther to regard one relatively large animal as most nearly allied to the families of Zonuridae and Scincidae. But it differs both from the Glass Snakes and Skinks, hence a new genus has been assigned it and the name *Didosaurus mauritianus* given. The remains of another form from Rodriguez shows it to be allied and indeed identical with the Geckos, close to *G. verus* but specifically distinct, and accordingly named *G. newtonii*.—The second part of contributions to the ornithology of New Guinea, by Mr. R. Bowdler Sharpe, dealt with a collection made by the late Dr. James. This young enthusiastic naturalist was murdered by the natives during an expedition to one of the islands in Hall's Sound, whither he had gone to collect Birds of Paradise. Of fifty-three species obtained only three are new to science, and from this it is inferred that the south-eastern province visited has by no means so rich an avifauna as the northern parts of New Guinea are known to possess. The new species are *Melidora collaris*, *Phonygama jameus*, and *Tanyptera microrhyncha*. But a still more interesting night-flying black hawk, *Machaerampus alcinus*, has turned up in this locality, whose habitat previously was supposed only to be Malacca and Tenasserim. Only four specimens of this rare bird are known to exist.—Samples of supposititious “manna” from Persia, and a bark (*Leptospermum?*) from New Zealand, with tonic qualities, were exhibited and remarked on by Mr. Stewart, of the Apothecaries Hall.

Zoological Society, March 20.—Dr. E. Hamilton, vice-president, in the chair.—Mr. Slater called the attention of the meeting to an article in the *Oriental Sporting Magazine* for May, 1876, by which it appeared that a two-horned rhinoceros had been killed in February, 1876, at a place some twenty miles south of Comillah, in Tipperah. Mr. Slater stated that this was the third recorded occurrence of a two-horned rhinoceros north of the Bay of Bengal.—Mr. Slater also called attention to the fact that Mr. W. Jasmrach had just imported a young living specimen of the rhinoceros of the Bengal Sunderbunds, which was either *Rh. sondaicus* or a very closely allied form.—Mr. Slater exhibited a small Hving Amphibian (*Blanus cinereus*), which had been accidentally brought to England in the roots of a hot-house plant from Port St. Mary, Spain.—Messrs. Charles G. Danford and Edward R. Alston read a paper on the mammals of Asia Minor, based principally on collections made by the former in that country. The list included one species of Bat, two of Insectivores, twenty of Carnivores, seven of Ungulates, and fourteen of Rodents. *Spermophilus philusanthopymnus*, Benn., was redescribed, and the name *Mus mystacinus* was proposed for a new species of field-mouse.—Mr. A. G. Butler read a paper on the Myriopoda obtained by the Rev. G. Brown in Duke of York Island. The species sent home were two in number, both of them allied to but distinct from previously described species. Mr. Butler proposed to designate them as *Heterostoma browni* and *Spirobotus cinctipes*.—A com-

communication was read from the Rev. O. P. Cambridge, in which he gave the descriptions of some spiders collected by the Rev. G. Brown in Duke of York Island, New Britain, and New Ireland. Two of these appeared to be undescribed, and were named *Argiops browni* and *Sarotes vulpinus*.—Prof. A. H. Garrod read a paper containing notes on the anatomy of the Musk-Deer (*Moschus moschiferus*).—A communication was read from Mr. Edward Bartlett, containing remarks on the affinity of *Mesites* and the position which it should occupy in a natural classification. From an examination of structure of the feathers, Mr. Bartlett had come to the conclusion that *Mesites* was an aberrant form of the Ardeine group.—Dr. Günther, F.R.S., read a paper containing an account of the fishes collected by Capt. Feilden during the last Arctic Expedition. Amongst these were several of great interest, especially a new species of Charr, for which the name *Salmo arcticus* was proposed. This Charr was discovered in fresh-water lakes of Grinnell-land, and was stated to be the most northern fresh-water fish known to exist.—Mr. Edward Newton, C.M.G., exhibited and read a paper on a collection of birds made in the island Anjuan or Johanna, one of the Comorro group, by Mr. Bewsher, of Mauritius, whereby the number of species now known to have occurred in that island was raised to thirty-five, of which fourteen were first observed there by that gentleman. Five of these, namely, *Zosterops anjuanensis*, *Tchitrea vulpina*, *Ellisia longicaudata*, *Turdus bewsheri*, and *Turtur comorensis*, were described as new.

**Meteorological Society, March 21.**—Mr. H. S. Eaton, M.A., president, in the chair.—Capt. Fellowes, R.E., George Jimman, Angus Mackintosh, M.D., Robert W. T. Morris, Rev. Edward Vincent Pigott, David S. Skinner, L.R.C.P., and Henry St. John Wood were elected Fellows of the Society.—The following papers were read:—Results of meteorological observations made at Patras, Greece, during 1874 and 1875, by the Rev. Herbert A. Boys. This is in continuation of a former paper read before the Society in 1875. The period embraced in the two papers—January, 1873, to June, 1875—covers a whole winter compressed into about thirty days, a very long and showery spring, an excessively hot summer, a dry winter of extreme cold, a summer of most prolonged drought, a remarkably wet and snowy winter, a very late beginning of hot weather, and the coldest day and night, and the lowest barometer reading for many years.—Contributions to the meteorology of the Pacific—Fiji, by Robert H. Scott, F.R.S. This paper contains a discussion of all published information as to the climate of Fiji which the author has been able to discover.—Local diurnal range, by S. H. Miller, F.R.A.S.—This was followed by another paper on the same subject, by William Marriott, F.M.S., which discussed the questions of whether the tables of corrections for diurnal range, at present used by a large number of observers, are trustworthy, and whether they are applicable to different places in the United Kingdom. The conclusions arrived at were that the present corrections could not be considered as accurate, that no strictly comparable records exist for instituting a satisfactory inquiry, and that it is very undesirable to apply any corrections whatever to the observations to deduce means from them.—Mr. Negretti exhibited several new instruments.

## PARIS

**Academy of Sciences, March 26.**—M. Peligot in the chair.—The following papers were read:—Remarks on the presence of benzine in coal gas, by M. Berthelot. The illuminating portion of the Parisian gas consists mostly of vapour of benzine, forming about 3 per cent. of the whole volume. Fuming nitric acid was employed in the analysis, producing nitrobenzine.—On a recent communication of Mr. Weddell regarding the advantage to be realised in replacing quinine by cinchonidine, by M. Pasteur. Mr. Weddell having stated that cinchonidine was discovered by M. Pasteur, the latter says this is attributing too much to him, and defines his researches on the subject in 1853.—On the digestion of albumen, by M. van Tieghem. The relation of the albumen to the embryo in seeds was studied by two methods—observing isolated albumen subjected to germination and observing the dissolution of albumen during germination, of the entire seed. There are two modes of digestion; the oleaginous and stercoraceous albumen has an activity of its own, it digests itself, and the embryo only absorbs the products of this interior digestion; it is a "nurse" to it. The amylaceous and cellulosic albumens, on the contrary, are passive; they are digested by the embryo, each in its fashion, and the products of this external digestion are then absorbed by it; they are to it only a nutri-

ment.—On precastive and early trepanation in vitreous fractures complicated by splinters, by M. Sedillot.—Observations of the satellites of Saturn, at the Observatory of Toulouse in 1876, with the large Foucault telescope, by M. Tisserand. These relate to the first five satellites only. From observations of three of them the apparent diameter of Saturn's ring is inferred to be  $40^{\circ} 51'$ .—On a theorem relative to the expansion of vapours without external work, by M. Hirn.—On the theory of plane elastic plates, by M. Levy.—The president of the Vine-growing Society of the Pyrenées Orientales sent a document affirming that it is the American plants that have brought phylloxera into France; all plantation of them is the signal of a fresh invasion.—On the theory of frigorific machines, by M. Terquem.—On the reflection of polarised light, by M. Croullebois. He studies one of the fringes discovered by Airy, and named by M. Billet the *courbe de semelle*; showing what may be inferred from it, as to the physical constitution of a mirror (*i.e.*, its positive, neutral, or negative nature); the value of the angle of maximum polarisation (first constant), and the azimuth of renewed polarisation (second constant).—On the transformation of crystallisable sugar into inactive glucose in raw cane sugars, by M. Gayon. Heat and moisture favour the transformation; there is a real fermentation, with carbonic acid given off. By the mere decrease of crystallisable and increase of uncrystallisable sugar, the yield in refining was diminished by 25 per cent. in one sugar, and 33 per cent. in another.—On the composition of gun-cotton, by MM. Champion and Pellet. The specimen analysed contained (ashes deducted 1.01 gr. per cent.) free cellulose, 1.00; dinitro-cellulose, 6.00; principal nitrated product (by difference), 93.00. Supposing this product pentanitrocellulose, and calculating the constituents on this hypothesis, we have, carbon, 26.54; hydrogen, 2.79; nitrogen, 12.51; oxygen, 58.16; which analysis confirms.—Studies on the series of the quinolines; transformation of leucoline into aniline, by Mr. James Dewar.—On nitrotoquinone and chloranilic acid, by M. Etard.—On the sewage waters of Paris, by M. Lauth. The facts cited prove that the sulphydric putrefaction of such water may be avoided by addition of lime, or (a much more important result) by simple aeration. Putrefaction only occurs when the sewage water is kept out of contact with air. As such conditions probably occur at the bottom of the Seine, the facts related may be utilised for its sanitation.—On the fecundation of the egg in the sea-urchin, by M. Perez. He questions M. Fol's statement that the spermatozooids penetrate into the interior.—Hailstorm at the Cape of Antibes on March 21, by M. Ferrière. The storm came from the depths of the marine horizon; its movement was from west to east, and the hailstones, judging from the orientation of the deposits, must have had a gyratory motion. These facts seem to bear on M. Faye's theory.—Chronic anæmia from stubborn nervous and digestive disorders continuing for five years; transfusion of blood and cure, by M. Oré. Only forty grammes of blood were used. Puncture was made without denudation of the vein. The transfused blood acts by stimulating the organs rendered atonic, and by causing a proliferation of new globules.—On the antiseptic properties of bichromate of potash, by M. Lajoinie. The addition of 100 to ordinary water will render this conservative of all organic products without decomposition, even in free air.

## CONTENTS

	PAGE
THE GEOLOGICAL SURVEY OF ONIO . . . . .	485
OUR BOOK SHELF:—	
"History of Nepal" . . . . .	488
LETTERS TO THE EDITOR:—	
The First Swallow at Menton.—DOUGLAS A. SPALDING . . . . .	488
Coal Fields of Nova Scotia.—R. B. GREENWICH as a Meteorological Observatory.—H. S. EATON . . . . .	489
Centralisation of Spectroscopy.—W. H. M. CHRISTIE . . . . .	489
Morphology of "Selaginella."—Prof. W. T. THRELTON DYER . . . . .	489
Tungstate of Soda.—MATTHEW W. WILLIAMS . . . . .	489
Traquair's Monograph on British Carboniferous Ganoids.—Dr. R. H. TRAQUAIR . . . . .	489
ALEXANDER BRAUN . . . . .	490
THE LOAN COLLECTION OF SCIENTIFIC APPARATUS . . . . .	490
THE DEVELOPMENT OF BATRACHIANS WITHOUT METAMORPHOSIS (With Illustrations) . . . . .	491
TYPICAL LAWS OF HEREDITY. By FRANCIS GALTON, F.R.S. (With Illustrations) . . . . .	492
ON THE STRUCTURE AND ORIGIN OF METEORITES. By H. C. SORBY, F.R.S. . . . .	493
MENDELÉEFF'S RESEARCHES ON MARIOTTE'S LAW. By Prof. MENDELÉEFF . . . . .	493
OUR ASTRONOMICAL COLUMN:—	
Binary Stars . . . . .	500
The Annular Eclipse of the Sun, 1737, March 7 . . . . .	500
NOTES . . . . .	501
SOCIETIES AND ACADEMIES . . . . .	502



THURSDAY, APRIL 12, 1877

## THE ARCTIC BLUE-BOOK

THE admirably illustrated volume which has just appeared in this uninviting form, tells a tale of adventures as interesting and heroic as anything in the long record of Arctic discovery. It throws little light on the question to which public attention has been too much directed this winter—whether any of the misfortunes of the expedition were due to the officers who started the sledge parties without adequate supplies of lime-juice. The report of the Scurvy Committee will appear in a few days. In the mean time it is clear that every pound weight on the sledges was calculated with the utmost care, that wherever anything was to be used in a fluid state an adequate corresponding supply of fuel needed to be carried; that none of the officers, judging from the experience of previous sledge expeditions, seem to have anticipated scurvy; and above all that the work of all the parties on and at the edge of the hitherto untrodden Palæocrystic sea proved so frightfully severe that if lime-juice in abundant quantities had been taken the sufferings of the men would probably have been only mitigated. It is to the severity of the work, not to the absence of lime-juice, that we believe the terrible outbreaks of scurvy which crippled the sledging parties to have been really due. In Commander Markham's Journal, written on the spot a month out from the ship, he says, "The invalids are not improving, and we are inclined to believe that they are all attacked with scurvy, though we have not been led to suppose that there is any probability of our being so afflicted and are ignorant of the symptoms." Swollen knees and ankles are of frequent occurrence in all Arctic sledging expeditions, and they were prepared to expect as much. Scurvy had scarcely been thought of, and the fact that it had not been thought of by officers whose lives and the lives of their men depended on their forethought, and who had studied the experience of their predecessors with anxious care, is sufficient to show that, *a priori*, there was little or no probability of its appearance. After the experience of Markham's, Aldrich's, and Beaumont's parties, no future travellers over the "Palæocrystic" will ~~take~~ their lime-juice, but these officers seem all to have been unprepared for scurvy. Aldrich says in his journal, 38th day out.—

"The men are nearly all suffering a great deal with their unfortunate legs, which appear to get worse every day. This we all feel to be very disappointing, as it affects the journey, and although stiff limbs were expected, everyone thought the stiffness would wear off in time. It seems, however, inclined to hang on, and sets at defiance all the limited medical skill we possess among us, and to scorn succumbing to turpentine liniment, bandages, good 'elbow grease,' &c. With regard to bandages, I am almost afraid to apply them, for some of the limbs are not at all healthy looking; the slightest pressure of the finger leaves a dent which remains a considerable time; and although I have given the most stringent orders about lacing the foot gear on very slackly, I find the loosest moccasin string cuts an ugly, red-looking mark. One or two cannot even bear anyone to lie against them, which makes it excessively inconvenient at night, although

everyone is very good tempered, and complaints are reduced to a minimum."

Lieut. Beaumont's party was accompanied by Dr. Coppinger till May 4, and Beaumont says.—

"It was at the end of this journey, May 6, that J. Hand, A.B., one of my sledge crew, told me in answer to my inquiry as to why he was walking lame, that his legs were becoming *very* stiff, he had spoken to Dr. Coppinger about them, but attributing the stiffness and soreness then to several falls that he had had, he did not think much of it, before that officer's departure; now, however, there was pain as well as stiffness, and both were increasing. I directed him to use liniment before he turned in, which he afterwards said made him better."

This was the first beginning of scurvy, but even a medical officer attached to the expedition had obviously supposed it the mere common swollen leg and ankle of ordinary Arctic sledging. Beaumont goes on—

"On coming into camp I examined Hand's legs, and found the thighs discoloured in patches, and from his description of the stiffness and pain I suspected scurvy. I had no reason to expect it, indeed I had never thought of it, but the striking resemblance of the symptoms to the ones described in the voyage of the *Fox*, as being those of Lieut. Hobson, who suffered severely from scurvy, suggested it to my mind, and my suspicions were confirmed by Gray, the captain of my sledge, an ice quartermaster, who, in his whaling experience, has seen much of it. He, however, led me to believe, at the same time, that it would probably wear off, saying that many of the men in whale ships who have it lying 'twixt the flesh and the bone all the winter,' as he expressed it, wear it off by the regular exercise and work of their occupation when the spring comes, it was a good sign, he said, that it should come to the surface. Thus, from the 7th until the 10th I waited, hoping that his words might prove true. I was very reluctant to order Lieut. Rawson to return, it was like sending back half the party, it would be, I felt, a great disappointment to him to turn back then, and his advice and assistance would be a very great loss to me, but the indications of the disease and their aggravated nature became too plain to be misunderstood—sore and inflamed gums, loss of appetite, &c., all pointed too clearly to scurvy, so on May 10 it was arranged that Lieut. Rawson, with his party, should take Hand back, deciding, on his arrival at Repulse Harbour, whether to cross over to the *Alert* or go on to Polaris Bay. I at the same time called upon the remainder of my men to say honestly if they suspected themselves to be suffering from the same disease, or could detect any of its symptoms, as in that case it would be better for the party to advance reduced in numbers than to be charged with the care of sick men. I did this because two of them had complained of stiff legs after the hard work on the snow slopes, but they all declared themselves to be now perfectly well, and most anxious to go on."

So much for the scurvy question. The Blue-Book makes it manifest that neither the commanders of the sledge parties nor Captains Nares and Stephenson, nor Dr. Coppinger suspected that the sledge parties would be in danger of that terrible disease.

The most interesting part of the story is told in the daily journals kept by Markham, Aldrich, and Beaumont. No reader of these simple and modest records will doubt that "the ancient spirit is not dead" which has carried the Union Jack in triumph over every ocean, and planted it wherever honour and danger were most surely to be found.

Markham and Aldrich left the *Alert* on April 3, ten-

munication was read from the Rev. O. P. Cambridge, in which he gave the descriptions of some spiders collected by the Rev. G. Brown in Duke of York Island, New Britain, and New Ireland. Two of these appeared to be undescribed, and were named *Argiope browni* and *Sarotes vulpinus*.—Prof. A. H. Garrod read a paper containing notes on the anatomy of the Musk Deer (*Moschus moschiferus*).—A communication was read from Mr. Edward Bartlett, containing remarks on the affinity of *Mesites* and the position which it should occupy in a natural classification. From an examination of structure of the feathers, Mr. Bartlett had come to the conclusion that *Mesites* was an aberrant form of the Ardeine group.—Dr. Gunther, F.R.S., read a paper containing an account of the fishes collected by Capt. Feilden during the last Arctic Expedition. Amongst these were several of great interest, especially a new species of Charr, for which the name *Salmo arcticus* was proposed. This Charr was discovered in freshwater lakes of Grimnell-land, and was stated to be the most northern fresh-water fish known to exist.—Mr. Edward Newton, C.M.G., exhibited and read a paper on a collection of birds made in the island Anjuan or Johanna, one of the Comorro group, by Mr. Bewsher, of Mauritius, whereby the number of species now known to have occurred in that island was raised to thirty-five, of which fourteen were first observed there by that gentleman. Five of these, namely, *Zosterops anjuanensis*, *Tachyura vulpina*, *Ellisia longicauda*, *Turdus bewsheri*, and *Turtur comorensis*, were described as new.

**Meteorological Society, March 21.**—Mr. H. S. Eaton, V.A., president, in the chair.—Capt. Fellowes, R.E., George Inman, Angus Mackintosh, M.D., Robert W. T. Morris, Rev. Edward Vincent Pigott, David S. Skinner, L.R.C.P., and Henry St. John Wood were elected Fellows of the Society.—The following papers were read:—Results of meteorological observations made at Patras, Greece, during 1874 and 1875, by the Rev. Herbert A. Boys. This is in continuation of a former paper read before the Society in 1875. The period embraced in the two papers—January, 1873, to June, 1875—covers a whole winter compressed into about thirty days, a very long and showery spring, an excessively hot summer, a dry winter of extreme cold, a summer of most prolonged drought, a remarkably wet and mowly winter, a very late beginning of hot weather, and the coldest day and night, and the lowest barometer reading for many years.—Contributions to the meteorology of the Pacific—Fiji, by Robert H. Scott, F.R.S. This paper contains a discussion of all published information as to the climate of Fiji which the author has been able to discover.—Local diurnal range, by S. H. Miller, F.R.A.S.—This was followed by another paper on the same subject, by William Marriott, F.M.S., which discussed the questions of whether the tables of corrections for diurnal range, at present used by a large number of observers, are trustworthy, and whether they are applicable to different places in the United Kingdom. The conclusions arrived at were that the present corrections could not be considered as accurate, that no strictly comparable records exist for instituting a satisfactory inquiry, and that it is very undesirable to apply any corrections whatever to the observations to deduce means from them.—Mr. Negretti exhibited several new instruments.

PARIS

**Academy of Sciences, March 26.**—M. Peligot in the chair.—The following papers were read:—Remarks on the presence of benzene in coal gas, by M. Berthelot. The illuminating portion of the Parisian gas consists mostly of vapour of benzene, forming about 3 per cent. of the whole volume. Fuming nitric acid was employed in the analysis, producing nitrobenzene.—On a recent communication of Mr. Weddell regarding the advantage to be realised in replacing quinine by cinchonidine, by M. Pasteur. Mr. Weddell having stated that cinchonidine was discovered by M. Pasteur, the latter says this is attributing too much to him, and defines his researches on the subject in 1853.—On the digestion of albumen, by M. van Tieghem. The relation of the albumen to the embryo in seeds was studied by two methods—observing isolated albumen subjected to germination and observing the dissolution of albumen during germination, of the entire seed. There are two modes of digestion; the oleaginous and aleuric albumen has an activity of its own, it digests itself, and the embryo only absorbs the products of this interior digestion; it is a "nurse" to it. The amyaceous and cellulosic albumens, on the contrary, are passive; they are digested by the embryo, each in its fashion, and the products of this external digestion are then absorbed by it; they are to it only a nutri-

ment.—On preventive and early trepanation in vitreous fractures complicated by aneurisms, by M. Sedillot.—Observations of the satellites of Saturn, at the Observatory of Toulouse in 1876, with the large Foucault telescope, by M. Tisserand. These relate to the first five satellites only. From observations of three of them the apparent diameter of Saturn's ring is inferred to be 40'' 51.—On a theorem relative to the expansion of vapours without external work, by M. Hirn.—On the theory of plane elastic plates, by M. Levy.—The president of the Vine-growing Society of the Pyrenées Orientales sent a document affirming that it is the American plants that have brought phylloxera into France; all plantation of them is the signal of a fresh invasion.—On the theory of frigorific machines, by M. Terquem.—On the reflection of polarised light, by M. Croullebois. He studies one of the fringes discovered by Airy, and named by M. Billet the *courbe de semelle*; showing what may be inferred from it, as to the physical constitution of a mirror (i.e., its positive, neutral, or negative nature); and the value of the angle of maximum polarisation (first constant), and the azimuth of renewed polarisation (second constant).—On the transformation of crystallisable sugar into inactive glucose in raw cane sugars, by M. Gayon. Heat and moisture favour the transformation; there is a real fermentation, with carbonic acid given off. By the mere decrease of crystallisable and increase of uncrystallisable sugar, the yield in refining was diminished by 25 per cent. in one sugar, and 33 per cent. in another.—On the composition of gun-cotton, by M. M. Champion and Pellet. The specimen analysed contained (ashes deducted 1.01 gr. per cent.) free cellulose, 1.00; dinitro-cellulose, 6.00; principal nitrated product (by difference), 93.00. Supposing this product pentanitrocellulose, and calculating the constituents on this hypothesis, we have, carbon, 26.54; hydrogen, 2.79; nitrogen, 12.51; oxygen, 58.16; which analysis confirms.—Studies on the series of the quinolines; transformation of leucoline into aniline, by Mr. James Dewar.—On nitrotoquinone and chloranilic acid, by M. Etard.—On the sewage waters of Paris, by M. Lauth. The facts cited prove that the sulphidic putrefaction of such water may be avoided by addition of lime, or (a much more important result) by simple aeration. Putrefaction only occurs when the sewage water is kept out of contact with air. As such conditions probably occur at the bottom of the Seine, the facts related may be utilised for its sanitation.—On the fecundation of the egg in the sea-urchin, by M. Perez. He questions M. Fol's statement that the spermatozooids penetrate into the interior.—Hailstorm at the Cape of Antibes on March 21, by M. Fernère. The storm came from the depths of the marine horizon; its movement was from west to east, and the hailstones, judging from the orientation of the deposits, must have had a gyratory motion. These facts seem to bear on M. Faye's theory.—Chronic anæmia from stubborn nervous and digestive disorders continuing for five years; transfusion of blood and cure, by M. Orc. Only forty grammes of blood were used. Puncture was made without denudation of the vein. The transfused blood acts by stimulating the organs, rendered atonic, and by causing a proliferation of new globules.—On the antiseptic properties of bichromate of potash, by M. Lajourols. The addition of 1/20 to ordinary water will render this conservative of all organic products without decomposition, even in free air.

CONTENTS

	PAGE
THE GEOLOGICAL SURVEY OF OHIO . . . . .	485
OUR BOOK SHELF:—	
"History of Nepal" . . . . .	488
LETTERS TO THE EDITOR:—	
The First Swallow at Menton.—DOUGLAS A. STALLING . . . . .	488
Coal Fields of Nova Scotia.—R. B. . . . .	488
Greenwich as a Meteorological Observatory.—H. S. EATON . . . . .	489
Centralisation of Spectroscopy.—W. H. M. CHRISTIE . . . . .	489
Morphology of "Selaginella."—Prof. W. L. THURSTON DYER . . . . .	489
Tungstate of Soda.—MATTHEW W. WILLIAMS . . . . .	489
Traquair's Monograph on British Carboniferous Ganoids.—Dr . . . . .	489
R. H. TRAQUAIR . . . . .	489
ALEXANDER BRAUN . . . . .	490
THE LOAN COLLECTION OF SCIENTIFIC APPARATUS . . . . .	490
THE DEVELOPMENT OF BATRACHIANS WITHOUT METAMORPHOSIS . . . . .	491
(With Illustrations) . . . . .	491
TYPICAL LAWS OF HEREDITY. By FRANCIS GALTON, F.R.S. (With . . . . .	492
Illustrations) . . . . .	492
ON THE STRUCTURE AND ORIGIN OF MEMBRANES. By H. C. SORBY, . . . . .	495
F.R.S. . . . .	495
MEMBERSHIP'S RESEARCHES ON MARIOTTE'S LAW. By Prof. MENDE . . . . .	496
LEBEY . . . . .	496
OUR ASTRONOMICAL COLUMN:—	
Daily Staff . . . . .	500
The Annual Eclipse of the Sun, 1877, March 1 . . . . .	500
NOTES . . . . .	504
SOCIETIES AND ACADEMIES . . . . .	503

ERRATUM.—P. 466, col. 2, line 26, for "Garrell" read "Yarrell."

THURSDAY, APRIL 12, 1877

## THE ARCTIC BLUE-BOOK

THE admirably illustrated volume which has just appeared in this uninviting form, tells a tale of adventures as interesting and heroic as anything in the long record of Arctic discovery. It throws little light on the question to which public attention has been too much directed this winter—whether any of the misfortunes of the expedition were due to the officers who started the sledge parties without adequate supplies of lime-juice. The report of the Scurvy Committee will appear in a few days. In the mean time it is clear that every pound weight on the sledges was calculated with the utmost care; that wherever anything was to be used in a fluid state an adequate corresponding supply of fuel needed to be carried; that none of the officers, judging from the experience of previous sledge expeditions, seem to have anticipated scurvy; and above all that the work of all the parties on and at the edge of the hitherto untrodden Palæocrystic sea proved so frightfully severe that if lime-juice in abundant rations had been taken the sufferings of the men would probably have been only mitigated. It is to the severity of the work, not to the absence of lime-juice, that we believe the terrible outbreaks of scurvy which crippled the sledging parties to have been really due. In Commander Markham's Journal, written on the spot a month out from the ship, he says, "The invalids are not improving, and we are inclined to believe that they are all attacked with scurvy, though we have not been led to suppose that there is any probability of our being so afflicted and are ignorant of the symptoms." Swollen knees and ankles are of frequent occurrence in all Arctic sledging expeditions, and they were prepared to expect as much. Scurvy had scarcely been thought of, and the fact that it had not been thought of by officers whose lives and the lives of their men depended on their forethought, and who had studied the experience of their predecessors with anxious care, is sufficient to show that, *à priori*, there was little or no probability of its appearance. After the experience of Markham's, Aldrich's, and Beaumont's parties, no future travellers over the "Palæocrystic" will omit their lime-juice, but these officers seem all to have been unprepared for scurvy. Aldrich says in his journal, 38th day out:—

"The men are nearly all suffering a great deal with their unfortunate legs, which appear to get worse every day. This we all feel to be very disappointing, as it affects the journey, and although stiff limbs were expected, everyone thought the stiffness would wear off in time. It seems, however, inclined to hang on, and sets at defiance all the limited medical skill we possess among us, and to scorn succumbing to turpentine liniment, bandages, good 'elbow grease,' &c. With regard to bandages, I am almost afraid to apply them, for some of the limbs are not at all healthy looking; the slightest pressure of the finger leaves a dent which remains a considerable time; and although I have given the most stringent orders about lacing the foot gear on very slackly, I find the loosest moccasin string cuts an ugly, red-looking mark. One or two cannot even bear anyone to lie against them, which makes it excessively inconvenient at night, although

everyone is very good tempered, and complaints are reduced to a minimum."

Lieut. Beaumont's party was accompanied by Dr. Coppinger till May 4, and Beaumont says:—

"It was at the end of this journey, May 6, that J. Hand, A.B., one of my sledge crew, told me in answer to my inquiry as to why he was walking lame, that his legs were becoming *very* stiff, he had spoken to Dr. Coppinger about them, but attributing the stiffness and soreness then to several falls that he had had, he did not think much of it, before that officer's departure; now, however, there was pain as well as stiffness, and both were increasing. I directed him to use liniment before he turned in, which he afterwards said made him better."

This was the first beginning of scurvy, but even a medical officer attached to the expedition had obviously supposed it the mere common swollen leg and ankle of ordinary Arctic sledging. Beaumont goes on:—

"On coming into camp I examined Hand's legs, and found the thighs discoloured in patches, and from his description of the stiffness and pain I suspected scurvy. I had no reason to expect it, indeed I had never thought of it, but the striking resemblance of the symptoms to the ones described in the voyage of the *Fox*, as being those of Lieut. Hobson, who suffered severely from scurvy, suggested it to my mind, and my suspicions were confirmed by Gray, the captain of my sledge, an ice quartermaster, who, in his whaling experience, has seen much of it. He however, led me to believe, at the same time, that it would probably wear off, saying that many of the men in whale ships who have it lying 'twixt the flesh and the bone all the winter,' as he expressed it, wear it off by the regular exercise and work of their occupation when the spring comes; it was a good sign, he said, that it should come to the surface. Thus, from the 7th until the 10th I waited, hoping that his words might prove true. I was very reluctant to order Lieut. Rawson to return, it was like sending back half the party; it would be, I felt, a great disappointment to him to turn back then, and his advice and assistance would be a very great loss to me, but the indications of the disease and their aggravated nature became too plain to be misunderstood—sore and inflamed gums, loss of appetite, &c., all pointed too clearly to scurvy; so on May 10 it was arranged that Lieut. Rawson, with his party, should take Hand back, deciding, on his arrival at Repulse Harbour, whether to cross over to the *Alert* or go on to Polaris Bay. I at the same time called upon the remainder of my men to say honestly if they suspected themselves to be suffering from the same disease, or could detect any of its symptoms, as in that case it would be better for the party to advance reduced in numbers than to be charged with the care of sick men. I did this because two of them had complained of stiff legs after the hard work on the snow slopes, but they all declared themselves to be now perfectly well, and most anxious to go on."

So much for the scurvy question. The Blue-Book makes it manifest that neither the commanders of the sledge parties nor Captains Narcs and Stephenson, nor Dr. Coppinger suspected that the sledge parties would be in danger of that terrible disease.

The most interesting part of the story is told in the daily journals kept by Markham, Aldrich, and Beaumont. No reader of these simple and modest records will doubt that "the ancient spirit is not dead" which has carried the Union Jack in triumph over every ocean, and planted it wherever honour and danger were most surely to be found.

Markham and Aldrich left the *Alert* on April 3, tra-

welling in company to Cape Joseph Henry—latitude 82°50'. From that point Markham struck straight north on April 11, with fifteen men and three sledges, weighing in all 6,079 lbs., or 405 lbs.—3½ cwts.—per man. They carried two ice-boats with them, the first of which, weighing 740 lbs., had to be abandoned on April 19, while the second, weighing 440 lbs., their only chance of safety if the ice should break up, had to be abandoned on May 27, while they were still seven miles or so from the nearest land. The ice on the surface of the floes was covered generally with snow some three feet deep, and the men sank in it beyond their knees. If the Palæocrystic sea had been a decently level plain covered with loose powdery snow, the work to get to the pole would have been hard enough. The party found it much such a place as South Kensington might be after an earthquake had toppled half the houses into ruin. There was seldom a floe or flat ice-surface of any extent—rarely as much as a mile in any direction—never more than a mile and three-quarters. "For the last ten or fifteen days of our outward journey," says Markham, "floes were few and far between, and it might almost be said that our road lay entirely through hummocks and deep snow-drifts." A hummock is a huge mass of ice-blocks piled up like builder's rubbish. The highest mass measured was 43 feet 2 inches, but many were observed which exceeded that height, and were estimated as between 50 and 60 feet. On the heavier floes were high hillocks apparently formed by snow drift, the accumulation probably of years, resembling diminutive snow mountains, and varying from 20 to over 50 feet in height. It was across this sort of material that the party had to drag themselves to the pole. They found that they could scarcely ever get along without "double banking." They had two sledge crews for three sledges, and they had calculated to pull the heavy sledge by the whole fifteen men, and to return for the lighter sledges which were to come up together, each dragged by its seven or eight men. Thus three miles of ground would have had to be traversed for every mile made good. In fact even the smaller sledges needed almost always the whole fifteen men, and after the larger ice-boat was abandoned on April 19th, there was little difference of weight between them. Thus each mile in advance cost five miles walking, three of them full loaded, two through the snow and without the steadying support of the drag-ropes. The back journeys were found almost as fatiguing as the others. From April 16th (Cape Joseph Henry) to May 12th, the most strenuous efforts carried them from 82.49½ to 83.20.26, i.e. 31 minutes nothing, or about thirty-six English miles in twenty-six days, an average of 1½ miles a-day advanced, and of seven miles walked. The advance was soon impeded by the illness of the men. It is on the 14th—eleven days from the ship, three days from the depot and last land at Cape Joseph Henry—that we first find the ominous entry, "pain in his ankle and knee, both of which exhibited slight symptoms of puffiness." On the 16th the patient had to be put on one of the sledges, so that already there were only fourteen men at the drag-ropes and 160 lbs. more to drag. "On the 17th another man cannot drag but is just able to hobble after us," carrying, that is to say, his own weight, but only for half the day. On the 19th both had to be carried, and another man fell out from the drag-ropes. Although

they dropped their ice-boat, 740 lbs. weight, on the 19th, on the 25th a fourth man is reported weak. A fifth man "can scarcely walk" on May 2nd, and on May 3rd all five are "utterly helpless and therefore useless." On May 4th "more of the men are complaining of stiffness and pain in their legs, which we fear are only the premonitory symptoms." Here is a glimpse of the party on May 6th:—

"The sick men are invariably the cause of great delay in starting, as they are perfectly helpless, being even unable to dress or undress without assistance. We appear to have arrived at a perfect barrier of hummocks and portions of floes, all broken and squeezed up and covered with deep snow. It is possible we may be able to penetrate these obstacles, eventually reaching larger and more level floes, on which we may be able to make more rapid progress. We ascended one large hummock, from the summit of which the prospect was anything but encouraging—nothing but one vast illimitable sea of hummocks. The height of this hummock was ascertained by means of a lead line, and was found to be from its summit to the surface of the snow at its base 43 feet 3 inches. It did not appear to be a floe-berg, but a mass of hummocks squeezed up and cemented together by several layers of snow, making it resemble one huge solid piece. The traveling has been exceedingly heavy, and with the weights on the sledges augmented, the deep snow, and a third of our band *hors de combat*, it is next to impossible to advance many feet without resorting to 'standing pulls,' or the endless 'one, two, three, haul.'"

On the 7th they had to "advance with one sledge, unload it, return with it empty, and then bring on the gear and invalids." On the 8th "the interior of our tents have more the appearance of hospitals than the habitations of strong working men. In addition to the cripples, four men are suffering from snow blindness." It is in this condition that they struggle through the sea of hummocks.

"The hummocks around us are of different heights and bulk, varying from small fragments of ice to huge piles over 40 feet high. Some of these larger ones are simply masses of squeezed-up ice, whilst others of great magnitude, but perhaps not quite so high, are the regular floe-bergs. Between these hummocks, and consequently along the only road that is practicable for our sledges, the snow has accumulated in drifts to a great depth, and these forming into ridges render the travelling all the more difficult. Some of the tops of these ridges are frozen hard, and it is no uncommon occurrence to step from deep snow through which we are floundering up to our waists, on to a hard frozen piece, and *vice versa*. Occasionally these ridges are only partially frozen, sufficiently only to deceive one, which makes it exceedingly disagreeable and laborious to get through."

On May 10, "with five out of our little force totally prostrate, four others exhibiting decided symptoms of the same complaint," Commander Markham sees that it would be "folly to persist pushing on." They have been forty days out and are only provisioned for thirty more. On the 12th those left decently strong go out in the morning for their farthest north—1½ miles out from the camp, 399½ from the pole. There they sang the "Union Jack of Old England," the "Grand Palæocrystic Sledging Chorus," winding up, like loyal subjects, with "God save the Queen." When they got back to the sledge they broached a magnum of whukey sent for the purpose by a genial and henceforth famous ecclesiastical potentate, "the Dean of Dundee," smoked a single cigar apiece, presented them *ad hoc* before leaving the ship, and

consumed the solitary hare they had shot on the way out. The story of their return journey is intensely interesting. On June 7, when they had still forty miles to go, and doubtless were near the end of their provisions, Lieut. Parr—whose untiring energy and admirable "road-making" made him the very perfection of companions for Commander Markham—started alone on a desperate walk to the ship for assistance. They had only *eleven good legs out of thirty-four in the party*, and "even some of these are shaky," says Markham on May 25. Fortunately two of them, both excellent, remained to Parr a fortnight later. The first death of the party happened next day, but the day after, June 9, late in the evening, relief came. Parr's wonderful walk—far more memorable than Weston's or O'Leary's—probably saved the lives of one or two men of the gallant party which has come nearest of any human being, possibly nearest of any living creature, to the solitude of the North Pole.

Space alone prevents us dwelling on the equally interesting work done by Aldrich on the northern shore of the American continent, and by Beaumont on North Greenland. The names of Markham, Aldrich, Beaumont, Parr, and Sir George Nares, have been added definitively to the long list of our Arctic heroes. Few things have been finer in seamanship than Sir George Nares' passage up Smith's Sound and Robeson Channel into the Palæocretic sea and home again. The skill with which he devised and combined the exploring parties and prepared everything so that the utmost was accomplished which it was possible for brave men to accomplish without useless sacrifice of human life, has scarcely yet received sufficient acknowledgment either from his country or from the public.

#### ANTHRACEN

*Anthracen; its Constitution, Properties, Manufacture, and Derivatives, including Artificial Alizarin, Anthrapurpurin, &c., with their Applications in Dyeing and Printing.* By G. Auerbach. Translated and edited by William Crookes, F.R.S. (London: Longmans, Green, and Co., 1877.)

FROM the extent to which the anthracene and artificial alizarin industries have grown within the last few years, and the interest taken in them in England, it has been deemed advisable to bring forward an English edition of Auerbach's text-book on the above subject. This work has been carried out by Mr. W. Crookes, from a revised manuscript supplied by the author.

In the author's preface to this volume we are told that since the production of the first German edition four years ago, from the amount of new facts recently brought to light, it has been found necessary to make various additions, so as to render the treatise complete up to the present date. The arrangement of the earlier edition has been to a certain extent adhered to, but made rather more systematic, placing certain of the compounds in groups to admit of easy reference.

At the commencement a short account of anthracene is given, and reference made to the first investigations of the body, by Dumas and Laurent in 1832, and the later discoveries of Fritzsche, Anderson, Berthelot, Graebe, and Liebermann, with some remarks on the views entertained

by these two latter chemists, with regard to the constitution of anthracene and its derivatives. After describing the physical properties of this body, and the different modes in which it may be formed, a full description is entered into of its manufacture on a large scale, from coal tar, according to the results obtained by E. Kopp, who has made a careful study of the preparation of anthracene from soft pitch. A description is also given of the furnace best adapted for the distillation of the pitch, and the different methods for purifying the crude anthracene by extraction with heavy naphtha, and sublimation.

In treating of the methods for the valuation of crude anthracene, the older processes in which it may be extracted by means of alcohol or carbon disulphide are mentioned, from their having to a certain extent an historical interest, but which have been superseded by the method of Luck, in which greater accuracy is obtained. This latter method depends on the conversion of anthracene into the theoretical quantity of anthraquinone when dissolved in glacial acetic acid and boiled with chromic acid. A full description is given of the hydrides of anthracene, and its chlorine and bromine derivatives. In the description of anthraquinone, before entering upon its properties and manufacture, the various methods in which it may be synthetically formed are discussed, among others, the method of Bayer and Caro, by means of which the anthraquinone derivatives may be formed from phthalic acid and phenolene; the discovery of which method has added much to a clearer conception of the nature of anthraquinone.

The latter half of the volume deals with the history and preparation of natural and artificial alizarin, and the consideration of its derivatives. In describing the different processes for the preparation of artificial alizarin, mention is made of the improvement on former methods introduced by Graebe, Liebermann, and Caro, in which they produce it from monosulphanthraquinone of soda; the advantage claimed by these over the other methods being the direct conversion of anthracene into bisulphanthracenic acid, and its transformation into bisulphanthraquinonic acid by cheap oxidising agents.

Anthraflavic acid, chrysameric acid, purpurin and their derivatives receive full consideration, and an appendix is attached containing some practical receipts for dyeing with purpurin and artificial alizarin.

The volume concludes with a most valuable bibliography embracing a list of the substances treated of throughout the work arranged in alphabetical order, with the names of the authors who have written on that particular branch of the subject, and with exact reference to the journals in which the researches have been published. As papers on the different subjects mentioned in the volume are scattered over many different periodicals, the completeness with which this bibliography has been arranged will prove a most valuable assistance to those who wish to consult the original memoirs.

We observe that throughout the edition Mr. Crookes has retained the German mode of writing anthracene without the final "e"; this may be unimportant, but it is not the method usually adopted in English text-books. There is a slight mistake at the top of page 157 in the use of the term "ferrous" instead of "ferric." This is

doubtless a slip, but in the particular reaction described is of some importance.

We feel sure that Mr. Crookes will receive the thanks of those interested in this subject in England for the care and completeness with which he has arranged and carried out the text-book.

### OUR BOOK SHELF

*Half-Hours among some English Antiquities.* By Llewellyn Jewitt, F.S.A., &c. (London: Hardwicke and Bogue, 1877.)

THIS ought to be an extremely useful little manual to those who desire to obtain a knowledge of the various classes of antiquities to be found in England, both prehistoric and historic. Mr. Jewitt writes with full knowledge and in a manner that cannot fail to secure the attention of the reader. He theorises very little, confining himself mainly to a statement of facts in reference to the various objects included under the name of antiquities. He speaks of barrows, stone-circles, cromlechs, flint and stone implements, bronze instruments, Roman remains of various kinds, ancient pottery, arms and armour, sepulchral slabs and brasses, coins, church bells, glass, tiles, tapestry, personal ornaments. Thus, it will be seen, Mr. Jewitt's programme is extensive and varied, and although much cannot be said in the space at his command, his little work will prove a very useful introduction to works of a more special kind. Not its least valuable features are the illustrations—upwards of 300—which accompany the text.

### LETTERS TO THE EDITOR

[The Editor does not hold himself responsible for opinions expressed by his correspondents. Neither can he undertake to return, or to correspond with the writers of, rejected manuscripts. No notice is taken of anonymous communications.]

#### Centralism in Spectroscopy

In NATURE, vol. xv. p. 489, there are some remarkable counter-assertions by Mr. Christie to certain of my matter-of-fact statements on your p. 449, of which the most pressing for me to notice is the paragraph wherein he declares that "the Edinburgh Observatory has, for the last four years, possessed three spectroscopes which are almost precisely identical with those used with such effect by Dr. Huggins."

I beg to say that the above is not the case, and for this, amongst other reasons, viz., that though three spectroscopes are there in part, they belong solely as yet to H.M. Office of Works in London, which office, moreover, decided long since to return all of them to their maker, in lieu of one new spectroscope. And Mr. Christie must have known of this perfectly well when he wrote the above paragraph, for the carpenters of the department, who fetched away, about nine months ago, the one and only collimator to all those three partial spectroscopes, in order to send it back to its maker, spoke, as a matter of notoriety, of Mr. Christie himself being the adviser of H.M. Office of Works in that transaction, as well as the designer of the one new spectroscope ordered by the London office to take the place of the former three, but not received here yet.

With regard to the other new, and far more important, Greenwich spectroscope, of which Mr. Christie both chides me for not waiting for the full account to appear, as he now intimates, in a forthcoming number of the *Proceedings* of the Royal Society, and also challenges me to discuss its principles with him at once, I beg to say that my former remarks had reference solely to the official *index* of last year's work at the Royal Observatory, Greenwich, as published by the Royal Astronomical Society in their last Anniversary Report, at p. 162, where all the world both may, and I suppose was intended to, see it, and where Mr. Christie's name appears no more than it did in my letter. And as in that letter (at your page 450) I ventured to assign the next anniversary meeting of the same society as the limit of time within which the full practical value of the said new Greenwich spectroscope will have been arrived at, I do not think we can do better than wait for that time to arrive.

15, Royal Terrace, Edinburgh, April 6 PIAZZI SKYTTÉ

Parhella and Paraselenæ seen on March 20, 1877, and again on March 21, 1877, at Highfield House Observatory

PERHAPS this phenomenon is the most remarkable of the many somewhat similar ones that it has been my good fortune to witness during the last forty years, the chief features being brilliancy and persistency

Fig. 1 represents the appearance at 8 A.M.: an ordinary halo of  $22\frac{1}{2}^\circ$  radius, with an elongated mock sun at the apex. This

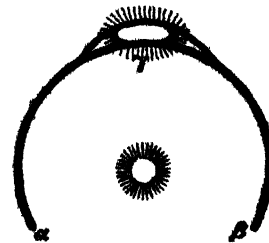

FIG. 1—8 A.M.

lasted till 9.30 A.M., when, in addition to the halo,  $\alpha\beta$ , and the mock sun,  $\gamma$ , there was a second circle,  $\delta\epsilon$ , of  $45^\circ$  radius, also having the true sun for its centre, an inverted portion of a third circle,  $\eta\theta$ , of  $22\frac{1}{2}^\circ$  radius having its centre  $45^\circ$  above the true sun; also a portion of a fourth circle,  $\iota\kappa$ , of  $90^\circ$  radius, whose centre was  $90^\circ$  below the sun. The mock sun,  $\gamma$ , was very bright and prismatic, as also was the circle,  $\alpha\beta$ . The other rings were colourless.

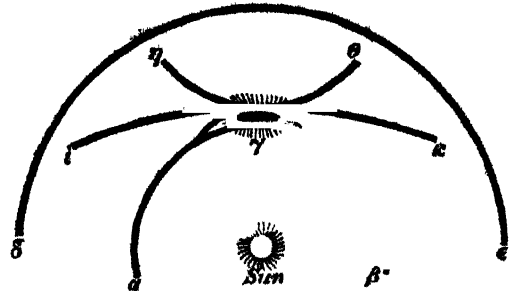

FIG. 2—9.30 A.M.

At 9.40 A.M. the portions of circles  $\eta\theta$  and  $\iota\kappa$  had vanished, but a wing-like portion was now visible, and brilliant (see Fig. 3,  $\lambda\omega$ ). This remained until 11.15 A.M., when only  $\alpha\beta$  and the mock sun  $\gamma$  remained, lasting all the morning. At 12.57 P.M. the arc,  $\iota\kappa$ , again appeared, and was visible until 1.22 P.M., the halo,  $\alpha\beta$ , and the mock sun,  $\gamma$ , lasting till 5 P.M.

At 7.40 P.M. an ordinary lunar halo ( $\alpha\beta$ , Fig. 5), and at 8.25 P.M. a portion of a second circle,  $\delta\epsilon$ , of  $45^\circ$  radius, and of a third circle,  $\iota\kappa$  (of  $90^\circ$  radius) and an elongated mock moon,  $\gamma$ ,

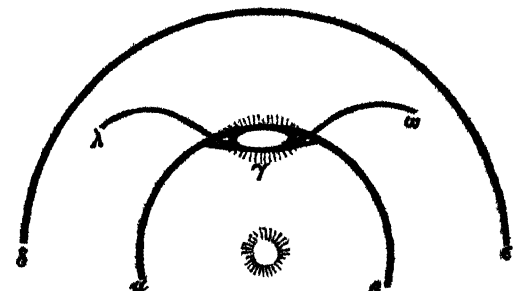

FIG. 3—8.31 P.M.

were very apparent. At 8.31 the ordinary lunar halo alone remained. At 9.10 a portion of a circle,  $\nu\alpha$ , not quite  $90^\circ$  radius, appeared (see Fig. 6), but this did not touch the circle  $\alpha\beta$ , but was  $10^\circ$  above it. At 9.15 P.M. this also vanished, but the lunar halo remained as long as the moon was above the horizon.

On March 21, at 8 A.M., there was a solar halo and mock sun exactly like the one seen at 8 A.M., March 20 (see

Fig. 1), and this lasted all day, with the addition at 4 P.M. till 5.40 P.M. of the arc *LM* (being the exact copy of Fig. 4 of March 20), at 6 P.M. there was the ordinary circle *αβ*, the mock sun  $\gamma$ , and an inverted portion  $\eta\theta$  (Fig 2) At 6.10 only the ordinary halo remained.

From 8 P.M. till 9.40 P.M. (21st) there was a lunar halo with

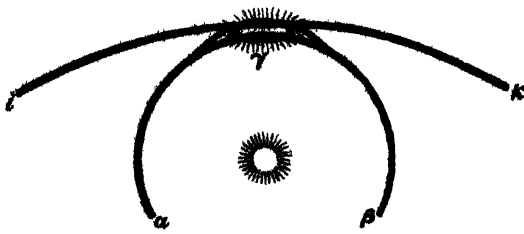

FIG 4

an elongated mock moon; so that a similar condition of the atmosphere prevailed for thirty-eight hours

Whenever the circles were brilliant, they were formed in a very thin haze-like cloud, through which the sun or moon (in either case) shone brightly

The weather was cold with thick ice in the morning

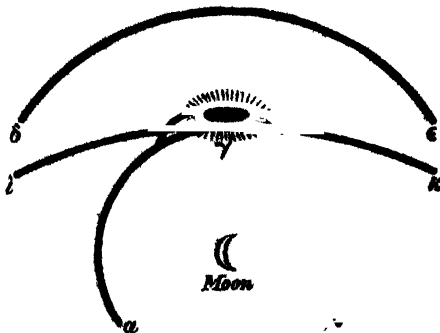

FIG 5

At 8 A.M. on the 20th the sky was scattered over with thin woolly cumuli, indistinct in outline, and dirty-white in colour, with here and there a small prominent white portion (the sky resembling a sea with a few white wave-crests here and there.) These clouds moved in a south current, but at 9 A.M. the clouds were again floating in a north-east current.

The wind on the 20th was north-east, and on the 21st north.

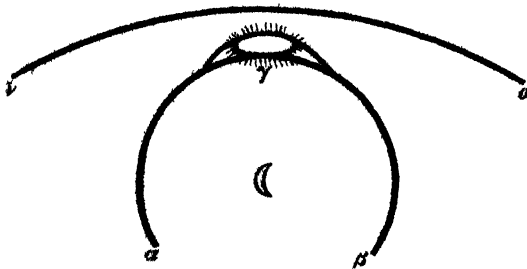

FIG 6

Temperature on 20th	Dry bulb.	Wet bulb	Temperature on 21st	Dry bulb	Wet bulb
8 A.M.	32.3	31.0	8 A.M.	35.0	32.7
1 P.M.	41.9	34.0	1 P.M.	42.1	34.0
6 P.M.	37.5	34.0	6 P.M.	39.7	33.6
11 P.M.	33.8	31.7	11 P.M.	30.0	28.3

March 22, solar halo and lunar halo.  
 " 23, " " "  
 " 27, " " "  
 " 28, solar halo.  
 " 30, lunar halo.

E. J. LOWE

Owens College

It seems probable that the claims of Owens College to be constituted into a university and degree-giving body for the north

of England, will soon be brought before the public in a more definite shape than that of newspaper correspondence. There are one or two considerations affecting the question, which do not seem to me to have been brought forward by any of those who have entered into the discussion, and I shall esteem it a favour if you will allow me briefly to notice these.

I may premise that no word in this letter is intended to derogate from any claims that Owens College may advance on the ground of past or prospective services to education in the district of England to which its efforts must be principally, though not entirely, confined. It is almost impossible to over-rate those claims, but when they are so put forward as to imply that Owens College is the only possible centre for giving degrees in the north of England, the dwellers on the banks of the Tyne, the Wear, and the Tees, are apt to feel that too little account is made both of the necessities and of the actual educational resources of their own part of the "north of England"

In the first place, a careful study of Bradshaw makes it clear that, for the counties of Durham and Northumberland, and even the north-east portion of Yorkshire, a university examination or college course is at least as accessible in London as at Manchester, so that for these counties the benefits of Owens College, whether as college or university, are practically on a par with those of University College, London, and the degree examinations of the University of London.

Secondly, it is a fact, although apparently unknown to the majority of those who have written on this question, that there already exists in the north of England—at Durham—a university with a Royal Charter for giving degrees in all faculties, and whose conditions for giving those degrees combine in an admirable manner the modern spirit with the strictness of the old requirements.

This university was originally founded by the liberality of the Cathedral authorities, who, with a spirit worthy of imitation elsewhere, set apart certain of their own funds for the purpose of giving a liberal education in arts and theology to students who for various reasons could not avail themselves of the advantages of Oxford and Cambridge. As always happens in such cases, benefactions of scholarships and fellowships have accrued which have considerably increased the funds available for educational purposes.

Nor have these funds been restricted, as many might expect, looking at the source from which they come, to sectarian purposes. While most of the colleges at Oxford and Cambridge were still compelling Jews and Nonconformists to attend religious services to which they objected, the regulations of the University of Durham anticipated the Universities' Tests Act by granting exemption in such cases, and during the last six years more than a thousand pounds a year of the university funds has been set aside for the purposes of the Science Faculty of the university which has its local habitation in Newcastle.

I may add that the Senate and Convocation of the university have in late years adopted a most liberal view in regard to the admission of students of other colleges than those at Durham and Newcastle to the degrees which they give, and I have personally little doubt that they would consider with favour any scheme for extending the area over which their degrees are available.

The question of the desirability of multiplying the number of centres for giving degrees is a wide one, into which I have no desire to enter. My only wish is that in any consideration of the question of establishing a new centre, all the facts regarding its sphere of action and the centres which already exist within what is claimed as that sphere should be known.

W STEADMAN ALDIS

College of Physical Science, Newcastle-on-Tyne, March 24

The Suspected Intra-Mercurial Planet, Occultation of Kappa Geminorum

MARCH 21 was fine here, but with frequent clouds. I had several observations of the sun from 9 o'clock to 12, Dublin mean time, and then at 12.35, 1.35, 2.0, and 3.50, after which the sun became permanently clouded for the remainder of the day. The only object remarked was a small spot with a double nucleus near the western limb followed by a few very small spots.

March 22 was finer, and I observed at 8.30, 9.12, 10.20, 10.50, 11.25, 12.38, 1.35, 1.50, 2.55, 4.25, 5.8, and 5.33. The small spots of the previous day had completely disappeared, and broad bright lacunae occupied their place. The large spot

at the last observation had so closely approached the edge that it was scarcely, if at all, visible, and the entire disc might then be said to appear free from spots of any kind. On March 23 the sun remained altogether clouded. At night, however, the sky cleared, and I had a good view of the occultation of Kappa Geminorum. The disappearance was, as usual, instantaneous, but immediately after it a delicate ray seemed to shoot out from the place of the star in a direction perpendicular to the edge of the moon, and the appearance lasted about eight seconds.

Milbrook, Tuam, March 24

J. BIRMINGHAM

#### a Centauri

At the meeting of the Royal Astronomical Society December 8, 1876, Mr. Marth asked for measures of this binary.

As the star never reaches more than  $11^\circ$  above my horizon, the definition must always be imperfect; but the following measures taken on the morning of February 22 appear consistent, and may be useful until better results are obtained from the southern hemisphere:—

Epoch 1877 '14.	Distance.	Position.
1 ... ..	3'4	64°0
2 ... ..	3'1	64°5
3 ... ..	3'1	64°3
4 ... ..	3'7	64°7
Mean . . .	3'3	64°4

The component stars are of about the first and second magnitudes, and their colour is yellow. Power employed, 240; definition very bad.

MAXWELL HALL

Jamaica

#### The Boomerang

WILL you allow me to add my experience of the use of this weapon to that furnished by your other correspondents? My experience is mainly confined to the natives about the Condamine and its affluents, where I was frequently in company with natives for about a year. They had two weapons—one large, for war, the other small, for game. I should think the weapon is seldom thrown in war, since most of their contests (such as they are) take place in scrub or forest, where it could not be used to advantage; but I have seen a native frightfully cut in the abdomen, and was told by a native that he had been struck by a boomerang thrown by the hostile party. I have seen a few of these contests, but never saw the boomerang used in any way. The "waddys" were thrown freely, the spear seldom. The game boomerang is thrown among flights of ducks, and also parrots when congregated on the trees and gathering nectar from their flowers, and with marked effect. Thus I have seen several times. There are two ways of throwing the weapon, which, as I could throw it well at one time, I will endeavour to describe. It is grasped quite at the end by the right hand and raised above the head, the elbow being bent, the weapon assuming a position with its convex edge downwards on a nearly horizontal line at right angles to the intended line of flight. The arm is brought swiftly round from left to right, becoming gradually extended until it reaches a line directly in front of the face, when the weapon is delivered from the now straight arm, with the concave edge towards the line of flight. This is the method of throwing into the air. No dependence can be placed on the return of the weapon within a circle of twenty yards, though it sometimes returns dangerously near the thrower. If it meets with an obstacle it is either stopped and falls dead to the earth, or its course is changed. In either case its peculiar motion is destroyed, as must be obvious. In the other method of throwing the weapon is held in the same way, but delivered nearly on line with the hip, and made to strike the earth about ten yards in front of the thrower, pitching, I believe (though it is not easy to observe), on one of its horns. Thence it ricochets and flies straight away for perhaps seventy or eighty yards, keeping a position of about four feet from the earth, and gradually rising until it is spent. It returns very little if at all. In this way only can it be used for war, since in the other it begins to mount at once, and would soon be above the enemy's head. The weapon is made of various woods, a piece with a slight elbow being selected. It is hardened by baking. The right form is arrived at by trial, as I have seen during the process of manufacture. Those sold to Europeans are the failures. I had to pay a good price for the two I brought home, but they were excellent specimens.

The natives drive ducks. A flight is marked down on a small creek; men are then posted along the bank, others drive the birds towards them, and the boomerangs are thrown as they pass. I do not recollect having seen the weapon used for ground game. These are surrounded and killed with spears and sticks.

ARTHUR NICOLS

#### Is Meteorology a Science?

THE recent article in NATURE on the Treasury Blue Book relating to meteorology brings into unpleasant prominence the opinion of the eminent astronomer, Sir G. Airy, that meteorology is not a science; and the evidence of the eminent physicist, Sir William Thomson, to the same effect; while a celebrated philosopher in the columns of the *Fortnightly Review* has not long since described meteorology as "a formless registry of facts."

But surely these eminent authorities have hardly realised the great change which has come over the whole aspect of meteorology since the introduction of synoptic charts?

Synoptic meteorology shows that the world is, broadly speaking, covered with shifting cyclones and anti-cyclones, which have each, subject to local, diurnal, and other variations, a characteristic weather, and physical appearance, and one great problem of meteorology is to explain the observed weather over any area, at any instant, by defining the position of these cyclones and anti-cyclones. It is in fact analogous to that branch of geology which explains the scenery and contours of any country by the position of areas of upheaval, crumbling, and subsequent denudation.

But there is another problem for the meteorologist to solve, viz. Given the position of the cyclones and anti-cyclones at any instant, to determine their future course and changes; and this can even now be done in certain cases. As if the geologist were asked what the future course of the present state of the earth's surface will be, where fresh upheavals or crumbling will occur, and what the corresponding changes in scenery will be? In this case the position of the meteorologist is far in advance of the geologist.

But still another reproach is cast upon meteorology—that the knowledge requisite to issue forecasts cannot be expressed in mathematical formulae or in simple maxims. Here, too, the analogy of geology may show that neither formulae nor maxims are necessary to make a science. Just as a number of skilled geologists, from long experience, agree as to the structure of a complicated piece of country, so will a number of meteorologists agree as to the probable course of any series of cyclones or anti-cyclones.

The limits of a letter do not permit me to show why mean values, or harmonic series can never much advance meteorology as a science, if any better argument were needed than their failure after a trial of forty years.

But I think we are justified in saying that, since the introduction of synoptic methods, meteorology is as much a science as geology; that both are pure observational sciences, and that their methods have much in common, while in some points meteorology is even the further advanced of the two.

21, Chapel Street, S.W. RALPH ABERCROMBY

#### Atmospheric Currents

I HOPE you will permit me to reply to Mr. Clement Ley's letter on atmospheric currents in NATURE, vol. xv. p. 450.

It is certain that the earth's rotation cannot originate any current, but modifies them when originated.

We are agreed as to the cause of the trade-winds. The controversy is as to the questions, Why the trade-winds do not extend to the poles? What is the cause of the counter-trades or west winds between the trade-wind regions and the poles? and what is the cause of the polar depression of the barometer?

The polar depression of the barometer is due to the centrifugal force of the vortex which is constituted by the counter-trades as they circulate round the pole from east to west. There is a depression at the centre of every vortex, as any one may see in a wash-basin.

The counter-trades are "the reaction of the trade-winds." The laws of motion make it impossible for the winds to have any effect in either accelerating or retarding the earth's rotation—supposing, what we are safe in taking as proved, that they originate exclusively as the effect of solar heat. The effect of the trade-winds alone, blowing from east to west, would be to



retard the earth's rotation, but this is exactly balanced by the counter-trades of the circumpolar vortexes, blowing from west to east.

I cannot agree with Mr. Clewnt Ley when he says that it involves a fallacy to explain the mean winds, or great currents, on one principle, and the actual winds, or temporary currents, on another. If the great currents were much feebler in proportion to the temporary currents than they are, the mean prevalence of east winds in the tropics, and of west winds in the higher latitudes, would be discernible only as a residual fact when a number of anemometric observations made at various places were completely discussed. JOSEPH JOHN MURPHY

The Germ Theory

Your number for March 22 contains a review of my work on the Germ Theory of Disease, which, in some points, conveys so erroneous an impression of my exact position that I must ask you to allow me space for a few remarks regarding it.

Adverse criticism is what the author of such a book as mine expects, and, to some extent, desires.

A fair representation of his views and arguments, is what every author may insist on as a right.

It is the misleading manner in which my position is stated in your review that has induced me to pen this note.

To one or two of your statements I would refer in illustration of what I complain.

After referring to my expressed belief that contagia are living organized particles—an opinion held by many eminent physicians and men of science—your reviewer says: "If, however, the particles in sheep-pox, small pox, and vaccine be the infecting matter, they are easily seen by the microscope, and ought, therefore, to be found in the blood, but such is not the case." This, the old and stock argument against the germ theory, is specially dealt with by me on two different occasions—at p. 25, *et seq.*, and at p. 204, *et seq.* If it was worth your reviewer's while to raise this old objection to the germ theory, it was equally worth his while to make some reference to my explanation of the fact on which it rests. This he has not done—a manifest unfairness.

A little further on the review says: "Increased elimination of urea is explained thus: *The increased consumption of liquor sanguinis by the contagium particles leads to increased formation of retrogressive albumen and of urea.* It seems by this that contagium particles have livers and kidneys."

The part which I put in italics is put in your review within inverted commas, conveying thereby the impression that it is a correct quotation from my book. It is far from being so. As given by you, it is a misquoted short passage, separated from its context, and altered to suit the purpose of your review.

The chapter on increased elimination of urea is perfectly clear and intelligible to any ordinary mind, and contains nothing which justifies your reviewer in attributing to me, as he has done, the absurd belief that contagia are possessed of livers and kidneys. Neither is he justified in using the words "eat" and "drink" to express the action of a minute organism on its environment. Such phraseology can serve only to mislead those who are ignorant of the mode in which these organisms grow; and is quite inapplicable to any nutritive process which goes on in such organisms as I have described contagia to be.

Your reviewer quotes my statement that "if we were to bleed, to purge, to give antimony to, or even simply to withhold food and water from all the cases of typhus and enteric fever which occur, there can be no doubt that we should find the mortality from these diseases greatly increased;" and remarks on this, "Dr. MacLagan is right here, for by simply withholding food and water there can be no doubt that he would greatly increase the mortality by starving his patients to death." Your reviewer seems to be unaware that I refer in these remarks to a mode of treating fever which at one time did prevail.

To one other point I would refer in illustration of your reviewer's inaccuracy.

He says "the heat of specific fevers is partly ascribed to the propagation of the contagium causing increased consumption of tissue. But increase of living matter causes the disappearance of heat, not its production."

Even according to this, your reviewer's own somewhat awkward statement of the matter, the increased heat is attributed by me to increased consumption of tissue, indirectly brought about by the propagation of the contagium. Nowhere do I say that increase of living matter causes production of heat; and nowhere does your reviewer attribute such a statement to me. Quite the

contrary. I distinctly say that the increased production of heat results from increased disintegration of the tissues; and your reviewer distinctly attributes this saying to me. What, then, is the meaning of the latter part of the sentence just quoted? It bears but one interpretation. Your reviewer attributes to the first half of the quotation a meaning the reverse of that which it conveys. While saying that I ascribe the increased heat to increased consumption of tissue, he seems to think that he is saying something quite different, and pens his criticism accordingly. If he thus misunderstands his own statements, I need, perhaps, scarcely be surprised at his sometimes misinterpreting mine. I do object, however, to such misinterpretations and inaccuracies appearing in so influential a journal as NATURE.

Dundee

T. MACLAGAN

SEXUALITY IN PLANTS<sup>1</sup>

THE concluding part of the tenth volume of Pringsheim's *Jahrbücher* contains three papers, one of them by Dr. Arnold Dodel, of Zurich, being of the highest importance. This paper occupies the greater part of the present Hefte, and is illustrated by eight coloured plates. The title is "*Ulothrix zonata*, its Sexual and Non-Sexual Reproduction, a Contribution to the Knowledge of the Lower Limit of Sexuality in Plants." The anatomy and life-history of the *Ulothrix* is exhaustively treated, the whole paper being a model of careful and accurate research, as well as a valuable contribution to our knowledge of the lower plants. The paper is divided into sections, of which the following is a short summary. The results given are those obtained during fourteen months' consecutive observation of the plant. The genus *Ulothrix* has been divided into many species, but Dodel shows that *U. zonata* is so variable in its different stages that most of the so-called species must be reduced to one. The alternation of generations is very remarkable and divisible into four stages. During the progress of the alternation of generation three distinct forms are to be distinguished, two being filamentous generations, and the third a zygospore generation. The filamentous generations are invariably produced non-sexually and reproduce themselves repeatedly, forming, in fact, the plant known to systematic botanists as *Ulothrix zonata*. The third generation, the zygospore, was unknown till discovered by Dodel. In the long series of filamentous generations two distinct forms are to be distinguished. The first is produced non-sexually and is the autumn or winter generation. It develops non-sexual macrozoospores and quickly spreads the species in a given locality. The second is a sexual stage developing microzoospores. It arises from the non-sexual macrozoospore, and gives rise to the microzoospores which by conjugation form the third generation, the zygospore or zoozygospore.

The production of the microzoospore-forming generation terminates the series of filamentous generations. This stage is found in spring and summer, and by giving rise to the zygospores which by remaining in a state of rest for some months during the hot dry summer weather, reproduce the plant in the autumn. During the hot weather the filamentous generations more or less completely disappear. The zygospore generation, although a product of gamogenesis, is itself non-sexual.

*Ulothrix zonata* exhibits polymorphism in a remarkable degree, hence many forms looked upon as distinct species must be suppressed. This opens up a wide question in regard to other algae, and shows how essential it is to obtain an accurate knowledge of the life history of all forms.

The cells of *Ulothrix* give rise to a variable number of zoospores. A mother cell may form 1, 2, 4, 8, 16, or 32 zoospores, there being no obvious distinctions between the sexual and non-sexual zoospores. On the one side is the large macrozoospore with four cilia, and then there is every gradation down to the smallest microzoospore.

<sup>1</sup> *Jahrbücher für wissenschaftliche Botanik*. Herausgegeben von Dr. N. Pringsheim. Zehnter Band, Viertes Heft. Leipzig. Engelmann, 1876.

which conjugates, and which is furnished with only two cilia. The only distinction between the macro- and microzoospores seems to be that the former have four cilia, the latter only two. When the microzoospores fail to conjugate they may develop non-sexually just like the macrozoospores. This is a fact of the highest importance. In this plant, belonging to the lowest group in which sexual reproduction occurs, the sexual and non-sexual zoospores are hardly to be distinguished, and if by any chance union of the sexual zoospores does not take place, the zoospore behaves like a macrozoospore and develops non-sexually.

After remaining in a state of rest, sometimes for nearly twelve months, the contents of the zygospore break up into zoospores, from which arise the filamentous stage of *Ulothrix*.

In *Ulothrix* the conjugating cells are generally morphologically and physiologically identical, but sometimes larger zoospores conjugate with smaller, a difference in sex being here indicated. In other cases the microzoospores which have not conjugated germinate and give rise to individuals capable of reproducing. The study of the formation and subsequent development of the zygospore shows that the product of conjugation is to be considered as a new sexually-produced generation. It is a unicellular plantlet, with a root-like process and a slowly-growing plant-body which performs the function of assimilation. It in fact represents the embryo and the sporophore of the Pteridophytes. The root-end of the plantlet is formed by the union of the germinal spots of the conjugating microzoospores, while the assimilating plant-body represents the united chlorophyll-bearing parts of the zoospore.

The *Ulothrix* is thus one of the *Zygosporæ*, and is probably related to *Hydrodictyon*, but it shows certain affinities to *Sphaeroplea*, the lowest of the *Oosporeæ*.

As this part concludes the tenth volume of this serial, a most useful table of contents and special index of names of plants and details treated of in all the papers in the ten volumes has been added by Herr Zopf. This enables the student at once to refer to any given plant, or even to the part of it described in the various papers.

W. R. McNAB

### THE ROYAL NAVAL COLLEGE, GREENWICH

ON February 1, 1873, the Royal Naval College was opened at Greenwich, "for the purpose of providing for the education of naval officers of all ranks above that of midshipman in all branches of theoretical and scientific study bearing upon their profession." The first annual report on the Royal Naval College thus established has been recently presented to both Houses of Parliament.

When the College was established it was determined by the Admiralty to bring together in it all the necessary means both for the higher education of naval officers and also of others connected with the navy. During the session which terminated last year four captains, four commanders, ninety-three lieutenants, and eight navigating-lieutenants joined the college as students, but of these only one captain, thirty-three lieutenants, and three navigating-lieutenants went through the whole nine months' course, although one captain, two commanders, fifty lieutenants, and three navigating-lieutenants underwent the final examination. Besides these officers, who may all be regarded as being purely voluntary students, there was also a large number of others studying at the college, with a view to passing certain examinations, which would qualify them either for promotion or advancement or for appointment to some special branch or department of the service.

Finally, ten private students are reported as having passed through a course of instruction, nine of the

number being foreign officers, a fact which testifies to the estimation in which the college is held abroad.

With regard to the subjects of study we find that, besides the course of mathematics, which is compulsory for all students, systematic courses of instruction, extending over the entire session, are given in physics, chemistry, steam, navigation, and nautical astronomy, marine surveying, permanent and field fortification, military surveying and drawing, military history, foreign languages—namely, French, German, and Spanish—and in freehand drawing. Special courses of lectures are also given on various subjects, among which the principal seem to be the Structural Arrangements of Men-of-War, International Law, Naval History, and Practical Ship-building.

### TYPICAL LAWS OF HEREDITY<sup>1</sup>

#### II.

FIRST let me point out a fact which Quetelet and all writers who have followed in his paths have unaccountably overlooked, and which has an intimate bearing on our work to-night. It is that, although characteristics of plants and animals conform to the law, the reason of their doing so is as yet totally unexplained. The essence of the law is that differences should be wholly due to the collective actions of a host of independent *petty* influences in various combinations, as was represented by the teeth of the harrow, among which the pellets tumbled in various ways. Now the processes of heredity that limit the number of the children of one class such as giants that diminish their resemblance to their fathers, and kill many of them, are not petty influences, but very important ones. Any selective tendency is ruin to the law of deviation, yet among the processes of heredity there is the large influence of natural selection. The conclusion is of the greatest importance to our problem. It is, that the processes of heredity must work harmoniously with the law of deviation, and be themselves in some sense conformable to it. Each of the processes must show this conformity separately, quite irrespectively of the rest. It is not an admissible hypothesis that any two or more of them, such as reversion and natural selection, should follow laws so exactly inverse to one another that the one should reform what the other had deformed, because characteristics, in which the relative importance of the various processes is very different, are none the less capable of conforming closely to the typical condition.

When the idea first occurred to me, it became evident that the problem might be solved by the aid of a very moderate amount of experiment. The properties of the law of deviation are not numerous and they are very peculiar. All, therefore, that was needed from experiment was suggestion. I did not want proof, because the theoretical exigencies of the problem would afford that. What I wanted was to be started in the right direction.

I will now allude to my experiments. I cast about for some time to find a population possessed of some measurable characteristic that conformed fairly well to the law and that was suitable for investigation. I determined to take seeds and their weights, and after many preparatory inquiries, fixed upon those of sweet-peas. They were particularly well suited to my purposes; they do not cross-fertilise, which is a very exceptional condition; they are hardy, prolific, of a convenient size to handle, and their weight does not alter when the air is damp or dry. The little pea at the end of the pod, so characteristic of ordinary peas, is absent in sweet peas. I weighed seeds individually, by thousands, and treated them as a census officer would treat a large population. Then I selected with great pains several sets for planting. Each set contained seven little packets, and in each packet were ten seeds, precisely of the same weight. Number one of the packets contained giant seeds, all as nearly as might be of +3° of deviation. Number seven contained very

<sup>1</sup> Lecture delivered at the Royal Institution, Friday evening, February 6, by Francis Galton, F. R. S. Continued from p. 493.

small seeds, all of  $\pm 3^\circ$  of deviation. The intermediate packets corresponded severally to the intermediate degrees  $\pm 2^\circ \pm 1^\circ$  and  $0^\circ$ . As the seeds are too small to exhibit, I have cut out discs of paper in strict proportion to their sizes, and strips in strict proportion to their weights, and have hung below them the foliage produced by one complete set. Many friends and acquaintances each undertook the planting and culture of a complete set, so that I had simultaneous experiments going on in various parts of the United Kingdom. Two proved failures, but the final result was this: that I obtained the more or less complete produce of seven sets, that is of  $7 \times 7 \times 10$ , or 490 carefully weighed seeds.

It would be wholly out of place if I were to enter into the details of the experiments themselves, the numerous little difficulties and imperfections in them, or how I balanced doubtful cases, how I divided returns into groups, to see if they confirmed one another, or how I conducted any other of the well-known statistical operations. Suffice it to say that I took immense pains, which if I had understood the general conditions of the problem as clearly as I do now, I should not perhaps have cared to bestow. The results were most satisfactory. They gave me two data, which were all that I required in order to understand the simplest form of descent, and so I got at the heart of the problem at once.

Simple descent means this. The parentage must be single, as in the case of the sweet peas which were not cross-fertilised, and the rate of production and the incidence of natural selection must both be independent of the characteristic. The processes concerned in simple descent are those of Family Variability and Reversion. It is well to define these words clearly. By family variability is meant the departure of the children of the same or similarly descended families from the ideal mean type of all of them. Reversion is the tendency of that ideal mean type to depart from the parent type, "reverting" towards what may be roughly and perhaps fairly described as the average ancestral type. If family variability had been the only process in simple descent, the dispersion of the race would indefinitely increase, with the number of the generations, but reversion checks this increase, and brings it to a standstill, under conditions which will now be explained.

On weighing and sorting large samples of the produce of each of the seven different classes of the peas, I found in every case the law of deviation to prevail, and in every case the value of  $1^\circ$  of deviation to be the same. I was certainly astonished to find the family variability of the produce of the little seeds to be equal to that of the big ones, but so it was, and I thankfully accept the fact, for if it had been otherwise I cannot imagine, from theoretical considerations, how the problem could be solved.

The next great fact was that Reversion followed the simplest possible law; for the proportion was constant between the deviation of the mean weight of the produce generally and the deviation of the parent seed, reckoning in every case from one standard point. In a typical case, that standard must be the mean of the race, otherwise the deviation would become unsymmetrical, and cease to conform to the law.

I have adjusted an apparatus (Fig. 1) to exhibit the action of these two processes. We may consider them to act not simultaneously but in succession, and it is purely a matter of convenience which of the two we suppose to act the first. I suppose first Reversion then Family Variability. That is to say, I suppose the parent first to revert and then to tend to breed his like. So there are three stages: (1) the population of parents, (2) that of reverted parents, (3) that of their offspring. In arranging the apparatus I have supposed the population to continue uniform in numbers. This is a matter of no theoretical concern, as the whole of this memoir relates to the distinguishing peculiarities of samples irrespectively of the absolute

number of individuals in those samples. The apparatus consists of a row of vertical compartments, with trap-doors below them, to hold pellets which serve as representatives of a population of seeds. I will begin with showing how it expresses Reversion. In the upper stage of the apparatus the number of pellets in each compartment represents the relative number in a population of seeds, whose weight deviates from the average, within the limits expressed by the distances of the sides of that compartment from the middle point. The correct shape of the heap has been ensured by my having cut a slit of the proper curvature in the board that forms the back of the apparatus. As it is glazed in front I have only to pour pellets in from above until they reach the level of the slit. Such overplus as may have been poured in will run through the slit, to waste, at the back. The pellets to the right of the heap represent the heaviest seeds, those to the left the lightest. I shall shortly open the trap-door on which the few representatives of the giant seeds rest. They will run downwards through an inclined shoot, and fall into another compartment nearer the centre than before. I shall repeat the process on a second compartment in the upper stage, and successively on all the others. Every shoot converges towards one standard point in the middle vertical line; thus the present shape of the heap of pellets is more contracted in width than it was before, and is of course more humped up in the middle. We need not regard the humping up: what we have to observe is that each degree of deviation is simultaneously lessened. The effect is as though the curve of the first heap had been copied on a stretched sheet of india-rubber that was subsequently released. It is obvious from this that the process of reversion-cooperates with the general law of deviation. Fig. 6 shows the principle of the process of reversion clearly.

I have now to exhibit the effects of variability among members of the same family. It will be recollected that the produce of peas of the same class deviated normally on either side of their own mean weight; that is to say, I must make the pellets which were in each of the upper compartments to deviate on either side of the compartment in which they now lie, which corresponds to that of the medium weight of their produce. I open the trap-door below one of the compartments in the second stage, the pellets run downwards through the harrow, dispersing as they run, and form a little heap in the lowest compartment, the centre of which heap lies vertically below the trap-door through which they fell. This is the contribution to the succeeding generation of all the individuals belonging to the compartment in the upper stage from which they came. They first reverted and then dispersed. I open another trap door, and a similar process is gone through; a few extreme pellets in this case add themselves to the first formed heap. Again, I continue the process; heap adds itself to heap, and when all the pellets have fallen through, we see that the aggregate contributions bear an exact resemblance to the heap from which we originally started. A simple formula (see Appendix) expresses the conditions of equilibrium. I attended to these, when I cut out the slit in the back board of the upper compartment, by which the shape of the original heap was regulated. Thus it follows from the formula that if deviation after reversion was to deviation before reversion as 4 to 5, and if  $1^\circ$  of family variability was six units, then the value of  $1^\circ$  in the population must be ten units.

It is easy to prove that the bottom heap is strictly a curve of deviation, and that its scale tends invariably to become the same as that of the upper one. It will be recollected that I showed that every variety of curve of deviation was producible by variations in the length of the harrow, and that if the pellets were intercepted at successive stages of their descent they would form a suc-

cession of curves of increasing scales of deviation. The curve in the second stage may therefore be looked upon as one of these intercepts; all that it receives in sinking to the third stage being an additional dose of dispersion.

As regards the precise scale of deviation that characterises each population, let us trace, in imagination, the history of the descendants of a single medium-sized seed. In the first generation the differences are merely those due to family variability; in the second generation the tendency to wider dispersion is somewhat restrained by the effect of reversion; in the third, the dispersion again increases, but is more largely restrained, and the same process continues in successive generations, until the step-by-step progress of dispersion has been overtaken and exactly checked by the growing antagonism of reversion. Reversion acts precisely after the law of an elastic spring, as was well shown by the illustration of the india-rubber sheet. Its tendency to recoil increases the more it is stretched, hence equilibrium must at length ensue between reversion and family variability, and therefore the scale of deviation of the lower heap must after many generations always become identical with that of the upper one.

We have now surmounted the greatest difficulty of our problem; what remains will be shortly disposed of. This refers to sexual selection, productiveness, and natural selection. Let us henceforth suppose the heights and every other characteristic of all members of a population to be reduced to a uniform adult male standard, so that we may treat it as a single group. Suppose, for example, a female whose height was equal to the average female height + 3° of female deviation, the equivalent in terms of male stature is the average male height + 3° of male deviation. Hence the female in question must be registered not in the feet and inches of her actual height, but in those of the equivalent male stature.

On this supposition we may take the numerical mean of the stature of each couple as the equivalent of a single parent, so that a male parent plant having 1° deviation and a female parent plant having 2° of deviation, would together rank as a single fertilised plant 0 + 1½°.

In order that the law of sexual selection should co-operate with the conditions of a typical population, it is necessary that selection should be *nil*, that is, that there should not be the least tendency for tall men to marry tall women rather than short ones. Each strictly typical quality taken by itself must go for nothing in sexual selection. Under these circumstances one of the best known properties of the law of deviation (technically called that of "two fallible measures") shows that the population of sums of couples would conform truly to the law, and the value of 1° would be that of the original population multiplied by  $\sqrt{2}$ . Consequently the population of means of couples would equally conform to the law, but in this case the 1° of original deviation would have to be divided by  $\sqrt{2}$ , the deviations of means of couples being half that of sums of couples.

The two remaining processes are productiveness and survival. Physiologically they are alike, and it is reasonable to expect the same general law to govern both. Natural selection is measured by the percentage of survival among individuals born with like characteristics. Productiveness is measured by the average number of children from all parents who have like characteristics, but it may physiologically be looked upon as the percentage of survival of a vast and unknown number of possible embryos, producible by such parents. The number being unknown creates no difficulty if they may be considered to be, on the average, the same in every class. Experiment could tell me little about either natural selection or productiveness. What I have to say is based on plain theory. I can explain this best by the process of natural selection. In each species, the height, &c., the

most favoured by natural selection, is the one in which the demerits of excess or deficiency are most frequently balanced. It is therefore not unreasonable to look at nature as a marksman, her aim being subject to the same law of deviation as that which causes the shot on a target to be dispersed on either side of the point aimed at. It would not be difficult, but it would be tedious, to justify the analogy; however, it is unnecessary to do so, as I propose to base the analogy on the exigences of the typical formula, no other supposition being capable of fulfilling its requirements. Suppose for a moment that nature aims, as a marksman, at the medium class, on purpose to destroy and not to save it. Let a block of stone (Fig. 4)

FIG. 4.

represent a rampart, and let a gun be directed at a vertical line on its side on purpose to breach it: the shots would fall with the greatest frequency in the neighbourhood of the vertical line, and their marks would diminish in frequency as the distance increased, in conformity with the law of deviation. Each shot batters away a bit of stone, and the shape of the breach would be such that its horizontal outline will be the well-known curve. This would be the action of nature were she to aim at the destruction of medium sizes. Her action as preserver of them is the exact converse, and would be represented by a cast that filled the gap and exactly replaced the material that had been battered away. The percentage of thickness of wall that had been destroyed at each degree of deviation is represented by the ordinate of the curve, therefore the percentage of survival is also an ordinate of the same curve of deviation. Its scale has a special value in each instance, subject to the general condition in every typical case, that its 0° shall correspond to the 0° of deviation of height, or whatever the characteristic may be.

In Fig. 5 the thickness of wall that has been destroyed at each degree of deviation is represented by the corresponding ordinate of the horizontal outline of the portion which remains. Similarly, in the case of an original

FIG. 5.

population, in which each class was equally numerous, the amount of survivors at each degree of deviation is also represented by the corresponding ordinate of this or a similar curve.

But in the original population at which we are supposing nature to aim the representatives of each class are not equally numerous, but are arranged according to the law of deviation; the middle class being most numerous, while the extreme classes are but scantily represented. The ordinate of the above-mentioned outline will in this case represent, not the absolute number, but the percentage of survivors at each degree of deviation.

(To be continued.)

ON THE SIMPLEST CONTINUOUS MANIFOLDNESS OF TWO DIMENSIONS AND OF FINITE EXTENT<sup>1</sup>

ONE of the most remarkable speculations of the present century is the speculation that the axioms of geometry may be only approximately true, and that the actual properties of space may be somewhat different from those which we are in the habit of ascribing to it. It was Lobatchewsky who first worked out the conception of a space in which some of the ordinary laws of geometry should no longer hold good. Among the axioms which lie at the foundation of the Euclidian scheme, he assumed all to be true except the one which relates to parallel straight lines. An equivalent form of this axiom, and the one now generally employed in works on geometry, is the statement that it is impossible to draw more than one straight line parallel to a given straight line through a given point outside it. In other

words, if we take a fixed straight line, A B, prolonged infinitely in both directions, and a fixed point, P, outside it; then, if a second straight line, also infinitely prolonged in both directions, be made to rotate about P, there is *only one* position in which it will not intersect A B. Now Lobatchewsky made the supposition that this axiom should be untrue, and that there should be a finite angle through which the rotating line might be turned, without ever intersecting the fixed straight line, A B. And in following out the consequences of this assumption he was never brought into collision with any of the other axioms, but was able to construct a perfectly self-consistent scheme of propositions, all of them valid as analytical conceptions, but all of them perfectly incapable of being realised in thought.

Many of the results he arrived at were very curious; such as, for instance, that the three angles of a triangle would not be together equal to two right angles, but would be together less than two right angles by a quantity proportional to the area of the triangle. If we were to increase the sides of such a triangle, keeping them always in the same proportion, the angles would become continually smaller and smaller, until at last the three sides would cease to form a triangle, because they would never meet at all.

There are many other assumptions, at variance with the axioms of Euclid, which may be made respecting distance-relations, and which yield self-consistent schemes of propositions differing widely from the propositions of geometry. We see, therefore, that geometry is only a particular branch of a more general science, and that the conception of space is a particular variety of a wider and more general conception. This wider conception, of which time and space are particular varieties, it has been proposed to denote by the term *manifoldness*. Whenever a general notion is susceptible of a variety of specialisations, the aggregate of all such specialisations is called a manifoldness. Thus space is the aggregate of all *points*, and each point is a specialisation of the general notion of *position*. In the same way time is the aggregate of all

*instants*, and each instant is a specialisation of the general notion of *position in time*. Space and time are, in fact, of all manifoldnesses, the ones with which we are by far the most frequently concerned.

Now there is an important feature in which these two manifoldnesses agree. They are both of them of such a nature that no limit can be conceived to their divisibility. However near together two points in space may be, we can always conceive the existence of intermediate points. And the same thing holds in regard to time. Mathematicians express this fact by saying that space and time are *continuous* manifoldnesses. But there is another feature, equally important with the foregoing, in regard to which space and time are strikingly contrasted. If we wish to travel away from any particular instant in time, there are only two directions in which we can set out. We must either ascend or descend the stream. But from a point in space we can set out in an infinite number of directions. This difference is expressed by saying that time is a manifoldness of *one dimension*, and that space is a manifoldness of *more than one dimension*. An aggregate of points in which we could only travel backwards or forwards would be, *not* solid space, but a *line*. A line, therefore, is a manifoldness of one dimension. A *surface*, again, may be regarded as an aggregate of lines; and it is an aggregate of such a nature, that if we wish to travel away from a particular line, there are only two directions in which we can set out. It is therefore a line-aggregate of one dimension. Considered as a point-aggregate it has two dimensions, and accordingly it is a manifoldness of two dimensions. In the same way it will be seen that solid space is a manifoldness of three dimensions.

I have endeavoured by these remarks to explain what is meant when we speak of a continuous manifoldness of two dimensions. It is the object of this paper to communicate some results I have arrived at respecting the properties of the simplest of such manifoldnesses which has a finite extent. The existence of the particular manifoldness I shall endeavour to describe has been referred to in a remarkable lecture by Prof. Clifford on "The Postulates of the Science of Space," but, so far as I am aware, its properties have not hitherto been worked out in detail.

The simplest of all doubly-extended continuous manifoldnesses is the *plane*. But it is not a manifoldness of finite extent. It reaches to infinity in every direction, and its area is greater than any assignable area. It is therefore not the manifoldness of which we are in search. Now the circumstance in which the plane differs from those doubly-extended manifoldnesses which are next to it in order of simplicity, is the possibility that figures constructed in it may be magnified or diminished to any extent without alteration of shape; in other words, that figures which can be constructed in it at all can be constructed to any scale. That this property is not possessed by curved surfaces, may be seen by considering the case of a spherical triangle. If the sides of a triangle constructed on a given sphere be all of them increased or diminished in the same proportion, the shape of the triangle will not remain the same. Now it has been found by Prof. Riemann that this property of the plane is equivalent to the following two axioms:—(1) That two geodesic lines which diverge from a point will never intersect again, or, as Euclid puts it, that two straight lines cannot inclose a space; and (2) that two geodesic lines which do not intersect will make equal angles with every other geodesic line. The second is precisely equivalent to Euclid's twelfth axiom. Deny the first of these axioms, and you have a manifoldness of uniform positive curvature; deny the second, and you have one of uniform negative curvature. The plane lies midway between the two, and its curvature is zero at every point.

Let us consider, then, the case of a doubly-extended manifoldness, of which the curvature is uniform and positive. The first of the before-mentioned two axioms

<sup>1</sup> Read before the London Mathematical Society, December 14, 1876

is no longer true. Geodesic lines diverging from a point do not continue to diverge for ever. They meet again and inclose a space. The first question which presents itself is with reference to the situation of the point towards which they ultimately converge. In the case of a spherical surface they will converge towards a point which is separated from the starting-point by half the length of a geodesic line. And this is the only case we are able to conceive. The surface of a sphere is the only doubly extended manifoldness of uniform positive curvature which geometry recognises, and it is the only one which we can figure to ourselves in thought. It is not, however, the *simplest* of such manifoldnesses. To obtain the simplest case we must suppose that the point towards which two geodesic lines converge is separated from their starting-point, not by *half*, but by the *entire* length of a geodesic line; or, what amounts to the same thing, that it *coincides* with the starting-point. It is true that we are utterly unable to figure to ourselves a surface in which two geodesic lines shall have only one point of intersection, and shall yet inclose a space. But we are perfectly at liberty to reason about such a surface, because there is nothing self-contradictory in the definition of it, and because, therefore, the analytical conception of it is perfectly valid. It is the simplest continuous manifoldness of two dimensions, and of finite extent, and those few properties of it which I have worked out appear to me to be very beautiful. In order to make my observations more intelligible, I shall for the future speak of it as a surface, and its geodesic lines I shall speak of as straight lines. I have the highest authority for using this nomenclature, and though it will impart to my theorems a very paradoxical sound, it is calculated, I think, to give a juster idea of their meaning, than if I were to use the more accurate, but less familiar terms.

Assuming, then, as the fundamental properties of our surface, that every straight line is of finite extent (in other words, that a point moving along it will arrive at the position from which it started after travelling a finite distance), and that two straight lines cannot have two points in common, the first corollary I propose to establish is that all straight lines in the surface are of equal extent.

Let A, B, be two straight lines in the given surface. If possible, let A be greater than B. From A cut off a portion equal to B. Let P, Q, be the extreme points of this segment, and let R be any point in B. Apply the line A to the line B in such a manner that the point P falls on the point R, then, since in a surface of uniform curvature equal lengths of geodesic lines may be made to coincide, the segment PQ will coincide with the entire straight line B. Hence Q will fall upon R. But P coincides with R, and P and Q do not coincide with one another, since PQ is less than the entire straight line A; therefore Q cannot coincide with R. Hence A cannot be greater than B.

The straight lines here spoken of are, of course, not *terminated* straight lines. What the proposition asserts is that the *entire* length of all straight lines in the given surface is the same. The corresponding proposition in spherical geometry is that all great circles of a given sphere are equal.

There are a great many other analogies between the imaginary surface here treated of and the surface of a sphere. Its straight lines, though they are like the straight lines of a plane in the circumstance that any two of them have only one point of intersection, are in many other respects analogous to great circles. In any of its straight lines, for instance, each point has a corresponding point which is *opposite* to it, and farther from it than any other point in the line. For if by setting out from a point and travelling a finite distance in a particular direction we get back to the starting-point, there must be a point half way on our journey which is farther from the starting-point than any other point in the line, and which may

very appropriately be called its opposite point. It is an obvious corollary that the distance between any two points will be the same as the distance between their opposite points.

Let us now consider the case of a number of straight lines radiating from a centre. In each of them there will be a point which is opposite to that centre. And it will be a separate point for every separate straight line. For no two straight lines can have two points in common, and since these radiating lines have a common centre of radiation, they can have no other point in common. Hence, if we suppose one of these lines to rotate about the centre, the point opposite to the centre will describe a continuous line, and one which finally returns into itself. It is the locus of all points in the surface opposite to the centre of radiation. What now is the character of this locus? In the first place it is a line which is of the same shape all along, and of which all equal segments therefore can be made to coincide. For any two positions of

the rotating line which contain a given angle may be placed upon any other two positions which contain an equal angle. Then, since the length of all straight lines in the surface is the same, the opposite points will coincide, and by parity of reasoning all intermediate points of the locus. But, in the second place, the locus is also of the same shape on both sides. For each point in it may be approached from the centre of radiation in two different ways, and it is at the same distance from that centre, whether it be approached in the one way or the other. Any particular segment, in fact, of the locus has its extreme points joined to the centre of radiation by lines which are of equal length, and which include an equal angle—lines, therefore, which may be made to coincide. Since this is the case for any segment whatever, and for every subdivision of a segment, all the points of a segment will still remain on it if the segment be turned round and applied to itself. Hence the locus is of the same shape, whether viewed from the one side or from the other. But since it is also of the

same shape all along, it satisfies Leibnitz's definition of a straight line, and it is, in fact, a geodesic line of the surface.

Hence we have this second proposition—that all points in the surface opposite to a given point lie in a straight line.

From the method of its construction, this straight line is farther from the given point than any other line in the surface. Travelling from the given point as a centre, in whatever direction we might set out, we should, after completing half our journey, arrive at this farthest straight line, we should cross it at right angles, and we should then keep getting nearer and nearer to our starting-point, until we finally reached it from the opposite side.

Each separate point in the surface, moreover, has a separate farthest line. For if any two points be taken, the points opposite to them on the straight line which joins them will be distinct. Hence their farthest lines will cut this joining line in two separate points. They must, therefore, be two separate lines, for the same straight line cannot cut another straight line in two separate points. In a similar manner it may be shown that each straight line in the surface has a separate farthest point. Hence there exists a reciprocal relation between the points and straight lines of the surface, a relation which we may express by saying that every point in the surface has a polar, and that every straight line in the surface has a pole. It is then easy to show that when a point is made to move along a straight line its polar will turn about a point, and that when a straight line is made to turn about a point, its pole will move along a straight line.

It is interesting to compare these propositions with the corresponding ones in spherical geometry. There, too, each point has a farthest geodesic line; that is to say, a geodesic line which is farther from it than any other geodesic line on the sphere. But each geodesic line has two farthest points or poles, instead of having only one. Hence there is not that perfect reciprocity of relationship between points and geodesic lines which exists in the surface we have been examining; and this is one of the many ways in which the sphere shows itself to be inferior to that surface in simplicity.

The most astounding fact I have elicited in connection with this surface is one which comes out in the theory of the circle. Defining a circle as the locus of points equidistant from a given point, we shall find that it assumes a very extraordinary shape when its radius is at all nearly equal to half the entire length of a straight line. For let us again figure to ourselves a number of straight lines radiating from a point. Let  $l$  be the total length of each straight line. Then the proposition we have to make is that the radius of our circle shall be nearly equal to  $\frac{l}{2}$ . Let us suppose it equal to  $\frac{l}{2} - m$ , where  $m$  is small as compared with  $l$ . Each of the radiating lines will cut the circle in two points, and each of these points will be at a distance from  $O$  equal to  $\frac{l}{2} - m$  or  $\frac{l}{2} + m$ ,

according as the distance is measured in the one direction or the other. And their distance from each other will be equal to  $2m$ , that is to say, it will be comparatively small. But each point on the polar of  $O$  will be at a distance from  $O$  equal to  $\frac{l}{2}$ . Hence each point on the circle will be at a distance from this polar equal to  $m$ . Moreover, every point at a distance of  $m$  from the polar will be a point on the circle, because it will be at a distance of  $\frac{l}{2} - m$

from  $O$ . But the locus of points at a distance of  $m$  from the straight line,  $AB$ , will consist of two branches,  $CD$  and  $EF$ , one on either side of  $AB$ , and at the same distance from it along their whole length. It is true that these branches form in reality a single continuous line.

A point travelling along from  $C$  to  $D$ , and further in the same direction, would ultimately appear at  $E$ , travel along to  $F$ , and then, after a further journey, reappear at the point  $C$ . But this does not alter the fact that when a small portion only of this line is contemplated, it presents the appearance of two straight lines, each of them parallel to, and equidistant from,  $AB$ .

In the limiting case, where the radius becomes equal to  $\frac{l}{2}$ ,  $CD$  and  $EF$  both of them coincide with  $AB$ . The circle merges into a straight line, and becomes, in fact, the polar of its own centre. It is not, indeed, quite accurate to say that it merges into a straight line, for it reduces itself rather to two coincident straight lines, and its equation in co-ordinate geometry would be one of the second degree.

In regard to the surface here treated of, it is easy to see that, as with the sphere, the smaller the portion of it we bring under our consideration, the more nearly its properties approach to those of the plane. Indeed, if we consider an area that is very small as compared with the total area of the surface, its properties will not differ sensibly from those of the plane. And on this ground it has been argued that the universe may in reality be of finite extent, and that each of its geodesic lines may return into itself, provided only that its total magnitude be very great as compared with any magnitude which we can bring under our observation.

In conclusion, I cannot do better than quote the passage in which Prof. Clifford explains what must be the constitution of space if this hypothesis should be true. "In this case," he says, "the universe, as known, is again a valid conception, for the extent of space is a finite number of cubic miles. And this comes about in a curious way. If you were to start in any direction whatever and move in that direction in a perfect straight line according to the definition of Leibnitz, after travelling a most prodigious distance, to which the parallax unit—200,000 times the diameter of the earth's orbit—would be only a few steps you would arrive at—this place. Only, if you had started upwards, you would appear from below. Now one of two things would be true. Either when you had got half way on your journey you came to a place that is opposite to this, and which you must have gone through, whatever direction you started in, or else all paths you could have taken diverge entirely from each other till they meet again at this place. In the former case every two straight lines in a plane meet in two points, in the latter they meet only in one. Upon this supposition of a positive curvature the whole of geometry is far more complete and interesting; the principle of duality, instead of half breaking down over metric relations, applies to all propositions without exception. In fact I do not mind confessing that I personally have often found relief from the dreary infinities of homaloidal space in the consoling hope that, after all, this other may be the true state of things."

F. W. FRANKLAND

#### HYDROGRAPHY OF WEST CENTRAL AFRICA

MR. STANLEY'S second letter in last Thursday's *Telegraph* contains important information on the district between Tanganyika and the Albert and Victoria Nyanza—information complementary to that given in his former letters, which we embodied in a map, vol. xiv. p. 374. He has, in fact, discovered another "source" of the Nile, and one evidently of great length and volume—the Kagera—which he has gallantly named the Alexandra Nile. This river issues from a large lake, Akanyaru or Alexandra Nyanza, in two branches and flows north, uniting under  $1^{\circ}$  S. lat., and flowing east to the Victoria Nyanza. Mr. Stanley was only able to see the Alexandra Nyanza from a distance, but it is evidently of consider-

able size, and receives a river at its west end, the Upper Alexandra Nile, which probably comes from a considerable distance. Mr. Stanley believes that the Alexandra Nyanza has a marshy connection with Kivu Lake on the south, from which issues the Rusizi, an affluent of the Tanganyika. If then these various connections are ultimately verified, the problem of African hydrography becomes more complicated than ever. The Rusizi will connect the Nile system with Tanganyika, and very shortly, at least, Mr. Stanley believes, the Lukuga will carry the water of the latter to the west—to the Congo, say some. Meantime Mr. Stanley is probably at or has already left Nyangwe. After deciding this question of the connection of Albert and Tanganyika Lakes from that side, he will probably devote himself to the task of tracing down the Lualaba, which, according to Cameron, should bring him into early communication with Dr. Nachtigal, who is to trace up the Congo.

It may not be uninteresting to point out what is the present state of the problem which these two explorers have set themselves to solve. Our principal scientific authorities on the Congo are still Capt. Tuckey and Prof. Smith, who in 1816 ascended about 200 miles up the river, and who have left us a record yet deserving of study. They left England at a time when the outlet of Mungo Park's Niger was a subject of speculation, and amongst the theories then started, the Congo, as an outlet, held a high place. The same notions of the magnitude of this river obtained then, and Capt. Tuckey and his civilian scientific staff started with the idea that they would be able to navigate it for hundreds of miles. They had, however, only been in the river some four or five days when Prof. Smith makes this entry in his diary:—"The channel is very narrow and the current never more than three knots . . . everything yet seems to indicate that the descriptions of the great breadth of the river, the length of its course, &c., have been exaggerated." Again, twelve days afterwards, when they had got considerably further up the river, he writes, "The whole appearance of the river, its numerous sandbanks, low shore, inconsiderable current, narrow channel, seem but little to justify its extravagant fame. Its sources cannot be further inland than those of the Senegal and Gambia." Capt. Tuckey, who ties himself very rigidly to a statement of facts, ventures to say that at Fathomless Point the true mouth of the river "is not three miles in breadth; and allowing the mean depth to be forty fathoms and the mean velocity of the stream four and a-half miles an hour, it will be evident that the calculated volume of water carried to the sea has been greatly exaggerated." The mean velocity of the current higher up the river than the true mouth appears to be about two miles, and Tuckey remarks that they found no difficulty in rowing the gigs to the foot of Casan Yellala *against the current*.

These falls or rapids (Yellala) deserve some notice. They extend continuously for about twenty miles along the river, and are very much like the rapids on the Somerset Nile between Foweira and Magungo, where Col. Gordon reports a fall of 700 feet in a space of ten or fifteen miles. On August 14, 1816, Prof. Smith says, "We discovered the celebrated fall of Yellala, at a distance of about a mile and a half. But how much were we disappointed in our expectations on seeing a pond of water only with a small fall of a few hundred yards." They had been led to expect a second Niagara, and instead of that, found a rapid having a perpendicular fall of thirty feet in a slope of 300 yards formed of a descending bed of mica slate. The width of the river is very various, sometimes expanding to half a mile. It is compared by Tuckey to Loch Tay and by Smith to the Drammen, in Norway, at the bridge. Sometimes it contracts to 100 yards; in one place it is reduced to fifty yards in breadth, but at this point the stream rushes through at the rate

of eight miles an hour. The rapid and considerable rise of the water during the rainy season is largely accounted for by the fact that "the hills do not absorb any of the water that falls, the whole of which is carried direct to the river by gullies and ravines, with which the hills are furrowed all over." These hills are composed entirely of slate, with masses of quartz and syenite, and their extreme barrenness forms one of the most striking features of the country.

It would appear from Capt. Tuckey's and Prof. Smith's reports that the farthest point they reached on the river was at least 1,000 feet above the sea, and as this point is about 800 miles in a direct line from Nyangwe, which Cameron has fixed at 1,400 feet, the connection between the Congo and Lualaba on the question of level alone seems very doubtful.

The Casai and Kwango are doubtless the chief affluents of the Congo; it may have tributaries from the north and north-west behind the coast ranges, but these will be of secondary importance. As soon as we get east of the Congo water-parting, we begin to descend to the great valley of the Lualaba, Livingstone's "central line of drainage." This river occupies the centre of a saucer-like depression, one tip being probably the Congo water-parting, the other the Bambarre, or perhaps Kabogo Mountains to the west of Tanganyika. The fall of this depression is from south to north; commencing at the Katanga copper mines of the Pombeiros, it runs to Lake Kassali 1,750 feet, to Nyangwe 1,400 feet; thence to the "Unvisited Lake" of Livingstone, the "Great Lake" of Poncet, or the "Sankorra" of Cameron, probably also the "Liba" of the Benin slaves, and so on by the Shari to Lake Chad, 830 feet.

From these statements, then, it will be seen that the solution of the hydrographical problem of Western Central Africa is difficult to arrive at on the data we at present possess, and that to advocate any special theory may be rash. The Congo theory is a fascinating one, but the levels seem against it. However, with two such men as Nachtigal and Stanley in the field, the solution of this problem, as of others almost equally interesting, will soon be discovered.

#### THE LONDON INDUSTRIAL UNIVERSITY

WE give below a series of extracts from an admirable letter addressed by Major Donnelly, the chief of the scientific staff of the Science and Art Department, to Sir Sydney Waterlow, with reference to the proposed Industrial University to be established by the City Guilds in London:—

London, March 14, 1877

DEAR SIR SYDNEY WATERLOW,—In reply to your request, I am happy to place at your service such suggestions, with regard to the proposed "City Guilds' Industrial University," as my experience in connection with the Science and Art Department enables me to offer. . . .

Under anything like a broad view of the subject it would be difficult to say what branch of learning should be omitted in an Industrial University. But if we confine ourselves to what is practicable with the probable means immediately at command, and if we look to commence by supplying that of which there is the greatest want, we shall, I think, have no hesitation—considering the relative facilities for obtaining instruction in the different branches of knowledge—in deciding that science as now understood, and particularly Applied Science, has the first call on our attention.

. . . The Industrial University might be commenced by establishing professorships with the necessary laboratories, tutorial staff, &c., in the following branches of Science and Art:—

- Mathematics (Pure and Applied and Practical Geometry).
- Chemistry.
- Physics (Heat, Light, Magnetism, and Electricity).
- Mechanics (Practical Mechanics, Machinery, and Machine Drawing).
- Engineering and Building Construction, and its



Applied Art (Modelling, Designing, Enamelling, Repousse work, Wood Carving, &c.).

As the teaching would be specially directed to the industrial applications of science it is needless to say that considerable subdivision would be required in the subjects named.

It is of great importance that the professors should be not only teachers, but investigators, constantly endeavouring to enlarge the field of accurate knowledge, and scientific procedure, in our industries. To appreciate how much may be effected in this way we have only to consider the millions saved to France by Pasteur's researches on the disease of the silkworm, or the knowledge obtained by his inquiry on fermentation.

The time of the professors may be much economised by making it no part of their duty to commence their courses with the elements of general science. It is quite unnecessary that they should do so. This teaching may be obtained at other places, with which the Industrial University would be only needlessly interfering if it gave elementary instruction. It should, on the contrary, be its object to supplement and specialise the knowledge obtainable in ordinary science classes from which the students should be drawn; and they should be expected to have acquired sufficient general knowledge of science before entering the classes and laboratories of the University to be able to follow its courses with advantage.

A leading feature of the University should be evening courses—not merely popular lectures—for the use of those whose circumstances in life have rendered it necessary that they should commence the practical work of life early. By circumstances in life I do not refer solely to poverty. There are many occupations that it is advisable, if not necessary, to enter upon early. For instance, it is of the utmost importance for a mechanical engineer to be a good practical workman. To do this he must join the workshop when young. And the lad who enters when he is thirteen has an advantage which might not be expected. Mr. Phythian, the Master of the Oldham School of Science and Art established by the Messrs. Platt, informs me that to the lads who come into the workshop at this age the evening intellectual work is no effort; it is a relaxation and recreation. To the apprentices who enter at eighteen it is almost an impossibility. They are so exhausted by their day's labour that they cannot pay attention.

It is agreed on all hands that if the teaching of science is to be of any use it must be essentially practical—that is to say, the teaching of the laboratory. And no pains should be spared to make the laboratories perfect and readily available. By them the University may supply a great want.

It is perhaps necessary to guard against the idea that the University is to teach any trade or business. There could be no greater mistake than for it to attempt to do so. The purely technical knowledge of a trade must be learnt by practising it. The teaching of a public institution can with advantage only extend as far as the special application of various branches of abstract science to the different arts. It is no doubt difficult to define how far the teaching of applied science may go without trenching on the workshop. But in practice the limits are readily found. This difficulty will be still less felt in an institution drawing its pupils from among those actually engaged in trade, who will know what they can acquire in the University, and what they can better learn directly in business. The programme of examinations in technology by the Society of Arts will give many suggestions on this subject.

I have no doubt that the Society of Arts would be willing to transfer the whole or a part of their system of examinations in technology to such a body as the City Guilds, who, with far larger funds at their disposal, may give it a development which the Society of Arts can never obtain for it. By employing local agencies and taking advantage of the machinery of the Science and Art Department, these examinations are held throughout the country. And by availing itself of this and similar organisations, the Central University might be brought *en rapport* with all parts of England, Scotland, and Ireland.

Through the action of the Government, stimulating local effort, the country is being rapidly covered by a network of Science and Art schools and classes, where the working classes—whose interests and advances the City Guilds are, I understand, especially anxious to promote by the Industrial University—have opportunities of obtaining that elementary instruction in Science and Art which must be the basis of any sound technical education. There are now 1,750 separate schools or classes in the country in connection with and receiving aid through the Science and Art Department.

It is therefore unnecessary to consider the question of the creation of any organisation for giving instruction in elementary general science or art. What are wanted are a stimulus to increase the number of students, the development of systematic courses of instruction onwards and upwards from the elementary school, and means to enable poor, but clever and industrious, youths to pursue such courses. The award of small scholarships or bursaries in competition which would support the holders while carrying forward their studies in a higher school—the retention of the bursary being contingent on a definite course of instruction being pursued satisfactorily—is therefore, I believe, the most effective means the Guilds can adopt to aid technical instruction.

It is very necessary to bear clearly in mind in what directions the University must look for its pupils. Broadly speaking, these will I believe be:—

1. The holders of Bursaries and Scholarships.
2. Young men whose means enable them to carry on their education beyond the school age, and who can attend an institution in London more conveniently than elsewhere.
3. A limited number of students of the same class who are attracted by the goodness of the instruction and its appropriateness to their future pursuits. I say a limited number, because, however good the instruction, it will take years to divert the class of students from the channels which time has consecrated.
4. Evening students—men who are engaged during the day.

It would be useless to expect many students from classes 2 and 3 at first.

The real point seems to me to make a beginning. Get a good site—by a 'good site' I mean a site in an accessible position, sufficiently large to allow of expansion as the University grows—build chemical and physical laboratories, and lecture rooms, and some mathematical class rooms, on a portion of the site. If these are well managed, and are in a prominent position, such as that suggested on the Embankment, where they cannot but be seen—it is difficult to make anything known in London—surely there must be many rich men in the city besides the city companies who will seize the opportunity, by adding to the endowment or the buildings, of perpetuating their memories as munificent patrons of what will eventually be a credit to the country.

It always seems to be forgotten that the population of London is as large as that of Scotland; and that if its provision for instruction were tenfold what it is, it would not be proportionately larger than that of the Canton of Zurich.

Any plan you commence upon must be much modified as the institution is expanded and developed. To succeed, the University must be built up by slow degrees and adapted, with the experience you gain from day to day, to meet the wants and circumstances of the time. That it will be a success, and a great success, if taken heartily in hand by the City of London, there can be no doubt.

Believe me,  
Yours very faithfully,  
J. F. D. DONNELLY

#### OUR ASTRONOMICAL COLUMN

THE OPPOSITION OF MARS IN 1892.—Early in August, 1892, the planet Mars will come into opposition at a distance sensibly the same as in September of the present year, when it is proposed to make a serious attempt to determine the solar parallax by observations of this planet, a method which has not hitherto been applied under such advantageous circumstances as are now possible, but which is calculated to furnish the sun's distance from the earth with a degree of precision comparable with that to be attained by the observation of a transit of Venus, and with far less trouble and expense. It will not perhaps be without interest at the present moment, when the attention of astronomers is particularly directed to the efficient observation of Mars near the opposition in September next, if we present an ephemeris for the opposition of 1892, the only one of the present century yet to come, which can be to all intents and purposes as favourable as that of 1877. The ephemeris is founded upon the tables of M. Leverrier, which have been applied with sufficient accuracy for the object in view. The positions are for mean noon at Paris,

1877	App. R.A. of Mars. h m. s.	App. Decl. of Mars. ° ' "	Log distance from earth.
July 23	21 18 47.4	22 25 24	9.50247
" 25	17 59	22 38 27	9.58837
" 27	15 16.0	22 51 22	9.58489
" 29	13 19.0	23 4 0	9.58201
" 31	11 16.4	23 16 13	9.57975
Aug. 2	9 9.3	23 27 51	9.57812
" 4	6 59.4	23 38 47	9.57714
" 6	4 48.1	23 48 55	9.57678
" 8	2 36.8	23 58 7	9.57705
" 10	21 0 27.1	24 6 18	9.57796
" 12	20 58 20.4	24 13 23	9.57951
" 14	56 18.0	24 19 18	9.58166
" 16	20 54 21.4	24 23 59	9.58443

The opposition will take place on August 4, and Mars will be in perigee on August 6 at a distance of 0.3774. The distance in perigee in the present year will be 0.3767.

THE COMET 1873 II. (TEMPEL, JULY 3).—This very interesting comet of short period will return to perihelion in 1878. The elements which rest upon the widest extent of observation are those of Mr. W. E. Plummer; in his orbit the period of revolution is 1850.25 days, or 5.066 years, and the perihelion passage in 1873 having taken place June 25 '38, G.M.T., the comet, neglecting the effect of perturbations which in the present revolution is not likely to be material, will be again due in perihelion about 1878, July 19.5. Probably geocentric places derived from Mr. Plummer's orbit, with this date for perihelion passage, will give a sufficient idea of the circumstances of the next appearance, and a few positions so derived are accordingly subjoined:—

At 24h	R.A.	N.P.D.	Distance from earth
June 29	322.5	97.4	0.437
July 9	328.7	100.7	0.400
" 19	334.7	104.9	0.377
" 29	340.0	109.8	0.369
Aug. 8	344.3	114.6	0.375
" 18	347.4	118.8	0.397

The comet, therefore, appears under conditions nearly as favourable as possible for observations, the least distance of its orbit from that of the earth being 0.33, at a greater radius-vector. In aphelion the comet is distant from the sun 4.555, and its distance from the orbit of the planet Jupiter at this point (which is that of nearest approach) is 0.736. Four days after perihelion passage the comet approaches the orbit of Mars within 0.05, all these distances being expressed in parts of the earth's mean distance from the sun.

There does not appear to have been any observation of this comet previous to 1873, notwithstanding its short period. It could neither have been the object seen on one morning only in October 1846 by Hind, nor that observed by Goldschmidt on May 16, 1855, which was at first mistaken for the short-period comet of De Vico (1844 I).

In addition to the comet in question, Tempel is also the discoverer of comet 1866 I, associated with the great November meteor-shower, and comet 1867 II, which was re-observed in 1873, after its orbit had undergone considerable change from a near encounter with Jupiter about the preceding aphelion passage.

NEW COMET.—Prof. Winnecke, the director of the Imperial Observatory at Strasburg, announces his discovery of "a fine bright comet, with nucleus and trace of a tail," early on the morning of April 6. The following position depends upon observations with an annular micrometer on a 3½ feet telescope, the comet being inconveniently situated for the larger instrument.

April 5 at 15h. 53m. 39s. mean time at Strasburg, Right Ascension 22h. 7m. 49.44s., Declination + 14° 54' 15.4". The diurnal motion in R.A. is rather less than 1m., and that in Decl. about 1", both increasing.

The death of comets which had prevailed since December 1874, appears to have terminated, and we must soon hear of the

re-discovery of the one which bears the name of D'Arrest, and has been so elaborately calculated by M. Leveau.

[Since the above was in type the following elements, calculated by Herr Hartwig, have been received from Prof. Winnecke:—Perihelion passage, April 18.1741, Berlin time, longitude of perihelion, 251° 59' 57"; ascending node, 317° 51' 18"; inclination, 56° 42' 42"; logarithm of perihelion distance, 9.96767, motion retrograde. By these elements the comet at midnight on April 25, in R.A. 22h. 39m. and N.P.D. 42° 7', will have twice the theoretical intensity of light that it had on the date of discovery.]

### CHEMICAL NOTES

THE NEW METALS ILMENIUM AND NEPTUNIUM.—About thirty years ago R. Hermann announced the discovery of a new metal, ilmenium, accompanying tantalum and niobium in various minerals, and closely allied to them in its general characters. Several years later he relinquished his claims to the discovery, in consequence of researches by Maignac in the same field leading to entirely different results. Later investigations have, however, strengthened his belief in the existence of ilmenium, and in the February number of Kolbe's *Journal für praktische Chemie* he not only brings forward results tending to establish the individual character of ilmenium, but describes a new metal, neptunium, belonging to the same group, and occurring in tantalite from Haddam, Connecticut. As the quantities obtained are small, the characteristic reactions limited, and as the spectral properties cannot be made use of, chemists will naturally reserve their opinion till confirmatory observations have been made by some other well-known investigator. The following are the essential results obtained by Hermann. The mineral was found to consist of equal portions of columbite ( $\text{ROMe}_2\text{O}_6$ ) and ferroilmenite ( $\text{RO}_2\text{MeO}_3$ ). By fusion with potassium bisulphate the hydrates of the metallic oxides were separated out in the following proportions:—

$\text{Ta}_2\text{O}_3$	..	..	..	32.39
$\text{Nb}_2\text{O}_7$	..	..	..	36.79
$\text{Il}_2\text{O}_7$	..	..	..	24.52
$\text{Np}_2\text{O}_7$	..	..	..	6.30
				100.00

The hydrates can be changed into double fluorides, and from the greater solubility of potassium-neptunium fluoride, it may be obtained free from tantalum and ilmenium salts but retaining a small quantity of the niobium salt; these, however, on being changed into niobate and neptunate of sodium may be separated on account of the greater solubility of the latter. By fusion of the neptunate of sodium with potassium bisulphate and treatment with water, the hydrate of neptunic acid was obtained in a pure condition. Neptunium may be distinguished from niobium and ilmenium by its having, along with tantalum, the property of forming an amorphous insoluble precipitate on the addition of caustic soda to the boiling solution of the fluoride; the other two form crystalline and easily soluble compounds. The very soluble character of neptunium-potassium fluoride as compared with the corresponding tantalum salt serves to distinguish it from that metal. The reactions with phosphorus salts in the inner part of the bunsen flame are the following:—tantalonic acid, colourless; niobic acid, blue; ilmenic acid, brown; neptunic acid, wine yellow. Addition of tincture of galls to solutions of the sodium salts gives characteristically coloured precipitates. The atomic weight of neptunium, determined from the double salt  $4\text{KFl} + \text{Np}_2\text{Fl}_2 \cdot 2\text{H}_2\text{O}$ , was found to be 118. Hermann has also obtained ilmenium in the form of a black powder by heating potassium-ilmenium fluoride with potassium chloride and potassium.

ABSORPTION OF HYDROGEN BY ORGANIC SUBSTANCES UNDER THE INFLUENCE OF THE SILICENT DISCHARGE.—M. Berthelot has recently found that under the effect of the dis-

charge, benzene absorbs about two atoms of hydrogen, yielding a polymeride of  $C_6H_8$ , a resinous substance with an irritating smell. On heating, benzene first distills over; then a liquid, soluble in strong nitric and sulphuric acid, finally leaving carbon containing a little hydrogen. Oil of turpentine absorbs about 2.5 atoms of hydrogen, yielding resinous products. Pure carbon does not combine with hydrogen under the influence of the discharge, and a mixture of hydrogen with acetylene behaves much in the same way as pure acetylene. A mixture of hydrogen and carbon monoxide yields the solid body observed by Brodie and Thénard,  $5CO + 3H_2 = CO_2 + C_4H_2O_3$ , a trace of acetylene being formed.

**PHOSPHORUS PENTAFLUORIDE.**—Professor Thorpe has lately described this body (Liebig, *Ann.* clxxxii.), which he prepares by the gradual addition of phosphorus pentachloride to arsenic trifluoride. Phosphorus pentafluoride is a colourless gas, with a pungent and extremely irritating odour; it reacts upon water, forming phosphoric and hydrofluoric acids. The density with regard to hydrogen was found to be 63.23 (theory requiring 63); under the pressure of twelve atmospheres at 7° it exhibits no marked deviation from Boyle's law; it does not seem to be affected by the passage through it of electric sparks either when pure or when mixed with hydrogen or oxygen. With dry ammonia it forms the compound  $2PF_5 \cdot 5(NH_3)$ .

**MOLECULAR VOLUMES OF SULPHATES AND SELENATES.**—An account of investigations on this subject has lately been published by Otto Pettersson (*Deut. chem. Ges. Ber.*, ix. 1559), in which he finds that, in the series of sulphates and selenates of potassium, ammonium, rubidium, and cesium the molecular volume of the compound is regularly increased by 6.6 when the group  $SO_4$  is exchanged for the group  $SeO_4$ ; also, that the substitution of a molecule of ammonium, rubidium, or cesium for a molecule of potassium produces an increase in volume of 9, 8, and 23 respectively in the selenates as well as in the sulphates. He has also examined the double sulphates and selenates of cobalt, nickel, and copper with potassium, in which results are found tending to confirm the hypothesis that in double salts the components are unaltered; this is more marked in the case of the selenates, in which the volumes of the double salts are equal to the sums of the volumes of their components. The author disagrees with Favre and Valson in their conclusions that double salts cannot exist in solution, and are formed at the moment of crystallisation; he believes on the contrary that as no contraction takes place on crystallisation these salts may be held to exist in the same condition in solution as after crystallisation; the double salt of thallium is, however, an exception. In the case of the alums also when obtained in an anhydrous condition the volume of the salt exactly equals the volumes of its components.

**CONTRIBUTIONS TO THE THEORY OF LUMINOUS FLAMES.**—A continuation of experiments on the above subject is given by K. Heumann (*Liebig's Ann.*, clxxxiii.), in which he finds that carbonaceous matter will give luminous or non-luminous flames, according as the temperature of the flame is high or low; diluting the gaseous combustible with indifferent gases also requires a higher temperature to cause a separation of the carbon, and thus produce luminosity. Reduction of temperature in a flame prevents either partially or entirely the formation of carbon, consequently the author thinks that the deposition of carbon on cold surfaces in a flame is not the consequence of cooling, as a deposition may be formed on red-hot surfaces, but burns away in contact with air. In burners of different materials, those of iron were found to prevent the luminosity of the lower part of the flame to a greater extent than those of steatite, also when the burner is heated, a greater amount of light is produced, the consumption of the combustible remaining the same. Herr Heumann thinks that by heating the burner the luminosity is increased, and extends to a greater extent over the lower part of the flame.

## NOTES

We are informed that H.M. Government has just been pleased to sanction the necessary expenditure to replace the important deep-soil thermometers of the Royal Observatory, Edinburgh, which were so cruelly broken by a madman last September. The estimate has been prepared by Messrs. Adie and Son, Princes Street, Edinburgh, and is understood to include everything that can conduce to scientific accuracy.

PROF. J. DEWAR, F.R.S.E., Jacksonian Professor of Natural Experimental Philosophy in the University of Cambridge, has been elected Fullerian Professor of Chemistry to the Royal Institution in the room of Dr. Gladstone, resigned.

DR. COLAN, the senior medical officer of the recent Arctic Expedition, has been promoted to be Deputy Inspector-General of Hospitals.

DR. W. B. CARPENTER, C.B., commenced, on Monday evening, at the School of Mines, Jermyn Street, a free course of lectures on geology, which he is delivering as Swiney Professor.

At the meeting of the French Geographical Society on April 4 it was announced that the great gold medal of the Society had been awarded to Commander Cameron in recognition of his services in the cause of geographical science.

THE estimate for "Education, science, and art in Great Britain amounted in 1853-4 to 578,000*l.*; this year the estimate was 3,546,000*l.*" "In 1835 the Government paid for public education a sum of 26,750*l.*, but in 1875-6 the amount had increased to 3,972,008*l.*"

AMONG the fifty-seven candidates for admission into the Royal Society are two clergymen of the Church of England, one Wesleyan minister, one peer, one foreign baron, one baronet, eleven M.D.s, &c.

THE late Mr. J. C. Tufnell has bequeathed to University College, Gower Street, 5,000*l.* to be used in establishing two scholarships, one in general chemistry and the other in analytical and practical chemistry.

THE Rev. E. Ledger, Gresham Professor of Astronomy, will deliver a course of Lectures on the Telescope, in the theatre of Gresham College, on the evenings of April 17, 18, 19, 20. The electric light will be used to illustrate the lectures.

LIEBIG is to have another monument. A few weeks ago we noted the "inauguration" of one at Darmstadt. Subscriptions are now being collected for the purpose of raising a statue to him in Munich. About 7,000*l.* has already been contributed.

MR. H. W. S. WORSLEY-BENISON, F.L.S., has been appointed Lecturer on Botany at Westminster Hospital.

THE services of Mr. W. Saville Kent, F.L.S., F.Z.S., have been engaged temporarily to superintend and place in thorough order the "Fish House" at the Zoological Society's Gardens, Regent's Park. A considerable number of marine fish and other specimens of interest have been imported to the tanks during the past week.

TWO views have been offered as to the mode of action of the gas in the radiometer. One attributes the motion to reaction of gas particles getting heated on the vanes, then dancing off; the other to air currents which are directed towards the plate in consequence of heated air rising from it. M. Neesen has endeavoured (*Pogg. Ann.*) to decide between these views. If the second view is correct, he argued, the wall of the vessel, by becoming also heated, must also acquire influence through rise of heated air from it as from the vanes. If the rotation be merely a phenomenon of reaction there is no reason to suppose such an influence of the fixed wall. Now by giving the radiometer an

eccentric position within the glass vessel such an influence of the walls should be readily recognised. He describes a number of experiments made in this way, and which he regards as supporting the second view.

IN an article contributed to *Poggendorff's Annalen*, M. Zollner is led to take the following positions in reference to the radiometer. The explanation of radiometric motions based on the principles of the mechanical theory of gases, makes suppositions about the relation of the mean lengths of path of the gas molecules to the dimensions of the vessel which are not realised in fact. This explanation further leaves out of consideration, without sufficient ground, the simultaneous existence of mercury vapours whose molecules have a more than seven times greater mass and a much smaller mean length of path than the molecules of the gas acting according to the mechanical theory of gases. Hence we are not warranted in regarding the radiometric motions discovered by Crookes as an empirical confirmation of the mechanical theory of gases.

BERLIN dealers in delicacies have recently received from the south, and especially from Upper Italy, immense quantities of edible birds which have been captured there in their flight northwards. Unfortunately there were not only snipe, fieldfare, and larks, or so-called "delicacies" among the birds sent, but also singing birds, that are never eaten in Germany, such as goldfinch, thrush, and nightingales. The animals were caught on their migratory flight by means of nets, or surprised during the flight and indiscriminately killed. A new indication of the importance of an international law for bird protection!

AN exhibition of objects relative to pre-historic archaeology will be opened shortly in Moscow, and promises to be very interesting.

AN elaborate volume just published by the Federal Statistical Bureau of Switzerland, gives the number of scientific societies in the country in 1875 as 46, with 54,955 members. The societies or educational purposes numbered 816, with 54,424 members.

THE municipal authorities of Berne have set aside the sum of 14,000*l.* for the foundation of a Museum of Natural History in that city.

ASSOCIATIONS and Committees are being formed in most of the large towns of the Netherlands with the object of "fitting out a suitable vessel for Nova Zembla and other stations of interest in the Arctic regions." The avowed aim of the expedition is not the discovery of the Pole, but the erection of some unpretentious granite monuments to the memory of the glorious discoveries of the earlier Dutch navigators. About the end of the seventeenth century, "in the name and on behalf of the honourable Council of the renowned City of Amsterdam," Willem Jansz set out on his third voyage, which ended in the explorer's wintering on Nova Zembla, whence he never returned. It is, above all, the memory of Barends which the Dutch re about to honour. The costs of the expedition are to be defrayed by voluntary subscriptions, and the vessel will, in all probability, be commanded by a Dutch lieutenant who has taken part in three Arctic expeditions under the British flag.

THE Committee of the German African Society has issued an appeal for help towards the establishment of a series of permanent stations in Africa, so as gradually to narrow the area of the unknown country, to serve as centres of culture, and to be depots of information and for trade with the natives. The effort would be in sympathy with that of the International Congress at Brussels, and the appeal is made specially to Germany to maintain the exceptionally high place she has taken in the scientific discovery of Central Africa.

GEOGRAPHICAL students will be glad to learn that an index to *Petersmann's Mittheilungen aus Justus Perthes's geographischer*

*Anstalt über Wichtige neue Forschungen auf dem Geographischen Gebiete der Geographie* has been published for the period between and including the years 1865 to 1874. The value of this is greatly increased by the publication therewith of index maps, which show at a single glance those parts of the world of which maps have been published in the *Mittheilungen* during the period in question, with references to the places where they have appeared.

GEN. UCHATIUS bases his invention of the steel bronze, or more correctly, hard bronze, cannons, now introduced into the Austrian service, on the observation, that all metals (with exception of lead and zinc) have their elasticity increased, when they have undergone a continuous weighting above their first limit of elasticity. In the first February number of *Dingler's polytechnisches Journal*, M. Uchatius gives, in reply to the objections of some technologists, the results of further experiments, which appear to show that even homogeneous bronze is capable of a great increase of its elasticity through simple stretching, without condensation. It is only a stretching of the metals above their limit of elasticity, whereby the molecules, brought to a state of flow, glide over each other, and assume a wholly new position more favourable to resistance, that causes the increase of elasticity. A simple condensation produces merely an increase of the absolute solidity and diminution of the tenacity, but no real increase of elasticity. The limit of elasticity may be raised nearly to the breaking consistence, so that in many cases it is six and seven times the original. Mere stretching for a short time is of little use; the tension must act a considerable time. It is also well to apply a gradually increasing weight.

A SINGULAR fact with reference to the production of heat is described by M. Olivier (*Comptes Rendus*). A square bar of steel 15 mm. in width and 70 to 80 cm. long is seized with the two hands, placed, one at one end, the other in the middle of the bar. The other end is pressed against an emery grind-stone rotating rapidly. In a few minutes the rubbed end is considerably heated. The band at the middle has no sensation of heat, but that at the extremity is strongly heated, so that it has to be taken from the bar. Thus, in certain cases, heat appears not to be propagated in metals from one part to that next it.

IN the year 1824 M. Wohler made the observation that palladium, whether in the form of sponge or of polished sheet, has the property of becoming sooty in a spirit flame, and gradually coated with a thick layer of carbon. A piece of spongy palladium will thus be enlarged to several times its original volume. The same phenomenon occurs if the metal is made to glow in a coal-gas flame. If the deposited carbon be burnt, there remains always a fine skeleton of palladium, which is then found to be penetrated with the carbon and quite brittle. By more recent experiments M. Wöhler convinced himself that the phenomenon is not due to a special affinity of palladium for carbon. He is rather of opinion that the strong absorption power of this metal for hydrogen is the reason why ethylene gas and the gases of the spirit flame, which themselves are not absorbed by palladium, are decomposed under the influence of this metal, as the experiments show, with separation of carbon.

LED by speculative considerations regarding the formation of the earth, M. Sacher, of Salzburg, made experiments a short time ago on the solidification of balls of spermaceti floating freely in a liquid, and he has more recently experimented on the propagation of heat in unequally dense liquids. In a beaker glass, 16 cm. high, he put five layers of alcohol varying in density from 0.98 to 0.82, and each 3 cm. thickness. Three thermometers were placed with their bulbs in the first, third, and fifth layers respectively, and the vessel was slowly heated from below. In another similar vessel containing liquid of the same density, the three thermometers showed nearly the same temperature;

but in the stratified liquid marked differences appeared between the layers on readings being taken every five minutes. Thus in ten minutes the readings were 31° (below), 18°5' (middle), 18° (top); after twenty minutes, 44°, 19°5', 18°; after fifty-five minutes, 77°, 40°, 21°. The numbers prove, then, that in liquids of decreasing density heat is distributed very slowly from below upwards. Experiments in cooling led to a similar result.

PROF. QUINCKE, of Heidelberg, has long experimented as to whether gases can penetrate through the pores of glass. A pressure of forty to one hundred and twenty atmospheres is found to be incapable of forcing a perceptible quantity of carbonic acid or hydrogen gas through a glass wall 1.5 mm. thickness, during a period of seventeen years. No loss of weight was perceptible. M. Quincke, however, will not draw the inference that the molecules of hydrogen and carbonic acid have larger dimensions than the molecules or pores of the glass. The distance at which the molecular forces of the glass act on the gas-particles is of course greater than the dimensions of the molecules themselves. The pore walls of the glass may get coated with an "absorbed" gas layer, which itself becomes immovable through the nearness of the solid substance, and hinders the passage of gas particles from the interior of the glass tube into the outer air. Perhaps, too, there may be dropable liquid in the pores of the glass, preventing outflow of the gas. A similar objection applies (according to M. Quincke) to M. Traube's method of determining the size of the molecules of a substance from the possibility of passing through a so-called "precipitate-membrane."

A DROUGHT in excess of any that have occurred during the last fourteen years, as regards long continuance and severity, has prevailed for some months in Victoria and parts of Australia adjoining. It terminated about February 12, and from that date to the 22nd of the same month, when the mail left, heavy thunderstorms and rainfall had prevailed, and cooler weather set in. The reports from Deniliquin and other places in the interior state that not a blade of grass was to be seen on the plains, and cattle were dying in thousands.

THE Russian Naval Department proposes to send a ship this summer to the mouths of the Obi and Jenissei to make a thorough maritime survey of both gulfs.

THE *Western Review of Science and Industry* is the title of a new monthly devoted to various departments of science, and published in Kansas City, Mo.

In view of the promising future of the African continent M. Bernardin, of Ghent, has done a good service by publishing a brochure (compiled from the works of various travellers), on the commercial products of Central Africa. An excellent map of Petermann's, showing the standpoint reached by exploration up to September, 1876, is included in the pamphlet.

THE death is announced of Prof. P. Panceri, the eminent Italian anatomist. He died suddenly whilst lecturing in the University at Naples.

THE additions to the Zoological Society's Gardens during the past week include a Common Wolf (*Canis lupus*) European, presented by Mr. J. A. Parlet; a Ceylon Fish Owl (*Katupa ceylonensis*) from Ceylon, presented by Capt. B. B. Turner; a Vulpine Phalanger (*Phalangerista vulpina*) from Australia, presented by Mr. W. Bazsley; two Sykes's Hemipodes (*Ternix sykesii*), a Rain Quail (*Coturnix coromandelica*), an Asiatic Quail (*Pardipha asiatica*) from India, three Chinese Quails (*Coturnix chinensis*) from China, presented by Mrs. Wood Mason; an Entellus Monkey (*Semnopithecus entellus*) from India, received in exchange; a Collared Fruit Bat (*Cynonycteris collaris*) born in the Gardens.

SOCIETIES AND ACADEMIES

LONDON

Chemical Society, April 5.—Prof. Odling, F.R.S., in the chair.—A lecture on the discrimination of crystals by their optical characters was delivered by Prof. N. S. Maskelyne, F.R.S. After a few general remarks on the use, to the chemist, of the methods employed by crystallographers, the lecturer proceeded to consider the methods of determining the symmetry of crystals by their optical characters. The origin and meaning of various terms used in crystallography were explained and illustrated by models, &c.; the lecturer then threw on the screen, by means of a polarising apparatus and the electric light, the beautiful coloured effects produced by crystals of curassite, barytes, borax, &c., the effect of heat in altering the position of the optical axes of a crystal of gypsum being especially beautiful. In conclusion, the lecturer pointed out the ready means, which the examination of the optical characters of a crystal under the polarising microscope often afforded to the chemist, of acquiring a great deal of information in a very short time, and expressed a belief, that if chemists would work up suitable groups of crystals for examination by the crystallographer, very important knowledge as to the functions of various groups of molecules in a crystal would be gained.

Anthropological Institute, March 27.—Col. A. Lane Fox, F.R.S., V.P., in the chair.—Capt. W. Samuells, of the Bengal Staff Corps, was elected a member.—An account of some Kitchen Middens near Ventnor, by Mr. Hodder M. Westropp was read by the director. A corn-crusher, of Scandinavian appearance, was found in one of them, and in another higher up in the cliff, there was discovered a small cinerary urn of unusual shape encircled with a pattern of coralline sea-weed.—Messrs. W. Power and E. Laws communicated a short paper on a Kitchen Midden near Tenby; Dr. Crockley Clapham a paper on the brain-weights of the Chinese and Pelew Islanders; and Mr. James Shaw some notes on right-handedness and improved instinct in animals during the human period. Dr. Clapham found that the weight of the brain both of the Chinese and the Islanders was above the average, but they presented certain peculiarities in their convolutions. The skulls of the Pelew Islanders were markedly dolichocephalic. The size of the brain of the Chinese and the Islanders was in no wise an index of the intelligence possessed by them.

MANCHESTER

Literary and Philosophical Society, February 6.—E. W. Binney, F.R.S., president, in the chair.—Notice of the Junior Literary and Philosophical Society of Manchester, 1806-1807, by W. E. A. Axon, M.R.S.L.—On compound combinations, by Prof. Cayley, F.R.S., &c.—On ternary differential equations, by Robert Rawson.—On the powerful oxidising action of animal charcoal upon organic matters as shown by the analysis of the drainage from a large heap of a mixture of night-soil and animal charcoal, by William Thomson, F.R.S. Edin.—A plea for the word "Anglo-Saxon," by Rooke Pennington, LL.B., F.G.S.

CAMBRIDGE

Philosophical Society, March 12.—Prof. Cayley, vice-president, in the chair.—Prof. Clerk Maxwell communicated to the Society a paradox in the theory of attraction.

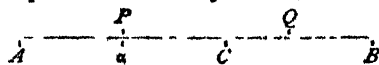

Let the line *AB* be divided in any given point *C*, and let

$$PC^{-1} - AC^{-1} = CQ^{-1} - CB^{-1}$$

be the condition of correspondence of two points *P* and *Q*, in the segments *AC*, *CB* respectively, then if *P* and *Q* vary simultaneously, still remaining correspondent,

$$PC^{-2}d(PC) = CQ^{-2}d(CQ),$$

or the corresponding elements are to each other as the squares of their distances from *C*. If we now suppose that *AB* is a material line of uniform density, the law of attraction being the inverse square of the distance, the attractions of corresponding elements on the point *C* will be equal and opposite. But every element of *AC* has a corresponding element in *CB*, and hence we might conclude that the attraction of *AC* on *C* is equal and opposite to that of *CB* on *C*, which is evidently not the case, unless *AC* = *CB*. The paradox is explained by considering that all that we have proved is that the attraction of *AP* on *C* is equal and opposite to that of *QB* on *C*, and this however near to *C* the

corresponding points *P* and *Q* are taken, and this is strictly true. But however near to *C* the corresponding points are taken, the attractions of *PC* and of *QC* are both infinite, but differ by a constant quantity, namely the attraction of *AC* on *C*, where *AC* is taken equal to *CB*.—Prof. Clerk Maxwell also made a communication on double and triple integration by summation.—Mr J. W. L. Glaisher gave a preliminary account of the results of an enumeration of the primes in Burckhardt's tables (1 to 3,000,000).

PARIS

Academy of Sciences, April 2.—M. Peligot in the chair.—The following papers were read:—Isoperimetric triangles having one side of constant length and satisfying three other conditions, by M. Chasles.—On a theorem relative to expansion of vapours without external work (continued), by M. Hirn.—Report on a new work of M. Bertin, following his note on rolling. This work gives an account of M. Bertin's double oscillograph, which records each instant the inclinations of the ship in the direction of the rolling and the inclination of the part of the wave which carries the ship; also observations with it from the war-ship *Crocodile*. Though the indications are only approximate, they are thought of considerable interest. Admiral Paris called to mind an instrument devised by his son in 1867, for tracing waves.—Experimental researches on natural sulphides, by M. Meunier. It is a general fact that natural sulphides brought into the presence of suitable metallic solutions cause reduction in the free state of the dissolved metal. The experimental facts given seem to have a bearing on the mineralogical associations so frequent in metalliferous veins. If a vein of galena receive the infiltrations of sea-water (which always contains silver), all the silver will be held and concentrated by the sulphide. Now native silver exists in a certain number of galenas, and we may suppose it has been thus introduced.—New nebulae discovered and observed at the Observatory of Marseilles, by M. Stephan. Thirty in number.—On the approximation of a class of transcendents which comprise, as a particular case, hyperelliptic integrals, by M. Laguerre.—On the paraboloid of eight straight lines, by M. Mannheim.—On the theory of frigorific machines, by M. Terquem. Even under the best conditions, frigorific air-machines cannot successfully compete with machines having volatile liquid, (1) because of the large size necessary, (2) the passive resistances due to this, and the use of two pumping bodies; and (3) the want of adaptability to produce different degrees of refrigeration. Their advantages are the production of lower temperatures, simplicity, and the use of a safe and cheap agent.—Researches on the metallic reflection of obscure and polarised calorific rays, by M. Mouton.—On the sulphide of manganese, by MM. De Clermont and Guot. They produce the green sulphide in new cases, and by reactions in which its formation was said never to have been observed. Thus M. Muck says it is impossible to transform manganous carbonate into green sulphide; but the authors effect this by heating in free air, with ebullition, carbonate of manganese, precipitated with some sulphhydrate of ammonia. They find the rose sulphide dried at 105° contains 9 per cent. of water (green sulphide at 110° is anhydrous). The rose sulphide is much more soluble in chlorhydrate of ammonia. These sulphides are thought isomeric modifications of one and the same body, more or less hydrated.—Reply to remarks of M. Chevreul concerning the phosphorescence of organic bodies, by M. Radziszewski. He adduces some facts showing that in phosphorescence the slowness of the reaction is an essential condition, though to define the maximum and minimum limits would be difficult at present.—Two cases of aneurism of the bend of the elbow treated successfully with the antiseptic ligature of catgut, by M. Boeckel.—On some abnormal fecundations in star fish, by M. Pol.—On the distribution of carbonic acid of the blood between the red corpuscles and the serum, by M. Fredericq. It is generally said that all or nearly all the carbonic acid held in the blood is in the serum (or plasma) in the state of combination or solution. Examining venous horse-blood, the author found the red corpuscles capable of absorbing a considerable quantity of CO<sub>2</sub>, though always less than that taken by an equal volume of serum (about a half less). Passing a current of CO<sub>2</sub> through the blood, the excess seemed to be distributed equally between the corpuscles and the serum. Whole blood can be almost directly deprived of its gases by vacuum and heat; it is quite otherwise with serum, which, after such treatment, will give a fresh liberation of CO<sub>2</sub>, when treated with phosphoric acid newly boiled. This invalidates some of MM. Mathieu and Urbain's results.—On the rôle of stomates and cuticular respira-

tion, by M. Barthélemy. He thinks M. Mejer's recent experiments overlook the most important factor in the case, viz., the living being submitted to experiment, the leaves having been detached from the plant and submitted to various vapours.—Observations of globular lightning formed and bursting without sound above a layer of clouds, by M. Blanc. The apparent diameter of the balls at 18 k. distance was 1°; they were reddish or yellow, but always white on bursting; they went horizontally, and looked like immense soap bubbles.

VIENNA

Imperial Academy of Sciences, March 1.—The following among other papers were read:—Main outlines of a theory of the sense of temperature, by M. Herzog.—Researches on the Tunicata of the Adriatic and the Mediterranean, by M. Heller. The freely-moving Salpæ and Salpæ-like Ascidians, which are numerous in the Mediterranean, are almost wholly wanting in the Adriatic.—On normal hexylic alcohol and normal cenanthylic acid, by M. Janacek.—Researches on the extension of the tonic vascular nerve-centres in the spinal cord of the dog, by M. Stricker.—The development of the antheridium of *Anthoceros*, by M. Waldner.—On Ranvier's representation of bone-structure, with remarks on the use of a Nicol in microscopic researches, by M. Ebner.—On metanitro- and metamido-benzocetyllic acid; on the action of animal charcoal on salts; on solution of sulphur in acetic acid; and on demonstration of fuchsin in wine, by Dr. Liebermann. Fuchsin solutions give very characteristic absorption bands, in the spectrum, between yellow and green. Fuchsin may be detected even with a dilution of 1:500,000.—Note on molecular transformations, by M. v. Sonstöff. Iodine crystals kept eight years in a glass vessel were found to grow by volatilisation and subsequent condensation. Amorphous phosphorus passed, in part, into the crystalline state.—On the origin of the sodiacal light, by M. Noe.—Behaviour of calcium-phosphate towards sugar solutions, by M. Krasan.—On new Rudista from the Bohemian chalk formation, by M. Teller.—On the Sarmatian deposits between the Danube and the Timok, by M. Toula.—Researches on the etiology of Pelorian flower-forms, by M. Peyritsch.—On a new method of determining the internal resistance of galvanic batteries, by M. Fieschl. The two like poles of two equal elements (of the kind to be measured) are connected, and the resistance of this currentless combination is then compared with a known resistance.—On the geological character of the Isthmus of Suez; the pliocene formations of Zante and Corfu, the nature of the Sarmatian formation and its analogies in the present and in earlier geological epochs, by M. Fuchs. The fauna of the Red Sea and Mediterranean are very different, but they appear to have been so also before the Isthmus arose.

CONTENTS

	PAGE
THE ARCTIC BLUE-BOOK . . . . .	505
ANTI-HACKER . . . . .	507
OUR BOOK SHELF:—	
Jewitt's "Half-Hours among some English Antiquities" . . . . .	508
LETTERS TO THE EDITOR —	
Centralism in Spectroscopy —Prof. PLAZZI SMITH . . . . .	508
Parthena and Paraselenia seen on March 20, 1877, and again on March 21, 1877, at Highfield House Observatory —L. J. LOWE (With Illustrations) . . . . .	508
Owens College —W. STEADMAN ALDIS . . . . .	509
The Suspected Intra-Mercurial Planet, Occultation of Kappa Centaurum, —J. BIRMINGHAM . . . . .	509
a Centauri —MAXWELL HALL . . . . .	510
The Boomerang —ARTHUR NICOLS . . . . .	510
in Meteorology a Science? —RALPH ABERCROMBY . . . . .	510
Atmospheric Currents, —JOSIEF JOHN MURPHY . . . . .	510
The Germ Theory —Dr. T. MALLAGAN . . . . .	511
SEXUALLY IN PLANTS, BY W. R. McNAB . . . . .	511
TYPICAL LAWS OF HEREDITY, II By FRANCIS GALTON, F.R.S (With Illustrations) . . . . .	512
ON THE SIMILAR CONTINUOUS MANIFOLDNESS OF TWO DIMENSIONS AND OF FINITE EXTENT By F. W. FRANKLAND (With Illustrations) . . . . .	513
HYDROGRAPHY OF WEST CENTRAL AFRICA . . . . .	517
THE LONDON INDUSTRIAL UNIVERSITY . . . . .	518
OUR ASTRONOMICAL COLUMN:—	
The Opposition of Mars in 1892 . . . . .	519
The Comet 1873 II (Tempel, July 3) . . . . .	520
New Comet . . . . .	520
CHEMICAL NOTES:—	
The New Metals Iridium and Neptunium . . . . .	520
Absorption of Hydrogen by Organic Substances under the Influence of the Silent Discharge . . . . .	520
Phosphorus Pentasulphide . . . . .	521
Molecular Volumes of Sulphates and Selenates . . . . .	521
Contributions to the Theory of Luminous Flames . . . . .	521
NEW BOOKS . . . . .	521
SOCIETIES AND ACADEMIES . . . . .	523

THURSDAY, APRIL 19, 1877

## AGRICULTURE IN THE UNITED STATES

Report of the Commissioners of Agriculture of the United States of America for the Year 1875. (Washington, Government Printing Office.)

THE first impression that strikes us upon taking up this substantial volume is closely allied to envy. Here is a fund of valuable and condensed information relating to every point connected with the development of the soil's resources, a record of original work and of experience at home, and abounding in suggestions from the practices of other countries. It is true we have to some extent, in the excellent transactions of our great agricultural societies, a means of presenting a digest of agricultural progress. But these are, and must to some extent be, written in popular style, whereas the Report before us, while deeply interesting, is essentially business-like and proportionally more useful to those whom it concerns.

It may be thought by many that a new country, of boundless extent like America, can scarcely have advanced to a stage in agricultural progress demanding the assistance of science; that the breaking up of virgin tracts by adventurous settlers is scarcely an occupation to elicit sympathy on the part of the workers in microscopic examinations and chemical analyses. Such is, however, not the case. "Farmers and planters," we are told, "now realise that there is something else in this important work beyond the mere drudgery of sowing, reaping, and curing;" and again, "the general awakening of interest in agricultural subjects has induced a considerable correspondence with the botanical division," as well as with the chemical and other departments.

The Report of the Commissioners includes those of the statistician, the entomologist, and the chemist; and besides these departments, details are given of the labours of the Horticultural, Botanical, Seed, and Microscopic Sections. The report of the statistician reveals the immense extent of cultivated land in the United States. Close upon 45,000,000 acres of maize, producing 1,321,000,000 bushels of corn account for the cheap rate at which this commodity has recently been offered in this country. The vast area of 26,381,512 acres of wheat producing, in 1875, 292,000,000 bushels, also throws light upon some of the difficulties of competition which now perplex the English wheat-grower. Here is a supply of wheat capable of feeding 53,000,000 human beings for one year, and, to put it in another light, grown upon eight times the area devoted to this purpose in Great Britain. The total population of the States is 38,115,641, so that they not only are able to feed themselves, but to export a sufficient amount to maintain the population of Great Britain nearly half a year.

The report of the Entomologist upon *Heteroptera* or "plant-bugs," contains a large number of illustrations and short descriptions of many species, some of which are injurious, while others, owing to their carnivorous tendencies, are beneficial. This information is followed with practical directions for coping with insect pests, which, if not novel, are at least useful. In the chemical section

the effect produced by various mineral substances upon growing vegetables when added to the soil have been demonstrated by Mr. Abram McMurtrie. The deleterious effect of arsenical compounds has been tested upon plants grown in pots, and the results are vividly brought before the reader by illustrations showing the comparative sizes attained by the plants experimented on. The agriculturist is not as interested in substances detrimental to plant life as in those which produce an opposite effect. The lesson taught by such experiments is, however, exceedingly useful, for there is, no doubt, great room for experiments upon growing plants so placed that the surrounding conditions of soil, air, and water may be regulated with a special purpose in view.

A considerable section in the middle of the volume is occupied with an account of the sheep exhibited in the Vienna Exhibition of 1873. The information is no doubt highly useful, as it gives the American reader a graphic idea of the various breeds of English and Continental races of sheep. The ample details regarding the Merino sheep are chiefly taken without acknowledgment from a report contributed by Prof. Wrightson to the Journal of the English Agricultural Society, and are therefore familiar to English readers.

After 150 pages upon "Statistics of Forestry" and varieties of fruit, there is an interesting account of the method of curing forage by *ensilage*. This process consists in burying green fodder in pits (*silos*) or trenches, and covering it with earth. The process is applied to green maize, rye, rye-grass, rape, red clover, and autumnal vetches. It is impossible in a short notice like the present, to give a description of the method pursued, but there is no doubt that it is practicable. M. Crevat, after several years' trial, has settled upon pits of the following dimensions. Depth 7'55 feet, length 28'25 feet at the surface of the ground, sloping down to 24'28 feet on the bottom; breadth 8'53 feet at the top, and 6'56 feet at the bottom. Each pit has a capacity of about 1,412½ cubic feet, and appears capable of holding about 10½ tons of green fodder. There appear to be many modifications of the process, some farmers partially drying the fodder before pitting it, while others prefer pitting it fresh. Contrary as this may appear to our usual system of carefully drying hay before carting it, the general adoption of this method of storing fodder in many continental countries proves that green fodder may be preserved if firmly trodden down so as to exclude the air. The same plan succeeds admirably with sugar-beet pulp which may be kept in pits for any length of time. English farmers preserve brewers' grains by trampling them firmly into large vats, and, at the same time, sprinkling salt among them. Salt is also frequently employed in the process of *ensilage*, or making sour hay, but as often the process is completed without its assistance. The report of the Commissioner certainly throws light upon the subject, which we think deserves the attention of English agriculturists, and especially of colonists.

The general interest in scientific agriculture is remarkably evinced in America by the large number of agricultural colleges. There are no fewer than thirty-nine agricultural and mechanical colleges attended by 3,703 students and taught by 453 professors. When it is remembered that the total population of the States is only fractionally

larger than our own, the fact of the existence of nearly 4,000 agricultural students is somewhat startling. In this country we have one agricultural college supported by less than 100 students. Yet we are the possessors of the most extensive colonies in the world, far exceeding, in extent, even the vast area of the United States. It may well be difficult for English agriculturists to compete with foreign rivals if the meagre number of agricultural students in England compared with America may be taken as in any degree a gauge by which interest in scientific progress may be measured.

#### CUMMING'S THEORY OF ELECTRICITY

*An Introduction to the Theory of Electricity.* By Linnæus Cumming, M.A. (London: Macmillan and Co., 1876.)

MR. CUMMING deserves our thanks for having made an effort to introduce into elementary teaching the advances in the treatment of electricity made chiefly by the labours of Green, Thomson, and Clerk-Maxwell. Mr. Cumming possesses all the qualifications necessary for such a task. He evidently has a full knowledge of the subject, and seems to possess, in addition, experience as a teacher. He has had, no doubt, great difficulties to encounter. These difficulties are not alone due to the limitations as to the mathematical knowledge of his readers, which Mr. Cumming has justly imposed on himself. The books and papers out of which Mr. Cumming had to take his material, were written from various points of view, and they were chiefly addressed by scientific men to scientific men. It was natural that the same words should not be always used exactly in the same sense, the great object being that men already possessing a knowledge of the subject should understand each other. It is only when the knowledge of a certain subject is comparatively advanced that the terms settle down into a definite meaning. A text book, on the other hand, is addressed to students who at the most have only a slight acquaintance with the subject, and it should not only teach that particular subject, but also scientific method, and scientific reasoning. It is, therefore, of primary importance that the precise meaning of the term should be scrupulously adhered to. Even a good definition does not always ensure this, for there is often a metaphysical colouring which does not come out in the definition, but which we soon discover in the way a term is used. We take one example. The word potential is defined by Sir Wm. Thomson thus:—

"The potential at a point is the work which would be done on a unit of positive electricity by the electric forces if it were placed at that point without disturbing the electric distribution, and carried from that point to an infinite distance."

Nothing could be more precise than this, yet the word potential will call forth different associations in different minds, and this will greatly influence the way in which the word is used. Some writers will attach no meaning to the potential at a point, except in so far as they can imagine an electrified particle to be placed at that point, to others the expression will convey a perfectly definite meaning, defining the state of the medium at that point,

irrespective of any electrified particle which might be placed there. It will generally be soon found out in what sense the writer uses the word.

The passage in Mr. Cumming's book which has suggested these remarks, is contained in Prop. 8, p. 203. The proposition runs thus:—

"In computing the potential of any closed circuit, we may substitute for it any closed circuit which is obtained by projecting the given circuit by means of lines of force."

The expression potential of a circuit may perhaps have sometimes been used for the induction or number of lines of force through a circuit; yet we imagine the term suggests rather the idea of action at a distance, and would be analogous to substituting in electro statics the expression "potential of a point" for that generally used—"potential at a point." Mr. Cumming has so consistently adopted the views and language of Faraday and Clerk-Maxwell, that we have been struck rather unpleasantly by the passage. This is, perhaps, only a matter of detail, and we may here remark that Mr. Cumming might with advantage have bestowed more care on the wording of his propositions. On p. 40, for instance, an experimental law is given, and two exceptions are added. With very little trouble the law might have been worded so as to admit of no exceptions. Other examples might be given.

There is one feature in the book about which we should like to make a few remarks. An occasional allusion to hypothetical matters cannot of course be altogether avoided, yet we think that in books like Mr. Cumming's, which are intended to give an outline of what is known, and not of what is unknown, of the subject, such allusions should be reduced to a minimum.

On p. 119 five propositions are given on molecules and atoms, which are not alluded to throughout the book except in the following passage:—

"From the last statement it can be easily seen that when the molecules of two different solids impinge on each other, as at the surface of contact, they cannot accommodate themselves to each other's motion, but constrain each other, this constraint producing a loss of energy. If, however, the two solids are of the same kind and at the same temperature, the molecules on each side of the surface of contact are swinging in exactly the same manner, and can easily accommodate themselves to each other's motion without more constraint than exists in the solid part of either body. It is this loss of energy owing to the unsymmetrical swinging of the molecules at the surface of contact which reappears as difference of potential between the two solids, or as the energy of electrical separation.

"The opposed electricities so separated will, for the most part, be heaped up on either side of the plane of separation by a Leyden jar action."

In the same chapter Mr. Cumming gives his opinion on the theory of the voltaic cell and electrolysis in general. We are told how we might imagine the atoms and molecules to be placed; we are told about polarisation; but Faraday's laws are not even alluded to.

It would, of course, be an advantage to science if Mr. Cumming were to take an active part in the theoretical and experimental investigation of the subject; yet we doubt whether a text-book on the theory of electricity is the best place to bring his views forward, especially if



they are in contradiction to the best experiments we have on the subject (Sir William Thomson's). A teacher ought to be spared as much as possible from having to tell his students that he does not agree with the writer of a text-book.

The parts of Mr. Cumming's book which we have ventured to criticise refer chiefly to matters of taste. There is no doubt that in the hands of a good teacher the book will prove very useful. We hope that it will have a wide circulation, and that a second edition will soon enable Mr. Cumming to introduce such improvements as on a reperusal of his own book may occur to him.

ARTHUR SCHUSTER

### OUR BOOK SHELF

*Proceedings of the London Mathematical Society*, vol. vii. November, 1875, to November, 1876. (London: Messrs. Hodgson and Son, Gough Square.)

IN the present volume we have about thirty communications made by eighteen writers. Prof. Cayley writes on Three-bar Motion (treating the matter in a different way from that in which it is handled in this same volume by Mr. S. Roberts, the priority of whose results is conceded by Mr. Cayley) on the Bicuspal Sextic; Prof. H. J. S. Smith contributes short papers on the value of a certain Arithmetical Determinant and a Note on the Theory of the Pellian Equation; Lord Rayleigh has a note on the Approximate Solution of certain Potential Problems; Mr. Spottiswoode writes on Determinants of Alternate Numbers, working out some suggestions of Prof. Clifford. This last-named gentleman contributes the transformation of Elliptic Functions with a Note, and Free Motion under no Forces of a Rigid System in an  $n$ -fold Homaloid.

In Analysis, there are further papers by Mr. J. W. L. Glaisher on an Elliptic Function Identity, and the Summation of the Geometrical Series of the  $n$ th Order as a Definite Integral; Prof. Lloyd Tanner on the Solution of Certain Partial Differential Equations of the Second Order (two papers); Mr. J. Hammond on the Relation between Bernoulli's Numbers and the Binomial Coefficients, and on the Mean of the Products of the Different Terms of a Series; Mr. T. Muir on the Transformation of Gauss's Hypergeometric Series into a Continued Fraction; Mr. S. Roberts a Further Note on the Motion of a Plane under Certain Conditions; Mr. Hewitt on a Theorem of Eisenstein's.

Under the heading of Geometry we may class Prof. Rudolf Sturm's paper on Correlative Pencils; Mr. A. B. Kempe's General Method of describing Plane Curves of the  $n$ th Degree by Linkwork; Prof. Wolstenholme's Loci Connected with the Rectangular Hyperbola.

There are a few shorter communications. We have said enough to give our mathematical readers an idea of the range of subjects treated in this volume. The names of the authors are a sufficient guarantee that the subjects are ably treated and brought down to the latest accepted results.

*A Primer of Chemistry, including Analysis.* By Arthur Vacher. (London: J. and A. Churchill, 1877.)

THIS little book attempts to present within the limits of a hundred pages "a general view of the elements of inorganic chemistry." It embodies the experience gained by the author during ten years in which he has been engaged in teaching the subject, and the result is that many points are treated in somewhat novel fashion. The subject is considered as fully as could be expected within the narrow limits mentioned, and the amount of information conveyed is really considerable and generally accurate.

The first sixty-seven pages contain chapters on "Ex-

periments with some of the Elements," "The Use of Symbols" in formulæ, equations, and calculations, "Experiments with some Compounds," "Weights and Measures," "Classification of Compounds," and "List of Substances." The remaining thirty pages or so are devoted to Qualitative Analysis.

Perhaps the greatest novelty introduced is the use of the term *unit* instead of atomic or combining weight, so as to avoid using the terms *atom* and *molecule*, which the author thinks are "unsuitable for ordinary use among beginners;" and of *antimetal* instead of *radicle* (which latter by the way he incorrectly writes "radical"). It may be questioned whether the use of the term "unit" may not interfere with the conception of the meanings to be attached to "atom" and "molecule," which the pupil must gain afterwards. "Antimetal" is objectionable since all radicles are not antimetals; ammonium, for example, is a radicle which plays the part of a metal. Clearly the term is intended as equivalent to "acid radicle," or acid minus its basic hydrogen; it is never used in any other sense in the book, and its use with this restricted meaning may be advantageous, or at least free from objection.

Several items may be pointed out as requiring alteration or improvement; notably the following: that "a compound" is any substance which is not an element" (p. 11); that chlorine has a "pale green colour" (pp. 6 and 61); that oxygen is *insoluble* in water (pp. 39 and 56); and that  $\text{KMnO}_4$  gives a *red* solution (p. 64). In working with test-tubes the student is several times directed to add "half an inch" of acid or water as the case may be. Of course it is evident what is meant, but test-tubes are of various sizes, and a large excess of acid or other liquid would be used if the directions were followed exactly with large tubes. On p. 77, "take the charcoal quickly to your nose" is another rather curious direction.

The analytical part of the book is the best; the tables throughout being reliable. The detection and separation of cobalt and nickel (Table III., p. 95) might be effected more quickly and easily by other methods than that given; and on p. 87,  $\text{NO}_2$ , as well as  $\text{CrO}_3$  and  $\text{Fe}^{+++}$  should be mentioned as decomposing  $\text{H}_2\text{S}$ . If these and several other minor improvements be made the "primer" will not be without value in imparting the rudiments of education in chemistry; and in these days when elementary text-books are becoming so numerous, may fairly count on being appreciated as it deserves by the class of students for whom it is intended.

W. H. W.

### LETTERS TO THE EDITOR

[The Editor does not hold himself responsible for opinions expressed by his correspondents. Neither can he undertake to return, or to correspond with the writers of, rejected manuscripts. No notice is taken of anonymous communications.]

#### Hibernation of Birds

IN NATURE (vol. xv., p. 465) there is a review of "Palmén on the Migration of Birds," and in the course of it the reviewer takes occasion to refer to what he calls the "hibernation mania" as one that is now and again revived, in spite of the fact that the migration of birds is fully proved, and that no evidence at first hand has ever been produced in favour of the supposition that birds ever lie dormant.

Having frequently heard my brother-in-law, Sir John McNeill, relate a circumstance which occurred to himself proving that swallows do occasionally lie dormant, I wrote to him asking him for the particulars. I now inclose his reply, which perhaps you will publish, as it may possibly elicit other evidence on the same matter.

Gilbert White's conviction that swallows do occasionally lie dormant in this country, was mainly founded on the fact that instances are not uncommon of swallows appearing suddenly

<sup>1</sup> A chemical compound being meant as is evident from the context.

during warm sunny days in winter, and again disappearing on the return of cold. This fact it is certainly very difficult to account for on any other supposition.

Argyll Lodge, Kensington, April 11

"In your letter received last night you tell me of an article in NATURE the author of which seems to deny that swallows ever hibernate, and asserts that no one has yet testified to the fact from his own personal observation. That, however, is a mistake, for I have stated and I now repeat that I have seen swallows in large numbers hibernating. The circumstances were these:—

"About twenty-five miles south of Teheran, the capital of Persia, there is a village called Kenara-gird near which is a stream of brackish water running in a deep bed with nearly perpendicular banks some forty or fifty feet high. Being largely impregnated with salt this stream is rarely if ever frozen, and in frosty weather is resorted to by flights of wild ducks. During a frost of unusual severity I went from Teheran to Kenara-gird, accompanied by Sir Henry Rawlinson, for the purpose of duck-shooting, the severity of the frost promising good sport. Having slept at the village we next morning followed the downward course of the stream along the north bank, and had proceeded about a mile, I should think, when we came to a place where there had quite recently been a small land-slip. The brink of the bank to the extent of perhaps twenty feet in length, and ten or twelve broad in the middle, tapering off to each end, had slipped, but had not fallen down the bank. Between this detached portion and the perpendicular face about ten feet high, from which it had broken off, we saw, to our great surprise, a number of swallows, not less, I am sure, than twenty or thirty, lying, as I at first supposed, dead, but on taking up one of them I found that it was alive but dormant; it was warm and its breathing was quite perceptible. I examined a considerable number, and found that they were all alive and breathing, but none of them gave any sign of consciousness. My attention was then attracted to the perpendicular face on our left, from which the slip had broken off, and which was perforated by a vast number of holes each about the size of a rat-hole. On looking into such of these as I was tall enough to see into, I found in all of them swallows in the same dormant state. I was able with finger and thumb to pull out swallows from several of these holes, and in each case found that the hole which penetrated horizontally a considerable way into the bank, contained more swallows in the same condition. In no case did I see one lying on another—they were all lying singly with their heads inwards, each head touching the tail of the bird before it. How far these holes penetrated into the bank, or what number of swallows each contained I did not ascertain, but it is plain that the original entrance to these dormitories, must have been in the external face of the portion that had slipped, which as I have stated, was, in the middle, from ten to twelve feet thick. The holes in the undisturbed portion may probably have been of equal or greater length, and if so the number of swallows hibernating there must have amounted to many hundreds."

Villa Poralto, Cannes, April 6

#### The Swallows and Cuckoo at Menton

THE swallow that arrived here on March 19 remained solitary until April 5. Early that morning a second arrived and entered the same room as the first. I saw them flying about together in the forenoon, and these two remain the only feathered occupants of that chamber. In the afternoon of the same day, however, a party of ten arrived and distributed themselves among the houses.

Madame Valctta, of whom I spoke in my previous letter (NATURE, vol. xv., p. 488), assures me that not during the last fifty years has one swallow preceded its fellows by so long an interval as this year; but perhaps it is only that her attention has not been drawn so much to the subject. It is certain, however, that unless more are yet to come, the swallows are this year fewer than ordinary by more than one-half. The opinion of the natives is that they have perished at sea.

I heard the cuckoo for the first time this year on April 1. But a lady had told me that she had heard it nearly a week before.

DOUGLAS A. SPALDING

Cabrolles, près de Menton, France, April 13

#### Greenwich as a Meteorological Observatory

THE facts of observation appealed to by Mr. Eaton with the view of proving that Greenwich is, from artificial causes, more

than half a degree warmer than the south-east of England generally, and is therefore not a suitable place for a meteorological observatory of the first order, evidently call for a closer critical examination than they have yet received. If from the sixteen stations within a radius of sixty miles from the metropolis given in the paper on "The Temperature of the British Islands," we omit those which are clearly inadmissible for the comparison with Greenwich owing to their position or to the short time during which observations were made, there remain the following eight stations as suitable for comparison:—Cardington, 52° 7' lat. N.; Royston, 52° 2'; Colchester, 51° 53'; Hartwell, 51° 49'; Oxford, 51° 46'; Great Berkhamstead, 51° 45'; Chatham, 51° 23'; and Aldershot, 51° 15'. The mean temperature of these eight stations, allowing for elevation, is 50°·6, and the mean temperature of Greenwich, 51°·1, results substantially agreeing with those given by Mr. Eaton.

It is necessary, however, to observe that the mean position of these places does not agree with that of Greenwich. Thus while the latitude of Greenwich is 51° 28' north, the mean latitude of the eight stations is 51° 45', or 0° 17' farther north, their true mean position being about two miles due north of St. Albans. For this difference in latitude a correction of fully 0°·2 is required, judging from the position of the isothermal lines. The figures then stand thus: mean temperature of Greenwich, 51°·1; of the eight stations, 50°·8. On comparing the monthly means of the eight stations with those of Greenwich, it is seen that the residual excess of Greenwich is all but wholly occasioned by the high mean temperatures of June, July, August, and September, which are in each case 0°·9 higher than the means of the eight stations, these eight stations being nearly all outside or on the outskirts of the patch of high temperature around London during the summer months. It follows that the 0°·3 of excess of annual temperature at Greenwich over the eight stations is accounted for by the higher temperature of four out of the twelve months, and consequently cannot be due to artificial sources of heat in London, such as the consumption of fuel.

When drawing the isothermals of the British Islands seven years ago, no district of Great Britain occasioned so much trouble and uncertainty as the south-east of England, owing to the meagreness of the materials available for the purpose. Since, however, immediately to westward, the mean temperature of Oxford was seen to be 50°·4, Aldershot 51°·2, and Osborne 51°·8, it was inferred as the most probable state of the case that the mean temperature increased southwards over the south-east of England in the manner indicated by the annual isothermals accompanying the paper. This supposition was confirmed by the temperatures at Colchester and Chatham, the only two stations furnishing satisfactory data on the point, for while at Colchester, for instance, the mean temperature was 0°·5 lower than that of Greenwich, no less than 0°·4 of this difference was due to the lower temperature of the east coast at Colchester as compared with Greenwich during the five months beginning with December, when the temperature in the south of England increases from east to west.

The coast stations of the Channel could not be considered as furnishing authoritative evidence on the question, owing to the irregular distribution of their temperature, which seemed to indicate certain obscure and ill-understood causes in operation modifying the climates of that coast. The force of this remark will be apparent from the following mean temperatures:—Helston, 53°·9; Truro, 52°·2; Torquay, 51°·6; Sidmouth, 51°·1; Bournemouth, 51°·5; Ventnor, 52°·4; and Worthing and Eastbourne, both 50°·7. It is perhaps scarcely necessary to remark that it would be a mistake to attempt to draw any conclusion from differences of mean temperatures of different stations amounting to 0°·3 and under, seeing that the English observations generally were made with thermometers in protecting-boxes quite open on one side, and therefore exposed in varying degrees to indirect radiation from walls and other objects.

While Mr. Eaton has thus failed to prove from past observations that the consumption of fuel and the marshing together of living beings in London has raised the mean temperature at Greenwich Observatory to the extent of half a degree, or indeed to any appreciable extent, above that of the south-east of England generally, it might nevertheless be well, seeing the question has been raised, to do something towards definitely answering it, by instituting at Greenwich and at about a dozen stations distributed over the south-east of England, observations of the temperature of the air, strict uniformity being secured by employing the same pattern of thermometer-box and by placing it under the same conditions at each place as regards height above the

ground, the vegetable covering of the soil, and openness of situation.

ALEXANDER BUCHAN

Edinburgh, April 9

THERE is one consideration which your correspondents, the secretary of the Scottish, and the president of the British Meteorological Societies have equally overlooked, and which may seriously affect the conclusions at which they arrive as to the suitability of Greenwich for a first-class meteorological station. Since the year 1846 the temperature observations at Greenwich have been made under conditions of exposure of thermometers which, whatever their merits or demerits, are not those usually adopted. In a paper published in the *Quarterly Journal of the Meteorological Society* (October, 1873) I have shown from the average of five years' daily comparisons that the effect of the method adopted at Greenwich upon the mean annual temperature is to obtain a result 0°·475 warmer than is obtained by the usual method. This quantity is almost identical with the excess which Mr. Eaton attributes to the local consumption of fuel, an explanation surely most inadequate. Thus the discrepancy pointed out by Mr. Eaton only serves to establish his opponent's case. Mr. Buchan on the other hand must be unaware that it is the eye observations alone, made from the revolving stand, that are relied upon for temperature results at Greenwich, and though his conclusion would seem to be correct it does not seem possible to sustain the argument by which he has arrived at it.

Orwell Dene, Nacton

JOHN I. PLUMMER

#### Cast-Iron

I HAVE been struck by the statement I found in several books on physics that cast-iron expands when it gets cool. As some of these books are used as text-books in schools in this country, and as this statement is contrary to the experience of all practical men with whom I have conversed upon the subject, I think the following translation of an article which appeared in *Der Civil Ingenieur*, edited by K. R. Bornemann, in Freiberg, 1863, ix. Band, iv. Heft, p. 219, may not be uninteresting, explaining, as it seems to me fully, at least one of the facts on which the statement mentioned above appears to be based, viz., the fact that cold iron swims in liquid iron:—

H. M.

"At a meeting of the Association of Saxon Engineers which took place in Freiberg in August last year (1862) Mr. H. Gison, of Buckau, near Magdeburg, called the attention of the members to a phenomenon which had frequently been observed by him, but of which no proper explanation could be given at the time, viz., that pieces of cold cast-iron swim perfectly in molten iron. The question was raised, to what causes this may be due, and as from the physical point of view it was thought an interesting one, it was suggested that experiments should be made in order to obtain a proper explanation thereof.

"In consequence of this, M. Centner, Inspector of the Jacol Iron-works, near Meissen, made such experiments, the result of which he communicated to the Association at a meeting on May 17, 1863. The following is an extract of Mr. Centner's report:—

(Signed) W. TAUBLERH

"Before answering this question I made some experiments in order to ascertain whether this swimming is not caused by the specific weight of the body; by these I found confirmed that cold cast-iron weighs  $\frac{1}{4}$  more than an equal volume of molten iron, for if a piece of cold cast-iron of 28 lbs. be used to form a mould, and if this mould be filled with molten iron, the new piece of metal thus obtained will only weigh 27 lbs. This weight, of course, is also that of the liquid metal which was required to fill the mould, formed from a piece weighing 28 lbs.

"For this reason, in making moulds for cast-iron, a measure is used which is  $\frac{1}{4}$  longer than the ordinary measure, if the piece of iron to be formed is to have the full size of the ordinary measure.

"Repeated experiments with a mass of molten iron of 2,000 lbs. gave me further proofs that the causes of this swimming must be other than the specific weight.

"For my experiments I used four bodies of cast-iron of different shapes, but of the same volume, viz. a plate of 6" inches in the square and 1" thick, a cube of  $3\frac{1}{8}$ ", a cylinder of 4" diameter, and 3" height, and a ball of 4" diameter. Each of these four bodies measured 36" cube and weighed 7 lbs.

"If the cause of the swimming were the specific weight, an equal part of the volume of all these bodies ought to remain

above the surface of the liquid iron, but such is not the case at all. The volume above the surface of the liquid iron is different in each of the four bodies; it is greatest with the plate and smallest with the ball. Thus it is dependent on the shape and position of the surface which rests on the liquid iron.

"In order to come to the real causes of this swimming, I must first remind the reader that in every hot liquid in an open vessel, in consequence of the more rapid cooling at the surface, a continuous current is originated, the interior hottest parts ascending and the exterior colder ones descending; and thus a more or less visible movement or agitation is produced in the mass. Such currents occur in every mass of molten iron, and are there especially remarkable in consequence of a contemporaneous ascension and separation of slags, which, when they have arrived at the surface, are generally pushed towards the edges.

"If a solid piece of iron be put on the liquid mass the former gets at once heated at the expense of the latter; the portions of water and of air which are contained in the solid piece get expanded and expelled with considerable force, thus forming a current in opposition to the ascending one above mentioned.

"This expulsion of air and water may even cause dangerous explosions, if the usual precaution is neglected to warm the solid piece somewhat, before it is brought into contact with the liquid mass.

"Now there is no doubt that these opposite forces alone are able to raise the heavier solid piece more or less according to the more or less favourable surface it presents.

"But besides this there is to be taken into consideration that the overweight of the solid piece of iron is diminished by the previous heating which when the solid piece comes into contact with the liquid, is at once augmented and that the proportion of heat of the molten iron to that of the solid piece must to some extent have an influence on the more or less deep immersion of the latter.

"A further cause, although a slight one, of this swimming of the solid piece is the cohesion of the liquid iron; but at any rate this becomes of some importance in conjunction with the above-mentioned continuous ascending of slags which collect under the swimming body and retain partly the air expelled by the latter, helping in this way to keep it afloat.

"Solid cast-iron being  $\frac{1}{4}$  heavier than an equal volume of molten iron, the overweight of each of the four bodies used for my experiments is consequently only  $\frac{1}{4}$  lb., and in the present case it is therefore only this one quarter of a pound which the above-mentioned opposite forces have to lift within areas of 12" to 36" square in order to keep the body swimming.

"On increasing the size of the solid bodies, however, it will be easily understood that a limit to this swimming will soon be reached, and indeed I accidentally found this limit on my first trial in quadrupling the sizes of the four bodies so that each of them weighed 28 lbs.; for all the bodies with the exception of the plate which was 12" in the square and 1" thick went to the bottom. The plate on being put gently on the liquid mass was just kept afloat, but its surface was a little below the surface of the molten iron. 1 lb. overweight therefore with a surface of 12" in the square could scarcely be kept swimming.

"The behaviour of the other three bodies at the bottom was remarkable in consequence of a continuous vehement ebullition accompanied by the shooting out of long white brilliant flames, and these phenomena can only be attributed to the water and air expelled by the heat.

"These experiments with bodies of 28 lbs. weight show therefore that above this weight, without giving to the body a more favourable surface than 12" in the square, these bodies do not what is properly called swim in the sense that part of the solid body is kept above the level of the liquid. For if the bodies, for instance the ball, the cube, and the cylinder on being moved, rise and fall a little alternately, this can no longer be called swimming, for it is just the transition from overweight to equilibrium.

"That the greater or lesser degree of density of the different sorts of iron will also exercise an influence cannot be doubted.

"Less fortunate but still interesting was an experiment which I made with four pieces of zinc of the same shapes as the pieces of iron on 200 lbs. of liquid zinc, when with the pieces of 7 lbs. each the same thing took place as with the cast-iron pieces of 28 lbs. each on liquid iron, viz., the plate was just kept afloat and the three other bodies went to the bottom.

"With zinc, therefore, this phenomenon of swimming does not occur with such heavy bodies as with iron, and this may be explained by the fact that with zinc, in consequence of the much smaller difference of temperature between the liquid and the

solid body, the currents mentioned above with reference to the iron must necessarily be far less strong.

"With similar modifications according to the temperature required for their liquefaction the swimming takes place with all other metals."

#### Tycho Brahe's Portrait

IN NATURE (vol. xv., p. 406) is published a copy of a portrait of Tycho Brahe in the possession of Dr. Crompton of Manchester. Although it seems, from the inscription in the corner, that the portrait is a contemporary one, there does not appear to me to be sufficient reason for preferring this portrait, of the origin of which nothing whatsoever is known, to others of the same date. Both Tycho's "Epistolæ" and "Mechanica" contain an engraving by J. D. Geyn from the year 1586, and if the newly-discovered portrait really (as conjectured by Dr. Crompton) should have been painted to be engraved for the "Mechanica," it can hardly have been considered a good likeness, as the engraving by Geyn was preferred. The latter is very like the portrait on Tycho's large wall-quadrant, of which an engraving in the "Mechanica" gives us an idea, and which Tycho himself mentions with the following words:—"Hanc effigiem magna solertia expressit Thobias Gemperlinus eximus artifex (quem mecum Augusta Vindelcorum in Daniam olim receperam) idque tam competenter, ut vix similior dari possit." This portrait is from 1587.

The Royal Gallery at Frederiksborg (about twenty English miles from Copenhagen) contained a fine portrait of Tycho Brahe, which unfortunately was burned in the great fire in 1859, when so much of that beautiful castle was destroyed. It agreed on the whole with the two above-mentioned portraits, while the long narrow face on the Manchester portrait shows hardly any resemblance to the features on the others. I may also add, that the fine monument erected by Tycho Brahe's heirs in the church in Prague (Teinkirche), where he was buried (of which I have seen a copy in Copenhagen), is very like Geyn's and Gemperlin's engravings.

The article which accompanies the portrait in NATURE contains several small mistakes, which perhaps also occur in Brewster's "Martyrs of Science." Tycho was not born in Sweden but in Denmark, as the province of Schonen (with the island of Hven) belonged to the latter country from ancient times and up to 1660, and he was of an ancient Danish noble family. His castle was called "Uraniborg" (Latin Uraniburgum, the Celestial Castle), the Observatory "Stjerneborg" (Stellæburgum).

J. L. E. DREYER  
Observatory, Birr Castle, Ireland

#### Yellow Crocuses

CAN any of your readers elucidate this problem? When, a fortnight ago, the yellow crocuses flowered, the sparrows all at once made a terrible onslaught upon them. I found the gardener in Lincoln's Inn Gardens one day mourning over a fine line of crocus plants, every flower of which was in absolute ruins. All the work of the sparrows, he said. I have seen them, too, on the flower-boxes in my windows here frequently, tearing at the crocus blooms. Yet now, later, the blue and striped crocuses are blowing, and the sparrows leave them altogether untouched. What is there in the London bloom specially that attracts the London sparrow? The taste is, I think, peculiar to the town bird. In gardens at a distance from, and immediately around, London, I have watched plenty of yellow crocus blossoms, not one flower of which has been attacked.

Gray's Inn, April 6 . ALFRED GEORGE RENSHAW

#### Tropical Forests of Hampshire

IN Mr. J. Starkie Gardner's lecture on The Tropical Forests of Hampshire (NATURE, vol. xv. p. 232), the following statement occurs which is open, I think, to considerable question:—"All the shipworms generally known to us live only in salt-water, and are so delicately organised that the slightest mixture of fresh-water instantly kills them." This sweeping assertion is partly qualified by allusion to the occurrence of a species described by Mr. George Jeffries as inhabiting fresh-water, and the fact of bored wood being found 300 miles up the Gambia River; still as Mr. Gardner speaks of these facts as a "theory" still in need of verification, I would point out that no waters are more infested with the shipworm than the deltas of tropical rivers wherein the water is often largely brackish if not potable.

My own experience is confined to the delta of the Irawadi, a

tangled maze of creeks, the waters of which are brackish or salt for about a third of the year, and slightly so, and even potable, during the other months. The large canoes, however, which traverse these creeks are much injured by some species of shipworm, and so little does the easy remedy of exposing them to fresh-water answer, that the Birmese are in the habit of firing their bottoms from time to time; opportunity is taken of a high spring tide to get the boat well on shore. The ends are supported on blocks of wood, and a shallow saucer-shaped cavity is made underneath which is filled with straw or other combustible matter, which gives a fierce but short-lived flame. Fire is now applied and the bottom of the boat is for some minutes kept wrapt in flame, which steams the worms to death in their holes. I cannot recall any instances of bored wood well above the tide-way, but wherever the water is occasionally brackish, thus far the worms seem capable of settling. What species occur in Pegu I cannot say. Percival Wright has described *Nausitora dunlopæi* from the rivers of Eastern Bengal, and it may not improbably extend to the Irawadi delta, as *Novaculina gangetica* and a species of Scaphula closely allied to the Gangetic species do. The two Birmese species of Scaphula are both estuary forms, whereas the type of the genus in the Ganges is found a thousand miles from the sea, which suggests the plasticity of some species, which if met with fossil would be unhesitatingly regarded as marine.

W. THEOBALD,  
Camp, Jhulum District Geological Survey of India

#### Hog Wallows or Prairie Mounds

IN NATURE (vol. xv., p. 274), Mr. Wallace quotes a letter from his brother in regard to the so-called Hog-wallows of California, in which their origin is ascribed to debris left at the broad foot of a retreating glacier modified by the erosion of innumerable issuing tills, and asks if this structure is known to occur elsewhere. As I have observed the same formation in many parts of the Pacific slope and have tried to explain it, I hope I may be allowed to say a few words on the subject.

The peculiar configuration of surface so well described by Mr. Wallace, is very widely diffused in America, and has been described under different names. In California the mounds are called *Hog-wallows*, but elsewhere they are known as *Prairie mounds*. This latter is the better name since they are found only in grassy, treeless, or nearly treeless regions. They occur over much of the Prairie region or "plains" east of the Rocky Mountains; also over portions of the basin region, e.g., in Arizona; also over much of the bare grassy portions of California, e.g., along the lower foothills of the Sierra and adjacent portions of the San Joaquin plains; also over enormous areas in Middle Oregon, on the eastern slope of the Cascade mountains, an undulating grassy region, also on the level grassy Prairies about the southern end of Puget Sound, Washington territory.

They have been ascribed to the most diverse causes. In Texas, where they are very small, Prof. Hildard thinks they are *ant-hills*. In Arizona, where they are also imperfectly developed, Mr. Gilbert thinks they are the ruined habitations of departed *Prairie dogs*. In some portions of California, also, where they are small, they have been popularly ascribed to *burrowing squirrels*. In the Prairies, about Puget Sound, where they are splendidly developed, their great size and extreme regularity has suggested that they are *burial mounds*, and that the Prairies are veritable cities of the dead. It is possible that the cause may be different in different places, but I am sure that no one who has examined them in California, and especially in Oregon and Washington, can for a moment entertain any of these theories for the Pacific slope.

In a paper "On the Structure and Age of the Cascade Mountains," published in the *American Journal* for March and April, 1874, p. 167 and p. 259, among some miscellaneous points suggested by the main subject in hand, I discuss this one of Prairie mound. I there attribute them to *surface erosion under peculiar conditions*, these conditions being a *bare country and a drift-soil finer and more movable above and coarser and less movable below*. Erosion removes the finer top-soil, leaving it only in spots. The process once commenced, weeds and shrubs take possession of the mounds as the best soil, or sometimes as the driest spots, and hold them, preventing or retarding erosion by their roots. In some cases, perhaps in most cases, a *departing vegetation, i.e., a vegetation gradually destroyed by increasing dryness*, seems to be an important condition. For my full reasons for holding this view I must refer the reader to my paper, but I may say in passing that in the bare hilly regions of Middle Oregon, on the

east side of the Cascade Mountains, every stage of gradation may be traced from circular mounds, through elliptic, long elliptic, to ordinary erosion furrows and ridges.

Mr. Wallace asks in conclusion whether so extensive and uniform a deposit could be due to *glaciers* alone, or is it necessary to suppose *submergence*?

In answer I would say that nothing is to me more puzzling than the drift deposits on the Pacific slope, and I suppose the same is true everywhere. The prairies about Puget Sound have evidently been submerged during the Champlain epoch, and I suppose the mound structure to have been formed after emergence, and the exceptional perfection of the mounds in that region may be due to this fact. But there is not the slightest evidence of submergence in the mound region of Oregon. All the high, bare, grassy, hilly, eastern slopes of the Cascade Mountains are covered evenly with a pebble and boulder drift, graduating upwards into a finer top soil. From this surface-soil are carved the mounds, which cover hill and dale so thickly that, viewed from an eminence the whole face of the country seems broken out with measles. This universal drift-covering, twenty to thirty feet thick over thousands of square miles, I know not what to call it, unless it be the *moraine profonde* of an ice-sheet.

JOSEPH L.E. CONTE

University of Cal., Oakland, Cal., March 6

OUR ASTRONOMICAL COLUMN

WINNECKE'S COMET, 1877, II.—In a note by Prof. Winnecke in M. Leverrier's *Bulletin* of April 13, it is remarked with respect to the elements of the comet discovered by him on April 5, "a great analogy exists between these elements and those of the comets 1827, II., and 1852, II., and it acquires a certain importance from the fact that the intervals are nearly equal."

The second comet of 1827 was discovered by Pons at Florence and Gambart at Marseilles, on June 20, and was observed at Florence until July 21; the original observations will be found in *Astron. Nach.*, No. 128. The best orbit is by Heiligenstein.

The second comet of 1852 was detected by M. Chacornac at Marseilles on May 15, and was observed at Vienna till June 8. On the suggestion of d'Arrest, the elements were calculated by Hartwig, without any assumption as to the eccentricity, and the resulting orbit proved to be a hyperbola, which, as d'Arrest remarked, rendered the identity of this comet with the second of 1827, which had been suspected by several astronomers very unlikely. Now, however, that a comet has made its appearance after a like interval with elements bearing a certain resemblance to those of the comets of 1827 and 1852, it may not be without interest to examine into the possibility of identity a little further. The elements of the three comets may be taken to be as follow:--

	1827, II.	1852, II	1877, II.
T	June 7 <sup>h</sup> 8 <sup>m</sup> 4	April 19 <sup>h</sup> 5 <sup>m</sup> 38	April 18 <sup>h</sup> 14 <sup>m</sup> 4
$\pi$	297° 31' 7	280° 0' 6	252° 0' 0
$\Omega$	318° 10' 5	317° 8' 4	317° 51' 3
$i$	43° 38' 8	48° 52' 9	56° 42' 7
$q$	0 8087	0 9050	0 9283

The motion is retrograde.

It is evident from a comparison of the three orbits that if they applied to the same comet, great perturbation must have taken place between the successive returns, the line of apsides in particular having considerably retrograded, and the inclination of the orbit increased by several degrees. This suggests an examination of the path of the comet near the nodes with respect to proximity to the orbits of the planets.

Assuming the mean of the two intervals for the period of revolution, we have 24.93 years, and for the semi-axis major 8.5338, and taking as sufficient for our present purpose the perihelion distance of 1852, the angle of eccentricity is 63° 22' 4. Hence it will be found that the radius-vector at the ascending node is 1.0008, which is less than 0.013 from the orbit of the earth; but to bring the two bodies together at this point the passage through perihelion must take place about September 3, which is not the case in any of the above years. At the opposite node the radius-vector is 5.966, not so very much greater

than the radius-vector of Jupiter in the same longitude as to forbid the hope of finding a much closer approach. Accordingly on calculating the distances at different points of the orbit about the descending node, it appears on the assumption we have made with regard to the period of revolution, that in heliocentric longitude 139° the comet would be distant from the orbit of this powerful planet only 0.15 of the earth's mean distance from the sun, and it would arrive in this longitude about 480 days after perihelion passage, and therefore at the end of September, 1828, and the middle of August, 1853, but at these times the heliocentric longitude of Jupiter was about 232° and 265° respectively, and the planet was far removed from the comet in both years.

The case is a very curious one and possibly unique of its kind: similarity of elements at three epochs separated by very nearly equal intervals, and on the assumption of a corresponding period of revolution, a very near apparent approach to the planet which so greatly disturbs the cometary orbits, yet action to account for outstanding differences of elements, could not have taken place on either occasion of the comet's passage through the part of its orbit where great perturbation would be looked for.

A NEW COMET.—On Monday morning telegraphic intimation of the discovery of a new comet by M. Borrelly on the evening of the 14th reached England from Marseilles, and its position was determined the same night at Mr. Barclay's Observatory, Leyton. The place is thus given in M. Borrelly's telegram:—April 14, at 9h. 30m., R.A. 16° 31', N.P.D. 34° 56'; daily motion in R.A. + 120', in N.P.D. - 50'. On the 16th the comet was visible enough in a large-sized Berlin "Cometensucher," but was not a bright object in such an instrument.

OBSERVATIONS AT CORDOBA.—Dr. R. A. Gould, director of the National Observatory of the Argentine Republic at Cordoba, writes with respect to several objects to which allusion has been made in this column. Referring to  $\mu$  Doradus—after remarking that it was noted as 5 m. by Lacaille, 6 m. by Rumker or Dunlop about 1825, and 8½ m. or 9 m. by Moesta, between February 1860 and January 1865, Dr. Gould says: "Our observations of it here have been on the following dates:—1870, Dec. 27; 1871, Jan. 19, 30, March 16, April 13; 1873, March 7, on which days it was looked for in the work upon the Uranometry. Also it has been observed with the meridian circle 1874, Jan. 12, 26; 1875, Jan. 5, 9, 11, 20; 1876, Jan. 5, Feb. 12, 14. Some difficulty was experienced in recognising it on account of several other stars of the same order of brightness being situated in its immediate vicinity. The identification was confirmed, however, as soon as the equatorial telescope was mounted. The estimates of magnitude were from 8 to 8½, but I see no reason to believe that it has changed since December 1870. \* \* Mr. Thome estimated it as 8.3 m. last night" (March 3). Dr. Gould proceeds, "While writing, let me add a word regarding the red star in Sculptor, mentioned in the same number of NATURE. This is one of the most intensely red stars which I know in the sky. But I should neither call it 'orange-red' nor 'red purple,' nor 'couleur rose,' but a brilliant scarlet. In such cases, however, different eyes bear different witness, and different individuals express themselves very differently to communicate the same idea." Dr. Gould intends at the earliest opportunity, to obtain numerical values for this and some other stars, by means of a Zohner's colorimeter. The star to which we are alluding is in R.A. 1h. 21m. 10s. N.P.D. 123° 11' 48" for 1874, according to observations at Cordoba.

The cluster  $\gamma$  Argus, respecting which Gillis reported changes since Sir John Herschel's observations, has been photographed several times, and Dr. Gould adds that he has similarly eight plates of  $\eta$  Argus and its surrounding stars—of which a very large number are secured upon the photograph by an exposure of eight or ten minutes.

TYPICAL LAWS OF HEREDITY<sup>1</sup>

## III.

IF a graphic representation is desired, which will give the absolute number of survivors at each degree, we must shape the rampart which forms nature's target so as to be highest in the middle and to slope away at each side according to the law of deviation. Thus Fig. 6 represents the curved rampart before it has been aimed at; Fig. 7, afterwards.

I have taken a block of wood similar to Fig. 4, to represent the rampart; it is of equal height throughout. A cut has been made at right angles to its base with a fret-saw, to divide it in two portions—that which would remain after it had been breached, Fig. 5, and the cast of the breach. Then a second cut with the fret-saw has been made at right angles to its face, to cut out of the rampart an equivalent to the heap of pellets that represents the original population. The gap that would be made in the heap and the cast that would fill the gap are curved on two faces, as in the model. This is sufficiently represented in Fig. 7.

The operation of natural selection on a population already arranged according to the law of deviation is represented more completely in an apparatus, Fig. 8, which I will set to work immediately.

It is faced with a sheet of glass. The heap, as shown in the upper compartment of the apparatus, is three inches in thickness, and the pellets rest on slides. Directly below the slides, and running from side to side of the apparatus, is a curved partition, which will separate the pellets as they fall upon it, into two portions, one that runs to waste at the back, and another that falls to the front, and forms a new heap. The curve of the partition is a curve of deviation. The shape of this heap is identical with the cast of the gap in Fig. 7. It is highest and thickest in the middle, and it tapers away towards either extremity. When the slide upon which it rests is removed, the pellets run down an inclined plane that directs them into a frame of uniform and shallow depth. The pellets from the deep central compartments (it has been impossible to represent in the diagram as many of these as there were in the apparatus) will stand very high from the bottom of the shallow frame, while those that came from the distant compartments will stand even lower than they did before. It follows that the selected pellets form, in the lower compartment, a heap of which the scale of deviation is much more contracted than that of the heap from which it was derived. It is perfectly normal in shape, owing to an interesting theoretical property of deviation (see formulae at end of this memoir).

Productiveness follows the same general law as survival, being a percentage of possible production, though it is usual to look on it as a simple multiple, without dividing by the 100. In this case the front face of each compartment in the upper heap represents the number of the parents of the same class, and the depth of the partition below that compartment represents the average number that each individual of that class produces.

To sum up. We now see clearly the way in which the resemblance of a population is maintained. In the purely typical case, each of the processes of heredity and selection is subject to a well-defined and simple law, which I have formulated in the appendix. It follows that when we know the values of  $i^\circ$  in the several curves of family variability, productiveness, and survival, and when we know the co-efficient of reversion, we know absolutely all about the ways in which that characteristic will be distributed among the population at large.

I have confined myself in this explanation to purely typical cases, but it is easy to understand how the actions of the processes would be modified in those that were

not typical. Reversion might not be directed towards the mean of the race, neither productiveness nor survival might be greatest in the medium classes, and none of their laws may be strictly of the typical character. However, in all cases the general principles would be the same. Again, the same actions that restrain variability would restrain the departure of average values beyond certain limits. The typical laws are those which most nearly express what takes place in nature generally; they may never be exactly correct in any one case, but at the same time they will always be approximately true and always serviceable for explanation. We estimate through their means the effects of the laws of sexual selection, of productiveness, and of survival, in aiding that of reversion in bridling the dispersive effect of family variability. They show us that natural selection does not act by carving out each new generation according to a definite pattern on a Procrustean bed, irrespective of waste. They also explain how small a contribution is made to future generations by those who deviate widely from the mean, either in excess or deficiency, and enable us to calculate whence the deficiency of exceptional types is supplied. We see by them that the ordinary genealogical course of a race consists in a constant outgrowth from its centre, a constant dying away at its margins, and a tendency of the scanty remnants of all exceptional stock to revert to that mediocrity, whence the majority of their ancestors originally sprang.

## APPENDIX.

I will now proceed to formulate the typical laws. In what has been written,  $i^\circ$  of deviation has been taken equal to the "probable error" =  $C \times 0.4769$  in the well-

known formula  $y = \frac{1}{c\sqrt{\pi}} \cdot e^{-\frac{x^2}{c^2}}$ . According to this, if

$x$  = amount of deviation in feet, inches, or any other external unit of measurement, then the number of individuals in any sample who deviate between  $x$  and  $x + \delta x$

will vary as  $e^{-\frac{x^2}{c^2}} \delta x$  (it will be borne in mind that we are for the most part not concerned with the coefficient in the above formula).

Let the modulus of deviation ( $c$ ) in the original population, after the process has been gone through, of converting the measurements of all its members (in respect to the characteristic in question), to the adult male standard, be written  $c_0$ .

1. Sexual selection has been taken as *nil*, therefore the population of "parentages" is a population of which each unit consists of the mean of a couple taken indiscriminately. This, as well known, will conform to the law of deviation, and its modulus which we will write  $c_1$  has already been shown to be equal to

$$\frac{1}{\sqrt{2}} c_0.$$

2. Reversion is expressed by a fractional coefficient of the deviation, which we will write  $r$ . In the "reverted" parentages (a phrase whose meaning and object have already been explained)

$$y = \frac{1}{rc\sqrt{\pi}} \cdot e^{-\frac{x^2}{r^2c^2}}.$$

In short, the population, of which each unit is a reverted parentage, follows the law of deviation, and has its modulus, which we will write  $c_2$ , equal to  $rc_1$ .

3. Productiveness:—We saw that it followed the law of deviation; let its modulus be written  $f$ . Then the number of children to each parentage that differs by the amount of  $x$  from the mean of the parentages generally (*i.e.*, from the mean of the race), will vary as  $e^{-\frac{x^2}{f^2}}$ ; but the number of such parentages varies as  $e^{-\frac{x^2}{c_2^2}}$ , therefore if each child

<sup>1</sup> Lecture delivered at the Royal Institution, Friday evening, February 10, by Francis Galton, F.R.S. Continued from p. 514.

absolutely resembled his parent, the number of children who deviated  $x$  would vary as  $e^{-\frac{x^2}{r^2}} \times e^{-\frac{x^2}{c_0^2}}$ , or as  $e^{-\frac{x^2}{f^2 + c_0^2}}$ . Hence the deviations of the children in their amount and frequency would conform to the law, and the modulus of the population of children in the supposed case of absolute resemblance to their parents, which we will write  $c_1$ , is such that—

$$\frac{1}{c_1^2} = \sqrt{\left(\frac{1}{f^2} + \frac{1}{c_0^2}\right)}.$$

We may, however, consider the parents to be multiplied

FIG. 6.

and the productivity of each of them to be uniform. It is more convenient than the converse supposition and it comes to the same thing. So we will suppose the reverted parentages to be more numerous but equally prolific, in which case their modulus will be  $c_2$ , as above.

4. Family variability was shown by experiment to follow the law of deviation, its modulus, which we will write  $v$ , being the same for all classes. Therefore the amount of deviation of any one of the offspring from the mean of his race is due to the combination of two influences, the deviation of his "reverted" parentage and his own family variability; both of which follow the law of deviation. This is obviously an instance of the well-known law of the "sum of two fallible measures" (Airy, "Theory of Errors," § 43). Therefore the modulus of the population in the present stage, which we will write  $c_3$ , is equal to  $\sqrt{v^2 + c_2^2}$ .

5. Natural selection follows, as has been explained, the same general law as productiveness. Let its modulus be written  $r$ ; then the percentage of survivals among children, who deviate  $x$  from the mean, varies as  $e^{-\frac{x^2}{r^2}}$ , and for the same reasons as those already given, its effect will be to leave the population still in conformity

FIG. 7.

with the law of deviation, but with an altered modulus, which we will write  $c_4$ , and

$$\frac{1}{c_4^2} = \sqrt{\left(\frac{1}{r^2} + \frac{1}{c_3^2}\right)}.$$

Putting these together we have, starting with the original population having a modulus =  $c_0$ :—

1.  $c_1 = \frac{1}{\sqrt{\frac{1}{f^2} + \frac{1}{c_0^2}}}$

2.  $c_2 = rc_1$

3.  $c_3 = \sqrt{v^2 + c_2^2}$

4.  $c_4 = \sqrt{r^2 + c_3^2}$

$$5. c_5 = \sqrt{\left\{\frac{v^2 c_4^2}{r^2 + c_4^2}\right\}}.$$

And lastly, as the condition of maintenance of statistical resemblance in consecutive generations:—

6.  $c_5 = c_0$ .

Hence, given the coefficient  $r$  and the modulus  $v, f, c_0$ , the value of  $c_5$  (or  $c_4$ ) can be easily calculated.

In the case of simple descent, which was the one first

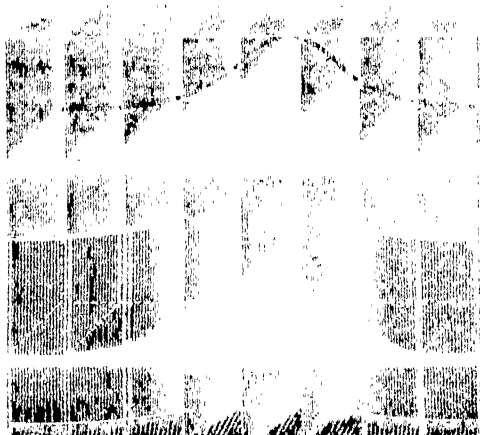

FIG. 8.

considered, we have nothing to do with  $c_0$ , but begin from  $c_1$ . Again, as both fertility and natural selection are in this case uniform, the values of  $f$  and  $r$  are infinite. Consequently our equations are reduced to—

$$c_2 = rc_1; c_3 = \sqrt{v^2 + c_2^2}; c_4 = c_3,$$

whence

$$c_4^2 = \frac{v^2}{1 - r^2}.$$

CARL FRIEDRICH GAUSS

BORN APRIL 30, 1777, DIED FEBRUARY 23, 1855.<sup>1</sup>

DE MORGAN in his "Budget of Paradoxes" (p. 187), tells the following story:—The late Francis Baily wrote a singular book, "Account of the Rev. John Flamsteed, the first Astronomer-Royal;" it was published by the Admiralty for distribution, and the author drew up the distribution list.

<sup>1</sup> We adopt the date given by the Baron Sartorius von Waltershausen in his "Gauss. Zum Gedächtnisse," Leipzig, 1856. Encyclopedias and other authorities are pretty equally divided between this date and April 23. All the English Cyclopedias we have consulted, with the exception of Chambers's (1874), give April 23. We may also mention that on the list of students of the Collegium Carolinum the name is Johann Friedrich Karl Gauss. We have followed Gauss himself in our heading.

Certain rumours led to a run upon the Admiralty for copies. "The Lords were in a difficulty; but on looking at the list they saw names, as they thought, which were as obscure, that they had a right to assume Mr. Baily had included persons who had no claim to such a compliment as presentation from the Admiralty. The secretary requested Mr. Baily to call upon him. "Mr. Baily, my Lords are inclined to think that some of the persons in this list are perhaps not of that note which would justify their lordships in presenting this work." "To whom does your observation apply, Mr. Secretary." "Well, now let us examine the list; let me see; now—now—now—come!—here's Gauss—what's Gauss?" "Gauss, Mr. Secretary, is the oldest mathematician now living, and is generally thought to be the greatest." Their lordships subsequently expressed themselves perfectly satisfied with the list. Who then was Gauss? He was the son of a bricklayer at Brunswick, and it was the wish of his father that the boy should be a bricklayer too. The lad, however, was another 'Pascal,' and early showed a marvellous aptitude for calculation; indeed he might be said to have "lisped in numbers," for he used jokingly to say that he could reckon before he could talk. When scarcely three years old he pointed out the inaccuracy of an account, "Vater, die Rechnung ist falsch, es macht so viel," and the boy was right. At the public school of Buttner he soon attracted the attention of Bartels, subsequently Professor of Mathematics at Dorpat, and father-in-law of Struve, by whom he was brought under the notice of Charles William, the reigning Duke of Brunswick. The Duke became Gauss's good friend, and sent him in 1792<sup>3</sup> to the Collegium Carolinum, much against the father's wish. Having nothing more to learn from the professors here, he went in 1795<sup>4</sup> to Göttingen, as yet undecided whether to pursue philology or mathematics. Kaestner was at this time mathematical professor, of whom Gauss said: "He was the first of geometers among poets and first of poets among geometers."

Here, too, he was independent of his teachers, and having made several of his greatest discoveries in analysis (the Higher Arithmetic especially became his favourite study, and he called it a divine science, "Mathematics, the Queen of the Sciences, and Arithmetic, the Queen of Mathematics"<sup>5</sup>), henceforth he made mathematics the main study of his life.

Having finished his college course, he returned to Brunswick, and in 1796 repaired for a short time to Helmstadt to consult the library there. Again the next year we find him at Helmstadt, and he is now able to improve his acquaintance with Pfaff, having had only an hour or two of intercourse with him in the previous year, and the two mathematicians were much together, the probability being that Gauss communicated more than he received.<sup>6</sup>

In 1807, whilst a private teacher at Brunswick, the Emperor of Russia offered him a chair at the Academy of St. Petersburg, but by the advice of Olbers he declined the appointment.<sup>7</sup> On July 9 in this year he was appointed the first director of the new Göttingen Observatory and Professor of Astronomy in the University. His life henceforth was spent at Göttingen, in the midst of continuous work; in other respects it was quite uneventful. From the year 1828, when he was invited to Berlin by Humboldt to attend a meeting of natural philosophers in that city, he never left his university until 1854, in which year railway communication was opened up between Hanover and

Göttingen.<sup>8</sup> His life was passed in a simple and regular manner, he enjoyed good sound health in spite of the fatigues of night observations, he seldom required a physician until a few months before his death, when he suffered much from asthma, which was subsequently complicated by the accession of dropsy. So passed away in his seventy-eighth year, Gauss, one of the greatest lights of the present age, a mathematician worthy to be placed on the same high platform as Archimedes and Newton.<sup>9</sup>

We are told that his tastes were simple (he never wore any of the numerous decorations which were showered down upon him), and that he had the full knowledge, which men of genius often have, of his superiority to the mass of mankind.<sup>10</sup> Though he looked upon mathematics as the principal means for developing human knowledge,<sup>11</sup> he yet fully recognised the beneficial influence of an acquaintance with classical literature. He had indeed a wonderful facility for the acquisition of languages; he was acquainted with most of the European languages, and could speak many of them well.<sup>12</sup> At the age of sixty-two he commenced the study of the Russian language, and mastered it in two years. He took a great interest too in politics to within a few weeks of his death. His lectures, in which he adopted the analytic method, were exceedingly clear expositions; in them he liked to discuss the methods and the roads by which he had arrived at his great results. He required the closest attention, and objected to the taking of notes, lest his hearers should lose the thread of his argument. The students seated round the lecture-table listened with delight to the lucid and animated addresses of their master; addresses more resembling conversations than set lectures. The chief figure in this group stands before us with clear, bright eyes, the right eyebrow raised higher than the left (*more Astynomorum*), a forehead high and wide, overhung with grey locks, and a countenance whose variations were all expressive of the great mind within.<sup>13</sup> We can well understand how his pupils revered him and never forgot these meetings. Gauss was always ready to converse even with persons unacquainted with the subjects he had made his own, and his animation in doing so bore evidence to the delight he took in the contemplation of nature. It was this feeling that led him a short time before his death to have engraved at the foot of his portrait the following lines as expressing best the philosophy of his ideas and of his writings—

"Thou, Nature, art my Goddess: to thy laws  
My services are bound!"

<sup>1</sup> Gauss. *Z. Ged.*, p. 79. Shakespeare, *King Lear*, Act I Scene ii

The full list of Gauss's writings would fill many of our columns; there is a list on columns 854-857 of Foggendorf's. Larrouse gives a very full list also, but the most complete list we know, not including the larger works, is given in the Royal Society's Catalogue of Scientific Papers. The titles are given of 124 papers.

One of Gauss's earliest discoveries is the "method of least squares." This method, though first published by Legendre, was applied by Gauss as early as the year 1795.<sup>14</sup> It is somewhat remarkable that Gauss has devoted so few memoirs to

<sup>1</sup> He is said never to have slept from under the roof of his own observatory but on the one above-named occasion, and in the last-named year, i.e., the year before he died, to have seen for the first time a locomotive. During this visit to Berlin, Gauss made the acquaintance of Weber. "*Z. Ged.*," p. 61.

<sup>2</sup> To use the words of Gauss's successor at Göttingen. A great living English mathematician says: "The mathematician lives long and lives young: the wings of his soul do not early drop off, nor do his potes become clogged with the earthy particles blown from the dusty highways of vulgar life." (Dr Sylvester's address at the Extra Meeting of the British Association, 1869.) He cites Leibnitz 70, Euler 76, Lagrange 77, Laplace 78, Gauss 78, Plato 82, Newton 83, Archimedes 75 (then killed by a Roman soldier), Pythagoras 90.

<sup>3</sup> Gauss *Z. Ged.*, p. 93. He was a man of determined character, of strong will, and one who disdained all half-heartedness. (and p. 102) His character showed a curious mixture of self-conscious dignity and childlike simplicity. Larrouse says he was but little communicative and modest, not to say peevish.

<sup>4</sup> A short time before his death he spoke to a celebrated psychologist on the possibility of putting psychology on a mathematical basis.

<sup>5</sup> Gauss. *Z. Ged.*, p. 94, says he read Gibbon and Macaulay's histories with great interest. He was immensely amused (p. 93) with "The Moon rises broad in the north-west," which occurs in one of Sir W. Scott's novels. He would not tell his friends what had set him laughing until after collecting a variety of citations of the novel in question he found that the passage was not a misprint.

<sup>6</sup> We are here indebted to M. Wagener the writer of the notice in the "*Biographie Universelle* (Michaud)," Paris, 1826.

<sup>7</sup> *Biographie Universelle*, lib. 2, p. 111. See Glaisher "On the Law of Facility of Errors of Observations, and On the Method of Least Squares," *Roy. Soc. Memoirs*, vol. xxxix (1872), in which is collected much information on the subject. Also Todhunter's "History of Theory of Probability," p. 107 and elsewhere. *Roy. Soc. Proceedings*, p. 202.

<sup>8</sup> Prof. H. J. S. Smith's Presidential Address, *Proceedings of London Mathematical Society*, vol. viii p. 12, and Larrouse. At the age of ten he was acquainted with the Binomial Theorem and the theory of infinite series, "*Gauss Z. Ged.*" p. 23.

<sup>9</sup> Gauss *Zum Gedächtniss*, p. 15. *Roy. Ast Soc Monthly Notices*, vol. xvi, pp. 80-83. Larrouse, "Grands Dictionnaire," Paris, 1872, gives erroneously 1789.

<sup>10</sup> Larrouse and Michaud's "*Biographie Universelle*," Paris, 1826, both give this date 1794, see also *Roy. Ast Soc Monthly Notices*.

<sup>11</sup> Gauss. *Z. Ged.*, pp. 79, 86.

<sup>12</sup> *Roy. Ast Soc. Notices* point out that the idea that Gauss studied under Pfaff is an erroneous one. This error occurs in the "*Encyclopaedia Brit.*," 1826 (2nd edition) Laplace, when asked who was the greatest mathematician in Germany replied, Pfaff, his interrogator said he should have thought Gauss was. "Oh," replied Laplace, "Pfaff est bien le plus grand mathématicien de l'Allemagne, mais Gauss est le plus grand mathématicien de l'Europe." The statement that Gauss graduated at Helmstadt in 1799 (*Proceedings of Roy. Soc.*, vol. vi p. 508) is erroneous, see "*Gauss. Z. Ged.*" p. 22. The degree was conferred upon him in absentia. No information upon this point is given either in Foggendorf, "*Biog. Lit. Handwörterbuch*," Leipzig, 1863, or in the *Göttingische gelehrte Anzeigen* (3rd vol. for 1855).

<sup>13</sup> Olbers, in a letter to Heeren, states that Gauss had a marked objection to a mathematical chair; his desire was to obtain the post of astronomer at an observatory, in order that he might spend all his time upon his observations and his profound studies for the advancement of science.



subjects of an algebraic character. If we except a comparatively unimportant paper on Descartes' Rule of Signs, which appeared in *Crelle's Journal* (1828), his only algebraical memoirs relate to the theorem that every equation has a root. Of this he gave no more than three distinct demonstrations, one in 1799, one in 1815, and one in 1816. That in 1799 formed the subject of his first published paper: "Demonstratio nova theorematis omnem functionem algebraicam, rationalem integram unius variabilis in factores reales primi vel secundi gradus resolvi posse"—his inaugural dissertation as a candidate for the degree of Doctor of Philosophy in the University of Göttingen. This demonstration was repeated over again in 1849 with certain changes and simplifications. These demonstrations are prior to any other; for various reasons those subsequently given by Cauchy have been justly preferred for insertion in modern text-books.

A new epoch in certain branches of analysis dates from the publication of the "Disquisitiones Arithmeticae" (Leipzig, 1801), and from the researches with which some years later Gauss supplemented or further developed the theories contained in that work. We must bear in mind that he found the theory of numbers as Euler and Lagrange had left it. The former enriched it with a multitude of results, relating to Diophantine problems, to the theory of the residues of powers, and to binary quadratic forms; the latter had given the character of a general theory to some at least of these results by his discovery of the reduction of quadratic forms and of the true principles of the solution of indeterminate equations of the second degree. Legendre (with many additions of his own) had endeavoured to arrange as much as possible of these scattered fragments of the science into a systematic whole in his "Essai sur la Théorie des Nombres." But the "D. Ar." was in the press when this important treatise appeared, and what in it was new to others was already known to Gauss. This grand work merits an analysis at our hands, but lack of space compels us to pass on at once to the fourth section. The greater portion of it is occupied with a research, which of itself alone would have placed Gauss in the first rank of mathematicians. "If  $p$  and  $q$  are positive uneven prime numbers,  $p$  has the same quadratic character with regard to  $q$  that  $q$  has with regard to  $p$ ; except when  $p$  and  $q$  are both of the form  $4n + 3$ , in which case the two characters are always opposite, instead of identical." This is the celebrated Fundamental Theorem of Gauss, known also as the Law of Quadratic Reciprocity of Legendre. Gauss discovered it (by induction) in March, 1795, before he was eighteen; the proof given of it in this section he discovered in April of the year following.<sup>1</sup> He cannot at the earlier date have been aware that the theorem had been already enunciated (though in a somewhat complex form) by Euler, and that Legendre had attempted, though unsuccessfully, to prove it in the *Memoirs* of the Academy of Paris for 1784. The question of priority of enunciation or of demonstrating by induction in this case is a trifling one; any rigorous demonstration of it involved apparently insuperable difficulties. Gauss was not content with once vanquishing the difficulty, he returns to it again in the fifth section, and there obtains another demonstration reposing on entirely different, but perhaps still less elementary principles. In January, 1808, he submitted a third demonstration to the Royal Society of Göttingen; a fourth in August of the same year; a fifth and sixth in February, 1817. It is no wonder he should have felt a sort of personal attachment to a theorem which he had made so completely his own, and which he used to call the "gem" of the higher arithmetic. His six demonstrations remained for some time the only efforts in this direction, but the subject subsequently attracted the attention of other eminent mathematicians, and several proofs differing substantially from one another, and from those of Gauss, have been given.<sup>2</sup> It would be impossible to exaggerate the important

influence which this theorem has had on the subsequent development of arithmetic, and the discovery of its demonstration by Gauss must be certainly regarded (it was so regarded by himself), as one of his greatest scientific achievements. The fifth section ("these marvellous pages") abounds with subjects, each of which has been the starting-point of long series of important researches by subsequent mathematicians. In the *Additiones* to this section Gauss characteristically adds: "ex voto votisque successit ut nihil amplius desiderandum superaret Nov. 30—Dec. 3, 1800." It is remarkable that he should never have published the wonderful researches to which he here alludes. They first saw the light sixty-three years later in the second volume of the collected edition of his works.<sup>3</sup> Till the time of Jacobi, it is not too much to say, that the profound researches of the fourth and fifth sections were passed over with almost universal neglect, but the seventh section at once made the reputation of the "D. Ar." The well-known theory of the division of the circle, comprised in this section, was received with great and deserved enthusiasm as a memorable addition to the theory of equations and to the geometry of the circle. Gauss's note on § 365 ("circulum in 17 partes dividibilem esse geometrico, deteximus 1796, Mart 30")<sup>4</sup> is interesting because it shows that he was not yet nineteen when he made this great discovery. Even more remarkable, however, is a passage (§ 335), in which he observes that the principles of his method are applicable to



Carl Friedrich Gauss.

many other functions beside the circular functions, and in particular to the transcendents dependent on the integral  $\int \frac{dx}{\sqrt{1-x^2}}$ .

This almost casual remark shows (as Jacobi long since observed) that Gauss at the date of the publication of the "D. Ar." had already examined the nature and properties of the elliptic functions and had discovered their fundamental property, that of double periodicity. This observation of Jacobi's is amply confirmed by the papers on elliptic transcendents, now published in the third volume of Gauss's collected works.<sup>5</sup>

The "D. Ar." were to have included an eighth section; at first it was intended to contain a complete theory of congruences, but subsequently Gauss appears to have proposed to confine the work by a more complete discussion of the theory of the division of the circle. Manuscript drafts on each of these subjects were found among his papers; the first of them is especially interesting, as it treats of the general theory of congruences from a point of view closely allied to that subsequently taken by

one by M. Zeller (see *Monograph of Mathematics*, No. 167, January, 1876 for an account by Prof. Paul Mansion).

<sup>1</sup> The theorem to which they refer had, in the interval, been rediscovered and demonstrated by Lejeune Dirichlet. This demonstration has been to a certain extent simplified by M. Hermite, and the form of proof found in Gauss's papers after his death approaches very nearly to that adopted by M. Hermite.

<sup>2</sup> Schering's edition, *ubi supra*. M. Chasles passes by this discovery without any notice of it; in this case the language could not be the better. "Par suite de notre ignorance de la langue dans laquelle ils sont écrits." "Aperçu Historique," p. 275. Delambre gives an account in his "Histoire Méthodique sur les progrès des Sciences," Paris, 1830. In the *Roy. Acad. Sci. Notices* are some pertinent remarks.

<sup>3</sup> On p. 523 Roy. See Obituary Notice will be found the story of Gauss and Jacobi. For every theorem in the subject of elliptic integrals published by the latter, Gauss could show its fellow among his manuscripts.

<sup>1</sup> This dissertation (Helmstadt, 1799), so little known that Lagrange appears not to have been acquainted with it, and Cauchy has received in France all the praise due to a first discoverer.—Larroux.

<sup>2</sup> For an amusing notice of this work see *Biographie nouvelle des Contemporains* (Paris, 1825): "Cet ouvrage a obtenu un succès d'après lequel on n'eût tenté de croire que le christianisme avait quelquefois jusqu'à un domaine des mathématiques" (see *Roy. Soc. Proceedings*, pp. 390, 391, *ubi supra*). Twelve years later "Biographie universelle et portative des Contemporains," Paris, 1834, we read: "Il suffit de dire qu'un grand nombre de travaux sont estimés des mathématiciens les plus distingués et qu'ils se recommandent surtout par leur exactitude que par la clarté, le précision et l'élégance du style." Lagrange's saying, quoted above, also shows in what estimation Gauss was held at that date. Lalande speaks of his talent and zeal. "Histoire," p. 313 (1803).

<sup>3</sup> See Gauss's note (pp. 473, 475 of vol. I. of his "Werke," edited by Schering).

<sup>4</sup> By Jacobi and Eisenstein in Germany; M. Liouville in France; perhaps the simplest of all (and allied in its character to the third proof of Gauss) is

Evariste Galois and by MM. Serret and Dedekind. This draft appears to belong to the years 1797 and 1798.

To complete our hasty sketch of the arithmetical works we need only mention (1) the remarkable interpretation of the arithmetical theory of positive binary and ternary quadratic forms, which will be found in his review of the works of L. Seeber [1831] ("Werke," vol. ii. p. 188); and (2) the two important memoirs on the theory of biquadratic residues (1825 and 1831). In the second of these memoirs he gives a theorem of biquadratic reciprocity between any two prime numbers no less important than the quadratic law, viz., "If  $p_1$  and  $p_2$  are two primary prime numbers, the biquadratic character of  $p_1$  with regard to  $p_2$  is the same as that of  $p_2$  with regard to  $p_1$ ." This theorem itself and the introduction of imaginary integers upon which it depends, are memorable in the history of arithmetic for the number and variety of the researches to which they have given rise.<sup>1</sup>

A writer remarks each work of Gauss is an event in the history of science, a revolution, which, overturning the old theories and methods, replaces them by new ones and advances science to a height which no one had before dreamed of.<sup>2</sup> We have given

proof of this in one branch of mathematics; we shall see that the witness is true as to other branches also.

The discovery of the planet Ceres at Palermo on the first day of the present century led to Gauss's taking up the subject of astronomy. He did not come into possession of the requisite data until the October following. In a few weeks he determined the elements of its orbit with sufficient accuracy so that the Baron de Zach was enabled to rediscover the planet at the first attempt he made for that purpose on December 7. This discovery was soon followed by that of three other small planets. These discoveries supplied Gauss with the means of further improving his solution of the problem, and in 1809 he brought out at Hamburg his "Theoria motus corporum celestium in sectionibus conicis solem ambientium." This contains an "elaborate discussion of the various problems which present themselves in the determination of the movements of planets and comets from observations made on them under any circumstances."<sup>3</sup> Gauss's other astronomical researches are chiefly contained in De Zach's *Monatliche Correspondenz*, the *Transactions* of the Royal Society of Göttingen, and the *Astronomische Nachrichten*; all are contributions of the highest order of excellence.



Gauss' Birthplace in Brunswick.

To astronomy Gauss joined geodesy, and the Hanoverian Government charged him with the triangulation and measurement of an arc of the meridian between Göttingen and Altona. This he accomplished between the years 1821 and 1824. For carrying out his purpose he invented many methods quite original.<sup>4</sup> It was his intention to publish an "extensive work upon geodesy, but he did not accomplish his purpose. He contributed two memoirs on the subject to the Royal Society of Berlin (1844, 1847).

<sup>1</sup> In our account of Gauss's arithmetical work we have throughout freely referred to Prof H. J. S. Smith's presidential address (see above) and his two reports on the theory of numbers (Brit. Assoc. Reports, 1855, pp. 268-267; 1856, pp. 120-172). But we are still more deeply indebted to him for references and criticisms most kindly given in the midst of the pressing claims of his other numerous engagements.

<sup>2</sup> Wagner, in Michaud's "Biographie Universelle" Prof. Cayley writes, "All that Gauss has written is first rate; the interesting thing would be to show the influence of his different memoirs in bringing to their present condition the subjects to which they relate, but this is to write a History of Mathematics from the year 1800.

<sup>3</sup> He invented the heliograph to render angles visible at as great a distance as possible; this he did by reflecting the rays of the sun. He also devised a method for the correction of the errors which occur in an extensive system of triangulation.—"Gauss. Z. Ged.," pp. 31-32.

Mr. Todhunter in his "History of the Theories of Attraction," devotes §§ 1162-1175 to an analysis of a memoir by Gauss, "Theoria attractionis corporum spheroidicorum ellipticorum homogeneorum methodo nova tractata" (Royal Society of Göttingen, March 18, 1813). Mr. Todhunter says, "he completely succeeds in his design; his solution is both simple and elegant." He further remarks, "Gauss's writings are distinguished for the combination of mathematical ability with power of expression; in his hands Latin and German rival French itself for clearness and precision."

In another of Mr. Todhunter's works ("Calculus of Variations," 1861) he discusses in his third chapter (pp. 37-52) a memoir

<sup>4</sup> Roy. Soc. Proceedings, p. 398; Roy. Ast. Soc. Monthly Notices (as above). A curious fact is recorded. The preface to this work is dated March 28, 1809, just two centuries after Kepler's "Praefatio de Stella Martis," March 28, 1609; "Gauss. Z. Ged.," p. 40. After the publication of this work Gauss became "a member of all the learned societies from the Polar Circle to the Tropics."

<sup>5</sup> Chacot (quoted by Todhunter) calls it "le beau mémoire de M. Gauss." Another celebrated memoir, "Allgemeine Lehrsätze . . . Anziehungs- und Abstoßungskräfte" (Leipzig, 1840), is treated by Todhunter, p. 122. In this last Gauss uses the name *Potential* (apparently independent of Gauss) § 790. See also Maxwell's "Electricity," 475.

oy Gauss entitled "Principia generalia Theoriæ figuræ Fluidorum in statu æquilibril" (Royal Society of Göttingen, 1833).<sup>1</sup> It relates to the theory of capillary attraction, and demonstrates in a new way some results which had already been obtained by Laplace. The part analysed by Mr. Todhunter is that devoted to the solution of a problem in the calculus of variations, "involving the variation of a certain double integral, the limits of the integration being also variable; it is the earliest example of the solution of such a problem." In 1831 we find Gauss commencing the study of crystallography; in a few weeks he had mastered the subject. We find that the question of the rationality or irrationality of the ratios of the crystallographic coefficients had attracted his attention.<sup>2</sup>

We can only touch upon Gauss's further contributions to geometry.<sup>3</sup> To him are due many fundamental theorems in the theory of curve-surfaces; also on the development of surfaces; thus it was he who found the equation to developable surfaces. He was used to say "that he had laid aside several questions which he had treated analytically, and hoped to apply to them geometrical methods in a future state of existence, when his conceptions of space should have become amplified and extended."<sup>4</sup>

Those not acquainted with Gauss's writings would think we must have exhausted our account of them. In 1831, however, on Weber's arrival at Göttingen, physical questions took the first place in Gauss's thoughts, and separately and in conjunction many works were brought out by these two philosophers. There is so full an account of Gauss's achievements in this direction in the Royal Society's Obituary Notice, that we need only refer to it.<sup>5</sup> His contributions, we may briefly say, to the knowledge of electro-magnetism and terrestrial magnetism were perhaps the most considerable and important of his achievements. He invented the magnetometer, and was one of the first to point out the possibility of sending signals by galvanic currents, and so contributed to the invention of the electric telegraph.

"If we except the great name of Newton (and the exception is one which Gauss himself would have been delighted to make) it is probable that no mathematician of any age or country has ever surpassed Gauss in the combination of an abundant fertility of invention with an absolute rigorousness in demonstration, which the ancient Greeks themselves might have envied. It may be admitted, without any disparagement to the eminence of such great mathematicians as Euler and Cauchy that they were so overwhelmed with the exuberant wealth of their own creations, and so fascinated by the interest attaching to the results at which they arrived, that they did not greatly care to expend their time in arranging their ideas in a strictly logical order, or even in establishing by irrefragable proof propositions which they instinctively felt, and could almost see to be true. With Gauss the case was otherwise. . . . It may seem paradoxical, but it is probably nevertheless true that it is precisely the effort after a logical perfection of form which has rendered the writings of Gauss open to the charge of obscurity and unnecessary difficulty. The fact is that there is neither obscurity nor difficulty in his writings, as long as we read them in the submissive spirit in which an intelligent schoolboy is made to read his Euclid.

Every assertion that is made is fully proved, and the assertions succeed one another in a perfectly just analogical order; there is nothing so far of which we can complain. But when we have finished the perusal, we soon begin to feel that our work is but begun, that we are still standing on the threshold of the temple, and that there is a secret which lies behind the veil and is as yet concealed from us. . . . no vestige appears of the process by which the result itself was obtained, perhaps not even a trace of the considerations which suggested the successive steps of the demonstration. Gauss says more than once that, for brevity, he only gives the synthesis, and suppresses the analysis of his propositions. '*Pauca sed matura*' were the words with which he delighted to describe the character which he endeavoured to impress upon his mathematical writings. . . . If, on the other hand, we turn to a memoir of Euler's, there is a sort of free and luxuriant gracefulness about the whole performance, which tells of the quiet pleasure which Euler must have taken in each step of his work; but we are conscious nevertheless that we are at an immense distance from the severe grandeur of design which is characteristic of all Gauss's greater efforts. The preceding criticism, if just, ought not to appear wholly trivial; for though it is quite true that in any mathematical work the substance is immeasurably more important than the form, yet it cannot be doubted that many mathematical memoirs of our own time suffer greatly (if we may dare to say so) from a certain slovenliness in the mode of presentation; and that (whatever may be the value of their contents) they are stamped with a character of slightness and perishableness, which contrasts strongly with the adamantine solidity and clear hard modelling, which (we may be sure) will keep the writings of Gauss from being forgotten long after the chief results and methods contained in them have been incorporated in treatises more easily read, and have come to form a part of the common patrimony of all working mathematicians. And we must never forget (what in an age so fertile of new mathematical conceptions as our own, we are only too apt to forget), that it is the business of mathematical science not only to discover new truths and new methods, but also to establish them, at whatever cost of time and labour, upon a basis of irrefragable reasoning.

"The μαθηματικὸς πιθανολογῶν has no more right to be listened to now than he had in the days of Aristotle; but it must be owned that since the invention of the 'royal roads' of analysis, defective modes of reasoning and of proof have had a chance of obtaining currency which they never had before. It is not the greatest, but it is perhaps not the least, of Gauss's claims to the admiration of mathematicians, that, while fully penetrated with a sense of the vastness of the science, he exacted the utmost rigorousness in every part of it, never passed over a difficulty, as if it did not exist, and never accepted a theorem as true beyond the limits within which it could actually be demonstrated."

It will be evident to our readers that this notice has been drawn up with a purpose. The town of Brunswick proposes to celebrate the hundredth anniversary of Gauss's birthday, and the committee hope to have received before the 30th instant, sufficient subscriptions to enable them to lay the foundation stone of a memorial statue. We have endeavoured to present in a strong light<sup>1</sup> the claims which this great mathematician has upon mathematicians, not only in Germany, but on mathematicians in this country.<sup>2</sup>

Gauss might himself have considered his works his best monument ("exegi monumentum aere perennius") and possibly if sufficient funds flow in, the committee might see their way to the bringing out a centenary edition of them. In this way they would confer a great boon upon mathematicians everywhere, for at present his writings are, as our great mathematical historian writes, "very costly."<sup>3</sup>

R. TUCKER

<sup>1</sup> Read Sept 28, 1869.  
<sup>2</sup> See Gauss's review of Seiber's Untersuchungen über die Eigenschaften der positiven ternären quadratischen Formen" in the *Göttingen gelehrte Anzeigen* (1831) or *Crelle*, vol. xx p. 412. Prof. H. J. S. Smith, On the Conditions of Perpendicularity in a Parallelepipedal System." (London Math Society's Proceedings, December, 1876). His method of drawing the crystals is essentially the same as that devised subsequently by Prof. Miller, of Cambridge. "Gauss. 2. Ged." p. 61.  
<sup>3</sup> *Disquisitiones generales circa superficies curvas* (Transactions, Göttingen, 1827).  
<sup>4</sup> "Gauss. 2. Ged." p. 81, quoted by Prof Sylvester (vide supra). Gauss's connection with the so-called (Gaussian) logarithms is pointed out on p. 75 of the Report of the Committee on Mathematical Tables (Brit. Assoc., 1873.) Reporter, Mr. J. W. L. Glaisher.  
<sup>5</sup> "Gauss, as a member of the German Magnetic Union, brought his powerful intellect to bear on the theory of magnetism and on the methods of observing it, and he not only added greatly to our knowledge of the theory of attractions, but reconstructed the whole of magnetic science as regards the instruments used, the method of observation, and the calculation of the results, so that his memoirs on Terrestrial Magnetism may be taken as models of physical research by all those who are engaged in the measurement of any of the forces in nature."—Prof. Clerk-Maxwell's "Electricity and Magnetism" (1873), p. viii. We may also refer for a statement of some of Gauss's discoveries to §§ 149, 144, 499, 491, 454, 706, and 744. Cf. also Prof. Maxwell's Address (Brit. Assoc., Liverpool, 1870) Pp 594-598 for portions of the memoir "Intensitas vis magnetice terrestris ad mensuram absolutam revocata" (1839) and of the Theory of the Earth's Magnetism (1839): "Allgemeine Theorie des Erdmagnetismus."  
<sup>6</sup> We quote freely from notes placed at our service for this article by Prof. J. J. Smith. "Summus Newton," "Gauss. 2. Ged." p. 84.

<sup>1</sup> Our task has given us much pleasure: it has been accomplished in the midst of many interruptions. All our authorities have been given. We close, as the author of the Book of Maccabees closes, with saying: "If I have done well and as is fitting the story, it is that which I desired; but if slenderly and meanly, it is that which I could attain unto." Subscriptions may be sent to the office of NATURE up to the 26th instant.  
<sup>2</sup> Sein God wird nicht allein in allen deutschen Landen sondern auch unter allen gebildeten Nationen der Welt die tiefste Trauer erzeugen. *Gelahrte Anzeigen*, No. 16, December 3, 1855.  
<sup>3</sup> Carl Friedrich Gauss Werke, Herausgegeben von der königlichen Gesellschaft der Wissenschaften zu Göttingen: vol. i. ii. 1863, vol. iii. 1866, vol. iv. 1873, vol. v. 1867, vol. vi. 1874, vol. vii. 1871. These are all we have seen. The editor is Soehring. The house in which Gauss was born bore the number 1550, and was situated on the west side of the Wenden-graben. It now has a memorial tablet. The house was sold in 1864, and the family removed to another in the Mühlentrasse, near St. Giles's Church. "Z. Ged." p. 8.

## METEOROLOGICAL NOTES

**METEOROLOGICAL LUSTRUM OF 1871-75.**—To the seventh Meteorological Report of the Grand Duchy of Baden, by H. Oscar Ruppel of Karlsruhe, just published, there is appended a paper giving the averages of the observations of pressure, temperature, humidity, rain, and snow, and thunderstorms made at the sixteen stations of the Grand Duchy during the Meteorological Lustrum ending with 1875. Considering the many physical and climatical inquiries of the highest importance which such averages, calculated for absolutely the same terms of years over considerable portions of the earth's surface, are certain greatly to elucidate, it is to be hoped that other meteorological institutes and societies will take the trouble to prepare and publish similar averages for their respective countries. In view of the more special inquiries which such averages are calculated to further, it will be necessary that anemometrical averages be included, and that all the averages be given for each of the different hours of observation.

**DISTRIBUTION OF BAROMETERS IN FRANCE.**—In virtue of the President's decree, signed by M. Thiers, for reorganising the French National Observatory, that establishment issues weather warnings for agricultural purposes. As it was impossible to send 40,000 telegrams daily (one to each parish) without gradually extending the institution, M. Leverrier decided that the daily telegrams should be sent only to those parishes which possessed an aneroid barometer and made arrangements for exposing it to public inspection at the same place where the official warnings were posted. Having obtained ready assistance from the Association Scientifique de France, of which he is the president, M. Leverrier was enabled to make the price of the aneroids as low as 20 francs (16s.). From the beginning of the year about 800 communes purchased the barometer, and now enjoy the free transmission of weather warnings. The number is increasing at the rate of about ten a day, and it is supposed that by the end of the present year 10,000 communes will be in constant communication with the national Observatory. The public barometer is to be used by local observers for interpreting, on their own responsibility, the weather-warnings issued by the Observatory. Special meteorological organisations have already issued general rules for this purpose partially based on Fitzroy's "Weather Manual," partly on special observations. The mean pressure for all these barometers, irrespective of the altitude of the stations is to be considered 760 mm., as it was supposed impossible to establish comparisons without thus displacing the variable. Isobaric curves are drawn daily on observatory maps after each observation has undergone correction by a constant number. M. Leverrier has established a rule for the determination of that constant. When he supposes the weather will be quite settled for a few days he sends to his correspondents a telegram stating *attention, réglage*. Each correspondent is ordered to observe the barometer at 6 P.M., and on the two following days at 9 A.M. and 6 P.M. The result of these three observations in millimetres is to be sent to the observatory for the determination of the value of the correction. When that number has been found it is sent to the station through the Minister of Public Instruction. The Mayor is informed officially how many divisions the indicating needle of his aneroid must be turned, left or right, in order that the correct reading may be read.

**STORM IN THE SOUTHERN AND EASTERN COUNTIES.**—A storm of unusual violence swept over this part of England on Wednesday last week, rising in Hertfordshire to a fearful hurricane. At Sacombe the whole of the farm buildings occupied by Mr. Mardell were destroyed, and one of his workmen killed. Large trees were broken across, hundreds of fruit-trees uprooted and carried away, and a large wall blown down. In a wood near Little Munden, one hundred fir trees were destroyed.

**AURORAS IN CANADA DURING THE PAST WINTER.**—We learn from a correspondent in Ontario that auroral phenomena have been unusually rare in that part of Canada during the four months preceding the middle of March. In that region, where auroras are usually very brilliant and frequent at that season of the year, only two have been noticed during these four months.

**SOLAR RADIATION IN WINTER AND SUMMER.**—M. A. Crova communicates to the *Bulletin International* of the Paris Observatory, March 20, a note on some observations he made near Montpellier on January 4 and July 11, 1876, with the view of ascertaining the calorific intensity of solar radiation received at the surface of the ground in winter and summer. These two days were selected as being characterised throughout by uninterrupted brilliant sunshine, and, there being no sea-breeze, uninterrupted calorific transparency of the air, and as being as near as possible to the winter and summer solstice respectively. The results arrived at are that the heat received normally on January 4 was 0.610 of that received on July 11, and the heat received over the surface of the ground on January 4 was 0.281 of that received on July 11. These results give a measure of the inequalities produced in winter and in summer by the obliquity of the sun's rays and by the duration of the sun above the horizon, between the absolute values of the intensity of solar radiation, and between the relations of the quantity of heat emitted directly to that which is received over the horizontal surface of the ground.

**HAILSTONES IN INDIA.**—Dr. Bonavia, of Lucknow, sends us the following:—On April 12, 1876, at 8.30 P.M., after a great deal of lightning and thunder in the north-west, a hail-storm occurred in Lucknow. We evidently only got the edge of the storm, as it was passing towards the north-east. The fall of hail was not plentiful, but the generality of the stones were enormous. The hailstones were of all sizes, from that of peas and marbles to that of oranges, two inches and more in diameter. The largest I measured, about half-an-hour after the fall, was a flat oval, resembling a paper-weight, with a depression in the centre above and below. Its circumference measured eight inches, its long diameter 2½ inches, its short diameter 2¼ inches, its thickness 1¼ inches. Two others I measured had a circumference of 7½ inches and 6¼ inches respectively. Some were of the above shape; others almost spherical; others might have readily served as models of the large flat China peach, with a depression above and below. Most of them had curious mammillary projections all over the surface, which strongly reminded one of some kind of Echinus. Their internal structure can best be described by stating that it resembled exactly that of agates. It consisted of concentric layers, with a more or less wavy outline, commencing from a small nucleus. The layers varied in thickness. Some were transparent; others opaque. One large oval stone, instead of having, like others, its nucleus in the centre of its oval, had it quite at one end. The nucleus was the size of a small marble; it was spherical, but the sphere was not complete. It appeared as if a small round hailstone had first been formed, then a bit of it chipped off, and afterwards a large oval hailstone agglomerated round it, leaving it at one end of the oval. I have been informed that one hailstone, weighed some time after it fell, was four ounces in weight; another weighed 2¼ ounces.

**THE WEATHER OF EUROPE.**—We have received the *Monthly Weather Reports* of the *Deutsche Seewarte* for March and April, 1876, in which the main features of the weather of Europe during these months are briefly detailed by various well-known meteorologists, particular attention being given to the remarkable storm of March 12 in its progress over the Continent. The tracks of all the storms of Europe during each month are shown by maps, and tables of figures are given of the means of the various meteorological elements for Germany and parts of the continent adjoining, from which the meteorology of a

ge portion of Europe could be graphically presented. We are much gratified to receive an intimation from the *Securite* that in future the *Monthly Reports* will be published regularly at the end of the second month after the one to which the Report refers. It would be a great boon if small maps accompanied the report, showing the mean pressure, temperature, rainfall, and direction of wind, in a manner similar to what is so well done in the United States of America.

**BALL LIGHTNING.**—A very fine display of this interesting meteor was witnessed at Venice, in the south-east of France, on the night of March 21-22, by M. Ed. Blanc, of which an interesting detailed account has just appeared in the *Comptes Rendus* of the French Academy, p. 666. Toward midnight there was observed, about eleven miles north-east of Venice, a large black undery cloud, in a state of extreme agitation, and continually rising and lowering its position. At the upper part of this cloud three or four balls of fire issued every two minutes, as if from the invisible centre of the cloud, diverging in all directions, and after running a course of from six to eight degrees, broke apart with effulgent brightness. Their apparent diameter, as seen at a distance of eleven miles, was about a degree. They were mostly of a reddish colour, a few, however, being of a lowish tinge, but all of them assumed a white colour in the moment of bursting. Their course, which was horizontal and parallel to the plane of the cloud, was relatively slow, not exceeding two degrees per second, and they bore a strong resemblance to dense soap-bubbles, both as regards apparent lightness and general appearance. From time to time a discharge of lightning issued through the cloud from above downwards, followed some moments after by a dull rumbling sound. The cloud, with its fine play of fire-balls, took a course from east to west, passing out a league to the north of Venice. The glimmering of the lightning with its low dull thunderous sound continued for more than an hour, after which the sky became darker and darker; hail mixed with hailstones fell, and lightning, accompanied with thunder, furrowed the sky in all directions.

NOTES

THE President of the Royal Astronomical Society has announced that the Council of that Society have determined to advance the requisite funds to enable Mr. Gill to carry out his projected expedition to the island of Ascension to measure theallax of Mars at the approaching opposition, in the expectation that they will be aided by Government or out of the Government grant to the Royal Society. At all events the Royal Astronomical Society will not allow the opportunity of making an important observation to be lost. Its duty in the matter was lent, and it has not hesitated for a moment in doing it. Mr. Gill will embark for the island of Ascension towards the end of the month.

SIR ROBERT CHRISTISON, who has been in failing health some time, has resigned the Chair of Materia Medica in the University of Edinburgh, which he has held with such distinction since the year 1832. Sir Robert, before being appointed to the Chair he has now relinquished, had filled for ten years that of Medical Jurisprudence.

LAST Sunday evening the first of a course of eight lectures to young men on science and literature was delivered at the Alban's Schools, Holborn. The lecture was by Mr. R. W. S. Sharpe, of the British Museum; the subject, "Birds of prey and their Geographical Distribution." Mr. Mackonochie expresses the hearty thanks of all interested in the welfare of the young classes for having undertaken so liberal an enterprise.

THE Annual Meeting of the Yorkshire College of Science held at Leeds on the 16th inst. A highly satisfactory report

was presented, in which it was urged that the college should now apply for a charter of incorporation. The great desirability of establishing a classical side in the college was recognised in the report and by the president, Lord F. Cavendish, and other speakers, and there is every reason to hope that in no long time the Yorkshire College will be a flourishing rival of Owens College. The munificence of the Clothworkers' Company deserves all praise and imitation; its last gift to the College is one of 10,000*l.*

DR. JANSSEN has removed his photographic apparatus from the Boulevard Ornano to Meudon, where he is establishing, in barracks given by the French War Office, a permanent physical observatory at the expense of the Government.

ON April 23 next the Paris Academy of Sciences will hold its anniversary meeting for the distribution of prizes. M. Dumas will deliver a lecture on the two brothers Alexander and Adolphe Brogniard, both of them members of the Academy of Sciences. Admiral Paris will be in the chair.

THE Paris Physical Society held its anniversary meeting on April 5. Various apparatus were exhibited, including a number of radiometers, M. Bischoff's gas engine without refrigerator, and a Mouchat reflector for utilising the heat from the sun.

IT has been decided by the Committee of the French Sociétés Savants that special warnings should be sent to the coal pits when large depressions are foreseen, in order to suggest precautions against an escape of fire-damp. Many mining engineers believe that the system will be efficacious. Experience will soon settle the question.

THE U.S. Congress having appropriated 18,000 dollars for a Commission to report on the depredations of the Rocky Mountain locusts, the Secretary of the Interior has appointed as members of the Commission Prof. C. V. Riley, Dr. Cyrus Thomas, and Dr. A. S. Packard. The Commissioners have already mapped out their work for the season, and will direct their attention to insect enemies and parasites, mechanical means for the destruction of the pests, geographical distribution, agricultural bearings of the subject, anatomy and embryology, remedial measures and migrations, &c. Bulletins giving the results of the Commission's inquiries will be issued at intervals.

THE opening meeting of the Yorkshire Naturalists' Union (formerly known as the West Riding Consolidated Naturalists' Society) was held at Pontefract on Easter Monday, April 2, and proved a great success in every way. The Union is a confederation of twenty-four Natural History and Scientific Societies in Yorkshire, banded together for the purpose of holding each summer a combined series of excursions and meetings, of investigating the fauna and flora of the country, and of publishing the results. The union is divided into five sections, viz., vertebrate zoology, conchology, entomology, botany, and geology, which work on the principle of the British Association. This plan was tried for the first time at Pontefract, and so far as it went proved a decided success. The towns represented in the Union are Huddersfield (three societies), Heckmondwike, Clayton West, Barnsley, Wakefield, Ovenden, Stainland, Ripponden, Holmfirth, Liversedge, Rastrick, Mirfield, Hunsley, Middles-town, Paddock, Bradford, Leeds (two societies), Goole, York, Selby, and Sheffield, numbering in the aggregate nearly 1,200 members. The next meeting will be held at Wetherly, on Whit Monday, May 21.

AT the last meeting of the French Anthropological Society, a long report was read which showed that Druidism was not quite extinct in Brittany, some country people still adhering to Pagan practices in spite of the priests' exertions. It was noticed that the clergy were anxious to destroy menhirs and

other similar relics. A petition has been sent to the ministry to put a stop to this iconoclastic zeal.

A WORK has just appeared in Berlin from the pen of Friedrich von Barenbach, in which the author endeavours to show that the main features of the evolution theory were partially comprehended and advocated by Herder.

THE German Ornithological Society instituted, during the past year, an extensive series of observations by means of schedules, on the dates of nest-building, appearance of the young broods, movements of migratory birds, &c. The statistics resulting from the first year's observations are now being compiled and will shortly be issued in book form.

THE following College Lectures in the Natural Sciences will be given at Cambridge during Easter Term, 1877:—Gonville and Caius College: On Organic Analysis and Elementary Organic Chemistry, by Mr. Apjohn. Christ's College: On the Elements of Electricity and Magnetism, by Mr. Chrystal. St. John's College: On Chemistry, by Mr. Main. Instruction in Practical Chemistry will also be given. On Stratigraphical Geology, by Mr. Bonney; On Elementary Geology; On Palæontology, by Mr. Bonney. Trinity College: On Electricity (continued), by Mr. Trotter; Elementary Physics (Light, &c.), by Mr. Trotter; Vertebrate Embryology with Practical work, by Mr. Balfour; Practical Elementary Biology, by the Trinity Praefector in Physiology (Dr. Michael Foster). Sidney Sussex College: On the Morphology of Cryptogams, by Mr. Hicks. Downing College: On Chemistry, by Mr. Lewis; On Comparative Anatomy and Physiology, by Mr. Saunders.

THE Trieste papers describe an extensive stalactite cavern, consisting of several galleries, lately discovered in the neighbourhood of the city.

ANOTHER valuable addition has been made to the already enormous ethnographical treasures of the Berlin Museum by the purchase of the extensive collections of the African traveller, Piaggia. The explorer, Schweinfurth calls it the best collection of the kind in existence, and unrivalled in its special department. Although much larger sums were offered by speculators, Piaggia preferred to dispose of it for 75,000*l.* to the Berlin Museum, with the condition that it should be preserved in special apartments bearing his name.

FATHER SECCHI has invented a new electric seismograph with moving smoked paper, which indicates the direction, number, intensity, duration of the shocks, and many other details of great value in connection with seismography.

THE principal article in the April number of Petermann's *Mittheilungen* is on the condition of the bed of the Pacific Ocean, based on the researches of the *Tuscarora*, the *Challenger*, and the *Gaselle*. It is accompanied by a carefully prepared and unusually clear chart, showing by a variety of tints the results which have been obtained.

THE forthcoming number of the Italian geographical journal *Cosmos* will contain an article urging that Italy ought to take a part in Arctic exploration.

It is stated that the Berlin gorilla, to which we have referred on more than one occasion, is to be brought to London during the present season.

THE annual session of the Congress of French Learned Societies took place at the Sorbonne on April 4, 5, 6, and 7. More than 1,000 savants from all parts of France, mostly professors in the several academies, were registered, 300 of whom belong to the scientific sections. M. Leverrier was the president of the scientific department. The question of weather warnings raised several interesting discussions. The final meeting took place as usual

on the 7th, the minister for public instruction, M. Waddington, being in the chair. Gold medals were granted to M. Allard, of the Puy de-Dôme Observatory; M. Tisserand, astronomer to the Observatory of Toulouse; Rollin, professor at Bordeaux for meteorology; Rouville, professor at Montpellier for geology; Grand-Eury, professor at the School of Mines at St. Etienne for geology. Nine silver medals were also granted to several provincial scientific men, and a number of similar distinctions to the members of the other sections.

THE Geographical Society of Paris held last week an extraordinary meeting for the purpose of procuring funds to build a large house for its own use to be ready by the time of the next International Exhibition. A sum of 300,000 francs is necessary, and will be raised by 1,000 bonds of 300 francs each.

M. LEVERRIER has been elected President of the Association Scientifique de France for the fifteenth time. The society spent about 1,200*l.* in scientific experiments last year.

WE have received from the United States Geological Survey a Hypsometric Map of the United States and a Drainage Map of Colorado.

NEWS has been again received at Munich after a long time, from the African traveller, Dr. Erwin v. Bary. He has safely returned to Ghât from his journey into the Valley Mihero. He is the first European who has visited the hot springs of Sebarbaret, and seen the crocodile-pond. Interesting geological and geognostic results, with a collection of many hitherto unknown plants have been gained from this journey. It was very dangerous owing to the war of the Asgar with the Hogr of Tuareg, and the traveller was in constant risk of attack. The sheikh of Tuareg, Jehenuchen, 102 years old, has lost two sons, so he is not easily propitiated. The murderer of the Dutch traveller, Alexandrine Tinne, whose unhappy fate excited European sympathy, goes about freely in Ghât. Dr. v. Bary will endeavour, notwithstanding the danger, to penetrate further into the country of the Tuareg, in order to prosecute his geological and botanical inquiries.

IN a recent note in *Fougenorff's Annalen* on Maxwell's electromagnetic theory of light, Dr. Frohlich finds that the application of that theory to good electric conductors leads to results which are in direct contradiction with experience. It is not, however (he considers), to be therefore wholly rejected, as the researches of Boltzmann, Schiller, Silow, and Root show that its consequences agree with experience very well in the case of dielectrics (solid bodies, liquids, and gases). And the cause of its divergence in the case of metals may probably be found in the simplicity of the theory. The processes in the interior of metals are of course more complicated than those which occur in transparent or non-conducting dielectric media. And as little as the reflection of light on metallic surfaces can be deduced from the simple undulation theory, is it possible for Maxwell's theory to represent such complicated processes.

A CORRESPONDENCE has recently been going on in the *Journal of the Society of Arts* on the suitability of the leaves of the coffee plant as a substitute for tea. There is nothing new in this suggestion, for in Sumatra as well as in Jamaica coffee leaves are "cured" in a similar manner to those of tea in China for use in the production of a beverage. In some parts of India likewise the leaves are gathered, partially dried, fermented, and finally roasted in imitation of the commercial kinds of tea. Considering the composition of coffee leaves there can be no doubt that if properly and carefully cured they might in time become of some commercial value. Whether the husk which surrounds the coffee seed could also be so utilised is another question that has been raised. This coffee husk seems to be generally used in Arabia under the name of "kishr." In a letter on this subject in a recent number of the above journal a correspondent com-

pars the capabilities of Ceylon as a coffee-producing country with that of Arabia, he says: "Ceylon being a damp climate and the coffee fruit succulent it is gathered when at maturity, otherwise like cherries, it would mould on the trees. It is then placed in heaps for a day or two and the pulp allowed to ferment, in which state it is removed by washing. The pulp so washed off is only fit for manure. On the other hand, the climate of Arabia being dry the fruit is allowed to ripen and drop off of itself. In this case the pulp and other coverings dry on the berry and are often not removed for months after. It is from these husks that the *kisr* is made, or, to speak more correctly, this husk is the *kisr*, a decoction of which is used generally as a beverage throughout Arabia. The parchment and silver skin of the coffee amount to a mere nothing, but the dried husk of the Arabian berry amounts on an average to twenty per cent. The Arabs make their *kisr* coffee or a decoction of these husks by bruising about a handful, which is put into hot water in an earthen pan, and placed over a slow fire. A few bruised cardamoms and a little dry cinnamon or ginger is added, the whole being allowed to simmer for about half an hour, when it is ready for use, and is described as a most agreeable beverage. A handful of husks thus treated yields about ten Arab coffee cups, which are about the size of two of our ordinary tea cups. The price of the dried coffee husk at Aden is about two shillings for twenty-eight pounds.

THE Italian Government have granted the sum of 6,000 francs for a special investigation of the natural history of Calabria. This part of Italy is only very imperfectly known; in fact its geognosy, its fauna and flora, both present and palæontological, are a *quasi terra ignota* to scientific research. The task has been confided to Messrs. Dr. Forsyth Mayor for the Palæontology and Zoology of Vertebrata, Dr. Cavanna for Zoology of Invertebrata, Dr. D. Stefani for Geology, and Dr. Arcangioli for Botany—all very earnest and able workers. We may, therefore, look forward with confidence and interest to the results of this expedition.

THE Russian Geographical Society has undertaken the publication of a most important work, being a description of the upper parts of the Oxus, of the Hindu-Kush, and Western Himalayas. The object of the publication is to collect all existing information on the peoples inhabiting the above-named countries—the cradle of the Aryan family. The information will be collected from the works of Burns, Wood, Ferrier, Cunningham, Shaw, Hayward, Abramof, Grébenkin, Kuhn, Sobolef, and Fedchenko, and also that obtained from Chinese sources by Klapproth, Rémusat, St. Jullien, Sakin, Palladiz, &c. This compendium will be accompanied by an ethnographical map and vocabularies of local dialects, as well as by bibliographical notices scattered in many papers, especially English. The Committee intrusted by the Society with the discussion of this scheme will add to the work a general geographical sketch of the country. The work will be under the direction of Prof. J. P. Minayeff.

THE same Society is now preparing a scheme for the ethnographical and anthropological exploration of the Finnish tribes inhabiting the neighbourhoods of the Volga.

AT the last meeting, March 14, of the Russian Geographical Society, Lieut. Onatsévich gave an account of his geographical work during 1874 to 1876 in North-eastern Siberia and the Sea of Okhotsk. The most interesting part of his account was that devoted to the attempt he made in the clipper *Vsadmik* to reach Wrangell Land through Behring Strait. Under lat. 67° the ship met, however, with a thick impenetrable barrier of ice, and was compelled to take a westerly course. In this direction, also, she soon met with ice and was forced to return. Lieut. Onatsévich then cruised about in the open parts of the ocean, making

a series of very valuable measurements of depths, temperature of water, &c. He noticed thus the existence of a warm current which, after running through Behring Strait, takes a westerly direction. A great number of very valuable maps and of profiles of the sea-bottom were exhibited during the reading of the paper.

WE have received the Annual Report of the Goole Scientific Society. Some very good papers have been read at the meetings and an attempt has been made to systematically work out the natural history of the neighbourhood.

THE slab of sandstone, from Corncockle quarries, with the impression of footprints, which lately came into the possession of Mr. M'Veekan, Dumfries, has just been acquired by the Museum of Science and Art in Edinburgh. This slab is an unusually interesting one, as it has the impressions of two distinct footprints on it—*Chelichnus ambiguus* and *Herpetichnus sauroplestius*—Jardine ("Ichology of Annandale"). On none of the slabs in the collection of the late Sir William Jardine, which is now in the Museum in Edinburgh, are to be found the footprints of two different animals, although both the above-mentioned footprints occur on separate slabs.

THE additions to the Zoological Society's Gardens during the past week include a Bennett's Wallaby (*Halmaturus bennetti*) from King's Island, presented by Miss E. Woollatt; a Malabar Green Bulbul (*Phyllornis aurifrons*) from India, presented by Mrs. Arabin, F.Z.S.; two Smooth Newts (*Triton tennatus*), European, presented by Master G. L. Sclater; eighteen Red-crested Whistling Ducks (*Fuligula rufina*), four Spotted-billed Ducks (*Anas pacillo-rhyncha*), a Ring-necked Parrakeet (*Palaeornis torquata*) from India, a Green Monkey (*Cercopithecus callitrichus*) from West Africa, a Brown Capuchin (*Cebus fatuellus*), two Scaly Doves (*Scardafella squamosa*), a Great American Egret (*Ardea egretta*) from South America, a White-fronted Guan (*Penelope jacucaca*), a White eye-browed Guan (*Penelope superciliosus*) from South East Brazil, deposited; an Impeyan Pheasant (*Lophophorus impeyanus*) from the Himalayas, two Siamese Pheasants (*Explocamus fralatus*) from Siam, purchased; two Alpine Marmots (*Arctomys marmotta*), European, received in exchange; a Chinchilla (*Chinchilla lanigera*) born in the Gardens.

### SCIENTIFIC SERIALS

*American Journal of Science and Arts*, March.—In memoirs Fielding Bradford Meek.—Notes on the age of the Rocky Mountains in Colorado, by A. C. Peale.—On some points in connection with vegetation, by S. H. Gilbert.—Apparatus for quantitative fat extraction; composition of the sweet potato; composition of maize fodder, by S. W. Johnson.—Meteoric stone of Rochester, Fulton Co. Indiana, by C. U. Shepard.—Examination of the Waconda meteoric stone, Bates County meteoric iron, and Rockingham County meteoric iron, by J. Lawrence Smith.—Certain features of the valleys or water-courses of Southern Long Island, by Elias Lewis.

*Poggendorff's Annalen der Physik und Chemie*, No. 1, 1877.—Measurements of diamagneto electric induction currents, by MM. Töpfer and Ettingshausen.—On the absorption of radiant heat by aqueous vapour, by M. Haga.—On the dependence of galvanic resistance on current-strength, and Edlund's theory of diaphragm-currents, by M. Doré.—On the intensity of fluorescence-light, by M. Lommel.—Remarks on Maxwell's electromagnetic theory of light, by M. Fröhlich.—New method of determining exactly the fusing-point of metals and of other matters which are bad conductors of heat, by M. Himly.—On the electric resistance of liquids under high pressure, by M. Herwig.—A perfectly air-tight barometer quickly, easily, and cheaply made without boiling, by M. Bohn.—On diffusion, and the question whether glass is impenetrable for gases, by M. Quincke.—On the polarized light of the rainbow, by M. Dechant.—On arsenic, and a method for separation of vanadic acid from argillaceous earth and iron oxide, by M. Bettendorff.—On the composition of pyrite of cobalt and allied minerals, by M. Rammelsberg.—On the Torricellian vacuum, by M. Moser.—Experiments with the

radiometer, by M. Neesen.—Researches on the motions of radiating and irradiated bodies, by M. Zollner.—On the determination of the principal and focal points of a lens-system, by M. Hoppe.—On thermo-electric determinations of temperature, by M. Rosenthal.—On the nature of gas-molecules, by M. Boltzmann.

*Beiblätter zu den Annalen der Physik und Chemie*, Band i. Stück 2.—We note here a useful paper on recent experiments with the radiometer and their explanation; also a doctorate-dissertation by M. Lorentz, on the theory of reflection and refraction of light.

FROM the *Naturforscher* (February) we note the following papers: On the most refrangible part of the solar spectrum, by T. L. Soret.—On the distribution of the electric current in conductors under decomposition, by R. Lenz.—On the southern shore of the northern diluvial sea, by Herr Credner.—On the mixed occurrence of different vegetations, by Oscar Drude.—On the nature of the substance which emits light in the flames of hydrocarbons, by Karl Heumann.—On a prehistoric steppe in the Prussian province of Saxony, by A. Nehring.—On the history of Tertiary deposits in South-eastern Europe, by M. Tournour.—On the differences in the chemical structure and in the digestion of higher and lower animals, by F. Hoppe-Seyler.—On a relation of chemical structure to the power of polarising light, by G. J. W. Bremer.—On the conduction of heat by liquids of different densities, by E. Sacher.—On the behaviour of palladium in the alcohol flame, by F. Wohler.

THE *Archives des Sciences Physiques et Naturelles* (January), contains the following original papers:—On the tendrils of climbing plants, by Casimir de Candolle (see our note on this paper).—On the origin of the ancient alluvium, by Ernest Favre.—On static electricity, by E. Mascart.—Description of *Niphar-gus puteanus*, var. Forelli, by Alois Humbert (see our note on this paper).—Some researches made in the physiological laboratory of Geneva; on the formation of pepsine before and after death, by Prof. Schiff.—Note on the effect of the irritation of a nerve through which a constant electric current is passing, by Dr. B. F. Lautenbach.

THE *Journal of the Russian Chemical and Physical Societies* (vol. viii., part 9, December, 1876), contains the following papers:—On the action of bromine upon acetone, by N. Sokolowsky.—Synthesis of  $\alpha$  oxybutyric acid, by S. Przibytok.—On the pinacolone of methylethyl acetone, by G. Lawrinowich.—On the synthesis and properties of diallyl-carbinol, by M. Saytzev.—On the action of the iodides of ethyl and allyl upon formiate of ethyl, by the same and J. Kanonnikow.—On the synthesis and the properties of dimethylallyl carbinol, by the same and M. Michail.—Theoretical researches concerning the distribution of static electricity on the surface of conductors constituted of heterogeneous parts, by D. Bohylew.—On electric rays, by O. Chwolson.

*Reale Istituto Lombardo di Scienze e Lettere*, Rendiconti, vol. x. fasc. 2.—On the co-ordinates of points and of lines in a plane, and of points and planes in space (continued), by M. Casorati.—Case of mammary hypertrophy, by M. Scarenzio.—Results of observations on the amplitude of the daily oscillations of the magnetic needle in 1875 and 1876, at the Observatory of Brera, in Milan, by M. Schiaparelli.—On some differential equations with algebraic integral, by M. Brioschi.

SOCIETIES AND ACADEMIES  
LONDON

Royal Society, March 8.—“Notes on Physical Geology,” by the Rev. Samuel Haughton, M.D. Dublin, D.C.L. Oxon., F.R.S., Professor of Geology in the University of Dublin.

No. I.—*Preliminary Formule relating to the Internal Change of Position of the Earth's Axis, arising from Elevations and Depressions caused by Geological Changes.*

In this paper the author proves the following preliminary formulæ, necessary for the further discussion of his subject:—

$$- \tan 2\theta = 935'6 \rho \sin 2\lambda \dots (1)$$

where  $\rho$  is the ratio of the weight of an elevated mass to the weight of the whole earth;

$\lambda$  is the latitude at which the elevation takes place, and

$\theta$  is the final displacement of the earth's axis of rotation.

$$r\theta = 14'11 (\cos^2 \lambda' - \cos^2 \lambda) \dots (2)$$

where  $r\theta$  is the displacement of the pole in English miles, caused by a continental slip of  $5^\circ$  longitude in breadth, and lying between the higher and lower latitudes of  $\lambda$  and  $\lambda'$ .

In proving the equations the author distinguishes between three level surfaces, viz.—

1. The surface of the sea.
2. The zero surface of the solid earth.
3. The zero surface, corrected for the weight of the ocean.

The zero plane, from which the elevations are measured, is the surface of the ellipsoid similar to the sea surface, and containing the same volume as the total solid matter of the globe. It is thus found, assuming the mean height of the continents above the sea-level at about 1,000 feet, and the mean depth of the ocean at about two miles, we have, in miles,

$$x = \frac{2'2L}{W + L}$$

where  $x$  is the height of the zero plane above the present mean sea-bottom, and  $L, W$  are the areas of land and water;

$L = 52$  millions of square miles.

$W = 145$  „ „ „

Substituting we find—  
 $x = 0'58$  mile.

The zero plane, therefore, or original surface of the solid earth, before it became wrinkled by geological forces, lies at a depth of 1'42 mile below the sea-level. In using the equations we must therefore write—

Elevation — + 1'62 mile (continent).

Depression — - 0'58 „ (ocean).

In calculating the motion of the pole caused by the ocean excavations, the weight of the sea water must be considered, and, by chance, it happens that the weight of the sea-water somewhat more than counter-balances the weight of the surface-rock excavated; so that the depression of the ocean-bottoms of the earth beneath the zero plane have had little or no effect in shifting the position of the pole.

Assuming 1'026 and 2'75 as the densities of sea-water and surface-rock, we have for the excess of weight of water added above that of rock excavated; expressed in depth of rock, in miles—

$$2 \times \frac{1'026}{2'75} - 0'58 \times 2'75 = 0'17 \text{ mile.}$$

The introduction of the weight of the sea will thus give us (raising the zero plane by 0'17 of a mile)—

Elevation = + 1'45 mile (continent),

Depression = 0'00 „ (ocean).

No. II.—*On the Amount of Shifting of the Earth's Axis, already caused by the Elevation of the existing Continent.*

Having shown in the preceding note that the motion of the earth's axis caused by the geological wrinkling of the earth's surface depends (in consequence of the weight of the sea-water) only on the continents, it remains to calculate the numerical amount of change of axis produced by each of the existing continents.

For this purpose the author selects the following meridians for the co-ordinates Y and X of the motion:—

Greenwich	...	0	+	Y
Rangoon	...	90	-	X
Behring's Strait	...	180	-	Y
Yucatan	...	270	+	X

Reckoning the longitudes eastward, round the whole circumference of the earth, the equation (2) gives—

$$r\theta = -14'11 (\cos^2 \lambda' - \cos^2 \lambda),$$

in which the meridian of each  $5^\circ$  of longitude is used,  $\lambda'$  and  $\lambda$  being the lowest and highest degrees of latitude of the land on each meridian.

The expression  $\cos^2 \lambda' - \cos^2 \lambda$  is found by observation on the globe, and resolved into its components X and Y, regarding the North Pole as the axis moved.

The equation (2) is then used (by quadratures) to determine the total effect of each continent taken separately. The tables of quadratures are given in the paper, and the final results are—  
Displacement of North Pole caused by each continent.



	Towards Greenwich.	Towards Behring's Strait.	Towards Yucatan.	Towards Rangoon.
	Mile.	Mile.	Mile.	Mile.
Europe and Asia ... ..	—	58'7	199'4	—
Africa ... ..	—	26'9	—	1'7
North America ... ..	15'2	—	—	105'5
South America ... ..	19'9	—	35'1	—
Australia, &c. ... ..	—	30'2	—	30.2

The power of Europe and Asia in moving the pole is partly due to the extension of this continent along the parallel of 45°, which is the most effective latitude. The actual effect produced by Europe and Asia was not much less than that of our imaginary continent (Note I.), occupying one eighth part of the surface of the globe.

The foregoing results are positive, and the motions of the pole indicated must have actually occurred when the existing continents were formed. But simultaneously with these elevations depressions must have gone on elsewhere, continents disappearing beneath the sea and sinking to the zero plane, while other continents were rising. It is to be noticed that although the excavation of the sea-bottom to its present depth below the zero plane, corrected for the weight of the ocean, produces no motion in the pole, yet that the depression of a continent down to the zero plane produces a motion of pole equal and opposite to that produced by its elevation. I have calculated the hypothetical effects of the depression of imaginary continents occupying the sites of the present Pacific Ocean, with the following results:—

North Pacific Ocean (depressed).	
Towards Yucatan ... ..	3'4 miles.
Towards Behring's Straits ... ..	250'6 "
South Pacific Ocean (depressed).	
Towards Rangoon ... ..	156'2 miles.
Towards Greenwich ... ..	238'2 "

The total effect of a continent equal to the North Pacific would be—

$$\sqrt{X^2 + Y^2} = 250'6 \text{ miles.}$$

$$\frac{X}{Y} = \tan(\phi), \phi = 0^\circ 47' \text{ E. of } 180^\circ.$$

The total effect of a continent equal to the South Pacific Ocean would be—

$$\sqrt{X^2 + Y^2} = 201'8 \text{ miles.}$$

$$\frac{X}{Y} = \tan(\phi), \phi = 23^\circ 17' \text{ E. of Greenwich.}$$

**Geological Society, March 21.**—Prof. P. Martin Duncan, F.R.S., president, in the chair.—William B. Colman, William James Grimshaw, and Alexander Ross were elected Fellows of the Society.—The following communications were read:—On the strata and their fossil contents between the Borrowdale series of the North of England and the Coniston flags, by Prof. Robert Harkness, F.R.S., Cork, and H. Alleyne Nicholson, F.R.S.E., Professor in St. Andrew's. The object of this paper was the investigation of the strata between the great volcanic series of the Lake-district, the Borrowdale rocks, and the sedimentary rocks called Coniston Flags by Prof. Sedgwick. The Borrowdale series, the Green Slates and Porphyries of Sedgwick, are underlain by the Skiddaw Slates, forming the base of the Silurian series, and equivalent in age to the Arenig rocks of Wales, according to their fossil contents. The Borrowdale rocks consist of ashes and breccias, alternating with ancient lavas, and are partly subaerial, partly submarine. They contain no fossils except in a band of calcareous ashes near the summit of the group, which is followed by the Coniston Limestone, with or without the intervention of a bed of trap. The fossils are of Bala types. Sometimes this band is recognisable, with no traces of fossils except cavities filled with peroxide of iron. The authors regard this as proving the prevalence of volcanic activity in the Lake District up to the later portion of the Bala period. The deposits specially discussed in the paper sent lie, apparently quite conformably, upon the Borrowdale rocks, and are grouped by the authors as follows, in ascending order:—(1) Dufton Shales; (2) Coniston Limestones and Shales; (3) Graptolitic Mudstones or Skeelgill beds; (4) Knock beds. The "Dufton Shales" are a well-marked but locally distributed group of muddy deposits, especially well developed in the Silurian area underlying the cross Fell range, where they are seen in four principal exposures, and their thickness probably exceeds 300

feet. They are richly fossiliferous. The "Coniston Limestone" has long been recognised as the best-defined division of the Lower Silurian rocks of the north of England. The "Graptolitic Mudstones" overlie the Coniston Limestone, wherever the summit of the latter is to be seen. Besides Graptolites, they contain many other fossils, including Corals, Brachiopods, Cephalopods, and Crustaceans; and from the consideration of the whole fauna, the authors are led to believe that the position of these deposits must correspond either with the highest beds of the Bala series or with the lower portion of the Llandovery group. The Graptolitic Mudstones are succeeded by the "Knock beds," so called from their great development in Swindale Beck, near Knock. Wherever they occur they consist chiefly of pale green, fine-grained slates, very ashy in appearance, and presenting many dendrites, and frequently crystals of cubic pyrites. There is no evidence of unconformity between them and the underlying Mudstones.—On a new area of Upper Cambrian Rocks in South Shropshire, with the description of a new fauna, by C. Callaway, F.G.S. The purpose of the author was to prove that certain olive, micaceous, thin-bedded shales exposed at Shineton, near Cressage, and covering an area of eight miles in length by two in the greatest breadth, which had been mapped as Caradoc in the survey, were of Tremadoc age. They were seen clearly to underlie the Hoar Edge Grit, the lowest beds in the district, with Caradoc fossils; and no rock distinctly underlying the shales could be detected. The evidence for their age was chiefly paleontological. With the exception of *Asaphus homfrayi*, a Tremadoc form, the species are new. Genera such as *Olenus*, *Conocoryphe*, *Obolella*, and *Lingulilla* suggested a very low horizon, but two Asaphoid forms (though not typical *Asaphi*) pointed in an opposite direction. Corroborative evidence was found in a correlation of the shales at Shineton with the *Dictyonema*-shales at Pedwardine and Malvern.

**Anthropological Institute, April 10.**—Mr. John Evans, F.R.S., president, in the chair.—The president exhibited two stone instruments from Sandoway District, North Burma.—Some flint arrow-heads, scrapers, &c., from Ditchley, Oxon, were exhibited by Capt. Harold Dillon.—A paper on some rude stone monuments in North Wales was read by Mr. A. L. Lewis. The chief point of interest being the existence, hitherto, we believe, unnoticed, of single outlying stones on the north-east of the circle near Penmaunmawr which is thus shown to conform to and to lend further confirmation to the rule found by him to exist generally in British circles of a special reference to the north-east by outlying stones or otherwise.—The director read a paper by the Rev. W. Ross, F.S.A. Scotland, on some curious coincidences in Celtic and Maori vocabulary.—Papers were also read by the director, on Australian aboriginal languages, traditions, &c., by Messrs. Greenway, McDonald, Rowley, Malone, and Dr. Creed, communicated by Mr. William Ridley, M.A., through the Colonial Office.—Col. A. Lane Fox, F.R.S., Messrs. Hyde Clarke, Walhouse, Moggridge, Park-Harrison, and the president, took part in the discussion.

**Royal Microscopical Society, April 4.**—H. C. Sorby, F.R.S., president, in the chair.—The following papers were read:—On the variability of the chlorophyll bands in the spectrum, by Mr. Thomas Palmer, in which he described the various effects produced by solutions in alcohol, &c., and by treatment with acids and alkalis.—On the mineralogical constitution and microscopical characters of the whetstones of Belgium, by M. l'Abbé Kénard, of Louvain.—On the microscopical character of Krupp's "silicate cotton," by Mr. H. J. Slack, and on the lower Silurian lavas of Cumbria, by Mr. Clifton Ward, in which it was shown that the difference between ancient and modern lavas was not so great as was usually supposed, their actual constituents being very nearly the same, though apparently they differed owing to conditions which had produced metamorphosis in the earlier series.

**Physical Society, March 17.**—Prof. G. C. Foster, president, in the chair.—Mr. W. S. Seaton was elected a member of the society. Mr. Spottiswoode exhibited some experiments on the stratification of the electric discharge in vacuum tubes, and described his attempts to produce the effects as obtained by Mr. Gassiot and Mr. de la Rue, with batteries of several thousand cells, by means of the induction coil. An account of his experiments has already been given in our pages.—Capt. Abney, R.E., then read a paper on the photographic image, prefacing it by a brief account of the two theories, the chemical and the physical, which are held regarding it. On the former, a molecule of bromide of silver is made an image on a surface of glass,

the latter of which is absorbed; and on the latter theory, light acts mechanically on the molecule, shifting the positions of the atoms. Poitevin has done much to confirm the former of these by placing a film of silver iodide in contact with a silver plate, when he succeeded in obtaining an image on the film of iodide and one on the silver plate produced by the liberated iodine. Capt. Abney has performed the following experiments: a portion of a dry plate which had been exposed, was wet with a sensitive collodion emulsion of bromide of silver, and developed by the alkaline method; the films were separated from the glass and from each other by means of gelatinised paper, and were found to bear images: and the same result was obtained when the emulsion was added after exposure, development, and fixing. These experiments entirely disprove the supposition that only those molecules acted on by light are reduced. If the two films be separated by a thick layer of albumen, the lower picture develops as a negative, and the upper as a positive. Capt. Abney is now engaged in an attempt to determine the attraction exercised by the sub-bromide, and this it is hoped, will do much towards the complete solution of the problem of the photographic image.—Mr. O. J. Lodge proposed a modification of Mance's method for determining the intensity of an electric current. This method, of which Wheatstone's Bridge is an application, depends upon the fact that if three conductors be united at a point *A*, and their extremities *BC* and *D* be united by three wires, *BC*, *CD*, *DB*, the resistance of *BC* will be independent of that of *AD* if *AB* is to *AC* as *BD* is to *CD*. In the arrangement proposed by Mr. Lodge, four wires are joined in the form of a square, and the circuit can be completed across one diagonal by means of a key, and in the other diagonal is included a condenser and a galvanometer, with a long fine wire. The greatest sensitiveness is obtained when the resistances in the four sides are equal. A great advantage of this method consists in the fact that it is equally applicable to the measurement of small and great resistances. Mr. Lodge then showed a modified form of Daniell's cell, capable of giving a constant current for a considerable period. A glass cell half filled with dilute sulphuric acid, contains two vertical glass tubes one of which, open at both ends, is traversed by a zinc rod, while the other is closed at its lower end, and contains cupric sulphate, from which rises a copper wire. The portion of the glass tube projecting above the acid is sufficiently moist to enable the current to traverse its surface while the zinc sulphate is prevented from reacting on the copper.

Victoria (Philosophical) Institute, April 18.—Rev. R. Thomson, D.D., vice-president, in the chair.—A paper on recent Assyrian research, and the light it threw on civilisation at the time of Abraham, was read by the Rev. H. G. Tomkins.

MANCHESTER

Literary and Philosophical Society, March 20.—Mr. E. W. Binney, F.R.S., president, in the chair.—On the action of sea-water upon lead and copper, by Mr. William H. Watson, F.C.S. Communicated by Dr. R. Angus Smith, F.R.S.—Note on the Upper Coal Measures of Canobie, Dumfriesshire, by Mr. E. W. Binney, president, F.R.S.—Losses and gains in the death-toll of England and Wales during the last thirty years, by Mr. Arthur Ransome, M.D.

PARIS

Academy of Sciences, April 9.—M. Peligot in the chair.—The following papers were read:—On the possibility of deducing from one only of the laws of Kepler the principle of attraction, by M. Bertrand.—Some of the fundamental data of thermo-chemistry, by M. Berthelot. He deals with the heat of formation of sulphurous acid and the compounds formed by bromine and iodine with hydrogen and oxygen.—On a theorem relative to the expansion of vapours without external work (continued), by M. Hirn.—Morphological relations between the antheridia and the sporules developed in the verticillate ramification of a particular form of *Rattachospermum moniliforme*, by M. Sirodot.—Substitution of chlorophyll for salts of copper ordinarily used in preparation and conservation of fruits and green vegetables, by M. Guillemae. This is based on three facts: (1) the chlorophyll of vegetables disappears in boiling; (2) vegetable fibre and its feculent matter put in contact, through washing, with dissolved chlorophyll, is saturated with it near 100°; (3) vegetables wholly or half saturated with chlorophyll, in washing, thenceforth retains, in boiling, this green matter.—On the presence of zinc in the bodies of animals and in plants, by M.M. Lechartier and Beilamy. A man's liver weighing 1,780 grammes contained 2 centigrammes

of oxide of zinc; 913 grammes muscular tissue of ox contains 3 centigrammes; 1,152 grammes of hens' eggs 2 centigrammes. Zinc was found also in grains of wheat, American maize, barley winter vetches, and white beans; while beet, the stems of maize green clover and its seed did not contain it in perceptible quantity. These facts have an important bearing on toxicological researches.—Discovery of a Gallo-Roman port and a Gaulish port, dated by a study of the layers of mud, in the neighbourhood of Saint Nazaire, by M. Bertrand. M. Gervais added some details.—Reconstitution of French wine-growing by sulphocarbonate of potassium, by M. Mouillefert.—Results obtained in the treatment of phylloxerised vines by alkaline sulphocarbonates, applied by means of the distributing pale, by M. Gueyraud.—Note on a new mode of manufacture of sulphides, carbonates and alkaline sulphocarbonates, by M. Vincent. He utilises the reactions produced in making beet sugar to prepare sulphide of barium. This, mixed with sulphate of potash, gives by double decomposition sulphate of baryta and sulphide of potassium, and the latter, submitted to the action of carbonic acid gives carbonate of potassium. M. Vincent extends his method to manufacture of sulphocarbonate, which he can obtain at 50 francs the kilogramme instead of 120, which it has lately cost.—List of thirty new nebulae discovered and observed at the observatory of Marseilles, by M. Stephan.—On a modification in the employment of electricity considered as agent of galvanic deposits and chemical decompositions, by M. Thenard. Instead of having only one bath with the two anodes, the conditions being those of small electric resistance and maximum effort, he has several, connecting their anodes like the elements of a battery connected for tension. The quantity of deposited copper increases with the number of baths.—New method for establishing the equivalent in volumes of vaporisable substances, by M. Troost. Given an inclosure filled with vapour of hydrate of chloral, then if the water is always combined, the atmosphere will behave as if it were dry in presence of a body capable of yielding water; if the water is simply in mixture the atmosphere will act as if saturated. Now the former occurs, and this confirms M. Dumas' hypothesis as against that of M. Naumann. The method may have other applications.—On the oxidation of metallic sulphides, by M. De Clermont.—Decomposition of liquid organic substances by the electric-spark, with production of fundamental carburets of hydrogen, by M. Truchot.—On the existence of veins of bitumen in granite in the environs of Clermont Ferrand, by M. Julien.—New experiments on the toxic action attributed to copper and to substances containing copper in combination, by M. Galippe. These confirm former conclusions.—Note on the first phenomena of the development of sea-urchins (*Echinus miliaris*), by M. Giard.—M. Chasles presented (from M. Riccardi) the first part of a work called *Biblioteca matematica Italiana*, which is to be a bibliography of all Italian works on mathematics from the earliest times to the beginning of the nineteenth century.

CONTENTS

	PAGE
AGRICULTURE IN THE UNITED STATES	51
CUMMING'S THEORY OF ELECTRICITY By Dr. ARTHUR SCHUSTER	51
OUR BOOK SHELF:—	
"Proceedings of the London Mathematical Society" . . . . .	51
Vacher's "Primer of Chemistry, including Analysis" . . . . .	51
LETTERS TO THE EDITOR.—	
Hibernation of Birds.—THE DUKE OF ARGYLL, F.R.S.	52
The Swallows and Cuckoo at Menton.—DOUGLAS A. SPALDING	52
Greenwich as a Meteorological Observatory.—ALEXANDER HUGHAN; JOHN I. PLUMMER . . . . .	52
Cast-Iron.—H. M.	53
Tycho Brahe's Portrait.—J. L. E. DREVER . . . . .	53
Yellow Crocuses.—ALFRED GEORGE RENNshaw . . . . .	53
Tropical Forests of Hampshire.—W. THEOBALD . . . . .	53
Hog-Wallows or Prairie Mounds.—PROF. JOSEPH LE CONTE . . . . .	53
OUR ASTRONOMICAL COLUMN:—	
Wuenecke's Comet, 1871, II.	54
A New Comet . . . . .	54
Observations at Cordoba . . . . .	54
TYPICAL LAWS OF HEREDITY, III By FRANCIS GALTON, F.R.S. (With Illustrations) . . . . .	54
CARL FRIEDRICH GAUSS By R. TUCKER (With Illustrations) . . . . .	54
METEOROLOGICAL NOTES:—	
Meteorological Lustrum of 1771-75 . . . . .	55
Distribution of Barometers in France . . . . .	55
Storm in the Southern and Eastern Counties . . . . .	55
Auroras in Canada during the Past Winter . . . . .	55
Solar Radiation in Winter and Summer . . . . .	55
Hailstones in India . . . . .	55
The Weather of Europe . . . . .	55
Ball Lightning . . . . .	55
NOTES . . . . .	55
SCIENTIFIC SERIALS . . . . .	55
SOCIETIES AND ACADEMIES . . . . .	55

THURSDAY, APRIL 26, 1877

## THE GEOLOGY OF THE LAKE COUNTRY

*The Geology of the Northern Part of the English Lake District. Memoirs of the Geological Survey of England and Wales.* By J. C. Ward, F.G.S. (London: Longmans, 1876.)

WHEN the staff of the Government Geological Survey first entered upon their labours, the Director, Sir H. de la Beche, saw very clearly that the work with which he was entrusted would be very imperfectly performed if he limited himself to the publication of geological maps and sections alone. He therefore gave orders that whenever from time to time sufficient portions of the country had been examined, descriptions of their geology should be issued, in which such details as could not be inscribed on the maps should be recorded, and questions of theoretical and practical interest should be discussed. The Memoirs published in compliance with this regulation by Sir Henry himself and his coadjutors Phillips, Ramsay, Forbes, Hooker, Playfair, and others, are lasting witnesses both of the wisdom of the regulation itself and of the skill and energy with which the work of the Survey was carried on.

Then there came a time when the publication of explanatory memoirs was for a while dropped altogether, and so it happens that in many districts of the highest interest and importance, as for instance the Dorsetshire Coast, the Carboniferous Limestone country of Derbyshire, and the great coalfields of Derbyshire and North Staffordshire, we miss those descriptions which are elsewhere such a boon to the geological student, and the work of the Survey becomes shorn of half its usefulness.

When the publication of descriptive memoirs was resumed they took the form of small pamphlets, good as far as they went, but of the slenderest dimensions and almost niggardly in their details, in which for instance the geology of Charnwood Forest is dismissed in three pages, and eighteen pages are considered enough for the illustration of the important coalfield of Wigan and St. Helens. It is impossible to avoid contrasting these scanty bundles of notes with the exhaustive detail and broad scientific treatment that characterise the earlier publications of the Survey.

Of late years, however, there has been a welcome return to the old traditions which has resulted in the production of the admirable monographs on the Geology of Rutland, the Weald of Kent and Sussex, and the London Basin. The memoir now before us on the "Geology of the Northern Part of the English Lake District" is fully entitled to take rank with these latest productions of the Survey. It is curious, however, to find in it what looks like evidence of the existence in certain quarters of a sort of hankering after the vastly inferior class of memoirs which formed for a long time the staple of the Survey issues. In his Introductory Notice the Director, Mr. Bristow, thinks it necessary to apologise for the length to which the description has run, and to give a reason why the work "has been allowed to exceed the usual limits to

which the explanations of such small areas as those comprised in quarter sheets have hitherto extended." We can assure the Director that he may make his mind easy on this point, for no one possessing even the most limited geological tastes and acquirements will find the book in any way too long; the only fear will be whether, from anxiety to cut down the memoir to regulation size, details and explanations that can be ill spared may not have been sacrificed. It will be an evil day for the Survey when it exchanges the scientific zeal which has hitherto so honourably distinguished its members, for a spirit in which devotion to official routine comes first and a desire for the spread of geological knowledge holds a subordinate place.

But *absit omen!* and a work like this furnishes good grounds for the hope that it never will be so. It might have been thought that the labours of Sedgwick and other eminent geologists had left little for their successors to do among the mountains and dells of Cumbria, but Mr. Ward has shown that there are many points yet remaining to be cleared up, and he has brought to bear on their elucidation the more refined methods and superior accuracy of the geology of the present day. He has investigated and admirably illustrated the microscopic character of many of the rocks; and though it is scarcely possible in the present state of our knowledge to determine exactly the geological bearing and value of some of his results, there are others whose great importance is even now obvious. In the case, for example, of some rocks which the naked eye cannot distinguish in hand specimens from flinty traps, microscopic examination confirms the conclusion arrived at on broad geological grounds that they are highly altered volcanic ashes. The descriptions of other altered rocks throw great light on the difficult question of metamorphism. The Skiddaw district is peculiarly interesting on account of the close parallel which its rocks present to the metamorphic beds of the Pyrenees so admirably worked out by Fuchs. We cannot but regret, however, that the papers which Mr. Ward has contributed on this subject to the Geological Society have not been more fully embodied in the present volume; a Survey memoir should aim at being a complete *valet mecum* for the local geologist, and it is not every one in the wilds of Cumberland who has access to the pages of the *Quarterly Journal* of the Society.

Perhaps the most generally interesting features in the work are the account of the volcanic products with the localisation of the vents from which they were discharged, and the description of the glacial phenomena of the district. The author has with great skill used his experience of modern volcanic countries to make the old ruined Cumbrian volcanoes tell the tale of their whereabouts and performances. The glacial phenomena are worked out with singular thoroughness, and strong evidence is brought forward in favour of the "great submergence" on which Mr. James Geikie has thrown such considerable doubt.

It is dangerous for an outsider to differ from an observer who has spent so much time and spent it so well in working out the geology of a particular district, but there are two points, and two points that to a certain extent hang together, on which we must confess we are not altogether satisfied. These are the absence of any unconformity

between the Skiddaw slate and the overlying Volcanic Series, and the existence of the chain of faults which everywhere separates the two groups. Mr. Ward relies on the fact that beds of volcanic ash occur on the upper part of the Skiddaw slate. This shows that volcanic activity began before the deposition of the Skiddaw slate was completed, but it scarcely proves that no upheaval and denudation attended the commencement of the volcanic outbursts. Volcanic activity and elevation are so intimately connected that it may well be that the early discharges were the heralds of an upward movement of the rocks. The author indeed admits thus much, and believes that slow upheaval did attend the advent of volcanic activity, and that the bulk of the volcanic products are terrestrial. We should be inclined to go further, and to suggest that a long period may have followed the first volcanic outbursts, during which the Skiddaw Slate was crumpled up and brought within the range of atmospheric denudation. Any volcanic deposits formed during this interval would of course be removed by denudation. By the time the volcanoes had reached their full growth, a land-surface, diversified by hill and valley, may have been produced, and when the volcanic products were showered down on this uneven floor, heaps of ash and sheets of lava would every here and there abut against banks of Skiddaw Slate, in a manner that produces to us a deceptive appearance of faulting. We give this hint merely for what it is worth, and have no wish to throw any doubt on the possibility of the boundary being such as the map represents it to be; indeed, instances about which there can be little doubt might be quoted, where two groups of rocks are parted by just such a jagged line of faults as that which Mr. Ward has drawn in the present case.

The book is liberally illustrated by maps and sections, and the bibliographical list of works relating to the geology of the district is a most welcome addition.

We cannot but feel that a great mistake has been made in the map which the memoir is intended to illustrate. As a typographical piece of work it is unsurpassed, but it is its excellence in this respect that makes it unsuited for geological purposes. The reliefs of the surface are admirably brought out by the hill shading, but in order to produce the desired effect, the hatching has been made so dark that in many places it is difficult, if not impossible, to distinguish the geological colouring and signs. The Ordnance Survey issue in the northern counties another set of one-inch maps, with contour-lines in the place of hill-shading, and had one of these been employed to receive the geological colouring, the very serious difficulty just mentioned would not have arisen. We have no hesitation in saying from actual experience in the use of both classes of maps, that had plain copies been used, the value of the map would have been well-nigh doubled.

Before concluding we would remonstrate with the author on his italics; the book bristles with them, till it reminds one of a school-girl's letter. This indiscriminate use of emphasis destroys that repose which is one of the chief charms of style, and in a very large number of cases there is no necessity for it, for the meaning would be perfectly clear without the adventitious aid of a variation in the type.

A. H. G.

#### VENNOR'S "ACCIPTRES OF CANADA"

*Our Birds of Prey; or, The Eagles, Hawks, and Owls of Canada.* By Henry G. Vennor, F.G.S. With Thirty Photographic Illustrations by W. Notman. 4to, pp. i.-viii., 1-154, plates i.-xxx. (Montreal: Dawson Brothers; London: Sampson Low and Co., 1876.)

SO little is really known respecting the ornithology of Canada that one cannot but welcome with great satisfaction such a substantial addition to our knowledge as has been given by Mr. Vennor in the present work. As a geologist employed on the survey of Canada the author has enjoyed unrivalled opportunities for studying many of the birds in the field, and although the fulfilment of his duties has prevented him from devoting his entire attention to ornithology, yet he has evidently kept his eyes open, and the work before us embodies the result of thirteen years' observation. It is to be regretted that at present Mr. Vennor has only written on the birds of prey, and it is to be hoped that he will continue his labours on the rest of the birds of Canada. The species themselves included in the present work are twenty-seven in number, and on all these very complete information seems to be given respecting their distribution in the Canadian dominion, including not only a *résumé* of the hitherto published facts, but giving also a large amount of new information. Excellent accounts of the habits of the birds are added, chiefly from the personal observations of the author himself, and each article concludes with the description of the species in which the colours of the soft parts are always given; this is a feature often omitted by Messrs. Baird, Brewer, and Ridgway in their recently-published "History of North American Birds." Mr. Vennor does not include among the species fully treated of, the Common Turkey Buzzard (*Rhynchoglyphus aurea*), which hardly extends to Canada in its northern range, though it is a regular summer visitant to "the extensive flats near Chatham and Lake St. Clair," while further to the westward it occurs frequently on the line of the forty-ninth parallel. Of the Barn Owl (*Strix flammea*), Mr. Vennor says that there is no authentic record of its occurrence in Canada, but we notice in Mr. Bowdler Sharpe's paper on the "Geographical Distribution of Barn Owls," published in Mr. Rowley's *Ornithological Miscellany*, that the British Museum contains a specimen from the neighbourhood of Toronto, collected near that city by Mr. James Whately, who has resided there for some years, and has sent many interesting birds to this country. Other small points might also be alluded to in which we think further consideration on the author's part desirable, such as the relations between *Falco candidus* and *F. labradorus*, *Circus cinereus* and *C. hudsonius*, &c. We are not disposed to quarrel with the photographic illustrations to the book, which are excellent specimens of photography, although this mode of illustrating scientific works does not commend itself to our fancy. At any rate, however, a good photograph is better than a bad plate, especially in a work like the present, where the author's chief aim has been to give such a figure as may render the identification of the species more easy to the student, his object being, in his own words, "a work of practical utility, not a mere exhibition of pretty photographs." As a new worker in the vast field

of ornithology we welcome Mr. Vennor, and only trust that many years will not elapse before he gives us a second instalment on the birds of Canada.

OUR BOOK SHELF

*The Use of the Spectroscope in its Application to Scientific and Practical Medicine.* By Emil Rosenberg, M.D. (New York: Putnam, 1876.)

THIS is an essay on the use of the spectroscope which obtained the Stevens triennial prize for 1876, awarded by the College of Physicians and Surgeons.

It treats mainly of the absorption spectra of blood in its normal state and after being acted upon by other substances. The first chapter gives a very short account of the optics of the spectroscope, which the author does not pretend to treat fully; then follows a short notice of the emission spectra of the metals. The absorption bands of oxyhæmoglobin (scarlet cruorine) and their change to the one reduction band of hæmoglobin (purple cruorine) by the abstraction of oxygen, discovered by Prof. Stokes, then comes in for recognition. The remainder of the book is chiefly on the absorption spectrum of blood with reference to forensic medicine and its spectrum after the introduction of foreign matters and gases.

It appears from the numerous references that the author has compiled this essay from books and papers rather than from observation, and the authors referred to are with few exceptions Germans. We think the book is well suited for the perusal and reference of the medical profession and others taking up this special subject.

*Journey in the Caucasus, Persia, and Turkey-in-Asia.* By Lieut. Baron Max von Thielmann. Translated by Charles Heneage, F.R.G.S. Two vols. Map and Woodcuts. (London, Murray.)

BARON THIELMANN'S journey, which was made in the year 1872, embraced all the Caucasian region, much of the western shore of the Caspian Sea, with the long stretch of country between Tabrez, Hillah, and Beyrout. Though this is a region about which a good deal has been written, the Baron's narrative will be found to contain a considerable addition to our knowledge. His observations on the people and the antiquities of the countries traversed are especially valuable, while the work contains as well much interesting topographical and geographical information. The Baron is an exceedingly pleasant travelling companion, and as Mr. Heneage has made a thoroughly readable translation, the work will be found of value both to the stay-at-home reader and as a guide to the intending tourist.

LETTERS TO THE EDITOR

[The Editor does not hold himself responsible for opinions expressed by his correspondents. Neither can he undertake to return, or to correspond with the writers of, rejected manuscripts. No notice is taken of anonymous communications.]

The Editor urgently requests correspondents to keep their letters as short as possible. The pressure on his space is so great that it is impossible otherwise to ensure the appearance even of communications containing interesting and novel facts.]

Structure and Origin of Meteorites

IN the abstract of Mr. H. C. Sorby's lecture "On the Structure and Origin of Meteorites," given in NATURE, vol. xv., p. 495, in reference to the subject of glass globules observed by the lecturer in certain meteorites, the condition in which glassy particles given off by terrestrial volcanoes occur, is contrasted with that produced artificially in furnace slag by the action of a strong blast of hot air or steam. In the furnace slag "pear-shaped globules, each having a long hair-like tail," are described as being formed, whereas in the case of volcanoes the glassy particles are said, when given off, to be immediately solidified on entering the atmosphere, and to be mere fibres, as Pele's hair, or more like pumice dust.

In fact, the formations in the two instances are closely similar. In the crater of Kilauea, in the Island of Hawai, wherever the well known Pele's hair is in process of formation, long-tailed pear-shaped globules are formed in abundance, and a large proportion of the "hairs" are to be found with larger or smaller globules in connection with their ends.

I saw the formation of Pele's hair in two places in the crater. In the one instance the formation occurred at the margin of one of the small hollow cones of molten lava. The lake was inclosed by a range of low cliffs, against the bases of which the waves of the extraordinarily fluid lava were constantly surging, being kept in perpetual commotion by the violent discharge of gases from beneath. The waves splashed up against the cliffs and spray and large drops were thrown into the air, and on the leeward side of the lake were driven by the wind over the top of the cliff so as to fall on a level platform of rock which was even with its summit.

The platform appeared as if melted pitch had been splashed out all over it, and was covered with small masses of pitch-like looking lava. Those of the masses which had evidently completely solidified before reaching the platform in their fall were pear-shaped, whilst in other cases where hardening had not been complete, the elongate masses falling in the soft condition had become flattened into irregular shapes, which showed more or less evident traces of the coiling of the masses as they fell.

All the masses had tails, some short and spike-like, others long and hair-like, and there was every gradation between stiff fine rods of transparent lava and the perfectly elastic hair of which a handful could readily be raked together with the fingers on the platform in a very short time.

In the other instance, the Pele's hair was seen by me around one of the small hollow cones or lava fountains which are constantly formed in the crater. The cone was not active at the time I saw it. It was surrounded with the small lava masses thrown out by it and forming a deposit closely similar to that formed at the margin of the lake, except that numerous larger lumps occurred amongst the smaller ones.

Very striking objects in the crater are large bubbles which have been formed in the lava when molten by the escaping gases. The surfaces of the bubbles are composed of extremely thin transparent laminae, which look just like thin green bottle glass. Such bubbles are encountered at almost every step on the floor of superficially solidified lava, on which the visitor walks in the crater.

A remarkable peculiarity of the Hawaiian lava is its extreme fluidity when in the molten condition. This property has brought about the unusual form of the great mountains of the island composed of it, which have so gradual a slope that the observer can hardly credit their great height when viewing them from the sea.

II. N. MOSELEY

Exeter College, Oxford

On the Simplest Continuous Manifolds of Two Dimensions and of Finite Extent

IT could hardly fail to be instructive if Mr. Frankland would explain the following obvious paradox in his theory (NATURE, vol. xv., p. 515). Let two "straight lines"  $XOX'$ ,  $LOL'$ , make an angle  $XOL$  other than a right angle, and consider the shortest line  $PN$  from a moving point  $P$  in  $LL'$  to  $XX'$ ; from the assumptions, this is a "straight line" perpendicular to  $XX'$ . As  $P$  moves from  $O$  along  $OL$ , it will by and by, according to the theory, be at  $L'$ ; that is, on the other side of  $XX'$ , if our "straight lines" are "of the same shape all along." Now, to put it algebraically, how does the perpendicular come to change sign? It does not pass through infinity, for the manifoldness is of finite extent: it does not vanish except when  $P$  is at  $O$ ; and though it is conceivable in itself that  $N$  should travel to a maximum distance along  $OX$  and come back again while  $P$  moves on yet this contradicts our principal assumption, for each perpendicular will then have two points in common with  $LL'$ . Is a door of escape to be found through any interpretation of "continuous"? Or, while "there is nothing self-contradictory in the definition," is there something in it contradictory of the superposition-principle by means of which its consequences are worked out?

The theory is partly exemplified upon the surface of revolution got by bending a hemisphere till it closes up. Correspondence is pretty close as to points in the equator and the simpler figures symmetrical to it.

C. J. MONRO

Hadley, Barnet

## Non-Amphibious Batrachians .

ON calling the attention of the Rev. L. Blomfield (formerly Jenyns) to the interesting article in NATURE (vol xv p 491) of a tree-frog which produced its young without their passing through the tadpole stage, he has been good enough to allow me to quote a MS note to his work, "Observations on Natural History," p 207, which may be useful to persons interested in the matter. It refers to a colony of toads which lived in a cellar of Bottisham Hall, Cambs, and without access to water. It runs as follows—

"See some remarks by Mr Iowe in *Natural History* (No 64, April, 1857 p 341), tending to show that under certain circumstances where the parent animals have no access to water, the reproduction of the toad and frog takes place without the intermediate stage of tadpole. He mentions instances of their depositing spawn in cellars and young toads being afterwards observed. Such was probably the case with the toads in the cellars of Bottisham Hall, though I never observed the spawn myself." "See further remarks by myself on this subject in *Annals of Natural History*, vol xi 2nd ser., p. 482. See also NATURE, vol vii p 401, on 'The Adaptation of Animals to External Conditions.'"

The following passage occurs in the Rev. L. Jenyns's "Manual of British Vertebrate Animals," p 304 5, and bears upon the same phenomenon

"*Friton fun talus*, Common Hft

"This species is subject to considerable variation. It is found on land, a circumstance which tends in some degree to alter its characters. In such specimens the skin loses its softness becoming opaque, and somewhat corrugated. The membranes of the back and tail entirely disappear, causing this last to appear narrower and thicker in proportion to its depth. The toes from being flattened become rounded, the colours are also everywhere more obscure. In this state it is the *L. stauntoni* of Sheppard and Turon, and considered as a distinct species by these and other authors. I am, however, perfectly satisfied that it is identical with the aquatic kind, and that all its peculiarities may be traced to the change of circumstances under which it is placed. I suspect that the period of time during which this species remains in the larva state is subject to much variation, and that if anything occur to oblige the young to exchange their native element for another before they would attain their perfect form, the gills are cast prematurely to enable the animal to accommodate itself to its new circumstances. The fact of such small specimens as Sheppard has noticed being found on land is indisputable, but I think I have generally observed some traces of there having *Lan* gills at no very long period before."

(GEORGE HENSLER)

## Morphology of "Selaginella"

IN consequence of my not having expressed myself sufficiently fully, Prof Thuiselton Dyer somewhat apprehends my remarks respecting Selaginella and Carex to which he is good enough to reply in NATURE (vol xv p 499), and I shall be glad of an opportunity of explaining the nature of the comparison that I drew between the reproductive organs in these two genera.

I purposely avoided asserting that the spike of the one was the "homologue" of that of the other, and I thought that my change of expression—"instead of regarding as the homologue we compare it"—would sufficiently indicate that I was not raising the question of exact homology at all, but merely comparing the male and female structures of Selaginella (each as a whole) with those of a unisexual-flowering plant. I regret that I did not state this in explicit terms.

Notwithstanding what has been written by Sachs and others, it appeared to me that the homology between the reproductive organs of Cryptogams and Phanerogams could not be regarded as yet so completely settled as to be past doubt, and I therefore wished to exclude, as not material to the line of argument I had in view, such questions as to homology as Prof Thuiselton Dyer brings forward. He considers that the ovule, and not the ovary, is the equivalent of the macrosporangium. I did not wish, even by implication, either to assert or to deny this fact, and it does not affect my comparison in the least, for the female structure of Carex comprises of course an ovule. He further considers that this leaves the ovary unaccounted for, and not only so, but the perigynium and seta also. The essential part of a female flower is the ovule, which may be naked as in Gymnosperms, and the surroundings, whether consisting of an open (peripetalous) leaf, an ovary, hypogynous scales, corolla, calyx, perigynium, or

seta are accessories, and any of them may be absent. A comparison may surely be made between the female flower of a conifer (as a whole) with the much more complex one of a dichinous polypetalous plant, without being vitiated by the fact that parts of the latter are unaccounted for, and I thought, and with due respect still venture to think, that the macrosporangium of Selaginella with its covering scale, and the female flower of Carex with its covering glume, may properly be regarded as comparable.

Prof Thuiselton Dyer had compared the sporangia of Selaginella with the male and female elements of a single hermaphrodite flower, reversing their relative position on the axis, and my object was to show that, as each sporangium had its own "lateral appendage," they might be equally compared with the male and female elements in the separate unisexual flowers of a dichinous plant, without reversing their position on the axis. It was quite unnecessary for me to discuss which particular parts of the phanerogamic flower were the exact homologues of the macro- or micro-sporangia of the cryptogam, and I did not intend to express any opinion on that subject.

I thank Prof Thuiselton Dyer for drawing my attention to his paper on *C. fulcaris*, which, however, I have already had the pleasure of perusing, for I read everything written by him to which I have access, and I can assure him that, as a non-professional myself, I always receive his opinions with the respect that is then due, although in the present instance I cannot adopt his view as to the hermaphroditism of the primordial flower. That subject is, I think, sufficiently important to be discussed by able pens than mine, and it was in the hope that it would receive the attention that it deserves that I ventured to point out the diametrically opposite views that had been pressed by high authorities.

THE MAN COMBE.

Newton le Willows, April 11

## The Rocks of Charnwood Forest

THE announcement by Messrs Pannoy and Hill (vol xv p 470) of their discovery of the *mississippian* character of the *lignite* rock, reaching from Groby on the south east to Ludlow Hill on the north west, is a valuable local geological fact, they having recognised its *mississippian* character for the last quarter of a century.

The rocks constituting the "ridge" are called by different names—*gneiss*, *quartzite*, *granite*, *granite*, &c., according to the greater or less degree of crystallisation of the components, and the abundance or scarcity, of some of them. Its intrusive character is very obvious. Just we have Cambrian Rocks on both sides (east and west) of the "ridge," and at places near Groby these Cambrian rocks are less than half a mile apart. Beyond, the *offshoot* of the *mississippian* is breaking up the formerly overlying beds, as well seen near Markfield, where there are several low hills called the "Altar Stones," these consist almost entirely of broken up fragments of unaltered Cambrian rocks embedded in a grey, coarse, siliceous base, the *fragments* forming more than two third of the mass, similar beds occur beyond Burdon Hill, but the quantity of embedded fragments is not so great, but pieces are found eight to ten inches square quite unaltered, and showing the "ribbed structure, red, purple, and green bands," characteristic of the Cambrian rock of this area. Over other parts of this "igneous ridge" the broken and disturbed beds have long since been removed by denudation, but the *debris* is found in the "dust," which stretches far and wide for miles over the surrounding country. I think both Mr Howell of the "Survey," who plotted this district, and Prof Hull who did the adjoining one, recognised the *mississippian* character of the igneous rocks on the west side of Charnwood Forest. Many other facts bearing on this subject are known, but cannot be described in this short note. Any new facts discovered by Messrs. Pannoy and Hill, in illustration of this matter, will be gladly received by local geologists.

Leicester

JAMES PIANI

## Patenas of Ceylon

I do not think Mr Abney's suggestion of a possible cause of the origin of the Ceylon patenas will be found to hold good to the extent he believes it will. On the *Dimbula* patenas rock of any kind is very scarce, even if you go several feet down, and where it does occur, it is, to the best of my recollection, almost entirely absent. On the *patenas* on my property it is certainly throughout. In part of the *Ouvah* patenas district, mentioned by

Mr. Abbay, the rock is limestone, as is proved by its being largely quarried and burned. Moreover, the patena soil in Ouva is not of the ordinary worthless quality, at any rate in the opinion of planters owning portions of it, as they frequently assert that it is as good as the jungle soil of Dimbula, and the neighbouring districts. What truth there is in this I cannot say.

Further, though cleared forest land when abandoned usually runs into "chena," I could show Mr. Abbay, if he were to return to Ceylon, as I wish he would, cases in which it has run into patena. The Dimbula cricket ground is a case in point.

Pendleton, Manchester, April 17

E. HEELIS

Cumming's Electricity

In a passage from my "Introduction to the Theory of Electricity" which you quote in a review of the work in NATURE, vol. xv. p. 526, occurs a very unfortunate misprint of the word *of* for the word *on*, which seems to have misled your reviewer, and I therefore beg a few lines to correct it. The passage in question is the statement of Prop. 8, p. 203, which ought to have been written: "In computing the potential on any closed circuit we may substitute for it any closed circuit which is obtained by projecting the given circuit by means of lines of force."

In defence of this phrase I may perhaps be allowed to point out that the definition of potential quoted by the reviewer as that of Sir William Thomson is not the definition of potential but of *electrostatic potential at a point*, which is given at p. 45 of my book. The phrase potential on an electrified body in a field of electrical force is, I hold, perfectly legitimate, denoting the work done against electrical forces in moving the body (supposing all electrification undisturbed by the movement) to an infinite distance out of the field.

The case in point, however, refers to electro-magnetic potential and the potential on the closed circuit really represents the work done in carrying the circuit against magnetic forces out of the magnetic field.

The phrase suggested in your review—induction through the circuit—I had purposely avoided as liable to be confused with ordinary "magnetic induction" in a mass of magnetic iron, or with the "self-induction" of the circuit, or even with the induced current produced by the movement of the circuit, while the phrase potential on the circuit is at once suggestive of its own meaning and clear from any ambiguity.

Rugby, April 19

L. CUMMING

Remarkable Papuan Skull

I WISH to call your attention to a remarkable Papuan skull which Prof. Mantegazza showed at the last meeting of the Anthropological Society of Italy. The upper jaw contained very distinctly no less than four molars and two canine teeth on each side, all the molars being well developed.

Unfortunately the lower jaw is missing, but if it corresponded with the upper jaw, as we may justly presume—the whole skull not showing any abnormality of structure—the total number of teeth would amount to *forty*. There are cases recorded of negro-skulls showing three, four, and five supernumerary teeth, but *eight* is certainly an *extremely rare* occurrence.

It would be interesting to know whether museums or collections in England contain any similar specimens.

J. E. Z.

Meteor

ABOUT 10.50 P.M. on the night of Monday, the 16th inst., the sky being cloudless and the young moon just setting, I observed a remarkable meteor in the northern heavens. It originated near to the star  $\gamma$  Cephei, and travelled towards the eastern horizon, its path forming an angle of about 35° with the perpendicular. The head, two or three times as large and bright as Venus, was bluish, and left a trail of yellowish light. I took it at first for a falling rocket, whose ascent I had not noticed; but its transient existence, its sudden extinction without noise or sparks, and the straightness of its path, with only a slight zig-zag, but no curve, preclude that explanation I think.

Leicester, April 17

F. T. MOTT

OUR ASTRONOMICAL COLUMN

THE U.S. NAVAL OBSERVATORY, WASHINGTON.—Under the title "Instruments and Publications of the United States Naval Observatory," the superintendent has circulated a series of

photographs of the instruments at present in use in that noble astronomical institution. They are taken by the heliotype process, and comprise (1) the mural circle, mounted in 1844, aperture 17 inches; the transit instrument, 5'33 inch aperture, mounted in 1844, and placed in the same room beside the mural circle; the smaller equatorial, mounted in 1844, with which so much good work has been performed, aperture 9'62 inch; the transit circle, by Pistor and Martins, Berlin, which was mounted in 1864, the aperture of the object-glass 8'52 inch, and the focal length 12 feet 1 inch; a general view of the grand 26-inch refractor, of 32 feet 5'8 inch focal length, mounted in 1873, and one of the most powerful telescopes in the world; the clock-work, &c., of this magnificent instrument is shown on a separate plate. Brief descriptions accompany these heliotypes, and in addition are drawings made with the 26-inch equatorial of the nebula in Orion, the omega nebula, the annular nebula in Lyra, and the planet Saturn. Some account of the foundation of the observatory and a list of its publications from 1845-76 precede the brief description of the instruments of which views are presented.

NEW VARIABLE STAR.—A recent number of M. Leverrier's *Bulletin International* contains a notice from MM. Heury respecting a variable star in Virgo, which they state has been under observation for some time. The period is about seven months, and the limits of variation 8m. to 14m.; at present it is near a maximum. The position for 1877 is in R.A. 12h. 27m. 32'2s., N.P.D. 93° 44' 37".

EARLY OBSERVATION OF SOLAR SPOTS.—In our popular astronomical works the Chinese are not usually credited with the observation of spots upon the sun at a distant date. Gaubil, however, records from the Chinese annals that on May 7, 826 black spots were seen on the sun's disc, and again on April 21, 832. There are, indeed, few phenomena which are not noted by this observant people, or rather by their watchful astronomers; yet, strange to say, the zodiacal light is amongst them. And it is singular that while Kepler's star of 1604 is duly recorded, the Chinese annals have no reference to the similar object in 1572, with which the name of Tycho Brahe is commonly associated.

COMET 1877 III.—The comet discovered by M. Borelly at Marseilles, on April 14, appears to have been detected three or four nights earlier by Mr. Lewis Swift, of Rochester, New York, who is already the independent discoverer of more than one of these bodies. We say three or four nights earlier, for although the telegram forwarded to Europe through the Smithsonian Institution dates the observation on the night of April 11, the rough place there assigned agrees more nearly with the computed position for the previous midnight. In circular No. xxv. of the Imperial Academy of Sciences at Vienna, are elements by Dr. Holetschek, from the first three nights' observations, which it is remarked have "a very great resemblance to those of the comet of the year 1762." The following orbit has been calculated by Mr. Hind from the first complete observation at Marseilles, on April 14, and at Mannheim by Prof. Schonfeld, on the 16th, and a third at the observatory of Mr. J. Gurney Barclay, at Leyton, on the 17th. For the sake of comparison the elements of the comet of 1762, calculated by Burckhardt, after a new reduction of the Paris observations, are annexed.

	COMET 1877 III.	COMET 1762.
Perihelion Passage (G.M.T.)	April 26'9501	May 28'3345
Long. of Perihelion	102 45 51	104 2 0
" Ascending Node	345 53 18	348 33 5
Inclination	77 8 50	85 38 13
Perihelion Distance	1'01089	1'00905

The motion is direct. It will be remarked that the only material difference is in the inclination of the orbits to the ecliptic. The comet of 1762 was discovered in the Netherlands, by Klimken.

burg, on May 17, and was observed by Messier and Maraldi at Paris until July 2. When first seen it was just visible to the naked eye. The interval between the perihelion passages is 114.91 years, and with such period of revolution, with the other elements of 1762, the descending node would fall about 0.27 from the orbit of Mars and the ascending node at a radius-vector of 3.35, or in the region occupied by the minor planets; thus the difference of inclination will not be easily explained on the supposition of identity of the comets, though it must be remarked that elements of the present comet founded upon the first few days' observations may be open to more sensible correction than is usually the case.

"THE OBSERVATORY, A MONTHLY REVIEW OF ASTRONOMY."—There is ample room for the new astronomical periodical, which has been launched by Mr. Christie, the First Assistant of the Royal Observatory, Greenwich, under the above title, during the last week. Its aim is to present in a popular form a general survey of the progress of astronomy and to afford early intimation of recent advances. Such a publication ought to be well supported in this country, where astronomical amateurs are in great force. The first number holds out good augury for the future; amongst the contents are a report of the proceedings at the last meeting of the Royal Astronomical Society, proceedings which are not detailed in the *Monthly Notices*, where the discussions following the reading of papers are, as a rule, ignored, but which, as everyone knows who has been in the habit of attending the meetings of our scientific societies, are frequently the most interesting feature in the evening's proceedings; and we hope this point will not be lost sight of in the new periodical. There is an article on the photographic spectra of stars, a subject known to have lately much occupied the attention of the president, by whom it is furnished; the first part of a contribution from Mr. Gill, on the determination of the solar parallax; remarks on the nebular hypothesis, by Mr. Darwin, being an account of an inquiry intended to suggest a cause which may fill up a hiatus in the theory, and an outline of the results of Dr. von Asten's [researches on the motion of Encke's Comet, recently communicated to the St. Petersburg Academy; also, ephemerides for physical observations of the moon and of Jupiter, by Mr. Marth, whose assistance in this direction deserves the high appreciation of observers. We will further express the hope that accuracy of typography may characterise the future numbers of Mr. Christie's publication; it is most important that this should be the case if the confidence of the practical astronomer is to be secured for it, and we are induced to offer this suggestion from remarking one or two inaccuracies in the first number, as on p. 4, where the search for an intra-mercurial planet by the Rev. S. J. Perry is dated in April instead of in March, and on p. 27, where Mr. Swift's discovery of the comet subsequently found by M. Borrelly, is erroneously referred to April 5, which was the date of discovery of the previous comet.

### THE NEBULÆ—WHAT ARE THEY?<sup>1</sup>

BEFORE the announcement of Mr. Huggins's discovery of the presence of bright lines in the spectra of nebulae, it was generally, if not universally, accepted as a fact that nebulae were merely stellar clusters irresolvable on account of their great distances from us. This view had become impressed on the minds of many of our greatest observing astronomers in the progress of their work, and is one therefore which should not lightly be abandoned.

It appears to me that Mr. Huggins's observations instead of being inconsistent with the view formerly held by astronomers, are rather confirmatory of the correctness of that view.

<sup>1</sup> On a Cause for the Appearance of Bright Lines in the Spectra of Irresolvable Star Clusters. Paper read at the Royal Society by E. J. Stone, M. A., F. R. S., Her Majesty's Astronomer, Cape of Good Hope.

The sun is known to be surrounded by a gaseous envelope of very considerable extent. Similar envelopes must surround the stars generally. Conceive a close stellar cluster. Each star, if isolated, would be surrounded by its own gaseous envelope. These gaseous envelopes might, in the case of a cluster, form over the whole, or a part of the cluster, a continuous mass of gas. So long as such a cluster was within a certain distance from us the light from the stellar masses would predominate over that of the gaseous envelopes. The spectrum would therefore be an ordinary stellar spectrum. Suppose such a cluster to be removed further and further from us, the light from each star would be diminished in the proportion of the inverse square of the distance; but such would not be the case with the light from the enveloping surface formed by the gaseous envelopes. The light from this envelope received on a slit in the focus of an object-glass would be sensibly constant because the contributing area would be increased in the same proportion that the light received from each part is diminished. The result would be that at some definite distance, and all greater distances, the preponderating light received from such a cluster would be derived from the gaseous envelopes and not from the isolated stellar masses. The spectrum of the cluster would therefore become a linear one, like that from the gaseous surroundings of our own sun. The linear spectrum might, of course, under certain circumstances, be seen mixed up with a feeble continuous spectrum from the light of the stars themselves.

It should be noticed that, in this view of the subject, the linear spectrum can only appear when the resolvability of the cluster is at least injuriously affected by the light of the gaseous envelopes, becoming sensibly proportional to that from the stellar masses, and that in the great majority of such cases it would only be in the light from the irresolvable portions of the cluster that bright lines could be seen in the spectrum.

The changes in form which would be presented to us by such a nebula might be expected to be small. These changes would depend chiefly upon changes in the distribution of the stellar masses constituting the cluster. It has always appeared to me difficult to realise the conditions under which isolated irregular masses of gas, presenting to us sharp angular points, could exist uncontrolled by any central gravitational mass without showing larger changes in form than appear to have been the case with many of the nebulae. In my view of the nature of nebulae this difficulty no longer exists.

### THE RACES AND TRIBES OF THE CHAD BASIN

ON this subject a most valuable paper has been contributed to the last number of the *Zeitschrift der Gesellschaft für Erdkunde* by Dr. G. Nachtigal, one of the few living writers entitled to speak with authority on the ethnography of Sudan. While the great problems now being rapidly solved in the portion of Africa lying south of the equator are almost exclusively of a strictly geographical nature, those still awaiting solution in the northern half of the Continent are on the contrary mainly of an ethnological character. The reason of this pointed difference is very obvious. Although there are vast regions south of the line still unexplored, enough is already known to warrant the conclusion that what remains to be there discovered is peopled by the same great race holding almost exclusive possession of the parts already opened up by the spirit of modern enterprise. With the sole exception of the extreme south-western corner, occupied by the Namaqua and Cape Hottentots, and of some districts also in the south still haunted by a few straggling Bushman tribes, the whole of Africa from the equator southwards would seem to be the domain of what is now conventionally known to philologists as the Bantu



family. Whatever be their origin, all the countless tribes here settled are now at least linguistically united into one group, all of them, with the exceptions already specified, apparently speaking dialects of some one common mother tongue now extinct. Hence however interesting the questions that still remain to be settled relating to the physical geography of Africa south of the equator, its ethnography, so far as that can be determined by the test of language, presents little or no further difficulty.

But north of the equator the case is completely reversed. Here there doubtless remain to be cleared up some few geographical points, such, for instance, as the water parting of the White Nile and Lake Chad, the course of the Upper Shari, and especially that of the Ogoway, so far as it may flow north of the line. But on the whole the main physical features of this half of the continent may be said to be at last fairly settled.

Its ethnology, on the contrary, only becomes all the more complicated in proportion as our knowledge of the land and its peoples increases.<sup>1</sup> No doubt we have here also one or two widespread linguistic groups, such as the Semitic, represented by two of its branches—the Arabic in the Barbary States and Egypt, and the Himyaritic (Lesana Gêr, Tigré, and Amharic) in Abyssinia. There is also the great Hamitic family, with its three distinct branches—Egyptian, Libyan, and Ethiopic—occupying more than one half of the Sahara, from about the 15° E. long. to the Atlantic seaboard, large tracts in the south of the Barbary States, parts of Egypt and Nubia, and the whole of the Galla country and Somaliland as far south as the River Dana or Pocomo, where it is met by the Waswahili and other Bantu tribes of the eastern seaboard.

But there still remains the pure negro race, properly so-called, occupying nearly the whole of the Sudan in its widest sense, the banks of the White Nile, and all its head streams, from Khartum to the Victoria Nile, and in all probability the still unexplored regions of the Ogoway, and of Central equatorial Africa generally, from Cape Lopez inland, to the Blue Mountains west of the Albert Nyanza, and from Lake Chad southwards to the equator. Here we find innumerable negro tribes, dwelling more especially in three great centres of population—the region between the Niger and the West Coast, the Basin of the Chad, and the Upper Nile, with all its head streams<sup>2</sup>—tribes generally speaking differing as much in speech as they would seem on the whole to resemble each other in their main physical features. Here live the Wolofs, the Veis, the numerous Mandenga and Haussa peoples, the Fulahs (who, however, are not Negroes), the Masa family, the Bagirmi, Babir, Nyamnyam, Shilluk, and many other Niger, Gambia, Chad, and Nilotic races, all speaking idioms seemingly in no way related to each other, and in fact possessing nothing in common with any known forms of speech beyond the general and somewhat vague feature of agglutination characteristic of most, if not of all, of them. Here, therefore, we have many linguistic and ethnological puzzles still awaiting solution, and forming, as stated, the counterpart of the topographical mysteries now being so successfully unveiled in the southern half of the continent.

The Basin of Lake Chad, situated in the very heart of this vast region, is peopled by such a bewildering number

<sup>1</sup> A striking proof of this is afforded by the recent expedition of Dr. W. Junker along the Lower Sobat from its junction with the White Nile to Nasser, the most advanced Egyptian military station in that direction. He informs us that between these two points are spoken no less than five distinct idioms, some of which are now heard of for the first time. These would seem to be the Nuer, along the right bank of the Sobat, and the Shilluk, Jangbey, Fellanghi, and Njank on the left. And beyond Nasser he reports the existence of many other independent tribes on the Middle and Upper Sobat, such as the Bonjak, Jibbe, Kunkung, Njkuar, and Chai, all apparently speaking different languages.

<sup>2</sup> Reporting last year to the Emperor on the White Nile between Duménil and Magungo, G. de Selve remarks: "Le pays est très peuplé; beaucoup plus qu'en Afrique."

of races, as to have hitherto baffled all attempts at analysis, or any general classification based on recognised scientific principles. Here we find dwelling either separately or together branches of the Semite, Hamite, Fulah, and Haussa, and, in addition, none of them, except the Semite Arabs, in any considerable numbers. Here is further represented the mysterious Tibu people, who dwell in the Great Desert with the Twareg (Tubal, Tubu, Tubu, and Dasa, that is, northern and southern), pure and mixed, nomad and settled. Here are the Kanembu,<sup>3</sup> or people of Kanem, who are Tibu, the degree removed, and the Kanuri or Magomi, the ruling race in Bornu, who may be described as Tibu, or rather Kanembu, in the third and fourth degree, in other words, half-caste descendants of Kanembu and the Aboriginal Negro inhabitants of the land. Here are, moreover, the Margi, Mandara, Makari, Logon, and other members of the Masa or Mosgu family, in all probability akin to, if not the collateral descendants of, the So or Sou people, now either extinct or absorbed in the Tara, Manga, Ngalmaduko, Dalatoa, and other Kanuri tribes. Here, too, are the Bede, Babir, and some other independent or unclassified Negro peoples, fragments of the Kuka and Bulala from Lake Fitri, and lastly, the Bagirmi from the neighbourhood of the Middle Shari, and apparently connected with the Jur and Dor tribes on the western head waters of the White Nile, thus forming a sort of connecting link between the Nilotic Negro tribes, and those of Central Sudan.

All or most of these data were doubtless previously known, at least in a vague or general way; but thanks to Dr. Nachtigal's careful investigations on the spot, we are now for the first time enabled to form a clear idea of the various geographical, political, social, and linguistic relations of these different peoples, one to the other. Unfortunately in his elaborate monograph he treats the whole subject under the threefold division of races in Kanem, Bornu, and the lake islands, a political rather than an ethnographic distribution, which is all the more confusing that several Kanembu tribes, such as the Sugurti and Tomagheri, are now settled also in Bornu, while on the other hand several Bornu or Kanuri people, such as the Magomi of Fuli on the east coast, the Bulua, Malemia, and Ngalma Dukko, have found their way back to Kanem, whence their forefathers originally migrated westwards.

The inconvenience, however, arising out of this arrangement of the subject matter is largely obviated by the excellent coloured map accompanying the paper, without which it would in fact be scarcely intelligible to the ordinary reader. It will therefore be necessary in the subjoined *résumé* of Nachtigal's conclusions to depart somewhat from his triple division, and give a general classification of all the Chad races, based rather on their permanent linguistic and physical affinities than on their accidental political relations, and in all other respects closely adhering to the data supplied by him.

The map above referred to is shaded in ten different colours, corresponding to so many distinct peoples. But one of these colours comprises four not yet classified Negro tribes on the west and south-west frontier of Bornu, between that state and the adjoining Haussa states further west. On the other hand, the Bagirmi are not represented at all by any of these colours, so that four more shades would really be needed to embrace all the Chad races, while even then excluding such more remote peoples as the Adamawa on the south-west and the Fulahs on the west.

It thus appears that all the peoples dwelling either round about the Chad or on its numerous islands may be grouped under the subjoined fourteen main divisions:—

- (1) Tibus (Teda, Dasa, and Kojam);
- (2) Kanembu;

<sup>3</sup> The suffix *bu* is simply the plural of the personal suffix *na*. *Kanembu* = a native of Kanem; *Kanembu* = the people of Kanem.

(3) Kanuri or Magomi; (4) Masa or Mosgu; (5) Yedina or Buduma and Kuri; (6) Bulala and Kuka; (7) Dana or Danawa; (8) Bede; (9) Ngisem; (10) Kerrikerri; (11) Babir; (12) Bagirmi; (13) Hausa; (14) Arabs.

1. **TIBUS**, of whom, as already stated, every variety is represented. They occupy the greater part of Kanem proper and are found on both banks of the Komodugu Yooce in Bornu, between the 12° and 13° E. long. Principal pure nomad Tibu tribes: Guada, Atereta, Worda, Juroa, or Osumma, Mada, Wandala, Dogorda, with a total population of 13,000. Principal pure settled Tibu tribes: Salemea, Beggaroa, Aborda, Nawarma, Oreddo, and Billea, numbering altogether 4,400. Mixed and doubtful Tibu tribes: Gadawa, Kumosoalla, Hawalla, or Famalla, Midoela, Jinoa or Mallemin, say 10,500, giving a total of 27,900 Tibus in the Chad district.

2. **KANEMBU**, dwell principally round the eastern, northern, and western shores of the lake, therefore, as already remarked, both in Kanem and Bornu. Their principal tribes are the Suguri and the Tomaghera or Tomagheri, both in Kanem and Bornu; the Konku, Gallabu, Kuburi, Kunkinna, &c., with a total population of over 18,000.

3. **KANURI**, the ruling people of Bornu, and by far the most important nation in the Chad basin. Nachtigal proposes two derivations of the name: first from the Arabic

نور = nūr = light, and the Kanuri prefix *Ka*, implying the concrete idea of "the people of light," as the first heralds of Islam in the Pagan lands occupied by them. But this mixture of elements from two radically distinct languages, though perhaps interesting to Mr. J. C. Clough and other advocates of mixed languages, can scarcely be meant seriously. It is as if the first English settlers in the Fiji Archipelago were to announce themselves as the "lumen-bearers," as the first messengers of the "lumen evangelii," or "light of the Gospel," to the natives of those islands. Second, and much more probably, a corruption of *Kanemuri*, implying their Kanem origin, already referred to. Principal Kanuri tribes in Kanem: Bulua, Anjalibu, Rogodubu, Bitadull, Biriwa, Melemia, Forebu, Ngalma Dukko, the Magomi of Fuli, and Dalatoa. These last, though claiming to be considered a Kanuri people, being really descended from slaves of other races subject to them. Principal tribes in Bornu: The Magomi or Kanuri proper, the Tura, Manga, Nguma, Kai, Ngallaga, Ngalmaduko, Ngomatibu, Ngasir, &c., with a total population of about 1,500,000.

4. **MO-GU** or **MASA** family occupies the region south of the Chad as far as Adamawa, and seems to belong to the same race as the extinct So and other autochthonous peoples of Bornu either extirpated by, or absorbed in, the Kanembu invaders of that region. Principal tribes: Margi, Mandara, Mekari or Kotoko, Logon, Gamergu, the unsettled Keibina, and the Mosgu or Masa proper. Masa is the name by which they call themselves. They may number altogether about one million.

5. **YEDINA**, or **BUDUMA** and **KURI**, are the two native lake tribes, the former dwelling on the great central group of islands, the latter on the Kaika, or smaller South-eastern Archipelago. Yedina is the proper name of the first, Buduma being the name by which they are known to the Kanuri, from *Budu* = hay, and the suffix *ma* singular (for the plural *bi*), meaning the "hay-people." They are fierce and daring pirates; the terror of the surrounding nations. The Kuri, so called by the Arabs and others, call themselves *Kalca* or *Kaleama*, and are undoubtedly akin to the Yedina, though the two languages vary not a little. Principal Yedina tribes: Maijoja, Maibulua, Buja, Guria, Margaua, Jilina; numbering from 15,000 to 20,000 altogether. Principal Kuri tribes: Arigna, Media, Kadiwa, Toshea, Karawa, Kalea.

6. **BULALA** and **KUKA**, kindred tribes, originally from Lake Fitri, whither most of them seem to have returned.

Some of the Bulala have withdrawn to a few of the islands in the lake, but the four following tribes are still in Kanem: Ngijem, Bedde, Sarabu, and Tirra, all off the south-east shore of the lake. The Kuka are now found only in Gujer, in the same neighbourhood. They jointly number about 5,800.

7. **DANA** or **DANAWA**, called by the Arabs *Haddad*, and by the Dasa or Southern Tibus *Asoa*, both terms meaning "Smiths," occupy a compact territory at the south-east corner of the lake opposite the Korio group of islands inhabited by the Kanembu. According to their tradition, the Danawa are half-caste Manga Tibus and Bulalas, but they now speak a Kanuri dialect.

8. **BEDÉ**, about 12° 30' N. lat., 11° E. long.

9. **NGISEM**, 12° N. lat., 11° E. long.

10. **KERRIKERRI**, 11° 30' N. lat., 11° E. long.

11. **BABIR**, 11° N. lat., 12° E. long.

12. **BAGIRMI**, along the eastern or right bank of the Lower Shari, with undefined southern limits, and extending north-eastwards in the direction of Lake Fitri and Waday. Are closely related to the Sara tribes of the Middle Shari, and are also connected with the Jur and Dor dwelling on some of the head waters of the White Nile. Some of the Bagirmi are settled in Bornu, where they are called Karde, possibly through some confusion with their northern neighbours, the Kredas of the Bahr-el-Ghazal, who are Dasa or Southern Tibus akin to the Sakerda further up the bed of that now dried-up stream.

13. **HAUSSA** communities exist in one place only in Bornu, the district round about Gummel, on the 13° parallel and the 10° E. long. north-east of Kano.

14. **ARAB TRIBES** are found both in Kanem and Bornu. The principal Kanem tribes are the Tunjer, Uledsoliman (Wassili), and Mgharba, about 80,000 altogether. The principal Bornu tribes are the Auiadhamed and Salamat, numbering perhaps 100,000. Many of them have become in some respects assimilated to the surrounding Kanuri people, but still hold tenaciously to their Semite speech. "I have met with Arabs settled in Bornu for a series of generations, near the centre of the kingdom, and who were still so little acquainted with the Kanuri language that I was obliged to act as their interpreter" (Nachtigal). These Bornu Arabs are called Shoa by the Kanuri, and are carefully to be distinguished from those Arabs who occasionally make their appearance in these regions, either as marauders or traders from the Barbary States.

Though mainly ethnological, Dr. Nachtigal's paper is introduced with a few geographical notes, which, however, present little or no novelty. The lake is described as about 27,000 square kilometres in superficial area, of a triangular shape, open and navigable in its western section, but along its eastern shores crowded by a large number of islands in many places separated only by narrow channels one from the other. The upper course of its one great affluent, the Shari, still remains to be determined, the writer merely remarking on that point that it flows "in two main streams apparently rising in the heathen lands to the south and south-east of Waday, receives a small portion of the rivers flowing down the western slopes of the Marra range, and throughout the whole year discharges a considerable volume of water into the lake." The Bahr-el-Ghazal, its former north-easterly outflow, has long been dried up, so that the Chad has now no outlet of any sort, its waters being kept by evaporation alone at their present variable levels.

But nothing could possibly be more thorough and satisfactory than Nachtigal's elucidation of the complicated ethnography of this region, which he has disentangled as successfully as Stanley has just solved the geographical problems connected with Lake Tanganyika.

A. H. KEANE

THE "LOST ATLANTIS" AND THE  
"CHALLENGER" SOUNDINGS.

IT may perhaps not be at first apparent what is the connection between those tubes and masses of metal and other apparatus on the right and these fossil leaves in the cases on the left. Those are some of the sounding apparatus used on board the *Challenger* in her four years' voyage. They have been brought from the galleries of the Loan Collection of Scientific Apparatus, where they are deposited by the Admiralty, into this theatre, in order to illustrate the method by which deep-sea soundings and temperatures are ascertained. It is the results obtained from soundings in the Atlantic Ocean alone that we shall consider this evening. While the working out of these results, as shown in the diagram, has been accomplished by the staff of the *Challenger*, there are some few other ships to which passing allusion will have to be made. These fossil leaves, deposited by Mr. J. Starkie Gardner, F.G.S., are also brought in from the Loan Collection. It is not these particular leaves we have to consider; these are all English: but we shall have to consider the teachings of collections of leaves similar as regards their manner of preservation, obtained from different parts of Europe and America. There are no specimens at present in the collection besides these, though until recently there was the small typical collection of the Baron von Ettingshausen. These English specimens will, however, serve our purpose very well as illustrations to convey an idea of what Tertiary fossil leaves look like.

The connection between these two subjects is here. We are going to consider certain past vegetations which are made known to us by their fossil remains. The study of some of them led Prof. Unger by a process of reasoning that will be presently indicated, to the belief that there existed in Tertiary times land between Europe and America by which the ancestors of the plants gradually travelled from America to Europe. It is now seventeen years ago that Prof. Unger proposed to call this hypothetical land the Island of Atlantis;—the sunken island or lost island of Atlantis. It was, no doubt, what our American cousins would call "a big thing" for a botanist to do, to "create" a former land in mid-ocean simply because he wanted it to account for the migration of the ancestors of fossil plants he had studied, and to do so without a particle of physical evidence. It was the first time in the history of geological science that so bold a step had been taken. The arguments by which Unger arrived at his conclusions were criticised at the time and another route for migration by the Pacific was suggested.<sup>2</sup> Whatever may be opinions as to the value of the evidence on which Prof. Unger based his "lost Atlantis," we now know from the *Challenger* working out of soundings that not only a "sunken island," but a ridge does lie in mid-Atlantic between the Old and New World.

Our subject groups itself into three divisions:—(1) Tertiary fossil plants; (2) Deep-sea soundings; (3) the "Atlantis ridge."

[The lecturer then turned to the fossil leaves, and described their manner of preservation and the conditions under which they are met with, and referring to diagrams and tables explained the meaning of the word Tertiary.]

No one now doubts these are really the remains of plants that grew and are not *lapides vivi generis*. In comparing them with living plants and determining their affinities there are many difficulties to be encountered. The remains themselves are often fragmentary. Even when they are tolerably perfect the comparisons have to be made for the most part with specimens in herbaria, and the variations seen

in the few leaves of a specimen often suggest that variations from different parts of the tree may be considerable. With fruits and with ferns preserving the fructification, the determination is safer, but with leaves alone, while in some well-studied cases there can be hardly a doubt, in a large number of cases the doubt is great. When the lecturer first paid attention to the Lower Bagshot flora, fourteen years ago, he thought, as many unacquainted with the subject might think, that with such herbaria as at Kew and the Botanic Museum the work of comparison would be simple. The riches of these places will soon show, however, that a wide experience and a trained eye are needed to refer to all the species, frequently of orders and genera widely separated in the natural classification, whose leaves resemble a fossil leaf under consideration. Those who may try the work will more readily understand how it was that a few years ago not a single English botanist of note was willing to attach any importance to the determinations based on fossil leaves alone.

Matters are looking more hopeful now, partly because more perfect and well-marked specimens are being frequently added to museums and private collections, and partly because the writers of monographs on any living order are now beginning to adopt the plan of adding what is known about its fossil forms. There can hardly be a doubt that the solid reliable progress in the determination of fossil leaves is to be made alone by botanists who select a particular group of plants for exhaustive study, and include such fossil forms as they find no hesitation in admitting. General botanists of even great experience may make good guesses, but nothing short of the determination of a specialist can be regarded as absolutely safe, even if that may be considered so.

While the feeling of English botanists a few years ago was as described, there were on the Continent some few whose hesitation with regard to fossil leaves did not prevent them from trying what could and what could not be done in the way of identification. [The lecturer then referred to the work of continental botanists, especially of Heer and Unger, and alluded to the confirmatory evidence which in some cases had occurred of fruits being found subsequently from the same locality as leaves, whose determination had been attempted.] Unger compared the Tertiary flora of America with that of Europe, and in 1860, in a lecture called "Die versunkene Insel Atlantis," made a comparison between the two, and detailed the steps by which, after twenty years' study, he had been led to the conclusion that the European Tertiary flora had a North American character. There have been two theories respecting the origin of plants in particular areas. One is that the plants of that area have been created there as fully developed as met with; another is that they have been partly the result of evolution in the same district, and partly or entirely the result of immigration from other districts. [Starting with familiar illustrations of the effects of climate on plants, the lecturer proceeded to show how plants retreated before climatal conditions that were hostile to them, and spread where the conditions were favourable, in other words changing the elevation at which they grew, in other words changing their area.] It was the consideration of the migration of the plants that led Prof. Unger to believe that a high proportion of the European Tertiary forms had come from North America.

It would occupy too much time and would fulfil no useful purpose in a popular lecture like this, to give in detail the data on which he based his conclusions. A résumé of them in a form convenient for reference may be found in a translation of his lecture in the *Journal of Botany* of January, 1865. Believing the evidence was sufficiently strong that the Tertiary plants he studied had come from North America, he proposed a hypothetical land between the two as the route by which they had travelled.

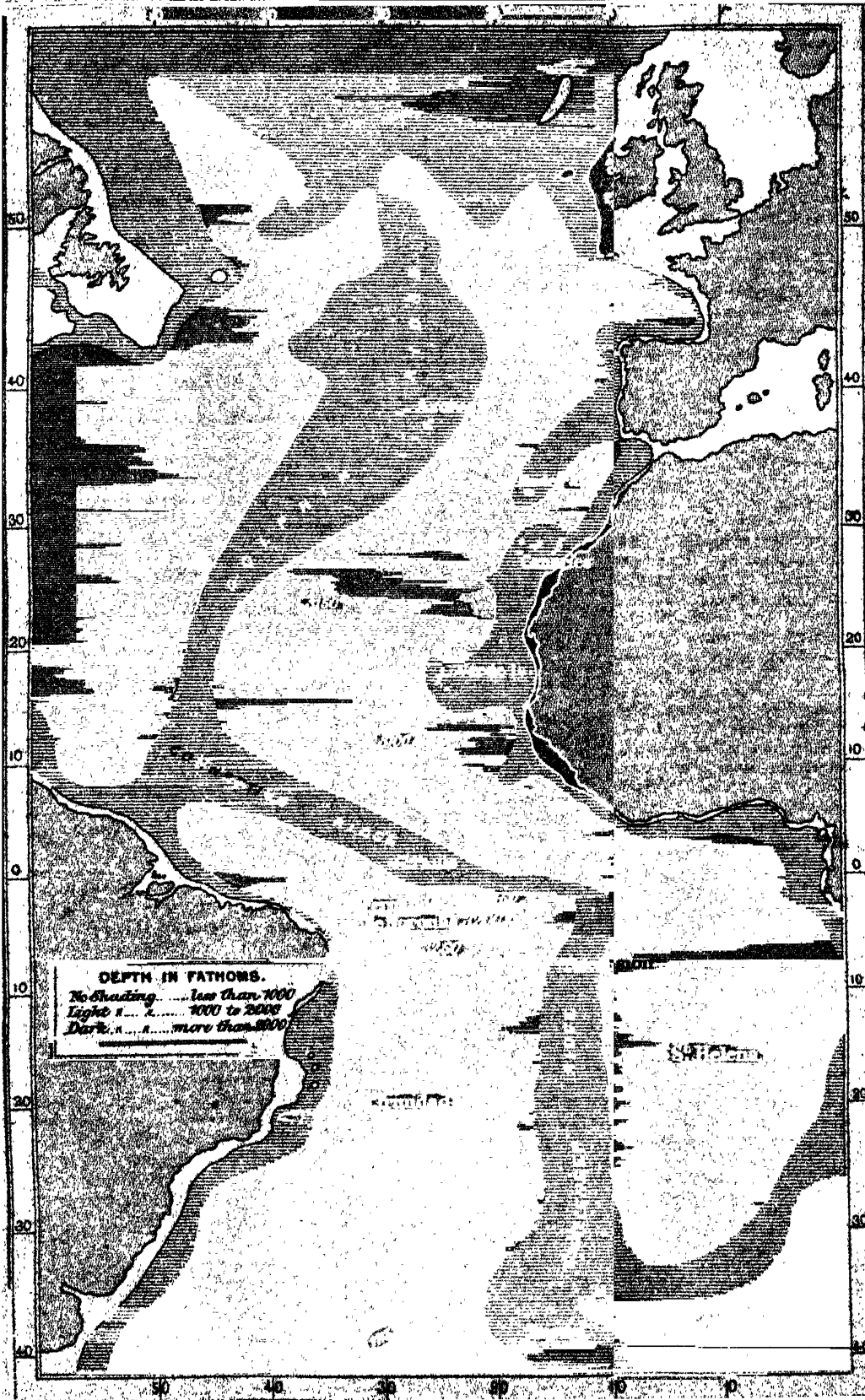

He took the name of his hypothetical land from a legend met with in the "Timæus" of Plato. In a conversation between a priest of Sais and Solon, when in Egypt, mention is made of a great island of Atlantis, situated beyond the pillars of Hercules, where lived a powerful nation that ruled over Libya as far as Egypt, and over Europe as far as Tyrrhenia. They tried to subjugate the Hellenes, but that heroic people defeated them. At a later period, during severe earthquakes and great floods, the island of Atlantis sank into the ocean. Such in brief outline is the legend. [The lecturer, alluding to the translations of Jowett and Whewell, referred to the puzzle this passage had been to students to know where an Egyptian priest could have known such a legend, or why (possibly) Plato had invented it, and alluded to one explanation that it was probably an exaggeration of some local phenomenon. In the *Journal of Botany* for January, 1865, a list of the literature of the subject is given.] This is as much as time will allow to be said to indicate the nature of the reasoning by which Unger, on the evidence of plant remains in Europe and America, conjectured former intervening land between the two, and why that hypothetical land was called "the sunken" or "the lost island of Atlantis."

We now turn to the *Challenger* soundings, and with these must be mentioned those of the United States ship *Dolphin*, the German frigate *Gazelle*, and the British ships *Hydra* and *Porcupine*. The generalisations of the soundings taken by these vessels, with inferences drawn from bottom temperatures, have been worked out by the staff of the *Challenger*, and a contour map has been prepared, of which the features which bear on our subject are reproduced in the diagram. Some of the most important soundings were taken from the *Challenger* herself, and as the working out of the whole results have been performed by the staff of that ship it is not unfair, at any rate in a short title for a popular lecture to mention only "*Challenger* soundings." That there was no feeling of international jealousy on the part of the *Challenger* staff is fully evidenced by the fact that the northern portion of the ridge has been named after the *Dolphin*.

Before referring to the results it may be of interest, as we have some of the *Challenger* apparatus here, to speak of the method of deep-sea soundings.

[The lecturer then briefly sketched the history of deep-sea soundings, alluded to the impulse given by the laying of cables, and mentioned how the improvement in mechanical appliances made possible now what was impossible a few years ago.]

The line used is about one inch in diameter; on this the twenty-five and seventy-five fathom distances are marked with white thread, interwoven, the fifty by red, and the 100 fathoms in blue. By this means the amount of line paid out can be easily ascertained. The weights to sink the line are so arranged, that when they touch the bottom they release themselves. There are several modifications of this apparatus, but the principle of those used on board the *Challenger* is that round flat weights with holes through them are placed one above another with a rod or tube running through them, the number of weights depending on the expected depth. To the bottom of the lowermost weight a wire ring is fastened, and a wire passes up and is fastened to a spring at the top of the tube. The tube is then attached to the line. So long as the strain of the weights is on this spring it remains closed. Directly the weights rest on the bottom the strain is removed, the spring opens, the wire is released, and when the line is hauled in it brings up the tube only, leaving the weights below. For taking temperatures a cup lead is generally used to sink the line, to which self-registering thermometers specially arranged to withstand great pressures are attached at every 100, and sometimes at every ten fathoms. It is not necessary

here to speak of dredging, nor of the means for bringing up water or samples of mud from the sea bottom. We have now only to speak of soundings and taking temperatures. In both operations the line is passed through a pulley-block, which is attached to a group of elastic "accumulators," the object of this being to break the shock of the roll of the ship.

Dr. Spry, writing about the *Challenger* voyage, has said:—

"It has been found that in all deep soundings it is necessary to use steam power. No trustworthy results can be obtained from a ship under sail, as even in the calmest weather the heave of the sea or the surface current is sufficient to drift the ship in a very short time a considerable distance from the place where the lead was originally let go. . . . The first thing therefore to be done is to shorten and furl all sail and bring the ship head to wind, regulating the speed in such a manner as to avoid forcing her through the water."

The soundings and temperatures obtained by the *Challenger* have been from time to time issued in special reports, of which there have been seven. In the seventh is given a map on which the soundings have been marked, together with those of the other ships already mentioned. On this map the ridges and deep basins have been contoured, and where soundings have been wanting the bottom temperatures have been taken as a guide of the probable position of the separating ridges. For the *Challenger* ridge there are plenty of soundings and nearly as many for the *Dolphin* ridge. The connecting ridge is, however, assumed from bottom temperatures.

It is on this map our diagram is based.

Having now obtained approximately the contour of this ridge, which throughout the greater part of its range is known as a FACT from actual soundings, there are some few speculations concerning it which naturally present themselves for consideration. In the first place it will be noticed that along the ridge itself there are four places where it rises to dry land, at the Azores, at St. Paul's rocks, at Ascension, and at Tristan d'Acunha. In the deeper basins there is land rising above the sea-level at Fernando de Noronha, at Trinidad, and at St. Helena. In the deeper basins too there are five soundings which show a depth of more than 3,000 fathoms. These are given on our diagram. The greatest depth recorded is 3,450 fathoms. A glance at the *Challenger* map on which the soundings are marked in figures is sufficient to show that if the contour lines were drawn at every 250 fathoms the Atlantic would be found to be diversified by hills and valleys. Geologists are familiarised with invoking former rises and falls in land to account for some of the facts they study. Indeed in some cases it seems almost as if it were believed that the axis of the earth may be shifted and its ice-caps, its soil-caps, and its continents moved about with impunity to suit any particular theory. At any rate it would not be received as a startling idea that the whole area of what is now the Atlantic has been dry land. True we know that deposits are now being formed on the floor of the ocean, and at different rates, and consequently producing different thicknesses; rivers carry material which is spread out according to conditions over large or small areas, and so produce variations in the thickness of their deposits; and perhaps allowance must also be made for currents. These circumstances may to some extent modify the relative levels of parts of the ocean bottom. But they could hardly account for such extent of variations in the hills and valleys as are met with. Some of the ridges may be the result of submarine elevation analogous to that which has raised high mountain ridges elsewhere, and in this case has never brought the ridge above the sea except in a few peaks. It must too be remarked that if we admit the ridge through its whole length to have been dry land, it does not necessarily follow it was so all at the same time. There is not

however, any readily apparent argument against the theory that it has been all dry land and at one and the same time. Let us for a while assume that it was, and let us then see what facts about climate we may infer with regard to it.

There are no doubt many other facts besides those already known where the depth exceeds 1,000 fathoms. Let us, however, take the group of the known depths which run in a line north-east and south-west, and which are respectively 3,450, 3,200, 3,250, and we may assume that they represent a valley line. Let us suppose that the area is raised till this valley is dry land; what then will be the height of our ridge, and what will be the highest peaks of the country? To the north-west of the valley, distant about as far as from here to the Grampians, would tower the peaks, now the islands of St. Paul's Rocks, and Fernando de Noronha, rising some 30,000 feet; and to the south-east would rise Ascension to a similar height. The "ridge" itself would be about 15,000 feet. There is no reason whatever for supposing that the ridge is a table land. On the contrary, it seems more probable, judging from the variations in the soundings, that it was diversified with hills and valleys. Now a ridge of this elevation would, in all probability, have a snow capping even at the equator. Astronomers tell us that in "former" times the earth's atmosphere was higher and its pressure greater than now, but that was in a very remote past, and we may fairly assume that at the time of this ridge being land the atmospheric conditions were much as now. We should thus have a mountain ridge with hot valleys and every variation in temperature according to height; so that so far as temperature is concerned botanists would have no difficulty in accounting for the migration across the equator of plants that would be killed by great heat. With regard to the part of the ridge between Europe and America, answering to Unger's "Atlantis," the soundings are more numerous. The undulations seem to have been many, and the general elevation was probably not more than 9,000 feet, unless the original depths are masked considerably by a deposit of globigerina-ooze. Some peaks—now the Azores—still remain above water. When the ridge sank is a question on which we have at present no evidence. The whole subject is still young, and we have much yet to learn.

In conclusion the lecturer said: I hope I have given sufficient prominence to the distinction that must be drawn between fact and inferences from those facts.

I should be very sorry for anyone to go away from this place and say that they heard a lecture at South Kensington in which they were told that there formerly was a continent running down the middle of the Atlantic, and that there was a lofty mountain ridge along it, capped with snow even at the equator.

I wish carefully to point out to you I have made no statement of the kind. I have simply told you the fact that a ridge less than 1,000 fathoms beneath the ocean runs down mid Atlantic in a westerly course, whose contour is roughly indicated by the soundings. That on each side of it are ocean depths, and in some cases thrice the distance it is below the sea-level. That if these depths were once land valleys, as geologists have no difficulty in believing possible, then there would be a ridge running north and south along the area of what is now the deep Atlantic, ranging from 9,000 to 15,000 feet above the sea-level, and that if the atmospheric conditions were the same then as now, judging from what we know of the Andes under the equator at the present time, there was probably a snow-capping.

Such a land-connection between Europe and America, if it existed as late as Tertiary times, would meet the requirements of Unger's hypothesis, varying in height as it sank, and the whole ridge would afford a solution of any difficulty botanists may have on the score of temperature

in accounting for the migration of cold-loving and heat-shunning plants across the torrid zone.

The remarks at the conclusion of the lecture, in reference to its being the last of the series, we have already reported at p. 490.

#### REMARKS ON THE INVESTIGATION OF CLIMATES

TO Prof. Balfour Stewart we are indebted for the separation of meteorology into its two great divisions of *physical* and *climatic*. The latter I have proposed to separate into two sub-divisions, viz. *normal* and *abnormal*. The first of these subordinate branches includes the investigation of the usual states of the atmosphere in different parts of the earth's surface, as ascertained by periodic data derived from the averages of observations continued for a series of years. The second subordinate branch has for its object the investigation of unusual temporary disturbances of the equilibrium of the atmosphere—such, for example, as storms of wind, by means of the comparison of individual observations, extending over only a few hours or a few days.

We need hardly wonder at the disfavour with which meteorology is regarded by some men of the highest standing in physical science, from whom valuable assistance might have been expected; for we know that there is a great want of agreement among meteorologists themselves as to the means of determining even the most important fundamental data. For example, it will hardly, one would think, be disputed that the essential condition in all meteorological inquiries is *uniformity in instrumental observation*. But towards the establishment of a uniform international system no progress has as yet been made. Points of subordinate importance may have been adjusted at the Congress meetings at Leipzig and Vienna, but this all-important question remains just where it was. To Mr. Glaisher is due the adoption among his observers of the uniform height of 4 feet above the ground for thermometers, and one invariable form of screen for protecting them. The Scottish Meteorological Society, when establishing their stations in 1855, followed the example of Mr. Glaisher by adopting the 4-foot standard height, and they ultimately selected the form of double-louvre boarded protecting box, which I proposed in 1864. The Meteorological Society of England have also adopted the same uniform system as that in Scotland of boxes, and their exposure, and hours of observation. But other observers follow different methods, and on the Continent it is believed there is still less approximation to uniformity than among ourselves. The very first matter which should be taken up by home and foreign meteorologists is the settlement once for all of the questions how, when, and with what position and exposure of instruments are observations to be made. Until this is done it is impossible to arrive at useful results, because the observations which are now being obtained at different stations are not comparable the one with the other. Unless there be some such general Council as that lately proposed in NATURE by Prof. Balfour Stewart for carrying out this and other important objects, I shall certainly despair of the future of this new science.

But let us now see in what way the mode of instrumental observation bears on the subject of climates. Climates may be defined as states of the atmosphere due to the joint operation of geographical, geological, and other conditions more or less local, and they are judged of by their effects on animal and vegetable life. They do not, therefore, depend simply on the geographical position on the earth's surface of the district where the observations are made, but are largely affected by various conditions, such as the distribution of land and water, the nature of the soil and its covering, and the elevation of

adjacent to, the place. Climates are, therefore, frequently of a local nature, by which I mean of small superficial extent. Thus many varieties of climate may coexist about the same parallel of latitude, and even over a very limited portion of that zone. Instead of saying, then, that a whole country such as Britain has a certain mean temperature, as ascertained by lumping together observations made at places of widely different character, level, and exposure, we should rather say that there are in that island mountainous districts with a certain mean temperature, districts of open plain, having another, and sheltered districts and valleys having another; while parts near the sea-shore, have their own peculiar characteristics. To take a familiar case, we may refer to the Isle of Wight, all parts of which, small though the island be, can hardly have the same climate as Bonchurch and Ventnor, which are the favourite retreats of invalids in pursuit of health. That such local atmospheric distinctions do really exist may at once be shown by a reference to the varied distribution of plant life which, though no doubt largely affected by the nature of the soil, is nevertheless to a considerable extent dependent on the existence of certain atmospheric conditions.

If meteorological stations were to be established in some place situate in a low latitude—such, for example, as the Island of Java, we should be told, as I have more than once been in similar cases, that though 4 feet above the ground may be suitable for thermometers in Britain, it would be quite preposterous for so hot a climate as Java. Now if what were wanted was to ascertain the amount of heat emitted directly by the sun, such a statement might be correct; for then the instruments should be kept as clear of terrestrial influence as possible, and by taking proper precautions we might perhaps make our observations indifferently at sea or onland. But these would not be observations of climate. Now, as in the case we have supposed, it is the *climates* of Java and Britain that are to be compared by ascertaining the amount of heat communicated to thermometers by conduction and convection of the air which has been heated by solar, and cooled by terrestrial radiation, the observations must be made on the islands themselves and not on the sea which surrounds them, and by instruments placed at the same level above the surface of the ground. It has been farther objected that in very hot countries there are large districts where canes or other kinds of jungle vegetation rise much above the level of the thermometers, while in Britain there is generally a grassy sward nearly 4 feet below them. These differing kinds of vegetation nevertheless largely influence the character of climates, and their effects ought not to be eliminated even although it could be done. The results which have been obtained in a jungle should not, however, as I have already said, be mixed up with those of other places which have a free exposure. The truth is that by adopting different kinds of protecting boxes, and by varying sufficiently their levels above the ground, we may so far depress the temperature of a hot country and exalt that of a colder, as *instrumentally* to equalise them.

There is but one mode of getting results which shall be comparable, and that is by adopting the same standard height and the same standard form of protecting box. The results may, however, be vitiated in another way by placing the instruments near or under shelter of buildings, or still more, by the monstrous system of fixing them to the walls of houses; for masses of masonry or other building materials prevent either extreme from being recorded by the instruments. It must also be kept in view that however valuable continuous registrations may be, in showing intermediate variations of temperature, no photographic self-registering thermometer hitherto constructed gives any result which can be regarded as correct because it does not record the temperature of the air of the locality and is not comparable with those of common thermometers, nor even, perhaps, is ever comparable with those

of other similar self-recording instruments. The house or framework with which the instruments are necessarily connected cannot fail variously to affect the mercury in the bulb and thus to veil the results. The only mode of counteracting this influence is to have common thermometers in the neighbourhood placed and protected in the usual way and to record their indications eight or twelve times in the course of the twenty-four hours.

It must be kept in view that I have been speaking only of local climates, or those which are subordinate to the *normal climate* due to geographical position. That such great climatic zones due to latitude exist and vary as we recede from the equator towards the poles is abundantly evident, both from the animal and the vegetable world. The best mode of investigating these climatic zones would be to select stations as little affected as possible by surrounding vegetation, the instruments being exposed as freely as possible all round and placed at the same level above the ground, and as nearly as possible at the same level above the sea, so as to avoid confusion with what have been termed the climatic zones of altitude. For this purpose I venture to suggest the use of an instrument which I proposed in 1870,<sup>1</sup> the indications of which depend on the heating up of a *large quantity of water* or other fluid contained in a thin glass globe which is freely exposed to the sun's rays. When the water expands under the influence of heat, the surplus fluid escapes into an adjoining vessel in which it can be afterwards weighed. On the other hand when the fluid is contracted by cold, the deficiency is continuously supplied from a connecting cistern kept always at the same, or sensibly the same, level. By this automatic arrangement the whole of the heat given out, however irregularly, by the sun, is constantly treasured up. The readings of maximum and minimum thermometers would also serve to correct errors due to the proximity of the tubes and cisterns of the instrument to which I have referred. The difference between the results of this and the common thermometer is the continuous registration of the alterations in bulk produced by the variations of temperature; whereas the common thermometer fails to record the many changes that take place between the maximum and minimum readings, and which are due to sudden obscurations and revelations of the sun caused by passing clouds during the day, while the terrestrial radiation at night is similarly affected. Even where this instrument is not used it would I think be an improvement on the present system were maximum and minimum thermometers kept constantly immersed in a large globe of thin glass filled with water.

THOMAS STEVENSON

#### VOLCANIC PHENOMENA DURING 1875

DR. GUSTAV TSCHERMAK'S *Mineralogische Mittheilungen* (1876, 2) contain a most interesting account of the volcanic occurrences during the year 1875, computed by Prof. C. W. C. Fuchs. In the short introduction Dr. Fuchs expresses his regret that the scientific academies and societies do not give more general attention to this most important branch of geological research, and points out that through the numerous and universal relations of the institutions in question the statistics of volcanic eruptions and earthquakes would become far more correct in details and numbers, than it is in his own power to make them. The publication of the valuable information now given by Prof. Fuchs therefore all the more deserves the highest praise and attention. Dr. Fuchs divides the events into two classes, viz., eruptions and earthquakes. The first volcano treated of is—

*Etna.*—After the short eruption of August 29, 1874, which lasted until the beginning of September, the mountain was perfectly at rest. Early in January, 1875, there were signs of new activity in the shape of repeated shocks, which, on the 8th, caused considerable damage near Acireale. But the shocks decreased again both in frequency and intensity, and a new period of rest ensued until the beginning of October. At that time a small crater on the south-side of the mountain became slightly active. From December 19, smoke mixed with reddish vapours

<sup>1</sup> *Trans. S. A. M. S.*, vol. III, p. 114

was seen to rise, and the reflection of subterraneous fire could be seen from Acireale.

*Vesuvius.*—With the exception of a small eruption on July 18, 1874, this mountain had only given off clouds of smoke, and had come to complete inactivity by the end of the year. From its slight earthshaking noises it was expected to return.

Only in December the interior of the mountain considerable changes took place, a great portion, towards the top, fell in, and thick clouds of black smoke rose at this spot. The glow of fire was seen in the crater, and all other phenomena increased in intensity, however, without it coming to an eruption by the close of the year.

*Iceland.*—The eruptions which occurred in this country during 1875 are the most important ones of all. They were numerous and followed each other in quick succession, some of them with extreme intensity. The first one was a side-eruption of the Vatna, which began with vehement earthquakes on January 2. A broad stream of red-hot lava broke forth on the following day and continued to flow until the third week of February. About this time a second eruption began in another locality. This was preceded by a copious fall of ashes spreading over Kelduverfet. The crater of this second eruption lies within one of the largest prehistoric lava fields, called Odarhaun. A third eruption took place on March 10 to the north of the latter, no less than sixteen small craters ejected masses of red-hot slakes, and more to the west a broad stream of incandescent lava flowed for several days to a distance of 600 yards. The fourth eruption was perceived on the whole of the island. It occurred on March 29 on the Vatna, and was accompanied by loud reports and subterraneous noise. The most remarkable phenomenon in this eruption was an enormous fall of ashes, which was so dense in Oesterland that the sun was darkened and lights had to be lit. The ferry on the Yokul river could not penetrate for several days the enormous masses of floating pumice stone. The fall lasted five hours in the Yokul Valley, three in the Fljotr Valley, and two at Seydusfjord. A strong west wind carried particles of these ashes to enormous distances, *i.e.*, to Norway and Sweden. (We have repeatedly reported on the ashes found in those countries at that time, and upon their origin.) Another prolonged eruption took place on April 4. The active crater this time lay to the south of Burfell, and the phenomenon was accompanied by violent explosions and the ejection of high garbs of incandescent slakes. It lasted about twelve days. The next eruption happened between April 20 and 24 in the so-called Oster Mountains. Matter was ejected to an enormous height and streams of lava overflowed the environs to a distance of fifteen miles at a breadth of from 800 to 2,000 metres. Towards the end of June another new crater formed and several lava streams broke forth near Thingu, between Vrvatn and the Yokulsan. The last eruption, another very violent one, occurred on August 15 at the same place as the last. Twenty different columns of smoke were ejected, and on the next day slakes and red-hot lava followed.

*Loa.*—This volcano, one of the less known mountains of Java, had a great eruption early in 1875, according to news dated February 3. An enormous stream of lava completely destroyed the settlement of Blikar, besides causing great damage in other localities.

Mexican mountain (situated at lat.  $21^{\circ}25'N$ ), which rises to a height of 4,000 metres (13,275 metres above sea-level) was believed extinct since the discovery of America, its first historical eruption taking place in 1870. Another great eruption followed on February 18, 1875, together with violent earthquakes, which particularly damaged St. Cristobal and Guadaluvera. On the evening of February 10 a fall of ashes occurred, and a high garb of fire rose in the night.

*Mauna Loa.*—A crater on the summit of the Mauna Loa, called Mukunweoweo, had an eruption of lava on August 11, 1875, but more detailed accounts have not reached Dr. Fuchs. This is the same crater which sometimes causes the whole island of Hawaii to be covered with the so-called "hair of the Goddess Pele," a fine thread-like obsidian, resembling fine threads of cotton.

*Tongarro.*—This volcano, situated in New Zealand, was active in the second half of 1875, and from time to time ejected lava and slakes. At intervals great geyser eruptions occurred, one time more than fifty jets of hot water, surrounded by vast columns of steam, were counted.

*Santorin.*—Since the last eruption the fumaroles on the island of Santorin were extremely active. On October 10, 1875, M.

Fouqué observed numerous openings ejecting gases, not differing much from air, in a chemical sense. During the night they reflected the reflection of fire, and the stones surrounding the were red-hot. A second group of fumaroles yielded sulphuretted hydrogen, carbonic acid, and water-vapour, at a temperature of  $90^{\circ}$ – $99^{\circ}C$ .

Speaking of earthquakes, Dr. Fuchs gives a complete list of all the earthquakes and terrestrial shocks which were felt in different parts of the globe during 1875, and they amounted to no less than ninety-seven in number, occurring on 100 different days. We regret that our space does not permit us to enumerate them, but compels us to confine ourselves to an account of the distribution of their number over the different months. Thus we have in January, 15; February, 7; March, 12; April, 7; May, 9; June, 10; July, 6; August, 5; September, 3; October, 2; November, 9; December, 12. Of fifty-two of which exact details could be obtained, thirty-six occurred in the night. On ten days earthquakes occurred simultaneously in different localities, and fourteen distinct places were repeatedly visited by them during the year. The most lamentable of all—real catastrophes—were those of Cucuta, on May 16–18, destroying several towns and numerous villages, and of St. Cristobal and Guadaluvera (February 11), which reached from the Pacific Ocean to Leon. Very severe were the earthquakes of the Lifu Island (March 28), of Utschak (May 3–5 and 12), of Lahore (December 12), and of Porto Rico (December 21). Altogether Dr. Fuchs estimates the number of lives lost in these earthquakes at 20,000, not to speak of the great damage to property. In conclusion the author gives an account of those earthquakes which were in evident connection with the eruptions of neighbouring volcanoes; and also mentions a few whose causes were undoubtedly not volcanic but mechanical phenomena. In a short appendix Dr. Fuchs gives some details of an eruption which occurred between September 7, 1873, and January 22, 1874, on the Island of Vulcano (one of the Lipari Isles), in continuation of his Report for 1874.

#### BIOLOGICAL NOTES

*BROCA'S STEREOGRAPH.*—A very ingenious instrument for taking mathematically accurate drawings of human crania and other objects of natural history, known as Broca's stereograph, has been lately presented to the College of Surgeons by the President, Mr. Prescott Hewett, which will prove a useful adjunct to the systematic study of the important anthropological collection now contained in the museum. It was exhibited and its use demonstrated by Prof. Flower at his concluding lecture on the Comparative Anatomy of Man. Among recent additions to this department of the collection are the valuable series of skulls of natives of New Guinea, collected by Dr. Comrie, Staff-Surgeon R. N. of H.M.S. *Bashish*, described in the last number of the *Journal* of the Anthropological Institute; also four of natives of the Navigation or Samoan Islands, presented by Dr. Pye Smith. On several occasions during the course, Prof. Flower pointed out the necessity of far larger series of human skeletons and skulls than are at present contained in our museums, before our knowledge of physical anthropology can be placed on a satisfactory basis, as the individual variations are so great that it is only when a considerable series of any race are brought together that their true characteristics can be determined.

*TENDRILS OF CLIMBING PLANTS.*—M. Casimir de Candolle publishes some interesting observations on the tendrils of climbing plants in the *Archives des Sciences Physiques et Naturelles* (January). The experiments the author made were suggested to him by reading Mr. Darwin's work on the movements and habits of these plants. With regard to the manner



composed of two segments which are curved in opposite directions. The curvatures increase gradually in both segments, and little by little transform themselves into two screws, of which the upper one is turned from left to right. The primitive sinuous curve very often spreads over nearly the whole of the tendril, and in this case only two screws are produced, wound, of course, in opposite directions. In all cases, with very few exceptions, the number of screws thus produced in the tendrils is an even one, and M. de Candolle demonstrates that the cause of this phenomenon is a simple mechanical law.

**EYELESS CRUSTACEANS.**—A valuable paper on the eyeless, cave, and deep-water crustaceans, by M. Alois Humbert, is published in the same periodical. It is principally a minute description of *Niphargus puteanus*, which M. Humbert believes to be an ancient genus, descended from a form which is now extinct, thus corresponding entirely with *Proteus*, *Leptodermis*, *Anohthalmus*, and others. With regard to the question whether the *Niphargus* found in the Swiss lakes are merely colonies from the other animals of the same genus, which inhabit subterranean waters, or whether the reverse is the case, the author expresses himself as follows:—If we suppose that the genus *Niphargus* appeared before the ice period, it is impossible to say anything with regard to its place of origin. But, if we do not suppose it to date so far back, and only look at the present fauna, I incline to the belief that the *Niphargus* of our Swiss lakes originate from those inhabiting subterranean waters. When they reached the lakes they acclimatised themselves at depths where they found the darkness sufficiently intense, and in such a zone, all but completely dark, where they found the necessary conditions for their existence. In a more illuminated zone they could not have escaped from their enemies so easily and could not sustain the competition with their fellow-inhabitants, which possessed better visual organs. If we consider the greater dimensions attained by the forms inhabiting caves, it seems that the lake species, although living in vaster bodies of water, yet find themselves in conditions which are less favourable to their development and are suffering, if it were, from atrophy.

**ORIGIN OF THE FLYING-POWER OF BEES.**—The following interesting experiments made with bees, by Herr Donhoff, are recorded in the *Archiv für Anatomie und Physiologie*. He took some bees from the hive, just as they came out of the entrance hole, and placed them under a glass bell at a temperature of 9° C. (66° F.). First they ran hastily up and down the sides of the glass and flew about in the jar. Later on their movements became less hasty, and after forty-five minutes they all sat quietly together, moved slowly and clumsily. They were no longer able to fly about. He let a few crawl upon a pencil, and by giving a jerk threw them into the air; they fell down perpendicularly without giving a humming sound, i.e. without moving their wings. He killed and opened one or two and found their honey-bags empty. To the others he then gave a solution of sugar, and after they had fed for about 3½ or 4 minutes he again threw some into the air. They no longer fell down perpendicularly at a little further off, and also moved their wings. A minute afterwards they did not fall down at all but flew to the window; they had become the same lively insects as before. If the temperature is under 19° C. they lose the power of flying even sooner, and a longer period elapses before it returns after they are fed with sugar-water. In higher temperatures the power returns sooner. Herr Donhoff thinks it probable "that the bees lose the power of flying because it does not possess the necessary strength to be converted into muscular action, and that this strength returns to its system because in sugar it finds the necessary vital support."

**THE BIRDS OF CELEBES.**—In the March session of the German Ornithological Society Dr. Reichenow gave a detailed account

of the birds of the Island of Celebes. Although this island is classed geographically with Borneo, Java, and Sumatra in the Sunda group, yet its fauna is almost entirely distinct from that of the other islands mentioned, approaching very closely to the Australian fauna. Late investigations show that this is peculiarly true of the ornithology of Celebes, and that in the geographical distribution of animals, the island must be classed with Australia, New Guinea, &c., and not with the other members of the Sunda group. The speaker exhibited six new varieties of Australian *Colibris* lately found in Celebes.

**ITALIAN PLEISTOCENE EQUIDÆ.**—Dr. Forsyth Major (Florence) will shortly publish a work embodying the results of his long and diligent researches on the Italian Pleistocene Equidæ which will form a very valuable contribution to the evolutionary history of the Horse. The publication of the book—illustrated with numerous finely executed plates—is being prepared by the Swiss Palæontological Society, under the supervision of Prof. Rüttimeyer. A short *résumé* of some parts of the work appeared some time since in the *Kivista Scientifico-Industriale*.

**DEVELOPMENT OF MOLLUSCA.**—Dr. Packard, of Salem, Mass., writes with reference to Prof. Lankester's review of his work entitled "Life Histories of Animals, including Man" (*NATURE*, vol. xv., p. 271), to the effect that on p. 112 of the work in question, and also on p. 110, Prof. Lankester's name is cited by him as the authority for the use of the word "trochosphere." The paper in which Prof. Lankester proposes the term "veliger" is quoted on p. 113. This he considers sufficient reply to the reviewer's statement that he (Dr. Packard) does not ascribe, either the terms "veliger" or "trochosphere," or the views connected with them, of which he makes use, to their author.

**PARTHENOGENESIS IN A PHANEROGAM.**—Prof. Kerner, of Innsbruck reprints from the "Sitzb. der k. Akad. der Wissensch. zu Wien" an account of a remarkable instance of parthenogenesis in a flowering plant. The instance is a small Alpine Composite, *Antennaria alpina*, a native of the high Alps and Arctic region. Like some other allied species it is dioecious, and the male plants are extremely scarce. Prof. Kerner has never seen the male plant, and in 1874 cultivated the female plant with very great care in the botanic garden at Innsbruck, excluding apparently all possibility of foreign impregnation either by this or any allied species. The plants produced, notwithstanding, a number of seeds, which were sown the following spring. Six of these seedlings germinated, but four out of these shortly perished. The two remaining ones reached maturity, growing as luxuriantly as the mother plant, and showing no signs of hybridisation. It is not stated, however, whether they also flowered and produced seed. From the extreme scarcity of the male plant, Kerner believes that the seeds are ordinarily matured without impregnation.

**RESPIRATION OF ROOTS.**—From recent experiments on the respiration of roots (the plants employed being ivy and veronica) MM. Deherain and Vesque conclude (1) That oxygen is necessary for all organs of plants, and that for the life of a plant it is not sufficient that its air-parts be in air; the roots must also find oxygen in the atmosphere of the ground in which they grow; (2) That the absorption of oxygen which takes place through the roots is accompanied with only a slight development of carbonic acid, so that the roots produce a partial vacuum in vessels in which they are contained; (3) That this development of carbonic acid takes place just as well in an atmosphere without oxygen as in one which contains it; whence may be inferred that the excreted carbonic acid does not come from superficial oxidation of some self-decomposing organs, but from a regular circulation of gases in the plant.

## NOTES

FIFTY-SEVEN candidates for the Fellowship of the Royal Society have offered themselves during the present session. From these the Council have selected the following names to be recommended to the Society for election at the annual meeting on June 7 next:—Prof. James Jewett, M.A.; Sir Joseph Banks, M.D., K.C.S.I.; Rev. Norman Macleod, M.A.; Thomas Richard Fraser, M.D.; Lewis Huggins, F.R.S.; F.L.S.; John W. Judd, F.G.S.; William Carmichael M'Intosh, M.D.; Robert M'Lachlan, F.L.S.; Prof. John William Mallet, Ph.D.; Henry B. Medlicott, M.A.; Henry Nottidge Moseley, M.A.; Prof. Osborne Reynolds, M.A.; William Roberts, M.D.; Prof. James Thomson, LL.D.; Prof. William Turner, M.B.

THE scientific men selected this year by the Universities of Edinburgh and Glasgow for the degree of LL.D. are well deserving of the honour. Among those on whom Edinburgh has conferred it are Mr. George Gore, F.R.S., Mr. J. B. Lawes, the well-known scientific agriculturist, Dr. Reinhold Rost, principal librarian to the India Office, and Mr. John Westlake, Q.C. Glasgow has given her degree to Prof. Andrews, F.R.S., president, and Prof. Allan Thomson, president-elect of the British Association.

THE Council of the Royal Microscopical Society have resolved to institute a lecture in memory of the late Prof. John Quekett, to be delivered from time to time by eminent microscopists, to whom will be presented the Quekett Medal provided out of the Medal Fund collected some years since. The first of these lectures will be delivered in the theatre of King's College on May 2, at 8 P.M., by Sir John Lubbock, Bart., M.P., F.R.S., the subject being "On Some Points in the Anatomy of Ants."

MR. WARD HUNT stated in the House of Commons last week that the deduction of the Astronomer-Royal with respect to the late transit of Venus will be ready in about six weeks, but that some months must elapse before the photographic records will be completed, without which the report would be imperfect.

THE Paris Academy of Sciences held its anniversary on the 23rd inst., Vice-Admiral Paris being in the chair. Only one national prize was awarded this year to M. Darboux for a memoir on "Singular Integrals," obtained in the solution of the differential equations of the first order. This work, of exceptional excellence, will be published in "Recueil des Savants Etrangers" at the expense of the Academy. A number of minor prizes were awarded for memoirs in botany, chemistry, medicine, &c. But the largest number of rewards were distributed amongst authors of works already published and not specially written for competition; this is a laudable innovation. The following are some of the awards:—The prize for the progress of the application of steam to the military navy to M. Ledieu, as author of an elementary treatise on "Marine Engines." The Poncelet Prize to M. Kretz, an engineer in the French Civil Service, for his publication of Poncelet's works on "Mechanics." The Delmont Prize to M. Ribaucourt, engineer of Ponts et Chaussées, for his geometrical disquisitions on the tri-orthogonal system. M. Violle was rewarded by a donation of 80*l.* for his researches on the heat generated by the sun; MM. Vicaire by a donation of 40*l.* each for similar researches. The Monthyon Medal to M. Melsens for his method of working mercury ores, as practised at Ydría, where working men have been effectually protected against toxic emanations. M. André took one prize for his experiments on the causes of the "black drop" seen by some observers of the transit of Venus last century. M. Gauguin obtained a similar reward for his long continued observations on tourmaline and other electrical disquisitions. The Cuvier prize was awarded to M.

Fouqué, the celebrated Santorin and Etna explorer. MM. Filhol and Velsine obtained one prize each for the excellent zoological preparations collected at St. Paul and at Campbell Islands on the occasion of the last transit of Venus. M. Palisa, director of the Pola Observatory, obtained the Lalande Medal for the discovery of nine small planets and the rediscovery of Maia, lost from 1861 to 1876. The usual number of prizes have been proposed for 1877 and following years. A programme stating the conditions will be sent to any person writing to the secretary of the Academy of Sciences. No limitation of nationality is imposed, and the necessity of writing in French or Latin is practically abolished, at least for several of the prizes. A sum of about 4,000*l.* is to be distributed amongst thirty-eight different competitors, exclusive of the Breant prize. M. Dumas read the *loge* of MM. Brogniard, two naturalists who were influential members of the Academy of Sciences, and whose lives were long associated in kindred work. The eminent perpetual secretary obtained one of the greatest successes of his whole academical career. The address was a masterpiece, most carefully written and admirably delivered.

A LECTURE delivered in Washington in the beginning of April, at the opening of the summer course of the National Medical College, by Dr. Elliott Coues, the well-known ornithologist, has attracted some attention in America not only by contrast with similar addresses, but for its mode of treatment and advanced views in discussing the bearings of anatomical science on the question of the origin of species and man's place in nature.

A VERY extensive Etruscan necropolis has been discovered at Monteparo, near Ascoli Piceno (Umbria). An enormous quantity of bronze, iron, and terra-cotta objects have been and are being found in the grounds, chiefly consisting of helmets, armillas, collars, buckles, nails, spurs, bows, rings, lances, spears, swords, and thousands of perforated bronze grains or beads, besides numerous objects of amber, glass, shells, and pottery, all of which are likely to be secured by the Italian Government for the Florentine Museums.

THE Bradford Scientific Association *convensazione*, we are glad to hear, has been a great success, over 1,600 persons having visited it. It was held for two days—Wednesday and Thursday, April 11 and 12—and the members were so encouraged by the support received, that they continued the exhibition until the Saturday. Over 100 microscopes were shown nightly, and the collective display of physical and chemical apparatus has, we believe, not been equalled in the north. The society introduced a novel feature in the management of the affair—admitting those engaged in teaching at a reduced charge, while demonstrations on various subjects took place each evening, according to a printed time table, given to each person on entrance. They endeavoured to take as their model the Loan Collection at South Kensington. This enterprising society have demonstrated the immense educational value which a collection of scientific instruments must have, if accompanied by proper explanation. They are so satisfied with the success, that they will attempt things on a much larger scale in the future.

IT was announced at the last meeting of the Paris Geographical Society that the expedition organised to investigate the possibility of cutting a channel through the Isthmus of Darien has proved a failure.

TWO Prussian officers have arrived in Paris for the purpose of determining telegraphically the longitude of Berlin. Two French officers have been despatched to Berlin in order to carry out similar operations. The apparatus to be used in Paris have been located at the observatory, under the superintendence of M. Mouchez and M. Le Verrier. The ultimate aim of

he operation is to connect the French trigonometrical triangulation with the system of the Geodetical International Association, which is covering almost the whole of Europe.

We recently announced that Mr. Siddal, of the Chester Society of Natural Science, had detected Radiolarians in Carboniferous limestone. At a meeting of the Society lately it was announced that another member of the Society (Mr. Shrubsole, F.G.S.) had discovered both Foraminifera and Radiolarians in the chalk of the North Wales border.

MR. GEORGE CROSS, of Chester, a member of the Chester Natural Science Society, and conductor and teacher of the classes formed in that city under the auspices of the Government Science and Art Department, died on the 16th inst. at the early age of forty. As an able scientific man of genial disposition and kindly feeling his loss is deplored by a large circle of friends.

THE Agricultural Society of France is building a large hotel on the Rue de Bellechasse at Paris, which will be fitted with every convenience for meetings and lectures, including museum and libraries. The expenses are defrayed by a benefactor who has taken effectual measures to conceal his name. The cost will be more than 20,000*l*.

THE Society of Arts are prepared to offer prizes of 5*l*, 3*l*, and 2*l*. respectively, and certificates, for proficiency in qualitative blowpipe analysis. The competition is open to any person, but it is intended principally for those interested in the mining industries of Devon and Cornwall, the examination will be held in the centre of the mining districts. The arrangements will be in the hands of the committee of the Miners' Association, and intending candidates should apply to the honorary secretary of the Association, Mr. J. H. Collins, Lemon Street, Truro. The examination will be held at Redruth, from 5 to 9 P.M., on Tuesday, June 5, 1877.

THE subject of the Rhind Lectures on Archaeology in connection with the Society of Antiquaries of Scotland this year is:— "Do we possess the means of determining scientifically the condition of primeval man and his age on the earth?" The lectures, six in number, commenced yesterday, the lecturer being Dr. Arthur Mitchell.

AT four o'clock on Monday morning a sharp shock of an earthquake was felt at Oban. The motion was undulatory, accompanied by a rumbling noise, and terminating in a sort of jerk. The motion did not last above six seconds. Furniture and articles of household use were jerked upwards, and pieces of crockery were thrown from the shelves. A lighter shock was felt in the Island of Kerrera last week, and a short time ago a shock was felt in Tobermory, Island of Mull.

AT the first meeting for the year of the West Riding Geological and Polytechnic Society held at Ripon on April 4, the Marquis of Ripon gave an address on scientific pursuits and their results. He advocated thoroughness in all such work, and urged his hearers not to accept facts without complete investigation, nor yet stubbornly to reject facts because they did not accord with their own preconceived ideas.

UNDER the title of "Giuseppe de Notaris, sua Vita e sue Opere," an interesting sketch of the life of this eminent botanist, who died in January last, is published, reprinted from the columns of the Roman journal, the *Opinione*. De Notaris was a member of a noble but poor Italian family, and was born at Milan in 1805. Brought up to the medical profession, he early devoted himself to the study of botany, and filled botanical posts successively at Milan, Turin, Genoa, and Rome. His labours were directed mainly to the description and the principles of the classification of cryptogams, especially of mosses, in which his services to science are very great and his publica-

tions very numerous. Until the last few years his labours received but little recognition by the State, and the publication of their results was frequently interrupted by his poverty; but the Municipality of Genoa did itself immortal honour by publishing at its expense his important "Epilogo della Briologia italiana." In 1872 de Notaris was elected a foreign member of the Linnæan Society of London.

THE Mathematical and Physical Sections of the Russian Geographical Society discussed at a recent meeting a scheme for the thorough exploration of the Lower Angara outflow of Lake Baikal, the pecuniary means for the purpose being offered by M. Sibiryakof. The navigability of this important water-communication would be the principal problem to be solved by the explorers. At the same meeting M. Vojeikoff described the results of his meteorological travels to British India.

SOME striking experiments have been lately made by M. Daubrée, on the physical and mechanical action of strongly-compressed incandescent gas arising from combustion of powder. In one case a thin steel plate (23 sq. cm. surface), rolled up, was inclosed in the chamber along with 12 gm. of powder, which was fired by electricity. The steel was completely fused, and transformed into an ingot curiously twisted and swollen, resembling the ferruginous skeleton of some meteoric irons. A good deal of the iron had passed into the state of sulphuret, found as a fine powder. These remarkable changes must have occurred in a fraction of a second. In another series of experiments the gases formed had opportunity of escape by a small orifice in the side of a hollow cylindrical cock (with conical top) adapted and screwed into the chamber. Here the hot particles of gas fused and carried off the steel in the state of fine powder, which was sulphurised immediately. The cock was put considerably out of shape, deep sinuous furrows being made in its surface, and in one case reaching the central cavity so as to make a second orifice, while the terminal cone wholly disappeared. An abundant metallic dust, incandescent, was projected into the atmosphere. Analogous phenomena probably occur in volcanoes, meteorites, &c.

OUR readers will remember the announcement made by us some time ago of the shipment of a consignment of white-fish eggs, furnished by the United States Fish Commission, to Wellington, New Zealand. We are happy to state that, as the result of this action, a report has been received of the safe arrival of these eggs at Wellington in good condition. The young fish at the end of five days from the time of hatching, were three-quarters of an inch long, very transparent, with bright yellow eyes, and very lively, apparently doing well.

ACCORDING to a recent Austrian census it appears that the percentage of cretinism ranges from a small figure up to as high as forty in the different districts of the Alpine parts of the empire. The proportion to every ten thousand inhabitants is, in the Salzburg district, 40; in Upper Austria, 18.3; in Styria, 17; in Silesia, 10; in Tyrol, 6, &c.

THE last number of the *Ivestia* of the Russian Geographical Society contains some extracts from the journal kept by Dr. Miklucho Maclay during his cruise in Western Micronesia, from March to June, 1876. In the early part of March, after visiting the Island of Geby, lying under the equator, Dr. Maclay, about the end of March, passed by Auropic Island, the inhabitants of which he describes as not very dark, with thick curly hair. Thence he proceeded to Mogemo, or Mackenzie Island, Woap Island, and others, on his way to the Pelew Archipelago, where he stayed about two weeks, studying very interesting specimens of the "picture-writing" and folklore. The shameful exportation of the inhabitants by whites, which he had opportunity of witnessing during his cruise, will

be the subject of a special report. From the Pelew Islands the indefatigable traveller proceeded to the southern and then to the northern shore of Admiralty Island, noticing the remarkable prognathous development of the Melanesian natives of this island, as well as those of the island Agomes, of the Hermitte Archipelago. After a short visit to the Misago Islands, Dr. MacLay returned to the shore bearing his name, the natives of which received him very kindly. He built a house for himself, where he intended to remain, pursuing his anthropological researches.

THE *Journal of Forestry and Estates Management* is the title of a new shilling monthly, which will appear on May, 1 published by Messrs. J. and W. Rider, of Bartholomew Close, E.C. It will be devoted to the interests of Arboriculture in its scientific, practical, and economic aspects, and will give a large portion of its space to matters appertaining to the general management of estates.

We have received through Mr. Tucker, from Mr. J. M. Wilson, Rugby, two guineas towards the Gauss Memorial Fund.

THE inventor of the new electric seismograph referred to last week is not Father Secchi, but Father Cecchi, of the Scuole pie at Florence.

THE additions to the Zoological Society's Gardens during the past week include a Rusa Deer (*Cervus rusa*) from Java, presented by Mr. A. A. Frazer, F.Z.S.; a Bay Bamboo Rat (*Rhizomys badius*) from India, presented by Mr. J. Wood Mason; a Horned Lizard (*Phrynosoma cornutum*) from Texas, presented by Mr. T. Clover; a Brown Monkey (*Macacus brunneus*) from Assam, deposited; a Demeraran Cock of the Rock (*Rufula crocea*) from Demerara, purchased; two Chinchillas (*Chinchilla lanigera*), born in the Gardens.

SOCIETIES AND ACADEMIES

LONDON

Royal Society, March 15.—“On the Tides of the Arctic Seas.—Part VII. Tides of Port Kennedy, in Bellot Strait.” (Final Discussion.) By the Rev. Samuel Haughton, M.D. Dublin, D.C.L. Oxon., F.R.S., Fellow of Trinity College, Dublin.

The tidal observations at Port Kennedy were made hourly for twenty-three days; and in my former discussion of these tides (Part VI.) I used only the observations made in the neighbourhood of H. W. and L. W., obtaining the following results for the tidal coefficients:—

<i>Diurnal Tide.</i>	<i>Semidiurnal Tide.</i>
S = 23.4 inches.	S = 7.0 inches.
<i>i</i> <sub>1</sub> = 5 <sup>h</sup> 12 <sup>m</sup> .	<i>i</i> <sub>1</sub> = “ “
M = 20.9 inches.	M = 17.0 inches.
<i>i</i> <sub>m</sub> = 0 <sup>h</sup> 33 <sup>m</sup> .8.	<i>i</i> <sub>m</sub> = - 0 <sup>h</sup> 12 <sup>m</sup> .

In the present discussion I have employed all the hourly observations made during the twenty-three days, and have obtained the following results:—

<i>Diurnal Tide.</i>	<i>Semidiurnal Tide.</i>
S = 36.4 inches.	S = 5.9 inches.
<i>i</i> <sub>1</sub> = 3 <sup>h</sup> 2 <sup>m</sup> .	<i>i</i> <sub>1</sub> = 2 <sup>h</sup> 48 <sup>m</sup> .
M = 18.5 inches.	M = 15.5 inches.
<i>i</i> <sub>m</sub> = - 2 <sup>h</sup> 48 <sup>m</sup> .	<i>i</i> <sub>m</sub> = 6 <sup>h</sup> 24 <sup>m</sup> .

The present more complete discussion fully confirms the result before obtained by me, respecting the great magnitude of the solar diurnal tide at this station, and also shows a satisfactory agreement in the other coefficients obtained from H. W. and L. W. observations only.

The method employed in the present paper is based on Fourier's Theorem, by which the height of tide is expressed as follows:—

$$F = A_0 + A_1 \cos s + A_2 \cos 2s + \&c., \\ + B_1 \sin s + B_2 \cos 2s + \&c.,$$

where

F = height of water.  
s = hour-angle of sun.

The coefficients A<sub>0</sub>, A<sub>1</sub>, A<sub>2</sub>, B<sub>1</sub>, B<sub>2</sub>, &c., being found by well known formulae, they are again expressed, by Fourier's Theorem as follows:—

$$A_n = a_0 + a_1 \cos n + a_2 \cos 2n + \&c. \\ + b_1 \sin n + b_2 \sin 2n,$$

where *n* passes through all its changes in a fortnight, and the coefficients are calculated in a similar manner.

The known theoretical formulae for the diurnal and semidiurnal tides, expressed in terms of parallax, declination, lun and solar, hour-angles, are now converted into functions of the true and mean anomaly, and of the sun's hour-angle, and final into simple functions of *s* and *n*. These expansions are no compared, term by term, with the terms of the tidal expansion found by means of Fourier's Theorem, and the final lunar and solar tidal coefficients calculated out with ease.

Although the short period of observation at Port Kennedy (23 days) renders this method of discussion not much more valuable than the usual method of H. W. and L. W. observations, I have developed it at length in the hope of applying the method to more complete series of Arctic tides, which I hope shortly to lay before the Royal Society.

March 22.—“On Friction between Surfaces moving at Lo Speeds,” by Fleeming Jenkin, F.R.S.S. L. and E., Professor Engineering in the University of Edinburgh, and J. A. Ewing

The common belief regarding friction, which is based on the researches of Coulomb and Morin, is that between surfaces: the friction is independent of the velocity, but that the force required to start the sliding is (in some cases at least) greater than the force required to overcome friction during motion; in other words, the static coefficient is usually considered to be greater than the kinetic. It occurred to the authors that there might possibly be continuity between the two kinds of friction, instead of an abrupt change at the instant in which motion begins. We should thus expect that when the relative motion of the surfaces is very slow there will be a gradual increase of friction as the velocity diminishes. Whether as such increase takes place at very low speed is left an open question by the experiments of Coulomb and Morin, whose methods do not enable definite measurements of the friction to be made when the velocity was exceedingly small. The authors have succeeded in measuring the friction between surfaces moving with as low velocity as one five-thousandth of a foot per second, and have found that in certain cases there is decided increase in the coefficient of friction as the velocity diminishes.

The surfaces examined were steel on steel, steel on brass, steel on agate, steel on beech, and steel on greenheart—in each case under the three conditions, dry, oiled, and wet with water. In the cases steel on beech oiled or wet with water, and steel on greenheart oiled or wet with water, the coefficient of friction increased as the velocity diminished between the two limits given above, the increase amounting to about twenty per cent of the lower value. It appeared that at the higher limit of velocity there was little further tendency to change in the coefficient, but it is impossible to say how much additional change might take place between the lower limit of the velocity and the higher. In the case of steel on agate wet with water there was similar but much less marked increase of friction as the velocity decreased. And in the case of steel on steel oiled there was slight and somewhat uncertain change of the opposite character that is, a decrease of the friction as the velocity decreased. This case, however, would require further examination. In other cases the friction seemed to be perfectly constant and independent of the velocity. Out of all the sets of circumstances investigated, the only ones in which there was a large difference between the static and kinetic values of the coefficient of friction were those in which a decided increase was observed in the kinetic value on the speed decreased. This result renders exceedingly probable that there is continuity between the two kinds of friction.

Linnean Society, April 5.—Prof. Allmann, F.R.S., president, in the chair.—Capt. Chimmo, R.N., the Rev. J. Co stable, and Prof. Liversidge, of Sydney, N.S.W., were elected Fellows of the Society. In addition a donation from the author (Mr. E. J. M. ... of the ... Monograph the Genus ... of the ... Society

the issue of this handsome work by the private energy of one of its members.—Sir Chas. Strickland exhibited a specimen of *Crotinus aquaticum* obtained from Grahamstown, South Africa, but which shows plant hitherto has rarely been seen in flower in Britain.—A paper on ferns collected by Miss Gilpin in the interior of Madagascar, was read by Mr. J. G. Baker. Some seventeen are new out of 150 species, a fair proportion, and evidence of an unsuspected richness in this department of the Madagascar flora.—The Secretary announced a paper on the fresh-water algae of the Cape of Good Hope, by Prof. Reinsch: this being of a technical character, and in Latin, was taken as read.—Mr. R. Collett, of Christiania, then read a communication on *Nyodes lemmus* in Norway. His observations on the habits and economy of the Lemming had extended over several years, and in 1876 he had published these in *Nyt. Mag. f. Naturusk.* But his attention had lately been called to Mr. Crotch's contributions in the *Linnean Journal*, and as in many particulars he differed from that author, the present notice resulted. The number of young at a birth vary from three to eight, and two sets are annually produced. Mr. Collett regards their wandering as a necessary consequence of their temporarily strong vitality, together with an inherent migratory instinct. The tendency at intervals to appear in unusually large numbers is not confined to the genus, but is common to all the species of the sub-family Arvicolinæ. The majority of the wanderers are young, and in one instance observed, by himself, were chiefly males. The migration closes with the death of the individuals, generally brought about by an epizootic disease, the result of over population; the denser the masses the higher the rate of mortality. The bare patch on the rump considered by Mr. Crotch to be due to the habit of protecting themselves against stones in resisting attack, Mr. Collett states is due to a skin disease. He however, supports Mr. Crotch's statement as to the number of winged and four-footed enemies which devour the Lemming, and also that domestic cattle and reindeer destroy them. Their occasional enormous increase in numbers he holds to be owing to periodic prolific years, the facility of rearing their young, and the early reproductive faculty of the latter. Parallel instances among other groups of animals, for instance unusual swarms of butterflies and locusts are well known; though as to the true reason of such departures a number, &c., much is only conjectural. Coincidentally with the notable years of the Lemming migrations, the increase above the normal number of rats, mice, shrews, and even the grouse rife, have been recorded. Mr. Collett affirms that the Lemmings ravel chiefly in the direction of the valleys, and not constantly the west as has been asserted; their great movements are chiefly nocturnal. He is inclined to question Mr. Crotch's notion of hereditary search for a "Miocene Atlantis," and rather is of opinion that in accounting for the periodical excess of multiplication and migratory impulse a physiological necessity impels them; the nature of this is at present beyond our power to explain rationally.—A further contribution to the natural history of swine, by Prof. Colleston, was read in abstract, this paper forming an appendix to that previously brought under the notice of the Society. The additional information is in the main confirmatory of the views already expressed, but several important facts relative to the tripping of the young of *Sus celebensis* and *S. verrucosus* according to Dr. A. B. Meyer, with information from others, necessarily causes a modification in former conclusions.—On South African hepaticæ (Liverworts), by Mr. W. Mitten, and on new Irish lichens, by the Rev. W. A. Leighton, were two technical papers the titles only of which were read by the Secretary.

Royal Astronomical Society, April 13, Dr. Huggins, F.R.S., president, in the chair.—Lord Lindsay read a paper on the diurnal parallax of Juno observed at Mauritius in 1874 with a heliometer, which (rejecting one discordant observation) gave a value of  $8''.82$  for the solar parallax.—Mr. Gill read a paper on the proposed expedition to observe the approaching opposition of Mars. Observations can be made during six weeks at the Island of Ascension the geometrical conditions are about as favourable as possible; and what is of great importance, the meteorological conditions are no less so, the range of temperature between 6 P.M. and 6 A.M. being only two or three degrees. None of the stars of comparison are of less than the sixth magnitude, and they are selected so as to determine the position of the planet in right ascension as accurately as possible. Mr. Gill proposes to observe the oppositions of the inner planets Venus and Mars, and the opposition of Ariadne near ten days earlier than Mars, the declination will be  $15''$  north. Melbourne, Victoria, Australia.—Mr. Christie

explained the principle of his new form of spectroscope. It depends on the fact that the half of an isosceles prism, cut perpendicular to the base, magnifies the angle between two incident pencils, by virtue of the oblique emergence. By using a compound prism composed of a half prism of flint with a prism of crown cemented to the oblique face, to correct the deviation, the magnifying effect might be increased to ten or fifteen times. By turning the half prism about its centre different parts of the spectrum would be brought into the field without any movement of the viewing telescope. With two half-prisms the dispersion of an ordinary compound prism has been obtained, and with better definition; for with ten prisms the errors of forty surfaces are accumulated. When the breadth of the lines is diminished by narrowing the slit, the spectrum is still far brighter than in the other form, for the loss by absorption is enormous, amounting to 50 per cent. for three or four inches of glass, and in the large Greenwich spectroscope only  $\frac{1}{1000}$  part of the incident light reaches the eye. Mr. Bidder, Lord Lindsay, and Mr. Gill offered some criticisms, and Mr. Christie replied, showing that he had anticipated all the objections offered.—Prof. Pritchard read a paper on the comets of 1877. The recent dearth of comets he attributed to the probable sleepiness of seekers. Two had been observed at Oxford, and the elements and an ephemeris of Winnecke's calculated. They had made observations on April 7 and 11, which were combined with Prof. Winnecke's of the 5h. in making the calculations.—Prof. Pritchard also read a paper on a mechanical solution of Kepler's problem.—Mr. J. W. L. Glaisher read a paper on an elliptic-function solution of Kepler's problem.—The Rev. S. J. Perry described how neither he nor his assistants could see Vulcan.—Lord Lindsay stated that M. Leverrier thought it would be useless to look for Vulcan for the next six years.

Mathematical Society, April 12.—Lord Rayleigh, F.R.S., president, in the chair.—Mr. C. Pendlebury was elected a member.—The following communications were made:—On Hesse's ternary operator and applications, by Mr. J. J. Walker.—Geometrical illustration of a theorem relating to an irrational function of an imaginary variable, and on the general differential equation  $\frac{d^2x}{\sqrt{X}} + \frac{d^2y}{\sqrt{Y}} = 0$ , where X, Y are the same quartic functions of x, y, respectively, by Prof. Cayley, F.R.S. (Profs. Smith and Henrici took part in a discussion on these papers, the former making remarks on the question whether infinity is a point or a straight line).—Mr. Merrifield, F.R.S., vice-president, having taken the chair, Mr. Harry Hart deduced some cases of parallel motion from the consideration that the contra parallelogram represents the motion of two equal ellipses rolling upon each other, and that of these (i.e., parallel motions) two especially were very simple, inasmuch as the motion was obtained in either case by the use of five bars only and was moreover perfectly continuous.—Mr. Tucker, hon. sec., read an abstract of a paper by Prof. H. W. Lloyd Tanner, on a method of solving partial differential equations which have a general first integral, applied to equations of the third order with two independent variables.

Chemical Society, April 19.—Dr. Gladstone in the chair.—The following papers were read:—On the estimation of manganese in spiegeleisen, and of manganese and iron in mangiferous iron ores, by E. Riley. For estimating manganese in spiegeleisen the author recommends the indirect method, i.e., estimating the iron, adding five per cent. for impurities, and taking the difference as manganese, for accuracy and rapidity; for the estimation of manganese in its ores the author prefers to separate the iron as basic peracetate with carbonate and acetate of ammonia, and to precipitate the manganese with bromine and ammonia, taking care that the ignited precipitate contains no baryta, zinc, or lime. For the determination of the iron a standard solution of bichromate of potash yields the best results, the iron being reduced with pure sulphite of soda.—On a method of detecting small quantities of bismuth, by M. M. Pattison Muir. The author proposes Schneider's reagent, consisting of a clear solution of 12 grm. of tartaric acid and 4 grm. stannous chloride in caustic potash; one part of bismuth in 210,000, if warmed to 60°–70° C. with this reagent, gives a brownish colour.—On certain bismuth compounds, by M. M. Pattison Muir. This paper gives an account of the properties and reactions of bismuth ferricyanide.—Notes on madder colouring matters, by E. Schunck and H. Roemer. Munjistin: this substance resembles purpuroxanthic acid in its physical properties. Purpurin: a pure specimen was examined, and its properties are

given. Alcoholic lead acetate gives with purpurin dissolved in alcohol a precipitate soluble in excess, with alizarin a precipitate insoluble in excess. Triacetyl-purpurin and brom-purpurin were prepared and analysed by the authors. By heating pure purpurin in sealed tubes to 300° C. it was found to be partially converted into quinizarin.

Physical Society, April 14.—Prof. G. C. Foster, president, in the chair.—The secretary described a new form of colorimeter, devised by Dr. Mills. It consists of two vertical glass tubes about ten centimetres in length and two centimetres in diameter, and contracted at their lower ends, which are graduated in millimetres and fixed in a frame. In each tube a loosely-fitting disc of white or black glass (as occasion may require) can be raised or lowered from below by means of a glass rod fitting water-tight, and the meniscus of the liquid is concealed by a wooden screen. The two liquids under examination are introduced into the tubes to the same level, and the discs adjusted until rendered invisible.—Mr. Christie gave an account of a new form of spectroscope, in which "half-prisms" are used to magnify the dispersion (see Astronomical Society).

GENEVA

Society of Physics and Natural History, March 1. —Prof. Zahn presents preparations of the human costal cartilage, showing a fragmentary infiltration of the cellulæ. This infiltration is very frequent; it is observed in half of the men over forty, and especially in such as have any touch of lung disease.—Dr. Prevost described a case of aphasia observed at the Cantonal Hospital, in a young girl attacked with a right *hemiplegia*, in whom the aphasia subsisted after the cure of the hemiplegia. Though she cannot speak she has recovered the power of articulating words when she sings, and her intellect is untouched.

March 15.—M. Alph. de Candolle announced the conclusion of his work on the family of the *Smilacæ* for the work which he will publish under the name of "Monographs of the Phanerogamæ." This family includes three principal species, *Helioselinax*, *Smilax*, and *Ripheosium*, and is found in the division of the globe between India, Japan, and the Sandwich Islands. The first of these species is probably the most ancient.

PARIS

Academy of Sciences, April 16.—M. Peligot in the chair.—The following papers were read: Note on a problem of mechanics, by M. Bertrand. Knowing that the planets describe conic sections, and without supposing more, to find the expression for the components of the force soliciting them, in function of co-ordinates of its point of application.—On a solar spot which appeared on April 15, by M. Janssen. While the disc had been wholly without spots on the 14th, it had, next day, a space near the centre some 2' diameter, covered with them. This is of the order of things that occurs at a maximum; and the old idea seems incorrect that the rarity of spots at the minimum is due to an absence of activity of the photosphere. There is a tendency to prompt extinction of the phenomena.—Researches on iodic acid, by M. Berthelot.—On the theory of plane elastic plates, by M. Kirchhoff.—Determination of the differences in longitude between Paris and Marseilles, and between Algiers and Marseilles, by MM. Loewy and Stephan. The apparatus comprised a meridian instrument and pendulum, a Hipp's chronograph, a very sensitive Siemens' relay, a galvanometer, and a rheostat. The difference of longitude observed between the Paris and Marseilles instruments was 12m. 13.430s. ± 0.009s.; that between the Algiers and Marseilles instruments 9m. 23.289s. ± 0.009s. The difference of these, viz., 2m. 50.211s. expresses the difference of longitude between Paris and Algiers; which closely agrees with that got by MM. Loewy and Perrier by direct measurement (viz., 2m. 50.217s.). The velocity of transmission of the signals the authors state to be 36,000 km. per second in the aerial line and 4,000 km. in the cable.—New experiments on the origin and nature of typhoid fever, by M. Guerin. Experimenting with vomited bilious matters, bile, and fecal matters proper from the larger intestine (of typhoid subjects) introduced into rabbits by injection, he found that they rarely caused death—once in twelve experiments; while the special diarrhetic matter from the small intestine caused death almost constantly in a few hours or days. Experiments distinguishing the periods of the disease also pointed to the special toxic matter being almost entirely contained in the smaller intestine. M. Guerin offers some interpretation of these facts.—Dreibility of the electric light, by MM. Denay-

rouze and Jablochhoff. Using alternating currents and induction coils with interrupter and condenser suppressed, and a kaolin plate between the wires, a steady light is obtained. There is a central artery of the series of interior wires, and as many distinct conductors branch off as there are coils in the circuit. Each luminous centre is thus quite independent, and each may be extinguished or lit separately.—Discovery of a Gallo-Roman port and a Gaulish port near St. Nazaire; determination of the age of the layers at different heights (second note), by M. Bertrand.—The Phylloxera in the department of the Gironde (continued), by M. Azam. At the end of 1873 97 communes were attacked; at the end of 1876, 268.—(On ozeans, by M. Brame.—Investigation of the law which must be obeyed by a central force, so that the trajectory it produces may be always a conic, by M. Darboux.—On the laws of reciprocity in the theory of the residues of powers, by M. Pepin.—On the radii of curvature of the successive podarics of a plane curve, by M. Niewnglowski.—On the rolling of ships in calm water, by M. Bourgoïn.—On the state of salts in solution, by M. Gernez. His experiments contradict M. Tscherbatschew's view that saturated solutions of sulphate of soda, made under 33°, contain the hydrate with 10H<sub>2</sub>O, those heated to a higher temperature the hydrate with 7H<sub>2</sub>O.—On a new series of acid salts, by M. Villiers.—Transformation of ordinary pyrotartaric acid with tribromic bromhydrate of ethylene, by M. Bourgoïn.—On the properties of resorcin, by M. Calderon.—Male flowers of Cordates, by M. Renault.—Note on the calcifugal flora of the Alps of Wurtemberg, by M. Costejean.—Researches on the cardiac disorders which produce the intermissions of the arterial pulse, called *false intermissions*, by M. François Franck.—Experiments proving that the septicity of putrefied blood is not due to a soluble ferment, by M. Feltz.—On the winter of 1877 in Paris, by M. Renou. It is very rare that the minimum of the cold season falls in November or March (which show the lowest in the present case), or that March should present the lowest monthly average.—On the thunderstorm of April 4, 1877, by M. Godefroy. Figures of the hailstones are given, the form being that of a solid of revolution from a spherical pyramid.—On poisoning with salts of copper, by M. Decaisne.—On the precautions taken by tortoises against cold, and the indications they may furnish to farmers, by M. Brouhard.

CONTENTS

THE GEOLOGY OF THE LAKE COUNTRY . . . . . 54
VENDUE'S 'ACCEPIRES OF CANADA' . . . . . 56
OUR BOOK SHELF:—
Rowenberg's "Use of the Spectroscope in its Application to Surgical and Punctual Medicine" . . . . . 547
Von Theilmann's "Journey in the Caucasus, Persia, and Turkey-in-Asia" . . . . . 547
LETTERS TO THE EDITOR:—
Structure and Origin of Meteorites.—H. N. MOSLEY . . . . . 547
On the Simplest Continuous Manifolds of Two Dimensions and of Finite Extent.—C. J. MORSE . . . . . 548
Non-Amphibious Batrachians.—REV. GEORGE HENSON . . . . . 548
Morphology of "Selaginella."—THOMAS COMBER . . . . . 548
The Rocks of Charnwood Forest.—JAMES PLAN . . . . . 548
Patenas of Ceylon.—E. ALBERT . . . . . 549
Cunning's Electricity.—I. COMING . . . . . 549
Remarkable Papuan Skull.—L. Z . . . . . 549
Meteor.—F. T. MOTTE . . . . . 549
OUR ASTRONOMICAL COLUMN:—
The U.S. Naval Observatory, Washington . . . . . 512
New Variable Star . . . . . 549
Early Observation of Solar Spots . . . . . 549
Comet 1877 III. . . . . 549
"The Observatory, a Monthly Review of Astronomy" . . . . . 550
THE NEBULE—WHAT ARE THEY? By E. J. STONE, M.A., F.R.S. . . . . 550
THE RALEGS AND TRILES OF THE CHAD BASIN. By A. H. KEANE . . . . . 550
THE "LOST ATLANTIS" AND THE "CHALLENGER" SOUNDINGS (With Map) . . . . . 553
REMARKS ON THE INVESTIGATION OF CLIMATES. By THOMAS STEVENSON, C.E. . . . . 550
VOLCANIC PHENOMENA DURING 1875 . . . . . 557
BIOLOGICAL NOTES:—
Broca's Stenograph . . . . . 558
Tendrils of Climbing Plants . . . . . 559
Eyeless Crustaceans . . . . . 559
Origin of the Flying-power of the Birds of Celebes . . . . . 559
Italian Pliocene Equidae . . . . . 559
Development of Mollusca . . . . . 559
Parthenogenesis in a Phanerogam . . . . . 559
Respiration of Weeds . . . . . 559
NOTES . . . . . 559
SOCIETIES AND ACADEMIES . . . . . 559





















